

Plot file version 1 created 24-MAR-2014 14:37:44

4C39.25 EP087F 5.UVDATA.1

Freq = 8.3520 GHz, Bw = 16.000 MH Calibrated with CL # 3 and BP # 1 (BP mode 1)

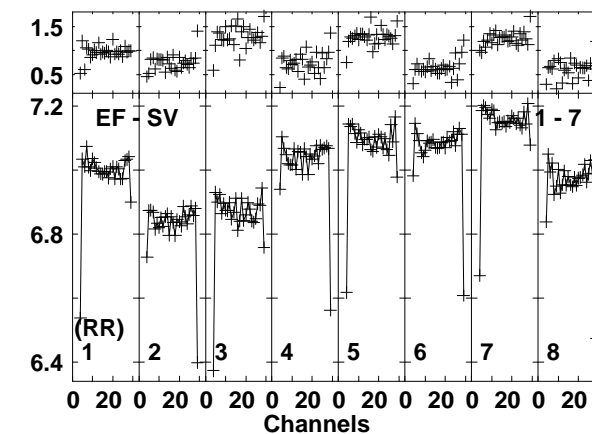
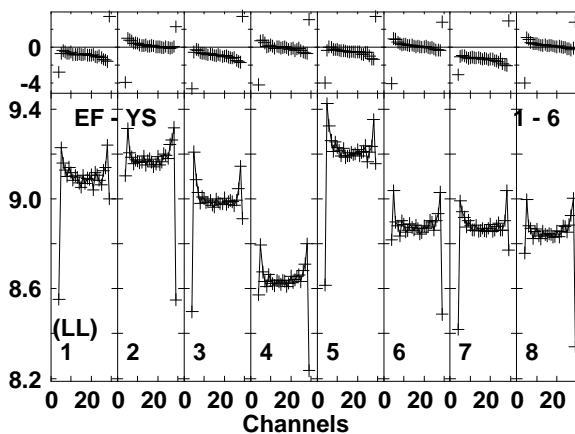
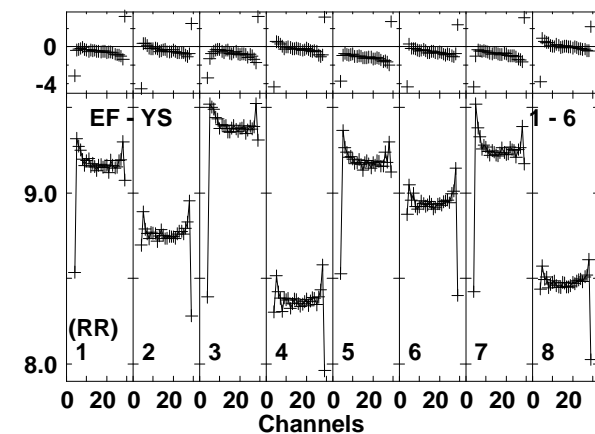
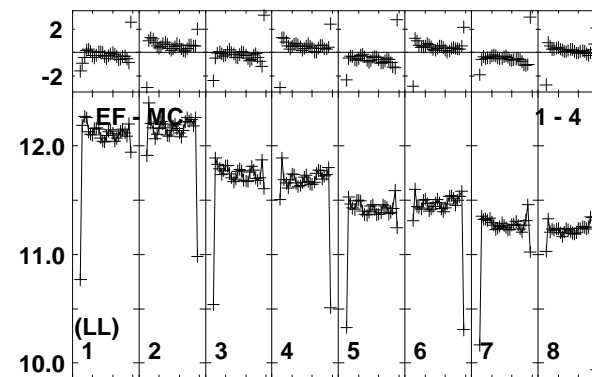
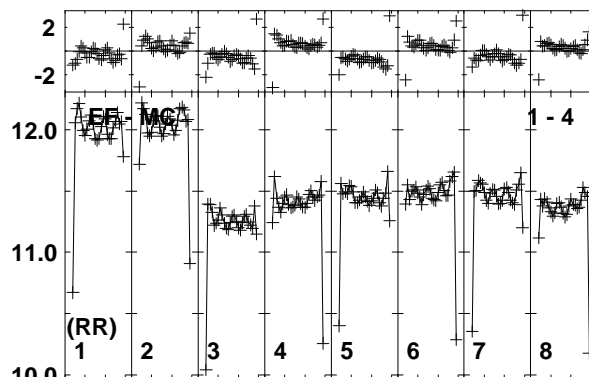
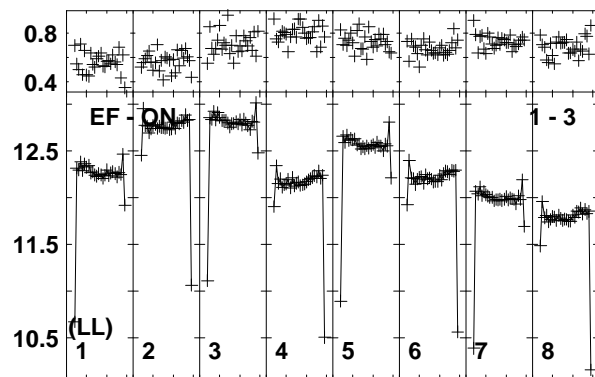
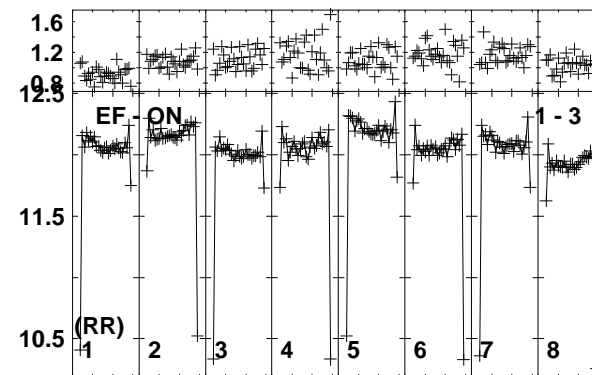
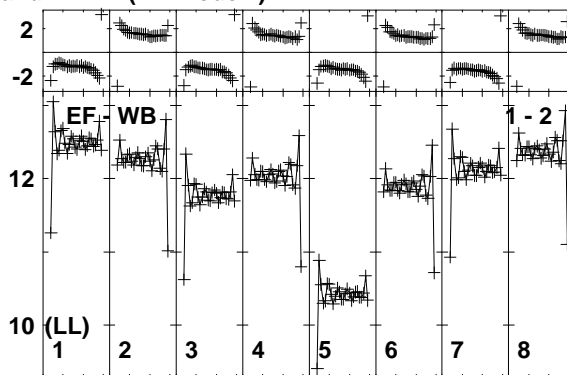
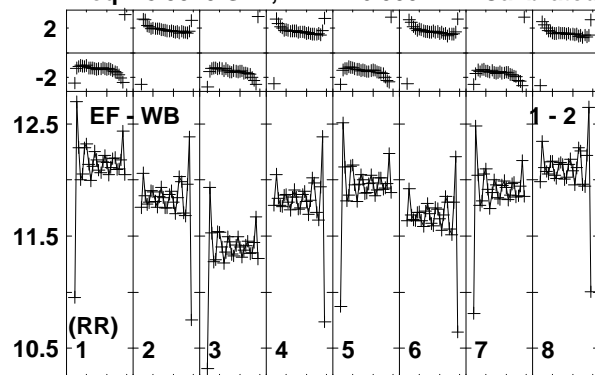

Lower frame: Ampl Jy Top frame: Phas deg
Vector averaged cross-power spectrum Baseline: EF (01) - WB (02)
Timerange: 00/02:30:00 to 00/02:35:30

Plot file version 2 created 24-MAR-2014 14:37:45
 4C39.25 EP087F 5.UVDATA.1
 Freq = 8.3520 GHz, Bw = 16.000 MH Calibrated with CL # 3 and BP # 1 (BP mode 1)

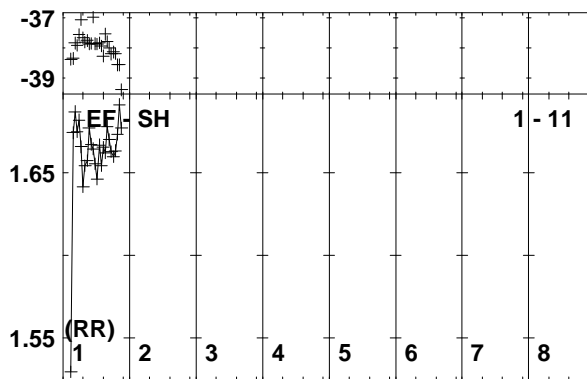
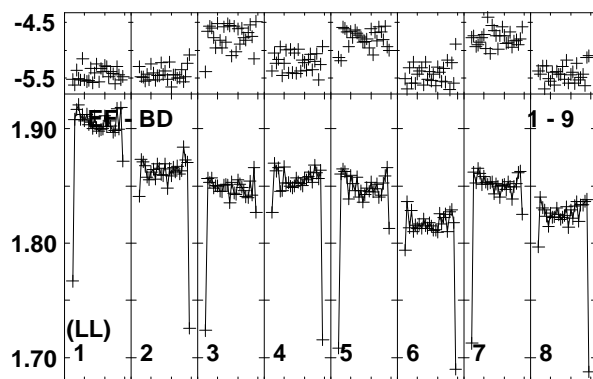
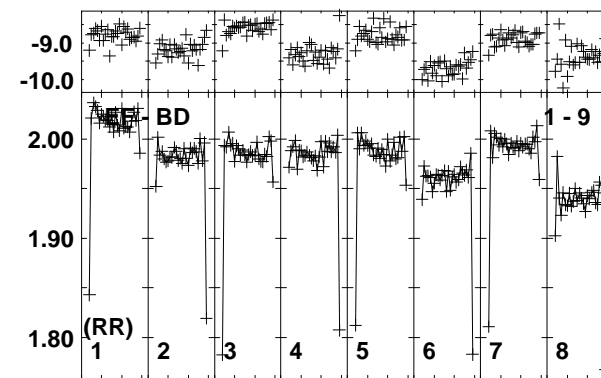
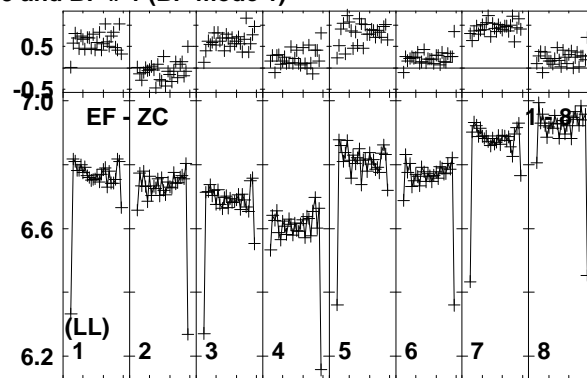
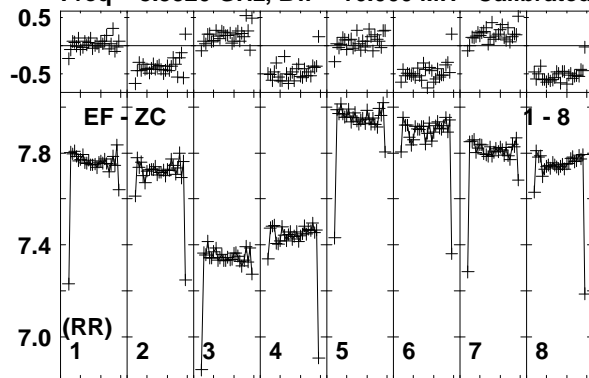

Lower frame: Ampl Jy Top frame: Phas deg
 Vector averaged cross-power spectrum Baseline: EF (01) - ZC (08)
 Timerange: 00/02:30:00 to 00/02:35:30

Plot file version 3 created 24-MAR-2014 14:37:45

J1128+5925 EP087F 5.UVDATA.1

Freq = 8.3520 GHz, Bw = 16.000 MH Calibrated with CL # 3 and BP # 1 (BP mode 1)

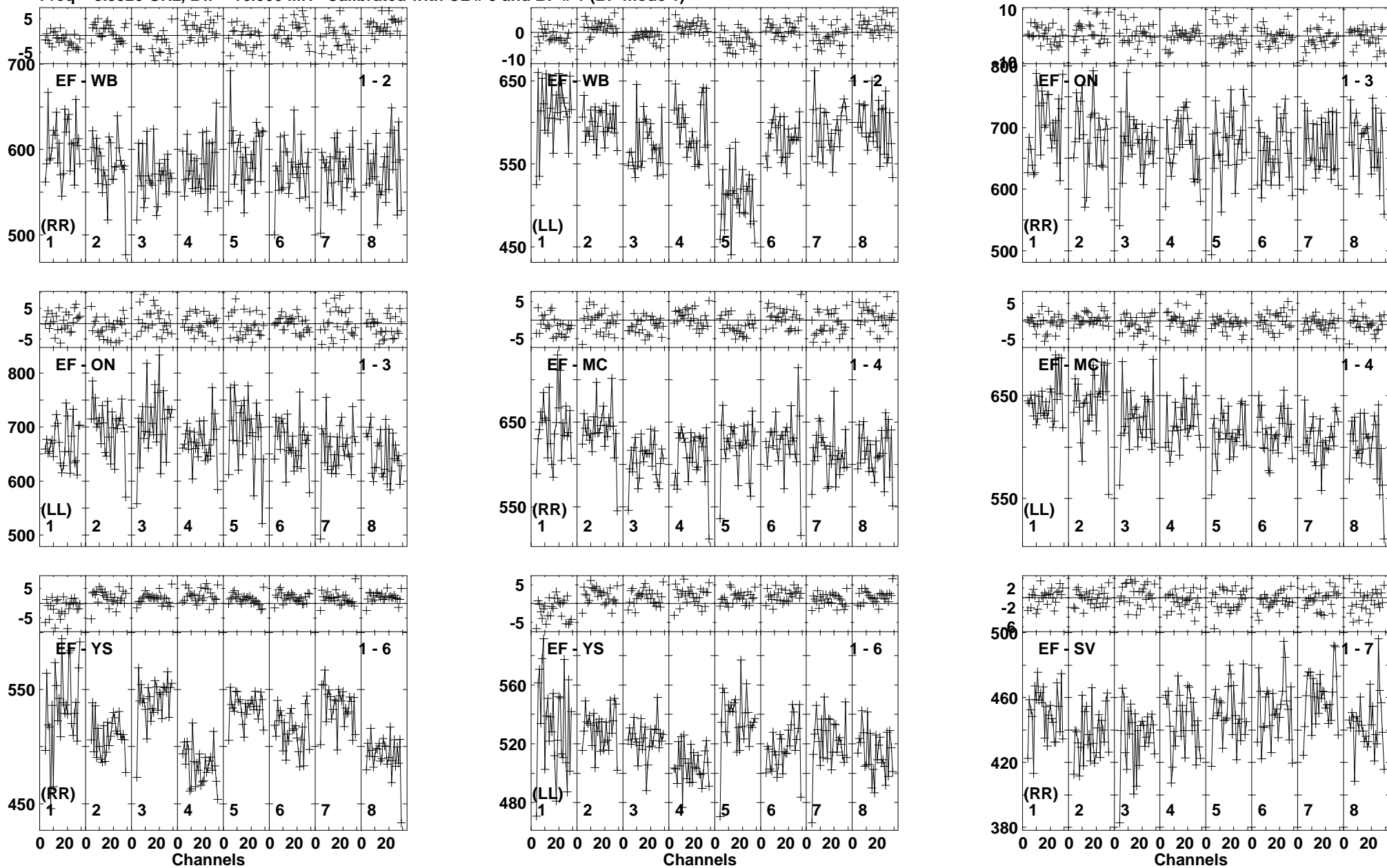

Lower frame: Milli Ampl Jy Top frame: Phas deg
Vector averaged cross-power spectrum Baseline: EF (01) - WB (02)
Timerange: 00/02:39:00 to 00/02:39:39

Plot file version 4 created 24-MAR-2014 14:37:45
 J1128+5925 EP087F 5.UVDATA.1
 Freq = 8.3520 GHz, Bw = 16.000 MH Calibrated with CL # 3 and BP # 1 (BP mode 1)

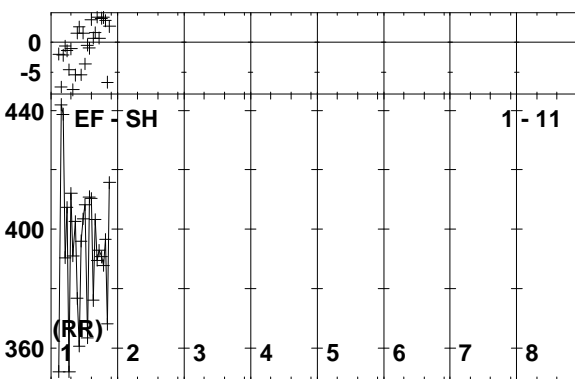
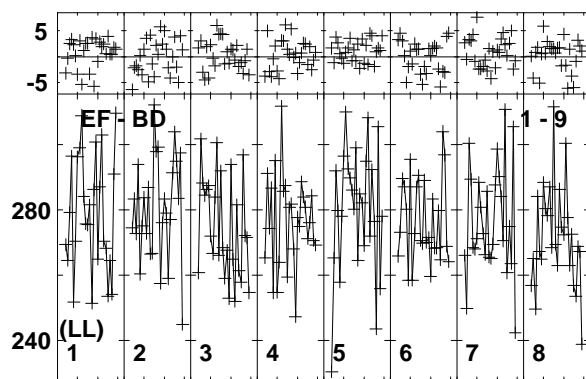
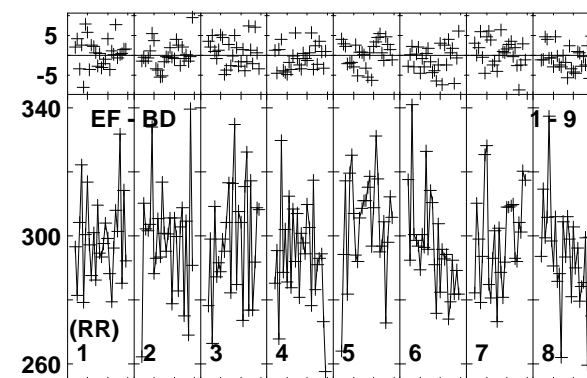
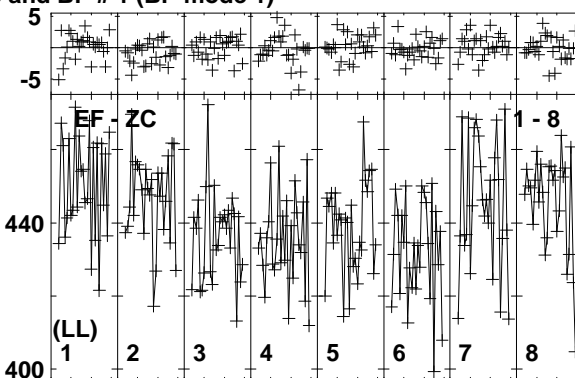
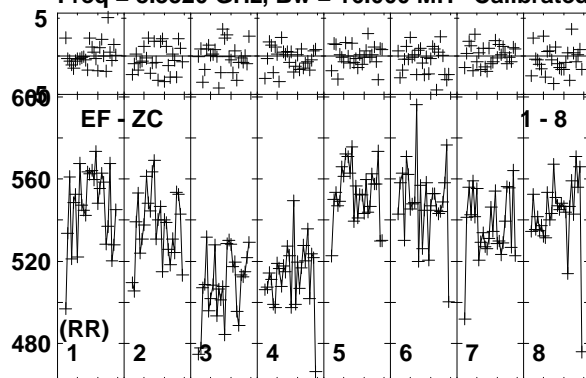

Lower frame: Milli Ampl Jy Top frame: Phas deg
 Vector averaged cross-power spectrum Baseline: EF (01) - ZC (08)
 Timerange: 00/02:39:00 to 00/02:39:39

Plot file version 5 created 24-MAR-2014 14:37:45

ARP299D EP087F 5.UVDATA.1

Freq = 8.3520 GHz, Bw = 16.000 MH Calibrated with CL # 3 and BP # 1 (BP mode 1)

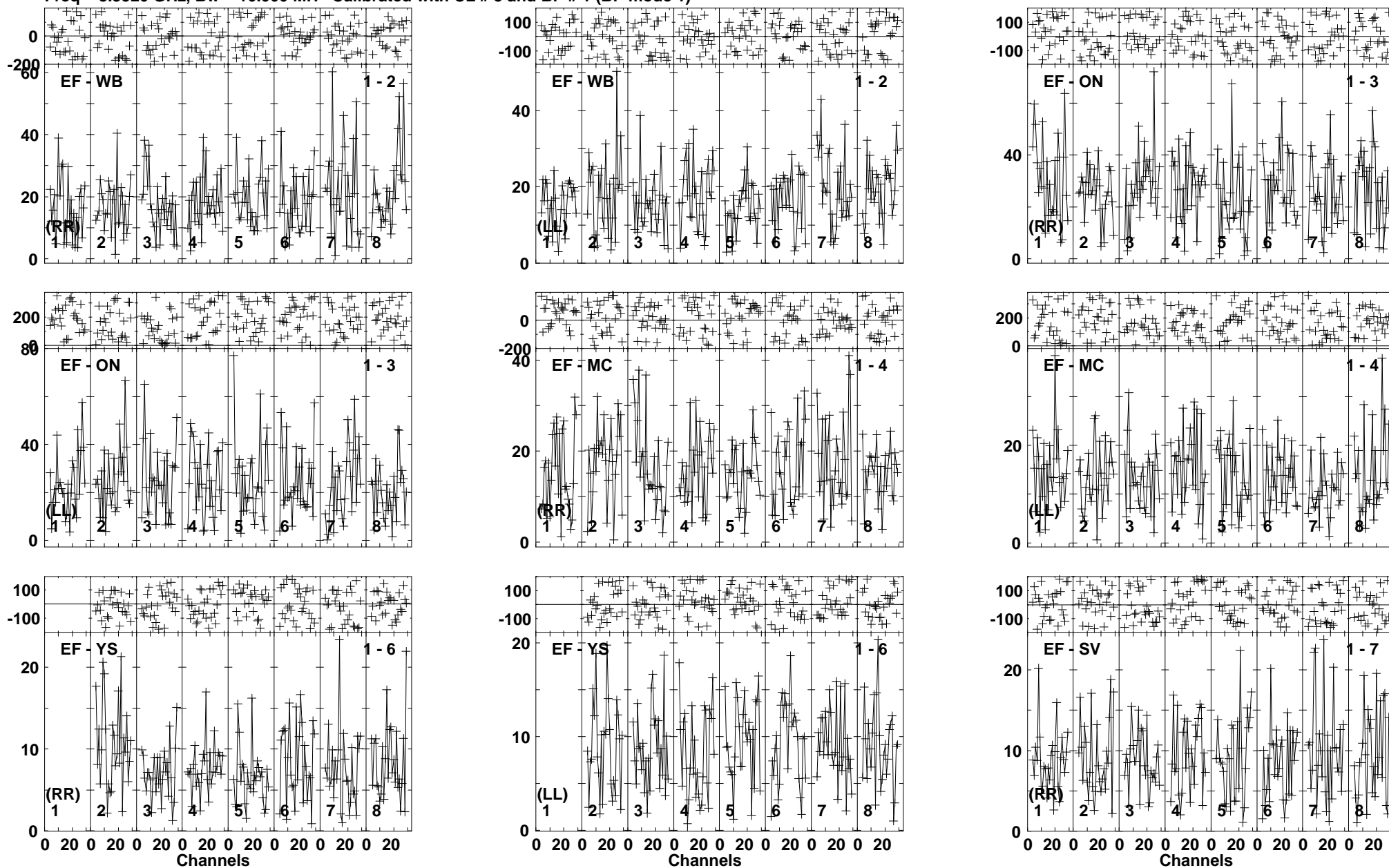

Lower frame: Milli Ampl Jy Top frame: Phas deg
Vector averaged cross-power spectrum Baseline: EF (01) - WB (02)
Timerange: 00/02:39:43 to 00/02:42:40

Plot file version 6 created 24-MAR-2014 14:37:46

ARP299D EP087F 5.UVDATA.1

Freq = 8.3520 GHz, Bw = 16.000 MH Calibrated with CL # 3 and BP # 1 (BP mode 1)

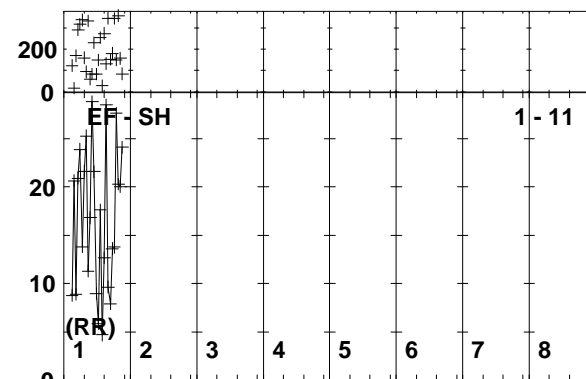
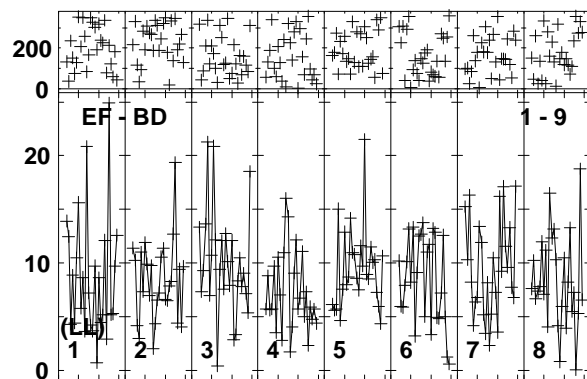
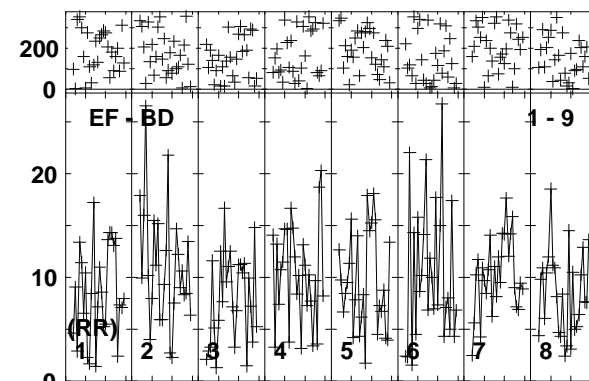
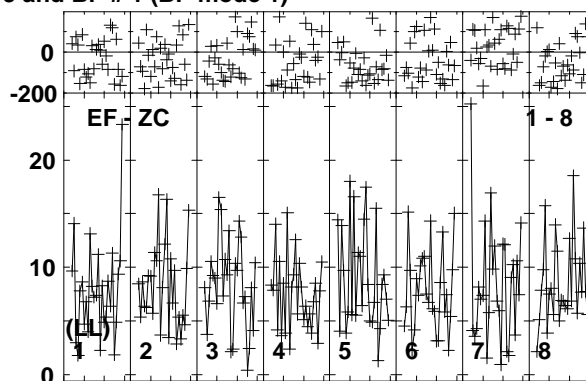
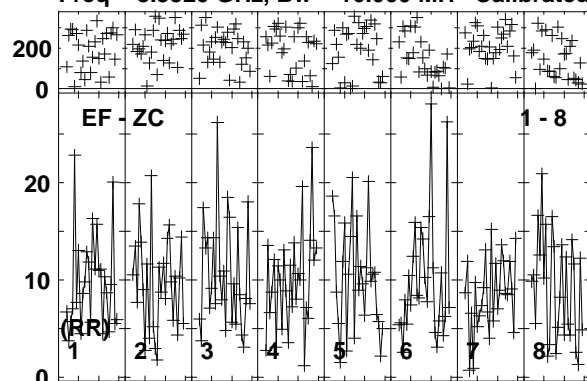

Lower frame: Milli Ampl Jy Top frame: Phas deg
Vector averaged cross-power spectrum Baseline: EF (01) - ZC (08)
Timerange: 00/02:39:43 to 00/02:42:40

Plot file version 7 created 24-MAR-2014 14:37:46

J1128+5925 EP087F 5.UVDATA.1

Freq = 8.3520 GHz, Bw = 16.000 MH Calibrated with CL # 3 and BP # 1 (BP mode 1)

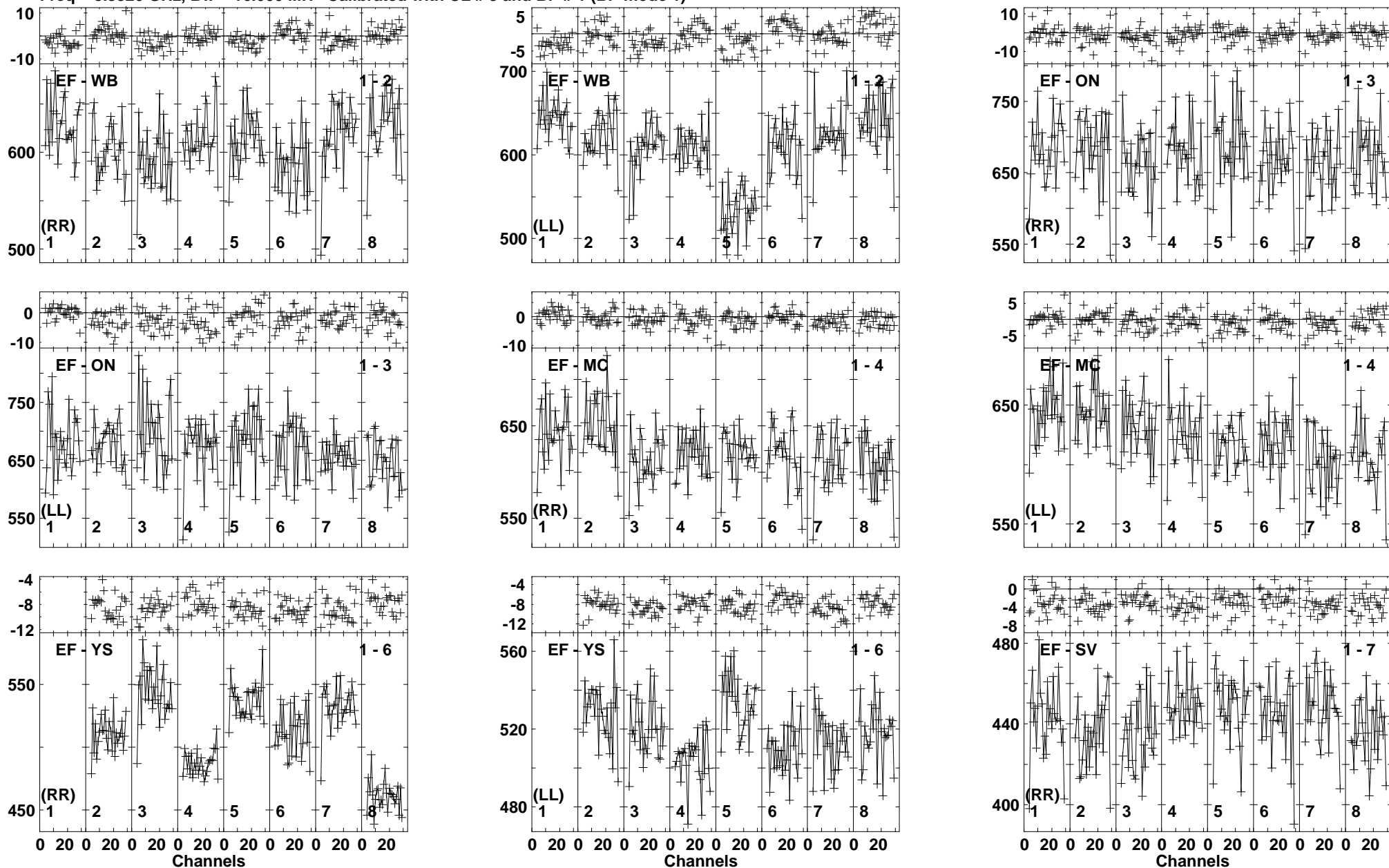

Plot file version 8 created 24-MAR-2014 14:37:46

J1128+5925 EP087F 5.UVDATA.1

Freq = 8.3520 GHz, Bw = 16.000 MH Calibrated with CL # 3 and BP # 1 (BP mode 1)

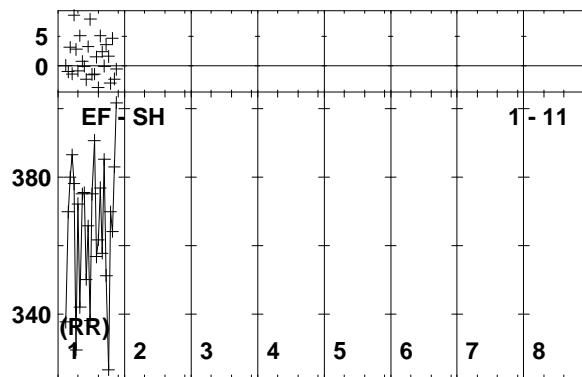
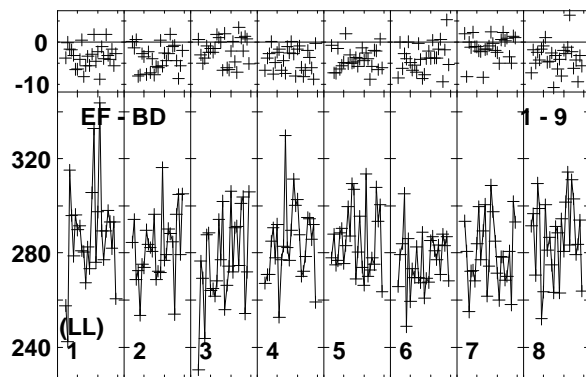
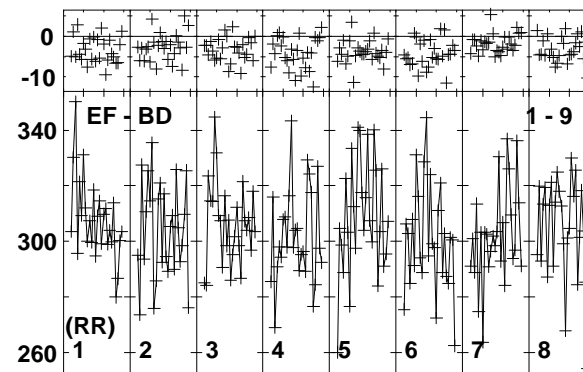
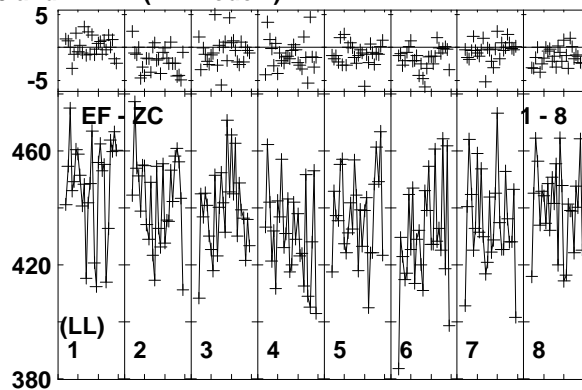
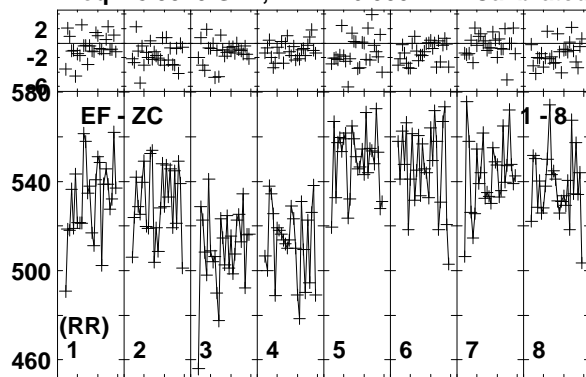

Lower frame: Milli Ampl Jy Top frame: Phas deg
Vector averaged cross-power spectrum Baseline: EF (01) - ZC (08)
Timerange: 00/02:42:41 to 00/02:43:44

Plot file version 9 created 24-MAR-2014 14:37:46

ARP299D EP087F 5.UVDATA.1

Freq = 8.3520 GHz, Bw = 16.000 MH Calibrated with CL # 3 and BP # 1 (BP mode 1)

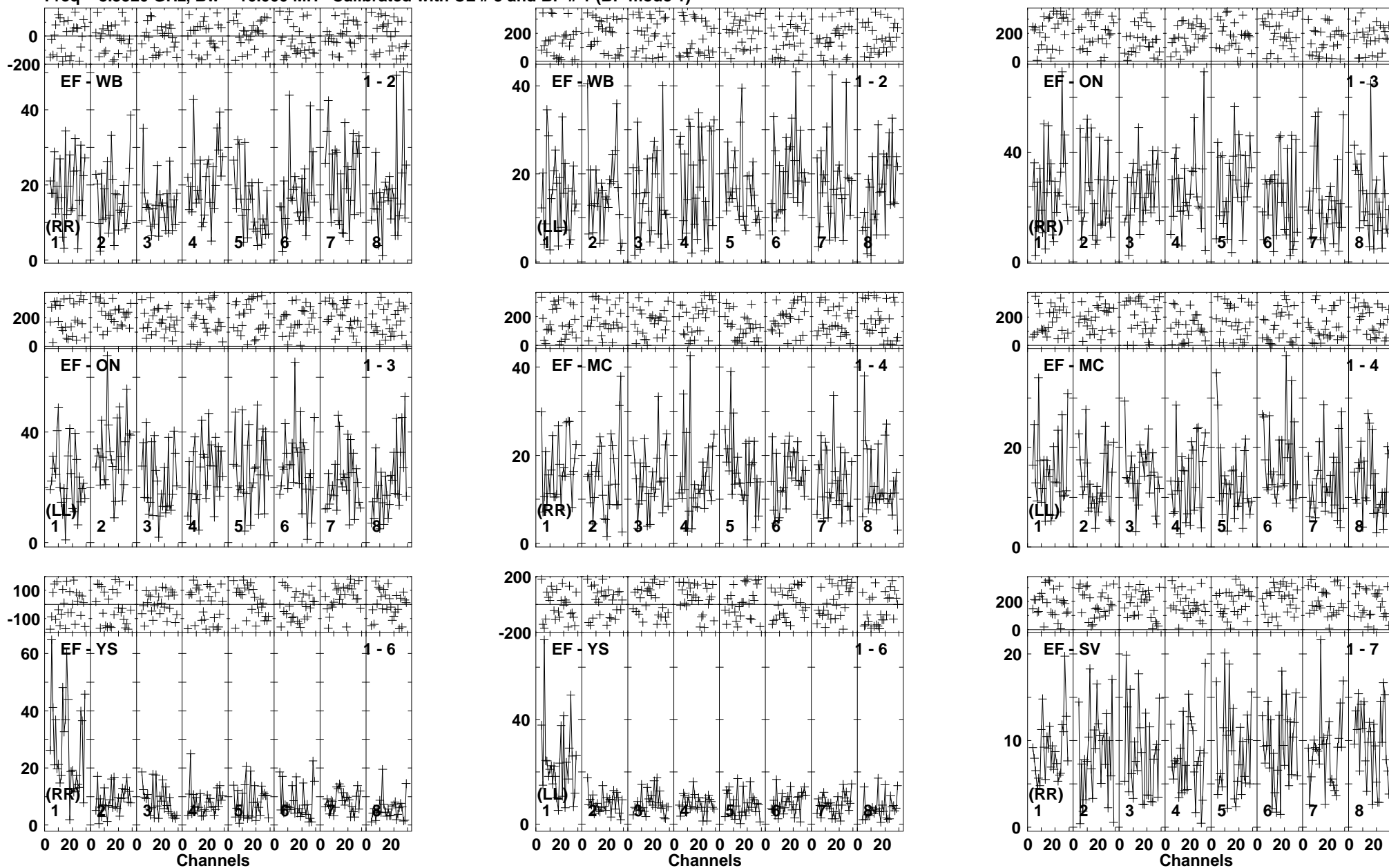

Lower frame: Milli Ampl Jy Top frame: Phas deg
Vector averaged cross-power spectrum Baseline: EF (01) - WB (02)
Timerange: 00/02:43:45 to 00/02:46:45

Plot file version 10 created 24-MAR-2014 14:37:47
 ARP299D EP087F 5.UVDATA.1
 Freq = 8.3520 GHz, Bw = 16.000 MH Calibrated with CL # 3 and BP # 1 (BP mode 1)

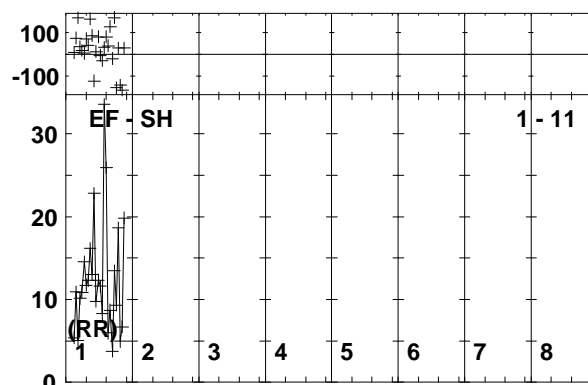
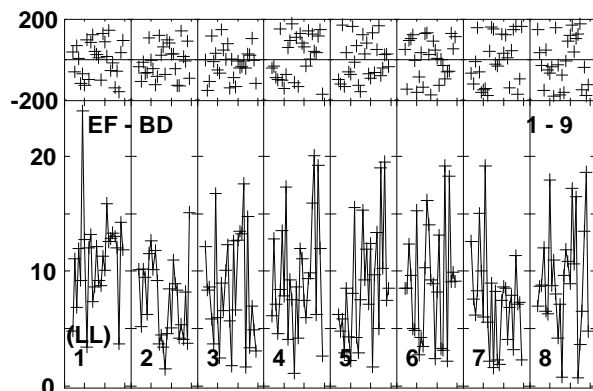
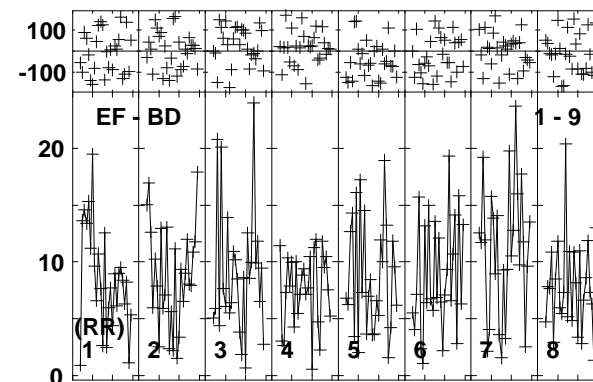
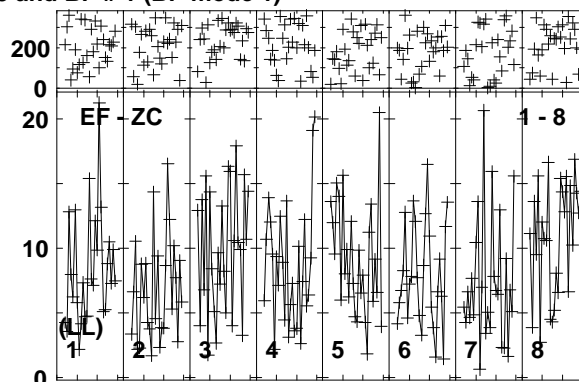
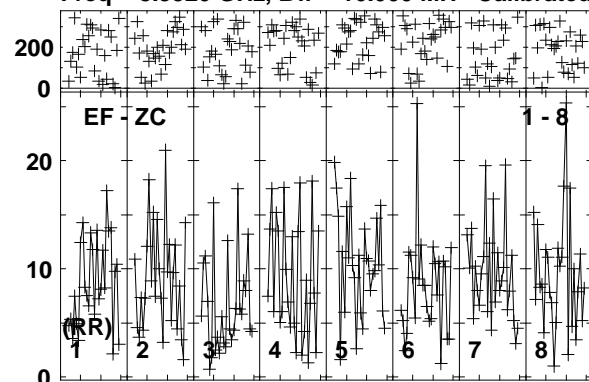

Lower frame: Milli Ampl Jy Top frame: Phas deg
 Vector averaged cross-power spectrum Baseline: EF (01) - ZC (08)
 Timerange: 00/02:43:45 to 00/02:46:45

Plot file version 11 created 24-MAR-2014 14:37:47

J1128+5925 EP087F 5.UVDATA.1

Freq = 8.3520 GHz, Bw = 16.000 MH Calibrated with CL # 3 and BP # 1 (BP mode 1)

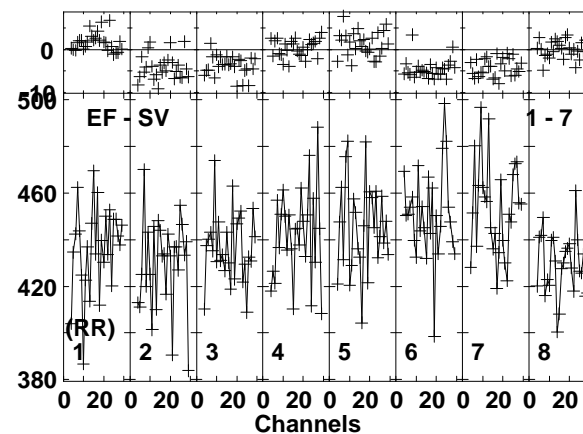
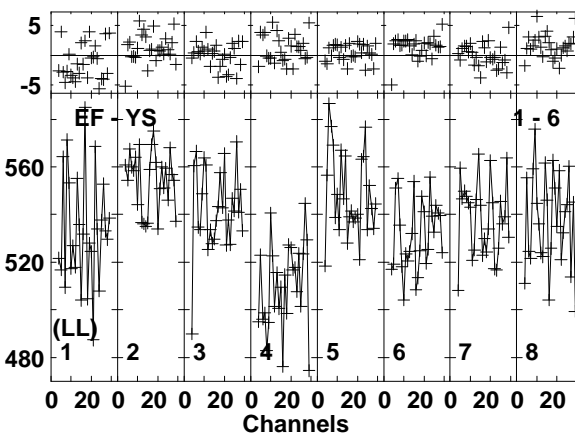
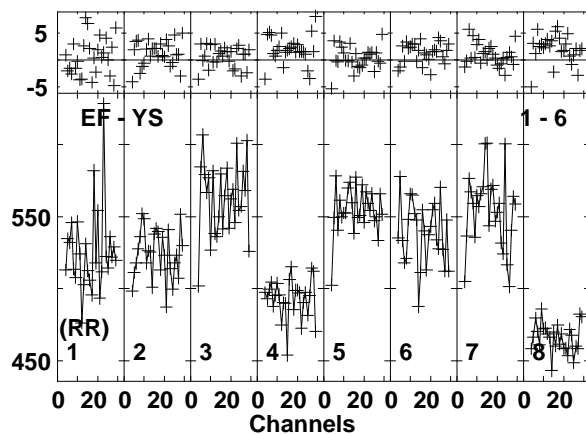
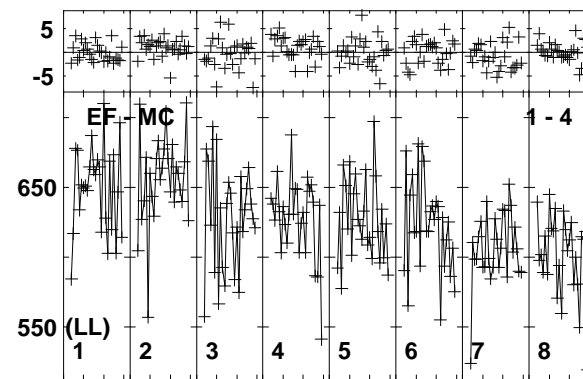
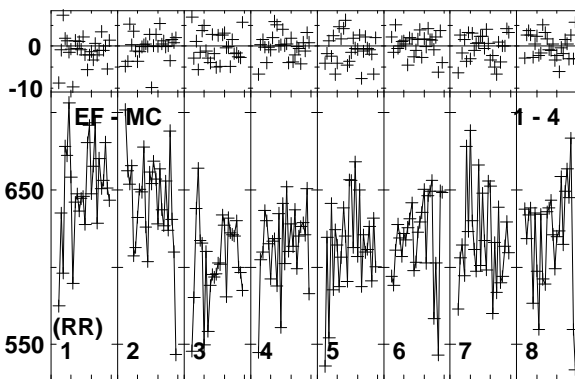
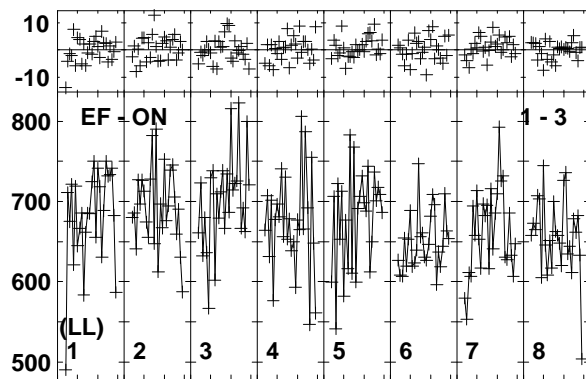
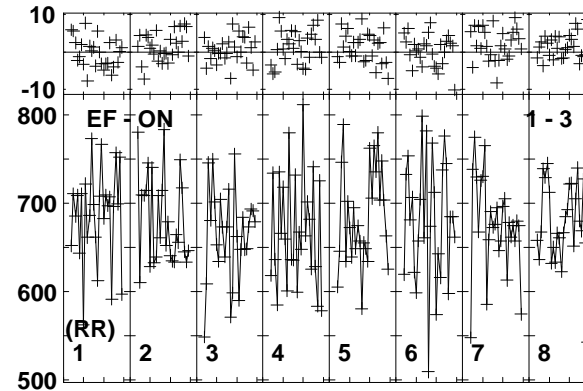
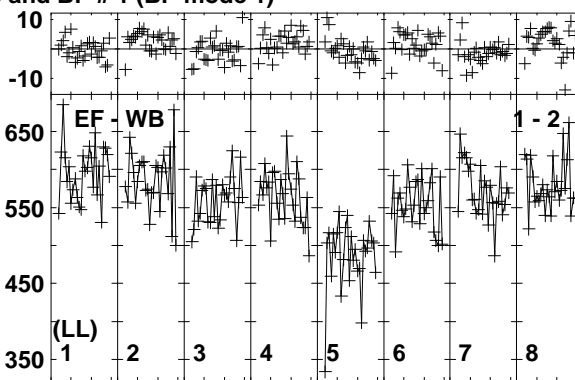
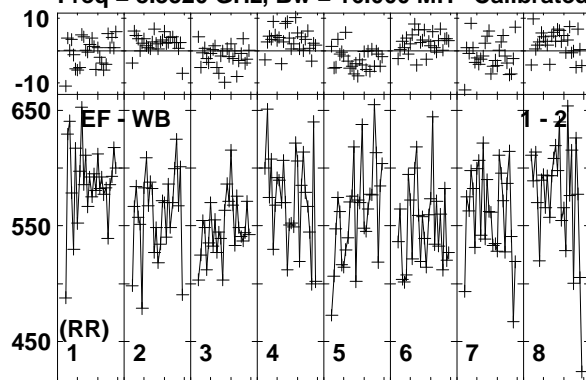

Lower frame: Milli Ampl Jy Top frame: Phas deg
Vector averaged cross-power spectrum Baseline: EF (01) - WB (02)
Timerange: 00/02:47:26 to 00/02:47:54

Plot file version 12 created 24-MAR-2014 14:37:47

J1128+5925 EP087F 5.UVDATA.1

Freq = 8.3520 GHz, Bw = 16.000 MH Calibrated with CL # 3 and BP # 1 (BP mode 1)

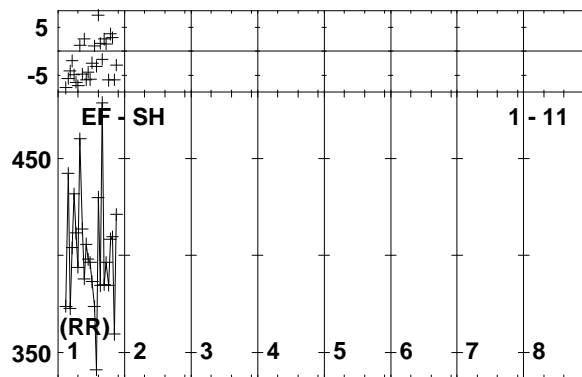
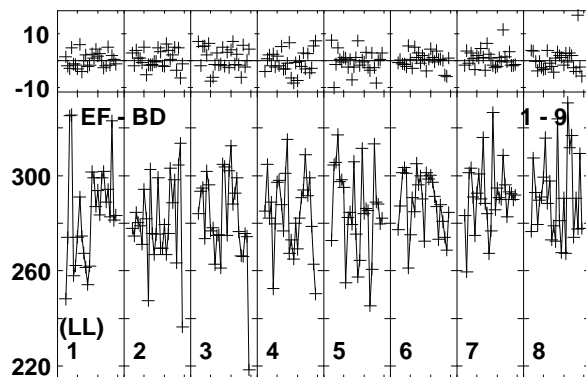
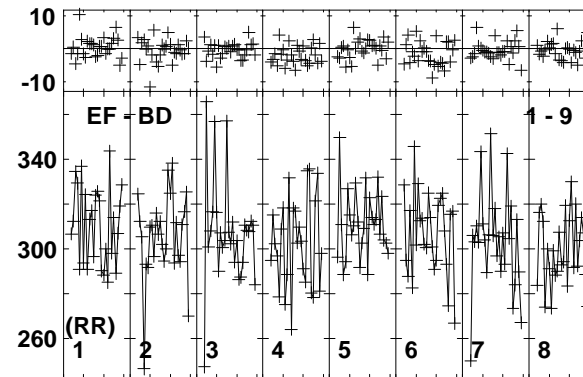
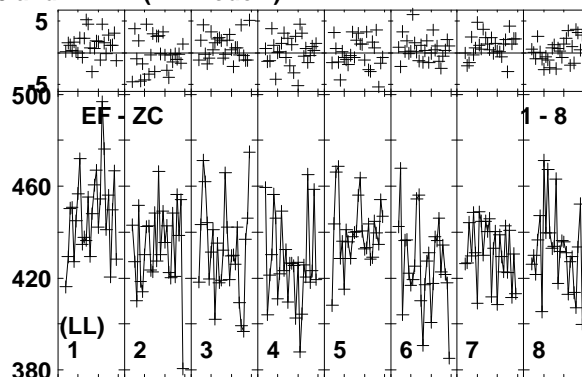
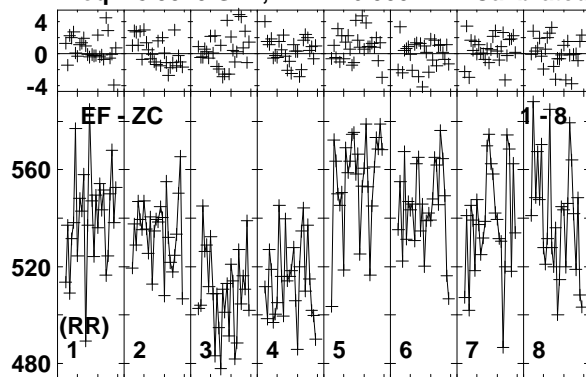

Lower frame: Milli Ampl Jy Top frame: Phas deg
Vector averaged cross-power spectrum Baseline: EF (01) - ZC (08)
Timerange: 00/02:47:26 to 00/02:47:54

Plot file version 13 created 24-MAR-2014 14:37:47

ARP299D EP087F 5.UVDATA.1

Freq = 8.3520 GHz, Bw = 16.000 MH Calibrated with CL # 3 and BP # 1 (BP mode 1)

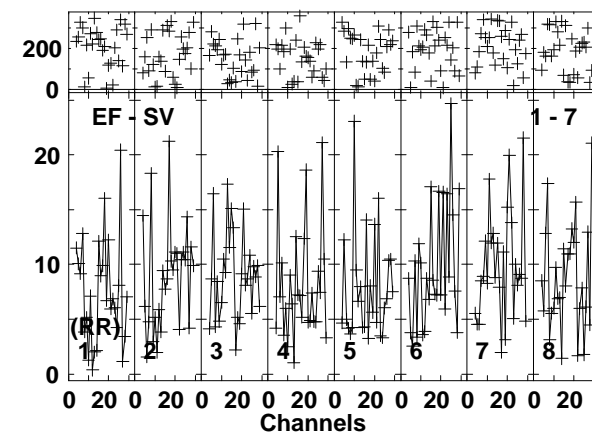
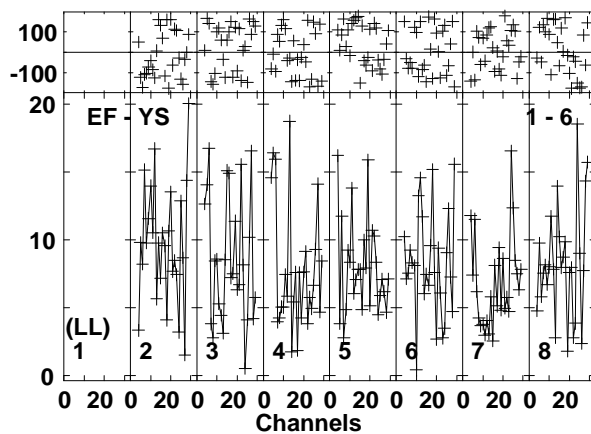
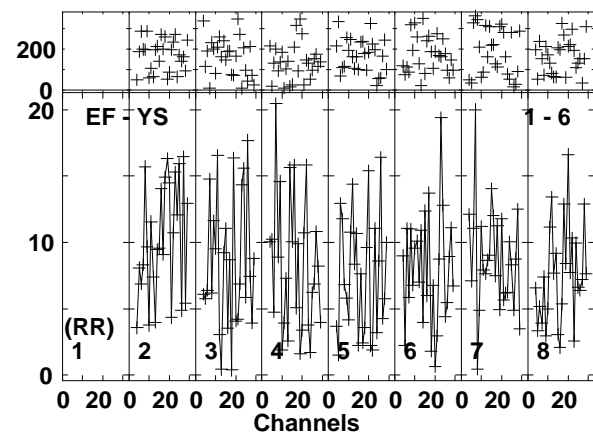
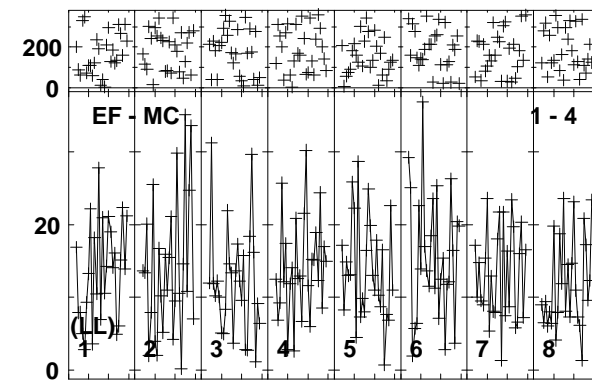
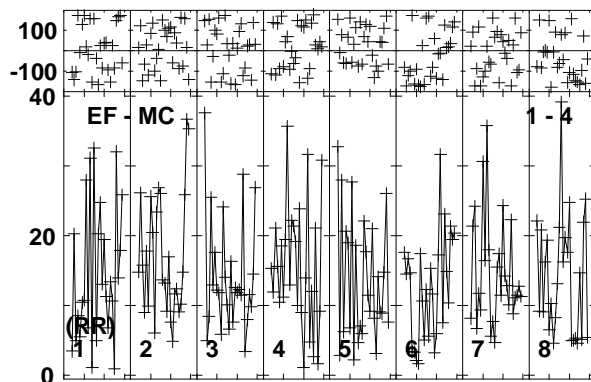
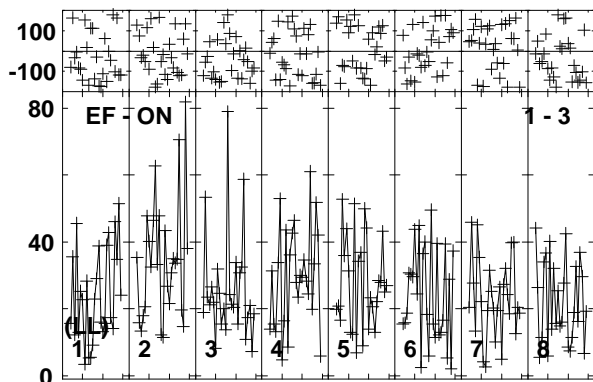
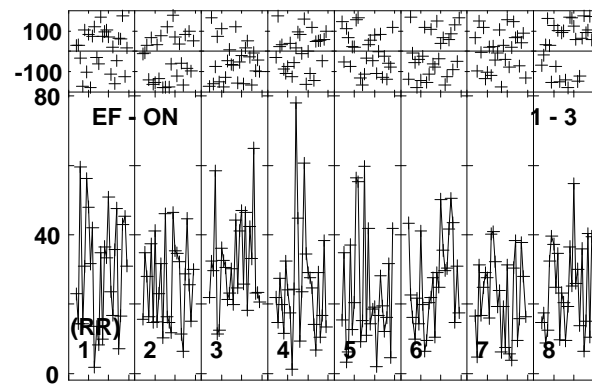
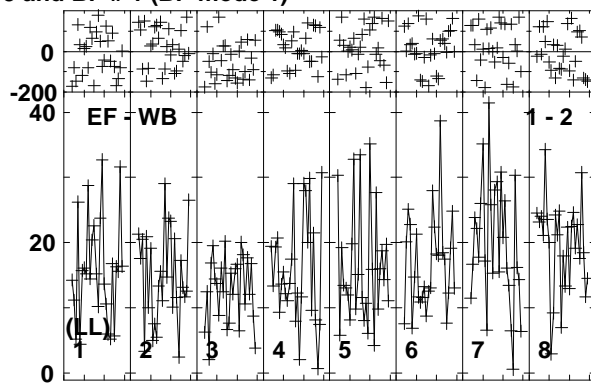
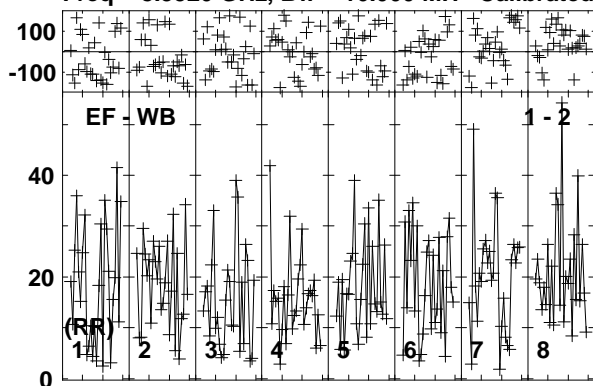

Lower frame: Milli Ampl Jy Top frame: Phas deg
Vector averaged cross-power spectrum Baseline: EF (01) - WB (02)
Timerange: 00/02:47:59 to 00/02:50:54

Plot file version 14 created 24-MAR-2014 14:37:47
 ARP299D EP087F 5.UVDATA.1
 Freq = 8.3520 GHz, Bw = 16.000 MH Calibrated with CL # 3 and BP # 1 (BP mode 1)

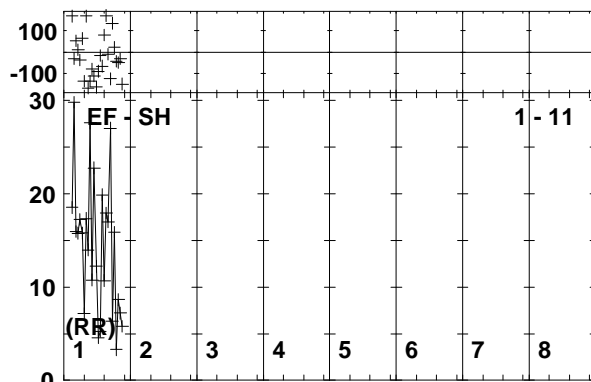
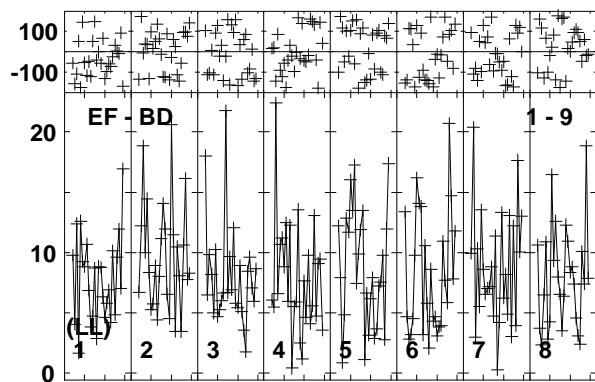
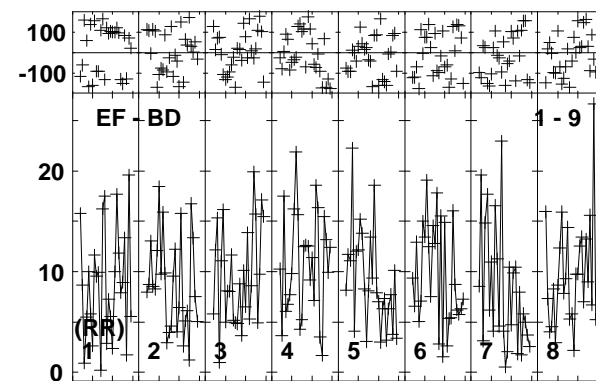
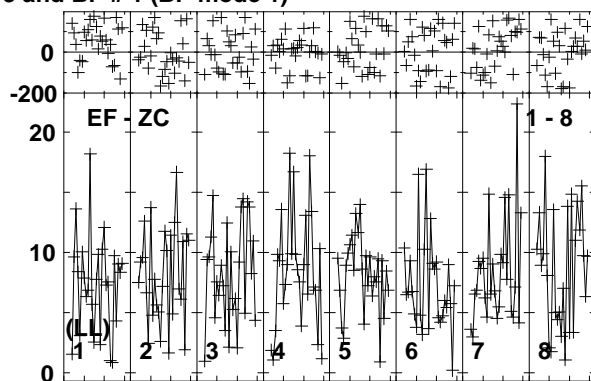
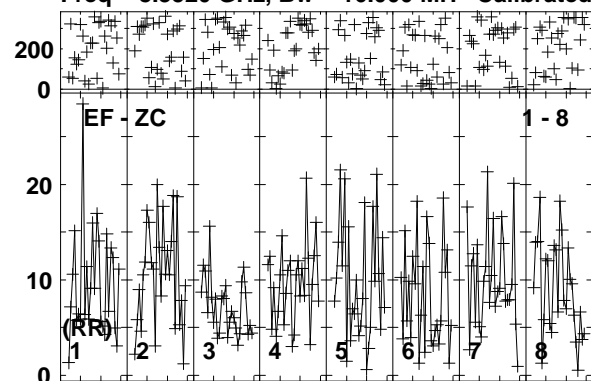

Lower frame: Milli Ampl Jy Top frame: Phas deg
 Vector averaged cross-power spectrum Baseline: EF (01) - ZC (08)
 Timerange: 00/02:47:59 to 00/02:50:54

Plot file version 15 created 24-MAR-2014 14:37:48

J1128+5925 EP087F 5.UVDATA.1

Freq = 8.3520 GHz, Bw = 16.000 MH Calibrated with CL # 3 and BP # 1 (BP mode 1)

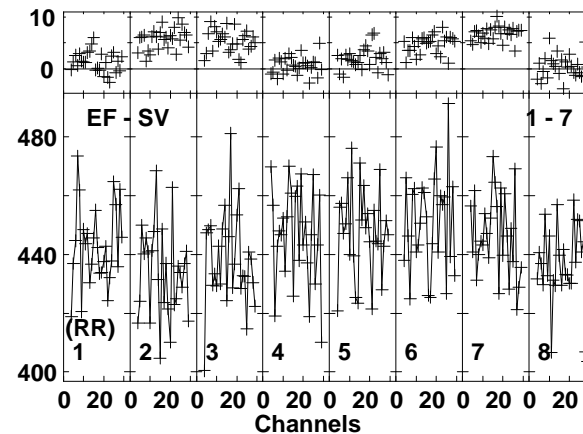
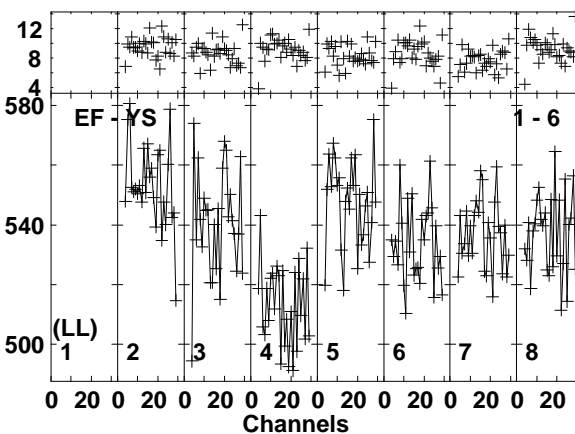
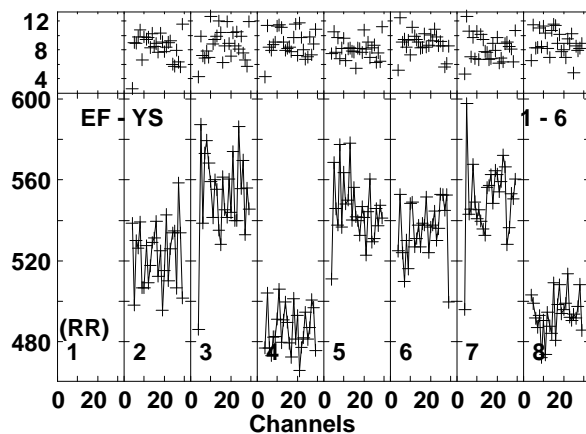
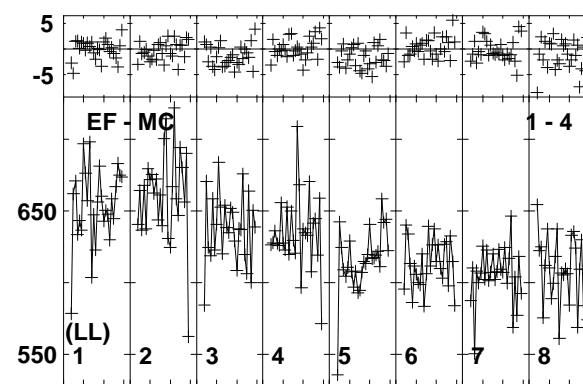
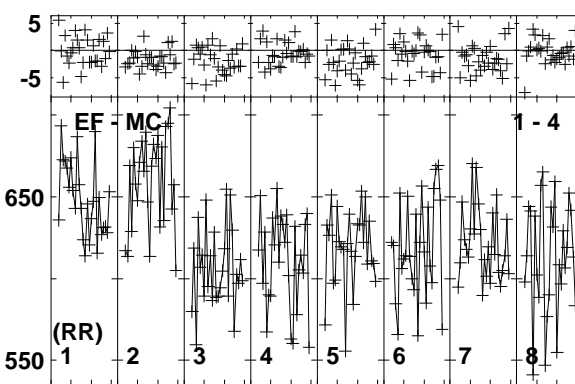
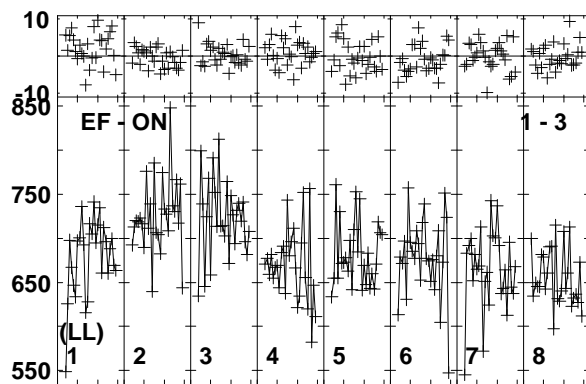
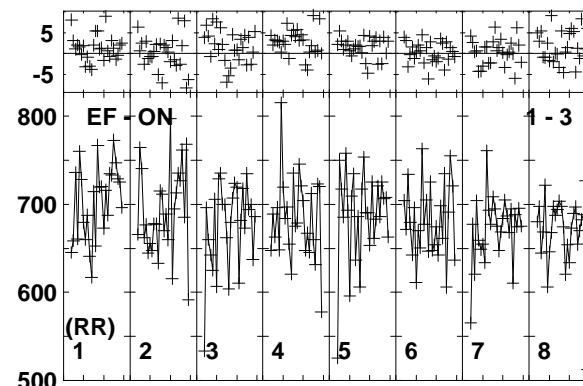
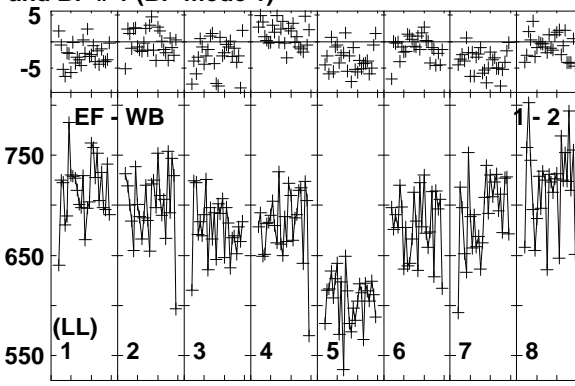
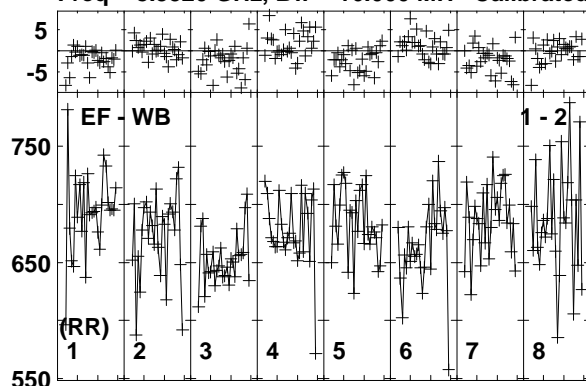

Lower frame: Milli Ampl Jy Top frame: Phas deg
Vector averaged cross-power spectrum Baseline: EF (01) - WB (02)
Timerange: 00/02:50:56 to 00/02:52:00

Plot file version 16 created 24-MAR-2014 14:37:48

J1128+5925 EP087F 5.UVDATA.1

Freq = 8.3520 GHz, Bw = 16.000 MH Calibrated with CL # 3 and BP # 1 (BP mode 1)

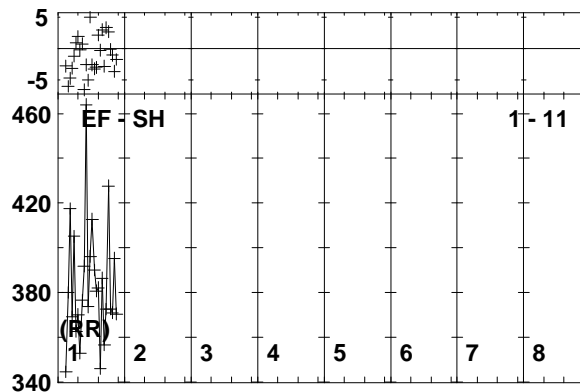
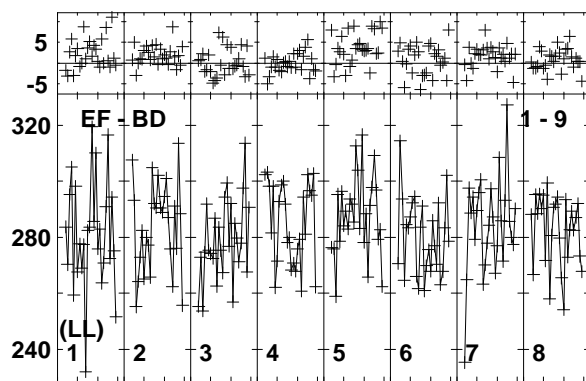
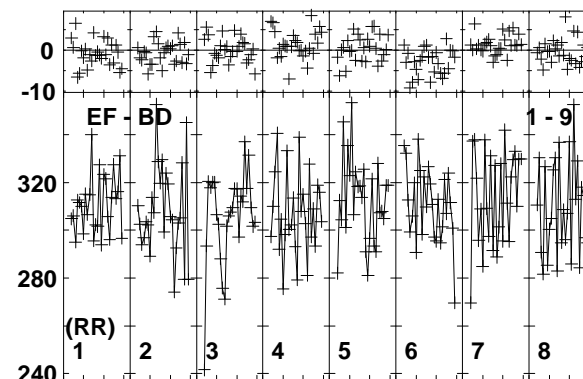
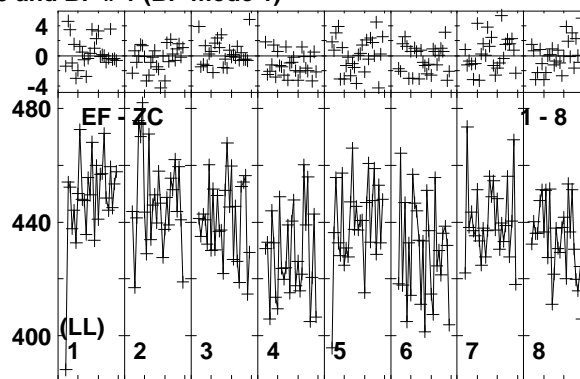
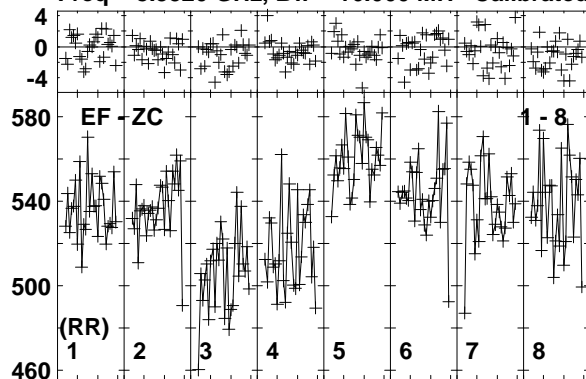

Lower frame: Milli Ampl Jy Top frame: Phas deg
Vector averaged cross-power spectrum Baseline: EF (01) - ZC (08)
Timerange: 00/02:50:56 to 00/02:52:00

Plot file version 17 created 24-MAR-2014 14:37:48

ARP299D EP087F 5.UVDATA.1

Freq = 8.3520 GHz, Bw = 16.000 MH Calibrated with CL # 3 and BP # 1 (BP mode 1)

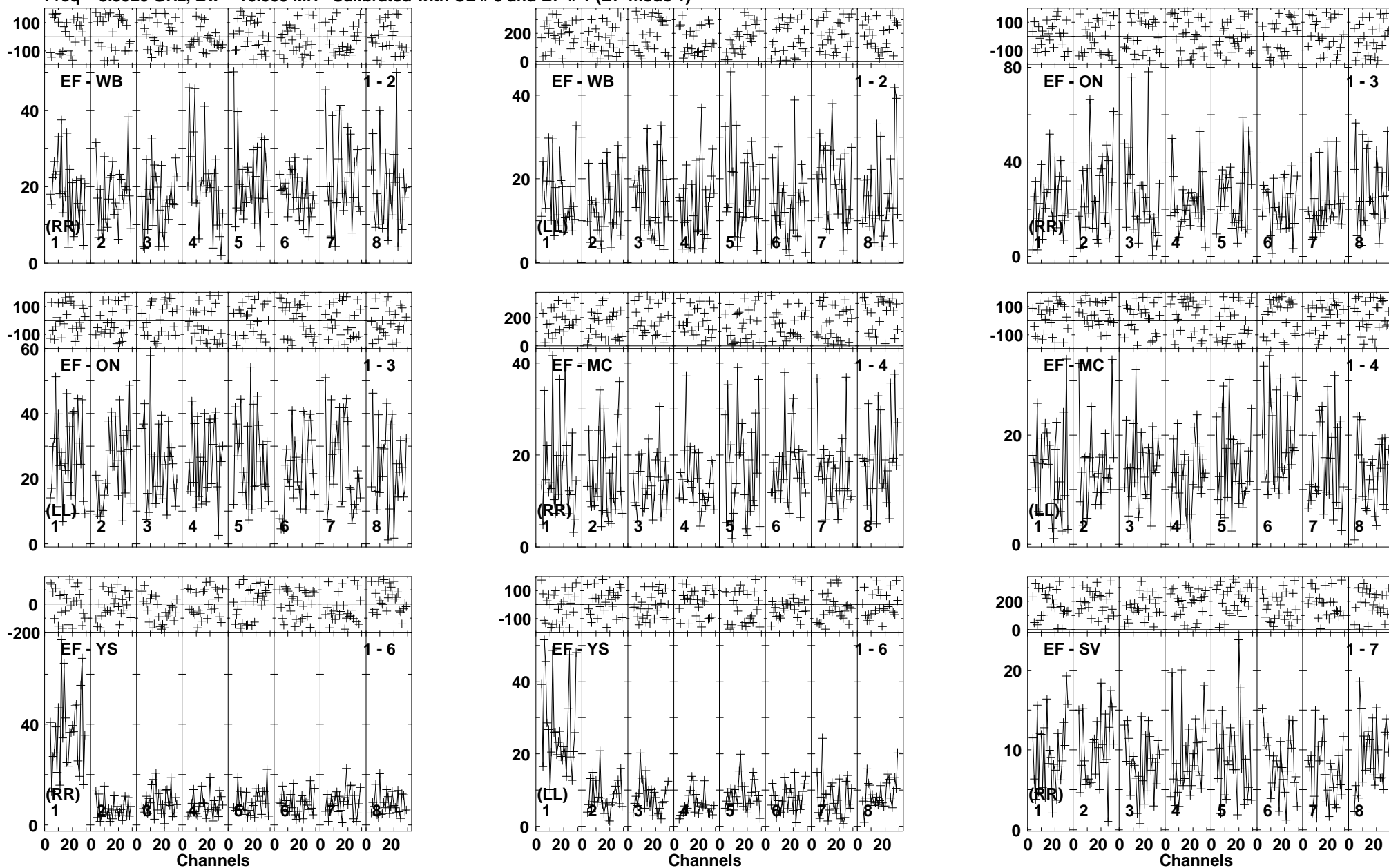

Lower frame: Milli Ampl Jy Top frame: Phas deg
Vector averaged cross-power spectrum Baseline: EF (01) - WB (02)
Timerange: 00/02:52:00 to 00/02:54:59

Plot file version 18 created 24-MAR-2014 14:37:49

ARP299D EP087F 5.UVDATA.1

Freq = 8.3520 GHz, Bw = 16.000 MH Calibrated with CL # 3 and BP # 1 (BP mode 1)

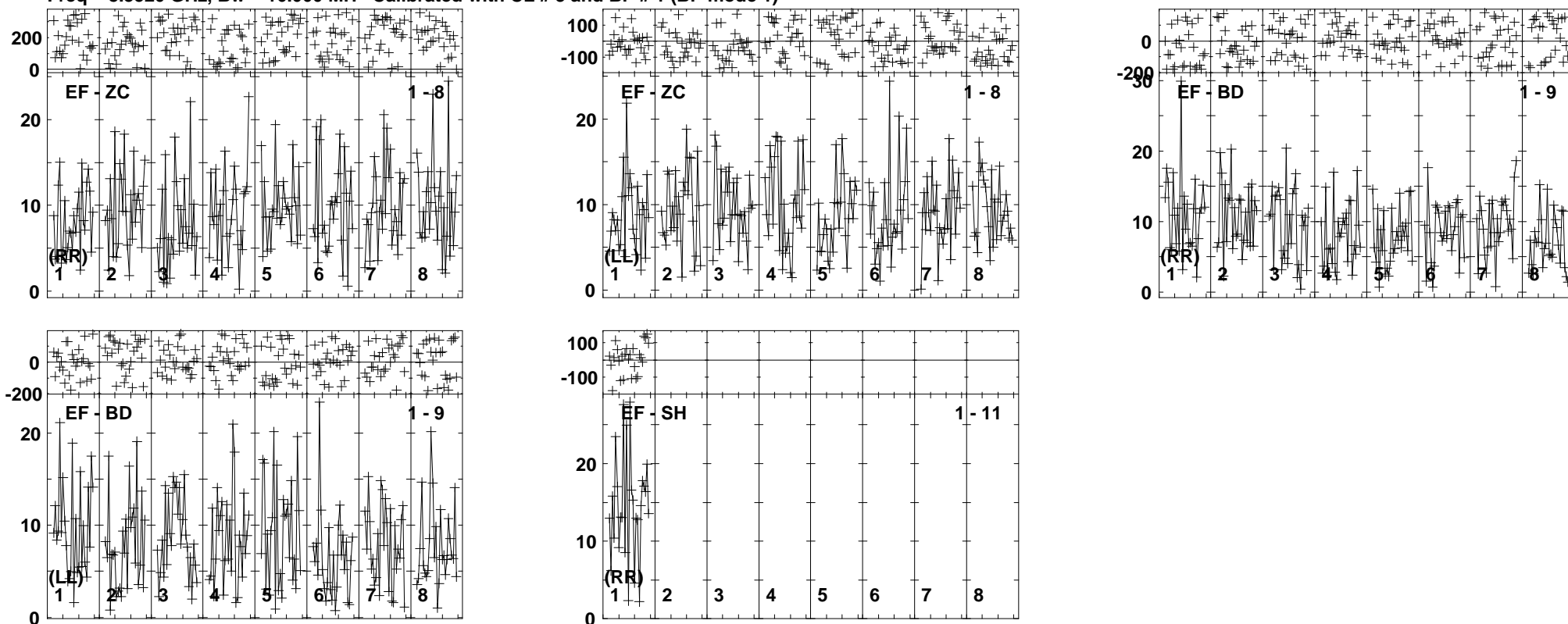

Lower frame: Milli Ampl Jy Top frame: Phas deg
Vector averaged cross-power spectrum Baseline: EF (01) - ZC (08)
Timerange: 00/02:52:00 to 00/02:54:59

Plot file version 19 created 24-MAR-2014 14:37:49

J1128+5925 EP087F 5.UVDATA.1

Freq = 8.3520 GHz, Bw = 16.000 MH Calibrated with CL # 3 and BP # 1 (BP mode 1)

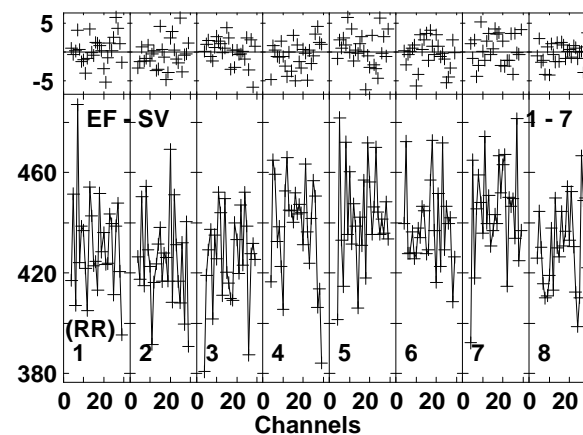
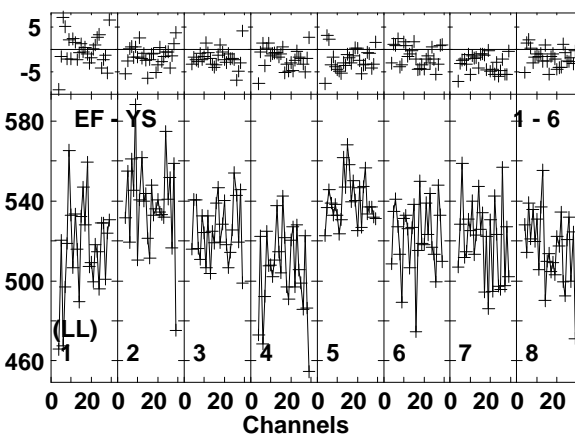
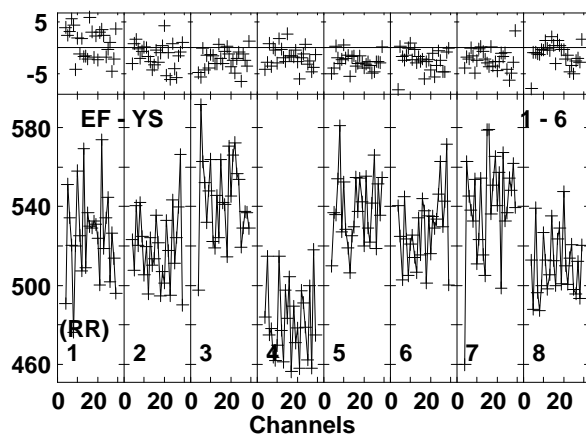
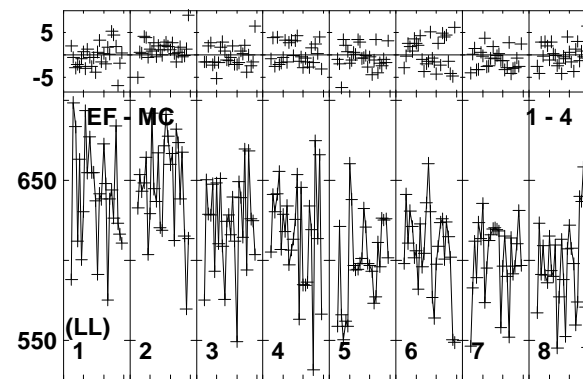
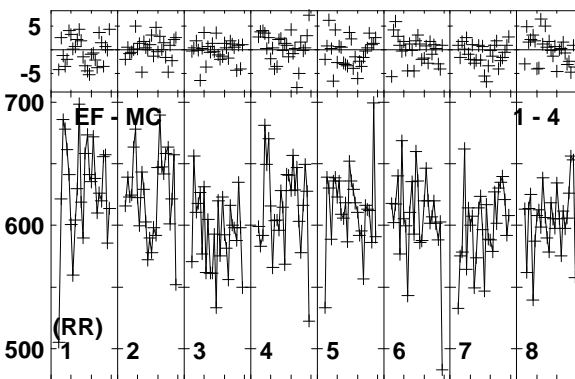
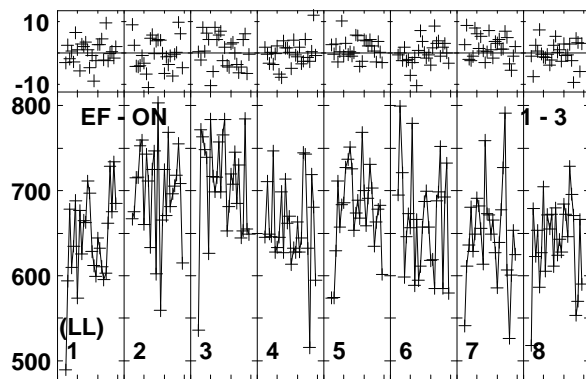
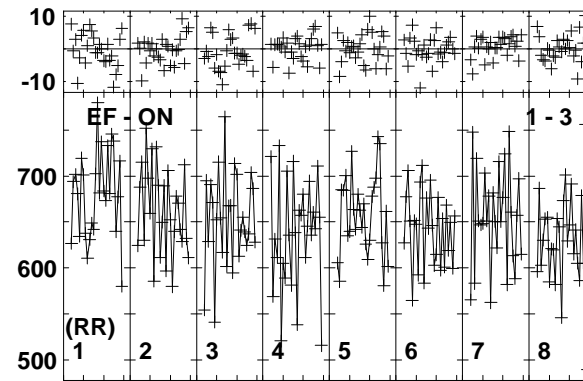
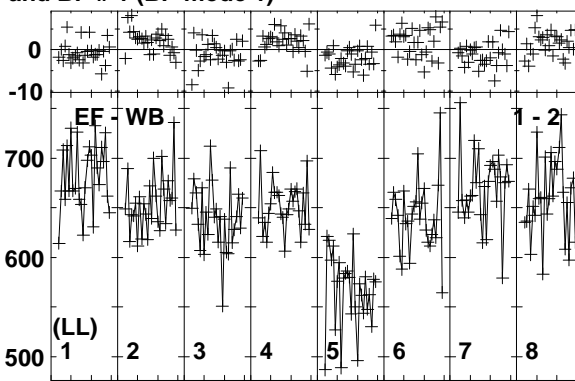
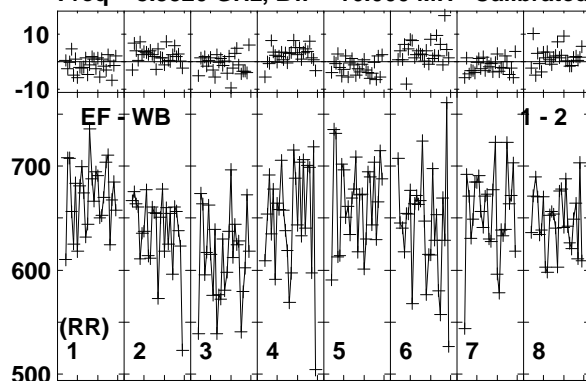

Lower frame: Milli Ampl Jy Top frame: Phas deg
Vector averaged cross-power spectrum Baseline: EF (01) - WB (02)
Timerange: 00/02:55:41 to 00/02:56:09

Plot file version 20 created 24-MAR-2014 14:37:49

J1128+5925 EP087F 5.UVDATA.1

Freq = 8.3520 GHz, Bw = 16.000 MH Calibrated with CL # 3 and BP # 1 (BP mode 1)

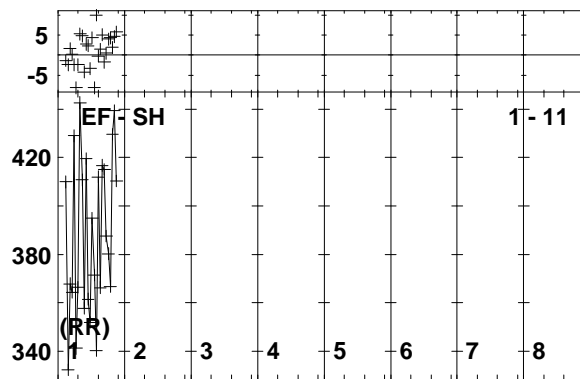
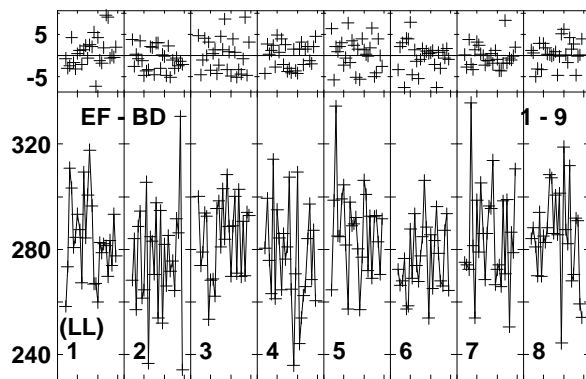
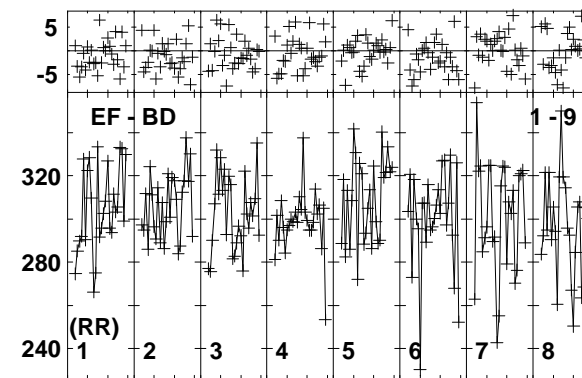
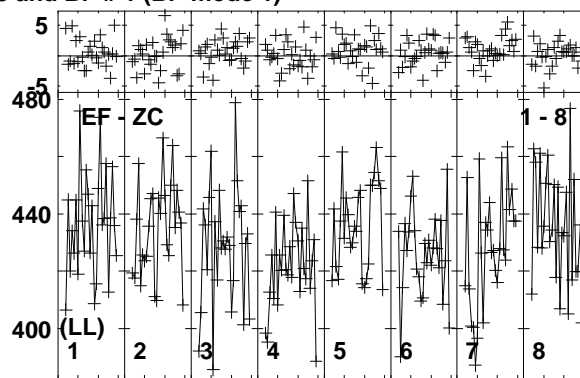
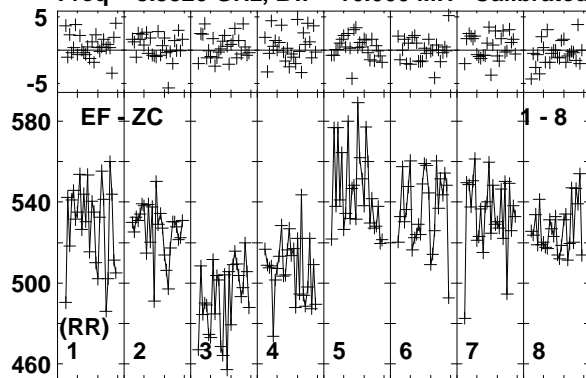

Lower frame: Milli Ampl Jy Top frame: Phas deg
Vector averaged cross-power spectrum Baseline: EF (01) - ZC (08)
Timerange: 00/02:55:41 to 00/02:56:09

Plot file version 21 created 24-MAR-2014 14:37:49

ARP299D EP087F 5.UVDATA.1

Freq = 8.3520 GHz, Bw = 16.000 MH Calibrated with CL # 3 and BP # 1 (BP mode 1)

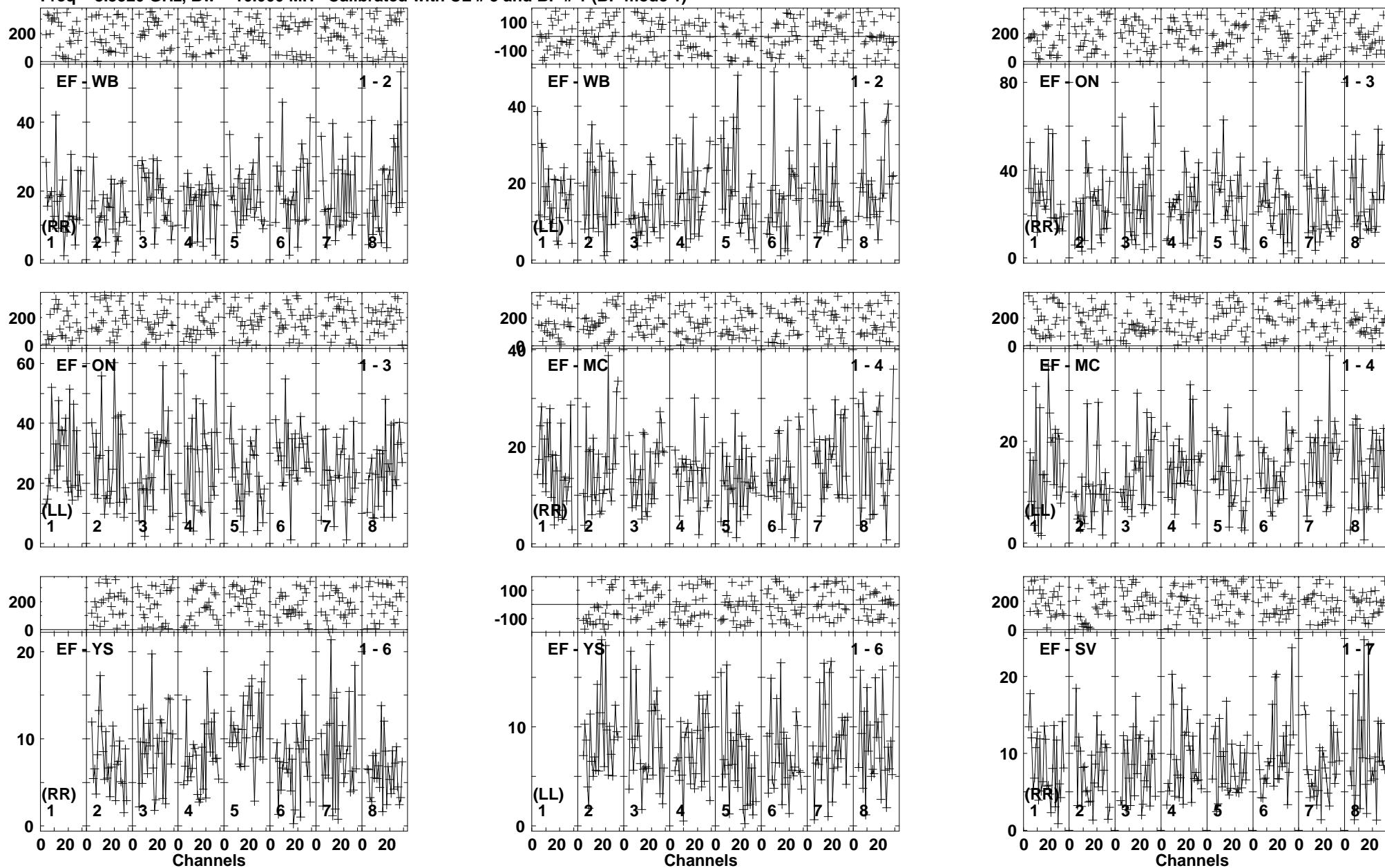

Lower frame: Milli Ampl Jy Top frame: Phas deg
Vector averaged cross-power spectrum Baseline: EF (01) - WB (02)
Timerange: 00/02:56:15 to 00/02:59:09

Plot file version 22 created 24-MAR-2014 14:37:50

ARP299D EP087F 5.UVDATA.1

Freq = 8.3520 GHz, Bw = 16.000 MH Calibrated with CL # 3 and BP # 1 (BP mode 1)

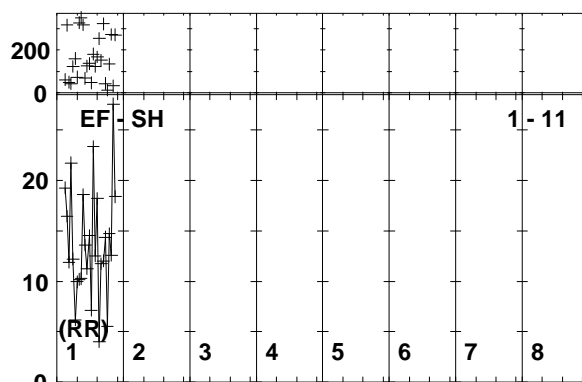
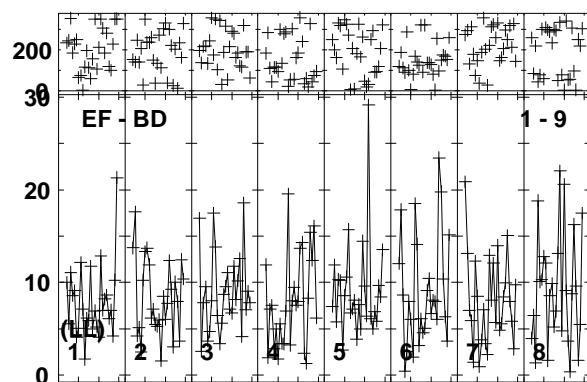
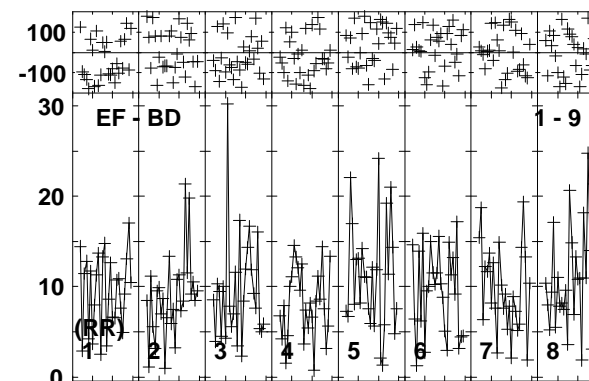
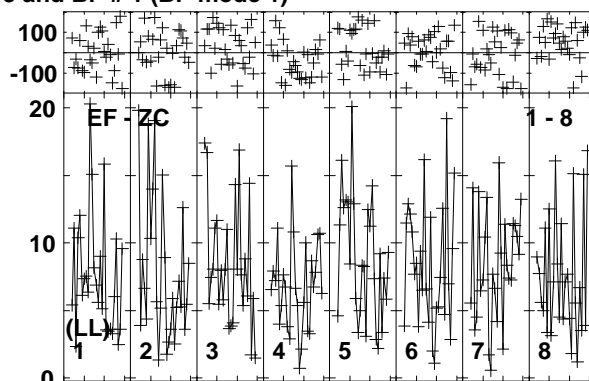
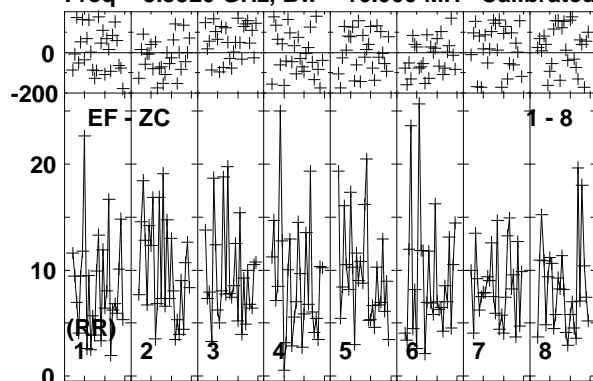

Lower frame: Milli Ampl Jy Top frame: Phas deg
Vector averaged cross-power spectrum Baseline: EF (01) - ZC (08)
Timerange: 00/02:56:15 to 00/02:59:09

Plot file version 23 created 24-MAR-2014 14:37:50

J1128+5925 EP087F 5.UVDATA.1

Freq = 8.3520 GHz, Bw = 16.000 MH Calibrated with CL # 3 and BP # 1 (BP mode 1)

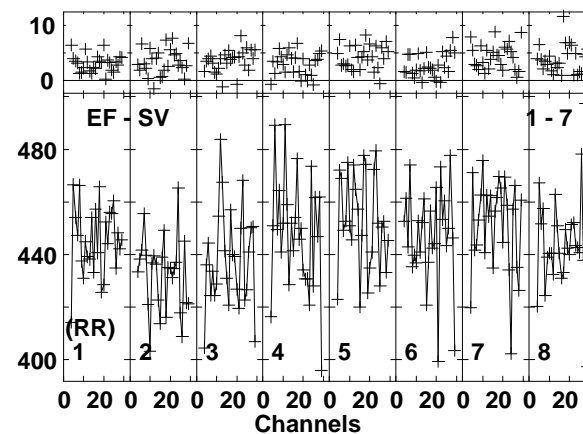
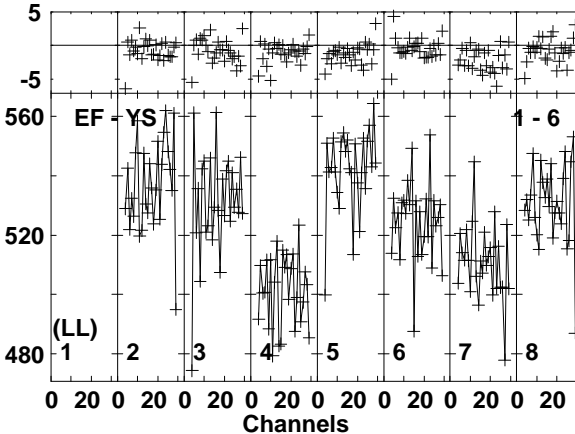
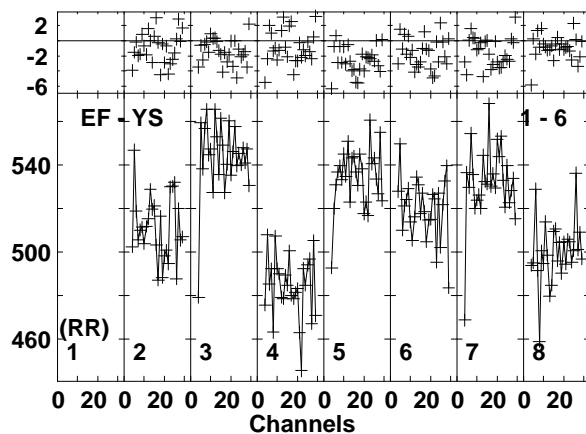
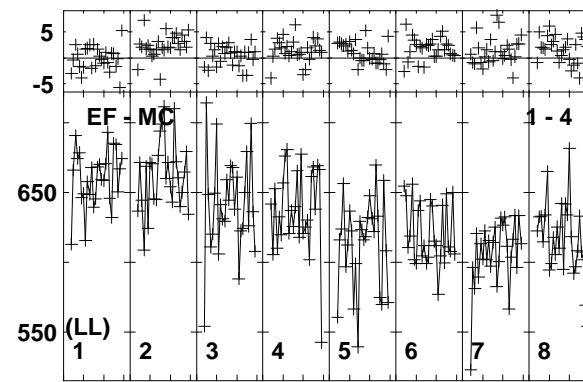
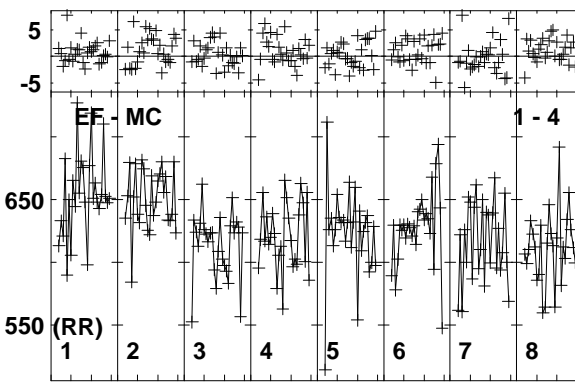
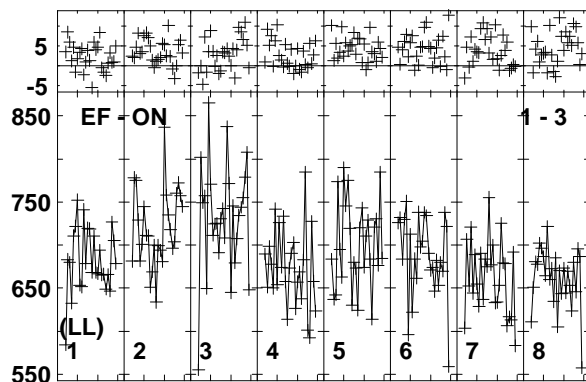
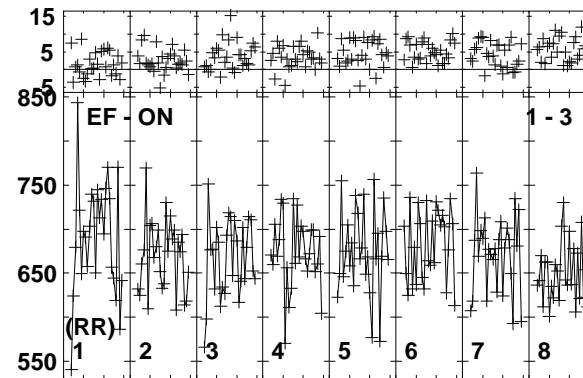
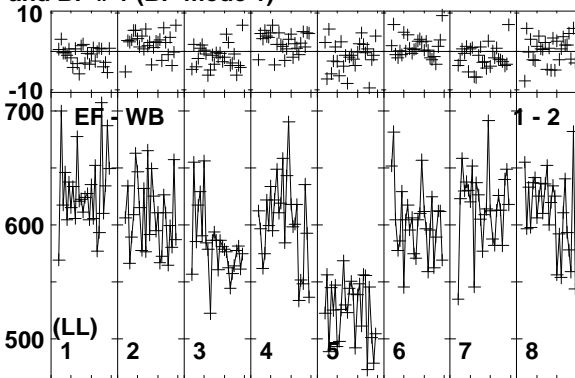
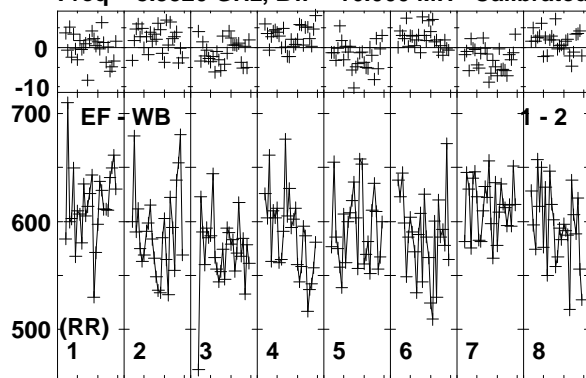

Lower frame: Milli Ampl Jy Top frame: Phas deg
Vector averaged cross-power spectrum Baseline: EF (01) - WB (02)
Timerange: 00/02:59:10 to 00/03:00:14

Plot file version 24 created 24-MAR-2014 14:37:50

J1128+5925 EP087F 5.UVDATA.1

Freq = 8.3520 GHz, Bw = 16.000 MH Calibrated with CL # 3 and BP # 1 (BP mode 1)

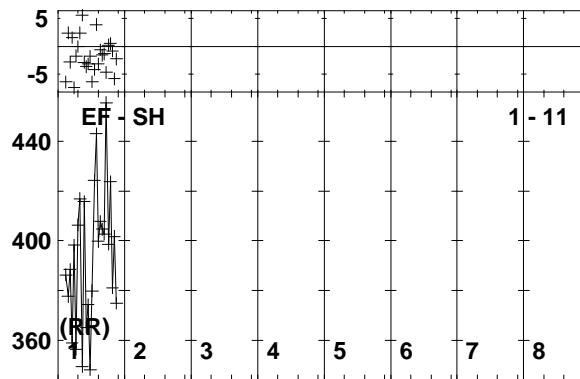
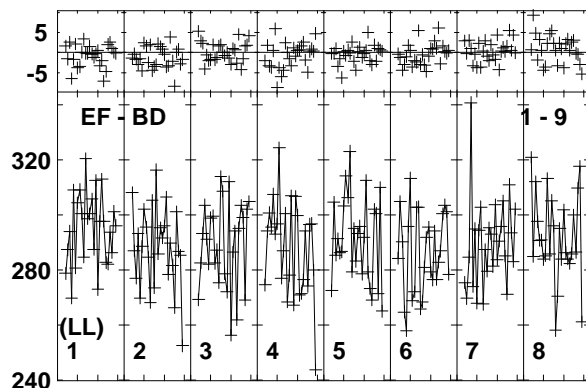
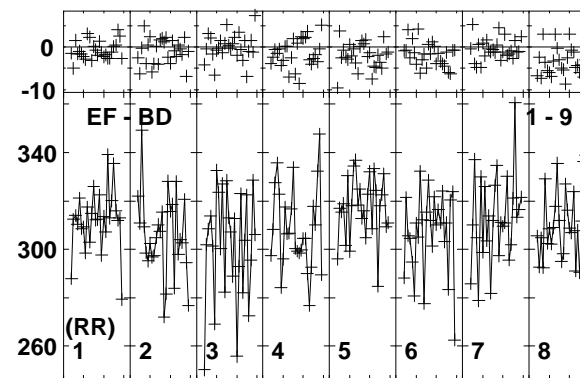
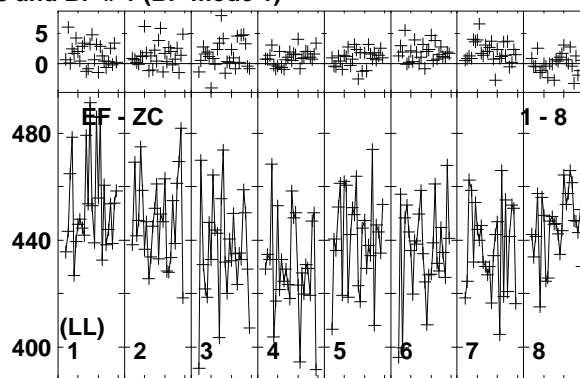
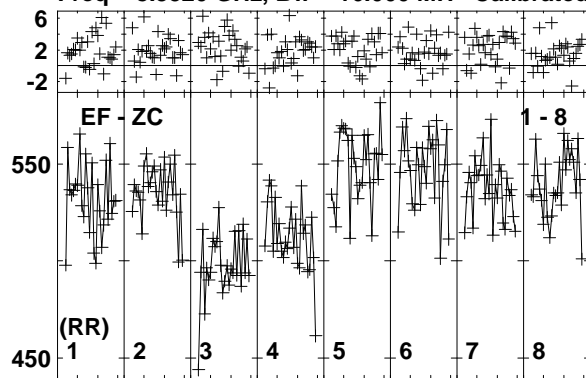

Lower frame: Milli Ampl Jy Top frame: Phas deg
Vector averaged cross-power spectrum Baseline: EF (01) - ZC (08)
Timerange: 00/02:59:10 to 00/03:00:14

Plot file version 25 created 24-MAR-2014 14:37:50

ARP299D EP087F 5.UVDATA.1

Freq = 8.3520 GHz, Bw = 16.000 MH Calibrated with CL # 3 and BP # 1 (BP mode 1)

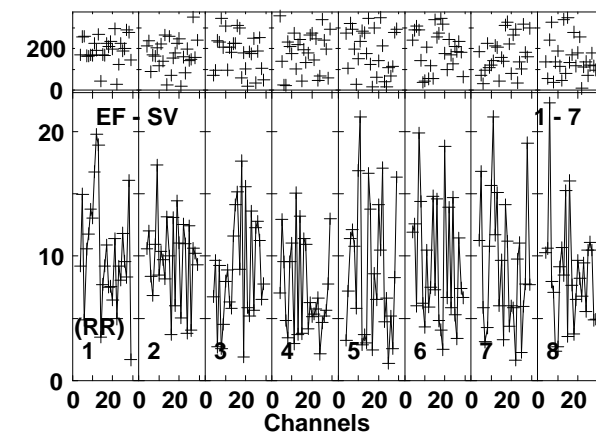
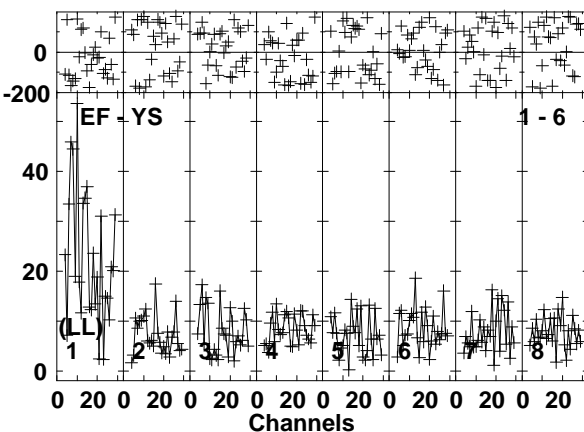
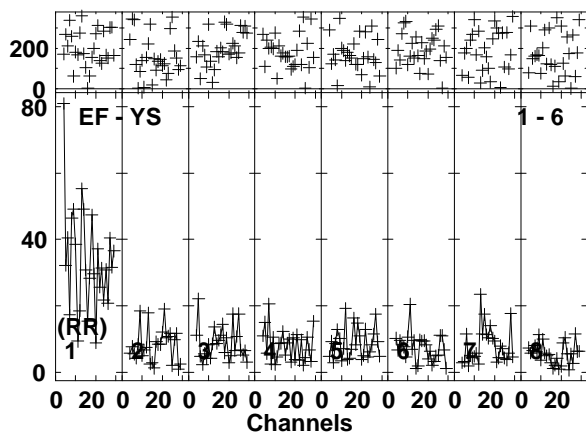
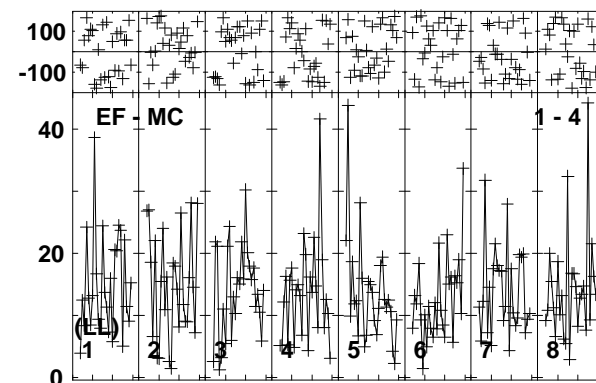
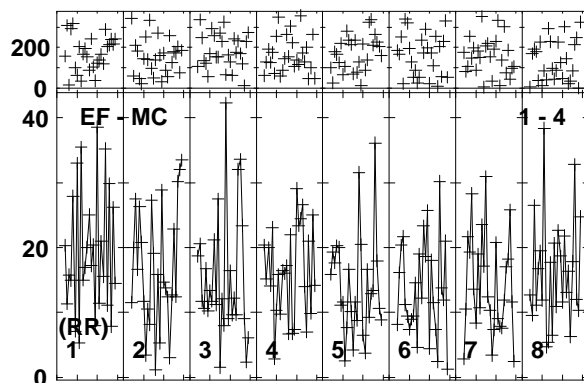
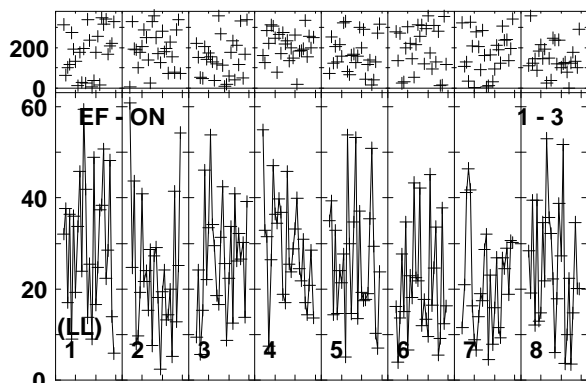
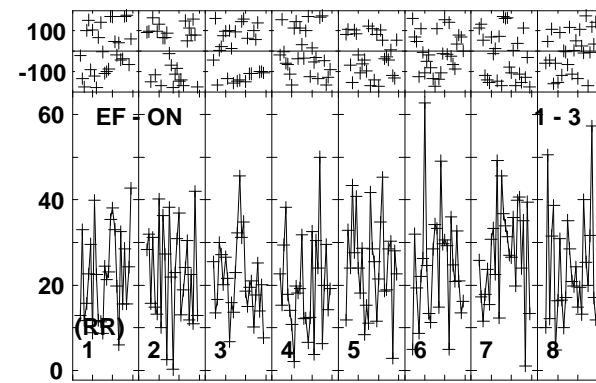
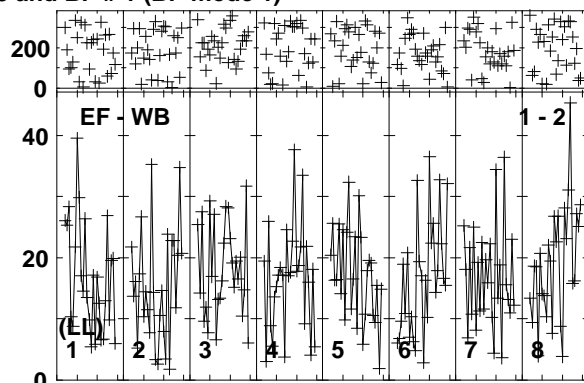
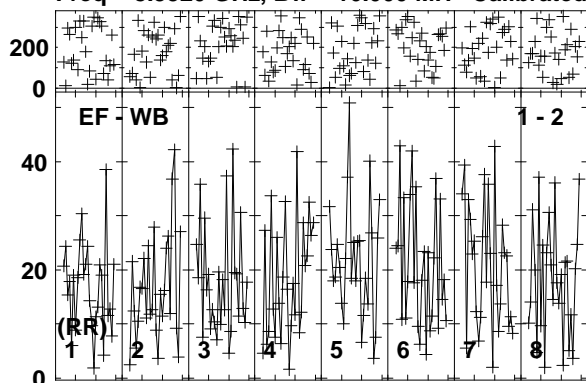

Lower frame: Milli Ampl Jy Top frame: Phas deg
Vector averaged cross-power spectrum Baseline: EF (01) - WB (02)
Timerange: 00/03:00:15 to 00/03:03:15

Plot file version 26 created 24-MAR-2014 14:37:51
 ARP299D EP087F 5.UVDATA.1
 Freq = 8.3520 GHz, Bw = 16.000 MH Calibrated with CL # 3 and BP # 1 (BP mode 1)

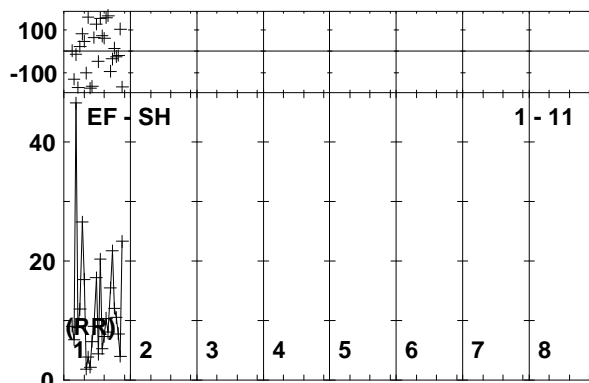
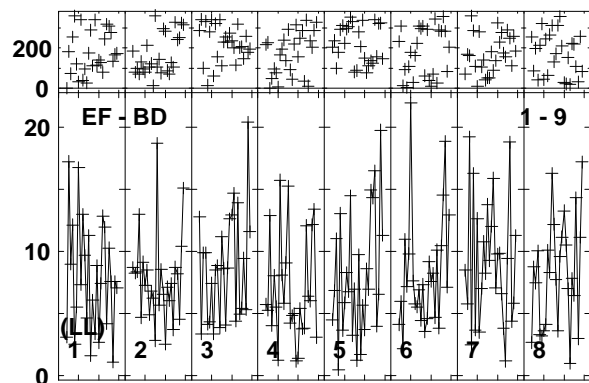
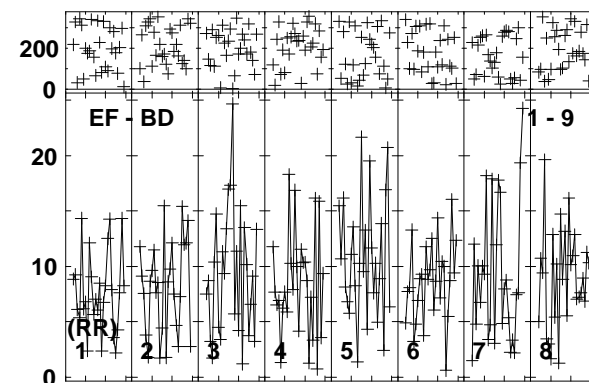
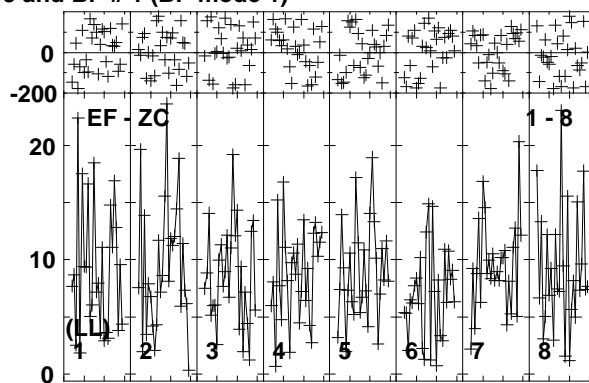
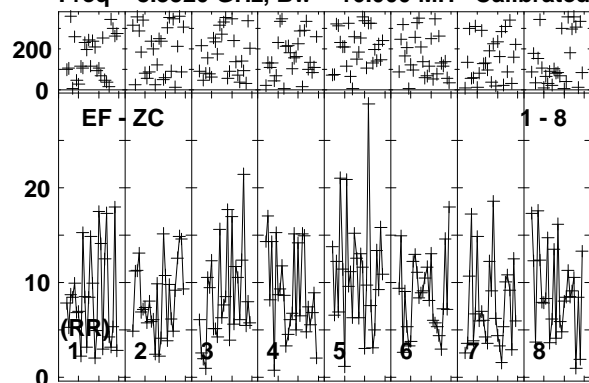

Lower frame: Milli Ampl Jy Top frame: Phas deg
 Vector averaged cross-power spectrum Baseline: EF (01) - ZC (08)
 Timerange: 00/03:00:15 to 00/03:03:15

Plot file version 27 created 24-MAR-2014 14:37:51

J1128+5925 EP087F 5.UVDATA.1

Freq = 8.3520 GHz, Bw = 16.000 MH Calibrated with CL # 3 and BP # 1 (BP mode 1)

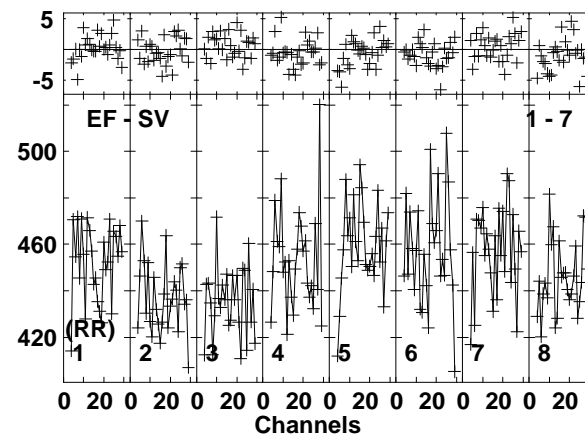
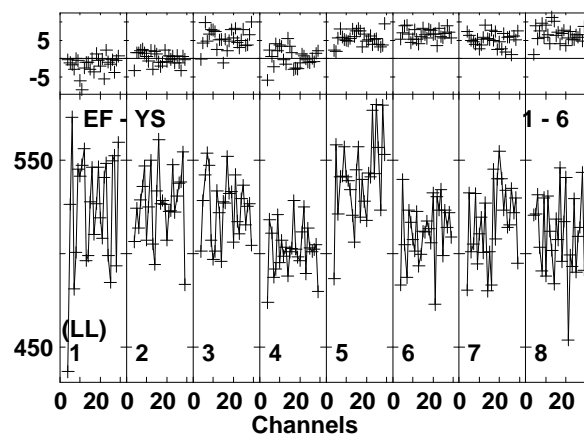
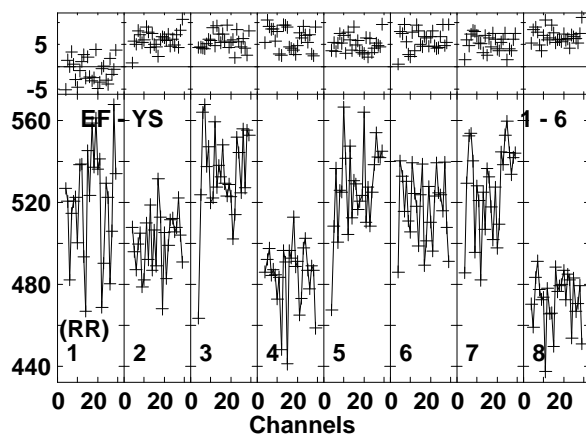
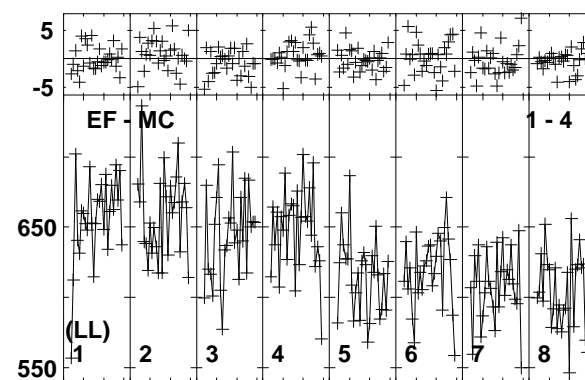
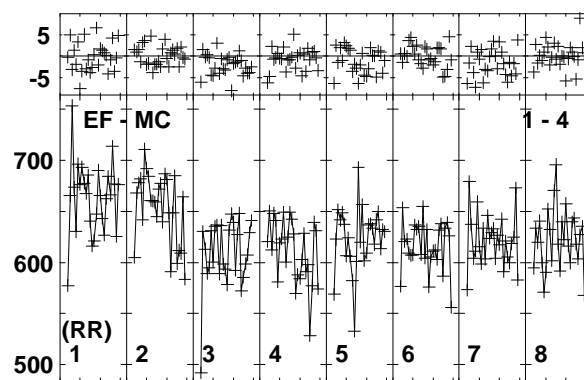
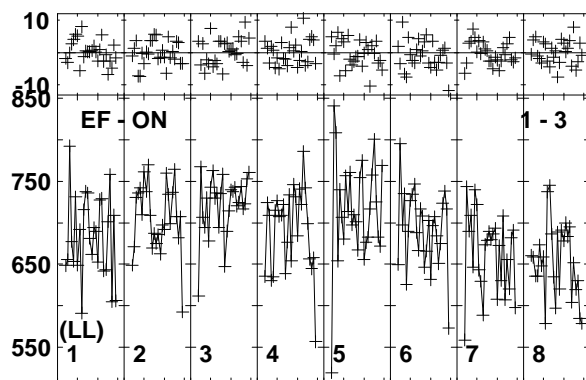
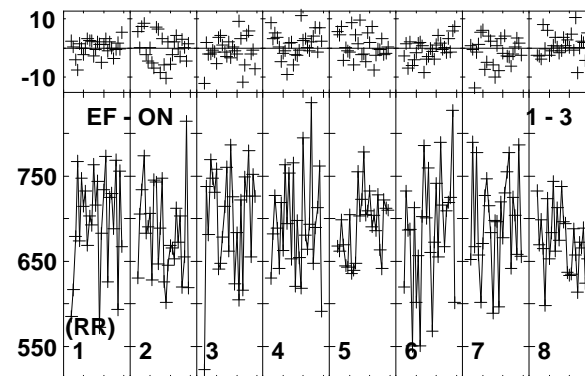
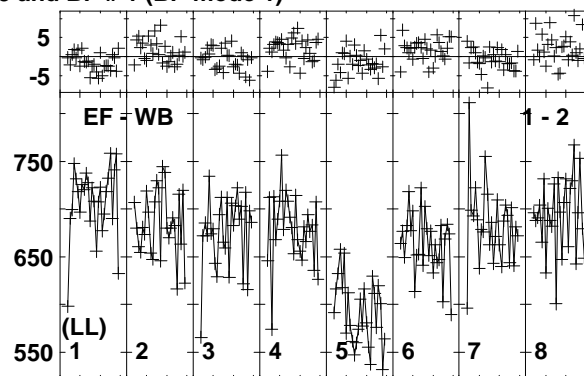
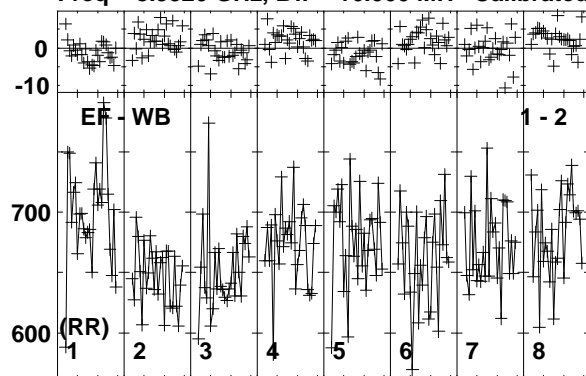

Lower frame: Milli Ampl Jy Top frame: Phas deg
Vector averaged cross-power spectrum Baseline: EF (01) - WB (02)
Timerange: 00/03:03:55 to 00/03:04:24

Plot file version 28 created 24-MAR-2014 14:37:51

J1128+5925 EP087F 5.UVDATA.1

Freq = 8.3520 GHz, Bw = 16.000 MH Calibrated with CL # 3 and BP # 1 (BP mode 1)

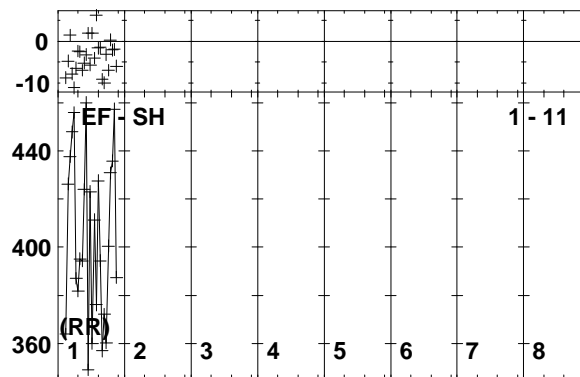
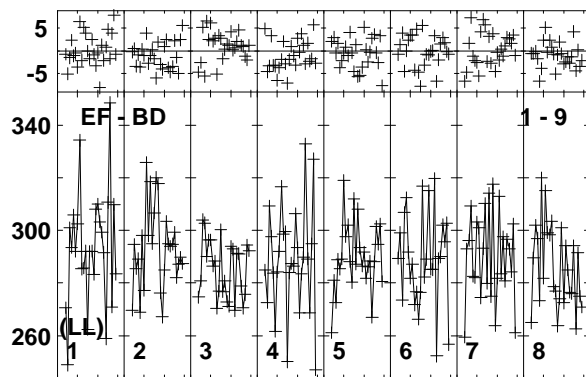
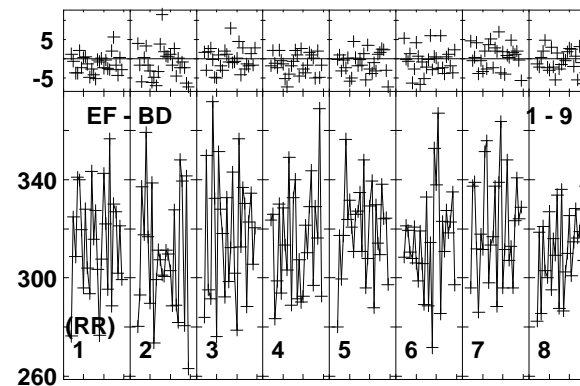
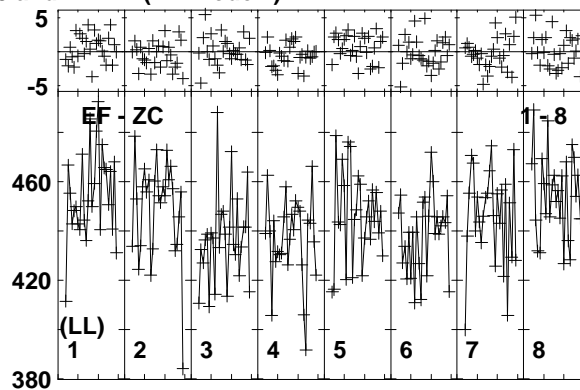
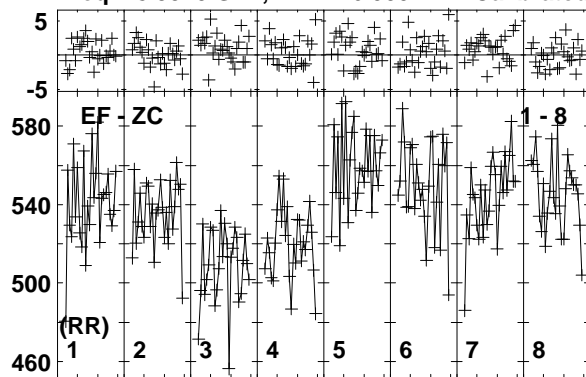

Lower frame: Milli Ampl Jy Top frame: Phas deg
Vector averaged cross-power spectrum Baseline: EF (01) - ZC (08)
Timerange: 00/03:03:55 to 00/03:04:24

Plot file version 29 created 24-MAR-2014 14:37:51
 ARP299D EP087F 5.UVDATA.1
 Freq = 8.3520 GHz, Bw = 16.000 MH Calibrated with CL # 3 and BP # 1 (BP mode 1)

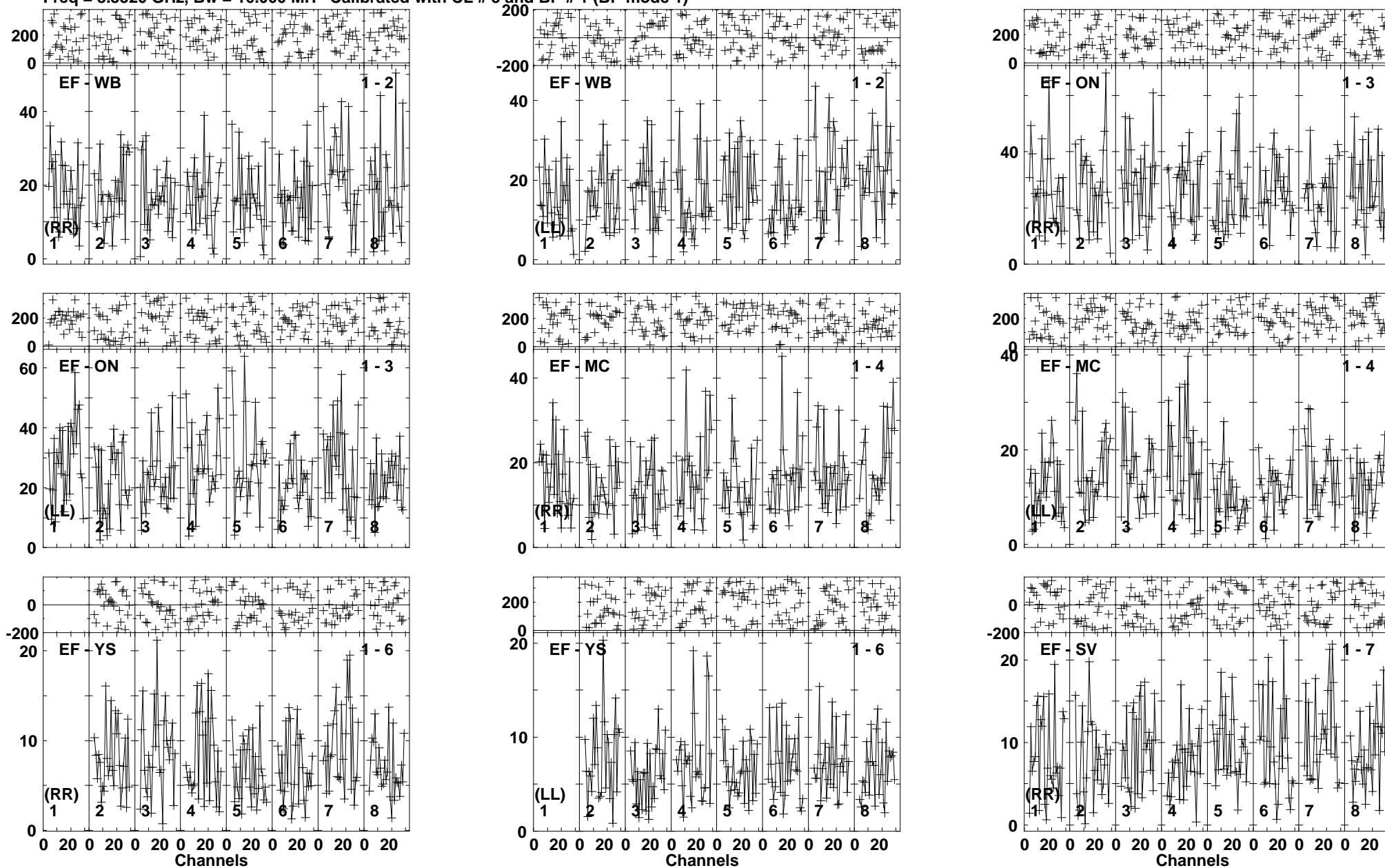

Lower frame: Milli Ampl Jy Top frame: Phas deg
 Vector averaged cross-power spectrum Baseline: EF (01) - WB (02)
 Timerange: 00/03:04:29 to 00/03:07:24

Plot file version 30 created 24-MAR-2014 14:37:52
 ARP299D EP087F 5.UVDATA.1
 Freq = 8.3520 GHz, Bw = 16.000 MH Calibrated with CL # 3 and BP # 1 (BP mode 1)

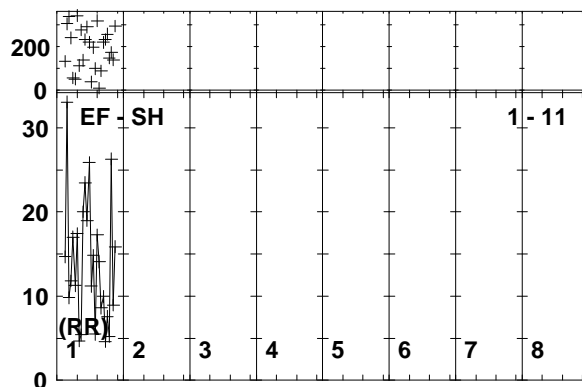
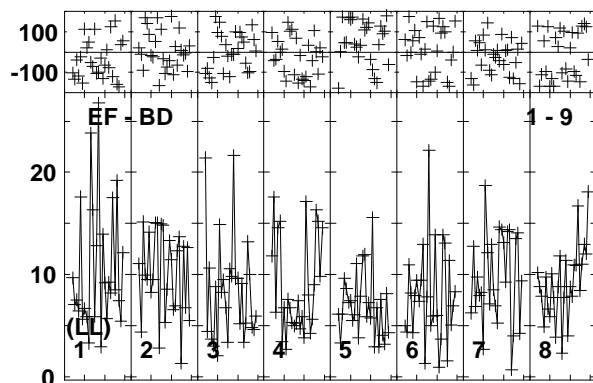
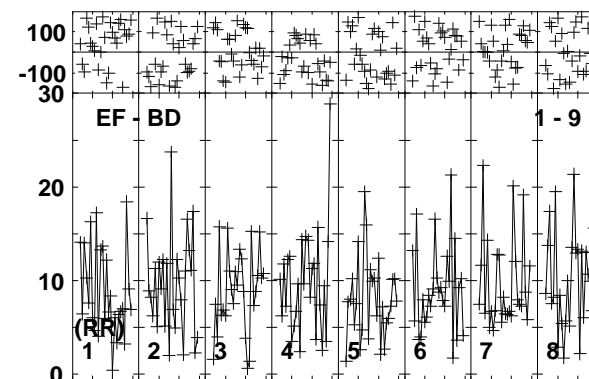
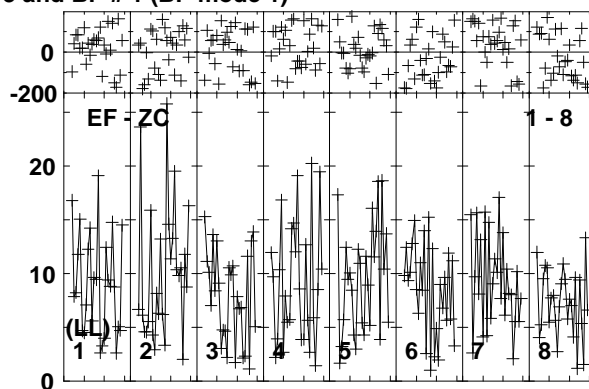
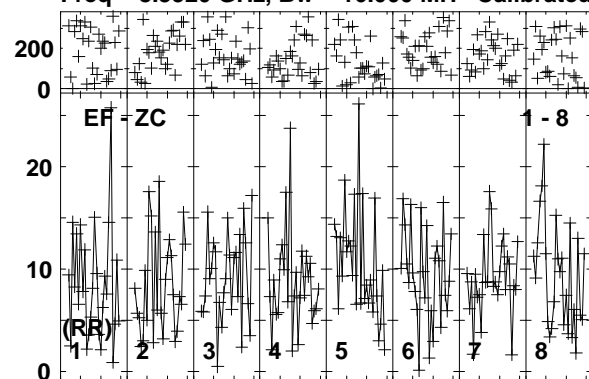

Lower frame: Milli Ampl Jy Top frame: Phas deg
 Vector averaged cross-power spectrum Baseline: EF (01) - ZC (08)
 Timerange: 00/03:04:29 to 00/03:07:24

Plot file version 31 created 24-MAR-2014 14:37:52

J1128+5925 EP087F 5.UVDATA.1

Freq = 8.3520 GHz, Bw = 16.000 MH Calibrated with CL # 3 and BP # 1 (BP mode 1)

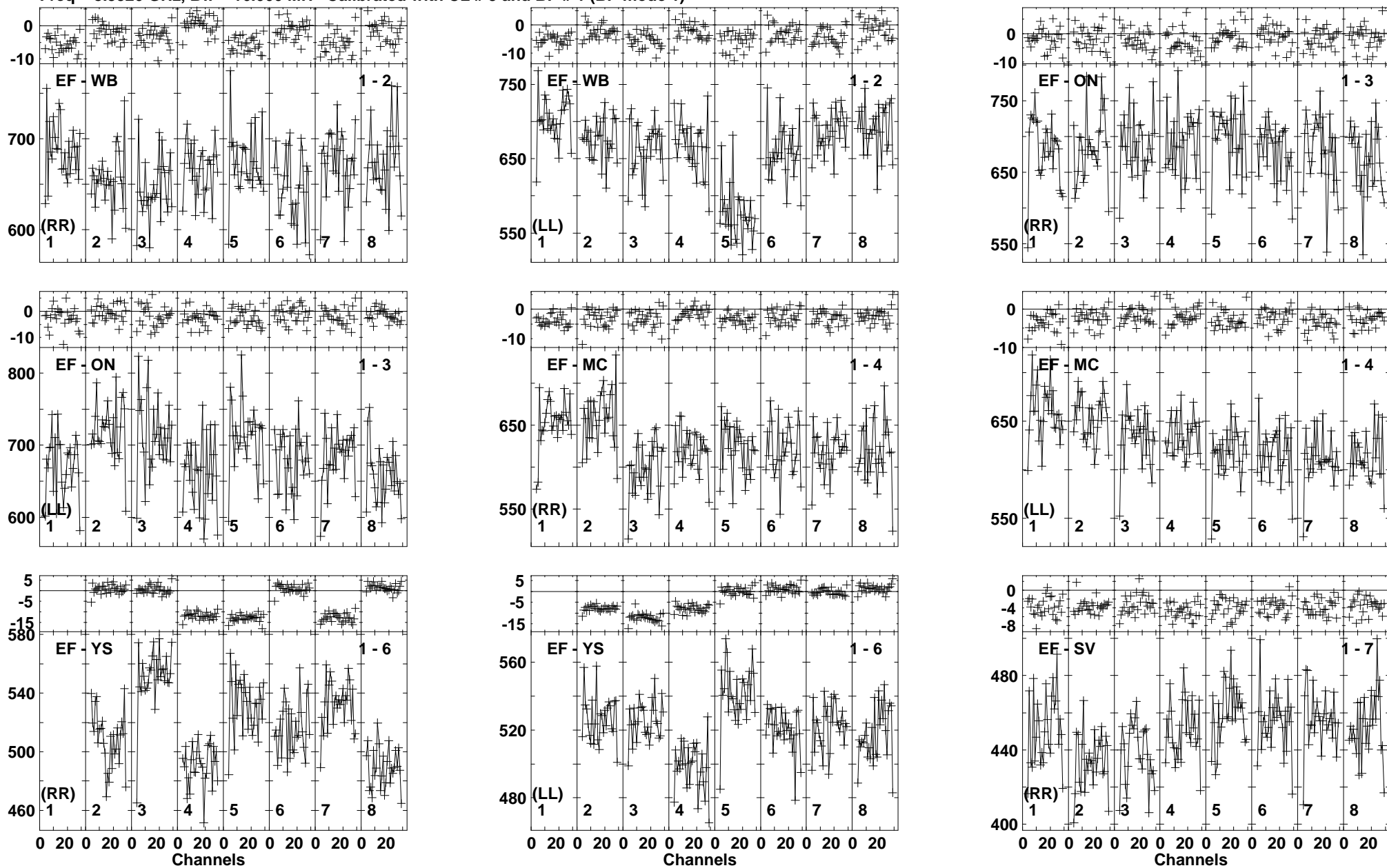

Lower frame: Milli Ampl Jy Top frame: Phas deg
Vector averaged cross-power spectrum Baseline: EF (01) - WB (02)
Timerange: 00/03:07:25 to 00/03:08:29

Plot file version 32 created 24-MAR-2014 14:37:52

J1128+5925 EP087F 5.UVDATA.1

Freq = 8.3520 GHz, Bw = 16.000 MH Calibrated with CL # 3 and BP # 1 (BP mode 1)

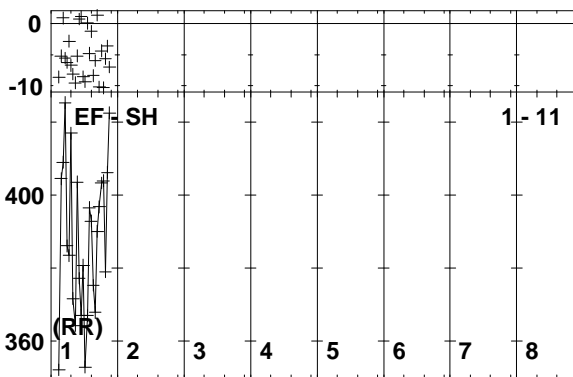
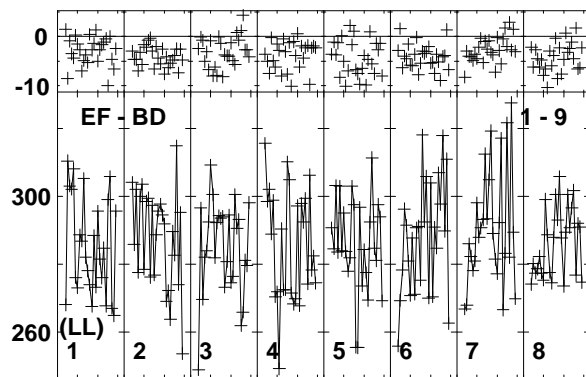
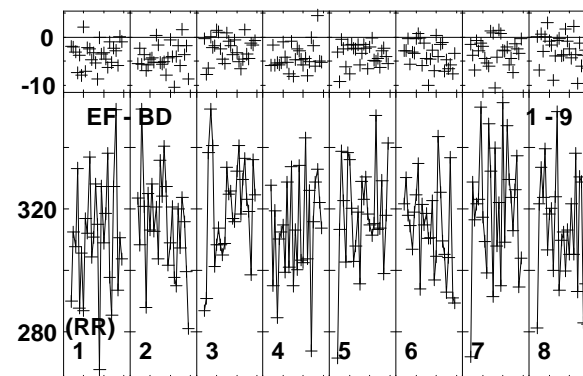
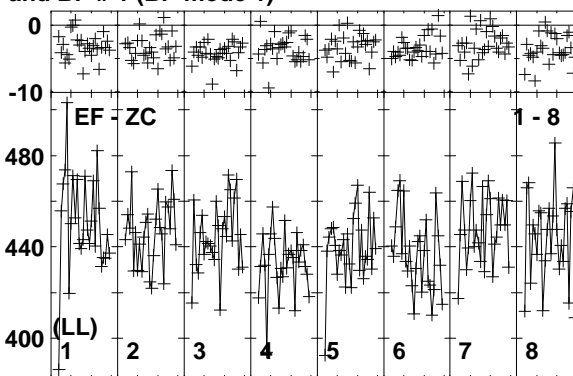
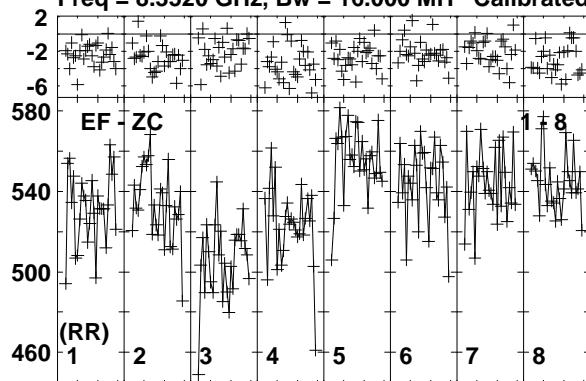

Lower frame: Milli Ampl Jy Top frame: Phas deg
Vector averaged cross-power spectrum Baseline: EF (01) - ZC (08)
Timerange: 00/03:07:25 to 00/03:08:29

Plot file version 33 created 24-MAR-2014 14:37:52

ARP299D EP087F 5.UVDATA.1

Freq = 8.3520 GHz, Bw = 16.000 MH Calibrated with CL # 3 and BP # 1 (BP mode 1)

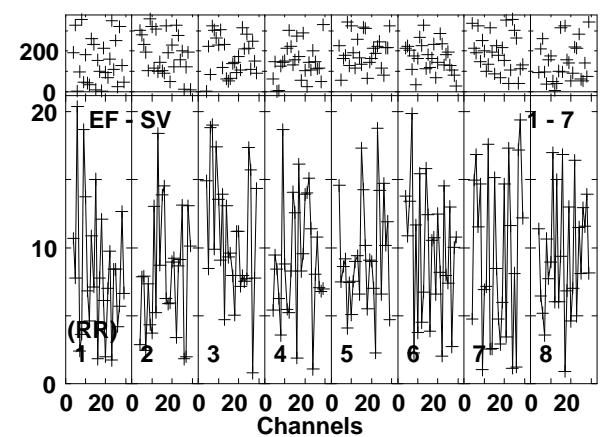
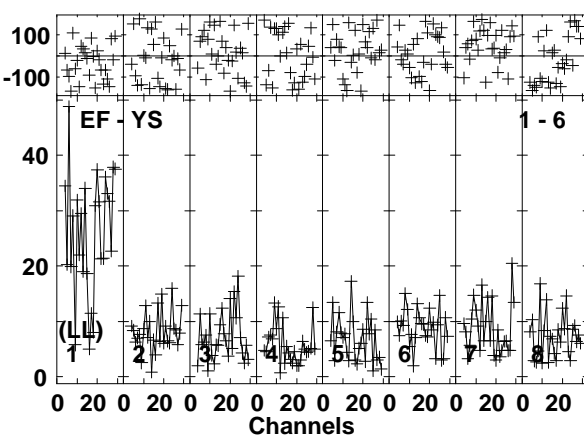
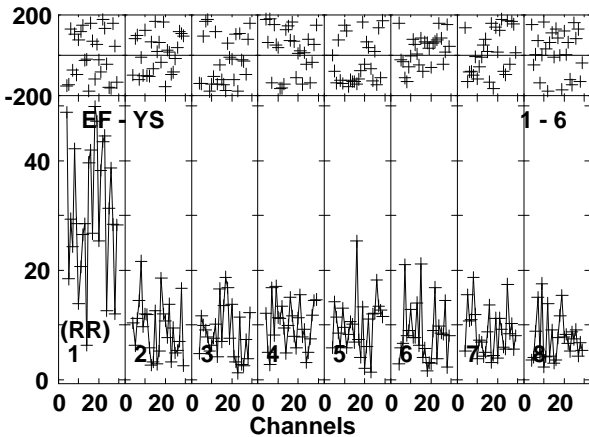
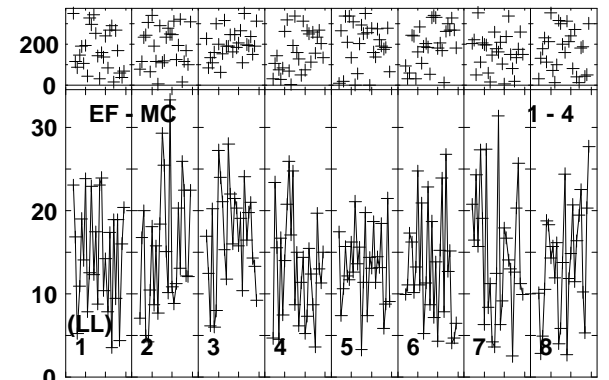
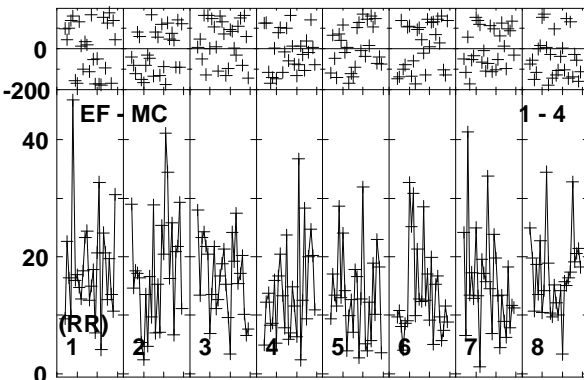
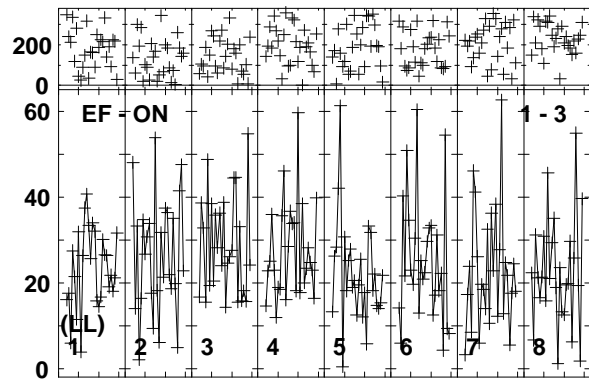
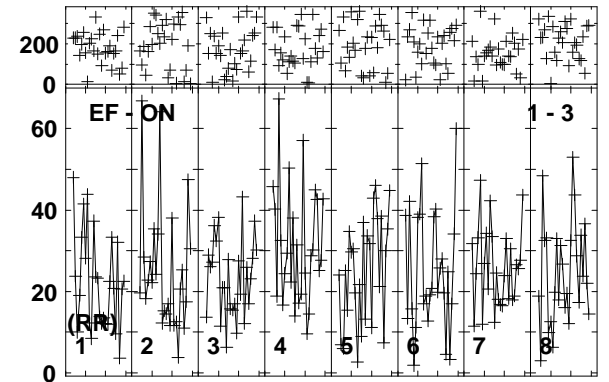
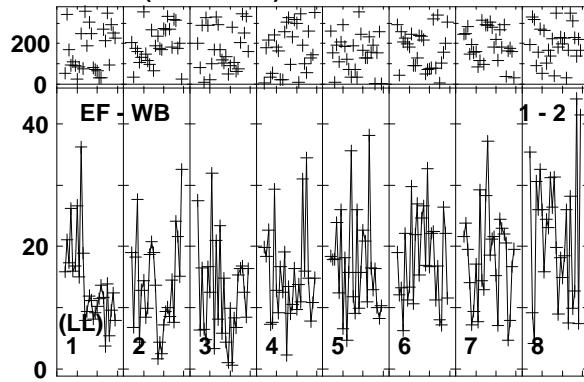
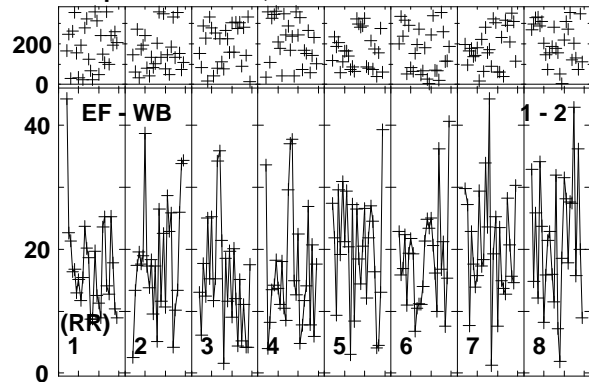

Lower frame: Milli Ampl Jy Top frame: Phas deg
Vector averaged cross-power spectrum Baseline: EF (01) - WB (02)
Timerange: 00/03:08:31 to 00/03:11:29

Plot file version 34 created 24-MAR-2014 14:37:53
 ARP299D EP087F 5.UVDATA.1
 Freq = 8.3520 GHz, Bw = 16.000 MH Calibrated with CL # 3 and BP # 1 (BP mode 1)

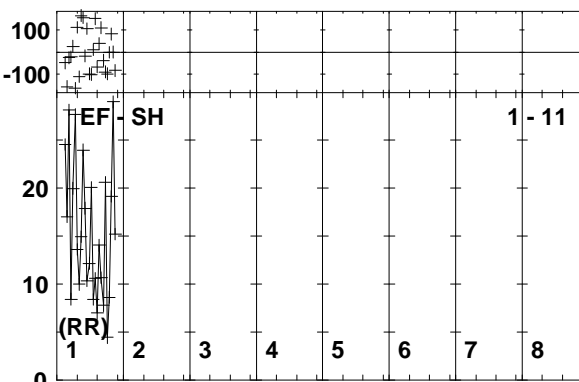
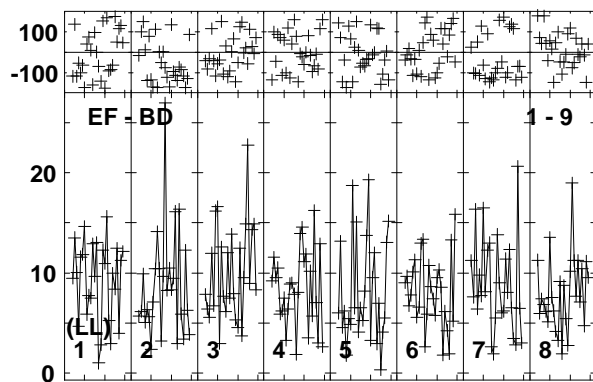
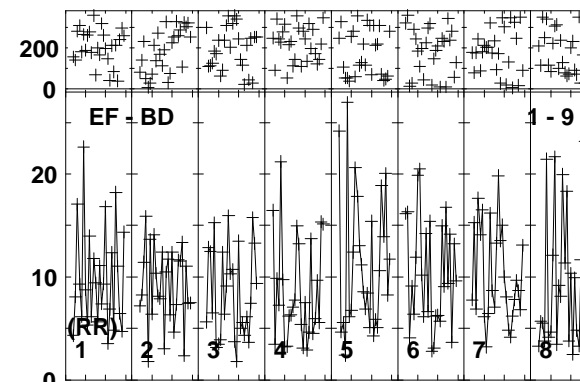
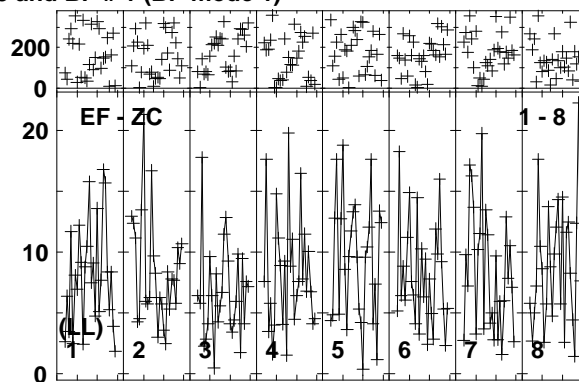
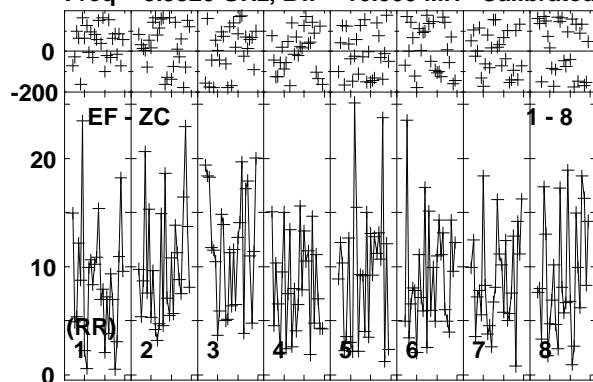

Lower frame: Milli Ampl Jy Top frame: Phas deg
 Vector averaged cross-power spectrum Baseline: EF (01) - ZC (08)
 Timerange: 00/03:08:31 to 00/03:11:29

Plot file version 35 created 24-MAR-2014 14:37:53

J1128+5925 EP087F 5.UVDATA.1

Freq = 8.3520 GHz, Bw = 16.000 MH Calibrated with CL # 3 and BP # 1 (BP mode 1)

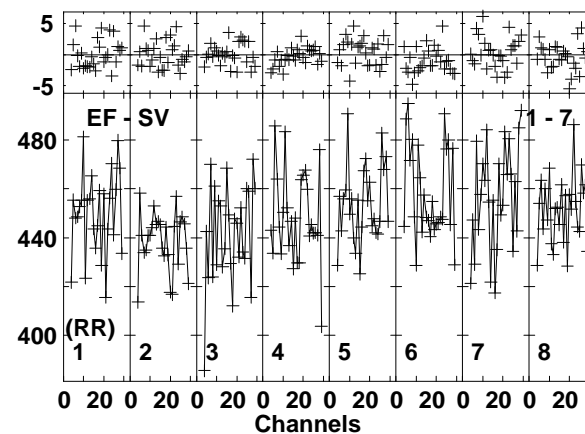
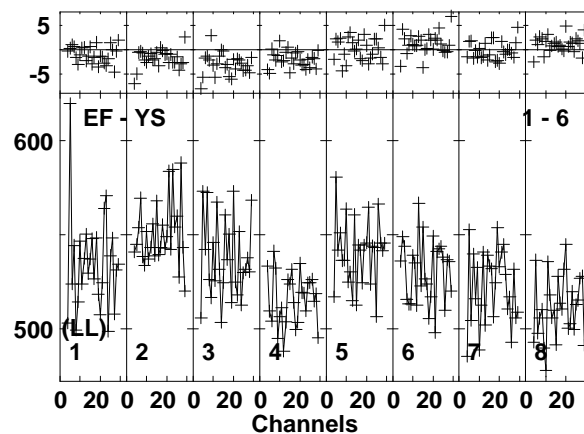
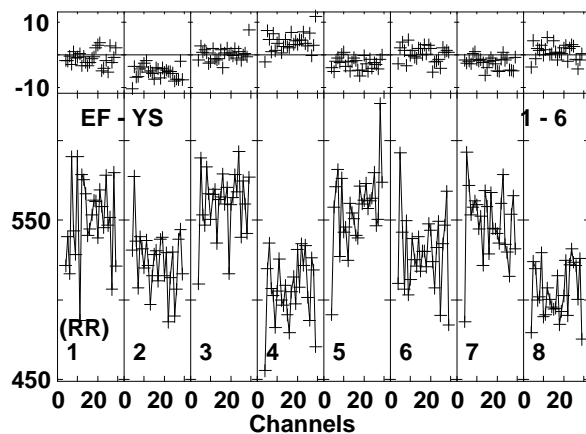
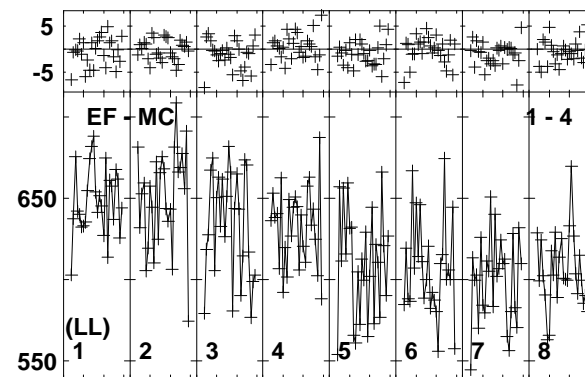
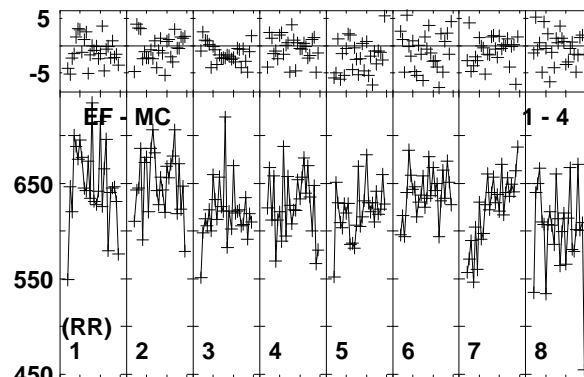
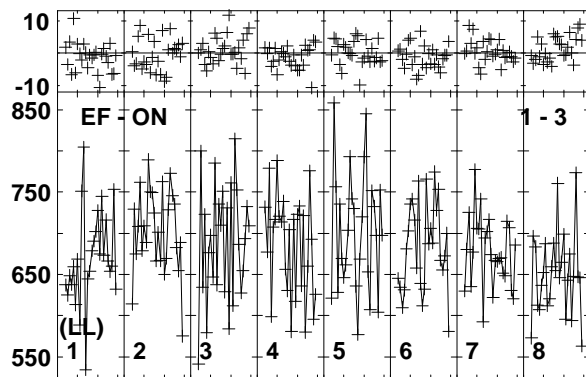
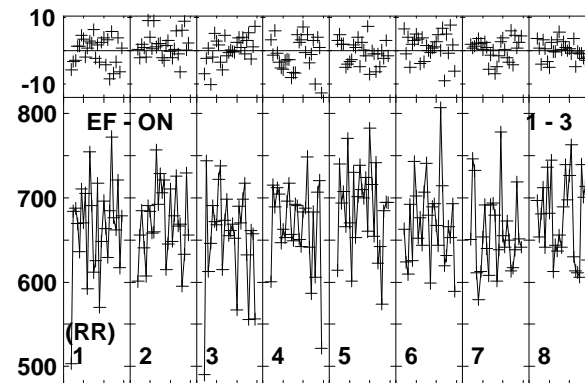
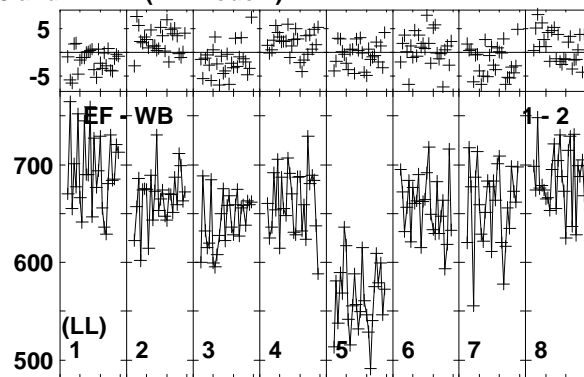
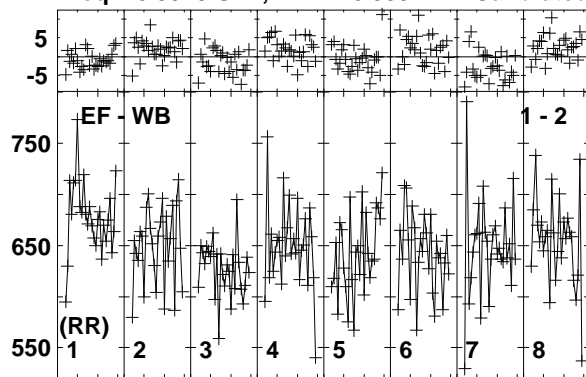

Lower frame: Milli Ampl Jy Top frame: Phas deg
Vector averaged cross-power spectrum Baseline: EF (01) - WB (02)
Timerange: 00/03:12:10 to 00/03:12:39

Plot file version 36 created 24-MAR-2014 14:37:53

J1128+5925 EP087F 5.UVDATA.1

Freq = 8.3520 GHz, Bw = 16.000 MH Calibrated with CL # 3 and BP # 1 (BP mode 1)

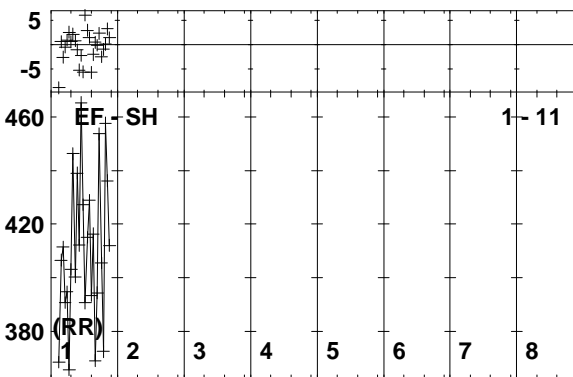
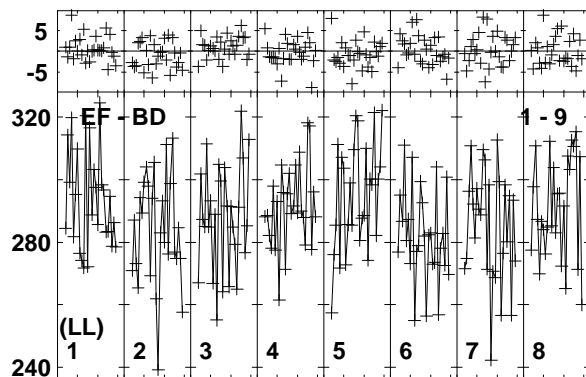
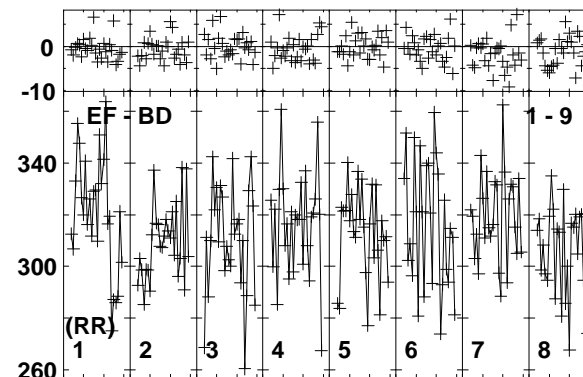
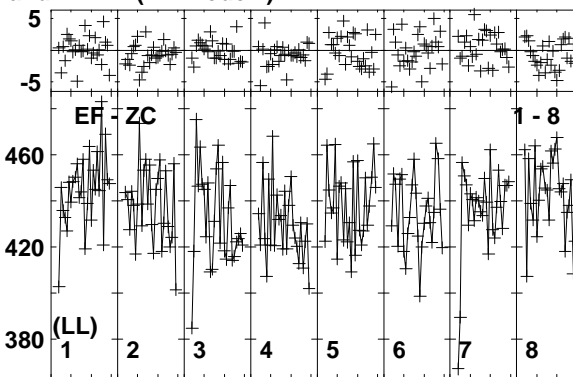
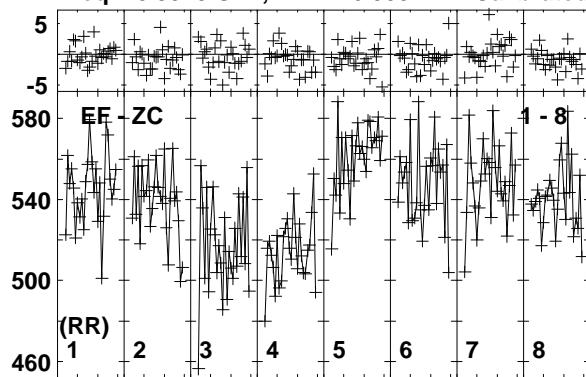

Lower frame: Milli Ampl Jy Top frame: Phas deg
Vector averaged cross-power spectrum Baseline: EF (01) - ZC (08)
Timerange: 00/03:12:10 to 00/03:12:39

Plot file version 37 created 24-MAR-2014 14:37:53

ARP299D EP087F 5.UVDATA.1

Freq = 8.3520 GHz, Bw = 16.000 MH Calibrated with CL # 3 and BP # 1 (BP mode 1)

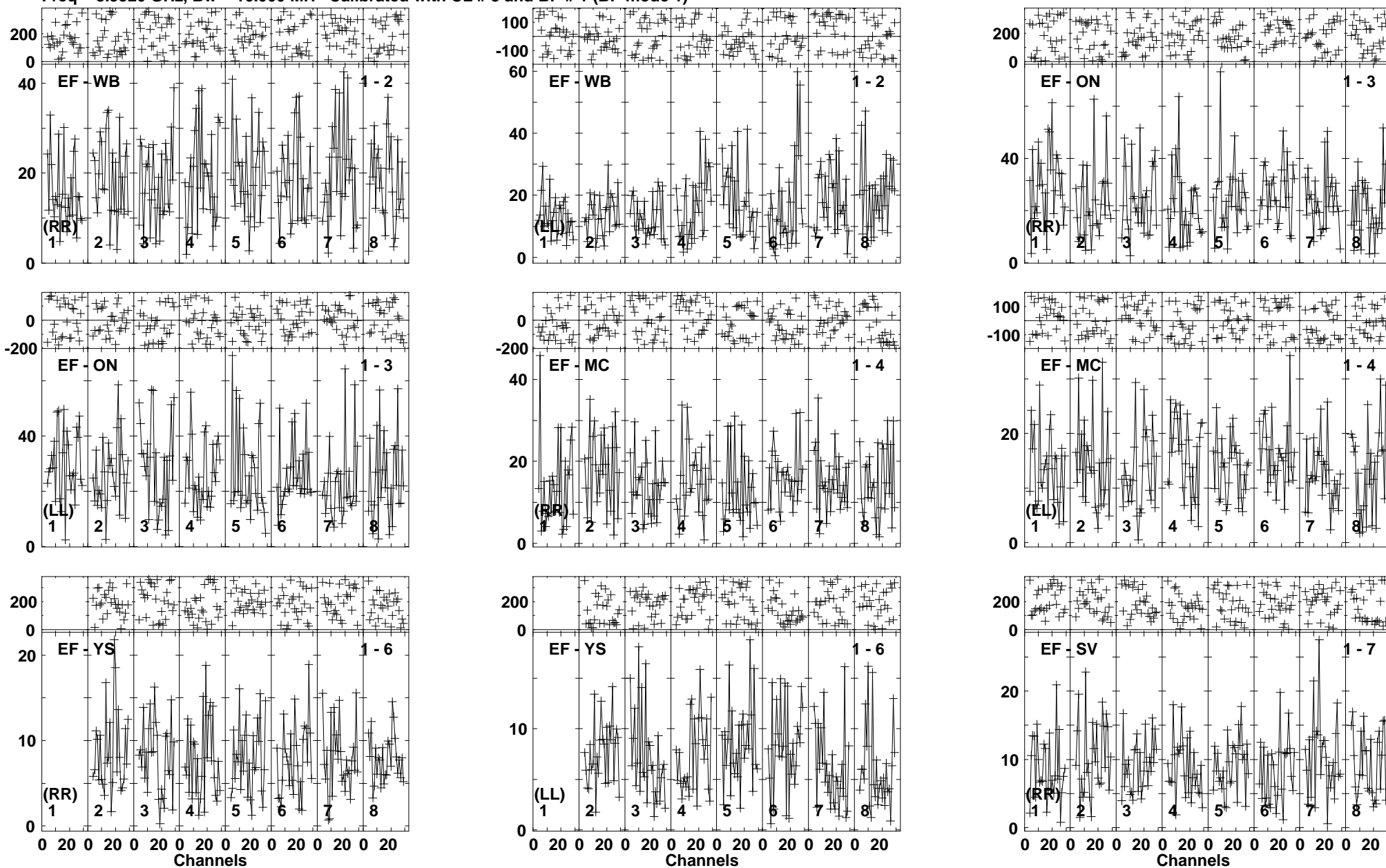

Lower frame: Milli Ampl Jy Top frame: Phas deg
Vector averaged cross-power spectrum Baseline: EF (01) - WB (02)
Timerange: 00/03:12:45 to 00/03:15:39

Plot file version 38 created 24-MAR-2014 14:37:54

ARP299D EP087F 5.UVDATA.1

Freq = 8.3520 GHz, Bw = 16.000 MH Calibrated with CL # 3 and BP # 1 (BP mode 1)

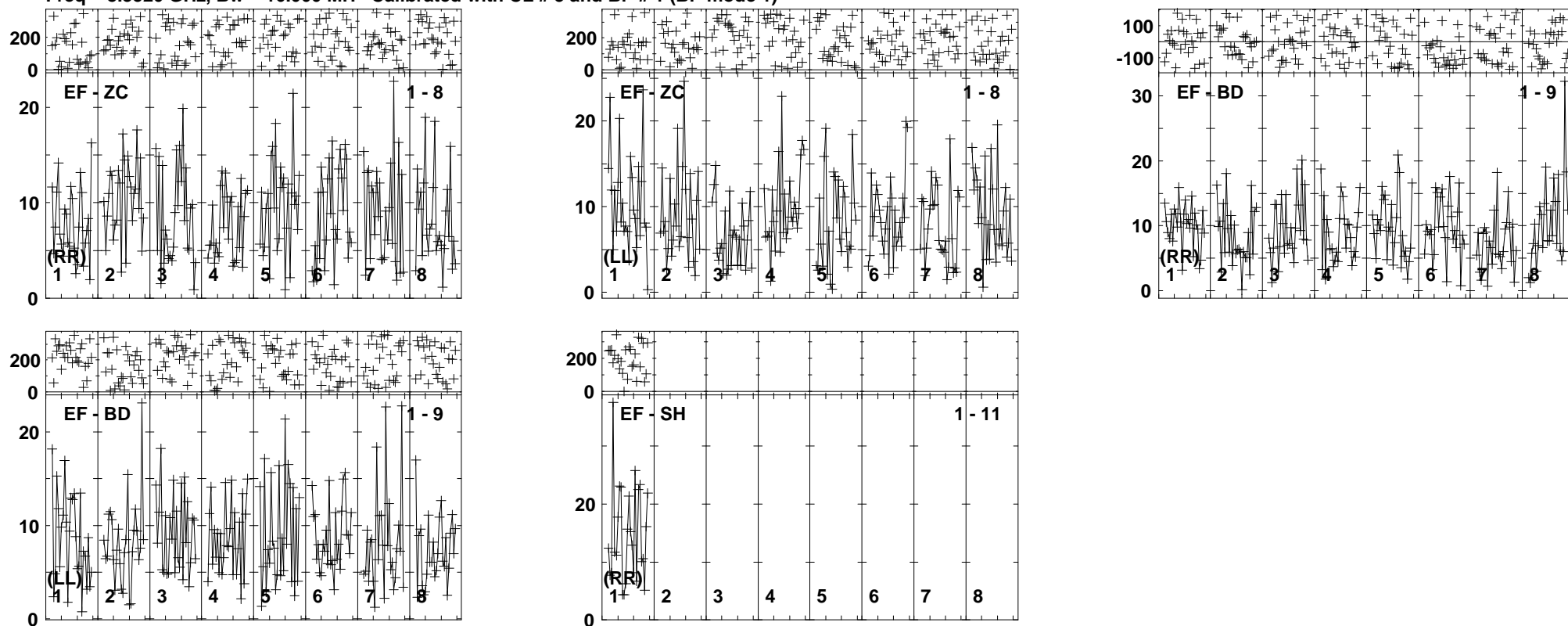

Lower frame: Milli Ampl Jy Top frame: Phas deg
Vector averaged cross-power spectrum Baseline: EF (01) - ZC (08)
Timerange: 00/03:12:45 to 00/03:15:39

Plot file version 39 created 24-MAR-2014 14:37:54

J1128+5925 EP087F 5.UVDATA.1

Freq = 8.3520 GHz, Bw = 16.000 MH Calibrated with CL # 3 and BP # 1 (BP mode 1)

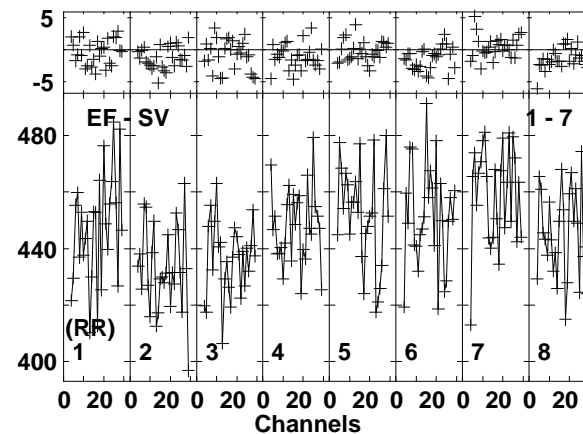
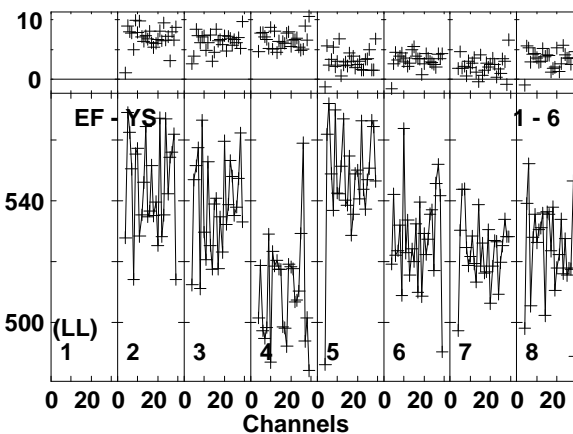
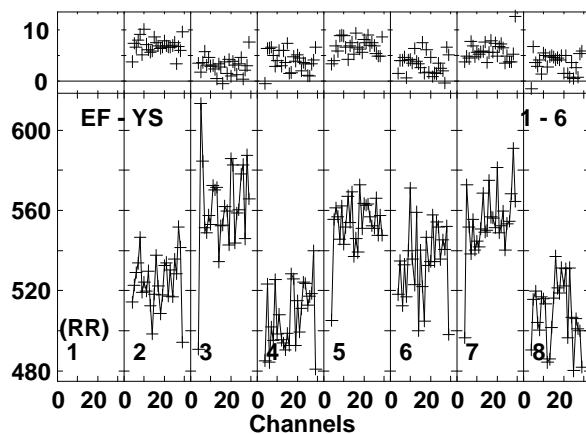
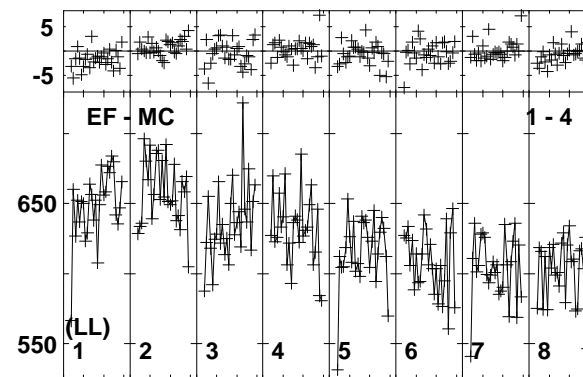
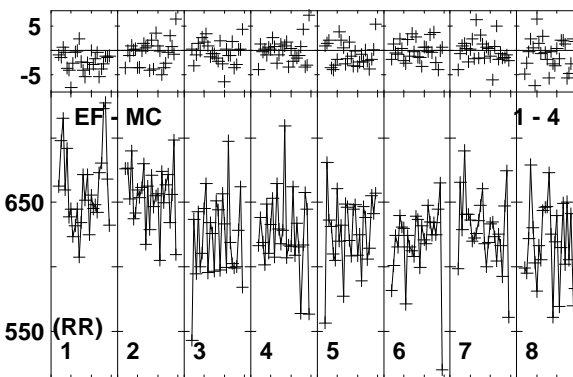
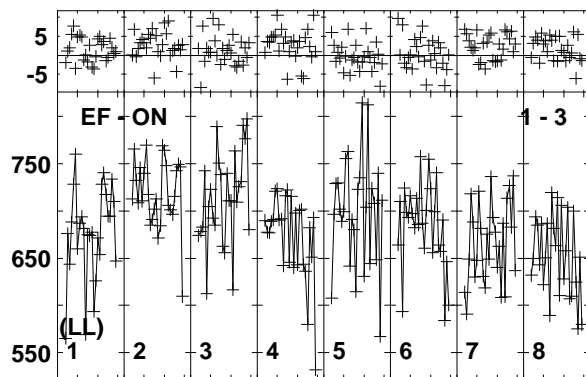
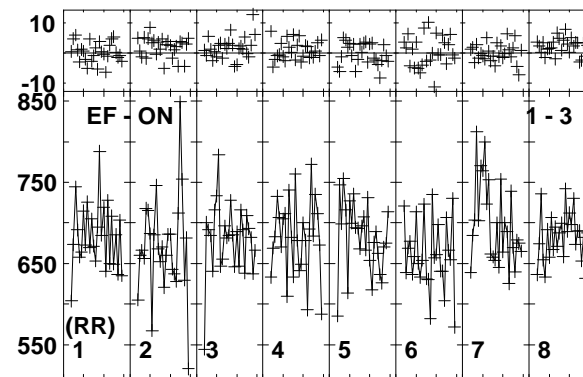
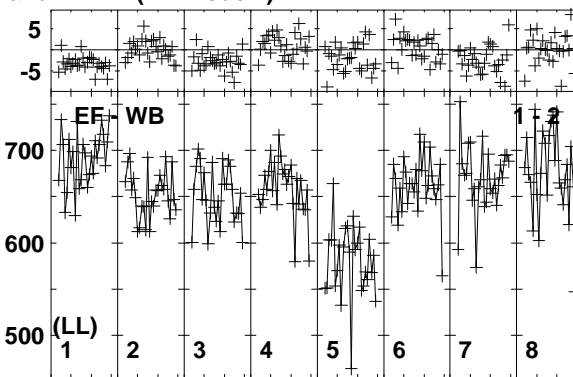
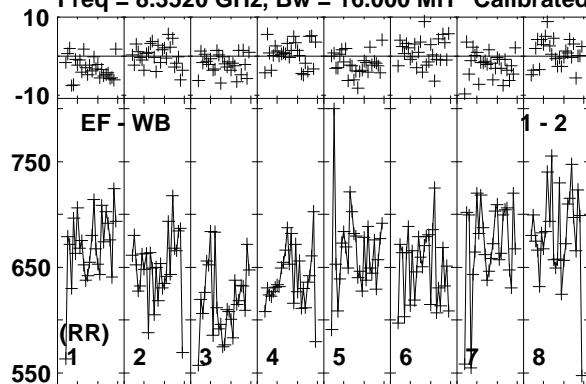

Lower frame: Milli Ampl Jy Top frame: Phas deg
Vector averaged cross-power spectrum Baseline: EF (01) - WB (02)
Timerange: 00/03:15:41 to 00/03:16:44

Plot file version 40 created 24-MAR-2014 14:37:54

J1128+5925 EP087F 5.UVDATA.1

Freq = 8.3520 GHz, Bw = 16.000 MH Calibrated with CL # 3 and BP # 1 (BP mode 1)

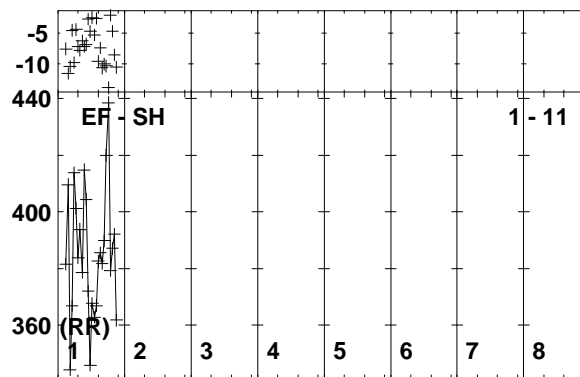
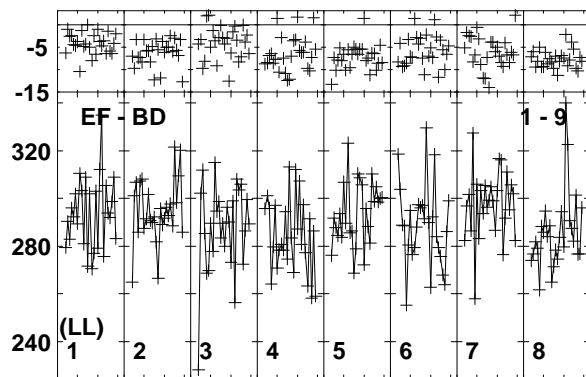
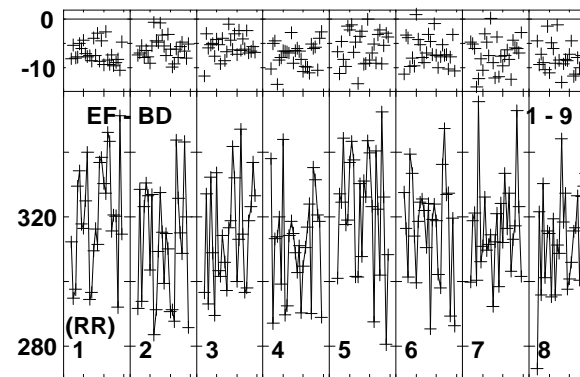
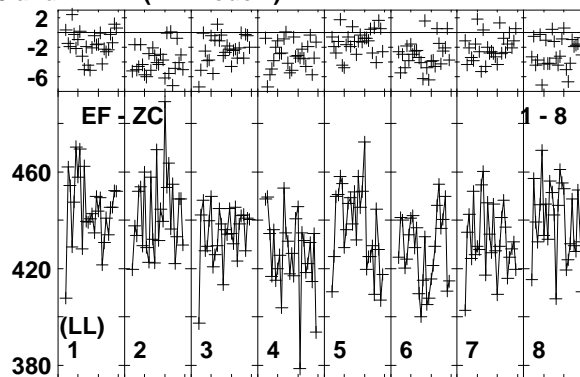
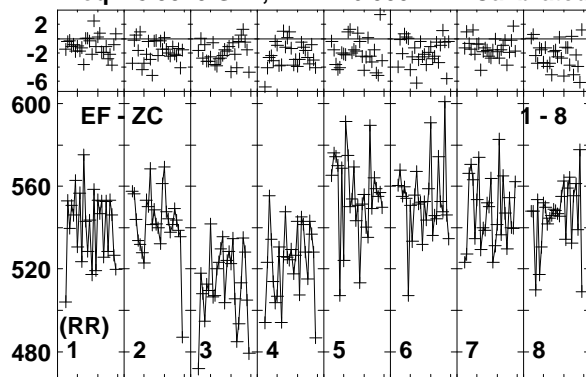

Lower frame: Milli Ampl Jy Top frame: Phas deg
Vector averaged cross-power spectrum Baseline: EF (01) - ZC (08)
Timerange: 00/03:15:41 to 00/03:16:44

Plot file version 41 created 24-MAR-2014 14:37:54
 ARP299D EP087F 5.UVDATA.1
 Freq = 8.3520 GHz, Bw = 16.000 MH Calibrated with CL # 3 and BP # 1 (BP mode 1)

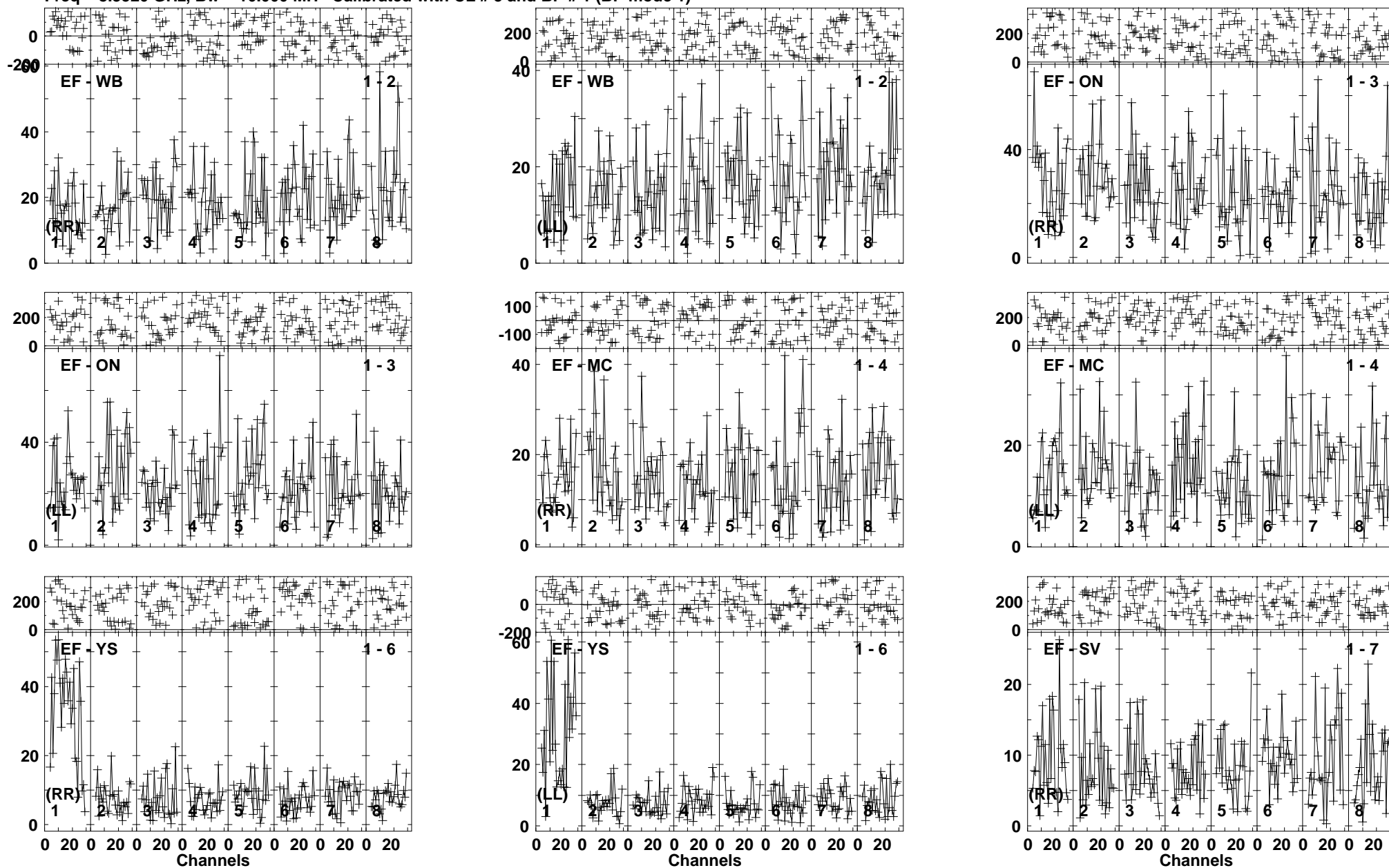

Lower frame: Milli Ampl Jy Top frame: Phas deg
 Vector averaged cross-power spectrum Baseline: EF (01) - WB (02)
 Timerange: 00/03:16:46 to 00/03:19:44

Plot file version 42 created 24-MAR-2014 14:37:55

ARP299D EP087F 5.UVDATA.1

Freq = 8.3520 GHz, Bw = 16.000 MH Calibrated with CL # 3 and BP # 1 (BP mode 1)

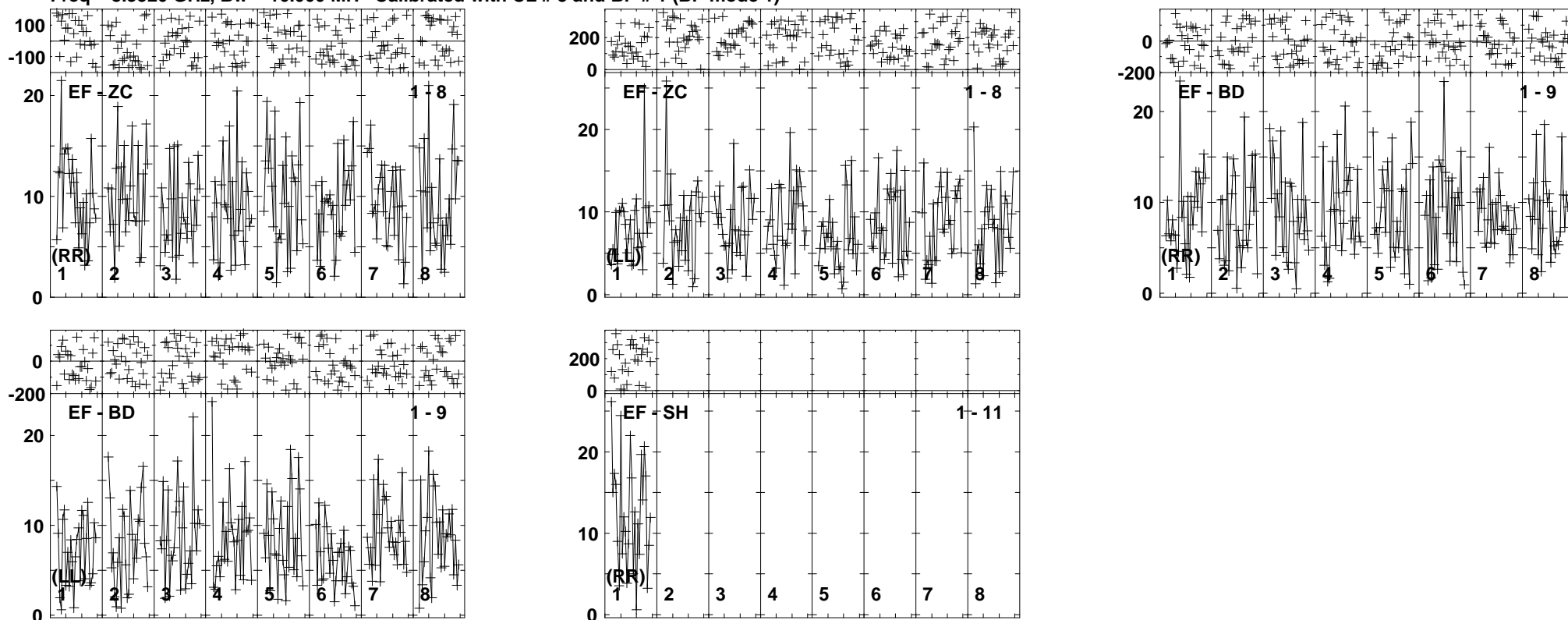

Lower frame: Milli Ampl Jy Top frame: Phas deg
Vector averaged cross-power spectrum Baseline: EF (01) - ZC (08)
Timerange: 00/03:16:46 to 00/03:19:44

Plot file version 43 created 24-MAR-2014 14:37:55

J1128+5925 EP087F 5.UVDATA.1

Freq = 8.3520 GHz, Bw = 16.000 MH Calibrated with CL # 3 and BP # 1 (BP mode 1)

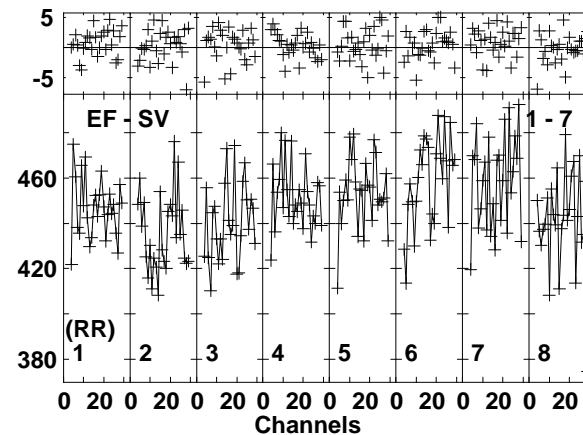
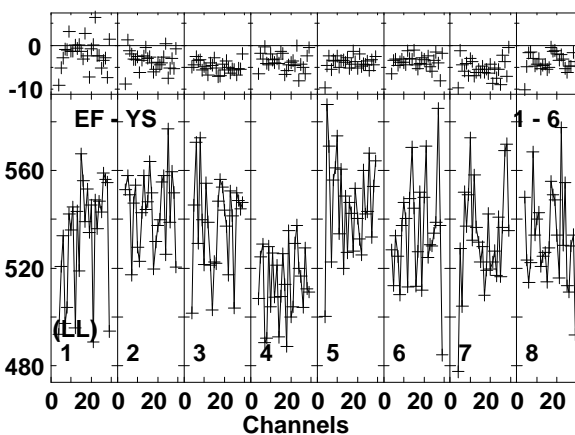
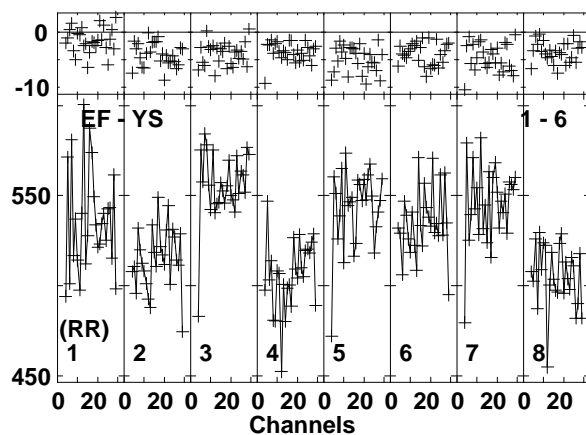
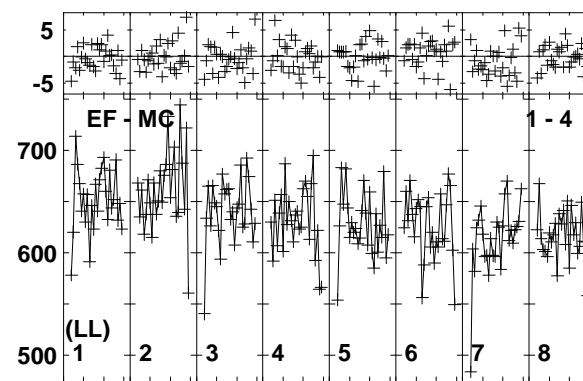
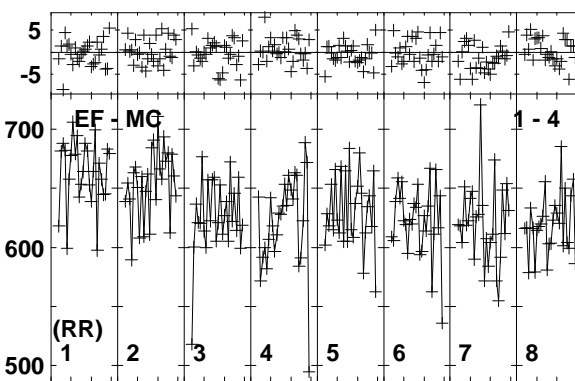
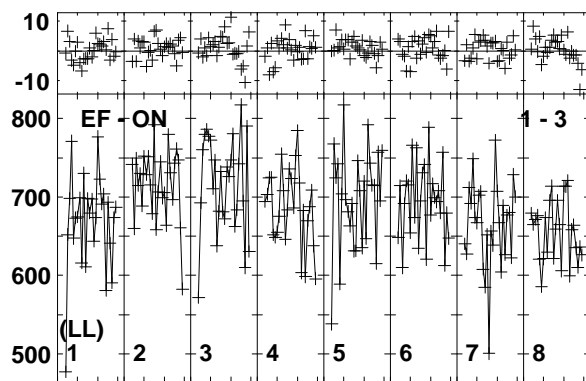
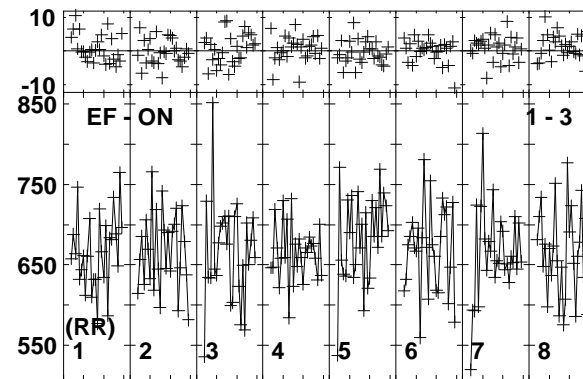
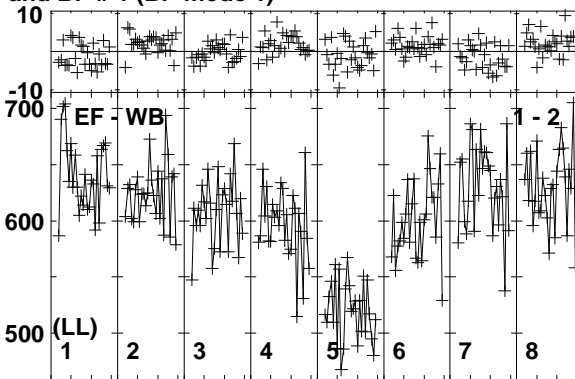
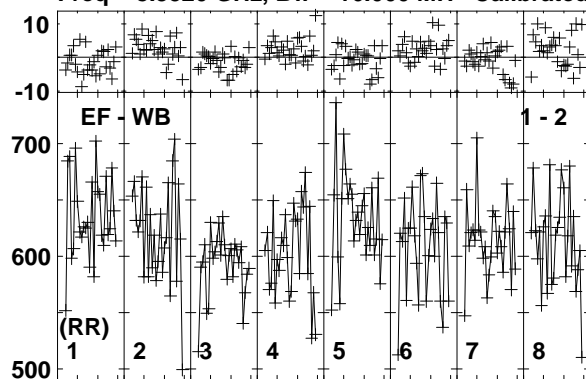

Lower frame: Milli Ampl Jy Top frame: Phas deg
Vector averaged cross-power spectrum Baseline: EF (01) - WB (02)
Timerange: 00/03:20:25 to 00/03:20:54

Plot file version 44 created 24-MAR-2014 14:37:55
 J1128+5925 EP087F 5.UVDATA.1
 Freq = 8.3520 GHz, Bw = 16.000 MH Calibrated with CL # 3 and BP # 1 (BP mode 1)

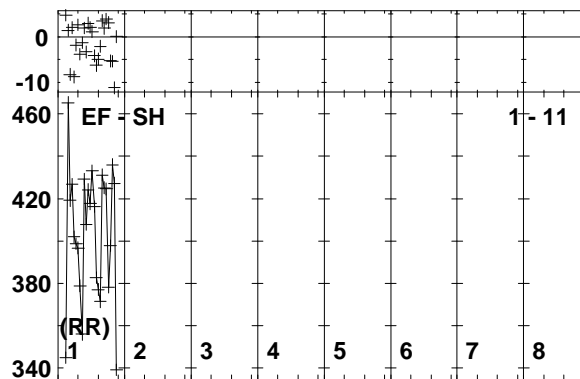
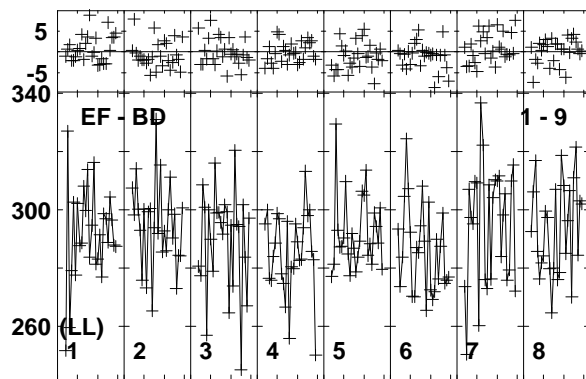
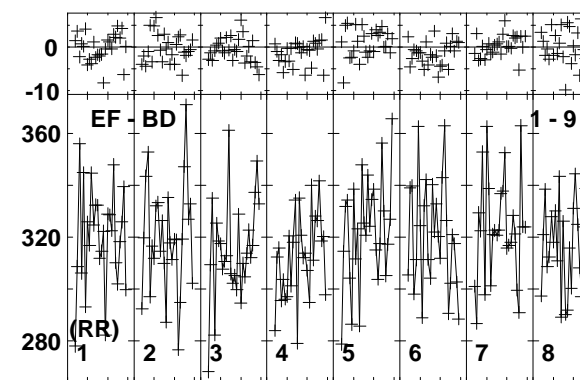
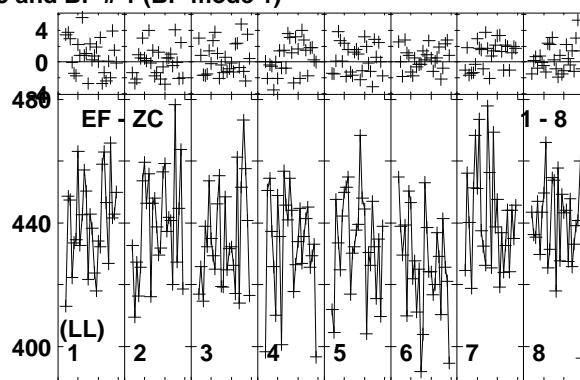
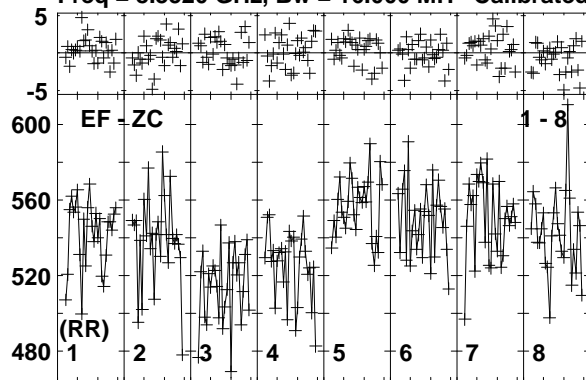

Lower frame: Milli Ampl Jy Top frame: Phas deg
 Vector averaged cross-power spectrum Baseline: EF (01) - ZC (08)
 Timerange: 00/03:20:25 to 00/03:20:54

Plot file version 45 created 24-MAR-2014 14:37:55

ARP299D EP087F 5.UVDATA.1

Freq = 8.3520 GHz, Bw = 16.000 MH Calibrated with CL # 3 and BP # 1 (BP mode 1)

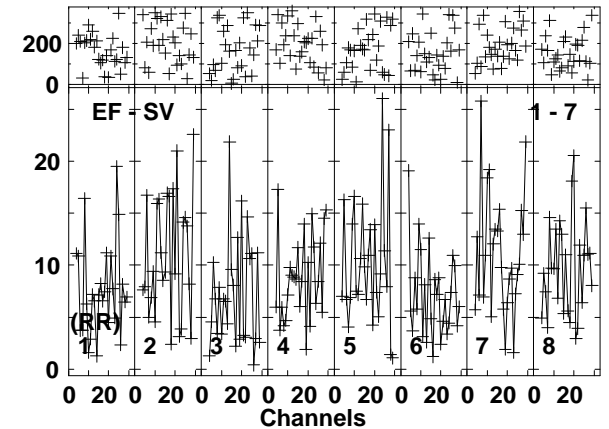
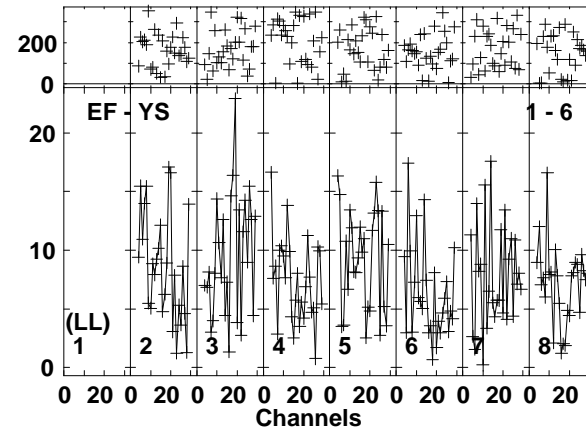
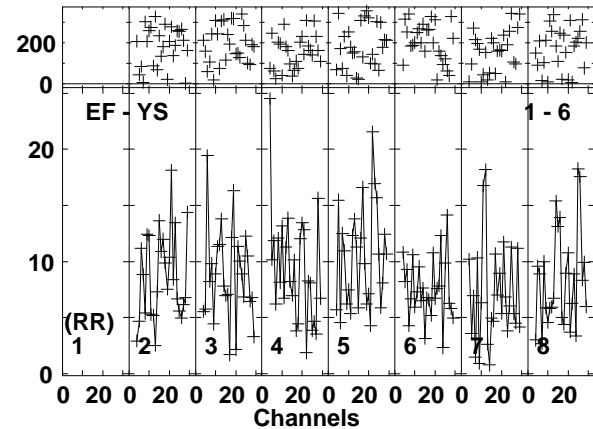
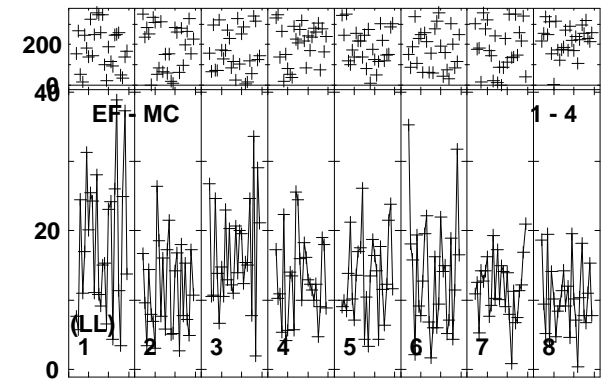
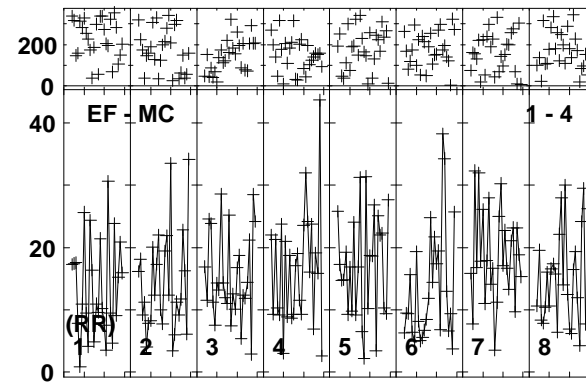
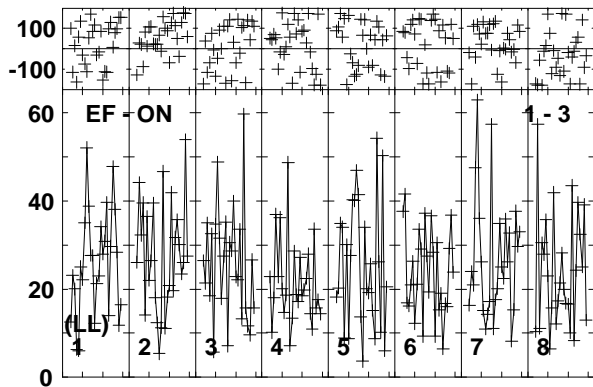
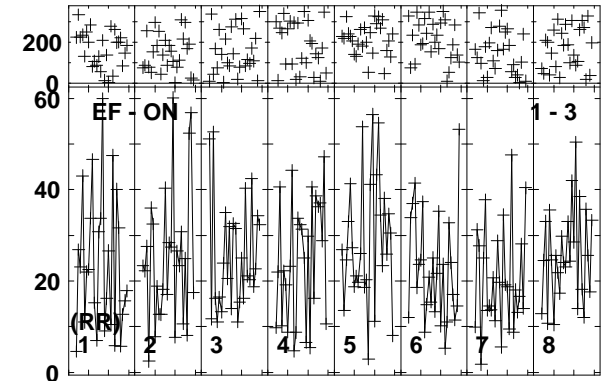
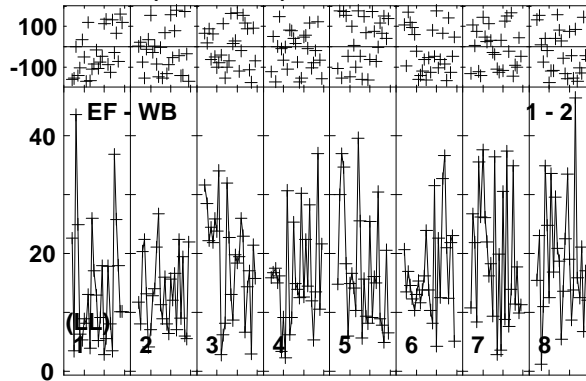
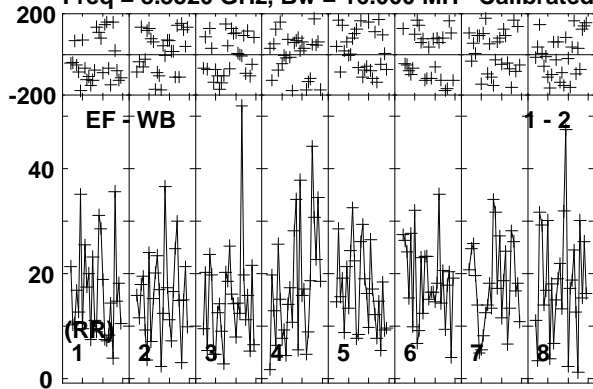

Lower frame: Milli Ampl Jy Top frame: Phas deg
Vector averaged cross-power spectrum Baseline: EF (01) - WB (02)
Timerange: 00/03:21:00 to 00/03:23:55

Plot file version 46 created 24-MAR-2014 14:37:56

ARP299D EP087F 5.UVDATA.1

Freq = 8.3520 GHz, Bw = 16.000 MH Calibrated with CL # 3 and BP # 1 (BP mode 1)

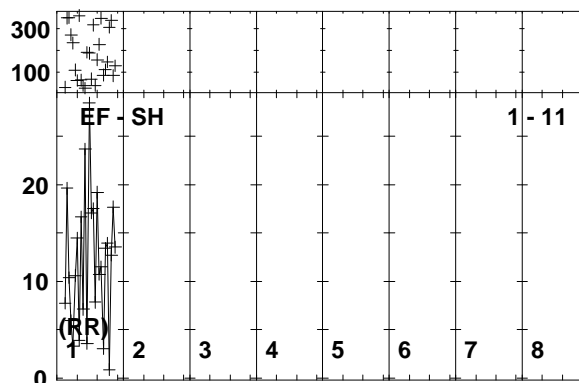
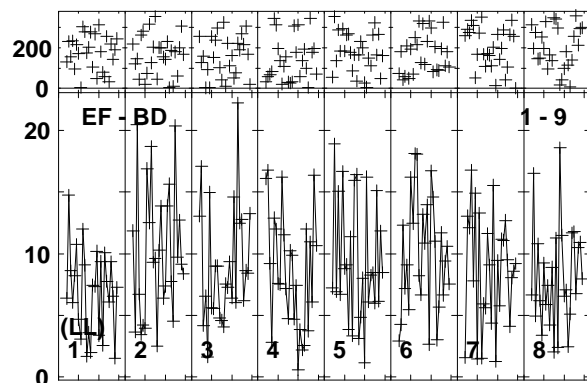
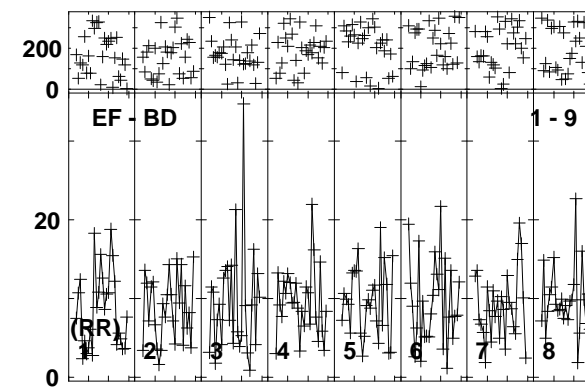
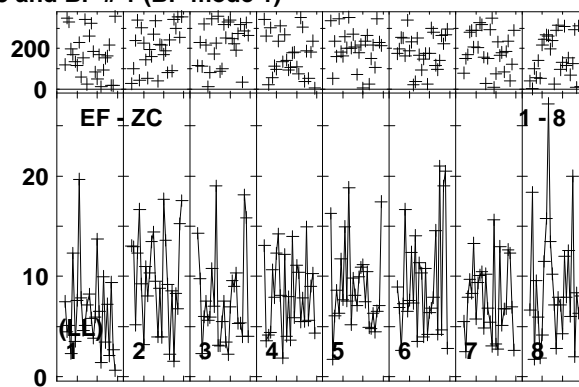
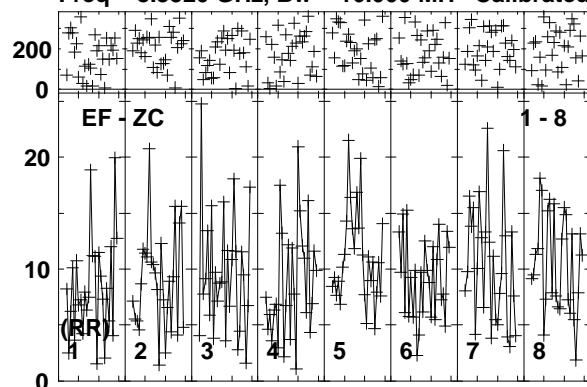

Lower frame: Milli Ampl Jy Top frame: Phas deg
Vector averaged cross-power spectrum Baseline: EF (01) - ZC (08)
Timerange: 00/03:21:00 to 00/03:23:55

Plot file version 47 created 24-MAR-2014 14:37:56

J1128+5925 EP087F 5.UVDATA.1

Freq = 8.3520 GHz, Bw = 16.000 MH Calibrated with CL # 3 and BP # 1 (BP mode 1)

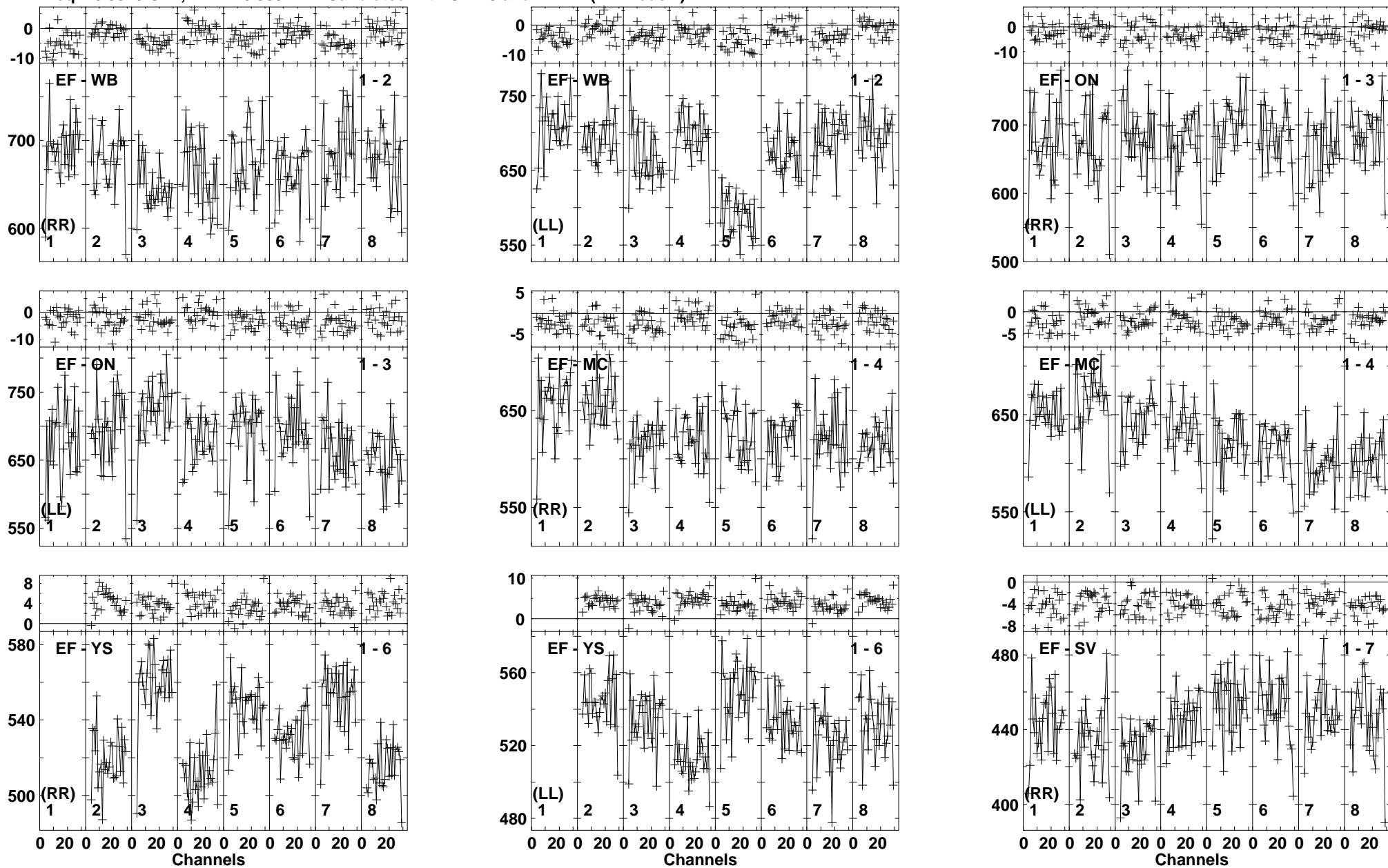

Lower frame: Milli Ampl Jy Top frame: Phas deg
Vector averaged cross-power spectrum Baseline: EF (01) - WB (02)
Timerange: 00/03:23:56 to 00/03:24:59

Plot file version 48 created 24-MAR-2014 14:37:56

J1128+5925 EP087F 5.UVDATA.1

Freq = 8.3520 GHz, Bw = 16.000 MH Calibrated with CL # 3 and BP # 1 (BP mode 1)

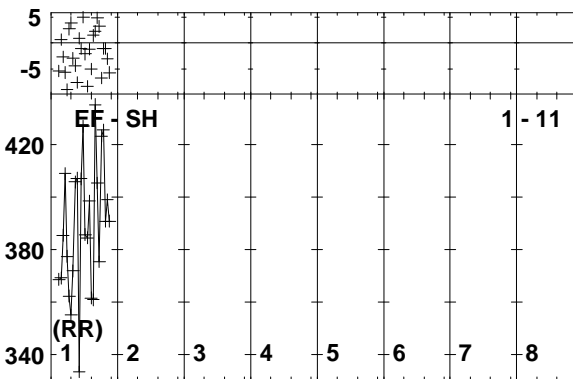
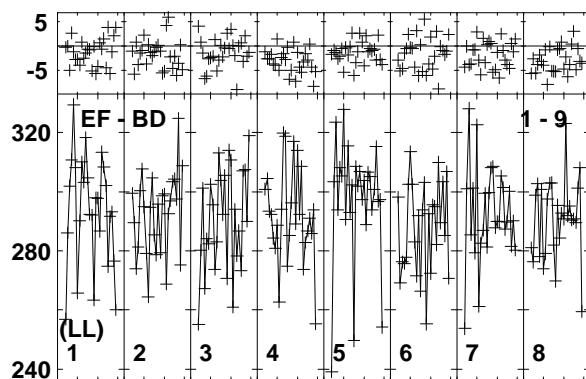
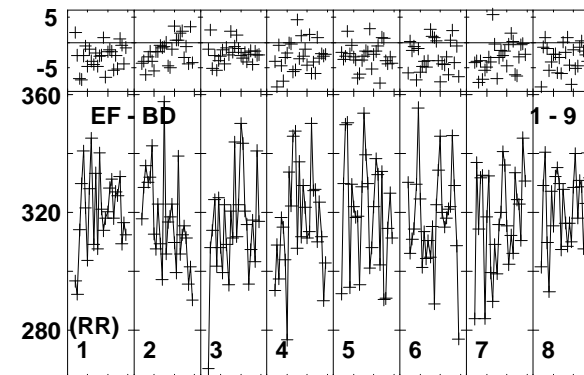
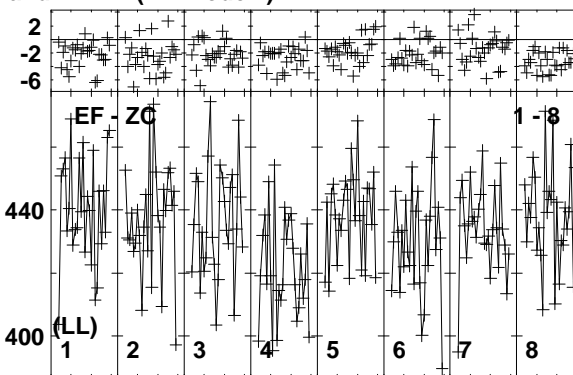
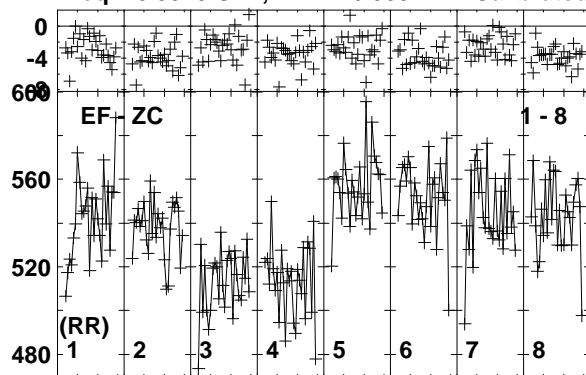

Lower frame: Milli Ampl Jy Top frame: Phas deg
Vector averaged cross-power spectrum Baseline: EF (01) - ZC (08)
Timerange: 00/03:23:56 to 00/03:24:59

Plot file version 49 created 24-MAR-2014 14:37:56
 ARP299D EP087F 5.UVDATA.1
 Freq = 8.3520 GHz, Bw = 16.000 MH Calibrated with CL # 3 and BP # 1 (BP mode 1)

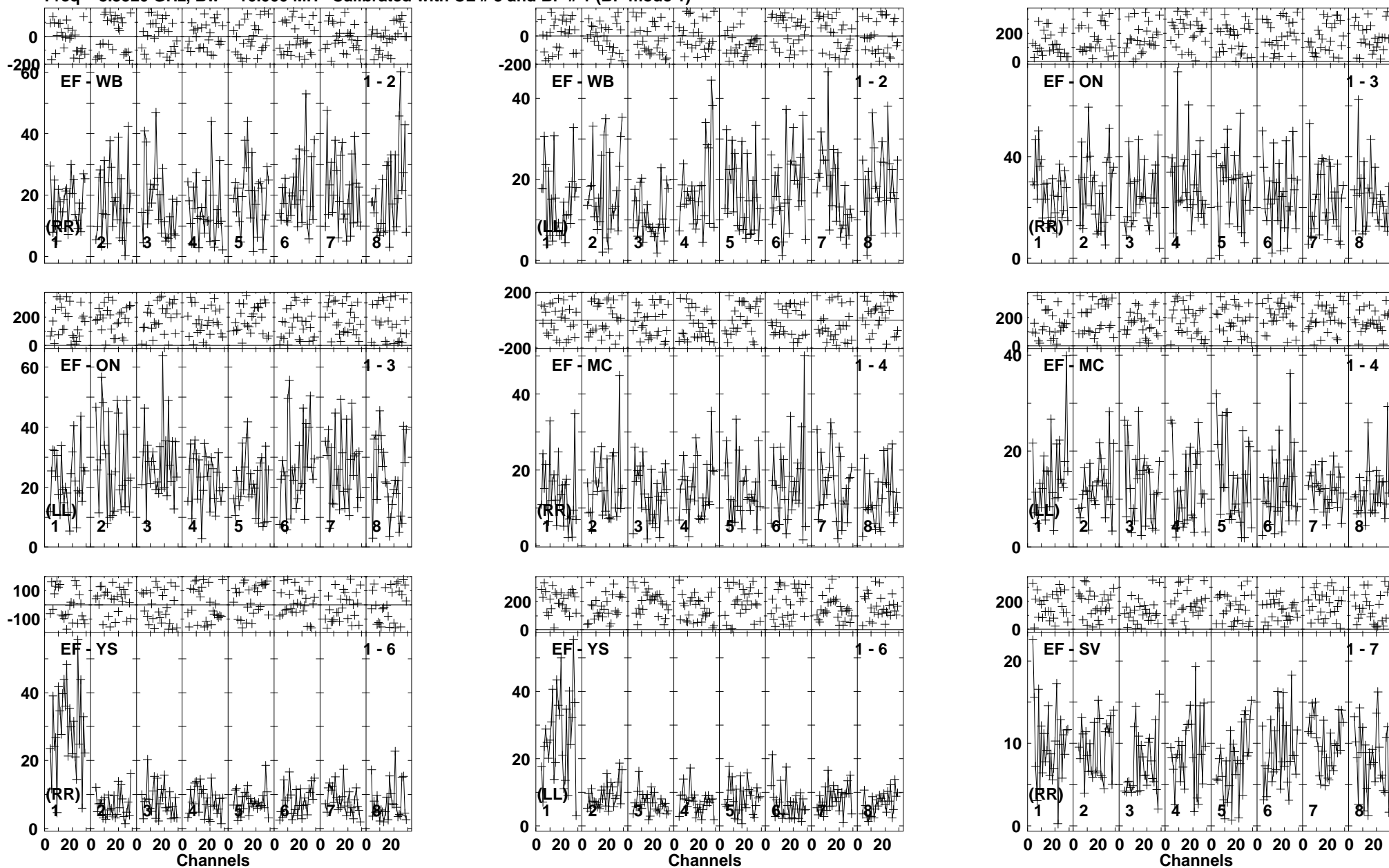

Lower frame: Milli Ampl Jy Top frame: Phas deg
 Vector averaged cross-power spectrum Baseline: EF (01) - WB (02)
 Timerange: 00/03:25:01 to 00/03:27:59

Plot file version 50 created 24-MAR-2014 14:37:57
 ARP299D EP087F 5.UVDATA.1
 Freq = 8.3520 GHz, Bw = 16.000 MH Calibrated with CL # 3 and BP # 1 (BP mode 1)

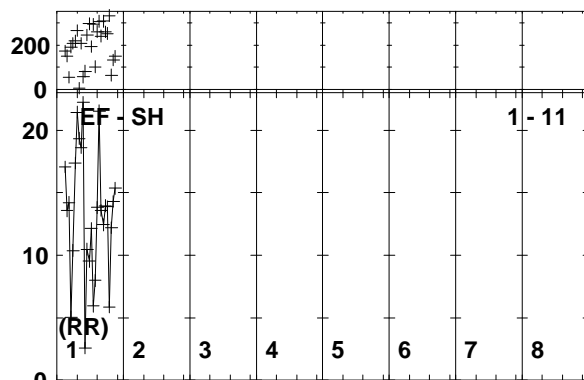
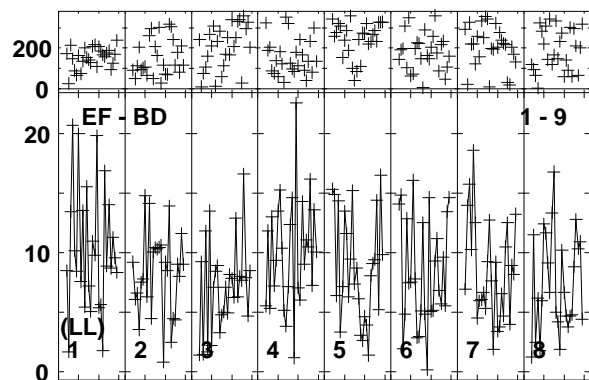
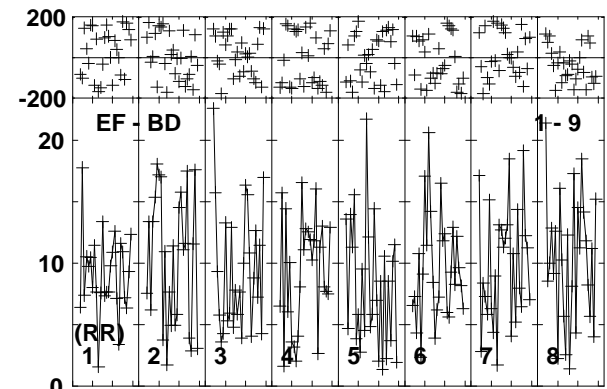
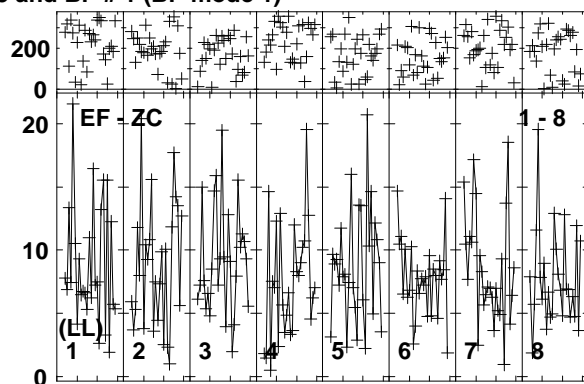
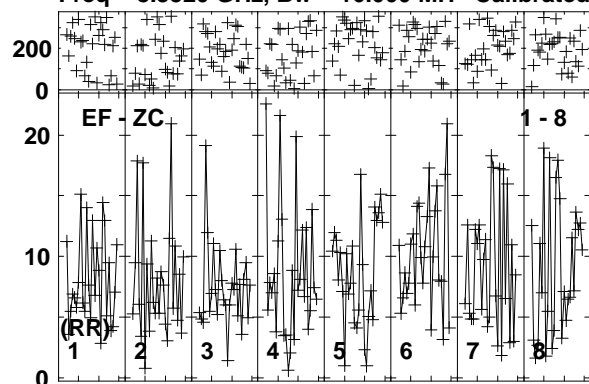

Lower frame: Milli Ampl Jy Top frame: Phas deg
 Vector averaged cross-power spectrum Baseline: EF (01) - ZC (08)
 Timerange: 00/03:25:01 to 00/03:27:59

Plot file version 51 created 24-MAR-2014 14:37:57

J1128+5925 EP087F 5.UVDATA.1

Freq = 8.3520 GHz, Bw = 16.000 MH Calibrated with CL # 3 and BP # 1 (BP mode 1)

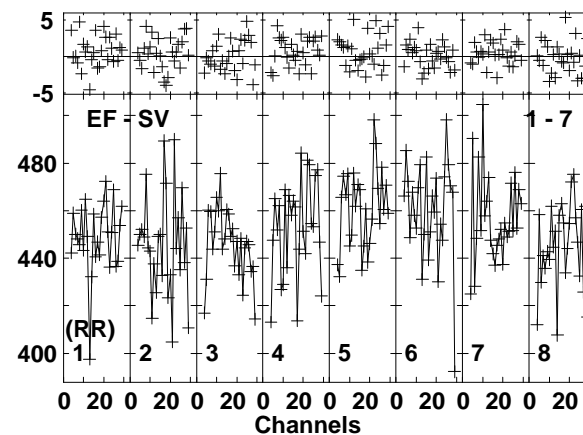
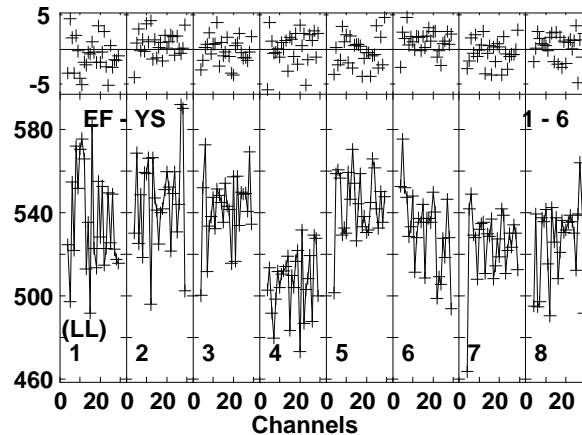
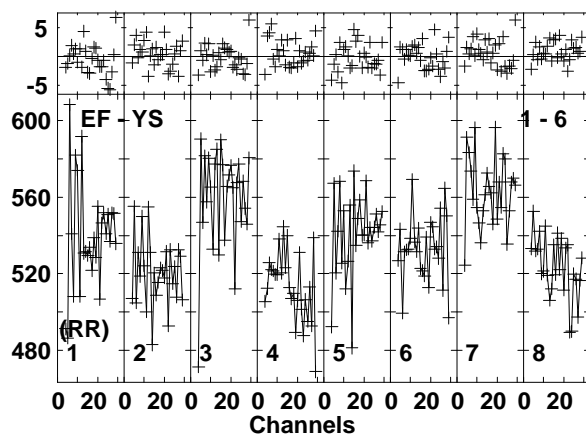
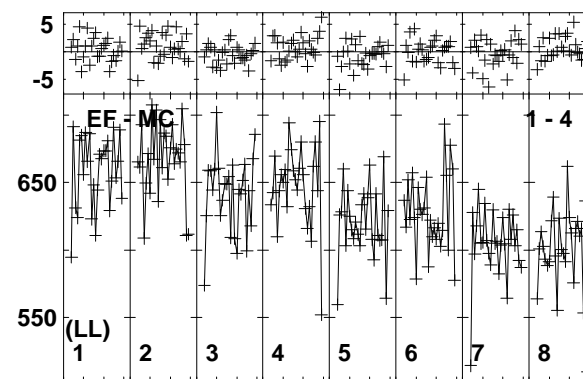
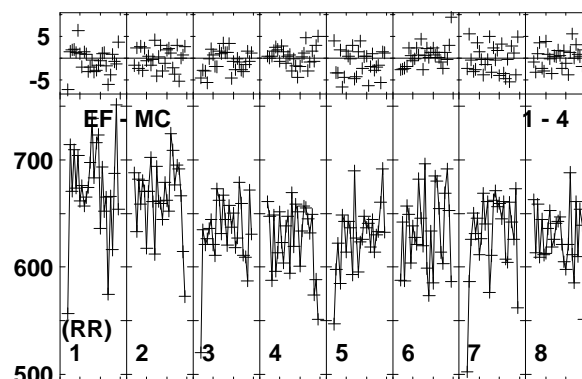
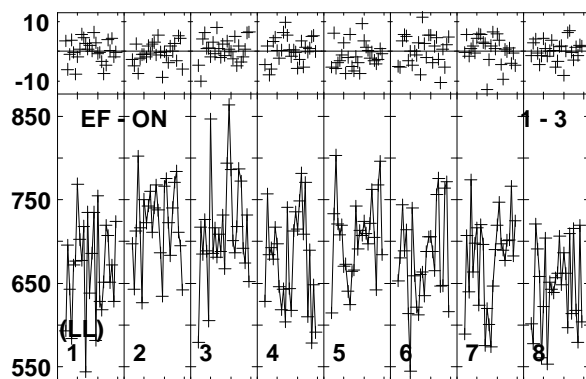
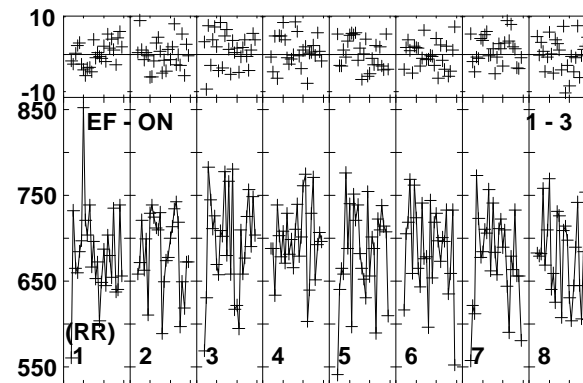
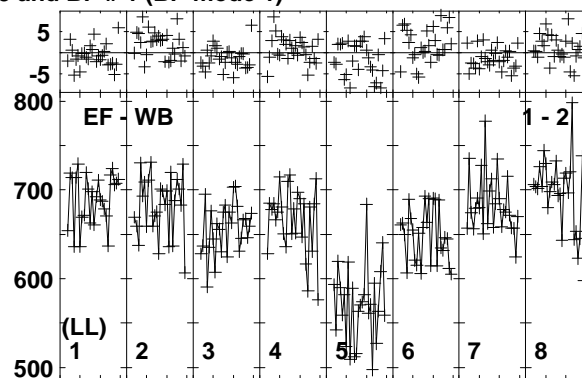
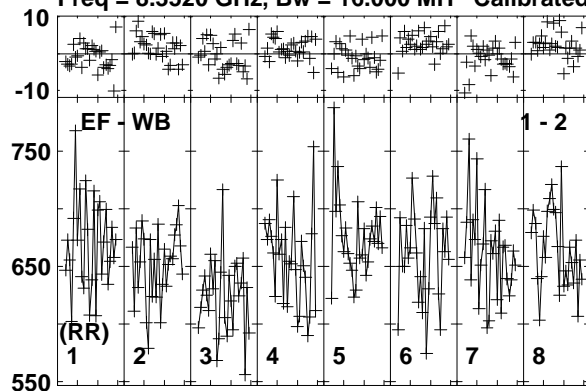

Lower frame: Milli Ampl Jy Top frame: Phas deg
Vector averaged cross-power spectrum Baseline: EF (01) - WB (02)
Timerange: 00/03:28:41 to 00/03:29:09

Plot file version 52 created 24-MAR-2014 14:37:57

J1128+5925 EP087F 5.UVDATA.1

Freq = 8.3520 GHz, Bw = 16.000 MH Calibrated with CL # 3 and BP # 1 (BP mode 1)

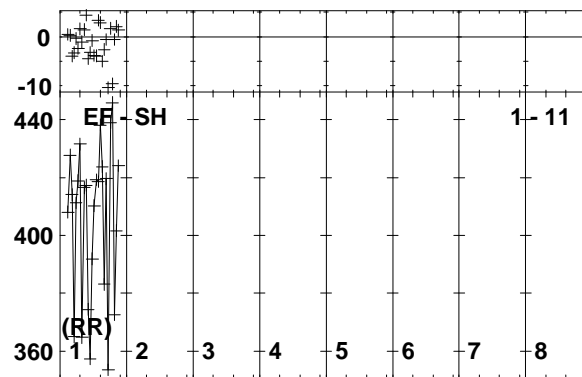
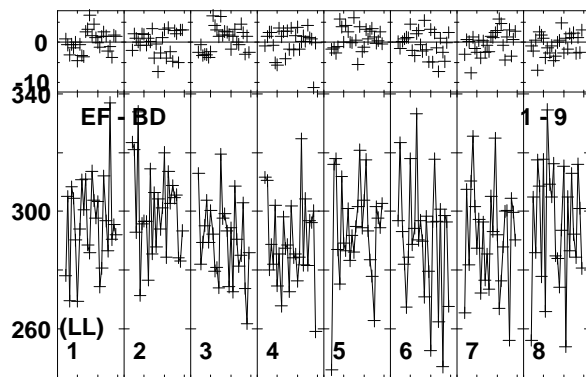
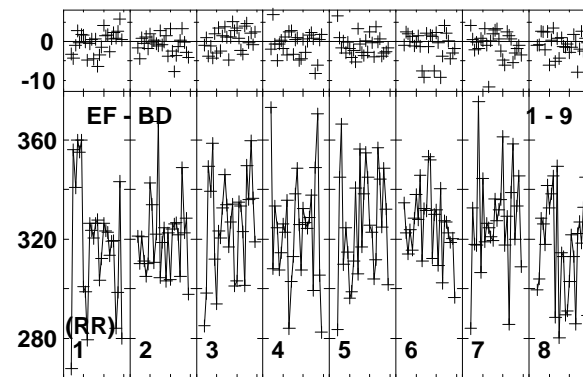
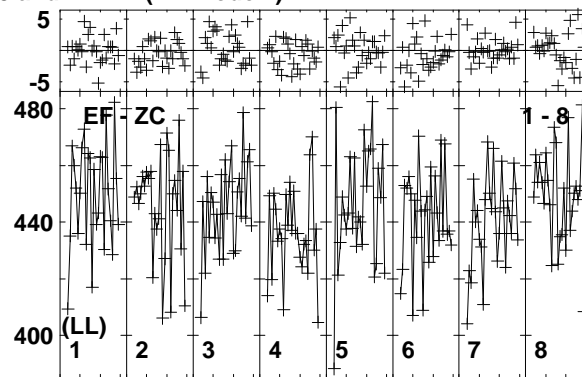
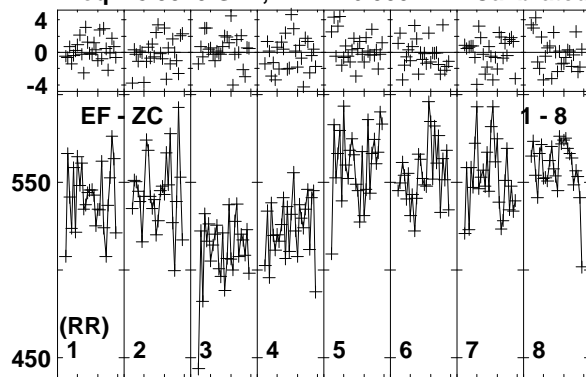

Lower frame: Milli Ampl Jy Top frame: Phas deg
Vector averaged cross-power spectrum Baseline: EF (01) - ZC (08)
Timerange: 00/03:28:41 to 00/03:29:09

Plot file version 53 created 24-MAR-2014 14:37:57

ARP299D EP087F 5.UVDATA.1

Freq = 8.3520 GHz, Bw = 16.000 MH Calibrated with CL # 3 and BP # 1 (BP mode 1)

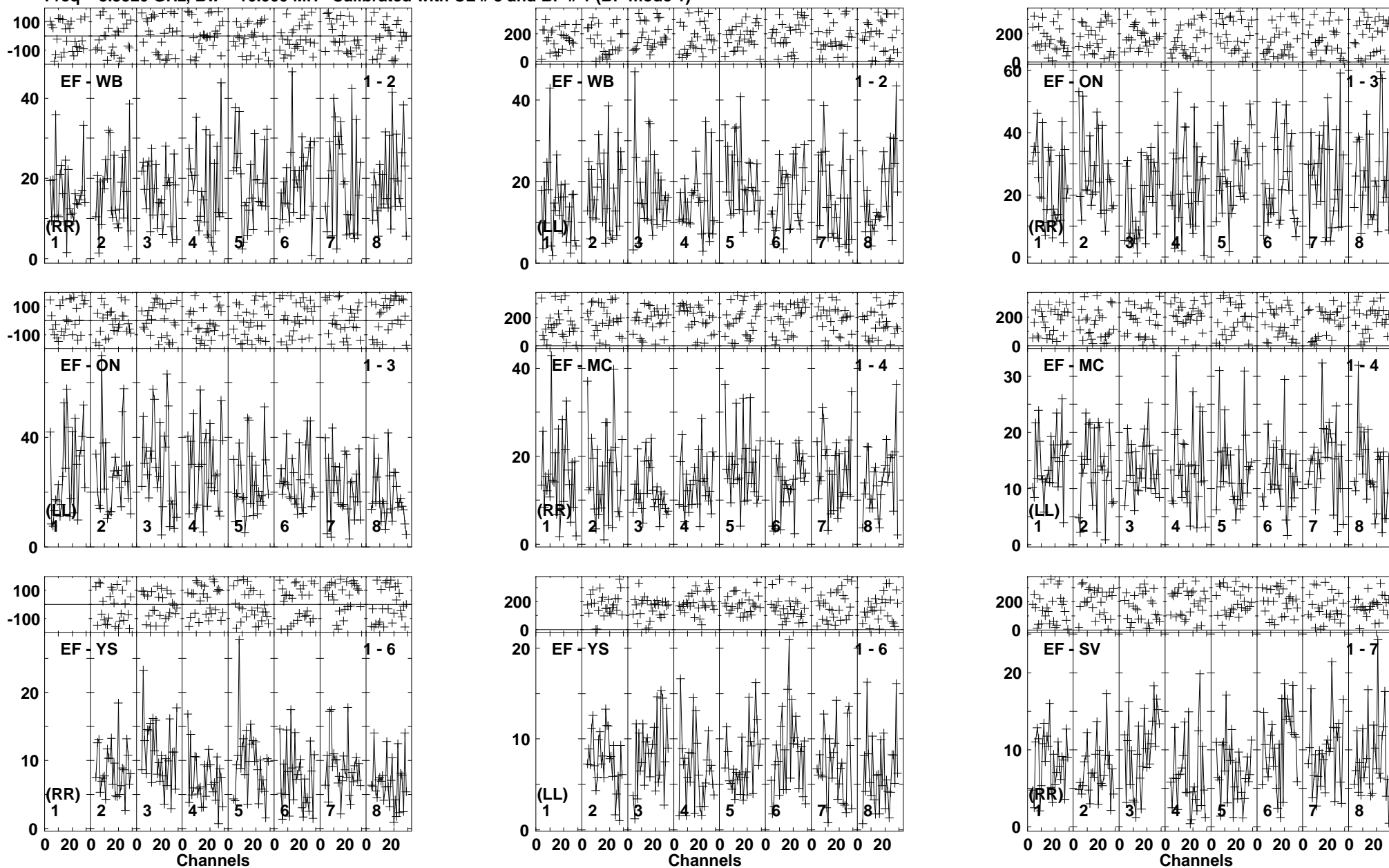

Lower frame: Milli Ampl Jy Top frame: Phas deg
Vector averaged cross-power spectrum Baseline: EF (01) - WB (02)
Timerange: 00/03:29:14 to 00/03:32:10

Plot file version 54 created 24-MAR-2014 14:37:58
 ARP299D EP087F 5.UVDATA.1
 Freq = 8.3520 GHz, Bw = 16.000 MH Calibrated with CL # 3 and BP # 1 (BP mode 1)

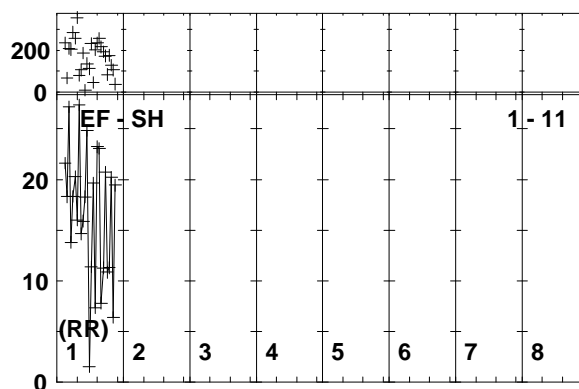
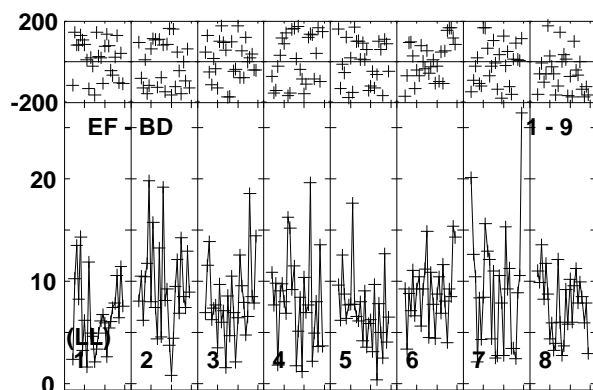
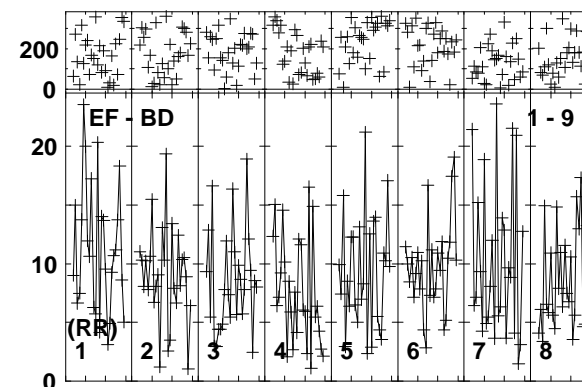
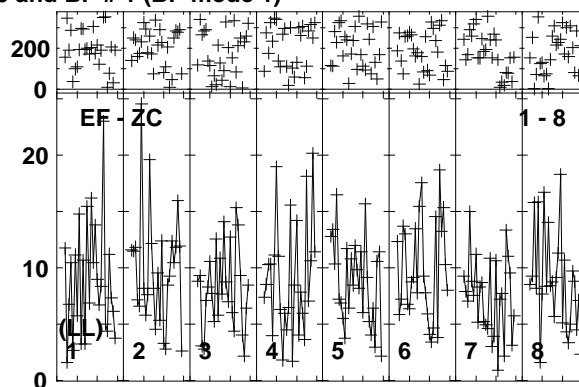
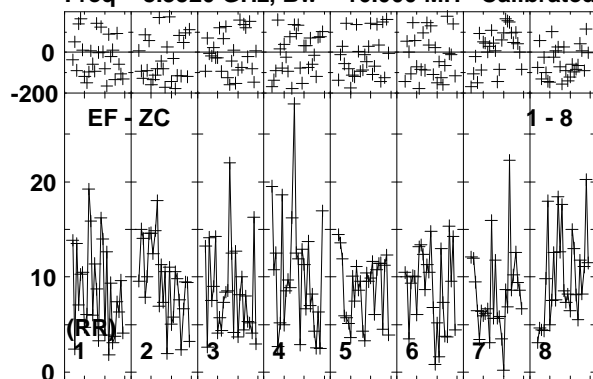

Lower frame: Milli Ampl Jy Top frame: Phas deg
 Vector averaged cross-power spectrum Baseline: EF (01) - ZC (08)
 Timerange: 00/03:29:14 to 00/03:32:10

Plot file version 55 created 24-MAR-2014 14:37:58

J1128+5925 EP087F 5.UVDATA.1

Freq = 8.3520 GHz, Bw = 16.000 MH Calibrated with CL # 3 and BP # 1 (BP mode 1)

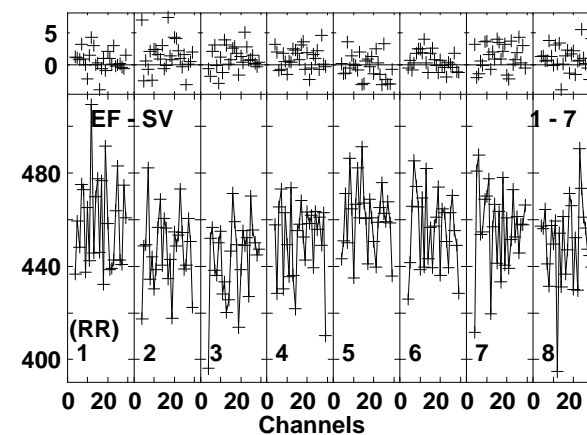
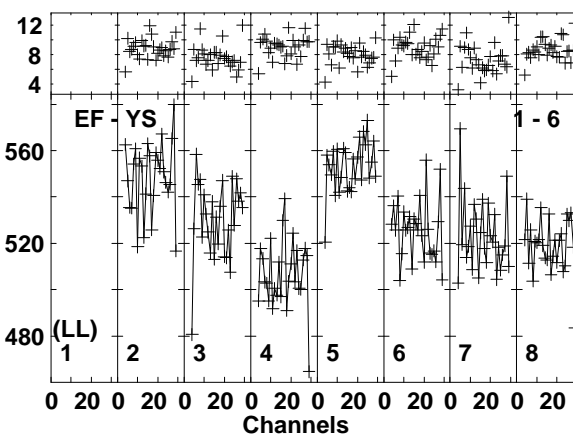
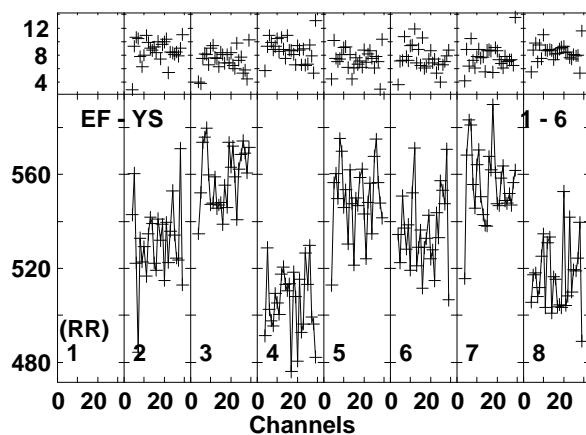
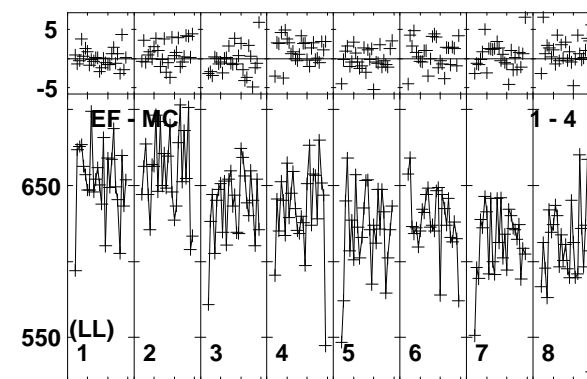
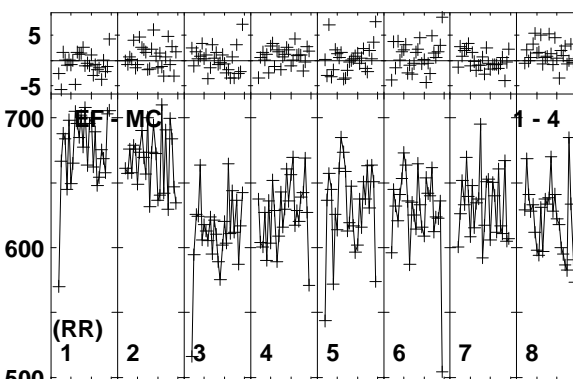
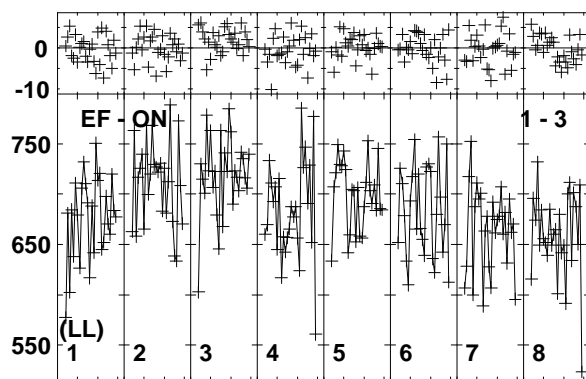
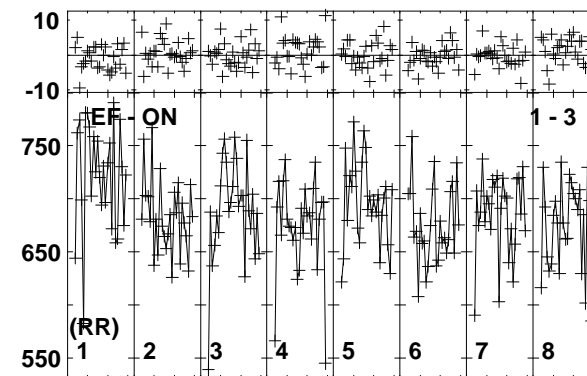
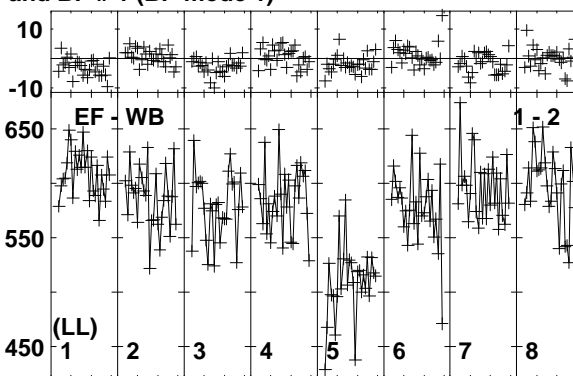
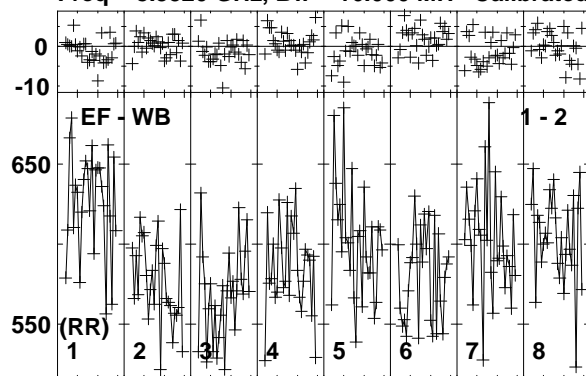

Lower frame: Milli Ampl Jy Top frame: Phas deg
Vector averaged cross-power spectrum Baseline: EF (01) - WB (02)
Timerange: 00/03:32:11 to 00/03:33:15

Plot file version 56 created 24-MAR-2014 14:37:58

J1128+5925 EP087F 5.UVDATA.1

Freq = 8.3520 GHz, Bw = 16.000 MH Calibrated with CL # 3 and BP # 1 (BP mode 1)

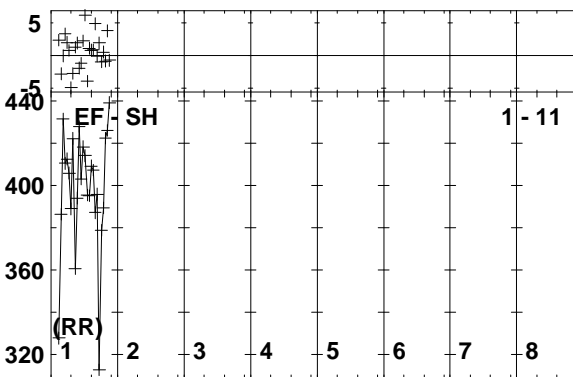
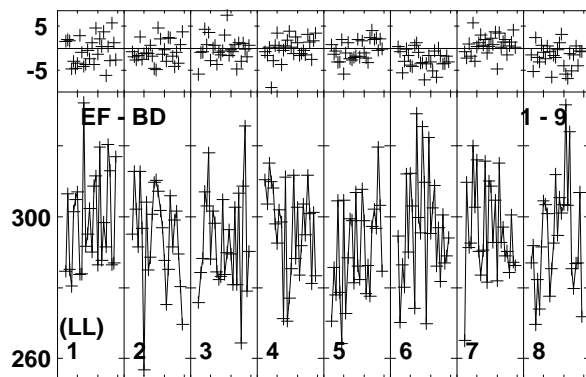
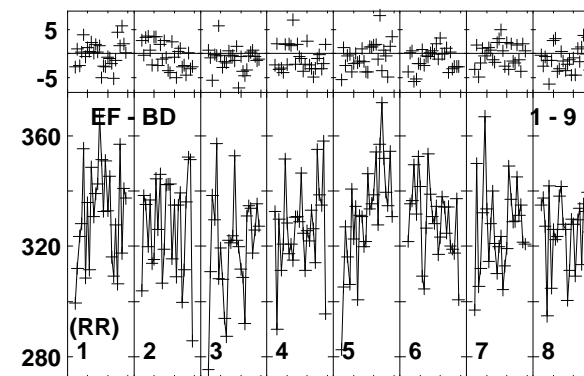
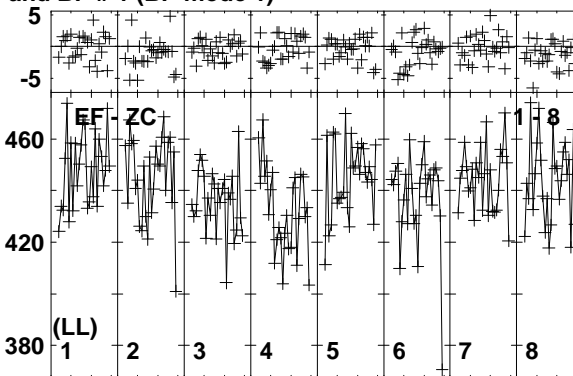
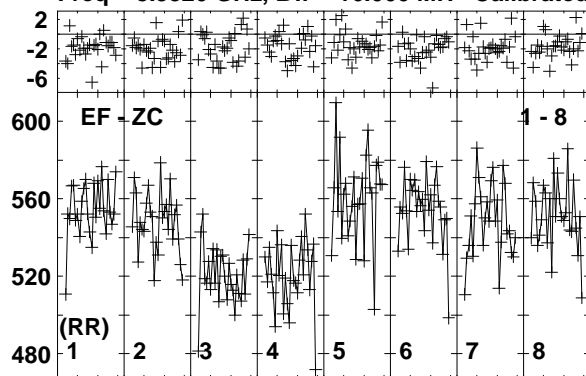

Lower frame: Milli Ampl Jy Top frame: Phas deg
Vector averaged cross-power spectrum Baseline: EF (01) - ZC (08)
Timerange: 00/03:32:11 to 00/03:33:15

Plot file version 57 created 24-MAR-2014 14:37:58

ARP299D EP087F 5.UVDATA.1

Freq = 8.3520 GHz, Bw = 16.000 MH Calibrated with CL # 3 and BP # 1 (BP mode 1)

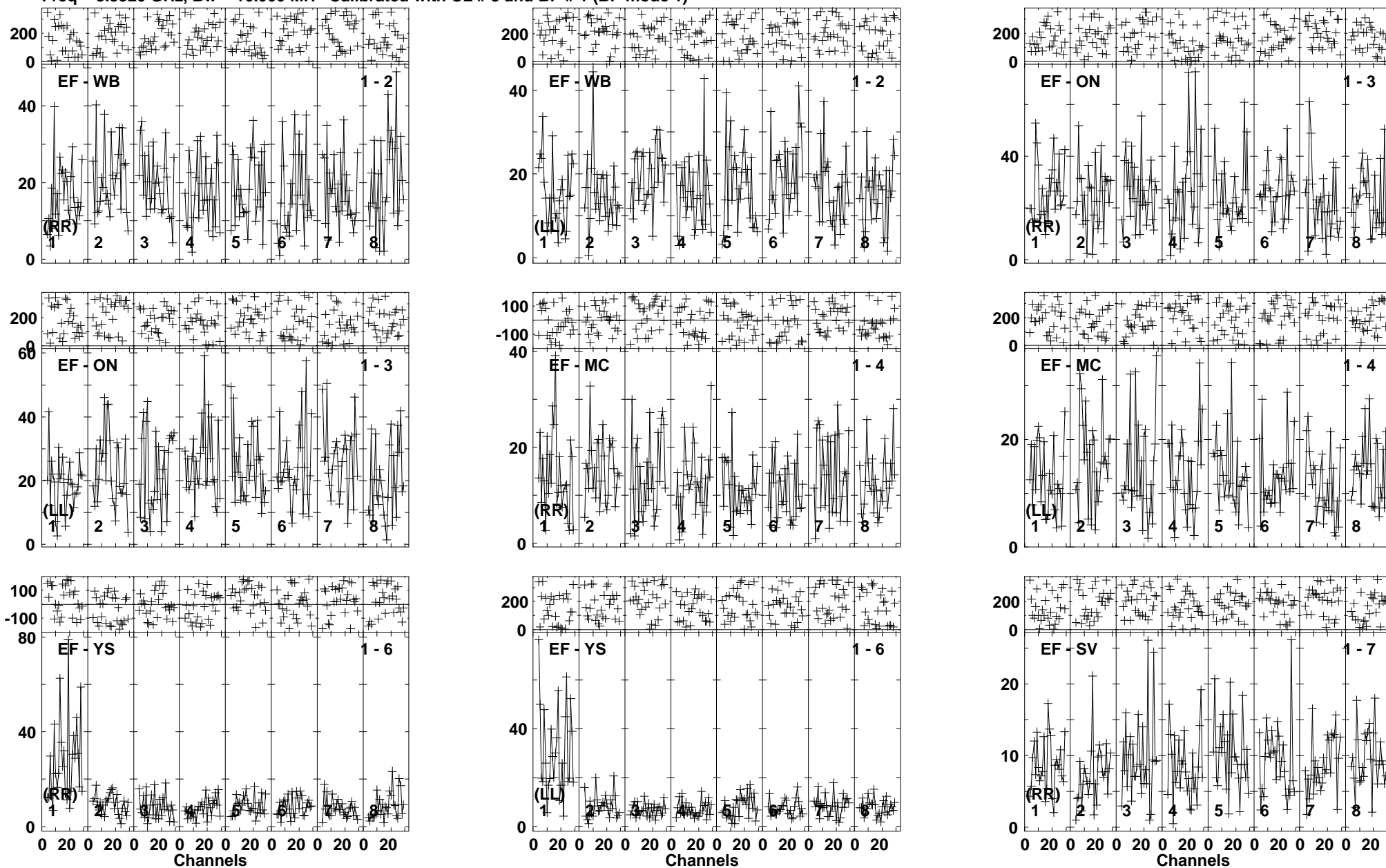

Lower frame: Milli Ampl Jy Top frame: Phas deg
Vector averaged cross-power spectrum Baseline: EF (01) - WB (02)
Timerange: 00/03:33:16 to 00/03:36:14

Plot file version 58 created 24-MAR-2014 14:37:59

ARP299D EP087F 5.UVDATA.1

Freq = 8.3520 GHz, Bw = 16.000 MH Calibrated with CL # 3 and BP # 1 (BP mode 1)

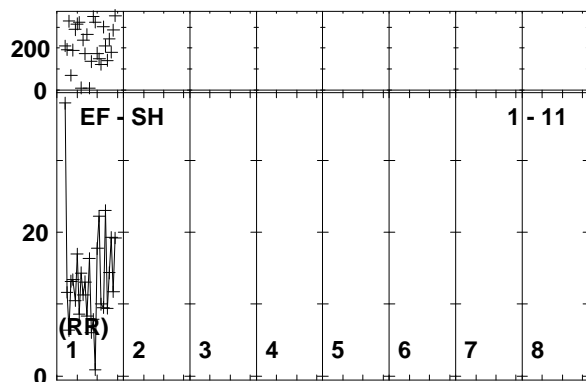
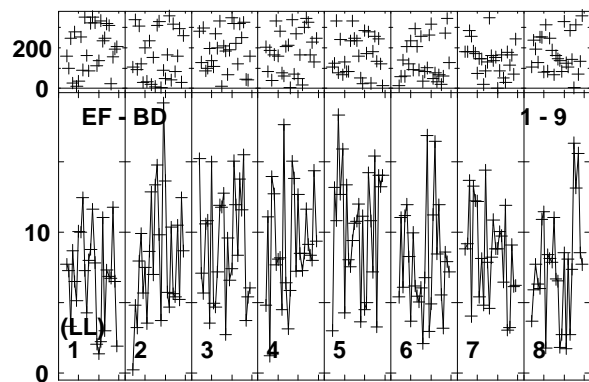
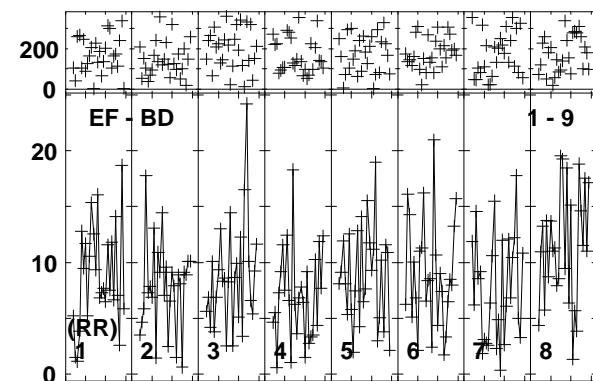
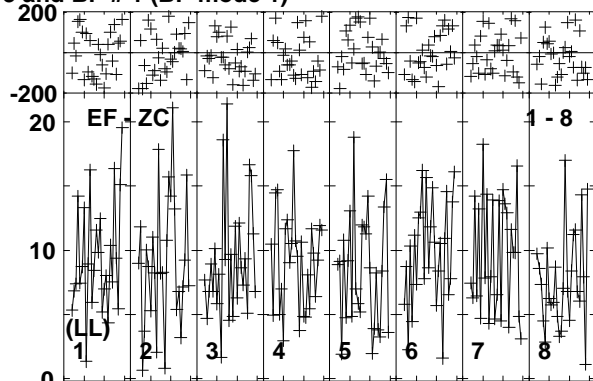
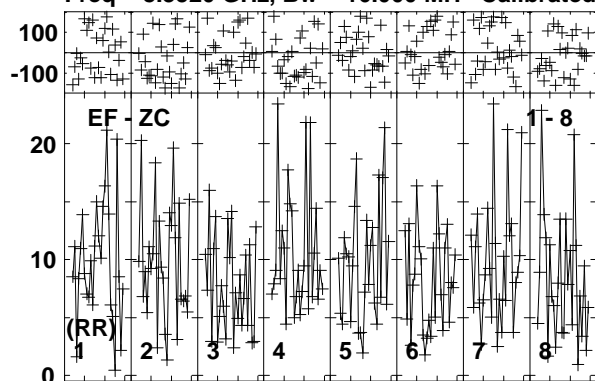

Lower frame: Milli Ampl Jy Top frame: Phas deg
Vector averaged cross-power spectrum Baseline: EF (01) - ZC (08)
Timerange: 00/03:33:16 to 00/03:36:14

Plot file version 59 created 24-MAR-2014 14:37:59

J1128+5925 EP087F 5.UVDATA.1

Freq = 8.3520 GHz, Bw = 16.000 MH Calibrated with CL # 3 and BP # 1 (BP mode 1)

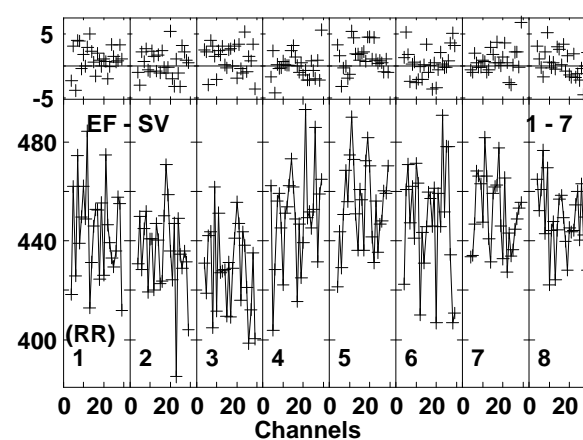
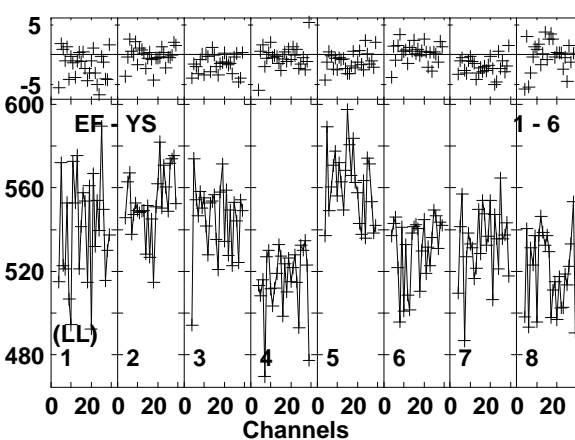
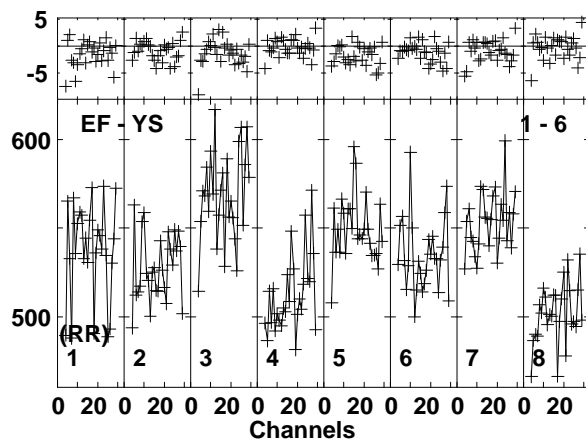
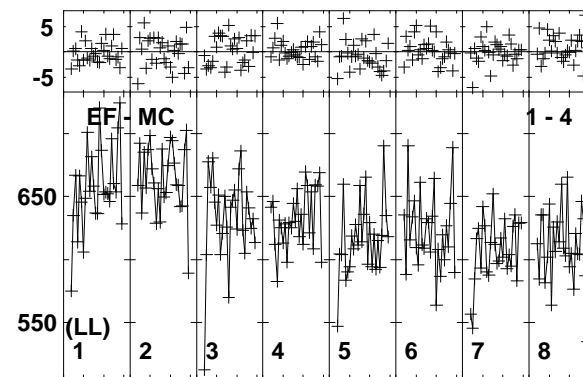
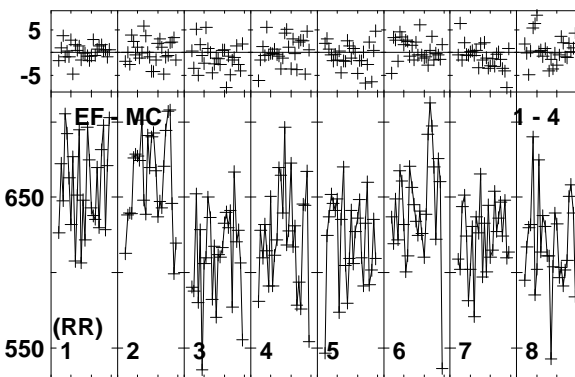
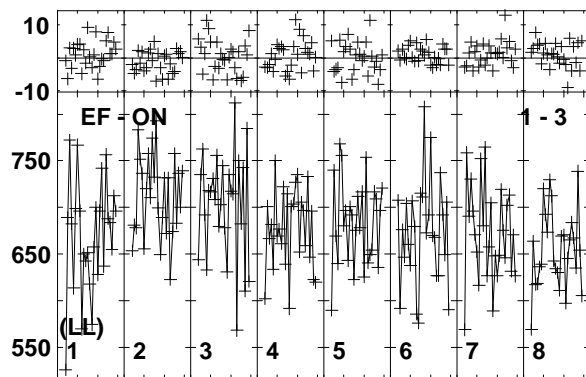
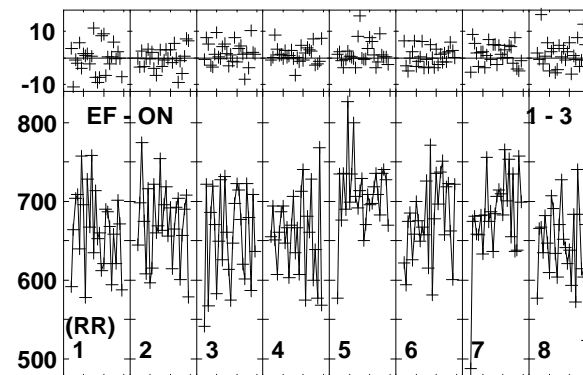
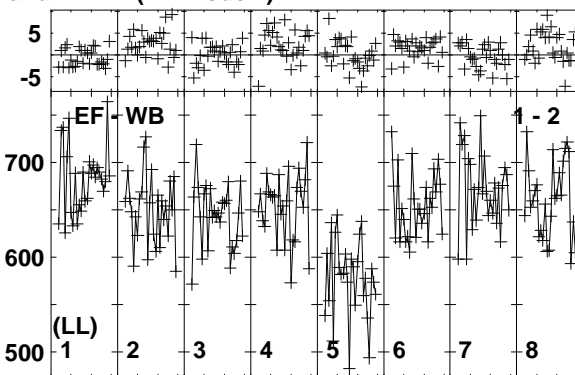
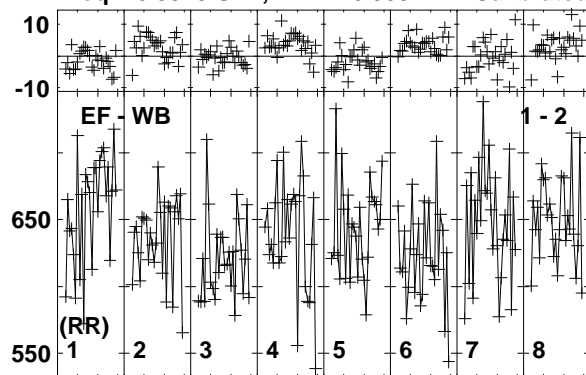

Lower frame: Milli Ampl Jy Top frame: Phas deg
Vector averaged cross-power spectrum Baseline: EF (01) - WB (02)
Timerange: 00/03:36:56 to 00/03:37:24

Plot file version 60 created 24-MAR-2014 14:37:59
 J1128+5925 EP087F 5.UVDATA.1
 Freq = 8.3520 GHz, Bw = 16.000 MH Calibrated with CL # 3 and BP # 1 (BP mode 1)

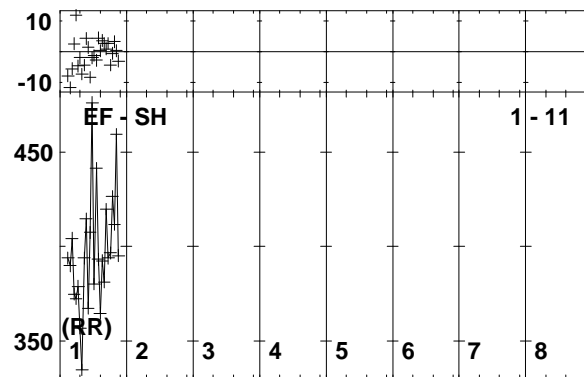
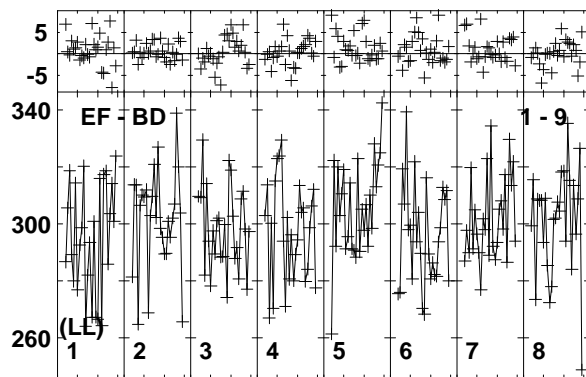
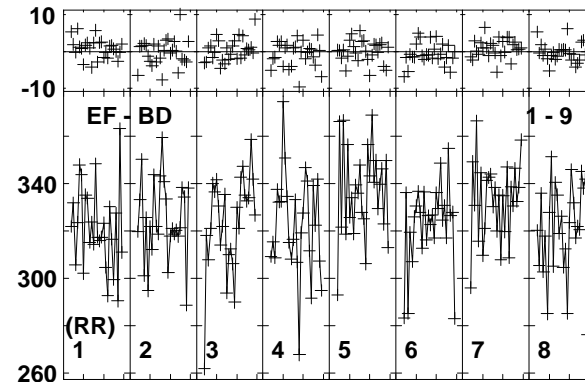
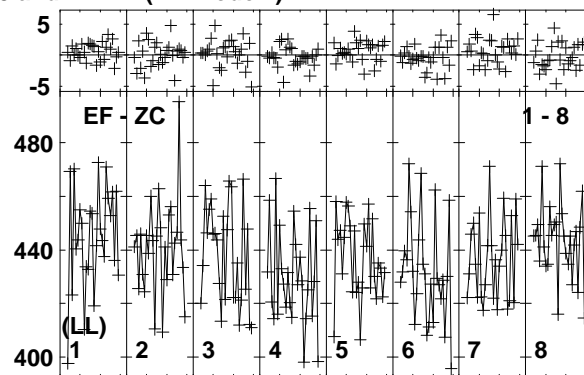
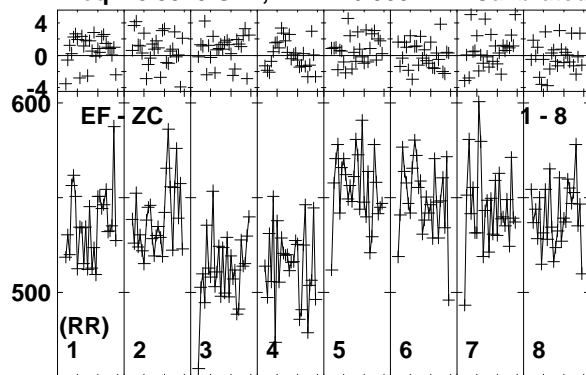

Lower frame: Milli Ampl Jy Top frame: Phas deg
 Vector averaged cross-power spectrum Baseline: EF (01) - ZC (08)
 Timerange: 00/03:36:56 to 00/03:37:24

Plot file version 61 created 24-MAR-2014 14:37:59

ARP299D EP087F 5.UVDATA.1

Freq = 8.3520 GHz, Bw = 16.000 MH Calibrated with CL # 3 and BP # 1 (BP mode 1)

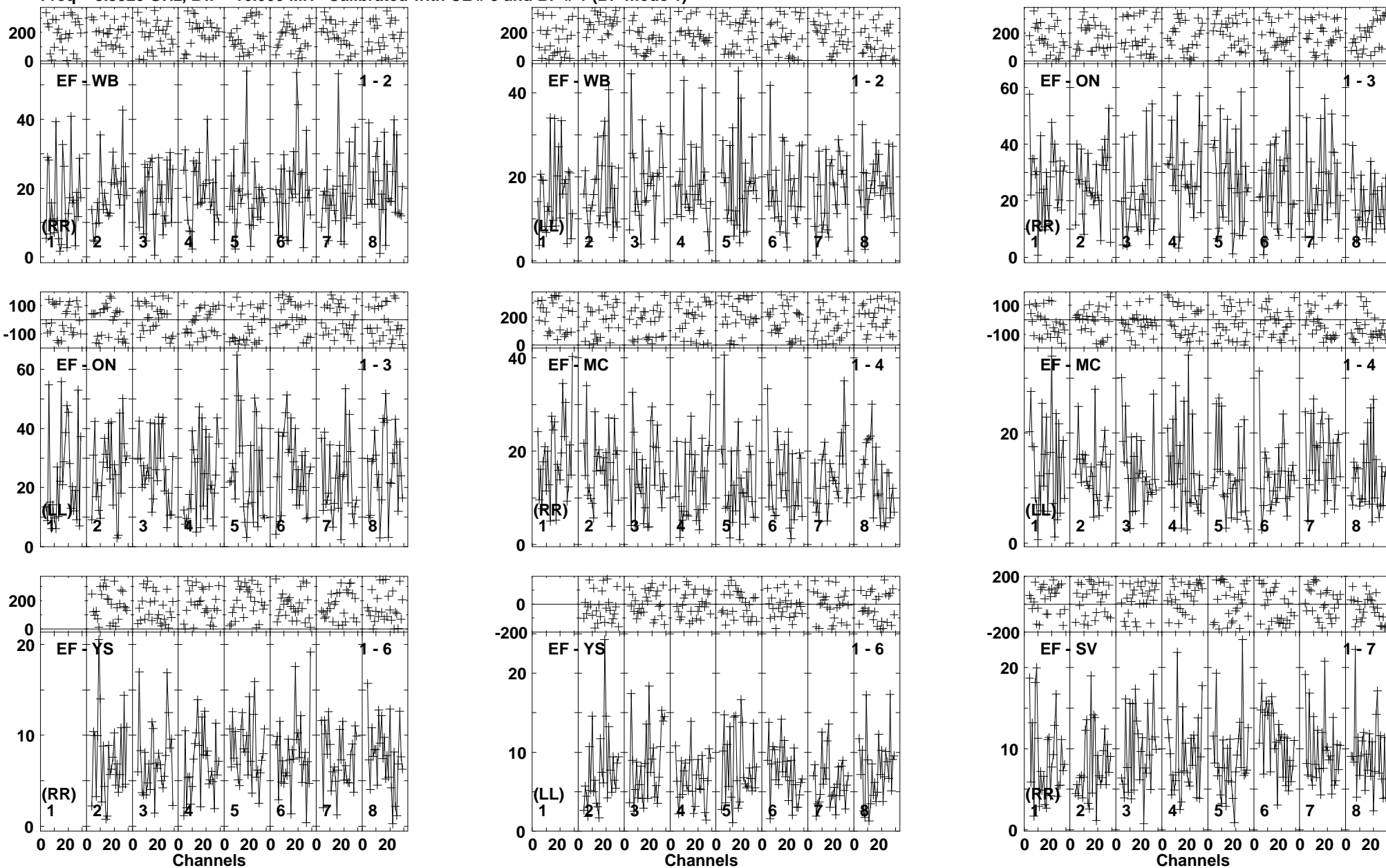

Lower frame: Milli Ampl Jy Top frame: Phas deg
Vector averaged cross-power spectrum Baseline: EF (01) - WB (02)
Timerange: 00/03:37:29 to 00/03:40:25

Plot file version 62 created 24-MAR-2014 14:38:00
 ARP299D EP087F 5.UVDATA.1
 Freq = 8.3520 GHz, Bw = 16.000 MH Calibrated with CL # 3 and BP # 1 (BP mode 1)

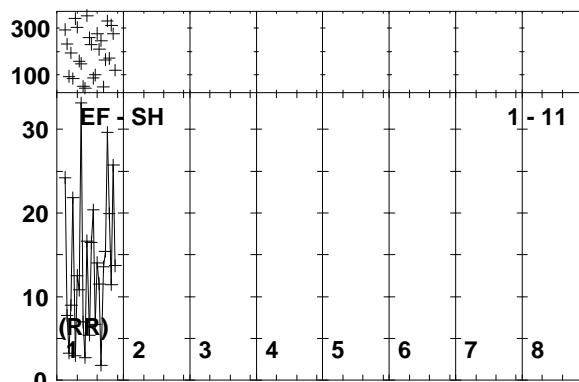
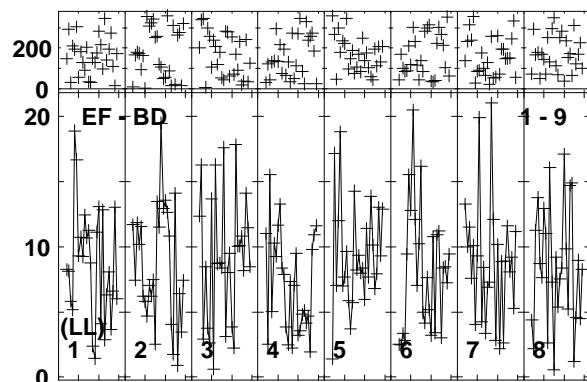
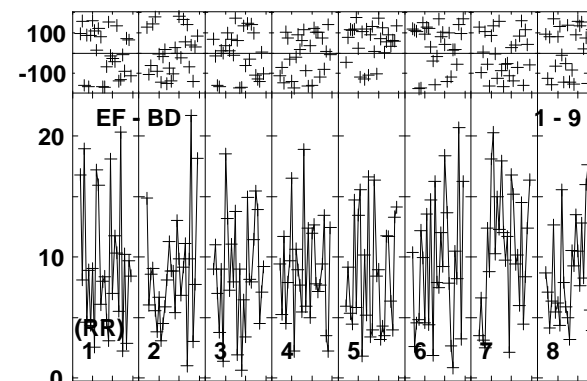
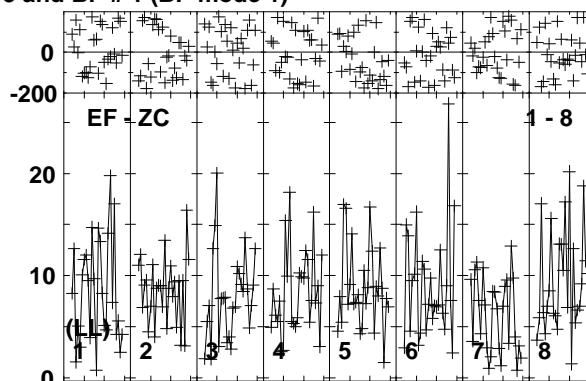
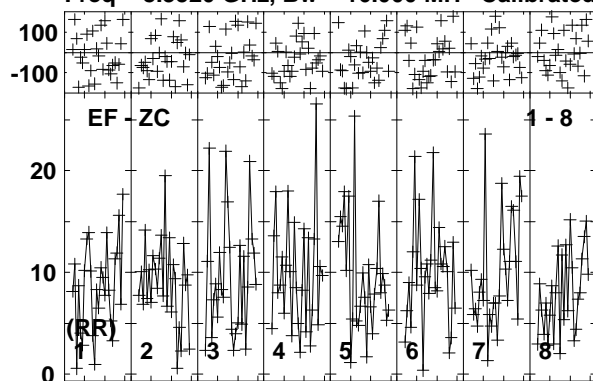

Lower frame: Milli Ampl Jy Top frame: Phas deg
 Vector averaged cross-power spectrum Baseline: EF (01) - ZC (08)
 Timerange: 00/03:37:29 to 00/03:40:25

Plot file version 63 created 24-MAR-2014 14:38:00

J1128+5925 EP087F 5.UVDATA.1

Freq = 8.3520 GHz, Bw = 16.000 MH Calibrated with CL # 3 and BP # 1 (BP mode 1)

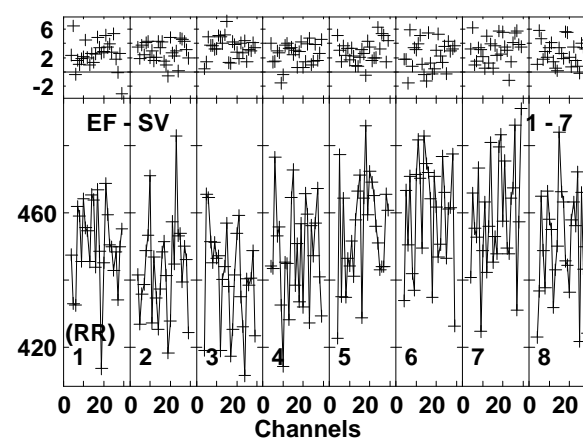
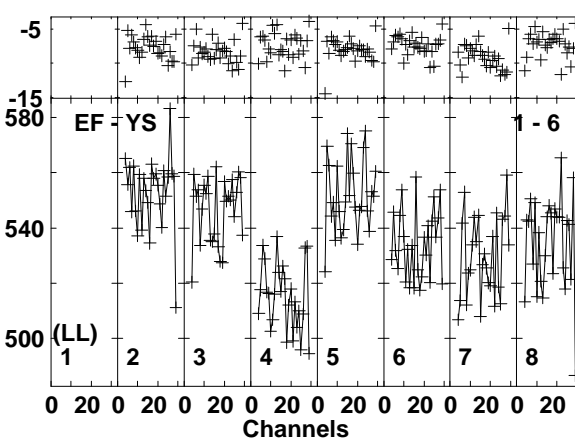
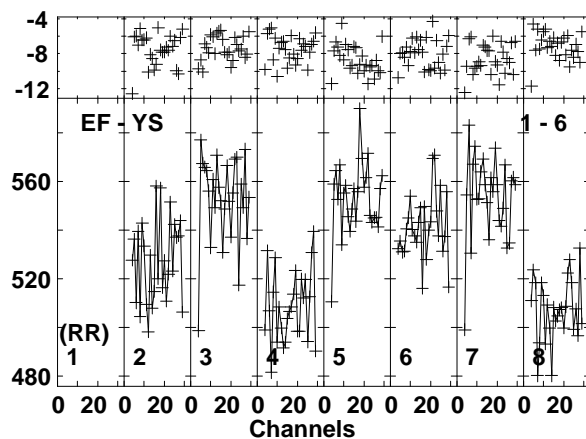
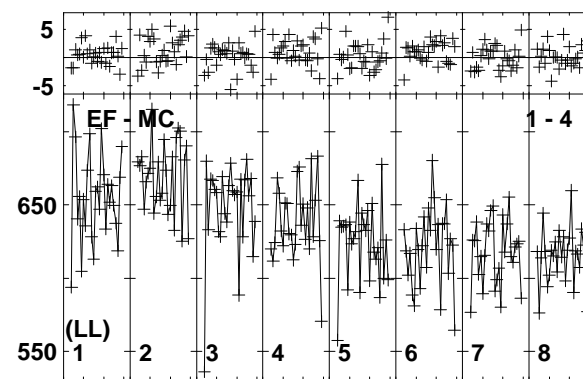
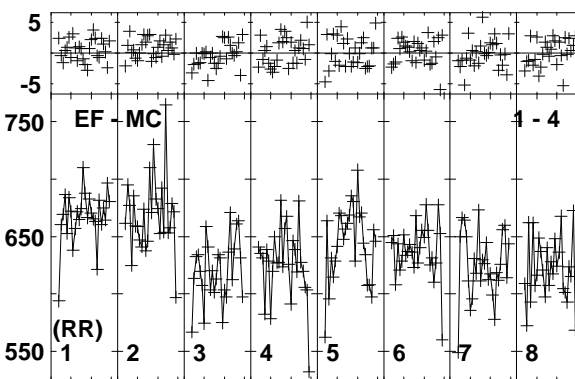
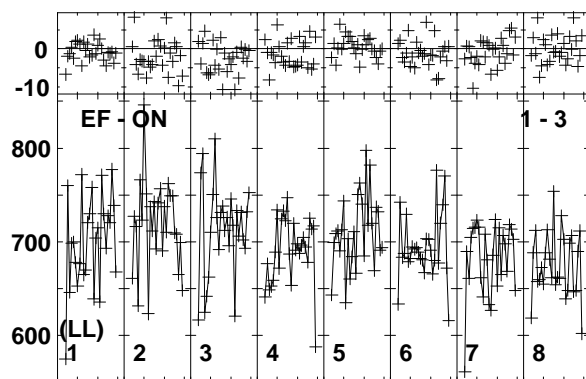
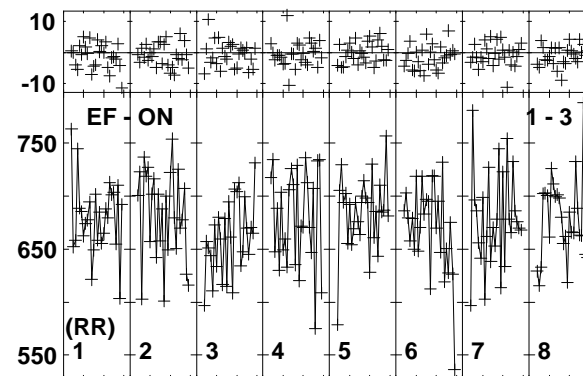
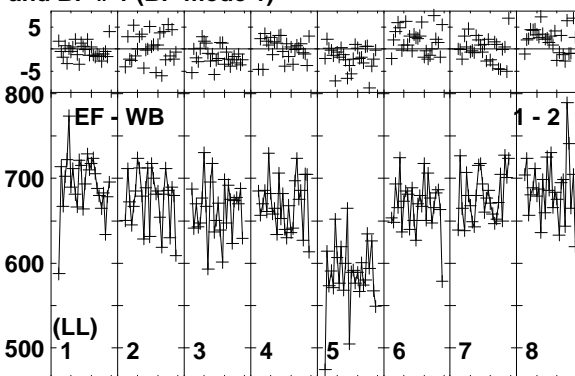
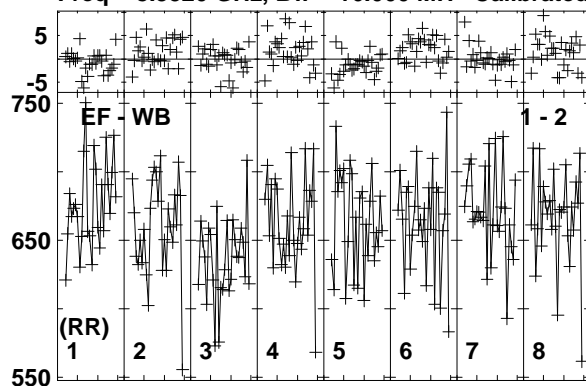

Lower frame: Milli Ampl Jy Top frame: Phas deg
Vector averaged cross-power spectrum Baseline: EF (01) - WB (02)
Timerange: 00/03:40:26 to 00/03:41:30

Plot file version 64 created 24-MAR-2014 14:38:00

J1128+5925 EP087F 5.UVDATA.1

Freq = 8.3520 GHz, Bw = 16.000 MH Calibrated with CL # 3 and BP # 1 (BP mode 1)

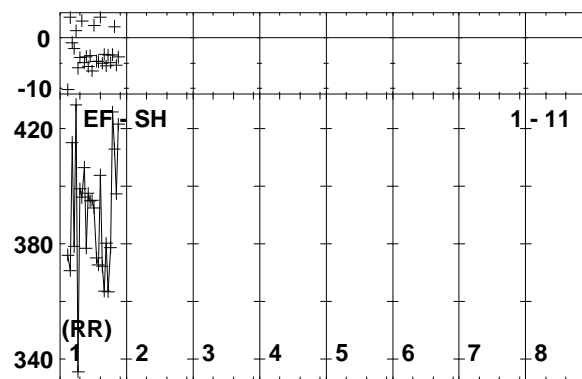
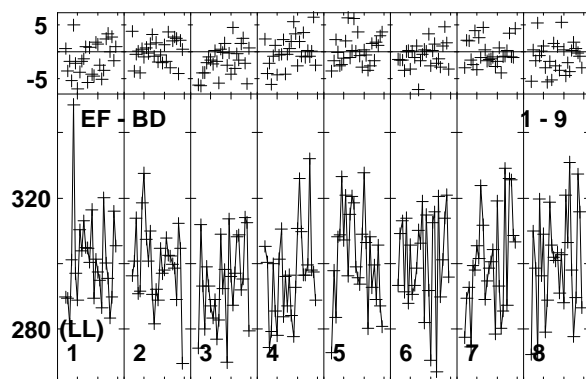
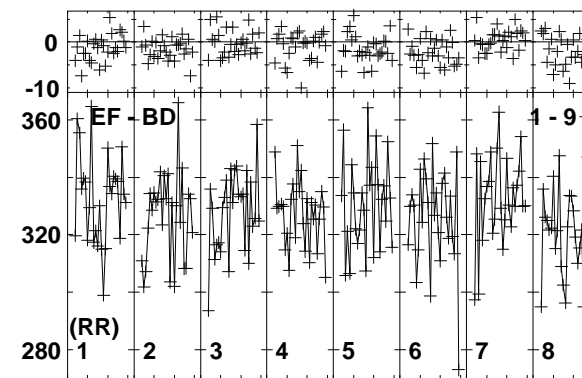
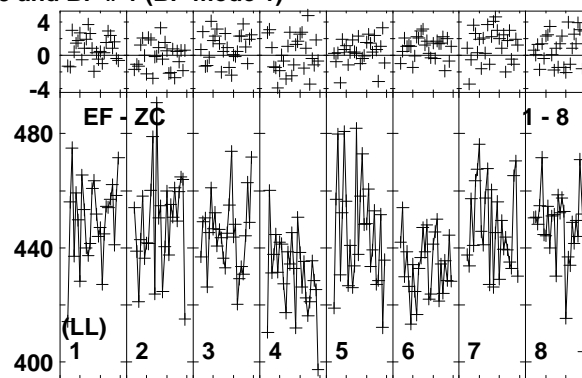
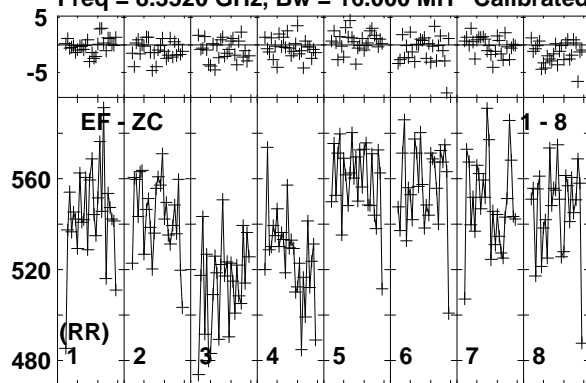

Lower frame: Milli Ampl Jy Top frame: Phas deg
Vector averaged cross-power spectrum Baseline: EF (01) - ZC (08)
Timerange: 00/03:40:26 to 00/03:41:30

Plot file version 65 created 24-MAR-2014 14:38:00

ARP299D EP087F 5.UVDATA.1

Freq = 8.3520 GHz, Bw = 16.000 MH Calibrated with CL # 3 and BP # 1 (BP mode 1)

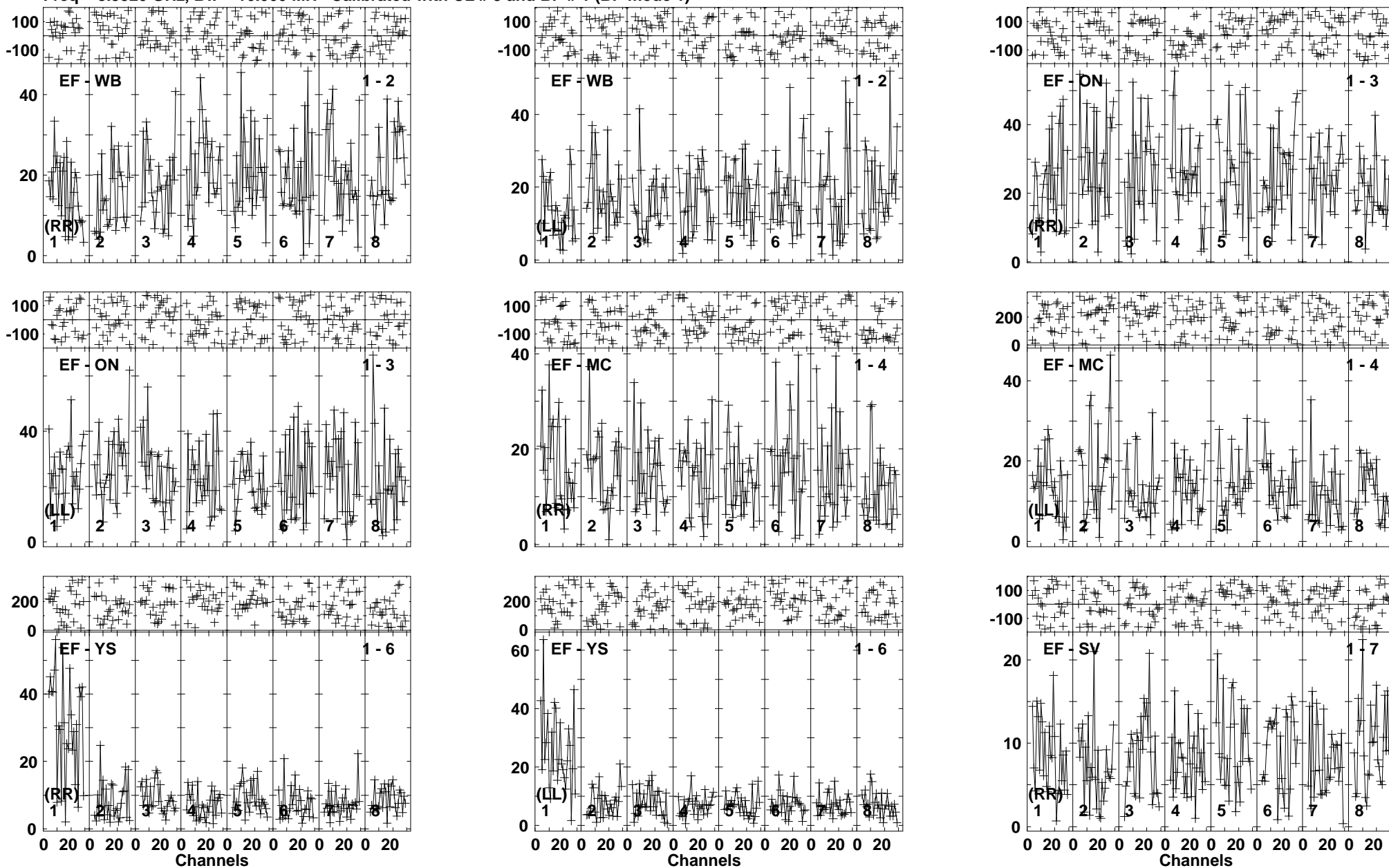

Lower frame: Milli Ampl Jy Top frame: Phas deg
Vector averaged cross-power spectrum Baseline: EF (01) - WB (02)
Timerange: 00/03:41:31 to 00/03:44:30

Plot file version 66 created 24-MAR-2014 14:38:01
 ARP299D EP087F 5.UVDATA.1
 Freq = 8.3520 GHz, Bw = 16.000 MH Calibrated with CL # 3 and BP # 1 (BP mode 1)

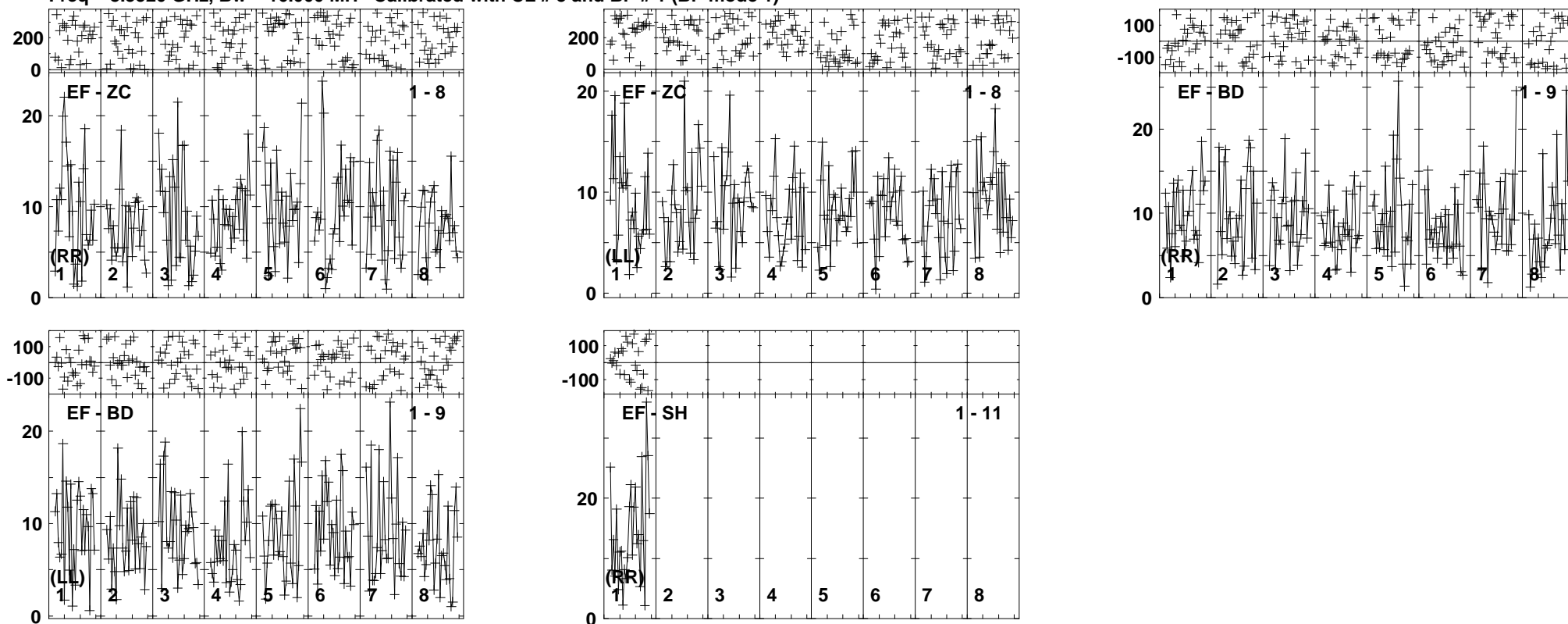

Lower frame: Milli Ampl Jy Top frame: Phas deg
 Vector averaged cross-power spectrum Baseline: EF (01) - ZC (08)
 Timerange: 00/03:41:31 to 00/03:44:30

Plot file version 67 created 24-MAR-2014 14:38:01

J1128+5925 EP087F 5.UVDATA.1

Freq = 8.3520 GHz, Bw = 16.000 MH Calibrated with CL # 3 and BP # 1 (BP mode 1)

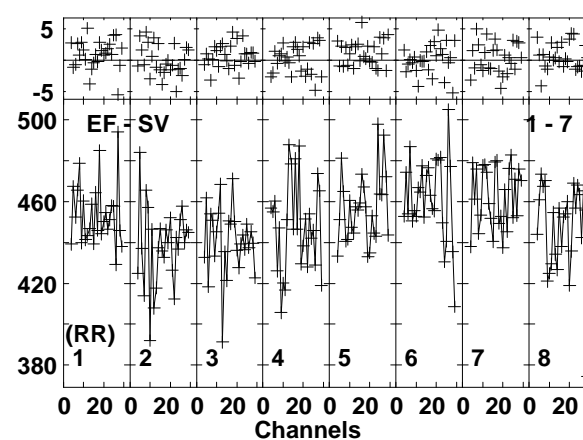
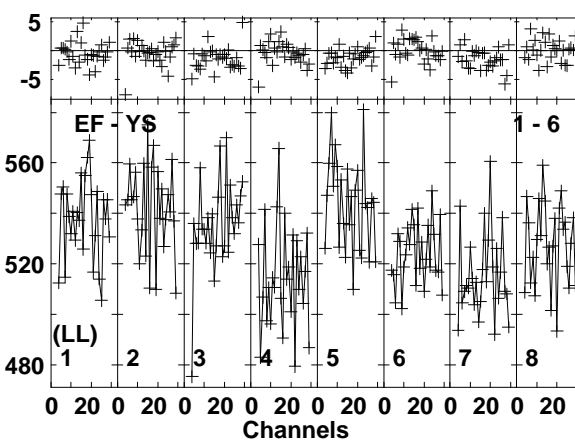
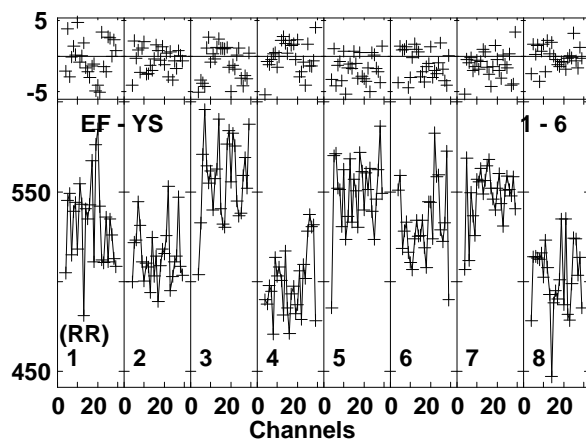
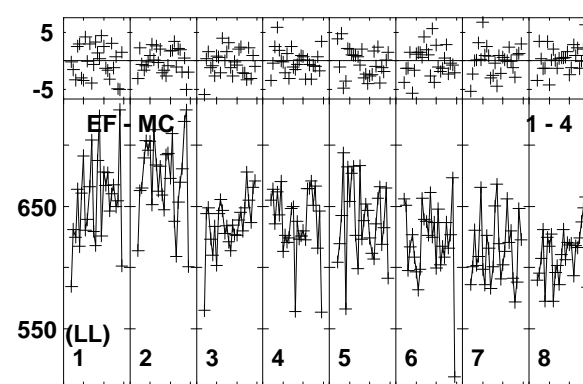
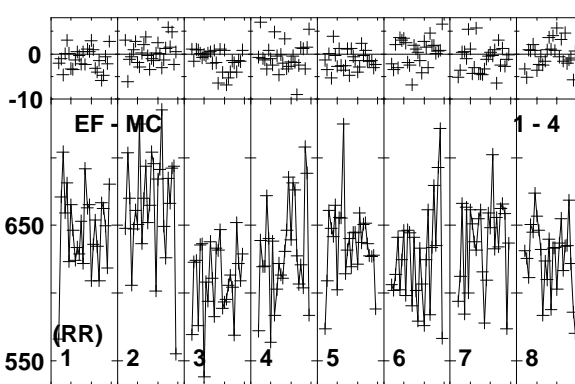
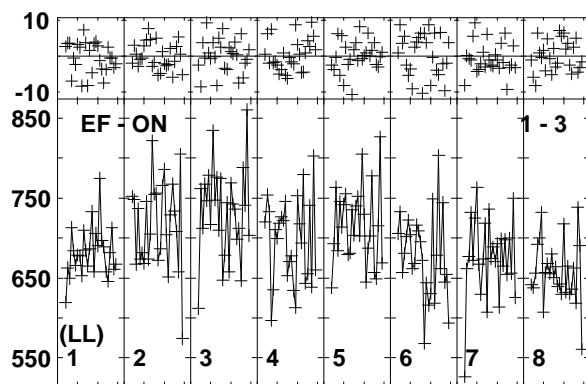
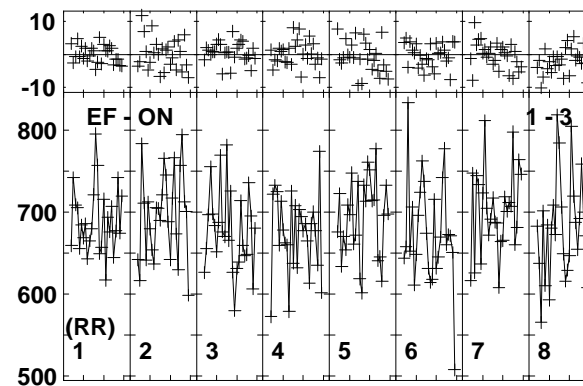
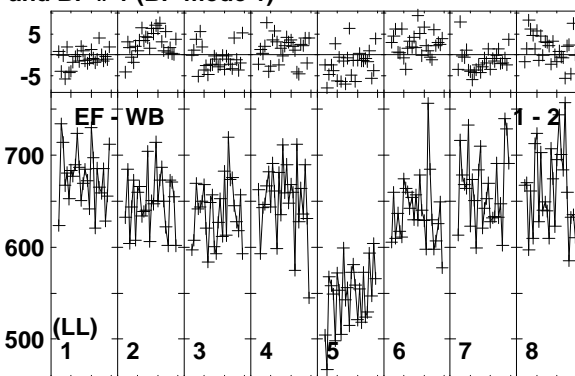
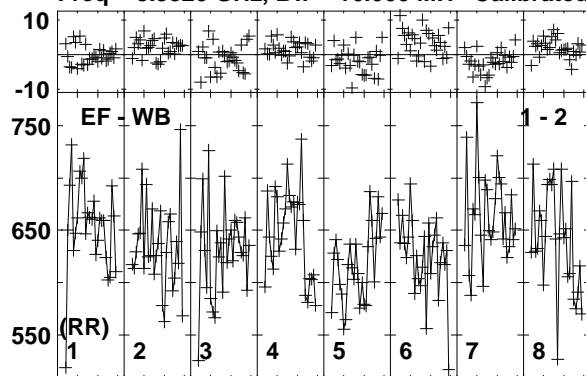

Lower frame: Milli Ampl Jy Top frame: Phas deg
Vector averaged cross-power spectrum Baseline: EF (01) - WB (02)
Timerange: 00/03:45:11 to 00/03:45:39

Plot file version 68 created 24-MAR-2014 14:38:01
 J1128+5925 EP087F 5.UVDATA.1
 Freq = 8.3520 GHz, Bw = 16.000 MH Calibrated with CL # 3 and BP # 1 (BP mode 1)

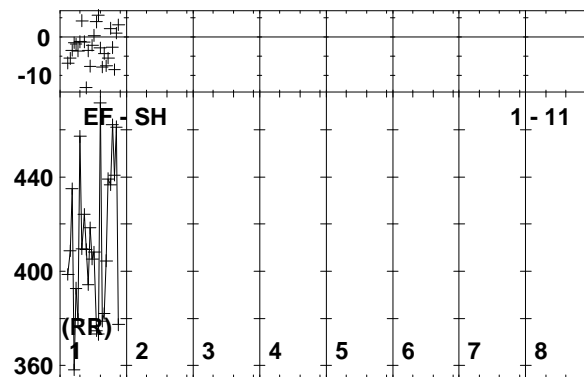
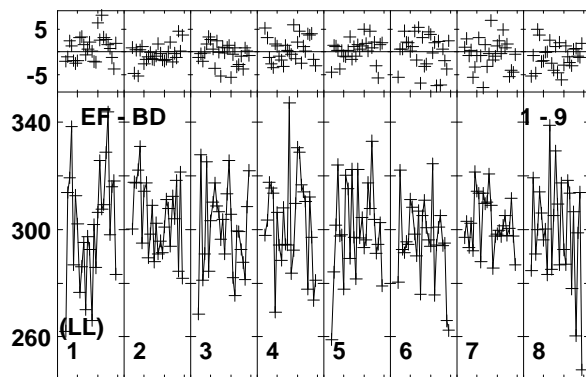
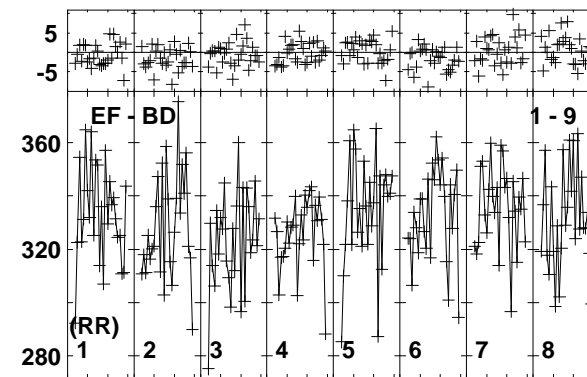
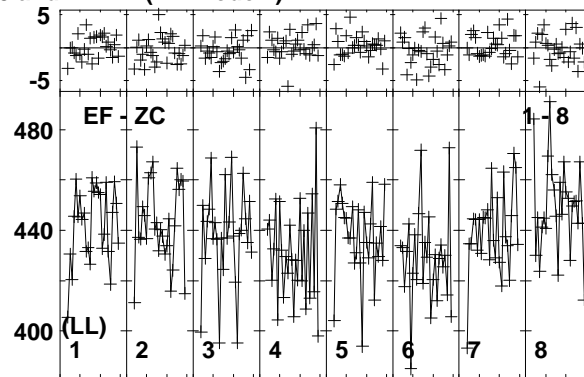
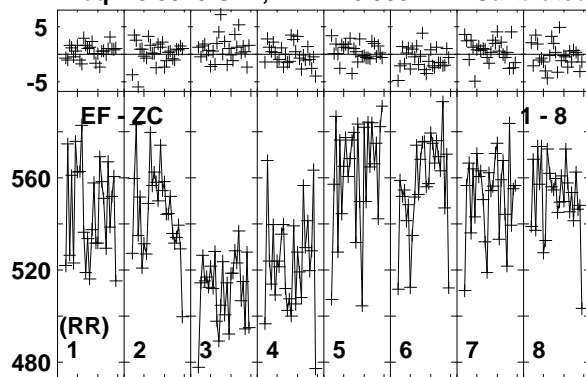

Lower frame: Milli Ampl Jy Top frame: Phas deg
 Vector averaged cross-power spectrum Baseline: EF (01) - ZC (08)
 Timerange: 00/03:45:11 to 00/03:45:39

Plot file version 69 created 24-MAR-2014 14:38:01
 ARP299D EP087F 5.UVDATA.1
 Freq = 8.3520 GHz, Bw = 16.000 MH Calibrated with CL # 3 and BP # 1 (BP mode 1)

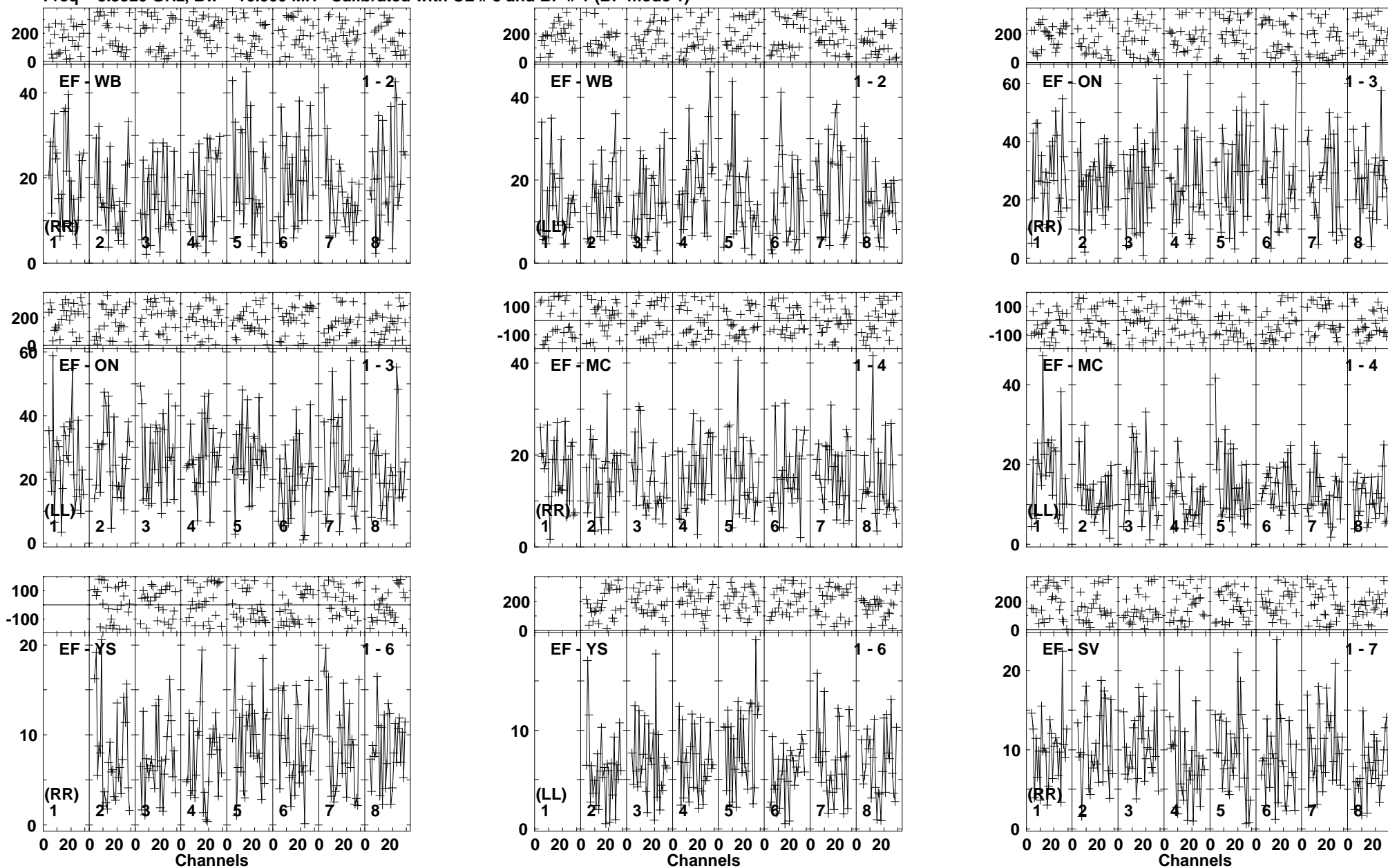

Lower frame: Milli Ampl Jy Top frame: Phas deg
 Vector averaged cross-power spectrum Baseline: EF (01) - WB (02)
 Timerange: 00/03:45:44 to 00/03:48:40

Plot file version 70 created 24-MAR-2014 14:38:02

ARP299D EP087F 5.UVDATA.1

Freq = 8.3520 GHz, Bw = 16.000 MH Calibrated with CL # 3 and BP # 1 (BP mode 1)

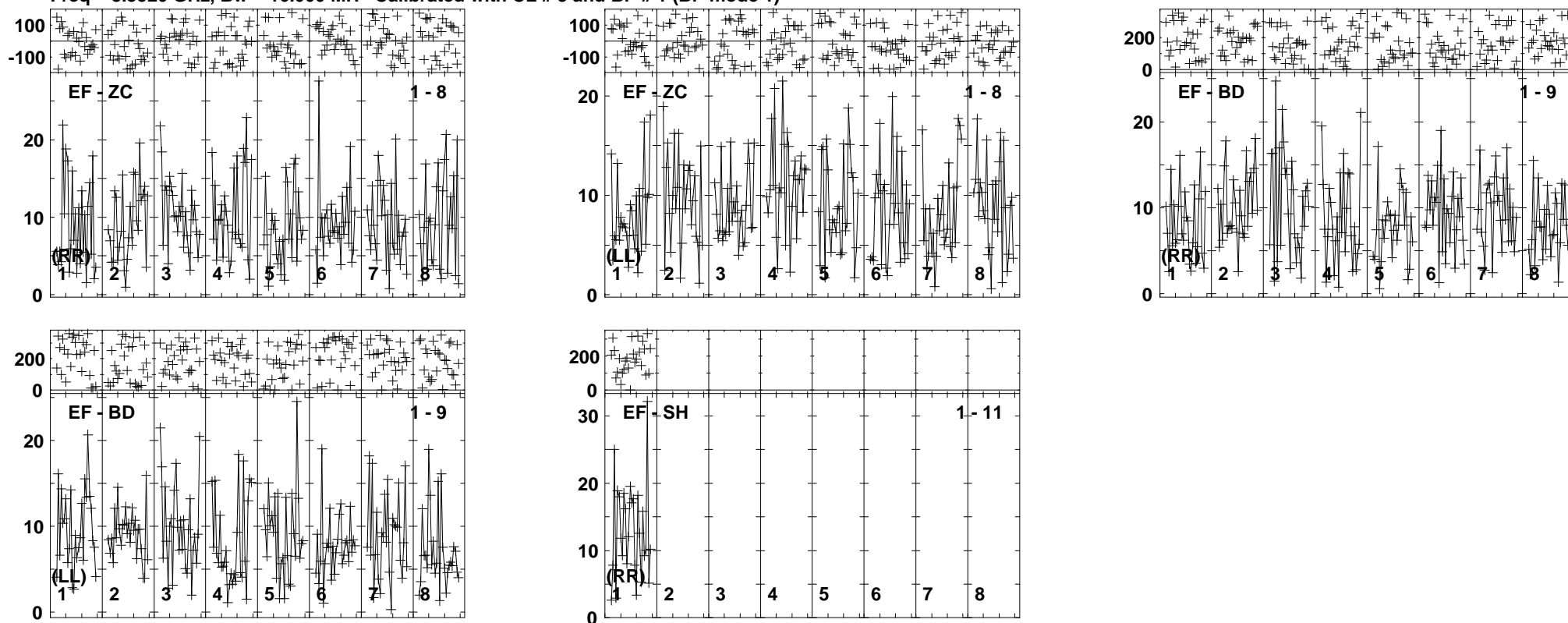

Lower frame: Milli Ampl Jy Top frame: Phas deg
Vector averaged cross-power spectrum Baseline: EF (01) - ZC (08)
Timerange: 00/03:45:44 to 00/03:48:40

Plot file version 71 created 24-MAR-2014 14:38:02

J1128+5925 EP087F 5.UVDATA.1

Freq = 8.3520 GHz, Bw = 16.000 MH Calibrated with CL # 3 and BP # 1 (BP mode 1)

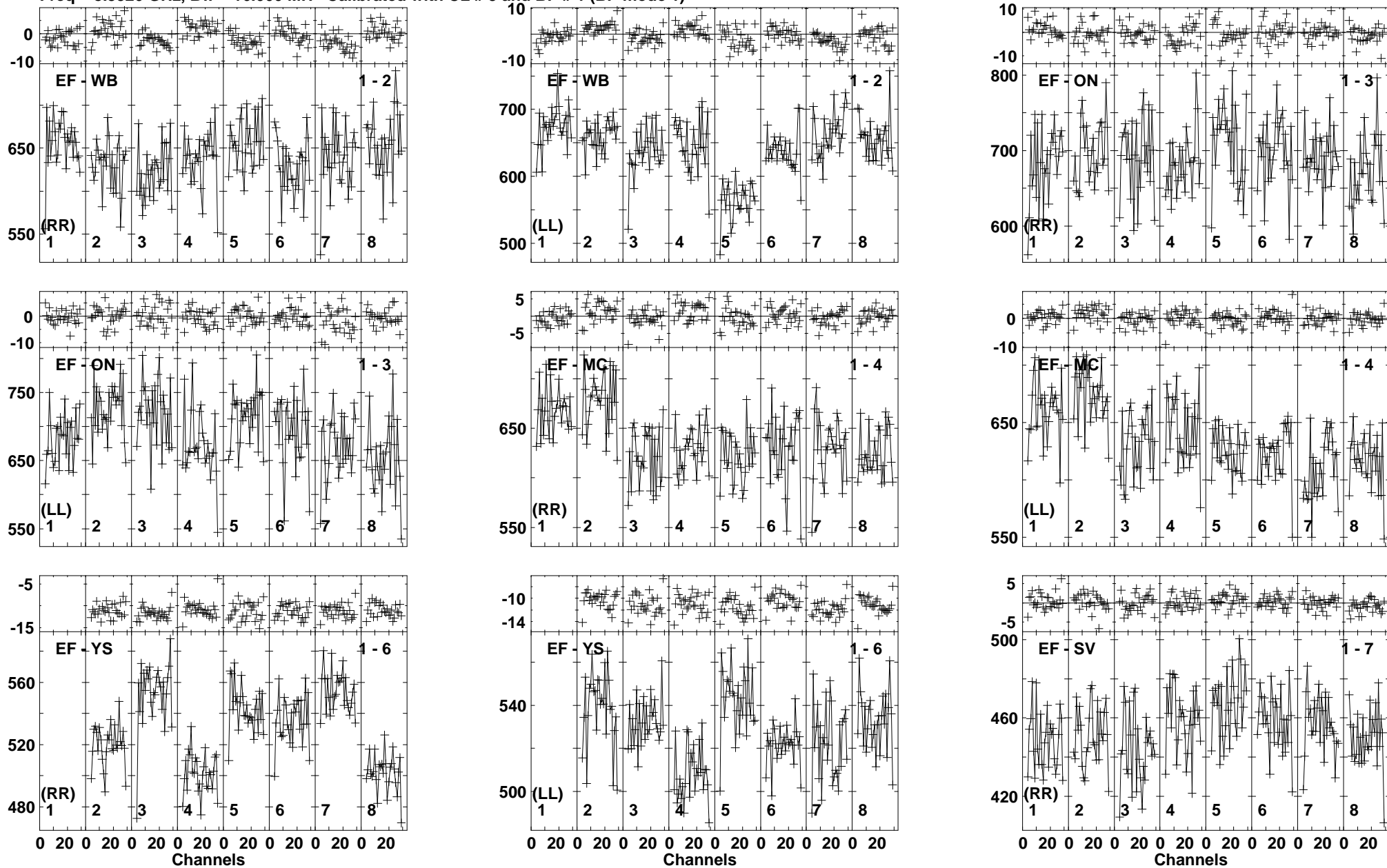

Lower frame: Milli Ampl Jy Top frame: Phas deg
Vector averaged cross-power spectrum Baseline: EF (01) - WB (02)
Timerange: 00/03:48:40 to 00/03:49:45

Plot file version 72 created 24-MAR-2014 14:38:02

J1128+5925 EP087F 5.UVDATA.1

Freq = 8.3520 GHz, Bw = 16.000 MH Calibrated with CL # 3 and BP # 1 (BP mode 1)

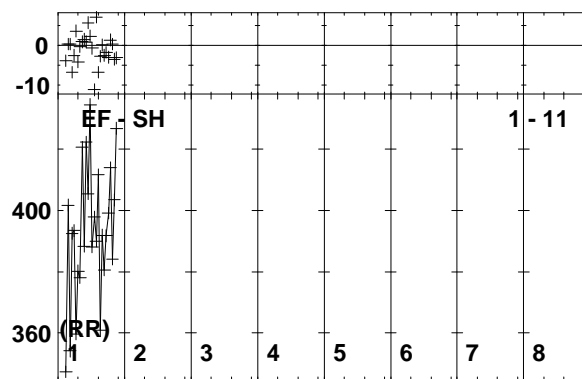
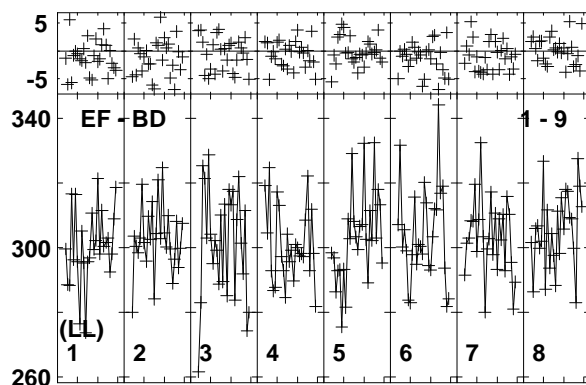
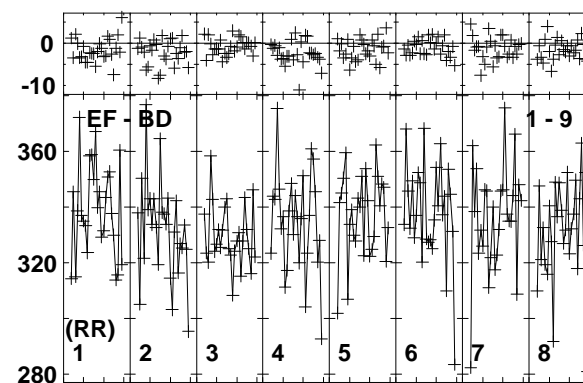
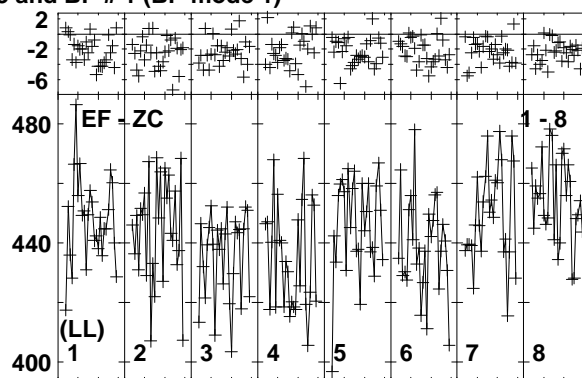
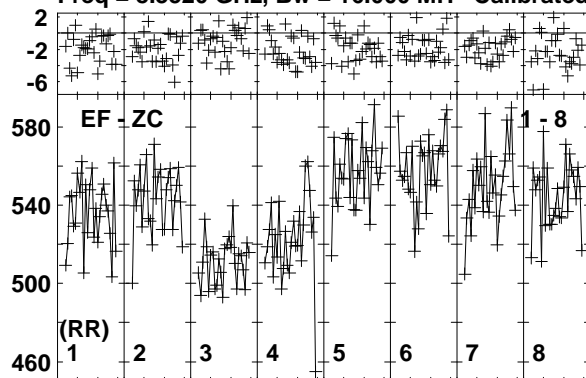

Lower frame: Milli Ampl Jy Top frame: Phas deg
Vector averaged cross-power spectrum Baseline: EF (01) - ZC (08)
Timerange: 00/03:48:40 to 00/03:49:45

Plot file version 73 created 24-MAR-2014 14:38:02

ARP299D EP087F 5.UVDATA.1

Freq = 8.3520 GHz, Bw = 16.000 MH Calibrated with CL # 3 and BP # 1 (BP mode 1)

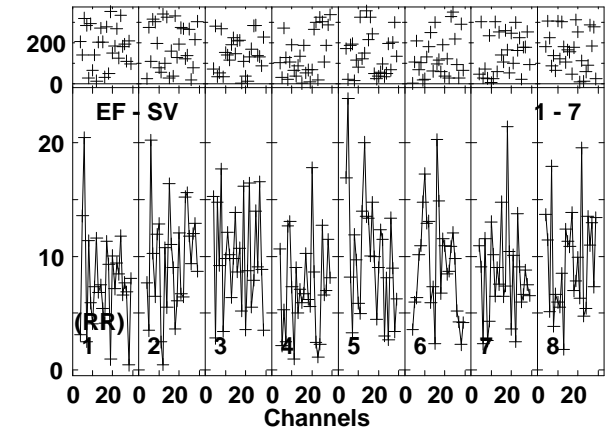
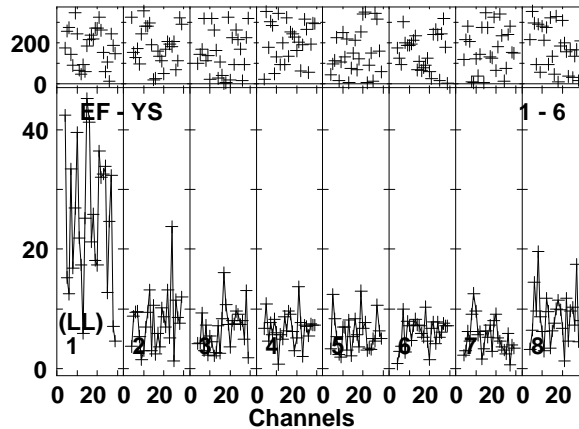
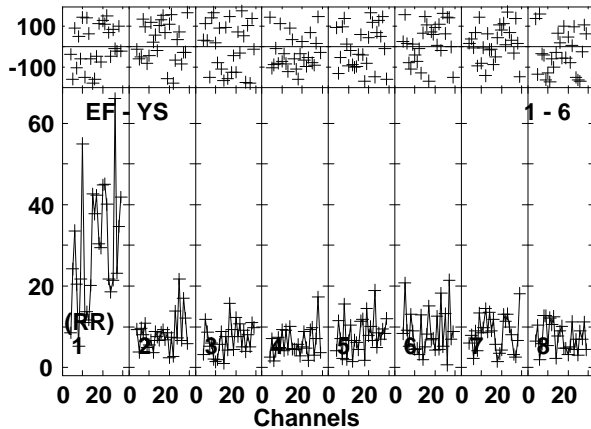
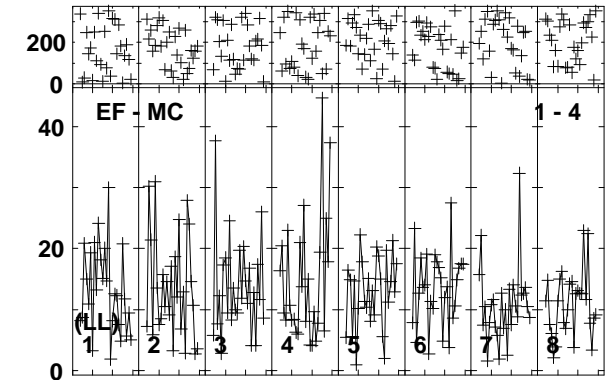
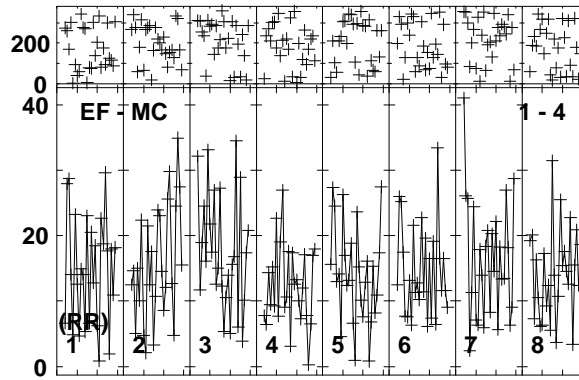
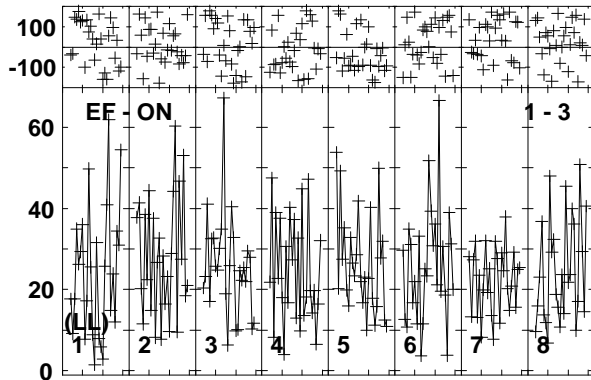
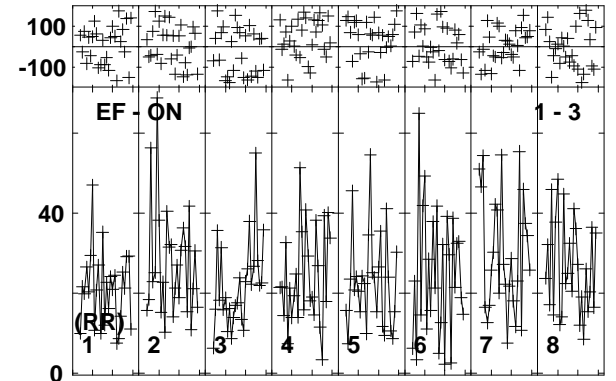
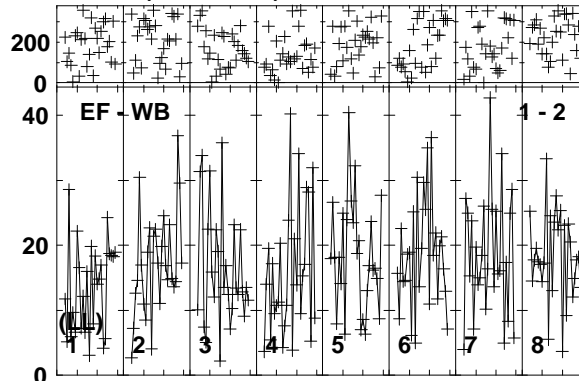
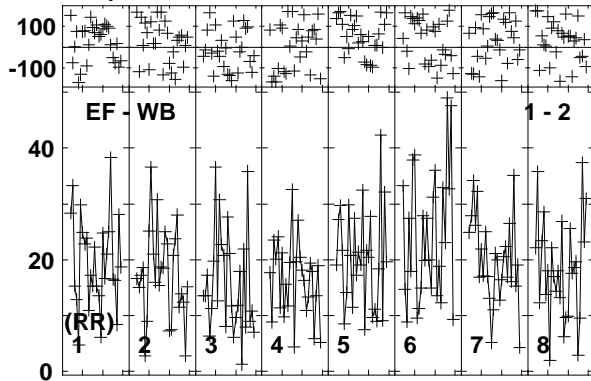

Lower frame: Milli Ampl Jy Top frame: Phas deg
Vector averaged cross-power spectrum Baseline: EF (01) - WB (02)
Timerange: 00/03:49:45 to 00/03:52:45

Plot file version 74 created 24-MAR-2014 14:38:03
 ARP299D EP087F 5.UVDATA.1
 Freq = 8.3520 GHz, Bw = 16.000 MH Calibrated with CL # 3 and BP # 1 (BP mode 1)

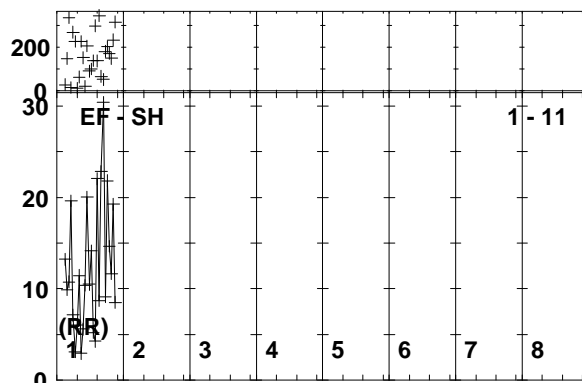
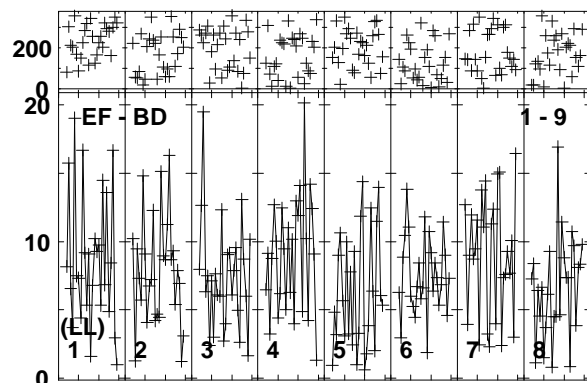
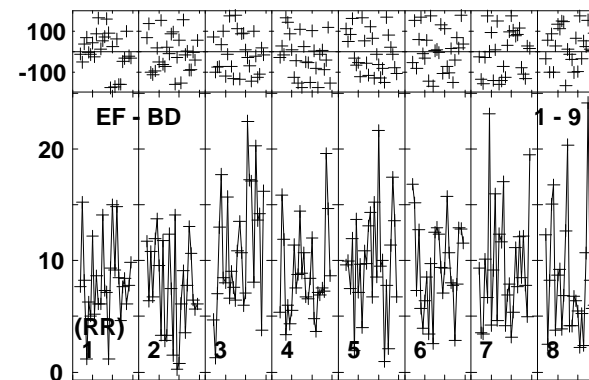
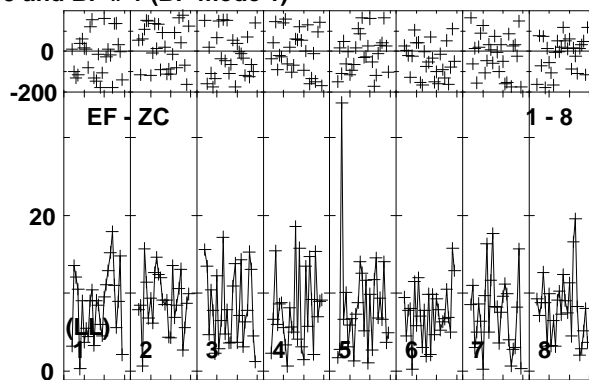
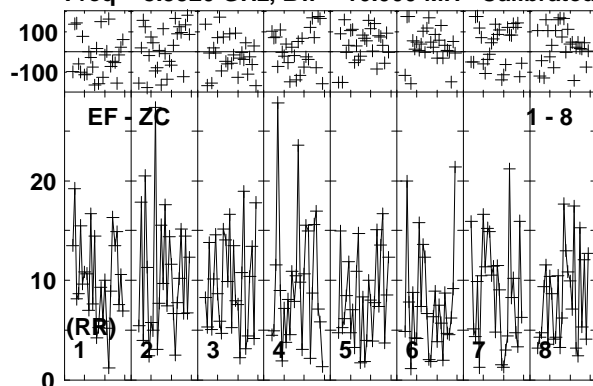

Lower frame: Milli Ampl Jy Top frame: Phas deg
 Vector averaged cross-power spectrum Baseline: EF (01) - ZC (08)
 Timerange: 00/03:49:45 to 00/03:52:45

Plot file version 75 created 24-MAR-2014 14:38:03

J1128+5925 EP087F 5.UVDATA.1

Freq = 8.3520 GHz, Bw = 16.000 MH Calibrated with CL # 3 and BP # 1 (BP mode 1)

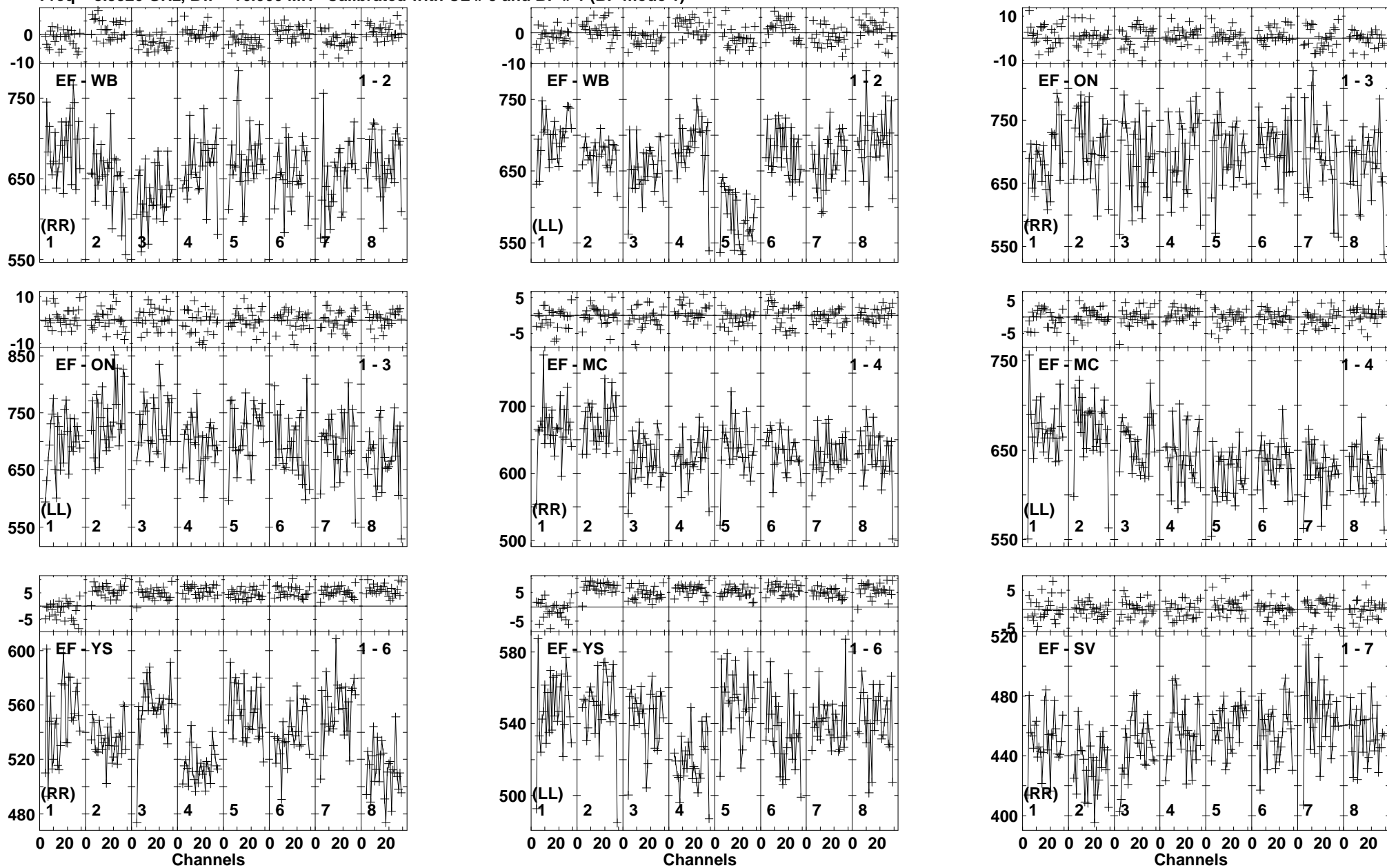

Lower frame: Milli Ampl Jy Top frame: Phas deg
Vector averaged cross-power spectrum Baseline: EF (01) - WB (02)
Timerange: 00/03:53:26 to 00/03:53:54

Plot file version 76 created 24-MAR-2014 14:38:03

J1128+5925 EP087F 5.UVDATA.1

Freq = 8.3520 GHz, Bw = 16.000 MH Calibrated with CL # 3 and BP # 1 (BP mode 1)

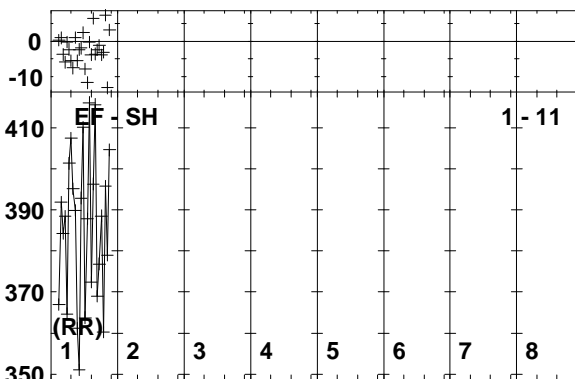
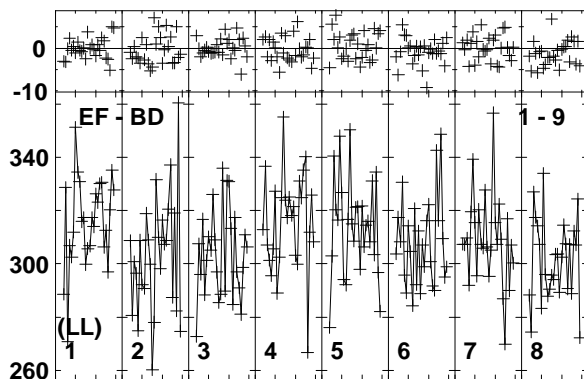
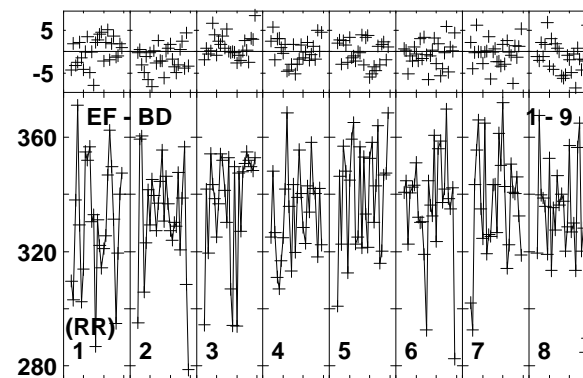
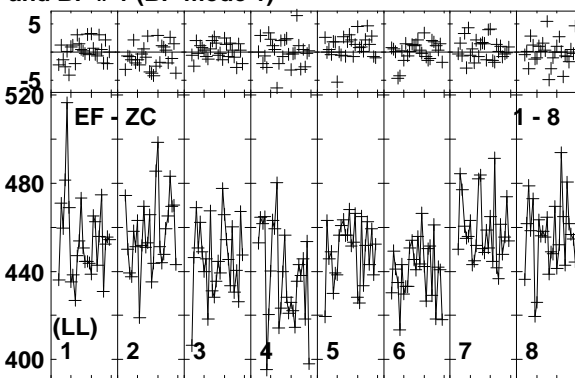
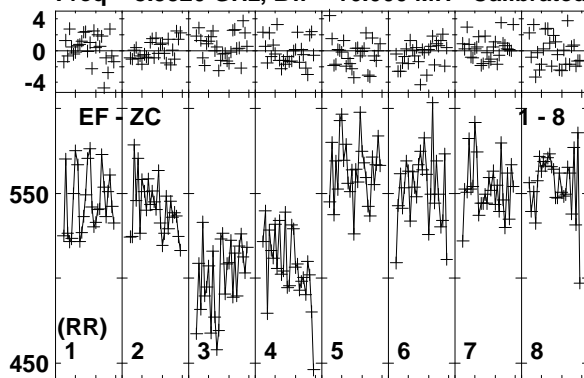

Lower frame: Milli Ampl Jy Top frame: Phas deg
Vector averaged cross-power spectrum Baseline: EF (01) - ZC (08)
Timerange: 00/03:53:26 to 00/03:53:54

Plot file version 77 created 24-MAR-2014 14:38:03
 ARP299D EP087F 5.UVDATA.1
 Freq = 8.3520 GHz, Bw = 16.000 MH Calibrated with CL # 3 and BP # 1 (BP mode 1)

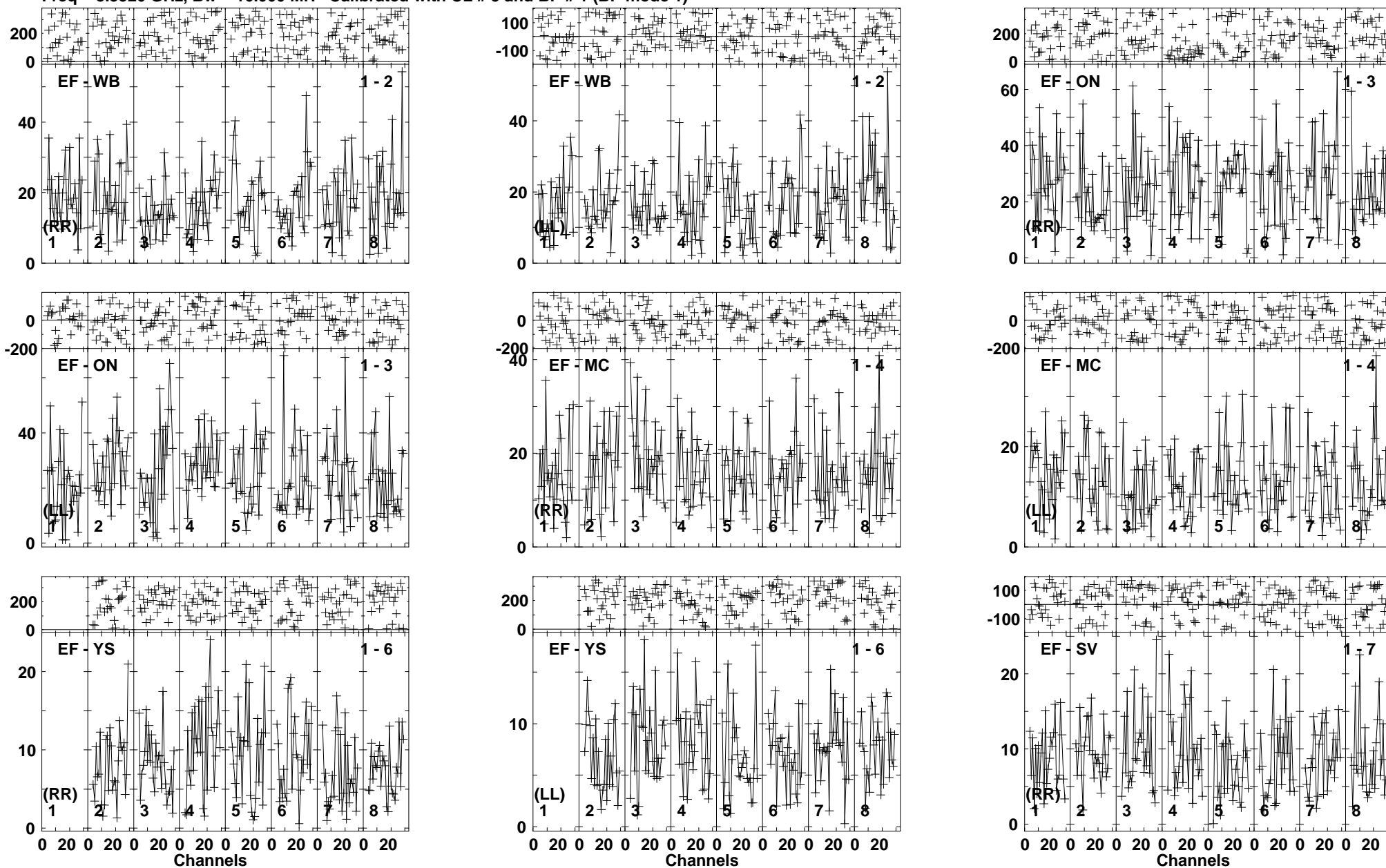

Lower frame: Milli Ampl Jy Top frame: Phas deg
 Vector averaged cross-power spectrum Baseline: EF (01) - WB (02)
 Timerange: 00/03:53:59 to 00/03:56:55

Plot file version 78 created 24-MAR-2014 14:38:04

ARP299D EP087F 5.UVDATA.1

Freq = 8.3520 GHz, Bw = 16.000 MH Calibrated with CL # 3 and BP # 1 (BP mode 1)

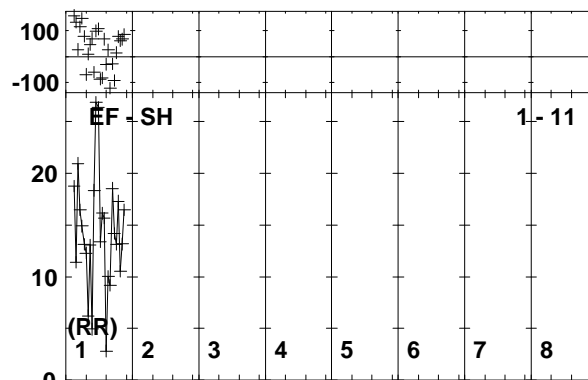
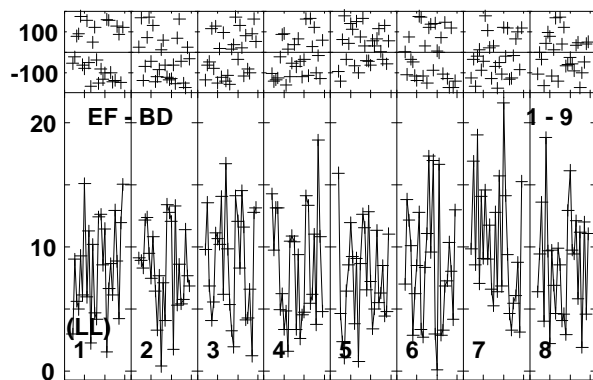
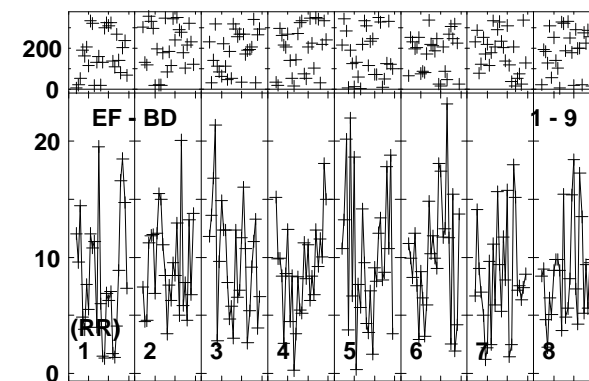
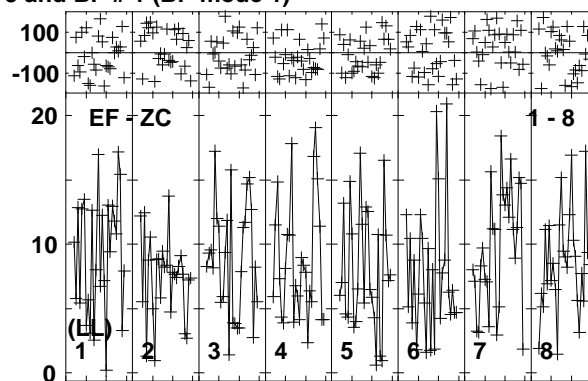
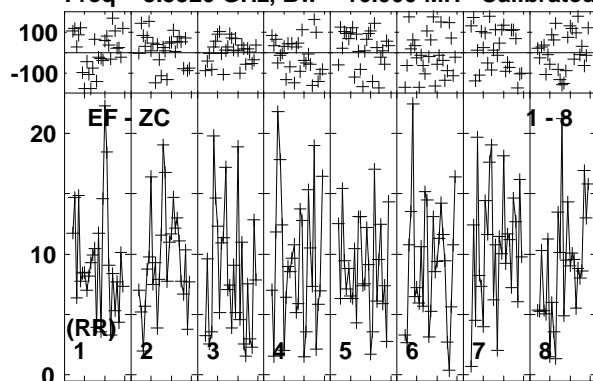

Lower frame: Milli Ampl Jy Top frame: Phas deg
Vector averaged cross-power spectrum Baseline: EF (01) - ZC (08)
Timerange: 00/03:53:59 to 00/03:56:55

Plot file version 79 created 24-MAR-2014 14:38:04

J1128+5925 EP087F 5.UVDATA.1

Freq = 8.3520 GHz, Bw = 16.000 MH Calibrated with CL # 3 and BP # 1 (BP mode 1)

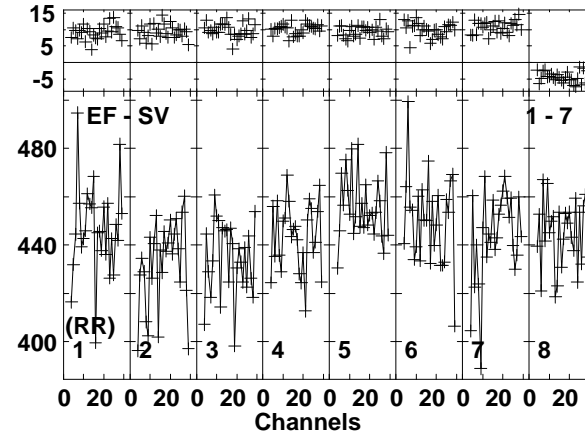
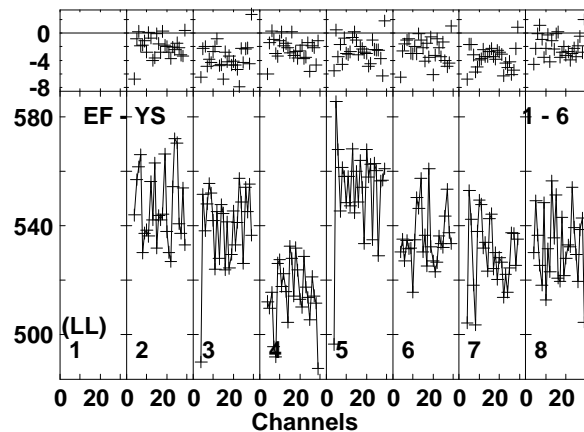
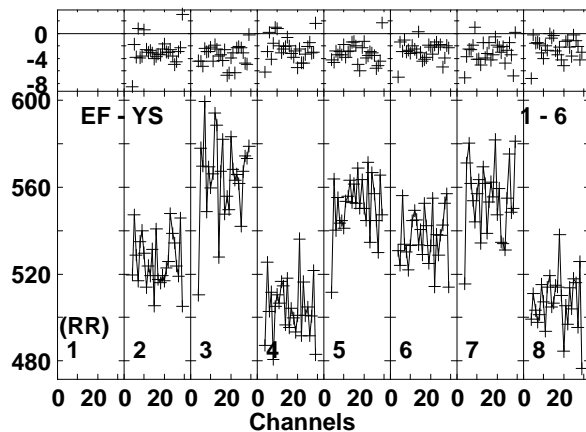
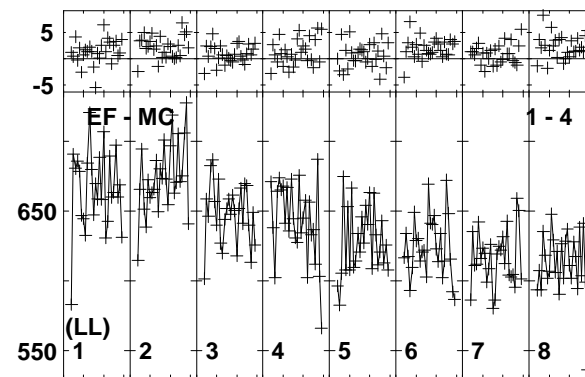
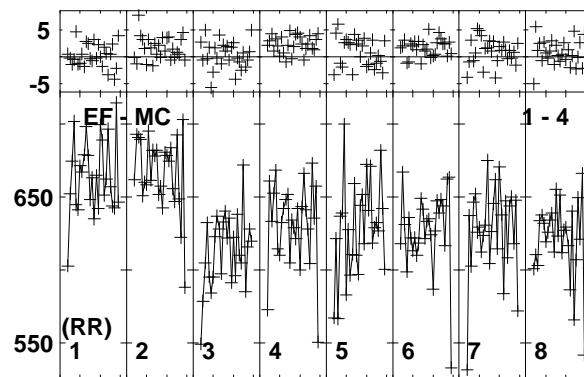
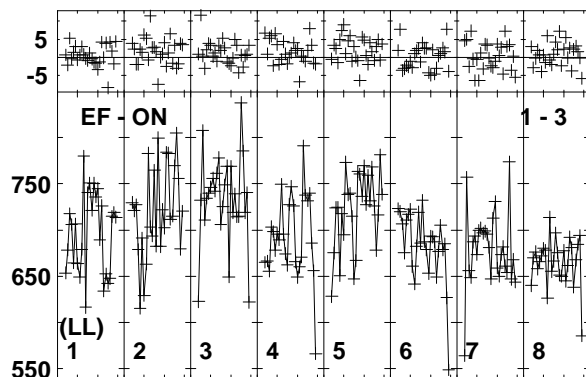
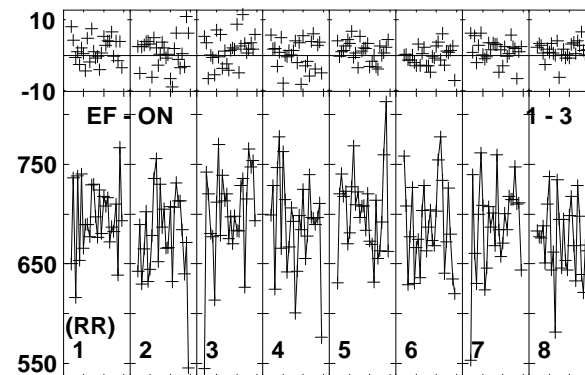
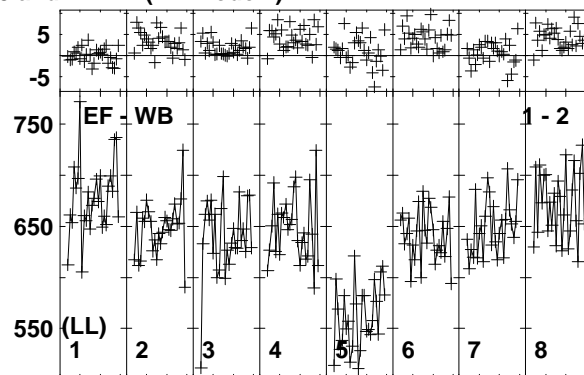
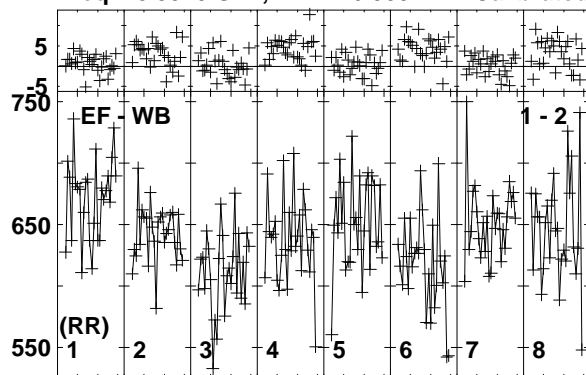

Lower frame: Milli Ampl Jy Top frame: Phas deg
Vector averaged cross-power spectrum Baseline: EF (01) - WB (02)
Timerange: 00/03:56:55 to 00/03:58:00

Plot file version 80 created 24-MAR-2014 14:38:04

J1128+5925 EP087F 5.UVDATA.1

Freq = 8.3520 GHz, Bw = 16.000 MH Calibrated with CL # 3 and BP # 1 (BP mode 1)

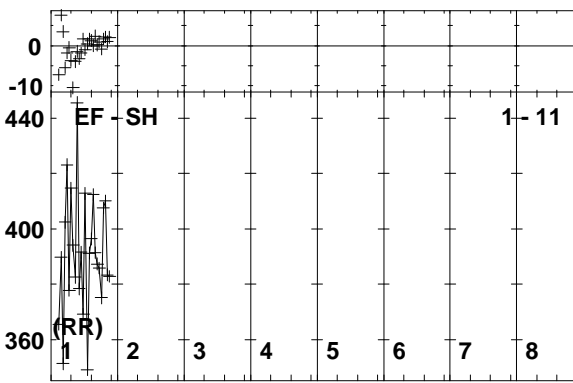
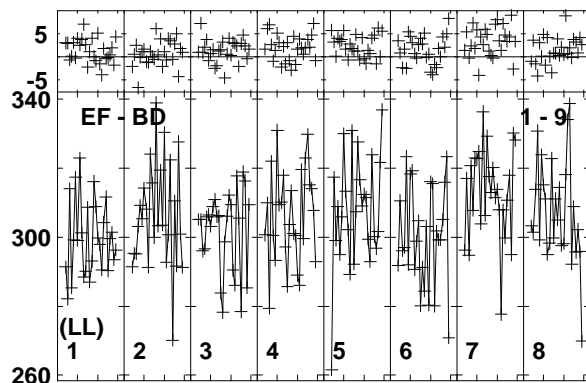
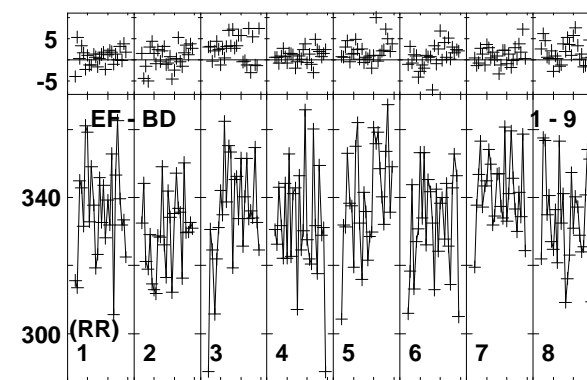
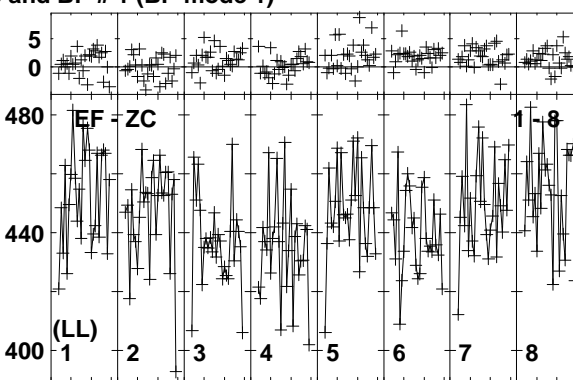
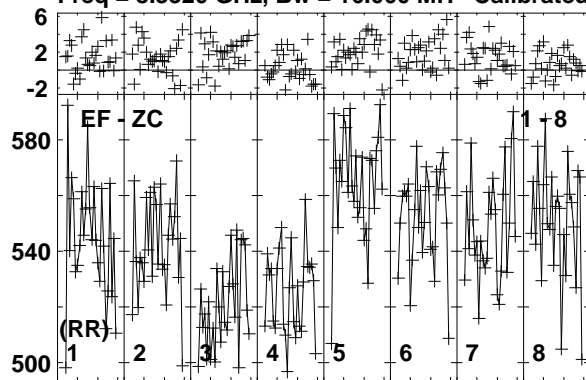

Lower frame: Milli Ampl Jy Top frame: Phas deg
Vector averaged cross-power spectrum Baseline: EF (01) - ZC (08)
Timerange: 00/03:56:55 to 00/03:58:00

Plot file version 81 created 24-MAR-2014 14:38:04

ARP299D EP087F 5.UVDATA.1

Freq = 8.3520 GHz, Bw = 16.000 MH Calibrated with CL # 3 and BP # 1 (BP mode 1)

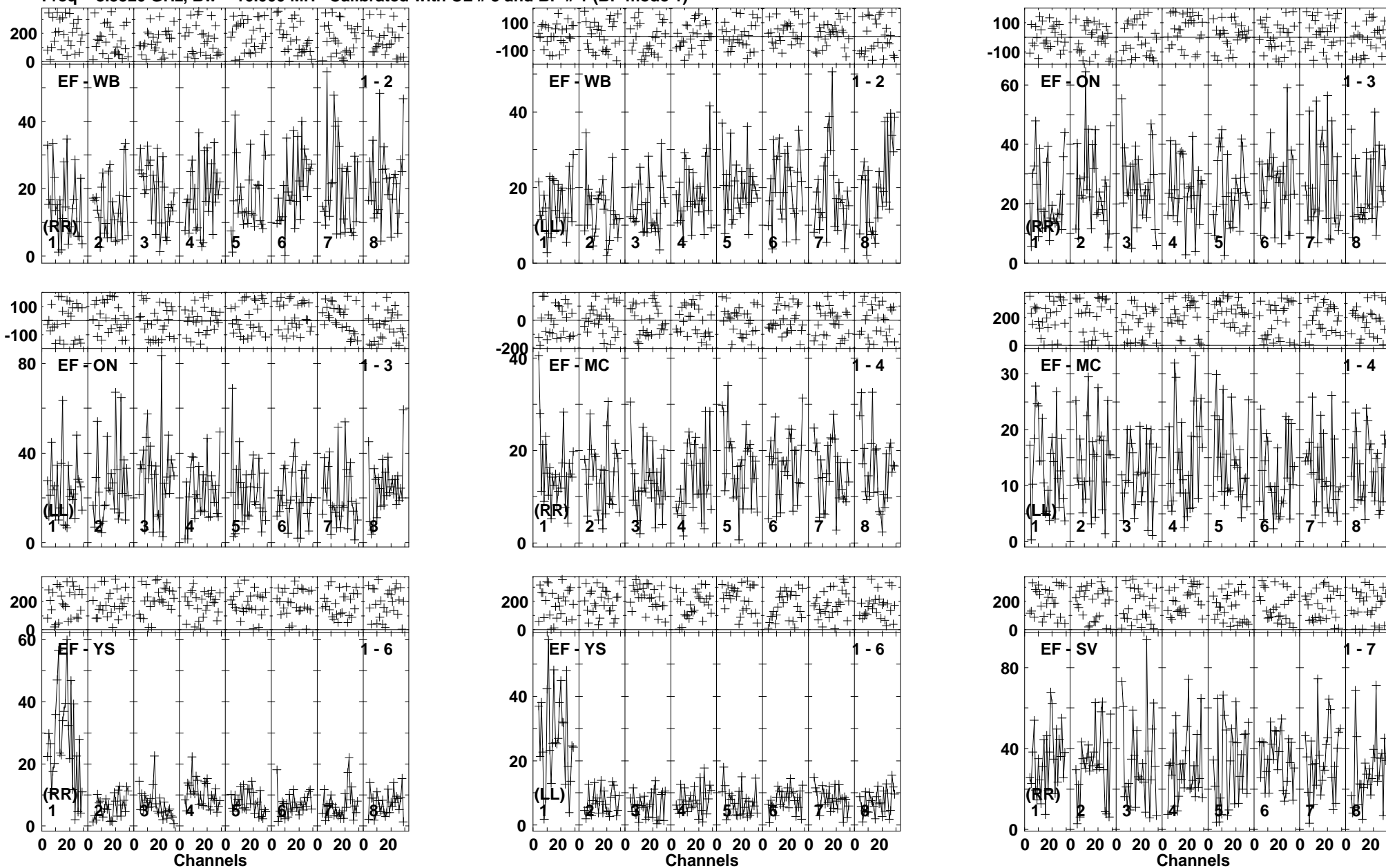

Lower frame: Milli Ampl Jy Top frame: Phas deg
Vector averaged cross-power spectrum Baseline: EF (01) - WB (02)
Timerange: 00/03:58:00 to 00/04:01:00

Plot file version 82 created 24-MAR-2014 14:38:05

ARP299D EP087F 5.UVDATA.1

Freq = 8.3520 GHz, Bw = 16.000 MH Calibrated with CL # 3 and BP # 1 (BP mode 1)

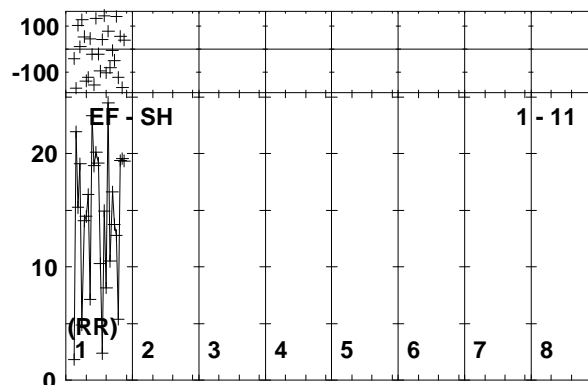
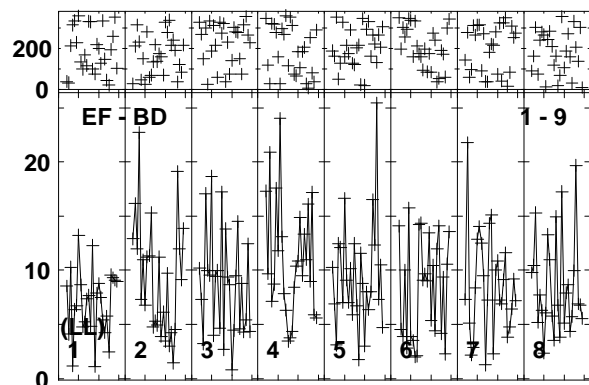
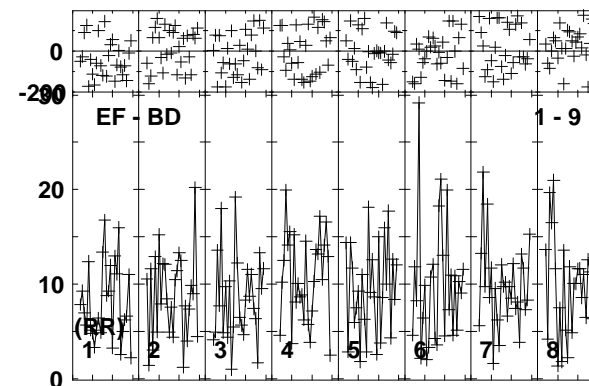
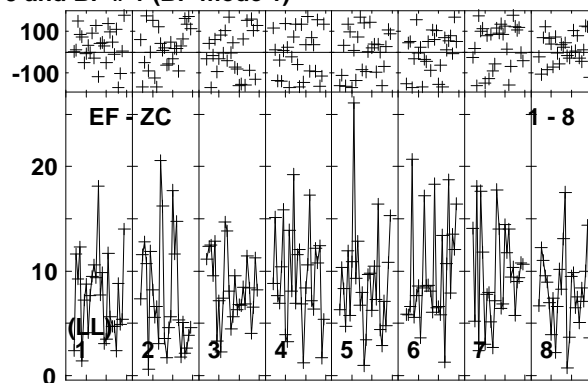
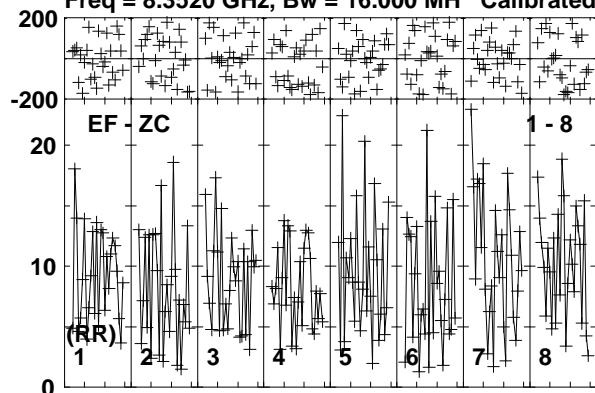

Lower frame: Milli Ampl Jy Top frame: Phas deg
Vector averaged cross-power spectrum Baseline: EF (01) - ZC (08)
Timerange: 00/03:58:00 to 00/04:01:00

Plot file version 83 created 24-MAR-2014 14:38:05

J1128+5925 EP087F 5.UVDATA.1

Freq = 8.3520 GHz, Bw = 16.000 MH Calibrated with CL # 3 and BP # 1 (BP mode 1)

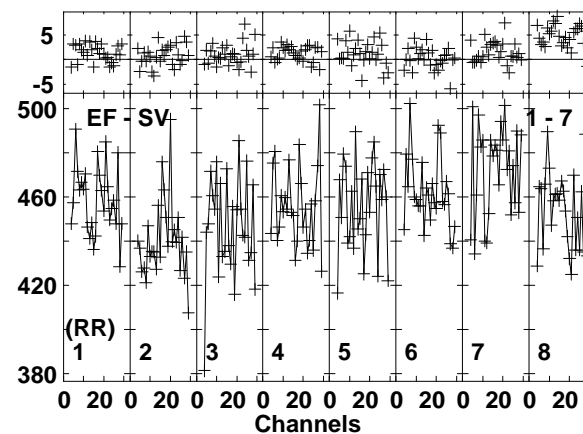
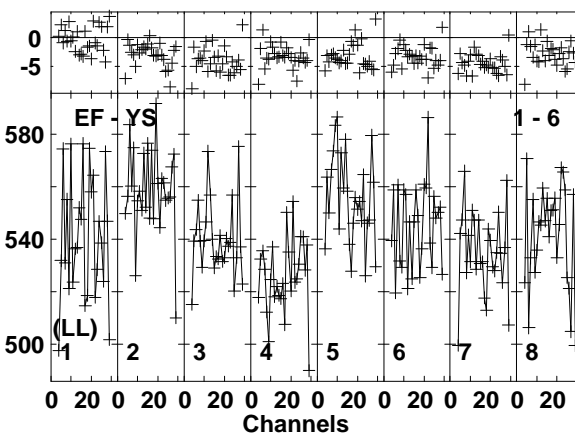
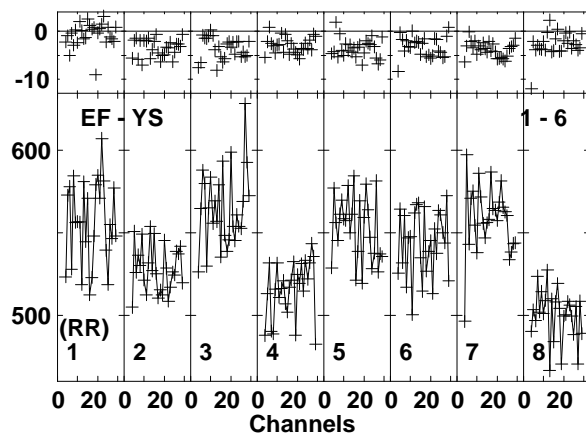
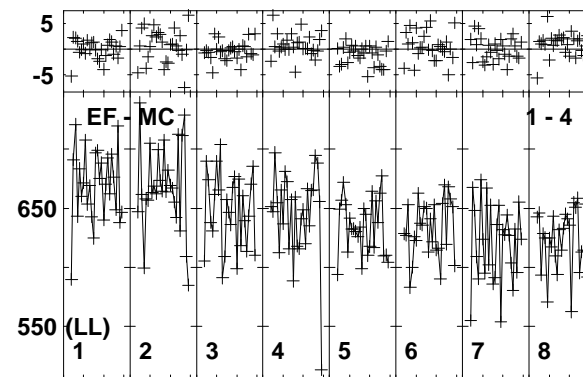
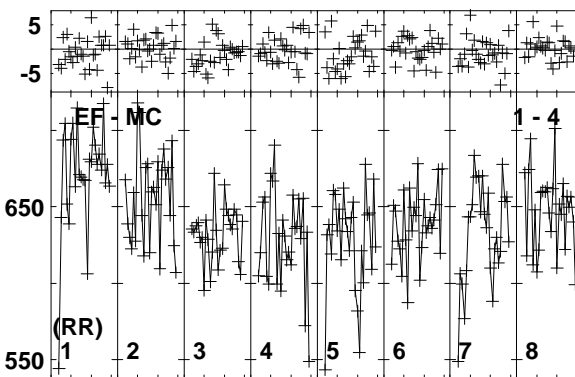
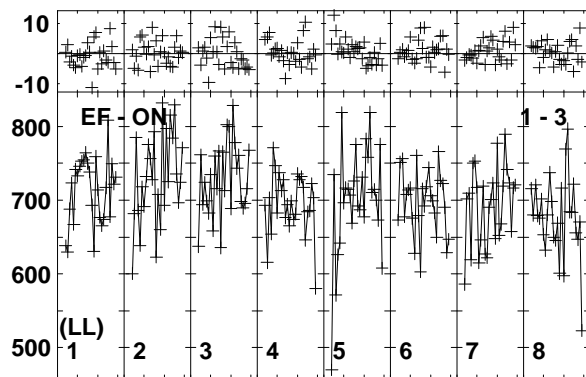
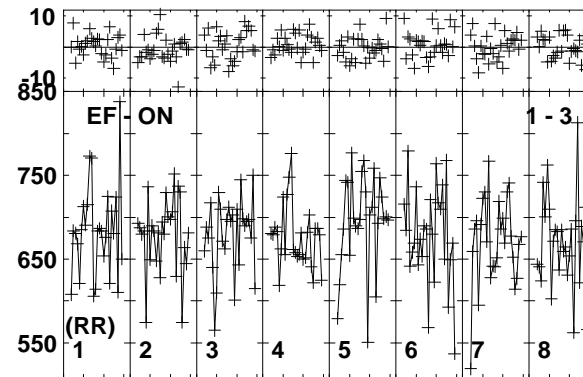
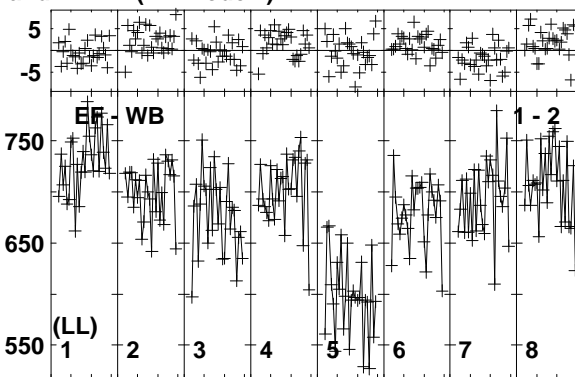
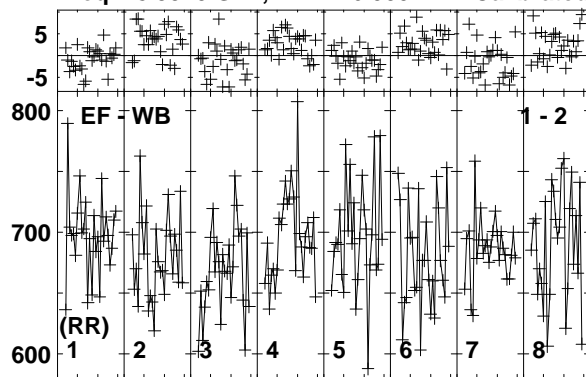

Lower frame: Milli Ampl Jy Top frame: Phas deg
Vector averaged cross-power spectrum Baseline: EF (01) - WB (02)
Timerange: 00/04:01:41 to 00/04:02:09

Plot file version 84 created 24-MAR-2014 14:38:05

J1128+5925 EP087F 5.UVDATA.1

Freq = 8.3520 GHz, Bw = 16.000 MH Calibrated with CL # 3 and BP # 1 (BP mode 1)

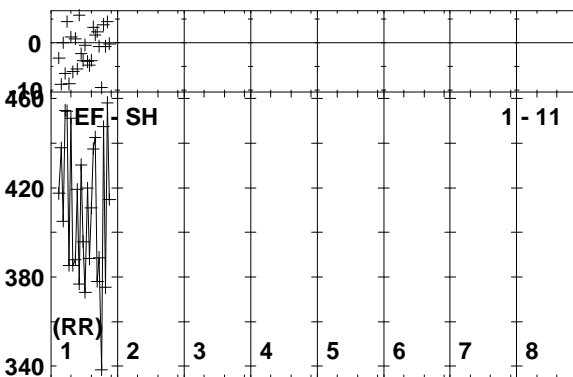
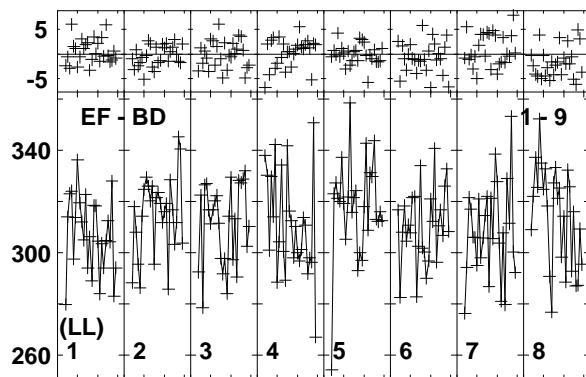
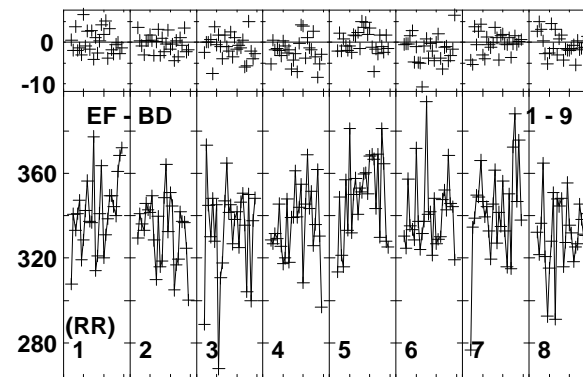
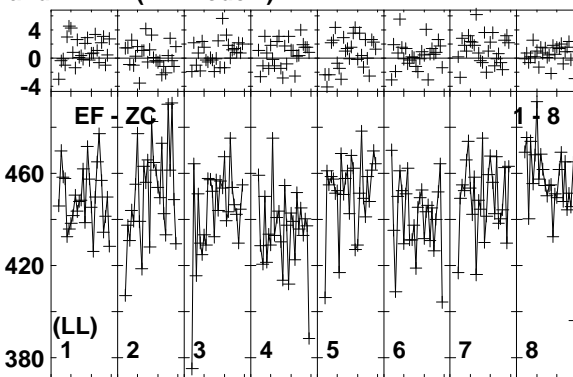
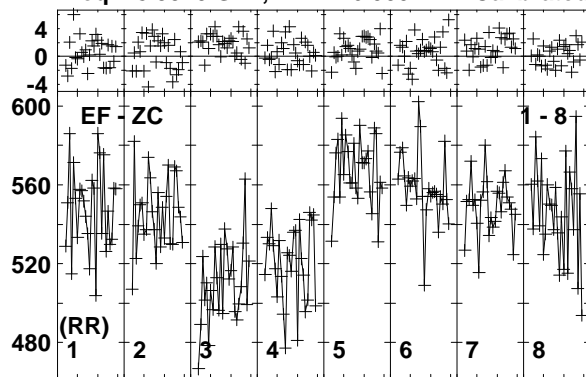

Lower frame: Milli Ampl Jy Top frame: Phas deg
Vector averaged cross-power spectrum Baseline: EF (01) - ZC (08)
Timerange: 00/04:01:41 to 00/04:02:09

Plot file version 85 created 24-MAR-2014 14:38:05

ARP299D EP087F 5.UVDATA.1

Freq = 8.3520 GHz, Bw = 16.000 MH Calibrated with CL # 3 and BP # 1 (BP mode 1)

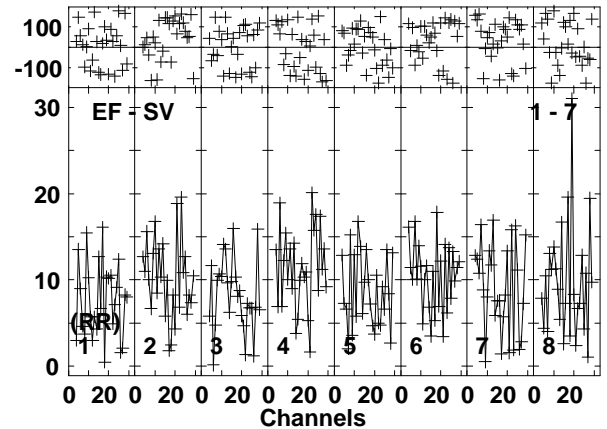
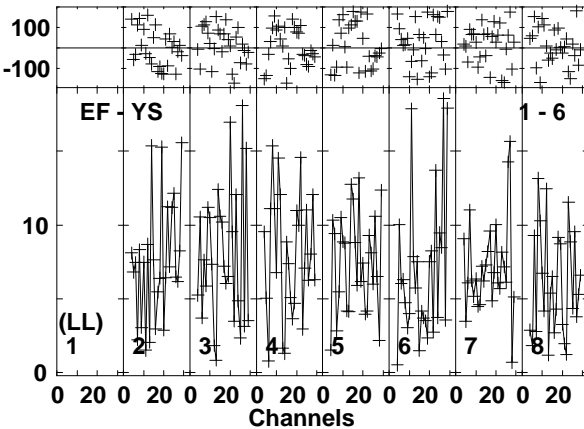
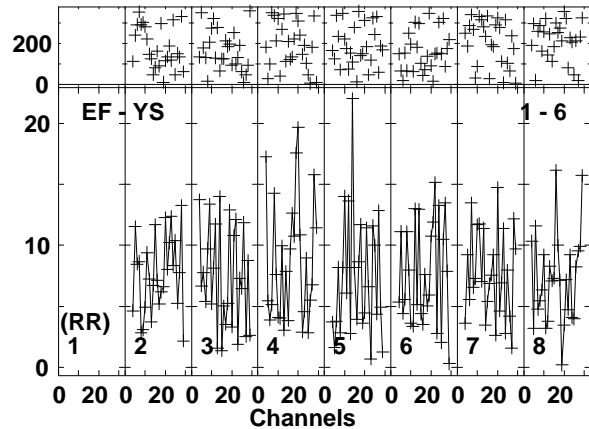
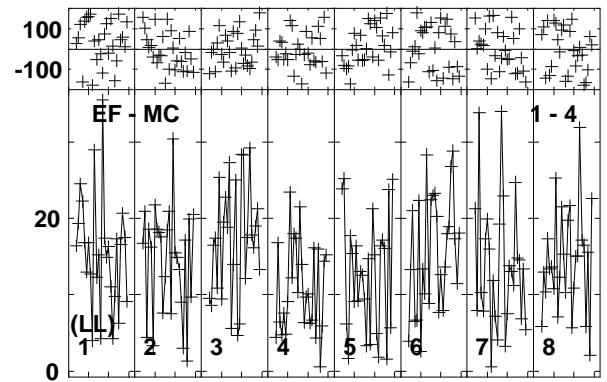
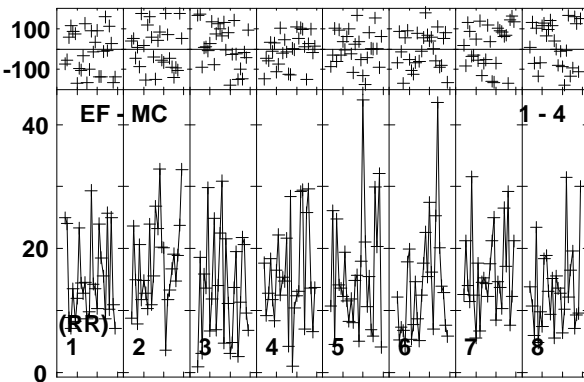
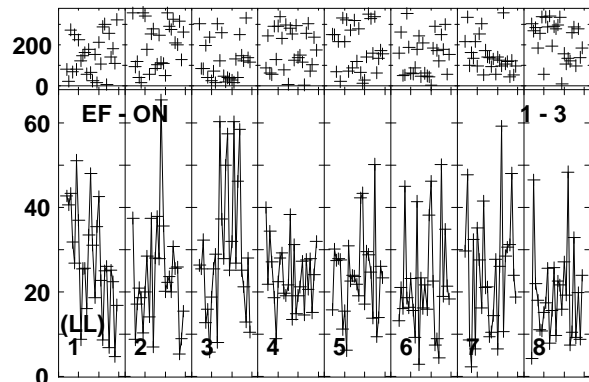
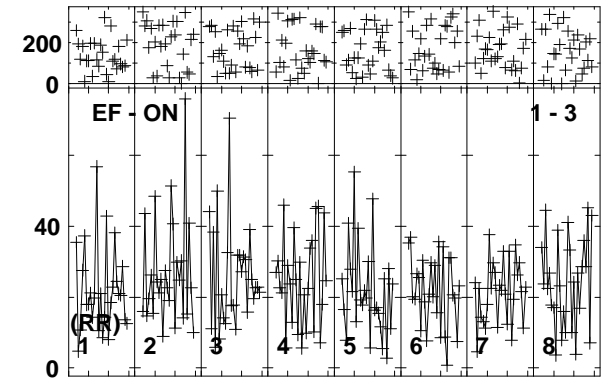
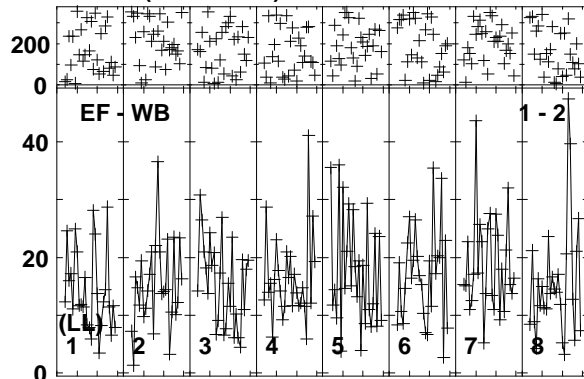
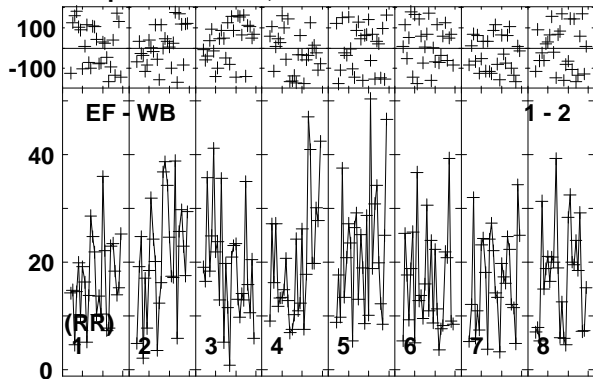

Lower frame: Milli Ampl Jy Top frame: Phas deg
Vector averaged cross-power spectrum Baseline: EF (01) - WB (02)
Timerange: 00/04:02:15 to 00/04:05:09

Plot file version 86 created 24-MAR-2014 14:38:06

ARP299D EP087F 5.UVDATA.1

Freq = 8.3520 GHz, Bw = 16.000 MH Calibrated with CL # 3 and BP # 1 (BP mode 1)

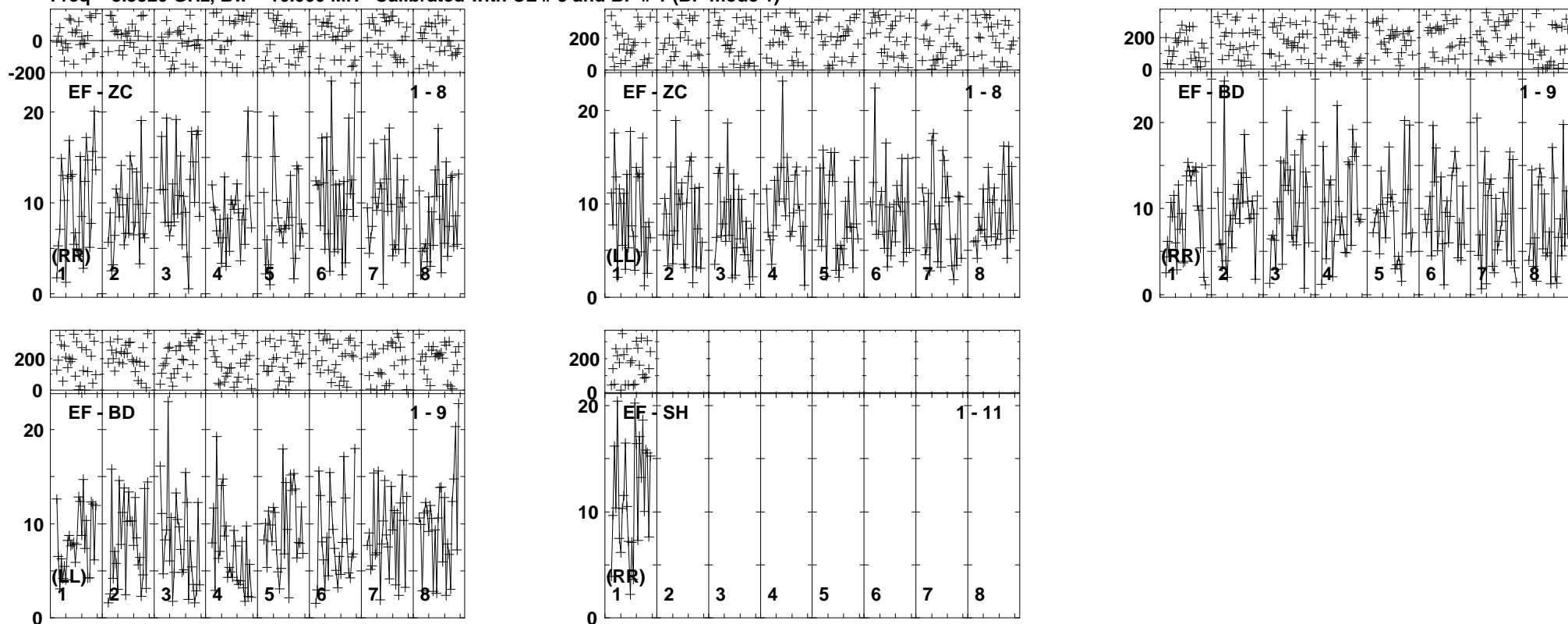

Lower frame: Milli Ampl Jy Top frame: Phas deg
Vector averaged cross-power spectrum Baseline: EF (01) - ZC (08)
Timerange: 00/04:02:15 to 00/04:05:09

Plot file version 87 created 24-MAR-2014 14:38:06

J1128+5925 EP087F 5.UVDATA.1

Freq = 8.3520 GHz, Bw = 16.000 MH Calibrated with CL # 3 and BP # 1 (BP mode 1)

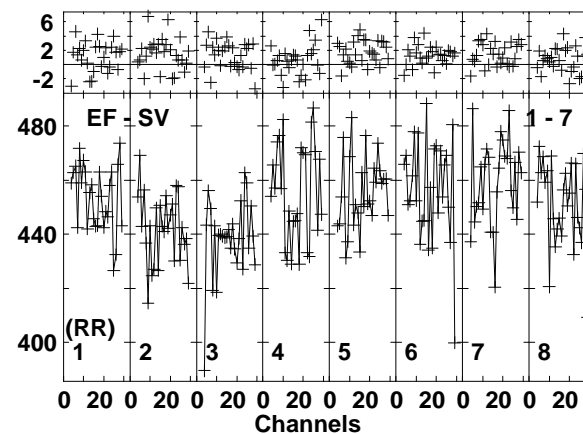
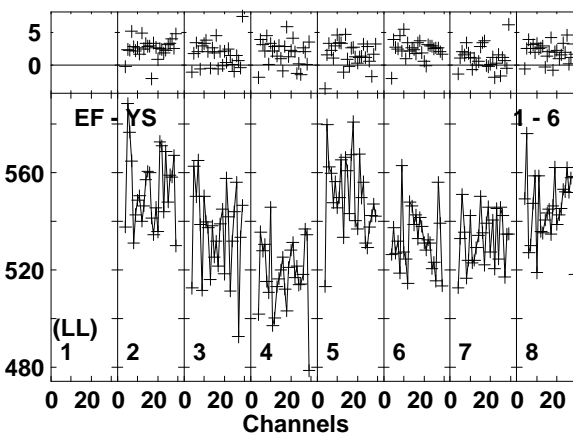
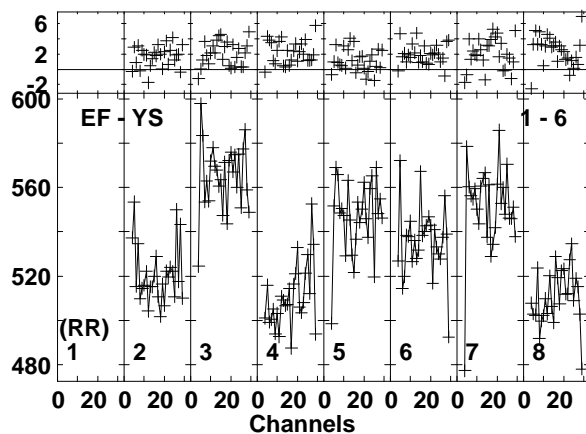
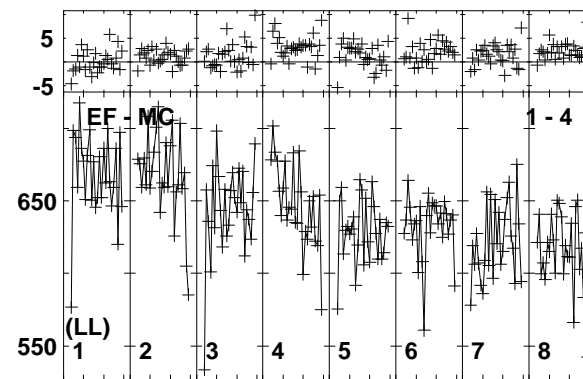
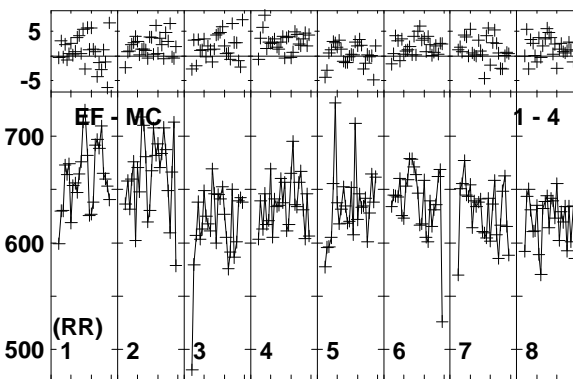
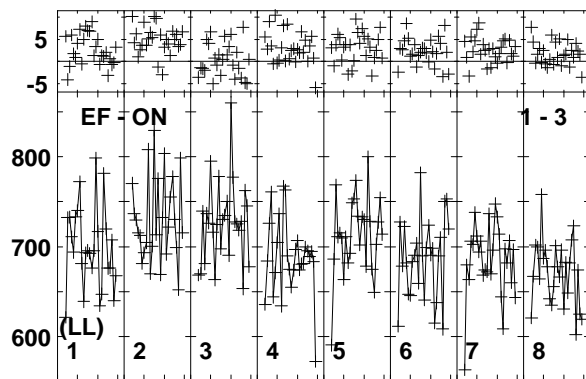
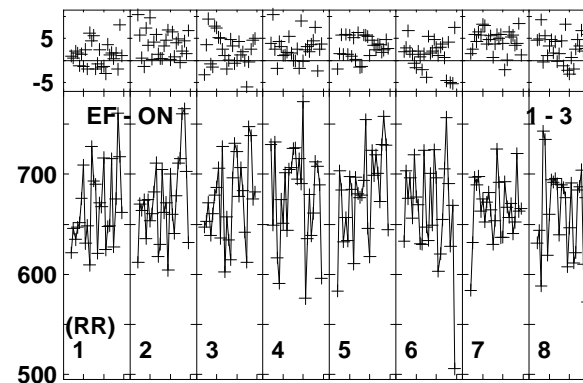
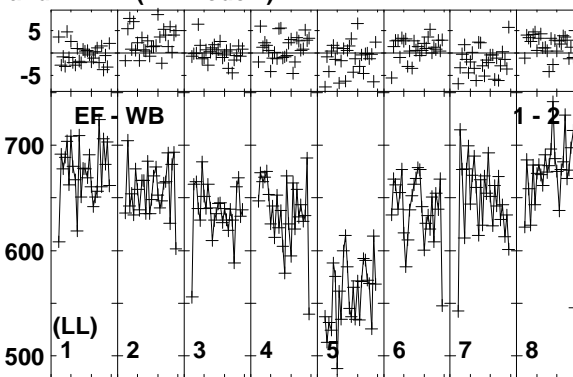
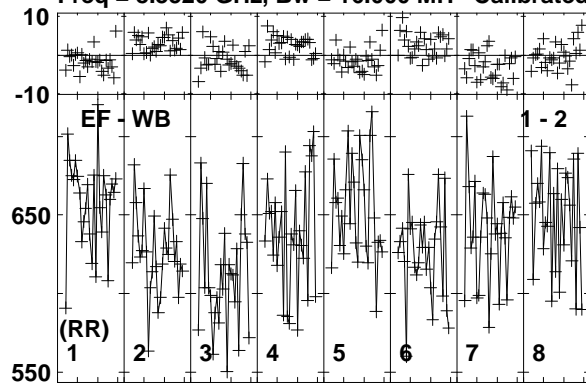

Lower frame: Milli Ampl Jy Top frame: Phas deg
Vector averaged cross-power spectrum Baseline: EF (01) - WB (02)
Timerange: 00/04:05:10 to 00/04:06:14

Plot file version 88 created 24-MAR-2014 14:38:06
 J1128+5925 EP087F 5.UVDATA.1
 Freq = 8.3520 GHz, Bw = 16.000 MH Calibrated with CL # 3 and BP # 1 (BP mode 1)

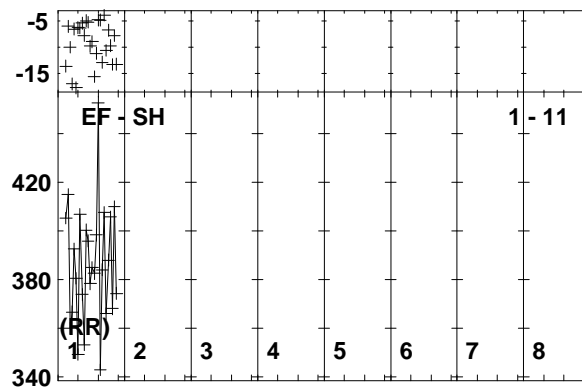
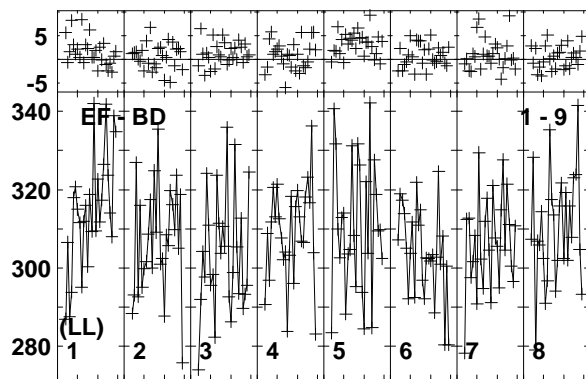
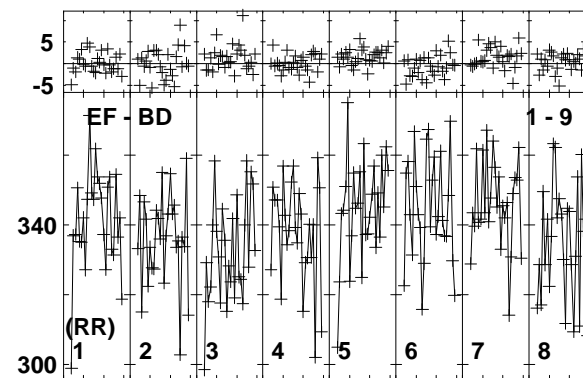
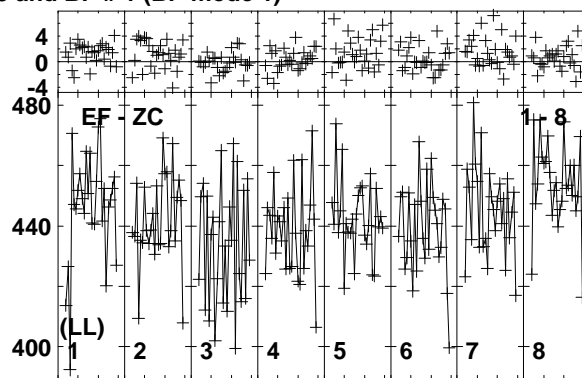
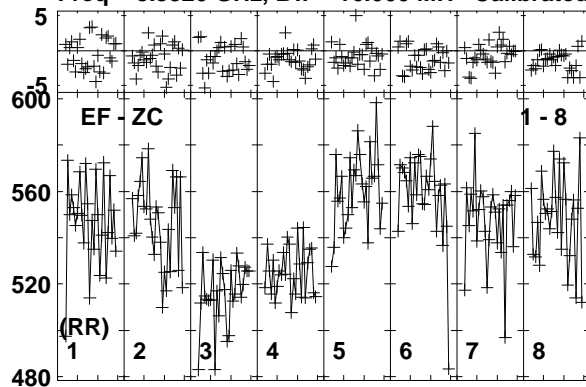

Lower frame: Milli Ampl Jy Top frame: Phas deg
 Vector averaged cross-power spectrum Baseline: EF (01) - ZC (08)
 Timerange: 00/04:05:10 to 00/04:06:14

Plot file version 89 created 24-MAR-2014 14:38:06

ARP299D EP087F 5.UVDATA.1

Freq = 8.3520 GHz, Bw = 16.000 MH Calibrated with CL # 3 and BP # 1 (BP mode 1)

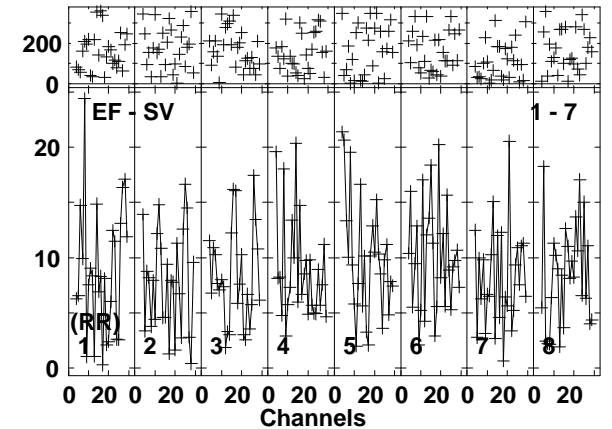
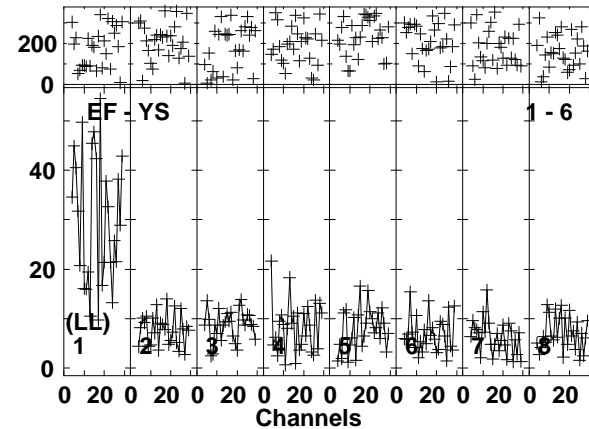
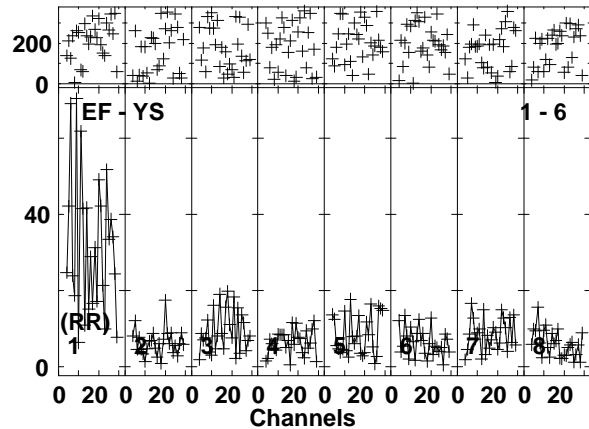
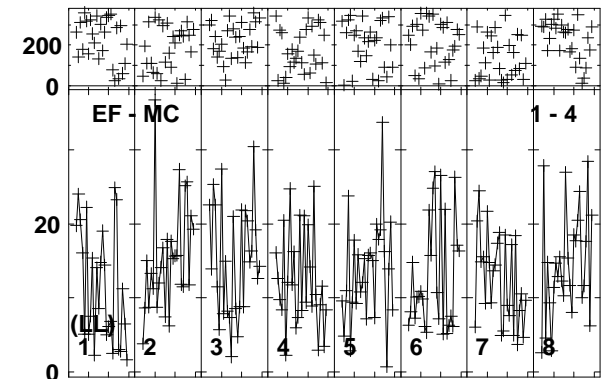
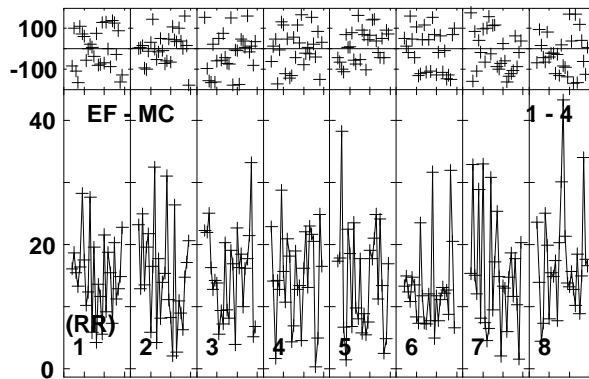
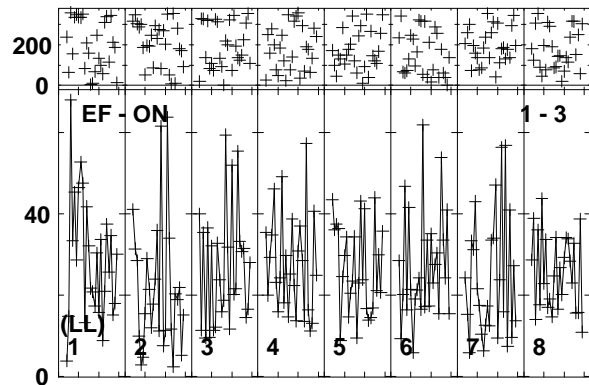
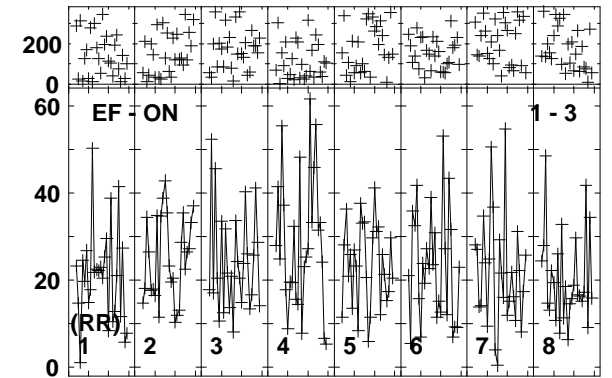
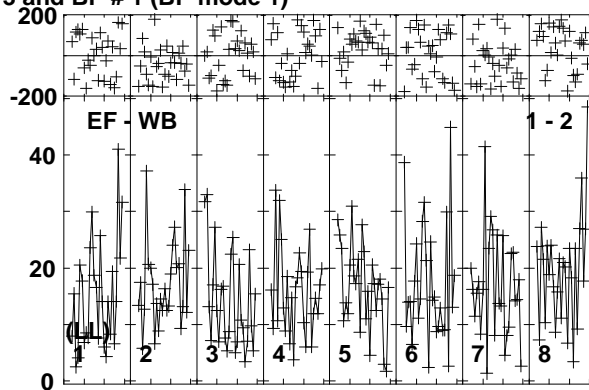
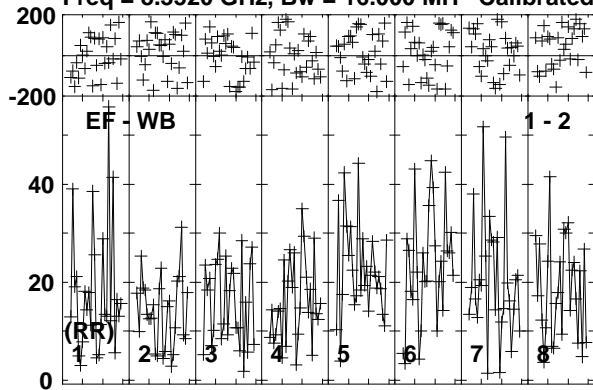

Lower frame: Milli Ampl Jy Top frame: Phas deg

Vector averaged cross-power spectrum Baseline: EF (01) - WB (02)

Timerange: 00/04:06:15 to 00/04:09:15

Plot file version 90 created 24-MAR-2014 14:38:07

ARP299D EP087F 5.UVDATA.1

Freq = 8.3520 GHz, Bw = 16.000 MH Calibrated with CL # 3 and BP # 1 (BP mode 1)

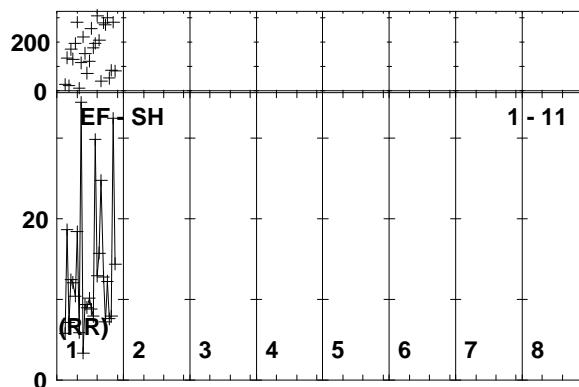
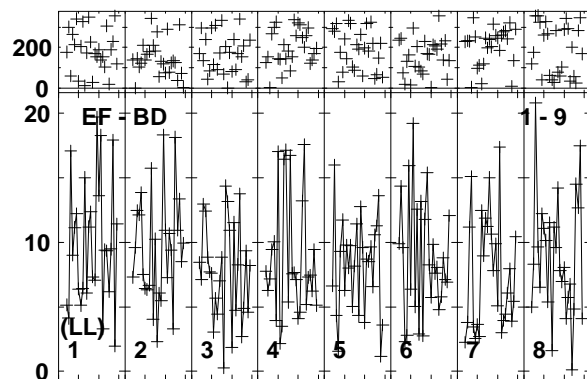
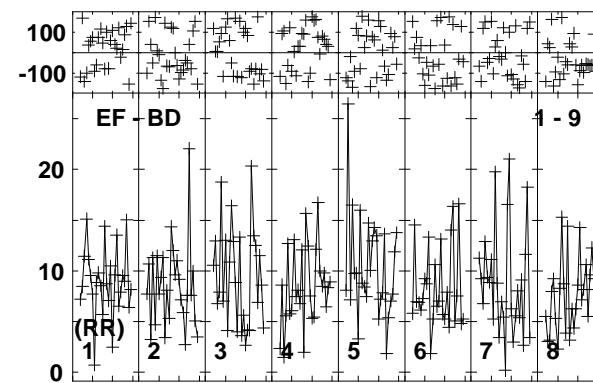
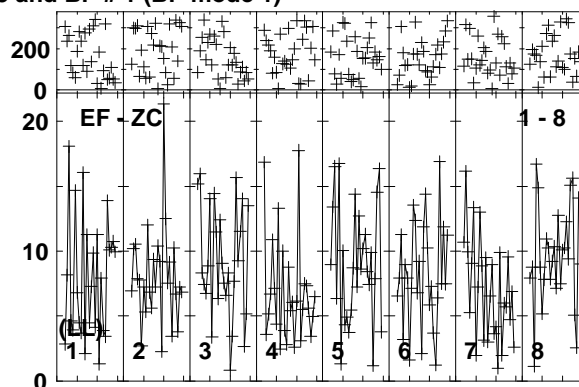
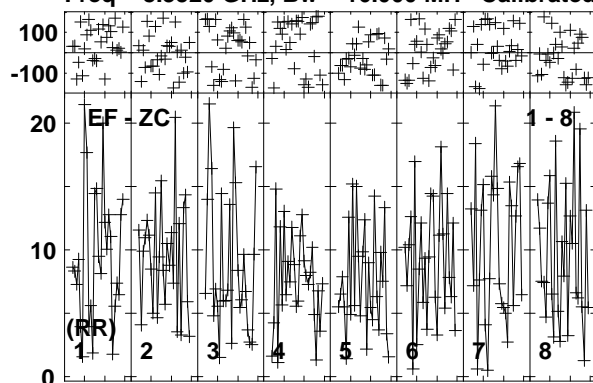

Lower frame: Milli Ampl Jy Top frame: Phas deg
Vector averaged cross-power spectrum Baseline: EF (01) - ZC (08)
Timerange: 00/04:06:15 to 00/04:09:15

Plot file version 91 created 24-MAR-2014 14:38:07

J1128+5925 EP087F 5.UVDATA.1

Freq = 8.3520 GHz, Bw = 16.000 MH Calibrated with CL # 3 and BP # 1 (BP mode 1)

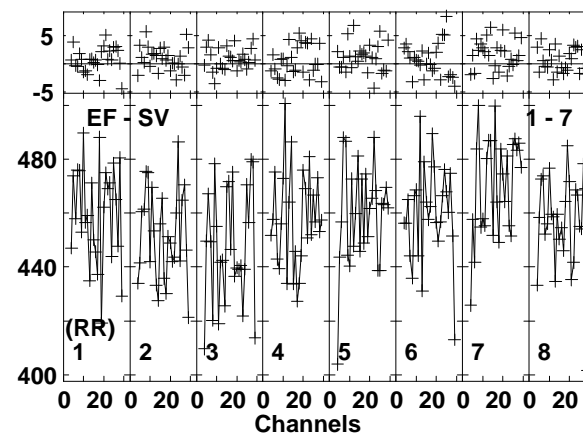
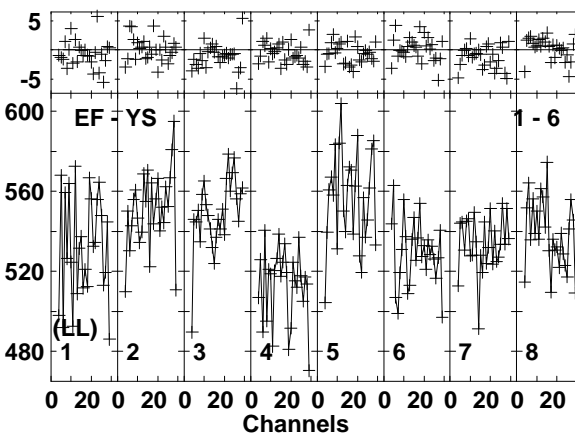
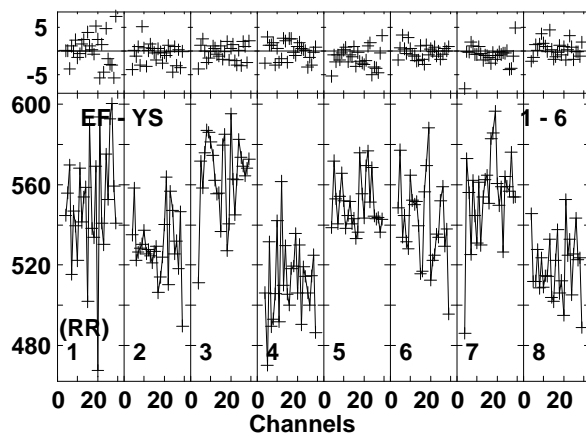
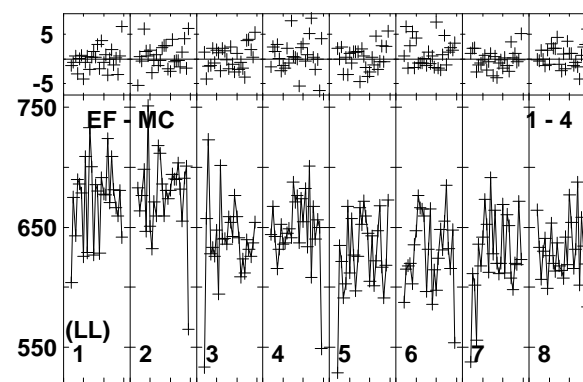
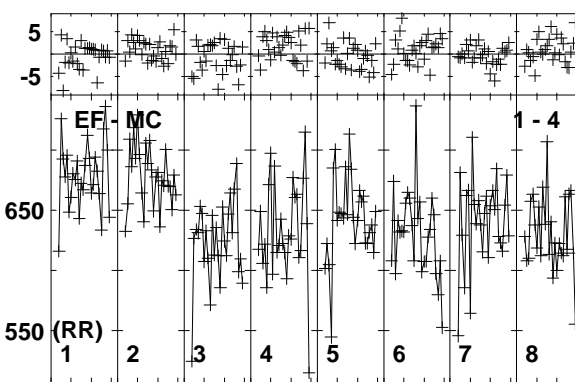
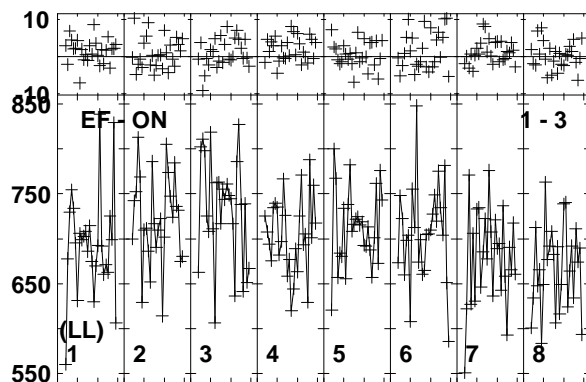
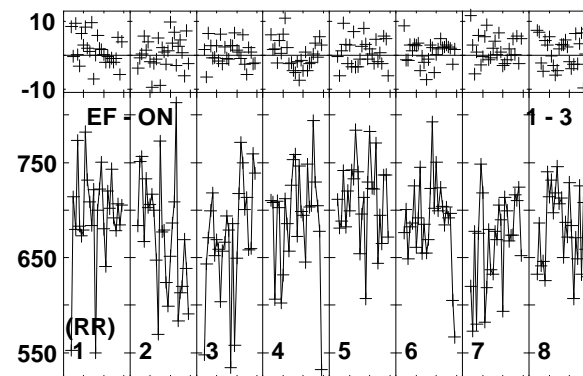
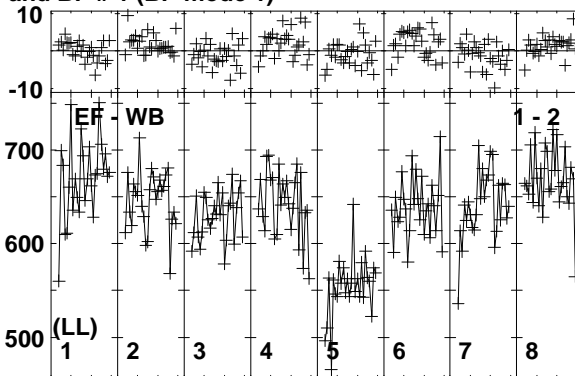
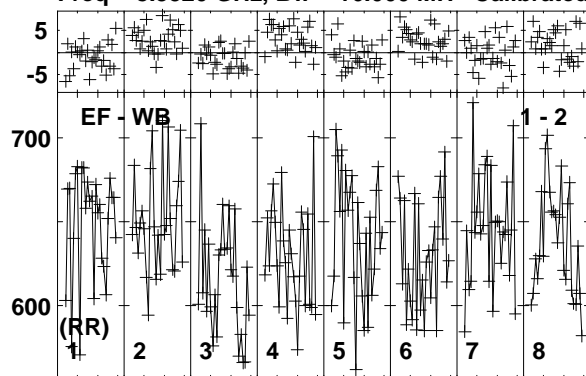

Lower frame: Milli Ampl Jy Top frame: Phas deg
Vector averaged cross-power spectrum Baseline: EF (01) - WB (02)
Timerange: 00/04:09:56 to 00/04:10:25

Plot file version 92 created 24-MAR-2014 14:38:07

J1128+5925 EP087F 5.UVDATA.1

Freq = 8.3520 GHz, Bw = 16.000 MH Calibrated with CL # 3 and BP # 1 (BP mode 1)

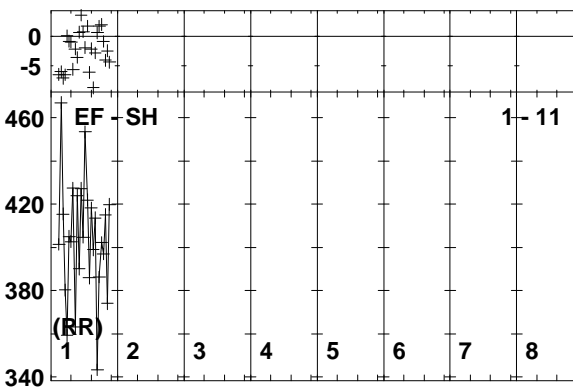
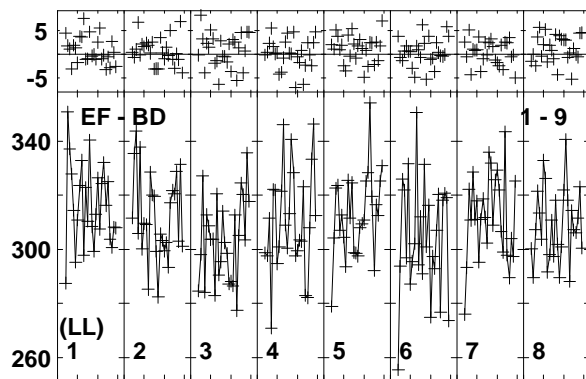
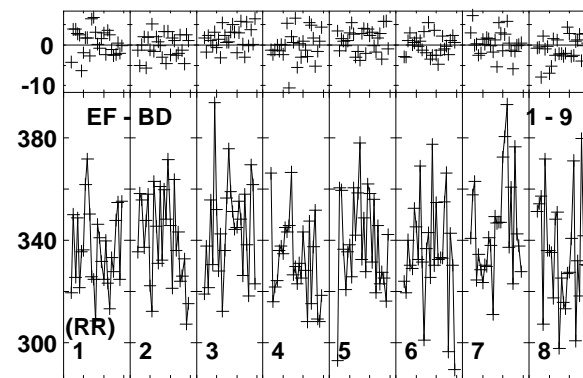
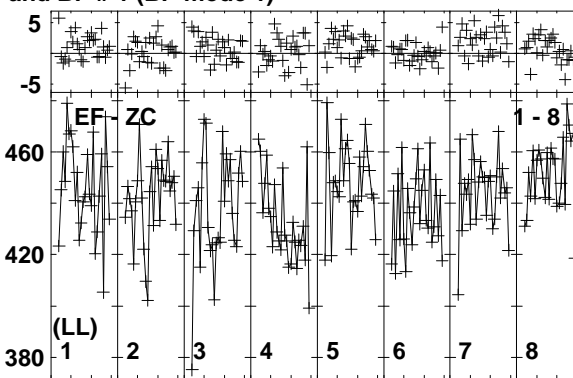
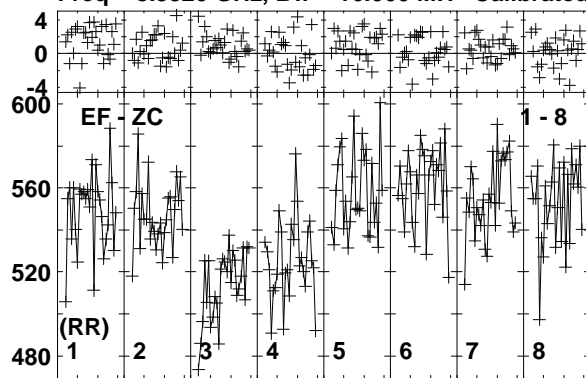

Lower frame: Milli Ampl Jy Top frame: Phas deg
Vector averaged cross-power spectrum Baseline: EF (01) - ZC (08)
Timerange: 00/04:09:56 to 00/04:10:25

Plot file version 93 created 24-MAR-2014 14:38:07

ARP299D EP087F 5.UVDATA.1

Freq = 8.3520 GHz, Bw = 16.000 MH Calibrated with CL # 3 and BP # 1 (BP mode 1)

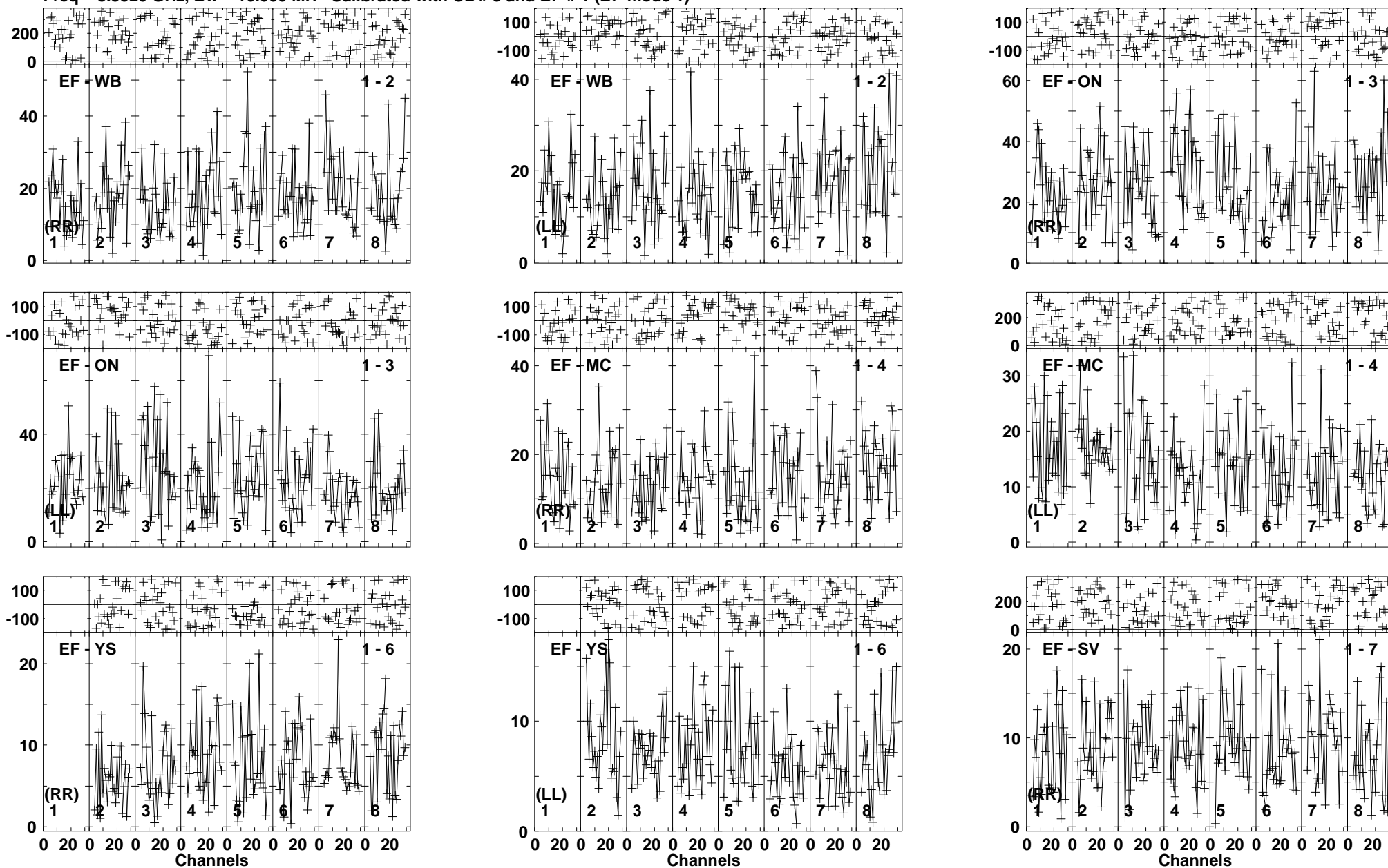

Lower frame: Milli Ampl Jy Top frame: Phas deg
Vector averaged cross-power spectrum Baseline: EF (01) - WB (02)
Timerange: 00/04:10:29 to 00/04:13:24

Plot file version 94 created 24-MAR-2014 14:38:08
 ARP299D EP087F 5.UVDATA.1
 Freq = 8.3520 GHz, Bw = 16.000 MH Calibrated with CL # 3 and BP # 1 (BP mode 1)

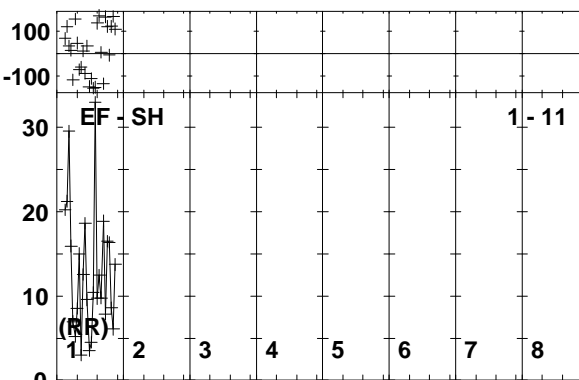
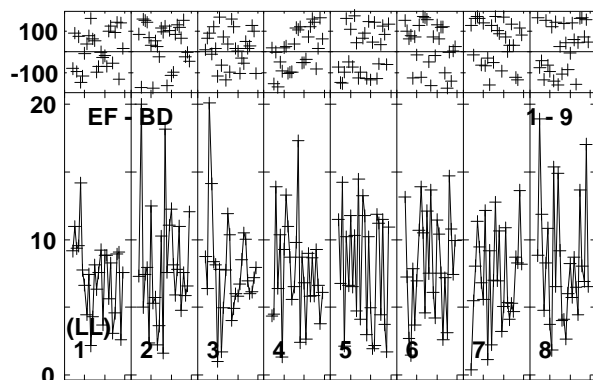
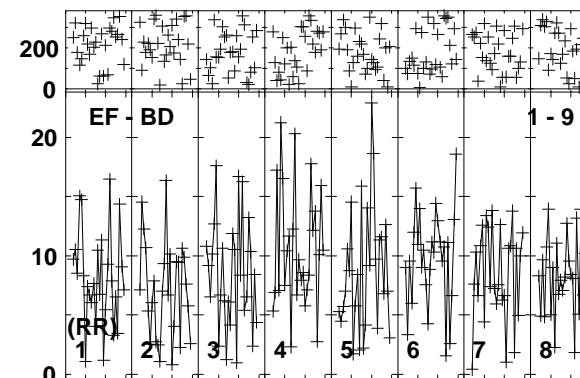
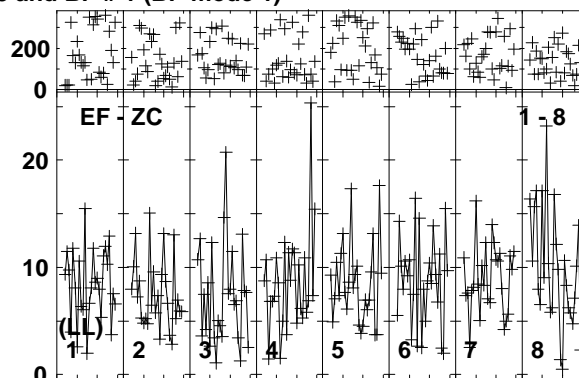
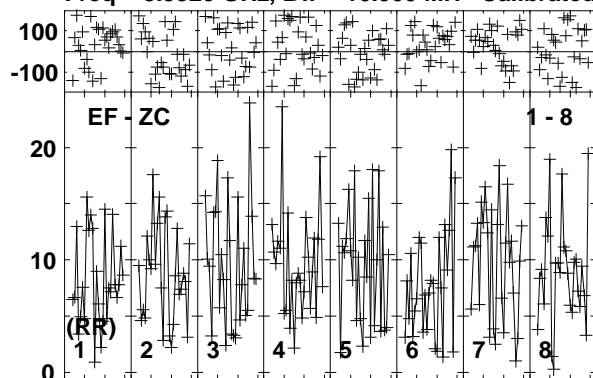

Lower frame: Milli Ampl Jy Top frame: Phas deg
 Vector averaged cross-power spectrum Baseline: EF (01) - ZC (08)
 Timerange: 00/04:10:29 to 00/04:13:24

Plot file version 95 created 24-MAR-2014 14:38:08

J1128+5925 EP087F 5.UVDATA.1

Freq = 8.3520 GHz, Bw = 16.000 MH Calibrated with CL # 3 and BP # 1 (BP mode 1)

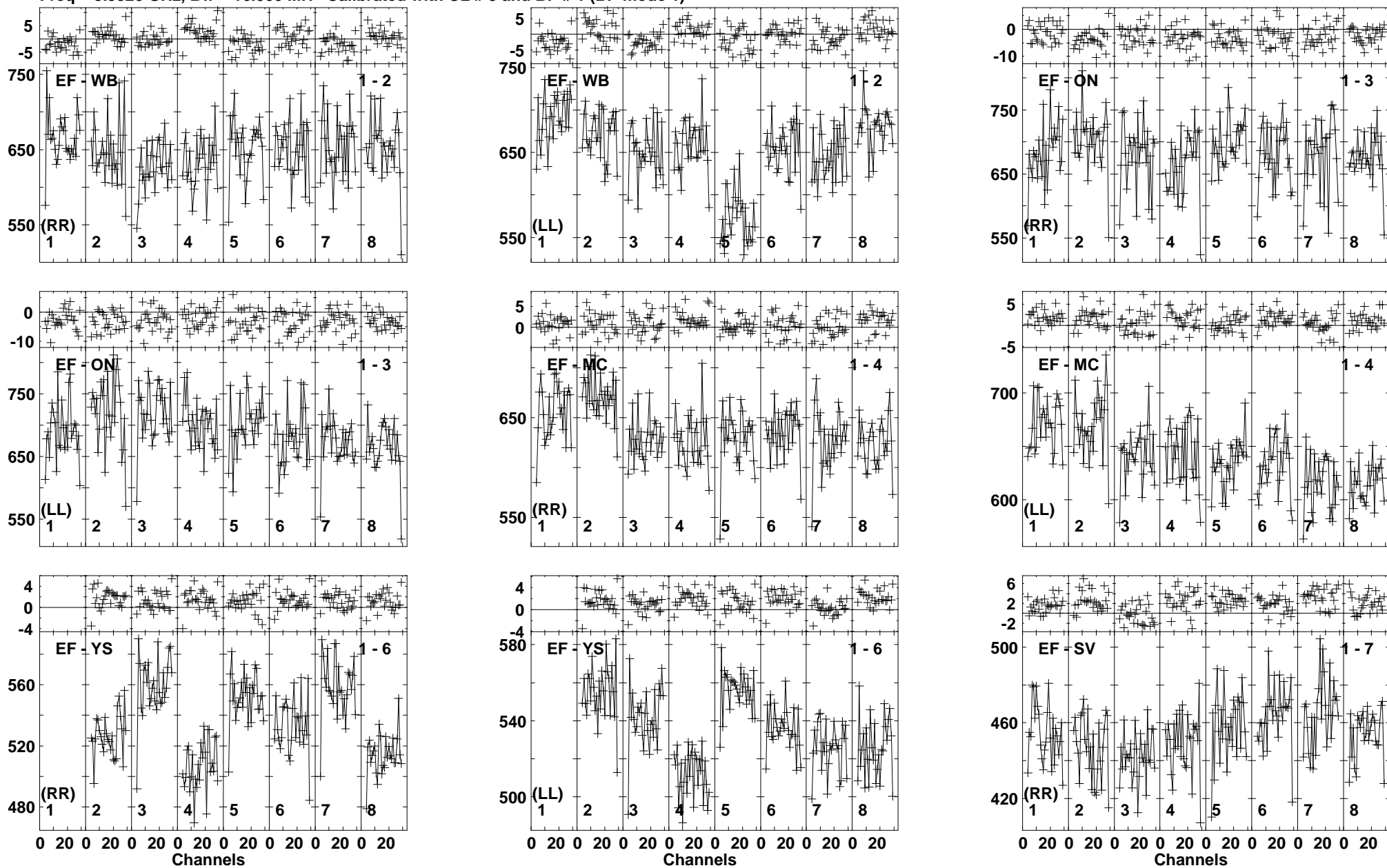

Lower frame: Milli Ampl Jy Top frame: Phas deg
Vector averaged cross-power spectrum Baseline: EF (01) - WB (02)
Timerange: 00/04:13:26 to 00/04:14:29

Plot file version 96 created 24-MAR-2014 14:38:08

J1128+5925 EP087F 5.UVDATA.1

Freq = 8.3520 GHz, Bw = 16.000 MH Calibrated with CL # 3 and BP # 1 (BP mode 1)

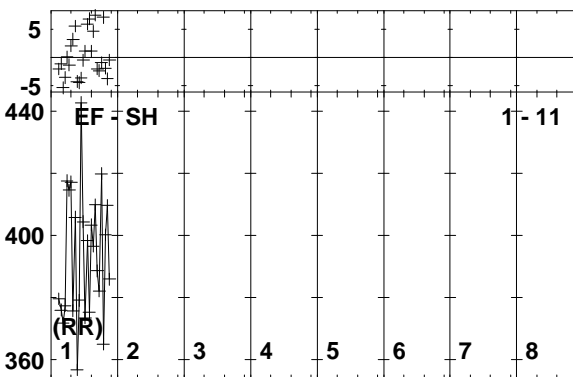
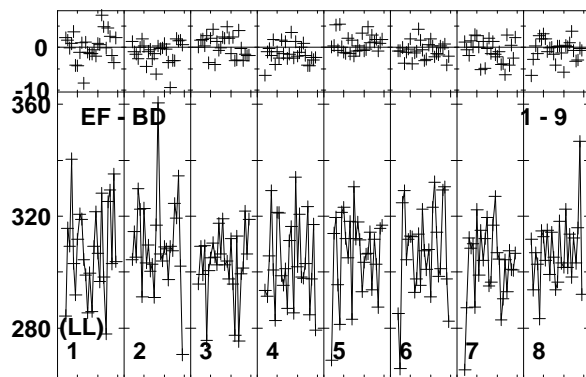
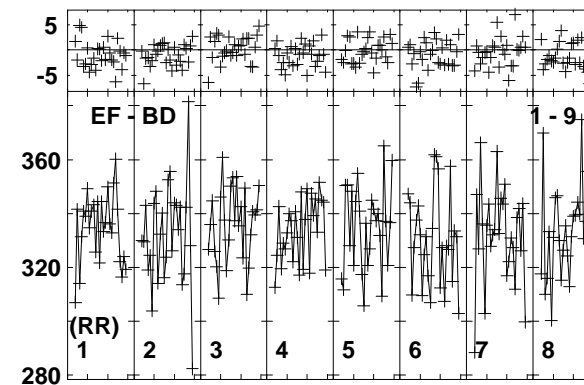
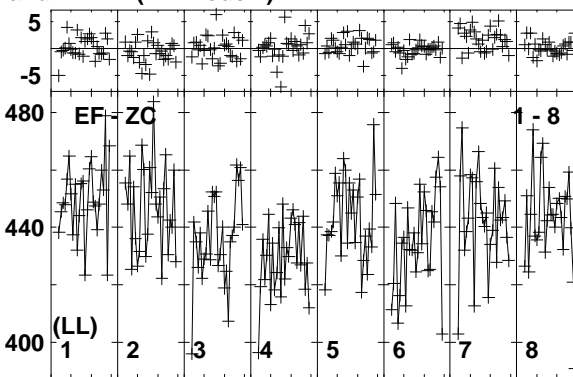
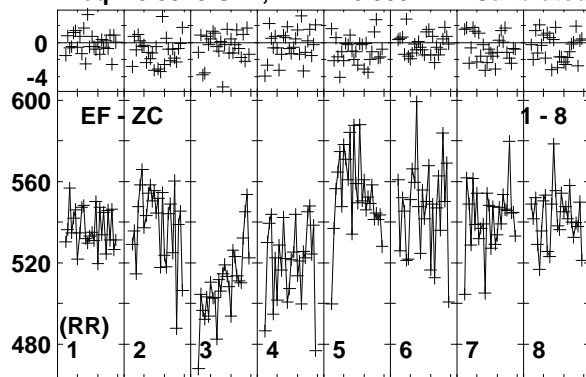

Lower frame: Milli Ampl Jy Top frame: Phas deg
Vector averaged cross-power spectrum Baseline: EF (01) - ZC (08)
Timerange: 00/04:13:26 to 00/04:14:29

Plot file version 97 created 24-MAR-2014 14:38:08

ARP299D EP087F 5.UVDATA.1

Freq = 8.3520 GHz, Bw = 16.000 MH Calibrated with CL # 3 and BP # 1 (BP mode 1)

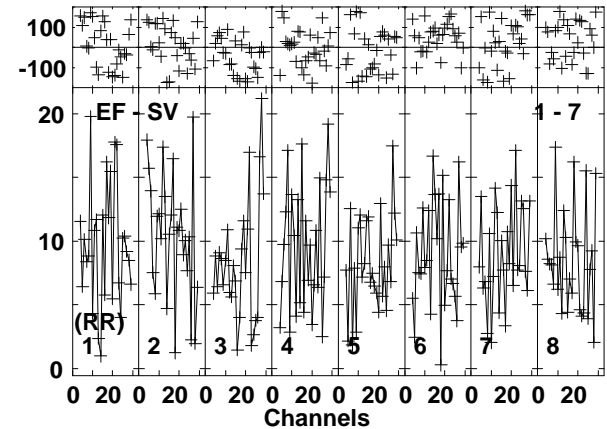
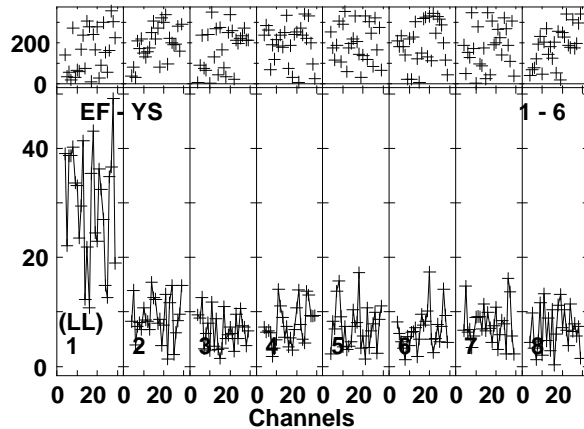
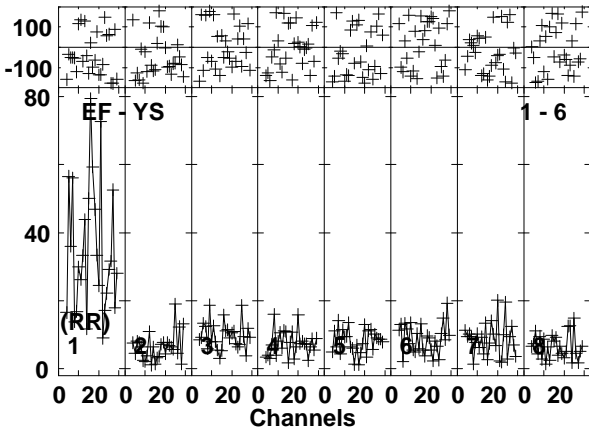
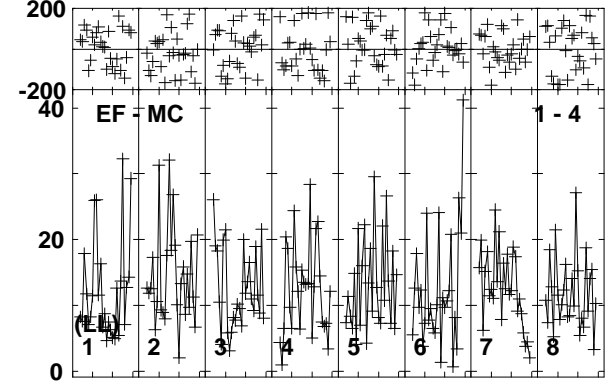
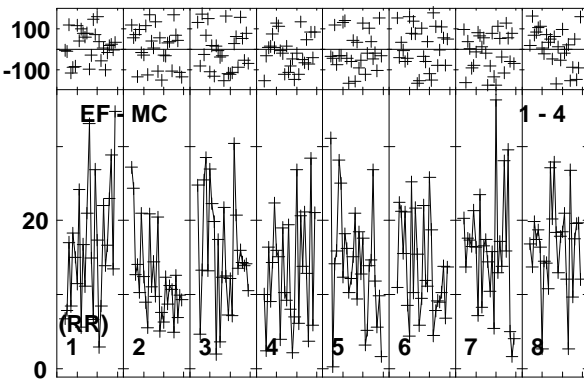
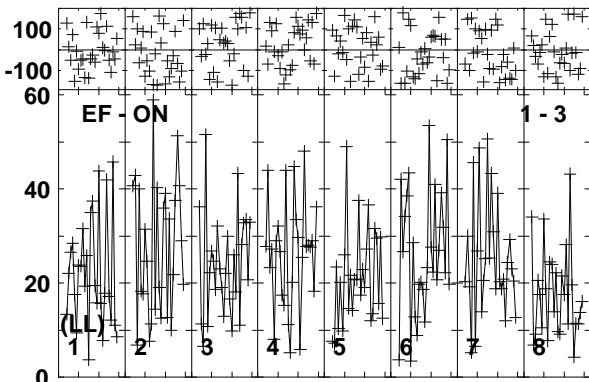
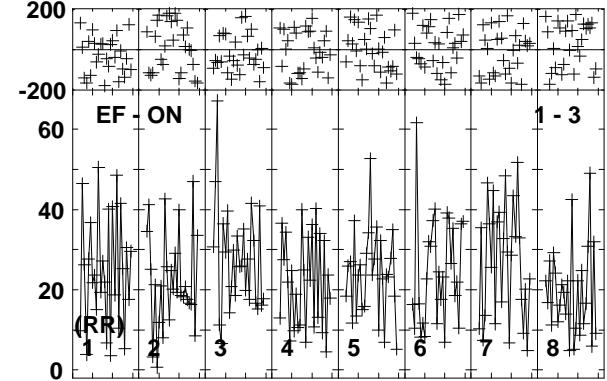
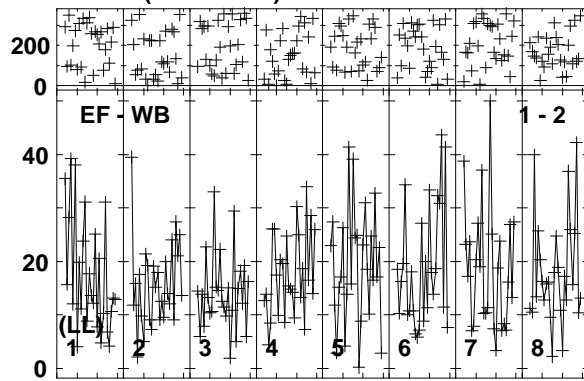
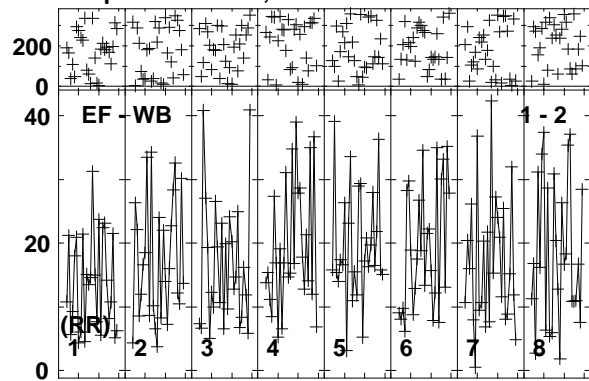

Lower frame: Milli Ampl Jy Top frame: Phas deg
Vector averaged cross-power spectrum Baseline: EF (01) - WB (02)
Timerange: 00/04:14:30 to 00/04:17:29

Plot file version 98 created 24-MAR-2014 14:38:09
 ARP299D EP087F 5.UVDATA.1
 Freq = 8.3520 GHz, Bw = 16.000 MH Calibrated with CL # 3 and BP # 1 (BP mode 1)

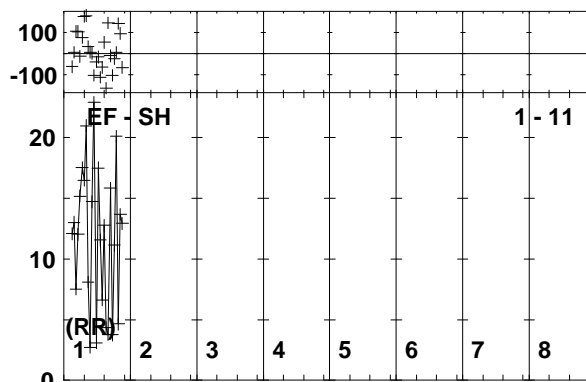
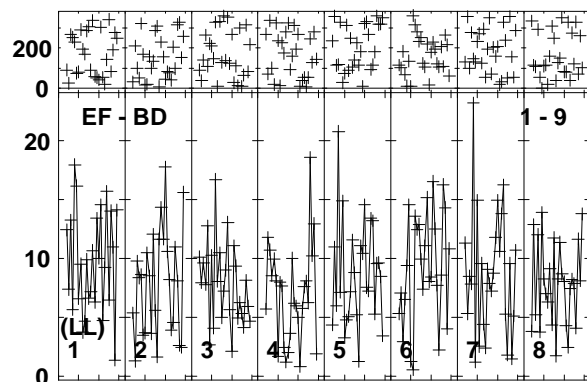
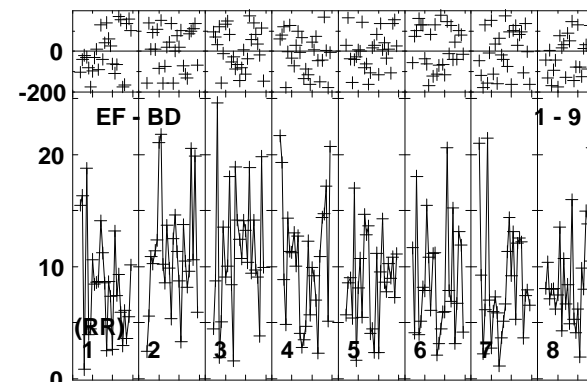
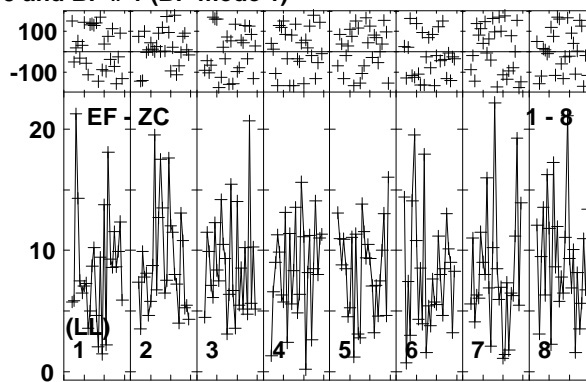
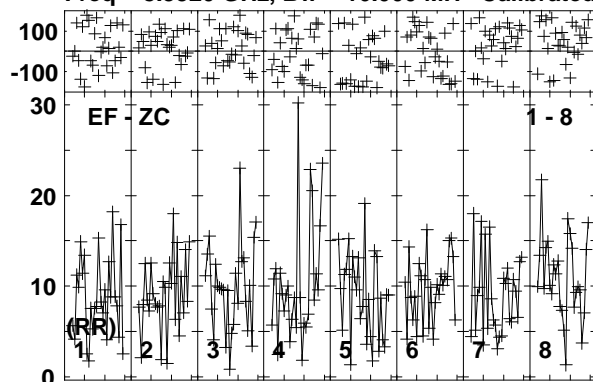

Lower frame: Milli Ampl Jy Top frame: Phas deg
 Vector averaged cross-power spectrum Baseline: EF (01) - ZC (08)
 Timerange: 00/04:14:30 to 00/04:17:29

Plot file version 99 created 24-MAR-2014 14:38:09

J1128+5925 EP087F 5.UVDATA.1

Freq = 8.3520 GHz, Bw = 16.000 MH Calibrated with CL # 3 and BP # 1 (BP mode 1)

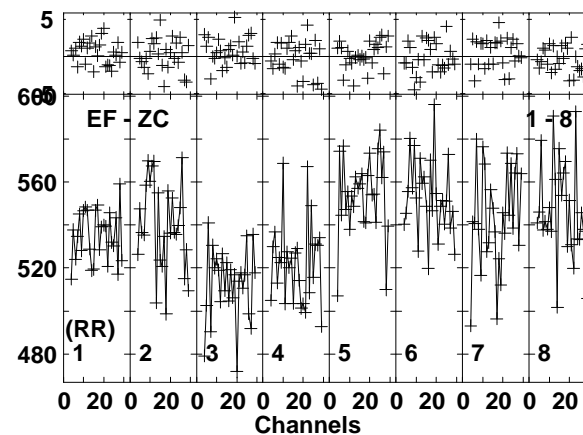
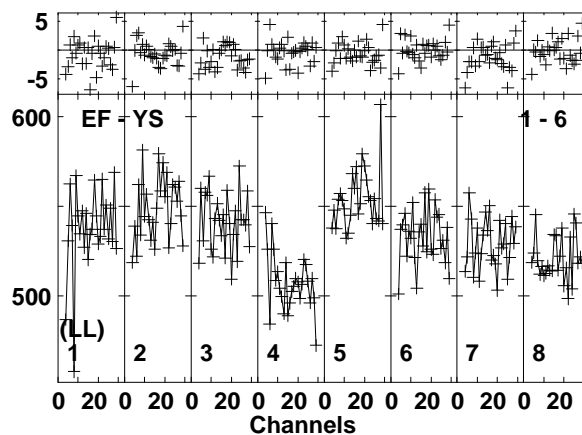
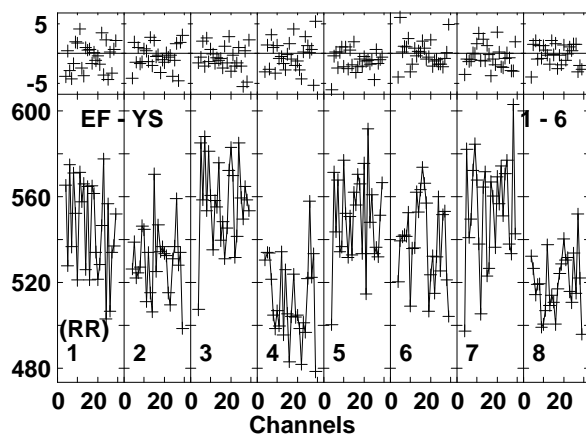
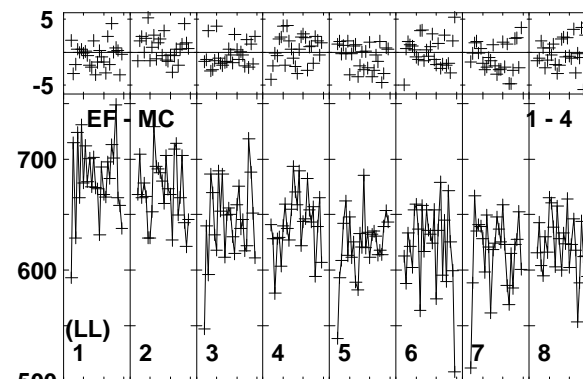
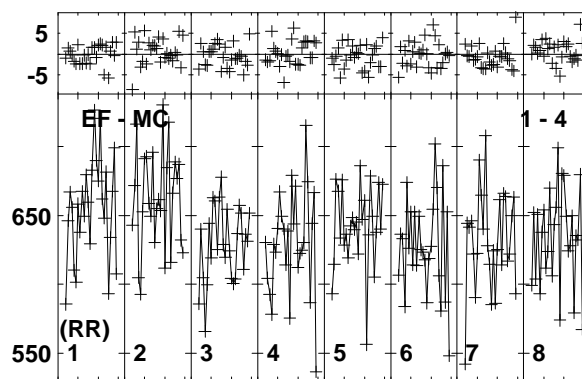
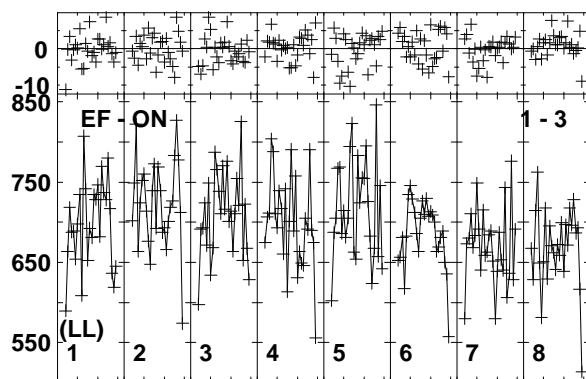
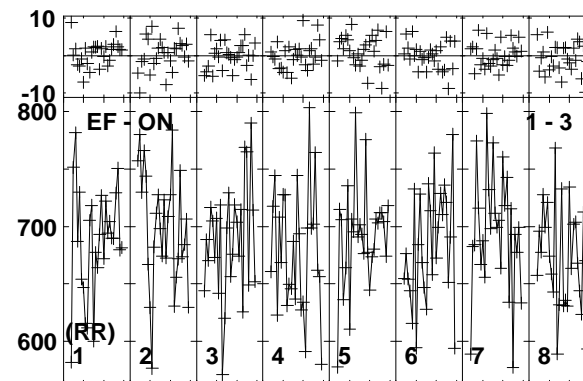
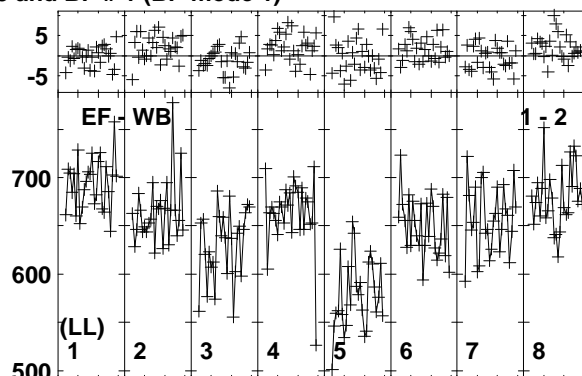
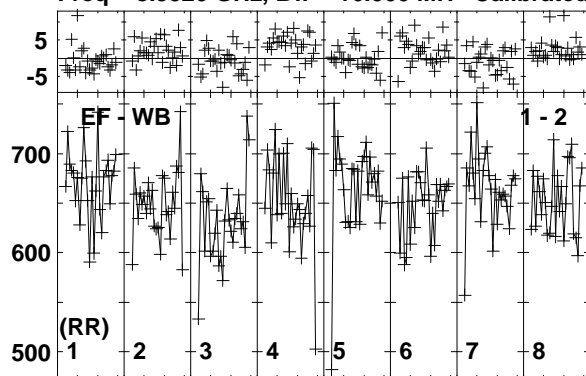

Lower frame: Milli Ampl Jy Top frame: Phas deg
Vector averaged cross-power spectrum Baseline: EF (01) - WB (02)
Timerange: 00/04:18:11 to 00/04:18:39

Plot file version 100 created 24-MAR-2014 14:38:09
 J1128+5925 EP087F 5.UVDATA.1
 Freq = 8.3520 GHz, Bw = 16.000 MH Calibrated with CL # 3 and BP # 1 (BP mode 1)

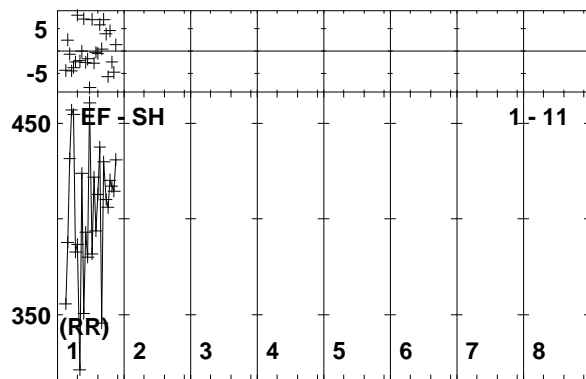
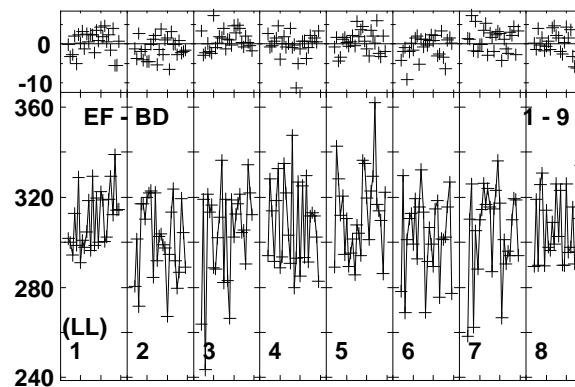
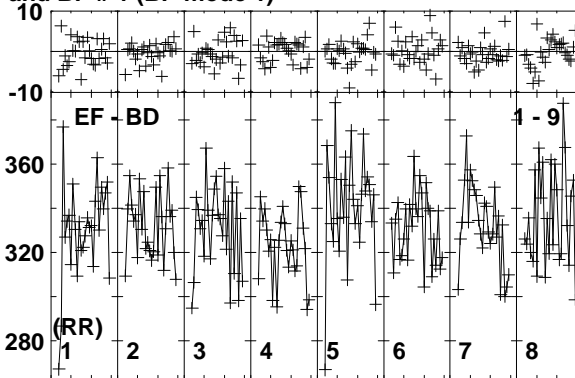
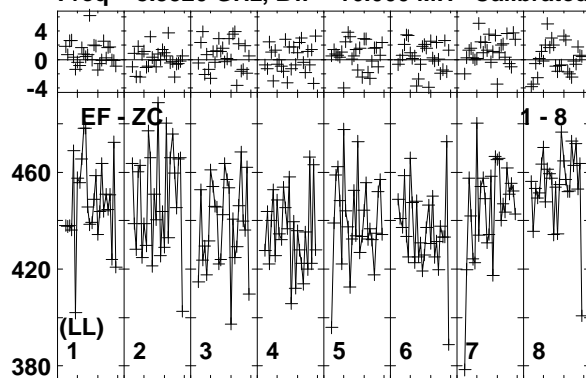

Lower frame: Milli Ampl Jy Top frame: Phas deg
 Vector averaged cross-power spectrum Baseline: EF (01) - ZC (08)
 Timerange: 00/04:18:11 to 00/04:18:39

Plot file version 101 created 24-MAR-2014 14:38:09
 ARP299D EP087F 5.UVDATA.1
 Freq = 8.3520 GHz, Bw = 16.000 MH Calibrated with CL # 3 and BP # 1 (BP mode 1)

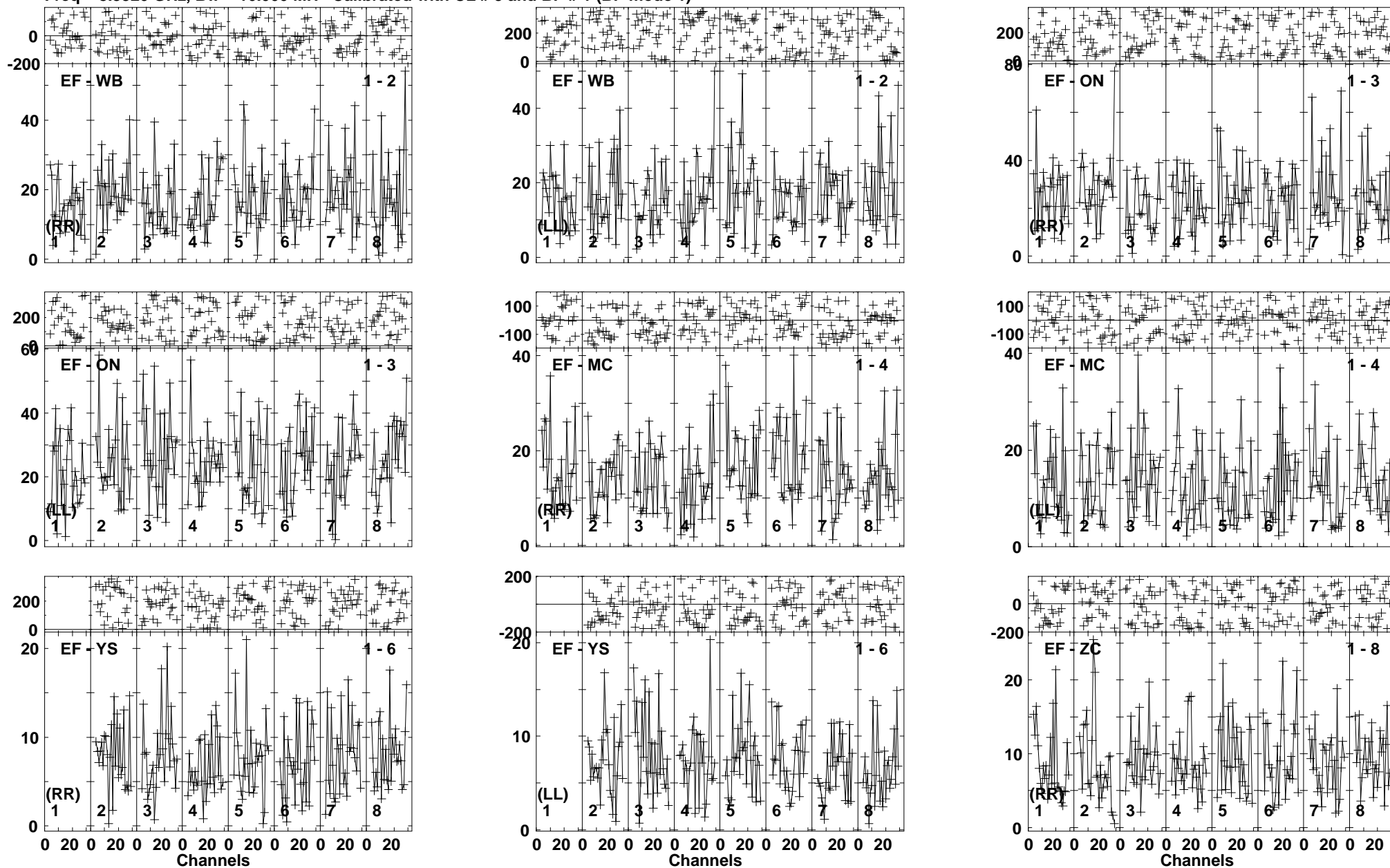

Lower frame: Milli Ampl Jy Top frame: Phas deg
 Vector averaged cross-power spectrum Baseline: EF (01) - WB (02)
 Timerange: 00/04:18:45 to 00/04:21:40

Plot file version 102 created 24-MAR-2014 14:38:09
 ARP299D EP087F 5.UVDATA.1
 Freq = 8.3520 GHz, Bw = 16.000 MH Calibrated with CL # 3 and BP # 1 (BP mode 1)

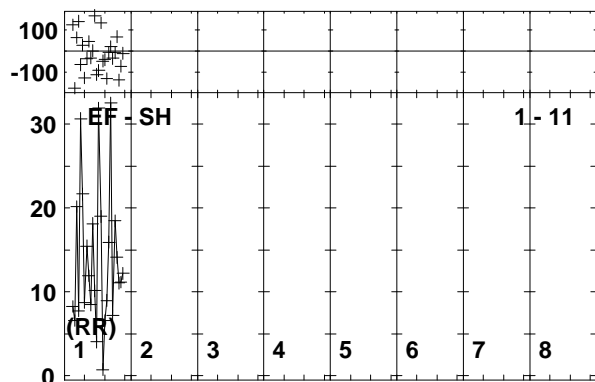
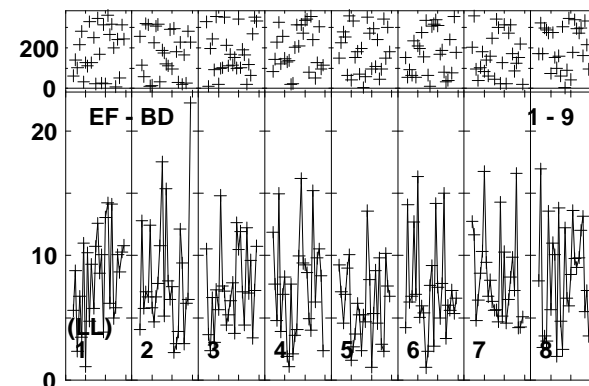
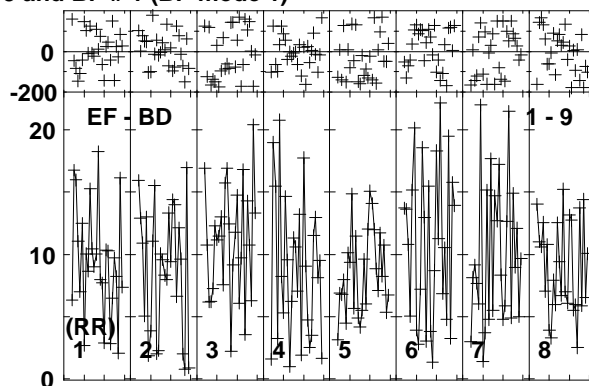
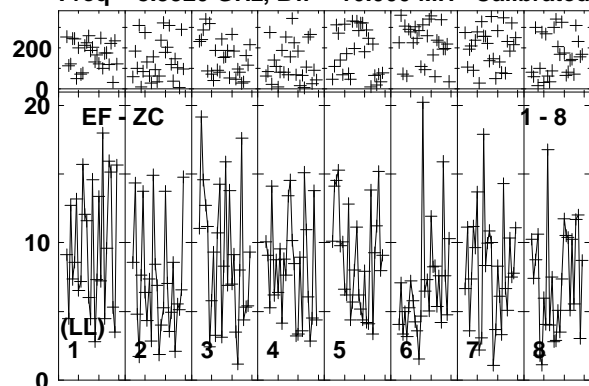

Lower frame: Milli Ampl Jy Top frame: Phas deg
 Vector averaged cross-power spectrum Baseline: EF (01) - ZC (08)
 Timerange: 00/04:18:45 to 00/04:21:40

Plot file version 103 created 24-MAR-2014 14:38:10

J1128+5925 EP087F 5.UVDATA.1

Freq = 8.3520 GHz, Bw = 16.000 MH Calibrated with CL # 3 and BP # 1 (BP mode 1)

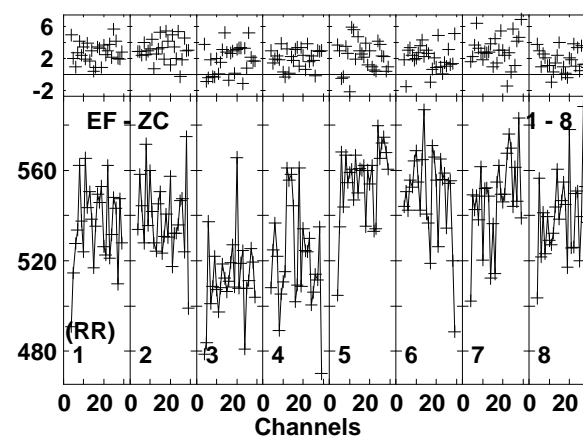
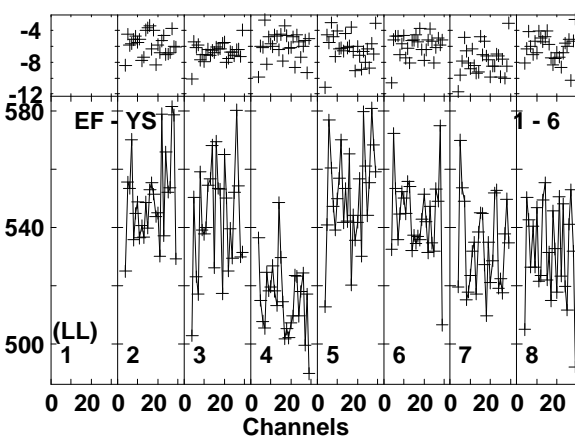
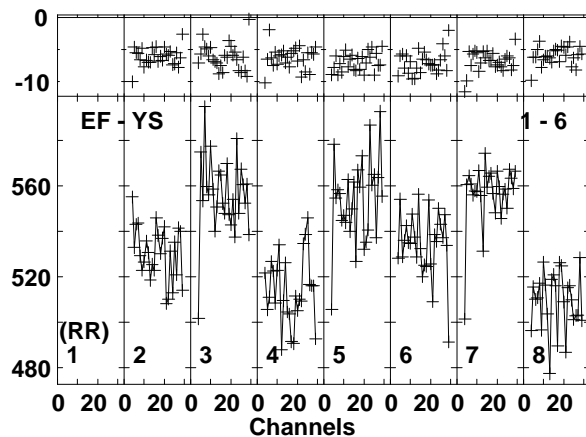
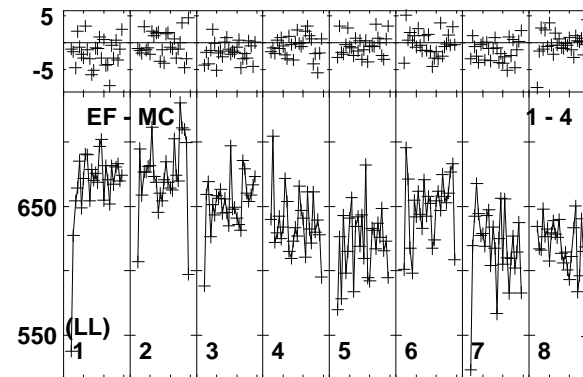
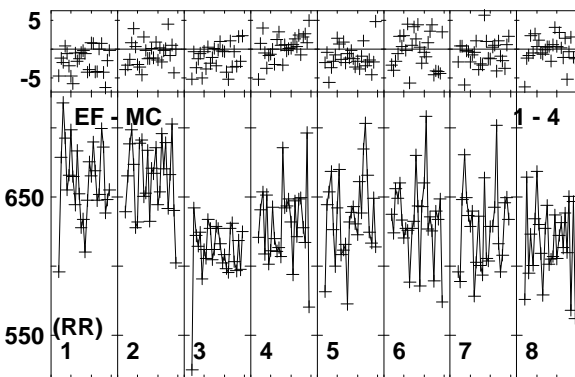
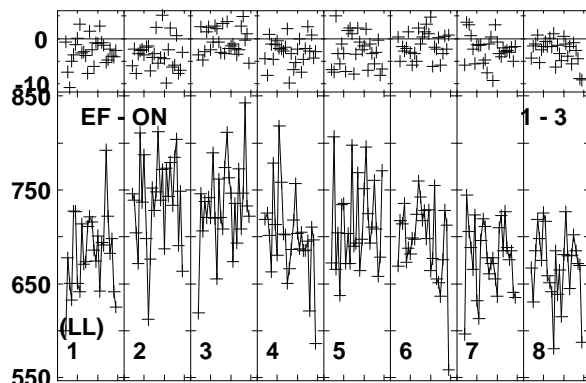
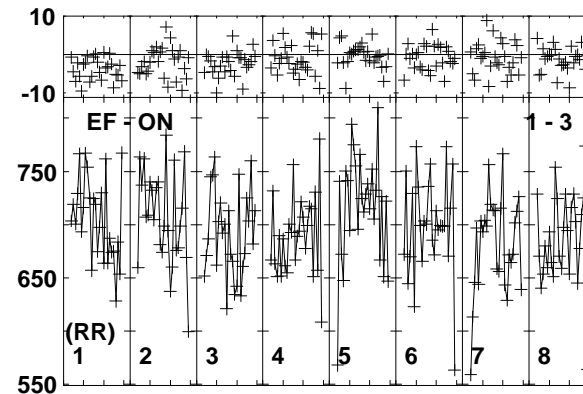
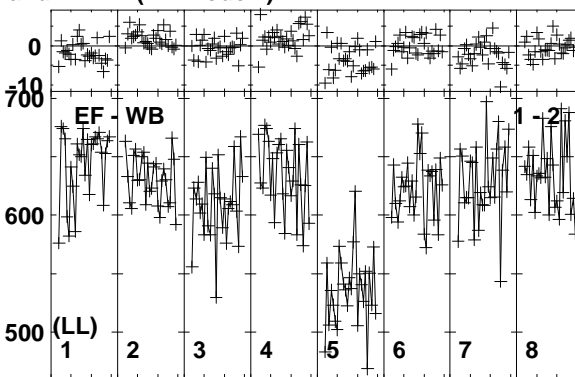
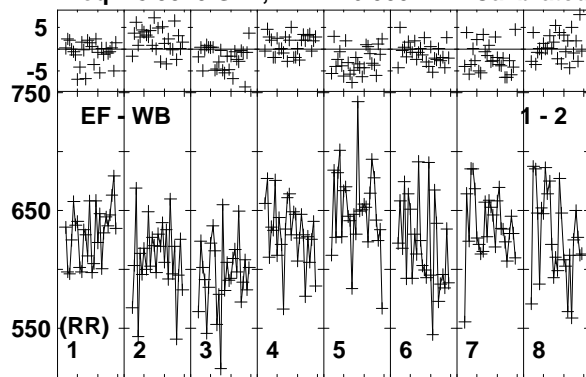

Lower frame: Milli Ampl Jy Top frame: Phas deg
Vector averaged cross-power spectrum Baseline: EF (01) - WB (02)
Timerange: 00/04:21:40 to 00/04:22:45

Plot file version 104 created 24-MAR-2014 14:38:10

J1128+5925 EP087F 5.UVDATA.1

Freq = 8.3520 GHz, Bw = 16.000 MH Calibrated with CL # 3 and BP # 1 (BP mode 1)

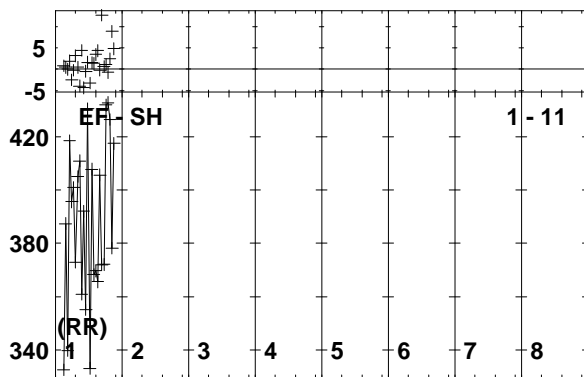
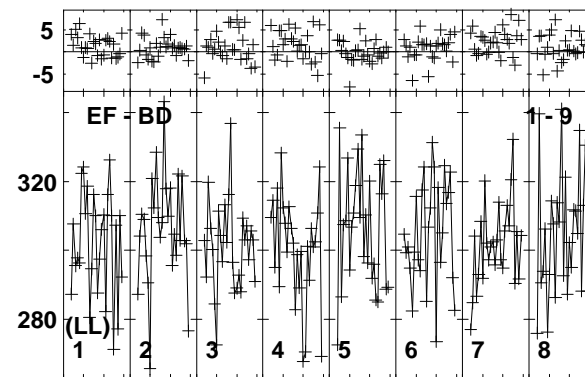
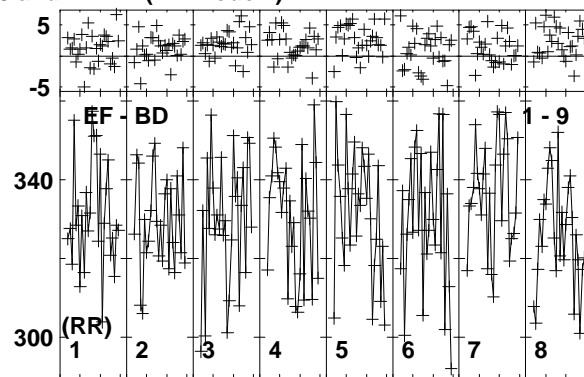
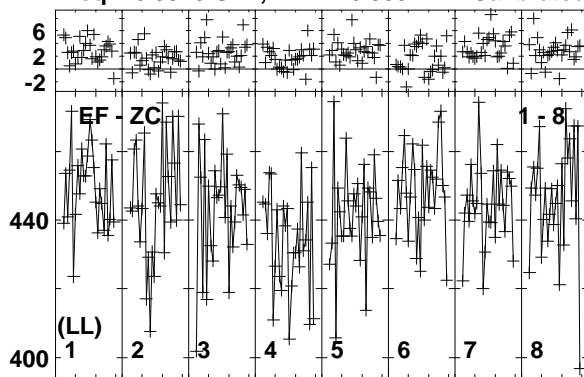

Lower frame: Milli Ampl Jy Top frame: Phas deg
Vector averaged cross-power spectrum Baseline: EF (01) - ZC (08)
Timerange: 00/04:21:40 to 00/04:22:45

Plot file version 105 created 24-MAR-2014 14:38:10
 ARP299D EP087F 5.UVDATA.1
 Freq = 8.3520 GHz, Bw = 16.000 MH Calibrated with CL # 3 and BP # 1 (BP mode 1)

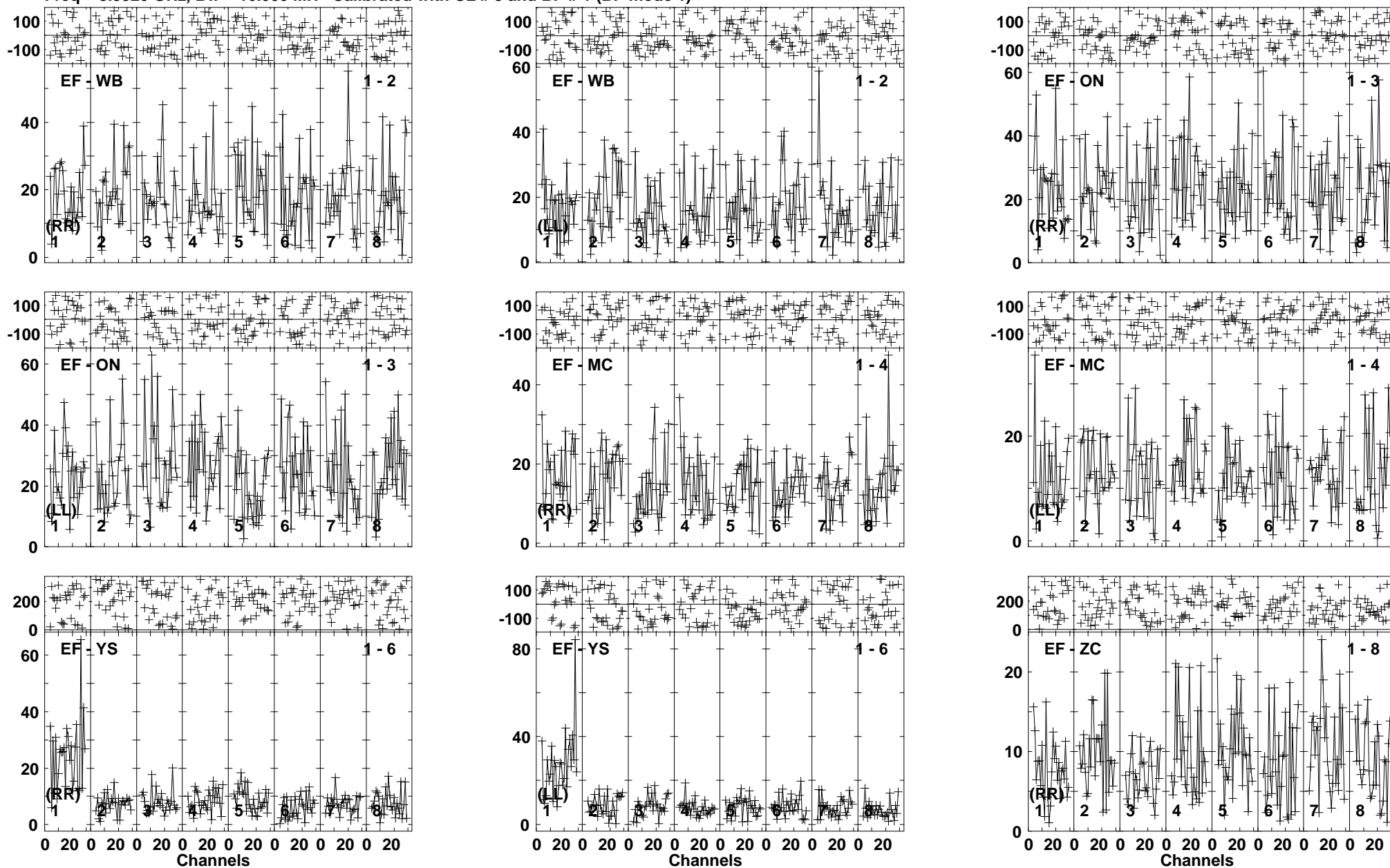

Lower frame: Milli Ampl Jy Top frame: Phas deg
 Vector averaged cross-power spectrum Baseline: EF (01) - WB (02)
 Timerange: 00/04:22:46 to 00/04:25:44

Plot file version 106 created 24-MAR-2014 14:38:10
 ARP299D EP087F 5.UVDATA.1
 Freq = 8.3520 GHz, Bw = 16.000 MH Calibrated with CL # 3 and BP # 1 (BP mode 1)

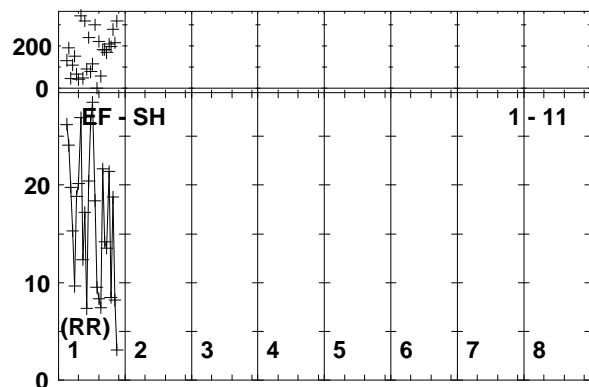
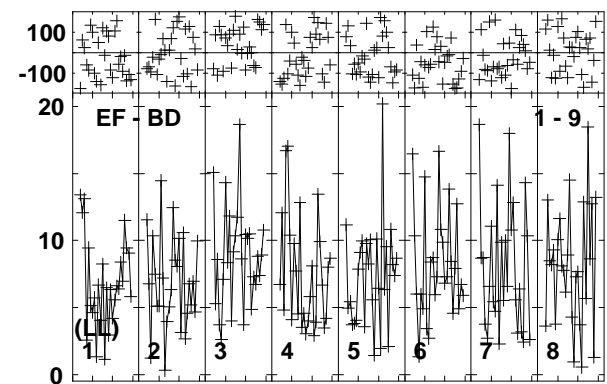
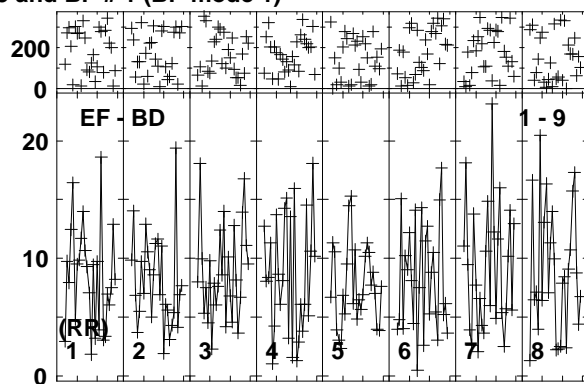
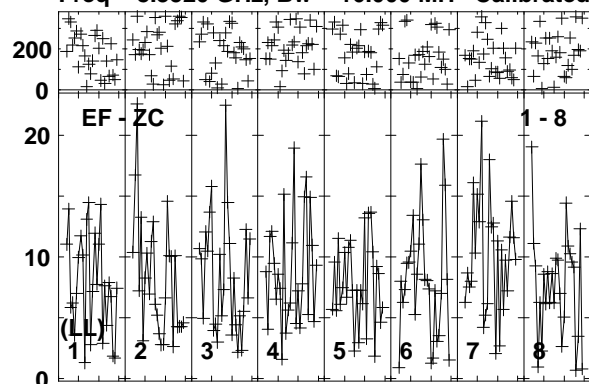

Lower frame: Milli Ampl Jy Top frame: Phas deg
 Vector averaged cross-power spectrum Baseline: EF (01) - ZC (08)
 Timerange: 00/04:22:46 to 00/04:25:44

Plot file version 107 created 24-MAR-2014 14:38:11

J1128+5925 EP087F 5.UVDATA.1

Freq = 8.3520 GHz, Bw = 16.000 MH Calibrated with CL # 3 and BP # 1 (BP mode 1)

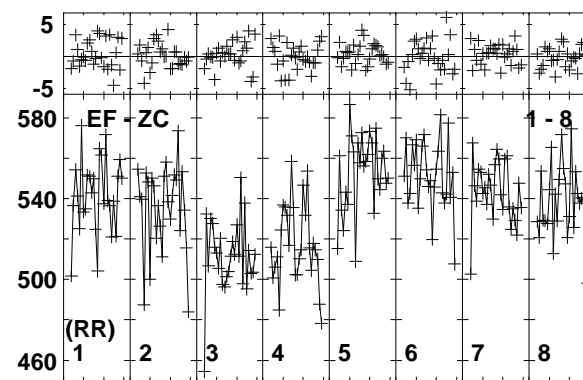
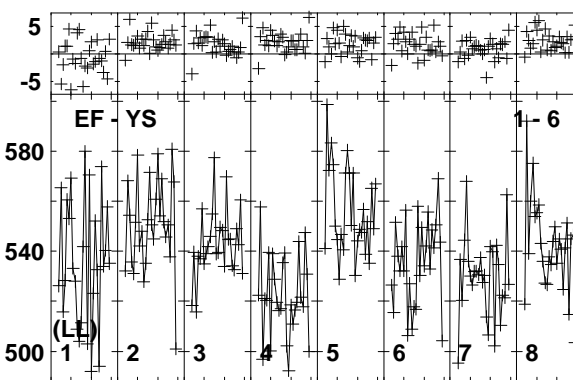
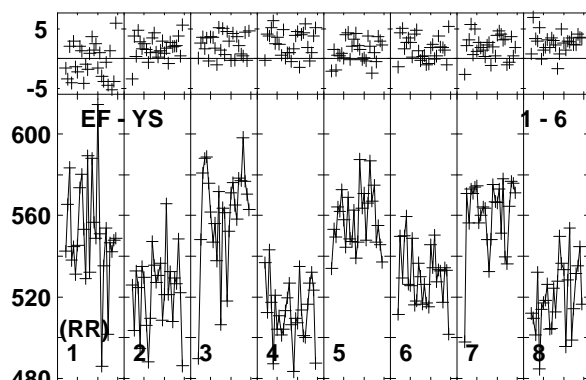
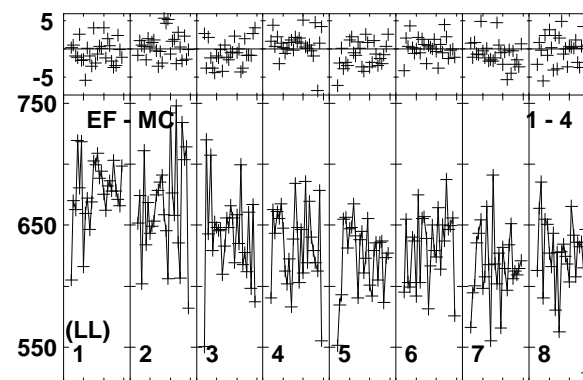
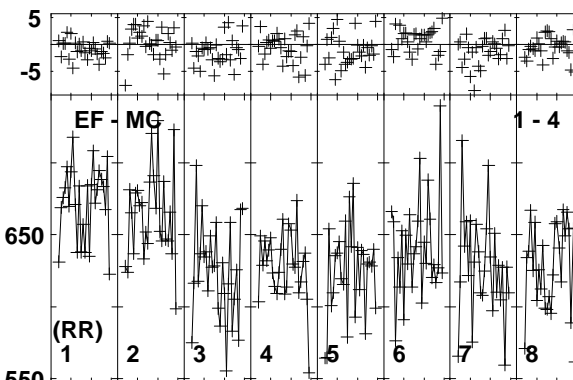
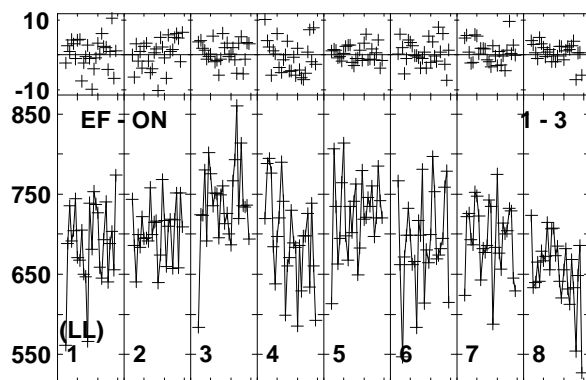
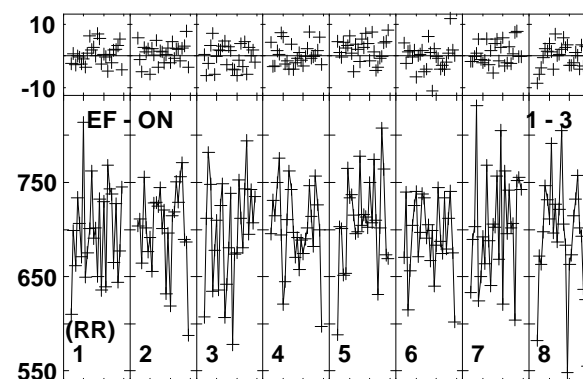
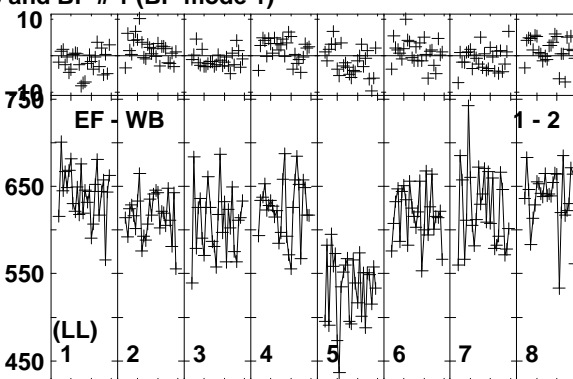
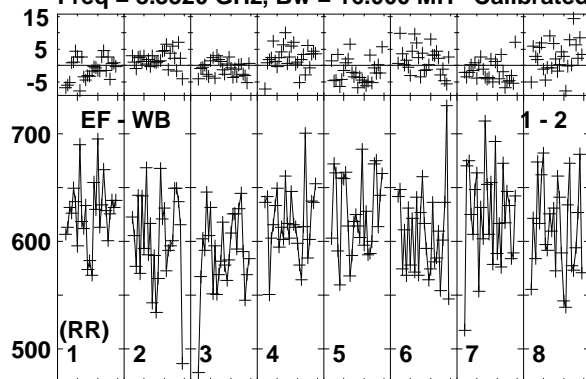

Lower frame: Milli Ampl Jy Top frame: Phas deg
Vector averaged cross-power spectrum Baseline: EF (01) - WB (02)
Timerange: 00/04:26:26 to 00/04:26:54

Plot file version 108 created 24-MAR-2014 14:38:11

J1128+5925 EP087F 5.UVDATA.1

Freq = 8.3520 GHz, Bw = 16.000 MH Calibrated with CL # 3 and BP # 1 (BP mode 1)

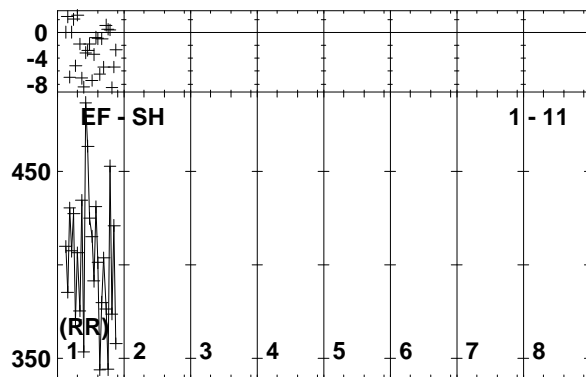
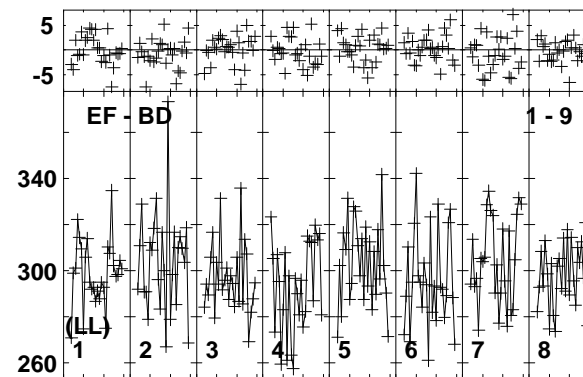
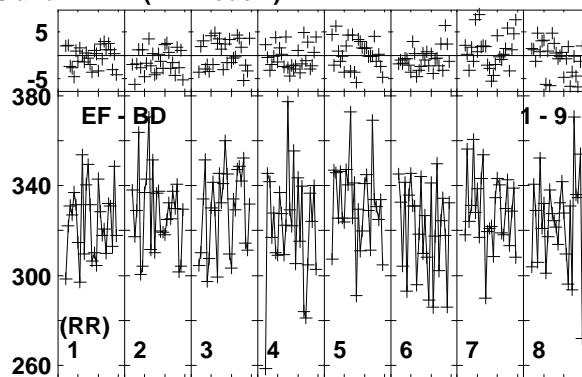
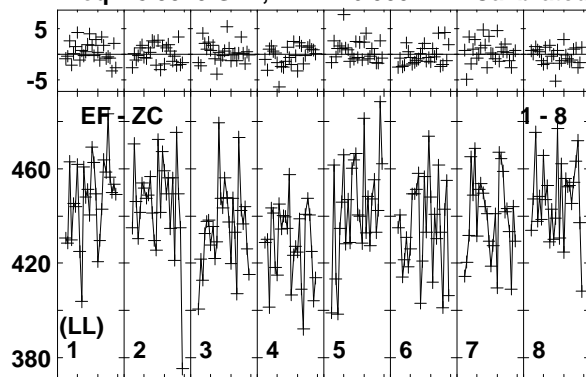

Lower frame: Milli Ampl Jy Top frame: Phas deg
Vector averaged cross-power spectrum Baseline: EF (01) - ZC (08)
Timerange: 00/04:26:26 to 00/04:26:54

Plot file version 109 created 24-MAR-2014 14:38:11
 ARP299D EP087F 5.UVDATA.1
 Freq = 8.3520 GHz, Bw = 16.000 MH Calibrated with CL # 3 and BP # 1 (BP mode 1)

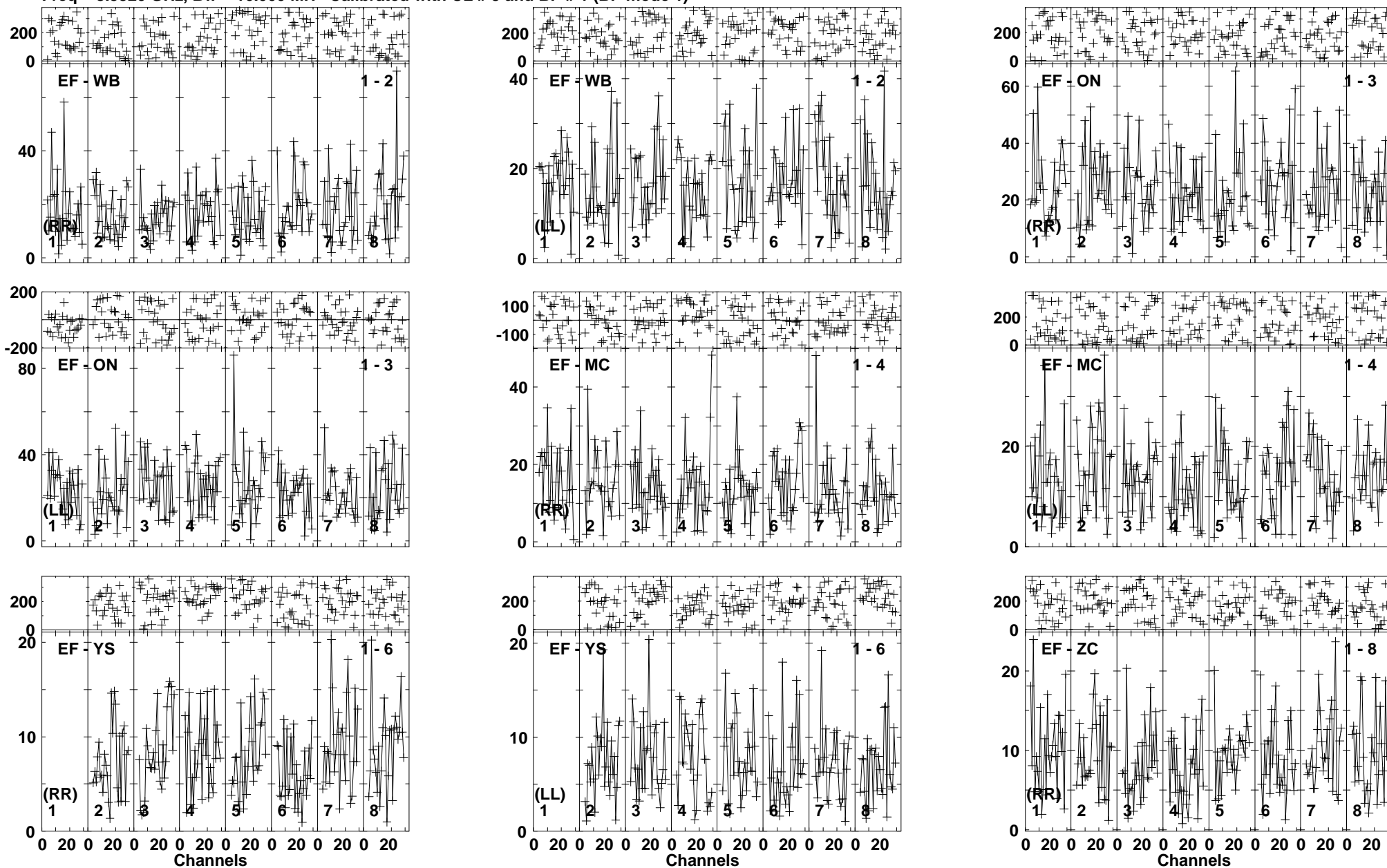

Lower frame: Milli Ampl Jy Top frame: Phas deg
 Vector averaged cross-power spectrum Baseline: EF (01) - WB (02)
 Timerange: 00/04:27:00 to 00/04:29:54

Plot file version 110 created 24-MAR-2014 14:38:11

ARP299D EP087F 5.UVDATA.1

Freq = 8.3520 GHz, Bw = 16.000 MH Calibrated with CL # 3 and BP # 1 (BP mode 1)

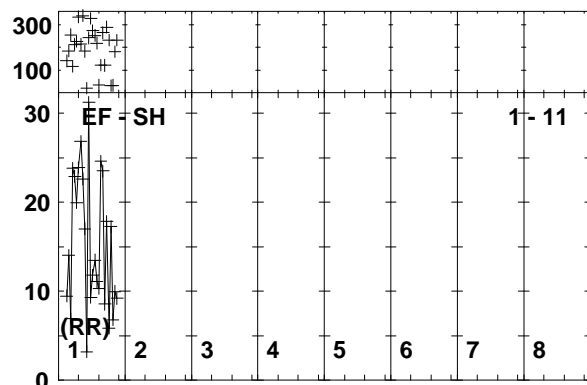
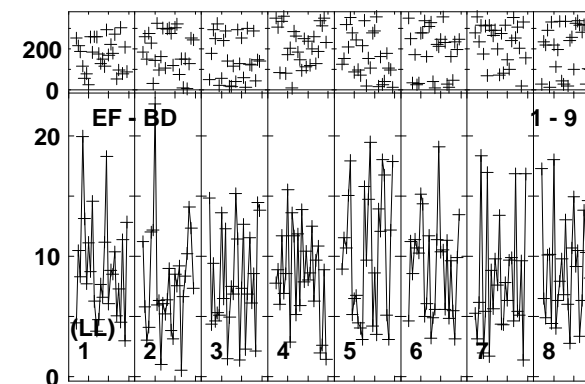
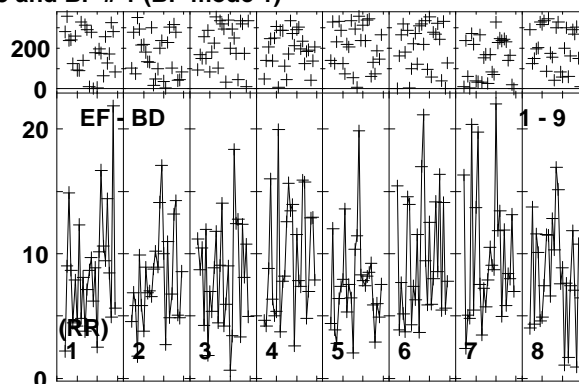
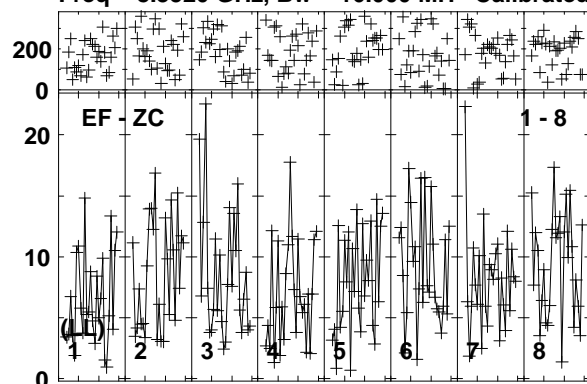

Lower frame: Milli Ampl Jy Top frame: Phas deg
Vector averaged cross-power spectrum Baseline: EF (01) - ZC (08)
Timerange: 00/04:27:00 to 00/04:29:54

Plot file version 111 created 24-MAR-2014 14:38:12

J1128+5925 EP087F 5.UVDATA.1

Freq = 8.3520 GHz, Bw = 16.000 MH Calibrated with CL # 3 and BP # 1 (BP mode 1)

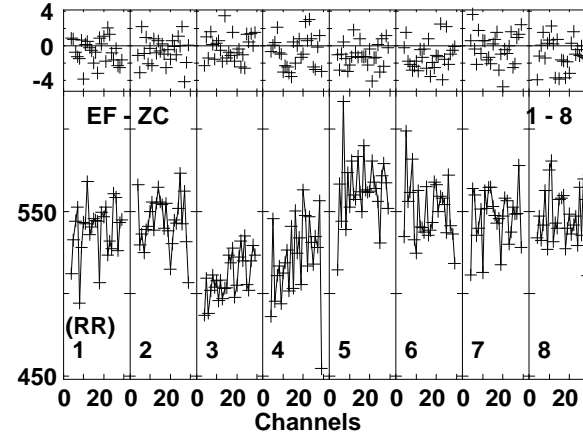
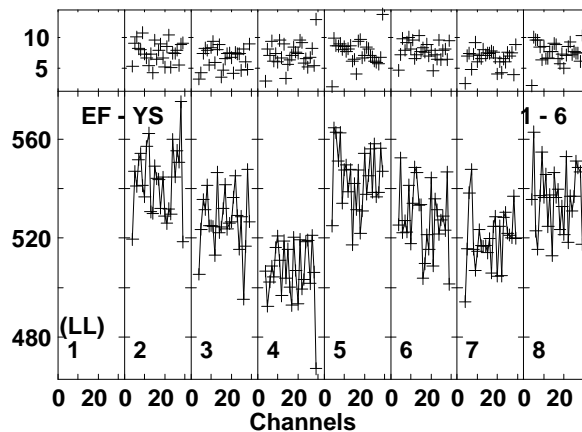
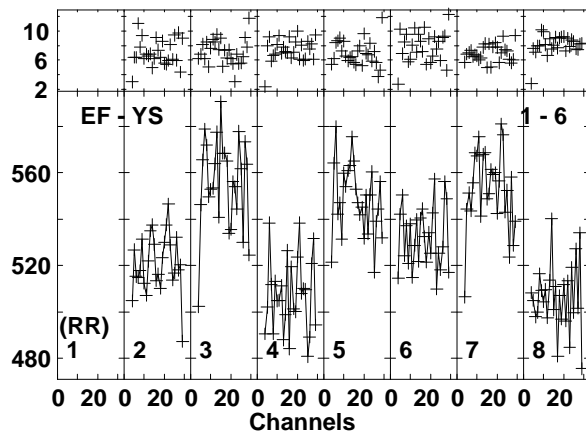
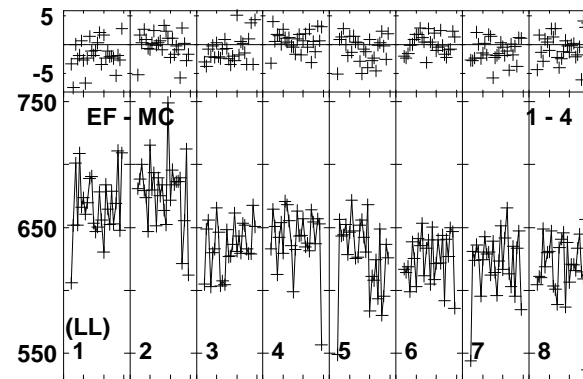
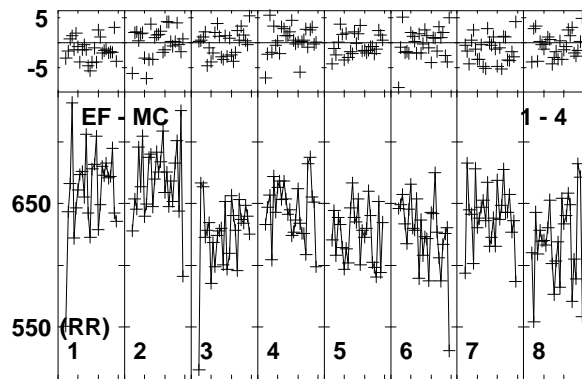
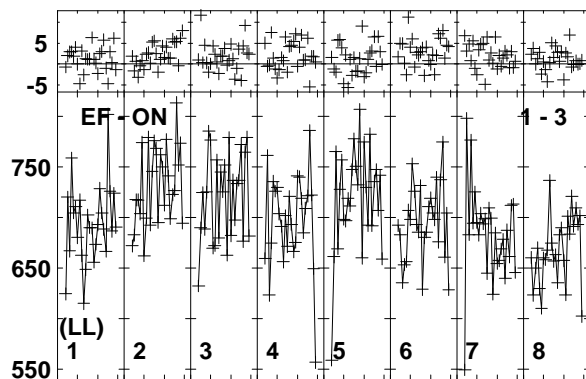
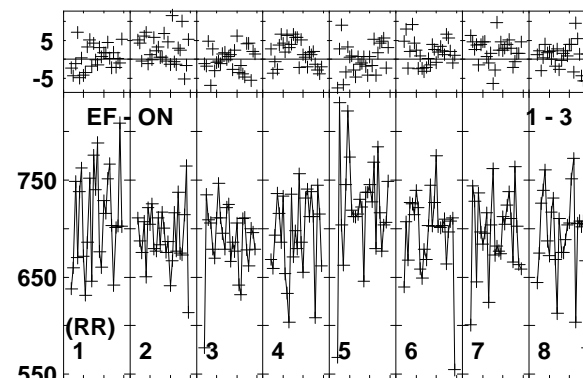
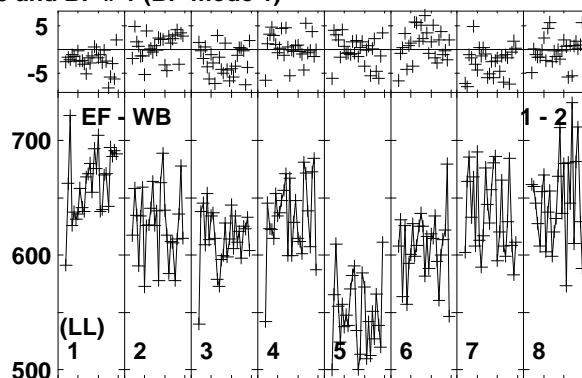
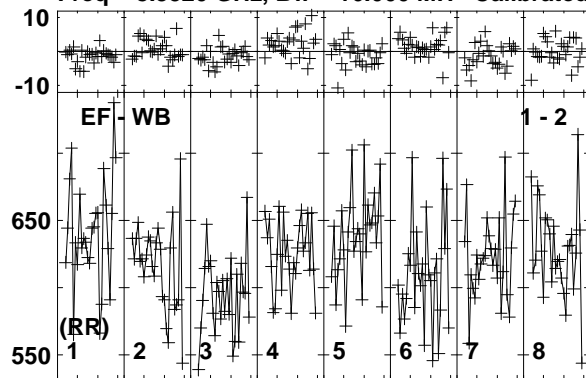

Lower frame: Milli Ampl Jy Top frame: Phas deg
Vector averaged cross-power spectrum Baseline: EF (01) - WB (02)
Timerange: 00/04:29:56 to 00/04:30:59

Plot file version 112 created 24-MAR-2014 14:38:12

J1128+5925 EP087F 5.UVDATA.1

Freq = 8.3520 GHz, Bw = 16.000 MH Calibrated with CL # 3 and BP # 1 (BP mode 1)

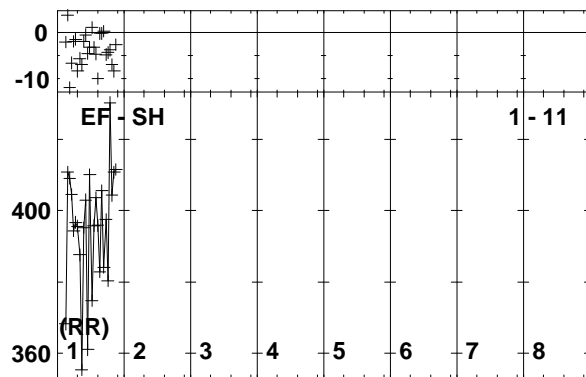
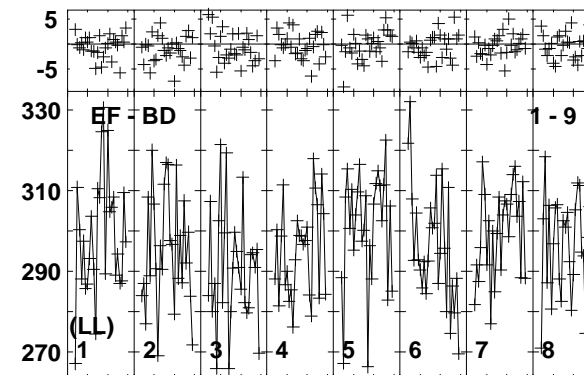
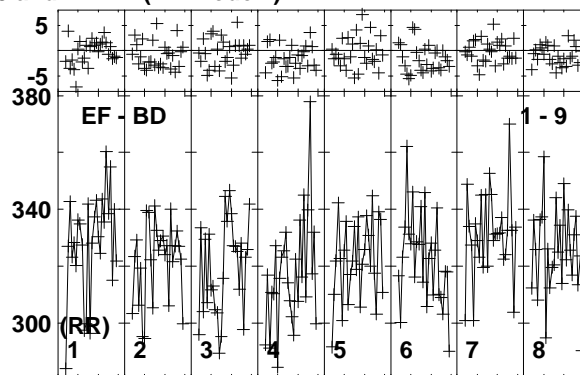
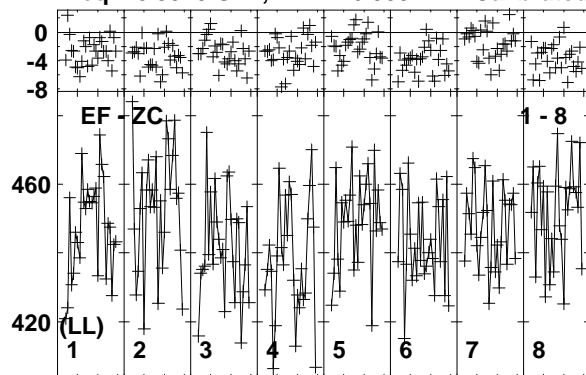

Lower frame: Milli Ampl Jy Top frame: Phas deg
Vector averaged cross-power spectrum Baseline: EF (01) - ZC (08)
Timerange: 00/04:29:56 to 00/04:30:59

Plot file version 113 created 24-MAR-2014 14:38:12

ARP299D EP087F 5.UVDATA.1

Freq = 8.3520 GHz, Bw = 16.000 MH Calibrated with CL # 3 and BP # 1 (BP mode 1)

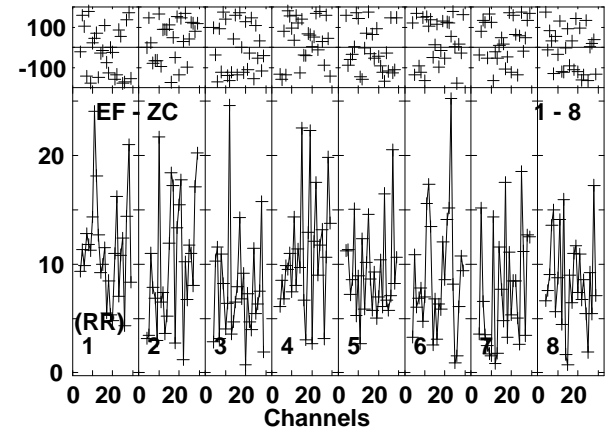
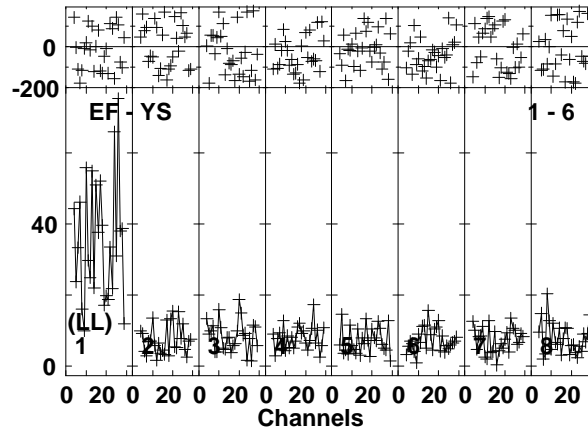
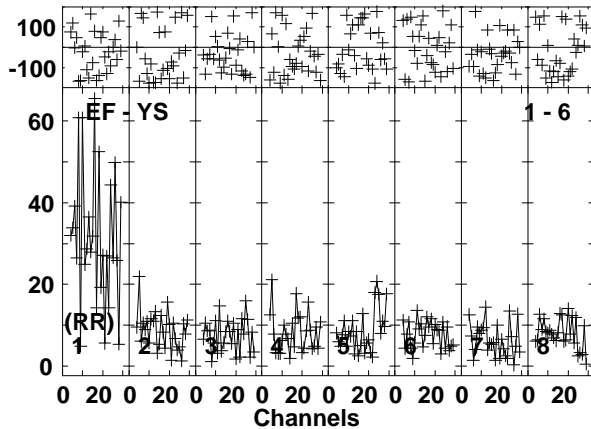
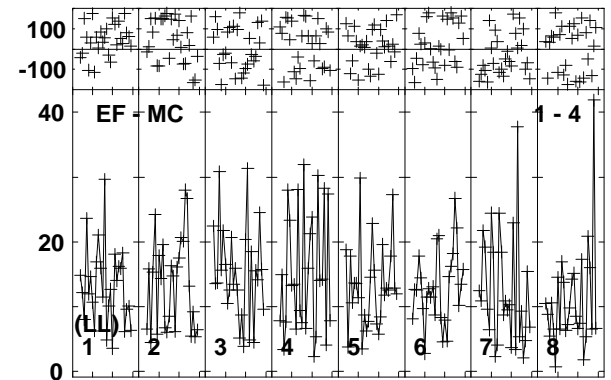
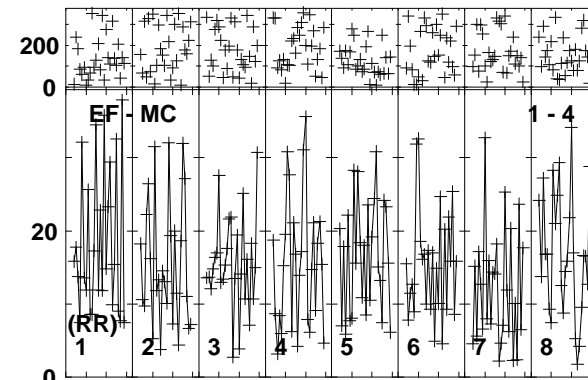
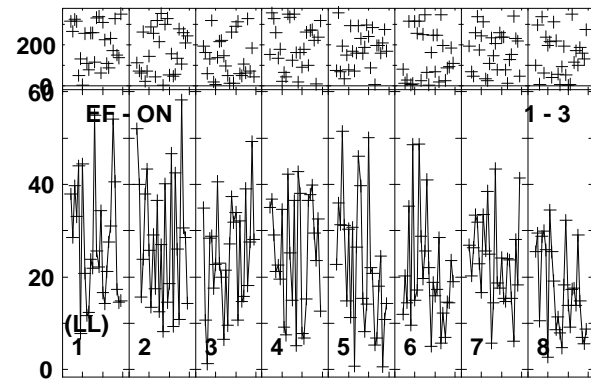
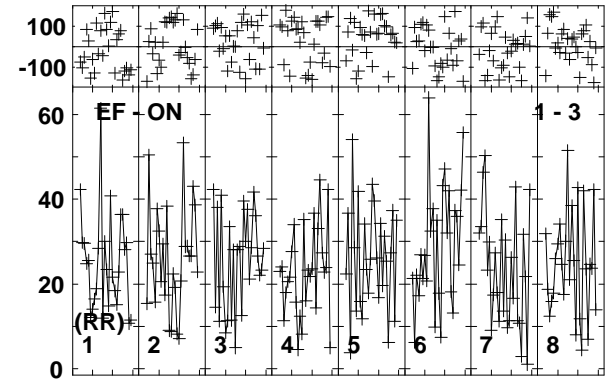
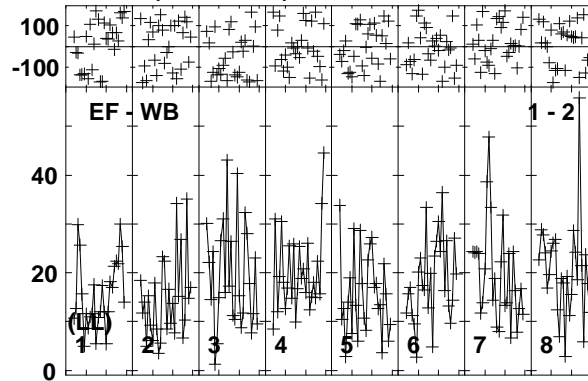
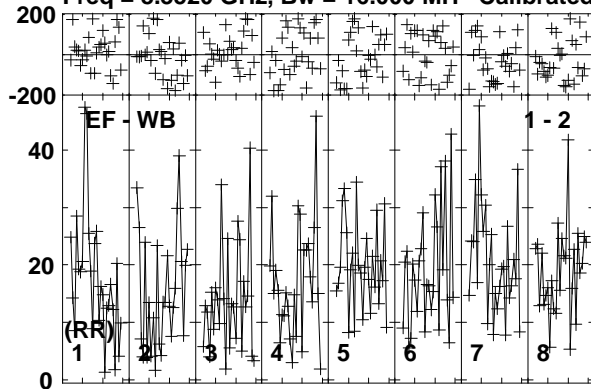

Lower frame: Milli Ampl Jy Top frame: Phas deg
Vector averaged cross-power spectrum Baseline: EF (01) - WB (02)
Timerange: 00/04:31:01 to 00/04:33:59

Plot file version 114 created 24-MAR-2014 14:38:12

ARP299D EP087F 5.UVDATA.1

Freq = 8.3520 GHz, Bw = 16.000 MH Calibrated with CL # 3 and BP # 1 (BP mode 1)

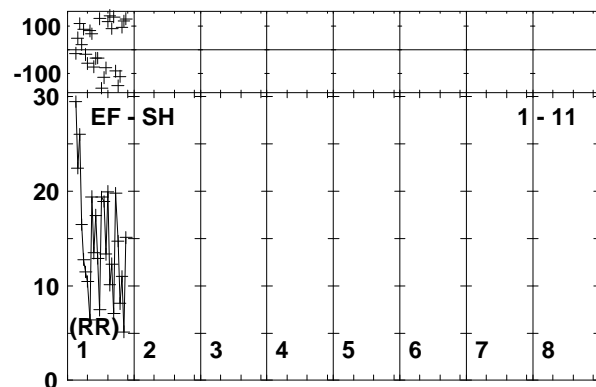
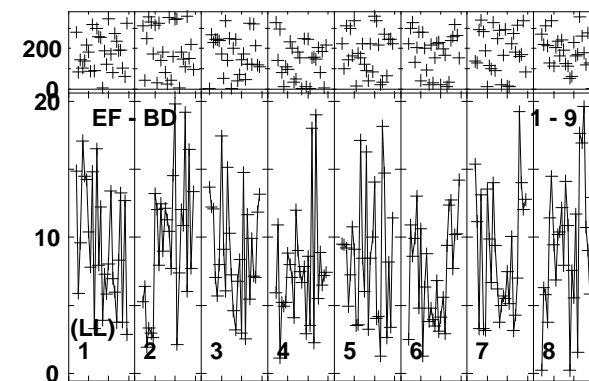
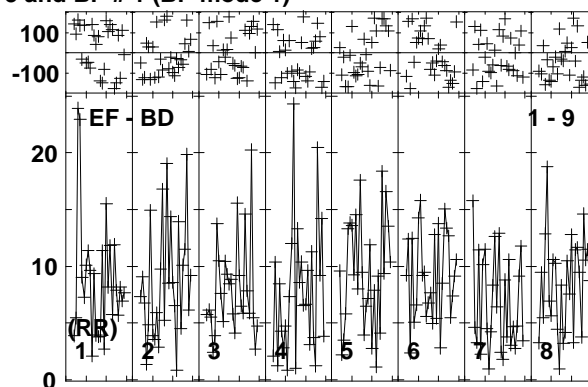
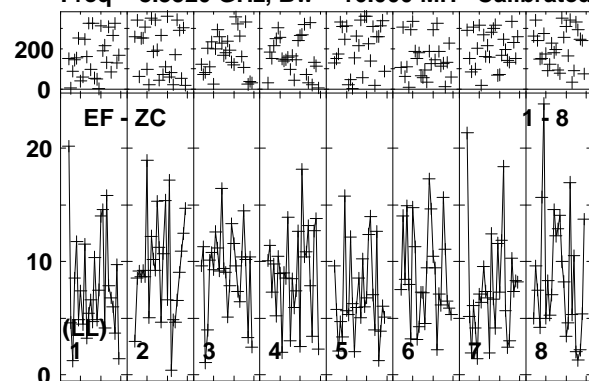

Lower frame: Milli Ampl Jy Top frame: Phas deg
Vector averaged cross-power spectrum Baseline: EF (01) - ZC (08)
Timerange: 00/04:31:01 to 00/04:33:59

Plot file version 115 created 24-MAR-2014 14:38:13

J1128+5925 EP087F 5.UVDATA.1

Freq = 8.3520 GHz, Bw = 16.000 MH Calibrated with CL # 3 and BP # 1 (BP mode 1)

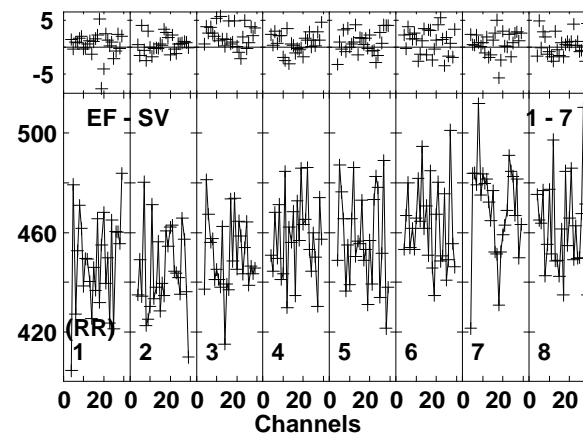
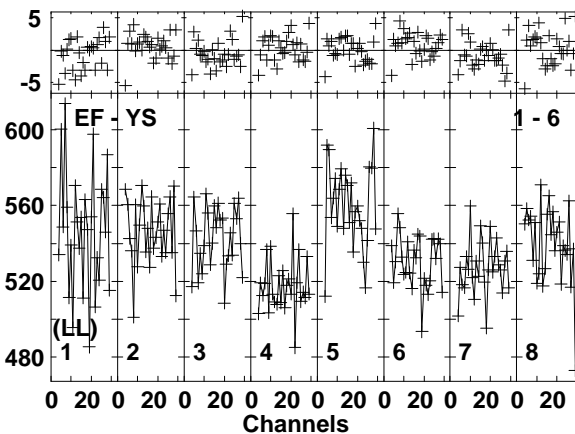
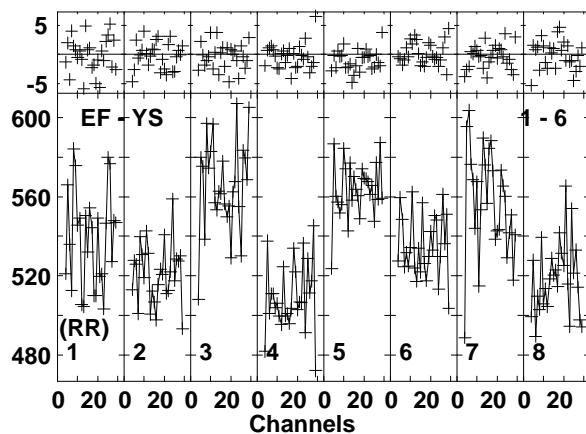
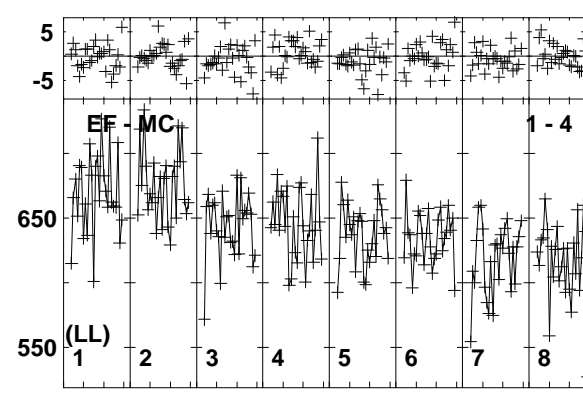
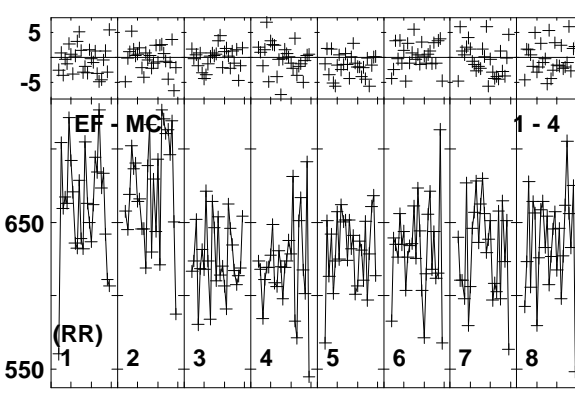
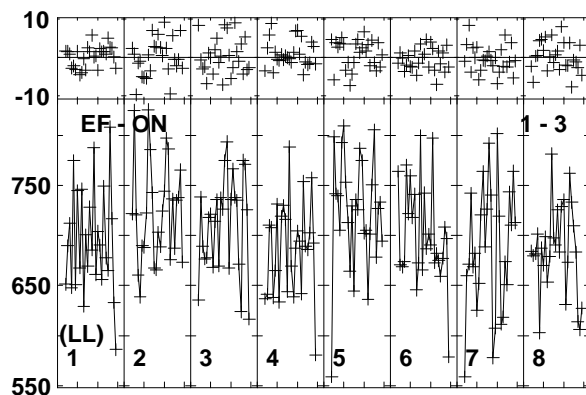
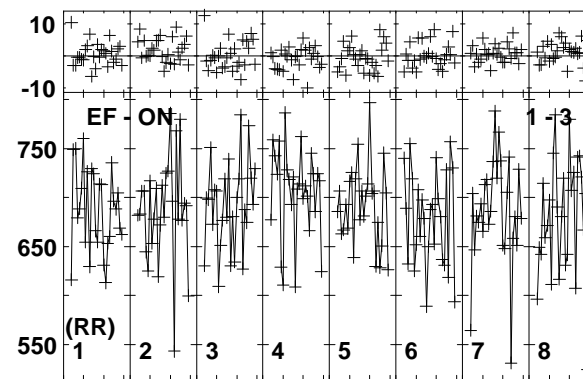
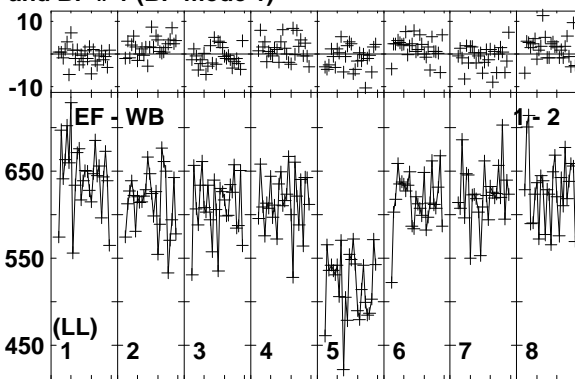
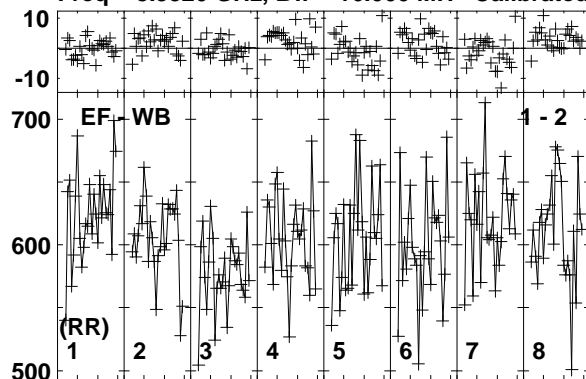

Lower frame: Milli Ampl Jy Top frame: Phas deg
Vector averaged cross-power spectrum Baseline: EF (01) - WB (02)
Timerange: 00/04:34:41 to 00/04:35:10

Plot file version 116 created 24-MAR-2014 14:38:13

J1128+5925 EP087F 5.UVDATA.1

Freq = 8.3520 GHz, Bw = 16.000 MH Calibrated with CL # 3 and BP # 1 (BP mode 1)

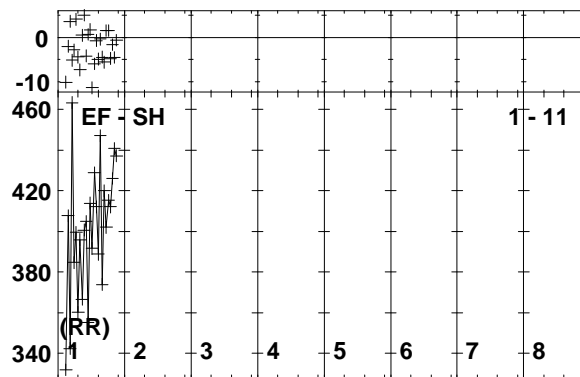
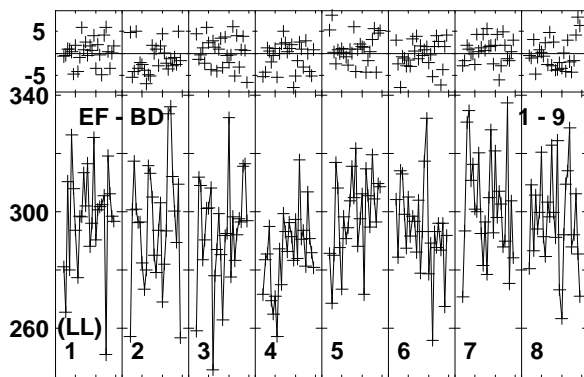
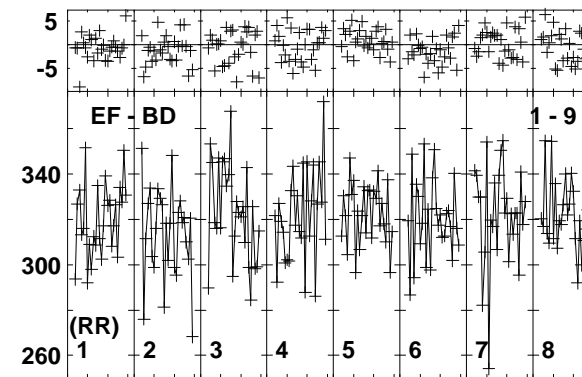
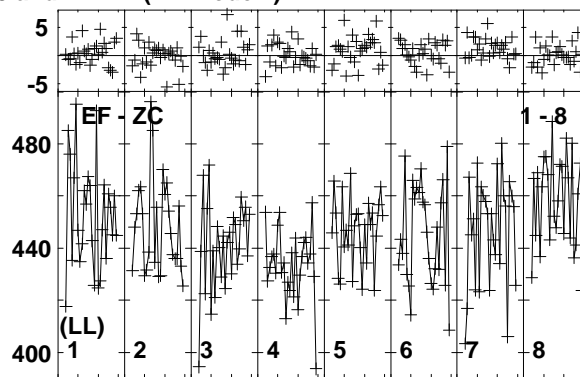
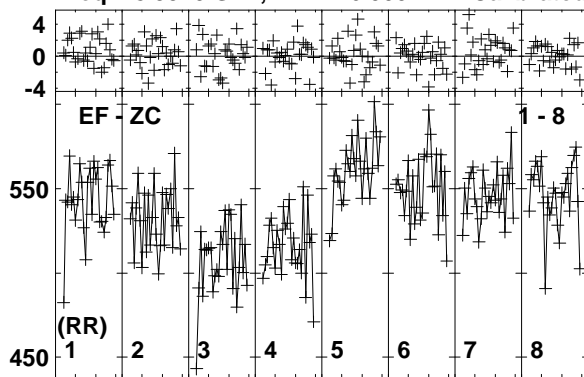

Lower frame: Milli Ampl Jy Top frame: Phas deg
Vector averaged cross-power spectrum Baseline: EF (01) - ZC (08)
Timerange: 00/04:34:41 to 00/04:35:10

Plot file version 117 created 24-MAR-2014 14:38:13
 ARP299D EP087F 5.UVDATA.1
 Freq = 8.3520 GHz, Bw = 16.000 MH Calibrated with CL # 3 and BP # 1 (BP mode 1)

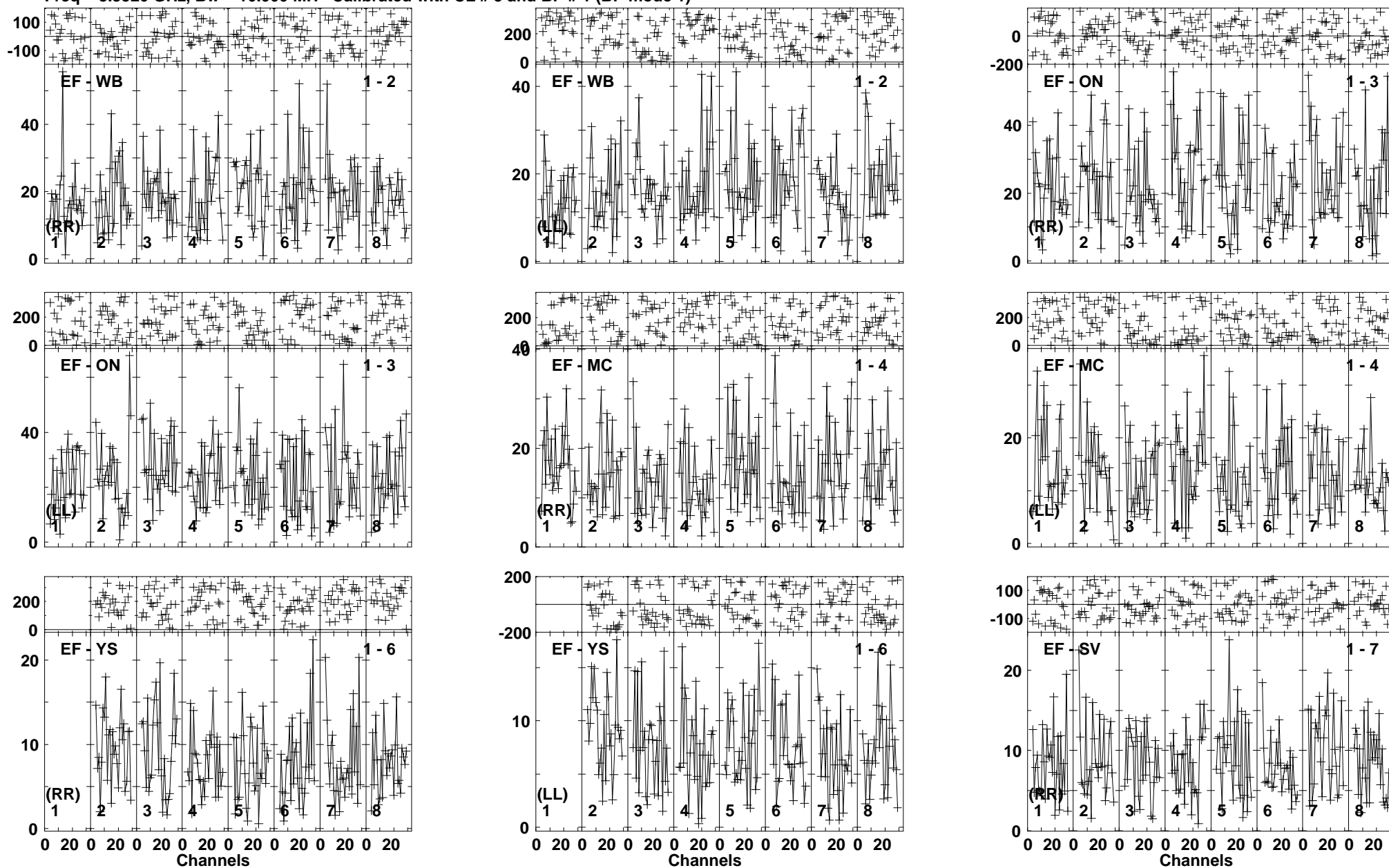

Lower frame: Milli Ampl Jy Top frame: Phas deg
 Vector averaged cross-power spectrum Baseline: EF (01) - WB (02)
 Timerange: 00/04:35:14 to 00/04:38:09

Plot file version 118 created 24-MAR-2014 14:38:13

ARP299D EP087F 5.UVDATA.1

Freq = 8.3520 GHz, Bw = 16.000 MH Calibrated with CL # 3 and BP # 1 (BP mode 1)

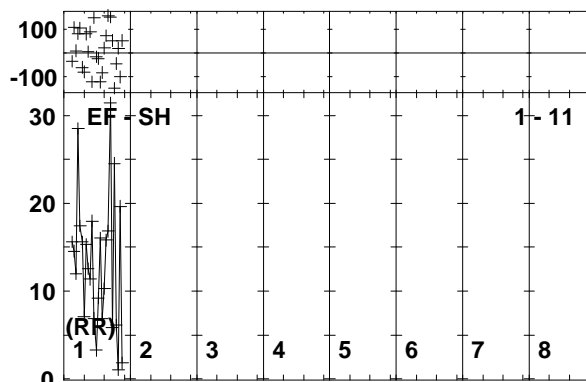
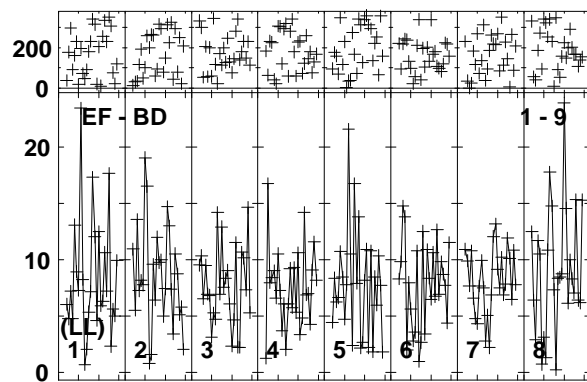
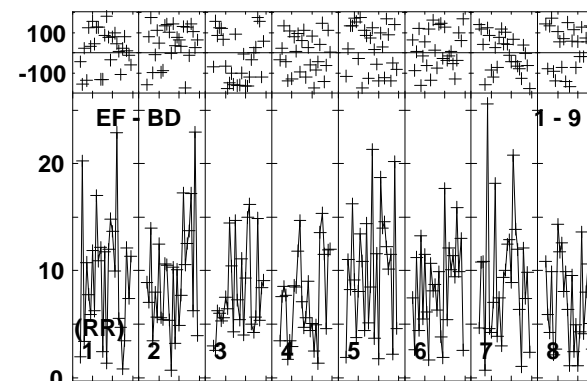
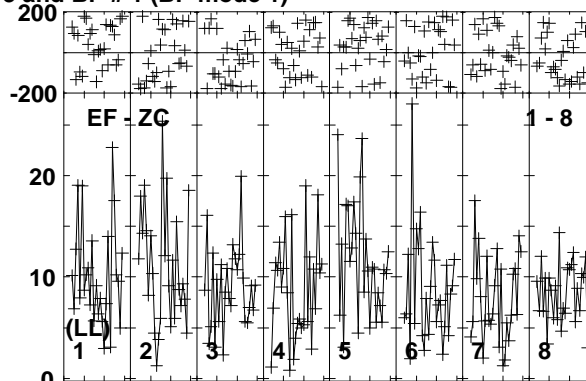
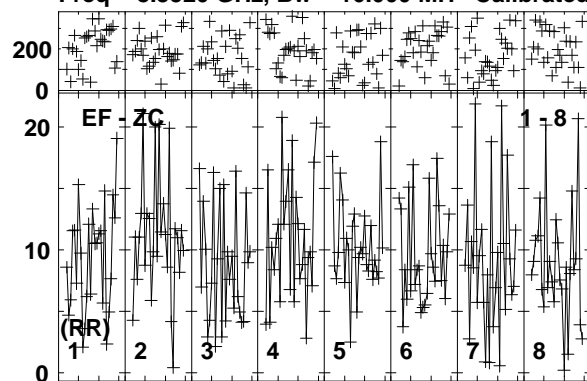

Lower frame: Milli Ampl Jy Top frame: Phas deg
Vector averaged cross-power spectrum Baseline: EF (01) - ZC (08)
Timerange: 00/04:35:14 to 00/04:38:09

Plot file version 119 created 24-MAR-2014 14:38:14

J1128+5925 EP087F 5.UVDATA.1

Freq = 8.3520 GHz, Bw = 16.000 MH Calibrated with CL # 3 and BP # 1 (BP mode 1)

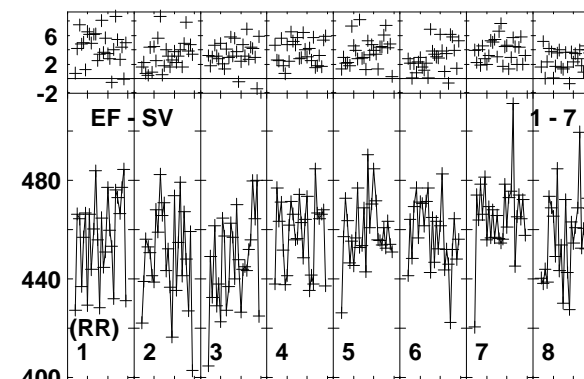
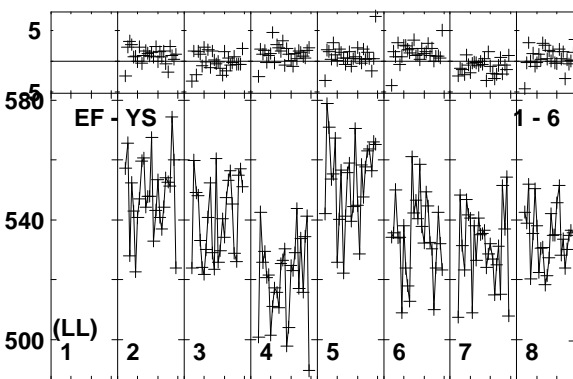
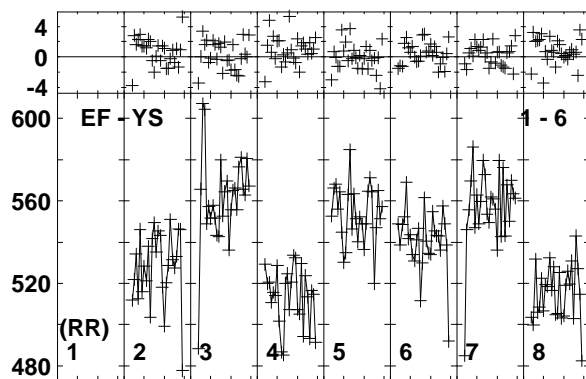
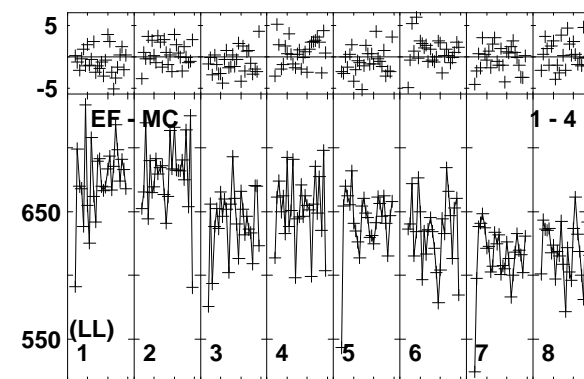
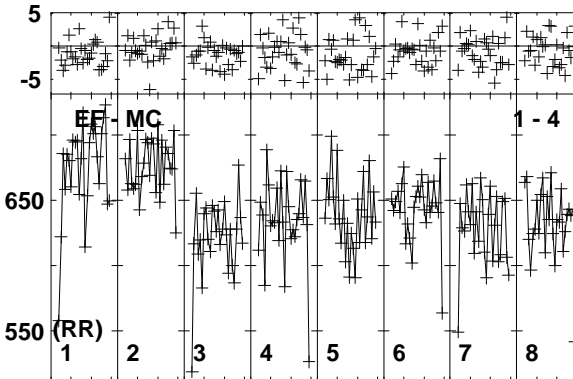
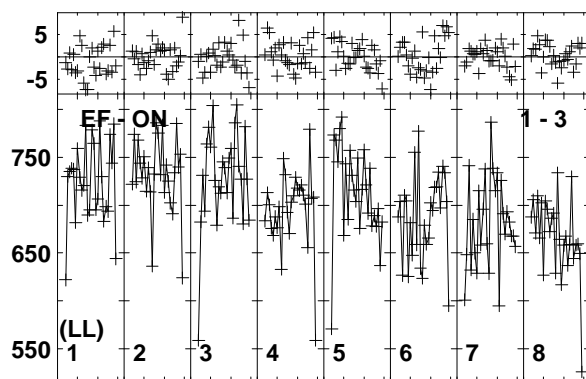
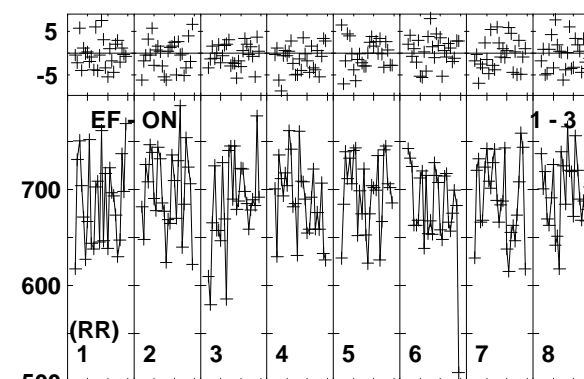
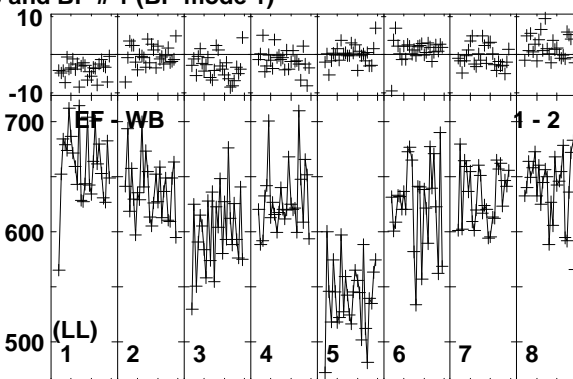
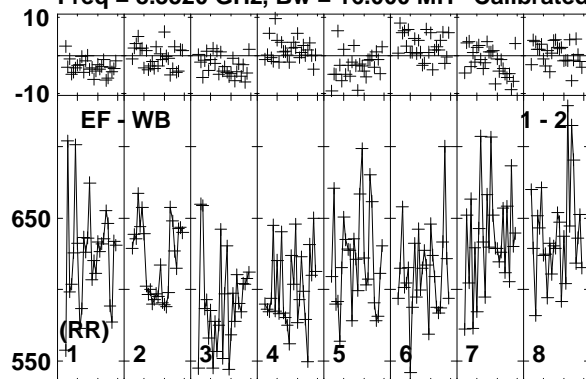

Lower frame: Milli Ampl Jy Top frame: Phas deg
Vector averaged cross-power spectrum Baseline: EF (01) - WB (02)
Timerange: 00/04:38:11 to 00/04:39:15

Plot file version 120 created 24-MAR-2014 14:38:14
 J1128+5925 EP087F 5.UVDATA.1
 Freq = 8.3520 GHz, Bw = 16.000 MH Calibrated with CL # 3 and BP # 1 (BP mode 1)

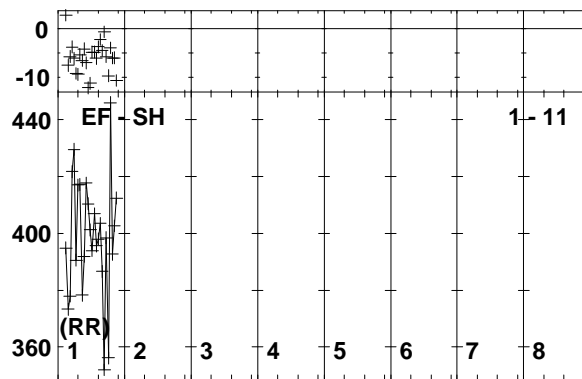
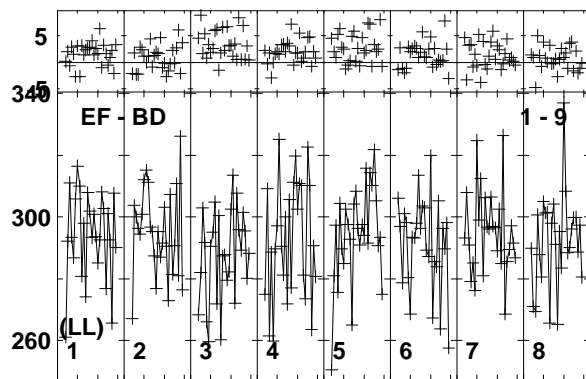
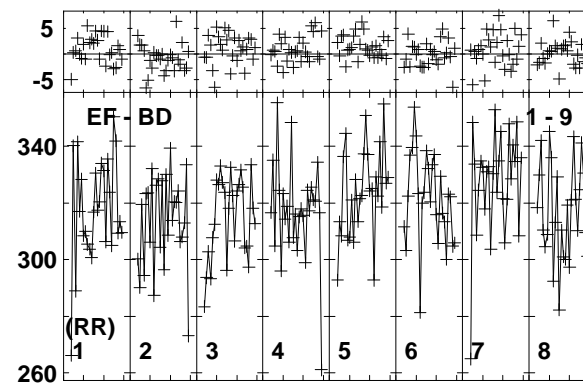
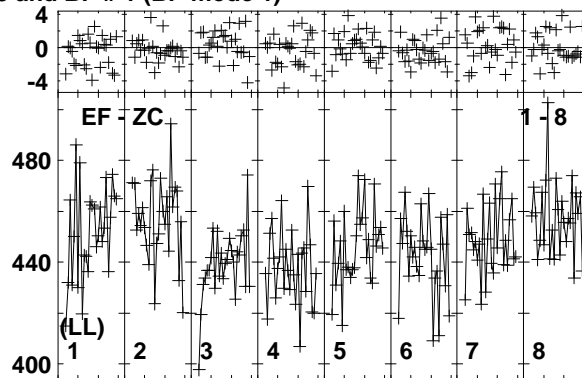
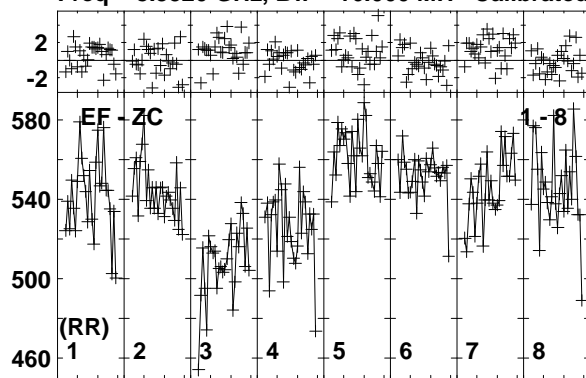

Lower frame: Milli Ampl Jy Top frame: Phas deg
 Vector averaged cross-power spectrum Baseline: EF (01) - ZC (08)
 Timerange: 00/04:38:11 to 00/04:39:15

Plot file version 121 created 24-MAR-2014 14:38:14

ARP299D EP087F 5.UVDATA.1

Freq = 8.3520 GHz, Bw = 16.000 MH Calibrated with CL # 3 and BP # 1 (BP mode 1)

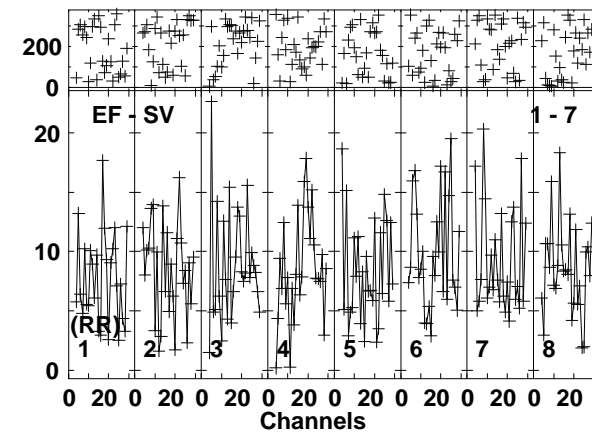
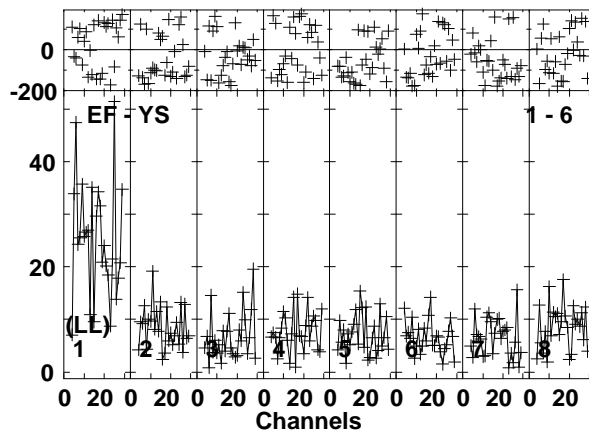
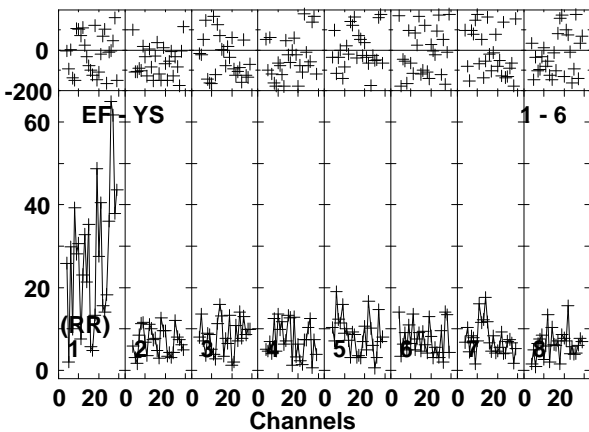
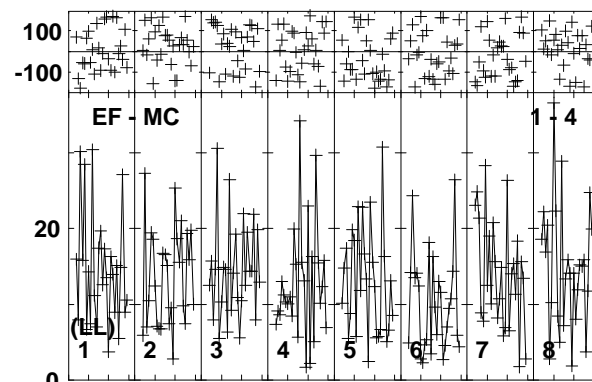
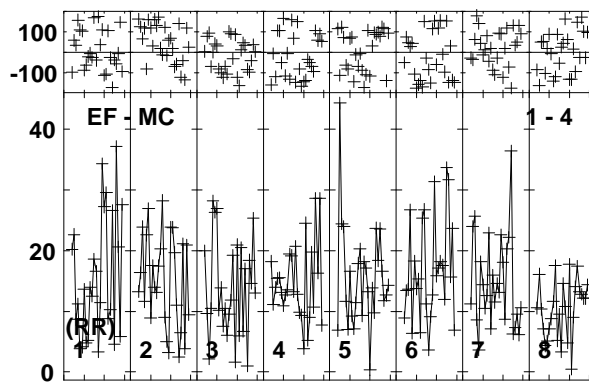
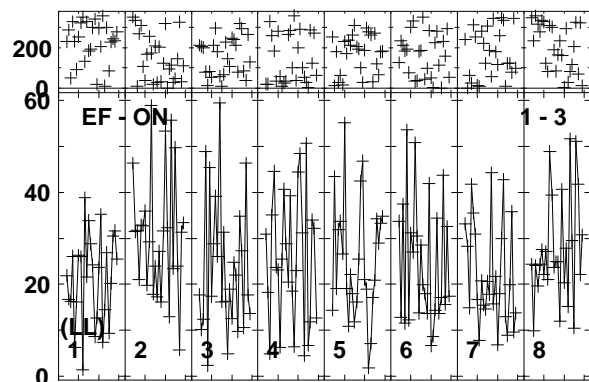
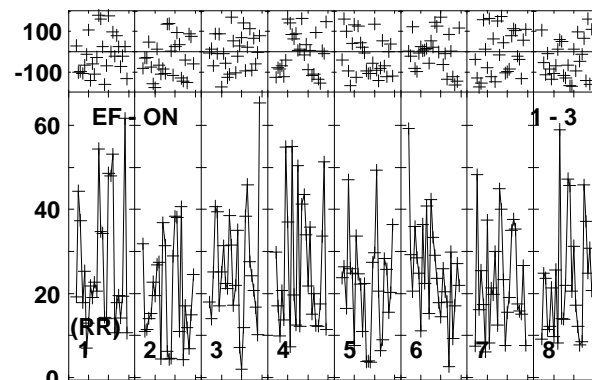
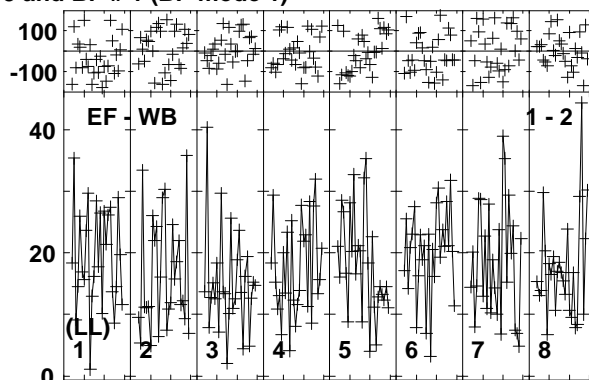
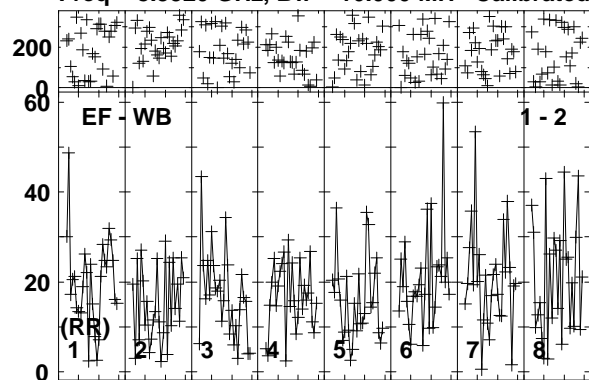

Lower frame: Milli Ampl Jy Top frame: Phas deg
Vector averaged cross-power spectrum Baseline: EF (01) - WB (02)
Timerange: 00/04:39:15 to 00/04:42:14

Plot file version 122 created 24-MAR-2014 14:38:14
 ARP299D EP087F 5.UVDATA.1
 Freq = 8.3520 GHz, Bw = 16.000 MH Calibrated with CL # 3 and BP # 1 (BP mode 1)

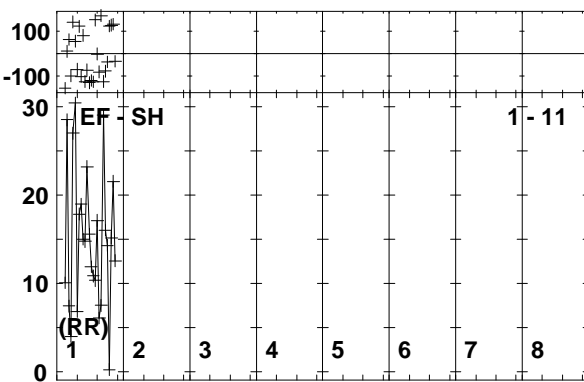
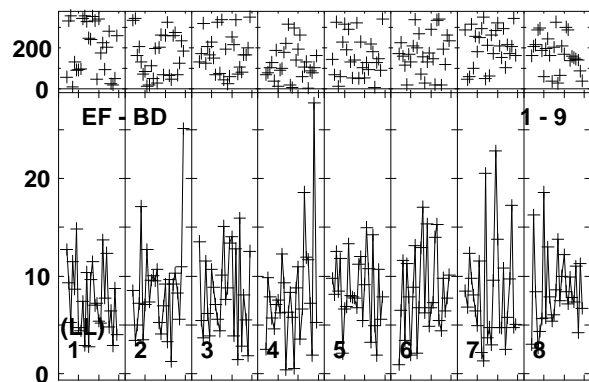
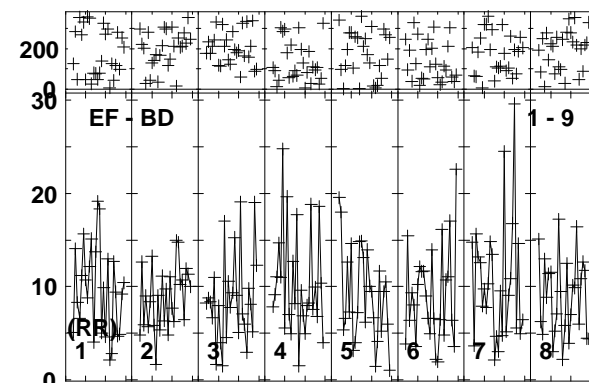
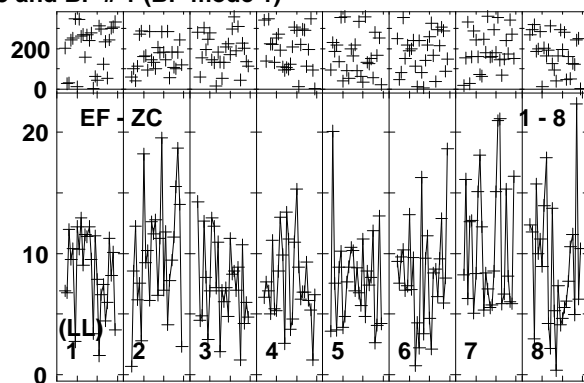
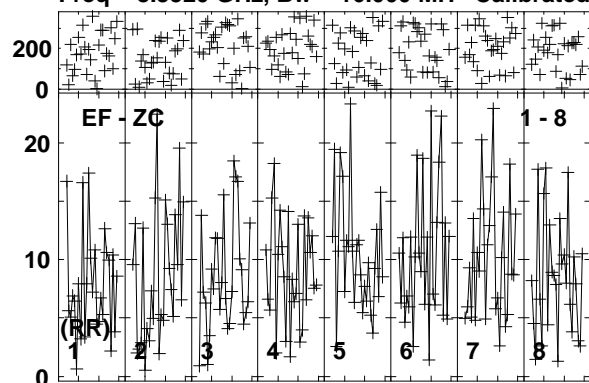

Lower frame: Milli Ampl Jy Top frame: Phas deg
 Vector averaged cross-power spectrum Baseline: EF (01) - ZC (08)
 Timerange: 00/04:39:15 to 00/04:42:14

Plot file version 123 created 24-MAR-2014 14:38:15

J1128+5925 EP087F 5.UVDATA.1

Freq = 8.3520 GHz, Bw = 16.000 MH Calibrated with CL # 3 and BP # 1 (BP mode 1)

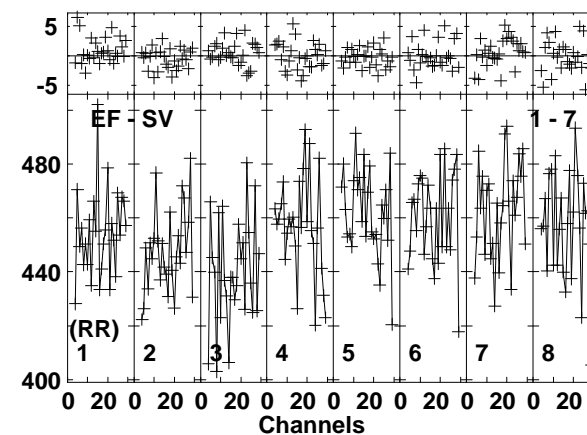
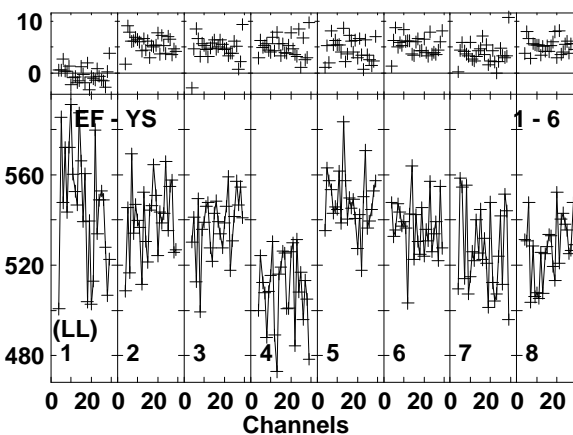
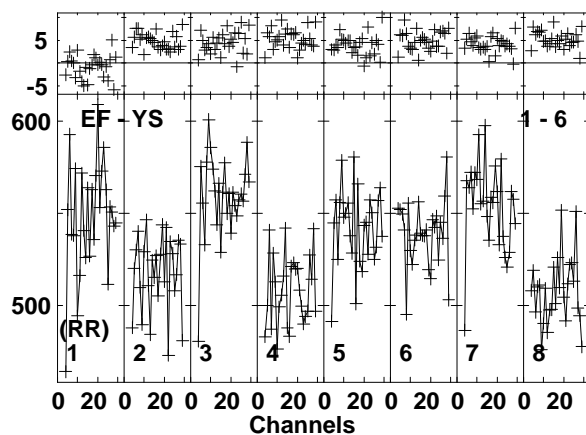
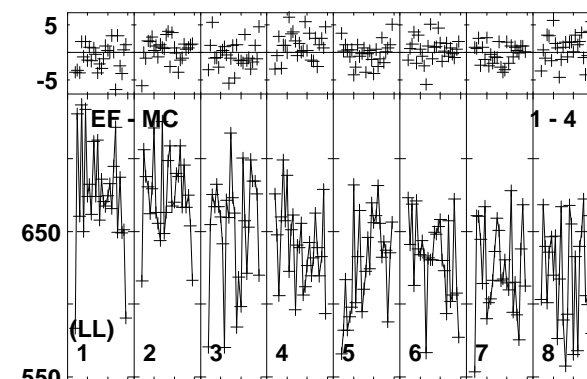
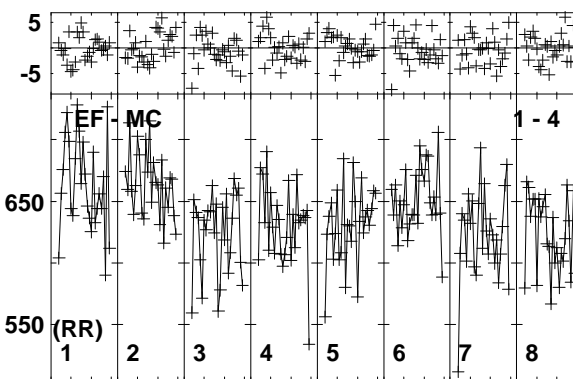
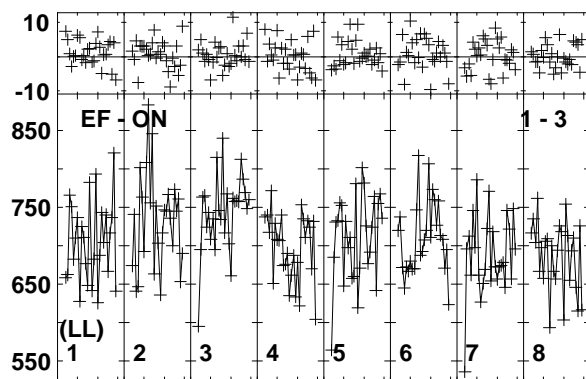
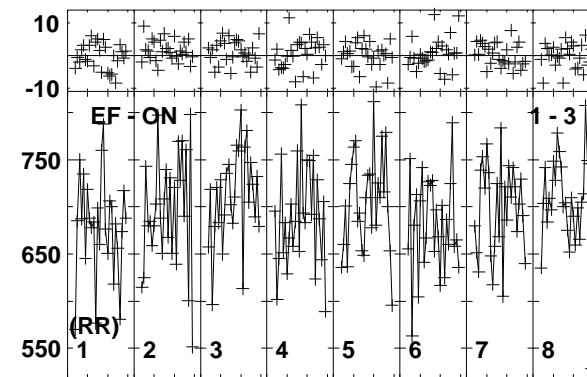
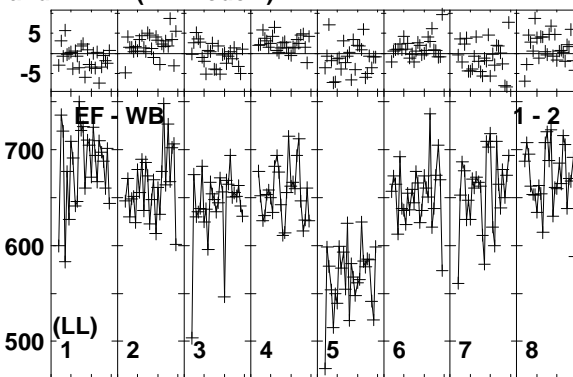
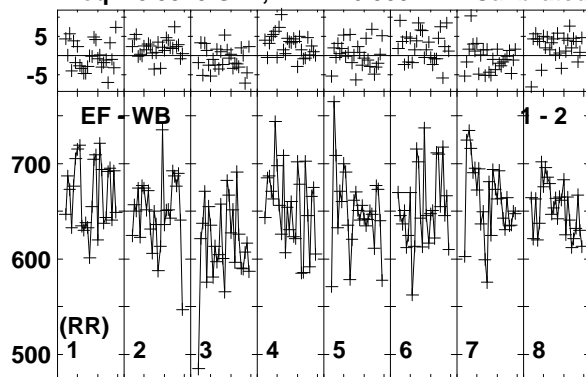

Lower frame: Milli Ampl Jy Top frame: Phas deg
Vector averaged cross-power spectrum Baseline: EF (01) - WB (02)
Timerange: 00/04:42:56 to 00/04:43:25

Plot file version 124 created 24-MAR-2014 14:38:15

J1128+5925 EP087F 5.UVDATA.1

Freq = 8.3520 GHz, Bw = 16.000 MH Calibrated with CL # 3 and BP # 1 (BP mode 1)

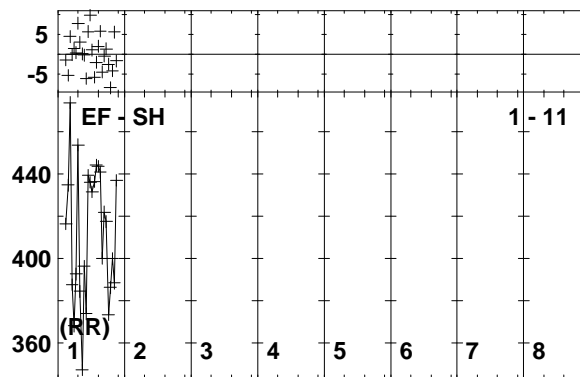
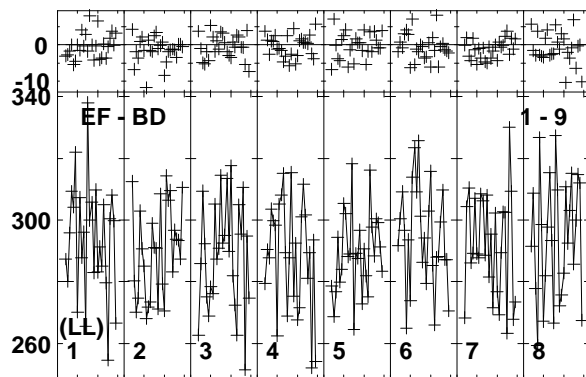
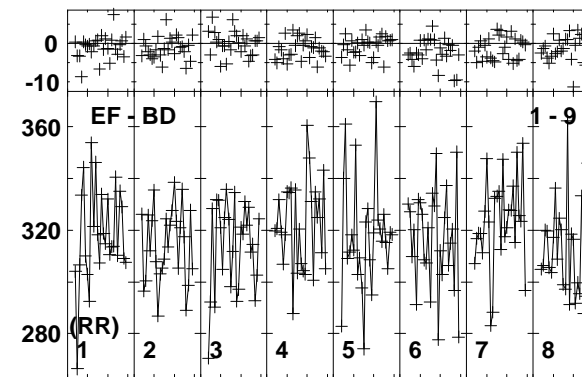
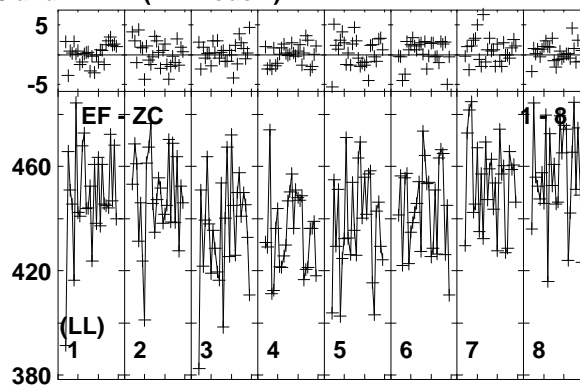
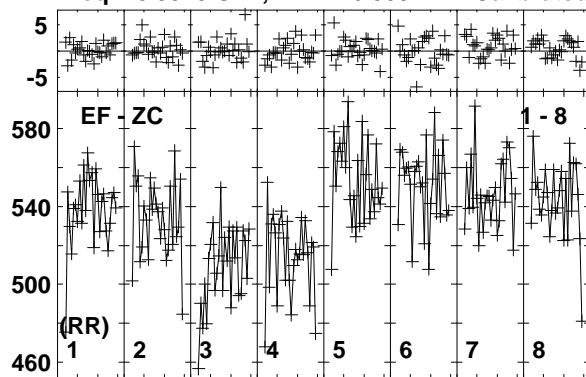

Lower frame: Milli Ampl Jy Top frame: Phas deg
Vector averaged cross-power spectrum Baseline: EF (01) - ZC (08)
Timerange: 00/04:42:56 to 00/04:43:25

Plot file version 125 created 24-MAR-2014 14:38:15
 ARP299D EP087F 5.UVDATA.1
 Freq = 8.3520 GHz, Bw = 16.000 MH Calibrated with CL # 3 and BP # 1 (BP mode 1)

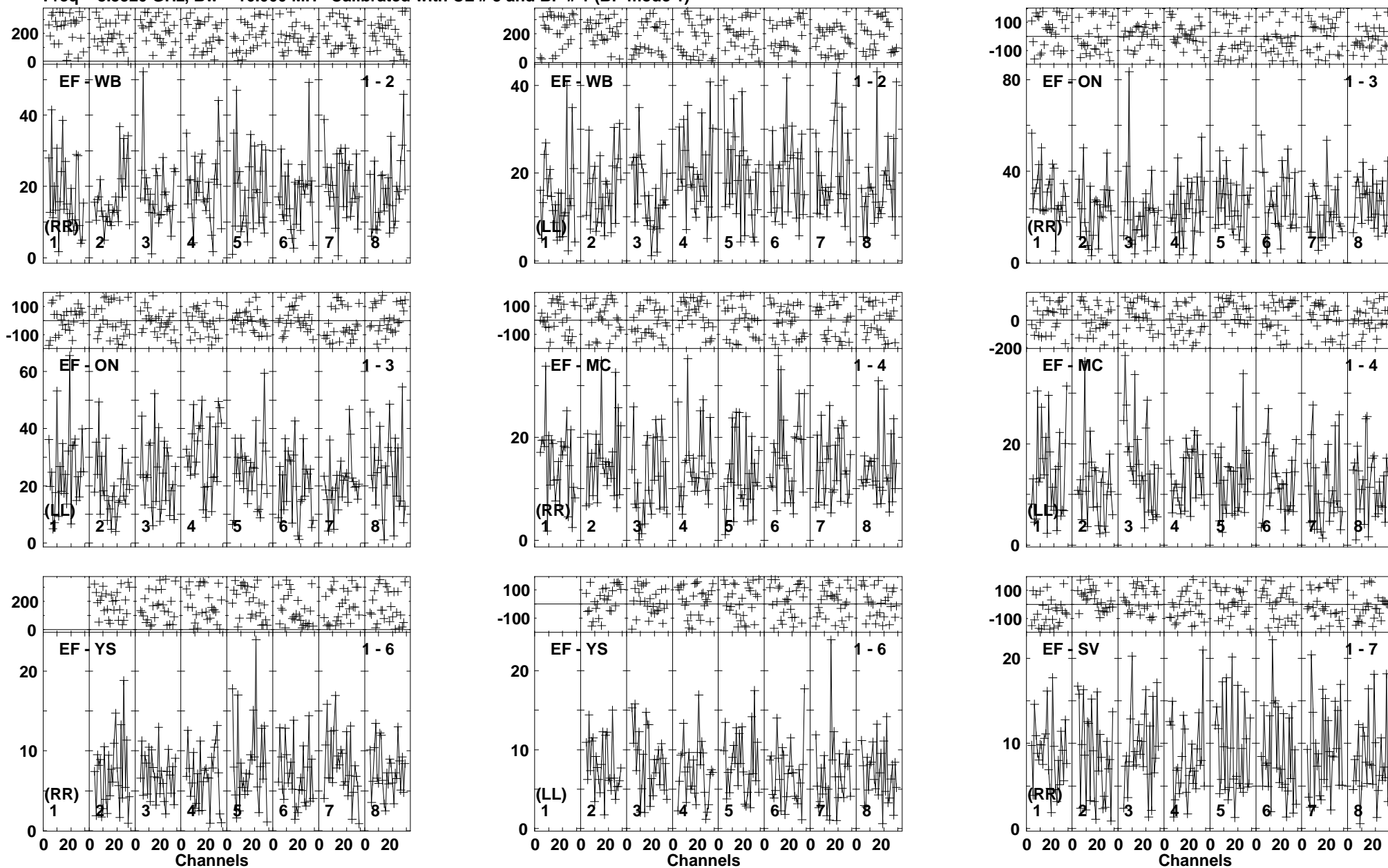

Lower frame: Milli Ampl Jy Top frame: Phas deg
 Vector averaged cross-power spectrum Baseline: EF (01) - WB (02)
 Timerange: 00/04:43:29 to 00/04:46:25

Plot file version 126 created 24-MAR-2014 14:38:15
 ARP299D EP087F 5.UVDATA.1
 Freq = 8.3520 GHz, Bw = 16.000 MH Calibrated with CL # 3 and BP # 1 (BP mode 1)

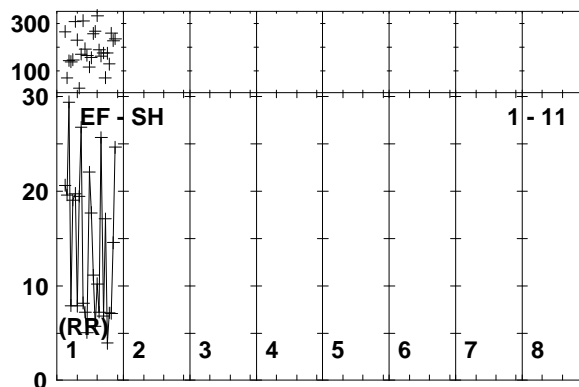
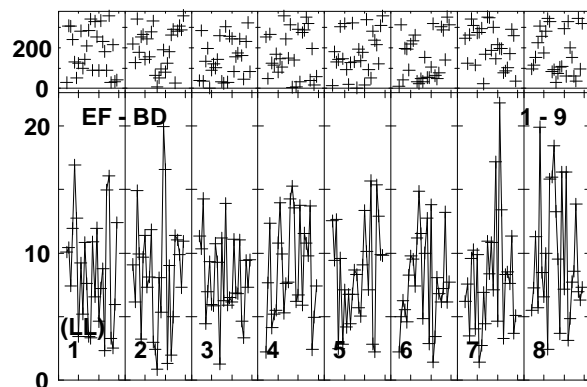
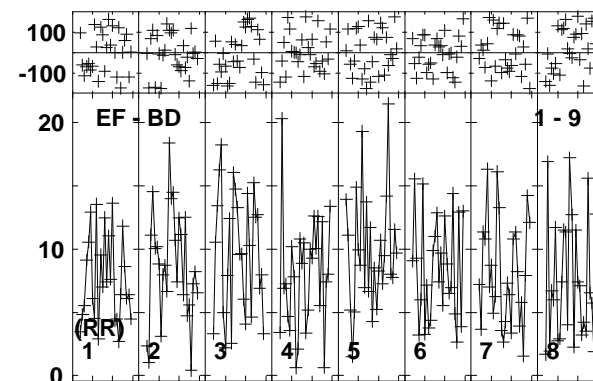
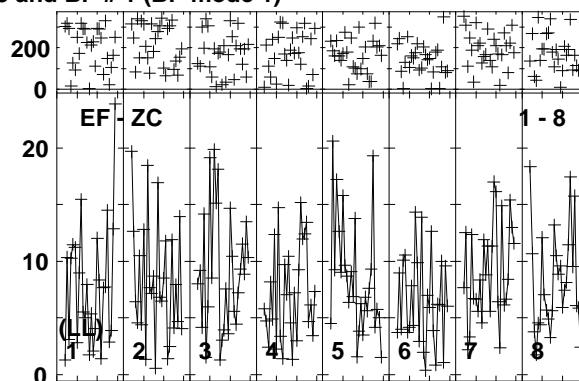
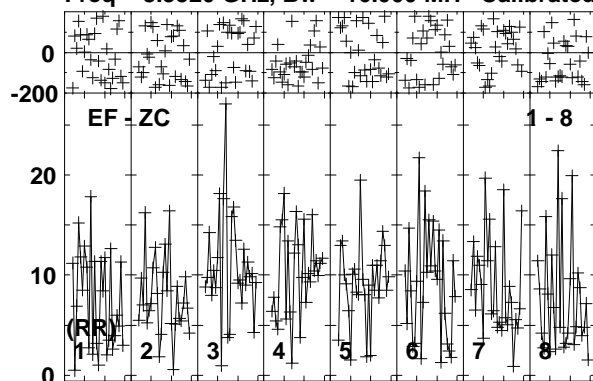

Lower frame: Milli Ampl Jy Top frame: Phas deg
 Vector averaged cross-power spectrum Baseline: EF (01) - ZC (08)
 Timerange: 00/04:43:29 to 00/04:46:25

Plot file version 127 created 24-MAR-2014 14:38:16

J1128+5925 EP087F 5.UVDATA.1

Freq = 8.3520 GHz, Bw = 16.000 MH Calibrated with CL # 3 and BP # 1 (BP mode 1)

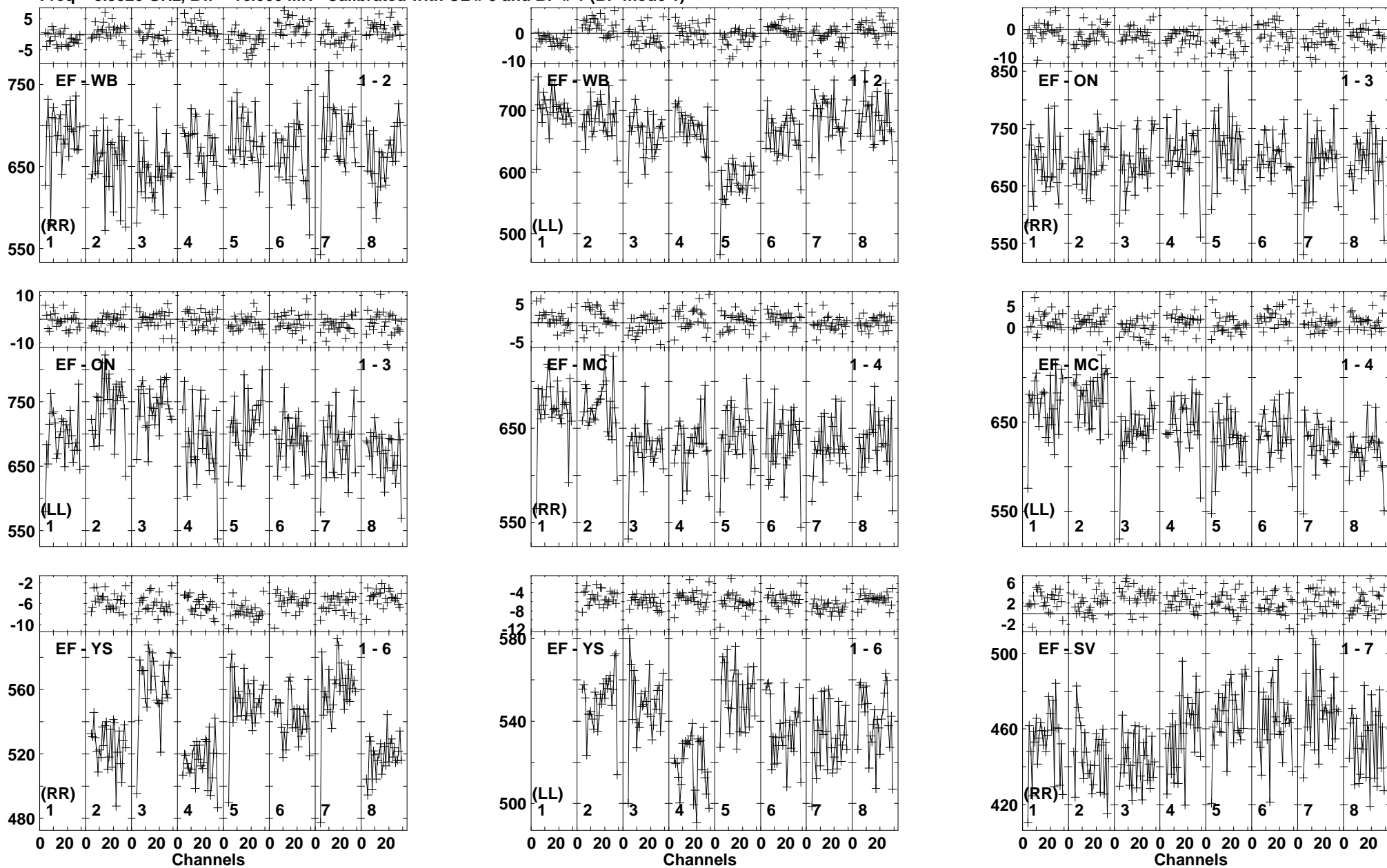

Plot file version 128 created 24-MAR-2014 14:38:16

J1128+5925 EP087F 5.UVDATA.1

Freq = 8.3520 GHz, Bw = 16.000 MH Calibrated with CL # 3 and BP # 1 (BP mode 1)

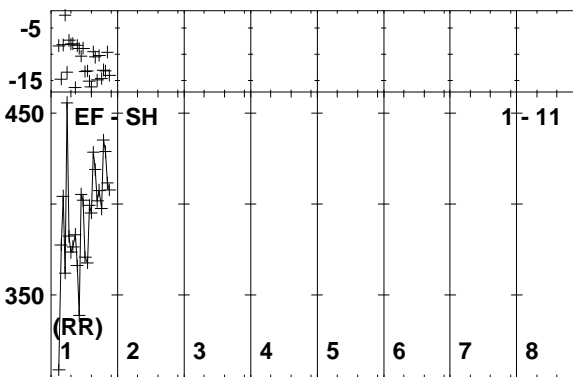
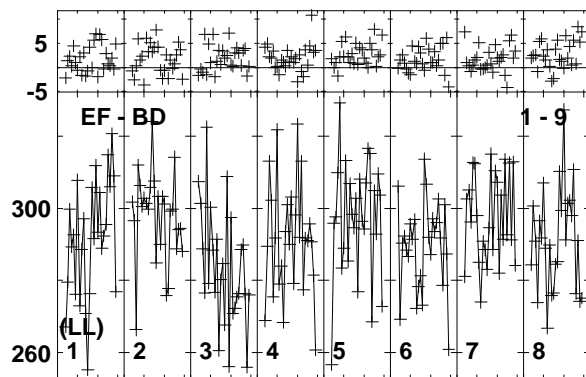
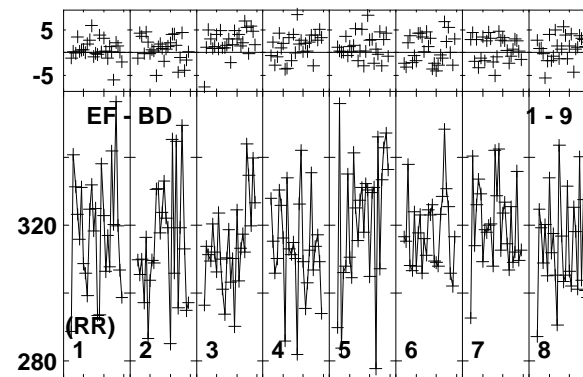
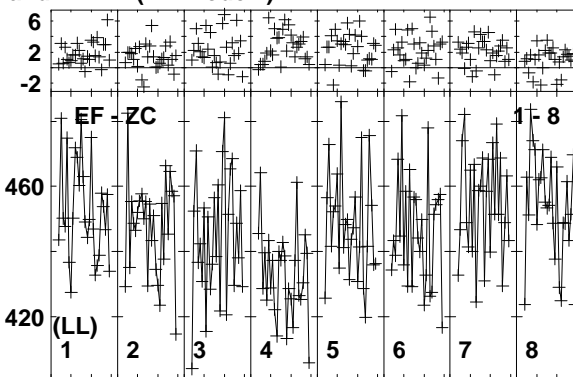
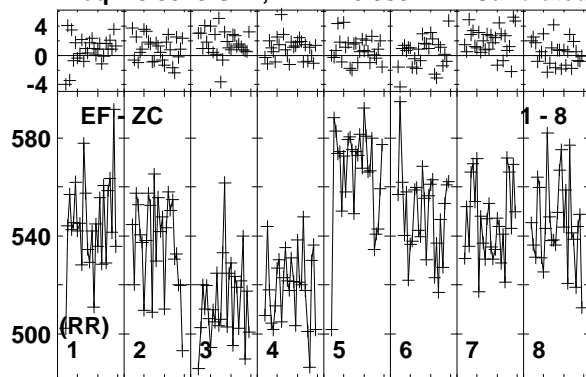

Lower frame: Milli Ampl Jy Top frame: Phas deg
Vector averaged cross-power spectrum Baseline: EF (01) - ZC (08)
Timerange: 00/04:46:25 to 00/04:47:30

Plot file version 129 created 24-MAR-2014 14:38:16

ARP299D EP087F 5.UVDATA.1

Freq = 8.3520 GHz, Bw = 16.000 MH Calibrated with CL # 3 and BP # 1 (BP mode 1)

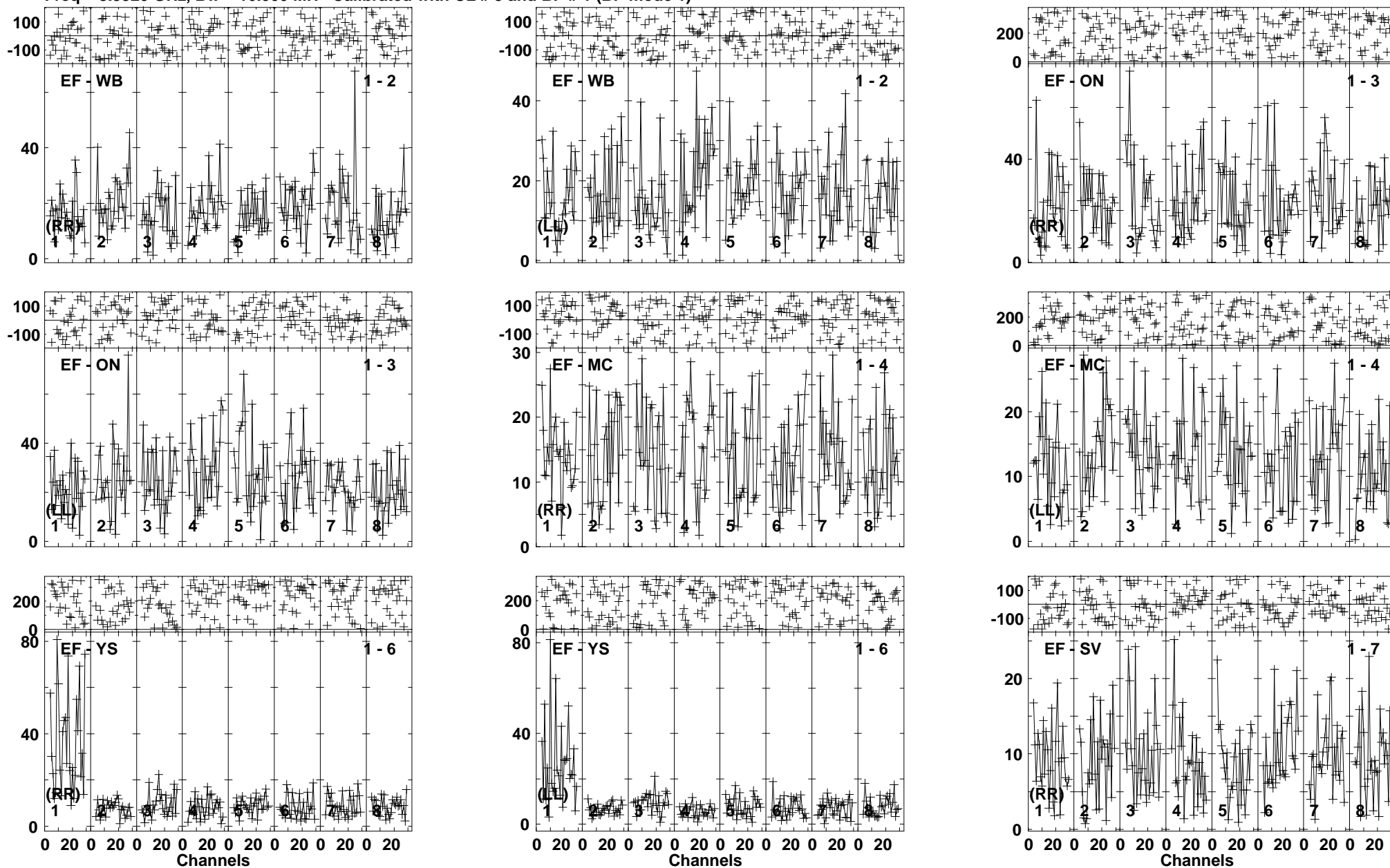

Lower frame: Milli Ampl Jy Top frame: Phas deg
Vector averaged cross-power spectrum Baseline: EF (01) - WB (02)
Timerange: 00/04:47:30 to 00/04:50:30

Plot file version 130 created 24-MAR-2014 14:38:16
 ARP299D EP087F 5.UVDATA.1
 Freq = 8.3520 GHz, Bw = 16.000 MH Calibrated with CL # 3 and BP # 1 (BP mode 1)

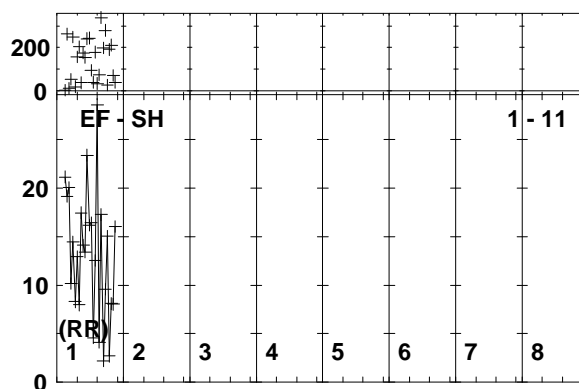
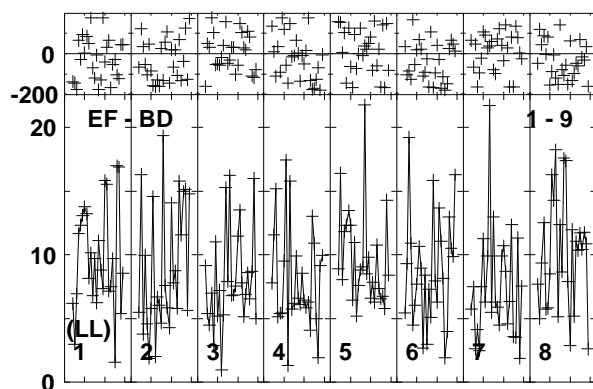
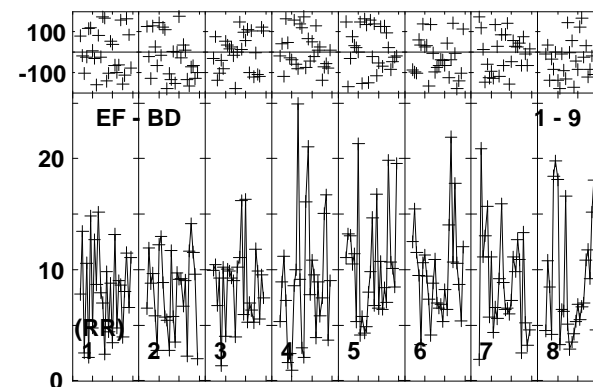
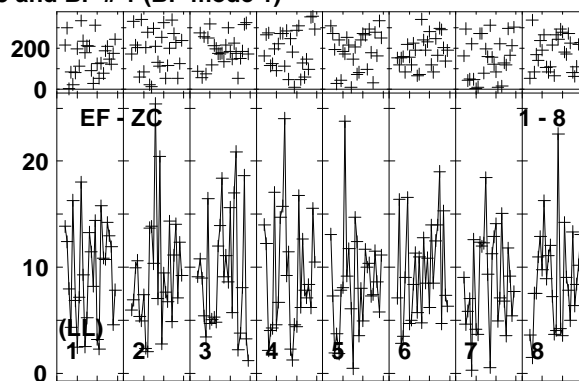
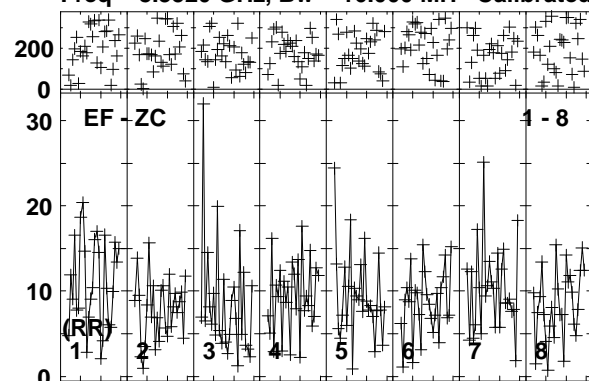

Lower frame: Milli Ampl Jy Top frame: Phas deg
 Vector averaged cross-power spectrum Baseline: EF (01) - ZC (08)
 Timerange: 00/04:47:30 to 00/04:50:30

Plot file version 131 created 24-MAR-2014 14:38:16

J1128+5925 EP087F 5.UVDATA.1

Freq = 8.3520 GHz, Bw = 16.000 MH Calibrated with CL # 3 and BP # 1 (BP mode 1)

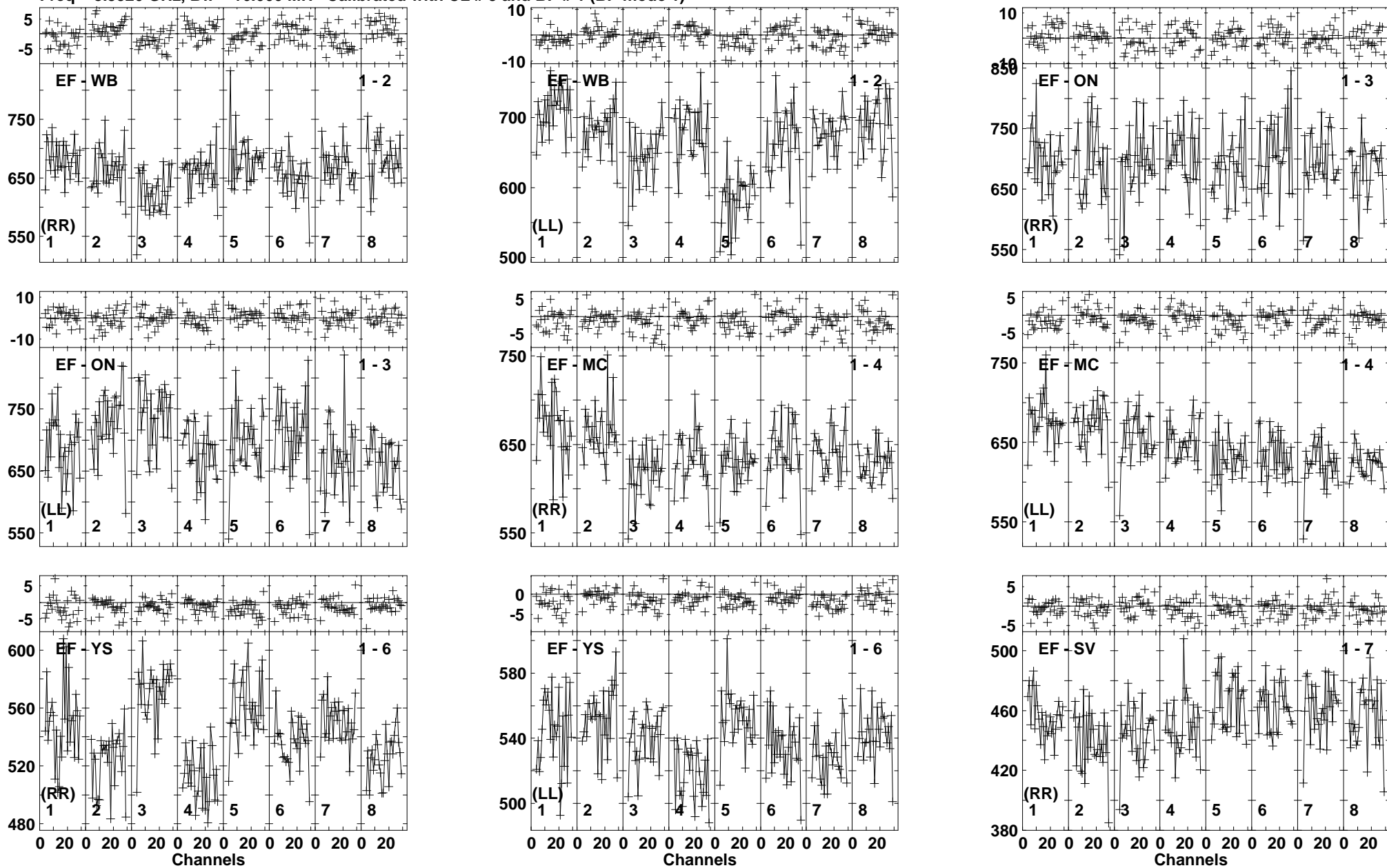

Lower frame: Milli Ampl Jy Top frame: Phas deg
Vector averaged cross-power spectrum Baseline: EF (01) - WB (02)
Timerange: 00/04:51:11 to 00/04:51:39

Plot file version 132 created 24-MAR-2014 14:38:17

J1128+5925 EP087F 5.UVDATA.1

Freq = 8.3520 GHz, Bw = 16.000 MH Calibrated with CL # 3 and BP # 1 (BP mode 1)

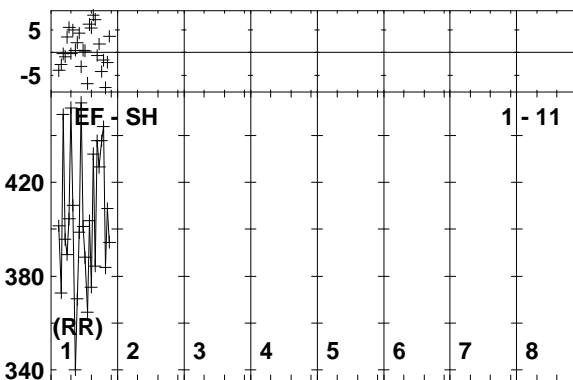
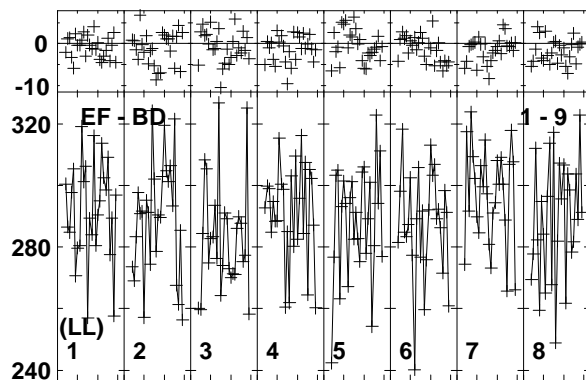
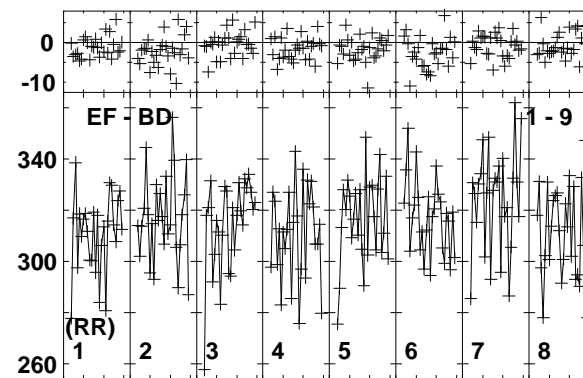
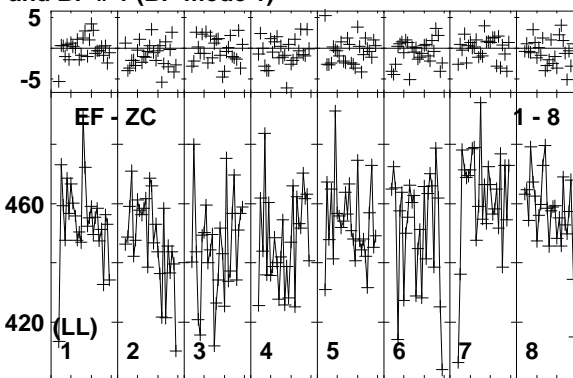
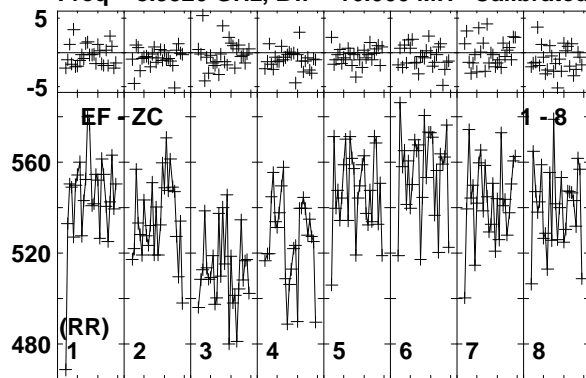

Lower frame: Milli Ampl Jy Top frame: Phas deg
Vector averaged cross-power spectrum Baseline: EF (01) - ZC (08)
Timerange: 00/04:51:11 to 00/04:51:39

Plot file version 133 created 24-MAR-2014 14:38:17
 ARP299D EP087F 5.UVDATA.1
 Freq = 8.3520 GHz, Bw = 16.000 MH Calibrated with CL # 3 and BP # 1 (BP mode 1)

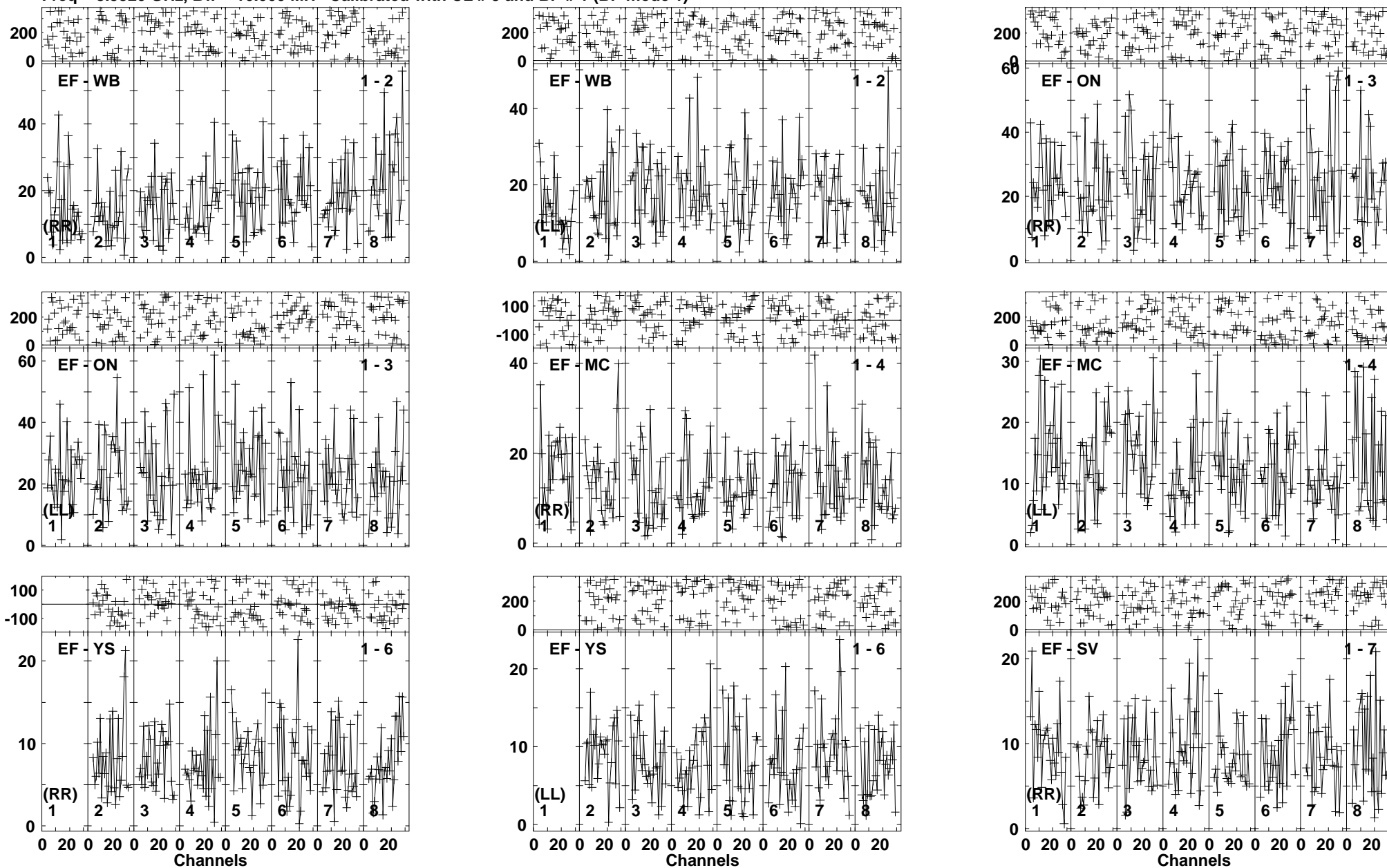

Lower frame: Milli Ampl Jy Top frame: Phas deg
 Vector averaged cross-power spectrum Baseline: EF (01) - WB (02)
 Timerange: 00/04:51:44 to 00/04:54:40

Plot file version 134 created 24-MAR-2014 14:38:17

ARP299D EP087F 5.UVDATA.1

Freq = 8.3520 GHz, Bw = 16.000 MH Calibrated with CL # 3 and BP # 1 (BP mode 1)

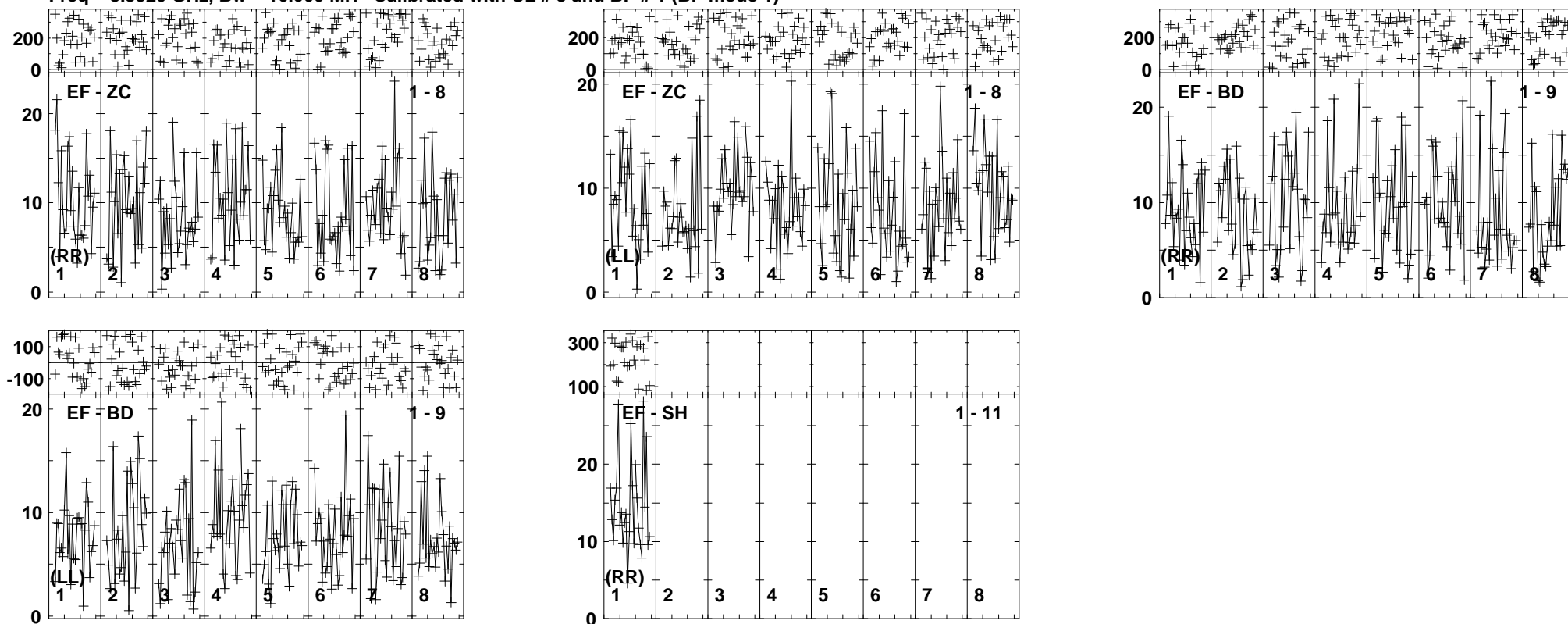

Lower frame: Milli Ampl Jy Top frame: Phas deg
Vector averaged cross-power spectrum Baseline: EF (01) - ZC (08)
Timerange: 00/04:51:44 to 00/04:54:40

Plot file version 135 created 24-MAR-2014 14:38:18

J1128+5925 EP087F 5.UVDATA.1

Freq = 8.3520 GHz, Bw = 16.000 MH Calibrated with CL # 3 and BP # 1 (BP mode 1)

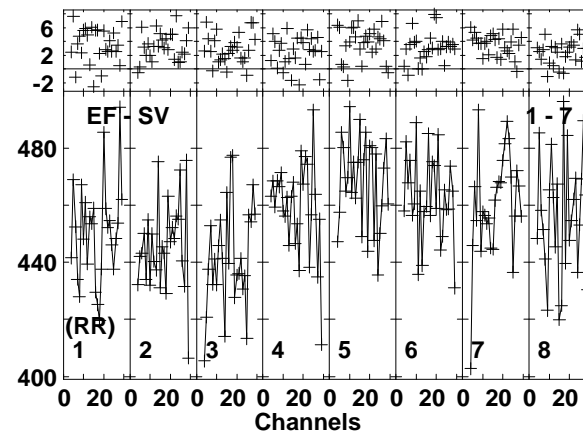
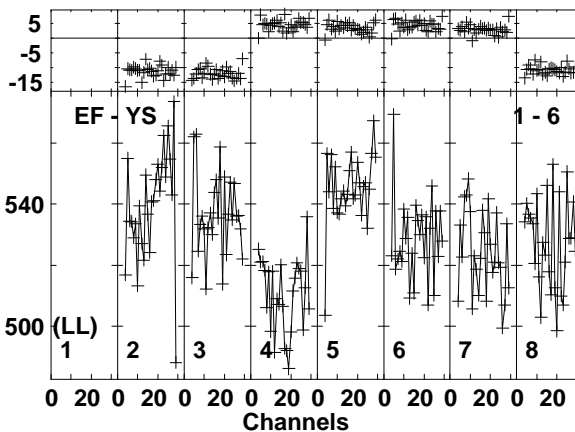
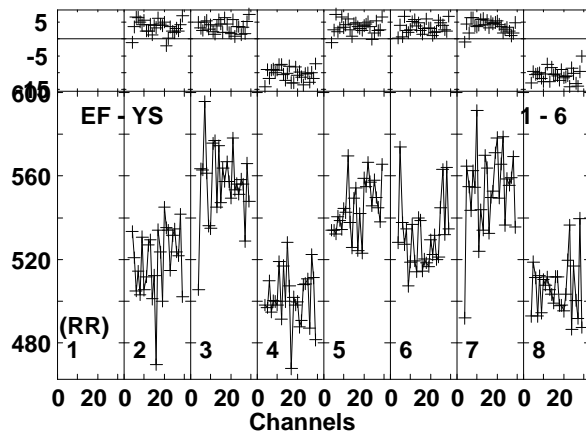
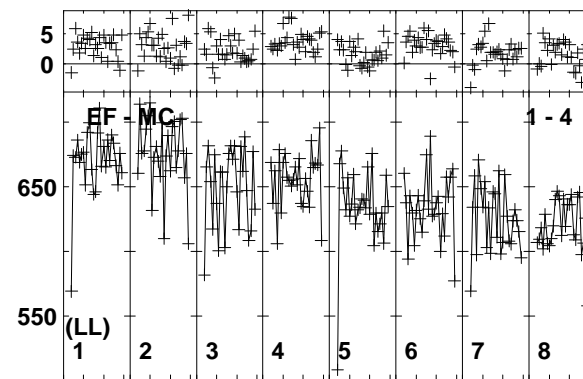
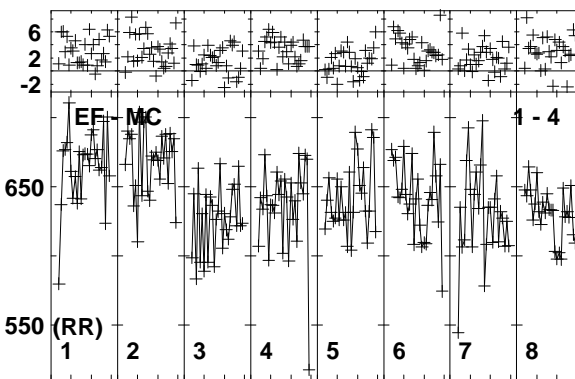
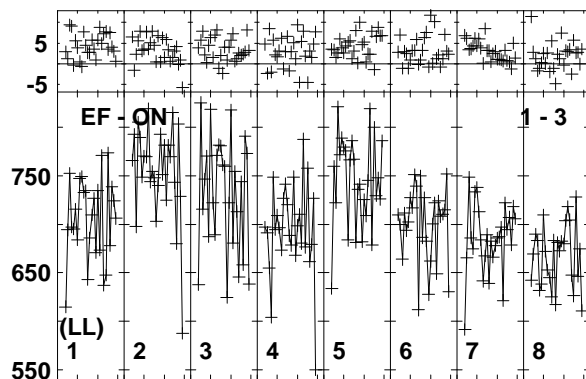
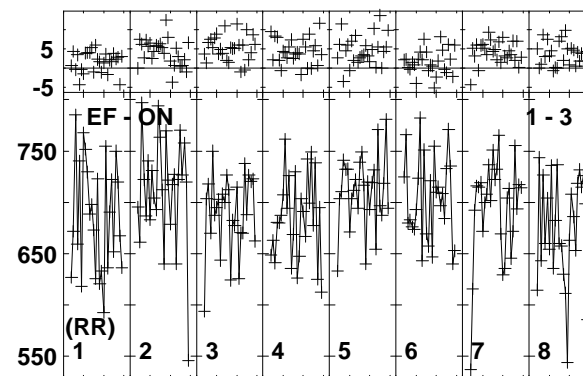
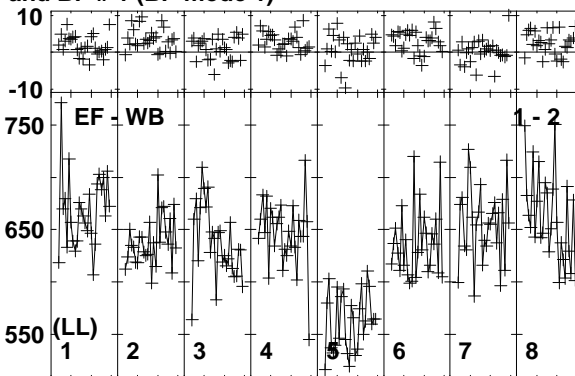
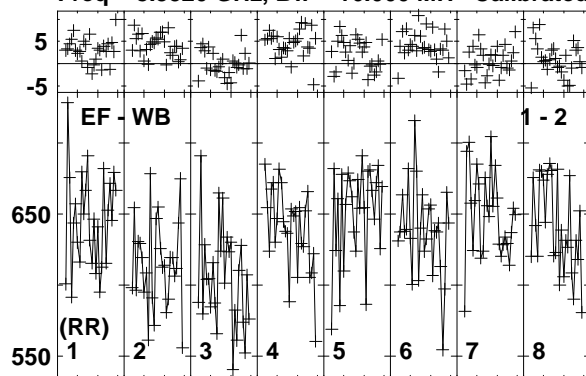

Lower frame: Milli Ampl Jy Top frame: Phas deg
Vector averaged cross-power spectrum Baseline: EF (01) - WB (02)
Timerange: 00/04:54:41 to 00/04:55:45

Plot file version 136 created 24-MAR-2014 14:38:18
 J1128+5925 EP087F 5.UVDATA.1
 Freq = 8.3520 GHz, Bw = 16.000 MH Calibrated with CL # 3 and BP # 1 (BP mode 1)

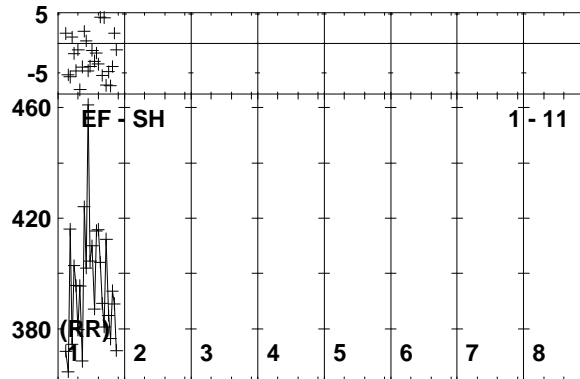
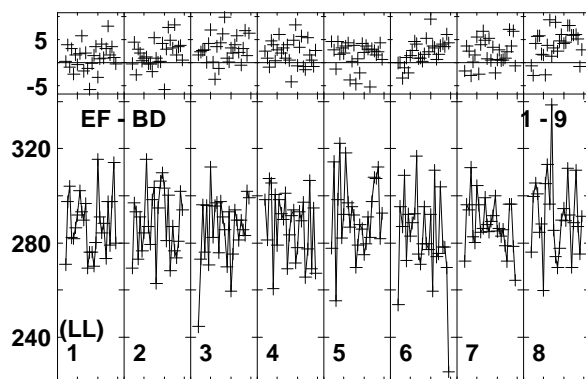
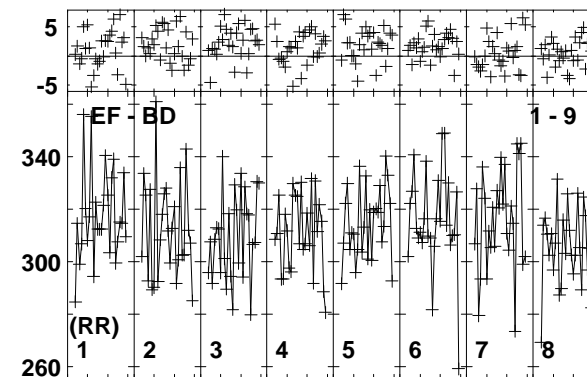
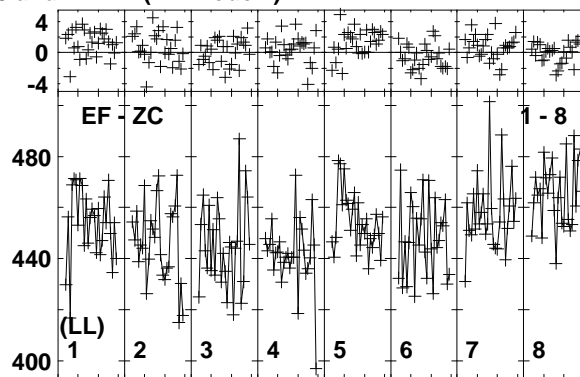
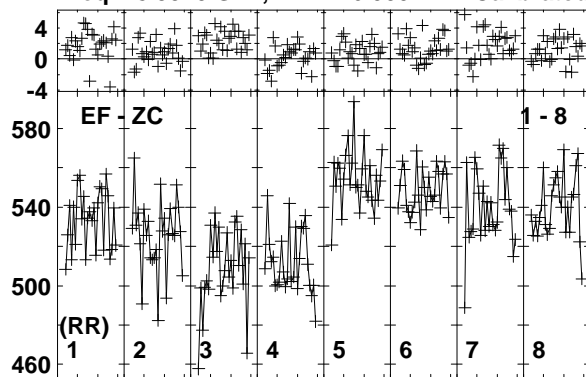

Lower frame: Milli Ampl Jy Top frame: Phas deg
 Vector averaged cross-power spectrum Baseline: EF (01) - ZC (08)
 Timerange: 00/04:54:41 to 00/04:55:45

Plot file version 137 created 24-MAR-2014 14:38:18

ARP299D EP087F 5.UVDATA.1

Freq = 8.3520 GHz, Bw = 16.000 MH Calibrated with CL # 3 and BP # 1 (BP mode 1)

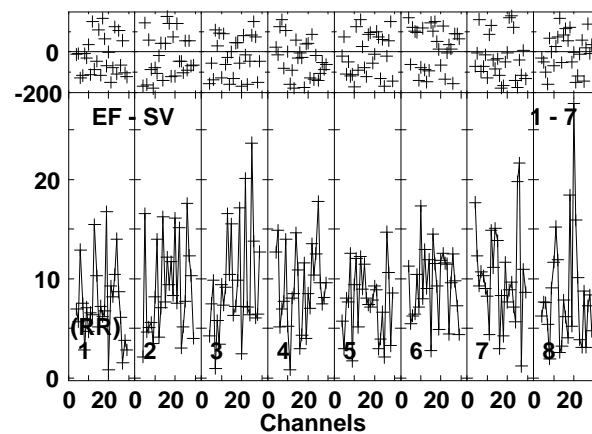
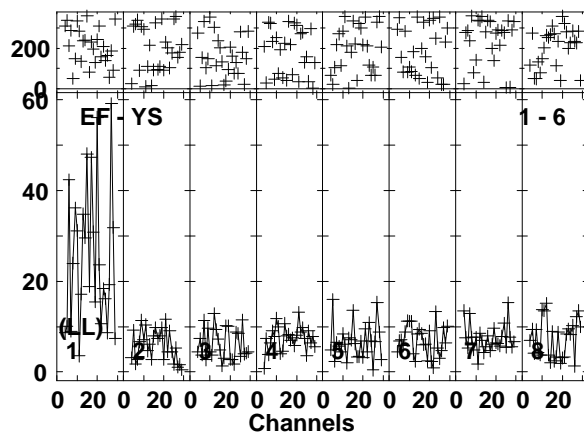
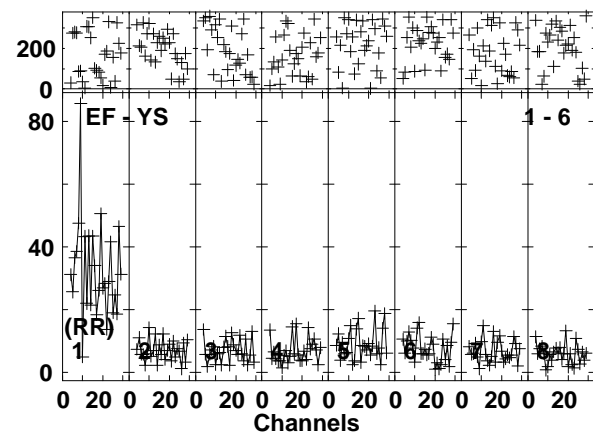
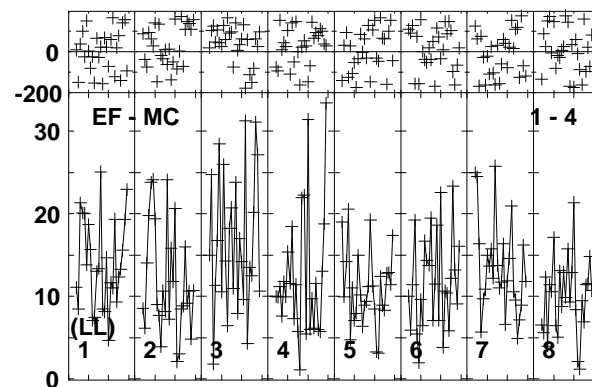
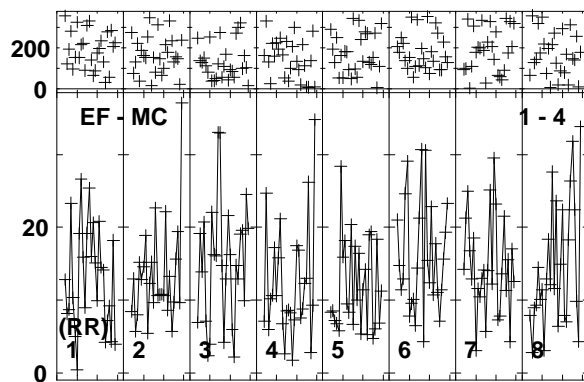
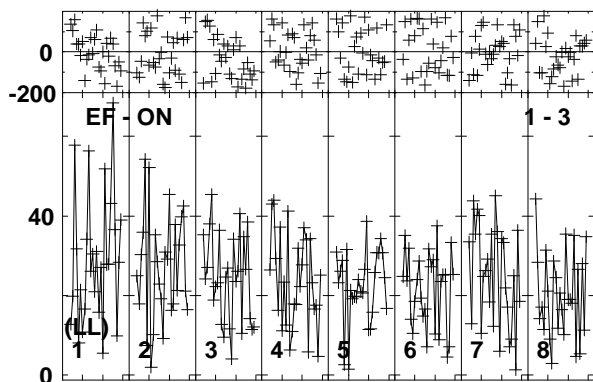
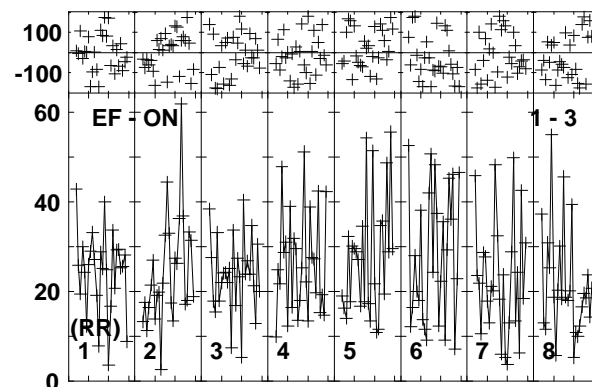
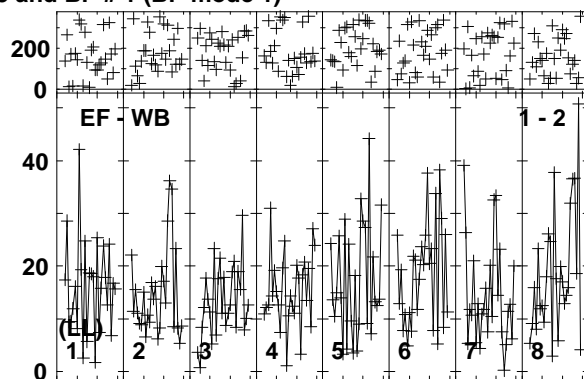
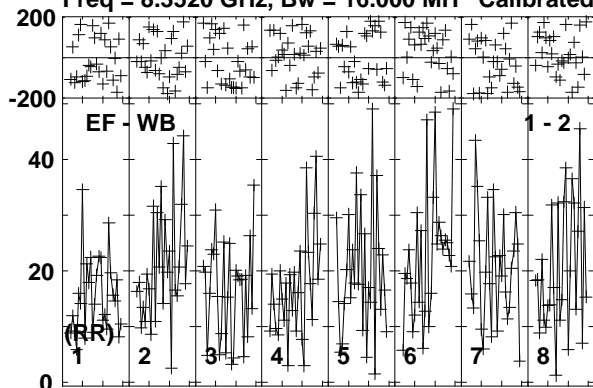

Lower frame: Milli Ampl Jy Top frame: Phas deg

Vector averaged cross-power spectrum Baseline: EF (01) - WB (02)

Timerange: 00/04:55:45 to 00/04:58:44

Plot file version 138 created 24-MAR-2014 14:38:18

ARP299D EP087F 5.UVDATA.1

Freq = 8.3520 GHz, Bw = 16.000 MH Calibrated with CL # 3 and BP # 1 (BP mode 1)

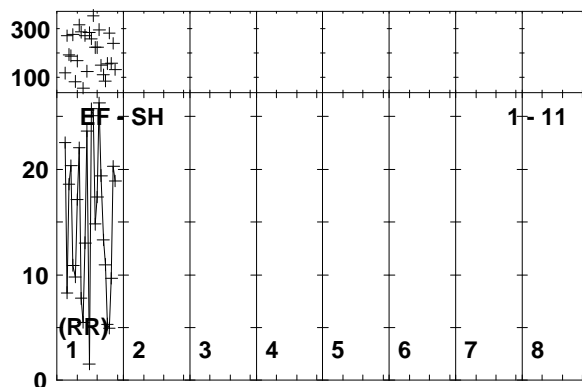
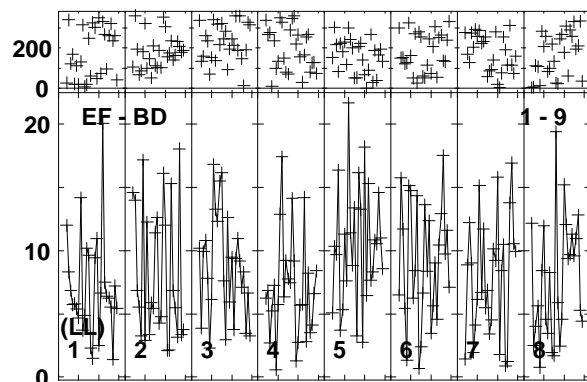
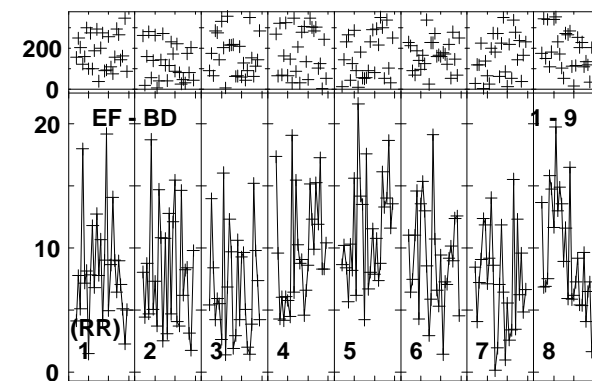
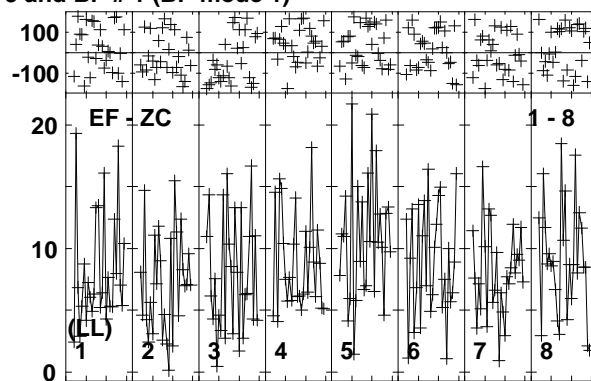
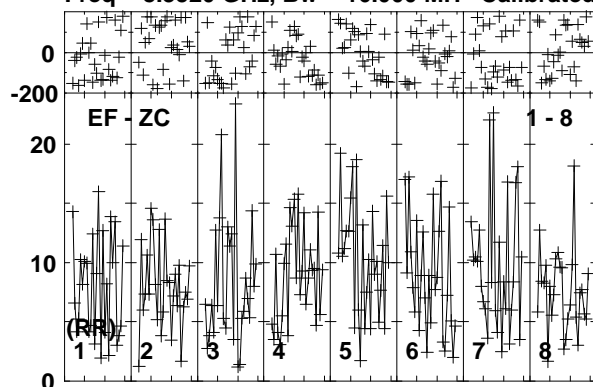

Lower frame: Milli Ampl Jy Top frame: Phas deg
Vector averaged cross-power spectrum Baseline: EF (01) - ZC (08)
Timerange: 00/04:55:45 to 00/04:58:44

Plot file version 139 created 24-MAR-2014 14:38:19

J1128+5925 EP087F 5.UVDATA.1

Freq = 8.3520 GHz, Bw = 16.000 MH Calibrated with CL # 3 and BP # 1 (BP mode 1)

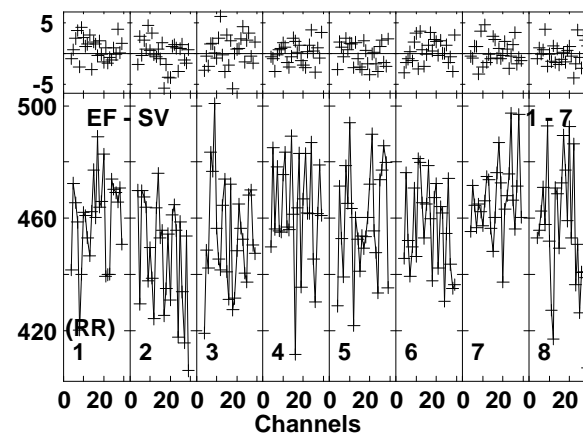
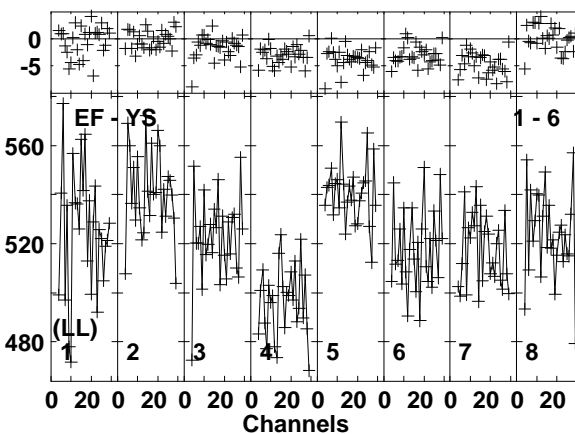
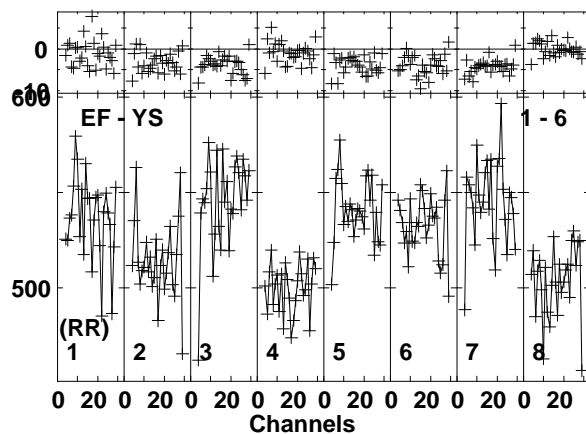
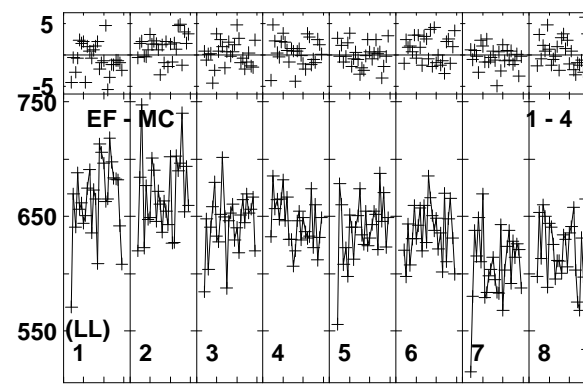
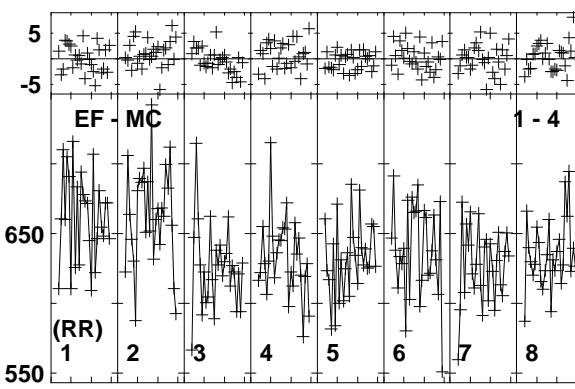
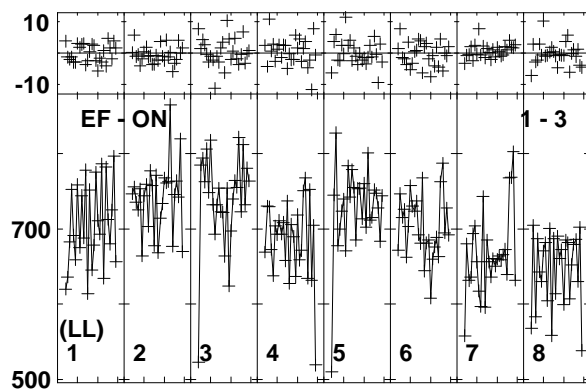
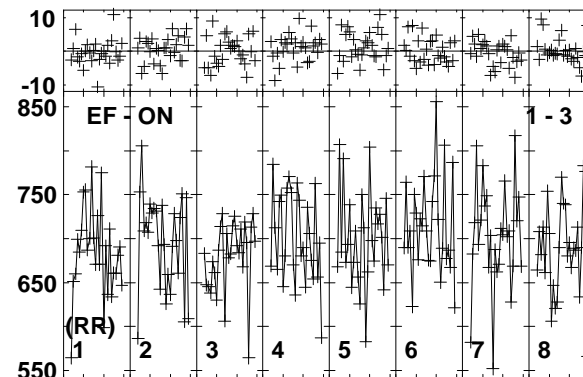
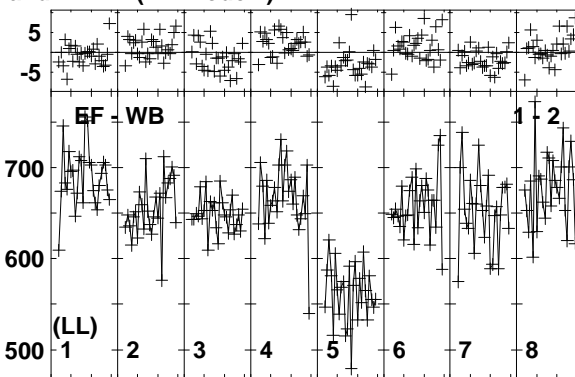
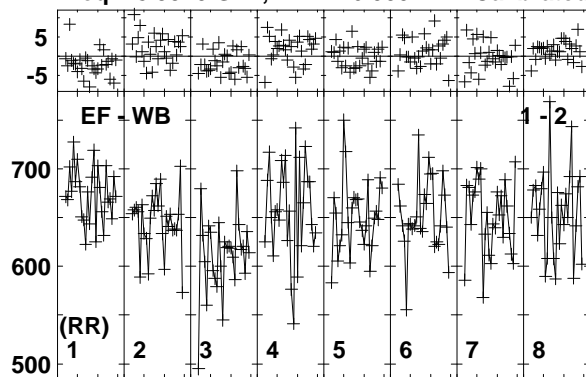

Lower frame: Milli Ampl Jy Top frame: Phas deg
Vector averaged cross-power spectrum Baseline: EF (01) - WB (02)
Timerange: 00/04:59:25 to 00/04:59:54

Plot file version 140 created 24-MAR-2014 14:38:19

J1128+5925 EP087F 5.UVDATA.1

Freq = 8.3520 GHz, Bw = 16.000 MH Calibrated with CL # 3 and BP # 1 (BP mode 1)

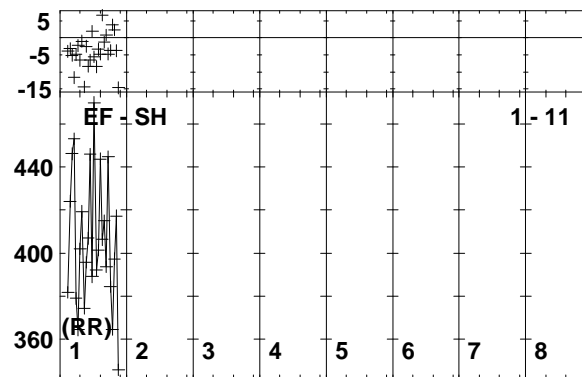
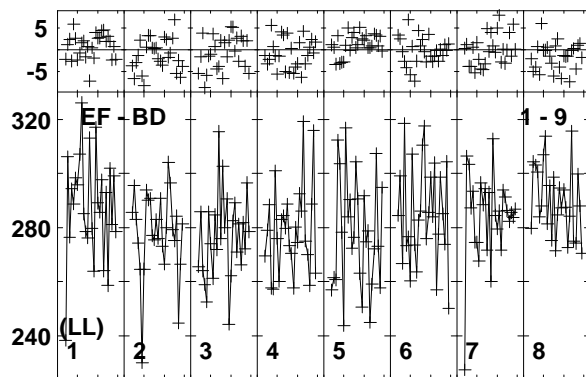
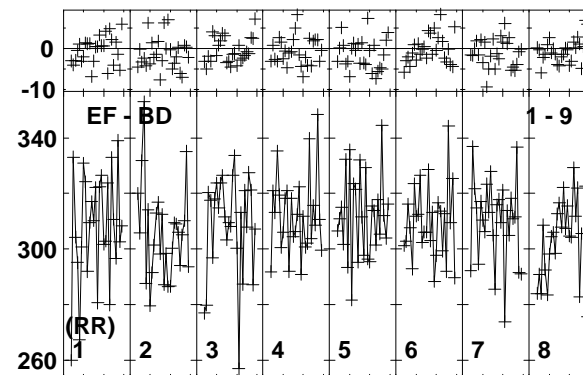
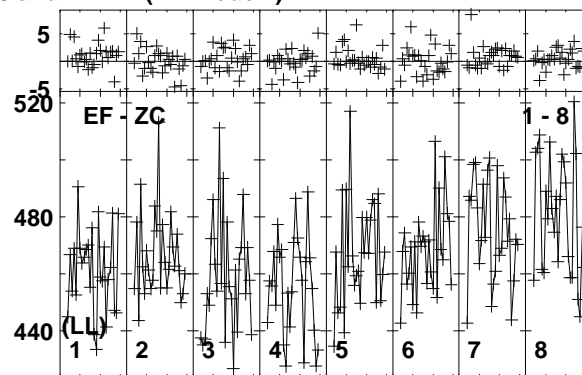
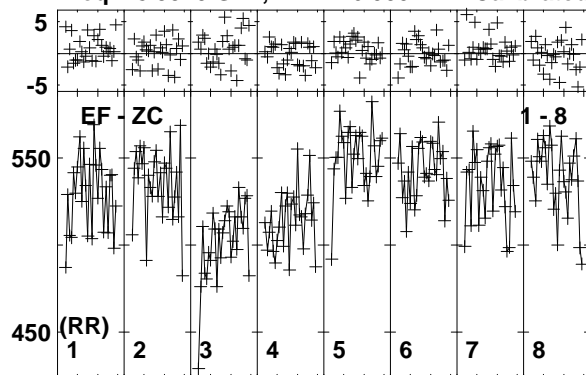

Lower frame: Milli Ampl Jy Top frame: Phas deg
Vector averaged cross-power spectrum Baseline: EF (01) - ZC (08)
Timerange: 00/04:59:25 to 00/04:59:54

Plot file version 141 created 24-MAR-2014 14:38:19

ARP299D EP087F 5.UVDATA.1

Freq = 8.3520 GHz, Bw = 16.000 MH Calibrated with CL # 3 and BP # 1 (BP mode 1)

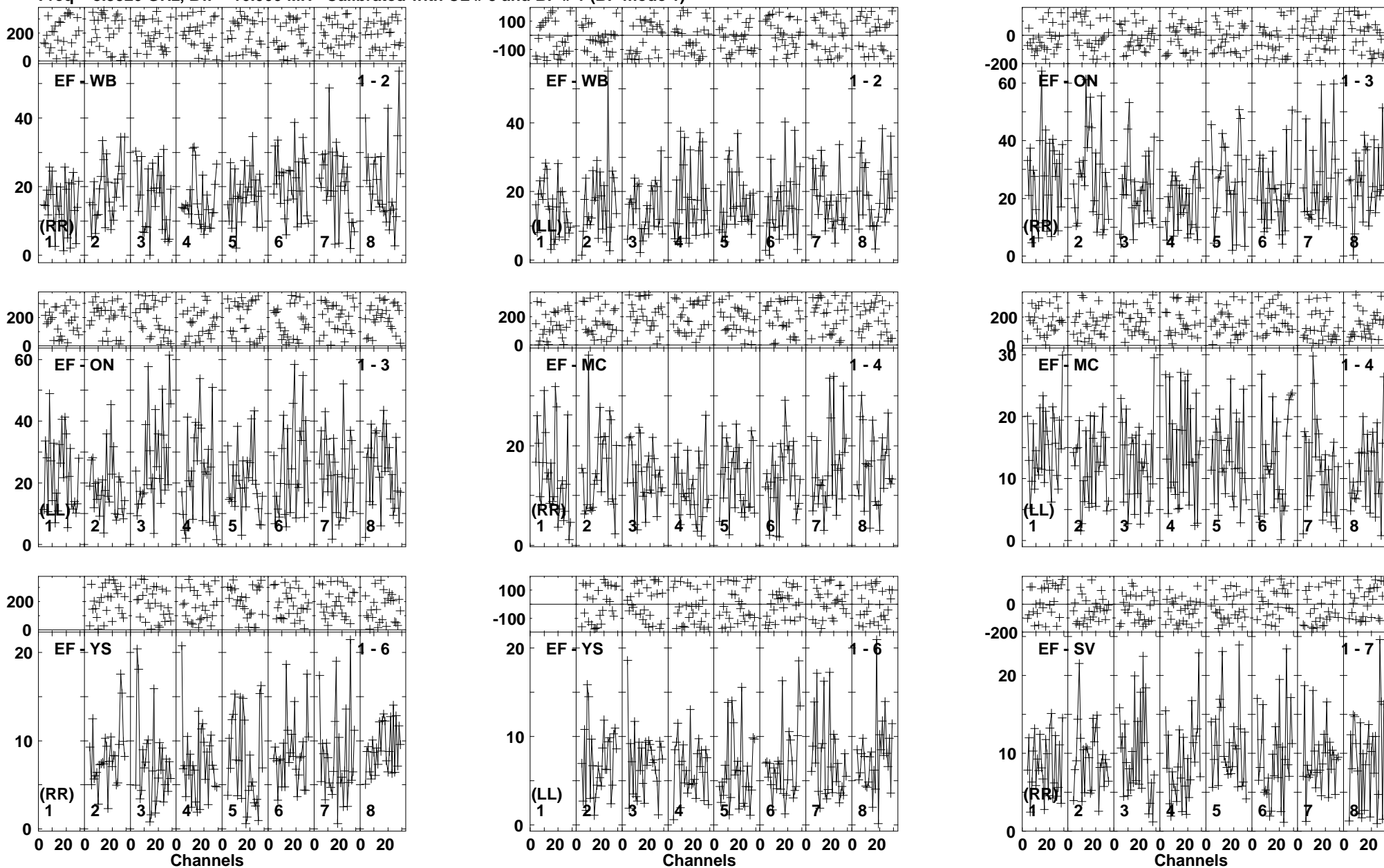

Lower frame: Milli Ampl Jy Top frame: Phas deg
Vector averaged cross-power spectrum Baseline: EF (01) - WB (02)
Timerange: 00/05:00:00 to 00/05:02:54

Plot file version 142 created 24-MAR-2014 14:38:19
 ARP299D EP087F 5.UVDATA.1
 Freq = 8.3520 GHz, Bw = 16.000 MH Calibrated with CL # 3 and BP # 1 (BP mode 1)

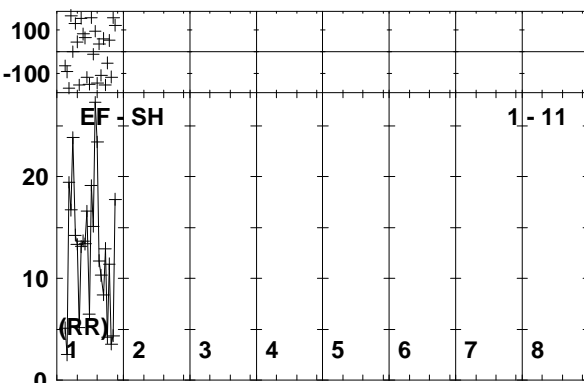
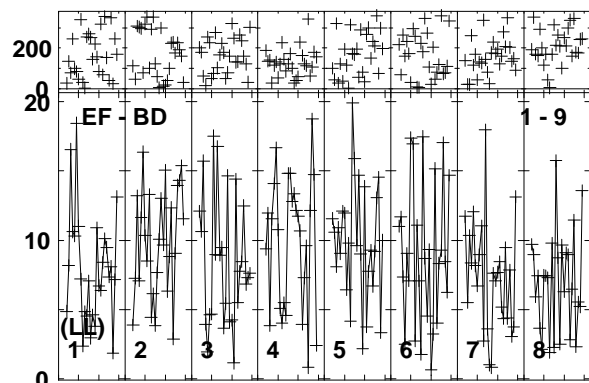
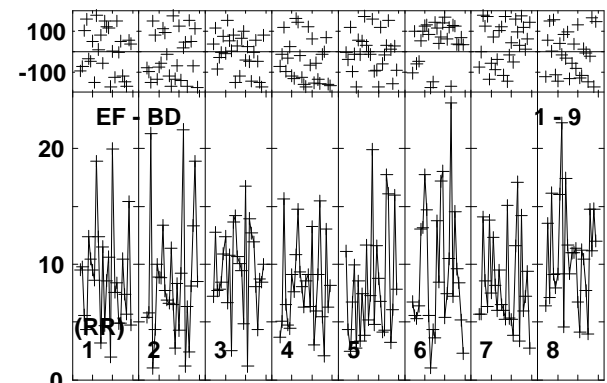
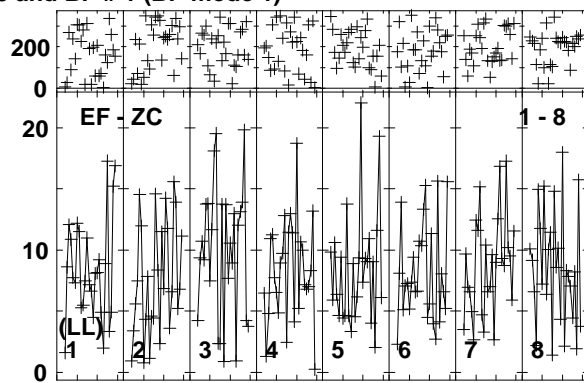
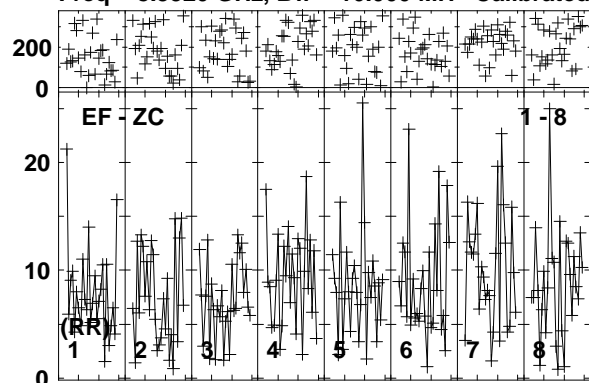

Lower frame: Milli Ampl Jy Top frame: Phas deg
 Vector averaged cross-power spectrum Baseline: EF (01) - ZC (08)
 Timerange: 00/05:00:00 to 00/05:02:54

Plot file version 143 created 24-MAR-2014 14:38:19

J1128+5925 EP087F 5.UVDATA.1

Freq = 8.3520 GHz, Bw = 16.000 MH Calibrated with CL # 3 and BP # 1 (BP mode 1)

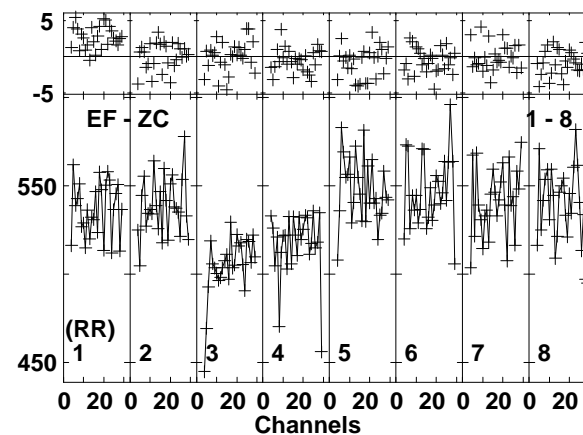
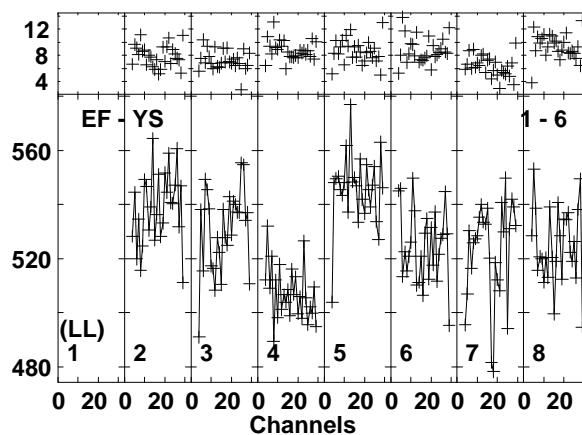
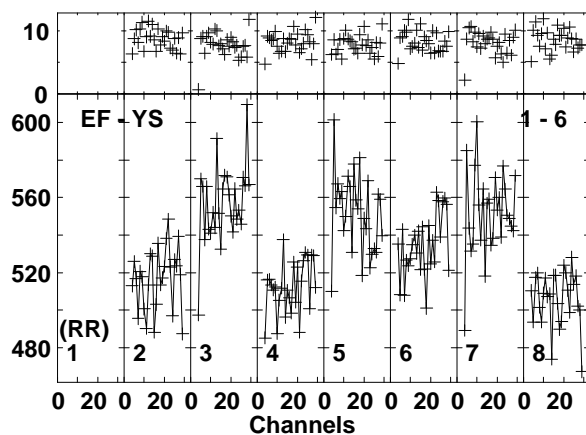
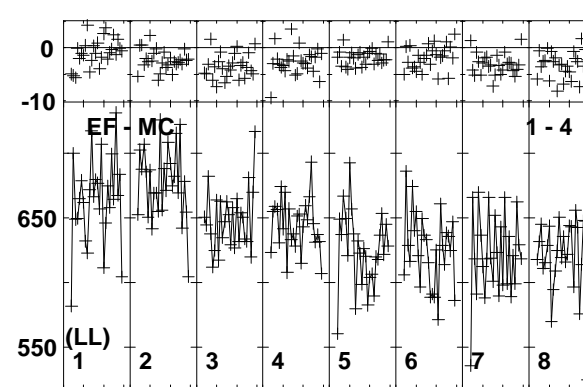
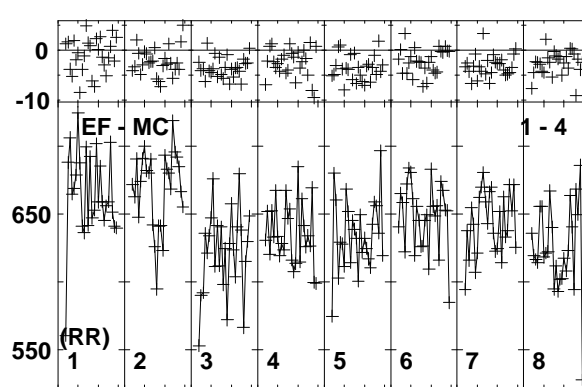
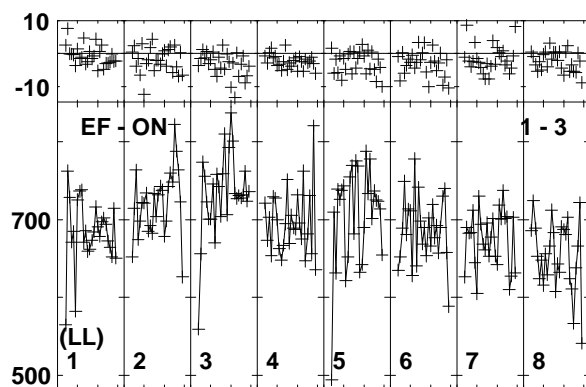
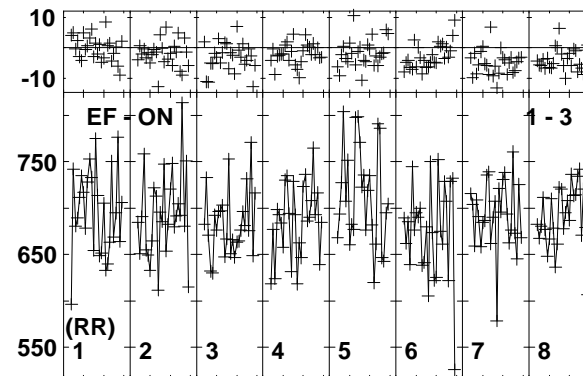
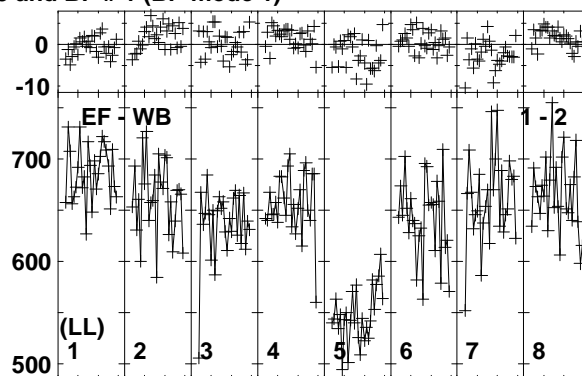
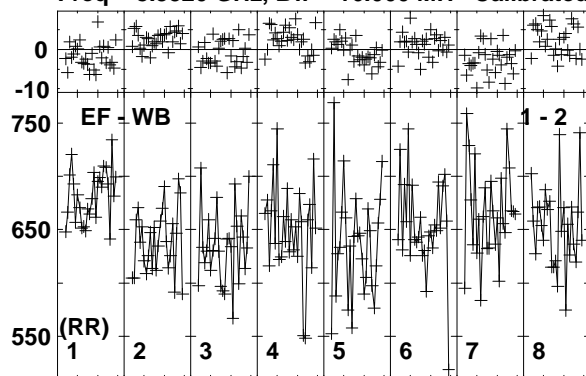

Lower frame: Milli Ampl Jy Top frame: Phas deg
Vector averaged cross-power spectrum Baseline: EF (01) - WB (02)
Timerange: 00/05:02:55 to 00/05:03:59

Plot file version 144 created 24-MAR-2014 14:38:20

J1128+5925 EP087F 5.UVDATA.1

Freq = 8.3520 GHz, Bw = 16.000 MH Calibrated with CL # 3 and BP # 1 (BP mode 1)

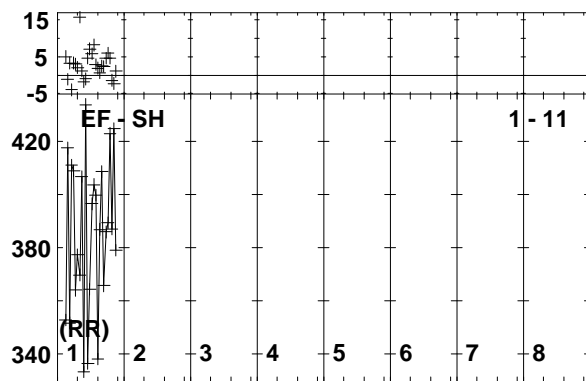
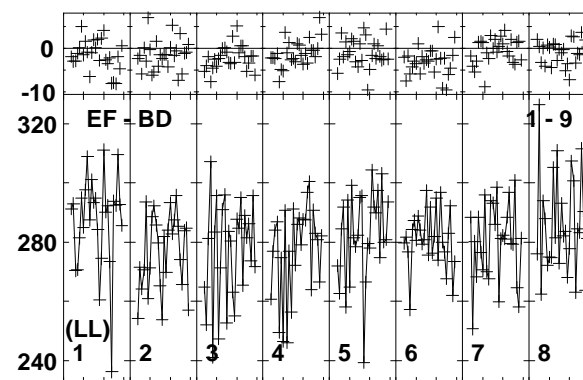
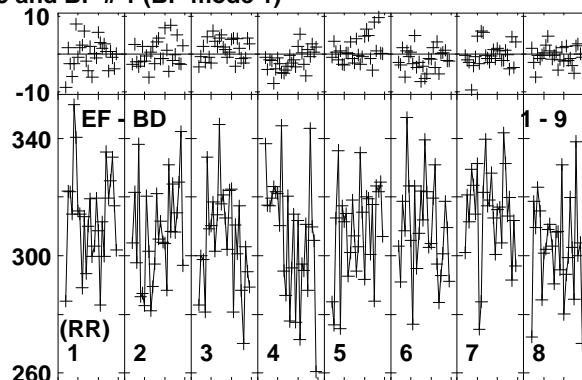
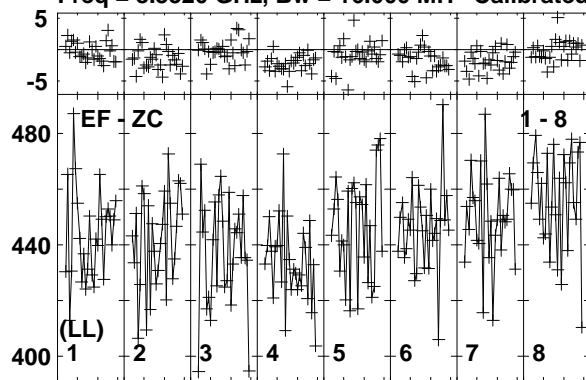

Lower frame: Milli Ampl Jy Top frame: Phas deg
Vector averaged cross-power spectrum Baseline: EF (01) - ZC (08)
Timerange: 00/05:02:55 to 00/05:03:59

Plot file version 145 created 24-MAR-2014 14:38:20

ARP299D EP087F 5.UVDATA.1

Freq = 8.3520 GHz, Bw = 16.000 MH Calibrated with CL # 3 and BP # 1 (BP mode 1)

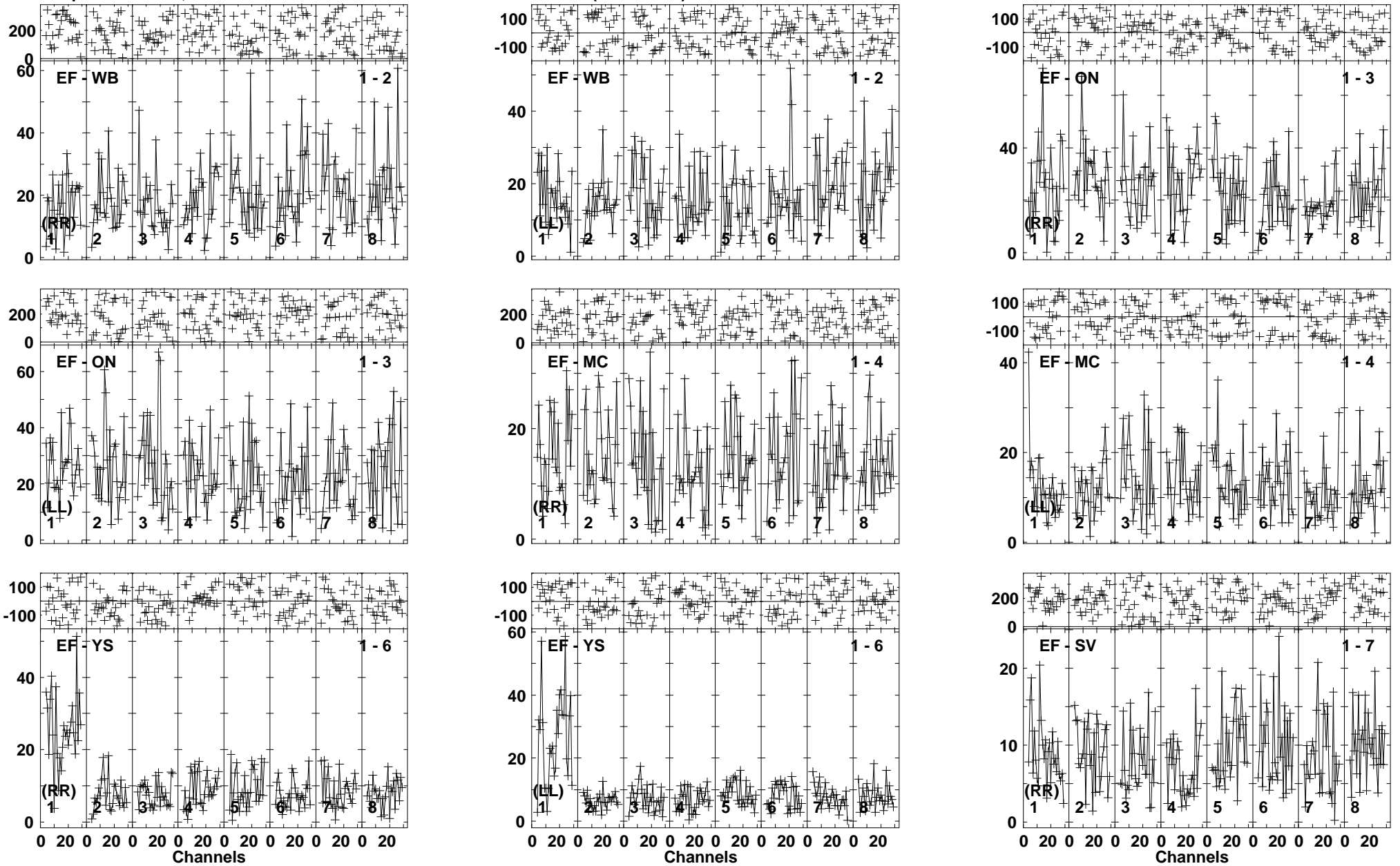

Lower frame: Milli Ampl Jy Top frame: Phas deg
Vector averaged cross-power spectrum Baseline: EF (01) - WB (02)
Timerange: 00/05:04:00 to 00/05:07:00

Plot file version 146 created 24-MAR-2014 14:38:20
 ARP299D EP087F 5.UVDATA.1
 Freq = 8.3520 GHz, Bw = 16.000 MH Calibrated with CL # 3 and BP # 1 (BP mode 1)

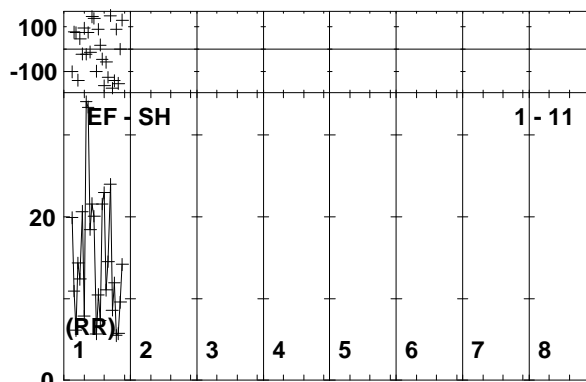
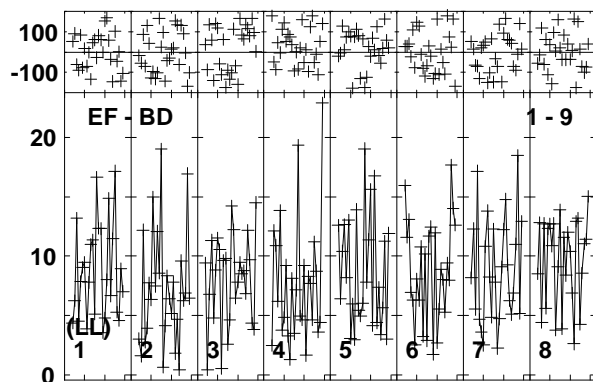
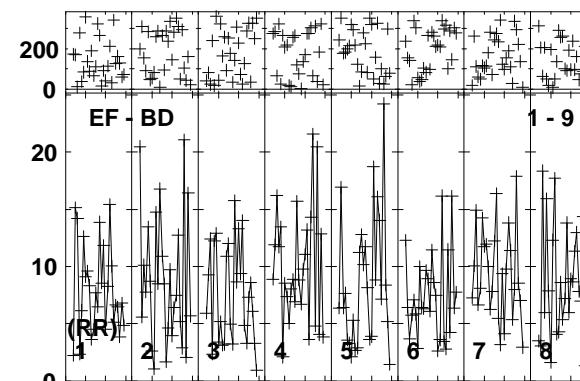
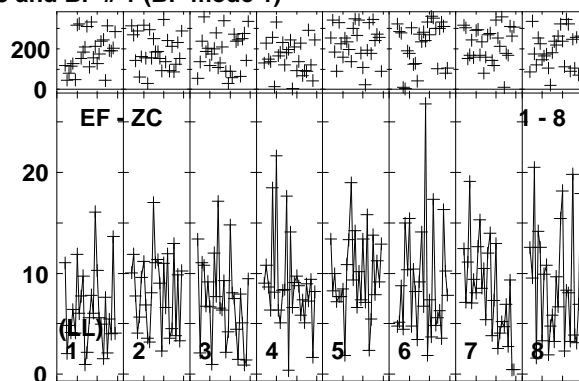
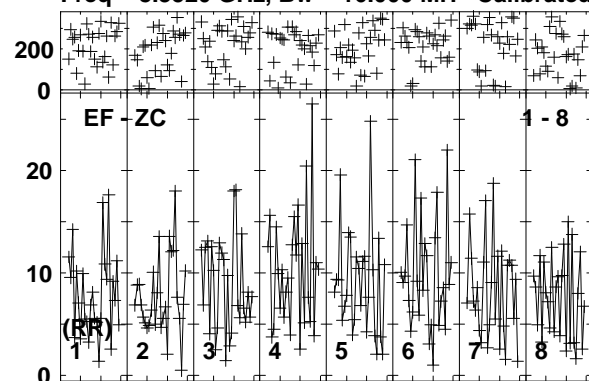

Lower frame: Milli Ampl Jy Top frame: Phas deg
 Vector averaged cross-power spectrum Baseline: EF (01) - ZC (08)
 Timerange: 00/05:04:00 to 00/05:07:00

Plot file version 147 created 24-MAR-2014 14:38:20
 J1128+5925 EP087F 5.UVDATA.1
 Freq = 8.3520 GHz, Bw = 16.000 MH Calibrated with CL # 3 and BP # 1 (BP mode 1)

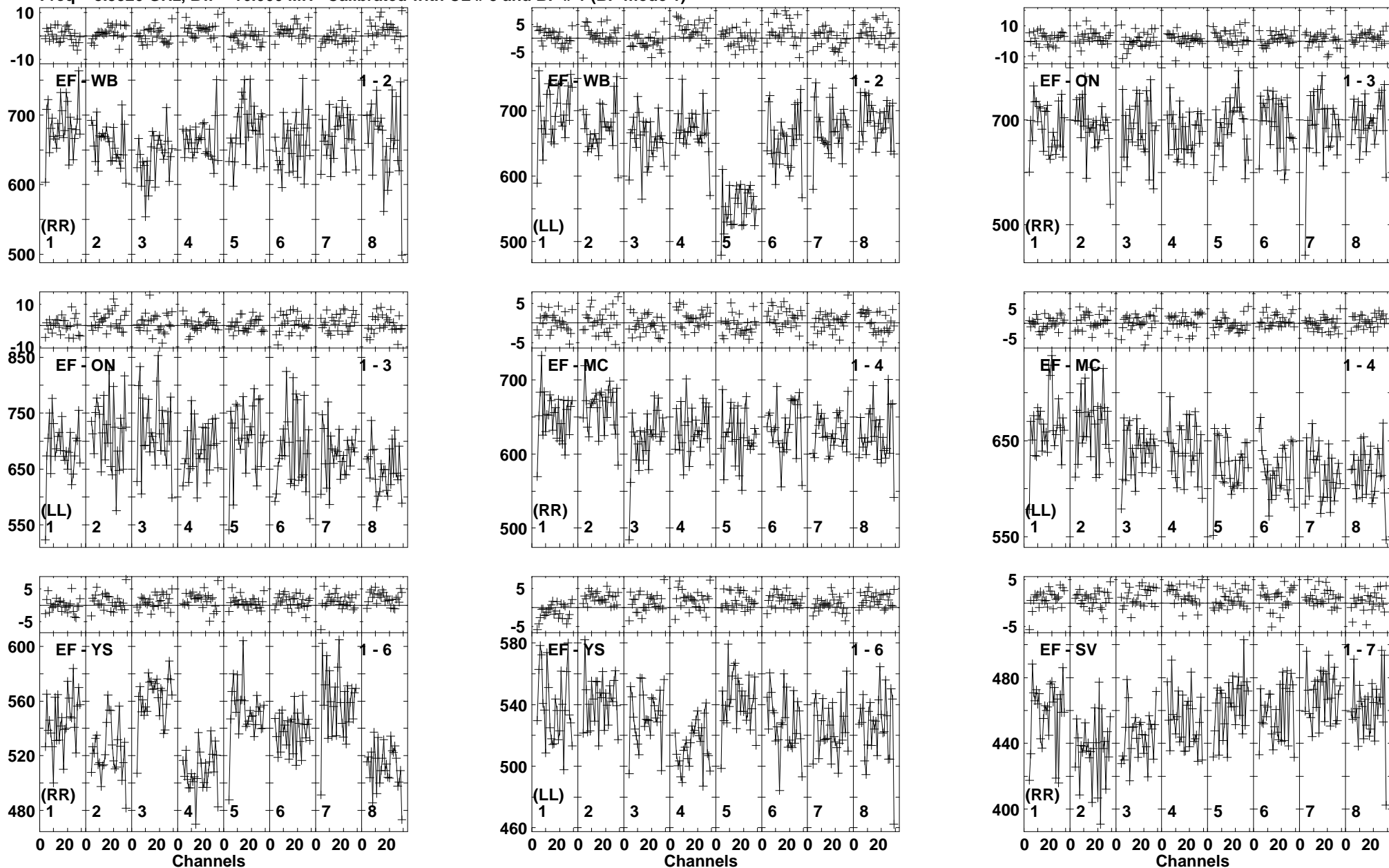

Lower frame: Milli Ampl Jy Top frame: Phas deg
 Vector averaged cross-power spectrum Baseline: EF (01) - WB (02)
 Timerange: 00/05:07:40 to 00/05:08:09

Plot file version 148 created 24-MAR-2014 14:38:21

J1128+5925 EP087F 5.UVDATA.1

Freq = 8.3520 GHz, Bw = 16.000 MH Calibrated with CL # 3 and BP # 1 (BP mode 1)

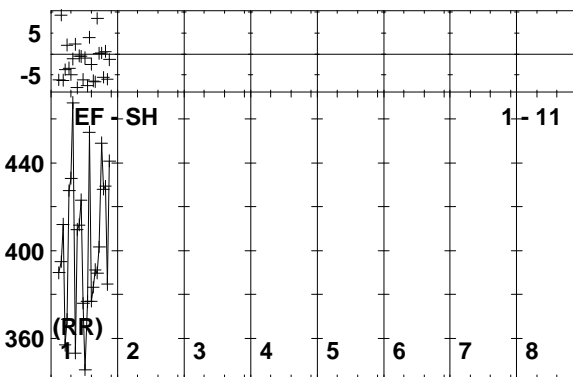
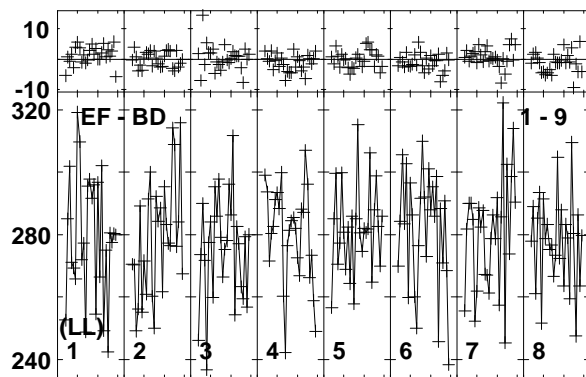
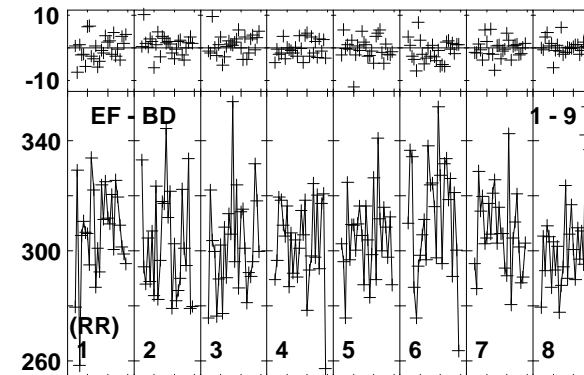
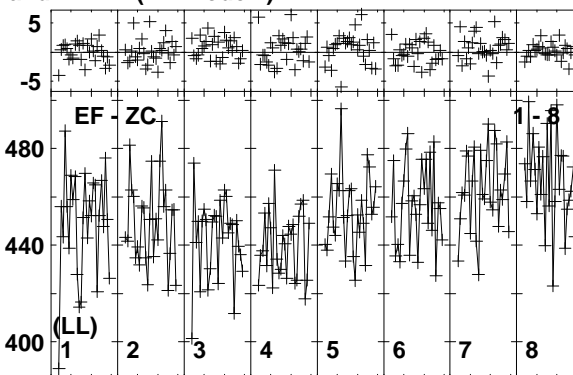
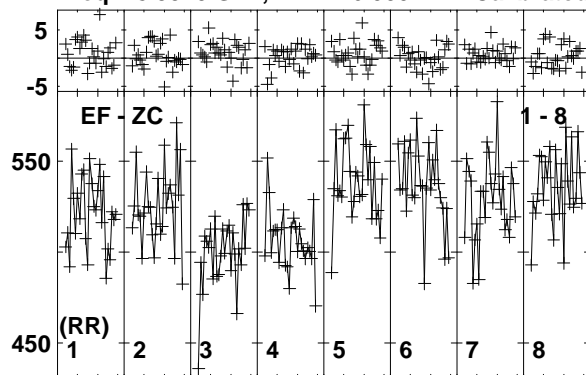

Lower frame: Milli Ampl Jy Top frame: Phas deg
Vector averaged cross-power spectrum Baseline: EF (01) - ZC (08)
Timerange: 00/05:07:40 to 00/05:08:09

Plot file version 149 created 24-MAR-2014 14:38:21

ARP299D EP087F 5.UVDATA.1

Freq = 8.3520 GHz, Bw = 16.000 MH Calibrated with CL # 3 and BP # 1 (BP mode 1)

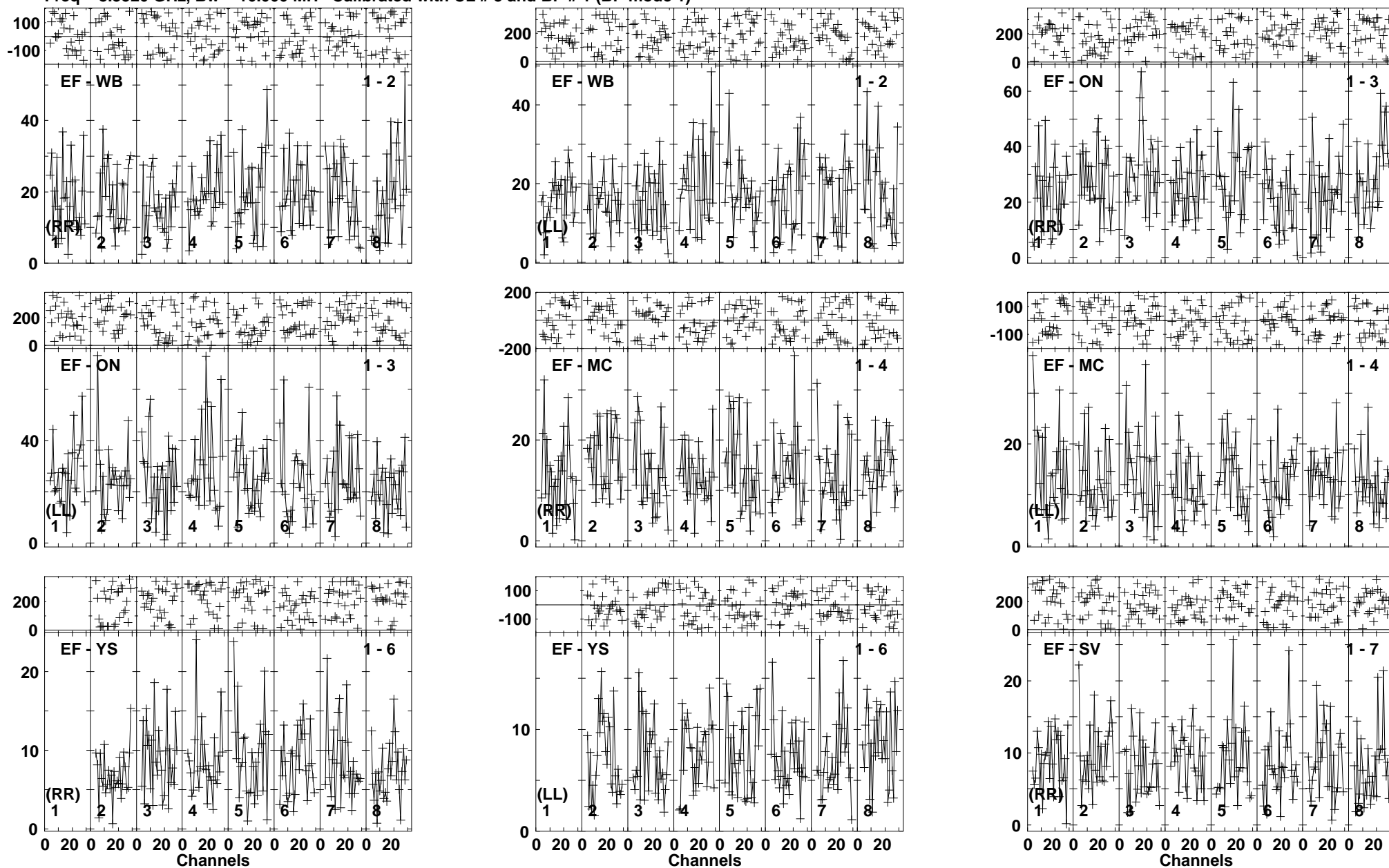

Lower frame: Milli Ampl Jy Top frame: Phas deg
Vector averaged cross-power spectrum Baseline: EF (01) - WB (02)
Timerange: 00/05:08:14 to 00/05:11:09

Plot file version 150 created 24-MAR-2014 14:38:21
 ARP299D EP087F 5.UVDATA.1
 Freq = 8.3520 GHz, Bw = 16.000 MH Calibrated with CL # 3 and BP # 1 (BP mode 1)

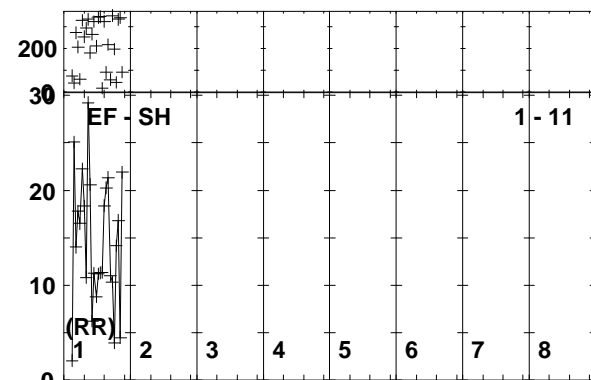
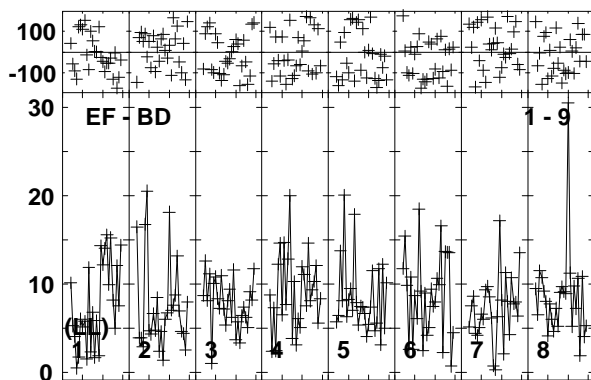
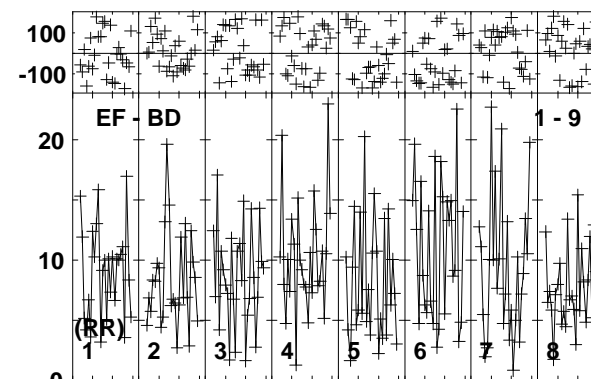
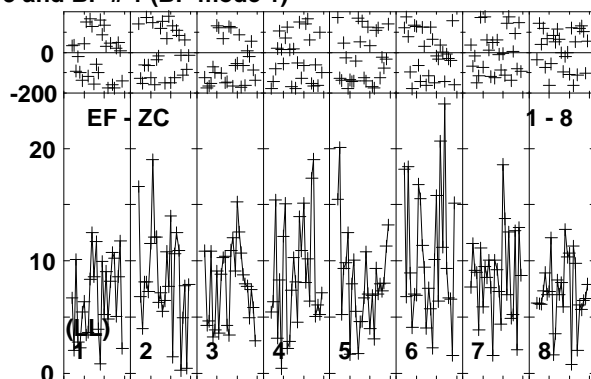
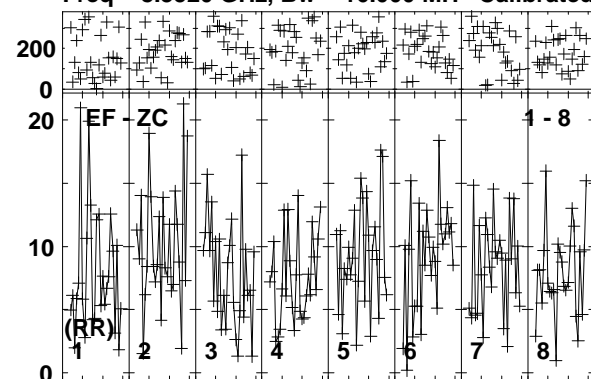

Lower frame: Milli Ampl Jy Top frame: Phas deg
 Vector averaged cross-power spectrum Baseline: EF (01) - ZC (08)
 Timerange: 00/05:08:14 to 00/05:11:09

Plot file version 151 created 24-MAR-2014 14:38:21

J1128+5925 EP087F 5.UVDATA.1

Freq = 8.3520 GHz, Bw = 16.000 MH Calibrated with CL # 3 and BP # 1 (BP mode 1)

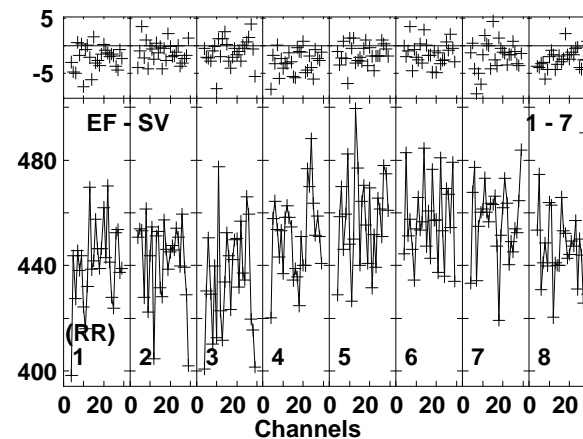
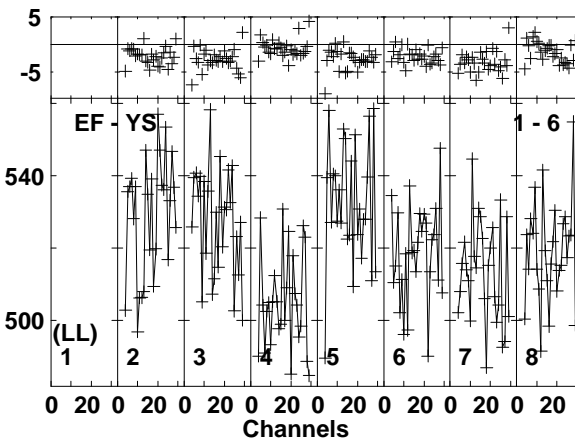
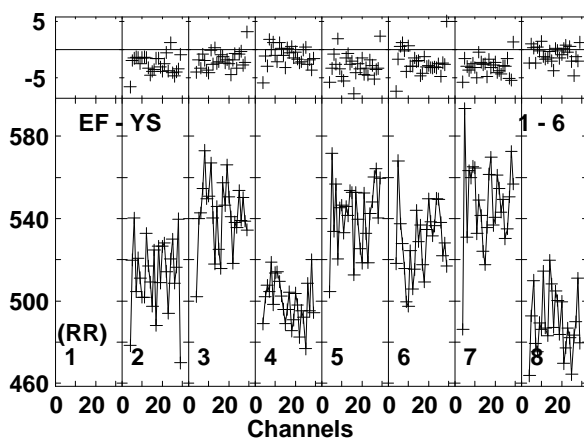
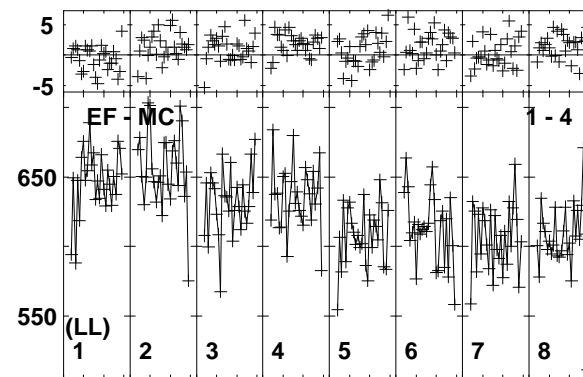
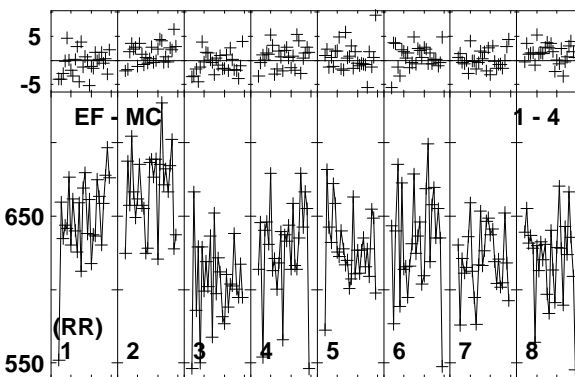
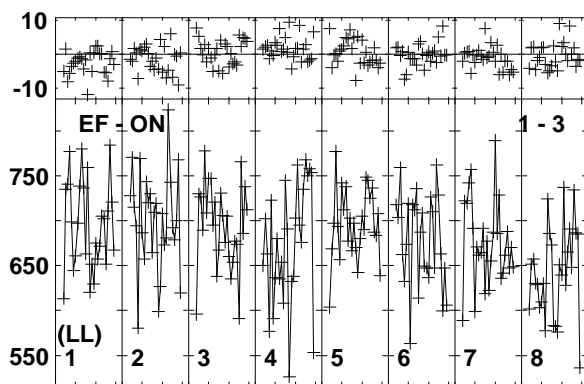
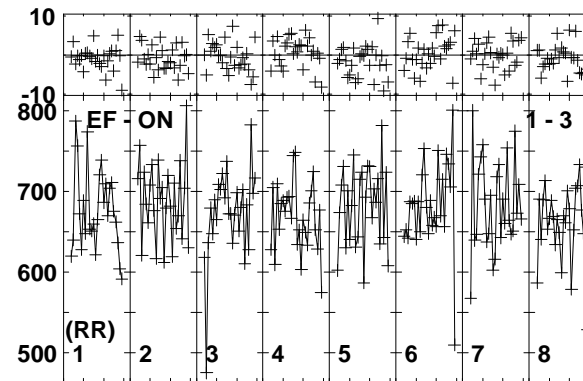
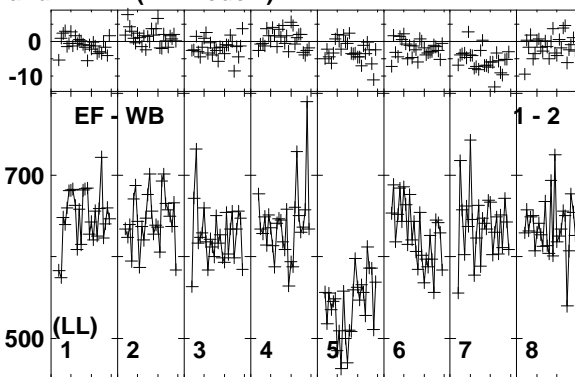
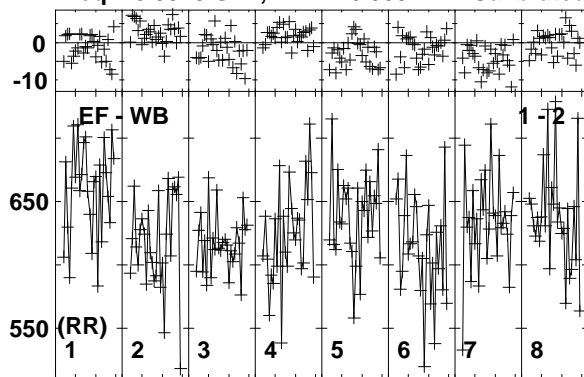

Lower frame: Milli Ampl Jy Top frame: Phas deg
Vector averaged cross-power spectrum Baseline: EF (01) - WB (02)
Timerange: 00/05:11:10 to 00/05:12:14

Plot file version 152 created 24-MAR-2014 14:38:22

J1128+5925 EP087F 5.UVDATA.1

Freq = 8.3520 GHz, Bw = 16.000 MH Calibrated with CL # 3 and BP # 1 (BP mode 1)

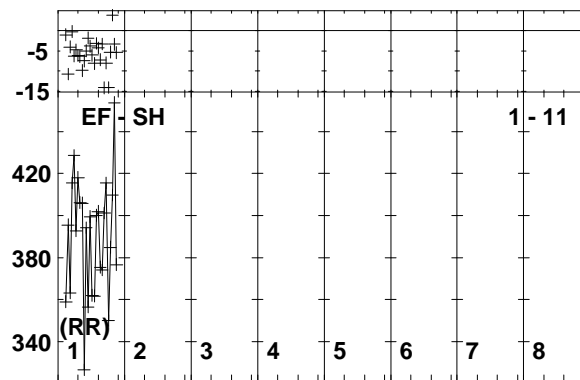
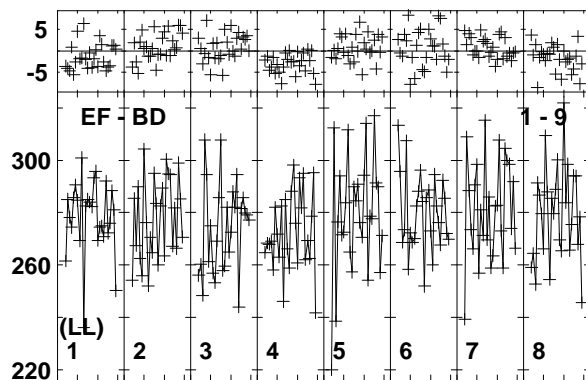
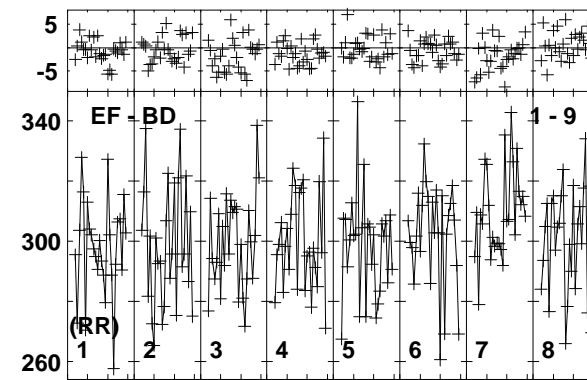
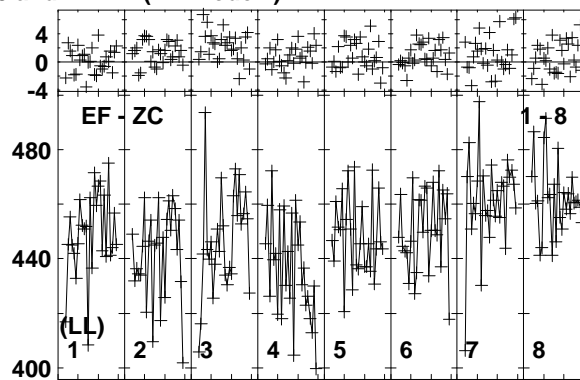
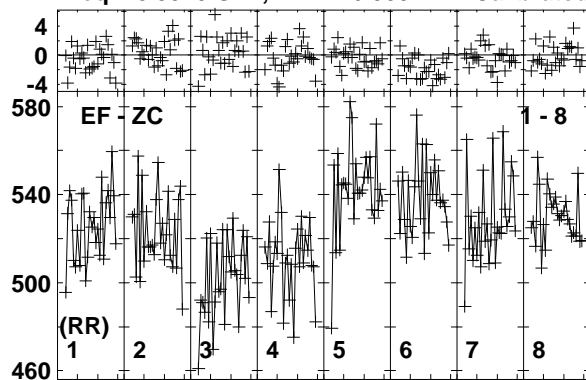

Lower frame: Milli Ampl Jy Top frame: Phas deg
Vector averaged cross-power spectrum Baseline: EF (01) - ZC (08)
Timerange: 00/05:11:10 to 00/05:12:14

Plot file version 153 created 24-MAR-2014 14:38:22
 ARP299D EP087F 5.UVDATA.1
 Freq = 8.3520 GHz, Bw = 16.000 MH Calibrated with CL # 3 and BP # 1 (BP mode 1)

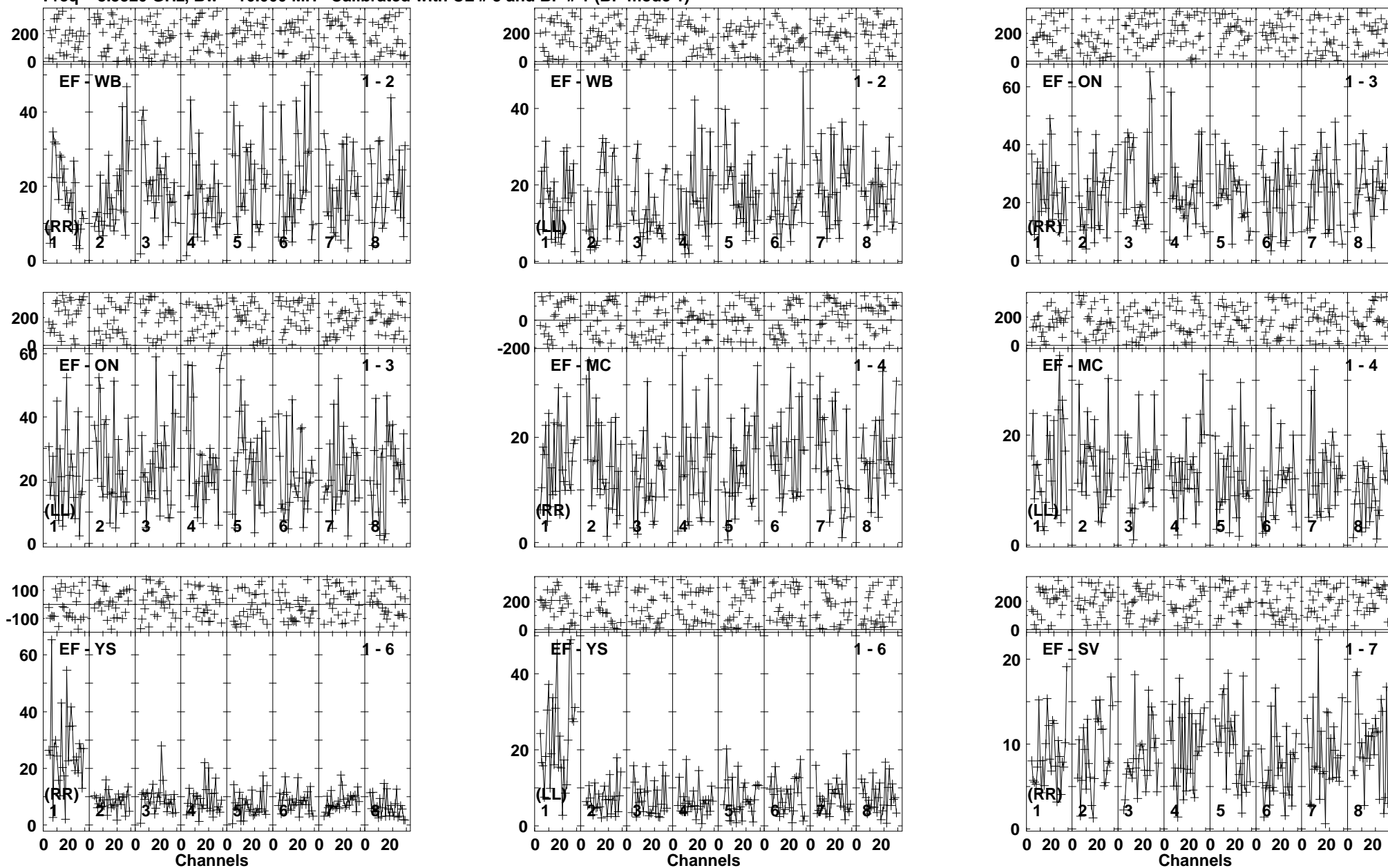

Lower frame: Milli Ampl Jy Top frame: Phas deg
 Vector averaged cross-power spectrum Baseline: EF (01) - WB (02)
 Timerange: 00/05:12:16 to 00/05:15:14

Plot file version 154 created 24-MAR-2014 14:38:22
 ARP299D EP087F 5.UVDATA.1
 Freq = 8.3520 GHz, Bw = 16.000 MH Calibrated with CL # 3 and BP # 1 (BP mode 1)

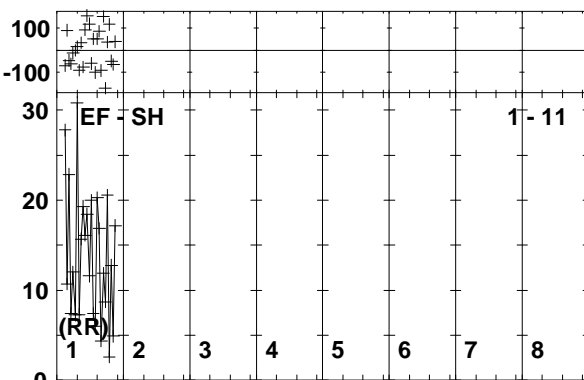
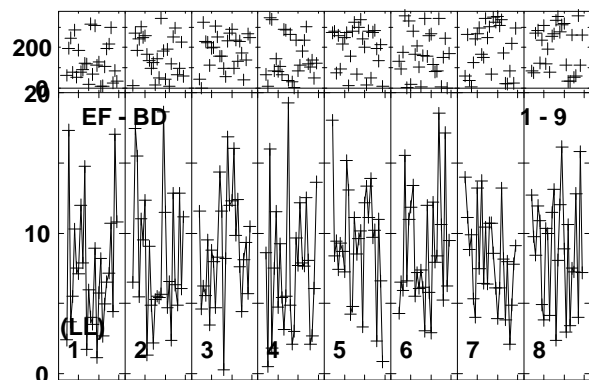
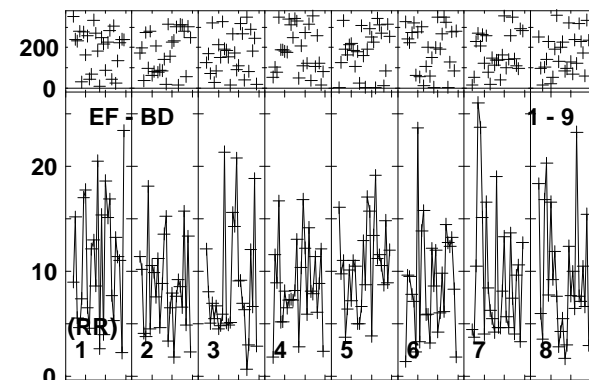
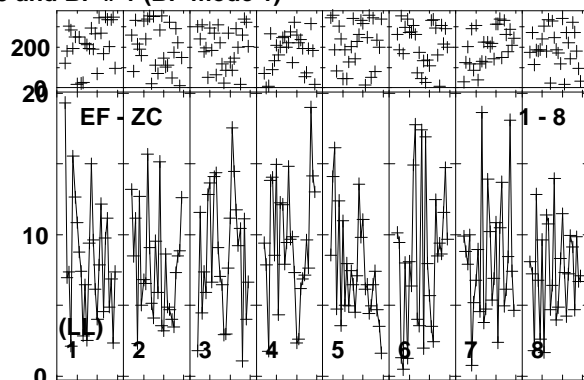
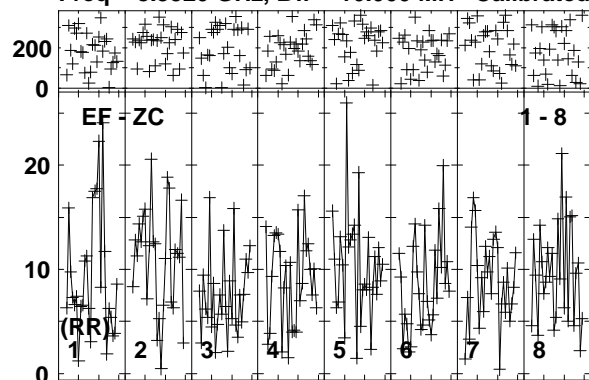

Lower frame: Milli Ampl Jy Top frame: Phas deg
 Vector averaged cross-power spectrum Baseline: EF (01) - ZC (08)
 Timerange: 00/05:12:16 to 00/05:15:14

Plot file version 155 created 24-MAR-2014 14:38:22

J1128+5925 EP087F 5.UVDATA.1

Freq = 8.3520 GHz, Bw = 16.000 MH Calibrated with CL # 3 and BP # 1 (BP mode 1)

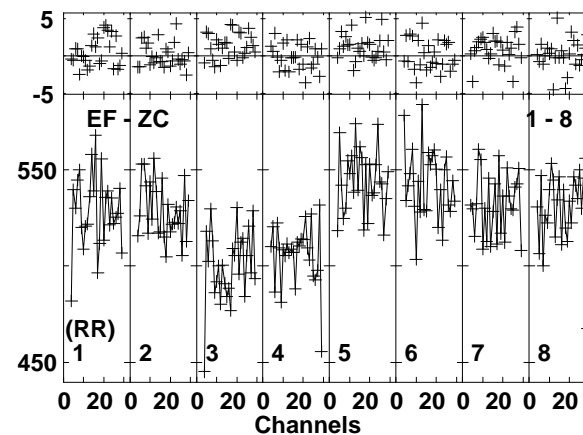
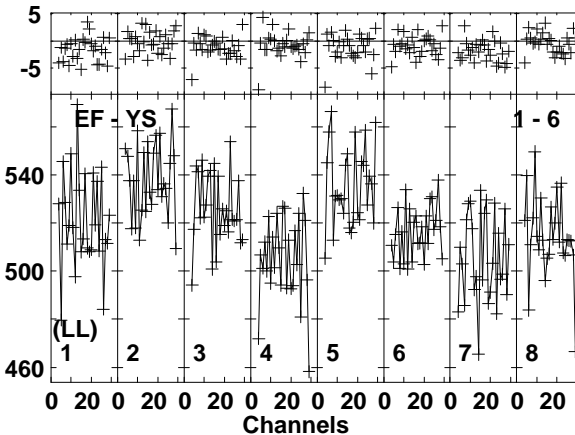
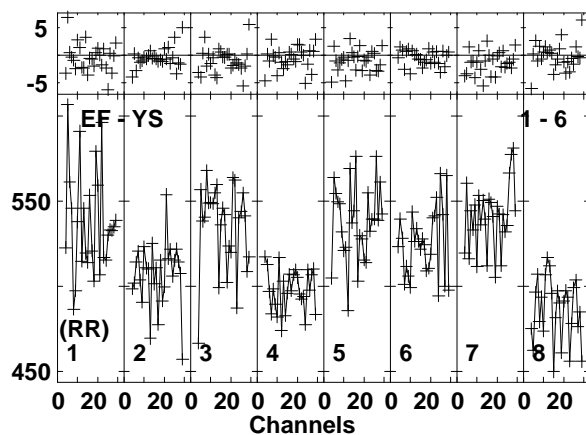
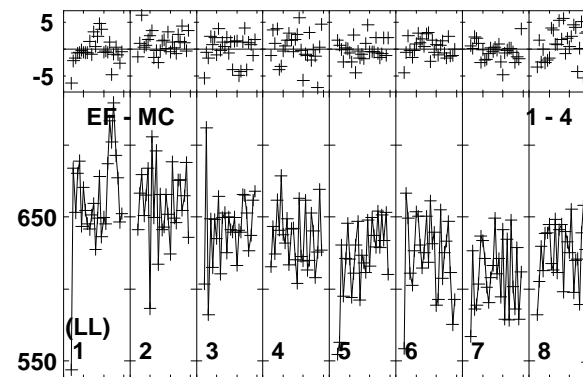
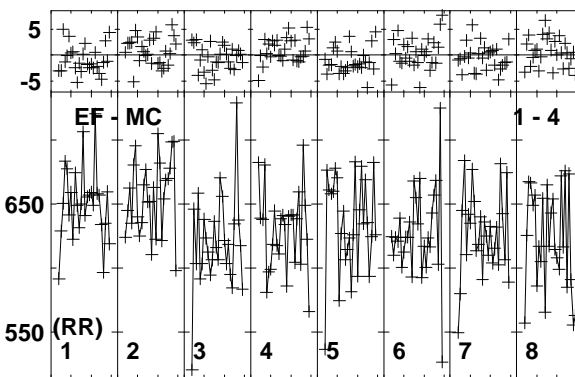
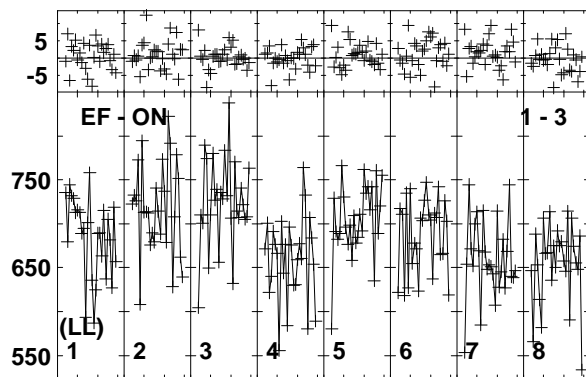
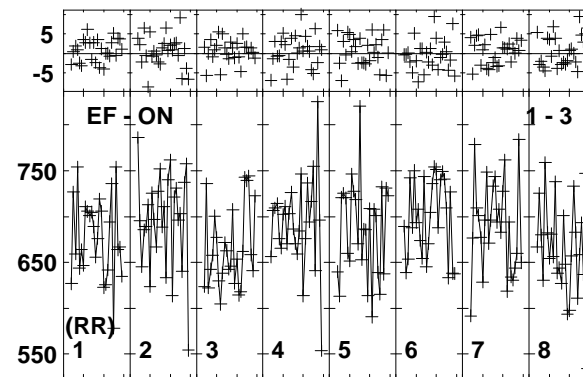
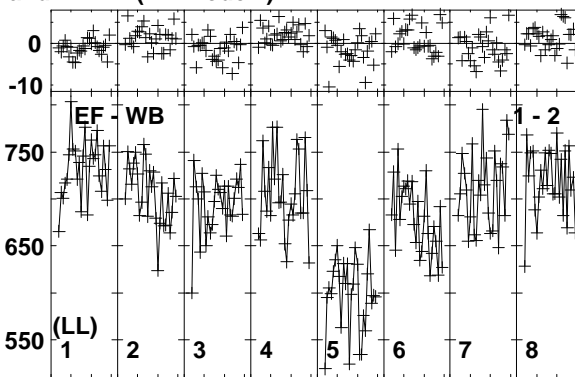
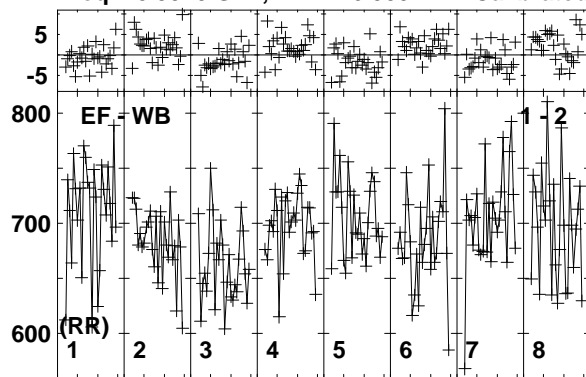

Lower frame: Milli Ampl Jy Top frame: Phas deg
Vector averaged cross-power spectrum Baseline: EF (01) - WB (02)
Timerange: 00/05:15:55 to 00/05:16:24

Plot file version 156 created 24-MAR-2014 14:38:22

J1128+5925 EP087F 5.UVDATA.1

Freq = 8.3520 GHz, Bw = 16.000 MH Calibrated with CL # 3 and BP # 1 (BP mode 1)

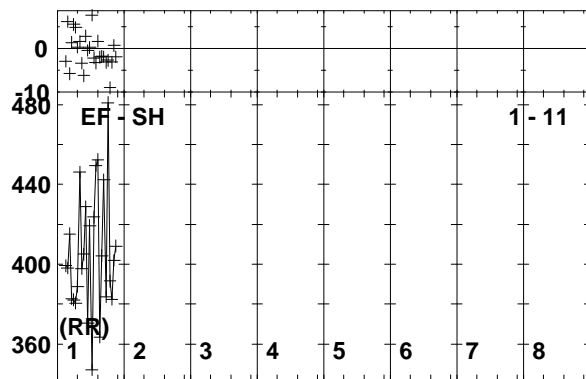
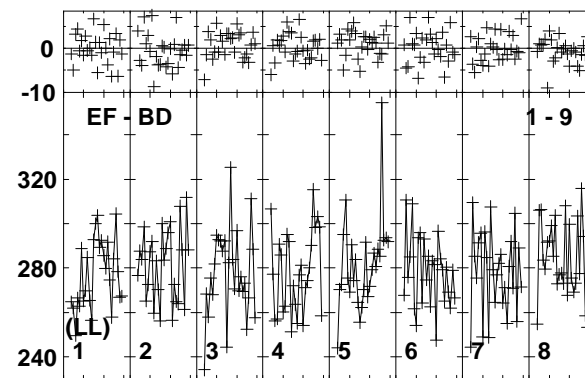
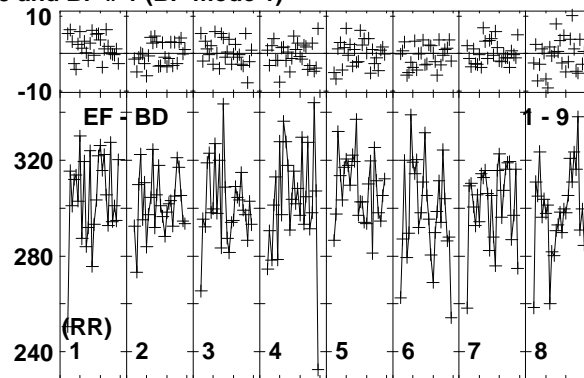
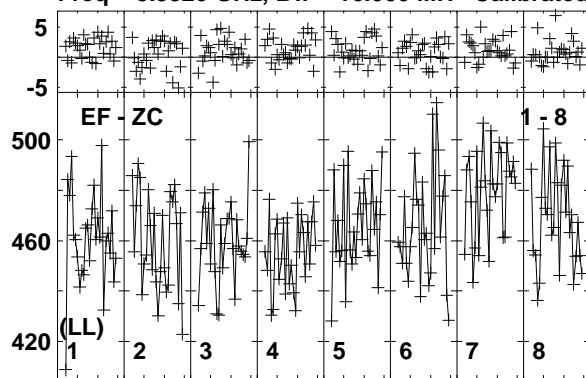

Lower frame: Milli Ampl Jy Top frame: Phas deg
Vector averaged cross-power spectrum Baseline: EF (01) - ZC (08)
Timerange: 00/05:15:55 to 00/05:16:24

Plot file version 157 created 24-MAR-2014 14:38:23
 ARP299D EP087F 5.UVDATA.1
 Freq = 8.3520 GHz, Bw = 16.000 MH Calibrated with CL # 3 and BP # 1 (BP mode 1)

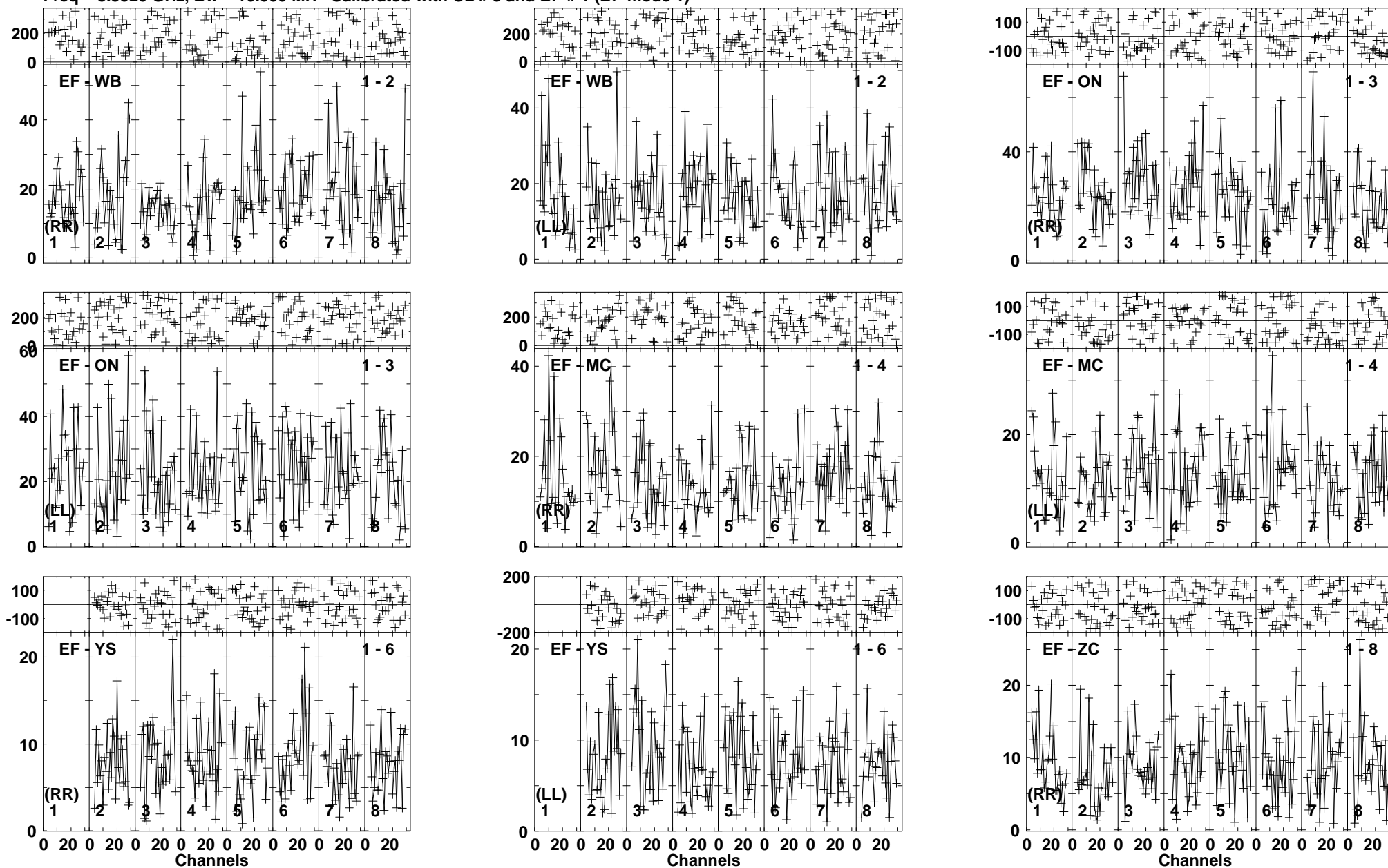

Lower frame: Milli Ampl Jy Top frame: Phas deg
 Vector averaged cross-power spectrum Baseline: EF (01) - WB (02)
 Timerange: 00/05:16:30 to 00/05:19:24

Plot file version 158 created 24-MAR-2014 14:38:23

ARP299D EP087F 5.UVDATA.1

Freq = 8.3520 GHz, Bw = 16.000 MH Calibrated with CL # 3 and BP # 1 (BP mode 1)

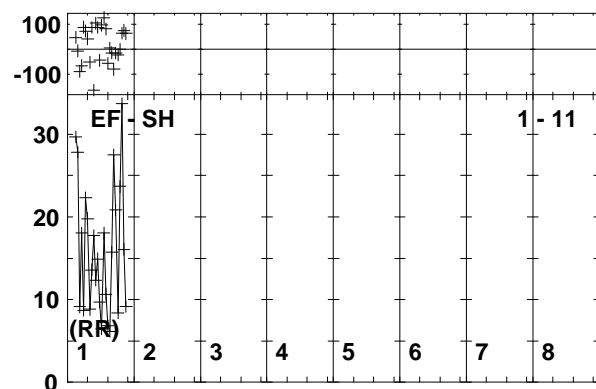
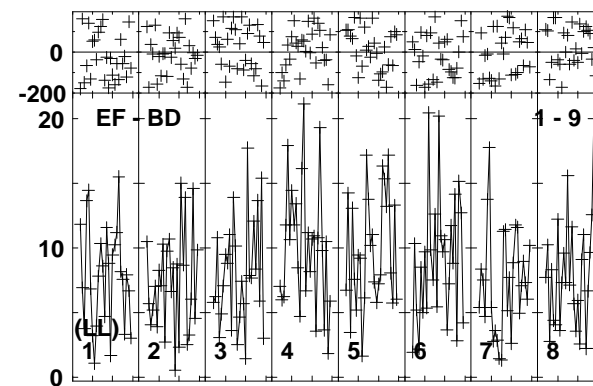
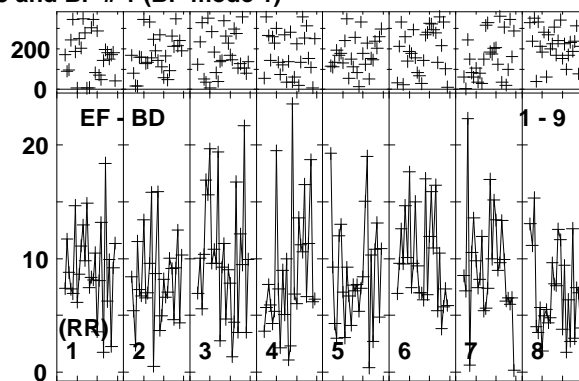
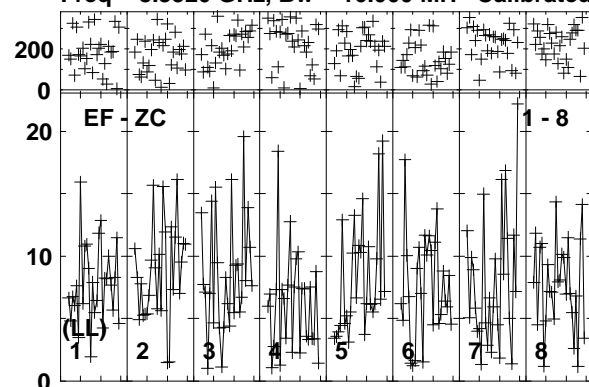

Lower frame: Milli Ampl Jy Top frame: Phas deg
Vector averaged cross-power spectrum Baseline: EF (01) - ZC (08)
Timerange: 00/05:16:30 to 00/05:19:24

Plot file version 159 created 24-MAR-2014 14:38:23

J1128+5925 EP087F 5.UVDATA.1

Freq = 8.3520 GHz, Bw = 16.000 MH Calibrated with CL # 3 and BP # 1 (BP mode 1)

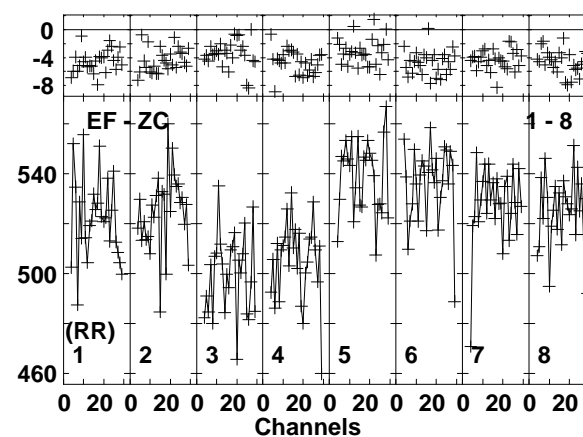
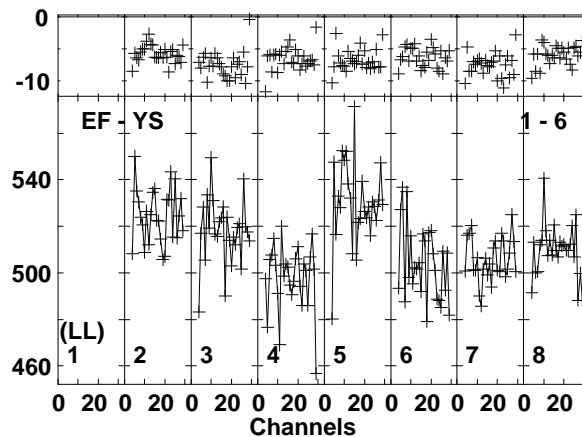
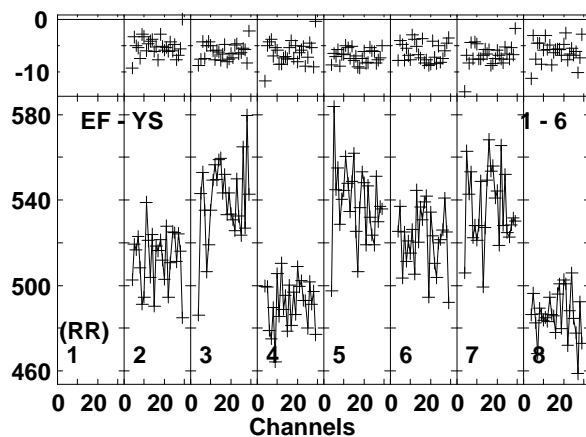
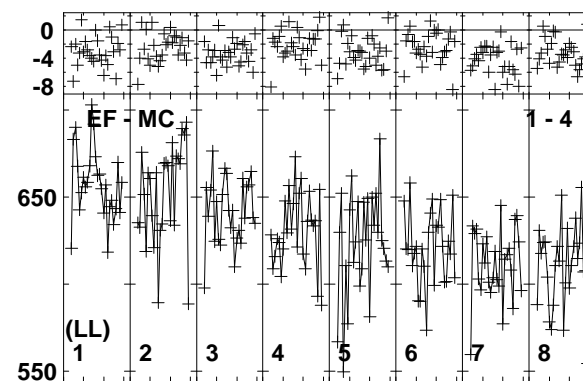
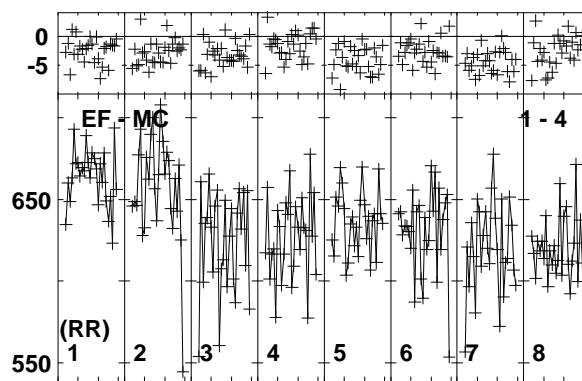
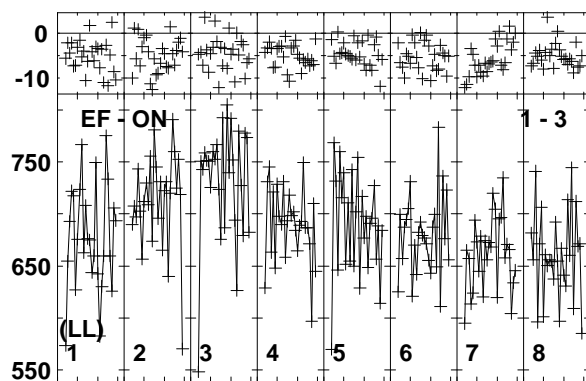
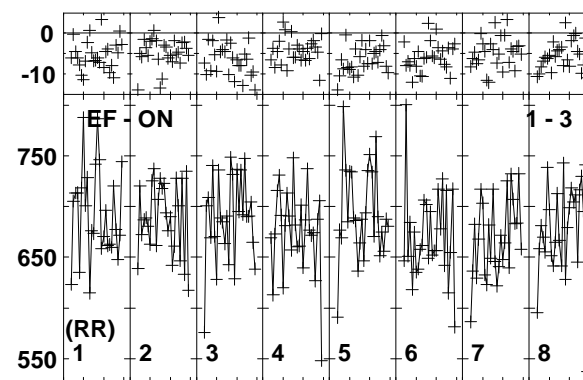
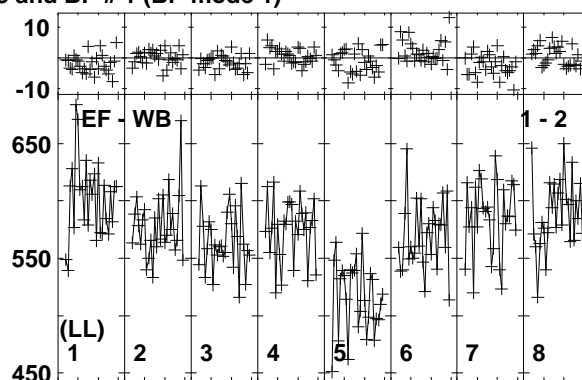
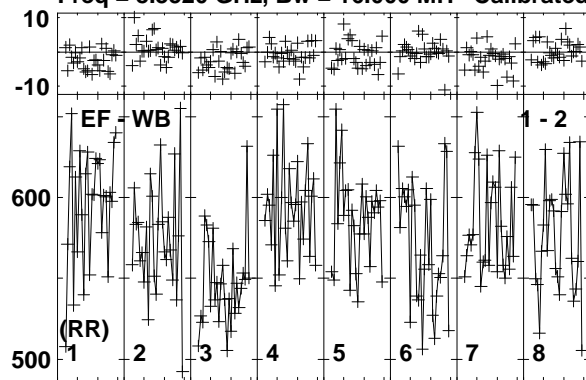

Lower frame: Milli Ampl Jy Top frame: Phas deg
Vector averaged cross-power spectrum Baseline: EF (01) - WB (02)
Timerange: 00/05:19:26 to 00/05:20:30

Plot file version 160 created 24-MAR-2014 14:38:23

J1128+5925 EP087F 5.UVDATA.1

Freq = 8.3520 GHz, Bw = 16.000 MH Calibrated with CL # 3 and BP # 1 (BP mode 1)

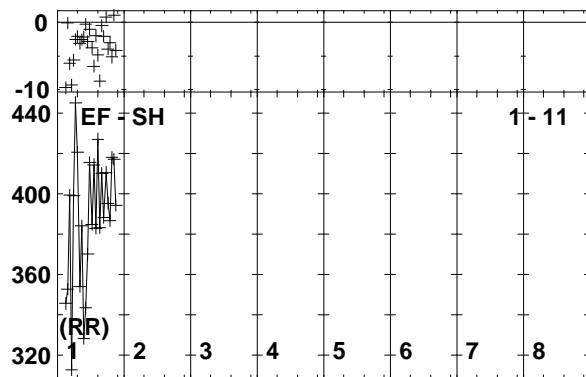
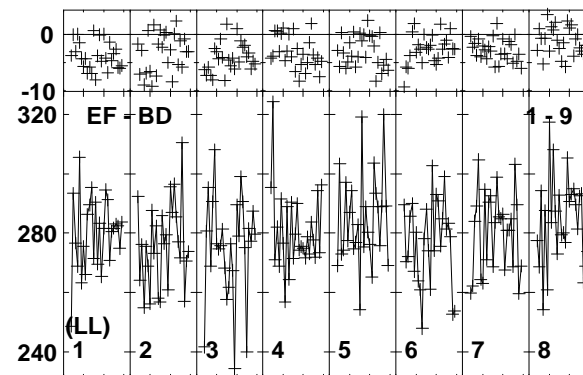
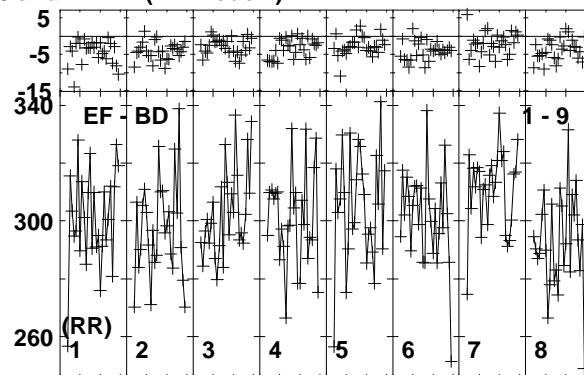
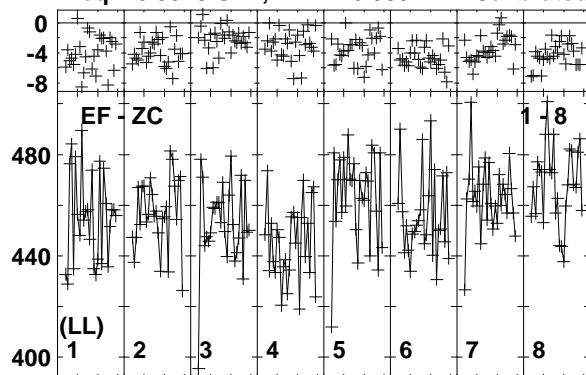

Lower frame: Milli Ampl Jy Top frame: Phas deg
Vector averaged cross-power spectrum Baseline: EF (01) - ZC (08)
Timerange: 00/05:19:26 to 00/05:20:30

Plot file version 161 created 24-MAR-2014 14:38:23

ARP299D EP087F 5.UVDATA.1

Freq = 8.3520 GHz, Bw = 16.000 MH Calibrated with CL # 3 and BP # 1 (BP mode 1)

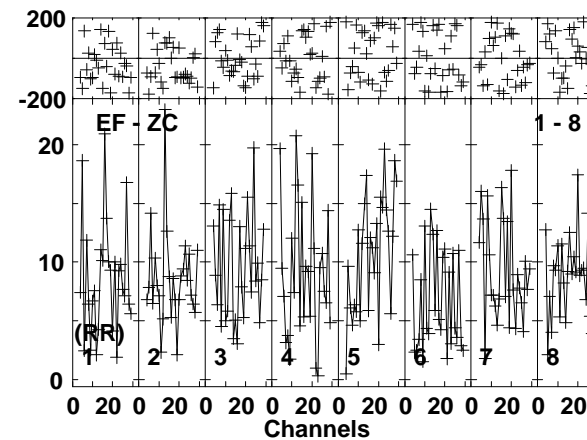
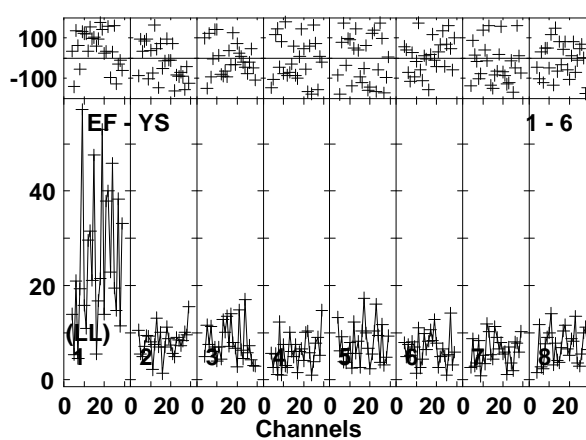
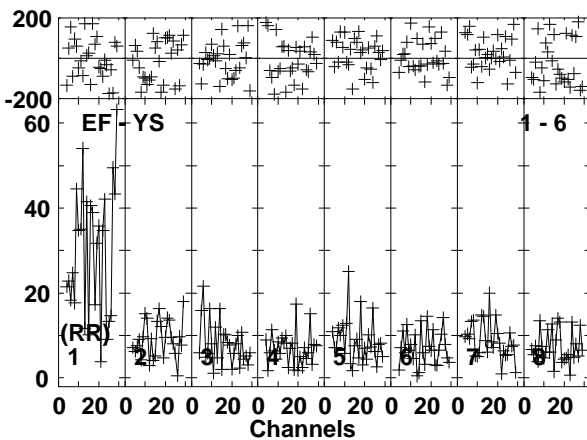
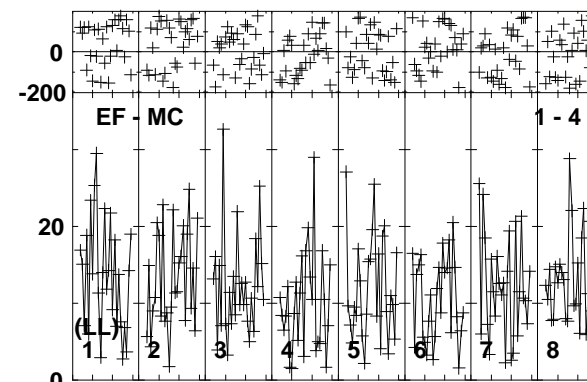
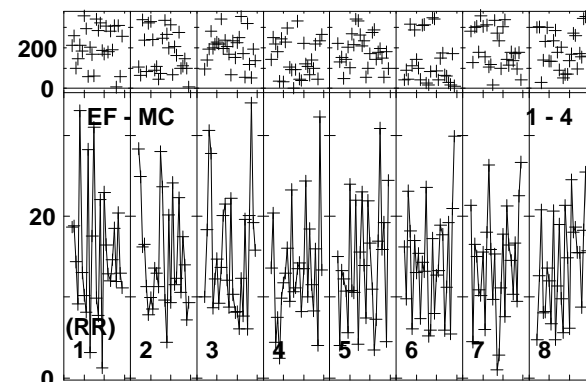
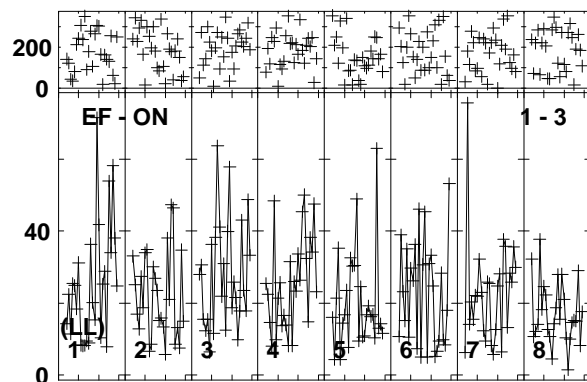
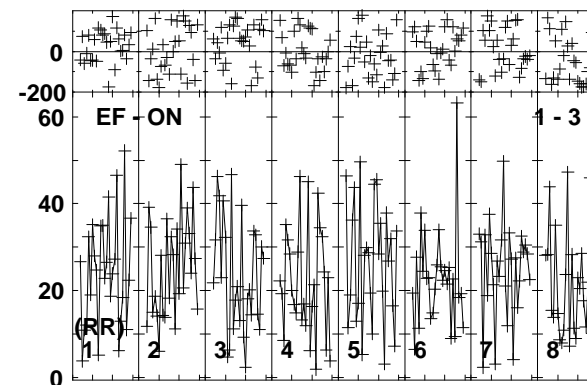
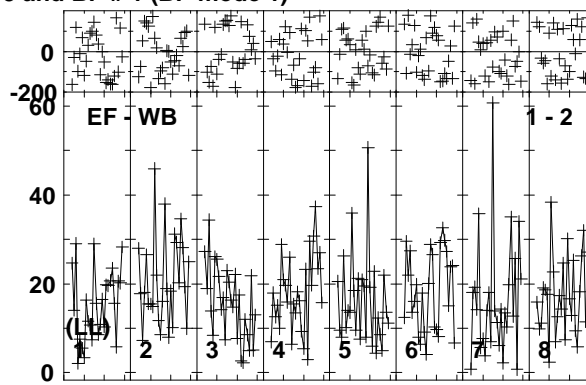
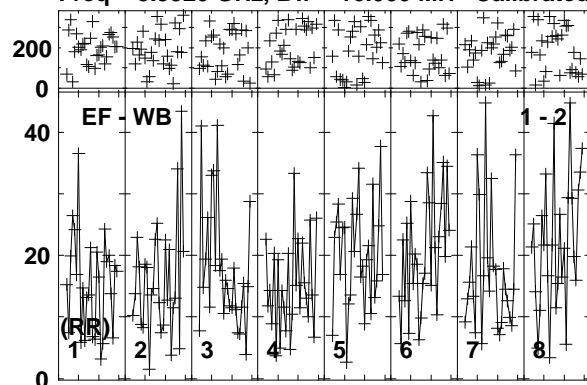

Lower frame: Milli Ampl Jy Top frame: Phas deg
Vector averaged cross-power spectrum Baseline: EF (01) - WB (02)
Timerange: 00/05:20:31 to 00/05:23:29

Plot file version 162 created 24-MAR-2014 14:38:24

ARP299D EP087F 5.UVDATA.1

Freq = 8.3520 GHz, Bw = 16.000 MH Calibrated with CL # 3 and BP # 1 (BP mode 1)

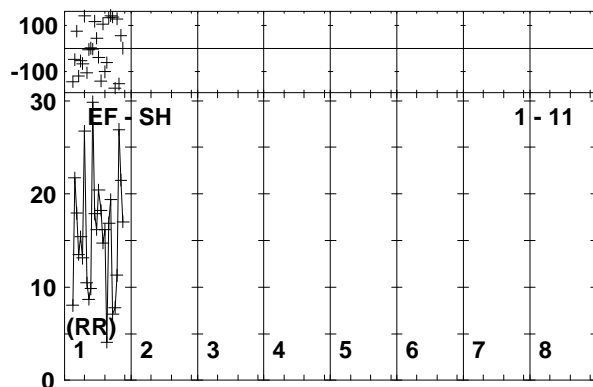
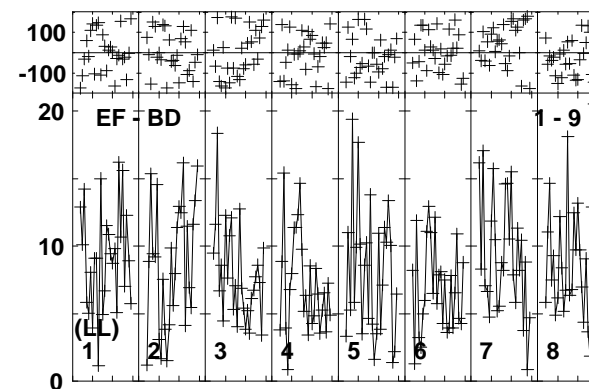
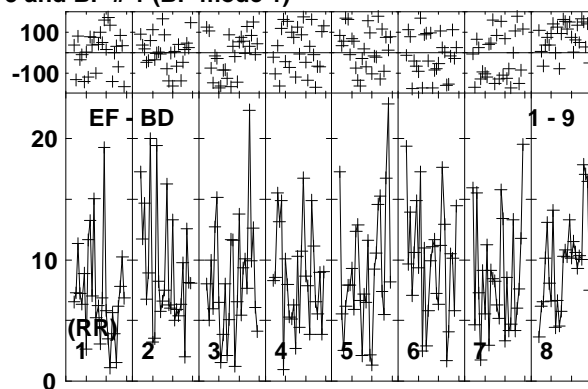
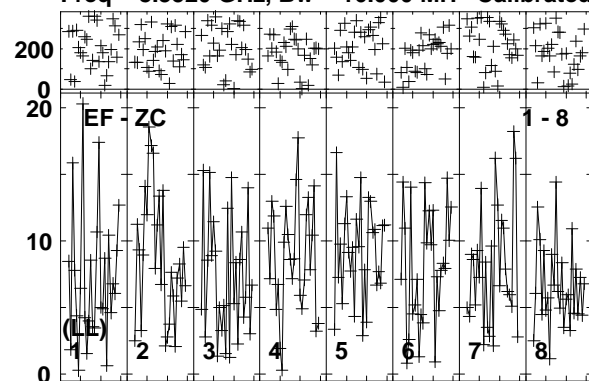

Lower frame: Milli Ampl Jy Top frame: Phas deg
Vector averaged cross-power spectrum Baseline: EF (01) - ZC (08)
Timerange: 00/05:20:31 to 00/05:23:29

Plot file version 163 created 24-MAR-2014 14:38:24

J1128+5925 EP087F 5.UVDATA.1

Freq = 8.3520 GHz, Bw = 16.000 MH Calibrated with CL # 3 and BP # 1 (BP mode 1)

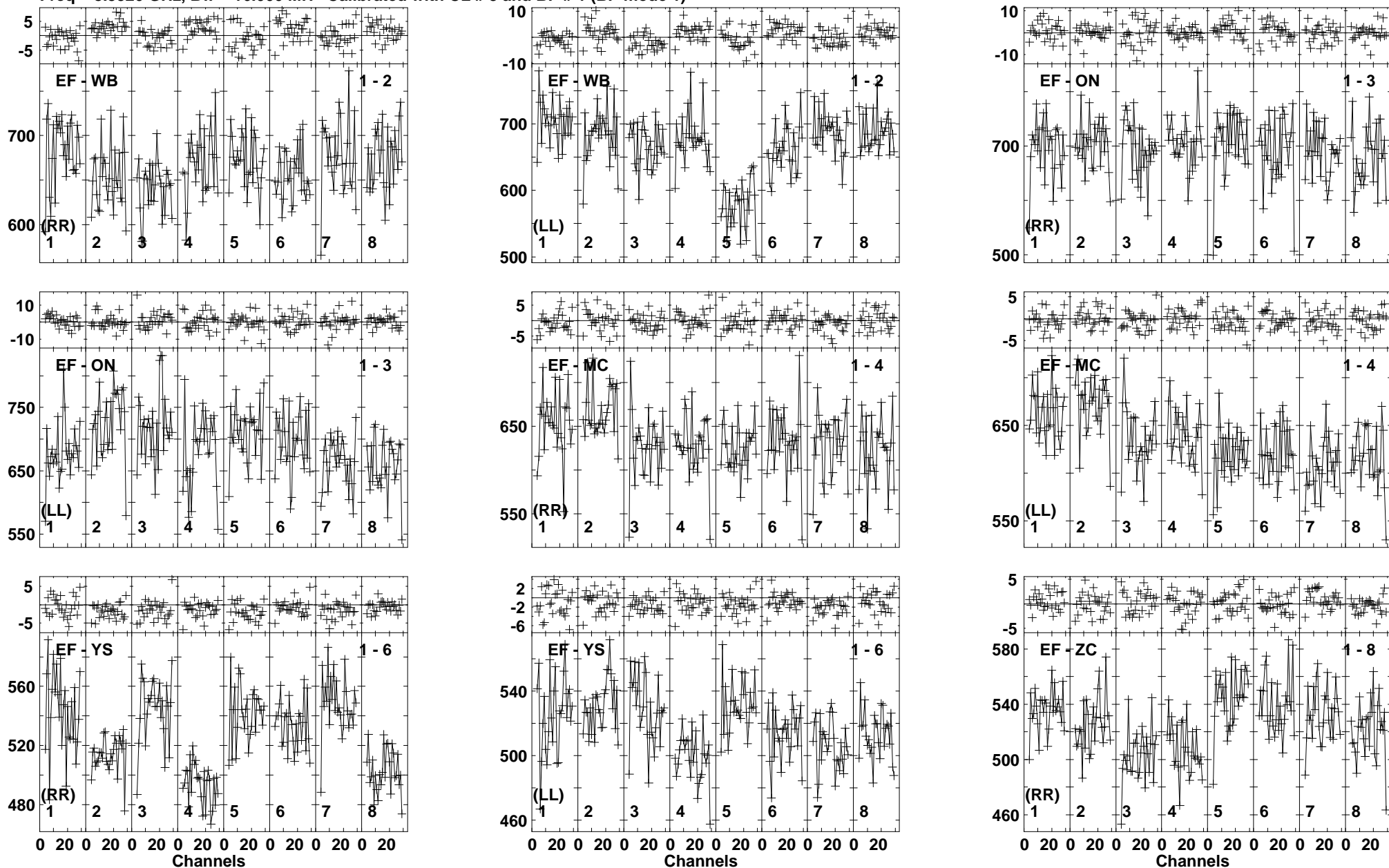

Lower frame: Milli Ampl Jy Top frame: Phas deg
Vector averaged cross-power spectrum Baseline: EF (01) - WB (02)
Timerange: 00/05:24:11 to 00/05:24:39

Plot file version 164 created 24-MAR-2014 14:38:24
 J1128+5925 EP087F 5.UVDATA.1
 Freq = 8.3520 GHz, Bw = 16.000 MH Calibrated with CL # 3 and BP # 1 (BP mode 1)

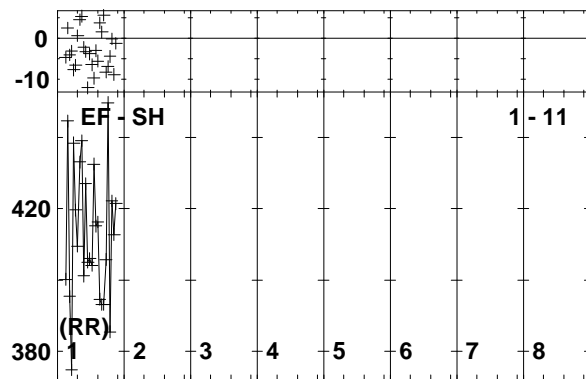
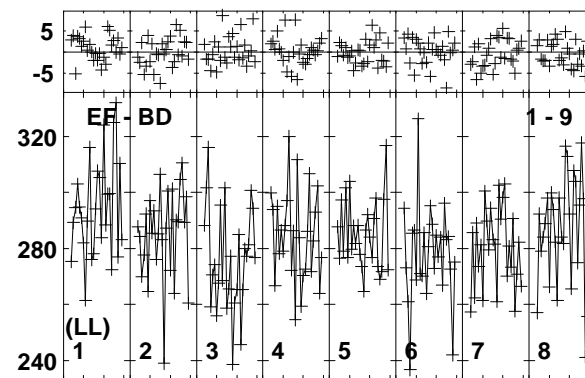
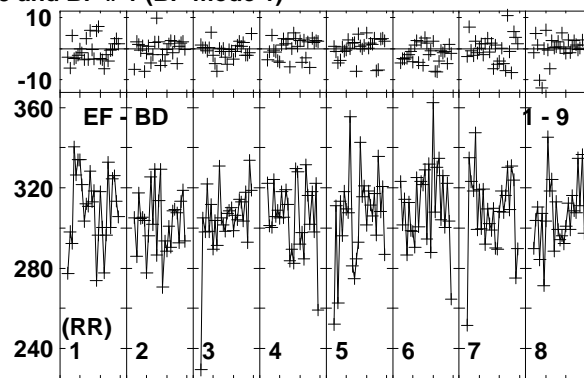
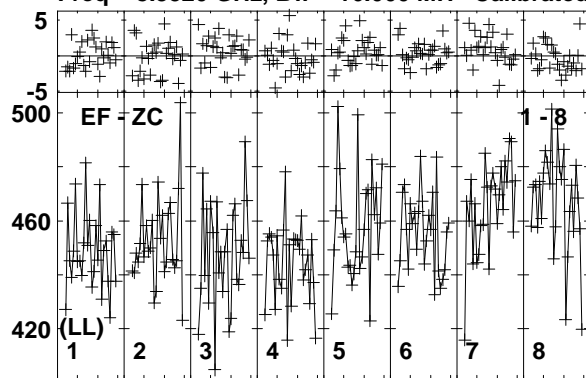

Lower frame: Milli Ampl Jy Top frame: Phas deg
 Vector averaged cross-power spectrum Baseline: EF (01) - ZC (08)
 Timerange: 00/05:24:11 to 00/05:24:39

Plot file version 165 created 24-MAR-2014 14:38:24
 ARP299D EP087F 5.UVDATA.1
 Freq = 8.3520 GHz, Bw = 16.000 MH Calibrated with CL # 3 and BP # 1 (BP mode 1)

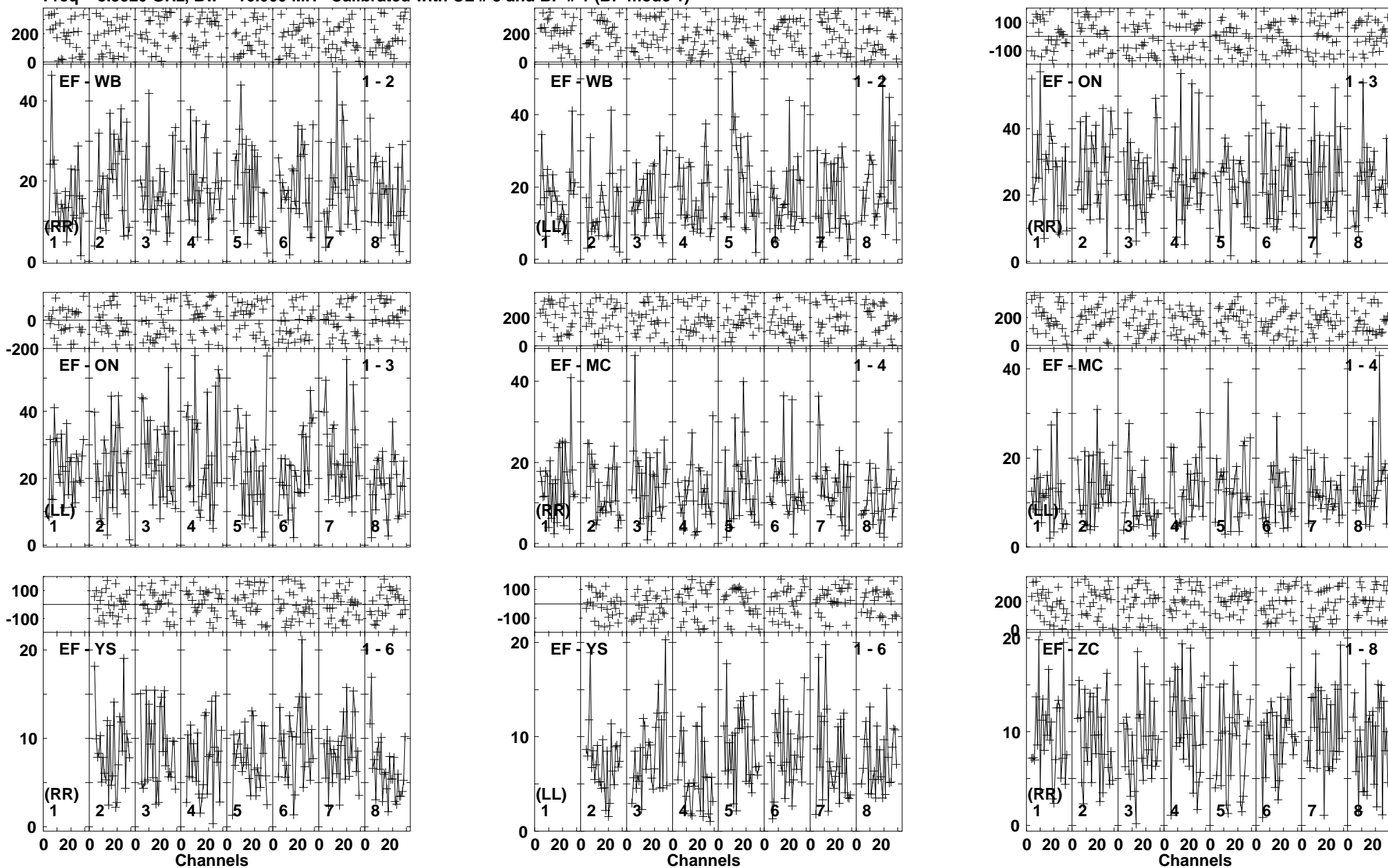

Lower frame: Milli Ampl Jy Top frame: Phas deg
 Vector averaged cross-power spectrum Baseline: EF (01) - WB (02)
 Timerange: 00/05:24:45 to 00/05:27:40

Plot file version 166 created 24-MAR-2014 14:38:25

ARP299D EP087F 5.UVDATA.1

Freq = 8.3520 GHz, Bw = 16.000 MH Calibrated with CL # 3 and BP # 1 (BP mode 1)

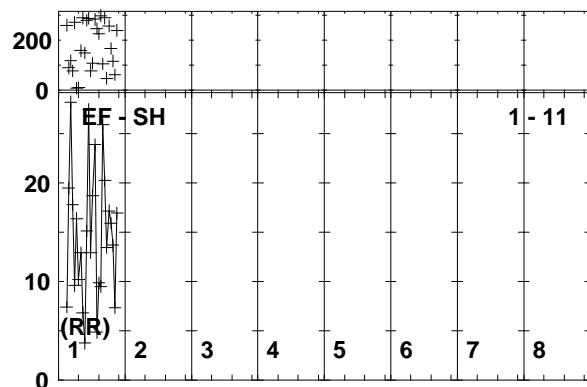
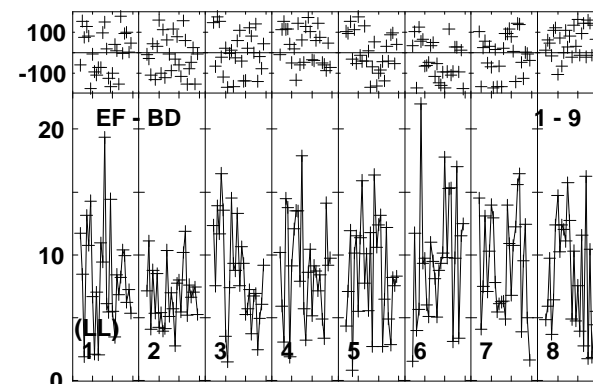
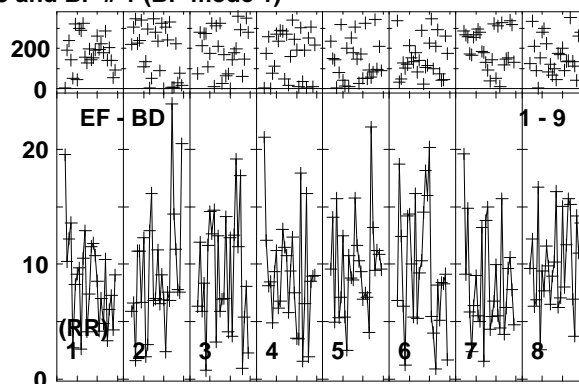
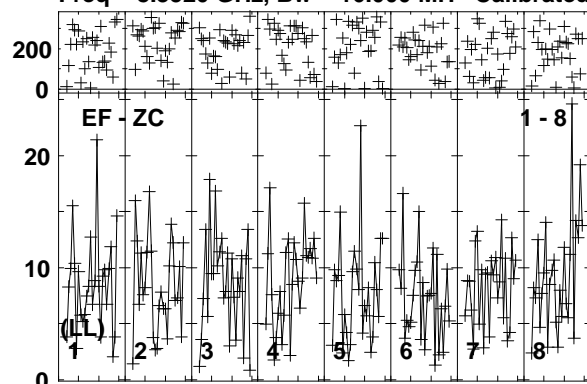

Lower frame: Milli Ampl Jy Top frame: Phas deg
Vector averaged cross-power spectrum Baseline: EF (01) - ZC (08)
Timerange: 00/05:24:45 to 00/05:27:40

Plot file version 167 created 24-MAR-2014 14:38:25

J1128+5925 EP087F 5.UVDATA.1

Freq = 8.3520 GHz, Bw = 16.000 MH Calibrated with CL # 3 and BP # 1 (BP mode 1)

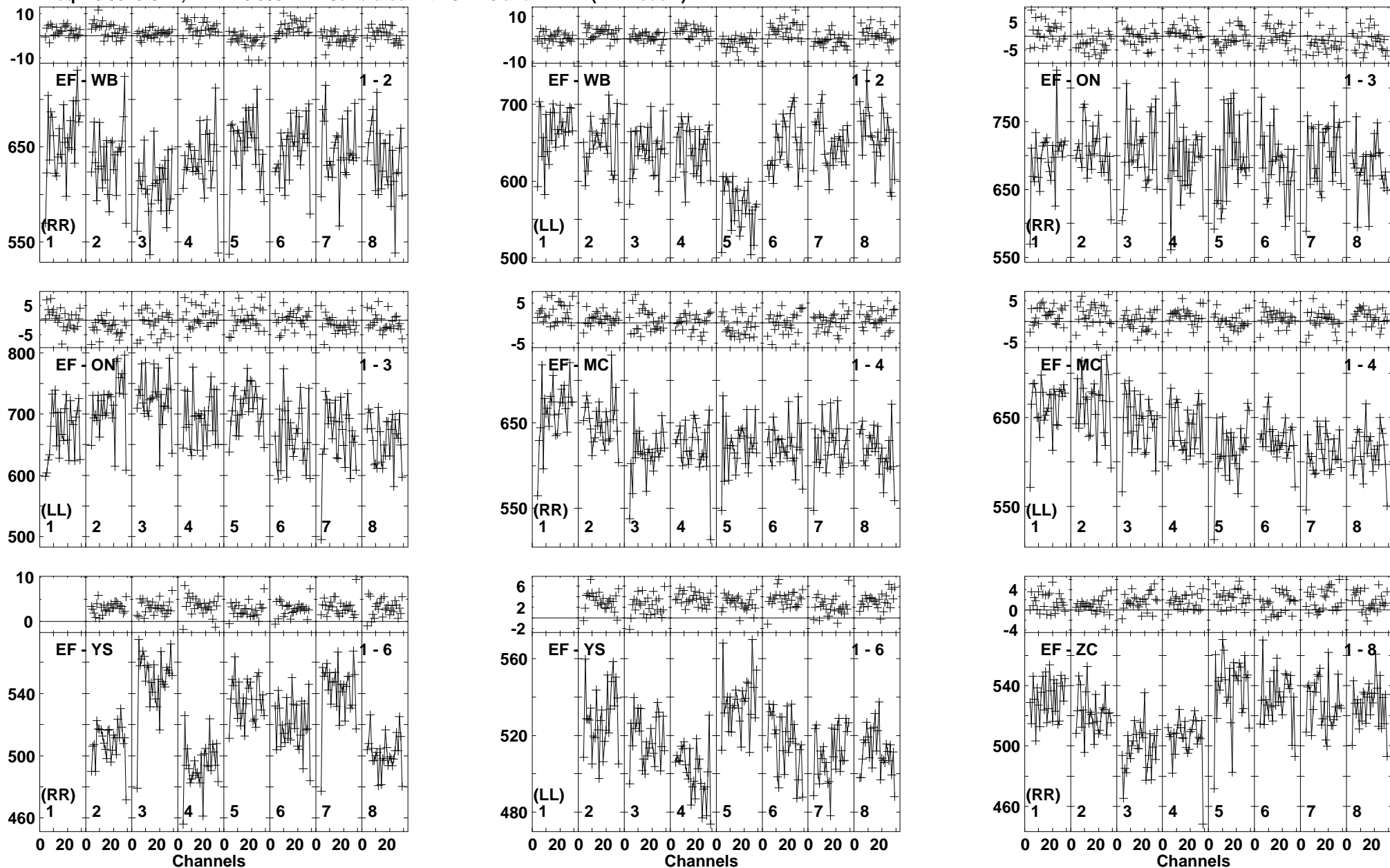

Lower frame: Milli Ampl Jy Top frame: Phas deg
Vector averaged cross-power spectrum Baseline: EF (01) - WB (02)
Timerange: 00/05:27:41 to 00/05:28:44

Plot file version 168 created 24-MAR-2014 14:38:25
 J1128+5925 EP087F 5.UVDATA.1
 Freq = 8.3520 GHz, Bw = 16.000 MH Calibrated with CL # 3 and BP # 1 (BP mode 1)

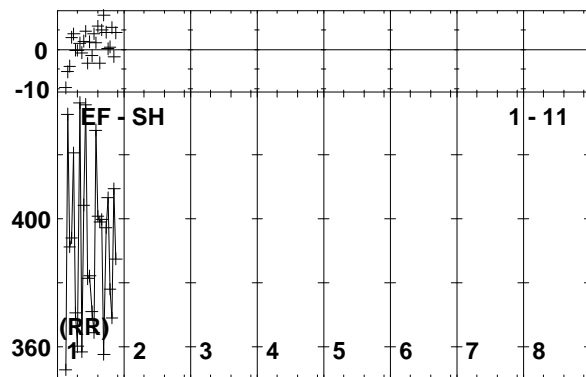
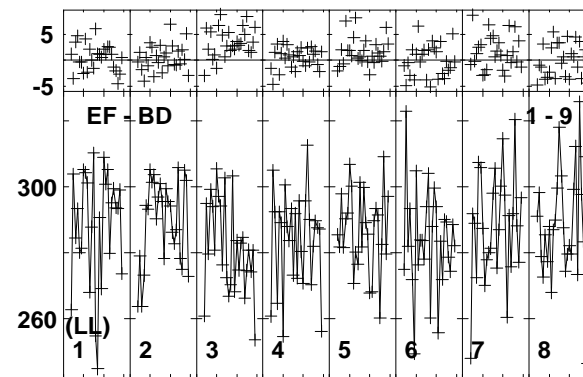
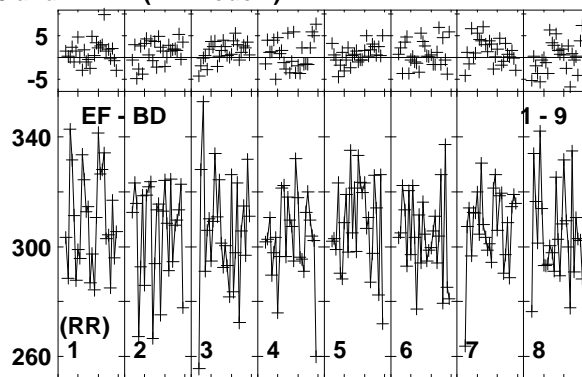
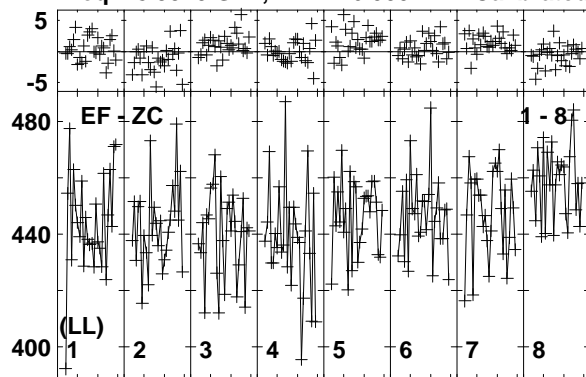

Lower frame: Milli Ampl Jy Top frame: Phas deg
 Vector averaged cross-power spectrum Baseline: EF (01) - ZC (08)
 Timerange: 00/05:27:41 to 00/05:28:44

Plot file version 169 created 24-MAR-2014 14:38:25

ARP299D EP087F 5.UVDATA.1

Freq = 8.3520 GHz, Bw = 16.000 MH Calibrated with CL # 3 and BP # 1 (BP mode 1)

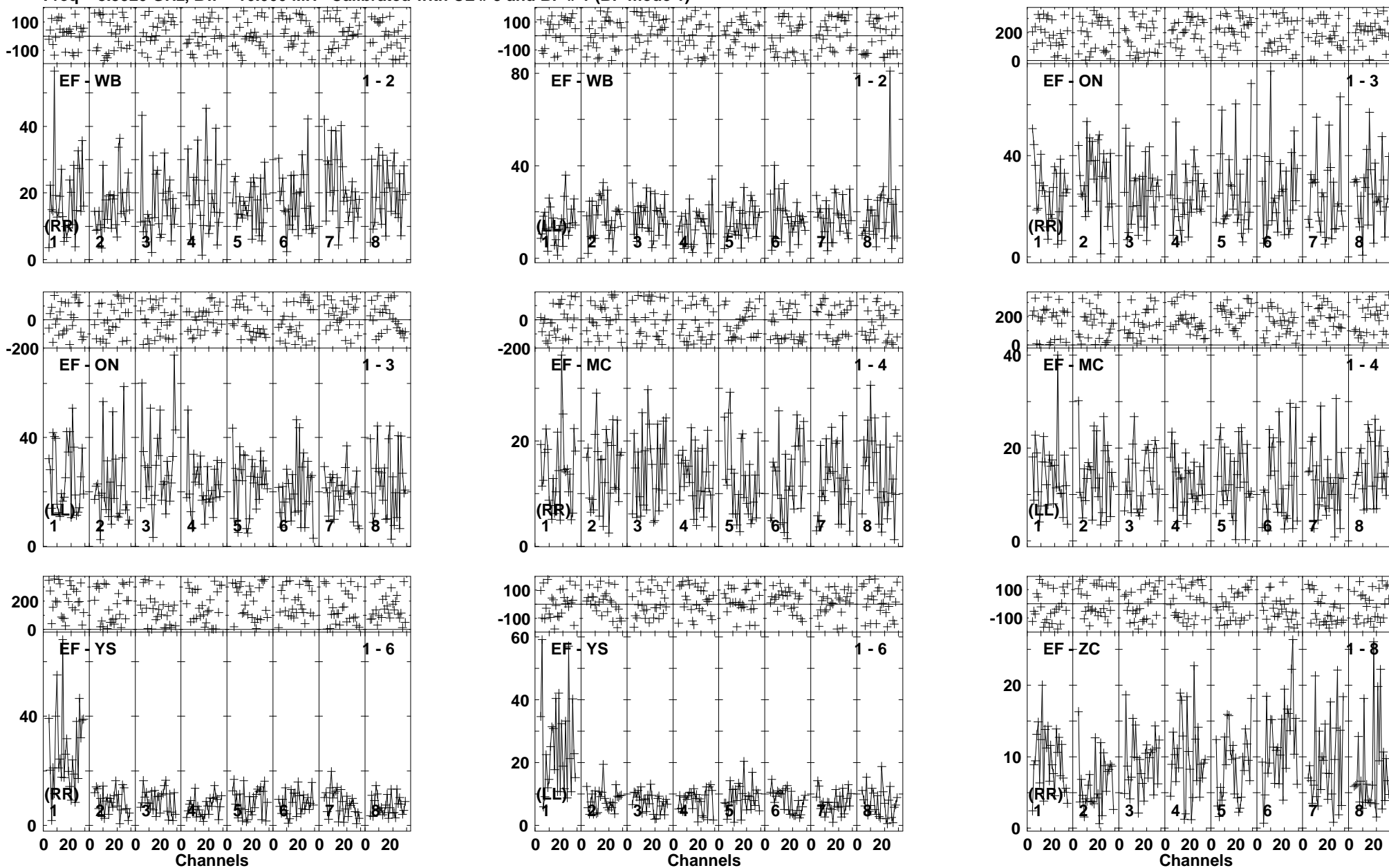

Lower frame: Milli Ampl Jy Top frame: Phas deg
Vector averaged cross-power spectrum Baseline: EF (01) - WB (02)
Timerange: 00/05:28:46 to 00/05:31:45

Plot file version 170 created 24-MAR-2014 14:38:25
 ARP299D EP087F 5.UVDATA.1
 Freq = 8.3520 GHz, Bw = 16.000 MH Calibrated with CL # 3 and BP # 1 (BP mode 1)

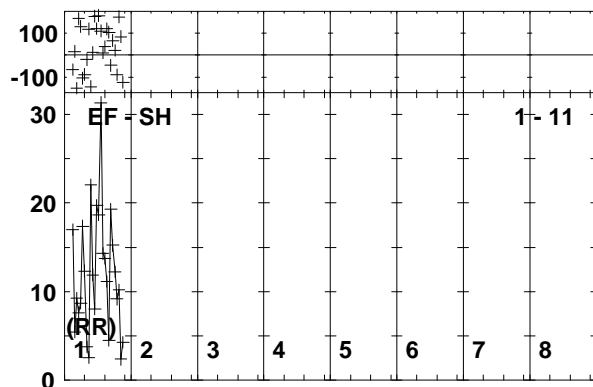
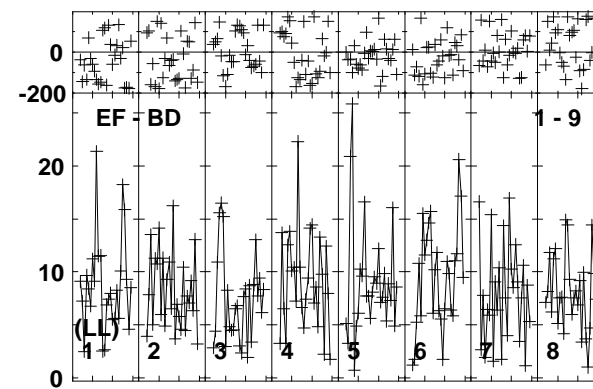
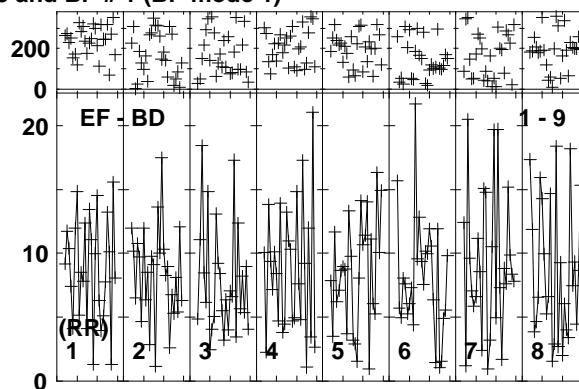
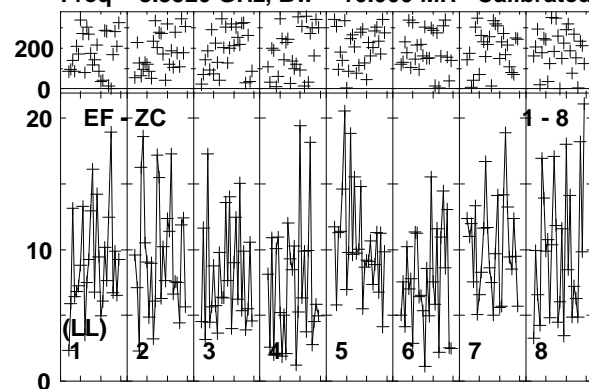

Lower frame: Milli Ampl Jy Top frame: Phas deg
 Vector averaged cross-power spectrum Baseline: EF (01) - ZC (08)
 Timerange: 00/05:28:46 to 00/05:31:45

Plot file version 171 created 24-MAR-2014 14:38:26

J1128+5925 EP087F 5.UVDATA.1

Freq = 8.3520 GHz, Bw = 16.000 MH Calibrated with CL # 3 and BP # 1 (BP mode 1)

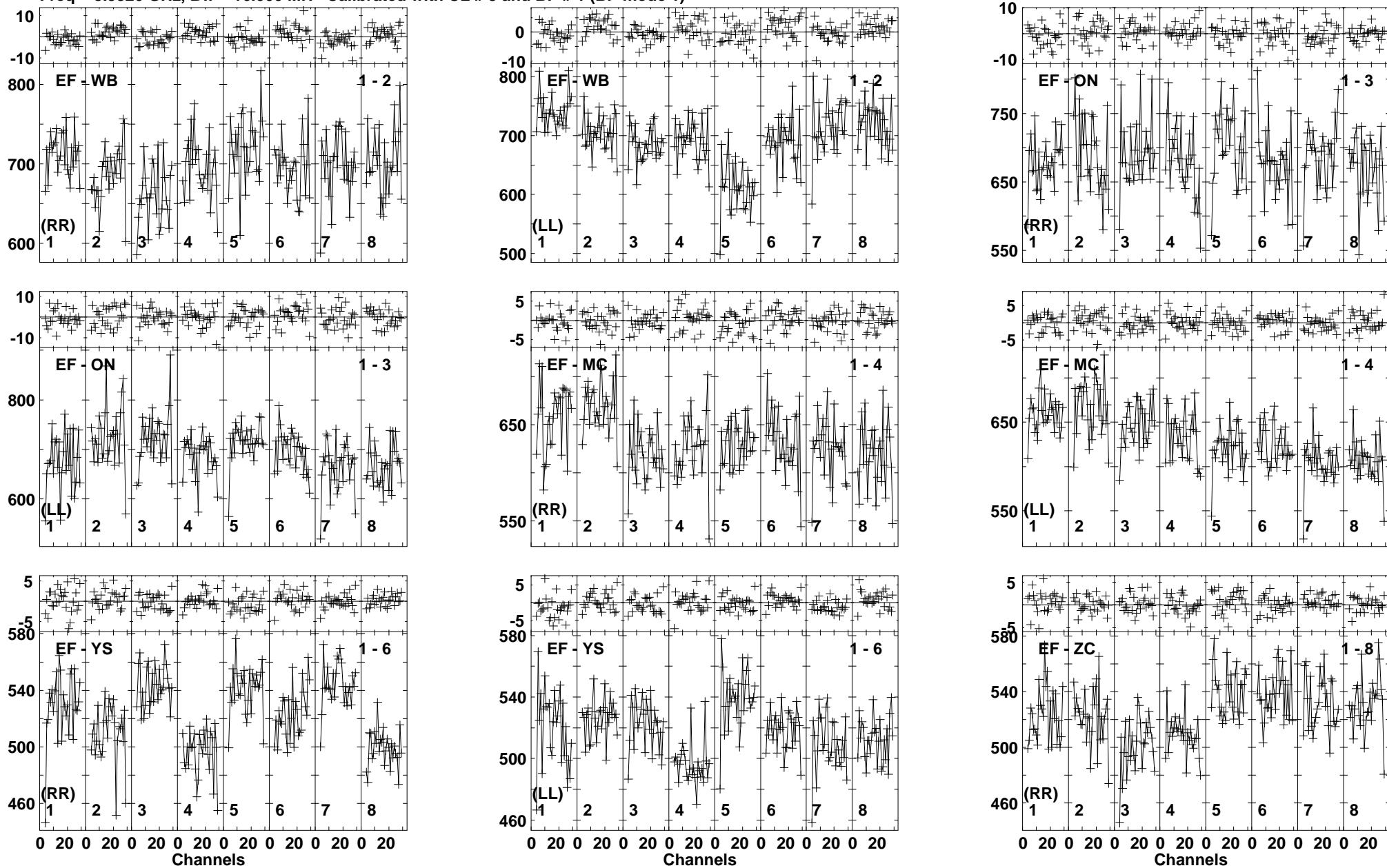

Lower frame: Milli Ampl Jy Top frame: Phas deg
Vector averaged cross-power spectrum Baseline: EF (01) - WB (02)
Timerange: 00/05:32:26 to 00/05:32:54

Plot file version 172 created 24-MAR-2014 14:38:26

J1128+5925 EP087F 5.UVDATA.1

Freq = 8.3520 GHz, Bw = 16.000 MH Calibrated with CL # 3 and BP # 1 (BP mode 1)

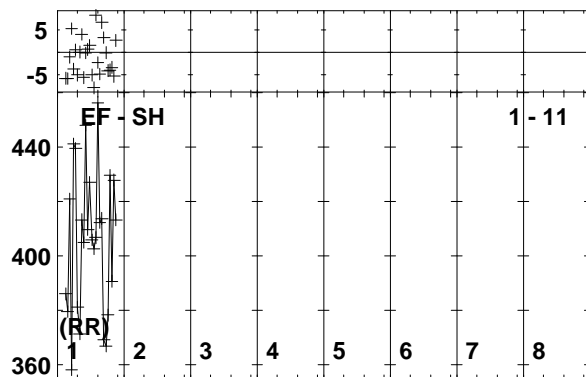
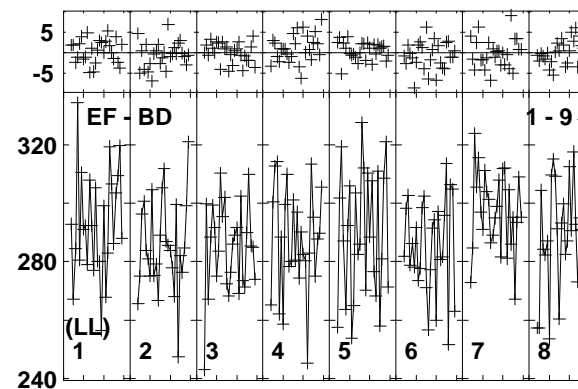
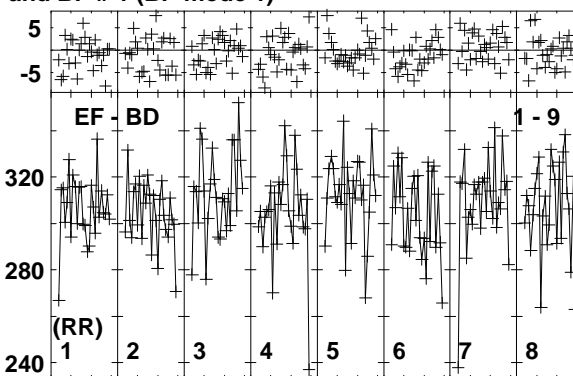
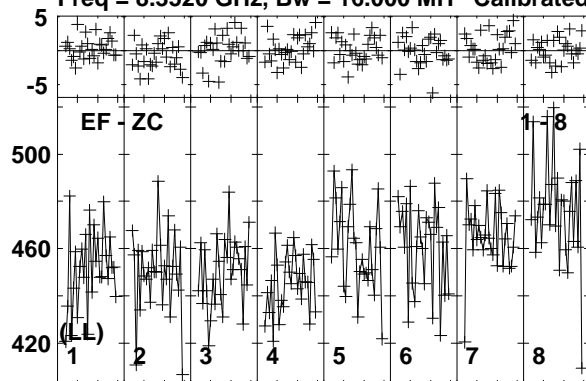

Lower frame: Milli Ampl Jy Top frame: Phas deg
Vector averaged cross-power spectrum Baseline: EF (01) - ZC (08)
Timerange: 00/05:32:26 to 00/05:32:54

Plot file version 173 created 24-MAR-2014 14:38:26
 ARP299D EP087F 5.UVDATA.1
 Freq = 8.3520 GHz, Bw = 16.000 MH Calibrated with CL # 3 and BP # 1 (BP mode 1)

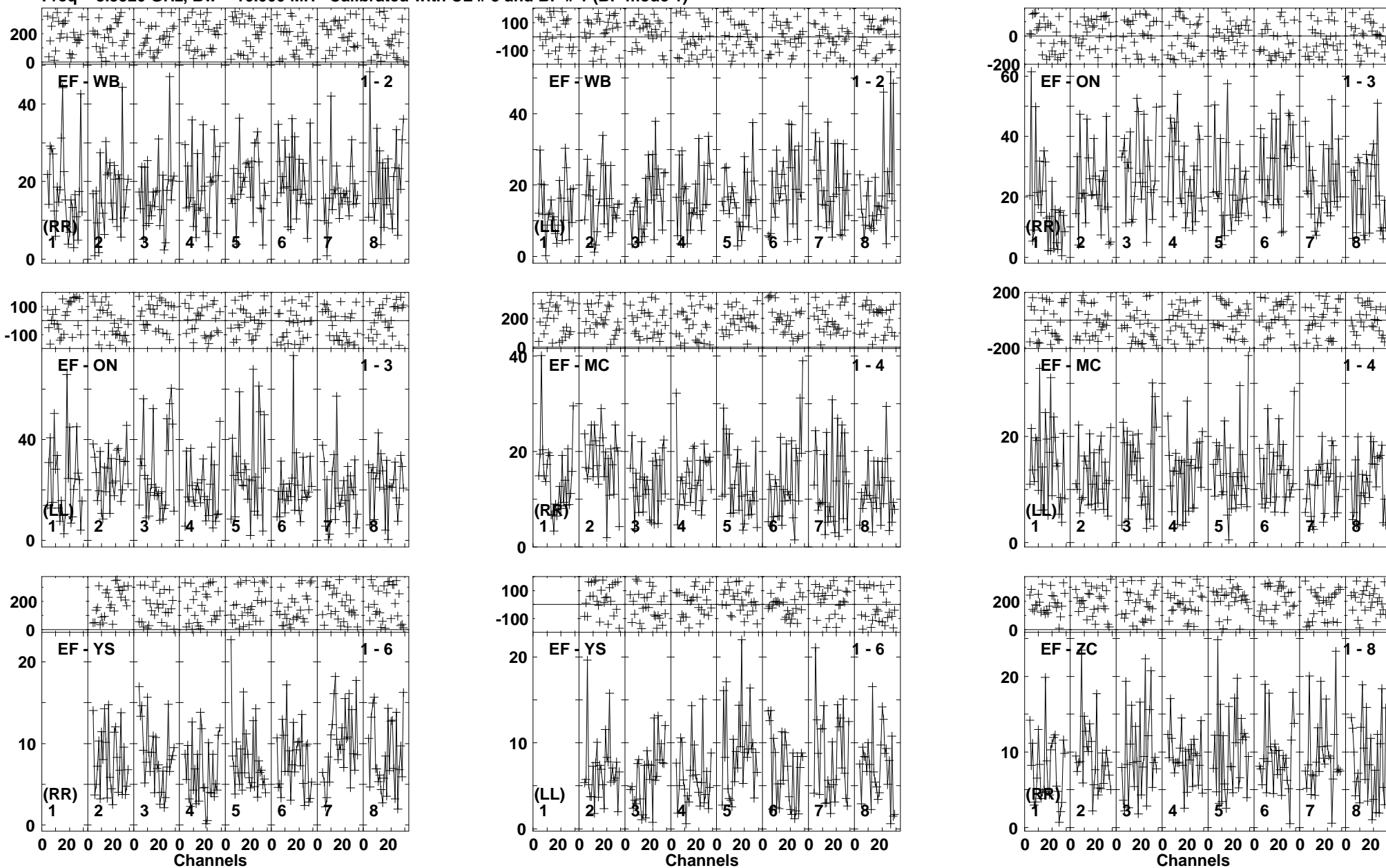

Lower frame: Milli Ampl Jy Top frame: Phas deg
 Vector averaged cross-power spectrum Baseline: EF (01) - WB (02)
 Timerange: 00/05:32:59 to 00/05:35:55

Plot file version 174 created 24-MAR-2014 14:38:26

ARP299D EP087F 5.UVDATA.1

Freq = 8.3520 GHz, Bw = 16.000 MH Calibrated with CL # 3 and BP # 1 (BP mode 1)

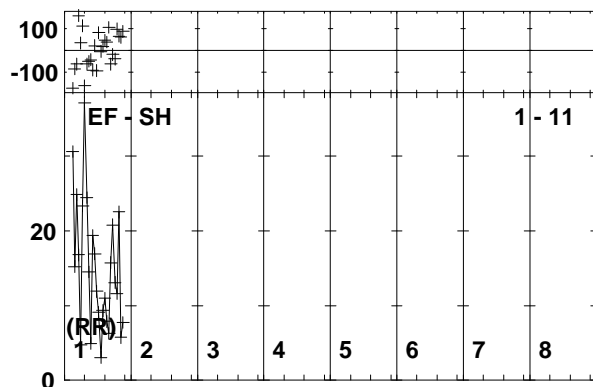
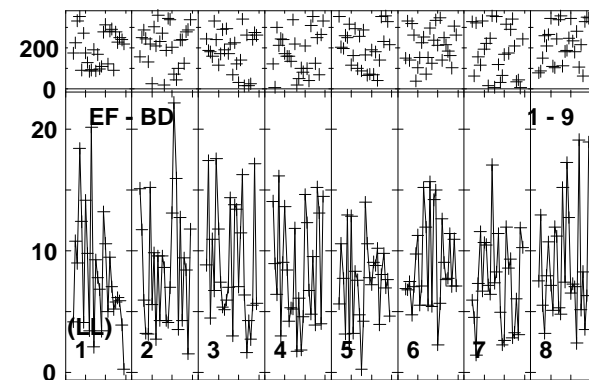
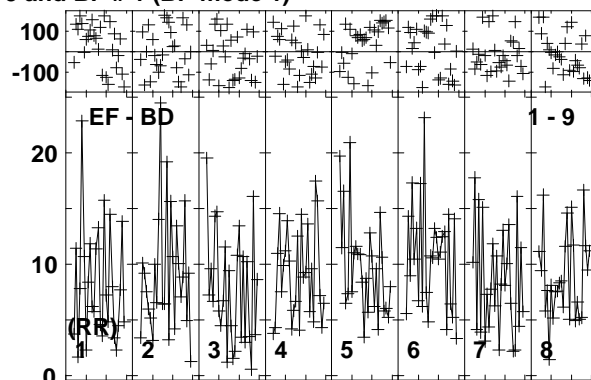
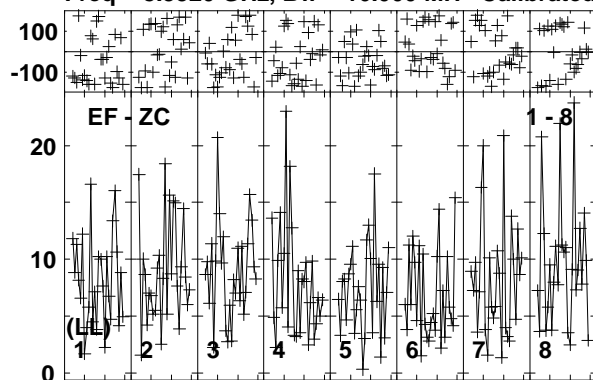

Lower frame: Milli Ampl Jy Top frame: Phas deg
Vector averaged cross-power spectrum Baseline: EF (01) - ZC (08)
Timerange: 00/05:32:59 to 00/05:35:55

Plot file version 175 created 24-MAR-2014 14:38:26

J1128+5925 EP087F 5.UVDATA.1

Freq = 8.3520 GHz, Bw = 16.000 MH Calibrated with CL # 3 and BP # 1 (BP mode 1)

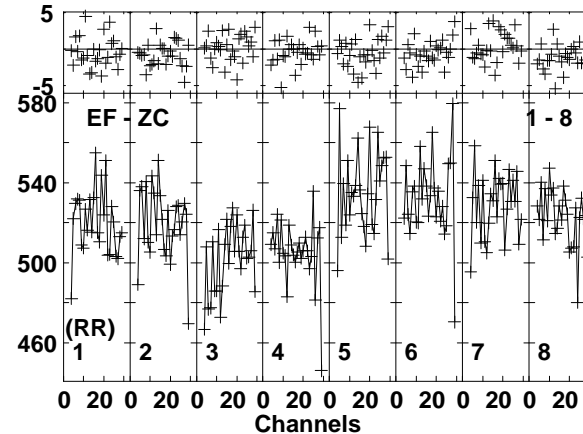
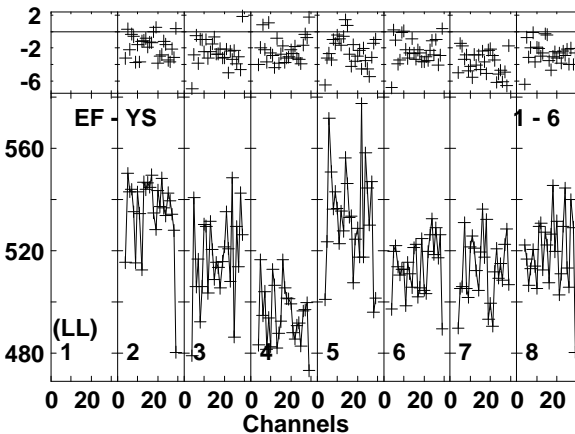
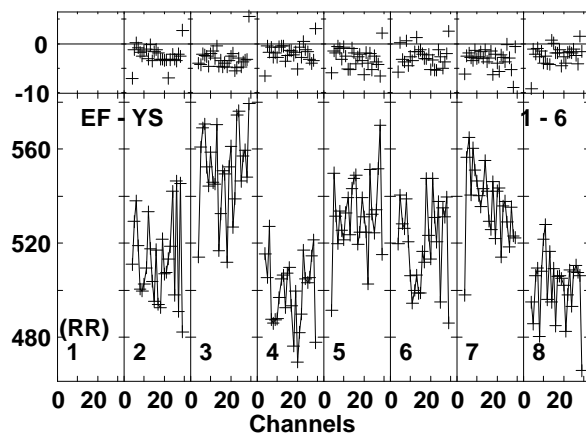
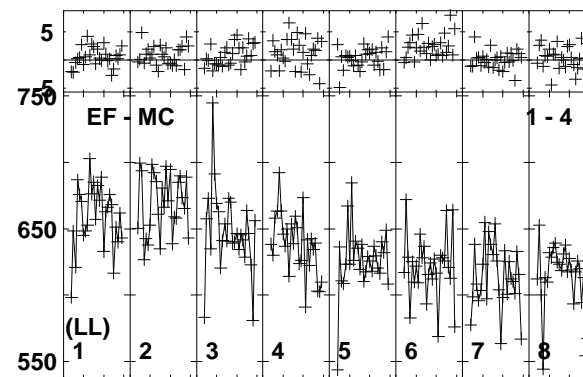
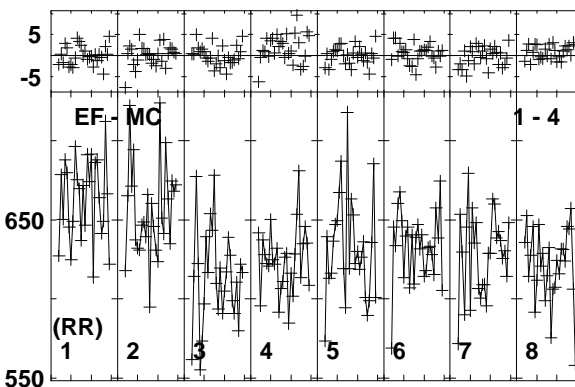
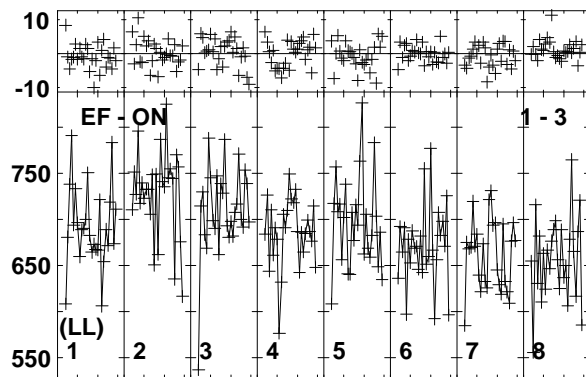
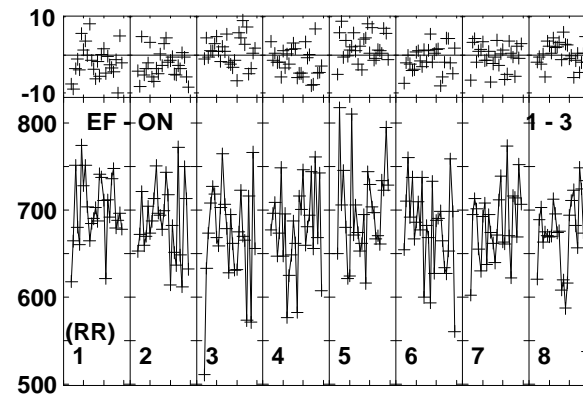
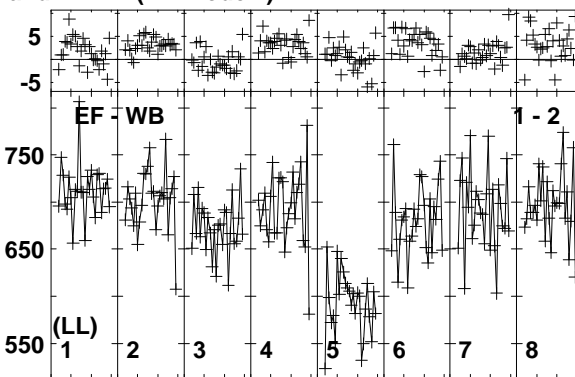
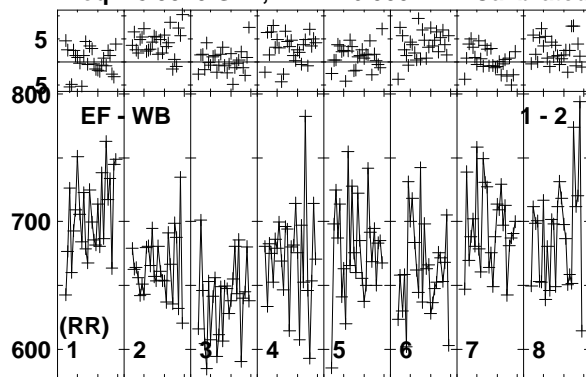

Lower frame: Milli Ampl Jy Top frame: Phas deg
Vector averaged cross-power spectrum Baseline: EF (01) - WB (02)
Timerange: 00/05:35:56 to 00/05:36:59

Plot file version 176 created 24-MAR-2014 14:38:27

J1128+5925 EP087F 5.UVDATA.1

Freq = 8.3520 GHz, Bw = 16.000 MH Calibrated with CL # 3 and BP # 1 (BP mode 1)

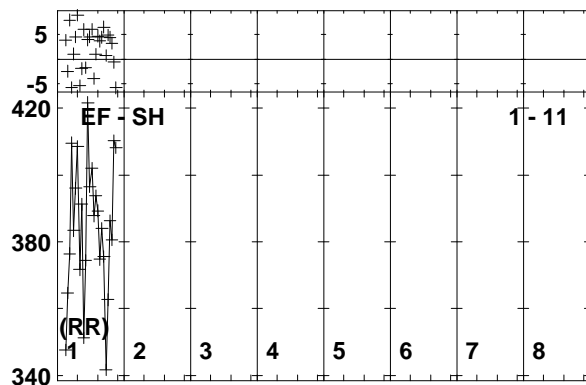
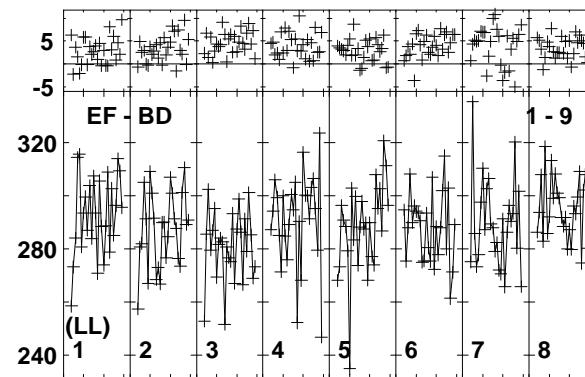
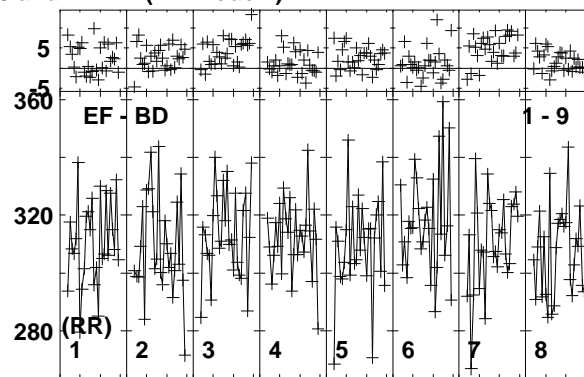
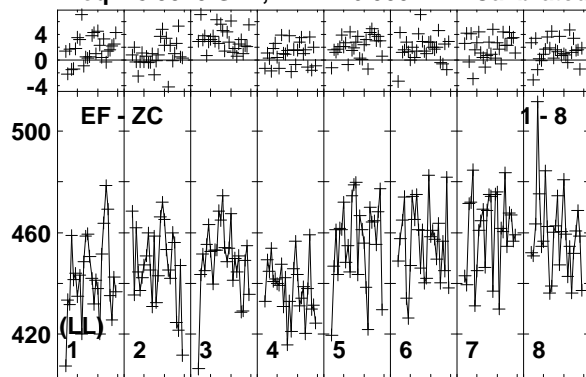

Lower frame: Milli Ampl Jy Top frame: Phas deg
Vector averaged cross-power spectrum Baseline: EF (01) - ZC (08)
Timerange: 00/05:35:56 to 00/05:36:59

Plot file version 177 created 24-MAR-2014 14:38:27

ARP299D EP087F 5.UVDATA.1

Freq = 8.3520 GHz, Bw = 16.000 MH Calibrated with CL # 3 and BP # 1 (BP mode 1)

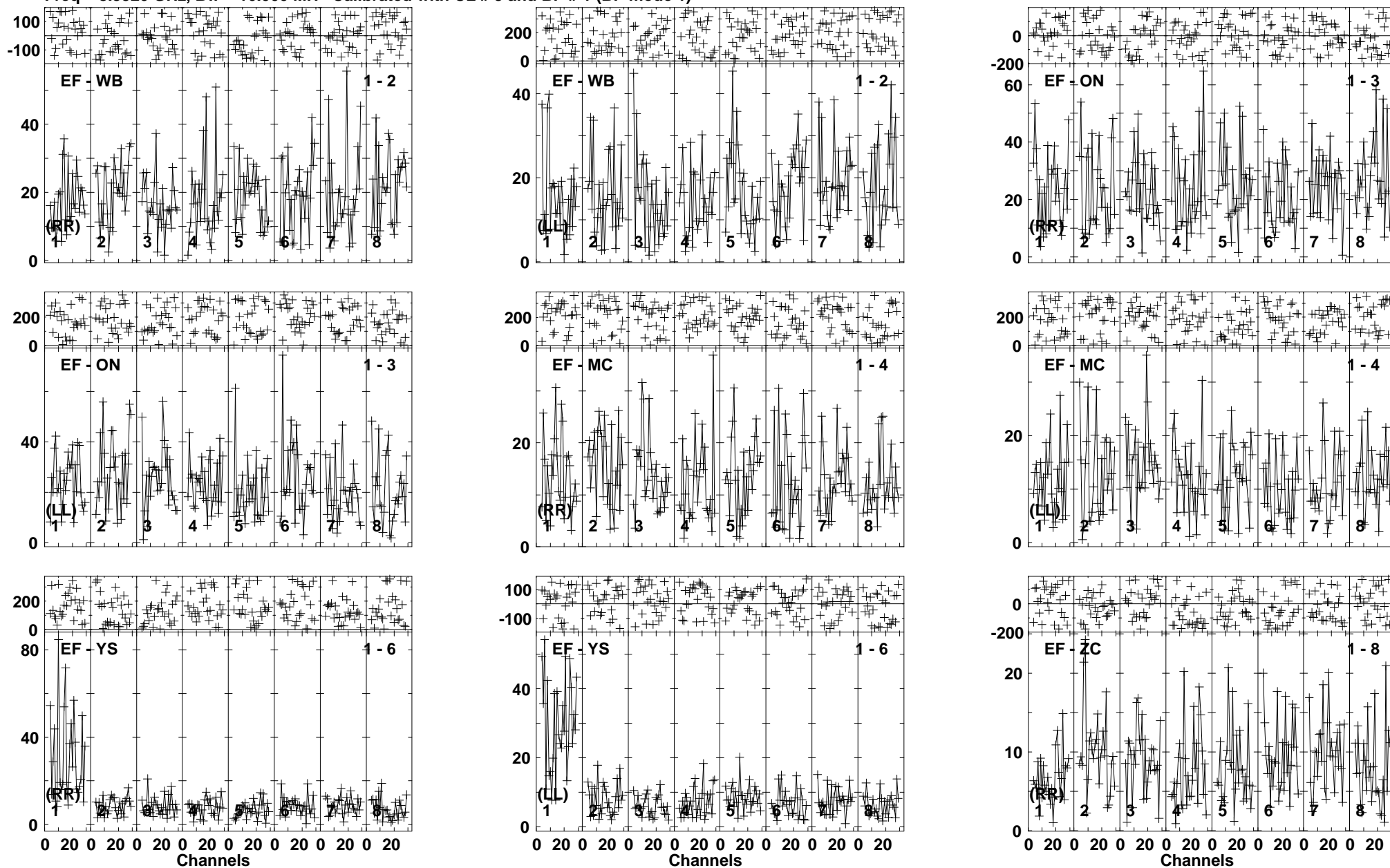

Lower frame: Milli Ampl Jy Top frame: Phas deg
Vector averaged cross-power spectrum Baseline: EF (01) - WB (02)
Timerange: 00/05:37:05 to 00/05:39:59

Plot file version 178 created 24-MAR-2014 14:38:27

ARP299D EP087F 5.UVDATA.1

Freq = 8.3520 GHz, Bw = 16.000 MH Calibrated with CL # 3 and BP # 1 (BP mode 1)

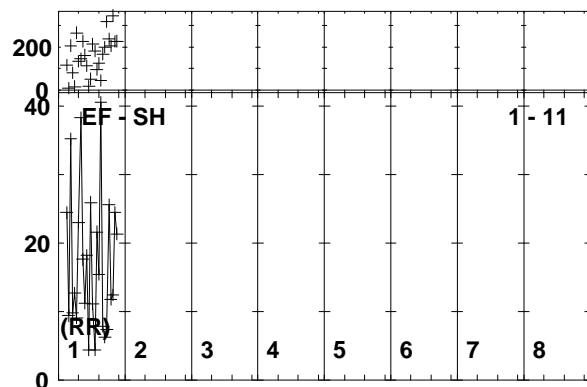
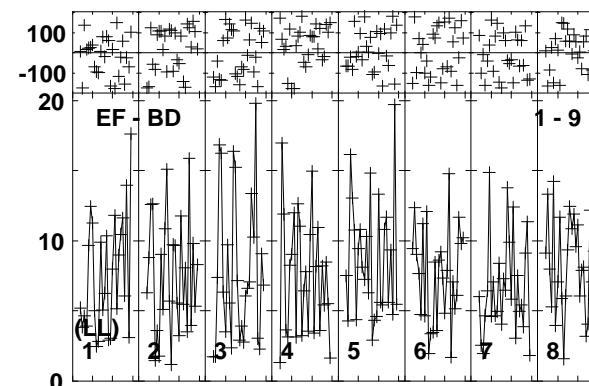
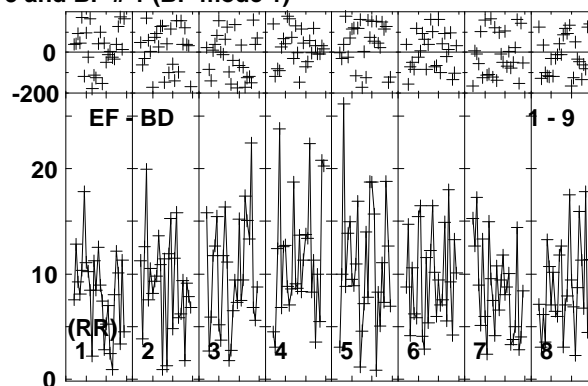
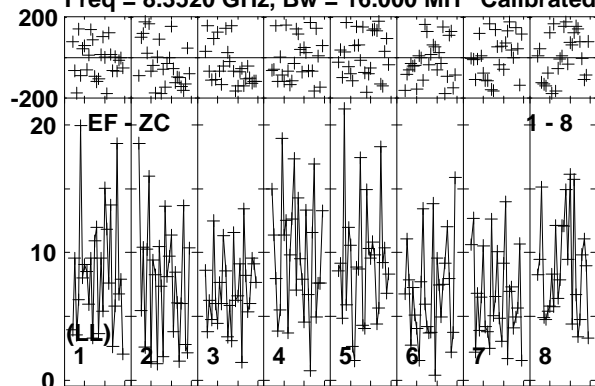

Lower frame: Milli Ampl Jy Top frame: Phas deg
Vector averaged cross-power spectrum Baseline: EF (01) - ZC (08)
Timerange: 00/05:37:05 to 00/05:39:59

Plot file version 179 created 24-MAR-2014 14:38:27

J1128+5925 EP087F 5.UVDATA.1

Freq = 8.3520 GHz, Bw = 16.000 MH Calibrated with CL # 3 and BP # 1 (BP mode 1)

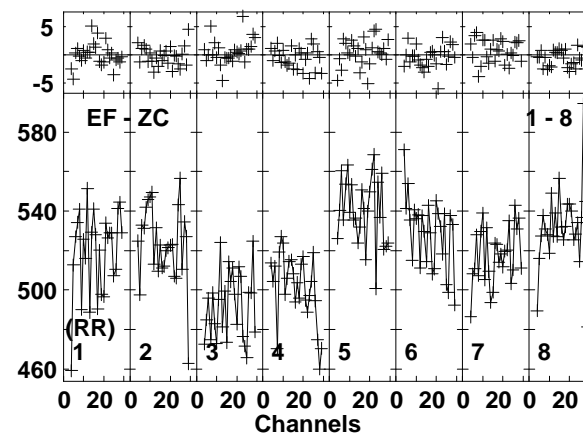
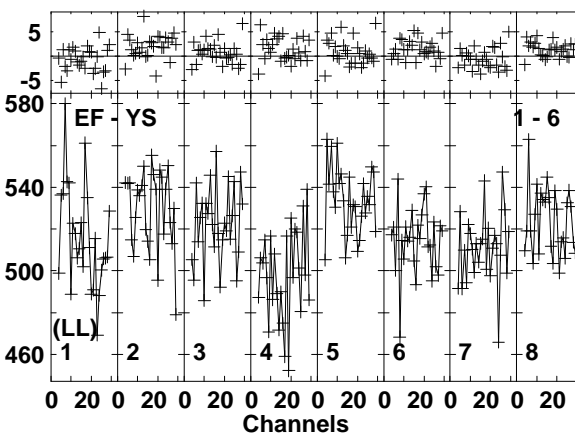
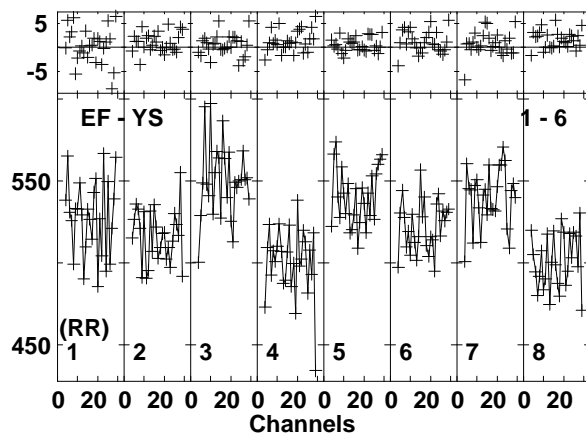
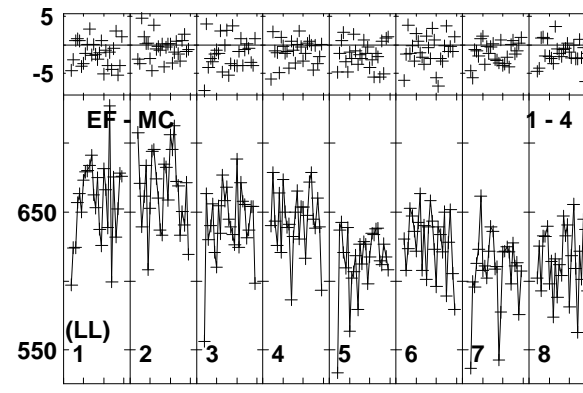
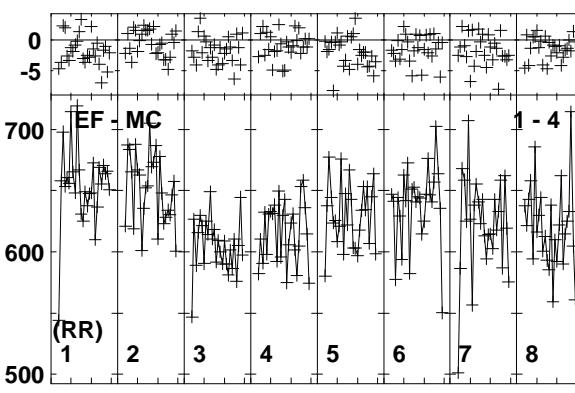
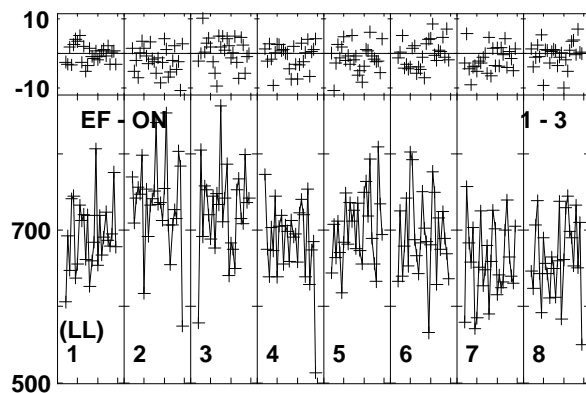
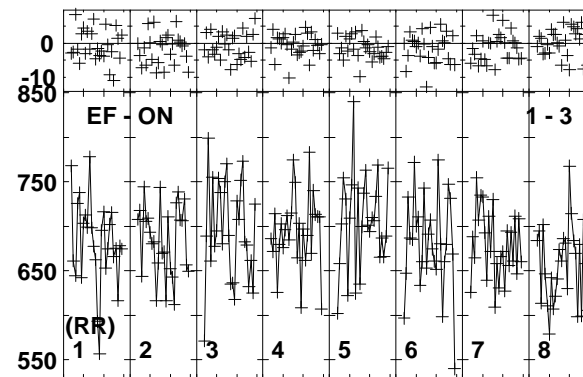
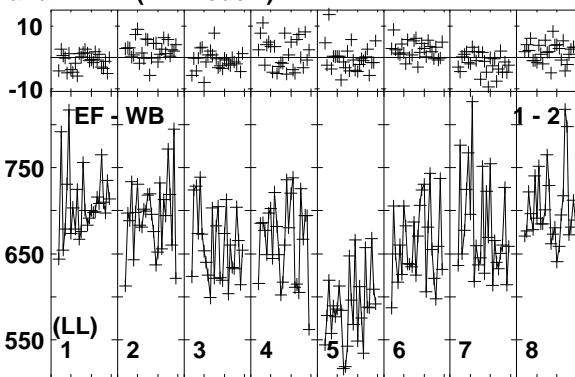
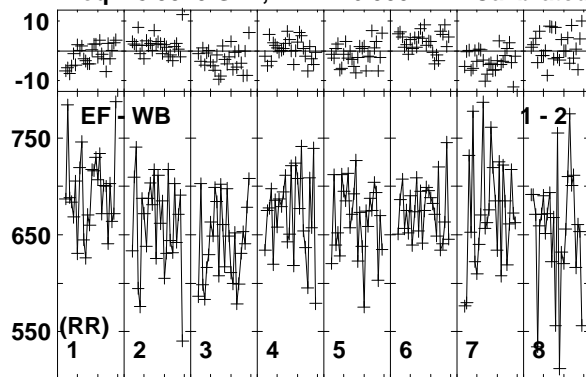

Lower frame: Milli Ampl Jy Top frame: Phas deg
Vector averaged cross-power spectrum Baseline: EF (01) - WB (02)
Timerange: 00/05:40:40 to 00/05:41:09

Plot file version 180 created 24-MAR-2014 14:38:28

J1128+5925 EP087F 5.UVDATA.1

Freq = 8.3520 GHz, Bw = 16.000 MH Calibrated with CL # 3 and BP # 1 (BP mode 1)

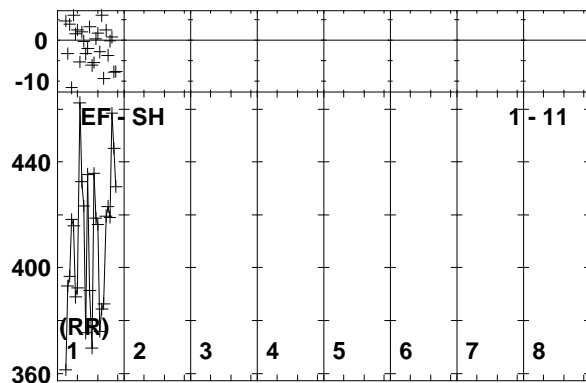
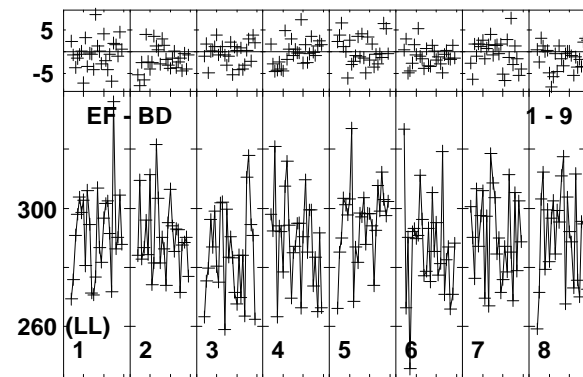
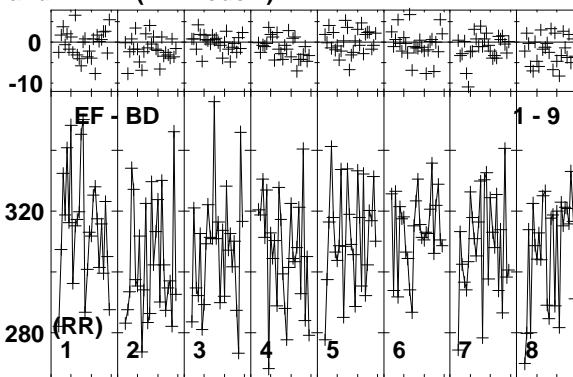
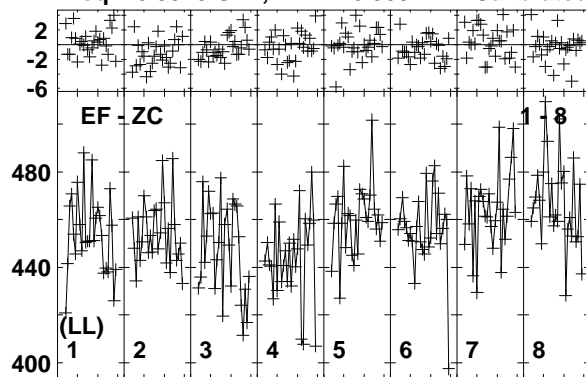

Lower frame: Milli Ampl Jy Top frame: Phas deg
Vector averaged cross-power spectrum Baseline: EF (01) - ZC (08)
Timerange: 00/05:40:40 to 00/05:41:09

Plot file version 181 created 24-MAR-2014 14:38:28
 ARP299D EP087F 5.UVDATA.1
 Freq = 8.3520 GHz, Bw = 16.000 MH Calibrated with CL # 3 and BP # 1 (BP mode 1)

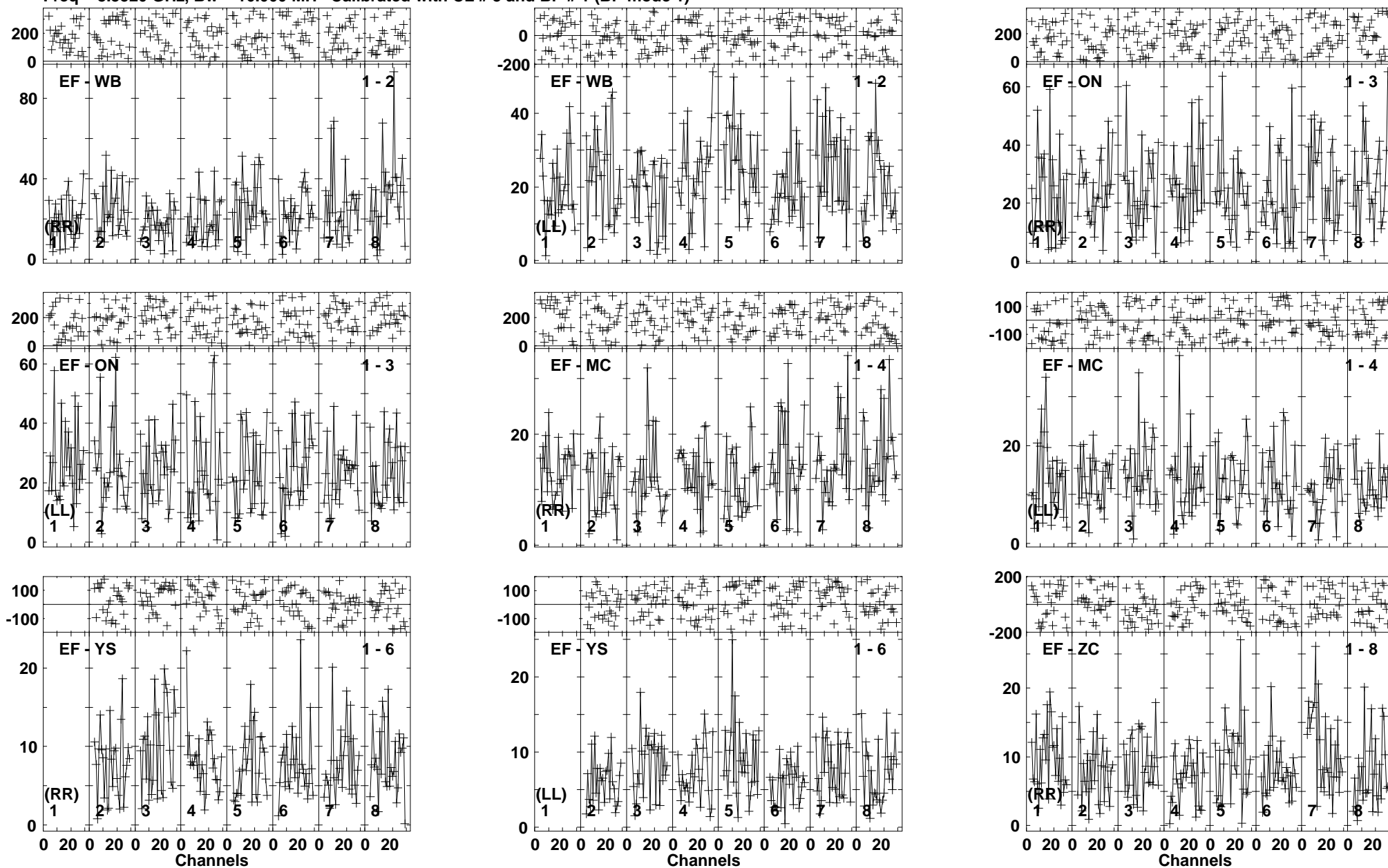

Lower frame: Milli Ampl Jy Top frame: Phas deg
 Vector averaged cross-power spectrum Baseline: EF (01) - WB (02)
 Timerange: 00/05:41:14 to 00/05:44:10

Plot file version 182 created 24-MAR-2014 14:38:28
 ARP299D EP087F 5.UVDATA.1
 Freq = 8.3520 GHz, Bw = 16.000 MH Calibrated with CL # 3 and BP # 1 (BP mode 1)

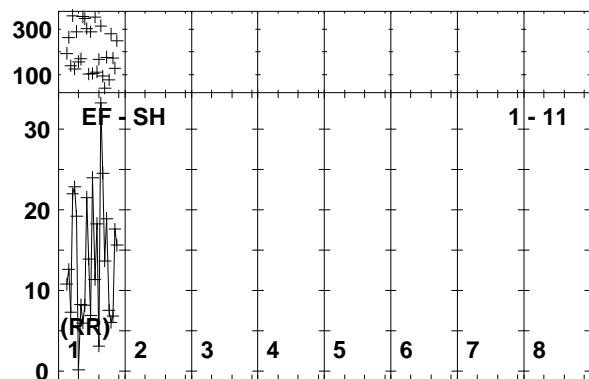
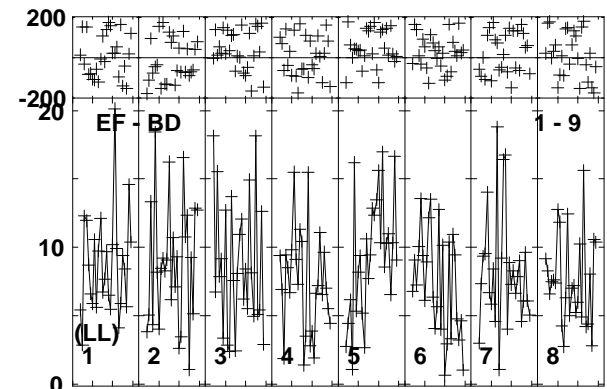
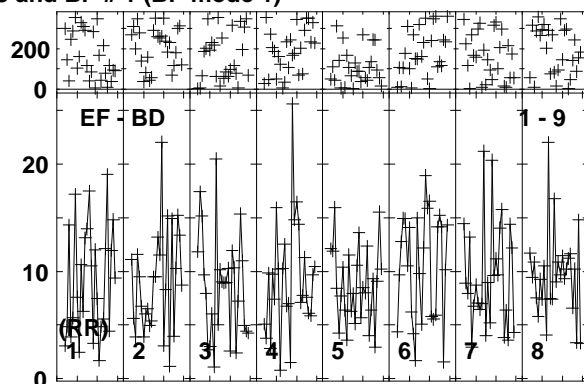
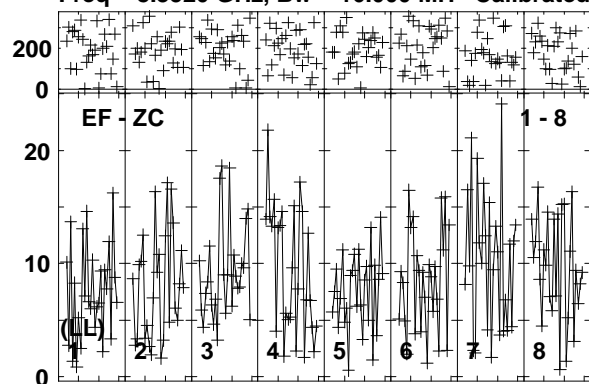

Lower frame: Milli Ampl Jy Top frame: Phas deg
 Vector averaged cross-power spectrum Baseline: EF (01) - ZC (08)
 Timerange: 00/05:41:14 to 00/05:44:10

Plot file version 183 created 24-MAR-2014 14:38:28

J1128+5925 EP087F 5.UVDATA.1

Freq = 8.3520 GHz, Bw = 16.000 MH Calibrated with CL # 3 and BP # 1 (BP mode 1)

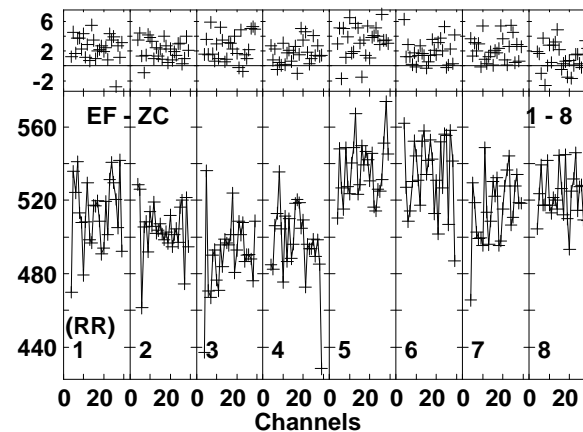
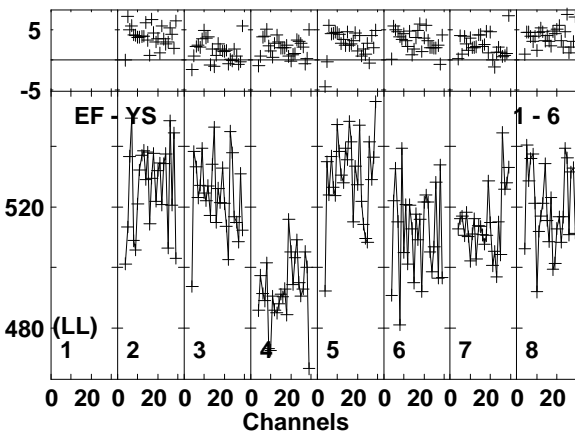
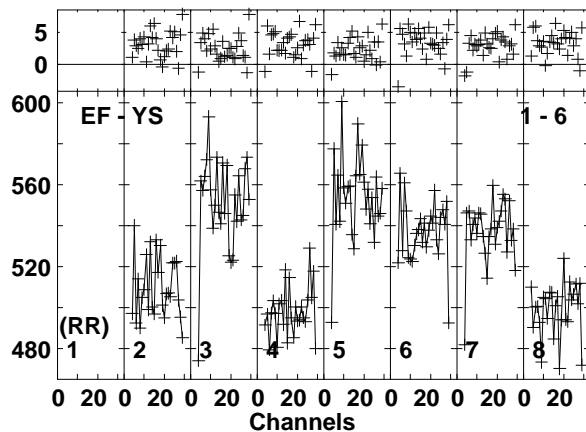
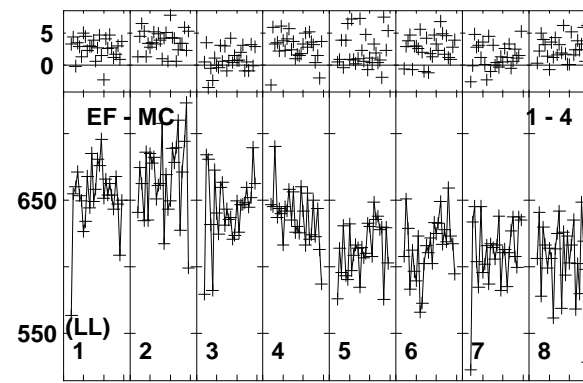
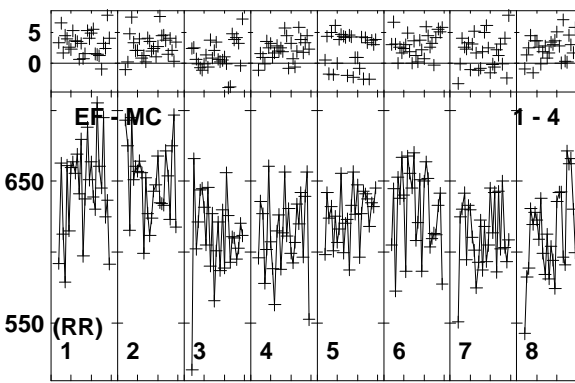
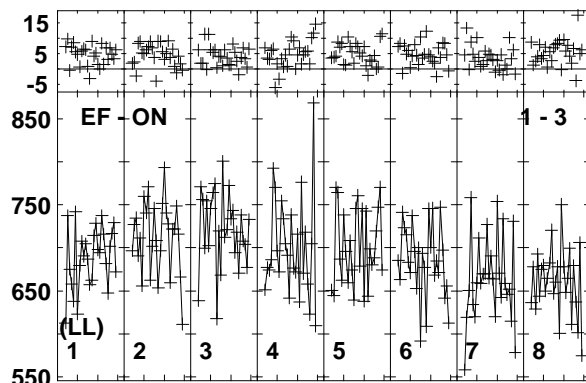
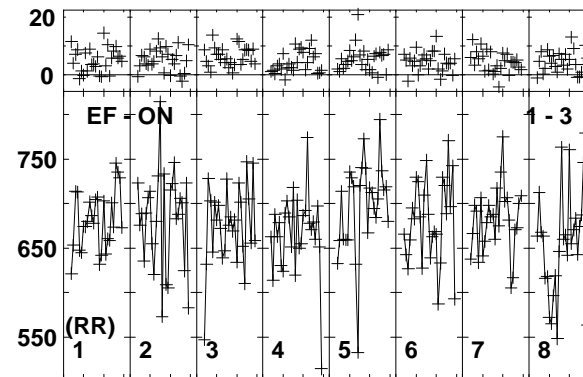
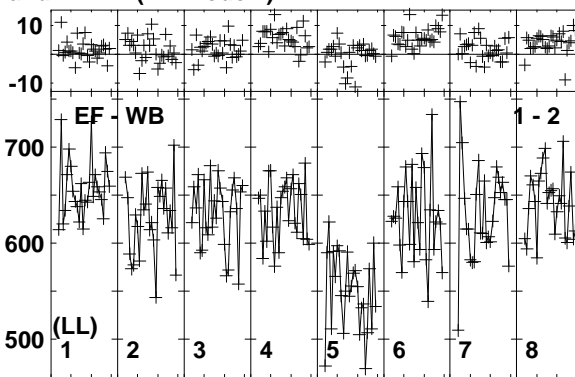
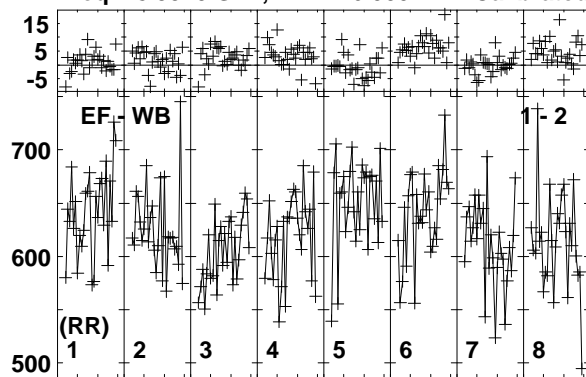

Lower frame: Milli Ampl Jy Top frame: Phas deg
Vector averaged cross-power spectrum Baseline: EF (01) - WB (02)
Timerange: 00/05:44:14 to 00/05:45:15

Plot file version 184 created 24-MAR-2014 14:38:29

J1128+5925 EP087F 5.UVDATA.1

Freq = 8.3520 GHz, Bw = 16.000 MH Calibrated with CL # 3 and BP # 1 (BP mode 1)

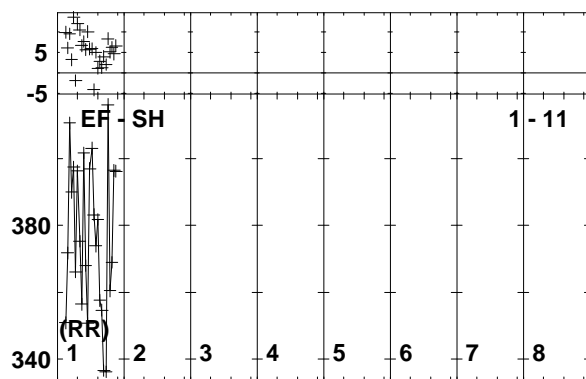
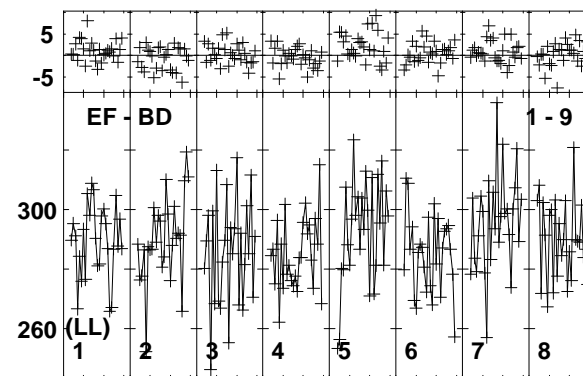
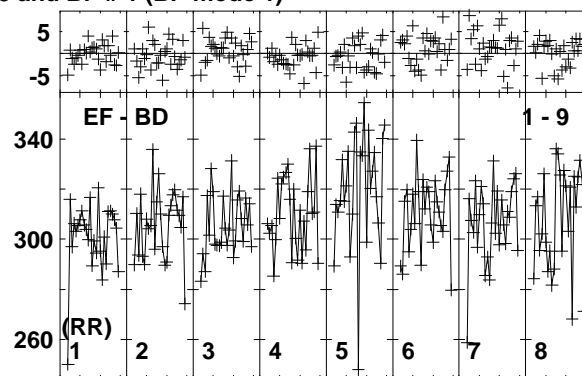
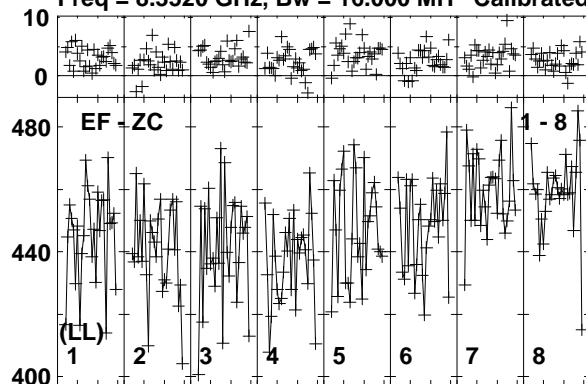

Lower frame: Milli Ampl Jy Top frame: Phas deg
Vector averaged cross-power spectrum Baseline: EF (01) - ZC (08)
Timerange: 00/05:44:14 to 00/05:45:15

Plot file version 185 created 24-MAR-2014 14:38:29

ARP299D EP087F 5.UVDATA.1

Freq = 8.3520 GHz, Bw = 16.000 MH Calibrated with CL # 3 and BP # 1 (BP mode 1)

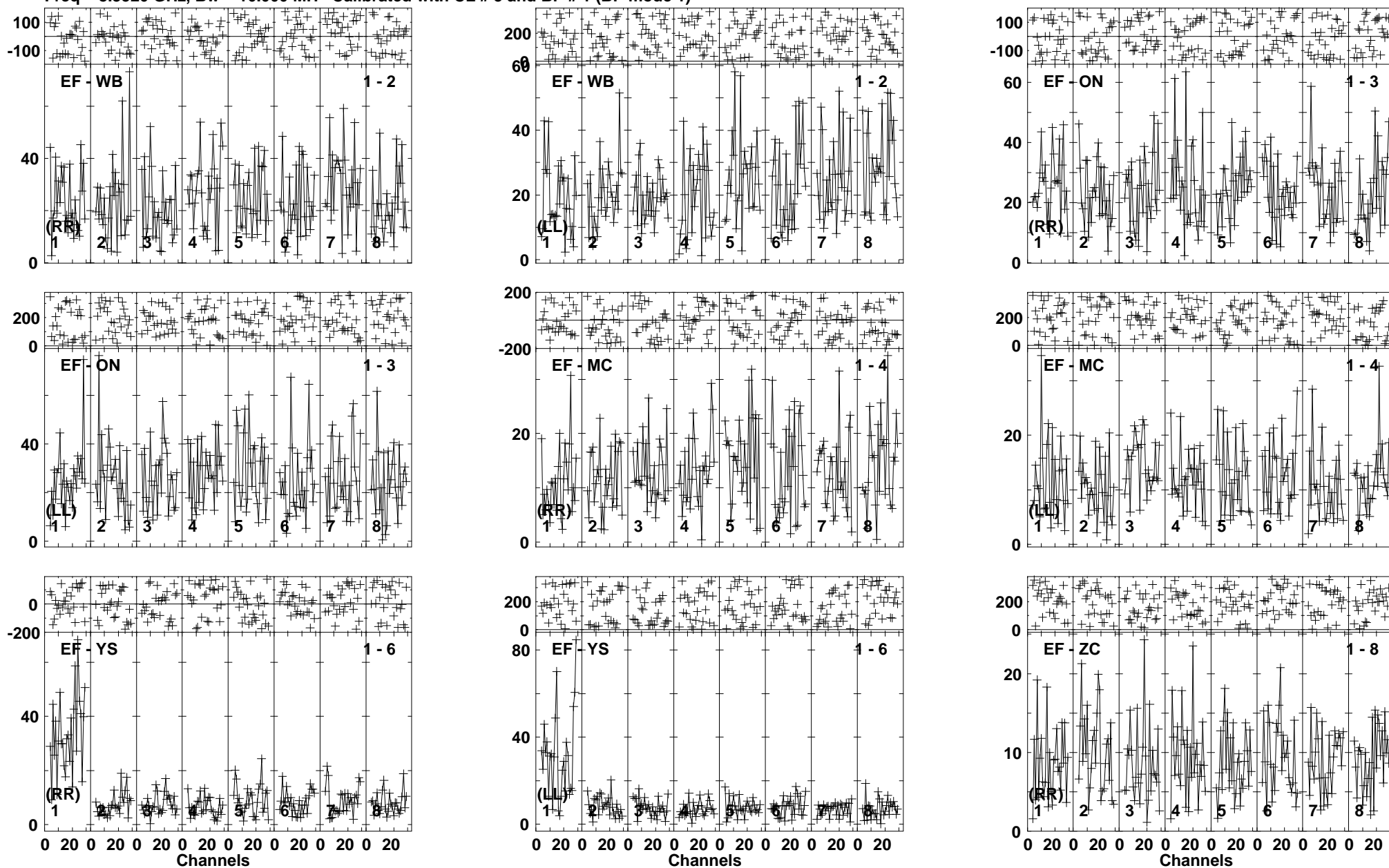

Lower frame: Milli Ampl Jy Top frame: Phas deg
Vector averaged cross-power spectrum Baseline: EF (01) - WB (02)
Timerange: 00/05:45:19 to 00/05:48:14

Plot file version 186 created 24-MAR-2014 14:38:29
ARP299D EP087F 5.UVDATA.1
Freq = 8.3520 GHz, Bw = 16.000 MH Calibrated with CL # 3 and BP # 1 (BP mode 1)

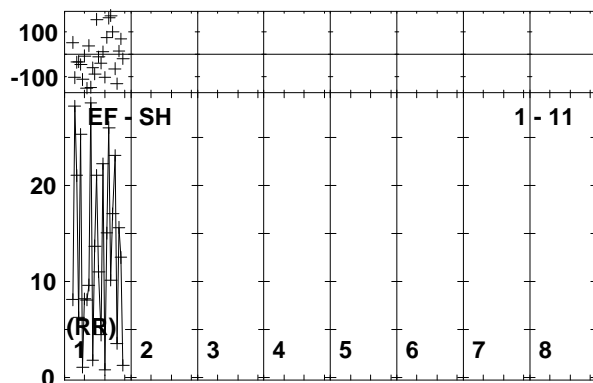
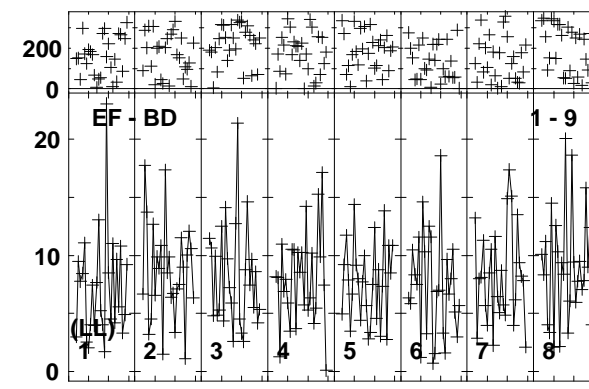
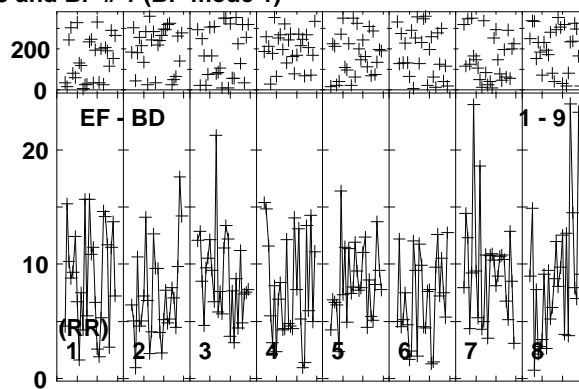
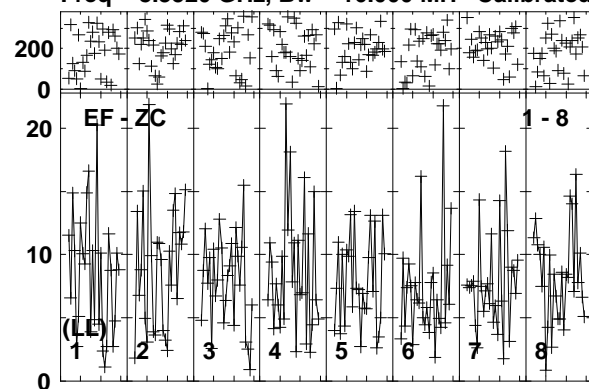

Lower frame: Milli Ampl Jy Top frame: Phas deg
Vector averaged cross-power spectrum Baseline: EF (01) - ZC (08)
Timerange: 00/05:45:19 to 00/05:48:14

Plot file version 187 created 24-MAR-2014 14:38:29

J1128+5925 EP087F 5.UVDATA.1

Freq = 8.3520 GHz, Bw = 16.000 MH Calibrated with CL # 3 and BP # 1 (BP mode 1)

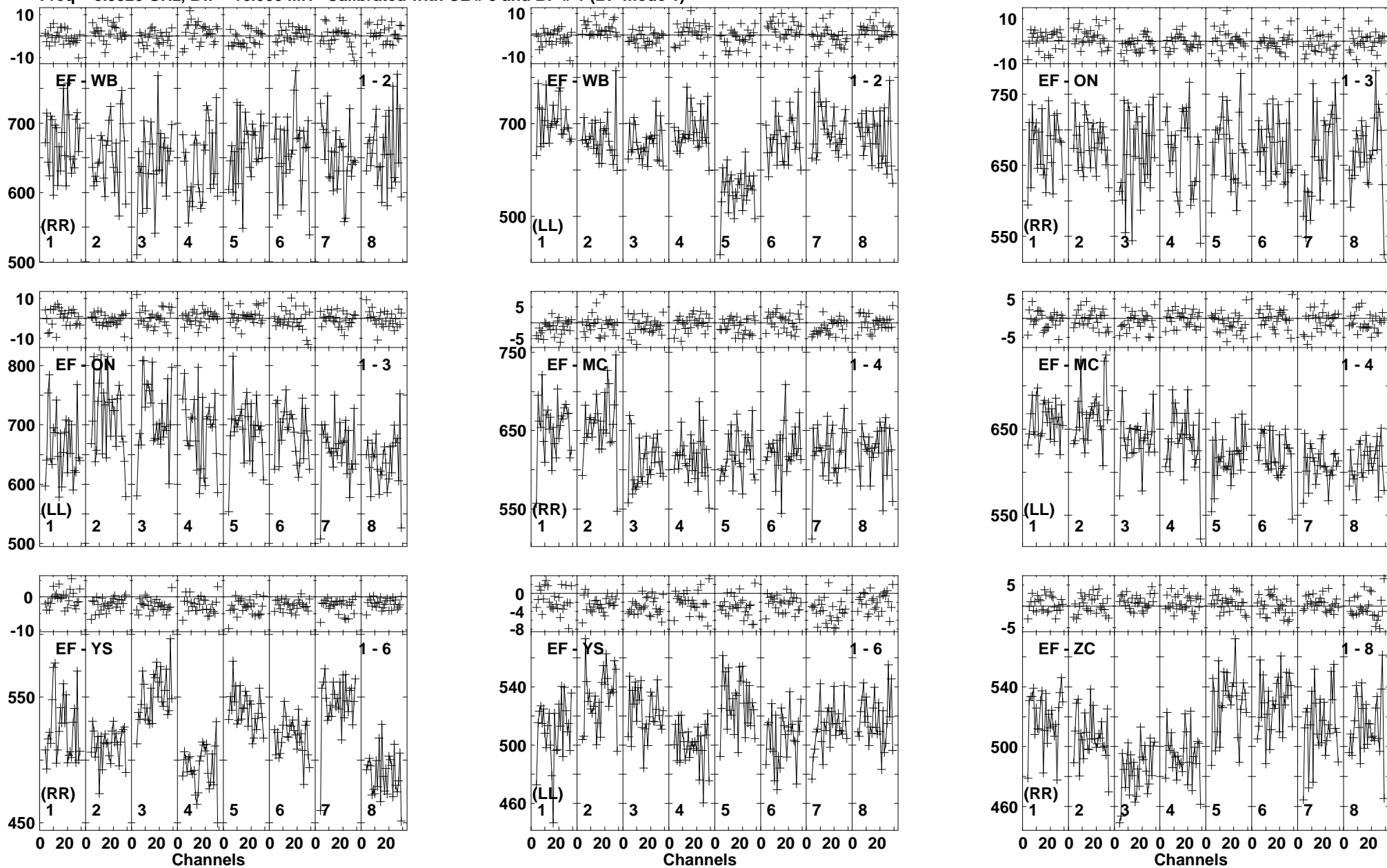

Lower frame: Milli Ampl Jy Top frame: Phas deg
Vector averaged cross-power spectrum Baseline: EF (01) - WB (02)
Timerange: 00/05:48:56 to 00/05:49:24

Plot file version 188 created 24-MAR-2014 14:38:29

J1128+5925 EP087F 5.UVDATA.1

Freq = 8.3520 GHz, Bw = 16.000 MH Calibrated with CL # 3 and BP # 1 (BP mode 1)

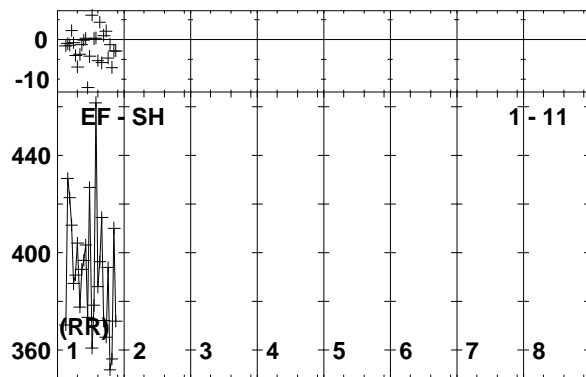
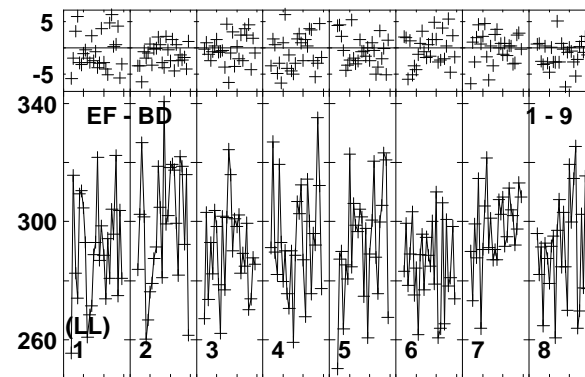
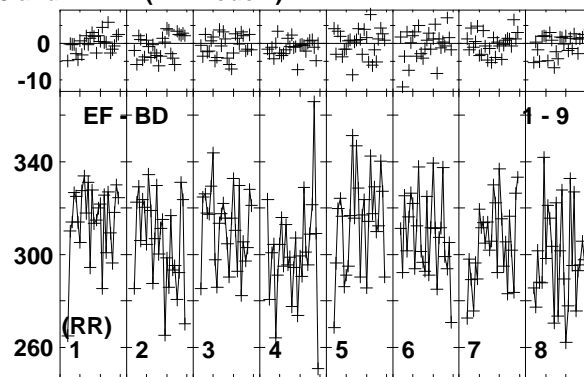
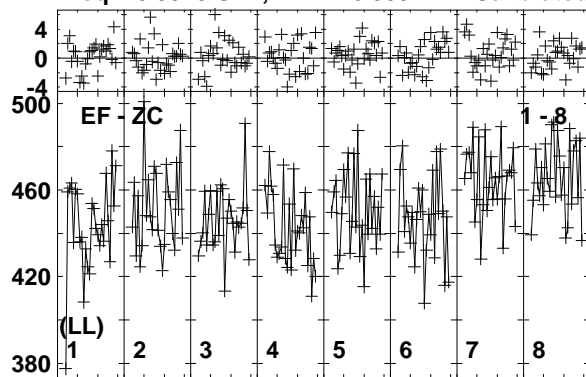

Lower frame: Milli Ampl Jy Top frame: Phas deg
Vector averaged cross-power spectrum Baseline: EF (01) - ZC (08)
Timerange: 00/05:48:56 to 00/05:49:24

Plot file version 189 created 24-MAR-2014 14:38:30
 ARP299D EP087F 5.UVDATA.1
 Freq = 8.3520 GHz, Bw = 16.000 MH Calibrated with CL # 3 and BP # 1 (BP mode 1)

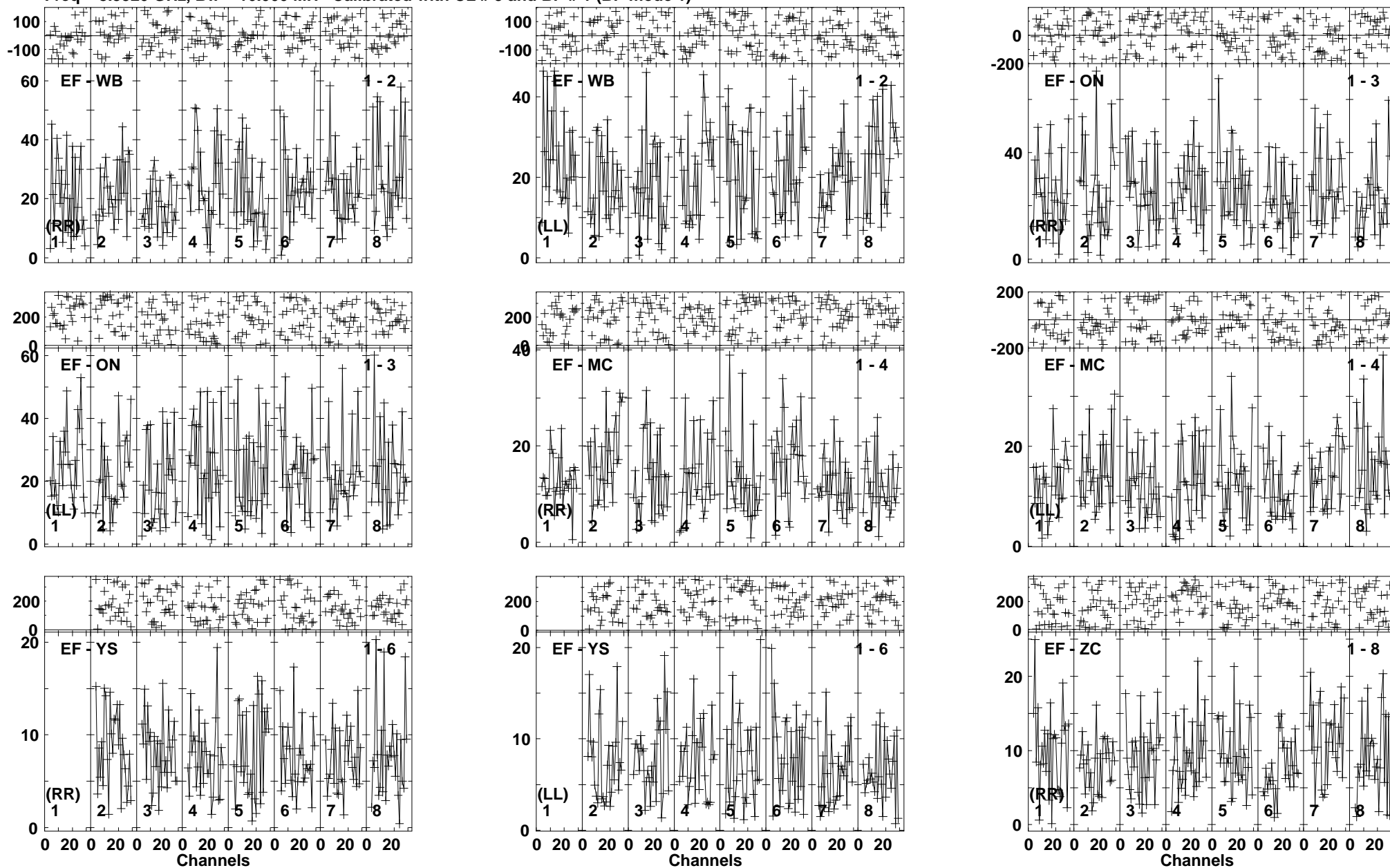

Lower frame: Milli Ampl Jy Top frame: Phas deg
 Vector averaged cross-power spectrum Baseline: EF (01) - WB (02)
 Timerange: 00/05:49:29 to 00/05:52:25

Plot file version 190 created 24-MAR-2014 14:38:30

ARP299D EP087F 5.UVDATA.1

Freq = 8.3520 GHz, Bw = 16.000 MH Calibrated with CL # 3 and BP # 1 (BP mode 1)

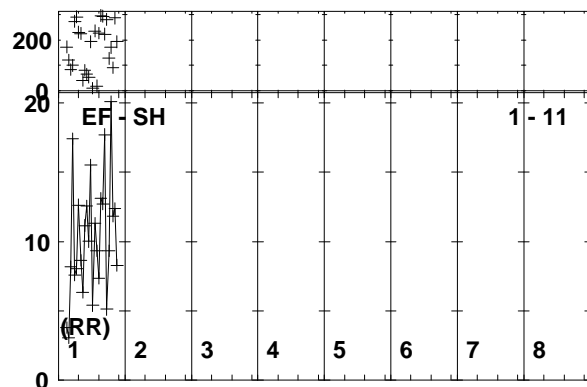
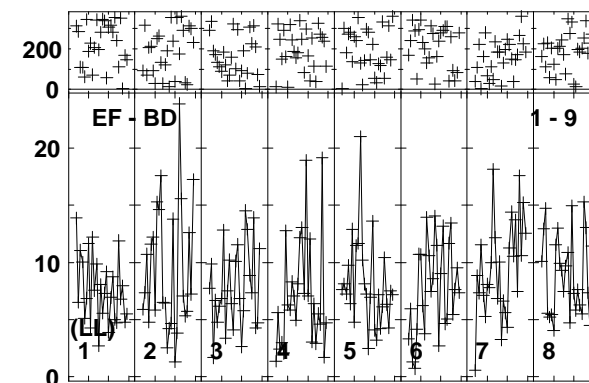
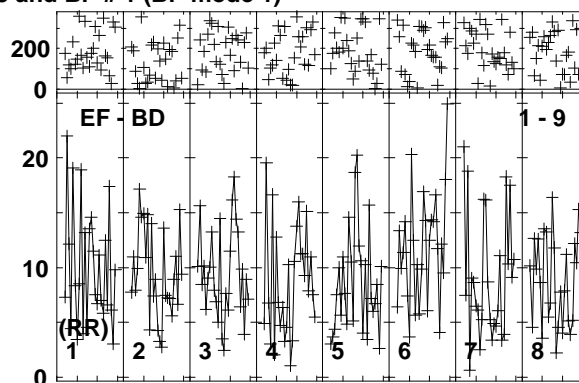
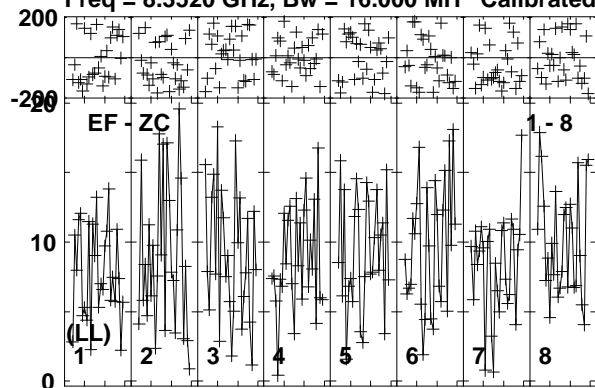

Lower frame: Milli Ampl Jy Top frame: Phas deg
Vector averaged cross-power spectrum Baseline: EF (01) - ZC (08)
Timerange: 00/05:49:29 to 00/05:52:25

Plot file version 191 created 24-MAR-2014 14:38:30

J1128+5925 EP087F 5.UVDATA.1

Freq = 8.3520 GHz, Bw = 16.000 MH Calibrated with CL # 3 and BP # 1 (BP mode 1)

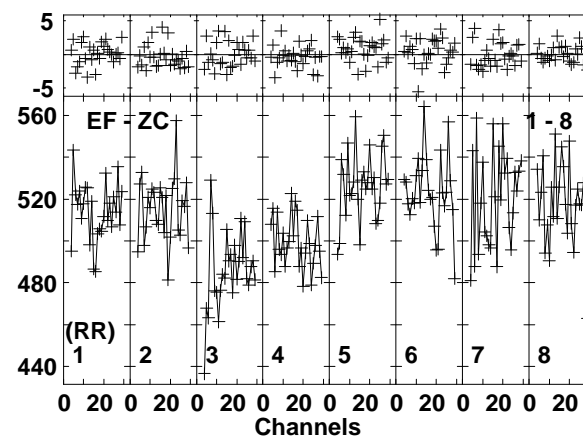
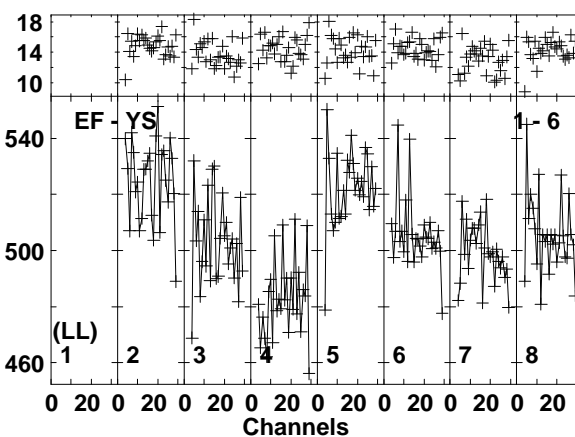
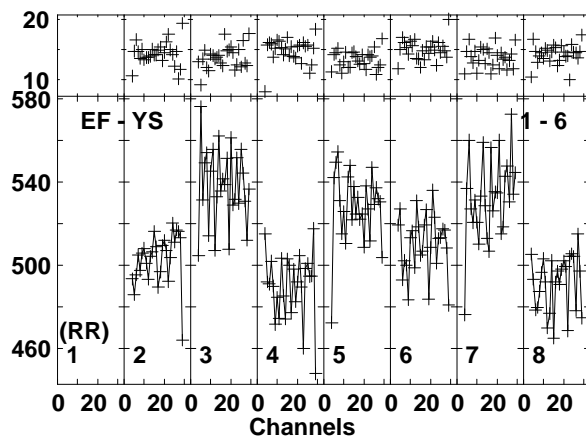
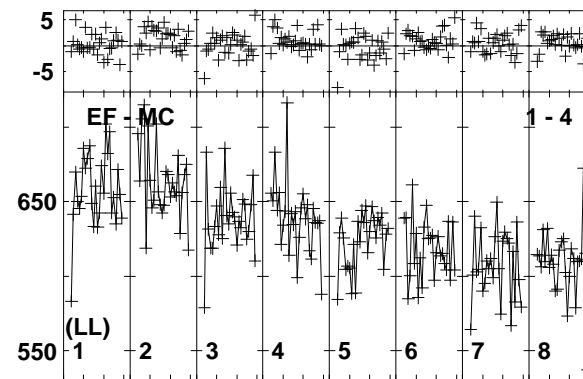
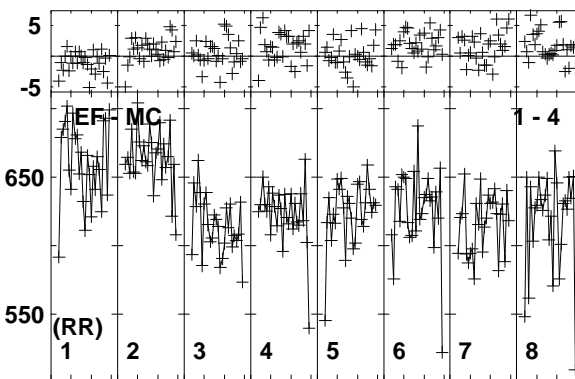
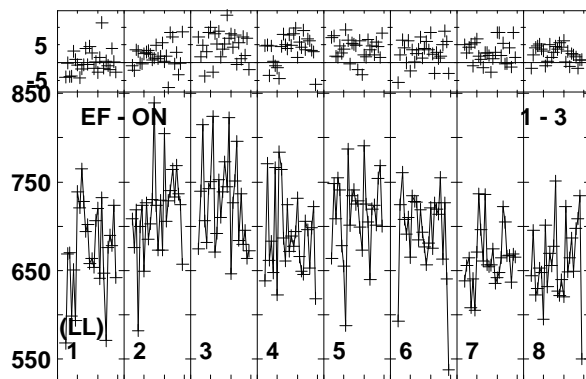
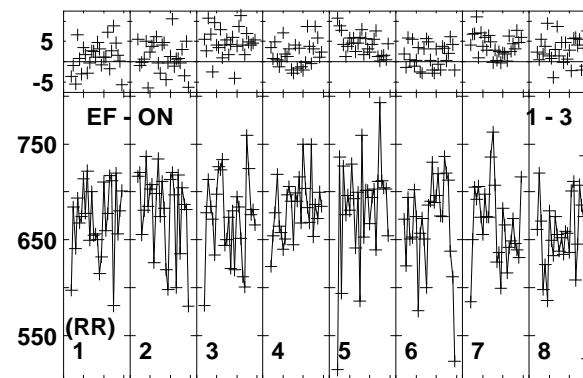
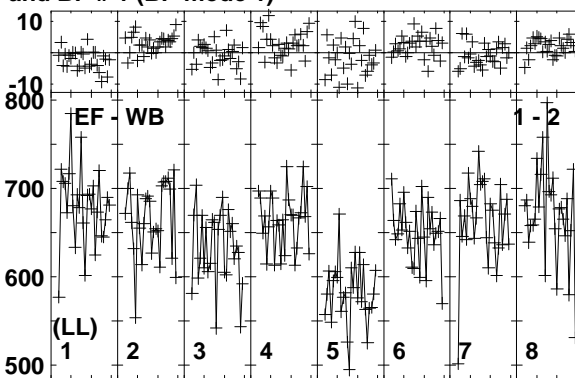
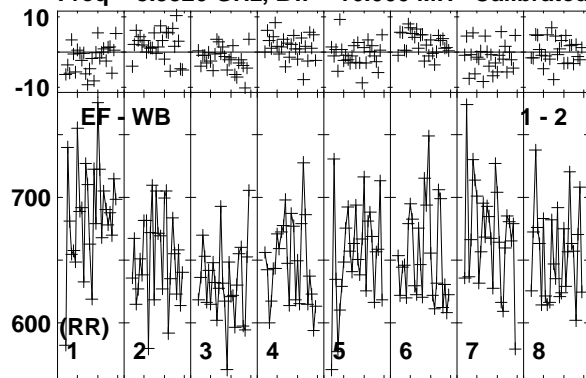

Lower frame: Milli Ampl Jy Top frame: Phas deg
Vector averaged cross-power spectrum Baseline: EF (01) - WB (02)
Timerange: 00/05:52:29 to 00/05:53:30

Plot file version 192 created 24-MAR-2014 14:38:30
J1128+5925 EP087F 5.UVDATA.1
Freq = 8.3520 GHz, Bw = 16.000 MH Calibrated with CL # 3 and BP # 1 (BP mode 1)

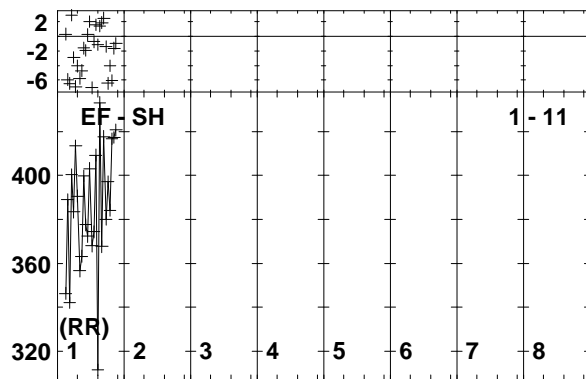
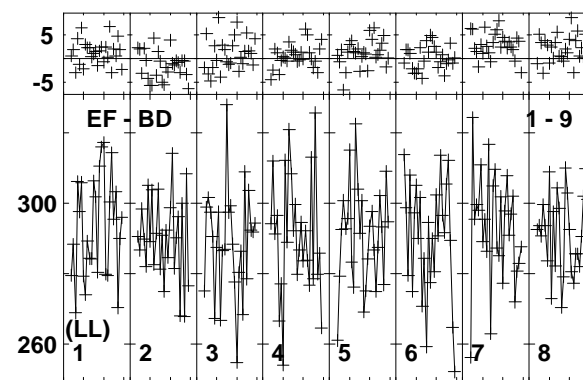
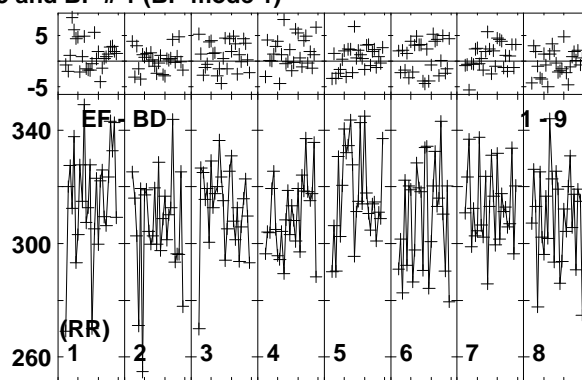
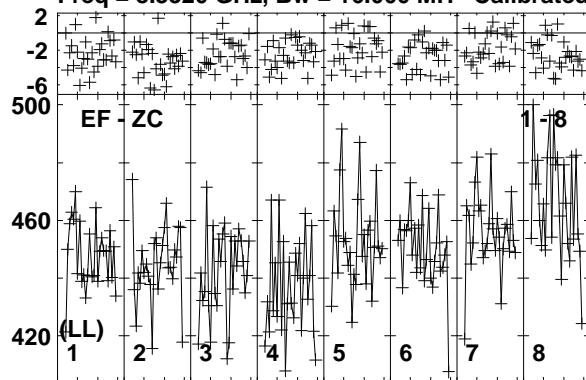

Lower frame: Milli Ampl Jy Top frame: Phas deg
Vector averaged cross-power spectrum Baseline: EF (01) - ZC (08)
Timerange: 00/05:52:29 to 00/05:53:30

Plot file version 193 created 24-MAR-2014 14:38:30
 ARP299D EP087F 5.UVDATA.1
 Freq = 8.3520 GHz, Bw = 16.000 MH Calibrated with CL # 3 and BP # 1 (BP mode 1)

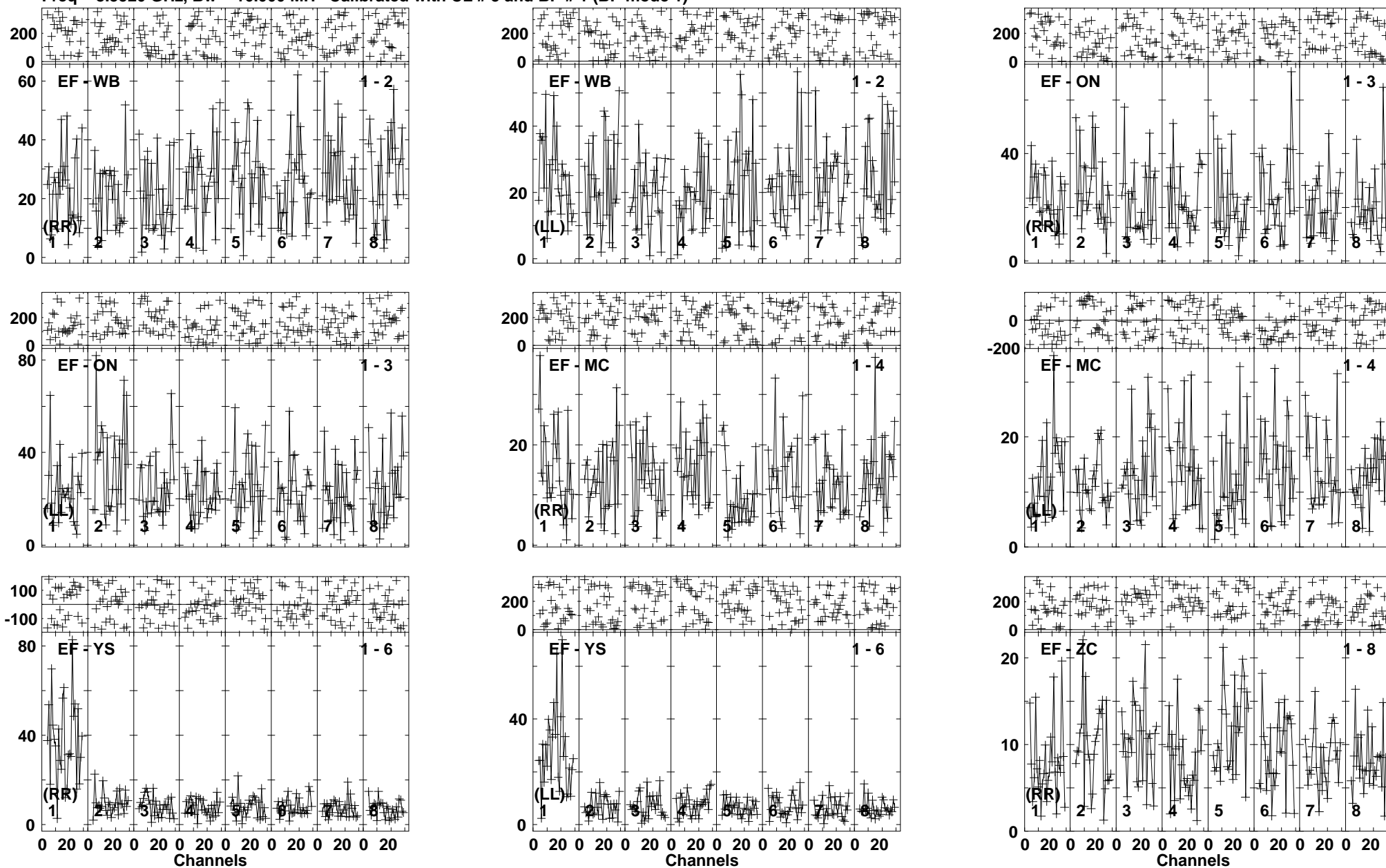

Lower frame: Milli Ampl Jy Top frame: Phas deg
 Vector averaged cross-power spectrum Baseline: EF (01) - WB (02)
 Timerange: 00/05:53:34 to 00/05:56:30

Plot file version 194 created 24-MAR-2014 14:38:31
 ARP299D EP087F 5.UVDATA.1
 Freq = 8.3520 GHz, Bw = 16.000 MH Calibrated with CL # 3 and BP # 1 (BP mode 1)

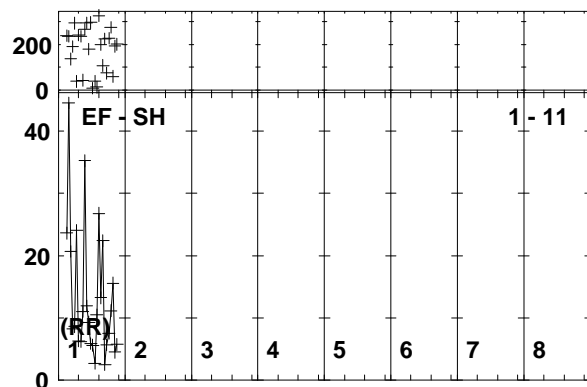
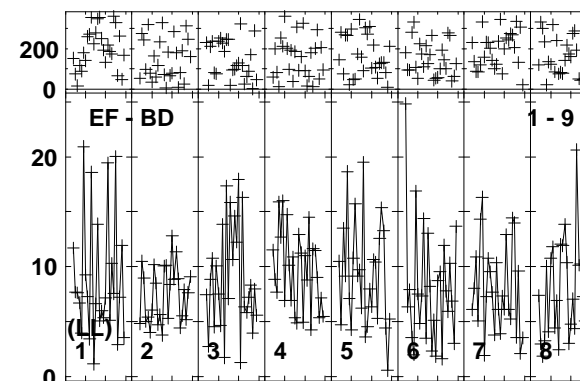
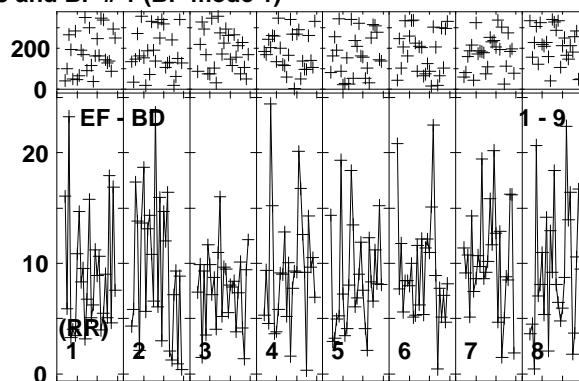
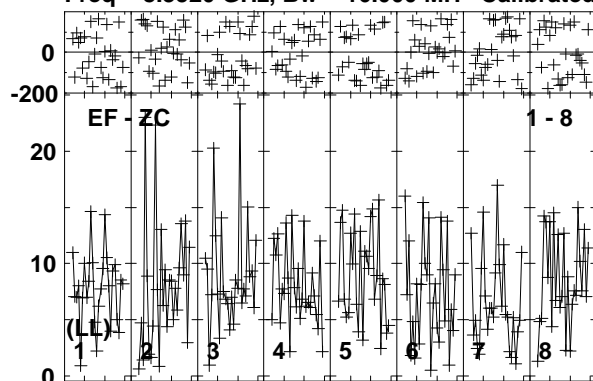

Lower frame: Milli Ampl Jy Top frame: Phas deg
 Vector averaged cross-power spectrum Baseline: EF (01) - ZC (08)
 Timerange: 00/05:53:34 to 00/05:56:30

Plot file version 195 created 24-MAR-2014 14:38:31

J1128+5925 EP087F 5.UVDATA.1

Freq = 8.3520 GHz, Bw = 16.000 MH Calibrated with CL # 3 and BP # 1 (BP mode 1)

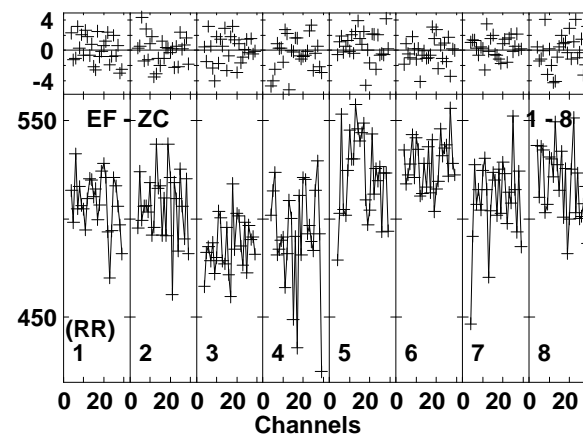
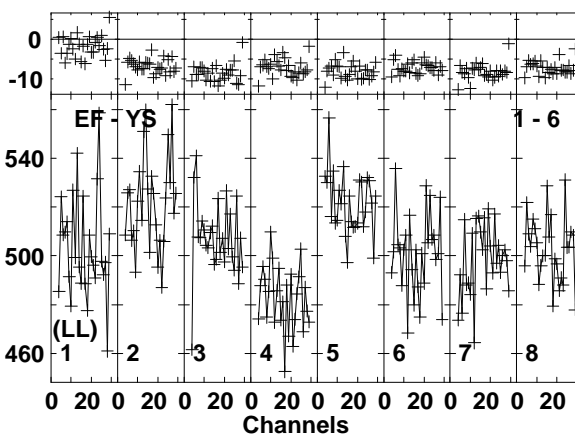
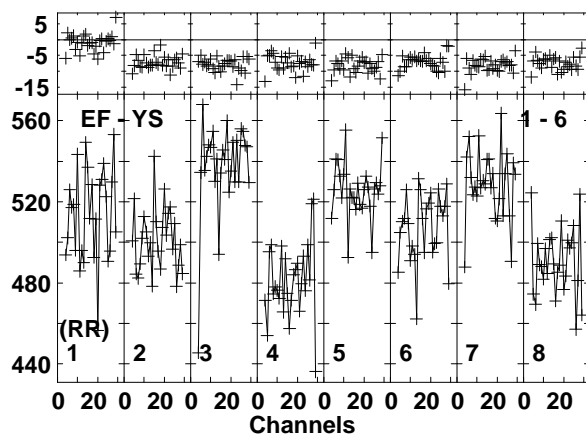
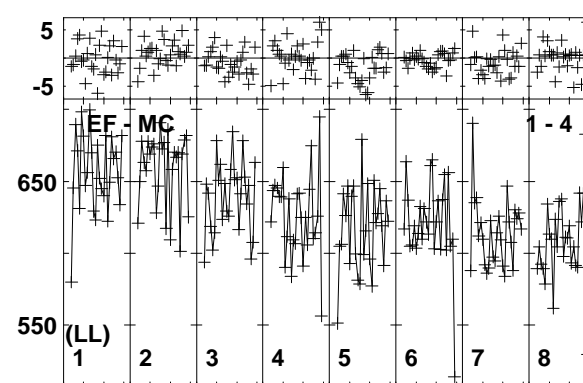
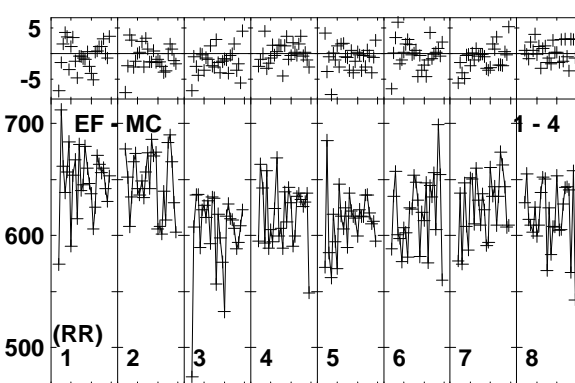
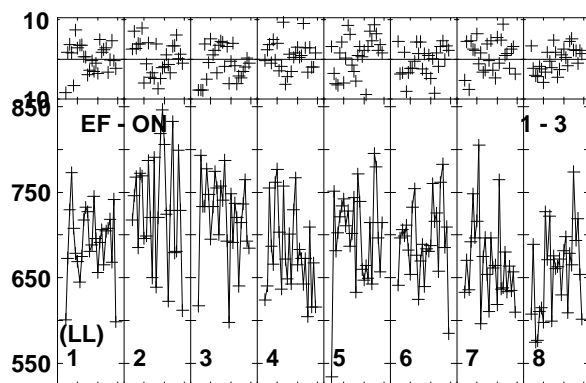
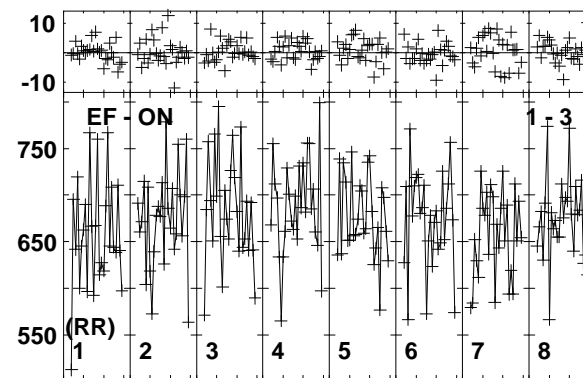
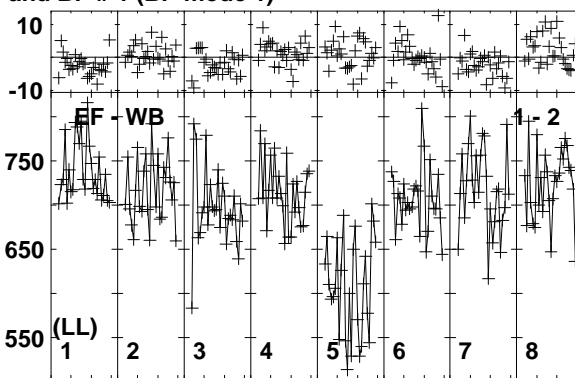
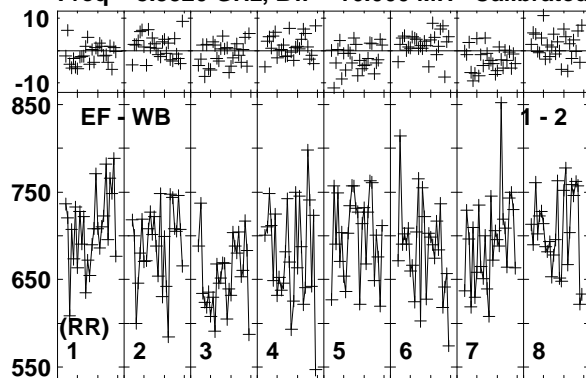

Lower frame: Milli Ampl Jy Top frame: Phas deg
Vector averaged cross-power spectrum Baseline: EF (01) - WB (02)
Timerange: 00/05:57:11 to 00/05:57:39

Plot file version 196 created 24-MAR-2014 14:38:31

J1128+5925 EP087F 5.UVDATA.1

Freq = 8.3520 GHz, Bw = 16.000 MH Calibrated with CL # 3 and BP # 1 (BP mode 1)

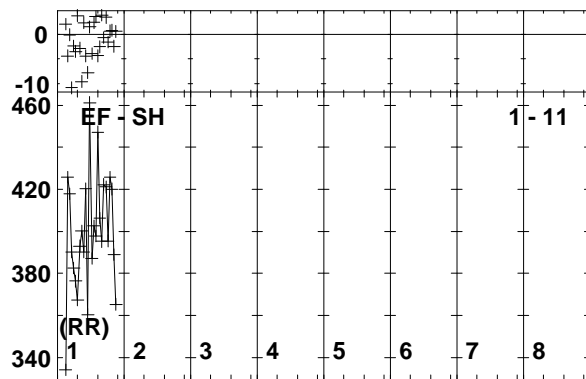
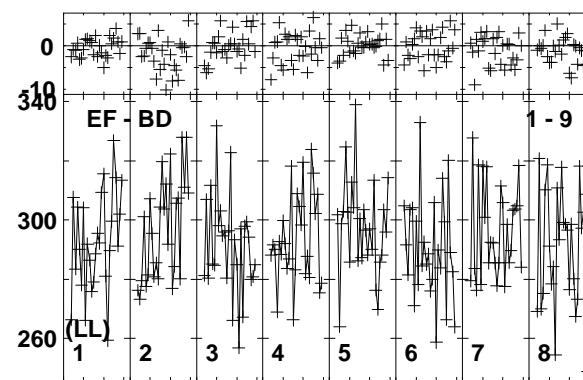
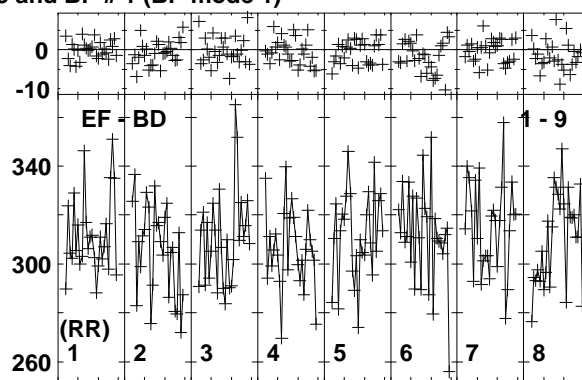
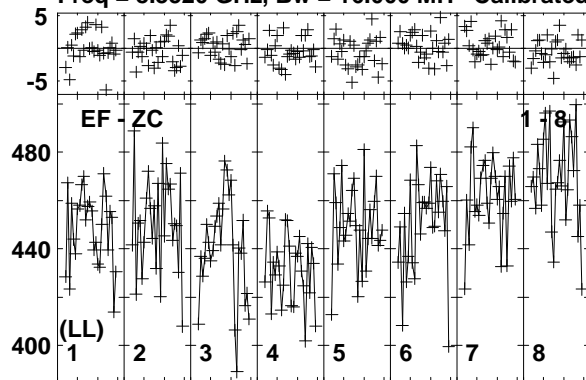

Lower frame: Milli Ampl Jy Top frame: Phas deg
Vector averaged cross-power spectrum Baseline: EF (01) - ZC (08)
Timerange: 00/05:57:11 to 00/05:57:39

Plot file version 197 created 24-MAR-2014 14:38:31

ARP299D EP087F 5.UVDATA.1

Freq = 8.3520 GHz, Bw = 16.000 MH Calibrated with CL # 3 and BP # 1 (BP mode 1)

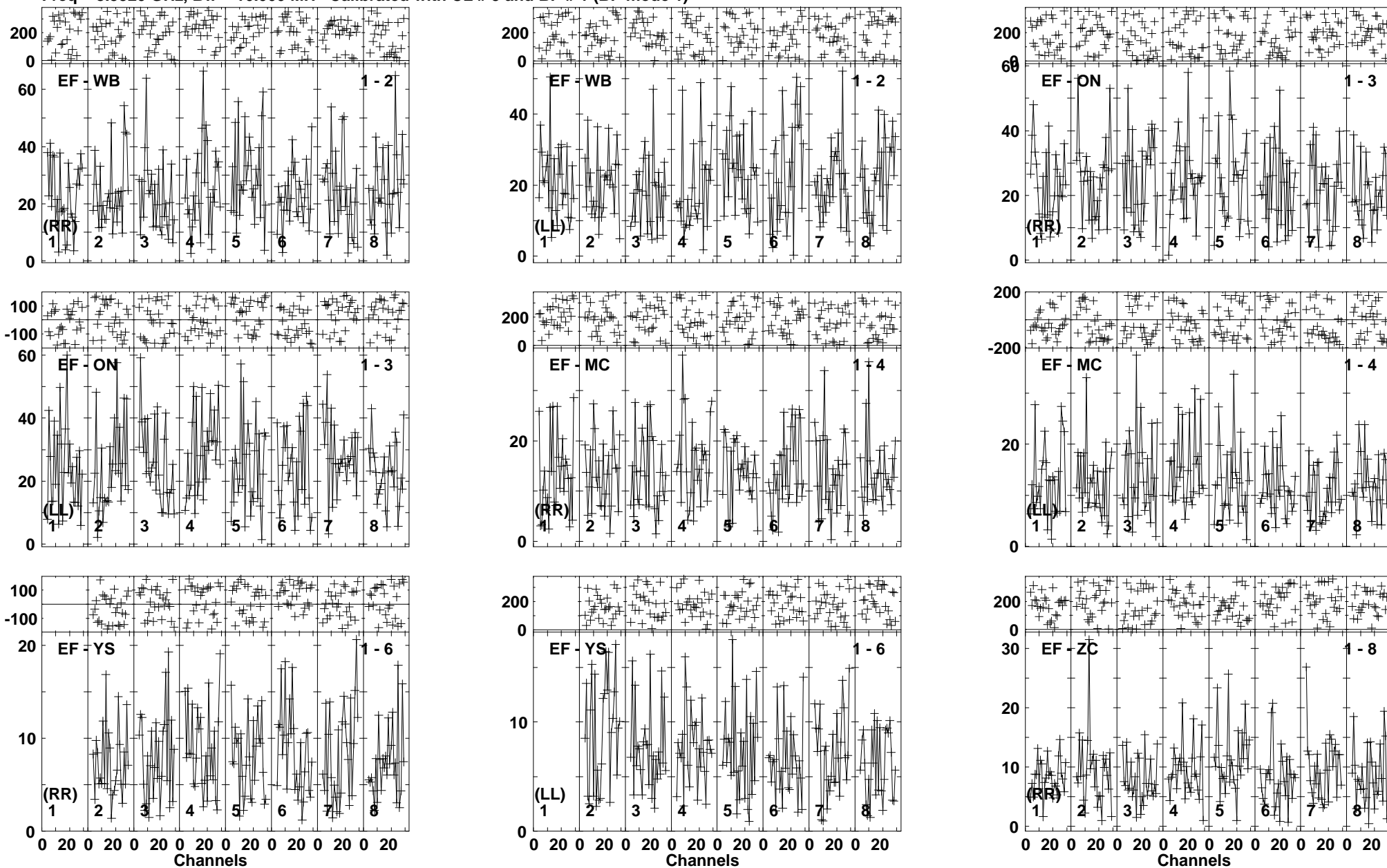

Lower frame: Milli Ampl Jy Top frame: Phas deg
Vector averaged cross-power spectrum Baseline: EF (01) - WB (02)
Timerange: 00/05:57:45 to 00/06:00:39

Plot file version 198 created 24-MAR-2014 14:38:32

ARP299D EP087F 5.UVDATA.1

Freq = 8.3520 GHz, Bw = 16.000 MH Calibrated with CL # 3 and BP # 1 (BP mode 1)

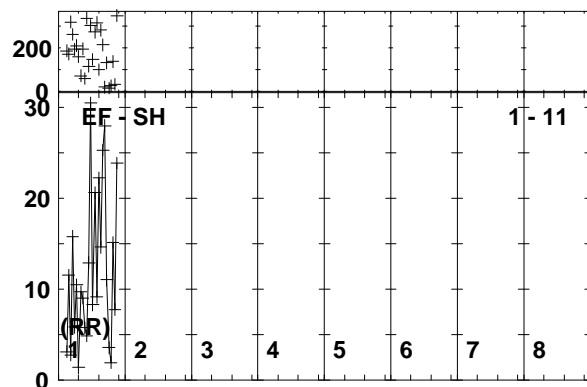
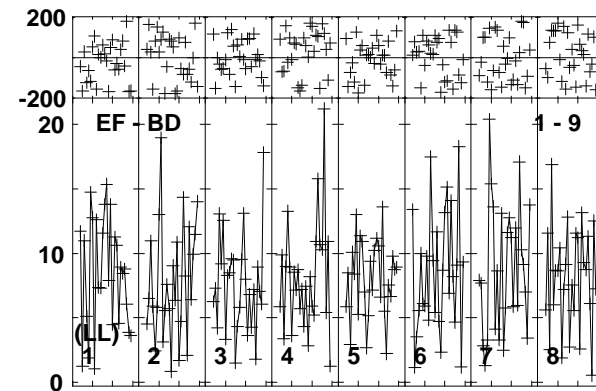
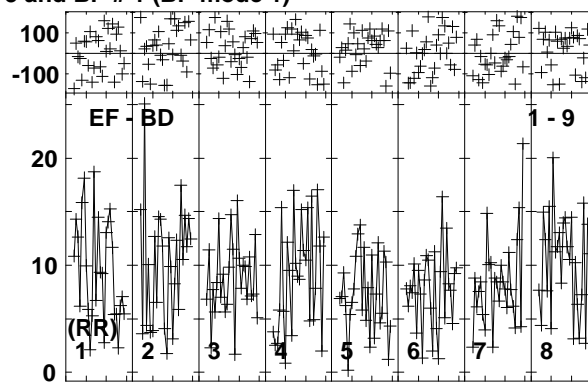
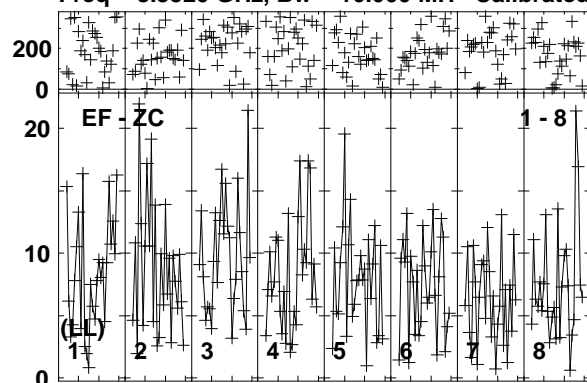

Lower frame: Milli Ampl Jy Top frame: Phas deg
Vector averaged cross-power spectrum Baseline: EF (01) - ZC (08)
Timerange: 00/05:57:45 to 00/06:00:39

Plot file version 199 created 24-MAR-2014 14:38:32

J1128+5925 EP087F 5.UVDATA.1

Freq = 8.3520 GHz, Bw = 16.000 MH Calibrated with CL # 3 and BP # 1 (BP mode 1)

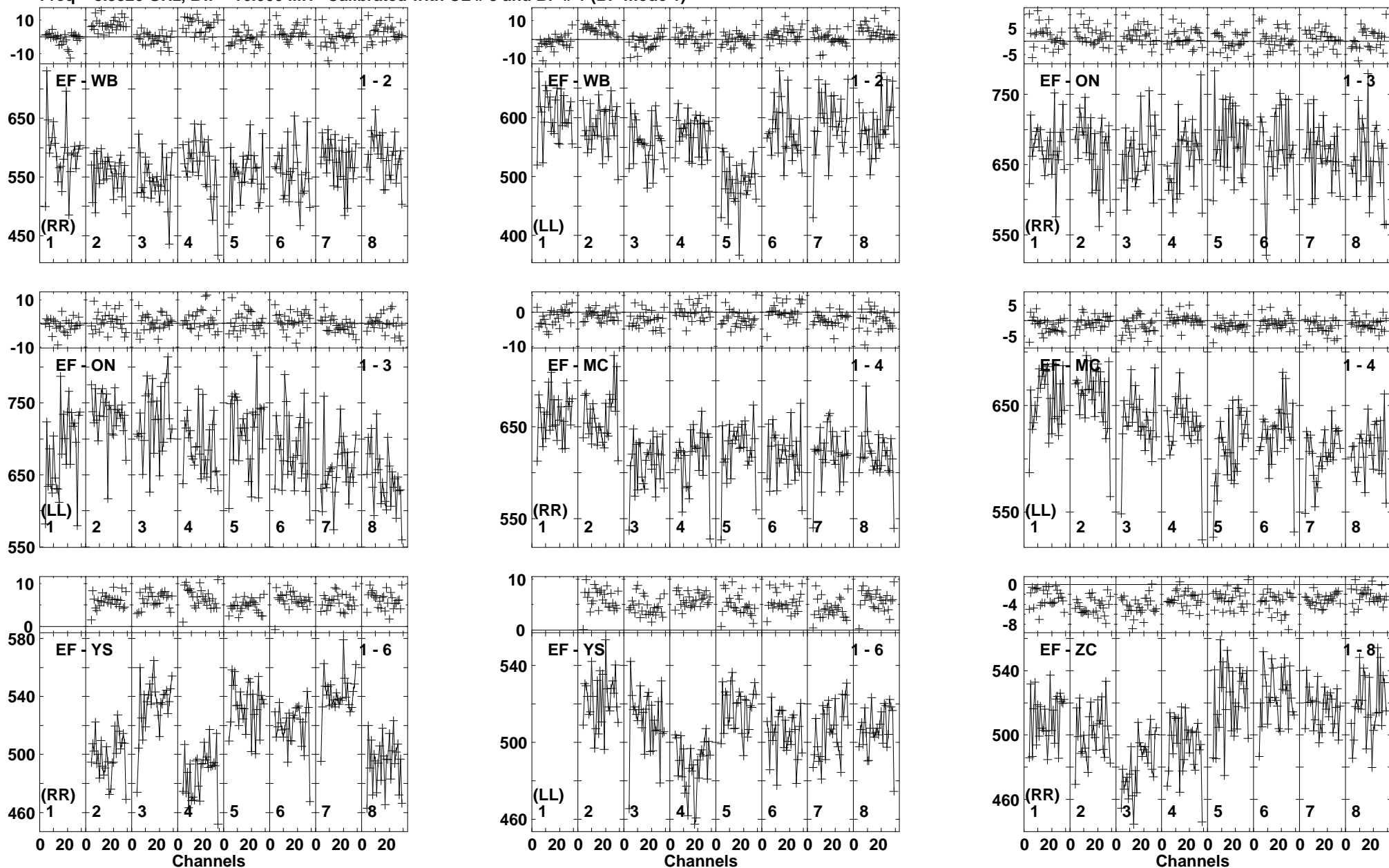

Lower frame: Milli Ampl Jy Top frame: Phas deg
Vector averaged cross-power spectrum Baseline: EF (01) - WB (02)
Timerange: 00/06:00:44 to 00/06:01:45

Plot file version 200 created 24-MAR-2014 14:38:32

J1128+5925 EP087F 5.UVDATA.1

Freq = 8.3520 GHz, Bw = 16.000 MH Calibrated with CL # 3 and BP # 1 (BP mode 1)

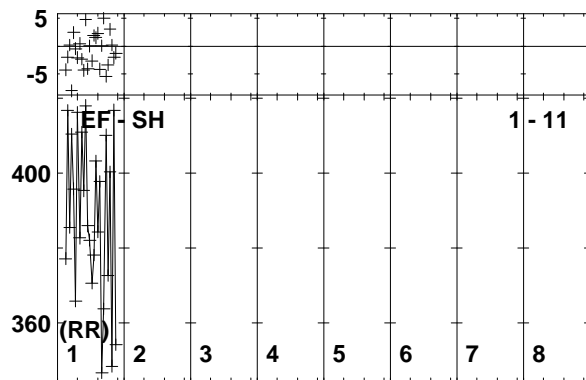
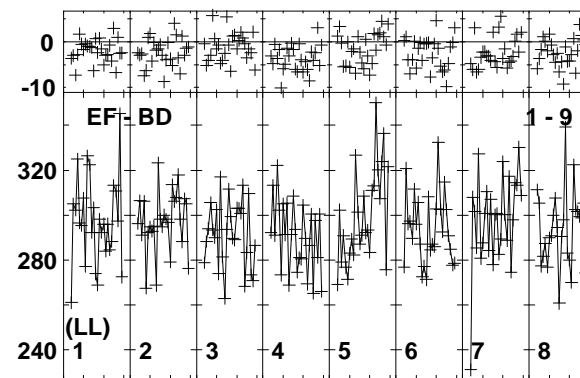
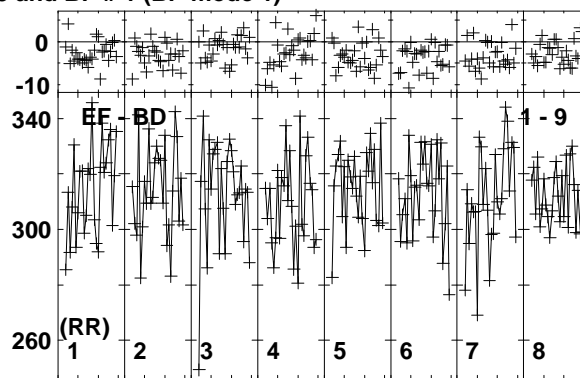
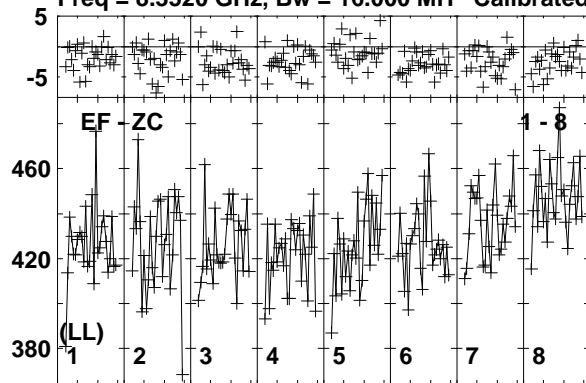

Lower frame: Milli Ampl Jy Top frame: Phas deg
Vector averaged cross-power spectrum Baseline: EF (01) - ZC (08)
Timerange: 00/06:00:44 to 00/06:01:45

Plot file version 201 created 24-MAR-2014 14:38:32
 ARP299D EP087F 5.UVDATA.1
 Freq = 8.3520 GHz, Bw = 16.000 MH Calibrated with CL # 3 and BP # 1 (BP mode 1)

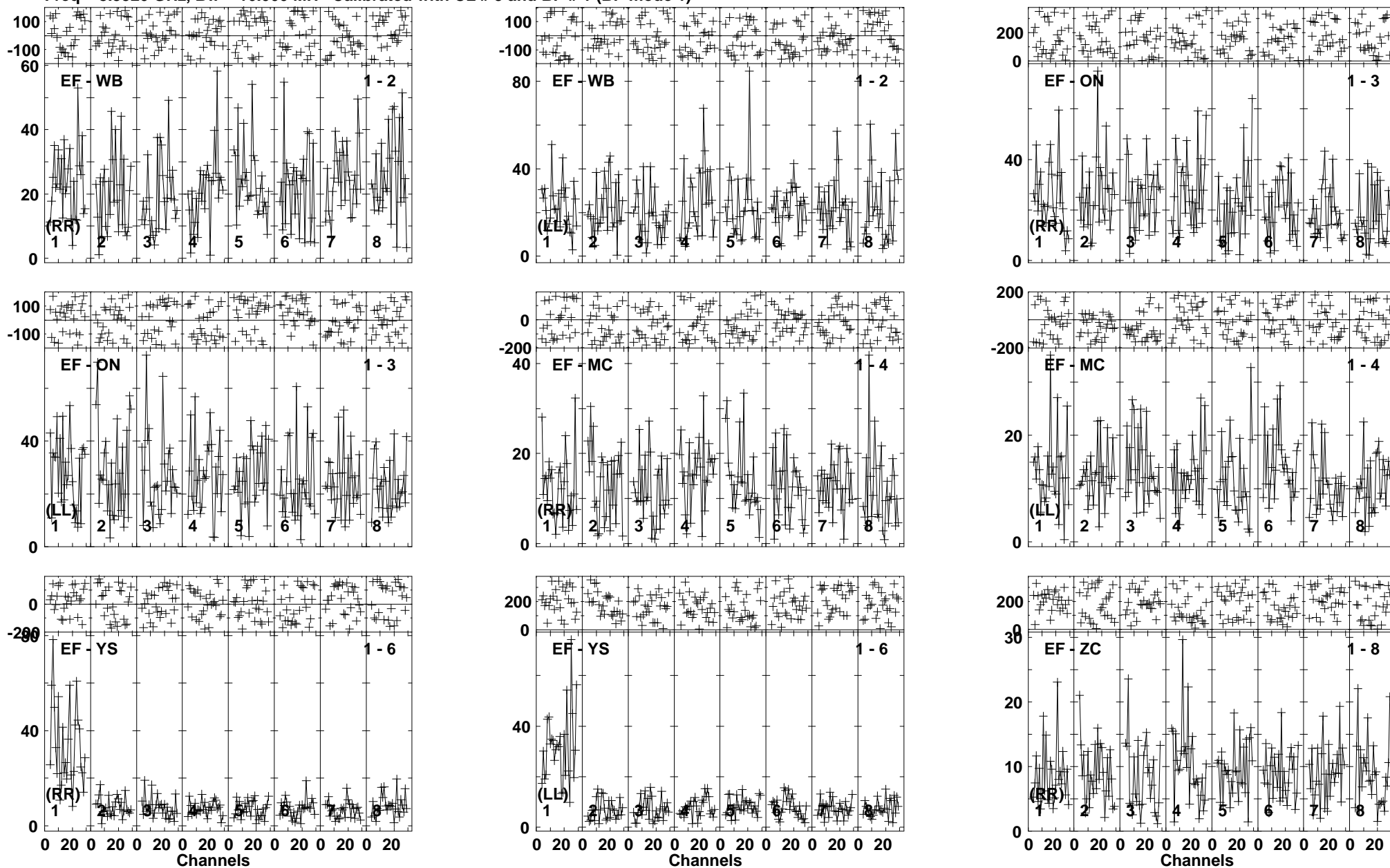

Lower frame: Milli Ampl Jy Top frame: Phas deg
 Vector averaged cross-power spectrum Baseline: EF (01) - WB (02)
 Timerange: 00/06:01:50 to 00/06:04:45

Plot file version 202 created 24-MAR-2014 14:38:32

ARP299D EP087F 5.UVDATA.1

Freq = 8.3520 GHz, Bw = 16.000 MH Calibrated with CL # 3 and BP # 1 (BP mode 1)

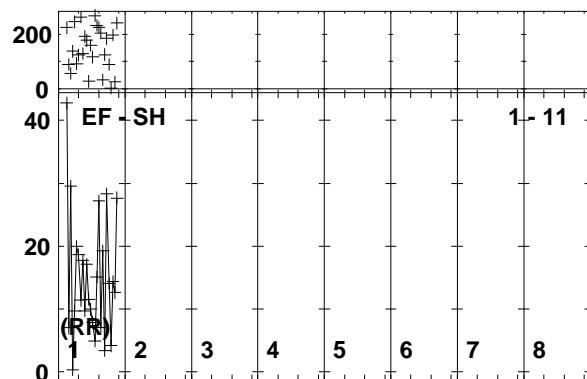
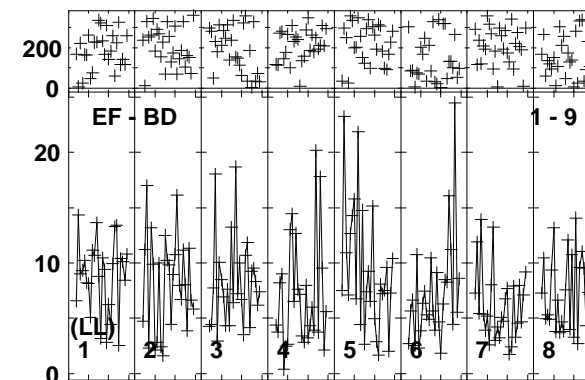
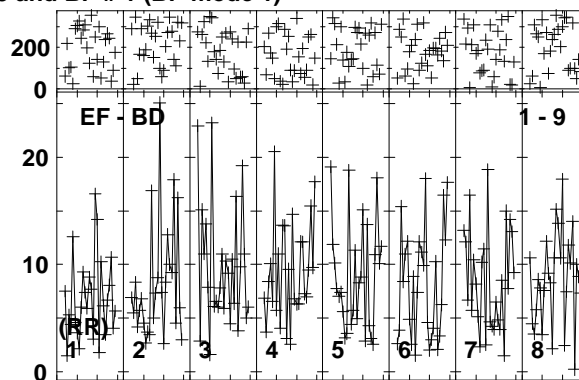
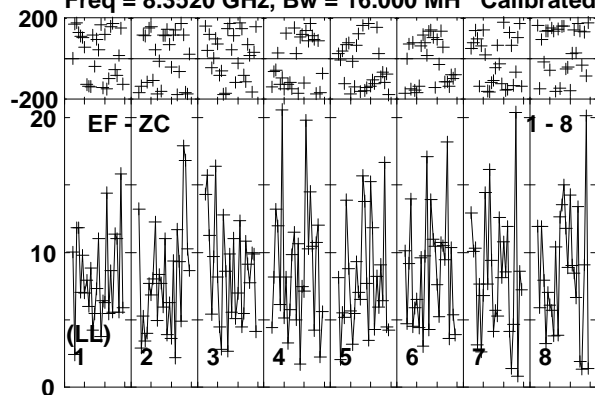

Lower frame: Milli Ampl Jy Top frame: Phas deg
Vector averaged cross-power spectrum Baseline: EF (01) - ZC (08)
Timerange: 00/06:01:50 to 00/06:04:45

Plot file version 203 created 24-MAR-2014 14:38:33

J1128+5925 EP087F 5.UVDATA.1

Freq = 8.3520 GHz, Bw = 16.000 MH Calibrated with CL # 3 and BP # 1 (BP mode 1)

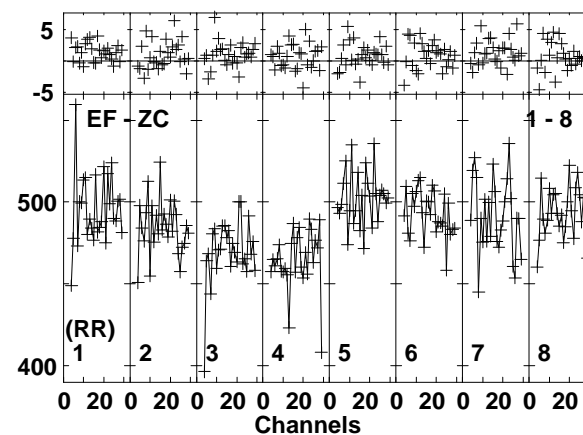
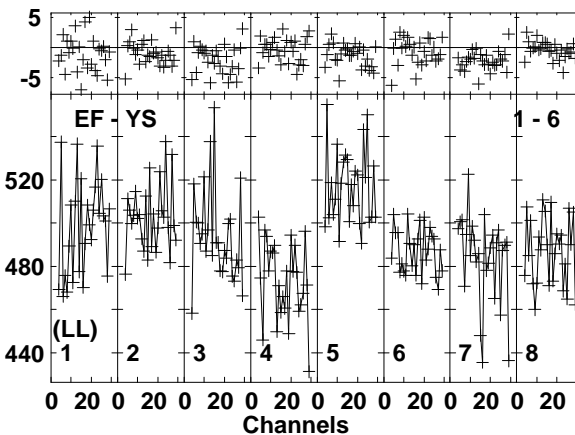
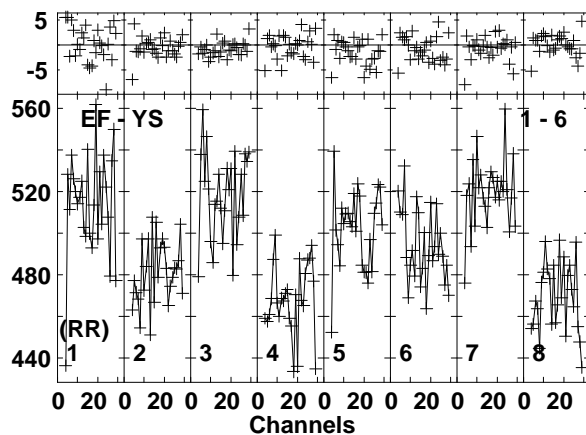
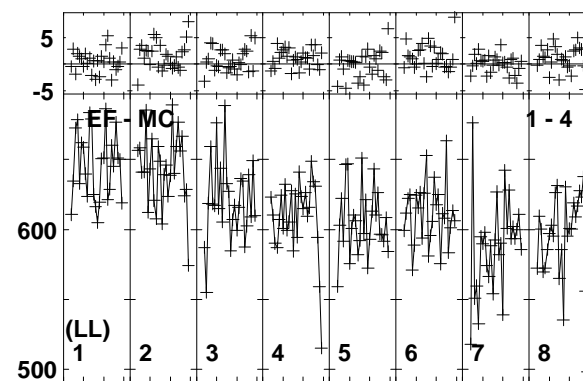
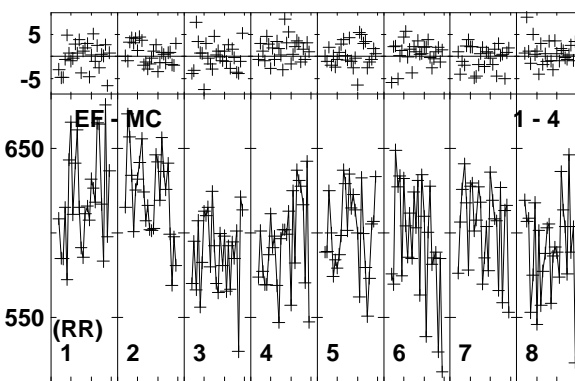
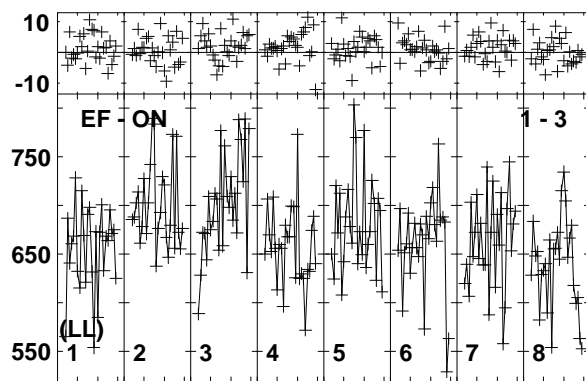
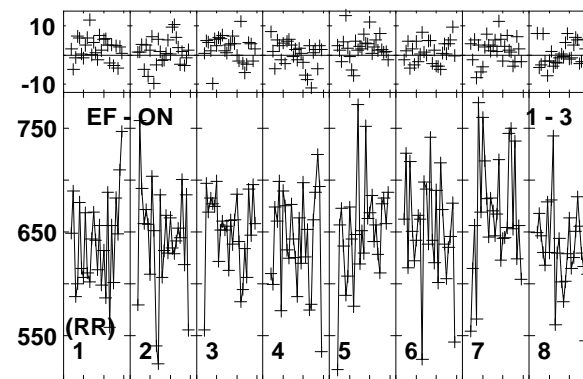
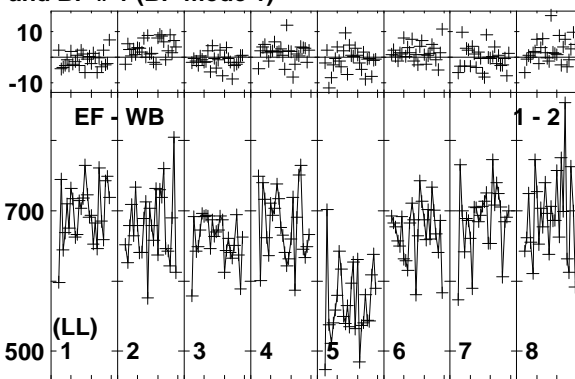
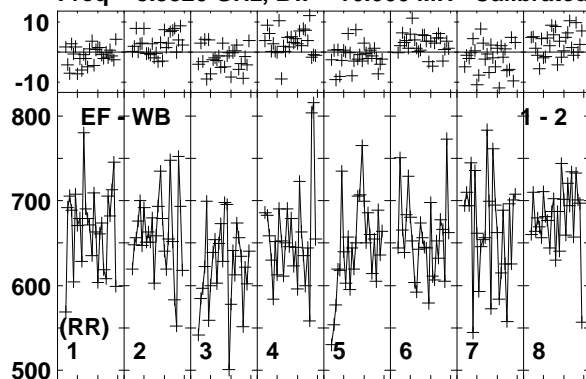

Lower frame: Milli Ampl Jy Top frame: Phas deg
Vector averaged cross-power spectrum Baseline: EF (01) - WB (02)
Timerange: 00/06:05:26 to 00/06:05:54

Plot file version 204 created 24-MAR-2014 14:38:33
 J1128+5925 EP087F 5.UVDATA.1
 Freq = 8.3520 GHz, Bw = 16.000 MH Calibrated with CL # 3 and BP # 1 (BP mode 1)

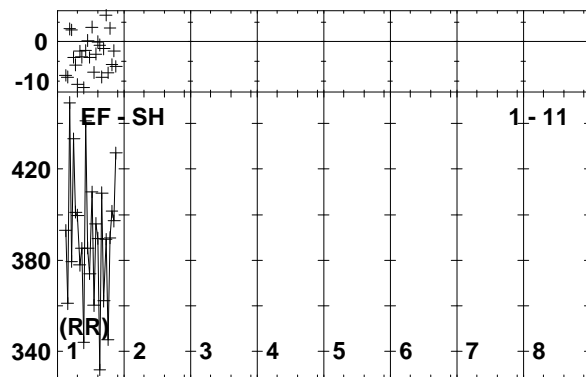
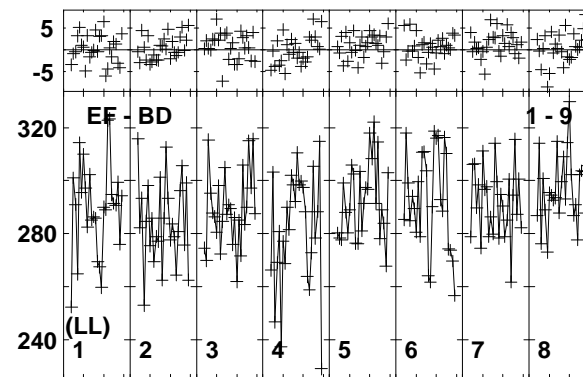
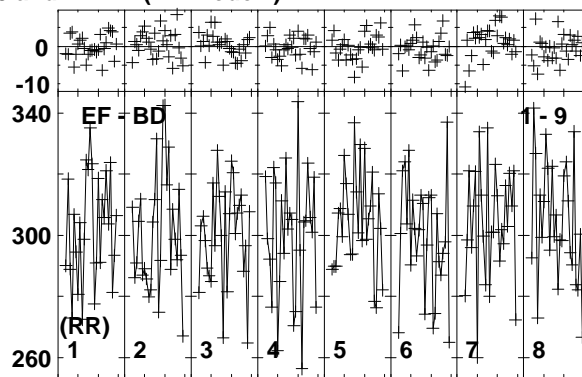
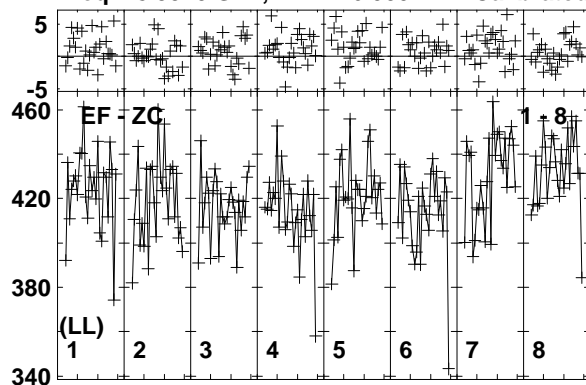

Lower frame: Milli Ampl Jy Top frame: Phas deg
 Vector averaged cross-power spectrum Baseline: EF (01) - ZC (08)
 Timerange: 00/06:05:26 to 00/06:05:54

Plot file version 205 created 24-MAR-2014 14:38:33

ARP299D EP087F 5.UVDATA.1

Freq = 8.3520 GHz, Bw = 16.000 MH Calibrated with CL # 3 and BP # 1 (BP mode 1)

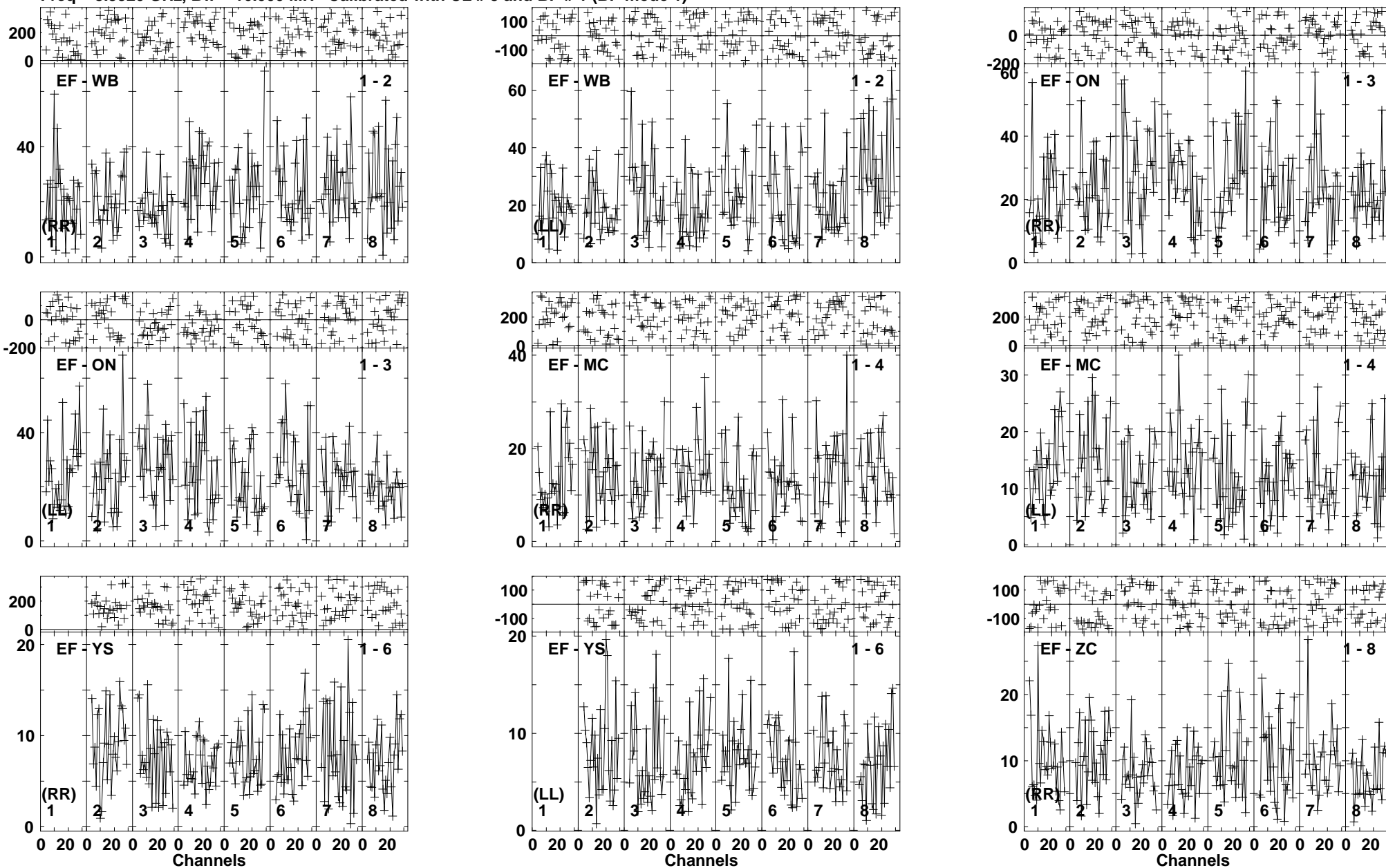

Lower frame: Milli Ampl Jy Top frame: Phas deg
Vector averaged cross-power spectrum Baseline: EF (01) - WB (02)
Timerange: 00/06:06:00 to 00/06:08:55

Plot file version 206 created 24-MAR-2014 14:38:33

ARP299D EP087F 5.UVDATA.1

Freq = 8.3520 GHz, Bw = 16.000 MH Calibrated with CL # 3 and BP # 1 (BP mode 1)

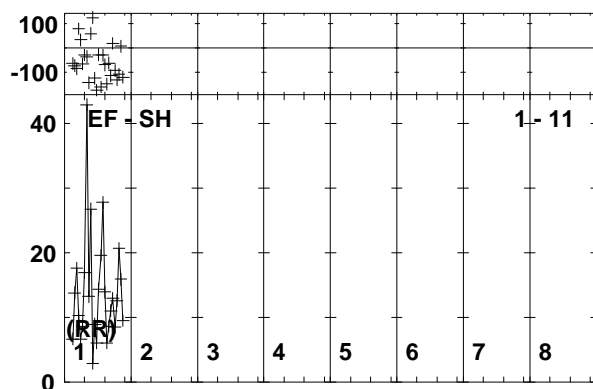
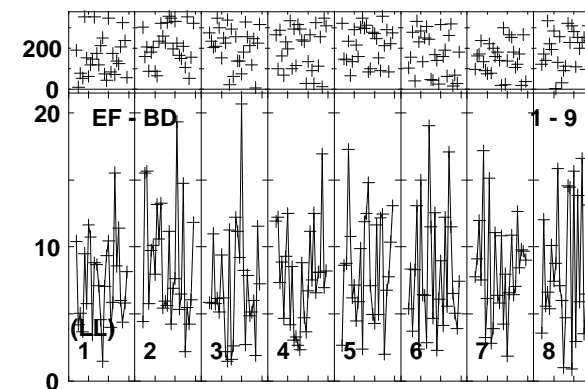
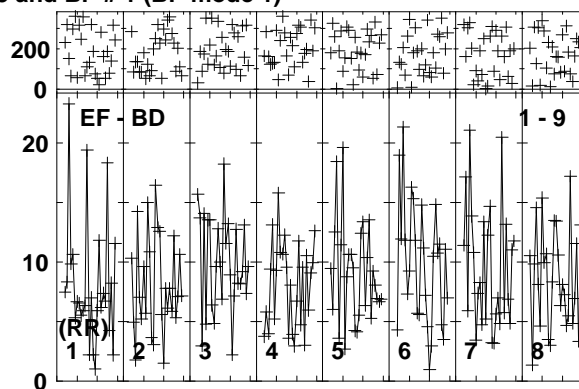
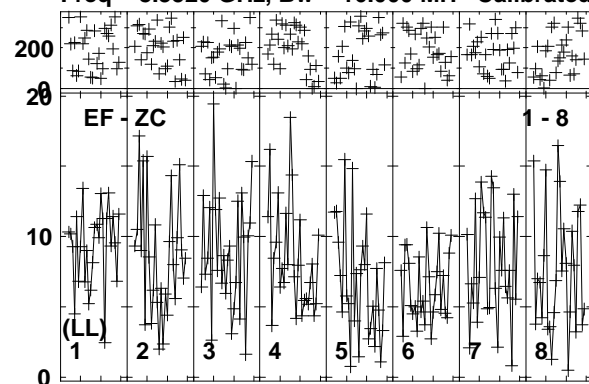

Lower frame: Milli Ampl Jy Top frame: Phas deg
Vector averaged cross-power spectrum Baseline: EF (01) - ZC (08)
Timerange: 00/06:06:00 to 00/06:08:55

Plot file version 207 created 24-MAR-2014 14:38:34

J1128+5925 EP087F 5.UVDATA.1

Freq = 8.3520 GHz, Bw = 16.000 MH Calibrated with CL # 3 and BP # 1 (BP mode 1)

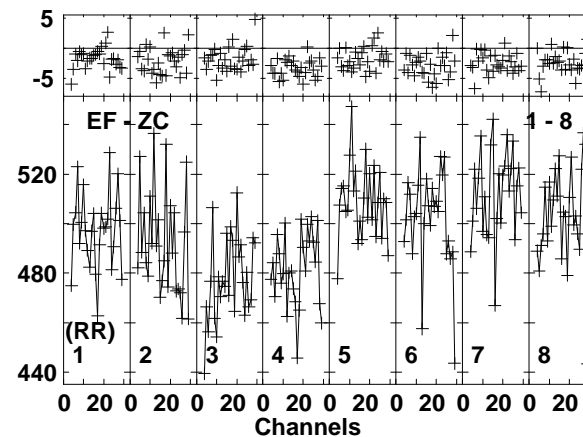
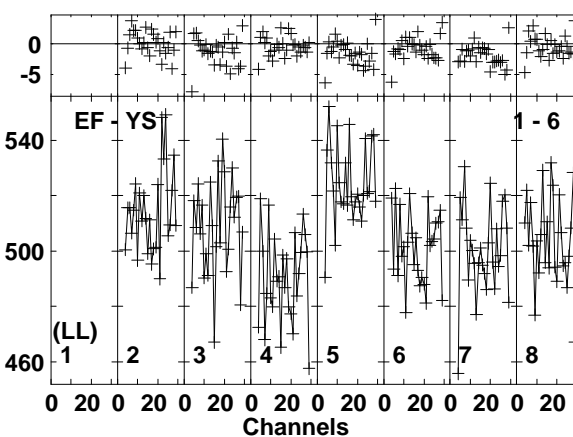
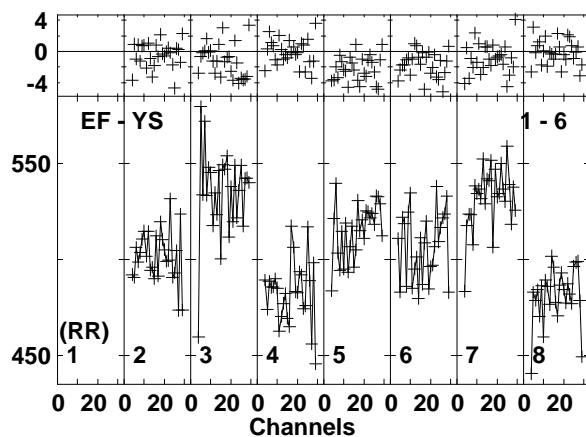
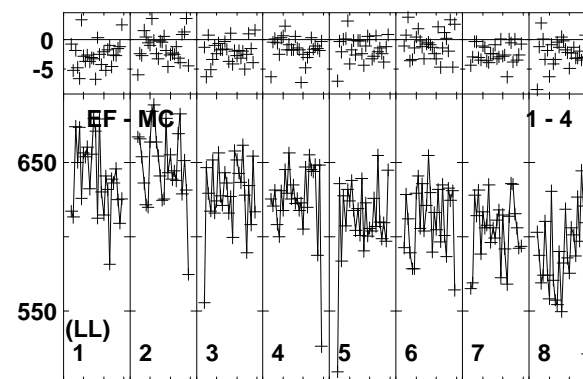
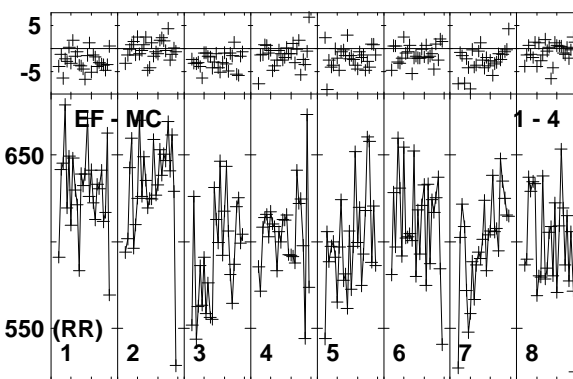
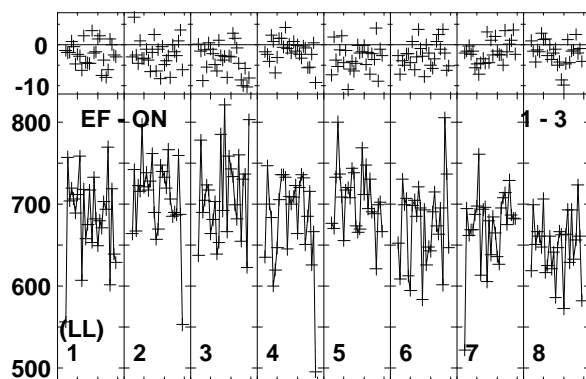
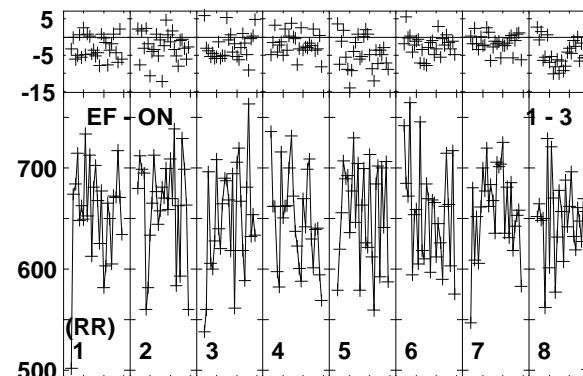
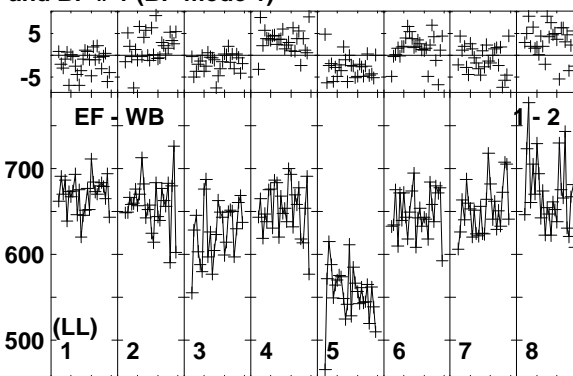
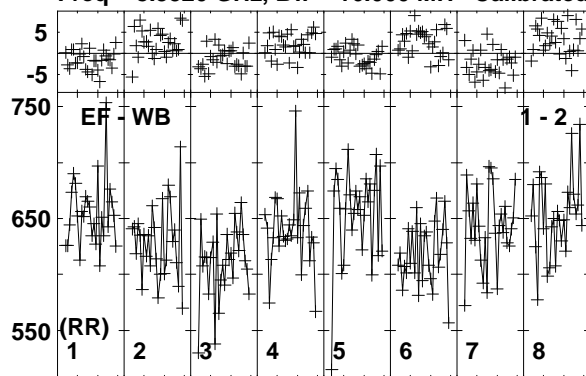

Lower frame: Milli Ampl Jy Top frame: Phas deg
Vector averaged cross-power spectrum Baseline: EF (01) - WB (02)
Timerange: 00/06:09:00 to 00/06:09:59

Plot file version 208 created 24-MAR-2014 14:38:34

J1128+5925 EP087F 5.UVDATA.1

Freq = 8.3520 GHz, Bw = 16.000 MH Calibrated with CL # 3 and BP # 1 (BP mode 1)

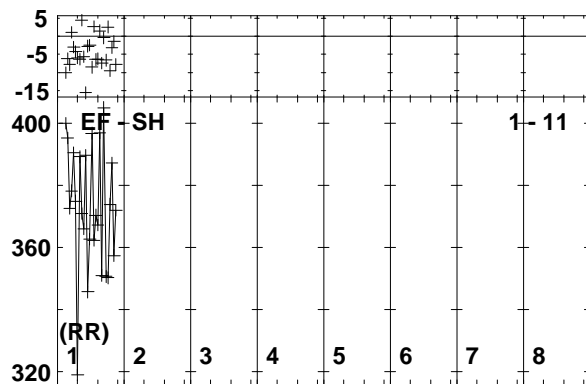
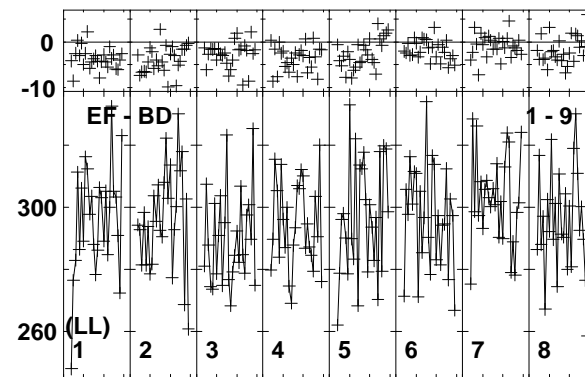
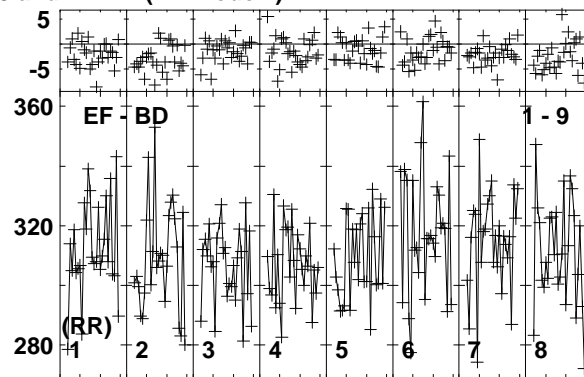
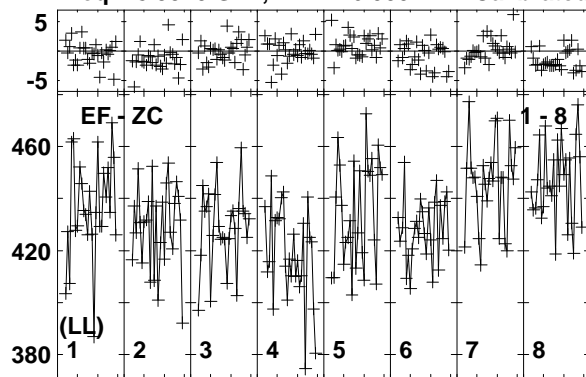

Lower frame: Milli Ampl Jy Top frame: Phas deg
Vector averaged cross-power spectrum Baseline: EF (01) - ZC (08)
Timerange: 00/06:09:00 to 00/06:09:59

Plot file version 209 created 24-MAR-2014 14:38:34
 ARP299D EP087F 5.UVDATA.1
 Freq = 8.3520 GHz, Bw = 16.000 MH Calibrated with CL # 3 and BP # 1 (BP mode 1)

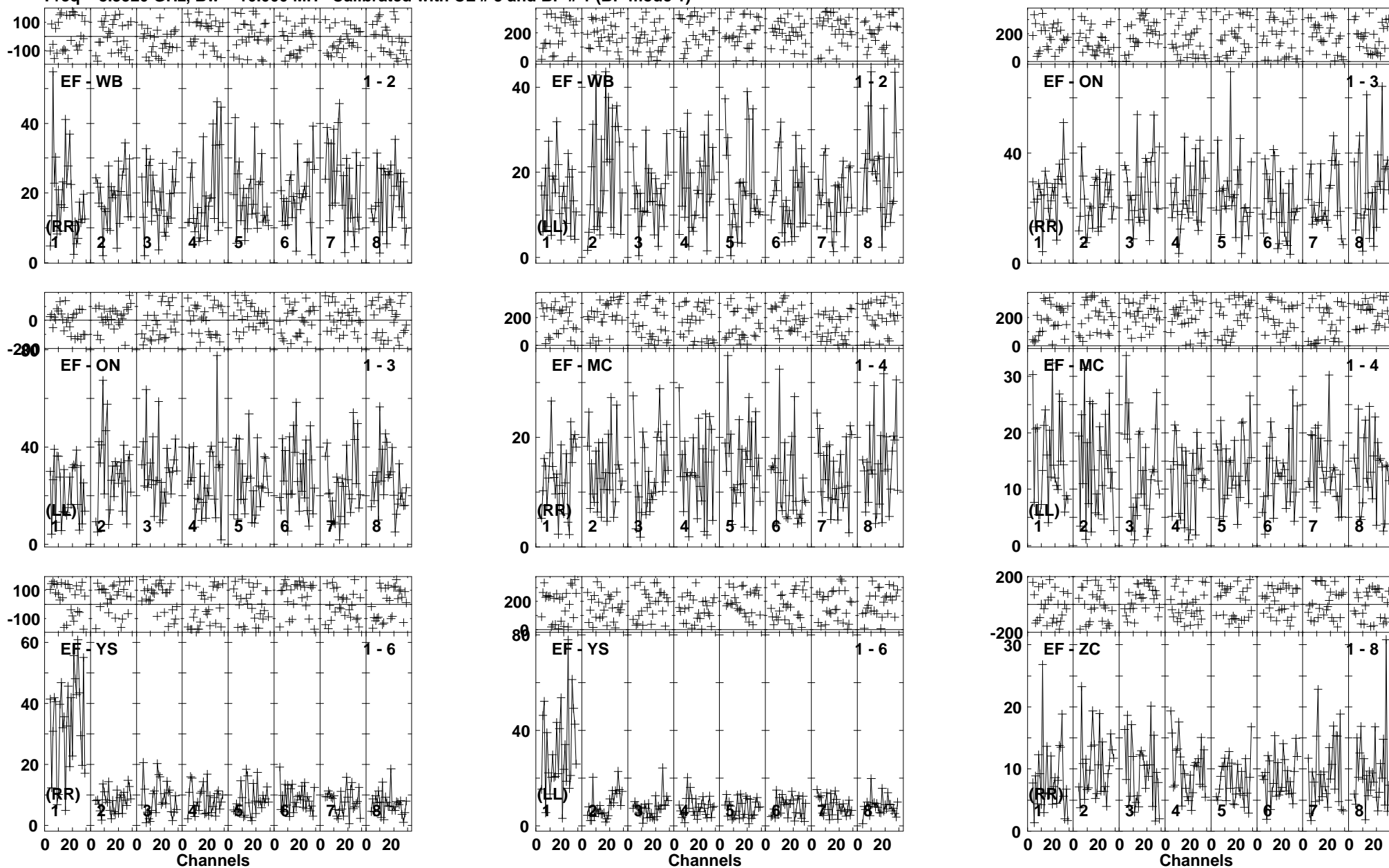

Lower frame: Milli Ampl Jy Top frame: Phas deg
 Vector averaged cross-power spectrum Baseline: EF (01) - WB (02)
 Timerange: 00/06:10:04 to 00/06:13:00

Plot file version 210 created 24-MAR-2014 14:38:34

ARP299D EP087F 5.UVDATA.1

Freq = 8.3520 GHz, Bw = 16.000 MH Calibrated with CL # 3 and BP # 1 (BP mode 1)

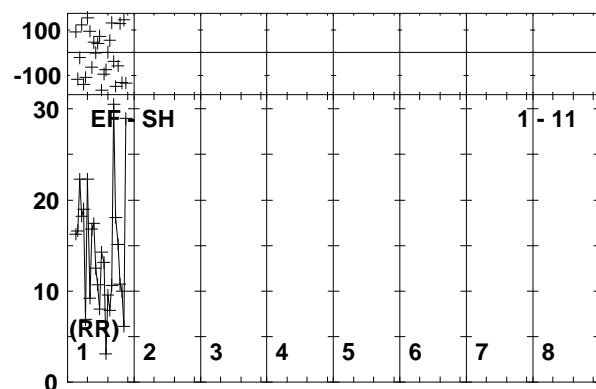
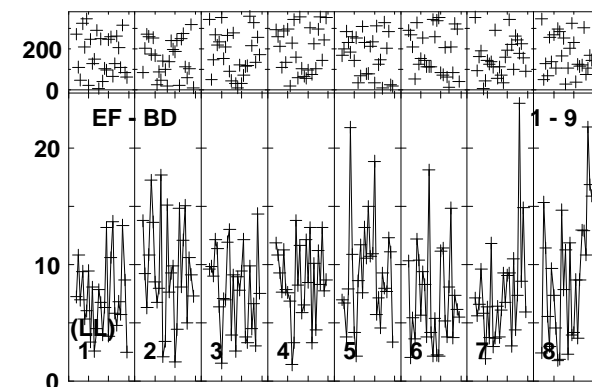
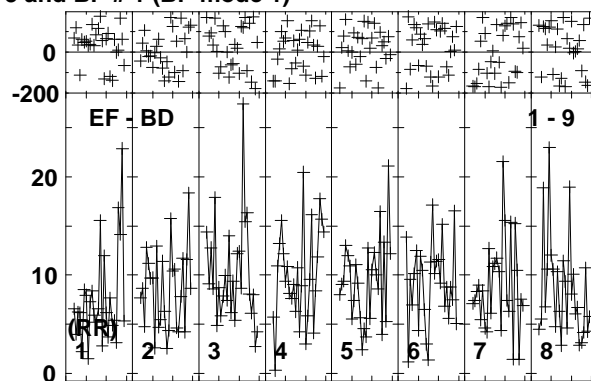
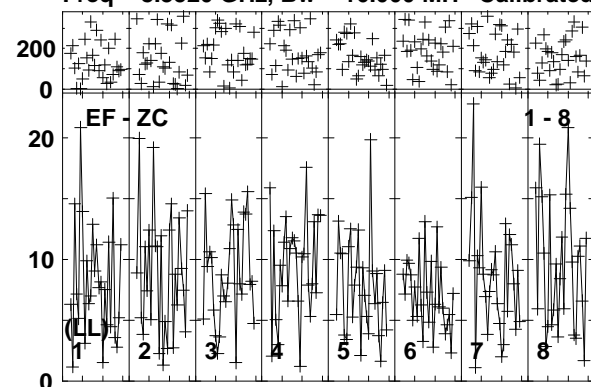

Lower frame: Milli Ampl Jy Top frame: Phas deg
Vector averaged cross-power spectrum Baseline: EF (01) - ZC (08)
Timerange: 00/06:10:04 to 00/06:13:00

Plot file version 211 created 24-MAR-2014 14:38:34

J1128+5925 EP087F 5.UVDATA.1

Freq = 8.3520 GHz, Bw = 16.000 MH Calibrated with CL # 3 and BP # 1 (BP mode 1)

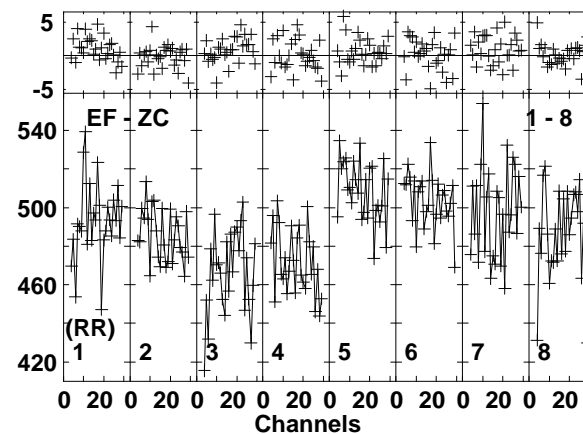
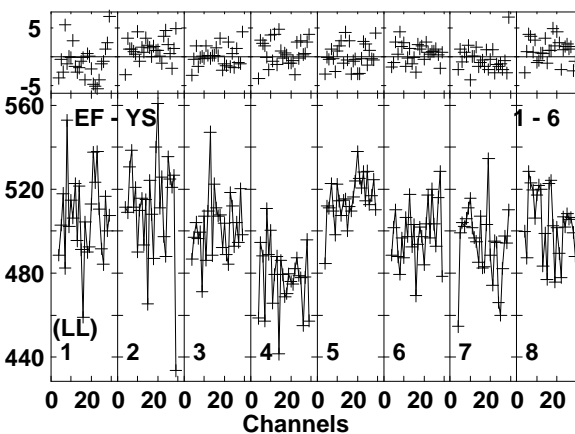
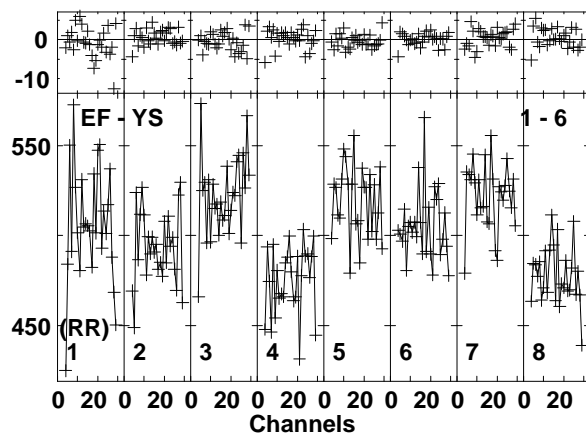
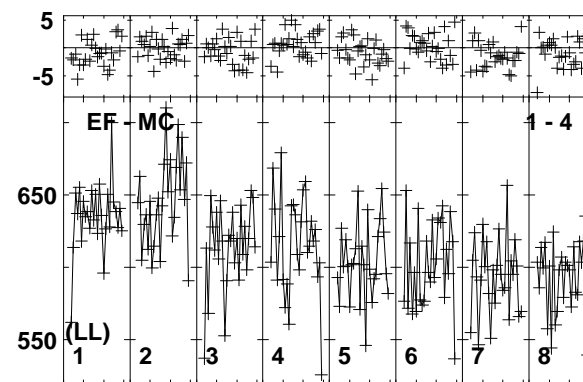
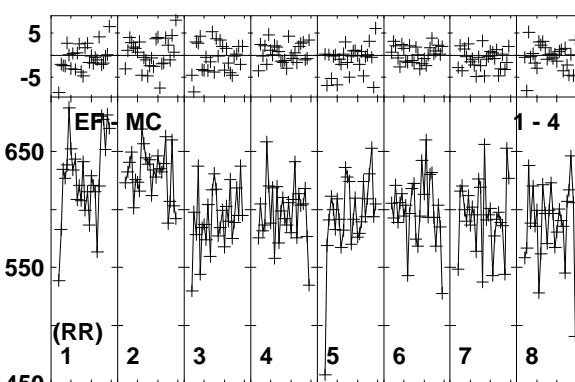
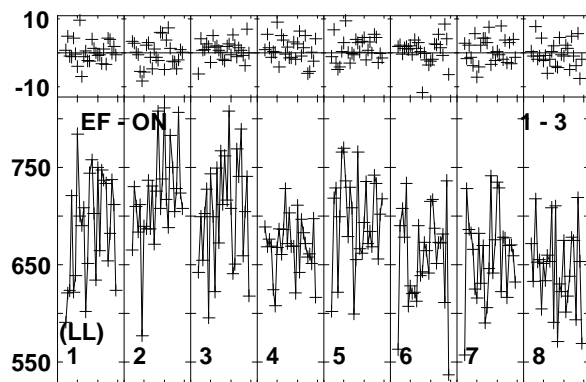
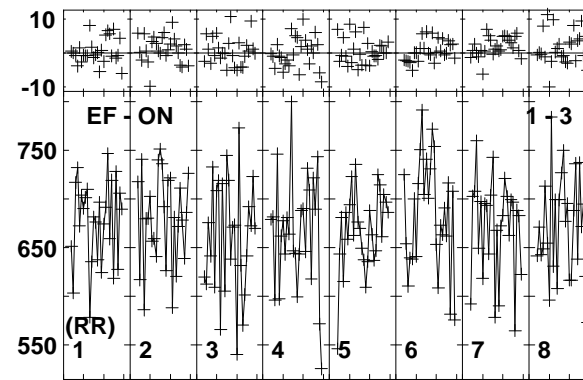
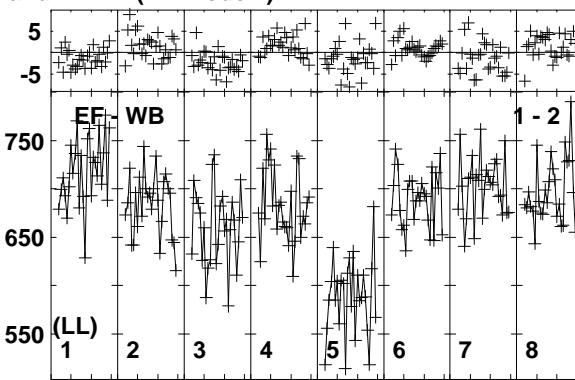
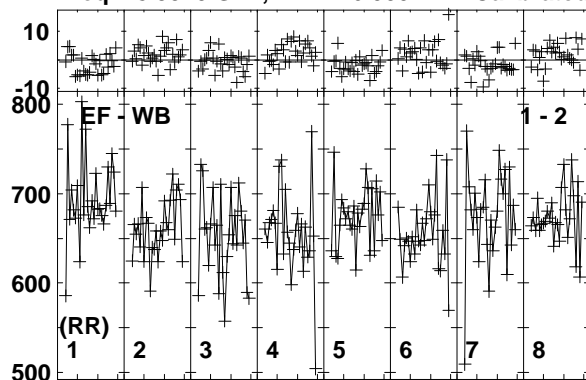

Lower frame: Milli Ampl Jy Top frame: Phas deg
Vector averaged cross-power spectrum Baseline: EF (01) - WB (02)
Timerange: 00/06:13:41 to 00/06:14:10

Plot file version 212 created 24-MAR-2014 14:38:35
 J1128+5925 EP087F 5.UVDATA.1
 Freq = 8.3520 GHz, Bw = 16.000 MH Calibrated with CL # 3 and BP # 1 (BP mode 1)

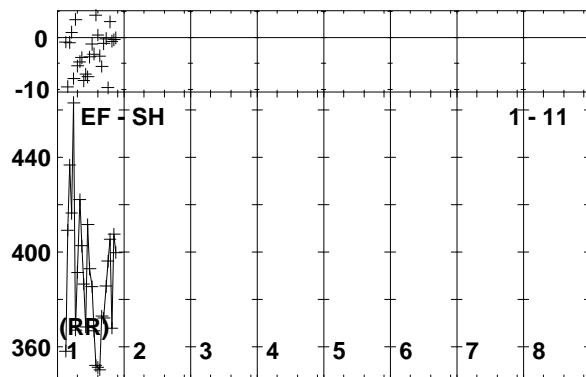
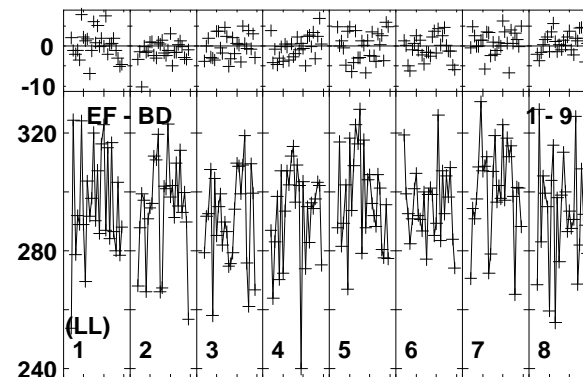
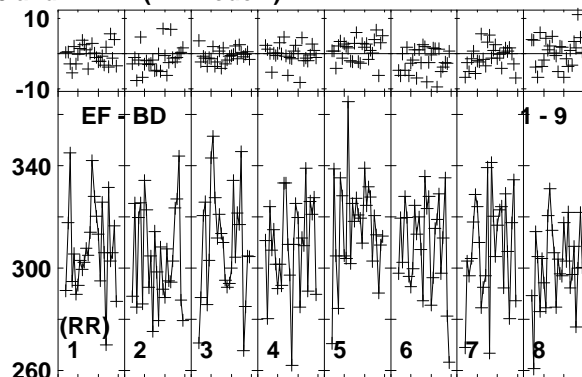
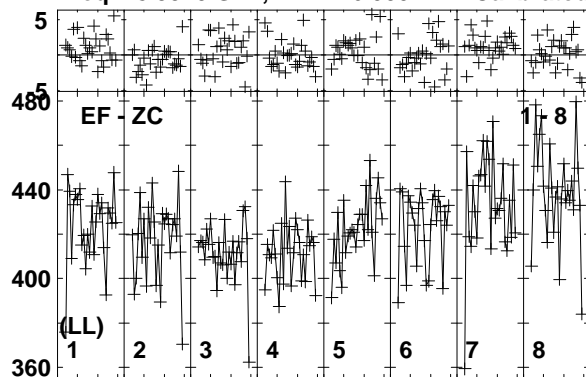

Lower frame: Milli Ampl Jy Top frame: Phas deg
 Vector averaged cross-power spectrum Baseline: EF (01) - ZC (08)
 Timerange: 00/06:13:41 to 00/06:14:10

Plot file version 213 created 24-MAR-2014 14:38:35
 ARP299D EP087F 5.UVDATA.1
 Freq = 8.3520 GHz, Bw = 16.000 MH Calibrated with CL # 3 and BP # 1 (BP mode 1)

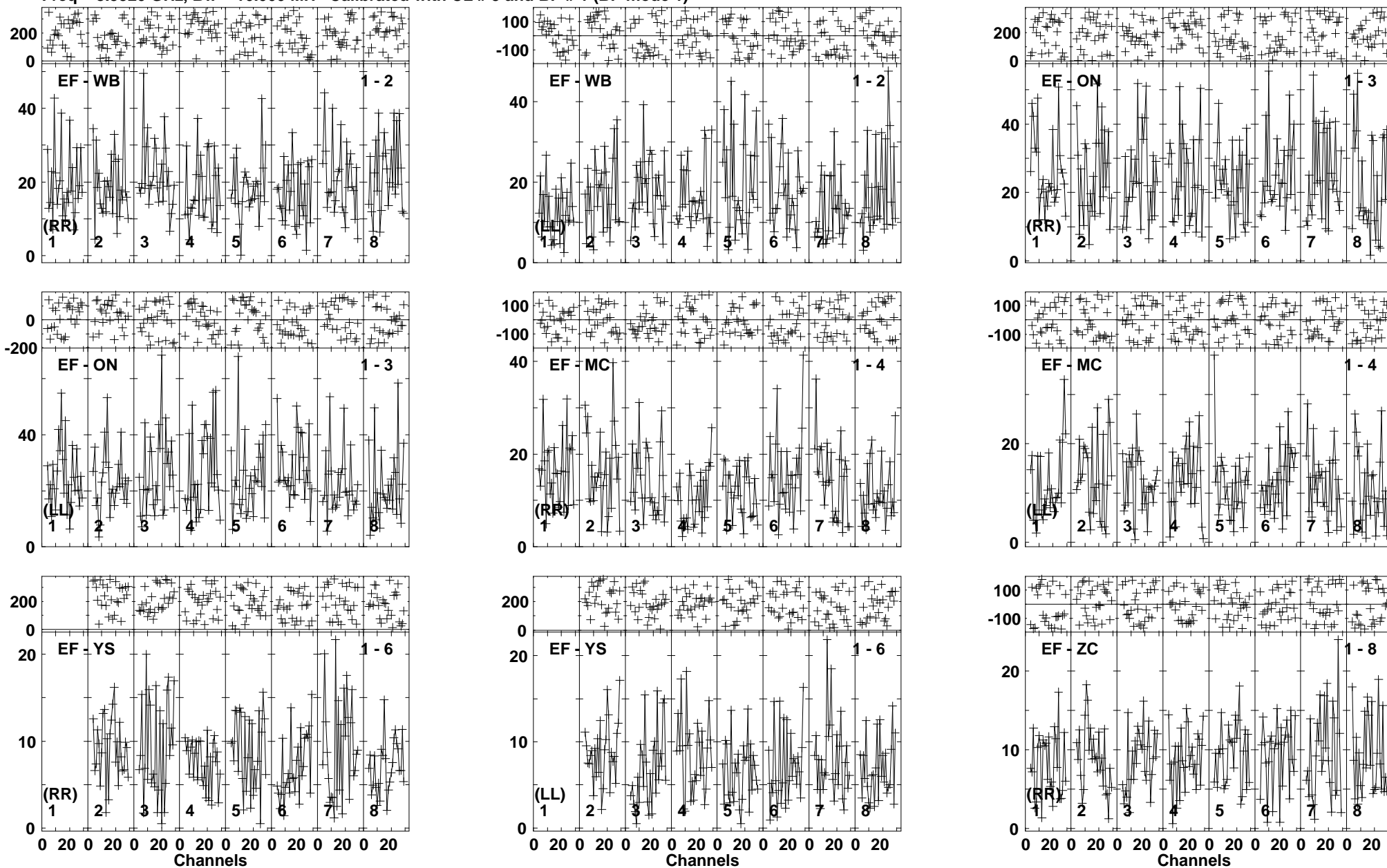

Lower frame: Milli Ampl Jy Top frame: Phas deg
 Vector averaged cross-power spectrum Baseline: EF (01) - WB (02)
 Timerange: 00/06:14:14 to 00/06:17:09

Plot file version 214 created 24-MAR-2014 14:38:35
 ARP299D EP087F 5.UVDATA.1
 Freq = 8.3520 GHz, Bw = 16.000 MH Calibrated with CL # 3 and BP # 1 (BP mode 1)

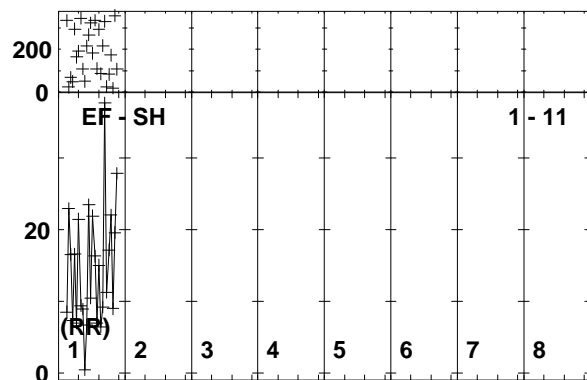
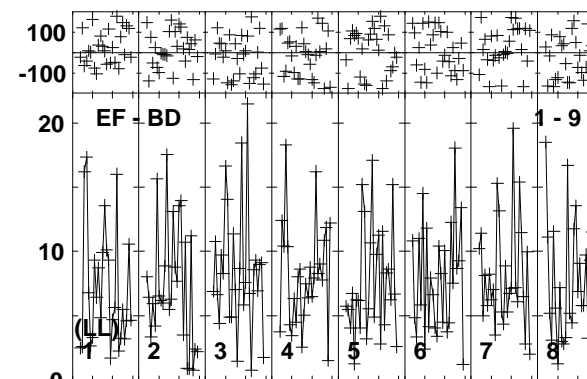
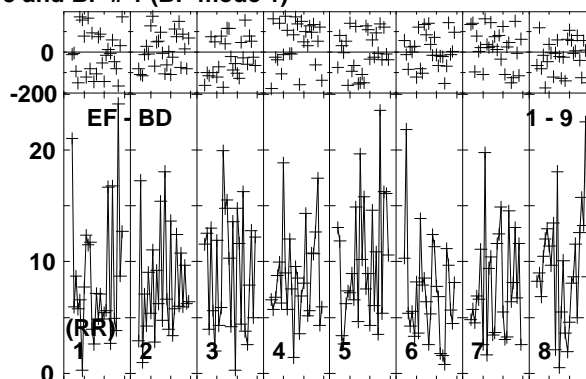
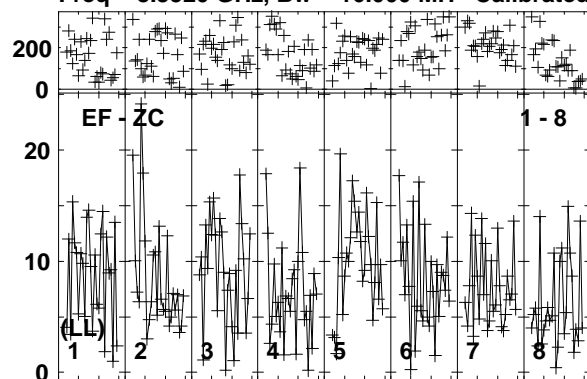

Lower frame: Milli Ampl Jy Top frame: Phas deg
 Vector averaged cross-power spectrum Baseline: EF (01) - ZC (08)
 Timerange: 00/06:14:14 to 00/06:17:09

Plot file version 215 created 24-MAR-2014 14:38:35

J1128+5925 EP087F 5.UVDATA.1

Freq = 8.3520 GHz, Bw = 16.000 MH Calibrated with CL # 3 and BP # 1 (BP mode 1)

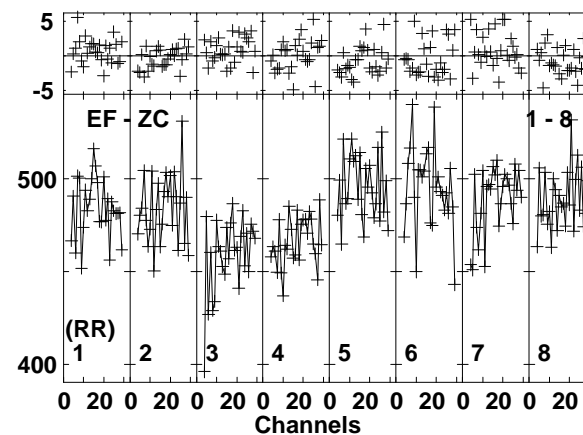
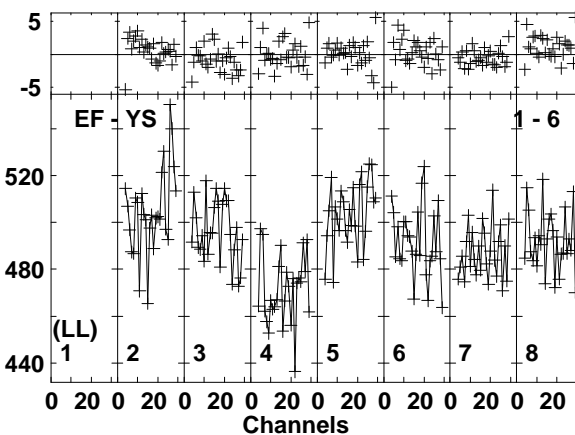
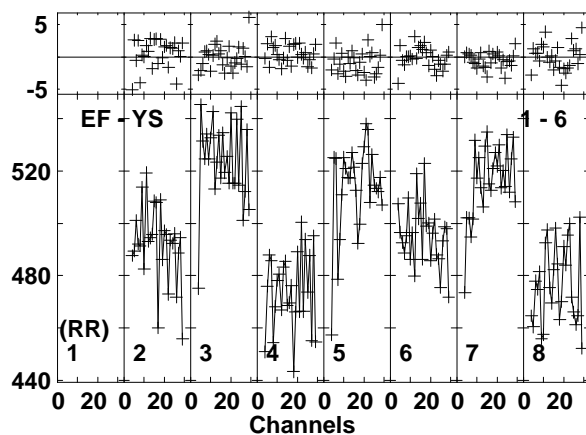
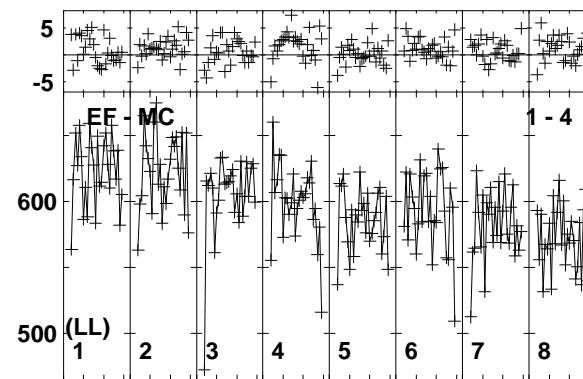
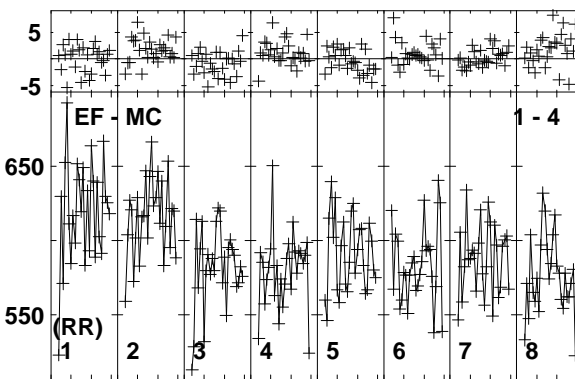
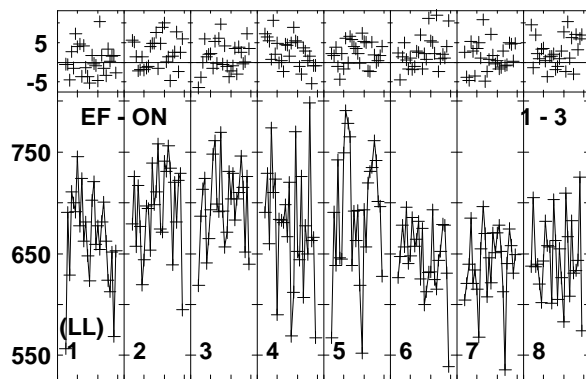
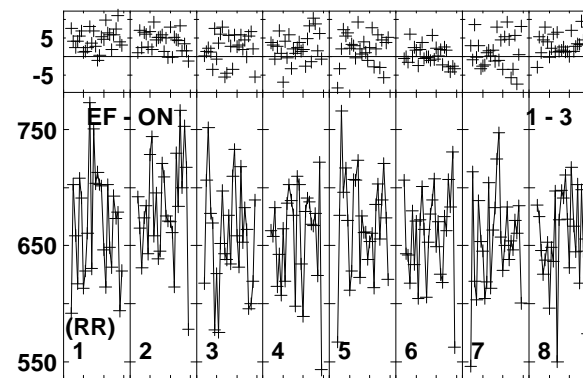
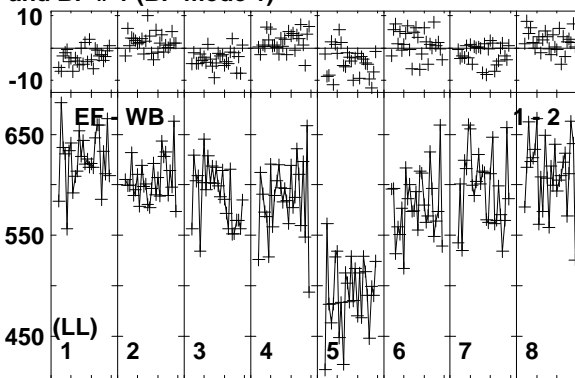
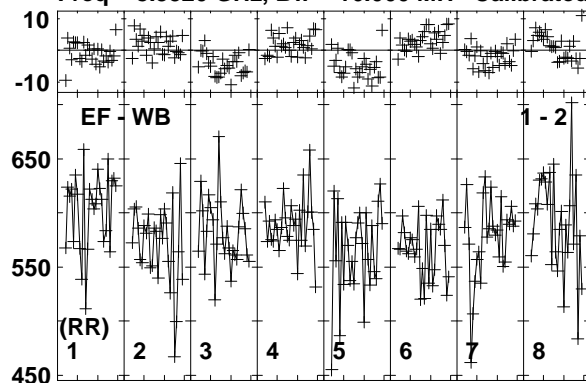

Lower frame: Milli Ampl Jy Top frame: Phas deg
Vector averaged cross-power spectrum Baseline: EF (01) - WB (02)
Timerange: 00/06:17:15 to 00/06:18:15

Plot file version 216 created 24-MAR-2014 14:38:35

J1128+5925 EP087F 5.UVDATA.1

Freq = 8.3520 GHz, Bw = 16.000 MH Calibrated with CL # 3 and BP # 1 (BP mode 1)

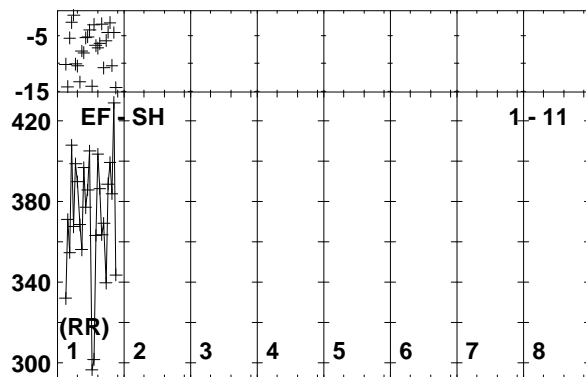
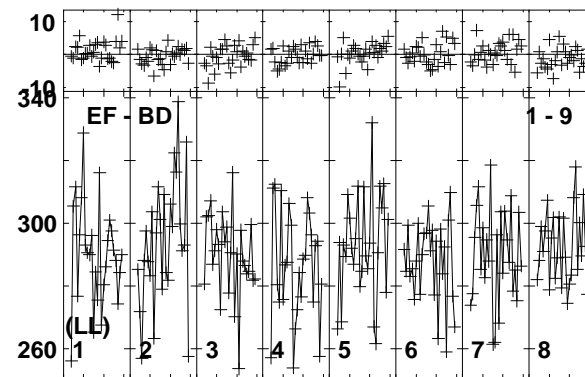
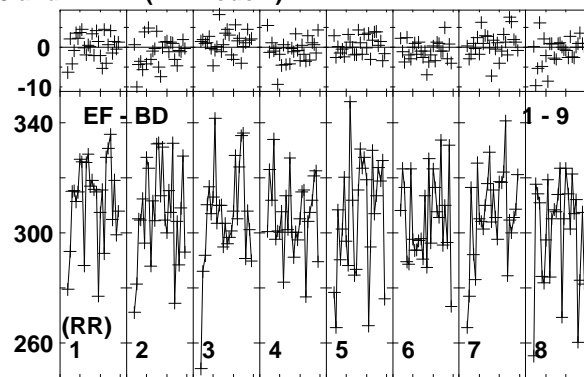
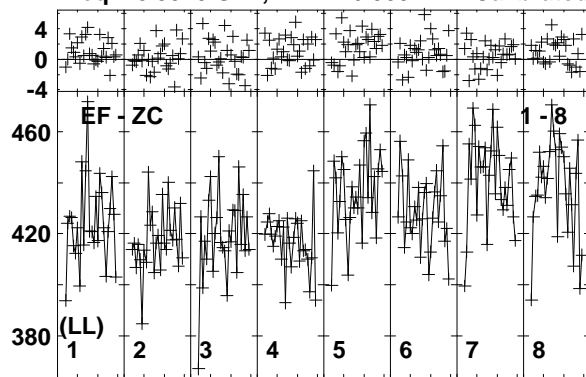

Lower frame: Milli Ampl Jy Top frame: Phas deg
Vector averaged cross-power spectrum Baseline: EF (01) - ZC (08)
Timerange: 00/06:17:15 to 00/06:18:15

Plot file version 217 created 24-MAR-2014 14:38:36

ARP299D EP087F 5.UVDATA.1

Freq = 8.3520 GHz, Bw = 16.000 MH Calibrated with CL # 3 and BP # 1 (BP mode 1)

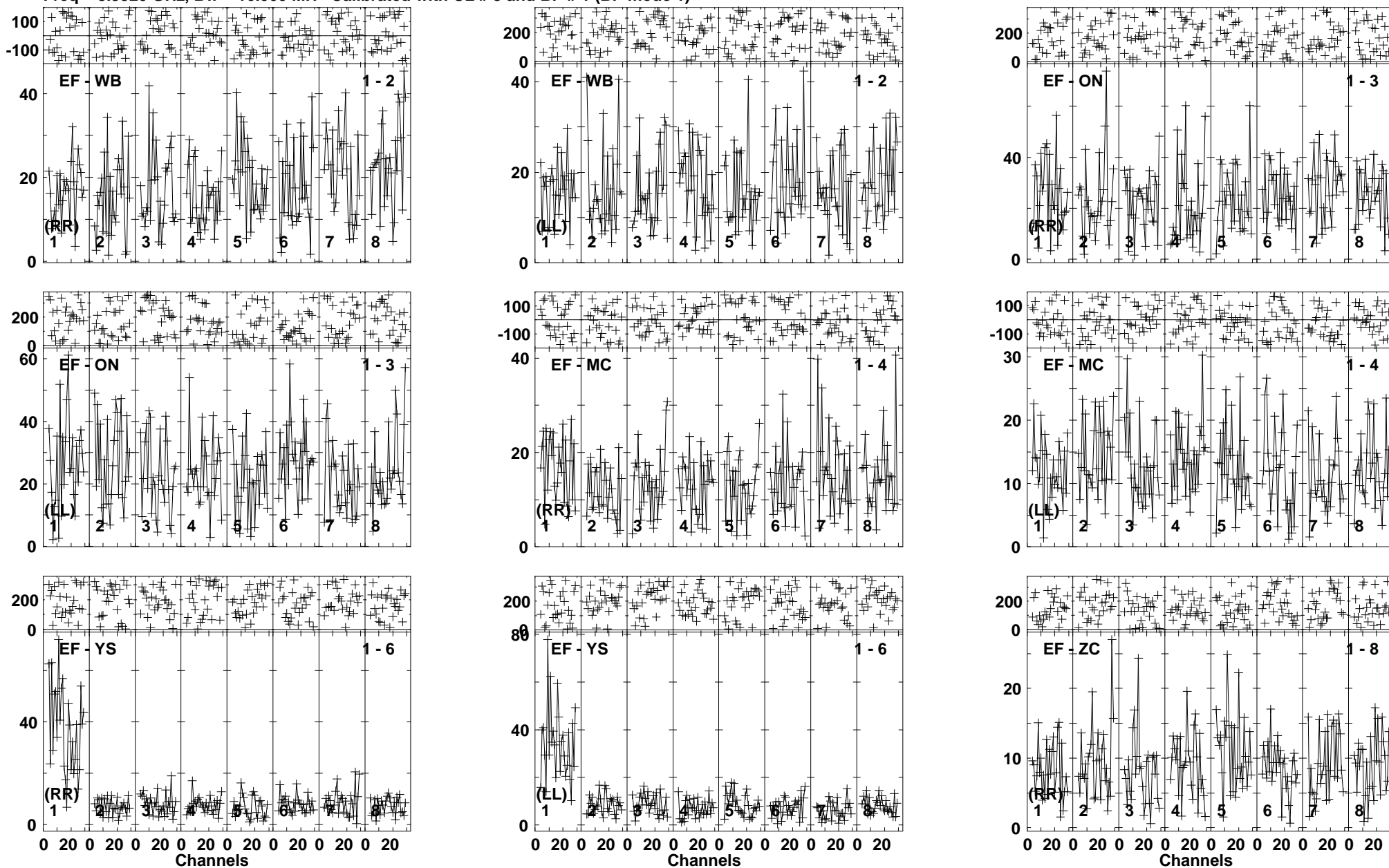

Lower frame: Milli Ampl Jy Top frame: Phas deg
Vector averaged cross-power spectrum Baseline: EF (01) - WB (02)
Timerange: 00/06:18:19 to 00/06:21:14

Plot file version 218 created 24-MAR-2014 14:38:36
ARP299D EP087F 5.UVDATA.1
Freq = 8.3520 GHz, Bw = 16.000 MH Calibrated with CL # 3 and BP # 1 (BP mode 1)

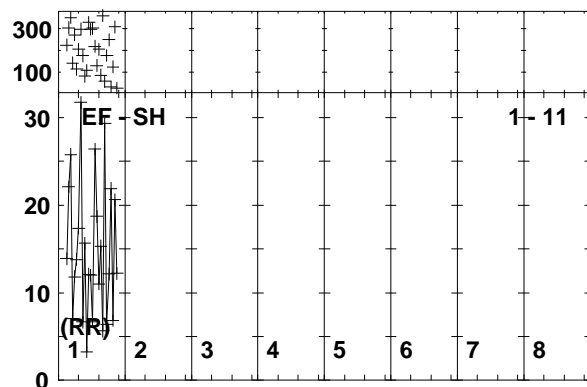
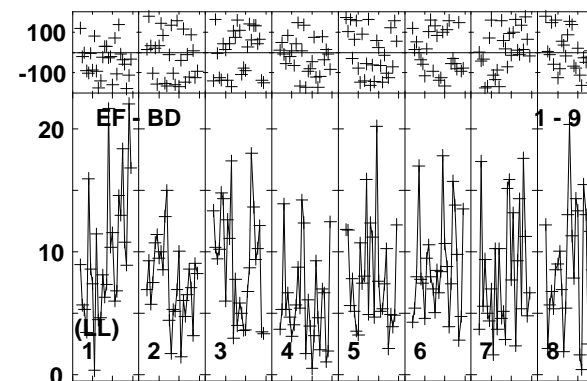
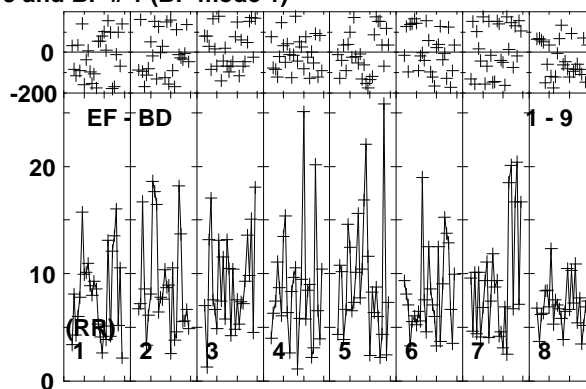
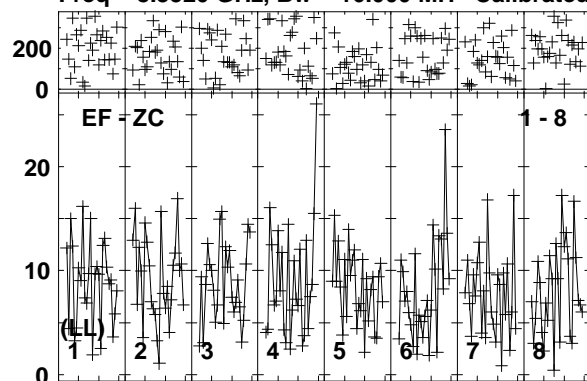

Lower frame: Milli Ampl Jy Top frame: Phas deg
Vector averaged cross-power spectrum Baseline: EF (01) - ZC (08)
Timerange: 00/06:18:19 to 00/06:21:14

Plot file version 219 created 24-MAR-2014 14:38:36

J1128+5925 EP087F 5.UVDATA.1

Freq = 8.3520 GHz, Bw = 16.000 MH Calibrated with CL # 3 and BP # 1 (BP mode 1)

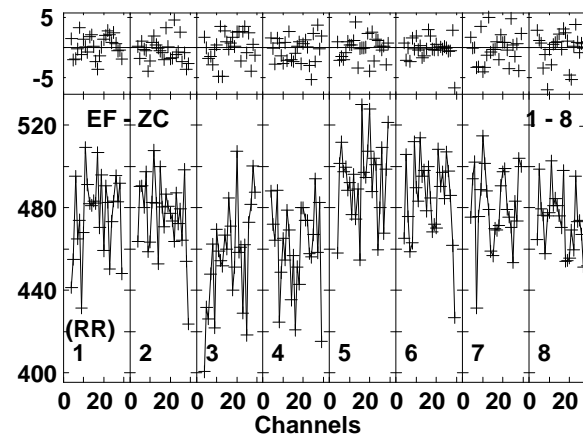
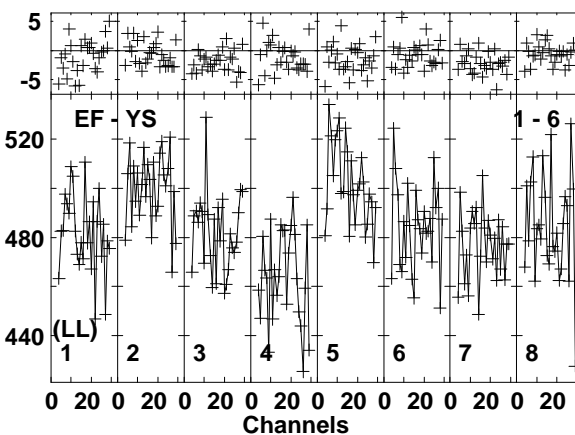
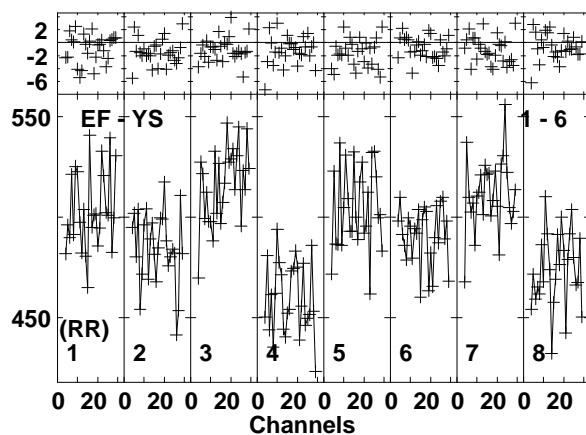
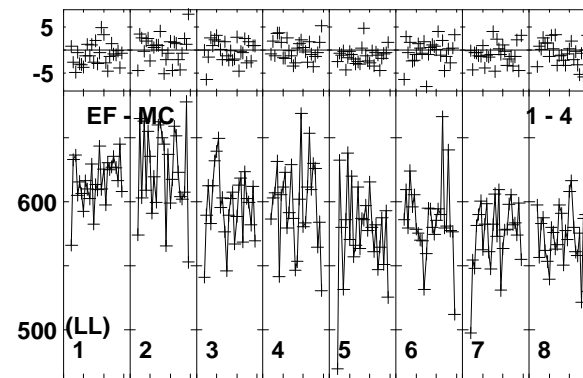
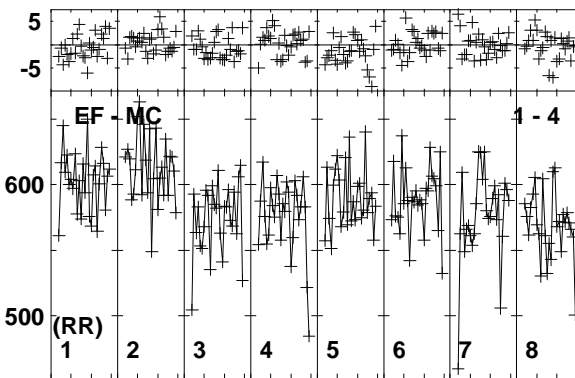
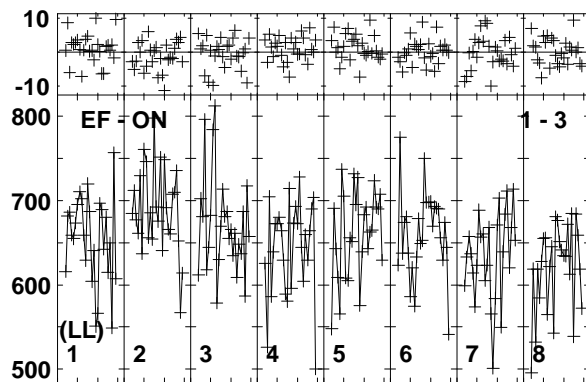
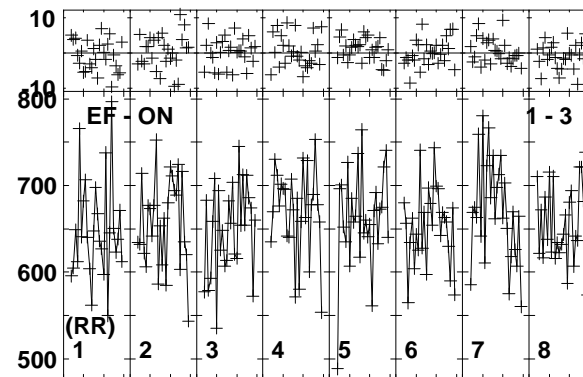
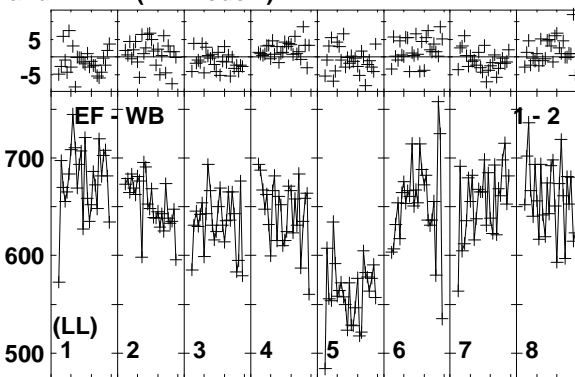
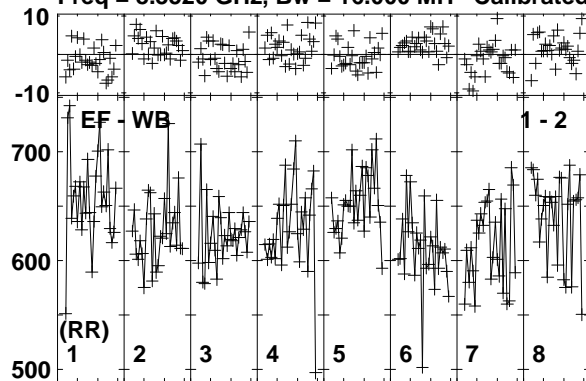

Lower frame: Milli Ampl Jy Top frame: Phas deg
Vector averaged cross-power spectrum Baseline: EF (01) - WB (02)
Timerange: 00/06:21:56 to 00/06:22:24

Plot file version 220 created 24-MAR-2014 14:38:36

J1128+5925 EP087F 5.UVDATA.1

Freq = 8.3520 GHz, Bw = 16.000 MH Calibrated with CL # 3 and BP # 1 (BP mode 1)

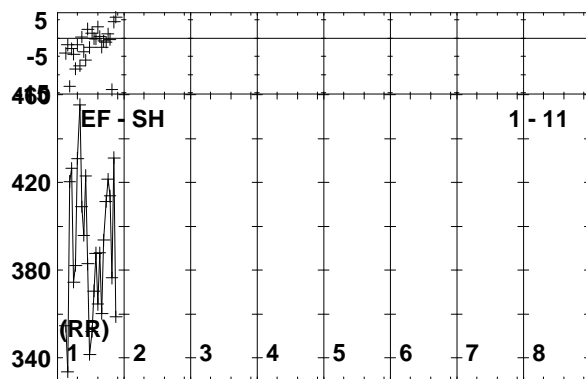
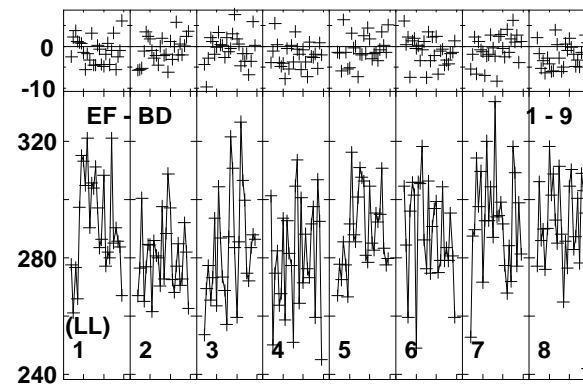
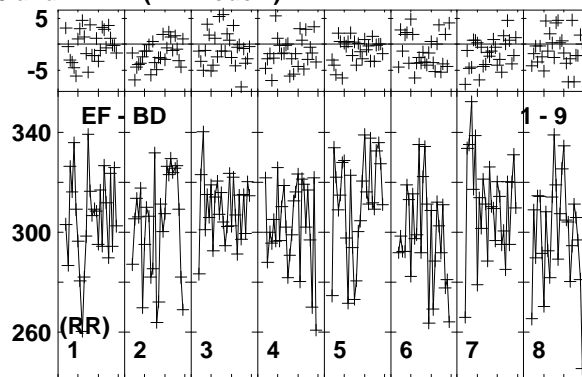
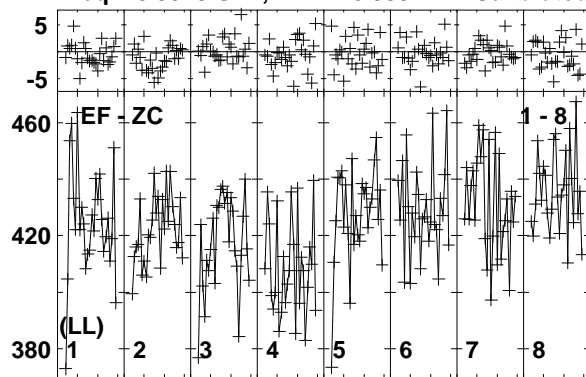

Lower frame: Milli Ampl Jy Top frame: Phas deg
Vector averaged cross-power spectrum Baseline: EF (01) - ZC (08)
Timerange: 00/06:21:56 to 00/06:22:24

Plot file version 221 created 24-MAR-2014 14:38:36

ARP299D EP087F 5.UVDATA.1

Freq = 8.3520 GHz, Bw = 16.000 MH Calibrated with CL # 3 and BP # 1 (BP mode 1)

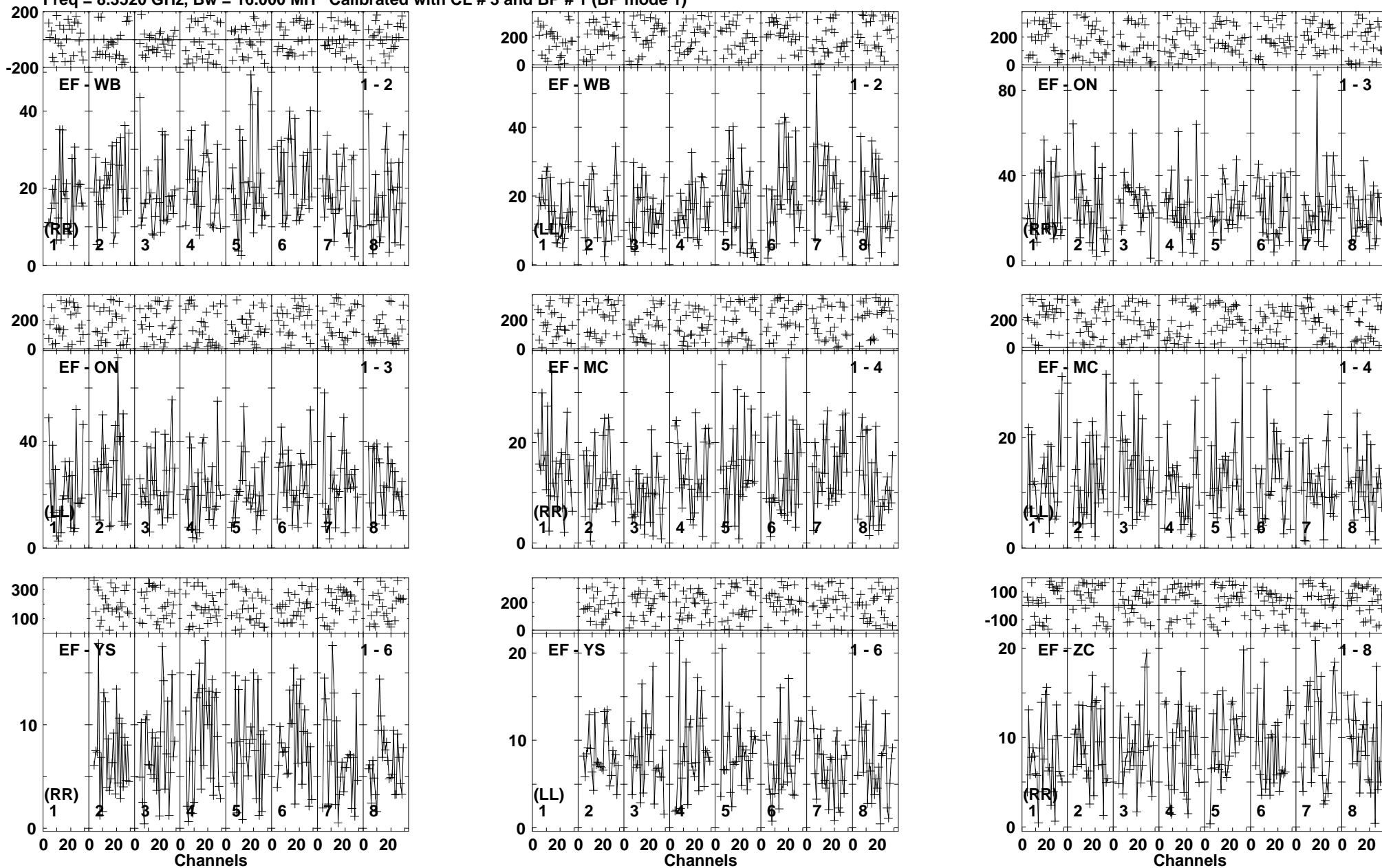

Lower frame: Milli Ampl Jy Top frame: Phas deg
Vector averaged cross-power spectrum Baseline: EF (01) - WB (02)
Timerange: 00/06:22:30 to 00/06:25:25

Plot file version 222 created 24-MAR-2014 14:38:37
 ARP299D EP087F 5.UVDATA.1
 Freq = 8.3520 GHz, Bw = 16.000 MH Calibrated with CL # 3 and BP # 1 (BP mode 1)

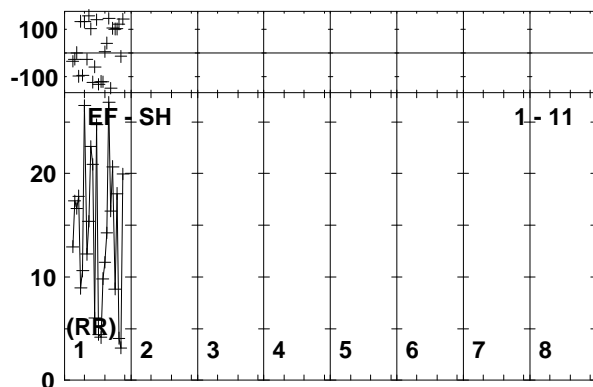
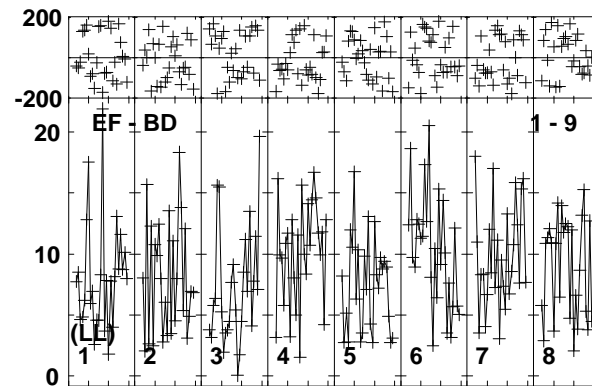
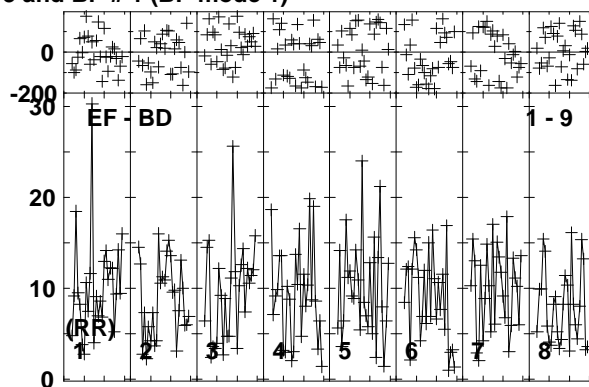
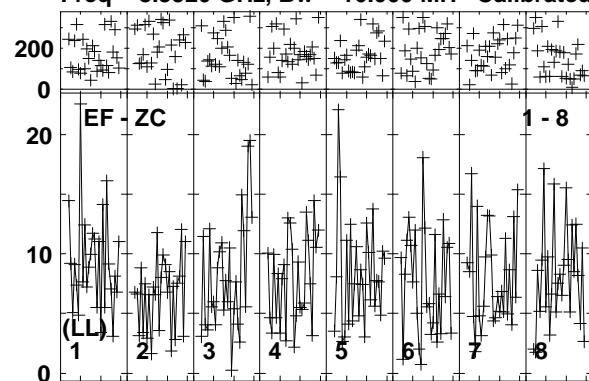

Lower frame: Milli Ampl Jy Top frame: Phas deg
 Vector averaged cross-power spectrum Baseline: EF (01) - ZC (08)
 Timerange: 00/06:22:30 to 00/06:25:25

Plot file version 223 created 24-MAR-2014 14:38:37

J1128+5925 EP087F 5.UVDATA.1

Freq = 8.3520 GHz, Bw = 16.000 MH Calibrated with CL # 3 and BP # 1 (BP mode 1)

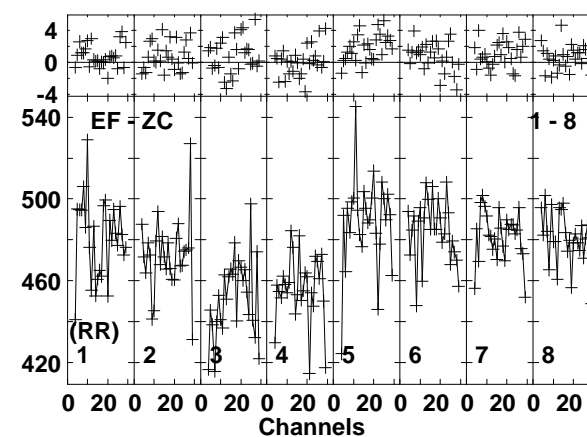
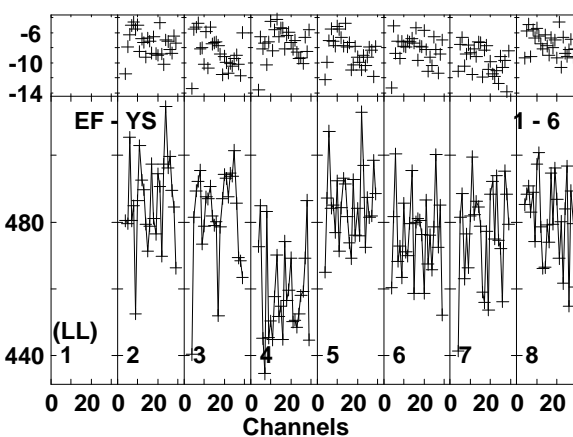
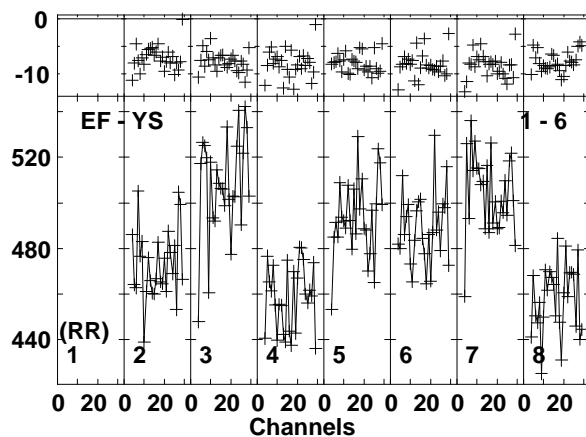
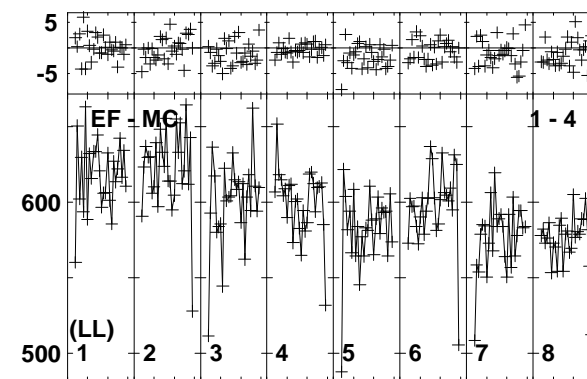
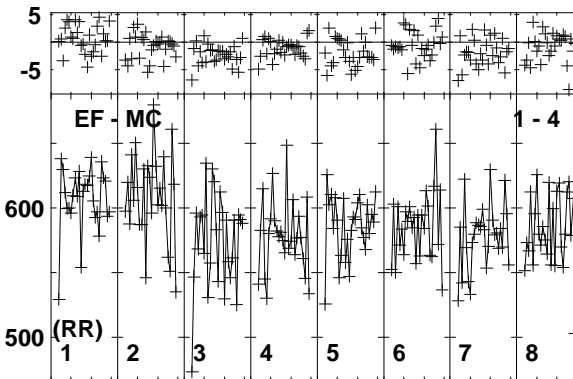
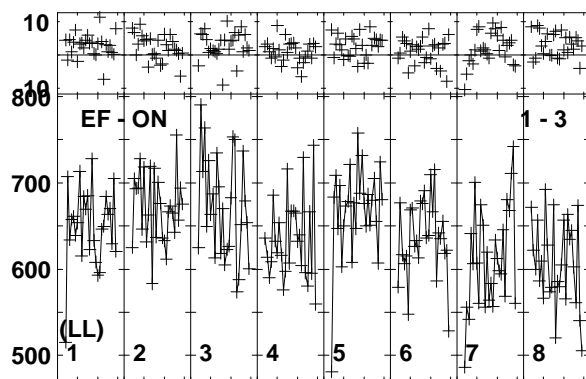
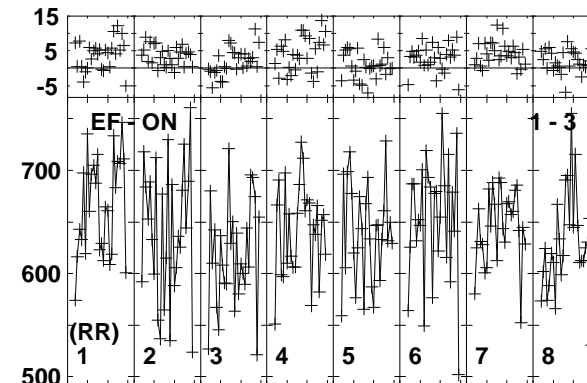
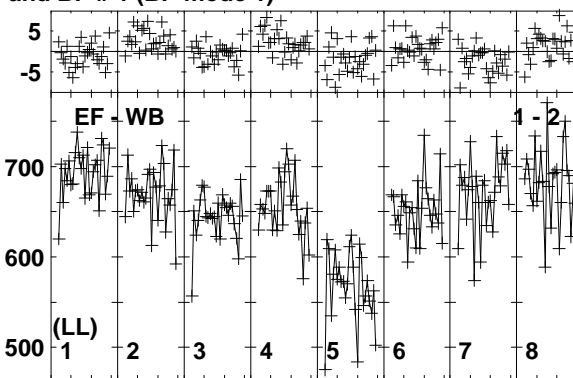
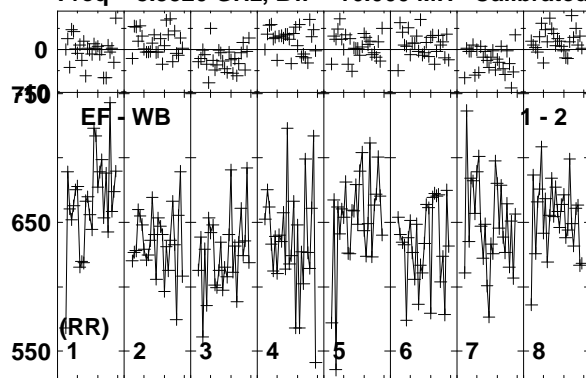

Lower frame: Milli Ampl Jy Top frame: Phas deg
Vector averaged cross-power spectrum Baseline: EF (01) - WB (02)
Timerange: 00/06:25:29 to 00/06:26:30

Plot file version 224 created 24-MAR-2014 14:38:37

J1128+5925 EP087F 5.UVDATA.1

Freq = 8.3520 GHz, Bw = 16.000 MH Calibrated with CL # 3 and BP # 1 (BP mode 1)

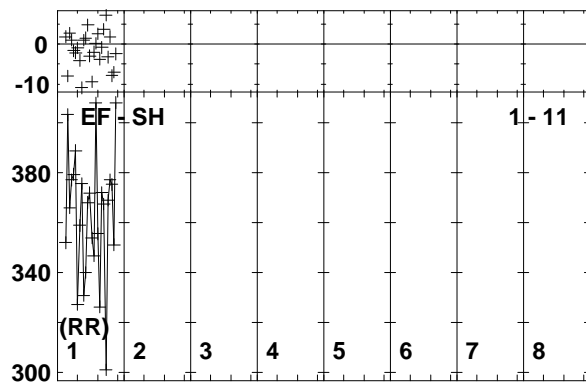
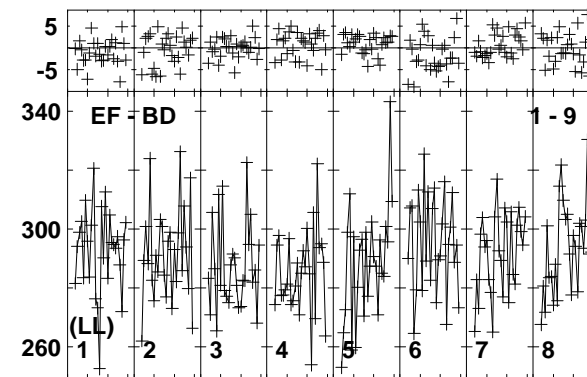
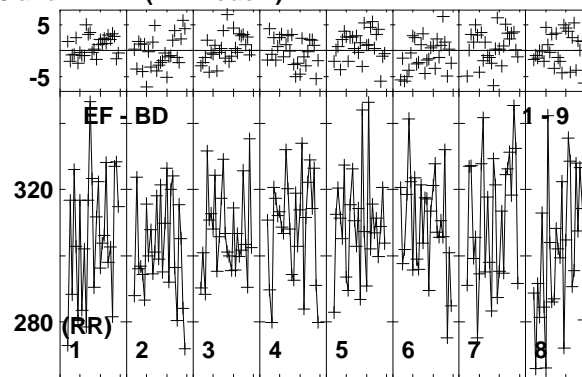
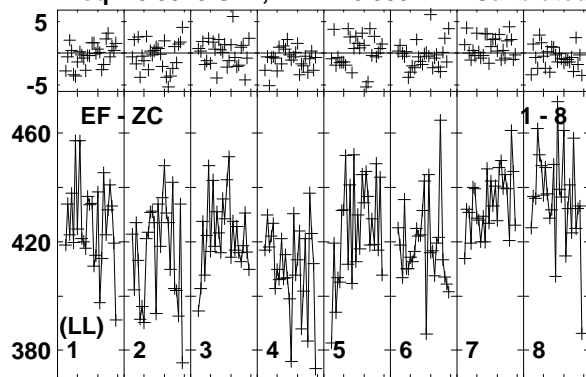

Lower frame: Milli Ampl Jy Top frame: Phas deg
Vector averaged cross-power spectrum Baseline: EF (01) - ZC (08)
Timerange: 00/06:25:29 to 00/06:26:30

Plot file version 225 created 24-MAR-2014 14:38:37
 ARP299D EP087F 5.UVDATA.1
 Freq = 8.3520 GHz, Bw = 16.000 MH Calibrated with CL # 3 and BP # 1 (BP mode 1)

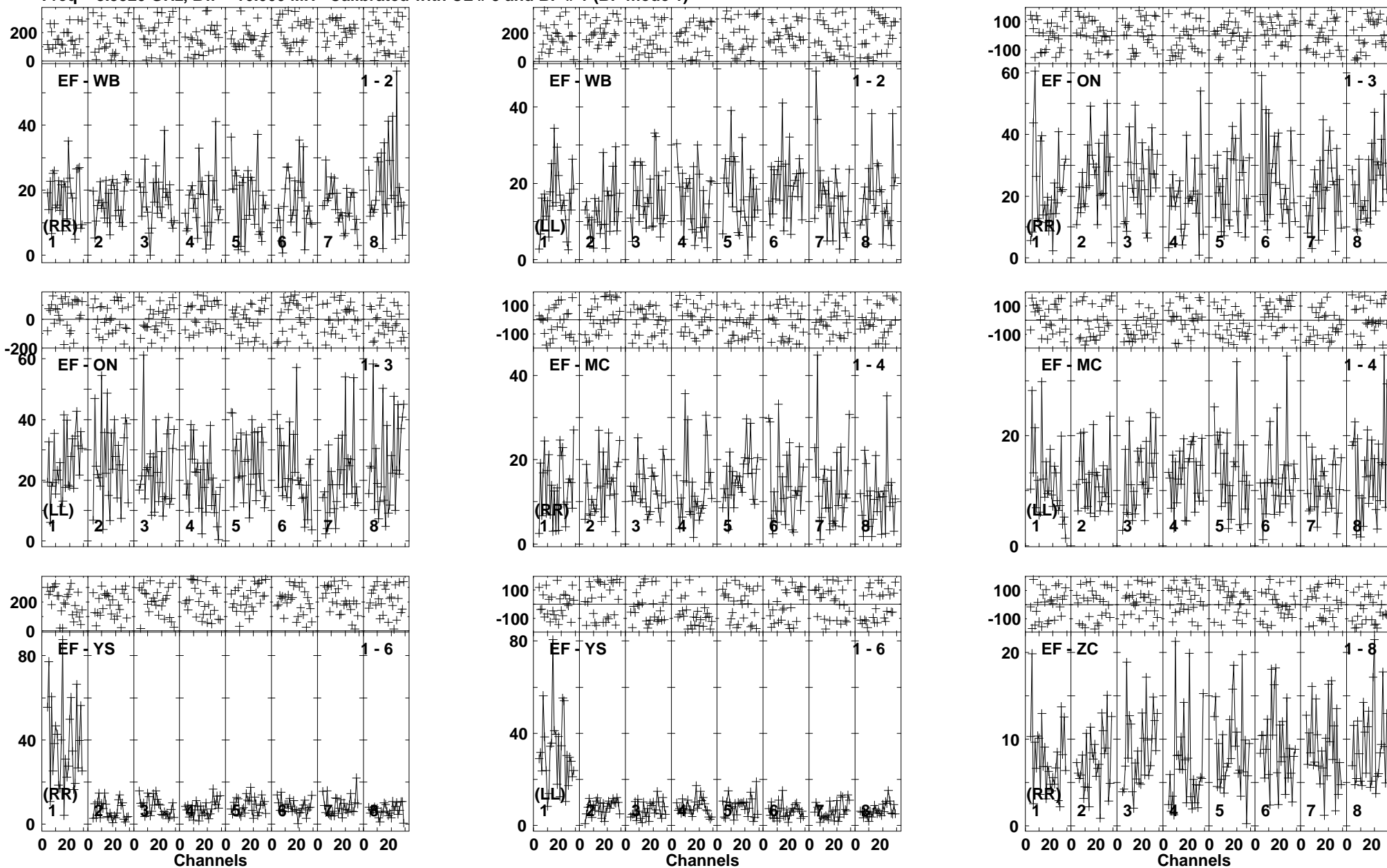

Lower frame: Milli Ampl Jy Top frame: Phas deg
 Vector averaged cross-power spectrum Baseline: EF (01) - WB (02)
 Timerange: 00/06:26:34 to 00/06:29:30

Plot file version 226 created 24-MAR-2014 14:38:38
 ARP299D EP087F 5.UVDATA.1
 Freq = 8.3520 GHz, Bw = 16.000 MH Calibrated with CL # 3 and BP # 1 (BP mode 1)

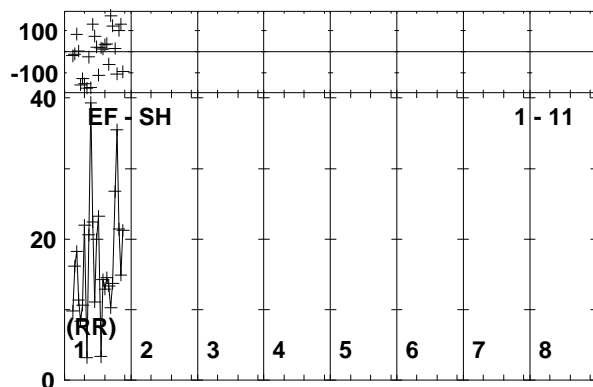
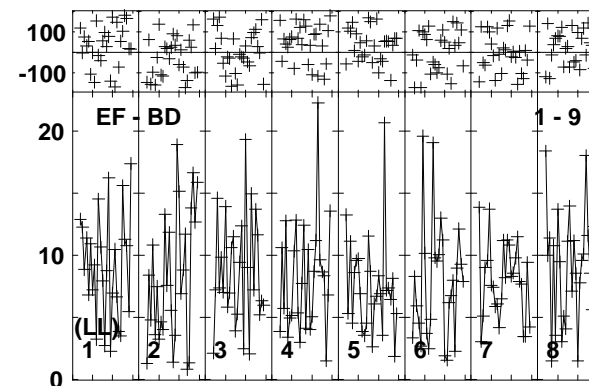
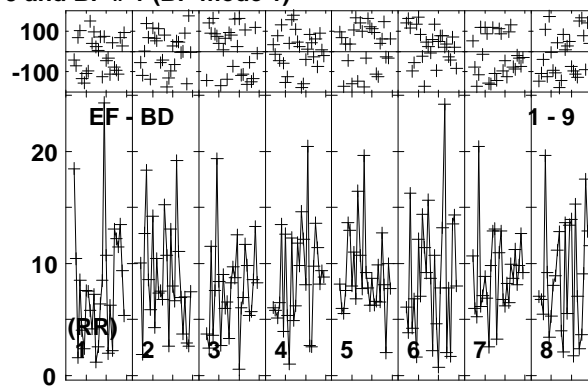
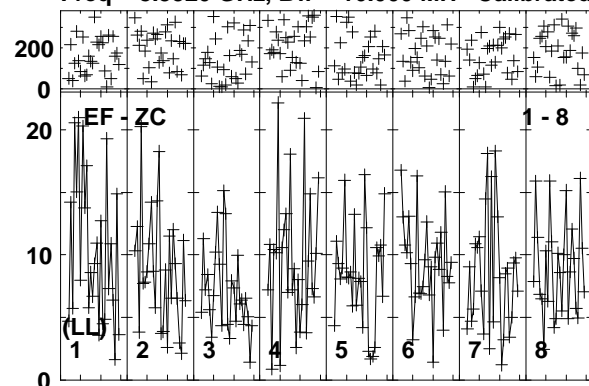

Lower frame: Milli Ampl Jy Top frame: Phas deg
 Vector averaged cross-power spectrum Baseline: EF (01) - ZC (08)
 Timerange: 00/06:26:34 to 00/06:29:30

Plot file version 227 created 24-MAR-2014 14:38:38
 J1128+5925 EP087F 5.UVDATA.1
 Freq = 8.3520 GHz, Bw = 16.000 MH Calibrated with CL # 3 and BP # 1 (BP mode 1)

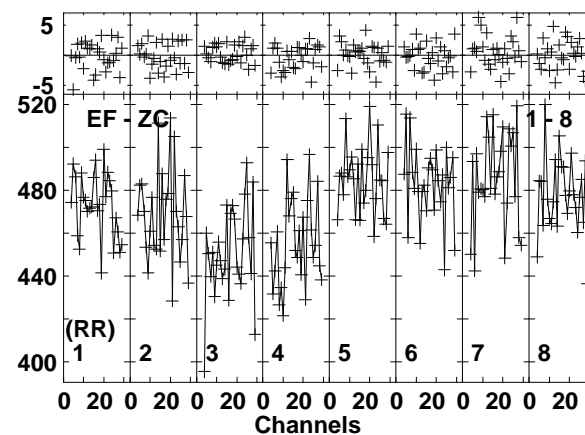
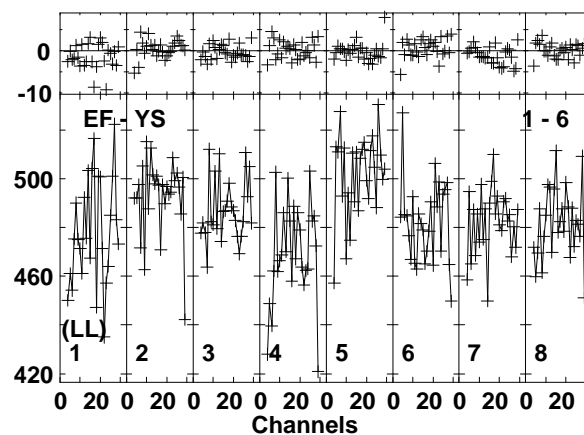
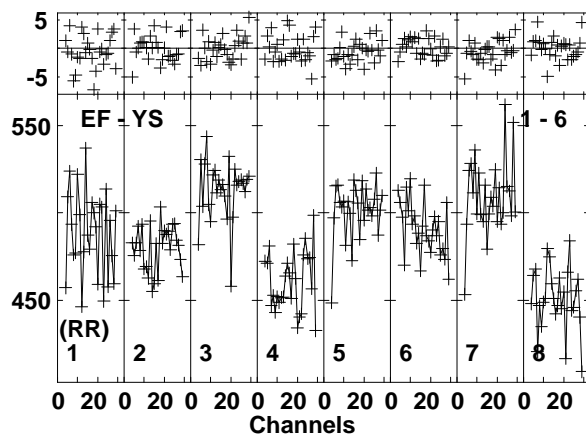
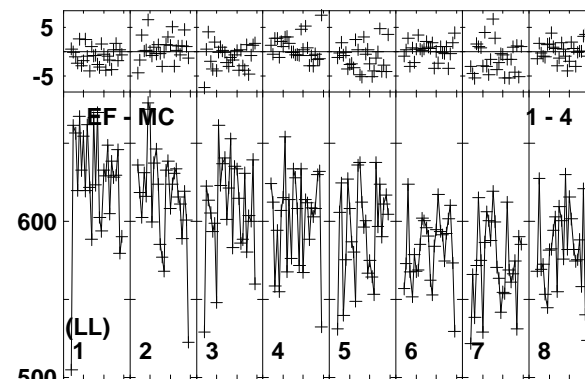
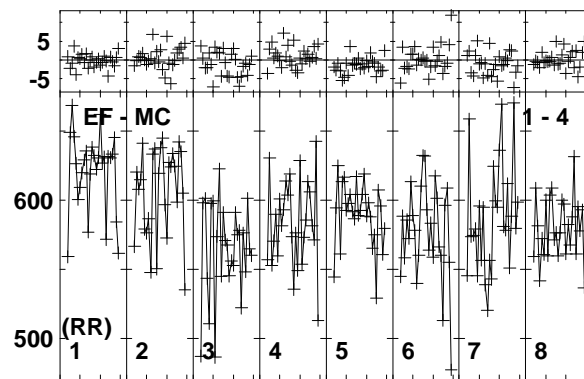
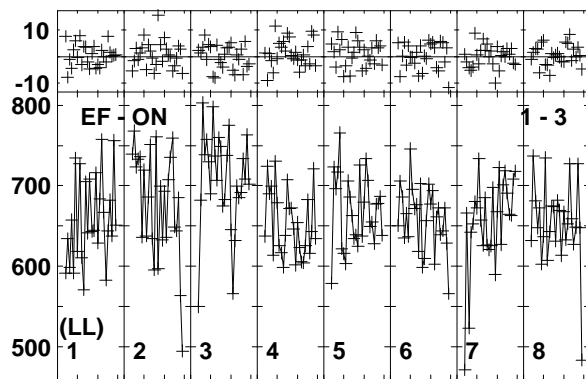
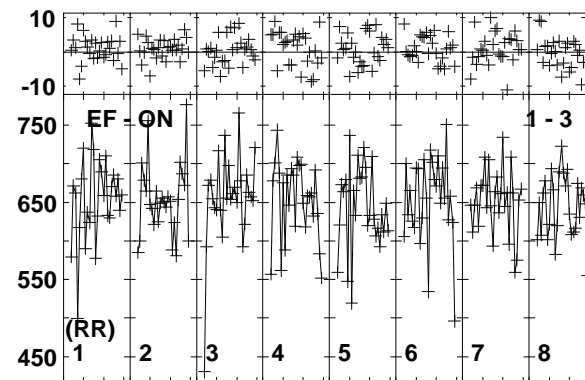
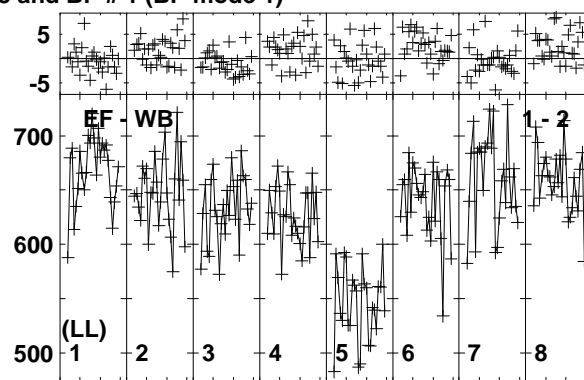
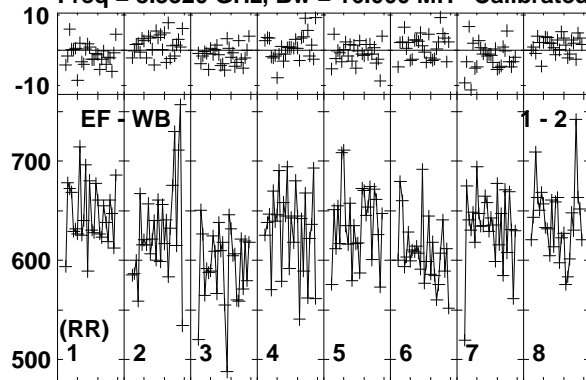

Lower frame: Milli Ampl Jy Top frame: Phas deg
 Vector averaged cross-power spectrum Baseline: EF (01) - WB (02)
 Timerange: 00/06:30:10 to 00/06:30:40

Plot file version 228 created 24-MAR-2014 14:38:38

J1128+5925 EP087F 5.UVDATA.1

Freq = 8.3520 GHz, Bw = 16.000 MH Calibrated with CL # 3 and BP # 1 (BP mode 1)

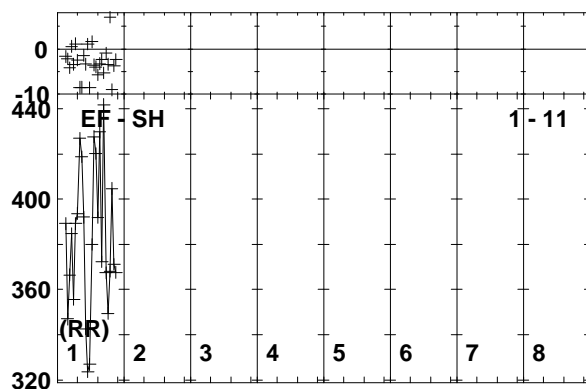
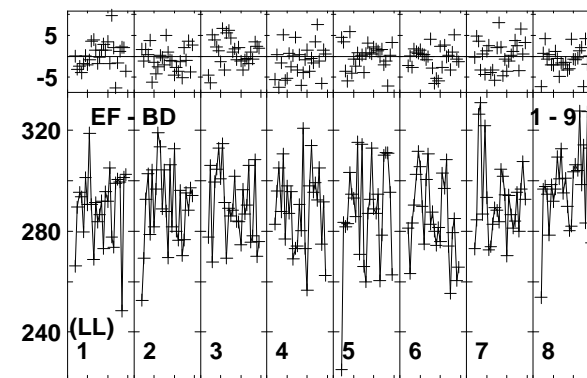
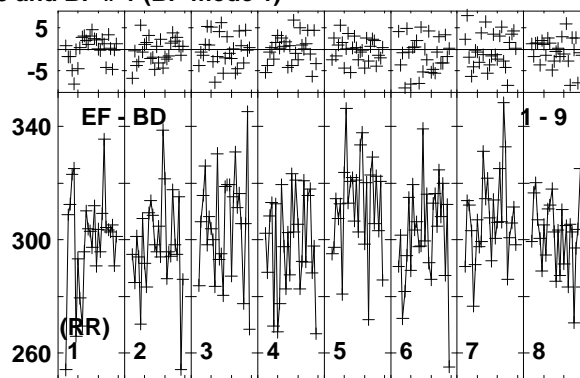
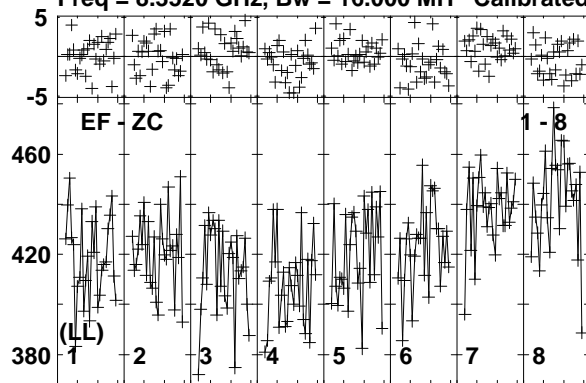

Lower frame: Milli Ampl Jy Top frame: Phas deg
Vector averaged cross-power spectrum Baseline: EF (01) - ZC (08)
Timerange: 00/06:30:10 to 00/06:30:40

Plot file version 229 created 24-MAR-2014 14:38:38
 ARP299D EP087F 5.UVDATA.1
 Freq = 8.3520 GHz, Bw = 16.000 MH Calibrated with CL # 3 and BP # 1 (BP mode 1)

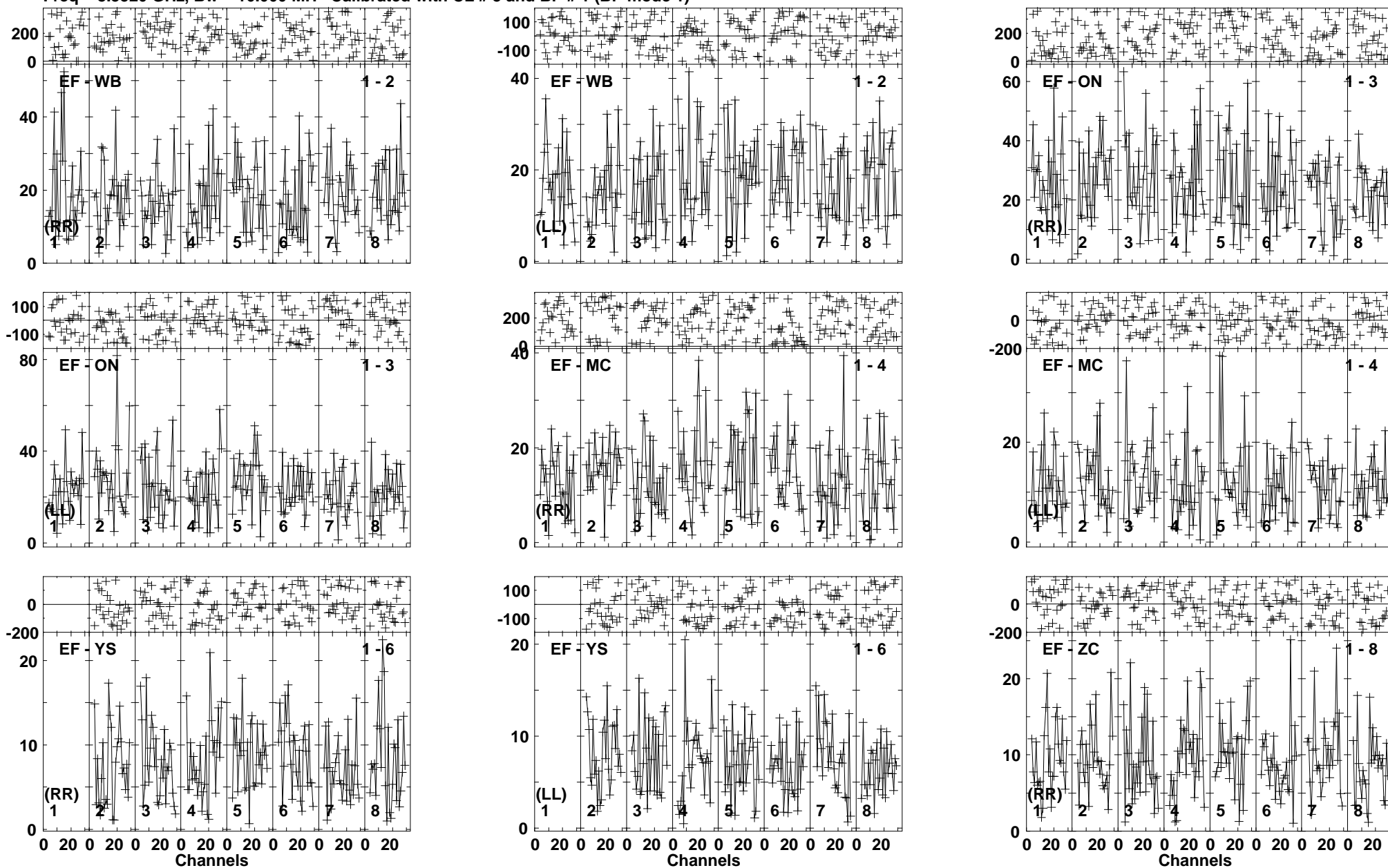

Lower frame: Milli Ampl Jy Top frame: Phas deg
 Vector averaged cross-power spectrum Baseline: EF (01) - WB (02)
 Timerange: 00/06:30:44 to 00/06:33:39

Plot file version 230 created 24-MAR-2014 14:38:39
 ARP299D EP087F 5.UVDATA.1
 Freq = 8.3520 GHz, Bw = 16.000 MH Calibrated with CL # 3 and BP # 1 (BP mode 1)

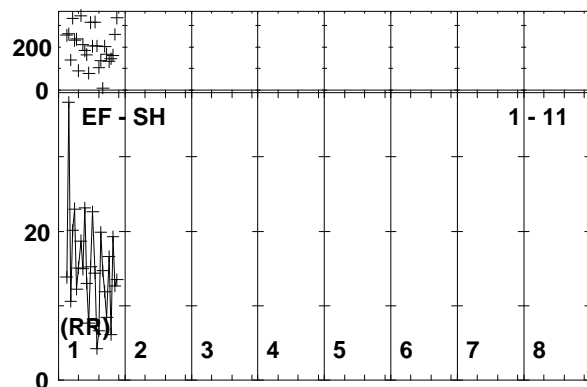
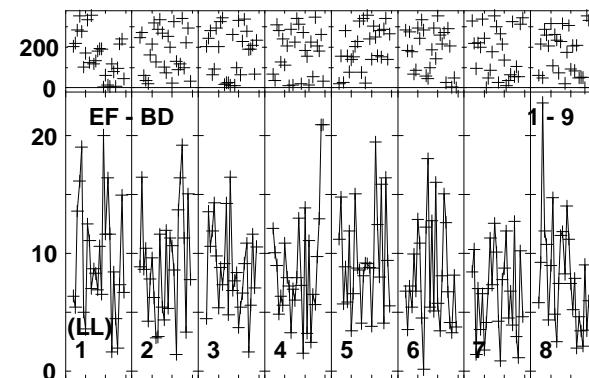
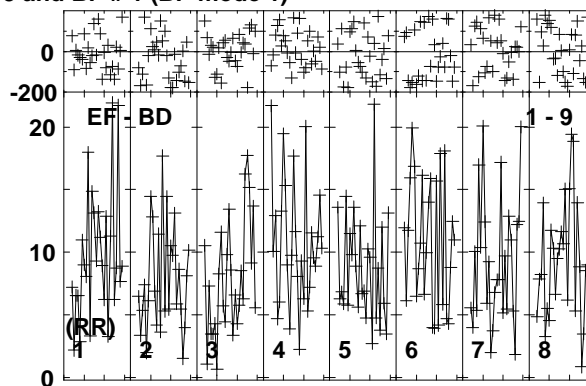
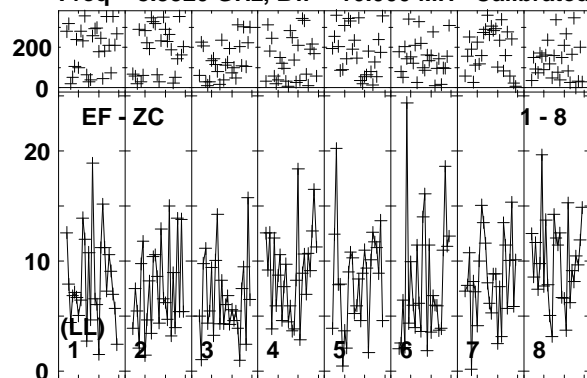

Lower frame: Milli Ampl Jy Top frame: Phas deg
 Vector averaged cross-power spectrum Baseline: EF (01) - ZC (08)
 Timerange: 00/06:30:44 to 00/06:33:39

Plot file version 231 created 24-MAR-2014 14:38:39

J1128+5925 EP087F 5.UVDATA.1

Freq = 8.3520 GHz, Bw = 16.000 MH Calibrated with CL # 3 and BP # 1 (BP mode 1)

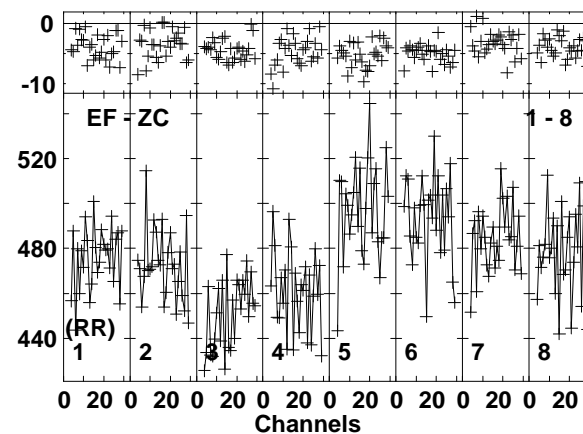
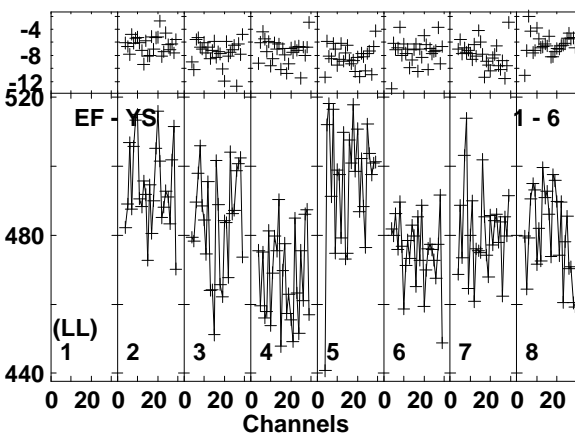
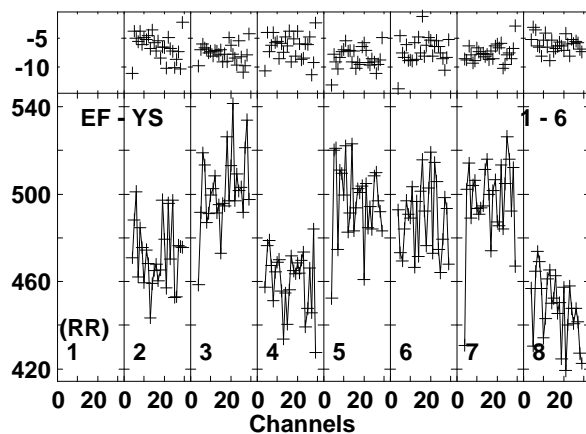
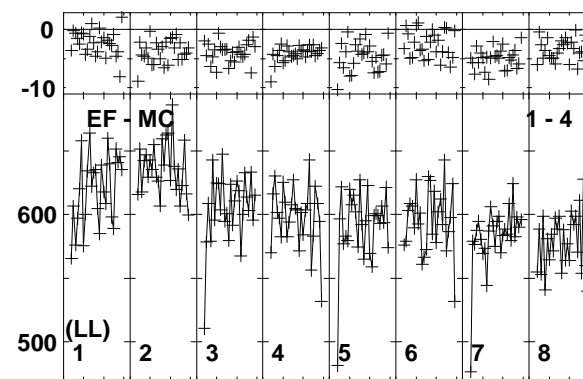
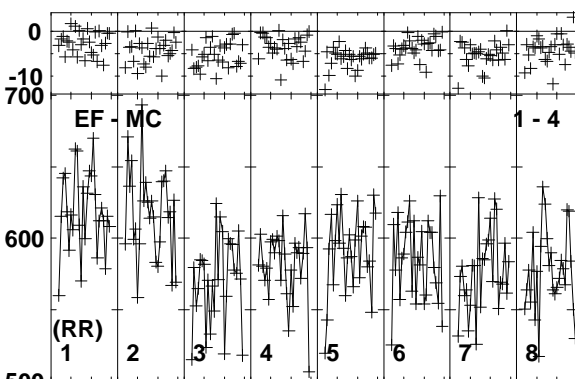
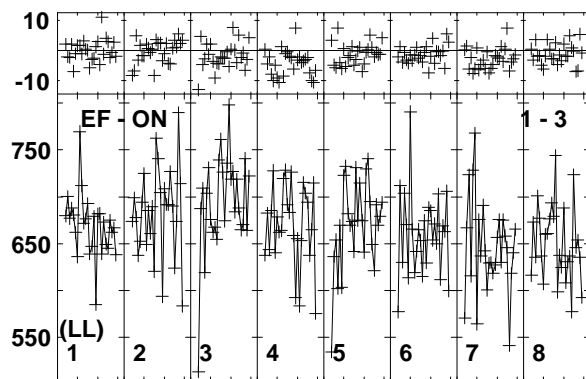
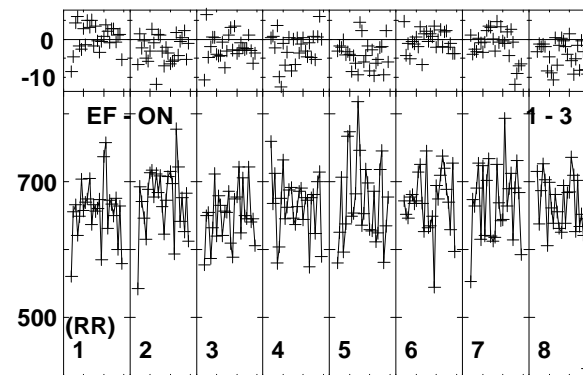
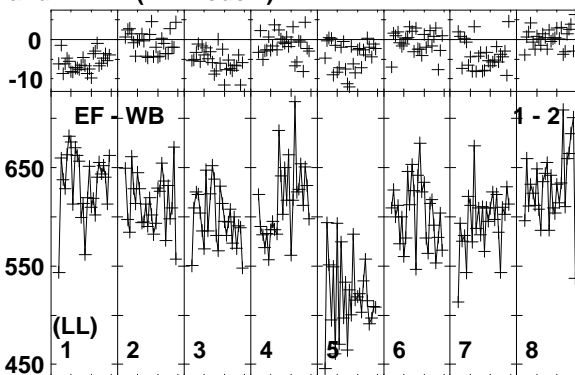
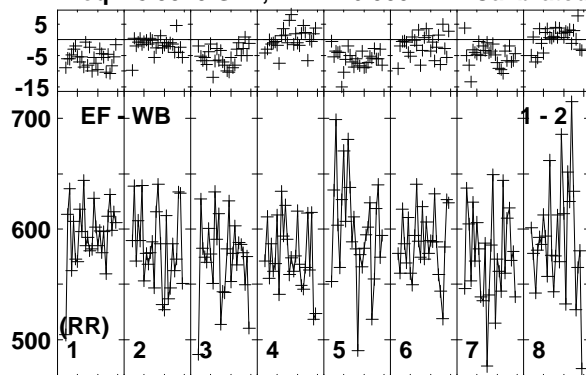

Lower frame: Milli Ampl Jy Top frame: Phas deg
Vector averaged cross-power spectrum Baseline: EF (01) - WB (02)
Timerange: 00/06:33:45 to 00/06:34:45

Plot file version 232 created 24-MAR-2014 14:38:39
J1128+5925 EP087F 5.UVDATA.1
Freq = 8.3520 GHz, Bw = 16.000 MH Calibrated with CL # 3 and BP # 1 (BP mode 1)

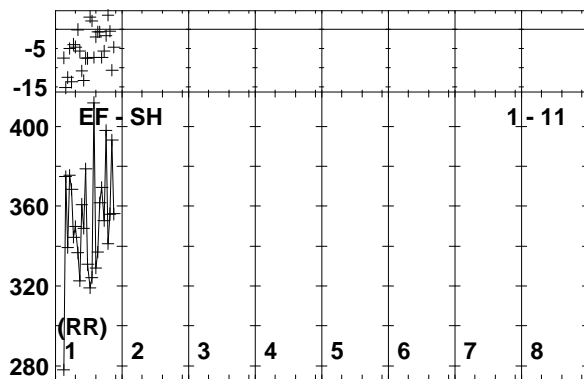
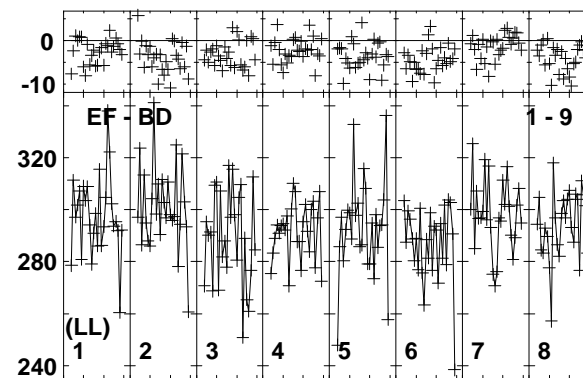
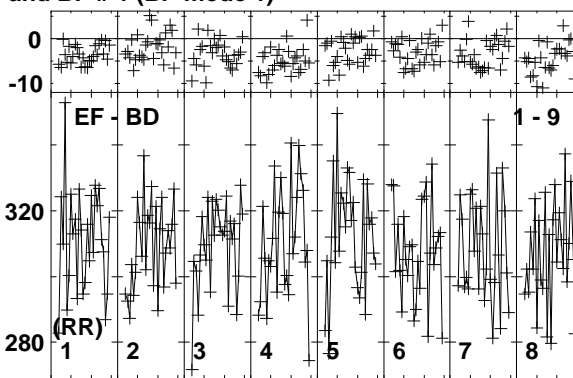
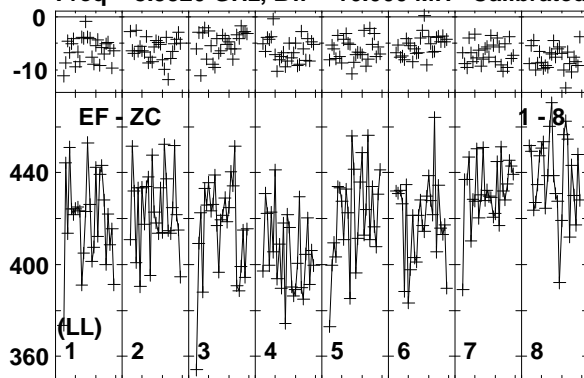

Lower frame: Milli Ampl Jy Top frame: Phas deg
Vector averaged cross-power spectrum Baseline: EF (01) - ZC (08)
Timerange: 00/06:33:45 to 00/06:34:45

Plot file version 233 created 24-MAR-2014 14:38:39

ARP299D EP087F 5.UVDATA.1

Freq = 8.3520 GHz, Bw = 16.000 MH Calibrated with CL # 3 and BP # 1 (BP mode 1)

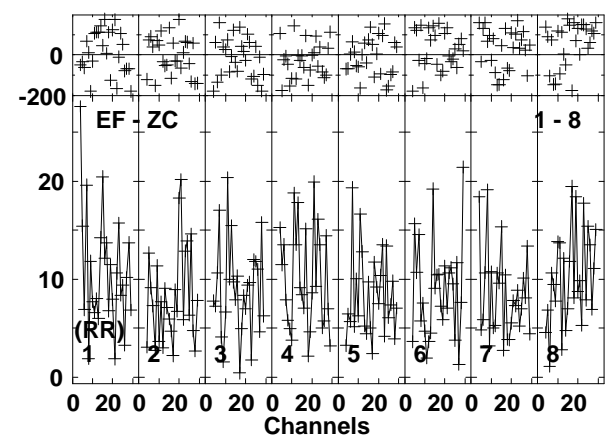
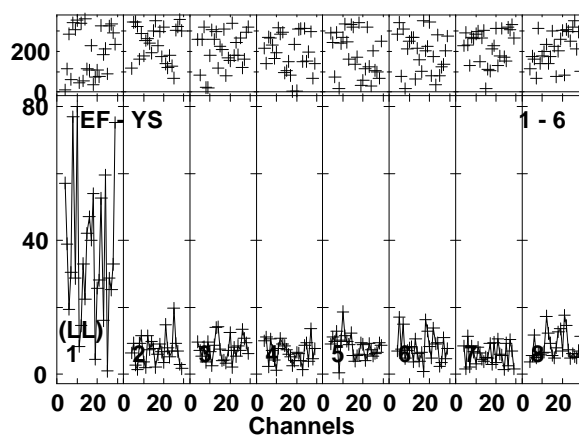
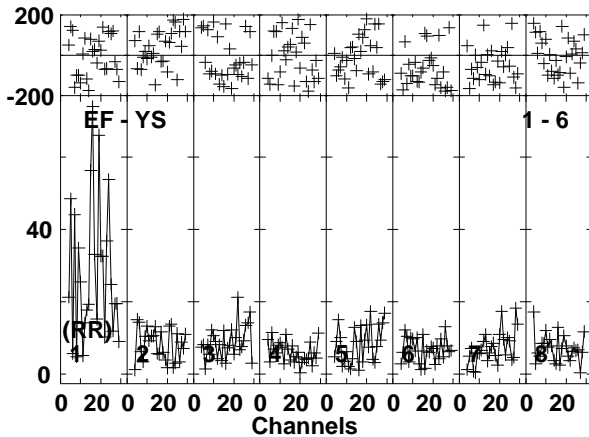
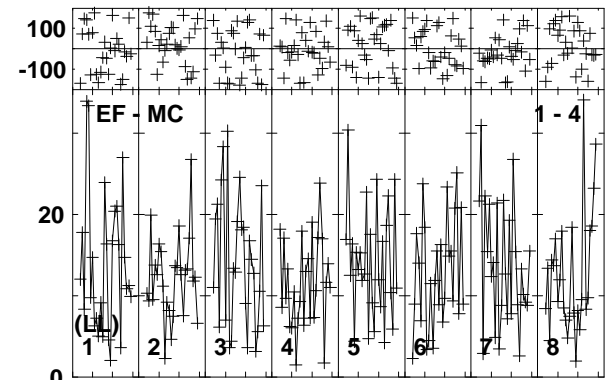
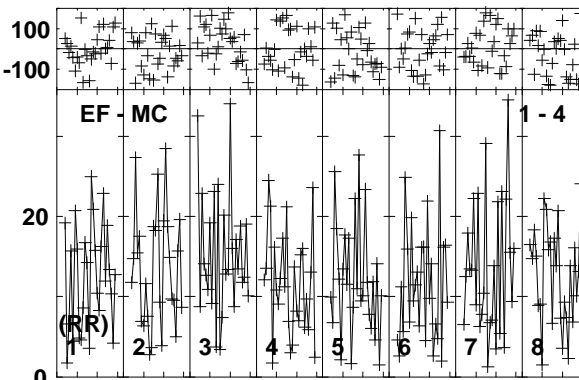
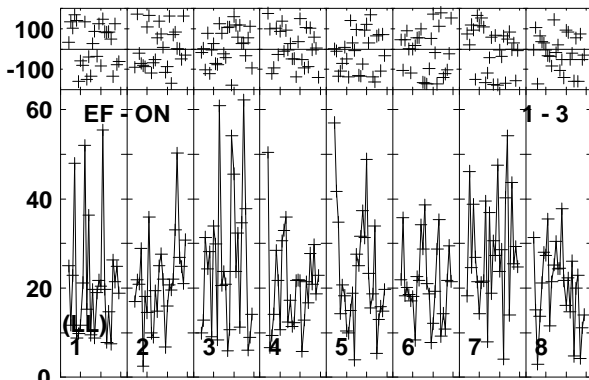
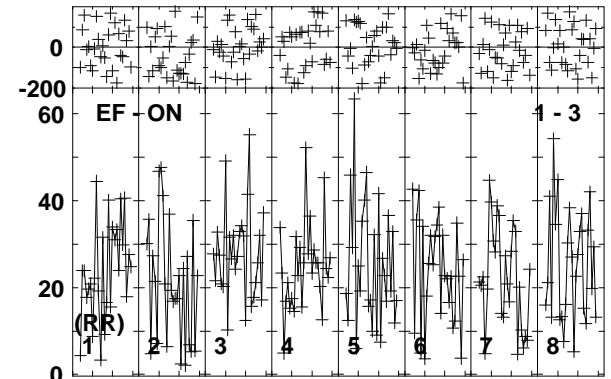
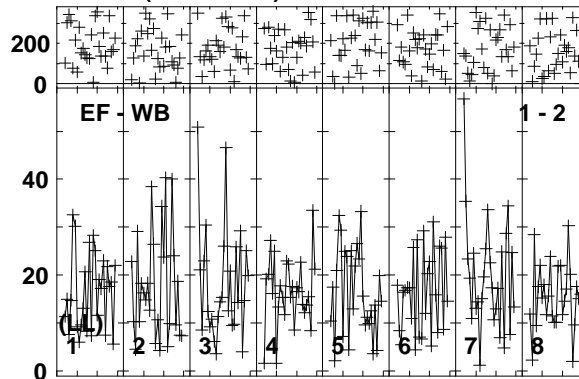
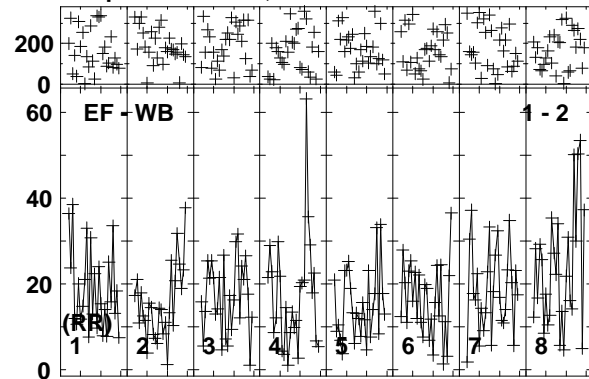

Lower frame: Milli Ampl Jy Top frame: Phas deg
Vector averaged cross-power spectrum Baseline: EF (01) - WB (02)
Timerange: 00/06:34:50 to 00/06:37:45

Plot file version 234 created 24-MAR-2014 14:38:40
 ARP299D EP087F 5.UVDATA.1
 Freq = 8.3520 GHz, Bw = 16.000 MH Calibrated with CL # 3 and BP # 1 (BP mode 1)

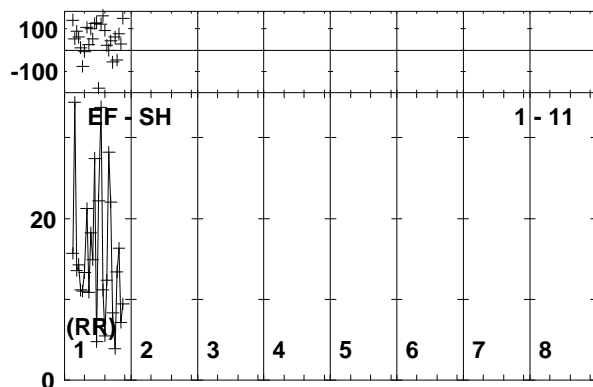
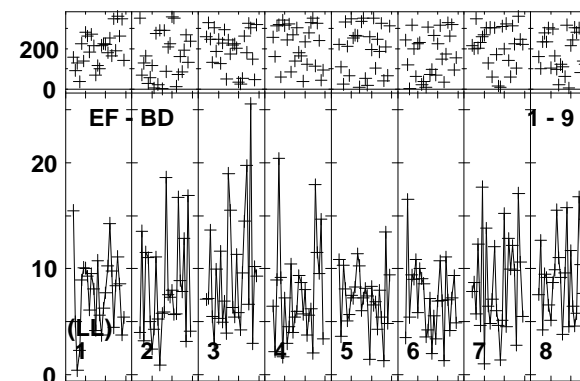
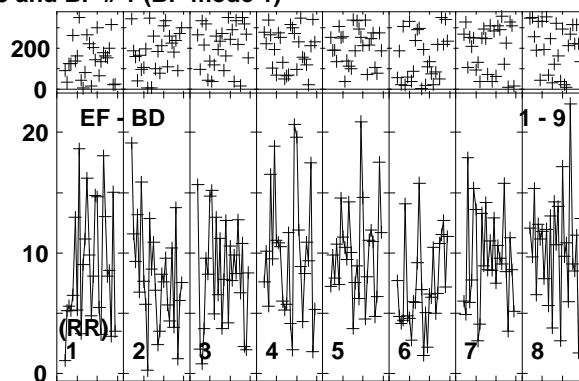
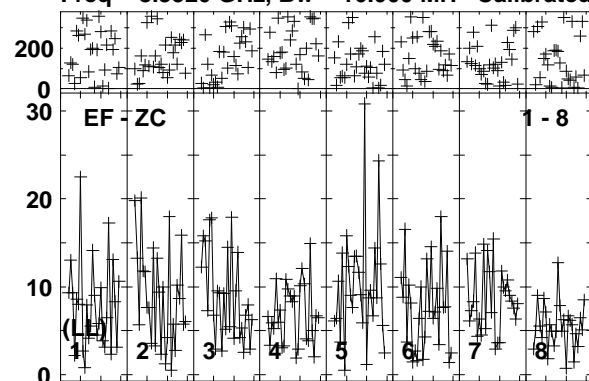

Lower frame: Milli Ampl Jy Top frame: Phas deg
 Vector averaged cross-power spectrum Baseline: EF (01) - ZC (08)
 Timerange: 00/06:34:50 to 00/06:37:45

Plot file version 235 created 24-MAR-2014 14:38:40
 J1128+5925 EP087F 5.UVDATA.1
 Freq = 8.3520 GHz, Bw = 16.000 MH Calibrated with CL # 3 and BP # 1 (BP mode 1)

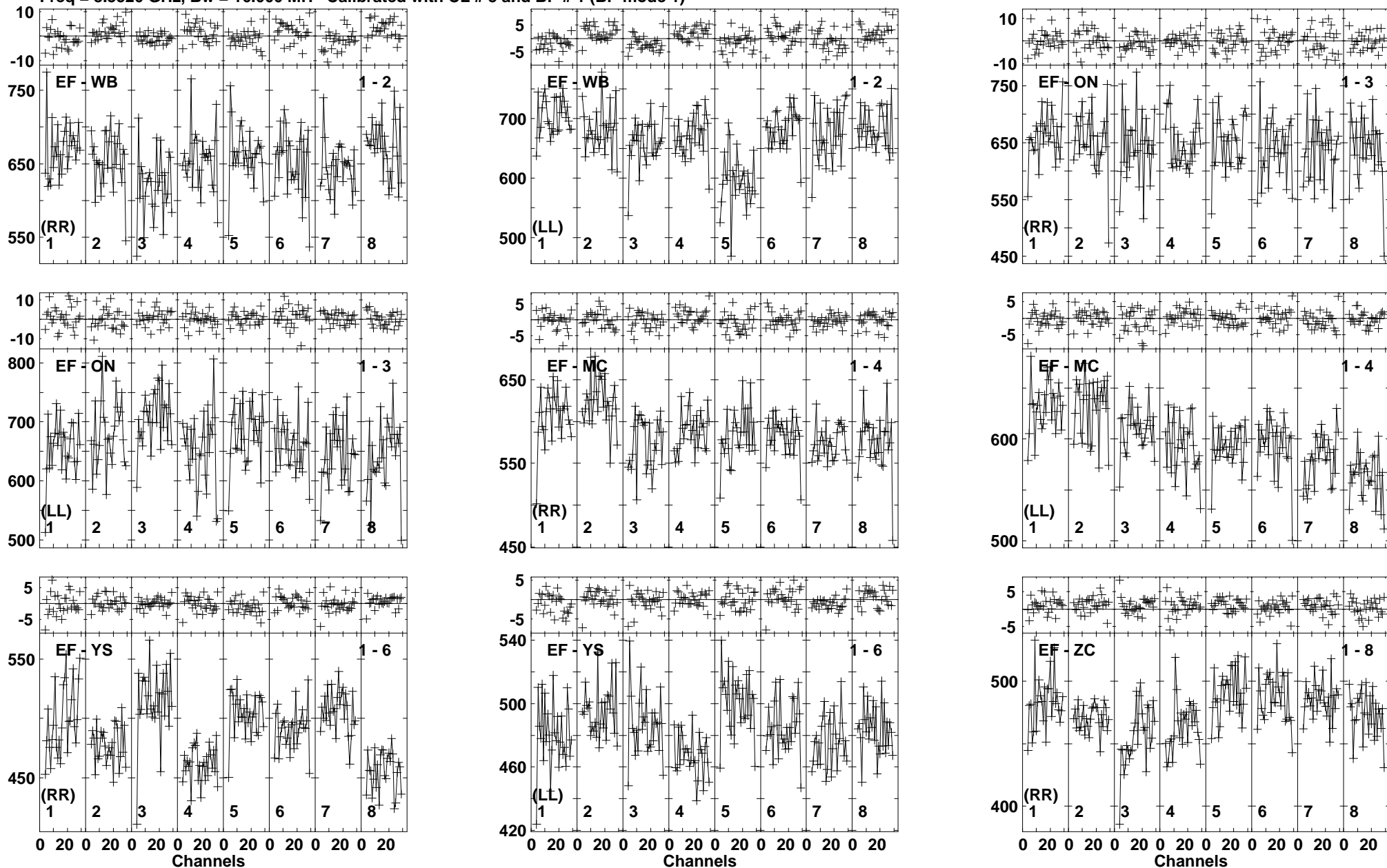

Lower frame: Milli Ampl Jy Top frame: Phas deg
 Vector averaged cross-power spectrum Baseline: EF (01) - WB (02)
 Timerange: 00/06:38:25 to 00/06:38:55

Plot file version 236 created 24-MAR-2014 14:38:40

J1128+5925 EP087F 5.UVDATA.1

Freq = 8.3520 GHz, Bw = 16.000 MH Calibrated with CL # 3 and BP # 1 (BP mode 1)

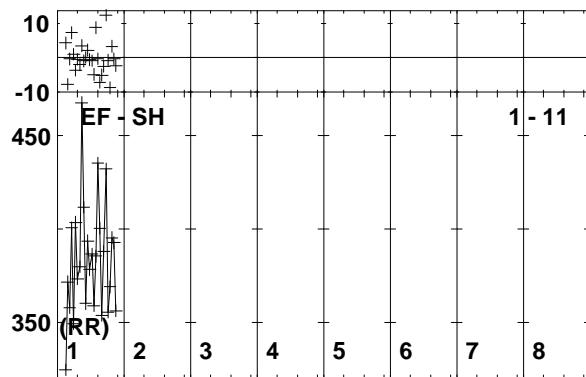
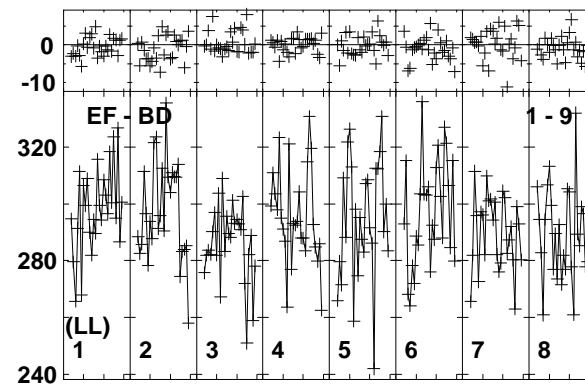
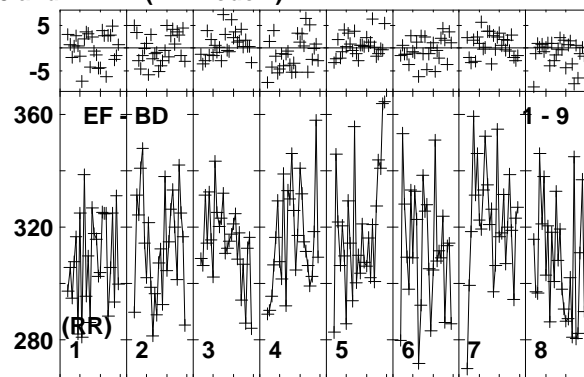
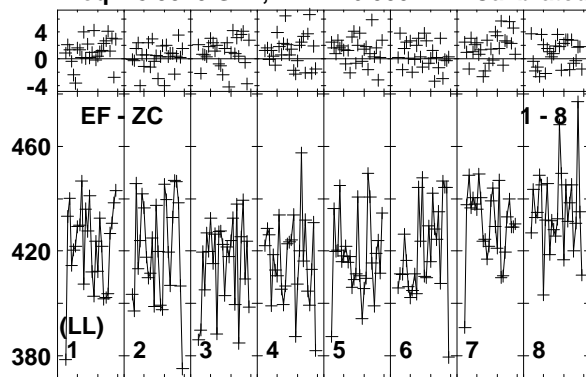

Lower frame: Milli Ampl Jy Top frame: Phas deg
Vector averaged cross-power spectrum Baseline: EF (01) - ZC (08)
Timerange: 00/06:38:25 to 00/06:38:55

Plot file version 237 created 24-MAR-2014 14:38:40
 ARP299D EP087F 5.UVDATA.1
 Freq = 8.3520 GHz, Bw = 16.000 MH Calibrated with CL # 3 and BP # 1 (BP mode 1)

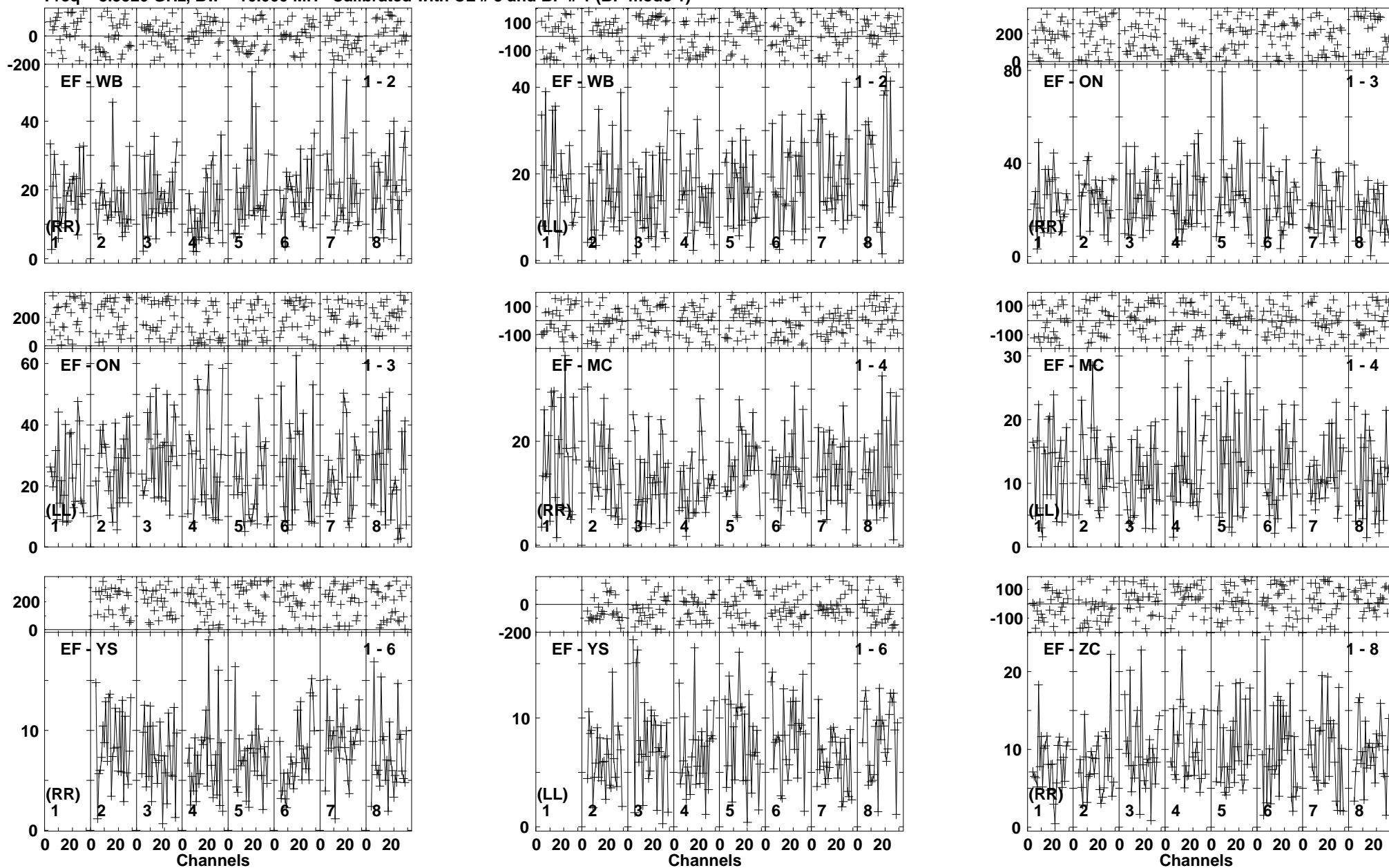

Lower frame: Milli Ampl Jy Top frame: Phas deg
 Vector averaged cross-power spectrum Baseline: EF (01) - WB (02)
 Timerange: 00/06:38:57 to 00/06:41:54

Plot file version 238 created 24-MAR-2014 14:38:40

ARP299D EP087F 5.UVDATA.1

Freq = 8.3520 GHz, Bw = 16.000 MH Calibrated with CL # 3 and BP # 1 (BP mode 1)

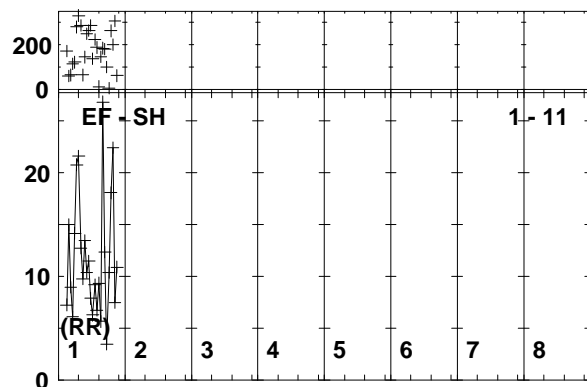
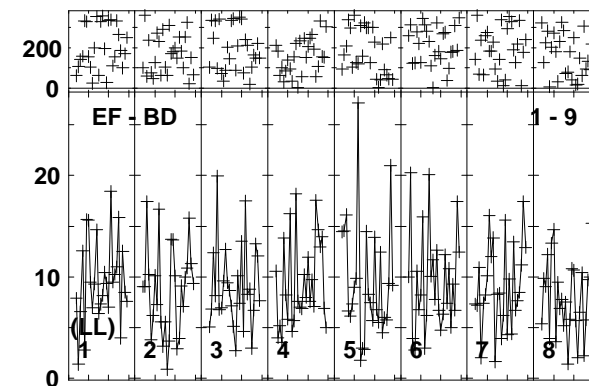
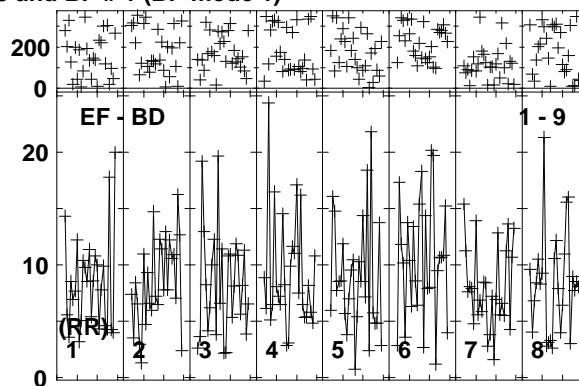
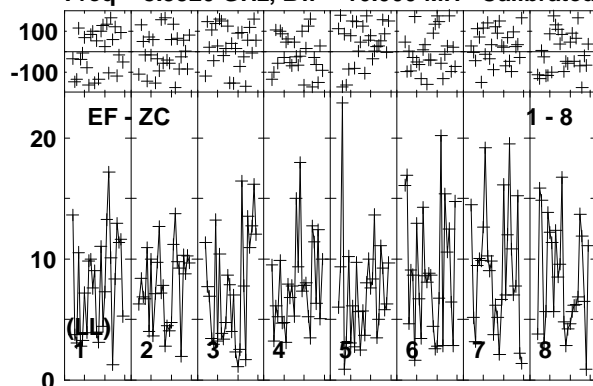

Lower frame: Milli Ampl Jy Top frame: Phas deg
Vector averaged cross-power spectrum Baseline: EF (01) - ZC (08)
Timerange: 00/06:38:57 to 00/06:41:54

Plot file version 239 created 24-MAR-2014 14:38:41

J1128+5925 EP087F 5.UVDATA.1

Freq = 8.3520 GHz, Bw = 16.000 MH Calibrated with CL # 3 and BP # 1 (BP mode 1)

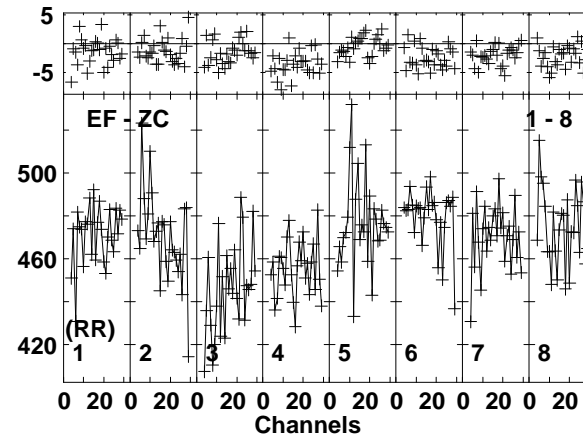
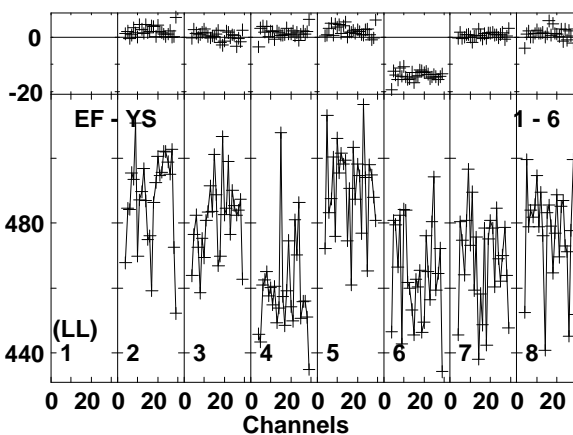
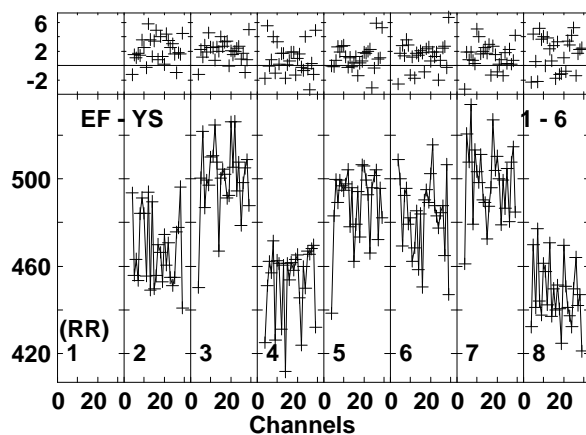
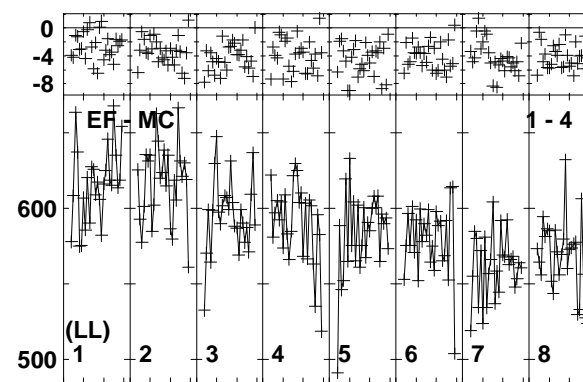
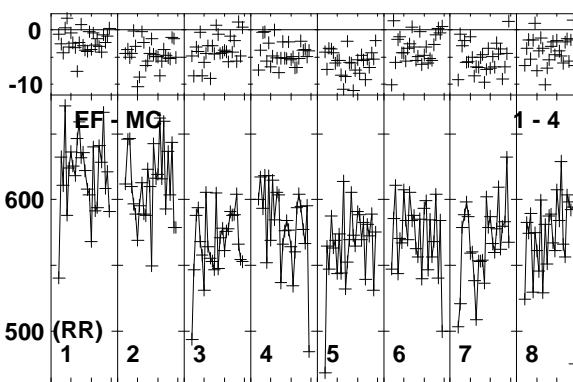
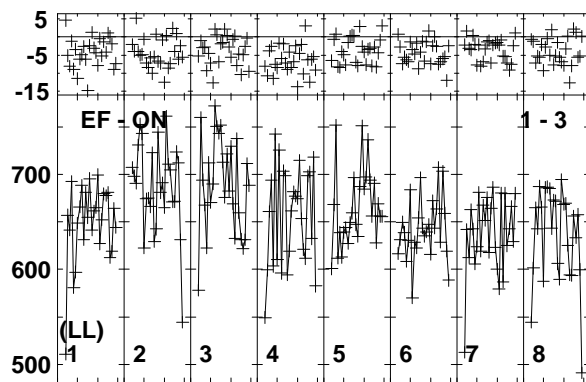
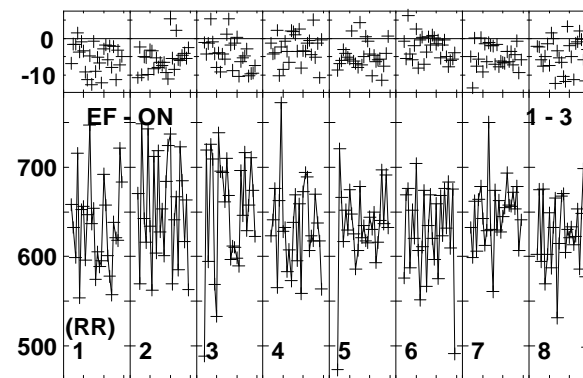
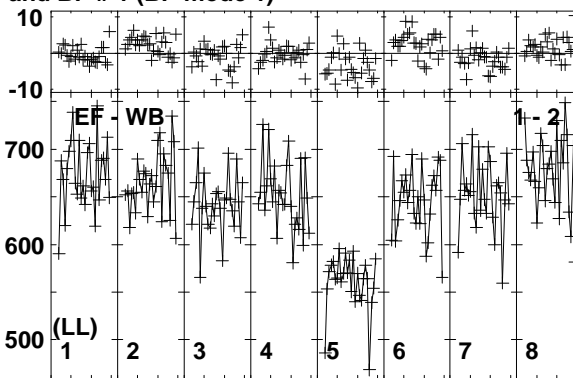
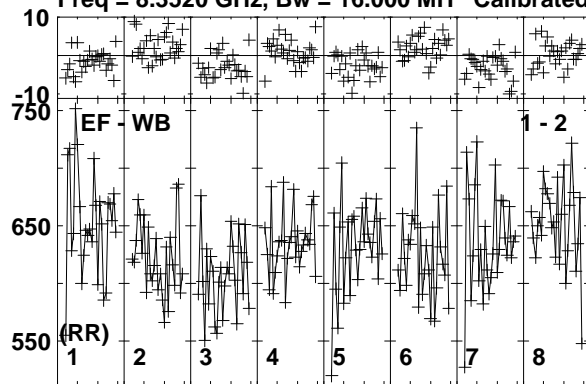

Lower frame: Milli Ampl Jy Top frame: Phas deg
Vector averaged cross-power spectrum Baseline: EF (01) - WB (02)
Timerange: 00/06:41:58 to 00/06:42:59

Plot file version 240 created 24-MAR-2014 14:38:41

J1128+5925 EP087F 5.UVDATA.1

Freq = 8.3520 GHz, Bw = 16.000 MH Calibrated with CL # 3 and BP # 1 (BP mode 1)

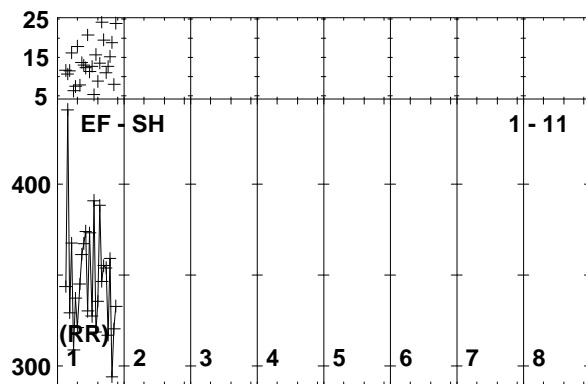
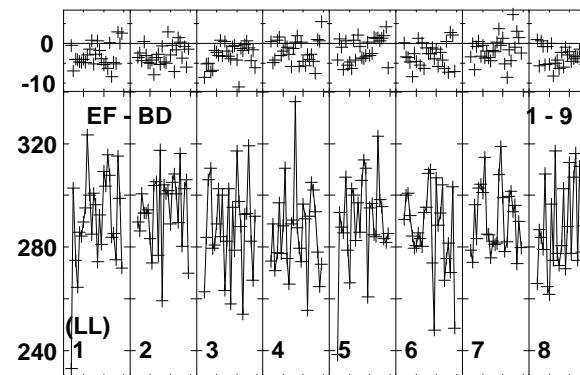
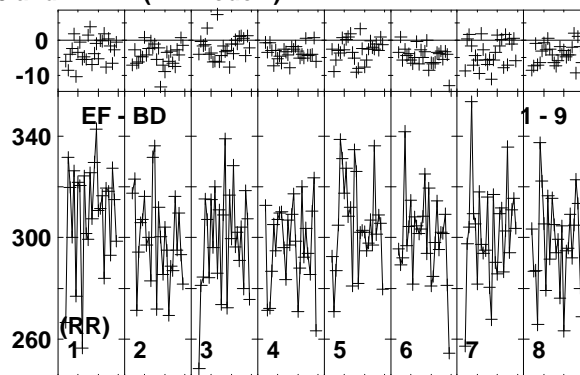
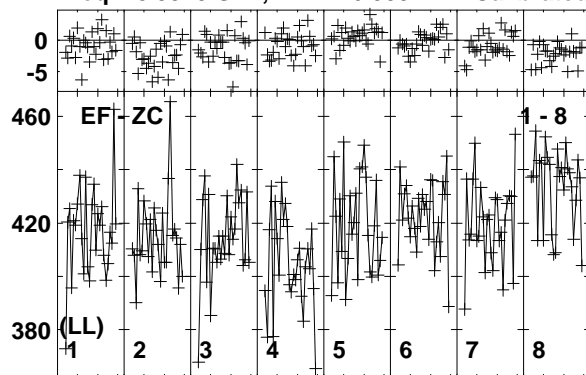

Lower frame: Milli Ampl Jy Top frame: Phas deg
Vector averaged cross-power spectrum Baseline: EF (01) - ZC (08)
Timerange: 00/06:41:58 to 00/06:42:59

Plot file version 241 created 24-MAR-2014 14:38:41
 ARP299D EP087F 5.UVDATA.1
 Freq = 8.3520 GHz, Bw = 16.000 MH Calibrated with CL # 3 and BP # 1 (BP mode 1)

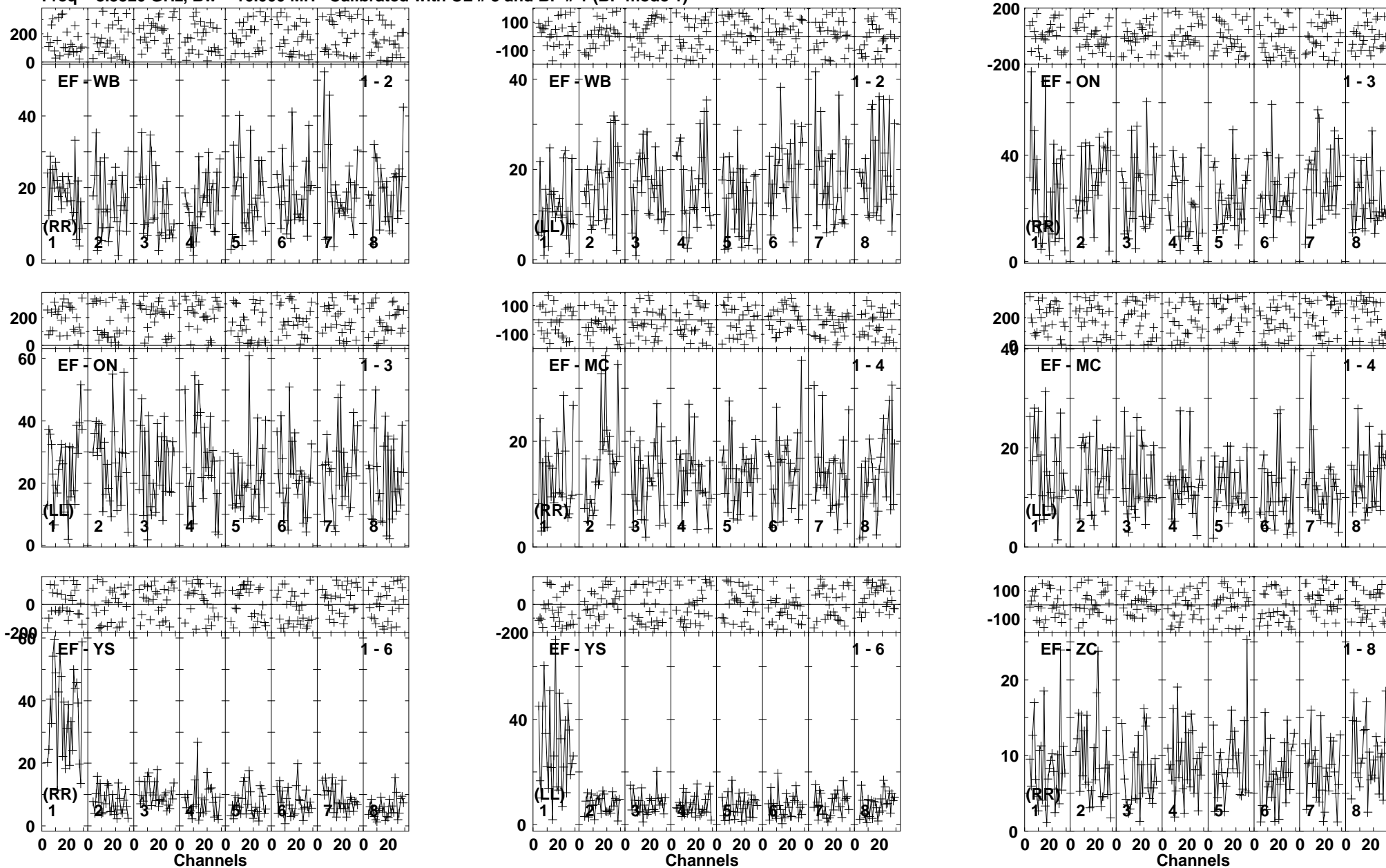

Lower frame: Milli Ampl Jy Top frame: Phas deg
 Vector averaged cross-power spectrum Baseline: EF (01) - WB (02)
 Timerange: 00/06:43:04 to 00/06:46:00

Plot file version 242 created 24-MAR-2014 14:38:41
ARP299D EP087F 5.UVDATA.1
Freq = 8.3520 GHz, Bw = 16.000 MH Calibrated with CL # 3 and BP # 1 (BP mode 1)

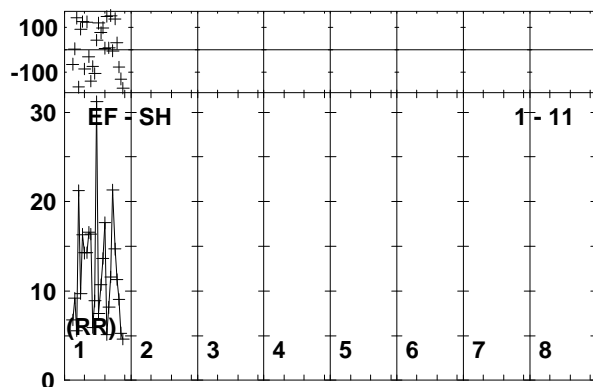
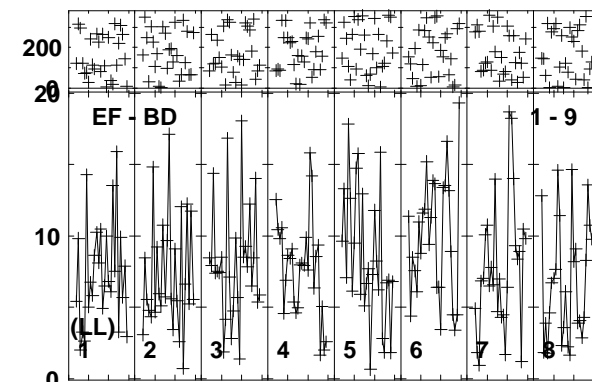
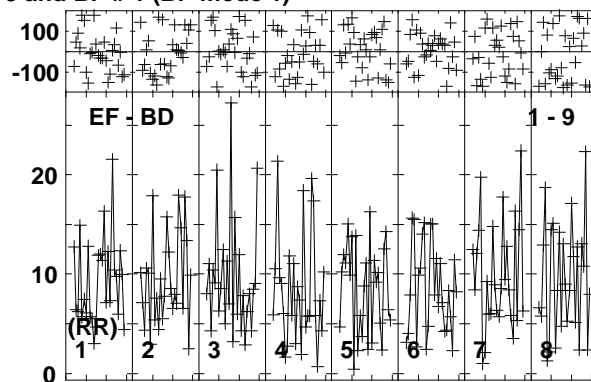
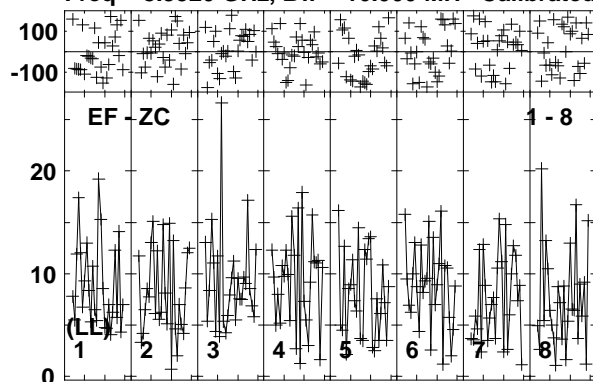

Lower frame: Milli Ampl Jy Top frame: Phas deg
Vector averaged cross-power spectrum Baseline: EF (01) - ZC (08)
Timerange: 00/06:43:04 to 00/06:46:00

Plot file version 243 created 24-MAR-2014 14:38:42

J1128+5925 EP087F 5.UVDATA.1

Freq = 8.3520 GHz, Bw = 16.000 MH Calibrated with CL # 3 and BP # 1 (BP mode 1)

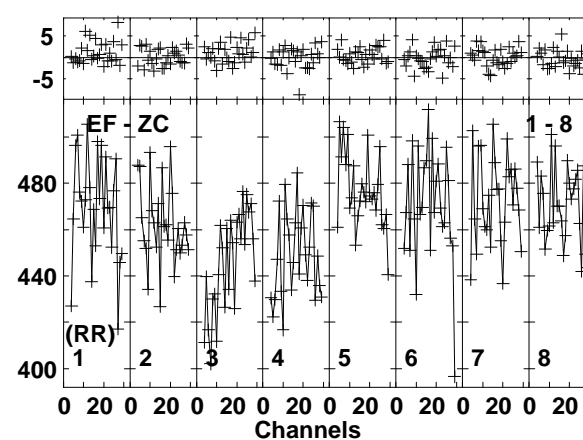
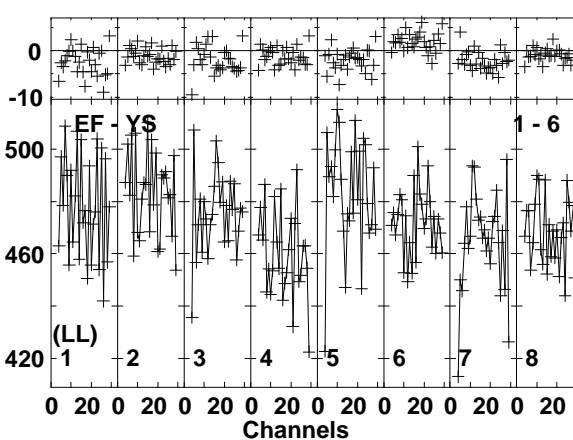
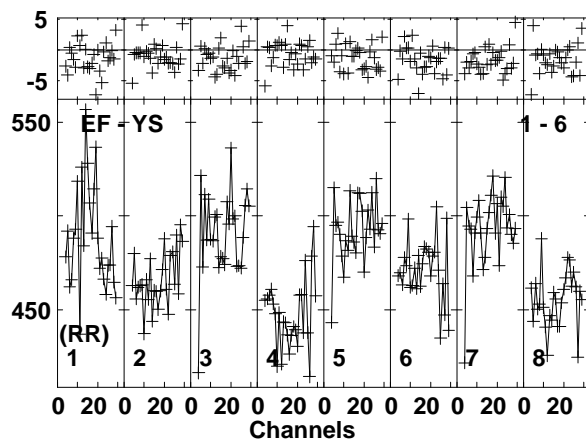
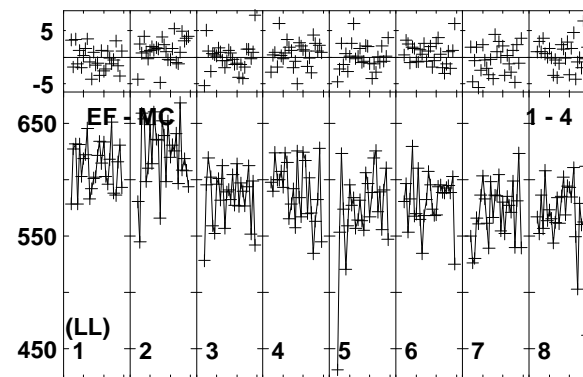
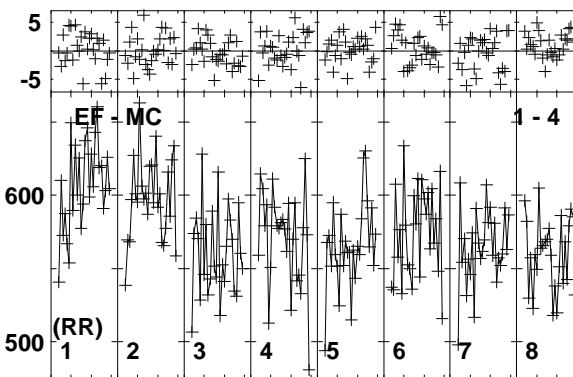
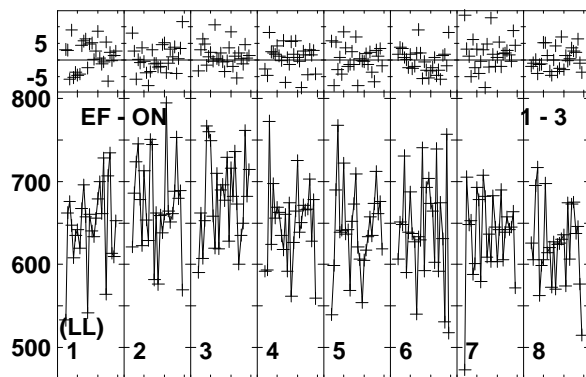
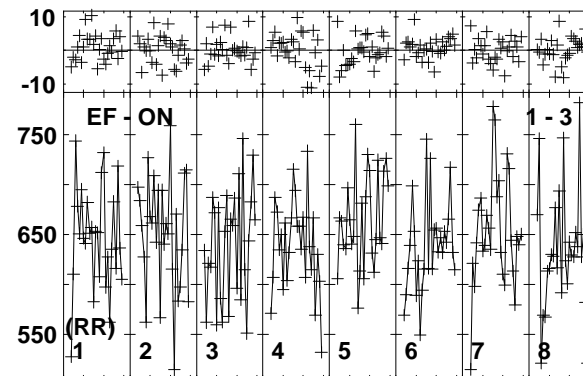
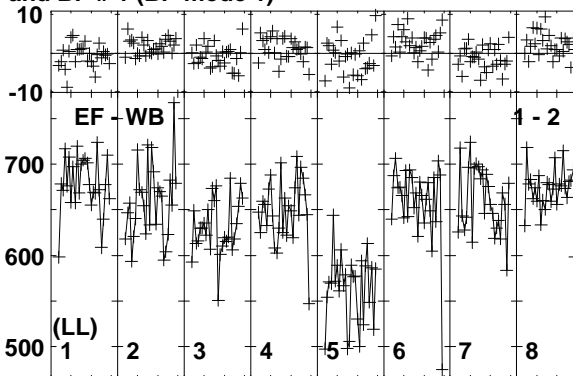
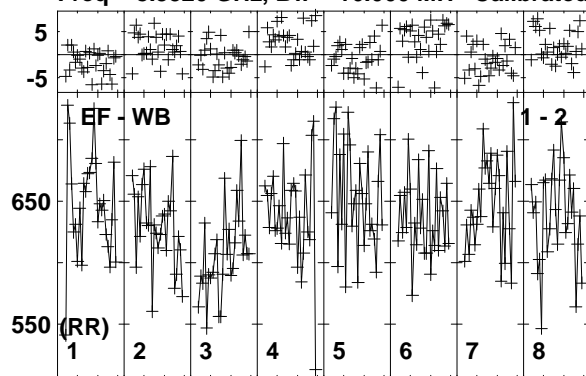

Lower frame: Milli Ampl Jy Top frame: Phas deg
Vector averaged cross-power spectrum Baseline: EF (01) - WB (02)
Timerange: 00/06:46:40 to 00/06:47:10

Plot file version 244 created 24-MAR-2014 14:38:42

J1128+5925 EP087F 5.UVDATA.1

Freq = 8.3520 GHz, Bw = 16.000 MH Calibrated with CL # 3 and BP # 1 (BP mode 1)

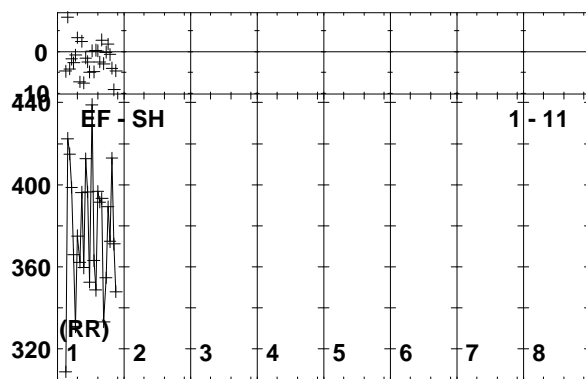
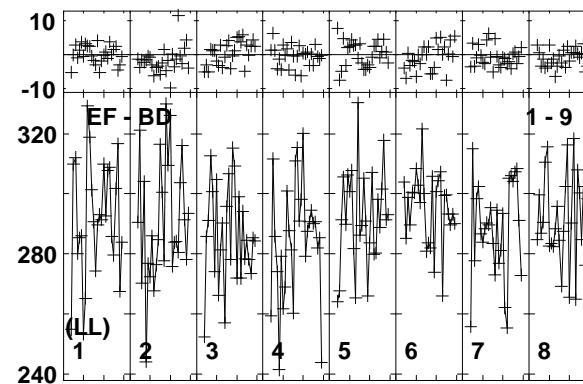
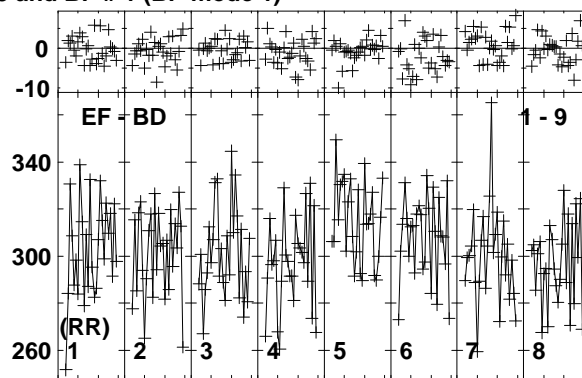
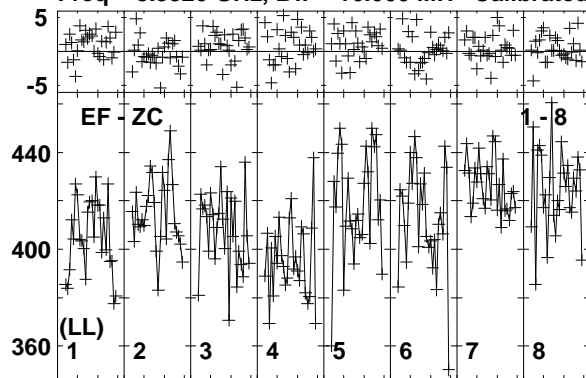

Lower frame: Milli Ampl Jy Top frame: Phas deg
Vector averaged cross-power spectrum Baseline: EF (01) - ZC (08)
Timerange: 00/06:46:40 to 00/06:47:10

Plot file version 245 created 24-MAR-2014 14:38:42

ARP299D EP087F 5.UVDATA.1

Freq = 8.3520 GHz, Bw = 16.000 MH Calibrated with CL # 3 and BP # 1 (BP mode 1)

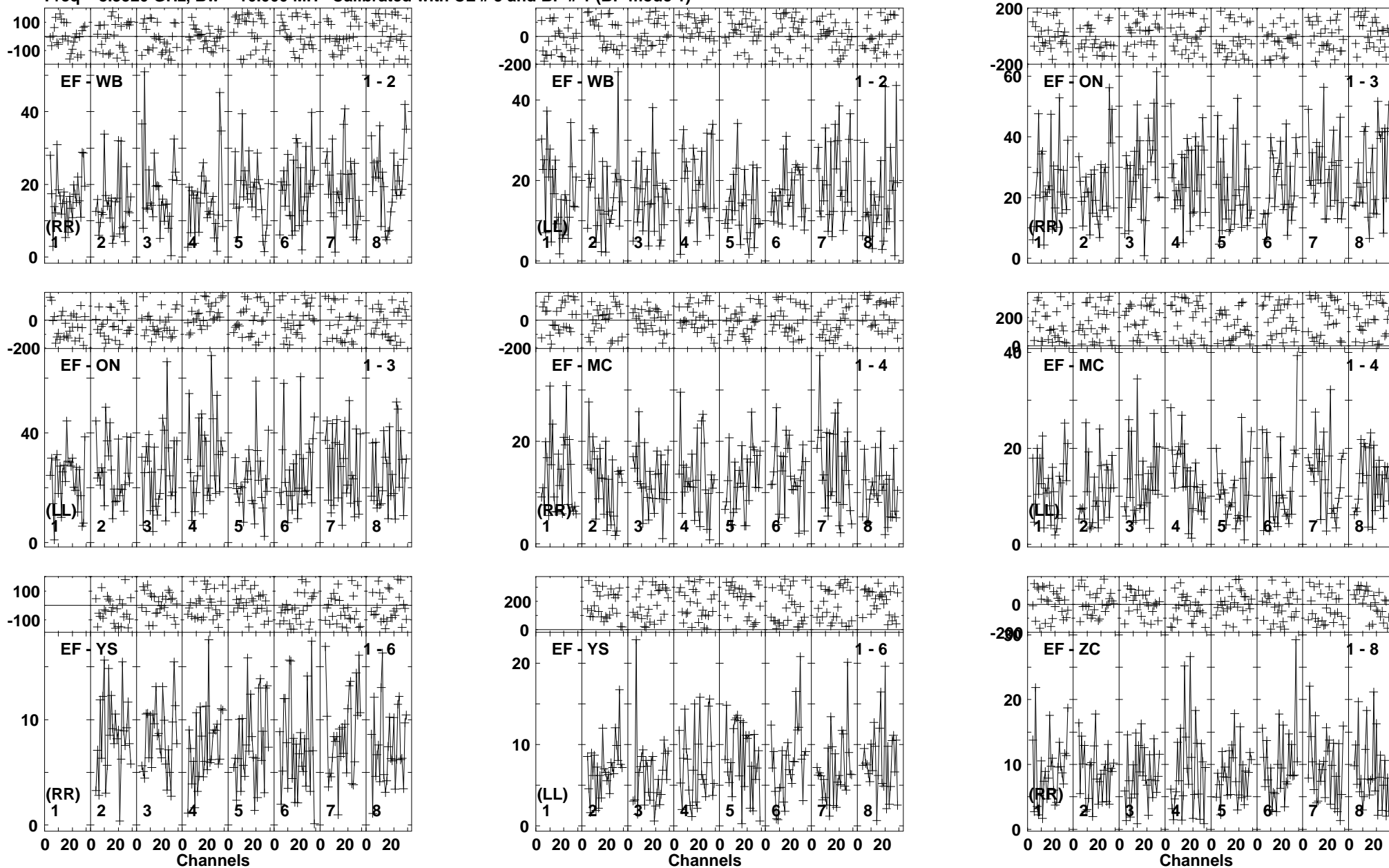

Lower frame: Milli Ampl Jy Top frame: Phas deg
Vector averaged cross-power spectrum Baseline: EF (01) - WB (02)
Timerange: 00/06:47:13 to 00/06:50:10

Plot file version 246 created 24-MAR-2014 14:38:42

ARP299D EP087F 5.UVDATA.1

Freq = 8.3520 GHz, Bw = 16.000 MH Calibrated with CL # 3 and BP # 1 (BP mode 1)

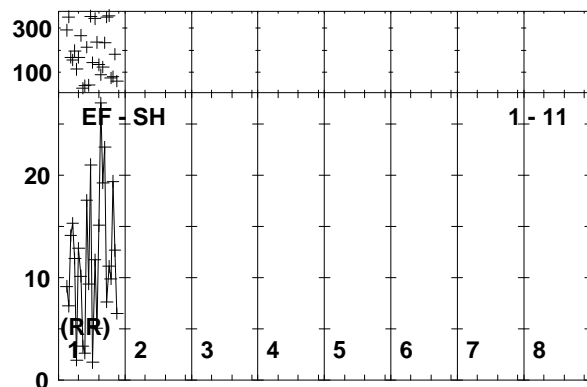
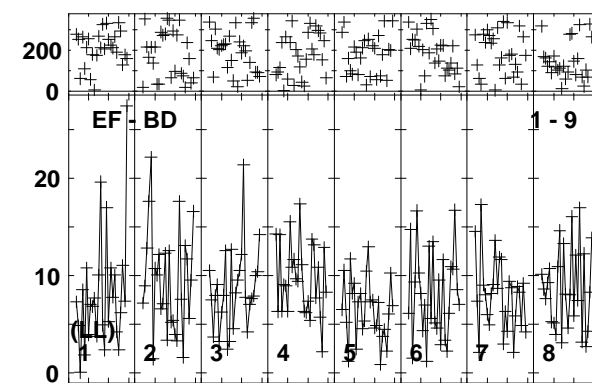
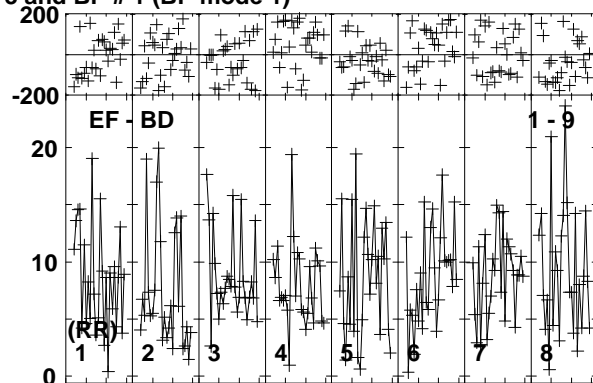
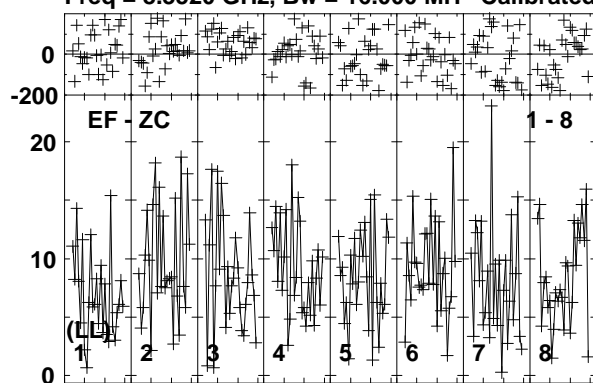

Lower frame: Milli Ampl Jy Top frame: Phas deg
Vector averaged cross-power spectrum Baseline: EF (01) - ZC (08)
Timerange: 00/06:47:13 to 00/06:50:10

Plot file version 247 created 24-MAR-2014 14:38:43

J1128+5925 EP087F 5.UVDATA.1

Freq = 8.3520 GHz, Bw = 16.000 MH Calibrated with CL # 3 and BP # 1 (BP mode 1)

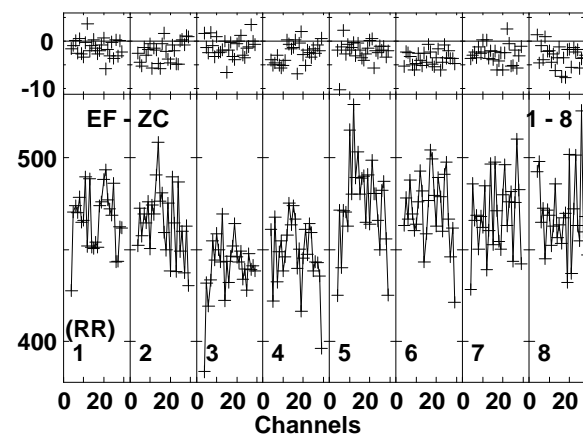
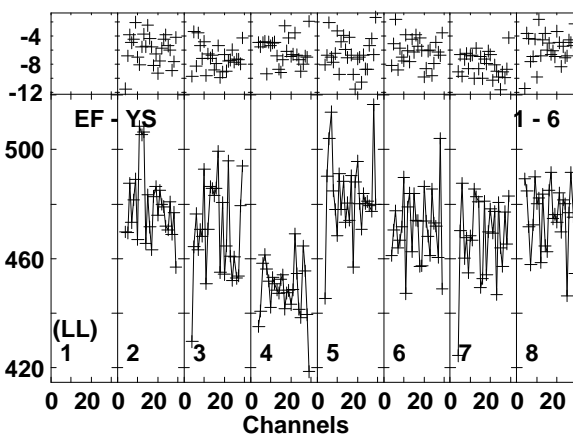
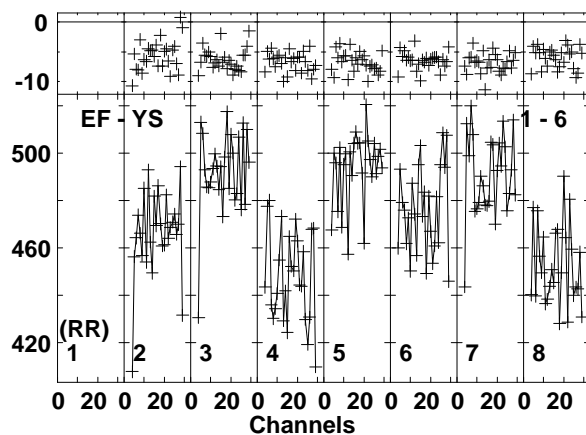
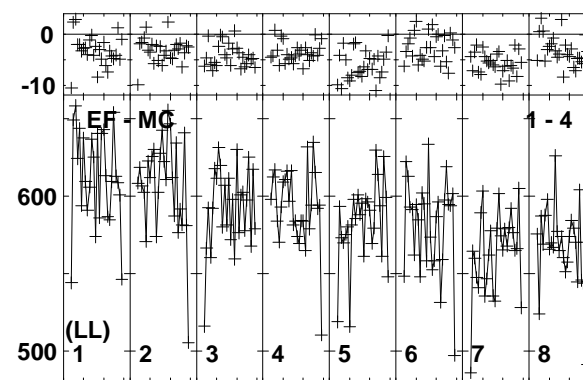
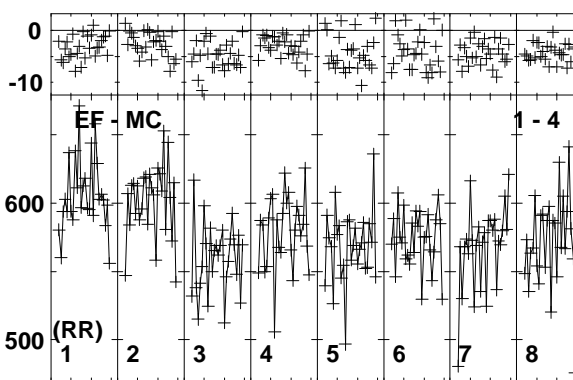
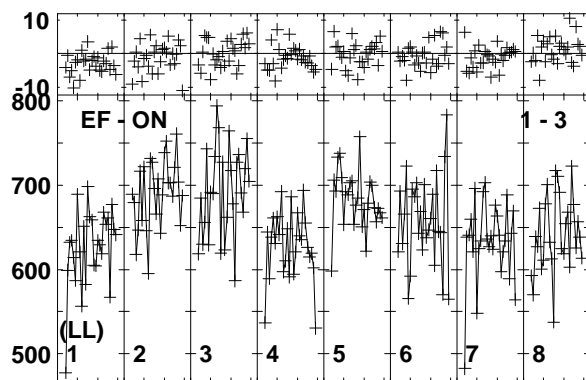
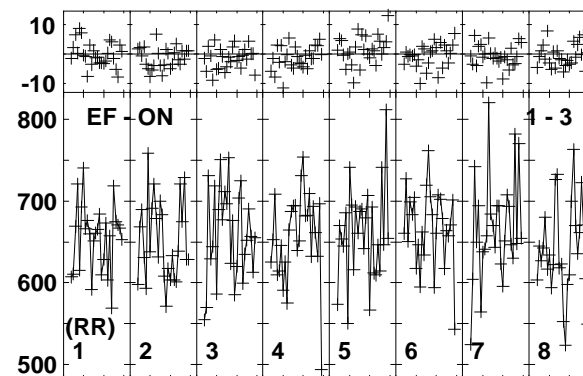
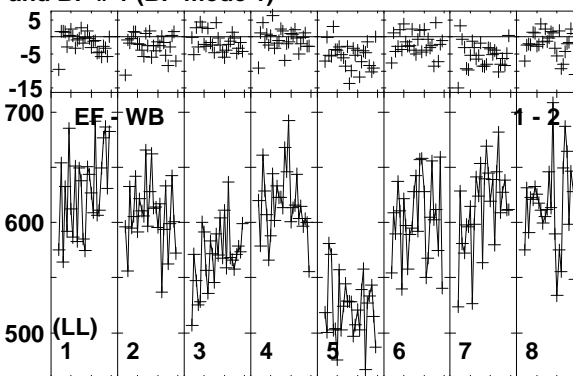
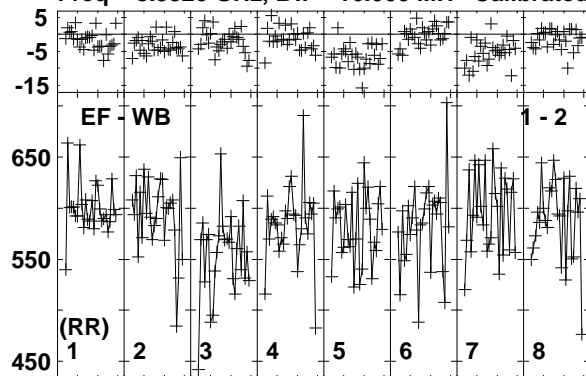

Lower frame: Milli Ampl Jy Top frame: Phas deg
Vector averaged cross-power spectrum Baseline: EF (01) - WB (02)
Timerange: 00/06:50:13 to 00/06:51:14

Plot file version 248 created 24-MAR-2014 14:38:43

J1128+5925 EP087F 5.UVDATA.1

Freq = 8.3520 GHz, Bw = 16.000 MH Calibrated with CL # 3 and BP # 1 (BP mode 1)

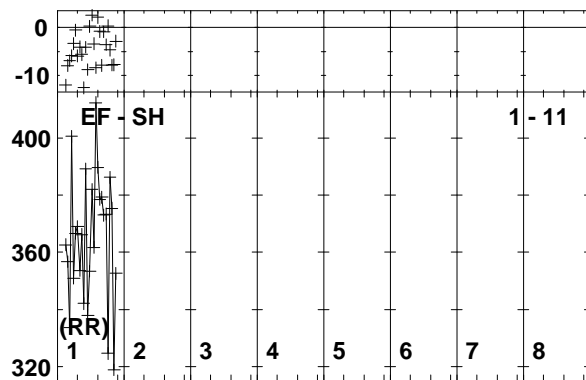
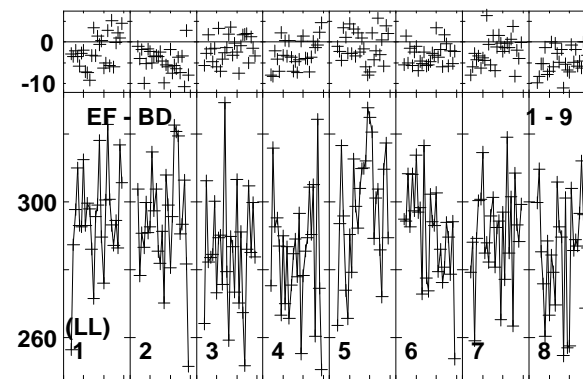
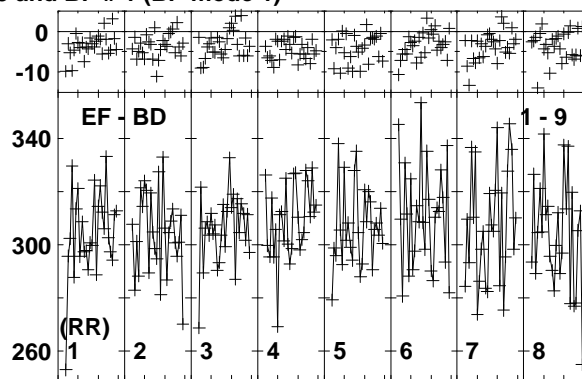
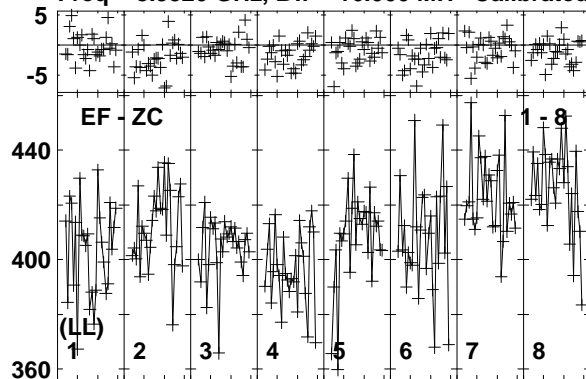

Lower frame: Milli Ampl Jy Top frame: Phas deg
Vector averaged cross-power spectrum Baseline: EF (01) - ZC (08)
Timerange: 00/06:50:13 to 00/06:51:14

Plot file version 249 created 24-MAR-2014 14:38:43

ARP299D EP087F 5.UVDATA.1

Freq = 8.3520 GHz, Bw = 16.000 MH Calibrated with CL # 3 and BP # 1 (BP mode 1)

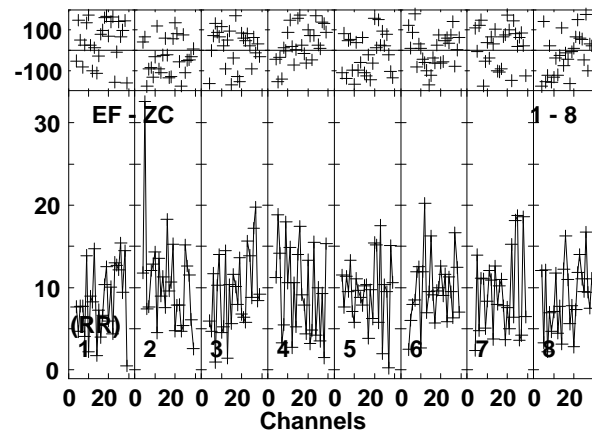
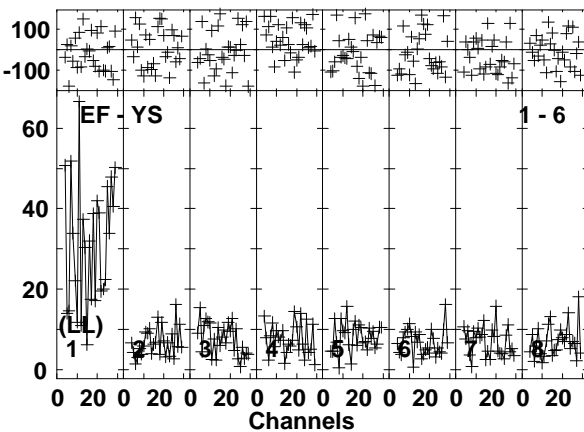
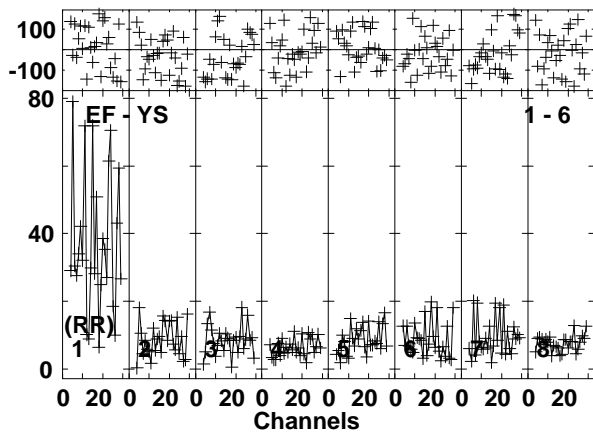
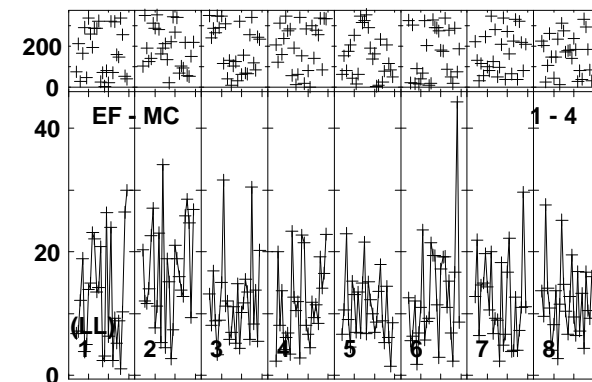
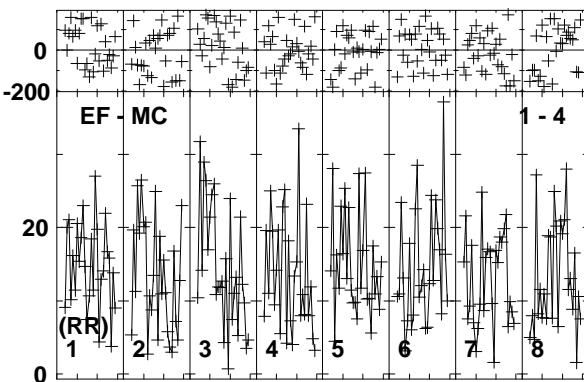
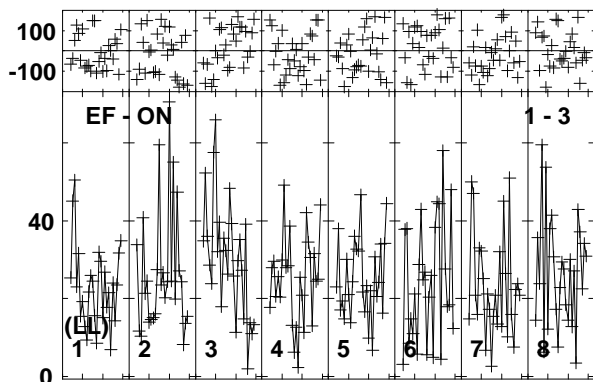
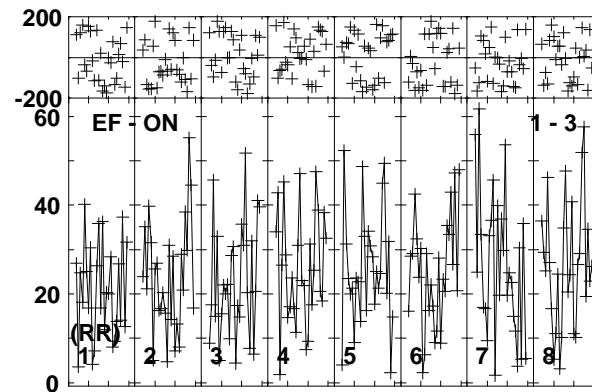
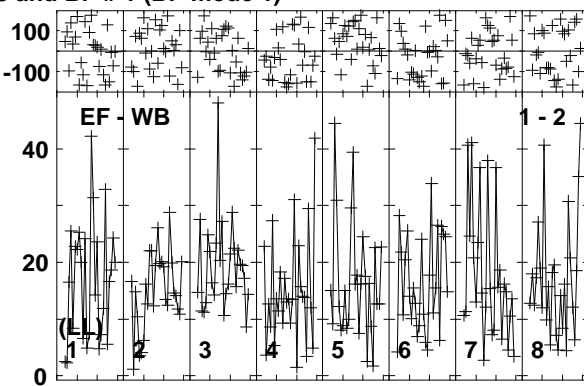
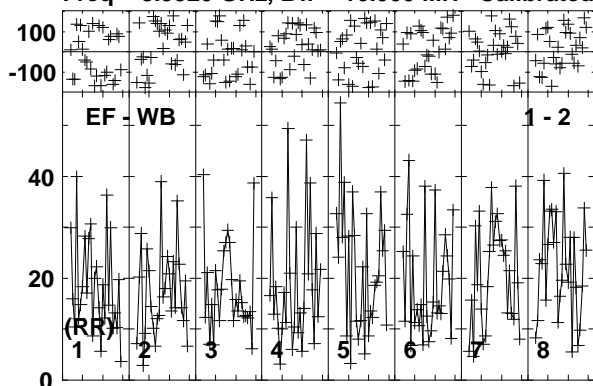

Lower frame: Milli Ampl Jy Top frame: Phas deg
Vector averaged cross-power spectrum Baseline: EF (01) - WB (02)
Timerange: 00/06:51:18 to 00/06:54:14

Plot file version 250 created 24-MAR-2014 14:38:43
 ARP299D EP087F 5.UVDATA.1
 Freq = 8.3520 GHz, Bw = 16.000 MH Calibrated with CL # 3 and BP # 1 (BP mode 1)

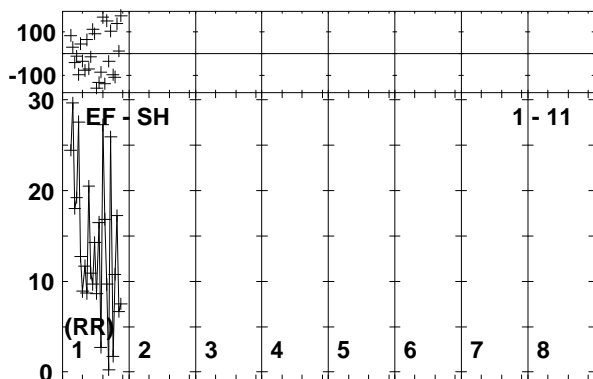
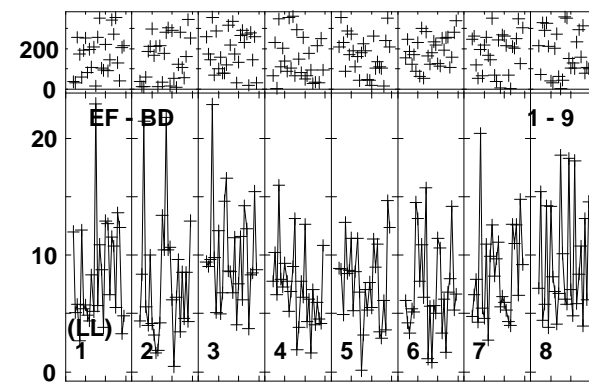
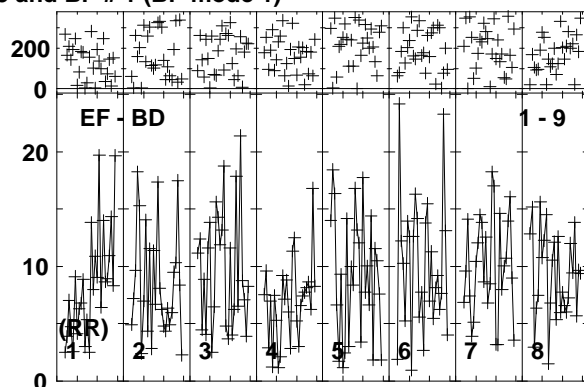
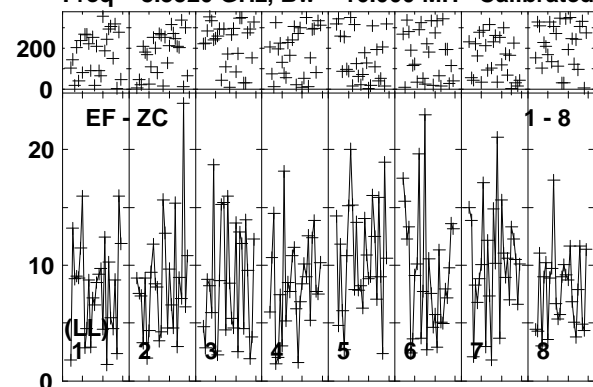

Lower frame: Milli Ampl Jy Top frame: Phas deg
 Vector averaged cross-power spectrum Baseline: EF (01) - ZC (08)
 Timerange: 00/06:51:18 to 00/06:54:14

Plot file version 251 created 24-MAR-2014 14:38:44

J1128+5925 EP087F 5.UVDATA.1

Freq = 8.3520 GHz, Bw = 16.000 MH Calibrated with CL # 3 and BP # 1 (BP mode 1)

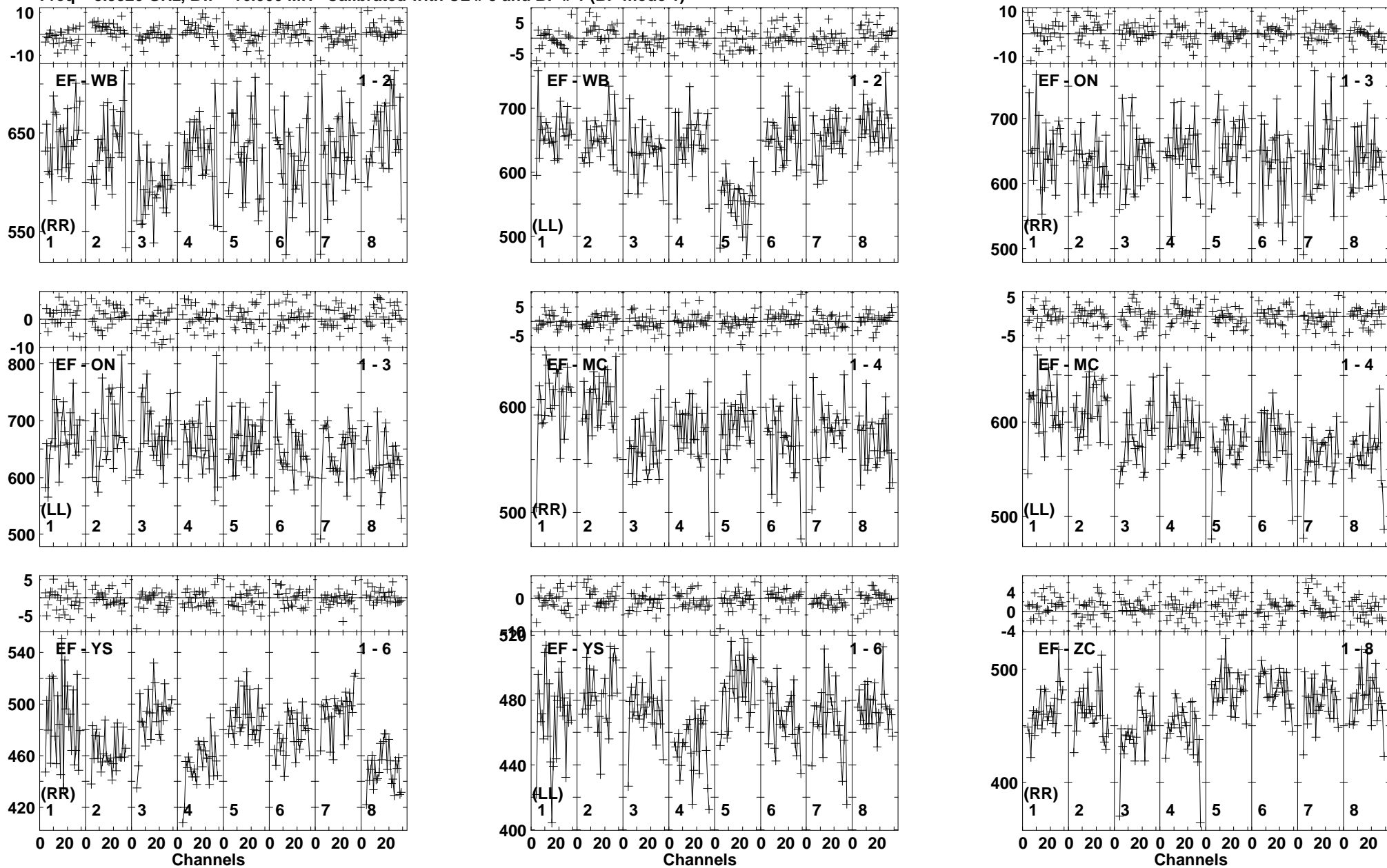

Lower frame: Milli Ampl Jy Top frame: Phas deg
Vector averaged cross-power spectrum Baseline: EF (01) - WB (02)
Timerange: 00/06:54:55 to 00/06:55:25

Plot file version 252 created 24-MAR-2014 14:38:44

J1128+5925 EP087F 5.UVDATA.1

Freq = 8.3520 GHz, Bw = 16.000 MH Calibrated with CL # 3 and BP # 1 (BP mode 1)

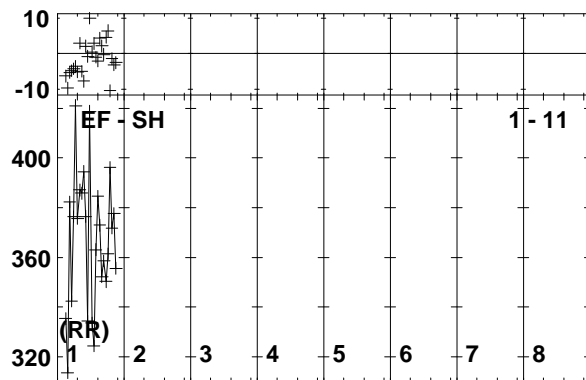
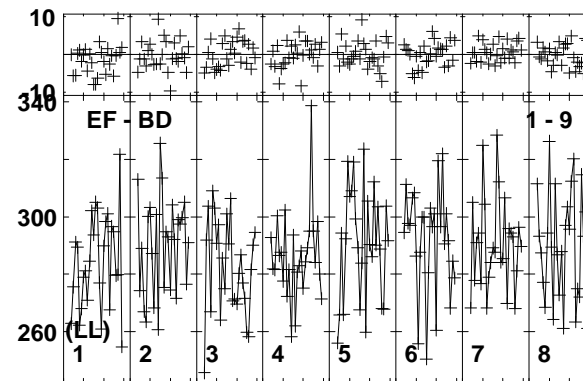
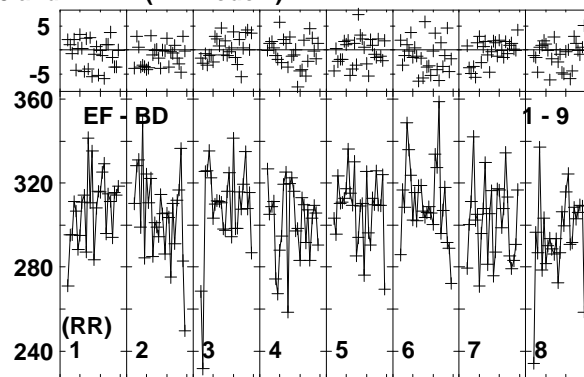
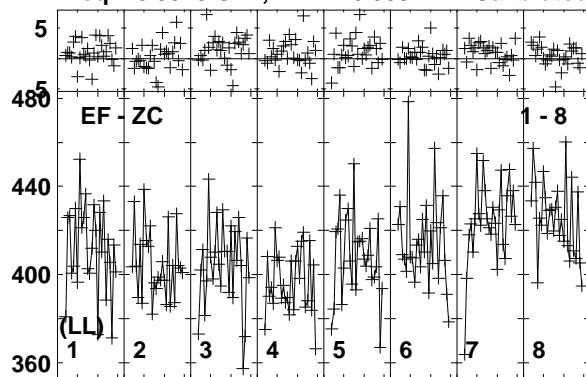

Lower frame: Milli Ampl Jy Top frame: Phas deg
Vector averaged cross-power spectrum Baseline: EF (01) - ZC (08)
Timerange: 00/06:54:55 to 00/06:55:25

Plot file version 253 created 24-MAR-2014 14:38:44

ARP299D EP087F 5.UVDATA.1

Freq = 8.3520 GHz, Bw = 16.000 MH Calibrated with CL # 3 and BP # 1 (BP mode 1)

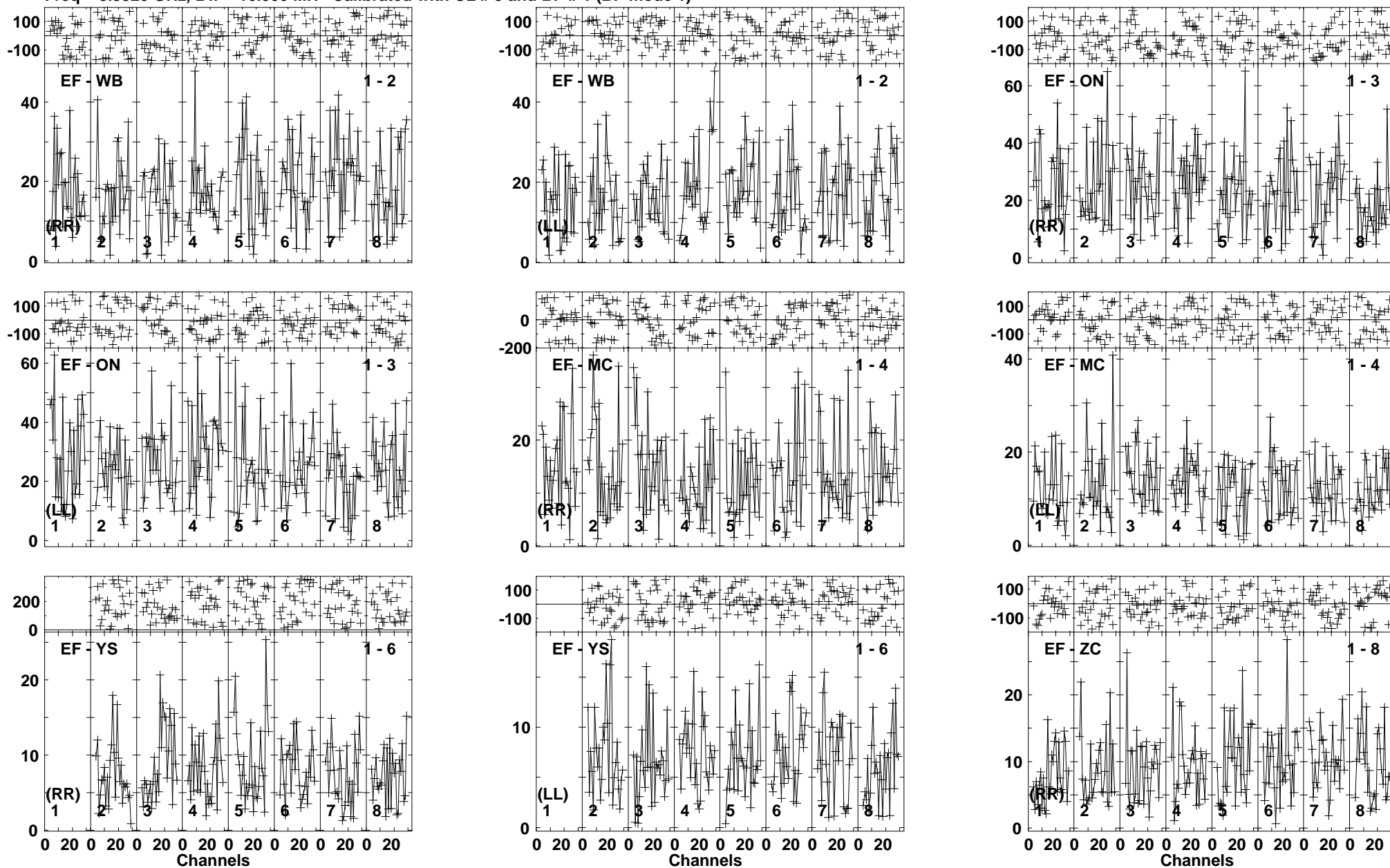

Lower frame: Milli Ampl Jy Top frame: Phas deg
Vector averaged cross-power spectrum Baseline: EF (01) - WB (02)
Timerange: 00/06:55:29 to 00/06:58:25

Plot file version 254 created 24-MAR-2014 14:38:44

ARP299D EP087F 5.UVDATA.1

Freq = 8.3520 GHz, Bw = 16.000 MH Calibrated with CL # 3 and BP # 1 (BP mode 1)

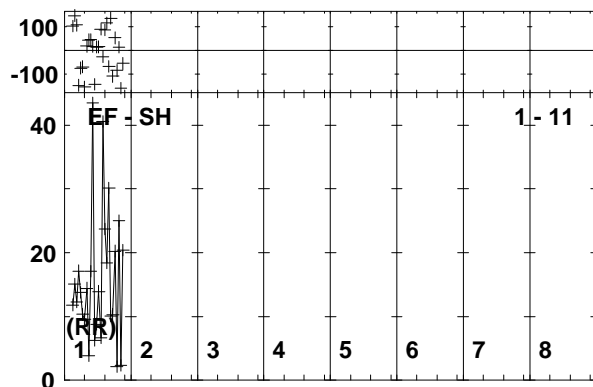
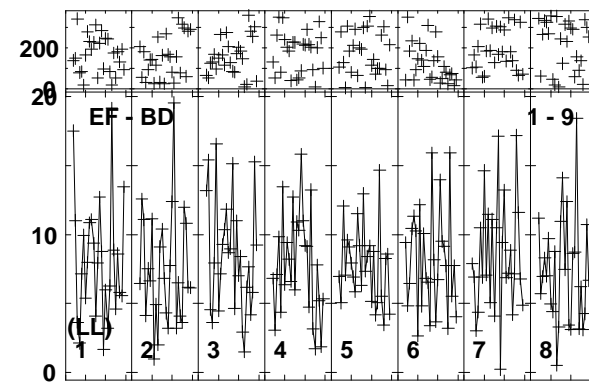
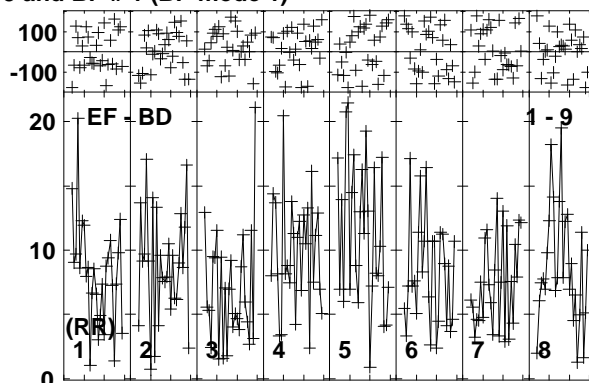
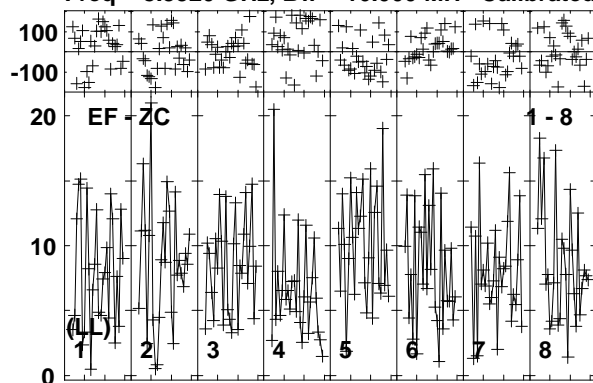

Lower frame: Milli Ampl Jy Top frame: Phas deg
Vector averaged cross-power spectrum Baseline: EF (01) - ZC (08)
Timerange: 00/06:55:29 to 00/06:58:25

Plot file version 255 created 24-MAR-2014 14:38:44

J1128+5925 EP087F 5.UVDATA.1

Freq = 8.3520 GHz, Bw = 16.000 MH Calibrated with CL # 3 and BP # 1 (BP mode 1)

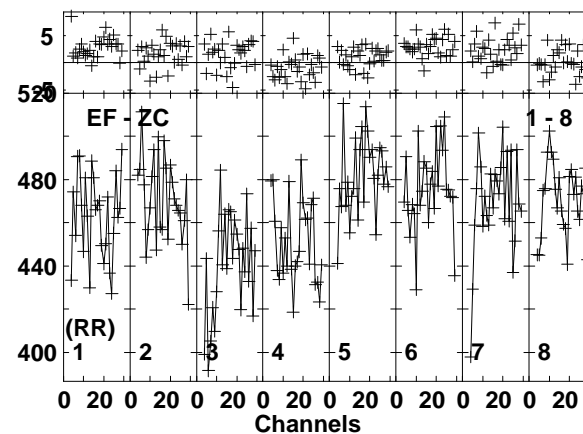
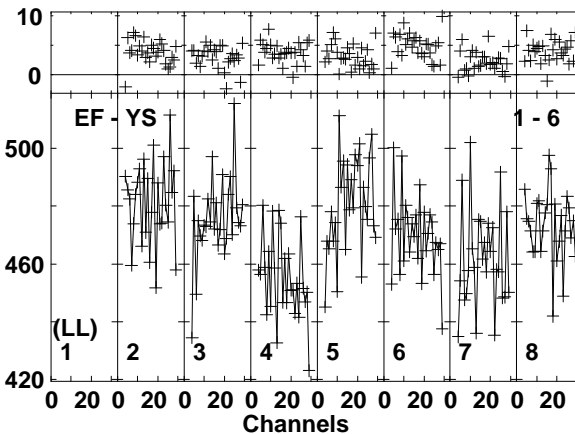
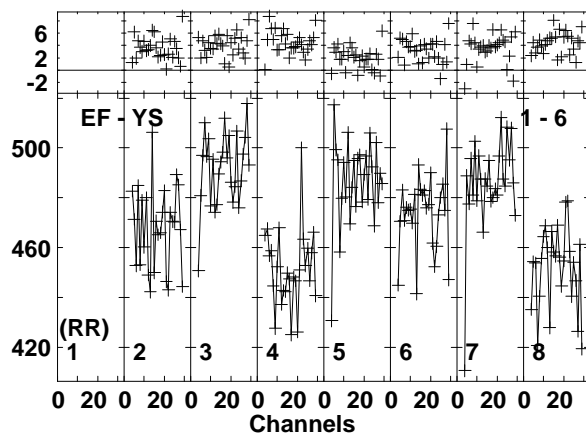
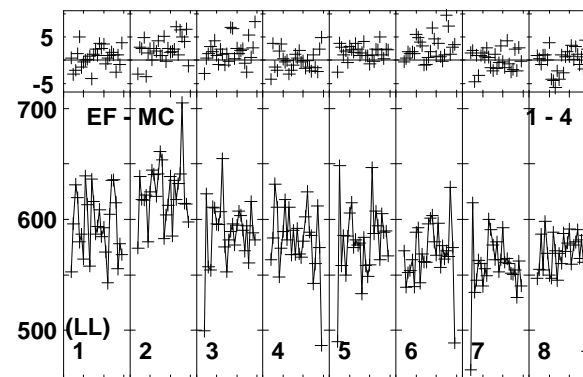
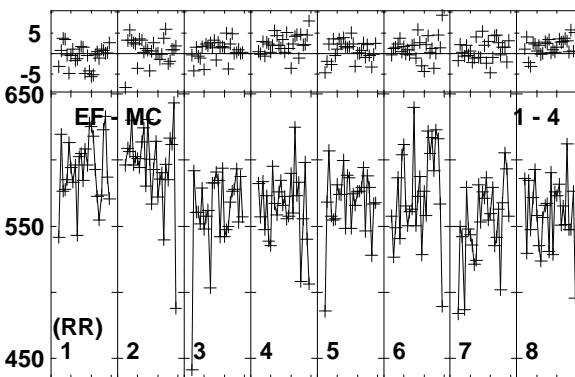
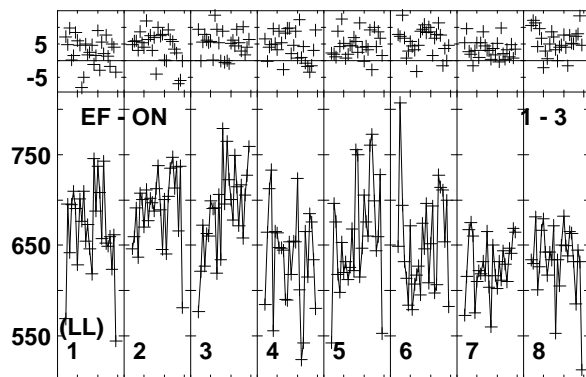
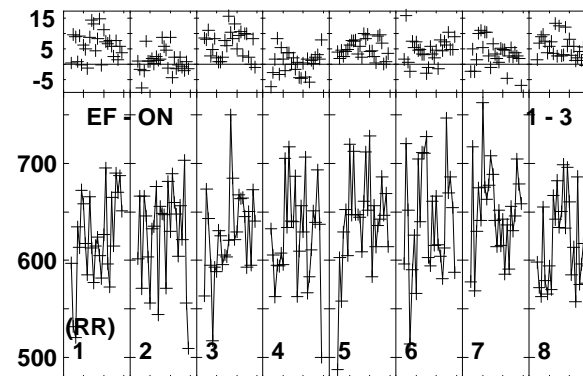
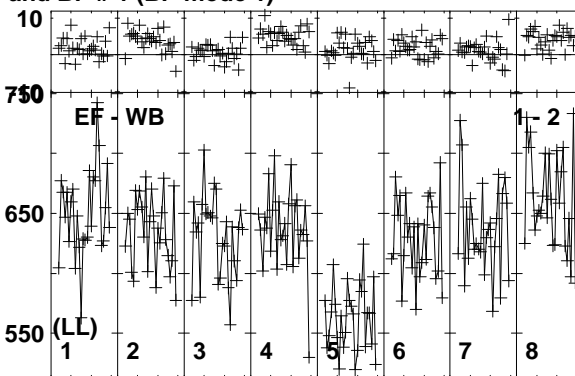
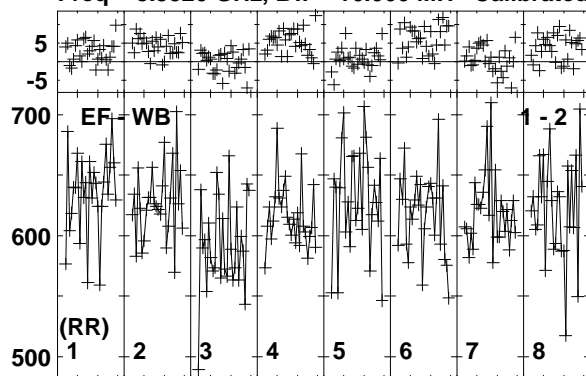

Lower frame: Milli Ampl Jy Top frame: Phas deg
Vector averaged cross-power spectrum Baseline: EF (01) - WB (02)
Timerange: 00/06:58:28 to 00/06:59:29

Plot file version 256 created 24-MAR-2014 14:38:45

J1128+5925 EP087F 5.UVDATA.1

Freq = 8.3520 GHz, Bw = 16.000 MH Calibrated with CL # 3 and BP # 1 (BP mode 1)

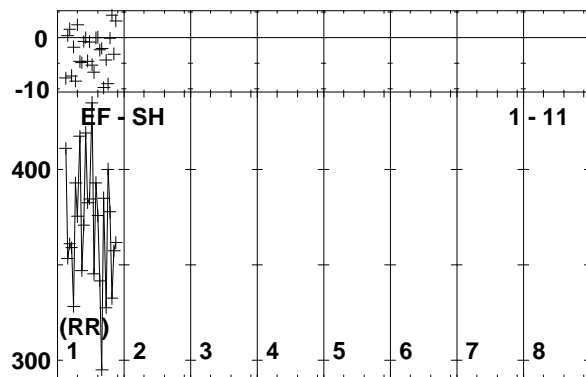
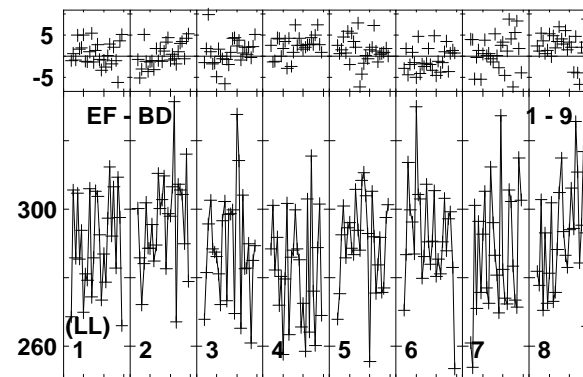
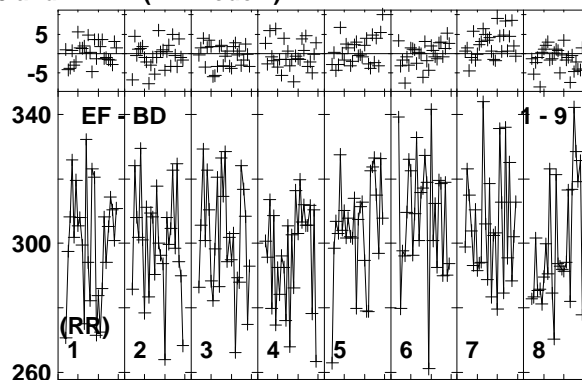
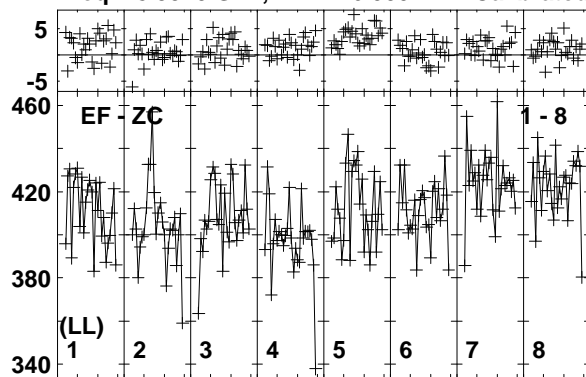

Lower frame: Milli Ampl Jy Top frame: Phas deg
Vector averaged cross-power spectrum Baseline: EF (01) - ZC (08)
Timerange: 00/06:58:28 to 00/06:59:29

Plot file version 257 created 24-MAR-2014 14:38:45

ARP299D EP087F 5.UVDATA.1

Freq = 8.3520 GHz, Bw = 16.000 MH Calibrated with CL # 3 and BP # 1 (BP mode 1)

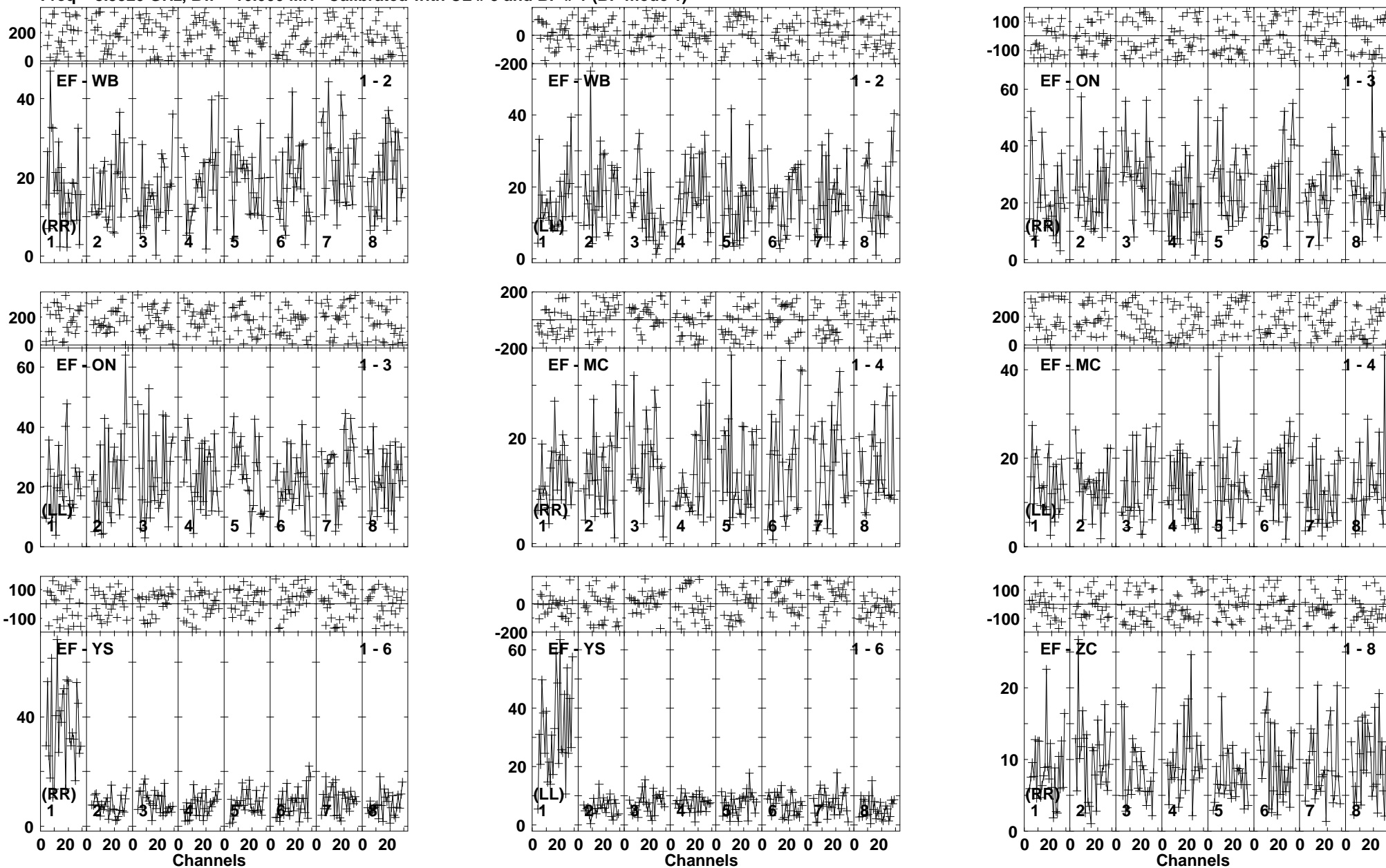

Lower frame: Milli Ampl Jy Top frame: Phas deg
Vector averaged cross-power spectrum Baseline: EF (01) - WB (02)
Timerange: 00/06:59:34 to 00/07:02:30

Plot file version 258 created 24-MAR-2014 14:38:45

ARP299D EP087F 5.UVDATA.1

Freq = 8.3520 GHz, Bw = 16.000 MH Calibrated with CL # 3 and BP # 1 (BP mode 1)

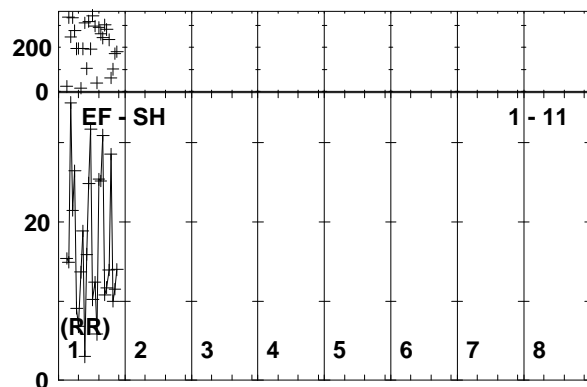
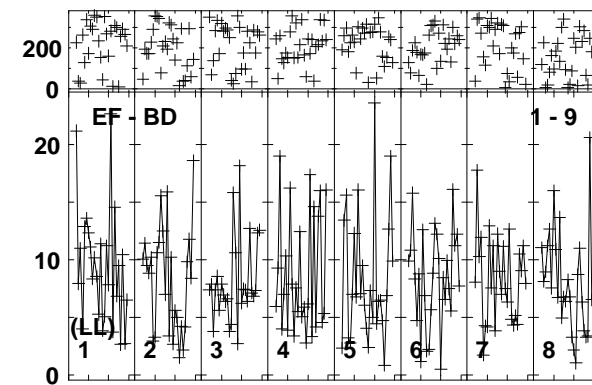
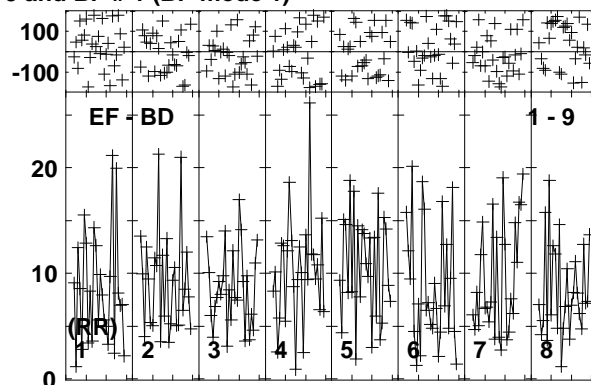
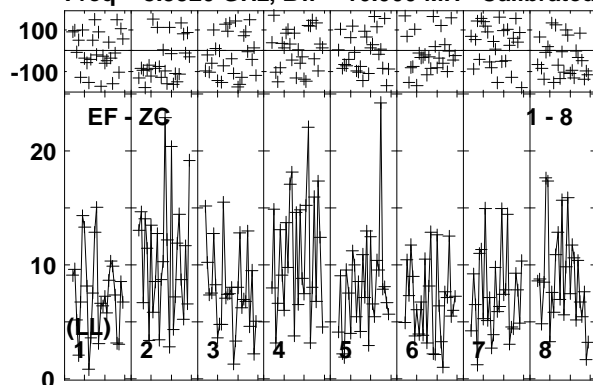

Lower frame: Milli Ampl Jy Top frame: Phas deg
Vector averaged cross-power spectrum Baseline: EF (01) - ZC (08)
Timerange: 00/06:59:34 to 00/07:02:30

Plot file version 259 created 24-MAR-2014 14:38:45

J1128+5925 EP087F 5.UVDATA.1

Freq = 8.3520 GHz, Bw = 16.000 MH Calibrated with CL # 3 and BP # 1 (BP mode 1)

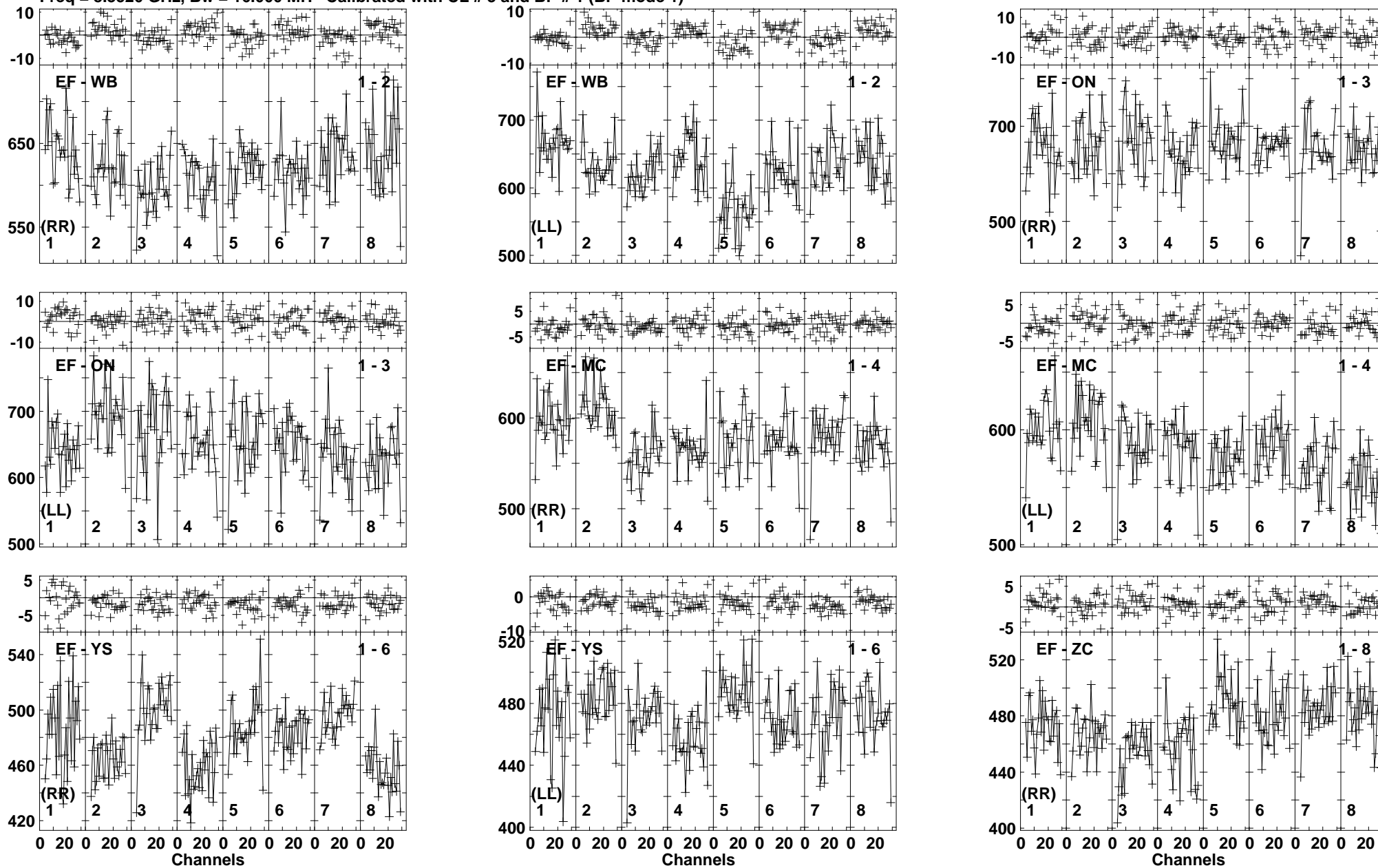

Lower frame: Milli Ampl Jy Top frame: Phas deg
Vector averaged cross-power spectrum Baseline: EF (01) - WB (02)
Timerange: 00/07:03:10 to 00/07:03:40

Plot file version 260 created 24-MAR-2014 14:38:45

J1128+5925 EP087F 5.UVDATA.1

Freq = 8.3520 GHz, Bw = 16.000 MH Calibrated with CL # 3 and BP # 1 (BP mode 1)

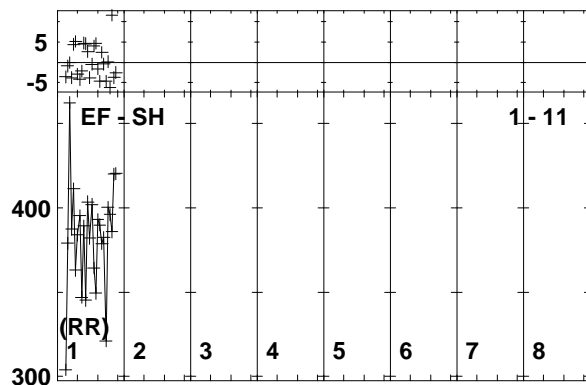
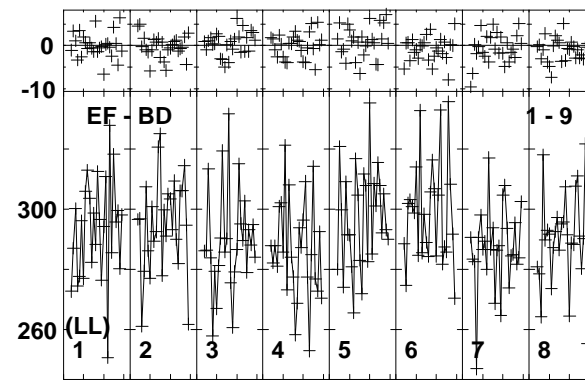
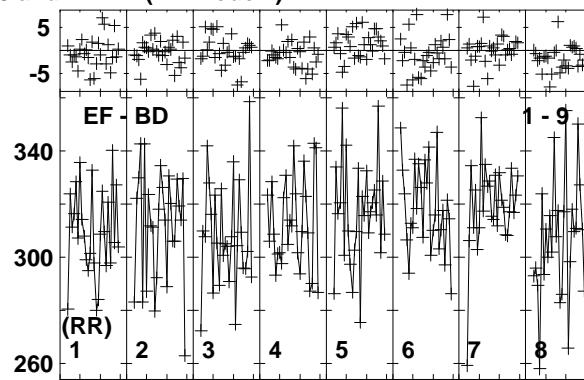
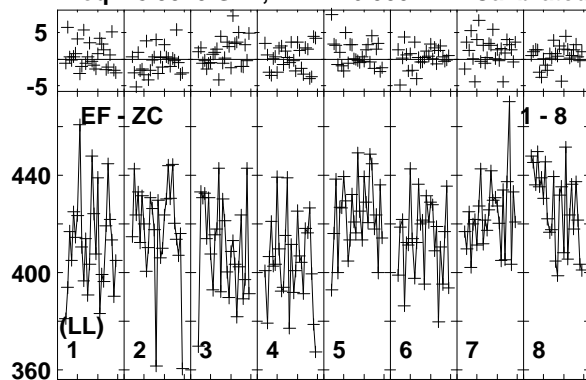

Lower frame: Milli Ampl Jy Top frame: Phas deg
Vector averaged cross-power spectrum Baseline: EF (01) - ZC (08)
Timerange: 00/07:03:10 to 00/07:03:40

Plot file version 261 created 24-MAR-2014 14:38:46
 ARP299D EP087F 5.UVDATA.1
 Freq = 8.3520 GHz, Bw = 16.000 MH Calibrated with CL # 3 and BP # 1 (BP mode 1)

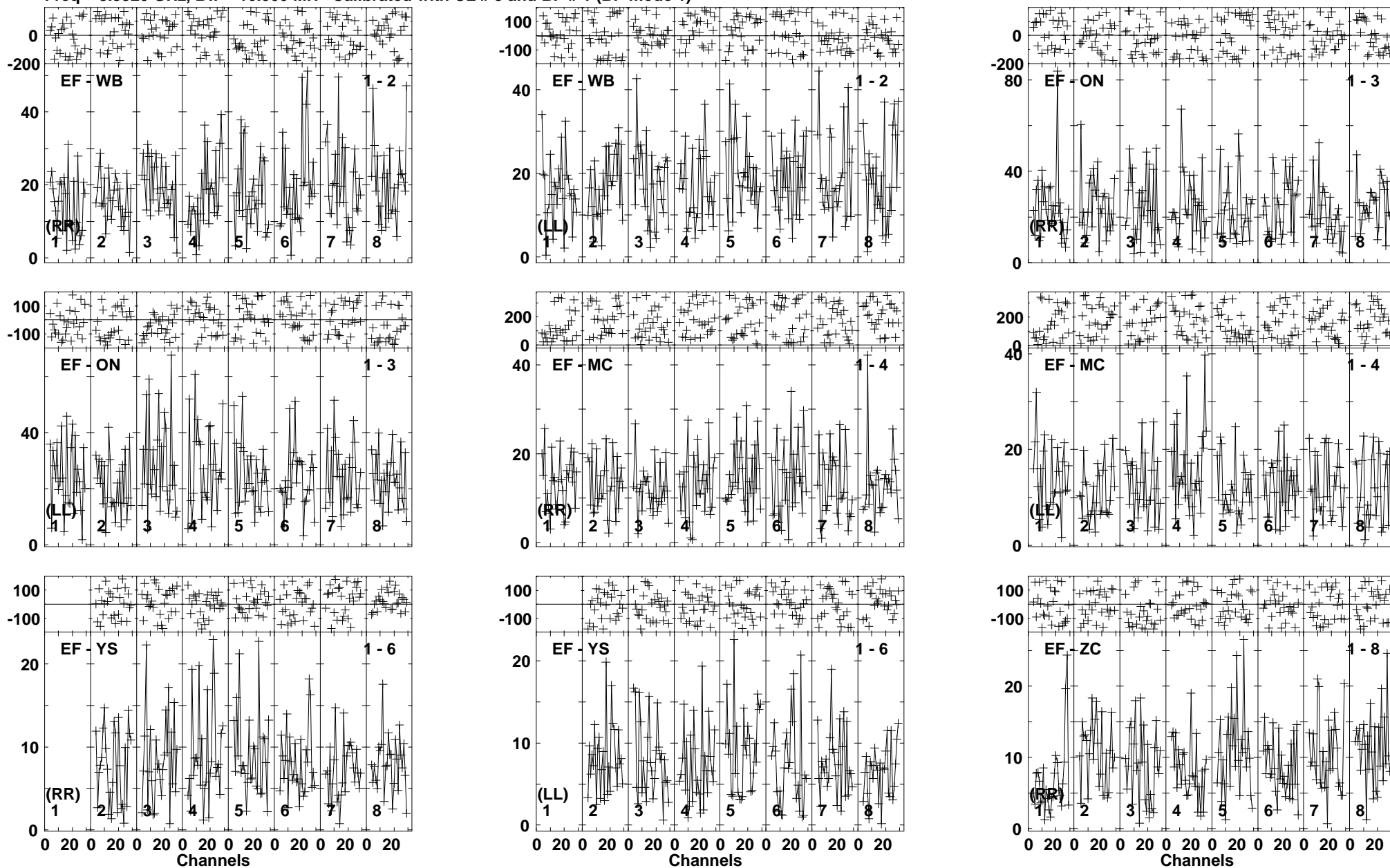

Lower frame: Milli Ampl Jy Top frame: Phas deg
 Vector averaged cross-power spectrum Baseline: EF (01) - WB (02)
 Timerange: 00/07:03:43 to 00/07:06:40

Plot file version 262 created 24-MAR-2014 14:38:46
 ARP299D EP087F 5.UVDATA.1
 Freq = 8.3520 GHz, Bw = 16.000 MH Calibrated with CL # 3 and BP # 1 (BP mode 1)

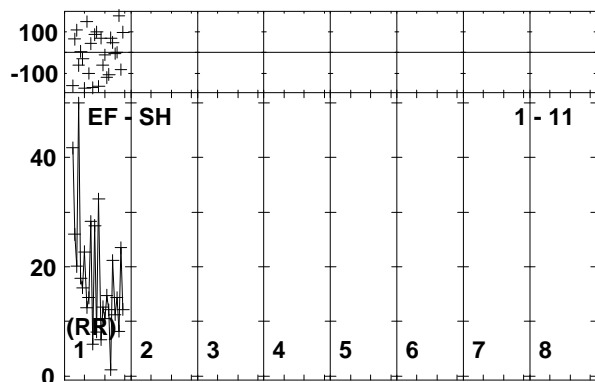
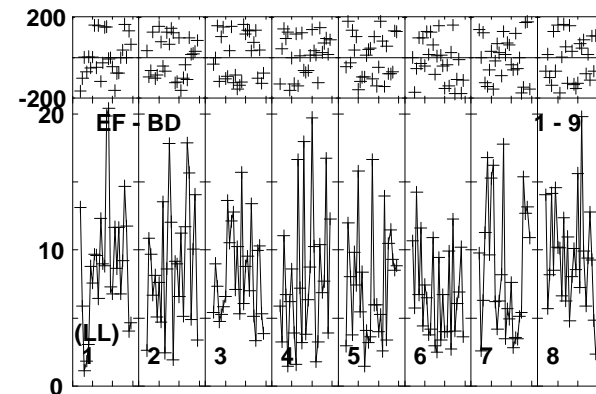
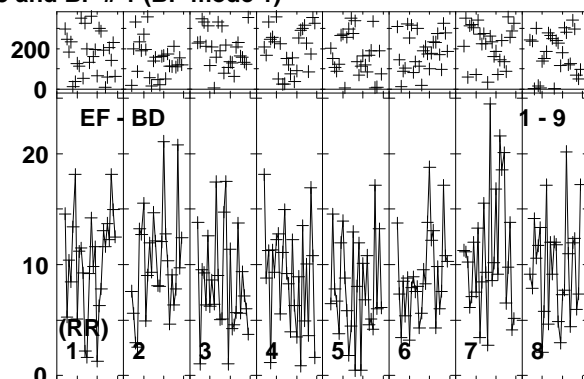
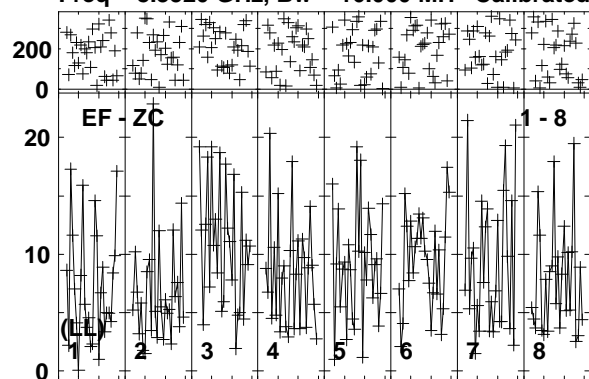

Lower frame: Milli Ampl Jy Top frame: Phas deg
 Vector averaged cross-power spectrum Baseline: EF (01) - ZC (08)
 Timerange: 00/07:03:43 to 00/07:06:40

Plot file version 263 created 24-MAR-2014 14:38:46

J1128+5925 EP087F 5.UVDATA.1

Freq = 8.3520 GHz, Bw = 16.000 MH Calibrated with CL # 3 and BP # 1 (BP mode 1)

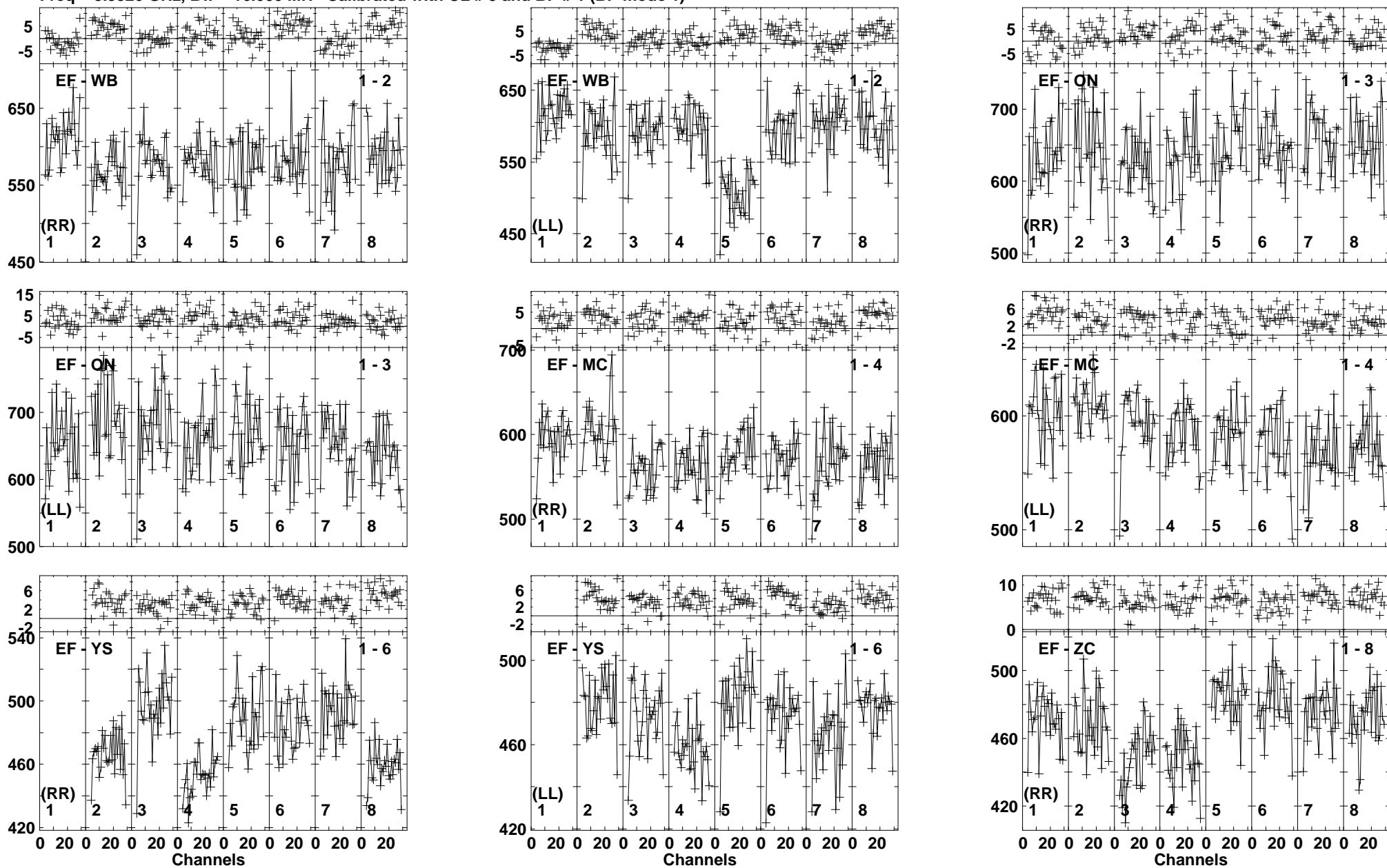

Lower frame: Milli Ampl Jy Top frame: Phas deg
Vector averaged cross-power spectrum Baseline: EF (01) - WB (02)
Timerange: 00/07:06:44 to 00/07:07:44

Plot file version 264 created 24-MAR-2014 14:38:46
 J1128+5925 EP087F 5.UVDATA.1
 Freq = 8.3520 GHz, Bw = 16.000 MH Calibrated with CL # 3 and BP # 1 (BP mode 1)

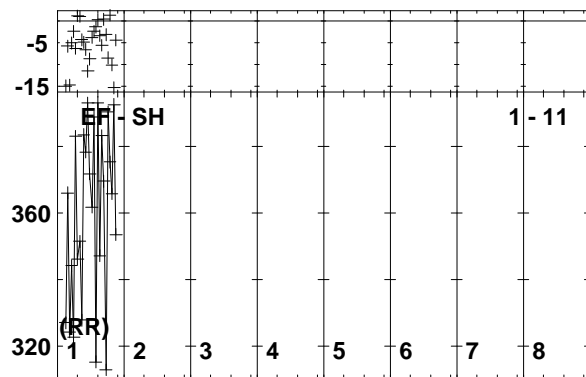
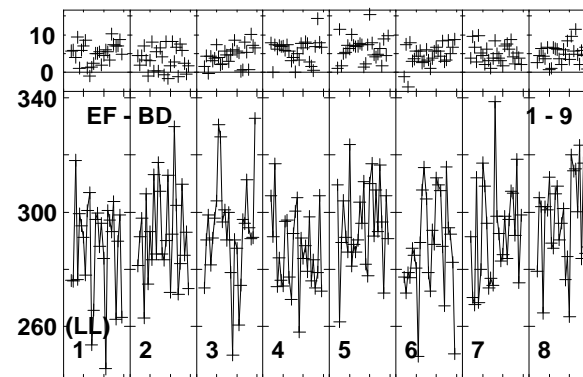
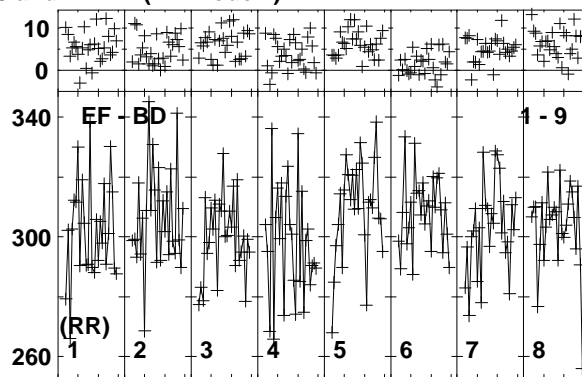
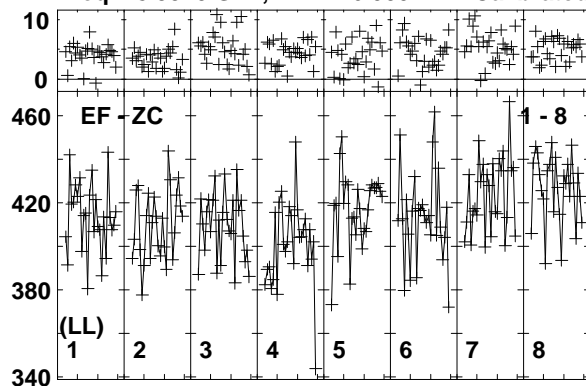

Lower frame: Milli Ampl Jy Top frame: Phas deg
 Vector averaged cross-power spectrum Baseline: EF (01) - ZC (08)
 Timerange: 00/07:06:44 to 00/07:07:44

Plot file version 265 created 24-MAR-2014 14:38:47
 ARP299D EP087F 5.UVDATA.1
 Freq = 8.3520 GHz, Bw = 16.000 MH Calibrated with CL # 3 and BP # 1 (BP mode 1)

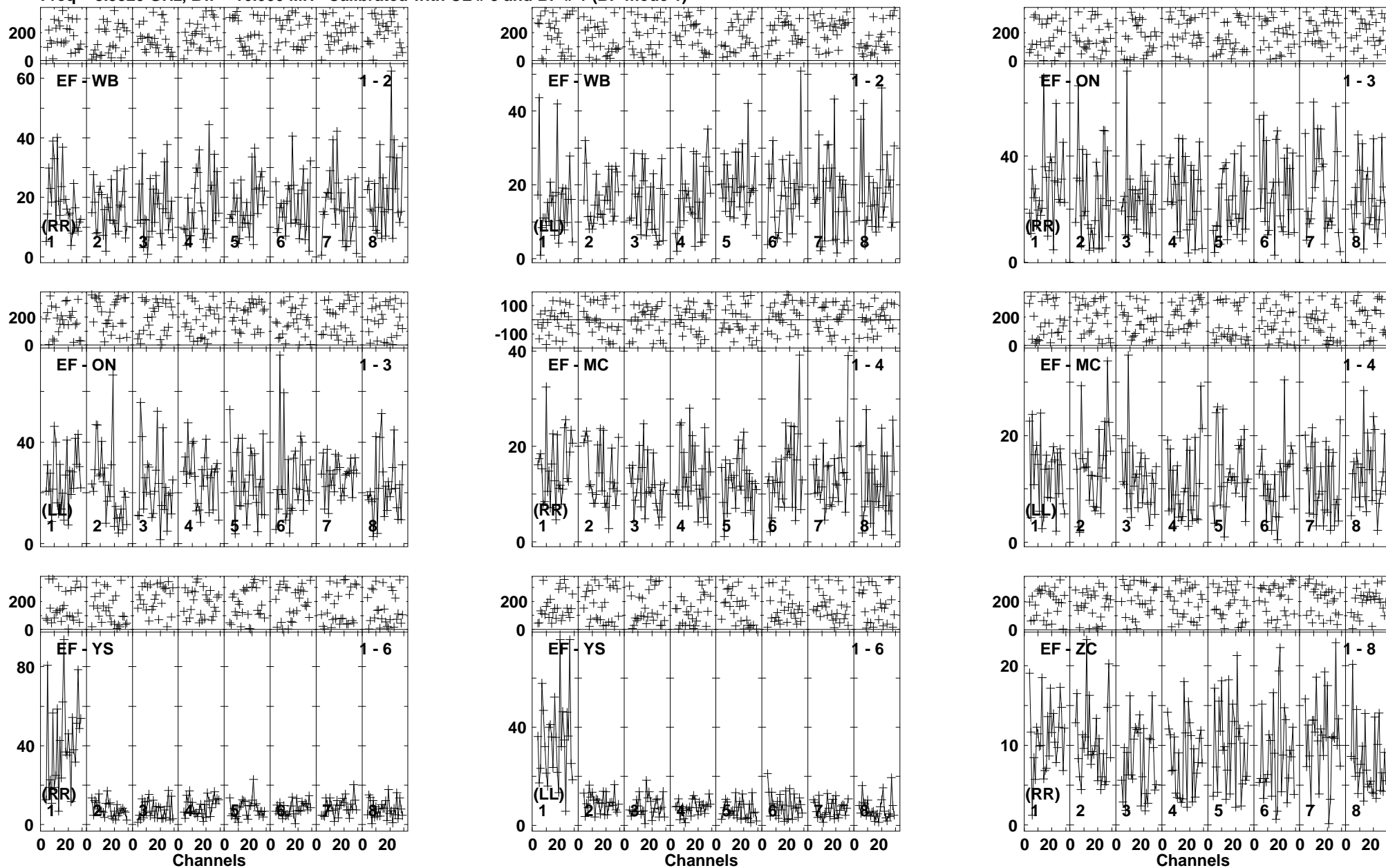

Lower frame: Milli Ampl Jy Top frame: Phas deg
 Vector averaged cross-power spectrum Baseline: EF (01) - WB (02)
 Timerange: 00/07:07:48 to 00/07:10:44

Plot file version 266 created 24-MAR-2014 14:38:47

ARP299D EP087F 5.UVDATA.1

Freq = 8.3520 GHz, Bw = 16.000 MH Calibrated with CL # 3 and BP # 1 (BP mode 1)

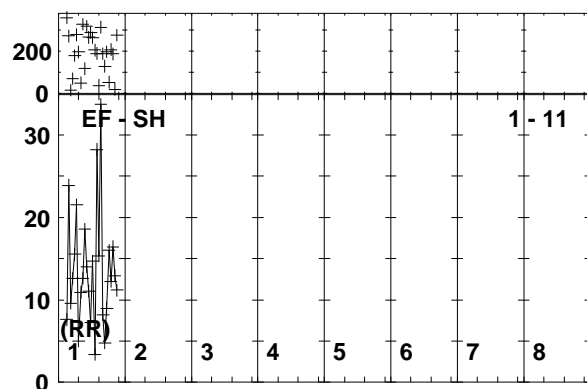
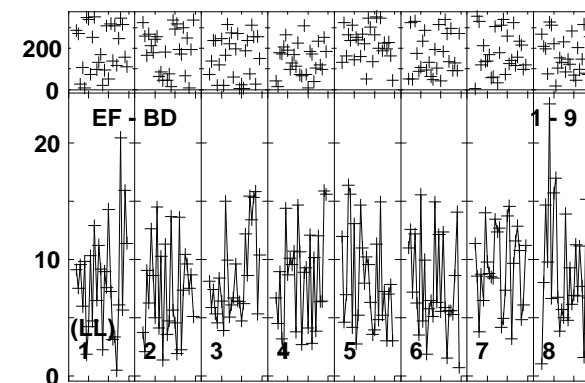
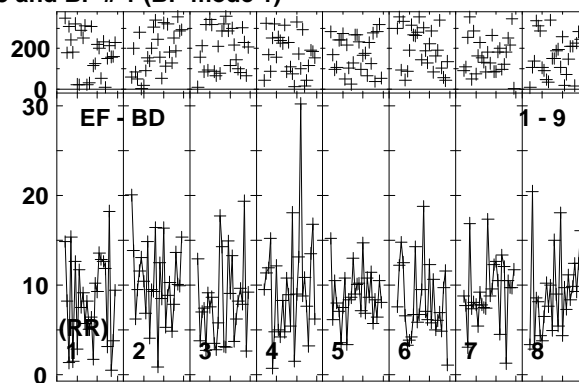
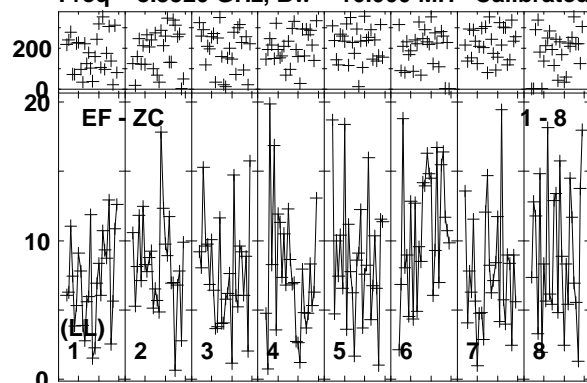

Lower frame: Milli Ampl Jy Top frame: Phas deg
Vector averaged cross-power spectrum Baseline: EF (01) - ZC (08)
Timerange: 00/07:07:48 to 00/07:10:44

Plot file version 267 created 24-MAR-2014 14:38:47

J1128+5925 EP087F 5.UVDATA.1

Freq = 8.3520 GHz, Bw = 16.000 MH Calibrated with CL # 3 and BP # 1 (BP mode 1)

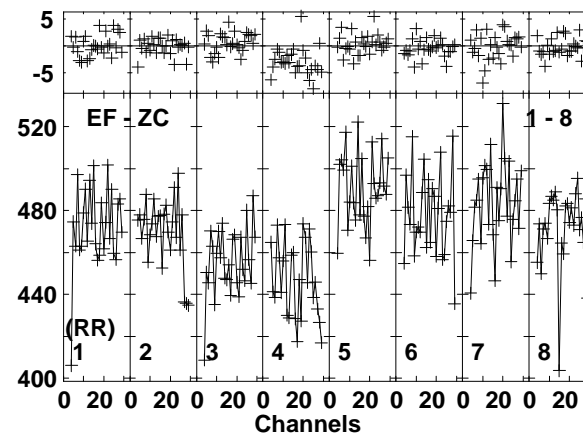
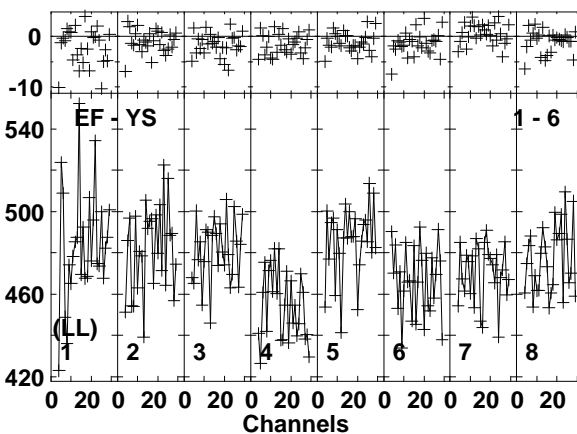
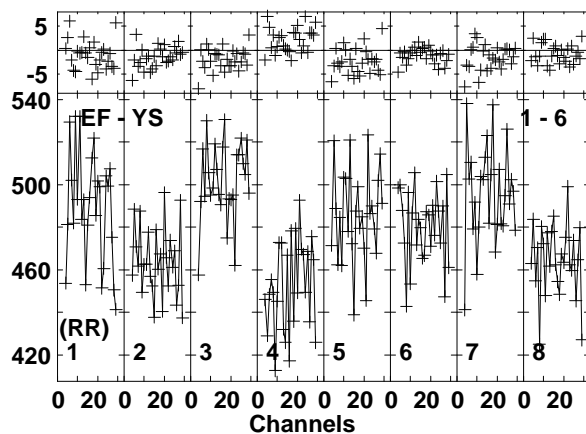
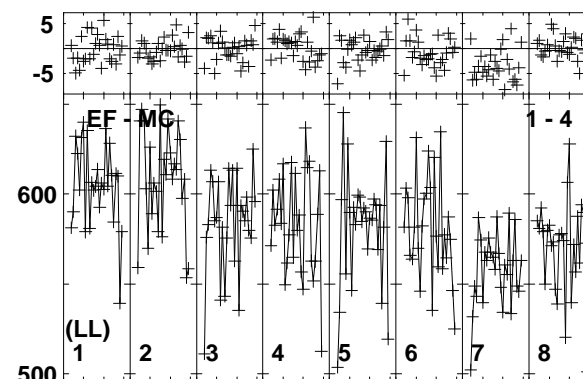
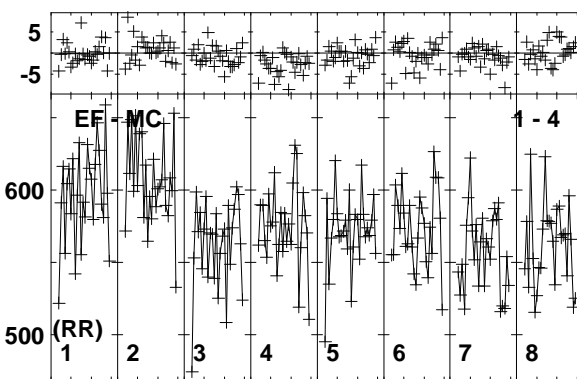
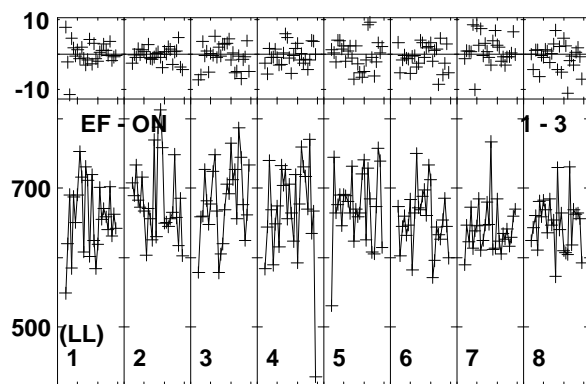
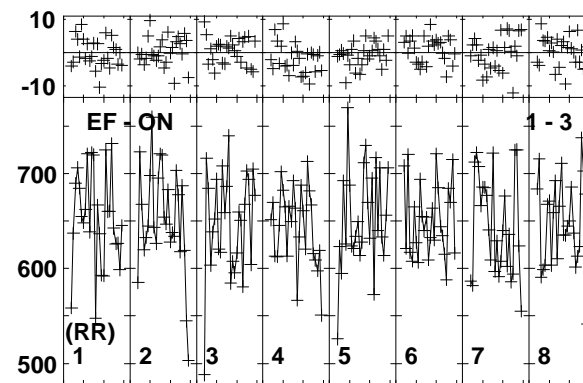
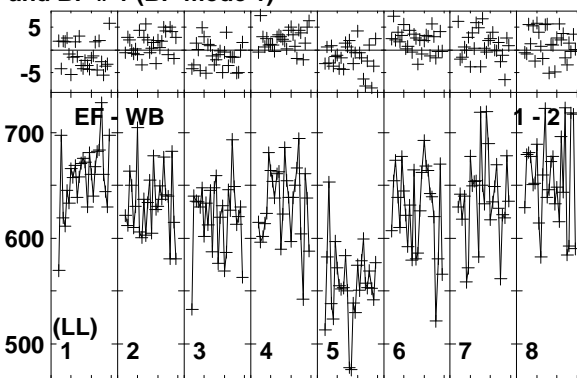
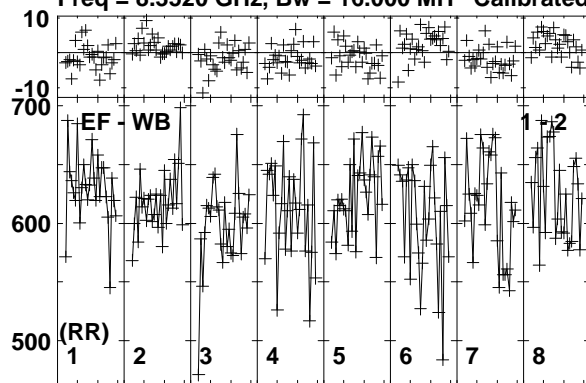

Lower frame: Milli Ampl Jy Top frame: Phas deg
Vector averaged cross-power spectrum Baseline: EF (01) - WB (02)
Timerange: 00/07:11:25 to 00/07:11:55

Plot file version 268 created 24-MAR-2014 14:38:47

J1128+5925 EP087F 5.UVDATA.1

Freq = 8.3520 GHz, Bw = 16.000 MH Calibrated with CL # 3 and BP # 1 (BP mode 1)

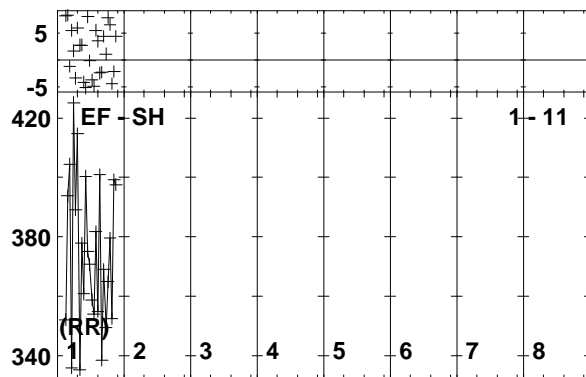
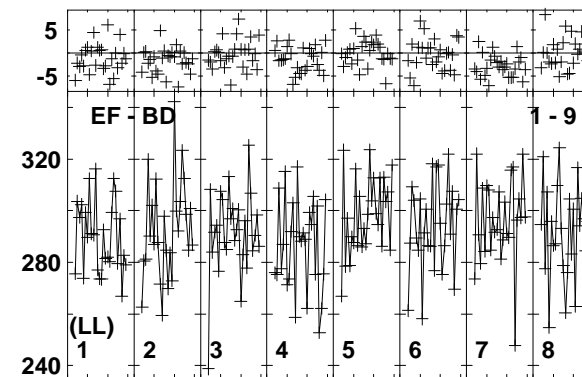
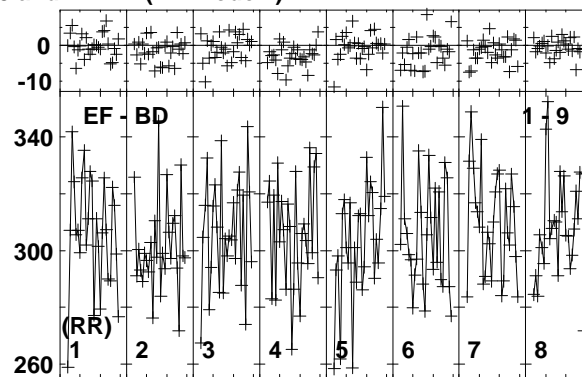
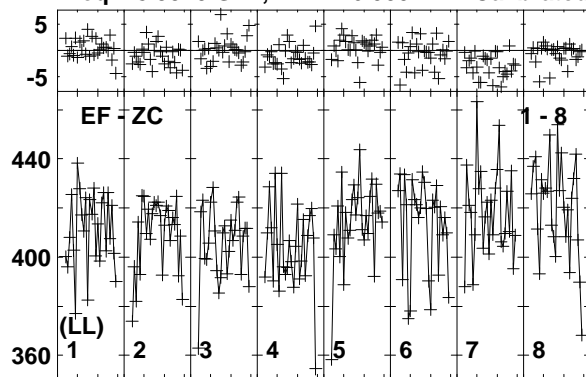

Lower frame: Milli Ampl Jy Top frame: Phas deg
Vector averaged cross-power spectrum Baseline: EF (01) - ZC (08)
Timerange: 00/07:11:25 to 00/07:11:55

Plot file version 269 created 24-MAR-2014 14:38:48

ARP299D EP087F 5.UVDATA.1

Freq = 8.3520 GHz, Bw = 16.000 MH Calibrated with CL # 3 and BP # 1 (BP mode 1)

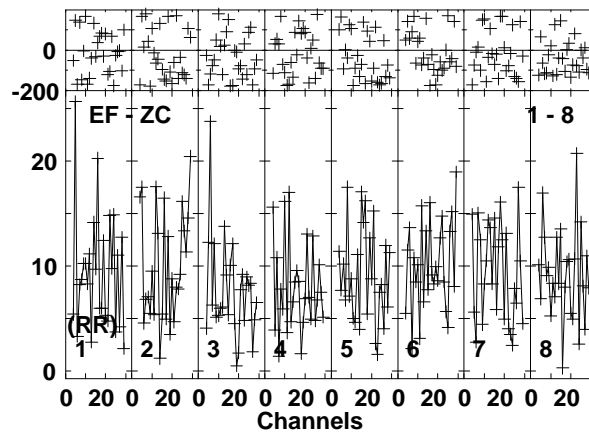
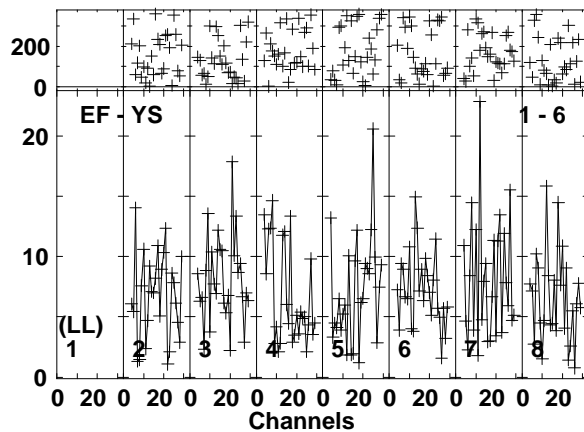
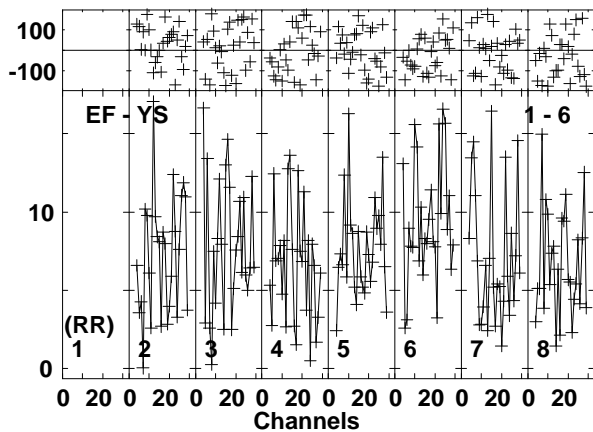
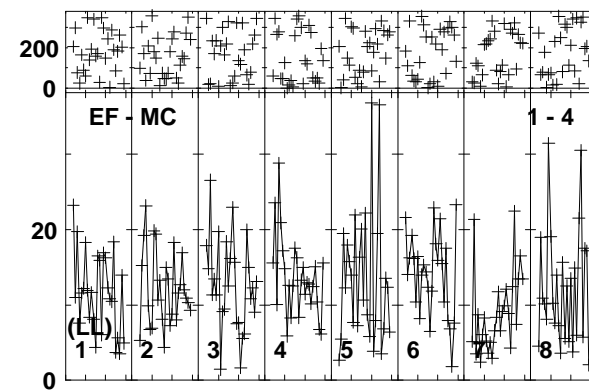
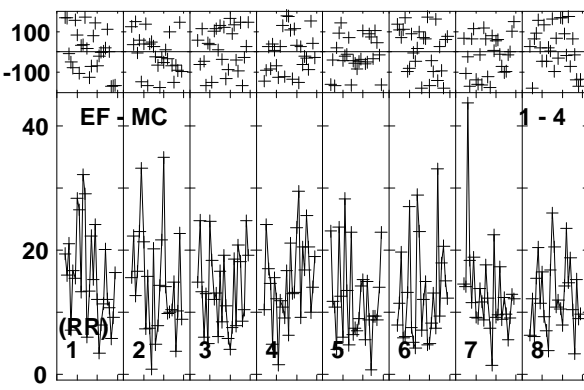
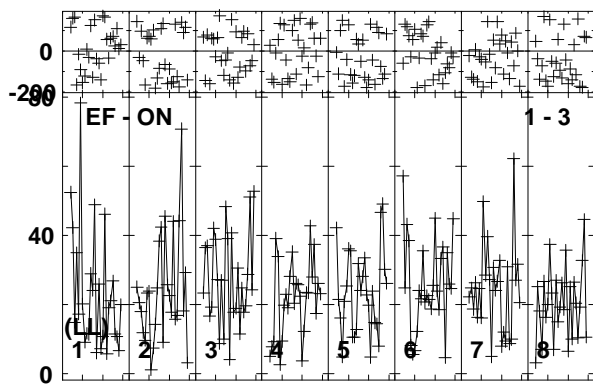
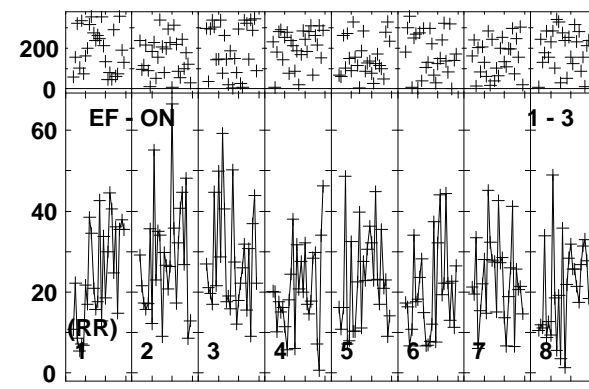
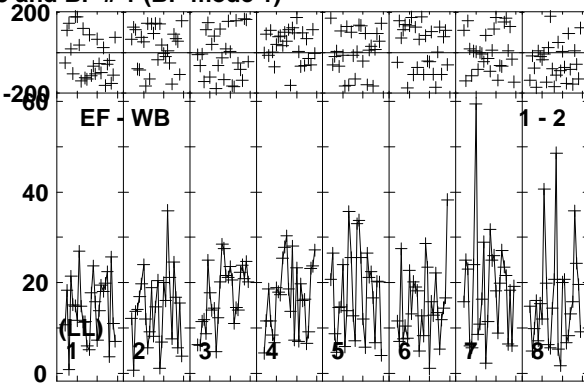
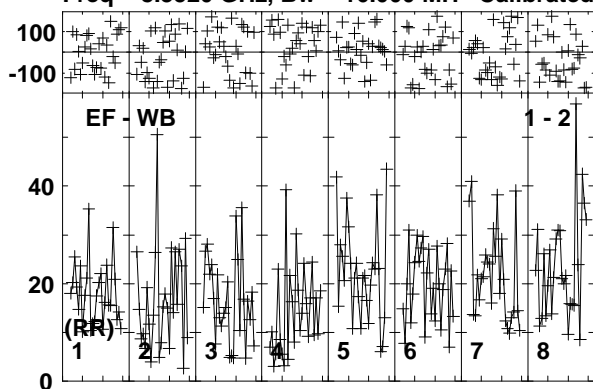

Lower frame: Milli Ampl Jy Top frame: Phas deg
Vector averaged cross-power spectrum Baseline: EF (01) - WB (02)
Timerange: 00/07:11:59 to 00/07:14:54

Plot file version 270 created 24-MAR-2014 14:38:48
ARP299D EP087F 5.UVDATA.1
Freq = 8.3520 GHz, Bw = 16.000 MH Calibrated with CL # 3 and BP # 1 (BP mode 1)

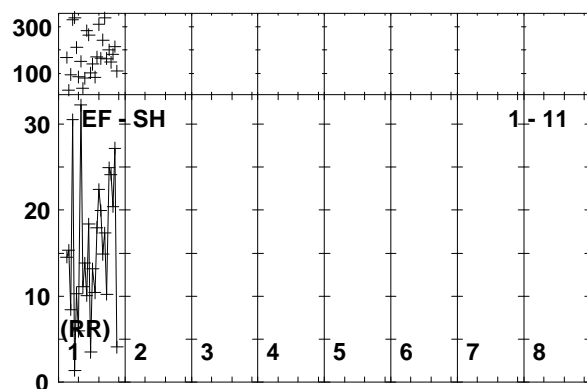
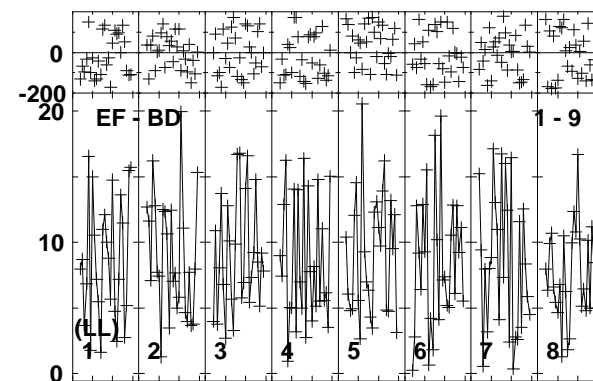
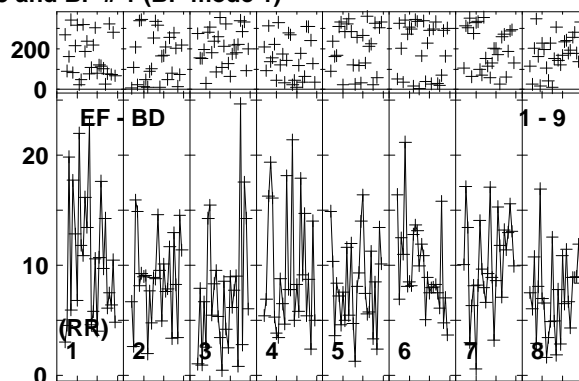
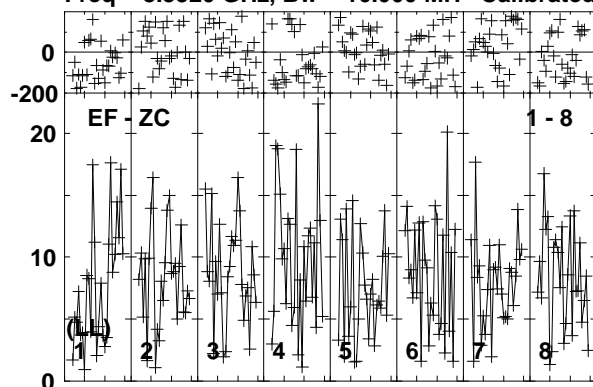

Lower frame: Milli Ampl Jy Top frame: Phas deg
Vector averaged cross-power spectrum Baseline: EF (01) - ZC (08)
Timerange: 00/07:11:59 to 00/07:14:54

Plot file version 271 created 24-MAR-2014 14:38:48
 ARP299D EP087F 5.UVDATA.1
 Freq = 8.3520 GHz, Bw = 16.000 MH Calibrated with CL # 3 and BP # 1 (BP mode 1)

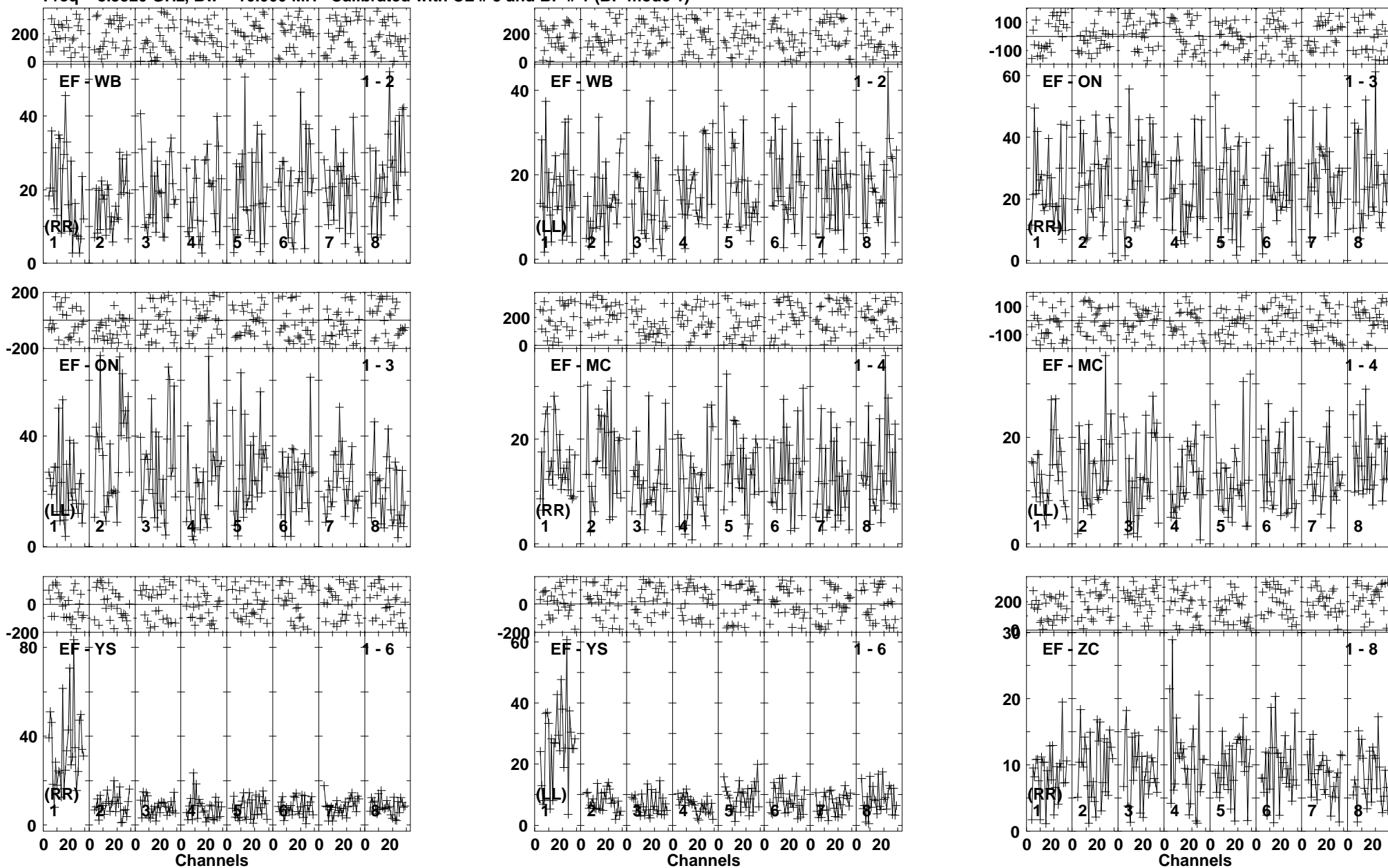

Lower frame: Milli Ampl Jy Top frame: Phas deg
 Vector averaged cross-power spectrum Baseline: EF (01) - WB (02)
 Timerange: 00/07:16:04 to 00/07:19:00

Plot file version 272 created 24-MAR-2014 14:38:49

ARP299D EP087F 5.UVDATA.1

Freq = 8.3520 GHz, Bw = 16.000 MH Calibrated with CL # 3 and BP # 1 (BP mode 1)

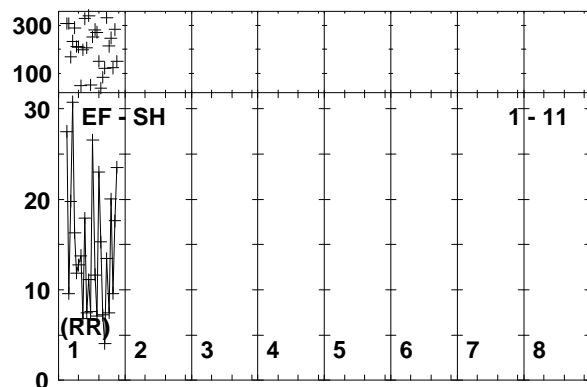
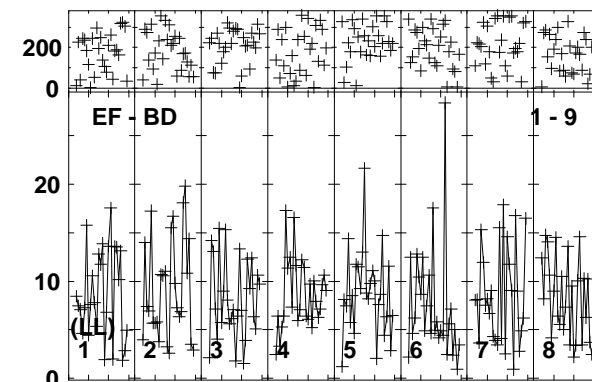
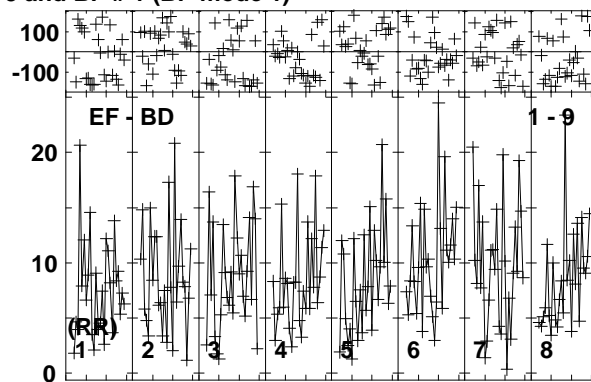
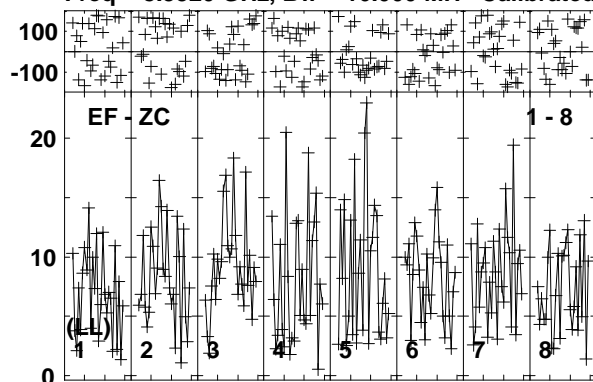

Lower frame: Milli Ampl Jy Top frame: Phas deg
Vector averaged cross-power spectrum Baseline: EF (01) - ZC (08)
Timerange: 00/07:16:04 to 00/07:19:00

Plot file version 273 created 24-MAR-2014 14:38:49

J1128+5925 EP087F 5.UVDATA.1

Freq = 8.3520 GHz, Bw = 16.000 MH Calibrated with CL # 3 and BP # 1 (BP mode 1)

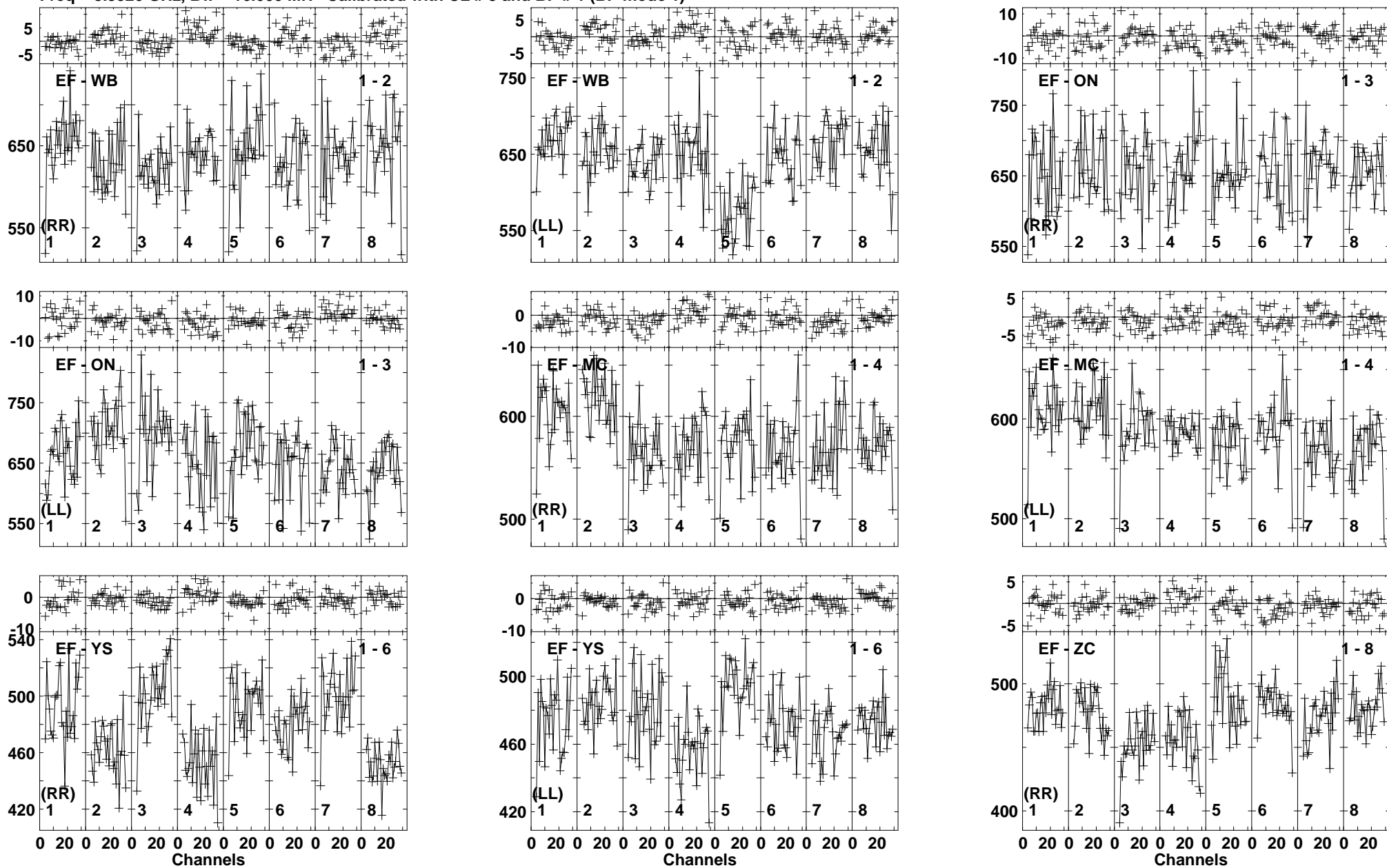

Lower frame: Milli Ampl Jy Top frame: Phas deg
Vector averaged cross-power spectrum Baseline: EF (01) - WB (02)
Timerange: 00/07:19:40 to 00/07:20:10

Plot file version 274 created 24-MAR-2014 14:38:49

J1128+5925 EP087F 5.UVDATA.1

Freq = 8.3520 GHz, Bw = 16.000 MH Calibrated with CL # 3 and BP # 1 (BP mode 1)

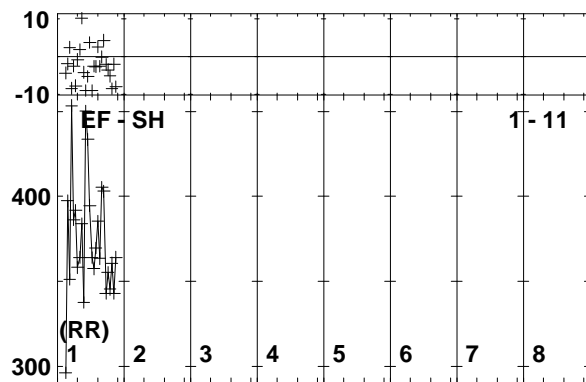
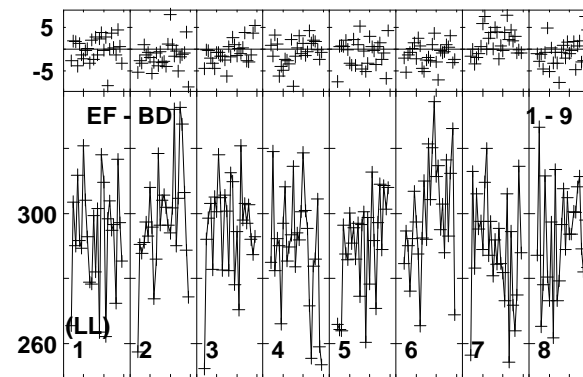
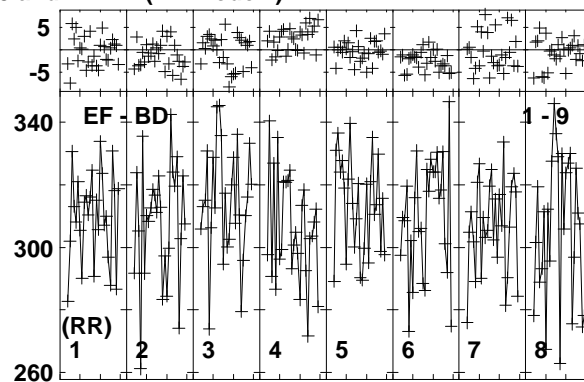
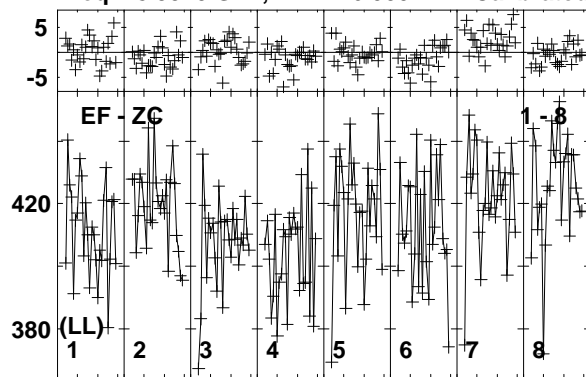

Lower frame: Milli Ampl Jy Top frame: Phas deg
Vector averaged cross-power spectrum Baseline: EF (01) - ZC (08)
Timerange: 00/07:19:40 to 00/07:20:10

Plot file version 275 created 24-MAR-2014 14:38:49

ARP299D EP087F 5.UVDATA.1

Freq = 8.3520 GHz, Bw = 16.000 MH Calibrated with CL # 3 and BP # 1 (BP mode 1)

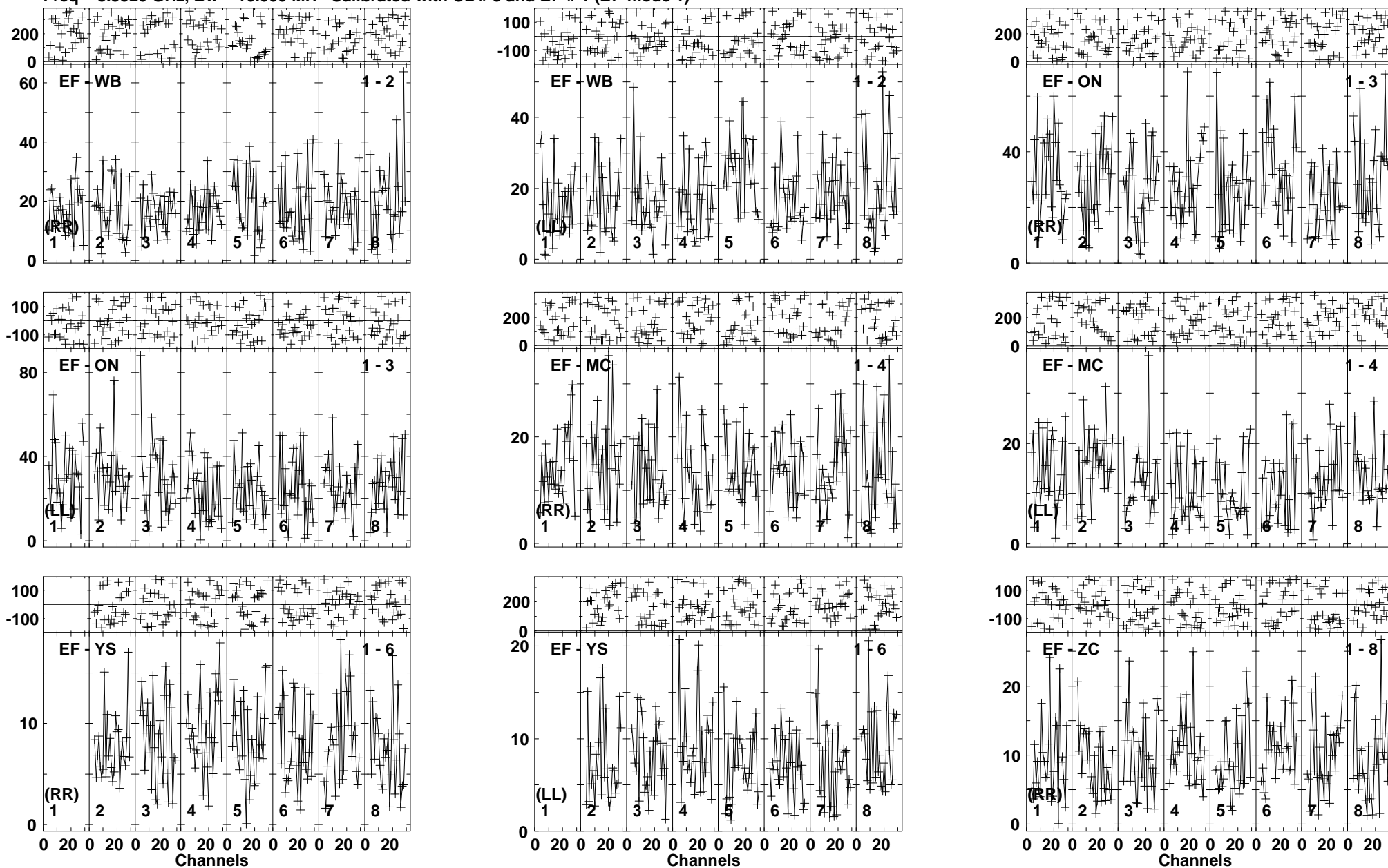

Lower frame: Milli Ampl Jy Top frame: Phas deg
Vector averaged cross-power spectrum Baseline: EF (01) - WB (02)
Timerange: 00/07:20:14 to 00/07:23:10

Plot file version 276 created 24-MAR-2014 14:38:50
 ARP299D EP087F 5.UVDATA.1
 Freq = 8.3520 GHz, Bw = 16.000 MH Calibrated with CL # 3 and BP # 1 (BP mode 1)

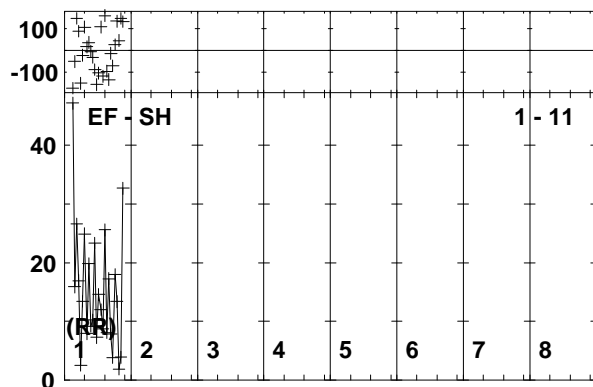
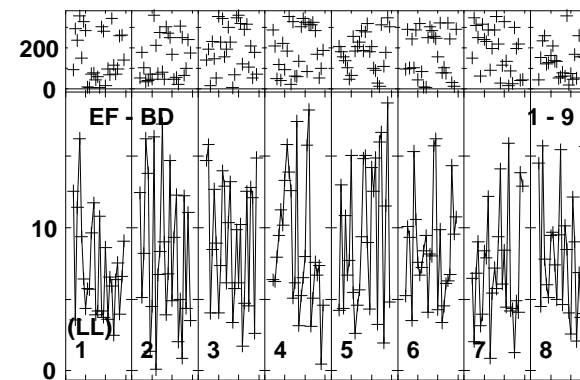
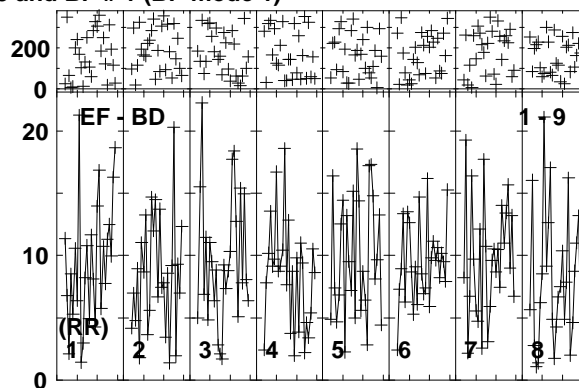
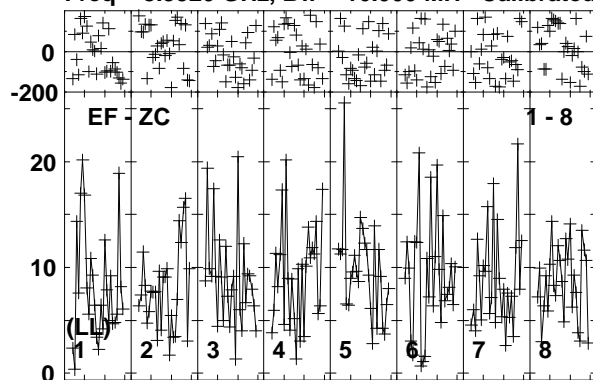

Lower frame: Milli Ampl Jy Top frame: Phas deg
 Vector averaged cross-power spectrum Baseline: EF (01) - ZC (08)
 Timerange: 00/07:20:14 to 00/07:23:10

Plot file version 277 created 24-MAR-2014 14:38:50

J1128+5925 EP087F 5.UVDATA.1

Freq = 8.3520 GHz, Bw = 16.000 MH Calibrated with CL # 3 and BP # 1 (BP mode 1)

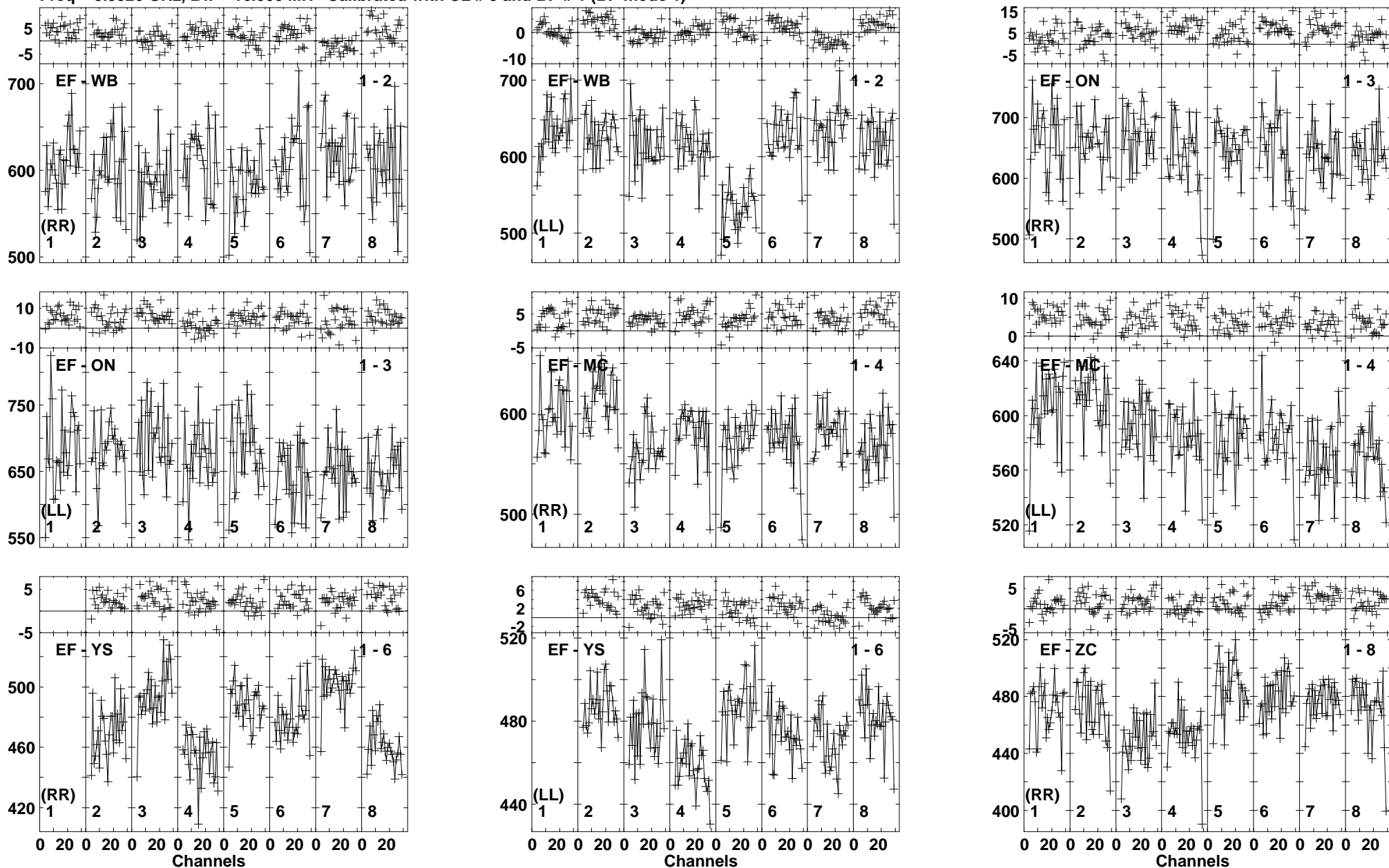

Lower frame: Milli Ampl Jy Top frame: Phas deg
Vector averaged cross-power spectrum Baseline: EF (01) - WB (02)
Timerange: 00/07:23:14 to 00/07:24:15

Plot file version 278 created 24-MAR-2014 14:38:50
 J1128+5925 EP087F 5.UVDATA.1
 Freq = 8.3520 GHz, Bw = 16.000 MH Calibrated with CL # 3 and BP # 1 (BP mode 1)

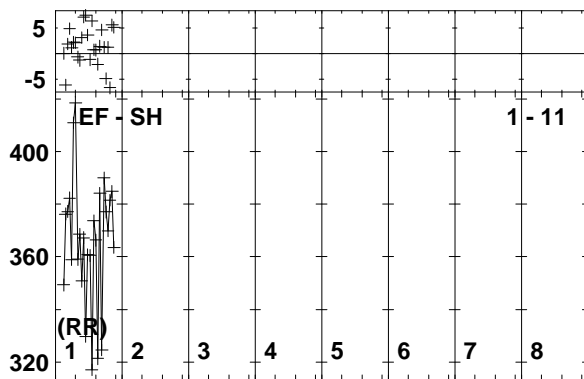
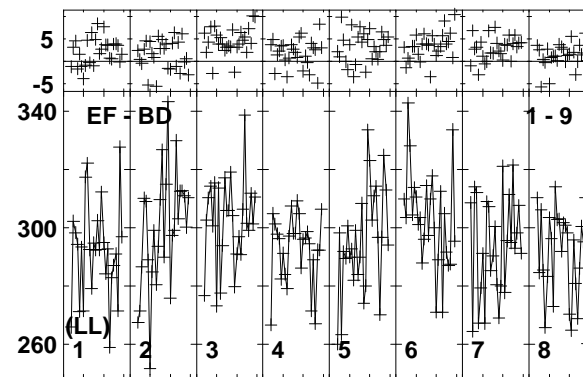
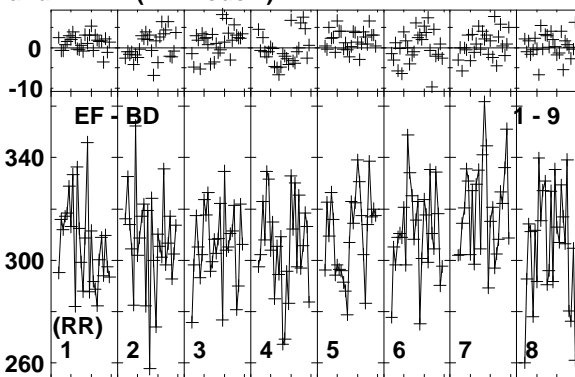
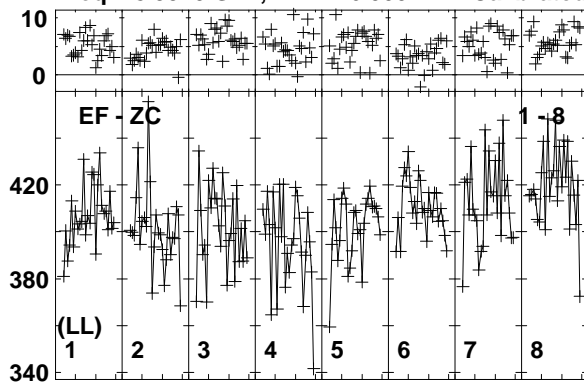

Lower frame: Milli Ampl Jy Top frame: Phas deg
 Vector averaged cross-power spectrum Baseline: EF (01) - ZC (08)
 Timerange: 00/07:23:14 to 00/07:24:15

Plot file version 279 created 24-MAR-2014 14:38:50

ARP299D EP087F 5.UVDATA.1

Freq = 8.3520 GHz, Bw = 16.000 MH Calibrated with CL # 3 and BP # 1 (BP mode 1)

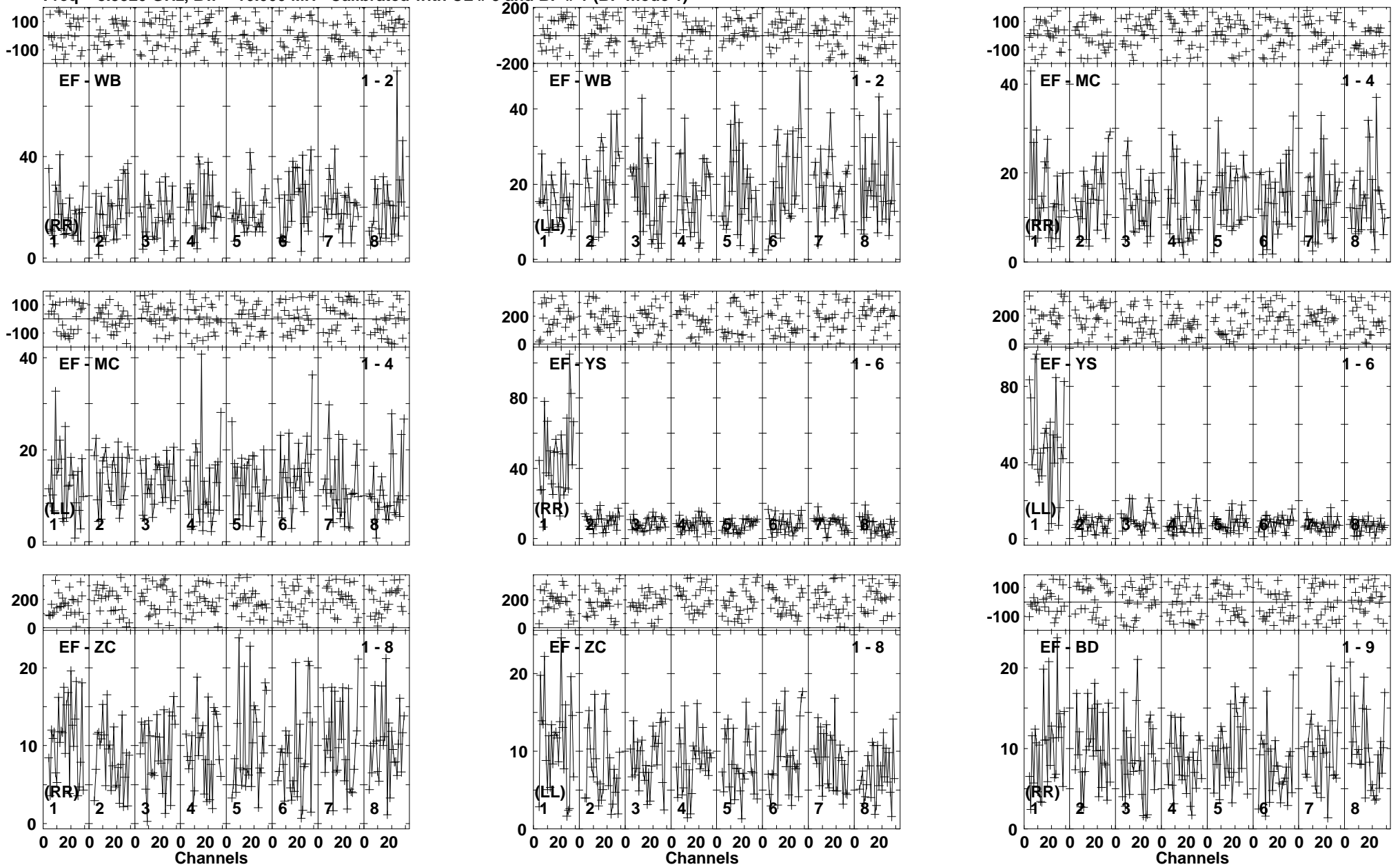

Lower frame: Milli Ampl Jy Top frame: Phas deg
Vector averaged cross-power spectrum Baseline: EF (01) - WB (02)
Timerange: 00/07:24:19 to 00/07:27:14

Plot file version 280 created 24-MAR-2014 14:38:51

ARP299D EP087F 5.UVDATA.1

Freq = 8.3520 GHz, Bw = 16.000 MH Calibrated with CL # 3 and BP # 1 (BP mode 1)

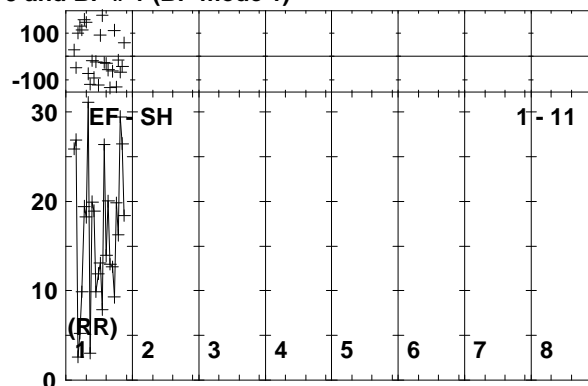
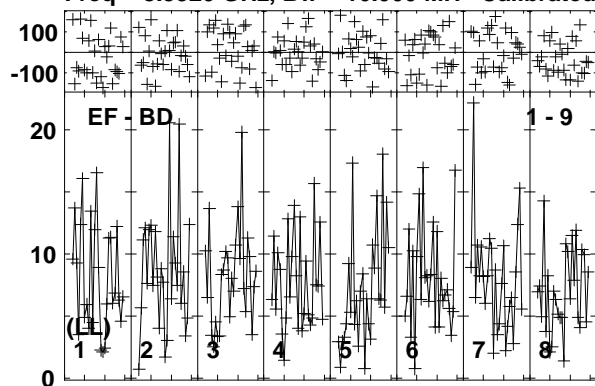

Lower frame: Milli Ampl Jy Top frame: Phas deg
Vector averaged cross-power spectrum Baseline: EF (01) - BD (09)
Timerange: 00/07:24:19 to 00/07:27:14

Plot file version 281 created 24-MAR-2014 14:38:51

J1128+5925 EP087F 5.UVDATA.1

Freq = 8.3520 GHz, Bw = 16.000 MH Calibrated with CL # 3 and BP # 1 (BP mode 1)

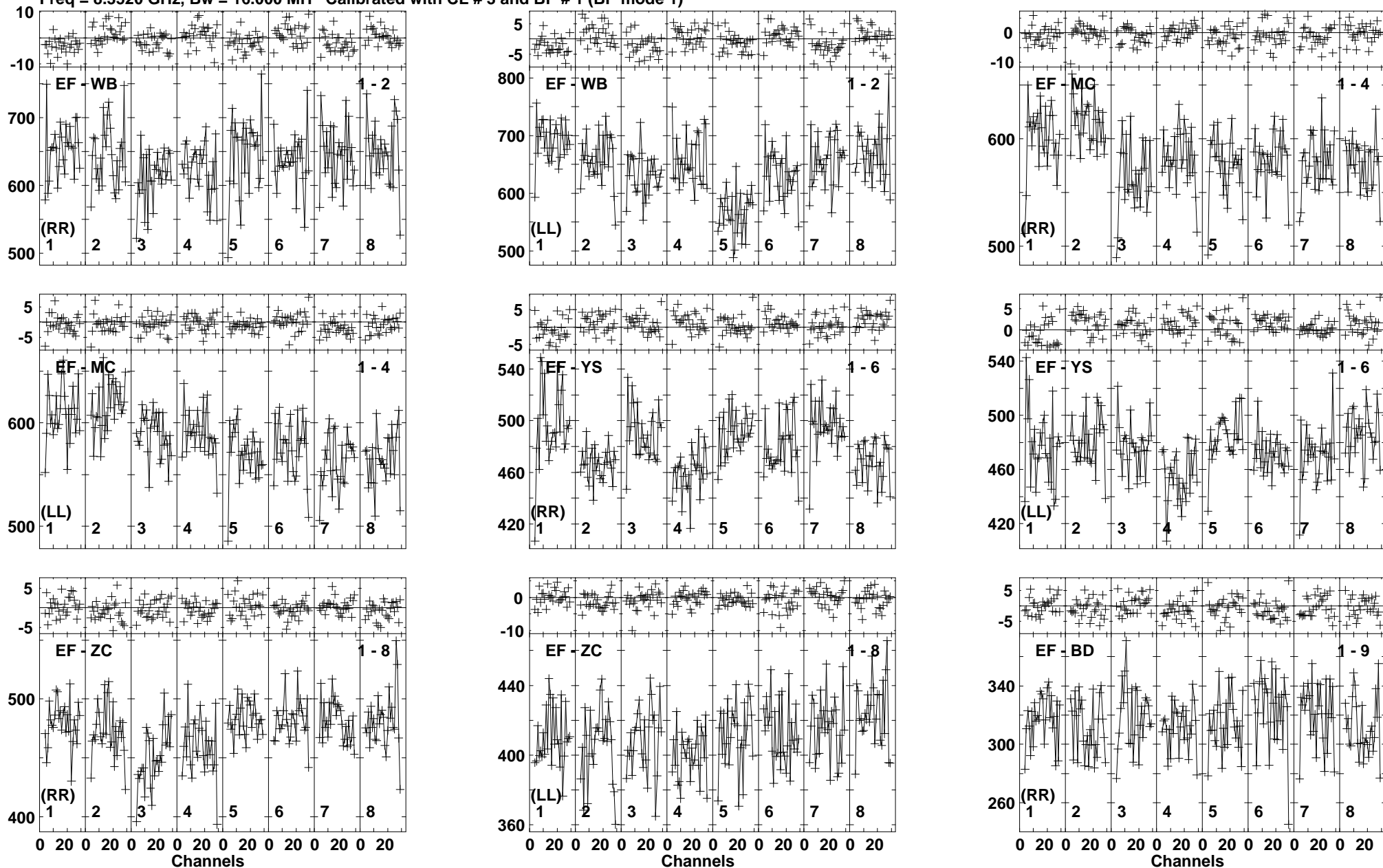

Lower frame: Milli Ampl Jy Top frame: Phas deg
Vector averaged cross-power spectrum Baseline: EF (01) - WB (02)
Timerange: 00/07:27:56 to 00/07:28:24

Plot file version 282 created 24-MAR-2014 14:38:51

J1128+5925 EP087F 5.UVDATA.1

Freq = 8.3520 GHz, Bw = 16.000 MH Calibrated with CL # 3 and BP # 1 (BP mode 1)

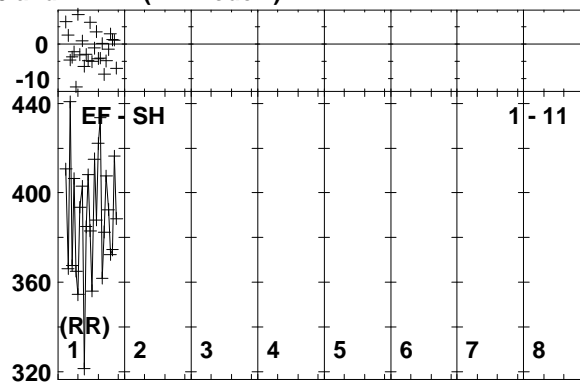
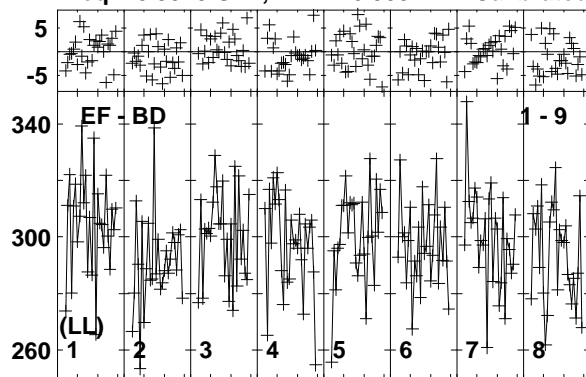

Lower frame: Milli Ampl Jy Top frame: Phas deg
Vector averaged cross-power spectrum Baseline: EF (01) - BD (09)
Timerange: 00/07:27:56 to 00/07:28:24

Plot file version 283 created 24-MAR-2014 14:38:51
 ARP299D EP087F 5.UVDATA.1
 Freq = 8.3520 GHz, Bw = 16.000 MH Calibrated with CL # 3 and BP # 1 (BP mode 1)

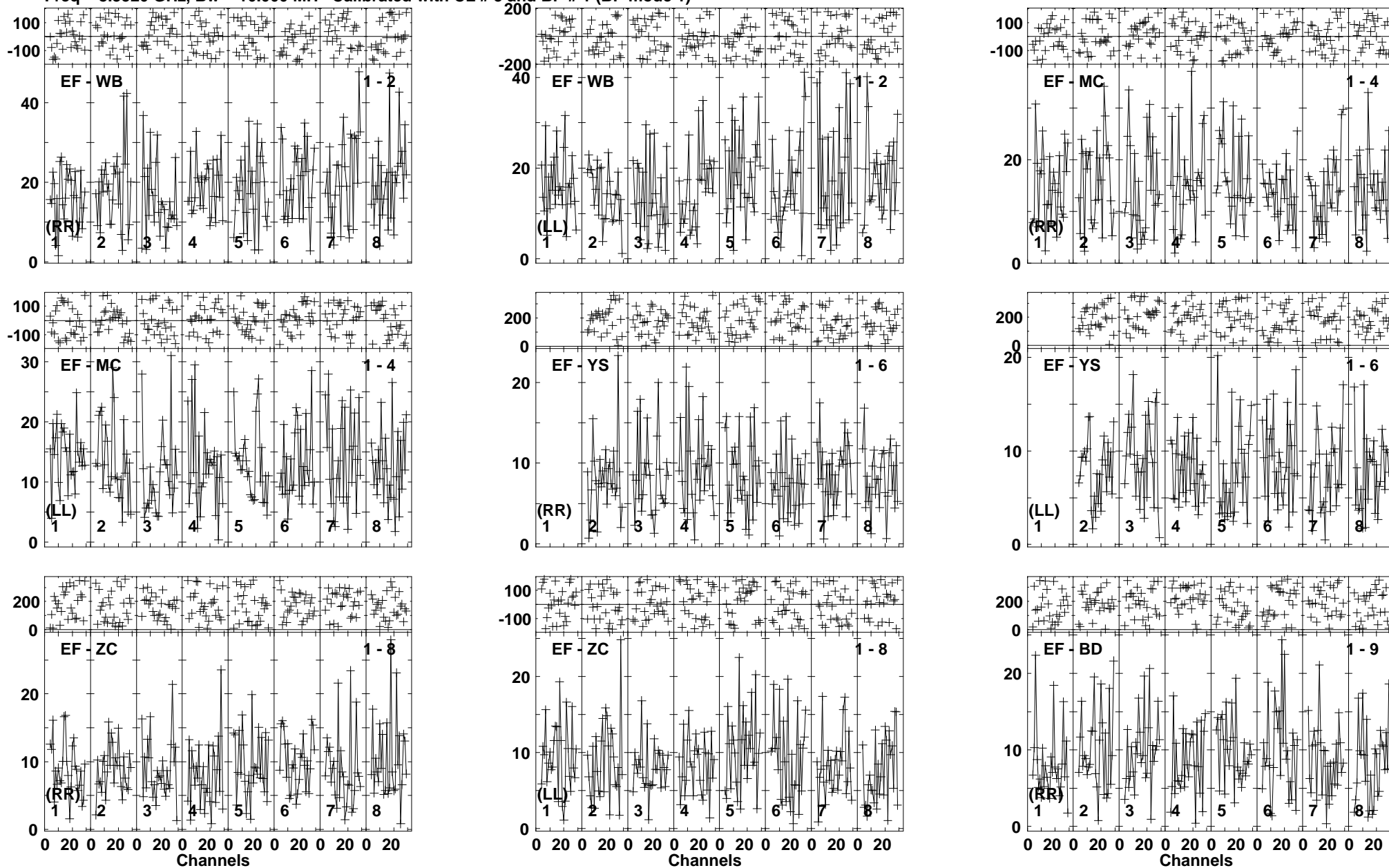

Lower frame: Milli Ampl Jy Top frame: Phas deg
 Vector averaged cross-power spectrum Baseline: EF (01) - WB (02)
 Timerange: 00/07:28:29 to 00/07:31:25

Plot file version 284 created 24-MAR-2014 14:38:52

ARP299D EP087F 5.UVDATA.1

Freq = 8.3520 GHz, Bw = 16.000 MH Calibrated with CL # 3 and BP # 1 (BP mode 1)

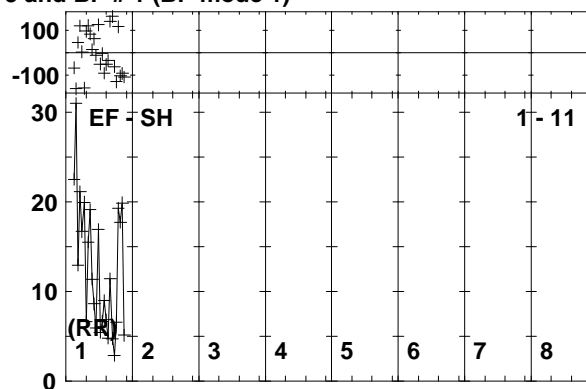
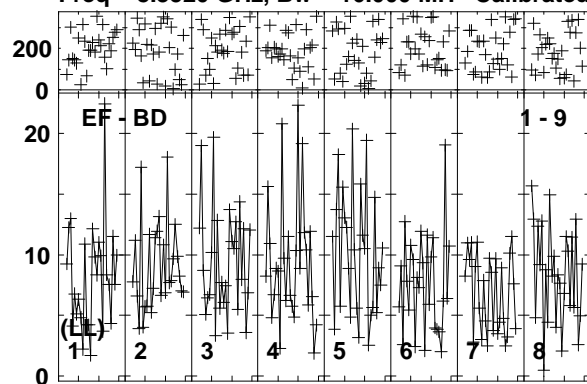

Lower frame: Milli Ampl Jy Top frame: Phas deg
Vector averaged cross-power spectrum Baseline: EF (01) - BD (09)
Timerange: 00/07:28:29 to 00/07:31:25

Plot file version 285 created 24-MAR-2014 14:38:52
 J1128+5925 EP087F 5.UVDATA.1
 Freq = 8.3520 GHz, Bw = 16.000 MH Calibrated with CL # 3 and BP # 1 (BP mode 1)

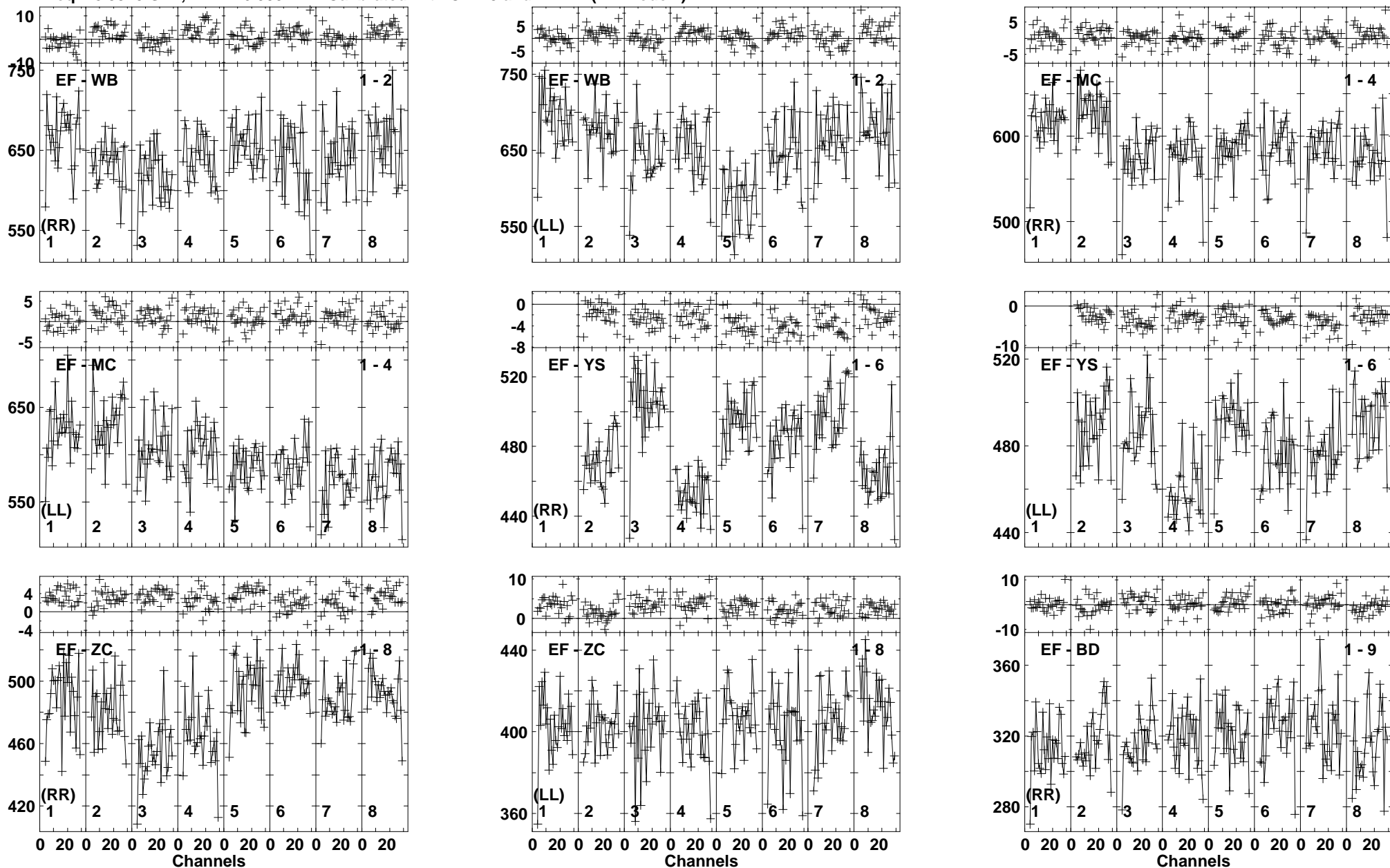

Lower frame: Milli Ampl Jy Top frame: Phas deg
 Vector averaged cross-power spectrum Baseline: EF (01) - WB (02)
 Timerange: 00/07:31:29 to 00/07:32:29

Plot file version 286 created 24-MAR-2014 14:38:52
J1128+5925 EP087F 5.UVDATA.1
Freq = 8.3520 GHz, Bw = 16.000 MH Calibrated with CL # 3 and BP # 1 (BP mode 1)

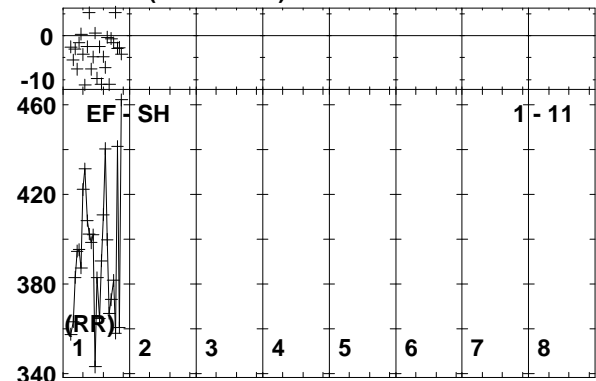
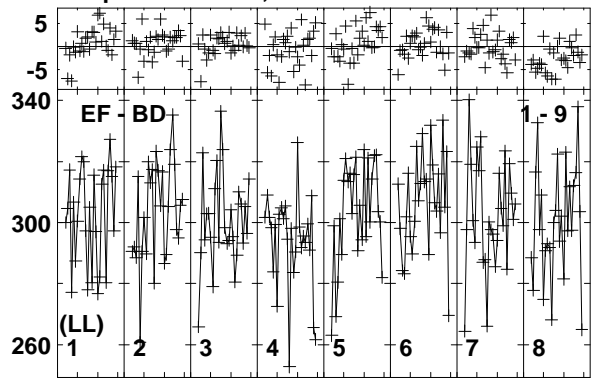

Lower frame: Milli Ampl Jy Top frame: Phas deg
Vector averaged cross-power spectrum Baseline: EF (01) - BD (09)
Timerange: 00/07:31:29 to 00/07:32:29

Plot file version 287 created 24-MAR-2014 14:38:52
 ARP299D EP087F 5.UVDATA.1
 Freq = 8.3520 GHz, Bw = 16.000 MH Calibrated with CL # 3 and BP # 1 (BP mode 1)

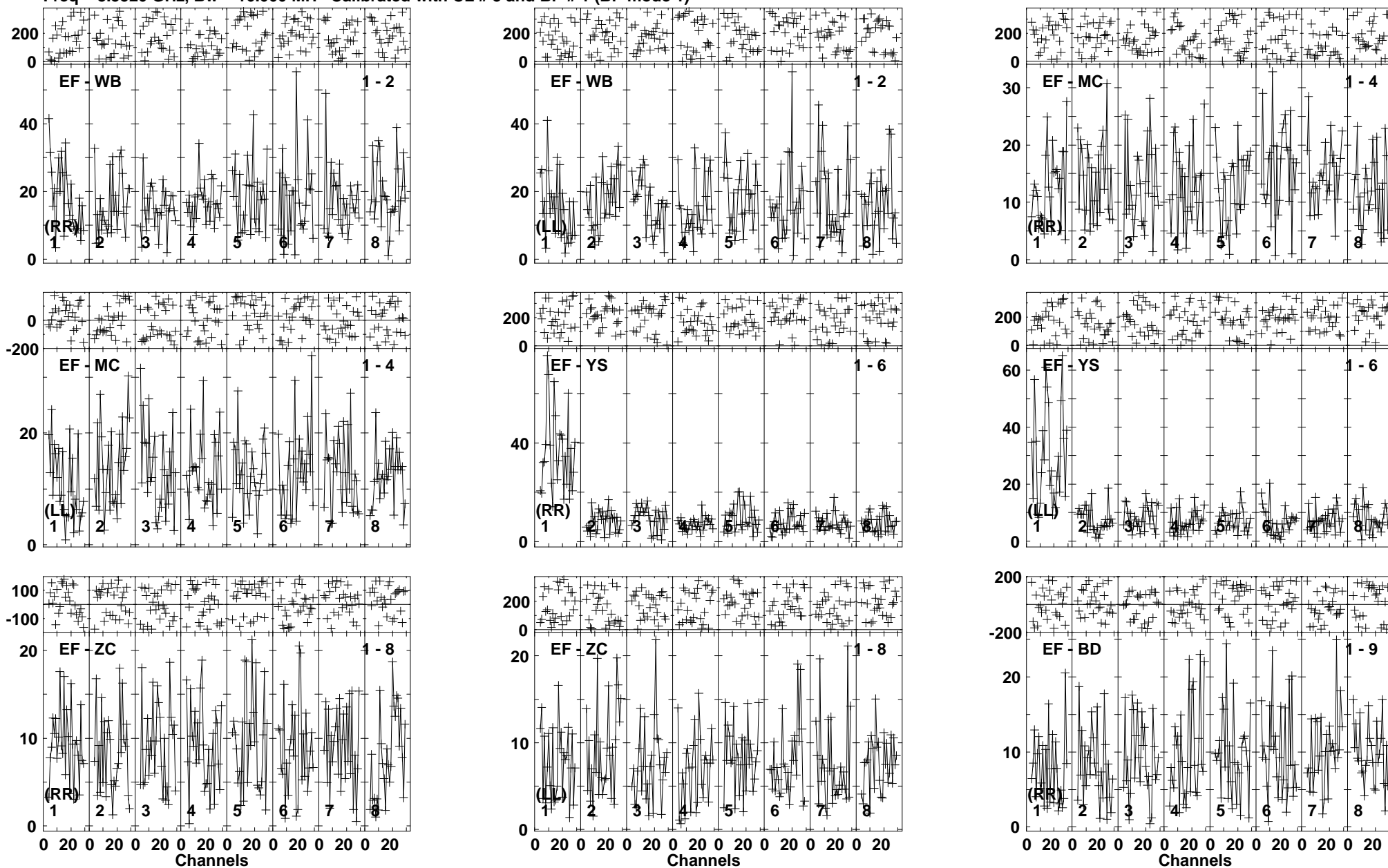

Lower frame: Milli Ampl Jy Top frame: Phas deg
 Vector averaged cross-power spectrum Baseline: EF (01) - WB (02)
 Timerange: 00/07:32:33 to 00/07:35:30

Plot file version 288 created 24-MAR-2014 14:38:52

ARP299D EP087F 5.UVDATA.1

Freq = 8.3520 GHz, Bw = 16.000 MH Calibrated with CL # 3 and BP # 1 (BP mode 1)

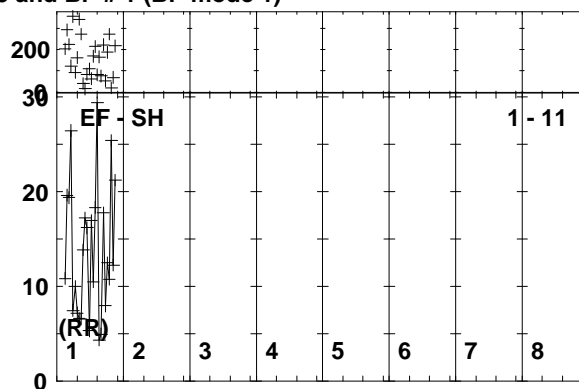
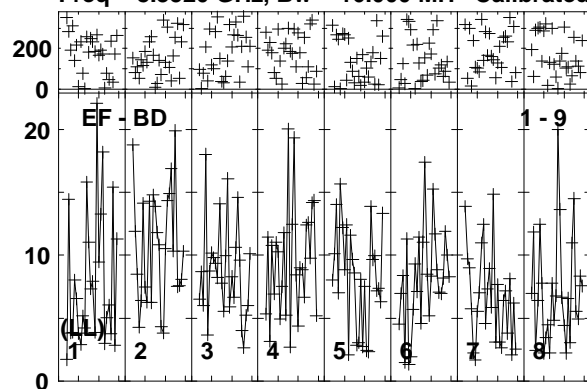

Lower frame: Milli Ampl Jy Top frame: Phas deg
Vector averaged cross-power spectrum Baseline: EF (01) - BD (09)
Timerange: 00/07:32:33 to 00/07:35:30

Plot file version 289 created 24-MAR-2014 14:38:53

J1128+5925 EP087F 5.UVDATA.1

Freq = 8.3520 GHz, Bw = 16.000 MH Calibrated with CL # 3 and BP # 1 (BP mode 1)

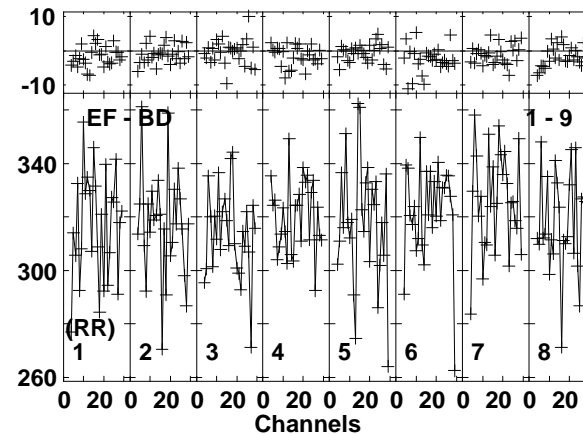
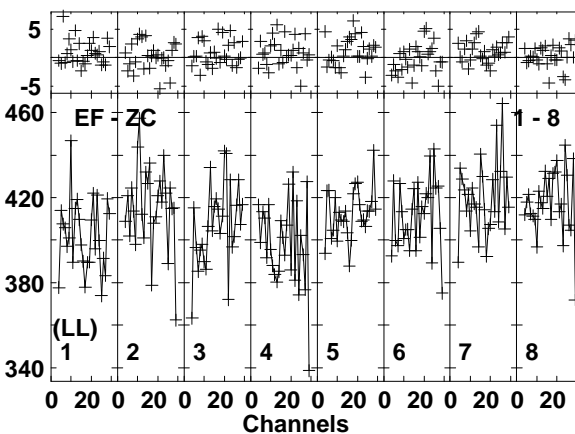
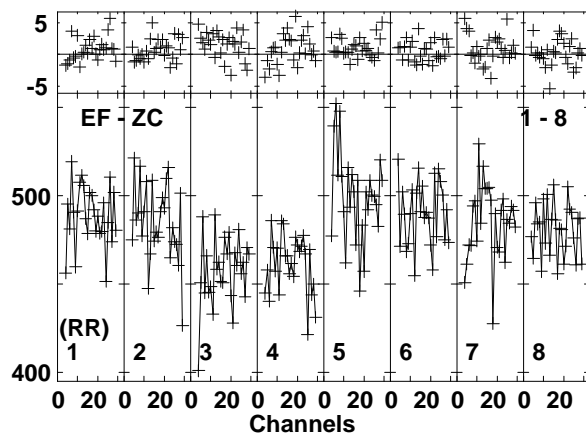
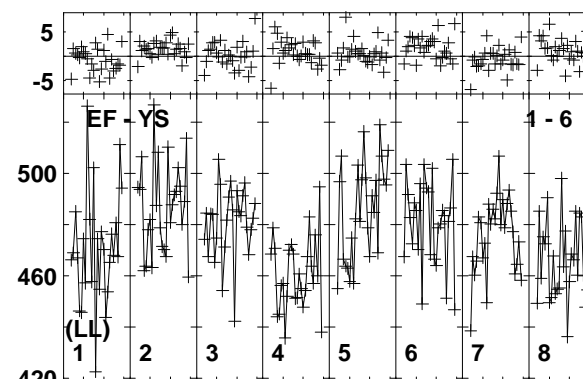
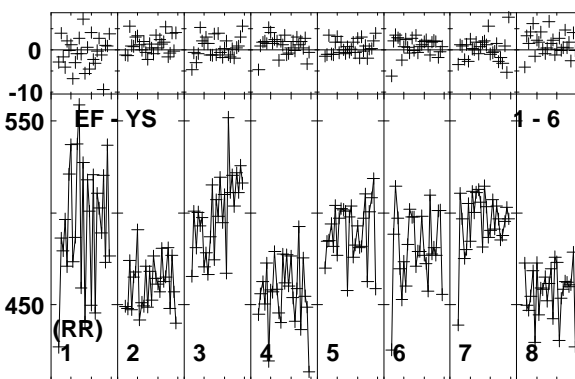
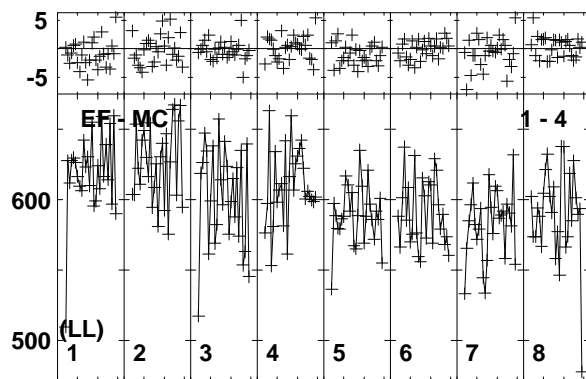
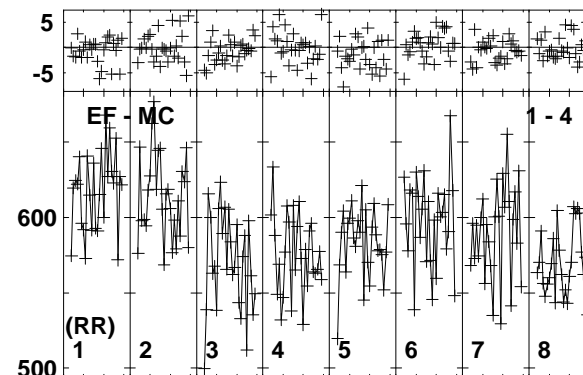
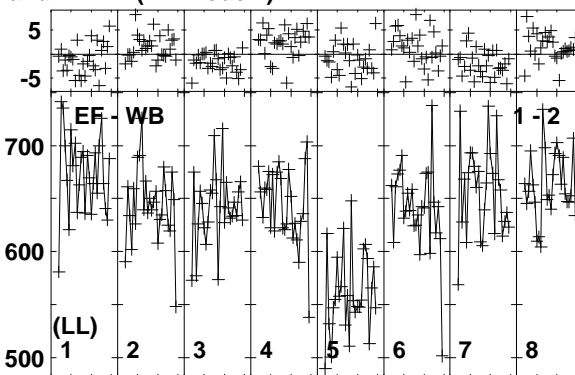
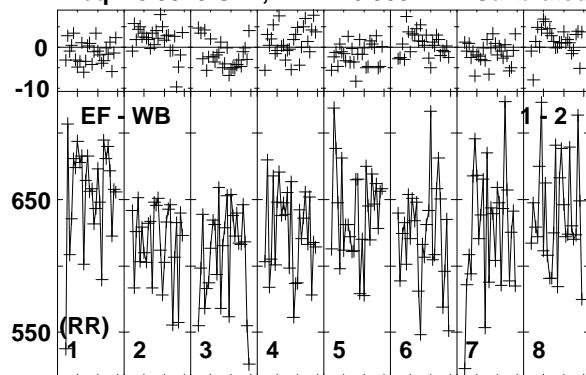

Lower frame: Milli Ampl Jy Top frame: Phas deg
Vector averaged cross-power spectrum Baseline: EF (01) - WB (02)
Timerange: 00/07:36:11 to 00/07:36:39

Plot file version 290 created 24-MAR-2014 14:38:53
J1128+5925 EP087F 5.UVDATA.1
Freq = 8.3520 GHz, Bw = 16.000 MH Calibrated with CL # 3 and BP # 1 (BP mode 1)

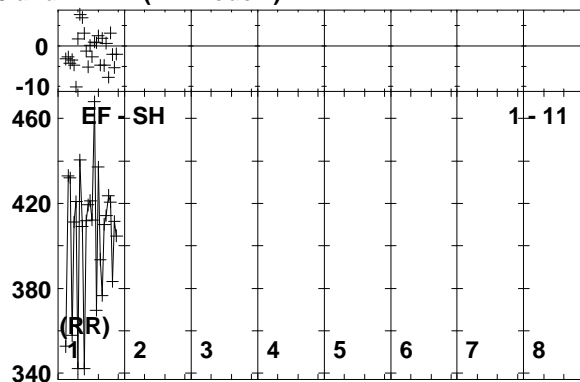
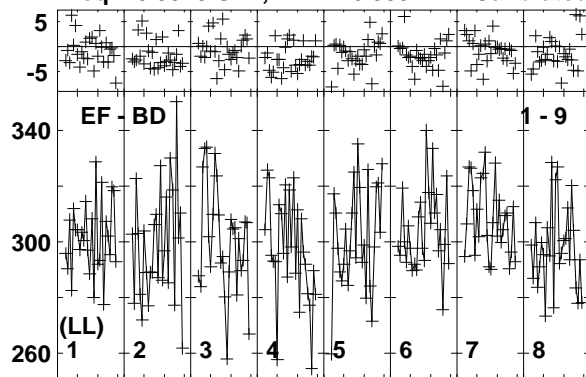

Lower frame: Milli Ampl Jy Top frame: Phas deg
Vector averaged cross-power spectrum Baseline: EF (01) - BD (09)
Timerange: 00/07:36:11 to 00/07:36:39

Plot file version 291 created 24-MAR-2014 14:38:53
 ARP299D EP087F 5.UVDATA.1
 Freq = 8.3520 GHz, Bw = 16.000 MH Calibrated with CL # 3 and BP # 1 (BP mode 1)

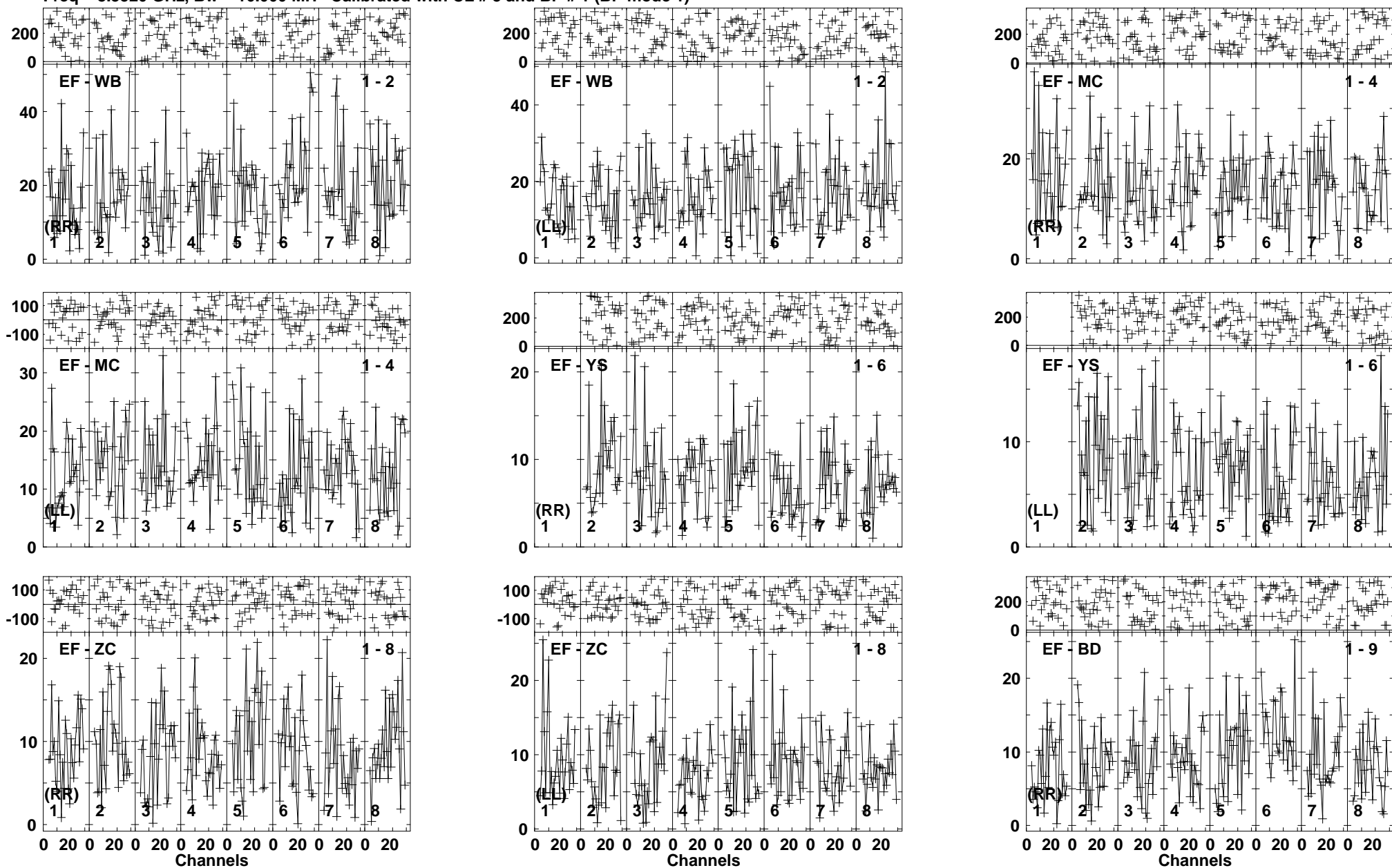

Lower frame: Milli Ampl Jy Top frame: Phas deg
 Vector averaged cross-power spectrum Baseline: EF (01) - WB (02)
 Timerange: 00/07:36:44 to 00/07:39:40

Plot file version 292 created 24-MAR-2014 14:38:53

ARP299D EP087F 5.UVDATA.1

Freq = 8.3520 GHz, Bw = 16.000 MH Calibrated with CL # 3 and BP # 1 (BP mode 1)

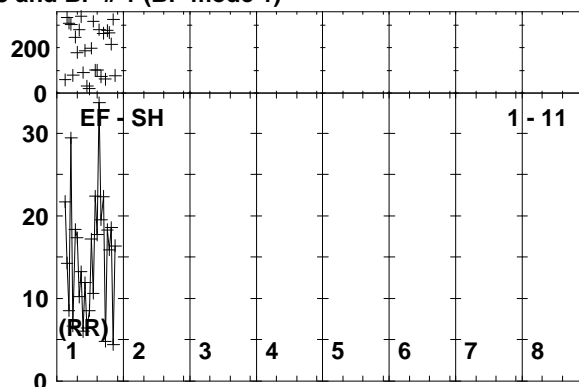
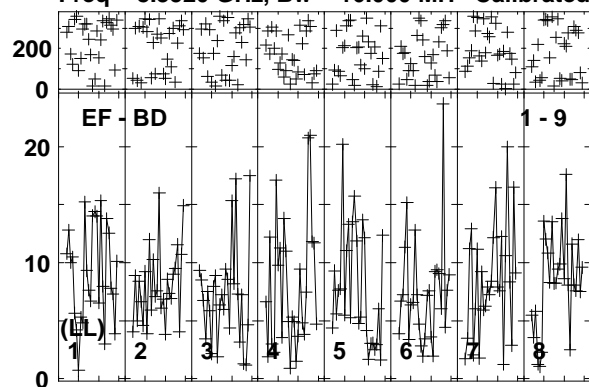

Lower frame: Milli Ampl Jy Top frame: Phas deg
Vector averaged cross-power spectrum Baseline: EF (01) - BD (09)
Timerange: 00/07:36:44 to 00/07:39:40

Plot file version 293 created 24-MAR-2014 14:38:53

J1128+5925 EP087F 5.UVDATA.1

Freq = 8.3520 GHz, Bw = 16.000 MH Calibrated with CL # 3 and BP # 1 (BP mode 1)

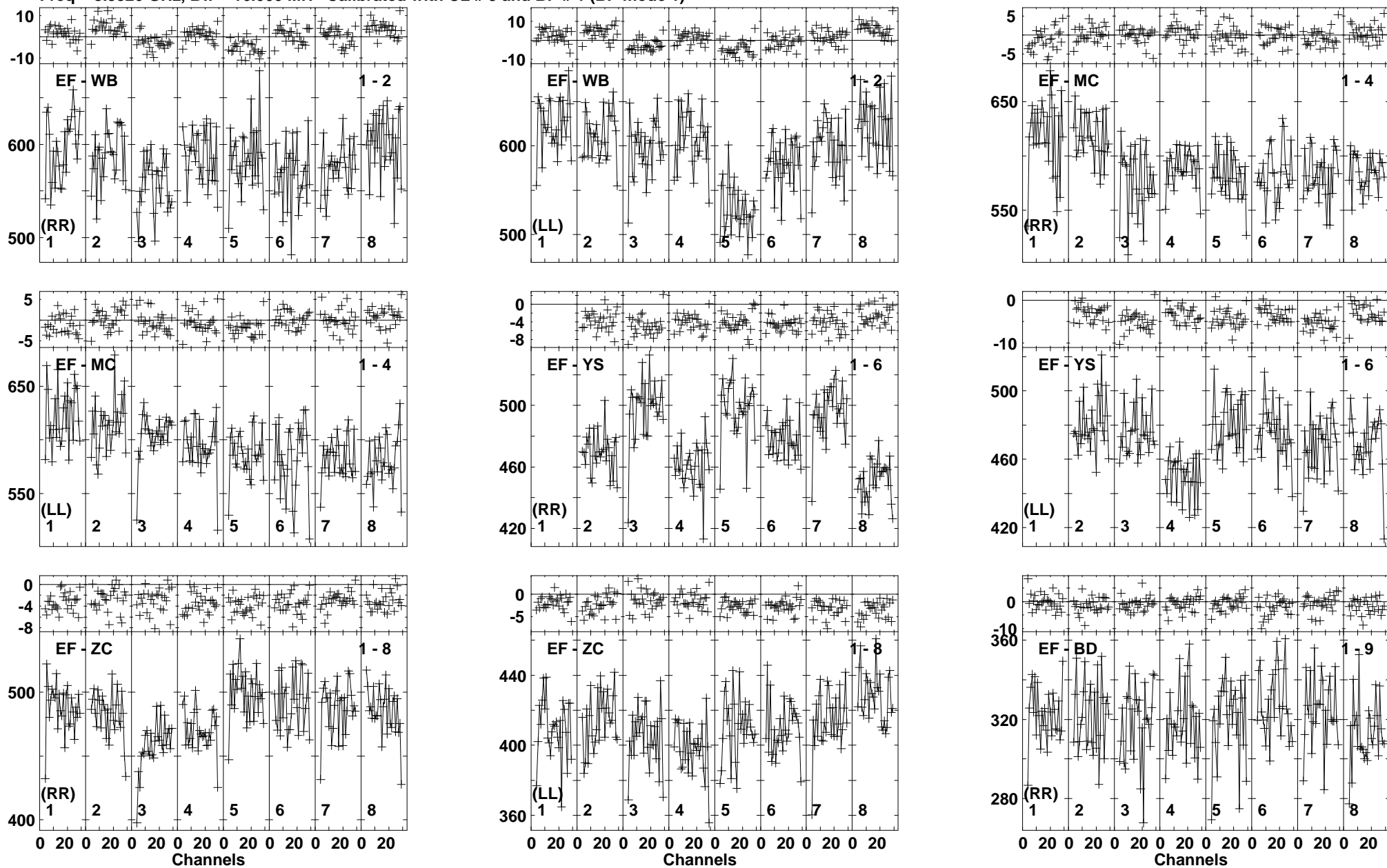

Lower frame: Milli Ampl Jy Top frame: Phas deg
Vector averaged cross-power spectrum Baseline: EF (01) - WB (02)
Timerange: 00/07:39:44 to 00/07:40:44

Plot file version 294 created 24-MAR-2014 14:38:54
J1128+5925 EP087F 5.UVDATA.1
Freq = 8.3520 GHz, Bw = 16.000 MH Calibrated with CL # 3 and BP # 1 (BP mode 1)

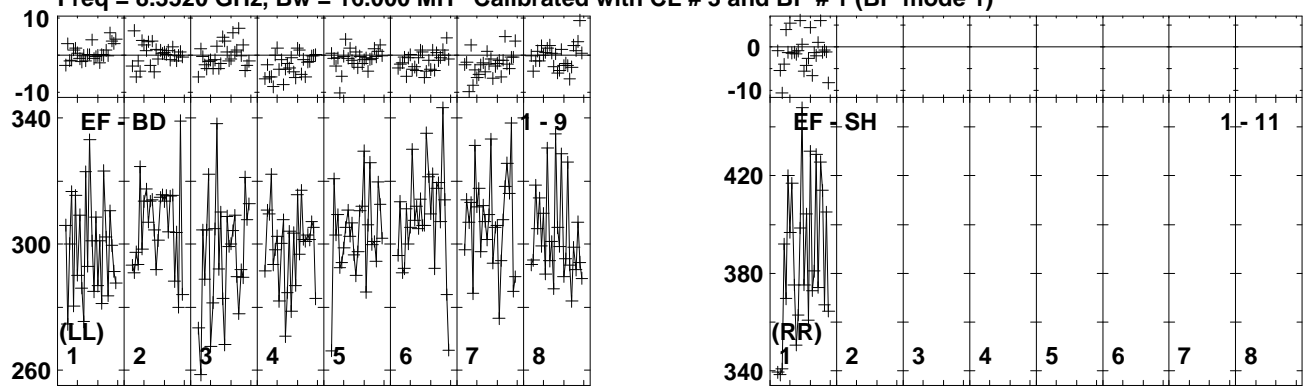

Lower frame: Milli Ampl Jy Top frame: Phas deg
Vector averaged cross-power spectrum Baseline: EF (01) - BD (09)
Timerange: 00/07:39:44 to 00/07:40:44

Plot file version 295 created 24-MAR-2014 14:38:54
 ARP299D EP087F 5.UVDATA.1
 Freq = 8.3520 GHz, Bw = 16.000 MH Calibrated with CL # 3 and BP # 1 (BP mode 1)

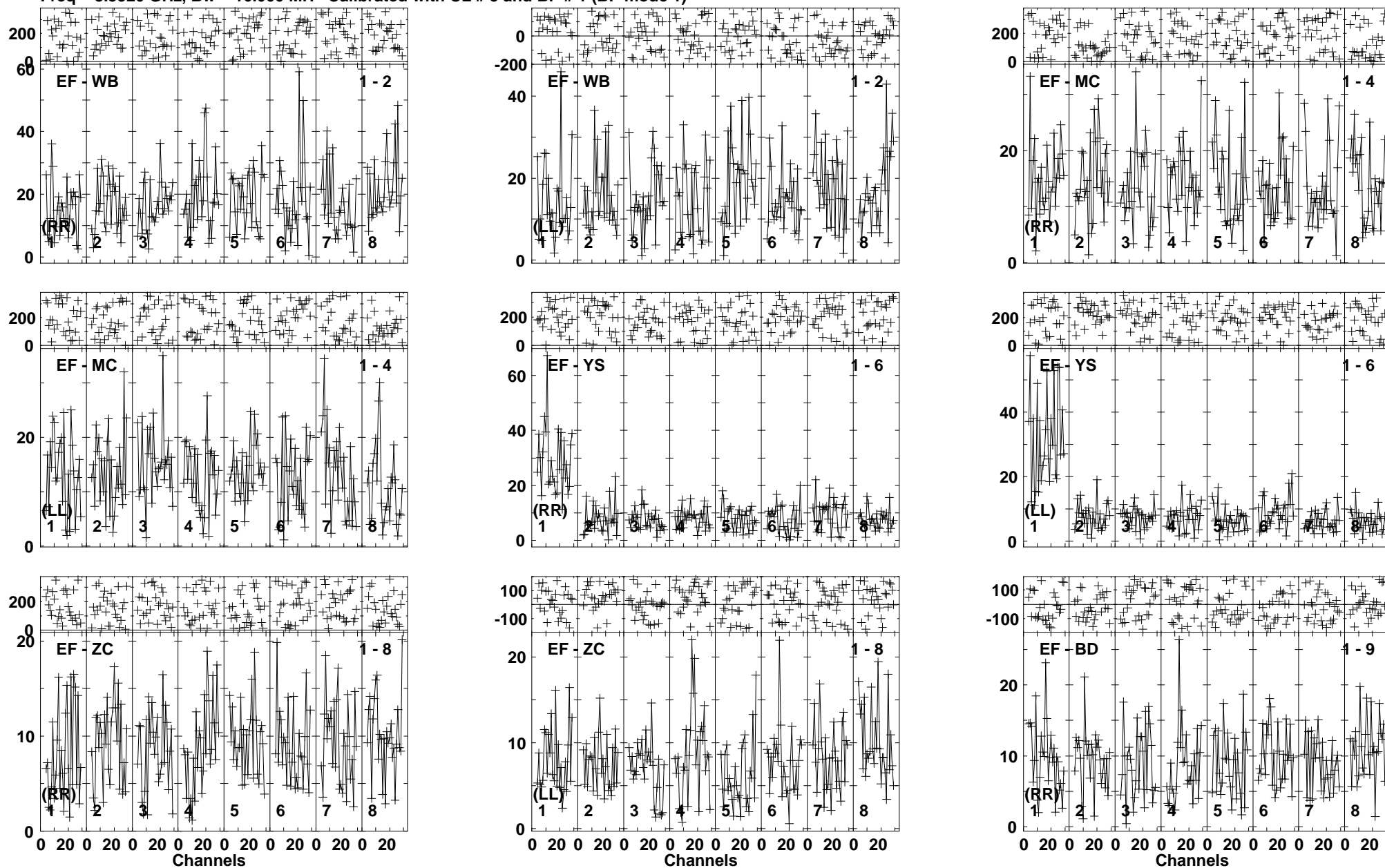

Lower frame: Milli Ampl Jy Top frame: Phas deg
 Vector averaged cross-power spectrum Baseline: EF (01) - WB (02)
 Timerange: 00/07:40:48 to 00/07:43:44

Plot file version 296 created 24-MAR-2014 14:38:54

ARP299D EP087F 5.UVDATA.1

Freq = 8.3520 GHz, Bw = 16.000 MH Calibrated with CL # 3 and BP # 1 (BP mode 1)

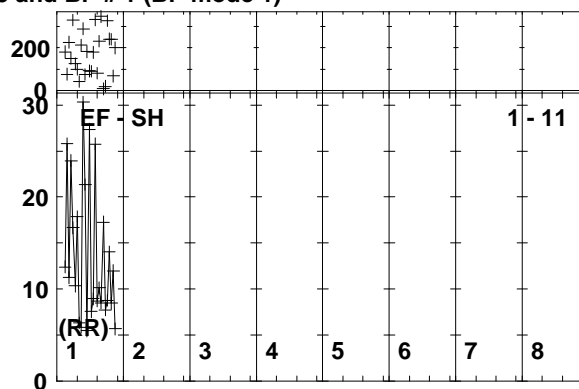
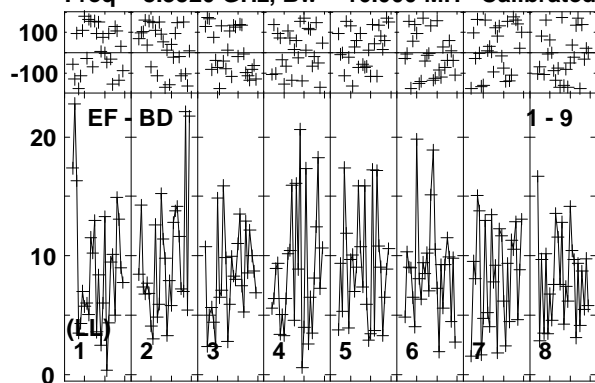

Lower frame: Milli Ampl Jy Top frame: Phas deg
Vector averaged cross-power spectrum Baseline: EF (01) - BD (09)
Timerange: 00/07:40:48 to 00/07:43:44

Plot file version 297 created 24-MAR-2014 14:38:54

J1128+5925 EP087F 5.UVDATA.1

Freq = 8.3520 GHz, Bw = 16.000 MH Calibrated with CL # 3 and BP # 1 (BP mode 1)

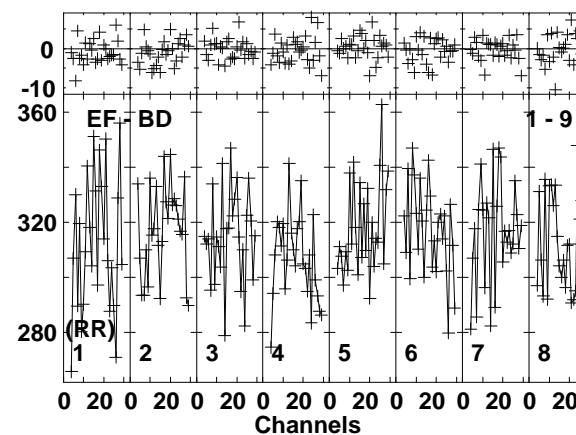
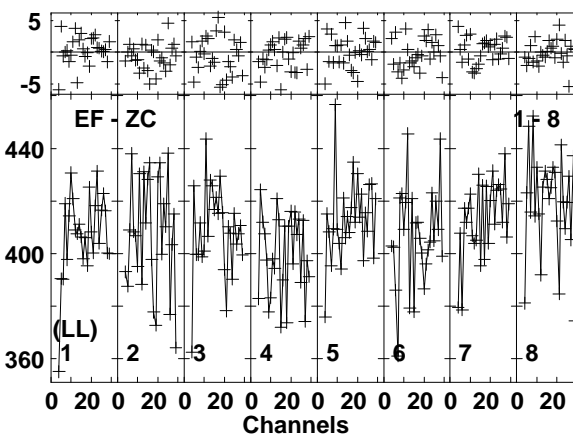
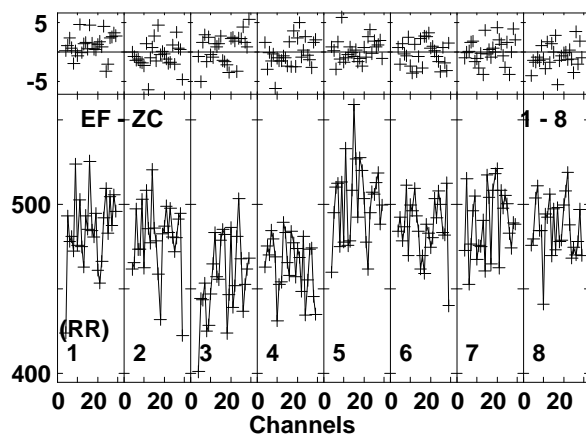
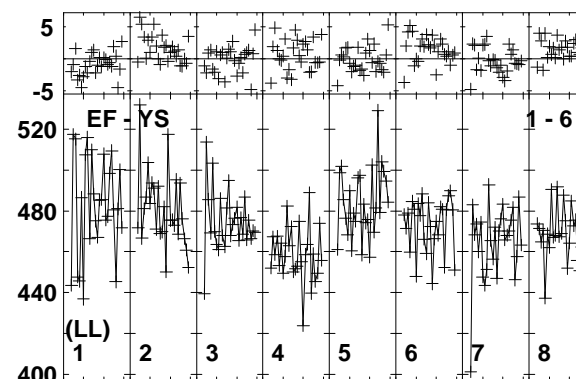
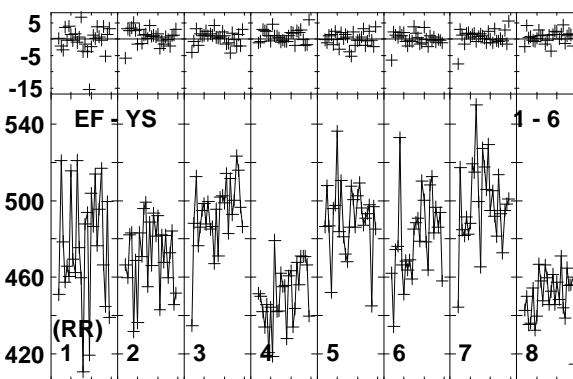
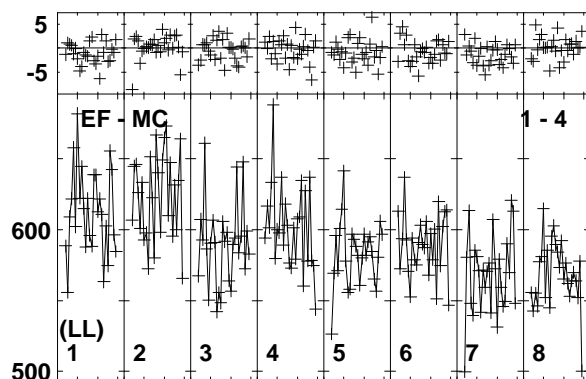
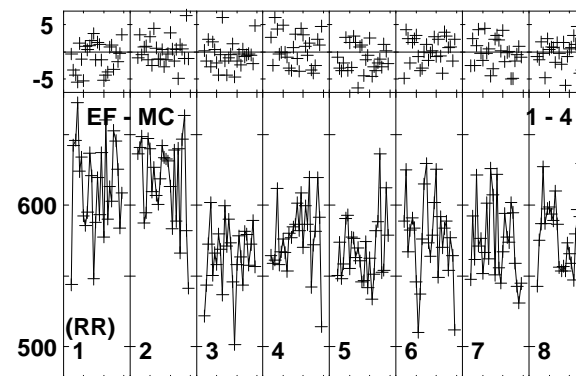
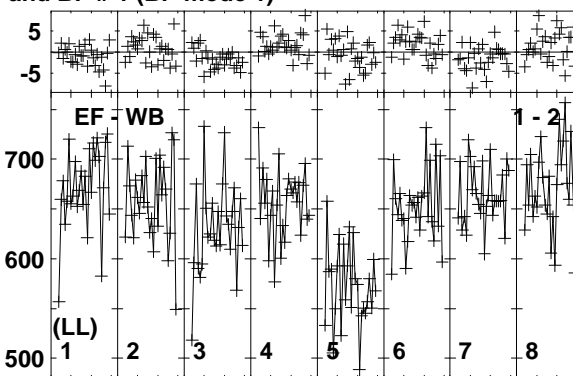
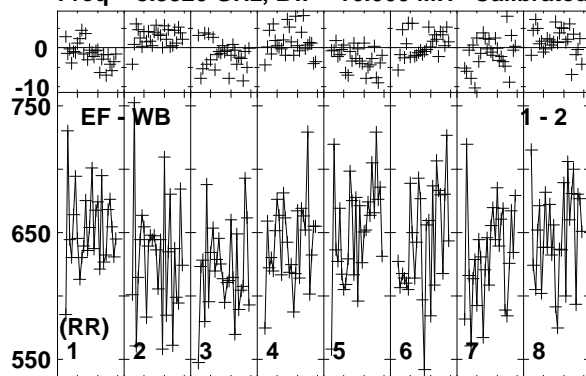

Lower frame: Milli Ampl Jy Top frame: Phas deg
Vector averaged cross-power spectrum Baseline: EF (01) - WB (02)
Timerange: 00/07:44:25 to 00/07:44:54

Plot file version 298 created 24-MAR-2014 14:38:55
J1128+5925 EP087F 5.UVDATA.1
Freq = 8.3520 GHz, Bw = 16.000 MH Calibrated with CL # 3 and BP # 1 (BP mode 1)

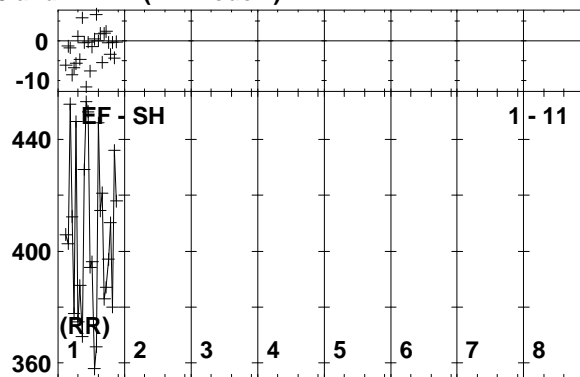
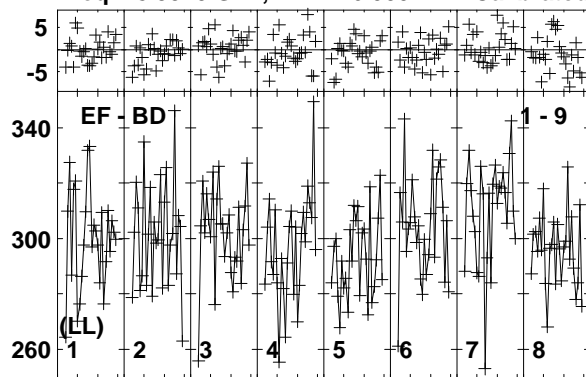

Lower frame: Milli Ampl Jy Top frame: Phas deg
Vector averaged cross-power spectrum Baseline: EF (01) - BD (09)
Timerange: 00/07:44:25 to 00/07:44:54

Plot file version 299 created 24-MAR-2014 14:38:55
 ARP299D EP087F 5.UVDATA.1
 Freq = 8.3520 GHz, Bw = 16.000 MH Calibrated with CL # 3 and BP # 1 (BP mode 1)

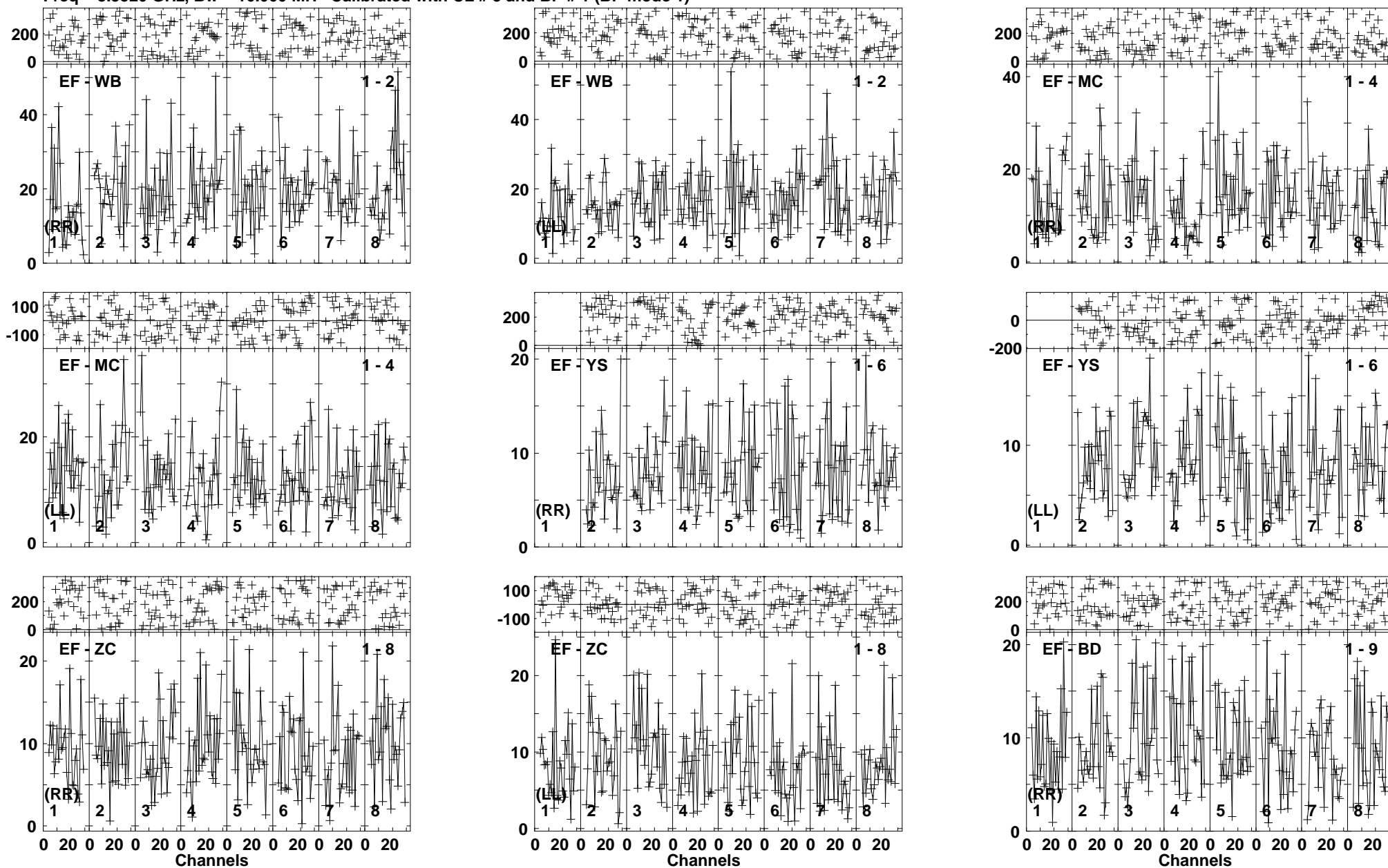

Lower frame: Milli Ampl Jy Top frame: Phas deg
 Vector averaged cross-power spectrum Baseline: EF (01) - WB (02)
 Timerange: 00/07:44:58 to 00/07:47:54

Plot file version 300 created 24-MAR-2014 14:38:55

ARP299D EP087F 5.UVDATA.1

Freq = 8.3520 GHz, Bw = 16.000 MH Calibrated with CL # 3 and BP # 1 (BP mode 1)

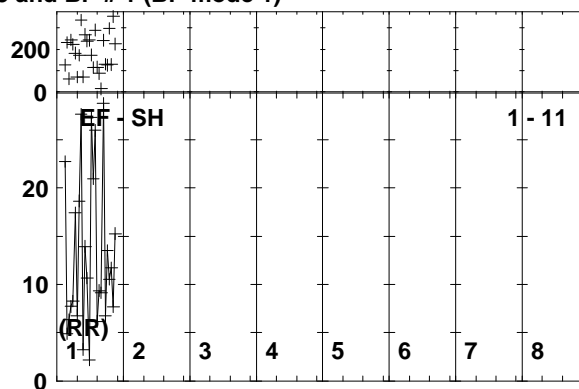
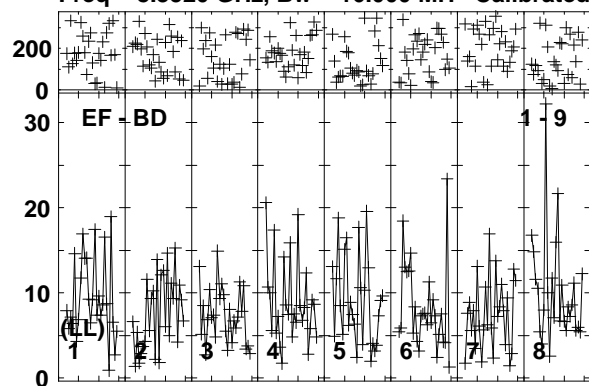

Lower frame: Milli Ampl Jy Top frame: Phas deg
Vector averaged cross-power spectrum Baseline: EF (01) - BD (09)
Timerange: 00/07:44:58 to 00/07:47:54

Plot file version 301 created 24-MAR-2014 14:38:55

J1128+5925 EP087F 5.UVDATA.1

Freq = 8.3520 GHz, Bw = 16.000 MH Calibrated with CL # 3 and BP # 1 (BP mode 1)

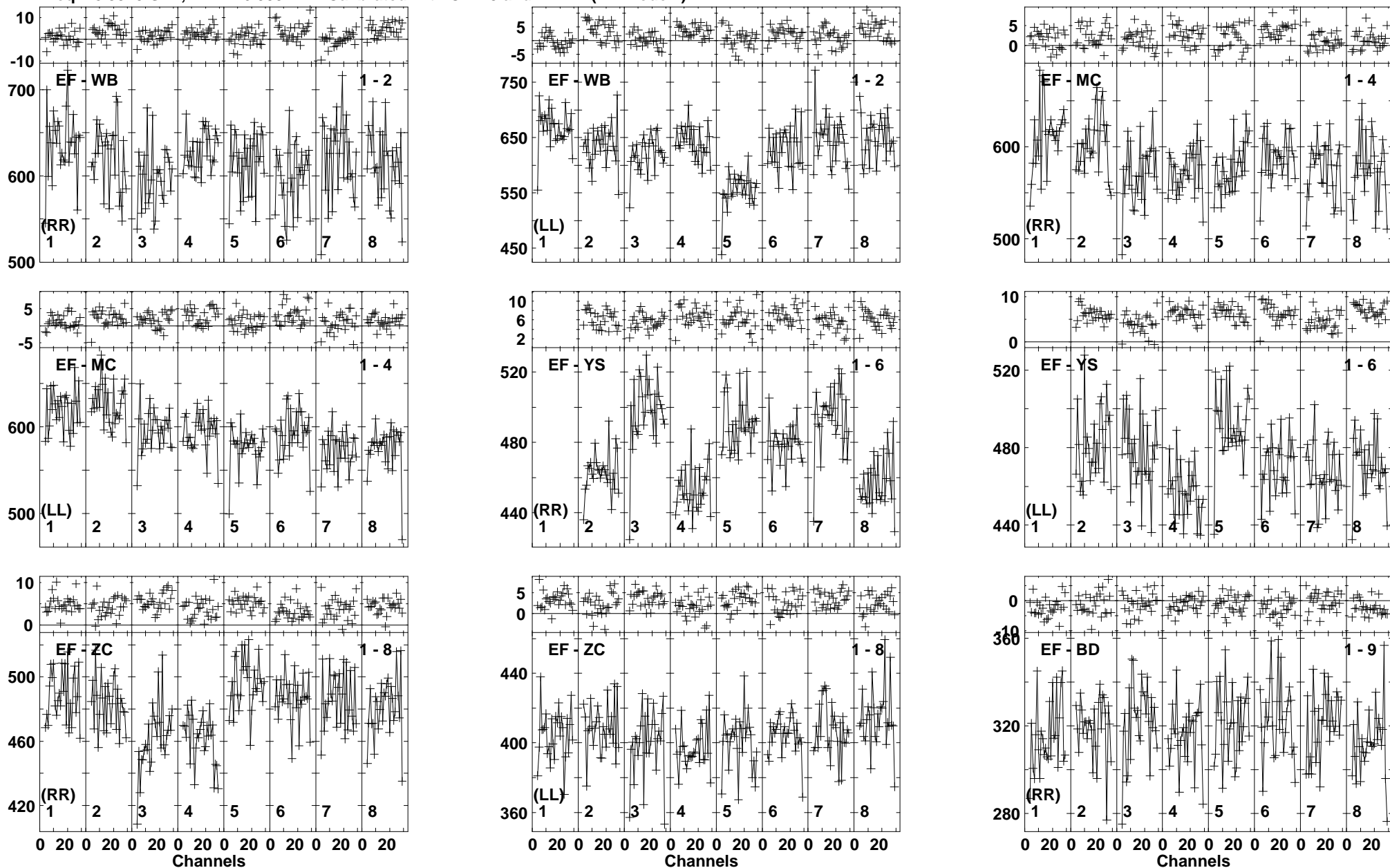

Plot file version 302 created 24-MAR-2014 14:38:55

J1128+5925 EP087F 5.UVDATA.1

Freq = 8.3520 GHz, Bw = 16.000 MH Calibrated with CL # 3 and BP # 1 (BP mode 1)

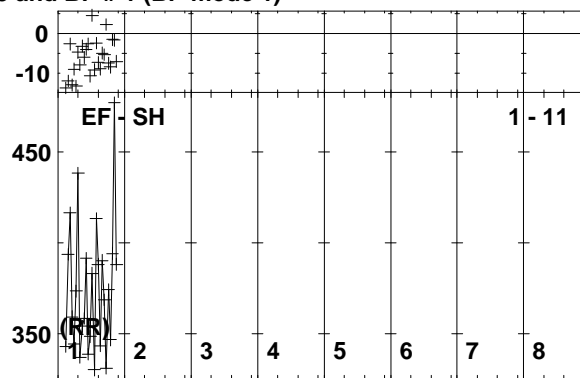
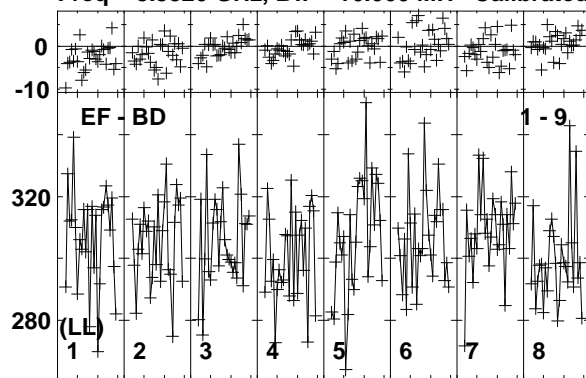

Lower frame: Milli Ampl Jy Top frame: Phas deg
Vector averaged cross-power spectrum Baseline: EF (01) - BD (09)
Timerange: 00/07:47:59 to 00/07:49:00

Plot file version 303 created 24-MAR-2014 14:38:56

ARP299D EP087F 5.UVDATA.1

Freq = 8.3520 GHz, Bw = 16.000 MH Calibrated with CL # 3 and BP # 1 (BP mode 1)

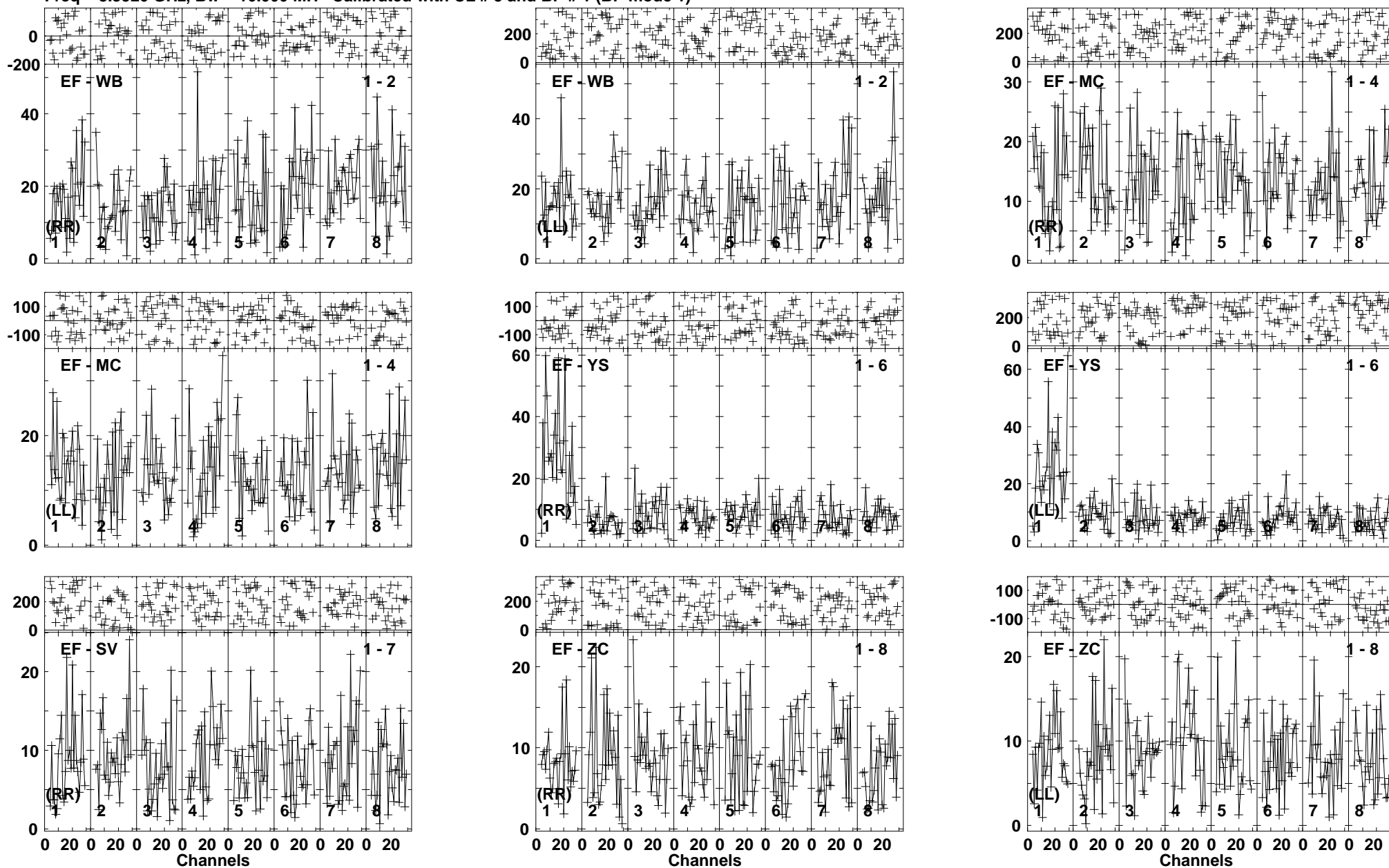

Lower frame: Milli Ampl Jy Top frame: Phas deg
Vector averaged cross-power spectrum Baseline: EF (01) - WB (02)
Timerange: 00/07:49:02 to 00/07:51:59

Plot file version 304 created 24-MAR-2014 14:38:56

ARP299D EP087F 5.UVDATA.1

Freq = 8.3520 GHz, Bw = 16.000 MH Calibrated with CL # 3 and BP # 1 (BP mode 1)

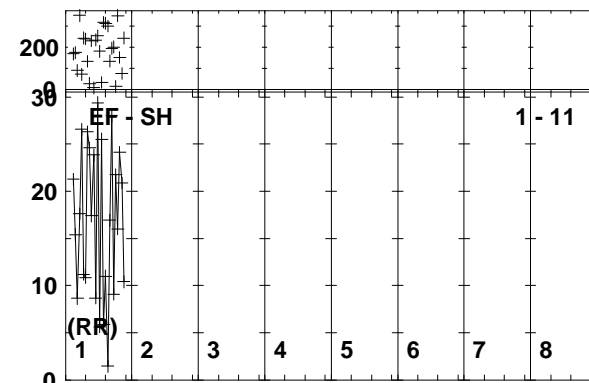
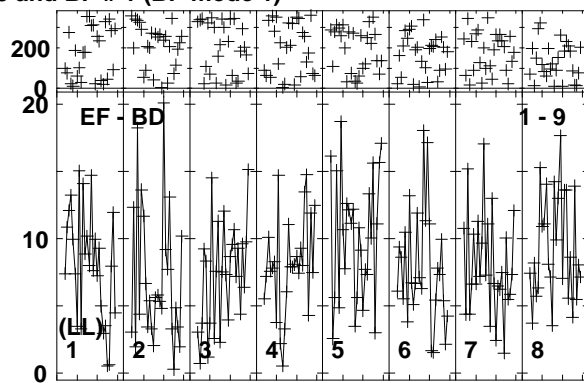
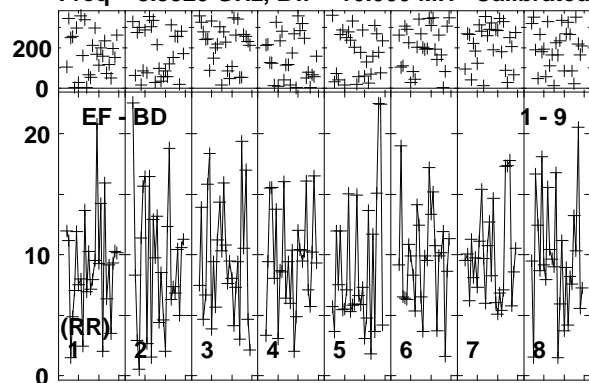

Lower frame: Milli Ampl Jy Top frame: Phas deg
Vector averaged cross-power spectrum Baseline: EF (01) - BD (09)
Timerange: 00/07:49:02 to 00/07:51:59

Plot file version 305 created 24-MAR-2014 14:38:56

J1128+5925 EP087F 5.UVDATA.1

Freq = 8.3520 GHz, Bw = 16.000 MH Calibrated with CL # 3 and BP # 1 (BP mode 1)

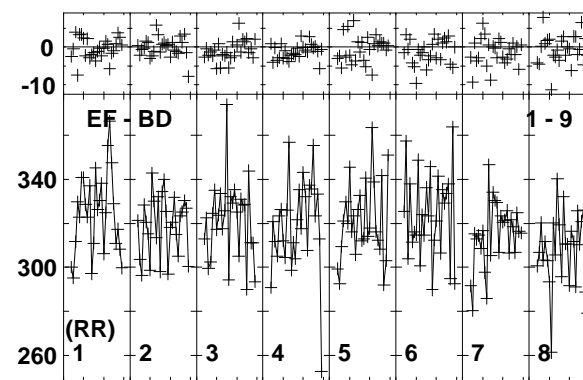
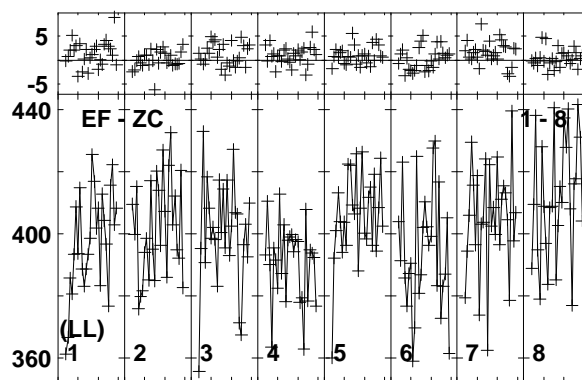
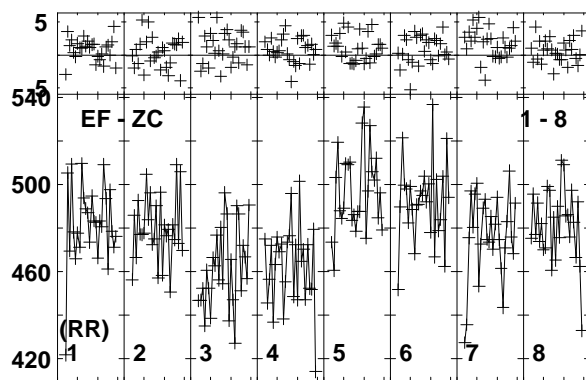
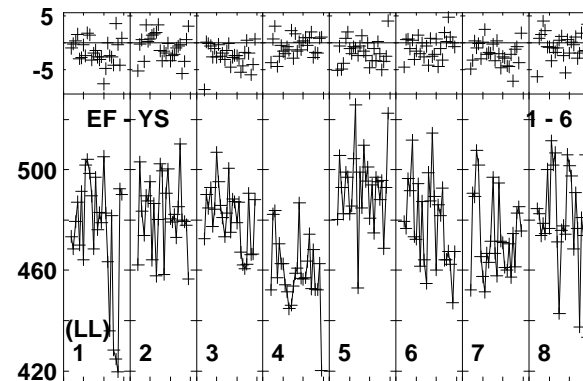
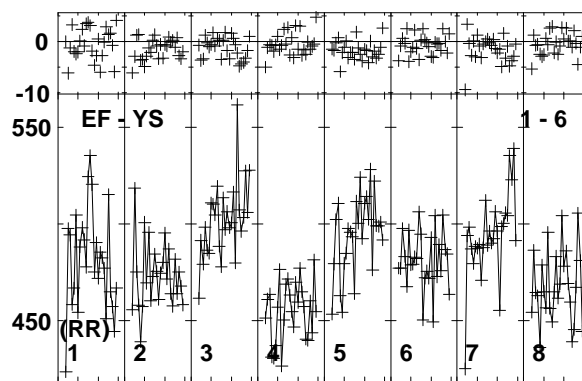
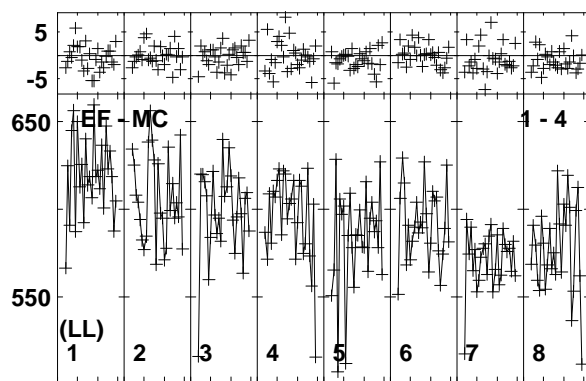
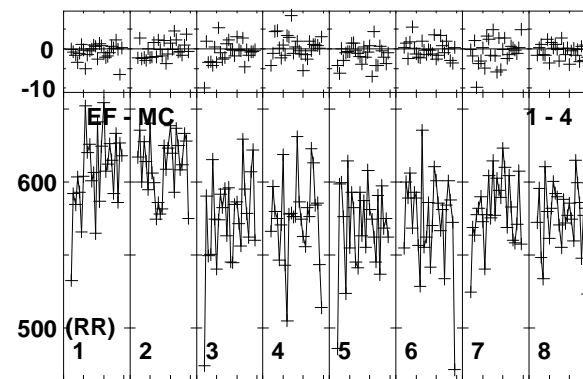
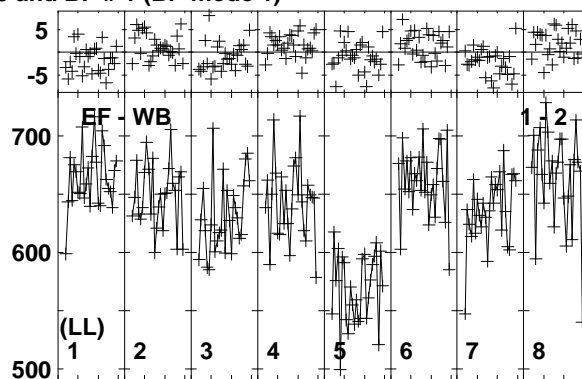
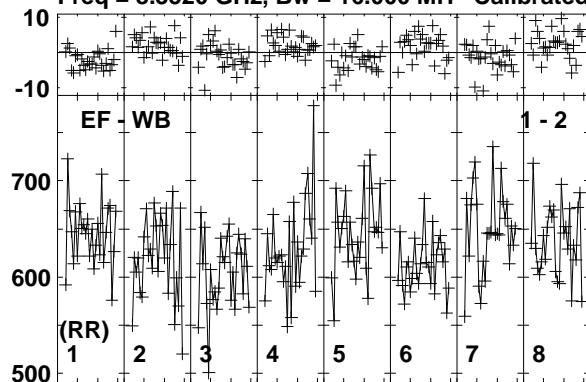

Lower frame: Milli Ampl Jy Top frame: Phas deg
Vector averaged cross-power spectrum Baseline: EF (01) - WB (02)
Timerange: 00/07:52:41 to 00/07:53:09

Plot file version 306 created 24-MAR-2014 14:38:56

J1128+5925 EP087F 5.UVDATA.1

Freq = 8.3520 GHz, Bw = 16.000 MH Calibrated with CL # 3 and BP # 1 (BP mode 1)

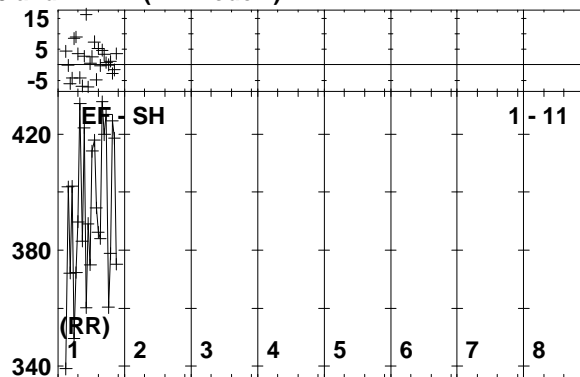
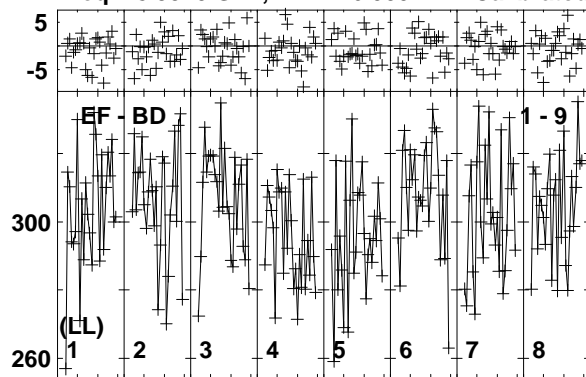

Lower frame: Milli Ampl Jy Top frame: Phas deg
Vector averaged cross-power spectrum Baseline: EF (01) - BD (09)
Timerange: 00/07:52:41 to 00/07:53:09

Plot file version 307 created 24-MAR-2014 14:38:56

ARP299D EP087F 5.UVDATA.1

Freq = 8.3520 GHz, Bw = 16.000 MH Calibrated with CL # 3 and BP # 1 (BP mode 1)

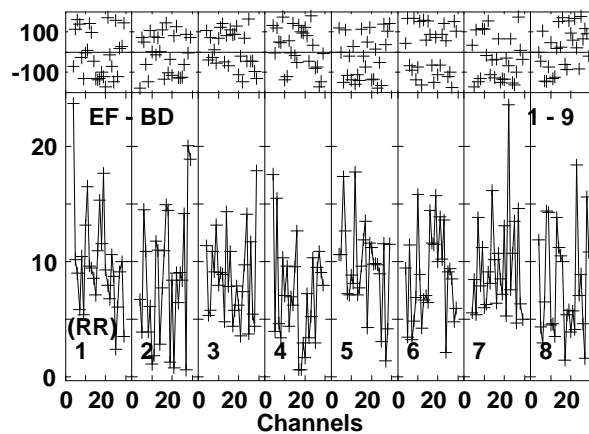
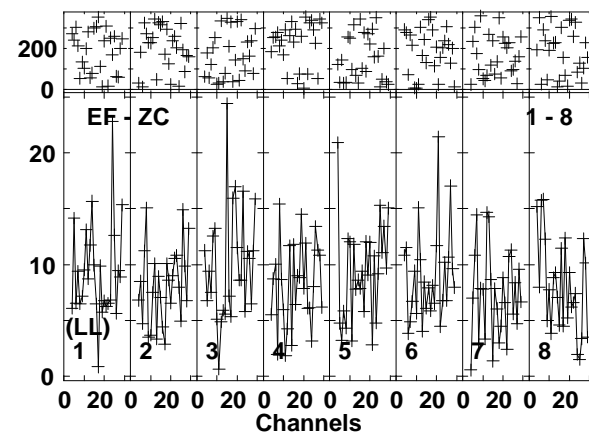
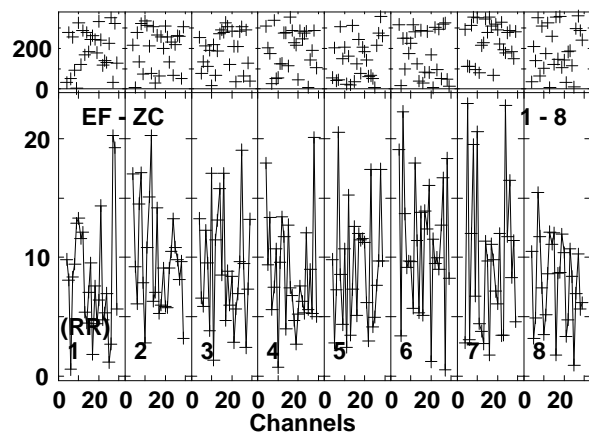
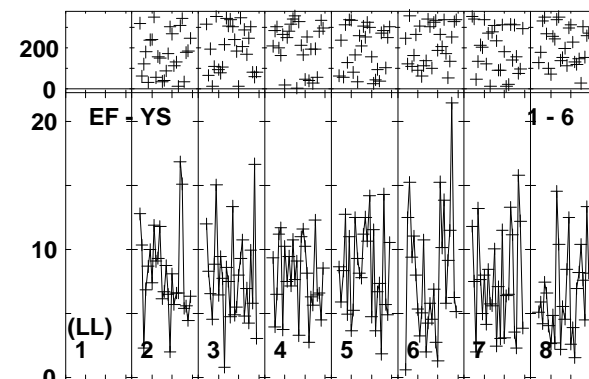
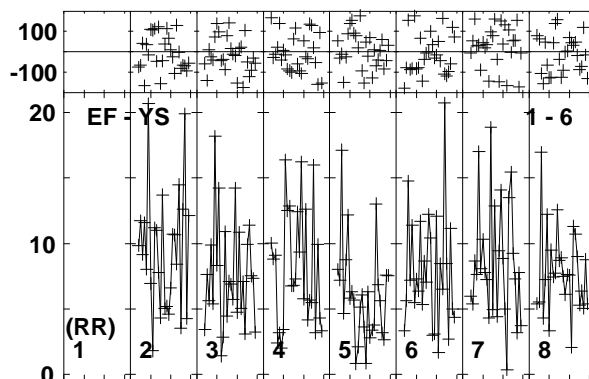
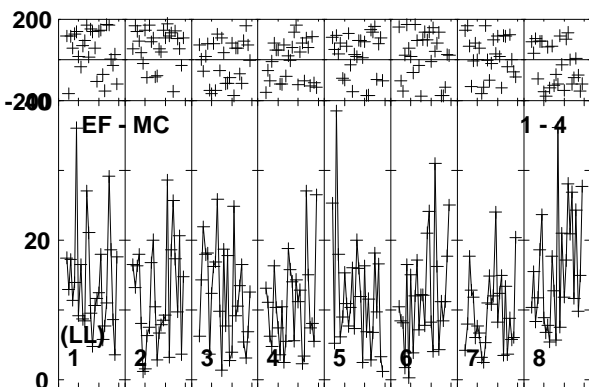
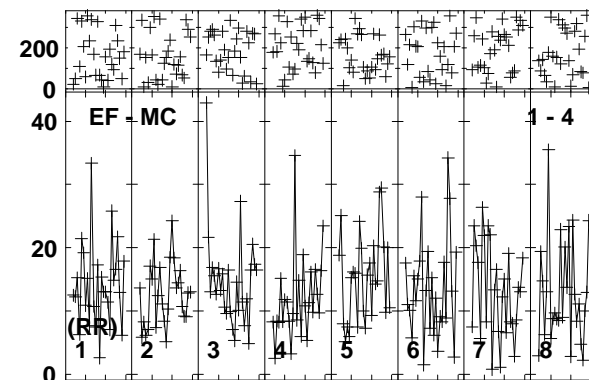
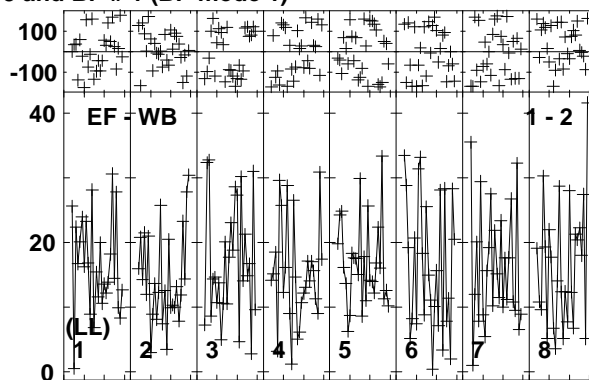
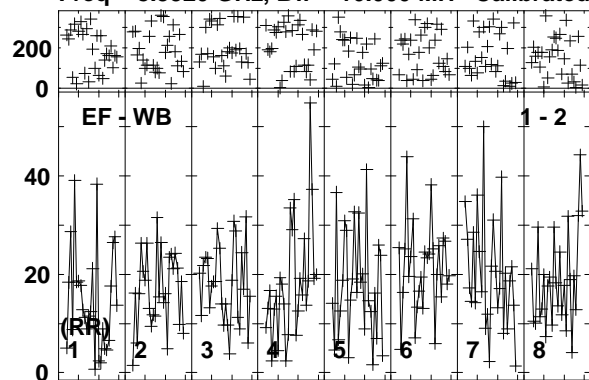

Lower frame: Milli Ampl Jy Top frame: Phas deg
Vector averaged cross-power spectrum Baseline: EF (01) - WB (02)
Timerange: 00/07:53:14 to 00/07:56:10

Plot file version 308 created 24-MAR-2014 14:38:57

ARP299D EP087F 5.UVDATA.1

Freq = 8.3520 GHz, Bw = 16.000 MH Calibrated with CL # 3 and BP # 1 (BP mode 1)

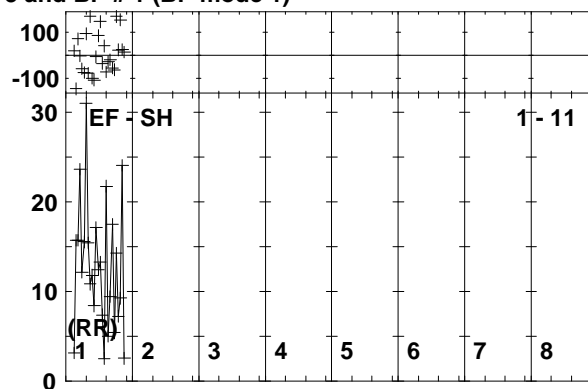
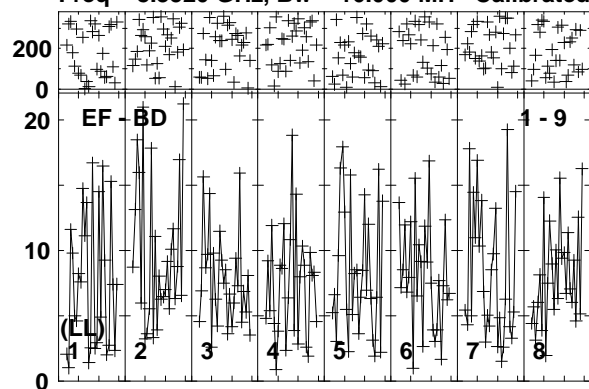

Lower frame: Milli Ampl Jy Top frame: Phas deg
Vector averaged cross-power spectrum Baseline: EF (01) - BD (09)
Timerange: 00/07:53:14 to 00/07:56:10

Plot file version 309 created 24-MAR-2014 14:38:57

J1128+5925 EP087F 5.UVDATA.1

Freq = 8.3520 GHz, Bw = 16.000 MH Calibrated with CL # 3 and BP # 1 (BP mode 1)

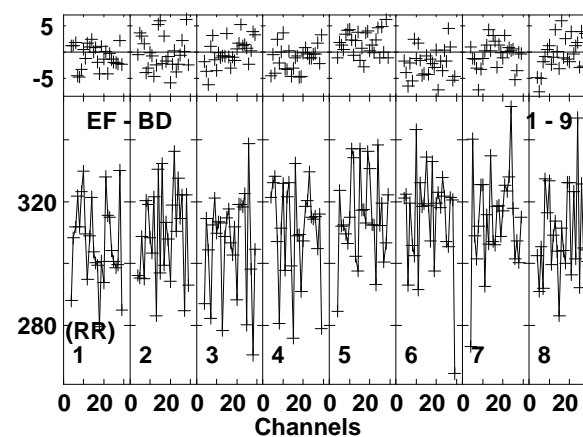
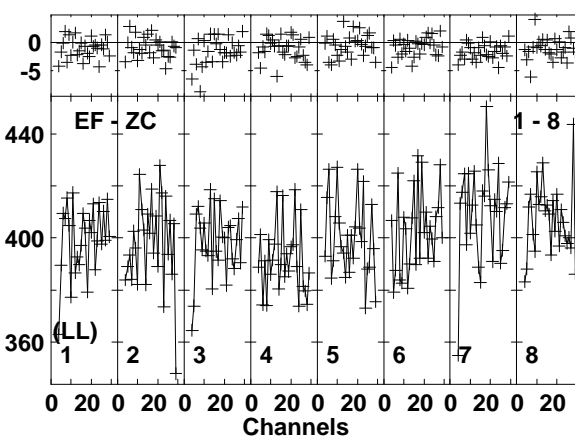
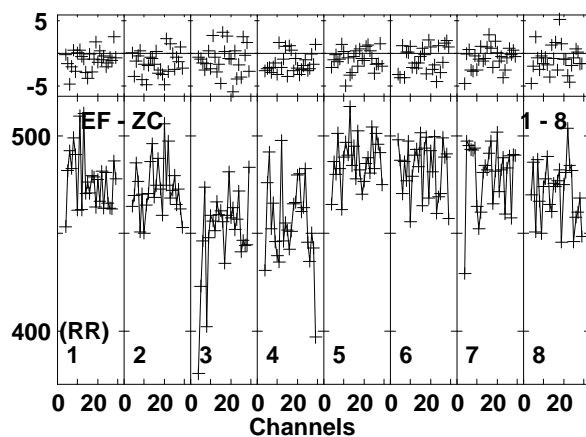
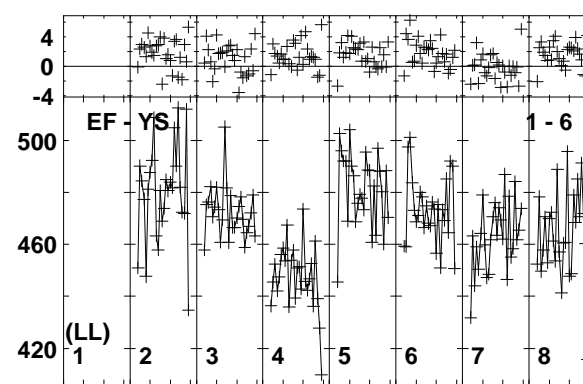
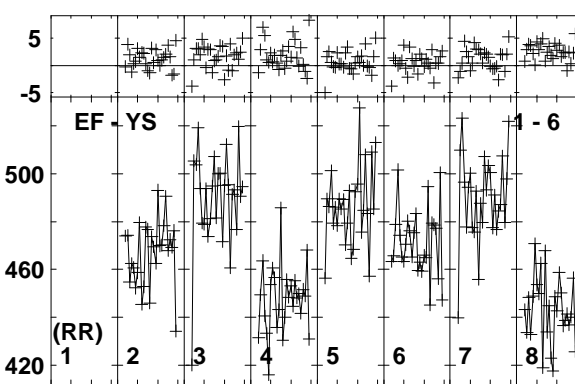
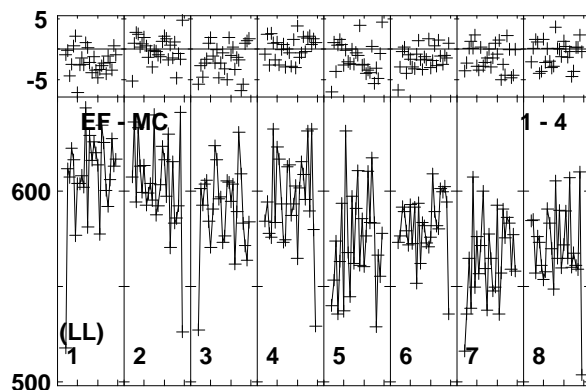
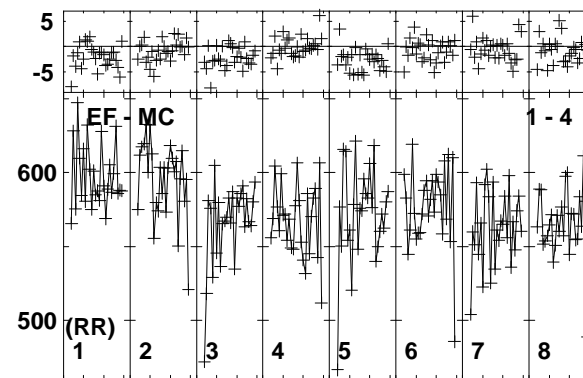
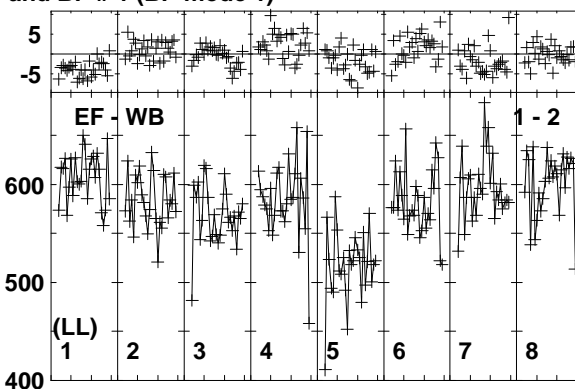
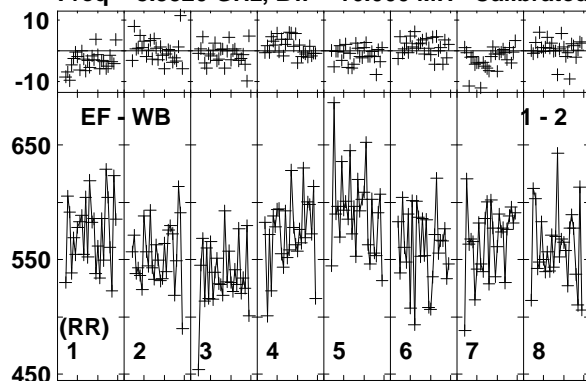

Lower frame: Milli Ampl Jy Top frame: Phas deg
Vector averaged cross-power spectrum Baseline: EF (01) - WB (02)
Timerange: 00/07:56:13 to 00/07:57:15

Plot file version 310 created 24-MAR-2014 14:38:57

J1128+5925 EP087F 5.UVDATA.1

Freq = 8.3520 GHz, Bw = 16.000 MH Calibrated with CL # 3 and BP # 1 (BP mode 1)

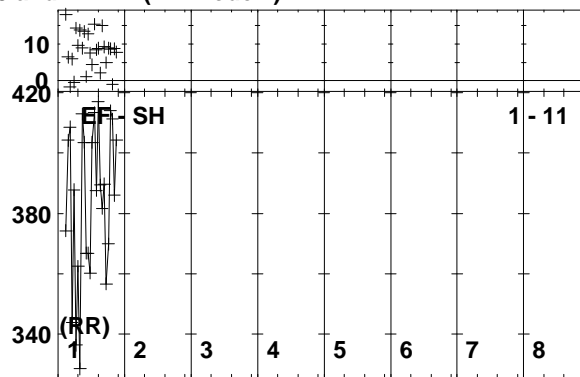
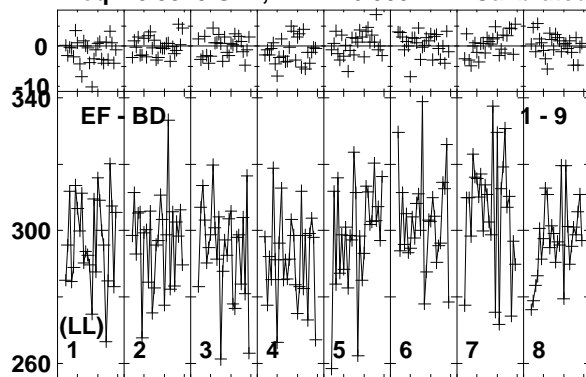

Lower frame: Milli Ampl Jy Top frame: Phas deg
Vector averaged cross-power spectrum Baseline: EF (01) - BD (09)
Timerange: 00/07:56:13 to 00/07:57:15

Plot file version 311 created 24-MAR-2014 14:38:57

ARP299D EP087F 5.UVDATA.1

Freq = 8.3520 GHz, Bw = 16.000 MH Calibrated with CL # 3 and BP # 1 (BP mode 1)

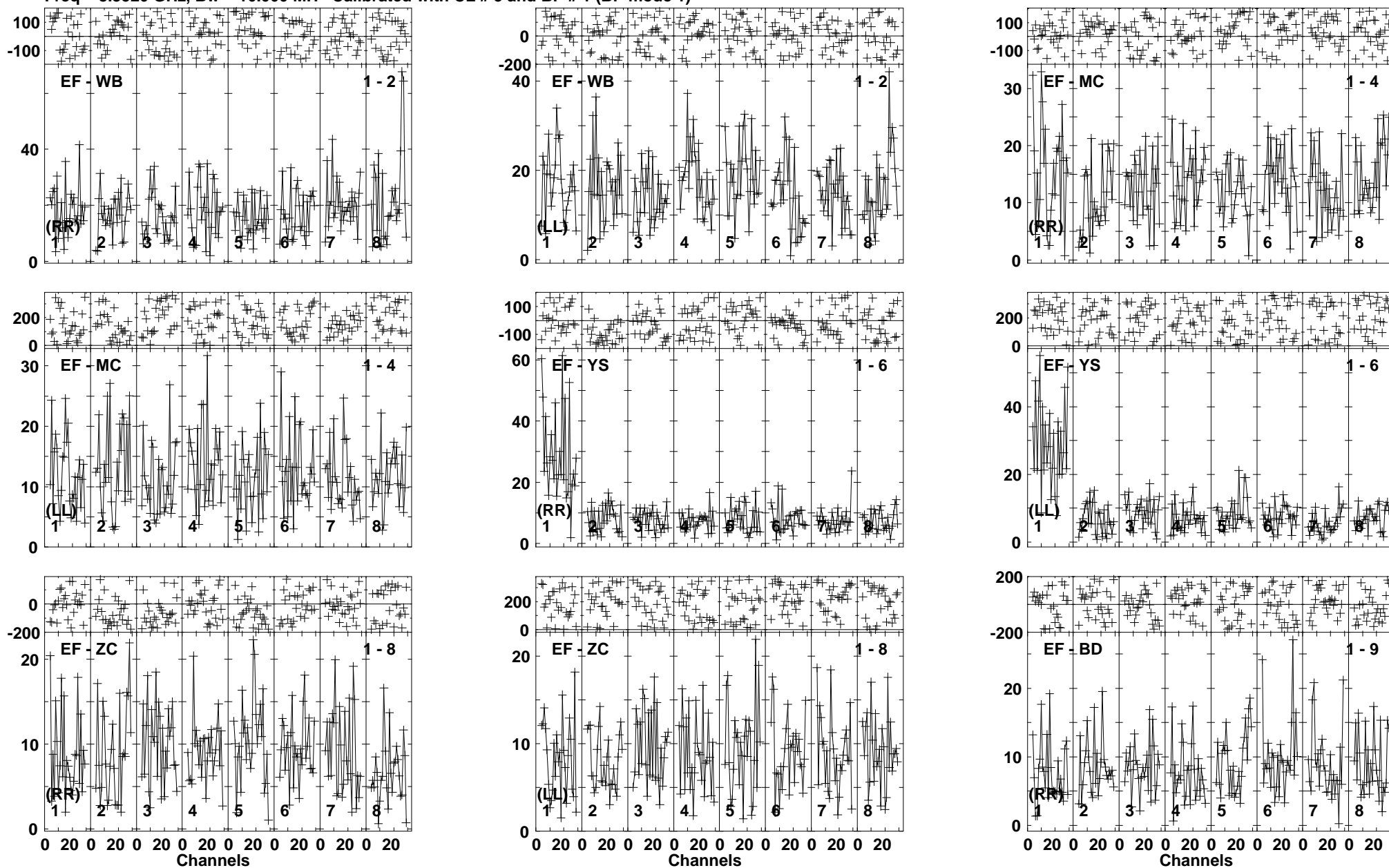

Lower frame: Milli Ampl Jy Top frame: Phas deg
Vector averaged cross-power spectrum Baseline: EF (01) - WB (02)
Timerange: 00/07:57:18 to 00/08:00:15

Plot file version 312 created 24-MAR-2014 14:38:58

ARP299D EP087F 5.UVDATA.1

Freq = 8.3520 GHz, Bw = 16.000 MH Calibrated with CL # 3 and BP # 1 (BP mode 1)

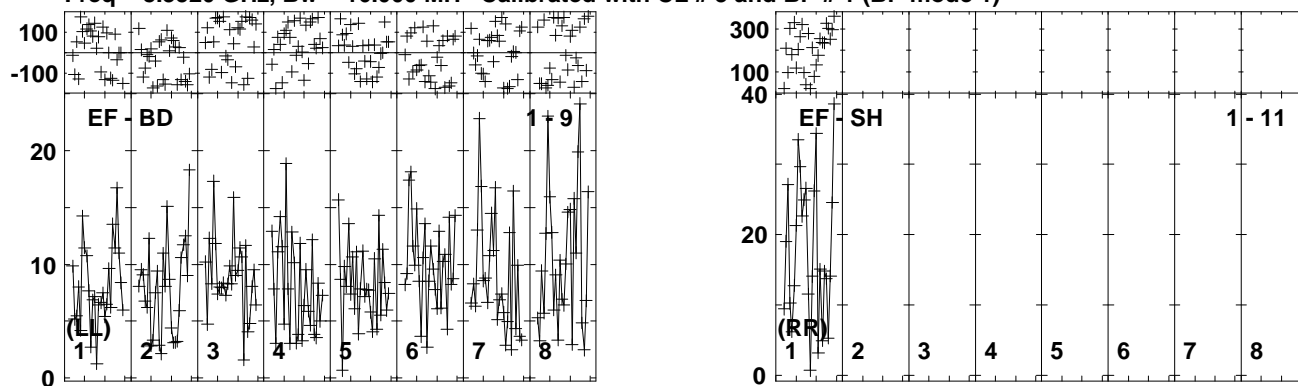

Lower frame: Milli Ampl Jy Top frame: Phas deg
Vector averaged cross-power spectrum Baseline: EF (01) - BD (09)
Timerange: 00/07:57:18 to 00/08:00:15

Plot file version 313 created 24-MAR-2014 14:38:58

J1128+5925 EP087F 5.UVDATA.1

Freq = 8.3520 GHz, Bw = 16.000 MH Calibrated with CL # 3 and BP # 1 (BP mode 1)

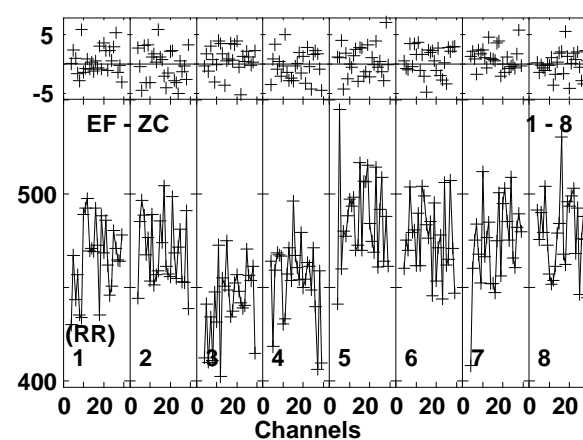
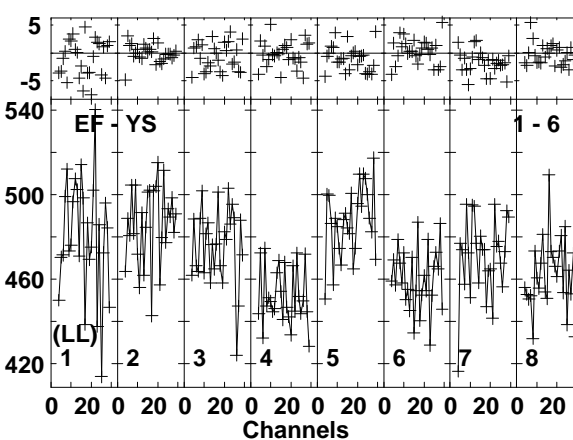
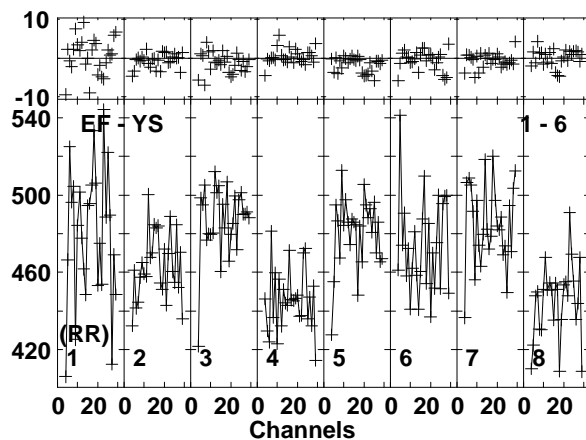
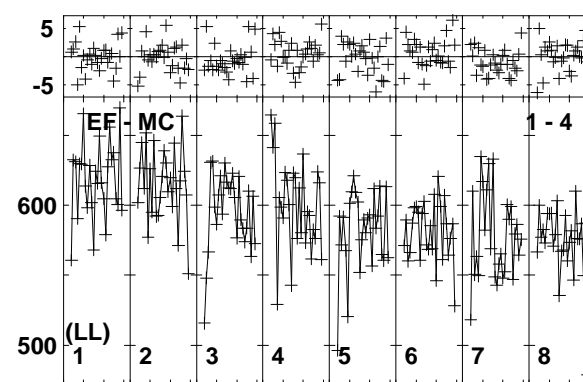
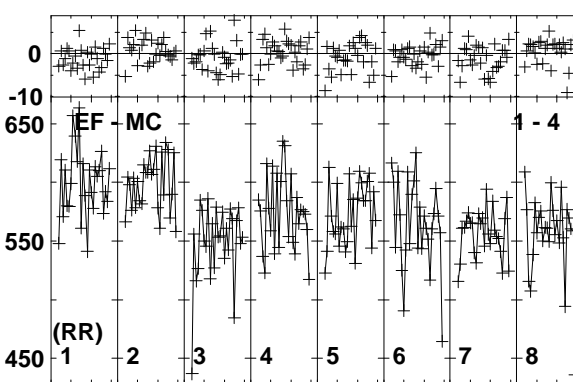
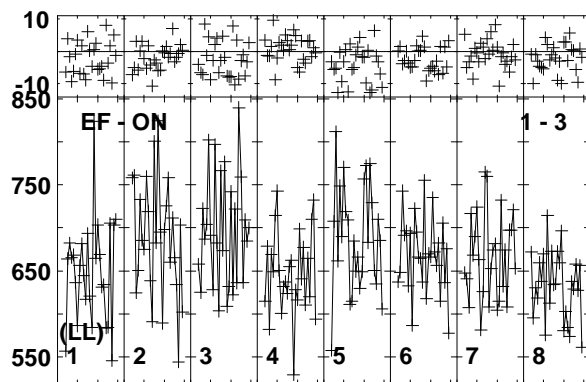
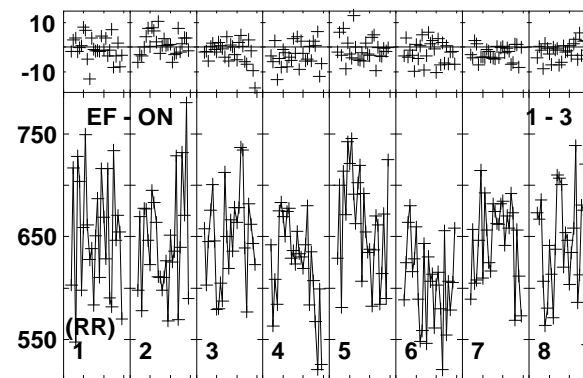
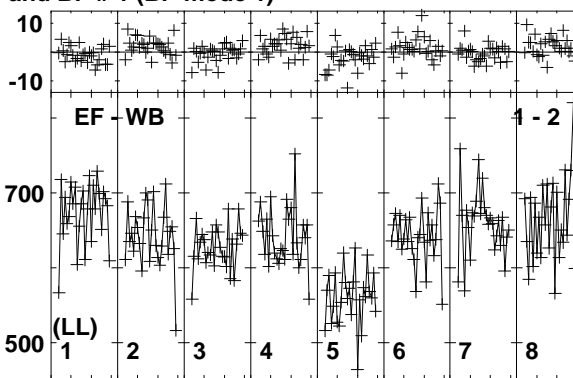
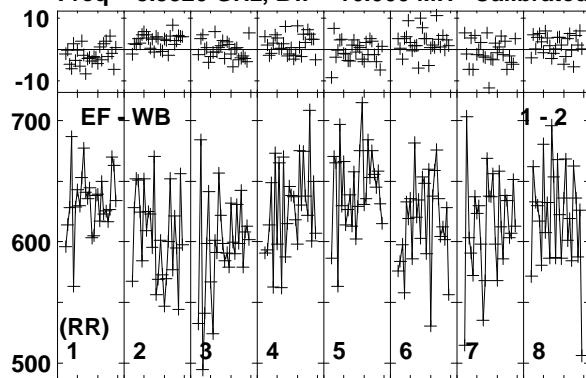

Lower frame: Milli Ampl Jy Top frame: Phas deg
Vector averaged cross-power spectrum Baseline: EF (01) - WB (02)
Timerange: 00/08:00:56 to 00/08:01:24

Plot file version 314 created 24-MAR-2014 14:38:58

J1128+5925 EP087F 5.UVDATA.1

Freq = 8.3520 GHz, Bw = 16.000 MH Calibrated with CL # 3 and BP # 1 (BP mode 1)

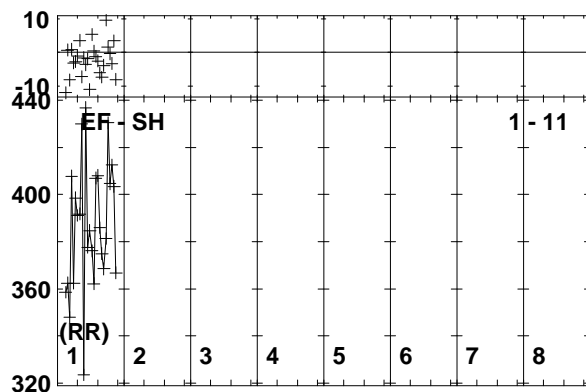
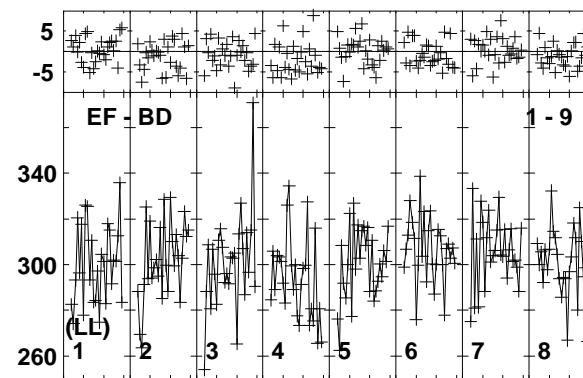
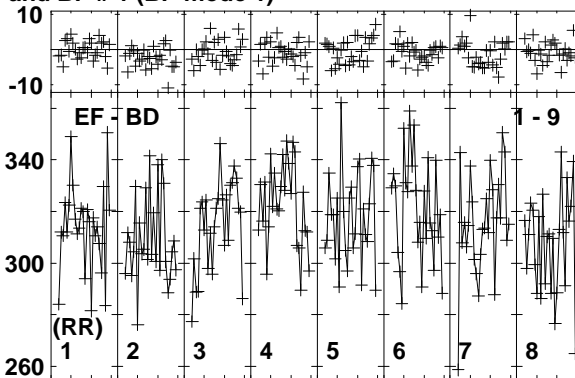
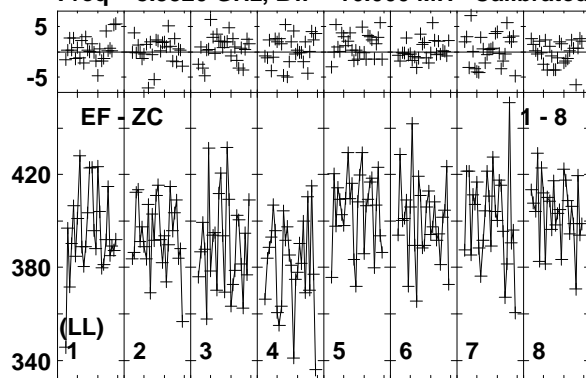

Lower frame: Milli Ampl Jy Top frame: Phas deg
Vector averaged cross-power spectrum Baseline: EF (01) - ZC (08)
Timerange: 00/08:00:56 to 00/08:01:24

Plot file version 315 created 24-MAR-2014 14:38:58

ARP299D EP087F 5.UVDATA.1

Freq = 8.3520 GHz, Bw = 16.000 MH Calibrated with CL # 3 and BP # 1 (BP mode 1)

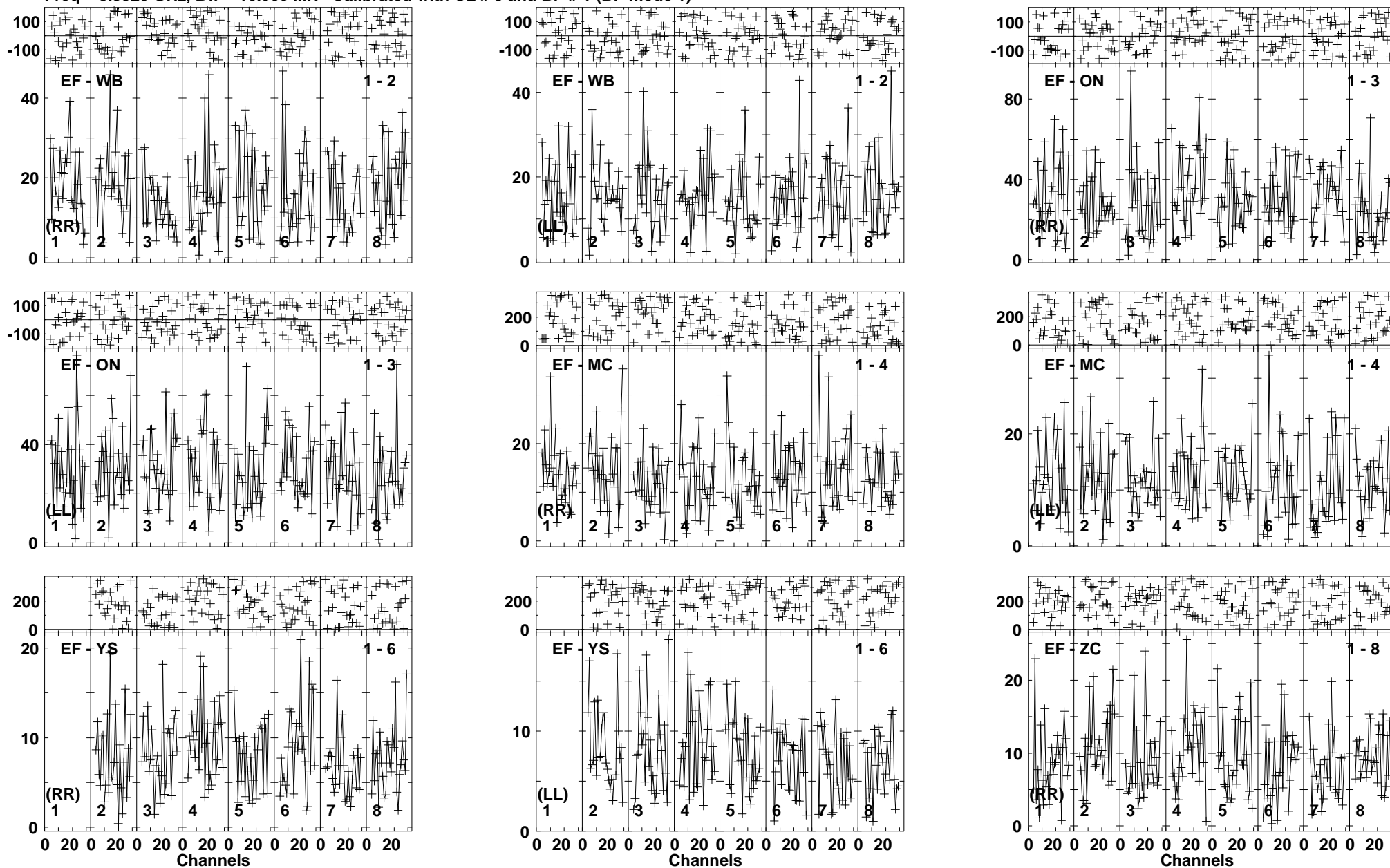

Lower frame: Milli Ampl Jy Top frame: Phas deg
Vector averaged cross-power spectrum Baseline: EF (01) - WB (02)
Timerange: 00/08:01:29 to 00/08:04:24

Plot file version 316 created 24-MAR-2014 14:38:59

ARP299D EP087F 5.UVDATA.1

Freq = 8.3520 GHz, Bw = 16.000 MH Calibrated with CL # 3 and BP # 1 (BP mode 1)

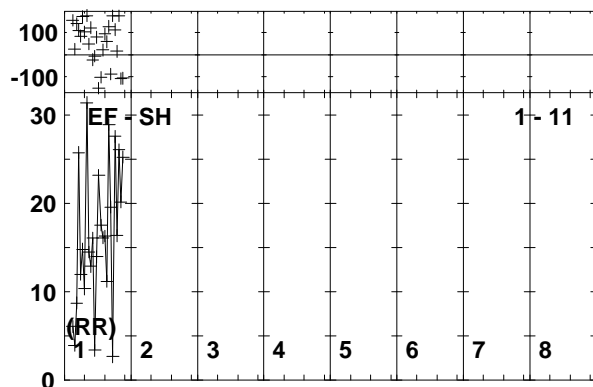
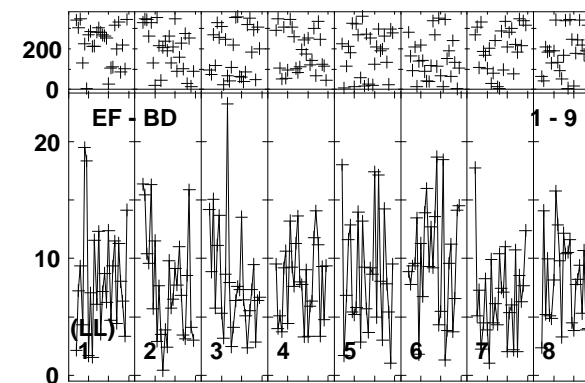
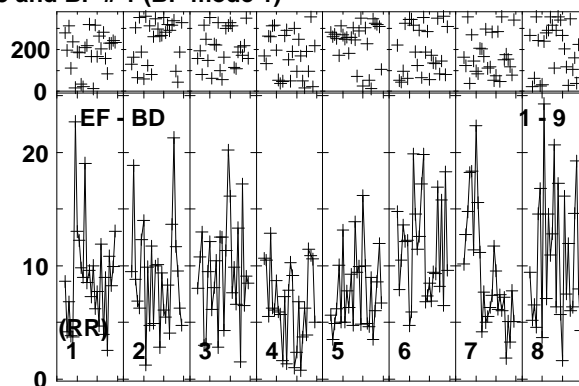
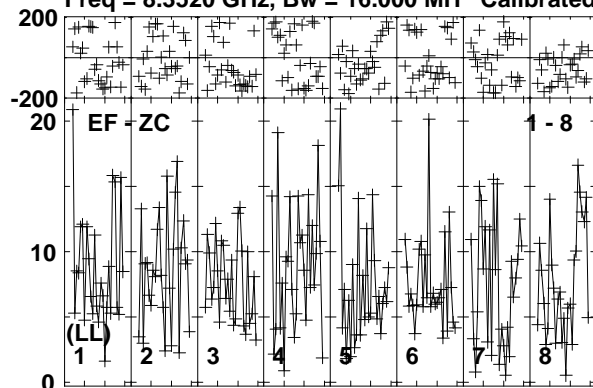

Lower frame: Milli Ampl Jy Top frame: Phas deg
Vector averaged cross-power spectrum Baseline: EF (01) - ZC (08)
Timerange: 00/08:01:29 to 00/08:04:24

Plot file version 317 created 24-MAR-2014 14:38:59

J1128+5925 EP087F 5.UVDATA.1

Freq = 8.3520 GHz, Bw = 16.000 MH Calibrated with CL # 3 and BP # 1 (BP mode 1)

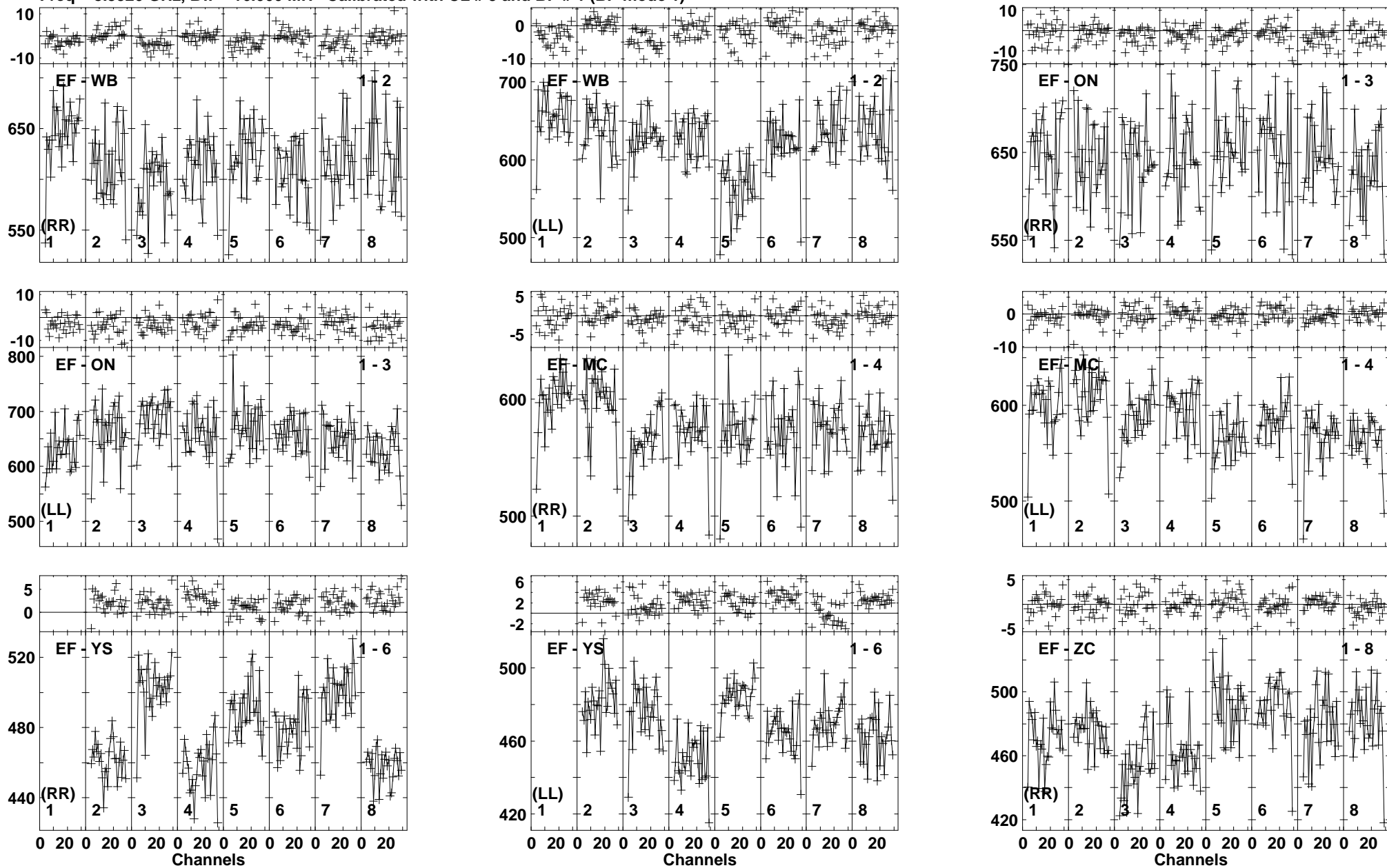

Lower frame: Milli Ampl Jy Top frame: Phas deg
Vector averaged cross-power spectrum Baseline: EF (01) - WB (02)
Timerange: 00/08:04:30 to 00/08:05:30

Plot file version 318 created 24-MAR-2014 14:38:59

J1128+5925 EP087F 5.UVDATA.1

Freq = 8.3520 GHz, Bw = 16.000 MH Calibrated with CL # 3 and BP # 1 (BP mode 1)

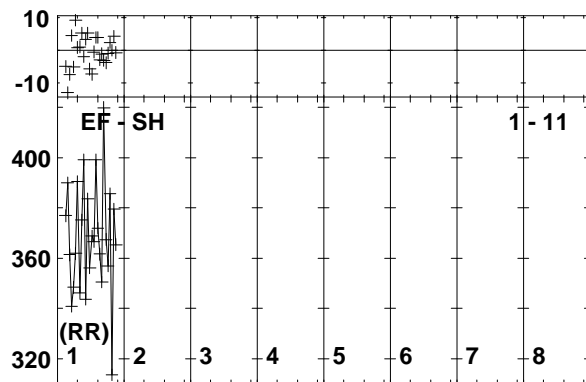
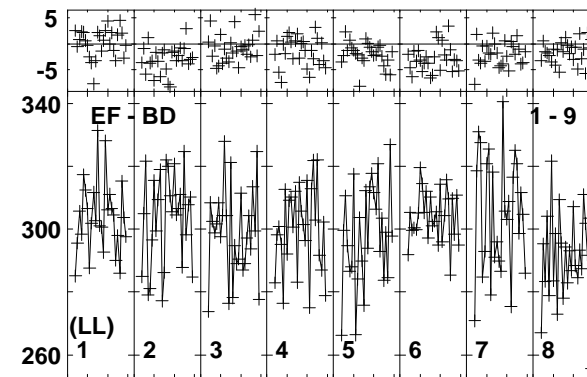
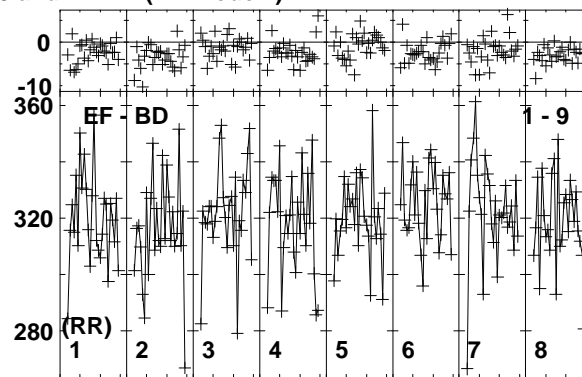
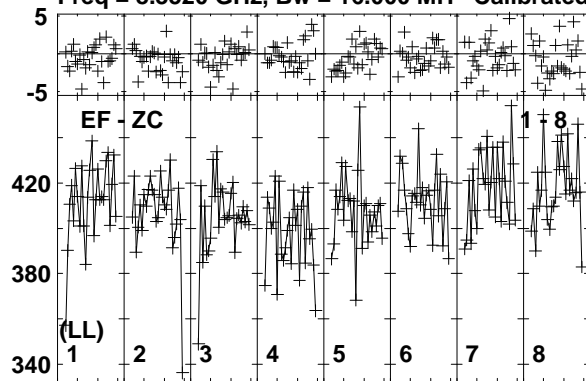

Lower frame: Milli Ampl Jy Top frame: Phas deg
Vector averaged cross-power spectrum Baseline: EF (01) - ZC (08)
Timerange: 00/08:04:30 to 00/08:05:30

Plot file version 319 created 24-MAR-2014 14:38:59

ARP299D EP087F 5.UVDATA.1

Freq = 8.3520 GHz, Bw = 16.000 MH Calibrated with CL # 3 and BP # 1 (BP mode 1)

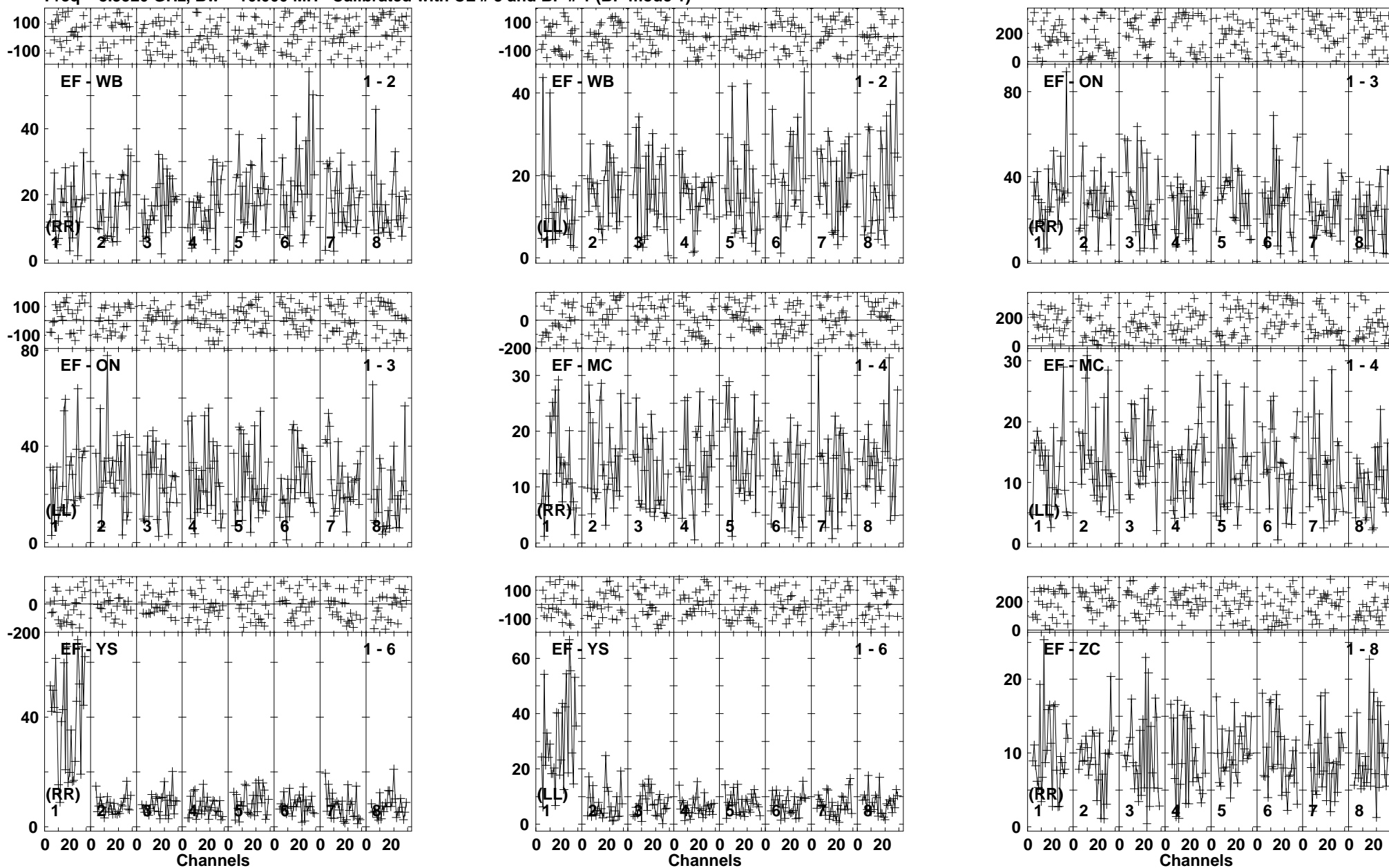

Lower frame: Milli Ampl Jy Top frame: Phas deg
Vector averaged cross-power spectrum Baseline: EF (01) - WB (02)
Timerange: 00/08:05:34 to 00/08:08:30

Plot file version 320 created 24-MAR-2014 14:39:00
 ARP299D EP087F 5.UVDATA.1
 Freq = 8.3520 GHz, Bw = 16.000 MH Calibrated with CL # 3 and BP # 1 (BP mode 1)

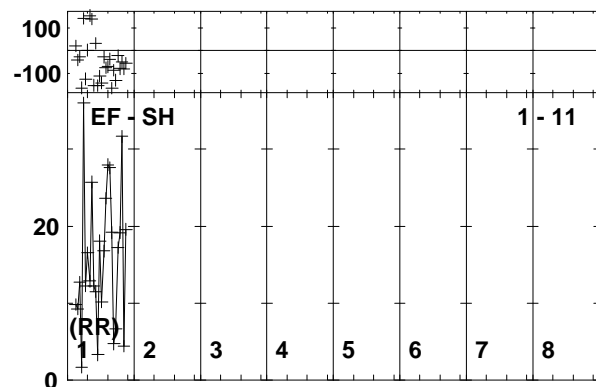
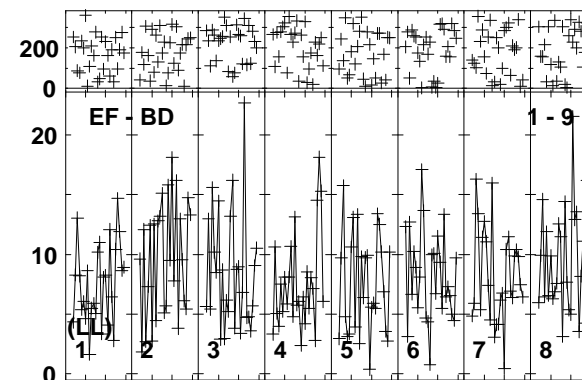
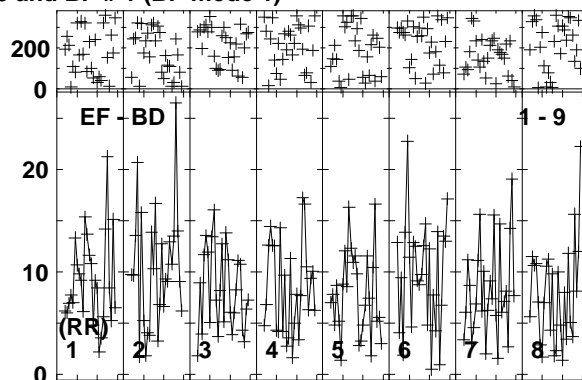
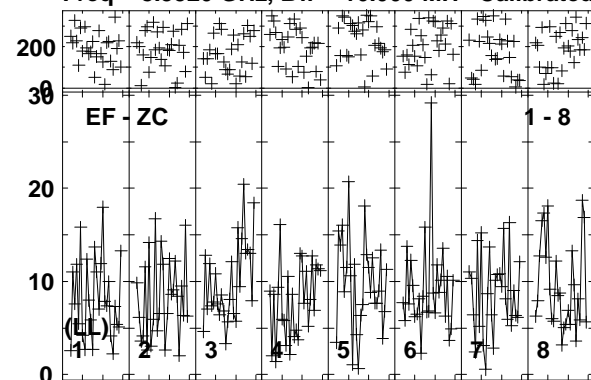

Lower frame: Milli Ampl Jy Top frame: Phas deg
 Vector averaged cross-power spectrum Baseline: EF (01) - ZC (08)
 Timerange: 00/08:05:34 to 00/08:08:30

Plot file version 321 created 24-MAR-2014 14:39:00

J1128+5925 EP087F 5.UVDATA.1

Freq = 8.3520 GHz, Bw = 16.000 MH Calibrated with CL # 3 and BP # 1 (BP mode 1)

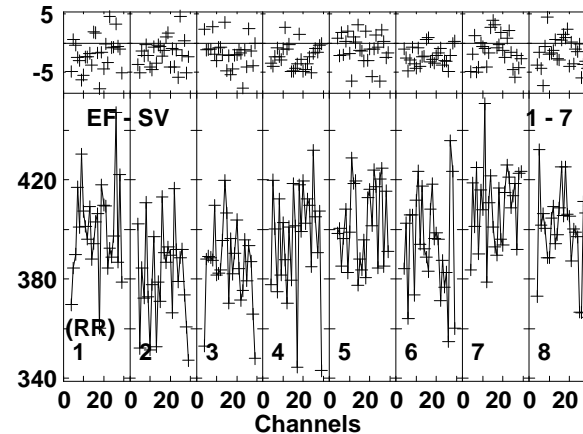
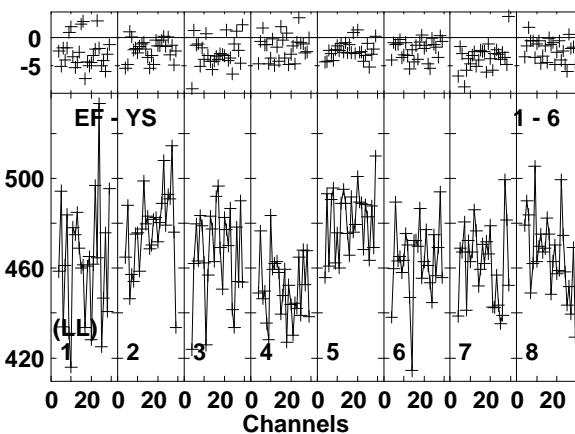
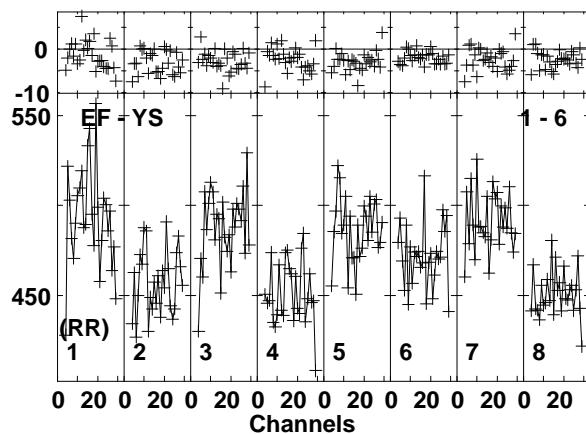
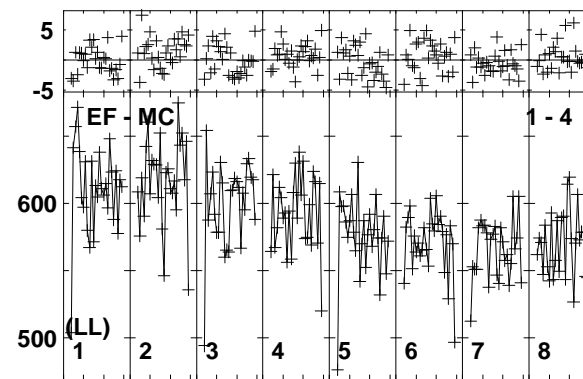
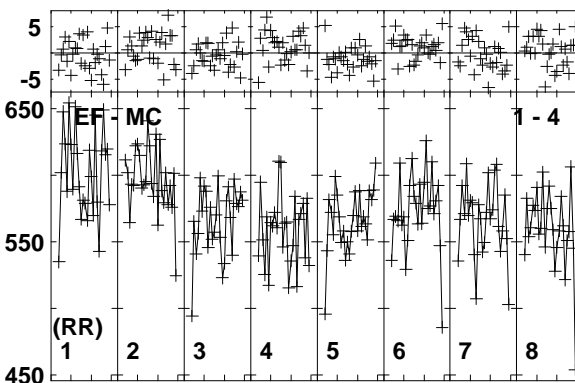
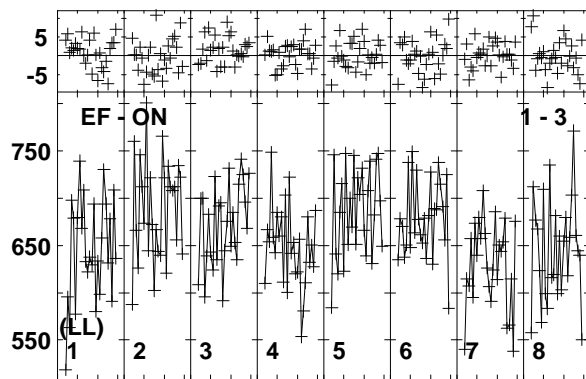
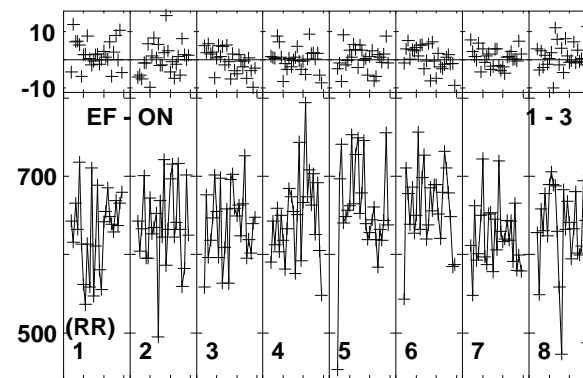
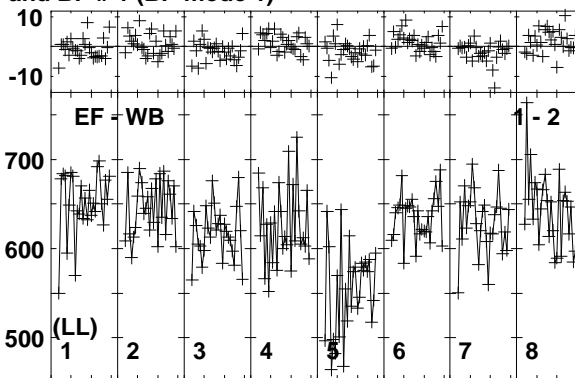
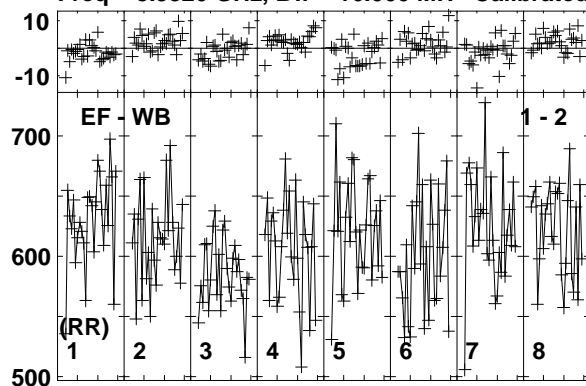

Lower frame: Milli Ampl Jy Top frame: Phas deg
Vector averaged cross-power spectrum Baseline: EF (01) - WB (02)
Timerange: 00/08:09:11 to 00/08:09:40

Plot file version 322 created 24-MAR-2014 14:39:00
 J1128+5925 EP087F 5.UVDATA.1
 Freq = 8.3520 GHz, Bw = 16.000 MH Calibrated with CL # 3 and BP # 1 (BP mode 1)

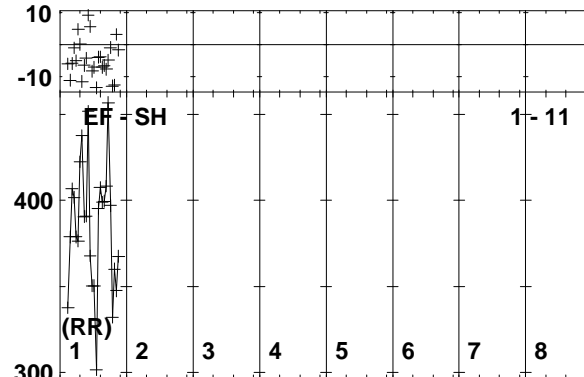
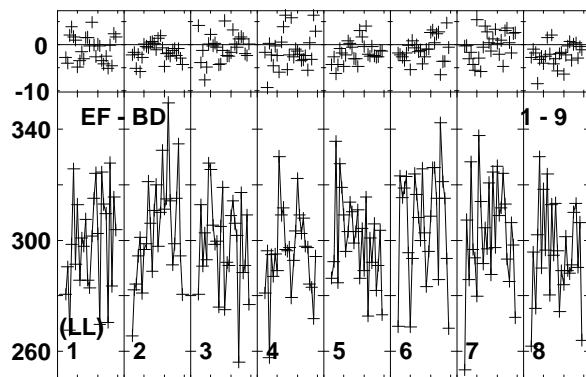
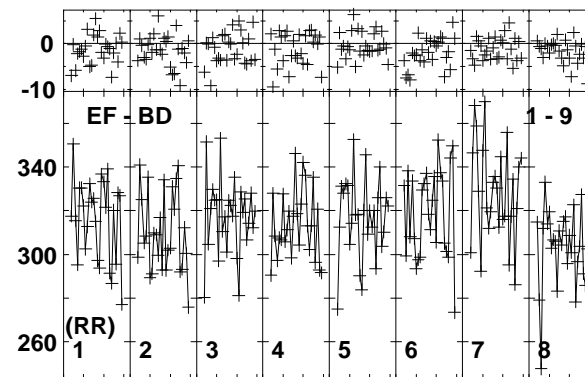
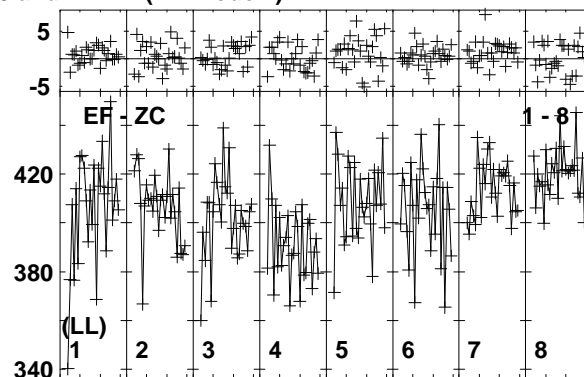
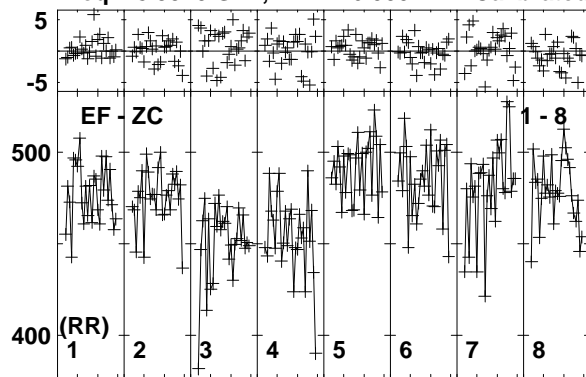

Lower frame: Milli Ampl Jy Top frame: Phas deg
 Vector averaged cross-power spectrum Baseline: EF (01) - ZC (08)
 Timerange: 00/08:09:11 to 00/08:09:40

Plot file version 323 created 24-MAR-2014 14:39:00

ARP299D EP087F 5.UVDATA.1

Freq = 8.3520 GHz, Bw = 16.000 MH Calibrated with CL # 3 and BP # 1 (BP mode 1)

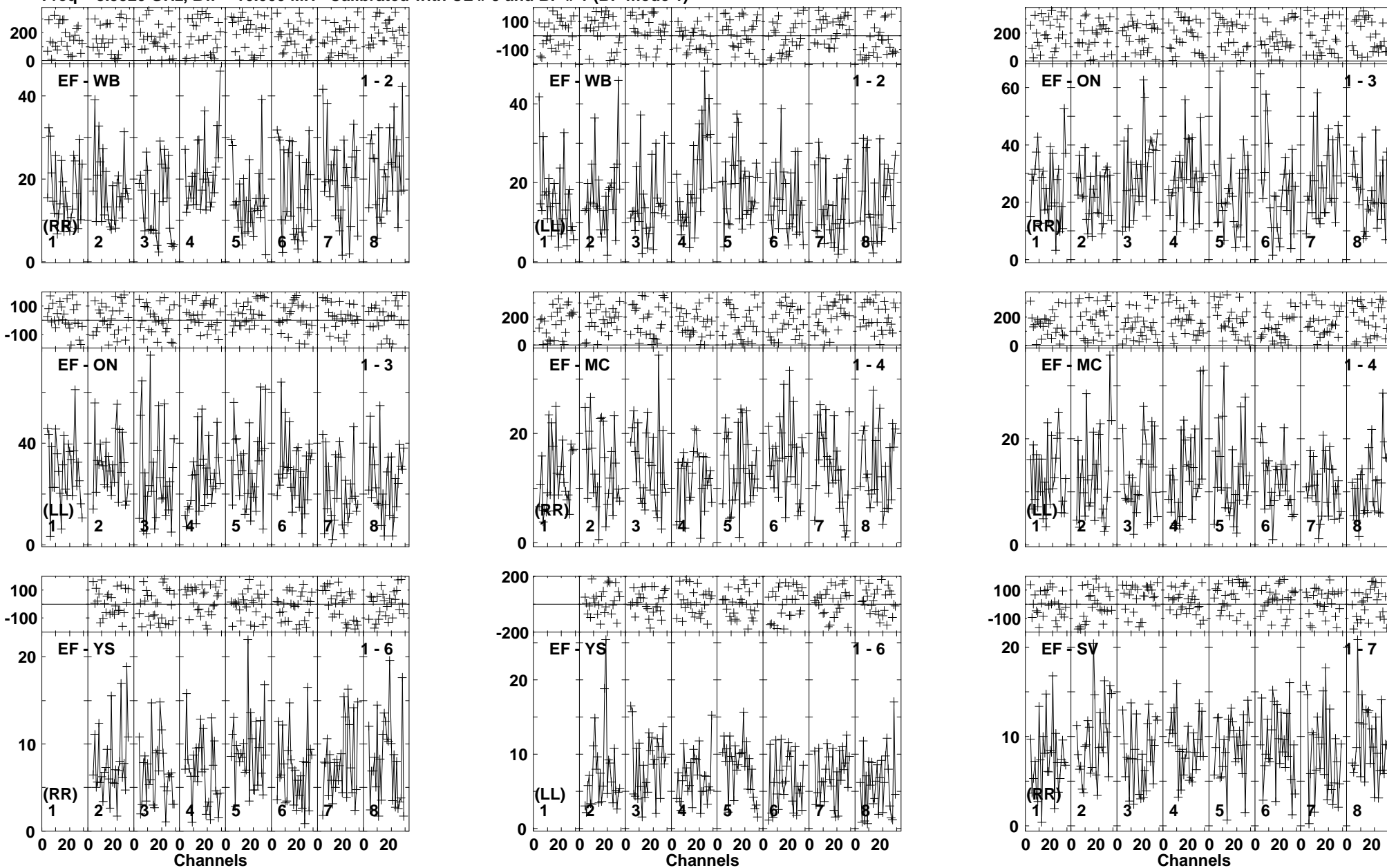

Lower frame: Milli Ampl Jy Top frame: Phas deg
Vector averaged cross-power spectrum Baseline: EF (01) - WB (02)
Timerange: 00/08:09:44 to 00/08:12:40

Plot file version 324 created 24-MAR-2014 14:39:01
 ARP299D EP087F 5.UVDATA.1
 Freq = 8.3520 GHz, Bw = 16.000 MH Calibrated with CL # 3 and BP # 1 (BP mode 1)

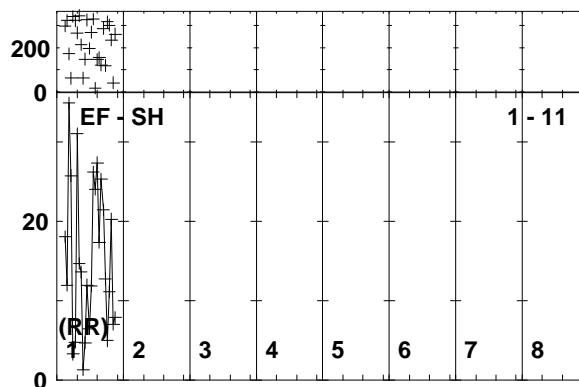
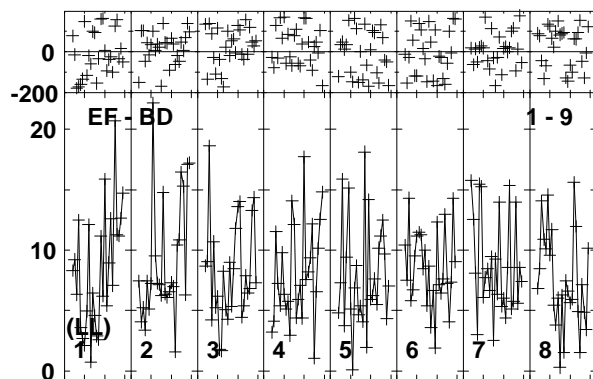
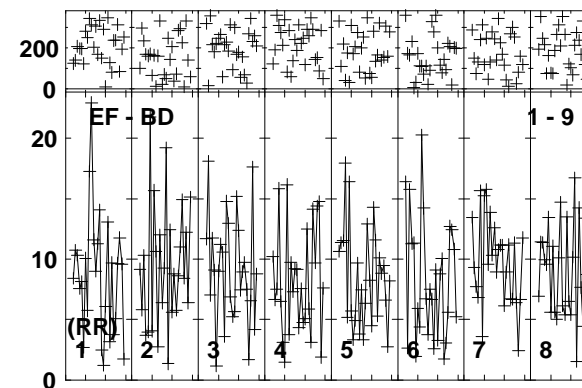
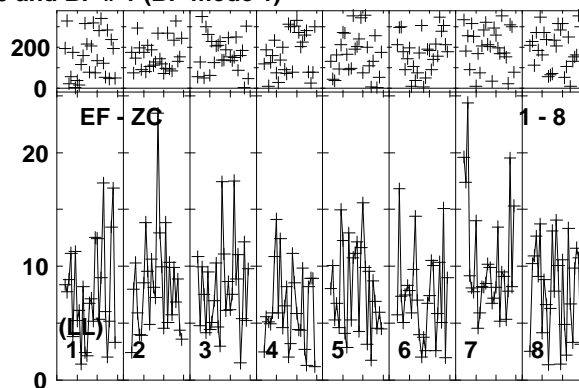
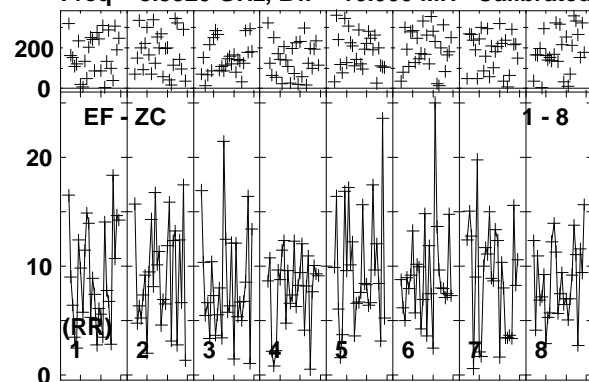

Lower frame: Milli Ampl Jy Top frame: Phas deg
 Vector averaged cross-power spectrum Baseline: EF (01) - ZC (08)
 Timerange: 00/08:09:44 to 00/08:12:40

Plot file version 325 created 24-MAR-2014 14:39:01

J1128+5925 EP087F 5.UVDATA.1

Freq = 8.3520 GHz, Bw = 16.000 MH Calibrated with CL # 3 and BP # 1 (BP mode 1)

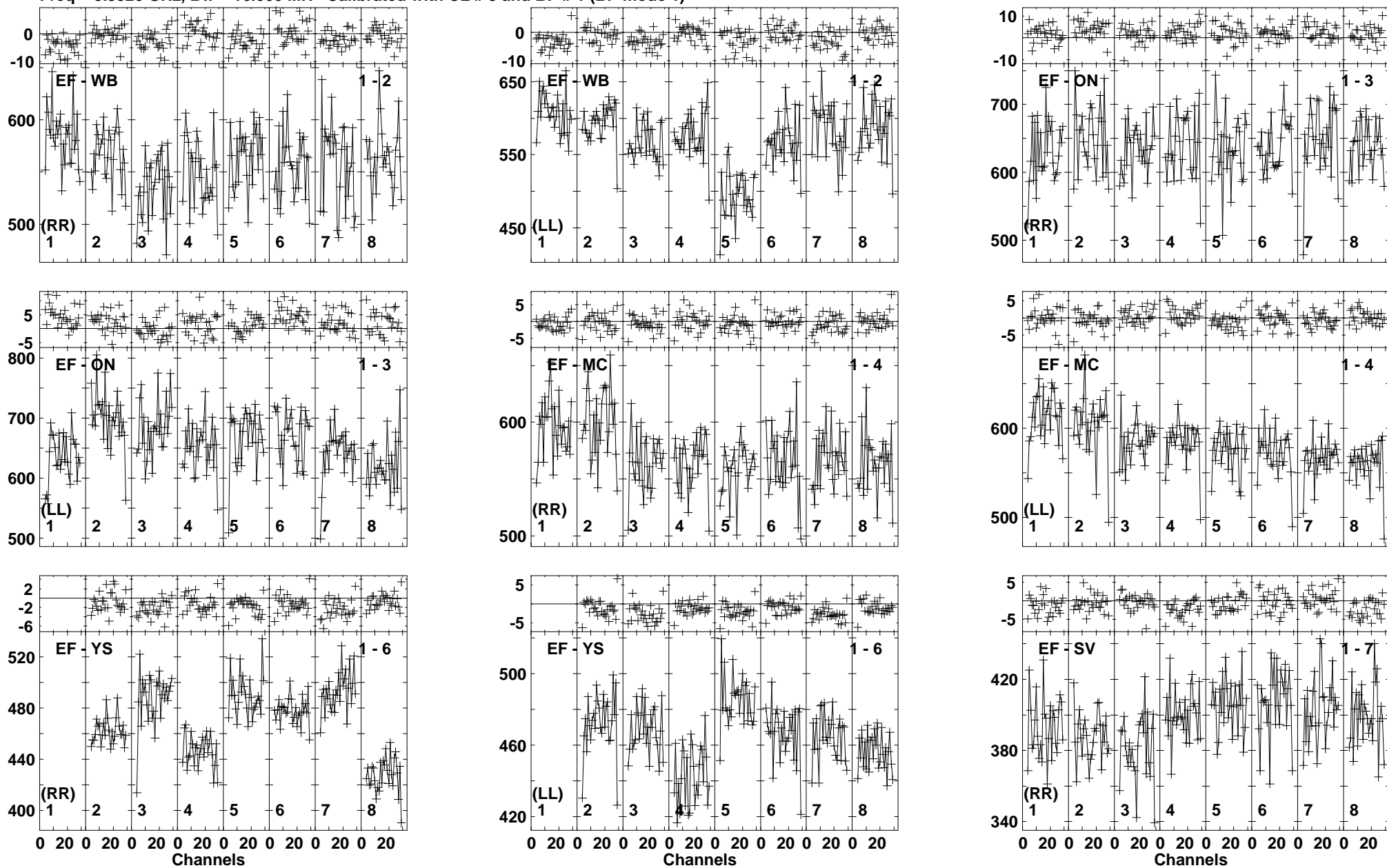

Lower frame: Milli Ampl Jy Top frame: Phas deg
Vector averaged cross-power spectrum Baseline: EF (01) - WB (02)
Timerange: 00/08:12:44 to 00/08:13:44

Plot file version 326 created 24-MAR-2014 14:39:01

J1128+5925 EP087F 5.UVDATA.1

Freq = 8.3520 GHz, Bw = 16.000 MH Calibrated with CL # 3 and BP # 1 (BP mode 1)

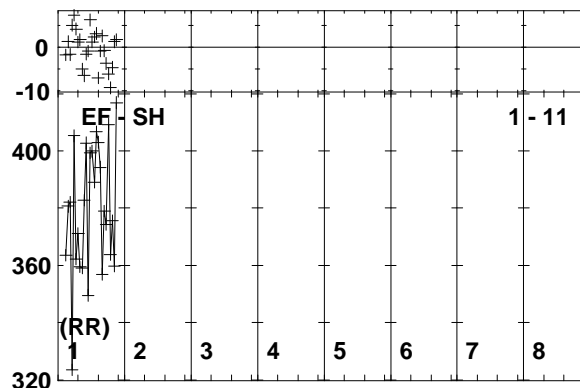
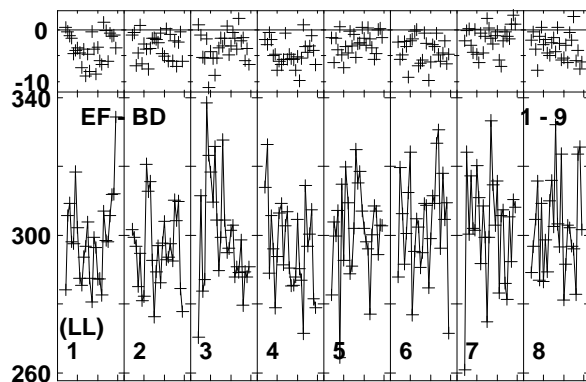
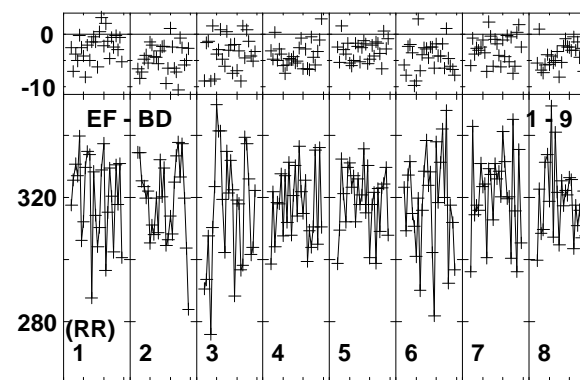
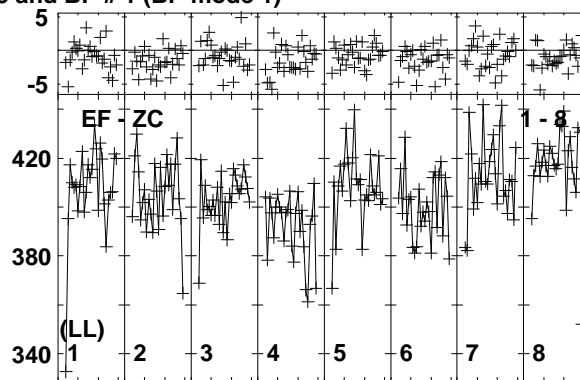
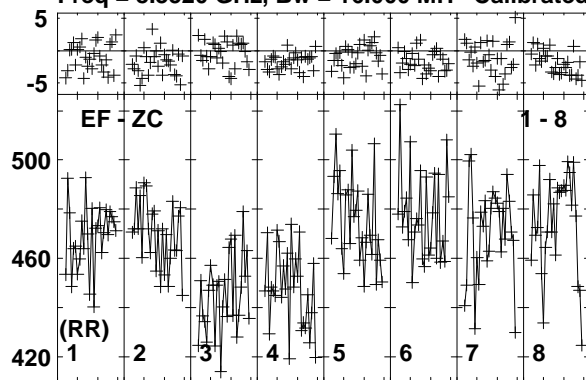

Lower frame: Milli Ampl Jy Top frame: Phas deg
Vector averaged cross-power spectrum Baseline: EF (01) - ZC (08)
Timerange: 00/08:12:44 to 00/08:13:44

Plot file version 327 created 24-MAR-2014 14:39:01
 ARP299D EP087F 5.UVDATA.1
 Freq = 8.3520 GHz, Bw = 16.000 MH Calibrated with CL # 3 and BP # 1 (BP mode 1)

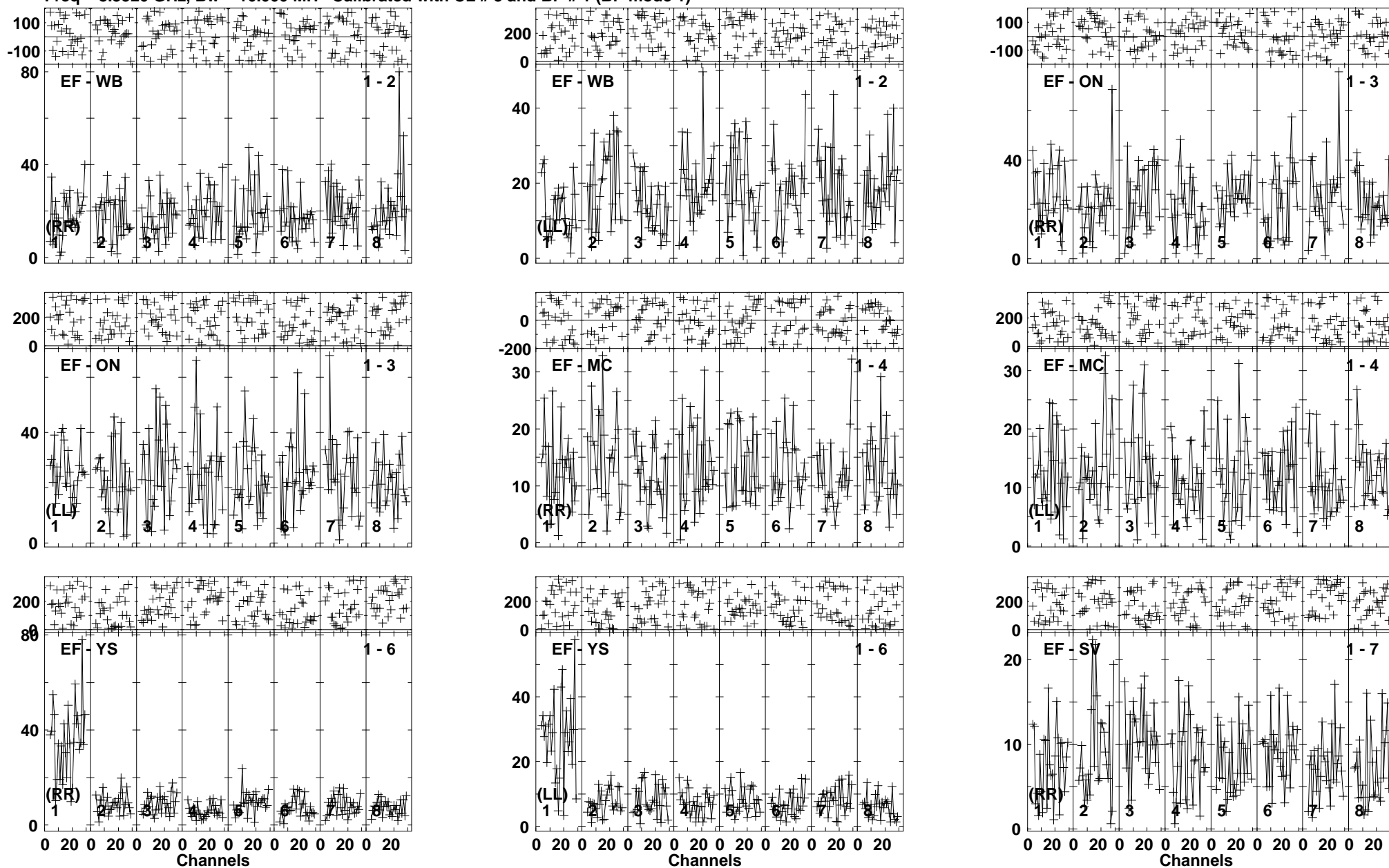

Lower frame: Milli Ampl Jy Top frame: Phas deg
 Vector averaged cross-power spectrum Baseline: EF (01) - WB (02)
 Timerange: 00/08:13:48 to 00/08:16:45

Plot file version 328 created 24-MAR-2014 14:39:02
 ARP299D EP087F 5.UVDATA.1
 Freq = 8.3520 GHz, Bw = 16.000 MH Calibrated with CL # 3 and BP # 1 (BP mode 1)

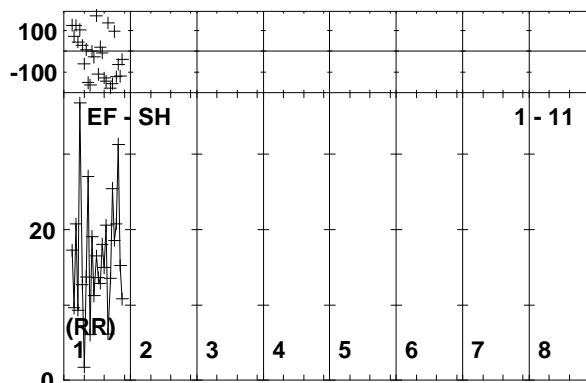
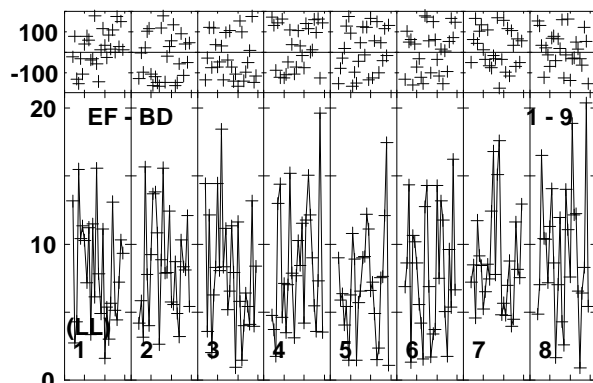
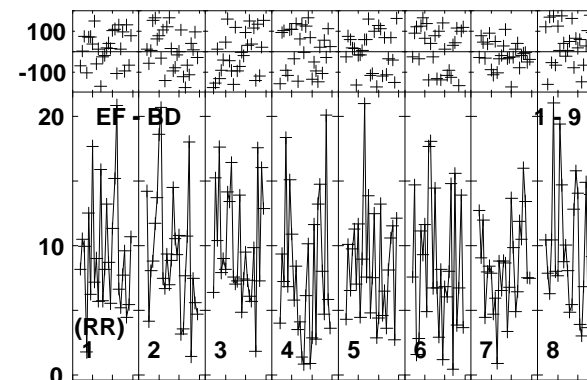
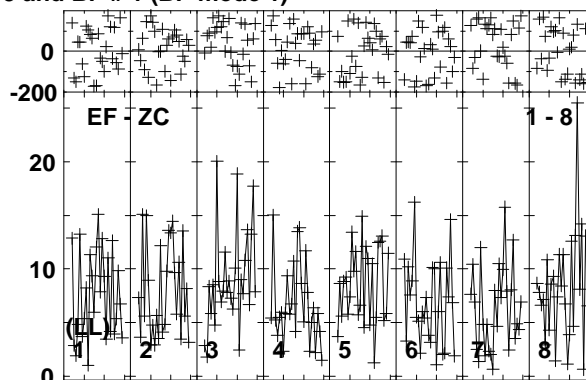
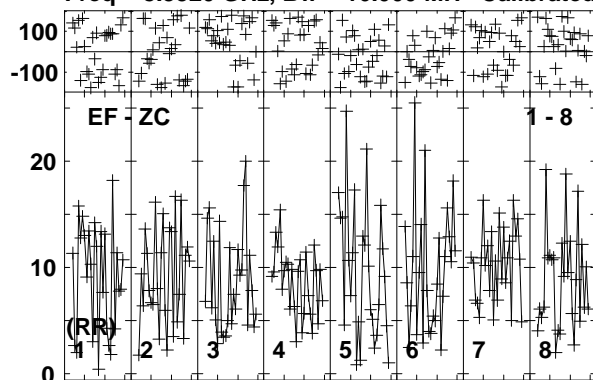

Lower frame: Milli Ampl Jy Top frame: Phas deg
 Vector averaged cross-power spectrum Baseline: EF (01) - ZC (08)
 Timerange: 00/08:13:48 to 00/08:16:45

Plot file version 329 created 24-MAR-2014 14:39:02

J1128+5925 EP087F 5.UVDATA.1

Freq = 8.3520 GHz, Bw = 16.000 MH Calibrated with CL # 3 and BP # 1 (BP mode 1)

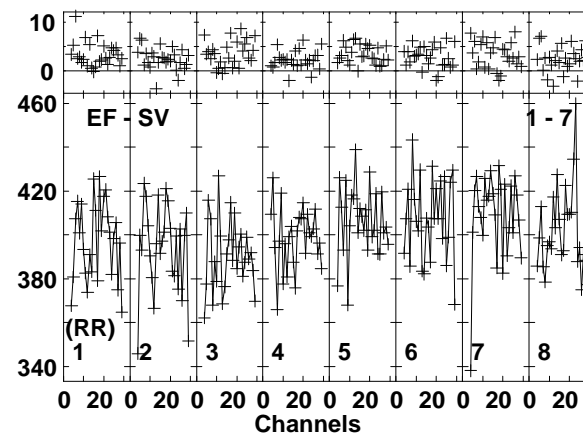
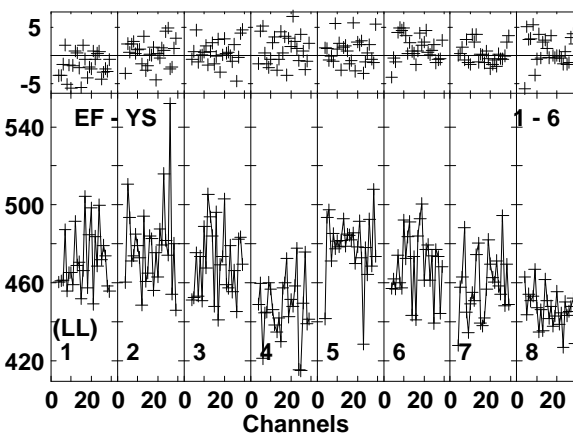
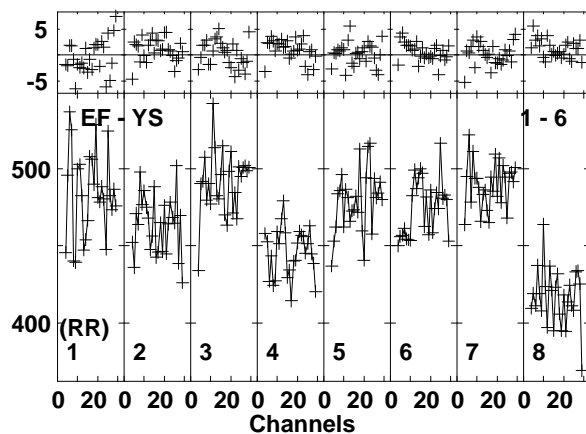
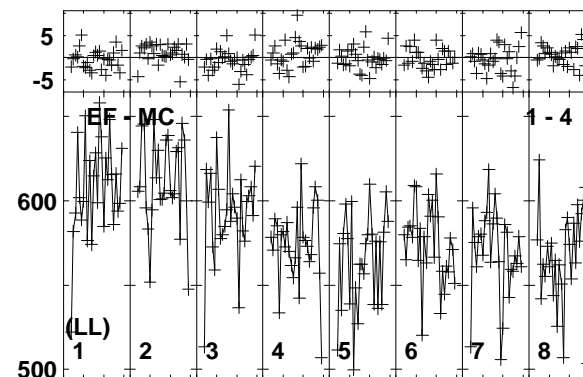
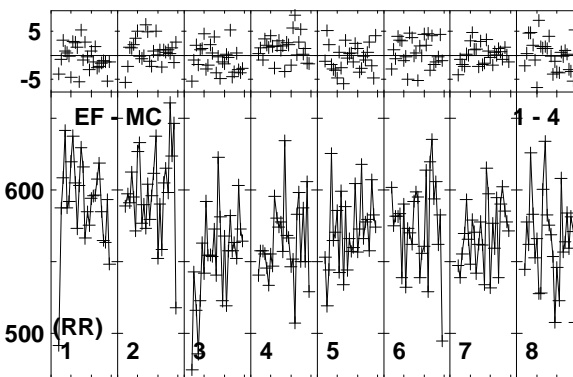
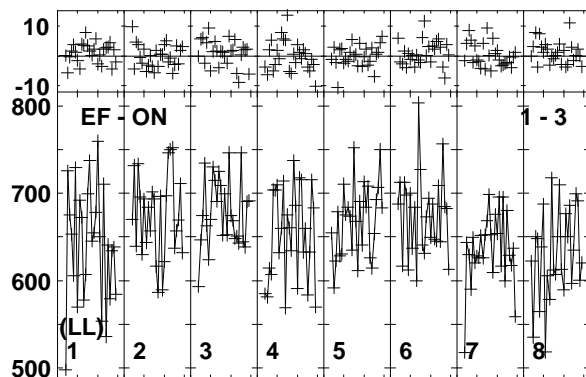
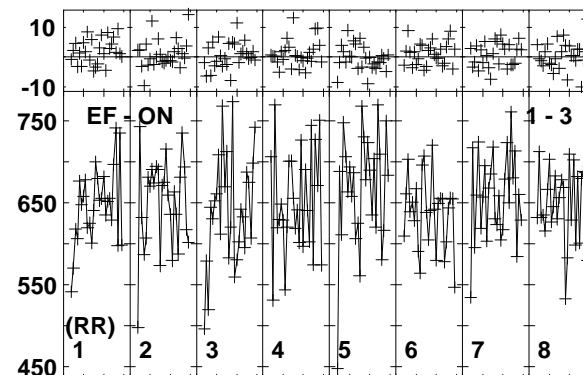
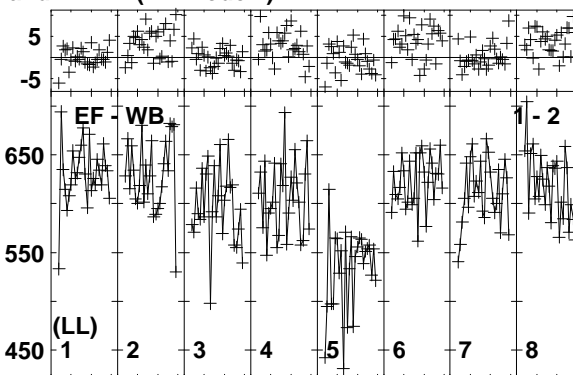
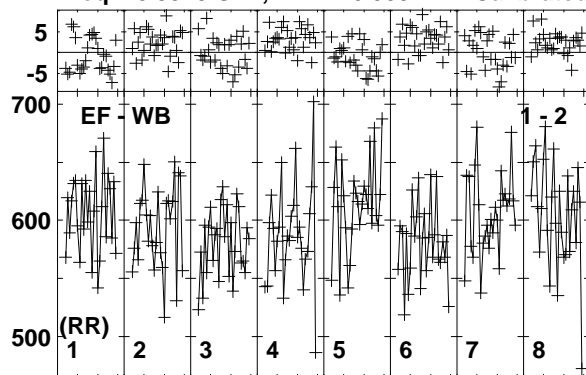

Lower frame: Milli Ampl Jy Top frame: Phas deg
Vector averaged cross-power spectrum Baseline: EF (01) - WB (02)
Timerange: 00/08:17:26 to 00/08:17:55

Plot file version 330 created 24-MAR-2014 14:39:02

J1128+5925 EP087F 5.UVDATA.1

Freq = 8.3520 GHz, Bw = 16.000 MH Calibrated with CL # 3 and BP # 1 (BP mode 1)

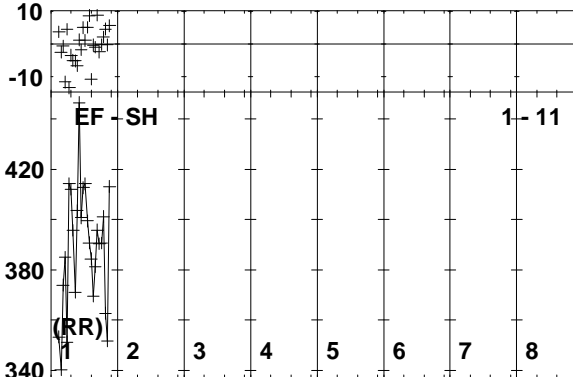
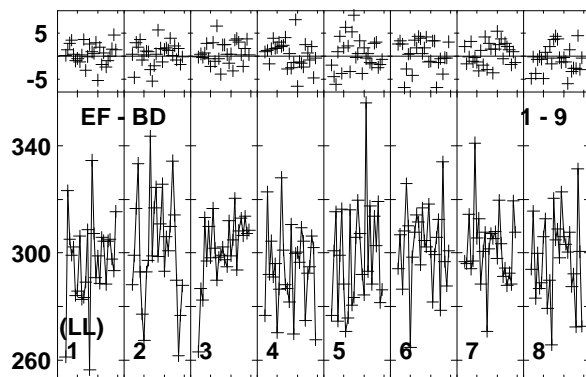
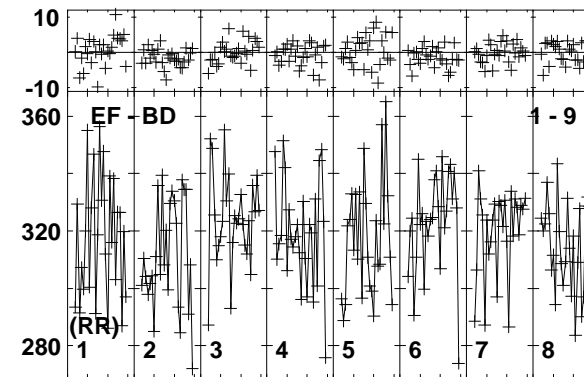
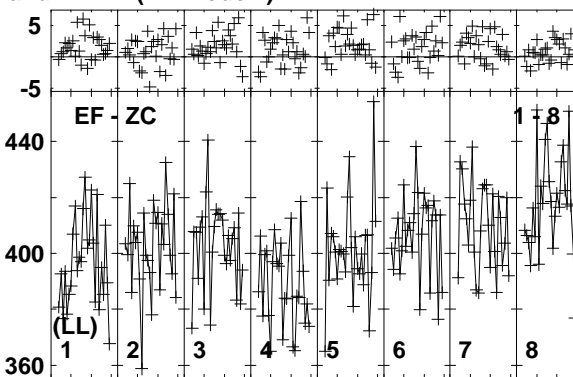
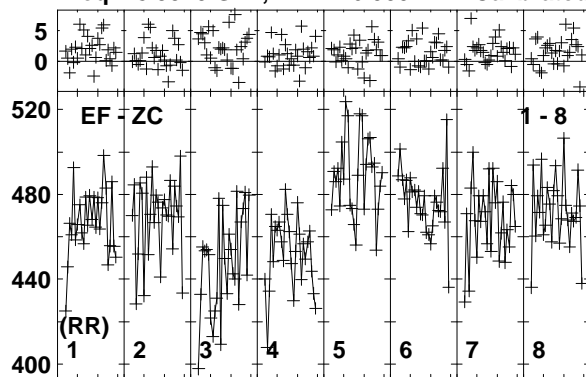

Lower frame: Milli Ampl Jy Top frame: Phas deg
Vector averaged cross-power spectrum Baseline: EF (01) - ZC (08)
Timerange: 00/08:17:26 to 00/08:17:55

Plot file version 331 created 24-MAR-2014 14:39:02

ARP299D EP087F 5.UVDATA.1

Freq = 8.3520 GHz, Bw = 16.000 MH Calibrated with CL # 3 and BP # 1 (BP mode 1)

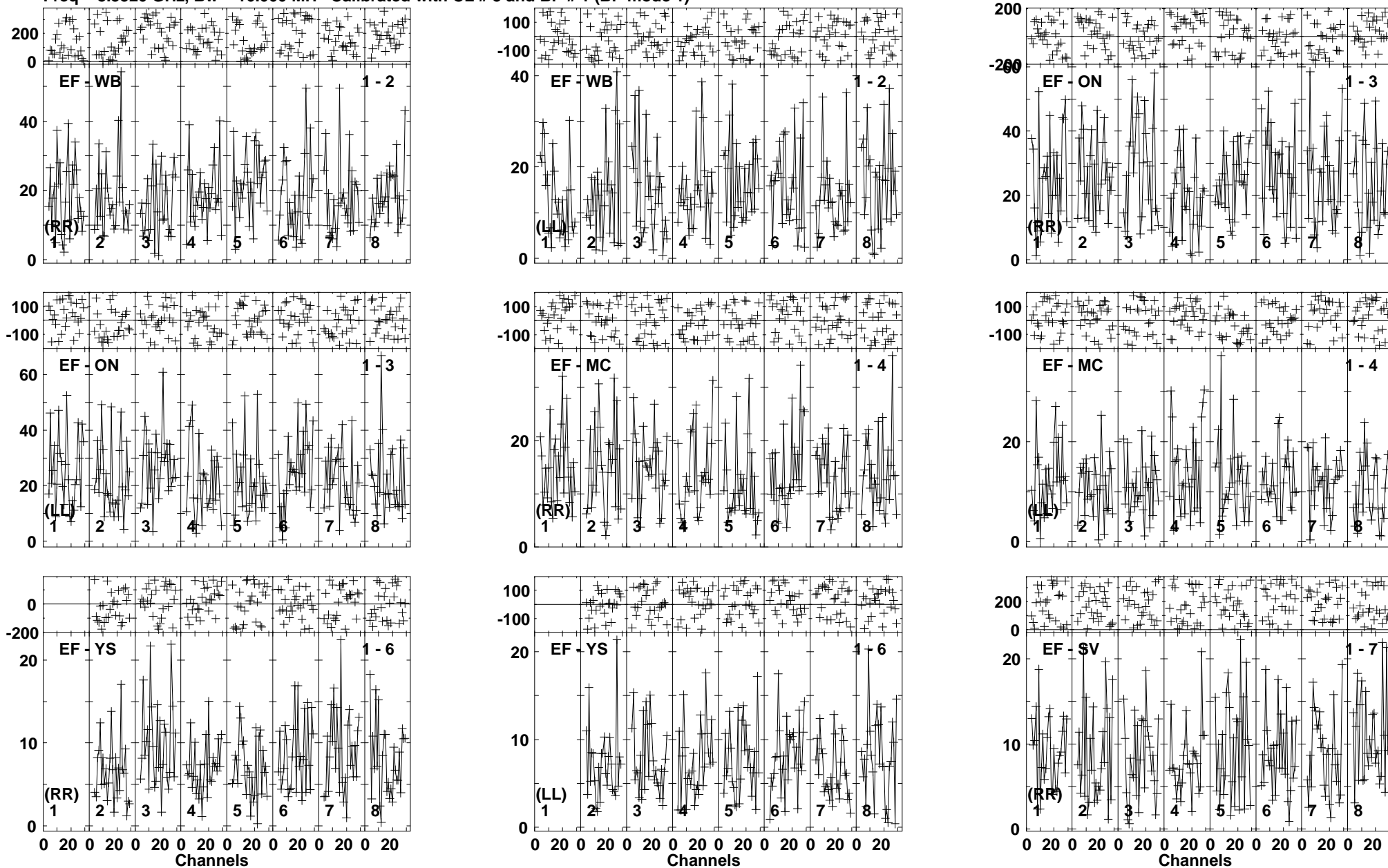

Lower frame: Milli Ampl Jy Top frame: Phas deg
Vector averaged cross-power spectrum Baseline: EF (01) - WB (02)
Timerange: 00/08:17:59 to 00/08:20:55

Plot file version 332 created 24-MAR-2014 14:39:03

ARP299D EP087F 5.UVDATA.1

Freq = 8.3520 GHz, Bw = 16.000 MH Calibrated with CL # 3 and BP # 1 (BP mode 1)

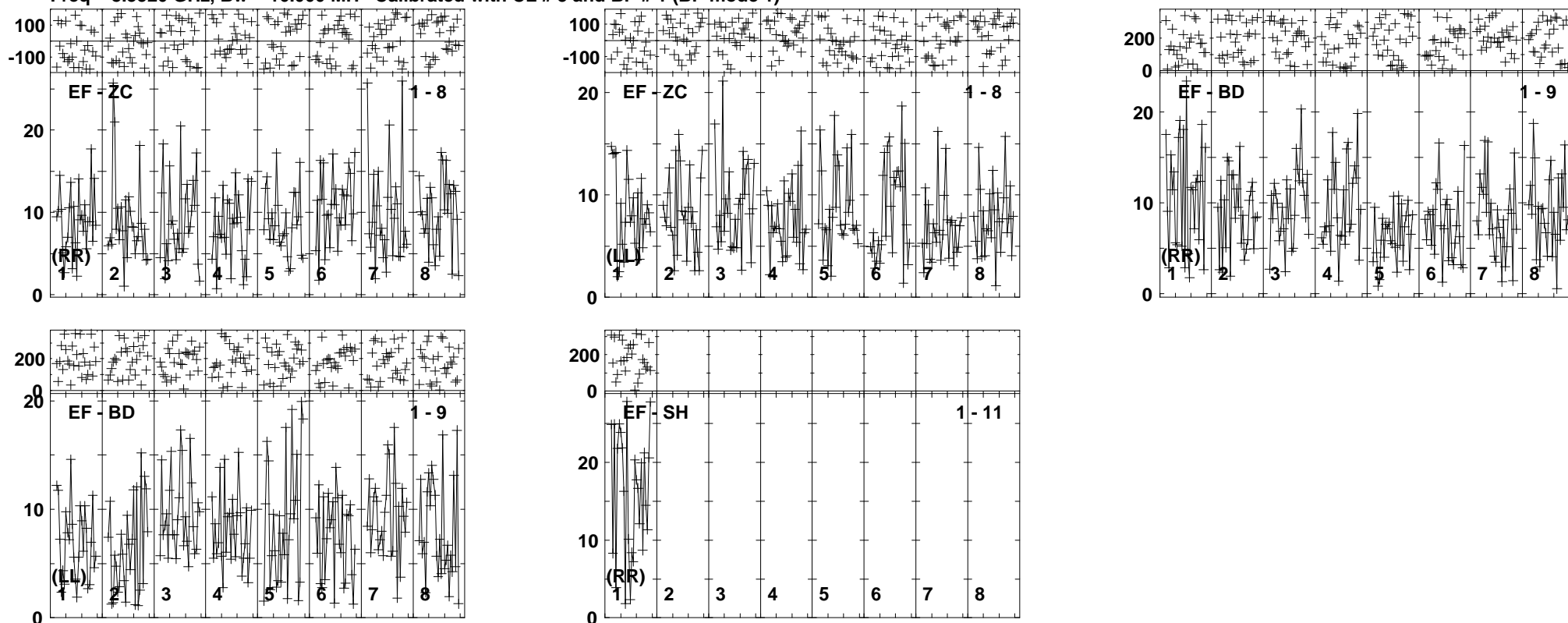

Lower frame: Milli Ampl Jy Top frame: Phas deg
Vector averaged cross-power spectrum Baseline: EF (01) - ZC (08)
Timerange: 00/08:17:59 to 00/08:20:55

Plot file version 333 created 24-MAR-2014 14:39:03

J1128+5925 EP087F 5.UVDATA.1

Freq = 8.3520 GHz, Bw = 16.000 MH Calibrated with CL # 3 and BP # 1 (BP mode 1)

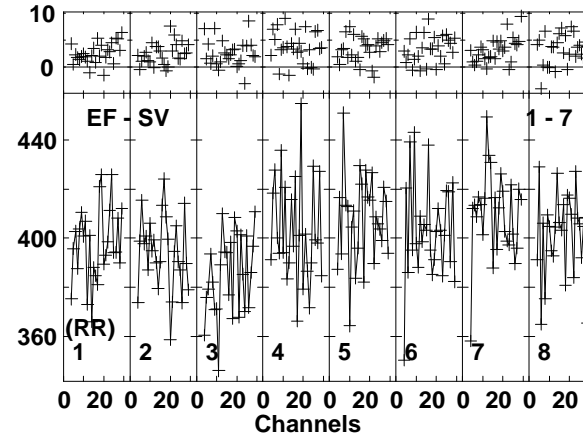
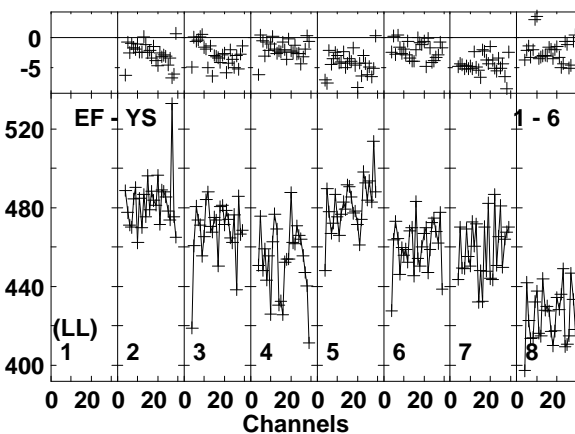
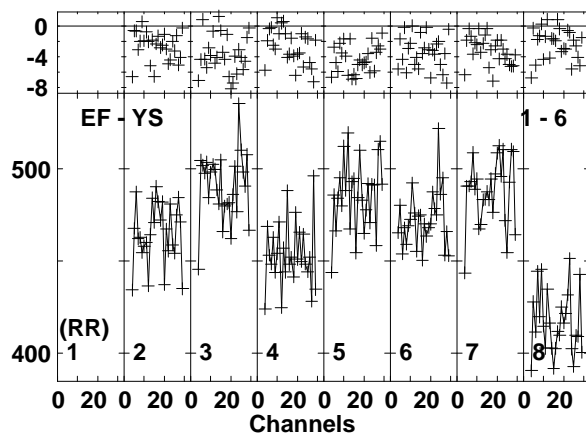
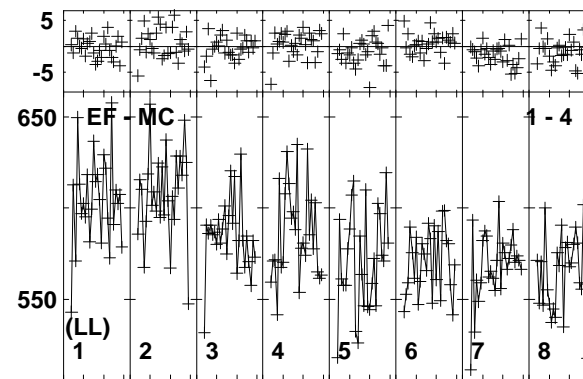
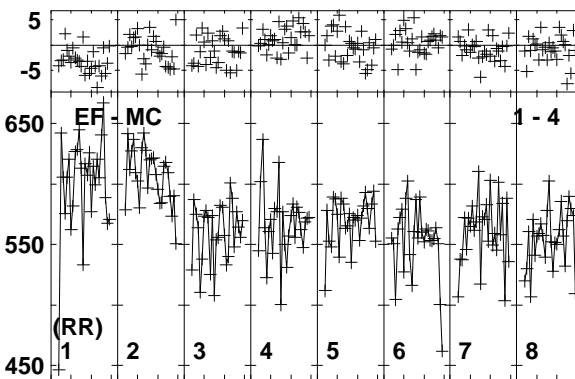
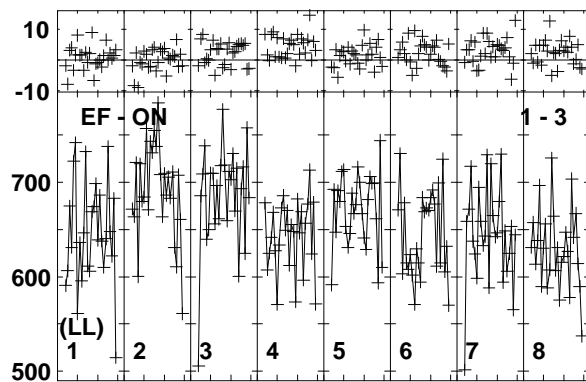
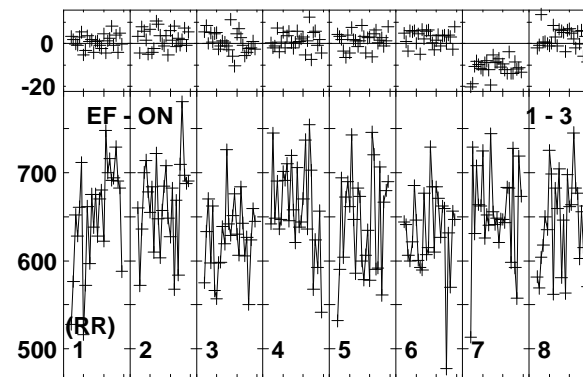
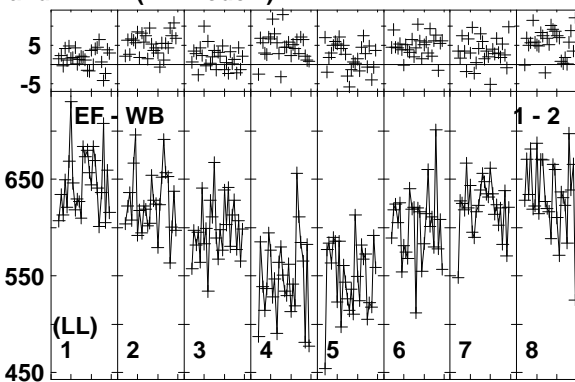
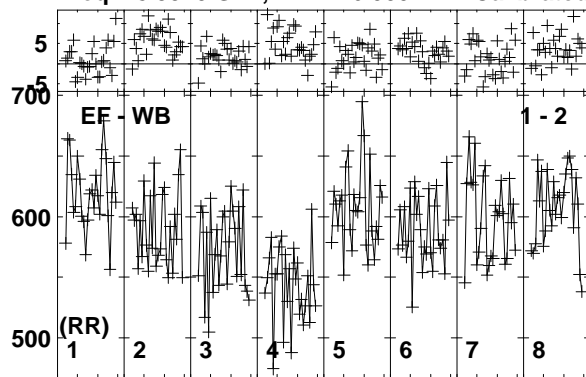

Lower frame: Milli Ampl Jy Top frame: Phas deg
Vector averaged cross-power spectrum Baseline: EF (01) - WB (02)
Timerange: 00/08:20:59 to 00/08:21:59

Plot file version 334 created 24-MAR-2014 14:39:03
 J1128+5925 EP087F 5.UVDATA.1
 Freq = 8.3520 GHz, Bw = 16.000 MH Calibrated with CL # 3 and BP # 1 (BP mode 1)

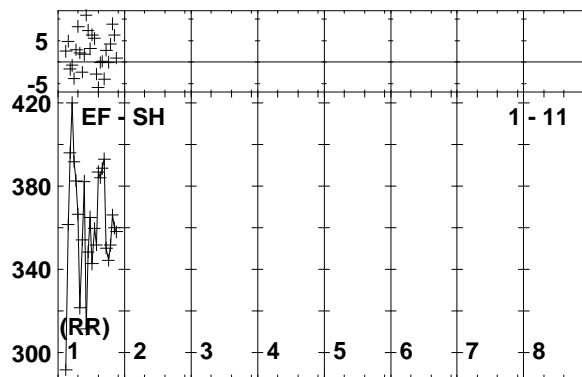
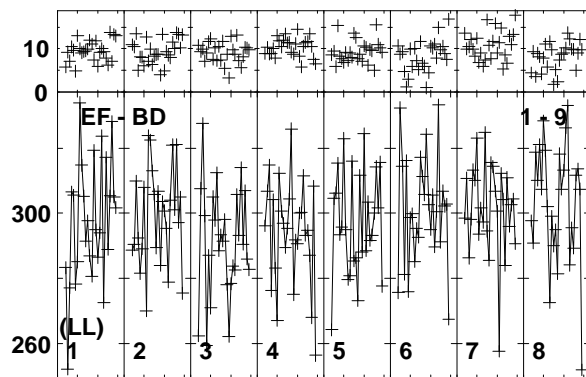
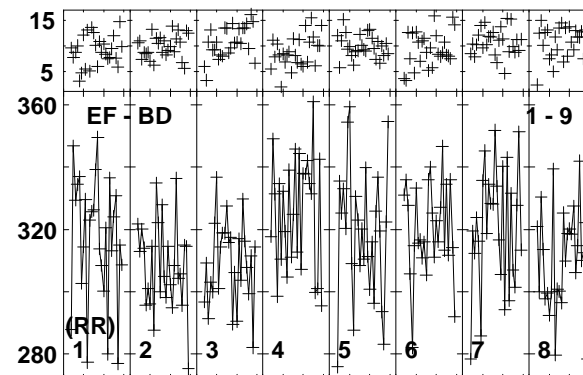
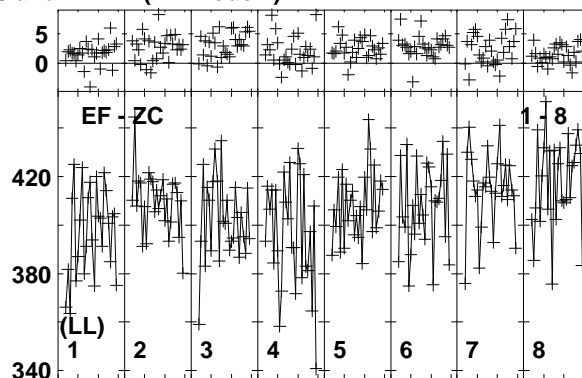
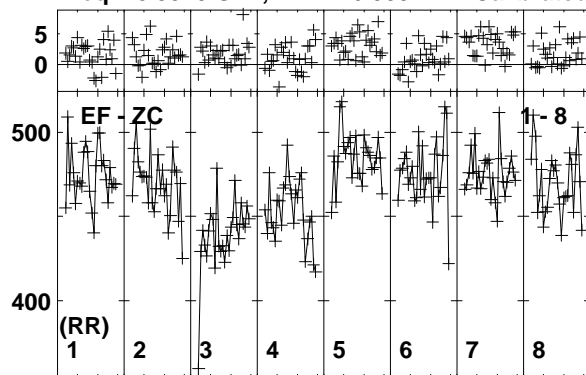

Lower frame: Milli Ampl Jy Top frame: Phas deg
 Vector averaged cross-power spectrum Baseline: EF (01) - ZC (08)
 Timerange: 00/08:20:59 to 00/08:21:59

Plot file version 335 created 24-MAR-2014 14:39:03
 ARP299D EP087F 5.UVDATA.1
 Freq = 8.3520 GHz, Bw = 16.000 MH Calibrated with CL # 3 and BP # 1 (BP mode 1)

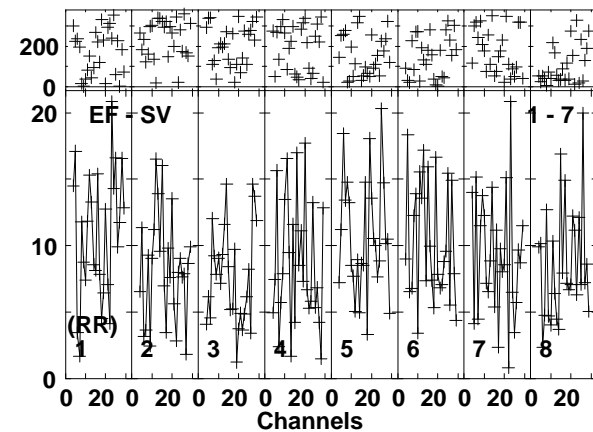
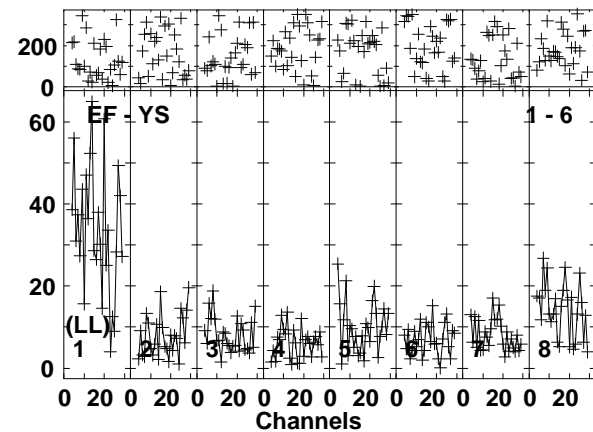
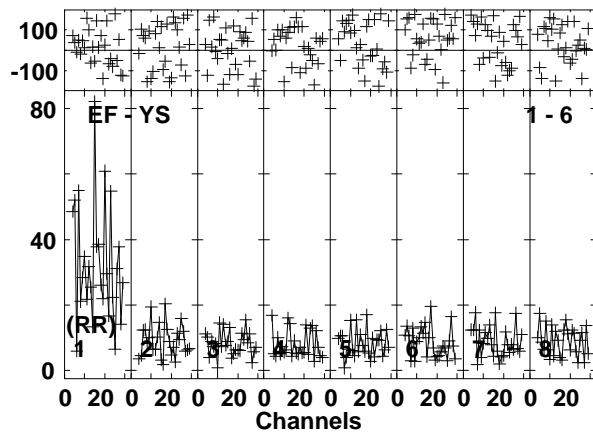
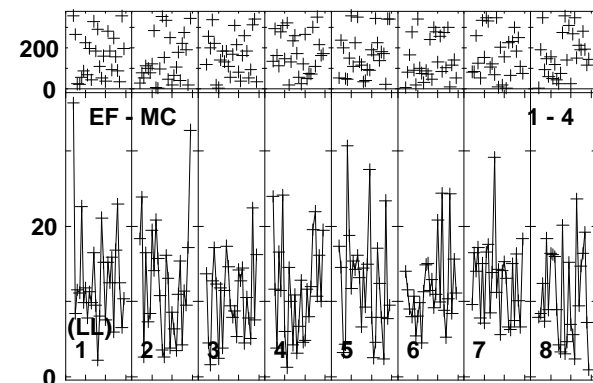
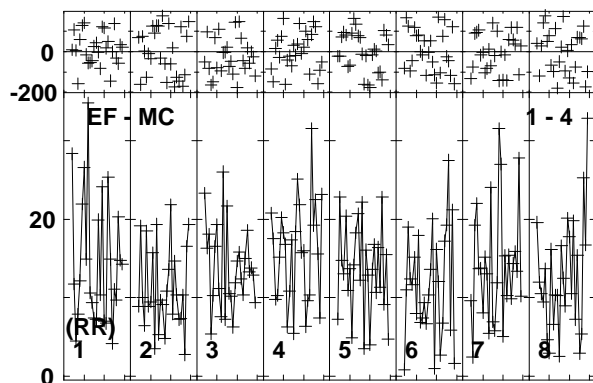
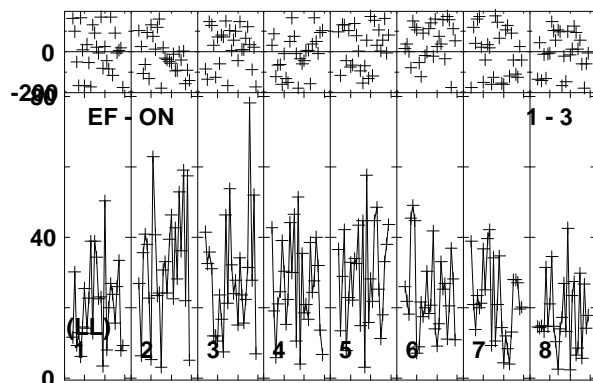
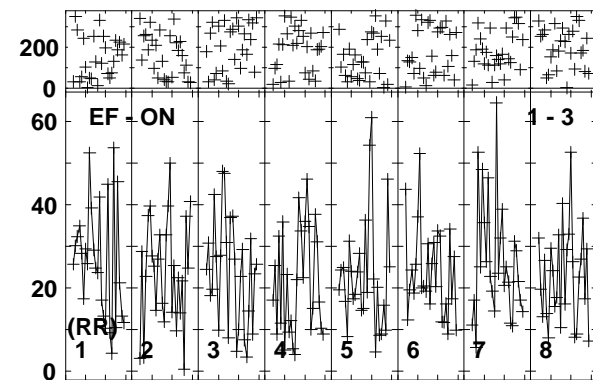
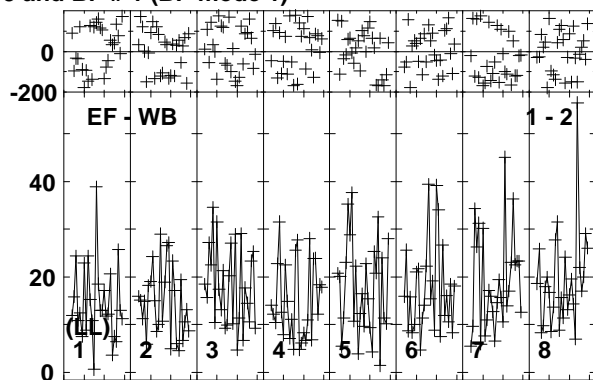
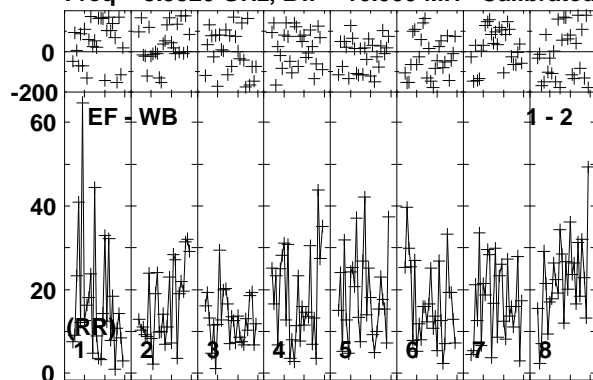

Lower frame: Milli Ampl Jy Top frame: Phas deg
 Vector averaged cross-power spectrum Baseline: EF (01) - WB (02)
 Timerange: 00/08:22:03 to 00/08:24:59

Plot file version 336 created 24-MAR-2014 14:39:04

ARP299D EP087F 5.UVDATA.1

Freq = 8.3520 GHz, Bw = 16.000 MH Calibrated with CL # 3 and BP # 1 (BP mode 1)

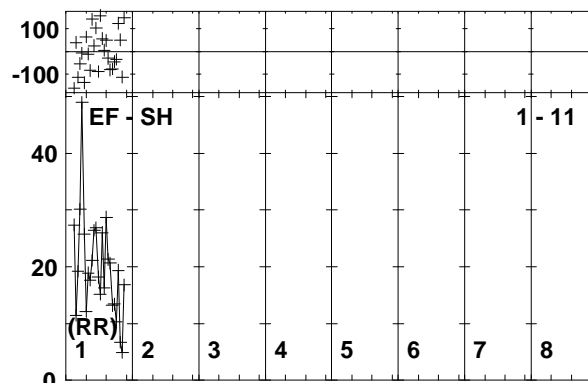
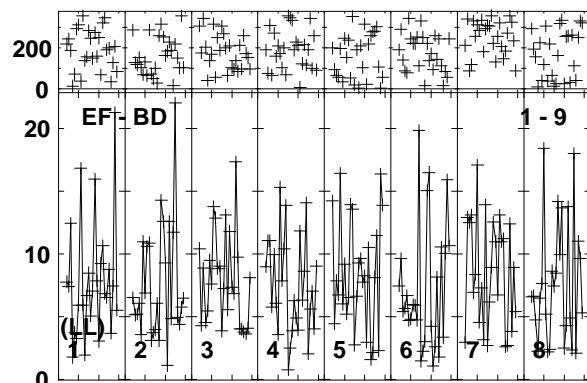
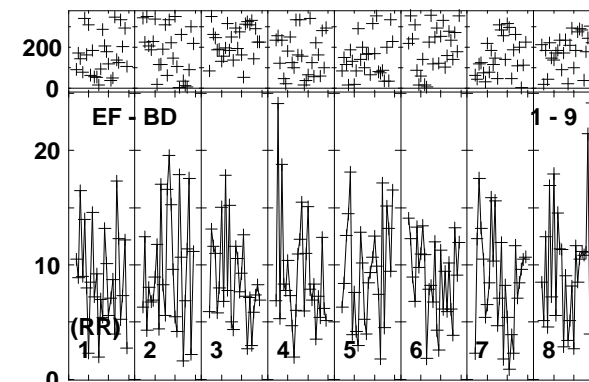
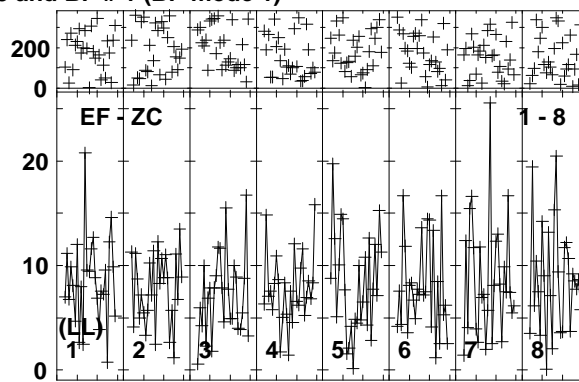
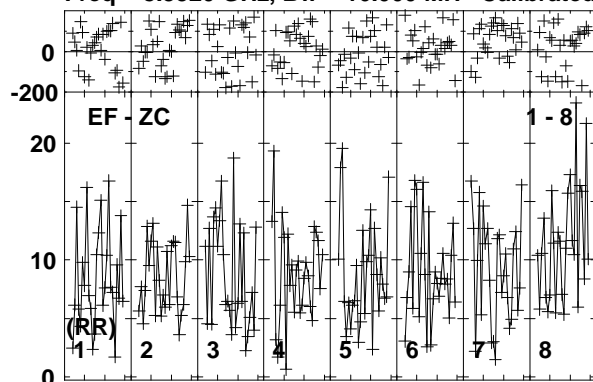

Lower frame: Milli Ampl Jy Top frame: Phas deg
Vector averaged cross-power spectrum Baseline: EF (01) - ZC (08)
Timerange: 00/08:22:03 to 00/08:24:59

Plot file version 337 created 24-MAR-2014 14:39:04
 J1128+5925 EP087F 5.UVDATA.1
 Freq = 8.3520 GHz, Bw = 16.000 MH Calibrated with CL # 3 and BP # 1 (BP mode 1)

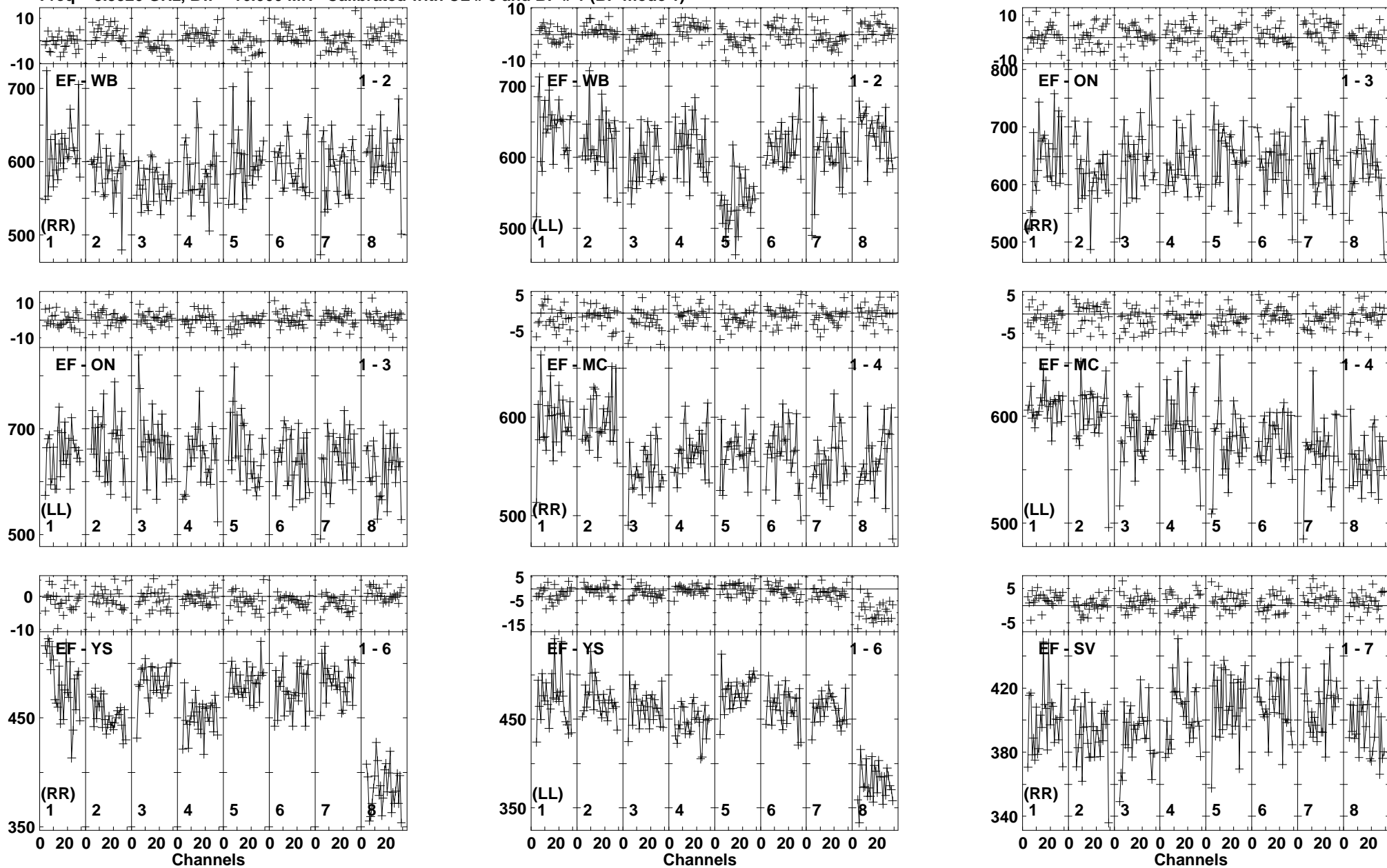

Lower frame: Milli Ampl Jy Top frame: Phas deg
 Vector averaged cross-power spectrum Baseline: EF (01) - WB (02)
 Timerange: 00/08:25:41 to 00/08:26:09

Plot file version 338 created 24-MAR-2014 14:39:04

J1128+5925 EP087F 5.UVDATA.1

Freq = 8.3520 GHz, Bw = 16.000 MH Calibrated with CL # 3 and BP # 1 (BP mode 1)

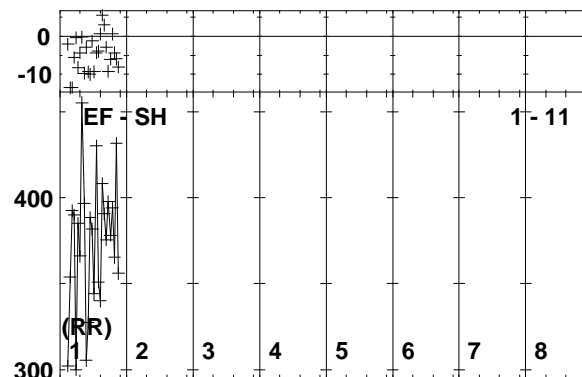
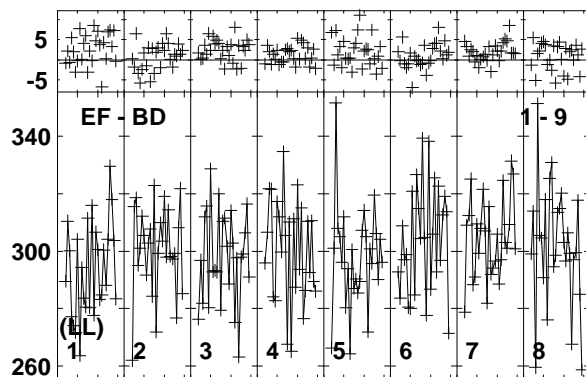
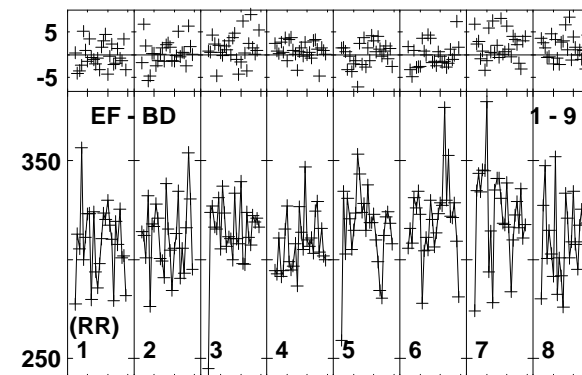
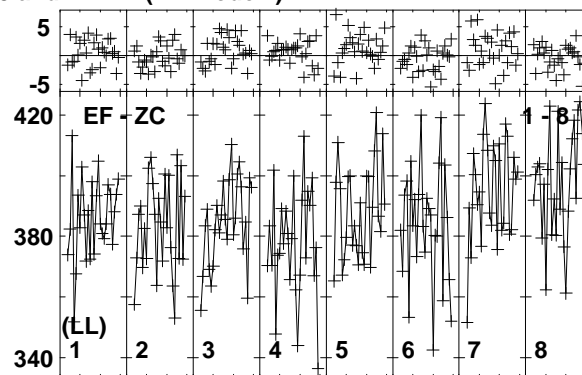
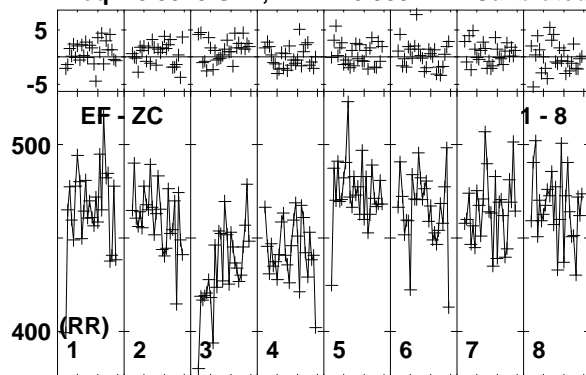

Lower frame: Milli Ampl Jy Top frame: Phas deg
Vector averaged cross-power spectrum Baseline: EF (01) - ZC (08)
Timerange: 00/08:25:41 to 00/08:26:09

Plot file version 339 created 24-MAR-2014 14:39:04
 ARP299D EP087F 5.UVDATA.1
 Freq = 8.3520 GHz, Bw = 16.000 MH Calibrated with CL # 3 and BP # 1 (BP mode 1)

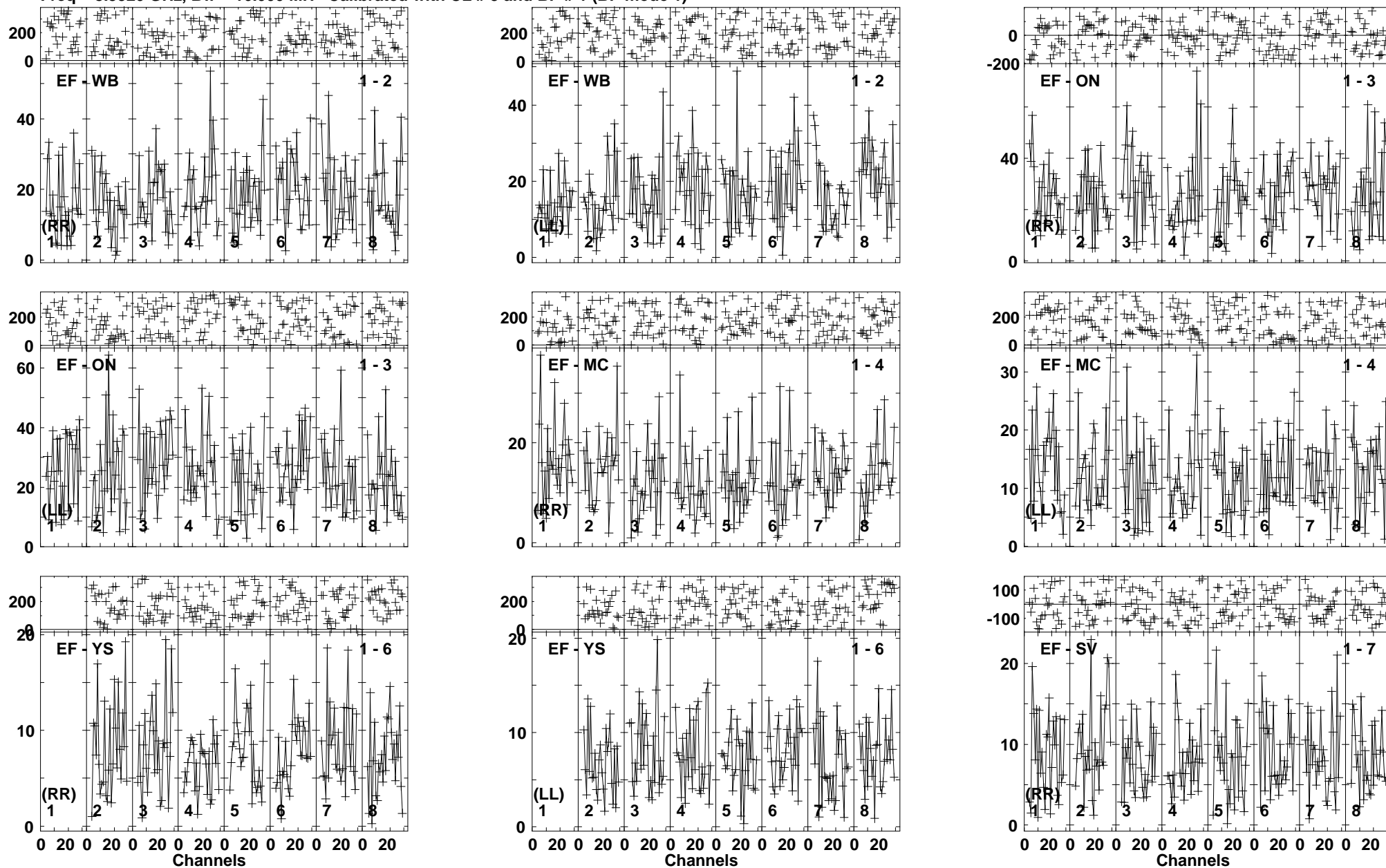

Lower frame: Milli Ampl Jy Top frame: Phas deg
 Vector averaged cross-power spectrum Baseline: EF (01) - WB (02)
 Timerange: 00/08:26:13 to 00/08:29:10

Plot file version 340 created 24-MAR-2014 14:39:05
 ARP299D EP087F 5.UVDATA.1
 Freq = 8.3520 GHz, Bw = 16.000 MH Calibrated with CL # 3 and BP # 1 (BP mode 1)

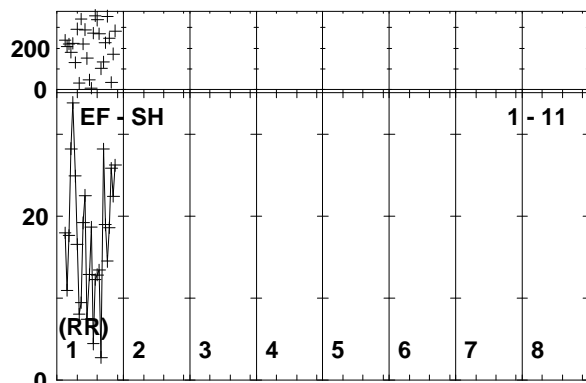
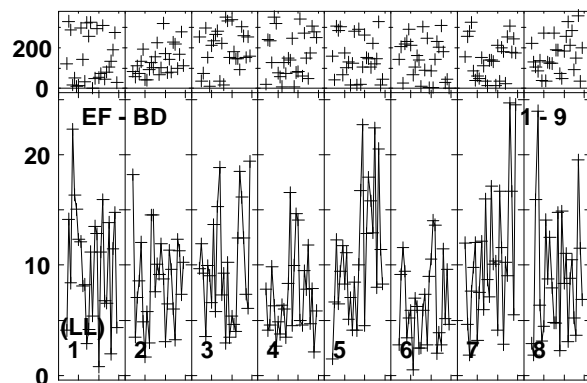
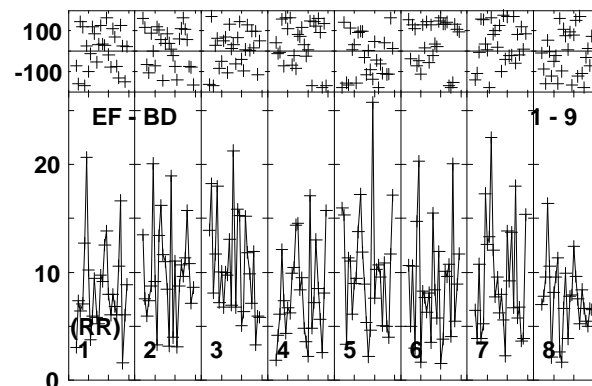
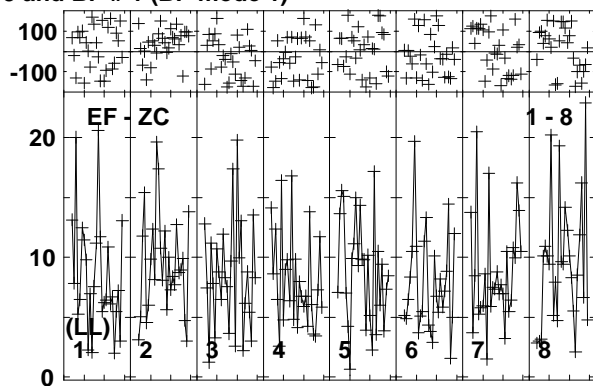
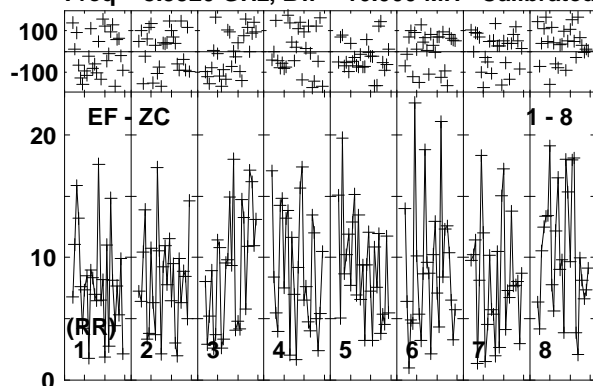

Lower frame: Milli Ampl Jy Top frame: Phas deg
 Vector averaged cross-power spectrum Baseline: EF (01) - ZC (08)
 Timerange: 00/08:26:13 to 00/08:29:10

Plot file version 341 created 24-MAR-2014 14:39:05

J1128+5925 EP087F 5.UVDATA.1

Freq = 8.3520 GHz, Bw = 16.000 MH Calibrated with CL # 3 and BP # 1 (BP mode 1)

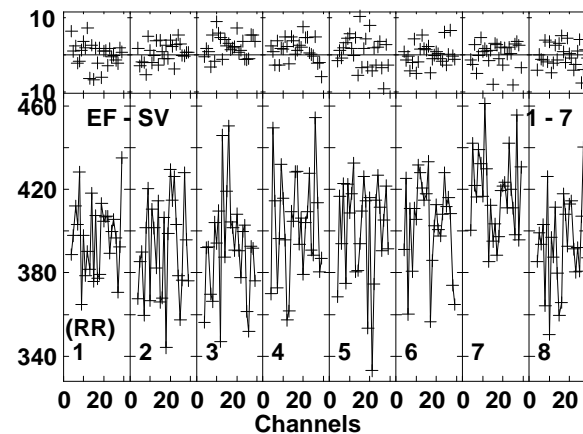
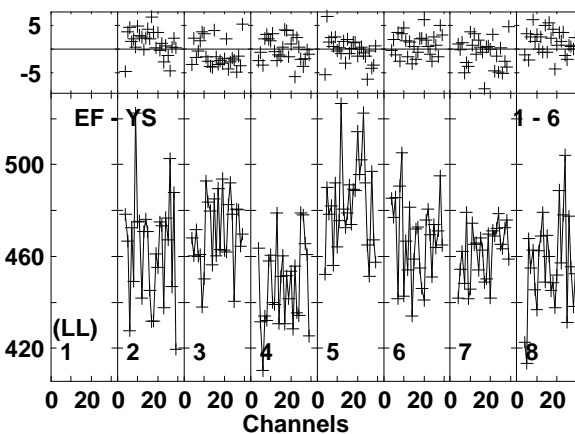
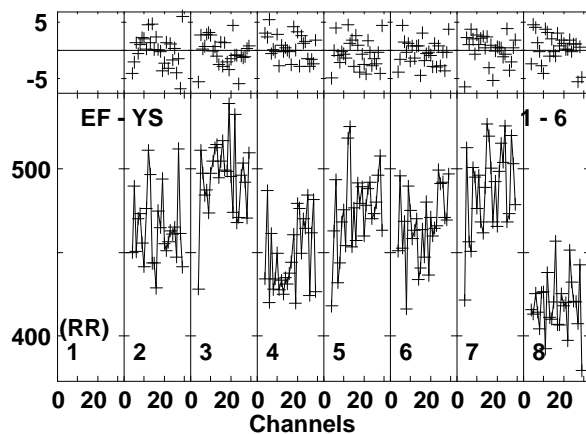
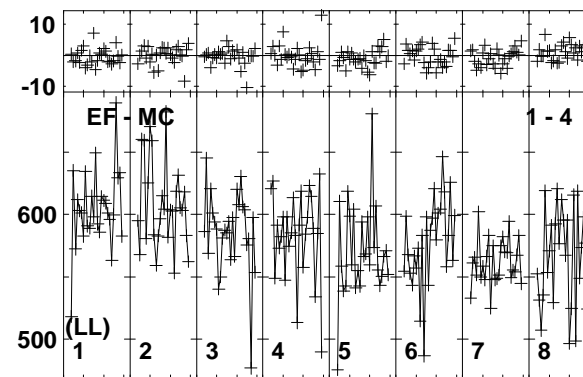
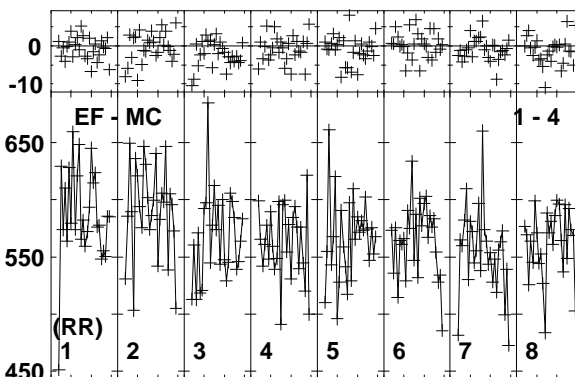
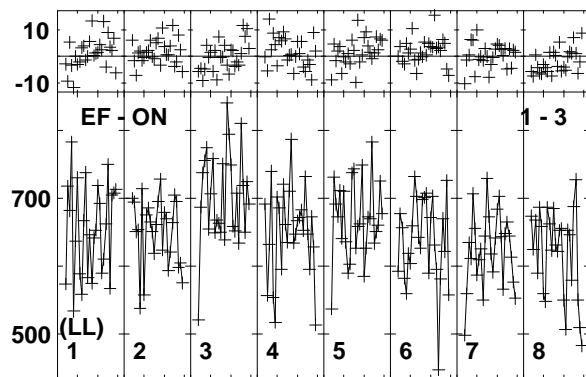
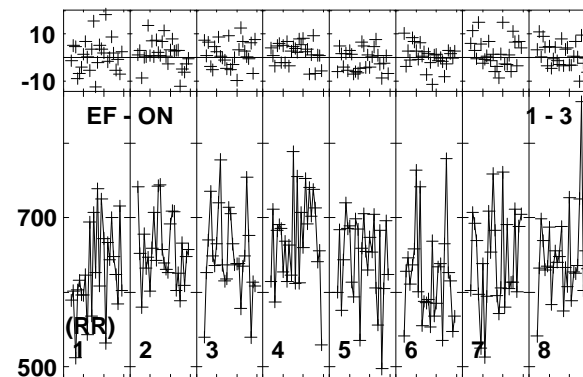
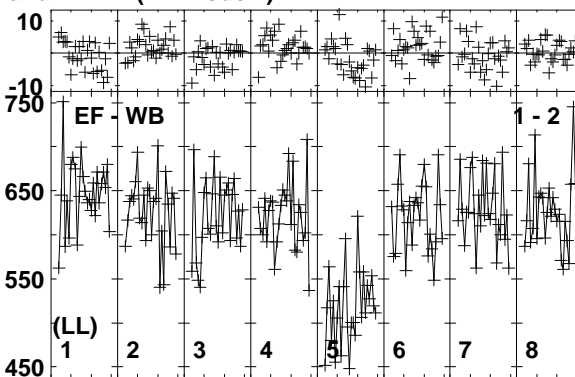
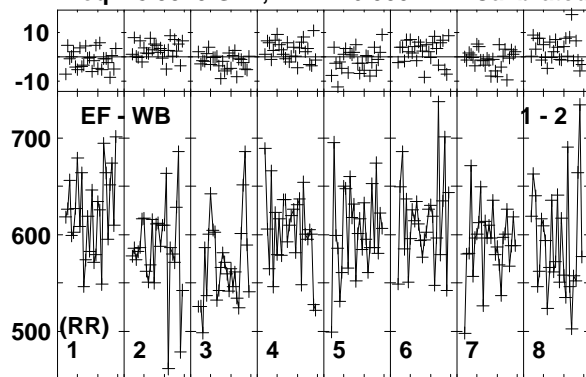

Lower frame: Milli Ampl Jy Top frame: Phas deg
Vector averaged cross-power spectrum Baseline: EF (01) - WB (02)
Timerange: 00/08:29:14 to 00/08:29:59

Plot file version 342 created 24-MAR-2014 14:39:05
 J1128+5925 EP087F 5.UVDATA.1
 Freq = 8.3520 GHz, Bw = 16.000 MH Calibrated with CL # 3 and BP # 1 (BP mode 1)

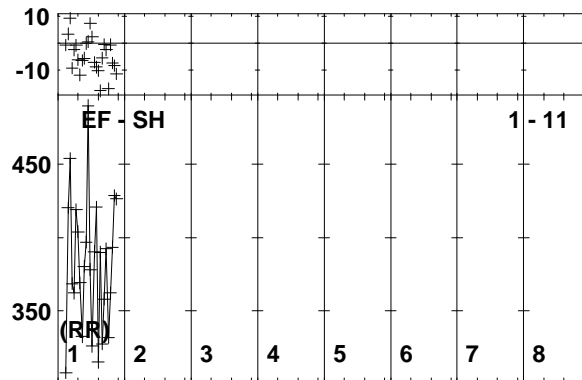
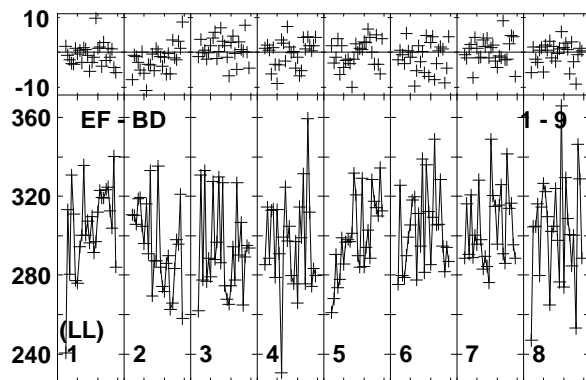
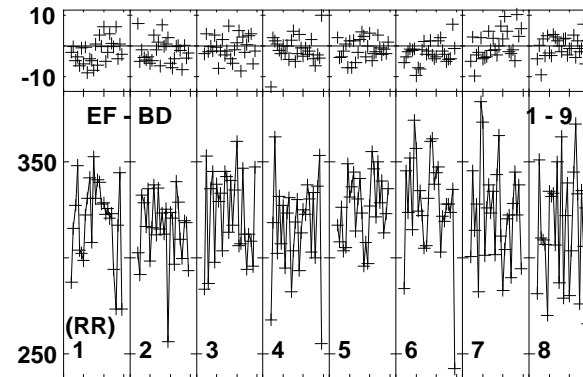
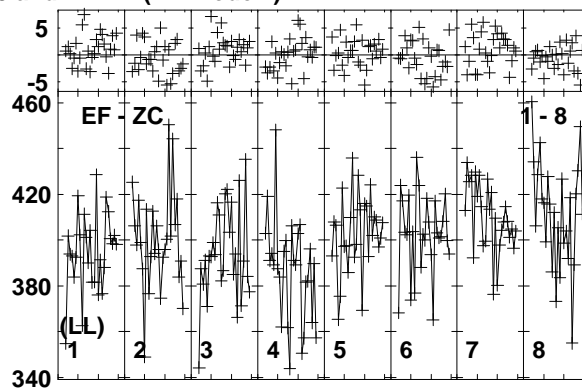
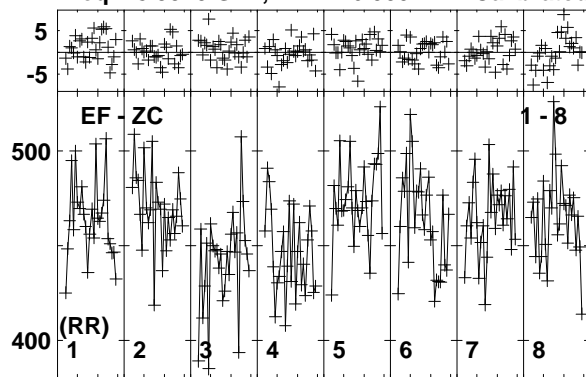

Lower frame: Milli Ampl Jy Top frame: Phas deg
 Vector averaged cross-power spectrum Baseline: EF (01) - ZC (08)
 Timerange: 00/08:29:14 to 00/08:29:59