

Plot file version 1 created 18-NOV-2014 15:23:03

4C39.25 EP087H 3.UVDATA.1

Freq = 4.9270 GHz, Bw = 16.000 MH Calibrated with CL # 3 and BP # 1 (BP mode 1)

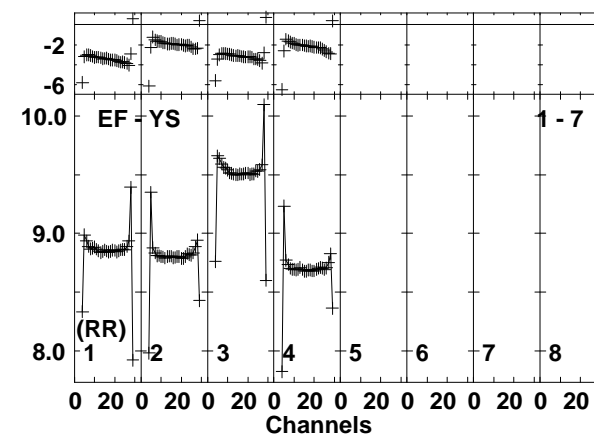
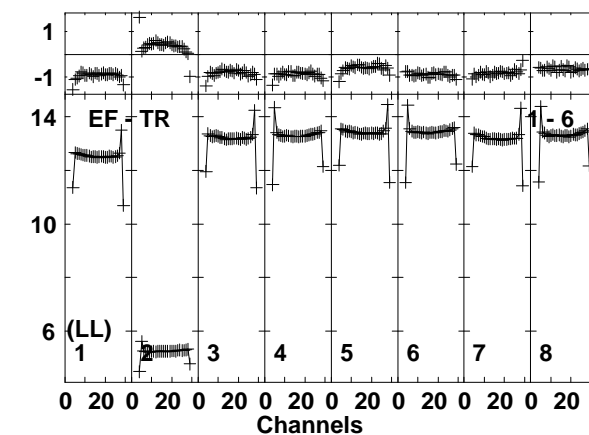
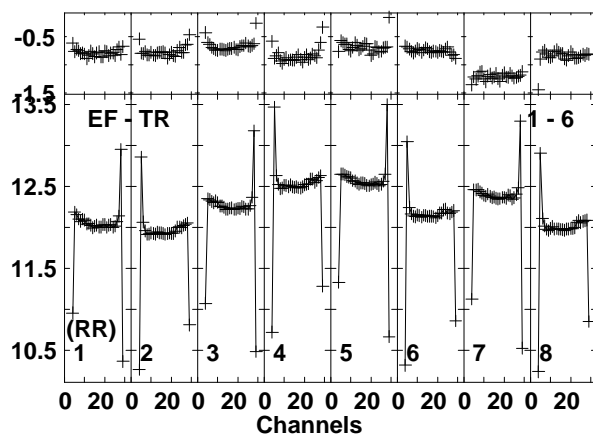
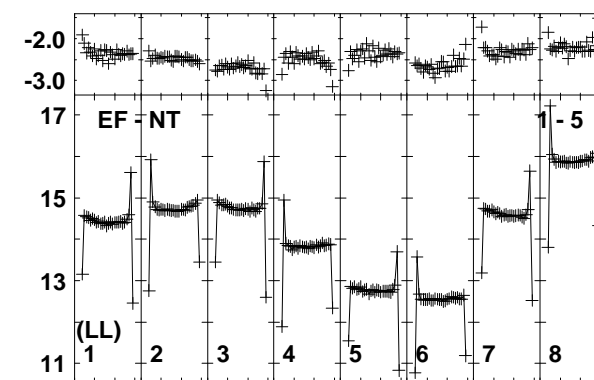
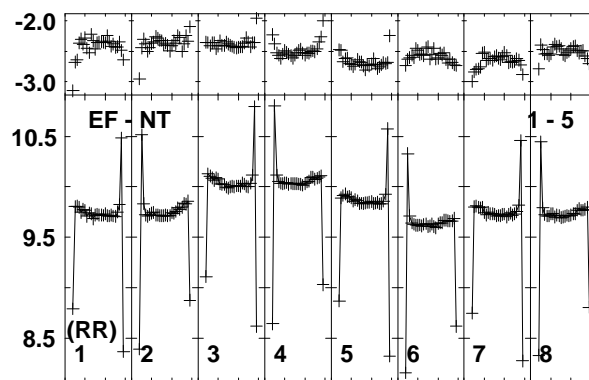
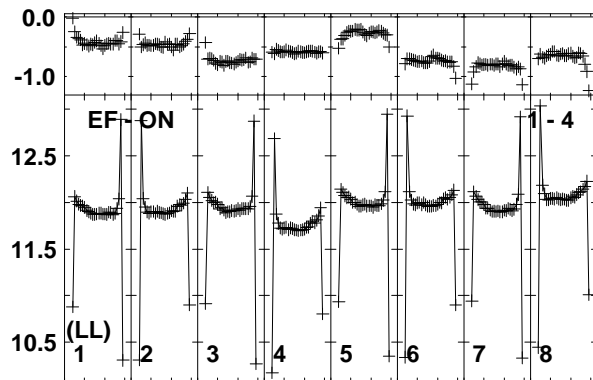
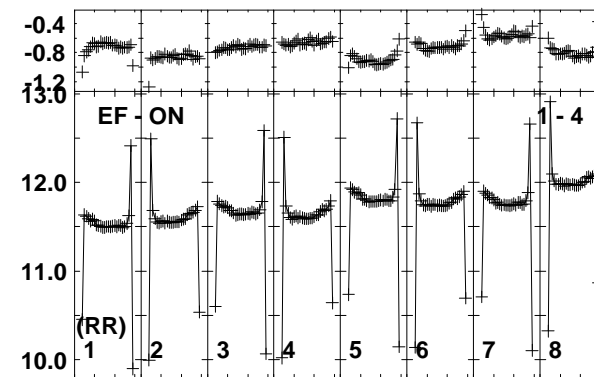
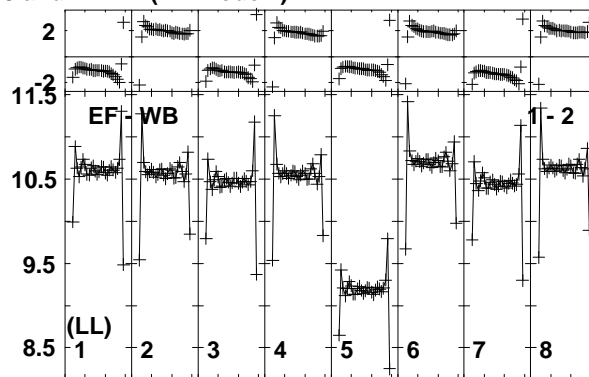
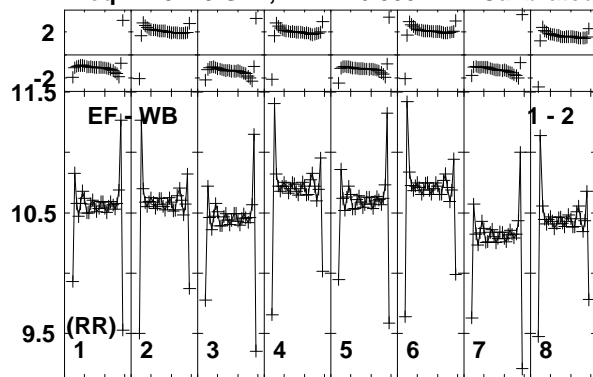

Lower frame: Ampl Jy Top frame: Phas deg  
Vector averaged cross-power spectrum Baseline: EF (01) - WB (02)  
Timerange: 00/12:30:03 to 00/12:34:59

Plot file version 2 created 18-NOV-2014 15:23:03

4C39.25 EP087H 3.UVDATA.1

Freq = 4.9270 GHz, Bw = 16.000 MH Calibrated with CL # 3 and BP # 1 (BP mode 1)

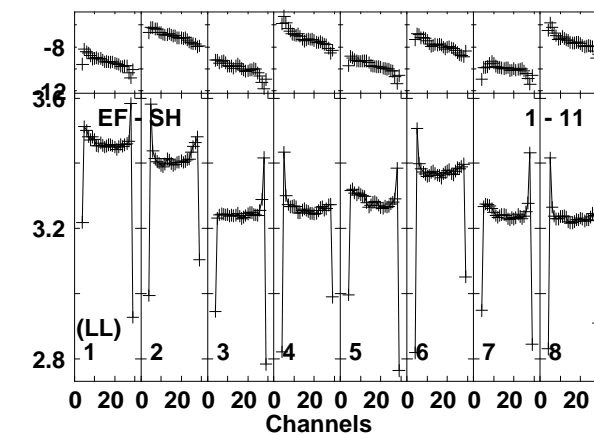
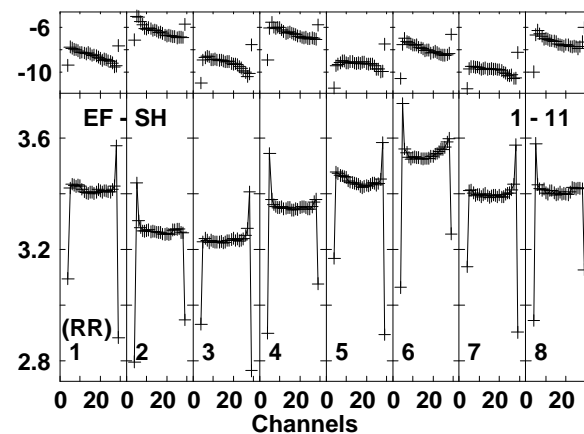
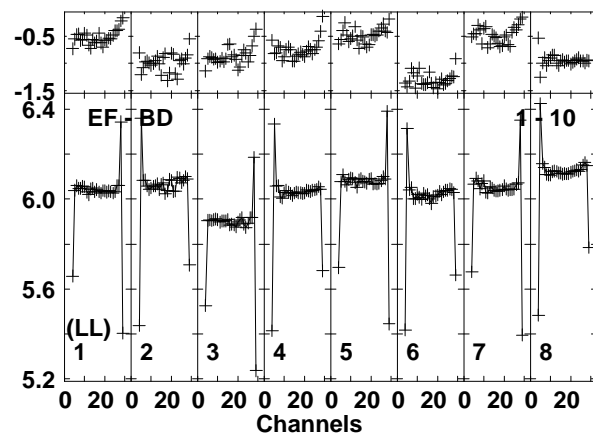
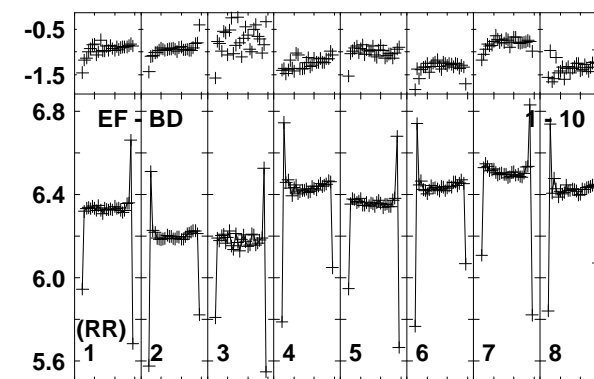
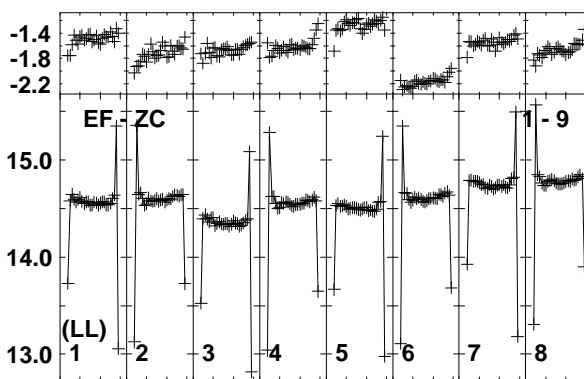
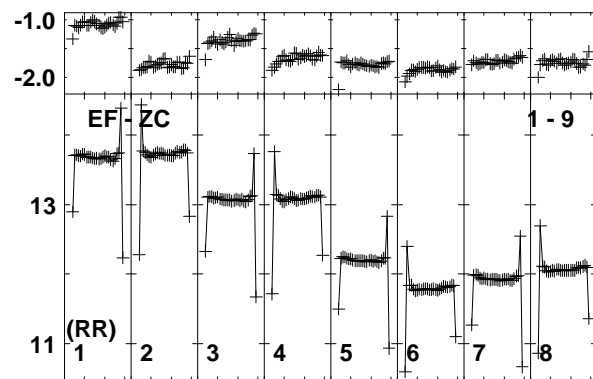
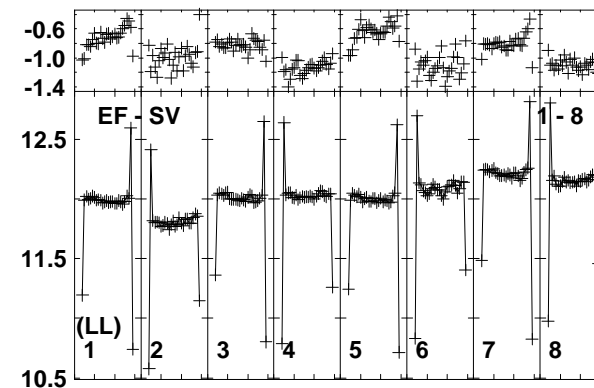
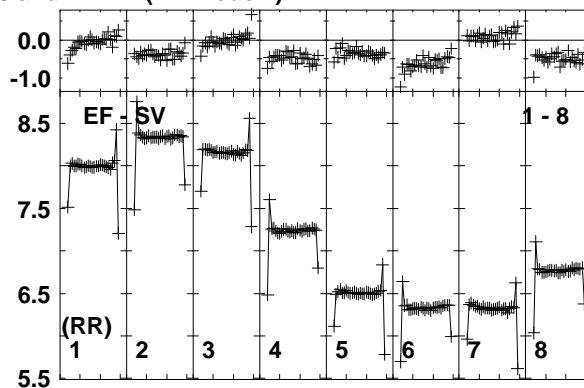
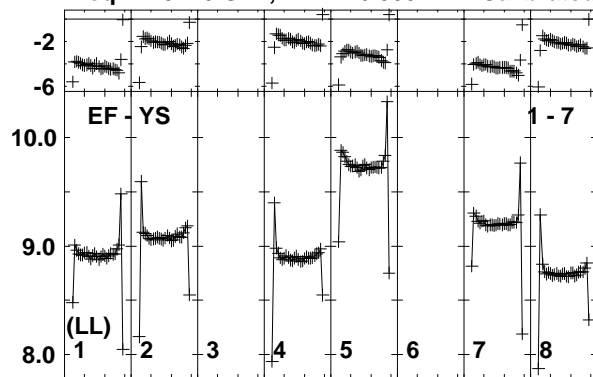

Lower frame: Ampl Jy Top frame: Phas deg  
Vector averaged cross-power spectrum Baseline: EF (01) - YS (07)  
Timerange: 00/12:30:03 to 00/12:34:59

Plot file version 3 created 18-NOV-2014 15:23:04  
 ARP299C EP087H 3.UVDATA.1  
 Freq = 4.9270 GHz, Bw = 16.000 MH Calibrated with CL # 3 and BP # 1 (BP mode 1)

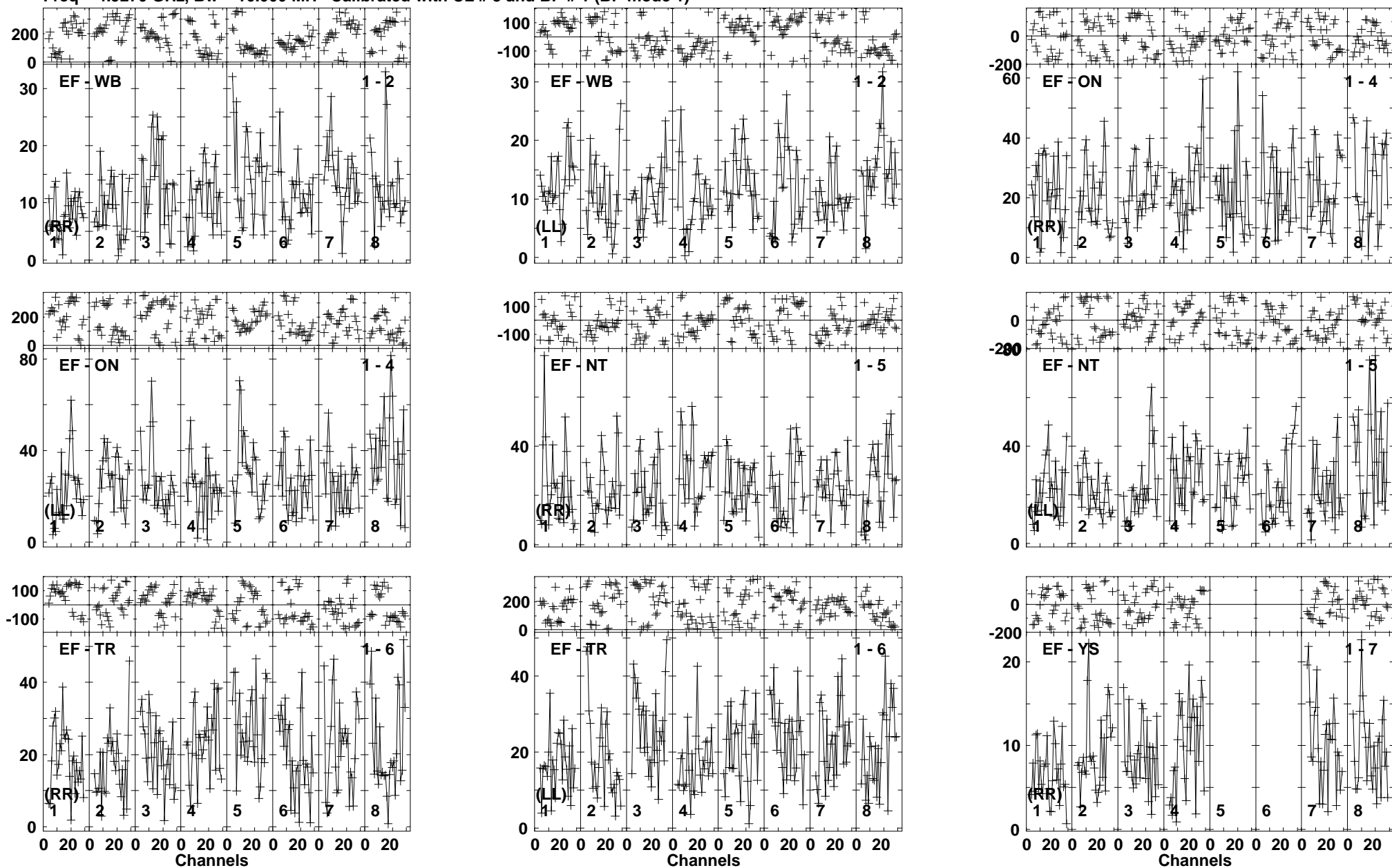

Lower frame: Milli Ampl Jy Top frame: Phas deg  
 Vector averaged cross-power spectrum Baseline: EF (01) - WB (02)  
 Timerange: 00/12:43:35 to 00/12:47:19

Plot file version 4 created 18-NOV-2014 15:23:04  
 ARP299C EP087H 3.UVDATA.1  
 Freq = 4.9270 GHz, Bw = 16.000 MH Calibrated with CL # 3 and BP # 1 (BP mode 1)

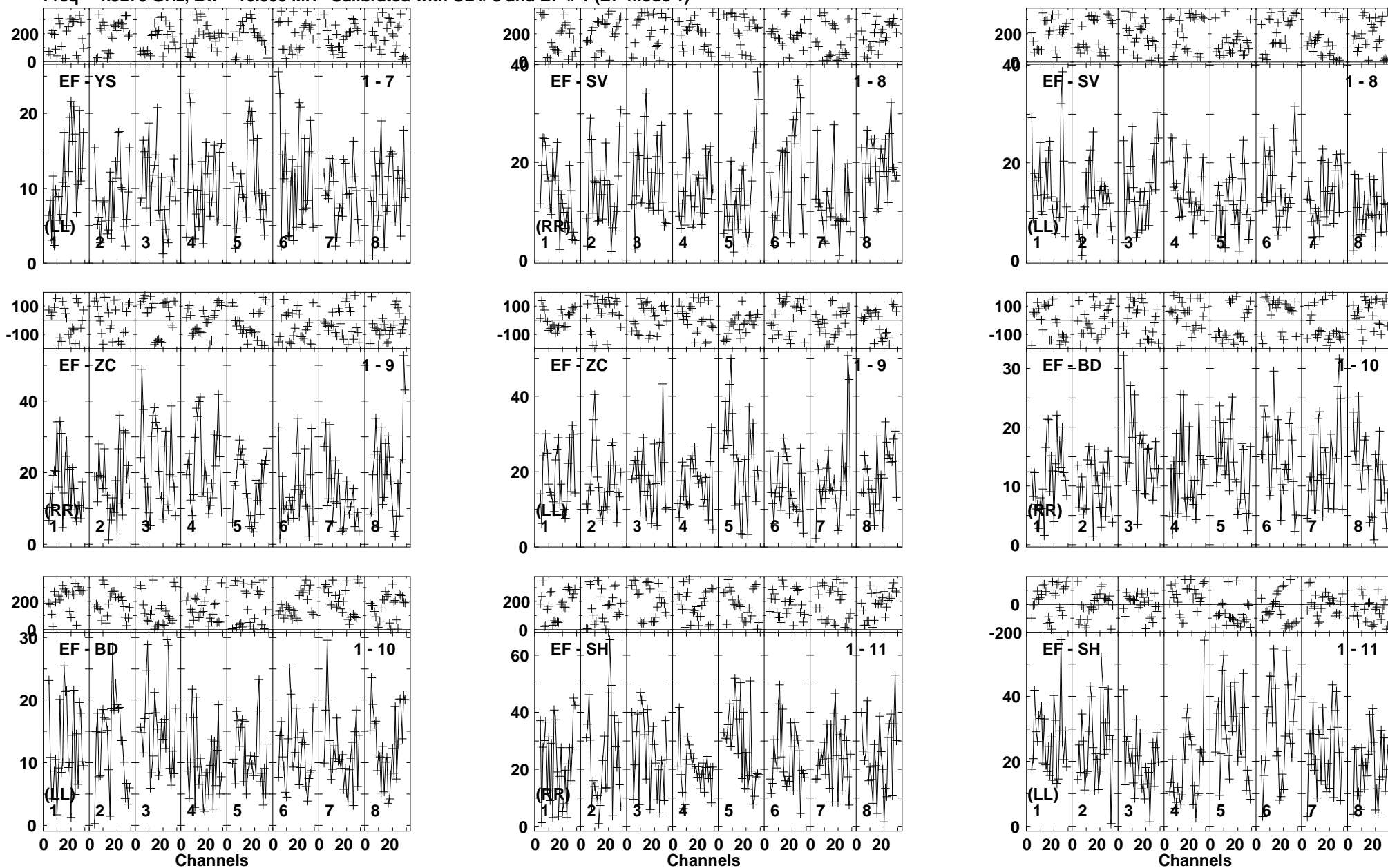

Lower frame: Milli Ampl Jy Top frame: Phas deg  
 Vector averaged cross-power spectrum Baseline: EF (01) - YS (07)  
 Timerange: 00:12:43:35 to 00:12:47:19

Plot file version 5 created 18-NOV-2014 15:23:04

J1128+5925 EP087H 3.UVDATA.1

Freq = 4.9270 GHz, Bw = 16.000 MH Calibrated with CL # 3 and BP # 1 (BP mode 1)

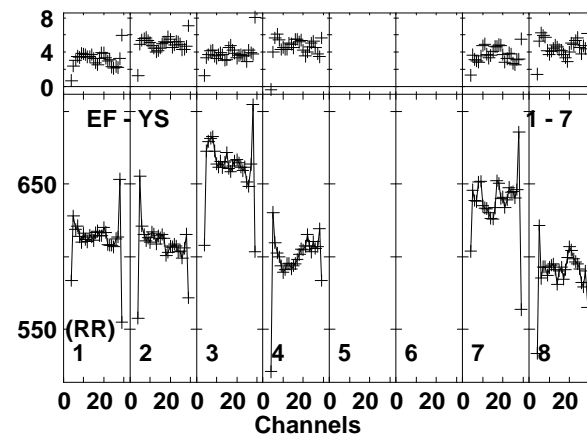
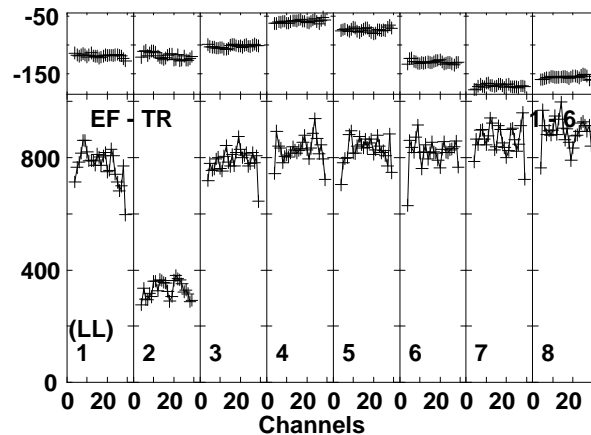
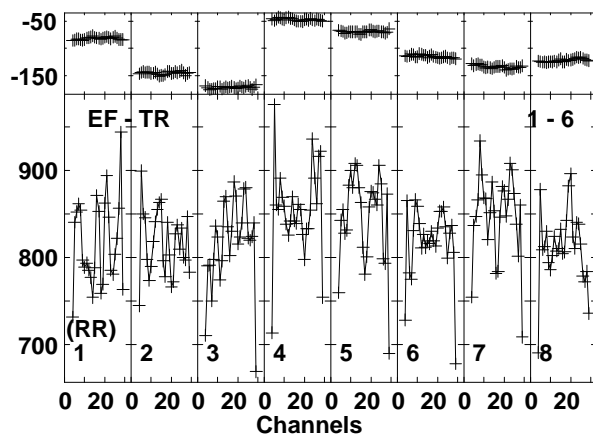
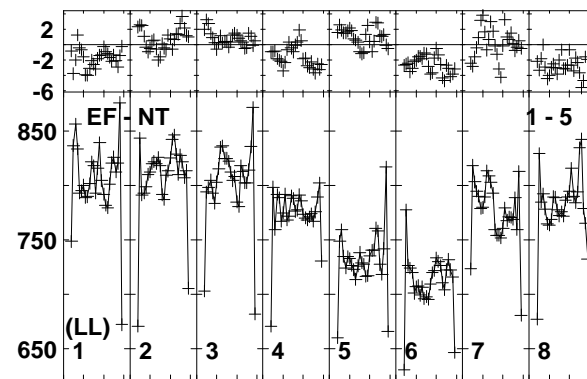
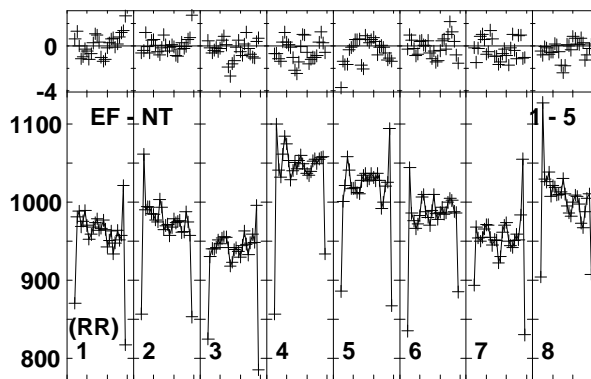
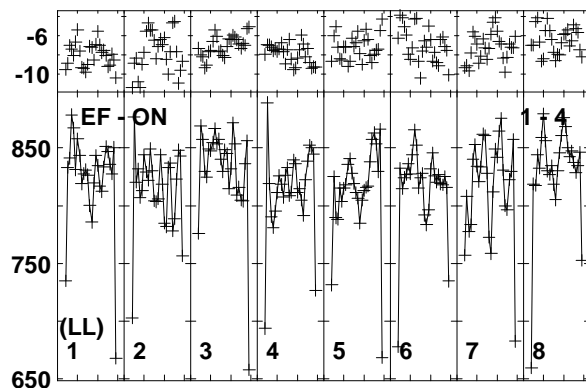
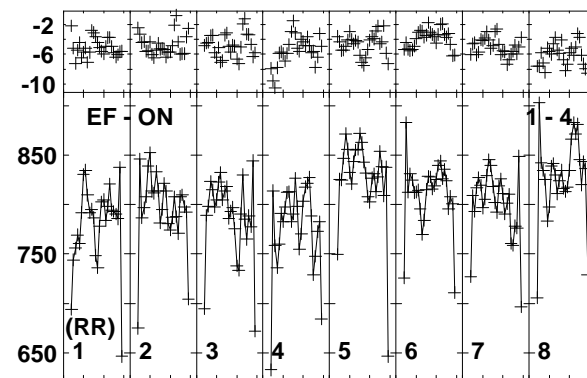
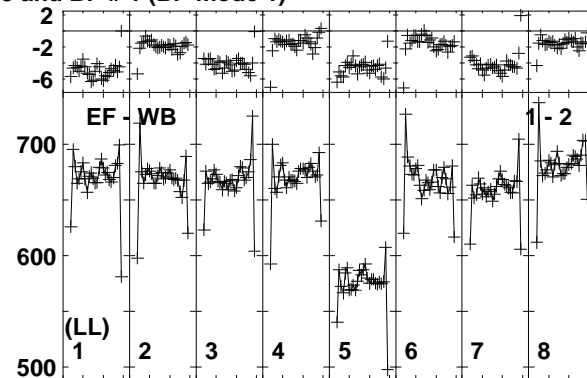
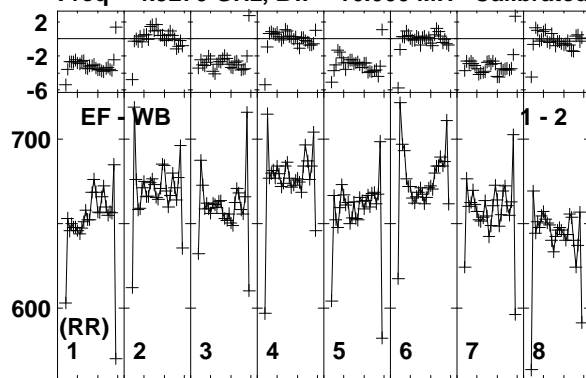

Lower frame: Milli Ampl Jy Top frame: Phas deg  
Vector averaged cross-power spectrum Baseline: EF (01) - WB (02)  
Timerange: 00/12:47:25 to 00/12:48:19

Plot file version 6 created 18-NOV-2014 15:23:05

J1128+5925 EP087H 3.UVDATA.1

Freq = 4.9270 GHz, Bw = 16.000 MH Calibrated with CL # 3 and BP # 1 (BP mode 1)

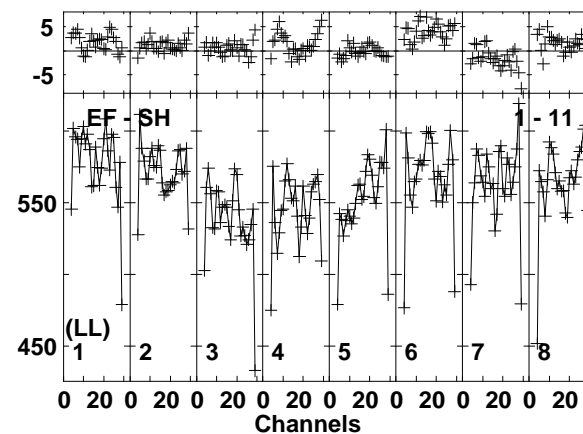
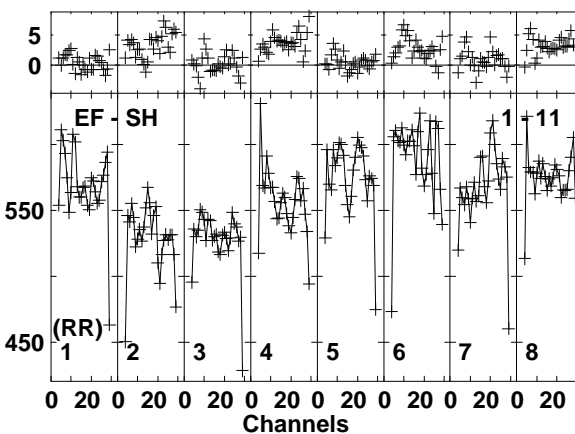
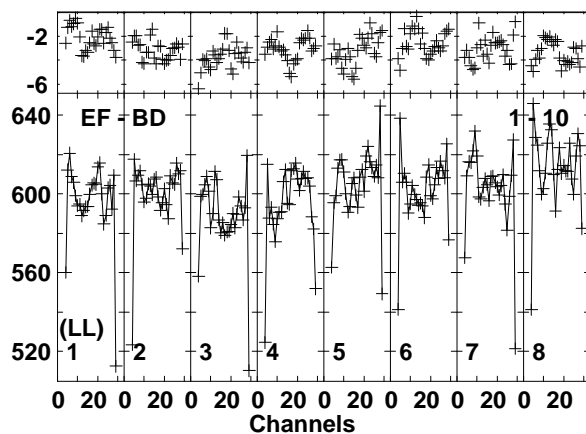
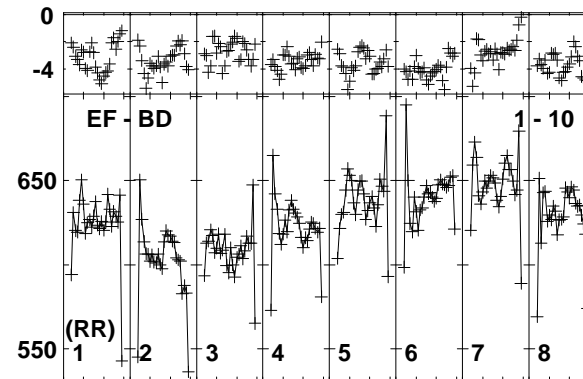
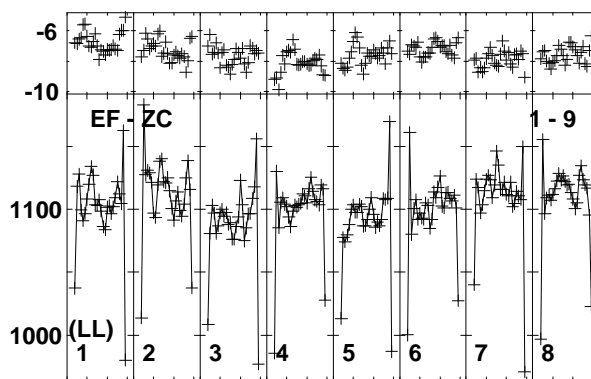
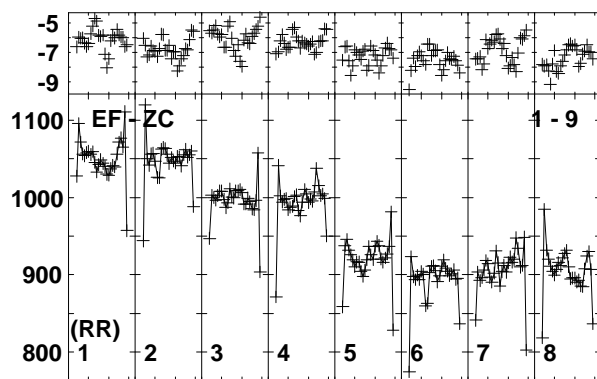
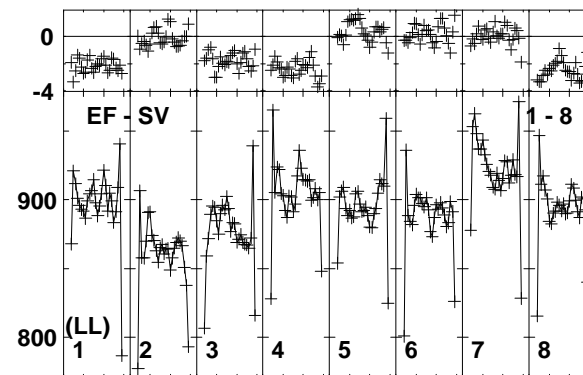
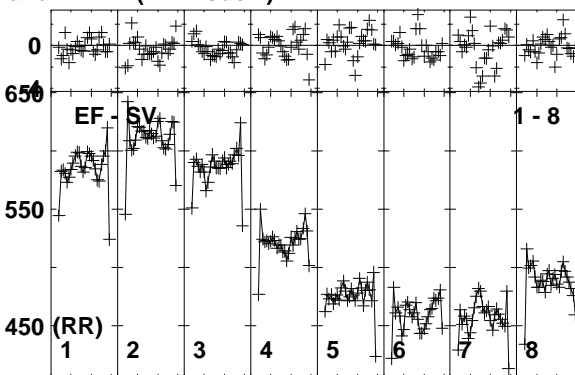
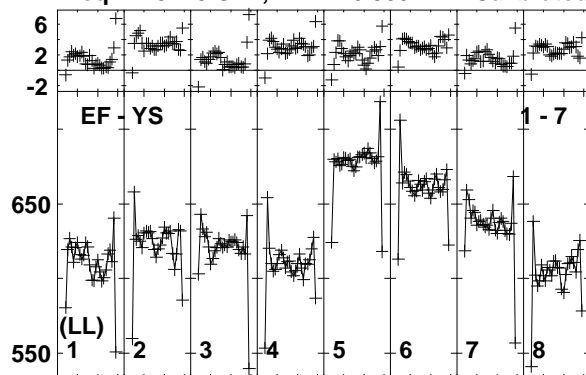

Lower frame: Milli Ampl Jy Top frame: Phas deg  
Vector averaged cross-power spectrum Baseline: EF (01) - YS (07)  
Timerange: 00/12:47:25 to 00/12:48:19

Plot file version 7 created 18-NOV-2014 15:23:05  
 ARP299C EP087H 3.UVDATA.1  
 Freq = 4.9270 GHz, Bw = 16.000 MH Calibrated with CL # 3 and BP # 1 (BP mode 1)

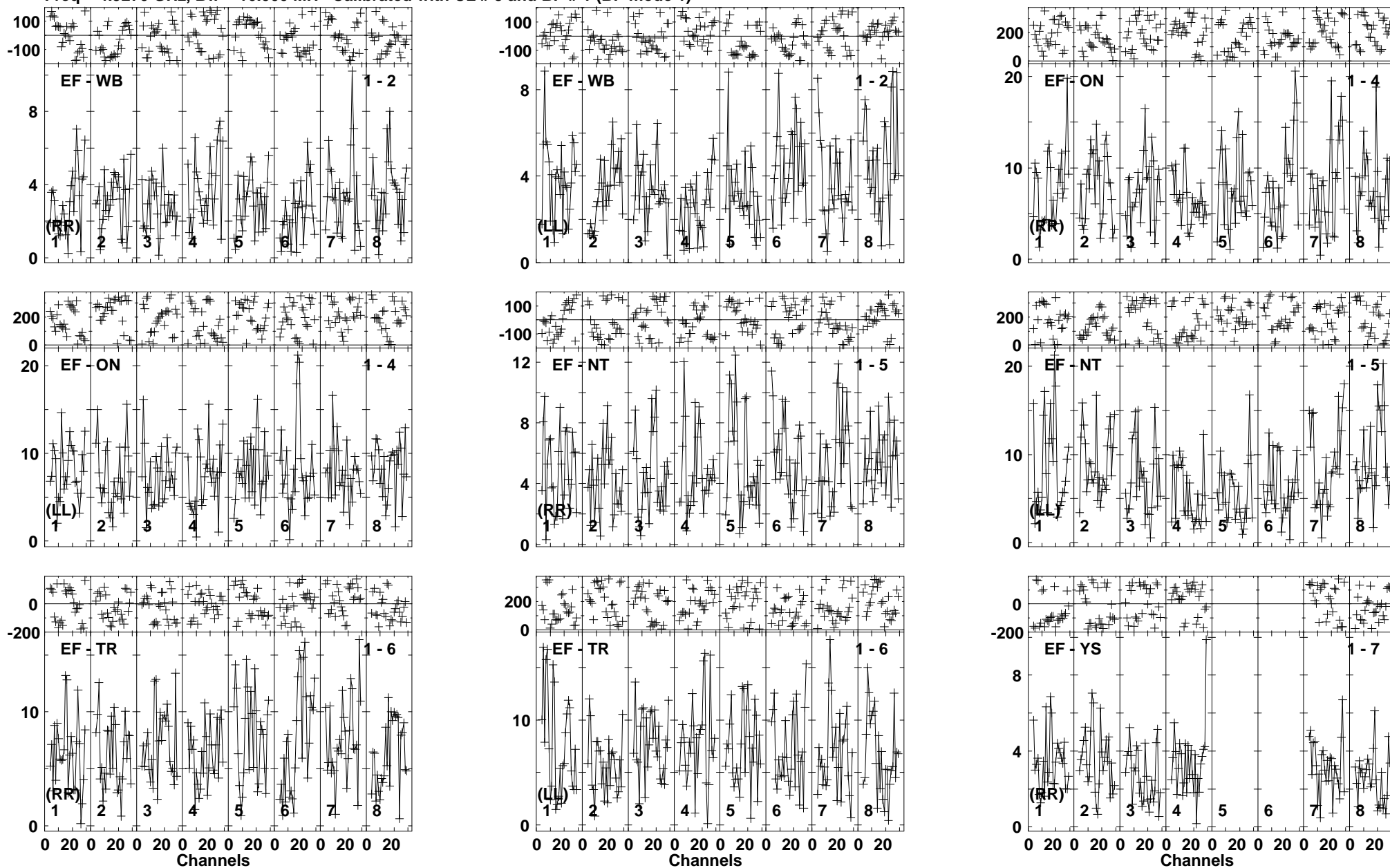

Lower frame: Milli Ampl Jy Top frame: Phas deg  
 Vector averaged cross-power spectrum Baseline: EF (01) - WB (02)  
 Timerange: 00:12:48:25 to 00:12:52:19

Plot file version 8 created 18-NOV-2014 15:23:05

ARP299C EP087H 3.UVDATA.1

Freq = 4.9270 GHz, Bw = 16.000 MH Calibrated with CL # 3 and BP # 1 (BP mode 1)

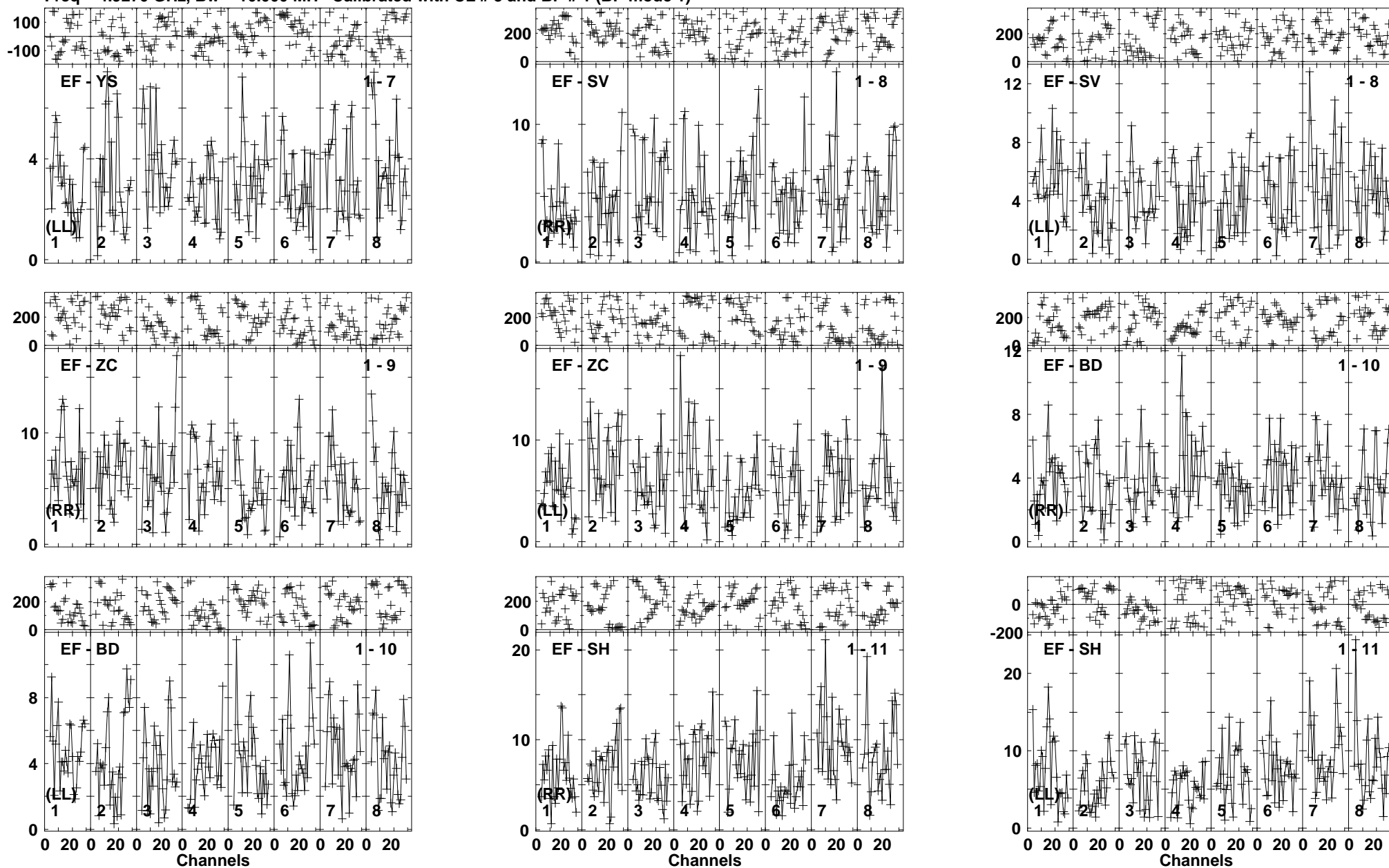

Lower frame: Milli Ampl Jy Top frame: Phas deg  
Vector averaged cross-power spectrum Baseline: EF (01) - YS (07)  
Timerange: 00:12:48:25 to 00:12:52:19



Plot file version 9 created 18-NOV-2014 15:23:05

J1128+5925 EP087H 3.UVDATA.1

Freq = 4.9270 GHz, Bw = 16.000 MH Calibrated with CL # 3 and BP # 1 (BP mode 1)

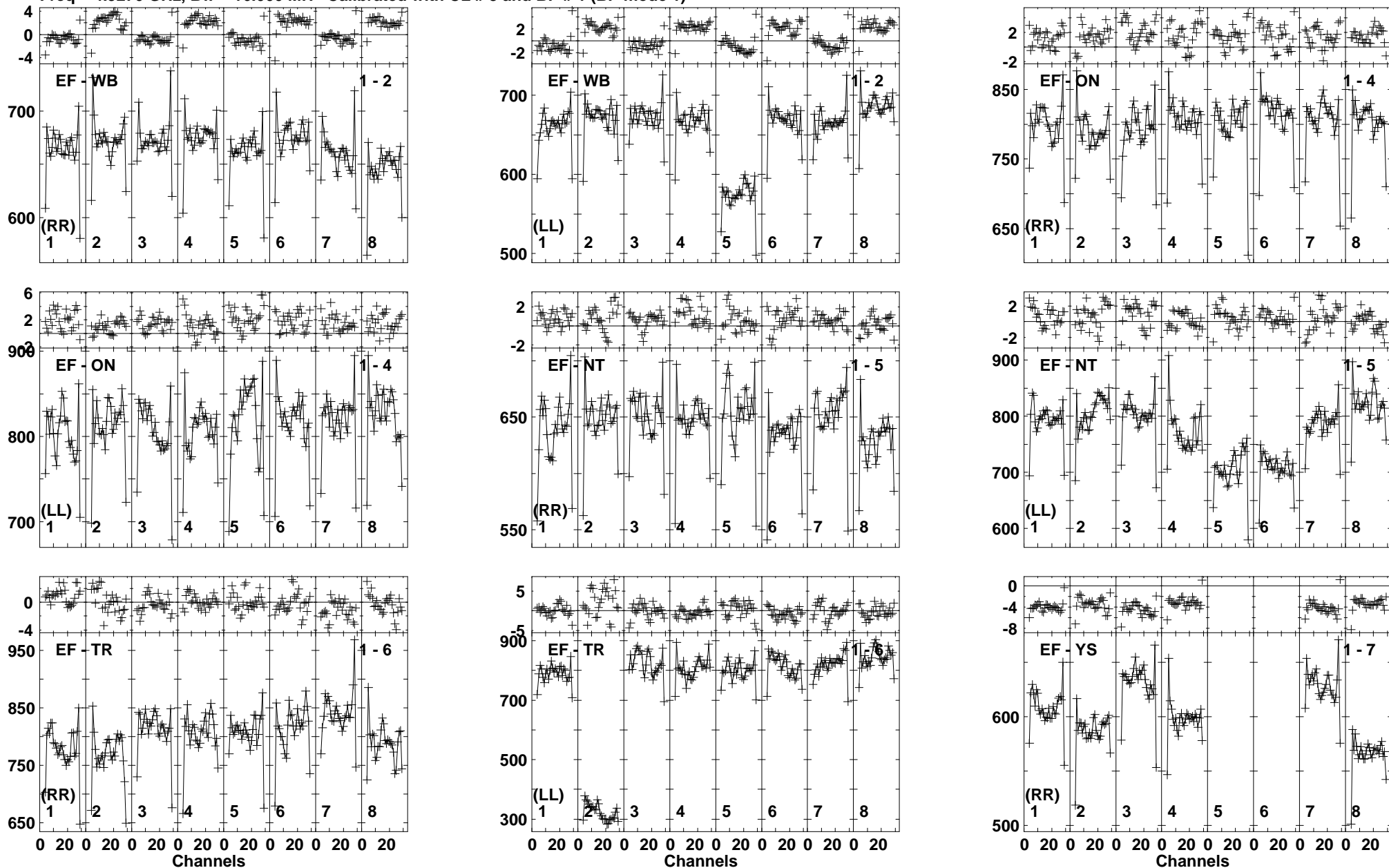

Lower frame: Milli Ampl Jy Top frame: Phas deg  
 Vector averaged cross-power spectrum Baseline: EF (01) - WB (02)  
 Timerange: 00/12:53:03 to 00/12:53:29

Plot file version 10 created 18-NOV-2014 15:23:06

J1128+5925 EP087H 3.UVDATA.1

Freq = 4.9270 GHz, Bw = 16.000 MH Calibrated with CL # 3 and BP # 1 (BP mode 1)

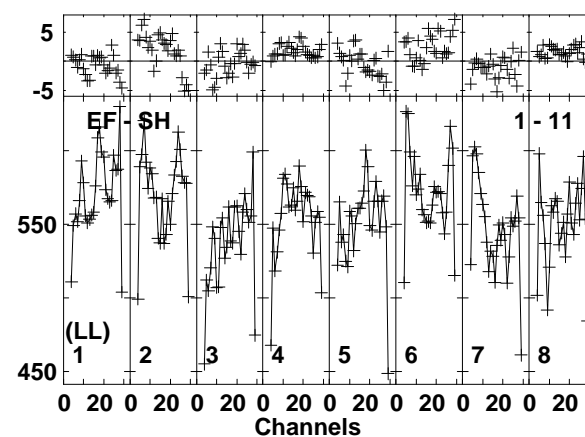
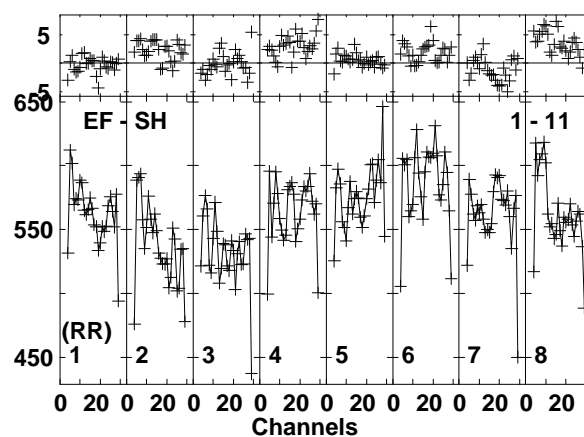
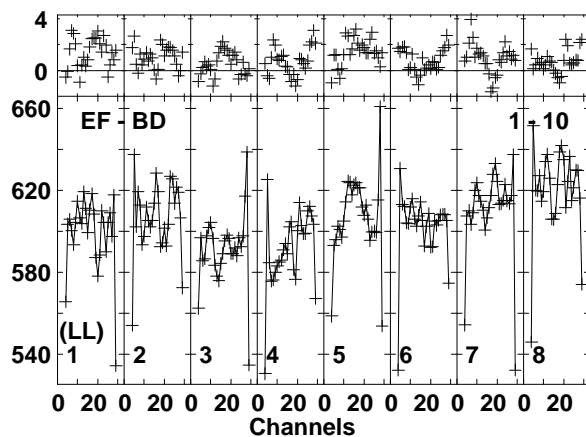
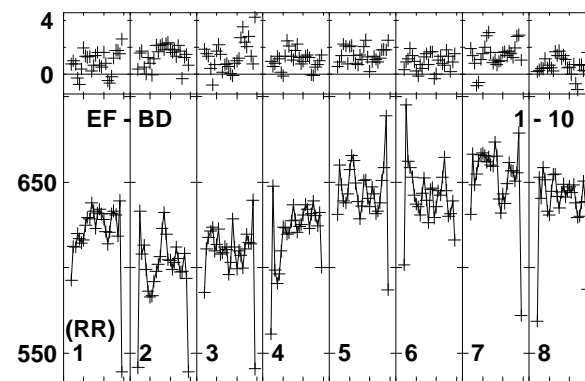
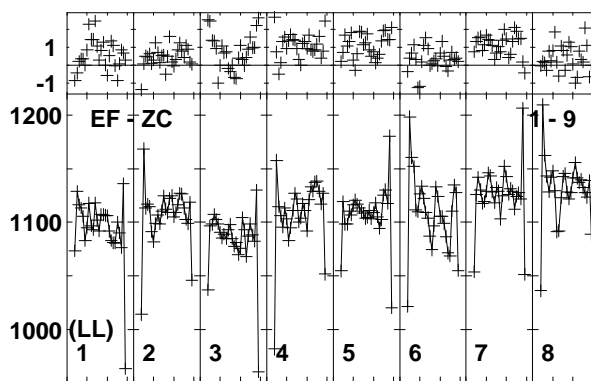
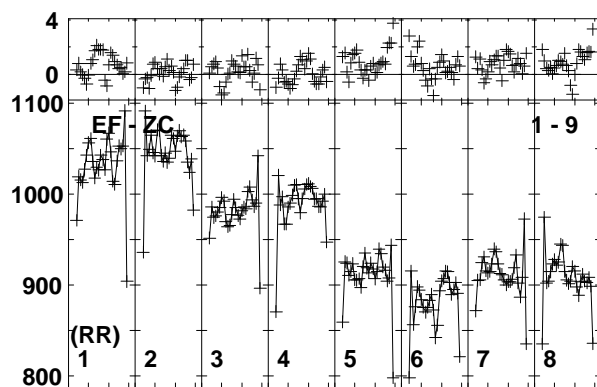
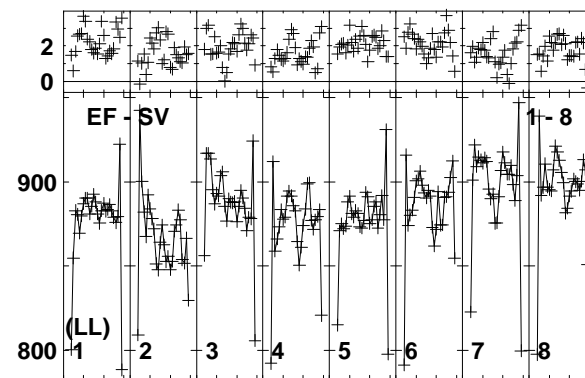
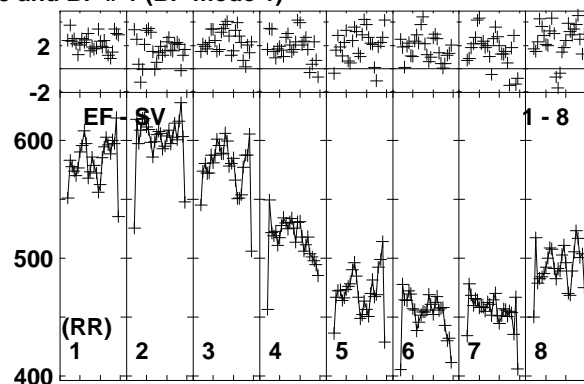
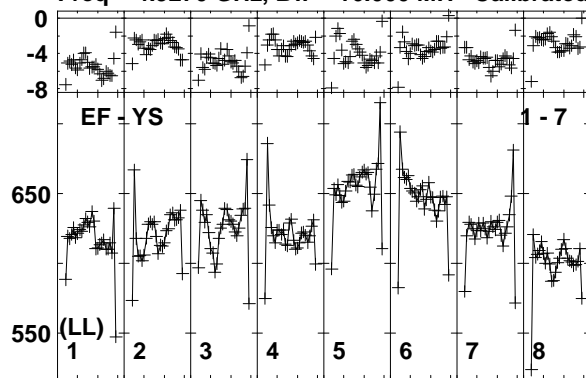

Lower frame: Milli Ampl Jy Top frame: Phas deg  
Vector averaged cross-power spectrum Baseline: EF (01) - YS (07)  
Timerange: 00/12:53:03 to 00/12:53:29

Plot file version 11 created 18-NOV-2014 15:23:06

ARP299C EP087H 3.UVDATA.1

Freq = 4.9270 GHz, Bw = 16.000 MH Calibrated with CL # 3 and BP # 1 (BP mode 1)

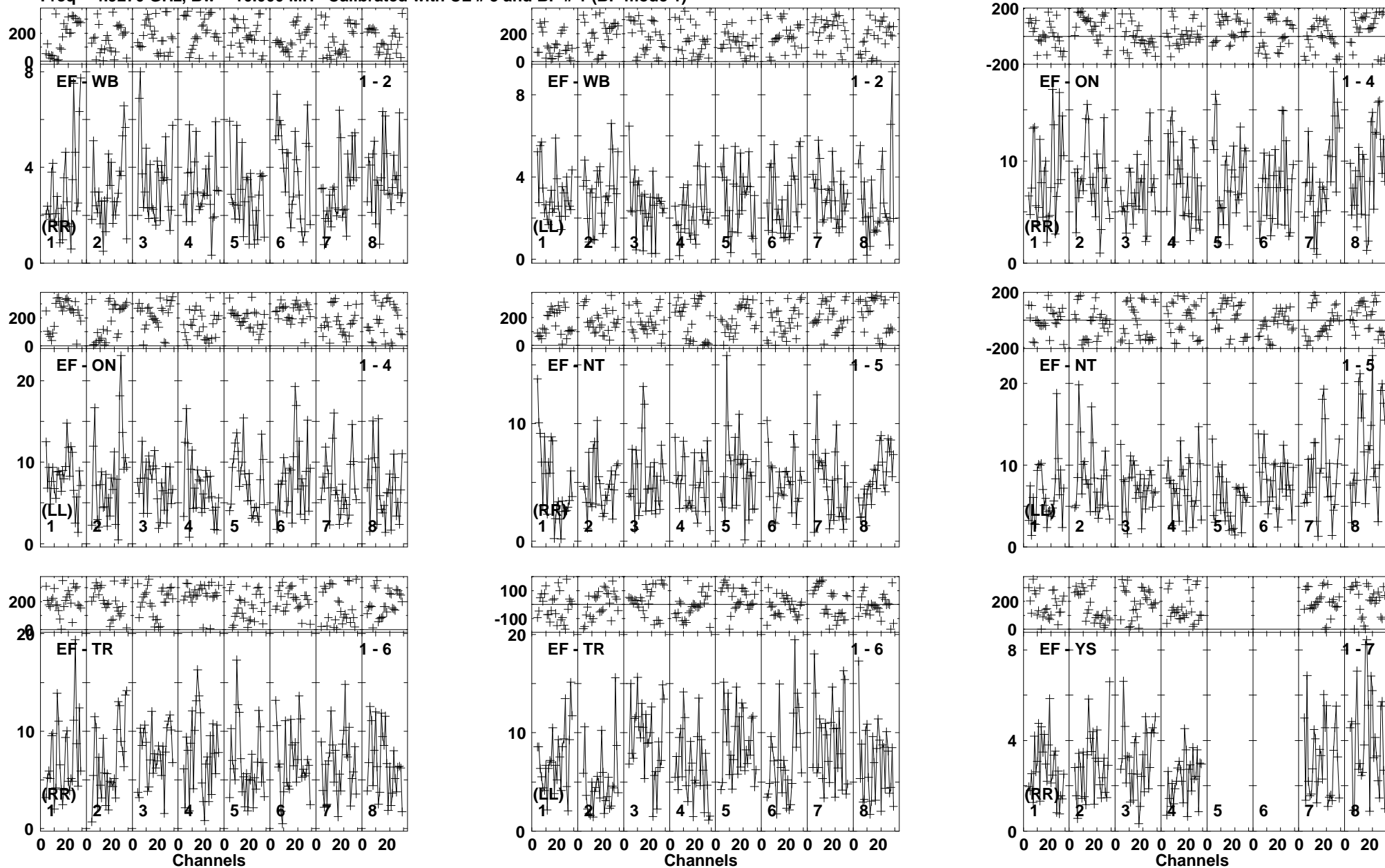

Lower frame: Milli Ampl Jy Top frame: Phas deg  
Vector averaged cross-power spectrum Baseline: EF (01) - WB (02)  
Timerange: 00/12:53:35 to 00/12:57:29

Plot file version 12 created 18-NOV-2014 15:23:06

ARP299C EP087H 3.UVDATA.1

Freq = 4.9270 GHz, Bw = 16.000 MH Calibrated with CL # 3 and BP # 1 (BP mode 1)

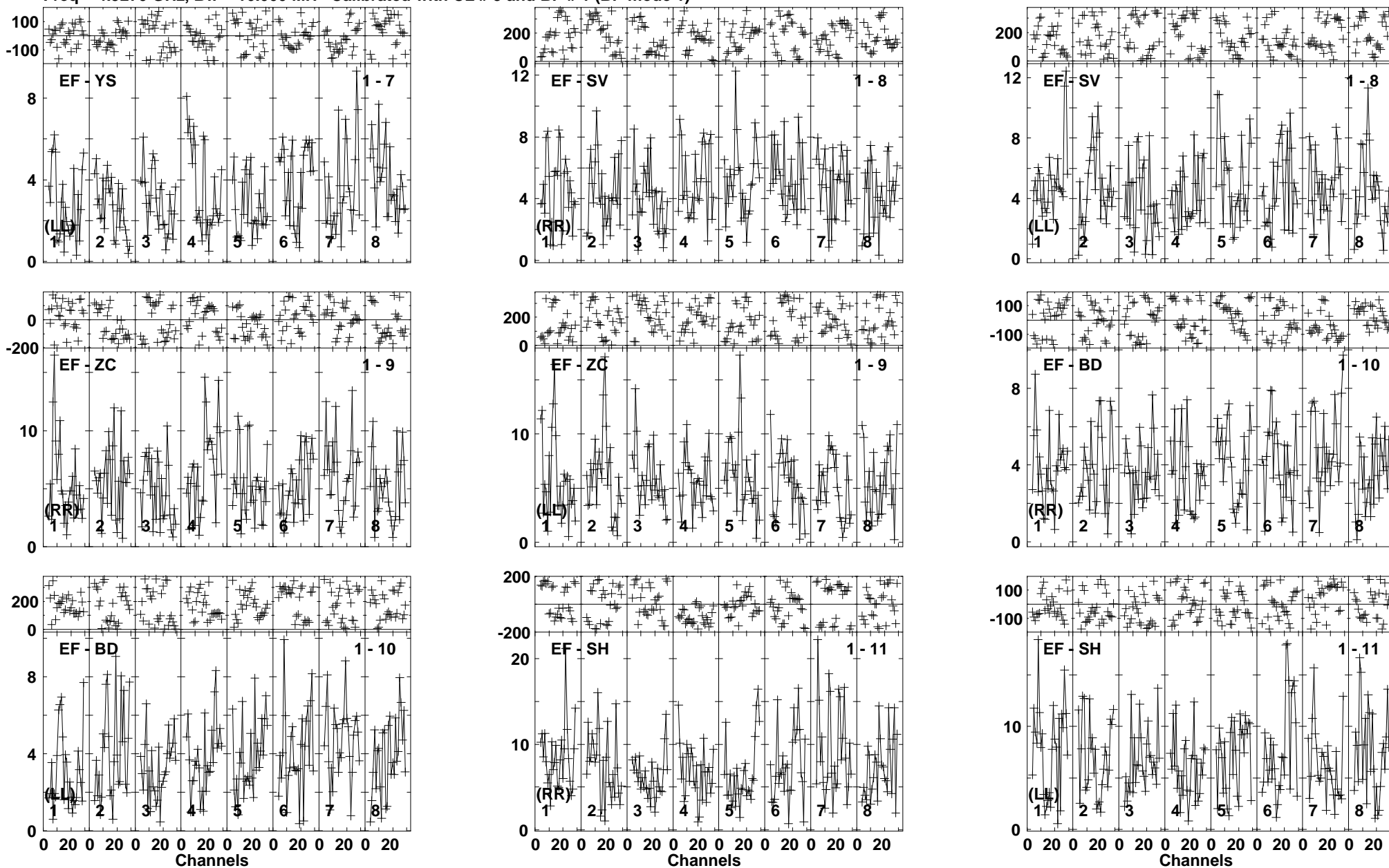

Lower frame: Milli Ampl Jy Top frame: Phas deg  
Vector averaged cross-power spectrum Baseline: EF (01) - YS (07)  
Timerange: 00/12:53:35 to 00/12:57:29

Plot file version 13 created 18-NOV-2014 15:23:06

J1128+5925 EP087H 3.UVDATA.1

Freq = 4.9270 GHz, Bw = 16.000 MH Calibrated with CL # 3 and BP # 1 (BP mode 1)

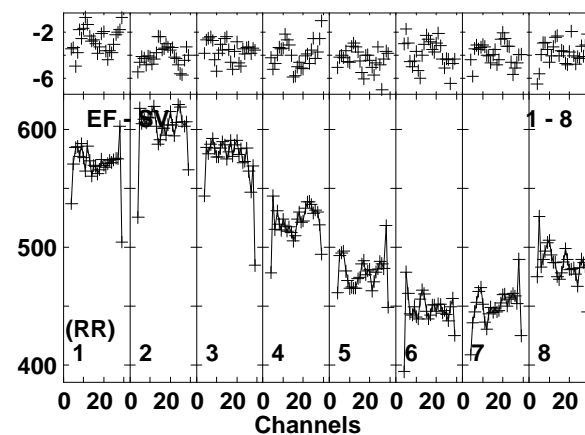
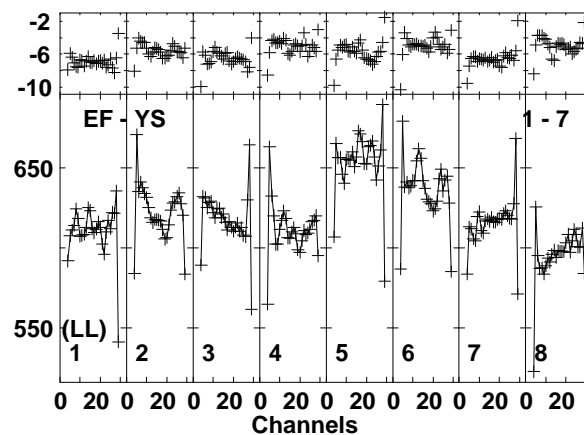
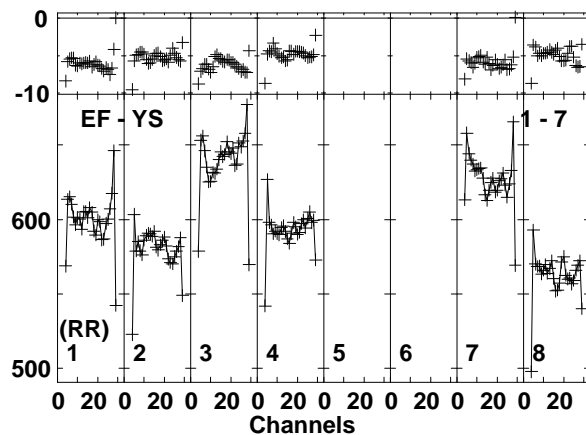
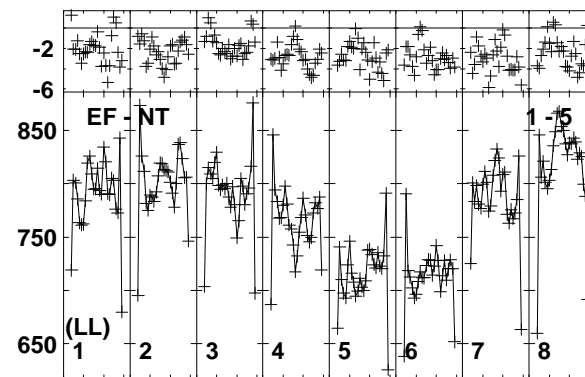
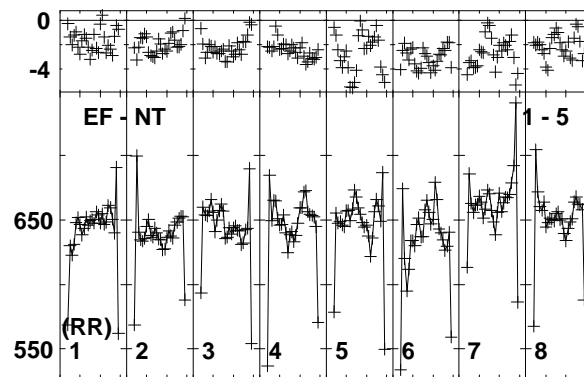
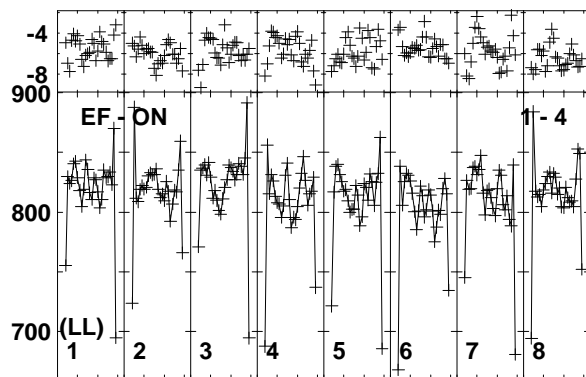
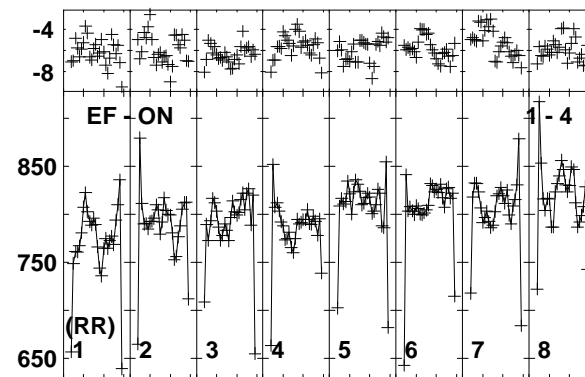
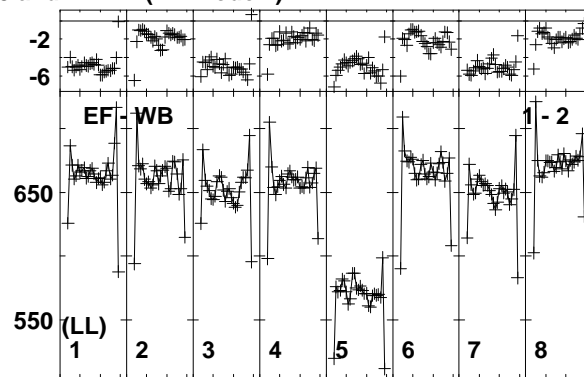
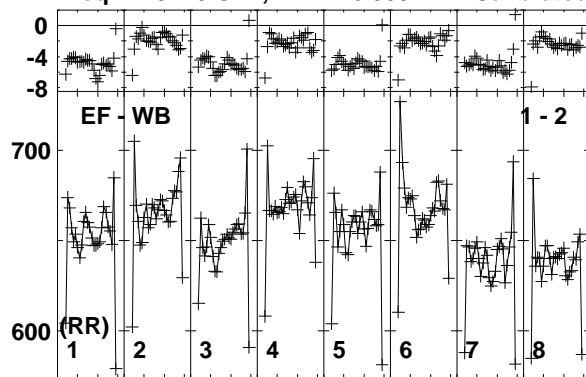

Lower frame: Milli Ampl Jy Top frame: Phas deg  
Vector averaged cross-power spectrum Baseline: EF (01) - WB (02)  
Timerange: 00/12:57:35 to 00/12:58:29

Plot file version 14 created 18-NOV-2014 15:23:07

J1128+5925 EP087H 3.UVDATA.1

Freq = 4.9270 GHz, Bw = 16.000 MH Calibrated with CL # 3 and BP # 1 (BP mode 1)

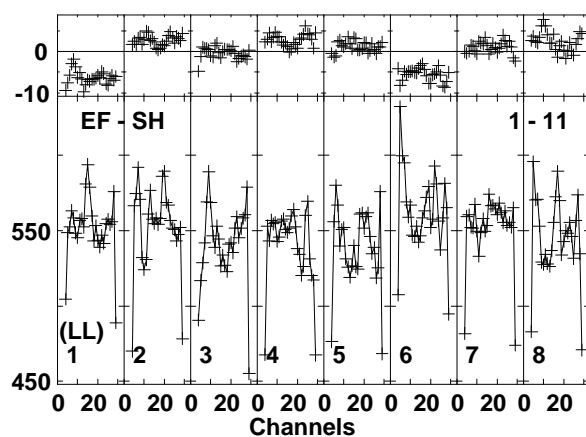
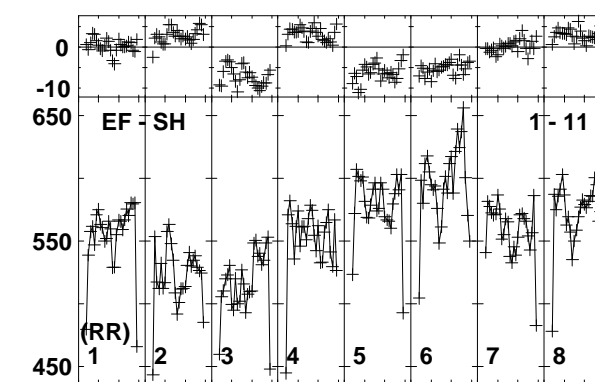
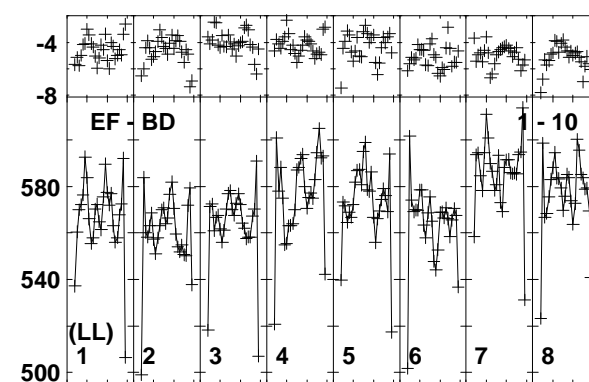
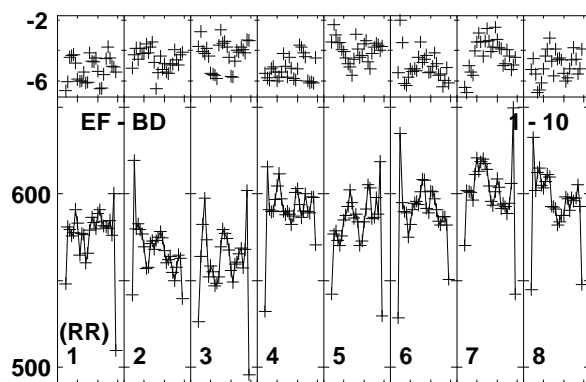
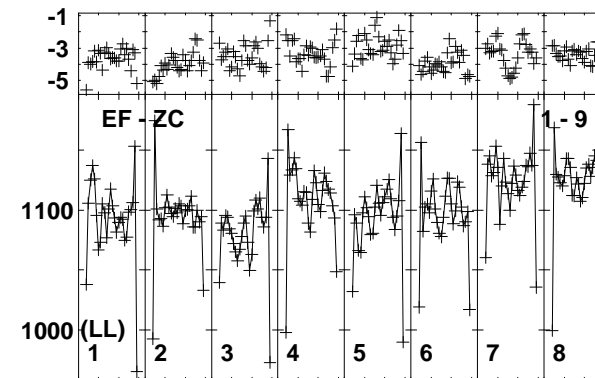
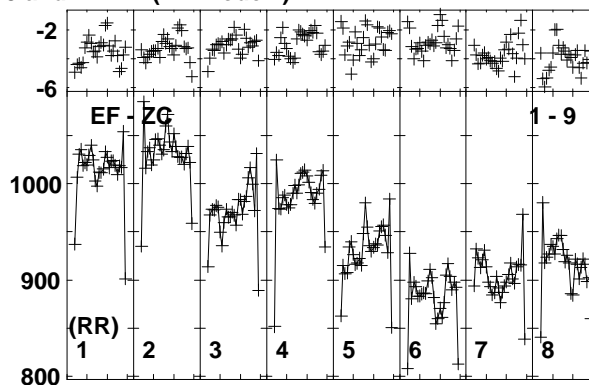
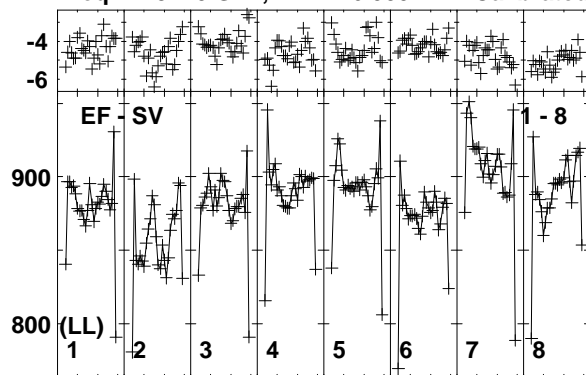

Lower frame: Milli Ampl Jy Top frame: Phas deg  
Vector averaged cross-power spectrum Baseline: EF (01) - SV (08)  
Timerange: 00/12:57:35 to 00/12:58:29

Plot file version 15 created 18-NOV-2014 15:23:07  
 ARP299C EP087H 3.UVDATA.1  
 Freq = 4.9270 GHz, Bw = 16.000 MH Calibrated with CL # 3 and BP # 1 (BP mode 1)

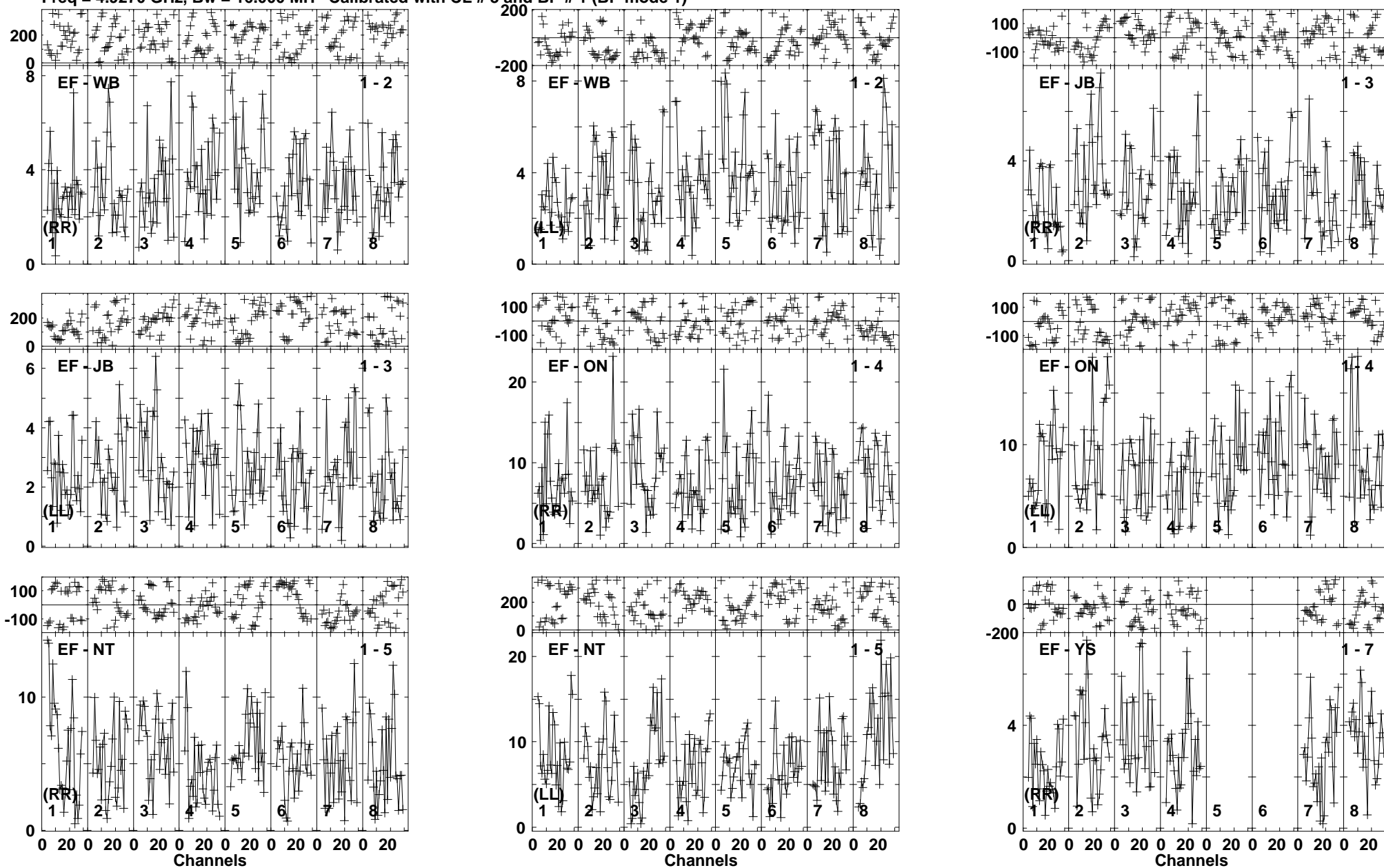

Lower frame: Milli Ampl Jy Top frame: Phas deg  
 Vector averaged cross-power spectrum Baseline: EF (01) - WB (02)  
 Timerange: 00/12:58:31 to 00/13:02:29

Plot file version 16 created 18-NOV-2014 15:23:07  
 ARP299C EP087H 3.UVDATA.1  
 Freq = 4.9270 GHz, Bw = 16.000 MH Calibrated with CL # 3 and BP # 1 (BP mode 1)

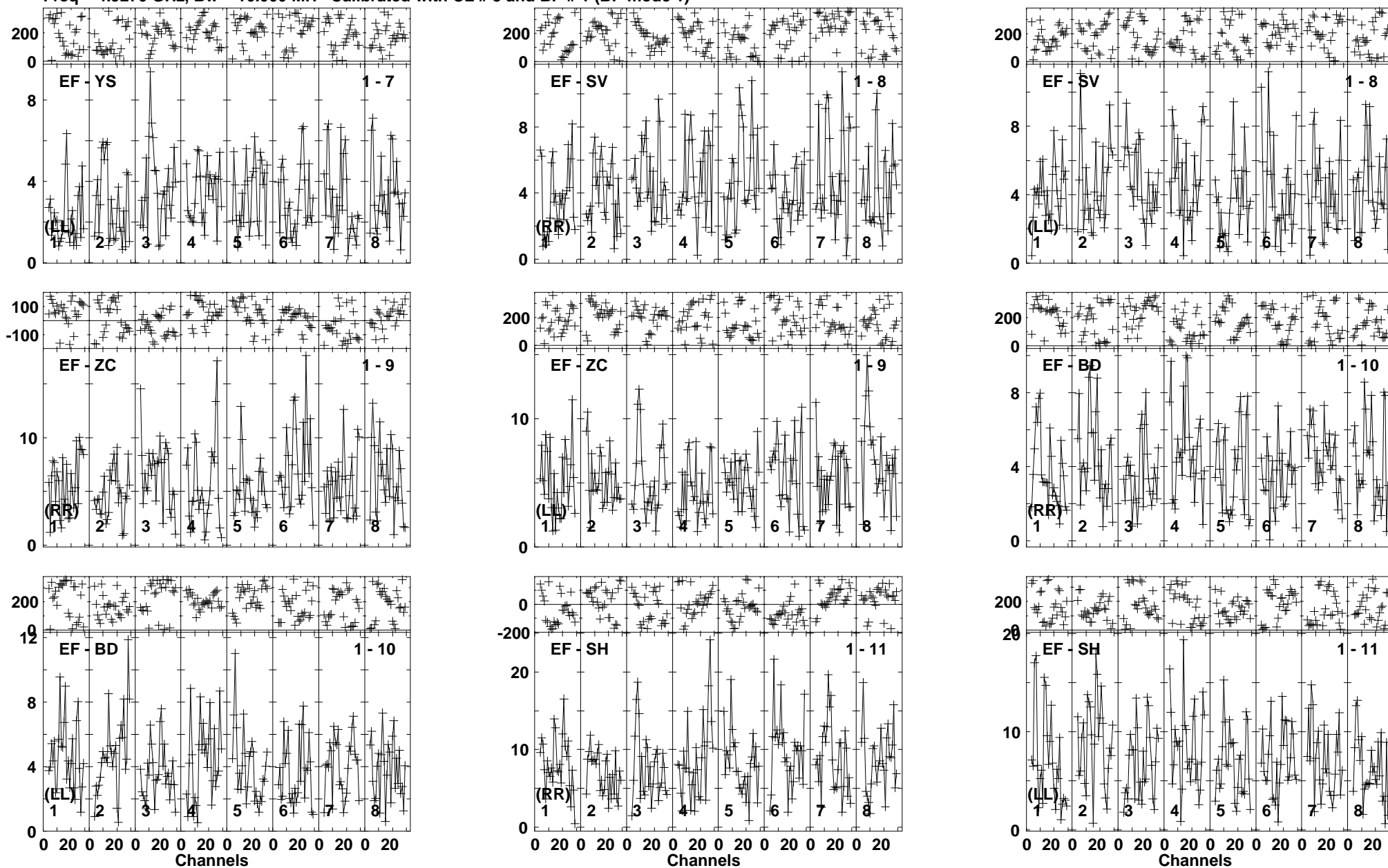

Lower frame: Milli Ampl Jy Top frame: Phas deg  
 Vector averaged cross-power spectrum Baseline: EF (01) - YS (07)  
 Timerange: 00/12:58:31 to 00/13:02:29



Plot file version 17 created 18-NOV-2014 15:23:07

J1128+5925 EP087H 3.UVDATA.1

Freq = 4.9270 GHz, Bw = 16.000 MH Calibrated with CL # 3 and BP # 1 (BP mode 1)

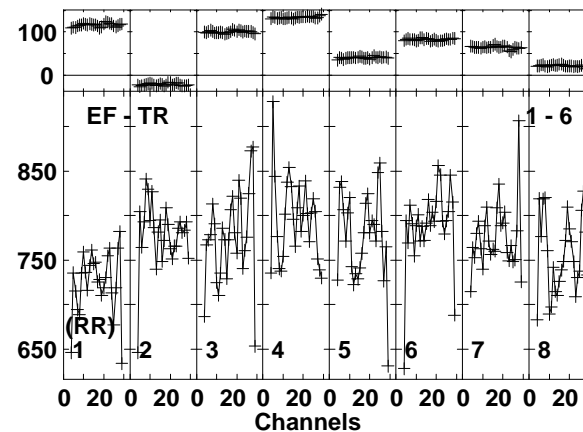
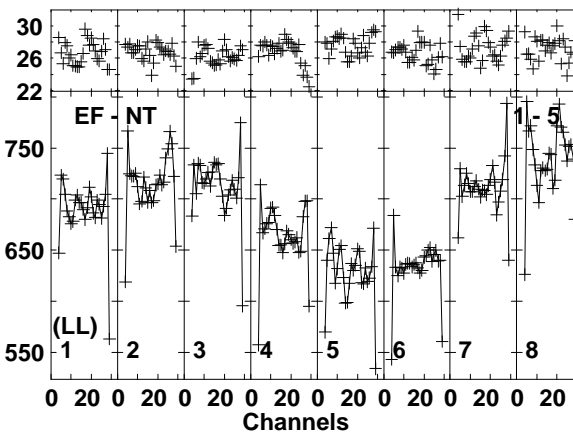
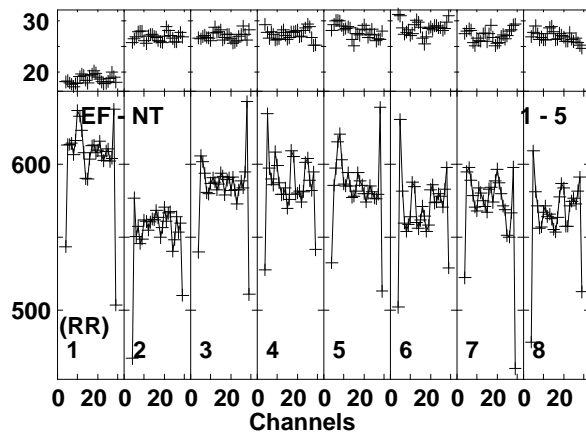
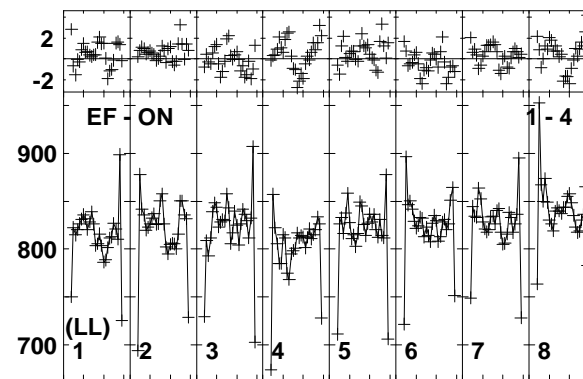
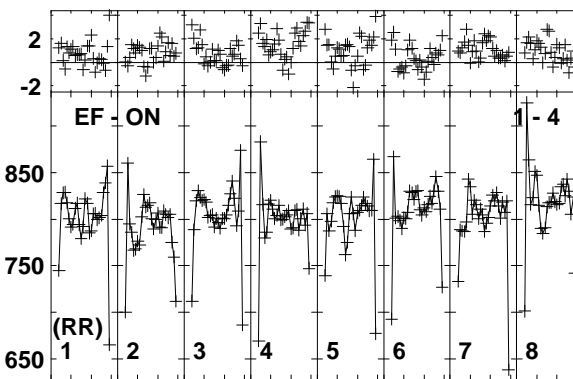
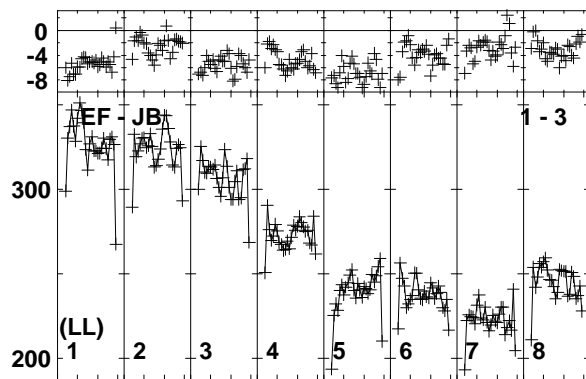
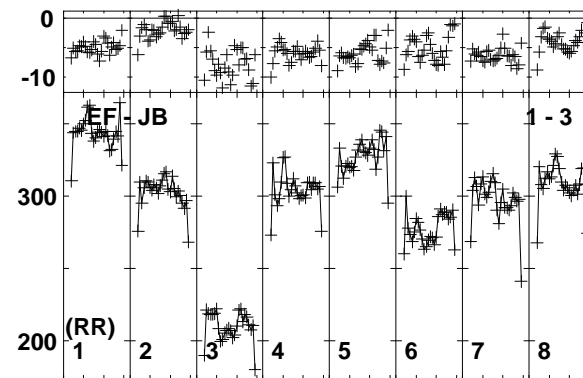
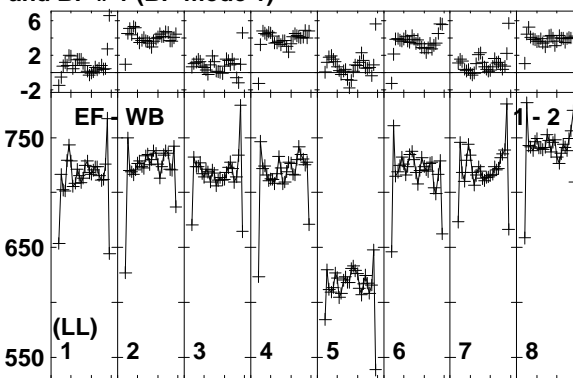
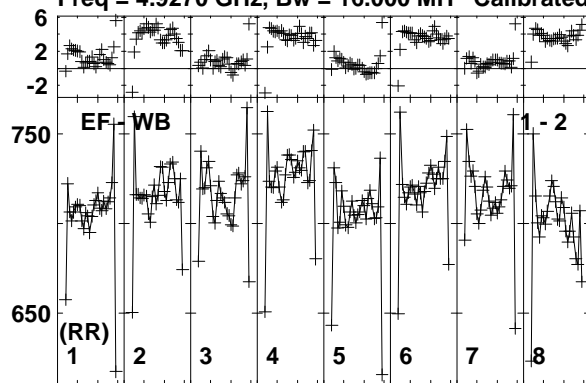

Lower frame: Milli Ampl Jy Top frame: Phas deg  
Vector averaged cross-power spectrum Baseline: EF (01) - WB (02)  
Timerange: 00/13:02:35 to 00/13:03:29

Plot file version 18 created 18-NOV-2014 15:23:08

J1128+5925 EP087H 3.UVDATA.1

Freq = 4.9270 GHz, Bw = 16.000 MH Calibrated with CL # 3 and BP # 1 (BP mode 1)

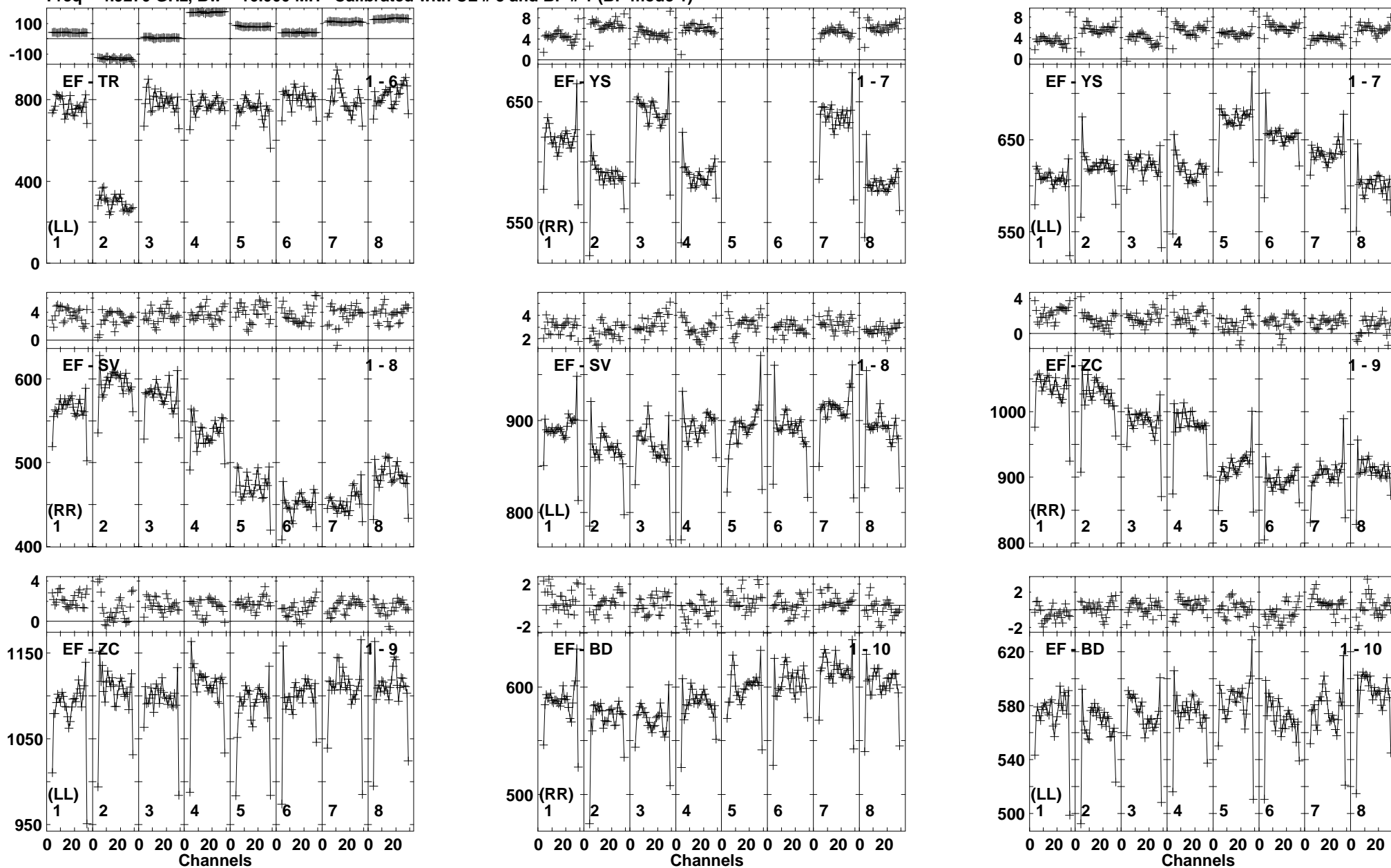

Plot file version 19 created 18-NOV-2014 15:23:08

J1128+5925 EP087H 3.UVDATA.1

Freq = 4.9270 GHz, Bw = 16.000 MH Calibrated with CL # 3 and BP # 1 (BP mode 1)

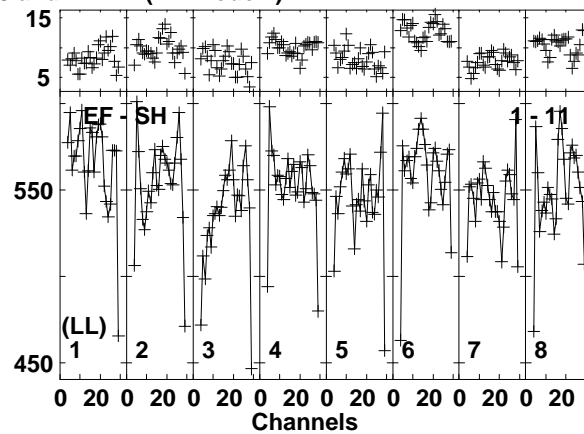
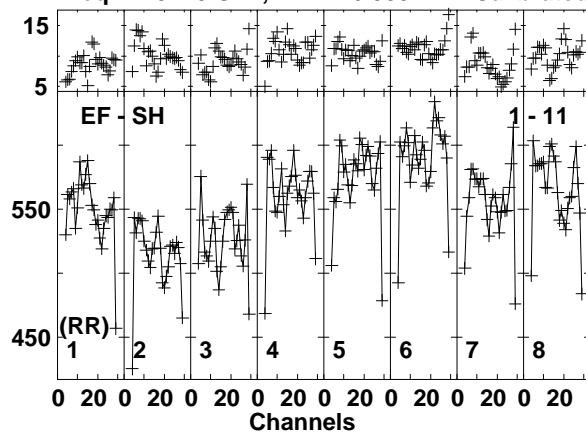

Lower frame: Milli Ampl Jy Top frame: Phas deg  
Vector averaged cross-power spectrum Baseline: EF (01) - SH (11)  
Timerange: 00/13:02:35 to 00/13:03:29

Plot file version 20 created 18-NOV-2014 15:23:08  
 ARP299C EP087H 3.UVDATA.1  
 Freq = 4.9270 GHz, Bw = 16.000 MH Calibrated with CL # 3 and BP # 1 (BP mode 1)

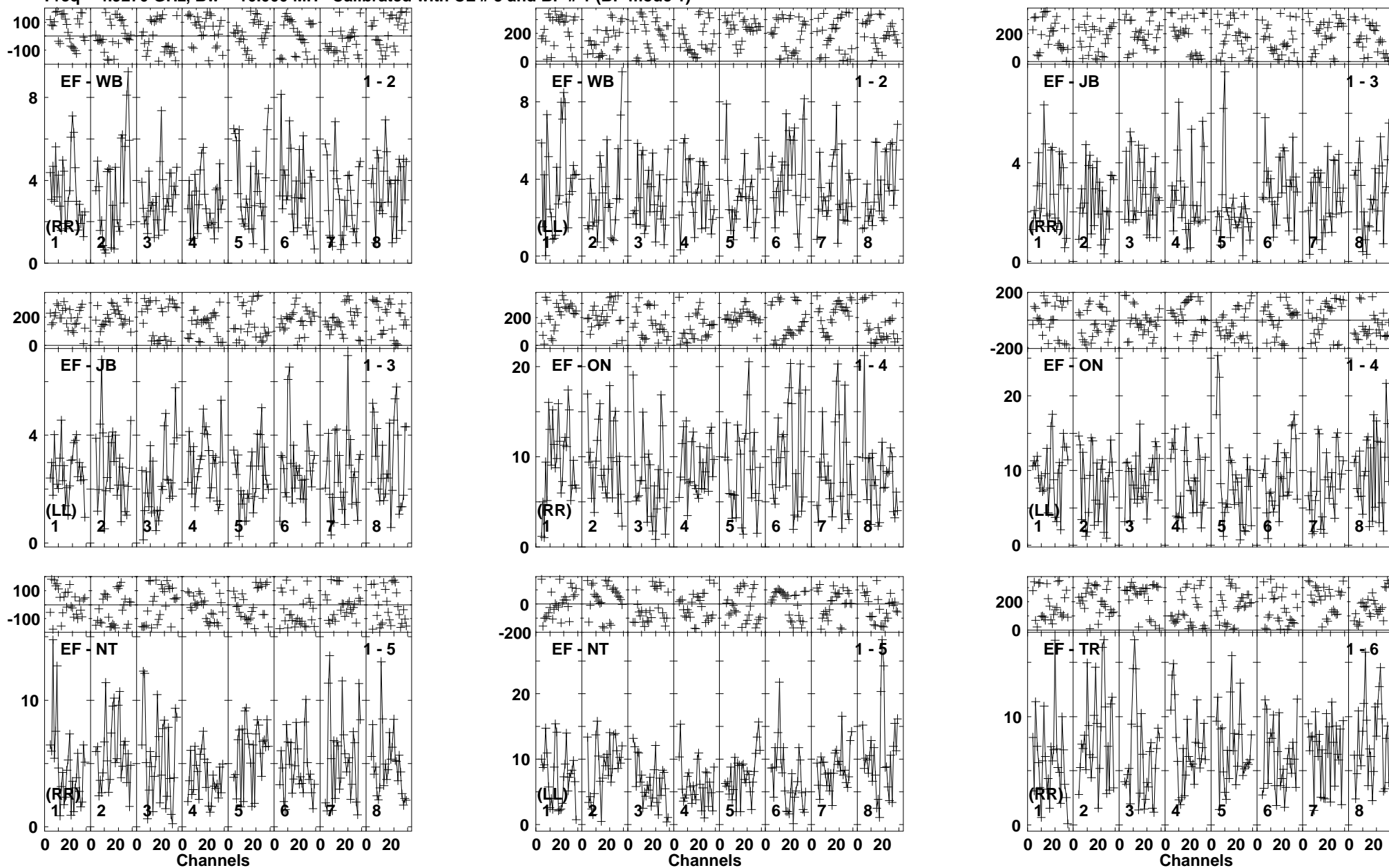

Lower frame: Milli Ampl Jy Top frame: Phas deg  
 Vector averaged cross-power spectrum Baseline: EF (01) - WB (02)  
 Timerange: 00/13:03:35 to 00/13:07:29

Plot file version 21 created 18-NOV-2014 15:23:08

ARP299C EP087H 3.UVDATA.1

Freq = 4.9270 GHz, Bw = 16.000 MH Calibrated with CL # 3 and BP # 1 (BP mode 1)

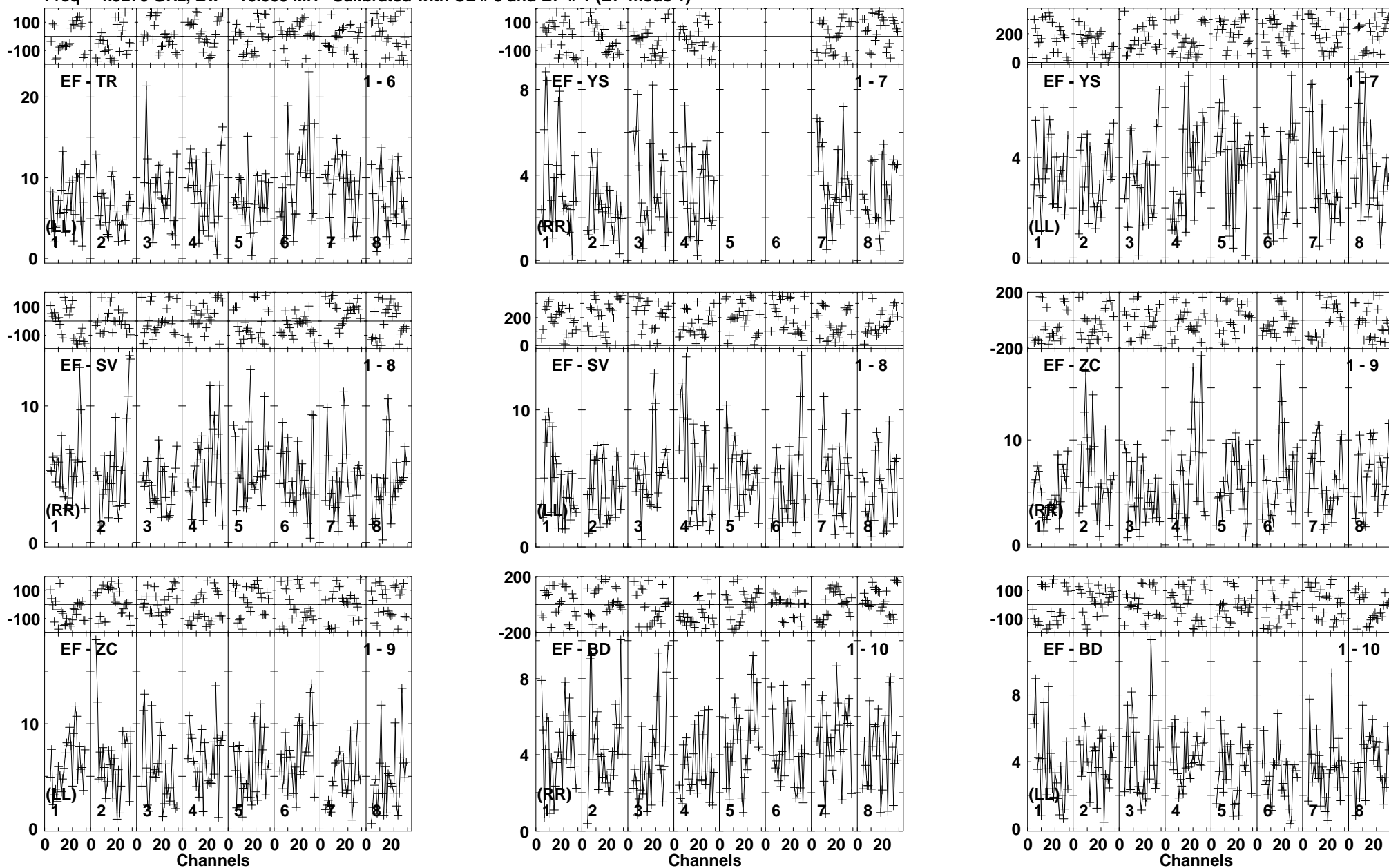

Lower frame: Milli Ampl Jy Top frame: Phas deg  
Vector averaged cross-power spectrum Baseline: EF (01) - TR (06)  
Timerange: 00/13:03:35 to 00/13:07:29

Plot file version 22 created 18-NOV-2014 15:23:08

ARP299C EP087H 3.UVDATA.1

Freq = 4.9270 GHz, Bw = 16.000 MH Calibrated with CL # 3 and BP # 1 (BP mode 1)

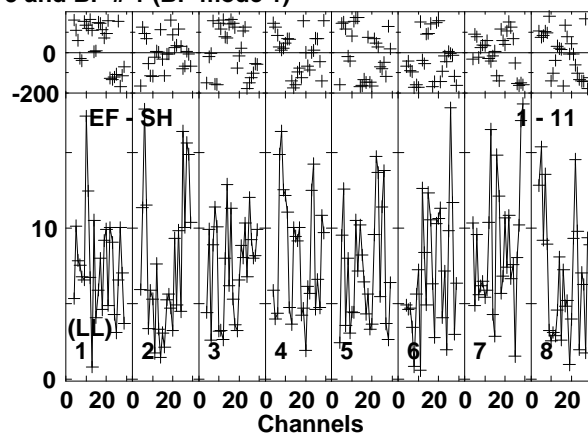
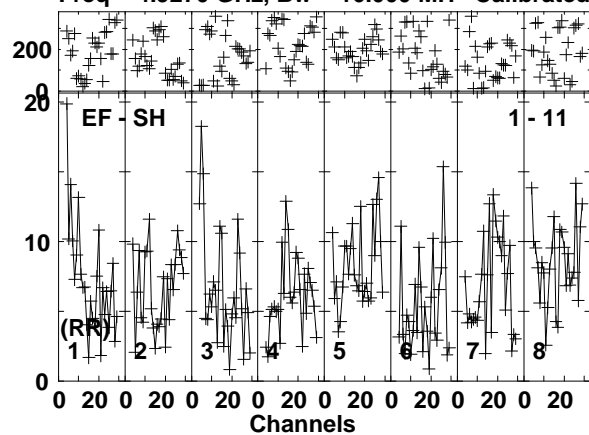

Lower frame: Milli Ampl Jy Top frame: Phas deg  
Vector averaged cross-power spectrum Baseline: EF (01) - SH (11)  
Timerange: 00/13:03:35 to 00/13:07:29

Plot file version 23 created 18-NOV-2014 15:23:08

J1128+5925 EP087H 3.UVDATA.1

Freq = 4.9270 GHz, Bw = 16.000 MH Calibrated with CL # 3 and BP # 1 (BP mode 1)

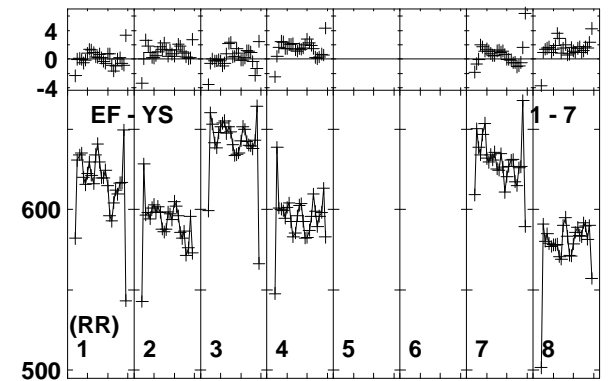
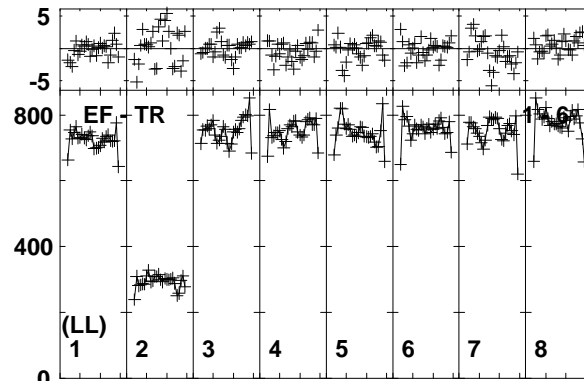
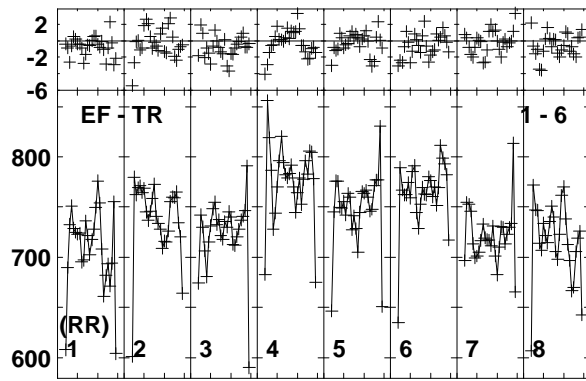
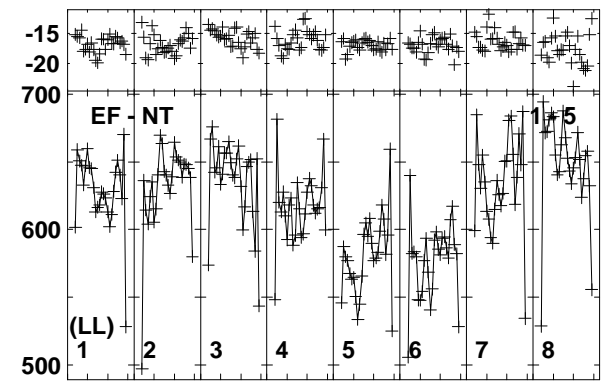
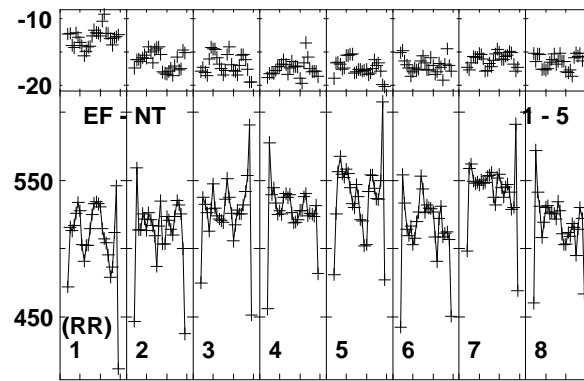
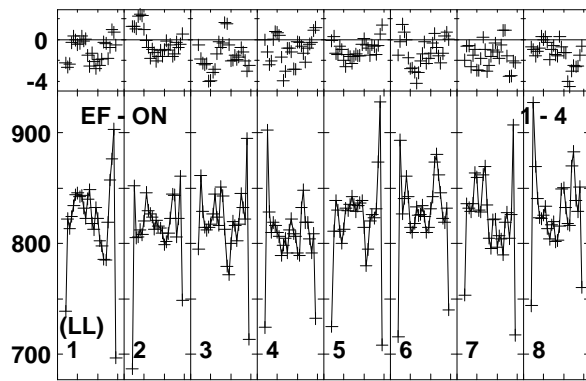
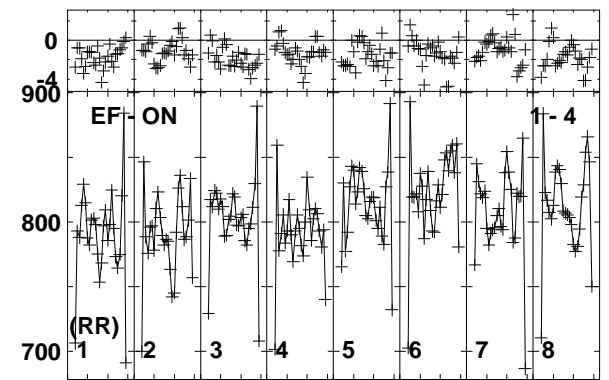
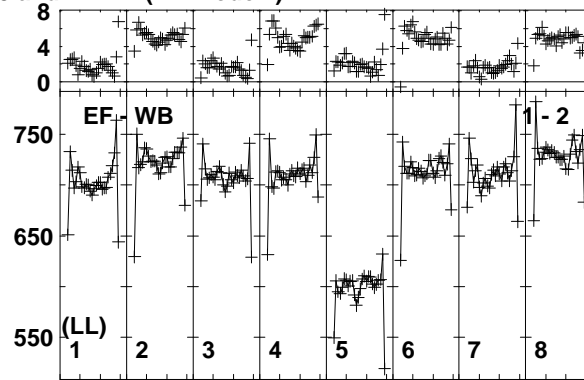
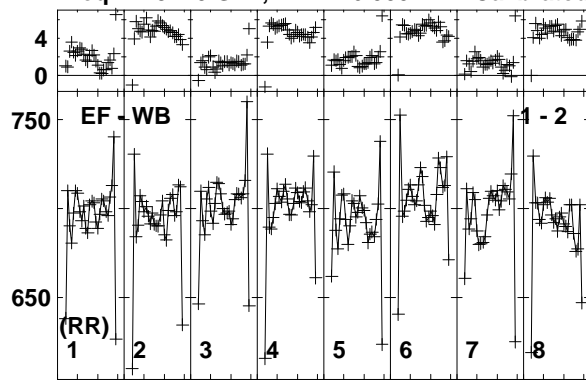

Lower frame: Milli Ampl Jy Top frame: Phas deg  
Vector averaged cross-power spectrum Baseline: EF (01) - WB (02)  
Timerange: 00/13:08:13 to 00/13:08:39

Plot file version 24 created 18-NOV-2014 15:23:09

J1128+5925 EP087H 3.UVDATA.1

Freq = 4.9270 GHz, Bw = 16.000 MH Calibrated with CL # 3 and BP # 1 (BP mode 1)

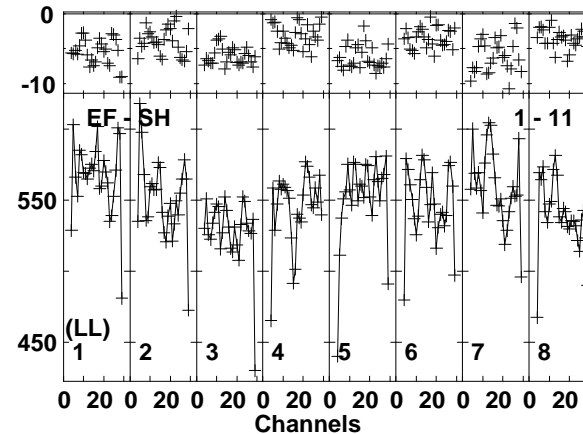
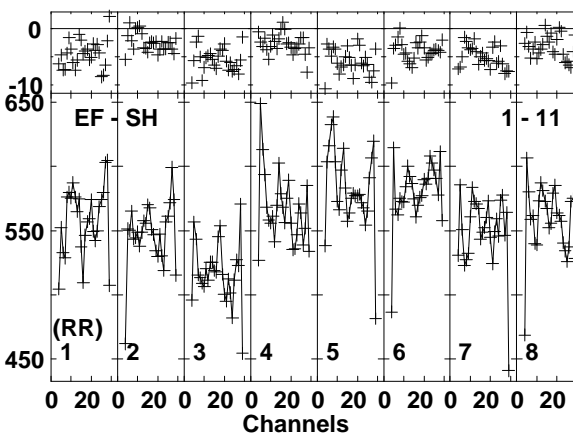
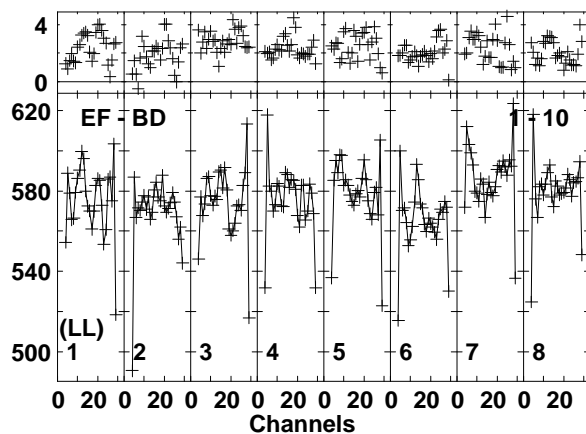
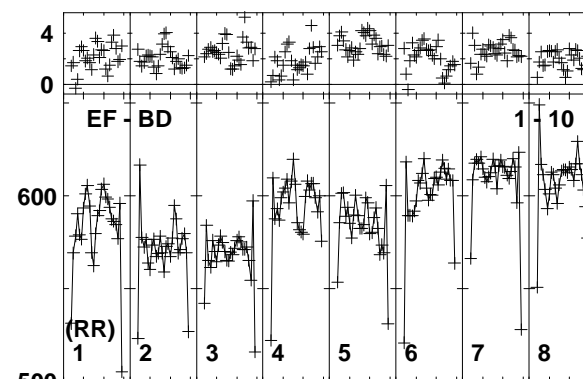
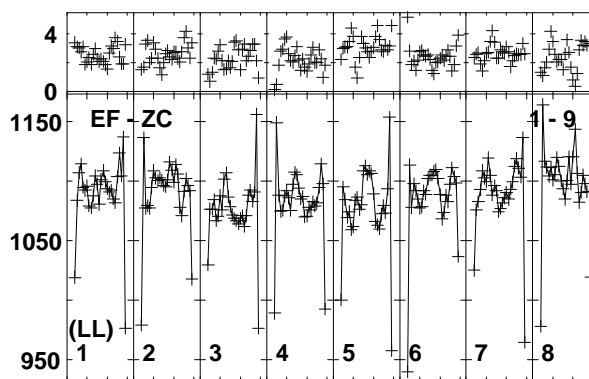
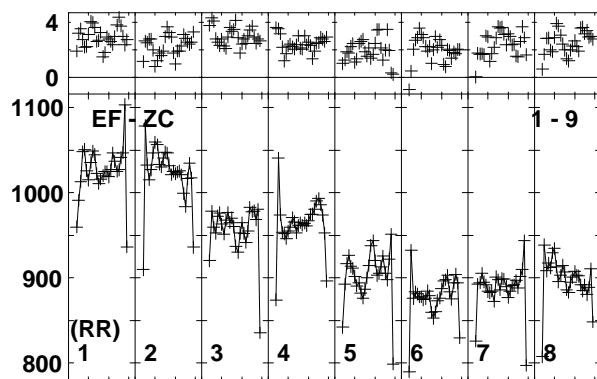
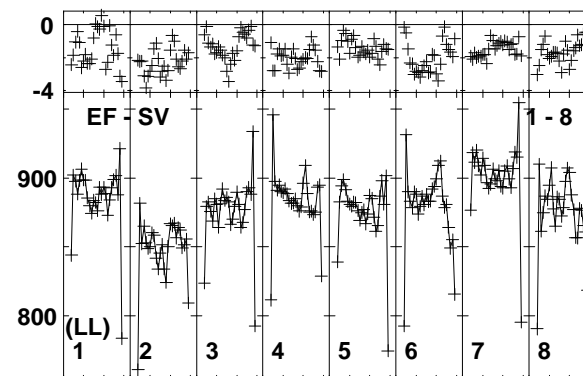
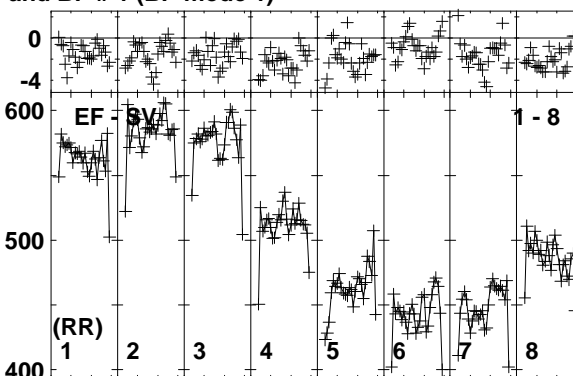
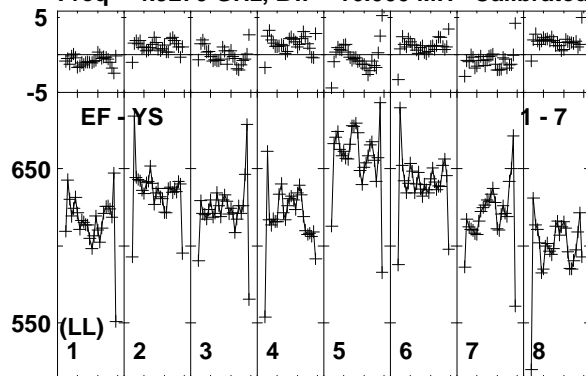

Lower frame: Milli Ampl Jy Top frame: Phas deg  
Vector averaged cross-power spectrum Baseline: EF (01) - YS (07)  
Timerange: 00/13:08:13 to 00/13:08:39



Plot file version 25 created 18-NOV-2014 15:23:09

ARP299C EP087H 3.UVDATA.1

Freq = 4.9270 GHz, Bw = 16.000 MH Calibrated with CL # 3 and BP # 1 (BP mode 1)

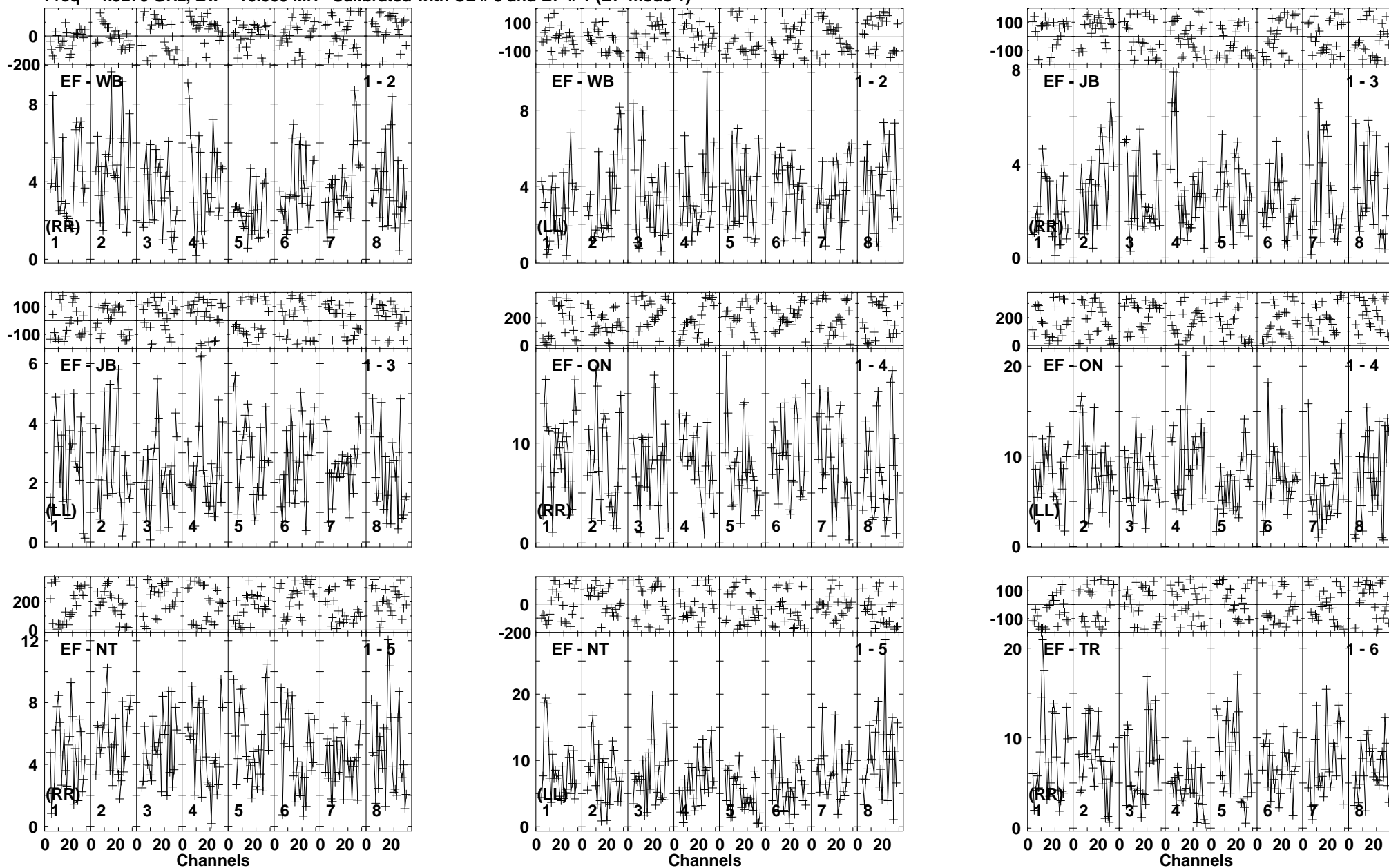

Lower frame: Milli Ampl Jy Top frame: Phas deg  
Vector averaged cross-power spectrum Baseline: EF (01) - WB (02)  
Timerange: 00/13:08:41 to 00/13:12:39

Plot file version 26 created 18-NOV-2014 15:23:09

ARP299C EP087H 3.UVDATA.1

Freq = 4.9270 GHz, Bw = 16.000 MH Calibrated with CL # 3 and BP # 1 (BP mode 1)

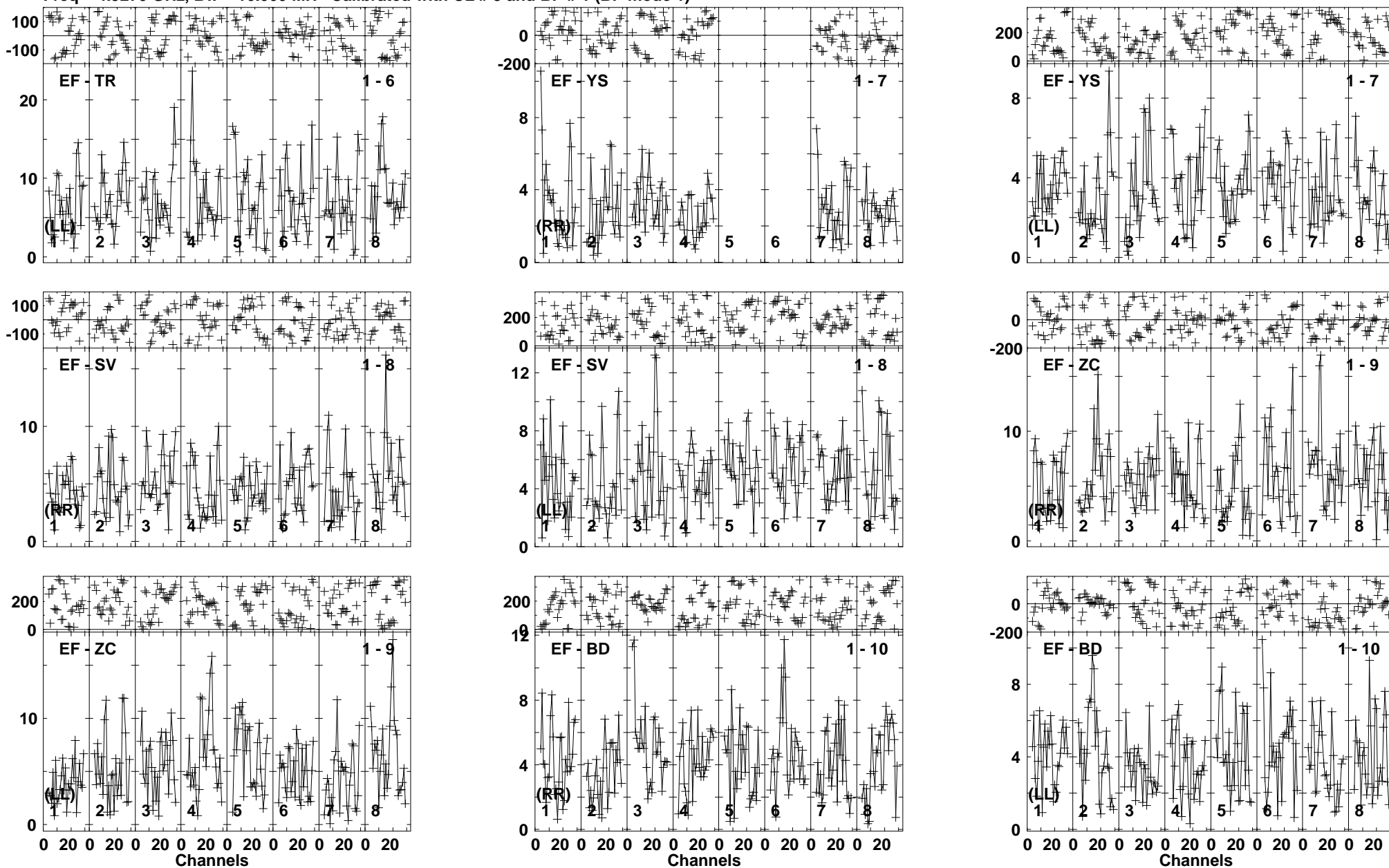

Plot file version 27 created 18-NOV-2014 15:23:09

ARP299C EP087H 3.UVDATA.1

Freq = 4.9270 GHz, Bw = 16.000 MH Calibrated with CL # 3 and BP # 1 (BP mode 1)

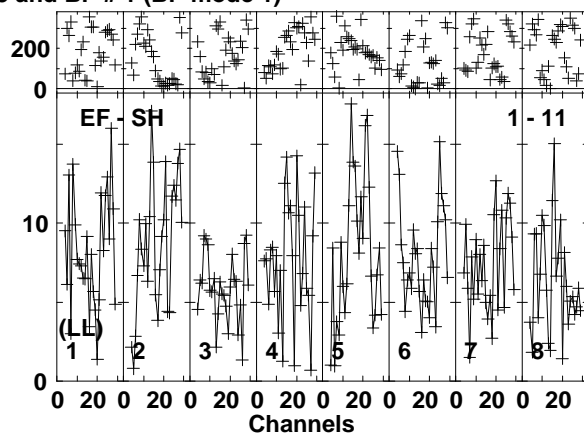
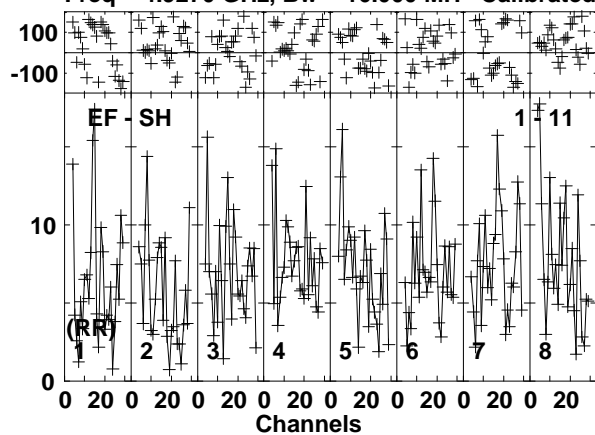

Lower frame: Milli Ampl Jy Top frame: Phas deg  
Vector averaged cross-power spectrum Baseline: EF (01) - SH (11)  
Timerange: 00/13:08:41 to 00/13:12:39

Plot file version 28 created 18-NOV-2014 15:23:09

J1128+5925 EP087H 3.UVDATA.1

Freq = 4.9270 GHz, Bw = 16.000 MH Calibrated with CL # 3 and BP # 1 (BP mode 1)

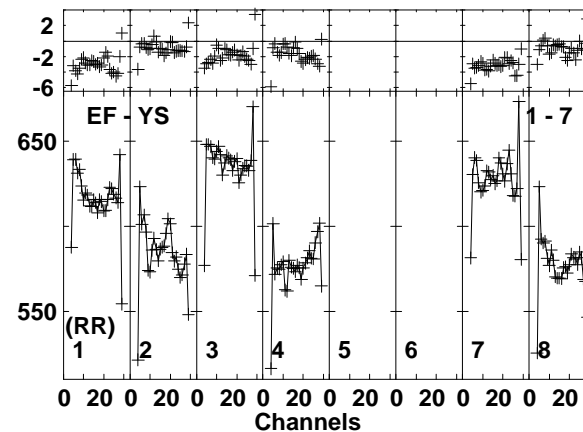
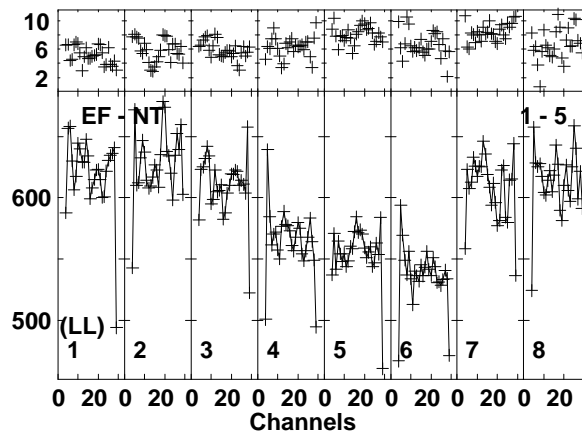
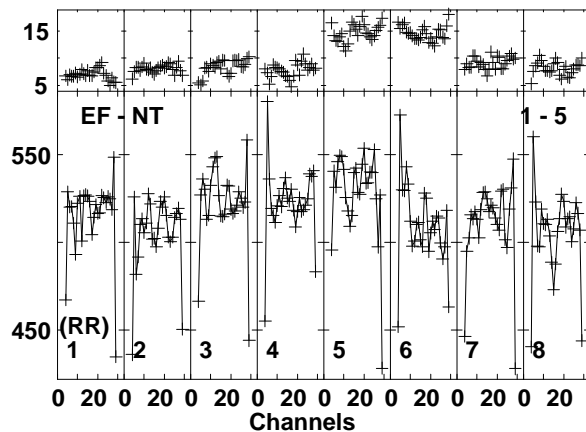
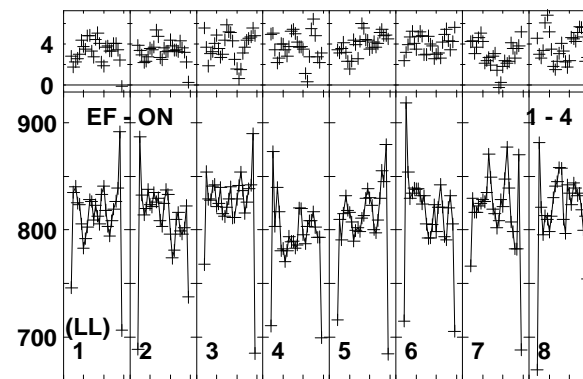
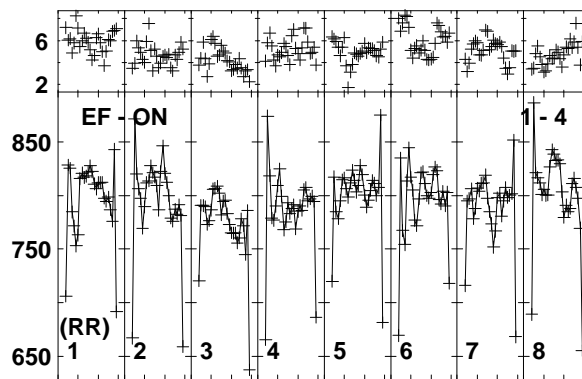
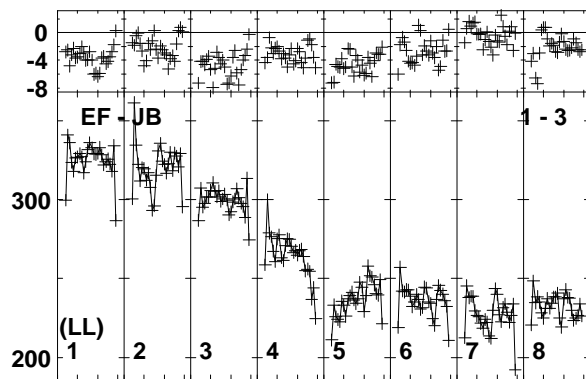
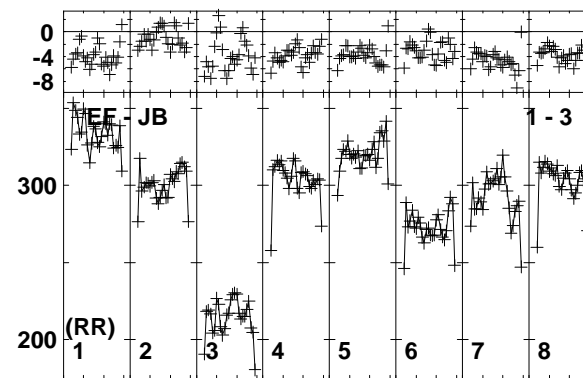
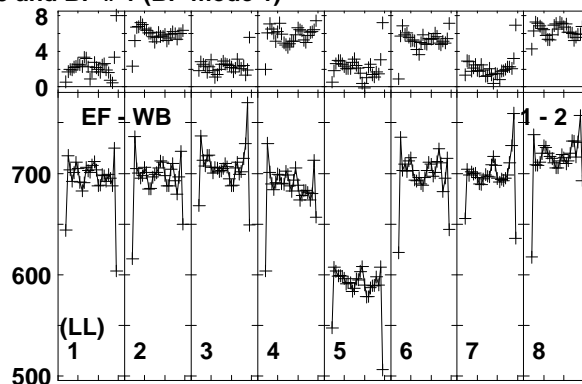
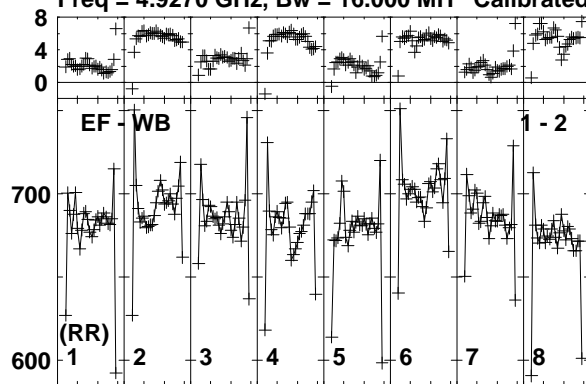

Lower frame: Milli Ampl Jy Top frame: Phas deg  
Vector averaged cross-power spectrum Baseline: EF (01) - WB (02)  
Timerange: 00/13:12:45 to 00/13:13:39

Plot file version 29 created 18-NOV-2014 15:23:10

J1128+5925 EP087H 3.UVDATA.1

Freq = 4.9270 GHz, Bw = 16.000 MH Calibrated with CL # 3 and BP # 1 (BP mode 1)

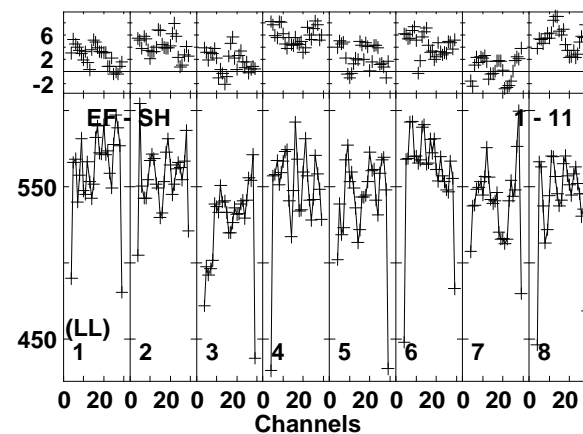
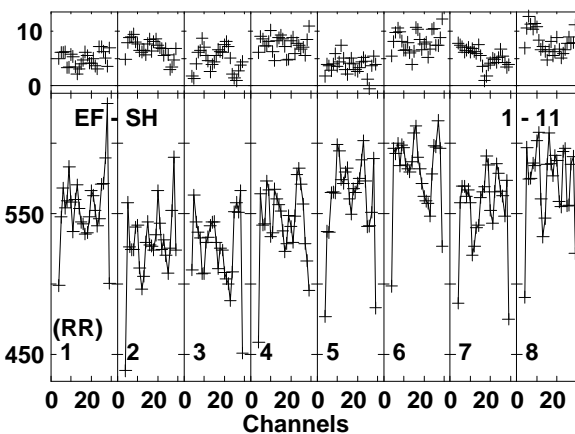
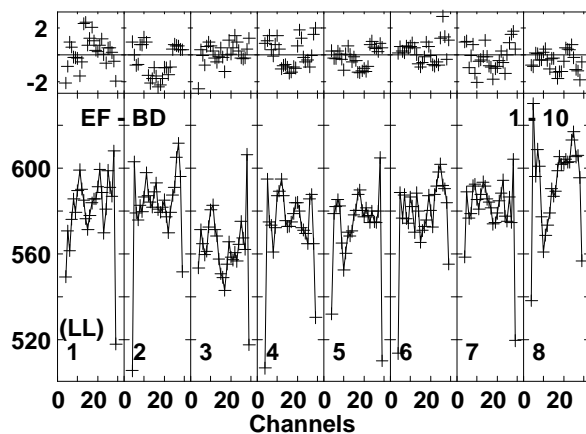
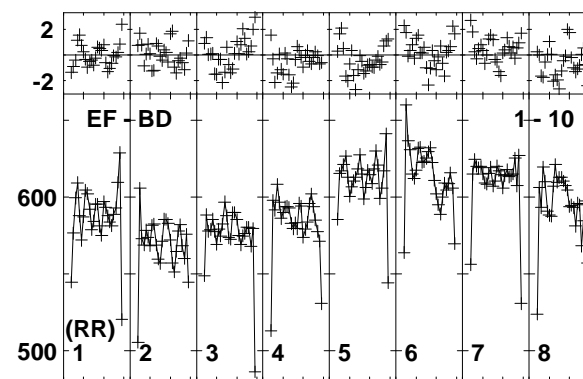
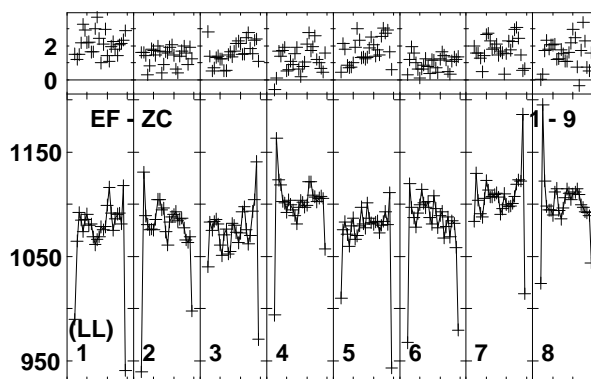
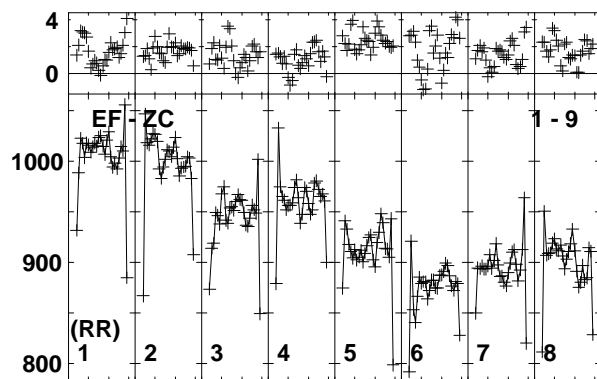
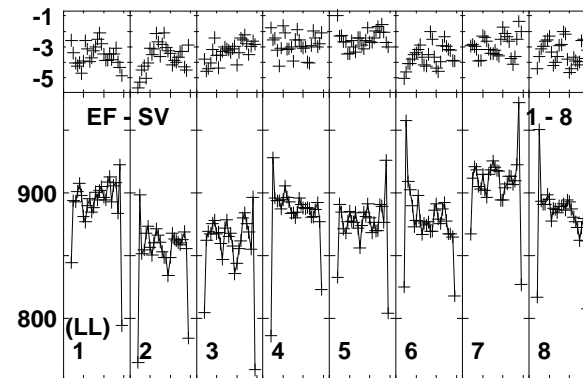
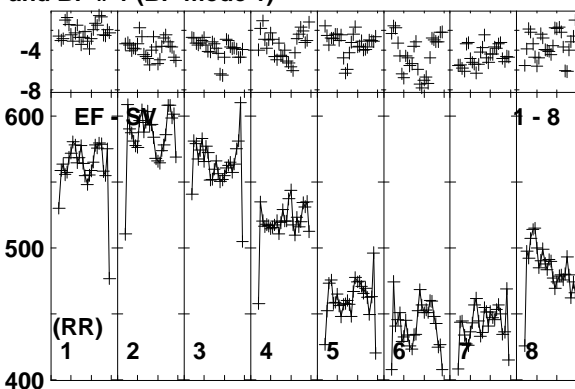
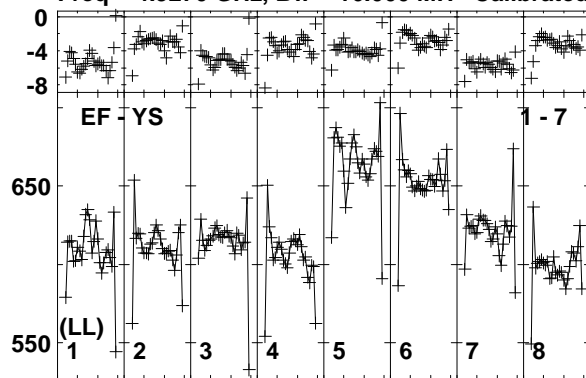

Lower frame: Milli Ampl Jy Top frame: Phas deg  
Vector averaged cross-power spectrum Baseline: EF (01) - YS (07)  
Timerange: 00/13:12:45 to 00/13:13:39

Plot file version 30 created 18-NOV-2014 15:23:10  
 ARP299C EP087H 3.UVDATA.1  
 Freq = 4.9270 GHz, Bw = 16.000 MH Calibrated with CL # 3 and BP # 1 (BP mode 1)

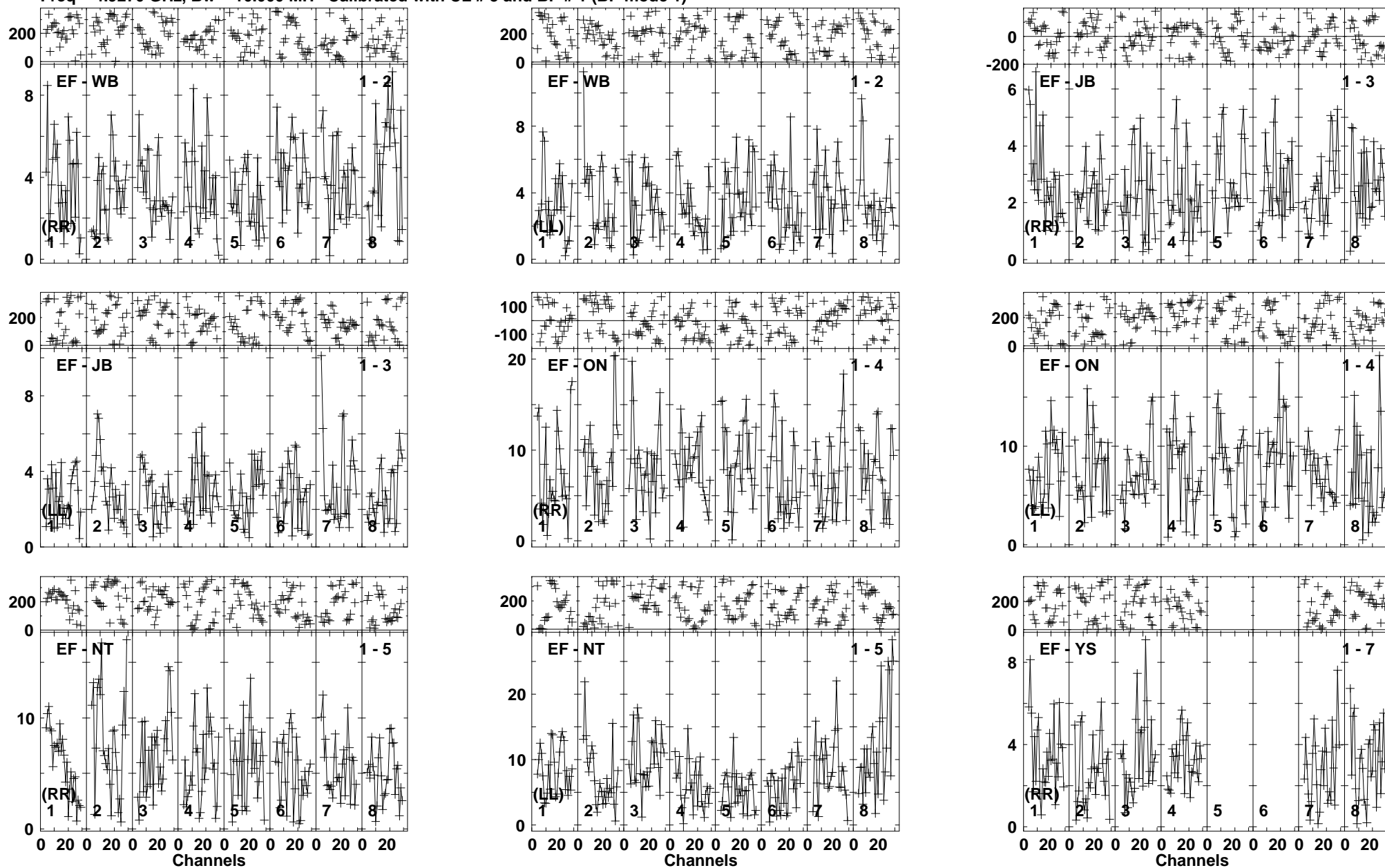

Lower frame: Milli Ampl Jy Top frame: Phas deg  
 Vector averaged cross-power spectrum Baseline: EF (01) - WB (02)  
 Timerange: 00/13:13:45 to 00/13:17:39

Plot file version 31 created 18-NOV-2014 15:23:10

ARP299C EP087H 3.UVDATA.1

Freq = 4.9270 GHz, Bw = 16.000 MH Calibrated with CL # 3 and BP # 1 (BP mode 1)

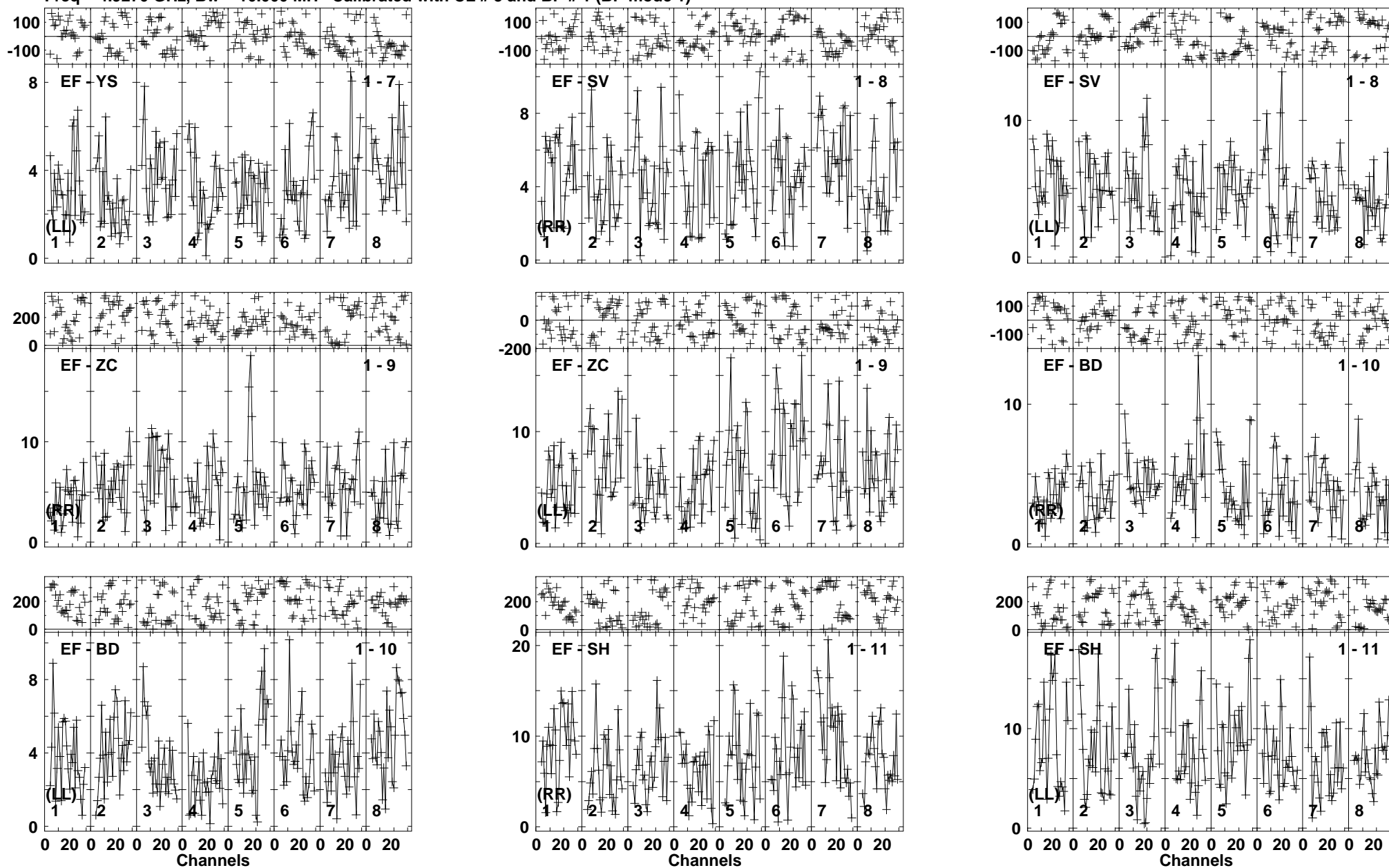

Lower frame: Milli Ampl Jy Top frame: Phas deg  
Vector averaged cross-power spectrum Baseline: EF (01) - YS (07)  
Timerange: 00/13:13:45 to 00/13:17:39

Plot file version 32 created 18-NOV-2014 15:23:10

J1128+5925 EP087H 3.UVDATA.1

Freq = 4.9270 GHz, Bw = 16.000 MH Calibrated with CL # 3 and BP # 1 (BP mode 1)

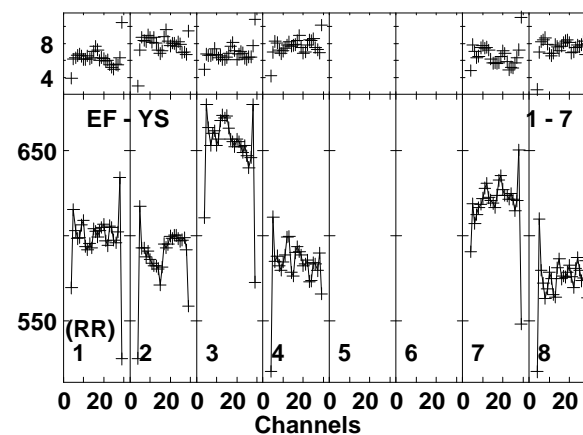
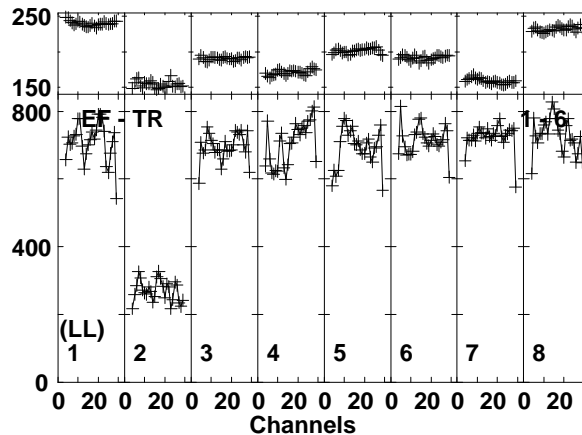
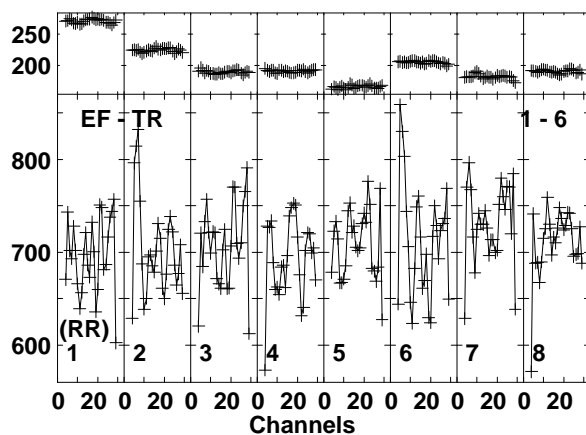
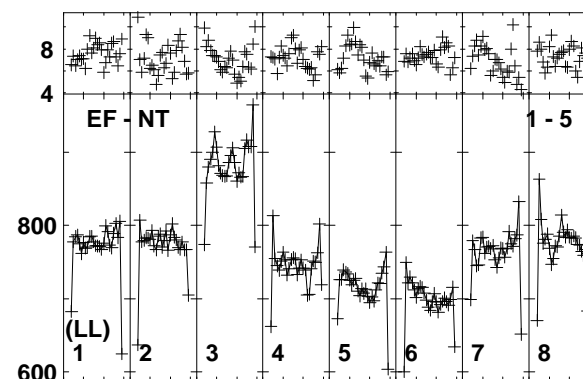
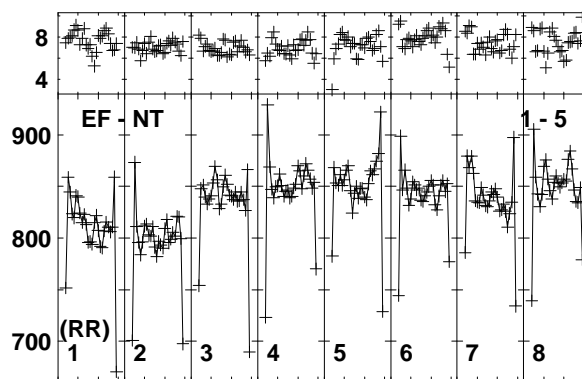
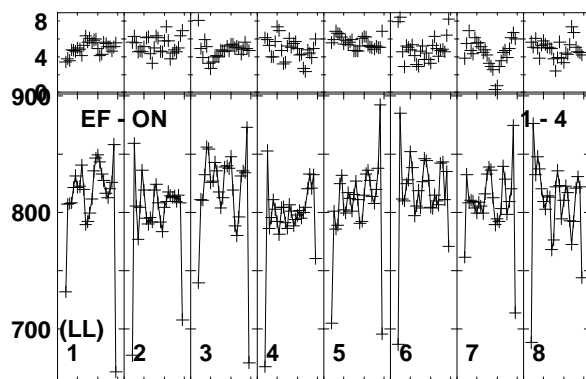
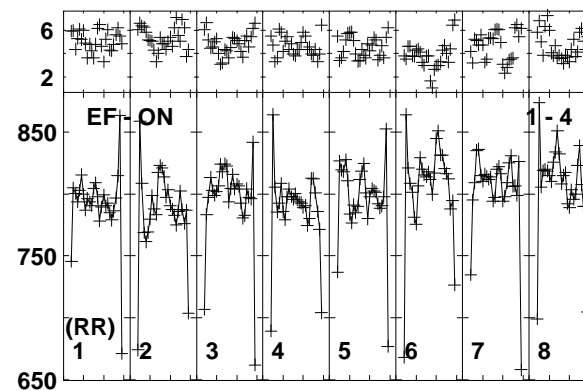
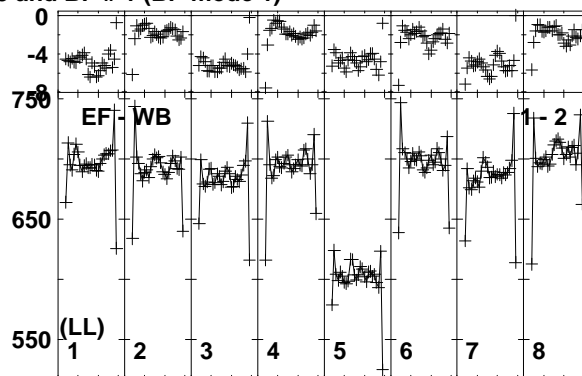
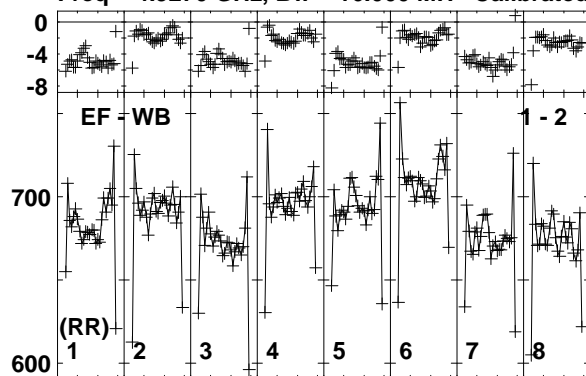

Lower frame: Milli Ampl Jy Top frame: Phas deg  
Vector averaged cross-power spectrum Baseline: EF (01) - WB (02)  
Timerange: 00/13:17:45 to 00/13:18:39



Plot file version 33 created 18-NOV-2014 15:23:11

J1128+5925 EP087H 3.UVDATA.1

Freq = 4.9270 GHz, Bw = 16.000 MH Calibrated with CL # 3 and BP # 1 (BP mode 1)

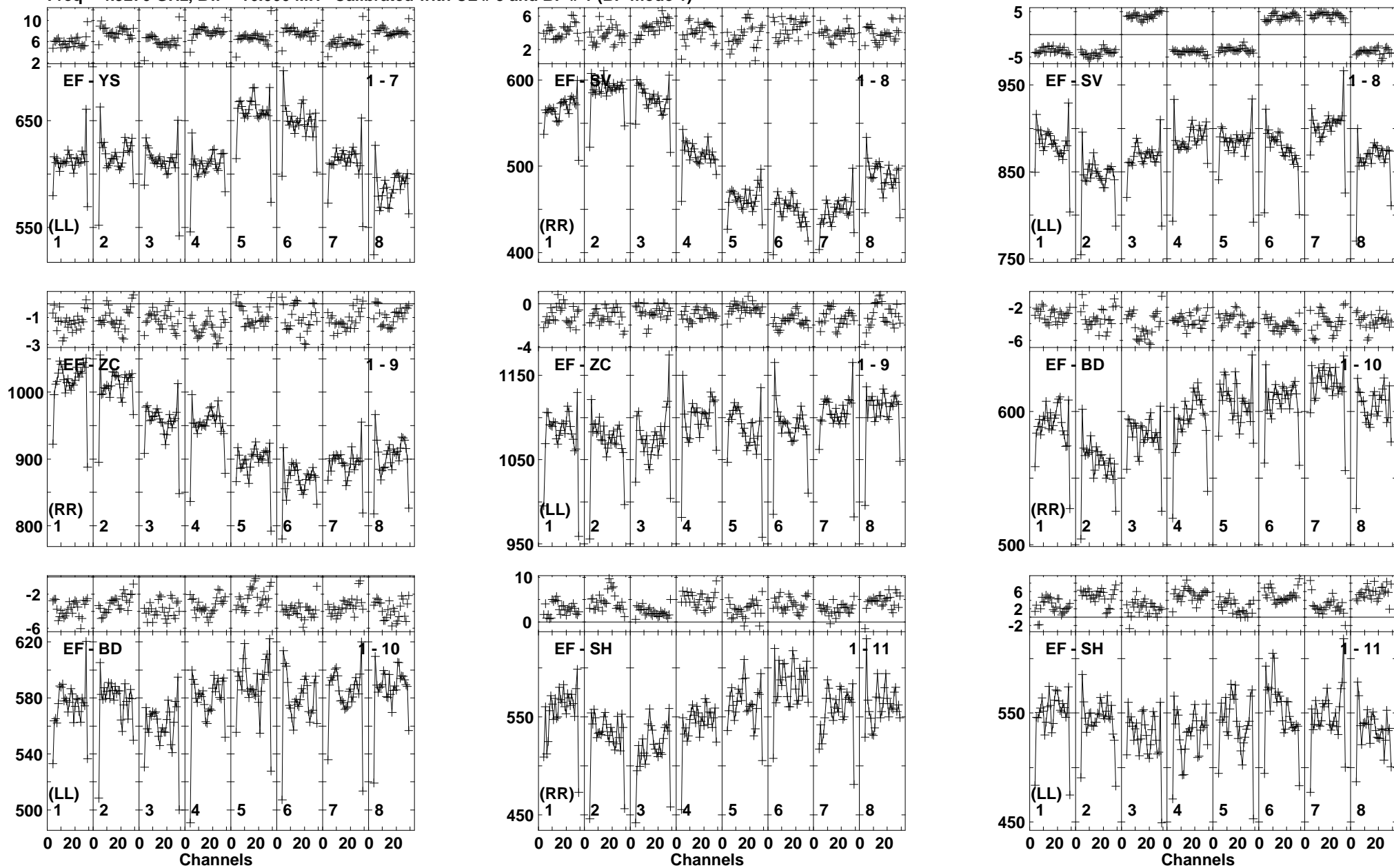

Lower frame: Milli Ampl Jy Top frame: Phas deg  
Vector averaged cross-power spectrum Baseline: EF (01) - YS (07)  
Timerange: 00/13:17:45 to 00/13:18:39

Plot file version 34 created 18-NOV-2014 15:23:11  
 ARP299C EP087H 3.UVDATA.1  
 Freq = 4.9270 GHz, Bw = 16.000 MH Calibrated with CL # 3 and BP # 1 (BP mode 1)

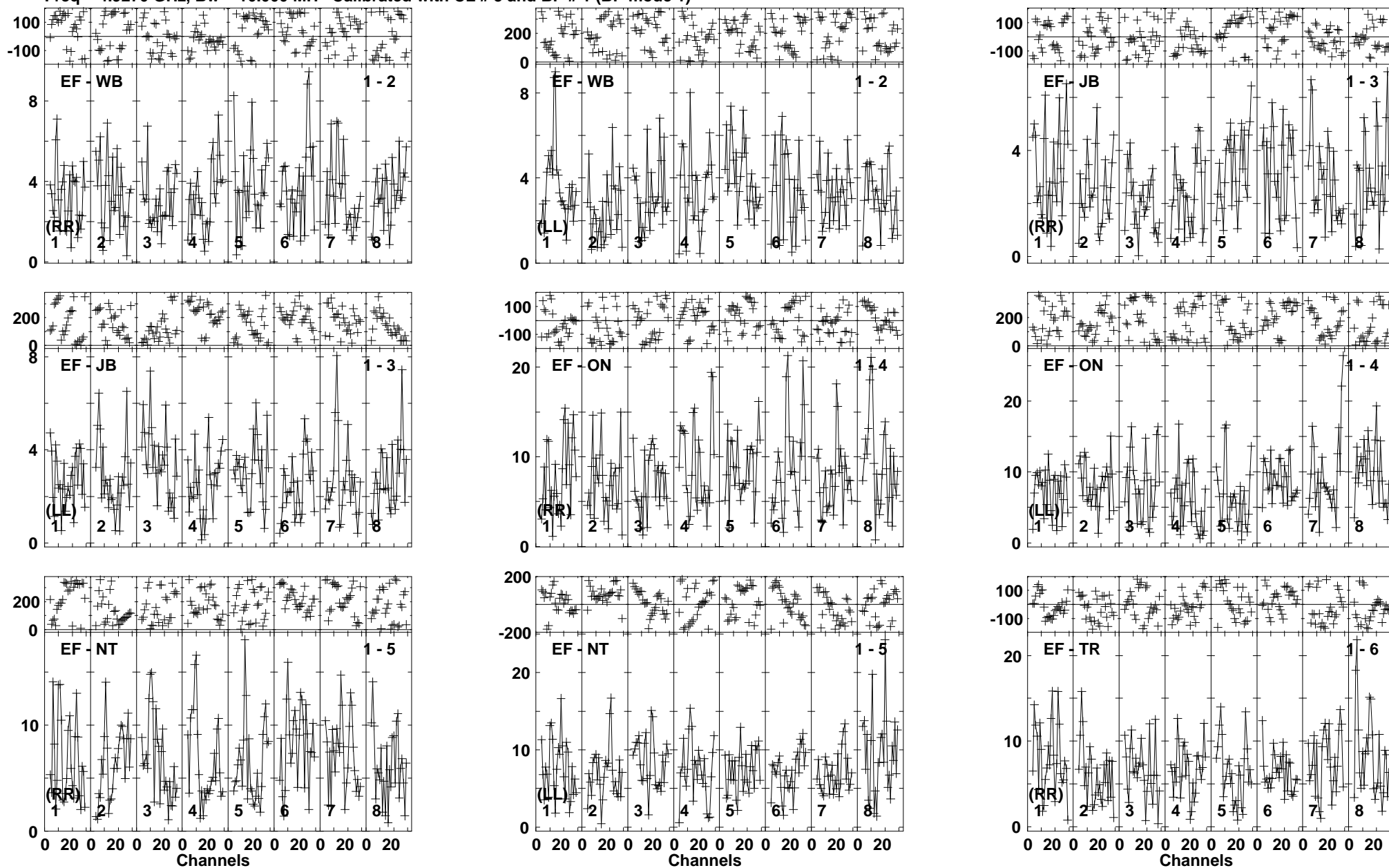

Lower frame: Milli Ampl Jy Top frame: Phas deg  
 Vector averaged cross-power spectrum Baseline: EF (01) - WB (02)  
 Timerange: 00/13:18:41 to 00/13:22:39

Plot file version 35 created 18-NOV-2014 15:23:11

ARP299C EP087H 3.UVDATA.1

Freq = 4.9270 GHz, Bw = 16.000 MH Calibrated with CL # 3 and BP # 1 (BP mode 1)

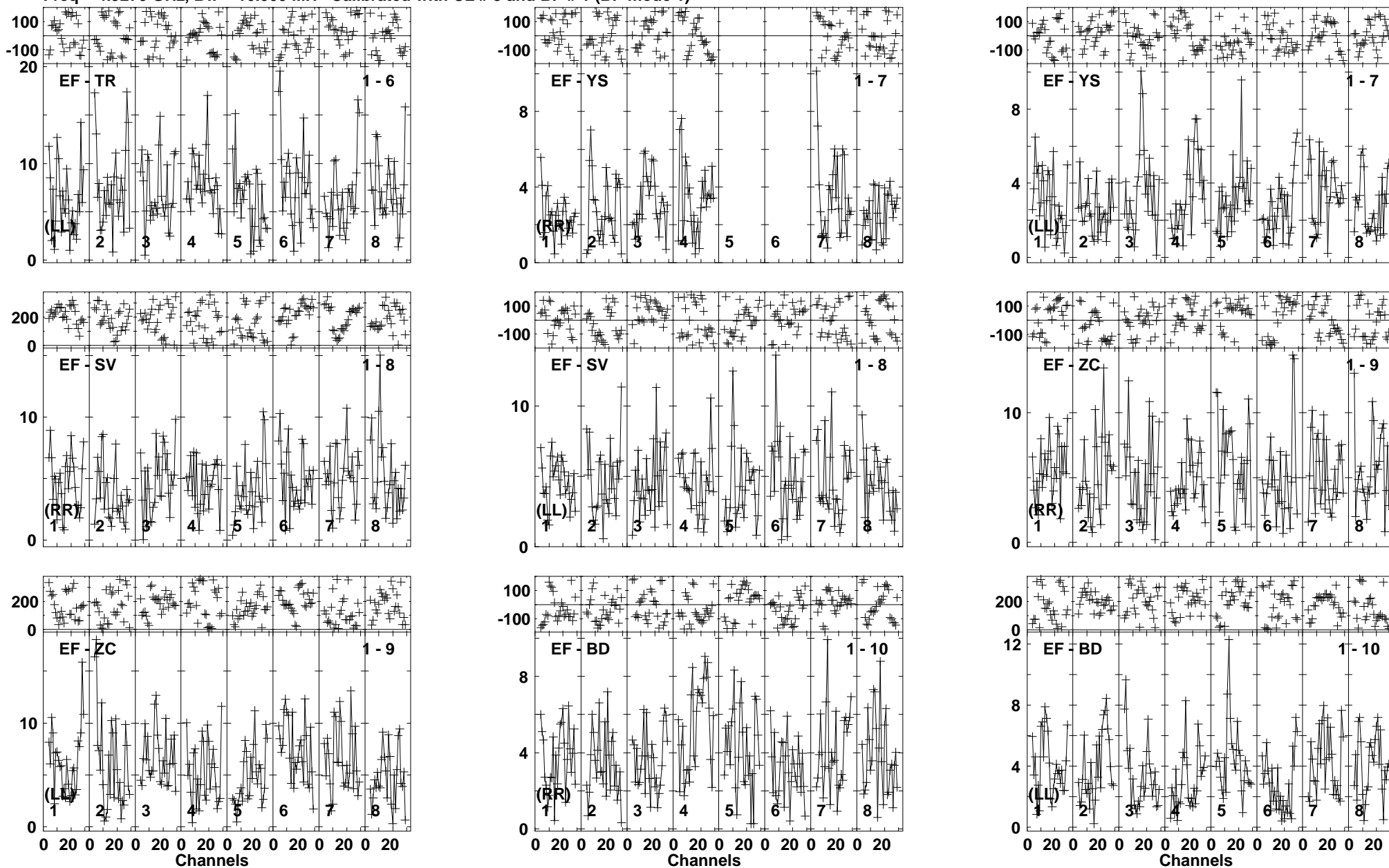

Lower frame: Milli Ampl Jy Top frame: Phas deg  
Vector averaged cross-power spectrum Baseline: EF (01) - TR (06)  
Timerange: 00/13:18:41 to 00/13:22:39

Plot file version 36 created 18-NOV-2014 15:23:11

ARP299C EP087H 3.UVDATA.1

Freq = 4.9270 GHz, Bw = 16.000 MH Calibrated with CL # 3 and BP # 1 (BP mode 1)

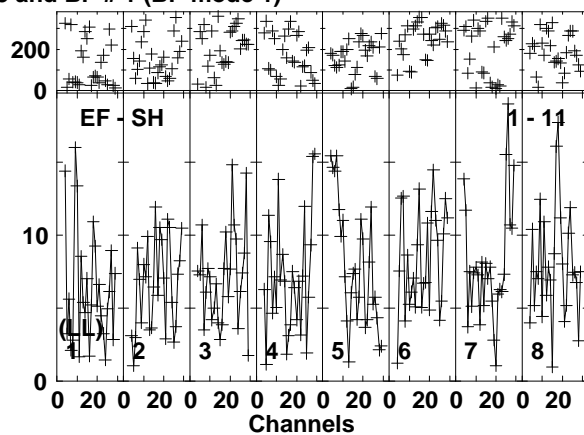
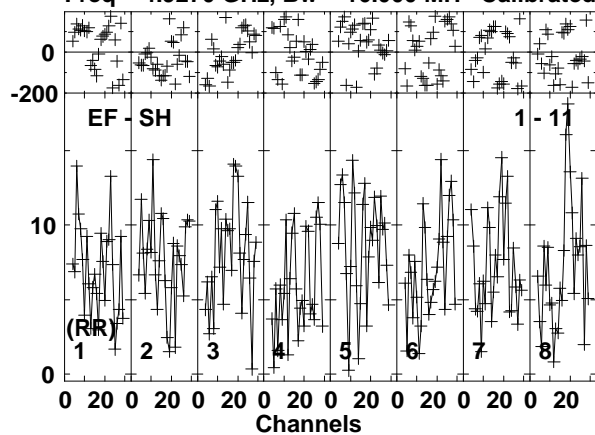

Lower frame: Milli Ampl Jy Top frame: Phas deg  
Vector averaged cross-power spectrum Baseline: EF (01) - SH (11)  
Timerange: 00/13:18:41 to 00/13:22:39

Plot file version 37 created 18-NOV-2014 15:23:11

J1128+5925 EP087H 3.UVDATA.1

Freq = 4.9270 GHz, Bw = 16.000 MH Calibrated with CL # 3 and BP # 1 (BP mode 1)

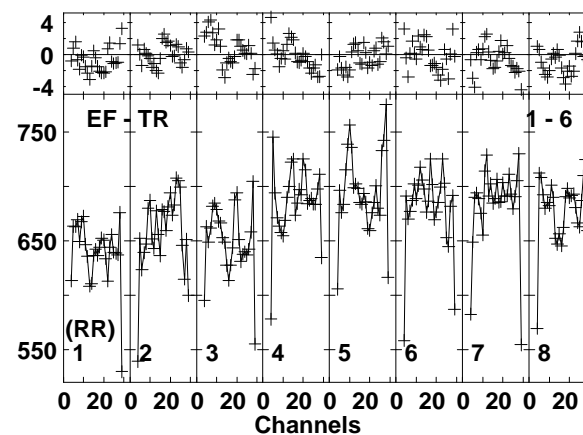
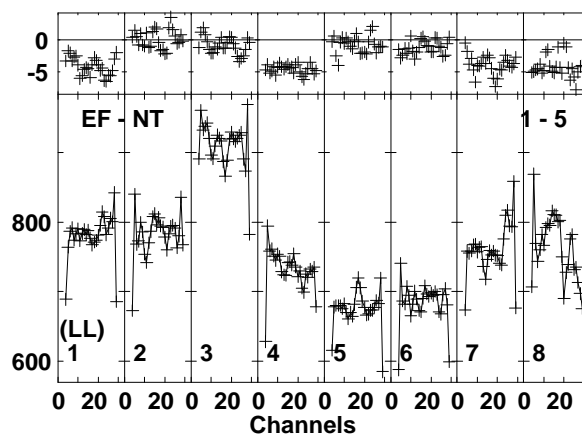
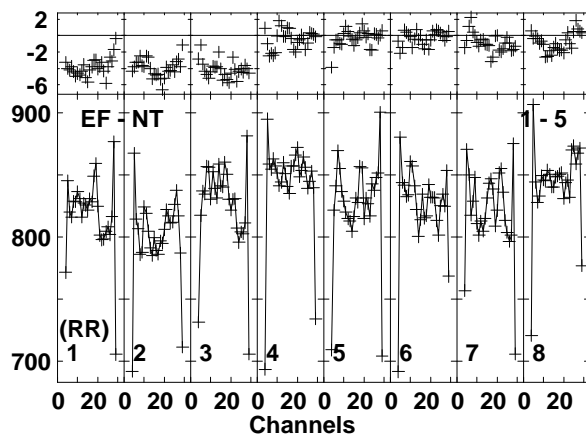
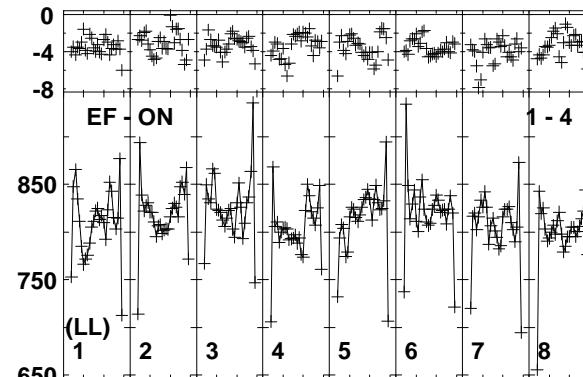
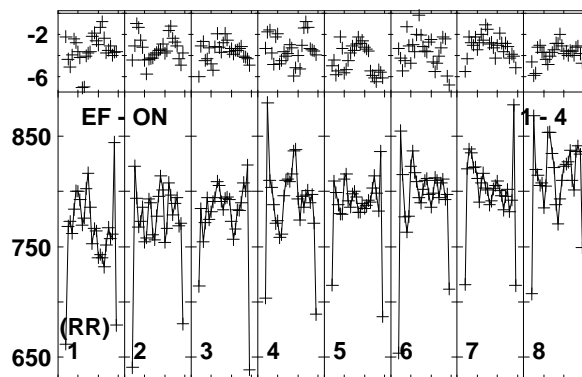
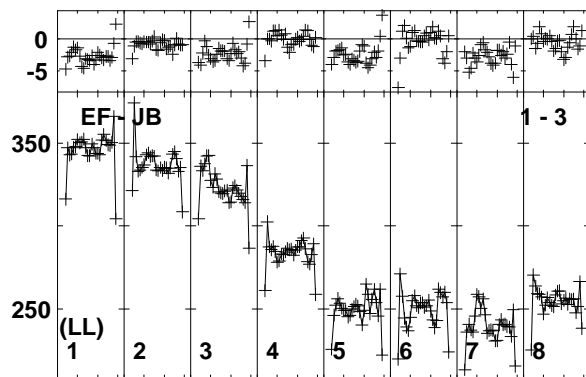
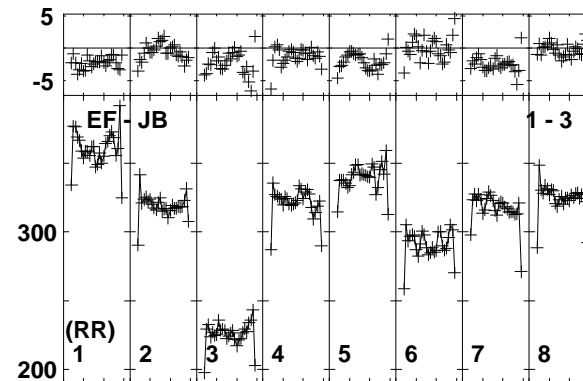
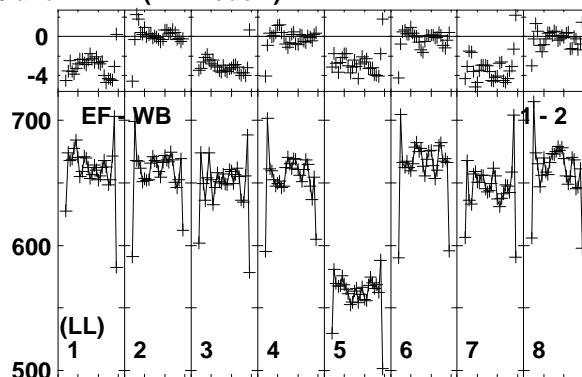
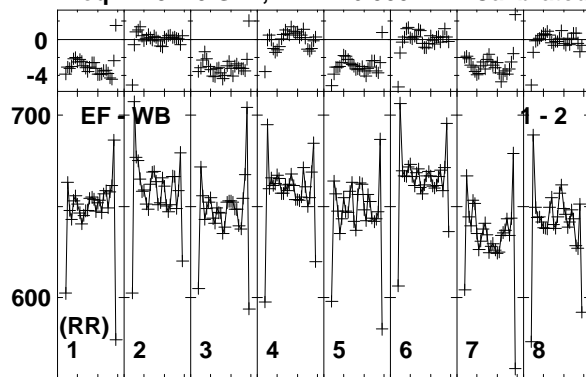

Lower frame: Milli Ampl Jy Top frame: Phas deg  
Vector averaged cross-power spectrum Baseline: EF (01) - WB (02)  
Timerange: 00/13:23:21 to 00/13:23:49

Plot file version 38 created 18-NOV-2014 15:23:12

J1128+5925 EP087H 3.UVDATA.1

Freq = 4.9270 GHz, Bw = 16.000 MH Calibrated with CL # 3 and BP # 1 (BP mode 1)

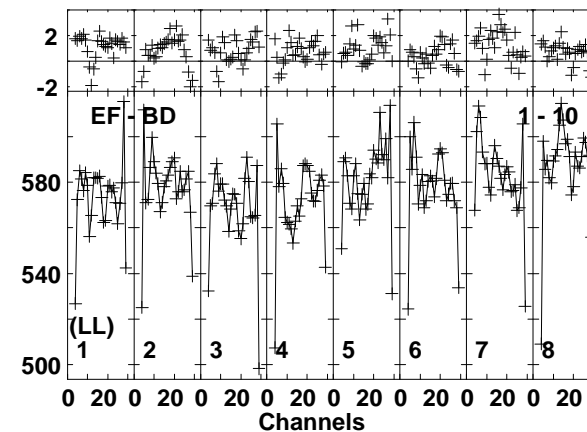
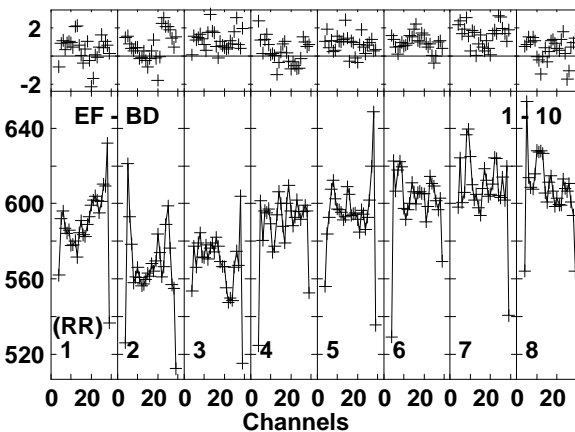
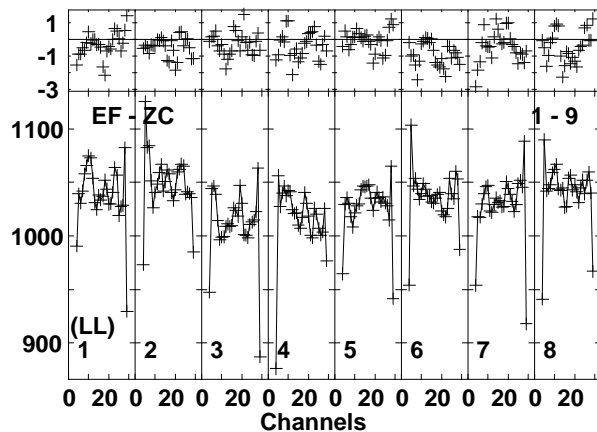
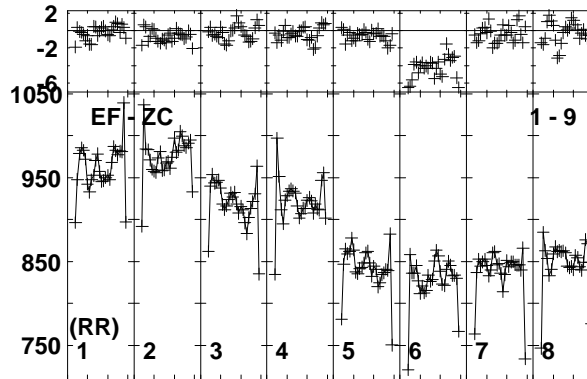
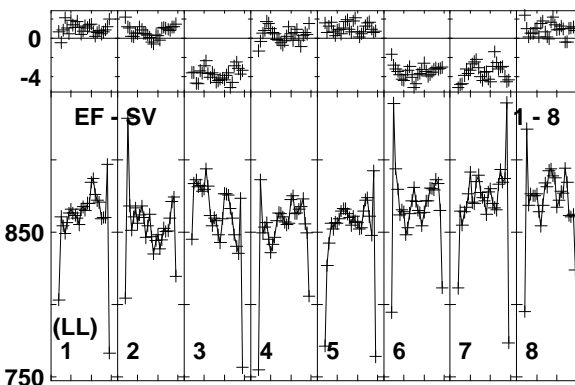
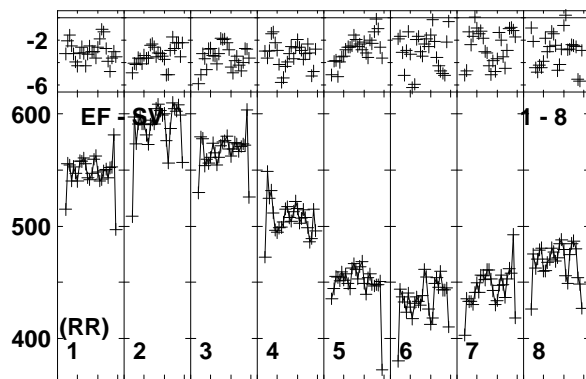
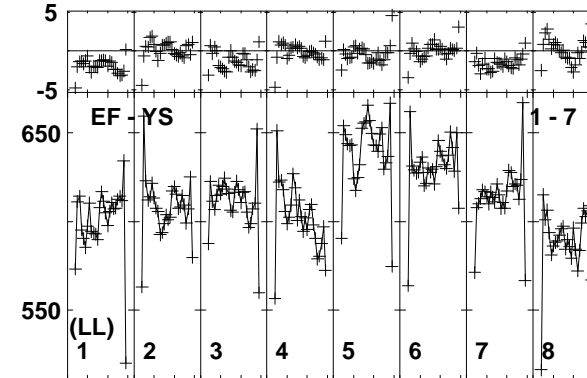
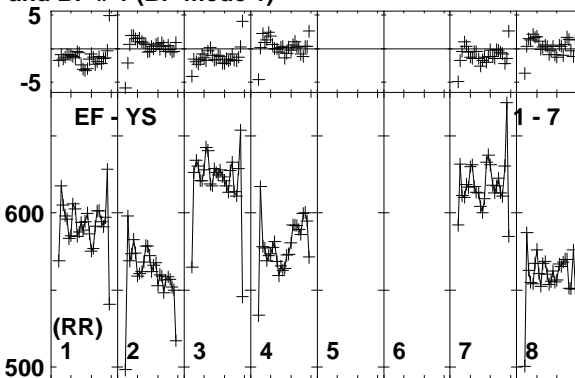
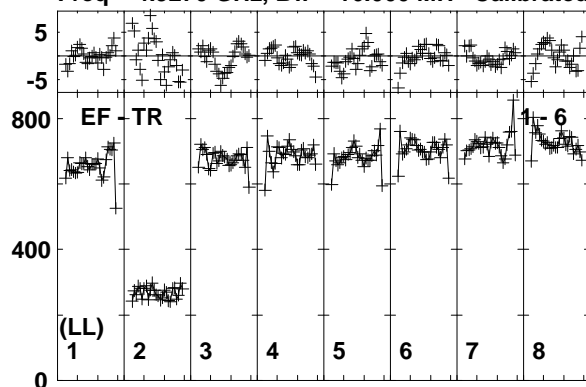

Lower frame: Milli Ampl Jy Top frame: Phas deg  
Vector averaged cross-power spectrum Baseline: EF (01) - TR (06)  
Timerange: 00/13:23:21 to 00/13:23:49

Plot file version 39 created 18-NOV-2014 15:23:12

J1128+5925 EP087H 3.UVDATA.1

Freq = 4.9270 GHz, Bw = 16.000 MH Calibrated with CL # 3 and BP # 1 (BP mode 1)

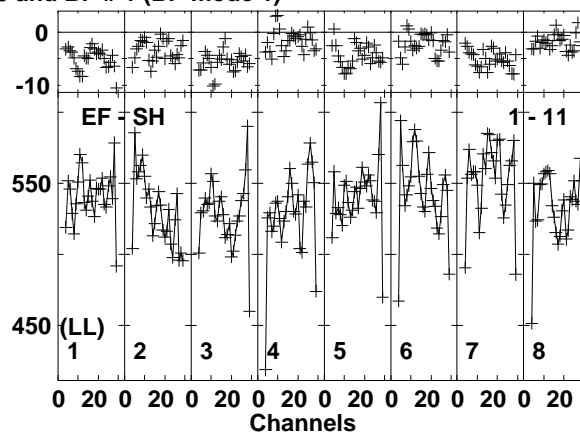
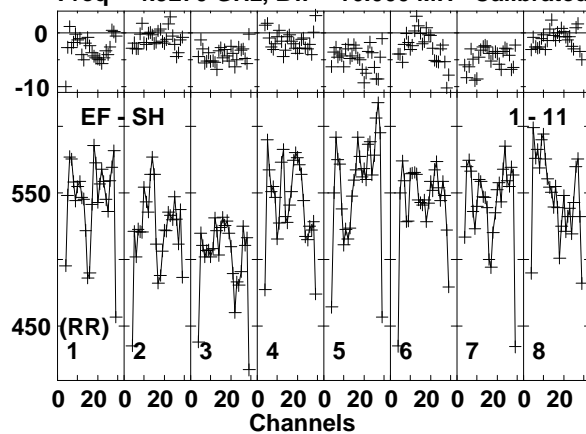

Lower frame: Milli Ampl Jy Top frame: Phas deg  
Vector averaged cross-power spectrum Baseline: EF (01) - SH (11)  
Timerange: 00/13:23:21 to 00/13:23:49

Plot file version 40 created 18-NOV-2014 15:23:12

ARP299C EP087H 3.UVDATA.1

Freq = 4.9270 GHz, Bw = 16.000 MH Calibrated with CL # 3 and BP # 1 (BP mode 1)

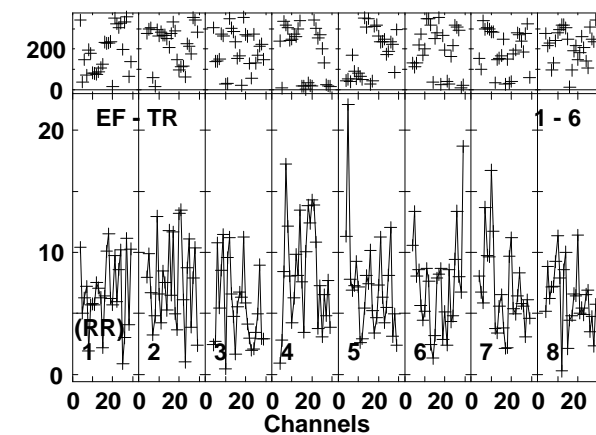
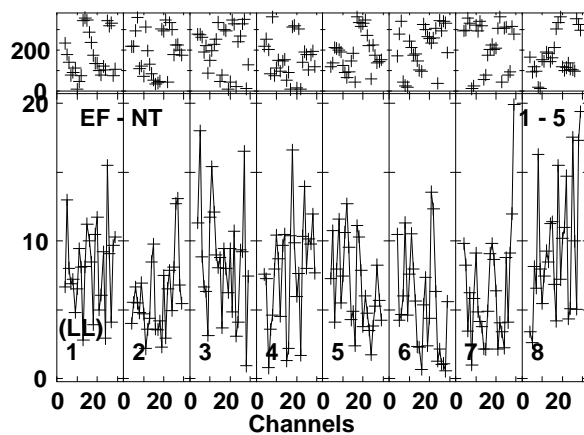
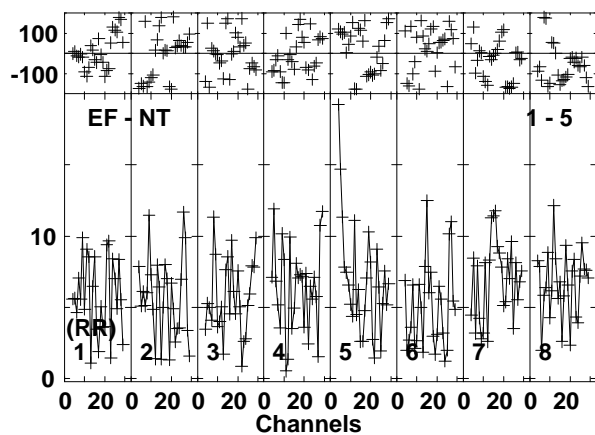
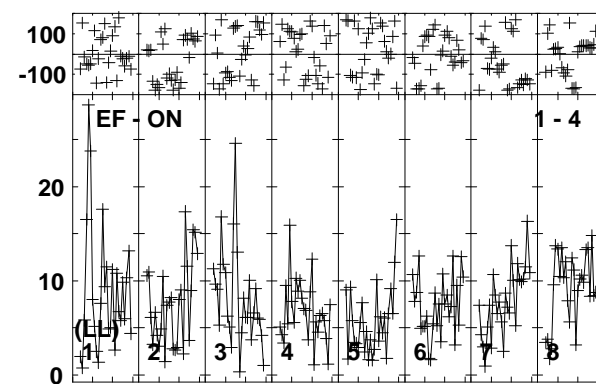
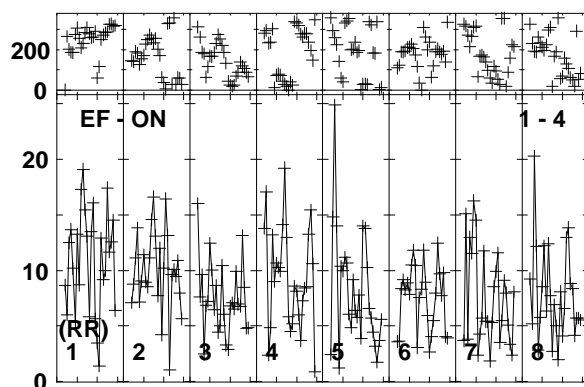
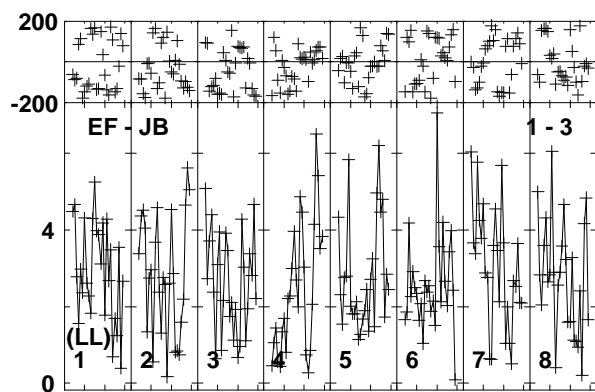
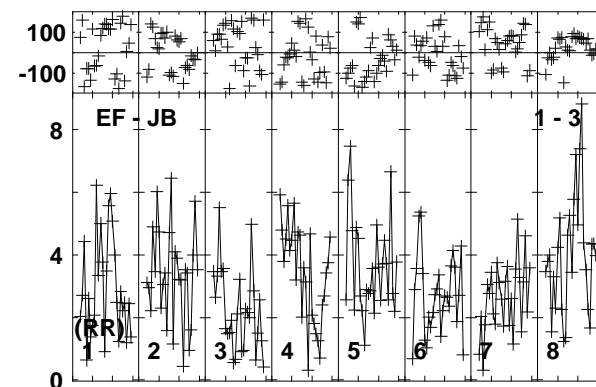
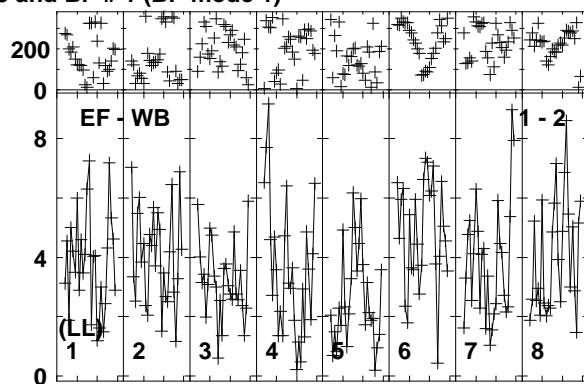
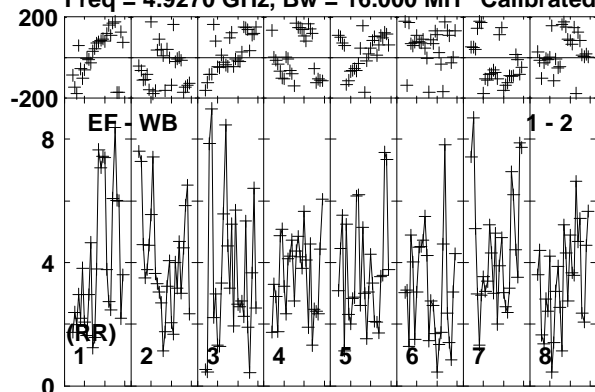

Lower frame: Milli Ampl Jy Top frame: Phas deg  
Vector averaged cross-power spectrum Baseline: EF (01) - WB (02)  
Timerange: 00/13:23:55 to 00/13:27:49



Plot file version 41 created 18-NOV-2014 15:23:12

ARP299C EP087H 3.UVDATA.1

Freq = 4.9270 GHz, Bw = 16.000 MH Calibrated with CL # 3 and BP # 1 (BP mode 1)

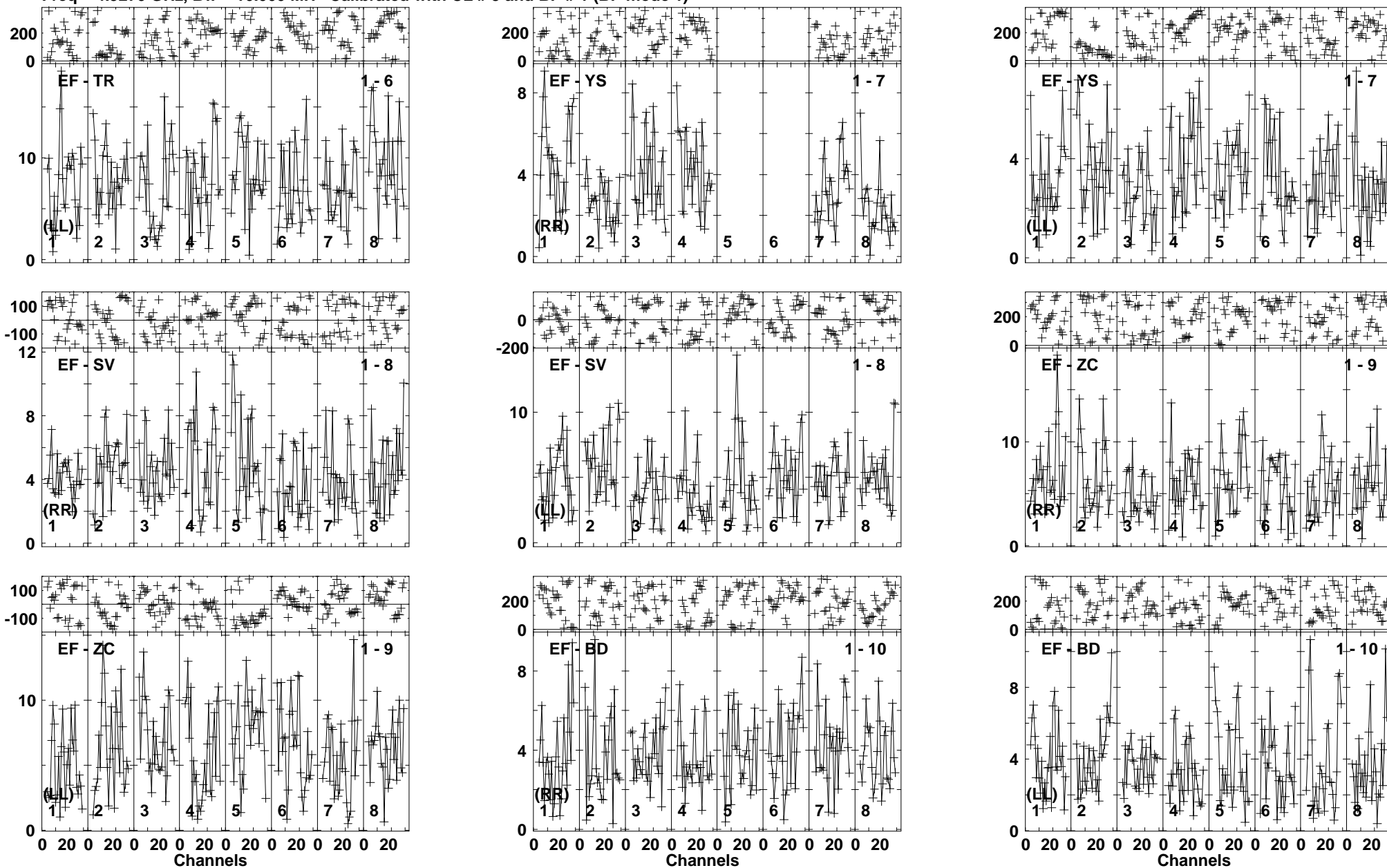

Lower frame: Milli Ampl Jy Top frame: Phas deg  
Vector averaged cross-power spectrum Baseline: EF (01) - TR (06)  
Timerange: 00/13:23:55 to 00/13:27:49

Plot file version 42 created 18-NOV-2014 15:23:12

ARP299C EP087H 3.UVDATA.1

Freq = 4.9270 GHz, Bw = 16.000 MH Calibrated with CL # 3 and BP # 1 (BP mode 1)

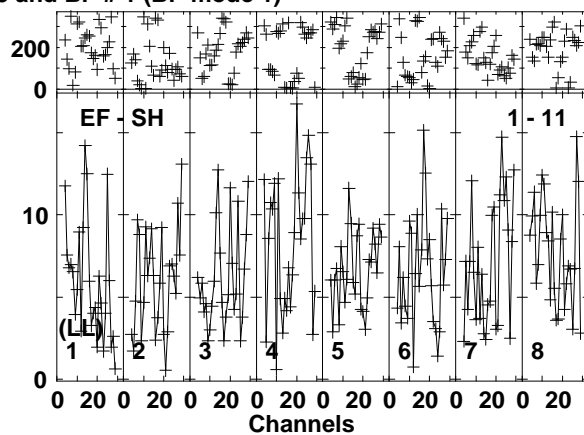
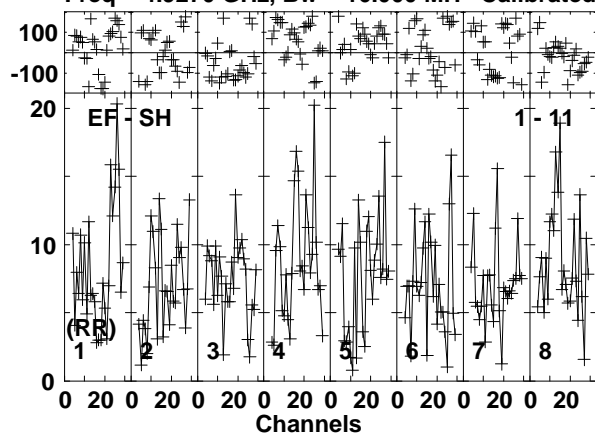

Lower frame: Milli Ampl Jy Top frame: Phas deg  
Vector averaged cross-power spectrum Baseline: EF (01) - SH (11)  
Timerange: 00/13:23:55 to 00/13:27:49

Plot file version 43 created 18-NOV-2014 15:23:13

J1128+5925 EP087H 3.UVDATA.1

Freq = 4.9270 GHz, Bw = 16.000 MH Calibrated with CL # 3 and BP # 1 (BP mode 1)

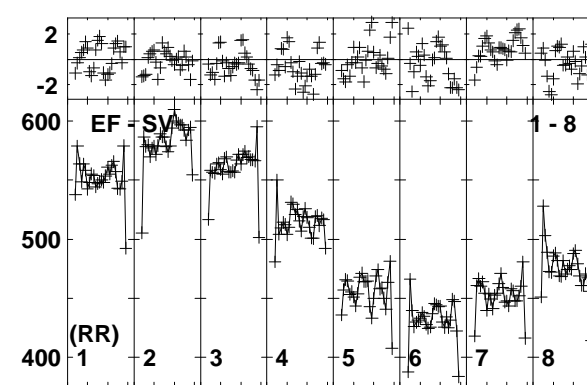
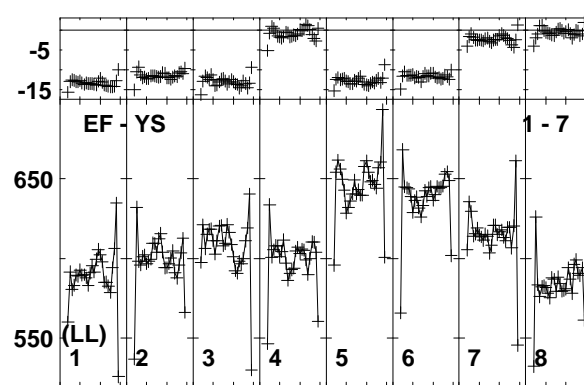
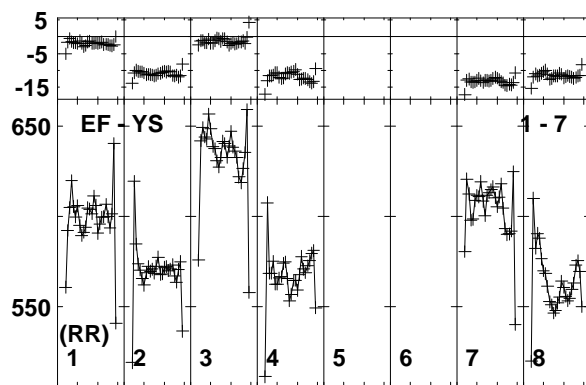
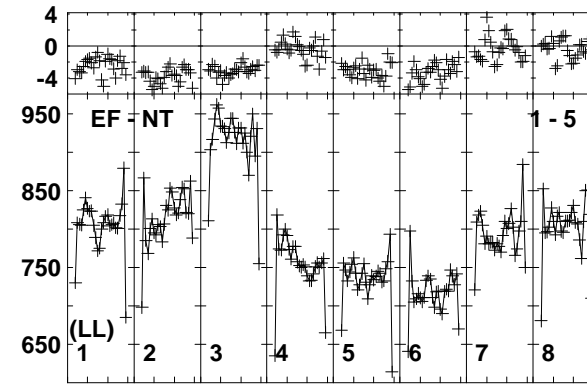
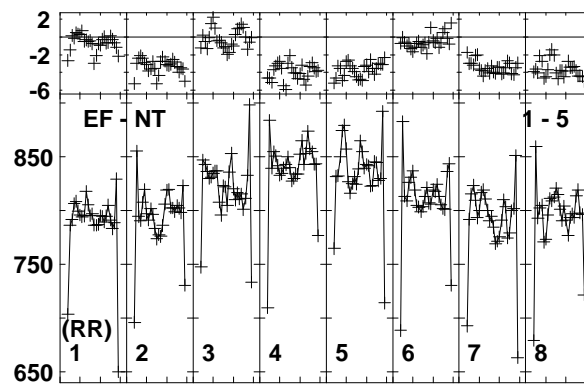
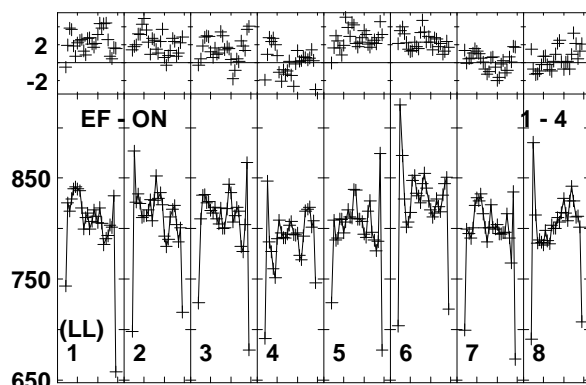
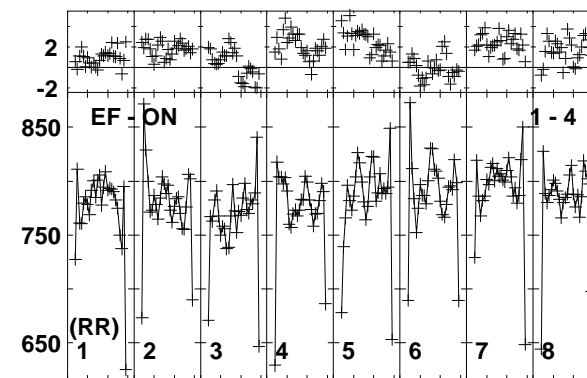
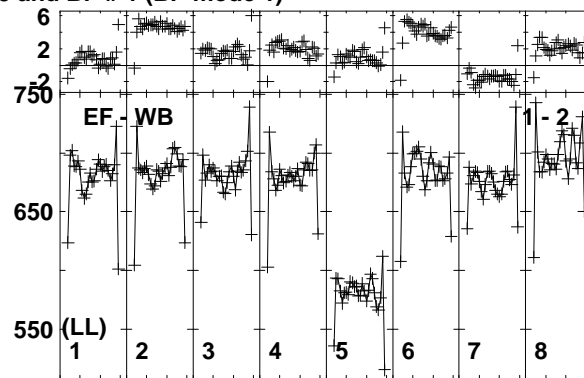
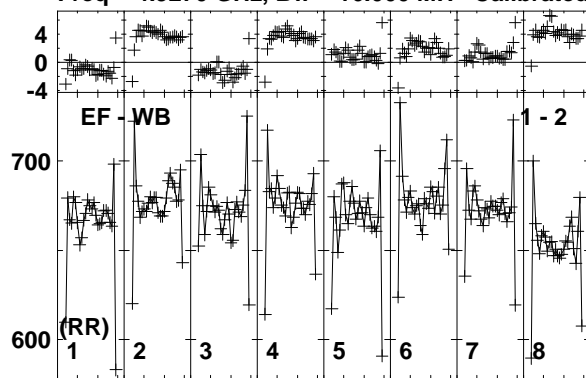

0 20 0 20 0 20 0 20 0 20 0 20 0 20 0 20 0 20  
Channels

0 20 0 20 0 20 0 20 0 20 0 20 0 20 0 20 0 20  
Channels

0 20 0 20 0 20 0 20 0 20 0 20 0 20 0 20 0 20  
Channels

Lower frame: Milli Ampl Jy Top frame: Phas deg  
Vector averaged cross-power spectrum Baseline: EF (01) - WB (02)  
Timerange: 00/13:27:55 to 00/13:28:49

Plot file version 44 created 18-NOV-2014 15:23:13

J1128+5925 EP087H 3.UVDATA.1

Freq = 4.9270 GHz, Bw = 16.000 MH Calibrated with CL # 3 and BP # 1 (BP mode 1)

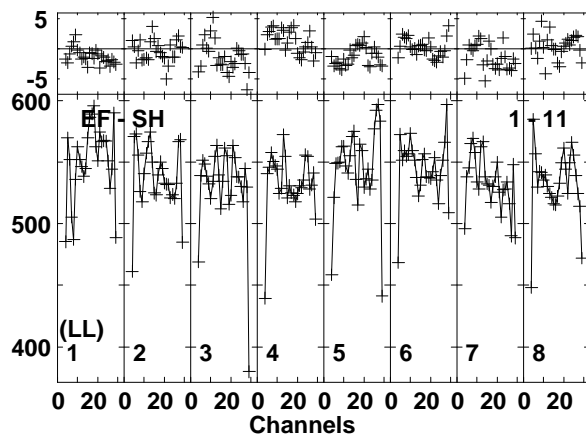
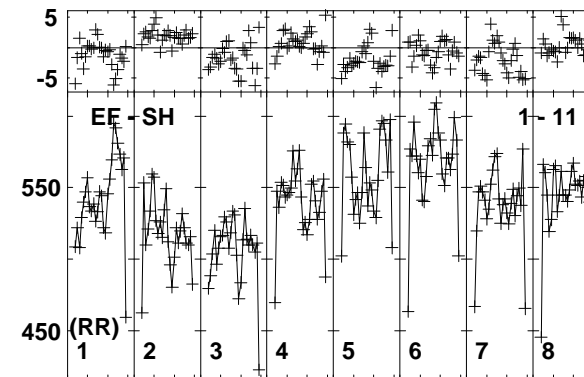
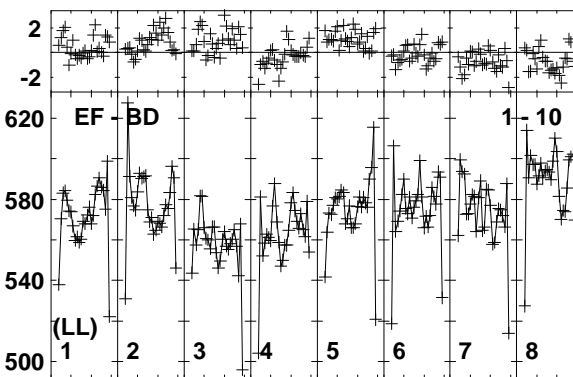
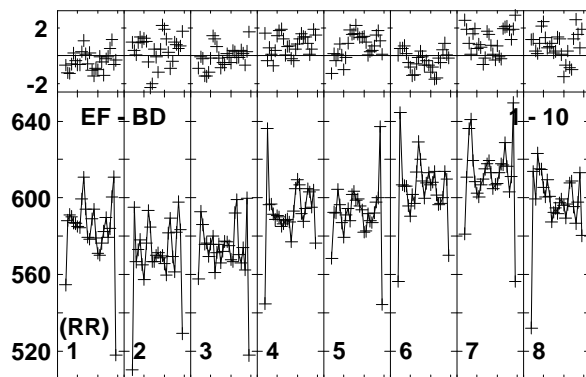
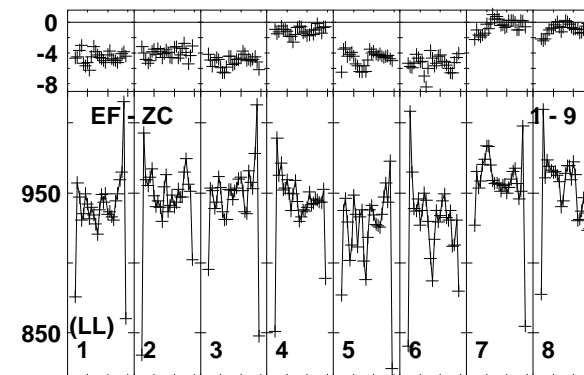
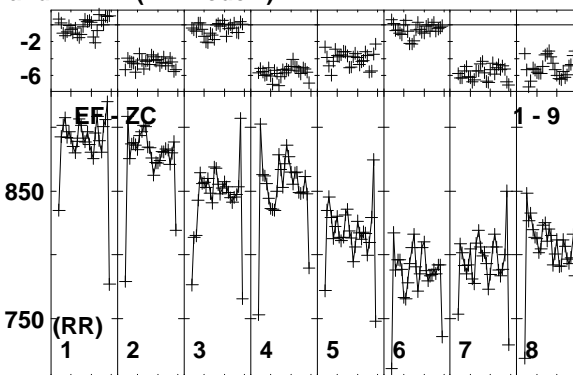
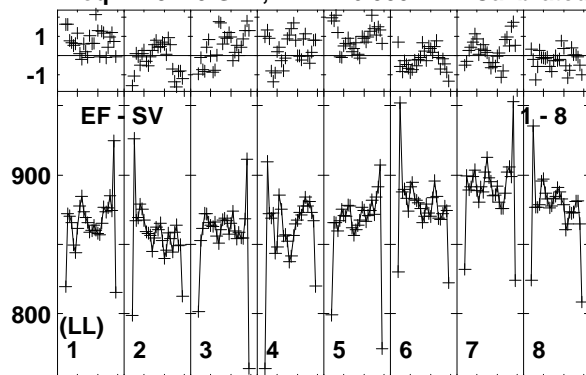

Lower frame: Milli Ampl Jy Top frame: Phas deg  
Vector averaged cross-power spectrum Baseline: EF (01) - SV (08)  
Timerange: 00/13:27:55 to 00/13:28:49

Plot file version 45 created 18-NOV-2014 15:23:13  
 ARP299C EP087H 3.UVDATA.1  
 Freq = 4.9270 GHz, Bw = 16.000 MH Calibrated with CL # 3 and BP # 1 (BP mode 1)

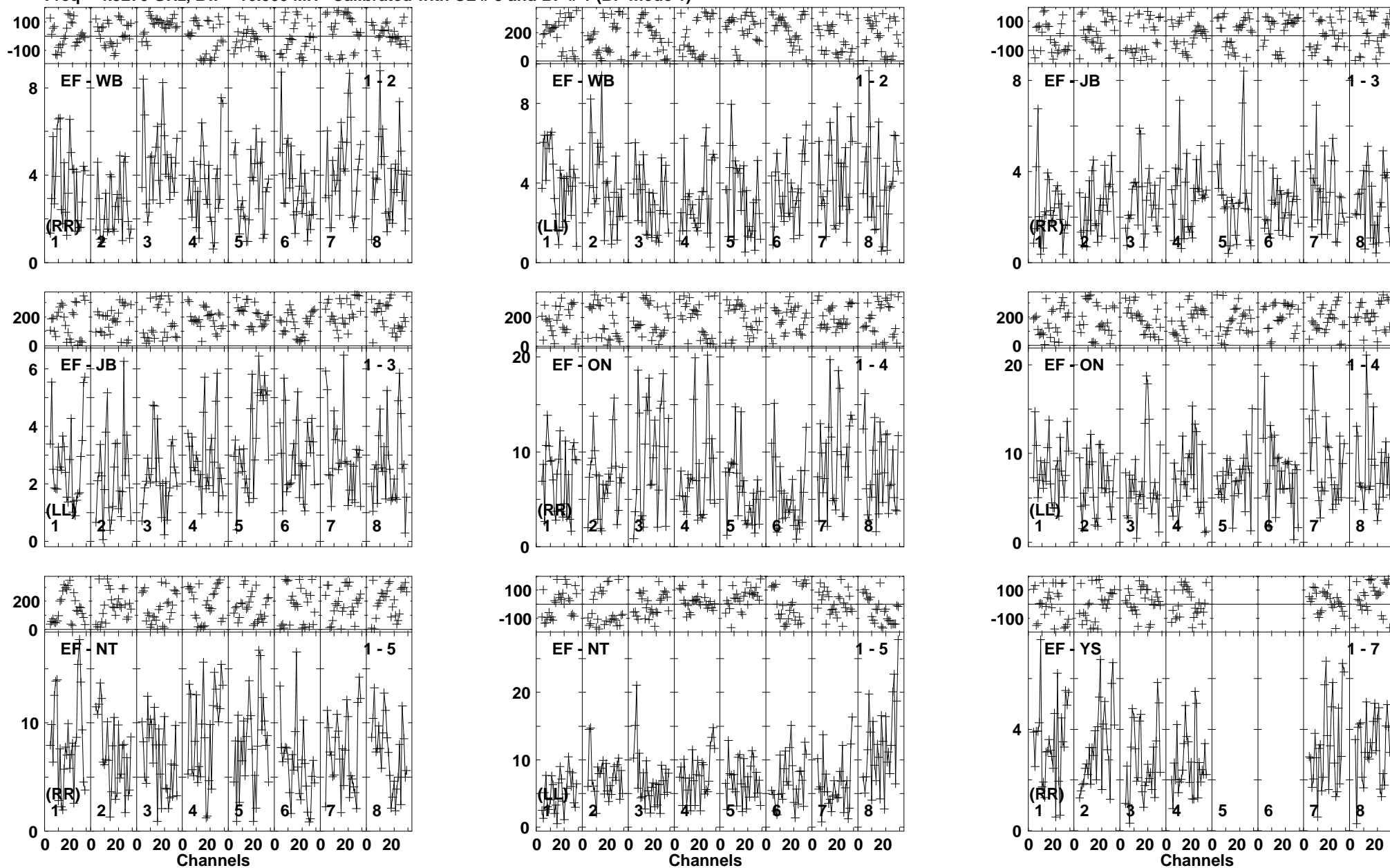

Lower frame: Milli Ampl Jy Top frame: Phas deg  
 Vector averaged cross-power spectrum Baseline: EF (01) - WB (02)  
 Timerange: 00/13:28:51 to 00/13:32:49

Plot file version 46 created 18-NOV-2014 15:23:13

ARP299C EP087H 3.UVDATA.1

Freq = 4.9270 GHz, Bw = 16.000 MH Calibrated with CL # 3 and BP # 1 (BP mode 1)

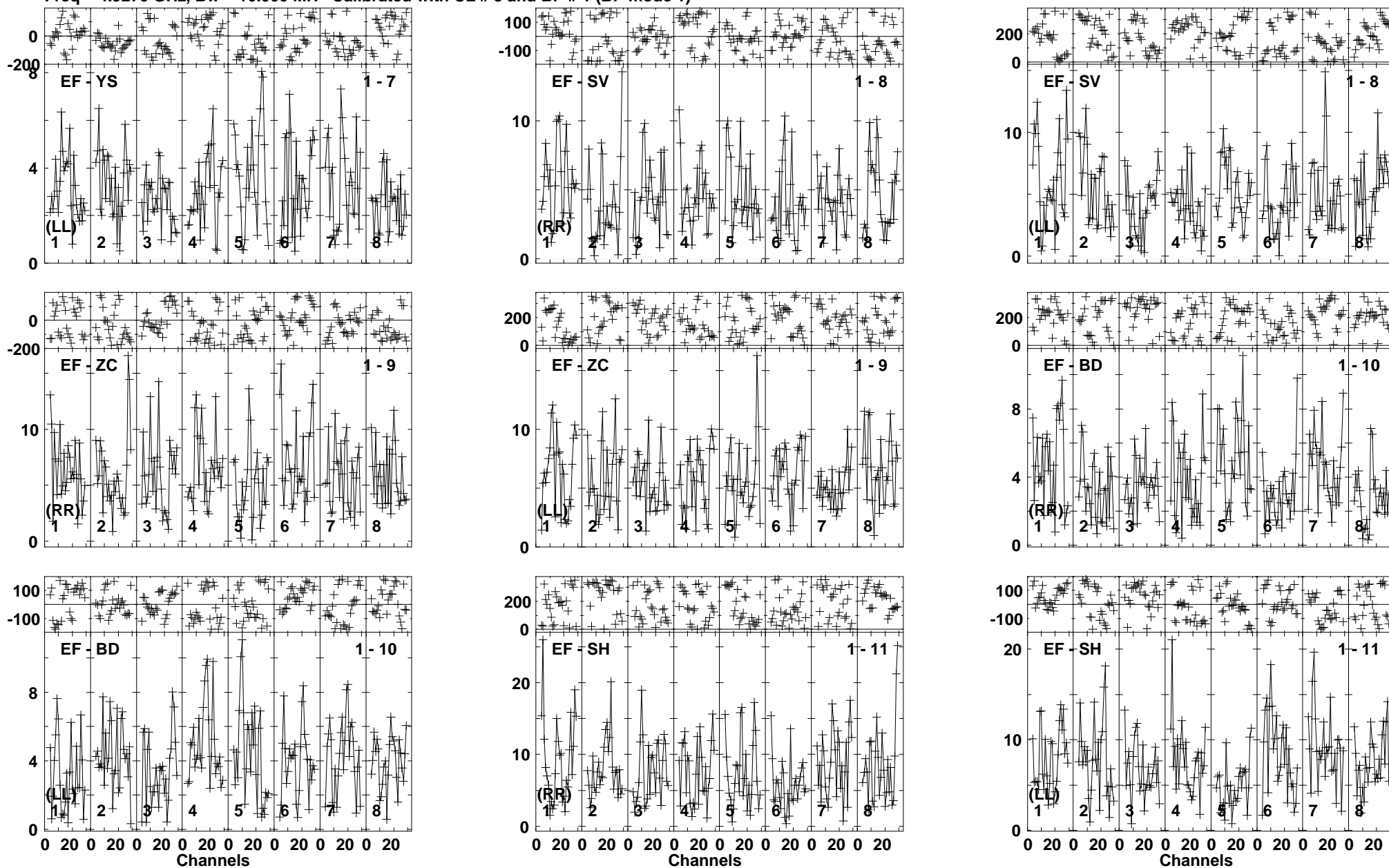

Lower frame: Milli Ampl Jy Top frame: Phas deg  
Vector averaged cross-power spectrum Baseline: EF (01) - YS (07)  
Timerange: 00/13:28:51 to 00/13:32:49

Plot file version 47 created 18-NOV-2014 15:23:14

J1128+5925 EP087H 3.UVDATA.1

Freq = 4.9270 GHz, Bw = 16.000 MH Calibrated with CL # 3 and BP # 1 (BP mode 1)

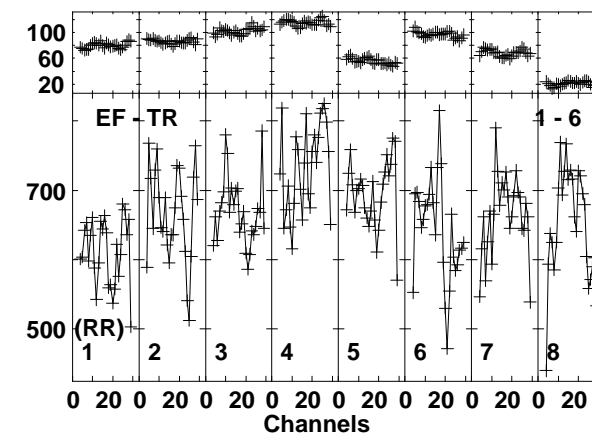
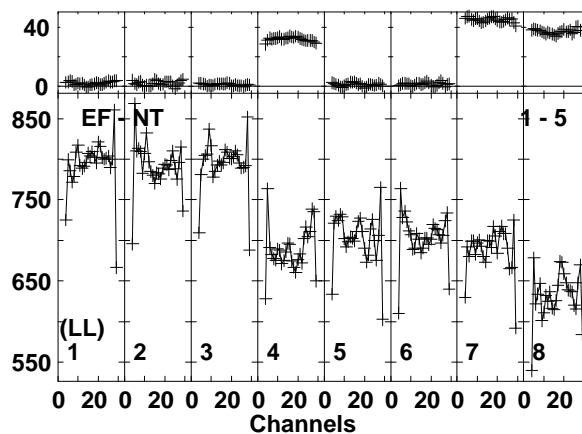
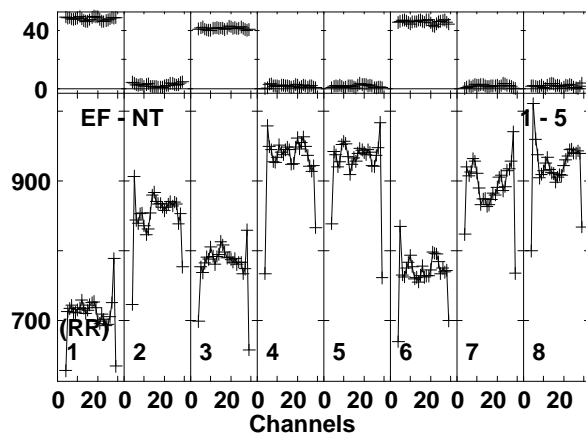
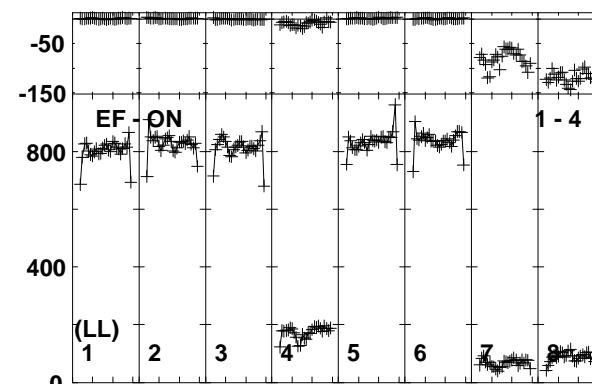
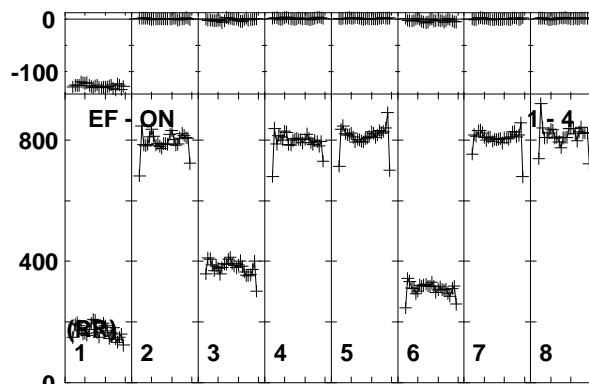
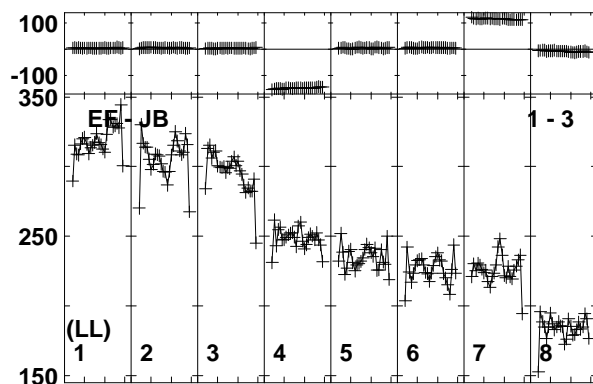
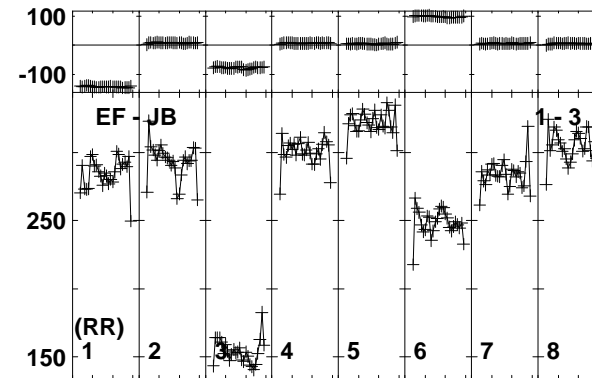
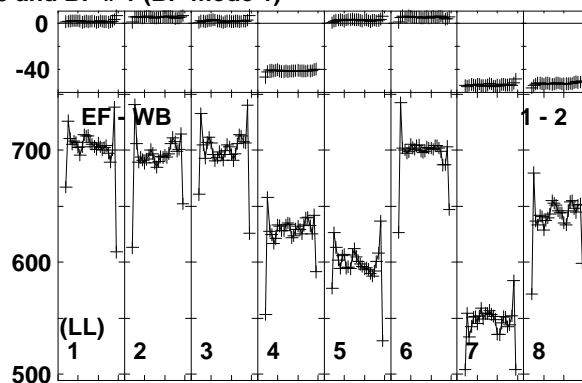
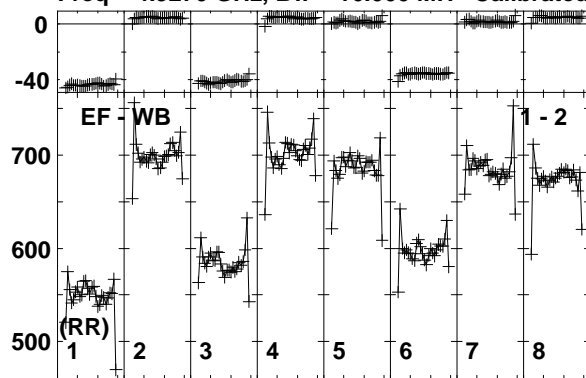

Lower frame: Milli Ampl Jy Top frame: Phas deg  
Vector averaged cross-power spectrum Baseline: EF (01) - WB (02)  
Timerange: 00/13/32:55 to 00/13/33:49

Plot file version 48 created 18-NOV-2014 15:23:14

J1128+5925 EP087H 3.UVDATA.1

Freq = 4.9270 GHz, Bw = 16.000 MH Calibrated with CL # 3 and BP # 1 (BP mode 1)

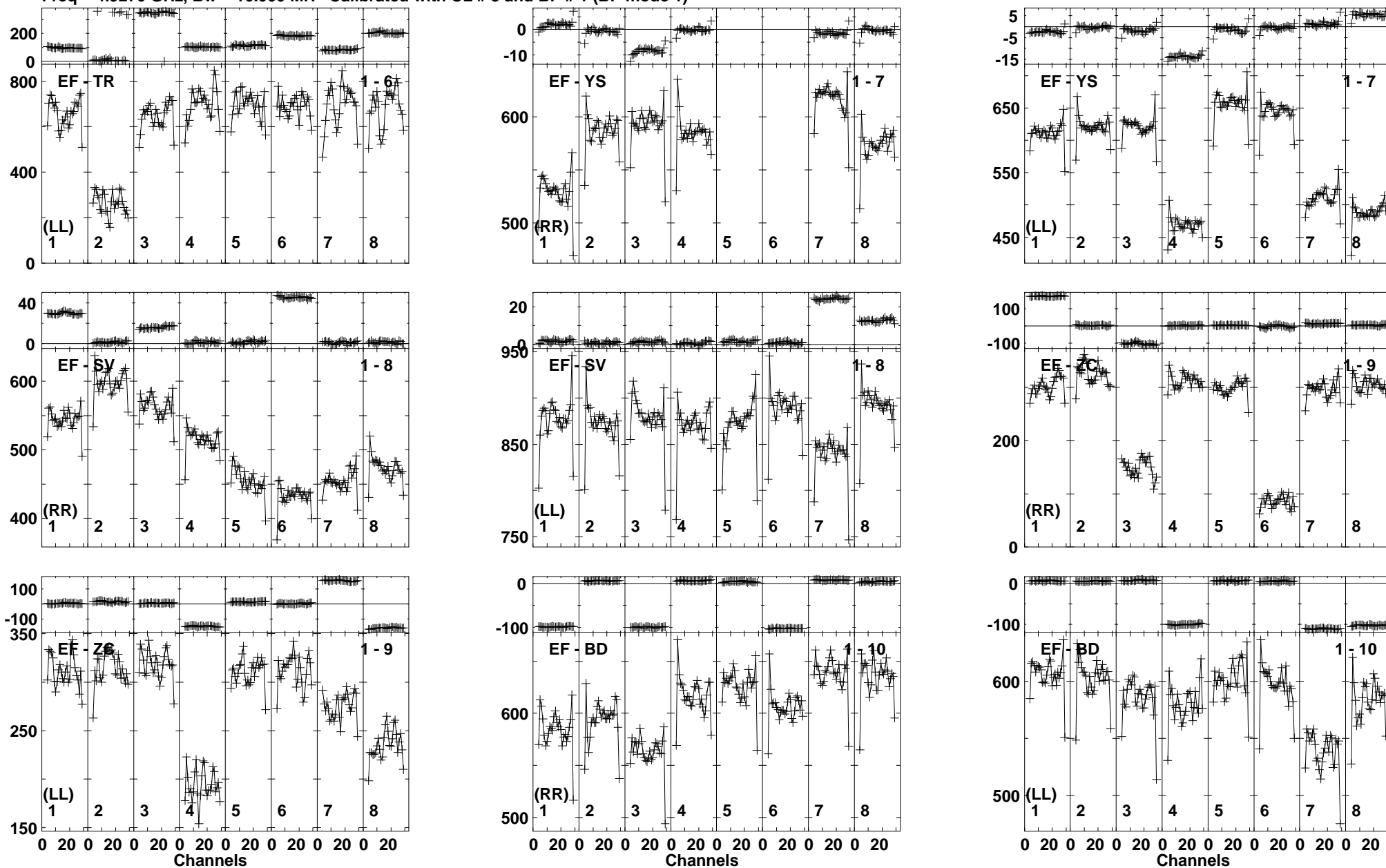

Lower frame: Milli Ampl Jy Top frame: Phas deg  
Vector averaged cross-power spectrum Baseline: EF (01) - TR (06)  
Timerange: 00/13:32:55 to 00/13:33:49



Plot file version 49 created 18-NOV-2014 15:23:14

J1128+5925 EP087H 3.UVDATA.1

Freq = 4.9270 GHz, Bw = 16.000 MH Calibrated with CL # 3 and BP # 1 (BP mode 1)

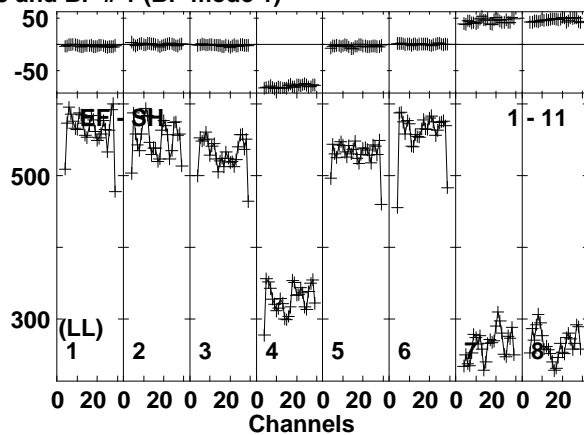
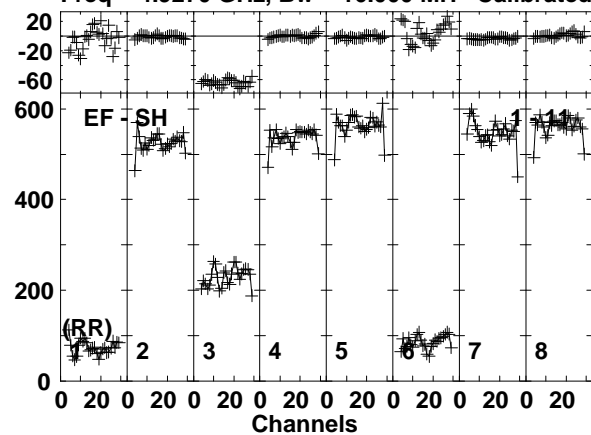

Lower frame: Milli Ampl Jy Top frame: Phas deg  
Vector averaged cross-power spectrum Baseline: EF (01) - SH (11)  
Timerange: 00/13:32:55 to 00/13:33:49

Plot file version 50 created 18-NOV-2014 15:23:14  
 ARP299C EP087H 3.UVDATA.1  
 Freq = 4.9270 GHz, Bw = 16.000 MH Calibrated with CL # 3 and BP # 1 (BP mode 1)

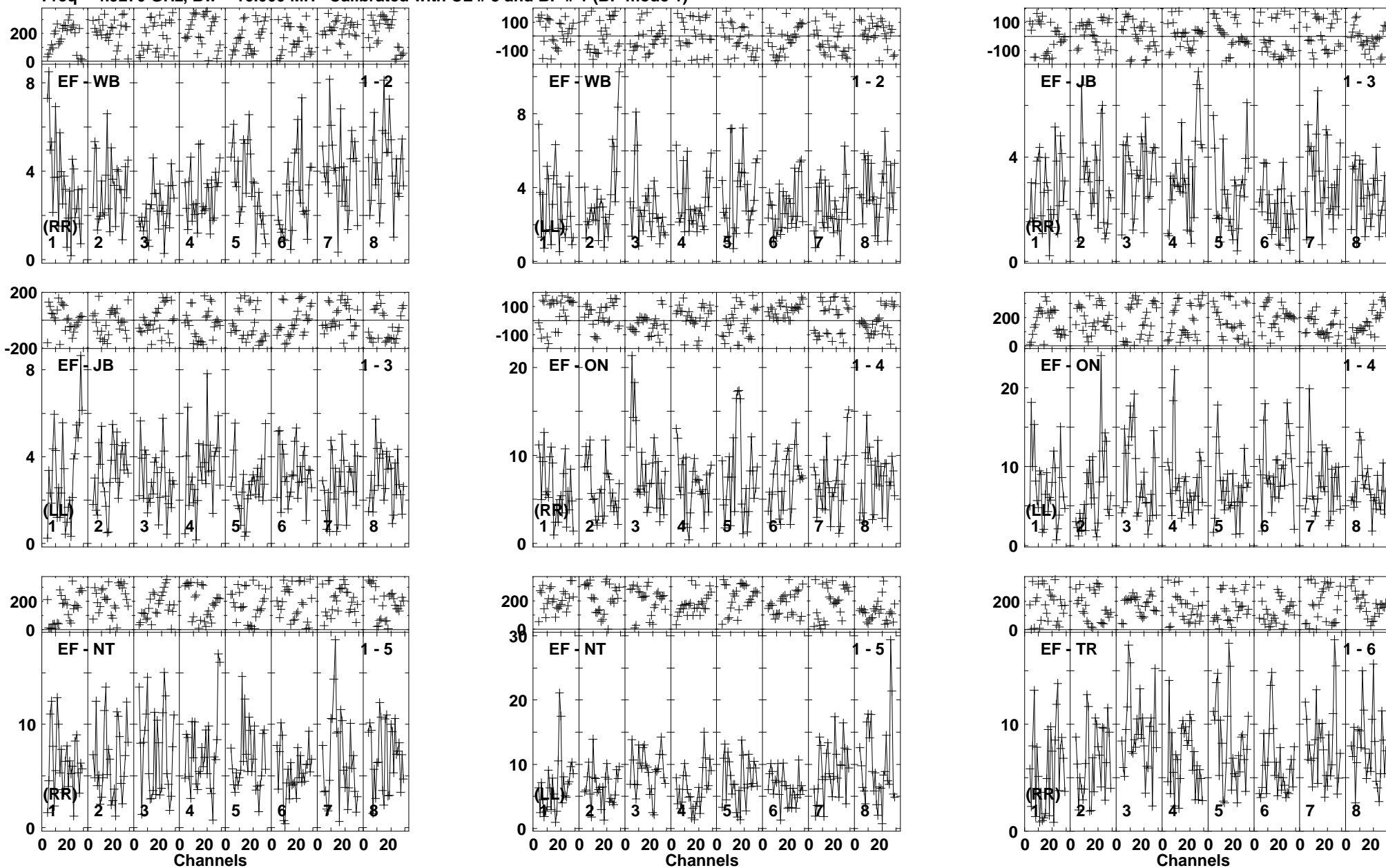

Lower frame: Milli Ampl Jy Top frame: Phas deg  
 Vector averaged cross-power spectrum Baseline: EF (01) - WB (02)  
 Timerange: 00/13:33:55 to 00/13:37:49

Plot file version 51 created 18-NOV-2014 15:23:14

ARP299C EP087H 3.UVDATA.1

Freq = 4.9270 GHz, Bw = 16.000 MH Calibrated with CL # 3 and BP # 1 (BP mode 1)

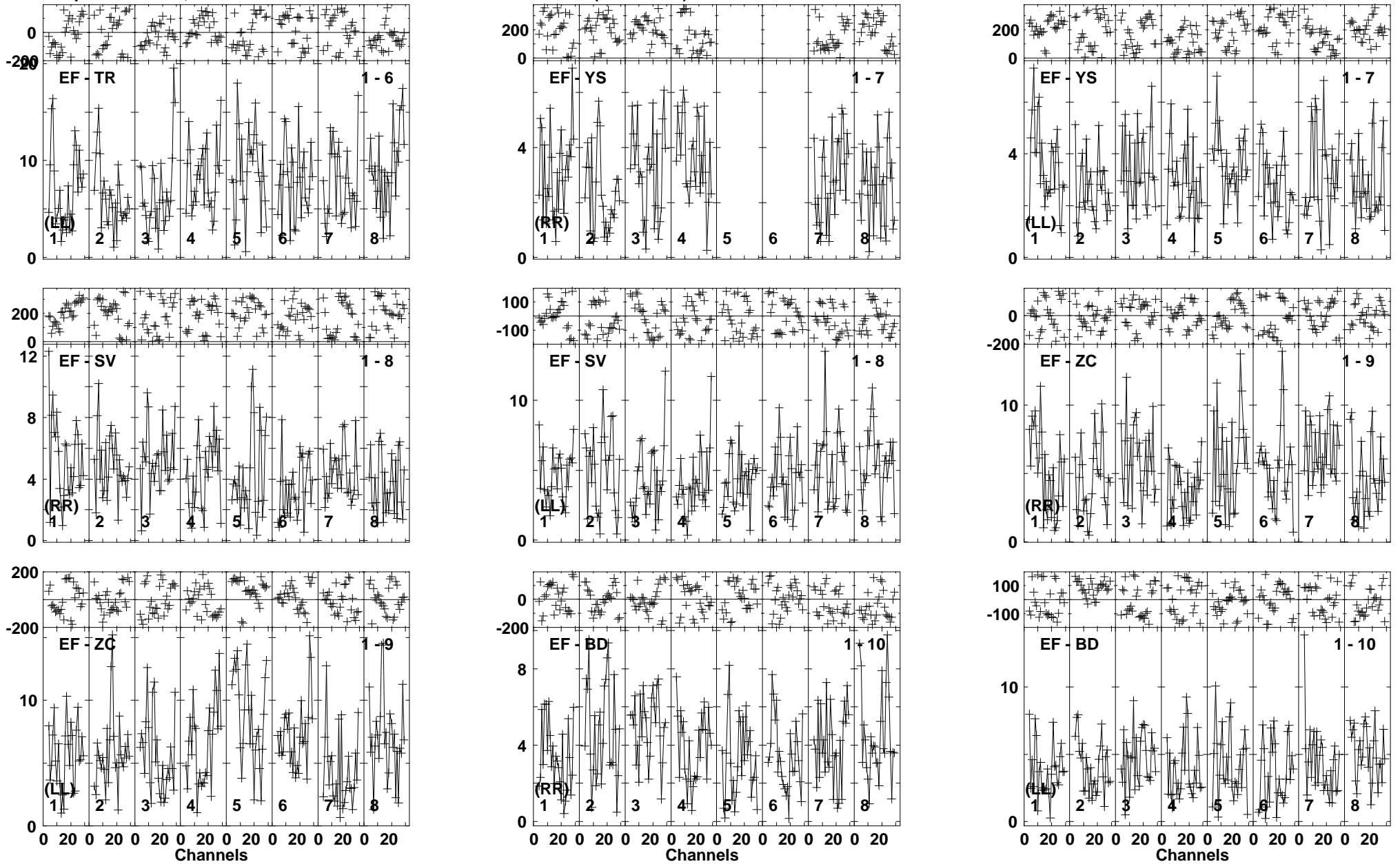

Lower frame: Milli Ampl Jy Top frame: Phas deg  
Vector averaged cross-power spectrum Baseline: EF (01) - TR (06)  
Timerange: 00/13:33:55 to 00/13:37:49

Plot file version 52 created 18-NOV-2014 15:23:14

ARP299C EP087H 3.UVDATA.1

Freq = 4.9270 GHz, Bw = 16.000 MH Calibrated with CL # 3 and BP # 1 (BP mode 1)

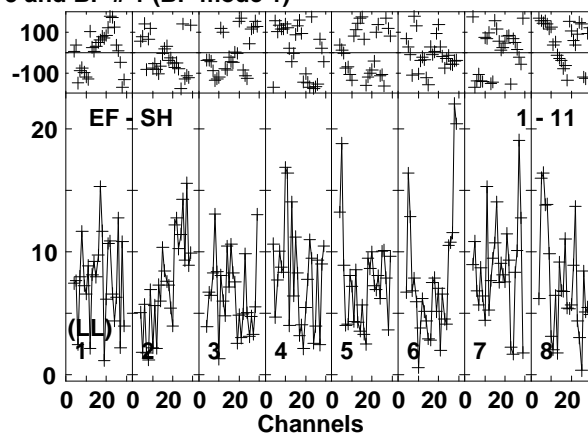
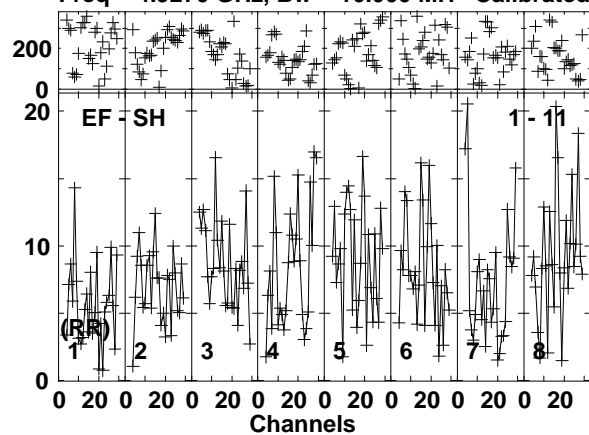

Lower frame: Milli Ampl Jy Top frame: Phas deg  
Vector averaged cross-power spectrum Baseline: EF (01) - SH (11)  
Timerange: 00/13:33:55 to 00/13:37:49

Plot file version 53 created 18-NOV-2014 15:23:15

J1128+5925 EP087H 3.UVDATA.1

Freq = 4.9270 GHz, Bw = 16.000 MH Calibrated with CL # 3 and BP # 1 (BP mode 1)

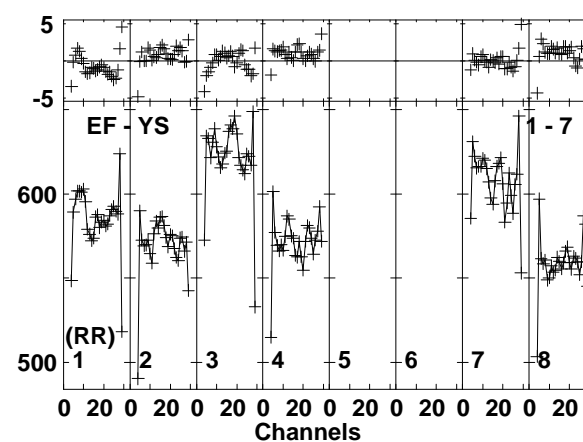
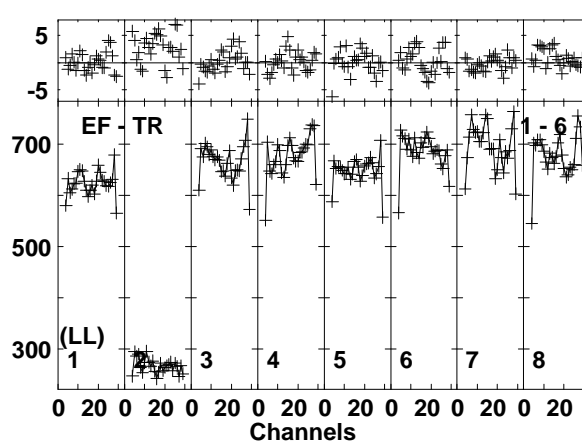
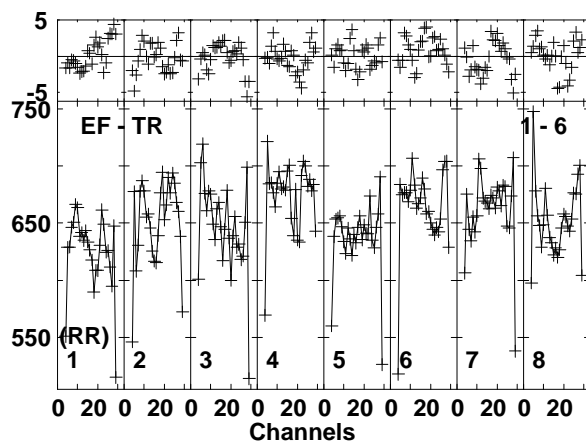
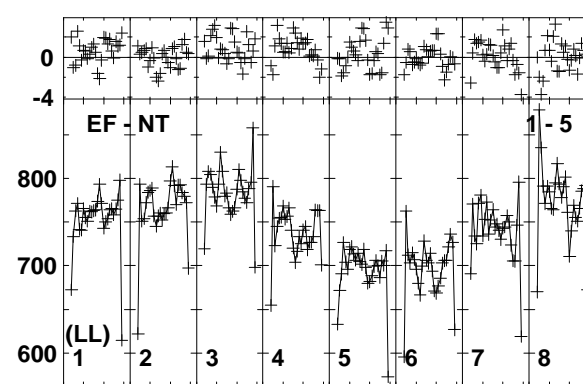
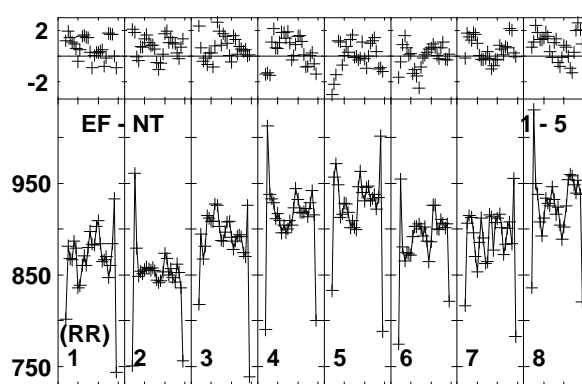
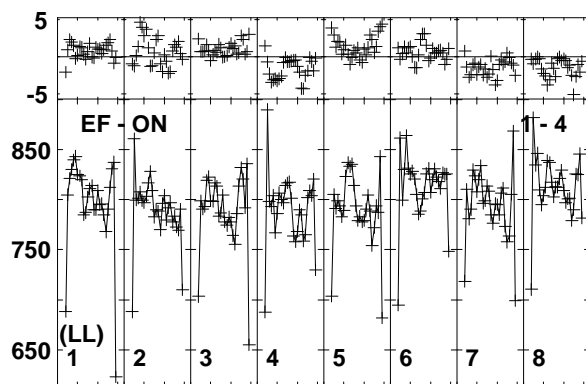
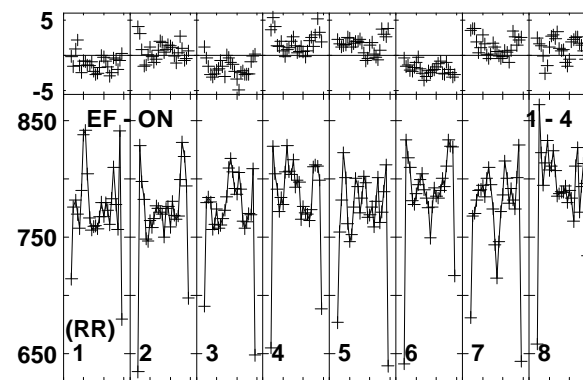
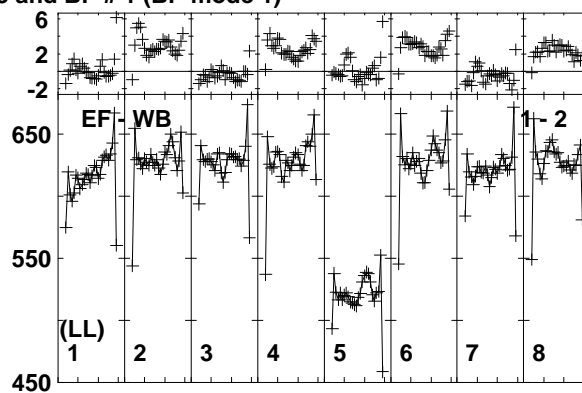
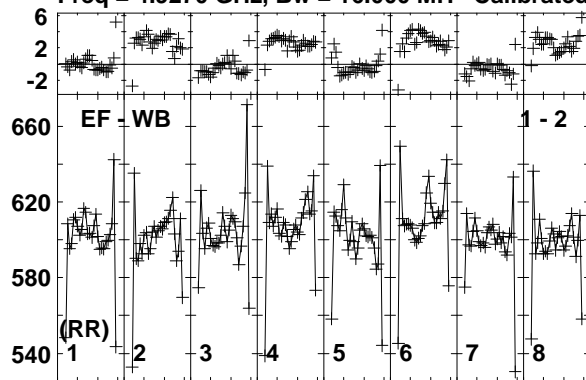

Lower frame: Milli Ampl Jy Top frame: Phas deg  
Vector averaged cross-power spectrum Baseline: EF (01) - WB (02)  
Timerange: 00/13:38:33 to 00/13:38:59

Plot file version 54 created 18-NOV-2014 15:23:15

J1128+5925 EP087H 3.UVDATA.1

Freq = 4.9270 GHz, Bw = 16.000 MH Calibrated with CL # 3 and BP # 1 (BP mode 1)

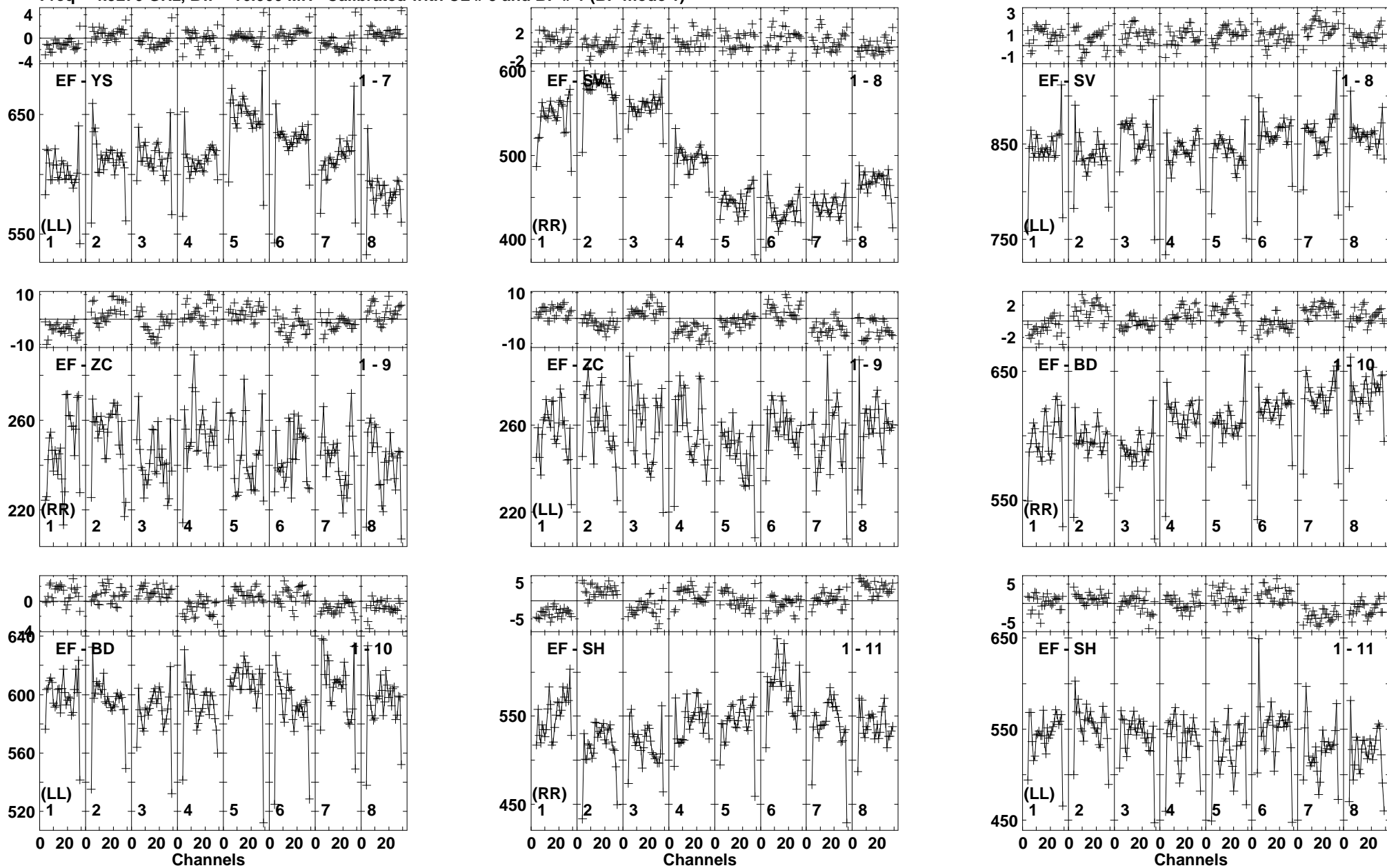

Plot file version 55 created 18-NOV-2014 15:23:15  
 ARP299C EP087H 3.UVDATA.1  
 Freq = 4.9270 GHz, Bw = 16.000 MH Calibrated with CL # 3 and BP # 1 (BP mode 1)

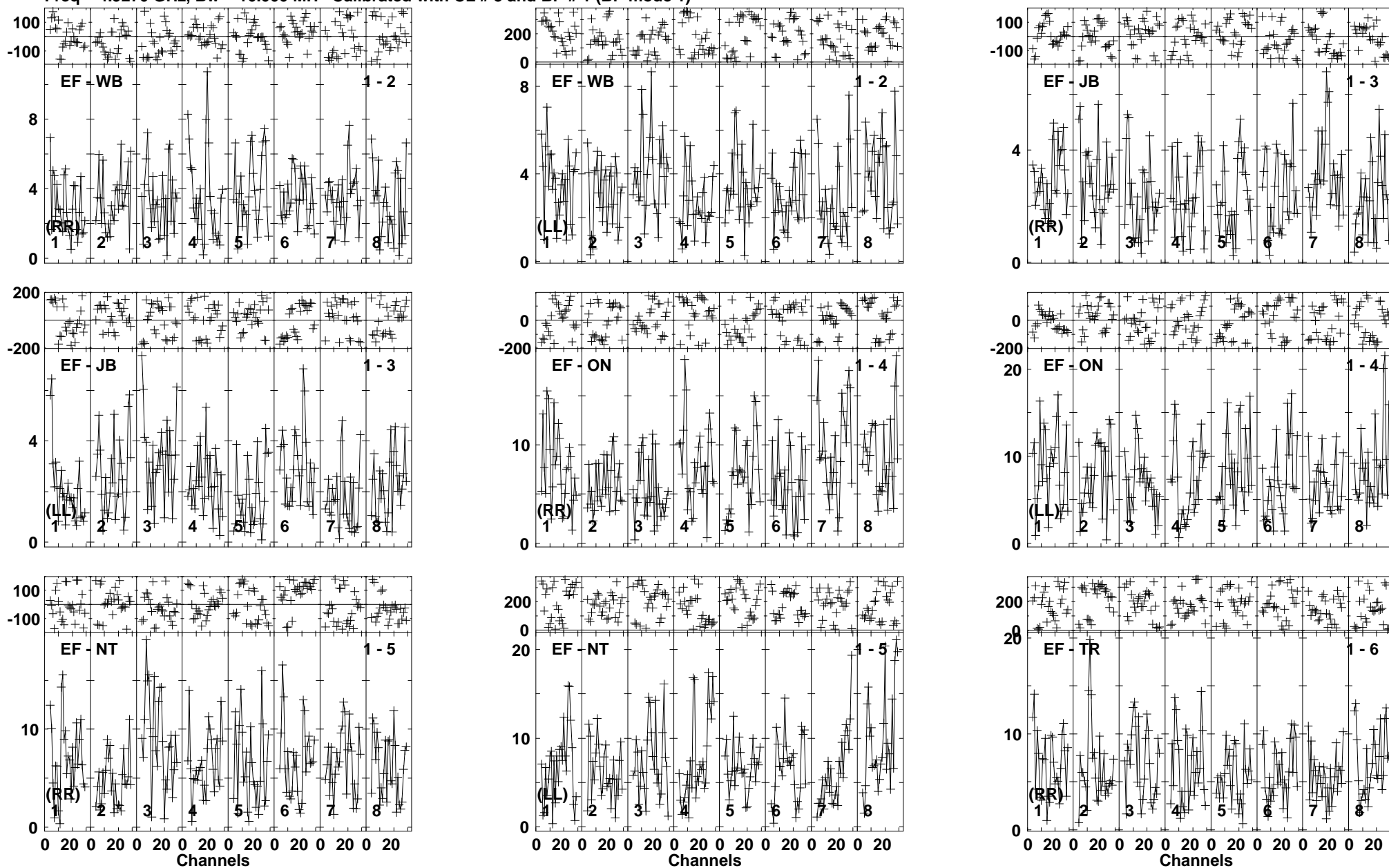

Lower frame: Milli Ampl Jy Top frame: Phas deg  
 Vector averaged cross-power spectrum Baseline: EF (01) - WB (02)  
 Timerange: 00:13:39:01 to 00:13:42:59

Plot file version 56 created 18-NOV-2014 15:23:15

ARP299C EP087H 3.UVDATA.1

Freq = 4.9270 GHz, Bw = 16.000 MH Calibrated with CL # 3 and BP # 1 (BP mode 1)

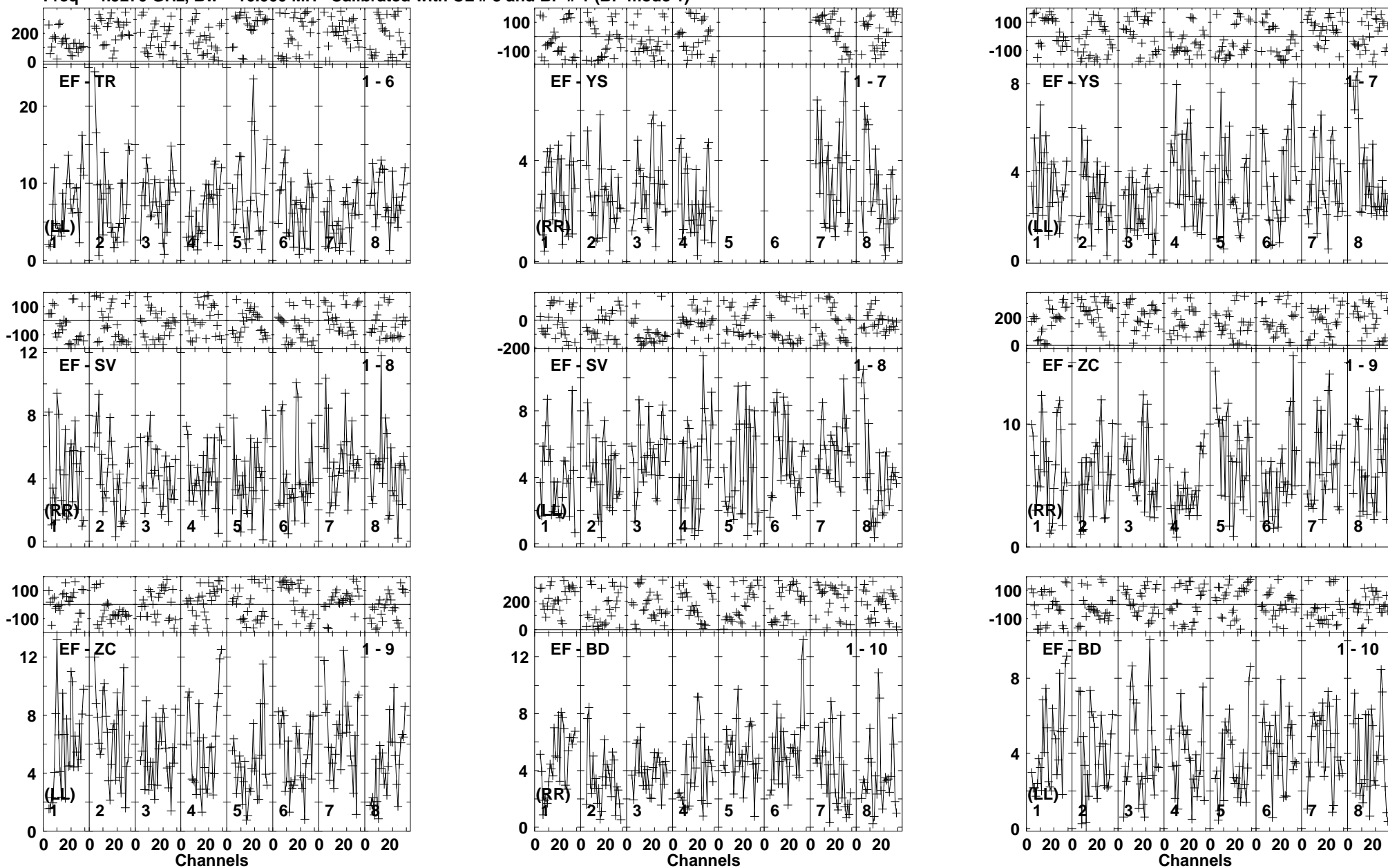

Lower frame: Milli Ampl Jy Top frame: Phas deg  
Vector averaged cross-power spectrum Baseline: EF (01) - TR (06)  
Timerange: 00/13:39:01 to 00/13:42:59



Plot file version 57 created 18-NOV-2014 15:23:15

ARP299C EP087H 3.UVDATA.1

Freq = 4.9270 GHz, Bw = 16.000 MH Calibrated with CL # 3 and BP # 1 (BP mode 1)

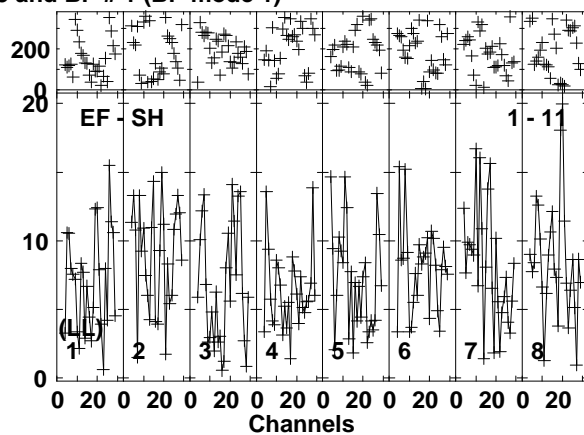
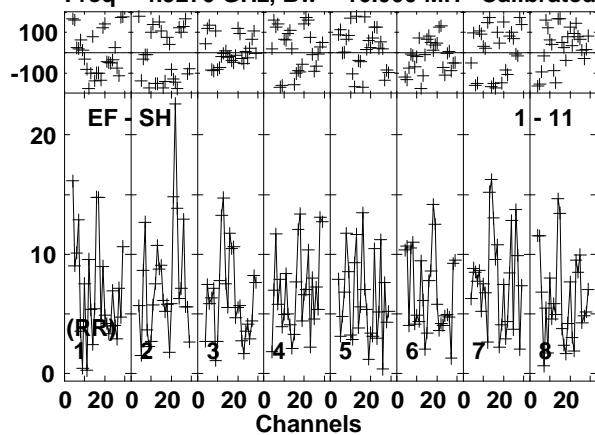

Lower frame: Milli Ampl Jy Top frame: Phas deg  
Vector averaged cross-power spectrum Baseline: EF (01) - SH (11)  
Timerange: 00/13:39:01 to 00/13:42:59

Plot file version 58 created 18-NOV-2014 15:23:16

J1128+5925 EP087H 3.UVDATA.1

Freq = 4.9270 GHz, Bw = 16.000 MH Calibrated with CL # 3 and BP # 1 (BP mode 1)

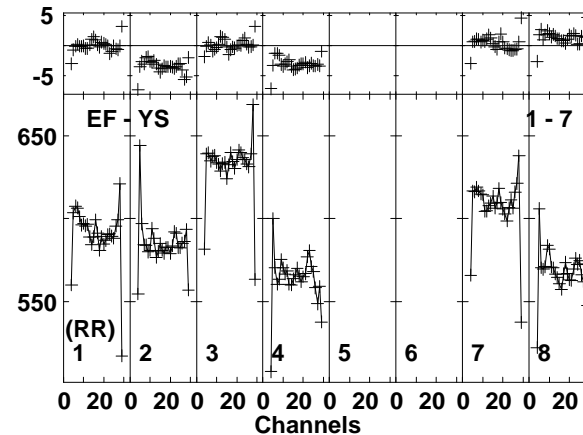
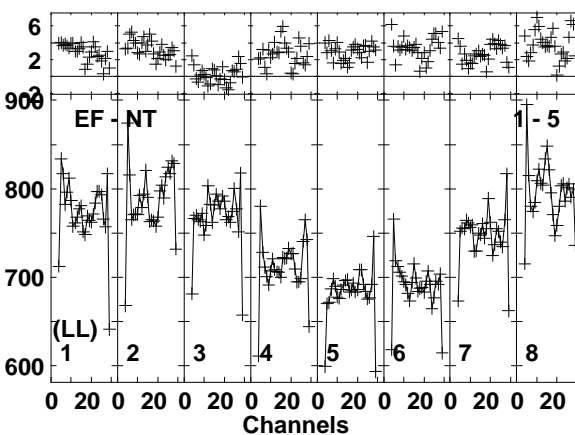
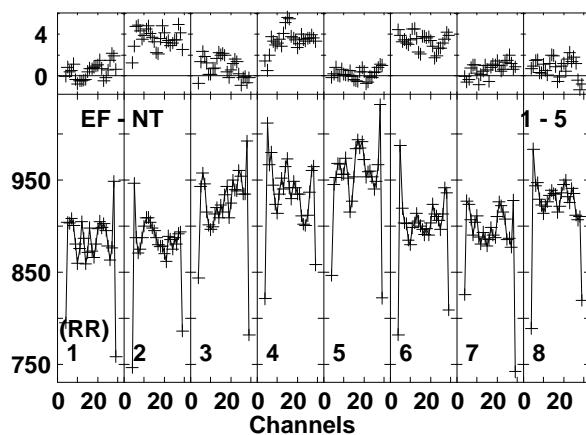
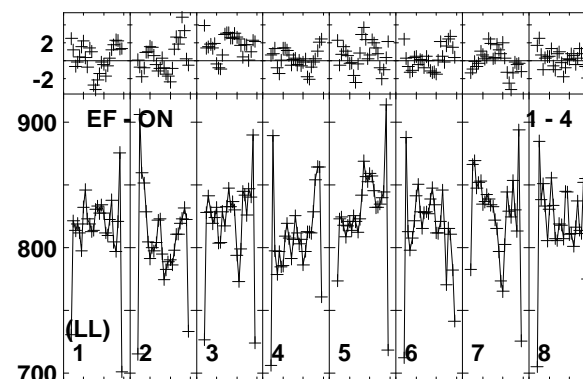
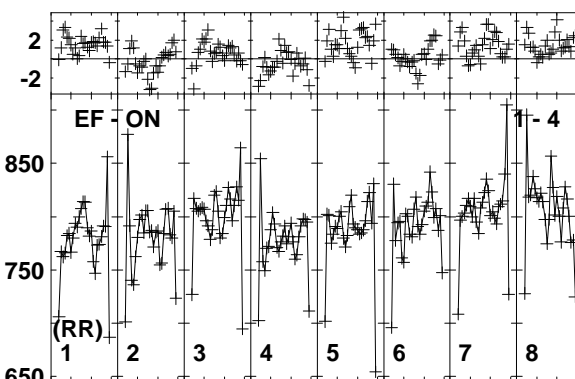
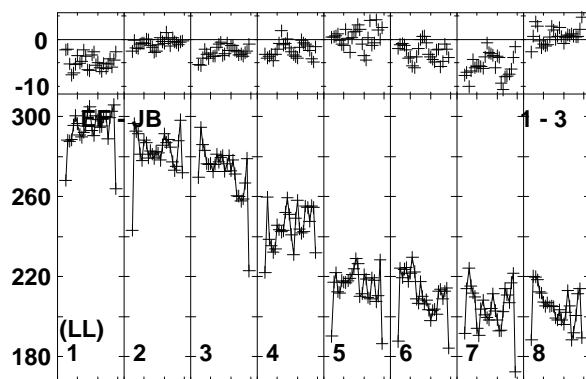
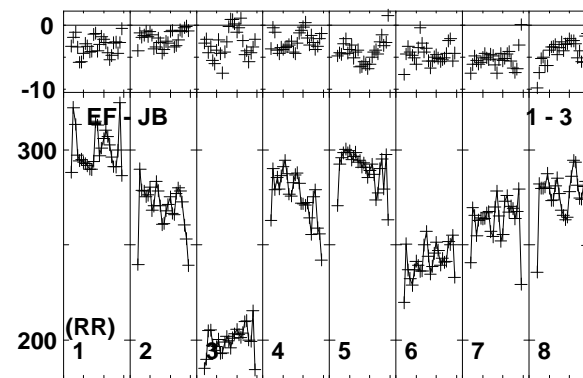
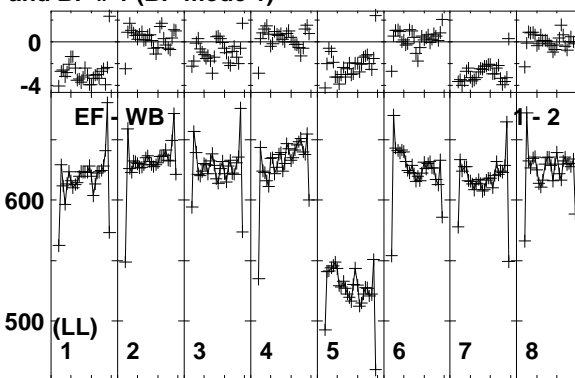
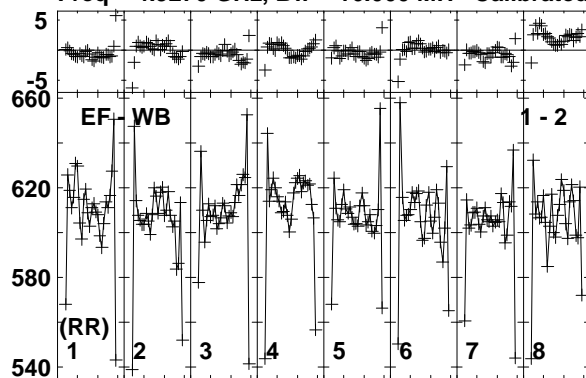

Lower frame: Milli Ampl Jy Top frame: Phas deg  
Vector averaged cross-power spectrum Baseline: EF (01) - WB (02)  
Timerange: 00/13:43:05 to 00/13:43:59

Plot file version 59 created 18-NOV-2014 15:23:16

J1128+5925 EP087H 3.UVDATA.1

Freq = 4.9270 GHz, Bw = 16.000 MH Calibrated with CL # 3 and BP # 1 (BP mode 1)

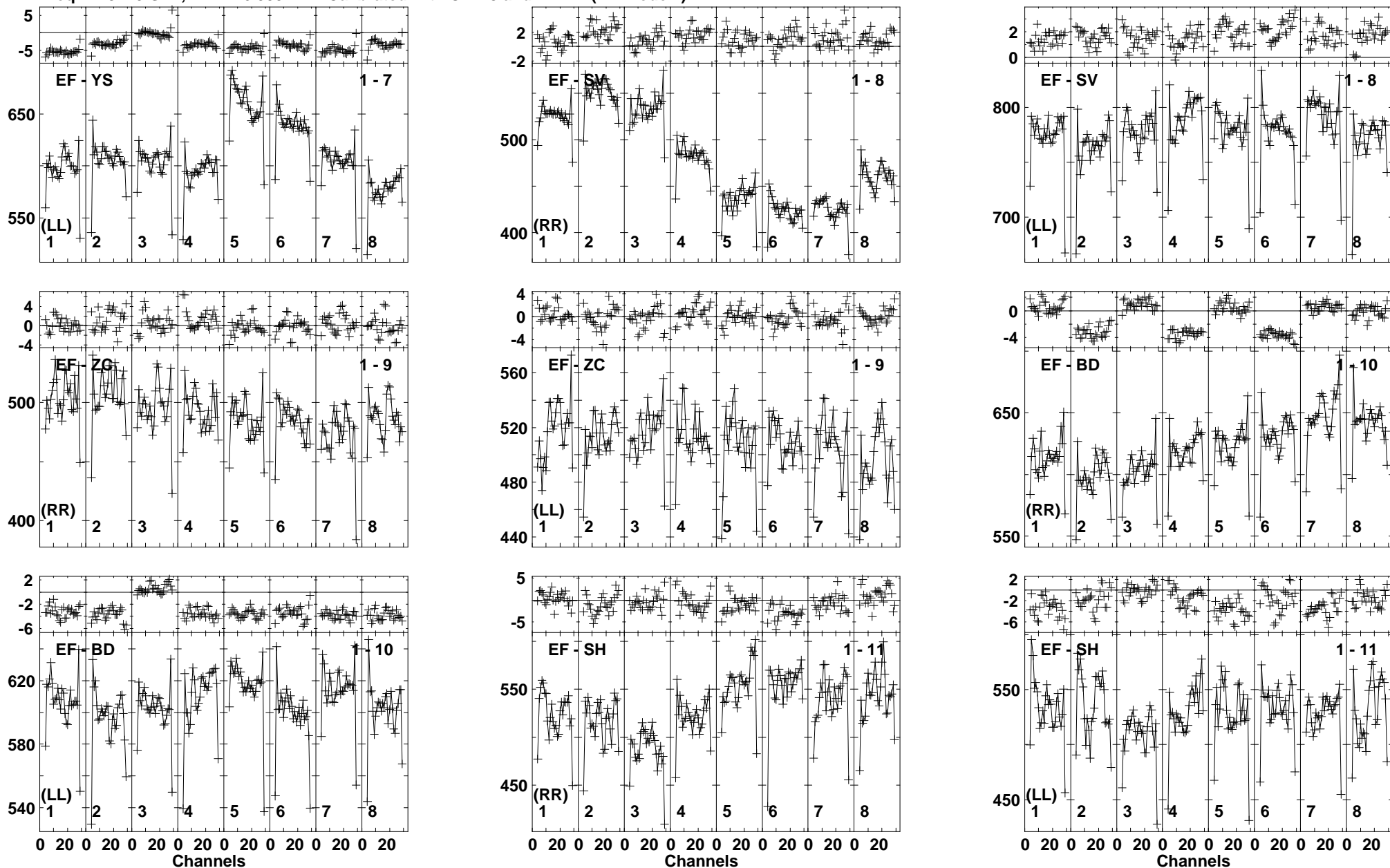

Lower frame: Milli Ampl Jy Top frame: Phas deg  
Vector averaged cross-power spectrum Baseline: EF (01) - YS (07)  
Timerange: 00/13:43:05 to 00/13:43:59

Plot file version 60 created 18-NOV-2014 15:23:16

ARP299C EP087H 3.UVDATA.1

Freq = 4.9270 GHz, Bw = 16.000 MH Calibrated with CL # 3 and BP # 1 (BP mode 1)

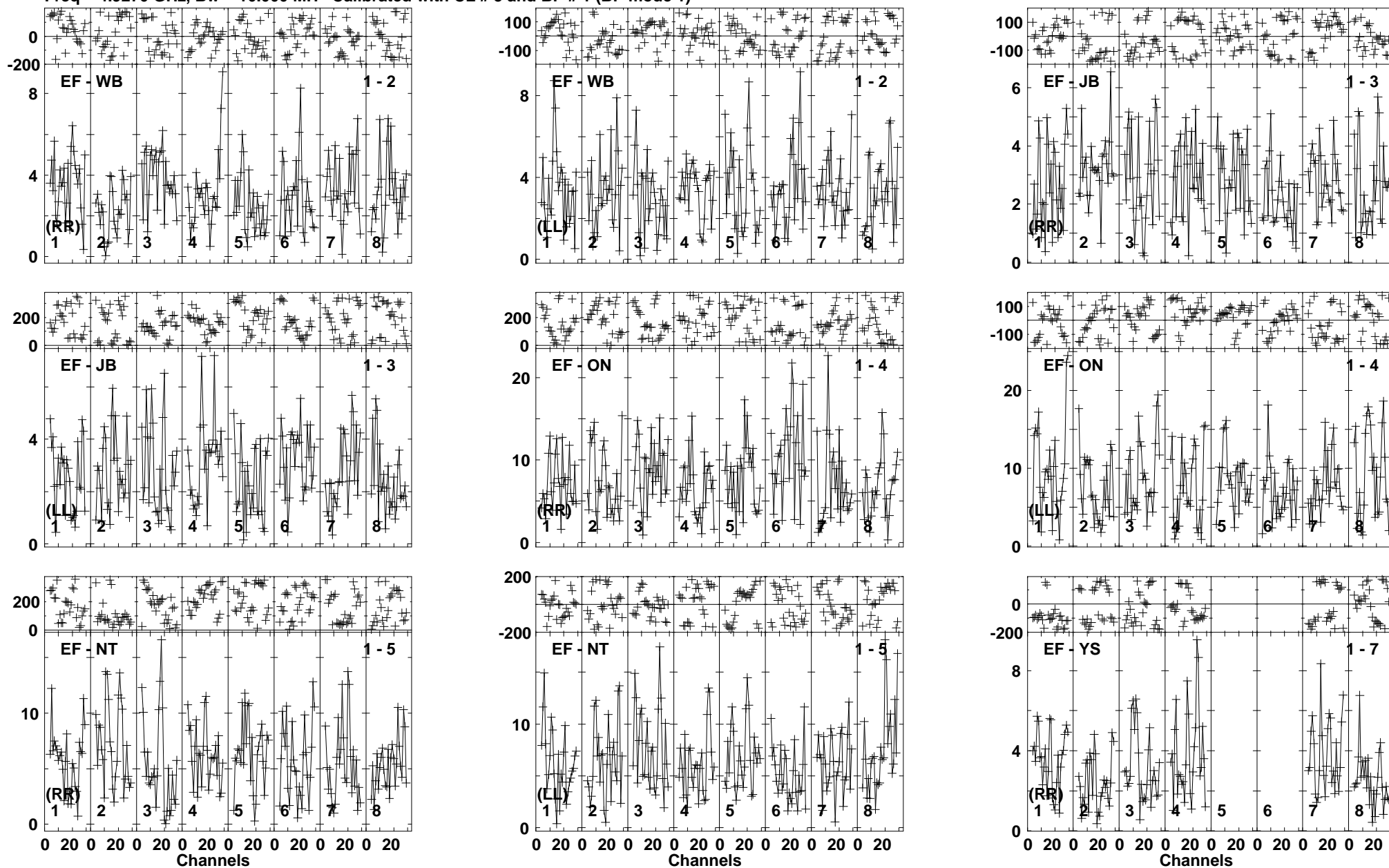

Lower frame: Milli Ampl Jy Top frame: Phas deg  
Vector averaged cross-power spectrum Baseline: EF (01) - WB (02)  
Timerange: 00/13:44:05 to 00/13:47:59

Plot file version 61 created 18-NOV-2014 15:23:16

ARP299C EP087H 3.UVDATA.1

Freq = 4.9270 GHz, Bw = 16.000 MH Calibrated with CL # 3 and BP # 1 (BP mode 1)

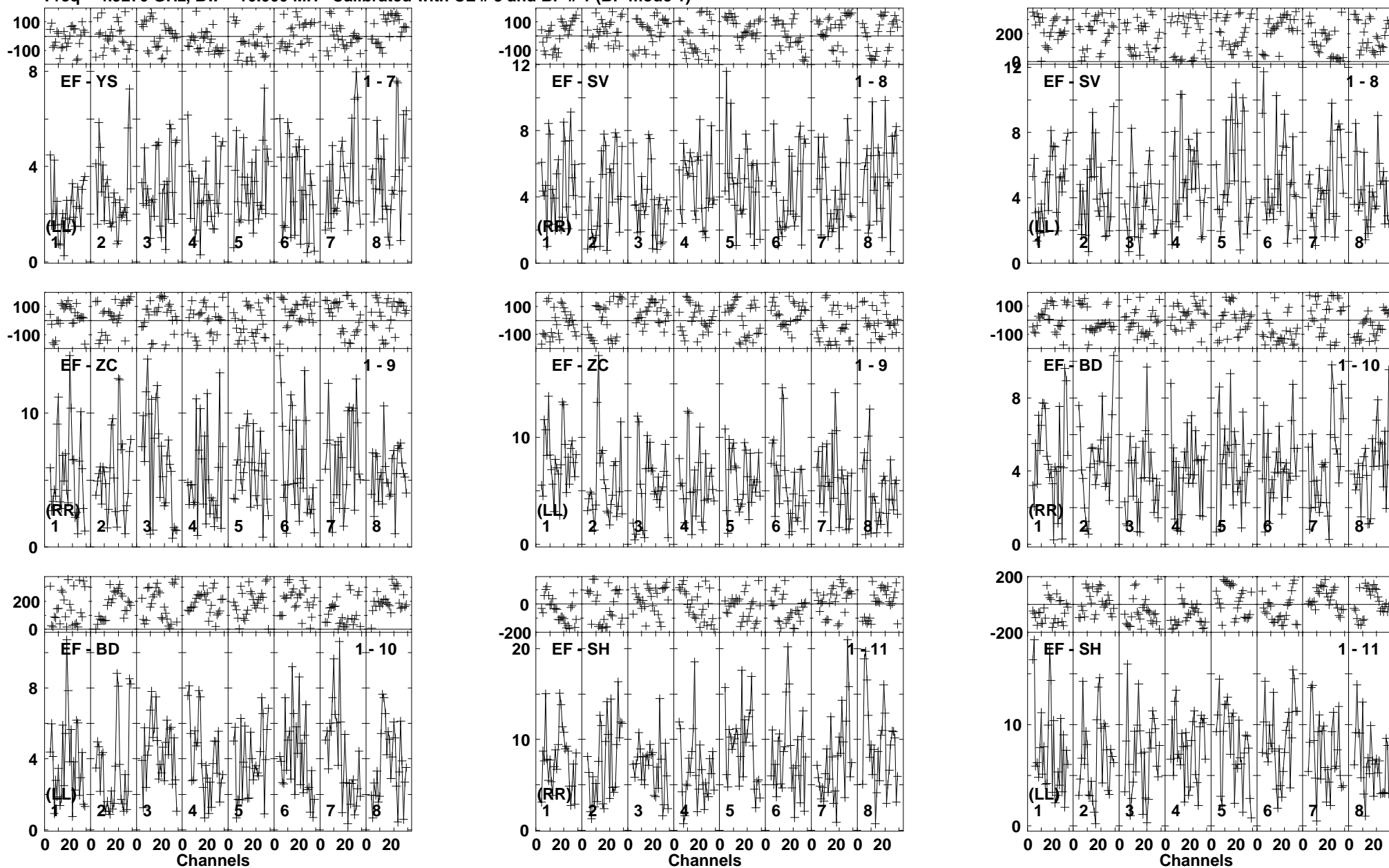

Lower frame: Milli Ampl Jy Top frame: Phas deg  
Vector averaged cross-power spectrum Baseline: EF (01) - YS (07)  
Timerange: 00/13:44:05 to 00/13:47:59

Plot file version 62 created 18-NOV-2014 15:23:17

J1128+5925 EP087H 3.UVDATA.1

Freq = 4.9270 GHz, Bw = 16.000 MH Calibrated with CL # 3 and BP # 1 (BP mode 1)

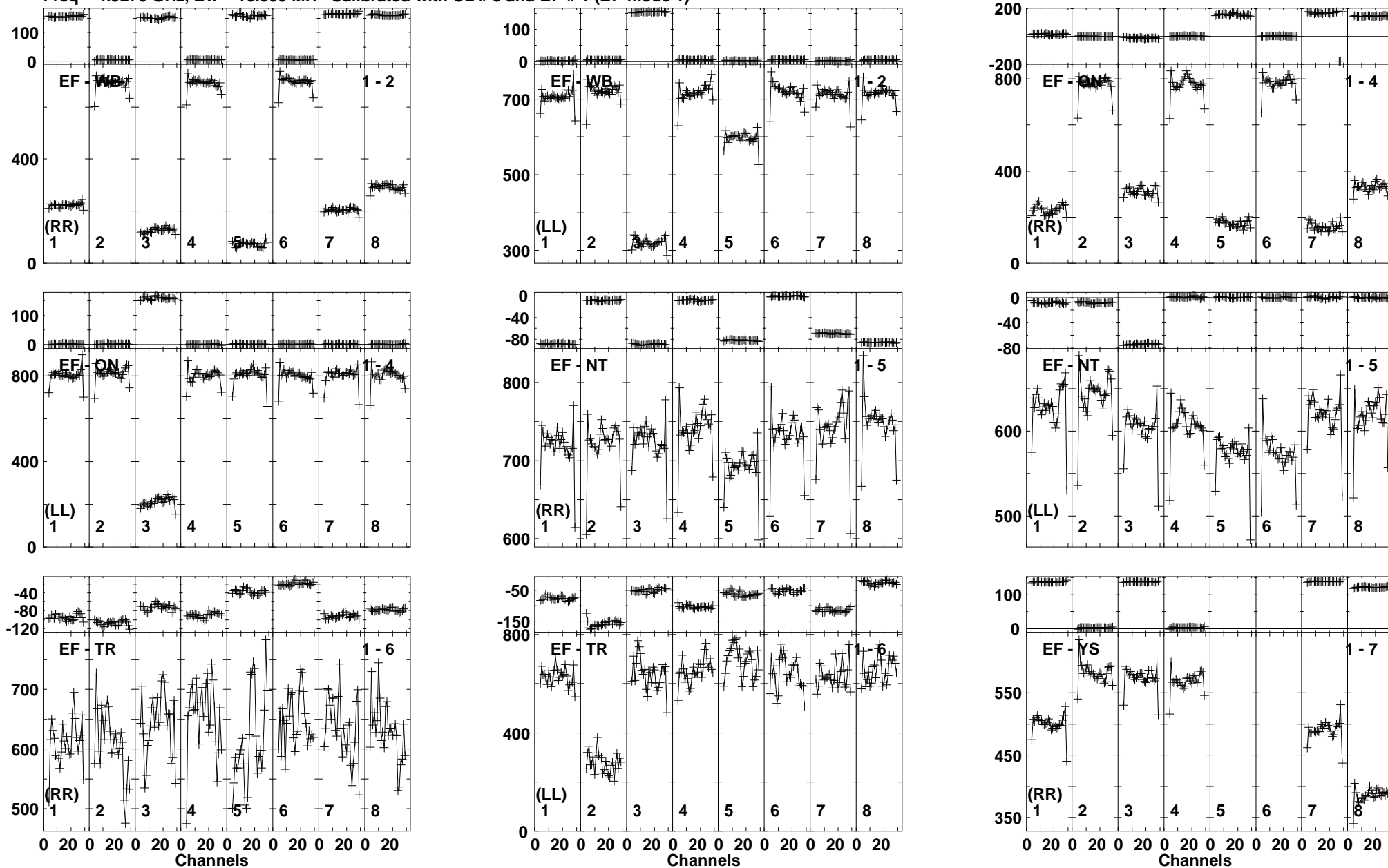

Lower frame: Milli Ampl Jy Top frame: Phas deg  
Vector averaged cross-power spectrum Baseline: EF (01) - WB (02)  
Timerange: 00/13:48:05 to 00/13:48:59

Plot file version 63 created 18-NOV-2014 15:23:17  
 J1128+5925 EP087H 3.UVDATA.1  
 Freq = 4.9270 GHz, Bw = 16.000 MH Calibrated with CL # 3 and BP # 1 (BP mode 1)

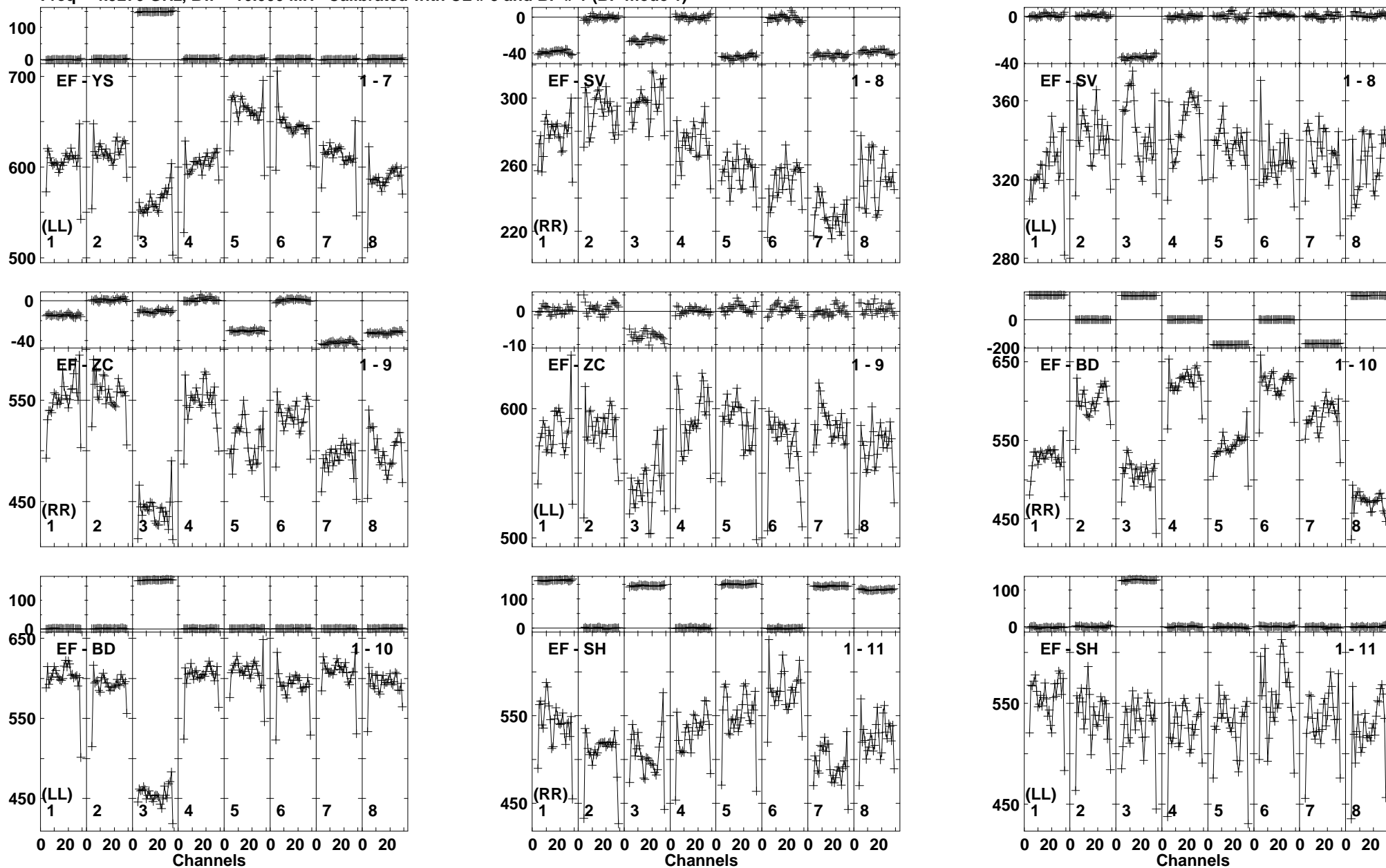

Lower frame: Milli Ampl Jy Top frame: Phas deg  
 Vector averaged cross-power spectrum Baseline: EF (01) - YS (07)  
 Timerange: 00/13:48:05 to 00/13:48:59

Plot file version 64 created 18-NOV-2014 15:23:17  
 ARP299C EP087H 3.UVDATA.1  
 Freq = 4.9270 GHz, Bw = 16.000 MH Calibrated with CL # 3 and BP # 1 (BP mode 1)

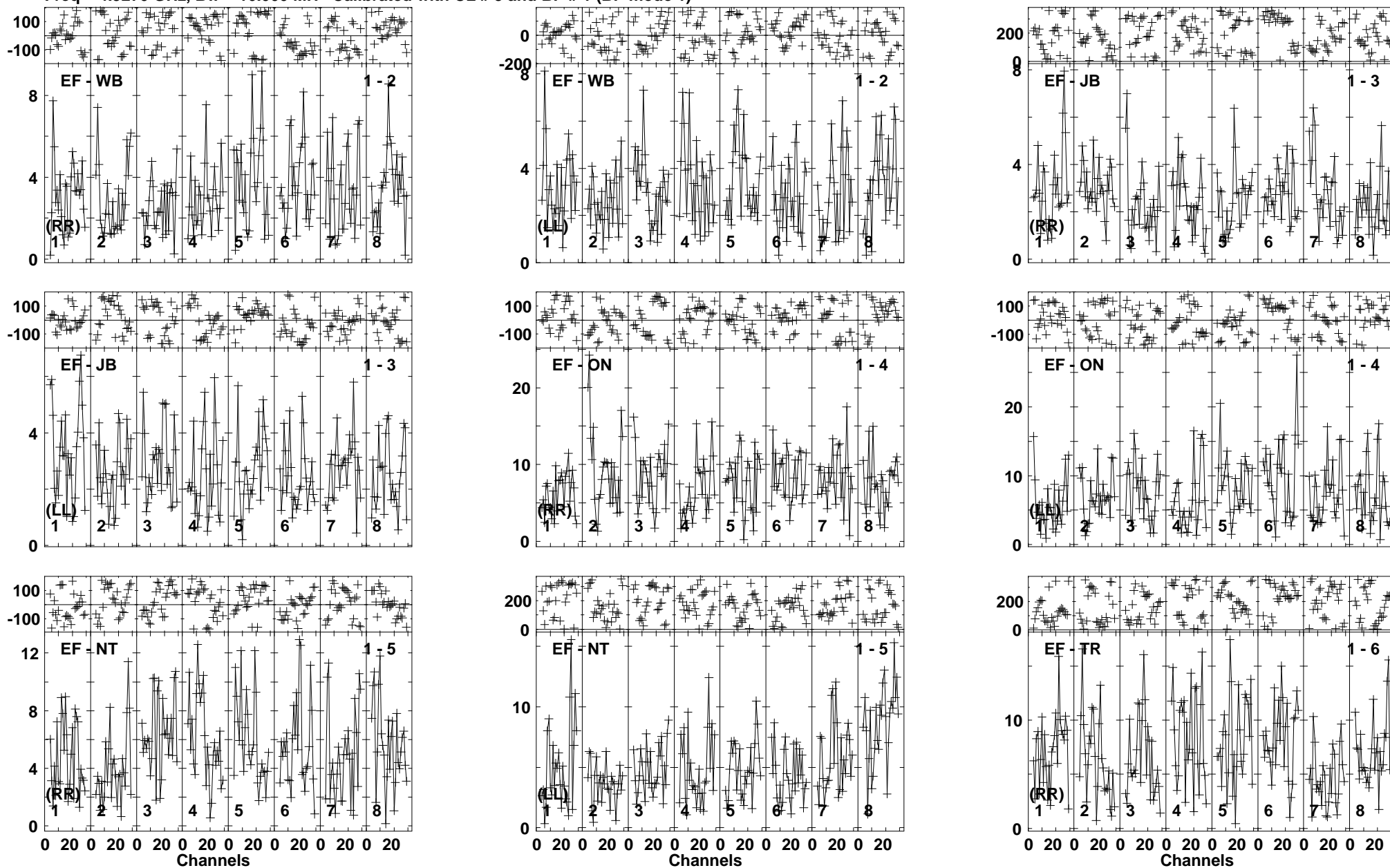

Lower frame: Milli Ampl Jy Top frame: Phas deg  
 Vector averaged cross-power spectrum Baseline: EF (01) - WB (02)  
 Timerange: 00:13:49:01 to 00:13:52:59



Plot file version 65 created 18-NOV-2014 15:23:17  
 ARP299C EP087H 3.UVDATA.1  
 Freq = 4.9270 GHz, Bw = 16.000 MH Calibrated with CL # 3 and BP # 1 (BP mode 1)

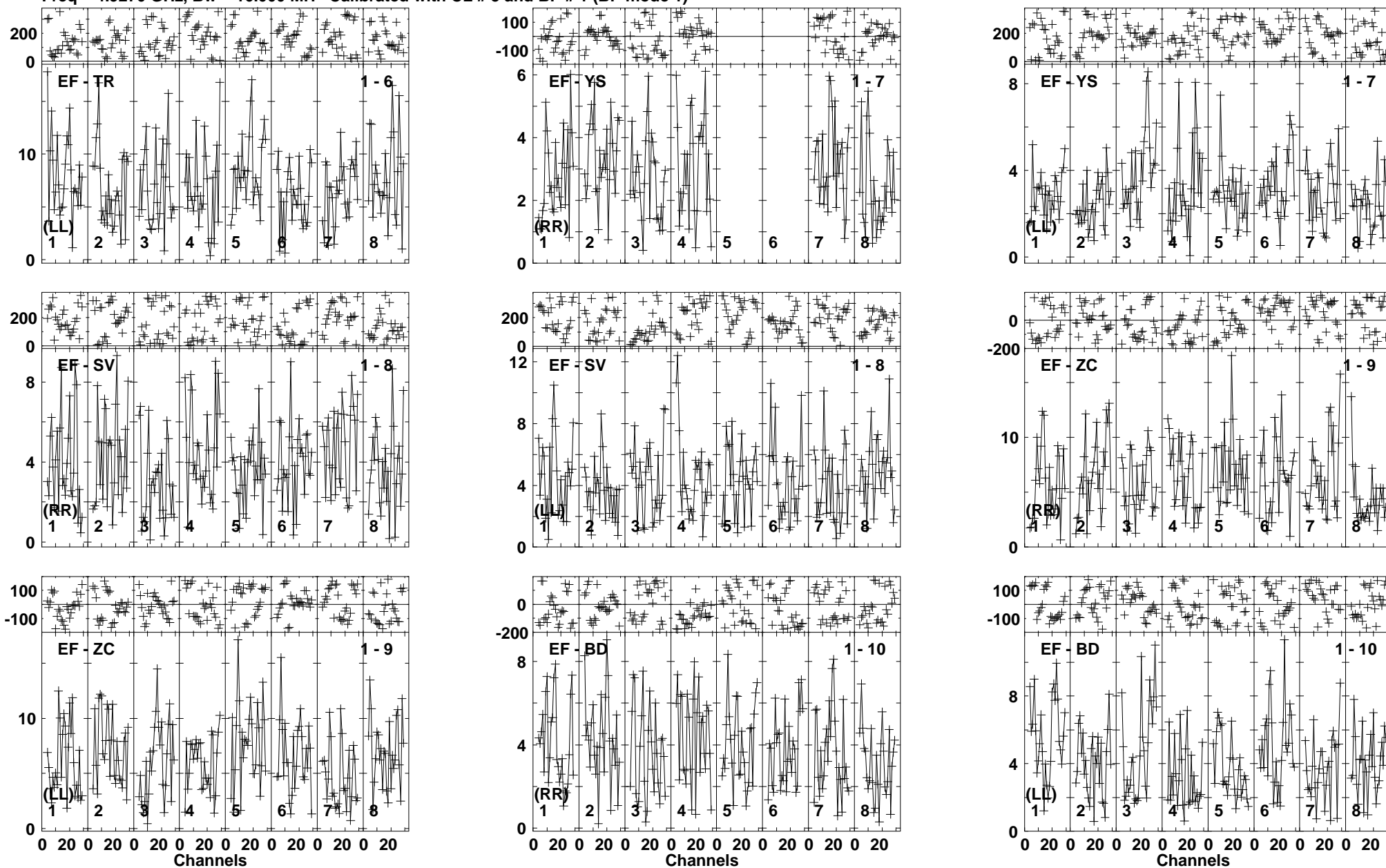

Lower frame: Milli Ampl Jy Top frame: Phas deg  
 Vector averaged cross-power spectrum Baseline: EF (01) - TR (06)  
 Timerange: 00/13:49:01 to 00/13:52:59

Plot file version 66 created 18-NOV-2014 15:23:18

ARP299C EP087H 3.UVDATA.1

Freq = 4.9270 GHz, Bw = 16.000 MH Calibrated with CL # 3 and BP # 1 (BP mode 1)

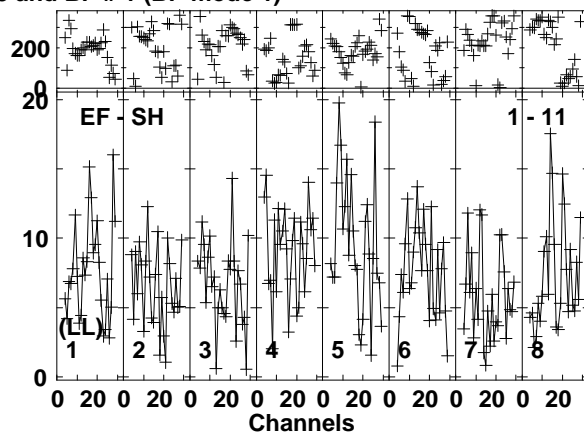
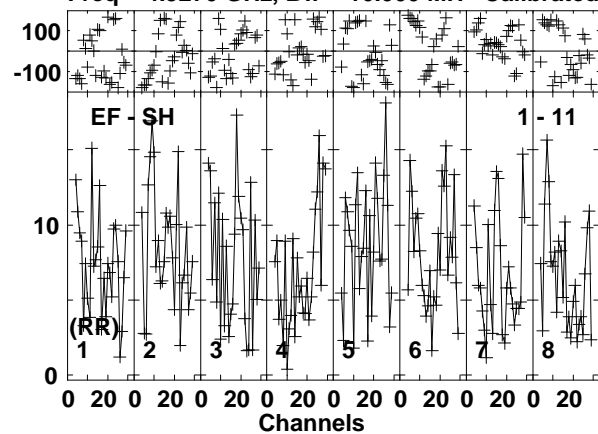

Lower frame: Milli Ampl Jy Top frame: Phas deg  
Vector averaged cross-power spectrum Baseline: EF (01) - SH (11)  
Timerange: 00/13:49:01 to 00/13:52:59

Plot file version 67 created 18-NOV-2014 15:23:18

J1128+5925 EP087H 3.UVDATA.1

Freq = 4.9270 GHz, Bw = 16.000 MH Calibrated with CL # 3 and BP # 1 (BP mode 1)

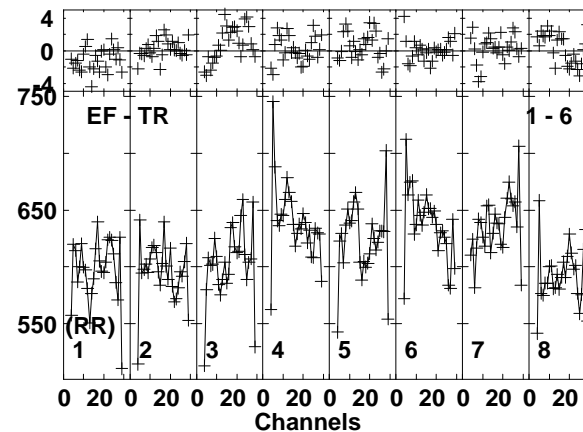
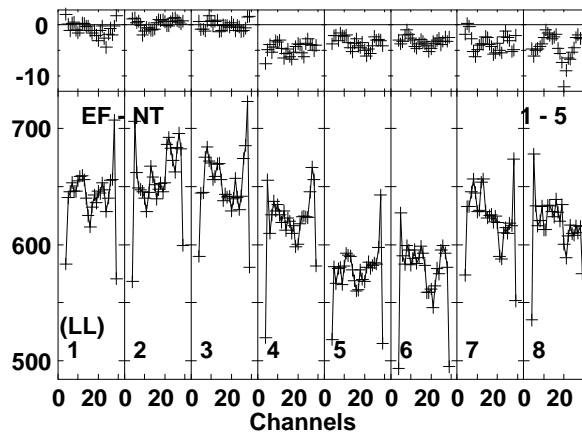
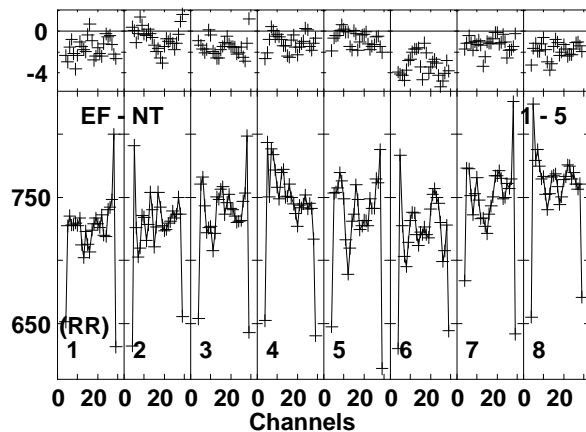
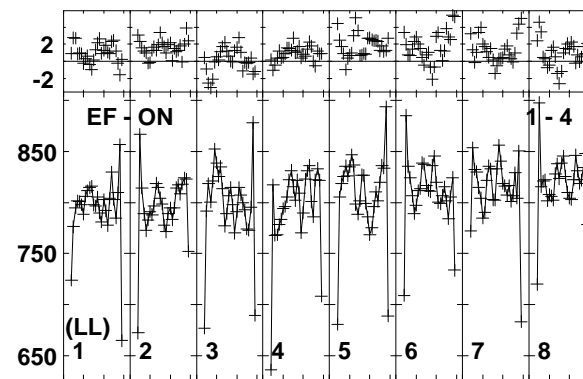
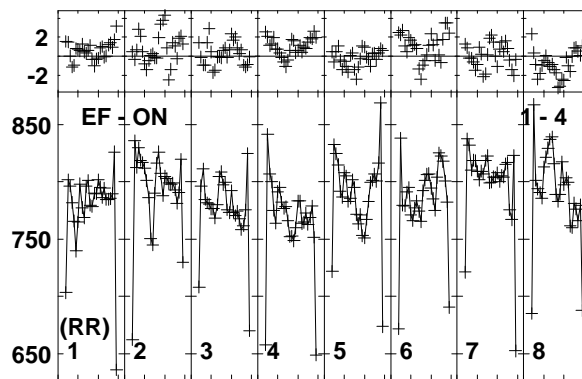
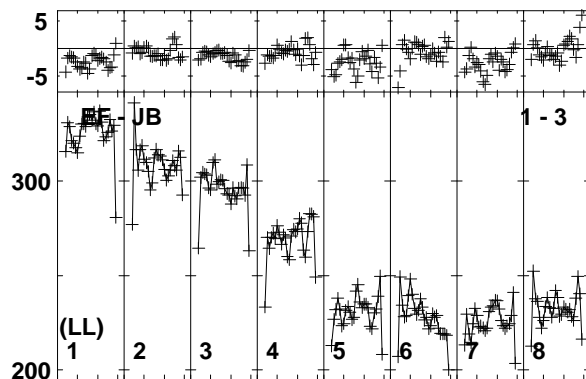
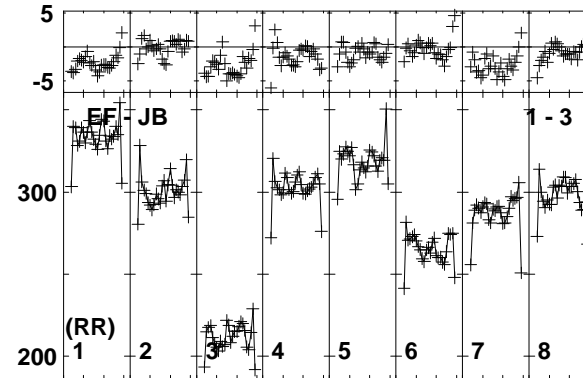
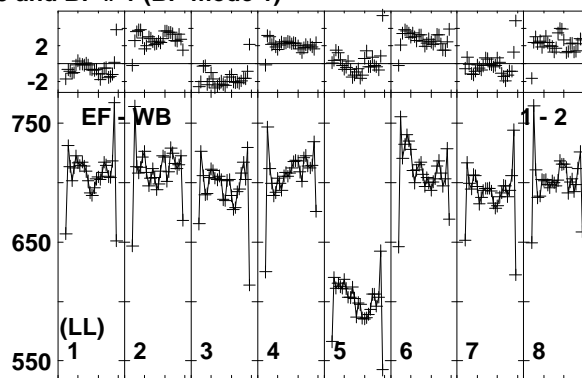
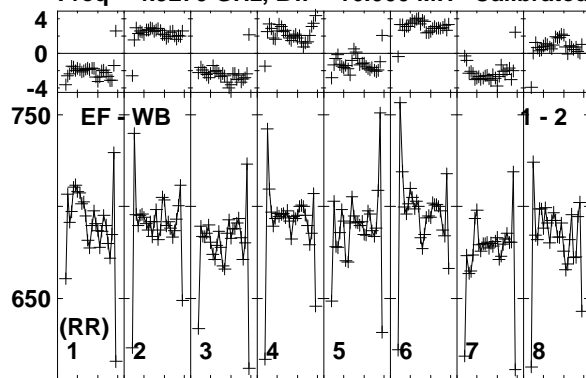

Lower frame: Milli Ampl Jy Top frame: Phas deg  
Vector averaged cross-power spectrum Baseline: EF (01) - WB (02)  
Timerange: 00/13:53:41 to 00/13:54:09

Plot file version 68 created 18-NOV-2014 15:23:18

J1128+5925 EP087H 3.UVDATA.1

Freq = 4.9270 GHz, Bw = 16.000 MH Calibrated with CL # 3 and BP # 1 (BP mode 1)

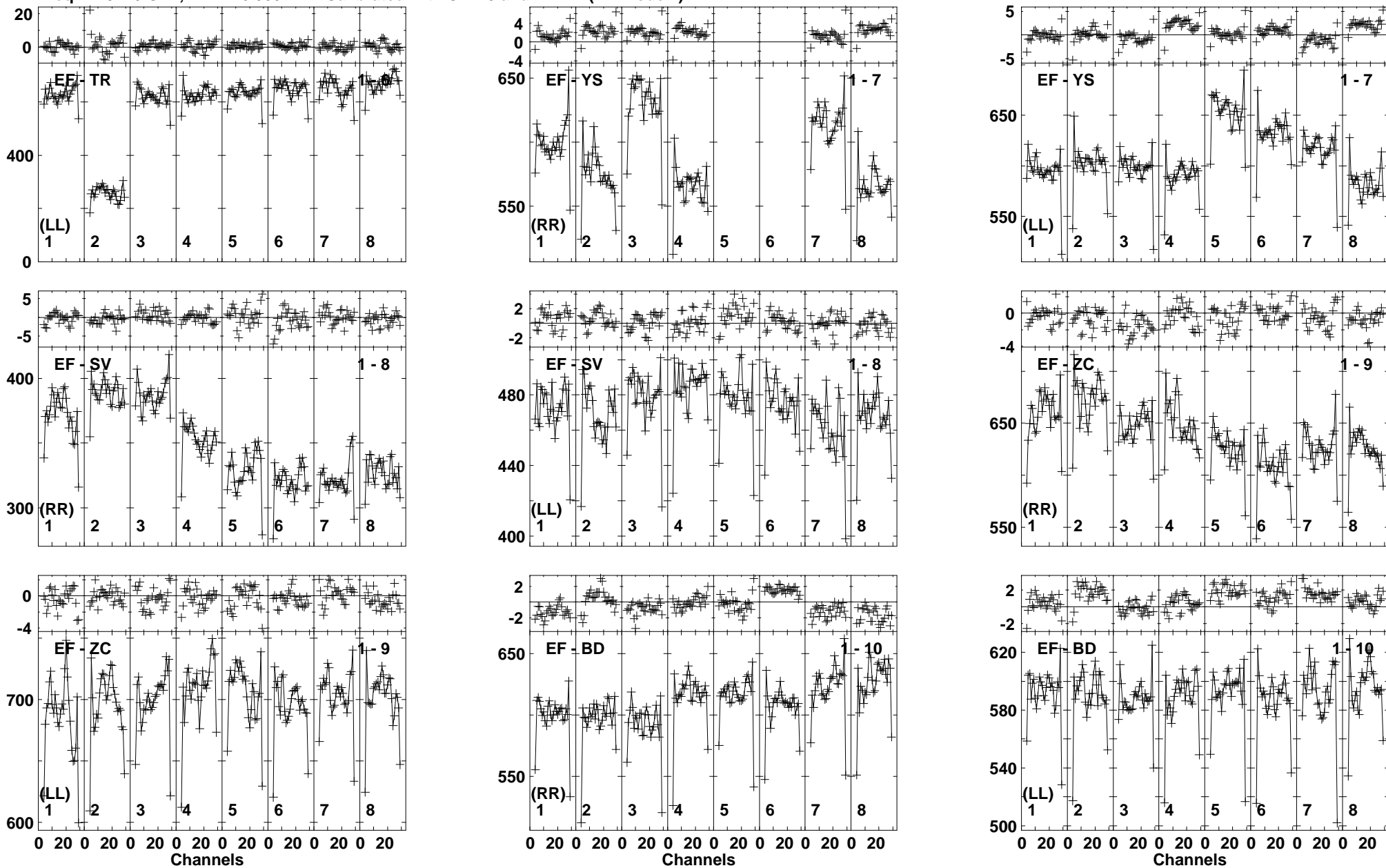

Lower frame: Milli Ampl Jy Top frame: Phas deg  
Vector averaged cross-power spectrum Baseline: EF (01) - TR (06)  
Timerange: 00/13:53:41 to 00/13:54:09

Plot file version 69 created 18-NOV-2014 15:23:18

J1128+5925 EP087H 3.UVDATA.1

Freq = 4.9270 GHz, Bw = 16.000 MH Calibrated with CL # 3 and BP # 1 (BP mode 1)

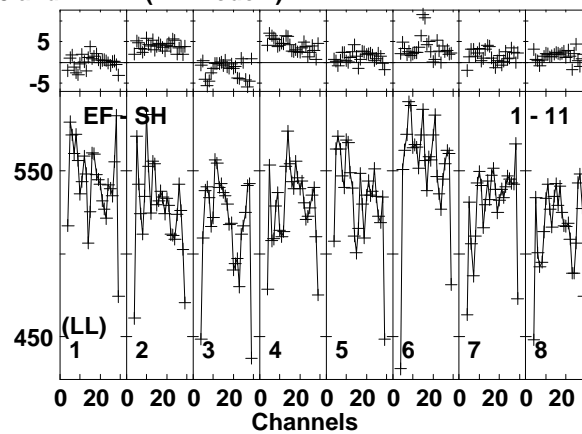
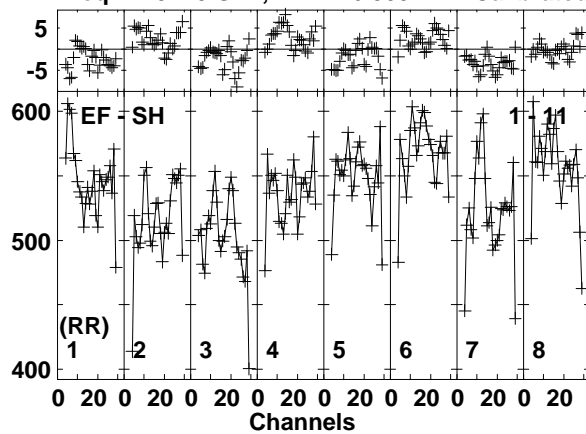

Lower frame: Milli Ampl Jy Top frame: Phas deg  
Vector averaged cross-power spectrum Baseline: EF (01) - SH (11)  
Timerange: 00/13:53:41 to 00/13:54:09

Plot file version 70 created 18-NOV-2014 15:23:18

ARP299C EP087H 3.UVDATA.1

Freq = 4.9270 GHz, Bw = 16.000 MH Calibrated with CL # 3 and BP # 1 (BP mode 1)

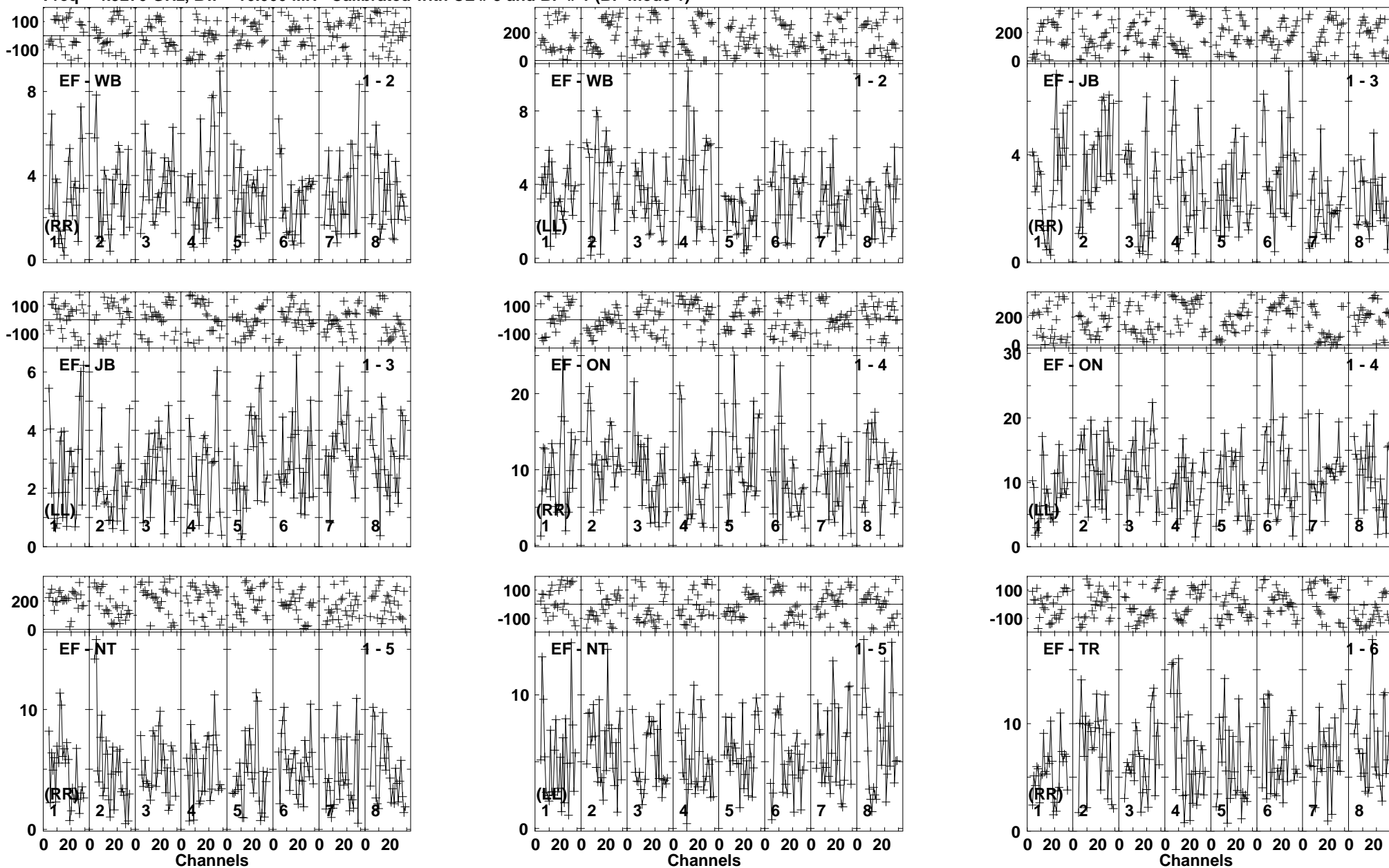

Lower frame: Milli Ampl Jy Top frame: Phas deg  
Vector averaged cross-power spectrum Baseline: EF (01) - WB (02)  
Timerange: 00/13:54:15 to 00/13:58:09

Plot file version 71 created 18-NOV-2014 15:23:18  
 ARP299C EP087H 3.UVDATA.1  
 Freq = 4.9270 GHz, Bw = 16.000 MH Calibrated with CL # 3 and BP # 1 (BP mode 1)

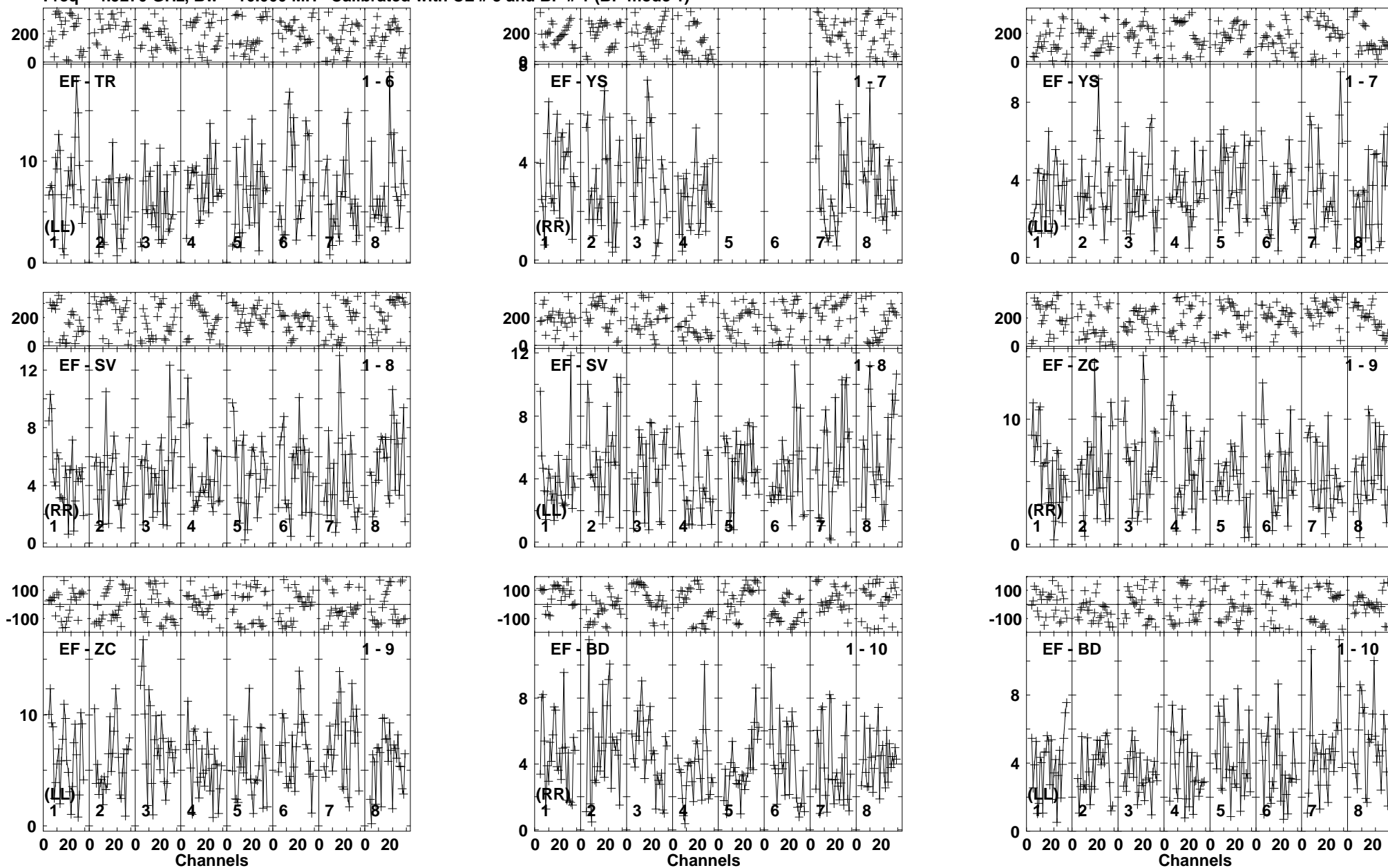

Lower frame: Milli Ampl Jy Top frame: Phas deg  
 Vector averaged cross-power spectrum Baseline: EF (01) - TR (06)  
 Timerange: 00/13:54:15 to 00/13:58:09

Plot file version 72 created 18-NOV-2014 15:23:19

ARP299C EP087H 3.UVDATA.1

Freq = 4.9270 GHz, Bw = 16.000 MH Calibrated with CL # 3 and BP # 1 (BP mode 1)

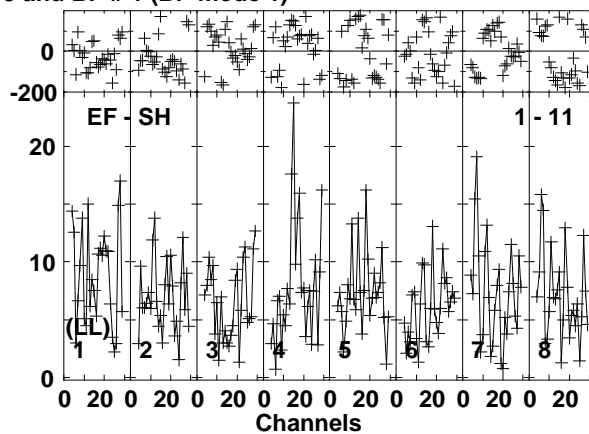
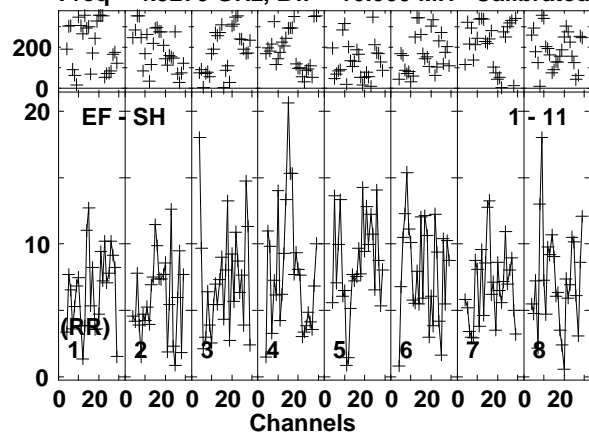

Lower frame: Milli Ampl Jy Top frame: Phas deg  
Vector averaged cross-power spectrum Baseline: EF (01) - SH (11)  
Timerange: 00/13:54:15 to 00/13:58:09



Plot file version 73 created 18-NOV-2014 15:23:19

J1128+5925 EP087H 3.UVDATA.1

Freq = 4.9270 GHz, Bw = 16.000 MH Calibrated with CL # 3 and BP # 1 (BP mode 1)

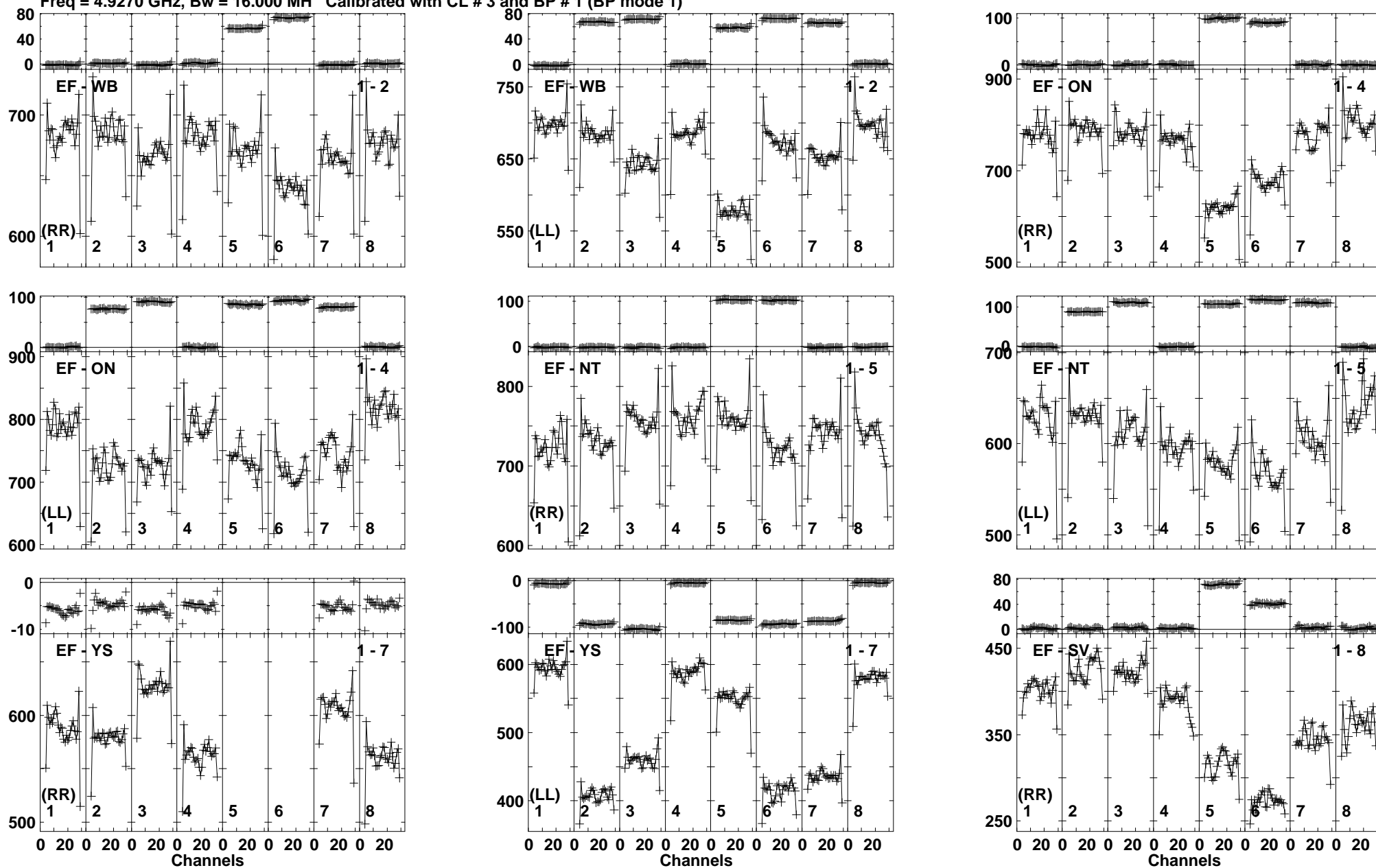

Lower frame: Milli Ampl Jy Top frame: Phas deg  
Vector averaged cross-power spectrum Baseline: EF (01) - WB (02)  
Timerange: 00/13:58:15 to 00/13:59:09

Plot file version 74 created 18-NOV-2014 15:23:19

J1128+5925 EP087H 3.UVDATA.1

Freq = 4.9270 GHz, Bw = 16.000 MH Calibrated with CL # 3 and BP # 1 (BP mode 1)

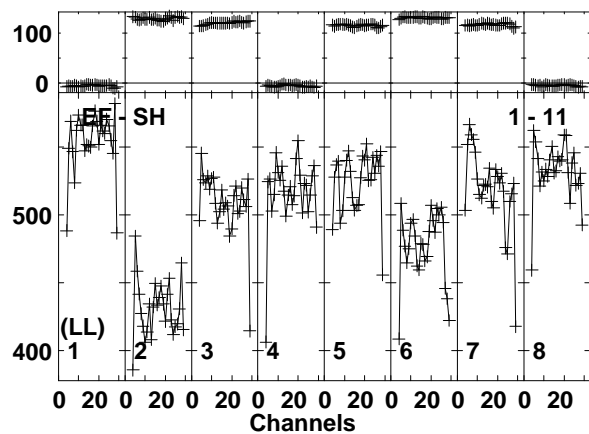
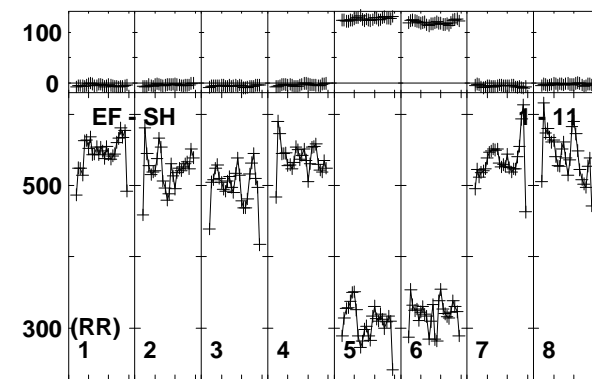
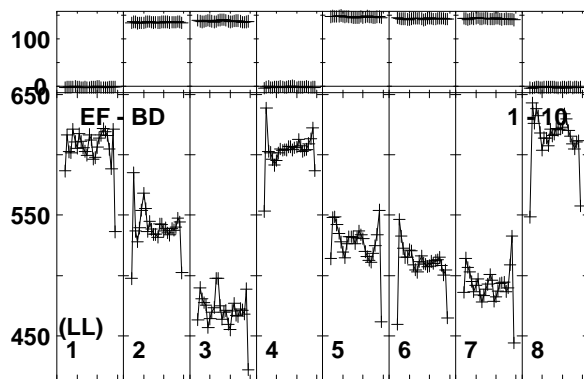
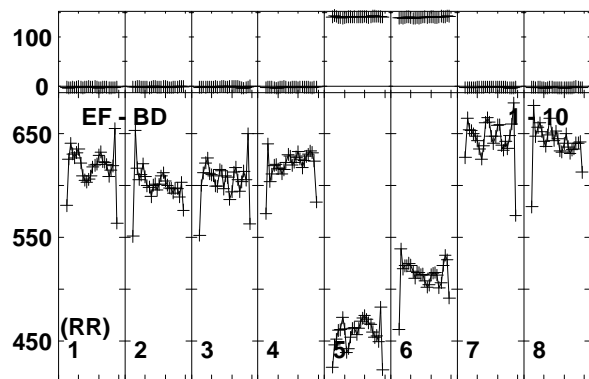
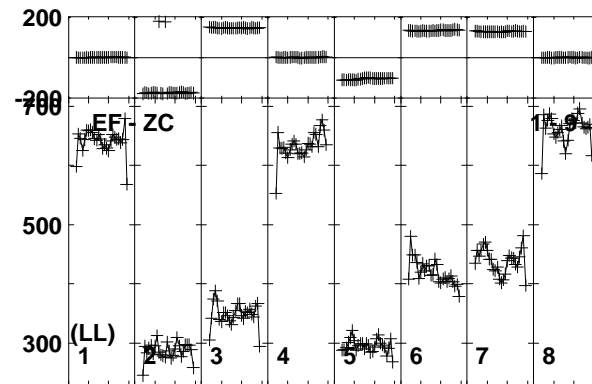
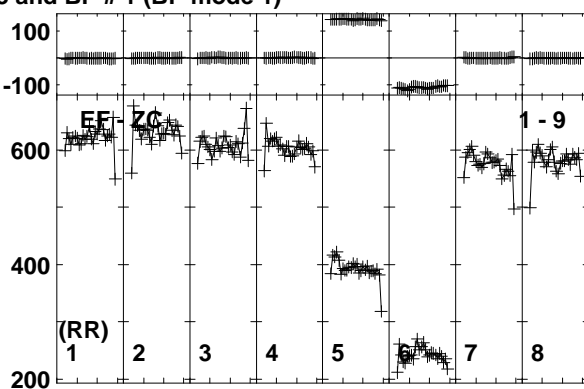
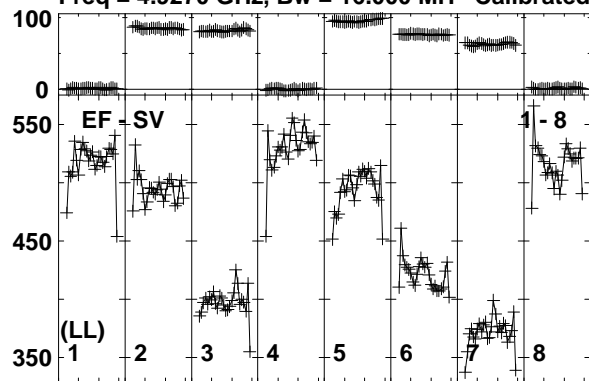

Lower frame: Milli Ampl Jy Top frame: Phas deg  
Vector averaged cross-power spectrum Baseline: EF (01) - SV (08)  
Timerange: 00/13:58:15 to 00/13:59:09

Plot file version 75 created 18-NOV-2014 15:23:19  
 ARP299C EP087H 3.UVDATA.1  
 Freq = 4.9270 GHz, Bw = 16.000 MH Calibrated with CL # 3 and BP # 1 (BP mode 1)

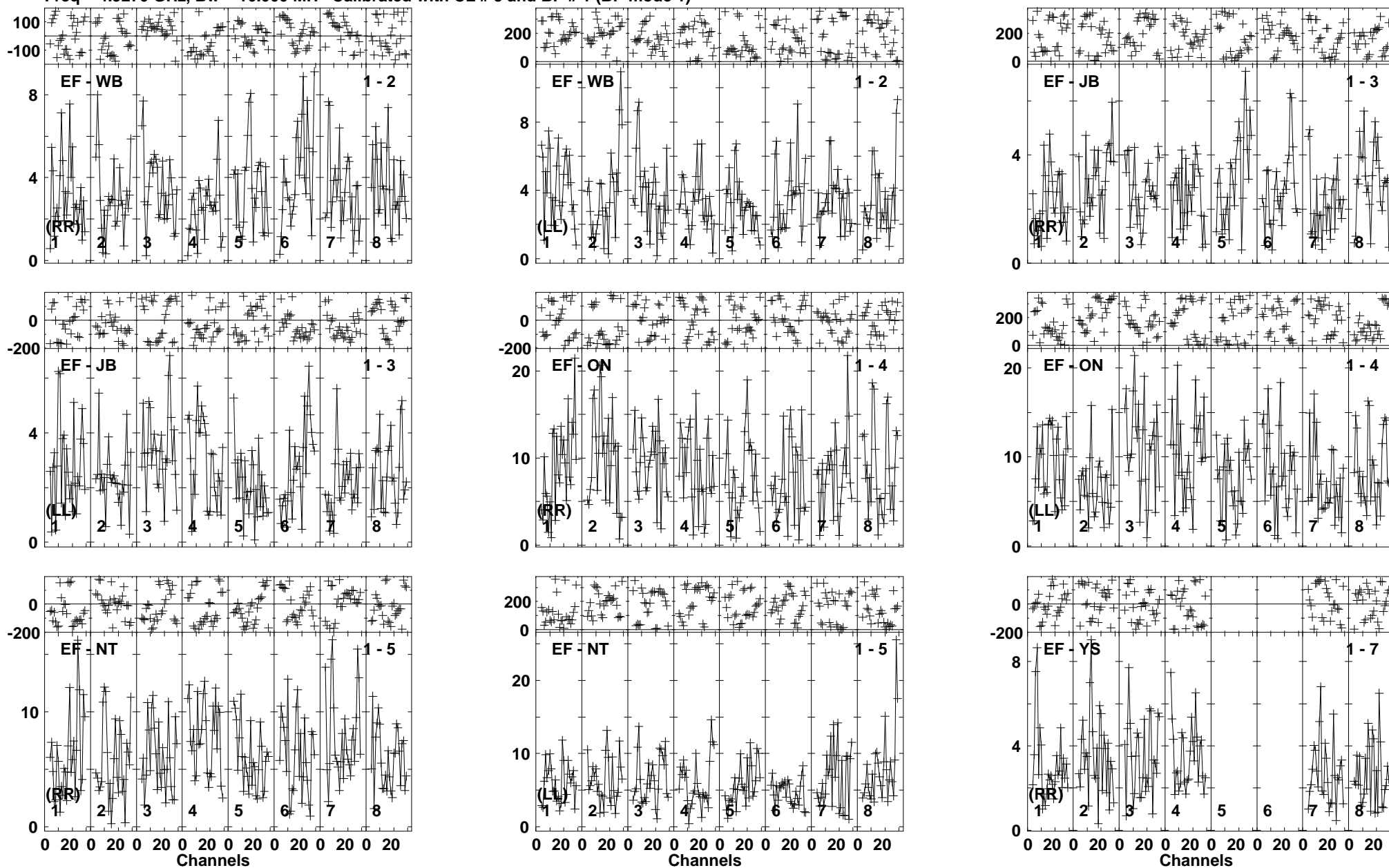

Lower frame: Milli Ampl Jy Top frame: Phas deg  
 Vector averaged cross-power spectrum Baseline: EF (01) - WB (02)  
 Timerange: 00/13:59:11 to 00/14:03:09

Plot file version 76 created 18-NOV-2014 15:23:19

ARP299C EP087H 3.UVDATA.1

Freq = 4.9270 GHz, Bw = 16.000 MH Calibrated with CL # 3 and BP # 1 (BP mode 1)

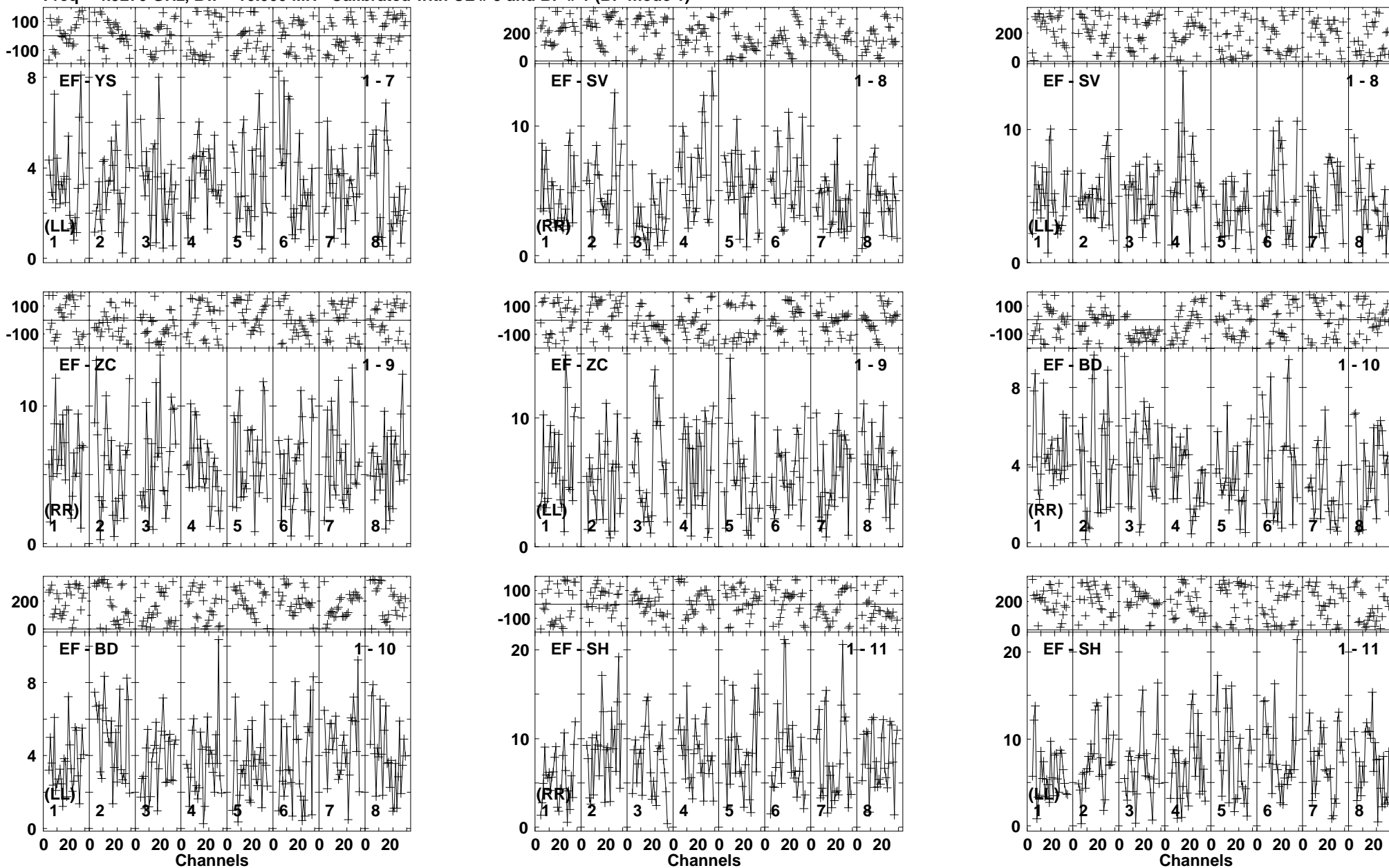

Lower frame: Milli Ampl Jy Top frame: Phas deg  
Vector averaged cross-power spectrum Baseline: EF (01) - YS (07)  
Timerange: 00/13:59:11 to 00/14:03:09

Plot file version 77 created 18-NOV-2014 15:23:20

J1128+5925 EP087H 3.UVDATA.1

Freq = 4.9270 GHz, Bw = 16.000 MH Calibrated with CL # 3 and BP # 1 (BP mode 1)

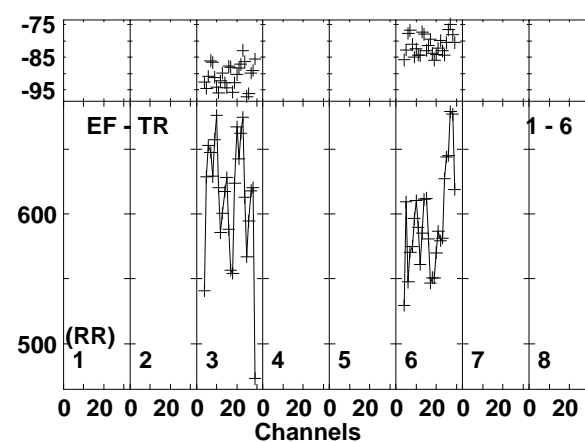
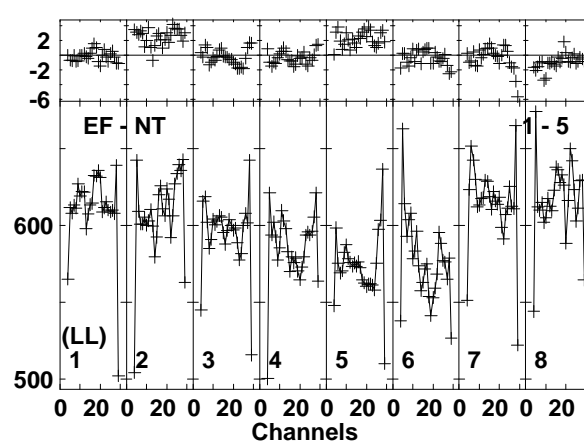
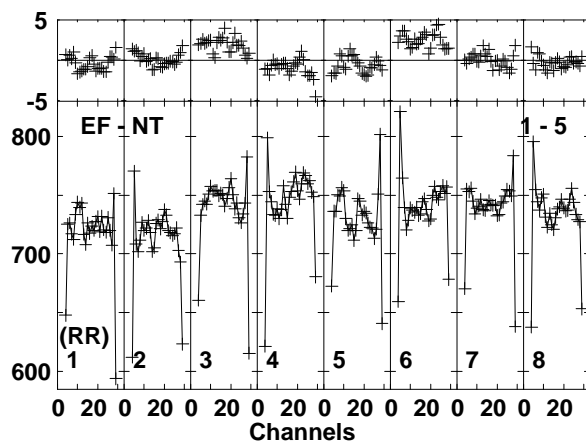
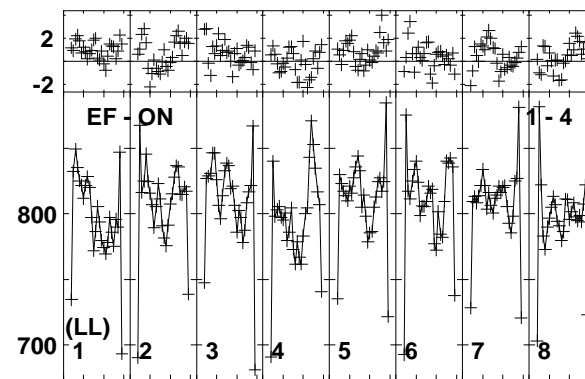
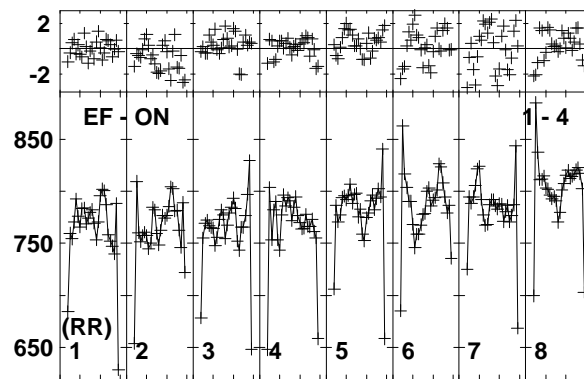
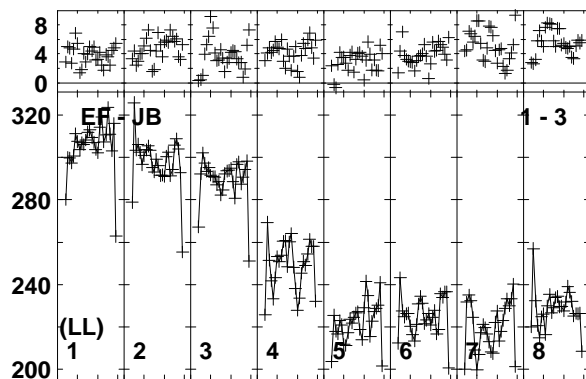
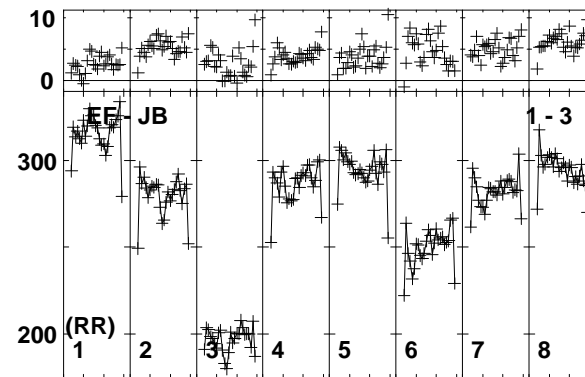
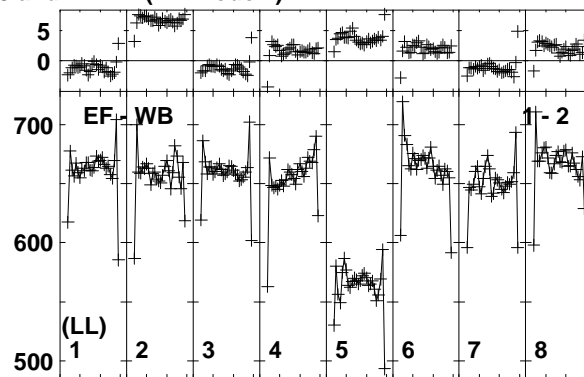
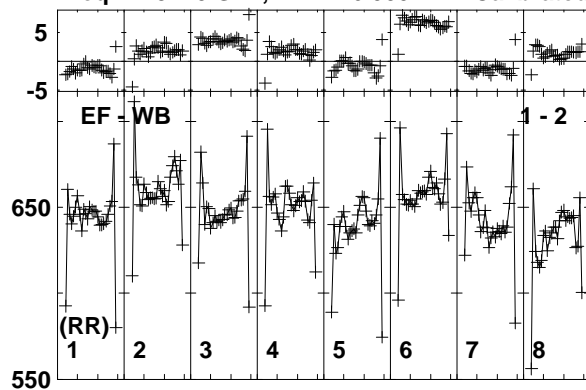

Lower frame: Milli Ampl Jy Top frame: Phas deg  
Vector averaged cross-power spectrum Baseline: EF (01) - WB (02)  
Timerange: 00/14:03:15 to 00/14:04:09

Plot file version 78 created 18-NOV-2014 15:23:20

J1128+5925 EP087H 3.UVDATA.1

Freq = 4.9270 GHz, Bw = 16.000 MH Calibrated with CL # 3 and BP # 1 (BP mode 1)

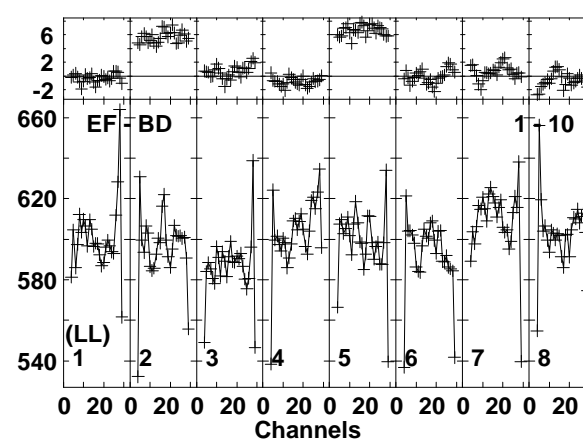
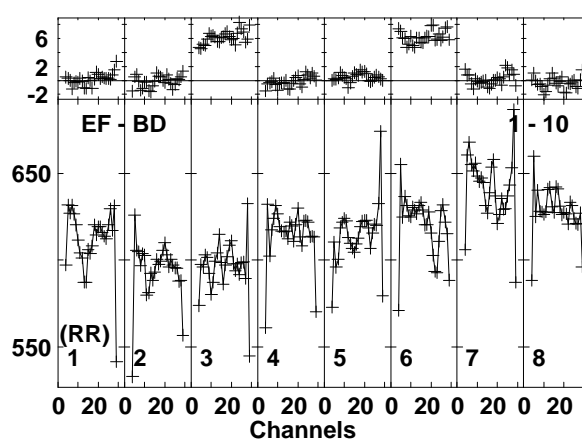
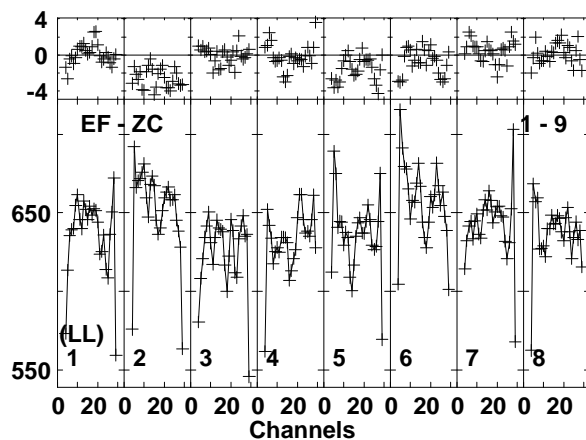
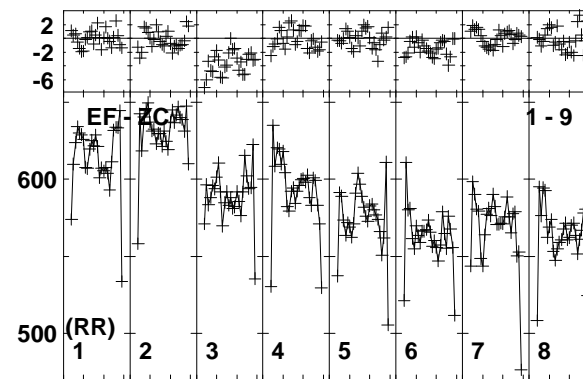
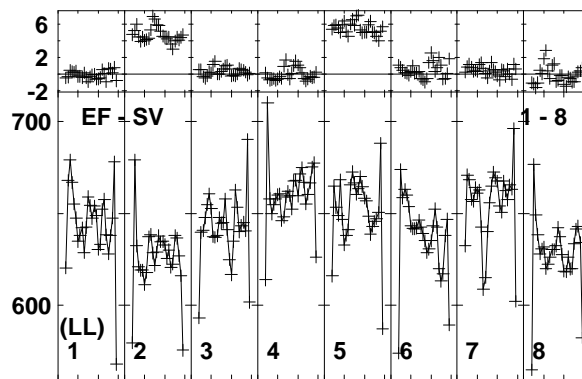
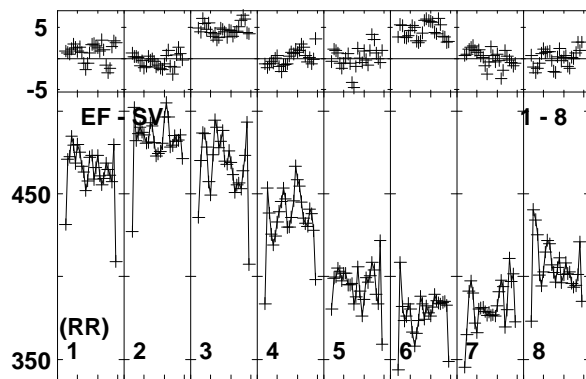
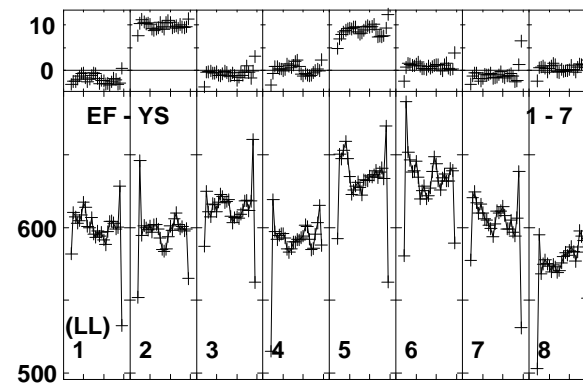
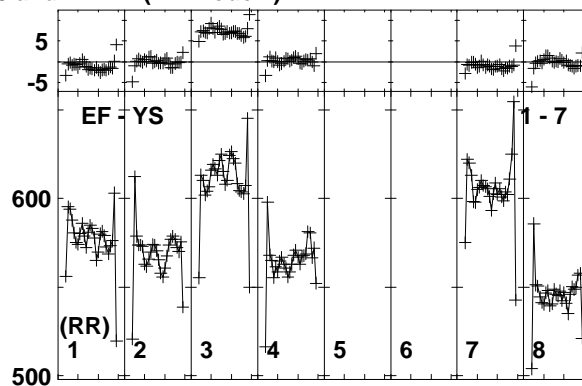
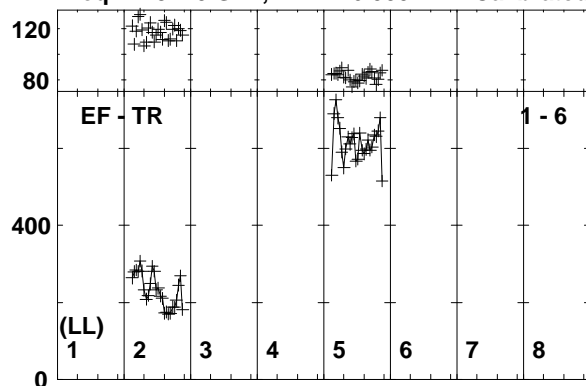

Lower frame: Milli Ampl Jy Top frame: Phas deg  
Vector averaged cross-power spectrum Baseline: EF (01) - TR (06)  
Timerange: 00/14:03:15 to 00/14:04:09

Plot file version 79 created 18-NOV-2014 15:23:20

J1128+5925 EP087H 3.UVDATA.1

Freq = 4.9270 GHz, Bw = 16.000 MH Calibrated with CL # 3 and BP # 1 (BP mode 1)

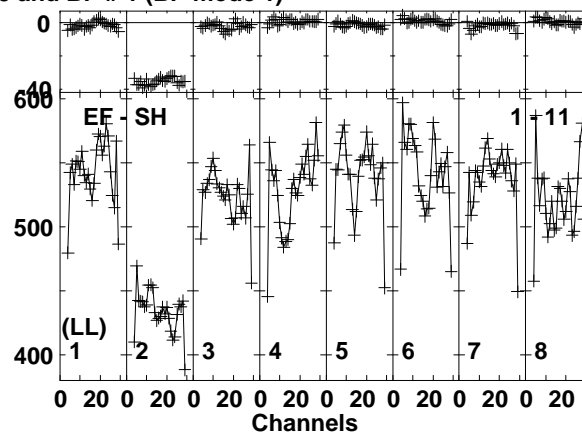
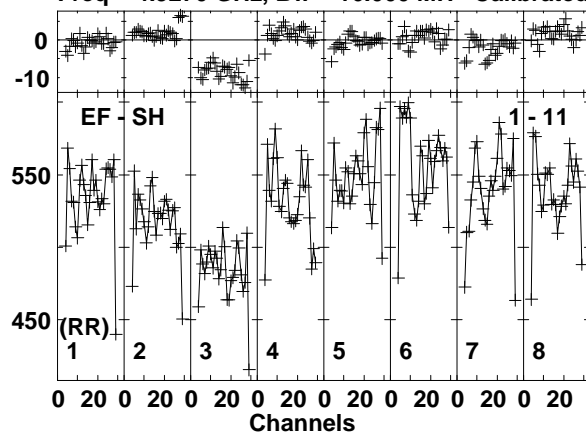

Lower frame: Milli Ampl Jy Top frame: Phas deg  
Vector averaged cross-power spectrum Baseline: EF (01) - SH (11)  
Timerange: 00/14:03:15 to 00/14:04:09

Plot file version 80 created 18-NOV-2014 15:23:20  
 ARP299C EP087H 3.UVDATA.1  
 Freq = 4.9270 GHz, Bw = 16.000 MH Calibrated with CL # 3 and BP # 1 (BP mode 1)

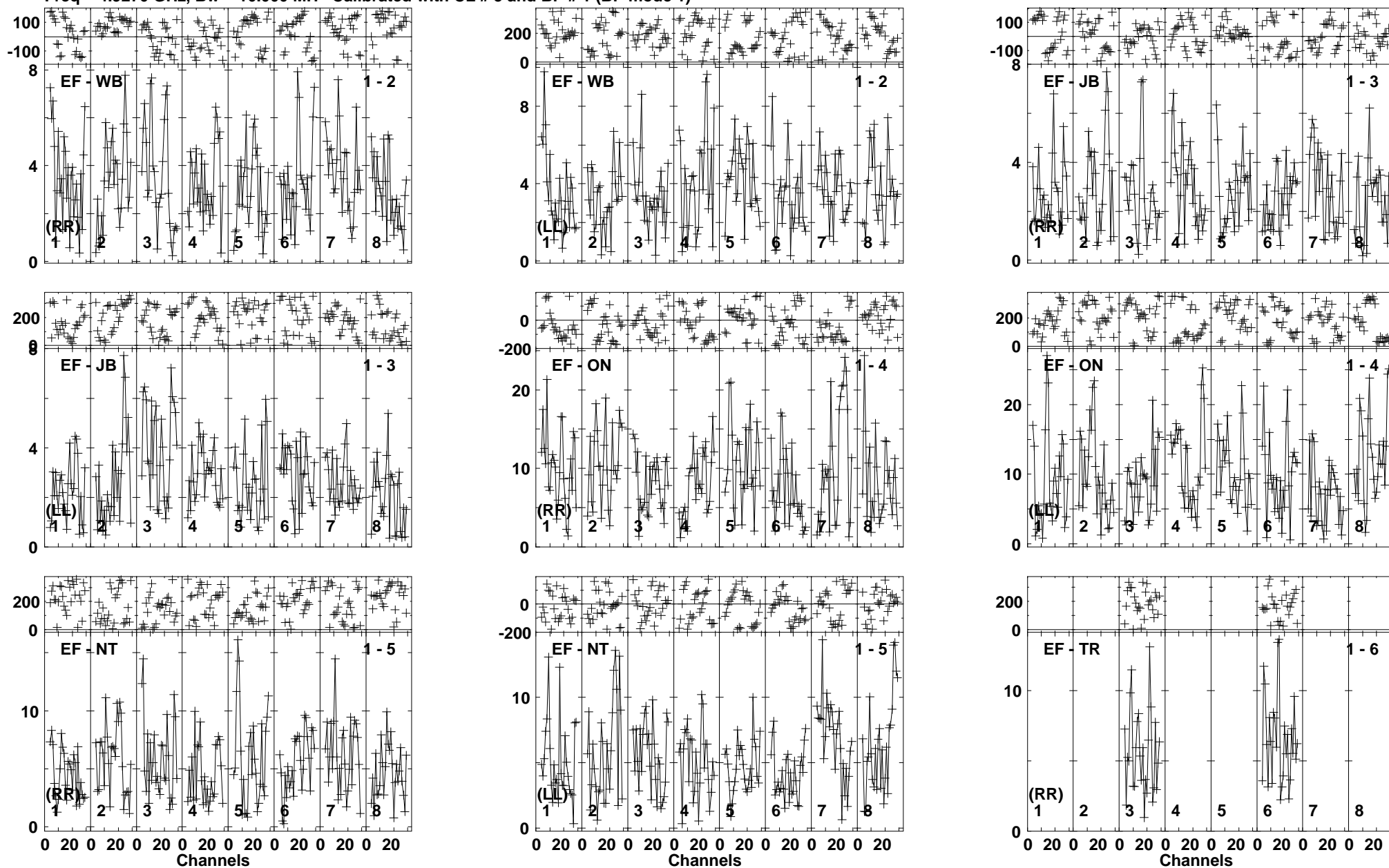

Lower frame: Milli Ampl Jy Top frame: Phas deg  
 Vector averaged cross-power spectrum Baseline: EF (01) - WB (02)  
 Timerange: 00/14:04:15 to 00/14:08:09



Plot file version 81 created 18-NOV-2014 15:23:20  
 ARP299C EP087H 3.UVDATA.1  
 Freq = 4.9270 GHz, Bw = 16.000 MH Calibrated with CL # 3 and BP # 1 (BP mode 1)

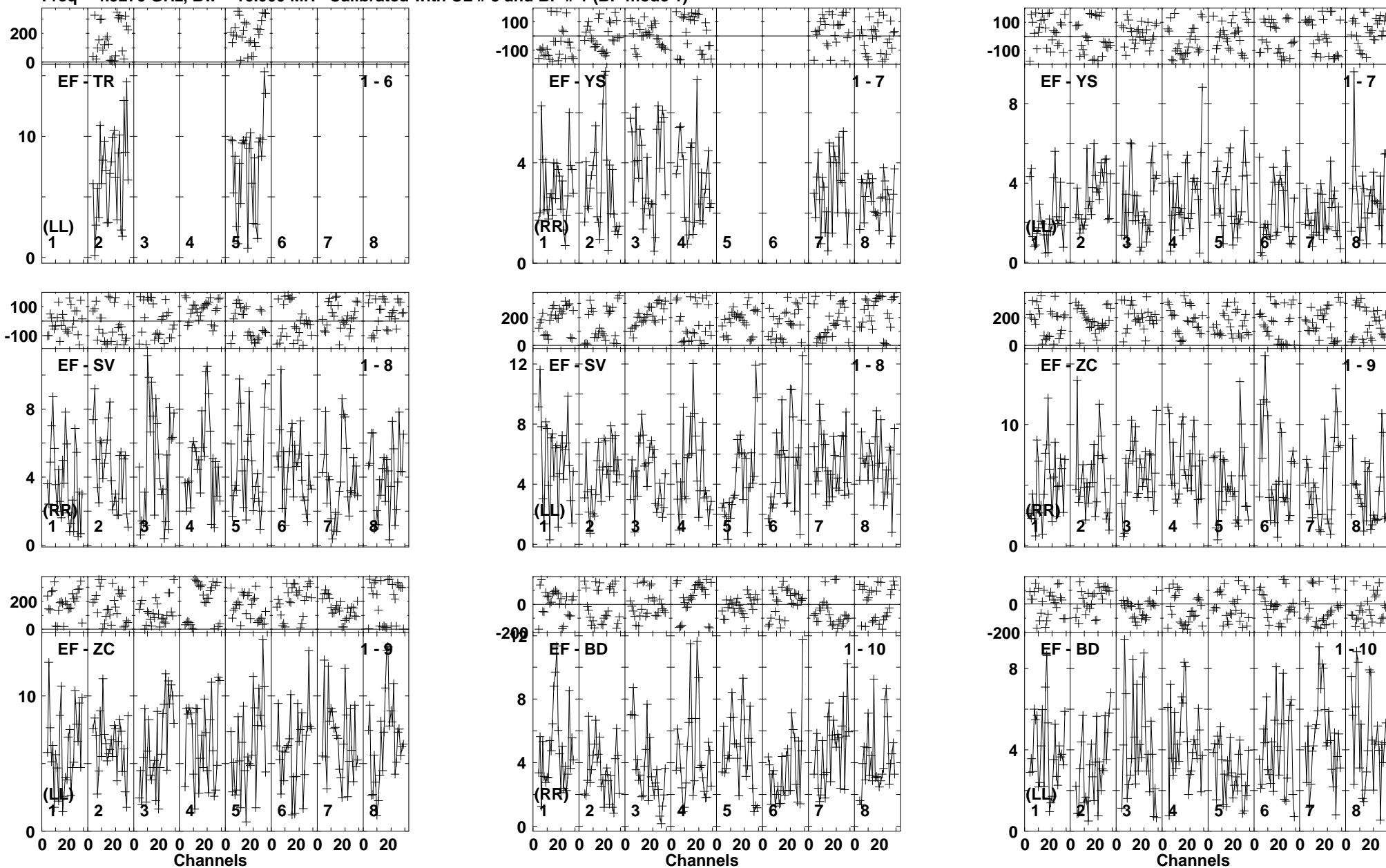

Lower frame: Milli Ampl Jy Top frame: Phas deg  
 Vector averaged cross-power spectrum Baseline: EF (01) - TR (06)  
 Timerange: 00/14:04:15 to 00/14:08:09

Plot file version 82 created 18-NOV-2014 15:23:21

ARP299C EP087H 3.UVDATA.1

Freq = 4.9270 GHz, Bw = 16.000 MH Calibrated with CL # 3 and BP # 1 (BP mode 1)

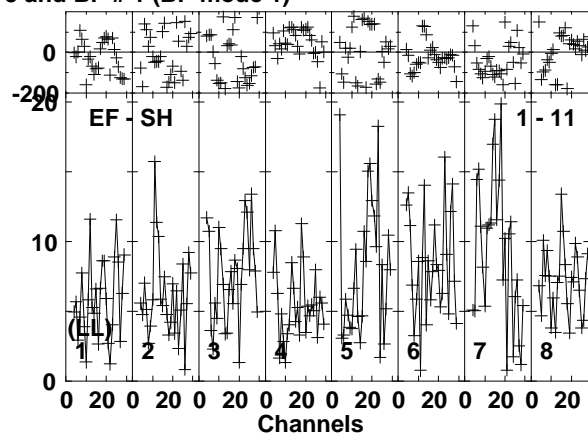
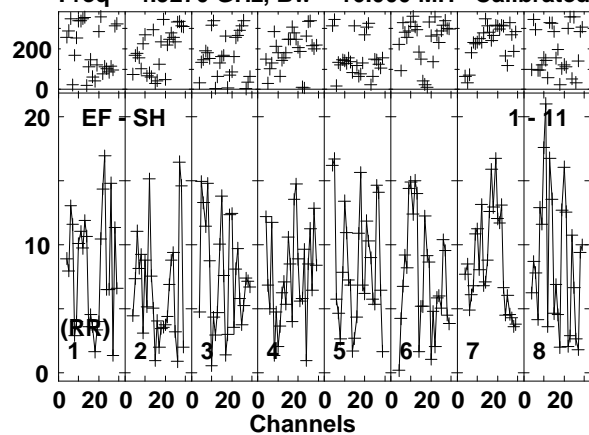

Lower frame: Milli Ampl Jy Top frame: Phas deg  
Vector averaged cross-power spectrum Baseline: EF (01) - SH (11)  
Timerange: 00/14:04:15 to 00/14:08:09

Plot file version 83 created 18-NOV-2014 15:23:21

J1128+5925 EP087H 3.UVDATA.1

Freq = 4.9270 GHz, Bw = 16.000 MH Calibrated with CL # 3 and BP # 1 (BP mode 1)

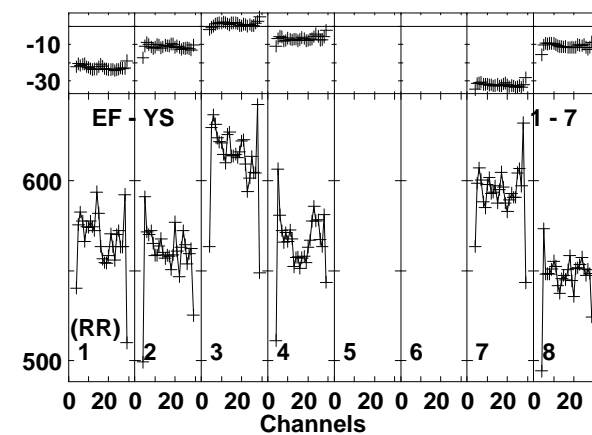
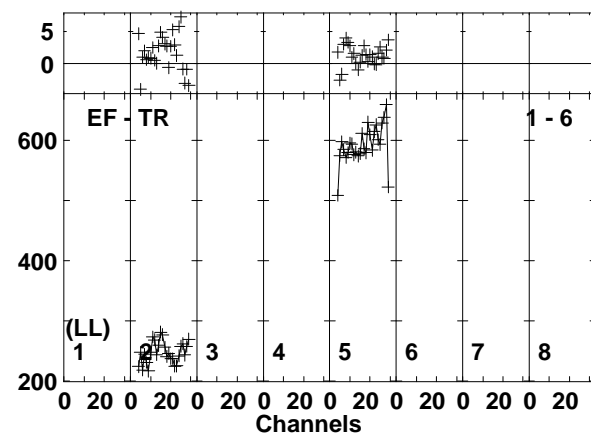
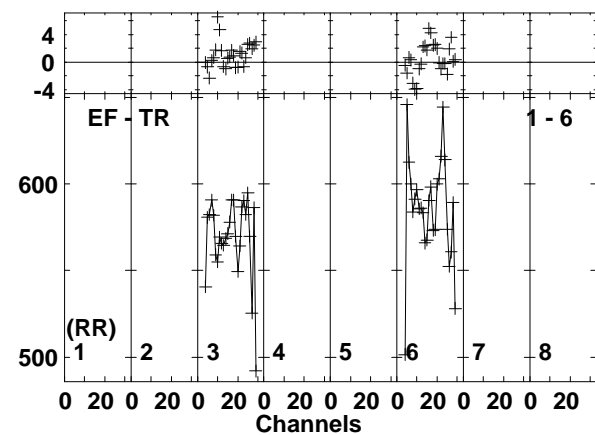
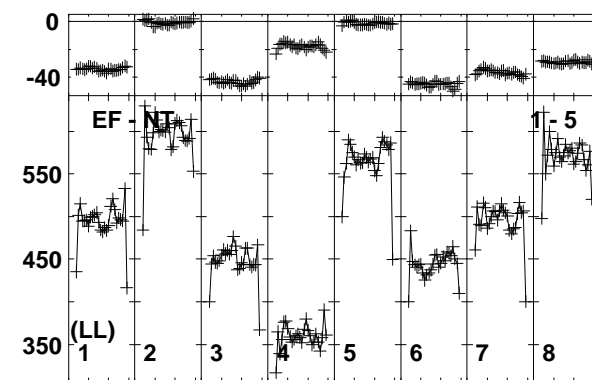
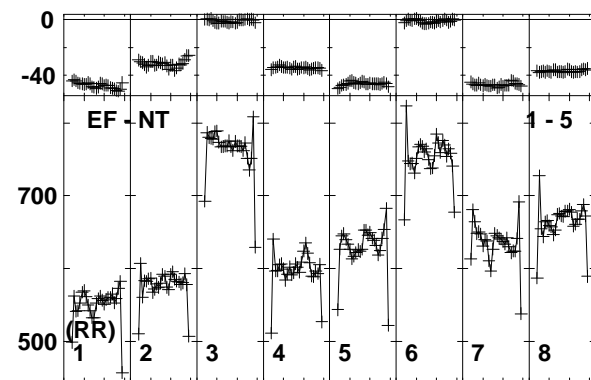
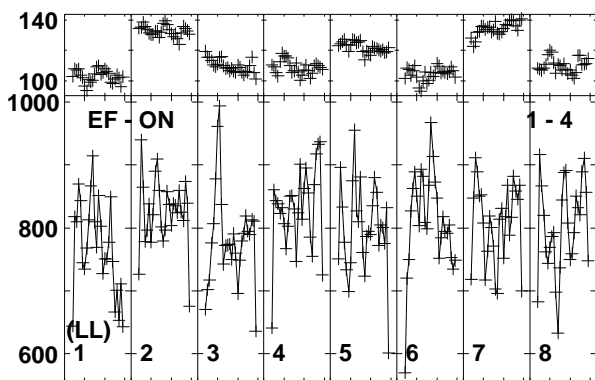
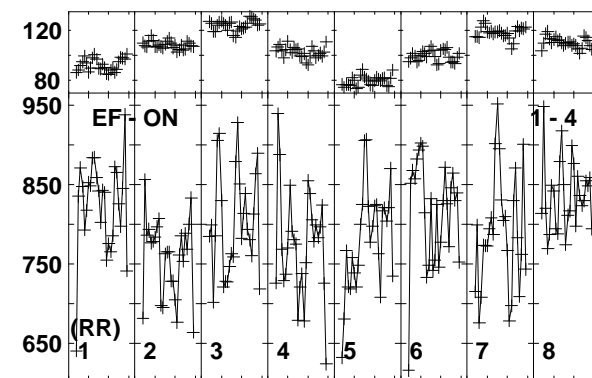
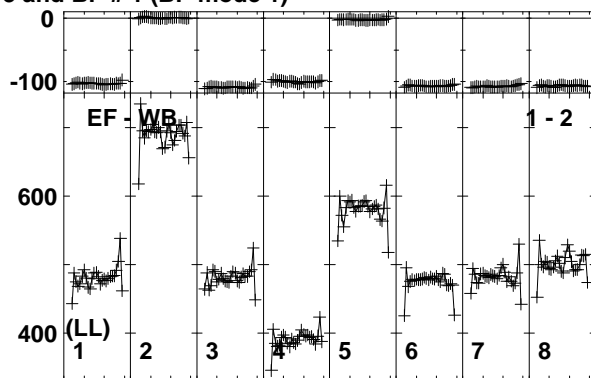
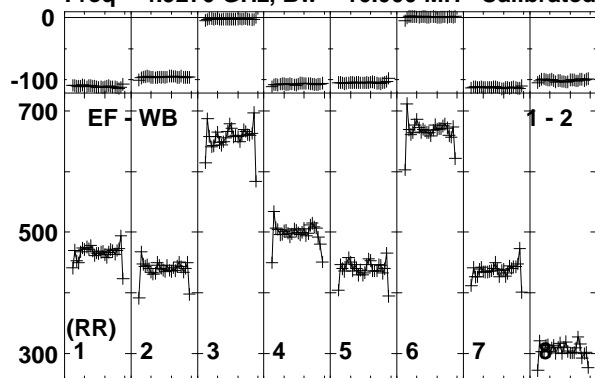

Lower frame: Milli Ampl Jy Top frame: Phas deg  
Vector averaged cross-power spectrum Baseline: EF (01) - WB (02)  
Timerange: 00/14:08:53 to 00/14:09:19

Plot file version 84 created 18-NOV-2014 15:23:21

J1128+5925 EP087H 3.UVDATA.1

Freq = 4.9270 GHz, Bw = 16.000 MH Calibrated with CL # 3 and BP # 1 (BP mode 1)

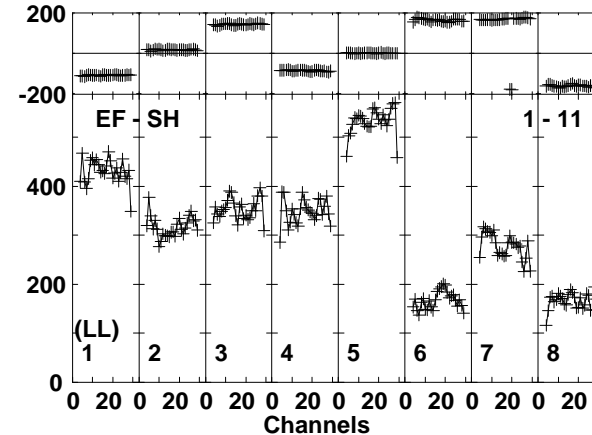
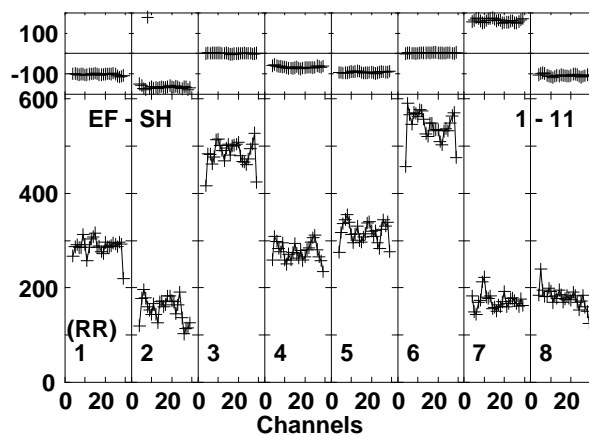
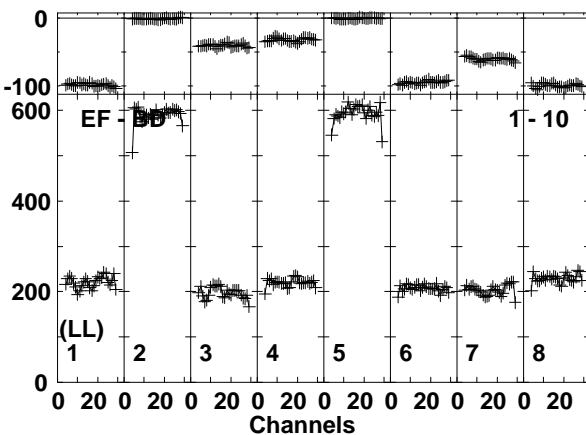
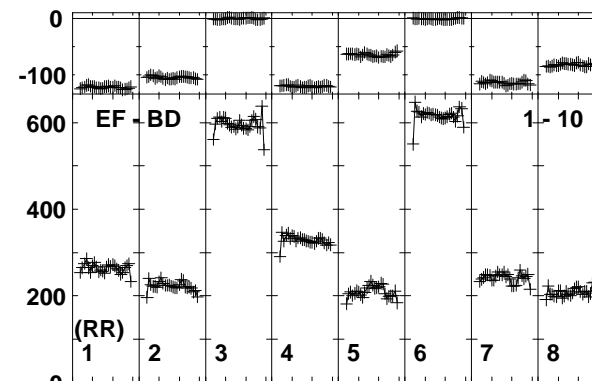
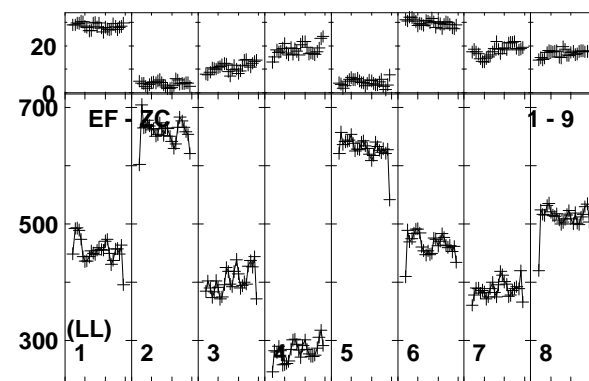
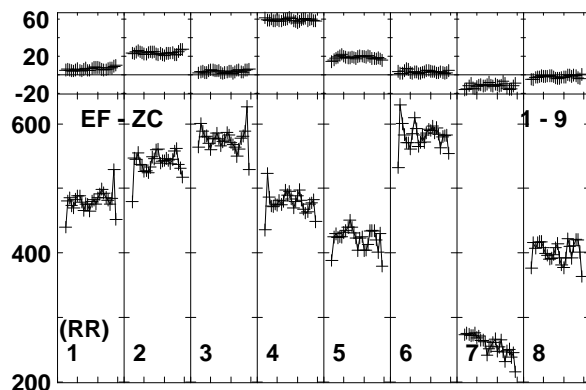
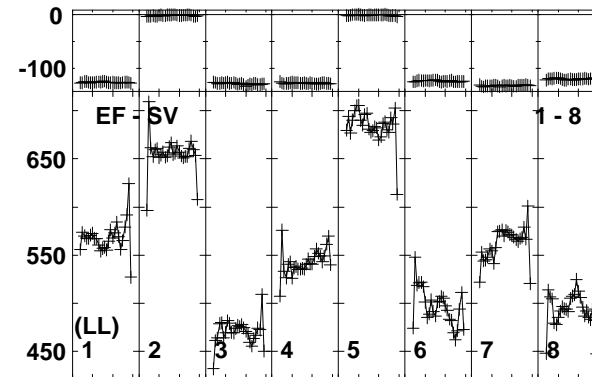
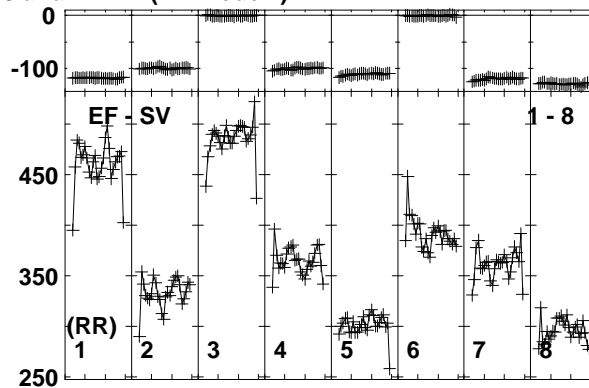
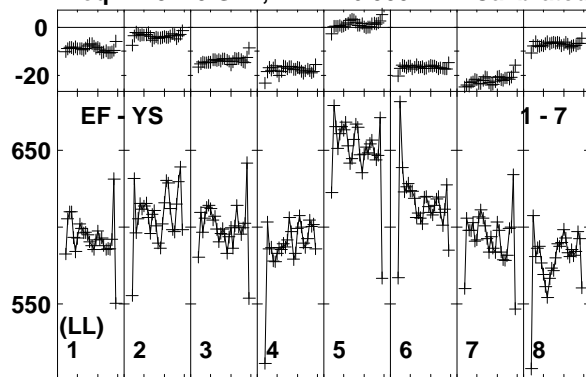

Lower frame: Milli Ampl Jy Top frame: Phas deg  
Vector averaged cross-power spectrum Baseline: EF (01) - YS (07)  
Timerange: 00/14:08:53 to 00/14:09:19

Plot file version 85 created 18-NOV-2014 15:23:21

ARP299C EP087H 3.UVDATA.1

Freq = 4.9270 GHz, Bw = 16.000 MH Calibrated with CL # 3 and BP # 1 (BP mode 1)

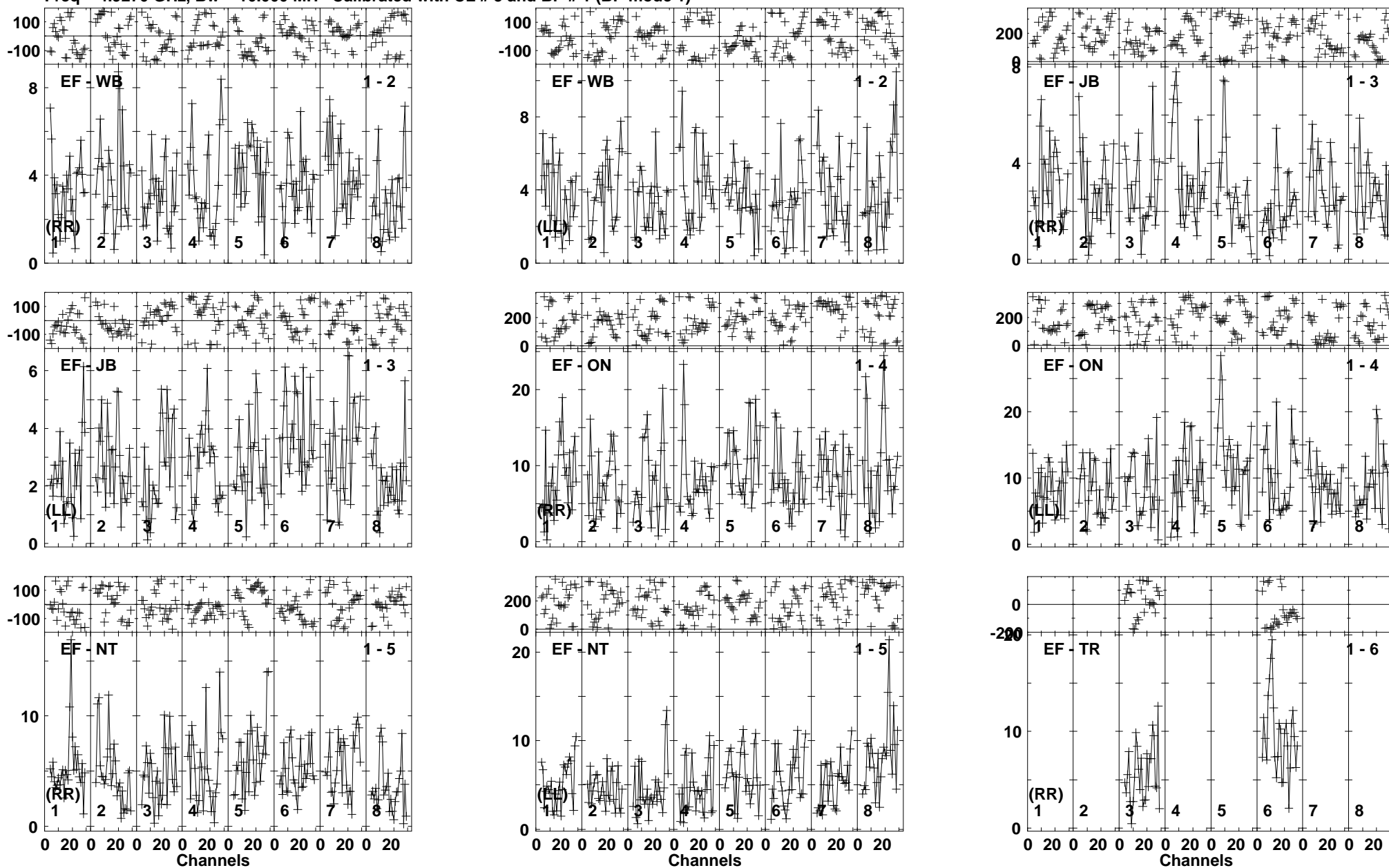

Lower frame: Milli Ampl Jy Top frame: Phas deg  
Vector averaged cross-power spectrum Baseline: EF (01) - WB (02)  
Timerange: 00/14:09:21 to 00/14:13:19

Plot file version 86 created 18-NOV-2014 15:23:21

ARP299C EP087H 3.UVDATA.1

Freq = 4.9270 GHz, Bw = 16.000 MH Calibrated with CL # 3 and BP # 1 (BP mode 1)

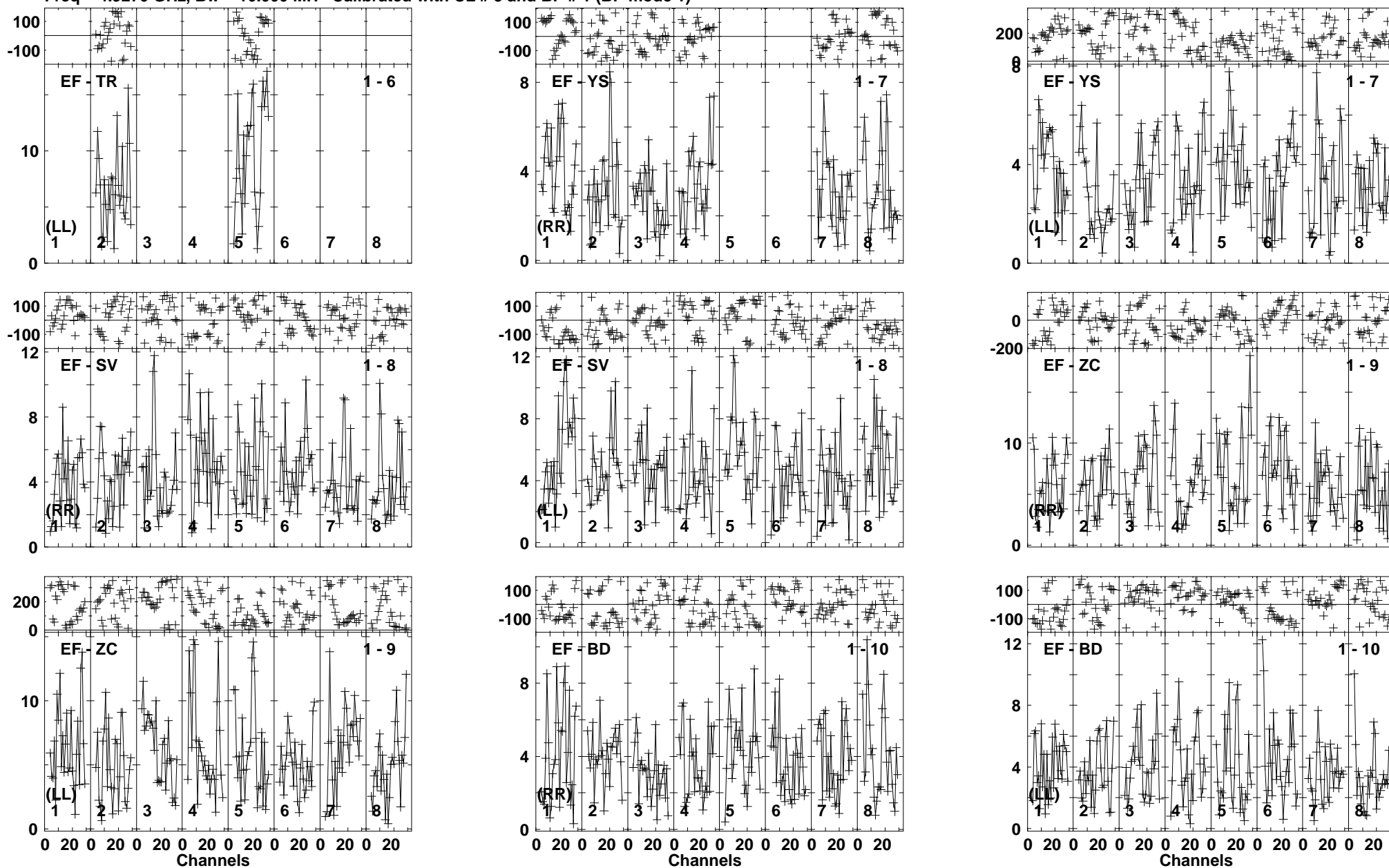

Lower frame: Milli Ampl Jy Top frame: Phas deg  
Vector averaged cross-power spectrum Baseline: EF (01) - TR (06)  
Timerange: 00/14:09:21 to 00/14:13:19

Plot file version 87 created 18-NOV-2014 15:23:22

ARP299C EP087H 3.UVDATA.1

Freq = 4.9270 GHz, Bw = 16.000 MH Calibrated with CL # 3 and BP # 1 (BP mode 1)

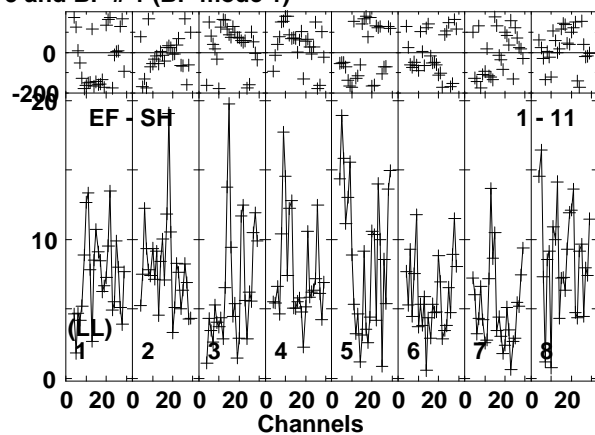
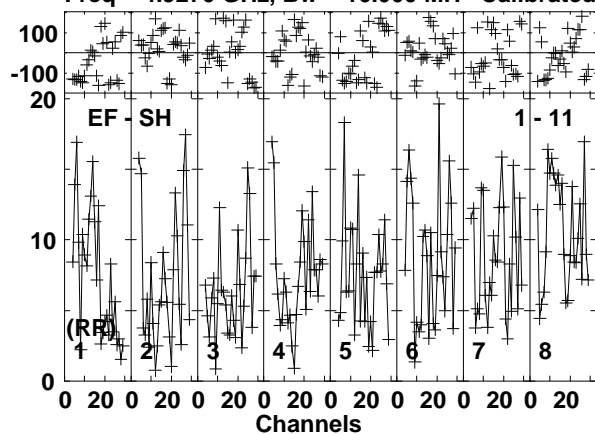

Lower frame: Milli Ampl Jy Top frame: Phas deg  
Vector averaged cross-power spectrum Baseline: EF (01) - SH (11)  
Timerange: 00/14:09:21 to 00/14:13:19

Plot file version 88 created 18-NOV-2014 15:23:22

J1128+5925 EP087H 3.UVDATA.1

Freq = 4.9270 GHz, Bw = 16.000 MH Calibrated with CL # 3 and BP # 1 (BP mode 1)

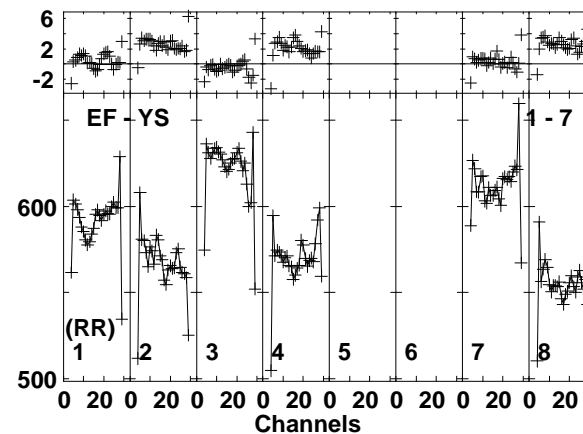
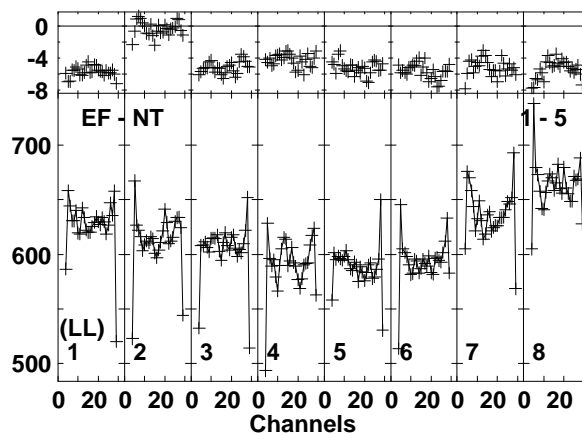
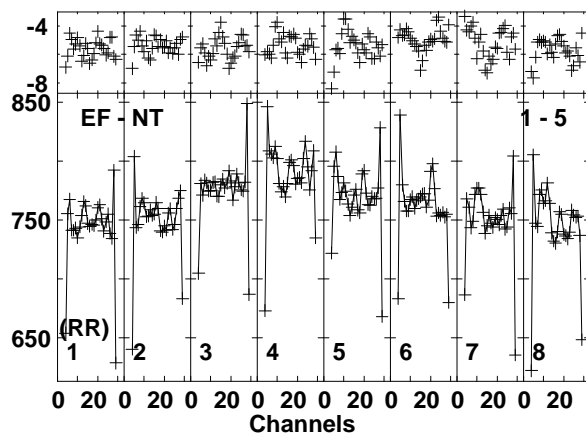
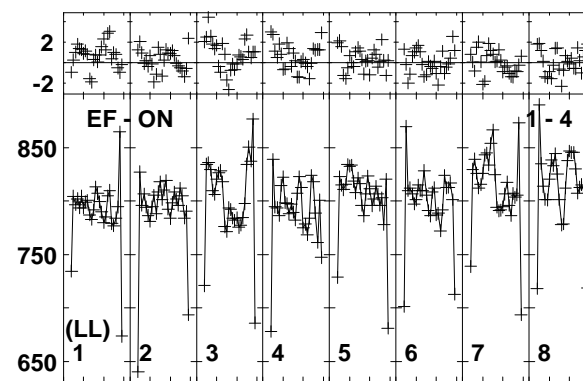
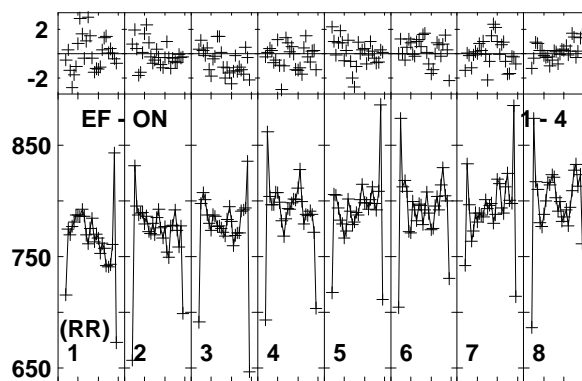
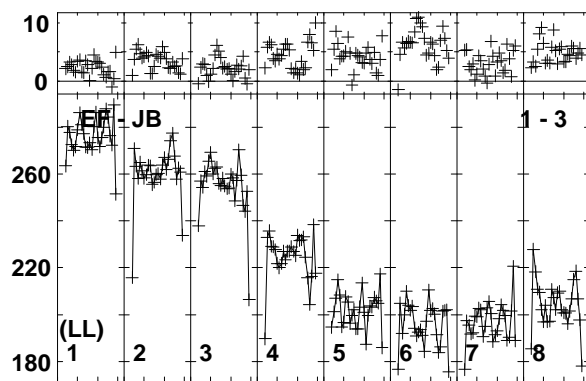
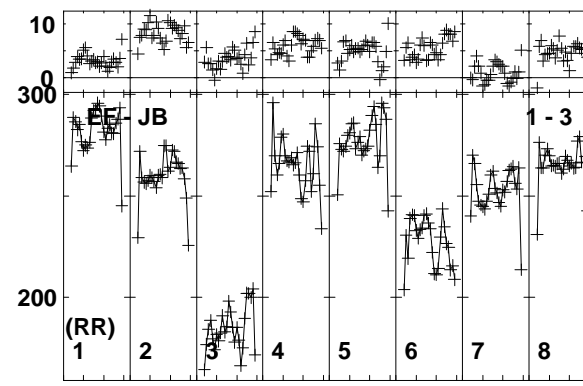
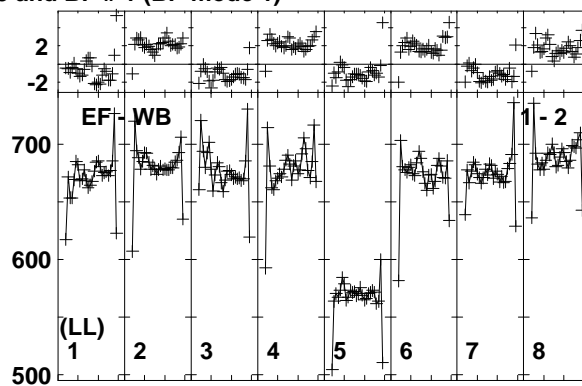
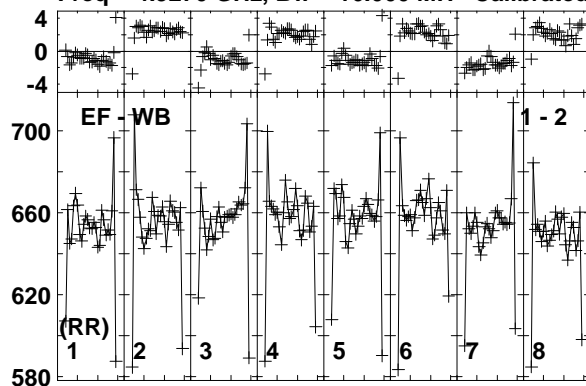

Lower frame: Milli Ampl Jy Top frame: Phas deg  
Vector averaged cross-power spectrum Baseline: EF (01) - WB (02)  
Timerange: 00/14:13:25 to 00/14:14:19



Plot file version 89 created 18-NOV-2014 15:23:22

J1128+5925 EP087H 3.UVDATA.1

Freq = 4.9270 GHz, Bw = 16.000 MH Calibrated with CL # 3 and BP # 1 (BP mode 1)

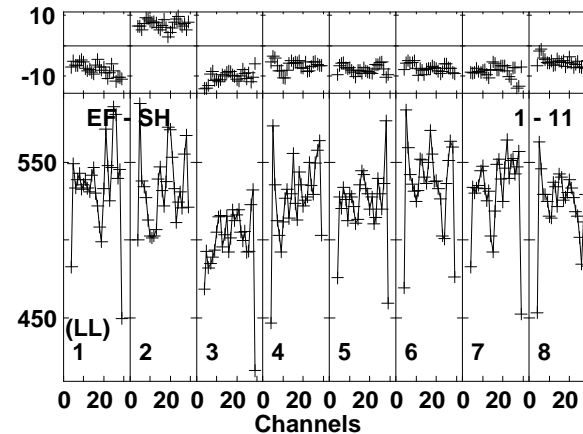
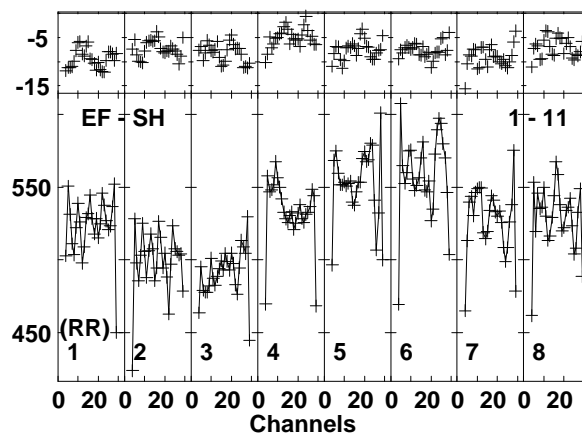
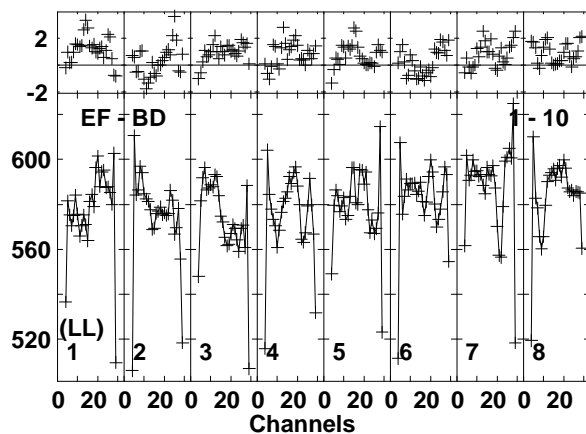
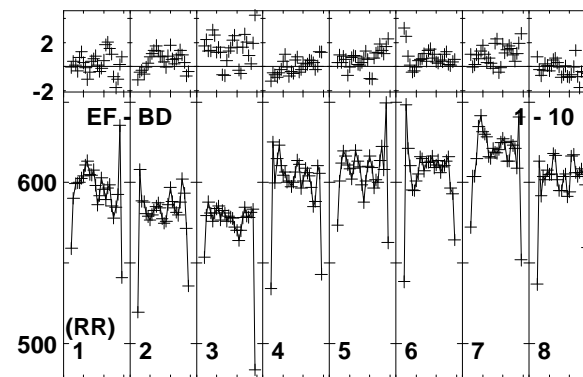
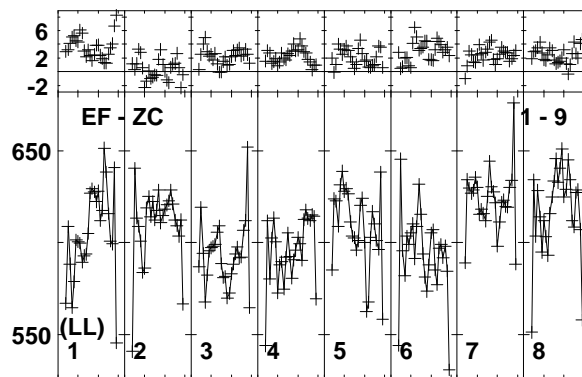
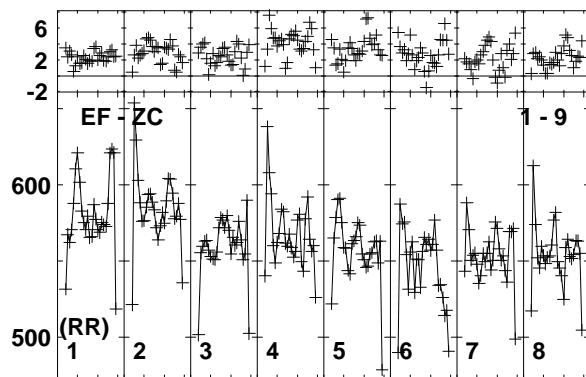
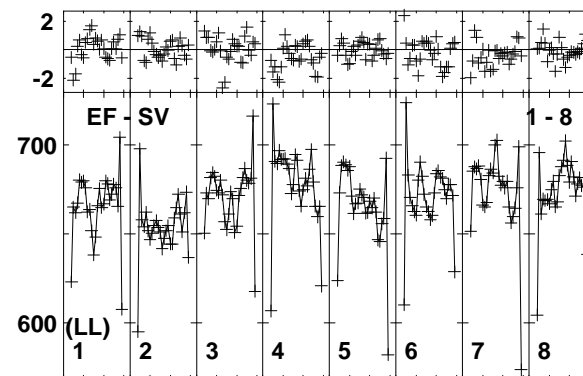
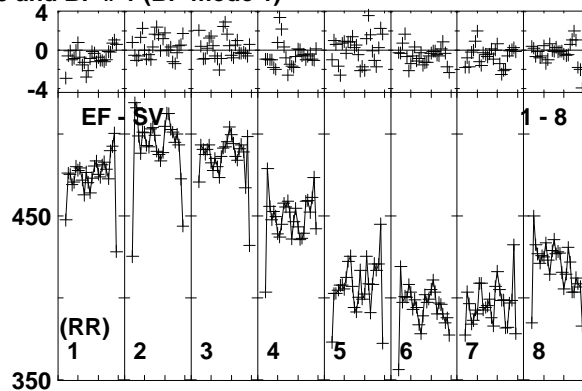
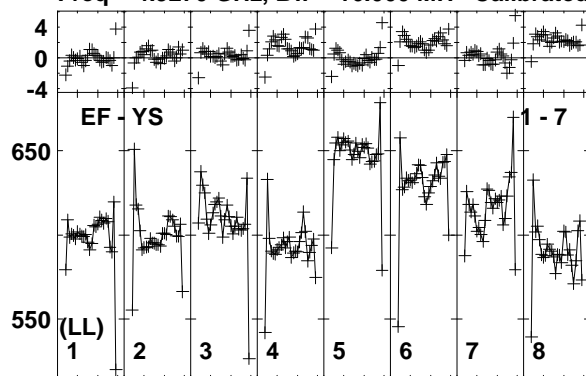

Lower frame: Milli Ampl Jy Top frame: Phas deg  
Vector averaged cross-power spectrum Baseline: EF (01) - YS (07)  
Timerange: 00/14:13:25 to 00/14:14:19

Plot file version 90 created 18-NOV-2014 15:23:22

ARP299C EP087H 3.UVDATA.1

Freq = 4.9270 GHz, Bw = 16.000 MH Calibrated with CL # 3 and BP # 1 (BP mode 1)

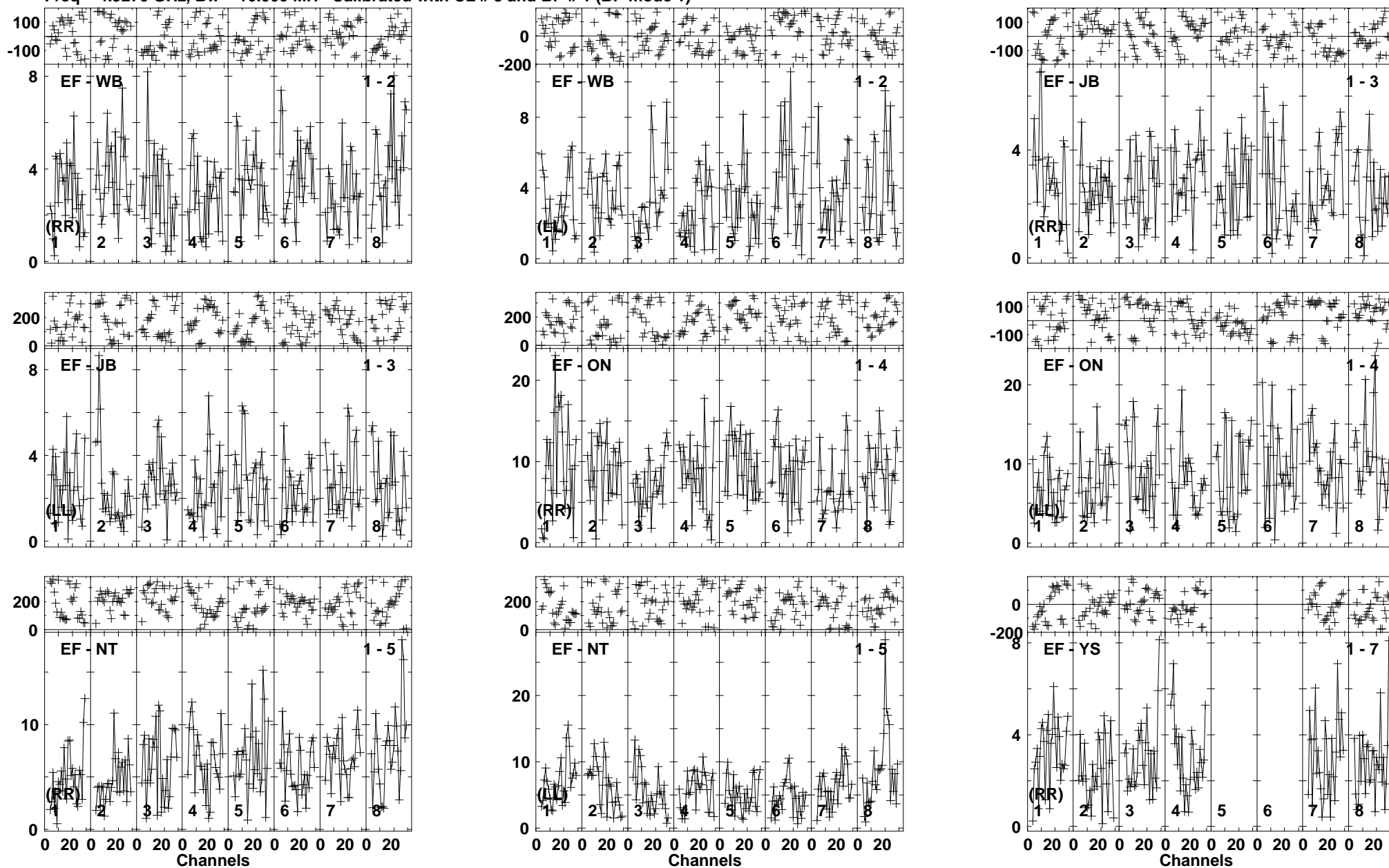

Lower frame: Milli Ampl Jy Top frame: Phas deg  
Vector averaged cross-power spectrum Baseline: EF (01) - WB (02)  
Timerange: 00/14:14:25 to 00/14:18:19

Plot file version 91 created 18-NOV-2014 15:23:22

ARP299C EP087H 3.UVDATA.1

Freq = 4.9270 GHz, Bw = 16.000 MH Calibrated with CL # 3 and BP # 1 (BP mode 1)

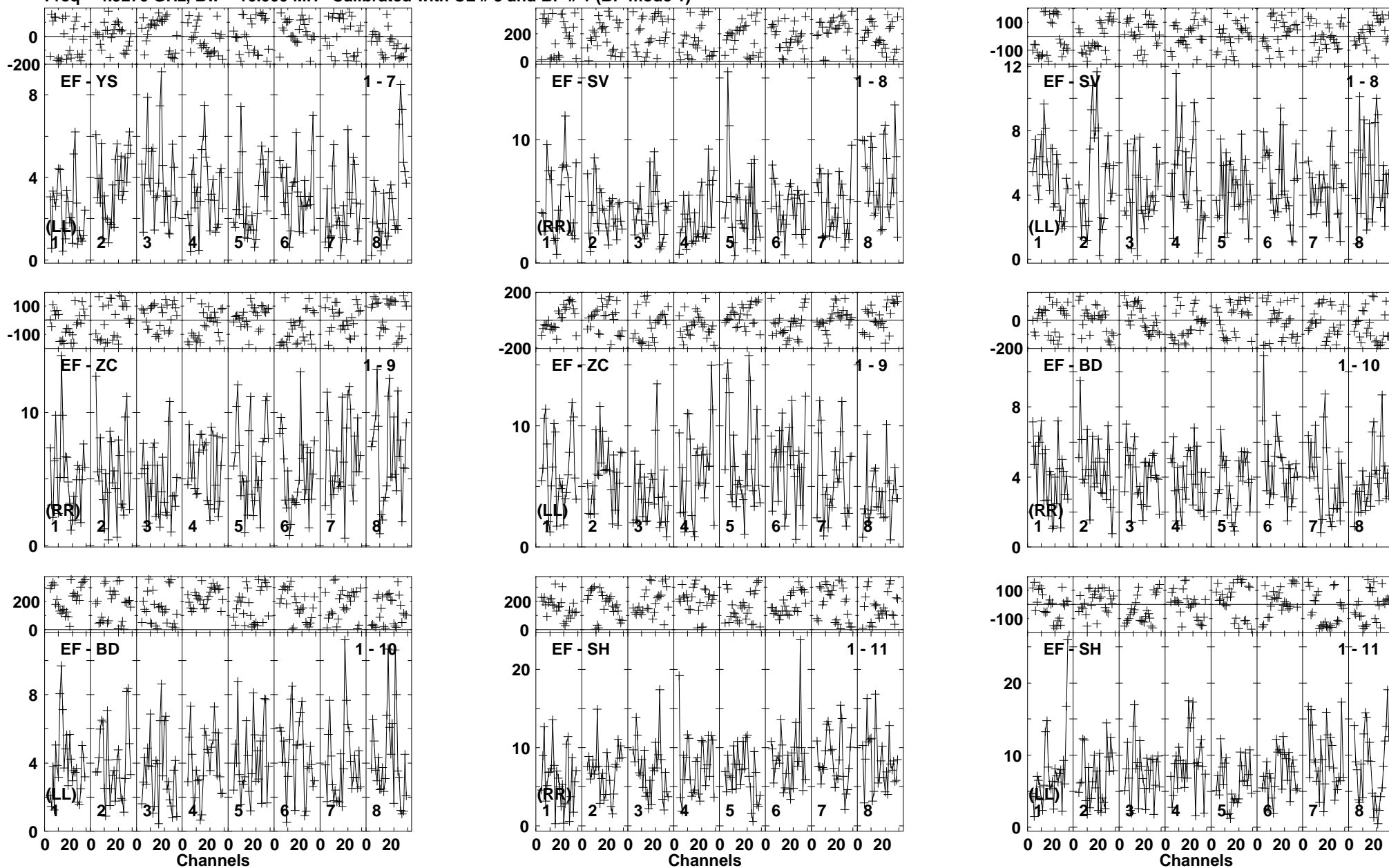

Lower frame: Milli Ampl Jy Top frame: Phas deg  
Vector averaged cross-power spectrum Baseline: EF (01) - YS (07)  
Timerange: 00/14:14:25 to 00/14:18:19

Plot file version 92 created 18-NOV-2014 15:23:23

J1128+5925 EP087H 3.UVDATA.1

Freq = 4.9270 GHz, Bw = 16.000 MH Calibrated with CL # 3 and BP # 1 (BP mode 1)

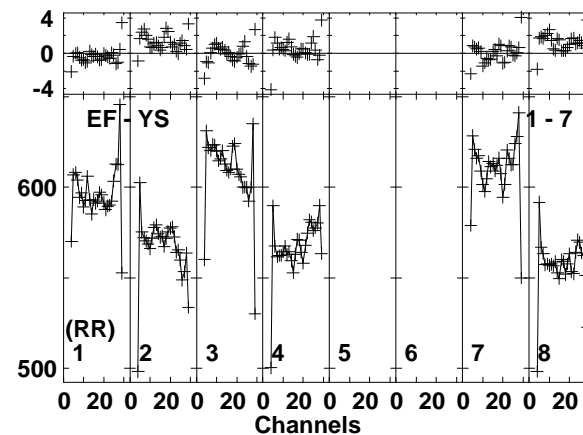
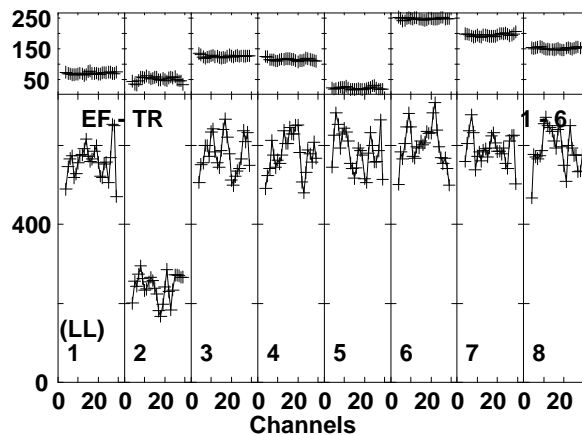
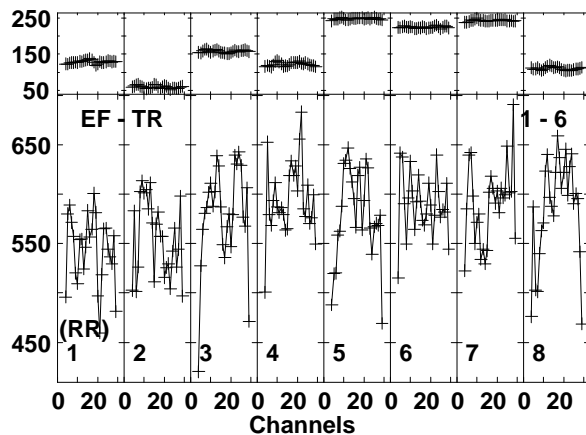
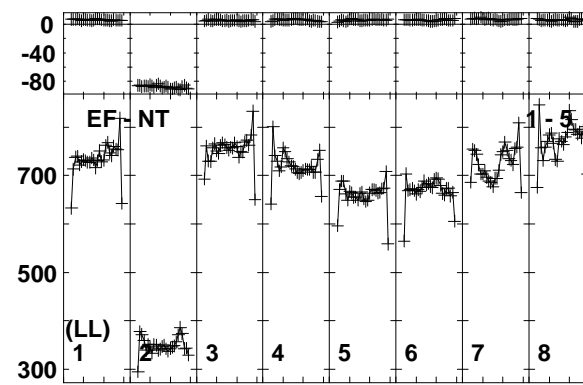
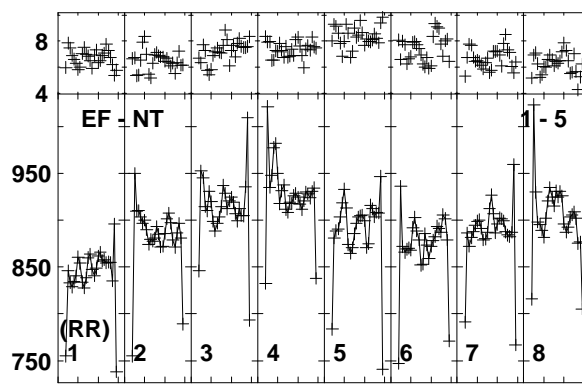
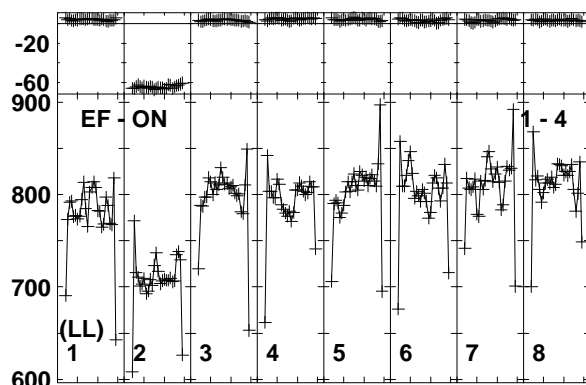
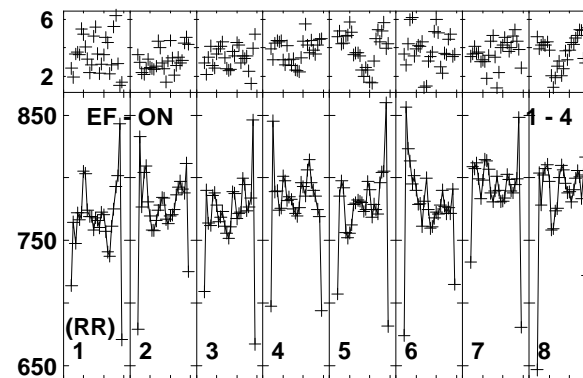
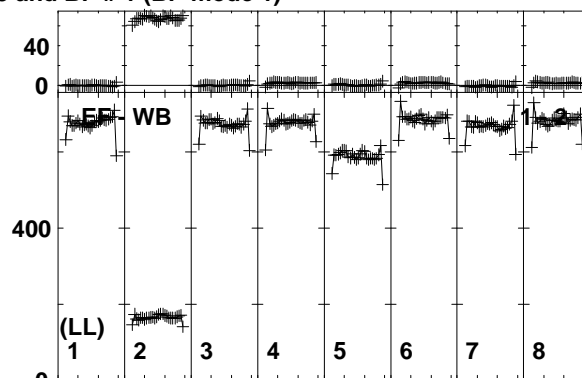
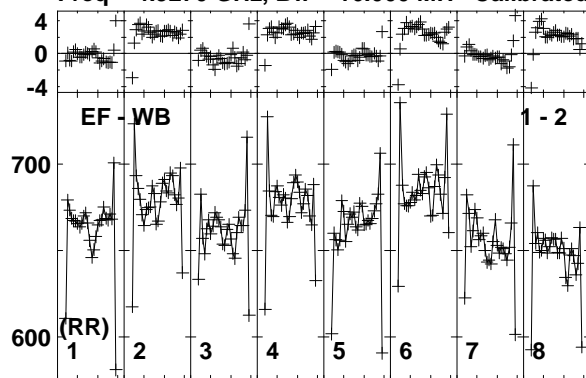

Lower frame: Milli Ampl Jy Top frame: Phas deg  
Vector averaged cross-power spectrum Baseline: EF (01) - WB (02)  
Timerange: 00/14:18:25 to 00/14:19:19

Plot file version 93 created 18-NOV-2014 15:23:23

J1128+5925 EP087H 3.UVDATA.1

Freq = 4.9270 GHz, Bw = 16.000 MH Calibrated with CL # 3 and BP # 1 (BP mode 1)

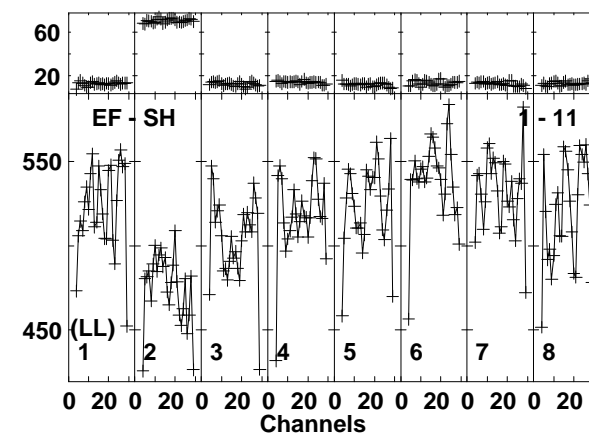
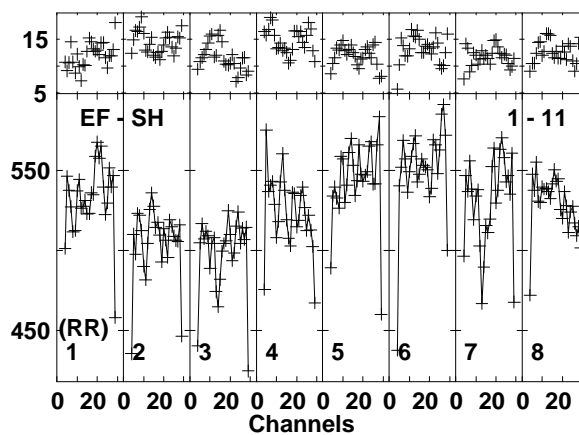
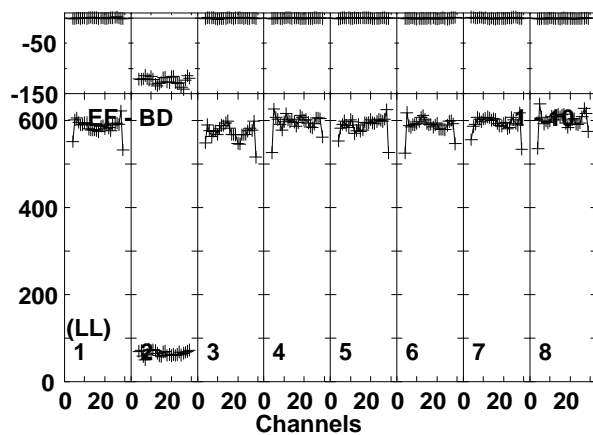
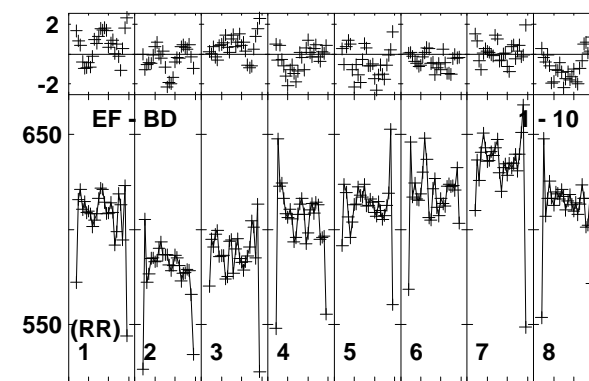
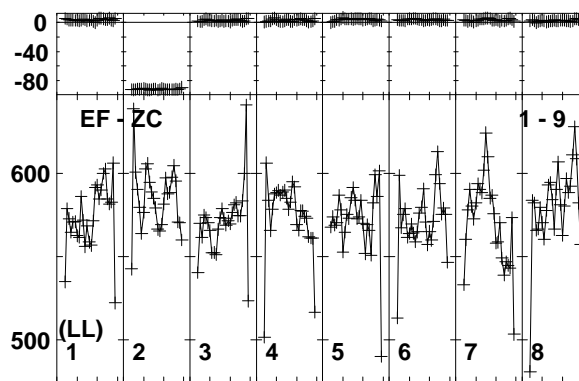
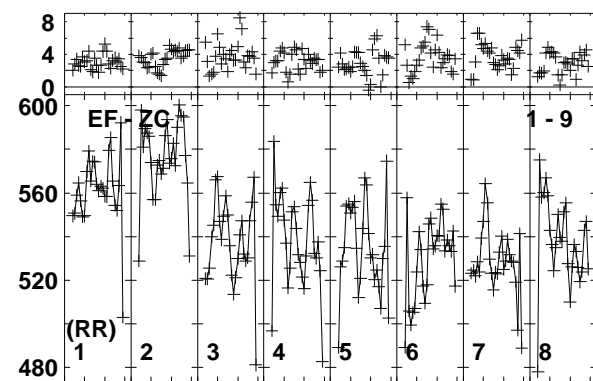
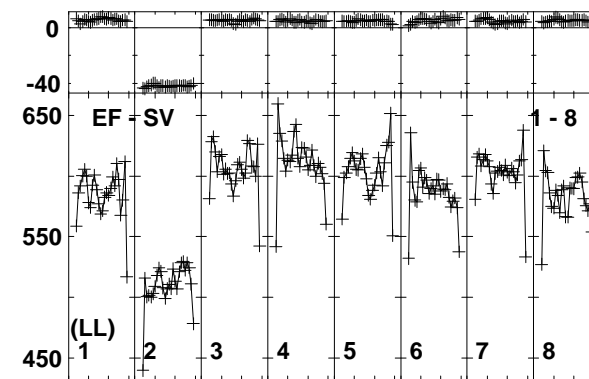
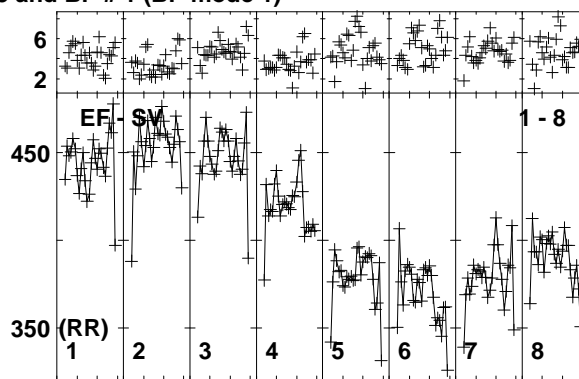
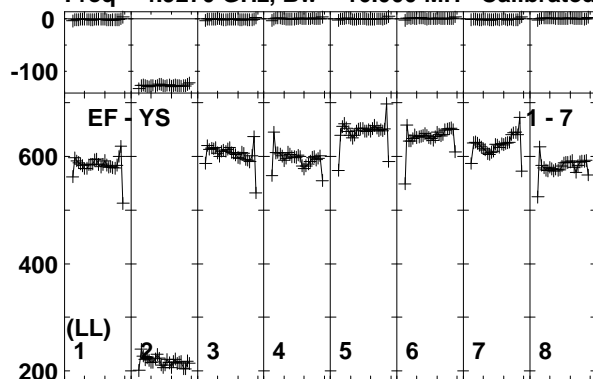

Lower frame: Milli Ampl Jy Top frame: Phas deg  
Vector averaged cross-power spectrum Baseline: EF (01) - YS (07)  
Timerange: 00/14:18:25 to 00/14:19:19

Plot file version 94 created 18-NOV-2014 15:23:23  
 ARP299C EP087H 3.UVDATA.1  
 Freq = 4.9270 GHz, Bw = 16.000 MH Calibrated with CL # 3 and BP # 1 (BP mode 1)

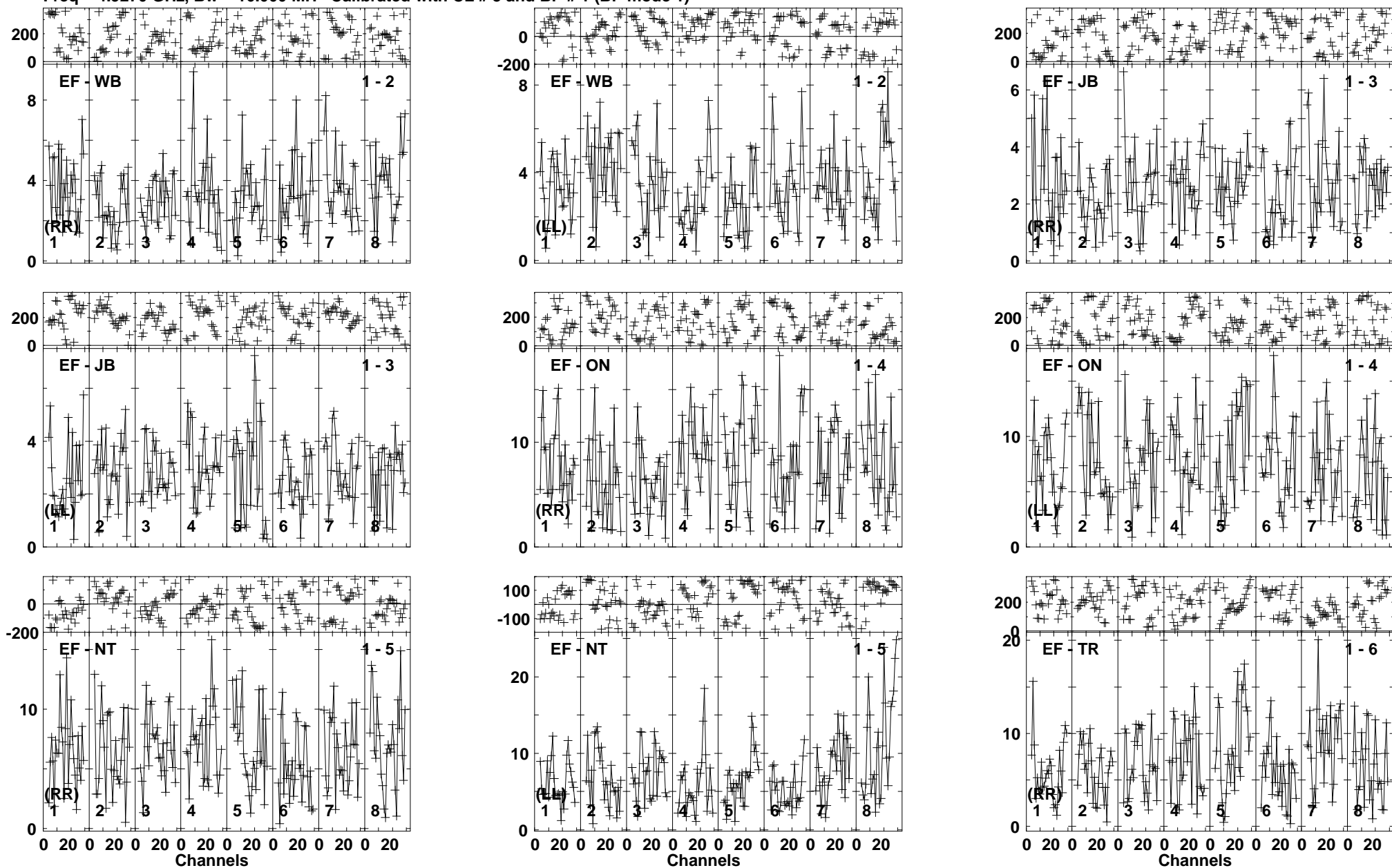

Lower frame: Milli Ampl Jy Top frame: Phas deg  
 Vector averaged cross-power spectrum Baseline: EF (01) - WB (02)  
 Timerange: 00/14:19:21 to 00/14:23:19

Plot file version 95 created 18-NOV-2014 15:23:23

ARP299C EP087H 3.UVDATA.1

Freq = 4.9270 GHz, Bw = 16.000 MH Calibrated with CL # 3 and BP # 1 (BP mode 1)

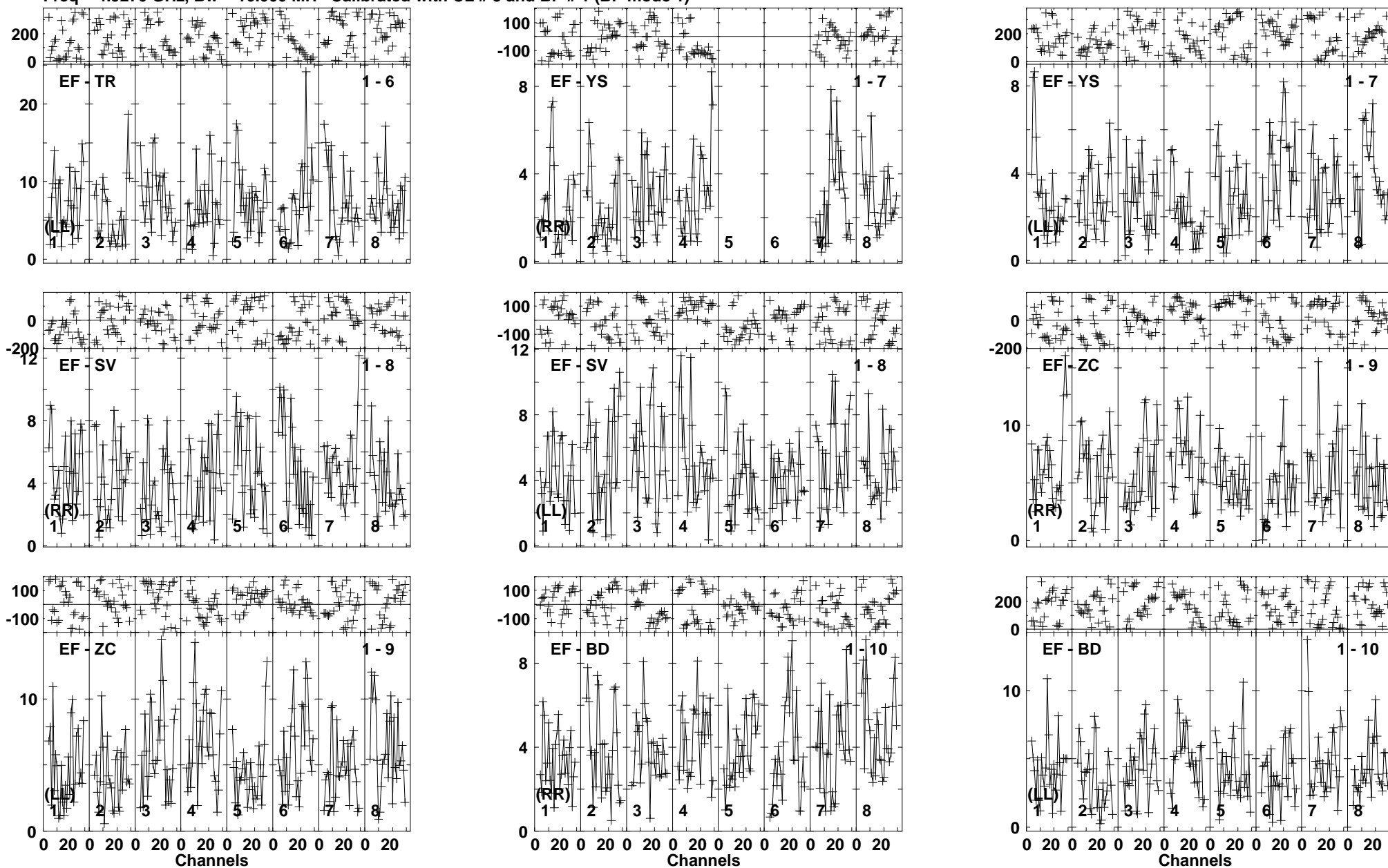

Lower frame: Milli Ampl Jy Top frame: Phas deg  
Vector averaged cross-power spectrum Baseline: EF (01) - TR (06)  
Timerange: 00/14:19:21 to 00/14:23:19

Plot file version 96 created 18-NOV-2014 15:23:24

ARP299C EP087H 3.UVDATA.1

Freq = 4.9270 GHz, Bw = 16.000 MH Calibrated with CL # 3 and BP # 1 (BP mode 1)

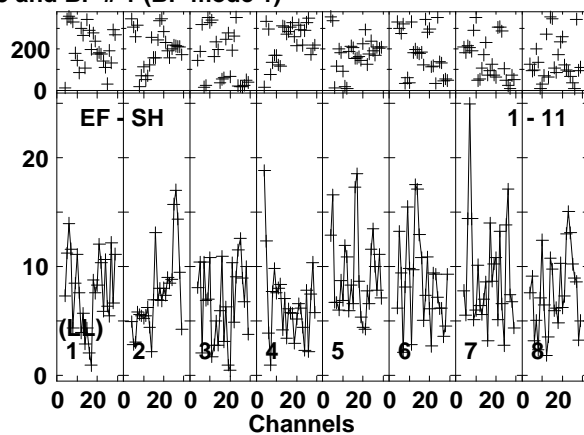
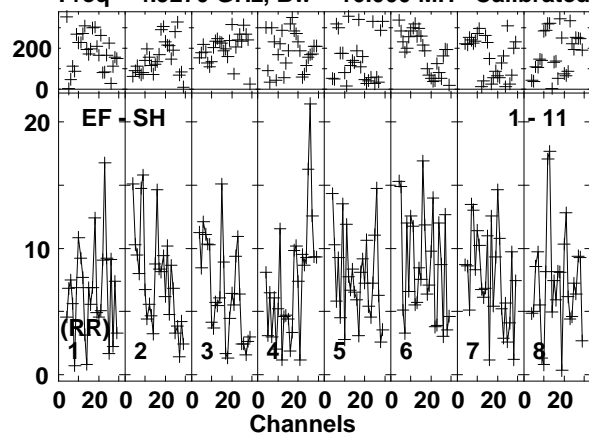

Lower frame: Milli Ampl Jy Top frame: Phas deg  
Vector averaged cross-power spectrum Baseline: EF (01) - SH (11)  
Timerange: 00/14:19:21 to 00/14:23:19



Plot file version 97 created 18-NOV-2014 15:23:24

J1128+5925 EP087H 3.UVDATA.1

Freq = 4.9270 GHz, Bw = 16.000 MH Calibrated with CL # 3 and BP # 1 (BP mode 1)

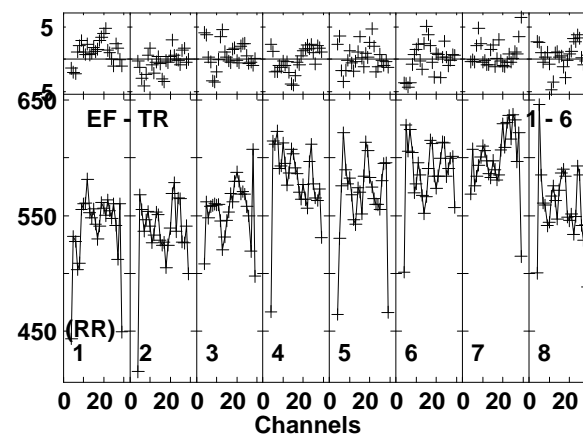
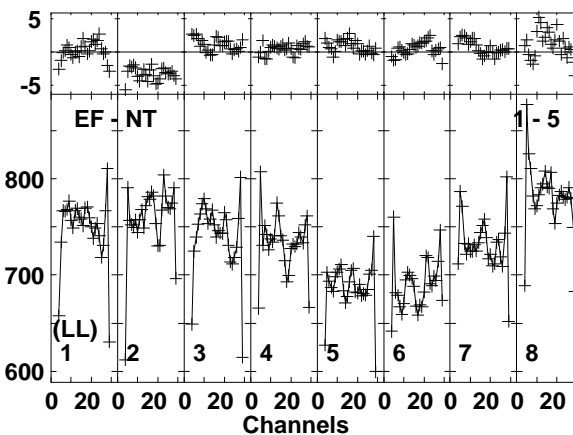
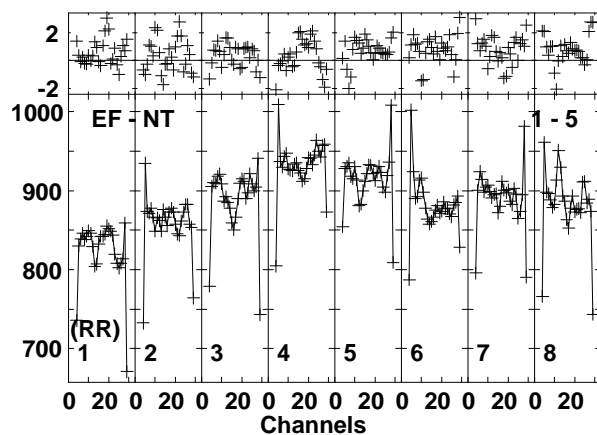
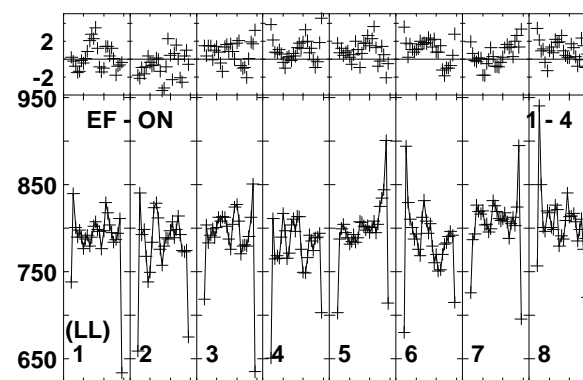
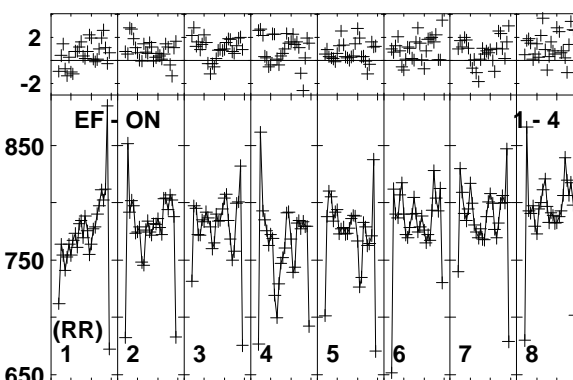
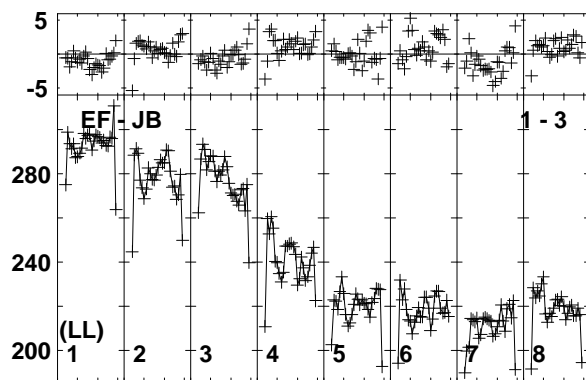
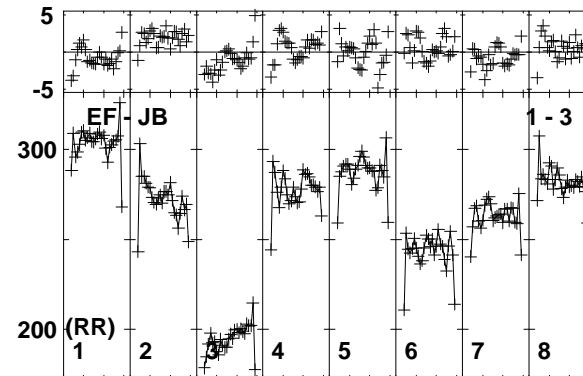
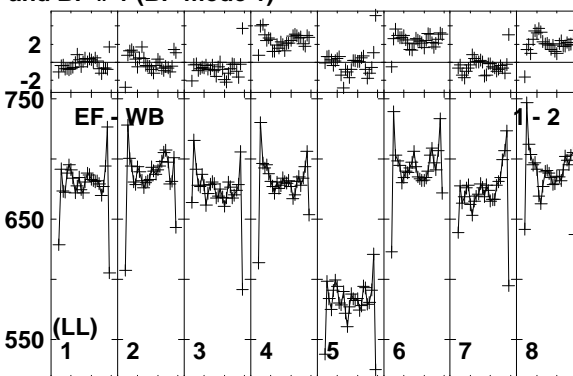
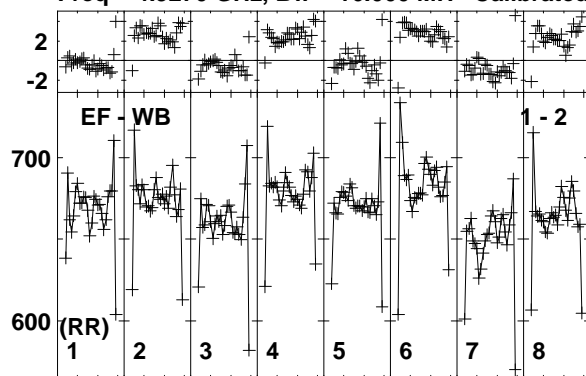

Lower frame: Milli Ampl Jy Top frame: Phas deg  
Vector averaged cross-power spectrum Baseline: EF (01) - WB (02)  
Timerange: 00/14:24:01 to 00/14:24:29

Plot file version 98 created 18-NOV-2014 15:23:24

J1128+5925 EP087H 3.UVDATA.1

Freq = 4.9270 GHz, Bw = 16.000 MH Calibrated with CL # 3 and BP # 1 (BP mode 1)

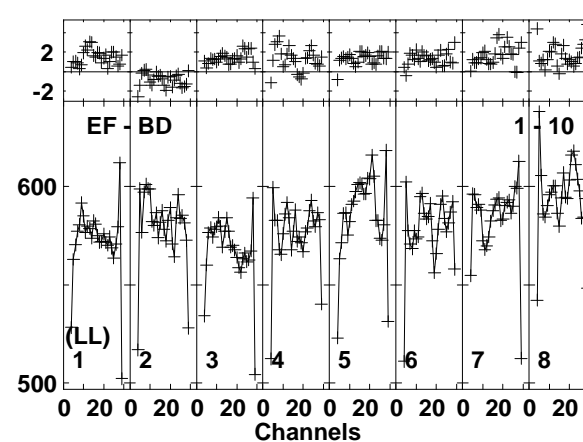
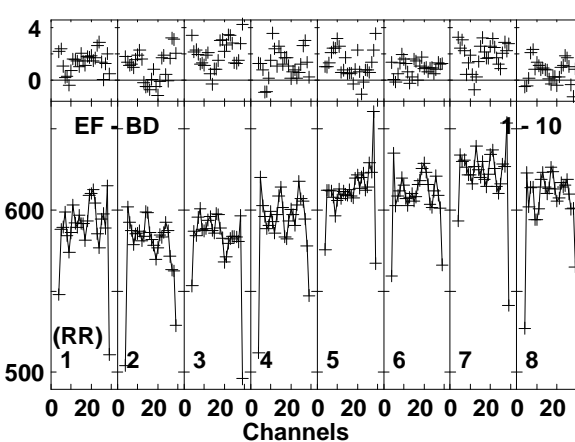
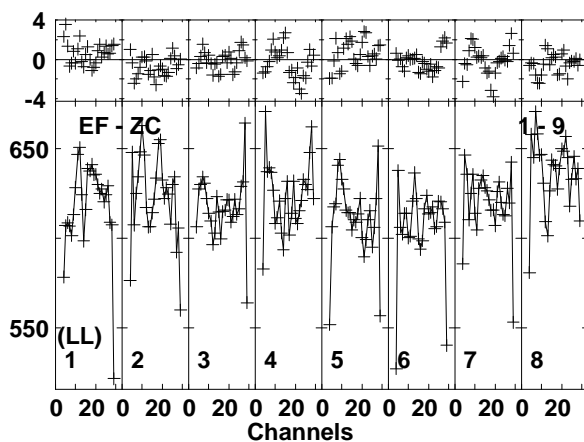
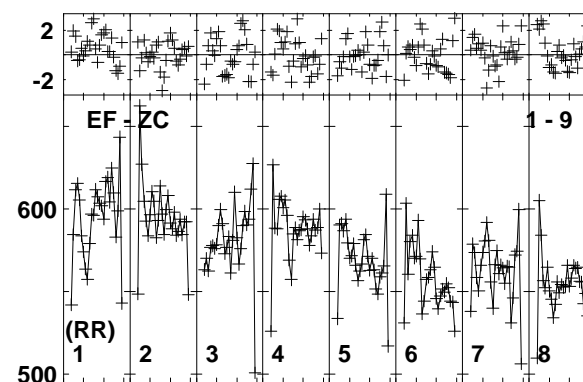
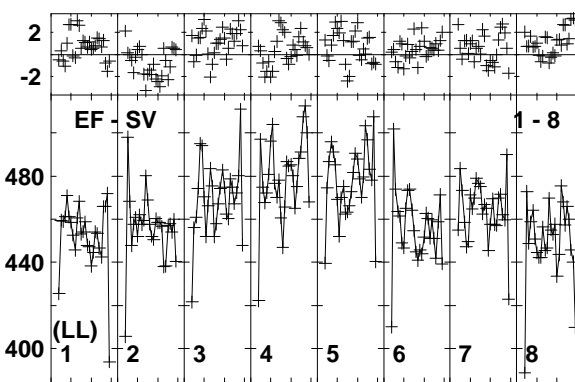
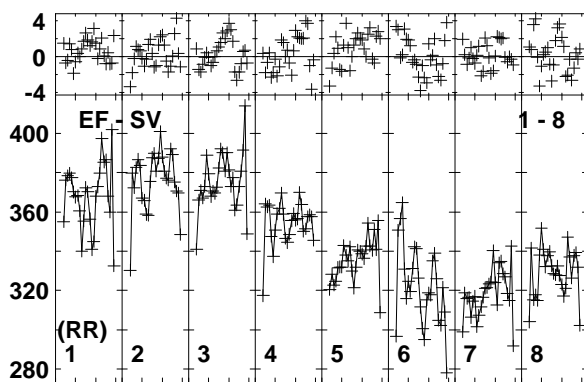
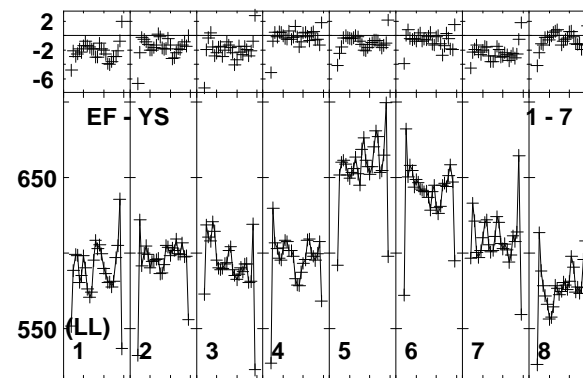
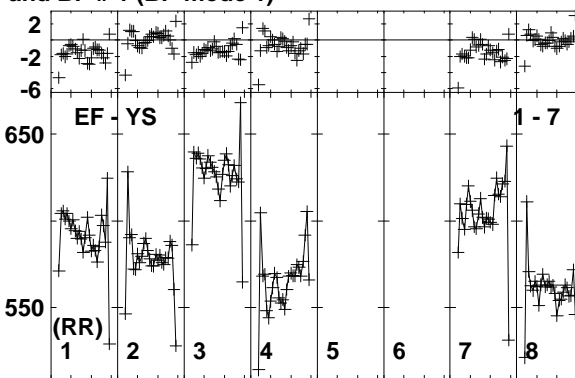
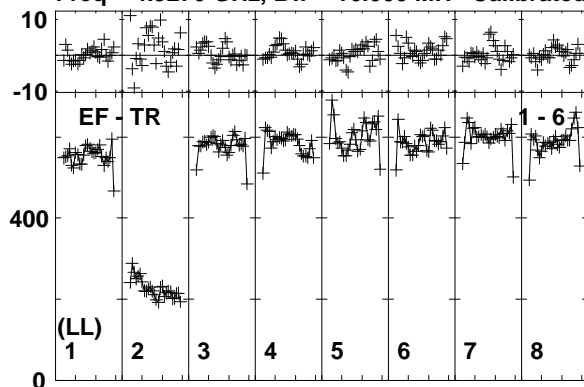

Lower frame: Milli Ampl Jy Top frame: Phas deg  
Vector averaged cross-power spectrum Baseline: EF (01) - TR (06)  
Timerange: 00/14:24:01 to 00/14:24:29

Plot file version 99 created 18-NOV-2014 15:23:24

J1128+5925 EP087H 3.UVDATA.1

Freq = 4.9270 GHz, Bw = 16.000 MH Calibrated with CL # 3 and BP # 1 (BP mode 1)

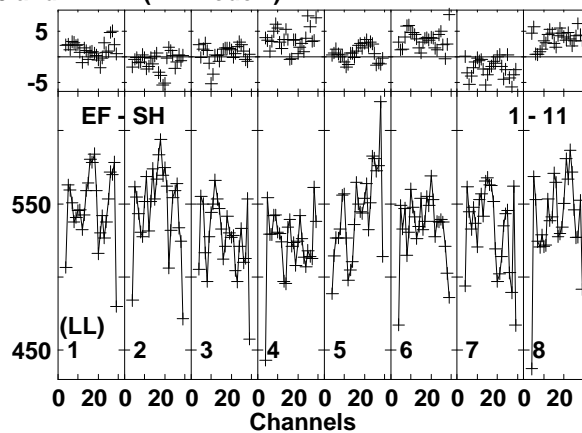
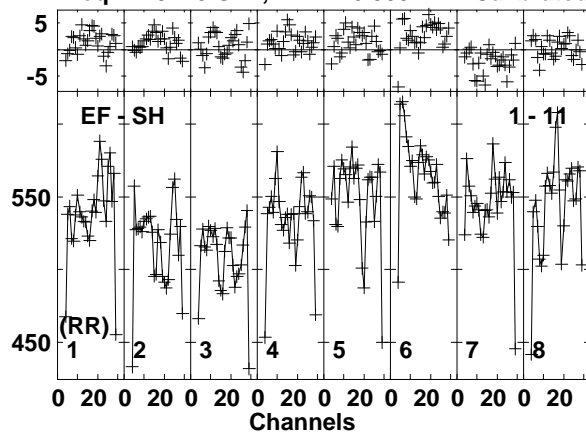

Lower frame: Milli Ampl Jy Top frame: Phas deg  
Vector averaged cross-power spectrum Baseline: EF (01) - SH (11)  
Timerange: 00/14:24:01 to 00/14:24:29

Plot file version 100 created 18-NOV-2014 15:23:24  
 ARP299C EP087H 3.UVDATA.1  
 Freq = 4.9270 GHz, Bw = 16.000 MH Calibrated with CL # 3 and BP # 1 (BP mode 1)

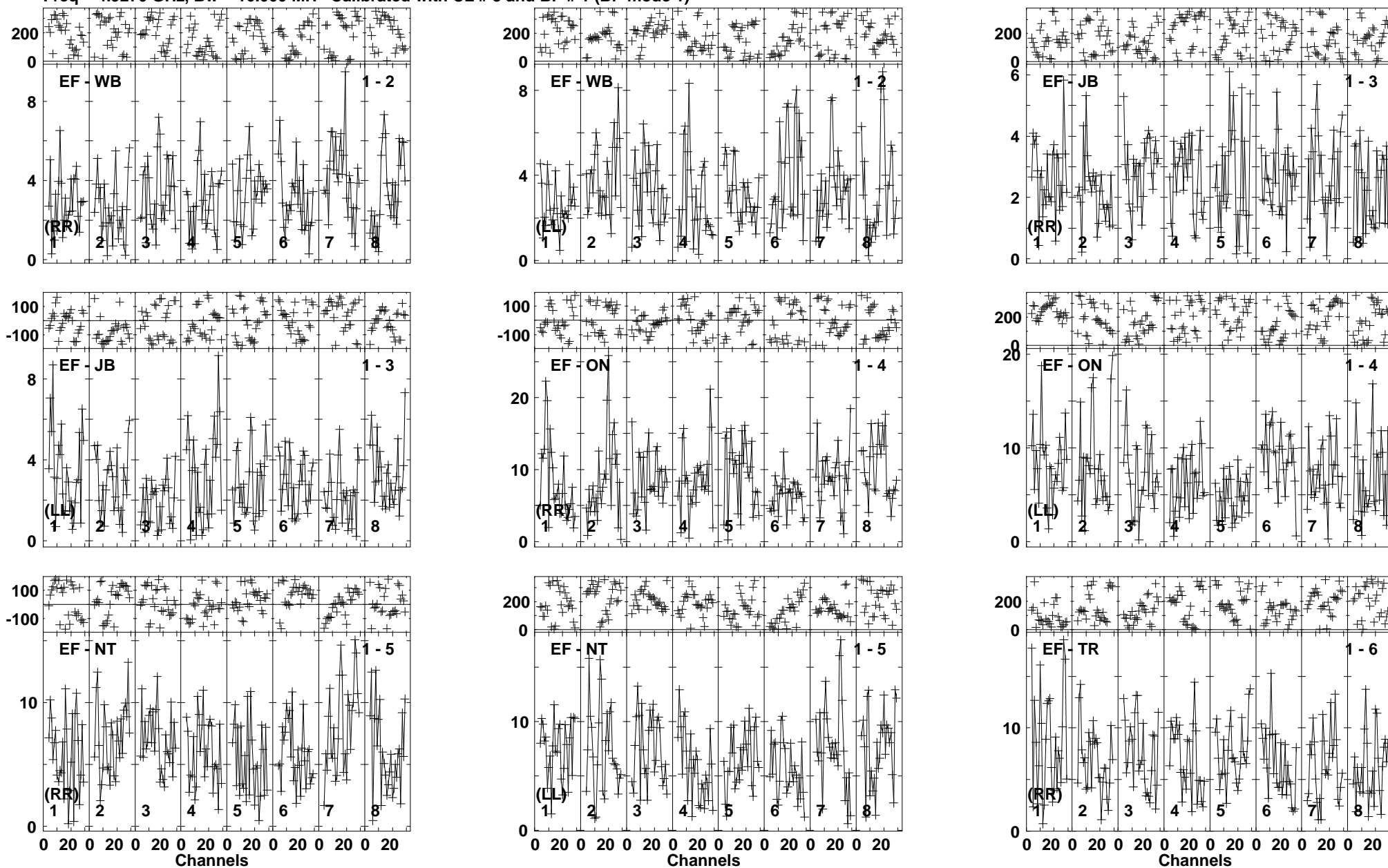

Lower frame: Milli Ampl Jy Top frame: Phas deg  
 Vector averaged cross-power spectrum Baseline: EF (01) - WB (02)  
 Timerange: 00/14:24:35 to 00/14:28:29

Plot file version 101 created 18-NOV-2014 15:23:24  
 ARP299C EP087H 3.UVDATA.1  
 Freq = 4.9270 GHz, Bw = 16.000 MH Calibrated with CL # 3 and BP # 1 (BP mode 1)

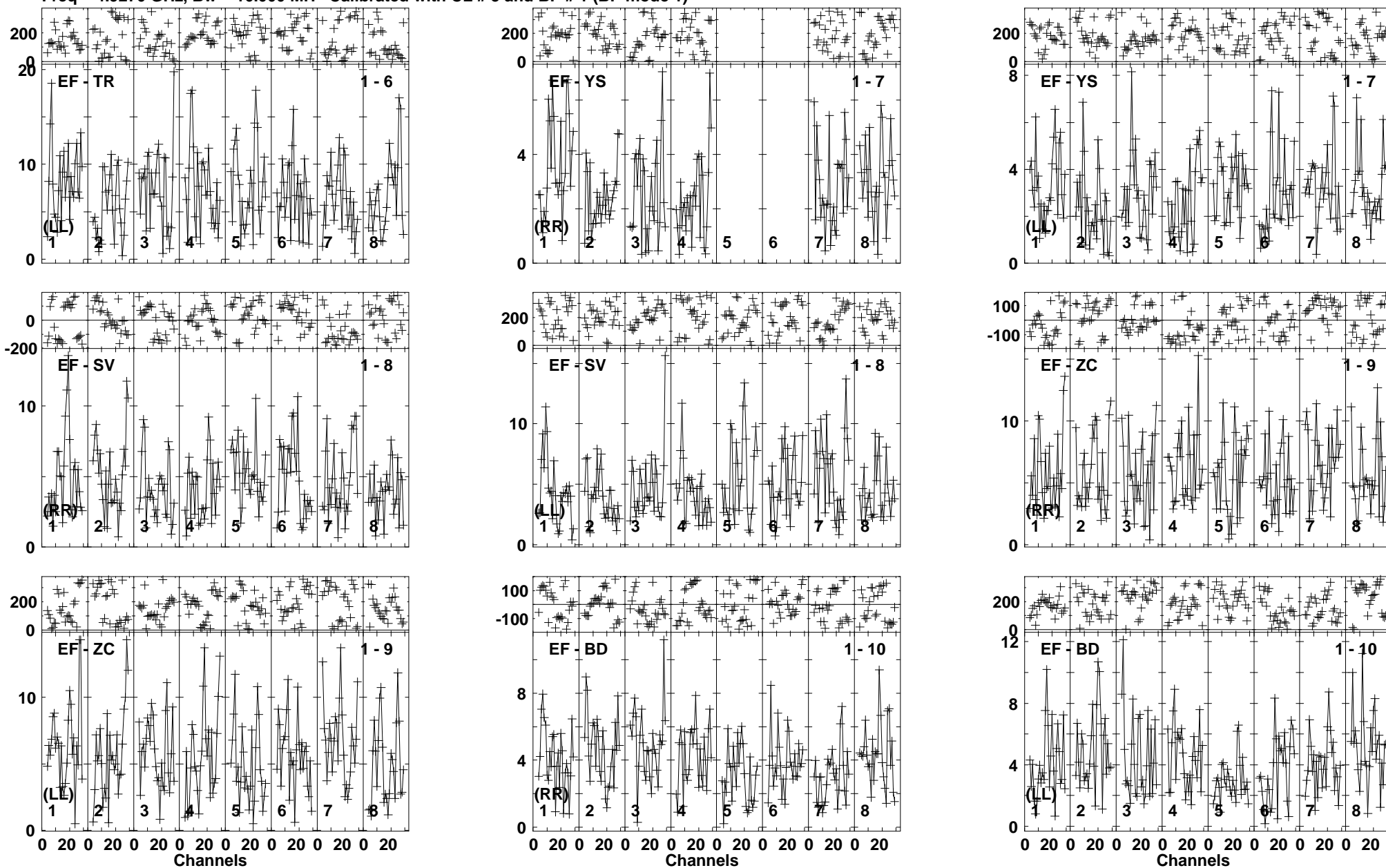

Lower frame: Milli Ampl Jy Top frame: Phas deg  
 Vector averaged cross-power spectrum Baseline: EF (01) - TR (06)  
 Timerange: 00/14:24:35 to 00/14:28:29

Plot file version 102 created 18-NOV-2014 15:23:25

ARP299C EP087H 3.UVDATA.1

Freq = 4.9270 GHz, Bw = 16.000 MH Calibrated with CL # 3 and BP # 1 (BP mode 1)

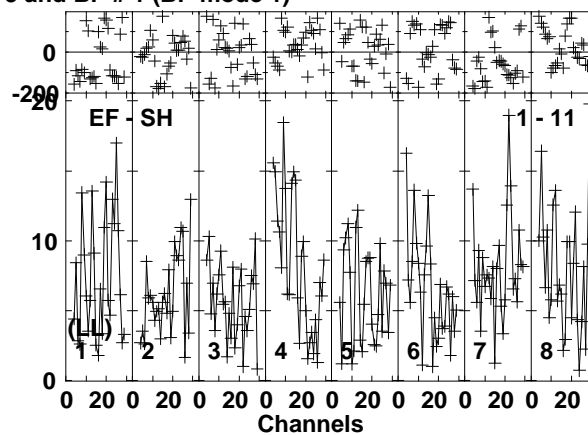
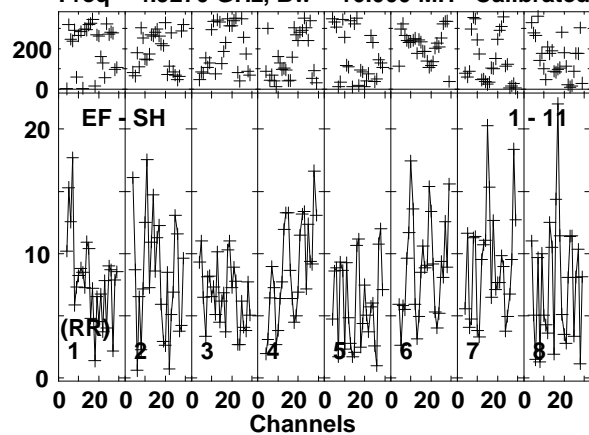

Lower frame: Milli Ampl Jy Top frame: Phas deg  
Vector averaged cross-power spectrum Baseline: EF (01) - SH (11)  
Timerange: 00/14:24:35 to 00/14:28:29

Plot file version 103 created 18-NOV-2014 15:23:25

J1128+5925 EP087H 3.UVDATA.1

Freq = 4.9270 GHz, Bw = 16.000 MH Calibrated with CL # 3 and BP # 1 (BP mode 1)

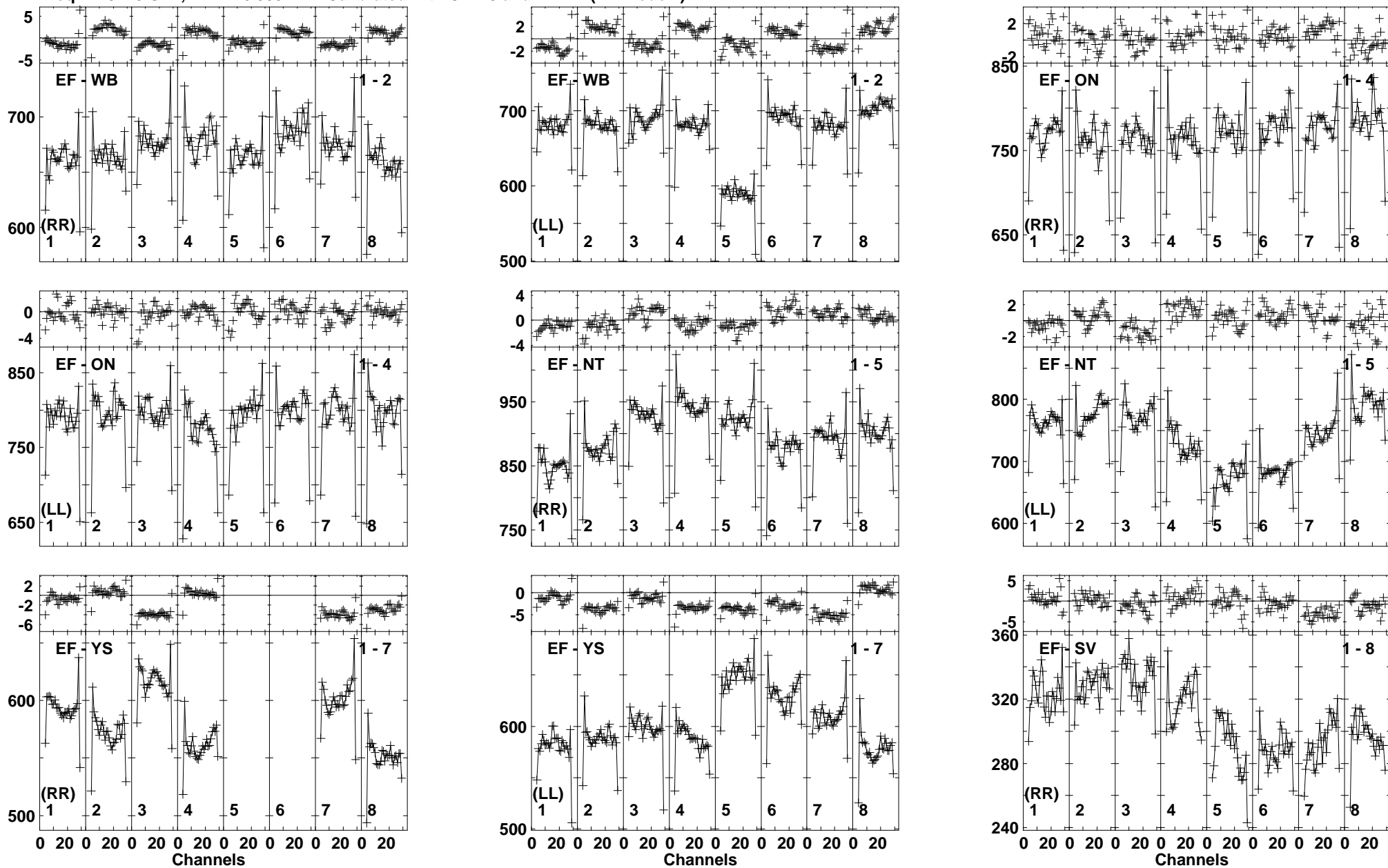

Lower frame: Milli Ampl Jy Top frame: Phas deg  
Vector averaged cross-power spectrum Baseline: EF (01) - WB (02)  
Timerange: 00/14:28:35 to 00/14:29:29

Plot file version 104 created 18-NOV-2014 15:23:25

J1128+5925 EP087H 3.UVDATA.1

Freq = 4.9270 GHz, Bw = 16.000 MH Calibrated with CL # 3 and BP # 1 (BP mode 1)

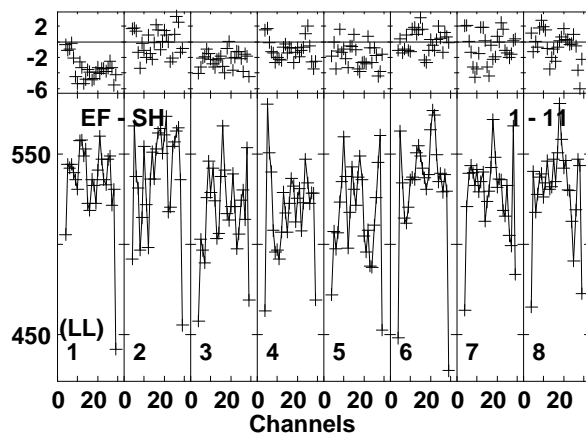
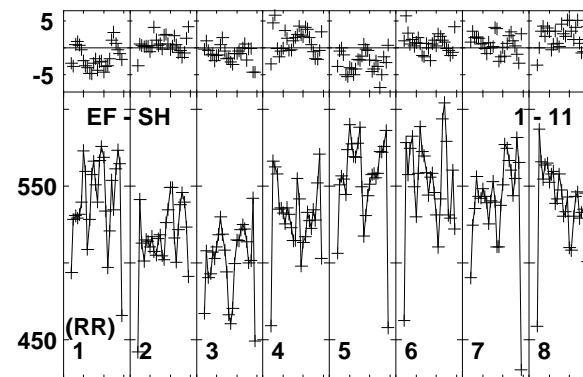
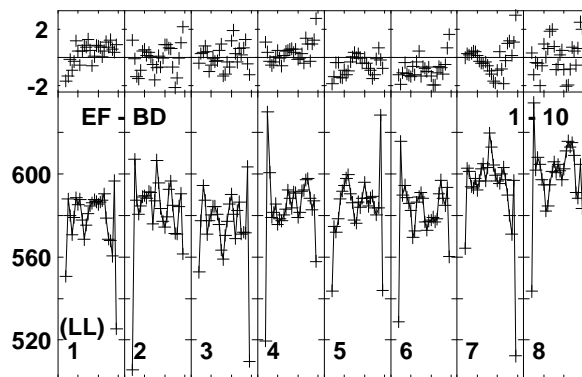
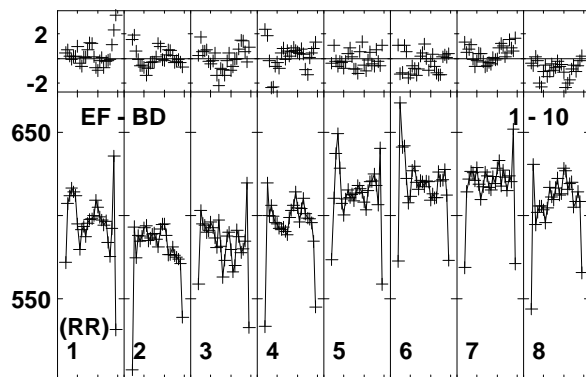
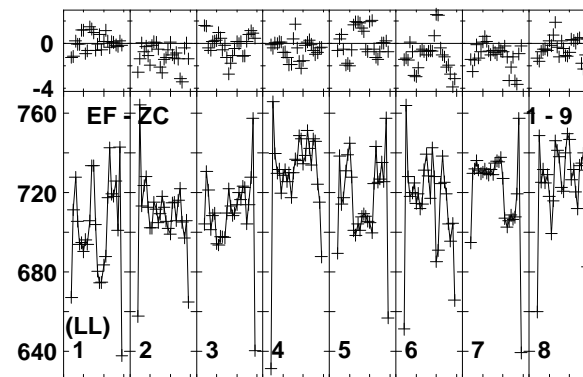
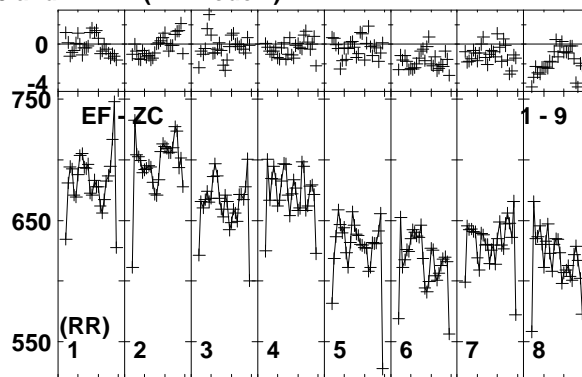
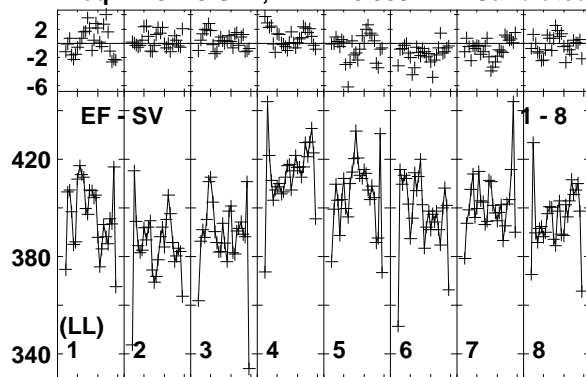

0 20 0 20 0 20 0 20 0 20 0 20 0 20 0 20 0 20 0 20  
Channels  
Lower frame: Milli Ampl Jy Top frame: Phas deg  
Vector averaged cross-power spectrum Baseline: EF (01) - SV (08)  
Timerange: 00/14:28:35 to 00/14:29:29



Plot file version 105 created 18-NOV-2014 15:23:25  
 ARP299C EP087H 3.UVDATA.1  
 Freq = 4.9270 GHz, Bw = 16.000 MH Calibrated with CL # 3 and BP # 1 (BP mode 1)

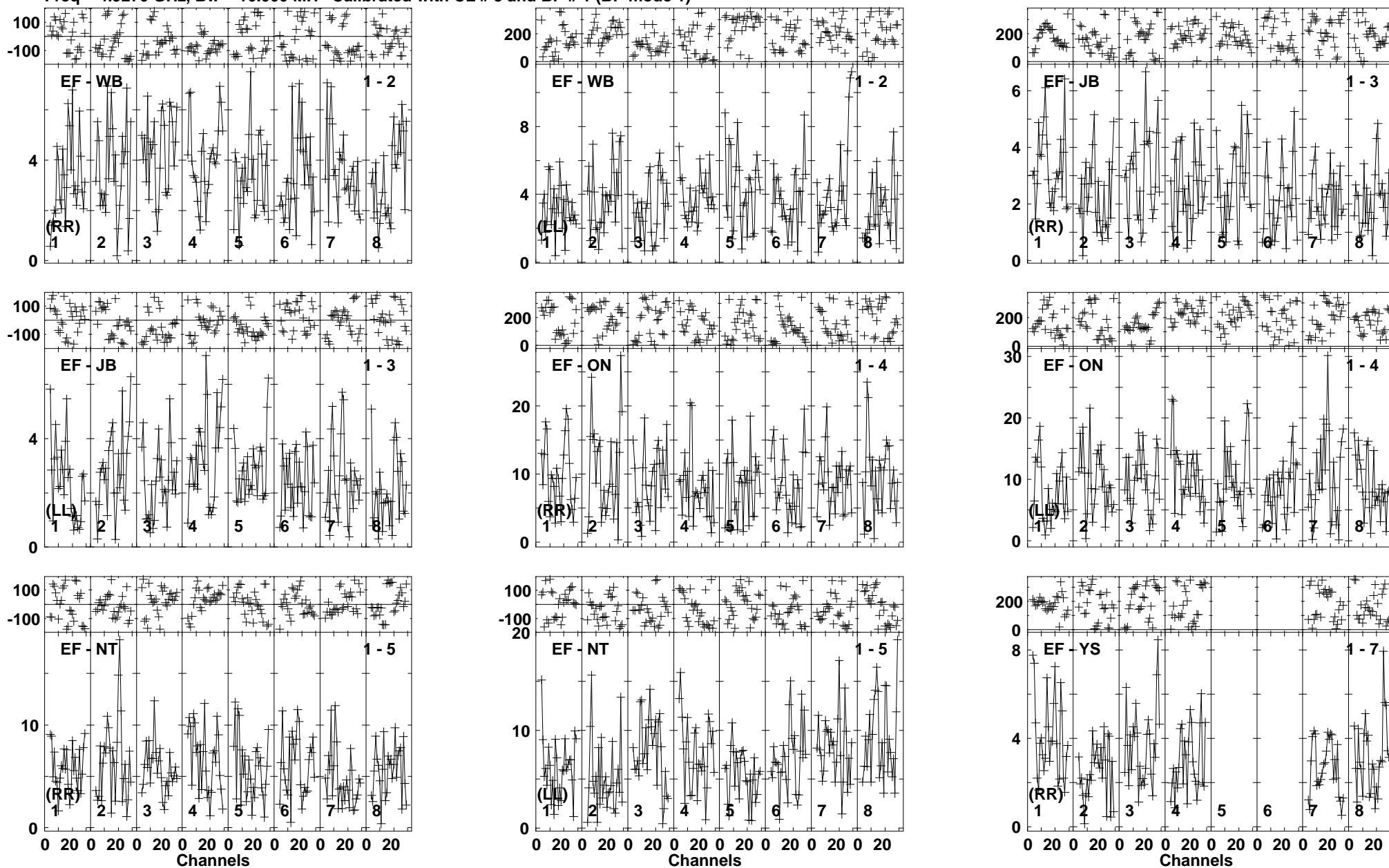

Lower frame: Milli Ampl Jy Top frame: Phas deg  
 Vector averaged cross-power spectrum Baseline: EF (01) - WB (02)  
 Timerange: 00/14:29:31 to 00/14:33:29

Plot file version 106 created 18-NOV-2014 15:23:25  
 ARP299C EP087H 3.UVDATA.1  
 Freq = 4.9270 GHz, Bw = 16.000 MH Calibrated with CL # 3 and BP # 1 (BP mode 1)

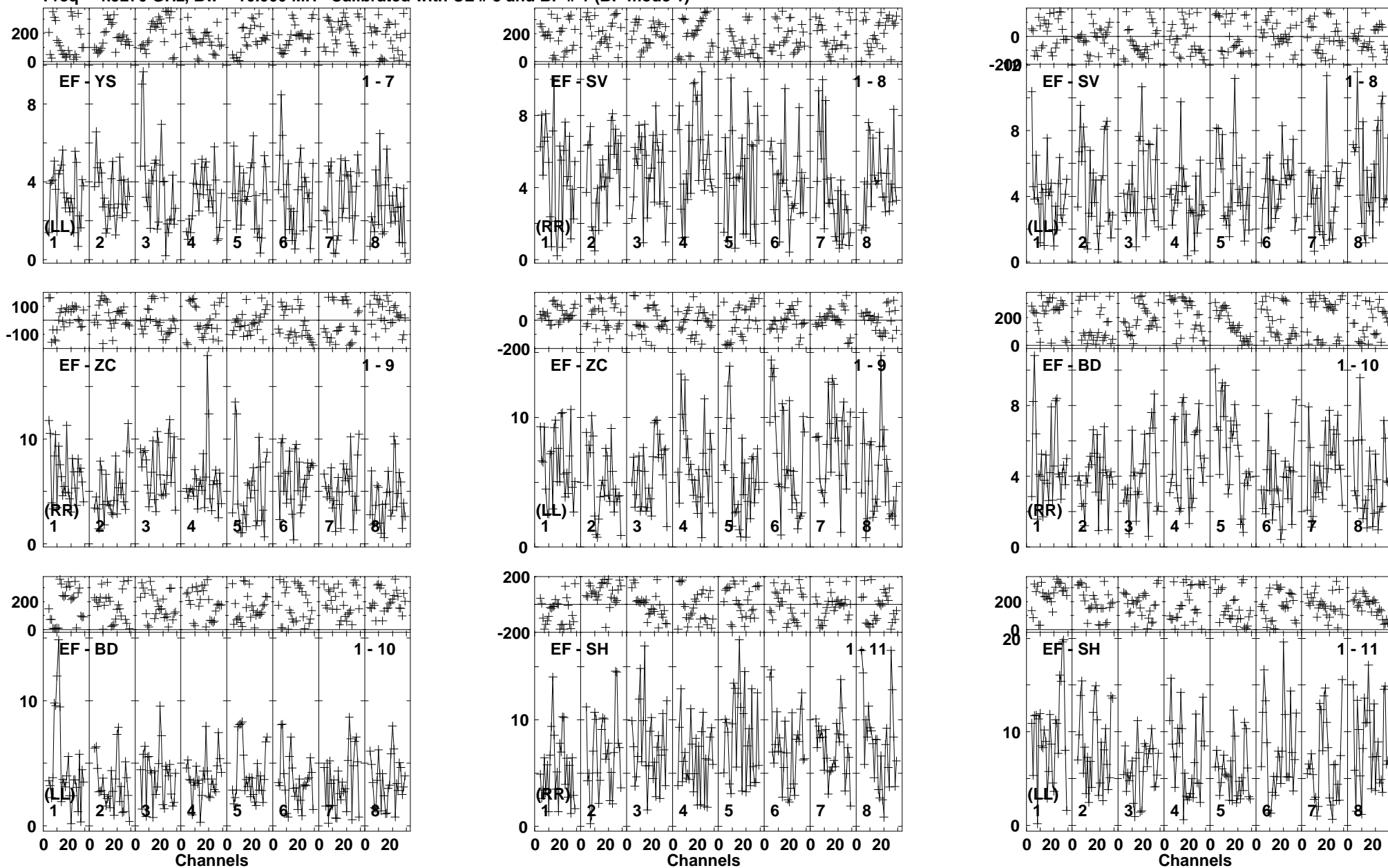

Lower frame: Milli Ampl Jy Top frame: Phas deg  
 Vector averaged cross-power spectrum Baseline: EF (01) - YS (07)  
 Timerange: 00/14:29:31 to 00/14:33:29

Plot file version 107 created 18-NOV-2014 15:23:26

J1128+5925 EP087H 3.UVDATA.1

Freq = 4.9270 GHz, Bw = 16.000 MH Calibrated with CL # 3 and BP # 1 (BP mode 1)

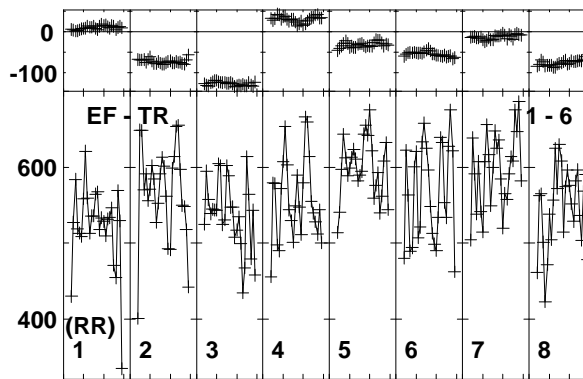
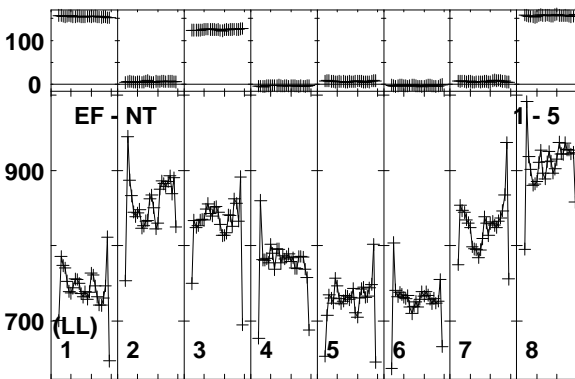
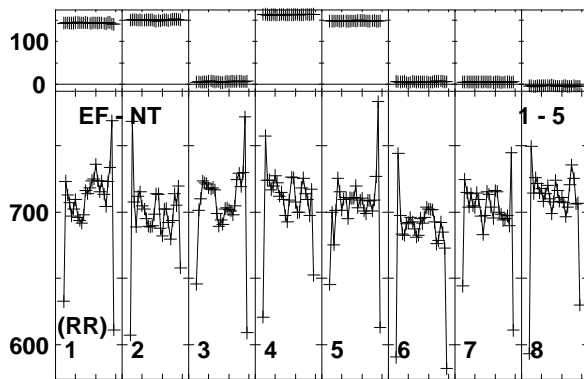
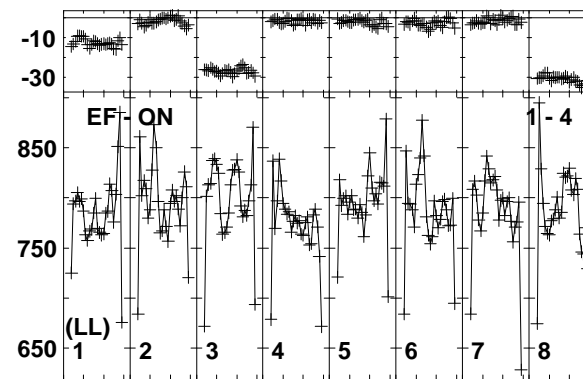
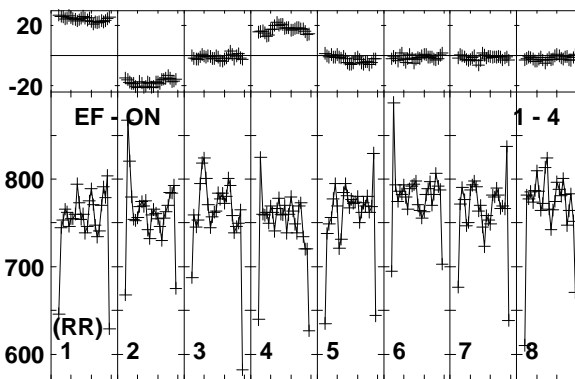
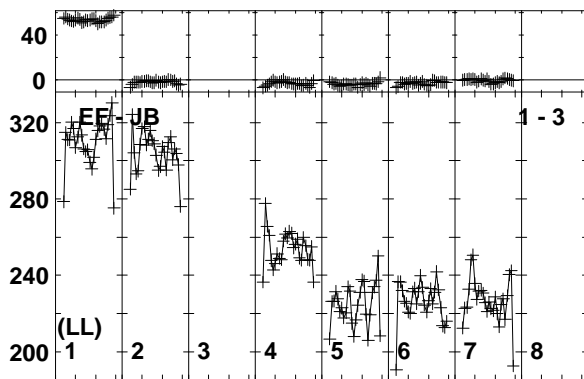
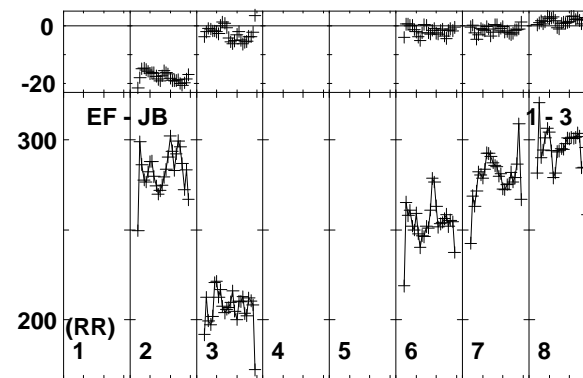
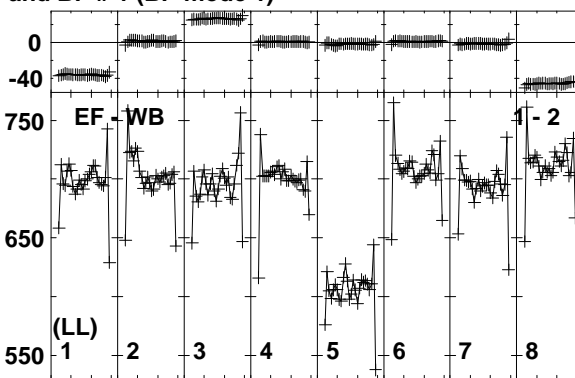
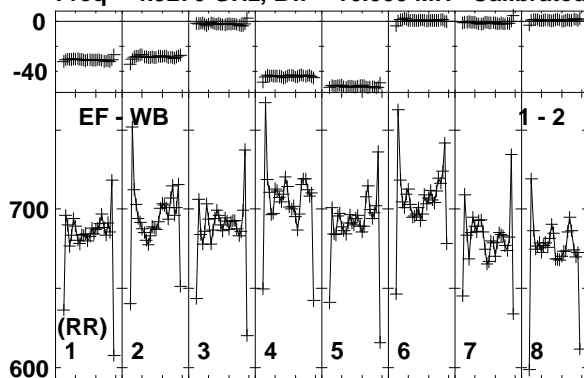

Lower frame: Milli Ampl Jy Top frame: Phas deg  
Vector averaged cross-power spectrum Baseline: EF (01) - WB (02)  
Timerange: 00/14:33:35 to 00/14:34:29

Plot file version 108 created 18-NOV-2014 15:23:26  
 J1128+5925 EP087H 3.UVDATA.1  
 Freq = 4.9270 GHz, Bw = 16.000 MH Calibrated with CL # 3 and BP # 1 (BP mode 1)

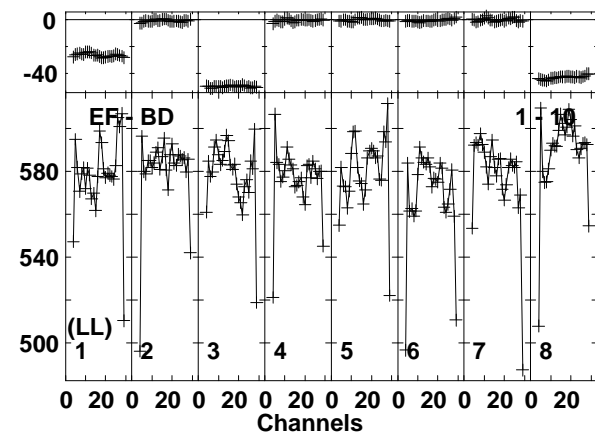
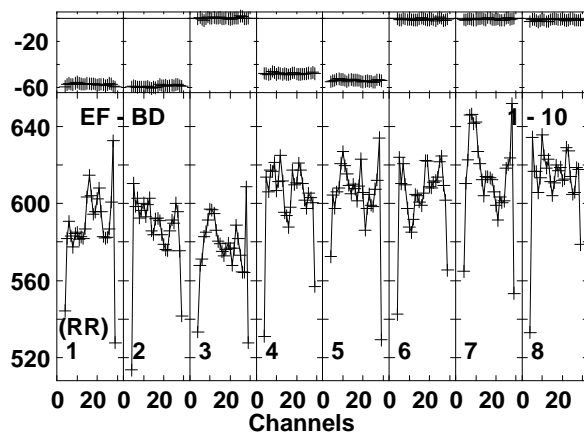
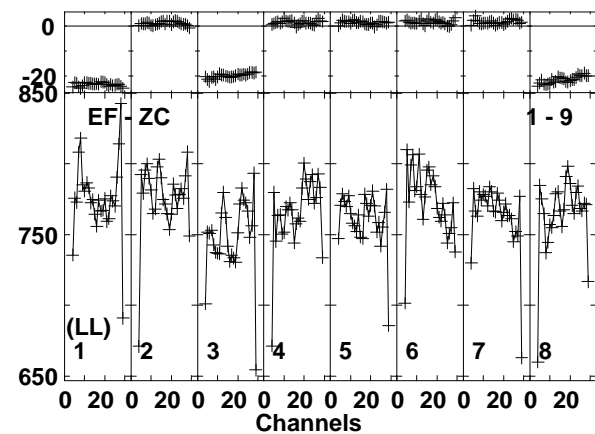
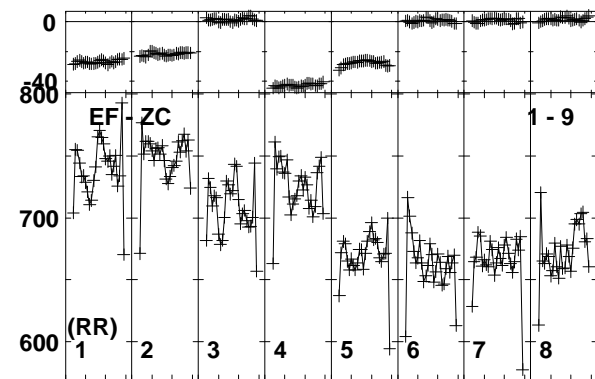
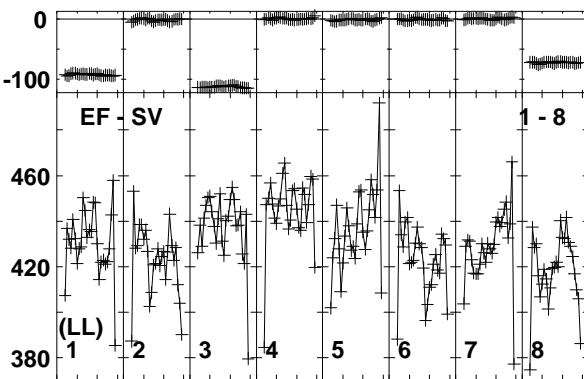
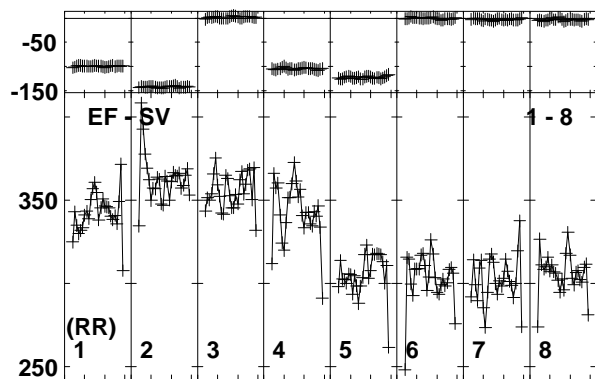
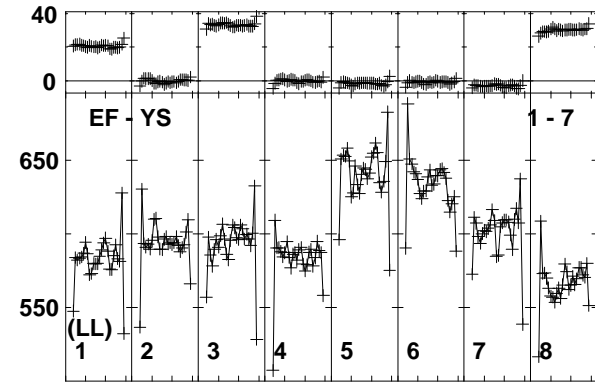
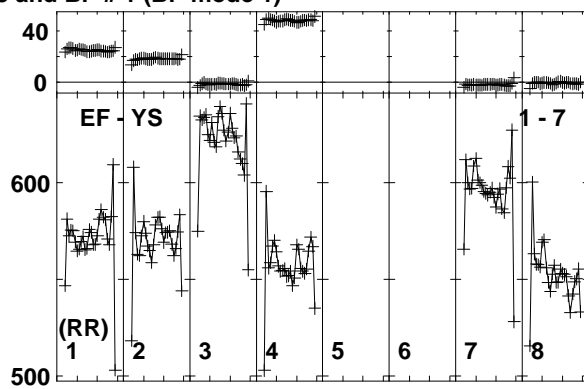
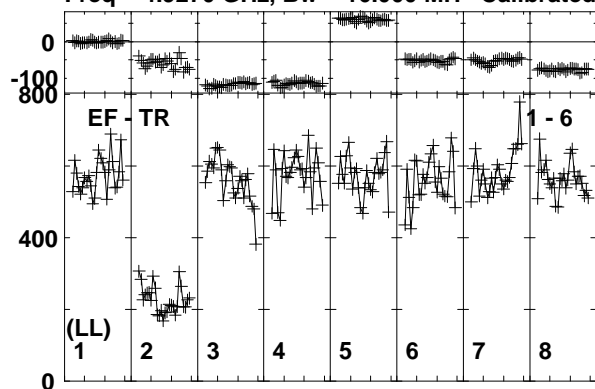

Lower frame: Milli Ampl Jy Top frame: Phas deg  
 Vector averaged cross-power spectrum Baseline: EF (01) - TR (06)  
 Timerange: 00/14:33:35 to 00/14:34:29

Plot file version 109 created 18-NOV-2014 15:23:26

J1128+5925 EP087H 3.UVDATA.1

Freq = 4.9270 GHz, Bw = 16.000 MH Calibrated with CL # 3 and BP # 1 (BP mode 1)

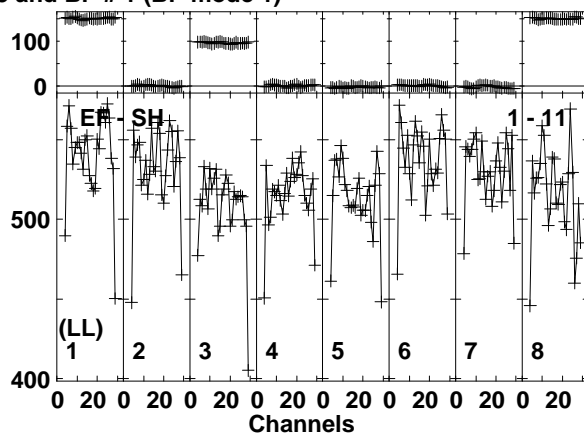
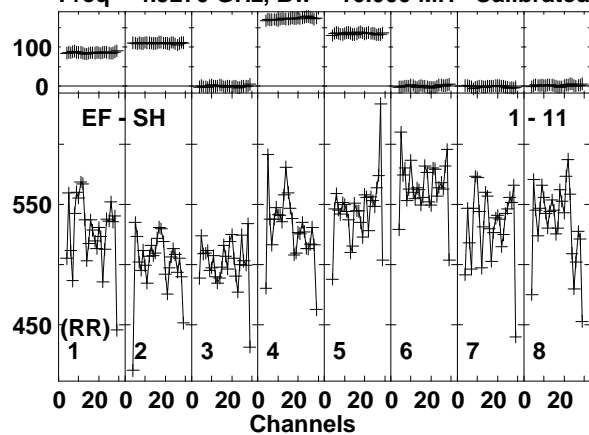

Lower frame: Milli Ampl Jy Top frame: Phas deg  
Vector averaged cross-power spectrum Baseline: EF (01) - SH (11)  
Timerange: 00/14:33:35 to 00/14:34:29

Plot file version 110 created 18-NOV-2014 15:23:26

ARP299C EP087H 3.UVDATA.1

Freq = 4.9270 GHz, Bw = 16.000 MH Calibrated with CL # 3 and BP # 1 (BP mode 1)

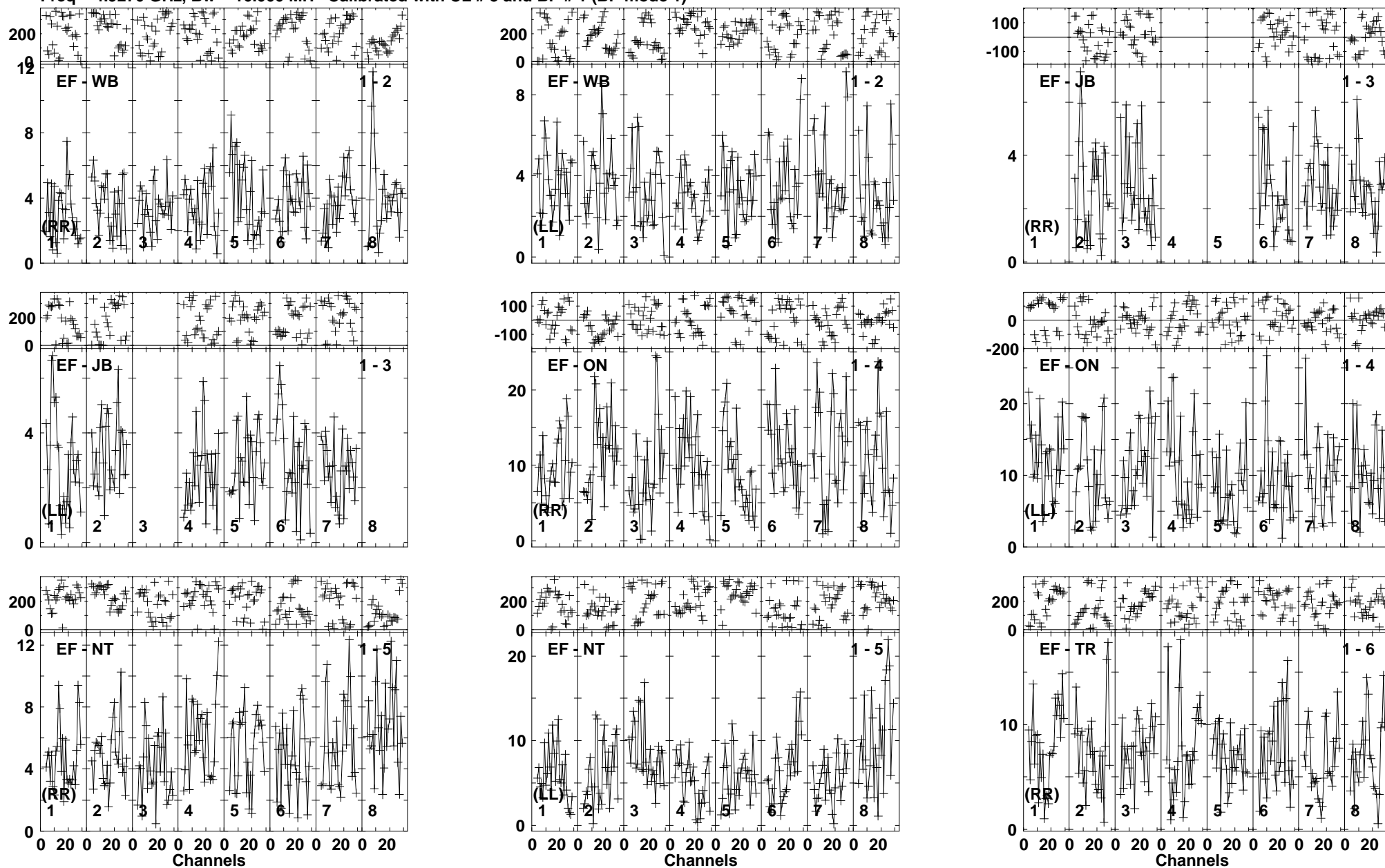

Lower frame: Milli Ampl Jy Top frame: Phas deg  
Vector averaged cross-power spectrum Baseline: EF (01) - WB (02)  
Timerange: 00/14:34:35 to 00/14:38:29

Plot file version 111 created 18-NOV-2014 15:23:26

ARP299C EP087H 3.UVDATA.1

Freq = 4.9270 GHz, Bw = 16.000 MH Calibrated with CL # 3 and BP # 1 (BP mode 1)

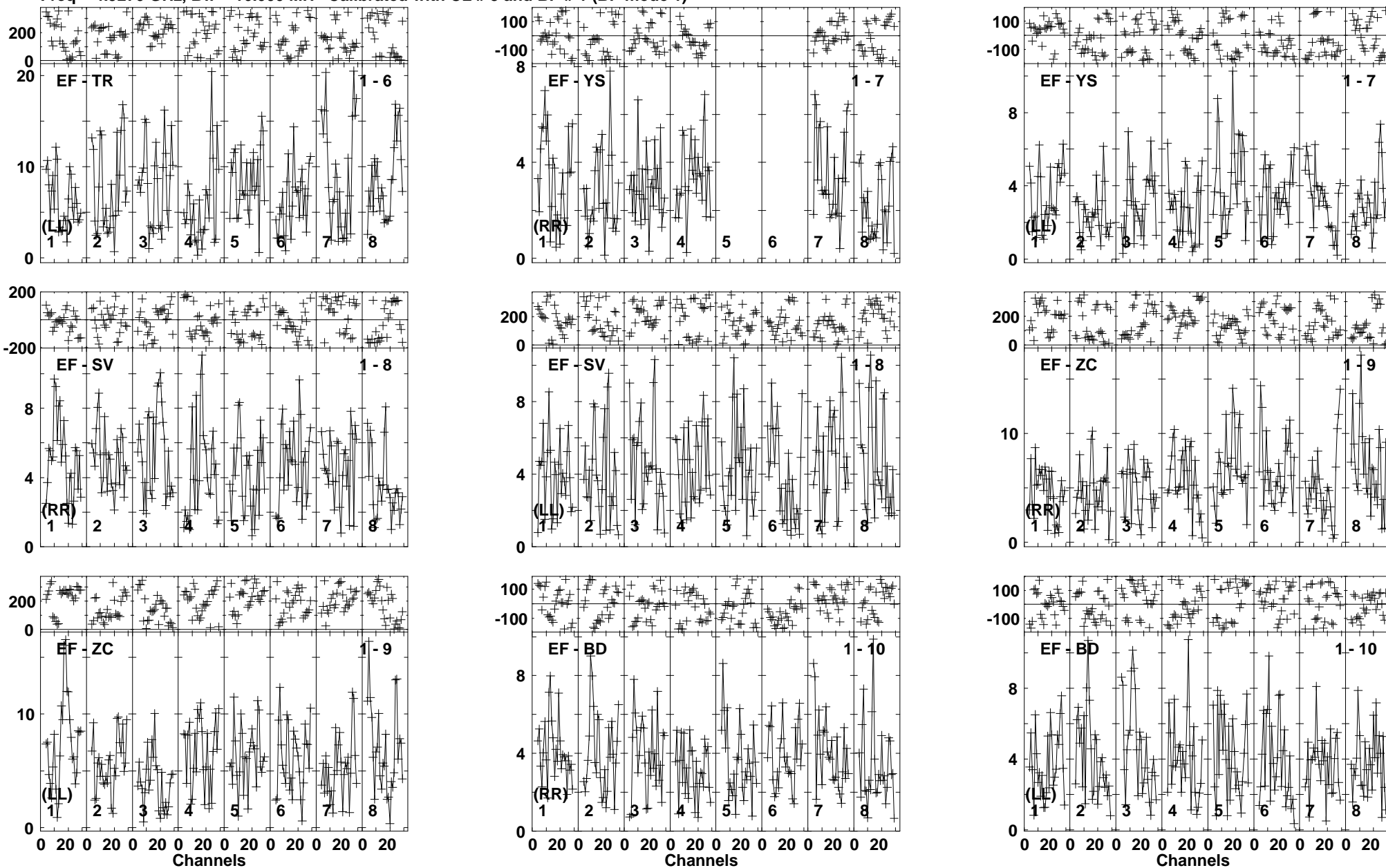

Lower frame: Milli Ampl Jy Top frame: Phas deg  
Vector averaged cross-power spectrum Baseline: EF (01) - TR (06)  
Timerange: 00/14:34:35 to 00/14:38:29

Plot file version 112 created 18-NOV-2014 15:23:27

ARP299C EP087H 3.UVDATA.1

Freq = 4.9270 GHz, Bw = 16.000 MH Calibrated with CL # 3 and BP # 1 (BP mode 1)

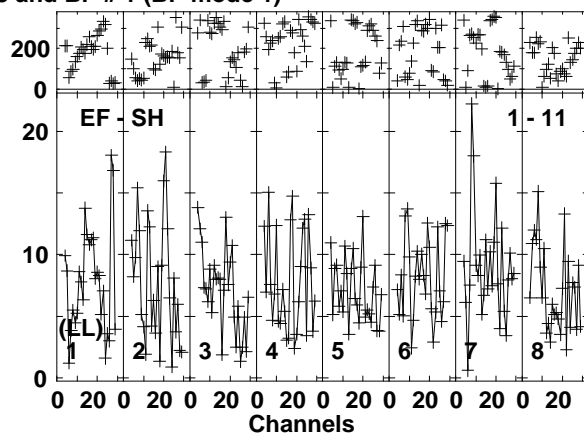
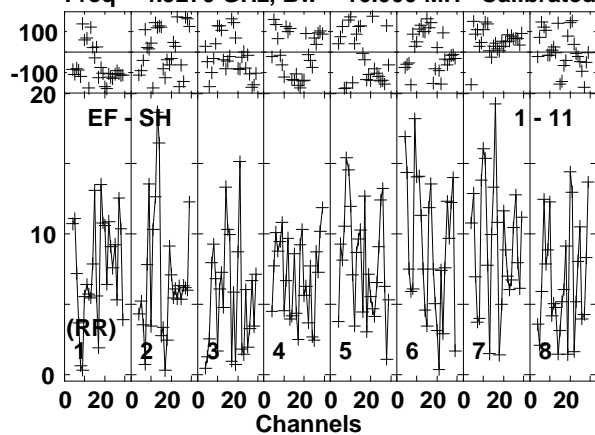

Lower frame: Milli Ampl Jy Top frame: Phas deg  
Vector averaged cross-power spectrum Baseline: EF (01) - SH (11)  
Timerange: 00/14:34:35 to 00/14:38:29



Plot file version 113 created 18-NOV-2014 15:23:27

J1128+5925 EP087H 3.UVDATA.1

Freq = 4.9270 GHz, Bw = 16.000 MH Calibrated with CL # 3 and BP # 1 (BP mode 1)

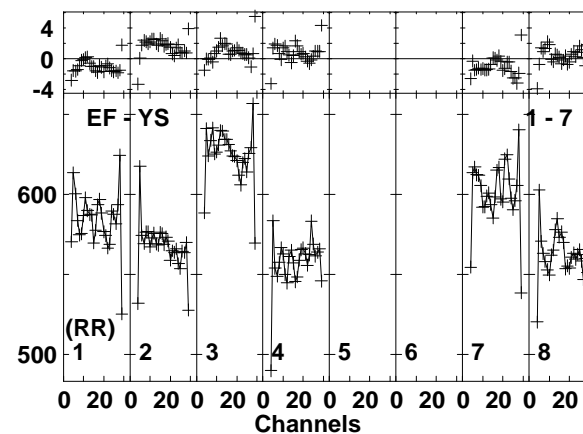
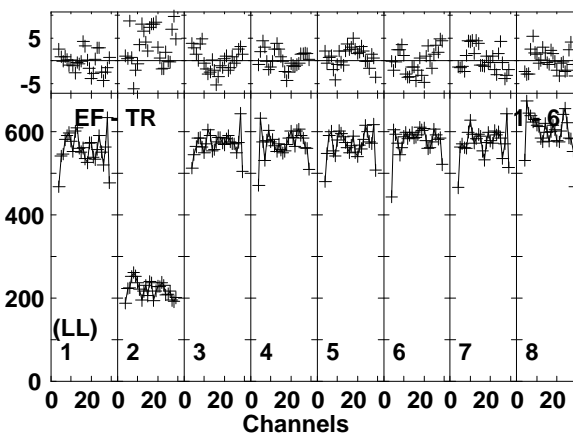
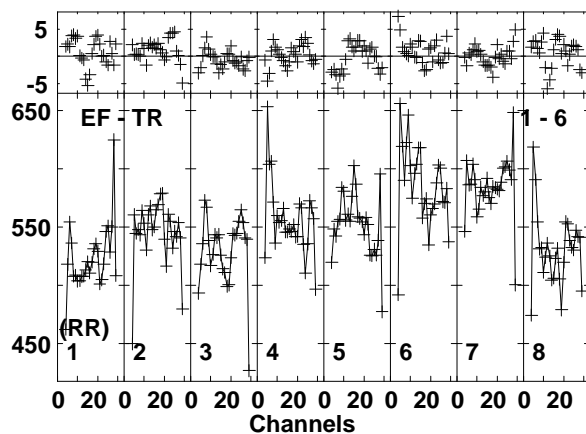
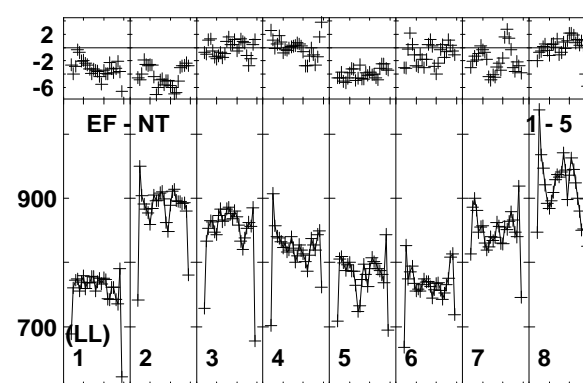
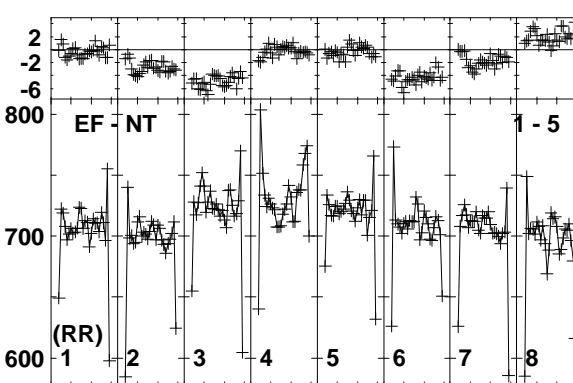
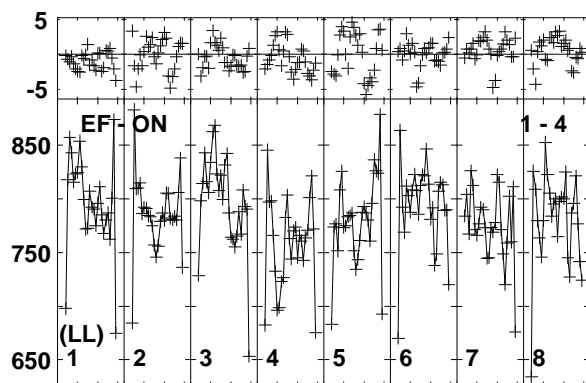
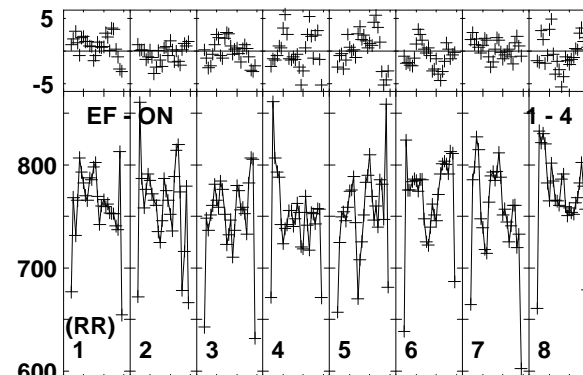
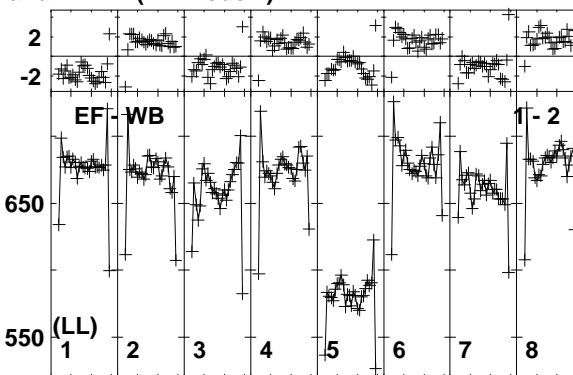
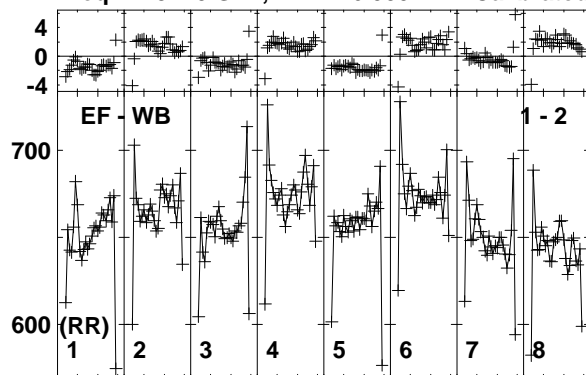

Lower frame: Milli Ampl Jy Top frame: Phas deg  
Vector averaged cross-power spectrum Baseline: EF (01) - WB (02)  
Timerange: 00/14:39:13 to 00/14:39:39

Plot file version 114 created 18-NOV-2014 15:23:27

J1128+5925 EP087H 3.UVDATA.1

Freq = 4.9270 GHz, Bw = 16.000 MH Calibrated with CL # 3 and BP # 1 (BP mode 1)

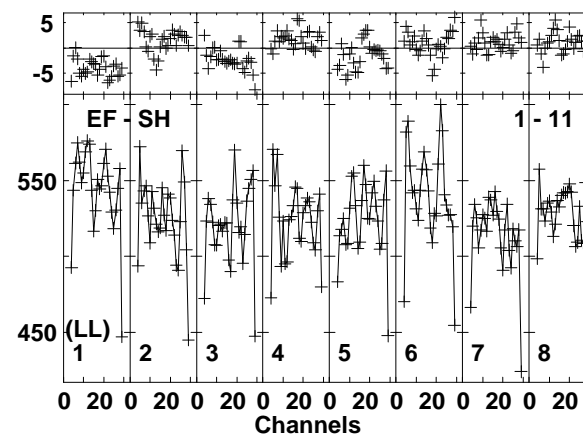
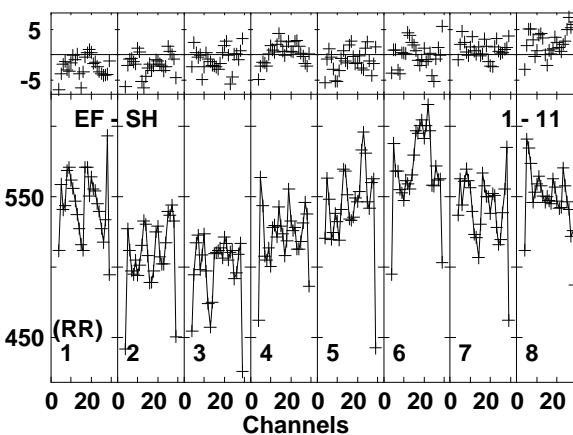
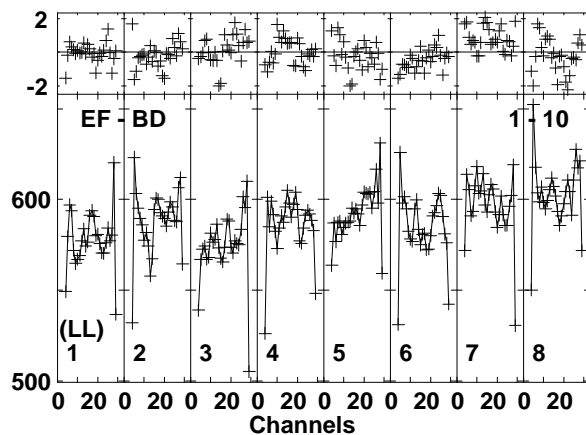
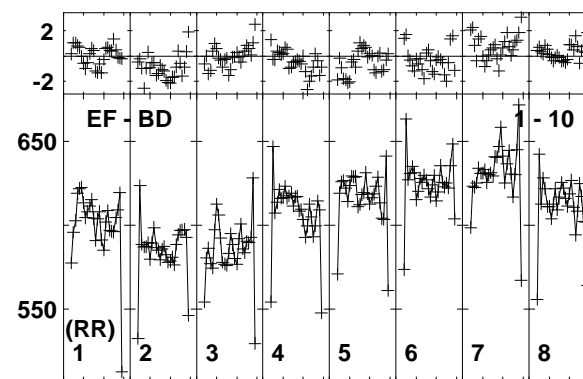
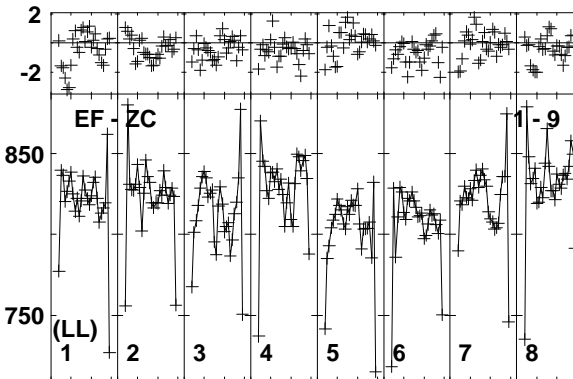
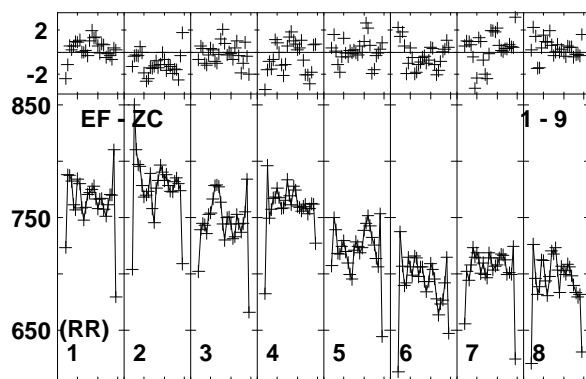
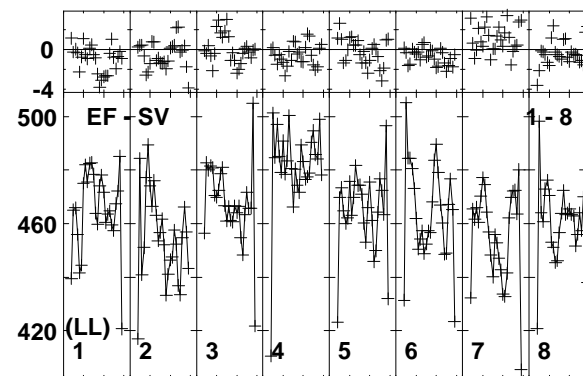
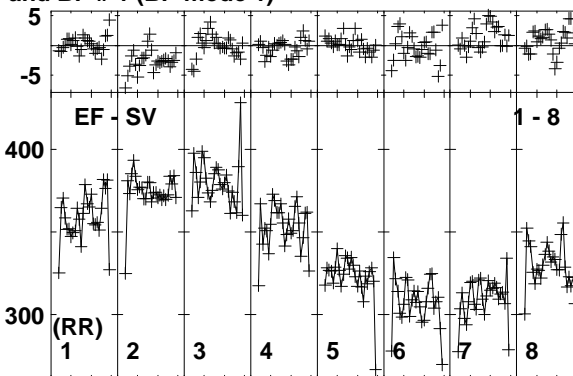
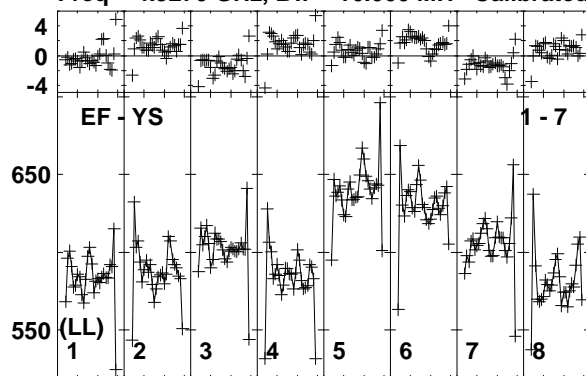

Lower frame: Milli Ampl Jy Top frame: Phas deg  
Vector averaged cross-power spectrum Baseline: EF (01) - YS (07)  
Timerange: 00/14:39:13 to 00/14:39:39

Plot file version 115 created 18-NOV-2014 15:23:27

ARP299C EP087H 3.UVDATA.1

Freq = 4.9270 GHz, Bw = 16.000 MH Calibrated with CL # 3 and BP # 1 (BP mode 1)

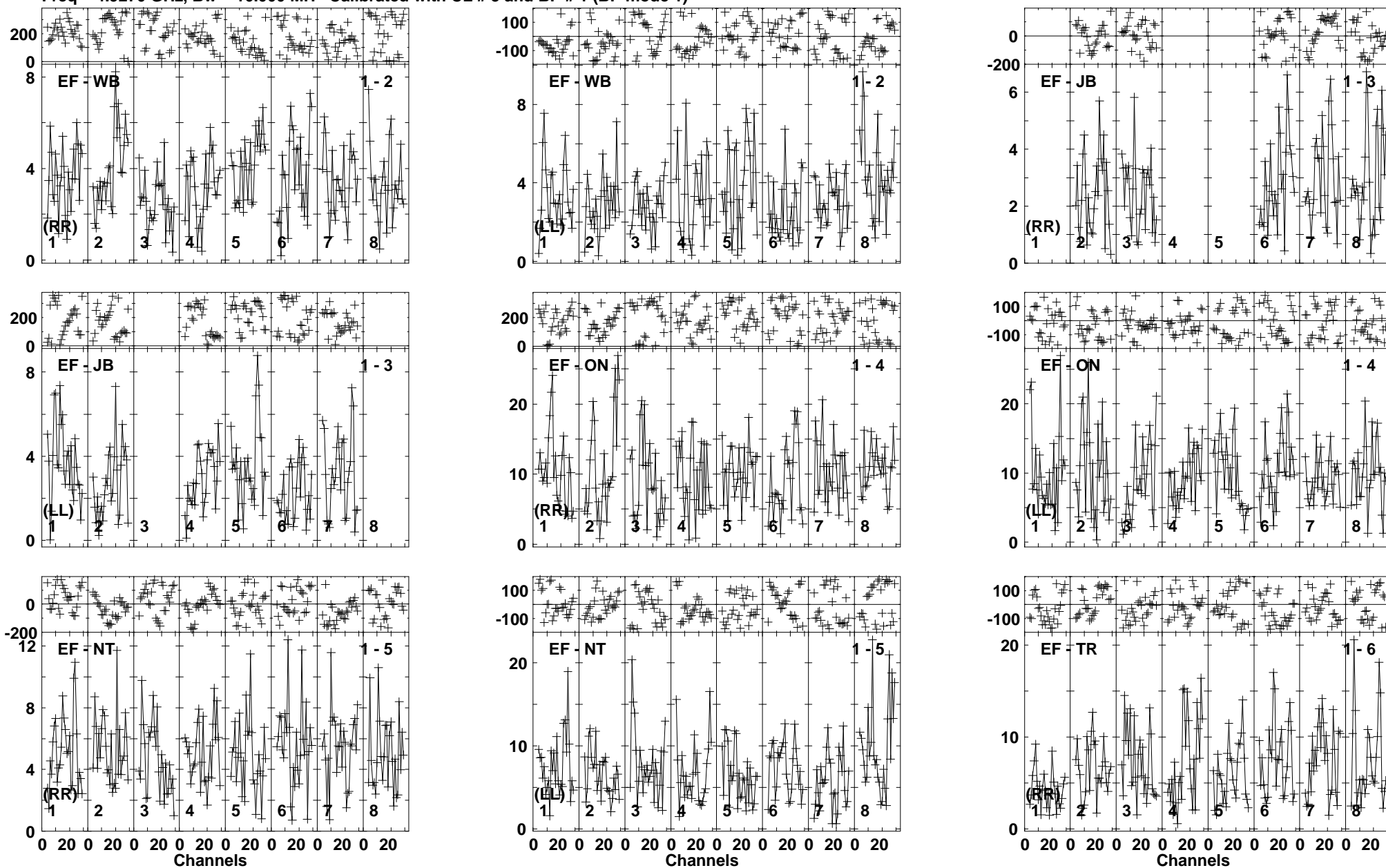

Lower frame: Milli Ampl Jy Top frame: Phas deg  
Vector averaged cross-power spectrum Baseline: EF (01) - WB (02)  
Timerange: 00/14:39:41 to 00/14:43:39

Plot file version 116 created 18-NOV-2014 15:23:27

ARP299C EP087H 3.UVDATA.1

Freq = 4.9270 GHz, Bw = 16.000 MH Calibrated with CL # 3 and BP # 1 (BP mode 1)

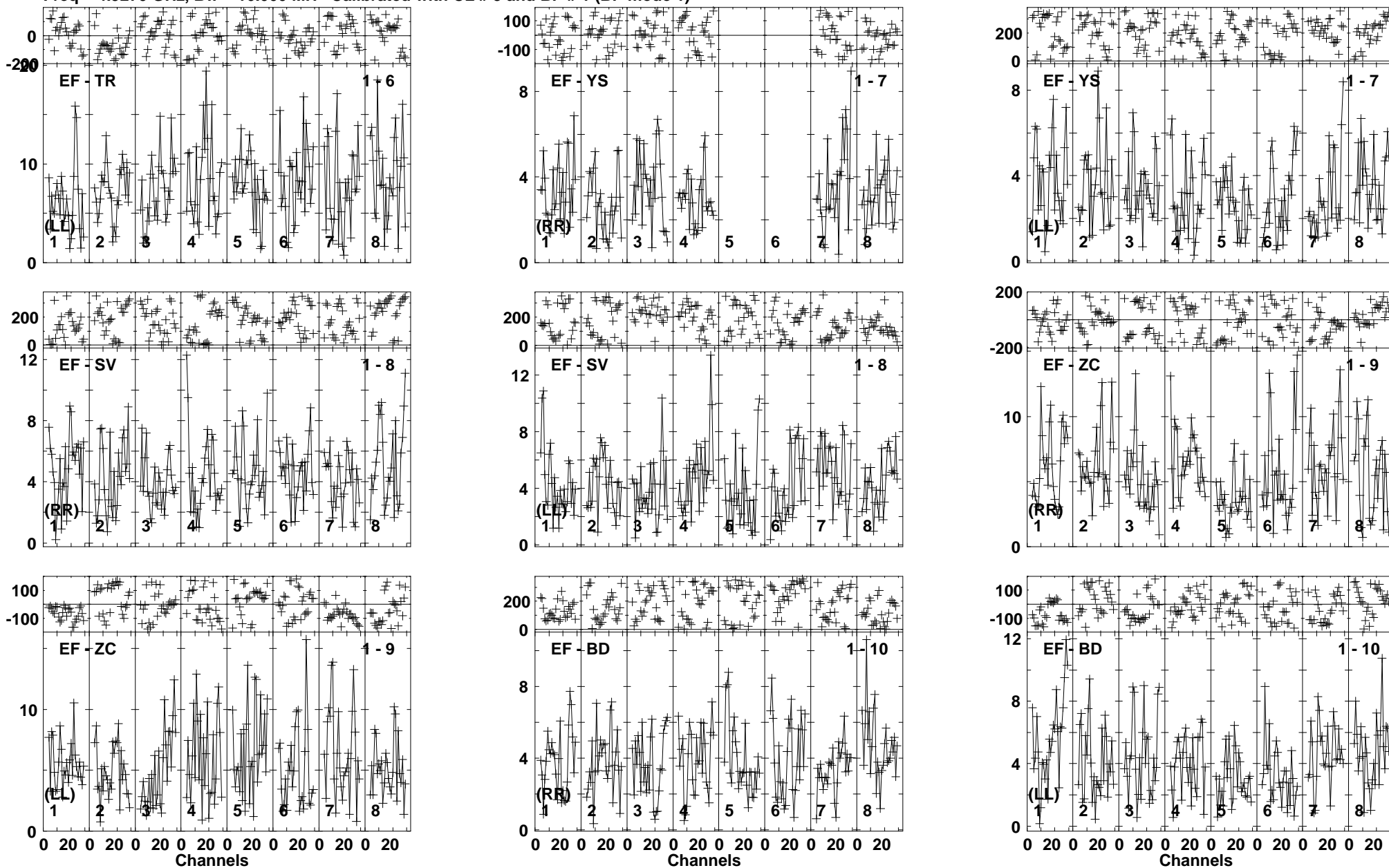

Lower frame: Milli Ampl Jy Top frame: Phas deg  
Vector averaged cross-power spectrum Baseline: EF (01) - TR (06)  
Timerange: 00/14:39:41 to 00/14:43:39

Plot file version 117 created 18-NOV-2014 15:23:28

ARP299C EP087H 3.UVDATA.1

Freq = 4.9270 GHz, Bw = 16.000 MH Calibrated with CL # 3 and BP # 1 (BP mode 1)

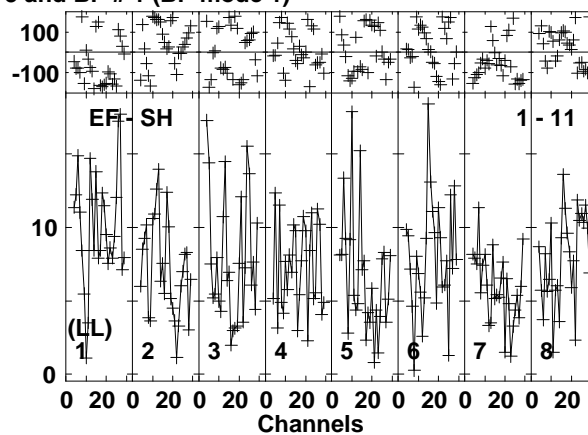
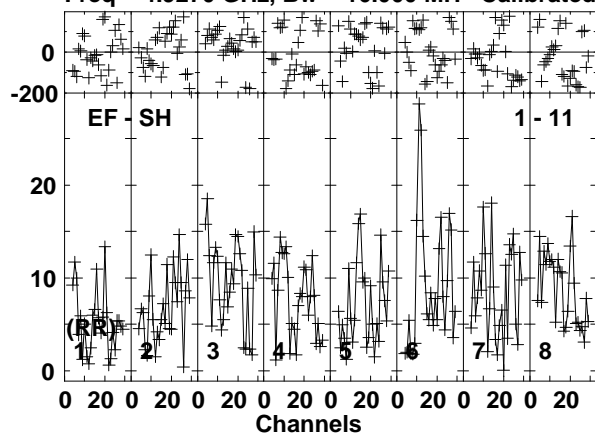

Lower frame: Milli Ampl Jy Top frame: Phas deg  
Vector averaged cross-power spectrum Baseline: EF (01) - SH (11)  
Timerange: 00/14:39:41 to 00/14:43:39

Plot file version 118 created 18-NOV-2014 15:23:28  
 J1128+5925 EP087H 3.UVDATA.1  
 Freq = 4.9270 GHz, Bw = 16.000 MH Calibrated with CL # 3 and BP # 1 (BP mode 1)

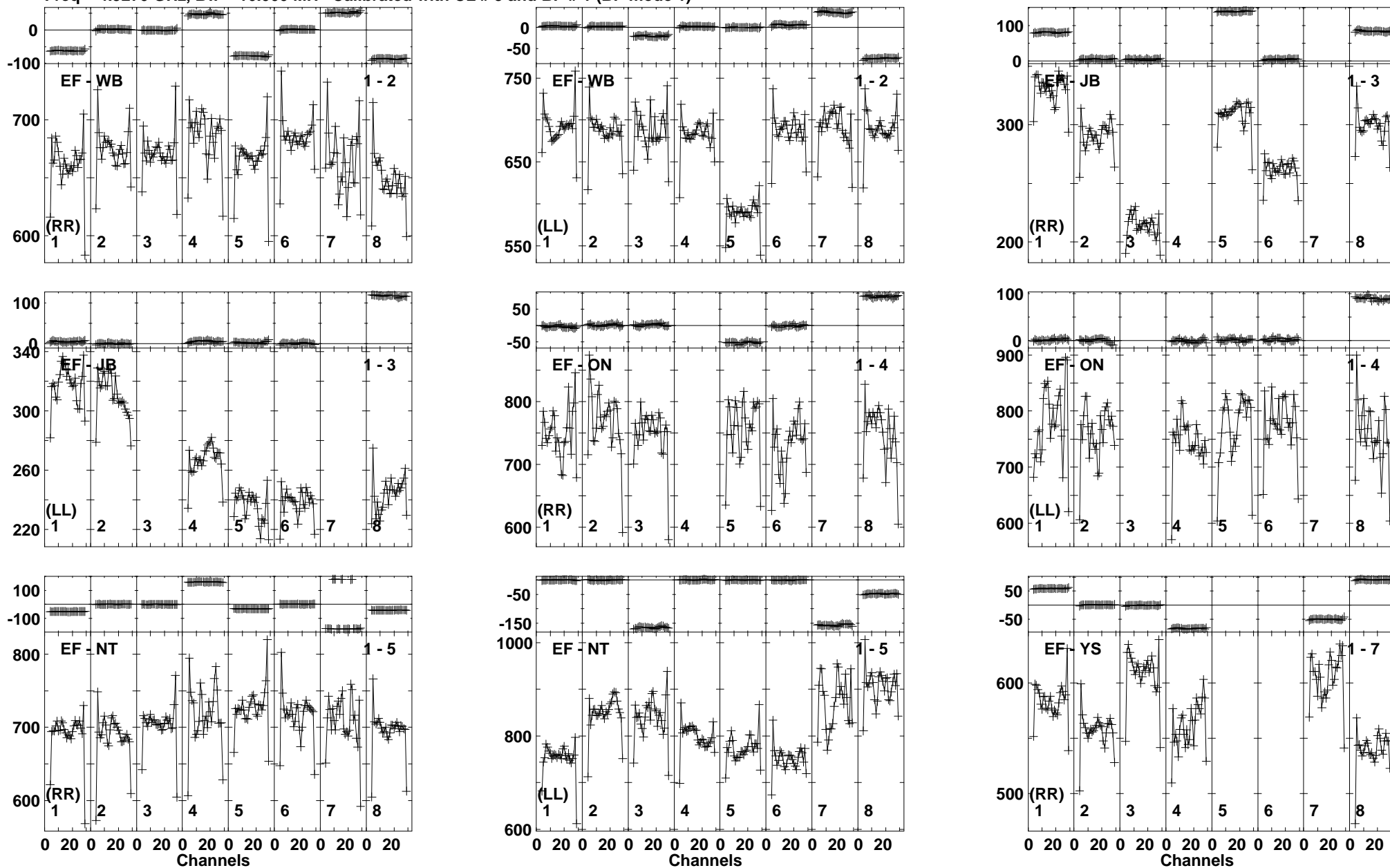

Lower frame: Milli Ampl Jy Top frame: Phas deg  
 Vector averaged cross-power spectrum Baseline: EF (01) - WB (02)  
 Timerange: 00/14:43:45 to 00/14:44:39

Plot file version 119 created 18-NOV-2014 15:23:28

J1128+5925 EP087H 3.UVDATA.1

Freq = 4.9270 GHz, Bw = 16.000 MH Calibrated with CL # 3 and BP # 1 (BP mode 1)

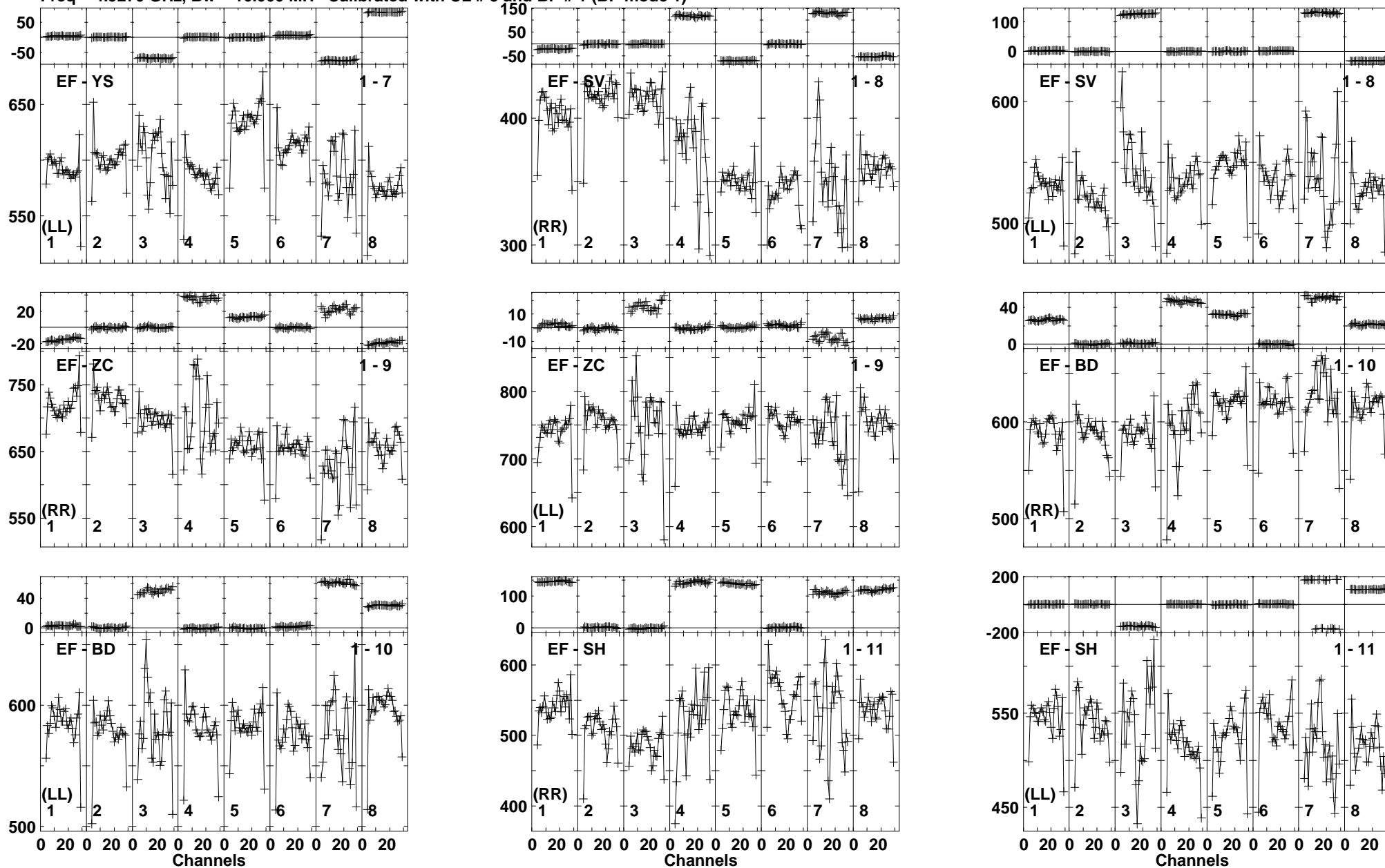

Lower frame: Milli Ampl Jy Top frame: Phas deg  
Vector averaged cross-power spectrum Baseline: EF (01) - YS (07)  
Timerange: 00/14:43:45 to 00/14:44:39

Plot file version 120 created 18-NOV-2014 15:23:28  
 ARP299C EP087H 3.UVDATA.1  
 Freq = 4.9270 GHz, Bw = 16.000 MH Calibrated with CL # 3 and BP # 1 (BP mode 1)

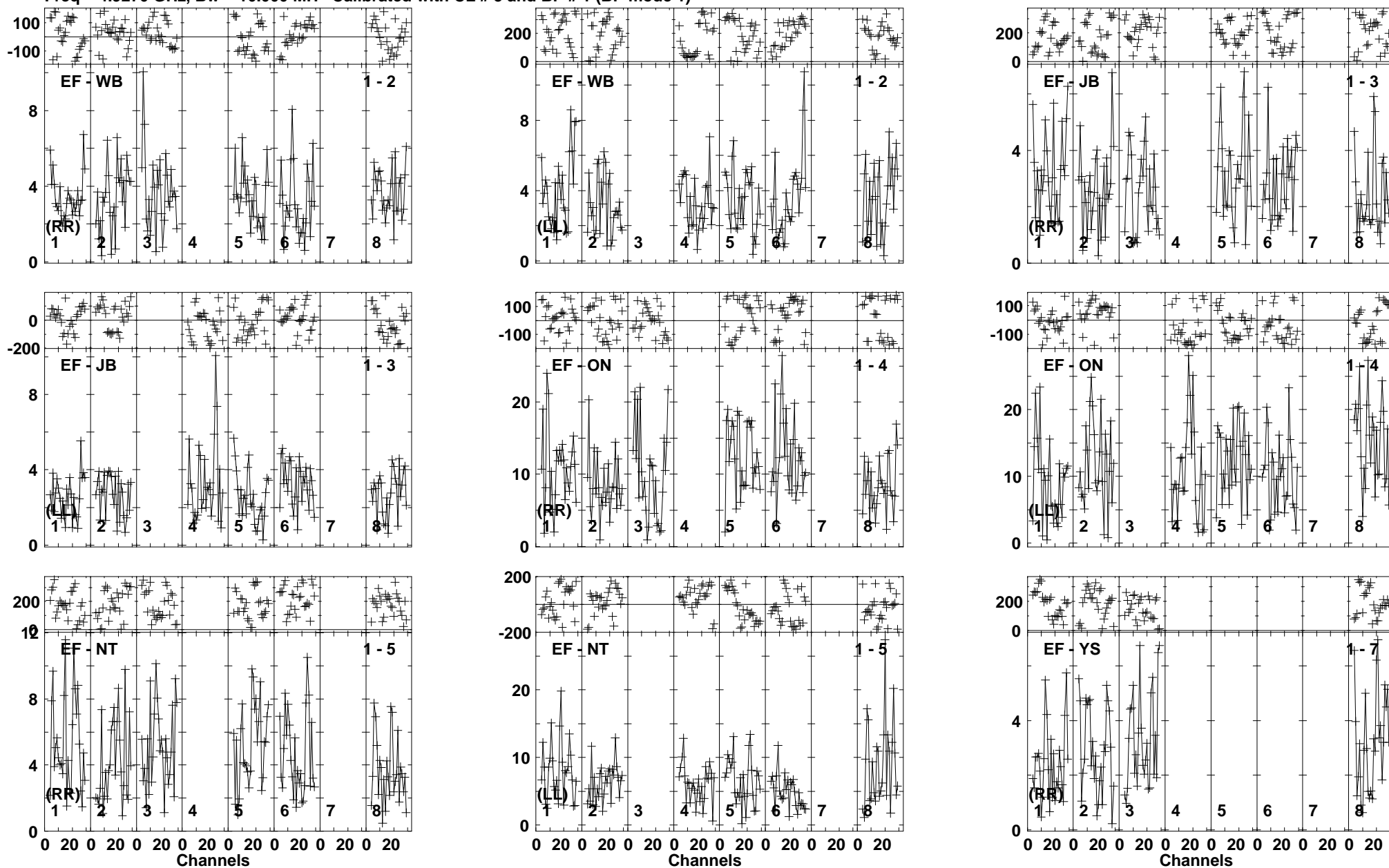

Lower frame: Milli Ampl Jy Top frame: Phas deg  
 Vector averaged cross-power spectrum Baseline: EF (01) - WB (02)  
 Timerange: 00/14:44:45 to 00/14:48:39



Plot file version 121 created 18-NOV-2014 15:23:28

ARP299C EP087H 3.UVDATA.1

Freq = 4.9270 GHz, Bw = 16.000 MH Calibrated with CL # 3 and BP # 1 (BP mode 1)

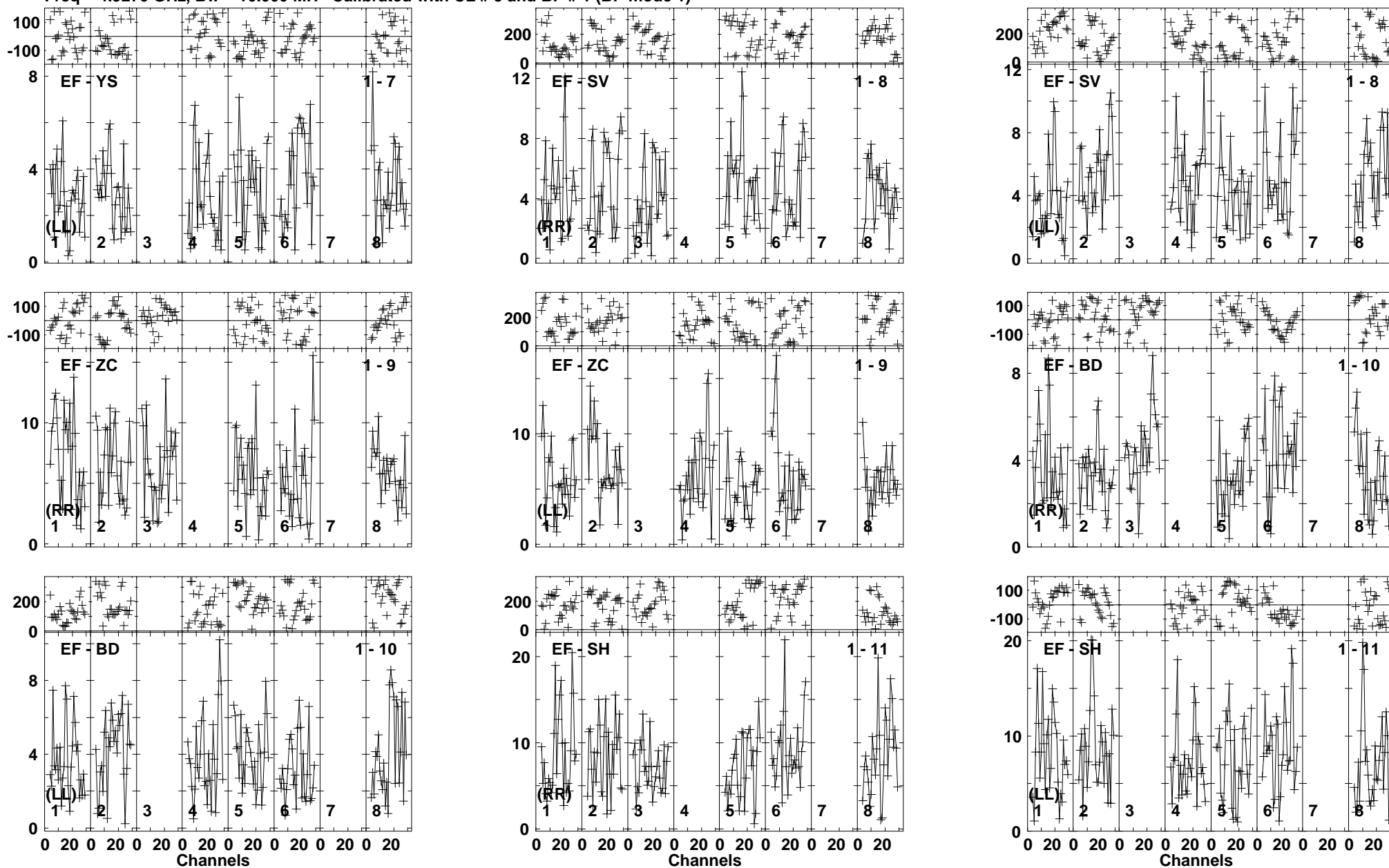

Lower frame: Milli Ampl Jy Top frame: Phas deg  
Vector averaged cross-power spectrum Baseline: EF (01) - YS (07)  
Timerange: 00/14:44:45 to 00/14:48:39

Plot file version 122 created 18-NOV-2014 15:23:29  
 J1128+5925 EP087H 3.UVDATA.1  
 Freq = 4.9270 GHz, Bw = 16.000 MH Calibrated with CL # 3 and BP # 1 (BP mode 1)

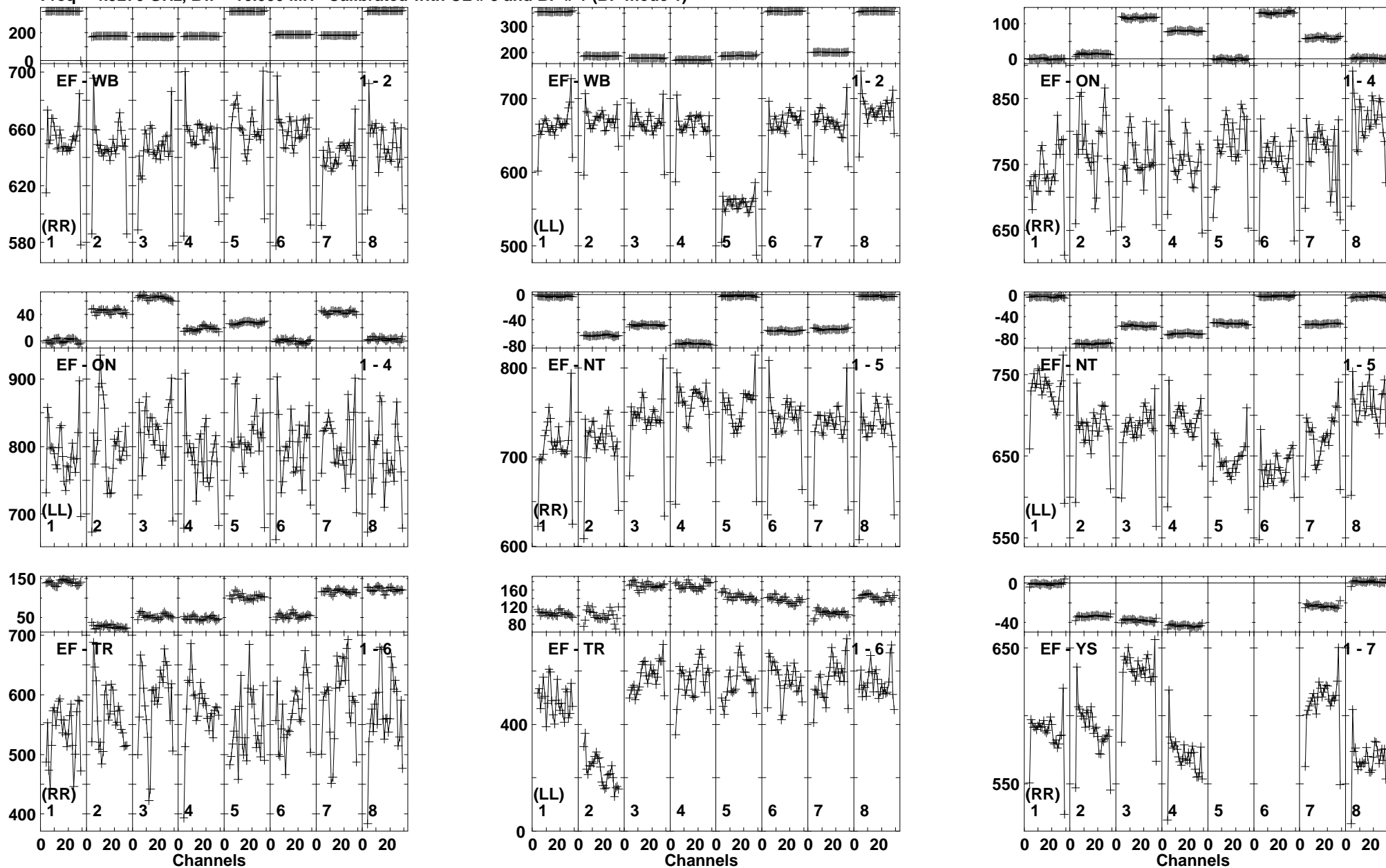

Lower frame: Milli Ampl Jy Top frame: Phas deg  
 Vector averaged cross-power spectrum Baseline: EF (01) - WB (02)  
 Timerange: 00/14:48:45 to 00/14:49:39

Plot file version 123 created 18-NOV-2014 15:23:29

J1128+5925 EP087H 3.UVDATA.1

Freq = 4.9270 GHz, Bw = 16.000 MH Calibrated with CL # 3 and BP # 1 (BP mode 1)

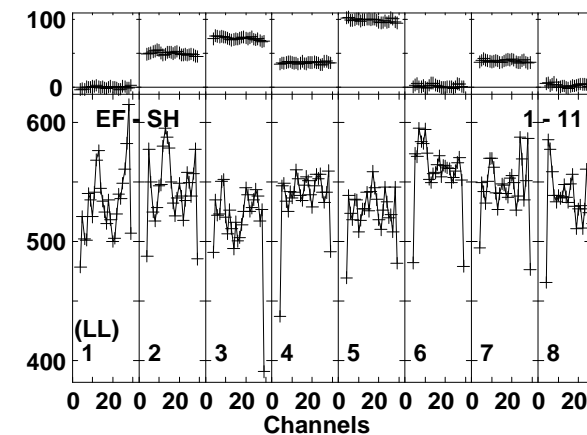
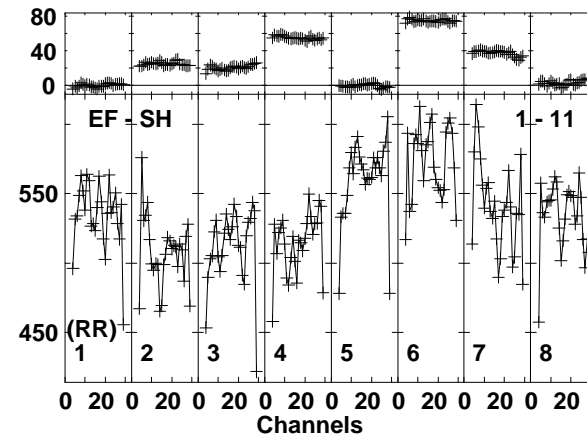
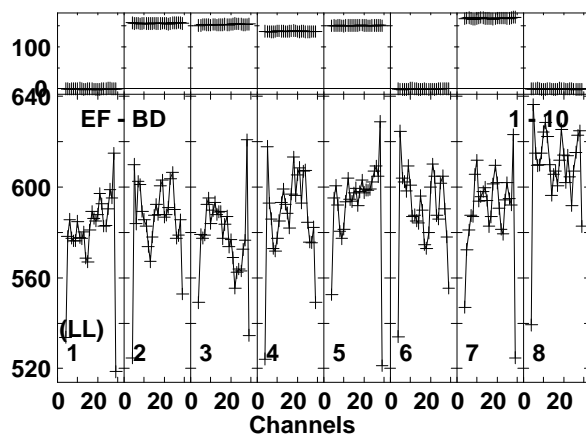
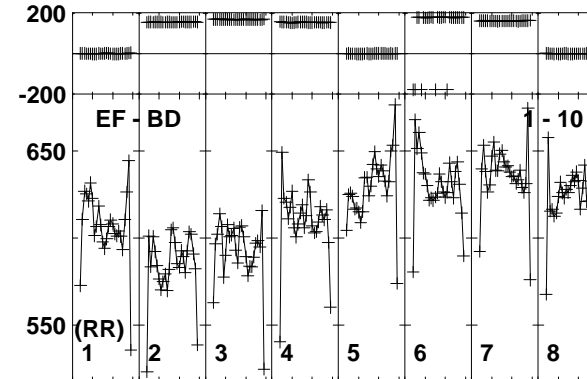
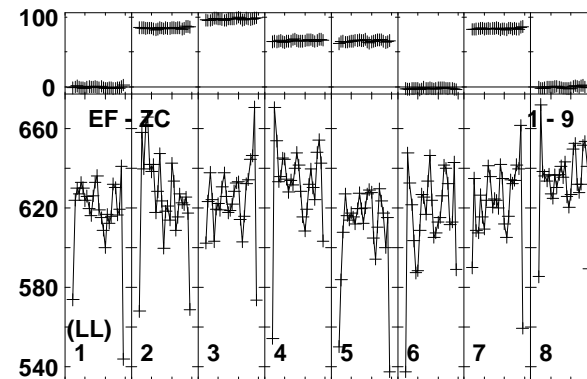
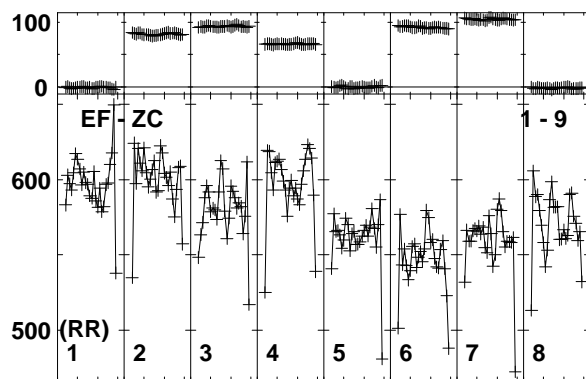
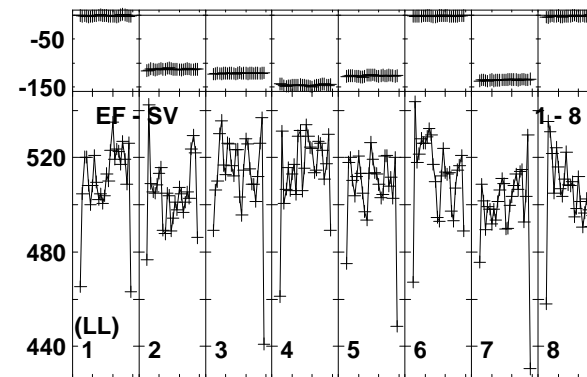
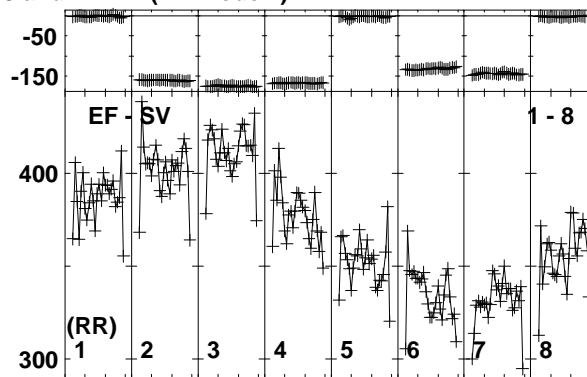
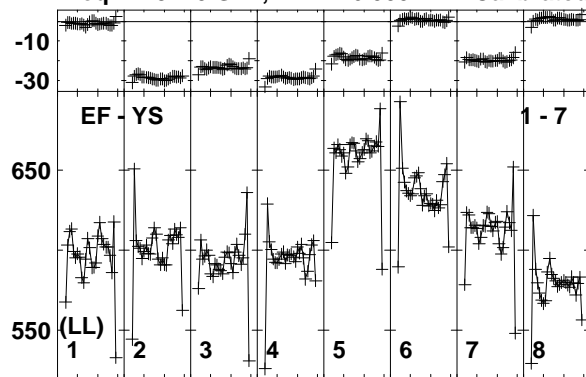

Lower frame: Milli Ampl Jy Top frame: Phas deg  
Vector averaged cross-power spectrum Baseline: EF (01) - YS (07)  
Timerange: 00/14:48:45 to 00/14:49:39

Plot file version 124 created 18-NOV-2014 15:23:29  
 ARP299C EP087H 3.UVDATA.1  
 Freq = 4.9270 GHz, Bw = 16.000 MH Calibrated with CL # 3 and BP # 1 (BP mode 1)

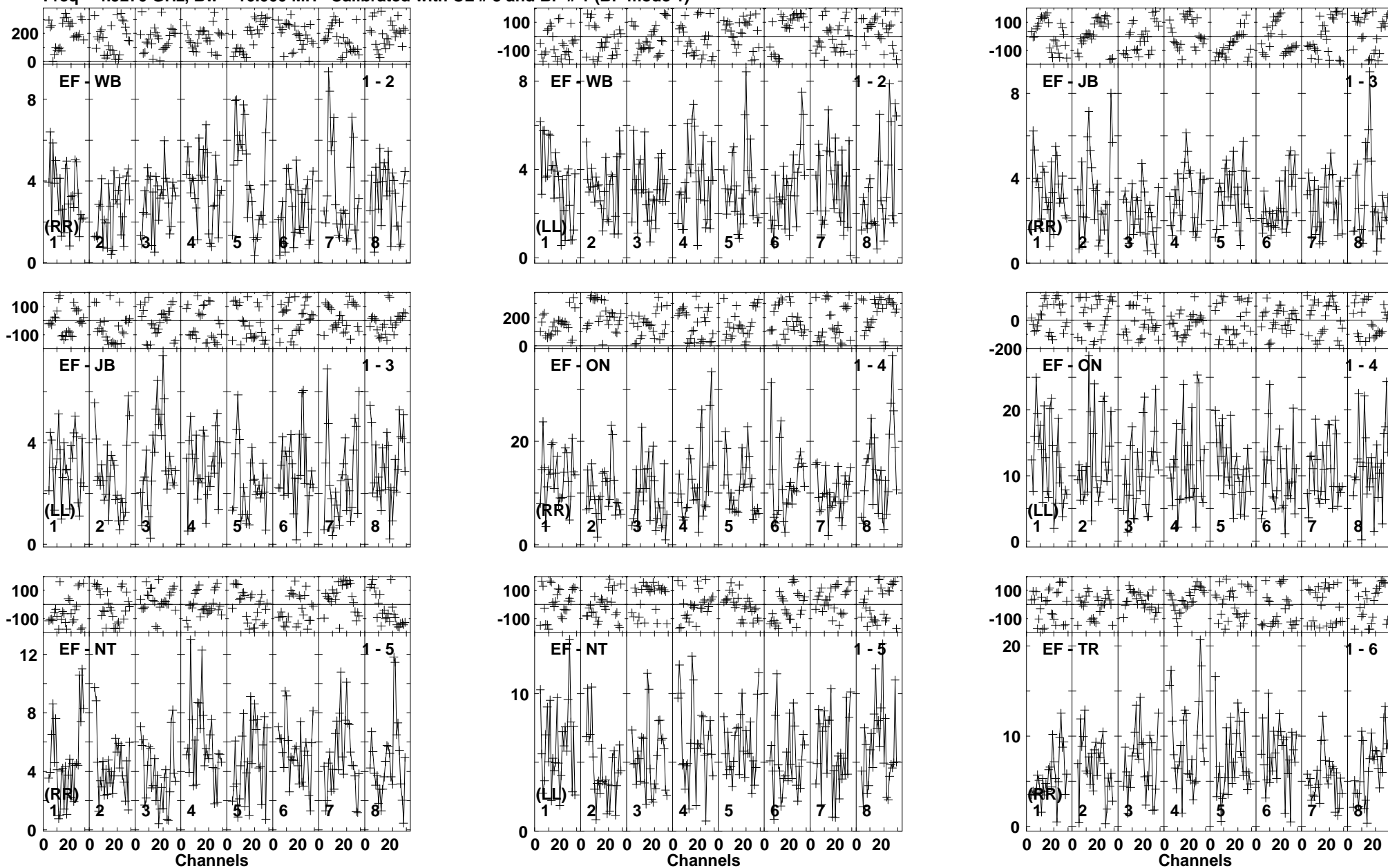

Lower frame: Milli Ampl Jy Top frame: Phas deg  
 Vector averaged cross-power spectrum Baseline: EF (01) - WB (02)  
 Timerange: 00/14:49:41 to 00/14:53:39

Plot file version 125 created 18-NOV-2014 15:23:29

ARP299C EP087H 3.UVDATA.1

Freq = 4.9270 GHz, Bw = 16.000 MH Calibrated with CL # 3 and BP # 1 (BP mode 1)

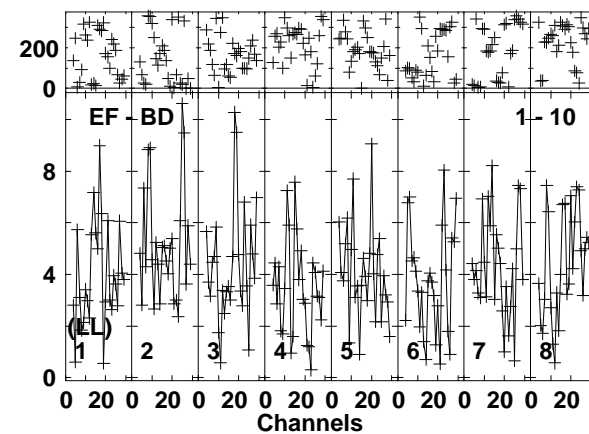
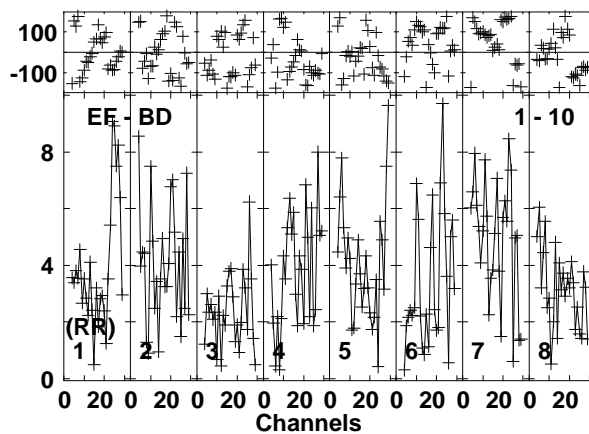
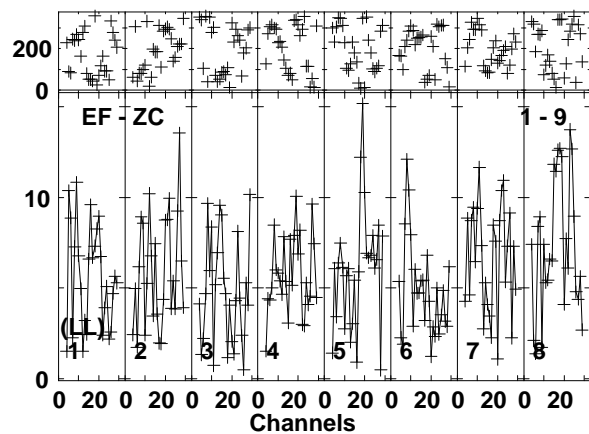
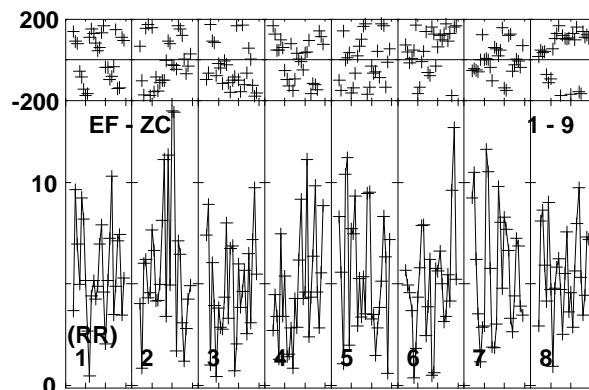
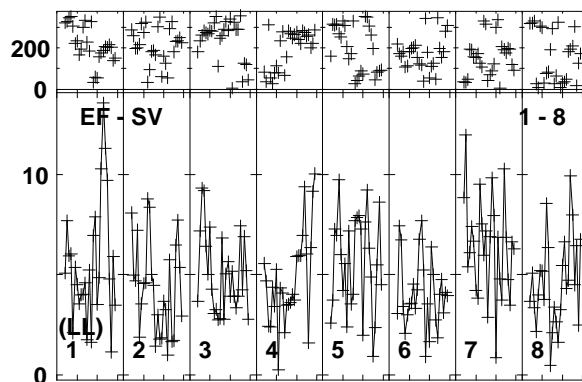
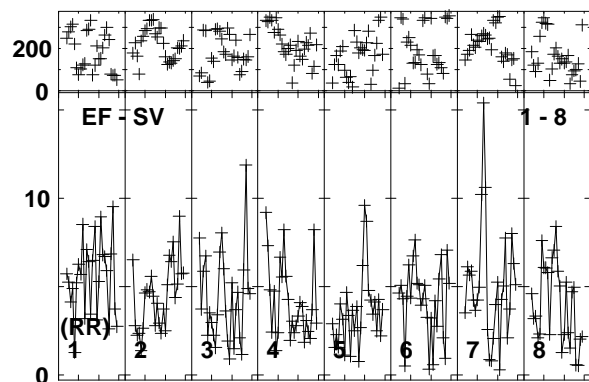
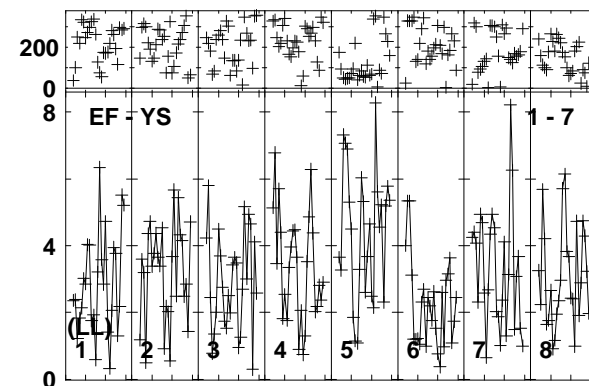
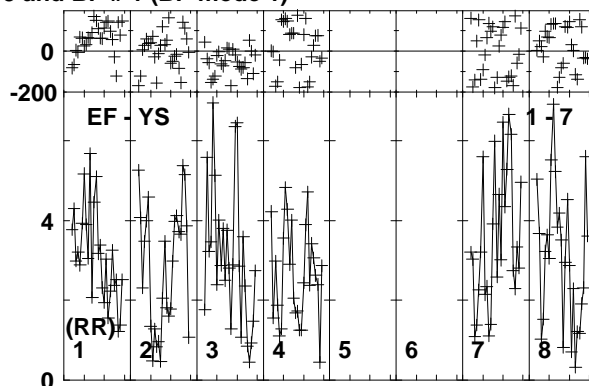
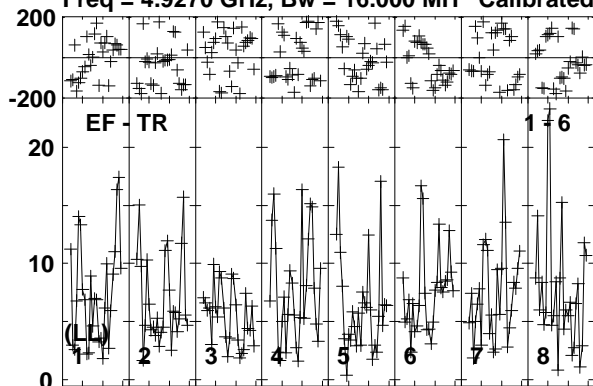

Lower frame: Milli Ampl Jy Top frame: Phas deg  
Vector averaged cross-power spectrum Baseline: EF (01) - TR (06)  
Timerange: 00/14:49:41 to 00/14:53:39

Plot file version 126 created 18-NOV-2014 15:23:30

ARP299C EP087H 3.UVDATA.1

Freq = 4.9270 GHz, Bw = 16.000 MH Calibrated with CL # 3 and BP # 1 (BP mode 1)

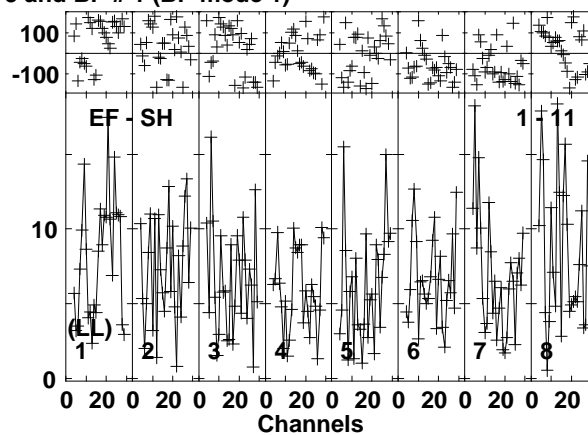
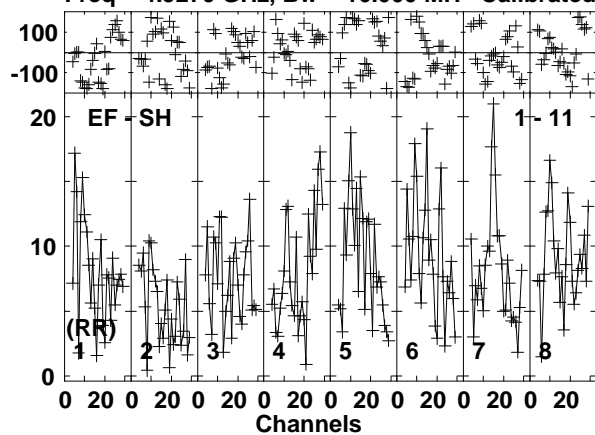

Lower frame: Milli Ampl Jy Top frame: Phas deg  
Vector averaged cross-power spectrum Baseline: EF (01) - SH (11)  
Timerange: 00/14:49:41 to 00/14:53:39

Plot file version 127 created 18-NOV-2014 15:23:30

J1128+5925 EP087H 3.UVDATA.1

Freq = 4.9270 GHz, Bw = 16.000 MH Calibrated with CL # 3 and BP # 1 (BP mode 1)

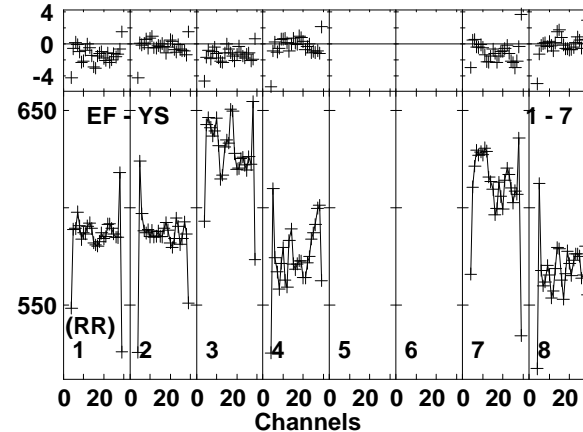
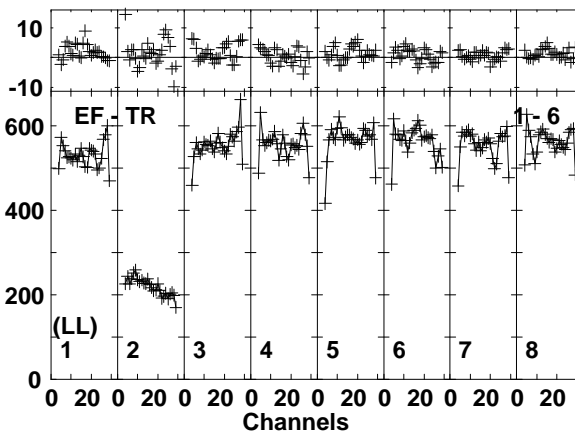
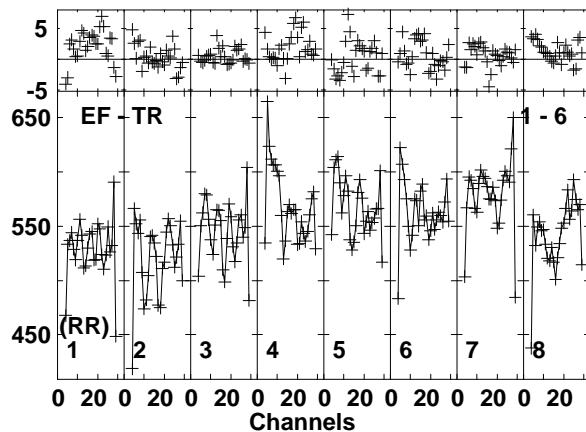
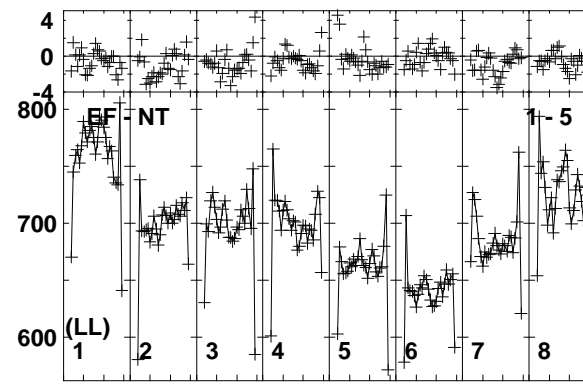
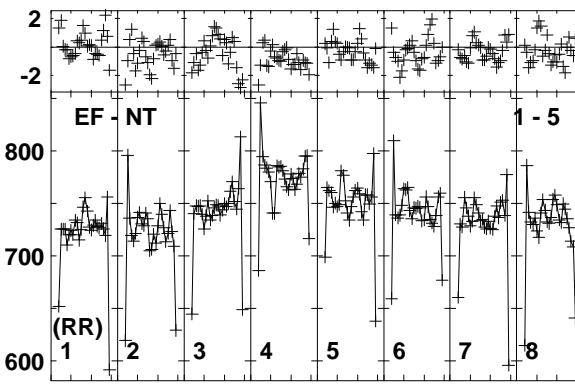
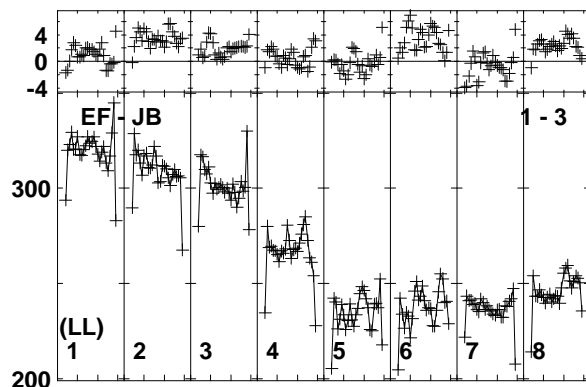
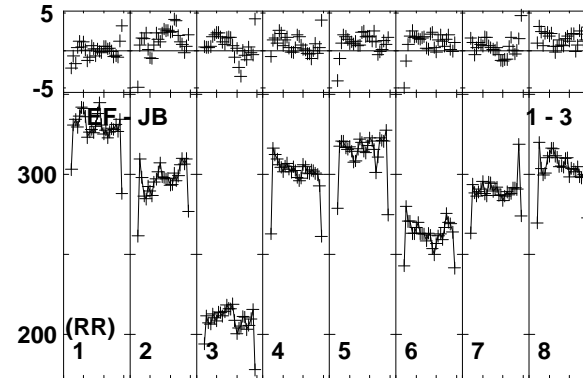
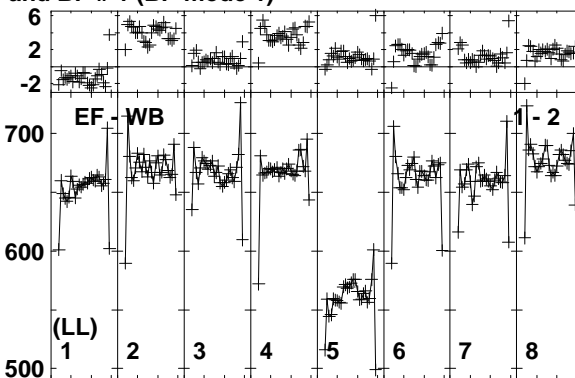
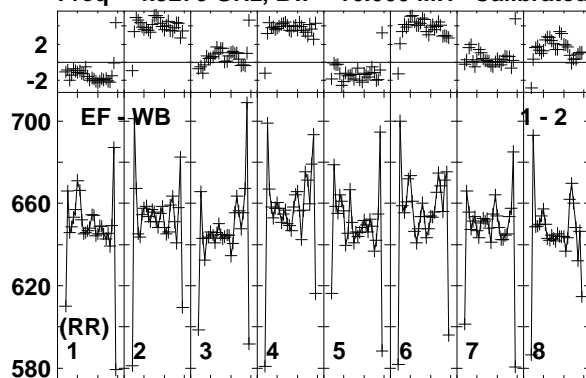

Lower frame: Milli Ampl Jy Top frame: Phas deg  
Vector averaged cross-power spectrum Baseline: EF (01) - WB (02)  
Timerange: 00/14:54:21 to 00/14:54:49

Plot file version 128 created 18-NOV-2014 15:23:30

J1128+5925 EP087H 3.UVDATA.1

Freq = 4.9270 GHz, Bw = 16.000 MH Calibrated with CL # 3 and BP # 1 (BP mode 1)

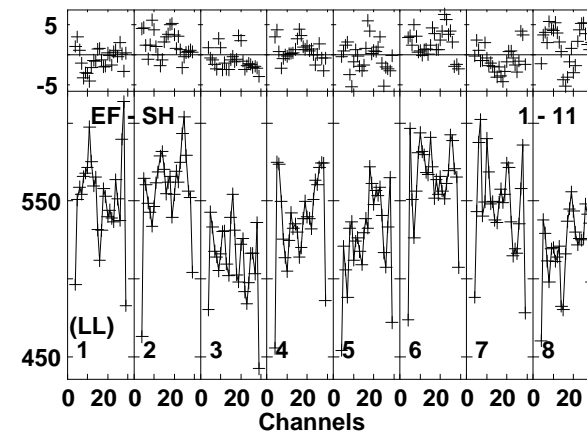
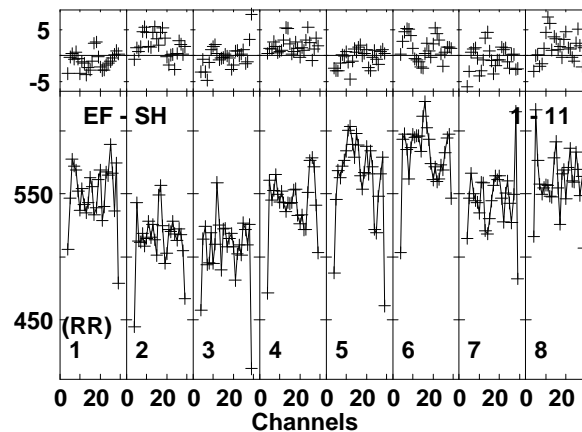
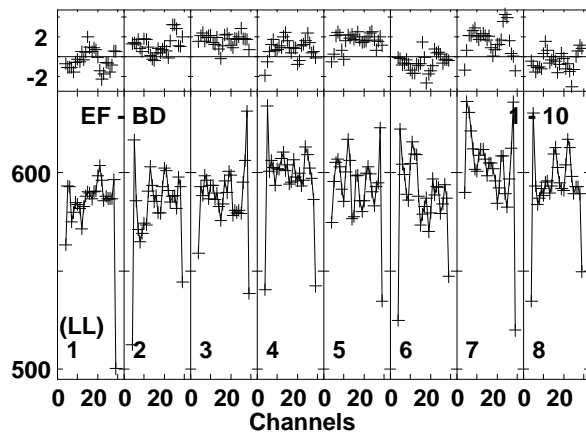
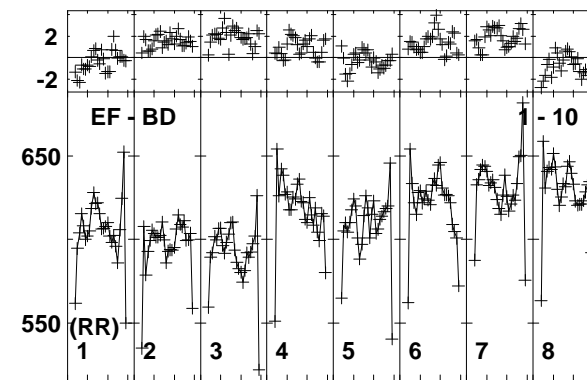
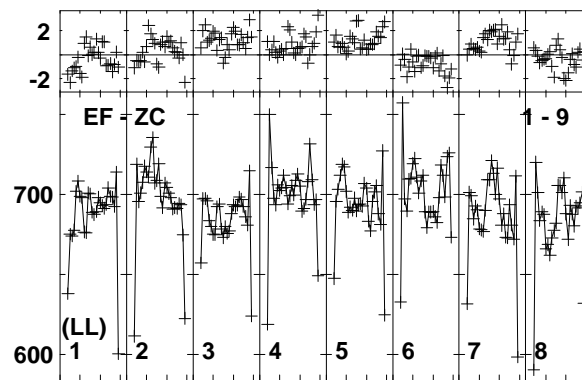
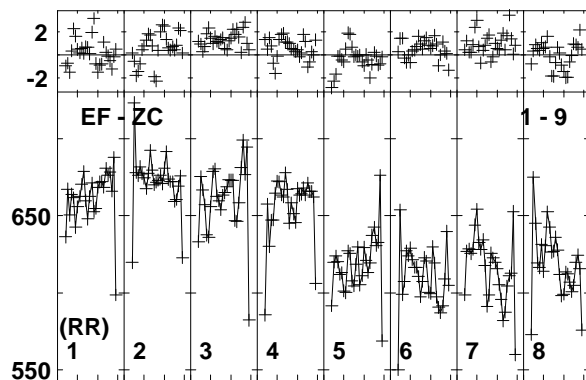
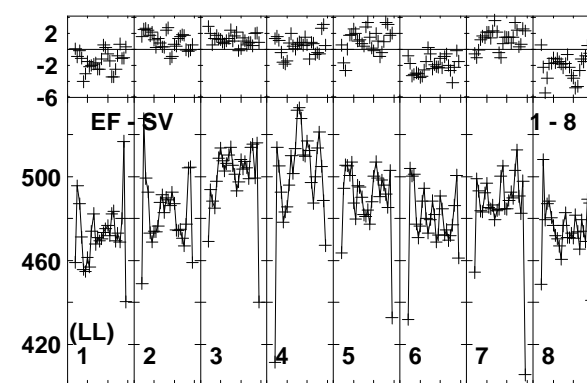
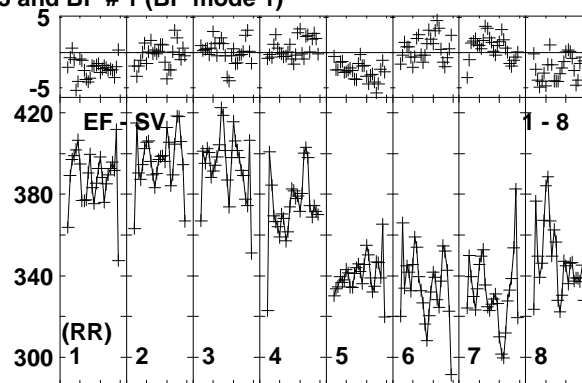
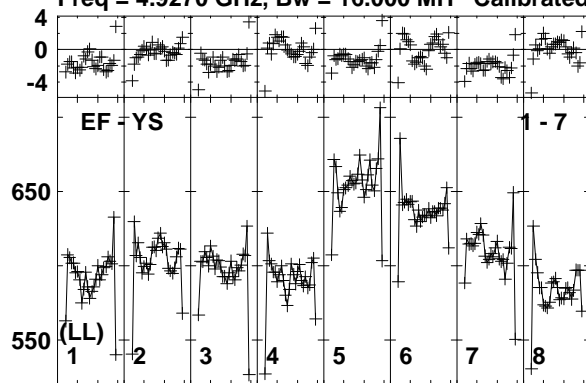

Lower frame: Milli Ampl Jy Top frame: Phas deg  
Vector averaged cross-power spectrum Baseline: EF (01) - YS (07)  
Timerange: 00/14:54:21 to 00/14:54:49



Plot file version 129 created 18-NOV-2014 15:23:30  
 ARP299C EP087H 3.UVDATA.1  
 Freq = 4.9270 GHz, Bw = 16.000 MH Calibrated with CL # 3 and BP # 1 (BP mode 1)

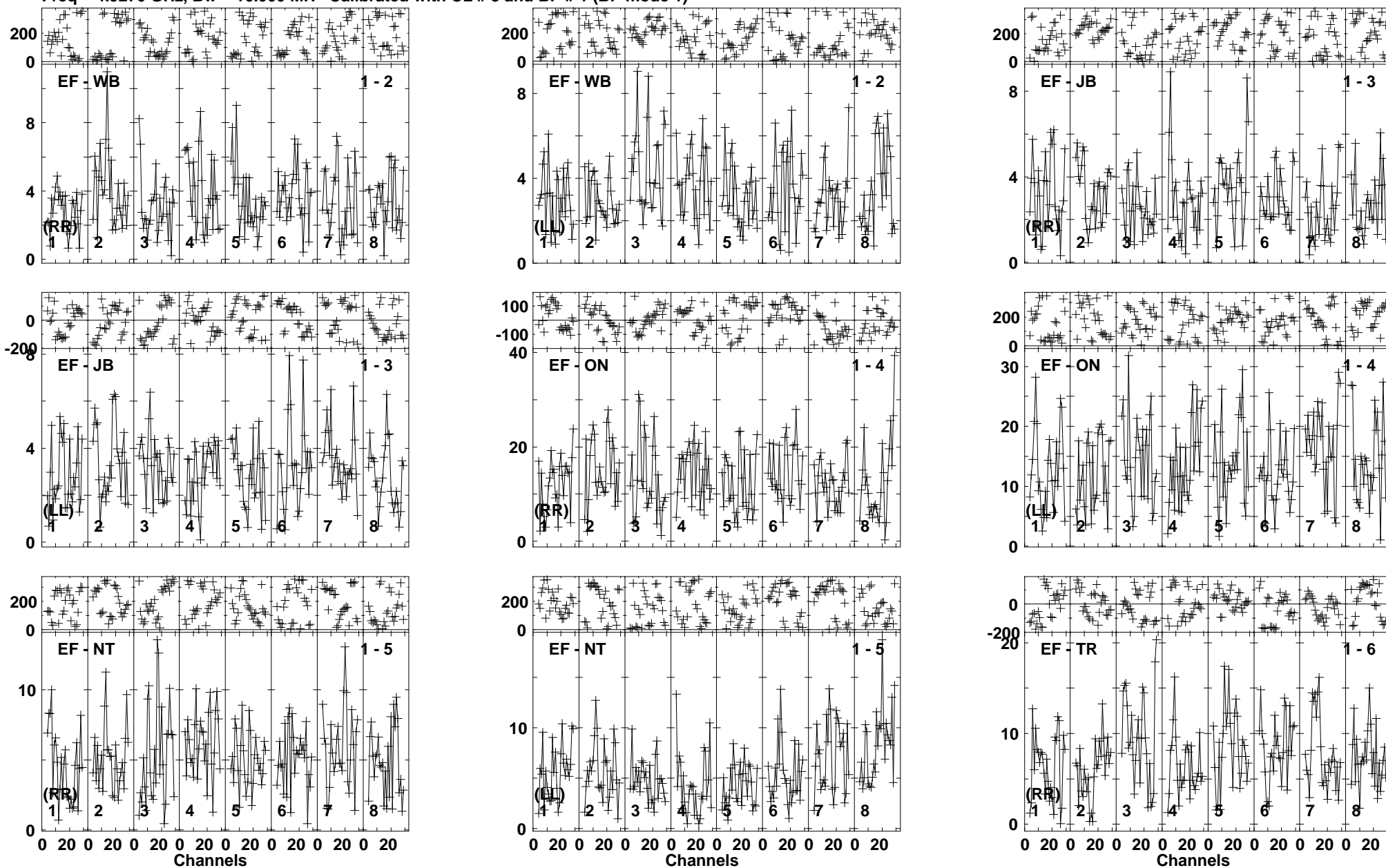

Lower frame: Milli Ampl Jy Top frame: Phas deg  
 Vector averaged cross-power spectrum Baseline: EF (01) - WB (02)  
 Timerange: 00/14:54:55 to 00/14:58:49

Plot file version 130 created 18-NOV-2014 15:23:30

ARP299C EP087H 3.UVDATA.1

Freq = 4.9270 GHz, Bw = 16.000 MH Calibrated with CL # 3 and BP # 1 (BP mode 1)

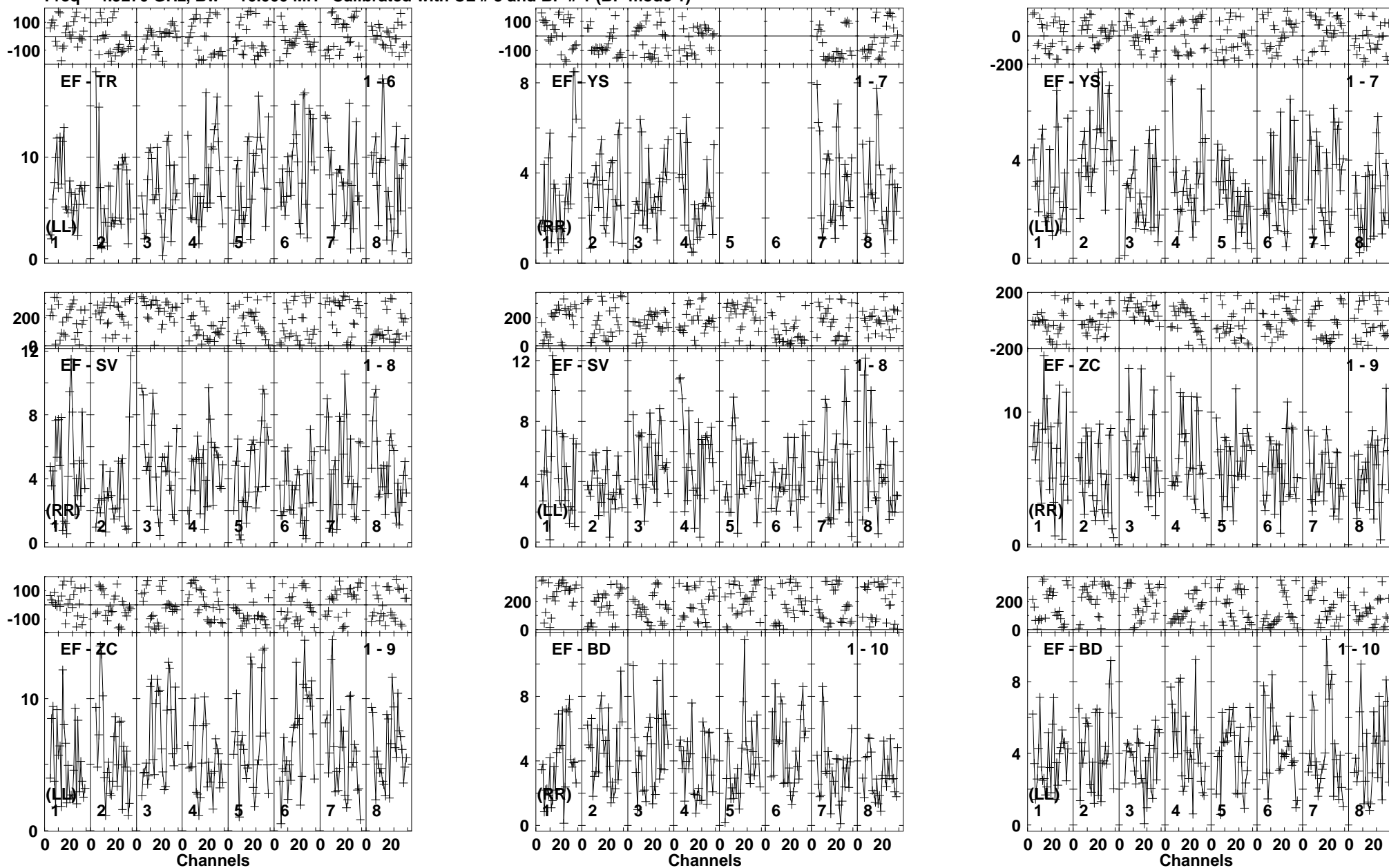

Lower frame: Milli Ampl Jy Top frame: Phas deg  
Vector averaged cross-power spectrum Baseline: EF (01) - TR (06)  
Timerange: 00/14:54:55 to 00/14:58:49

Plot file version 131 created 18-NOV-2014 15:23:31

ARP299C EP087H 3.UVDATA.1

Freq = 4.9270 GHz, Bw = 16.000 MH Calibrated with CL # 3 and BP # 1 (BP mode 1)

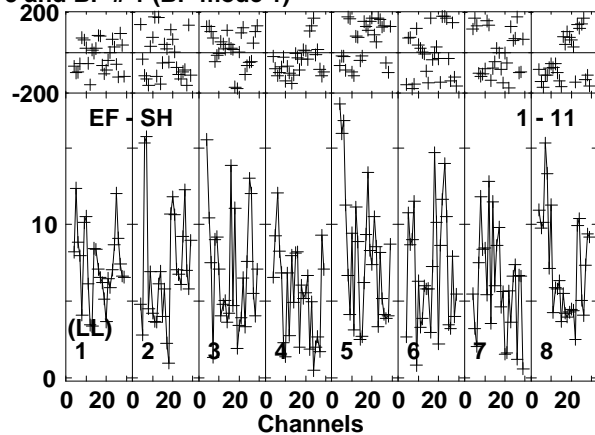
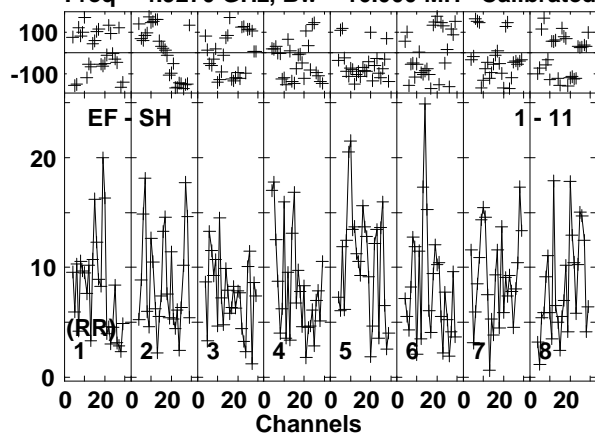

Lower frame: Milli Ampl Jy Top frame: Phas deg  
Vector averaged cross-power spectrum Baseline: EF (01) - SH (11)  
Timerange: 00/14:54:55 to 00/14:58:49

Plot file version 132 created 18-NOV-2014 15:23:31

J1128+5925 EP087H 3.UVDATA.1

Freq = 4.9270 GHz, Bw = 16.000 MH Calibrated with CL # 3 and BP # 1 (BP mode 1)

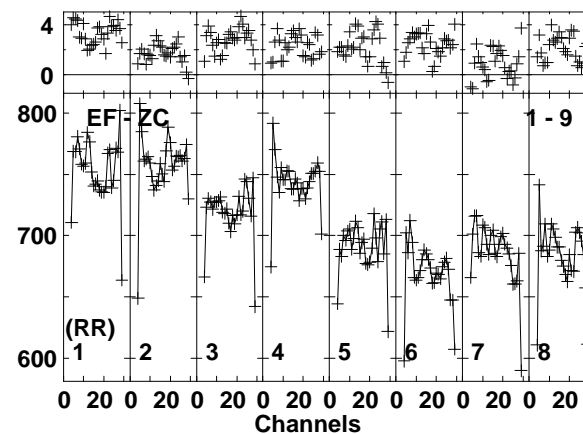
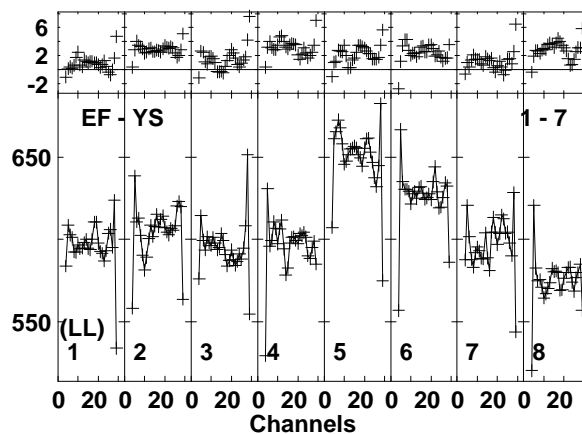
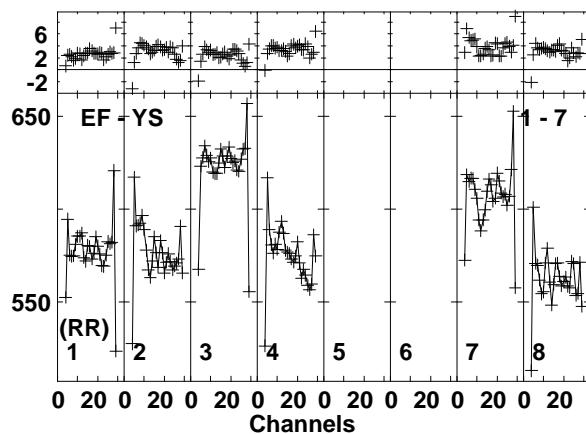
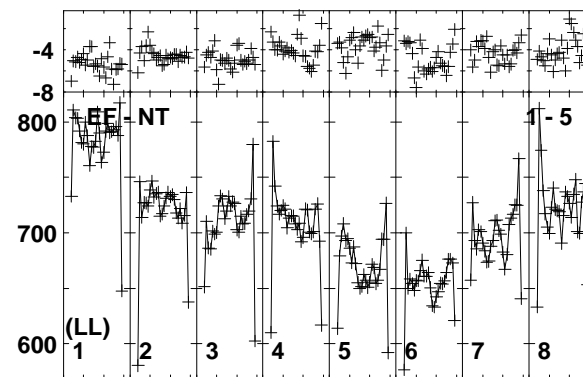
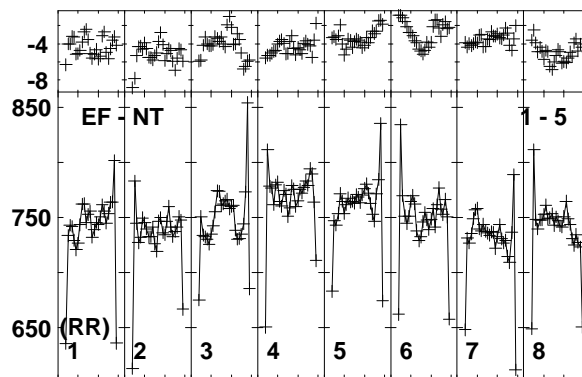
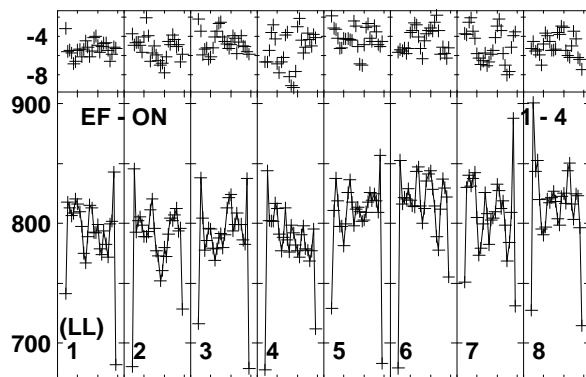
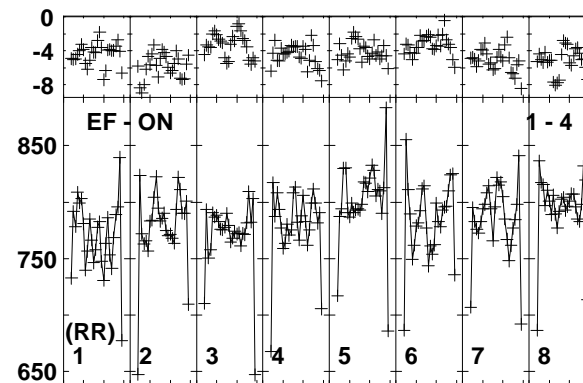
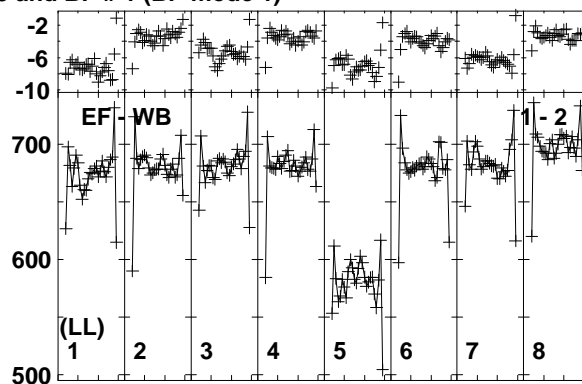
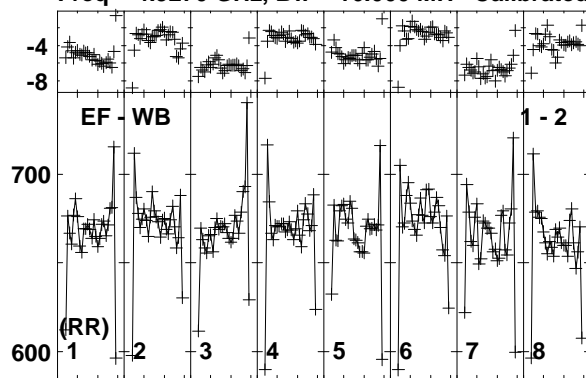

Lower frame: Milli Ampl Jy Top frame: Phas deg  
Vector averaged cross-power spectrum Baseline: EF (01) - WB (02)  
Timerange: 00/14:58:55 to 00/14:59:49

Plot file version 133 created 18-NOV-2014 15:23:31

J1128+5925 EP087H 3.UVDATA.1

Freq = 4.9270 GHz, Bw = 16.000 MH Calibrated with CL # 3 and BP # 1 (BP mode 1)

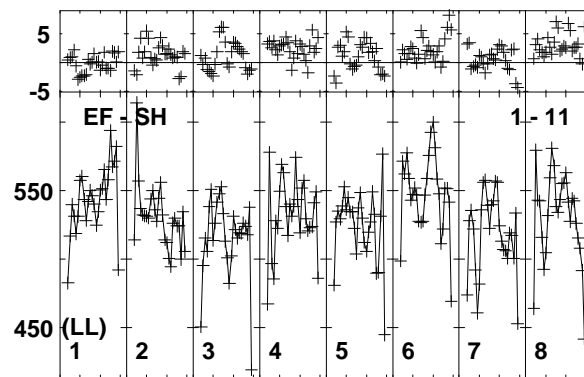
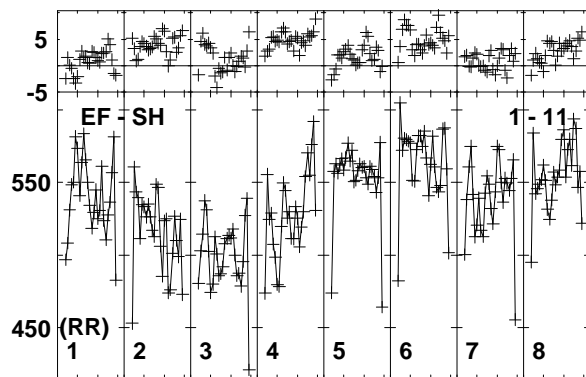
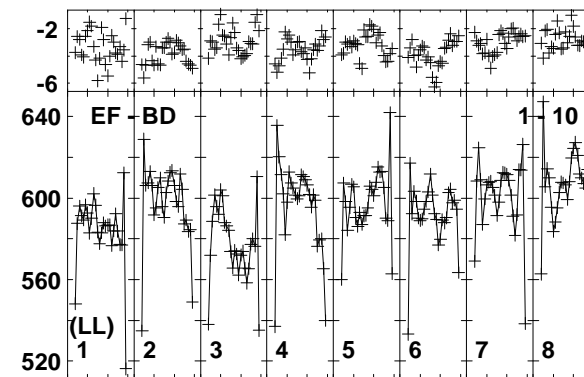
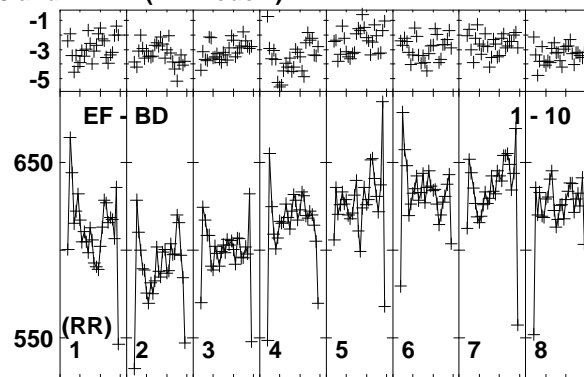
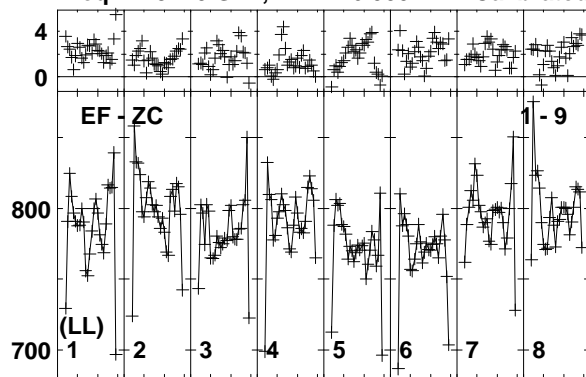

Lower frame: Milli Ampl Jy Top frame: Phas deg  
Vector averaged cross-power spectrum Baseline: EF (01) - ZC (09)  
Timerange: 00/14:58:55 to 00/14:59:49

Plot file version 134 created 18-NOV-2014 15:23:31

ARP299C EP087H 3.UVDATA.1

Freq = 4.9270 GHz, Bw = 16.000 MH Calibrated with CL # 3 and BP # 1 (BP mode 1)

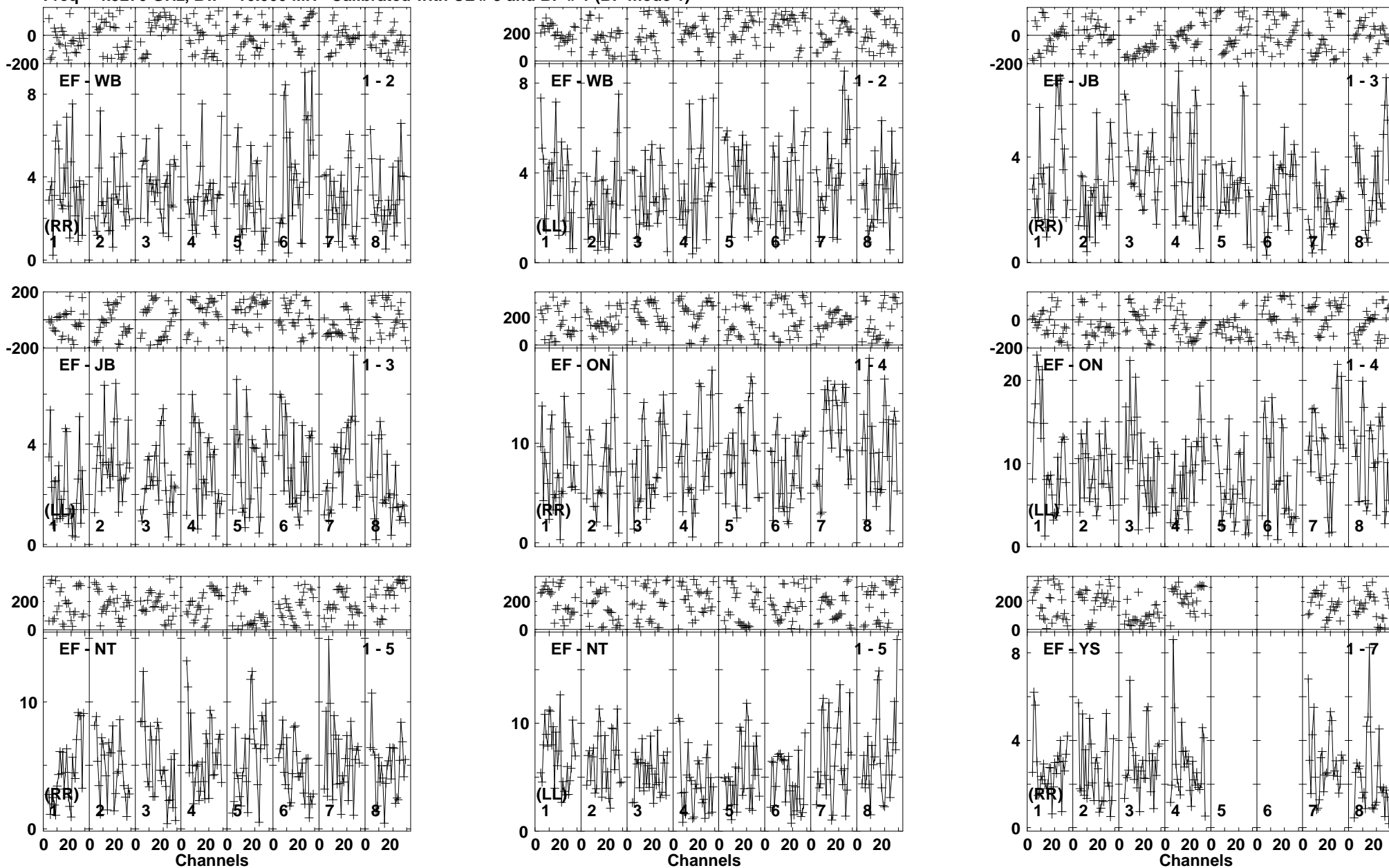

Lower frame: Milli Ampl Jy Top frame: Phas deg  
Vector averaged cross-power spectrum Baseline: EF (01) - WB (02)  
Timerange: 00/14:59:51 to 00/15:03:49

Plot file version 135 created 18-NOV-2014 15:23:31

ARP299C EP087H 3.UVDATA.1

Freq = 4.9270 GHz, Bw = 16.000 MH Calibrated with CL # 3 and BP # 1 (BP mode 1)

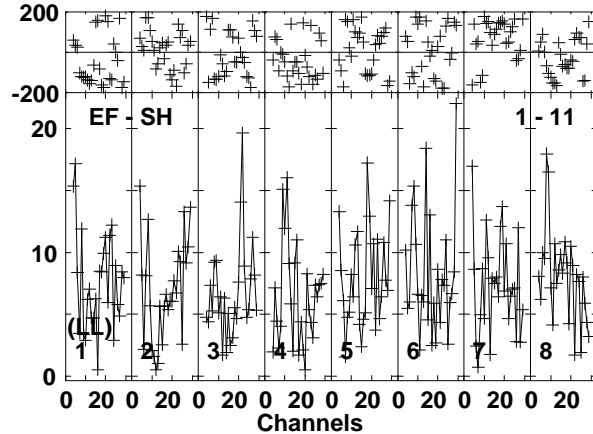
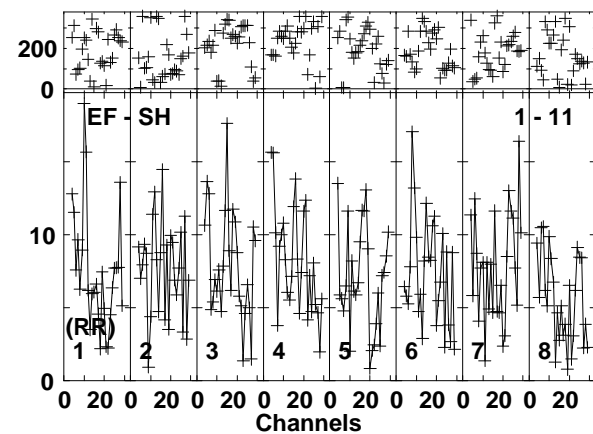
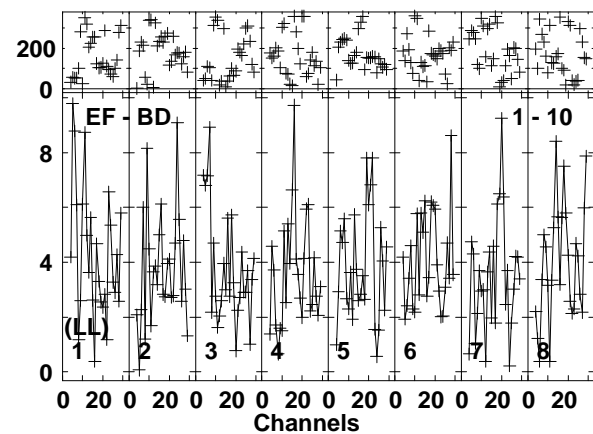
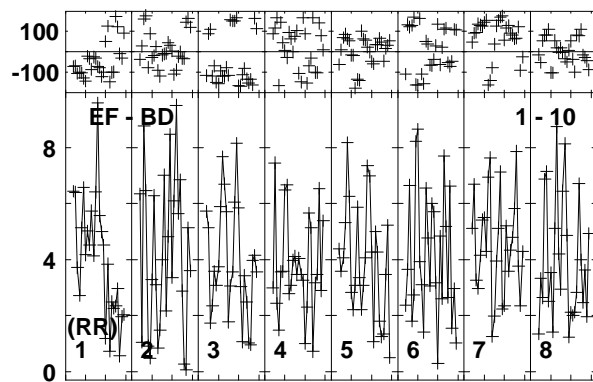
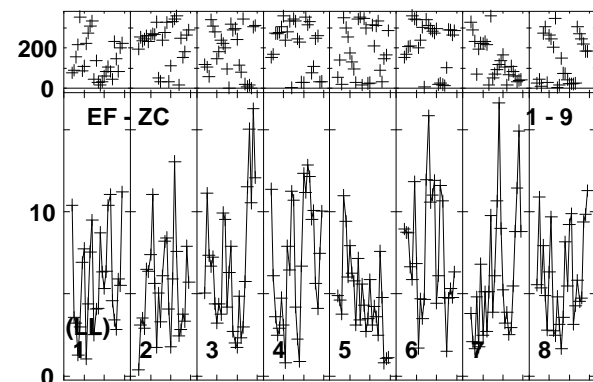
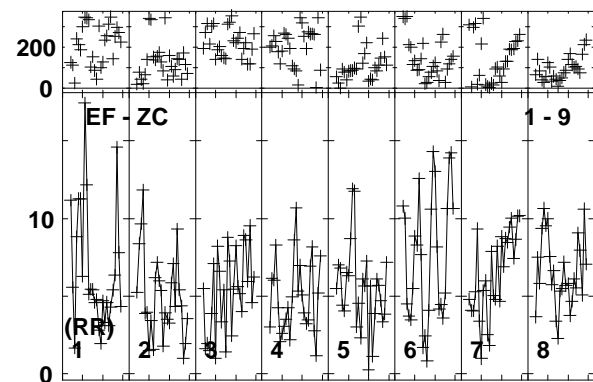
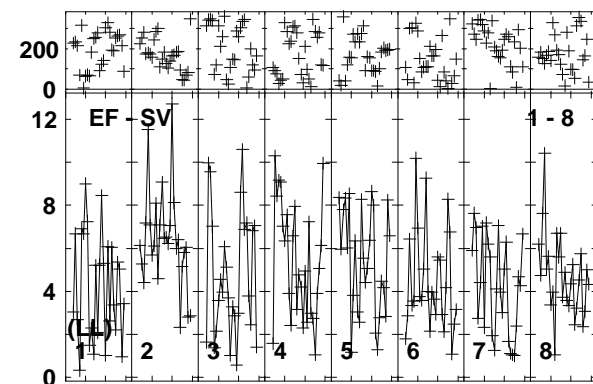
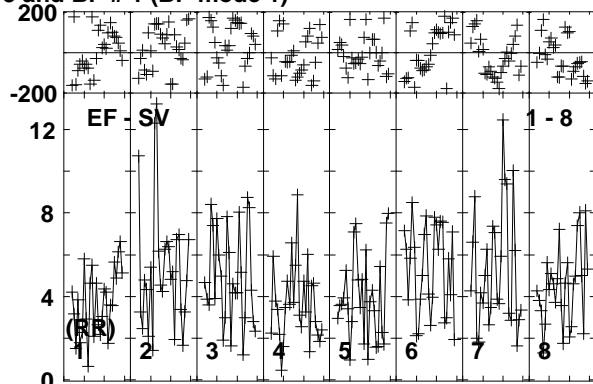
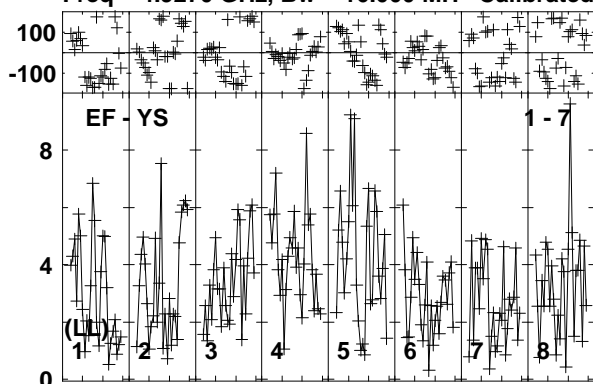

Lower frame: Milli Ampl Jy Top frame: Phas deg  
Vector averaged cross-power spectrum Baseline: EF (01) - YS (07)  
Timerange: 00/14:59:51 to 00/15:03:49

Plot file version 136 created 18-NOV-2014 15:23:32

J1128+5925 EP087H 3.UVDATA.1

Freq = 4.9270 GHz, Bw = 16.000 MH Calibrated with CL # 3 and BP # 1 (BP mode 1)

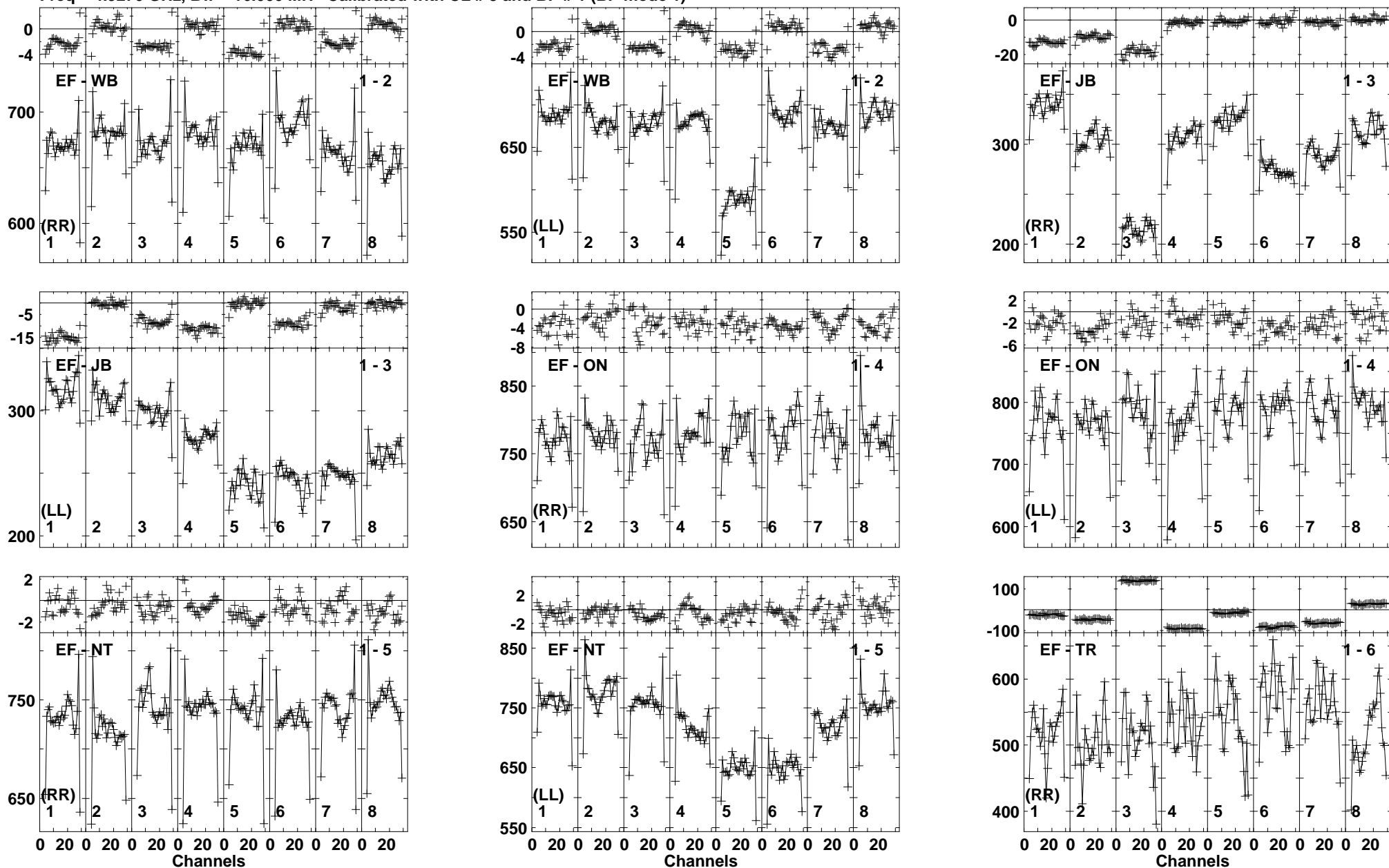

Lower frame: Milli Ampl Jy Top frame: Phas deg  
Vector averaged cross-power spectrum Baseline: EF (01) - WB (02)  
Timerange: 00/15:03:55 to 00/15:04:49



Plot file version 137 created 18-NOV-2014 15:23:32

J1128+5925 EP087H 3.UVDATA.1

Freq = 4.9270 GHz, Bw = 16.000 MH Calibrated with CL # 3 and BP # 1 (BP mode 1)

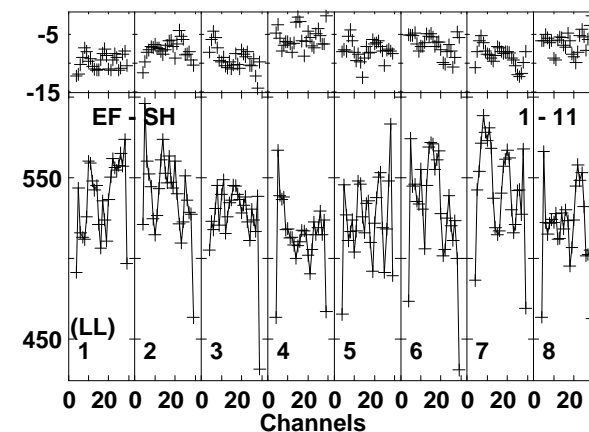
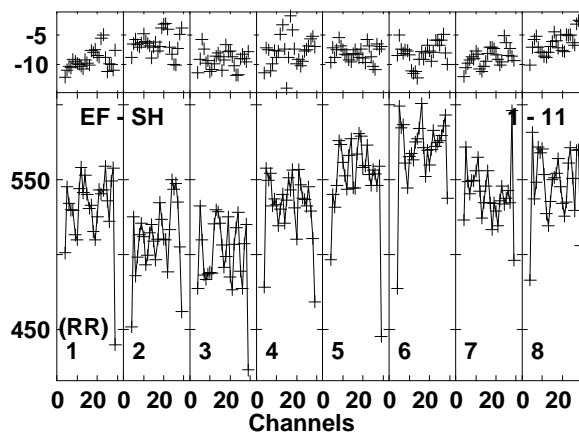
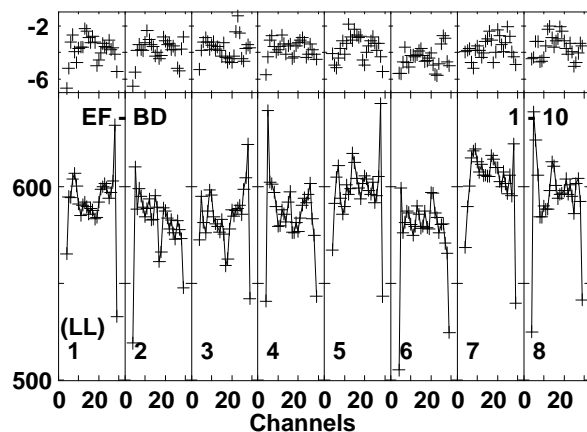
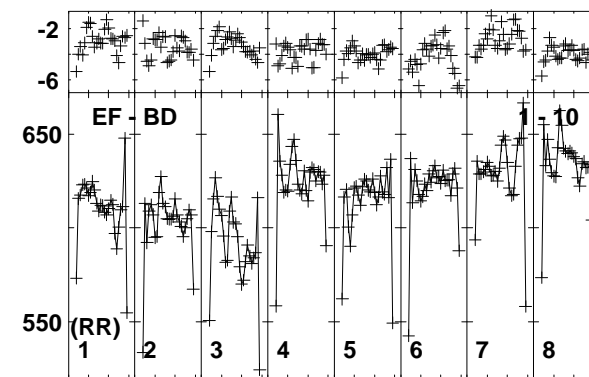
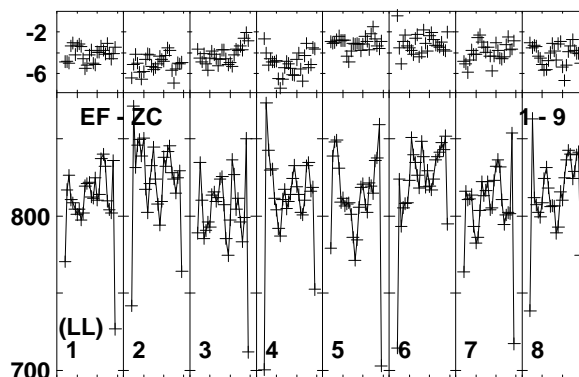
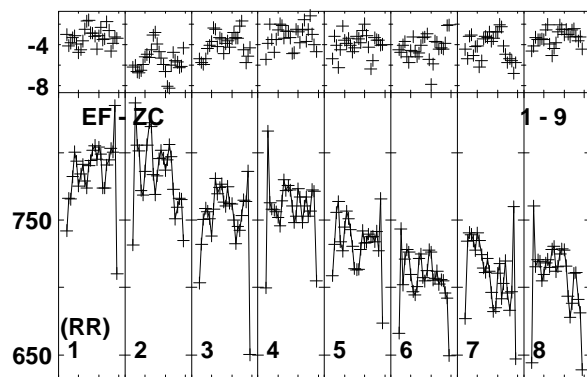
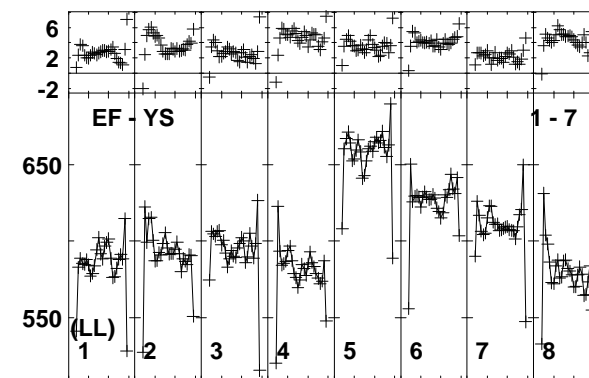
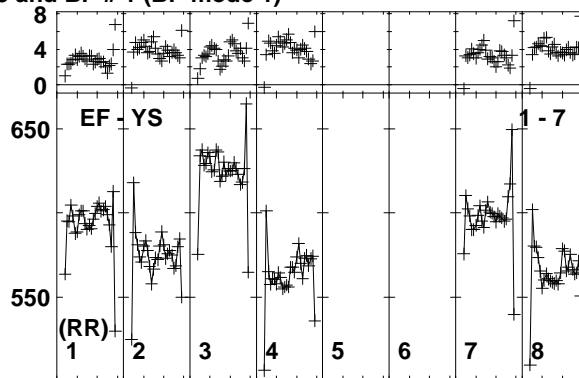
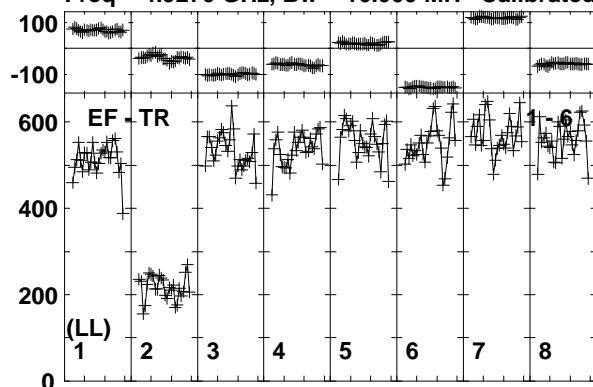

Lower frame: Milli Ampl Jy Top frame: Phas deg  
Vector averaged cross-power spectrum Baseline: EF (01) - TR (06)  
Timerange: 00/15:03:55 to 00/15:04:49

Plot file version 138 created 18-NOV-2014 15:23:32  
 ARP299C EP087H 3.UVDATA.1  
 Freq = 4.9270 GHz, Bw = 16.000 MH Calibrated with CL # 3 and BP # 1 (BP mode 1)

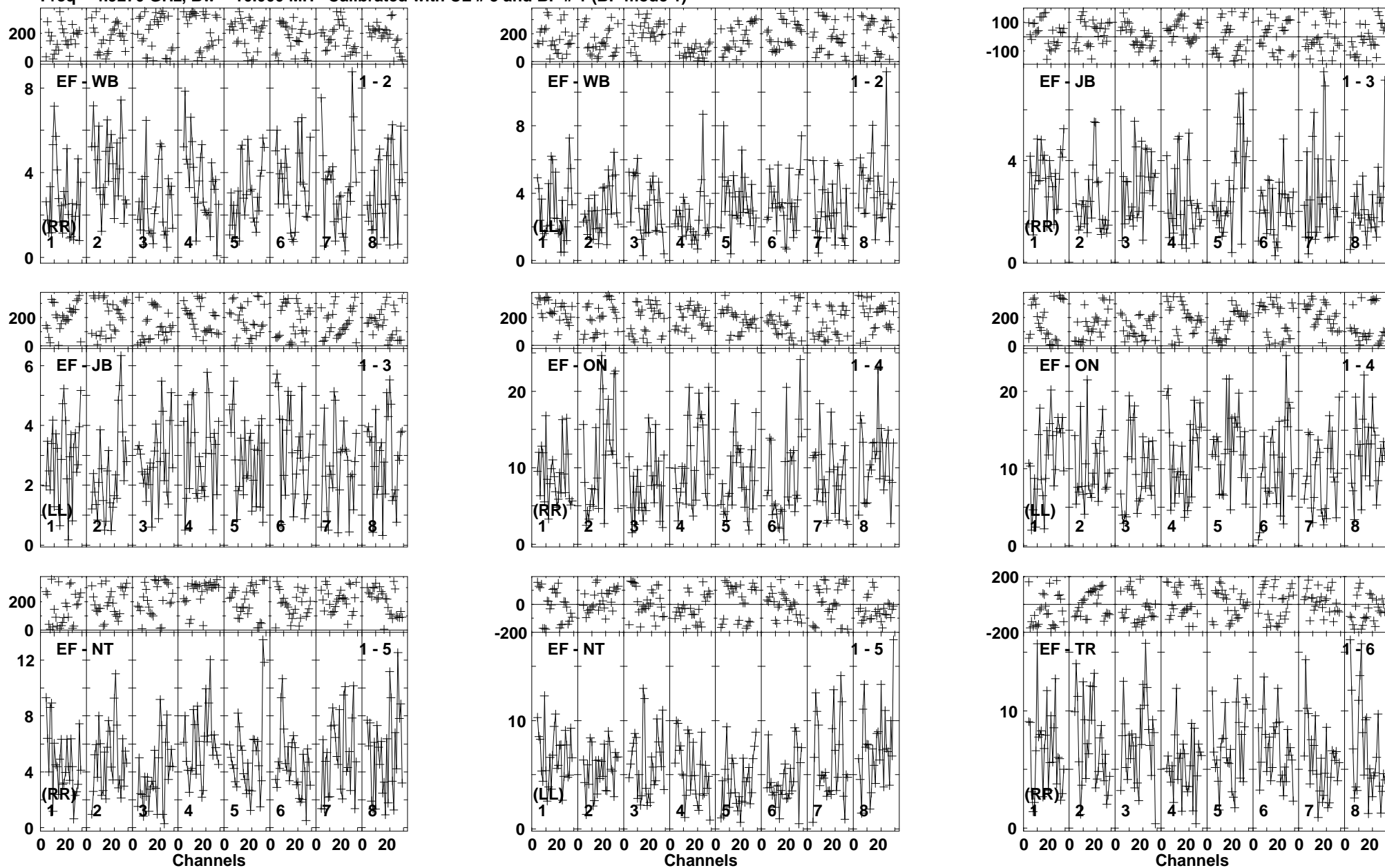

Lower frame: Milli Ampl Jy Top frame: Phas deg  
 Vector averaged cross-power spectrum Baseline: EF (01) - WB (02)  
 Timerange: 00/15:04:55 to 00/15:08:49

Plot file version 139 created 18-NOV-2014 15:23:32  
 ARP299C EP087H 3.UVDATA.1  
 Freq = 4.9270 GHz, Bw = 16.000 MH Calibrated with CL # 3 and BP # 1 (BP mode 1)

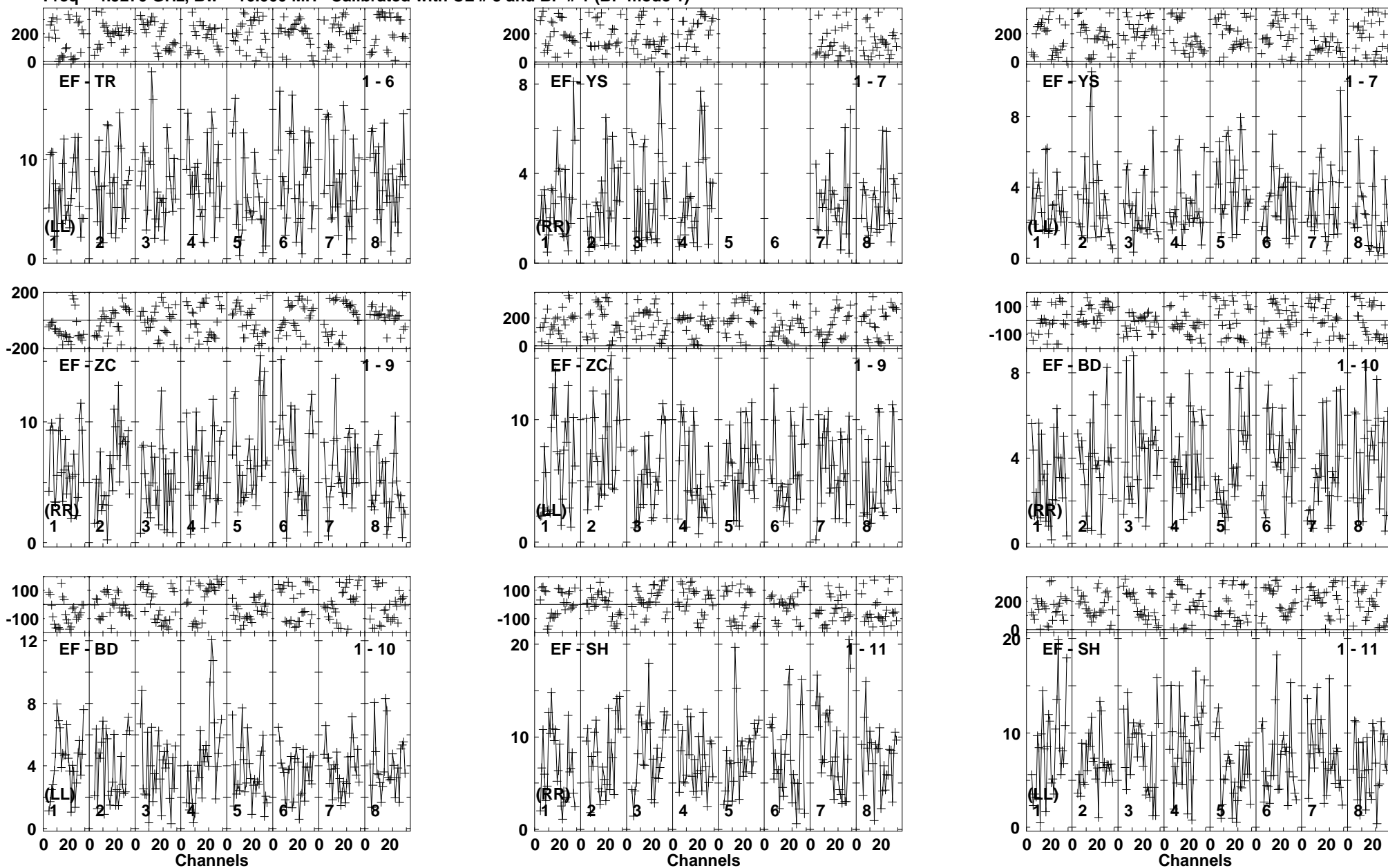

Lower frame: Milli Ampl Jy Top frame: Phas deg  
 Vector averaged cross-power spectrum Baseline: EF (01) - TR (06)  
 Timerange: 00/15:04:55 to 00/15:08:49

Plot file version 140 created 18-NOV-2014 15:23:32

J1128+5925 EP087H 3.UVDATA.1

Freq = 4.9270 GHz, Bw = 16.000 MH Calibrated with CL # 3 and BP # 1 (BP mode 1)

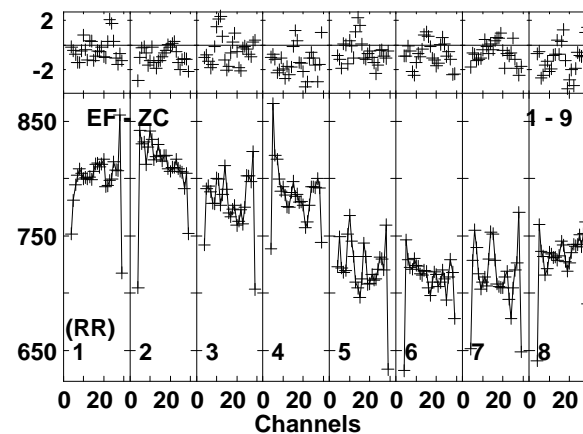
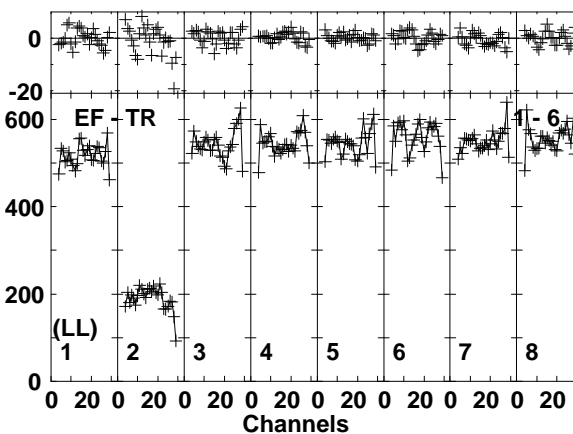
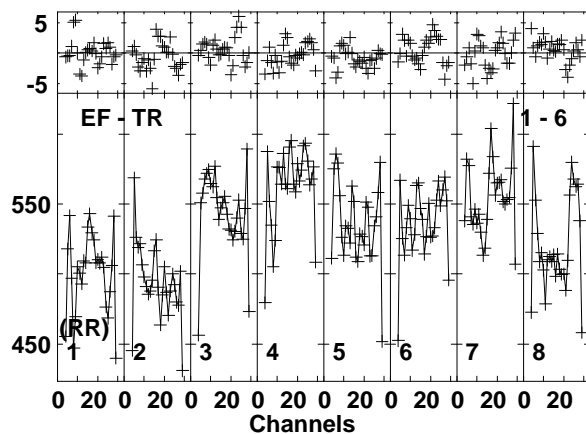
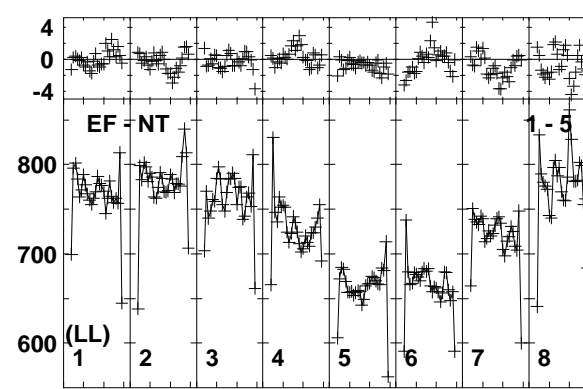
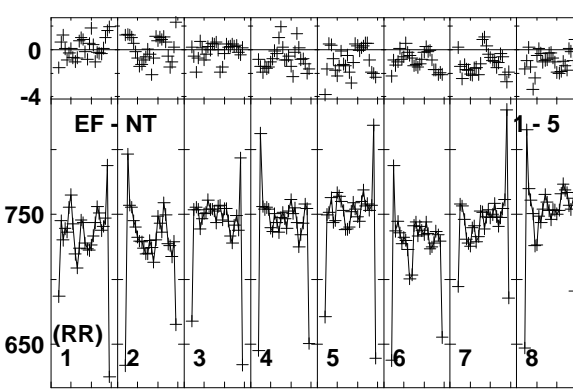
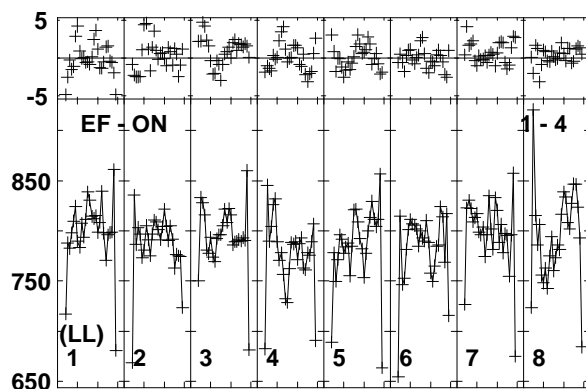
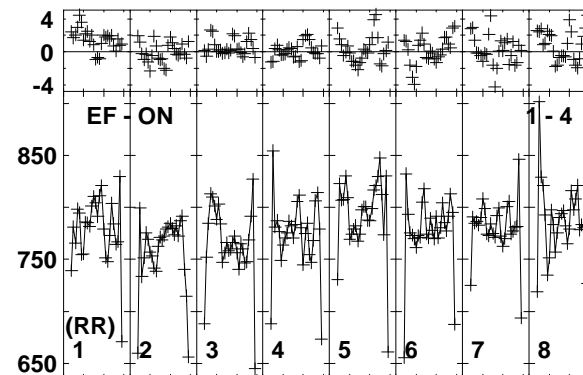
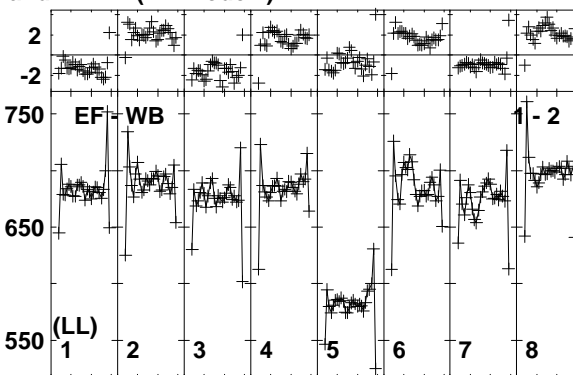
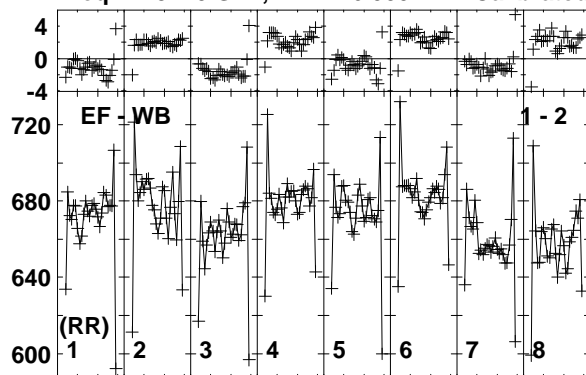

Lower frame: Milli Ampl Jy Top frame: Phas deg  
Vector averaged cross-power spectrum Baseline: EF (01) - WB (02)  
Timerange: 00/15:09:33 to 00/15:09:59

Plot file version 141 created 18-NOV-2014 15:23:33

J1128+5925 EP087H 3.UVDATA.1

Freq = 4.9270 GHz, Bw = 16.000 MH Calibrated with CL # 3 and BP # 1 (BP mode 1)

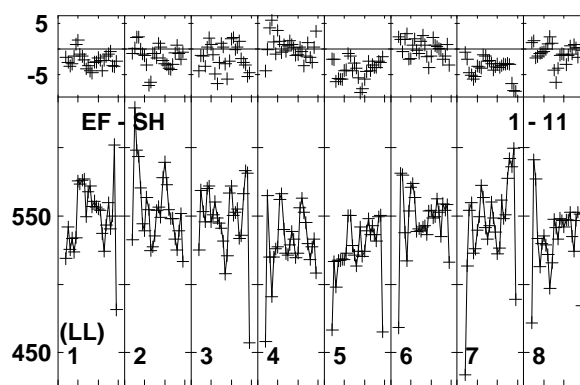
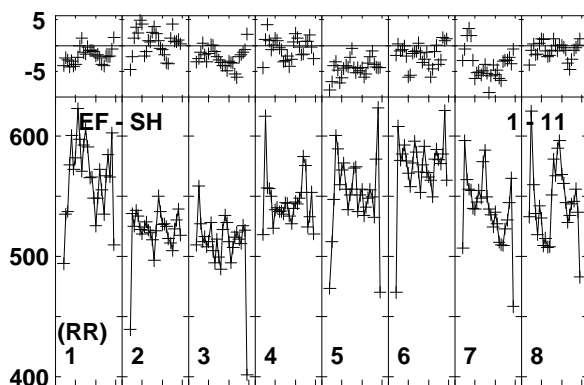
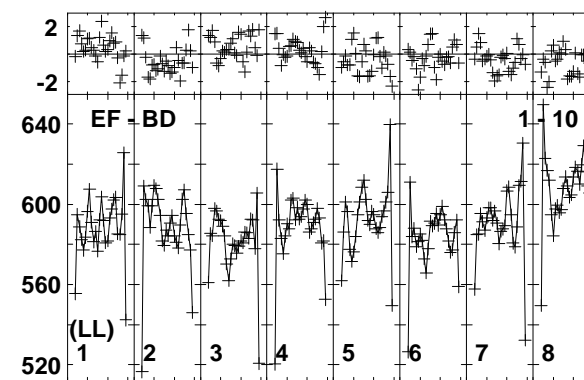
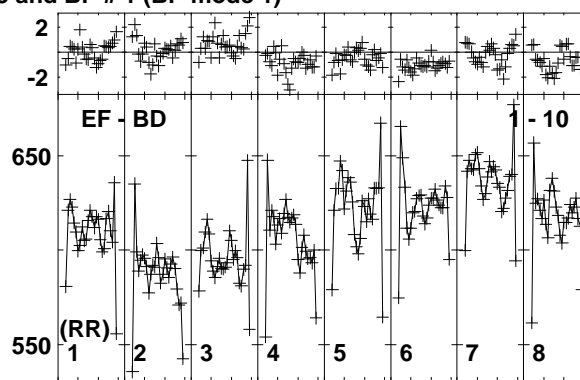
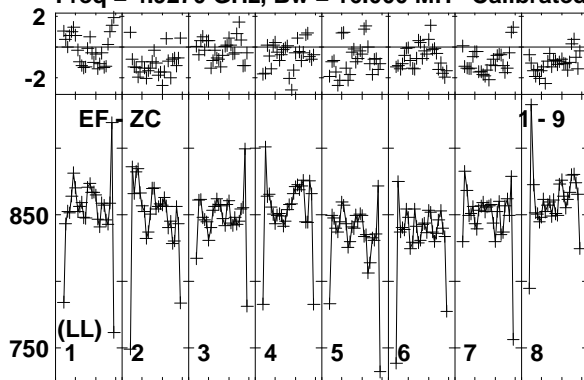

Lower frame: Milli Ampl Jy Top frame: Phas deg  
Vector averaged cross-power spectrum Baseline: EF (01) - ZC (09)  
Timerange: 00/15:09:33 to 00/15:09:59

Plot file version 142 created 18-NOV-2014 15:23:33

ARP299C EP087H 3.UVDATA.1

Freq = 4.9270 GHz, Bw = 16.000 MH Calibrated with CL # 3 and BP # 1 (BP mode 1)

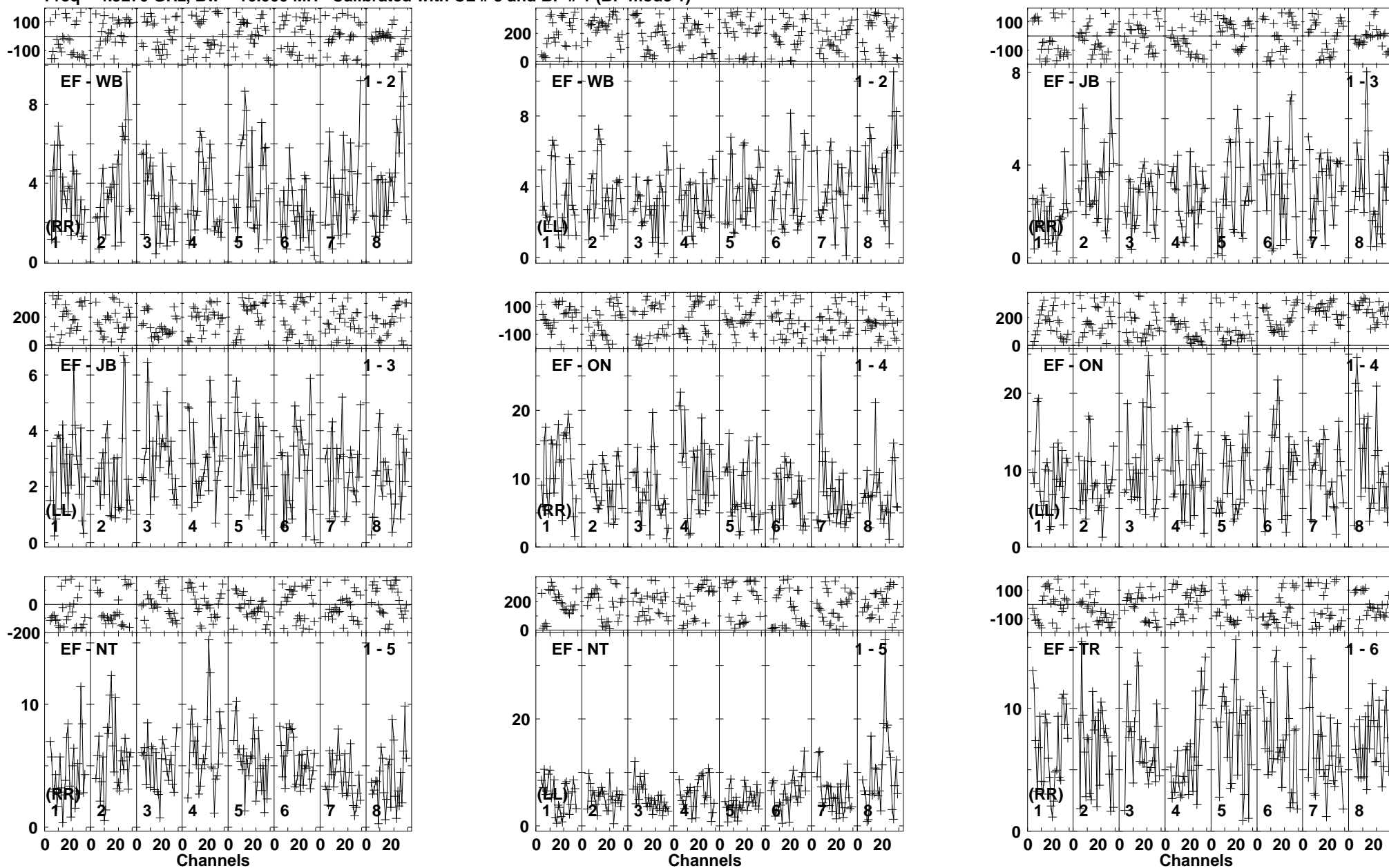

Lower frame: Milli Ampl Jy Top frame: Phas deg  
Vector averaged cross-power spectrum Baseline: EF (01) - WB (02)  
Timerange: 00/15:10:01 to 00/15:13:59

Plot file version 143 created 18-NOV-2014 15:23:33

ARP299C EP087H 3.UVDATA.1

Freq = 4.9270 GHz, Bw = 16.000 MH Calibrated with CL # 3 and BP # 1 (BP mode 1)

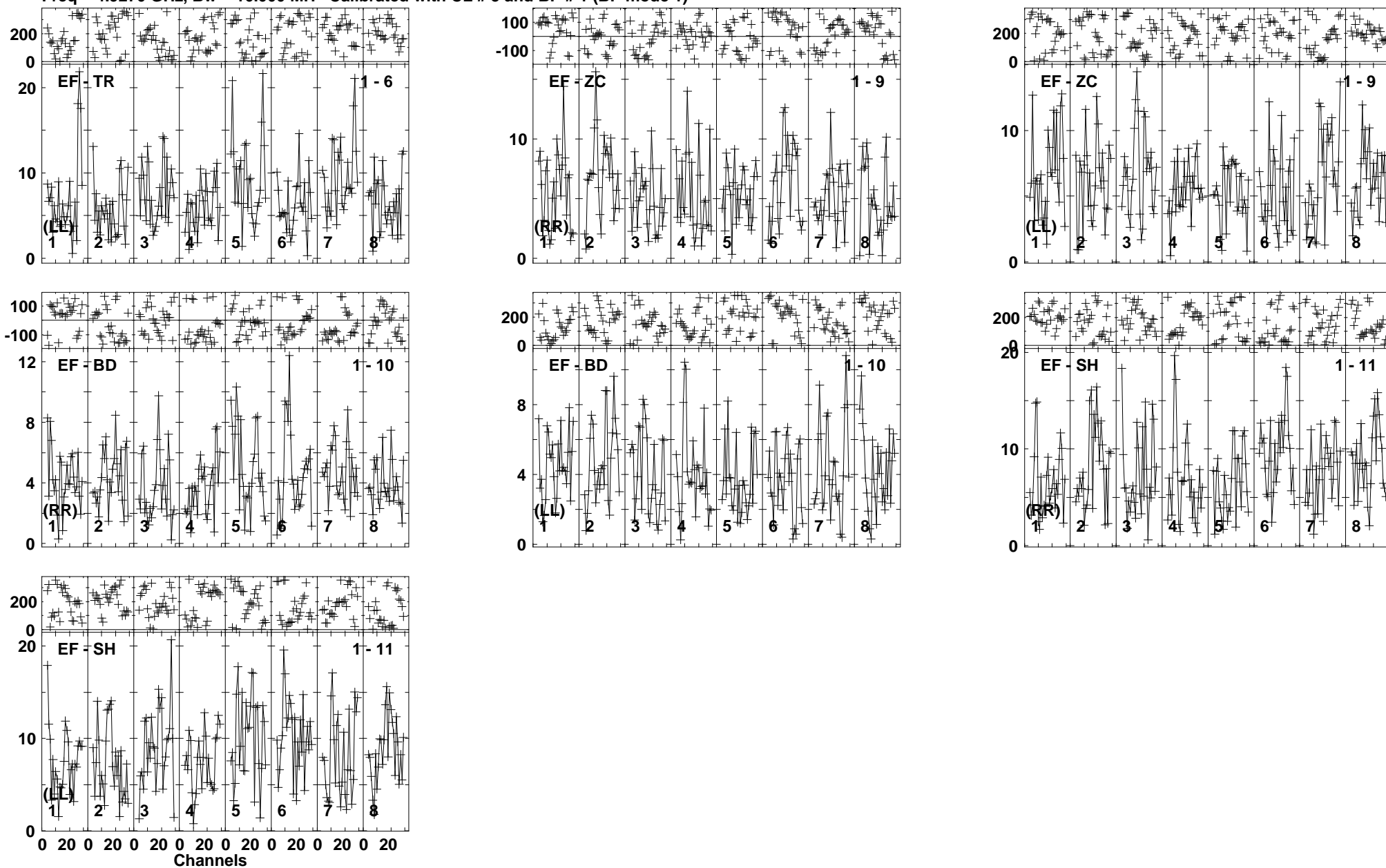

Lower frame: Milli Ampl Jy Top frame: Phas deg  
Vector averaged cross-power spectrum Baseline: EF (01) - TR (06)  
Timerange: 00/15:10:01 to 00/15:13:59

Plot file version 144 created 18-NOV-2014 15:23:33

J1128+5925 EP087H 3.UVDATA.1

Freq = 4.9270 GHz, Bw = 16.000 MH Calibrated with CL # 3 and BP # 1 (BP mode 1)

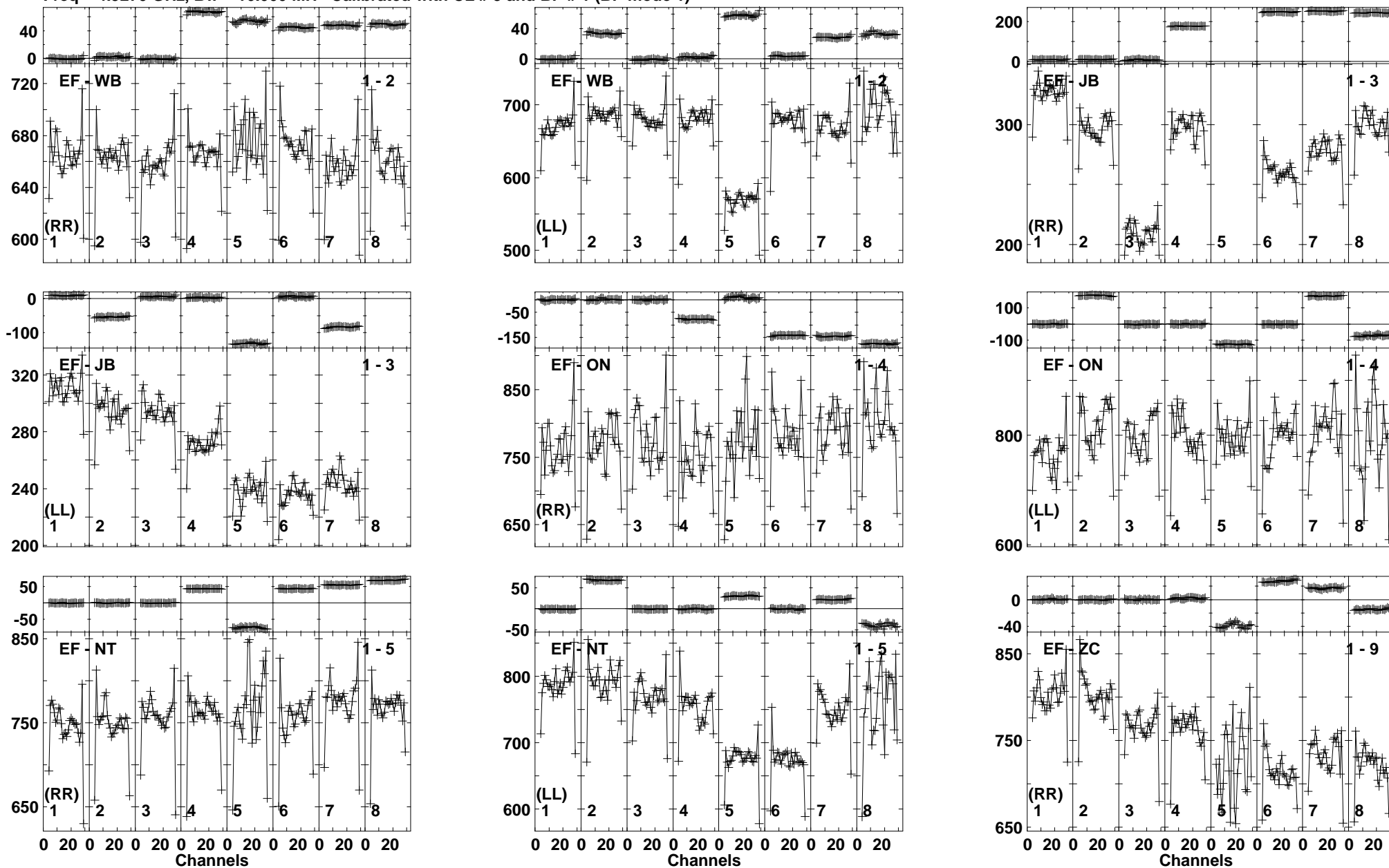

Lower frame: Milli Ampl Jy Top frame: Phas deg  
Vector averaged cross-power spectrum Baseline: EF (01) - WB (02)  
Timerange: 00/15:14:05 to 00/15:14:59



Plot file version 145 created 18-NOV-2014 15:23:34

J1128+5925 EP087H 3.UVDATA.1

Freq = 4.9270 GHz, Bw = 16.000 MH Calibrated with CL # 3 and BP # 1 (BP mode 1)

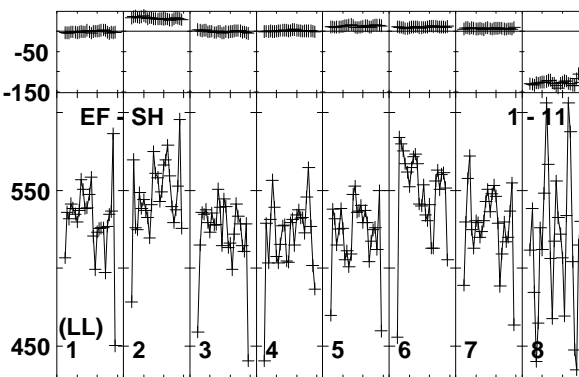
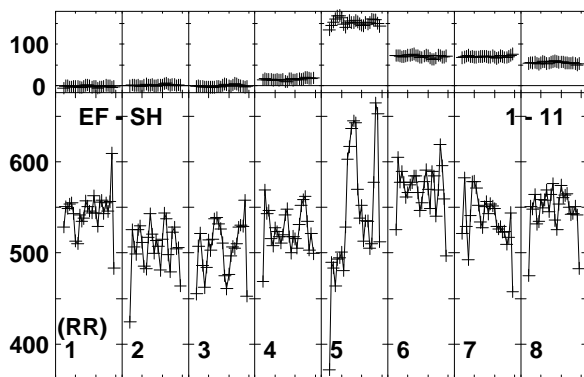
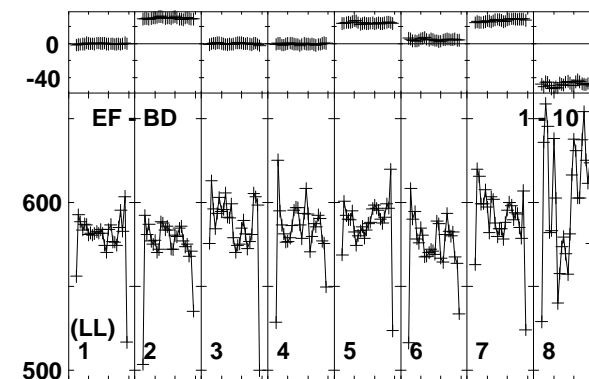
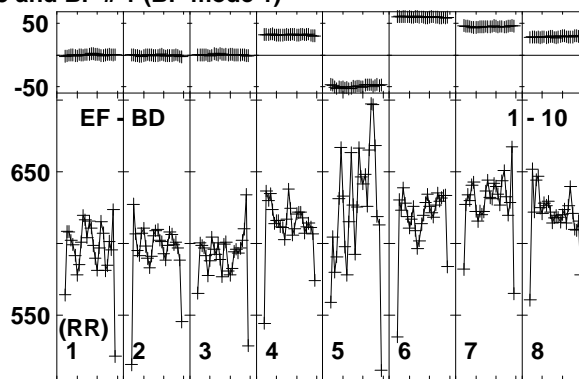
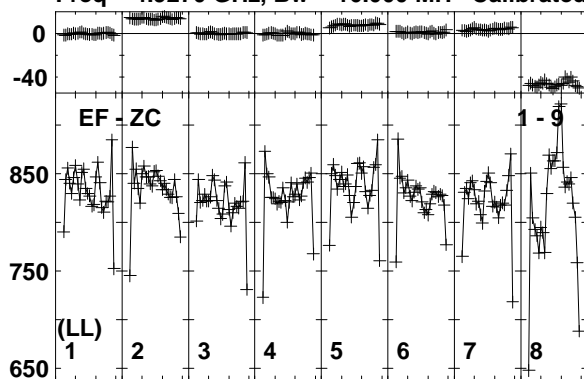

Lower frame: Milli Ampl Jy Top frame: Phas deg  
Vector averaged cross-power spectrum Baseline: EF (01) - ZC (09)  
Timerange: 00/15:14:05 to 00/15:14:59

Plot file version 146 created 18-NOV-2014 15:23:34  
 ARP299C EP087H 3.UVDATA.1  
 Freq = 4.9270 GHz, Bw = 16.000 MH Calibrated with CL # 3 and BP # 1 (BP mode 1)

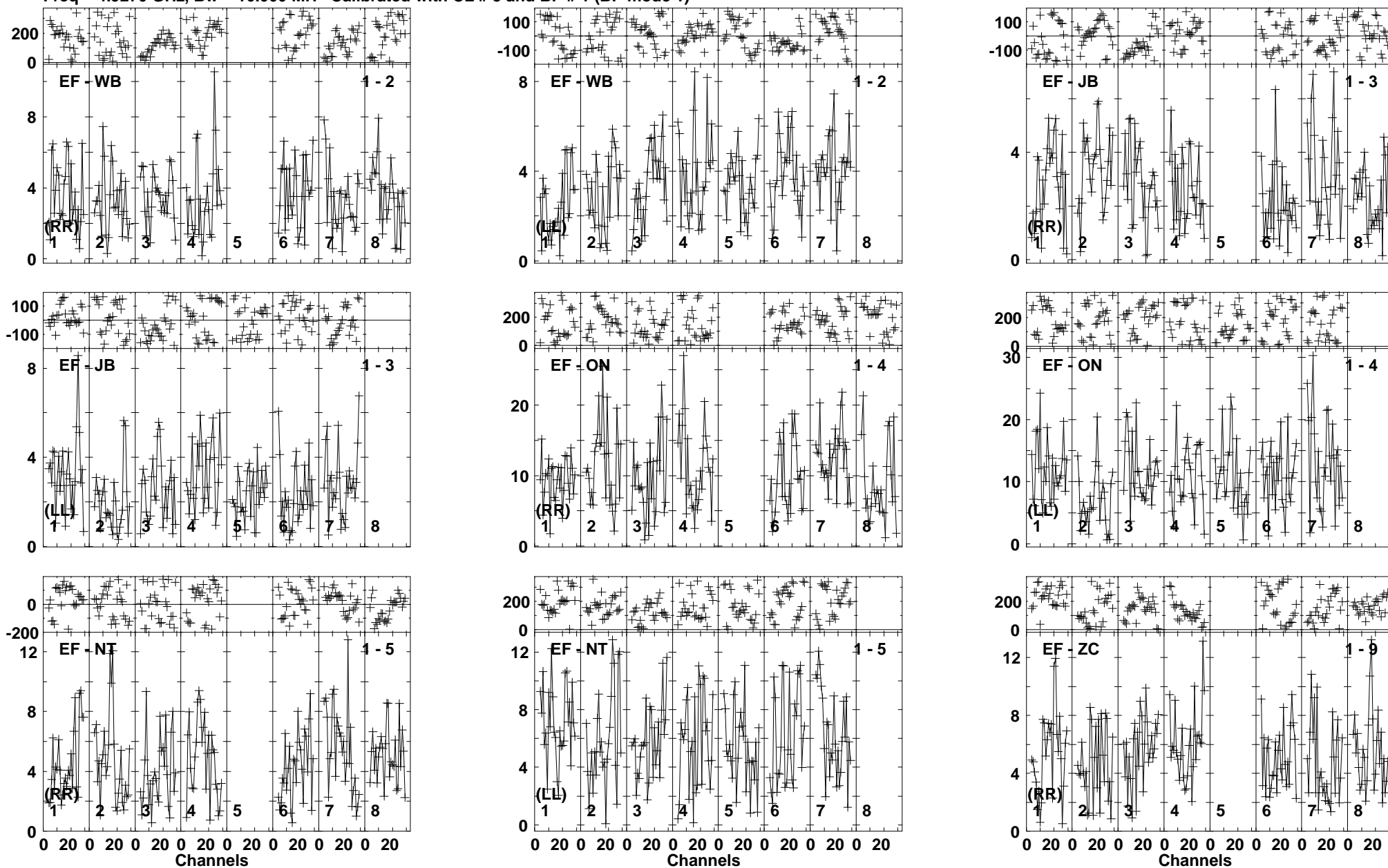

Lower frame: Milli Ampl Jy Top frame: Phas deg  
 Vector averaged cross-power spectrum Baseline: EF (01) - WB (02)  
 Timerange: 00/15:15:05 to 00/15:18:59

Plot file version 147 created 18-NOV-2014 15:23:34  
 ARP299C EP087H 3.UVDATA.1  
 Freq = 4.9270 GHz, Bw = 16.000 MH Calibrated with CL # 3 and BP # 1 (BP mode 1)

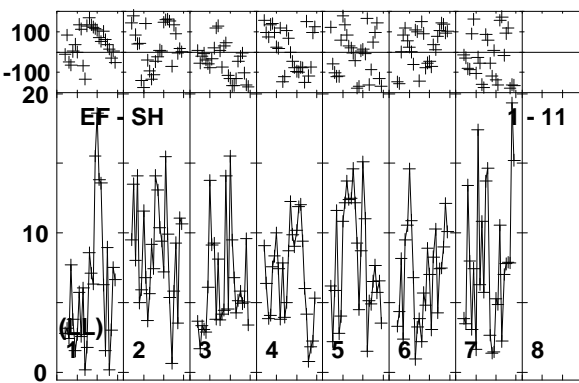
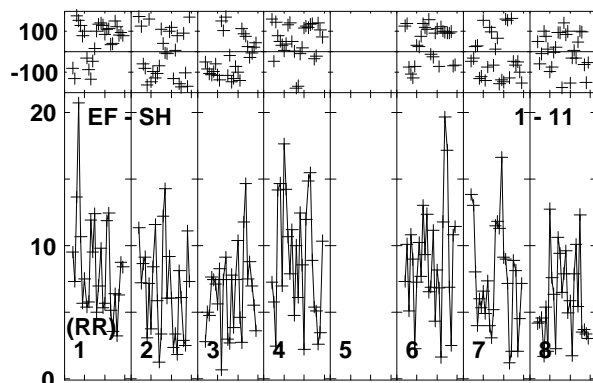
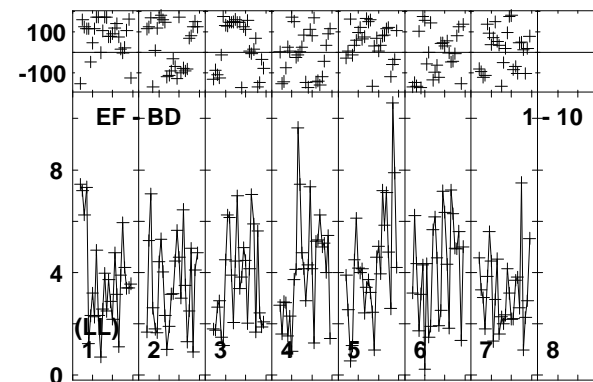
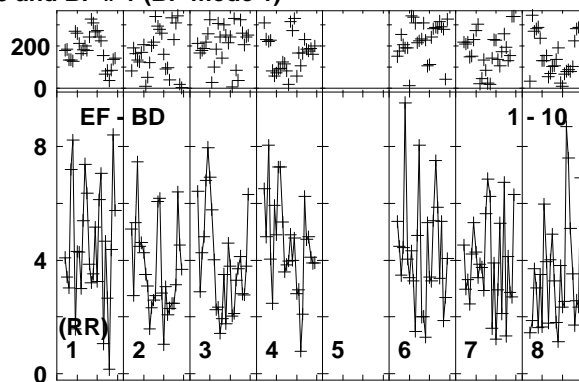
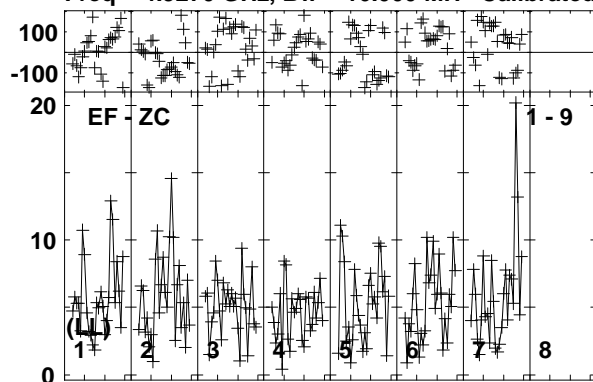

Lower frame: Milli Ampl Jy Top frame: Phas deg  
 Vector averaged cross-power spectrum Baseline: EF (01) - ZC (09)  
 Timerange: 00/15:15:05 to 00/15:18:59

Plot file version 148 created 18-NOV-2014 15:23:34

J1128+5925 EP087H 3.UVDATA.1

Freq = 4.9270 GHz, Bw = 16.000 MH Calibrated with CL # 3 and BP # 1 (BP mode 1)

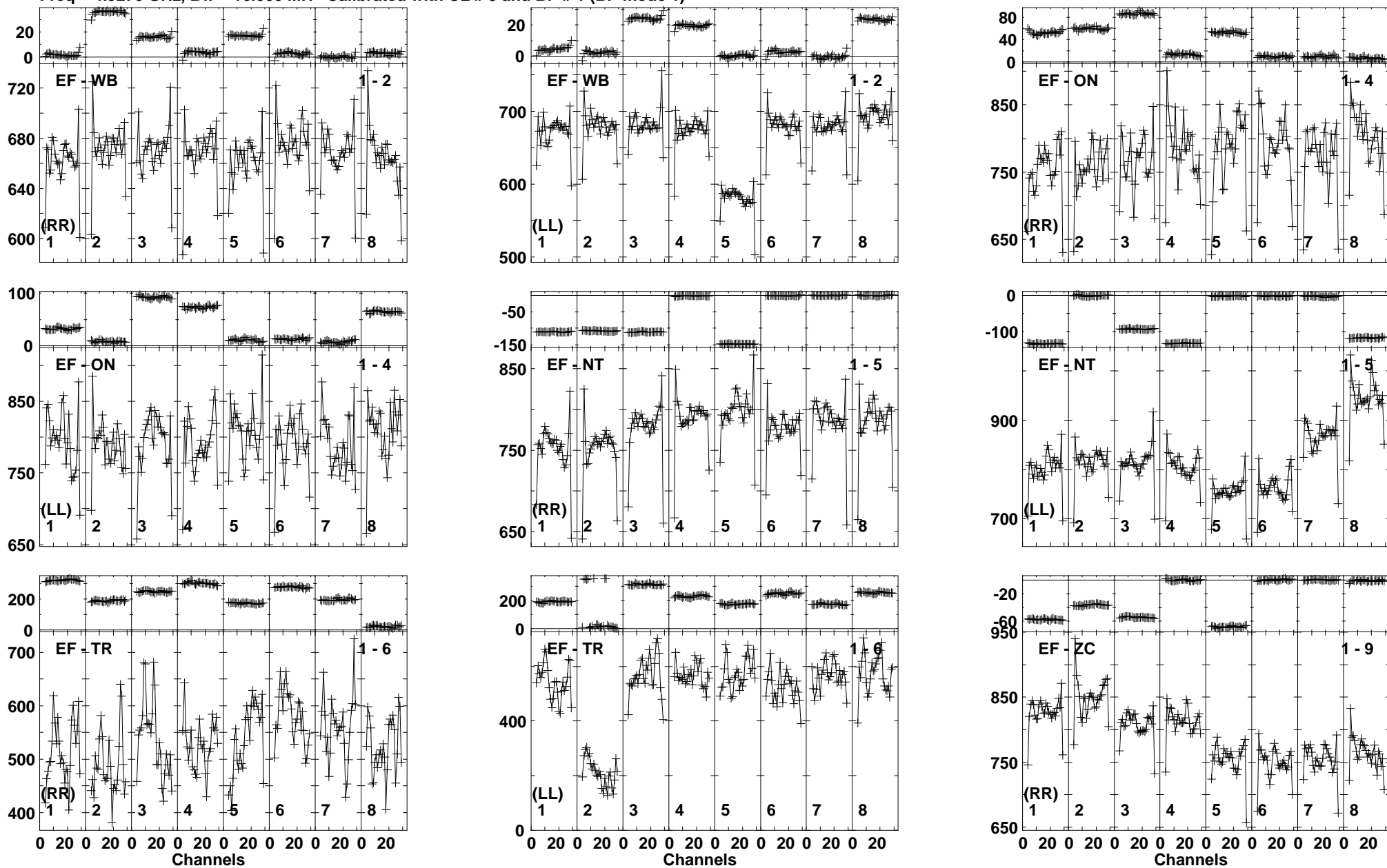

Lower frame: Milli Ampl Jy Top frame: Phas deg  
Vector averaged cross-power spectrum Baseline: EF (01) - WB (02)  
Timerange: 00/15:19:05 to 00/15:19:59

Plot file version 149 created 18-NOV-2014 15:23:34

J1128+5925 EP087H 3.UVDATA.1

Freq = 4.9270 GHz, Bw = 16.000 MH Calibrated with CL # 3 and BP # 1 (BP mode 1)

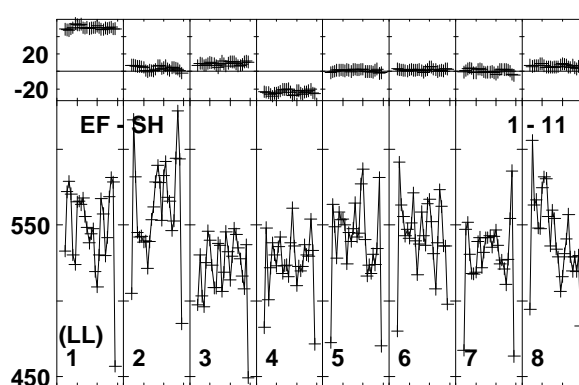
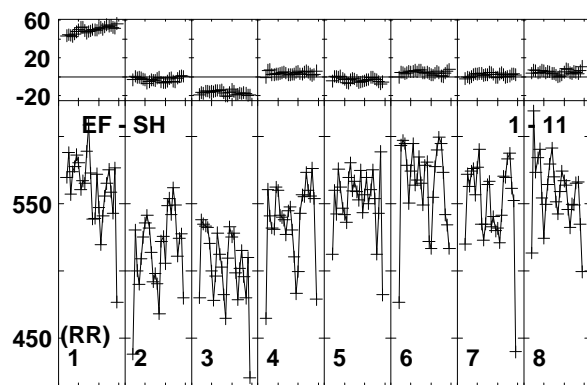
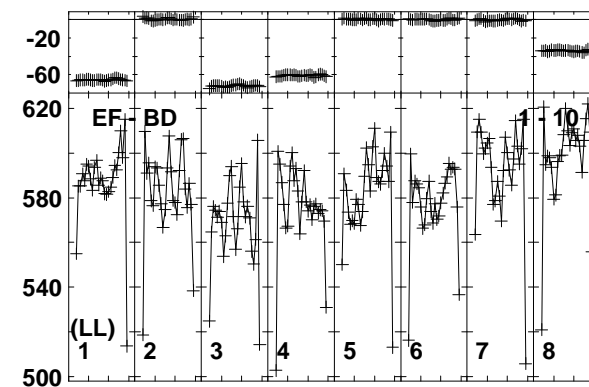
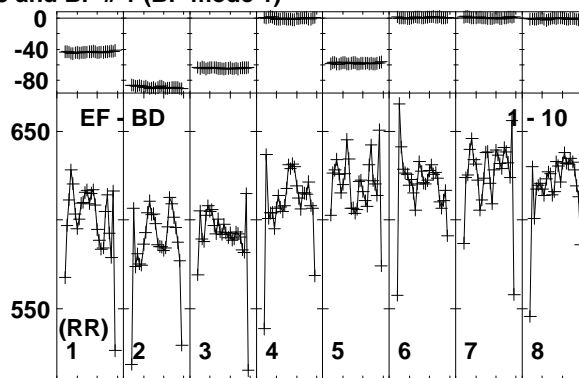
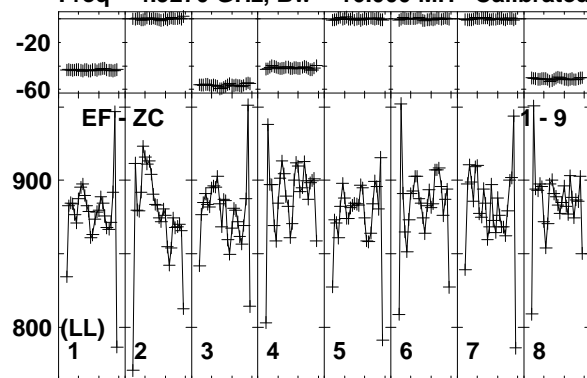

Lower frame: Milli Ampl Jy Top frame: Phas deg  
Vector averaged cross-power spectrum Baseline: EF (01) - ZC (09)  
Timerange: 00/15:19:05 to 00/15:19:59

Plot file version 150 created 18-NOV-2014 15:23:35

ARP299C EP087H 3.UVDATA.1

Freq = 4.9270 GHz, Bw = 16.000 MH Calibrated with CL # 3 and BP # 1 (BP mode 1)

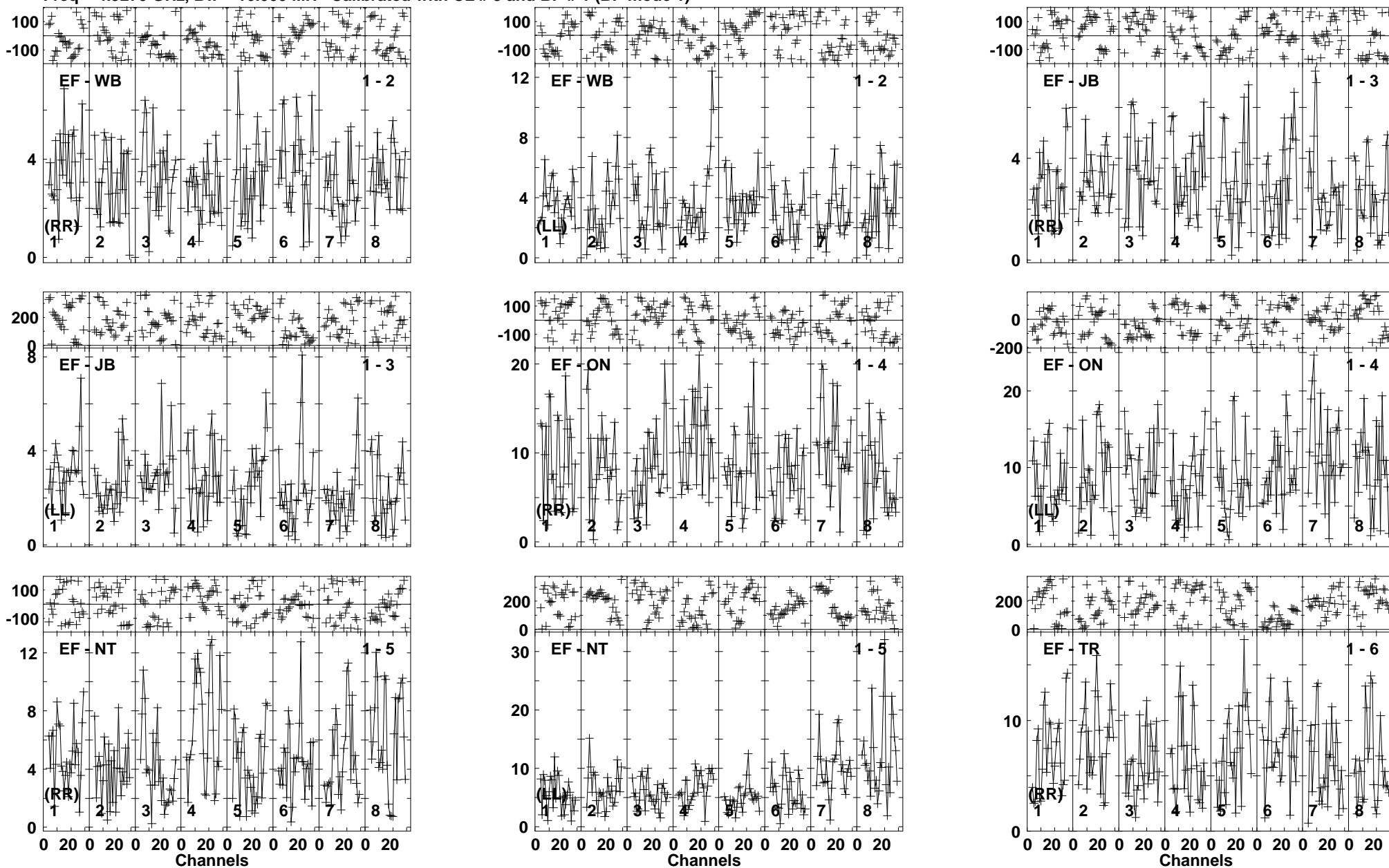

Lower frame: Milli Ampl Jy Top frame: Phas deg  
Vector averaged cross-power spectrum Baseline: EF (01) - WB (02)  
Timerange: 00/15:20:01 to 00/15:23:59

Plot file version 151 created 18-NOV-2014 15:23:35

ARP299C EP087H 3.UVDATA.1

Freq = 4.9270 GHz, Bw = 16.000 MH Calibrated with CL # 3 and BP # 1 (BP mode 1)

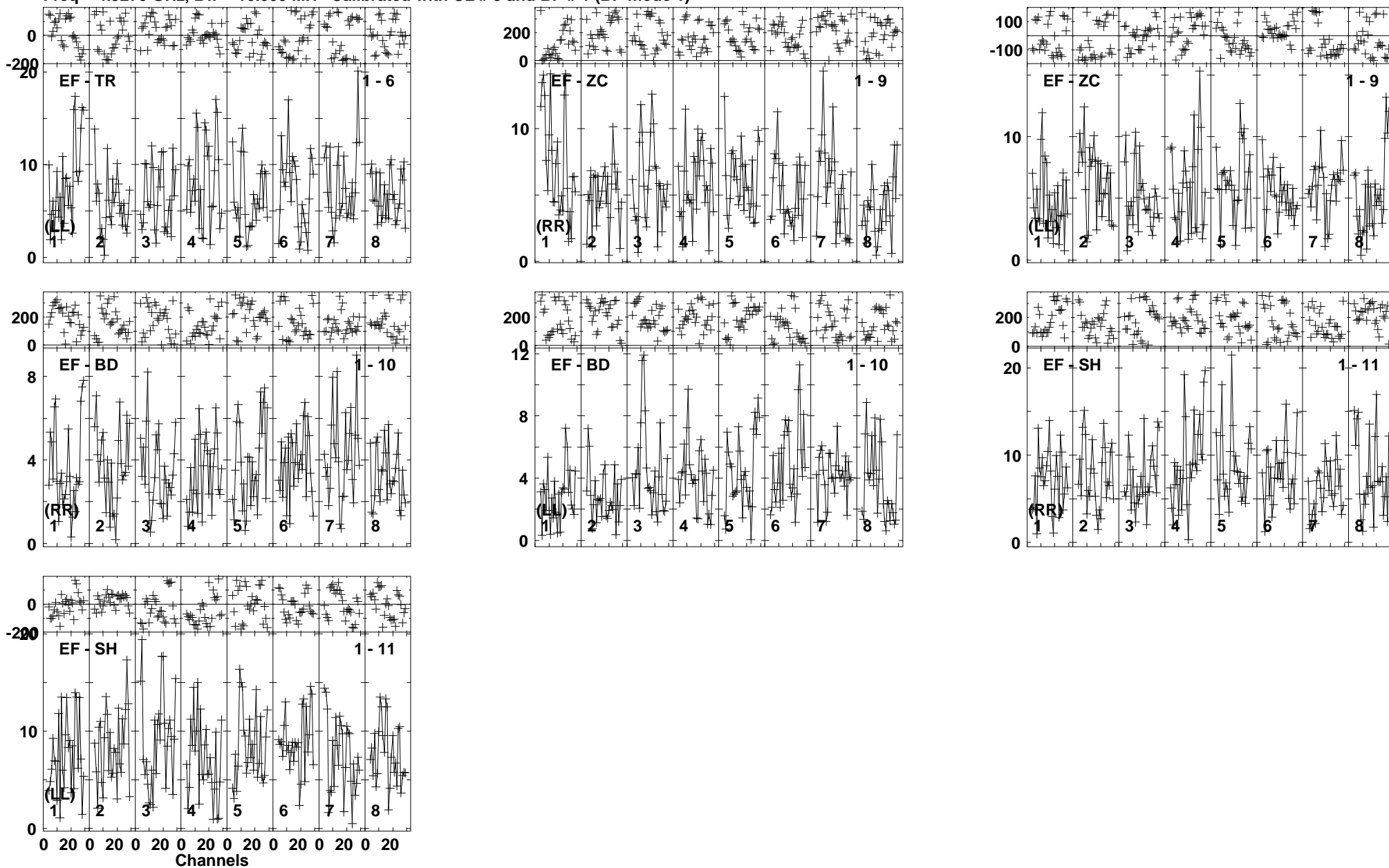

Lower frame: Milli Ampl Jy Top frame: Phas deg  
Vector averaged cross-power spectrum Baseline: EF (01) - TR (06)  
Timerange: 00/15:20:01 to 00/15:23:59

Plot file version 152 created 18-NOV-2014 15:23:35

J1128+5925 EP087H 3.UVDATA.1

Freq = 4.9270 GHz, Bw = 16.000 MH Calibrated with CL # 3 and BP # 1 (BP mode 1)

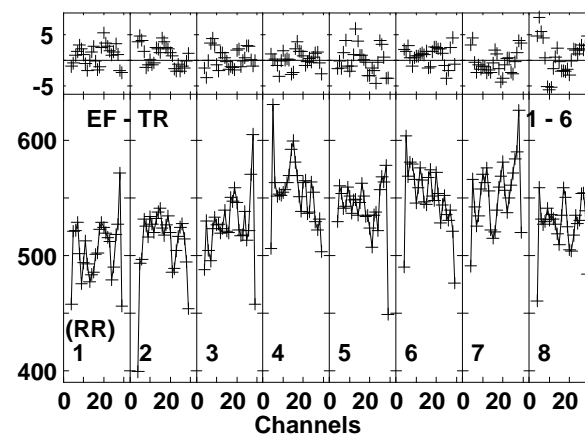
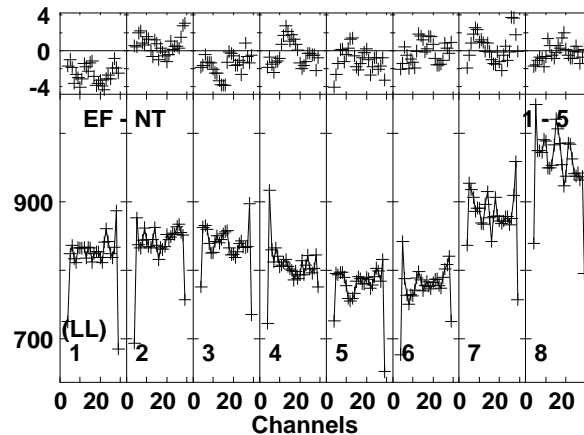
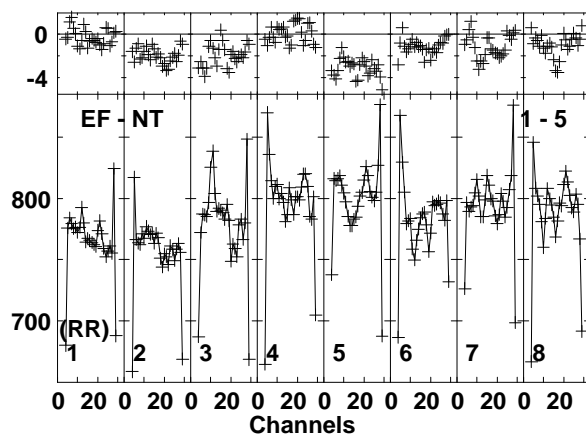
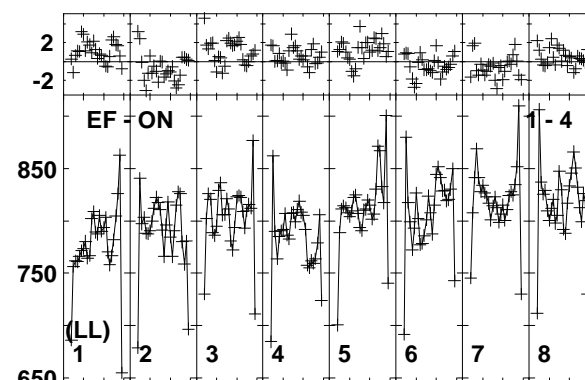
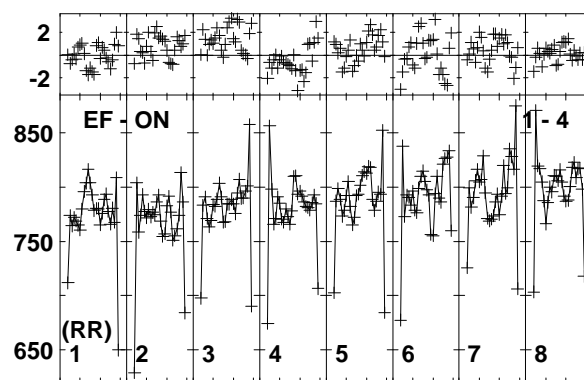
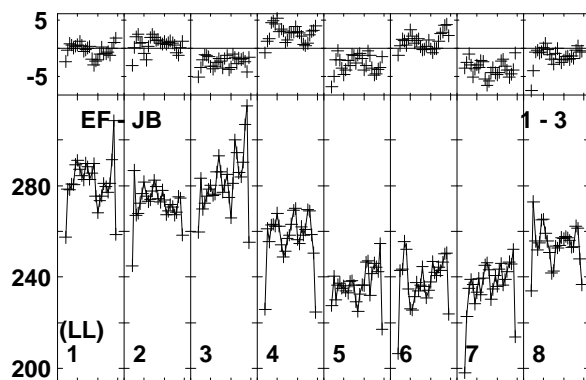
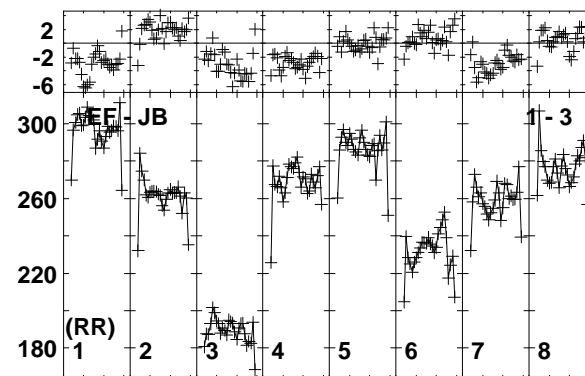
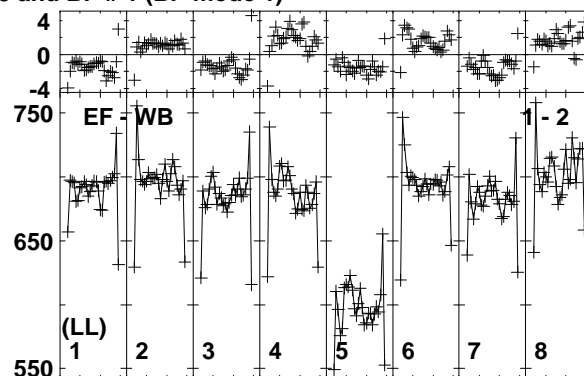
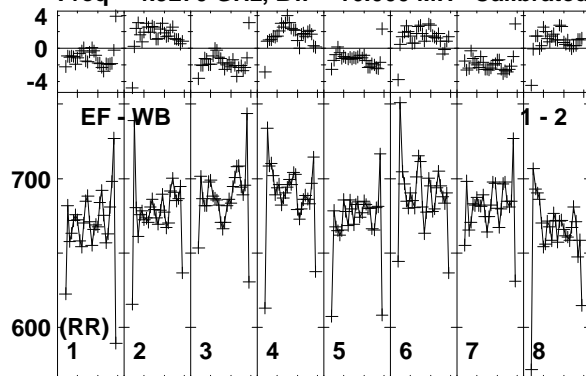

Lower frame: Milli Ampl Jy Top frame: Phas deg  
Vector averaged cross-power spectrum Baseline: EF (01) - WB (02)  
Timerange: 00/15:24:41 to 00/15:25:09



Plot file version 153 created 18-NOV-2014 15:23:35

J1128+5925 EP087H 3.UVDATA.1

Freq = 4.9270 GHz, Bw = 16.000 MH Calibrated with CL # 3 and BP # 1 (BP mode 1)

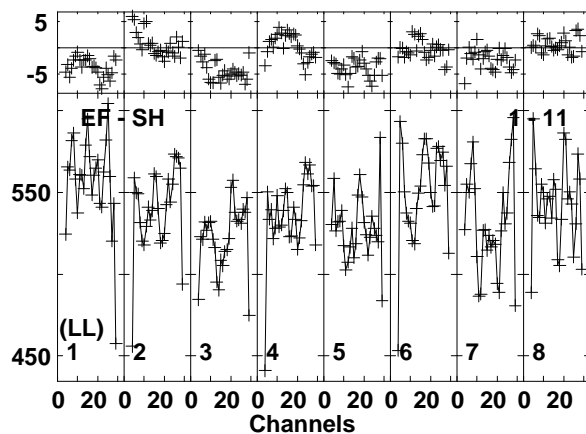
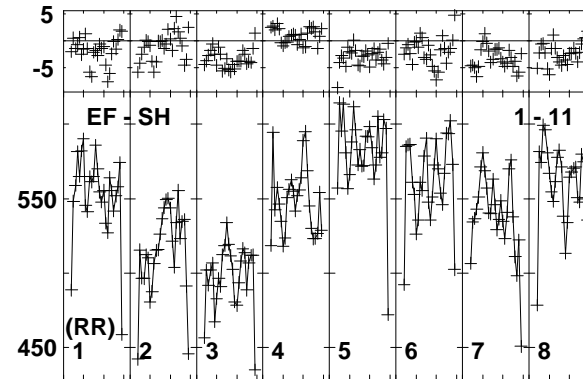
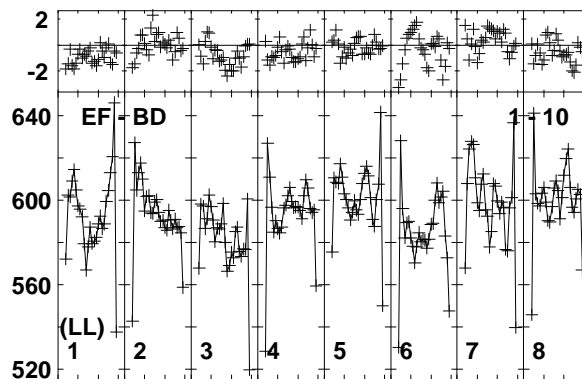
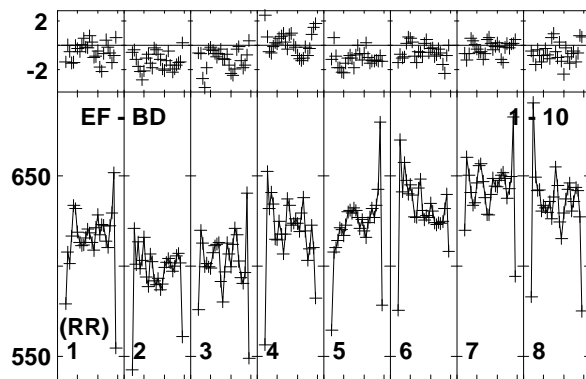
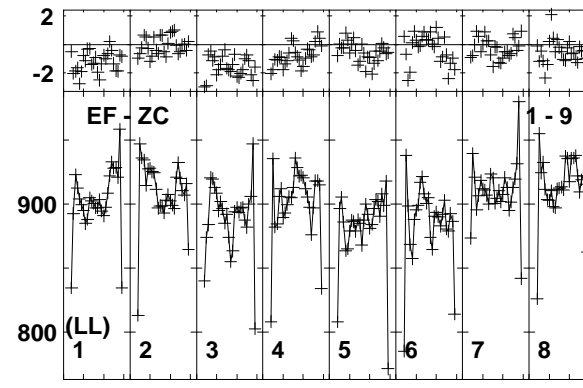
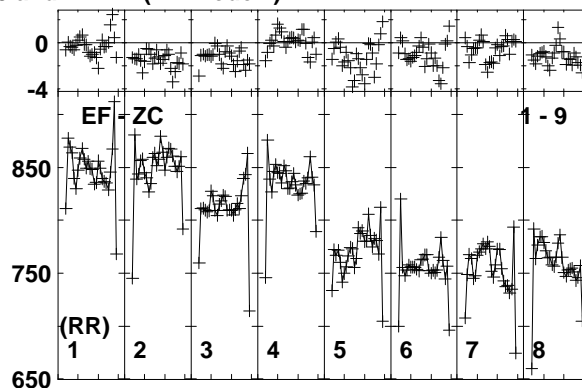
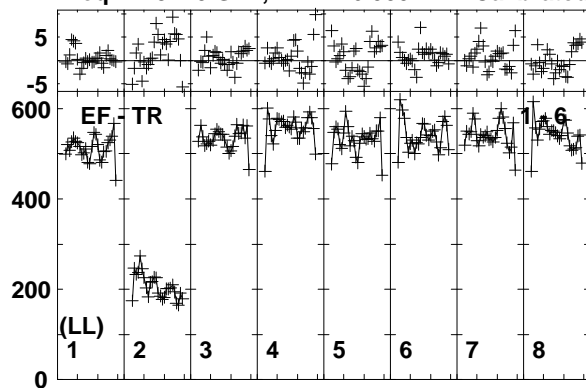

Lower frame: Milli Ampl Jy Top frame: Phas deg  
Vector averaged cross-power spectrum Baseline: EF (01) - TR (06)  
Timerange: 00/15:24:41 to 00/15:25:09

Plot file version 154 created 18-NOV-2014 15:23:36  
 ARP299C EP087H 3.UVDATA.1  
 Freq = 4.9270 GHz, Bw = 16.000 MH Calibrated with CL # 3 and BP # 1 (BP mode 1)

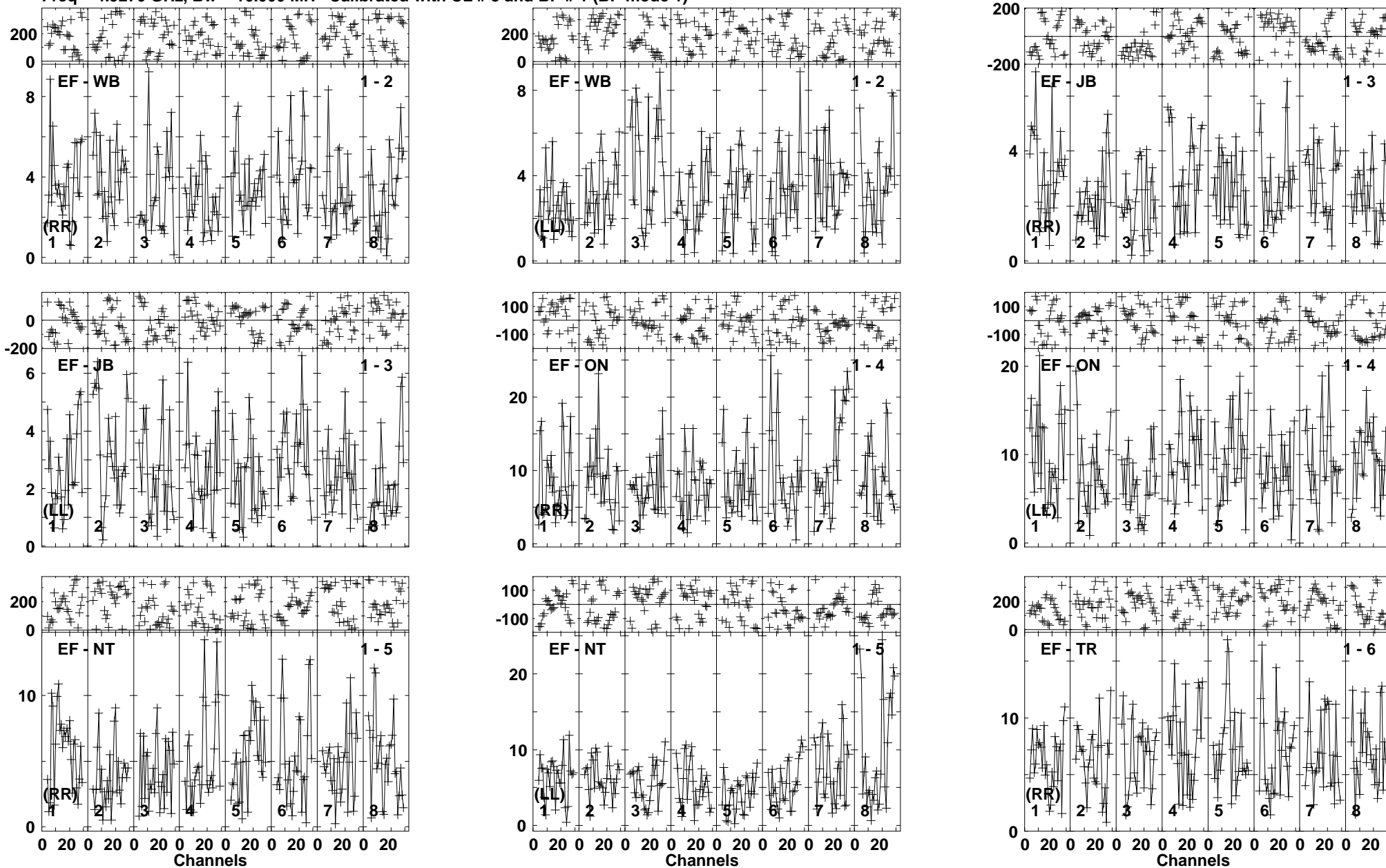

Lower frame: Milli Ampl Jy Top frame: Phas deg  
 Vector averaged cross-power spectrum Baseline: EF (01) - WB (02)  
 Timerange: 00/15:25:15 to 00/15:29:09

Plot file version 155 created 18-NOV-2014 15:23:36

ARP299C EP087H 3.UVDATA.1

Freq = 4.9270 GHz, Bw = 16.000 MH Calibrated with CL # 3 and BP # 1 (BP mode 1)

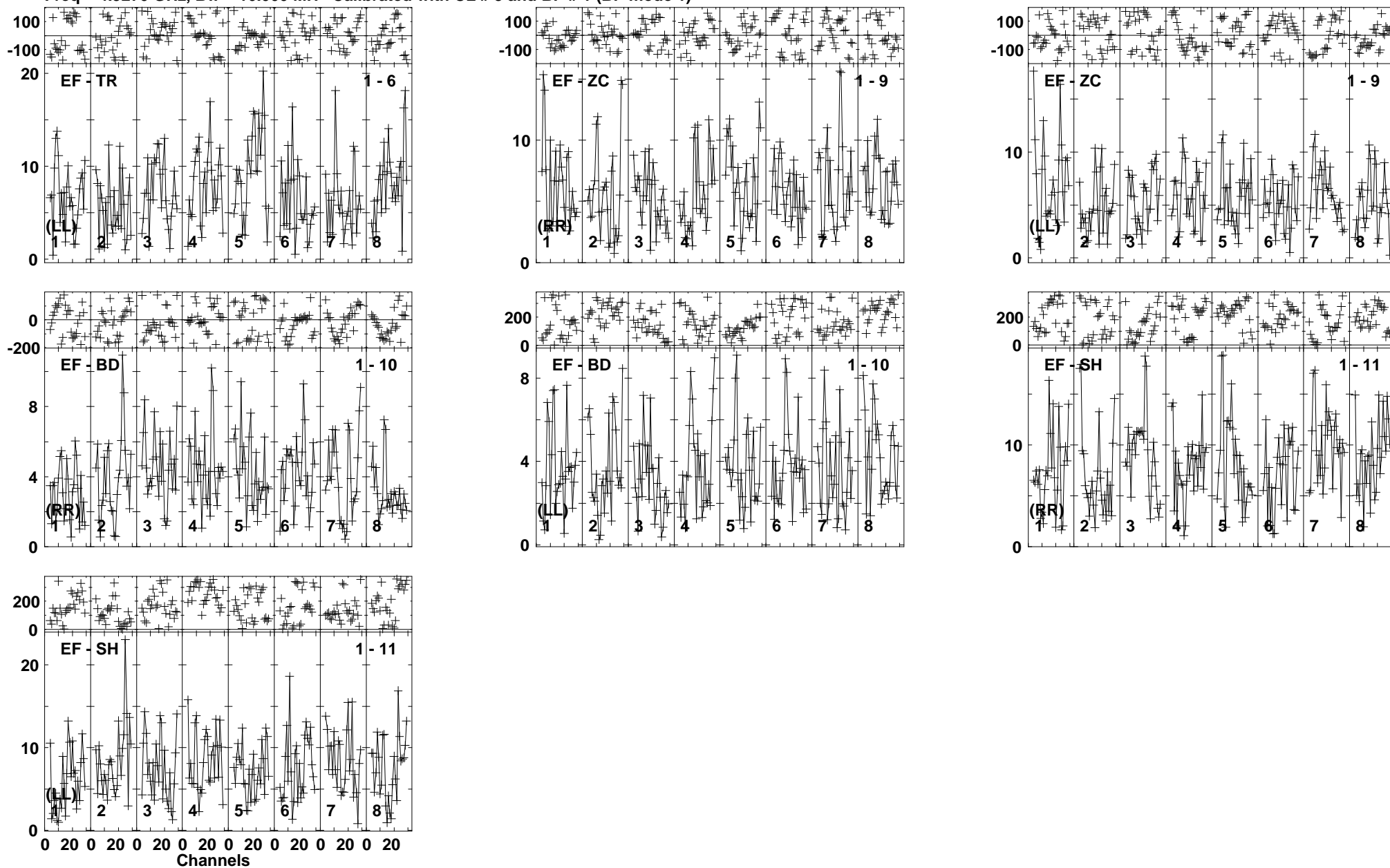

Lower frame: Milli Ampl Jy Top frame: Phas deg  
Vector averaged cross-power spectrum Baseline: EF (01) - TR (06)  
Timerange: 00/15:25:15 to 00/15:29:09

Plot file version 156 created 18-NOV-2014 15:23:36

J1128+5925 EP087H 3.UVDATA.1

Freq = 4.9270 GHz, Bw = 16.000 MH Calibrated with CL # 3 and BP # 1 (BP mode 1)

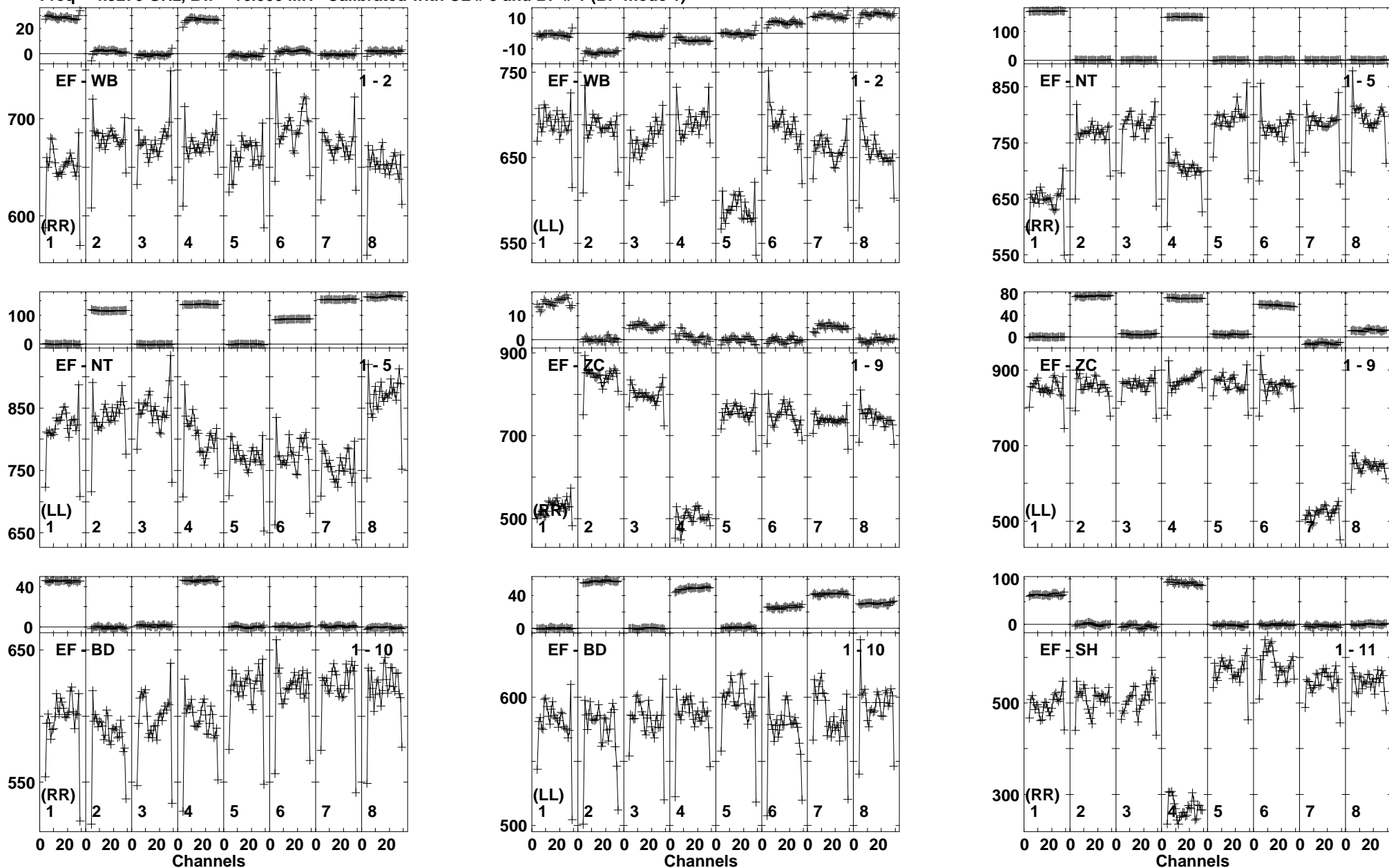

Lower frame: Milli Ampl Jy Top frame: Phas deg  
Vector averaged cross-power spectrum Baseline: EF (01) - WB (02)  
Timerange: 00/15:29:15 to 00/15:30:09

Plot file version 157 created 18-NOV-2014 15:23:36  
J1128+5925 EP087H 3.UVDATA.1  
Freq = 4.9270 GHz, Bw = 16.000 MH Calibrated with CL # 3 and BP # 1 (BP mode 1)

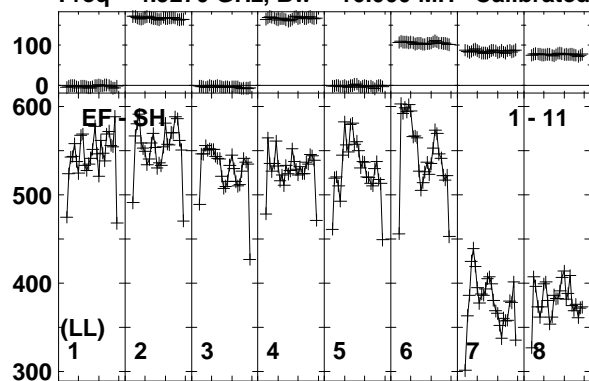

Lower frame: Milli Ampl Jy Top frame: Phas deg  
Vector averaged cross-power spectrum Baseline: EF (01) - SH (11)  
Timerange: 00/15:29:15 to 00/15:30:09

Plot file version 158 created 18-NOV-2014 15:23:36  
 ARP299C EP087H 3.UVDATA.1  
 Freq = 4.9270 GHz, Bw = 16.000 MH Calibrated with CL # 3 and BP # 1 (BP mode 1)

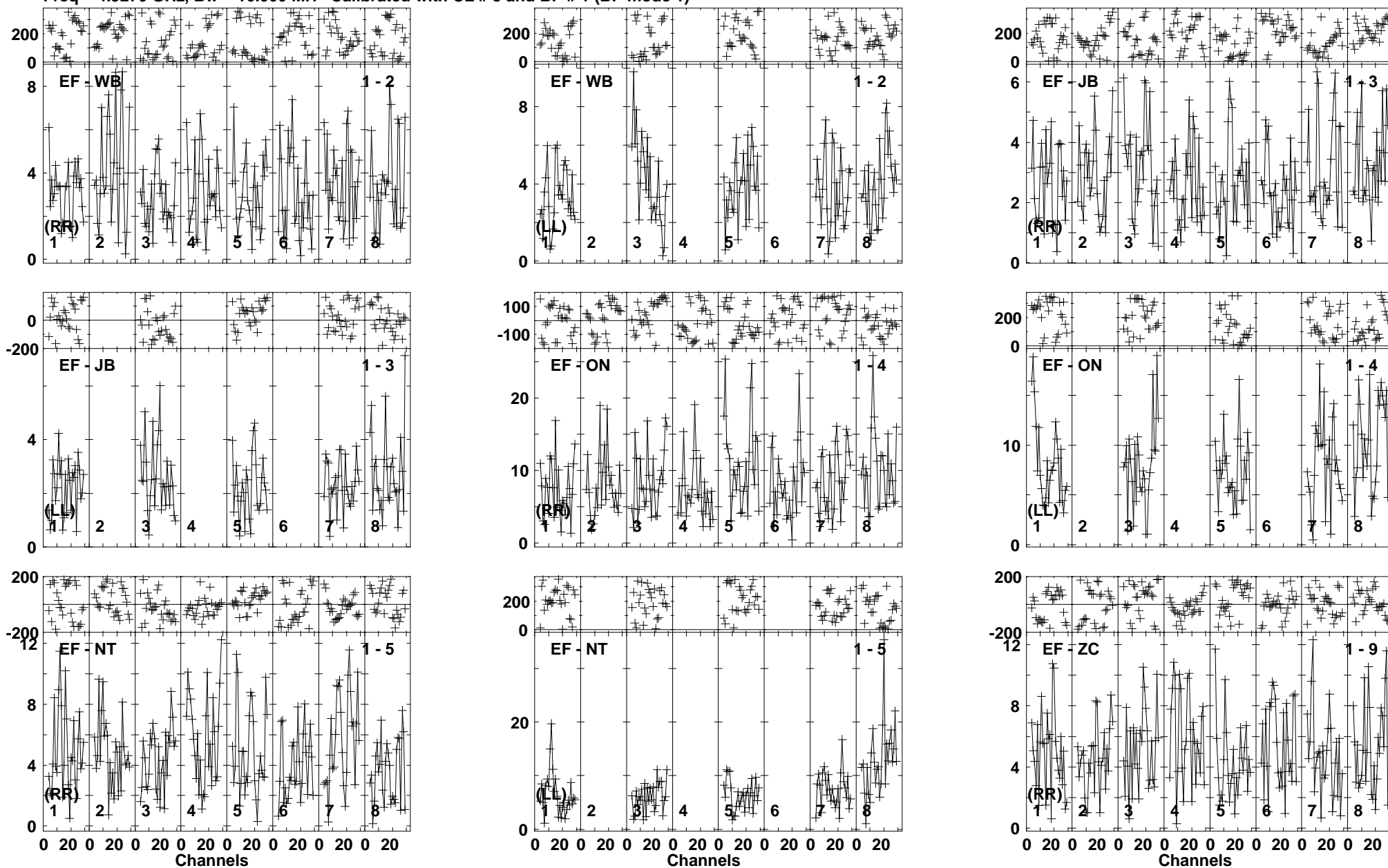

Lower frame: Milli Ampl Jy Top frame: Phas deg  
 Vector averaged cross-power spectrum Baseline: EF (01) - WB (02)  
 Timerange: 00/15:30:11 to 00/15:34:09

Plot file version 159 created 18-NOV-2014 15:23:37  
 ARP299C EP087H 3.UVDATA.1  
 Freq = 4.9270 GHz, Bw = 16.000 MH Calibrated with CL # 3 and BP # 1 (BP mode 1)

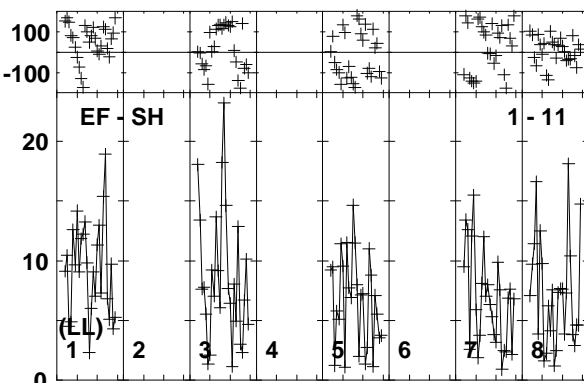
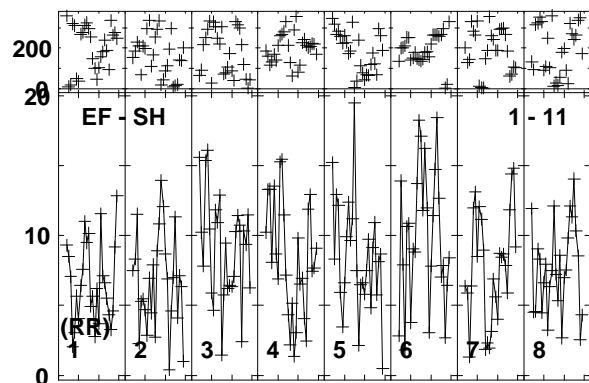
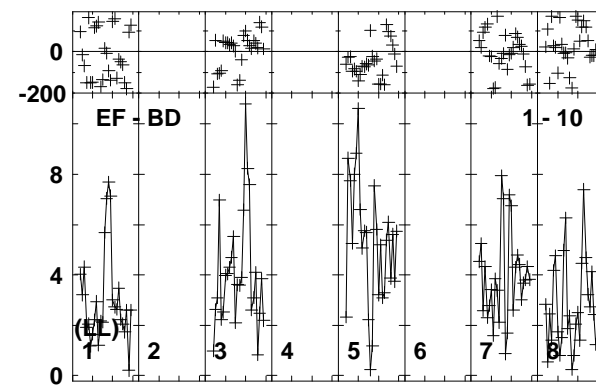
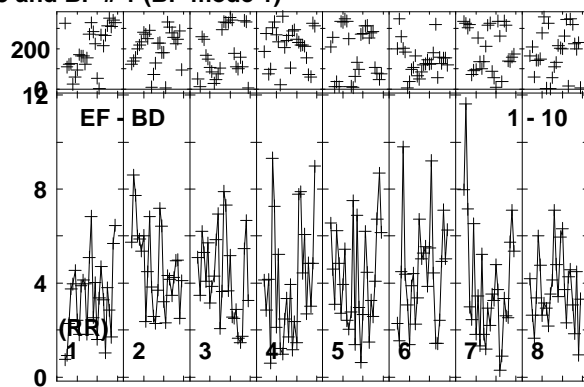
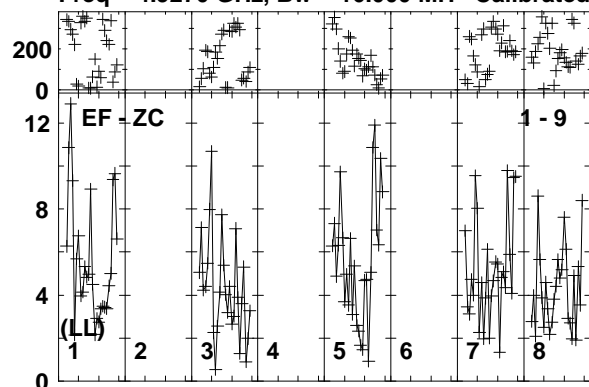

Lower frame: Milli Ampl Jy Top frame: Phas deg  
 Vector averaged cross-power spectrum Baseline: EF (01) - ZC (09)  
 Timerange: 00/15:30:11 to 00/15:34:09

Plot file version 160 created 18-NOV-2014 15:23:37

J1128+5925 EP087H 3.UVDATA.1

Freq = 4.9270 GHz, Bw = 16.000 MH Calibrated with CL # 3 and BP # 1 (BP mode 1)

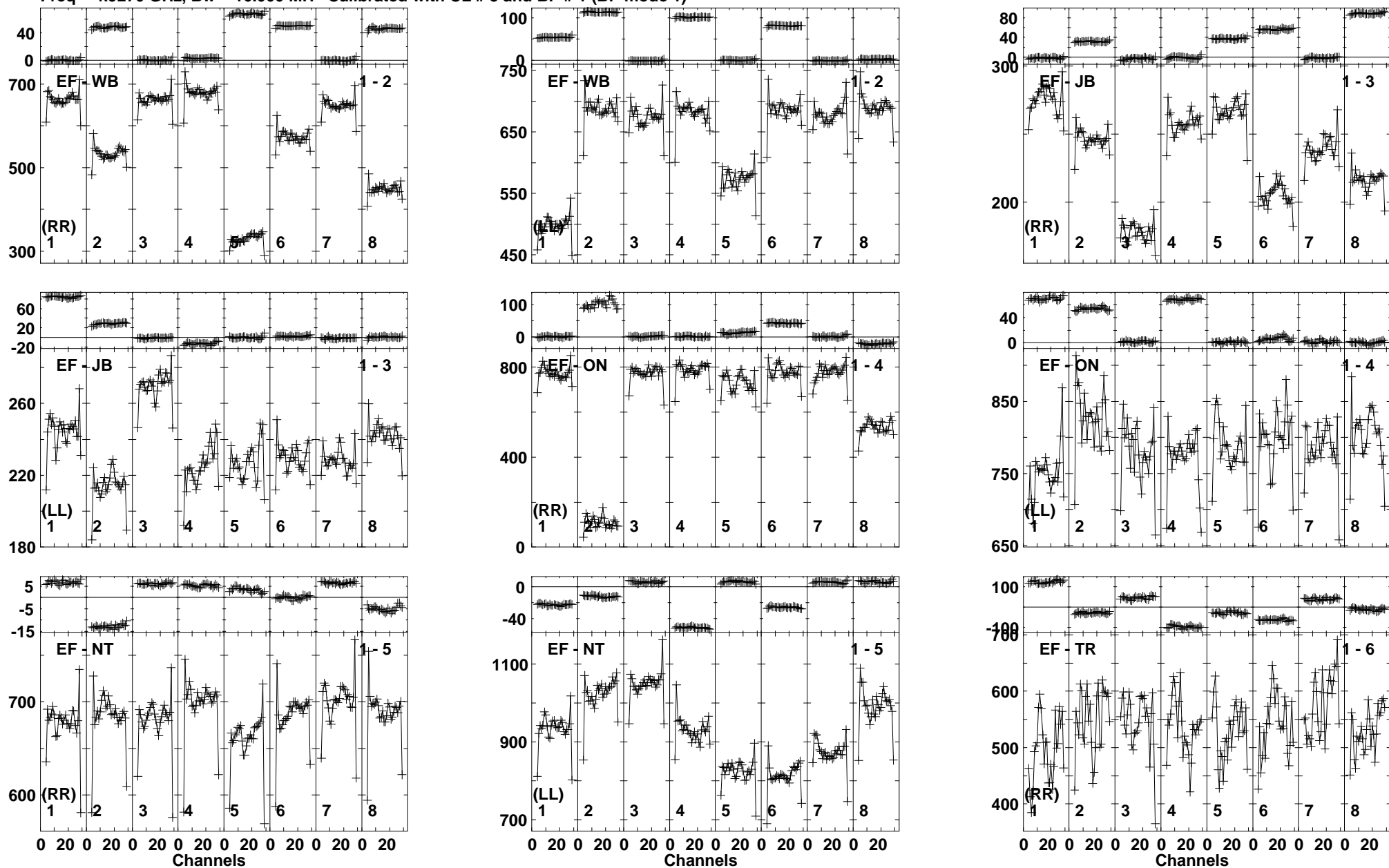

Lower frame: Milli Ampl Jy Top frame: Phas deg

Vector averaged cross-power spectrum Baseline: EF (01) - WB (02)

Timerange: 00/15:34:15 to 00/15:35:09



Plot file version 161 created 18-NOV-2014 15:23:37

J1128+5925 EP087H 3.UVDATA.1

Freq = 4.9270 GHz, Bw = 16.000 MH Calibrated with CL # 3 and BP # 1 (BP mode 1)

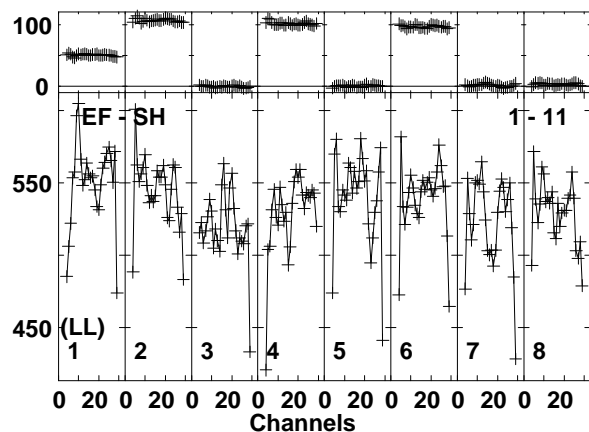
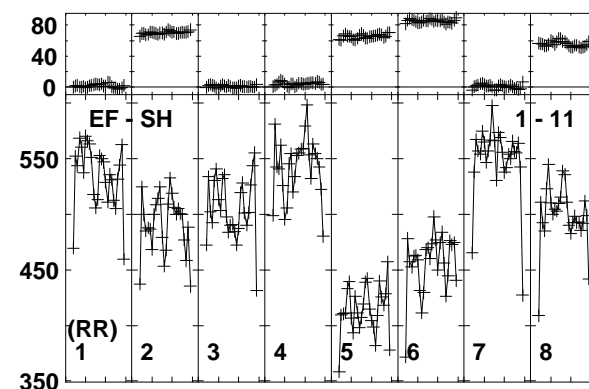
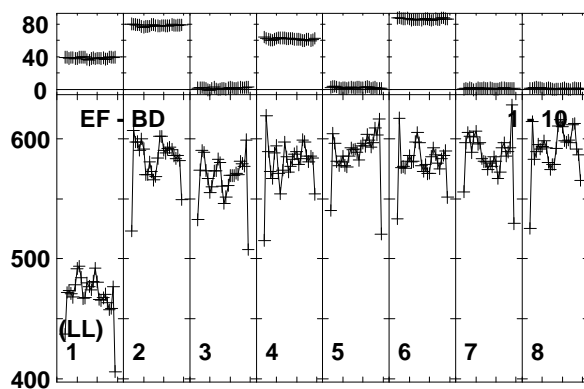
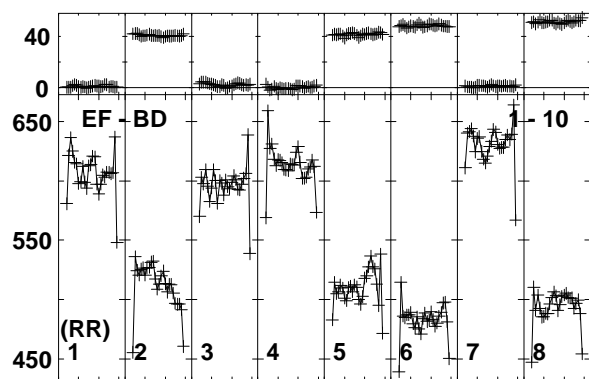
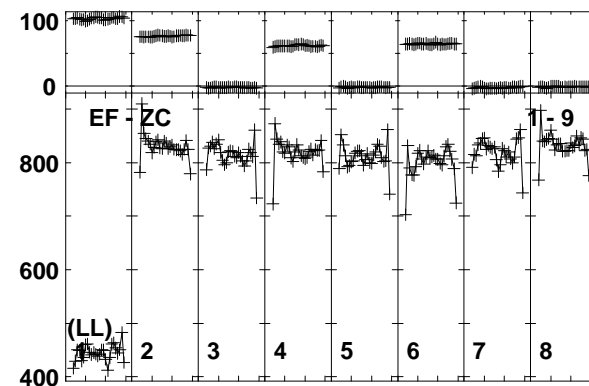
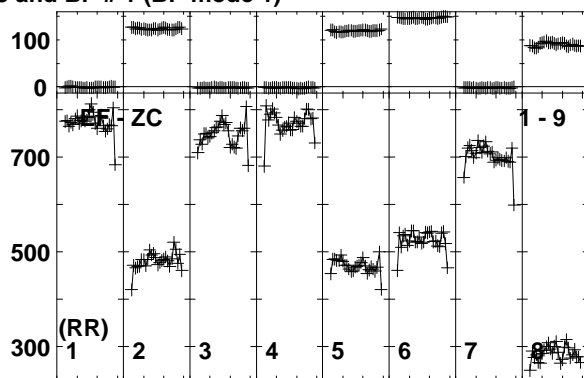
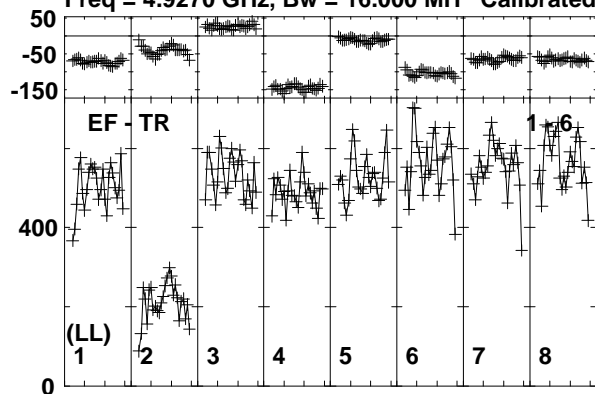

Lower frame: Milli Ampl Jy Top frame: Phas deg  
Vector averaged cross-power spectrum Baseline: EF (01) - TR (06)  
Timerange: 00/15:34:15 to 00/15:35:09

Plot file version 162 created 18-NOV-2014 15:23:37  
 ARP299C EP087H 3.UVDATA.1  
 Freq = 4.9270 GHz, Bw = 16.000 MH Calibrated with CL # 3 and BP # 1 (BP mode 1)

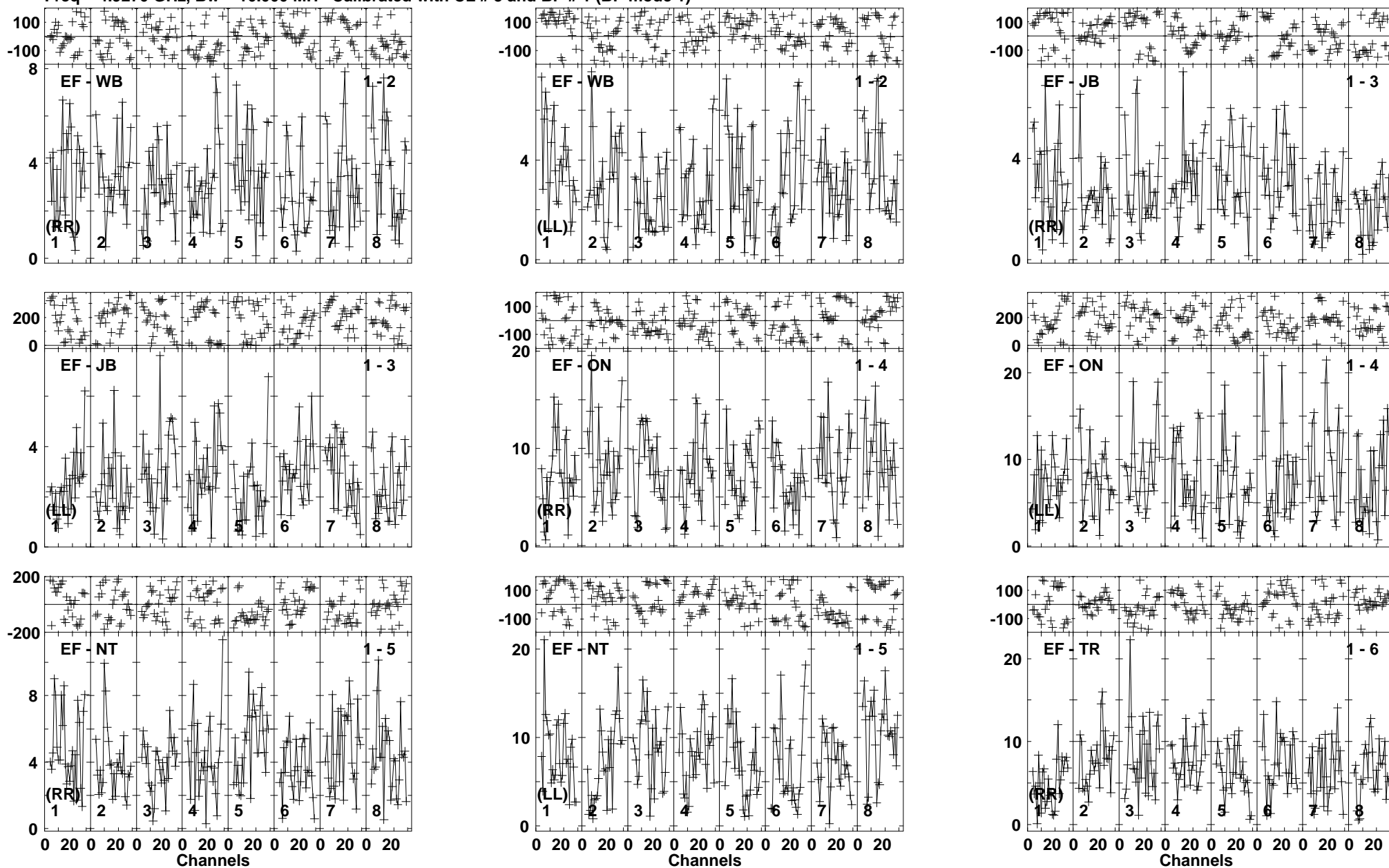

Lower frame: Milli Ampl Jy Top frame: Phas deg  
 Vector averaged cross-power spectrum Baseline: EF (01) - WB (02)  
 Timerange: 00/15:35:15 to 00/15:39:09

Plot file version 163 created 18-NOV-2014 15:23:37

ARP299C EP087H 3.UVDATA.1

Freq = 4.9270 GHz, Bw = 16.000 MH Calibrated with CL # 3 and BP # 1 (BP mode 1)

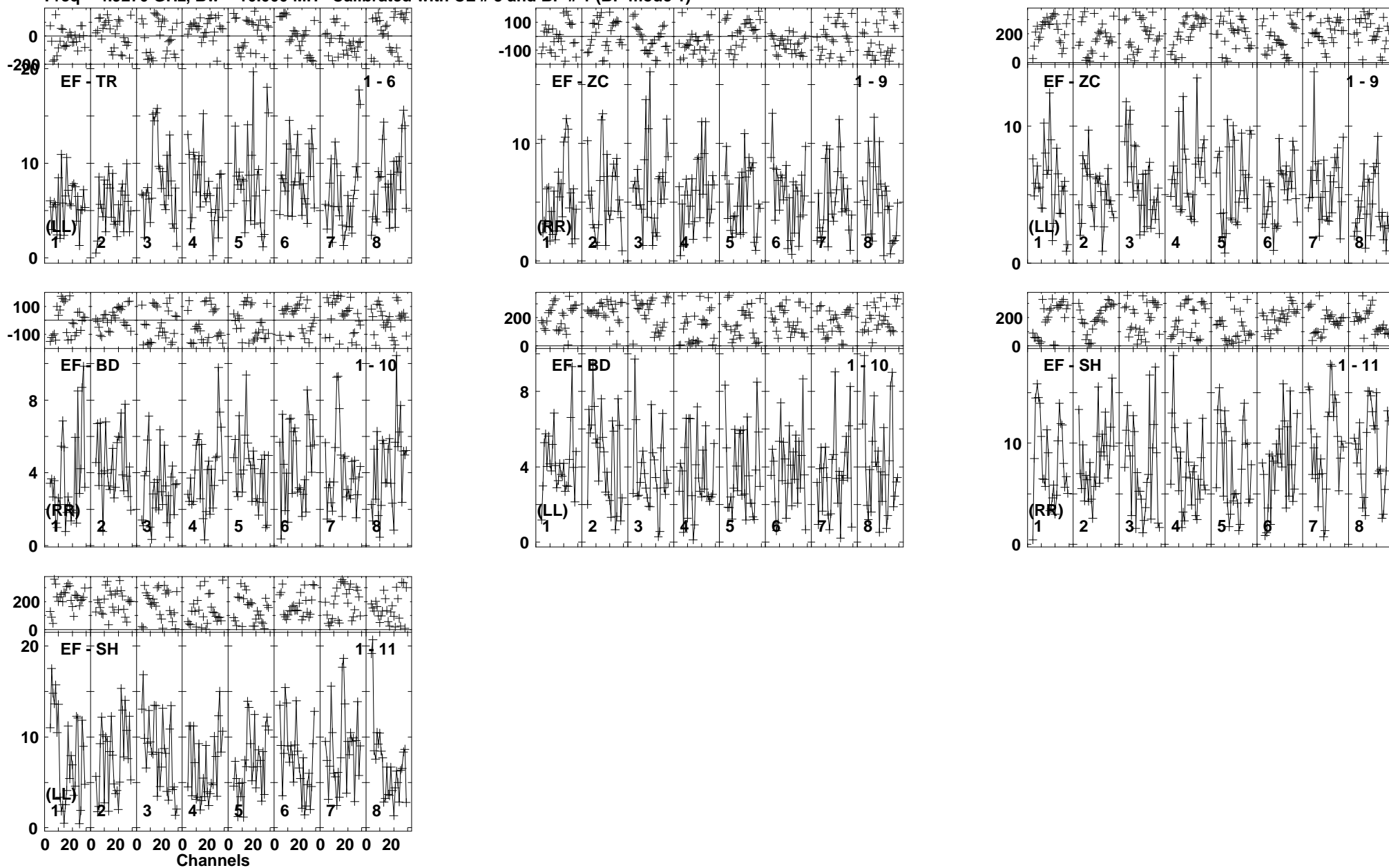

Lower frame: Milli Ampl Jy Top frame: Phas deg  
Vector averaged cross-power spectrum Baseline: EF (01) - TR (06)  
Timerange: 00/15:35:15 to 00/15:39:09

Plot file version 164 created 18-NOV-2014 15:23:38

J1128+5925 EP087H 3.UVDATA.1

Freq = 4.9270 GHz, Bw = 16.000 MH Calibrated with CL # 3 and BP # 1 (BP mode 1)

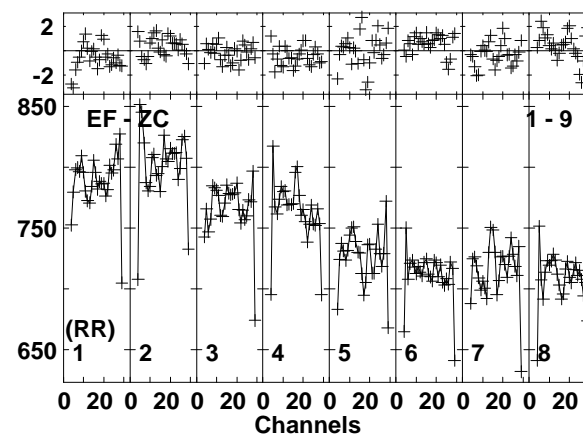
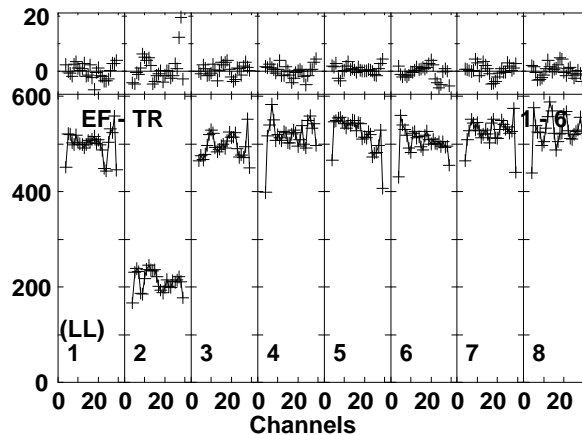
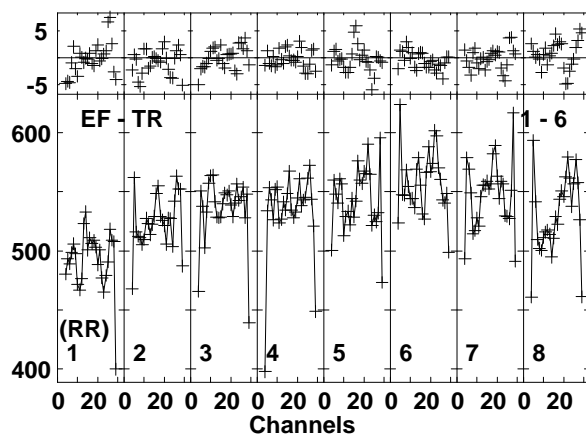
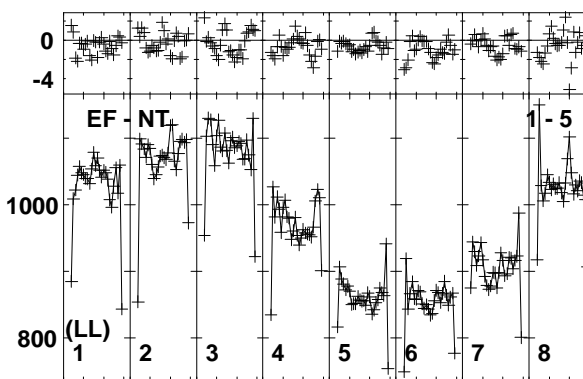
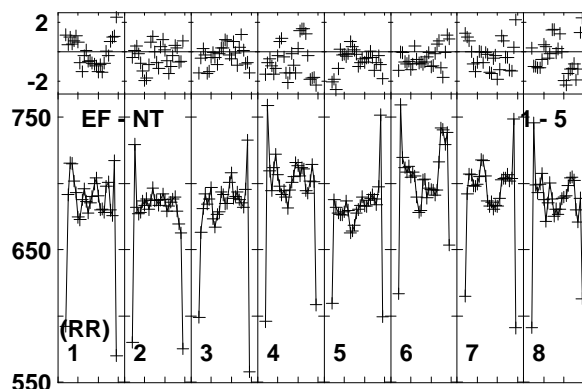
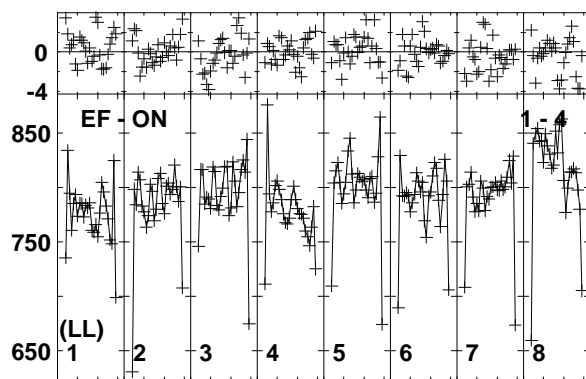
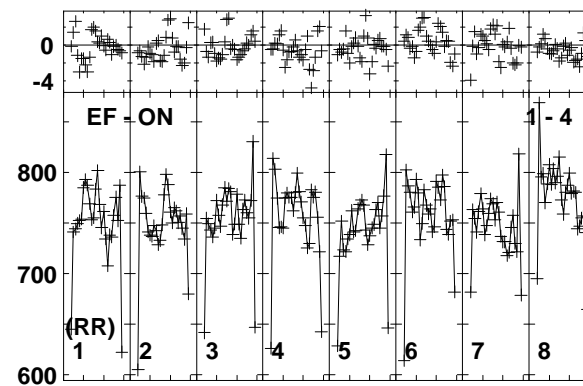
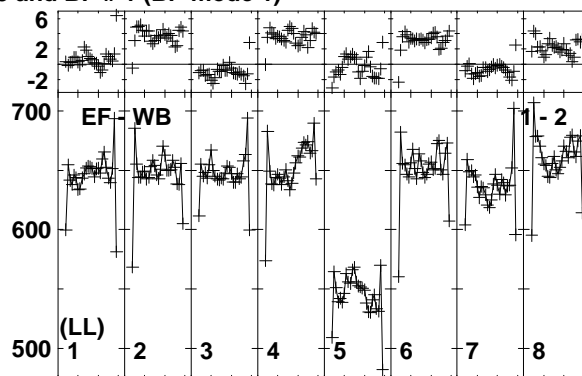
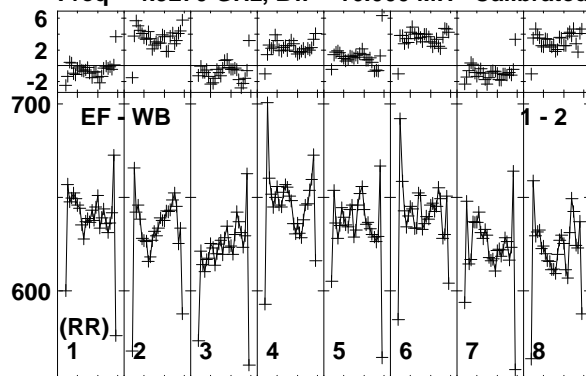

Lower frame: Milli Ampl Jy Top frame: Phas deg  
Vector averaged cross-power spectrum Baseline: EF (01) - WB (02)  
Timerange: 00/15:39:53 to 00/15:40:19

Plot file version 165 created 18-NOV-2014 15:23:38

J1128+5925 EP087H 3.UVDATA.1

Freq = 4.9270 GHz, Bw = 16.000 MH Calibrated with CL # 3 and BP # 1 (BP mode 1)

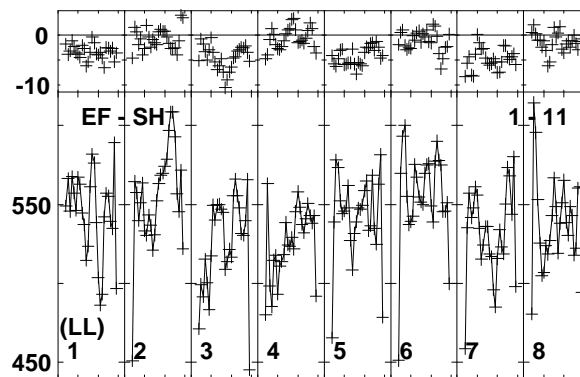
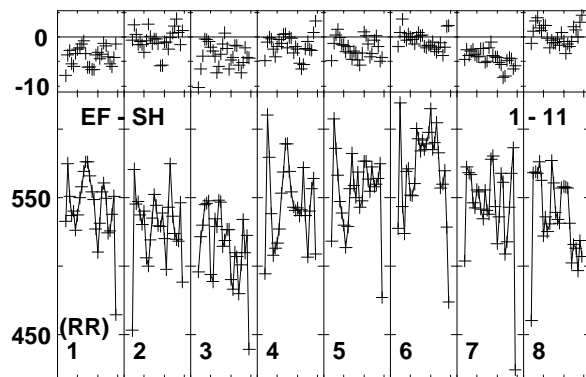
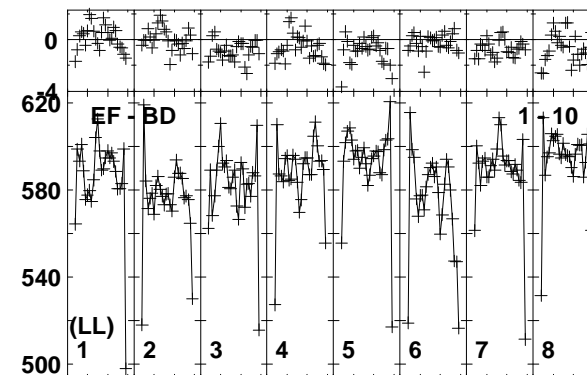
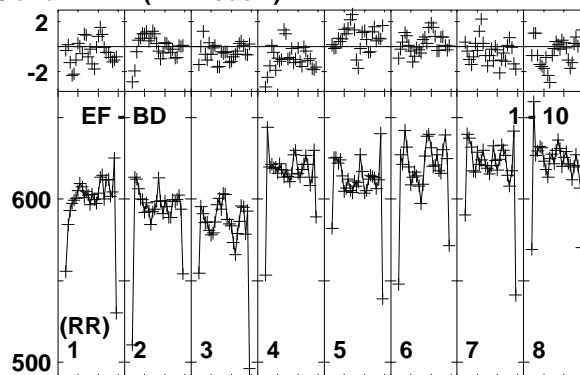
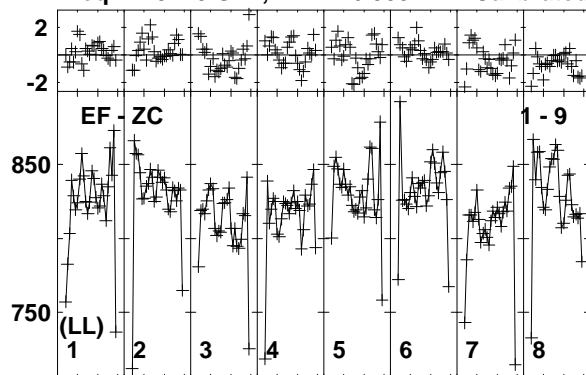

Lower frame: Milli Ampl Jy Top frame: Phas deg  
Vector averaged cross-power spectrum Baseline: EF (01) - ZC (09)  
Timerange: 00/15:39:53 to 00/15:40:19

Plot file version 166 created 18-NOV-2014 15:23:38  
 ARP299C EP087H 3.UVDATA.1  
 Freq = 4.9270 GHz, Bw = 16.000 MH Calibrated with CL # 3 and BP # 1 (BP mode 1)

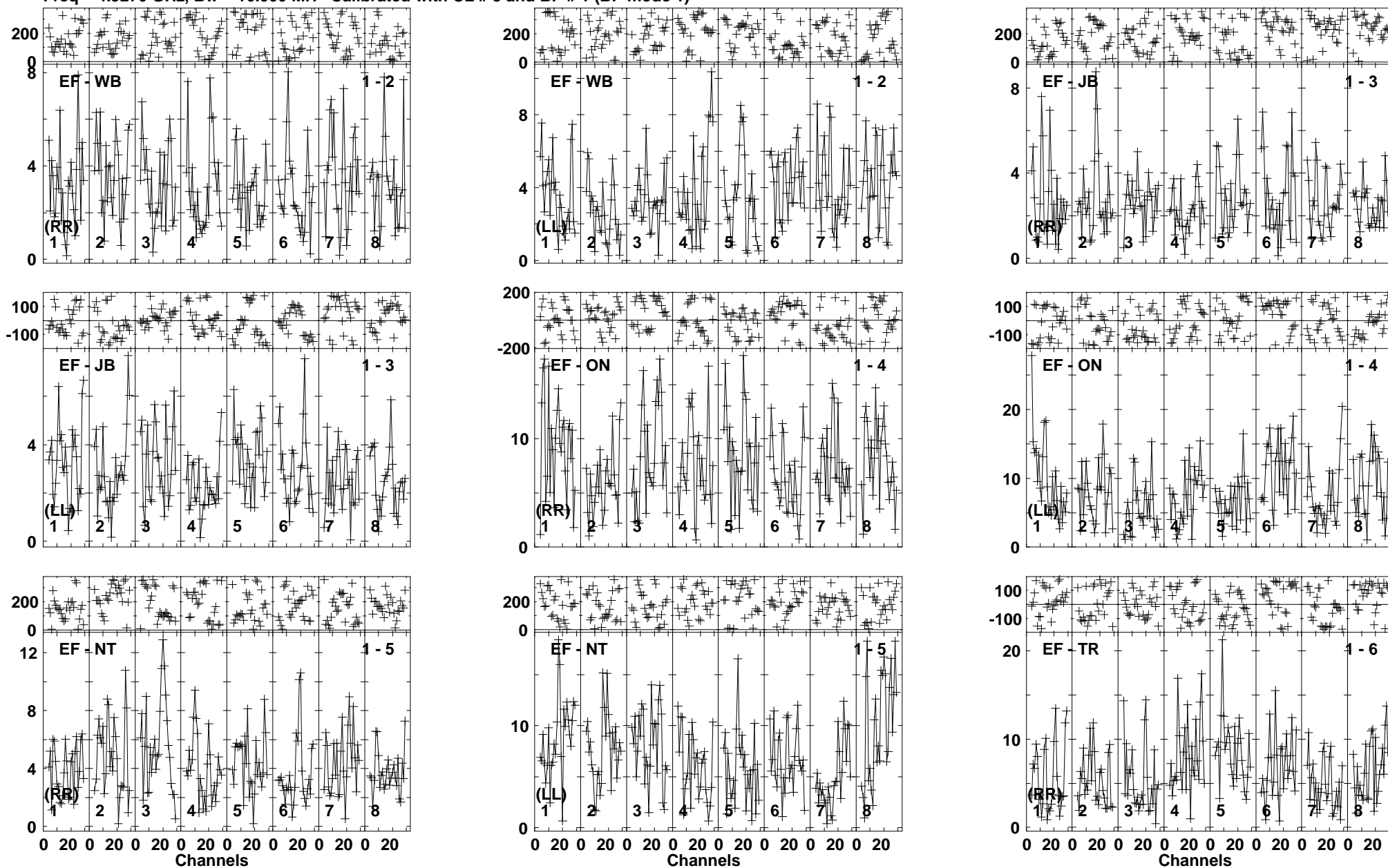

Lower frame: Milli Ampl Jy Top frame: Phas deg  
 Vector averaged cross-power spectrum Baseline: EF (01) - WB (02)  
 Timerange: 00/15:40:21 to 00/15:44:19

Plot file version 167 created 18-NOV-2014 15:23:38

ARP299C EP087H 3.UVDATA.1

Freq = 4.9270 GHz, Bw = 16.000 MH Calibrated with CL # 3 and BP # 1 (BP mode 1)

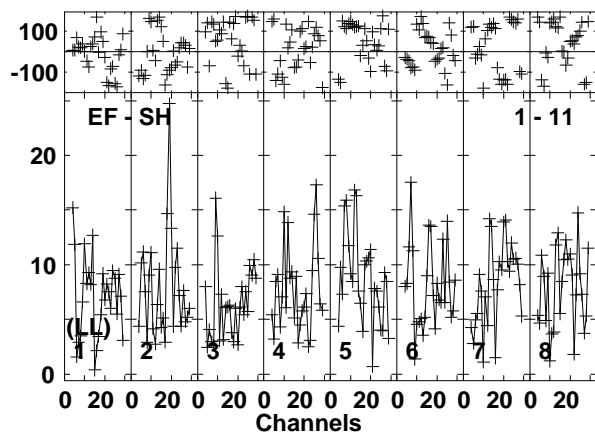
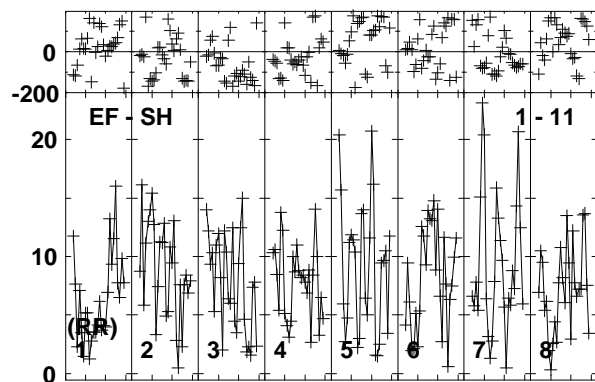
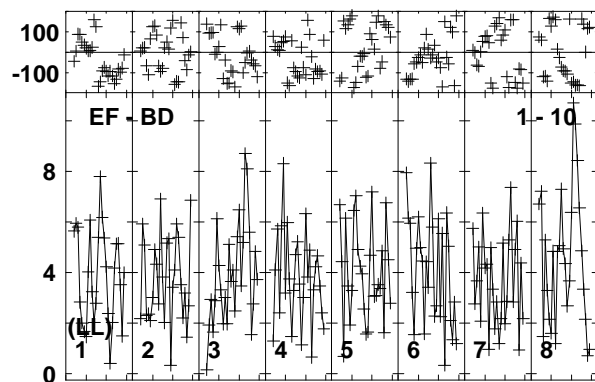
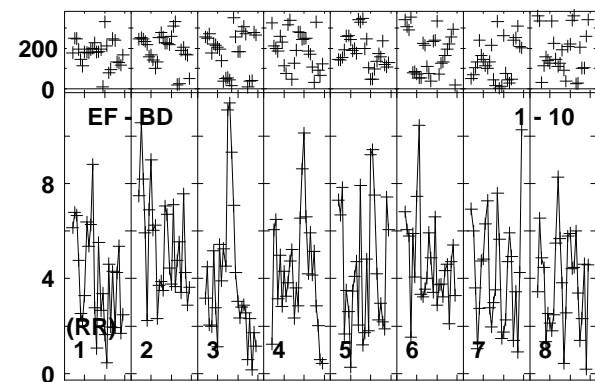
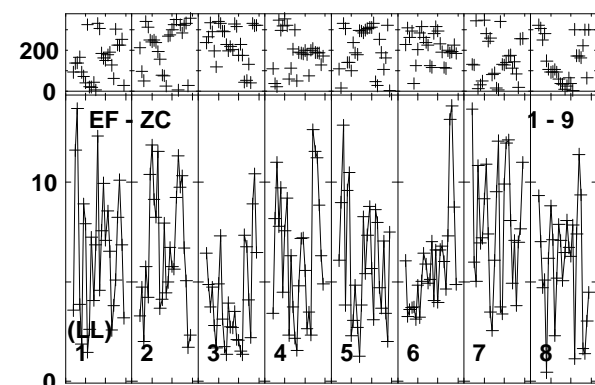
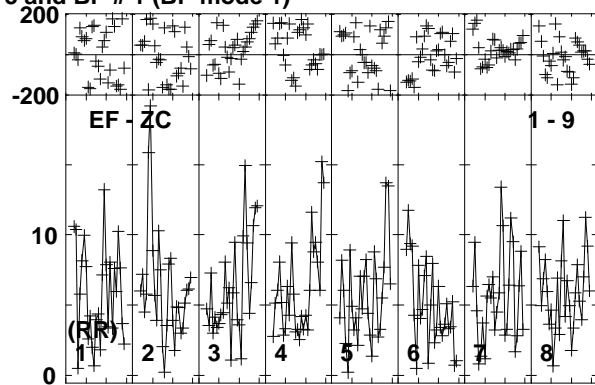
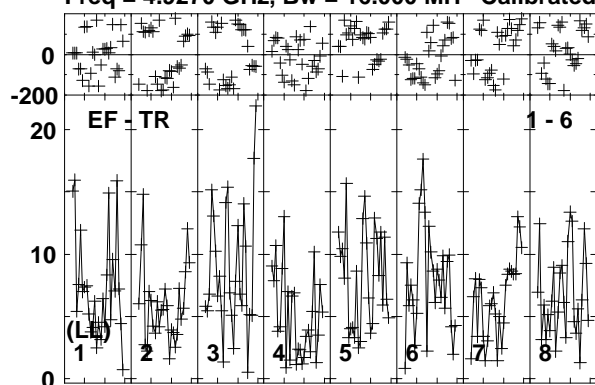

Lower frame: Milli Ampl Jy Top frame: Phas deg  
Vector averaged cross-power spectrum Baseline: EF (01) - TR (06)  
Timerange: 00/15:40:21 to 00/15:44:19

Plot file version 168 created 18-NOV-2014 15:23:39

J1128+5925 EP087H 3.UVDATA.1

Freq = 4.9270 GHz, Bw = 16.000 MH Calibrated with CL # 3 and BP # 1 (BP mode 1)

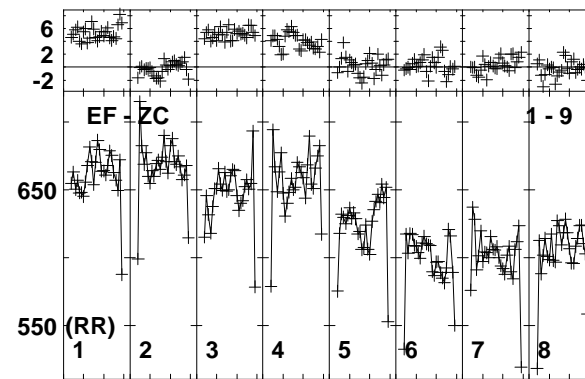
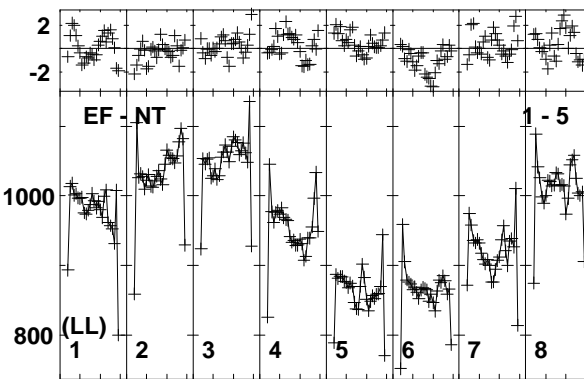
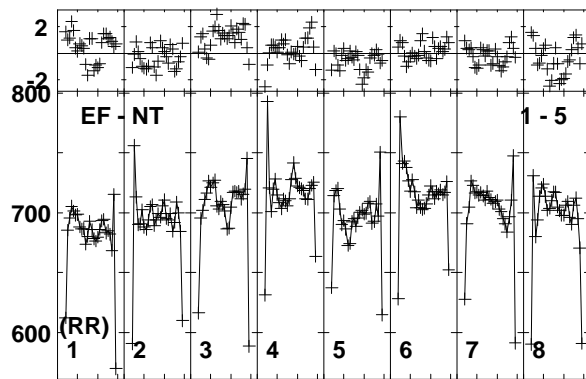
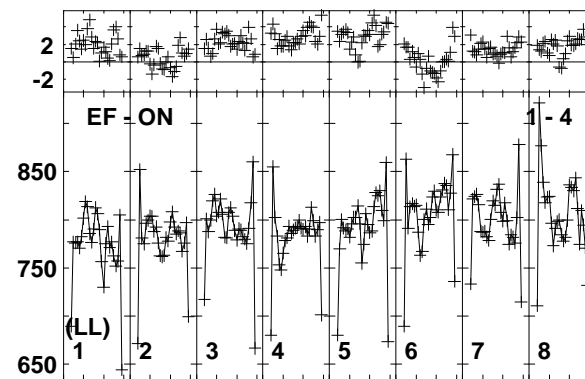
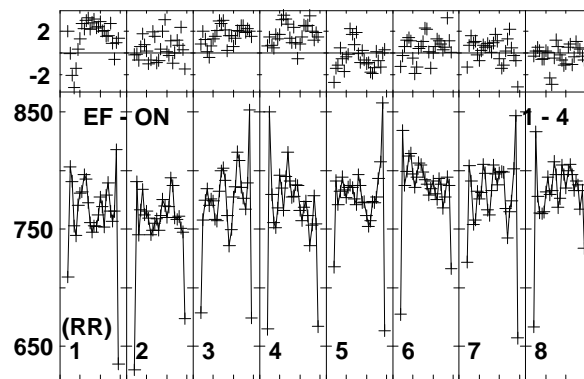
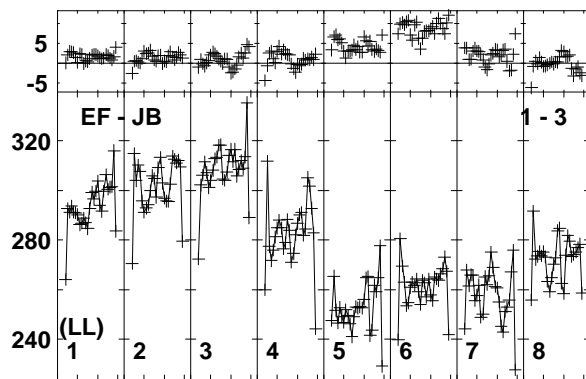
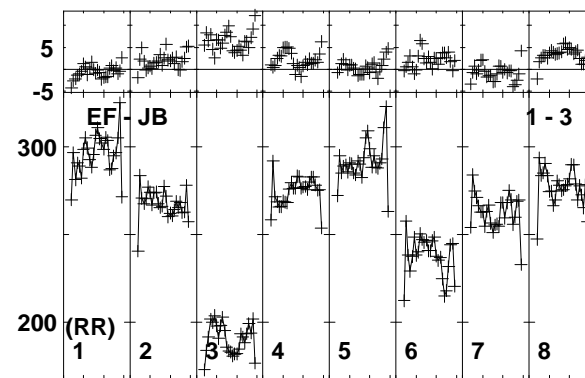
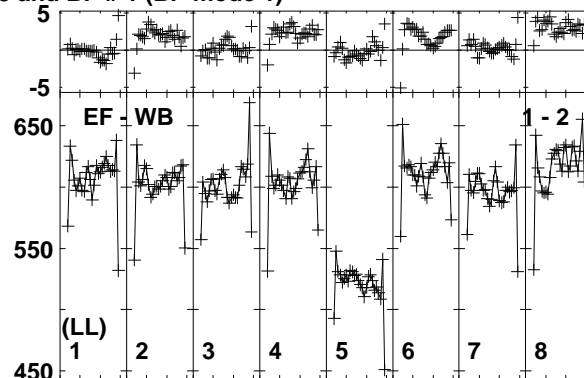
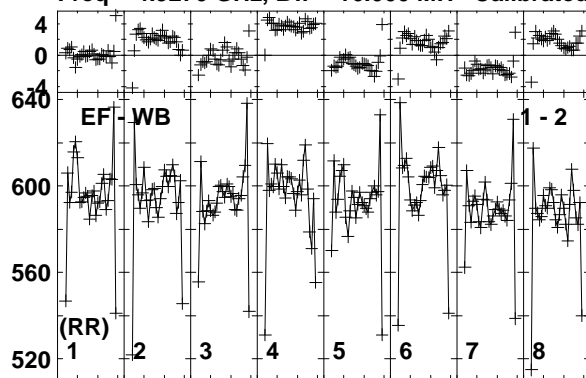

Lower frame: Milli Ampl Jy Top frame: Phas deg  
Vector averaged cross-power spectrum Baseline: EF (01) - WB (02)  
Timerange: 00/15:44:25 to 00/15:45:19



Plot file version 169 created 18-NOV-2014 15:23:39

J1128+5925 EP087H 3.UVDATA.1

Freq = 4.9270 GHz, Bw = 16.000 MH Calibrated with CL # 3 and BP # 1 (BP mode 1)

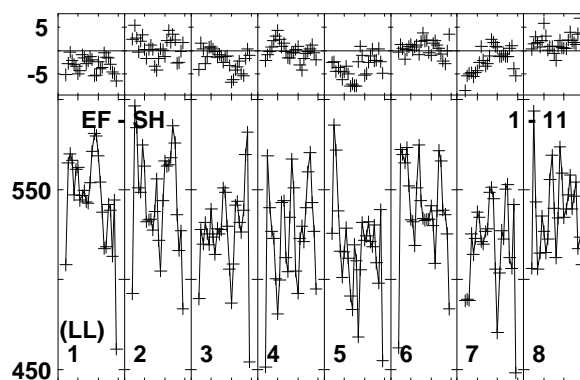
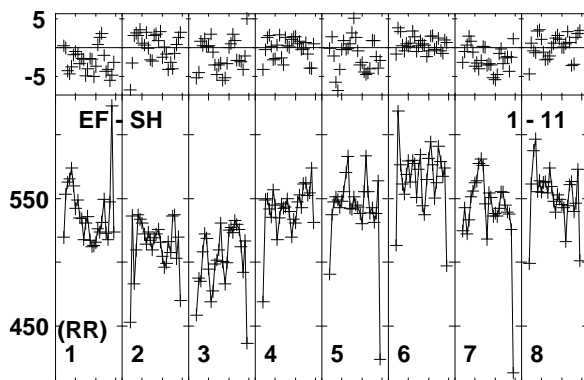
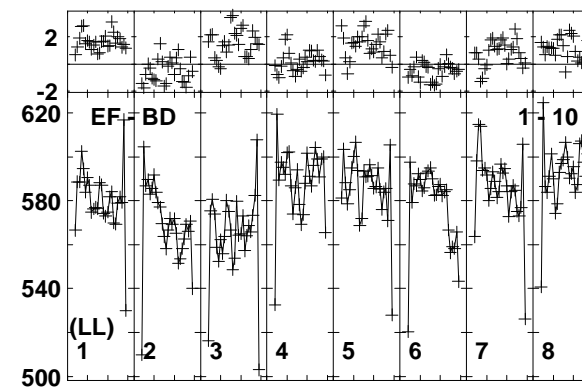
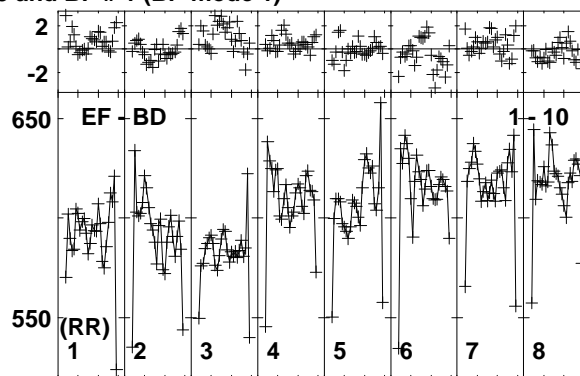
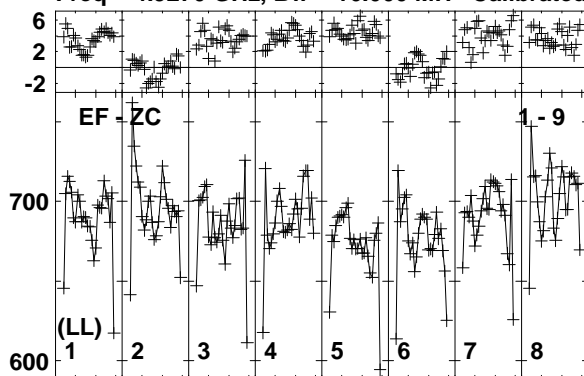

Lower frame: Milli Ampl Jy Top frame: Phas deg  
Vector averaged cross-power spectrum Baseline: EF (01) - ZC (09)  
Timerange: 00/15:44:25 to 00/15:45:19

Plot file version 170 created 18-NOV-2014 15:23:39

ARP299C EP087H 3.UVDATA.1

Freq = 4.9270 GHz, Bw = 16.000 MH Calibrated with CL # 3 and BP # 1 (BP mode 1)

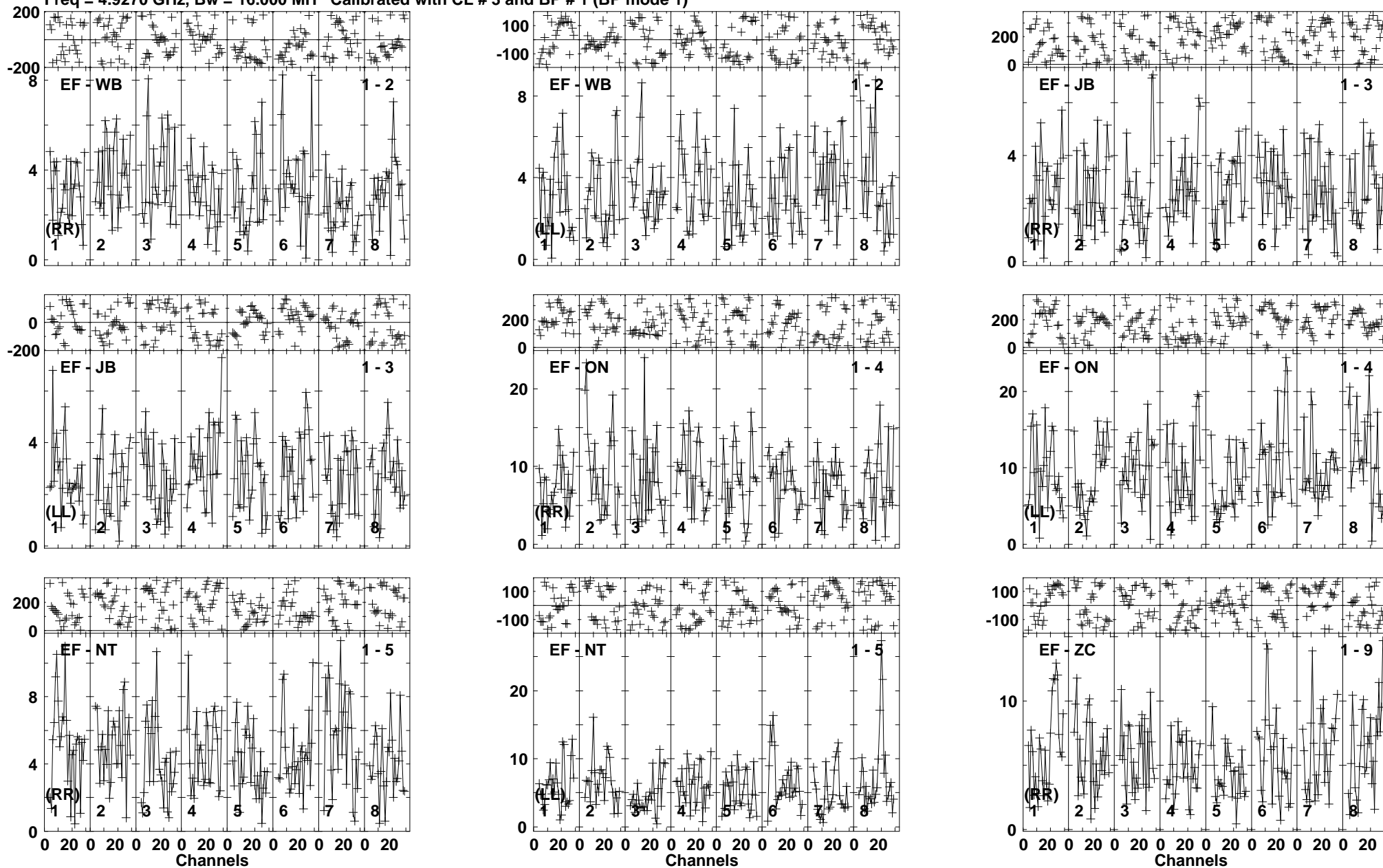

Lower frame: Milli Ampl Jy Top frame: Phas deg  
Vector averaged cross-power spectrum Baseline: EF (01) - WB (02)  
Timerange: 00/15:45:25 to 00/15:49:19

Plot file version 171 created 18-NOV-2014 15:23:39  
 ARP299C EP087H 3.UVDATA.1  
 Freq = 4.9270 GHz, Bw = 16.000 MH Calibrated with CL # 3 and BP # 1 (BP mode 1)

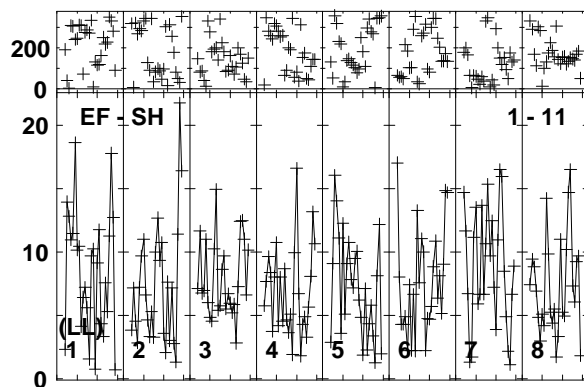
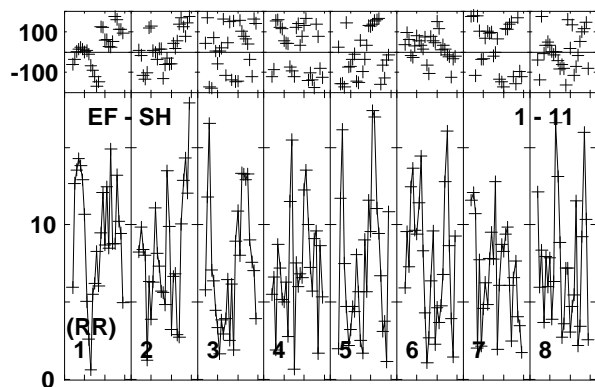
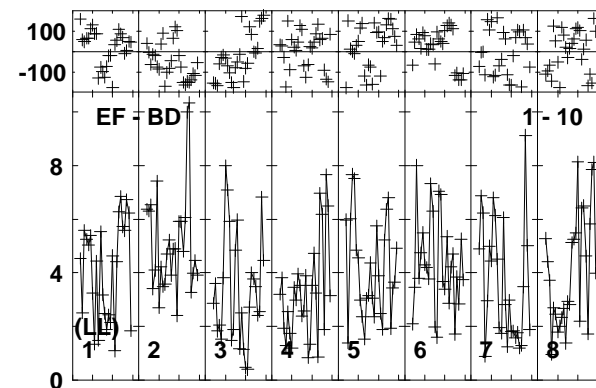
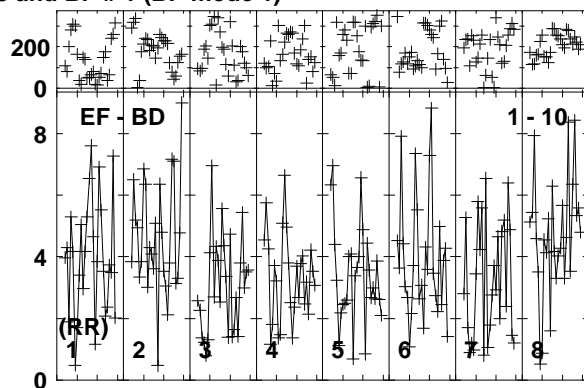
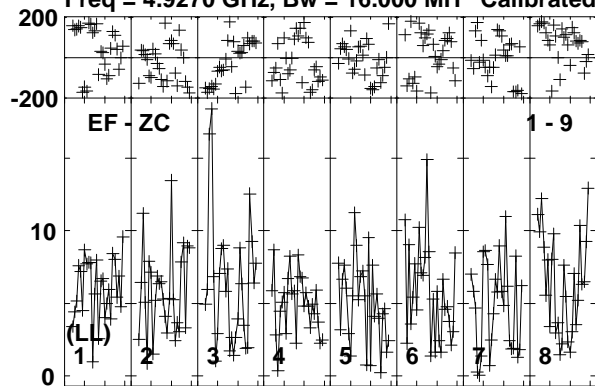

Lower frame: Milli Ampl Jy Top frame: Phas deg  
 Vector averaged cross-power spectrum Baseline: EF (01) - ZC (09)  
 Timerange: 00/15:45:25 to 00/15:49:19

Plot file version 172 created 18-NOV-2014 15:23:40  
 J1128+5925 EP087H 3.UVDATA.1  
 Freq = 4.9270 GHz, Bw = 16.000 MH Calibrated with CL # 3 and BP # 1 (BP mode 1)

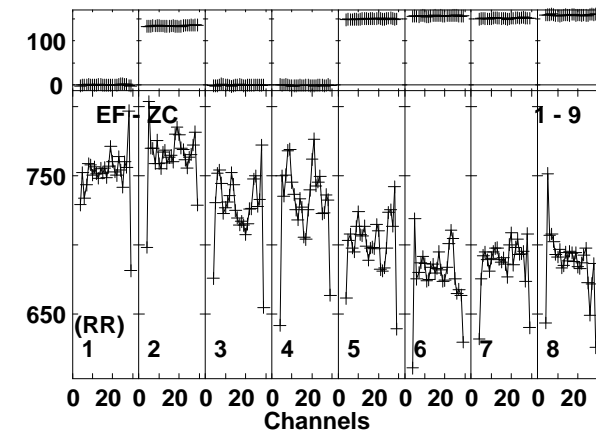
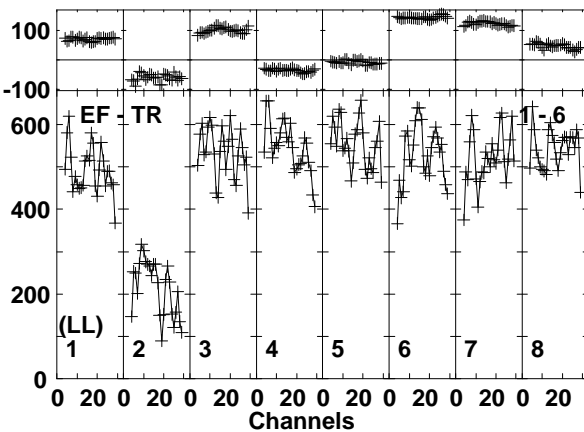
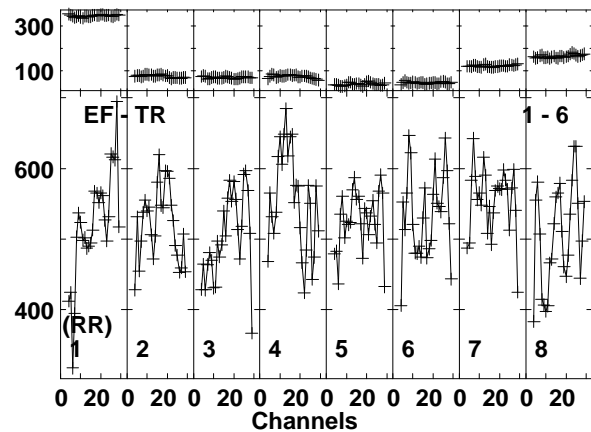
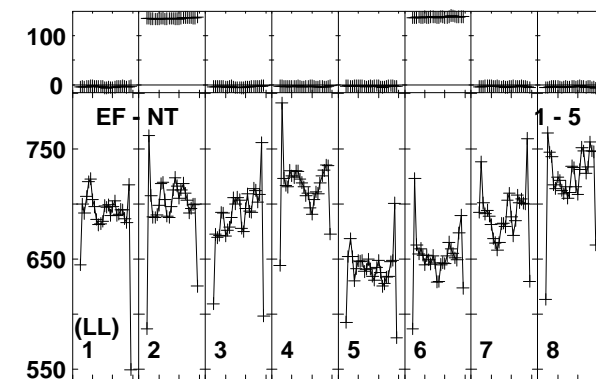
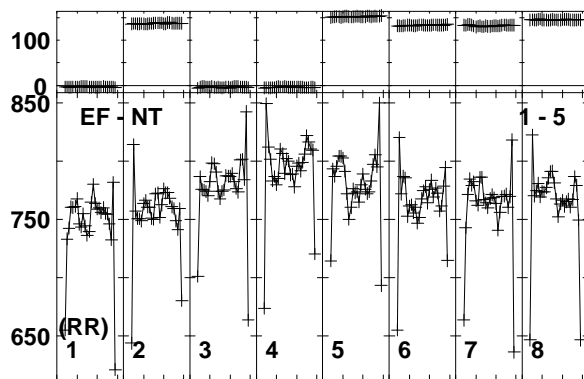
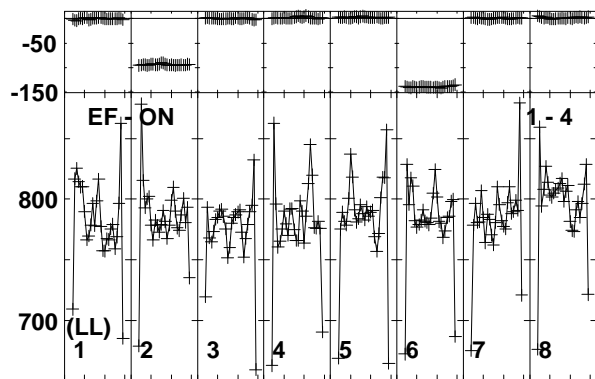
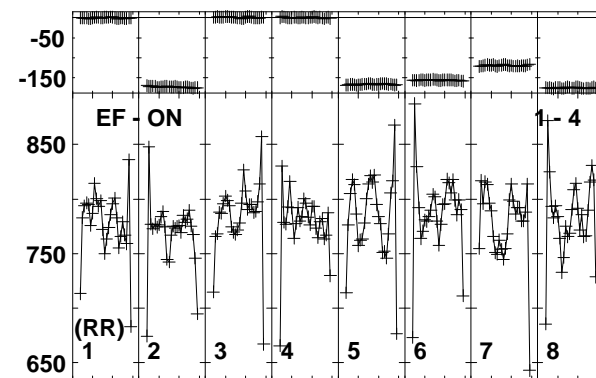
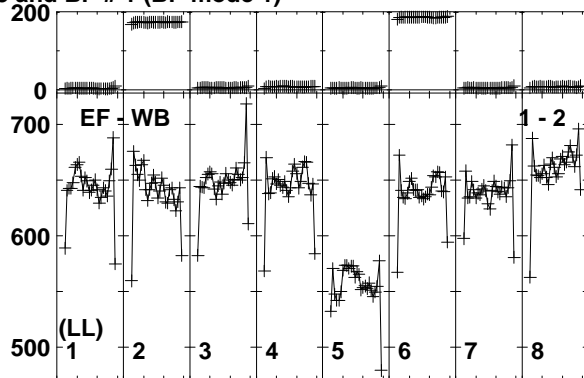
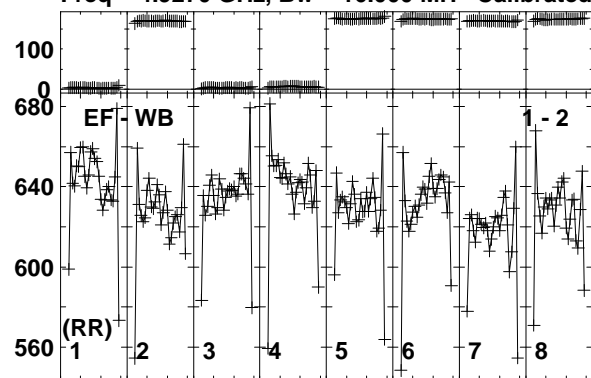

Lower frame: Milli Ampl Jy Top frame: Phas deg  
 Vector averaged cross-power spectrum Baseline: EF (01) - WB (02)  
 Timerange: 00/15:49:25 to 00/15:50:19

Plot file version 173 created 18-NOV-2014 15:23:40

J1128+5925 EP087H 3.UVDATA.1

Freq = 4.9270 GHz, Bw = 16.000 MH Calibrated with CL # 3 and BP # 1 (BP mode 1)

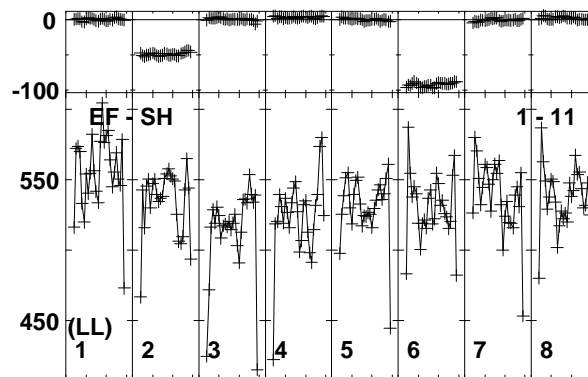
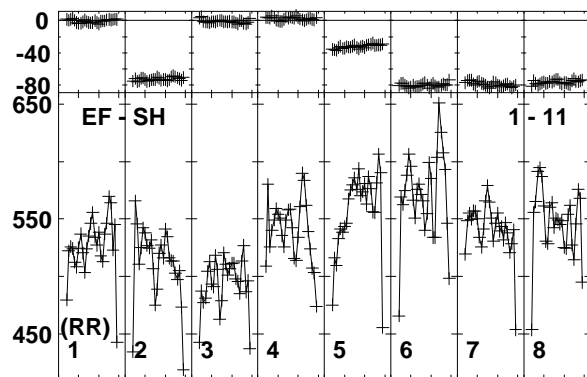
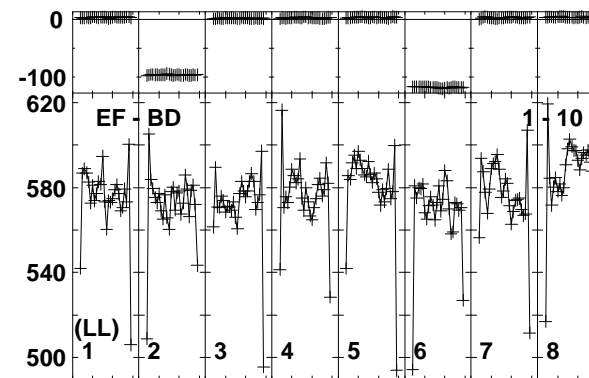
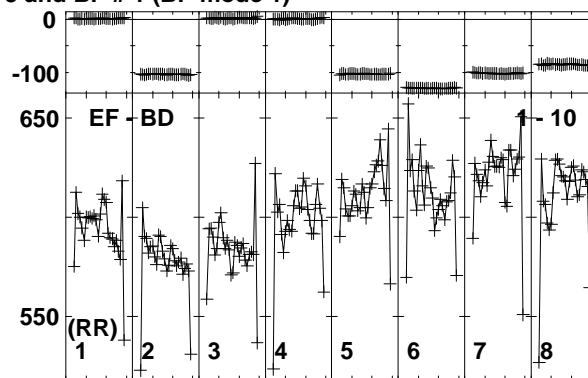
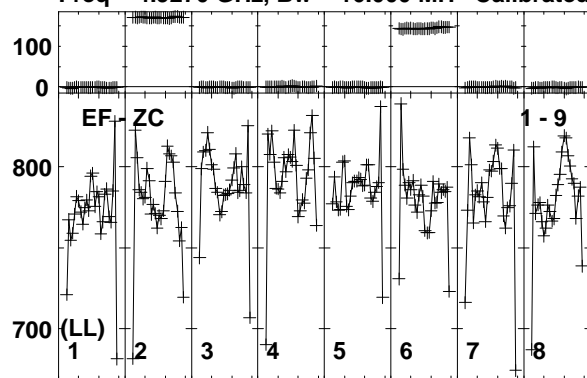

Lower frame: Milli Ampl Jy Top frame: Phas deg  
Vector averaged cross-power spectrum Baseline: EF (01) - ZC (09)  
Timerange: 00/15:49:25 to 00/15:50:19

Plot file version 174 created 18-NOV-2014 15:23:40  
 ARP299C EP087H 3.UVDATA.1  
 Freq = 4.9270 GHz, Bw = 16.000 MH Calibrated with CL # 3 and BP # 1 (BP mode 1)

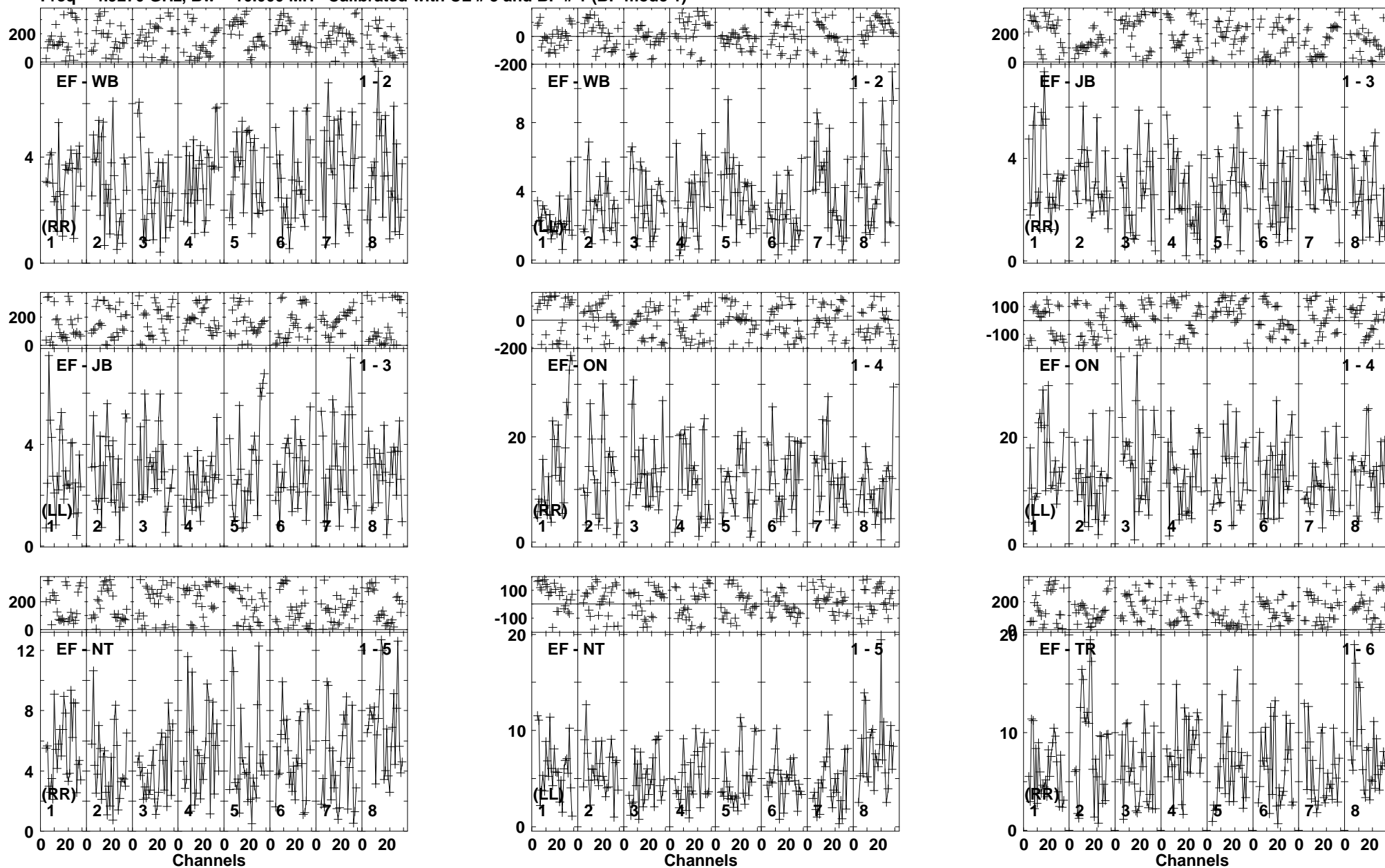

Lower frame: Milli Ampl Jy Top frame: Phas deg  
 Vector averaged cross-power spectrum Baseline: EF (01) - WB (02)  
 Timerange: 00/15:50:21 to 00/15:54:19

Plot file version 175 created 18-NOV-2014 15:23:40  
 ARP299C EP087H 3.UVDATA.1  
 Freq = 4.9270 GHz, Bw = 16.000 MH Calibrated with CL # 3 and BP # 1 (BP mode 1)

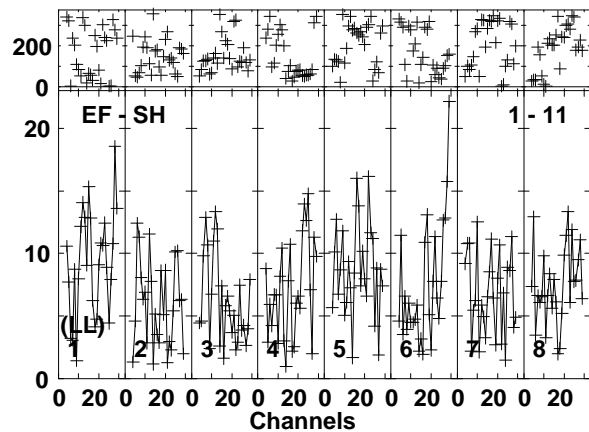
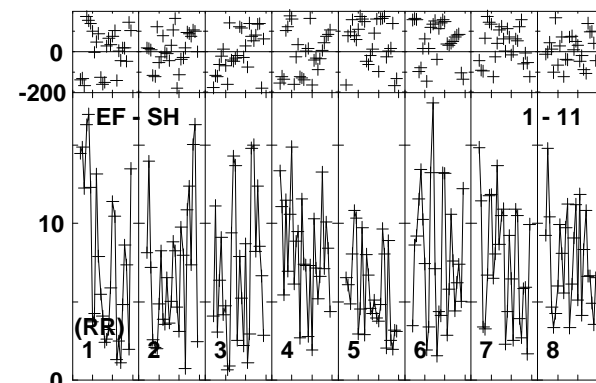
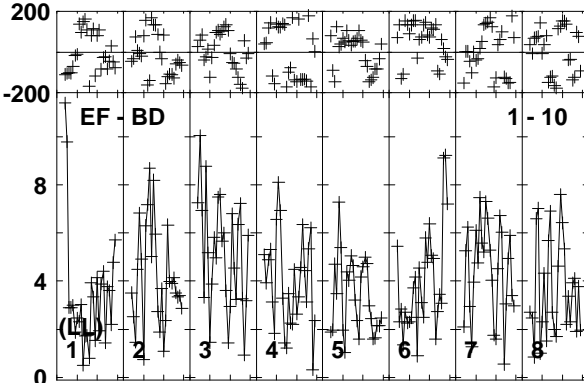
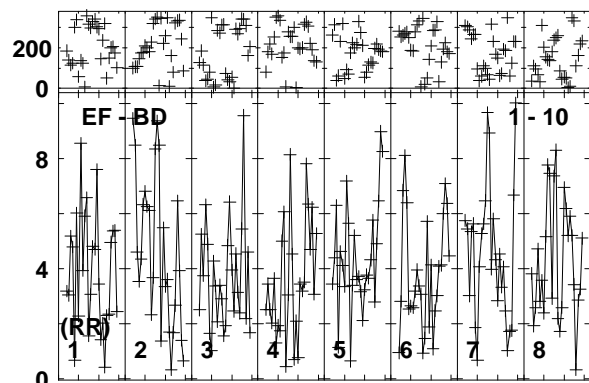
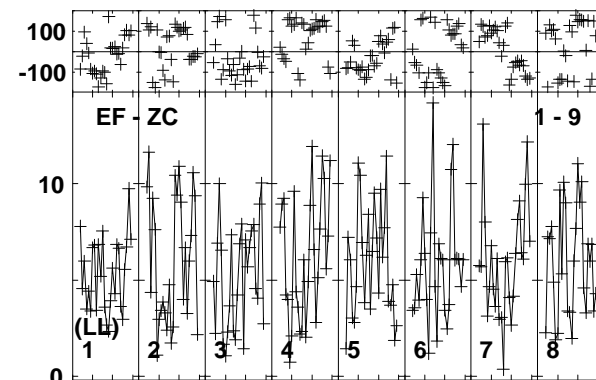
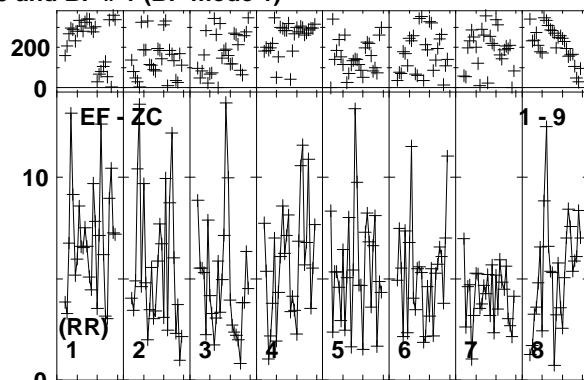
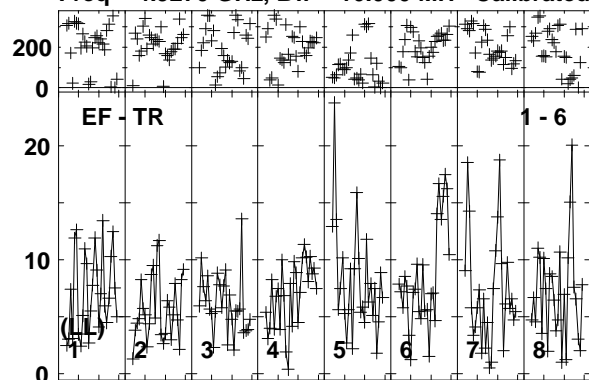

Lower frame: Milli Ampl Jy Top frame: Phas deg  
 Vector averaged cross-power spectrum Baseline: EF (01) - TR (06)  
 Timerange: 00/15:50:21 to 00/15:54:19

Plot file version 176 created 18-NOV-2014 15:23:40

J1128+5925 EP087H 3.UVDATA.1

Freq = 4.9270 GHz, Bw = 16.000 MH Calibrated with CL # 3 and BP # 1 (BP mode 1)

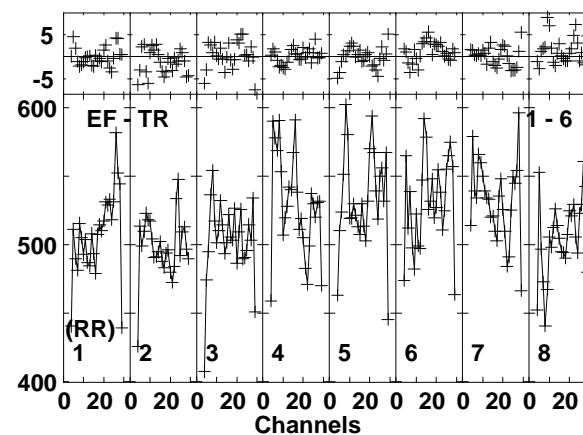
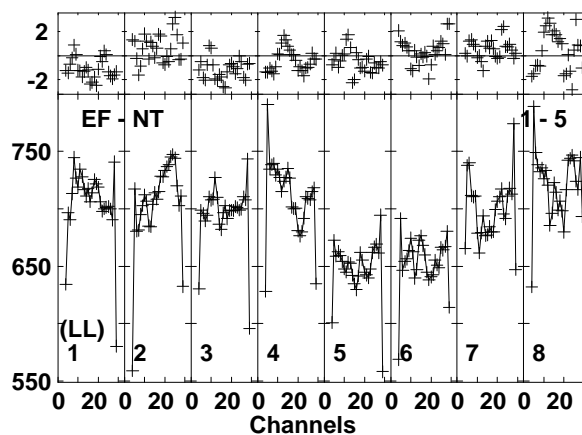
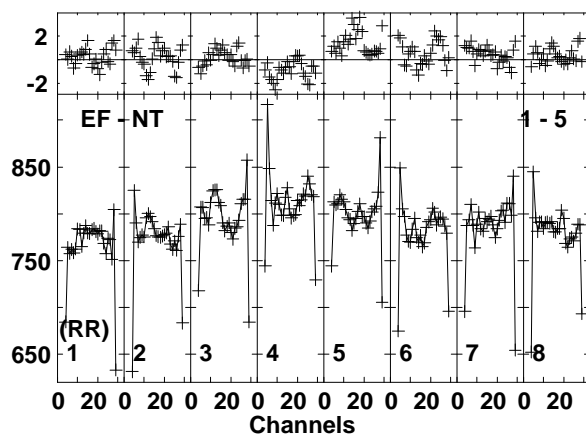
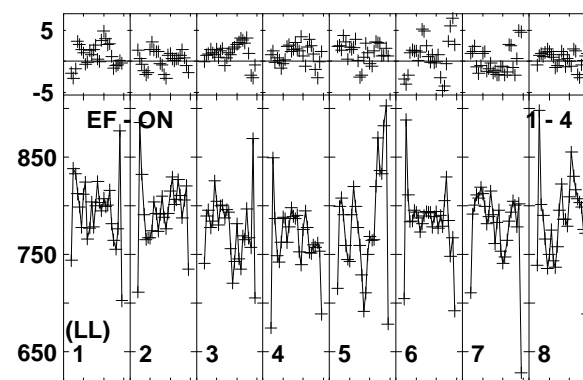
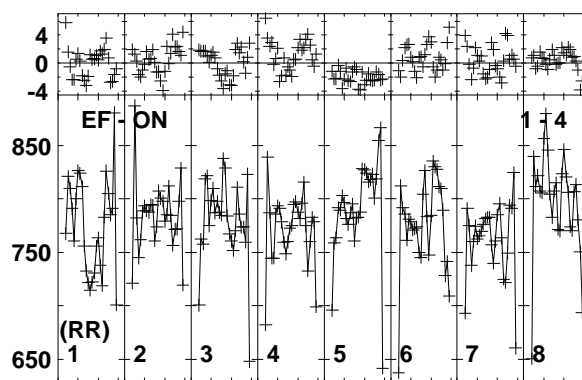
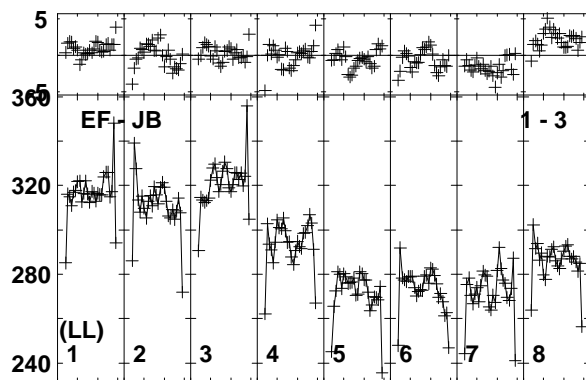
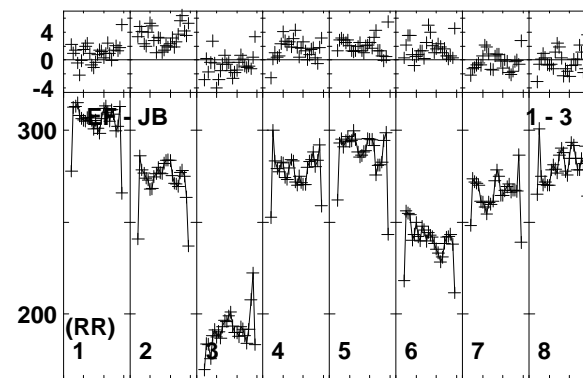
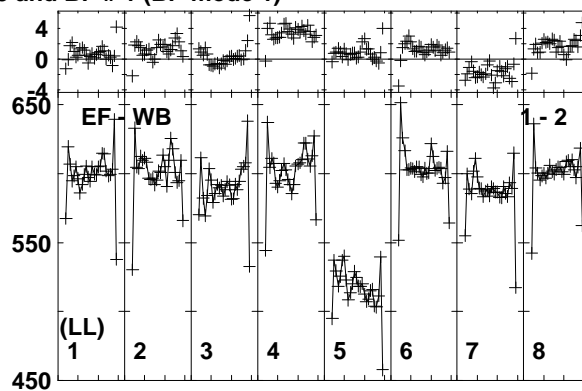
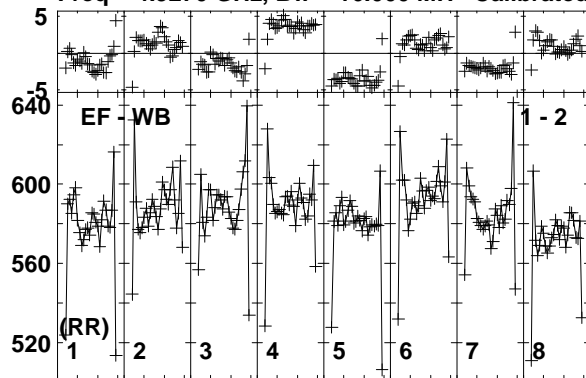

Lower frame: Milli Ampl Jy Top frame: Phas deg  
Vector averaged cross-power spectrum Baseline: EF (01) - WB (02)  
Timerange: 00/15:55:01 to 00/15:55:29



Plot file version 177 created 18-NOV-2014 15:23:41

J1128+5925 EP087H 3.UVDATA.1

Freq = 4.9270 GHz, Bw = 16.000 MH Calibrated with CL # 3 and BP # 1 (BP mode 1)

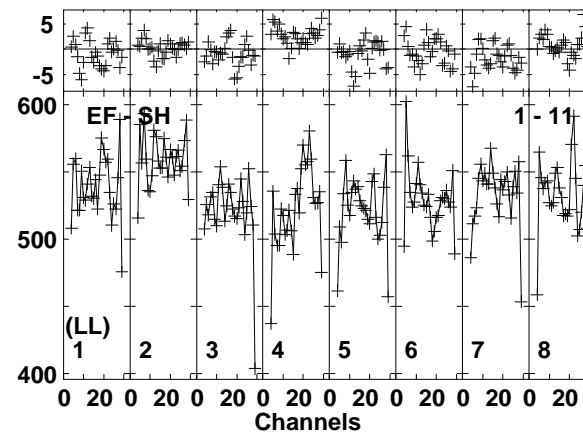
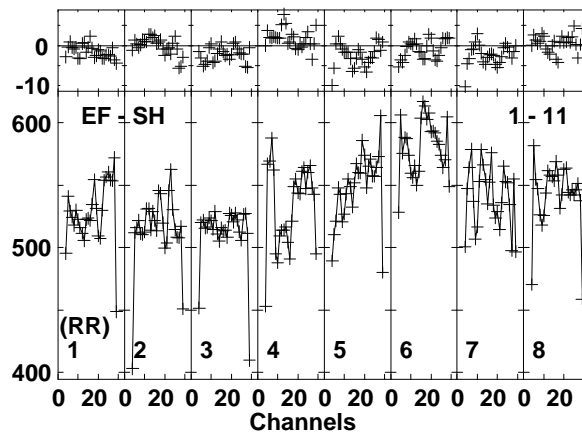
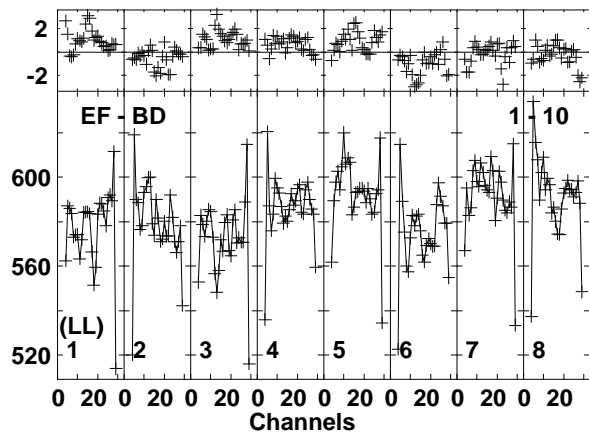
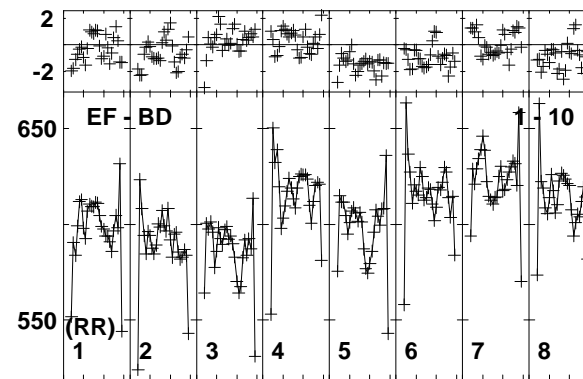
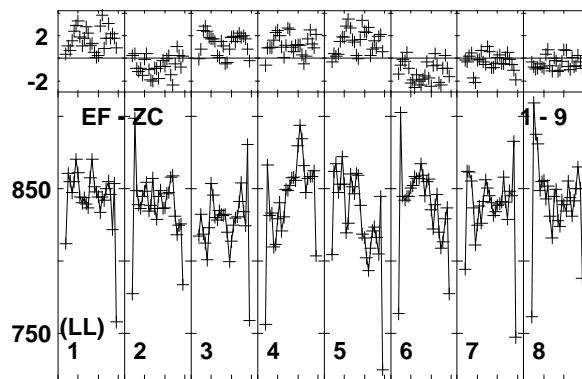
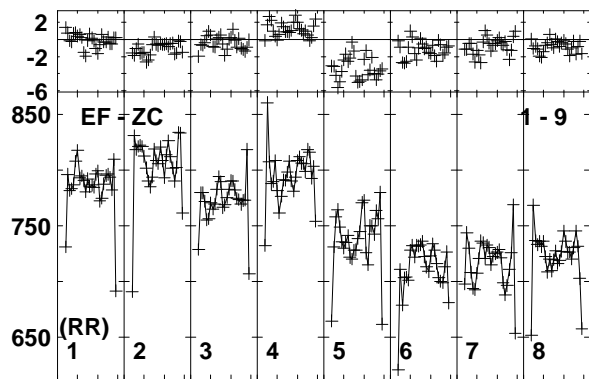
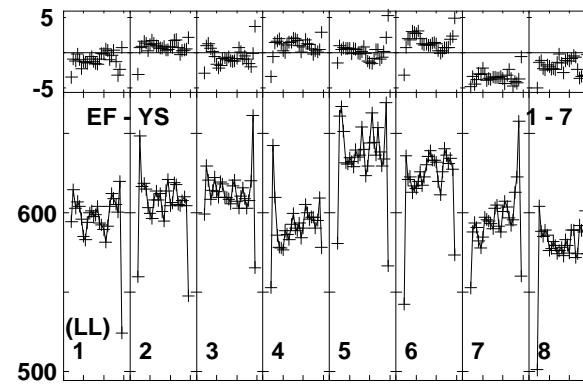
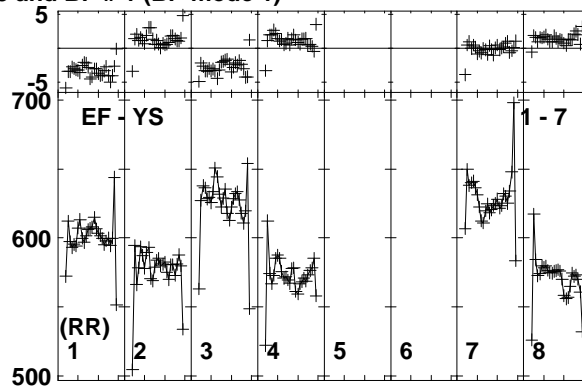
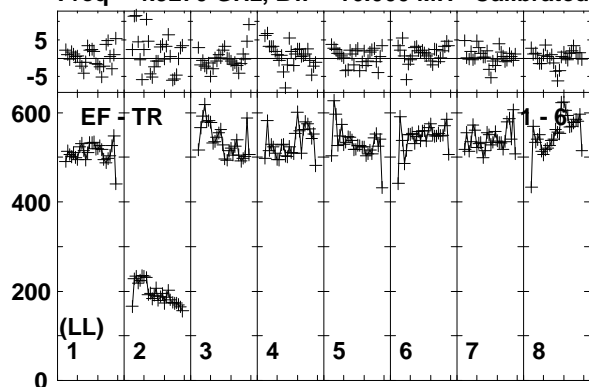

Lower frame: Milli Ampl Jy Top frame: Phas deg  
Vector averaged cross-power spectrum Baseline: EF (01) - TR (06)  
Timerange: 00/15:55:01 to 00/15:55:29

Plot file version 178 created 18-NOV-2014 15:23:41  
 ARP299C EP087H 3.UVDATA.1  
 Freq = 4.9270 GHz, Bw = 16.000 MH Calibrated with CL # 3 and BP # 1 (BP mode 1)

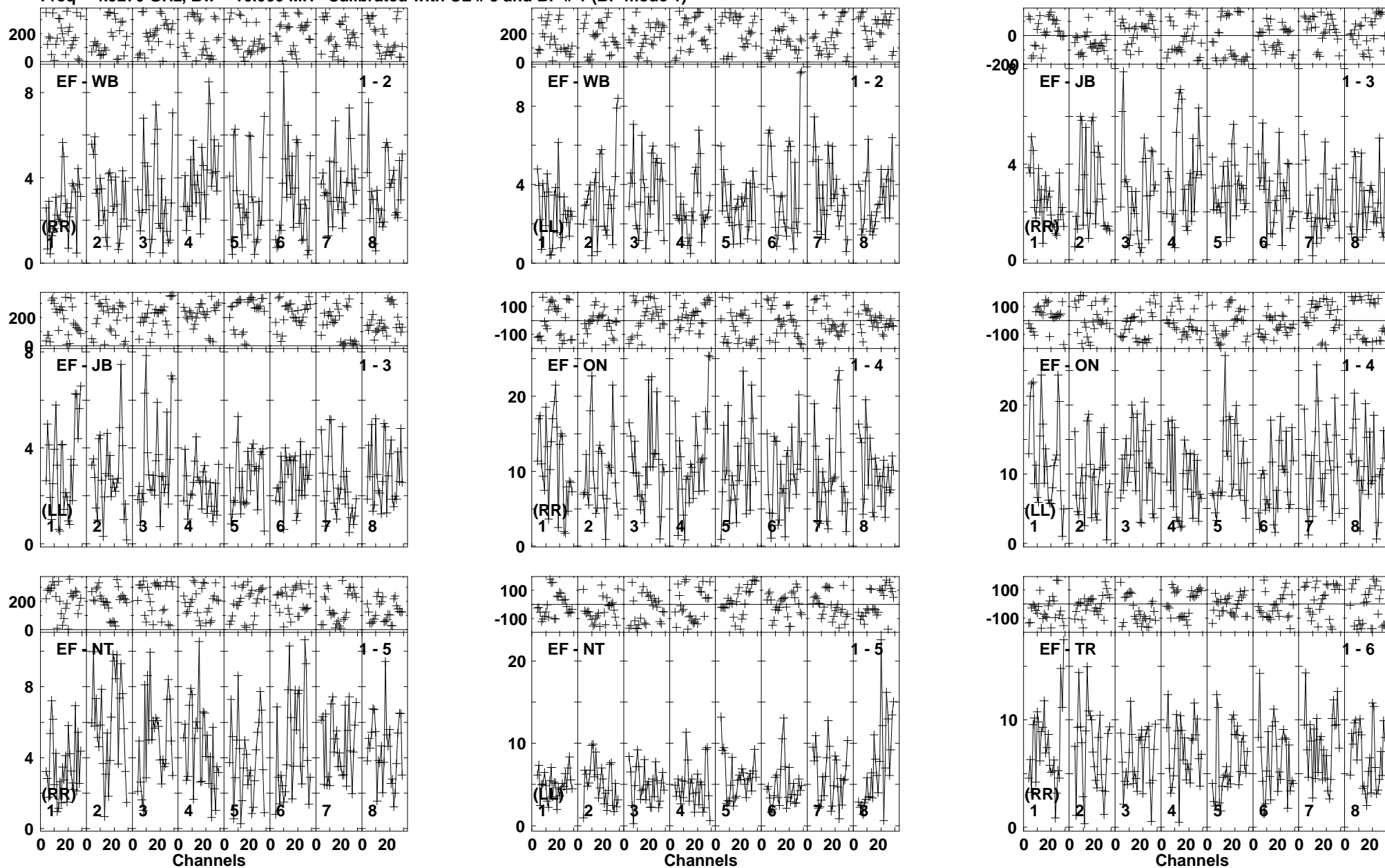

Lower frame: Milli Ampl Jy Top frame: Phas deg  
 Vector averaged cross-power spectrum Baseline: EF (01) - WB (02)  
 Timerange: 00/15:55:35 to 00/15:59:29

Plot file version 179 created 18-NOV-2014 15:23:41

ARP299C EP087H 3.UVDATA.1

Freq = 4.9270 GHz, Bw = 16.000 MH Calibrated with CL # 3 and BP # 1 (BP mode 1)

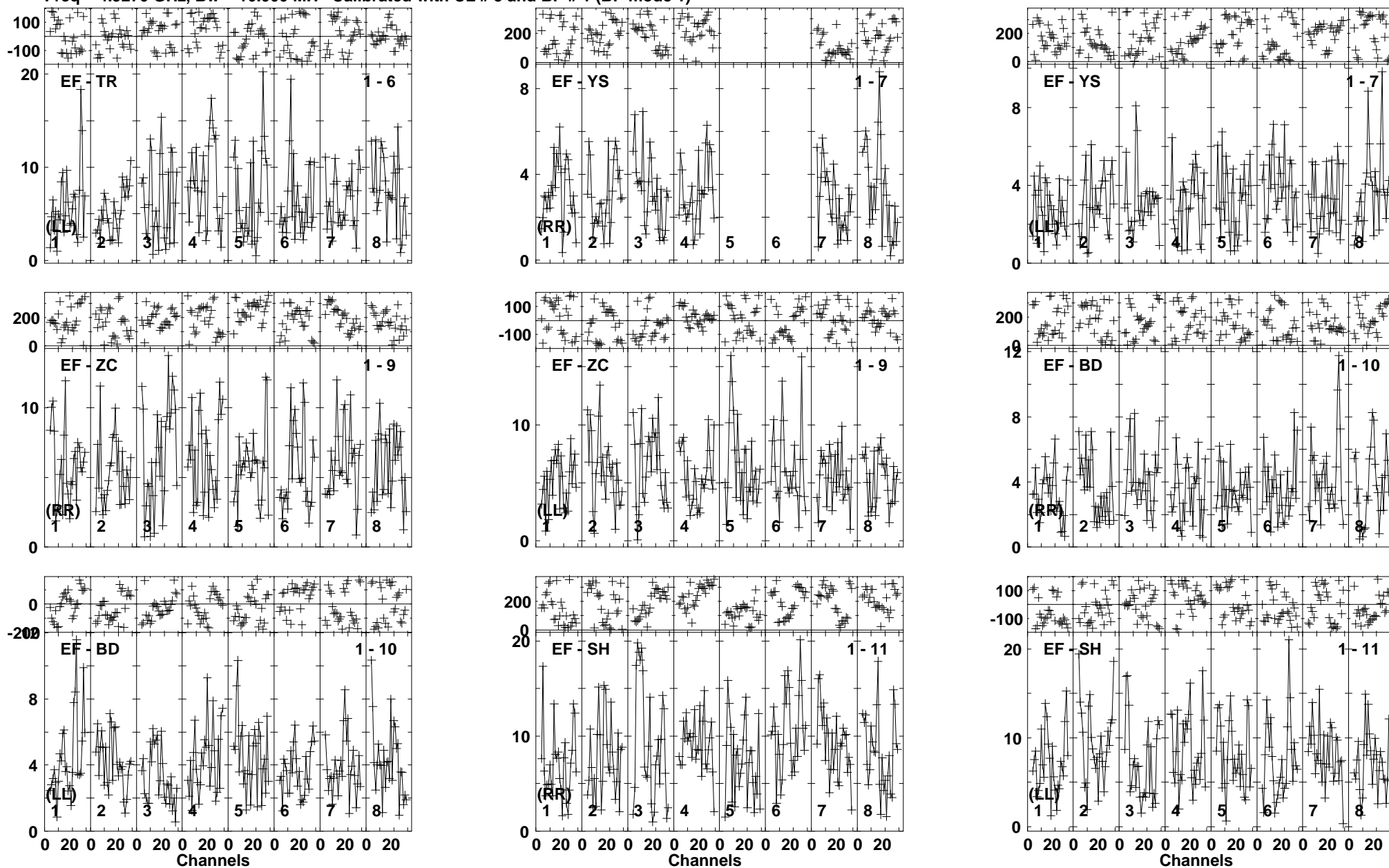

Lower frame: Milli Ampl Jy Top frame: Phas deg  
Vector averaged cross-power spectrum Baseline: EF (01) - TR (06)  
Timerange: 00/15:55:35 to 00/15:59:29

Plot file version 180 created 18-NOV-2014 15:23:41

J1128+5925 EP087H 3.UVDATA.1

Freq = 4.9270 GHz, Bw = 16.000 MH Calibrated with CL # 3 and BP # 1 (BP mode 1)

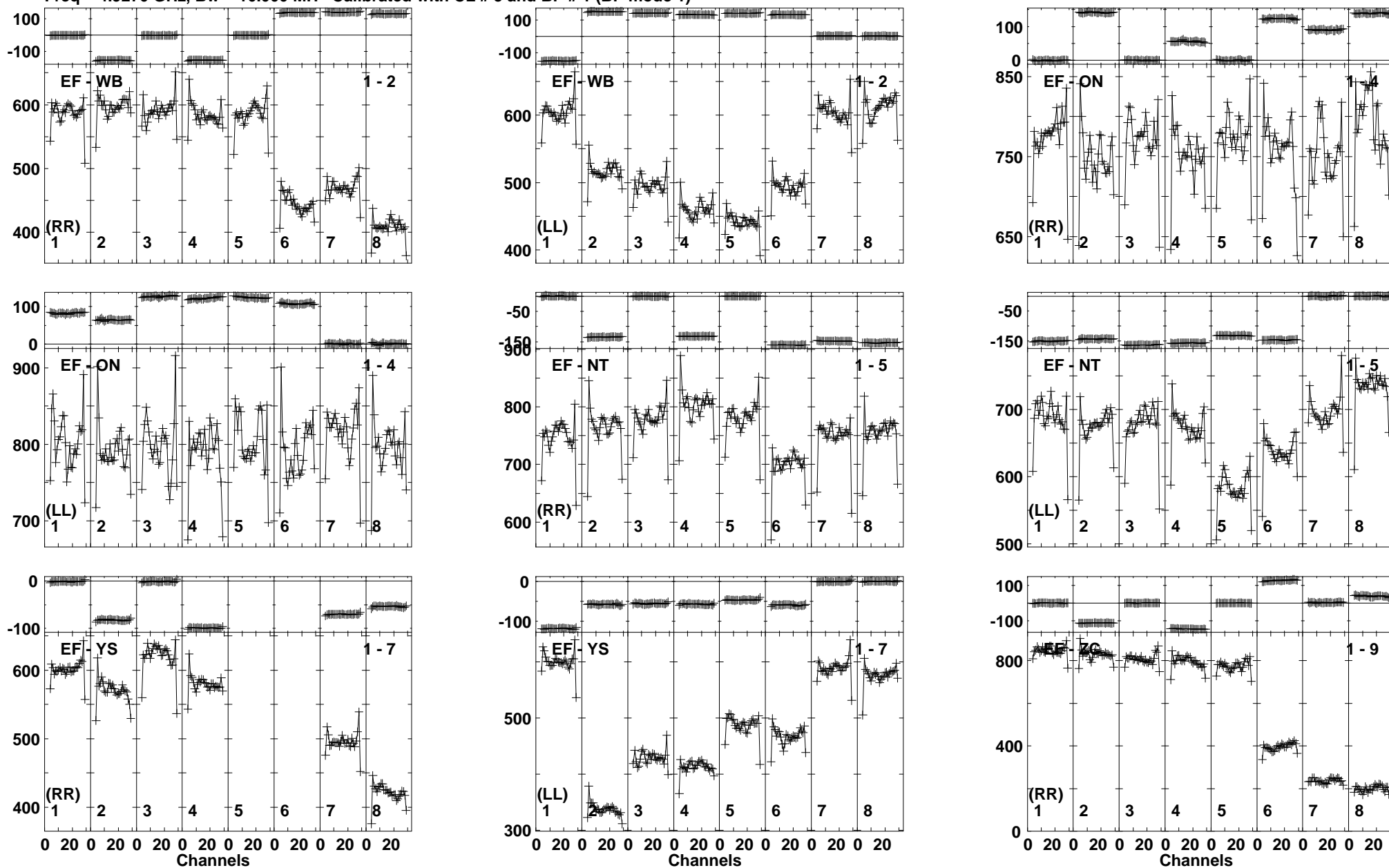

Lower frame: Milli Ampl Jy Top frame: Phas deg  
Vector averaged cross-power spectrum Baseline: EF (01) - WB (02)  
Timerange: 00/15:59:35 to 00/16:00:29

Plot file version 181 created 18-NOV-2014 15:23:42  
 J1128+5925 EP087H 3.UVDATA.1  
 Freq = 4.9270 GHz, Bw = 16.000 MH Calibrated with CL # 3 and BP # 1 (BP mode 1)

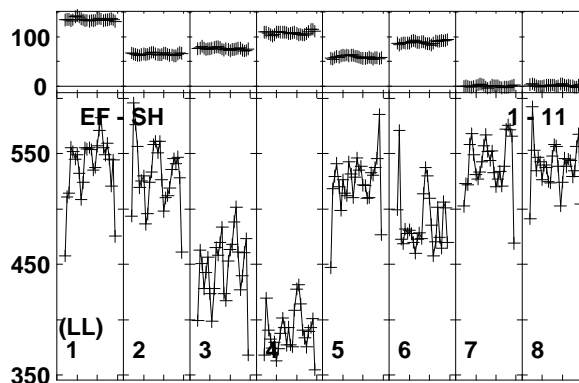
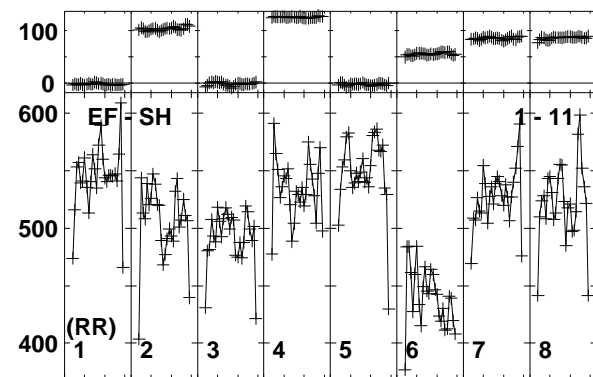
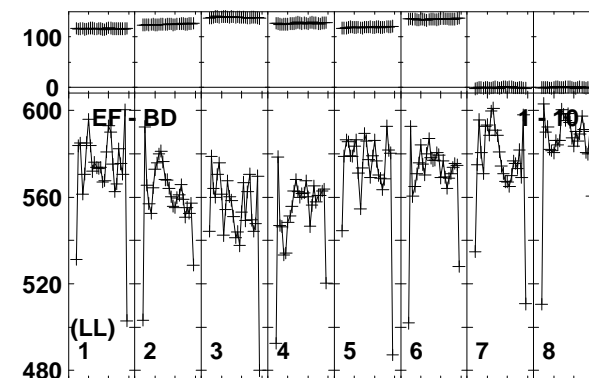
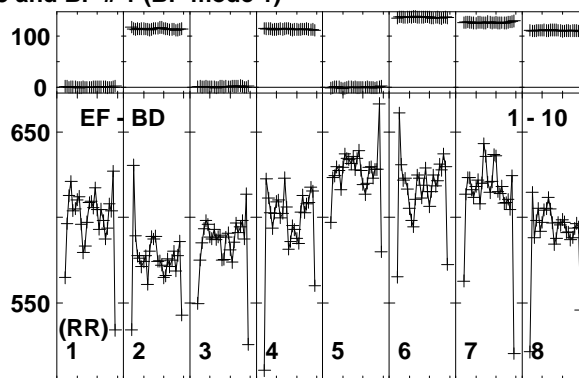
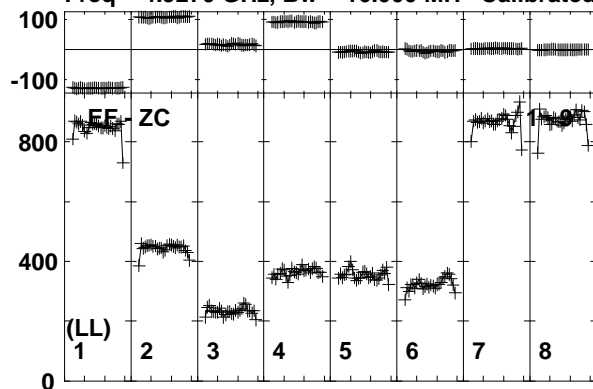

Lower frame: Milli Ampl Jy Top frame: Phas deg  
 Vector averaged cross-power spectrum Baseline: EF (01) - ZC (09)  
 Timerange: 00/15:59:35 to 00/16:00:29

Plot file version 182 created 18-NOV-2014 15:23:42

ARP299C EP087H 3.UVDATA.1

Freq = 4.9270 GHz, Bw = 16.000 MH Calibrated with CL # 3 and BP # 1 (BP mode 1)

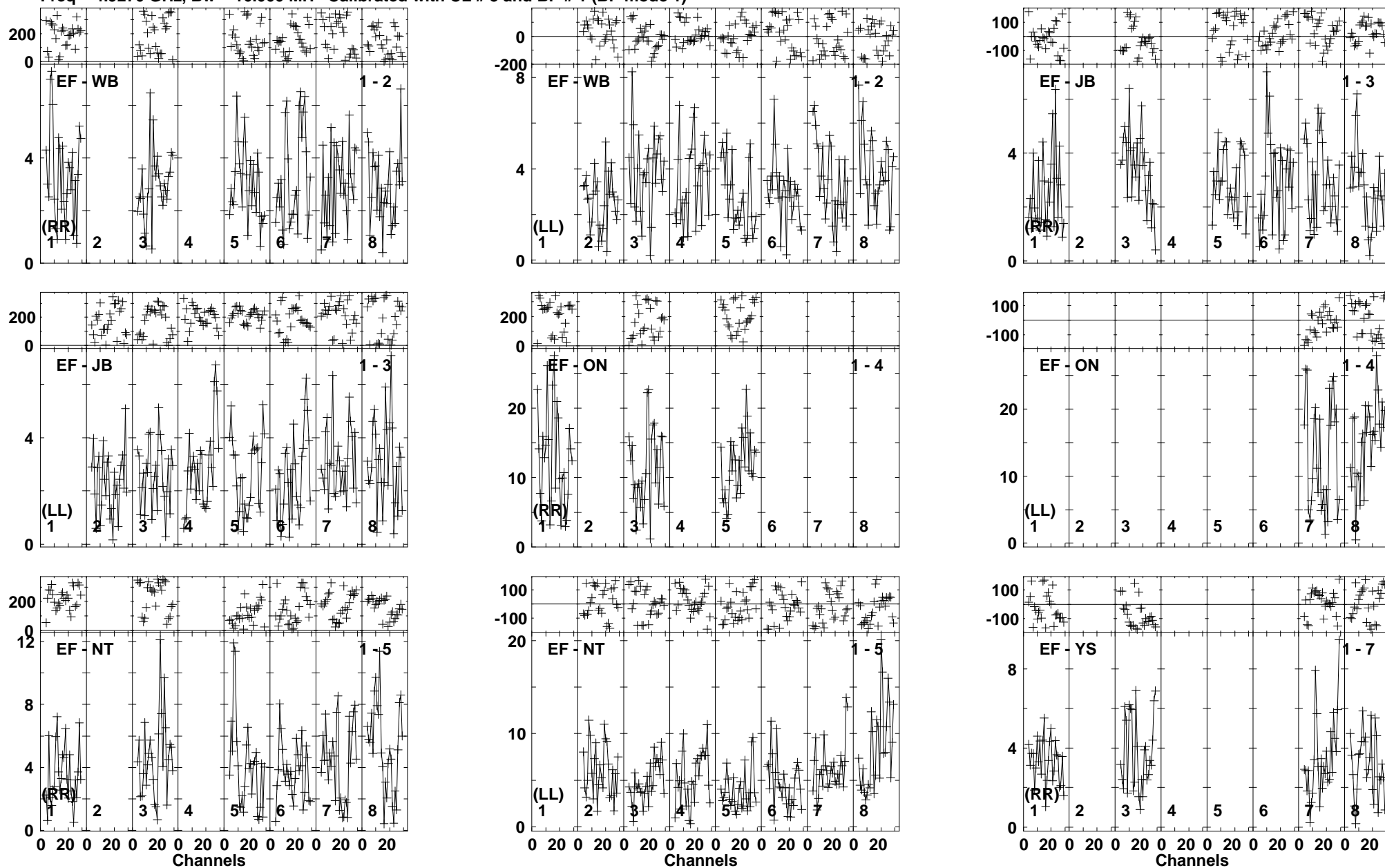

Lower frame: Milli Ampl Jy Top frame: Phas deg  
Vector averaged cross-power spectrum Baseline: EF (01) - WB (02)  
Timerange: 00/16:00:31 to 00/16:04:29

Plot file version 183 created 18-NOV-2014 15:23:42

ARP299C EP087H 3.UVDATA.1

Freq = 4.9270 GHz, Bw = 16.000 MH Calibrated with CL # 3 and BP # 1 (BP mode 1)

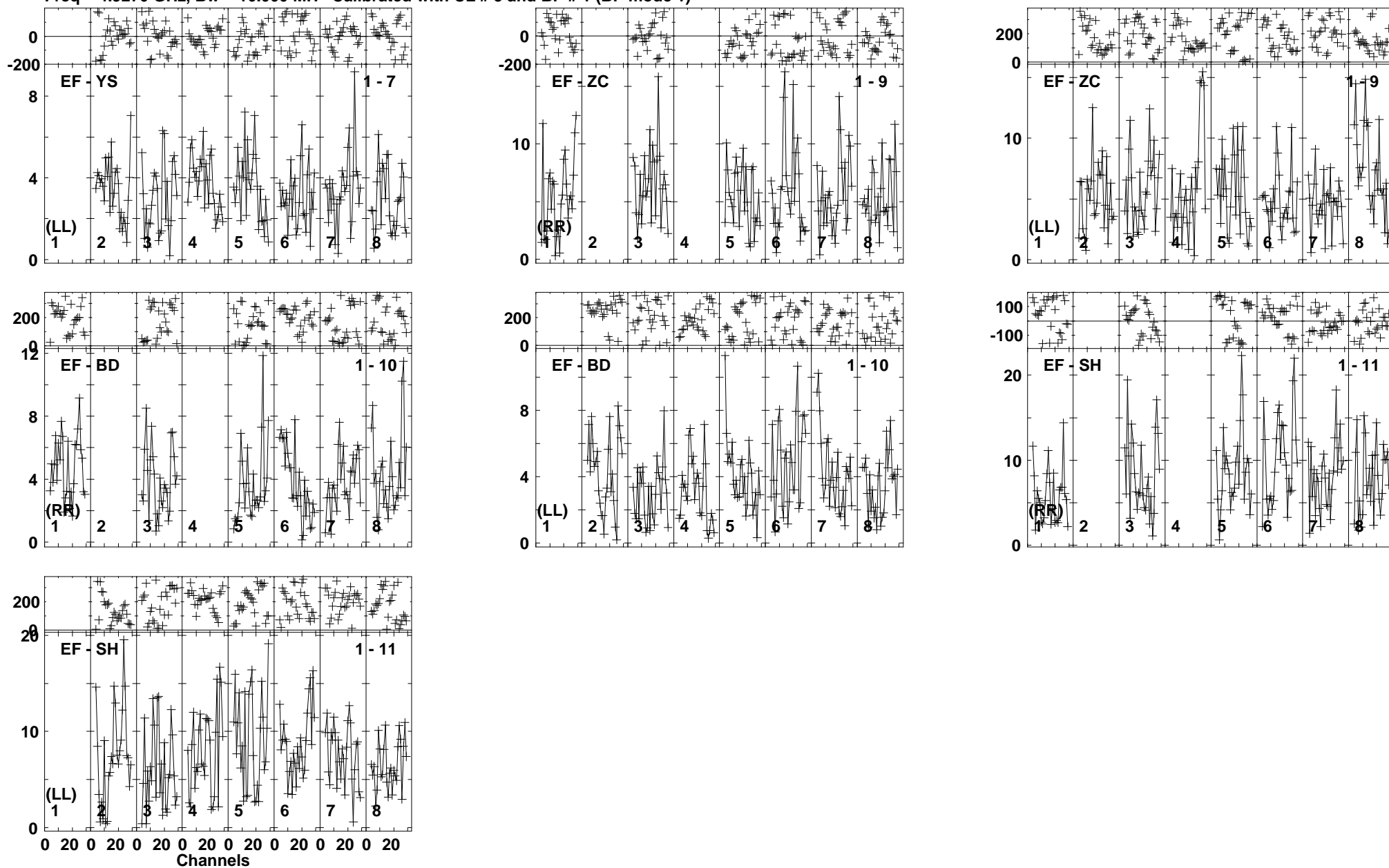

Lower frame: Milli Ampl Jy Top frame: Phas deg  
Vector averaged cross-power spectrum Baseline: EF (01) - YS (07)  
Timerange: 00/16:00:31 to 00/16:04:29

Plot file version 184 created 18-NOV-2014 15:23:42

J1128+5925 EP087H 3.UVDATA.1

Freq = 4.9270 GHz, Bw = 16.000 MH Calibrated with CL # 3 and BP # 1 (BP mode 1)

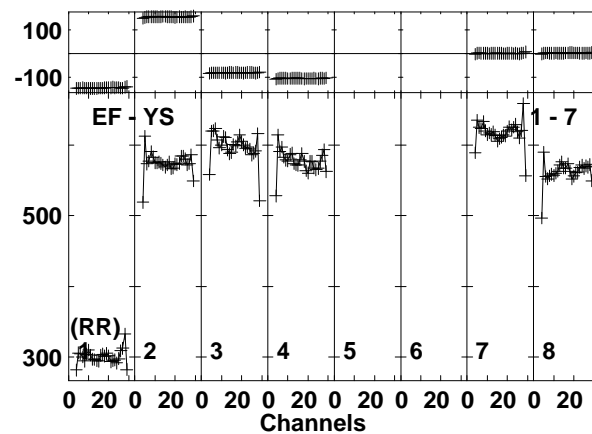
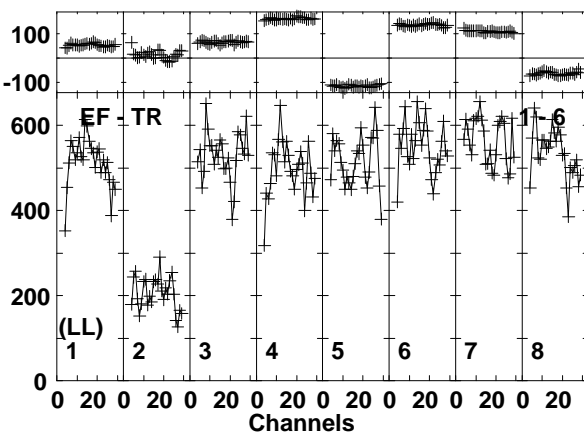
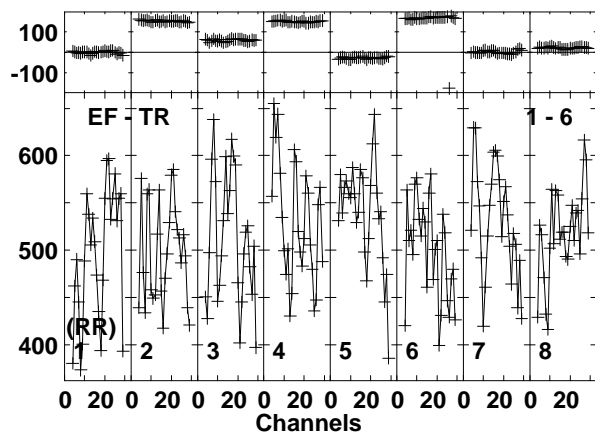
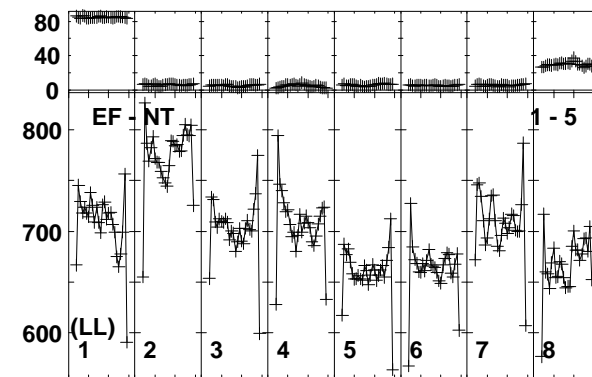
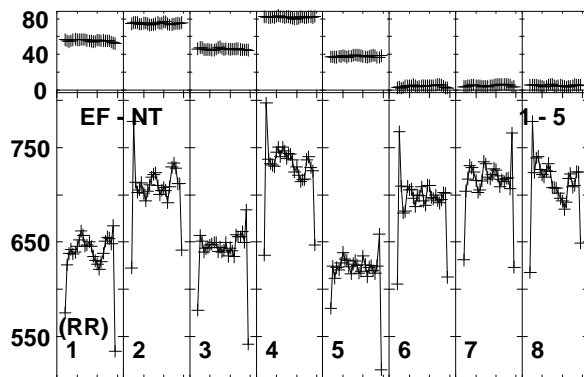
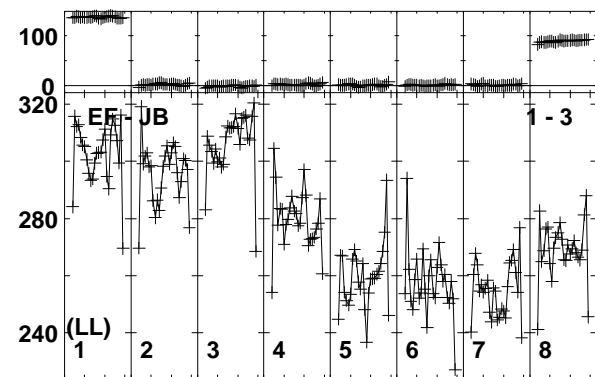
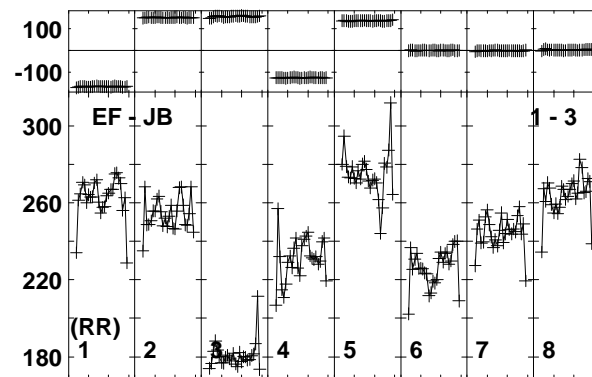
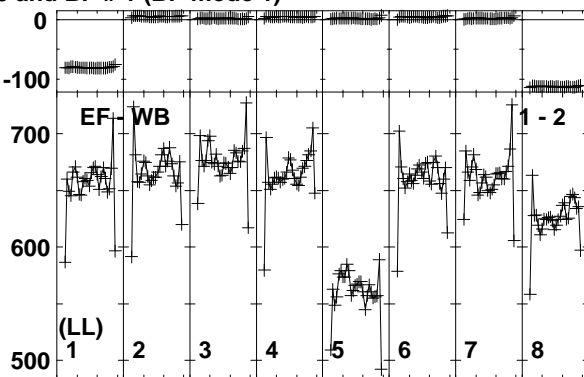
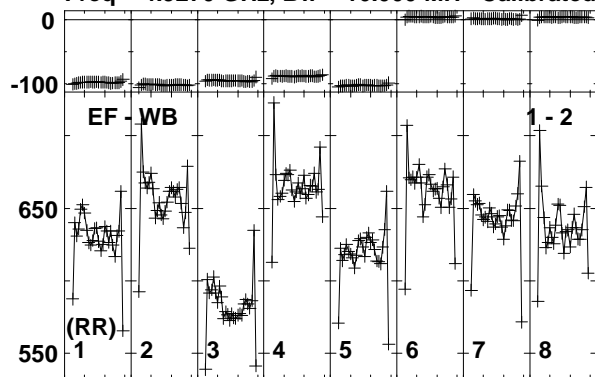

Lower frame: Milli Ampl Jy Top frame: Phas deg  
Vector averaged cross-power spectrum Baseline: EF (01) - WB (02)  
Timerange: 00/16:04:35 to 00/16:05:29



Plot file version 185 created 18-NOV-2014 15:23:43

J1128+5925 EP087H 3.UVDATA.1

Freq = 4.9270 GHz, Bw = 16.000 MH Calibrated with CL # 3 and BP # 1 (BP mode 1)

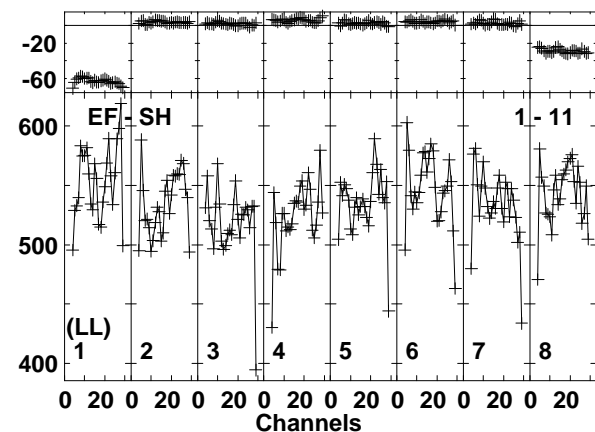
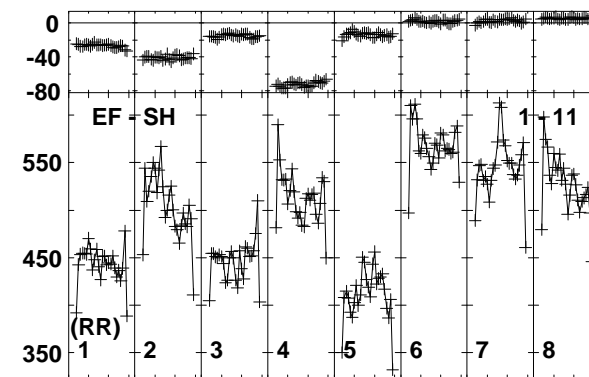
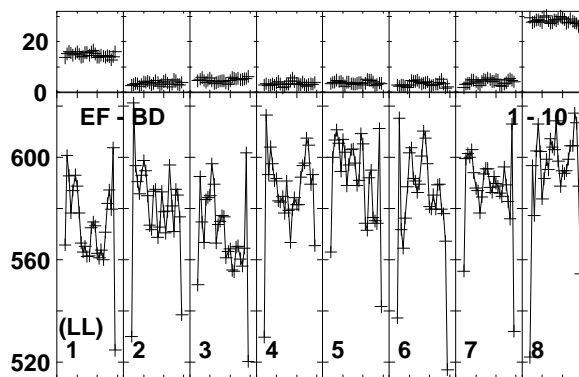
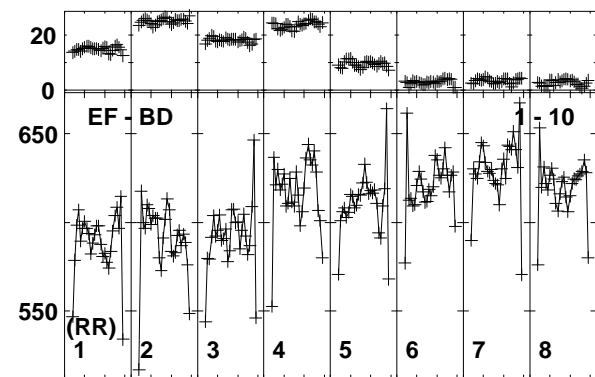
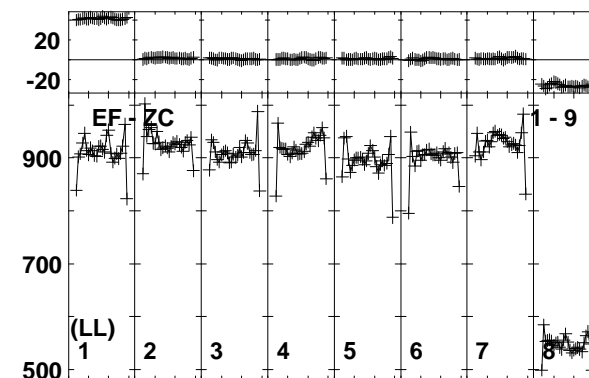
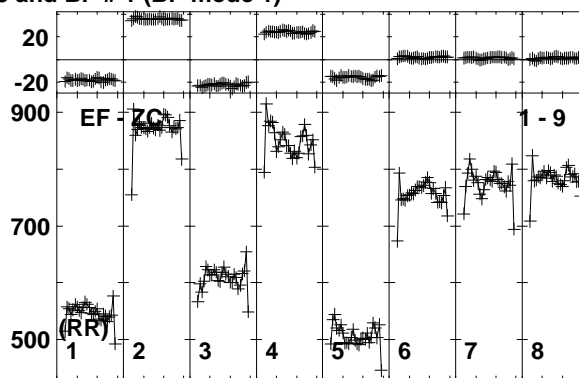
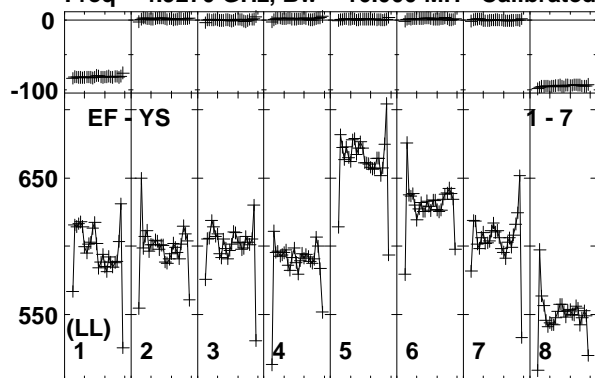

Lower frame: Milli Ampl Jy Top frame: Phas deg  
Vector averaged cross-power spectrum Baseline: EF (01) - YS (07)  
Timerange: 00/16:04:35 to 00/16:05:29

Plot file version 186 created 18-NOV-2014 15:23:43  
 ARP299C EP087H 3.UVDATA.1  
 Freq = 4.9270 GHz, Bw = 16.000 MH Calibrated with CL # 3 and BP # 1 (BP mode 1)

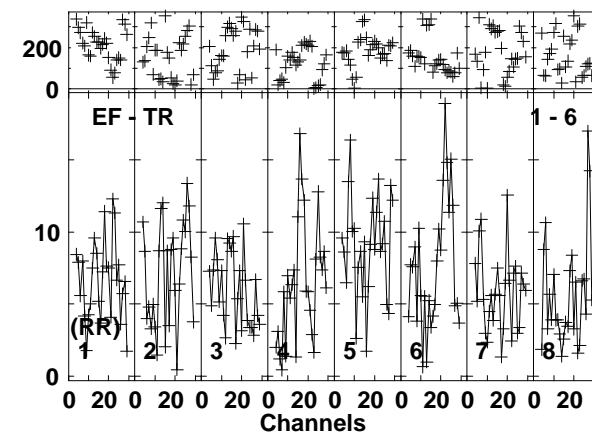
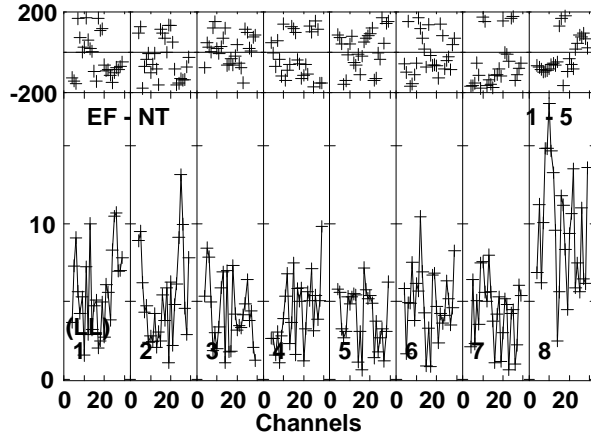
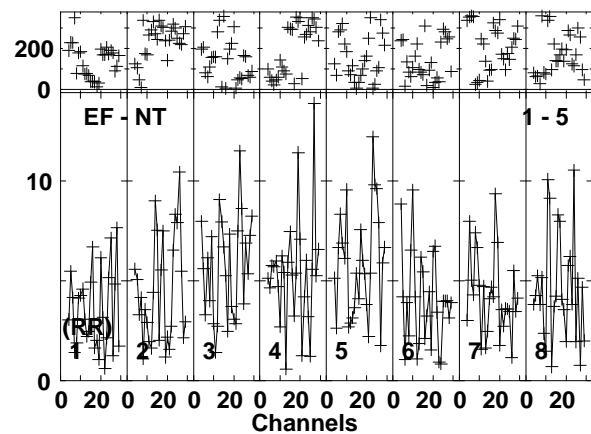
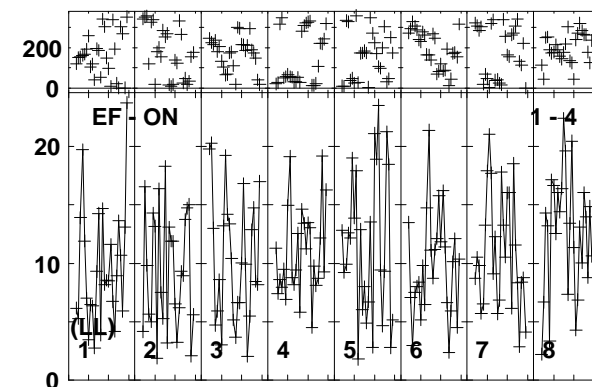
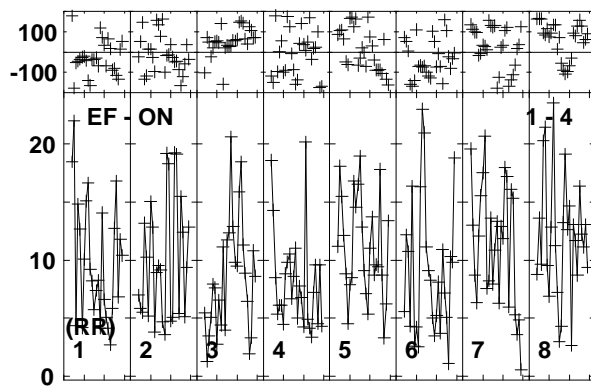
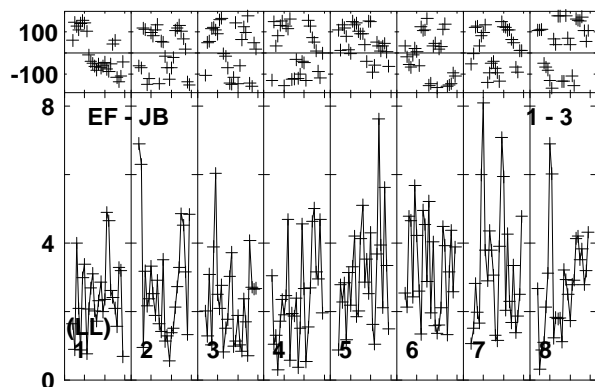
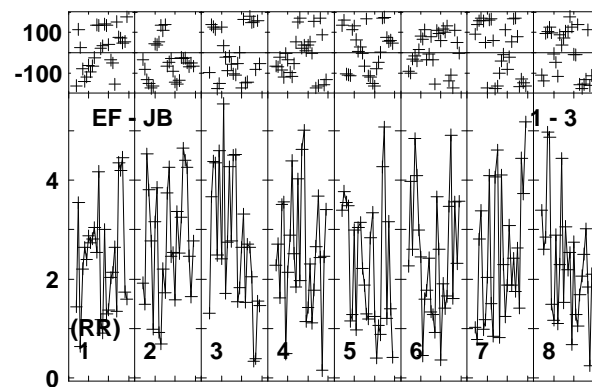
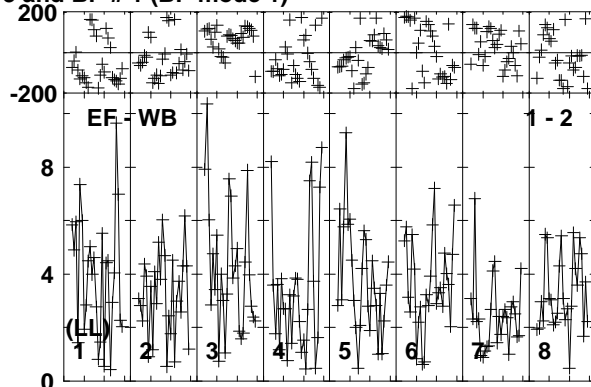
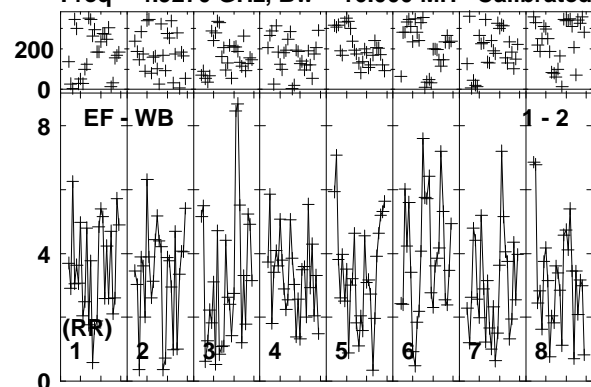

Lower frame: Milli Ampl Jy Top frame: Phas deg  
 Vector averaged cross-power spectrum Baseline: EF (01) - WB (02)  
 Timerange: 00/16:05:35 to 00/16:09:29

Plot file version 187 created 18-NOV-2014 15:23:43

ARP299C EP087H 3.UVDATA.1

Freq = 4.9270 GHz, Bw = 16.000 MH Calibrated with CL # 3 and BP # 1 (BP mode 1)

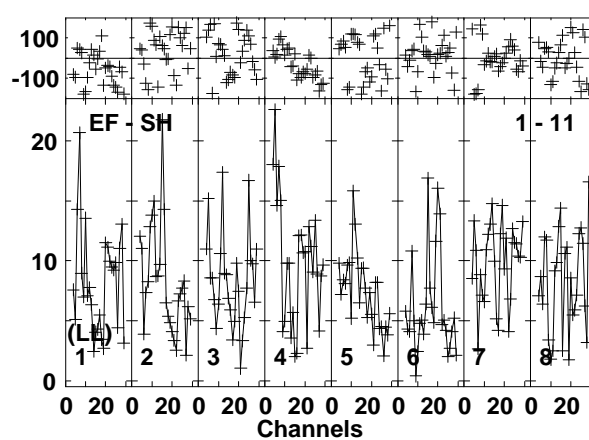
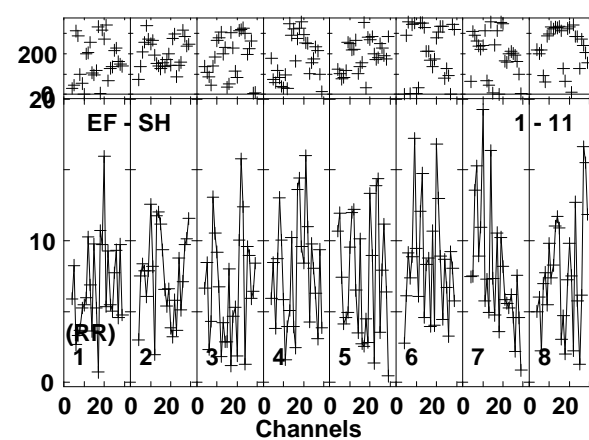
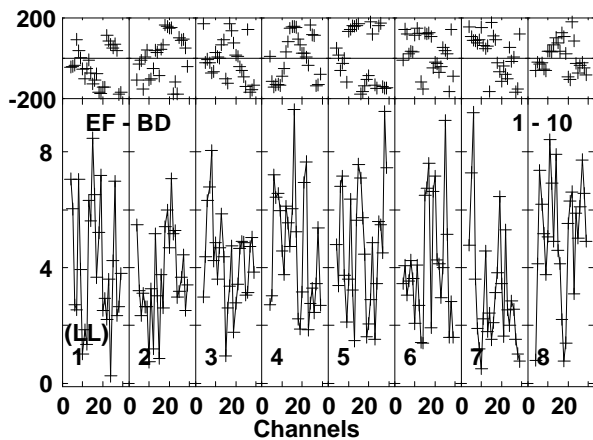
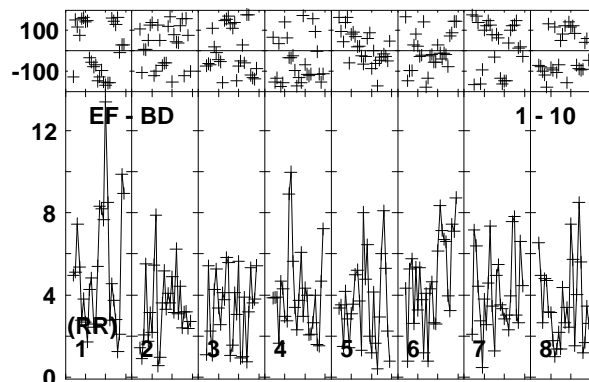
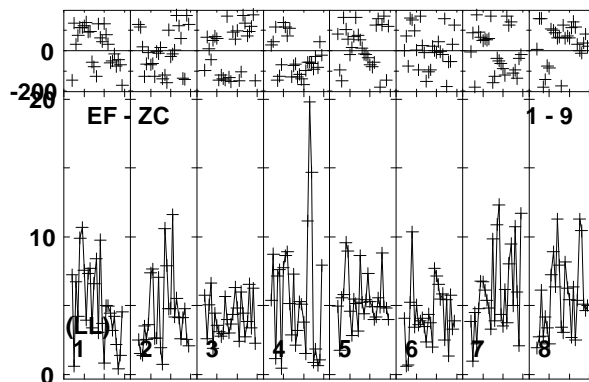
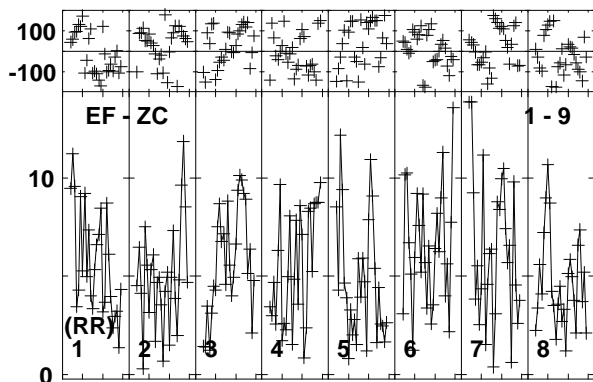
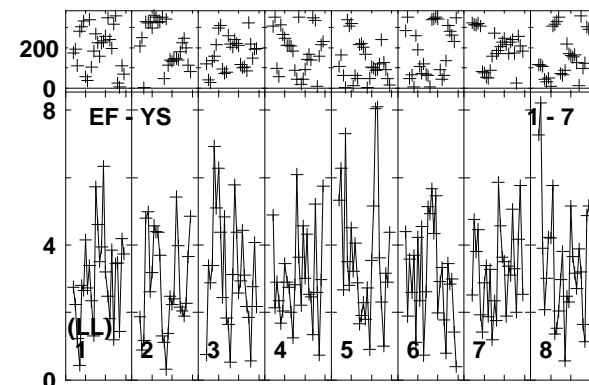
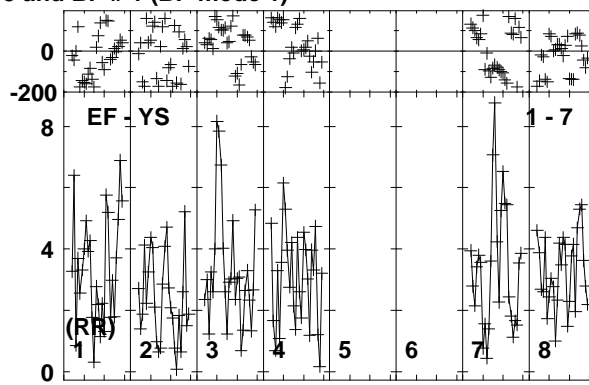
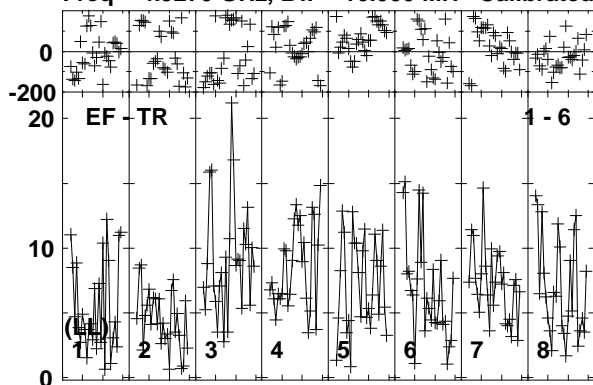

Lower frame: Milli Ampl Jy Top frame: Phas deg  
Vector averaged cross-power spectrum Baseline: EF (01) - TR (06)  
Timerange: 00/16:05:35 to 00/16:09:29

Plot file version 188 created 18-NOV-2014 15:23:43

J1128+5925 EP087H 3.UVDATA.1

Freq = 4.9270 GHz, Bw = 16.000 MH Calibrated with CL # 3 and BP # 1 (BP mode 1)

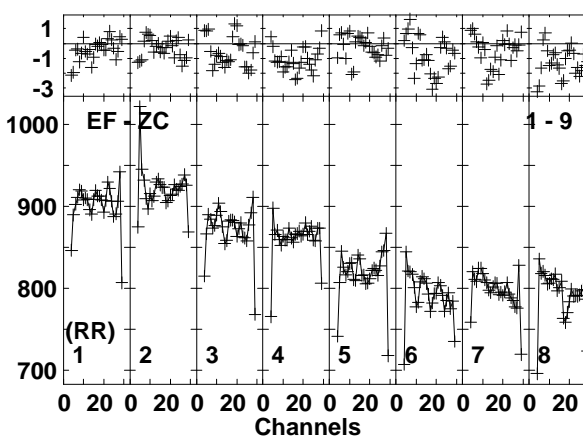
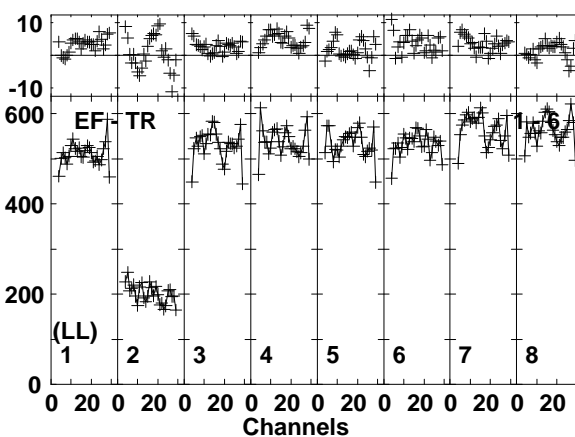
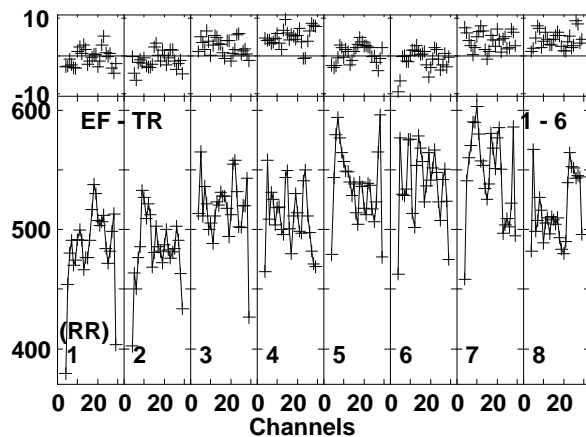
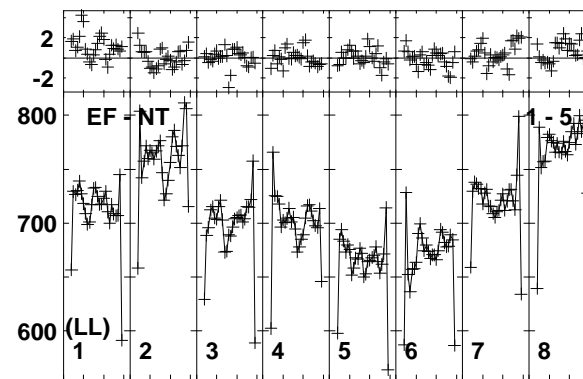
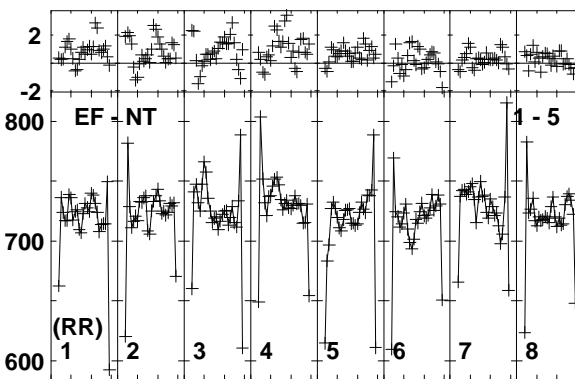
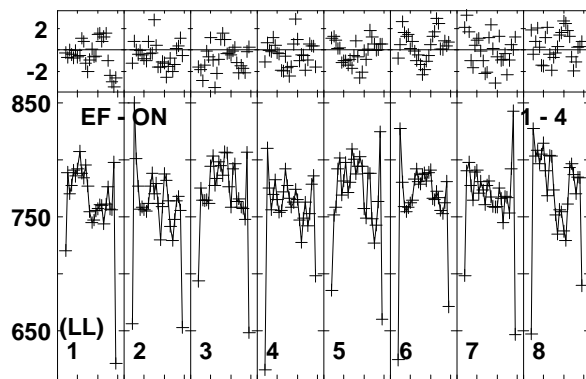
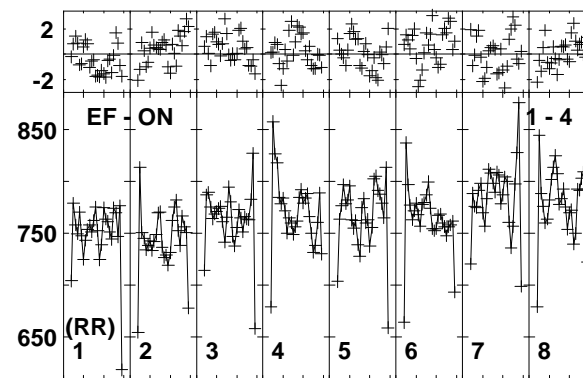
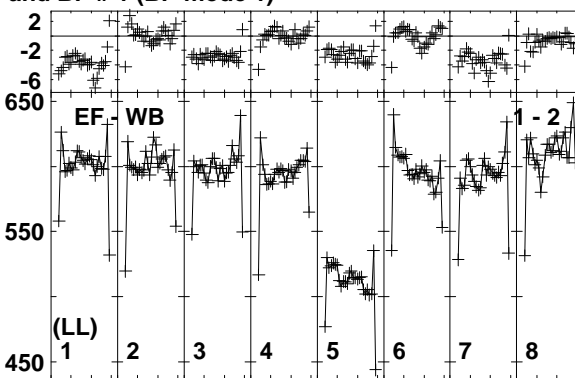
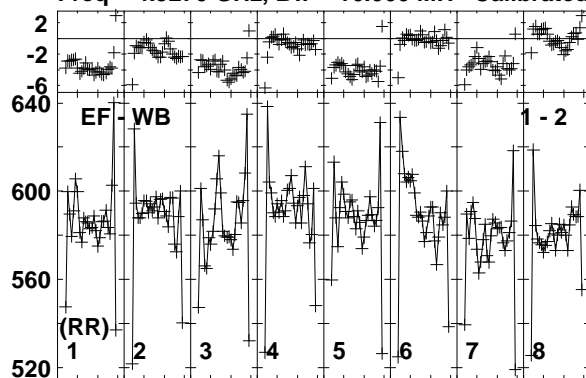

Lower frame: Milli Ampl Jy Top frame: Phas deg  
Vector averaged cross-power spectrum Baseline: EF (01) - WB (02)  
Timerange: 00/16:10:13 to 00/16:10:39

Plot file version 189 created 18-NOV-2014 15:23:44

J1128+5925 EP087H 3.UVDATA.1

Freq = 4.9270 GHz, Bw = 16.000 MH Calibrated with CL # 3 and BP # 1 (BP mode 1)

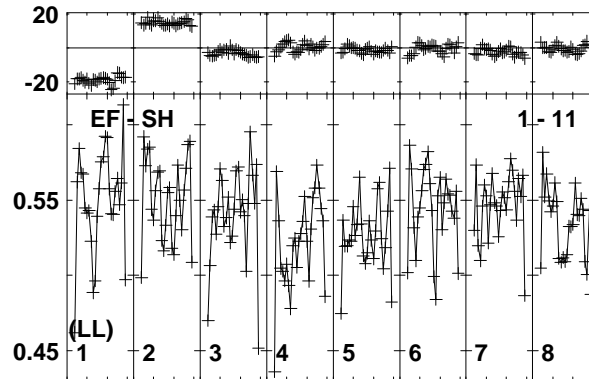
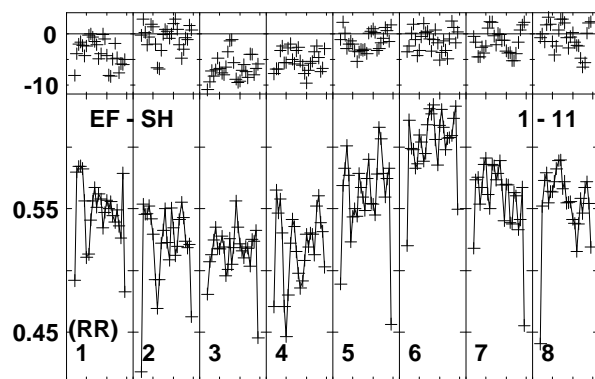
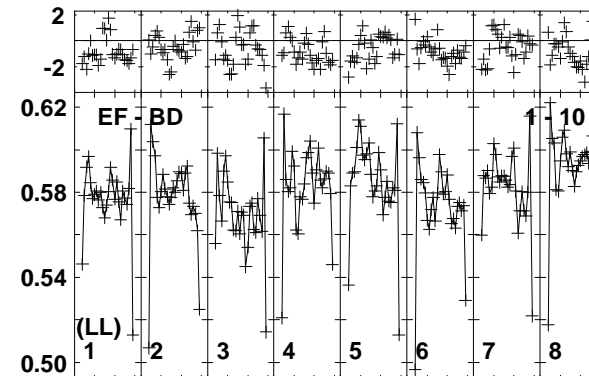
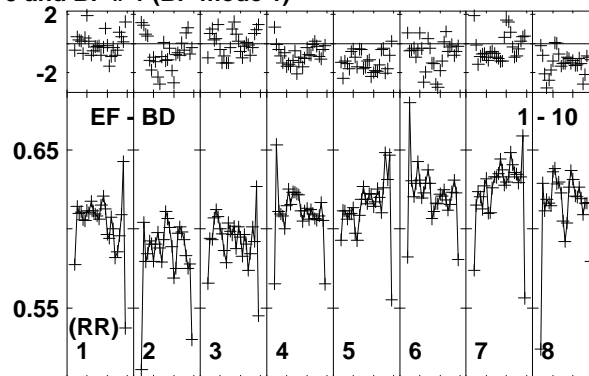
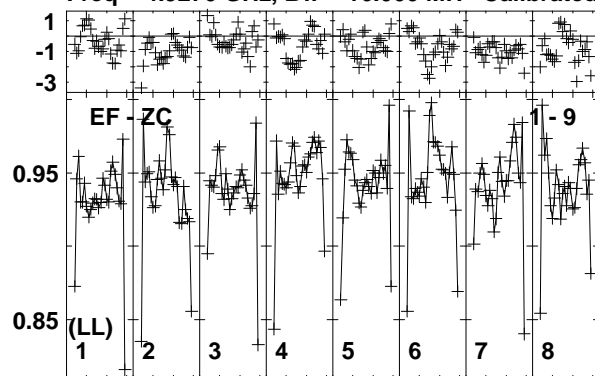

Lower frame: Ampl Jy Top frame: Phas deg  
Vector averaged cross-power spectrum Baseline: EF (01) - ZC (09)  
Timerange: 00/16:10:13 to 00/16:10:39

Plot file version 190 created 18-NOV-2014 15:23:44  
 ARP299C EP087H 3.UVDATA.1  
 Freq = 4.9270 GHz, Bw = 16.000 MH Calibrated with CL # 3 and BP # 1 (BP mode 1)

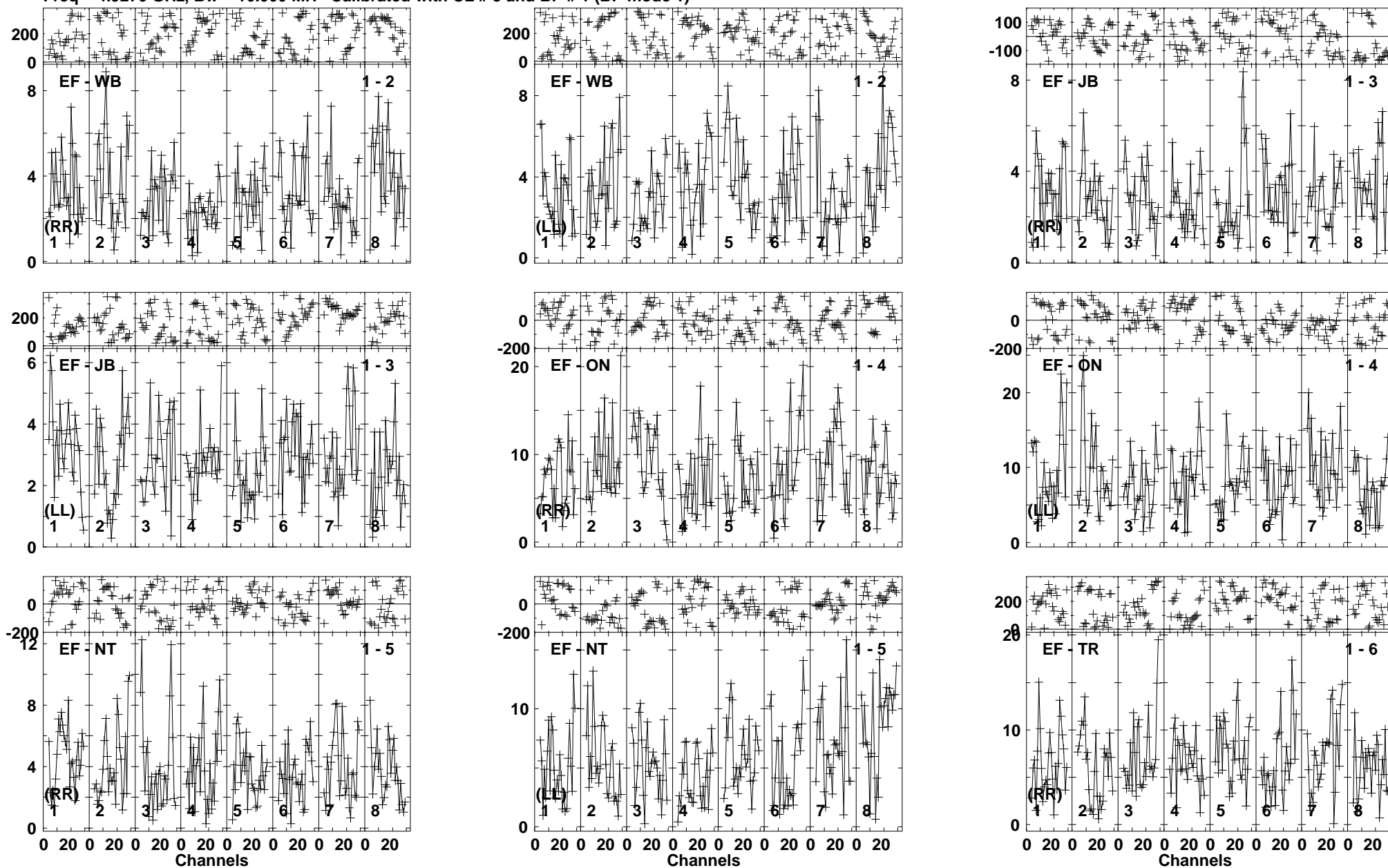

Lower frame: Milli Ampl Jy Top frame: Phas deg  
 Vector averaged cross-power spectrum Baseline: EF (01) - WB (02)  
 Timerange: 00/16:10:41 to 00/16:14:39

Plot file version 191 created 18-NOV-2014 15:23:44  
 ARP299C EP087H 3.UVDATA.1  
 Freq = 4.9270 GHz, Bw = 16.000 MH Calibrated with CL # 3 and BP # 1 (BP mode 1)

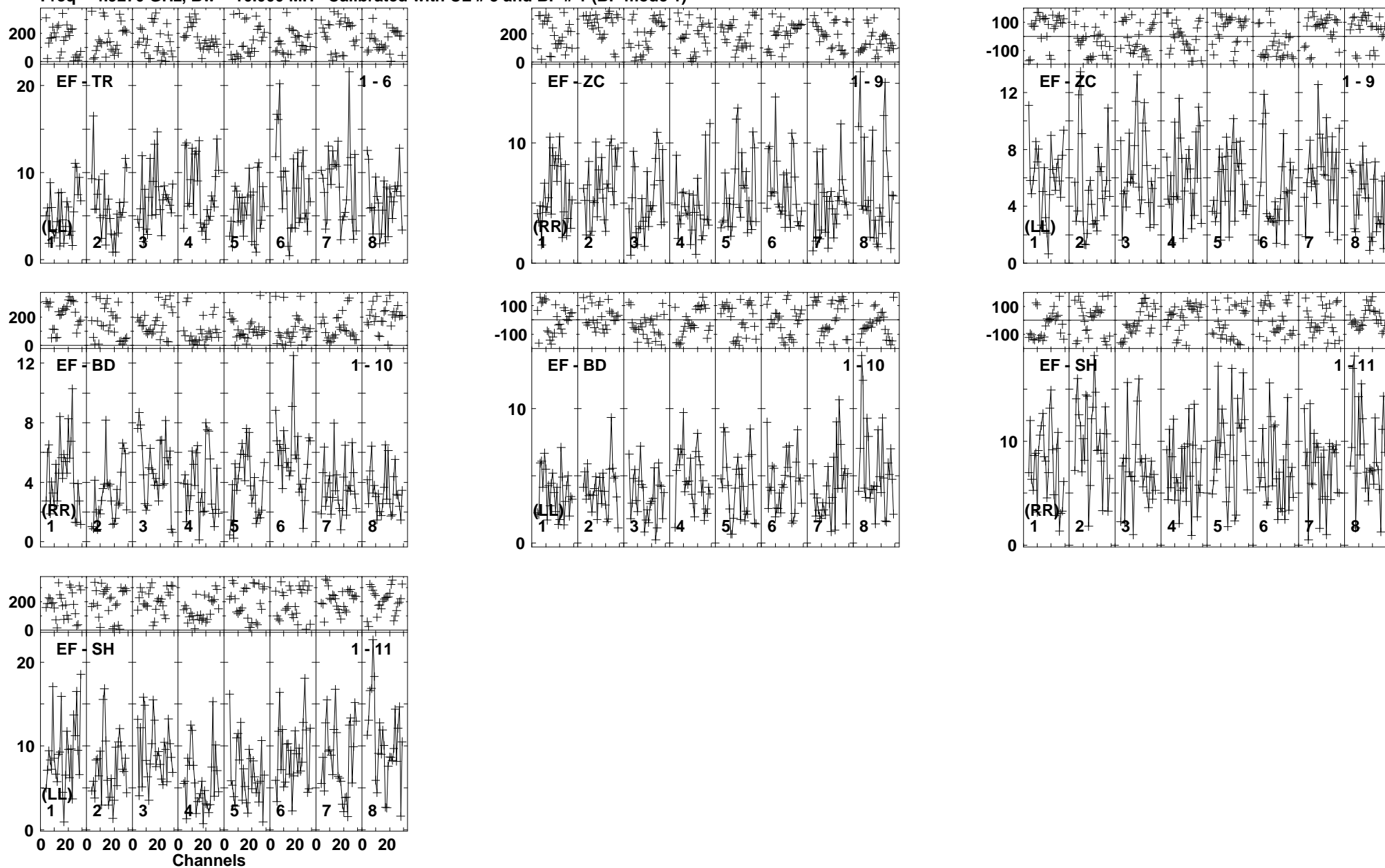

Lower frame: Milli Ampl Jy Top frame: Phas deg  
 Vector averaged cross-power spectrum Baseline: EF (01) - TR (06)  
 Timerange: 00/16:10:41 to 00/16:14:39

Plot file version 192 created 18-NOV-2014 15:23:44

J1128+5925 EP087H 3.UVDATA.1

Freq = 4.9270 GHz, Bw = 16.000 MH Calibrated with CL # 3 and BP # 1 (BP mode 1)

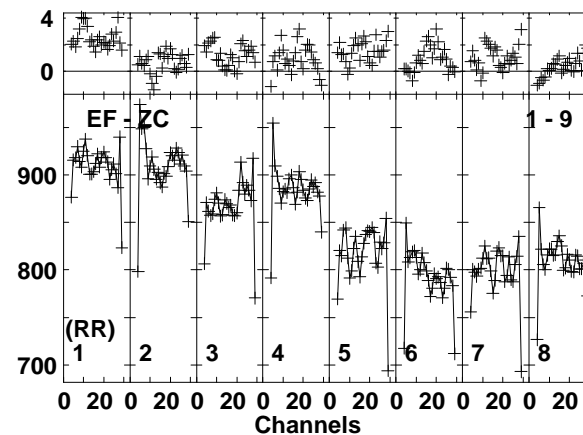
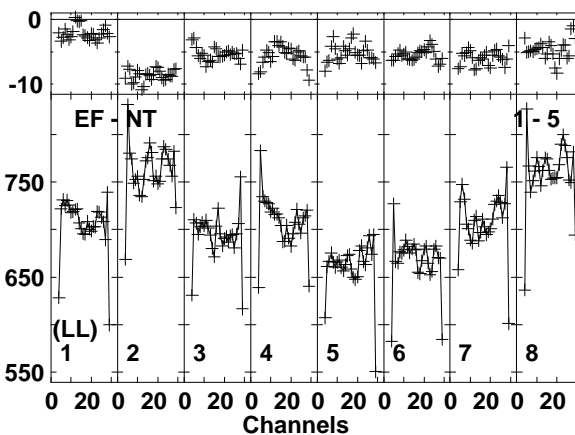
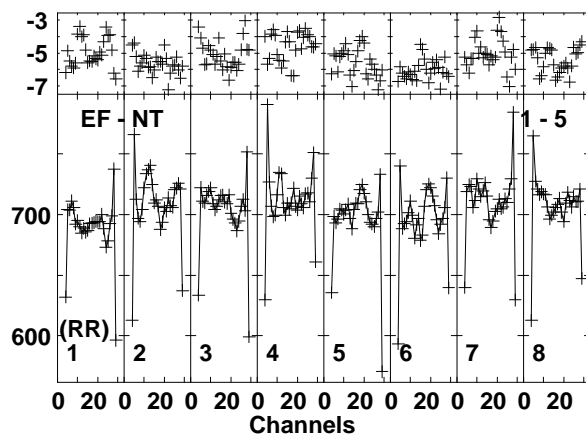
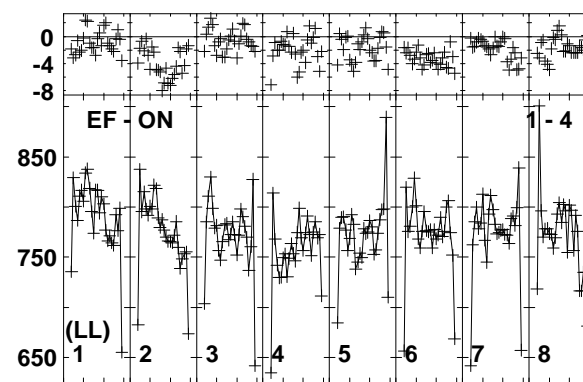
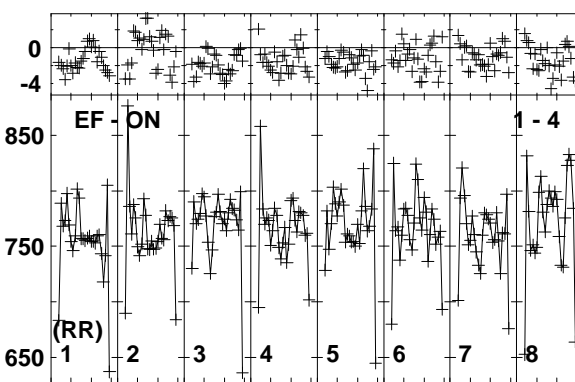
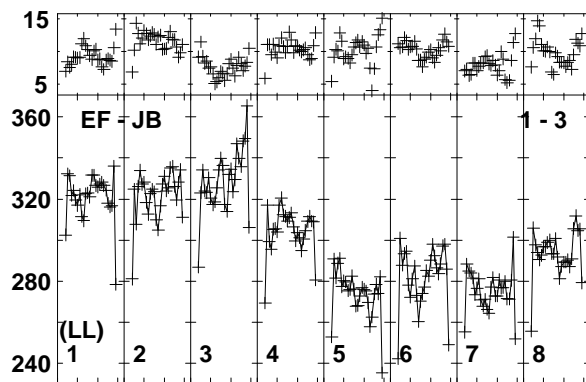
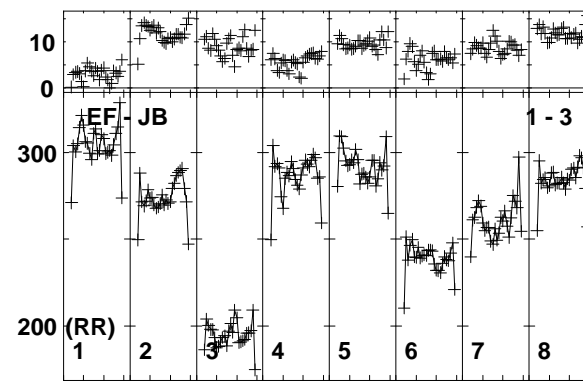
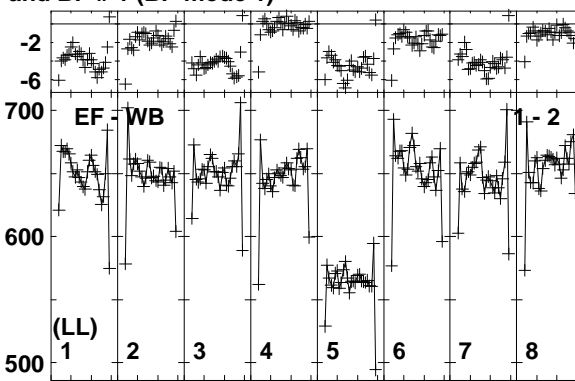
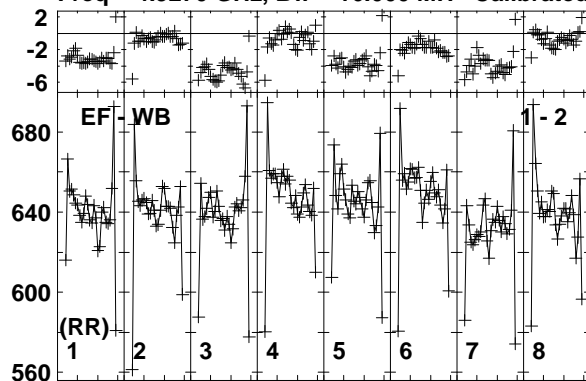

Lower frame: Milli Ampl Jy Top frame: Phas deg  
Vector averaged cross-power spectrum Baseline: EF (01) - WB (02)  
Timerange: 00/16:14:45 to 00/16:15:39



Plot file version 193 created 18-NOV-2014 15:23:45

J1128+5925 EP087H 3.UVDATA.1

Freq = 4.9270 GHz, Bw = 16.000 MH Calibrated with CL # 3 and BP # 1 (BP mode 1)

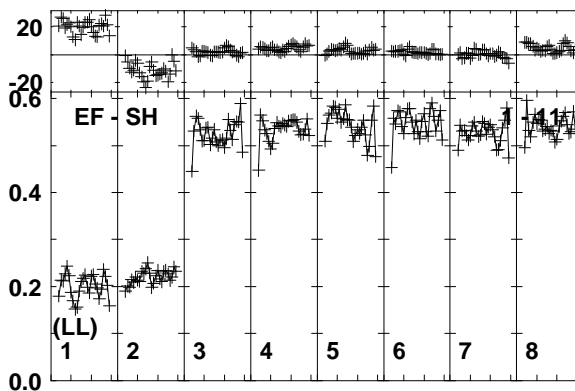
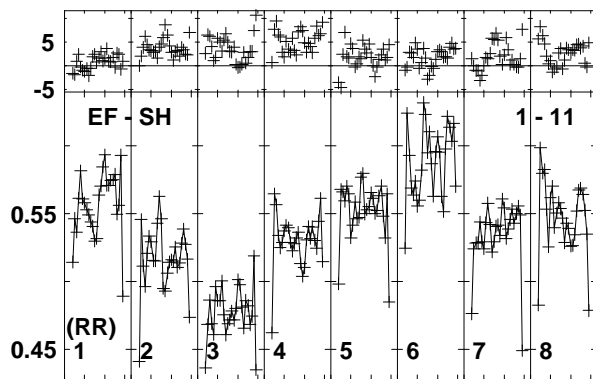
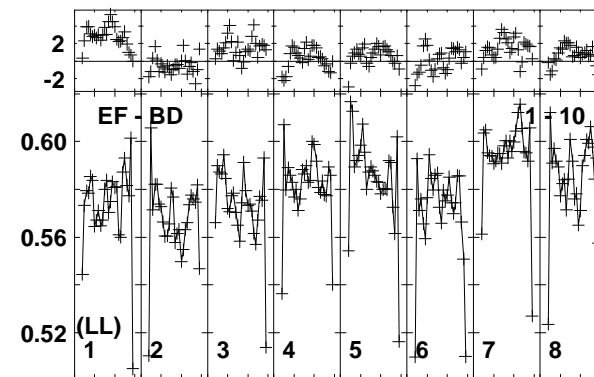
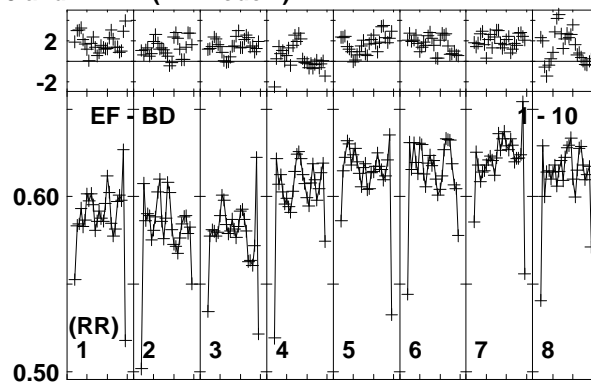
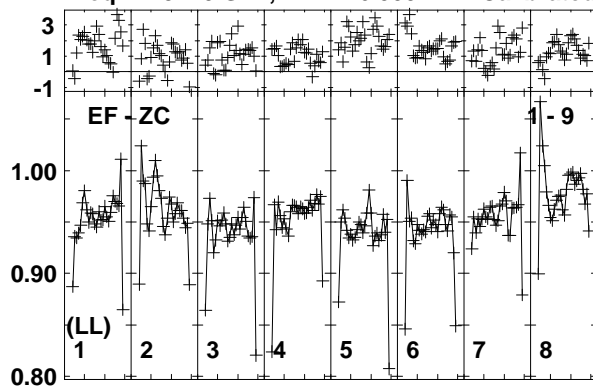

Lower frame: Ampl Jy Top frame: Phas deg  
Vector averaged cross-power spectrum Baseline: EF (01) - ZC (09)  
Timerange: 00/16:14:45 to 00/16:15:39

Plot file version 194 created 18-NOV-2014 15:23:45  
 ARP299C EP087H 3.UVDATA.1  
 Freq = 4.9270 GHz, Bw = 16.000 MH Calibrated with CL # 3 and BP # 1 (BP mode 1)

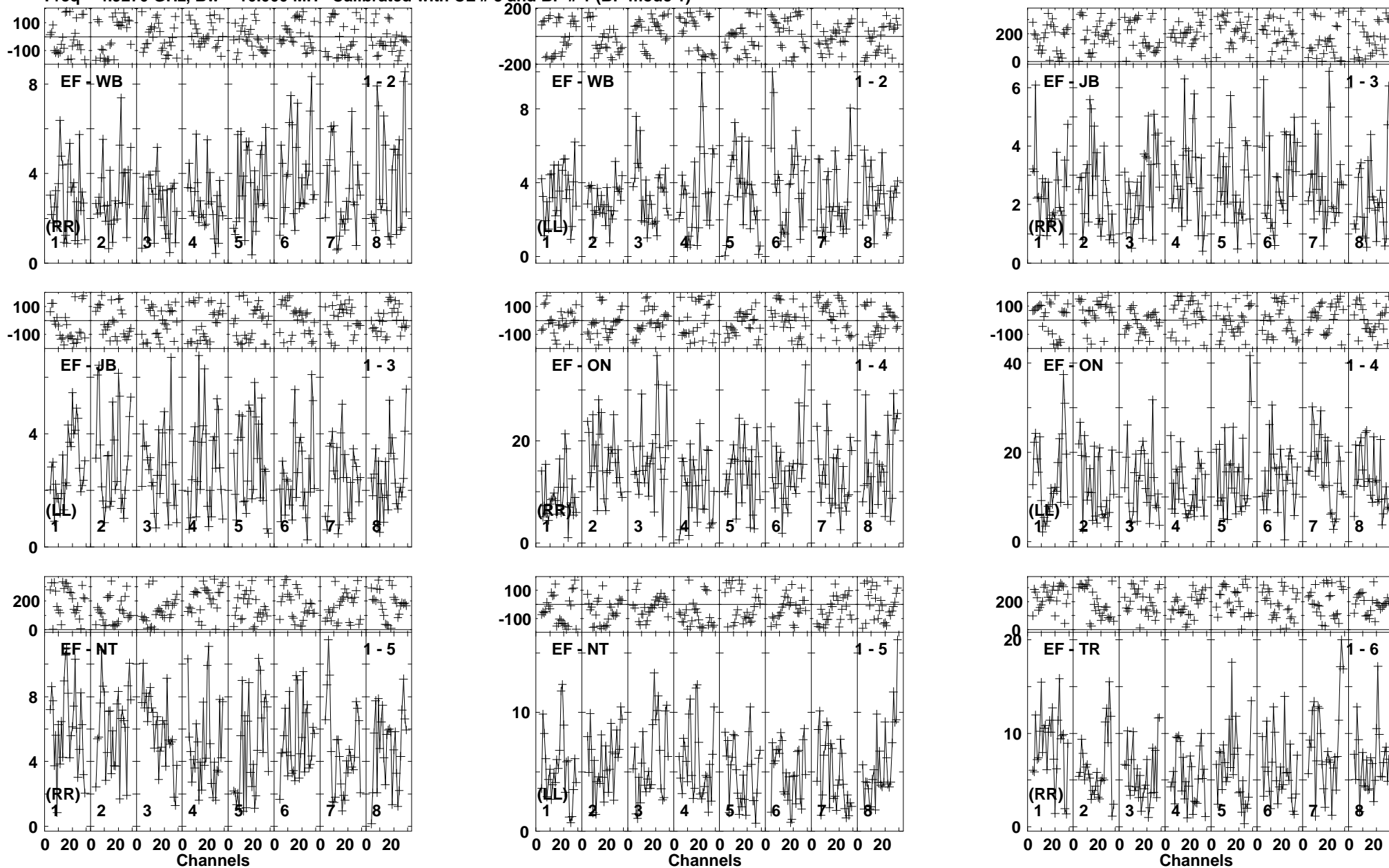

Lower frame: Milli Ampl Jy Top frame: Phas deg  
 Vector averaged cross-power spectrum Baseline: EF (01) - WB (02)  
 Timerange: 00/16:15:45 to 00/16:19:39

Plot file version 195 created 18-NOV-2014 15:23:45

ARP299C EP087H 3.UVDATA.1

Freq = 4.9270 GHz, Bw = 16.000 MH Calibrated with CL # 3 and BP # 1 (BP mode 1)

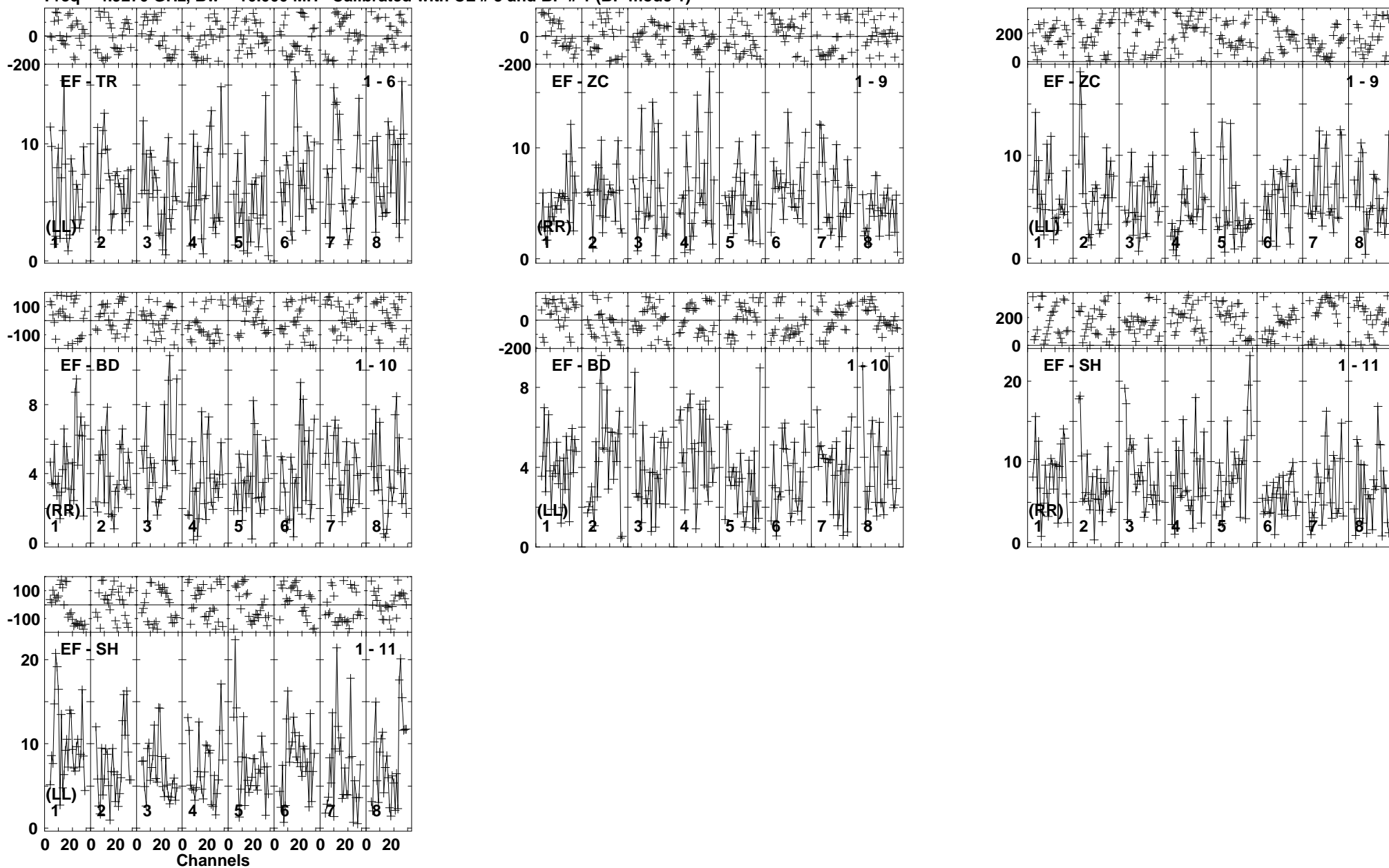

Lower frame: Milli Ampl Jy Top frame: Phas deg  
Vector averaged cross-power spectrum Baseline: EF (01) - TR (06)  
Timerange: 00/16:15:45 to 00/16:19:39

Plot file version 196 created 18-NOV-2014 15:23:45

J1128+5925 EP087H 3.UVDATA.1

Freq = 4.9270 GHz, Bw = 16.000 MH Calibrated with CL # 3 and BP # 1 (BP mode 1)

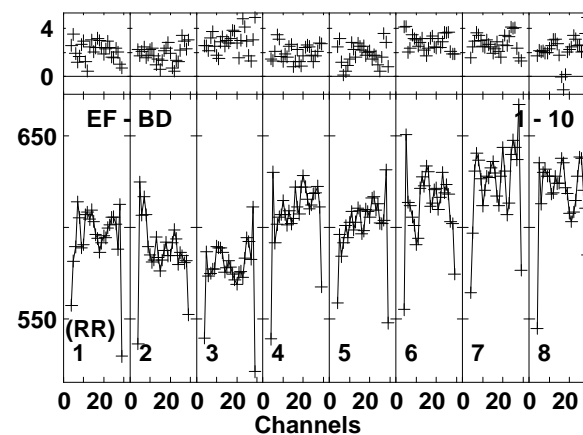
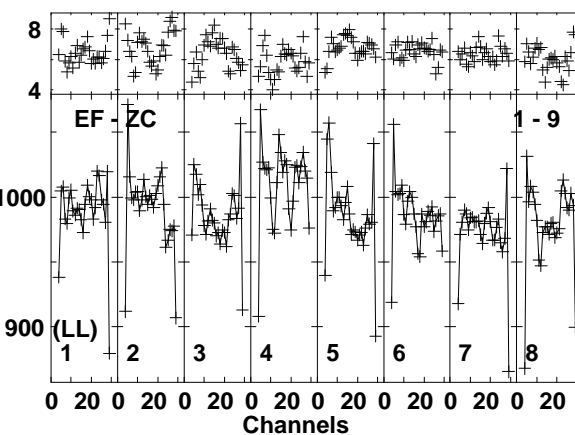
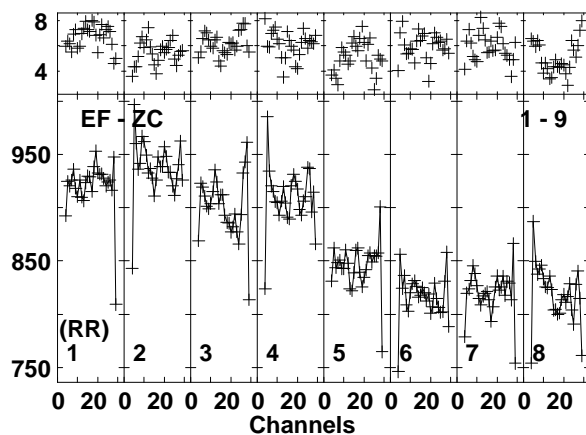
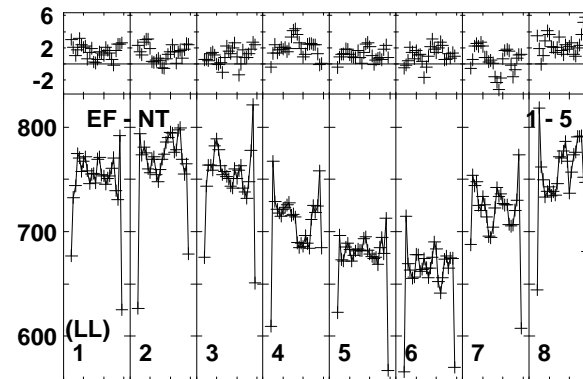
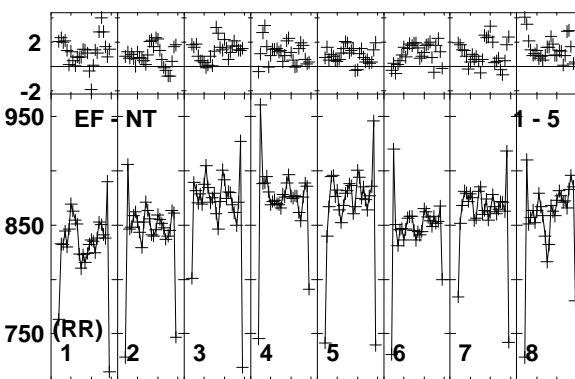
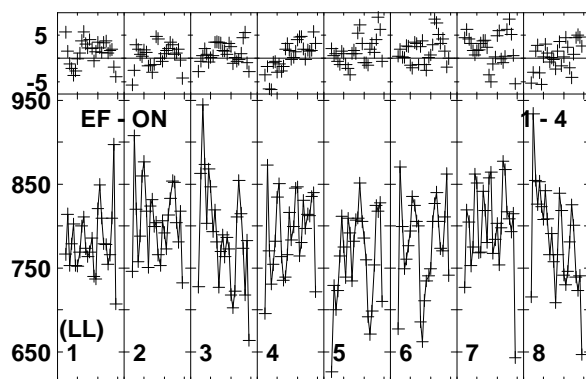
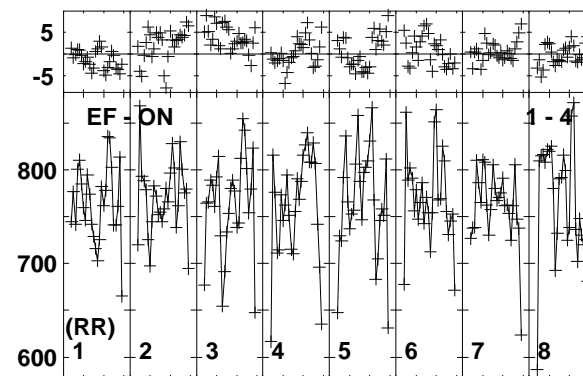
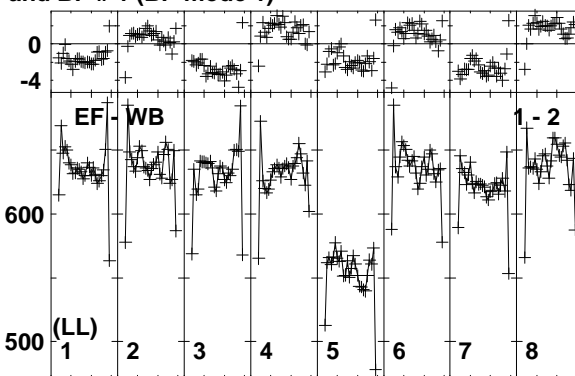
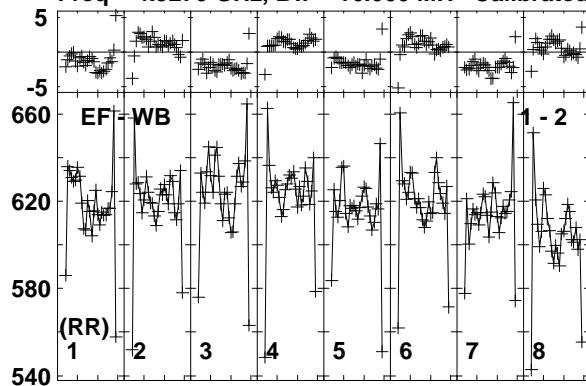

Lower frame: Milli Ampl Jy Top frame: Phas deg  
Vector averaged cross-power spectrum Baseline: EF (01) - WB (02)  
Timerange: 00/16:19:45 to 00/16:20:39

Plot file version 197 created 18-NOV-2014 15:23:45

J1128+5925 EP087H 3.UVDATA.1

Freq = 4.9270 GHz, Bw = 16.000 MH Calibrated with CL # 3 and BP # 1 (BP mode 1)

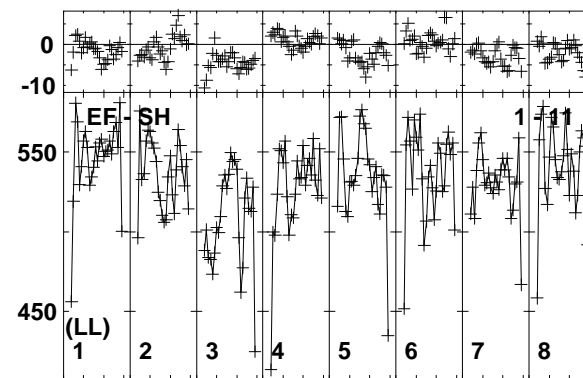
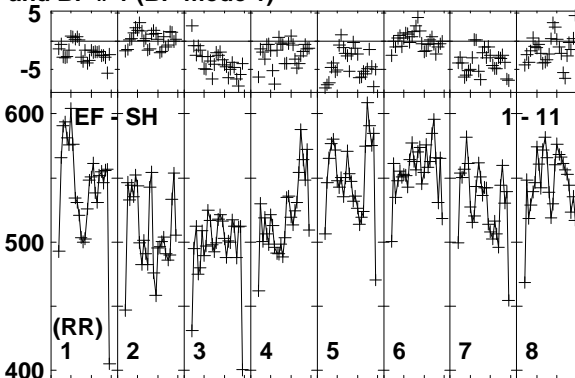
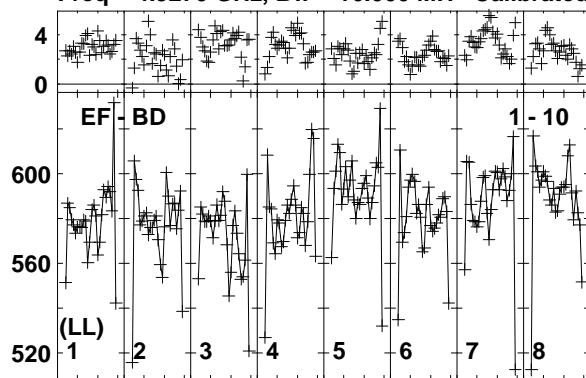

Lower frame: Milli Ampl Jy Top frame: Phas deg  
Vector averaged cross-power spectrum Baseline: EF (01) - BD (10)  
Timerange: 00/16:19:45 to 00/16:20:39

Plot file version 198 created 18-NOV-2014 15:23:46

ARP299C EP087H 3.UVDATA.1

Freq = 4.9270 GHz, Bw = 16.000 MH Calibrated with CL # 3 and BP # 1 (BP mode 1)

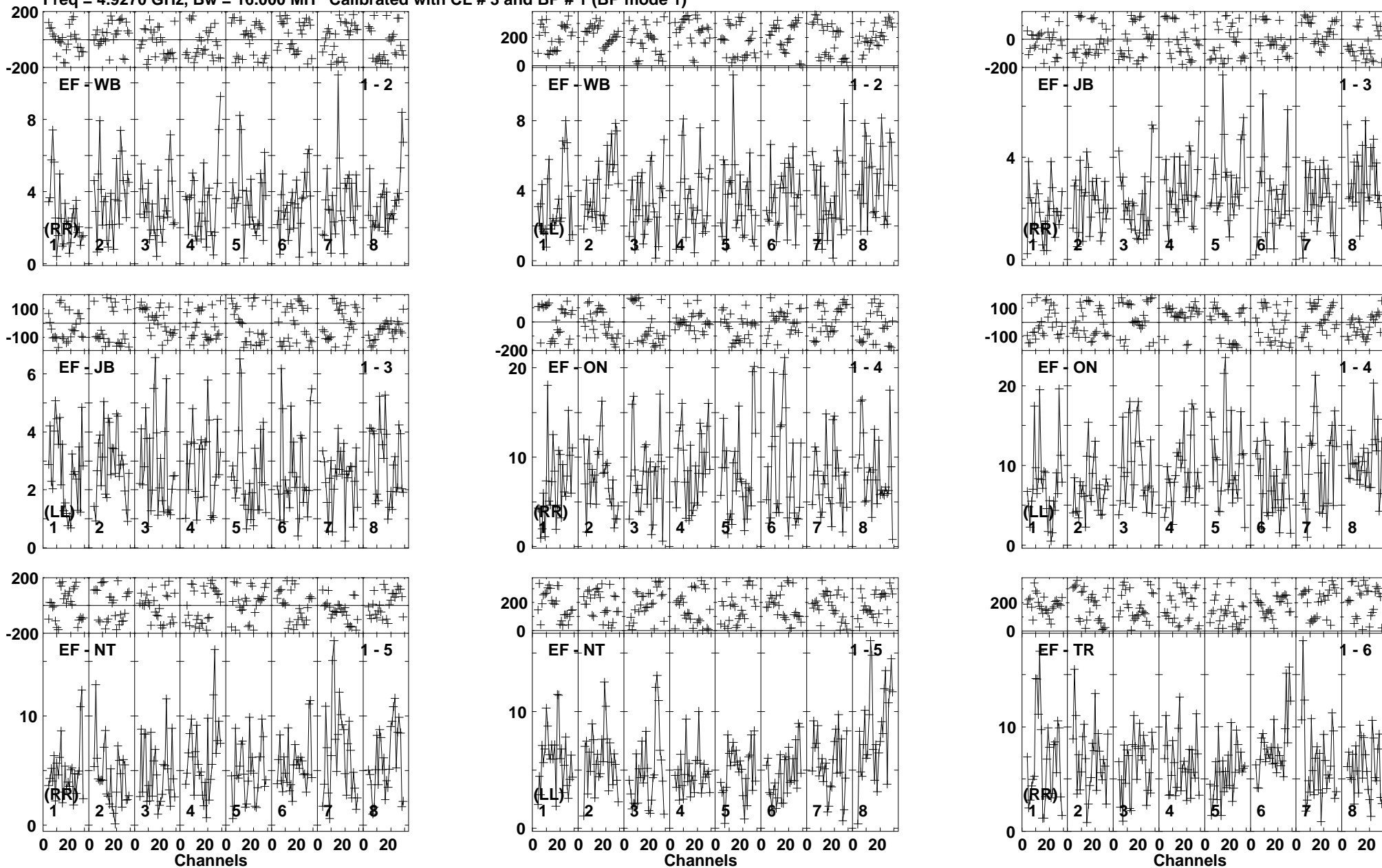

Lower frame: Milli Ampl Jy Top frame: Phas deg  
Vector averaged cross-power spectrum Baseline: EF (01) - WB (02)  
Timerange: 00/16:20:41 to 00/16:24:39

Plot file version 199 created 18-NOV-2014 15:23:46

ARP299C EP087H 3.UVDATA.1

Freq = 4.9270 GHz, Bw = 16.000 MH Calibrated with CL # 3 and BP # 1 (BP mode 1)

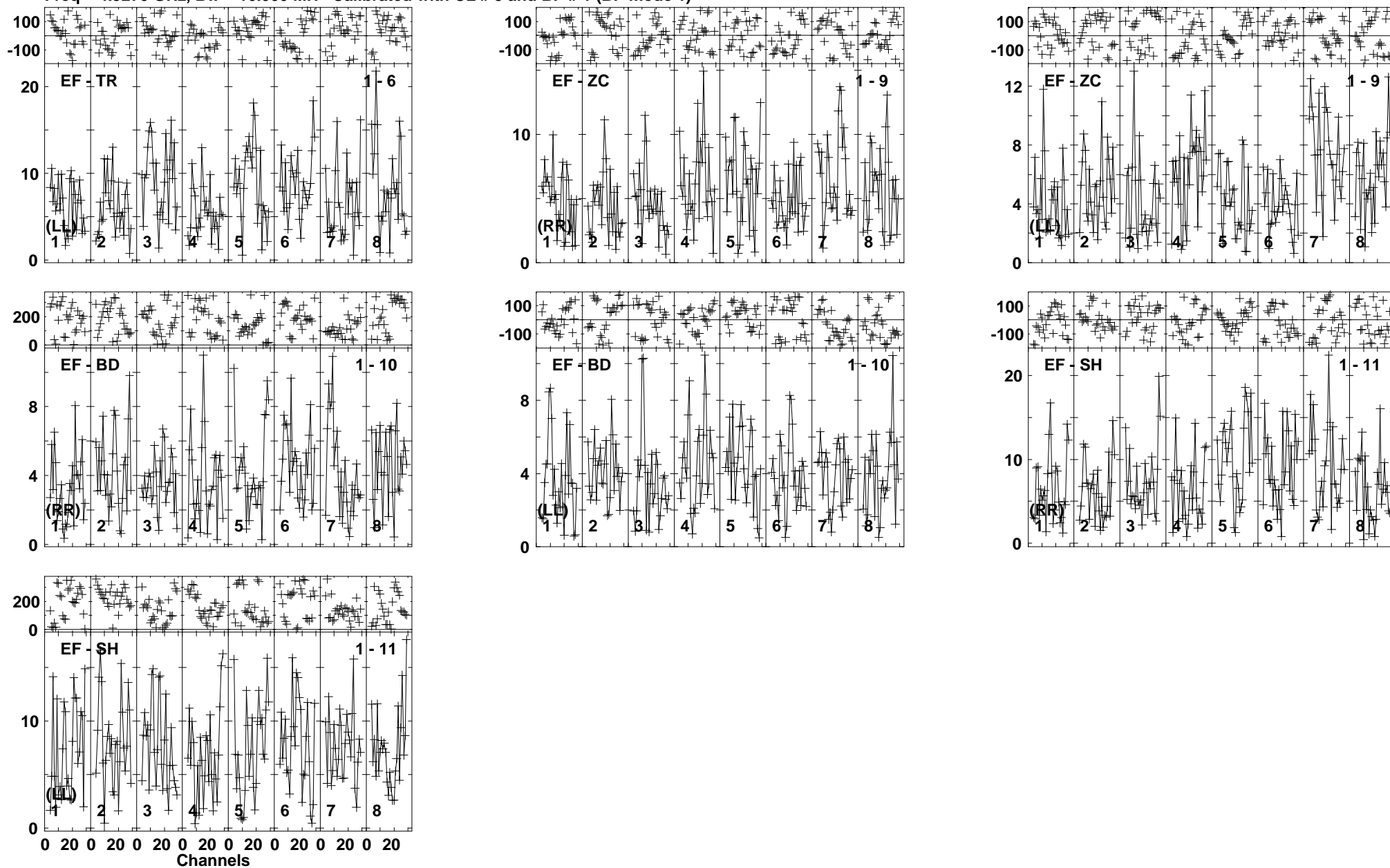

Lower frame: Milli Ampl Jy Top frame: Phas deg  
Vector averaged cross-power spectrum Baseline: EF (01) - TR (06)  
Timerange: 00/16:20:41 to 00/16:24:39

Plot file version 200 created 18-NOV-2014 15:23:46

J1128+5925 EP087H 3.UVDATA.1

Freq = 4.9270 GHz, Bw = 16.000 MH Calibrated with CL # 3 and BP # 1 (BP mode 1)

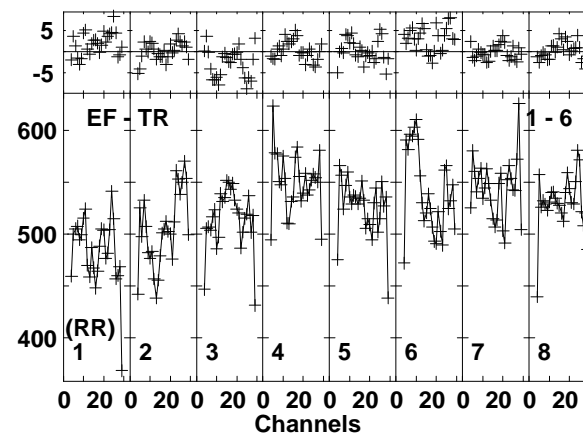
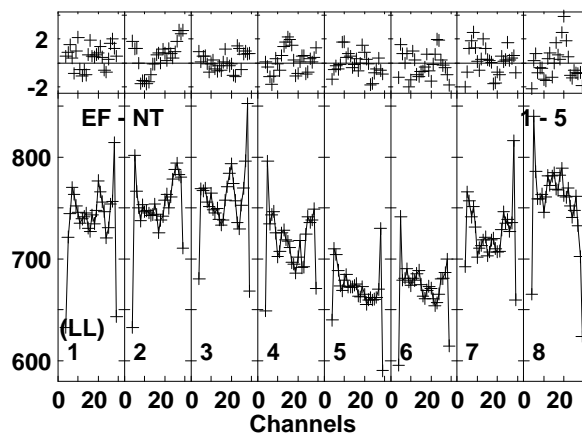
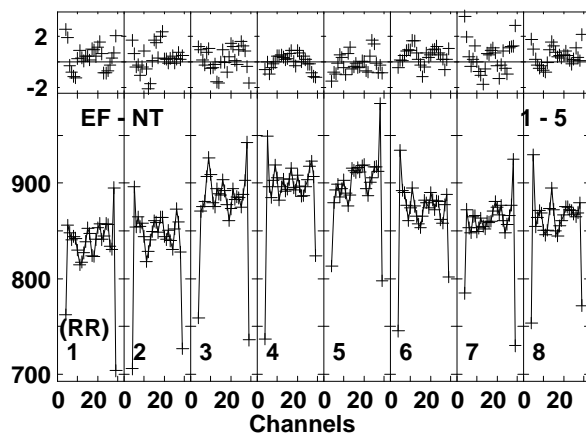
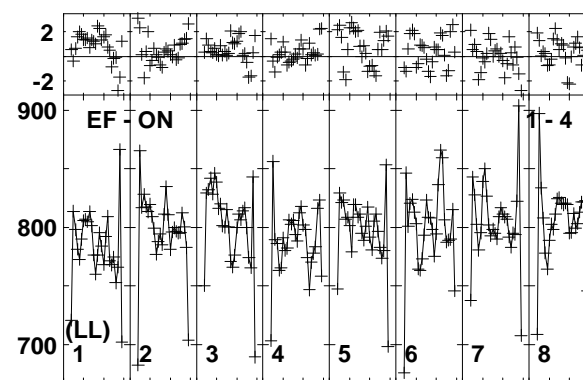
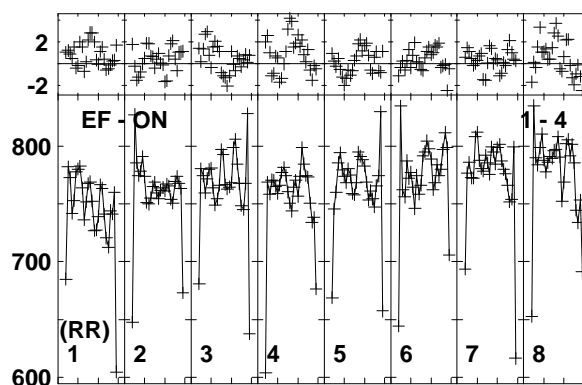
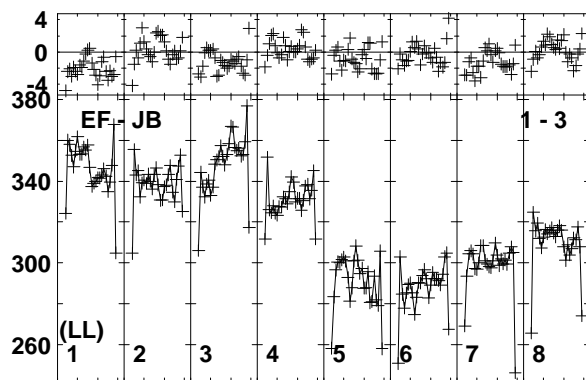
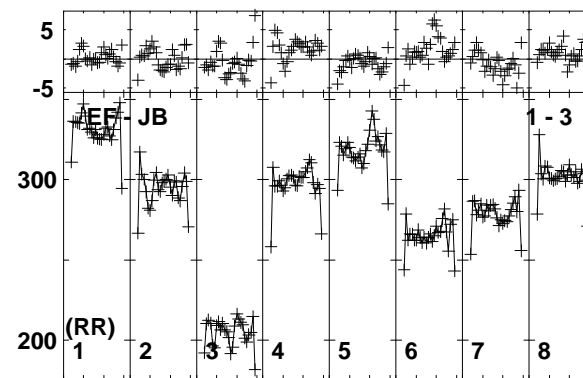
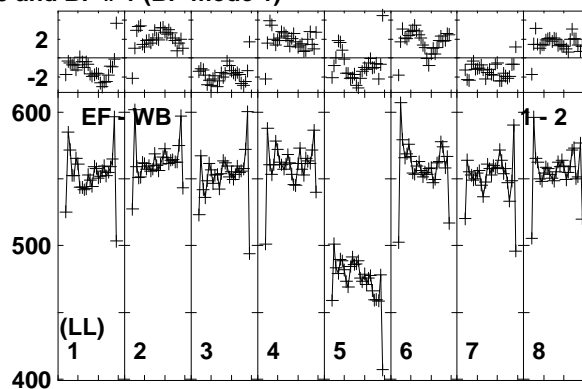
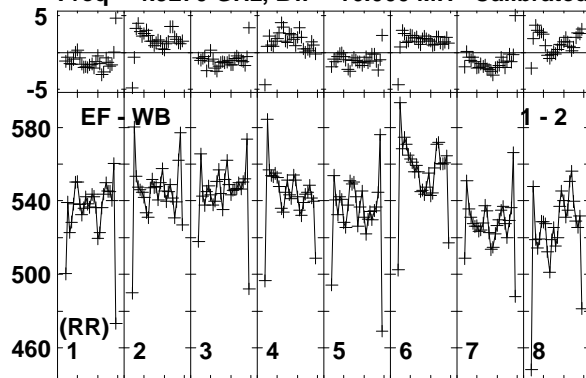

Lower frame: Milli Ampl Jy Top frame: Phas deg  
Vector averaged cross-power spectrum Baseline: EF (01) - WB (02)  
Timerange: 00/16:25:23 to 00/16:25:49



Plot file version 201 created 18-NOV-2014 15:23:46

J1128+5925 EP087H 3.UVDATA.1

Freq = 4.9270 GHz, Bw = 16.000 MH Calibrated with CL # 3 and BP # 1 (BP mode 1)

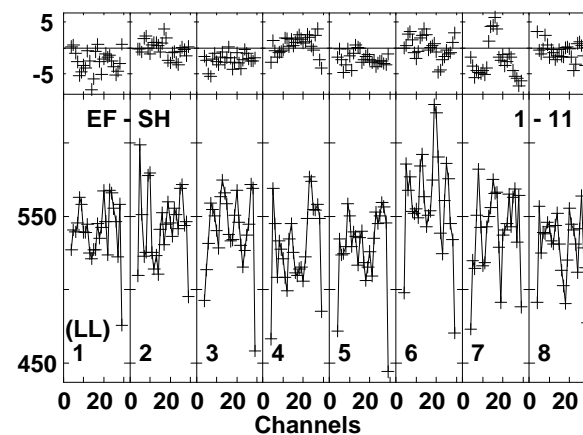
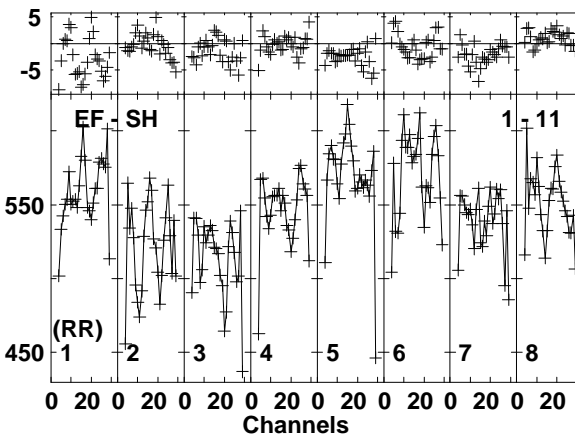
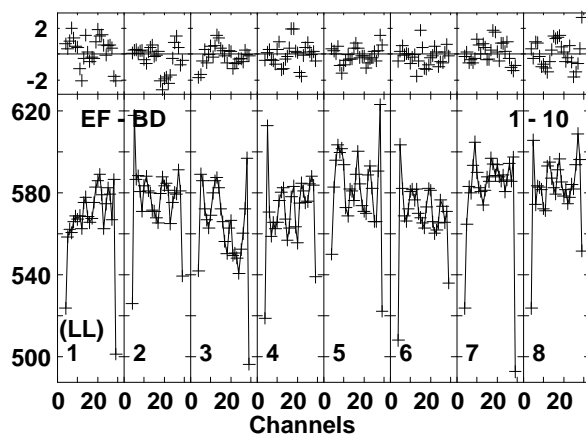
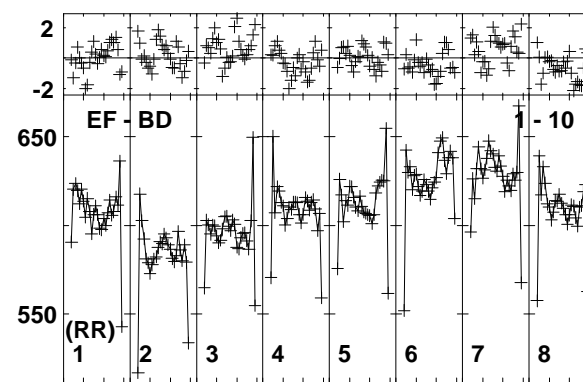
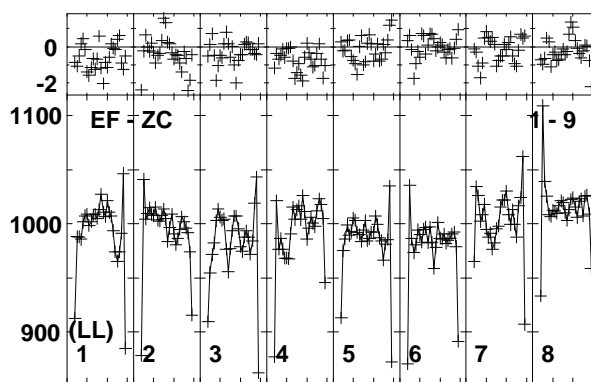
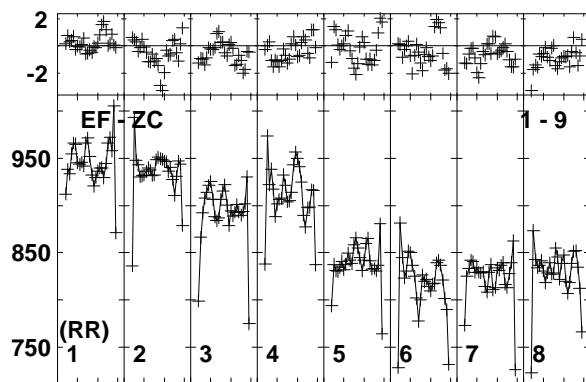
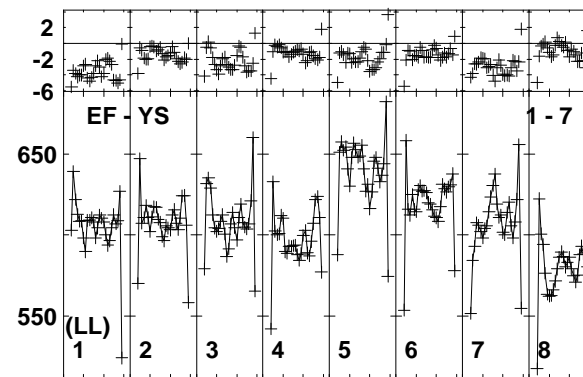
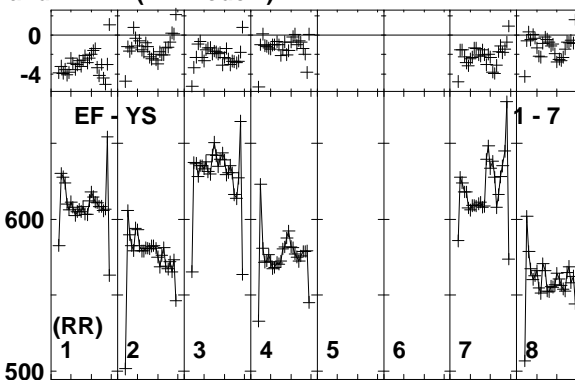
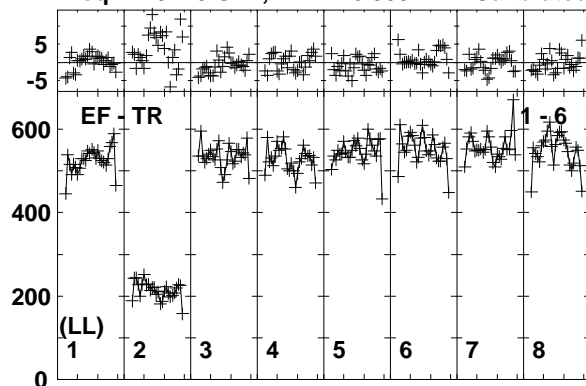

Lower frame: Milli Ampl Jy Top frame: Phas deg  
Vector averaged cross-power spectrum Baseline: EF (01) - TR (06)  
Timerange: 00/16:25:23 to 00/16:25:49

Plot file version 202 created 18-NOV-2014 15:23:46

ARP299C EP087H 3.UVDATA.1

Freq = 4.9270 GHz, Bw = 16.000 MH Calibrated with CL # 3 and BP # 1 (BP mode 1)

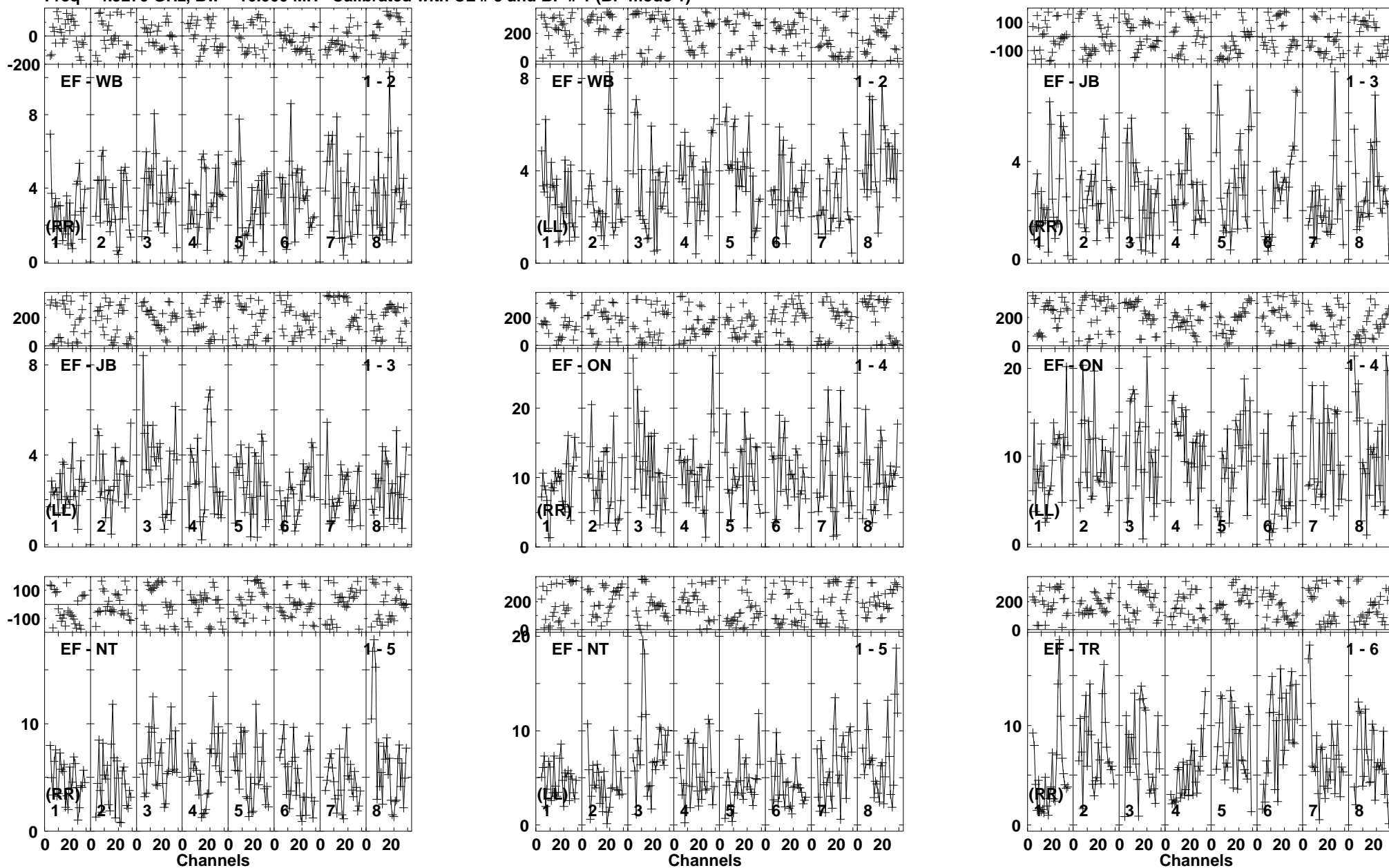

Lower frame: Milli Ampl Jy Top frame: Phas deg  
Vector averaged cross-power spectrum Baseline: EF (01) - WB (02)  
Timerange: 00/16:25:55 to 00/16:29:49

Plot file version 203 created 18-NOV-2014 15:23:47  
 ARP299C EP087H 3.UVDATA.1  
 Freq = 4.9270 GHz, Bw = 16.000 MH Calibrated with CL # 3 and BP # 1 (BP mode 1)

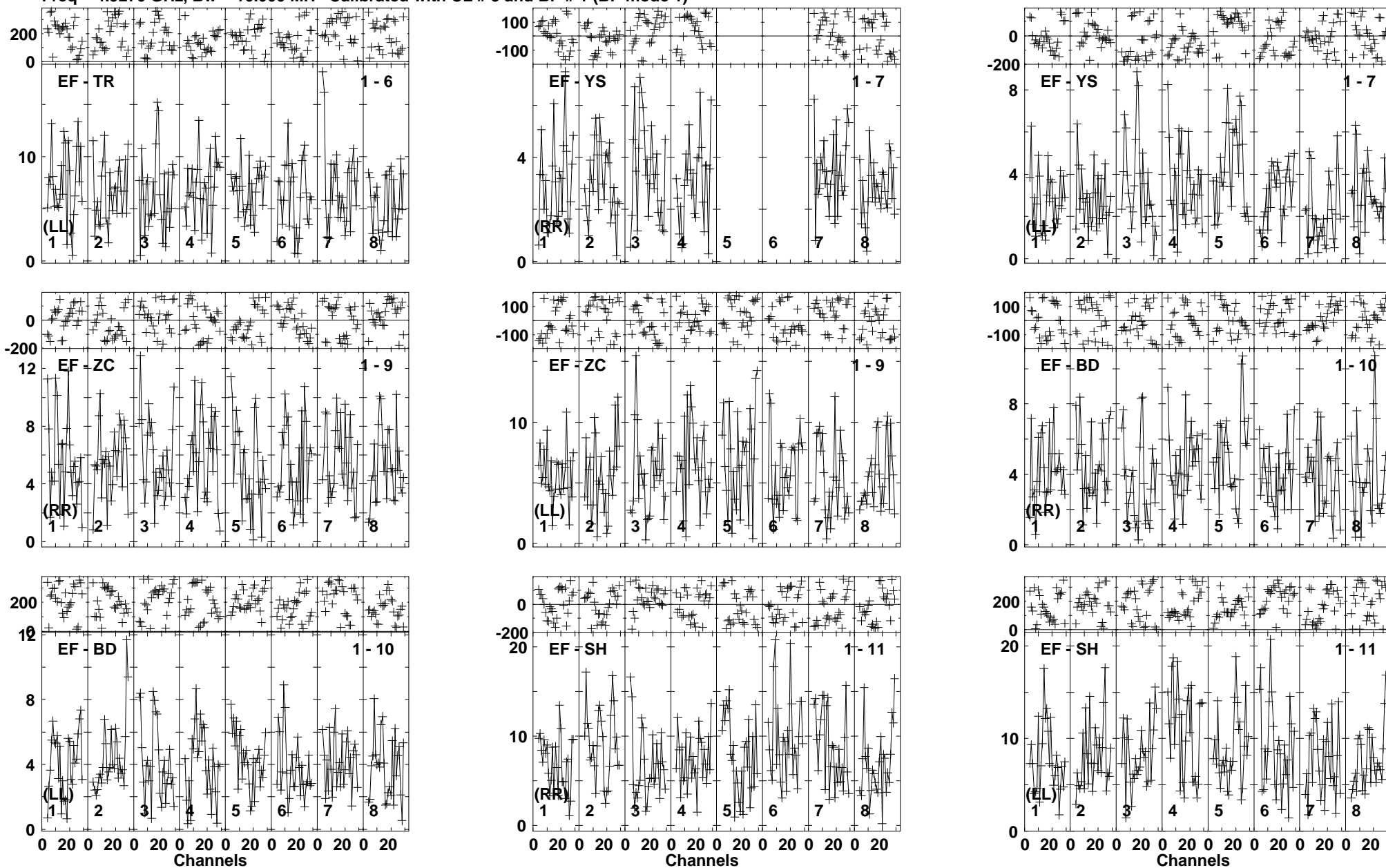

Lower frame: Milli Ampl Jy Top frame: Phas deg  
 Vector averaged cross-spectrum Baseline: EF (01) - TR (06)  
 Timerange: 00/16:25:55 to 00/16:29:49

Plot file version 204 created 18-NOV-2014 15:23:47

J1128+5925 EP087H 3.UVDATA.1

Freq = 4.9270 GHz, Bw = 16.000 MH Calibrated with CL # 3 and BP # 1 (BP mode 1)

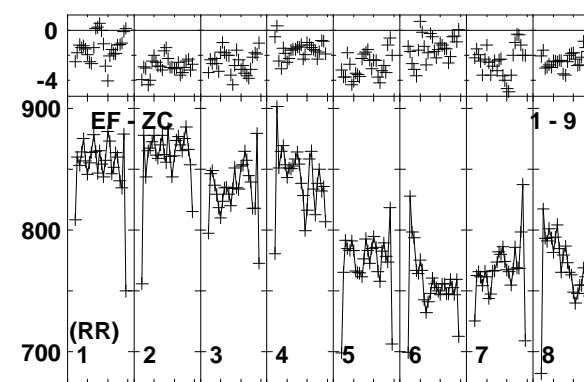
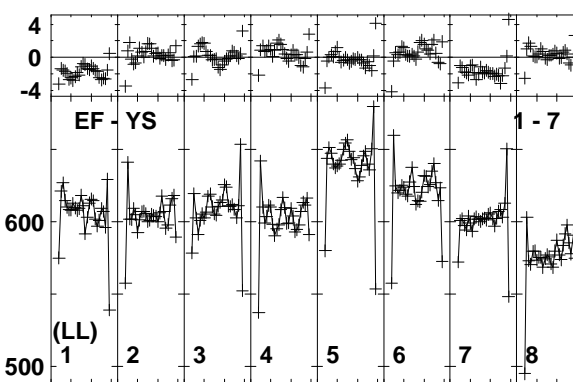
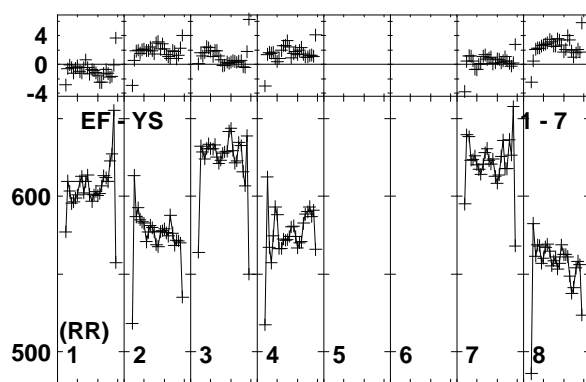
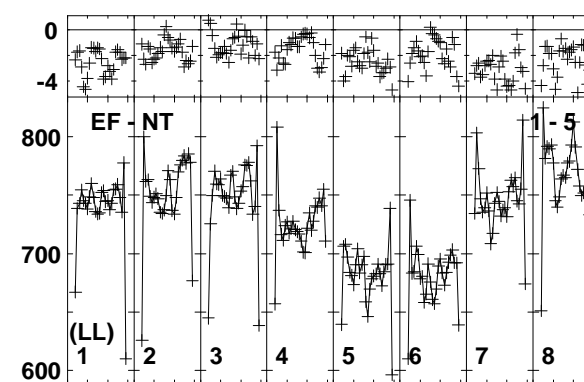
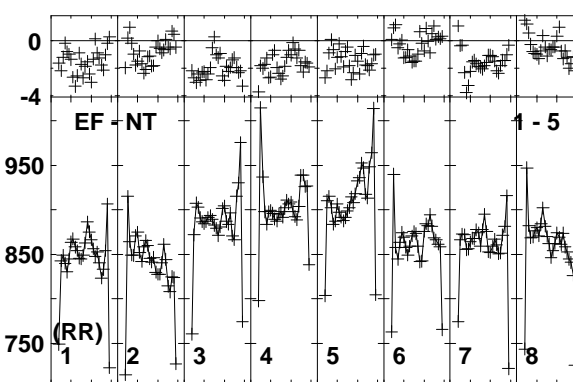
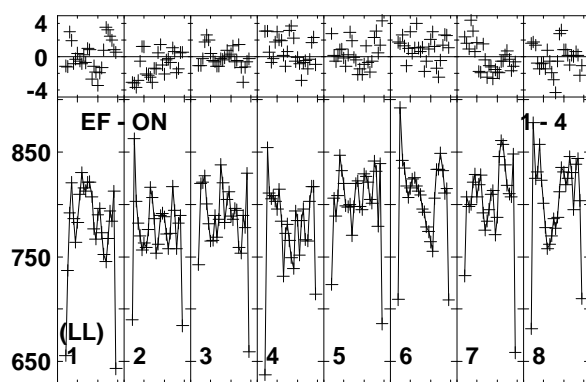
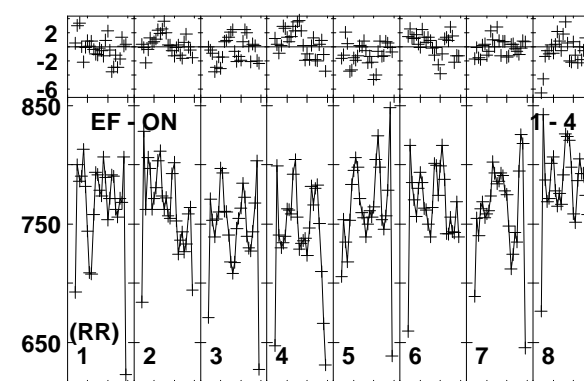
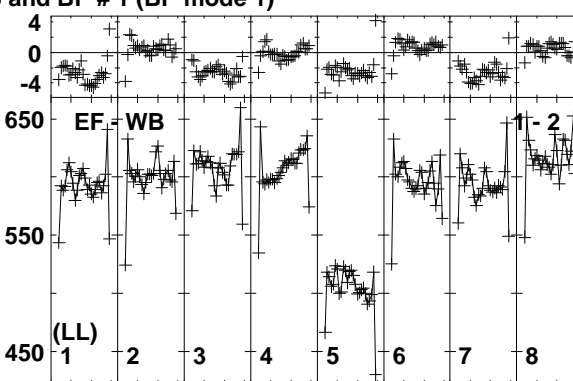
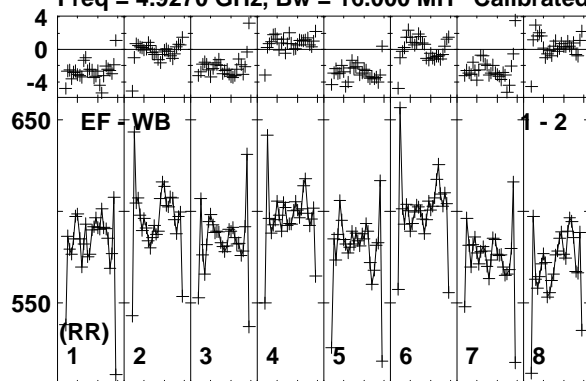

Lower frame: Milli Ampl Jy Top frame: Phas deg  
Vector averaged cross-power spectrum Baseline: EF (01) - WB (02)  
Timerange: 00/16:29:55 to 00/16:30:49

Plot file version 205 created 18-NOV-2014 15:23:47

J1128+5925 EP087H 3.UVDATA.1

Freq = 4.9270 GHz, Bw = 16.000 MH Calibrated with CL # 3 and BP # 1 (BP mode 1)

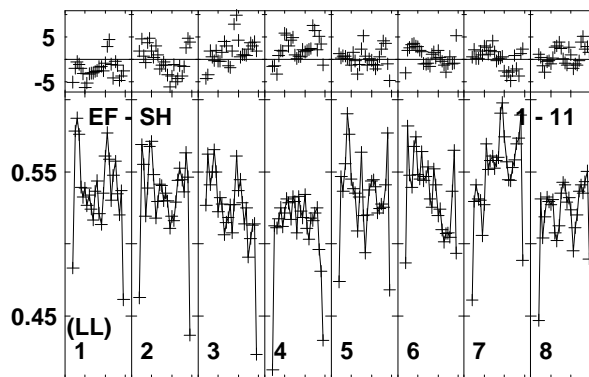
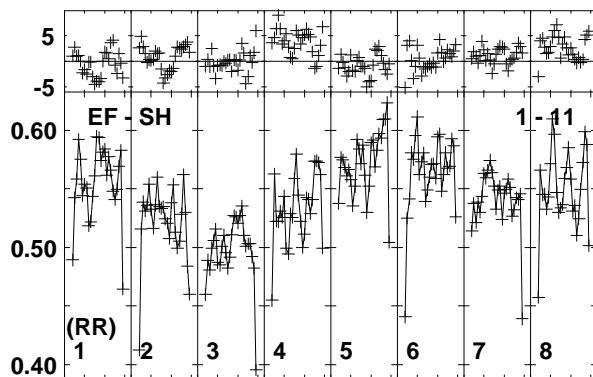
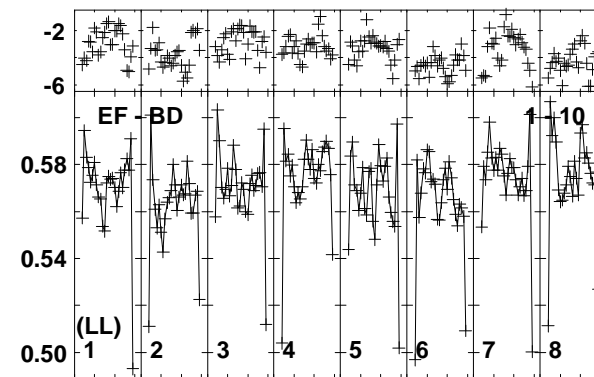
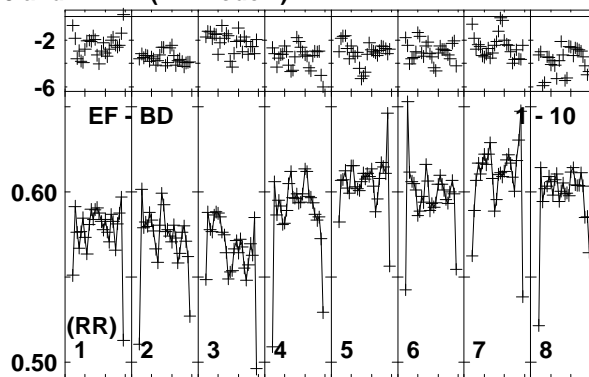
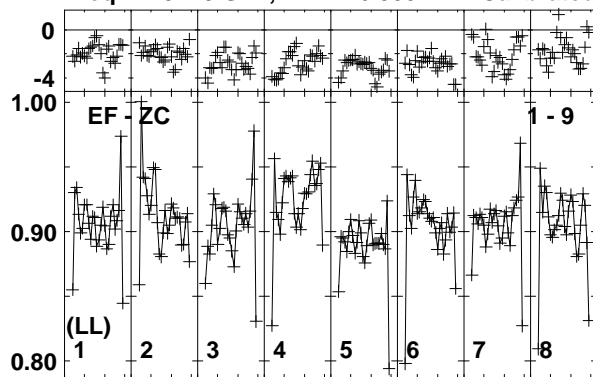

Lower frame: Ampl Jy Top frame: Phas deg  
Vector averaged cross-power spectrum Baseline: EF (01) - ZC (09)  
Timerange: 00/16:29:55 to 00/16:30:49

Plot file version 206 created 18-NOV-2014 15:23:47

ARP299C EP087H 3.UVDATA.1

Freq = 4.9270 GHz, Bw = 16.000 MH Calibrated with CL # 3 and BP # 1 (BP mode 1)

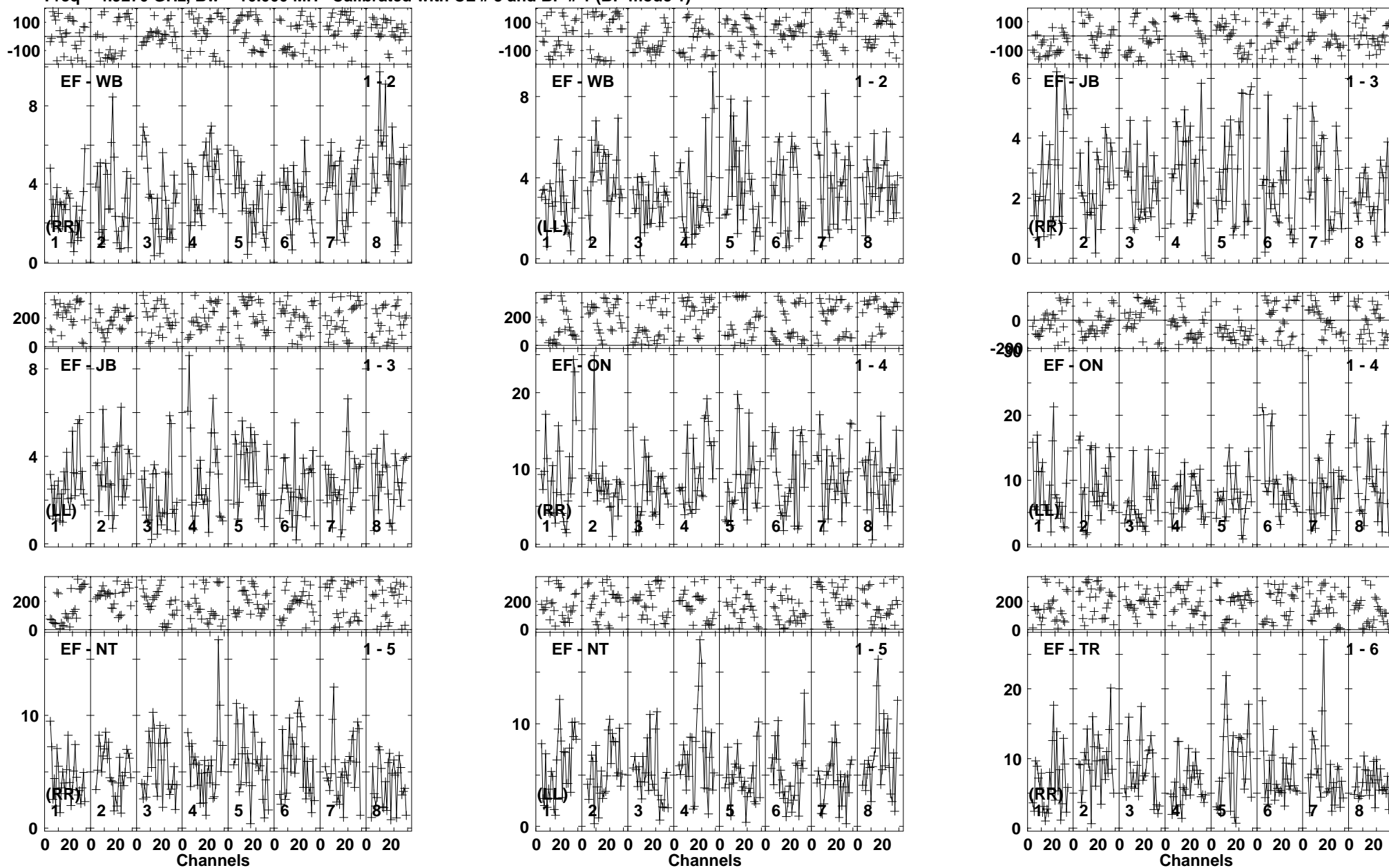

Lower frame: Milli Ampl Jy Top frame: Phas deg  
Vector averaged cross-power spectrum Baseline: EF (01) - WB (02)  
Timerange: 00/16:30:51 to 00/16:34:49

Plot file version 207 created 18-NOV-2014 15:23:48

ARP299C EP087H 3.UVDATA.1

Freq = 4.9270 GHz, Bw = 16.000 MH Calibrated with CL # 3 and BP # 1 (BP mode 1)

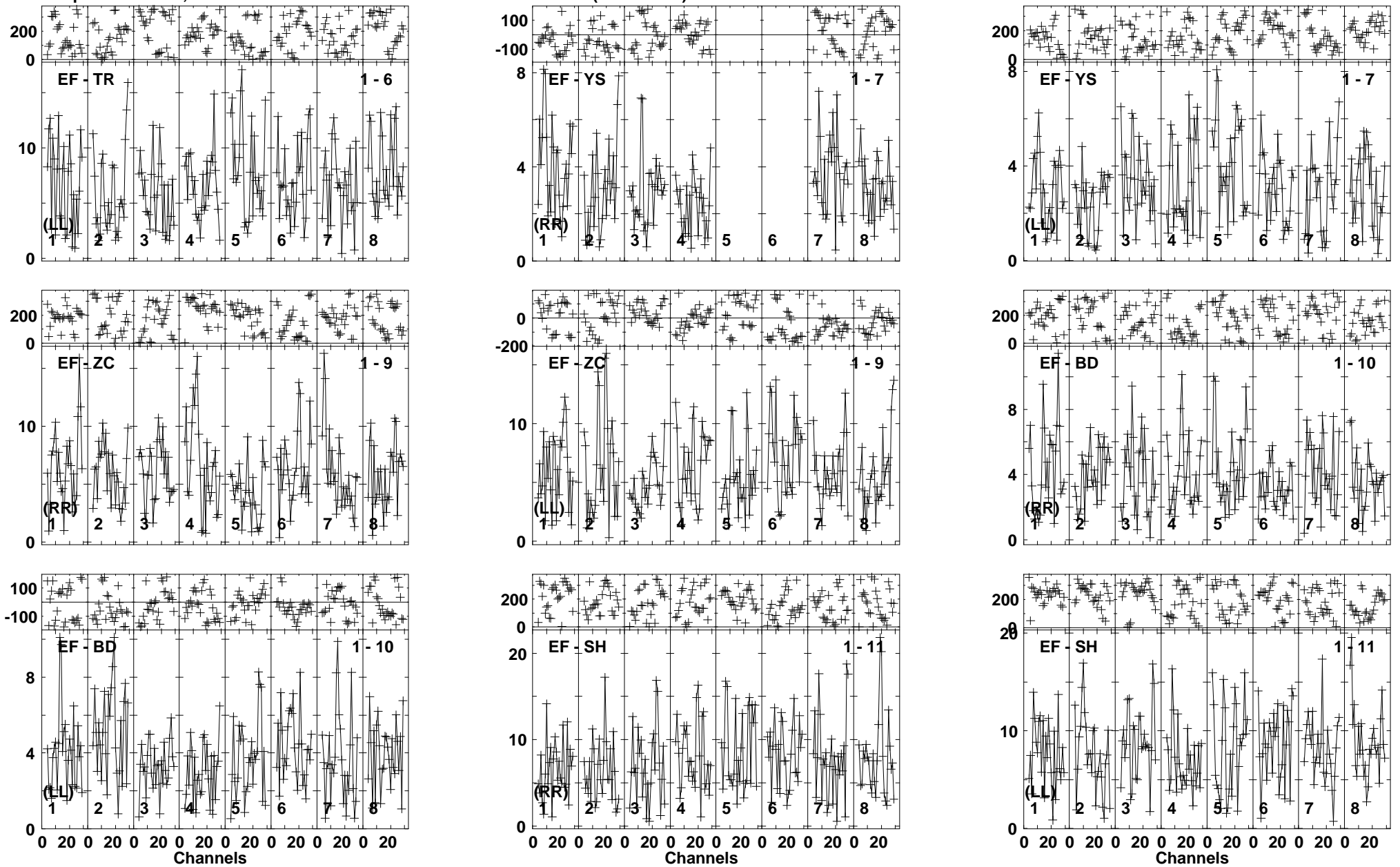

Lower frame: Milli Ampl Jy Top frame: Phas deg  
Vector averaged cross-power spectrum Baseline: EF (01) - TR (06)  
Timerange: 00/16:30:51 to 00/16:34:49

Plot file version 208 created 18-NOV-2014 15:23:48

J1128+5925 EP087H 3.UVDATA.1

Freq = 4.9270 GHz, Bw = 16.000 MH Calibrated with CL # 3 and BP # 1 (BP mode 1)

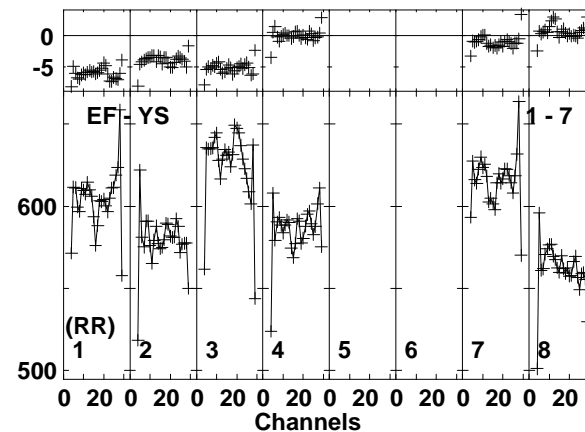
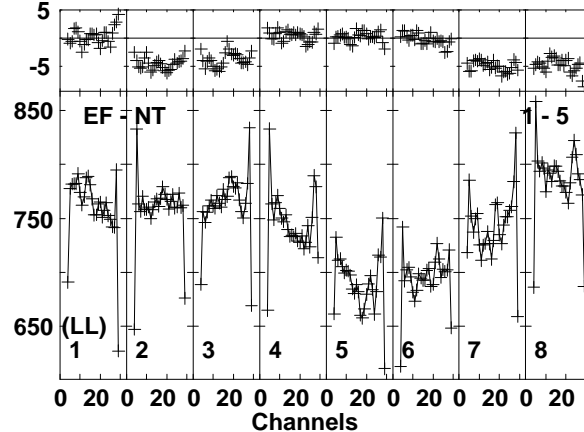
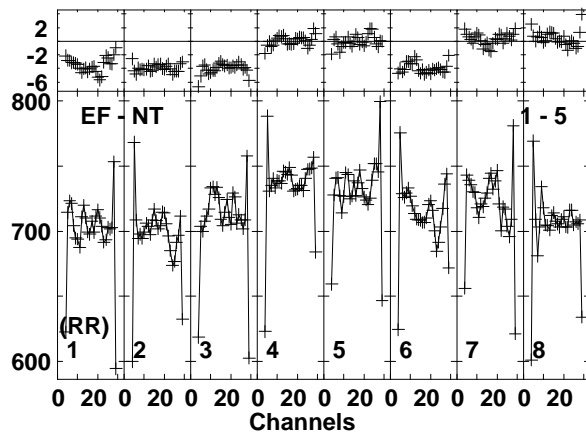
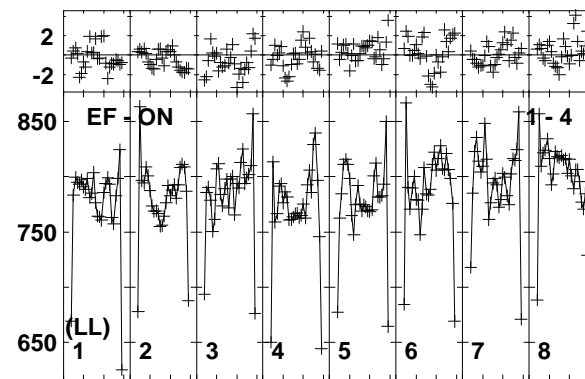
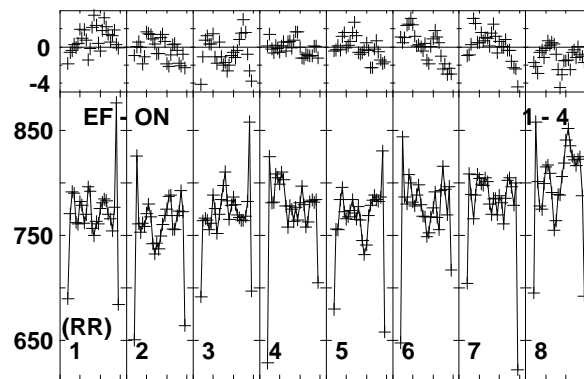
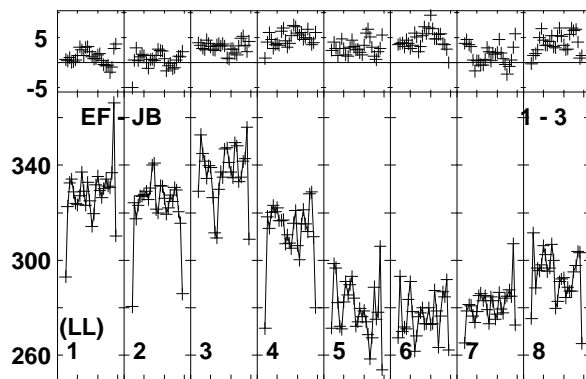
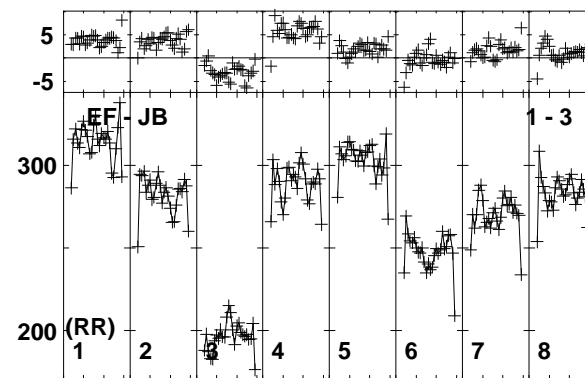
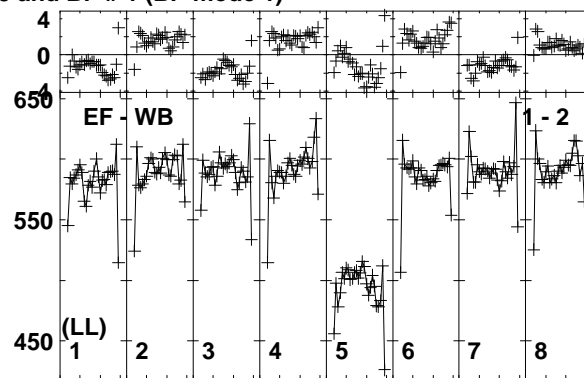
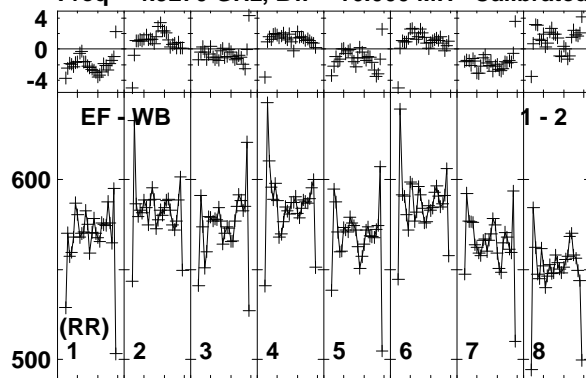

Lower frame: Milli Ampl Jy Top frame: Phas deg  
Vector averaged cross-power spectrum Baseline: EF (01) - WB (02)  
Timerange: 00/16:34:55 to 00/16:35:49



Plot file version 209 created 18-NOV-2014 15:23:48

J1128+5925 EP087H 3.UVDATA.1

Freq = 4.9270 GHz, Bw = 16.000 MH Calibrated with CL # 3 and BP # 1 (BP mode 1)

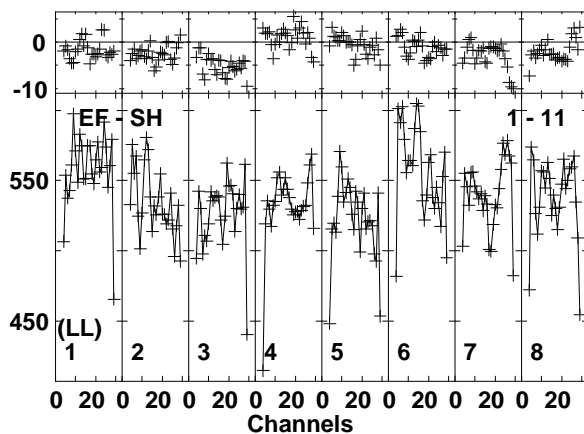
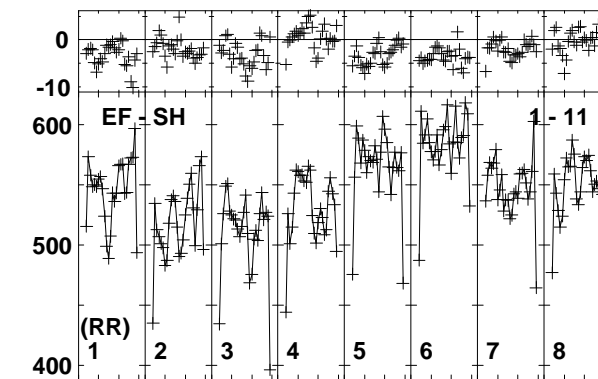
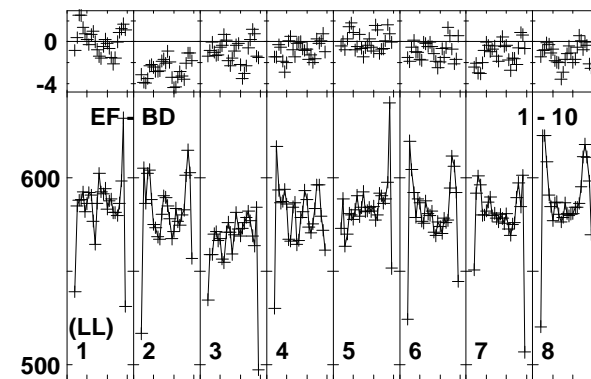
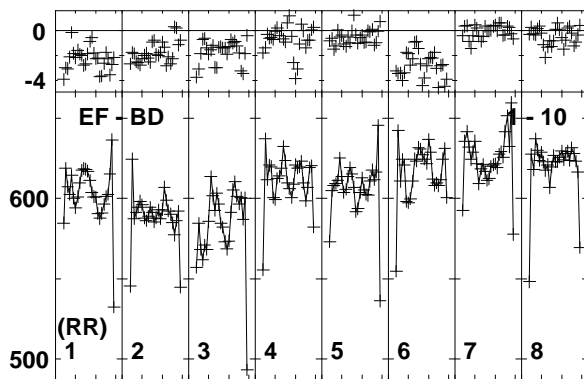
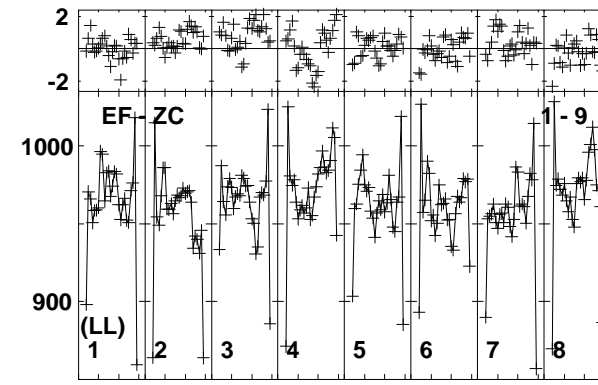
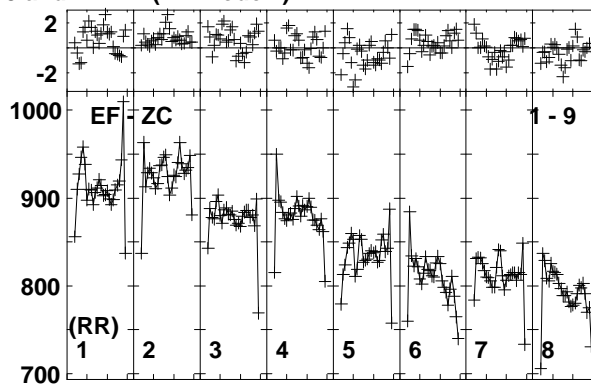
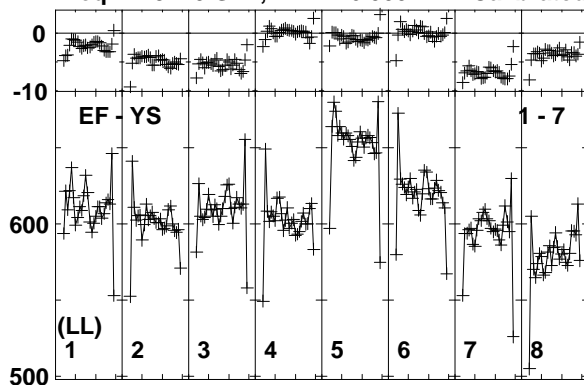

Lower frame: Milli Ampl Jy Top frame: Phas deg  
Vector averaged cross-power spectrum Baseline: EF (01) - YS (07)  
Timerange: 00/16:34:55 to 00/16:35:49

Plot file version 210 created 18-NOV-2014 15:23:49  
 ARP299C EP087H 3.UVDATA.1  
 Freq = 4.9270 GHz, Bw = 16.000 MH Calibrated with CL # 3 and BP # 1 (BP mode 1)

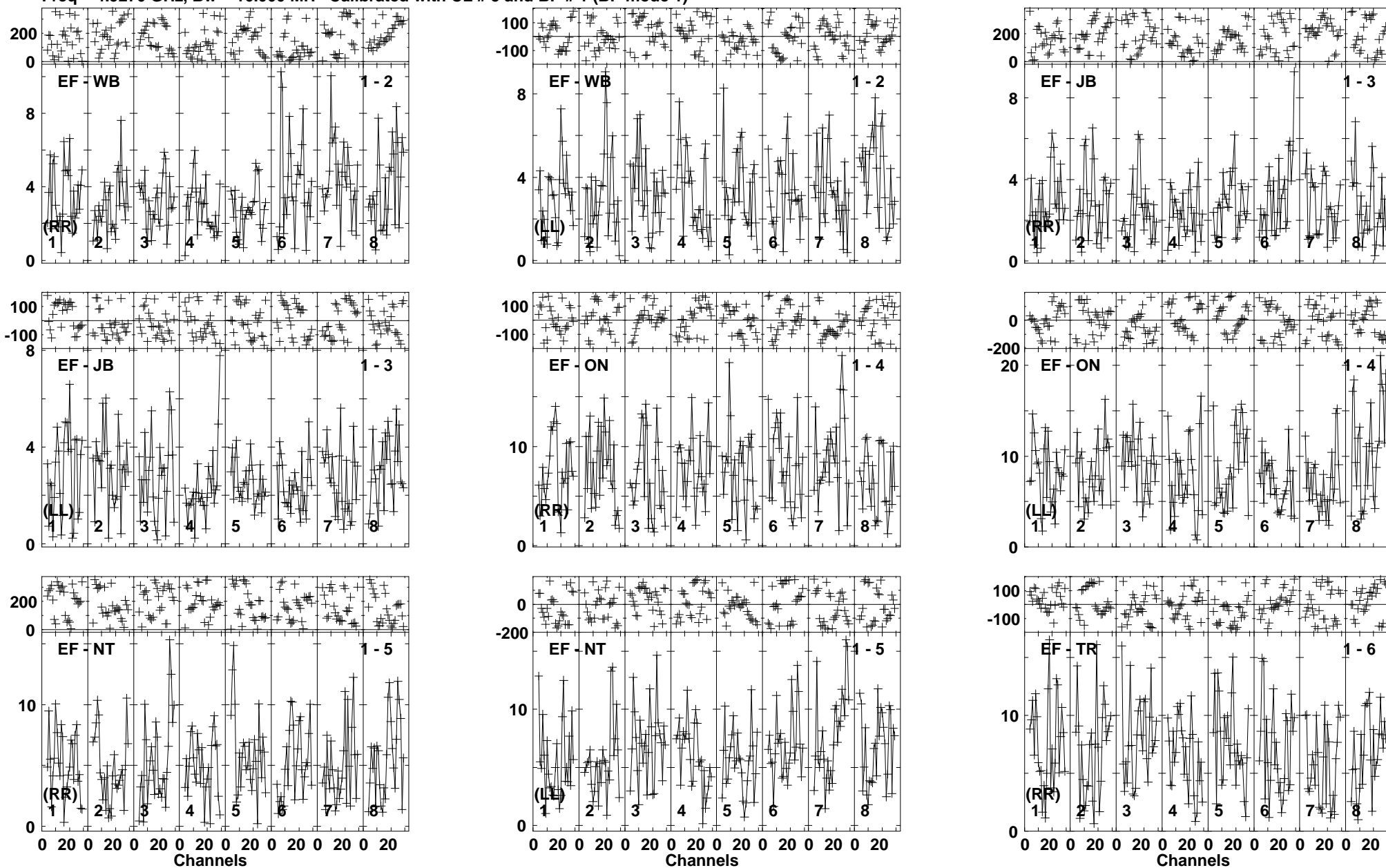

Lower frame: Milli Ampl Jy Top frame: Phas deg  
 Vector averaged cross-power spectrum Baseline: EF (01) - WB (02)  
 Timerange: 00/16:35:55 to 00/16:39:49

Plot file version 211 created 18-NOV-2014 15:23:49

ARP299C EP087H 3.UVDATA.1

Freq = 4.9270 GHz, Bw = 16.000 MH Calibrated with CL # 3 and BP # 1 (BP mode 1)

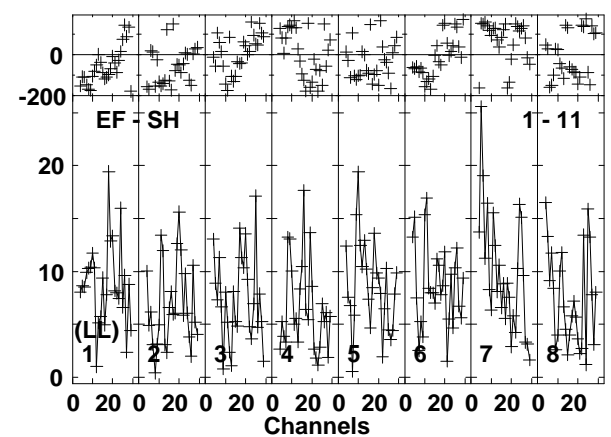
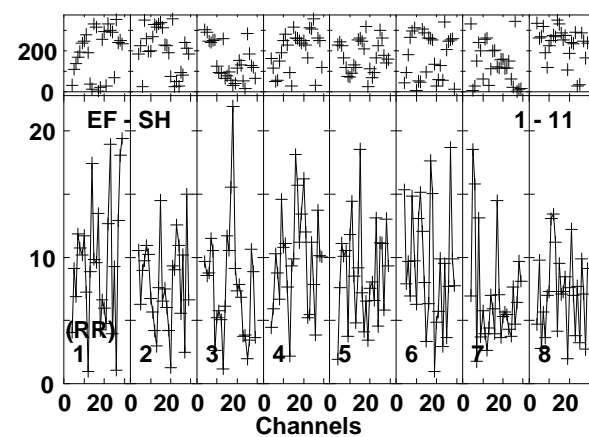
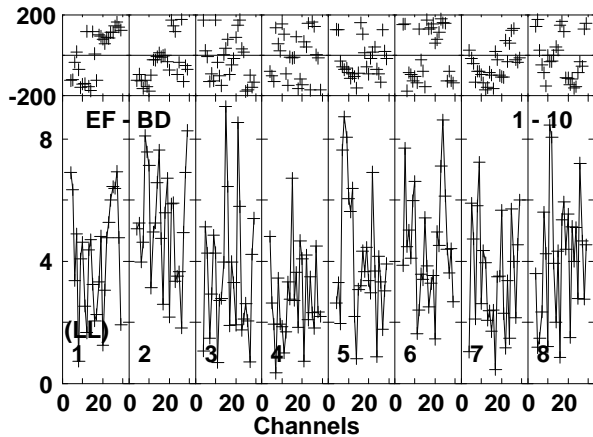
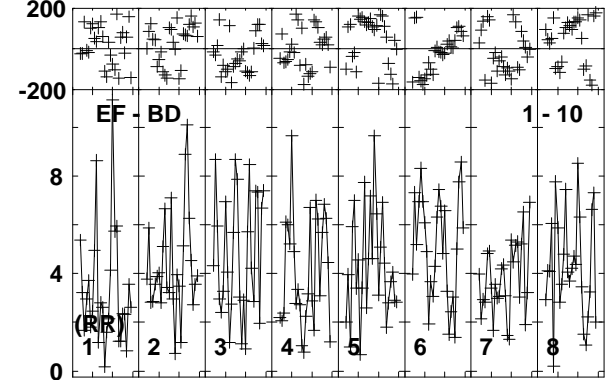
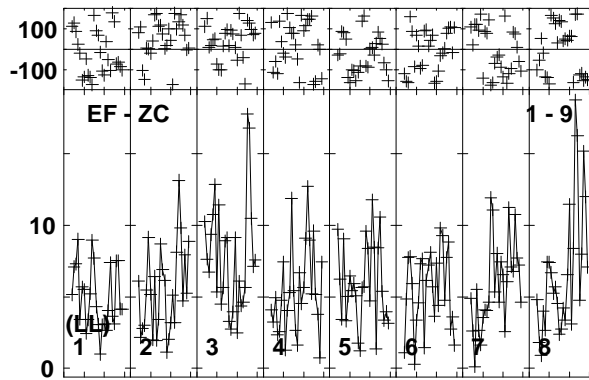
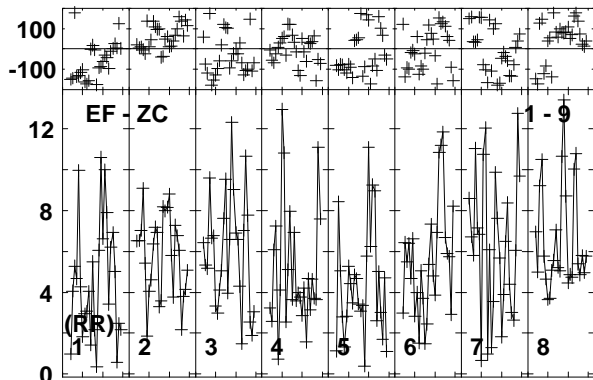
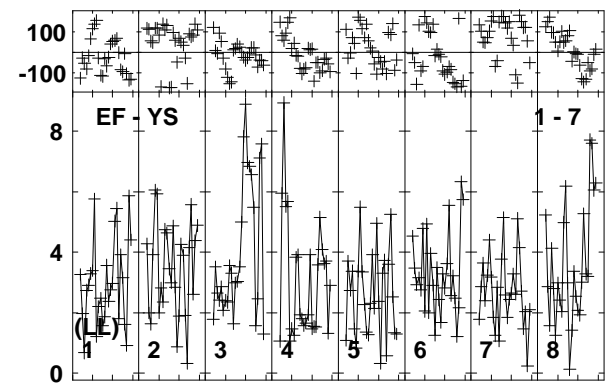
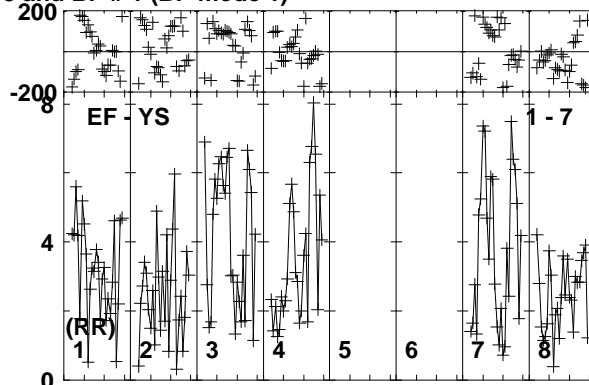
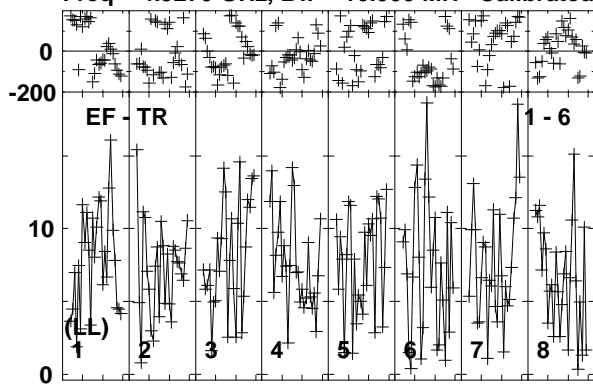

Lower frame: Milli Ampl Jy Top frame: Phas deg  
Vector averaged cross-power spectrum Baseline: EF (01) - TR (06)  
Timerange: 00/16:35:55 to 00/16:39:49

Plot file version 212 created 18-NOV-2014 15:23:49

J1128+5925 EP087H 3.UVDATA.1

Freq = 4.9270 GHz, Bw = 16.000 MH Calibrated with CL # 3 and BP # 1 (BP mode 1)

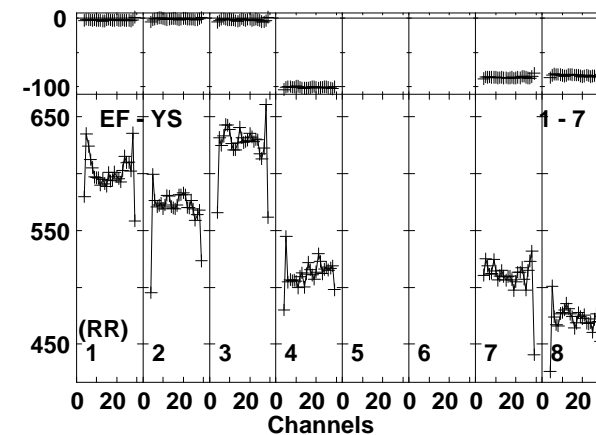
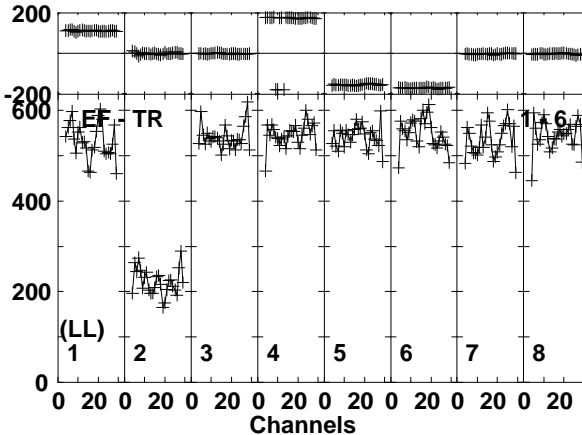
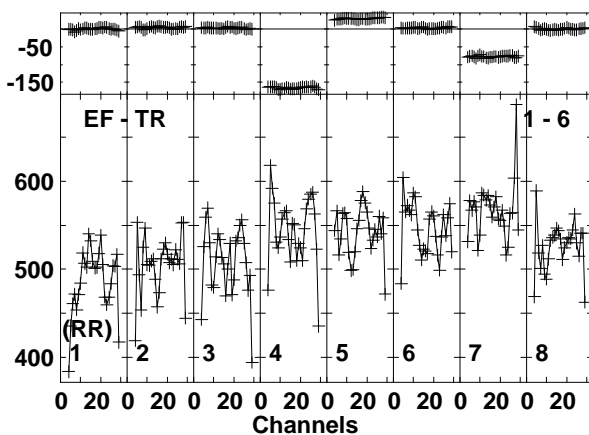
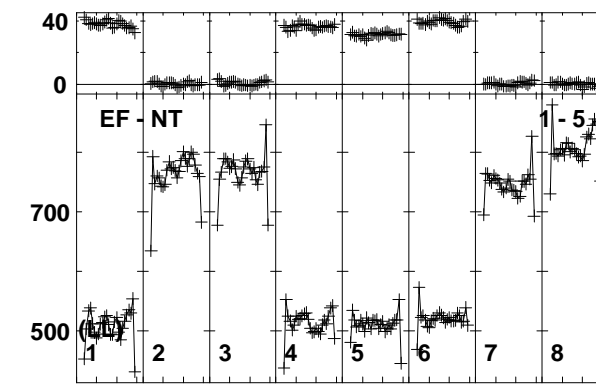
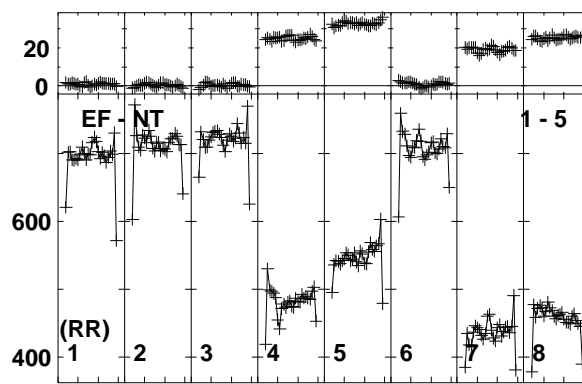
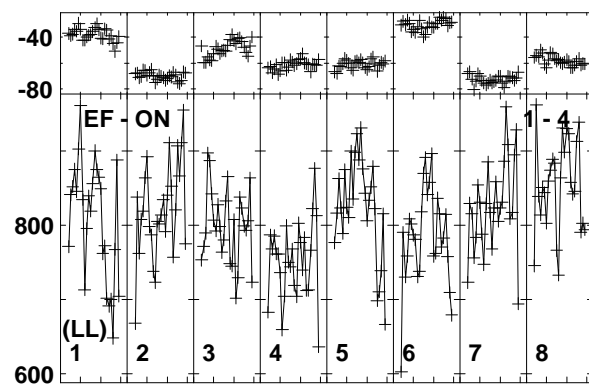
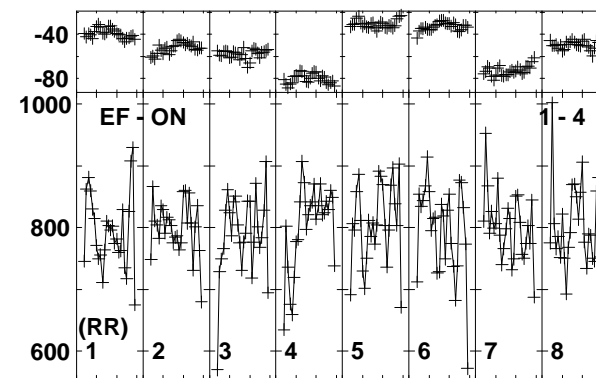
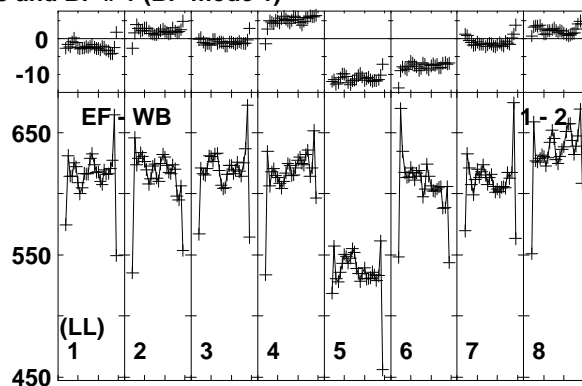
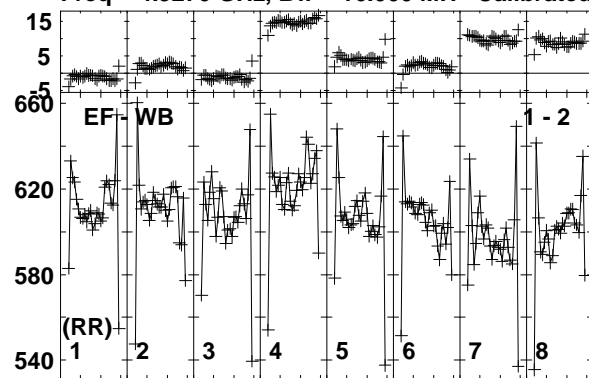

Lower frame: Milli Ampl Jy Top frame: Phas deg  
Vector averaged cross-power spectrum Baseline: EF (01) - WB (02)  
Timerange: 00/16:40:33 to 00/16:40:59

Plot file version 213 created 18-NOV-2014 15:23:49

J1128+5925 EP087H 3.UVDATA.1

Freq = 4.9270 GHz, Bw = 16.000 MH Calibrated with CL # 3 and BP # 1 (BP mode 1)

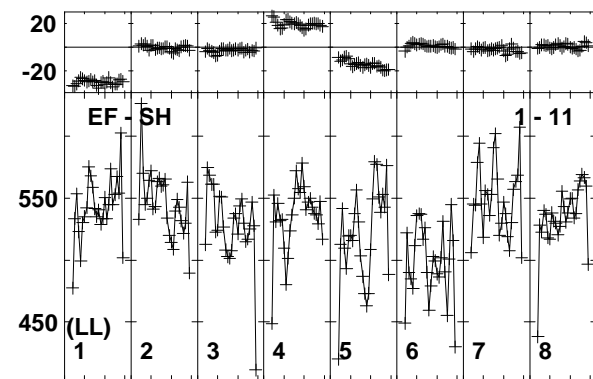
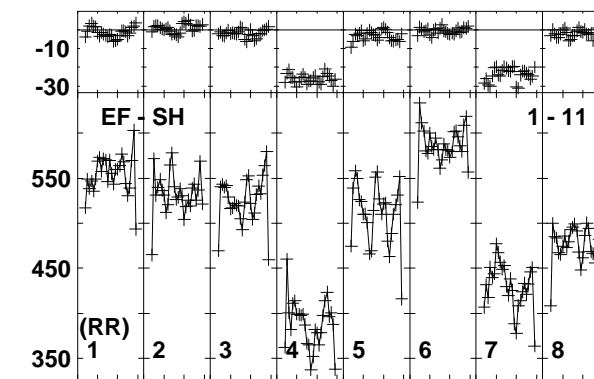
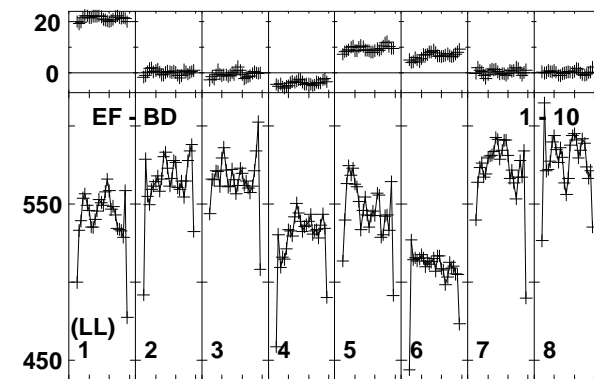
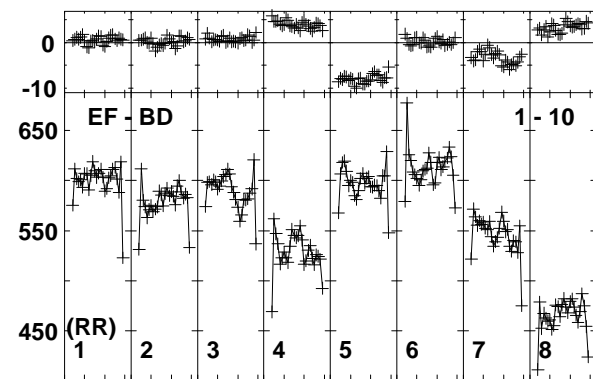
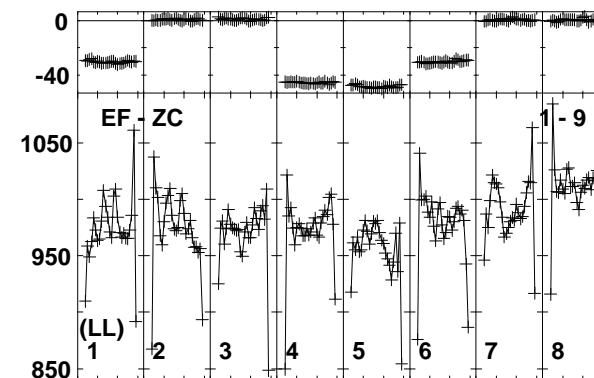
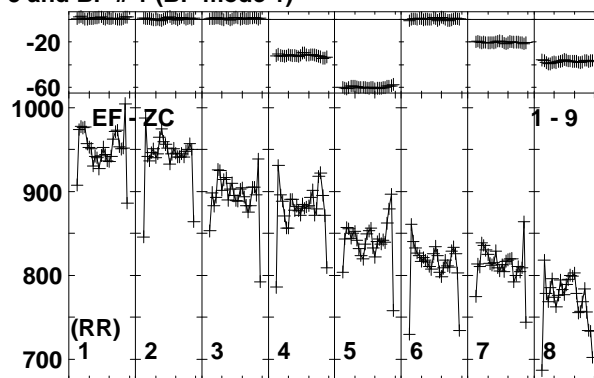
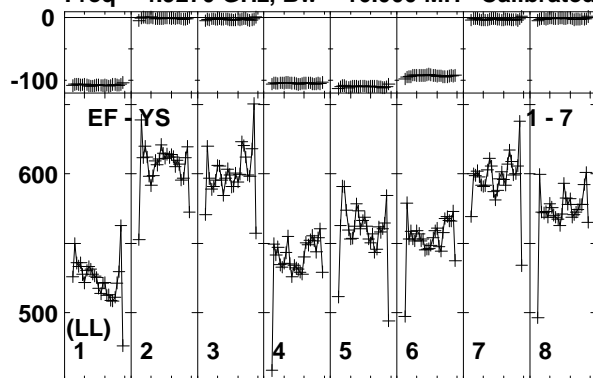

0 20 0 20 0 20 0 20 0 20 0 20 0 20 0 20 0 20 0 20 0 20 0 20

Lower frame: Milli Ampl Jy Top frame: Phas deg  
Vector averaged cross-power spectrum Baseline: EF (01) - YS (07)  
Timerange: 00/16:40:33 to 00/16:40:59

Plot file version 214 created 18-NOV-2014 15:23:50  
 ARP299C EP087H 3.UVDATA.1  
 Freq = 4.9270 GHz, Bw = 16.000 MH Calibrated with CL # 3 and BP # 1 (BP mode 1)

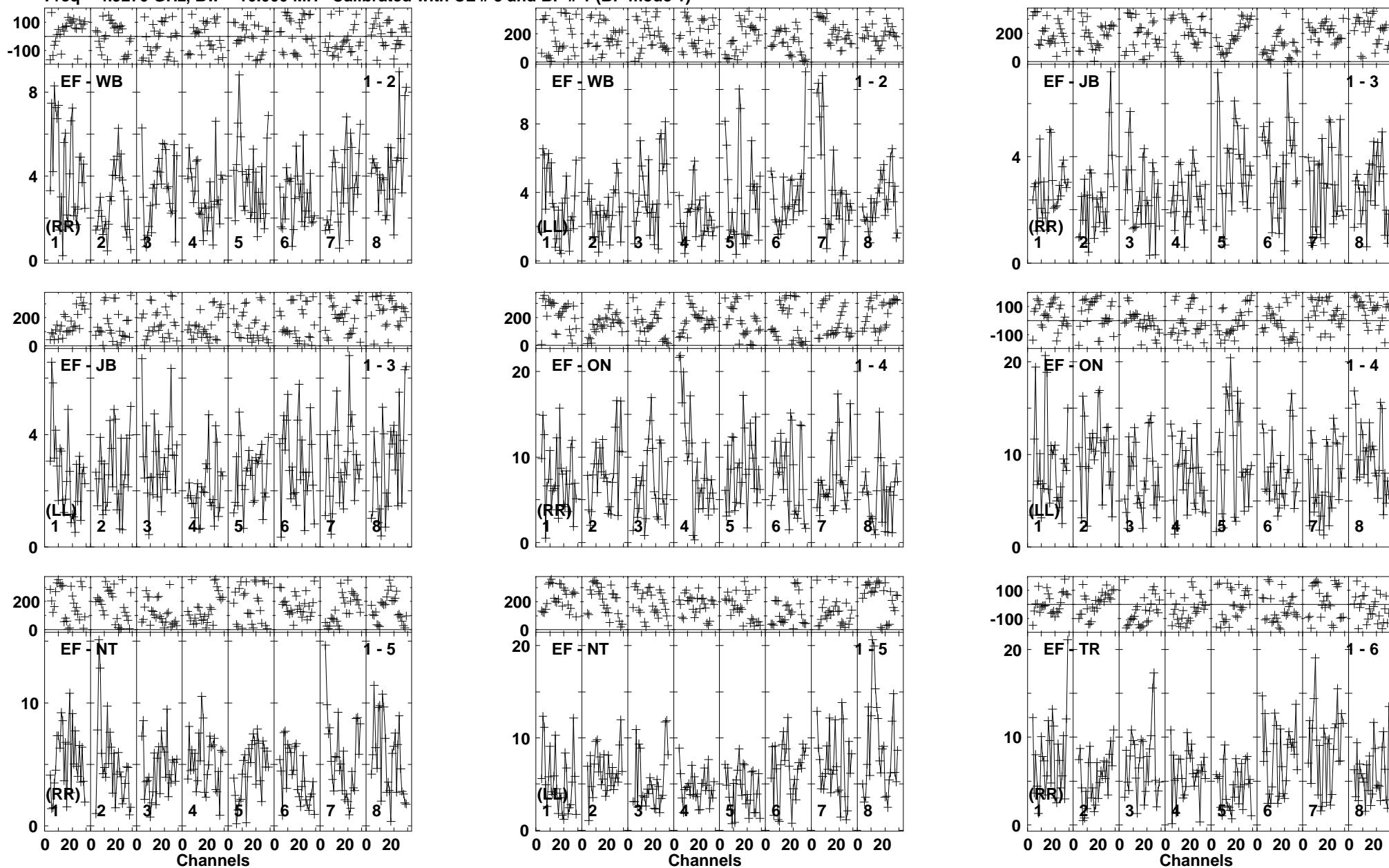

Lower frame: Milli Ampl Jy Top frame: Phas deg  
 Vector averaged cross-power spectrum Baseline: EF (01) - WB (02)  
 Timerange: 00/16:41:01 to 00/16:44:59

Plot file version 215 created 18-NOV-2014 15:23:50  
 ARP299C EP087H 3.UVDATA.1  
 Freq = 4.9270 GHz, Bw = 16.000 MH Calibrated with CL # 3 and BP # 1 (BP mode 1)

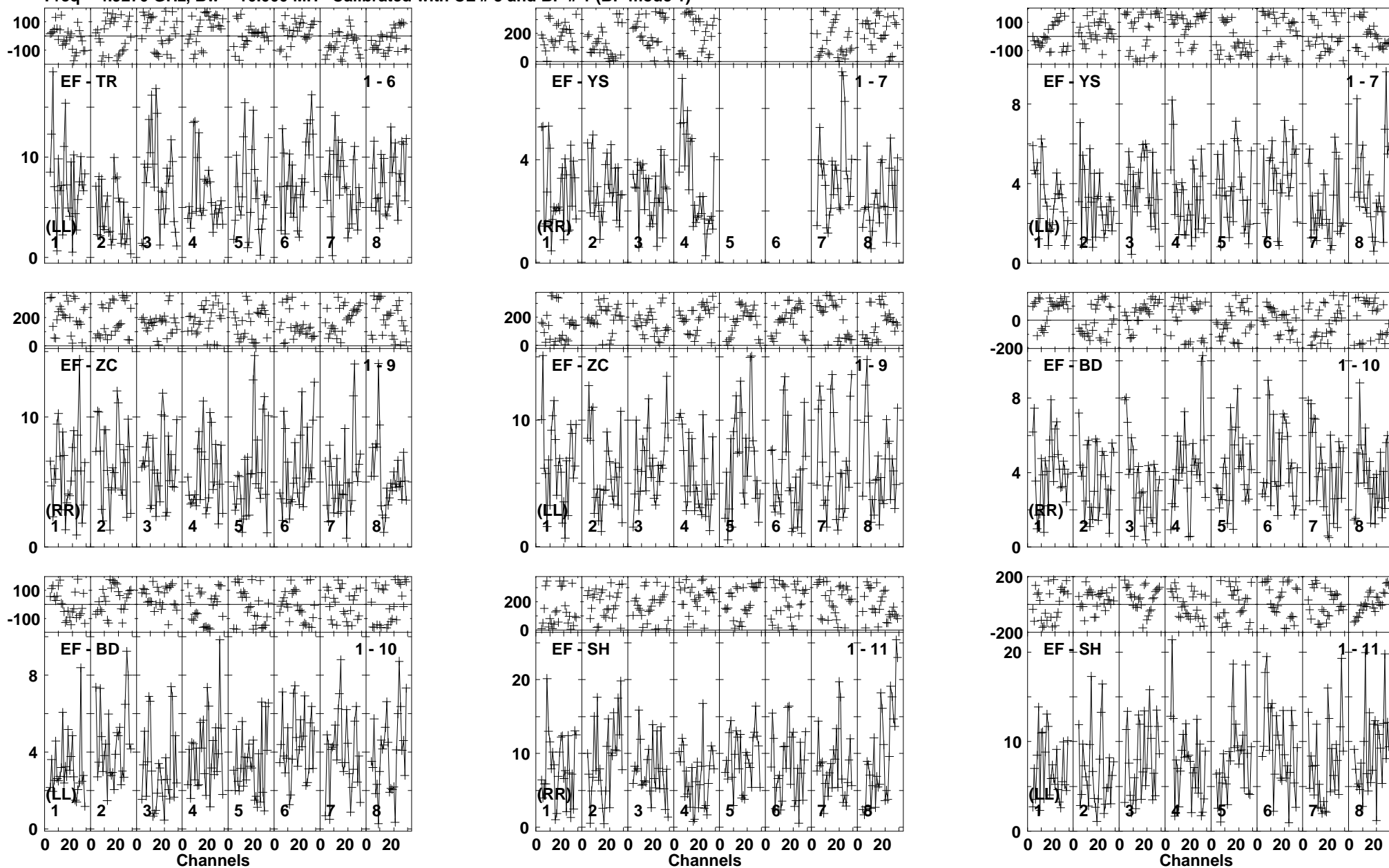

Lower frame: Milli Ampl Jy Top frame: Phas deg  
 Vector averaged cross-power spectrum Baseline: EF (01) - TR (06)  
 Timerange: 00/16:41:01 to 00/16:44:59

Plot file version 216 created 18-NOV-2014 15:23:50

J1128+5925 EP087H 3.UVDATA.1

Freq = 4.9270 GHz, Bw = 16.000 MH Calibrated with CL # 3 and BP # 1 (BP mode 1)

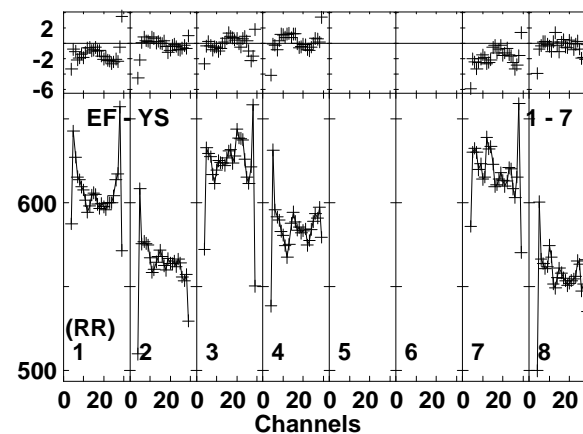
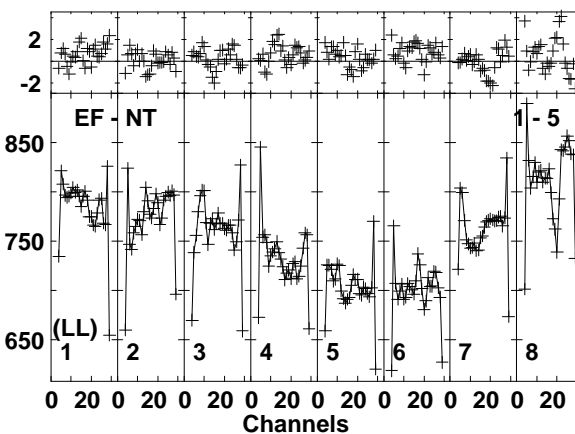
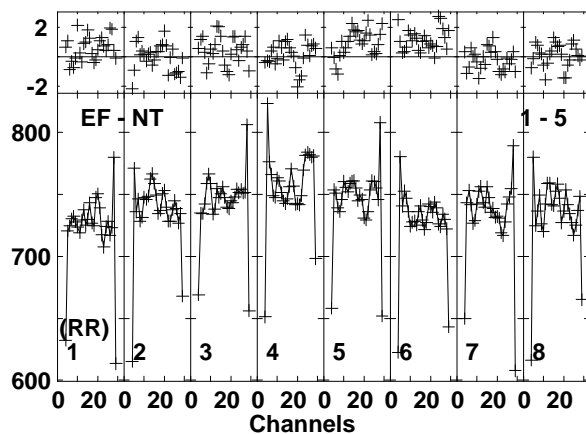
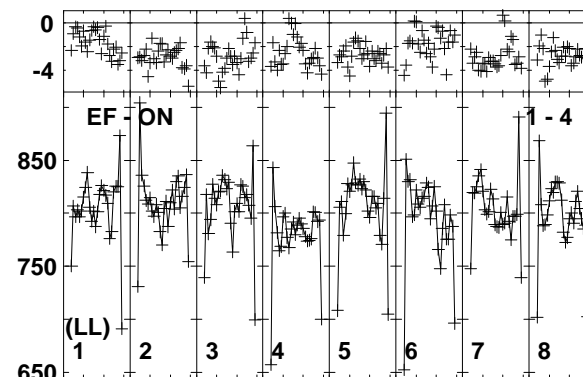
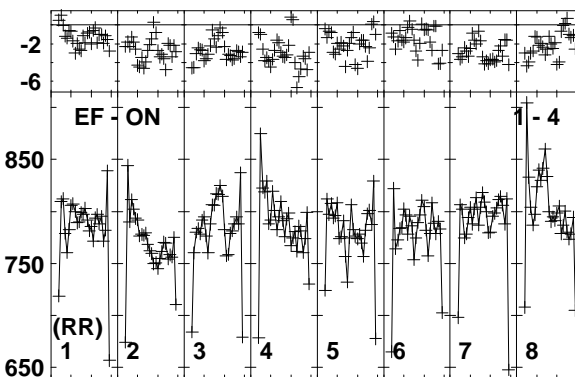
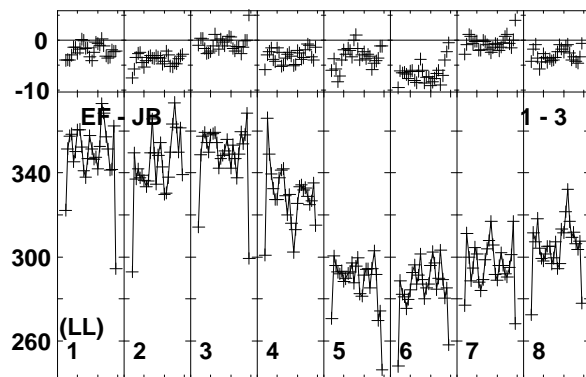
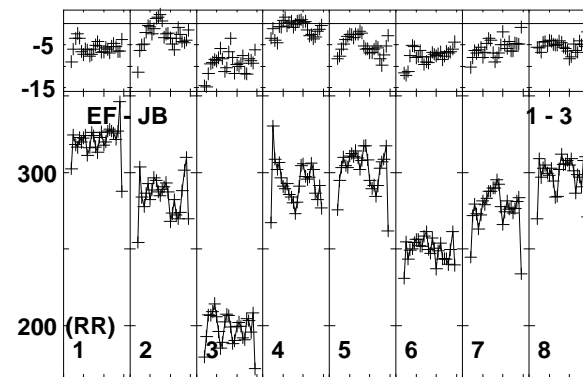
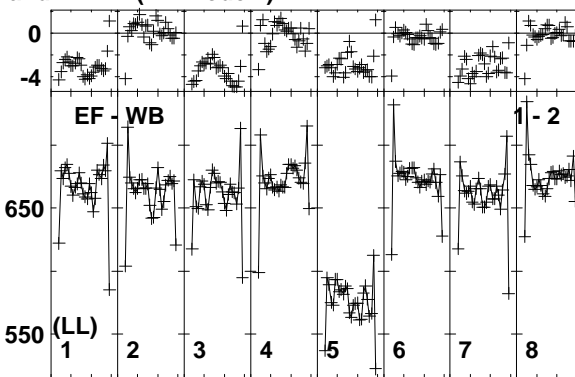
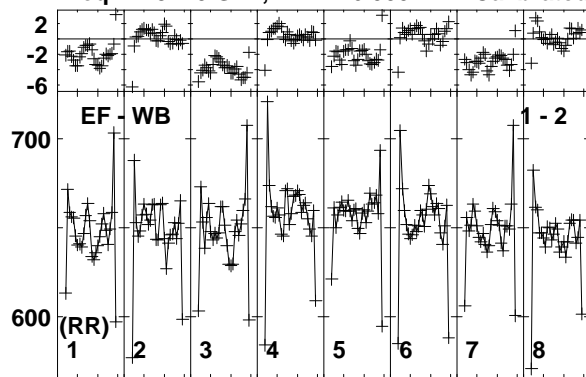

Lower frame: Milli Ampl Jy Top frame: Phas deg  
Vector averaged cross-power spectrum Baseline: EF (01) - WB (02)  
Timerange: 00/16:45:05 to 00/16:45:59



Plot file version 217 created 18-NOV-2014 15:23:50

J1128+5925 EP087H 3.UVDATA.1

Freq = 4.9270 GHz, Bw = 16.000 MH Calibrated with CL # 3 and BP # 1 (BP mode 1)

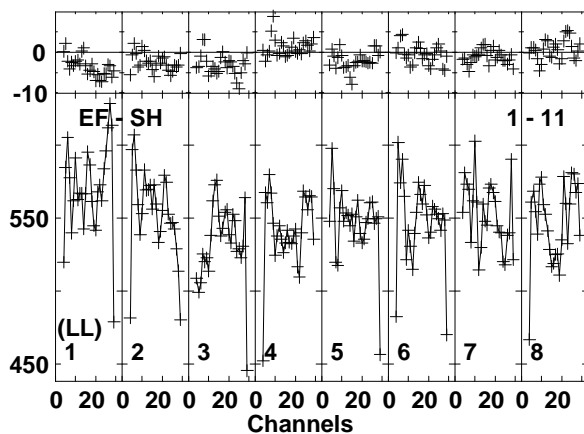
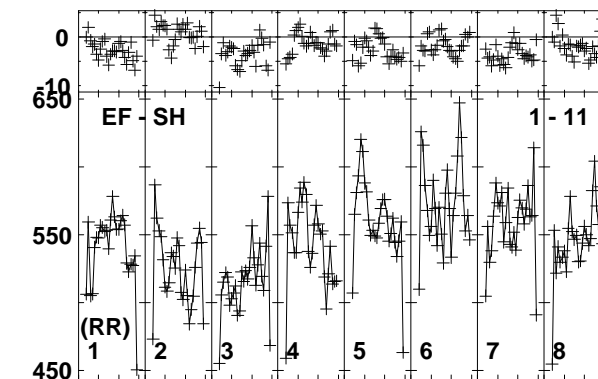
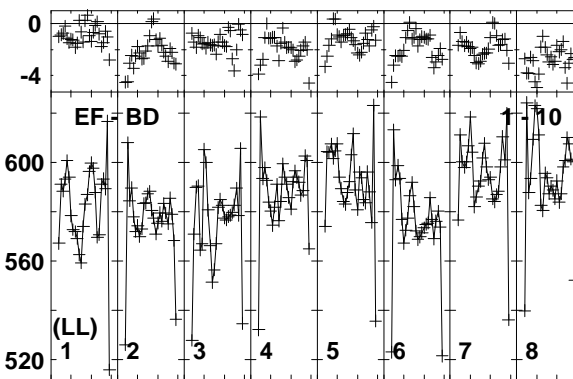
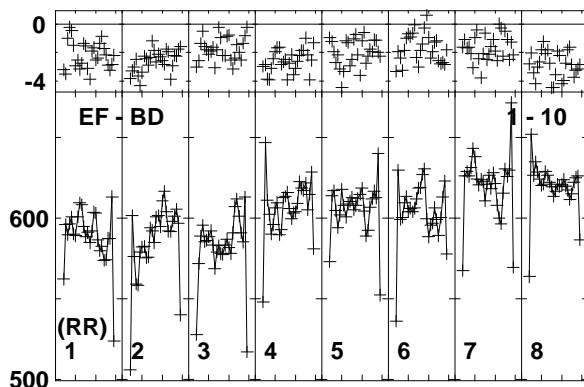
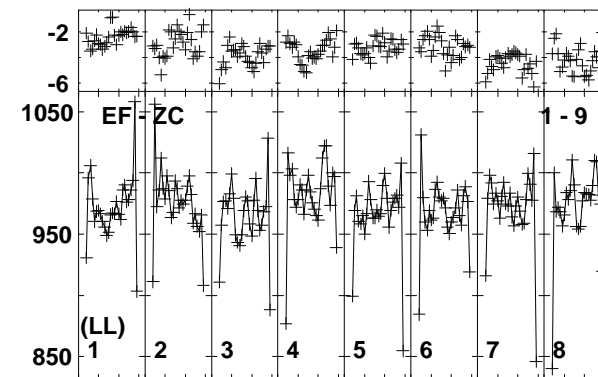
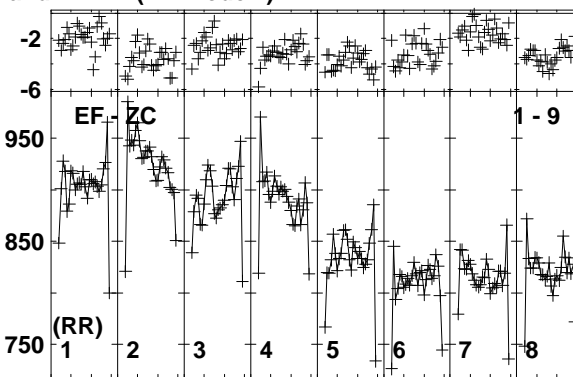
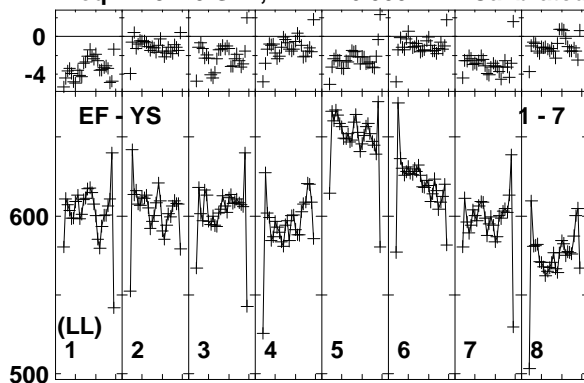

Lower frame: Milli Ampl Jy Top frame: Phas deg  
Vector averaged cross-power spectrum Baseline: EF (01) - YS (07)  
Timerange: 00/16:45:05 to 00/16:45:59

Plot file version 218 created 18-NOV-2014 15:23:51

ARP299C EP087H 3.UVDATA.1

Freq = 4.9270 GHz, Bw = 16.000 MH Calibrated with CL # 3 and BP # 1 (BP mode 1)

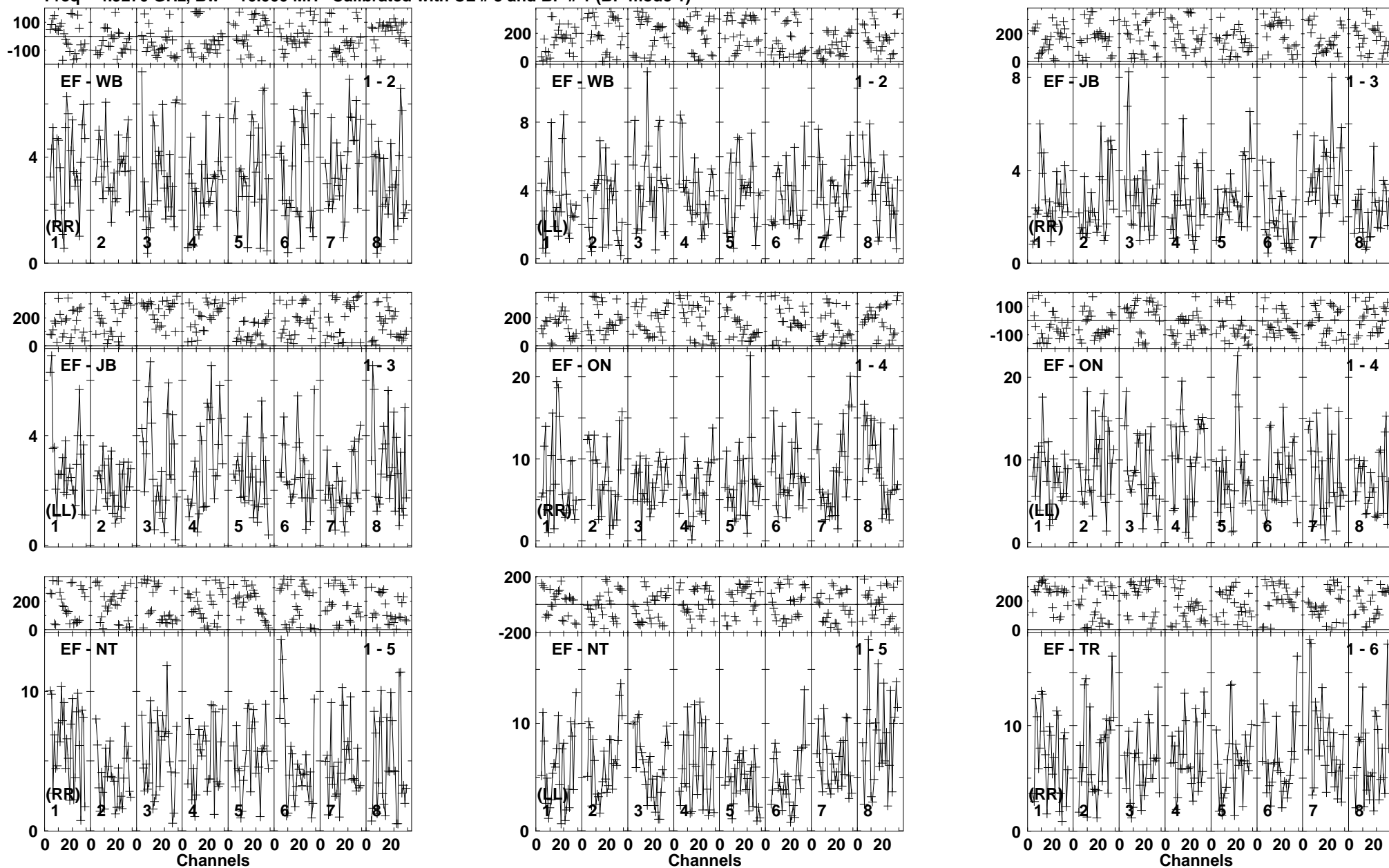

Lower frame: Milli Ampl Jy Top frame: Phas deg  
Vector averaged cross-power spectrum Baseline: EF (01) - WB (02)  
Timerange: 00/16:46:05 to 00/16:49:59

Plot file version 219 created 18-NOV-2014 15:23:51  
 ARP299C EP087H 3.UVDATA.1  
 Freq = 4.9270 GHz, Bw = 16.000 MH Calibrated with CL # 3 and BP # 1 (BP mode 1)

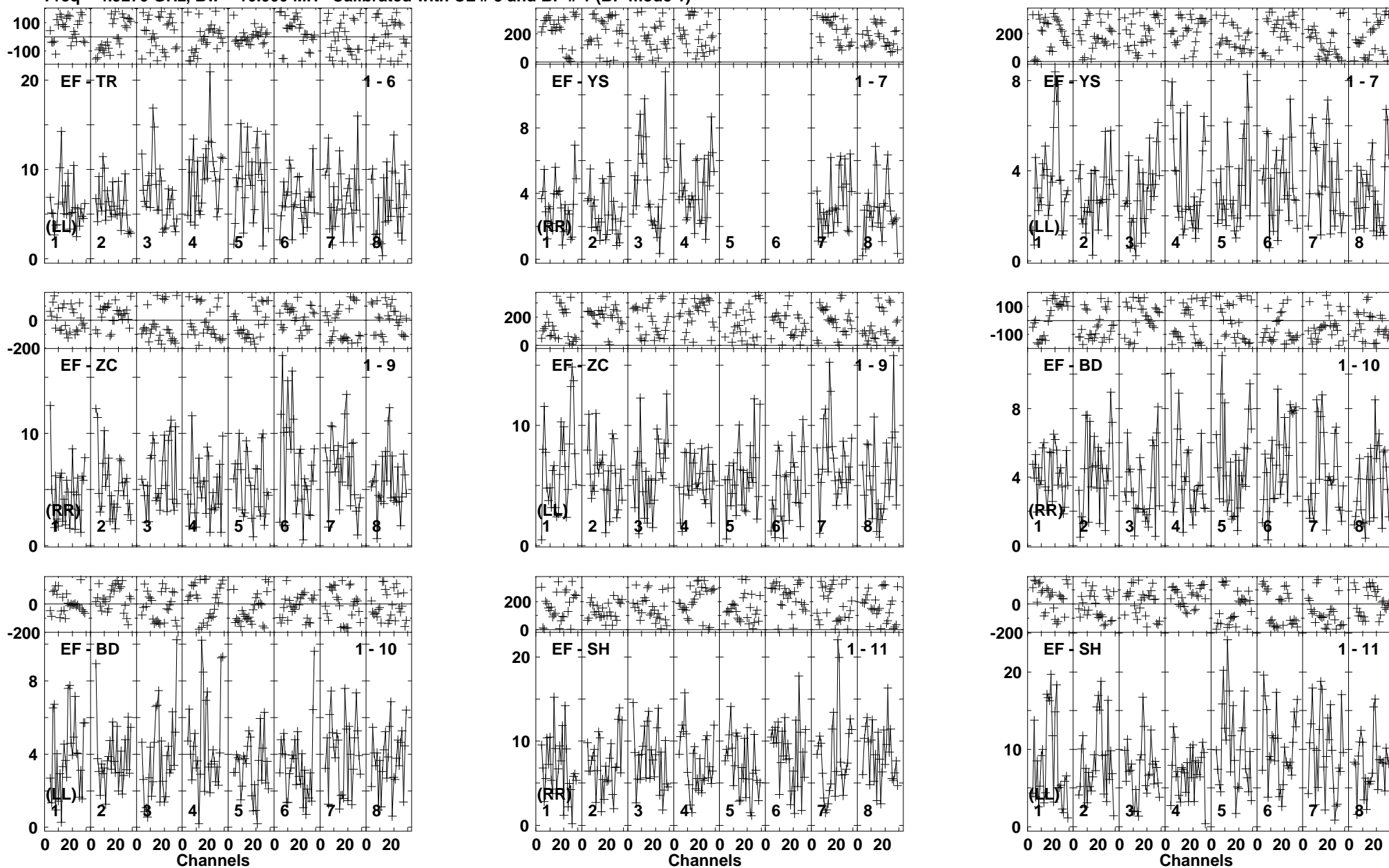

Lower frame: Milli Ampl Jy Top frame: Phas deg  
 Vector averaged cross-power spectrum Baseline: EF (01) - TR (06)  
 Timerange: 00/16:46:05 to 00/16:49:59

Plot file version 220 created 18-NOV-2014 15:23:51

J1128+5925 EP087H 3.UVDATA.1

Freq = 4.9270 GHz, Bw = 16.000 MH Calibrated with CL # 3 and BP # 1 (BP mode 1)

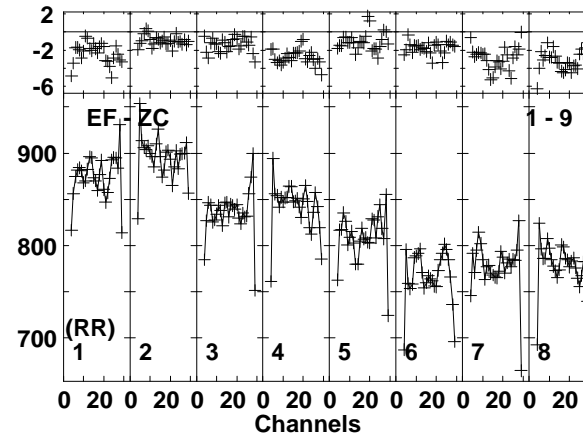
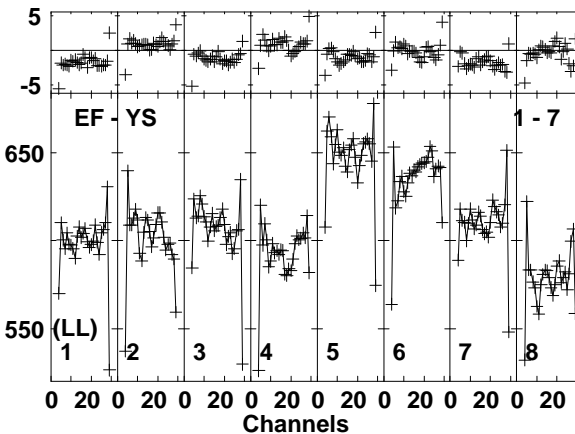
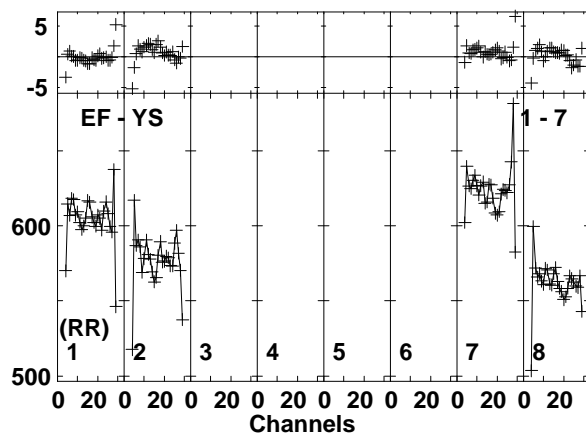
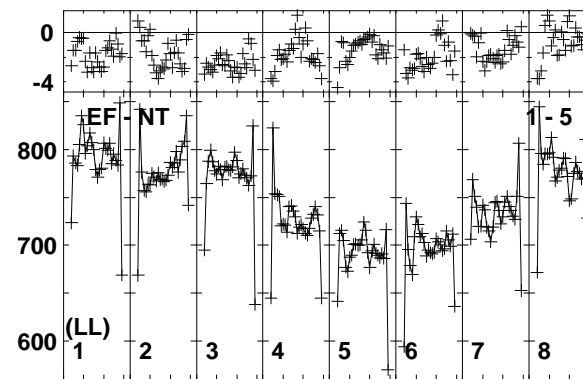
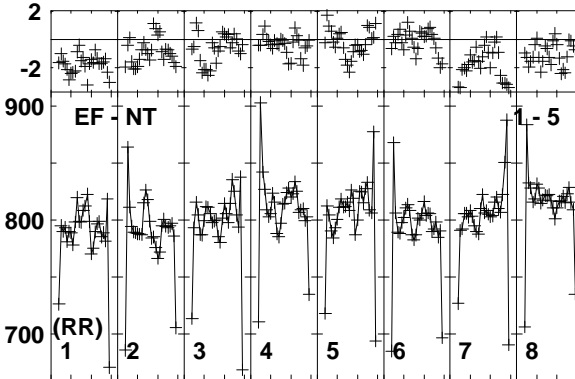
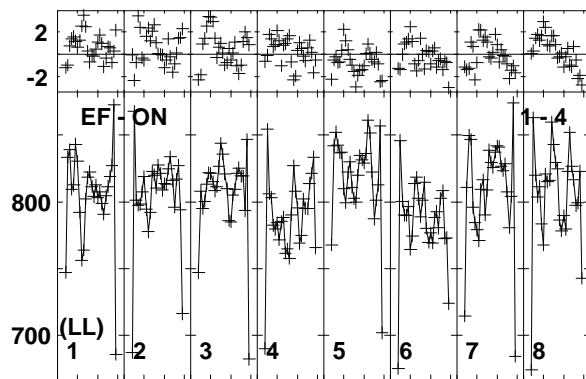
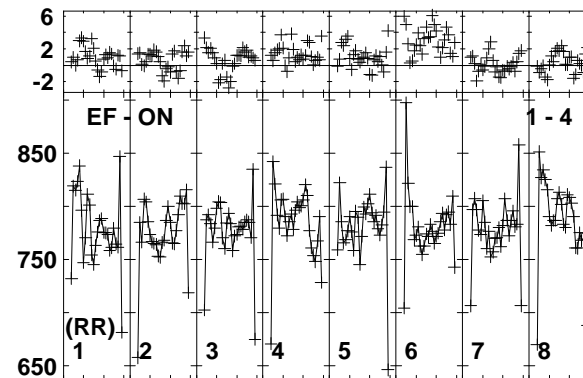
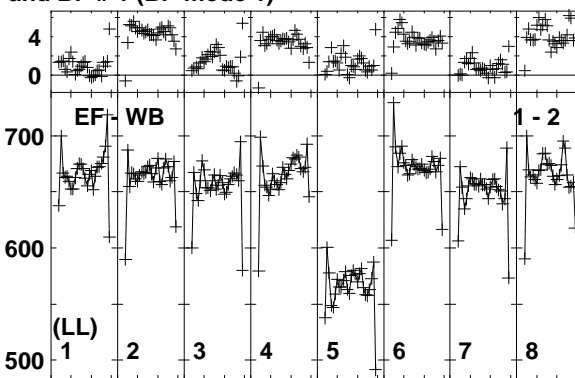
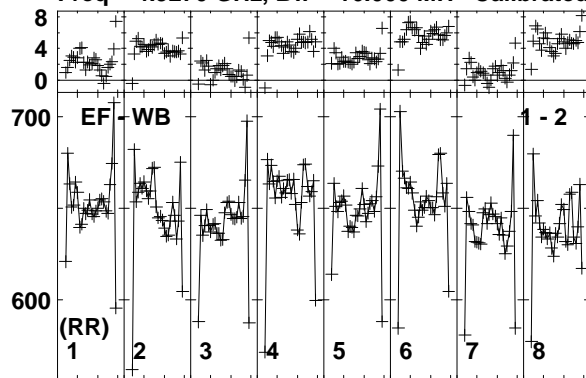

Lower frame: Milli Ampl Jy Top frame: Phas deg  
Vector averaged cross-power spectrum Baseline: EF (01) - WB (02)  
Timerange: 00/16:50:05 to 00/16:50:59

Plot file version 221 created 18-NOV-2014 15:23:52

J1128+5925 EP087H 3.UVDATA.1

Freq = 4.9270 GHz, Bw = 16.000 MH Calibrated with CL # 3 and BP # 1 (BP mode 1)

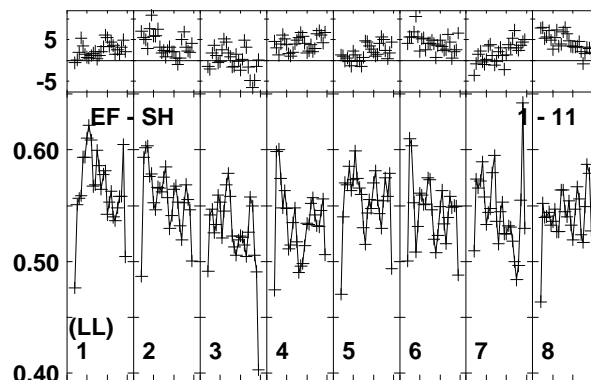
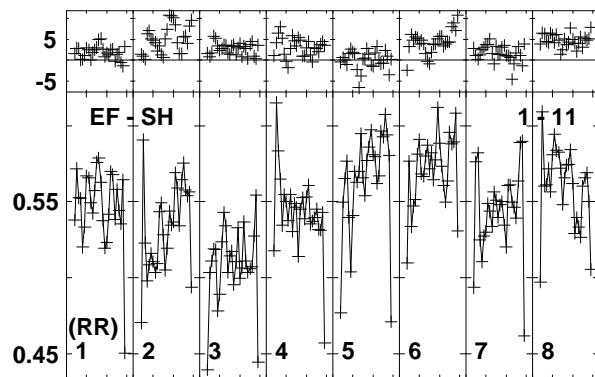
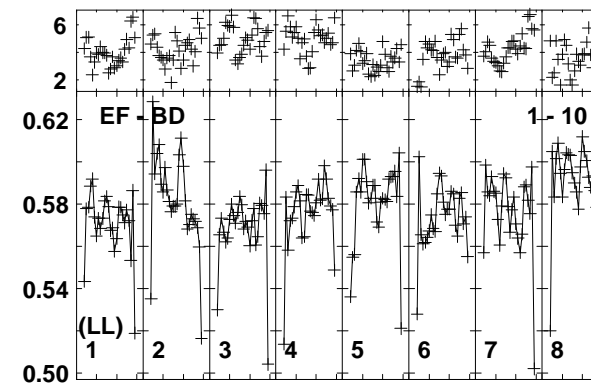
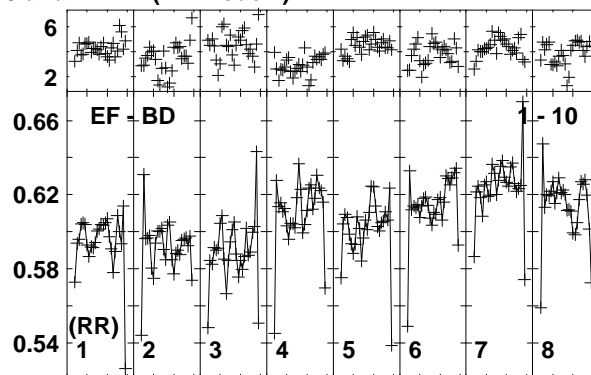
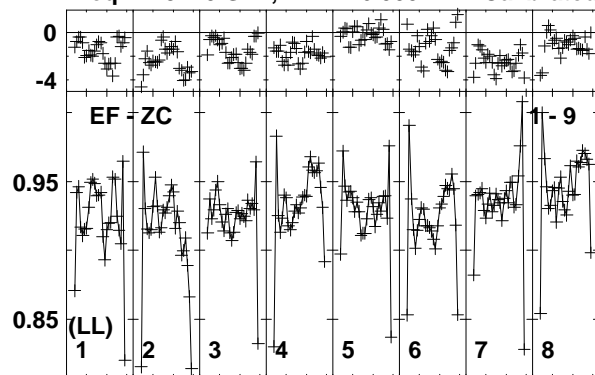

Lower frame: Ampl Jy Top frame: Phas deg  
Vector averaged cross-power spectrum Baseline: EF (01) - ZC (09)  
Timerange: 00/16:50:05 to 00/16:50:59

Plot file version 222 created 18-NOV-2014 15:23:52  
 ARP299C EP087H 3.UVDATA.1  
 Freq = 4.9270 GHz, Bw = 16.000 MH Calibrated with CL # 3 and BP # 1 (BP mode 1)

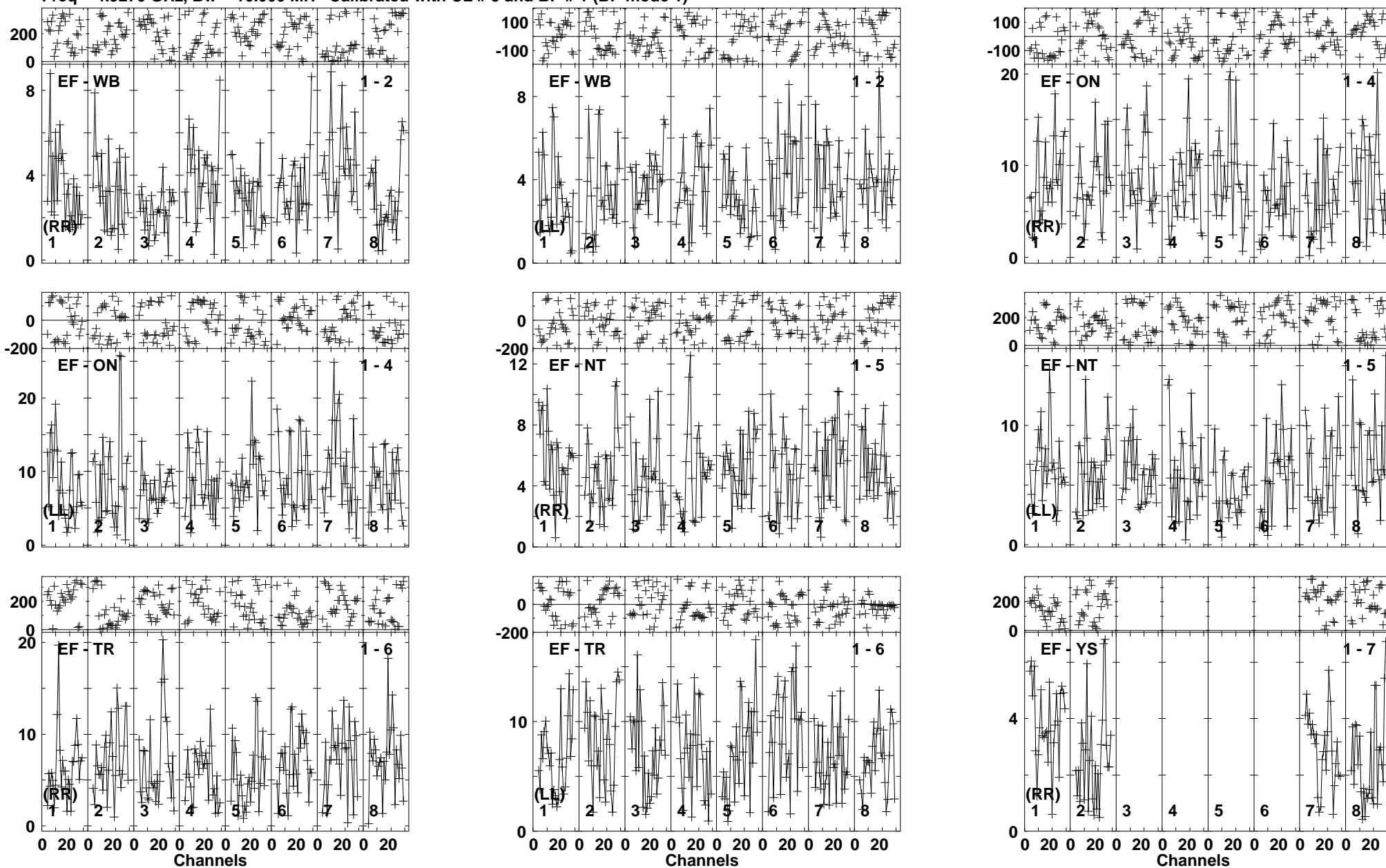

Lower frame: Milli Ampl Jy Top frame: Phas deg  
 Vector averaged cross-power spectrum Baseline: EF (01) - WB (02)  
 Timerange: 00/16:51:05 to 00/16:54:59

Plot file version 223 created 18-NOV-2014 15:23:52  
 ARP299C EP087H 3.UVDATA.1  
 Freq = 4.9270 GHz, Bw = 16.000 MH Calibrated with CL # 3 and BP # 1 (BP mode 1)

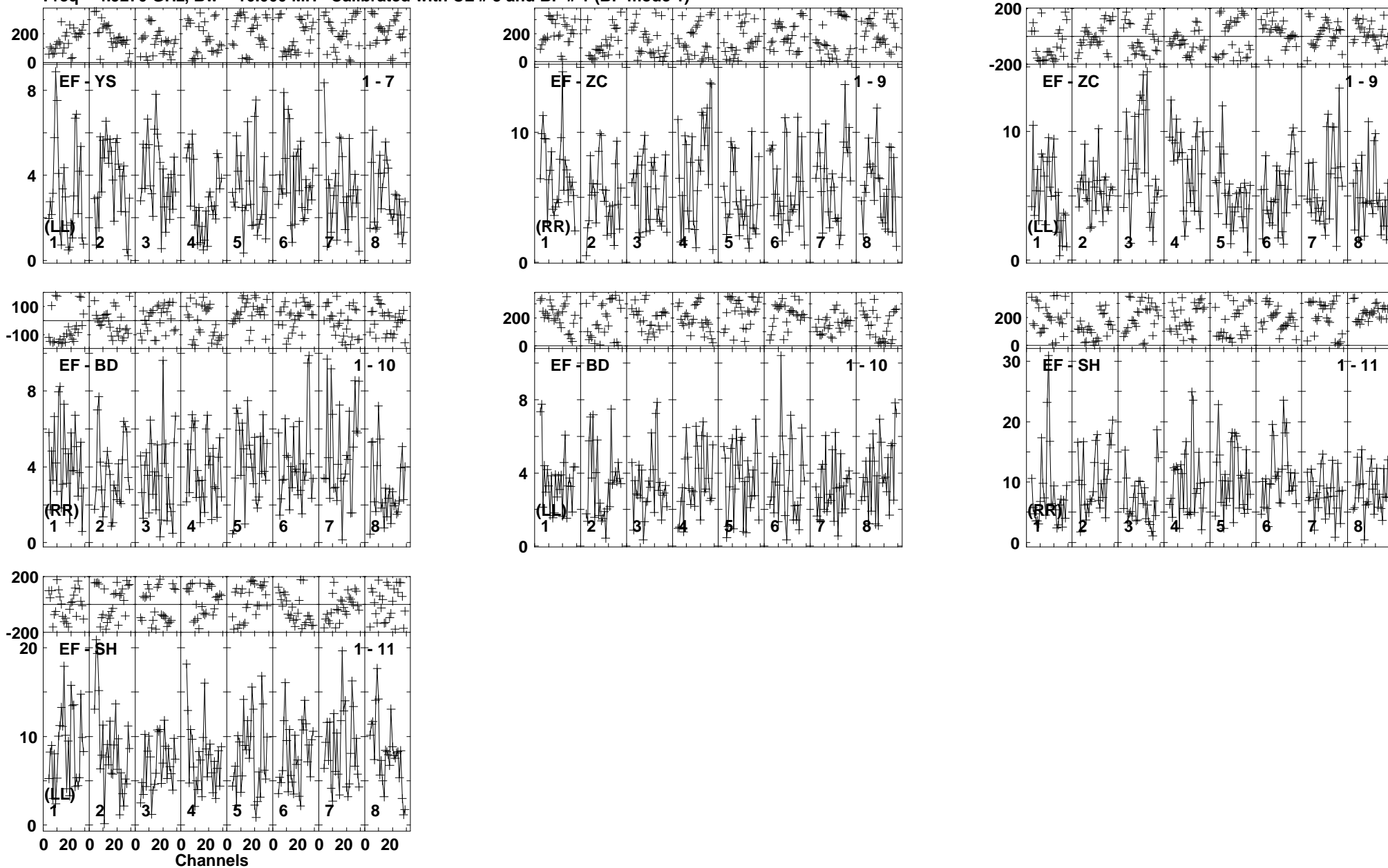

Lower frame: Milli Ampl Jy Top frame: Phas deg  
 Vector averaged cross-power spectrum Baseline: EF (01) - YS (07)  
 Timerange: 00/16:51:05 to 00/16:54:59

Plot file version 224 created 18-NOV-2014 15:23:52

J1128+5925 EP087H 3.UVDATA.1

Freq = 4.9270 GHz, Bw = 16.000 MH Calibrated with CL # 3 and BP # 1 (BP mode 1)

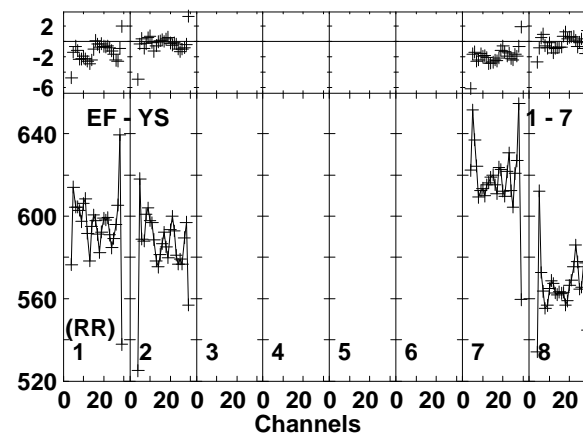
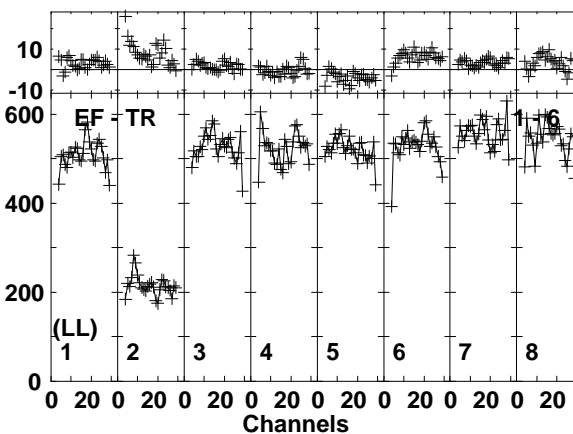
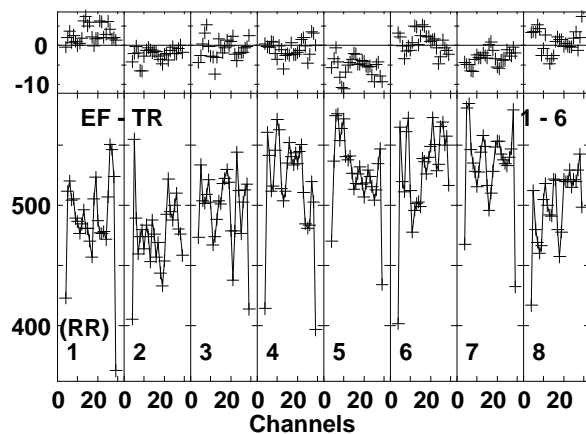
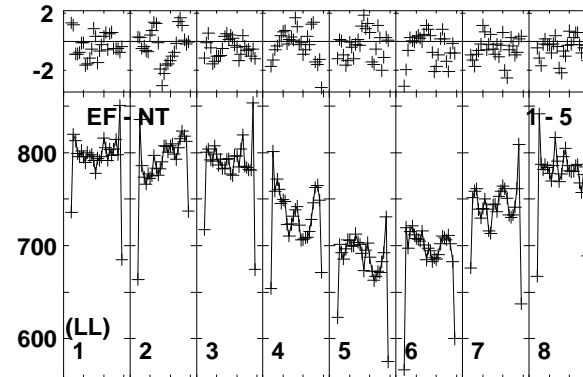
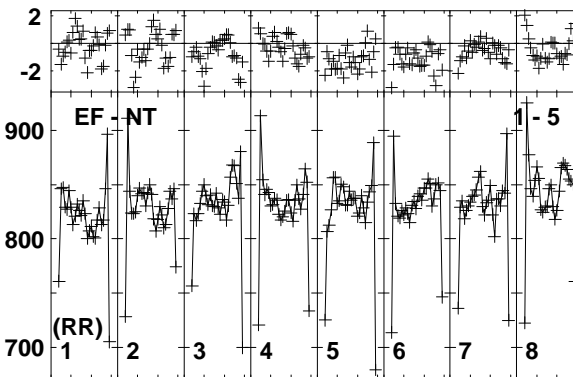
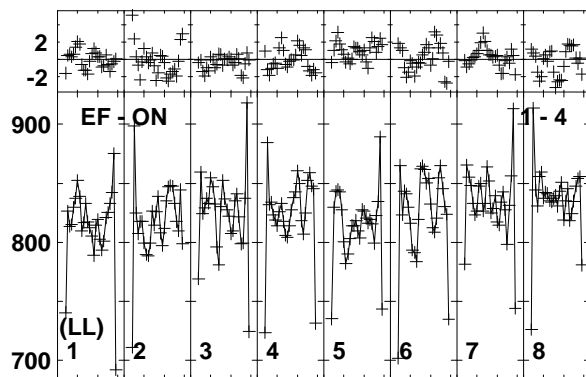
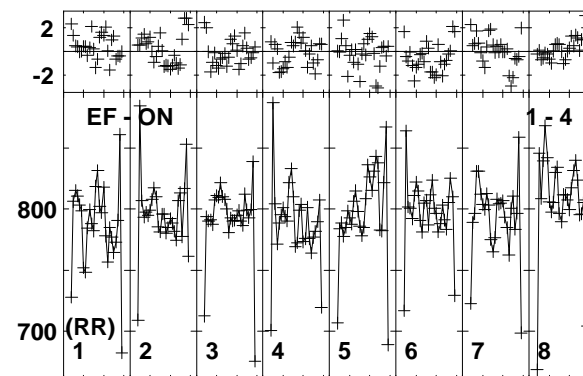
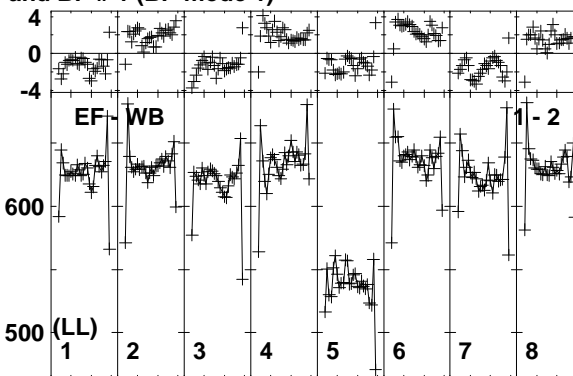
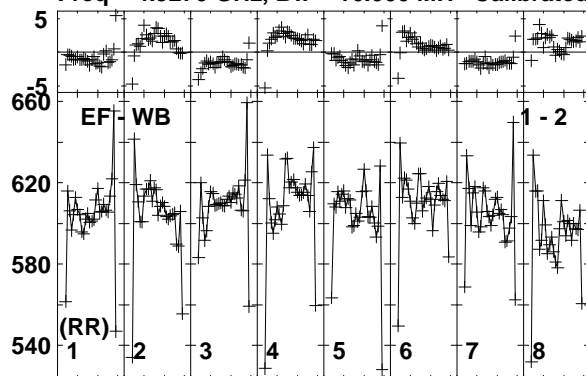

Lower frame: Milli Ampl Jy Top frame: Phas deg  
Vector averaged cross-power spectrum Baseline: EF (01) - WB (02)  
Timerange: 00/16:55:43 to 00/16:56:09



Plot file version 225 created 18-NOV-2014 15:23:52

J1128+5925 EP087H 3.UVDATA.1

Freq = 4.9270 GHz, Bw = 16.000 MH Calibrated with CL # 3 and BP # 1 (BP mode 1)

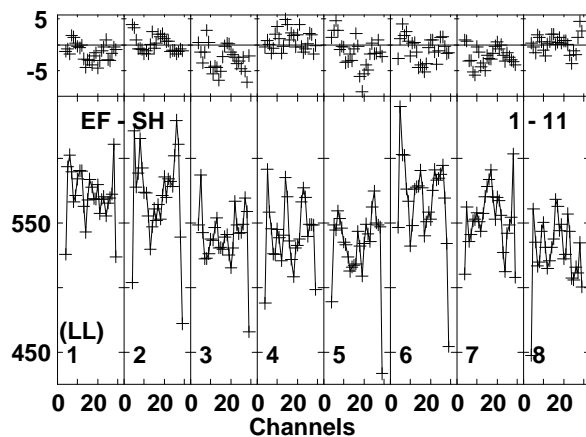
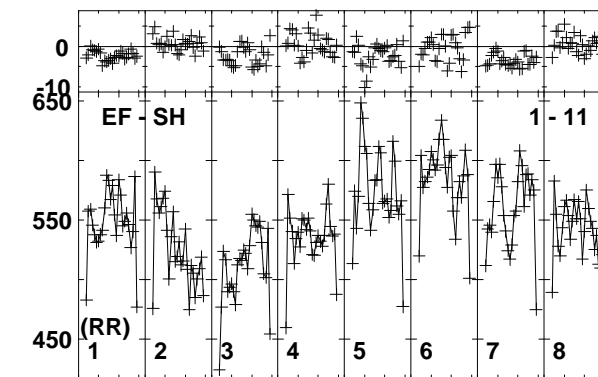
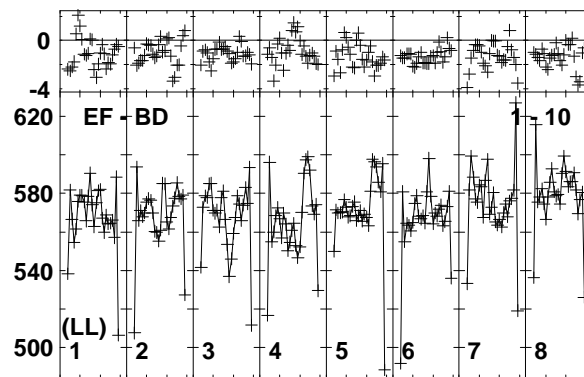
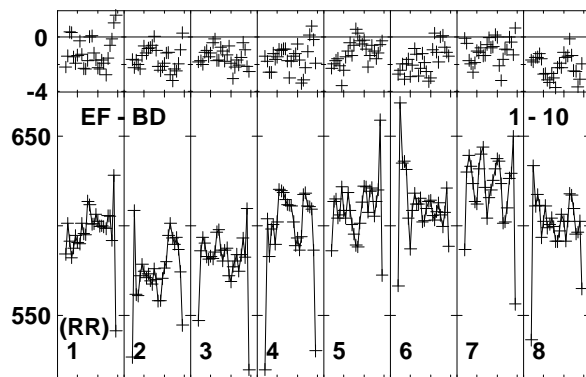
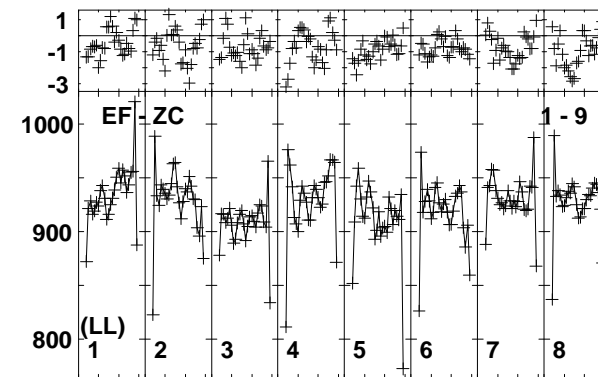
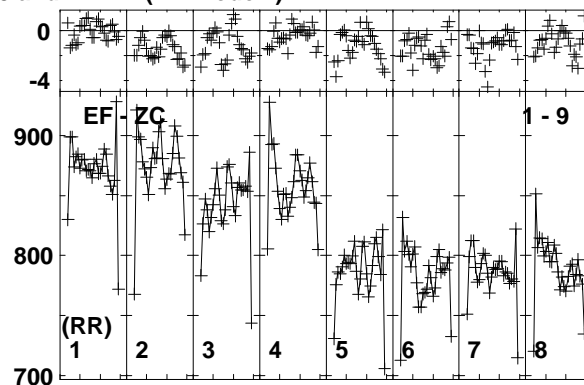
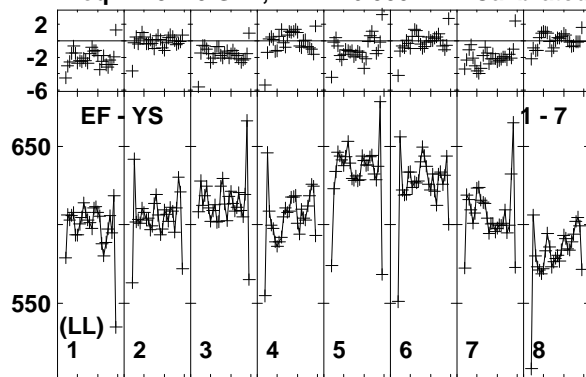

0 20 0 20 0 20 0 20 0 20 0 20 0 20 0 20 0 20  
Channels  
Lower frame: Milli Ampl Jy Top frame: Phas deg  
Vector averaged cross-power spectrum Baseline: EF (01) - YS (07)  
Timerange: 00/16:55:43 to 00/16:56:09

Plot file version 226 created 18-NOV-2014 15:23:53

ARP299C EP087H 3.UVDATA.1

Freq = 4.9270 GHz, Bw = 16.000 MH Calibrated with CL # 3 and BP # 1 (BP mode 1)

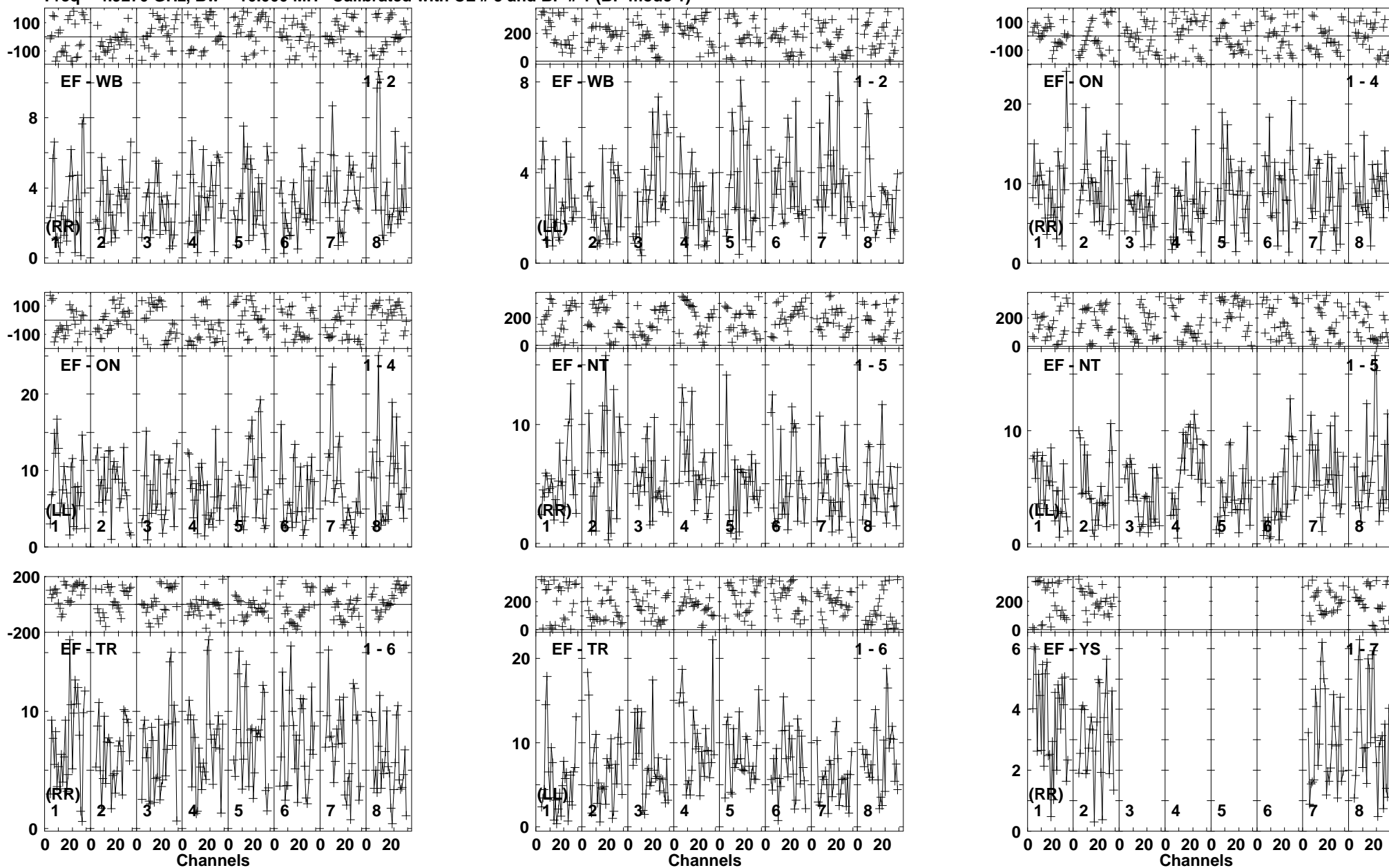

Lower frame: Milli Ampl Jy Top frame: Phas deg  
Vector averaged cross-power spectrum Baseline: EF (01) - WB (02)  
Timerange: 00/16:56:15 to 00/17:00:09

Plot file version 227 created 18-NOV-2014 15:23:53  
 ARP299C EP087H 3.UVDATA.1  
 Freq = 4.9270 GHz, Bw = 16.000 MH Calibrated with CL # 3 and BP # 1 (BP mode 1)

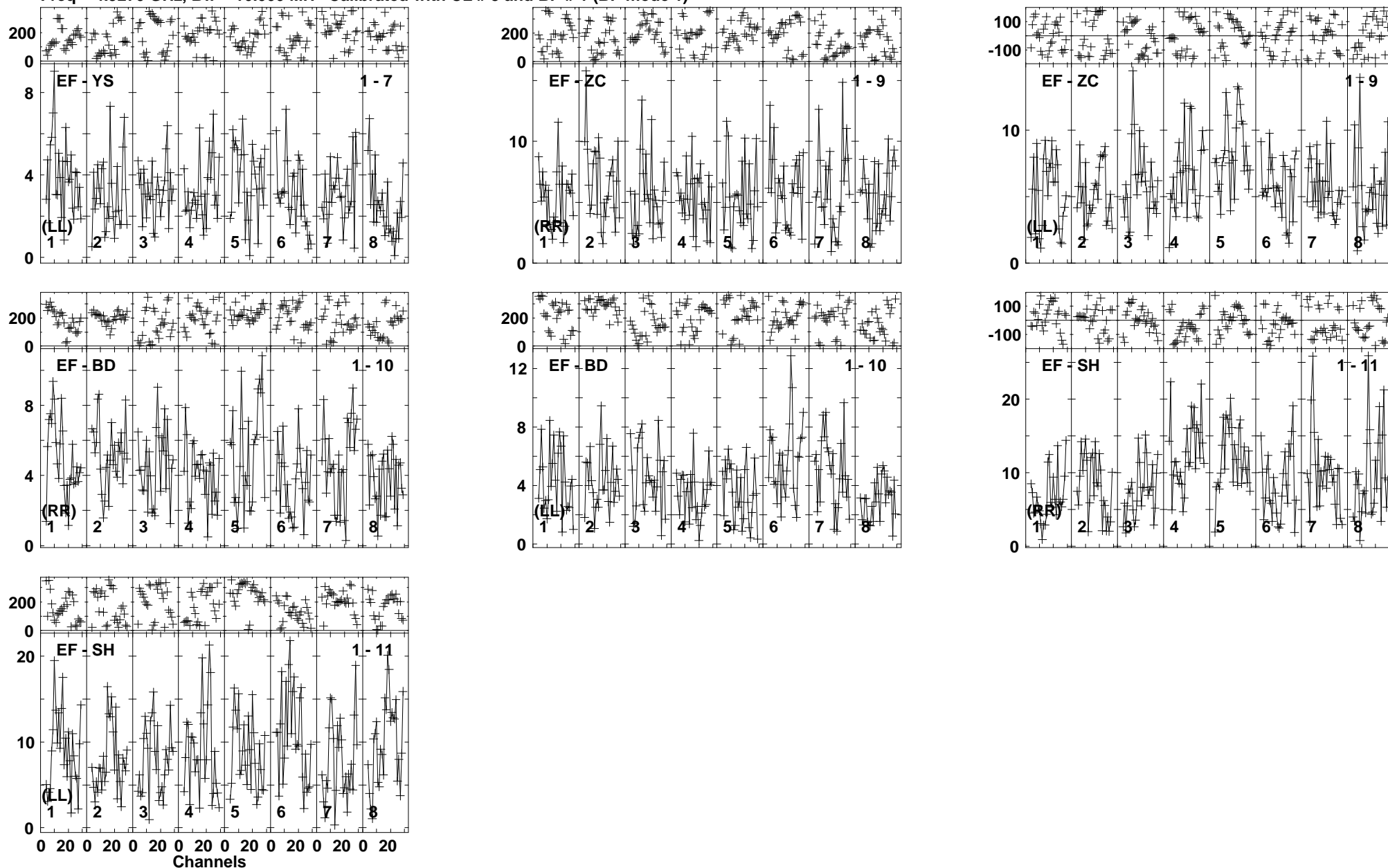

Lower frame: Milli Ampl Jy Top frame: Phas deg  
 Vector averaged cross-power spectrum Baseline: EF (01) - YS (07)  
 Timerange: 00/16:56:15 to 00/17:00:09

Plot file version 228 created 18-NOV-2014 15:23:54  
 ARP299C EP087H 3.UVDATA.1  
 Freq = 4.9270 GHz, Bw = 16.000 MH Calibrated with CL # 3 and BP # 1 (BP mode 1)

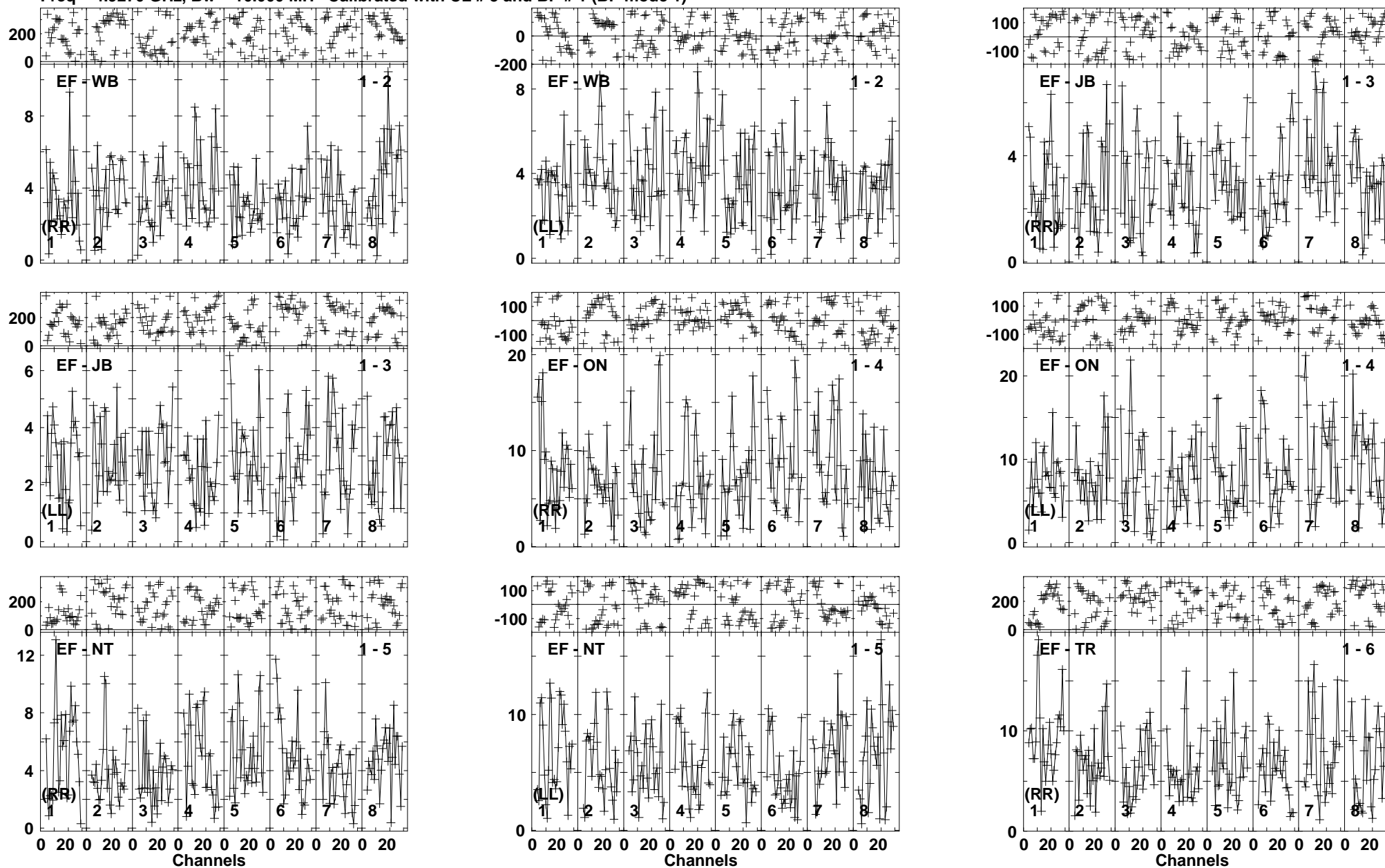

Lower frame: Milli Ampl Jy Top frame: Phas deg  
 Vector averaged cross-power spectrum Baseline: EF (01) - WB (02)  
 Timerange: 00/17:01:15 to 00/17:05:09

Plot file version 229 created 18-NOV-2014 15:23:54  
 ARP299C EP087H 3.UVDATA.1  
 Freq = 4.9270 GHz, Bw = 16.000 MH Calibrated with CL # 3 and BP # 1 (BP mode 1)

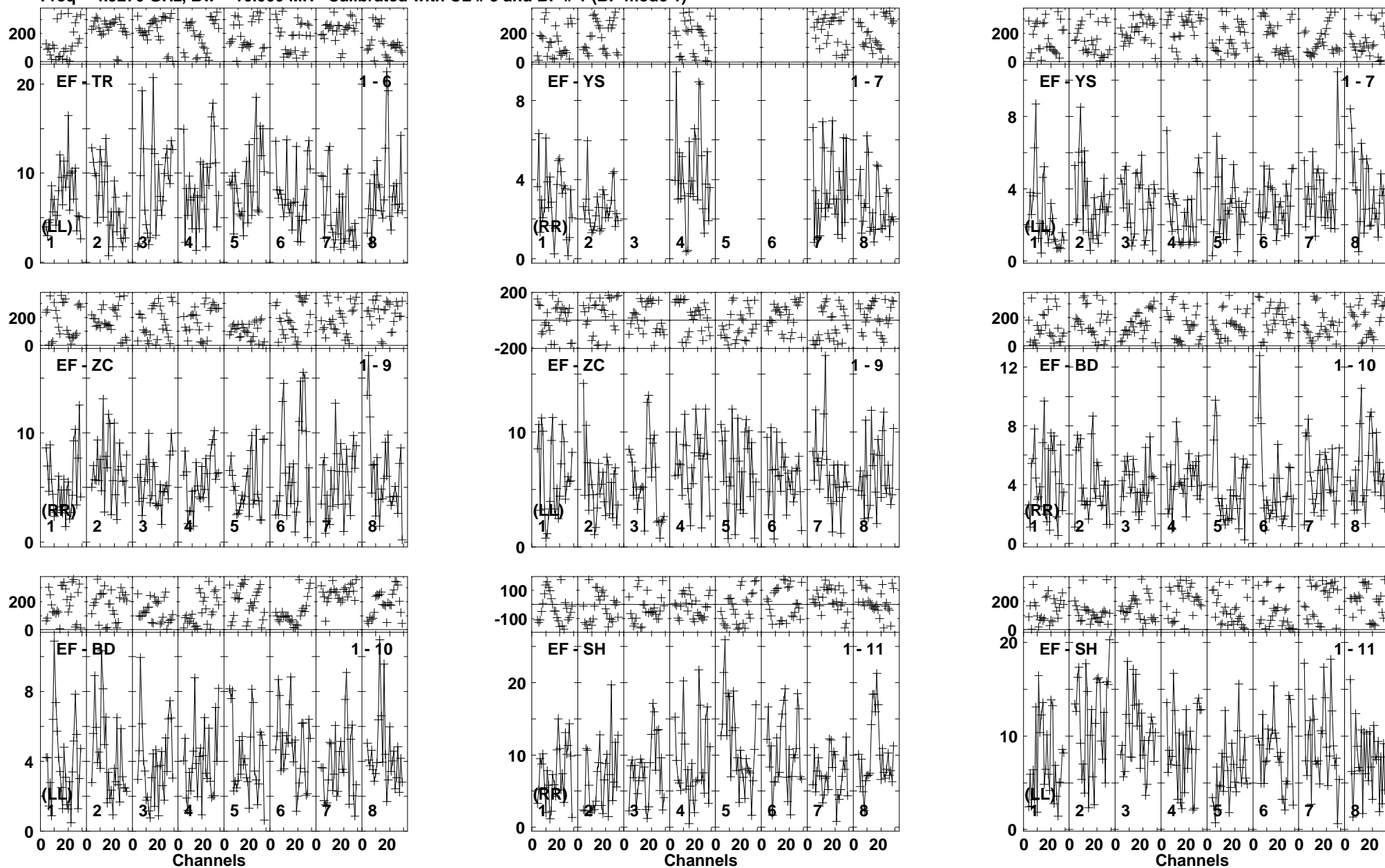

Lower frame: Milli Ampl Jy Top frame: Phas deg  
 Vector averaged cross-power spectrum Baseline: EF (01) - TR (06)  
 Timerange: 00/17:01:15 to 00/17:05:09

Plot file version 230 created 18-NOV-2014 15:23:54

J1128+5925 EP087H 3.UVDATA.1

Freq = 4.9270 GHz, Bw = 16.000 MH Calibrated with CL # 3 and BP # 1 (BP mode 1)

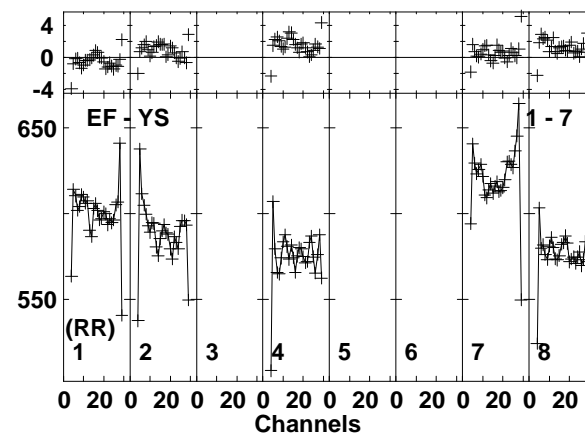
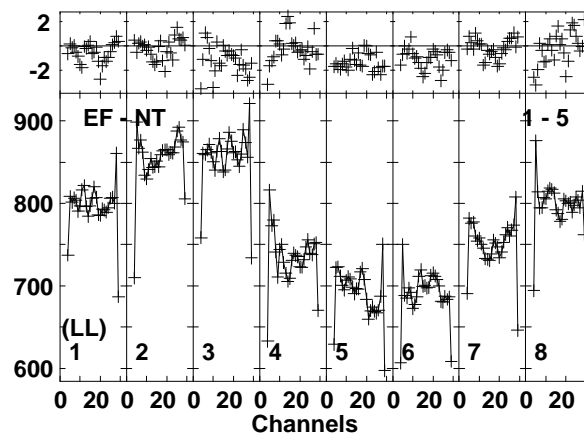
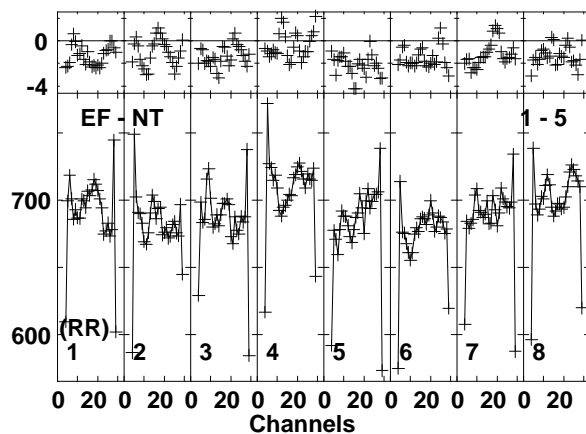
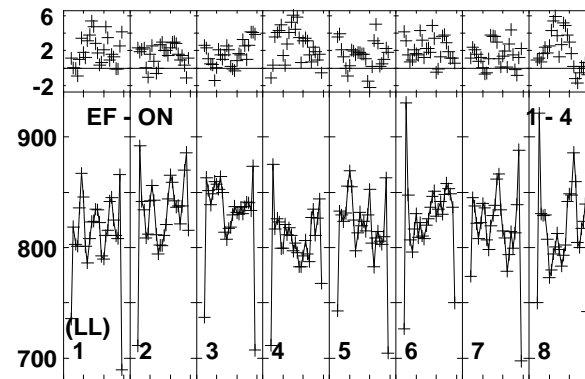
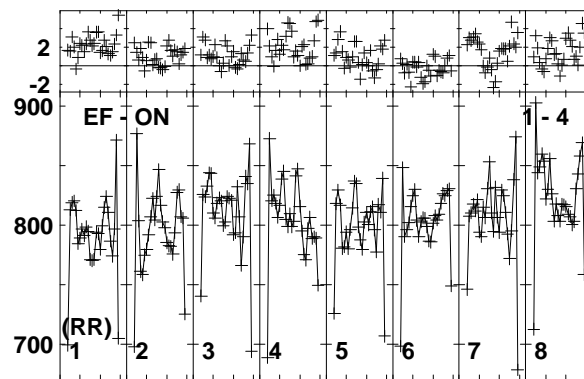
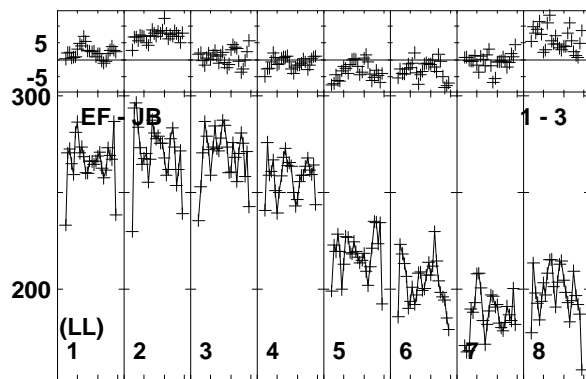
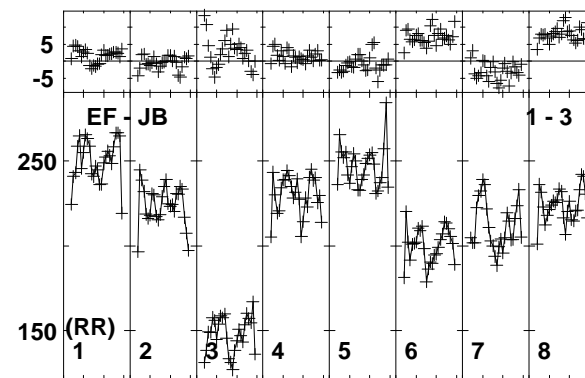
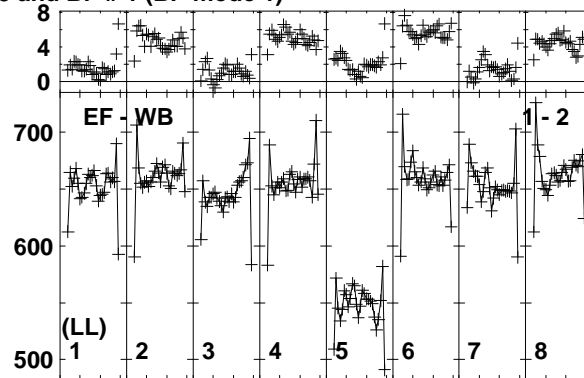
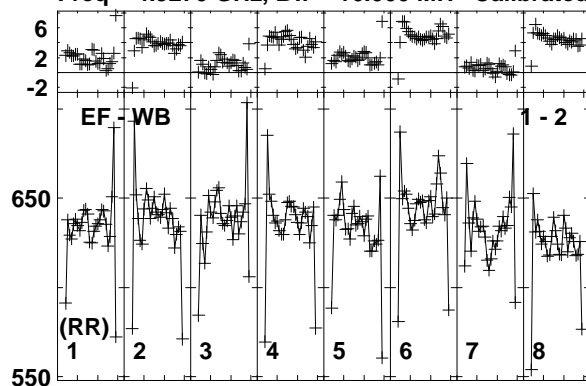

Lower frame: Milli Ampl Jy Top frame: Phas deg  
Vector averaged cross-power spectrum Baseline: EF (01) - WB (02)  
Timerange: 00/17:05:15 to 00/17:06:09

Plot file version 231 created 18-NOV-2014 15:23:54

J1128+5925 EP087H 3.UVDATA.1

Freq = 4.9270 GHz, Bw = 16.000 MH Calibrated with CL # 3 and BP # 1 (BP mode 1)

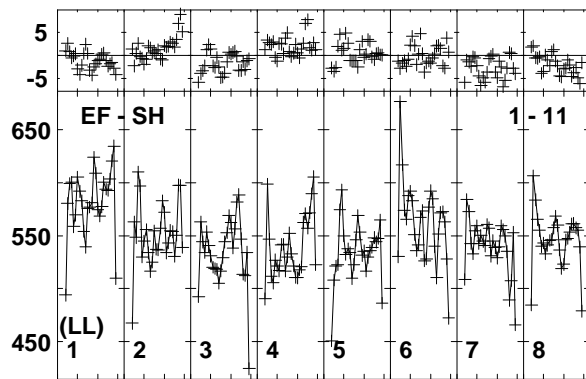
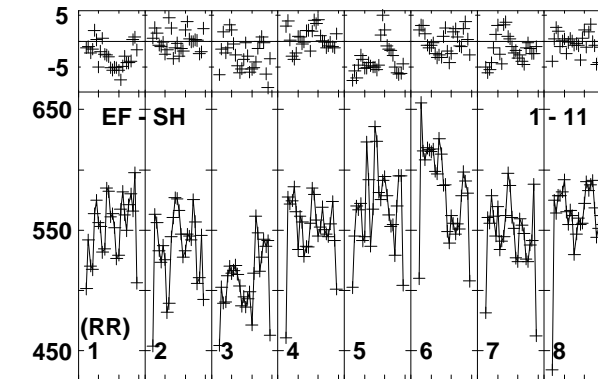
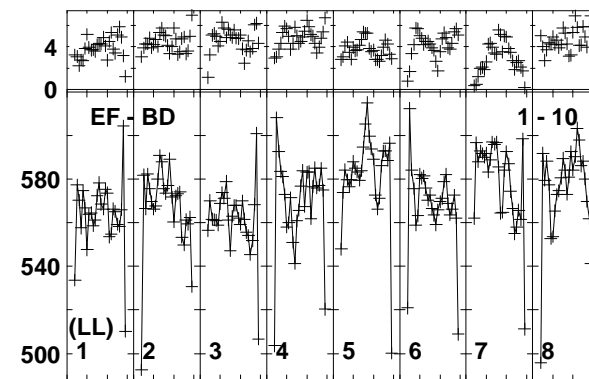
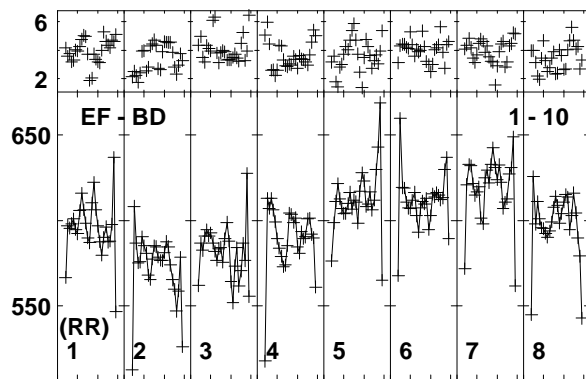
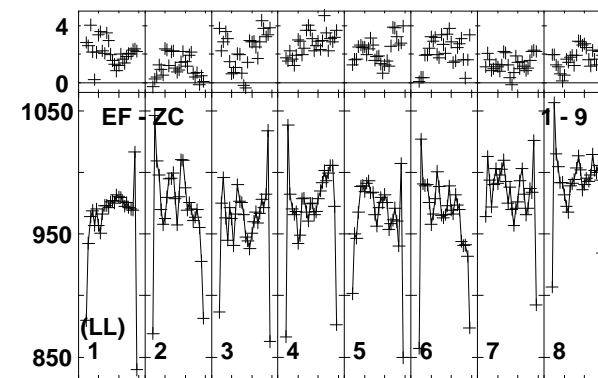
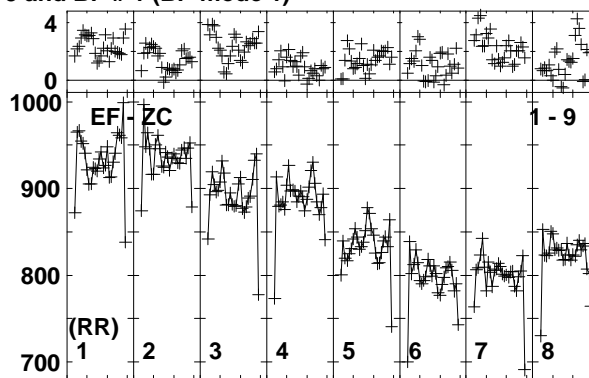
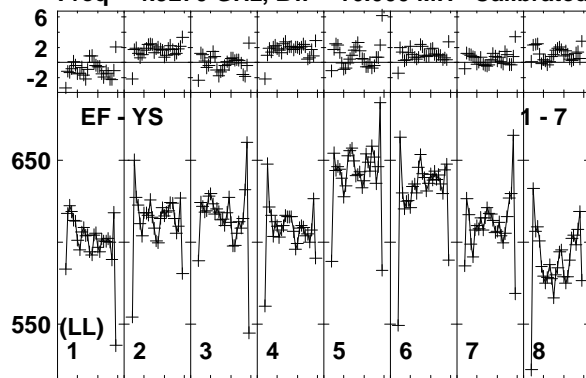

0 20 0 20 0 20 0 20 0 20 0 20 0 20 0 20 0 20 0 20  
Channels

Lower frame: Milli Ampl Jy Top frame: Phas deg  
Vector averaged cross-power spectrum Baseline: EF (01) - YS (07)  
Timerange: 00/17:05:15 to 00/17:06:09

Plot file version 232 created 18-NOV-2014 15:23:54  
 ARP299C EP087H 3.UVDATA.1  
 Freq = 4.9270 GHz, Bw = 16.000 MH Calibrated with CL # 3 and BP # 1 (BP mode 1)

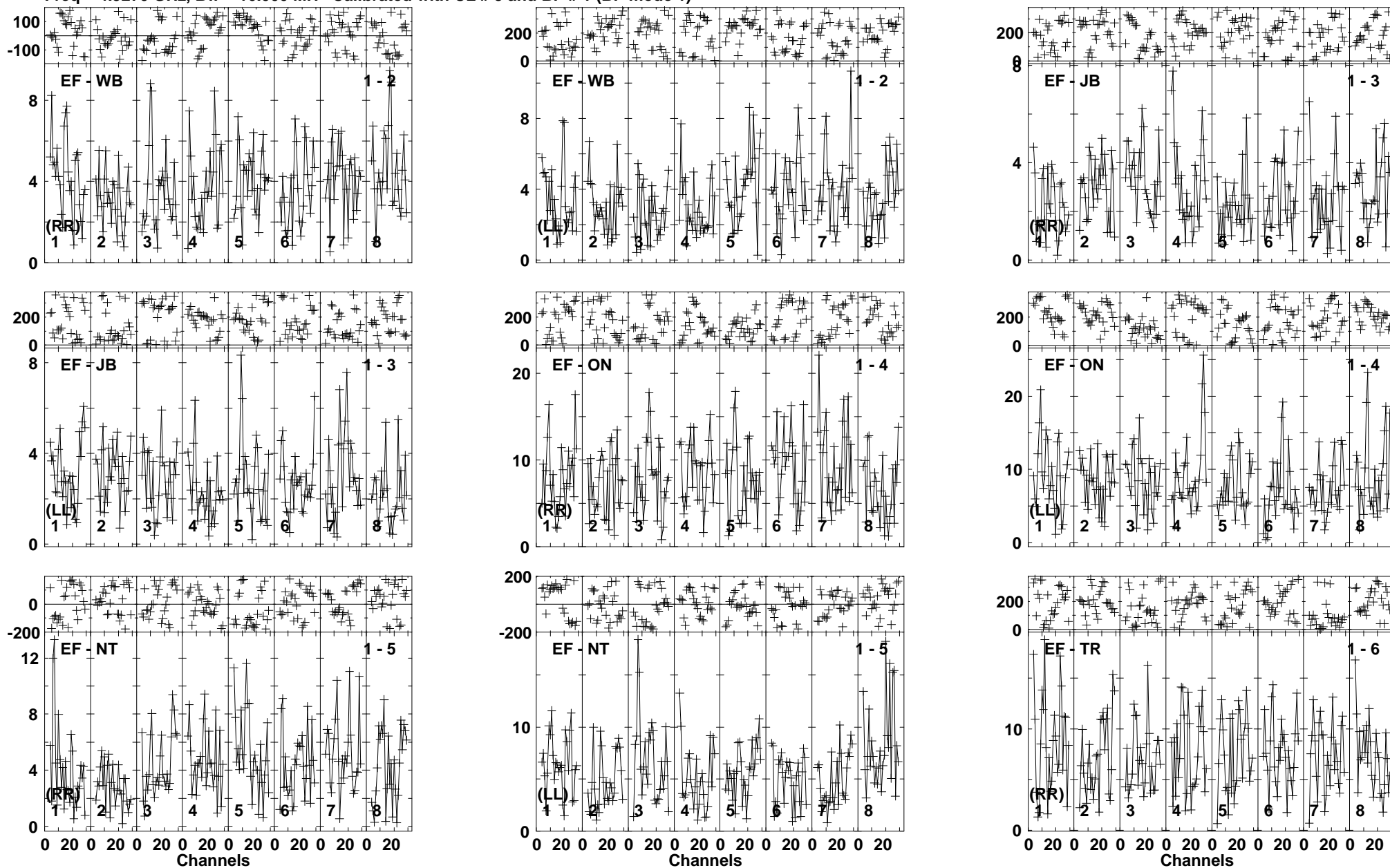

Lower frame: Milli Ampl Jy Top frame: Phas deg  
 Vector averaged cross-power spectrum Baseline: EF (01) - WB (02)  
 Timerange: 00/17:06:15 to 00/17:10:09



Plot file version 233 created 18-NOV-2014 15:23:55

ARP299C EP087H 3.UVDATA.1

Freq = 4.9270 GHz, Bw = 16.000 MH Calibrated with CL # 3 and BP # 1 (BP mode 1)

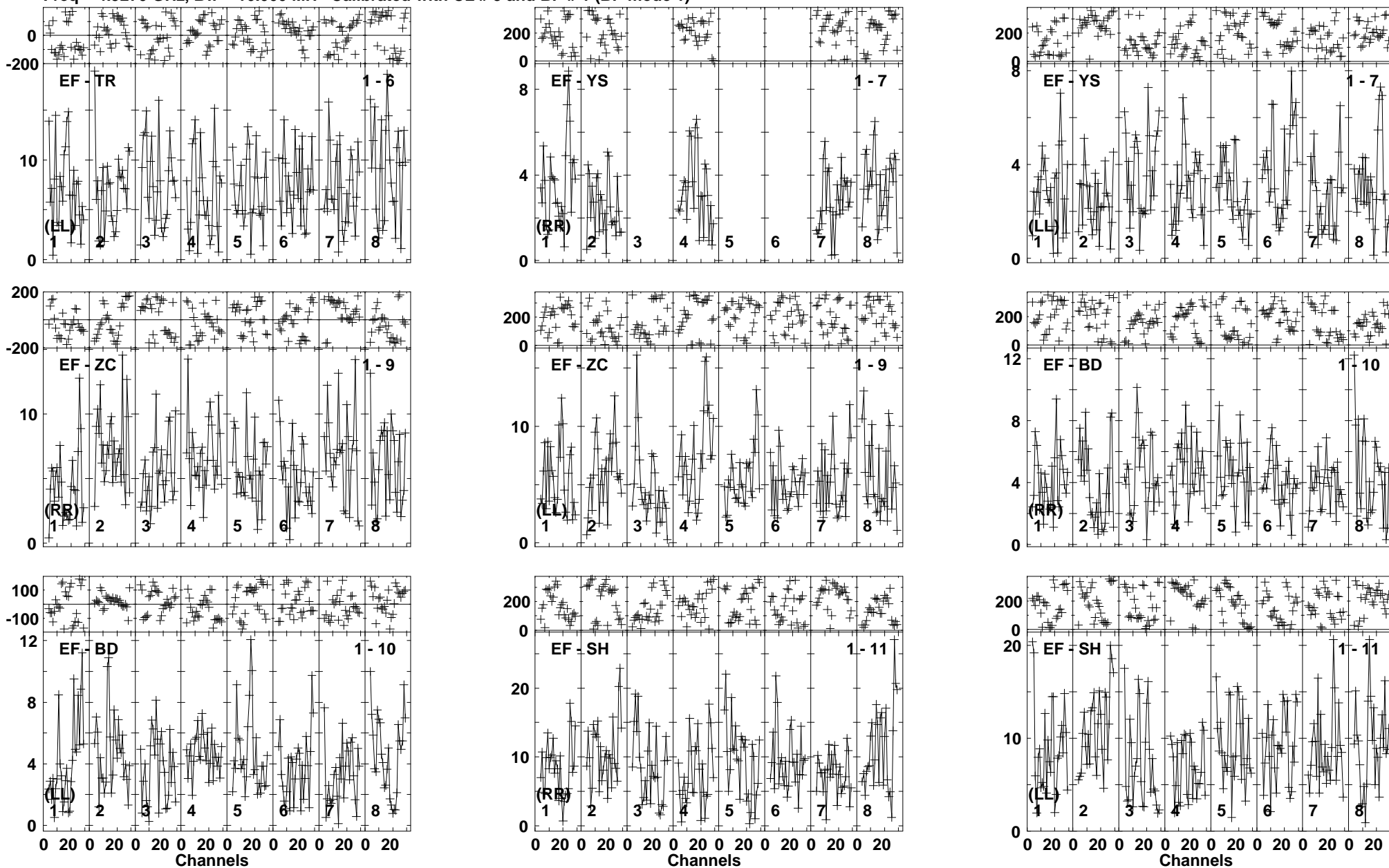

Lower frame: Milli Ampl Jy Top frame: Phas deg  
Vector averaged cross-power spectrum Baseline: EF (01) - TR (06)  
Timerange: 00/17:06:15 to 00/17:10:09

Plot file version 234 created 18-NOV-2014 15:23:55  
 J1128+5925 EP087H 3.UVDATA.1  
 Freq = 4.9270 GHz, Bw = 16.000 MH Calibrated with CL # 3 and BP # 1 (BP mode 1)

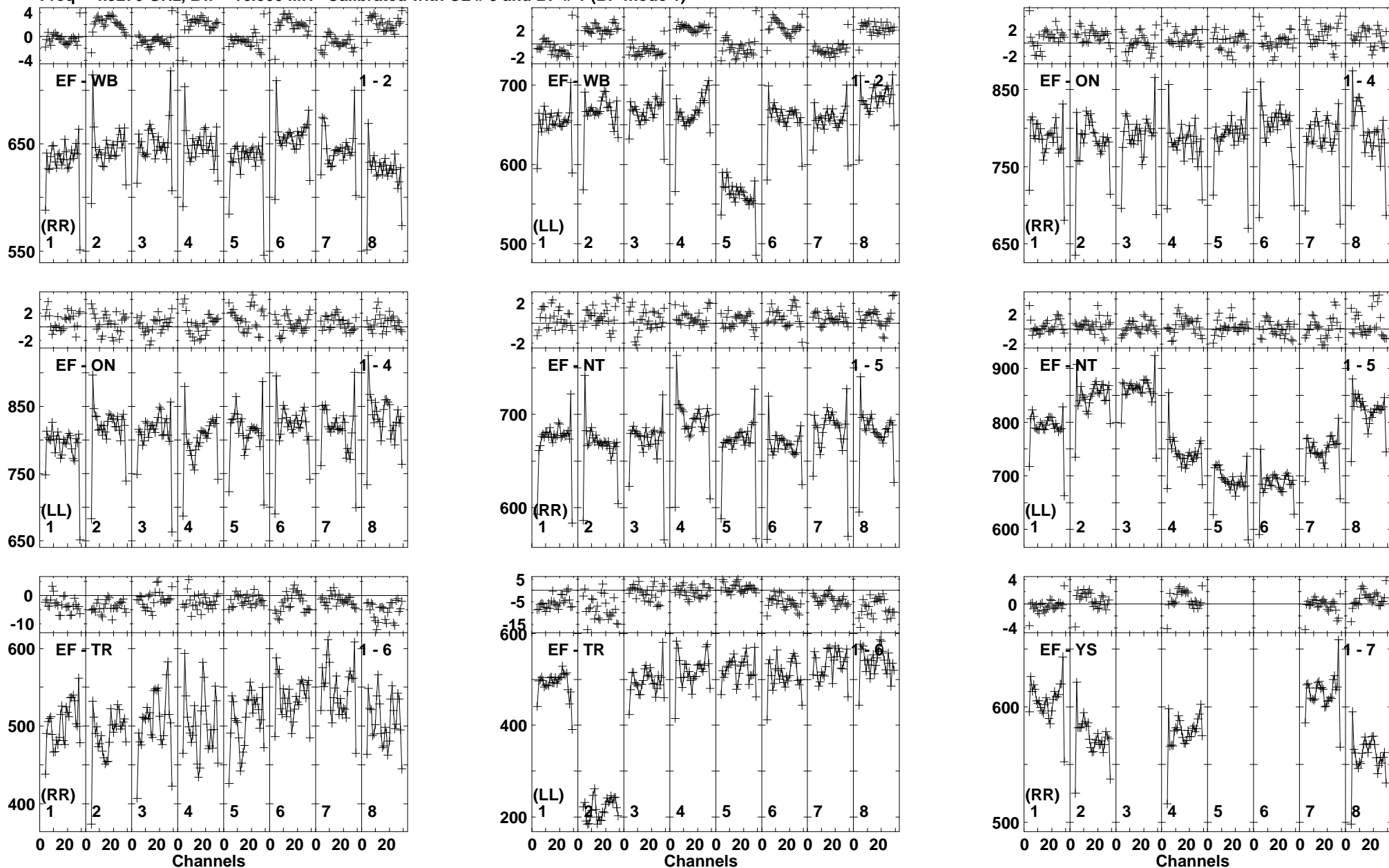

Lower frame: Milli Ampl Jy Top frame: Phas deg  
 Vector averaged cross-power spectrum Baseline: EF (01) - WB (02)  
 Timerange: 00/17:10:53 to 00/17:11:19

Plot file version 235 created 18-NOV-2014 15:23:55

J1128+5925 EP087H 3.UVDATA.1

Freq = 4.9270 GHz, Bw = 16.000 MH Calibrated with CL # 3 and BP # 1 (BP mode 1)

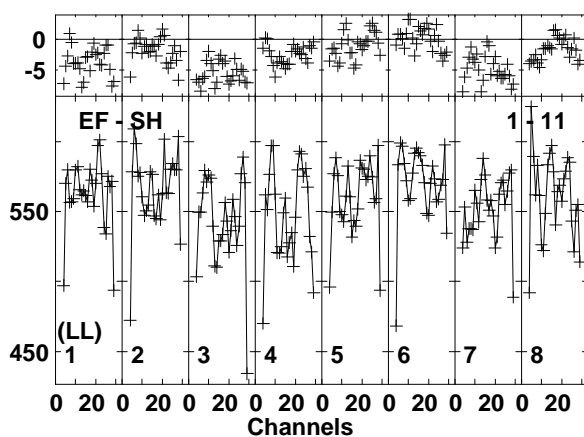
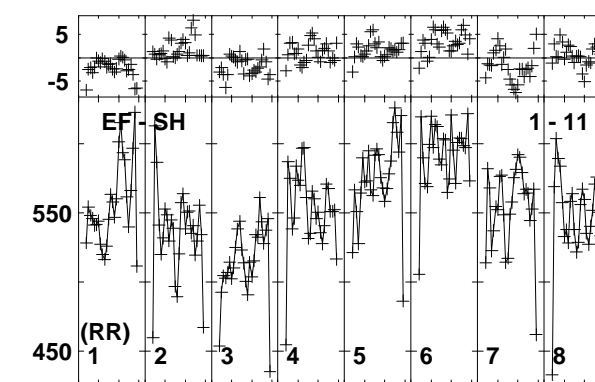
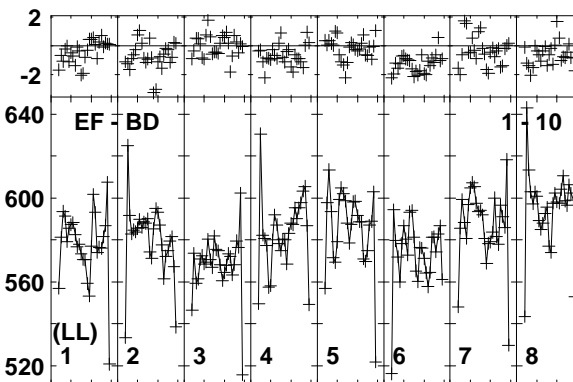
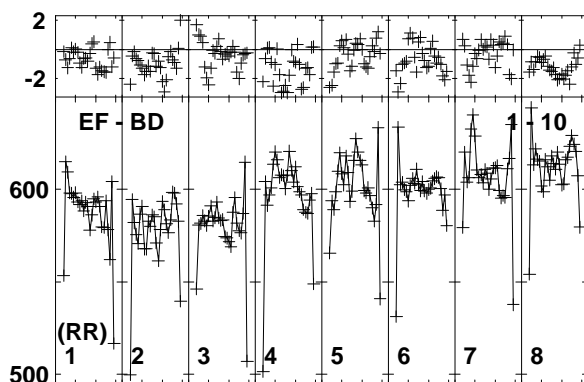
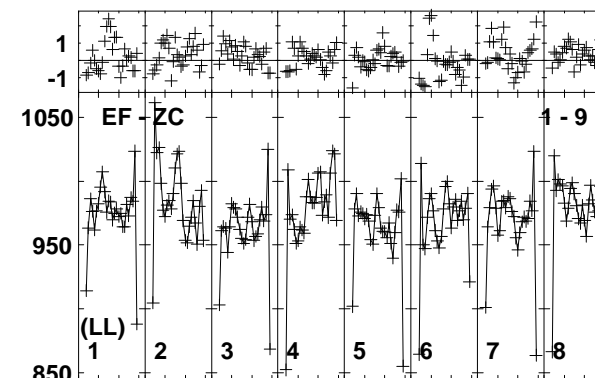
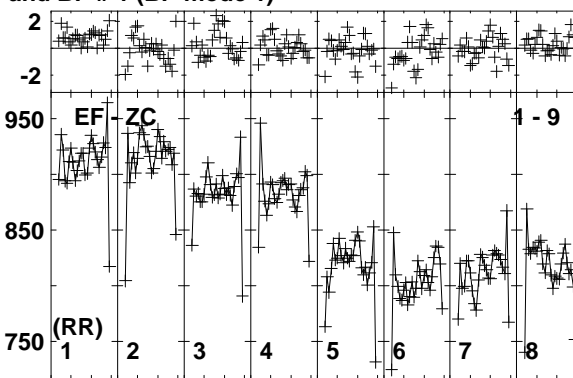
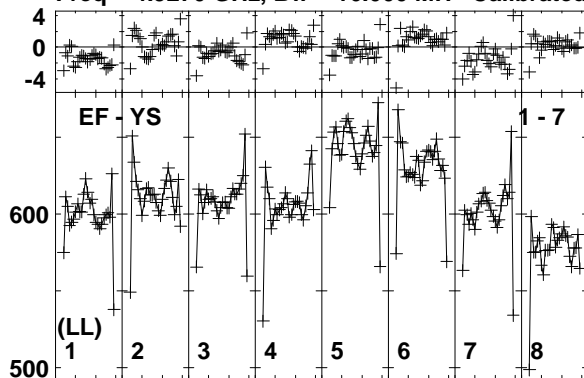

0 20 0 20 0 20 0 20 0 20 0 20 0 20 0 20 0 20  
Channels  
Lower frame: Milli Ampl Jy Top frame: Phas deg  
Vector averaged cross-power spectrum Baseline: EF (01) - YS (07)  
Timerange: 00/17:10:53 to 00/17:11:19

Plot file version 236 created 18-NOV-2014 15:23:55  
 ARP299C EP087H 3.UVDATA.1  
 Freq = 4.9270 GHz, Bw = 16.000 MH Calibrated with CL # 3 and BP # 1 (BP mode 1)

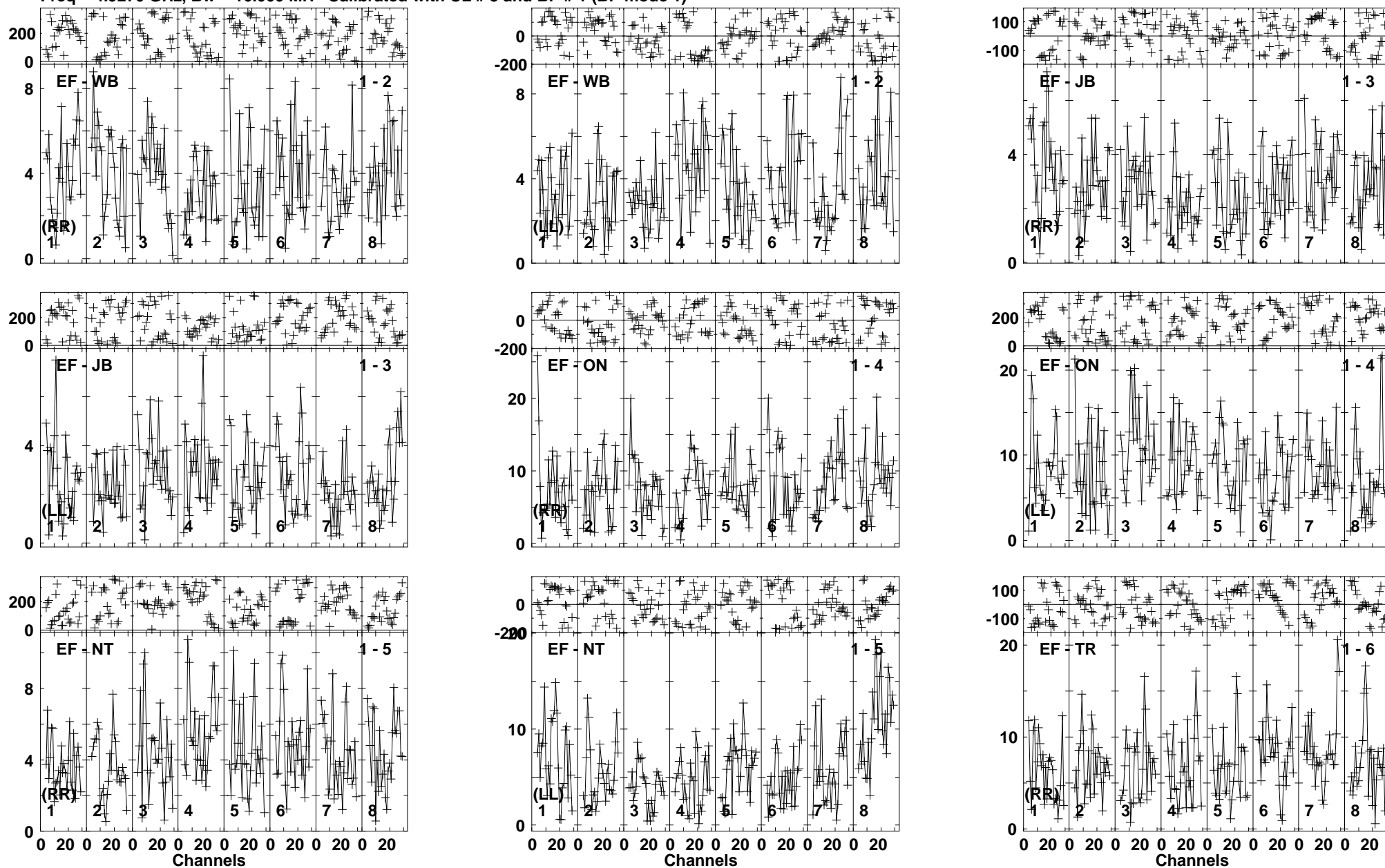

Lower frame: Milli Ampl Jy Top frame: Phas deg  
 Vector averaged cross-power spectrum Baseline: EF (01) - WB (02)  
 Timerange: 00:17:11:21 to 00:17:15:19

Plot file version 237 created 18-NOV-2014 15:23:56  
 ARP299C EP087H 3.UVDATA.1  
 Freq = 4.9270 GHz, Bw = 16.000 MH Calibrated with CL # 3 and BP # 1 (BP mode 1)

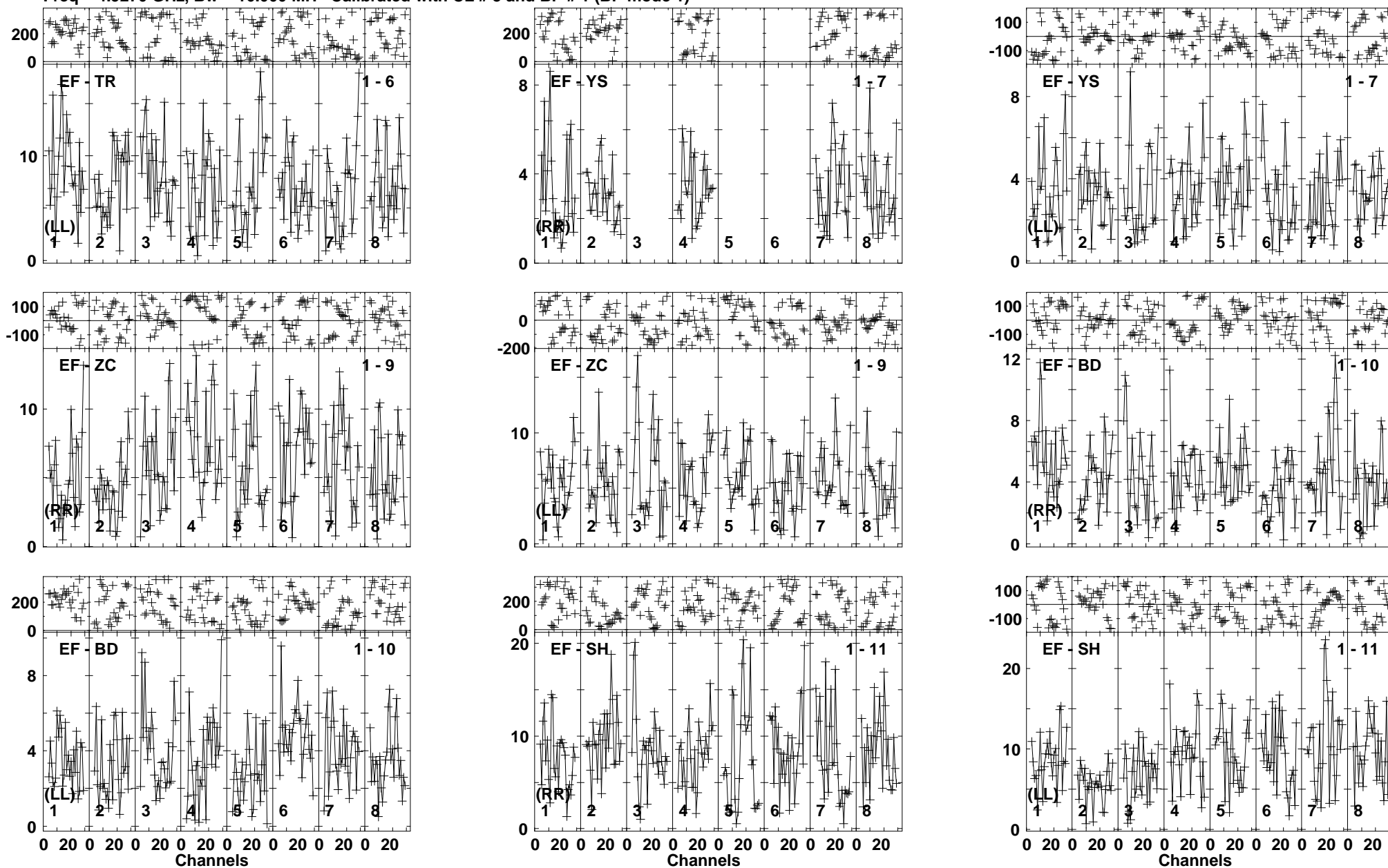

Lower frame: Milli Ampl Jy Top frame: Phas deg  
 Vector averaged cross-power spectrum Baseline: EF (01) - TR (06)  
 Timerange: 00/17:11:21 to 00/17:15:19

Plot file version 238 created 18-NOV-2014 15:23:56

J1128+5925 EP087H 3.UVDATA.1

Freq = 4.9270 GHz, Bw = 16.000 MH Calibrated with CL # 3 and BP # 1 (BP mode 1)

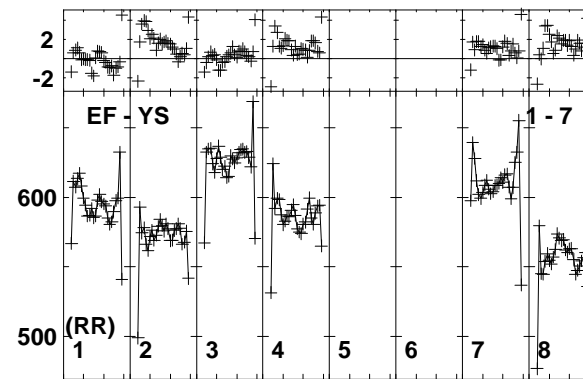
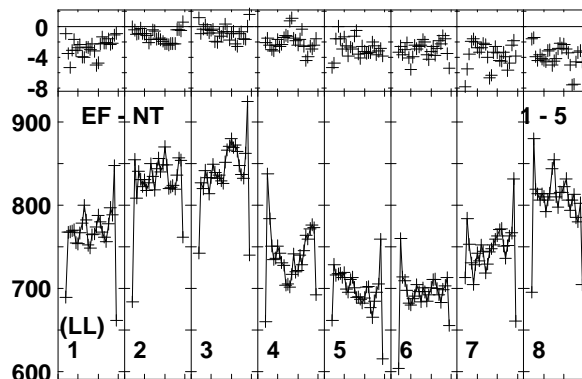
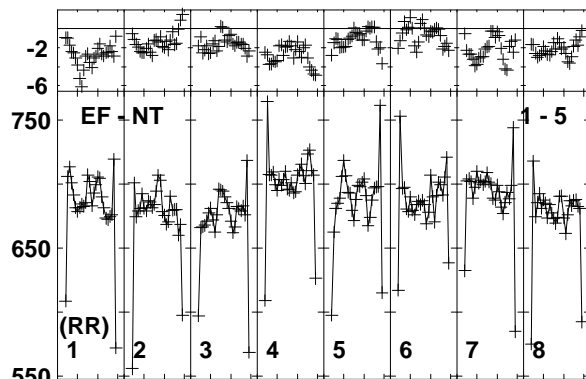
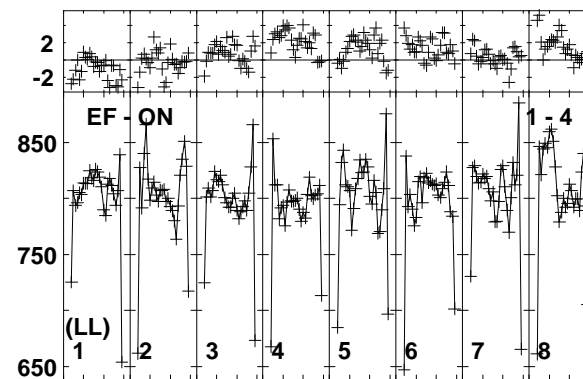
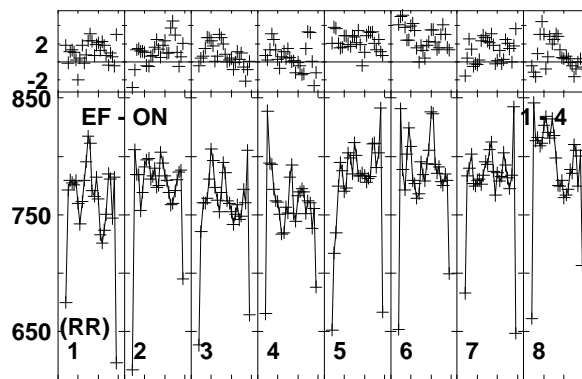
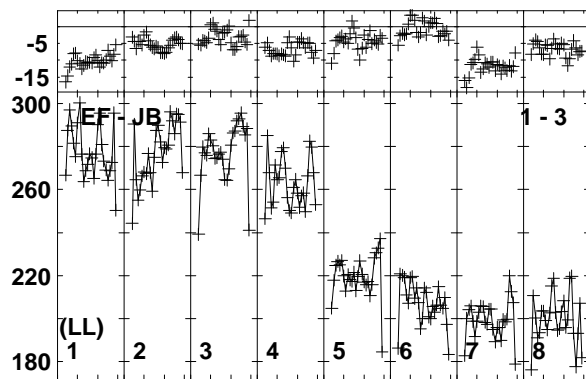
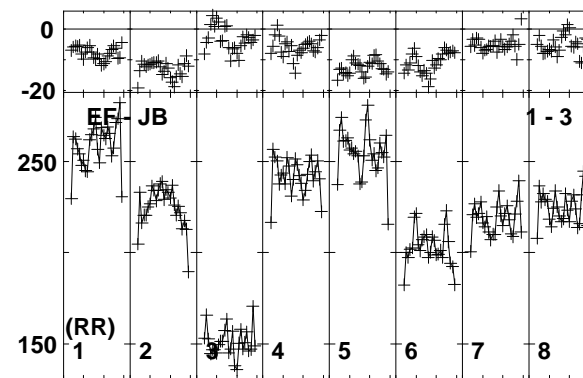
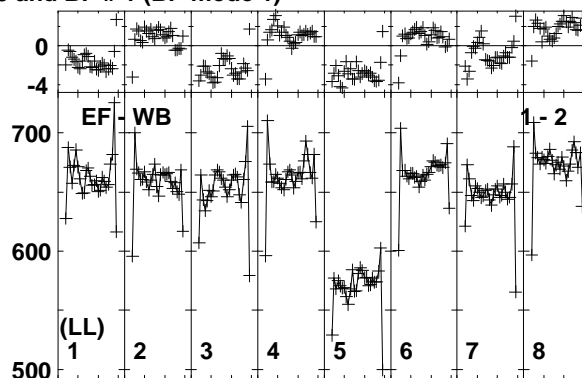
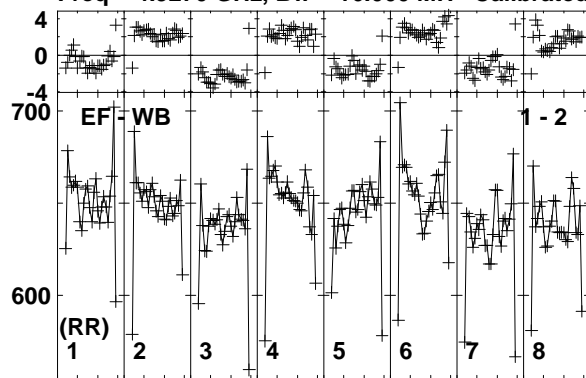

Lower frame: Milli Ampl Jy Top frame: Phas deg  
Vector averaged cross-power spectrum Baseline: EF (01) - WB (02)  
Timerange: 00/17:15:25 to 00/17:16:19

Plot file version 239 created 18-NOV-2014 15:23:56

J1128+5925 EP087H 3.UVDATA.1

Freq = 4.9270 GHz, Bw = 16.000 MH Calibrated with CL # 3 and BP # 1 (BP mode 1)

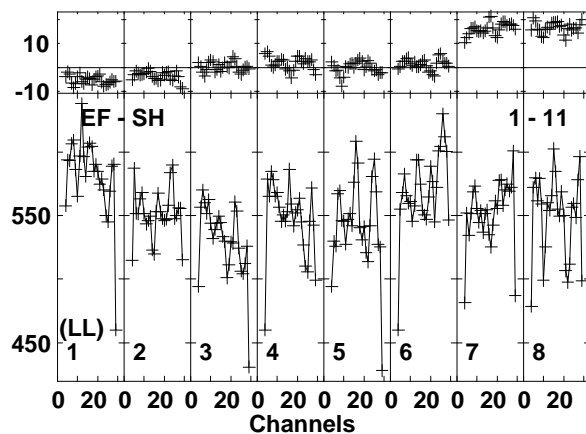
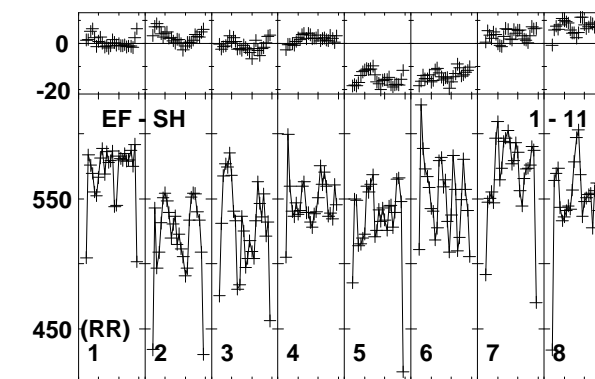
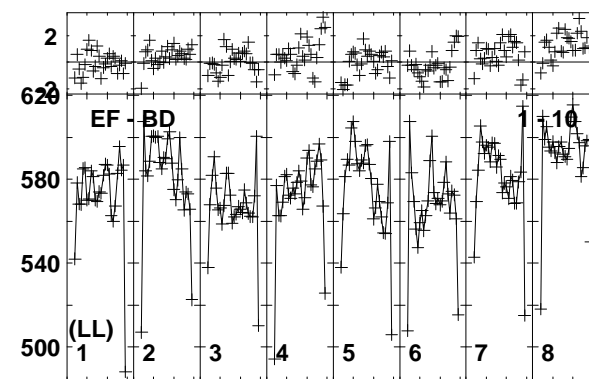
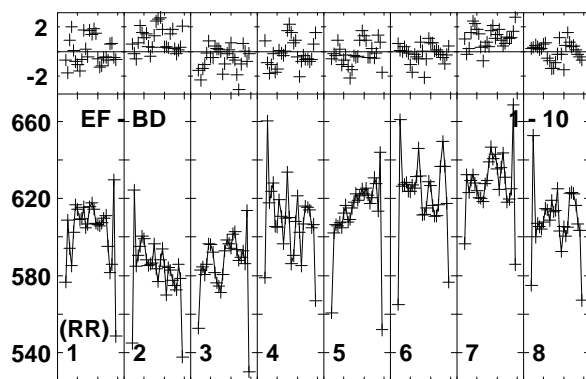
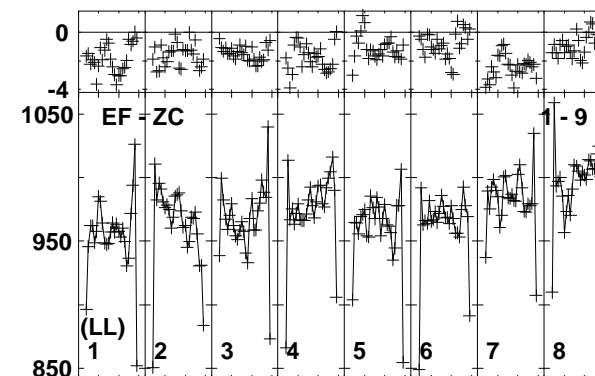
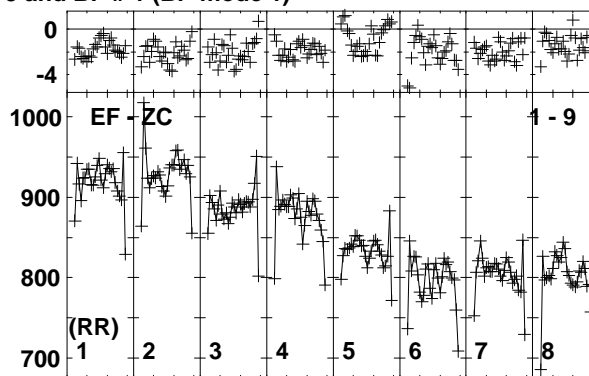
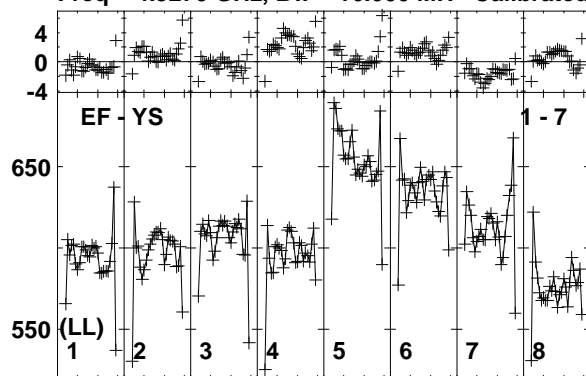

0 20 0 20 0 20 0 20 0 20 0 20 0 20 0 20 0 20  
Channels  
Lower frame: Milli Ampl Jy Top frame: Phas deg  
Vector averaged cross-power spectrum Baseline: EF (01) - YS (07)  
Timerange: 00/17:15:25 to 00/17:16:19

Plot file version 240 created 18-NOV-2014 15:23:56  
 ARP299C EP087H 3.UVDATA.1  
 Freq = 4.9270 GHz, Bw = 16.000 MH Calibrated with CL # 3 and BP # 1 (BP mode 1)

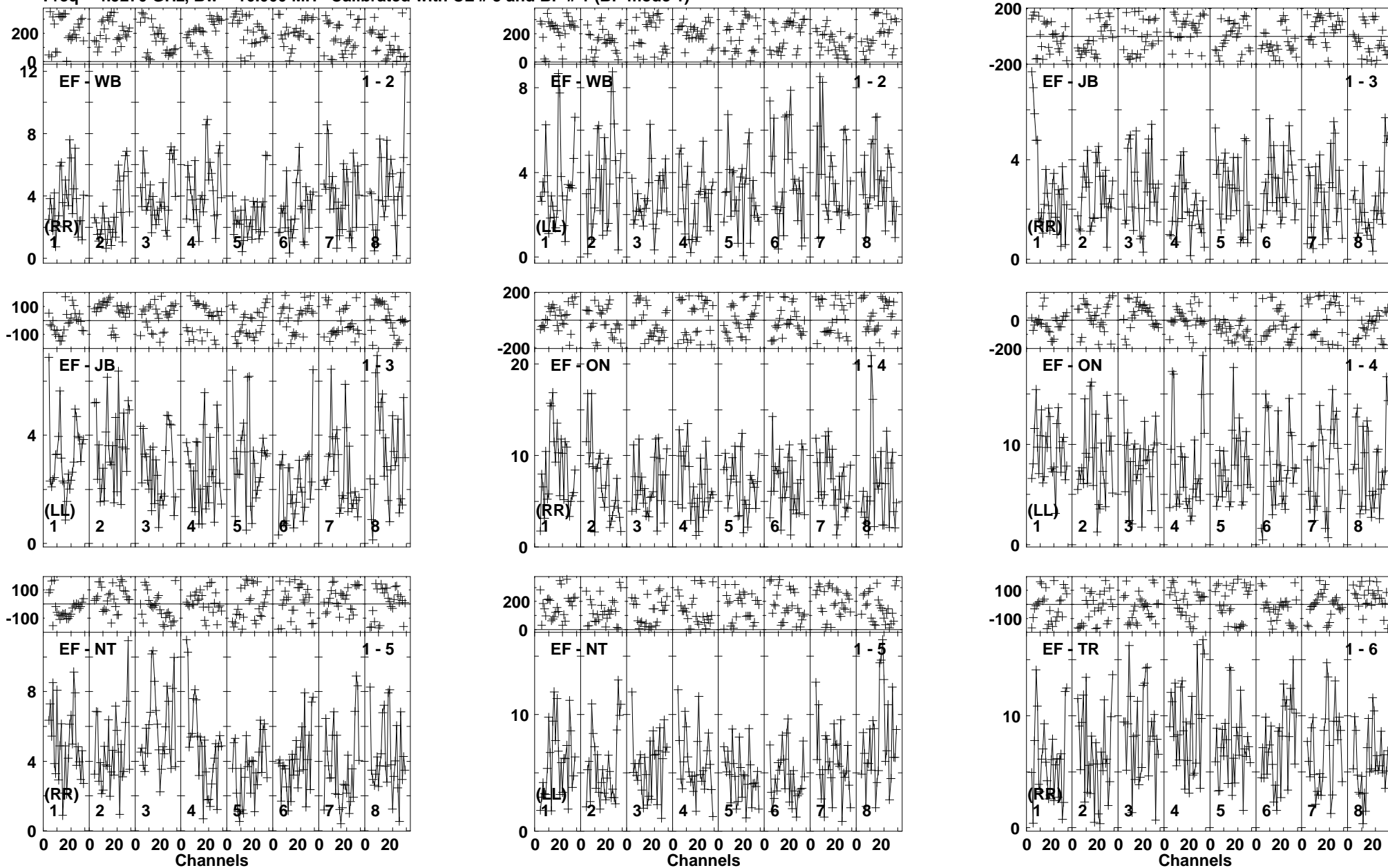

Lower frame: Milli Ampl Jy Top frame: Phas deg  
 Vector averaged cross-power spectrum Baseline: EF (01) - WB (02)  
 Timerange: 00/17:16:25 to 00/17:20:19



Plot file version 241 created 18-NOV-2014 15:23:57

ARP299C EP087H 3.UVDATA.1

Freq = 4.9270 GHz, Bw = 16.000 MH Calibrated with CL # 3 and BP # 1 (BP mode 1)

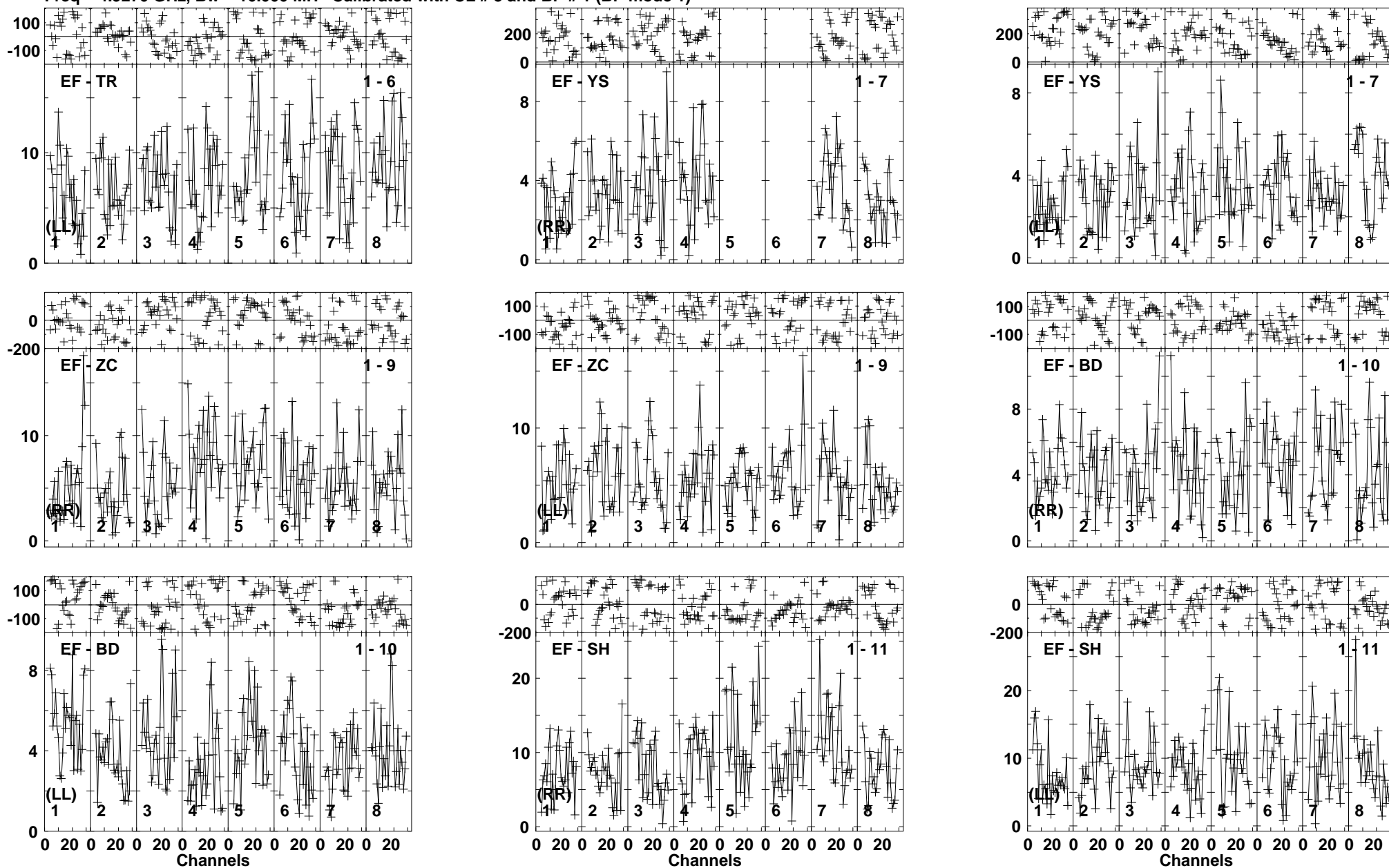

Lower frame: Milli Ampl Jy Top frame: Phas deg  
Vector averaged cross-power spectrum Baseline: EF (01) - TR (06)  
Timerange: 00/17:16:25 to 00/17:20:19

Plot file version 242 created 18-NOV-2014 15:23:57

J1128+5925 EP087H 3.UVDATA.1

Freq = 4.9270 GHz, Bw = 16.000 MH Calibrated with CL # 3 and BP # 1 (BP mode 1)

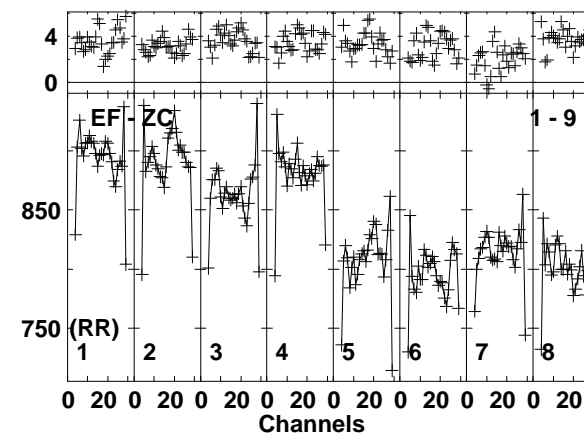
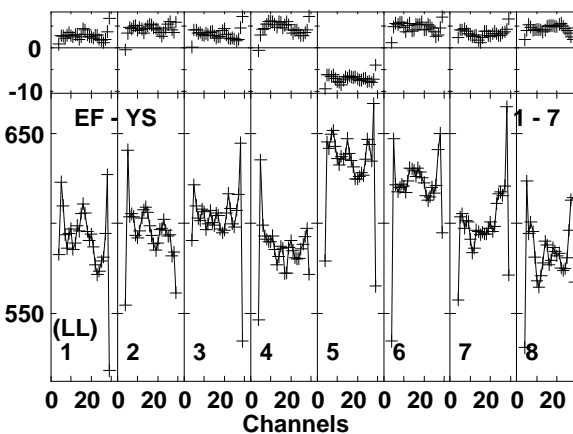
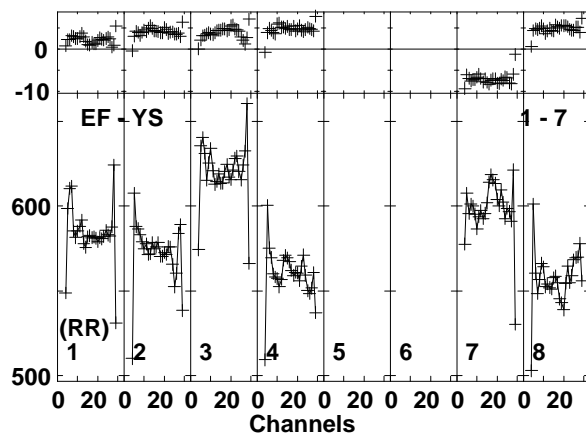
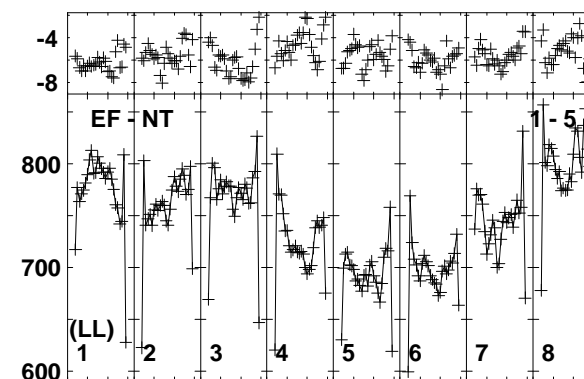
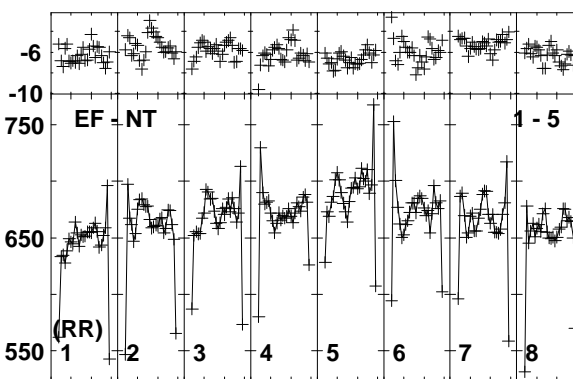
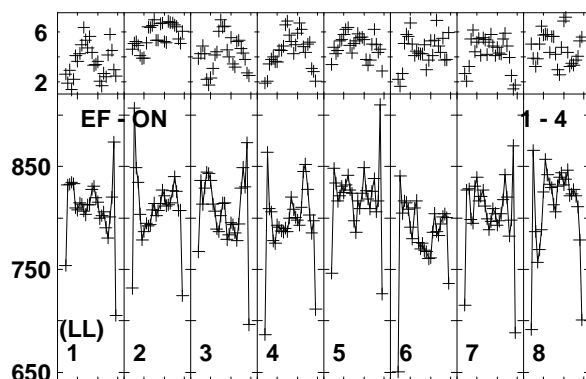
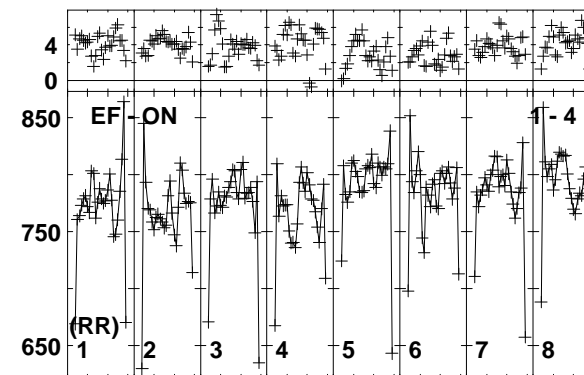
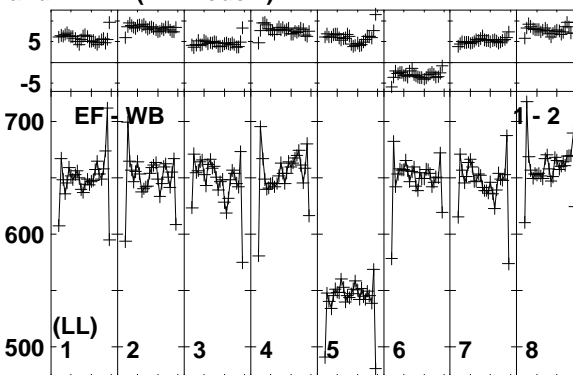
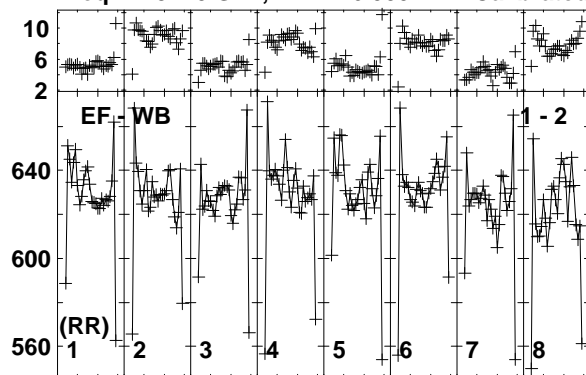

Lower frame: Milli Ampl Jy Top frame: Phas deg  
Vector averaged cross-power spectrum Baseline: EF (01) - WB (02)  
Timerange: 00/17:20:25 to 00/17:21:19

Plot file version 243 created 18-NOV-2014 15:23:57

J1128+5925 EP087H 3.UVDATA.1

Freq = 4.9270 GHz, Bw = 16.000 MH Calibrated with CL # 3 and BP # 1 (BP mode 1)

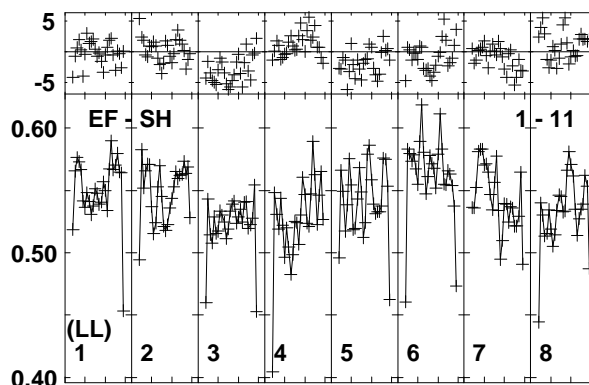
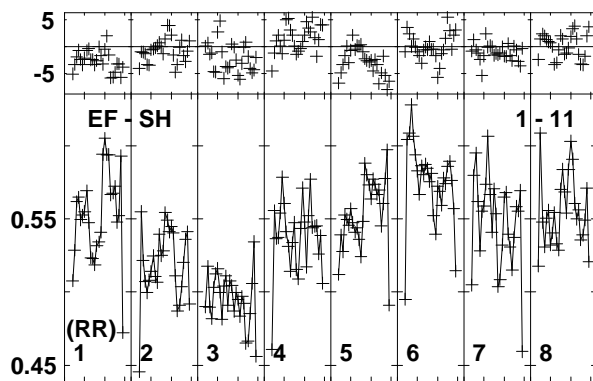
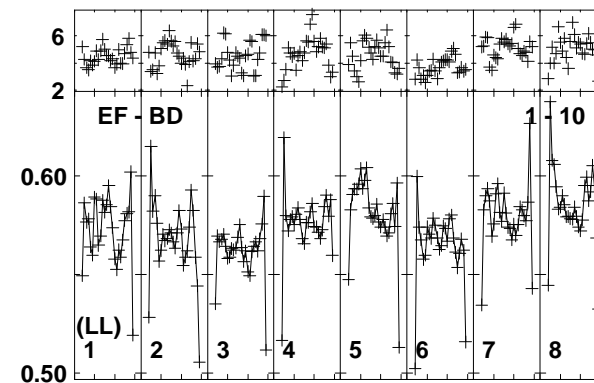
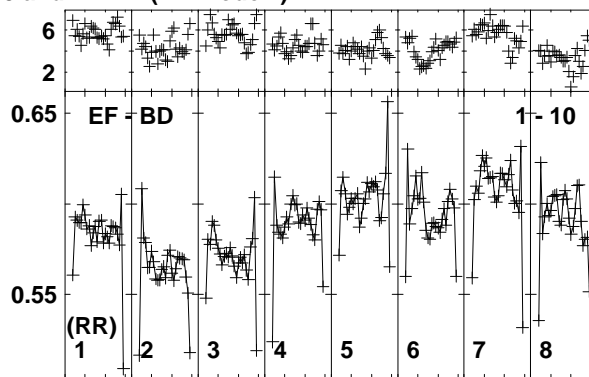
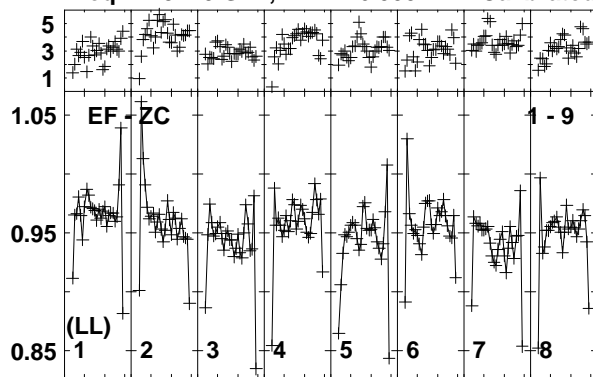

Lower frame: Ampl Jy Top frame: Phas deg  
Vector averaged cross-power spectrum Baseline: EF (01) - ZC (09)  
Timerange: 00/17:20:25 to 00/17:21:19

Plot file version 244 created 18-NOV-2014 15:23:57  
 ARP299C EP087H 3.UVDATA.1  
 Freq = 4.9270 GHz, Bw = 16.000 MH Calibrated with CL # 3 and BP # 1 (BP mode 1)

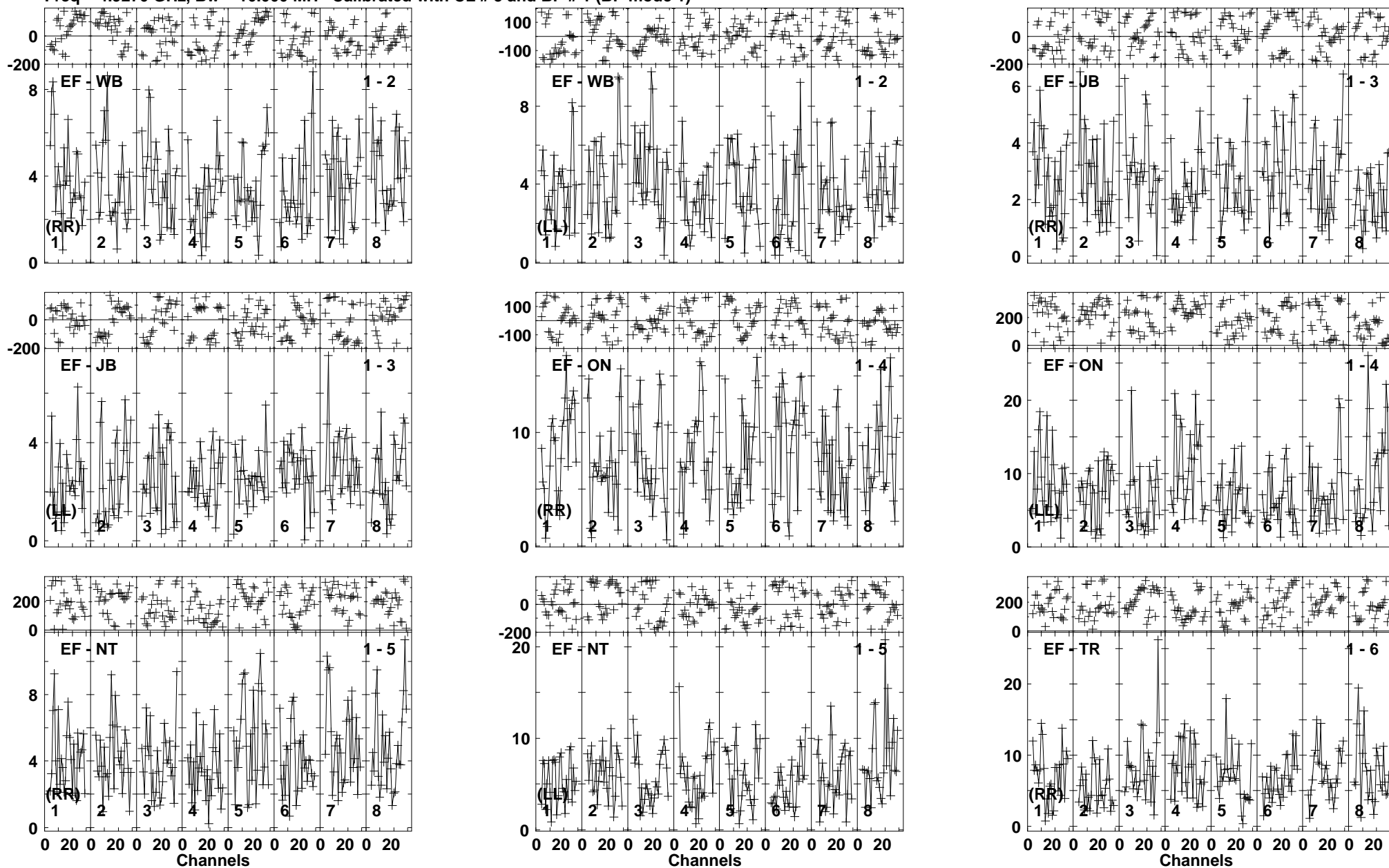

Lower frame: Milli Ampl Jy Top frame: Phas deg  
 Vector averaged cross-power spectrum Baseline: EF (01) - WB (02)  
 Timerange: 00/17:21:21 to 00/17:25:19

Plot file version 245 created 18-NOV-2014 15:23:58  
 ARP299C EP087H 3.UVDATA.1  
 Freq = 4.9270 GHz, Bw = 16.000 MH Calibrated with CL # 3 and BP # 1 (BP mode 1)

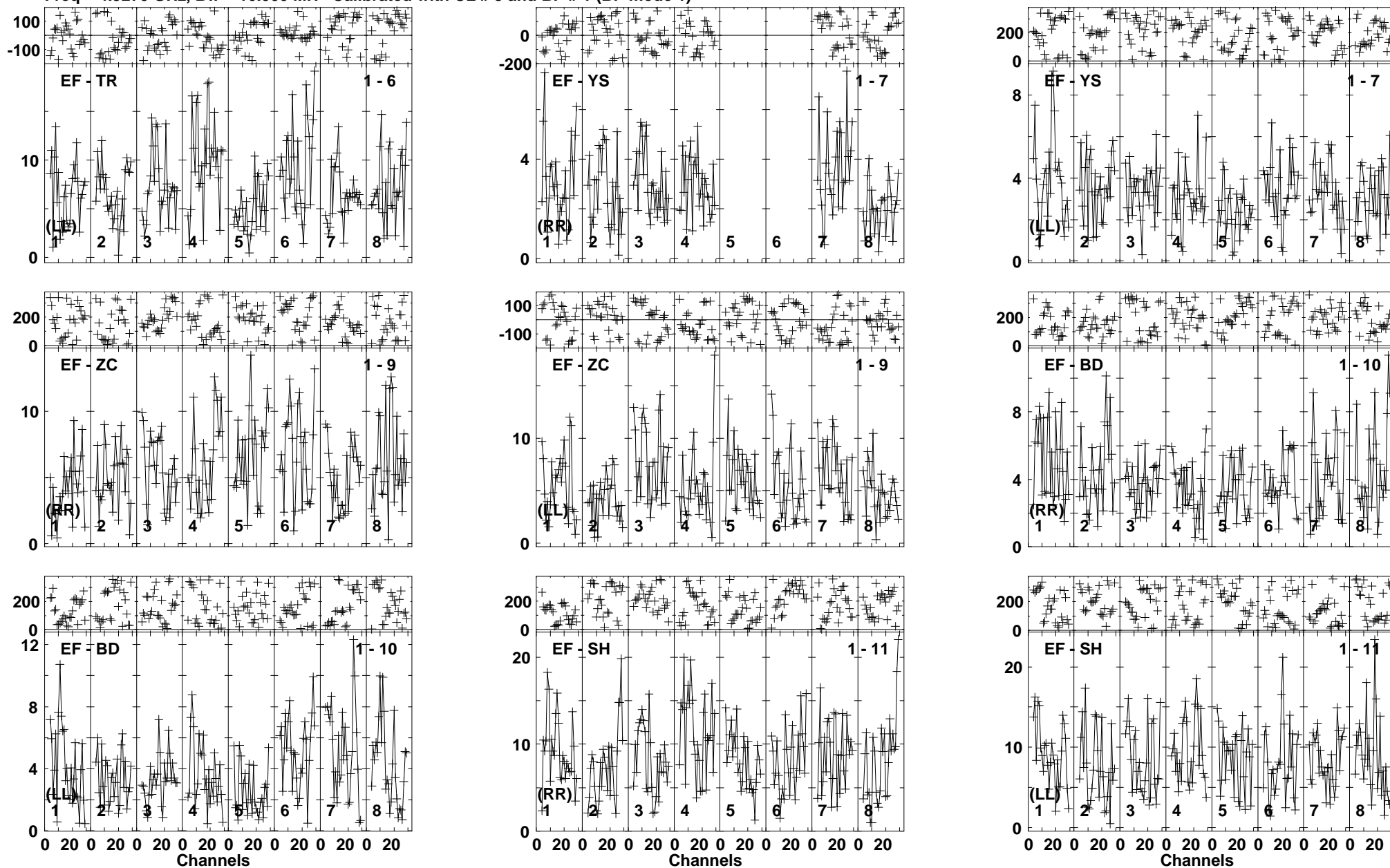

Lower frame: Milli Ampl Jy Top frame: Phas deg  
 Vector averaged cross-power spectrum Baseline: EF (01) - TR (06)  
 Timerange: 00/17:21:21 to 00/17:25:19

Plot file version 246 created 18-NOV-2014 15:23:58

J1128+5925 EP087H 3.UVDATA.1

Freq = 4.9270 GHz, Bw = 16.000 MH Calibrated with CL # 3 and BP # 1 (BP mode 1)

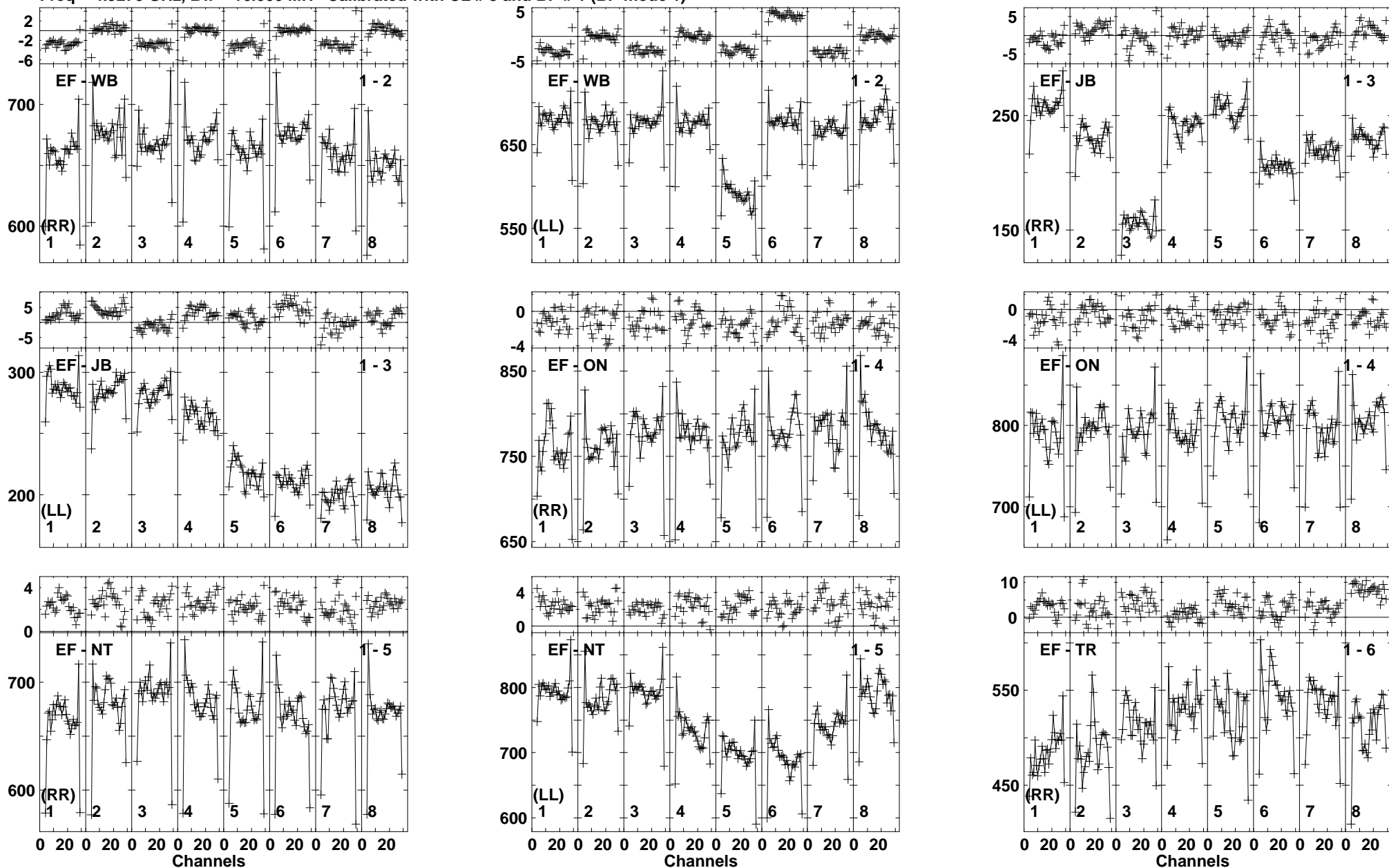

Plot file version 247 created 18-NOV-2014 15:23:58

J1128+5925 EP087H 3.UVDATA.1

Freq = 4.9270 GHz, Bw = 16.000 MH Calibrated with CL # 3 and BP # 1 (BP mode 1)

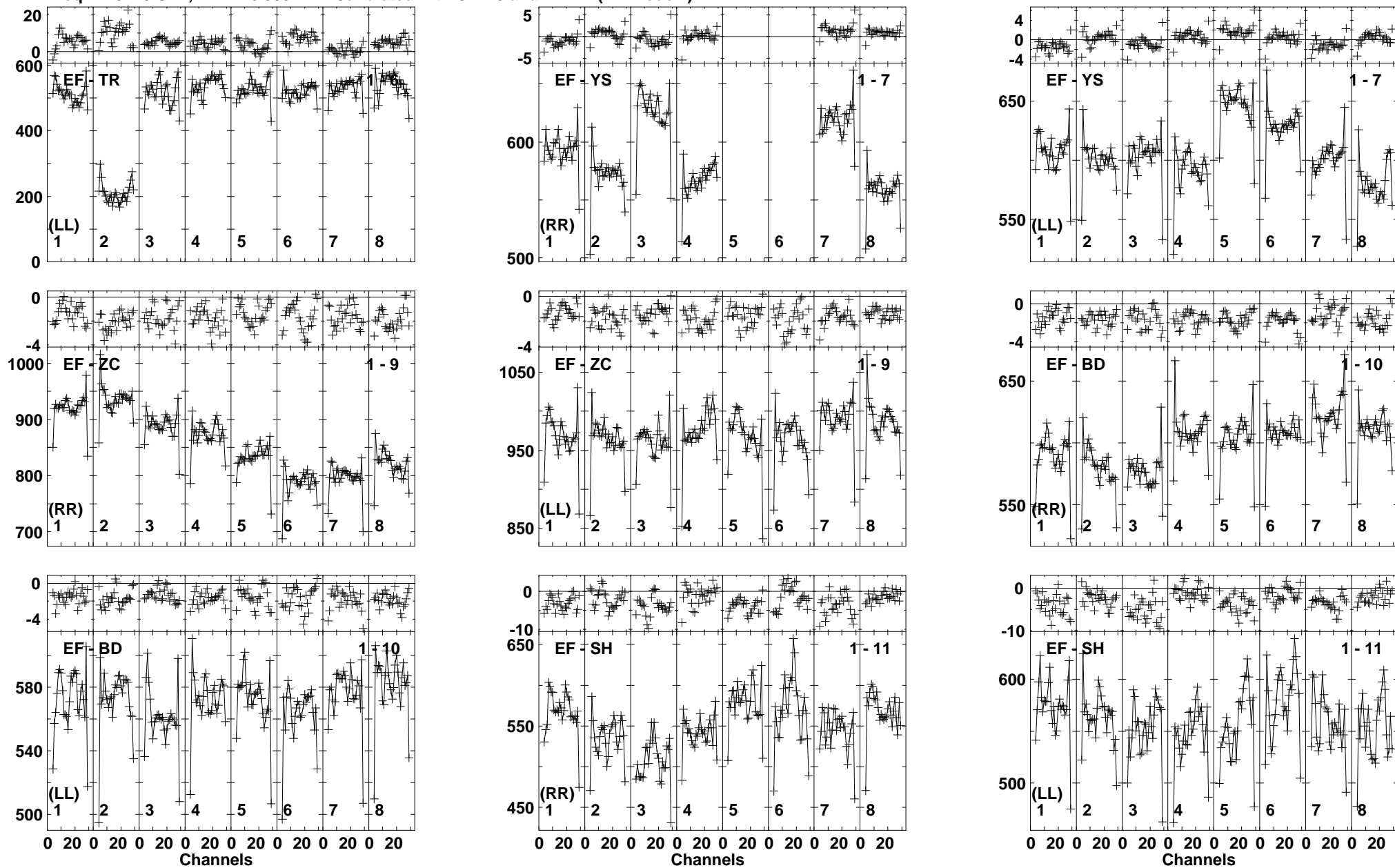

Lower frame: Milli Ampl Jy Top frame: Phas deg  
Vector averaged cross-power spectrum Baseline: EF (01) - TR (06)  
Timerange: 00/17:26:01 to 00/17:26:29

Plot file version 248 created 18-NOV-2014 15:23:58  
 ARP299C EP087H 3.UVDATA.1  
 Freq = 4.9270 GHz, Bw = 16.000 MH Calibrated with CL # 3 and BP # 1 (BP mode 1)

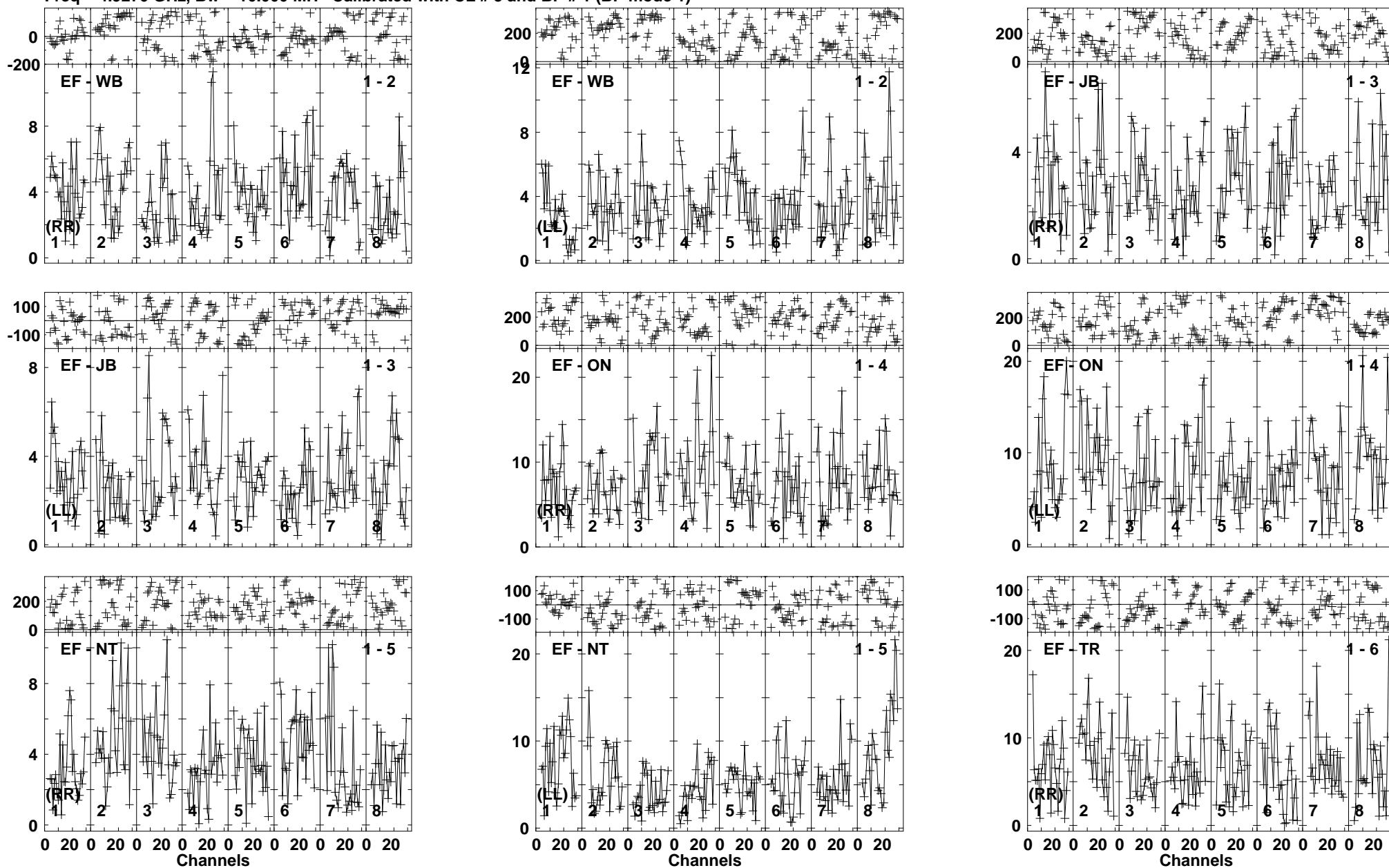

Lower frame: Milli Ampl Jy Top frame: Phas deg  
 Vector averaged cross-power spectrum Baseline: EF (01) - WB (02)  
 Timerange: 00/17:26:35 to 00/17:30:29



Plot file version 249 created 18-NOV-2014 15:23:59  
 ARP299C EP087H 3.UVDATA.1  
 Freq = 4.9270 GHz, Bw = 16.000 MH Calibrated with CL # 3 and BP # 1 (BP mode 1)

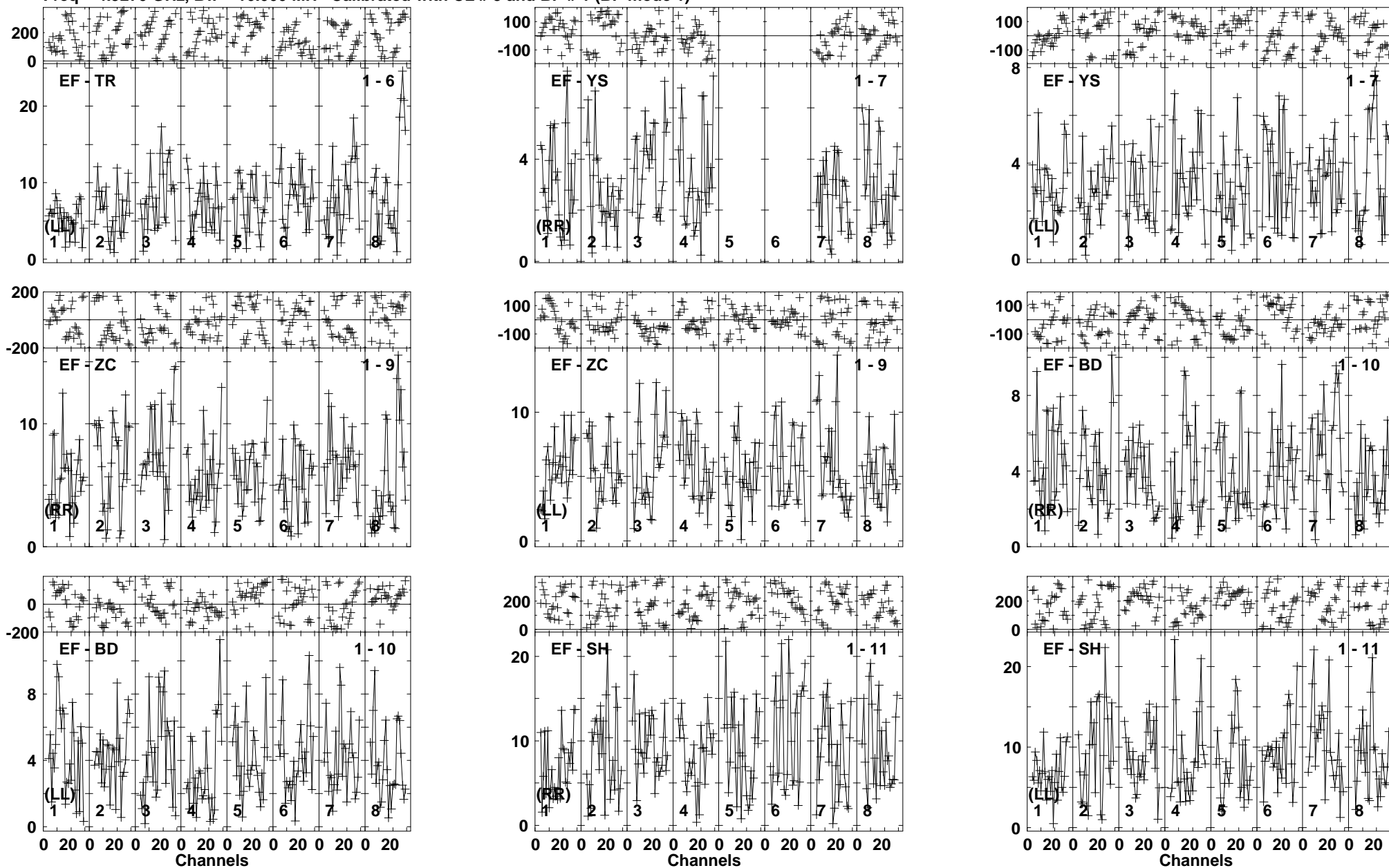

Lower frame: Milli Ampl Jy Top frame: Phas deg  
 Vector averaged cross-power spectrum Baseline: EF (01) - TR (06)  
 Timerange: 00/17:26:35 to 00/17:30:29

Plot file version 250 created 18-NOV-2014 15:23:59

J1128+5925 EP087H 3.UVDATA.1

Freq = 4.9270 GHz, Bw = 16.000 MH Calibrated with CL # 3 and BP # 1 (BP mode 1)

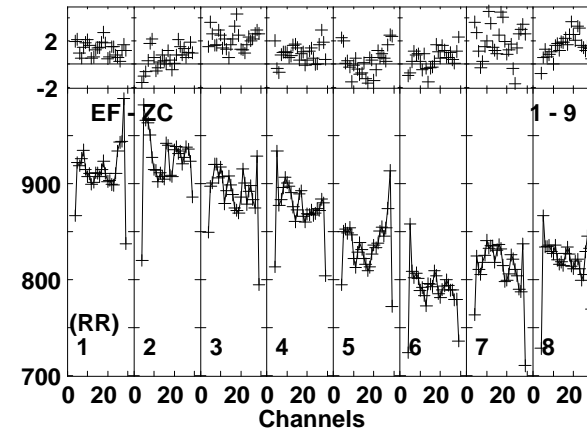
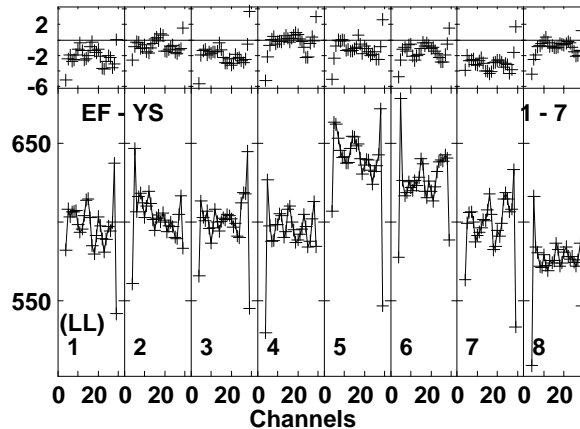
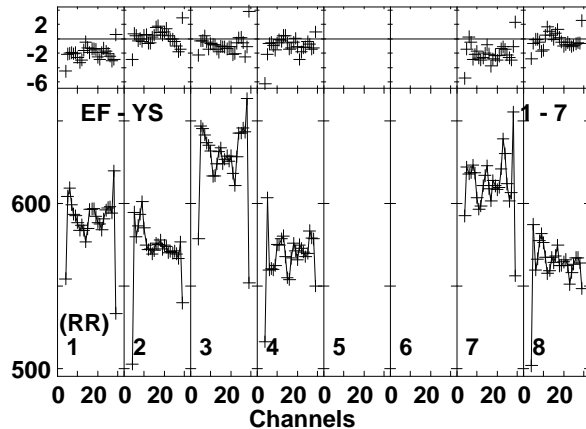
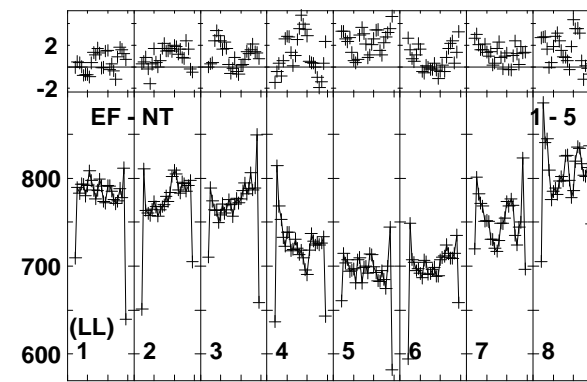
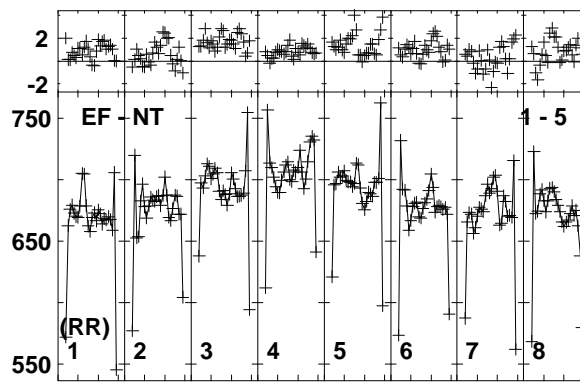
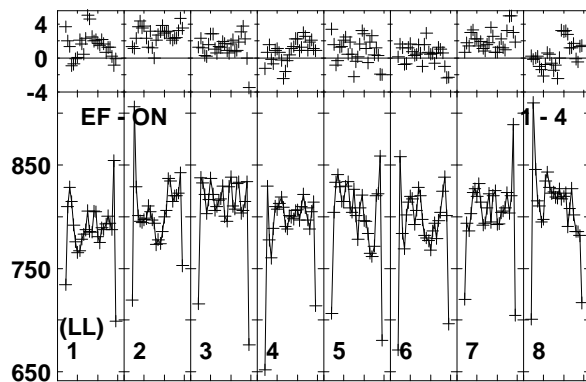
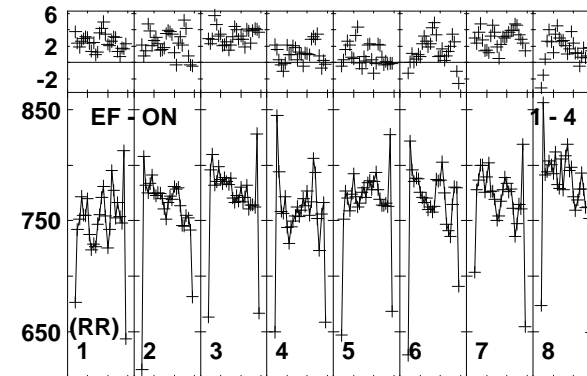
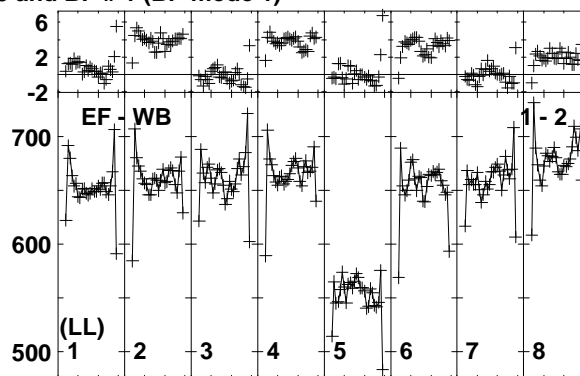
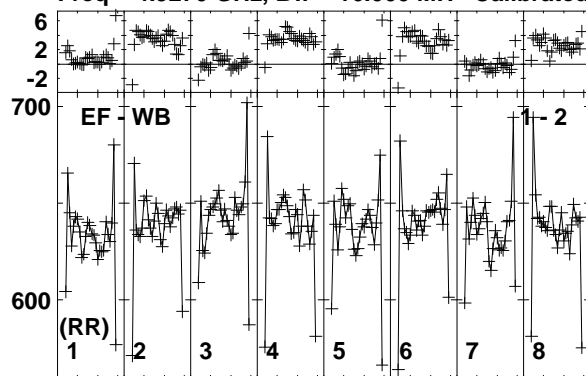

Lower frame: Milli Ampl Jy Top frame: Phas deg  
Vector averaged cross-power spectrum Baseline: EF (01) - WB (02)  
Timerange: 00/17:30:35 to 00/17:31:29

Plot file version 251 created 18-NOV-2014 15:23:59

J1128+5925 EP087H 3.UVDATA.1

Freq = 4.9270 GHz, Bw = 16.000 MH Calibrated with CL # 3 and BP # 1 (BP mode 1)

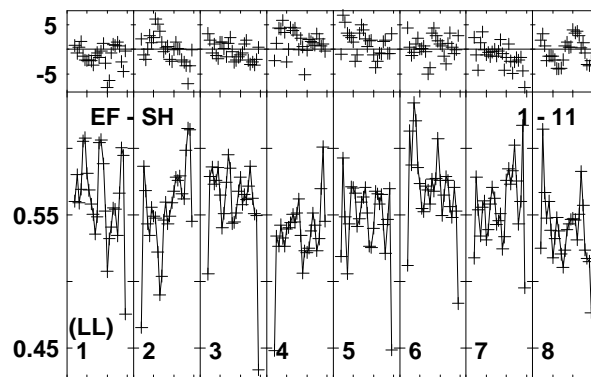
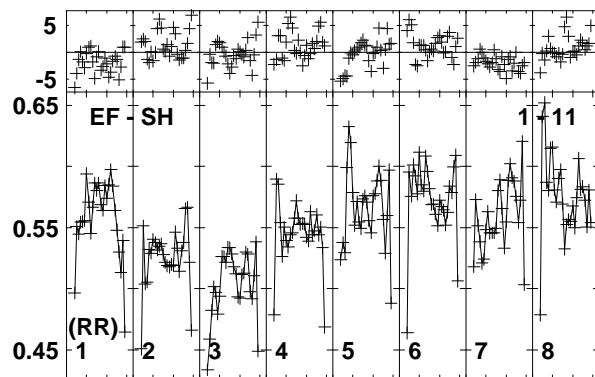
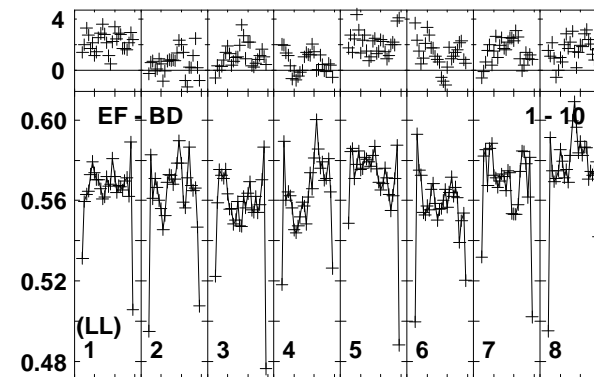
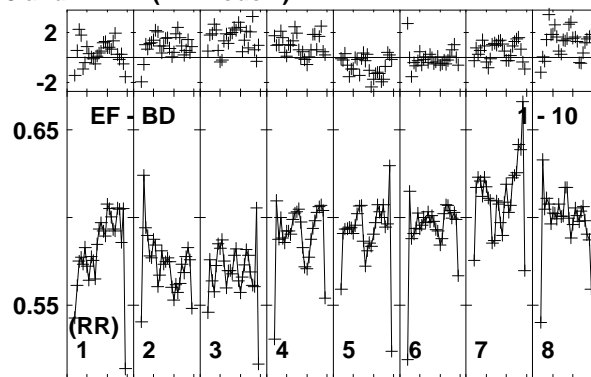
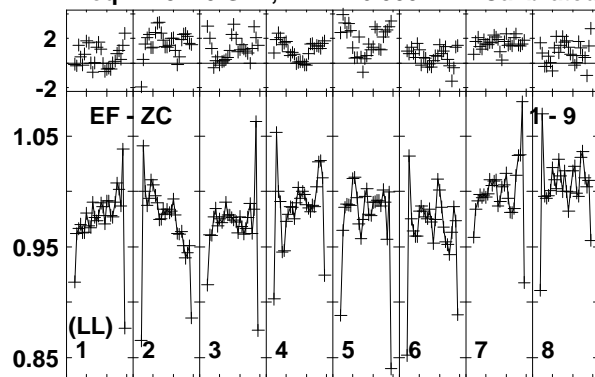

Lower frame: Ampl Jy Top frame: Phas deg  
Vector averaged cross-power spectrum Baseline: EF (01) - ZC (09)  
Timerange: 00/17:30:35 to 00/17:31:29

Plot file version 252 created 18-NOV-2014 15:23:59  
 ARP299C EP087H 3.UVDATA.1  
 Freq = 4.9270 GHz, Bw = 16.000 MH Calibrated with CL # 3 and BP # 1 (BP mode 1)

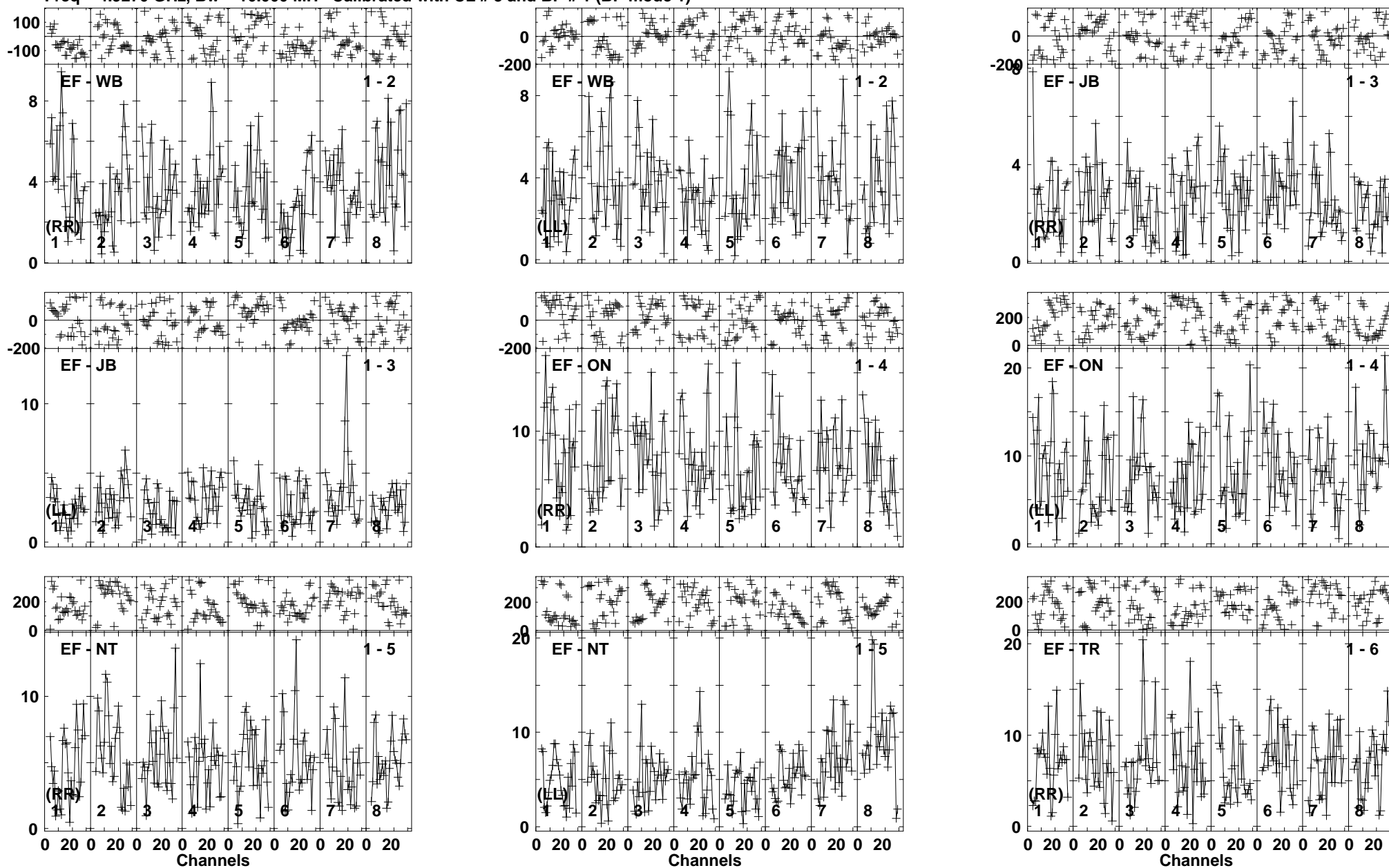

Lower frame: Milli Ampl Jy Top frame: Phas deg  
 Vector averaged cross-power spectrum Baseline: EF (01) - WB (02)  
 Timerange: 00/17:31:31 to 00/17:35:29

Plot file version 253 created 18-NOV-2014 15:24:00  
 ARP299C EP087H 3.UVDATA.1  
 Freq = 4.9270 GHz, Bw = 16.000 MH Calibrated with CL # 3 and BP # 1 (BP mode 1)

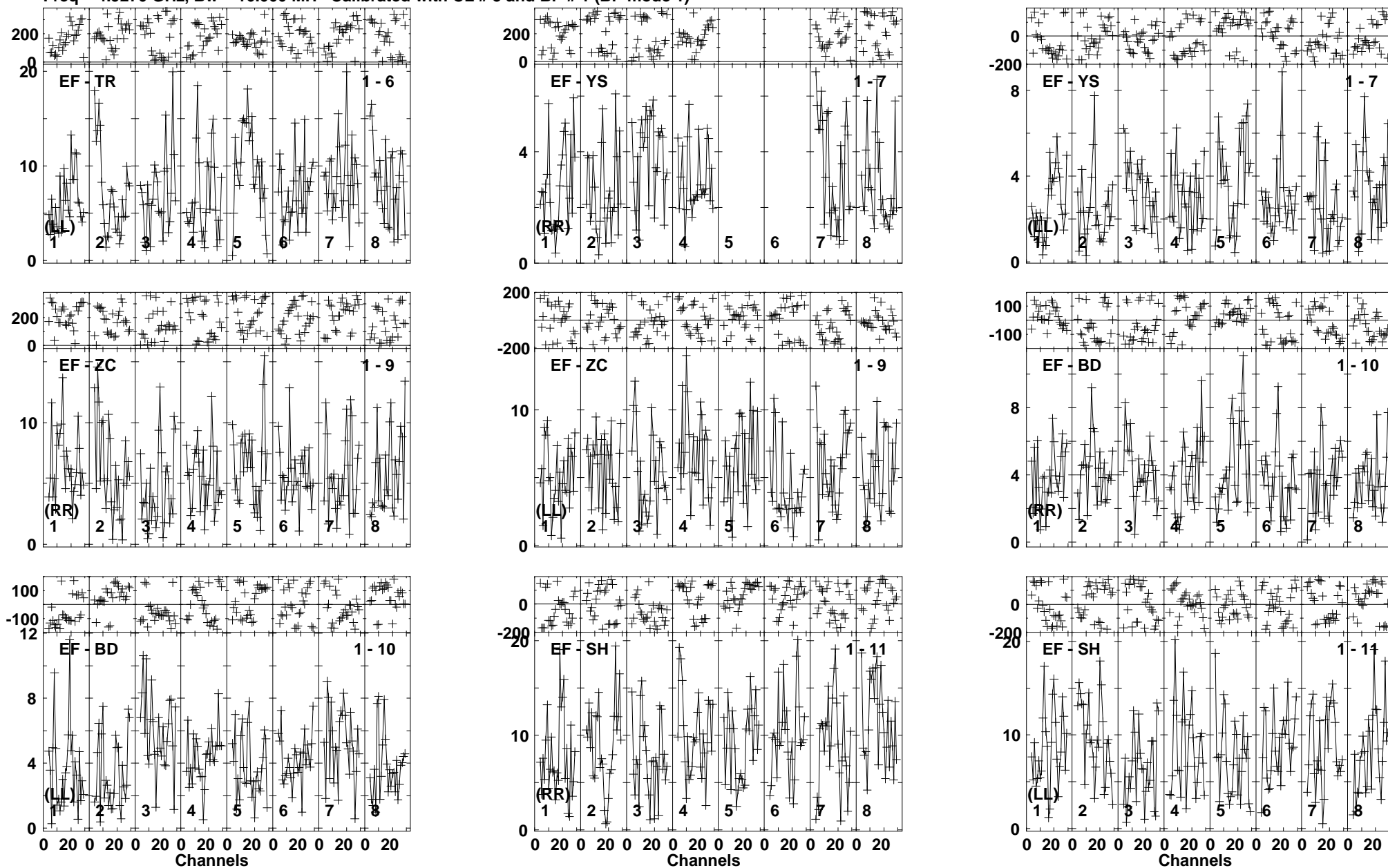

Lower frame: Milli Ampl Jy Top frame: Phas deg  
 Vector averaged cross-power spectrum Baseline: EF (01) - TR (06)  
 Timerange: 00/17:31:31 to 00/17:35:29

Plot file version 254 created 18-NOV-2014 15:24:00

J1128+5925 EP087H 3.UVDATA.1

Freq = 4.9270 GHz, Bw = 16.000 MH Calibrated with CL # 3 and BP # 1 (BP mode 1)

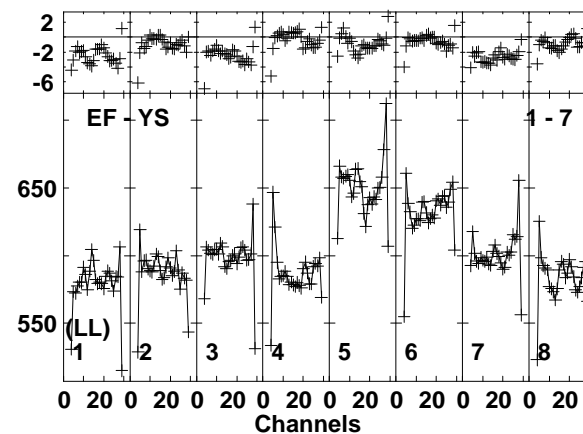
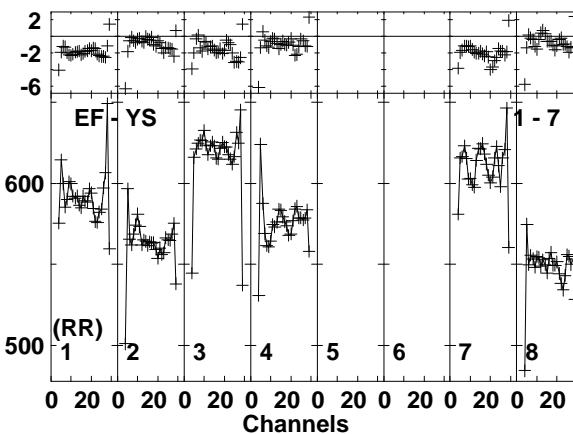
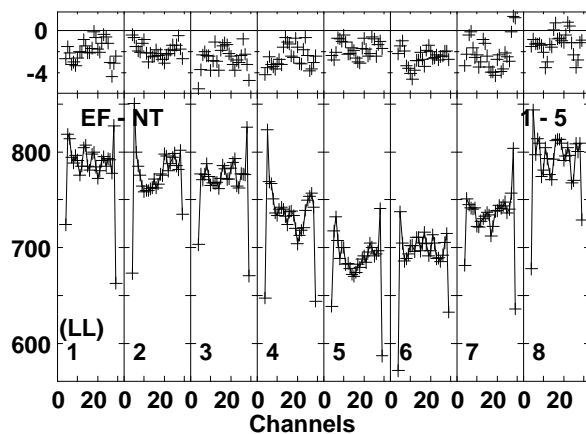
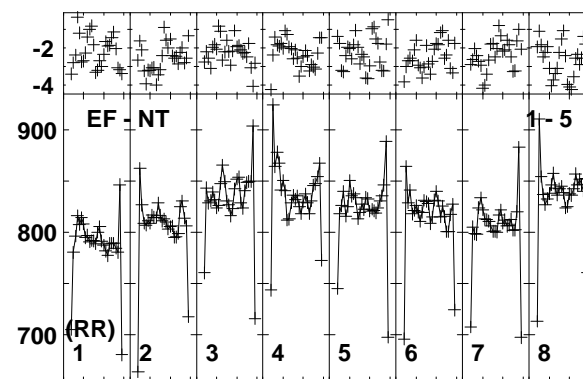
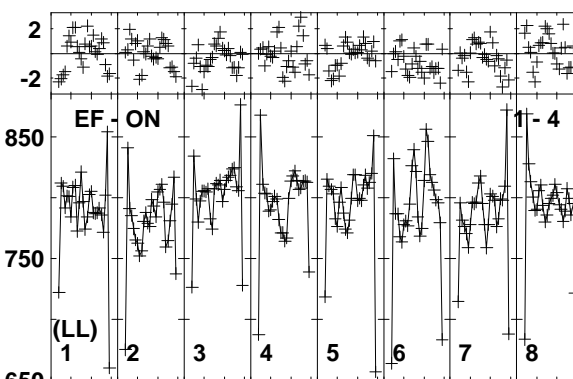
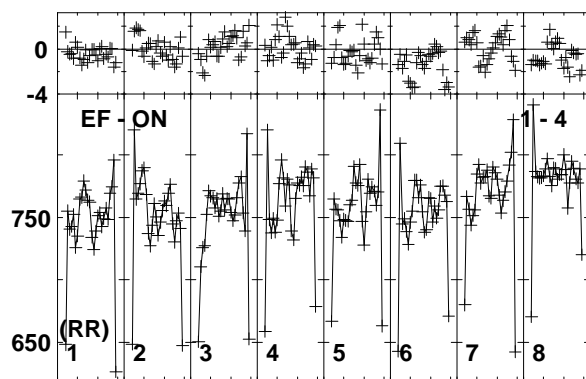
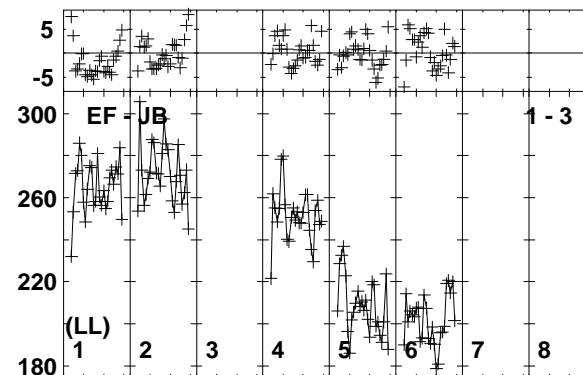
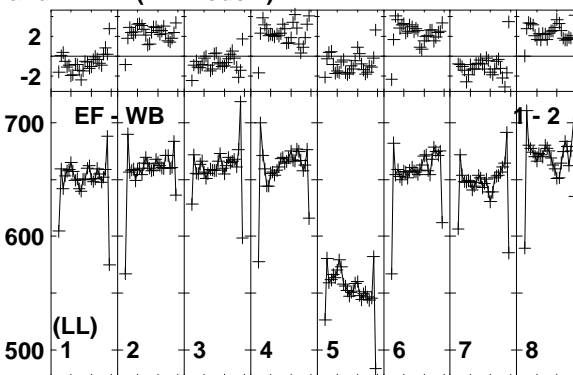
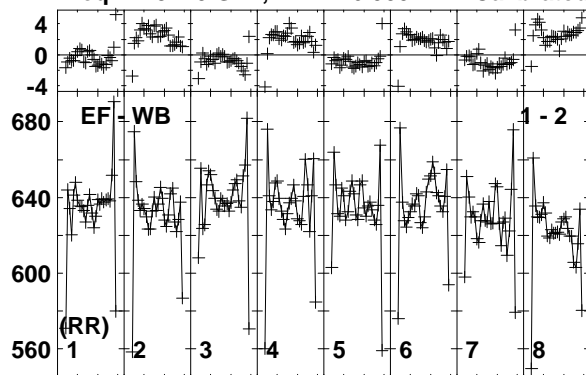

Lower frame: Milli Ampl Jy Top frame: Phas deg  
Vector averaged cross-power spectrum Baseline: EF (01) - WB (02)  
Timerange: 00/17:35:35 to 00/17:36:29

Plot file version 255 created 18-NOV-2014 15:24:00

J1128+5925 EP087H 3.UVDATA.1

Freq = 4.9270 GHz, Bw = 16.000 MH Calibrated with CL # 3 and BP # 1 (BP mode 1)

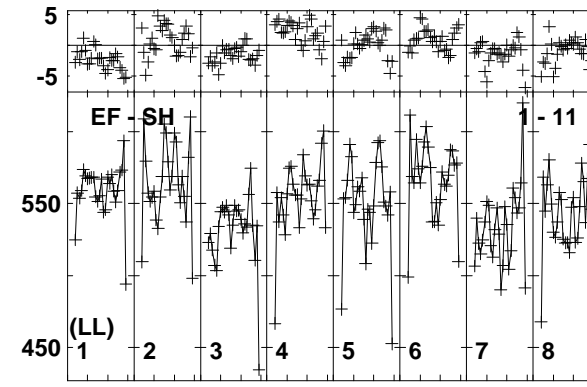
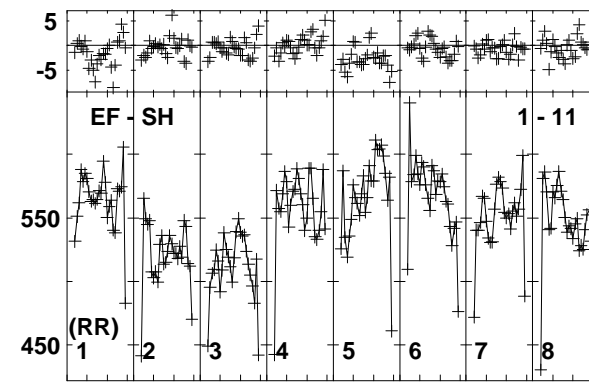
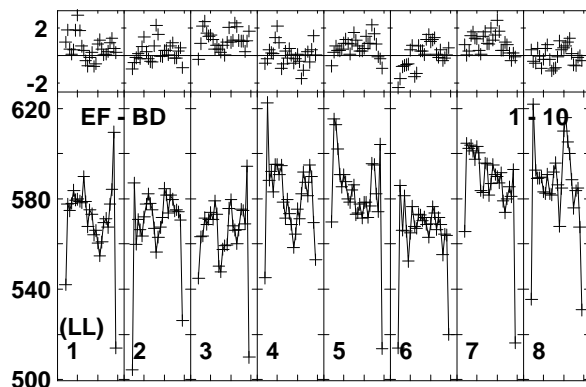
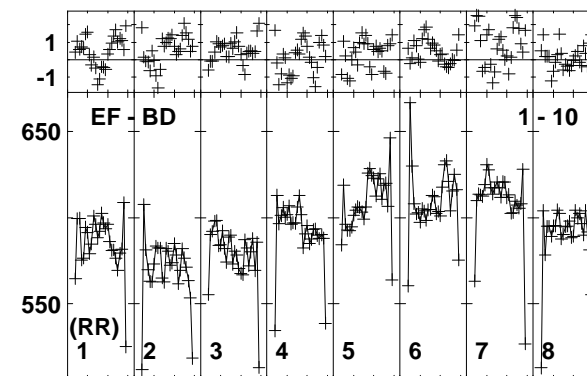
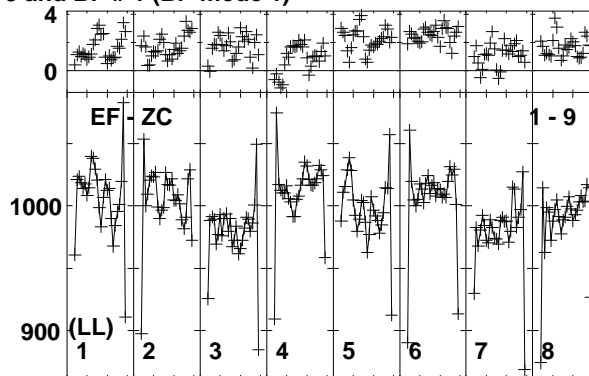
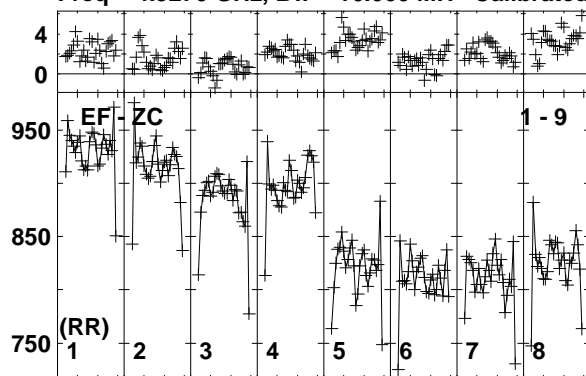

Lower frame: Milli Ampl Jy Top frame: Phas deg  
Vector averaged cross-power spectrum Baseline: EF (01) - ZC (09)  
Timerange: 00/17:35:35 to 00/17:36:29

Plot file version 256 created 18-NOV-2014 15:24:00

ARP299C EP087H 3.UVDATA.1

Freq = 4.9270 GHz, Bw = 16.000 MH Calibrated with CL # 3 and BP # 1 (BP mode 1)

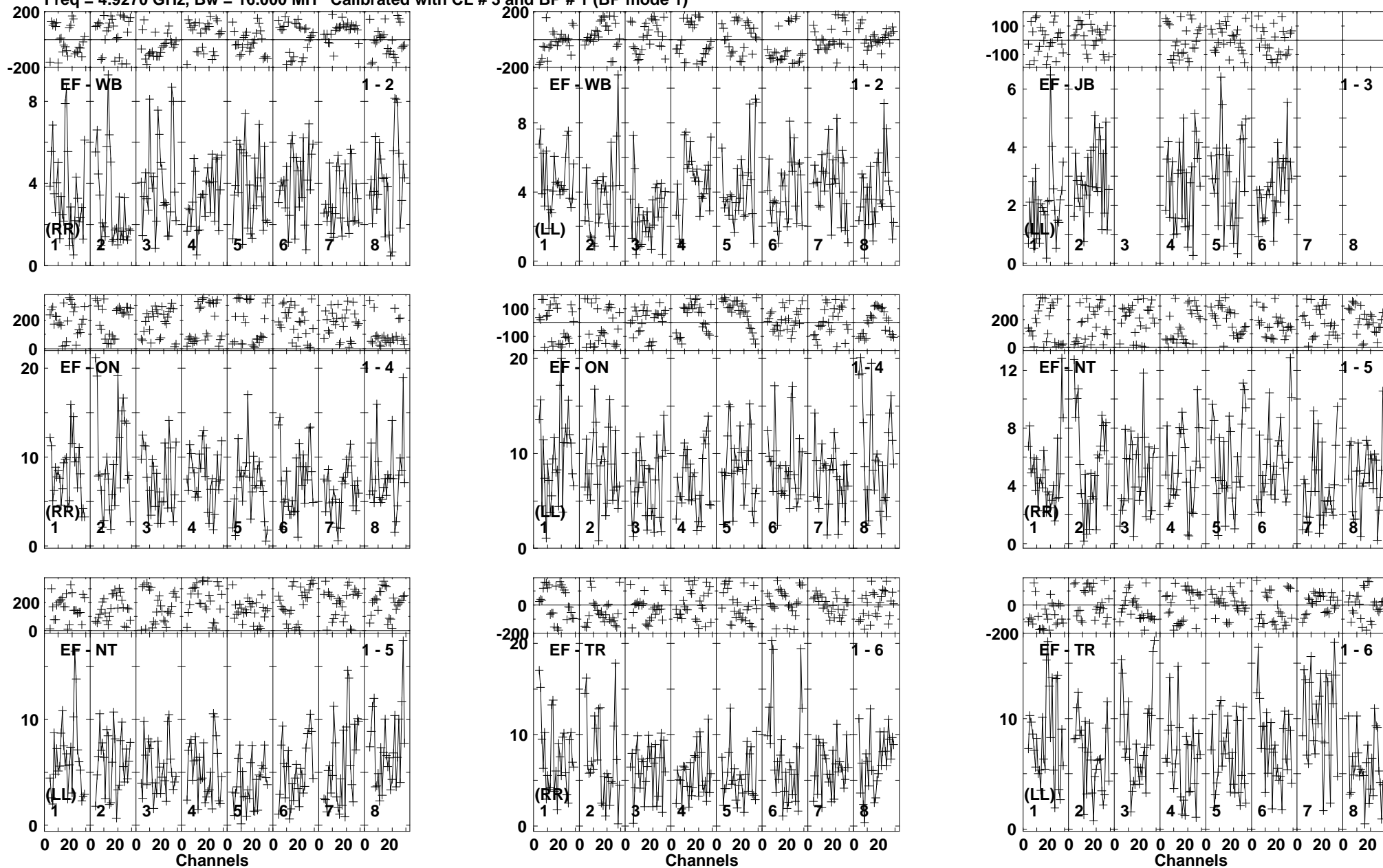

Lower frame: Milli Ampl Jy Top frame: Phas deg  
Vector averaged cross-power spectrum Baseline: EF (01) - WB (02)  
Timerange: 00/17:36:33 to 00/17:40:29



Plot file version 257 created 18-NOV-2014 15:24:01  
 ARP299C EP087H 3.UVDATA.1  
 Freq = 4.9270 GHz, Bw = 16.000 MH Calibrated with CL # 3 and BP # 1 (BP mode 1)

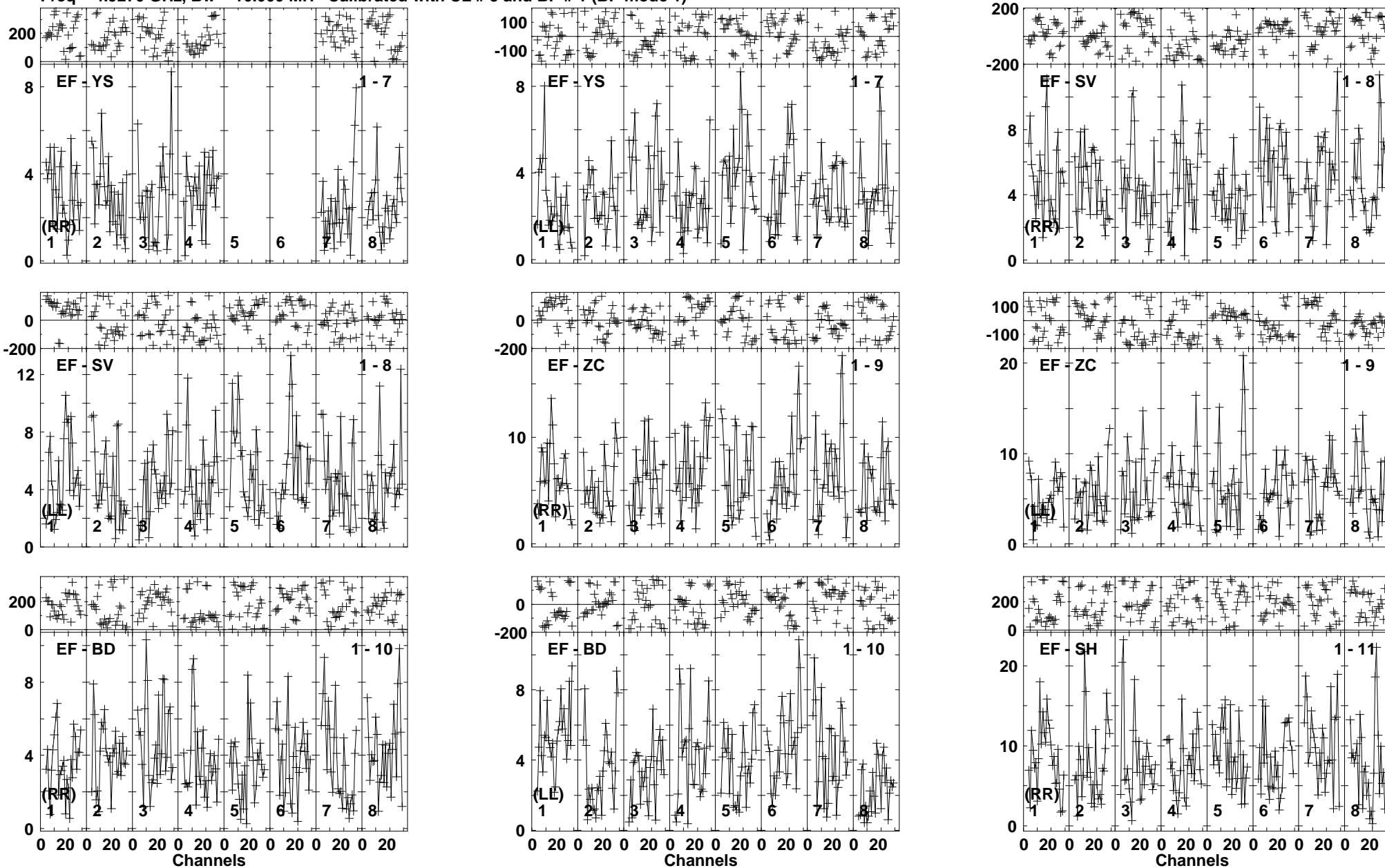

Lower frame: Milli Ampl Jy Top frame: Phas deg  
 Vector averaged cross-power spectrum Baseline: EF (01) - YS (07)  
 Timerange: 00/17:36:33 to 00/17:40:29

Plot file version 258 created 18-NOV-2014 15:24:01  
ARP299C EP087H 3.UVDATA.1  
Freq = 4.9270 GHz, Bw = 16.000 MH Calibrated with CL # 3 and BP # 1 (BP mode 1)

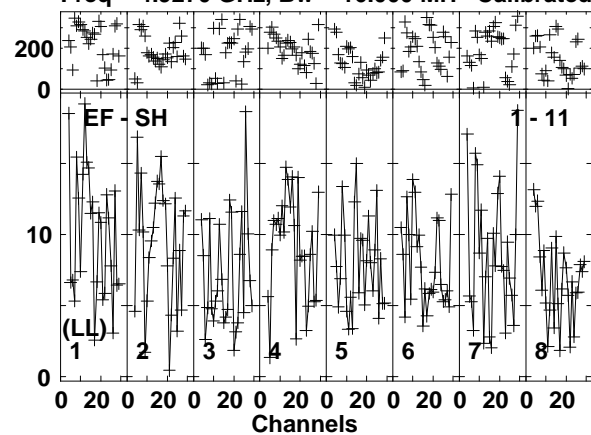

Lower frame: Milli Ampl Jy Top frame: Phas deg  
Vector averaged cross-power spectrum Baseline: EF (01) - SH (11)  
Timerange: 00/17:36:33 to 00/17:40:29

Plot file version 259 created 18-NOV-2014 15:24:01

J1128+5925 EP087H 3.UVDATA.1

Freq = 4.9270 GHz, Bw = 16.000 MH Calibrated with CL # 3 and BP # 1 (BP mode 1)

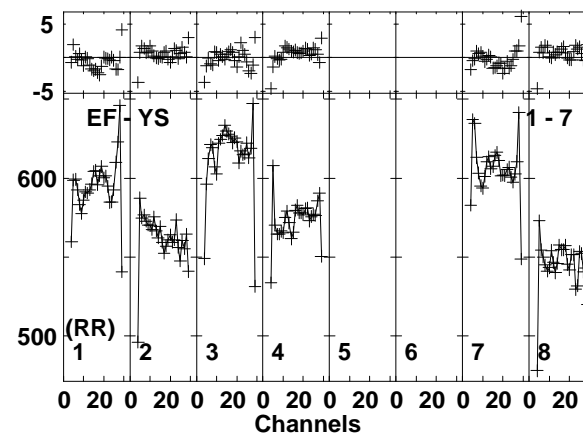
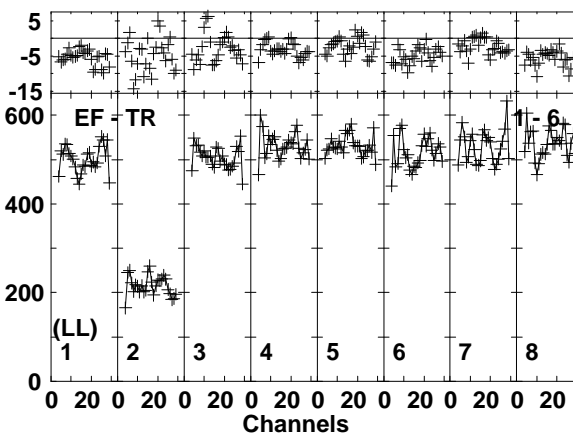
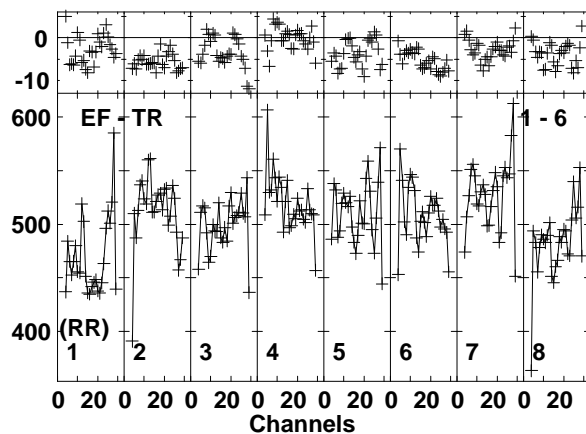
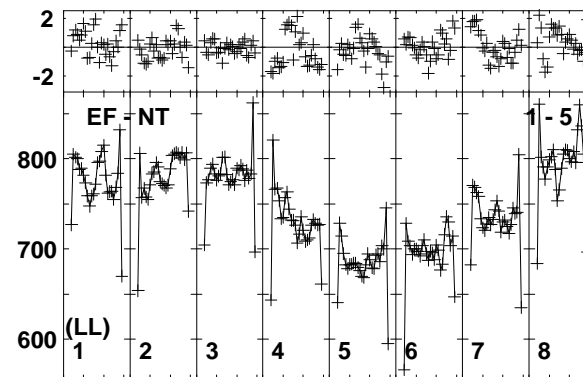
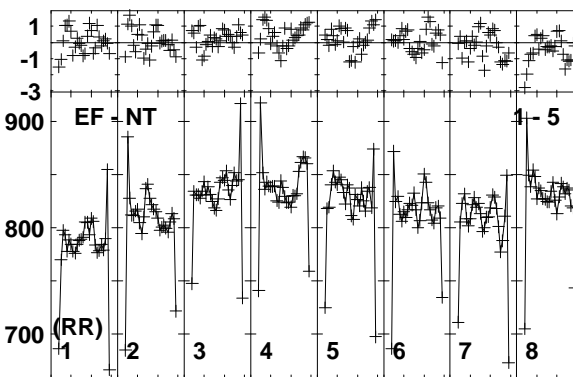
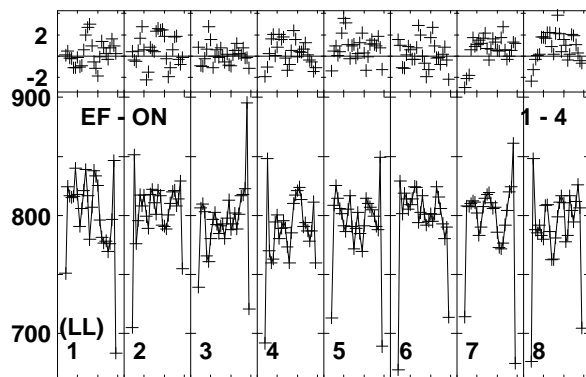
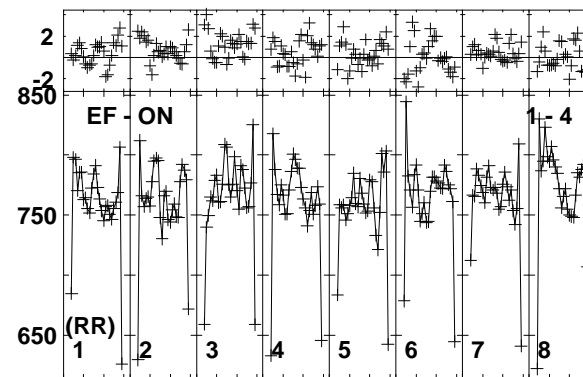
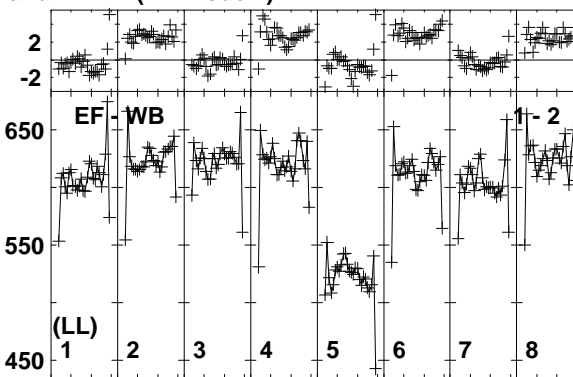
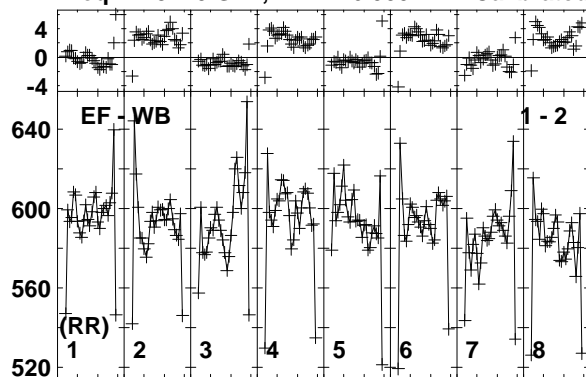

Lower frame: Milli Ampl Jy Top frame: Phas deg  
Vector averaged cross-power spectrum Baseline: EF (01) - WB (02)  
Timerange: 00/17:41:13 to 00/17:41:39

Plot file version 260 created 18-NOV-2014 15:24:01  
 J1128+5925 EP087H 3.UVDATA.1  
 Freq = 4.9270 GHz, Bw = 16.000 MH Calibrated with CL # 3 and BP # 1 (BP mode 1)

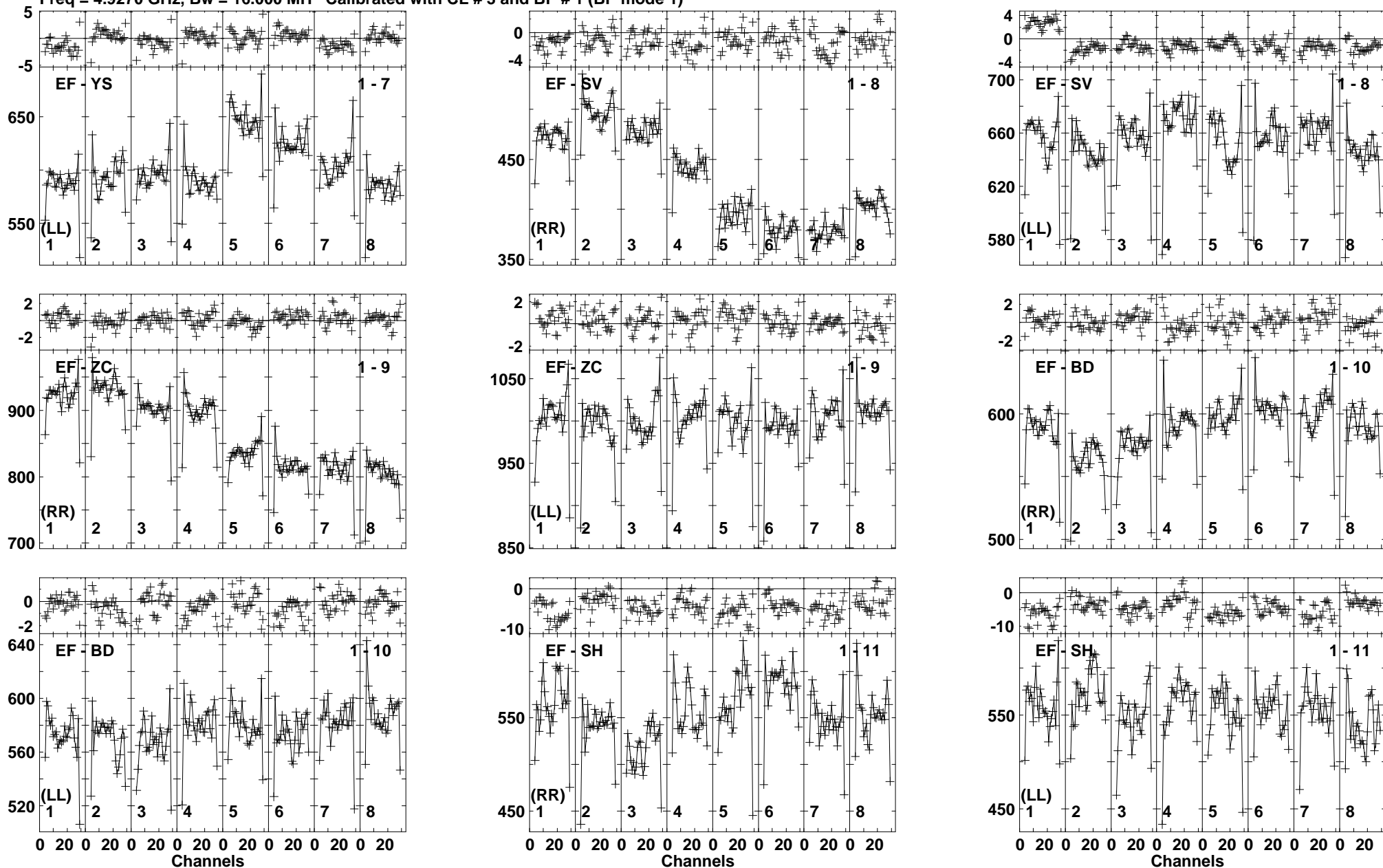

Lower frame: Milli Ampl Jy Top frame: Phas deg  
 Vector averaged cross-power spectrum Baseline: EF (01) - YS (07)  
 Timerange: 00/17:41:13 to 00/17:41:39

Plot file version 261 created 18-NOV-2014 15:24:01  
 ARP299C EP087H 3.UVDATA.1  
 Freq = 4.9270 GHz, Bw = 16.000 MH Calibrated with CL # 3 and BP # 1 (BP mode 1)

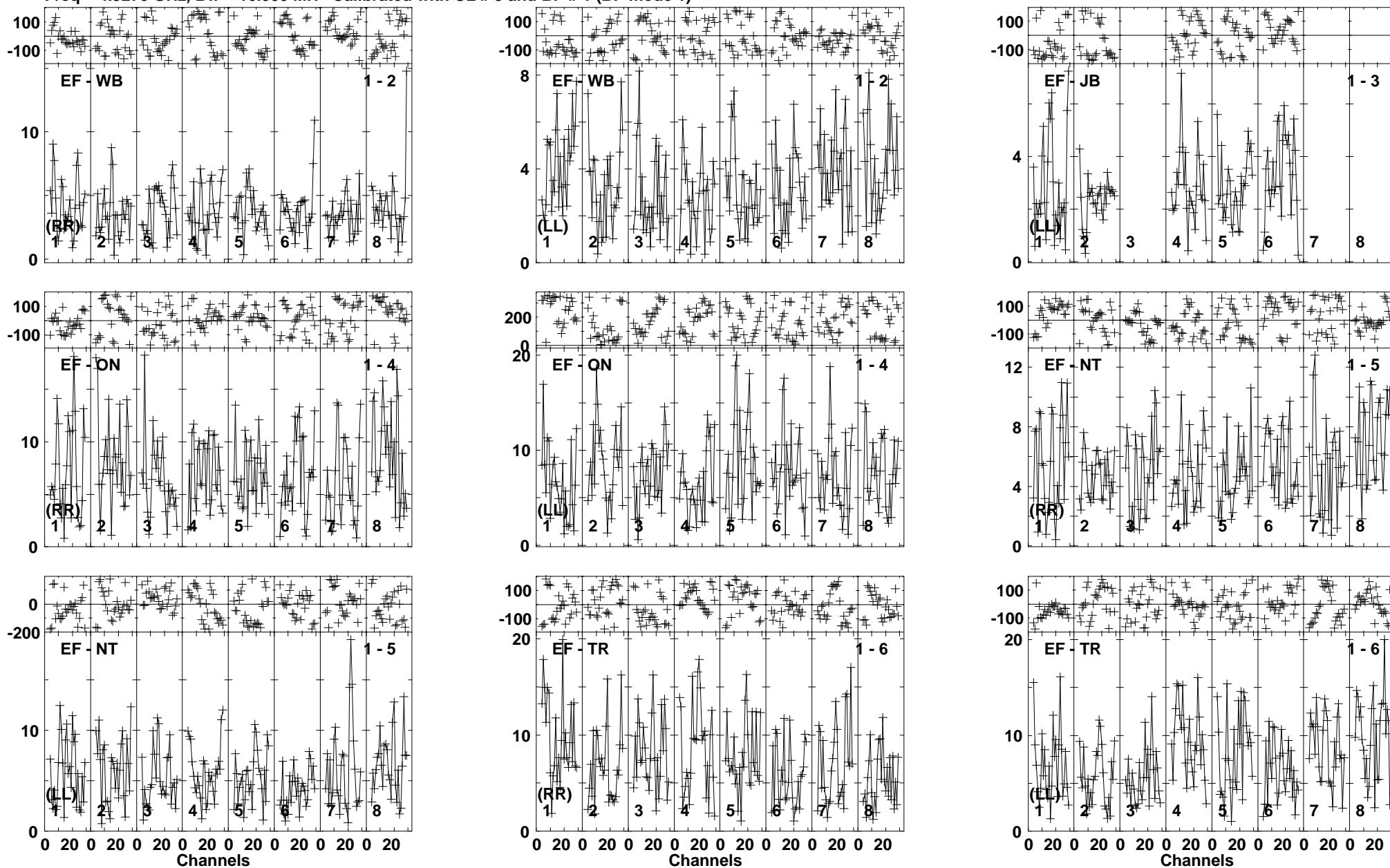

Lower frame: Milli Ampl Jy Top frame: Phas deg  
 Vector averaged cross-power spectrum Baseline: EF (01) - WB (02)  
 Timerange: 00/17:41:41 to 00/17:45:39

Plot file version 262 created 18-NOV-2014 15:24:02  
 ARP299C EP087H 3.UVDATA.1  
 Freq = 4.9270 GHz, Bw = 16.000 MH Calibrated with CL # 3 and BP # 1 (BP mode 1)

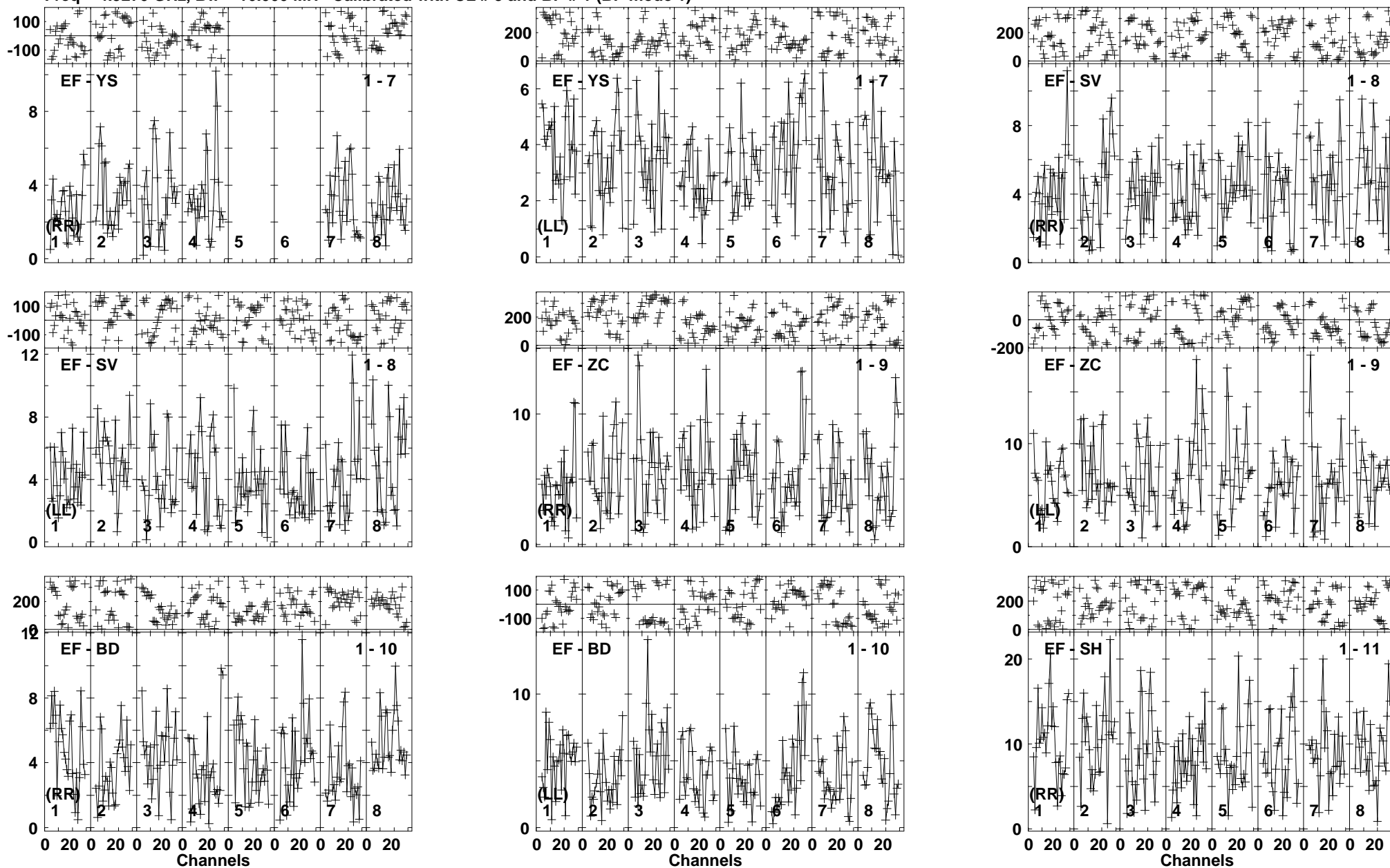

Lower frame: Milli Ampl Jy Top frame: Phas deg  
 Vector averaged cross-power spectrum Baseline: EF (01) - YS (07)  
 Timerange: 00/17:41:41 to 00/17:45:39

Plot file version 263 created 18-NOV-2014 15:24:02  
ARP299C EP087H 3.UVDATA.1  
Freq = 4.9270 GHz, Bw = 16.000 MH Calibrated with CL # 3 and BP # 1 (BP mode 1)

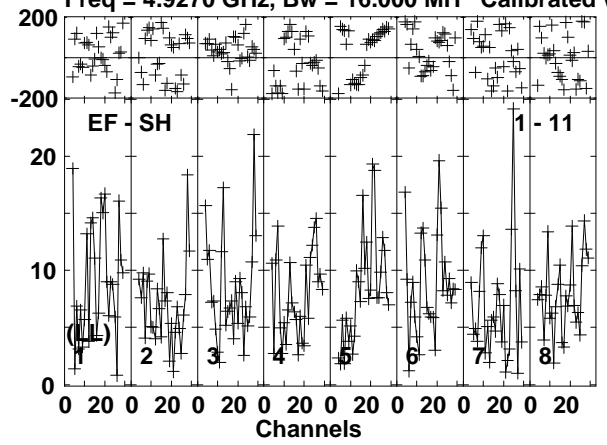

Lower frame: Milli Ampl Jy Top frame: Phas deg  
Vector averaged cross-power spectrum Baseline: EF (01) - SH (11)  
Timerange: 00/17:41:41 to 00/17:45:39

Plot file version 264 created 18-NOV-2014 15:24:02

J1128+5925 EP087H 3.UVDATA.1

Freq = 4.9270 GHz, Bw = 16.000 MH Calibrated with CL # 3 and BP # 1 (BP mode 1)

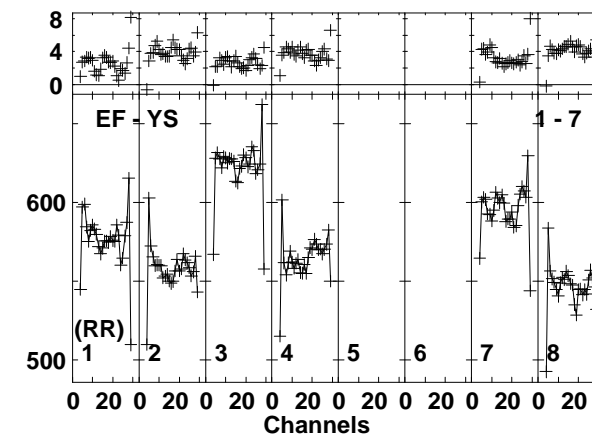
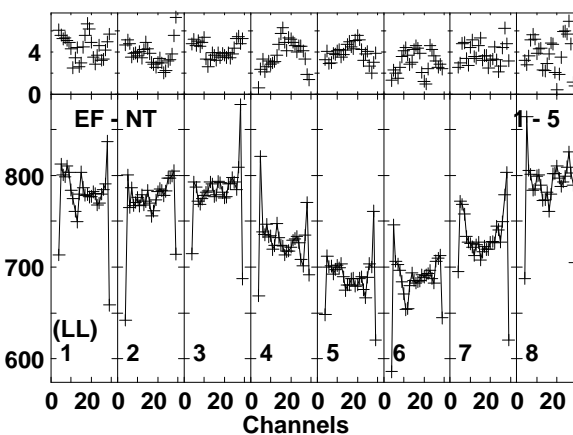
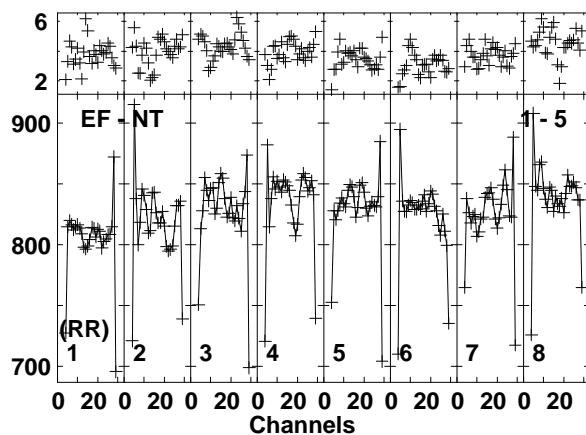
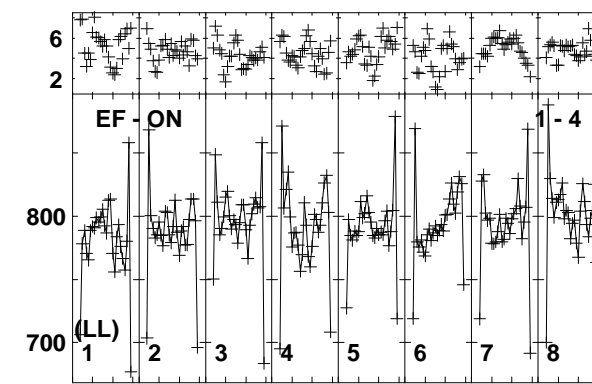
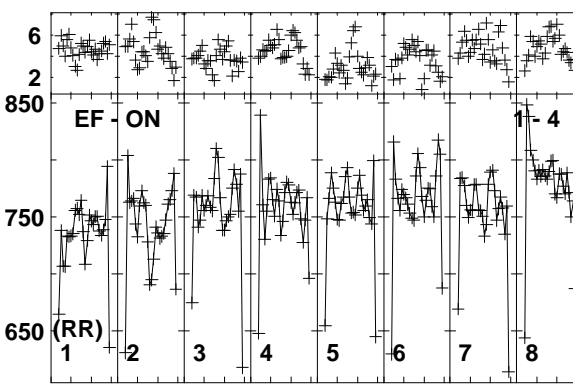
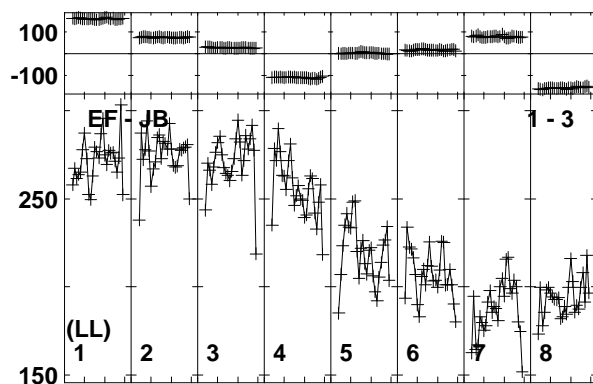
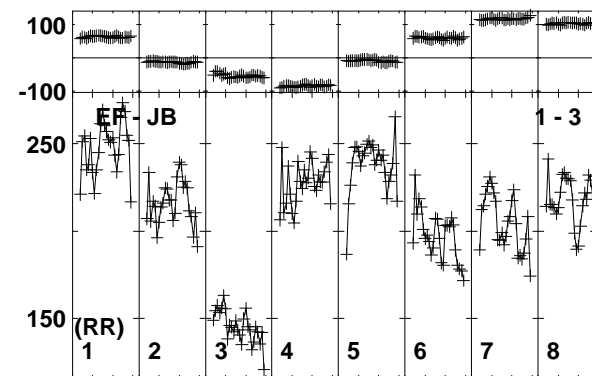
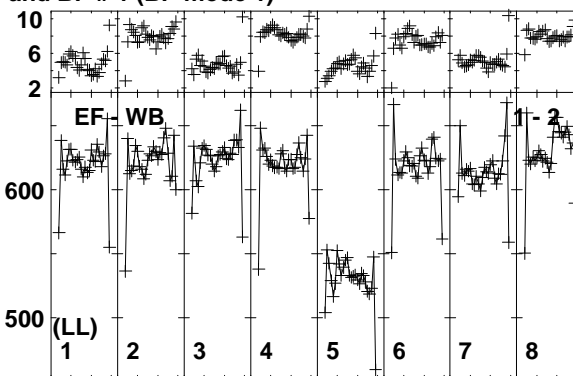
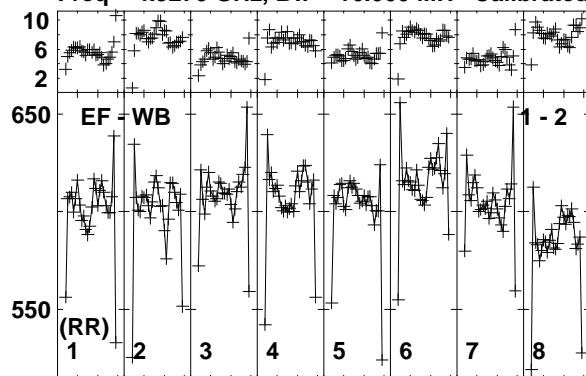

Lower frame: Milli Ampl Jy Top frame: Phas deg  
Vector averaged cross-power spectrum Baseline: EF (01) - WB (02)  
Timerange: 00/17:45:45 to 00/17:46:39



Plot file version 265 created 18-NOV-2014 15:24:02

J1128+5925 EP087H 3.UVDATA.1

Freq = 4.9270 GHz, Bw = 16.000 MH Calibrated with CL # 3 and BP # 1 (BP mode 1)

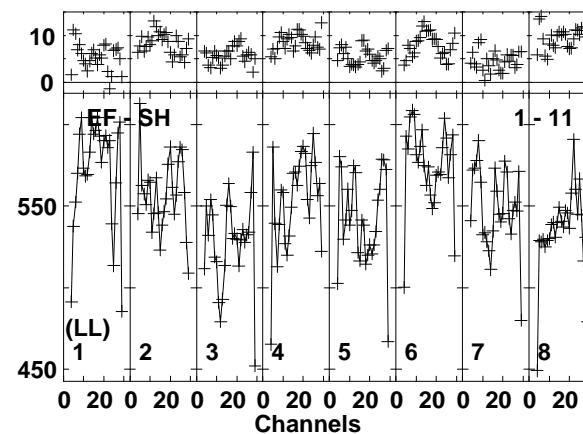
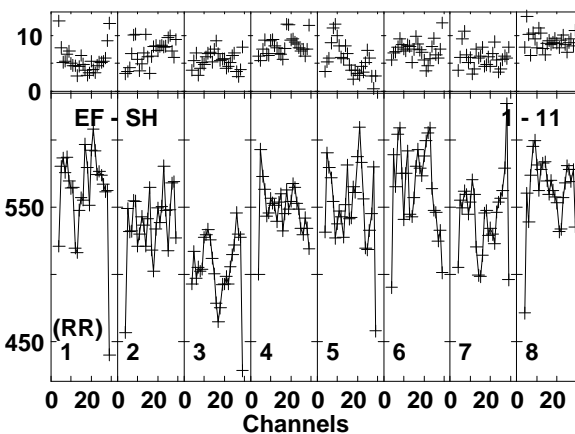
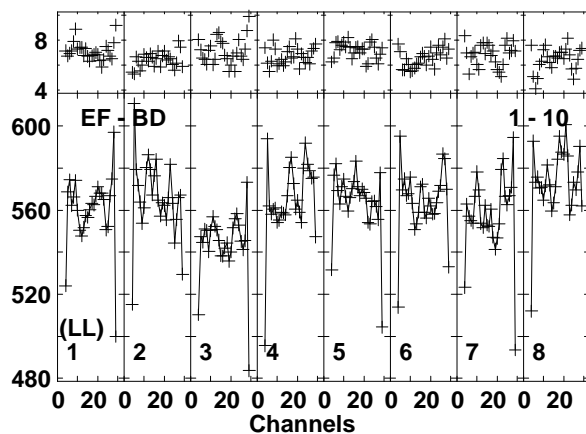
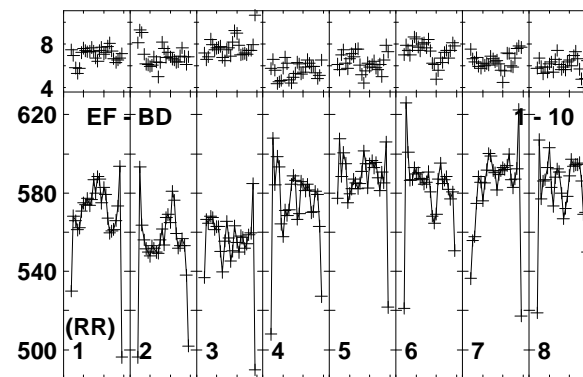
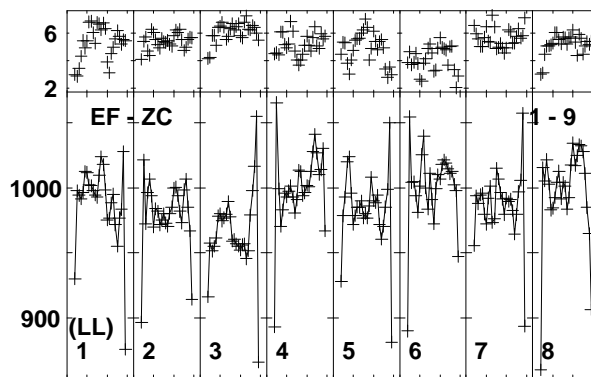
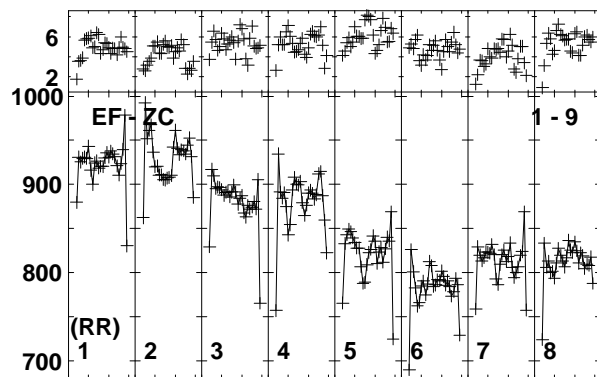
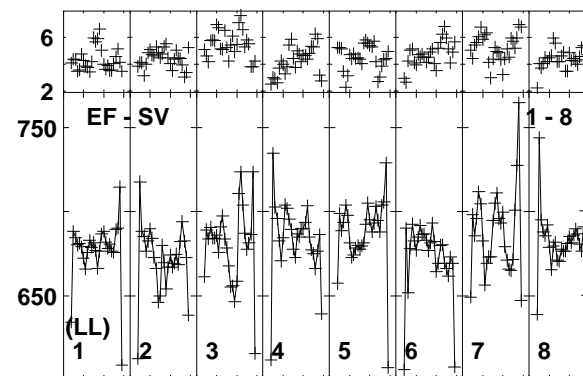
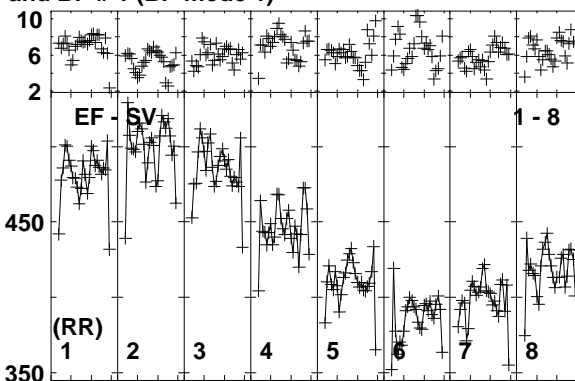
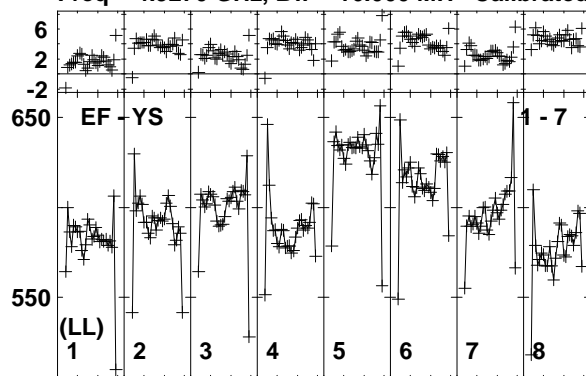

Lower frame: Milli Ampl Jy Top frame: Phas deg  
Vector averaged cross-power spectrum Baseline: EF (01) - YS (07)  
Timerange: 00/17:45:45 to 00/17:46:39

Plot file version 266 created 18-NOV-2014 15:24:02  
 ARP299C EP087H 3.UVDATA.1  
 Freq = 4.9270 GHz, Bw = 16.000 MH Calibrated with CL # 3 and BP # 1 (BP mode 1)

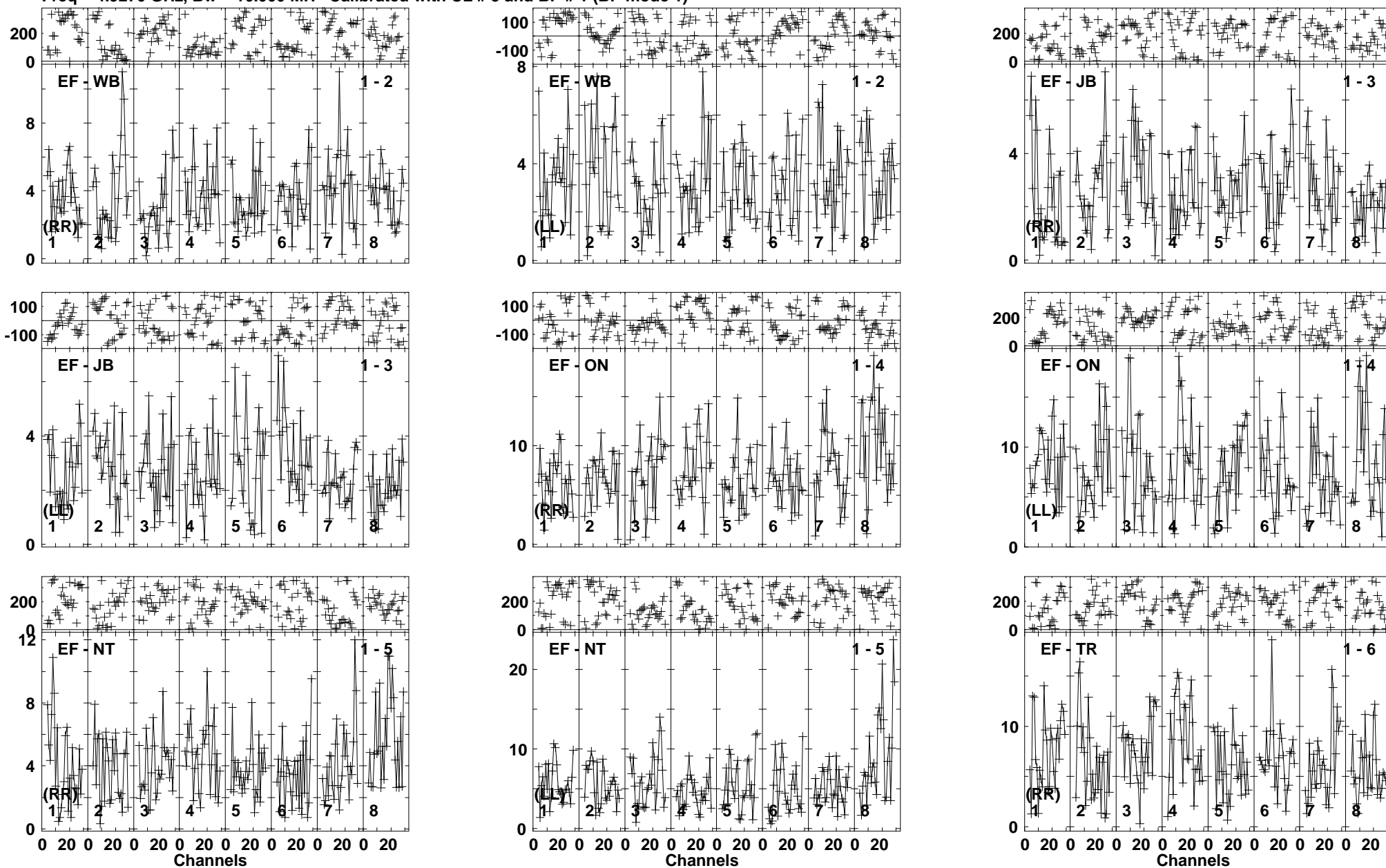

Lower frame: Milli Ampl Jy Top frame: Phas deg  
 Vector averaged cross-power spectrum Baseline: EF (01) - WB (02)  
 Timerange: 00/17:46:45 to 00/17:50:39

Plot file version 267 created 18-NOV-2014 15:24:03

ARP299C EP087H 3.UVDATA.1

Freq = 4.9270 GHz, Bw = 16.000 MH Calibrated with CL # 3 and BP # 1 (BP mode 1)

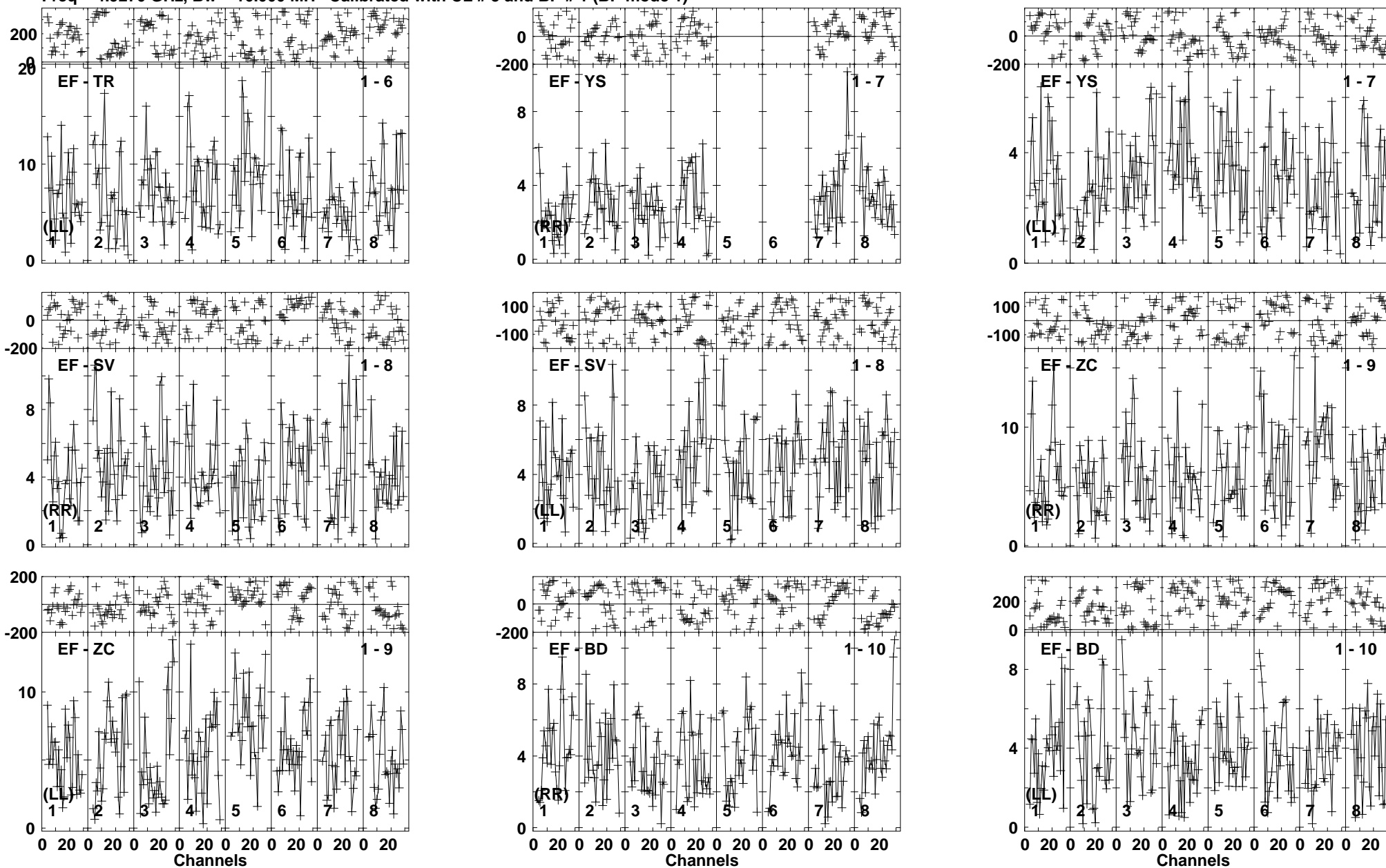

Lower frame: Milli Ampl Jy Top frame: Phas deg

Vector averaged cross-power spectrum Baseline: EF (01) - TR (06)

Timerange: 00/17:46:45 to 00/17:50:39

Plot file version 268 created 18-NOV-2014 15:24:03

ARP299C EP087H 3.UVDATA.1

Freq = 4.9270 GHz, Bw = 16.000 MH Calibrated with CL # 3 and BP # 1 (BP mode 1)

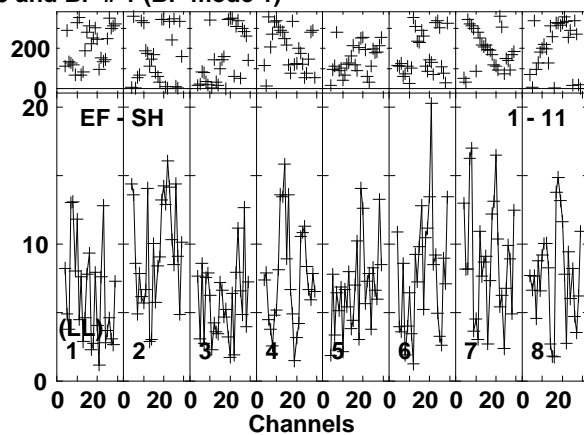
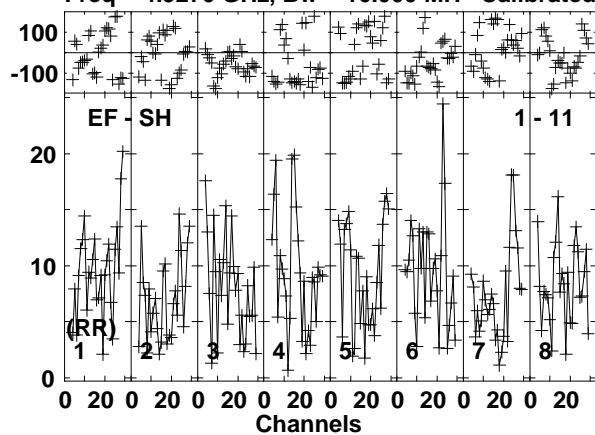

Lower frame: Milli Ampl Jy Top frame: Phas deg  
Vector averaged cross-power spectrum Baseline: EF (01) - SH (11)  
Timerange: 00/17:46:45 to 00/17:50:39

Plot file version 269 created 18-NOV-2014 15:24:03

J1128+5925 EP087H 3.UVDATA.1

Freq = 4.9270 GHz, Bw = 16.000 MH Calibrated with CL # 3 and BP # 1 (BP mode 1)

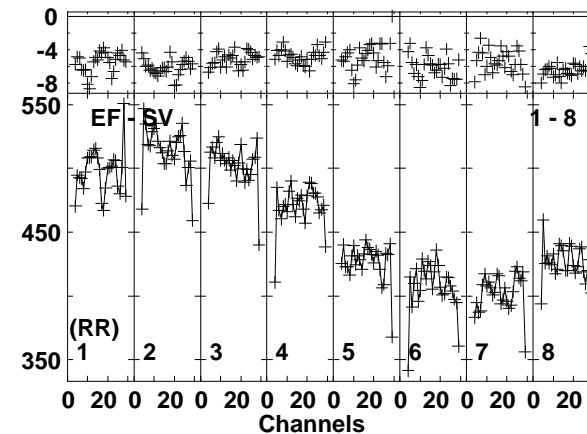
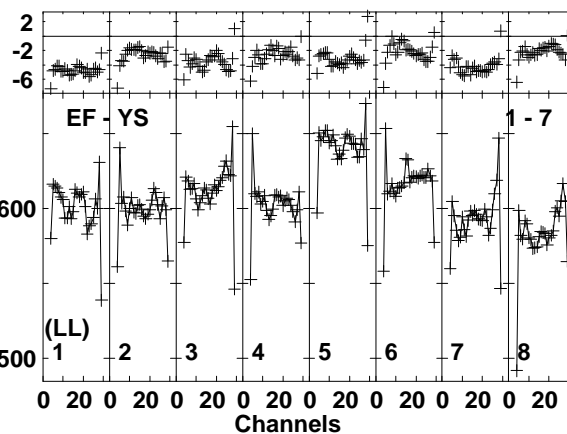
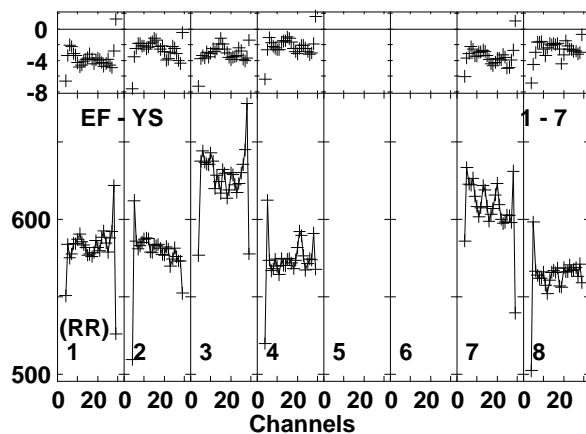
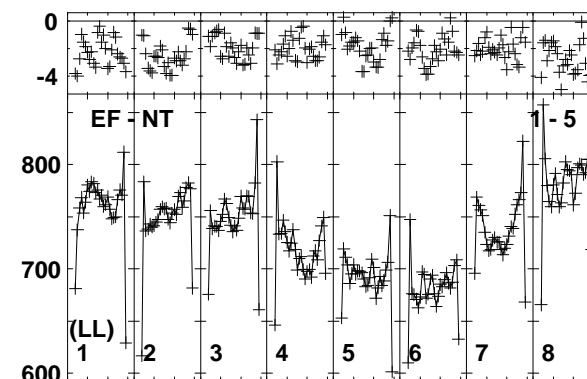
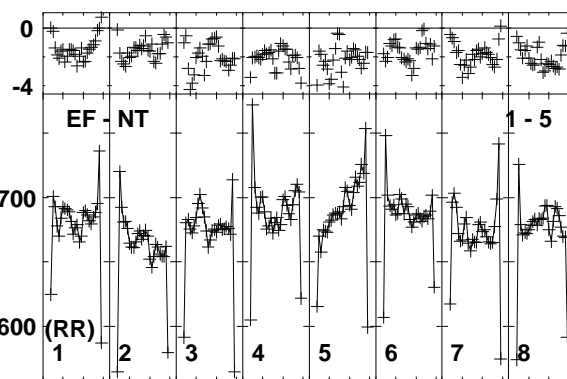
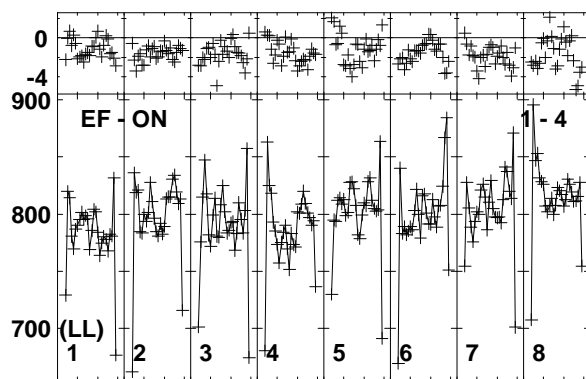
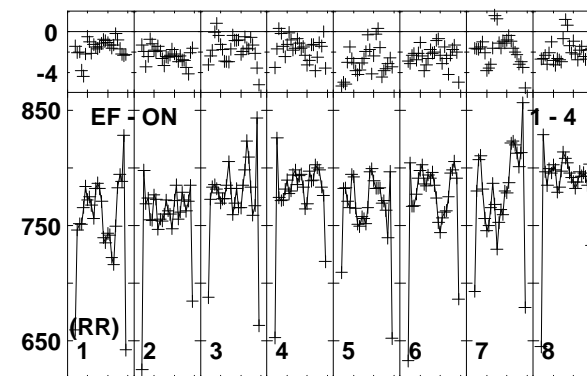
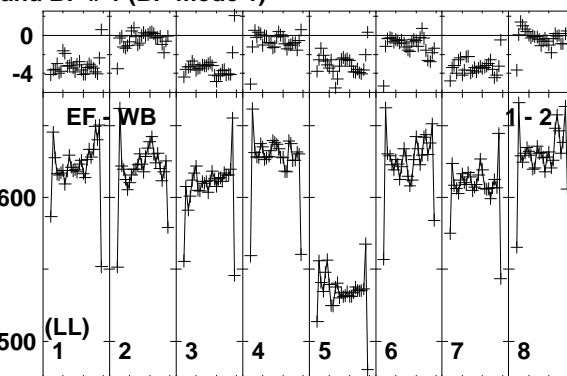
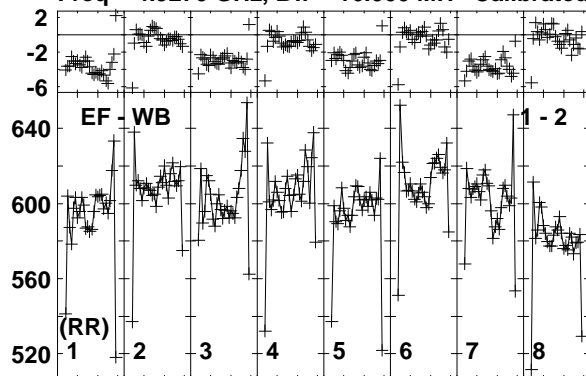

Lower frame: Milli Ampl Jy Top frame: Phas deg  
Vector averaged cross-power spectrum Baseline: EF (01) - WB (02)  
Timerange: 00/17:50:45 to 00/17:51:39

Plot file version 270 created 18-NOV-2014 15:24:03

J1128+5925 EP087H 3.UVDATA.1

Freq = 4.9270 GHz, Bw = 16.000 MH Calibrated with CL # 3 and BP # 1 (BP mode 1)

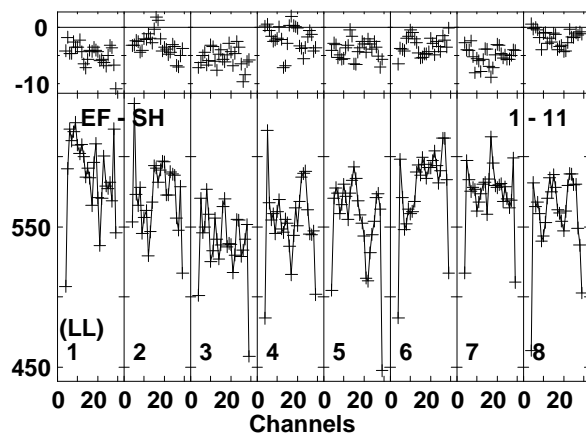
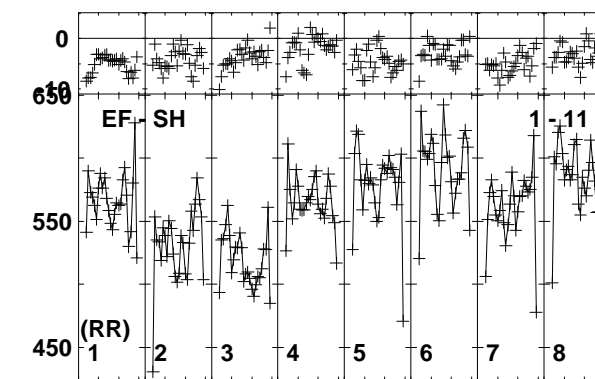
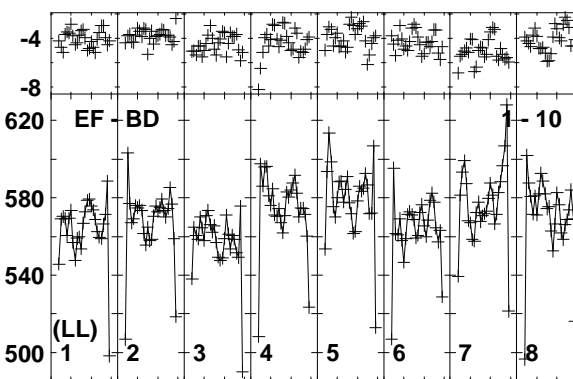
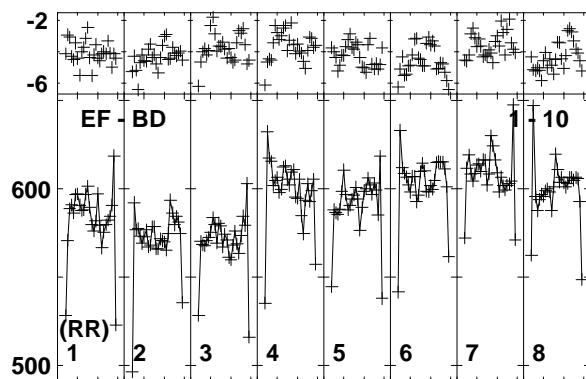
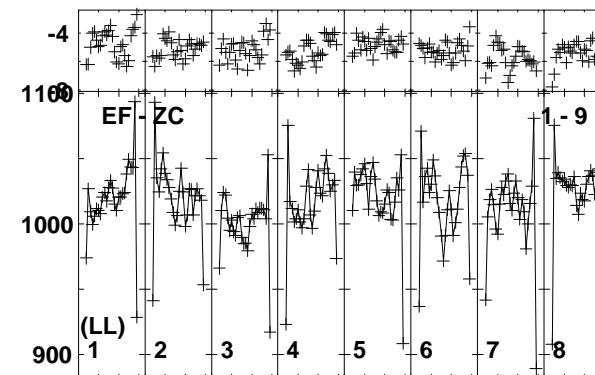
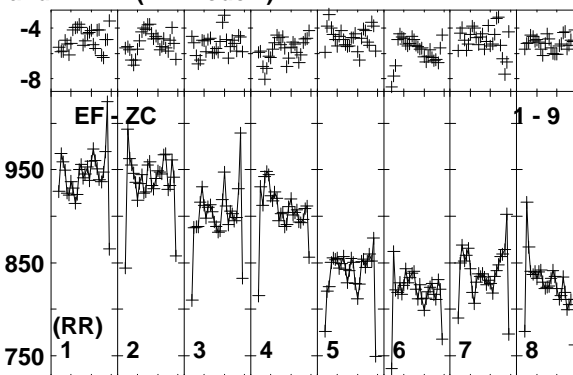
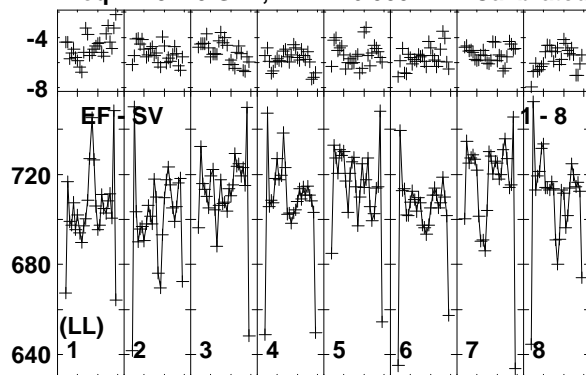

Lower frame: Milli Ampl Jy Top frame: Phas deg  
Vector averaged cross-power spectrum Baseline: EF (01) - SV (08)  
Timerange: 00/17:50:45 to 00/17:51:39

Plot file version 271 created 18-NOV-2014 15:24:04  
 ARP299C EP087H 3.UVDATA.1  
 Freq = 4.9270 GHz, Bw = 16.000 MH Calibrated with CL # 3 and BP # 1 (BP mode 1)

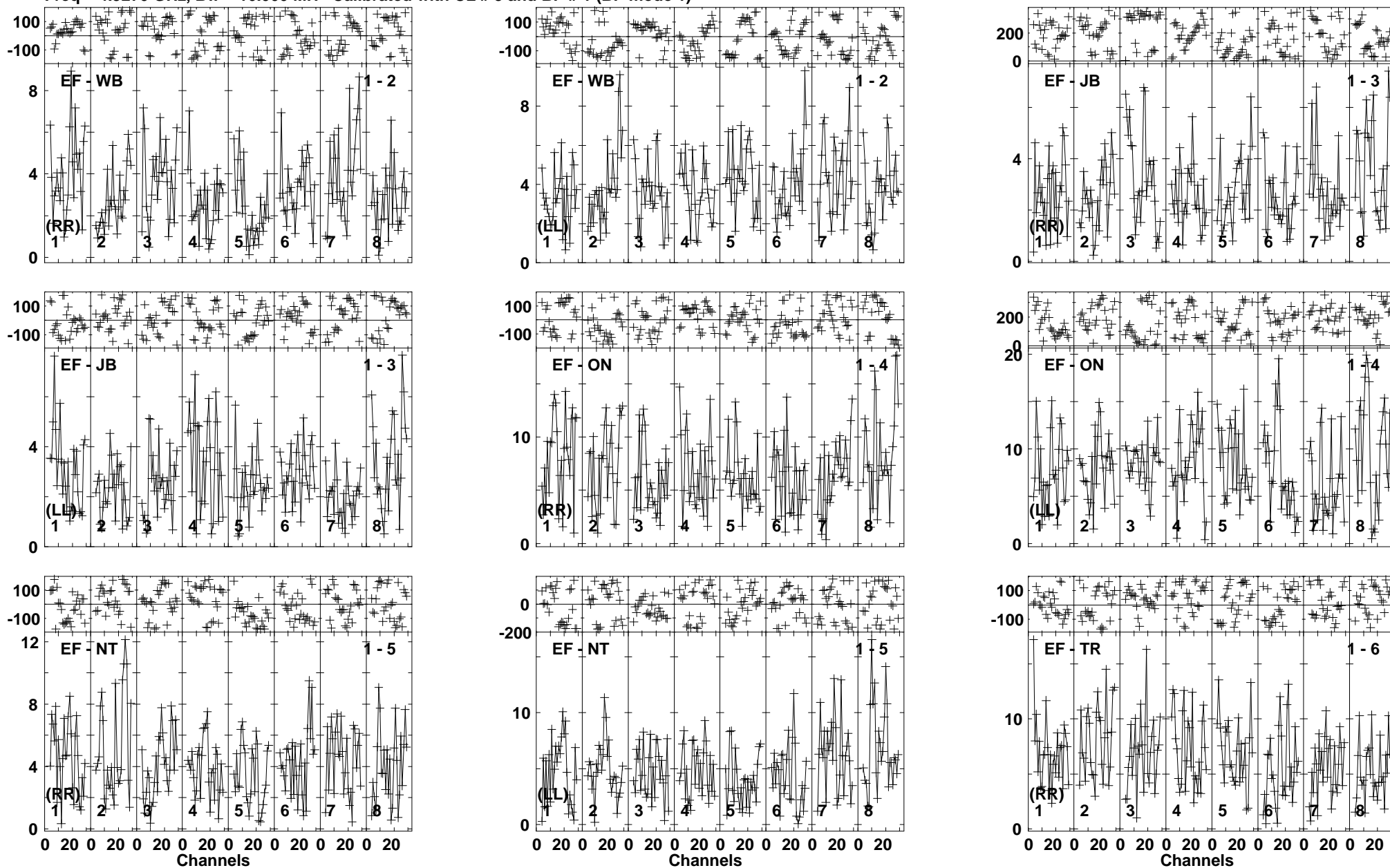

Lower frame: Milli Ampl Jy Top frame: Phas deg  
 Vector averaged cross-power spectrum Baseline: EF (01) - WB (02)  
 Timerange: 00/17:51:41 to 00/17:55:39

Plot file version 272 created 18-NOV-2014 15:24:04

ARP299C EP087H 3.UVDATA.1

Freq = 4.9270 GHz, Bw = 16.000 MH Calibrated with CL # 3 and BP # 1 (BP mode 1)

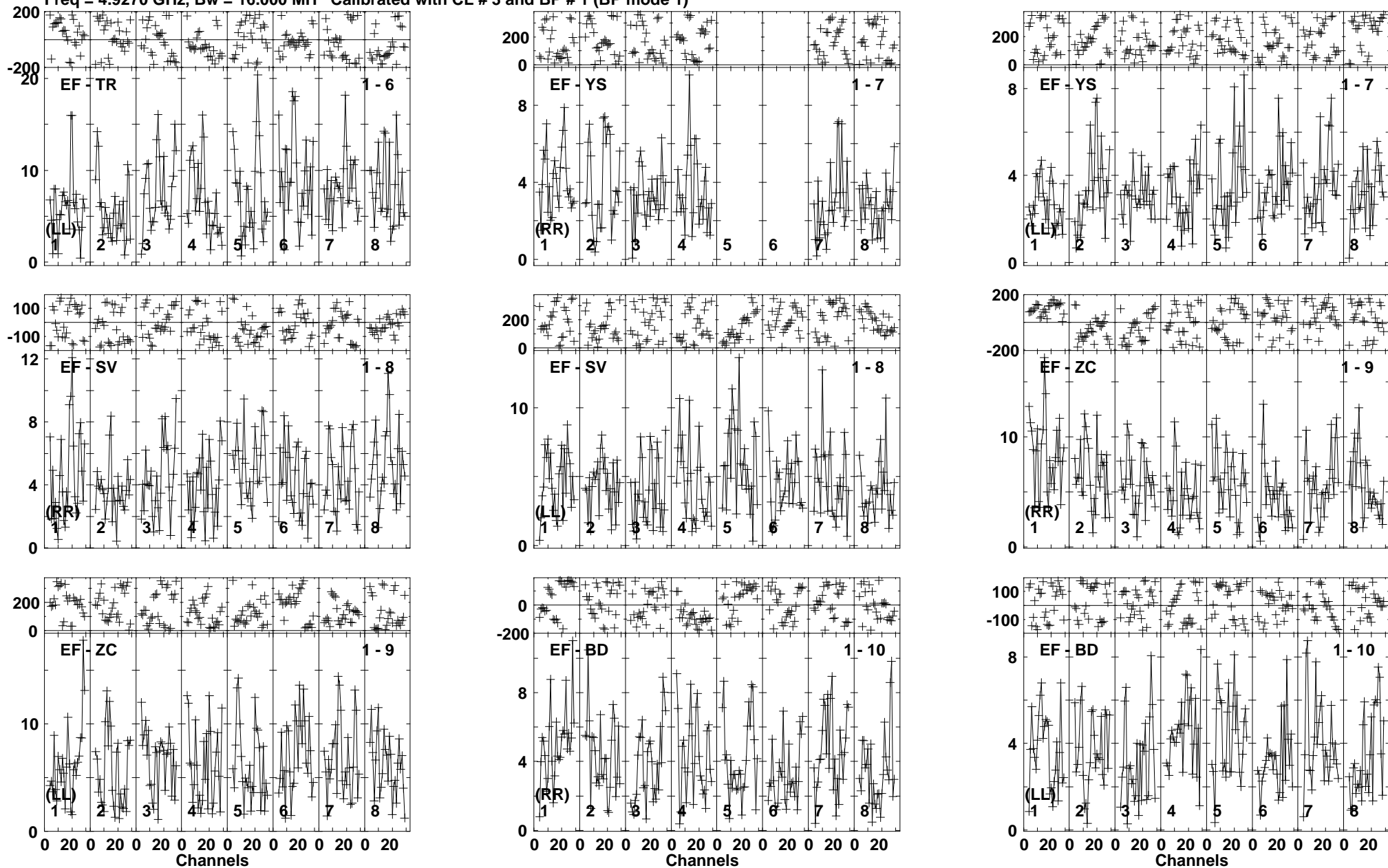

Lower frame: Milli Ampl Jy Top frame: Phas deg  
Vector averaged cross-power spectrum Baseline: EF (01) - TR (06)  
Timerange: 00/17:51:41 to 00/17:55:39



Plot file version 273 created 18-NOV-2014 15:24:04

ARP299C EP087H 3.UVDATA.1

Freq = 4.9270 GHz, Bw = 16.000 MH Calibrated with CL # 3 and BP # 1 (BP mode 1)

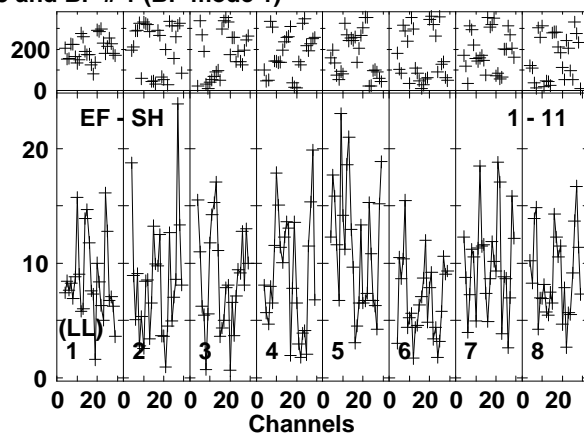
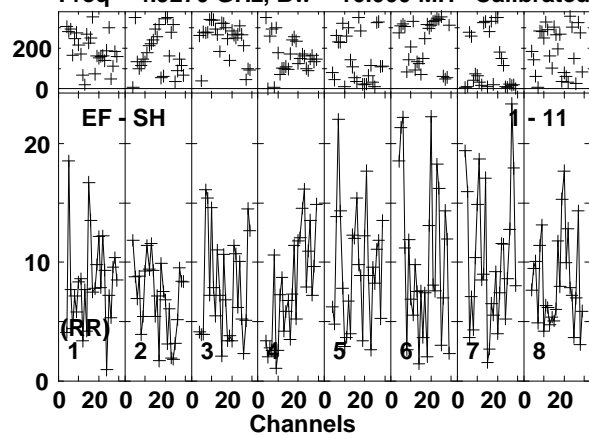

Lower frame: Milli Ampl Jy Top frame: Phas deg  
Vector averaged cross-power spectrum Baseline: EF (01) - SH (11)  
Timerange: 00/17:51:41 to 00/17:55:39



Plot file version 275 created 18-NOV-2014 15:24:04

J1128+5925 EP087H 3.UVDATA.1

Freq = 4.9270 GHz, Bw = 16.000 MH Calibrated with CL # 3 and BP # 1 (BP mode 1)

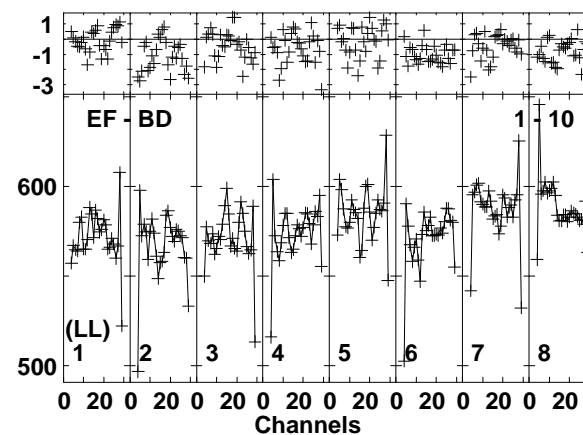
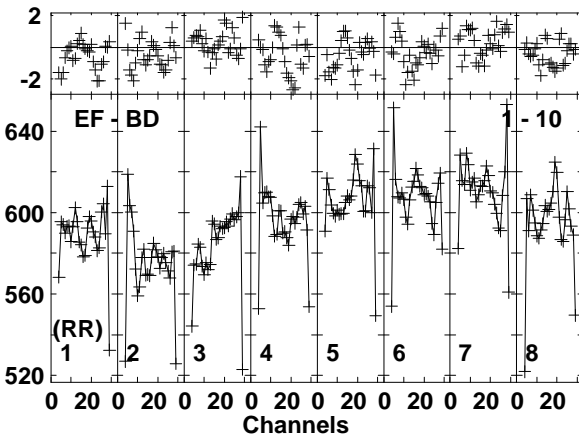
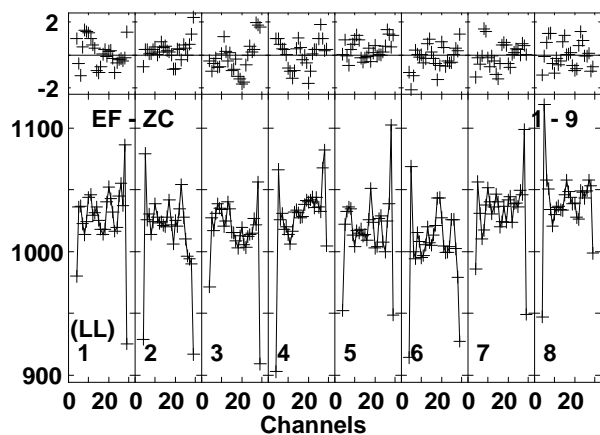
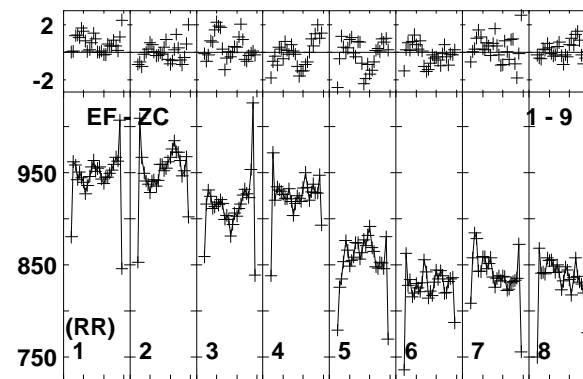
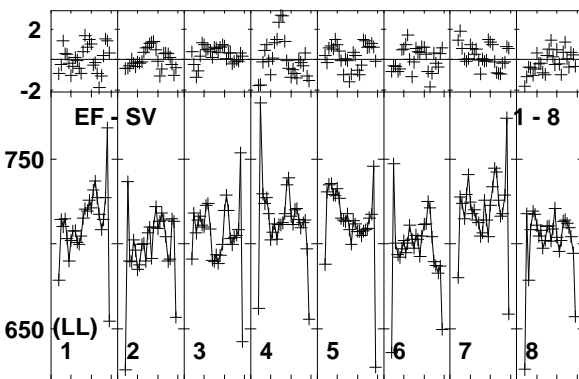
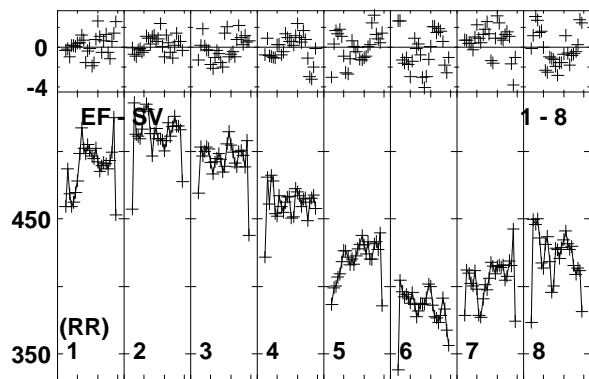
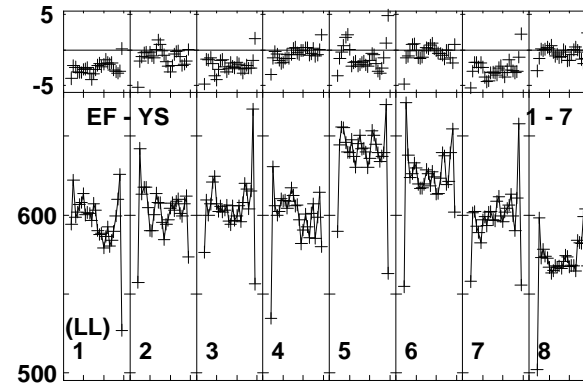
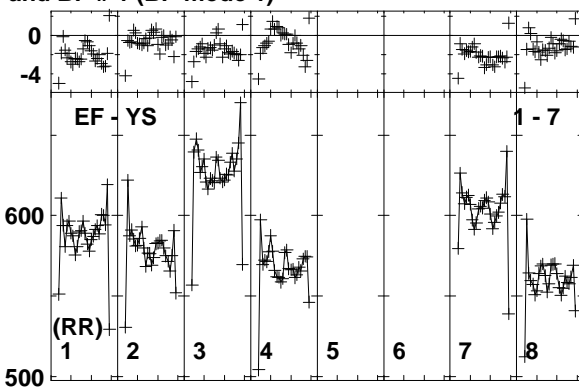
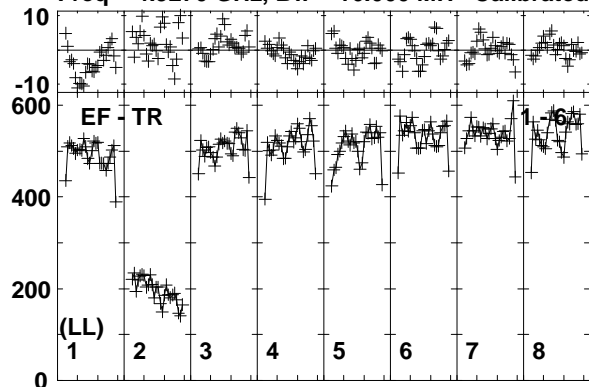

Lower frame: Milli Ampl Jy Top frame: Phas deg  
Vector averaged cross-power spectrum Baseline: EF (01) - TR (06)  
Timerange: 00/17:56:21 to 00/17:56:49

Plot file version 276 created 18-NOV-2014 15:24:05

J1128+5925 EP087H 3.UVDATA.1

Freq = 4.9270 GHz, Bw = 16.000 MH Calibrated with CL # 3 and BP # 1 (BP mode 1)

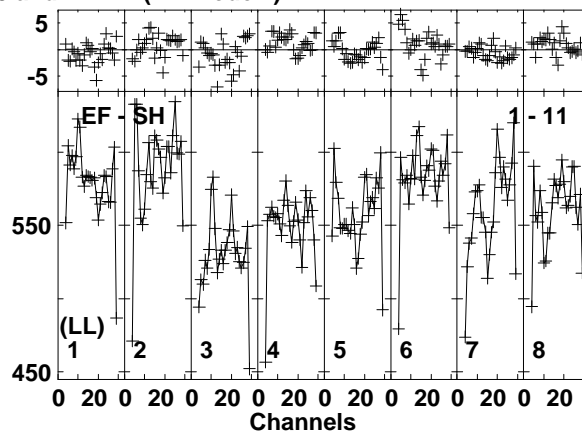
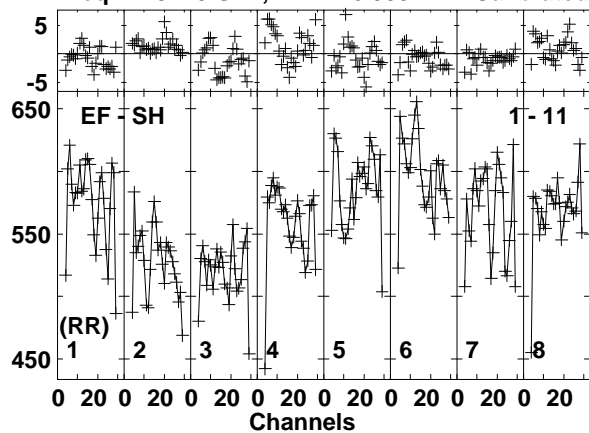

Lower frame: Milli Ampl Jy Top frame: Phas deg  
Vector averaged cross-power spectrum Baseline: EF (01) - SH (11)  
Timerange: 00/17:56:21 to 00/17:56:49

Plot file version 277 created 18-NOV-2014 15:24:05

ARP299C EP087H 3.UVDATA.1

Freq = 4.9270 GHz, Bw = 16.000 MH Calibrated with CL # 3 and BP # 1 (BP mode 1)

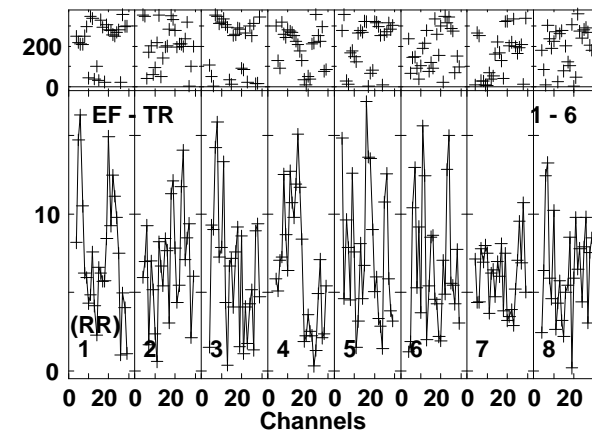
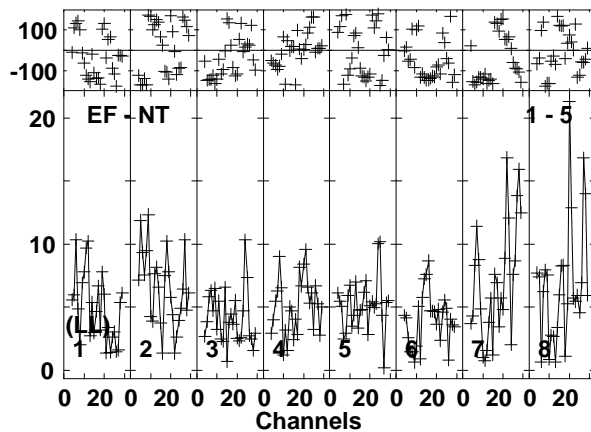
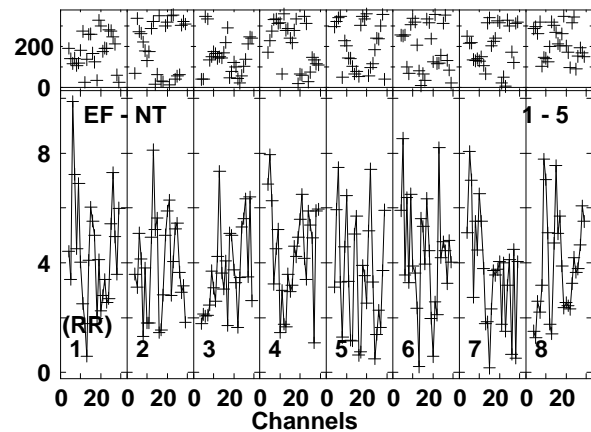
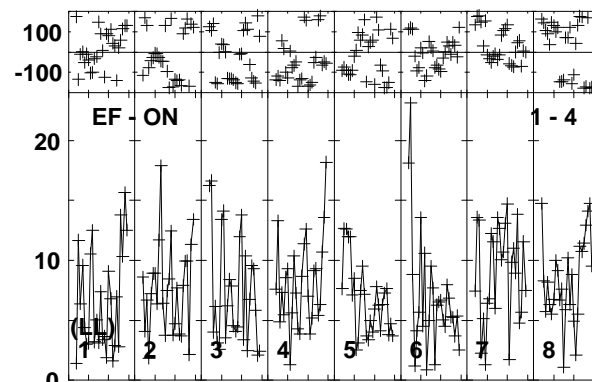
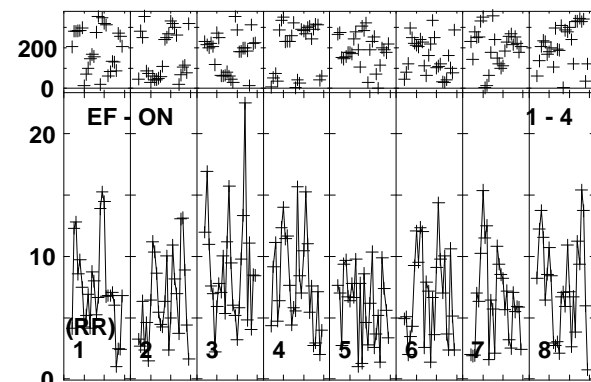
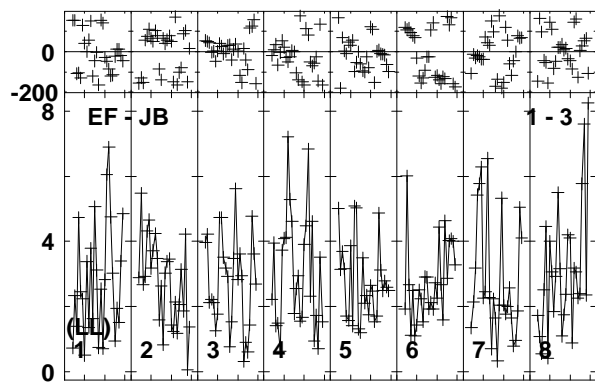
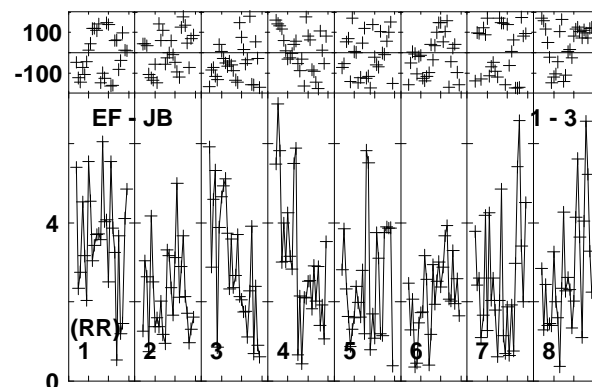
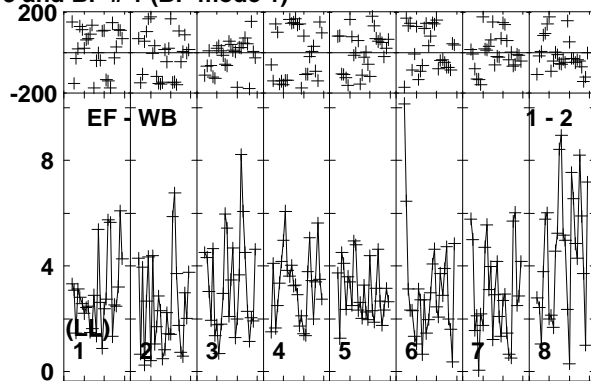
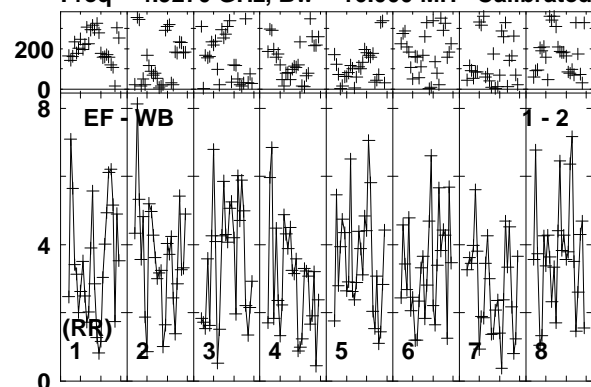

Lower frame: Milli Ampl Jy Top frame: Phas deg

Vector averaged cross-power spectrum Baseline: EF (01) - WB (02)

Timerange: 00/17:56:55 to 00/18:00:49

Plot file version 278 created 18-NOV-2014 15:24:05  
 ARP299C EP087H 3.UVDATA.1  
 Freq = 4.9270 GHz, Bw = 16.000 MH Calibrated with CL # 3 and BP # 1 (BP mode 1)

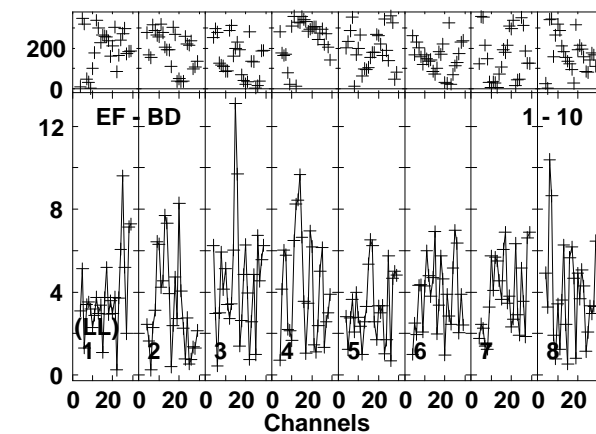
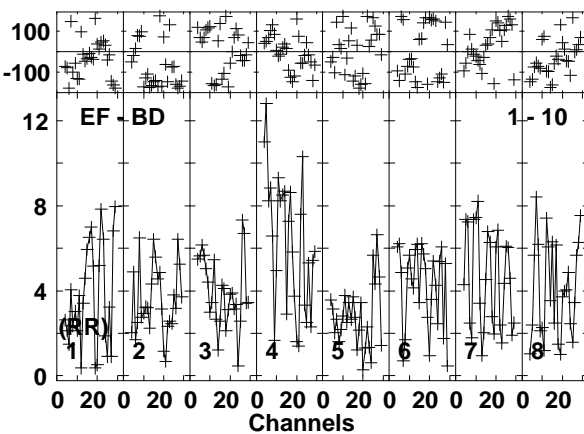
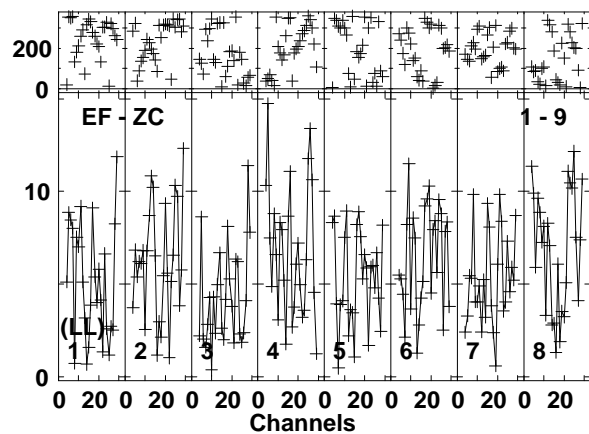
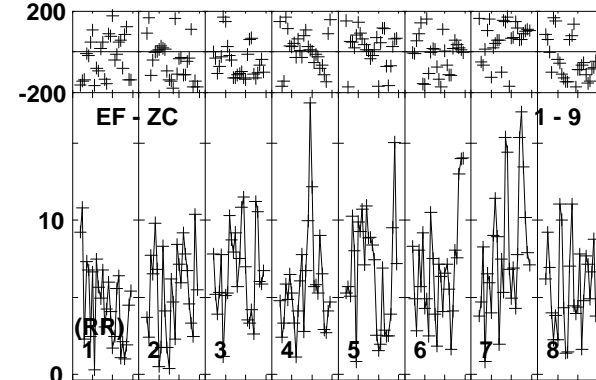
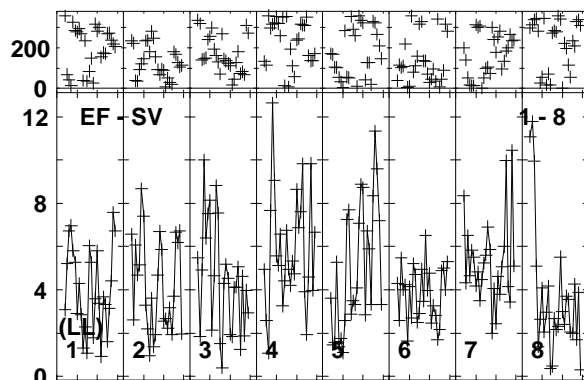
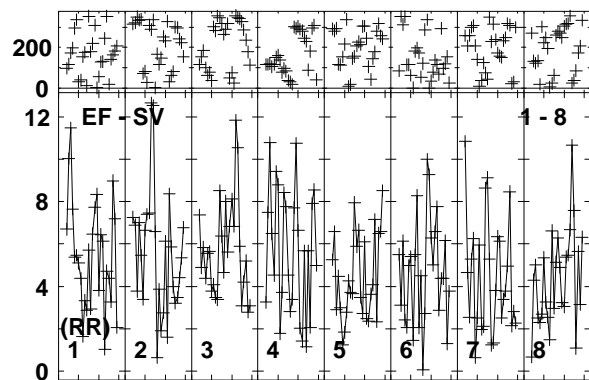
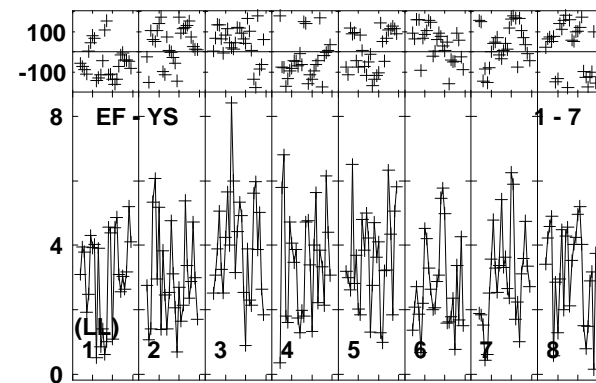
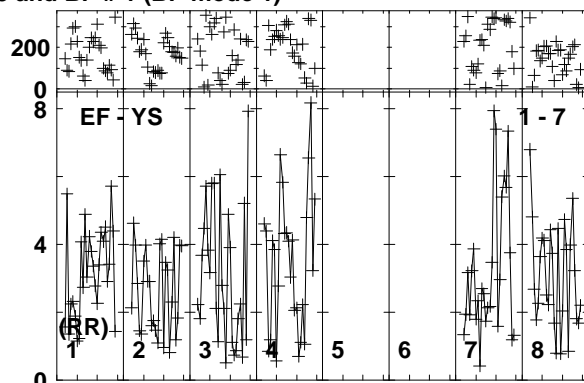
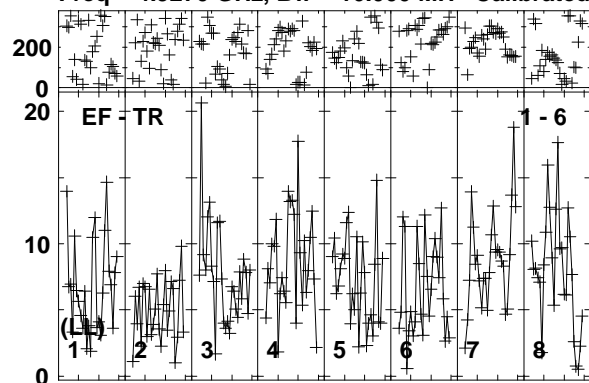

Lower frame: Milli Ampl Jy Top frame: Phas deg  
 Vector averaged cross-power spectrum Baseline: EF (01) - TR (06)  
 Timerange: 00/17:56:55 to 00/18:00:49

Plot file version 279 created 18-NOV-2014 15:24:05

ARP299C EP087H 3.UVDATA.1

Freq = 4.9270 GHz, Bw = 16.000 MH Calibrated with CL # 3 and BP # 1 (BP mode 1)

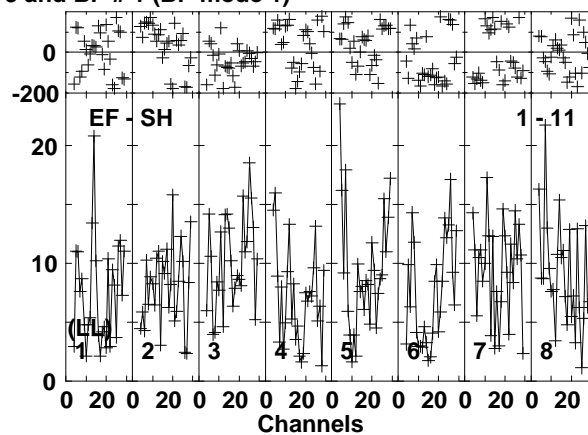
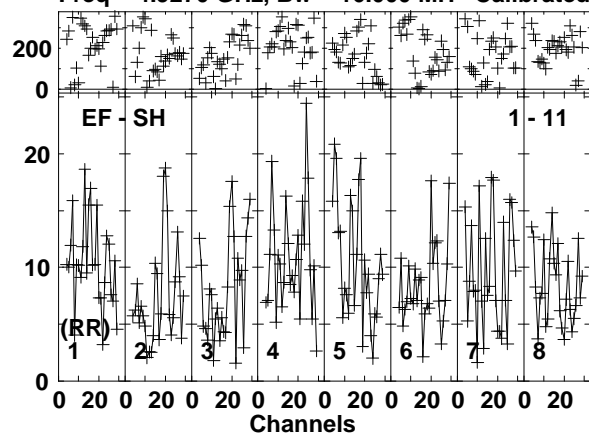

Lower frame: Milli Ampl Jy Top frame: Phas deg  
Vector averaged cross-power spectrum Baseline: EF (01) - SH (11)  
Timerange: 00/17:56:55 to 00/18:00:49

Plot file version 280 created 18-NOV-2014 15:24:05

J1128+5925 EP087H 3.UVDATA.1

Freq = 4.9270 GHz, Bw = 16.000 MH Calibrated with CL # 3 and BP # 1 (BP mode 1)

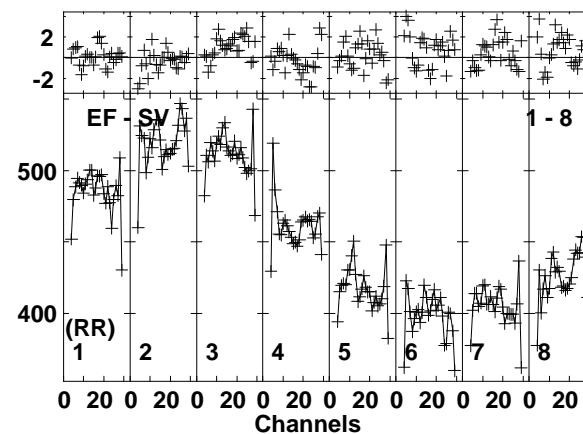
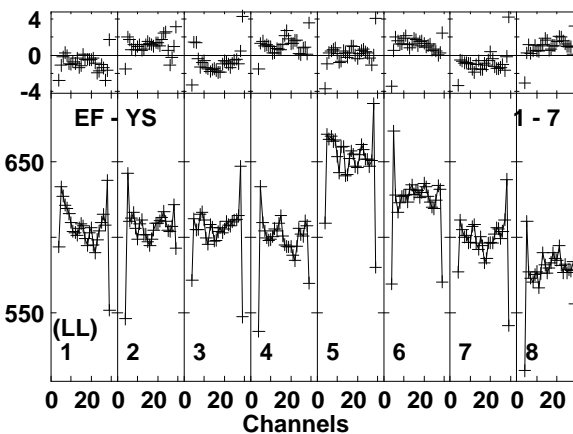
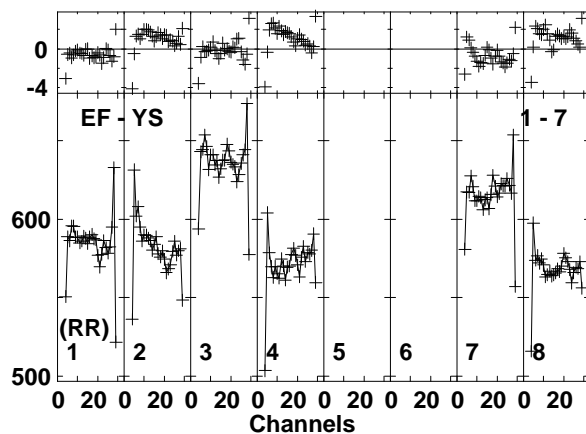
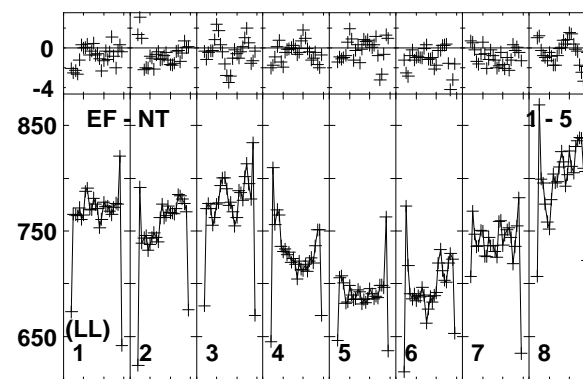
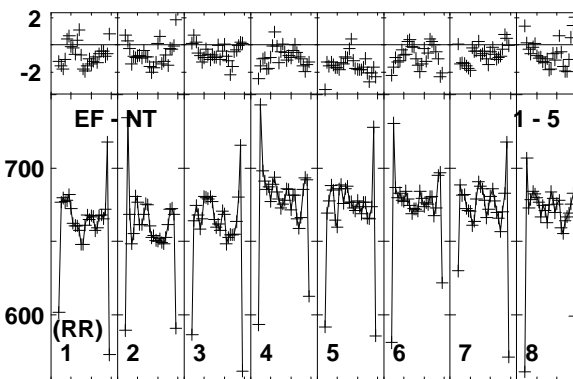
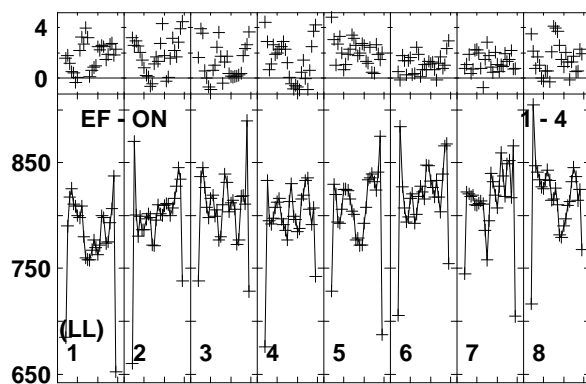
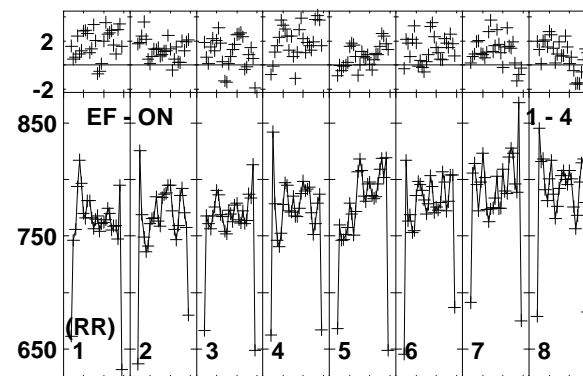
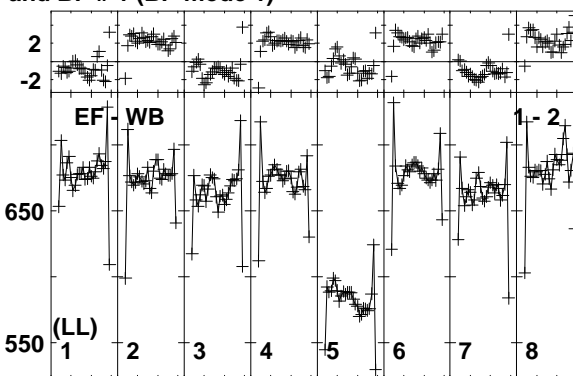
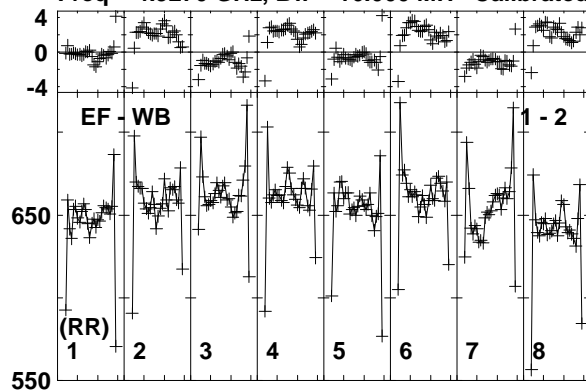

Lower frame: Milli Ampl Jy Top frame: Phas deg  
Vector averaged cross-power spectrum Baseline: EF (01) - WB (02)  
Timerange: 00/18:00:55 to 00/18:01:49



Plot file version 281 created 18-NOV-2014 15:24:05

J1128+5925 EP087H 3.UVDATA.1

Freq = 4.9270 GHz, Bw = 16.000 MH Calibrated with CL # 3 and BP # 1 (BP mode 1)

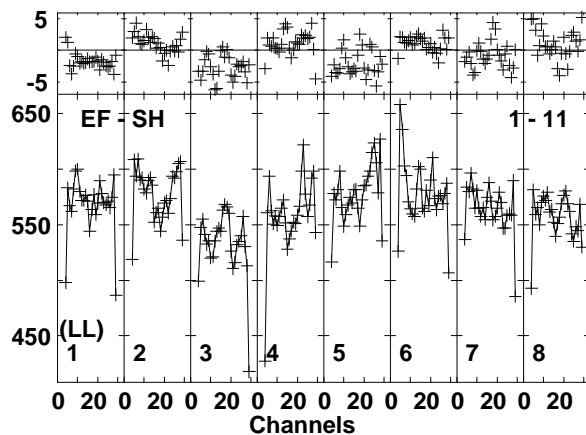
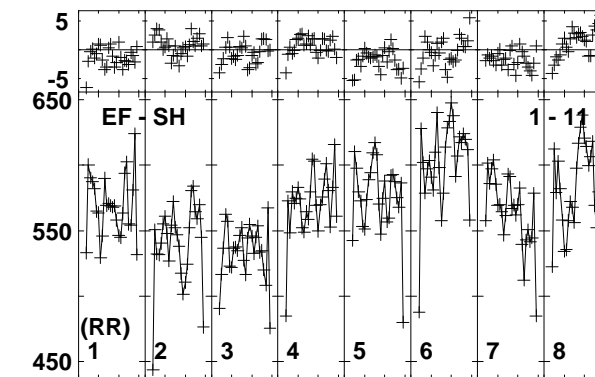
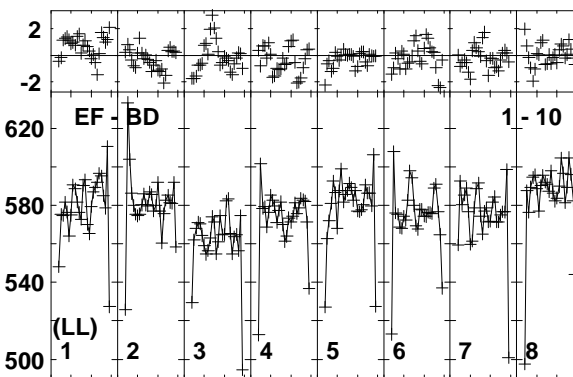
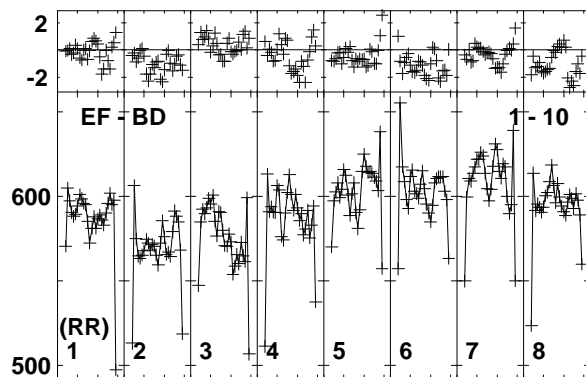
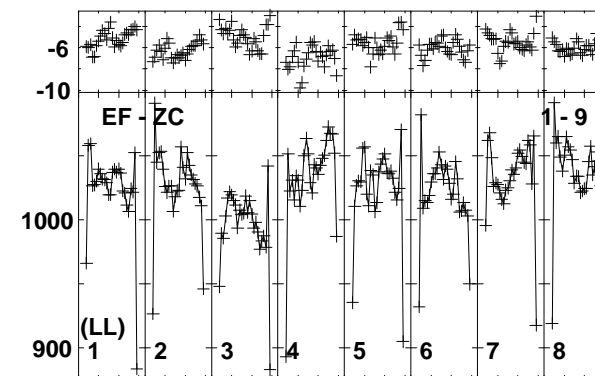
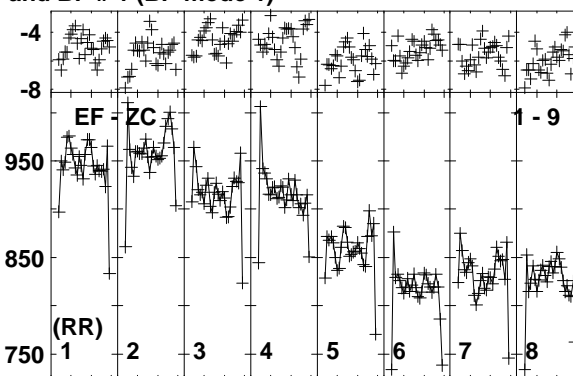
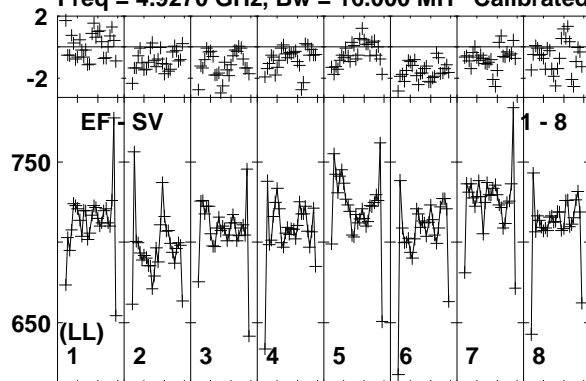

Lower frame: Milli Ampl Jy Top frame: Phas deg  
Vector averaged cross-power spectrum Baseline: EF (01) - SV (08)  
Timerange: 00/18:00:55 to 00/18:01:49

Plot file version 282 created 18-NOV-2014 15:24:06

ARP299C EP087H 3.UVDATA.1

Freq = 4.9270 GHz, Bw = 16.000 MH Calibrated with CL # 3 and BP # 1 (BP mode 1)

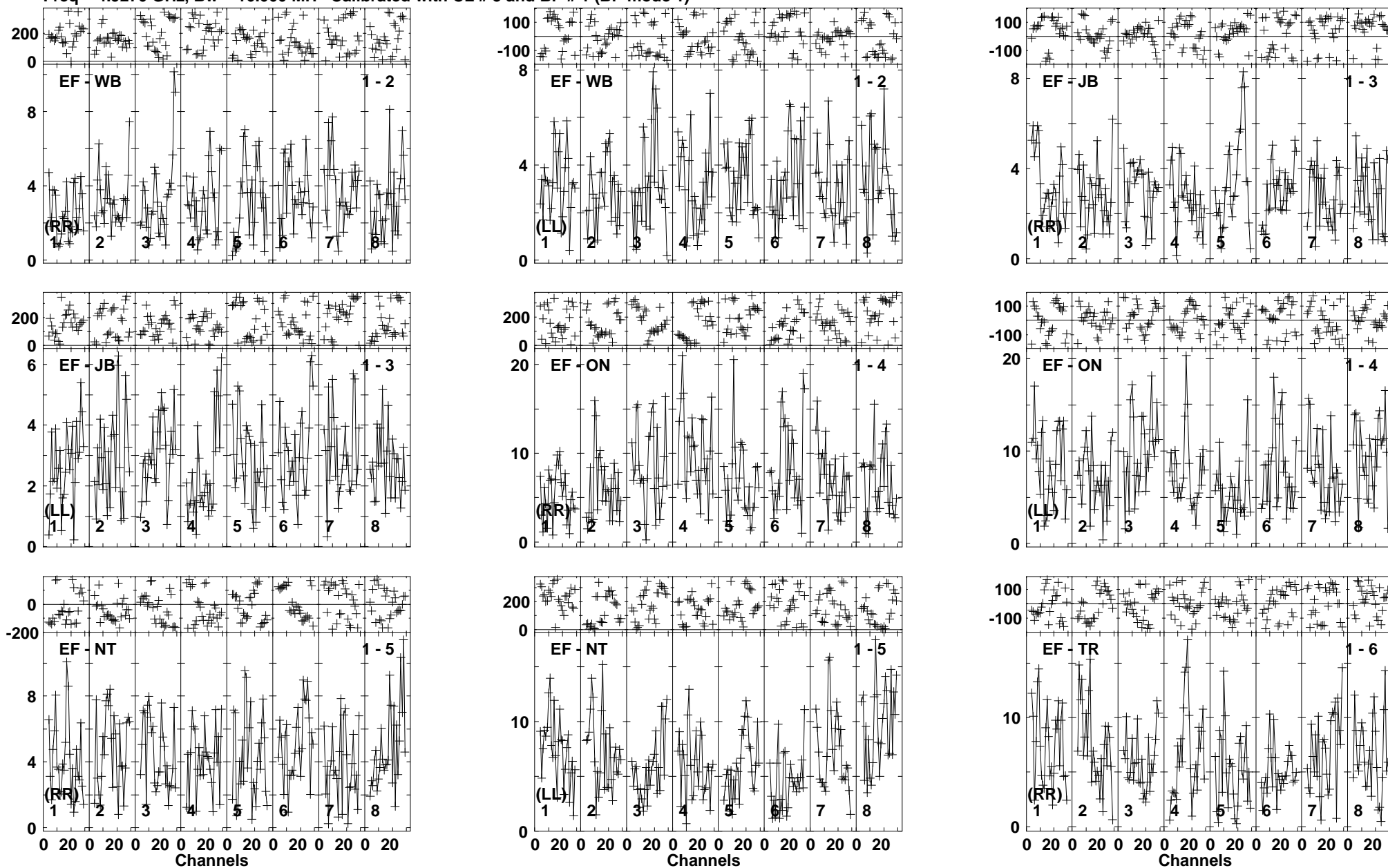

Lower frame: Milli Ampl Jy Top frame: Phas deg  
Vector averaged cross-power spectrum Baseline: EF (01) - WB (02)  
Timerange: 00/18:01:51 to 00/18:05:49

Plot file version 283 created 18-NOV-2014 15:24:06  
 ARP299C EP087H 3.UVDATA.1  
 Freq = 4.9270 GHz, Bw = 16.000 MH Calibrated with CL # 3 and BP # 1 (BP mode 1)

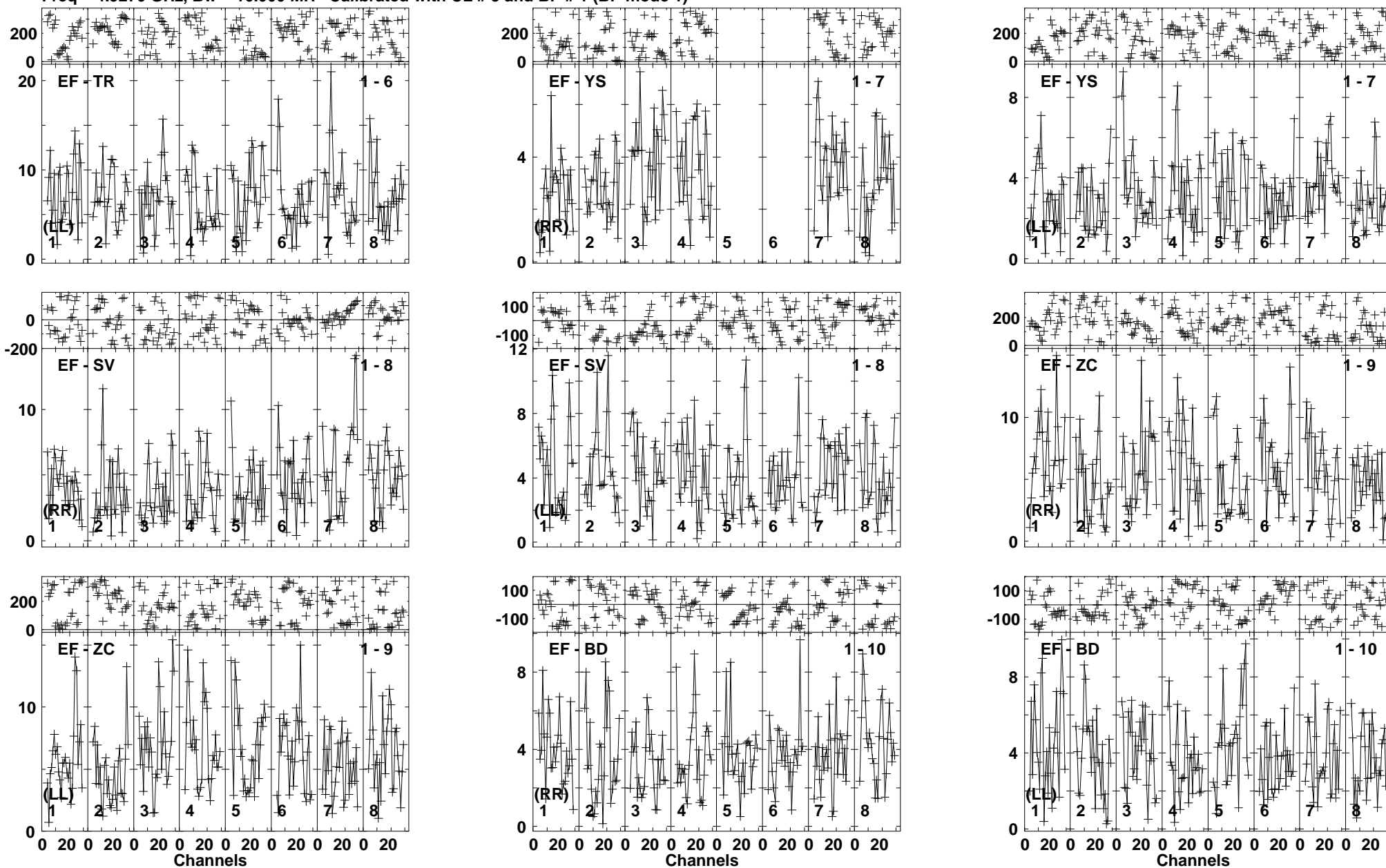

Lower frame: Milli Ampl Jy Top frame: Phas deg  
 Vector averaged cross-power spectrum Baseline: EF (01) - TR (06)  
 Timerange: 00/18:01:51 to 00/18:05:49

Plot file version 284 created 18-NOV-2014 15:24:06

ARP299C EP087H 3.UVDATA.1

Freq = 4.9270 GHz, Bw = 16.000 MH Calibrated with CL # 3 and BP # 1 (BP mode 1)

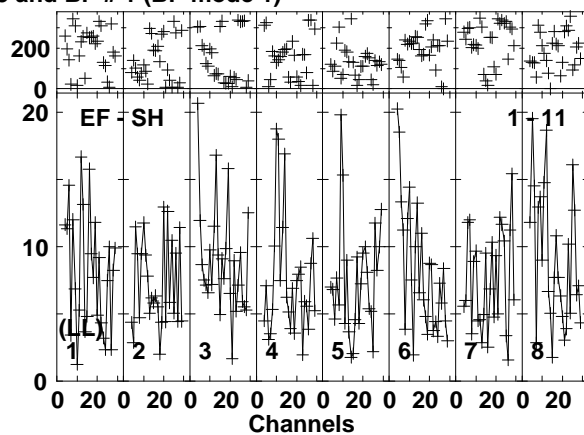
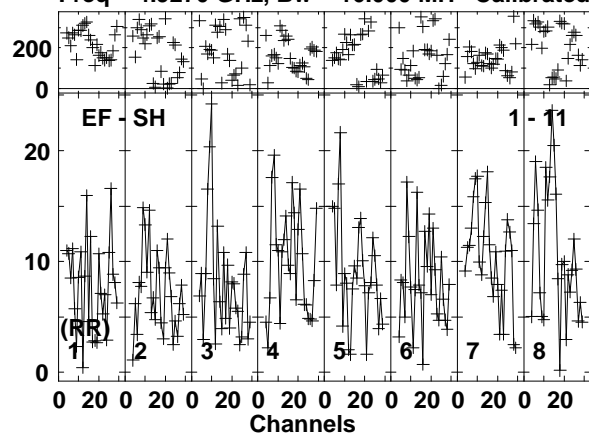

Lower frame: Milli Ampl Jy Top frame: Phas deg  
Vector averaged cross-power spectrum Baseline: EF (01) - SH (11)  
Timerange: 00/18:01:51 to 00/18:05:49

Plot file version 285 created 18-NOV-2014 15:24:06

J1128+5925 EP087H 3.UVDATA.1

Freq = 4.9270 GHz, Bw = 16.000 MH Calibrated with CL # 3 and BP # 1 (BP mode 1)

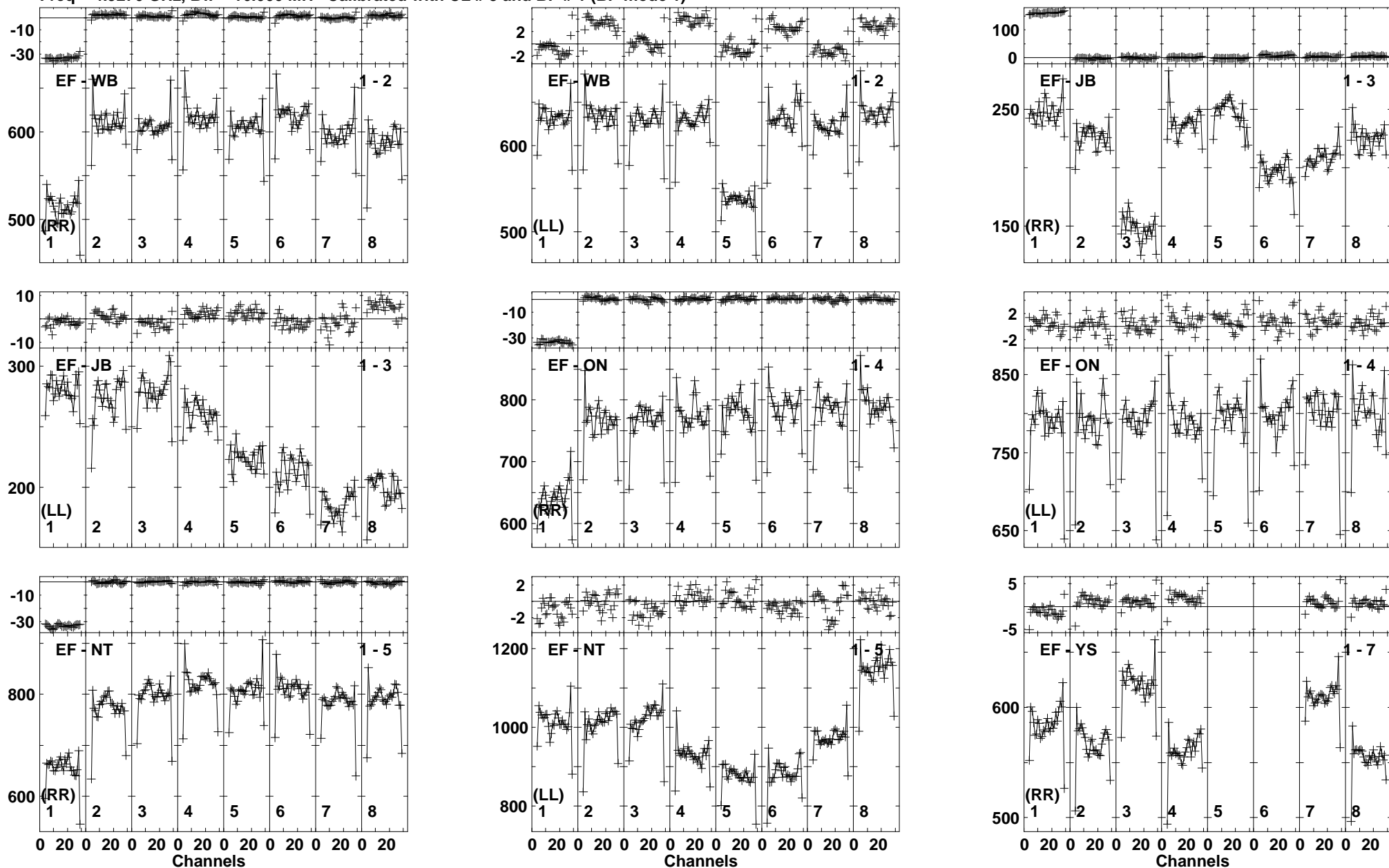

Lower frame: Milli Ampl Jy Top frame: Phas deg  
Vector averaged cross-power spectrum Baseline: EF (01) - WB (02)  
Timerange: 00:18:05:55 to 00:18:06:49

Plot file version 286 created 18-NOV-2014 15:24:06

J1128+5925 EP087H 3.UVDATA.1

Freq = 4.9270 GHz, Bw = 16.000 MH Calibrated with CL # 3 and BP # 1 (BP mode 1)

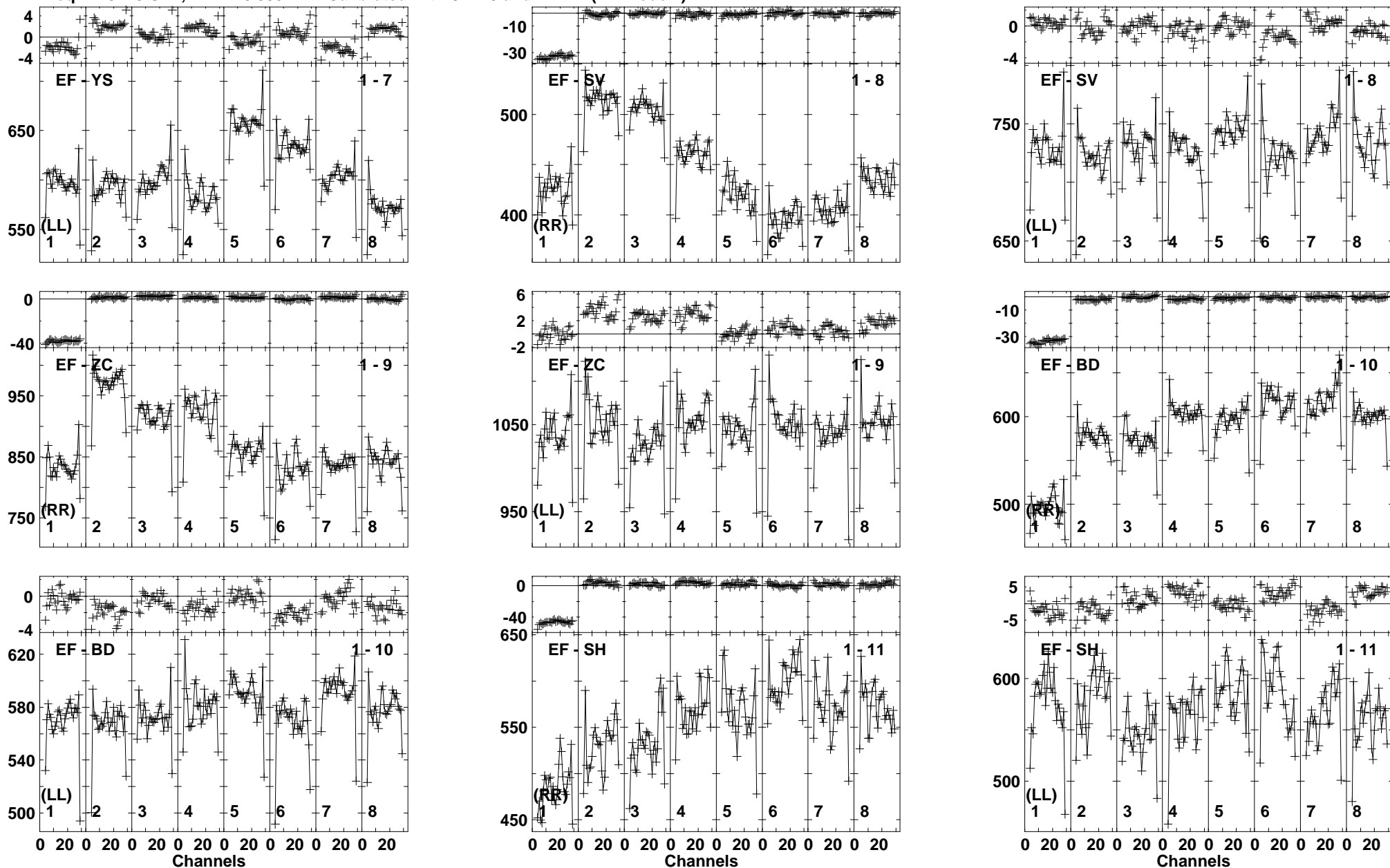

Lower frame: Milli Ampl Jy Top frame: Phas deg  
Vector averaged cross-power spectrum Baseline: EF (01) - YS (07)  
Timerange: 00/18:05:55 to 00/18:06:49

Plot file version 287 created 18-NOV-2014 15:24:07

ARP299C EP087H 3.UVDATA.1

Freq = 4.9270 GHz, Bw = 16.000 MH Calibrated with CL # 3 and BP # 1 (BP mode 1)

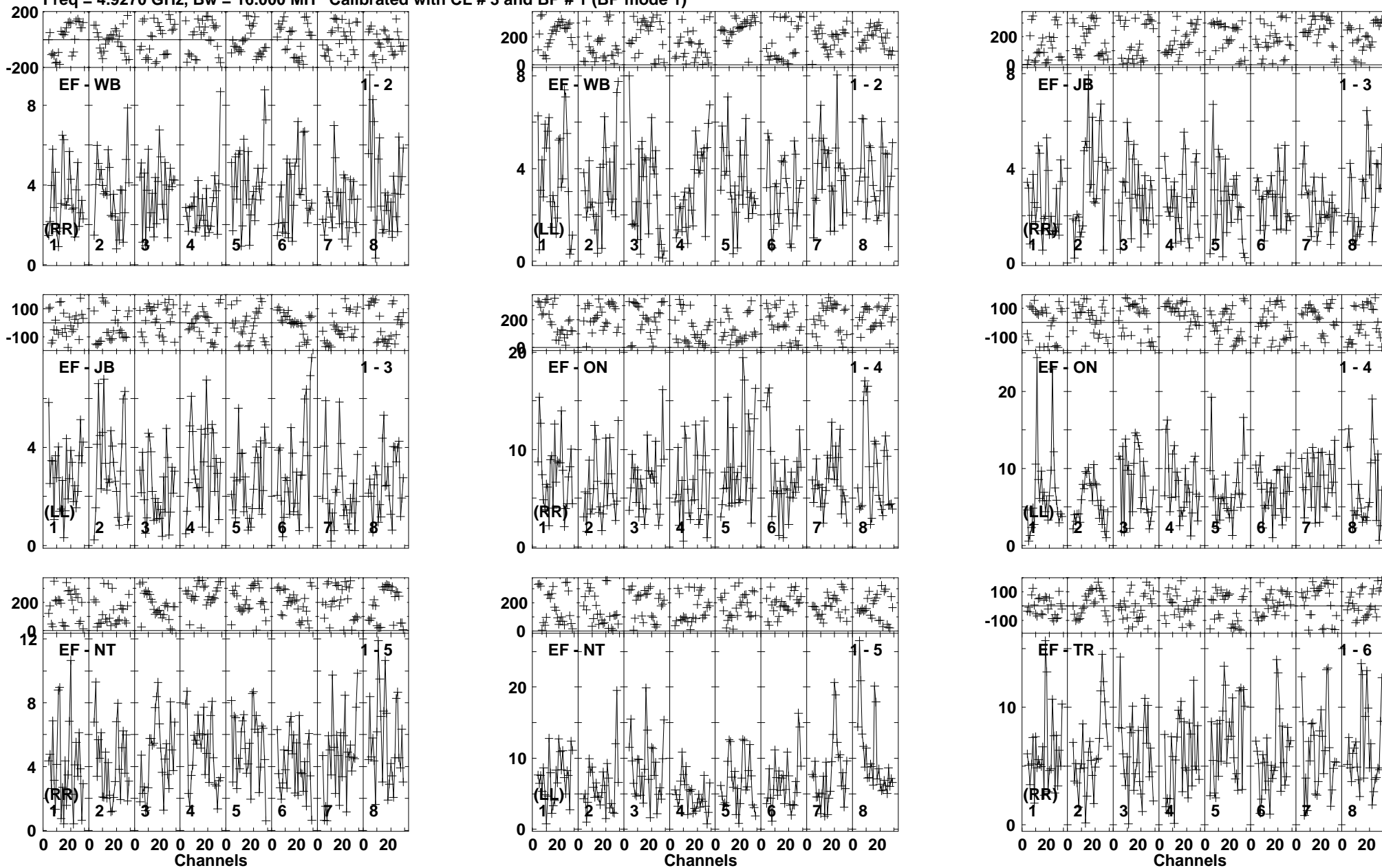

Lower frame: Milli Ampl Jy Top frame: Phas deg  
Vector averaged cross-power spectrum Baseline: EF (01) - WB (02)  
Timerange: 00/18:06:55 to 00/18:10:49

Plot file version 288 created 18-NOV-2014 15:24:07

ARP299C EP087H 3.UVDATA.1

Freq = 4.9270 GHz, Bw = 16.000 MH Calibrated with CL # 3 and BP # 1 (BP mode 1)

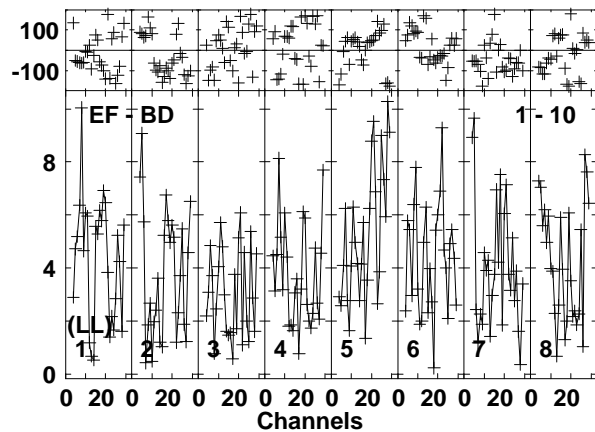
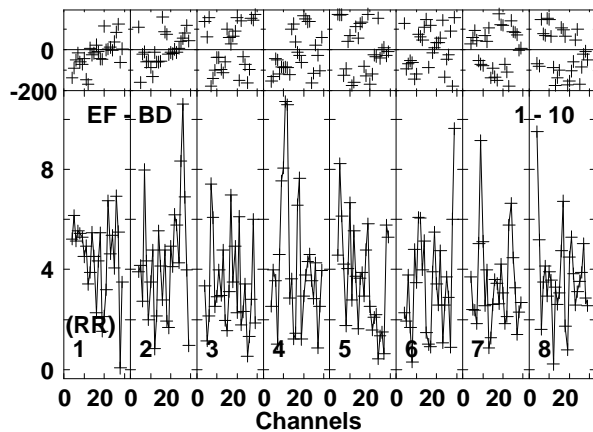
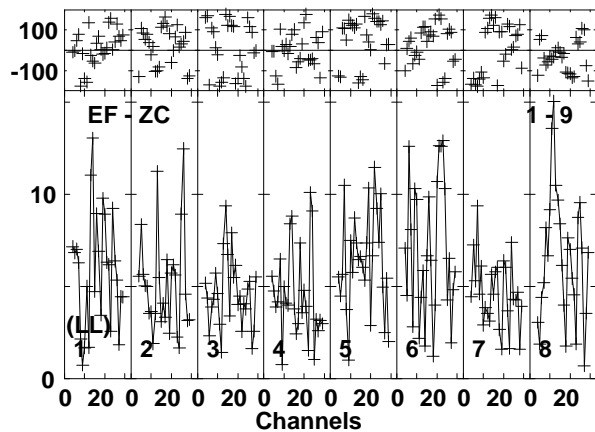
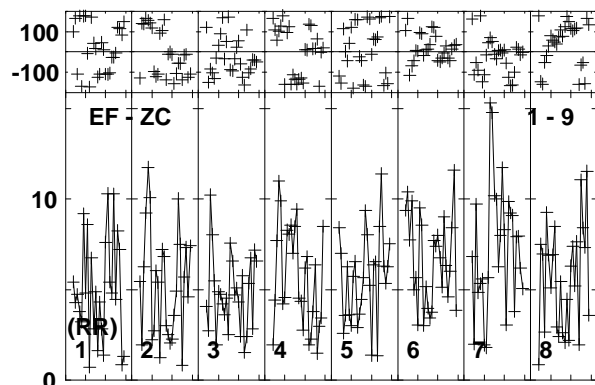
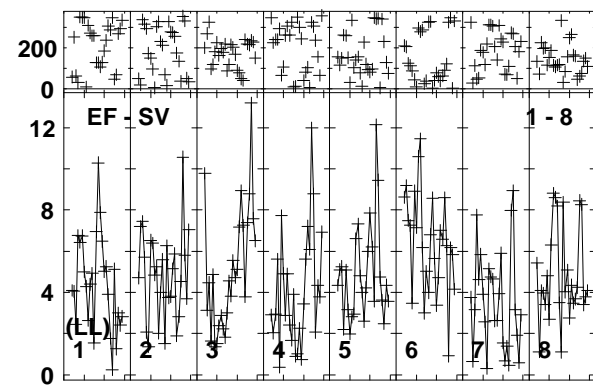
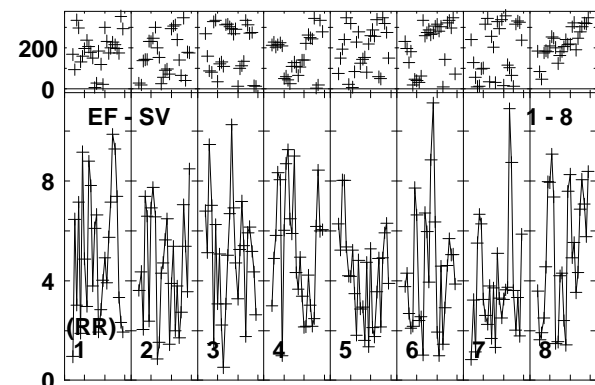
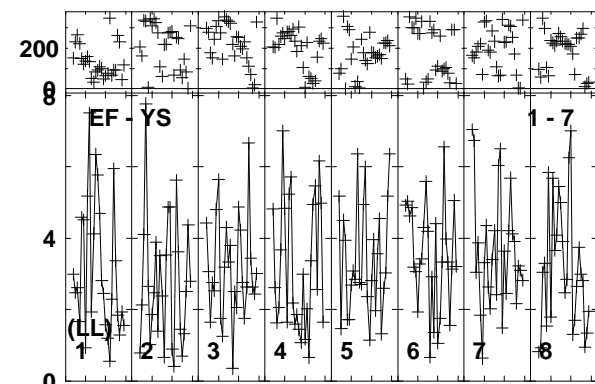
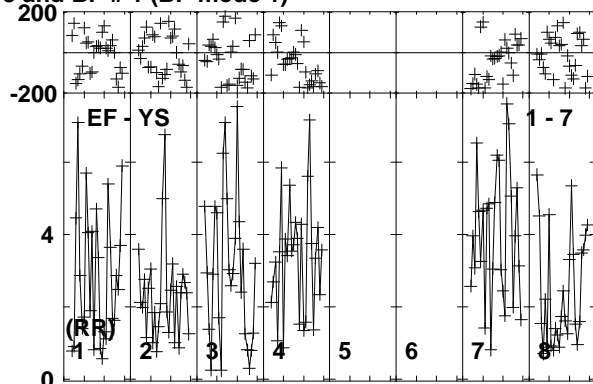
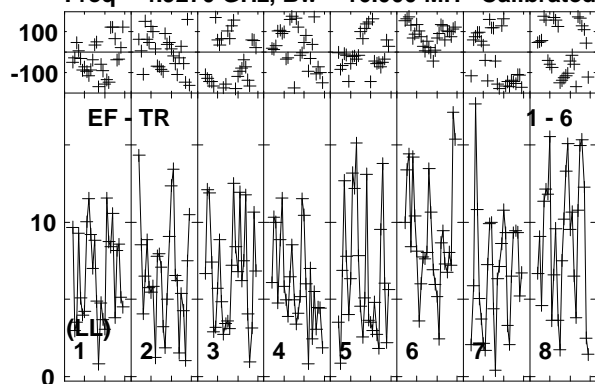

Lower frame: Milli Ampl Jy Top frame: Phas deg  
Vector averaged cross-power spectrum Baseline: EF (01) - TR (06)  
Timerange: 00/18:06:55 to 00/18:10:49



Plot file version 289 created 18-NOV-2014 15:24:07

ARP299C EP087H 3.UVDATA.1

Freq = 4.9270 GHz, Bw = 16.000 MH Calibrated with CL # 3 and BP # 1 (BP mode 1)

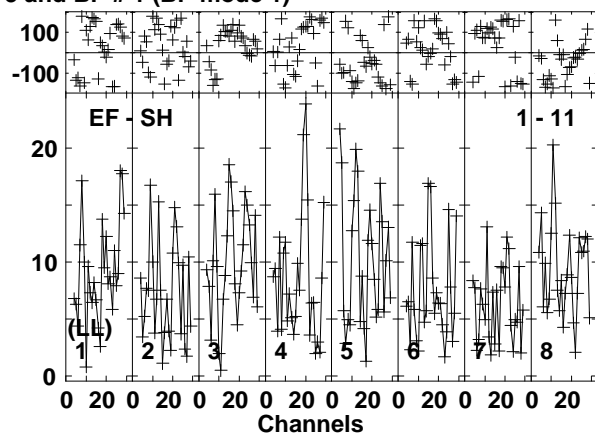
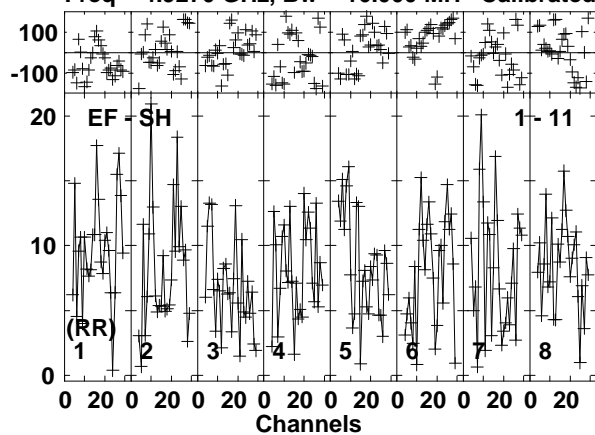

Lower frame: Milli Ampl Jy Top frame: Phas deg  
Vector averaged cross-power spectrum Baseline: EF (01) - SH (11)  
Timerange: 00/18:06:55 to 00/18:10:49

Plot file version 290 created 18-NOV-2014 15:24:07  
 J1128+5925 EP087H 3.UVDATA.1  
 Freq = 4.9270 GHz, Bw = 16.000 MH Calibrated with CL # 3 and BP # 1 (BP mode 1)

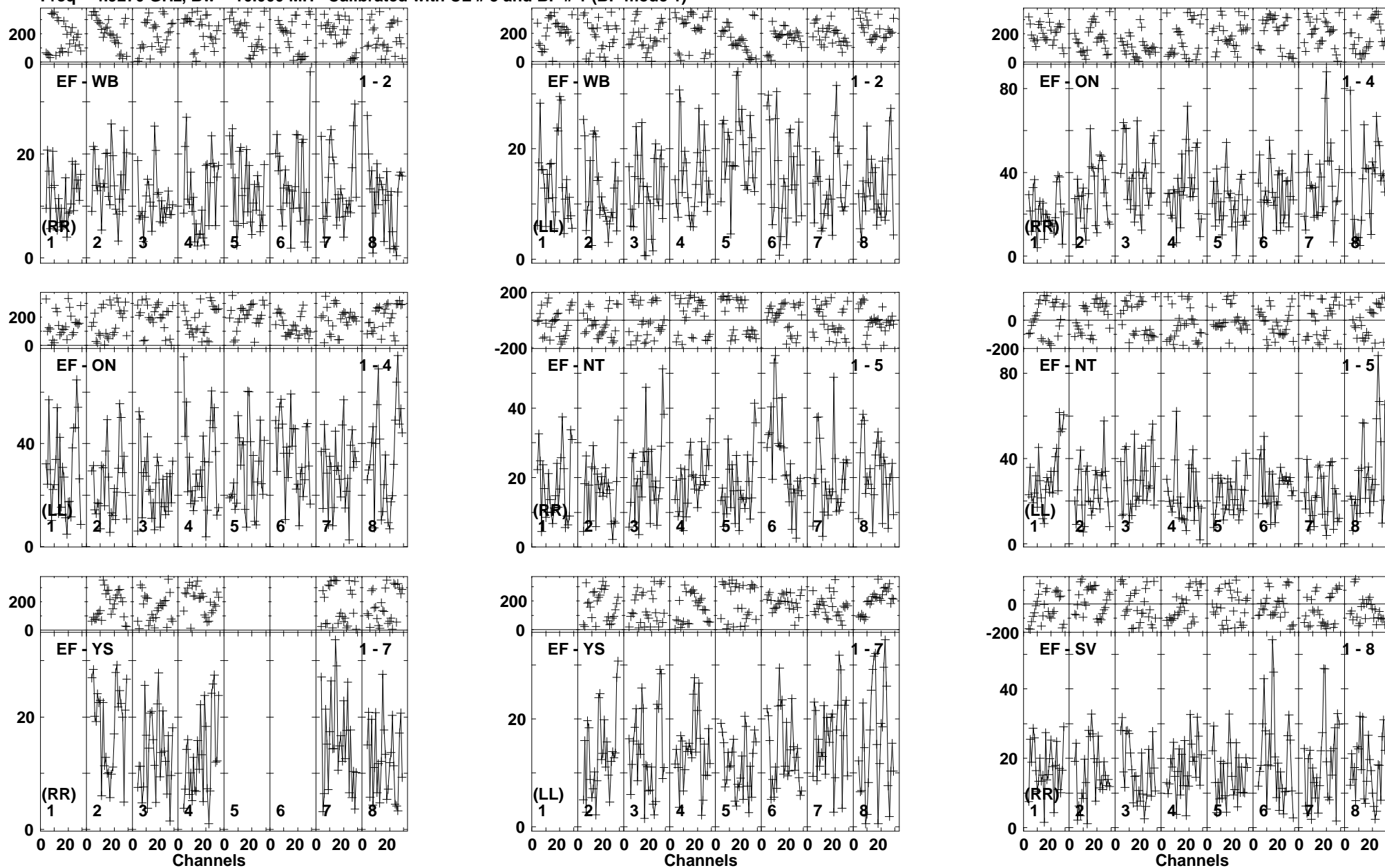

Lower frame: Milli Amp Jy Top frame: Phas deg  
 Vector averaged cross-power spectrum Baseline: EF (01) - WB (02)  
 Timerange: 00/18:11:33 to 00/18:11:59

Plot file version 291 created 18-NOV-2014 15:24:07  
 J1128+5925 EP087H 3.UVDATA.1  
 Freq = 4.9270 GHz, Bw = 16.000 MH Calibrated with CL # 3 and BP # 1 (BP mode 1)

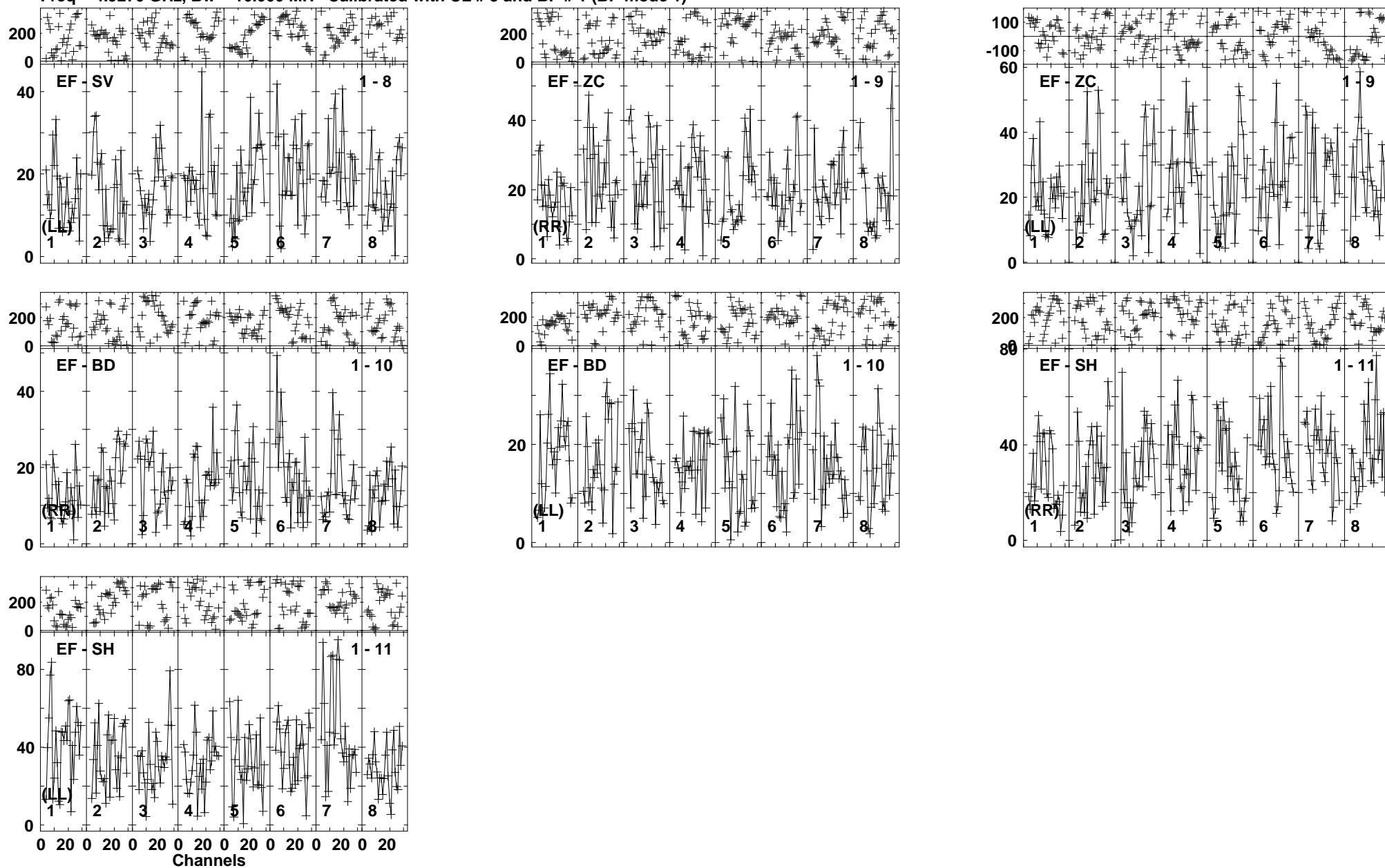

Lower frame: Milli Ampl Jy Top frame: Phas deg  
 Vector averaged cross-power spectrum Baseline: EF (01) - SV (08)  
 Timerange: 00:18:11:33 to 00:18:11:59

Plot file version 292 created 18-NOV-2014 15:24:08

ARP299C EP087H 3.UVDATA.1

Freq = 4.9270 GHz, Bw = 16.000 MH Calibrated with CL # 3 and BP # 1 (BP mode 1)

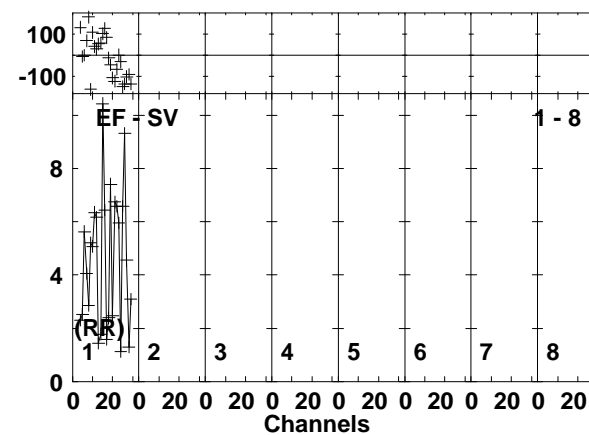
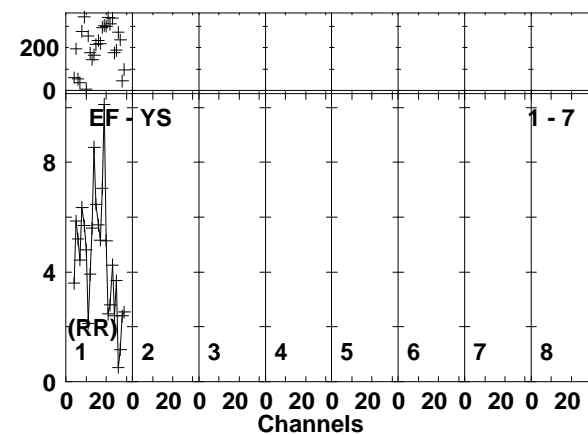
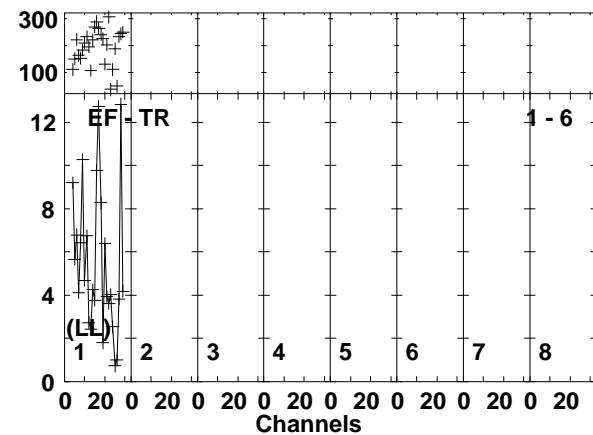
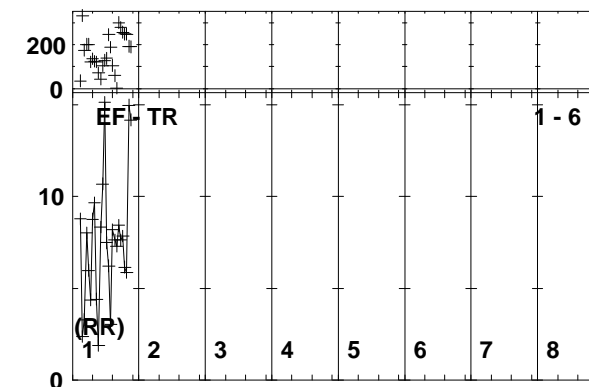
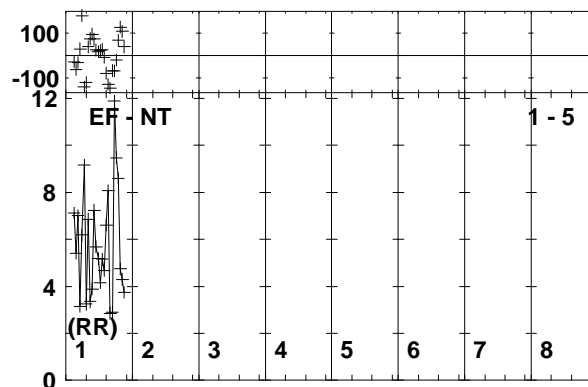
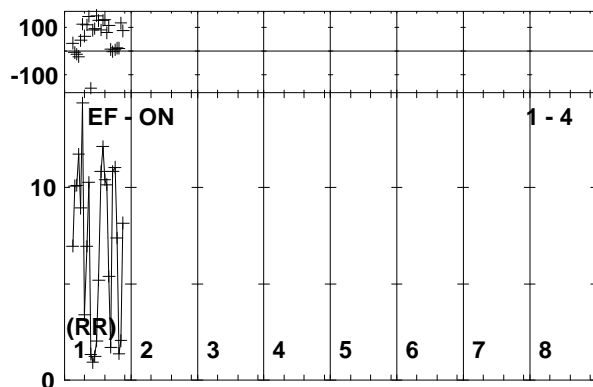
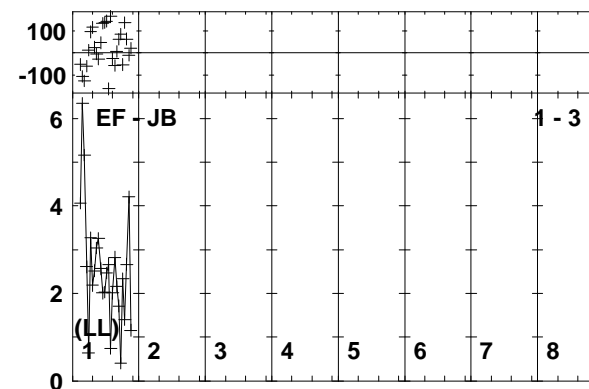
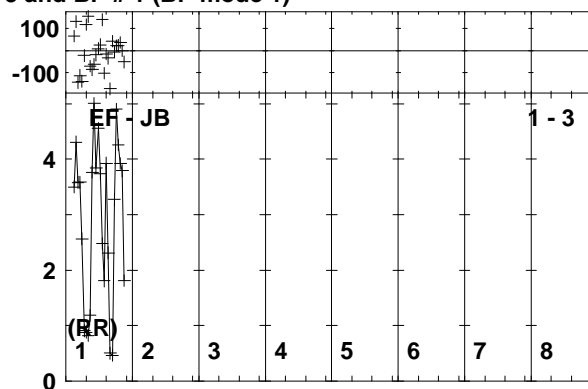
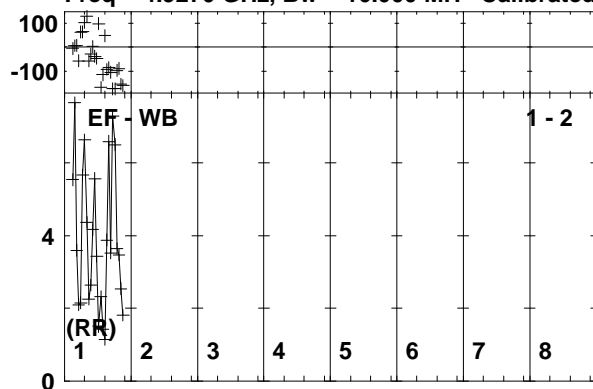

Lower frame: Milli Ampl Jy Top frame: Phas deg  
Vector averaged cross-power spectrum Baseline: EF (01) - WB (02)  
Timerange: 00/18:12:01 to 00/18:15:59

Plot file version 293 created 18-NOV-2014 15:24:08  
ARP299C EP087H 3.UVDATA.1  
Freq = 4.9270 GHz, Bw = 16.000 MH Calibrated with CL # 3 and BP # 1 (BP mode 1)

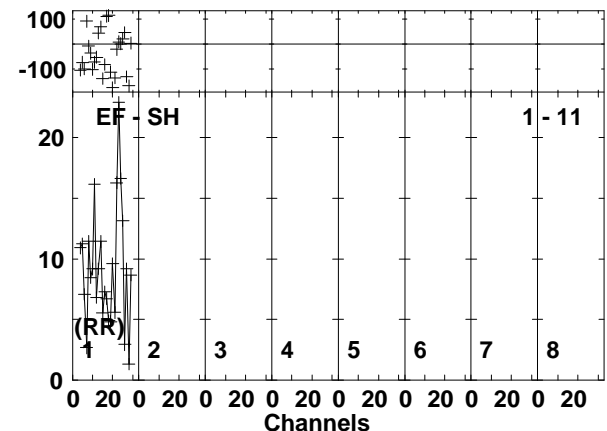
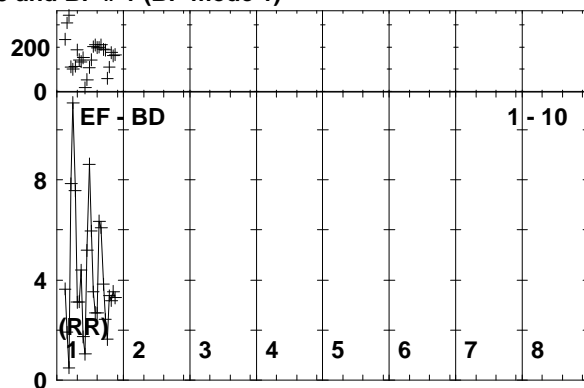
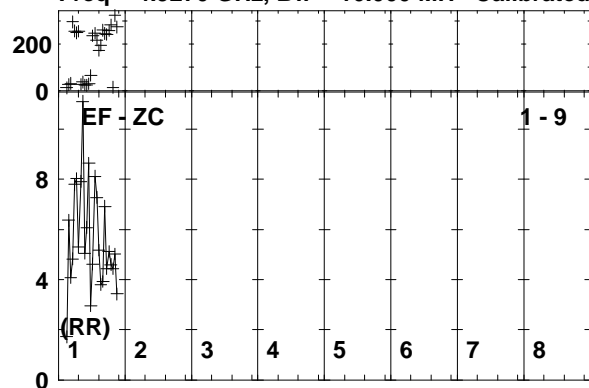

Lower frame: Milli Ampl Jy Top frame: Phas deg  
Vector averaged cross-power spectrum Baseline: EF (01) - ZC (09)  
Timerange: 00/18:12:01 to 00/18:15:59

Plot file version 294 created 18-NOV-2014 15:24:08  
 J1128+5925 EP087H 3.UVDATA.1  
 Freq = 4.9270 GHz, Bw = 16.000 MH Calibrated with CL # 3 and BP # 1 (BP mode 1)

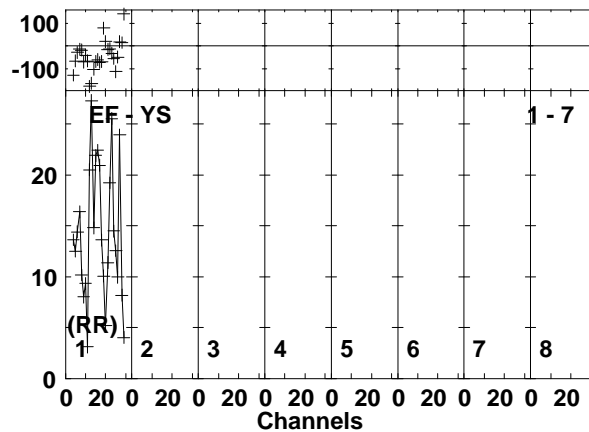
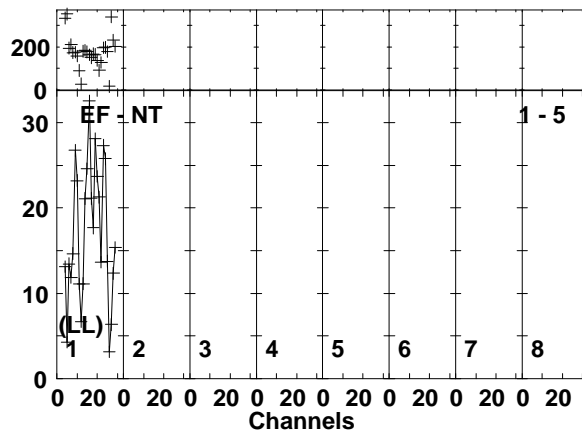
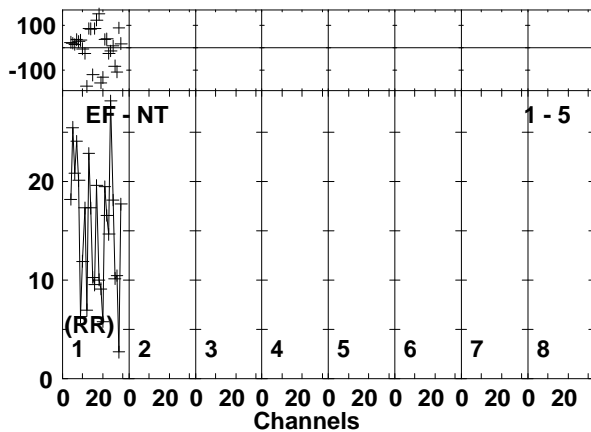
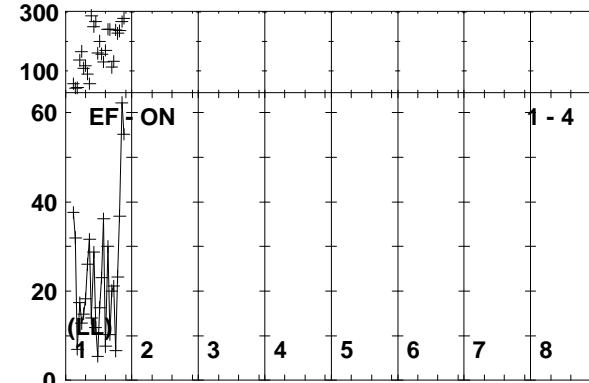
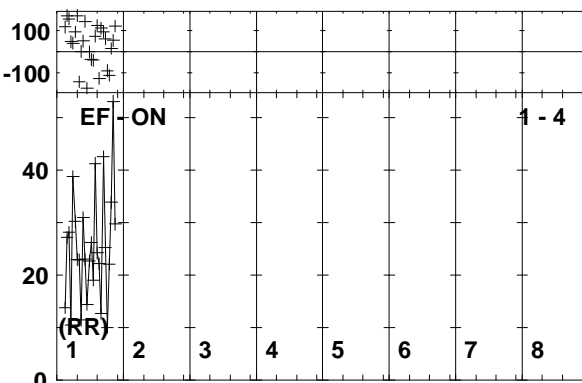
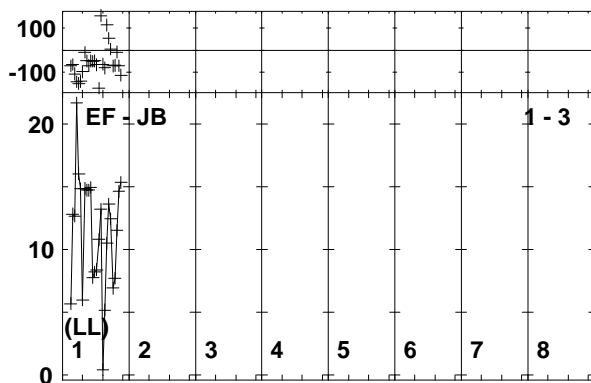
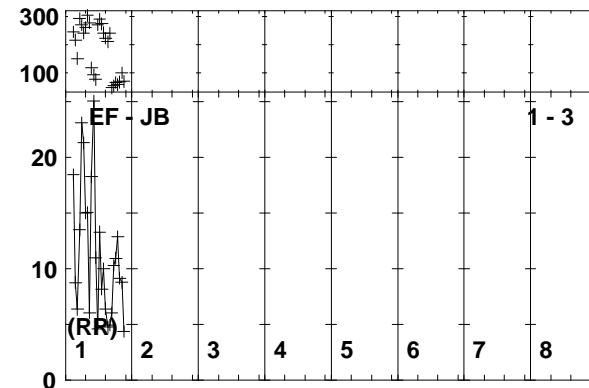
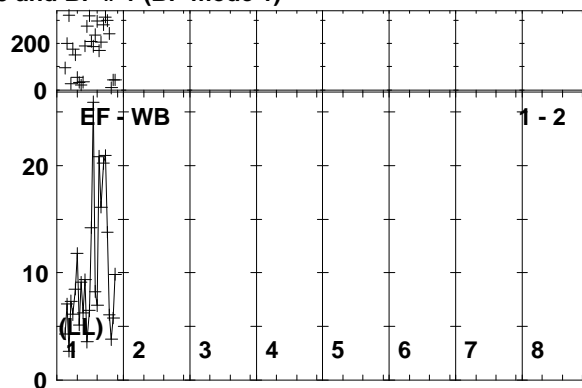
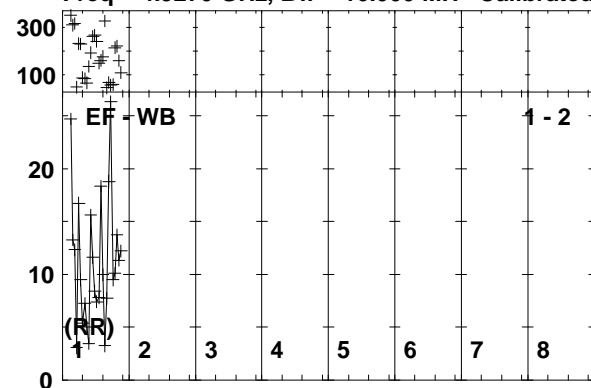

Lower frame: Milli Ampl Jy Top frame: Phas deg  
 Vector averaged cross-power spectrum Baseline: EF (01) - WB (02)  
 Timerange: 00/18:16:05 to 00/18:16:59

Plot file version 295 created 18-NOV-2014 15:24:08  
 J1128+5925 EP087H 3.UVDATA.1  
 Freq = 4.9270 GHz, Bw = 16.000 MH Calibrated with CL # 3 and BP # 1 (BP mode 1)

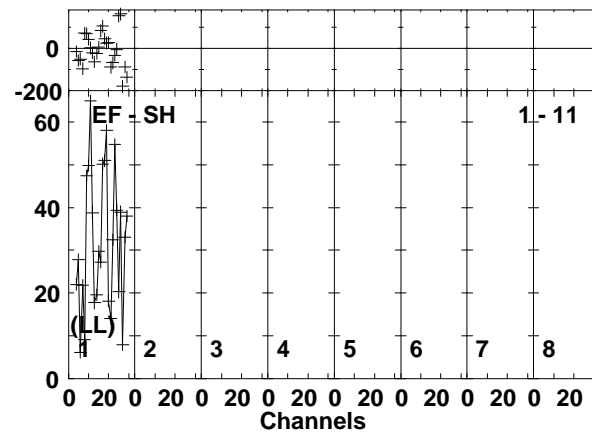
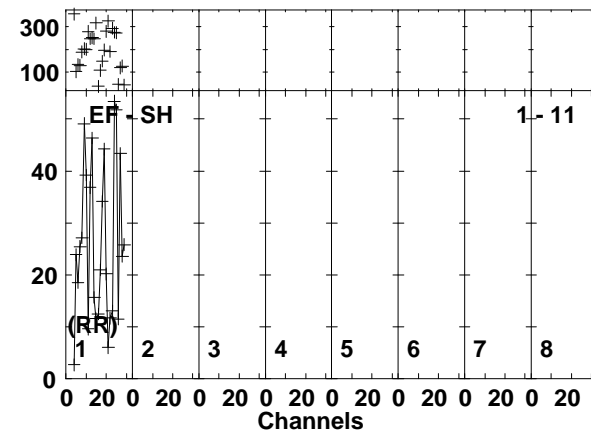
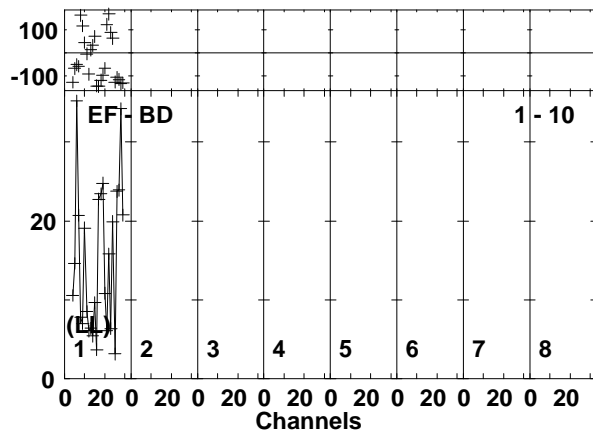
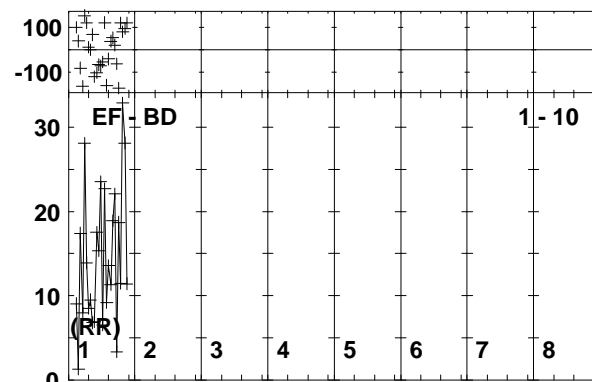
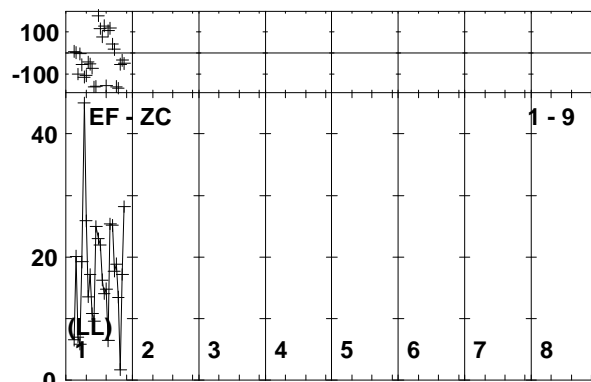
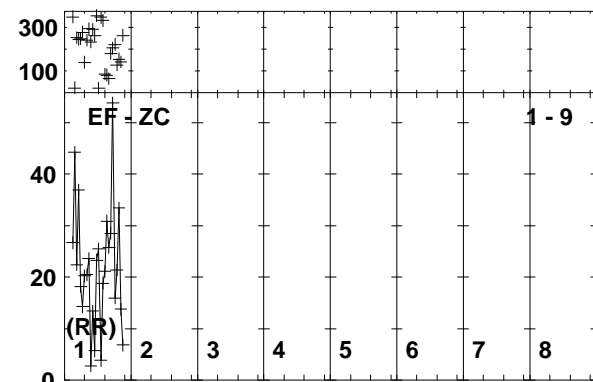
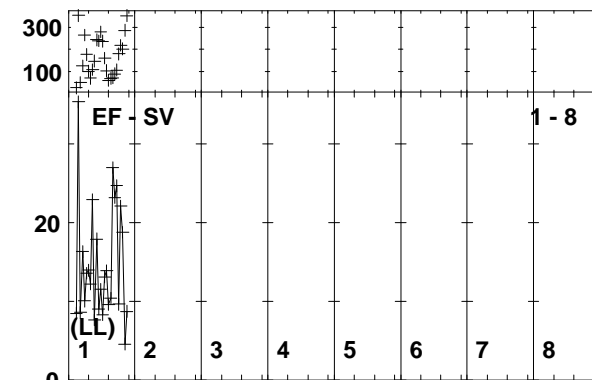
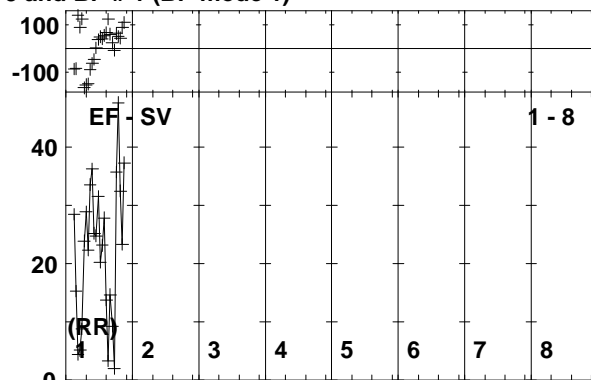
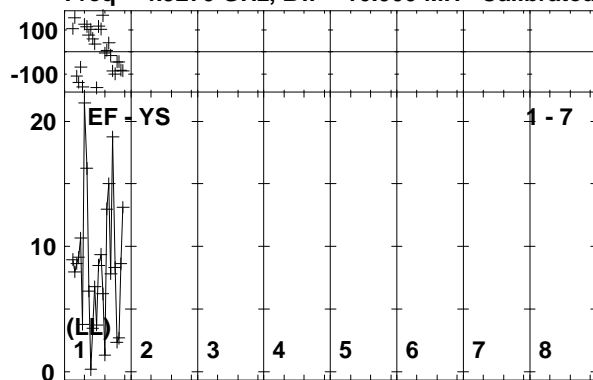

Lower frame: Milli Ampl Jy Top frame: Phas deg  
 Vector averaged cross-power spectrum Baseline: EF (01) - YS (07)  
 Timerange: 00/18:16:05 to 00/18:16:59

Plot file version 296 created 18-NOV-2014 15:24:09  
 ARP299C EP087H 3.UVDATA.1  
 Freq = 4.9270 GHz, Bw = 16.000 MH Calibrated with CL # 3 and BP # 1 (BP mode 1)

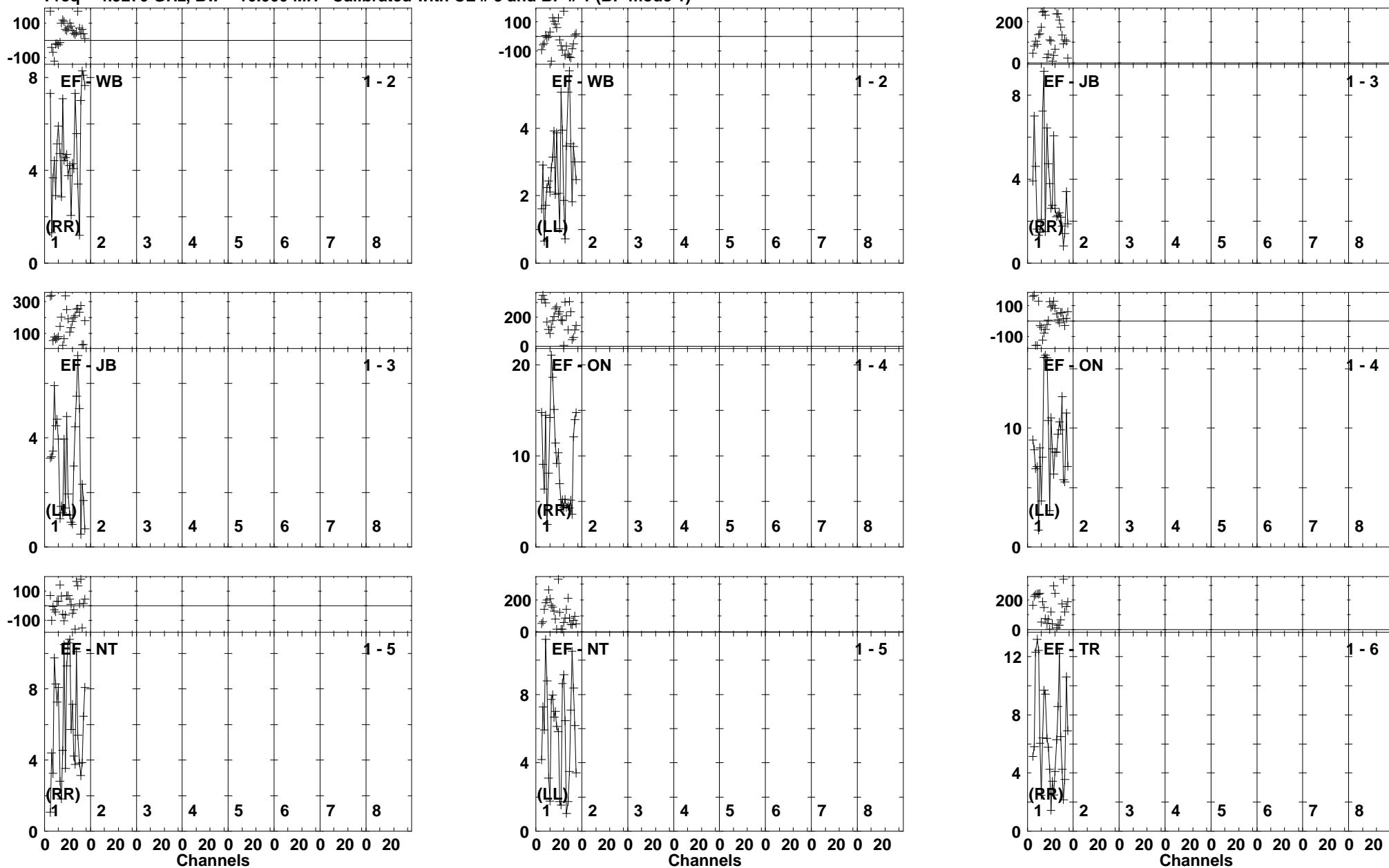

Lower frame: Milli Ampl Jy Top frame: Phas deg  
 Vector averaged cross-power spectrum Baseline: EF (01) - WB (02)  
 Timerange: 00/18:17:05 to 00/18:20:59



Plot file version 297 created 18-NOV-2014 15:24:09  
 ARP299C EP087H 3.UVDATA.1  
 Freq = 4.9270 GHz, Bw = 16.000 MH Calibrated with CL # 3 and BP # 1 (BP mode 1)

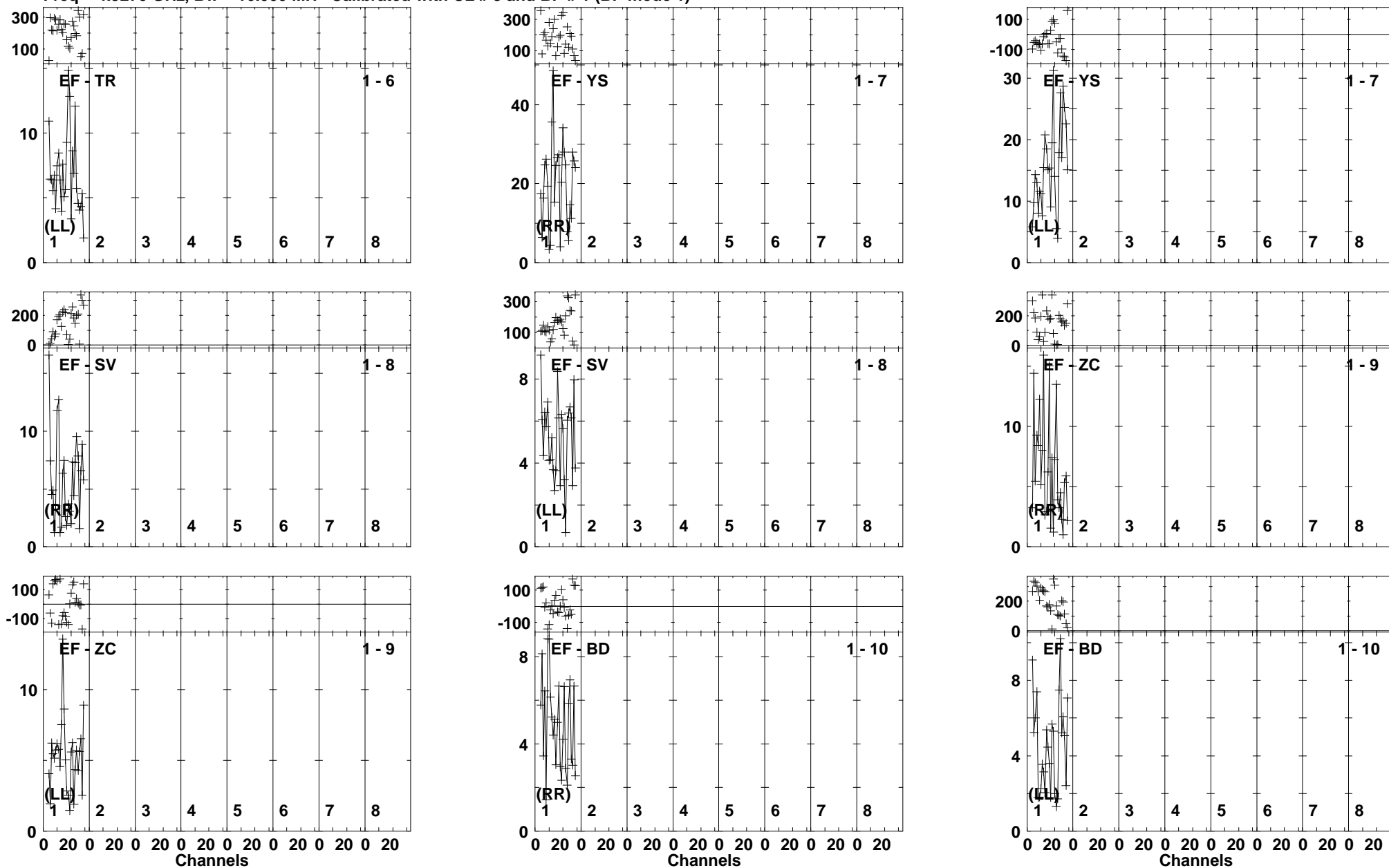

Lower frame: Milli Ampl Jy Top frame: Phas deg  
 Vector averaged cross-power spectrum Baseline: EF (01) - TR (06)  
 Timerange: 00/18:17:05 to 00/18:20:59

Plot file version 298 created 18-NOV-2014 15:24:09

ARP299C EP087H 3.UVDATA.1

Freq = 4.9270 GHz, Bw = 16.000 MH Calibrated with CL # 3 and BP # 1 (BP mode 1)

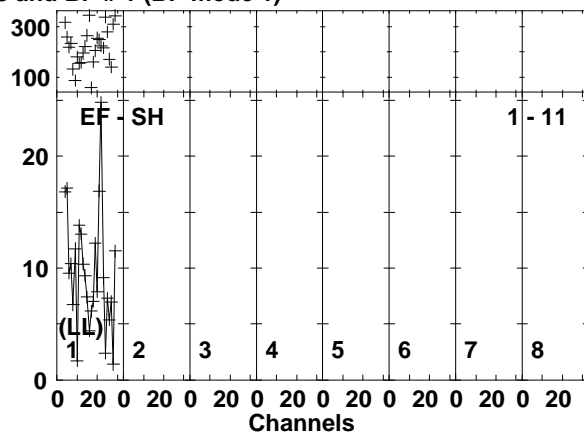
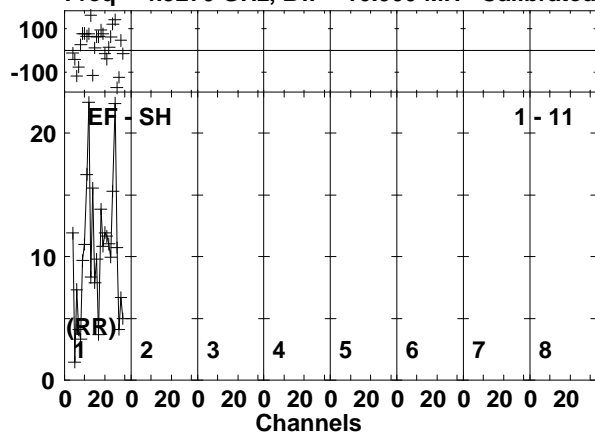

Lower frame: Milli Ampl Jy Top frame: Phas deg  
Vector averaged cross-power spectrum Baseline: EF (01) - SH (11)  
Timerange: 00/18:17:05 to 00/18:20:59

Plot file version 299 created 18-NOV-2014 15:24:09  
 J1128+5925 EP087H 3.UVDATA.1  
 Freq = 4.9270 GHz, Bw = 16.000 MH Calibrated with CL # 3 and BP # 1 (BP mode 1)

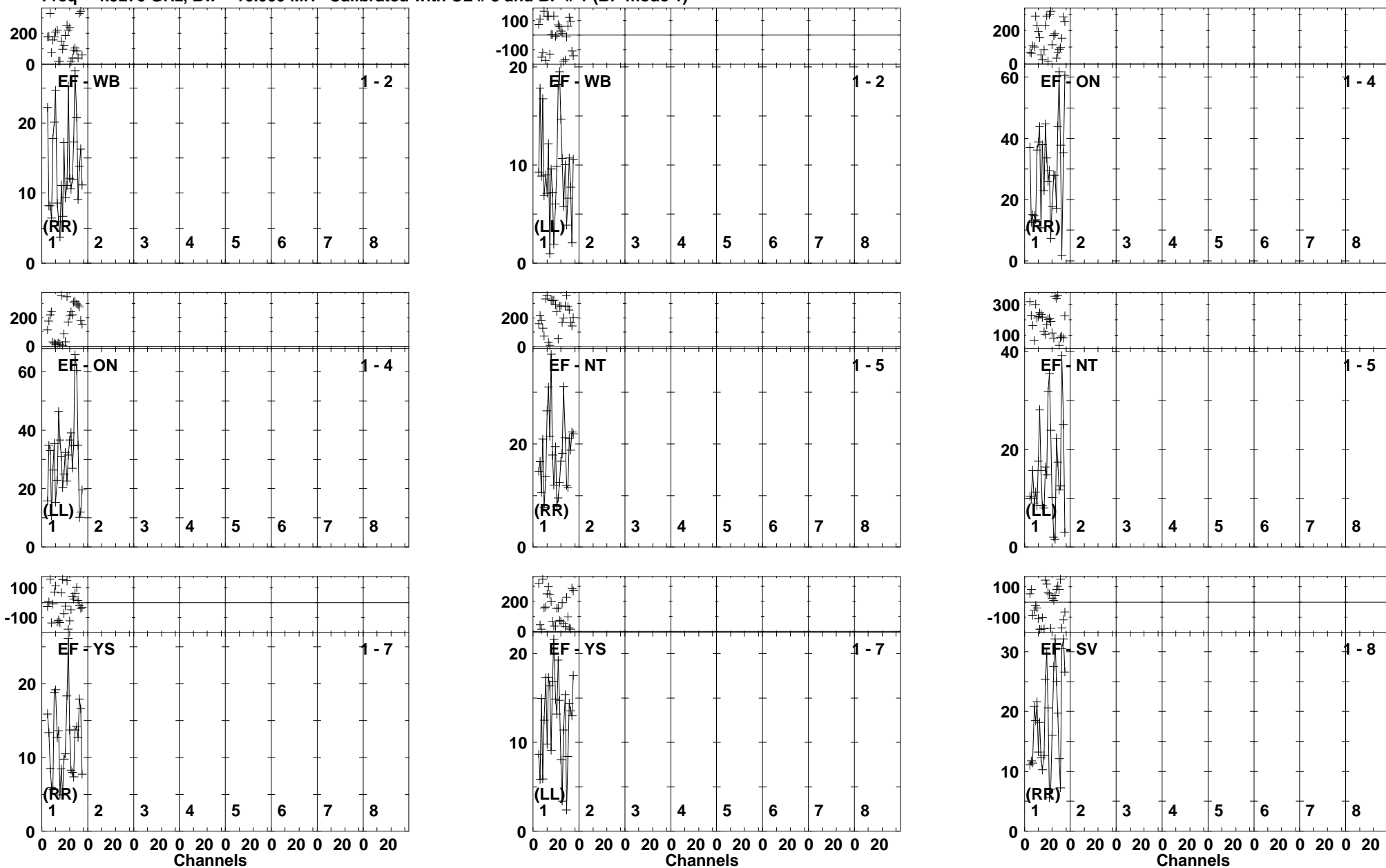

Lower frame: Milli Ampl Jy Top frame: Phas deg  
 Vector averaged cross-power spectrum Baseline: EF (01) - WB (02)  
 Timerange: 00/18:21:43 to 00/18:22:09

Plot file version 300 created 18-NOV-2014 15:24:09  
 J1128+5925 EP087H 3.UVDATA.1  
 Freq = 4.9270 GHz, Bw = 16.000 MH Calibrated with CL # 3 and BP # 1 (BP mode 1)

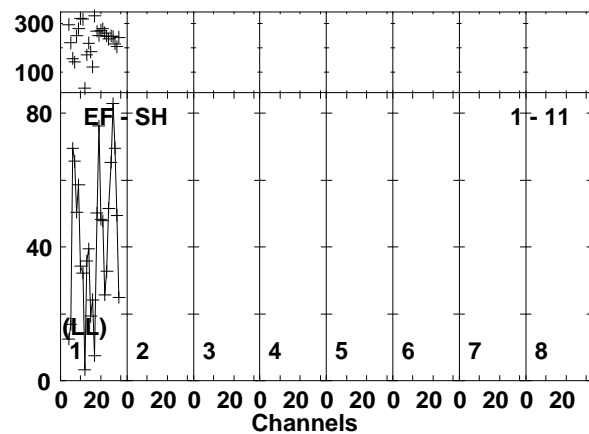
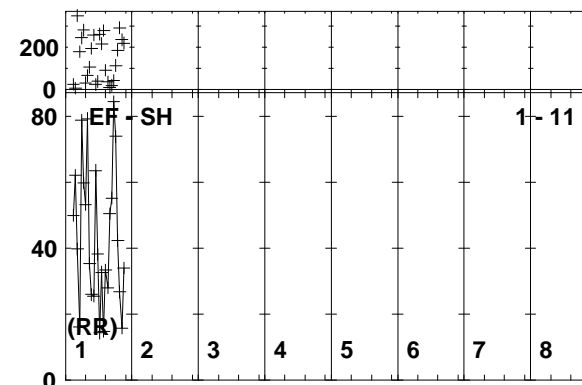
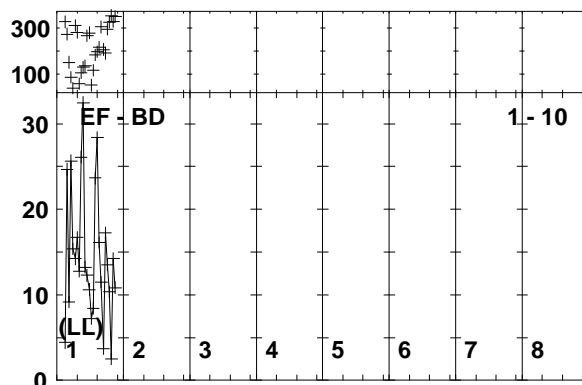
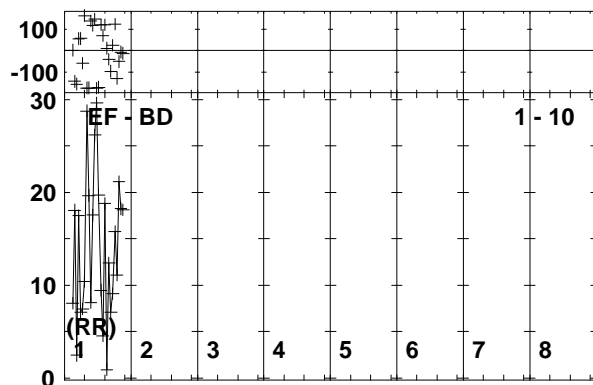
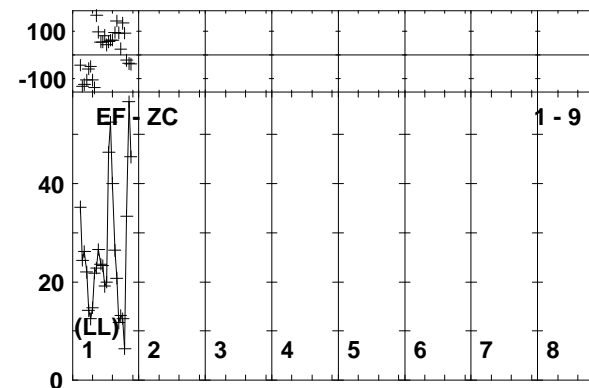
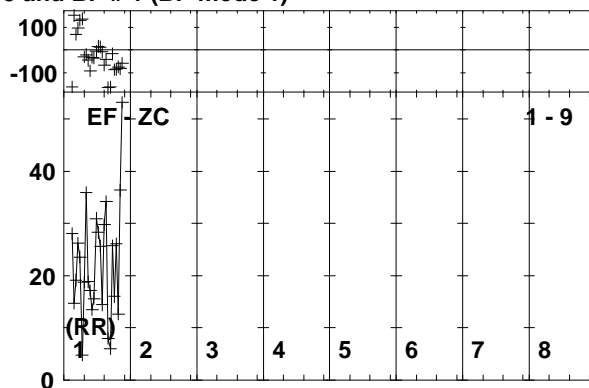
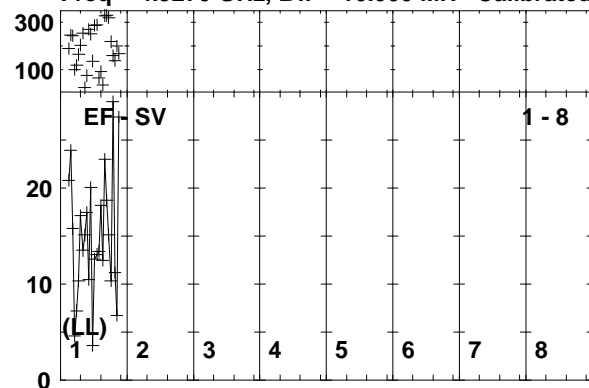

Lower frame: Milli Ampl Jy Top frame: Phas deg  
 Vector averaged cross-power spectrum Baseline: EF (01) - SV (08)  
 Timerange: 00/18:21:43 to 00/18:22:09

Plot file version 301 created 18-NOV-2014 15:24:10  
 ARP299C EP087H 3.UVDATA.1  
 Freq = 4.9270 GHz, Bw = 16.000 MH Calibrated with CL # 3 and BP # 1 (BP mode 1)

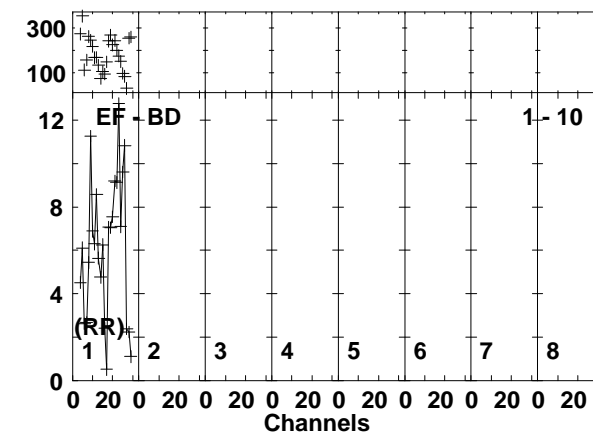
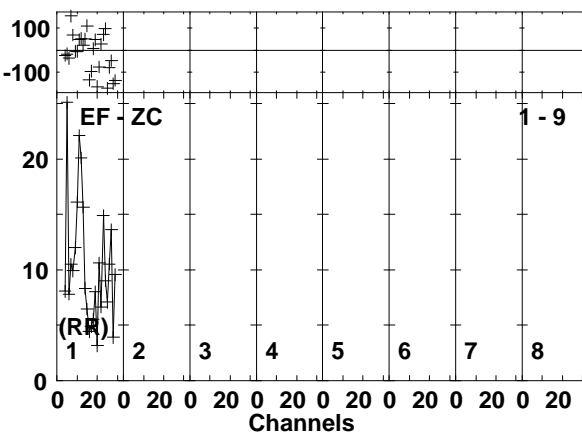
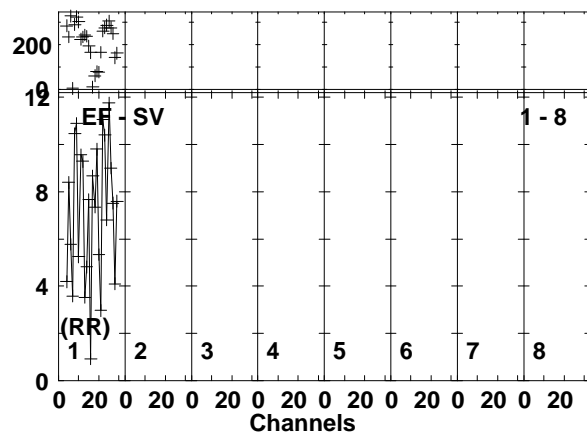
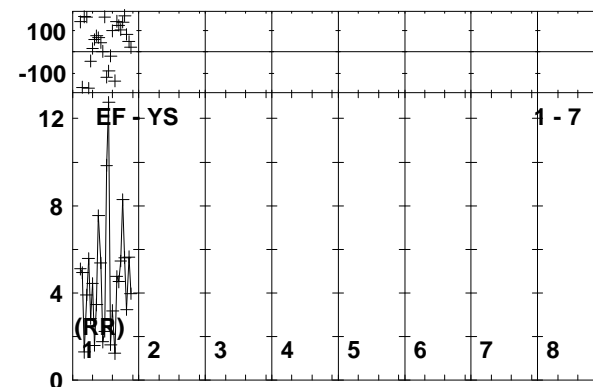
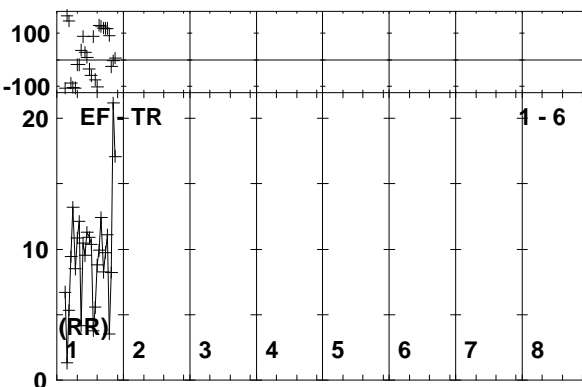
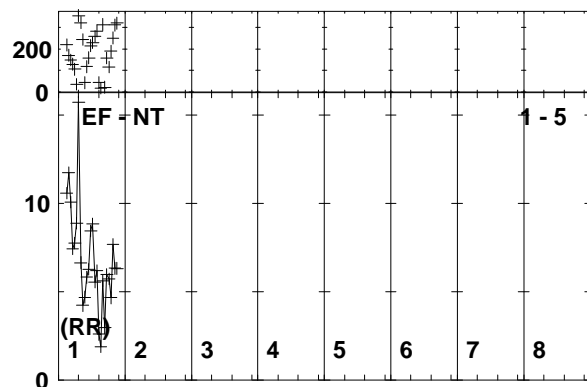
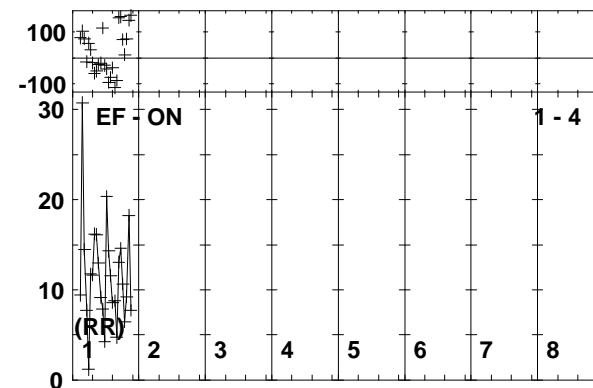
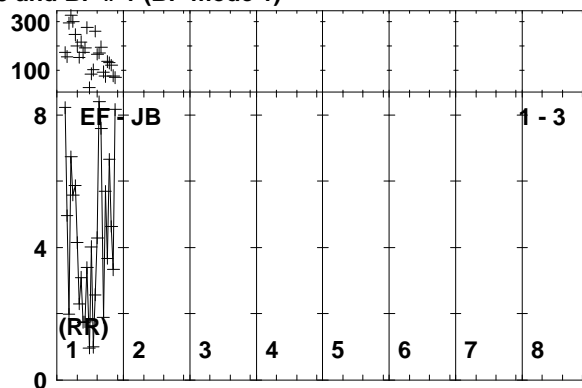
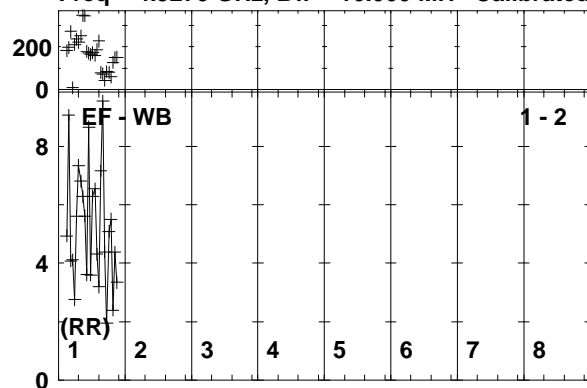

Lower frame: Milli Ampl Jy Top frame: Phas deg  
 Vector averaged cross-power spectrum Baseline: EF (01) - WB (02)  
 Timerange: 00/18:22:11 to 00/18:24:59

Plot file version 302 created 18-NOV-2014 15:24:10  
ARP299C EP087H 3.UVDATA.1  
Freq = 4.9270 GHz, Bw = 16.000 MH Calibrated with CL # 3 and BP # 1 (BP mode 1)

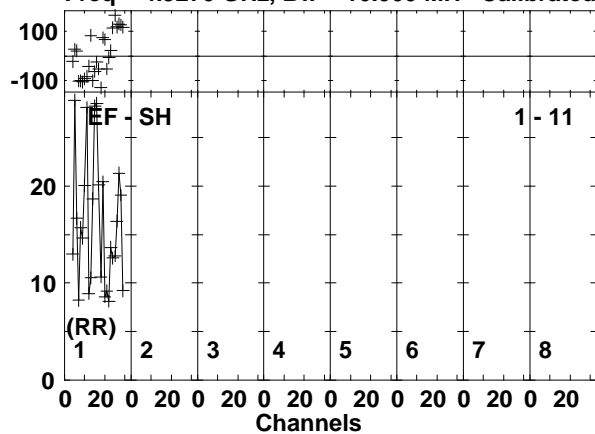

Lower frame: Milli Ampl Jy Top frame: Phas deg  
Vector averaged cross-power spectrum Baseline: EF (01) - SH (11)  
Timerange: 00/18:22:11 to 00/18:24:59

Plot file version 303 created 18-NOV-2014 15:24:10

J1128+5925 EP087H 3.UVDATA.1

Freq = 4.9270 GHz, Bw = 16.000 MH Calibrated with CL # 3 and BP # 1 (BP mode 1)

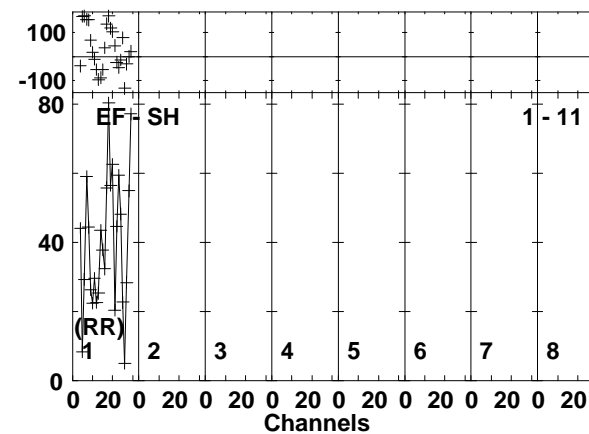
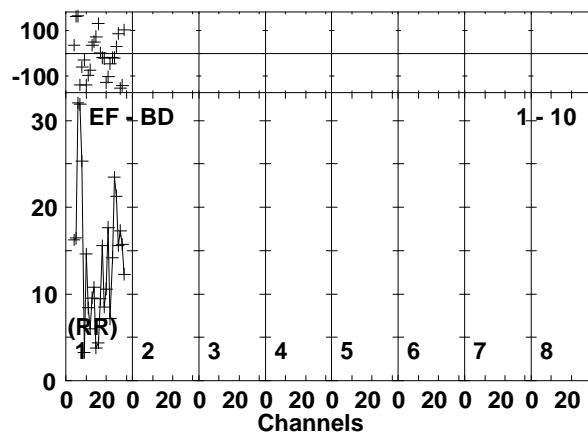
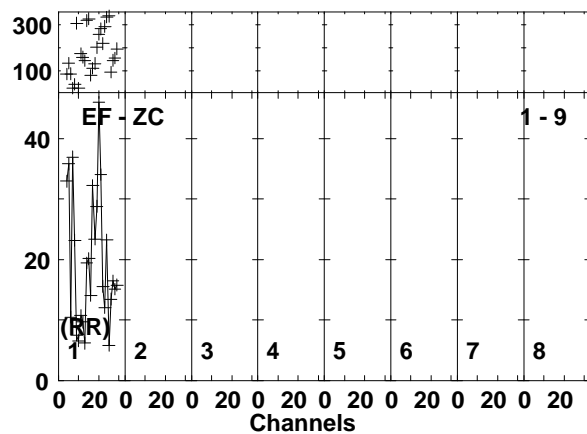
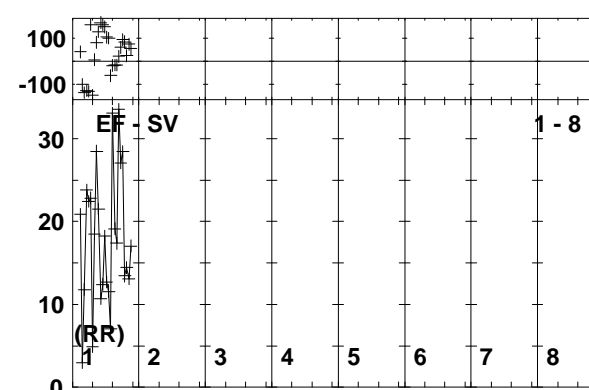
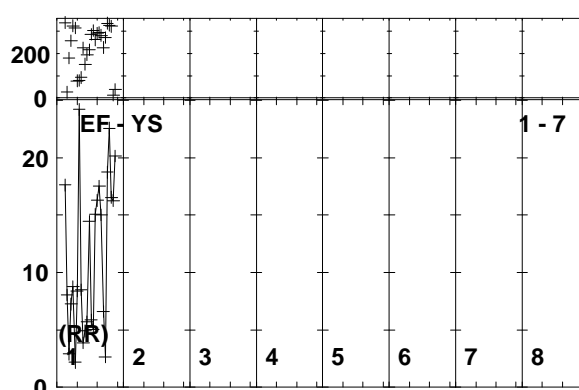
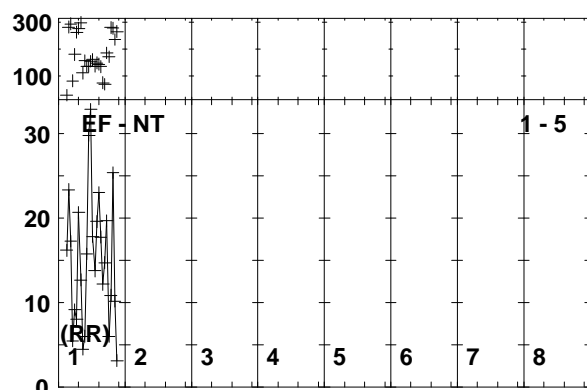
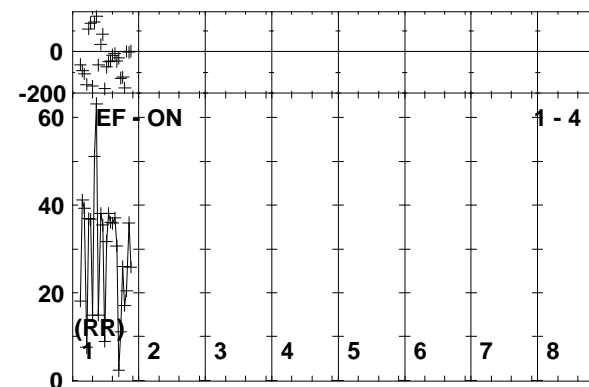
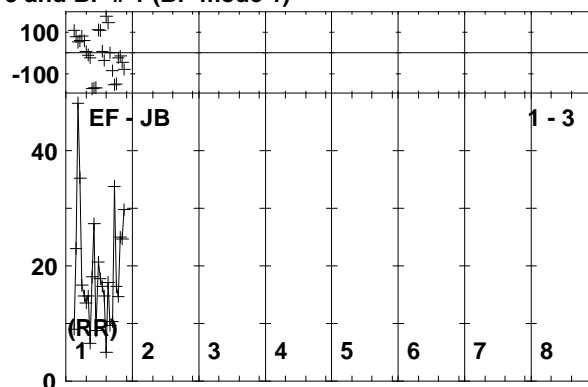
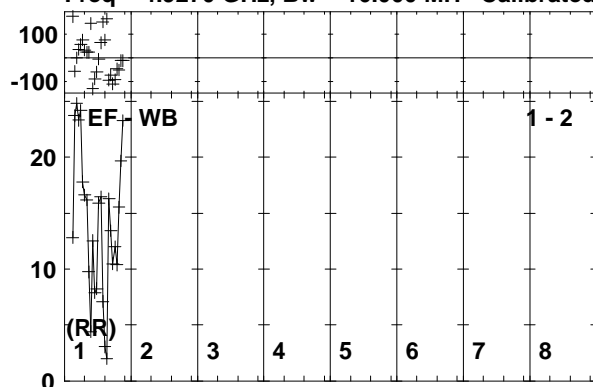

Lower frame: Milli Ampl Jy Top frame: Phas deg  
Vector averaged cross-power spectrum Baseline: EF (01) - WB (02)  
Timerange: 00/18:25:04 to 00/18:25:58

Plot file version 304 created 18-NOV-2014 15:24:10

ARP299C EP087H 3.UVDATA.1

Freq = 4.9270 GHz, Bw = 16.000 MH Calibrated with CL # 3 and BP # 1 (BP mode 1)

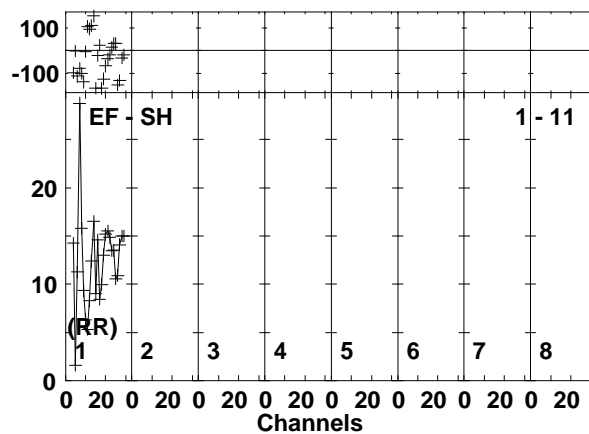
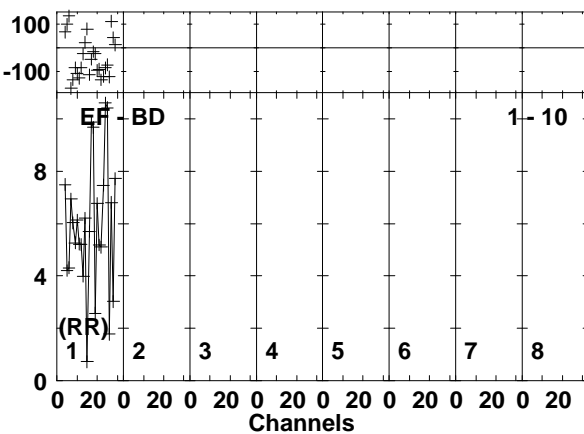
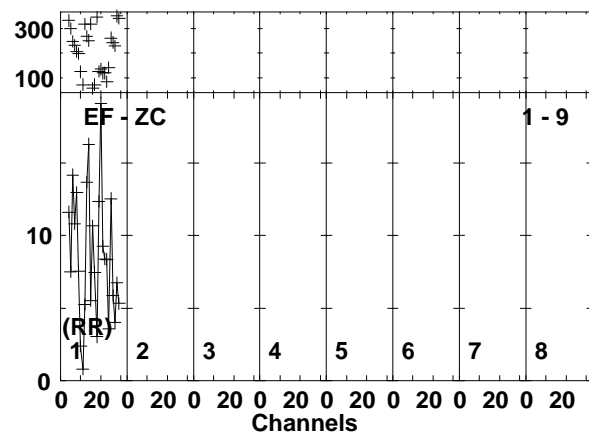
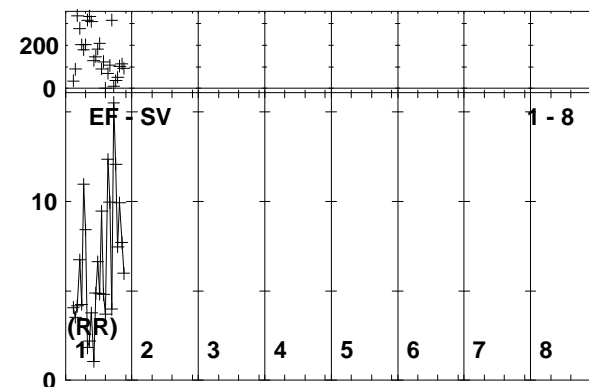
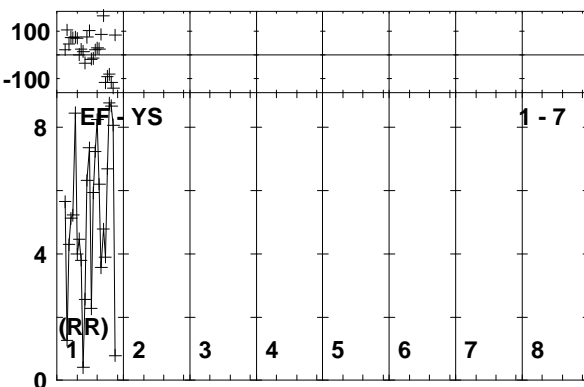
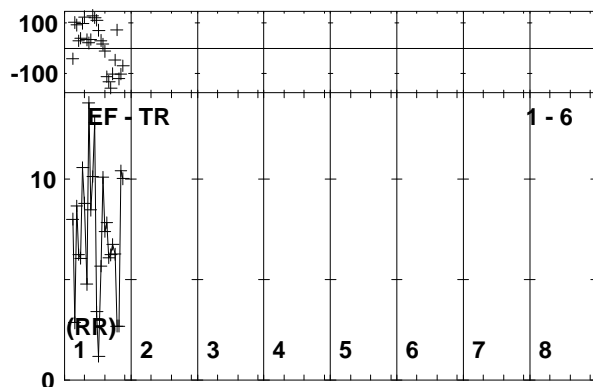
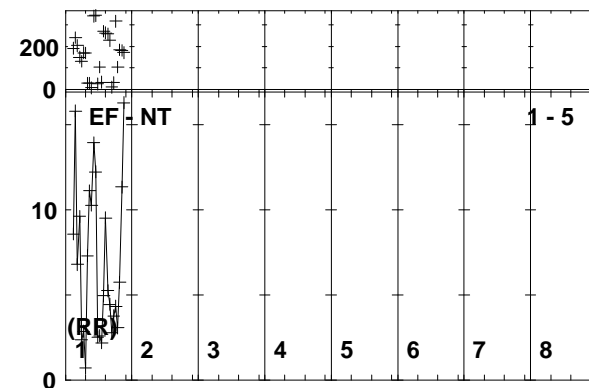
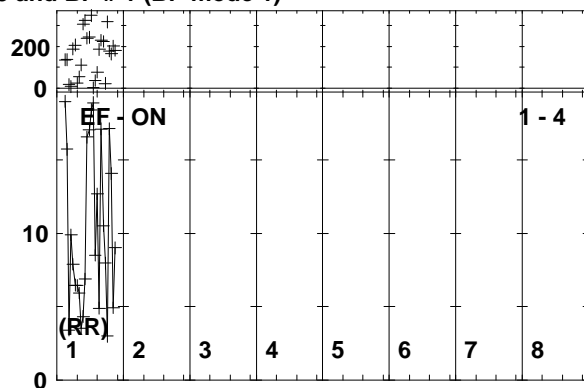
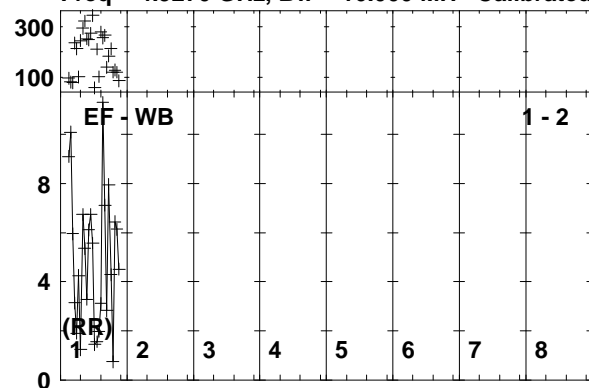

Lower frame: Milli Ampl Jy Top frame: Phas deg  
Vector averaged cross-power spectrum Baseline: EF (01) - WB (02)  
Timerange: 00/18:26:05 to 00/18:28:59



Plot file version 305 created 18-NOV-2014 15:24:11

J1128+5925 EP087H 3.UVDATA.1

Freq = 4.9270 GHz, Bw = 16.000 MH Calibrated with CL # 3 and BP # 1 (BP mode 1)

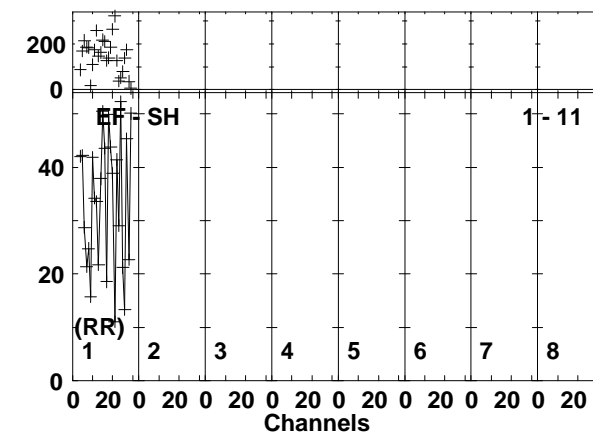
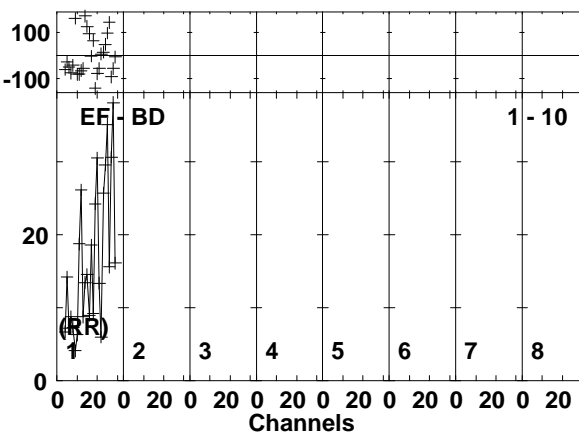
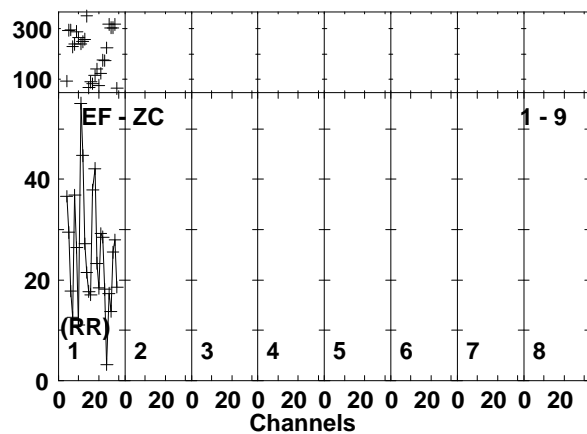
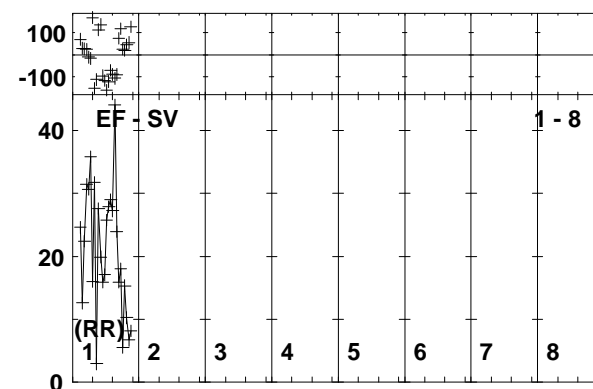
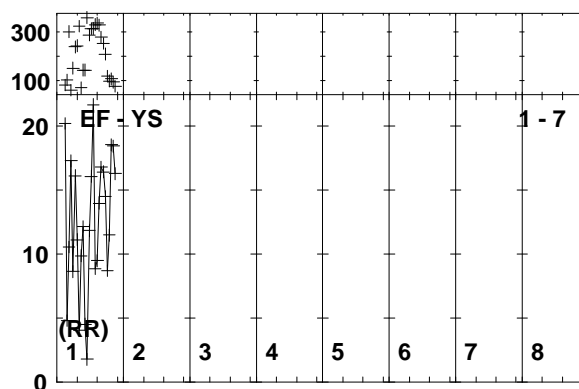
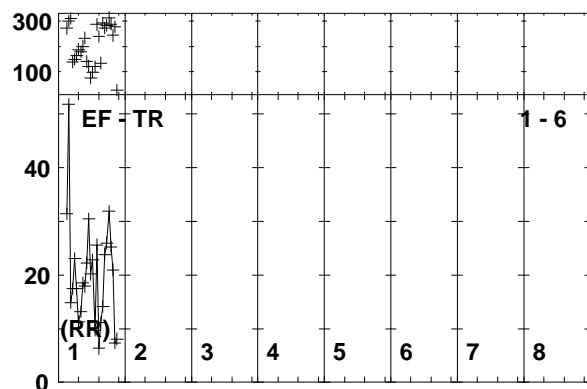
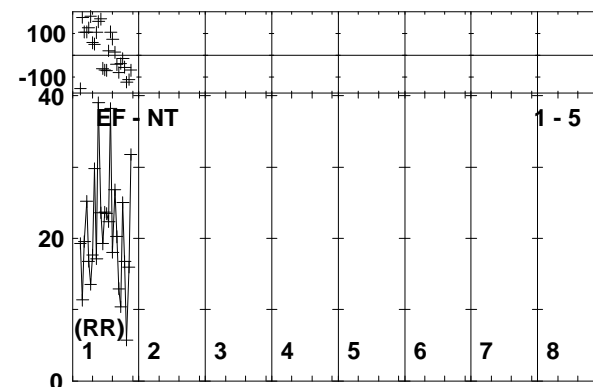
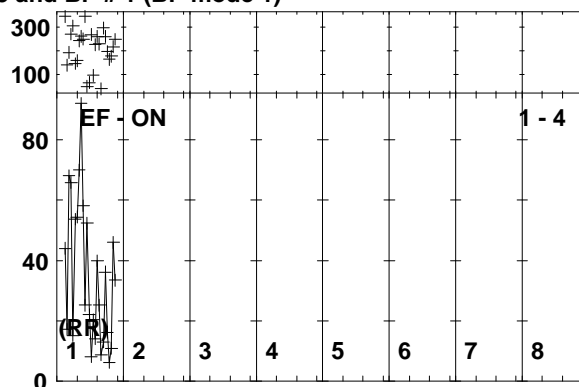
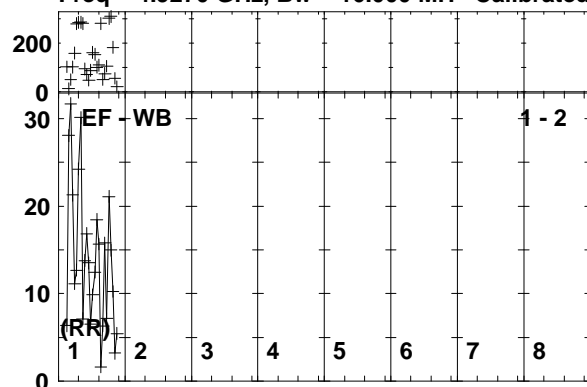

Lower frame: Milli Ampl Jy Top frame: Phas deg  
Vector averaged cross-power spectrum Baseline: EF (01) - WB (02)  
Timerange: 00/18:29:05 to 00/18:29:59