

Plot file version 1 created 21-JUN-2019 11:53:19

J1222+0413 EP111A 1.UVDATA.1

Freq = 1.4829 GHz, Bw = 16.000 MH Calibrated with CL # 3 and BP # 1 (BP mode 1)

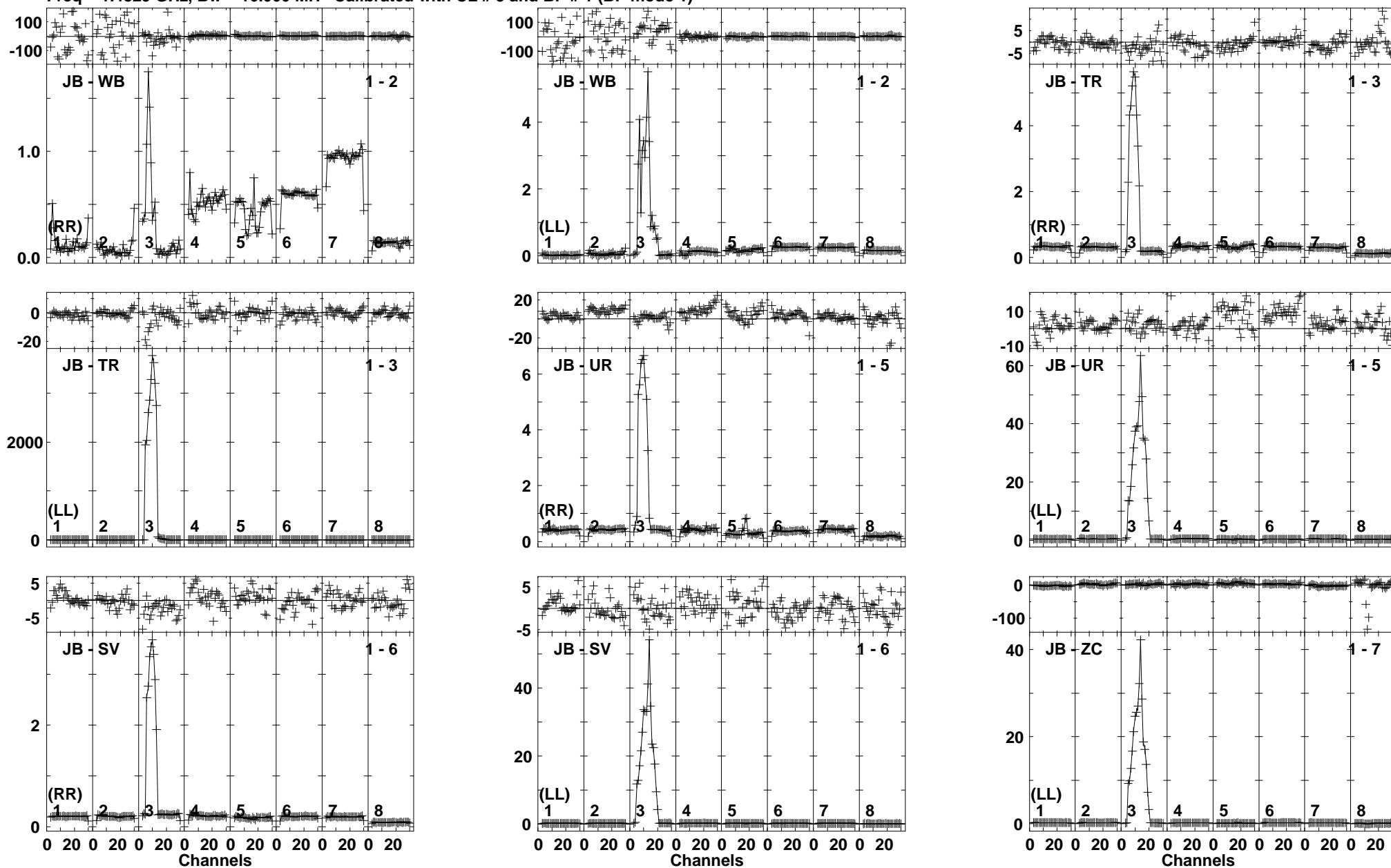

Lower frame: Ampl Jy Top frame: Phas deg
Vector averaged cross-power spectrum Baseline: JB (01) - WB (02)
Timerange: 00/04:00:01 to 00/04:02:59

Plot file version 2 created 21-JUN-2019 11:53:19

J1222+0413 EP111A 1.UVDATA.1

Freq = 1.4829 GHz, Bw = 16.000 MH Calibrated with CL # 3 and BP # 1 (BP mode 1)

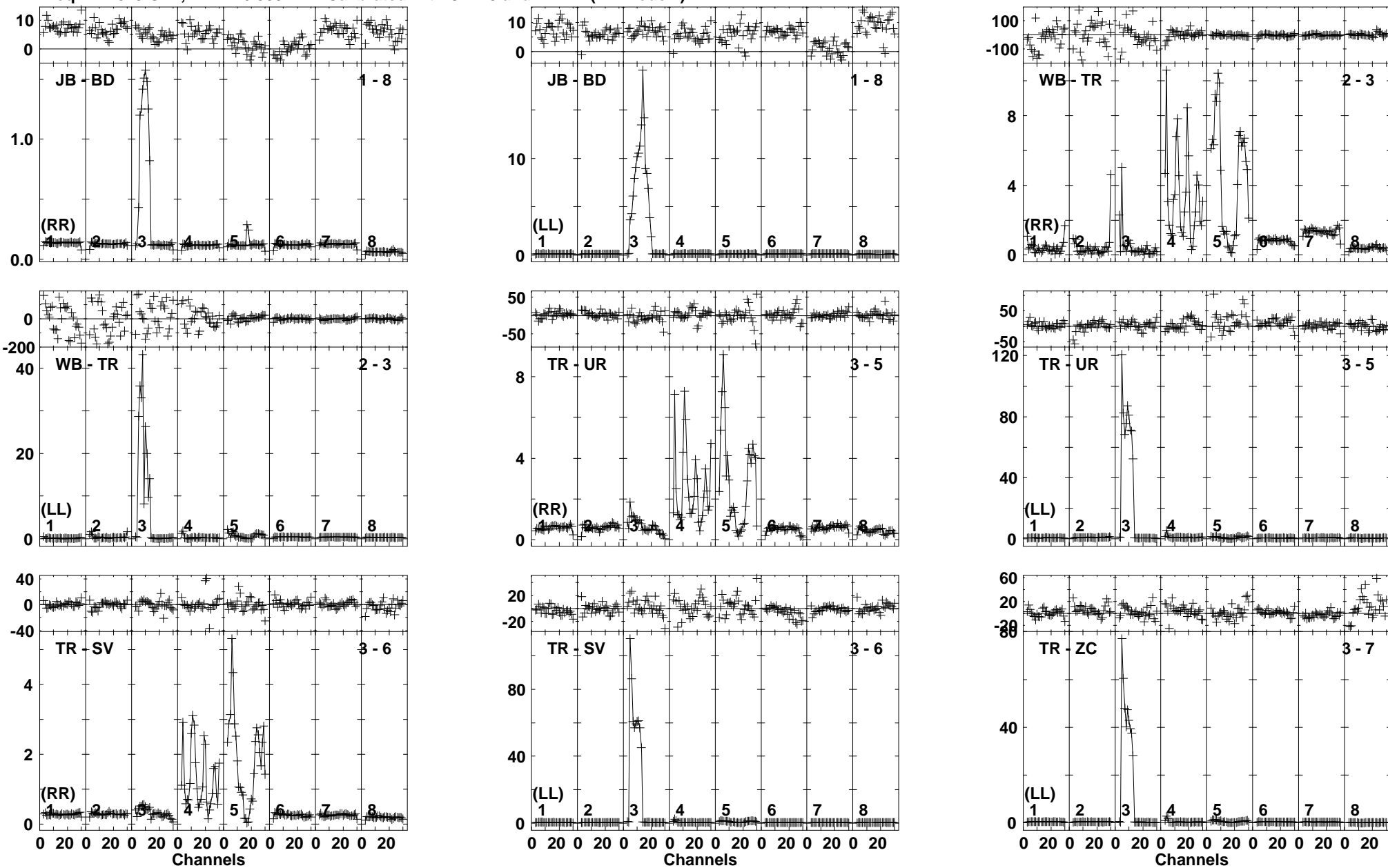

Lower frame: Ampl Jy Top frame: Phas deg
Vector averaged cross-power spectrum Baseline: JB (01) - BD (08)
Timerange: 00/04:00:01 to 00/04:02:59

Plot file version 3 created 21-JUN-2019 11:53:20

J1222+0413 EP1111A 1.UVDATA.1

Freq = 1.4829 GHz, Bw = 16.000 MH Calibrated with CL # 3 and BP # 1 (BP mode 1)

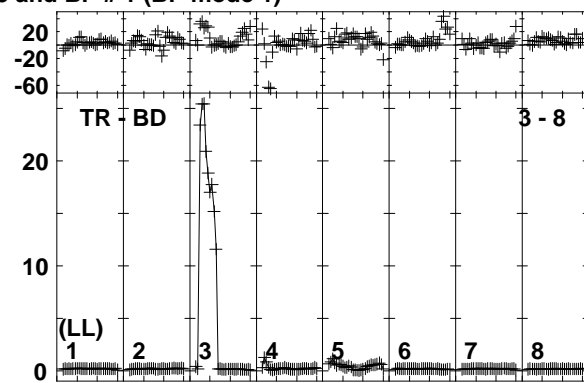
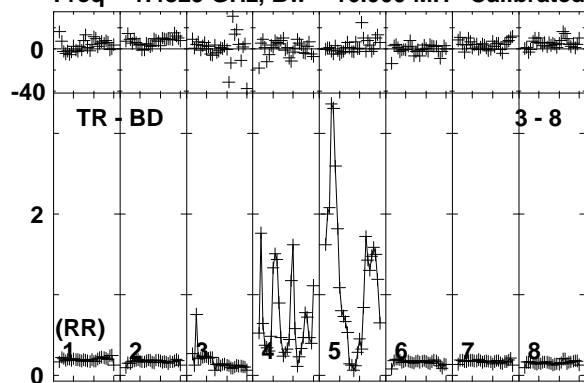

Lower frame: Ampl Jy Top frame: Phas deg
Vector averaged cross-power spectrum Baseline: TR (03) - BD (08)
Timerange: 00/04:00:01 to 00/04:02:59

Plot file version 4 created 21-JUN-2019 11:53:20

IRAS12112 EP111A 1.UVDATA.1

Freq = 1.4829 GHz, Bw = 16.000 MH Calibrated with CL # 3 and BP # 1 (BP mode 1)

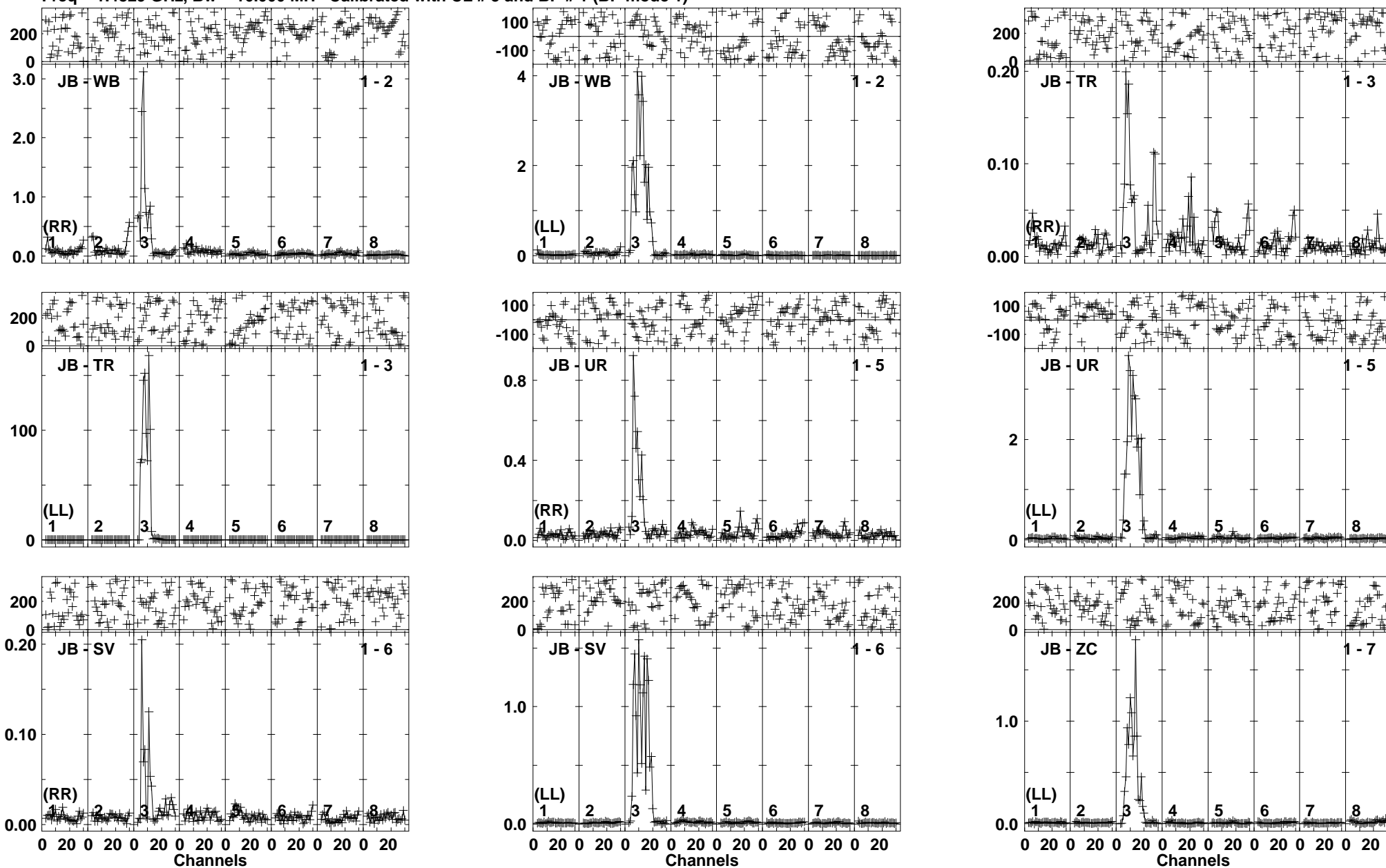

Lower frame: Ampl Jy Top frame: Phas deg
Vector averaged cross-power spectrum Baseline: JB (01) - WB (02)
Timerange: 00/04:03:01 to 00/04:06:29

Plot file version 5 created 21-JUN-2019 11:53:20

IRAS12112 EP111A 1.UVDATA.1

Freq = 1.4829 GHz, Bw = 16.000 MH Calibrated with CL # 3 and BP # 1 (BP mode 1)

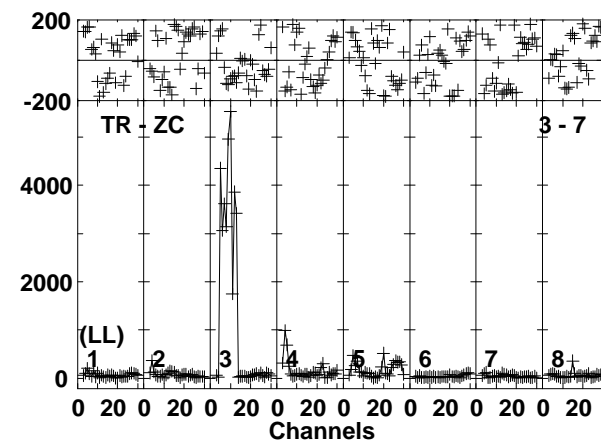
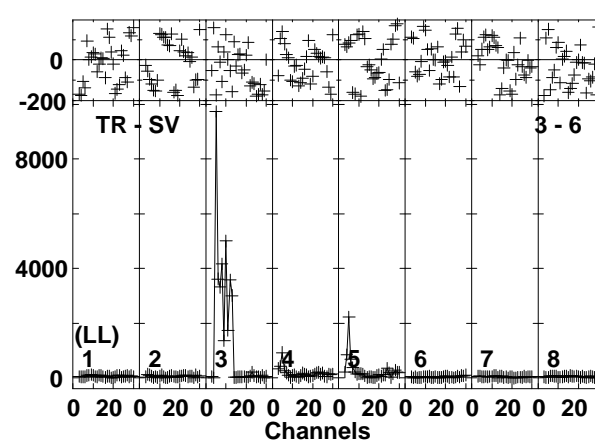
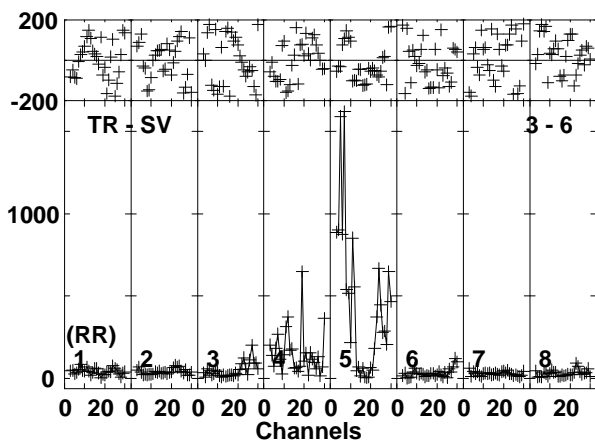
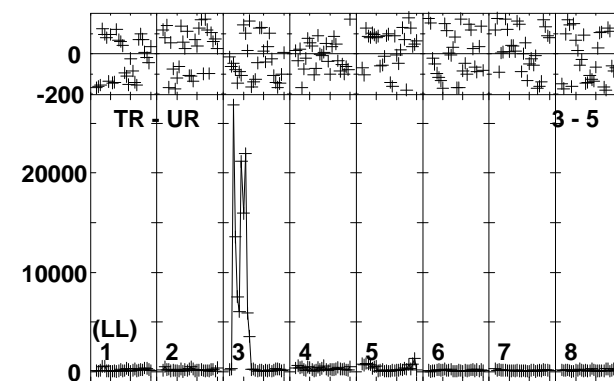
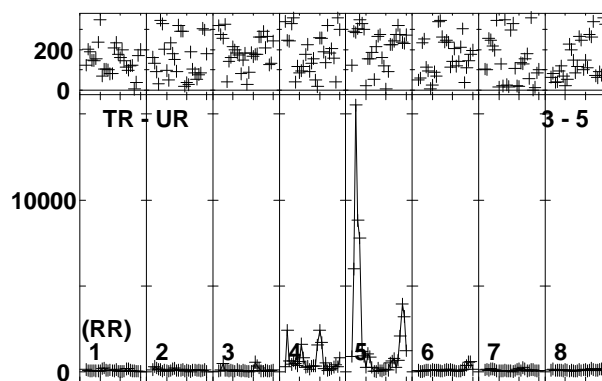
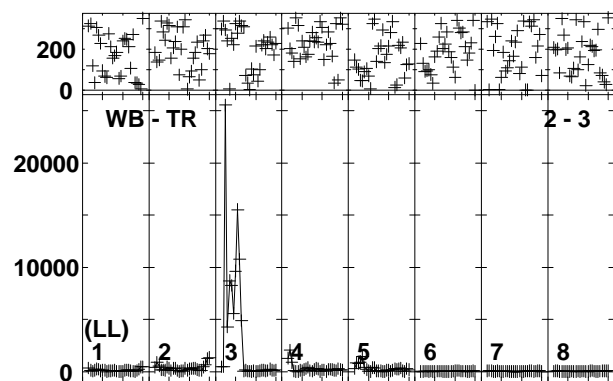
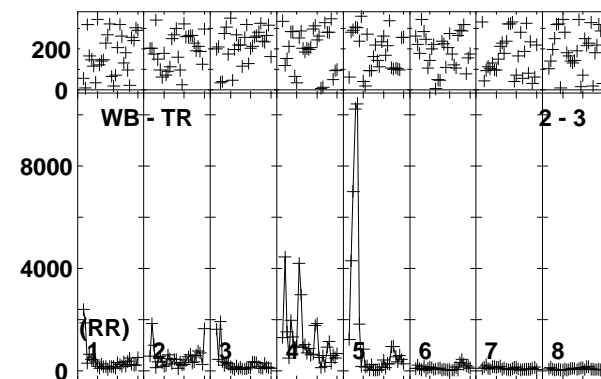
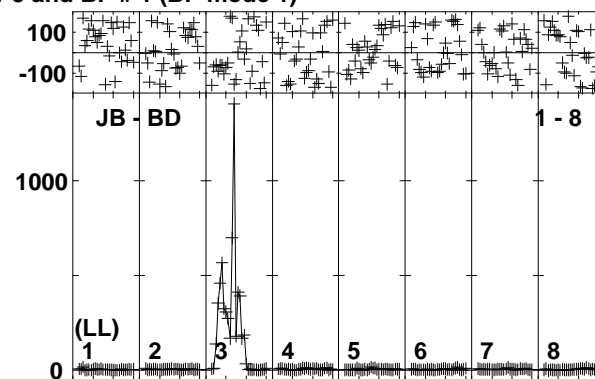
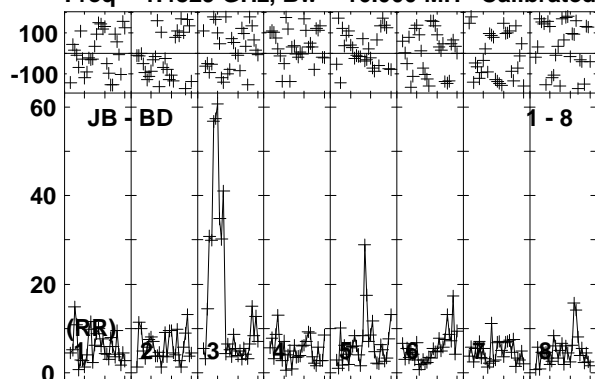

Lower frame: Milli Ampl Jy Top frame: Phas deg
Vector averaged cross-power spectrum Baseline: JB (01) - BD (08)
Timerange: 00/04:03:01 to 00/04:06:29

Plot file version 6 created 21-JUN-2019 11:53:21

IRAS12112 EP111A 1.UVDATA.1

Freq = 1.4829 GHz, Bw = 16.000 MH Calibrated with CL # 3 and BP # 1 (BP mode 1)

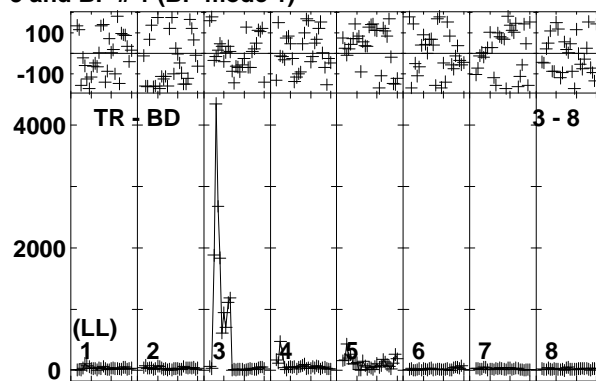
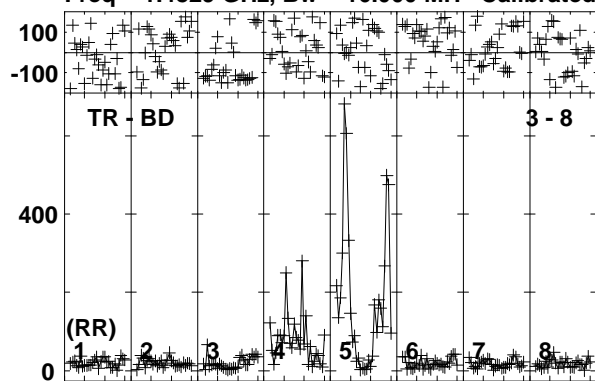

Lower frame: Milli Ampl Jy Top frame: Phas deg
Vector averaged cross-power spectrum Baseline: TR (03) - BD (08)
Timerange: 00/04:03:01 to 00/04:06:29

Plot file version 7 created 21-JUN-2019 11:53:21

J1222+0413 EP111A 1.UVDATA.1

Freq = 1.4829 GHz, Bw = 16.000 MH Calibrated with CL # 3 and BP # 1 (BP mode 1)

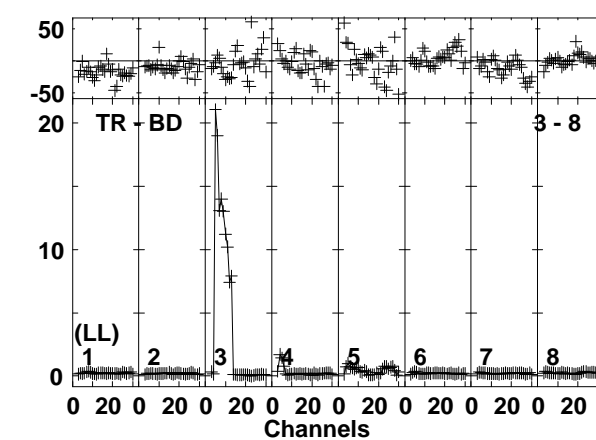
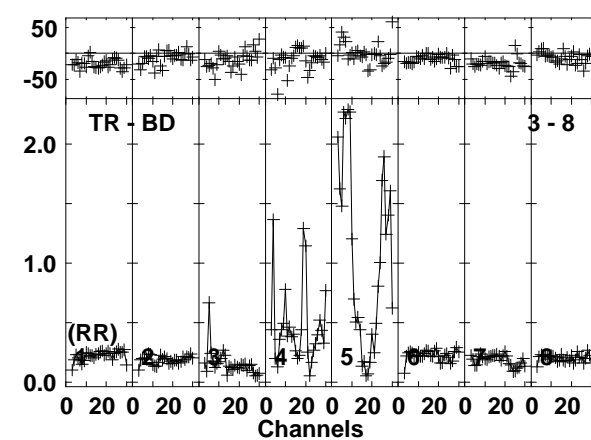
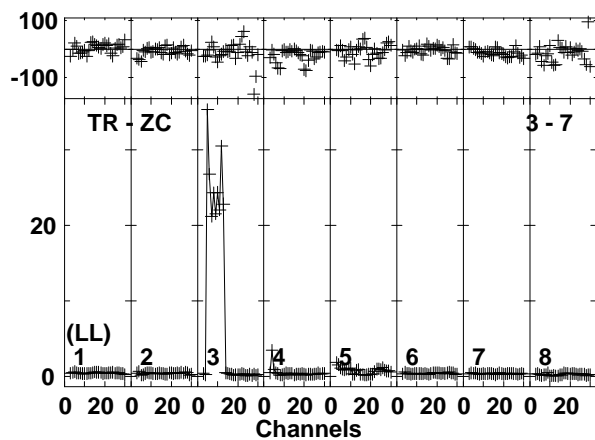
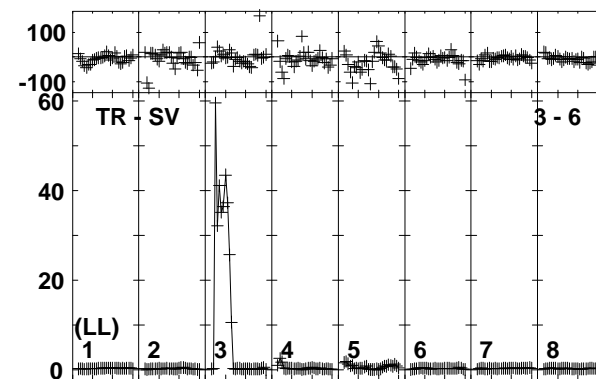
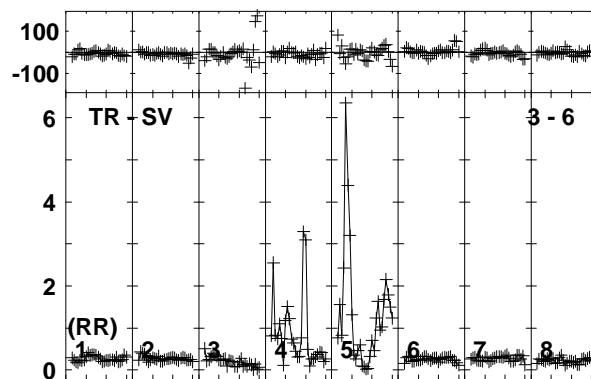
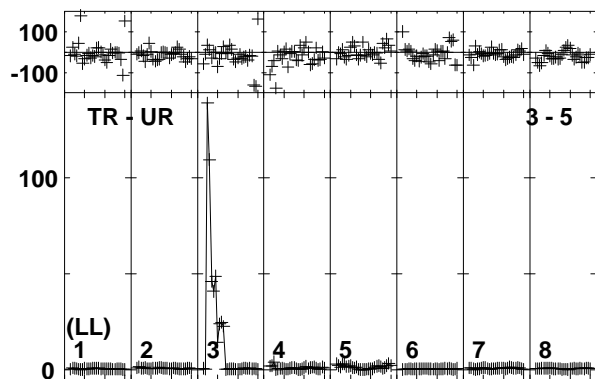
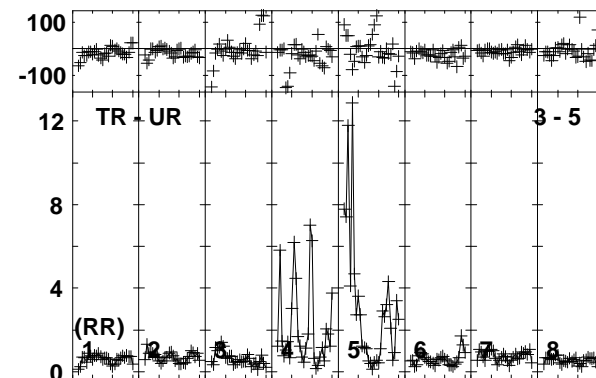
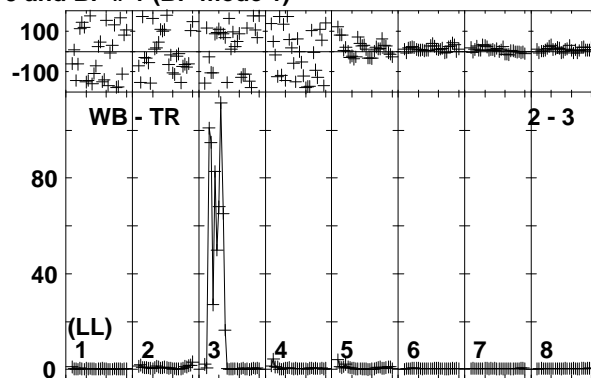
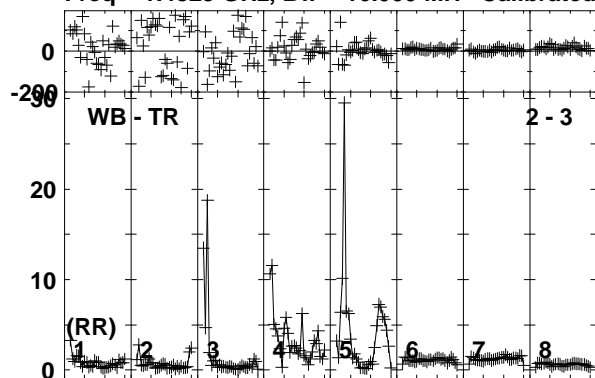

Lower frame: Ampl Jy Top frame: Phas deg
Vector averaged cross-power spectrum Baseline: WB (02) - TR (03)
Timerange: 00/04:06:31 to 00/04:07:59

Plot file version 8 created 21-JUN-2019 11:53:22

IRAS12112 EP111A 1.UVDATA.1

Freq = 1.4829 GHz, Bw = 16.000 MH Calibrated with CL # 3 and BP # 1 (BP mode 1)

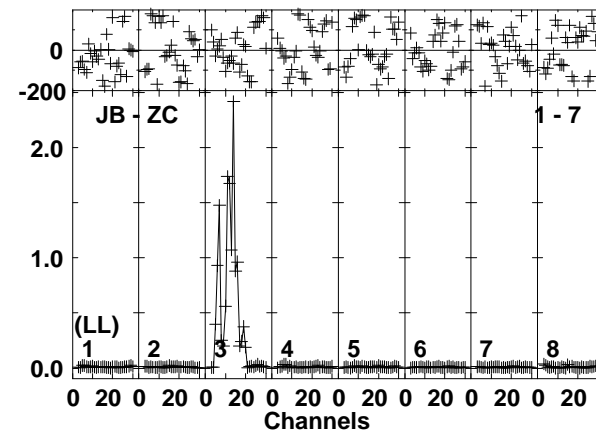
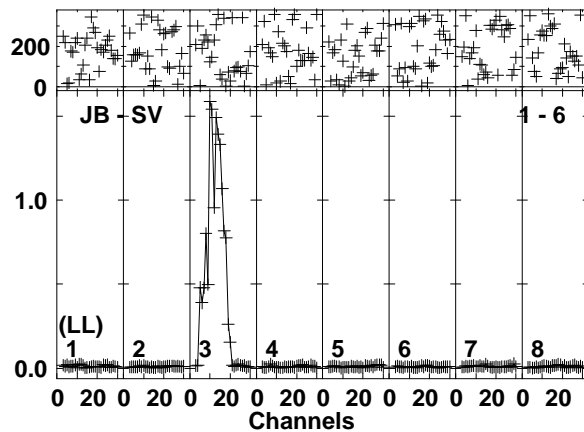
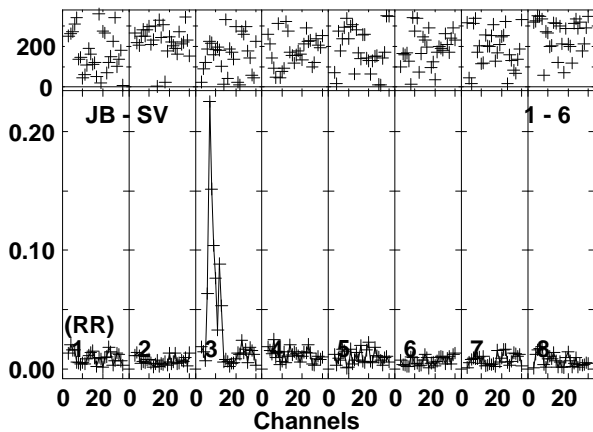
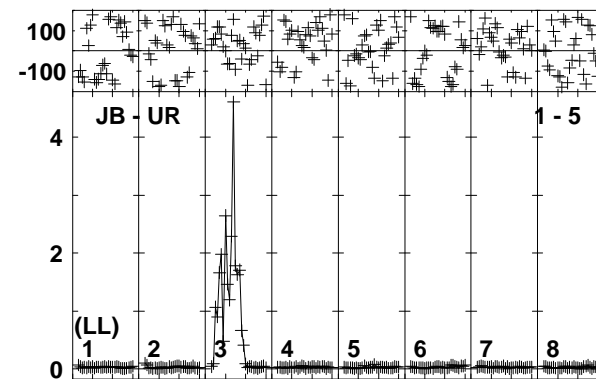
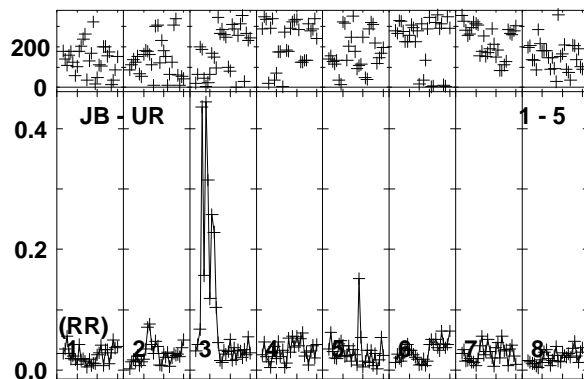
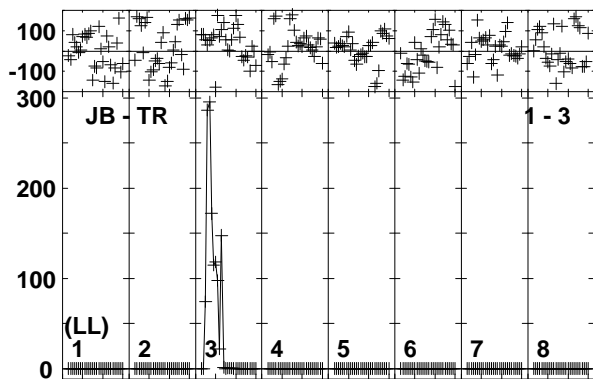
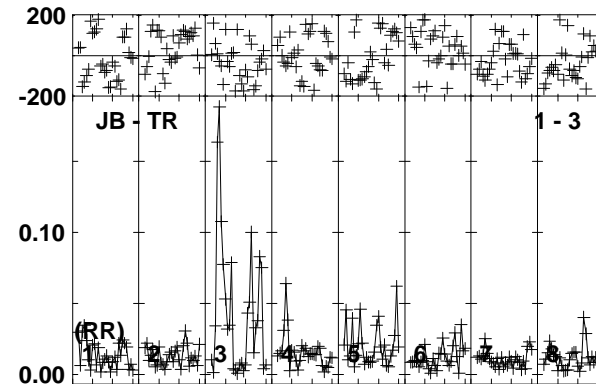
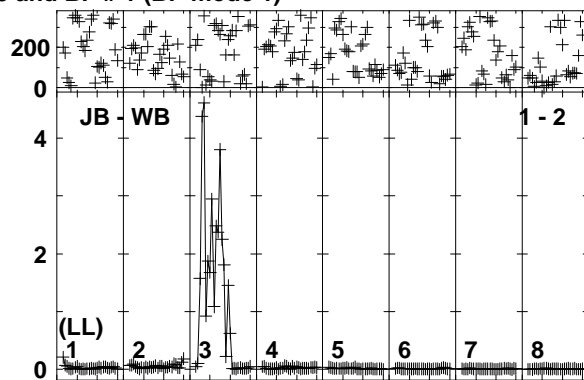
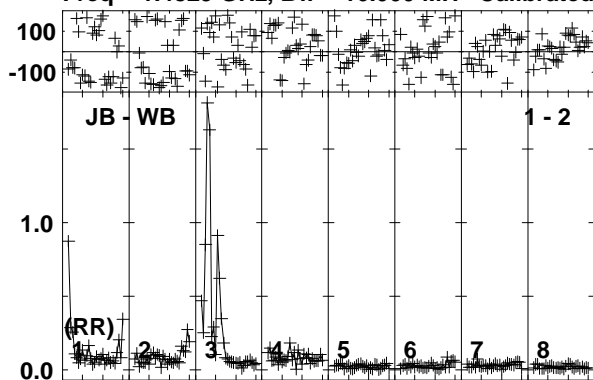

Lower frame: Ampl Jy Top frame: Phas deg
Vector averaged cross-power spectrum Baseline: JB (01) - WB (02)
Timerange: 00/04:08:01 to 00/04:11:29

Plot file version 9 created 21-JUN-2019 11:53:22

IRAS12112 EP111A 1.UVDATA.1

Freq = 1.4829 GHz, Bw = 16.000 MH Calibrated with CL # 3 and BP # 1 (BP mode 1)

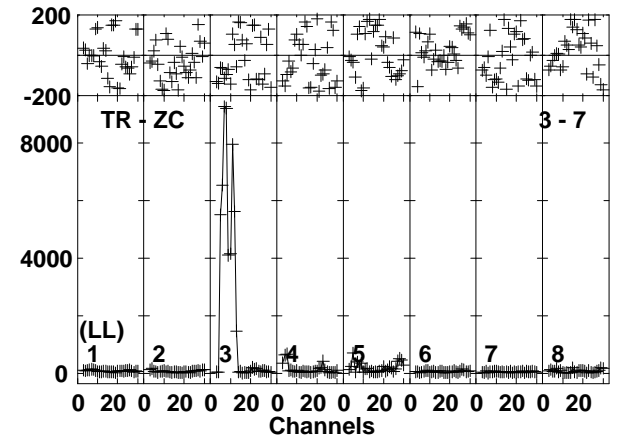
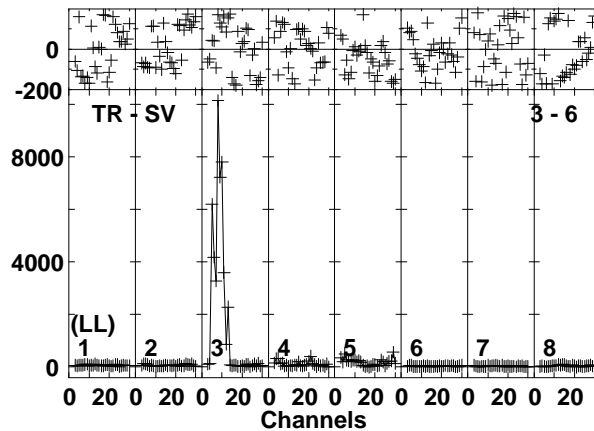
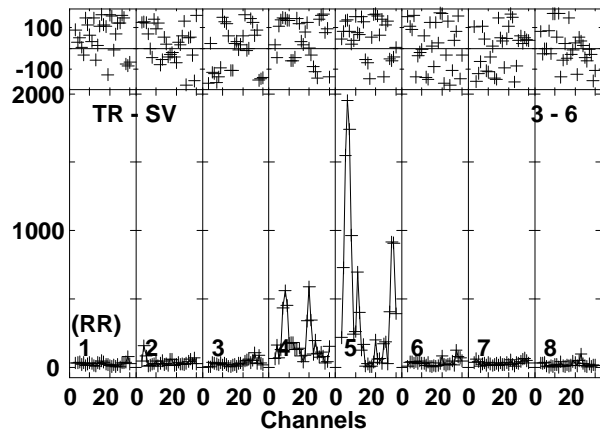
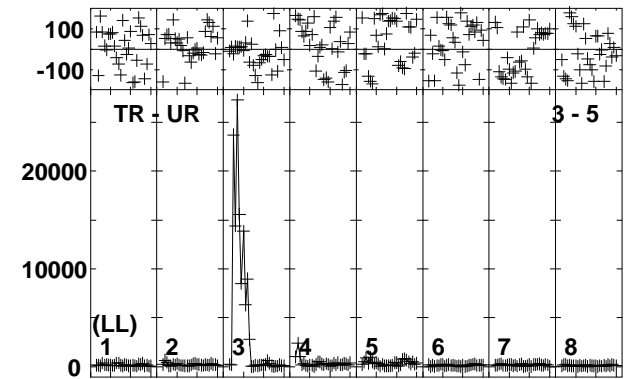
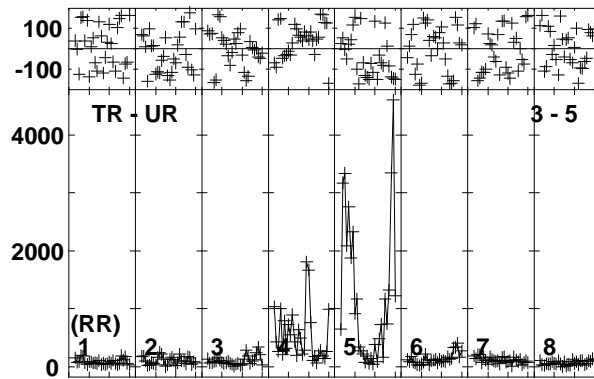
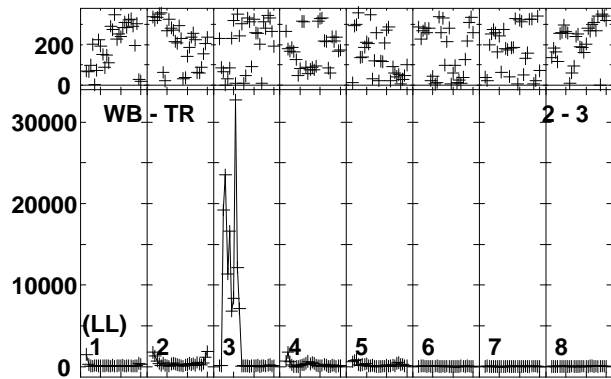
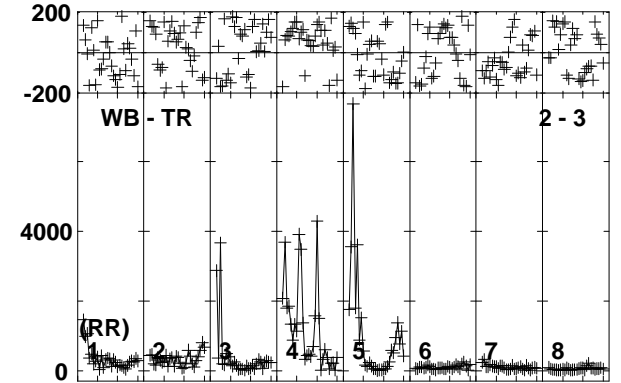
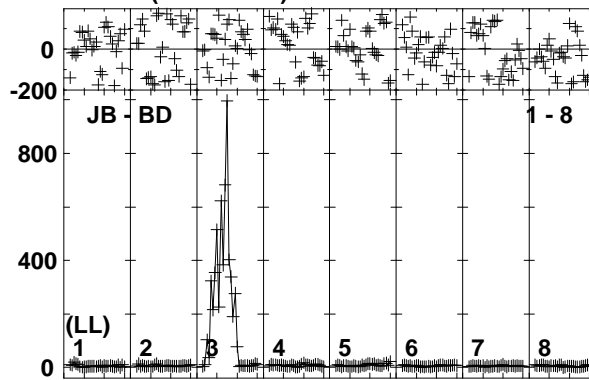
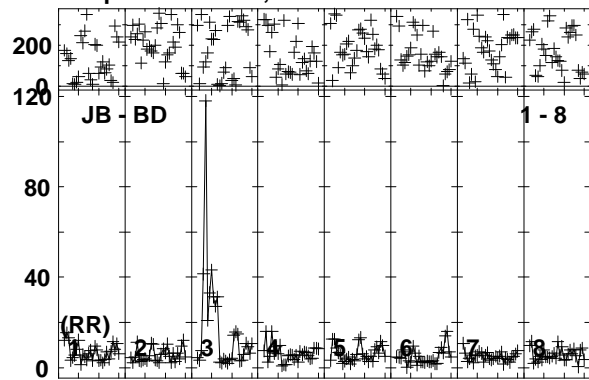

Lower frame: Milli Ampl Jy Top frame: Phas deg
Vector averaged cross-power spectrum Baseline: JB (01) - BD (08)
Timerange: 00/04:08:01 to 00/04:11:29

Plot file version 10 created 21-JUN-2019 11:53:23

IRAS12112 EP111A 1.UVDATA.1

Freq = 1.4829 GHz, Bw = 16.000 MH Calibrated with CL # 3 and BP # 1 (BP mode 1)

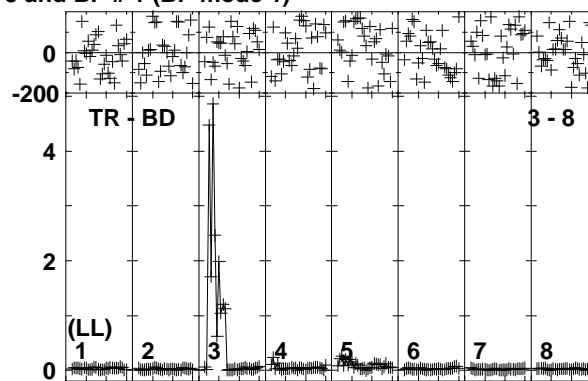
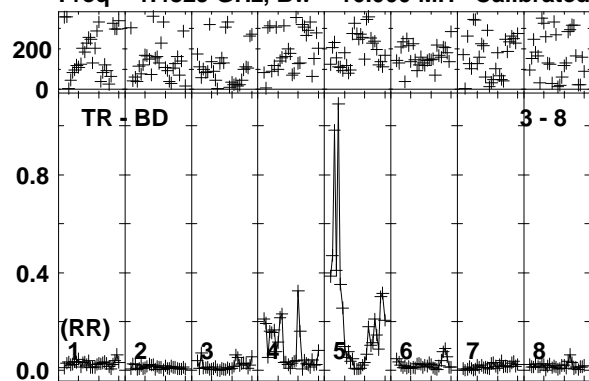

Lower frame: Ampl Jy Top frame: Phas deg
Vector averaged cross-power spectrum Baseline: TR (03) - BD (08)
Timerange: 00/04:08:01 to 00/04:11:29

Plot file version 11 created 21-JUN-2019 11:53:23

J1222+0413 EP111A 1.UVDATA.1

Freq = 1.4829 GHz, Bw = 16.000 MH Calibrated with CL # 3 and BP # 1 (BP mode 1)

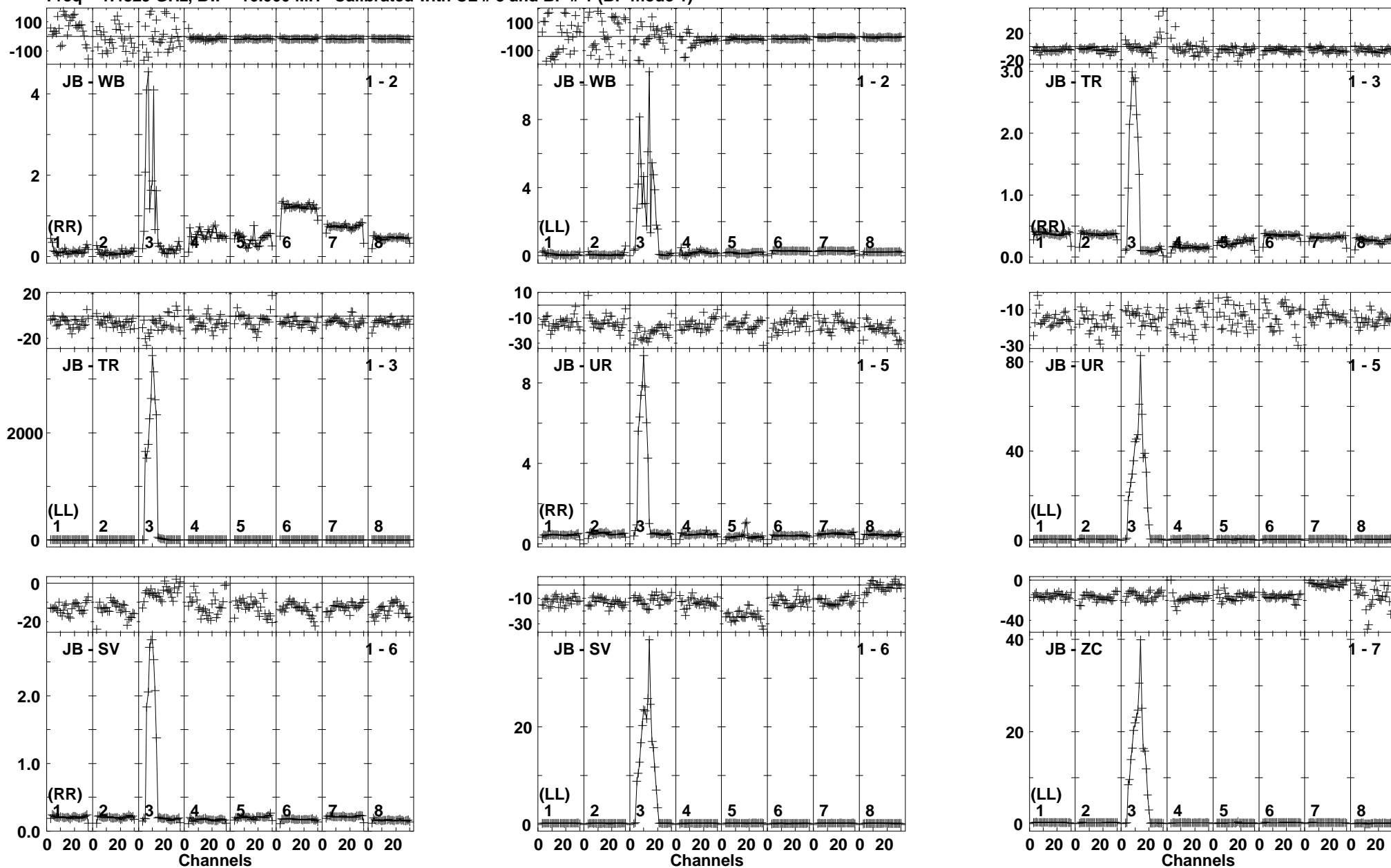

Lower frame: Ampl Jy Top frame: Phas deg
Vector averaged cross-power spectrum Baseline: JB (01) - WB (02)
Timerange: 00/04:12:11 to 00/04:13:39

Plot file version 12 created 21-JUN-2019 11:53:23

J1222+0413 EP111A 1.UVDATA.1

Freq = 1.4829 GHz, Bw = 16.000 MH Calibrated with CL # 3 and BP # 1 (BP mode 1)

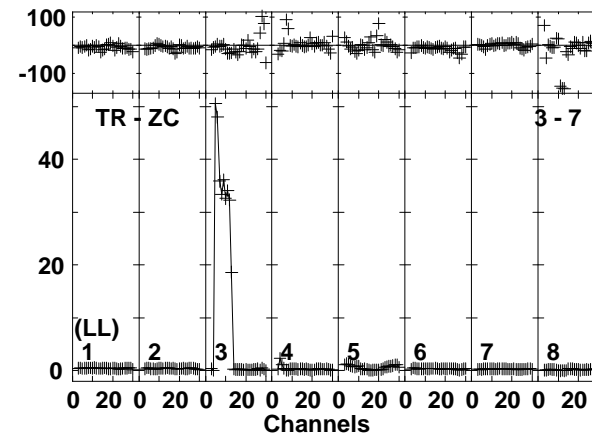
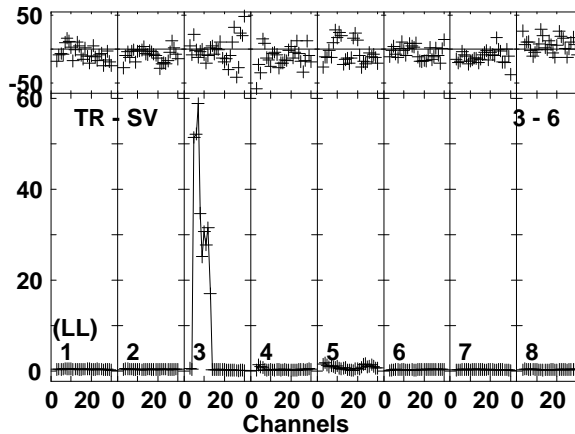
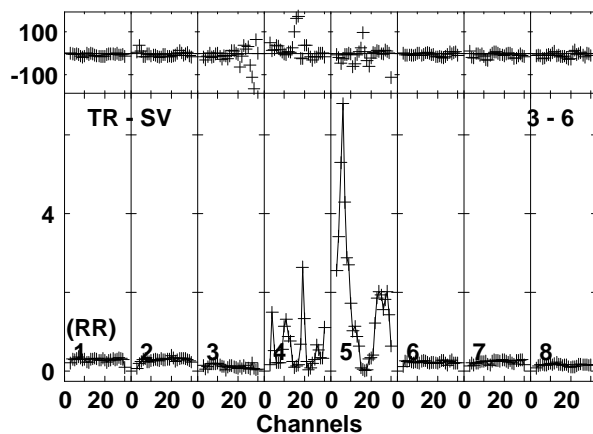
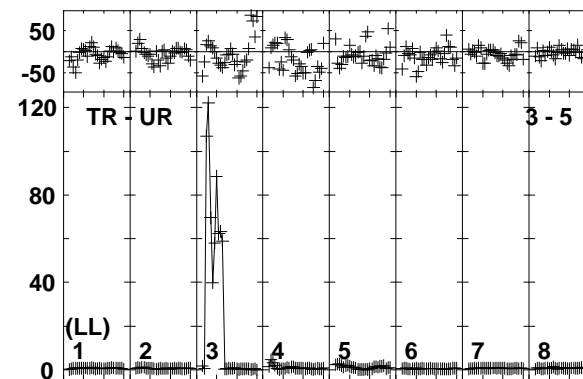
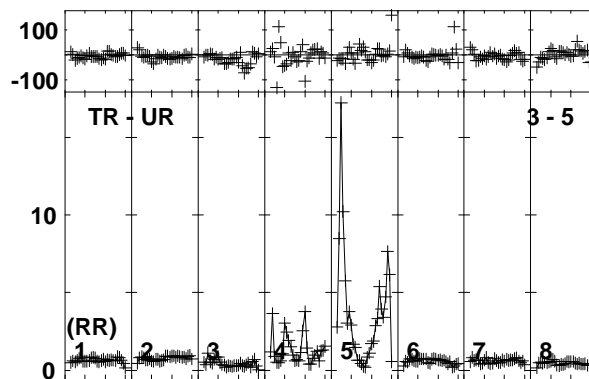
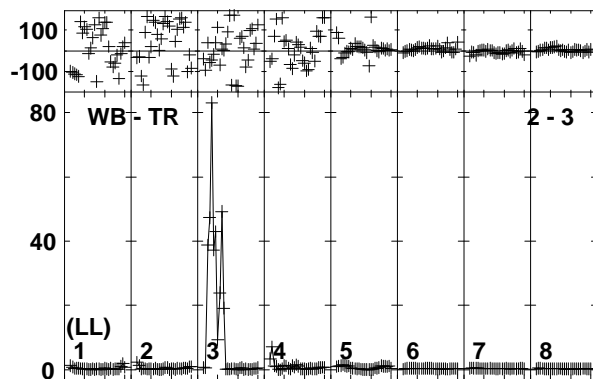
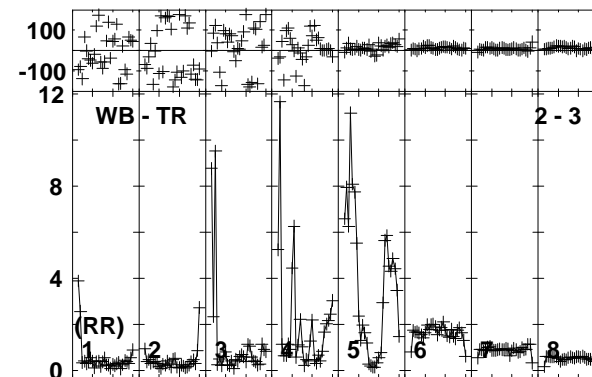
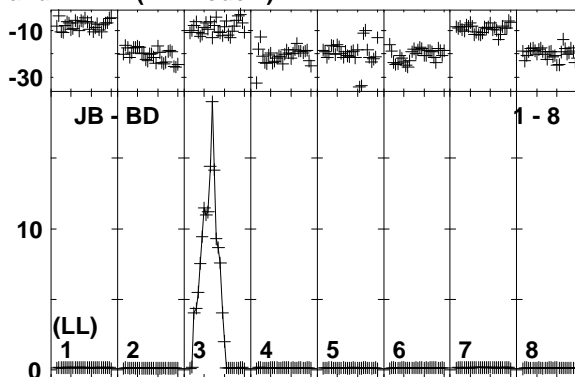
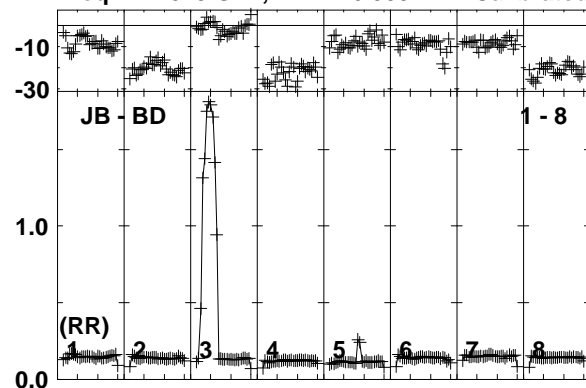

Lower frame: Ampl Jy Top frame: Phas deg
Vector averaged cross-power spectrum Baseline: JB (01) - BD (08)
Timerange: 00/04:12:11 to 00/04:13:39

Plot file version 13 created 21-JUN-2019 11:53:24

J1222+0413 EP111A 1.UVDATA.1

Freq = 1.4829 GHz, Bw = 16.000 MH Calibrated with CL # 3 and BP # 1 (BP mode 1)

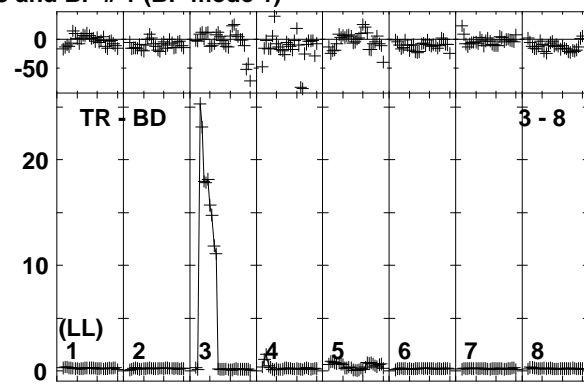
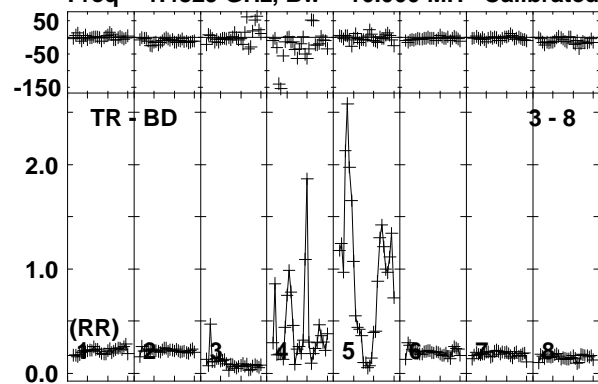

Lower frame: Ampl Jy Top frame: Phas deg
Vector averaged cross-power spectrum Baseline: TR (03) - BD (08)
Timerange: 00/04:12:11 to 00/04:13:39

Plot file version 14 created 21-JUN-2019 11:53:24

IRAS12112 EP111A 1.UVDATA.1

Freq = 1.4829 GHz, Bw = 16.000 MH Calibrated with CL # 3 and BP # 1 (BP mode 1)

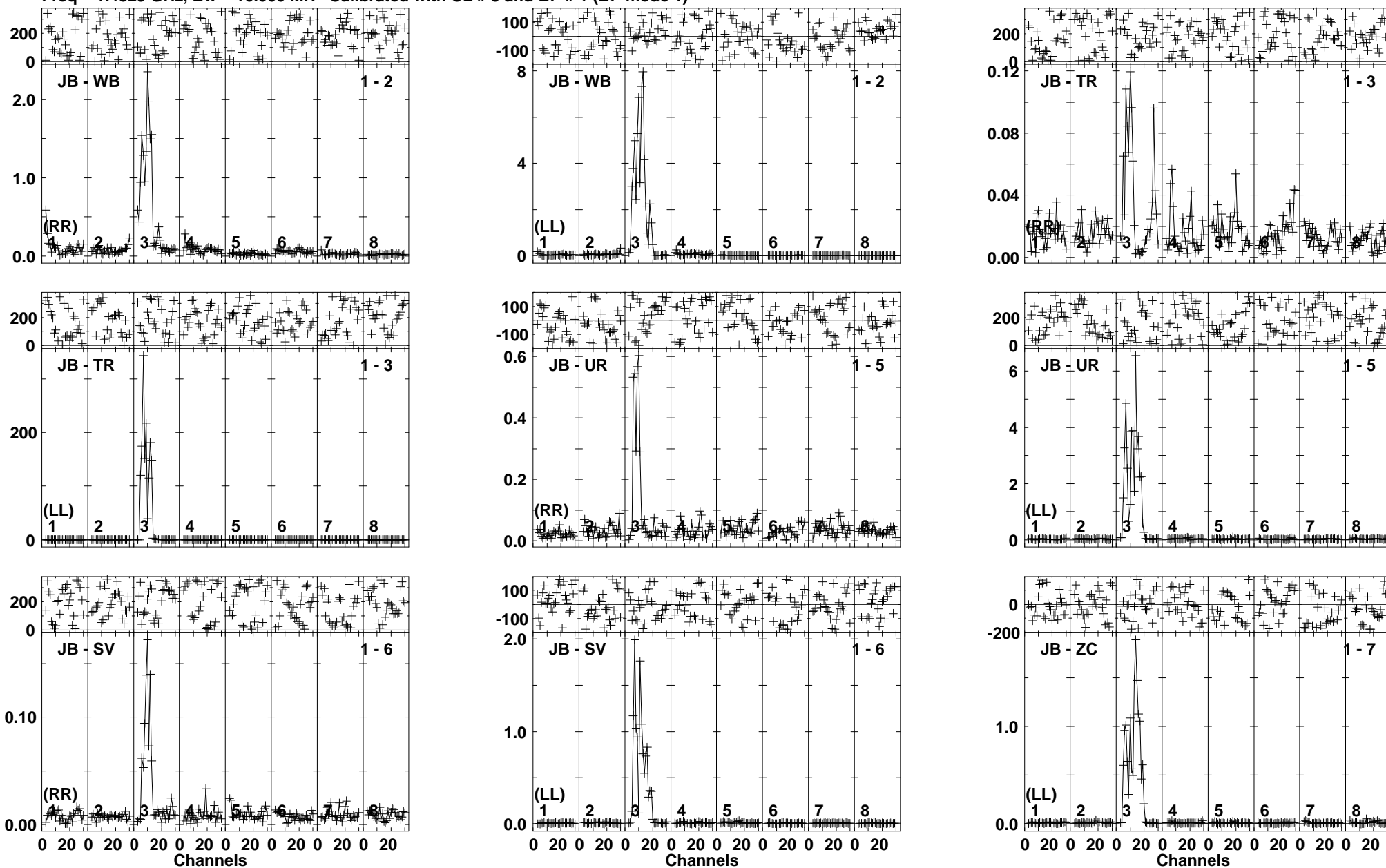

Lower frame: Ampl Jy Top frame: Phas deg
Vector averaged cross-power spectrum Baseline: JB (01) - WB (02)
Timerange: 00/04:13:41 to 00/04:17:09

Plot file version 15 created 21-JUN-2019 11:53:24

IRAS12112 EP111A 1.UVDATA.1

Freq = 1.4829 GHz, Bw = 16.000 MH Calibrated with CL # 3 and BP # 1 (BP mode 1)

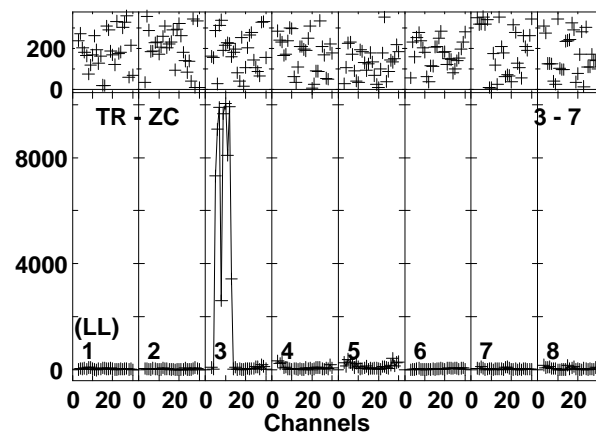
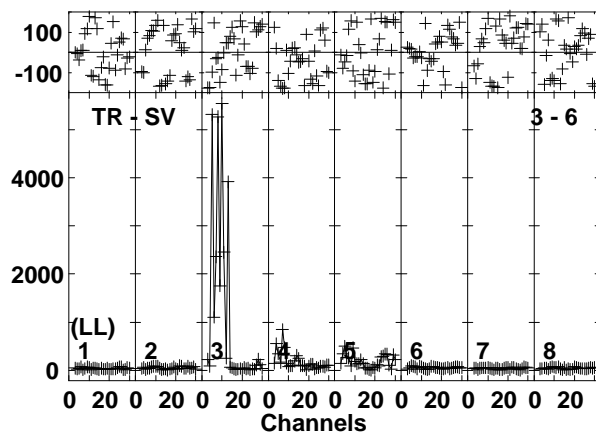
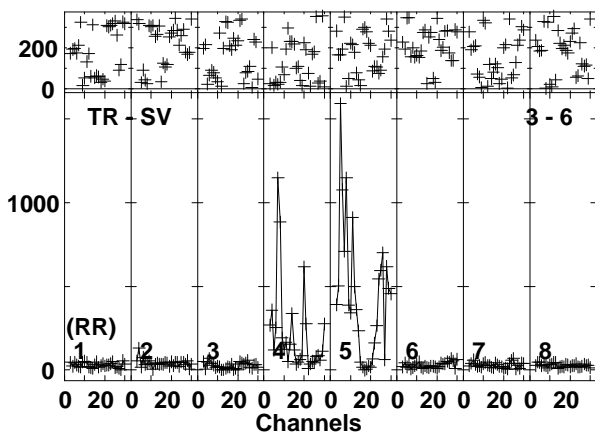
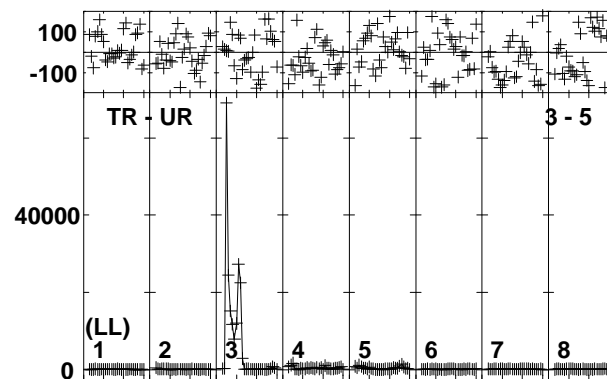
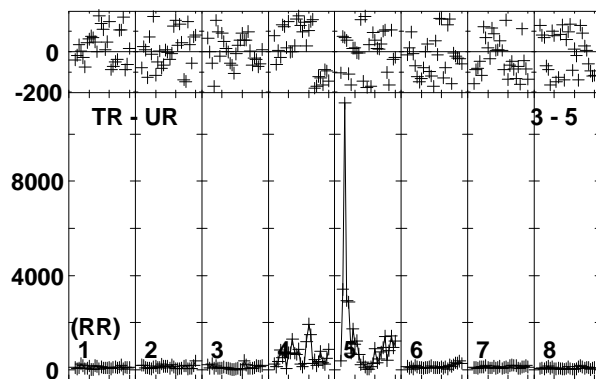
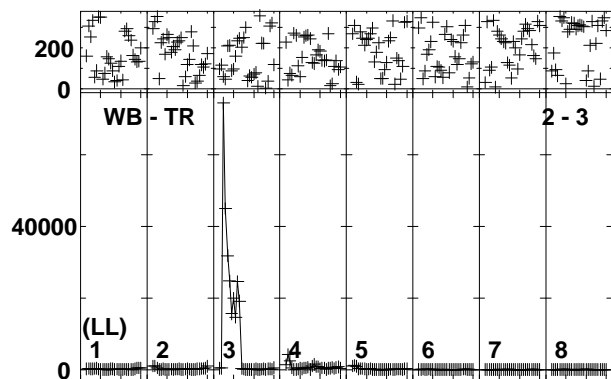
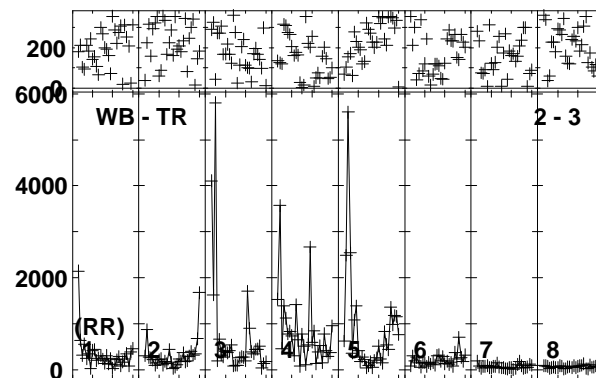
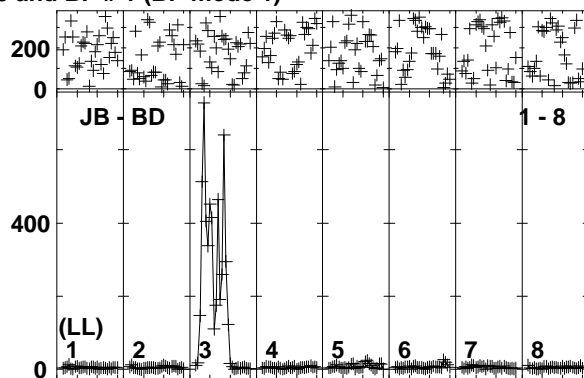
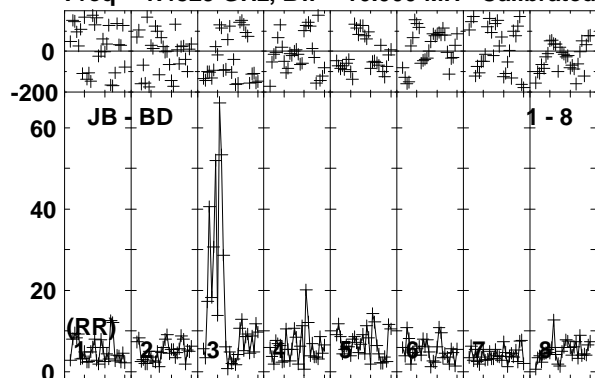

Lower frame: Milli Ampl Jy Top frame: Phas deg
Vector averaged cross-power spectrum Baseline: JB (01) - BD (08)
Timerange: 00/04:13:41 to 00/04:17:09

Plot file version 16 created 21-JUN-2019 11:53:25

IRAS12112 EP111A 1.UVDATA.1

Freq = 1.4829 GHz, Bw = 16.000 MH Calibrated with CL # 3 and BP # 1 (BP mode 1)

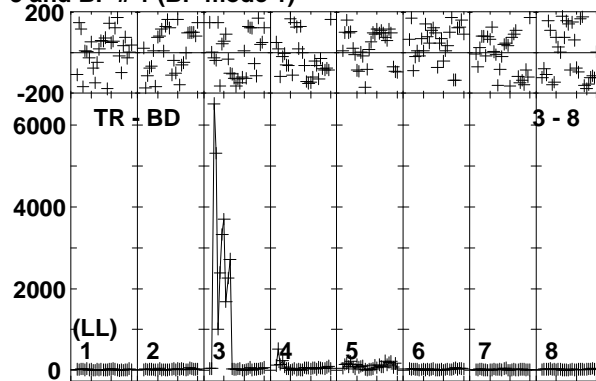
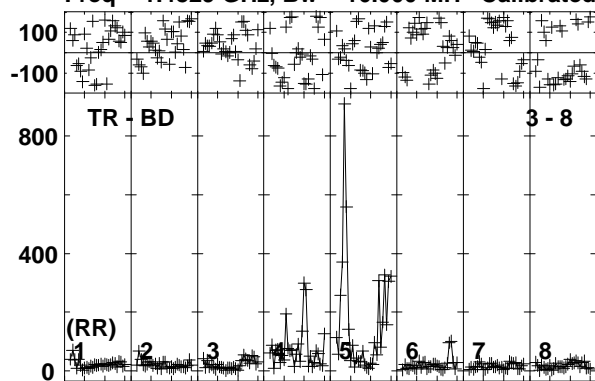

Lower frame: Milli Ampl Jy Top frame: Phas deg
Vector averaged cross-power spectrum Baseline: TR (03) - BD (08)
Timerange: 00/04:13:41 to 00/04:17:09

Plot file version 17 created 21-JUN-2019 11:53:25

J1222+0413 EP111A 1.UVDATA.1

Freq = 1.4829 GHz, Bw = 16.000 MH Calibrated with CL # 3 and BP # 1 (BP mode 1)

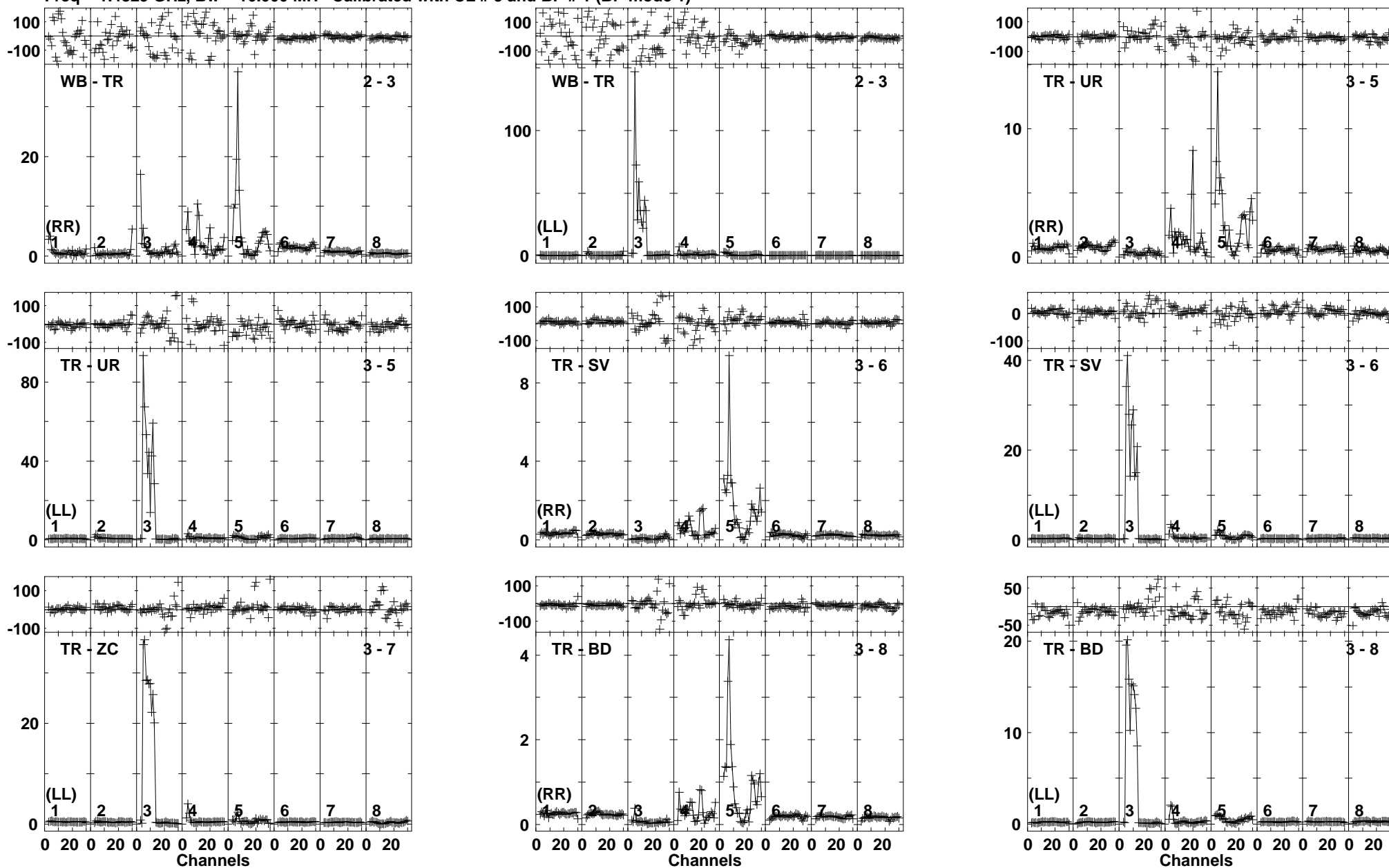

Lower frame: Ampl Jy Top frame: Phas deg
Vector averaged cross-power spectrum Baseline: WB (02) - TR (03)
Timerange: 00/04:17:11 to 00/04:18:39

Plot file version 18 created 21-JUN-2019 11:53:26

IRAS12112 EP111A 1.UVDATA.1

Freq = 1.4829 GHz, Bw = 16.000 MH Calibrated with CL # 3 and BP # 1 (BP mode 1)

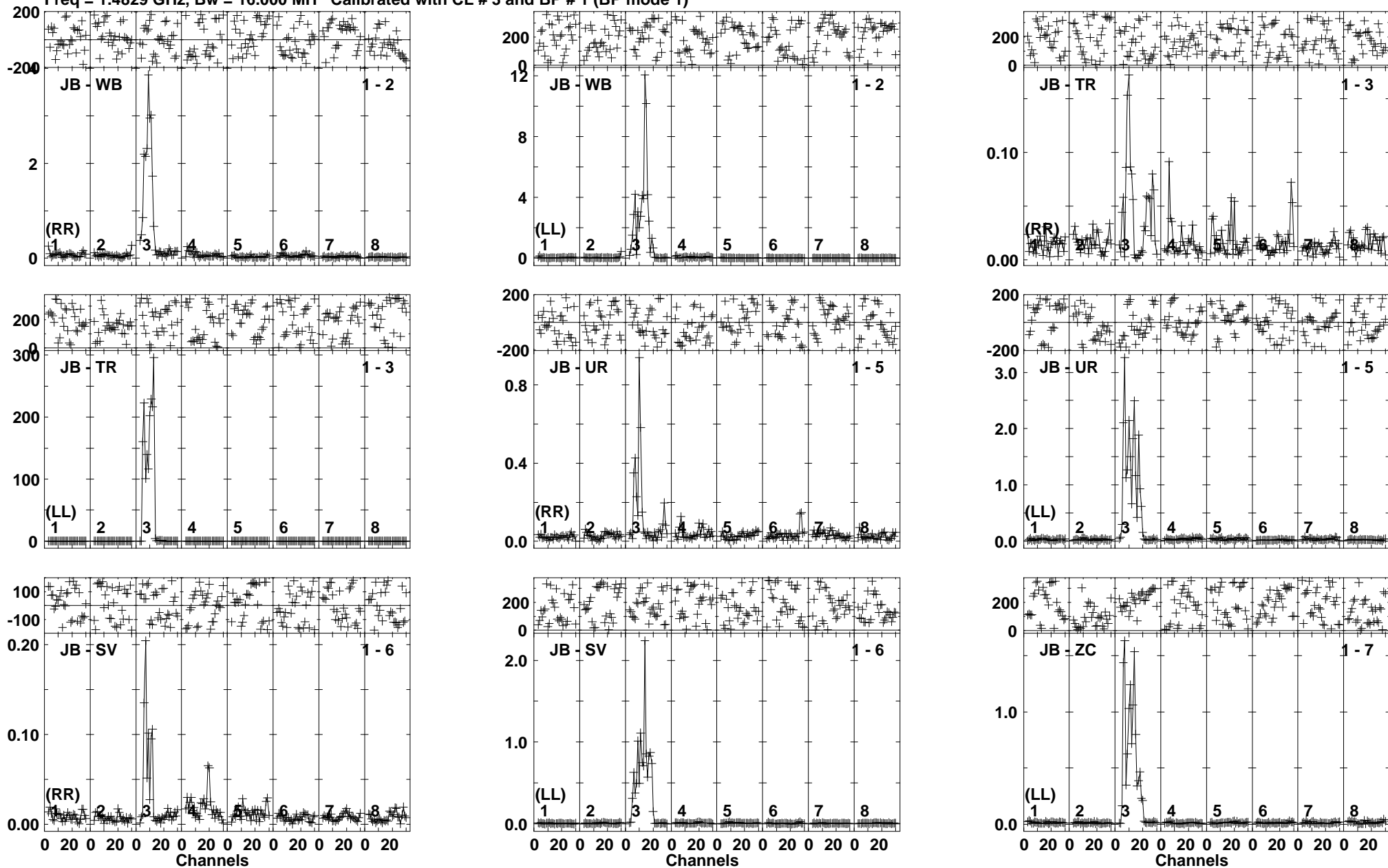

Lower frame: Ampl Jy Top frame: Phas deg
Vector averaged cross-power spectrum Baseline: JB (01) - WB (02)
Timerange: 00/04:18:41 to 00/04:22:09

Plot file version 19 created 21-JUN-2019 11:53:26

IRAS12112 EP111A 1.UVDATA.1

Freq = 1.4829 GHz, Bw = 16.000 MH Calibrated with CL # 3 and BP # 1 (BP mode 1)

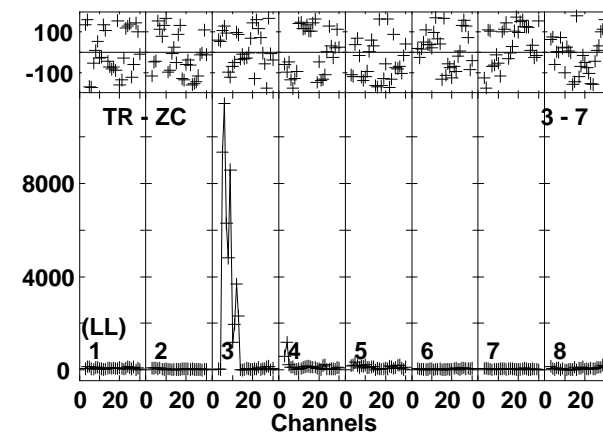
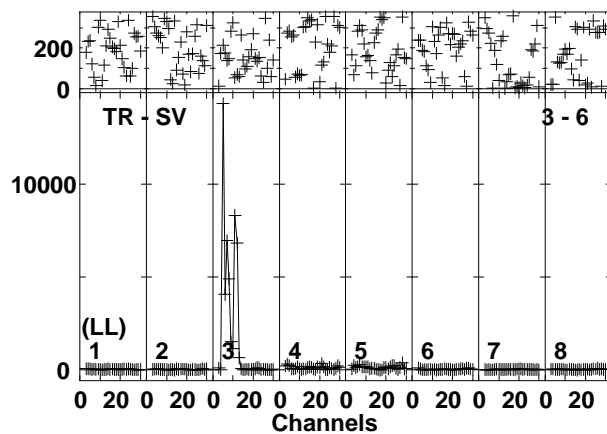
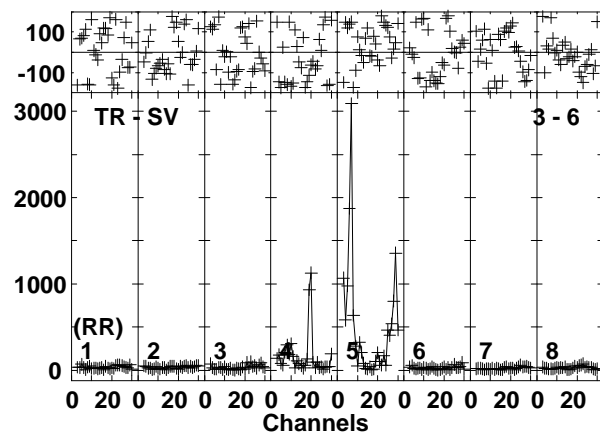
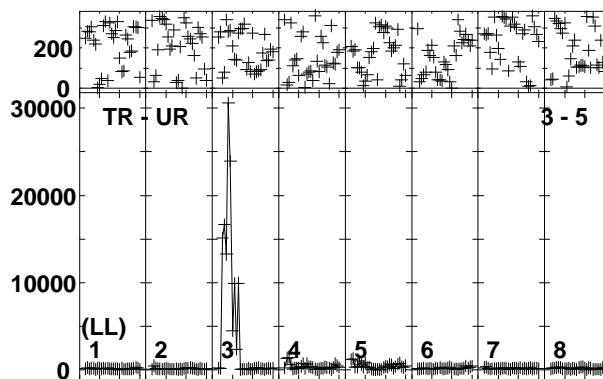
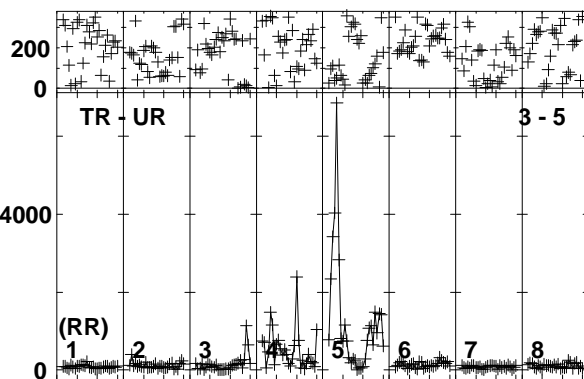
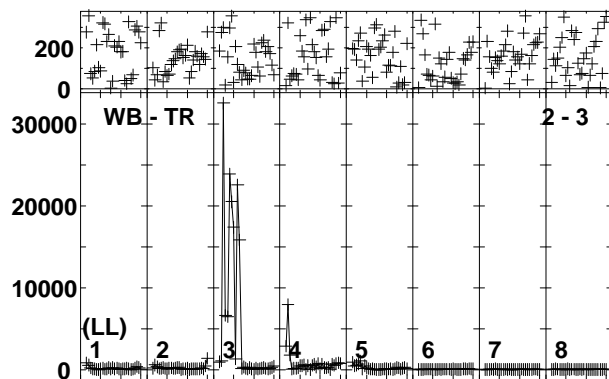
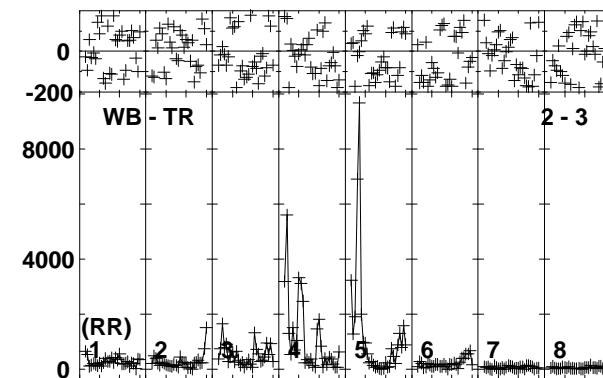
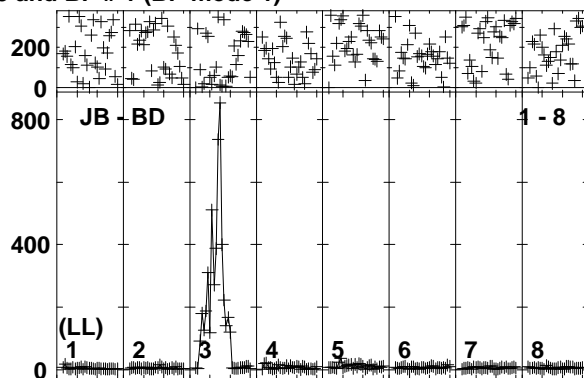
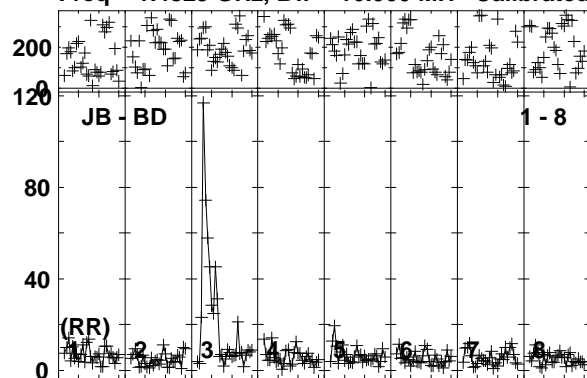

Lower frame: Milli Ampl Jy Top frame: Phas deg
Vector averaged cross-power spectrum Baseline: JB (01) - BD (08)
Timerange: 00/04:18:41 to 00/04:22:09

Plot file version 20 created 21-JUN-2019 11:53:27

IRAS12112 EP111A 1.UVDATA.1

Freq = 1.4829 GHz, Bw = 16.000 MH Calibrated with CL # 3 and BP # 1 (BP mode 1)

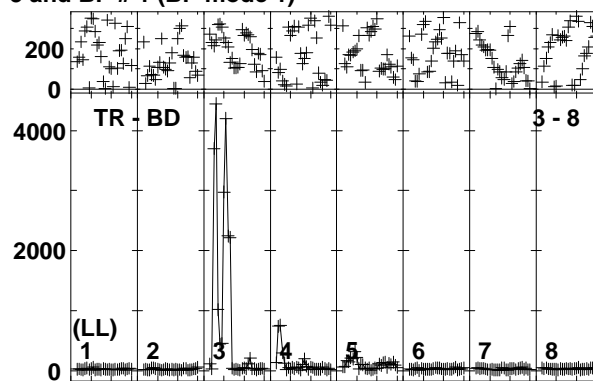
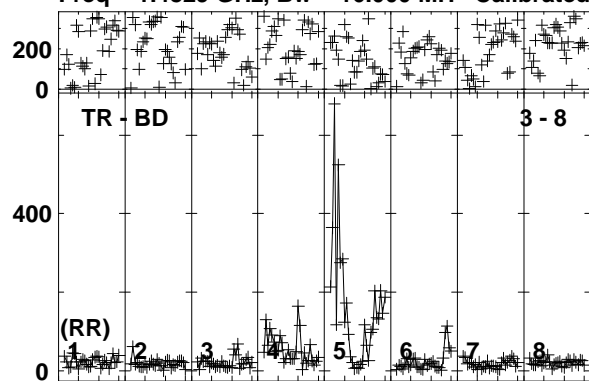

Lower frame: Milli Ampl Jy Top frame: Phas deg
Vector averaged cross-power spectrum Baseline: TR (03) - BD (08)
Timerange: 00/04:18:41 to 00/04:22:09

Plot file version 21 created 21-JUN-2019 11:53:27

J1222+0413 EP111A 1.UVDATA.1

Freq = 1.4829 GHz, Bw = 16.000 MH Calibrated with CL # 3 and BP # 1 (BP mode 1)

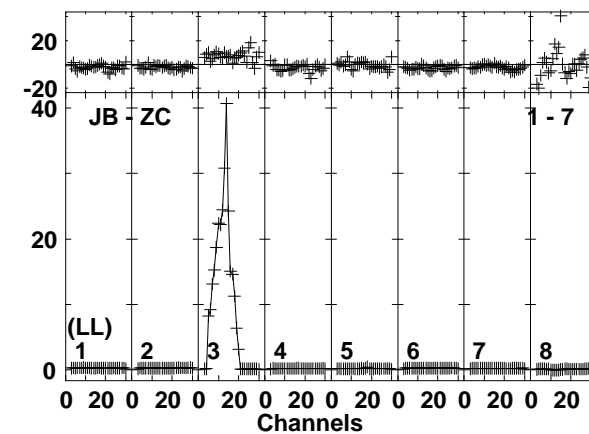
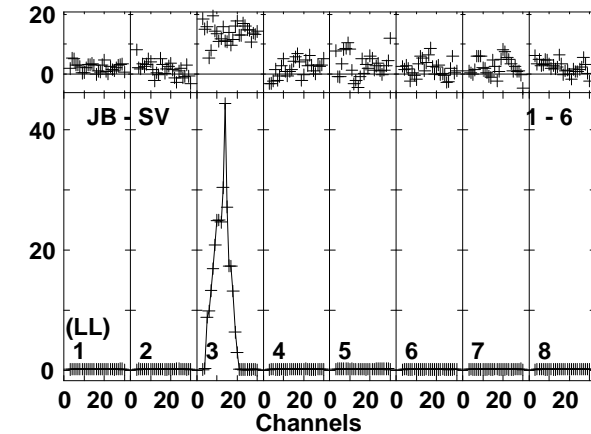
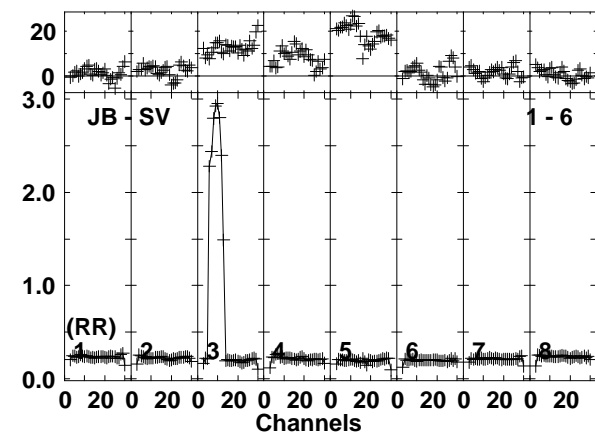
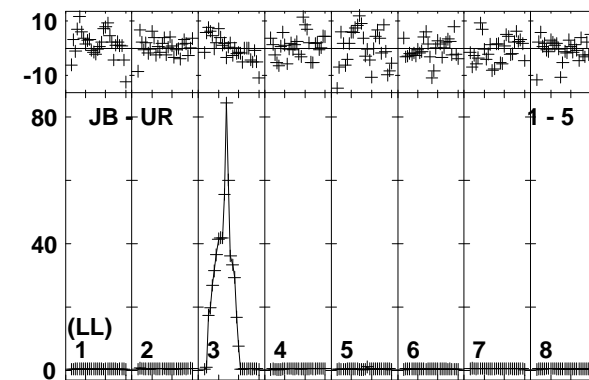
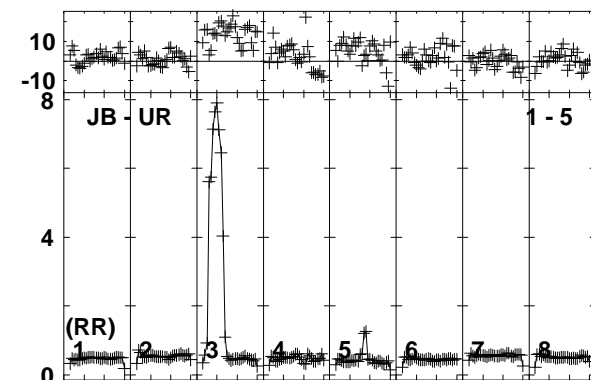
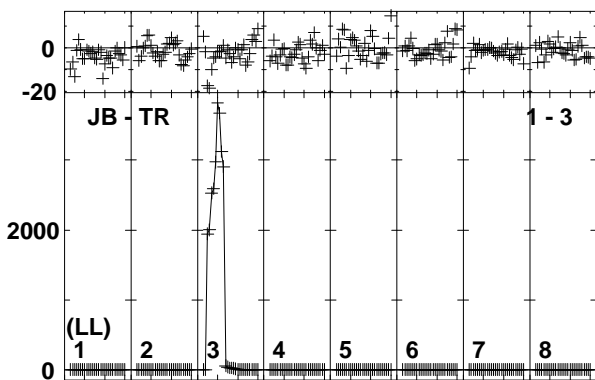
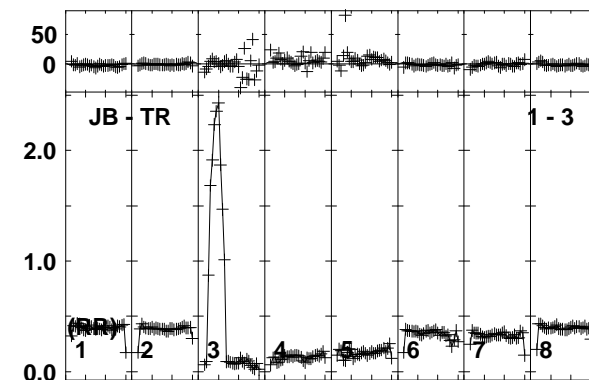
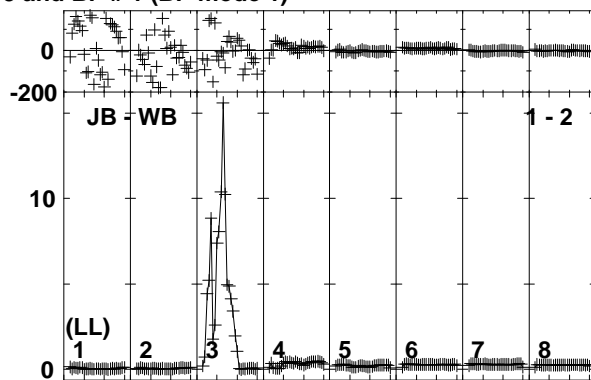
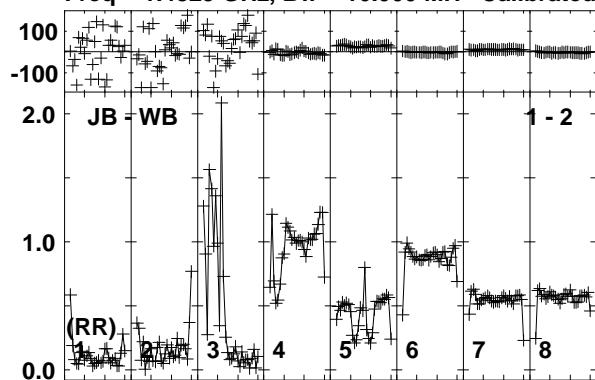

Lower frame: Ampl Jy Top frame: Phas deg
Vector averaged cross-power spectrum Baseline: JB (01) - WB (02)
Timerange: 00/04:22:51 to 00/04:24:19

Plot file version 22 created 21-JUN-2019 11:53:27

J1222+0413 EP111A 1.UVDATA.1

Freq = 1.4829 GHz, Bw = 16.000 MH Calibrated with CL # 3 and BP # 1 (BP mode 1)

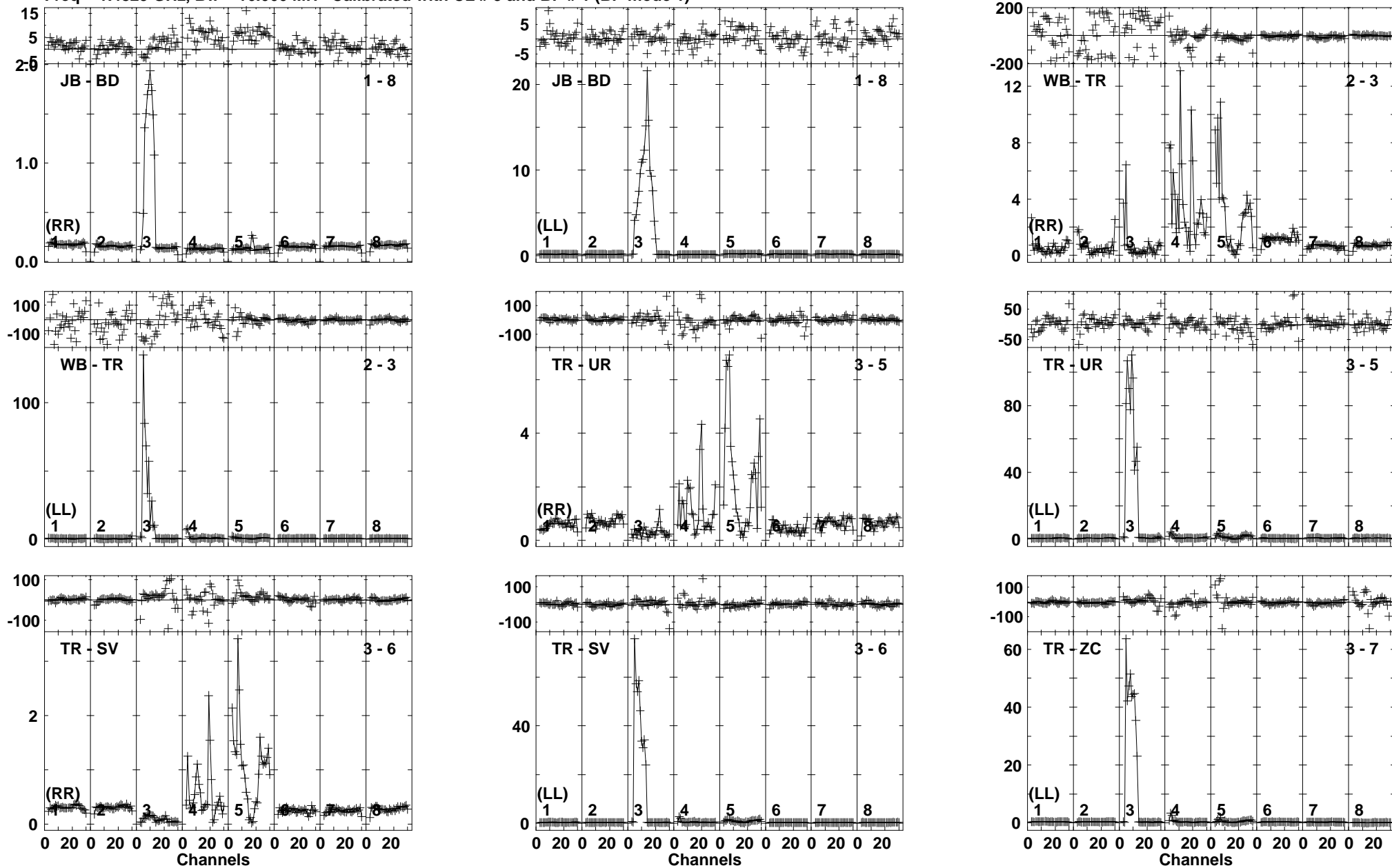

Lower frame: Ampl Jy Top frame: Phas deg
Vector averaged cross-power spectrum Baseline: JB (01) - BD (08)
Timerange: 00/04:22:51 to 00/04:24:19

Plot file version 23 created 21-JUN-2019 11:53:28

J1222+0413 EP1111A 1.UVDATA.1

Freq = 1.4829 GHz, Bw = 16.000 MH Calibrated with CL # 3 and BP # 1 (BP mode 1)

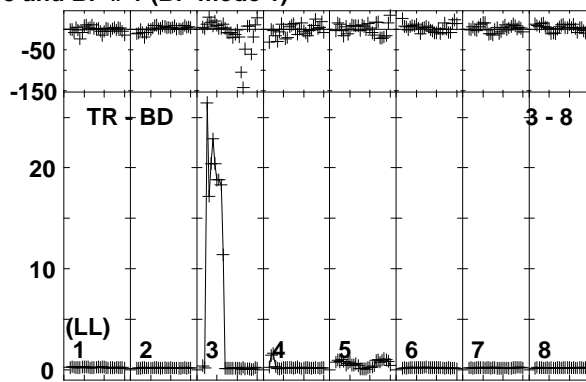
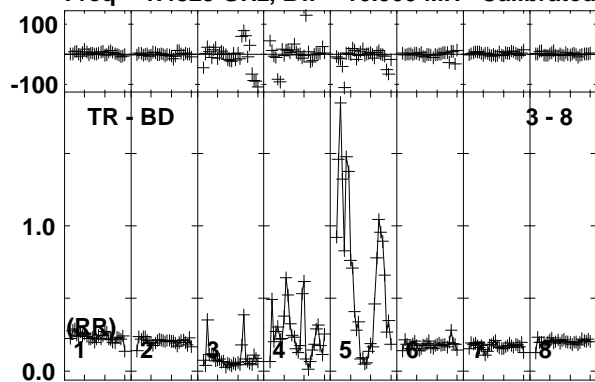

Lower frame: Ampl Jy Top frame: Phas deg
Vector averaged cross-power spectrum Baseline: TR (03) - BD (08)
Timerange: 00/04:22:51 to 00/04:24:19

Plot file version 25 created 21-JUN-2019 11:53:28

IRAS12112 EP111A 1.UVDATA.1

Freq = 1.4829 GHz, Bw = 16.000 MH Calibrated with CL # 3 and BP # 1 (BP mode 1)

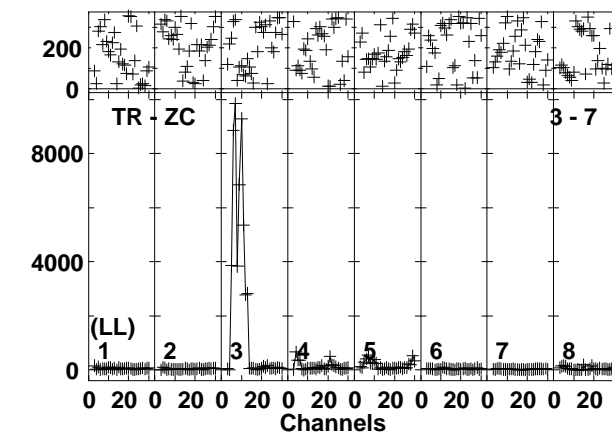
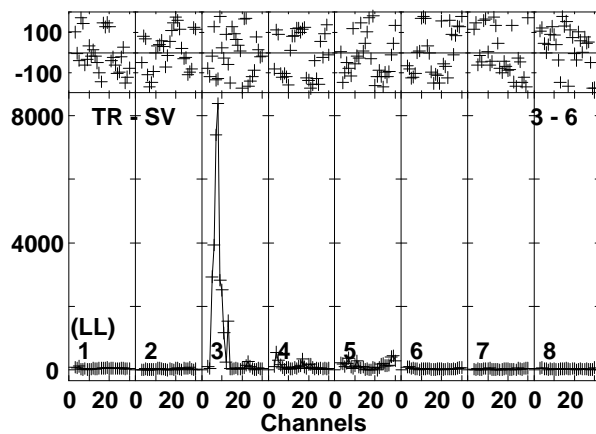
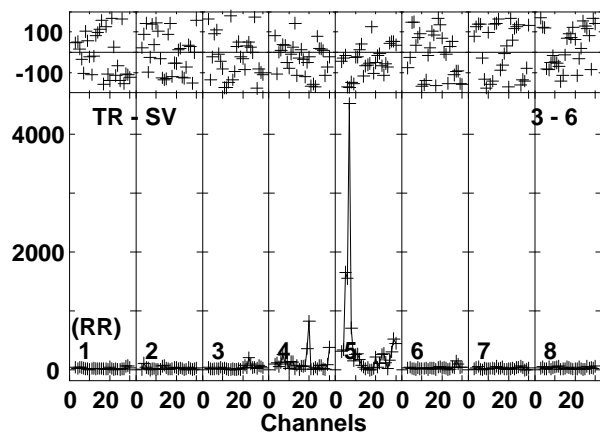
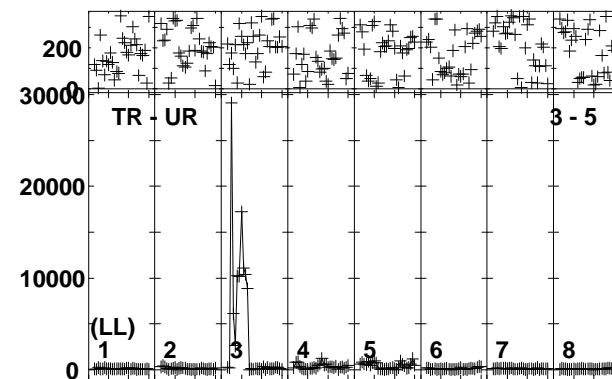
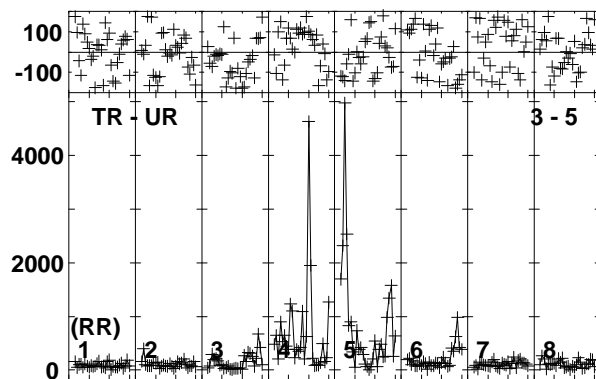
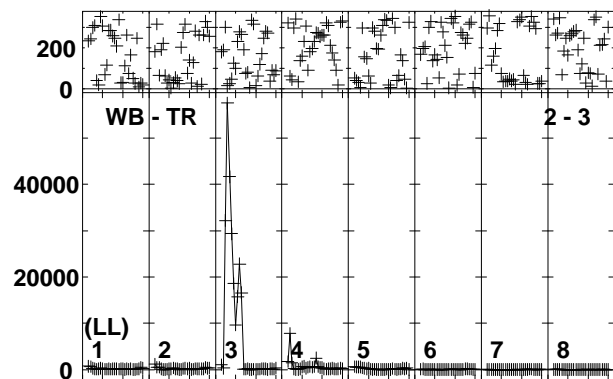
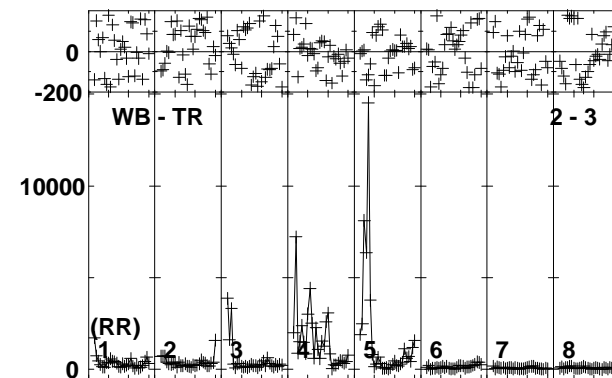
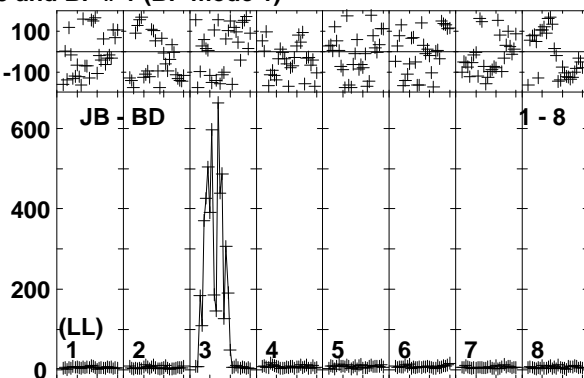
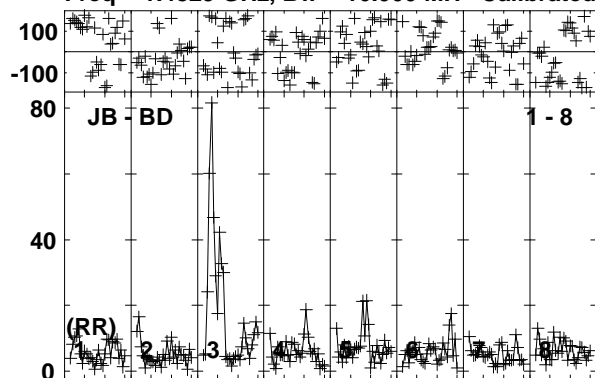

Lower frame: Milli Ampl Jy Top frame: Phas deg
Vector averaged cross-power spectrum Baseline: JB (01) - BD (08)
Timerange: 00/04:24:21 to 00/04:27:49

Plot file version 26 created 21-JUN-2019 11:53:29

IRAS12112 EP111A 1.UVDATA.1

Freq = 1.4829 GHz, Bw = 16.000 MH Calibrated with CL # 3 and BP # 1 (BP mode 1)

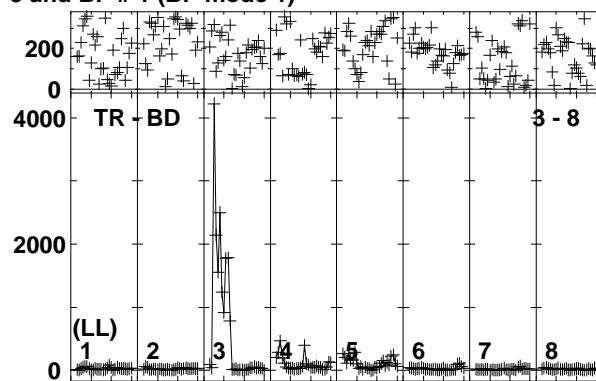
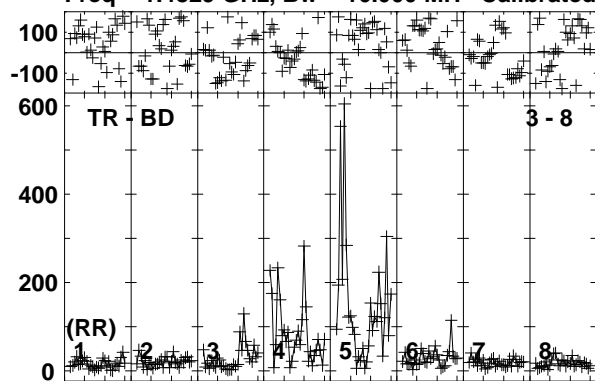

Lower frame: Milli Ampl Jy Top frame: Phas deg
Vector averaged cross-power spectrum Baseline: TR (03) - BD (08)
Timerange: 00/04:24:21 to 00/04:27:49

Plot file version 27 created 21-JUN-2019 11:53:29

J1222+0413 EP111A 1.UVDATA.1

Freq = 1.4829 GHz, Bw = 16.000 MH Calibrated with CL # 3 and BP # 1 (BP mode 1)

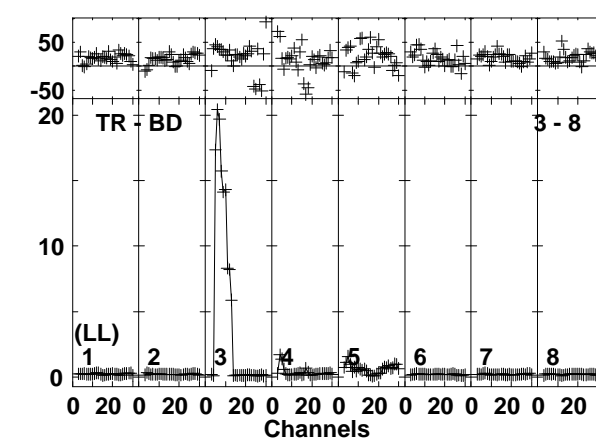
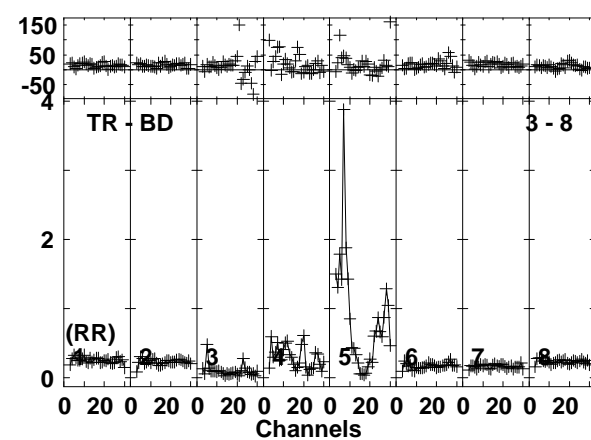
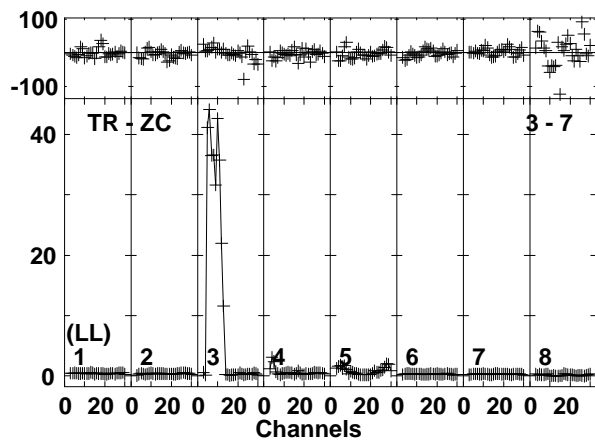
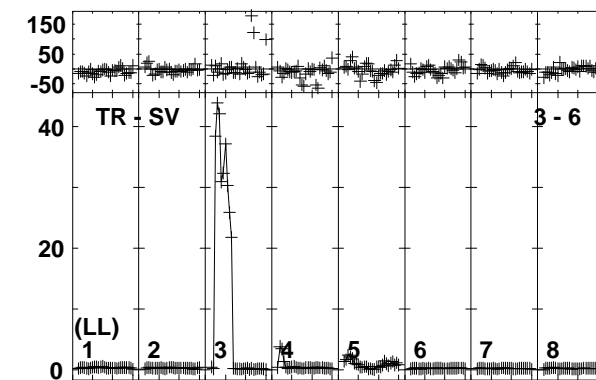
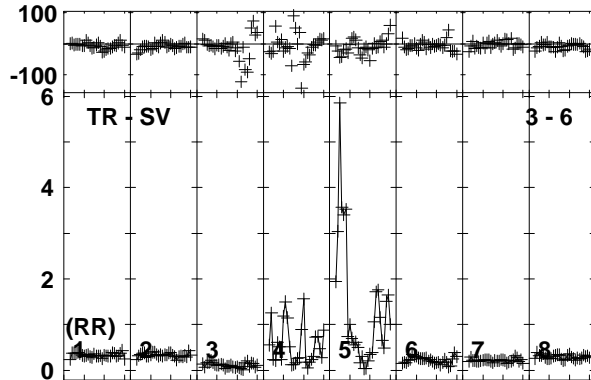
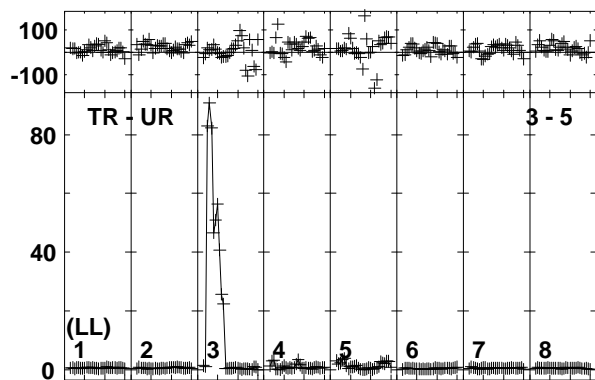
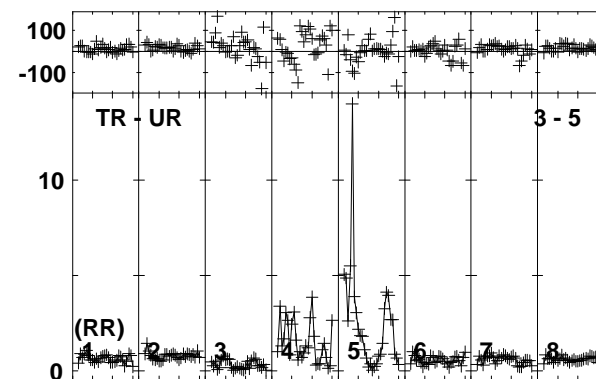
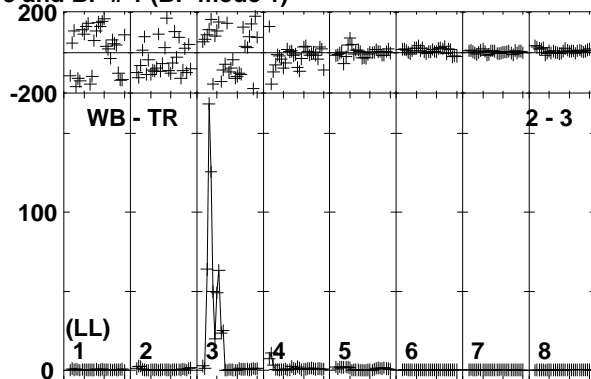
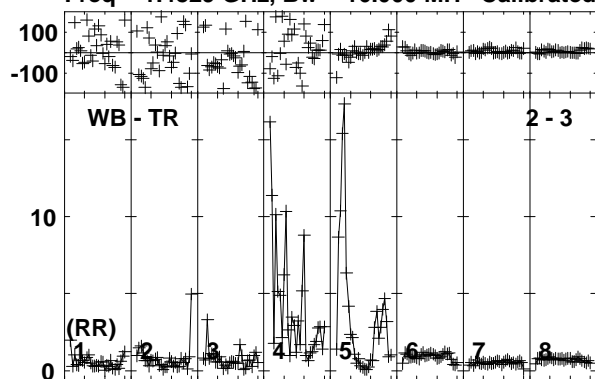

Lower frame: Ampl Jy Top frame: Phas deg
Vector averaged cross-power spectrum Baseline: WB (02) - TR (03)
Timerange: 00/04:27:51 to 00/04:29:19

Plot file version 28 created 21-JUN-2019 11:53:30

IRAS12112 EP111A 1.UVDATA.1

Freq = 1.4829 GHz, Bw = 16.000 MH Calibrated with CL # 3 and BP # 1 (BP mode 1)

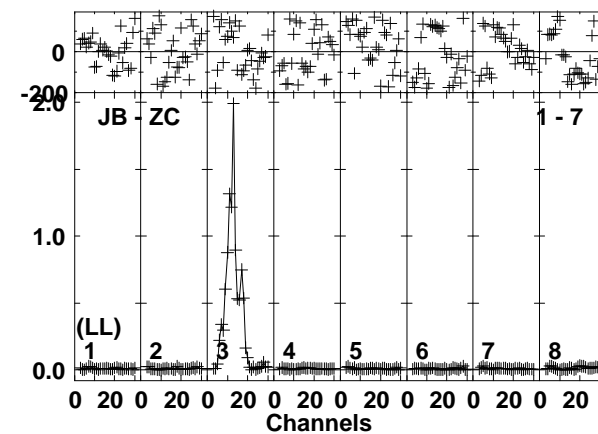
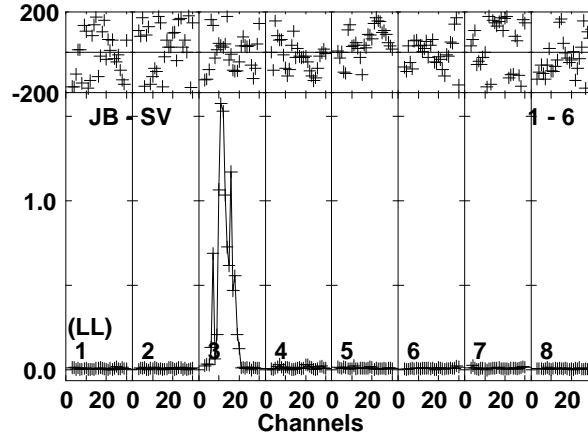
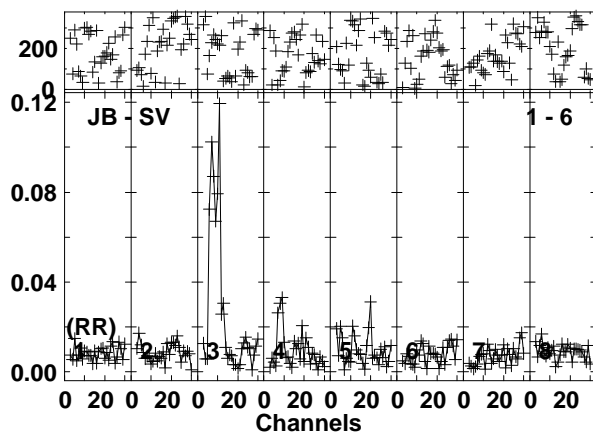
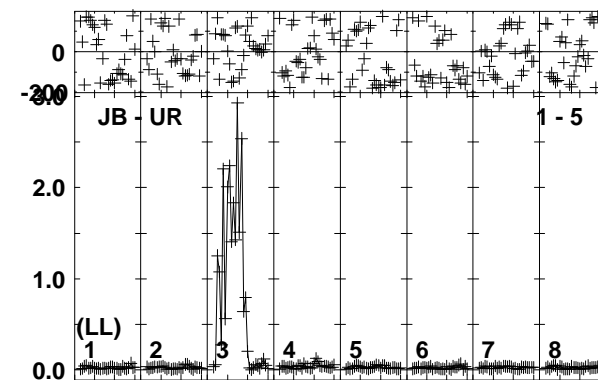
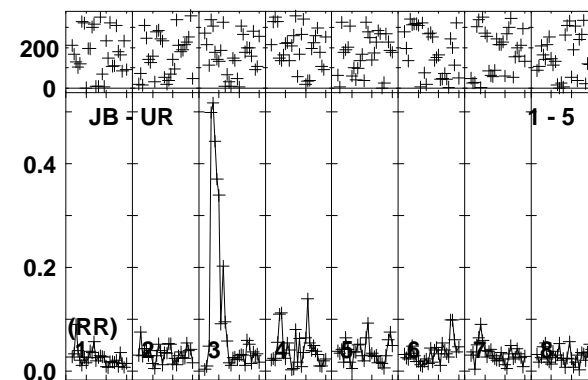
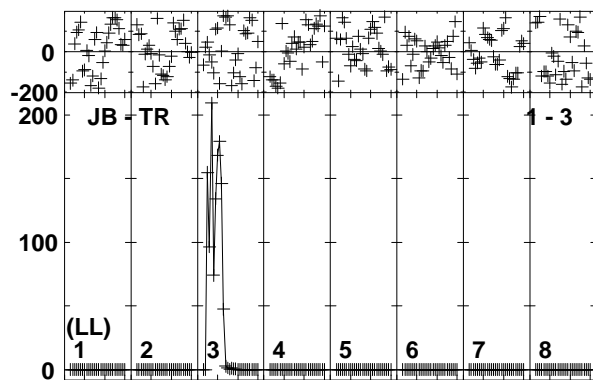
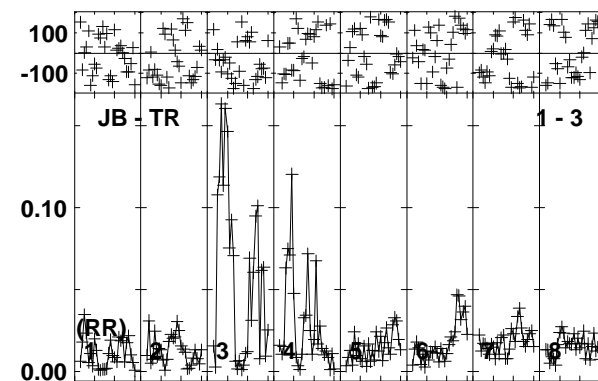
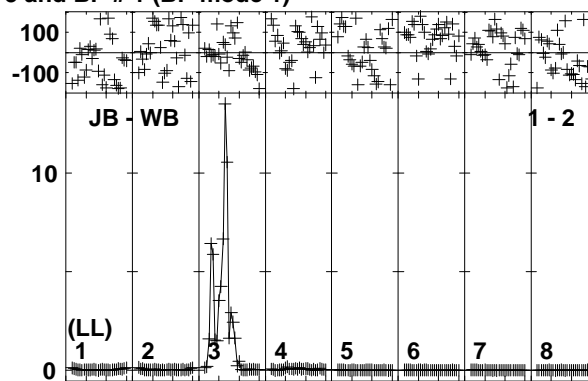
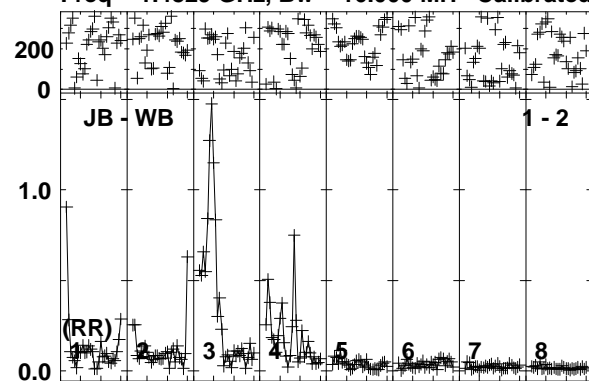

Lower frame: Ampl Jy Top frame: Phas deg
Vector averaged cross-power spectrum Baseline: JB (01) - WB (02)
Timerange: 00/04:29:21 to 00/04:32:49

Plot file version 29 created 21-JUN-2019 11:53:30

IRAS12112 EP111A 1.UVDATA.1

Freq = 1.4829 GHz, Bw = 16.000 MH Calibrated with CL # 3 and BP # 1 (BP mode 1)

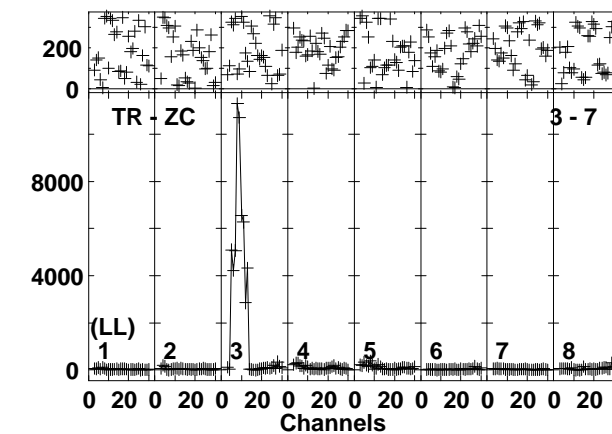
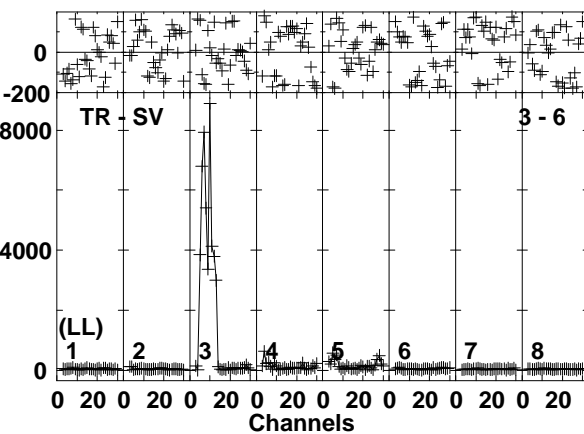
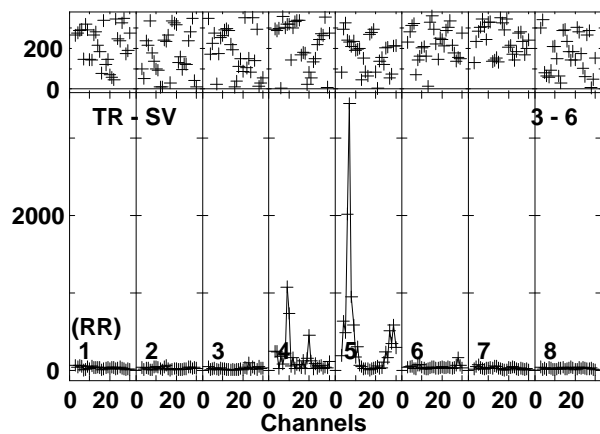
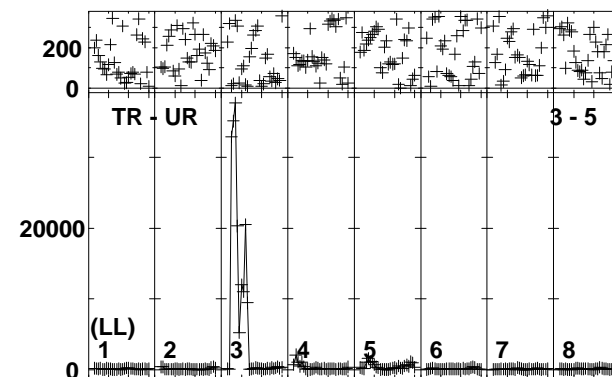
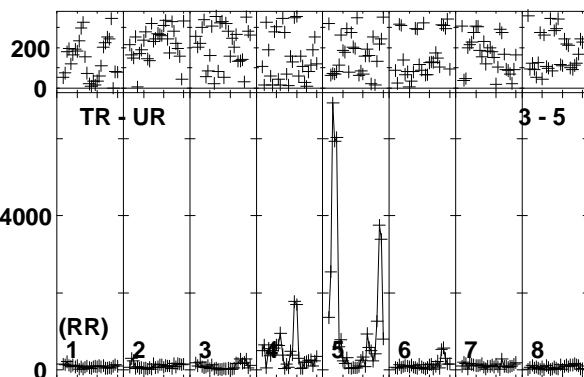
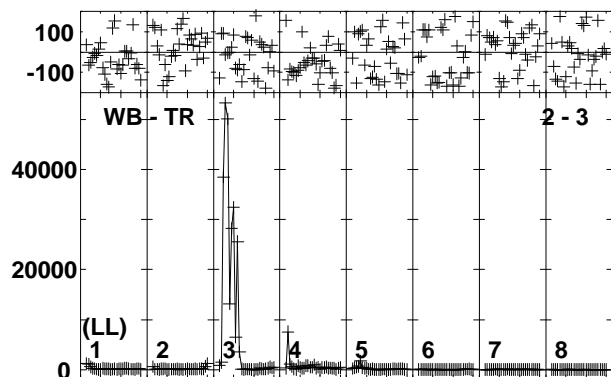
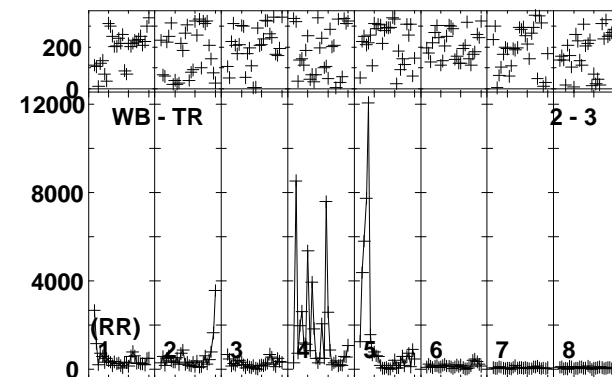
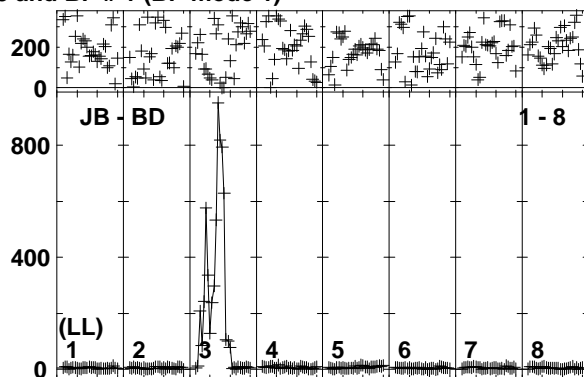
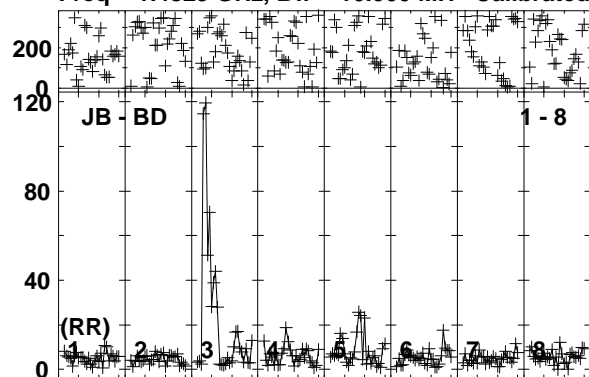

Lower frame: Milli Ampl Jy Top frame: Phas deg
Vector averaged cross-power spectrum Baseline: JB (01) - BD (08)
Timerange: 00/04:29:21 to 00/04:32:49

Plot file version 30 created 21-JUN-2019 11:53:31

IRAS12112 EP111A 1.UVDATA.1

Freq = 1.4829 GHz, Bw = 16.000 MH Calibrated with CL # 3 and BP # 1 (BP mode 1)

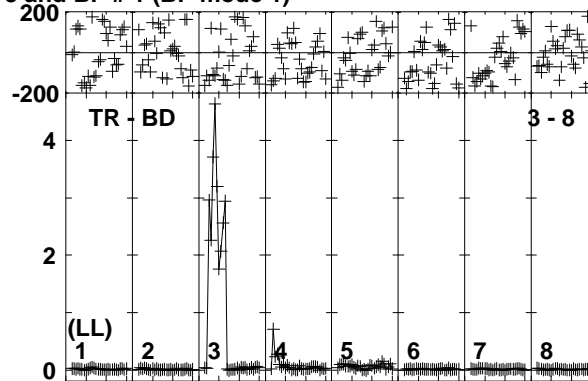
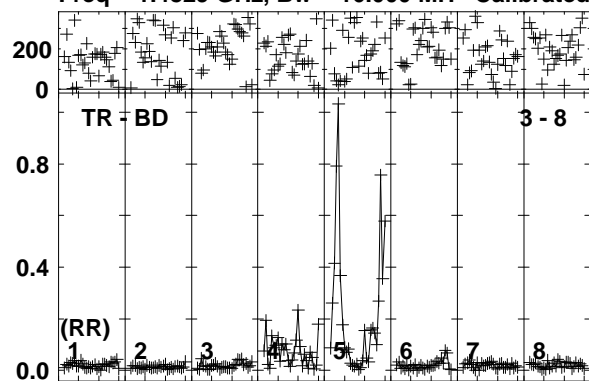

Lower frame: Ampl Jy Top frame: Phas deg
Vector averaged cross-power spectrum Baseline: TR (03) - BD (08)
Timerange: 00/04:29:21 to 00/04:32:49

Plot file version 31 created 21-JUN-2019 11:53:31
 J1222+0413 EP111A 1.UVDATA.1
 Freq = 1.4829 GHz, Bw = 16.000 MH Calibrated with CL # 3 and BP # 1 (BP mode 1)

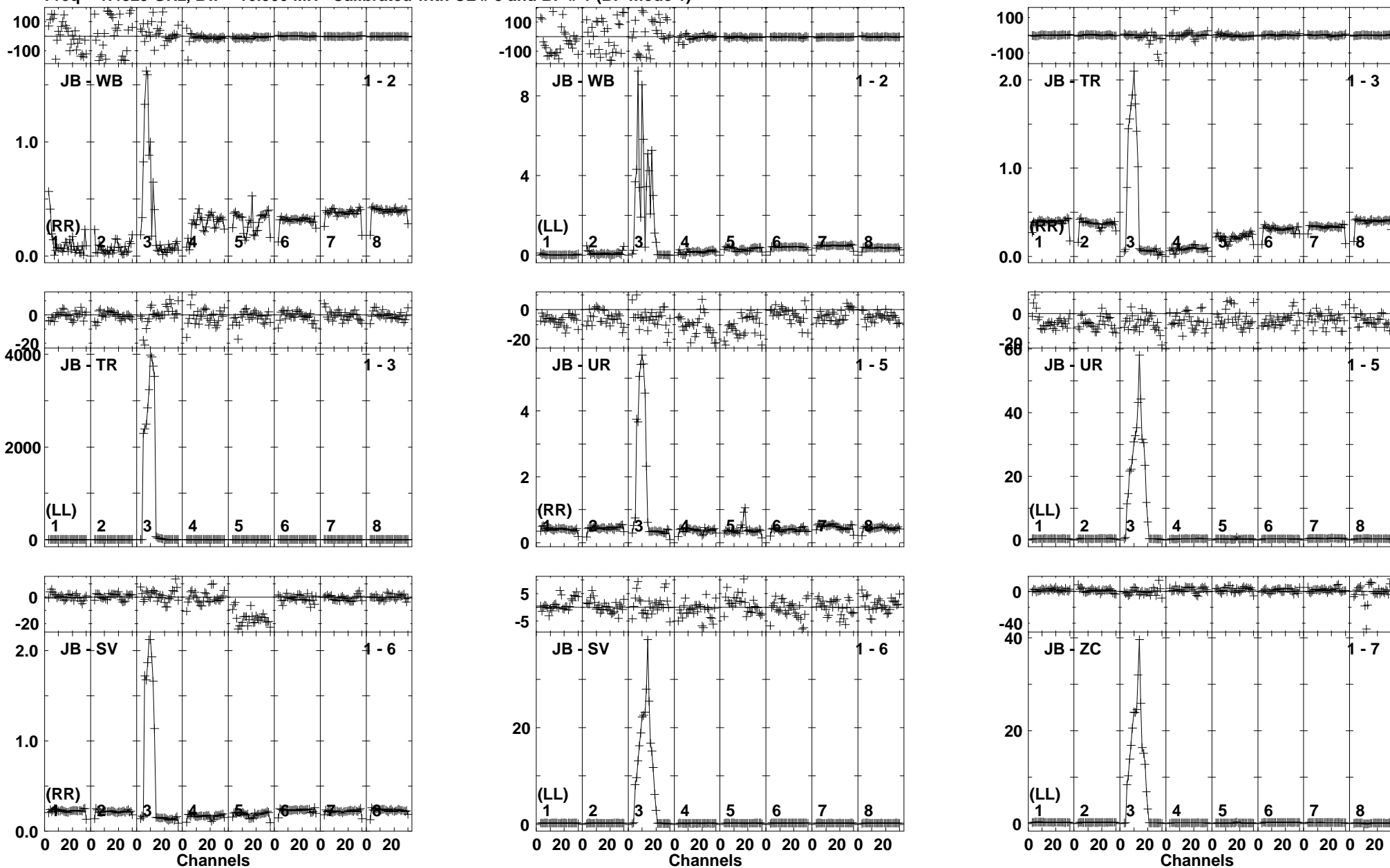

Lower frame: Ampl Jy Top frame: Phas deg
 Vector averaged cross-power spectrum Baseline: JB (01) - WB (02)
 Timerange: 00/04:33:31 to 00/04:34:59

Plot file version 32 created 21-JUN-2019 11:53:31

J1222+0413 EP111A 1.UVDATA.1

Freq = 1.4829 GHz, Bw = 16.000 MH Calibrated with CL # 3 and BP # 1 (BP mode 1)

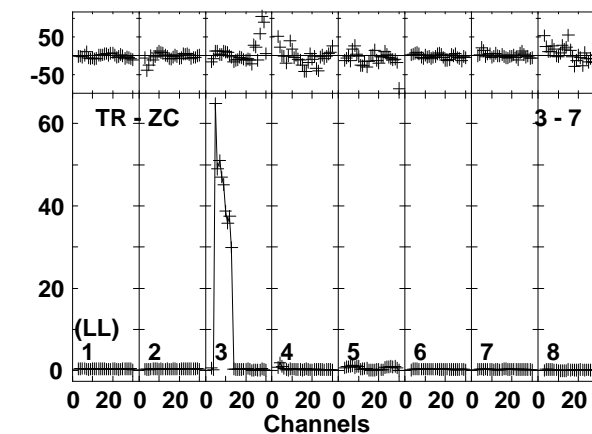
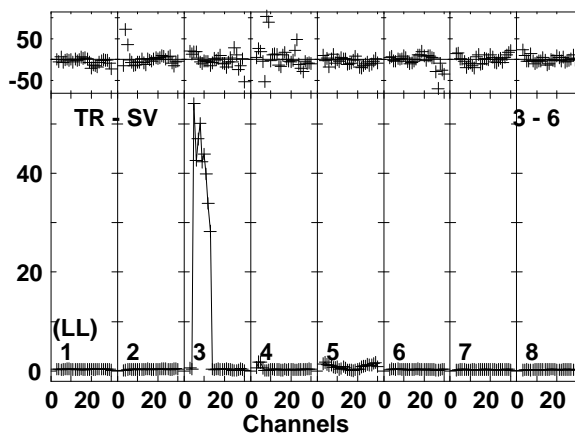
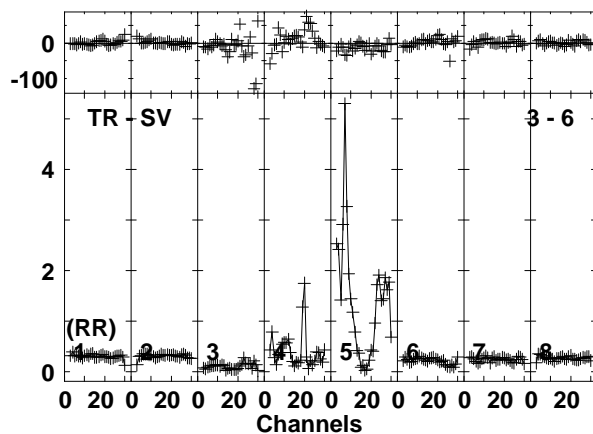
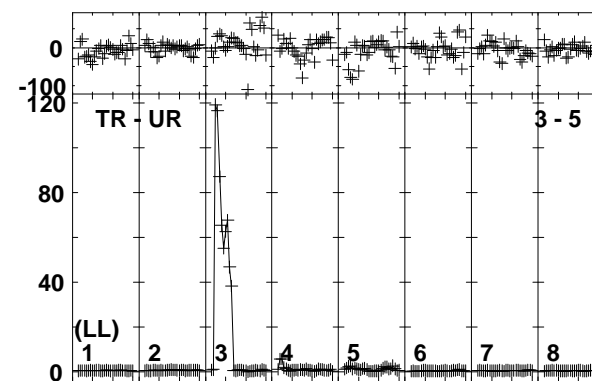
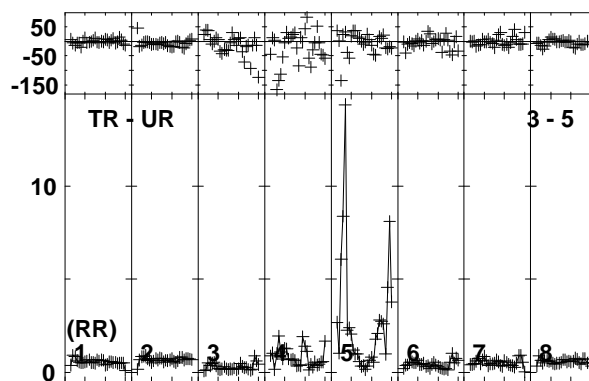
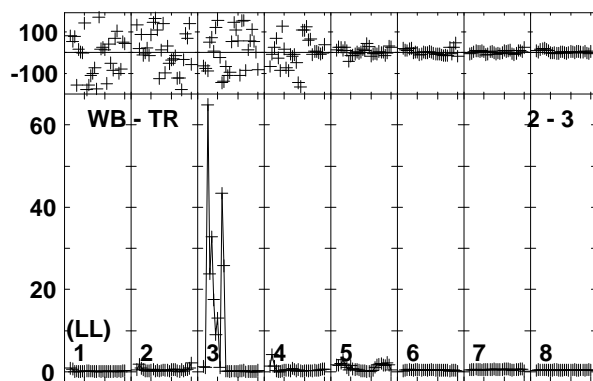
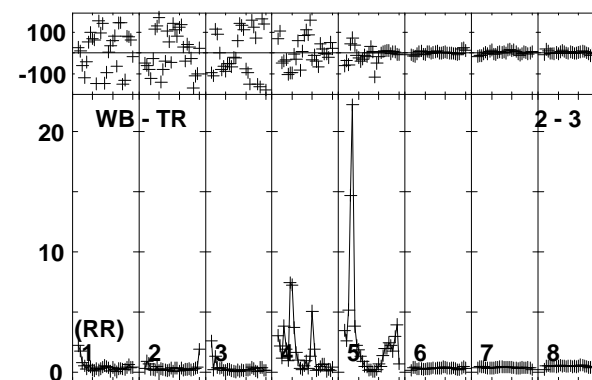
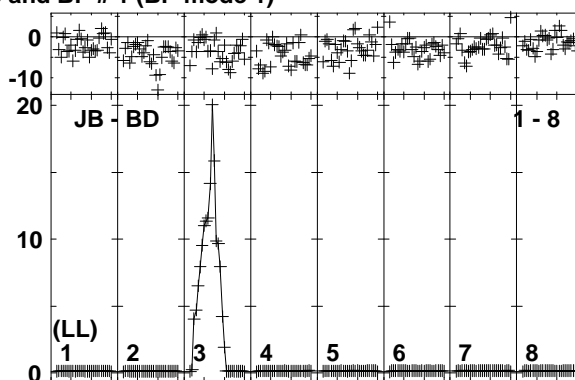
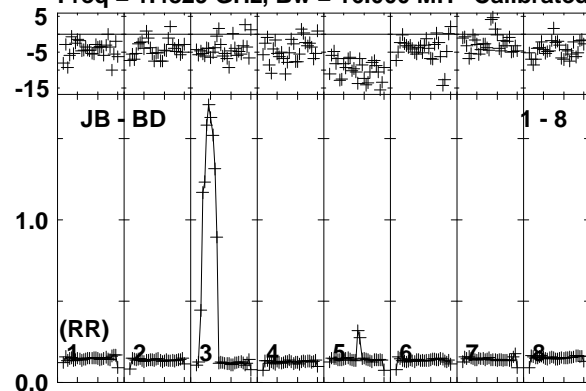

Lower frame: Ampl Jy Top frame: Phas deg
Vector averaged cross-power spectrum Baseline: JB (01) - BD (08)
Timerange: 00/04:33:31 to 00/04:34:59

Plot file version 33 created 21-JUN-2019 11:53:32

J1222+0413 EP111A 1.UVDATA.1

Freq = 1.4829 GHz, Bw = 16.000 MH Calibrated with CL # 3 and BP # 1 (BP mode 1)

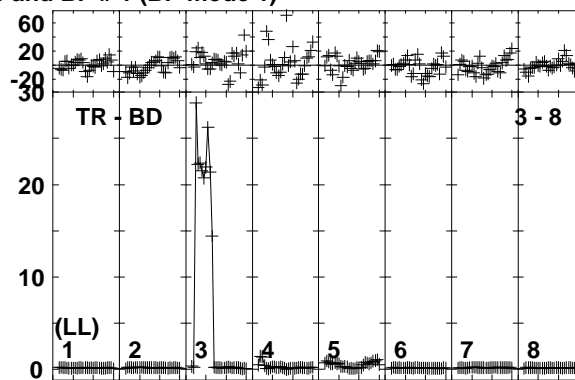
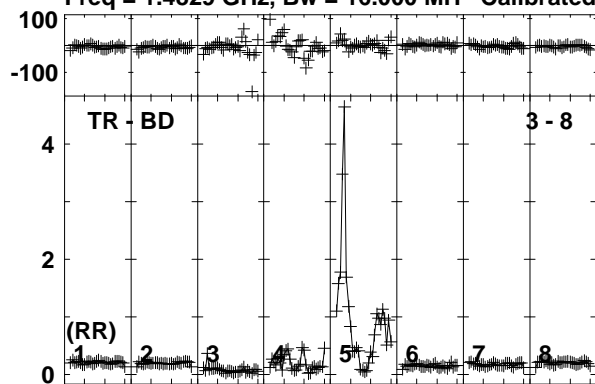

Lower frame: Ampl Jy Top frame: Phas deg
Vector averaged cross-power spectrum Baseline: TR (03) - BD (08)
Timerange: 00/04:33:31 to 00/04:34:59

Plot file version 34 created 21-JUN-2019 11:53:32

IRAS12112 EP111A 1.UVDATA.1

Freq = 1.4829 GHz, Bw = 16.000 MH Calibrated with CL # 3 and BP # 1 (BP mode 1)

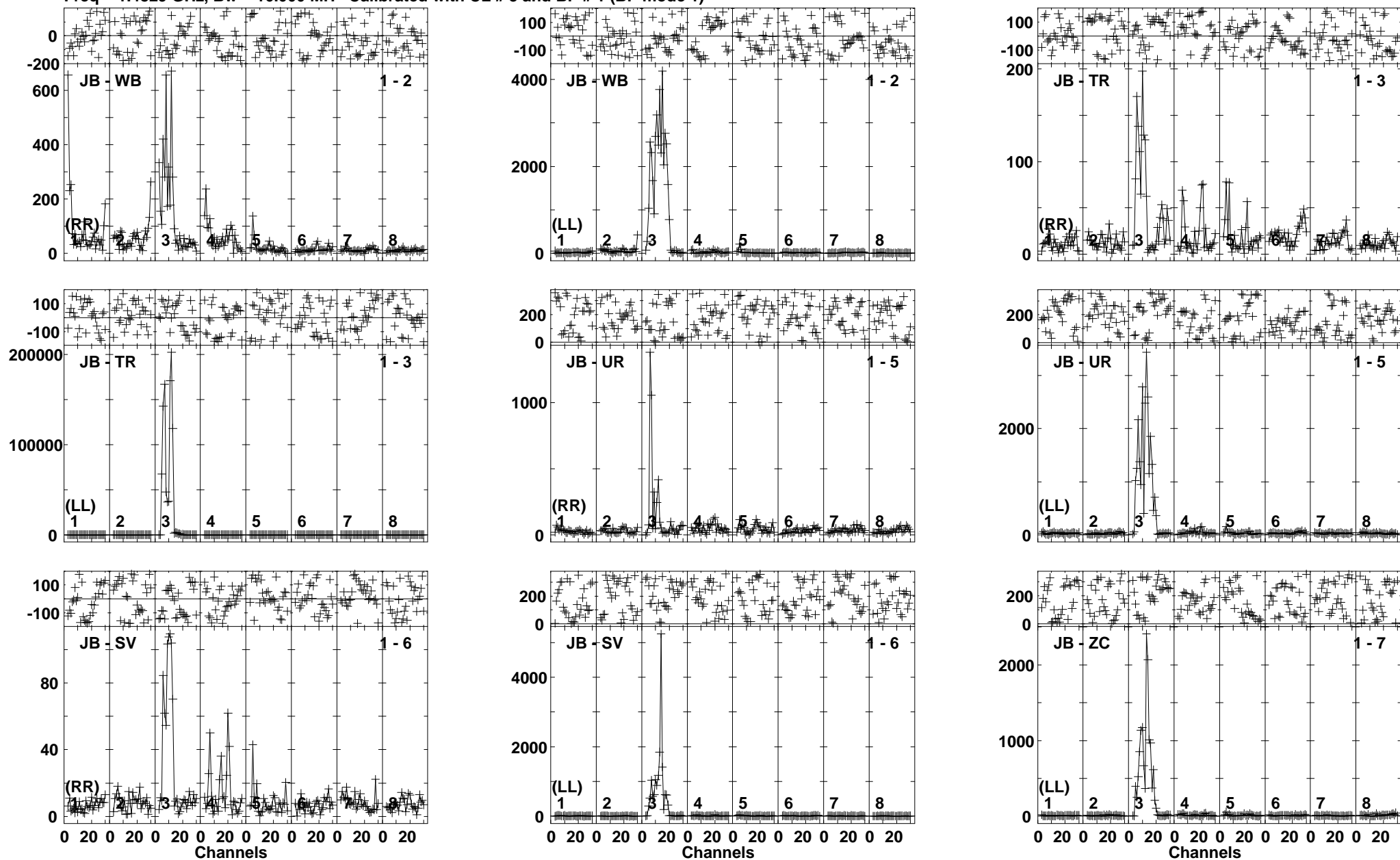

Lower frame: Milli Ampl Jy Top frame: Phas deg
Vector averaged cross-power spectrum Baseline: JB (01) - WB (02)
Timerange: 00/04:35:01 to 00/04:38:29

Plot file version 35 created 21-JUN-2019 11:53:32

IRAS12112 EP111A 1.UVDATA.1

Freq = 1.4829 GHz, Bw = 16.000 MH Calibrated with CL # 3 and BP # 1 (BP mode 1)

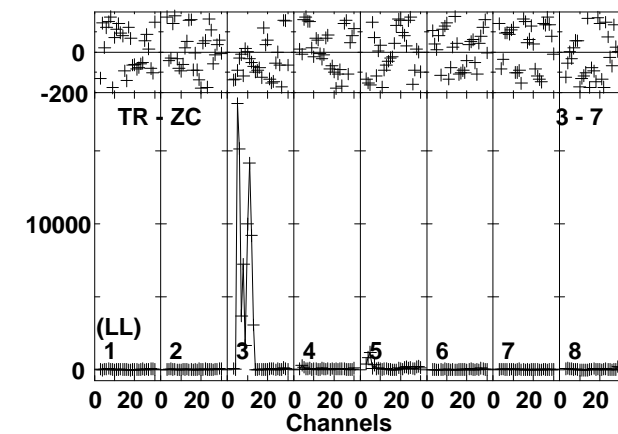
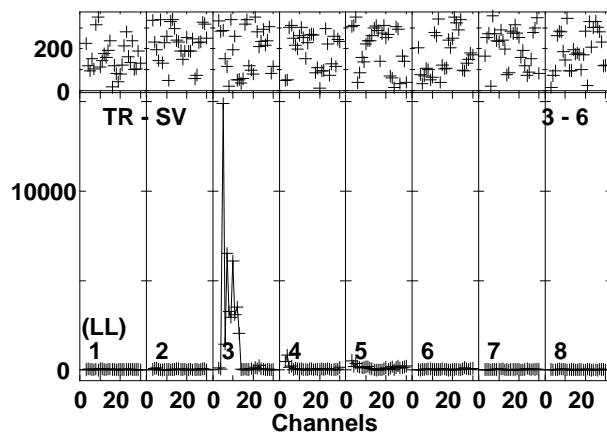
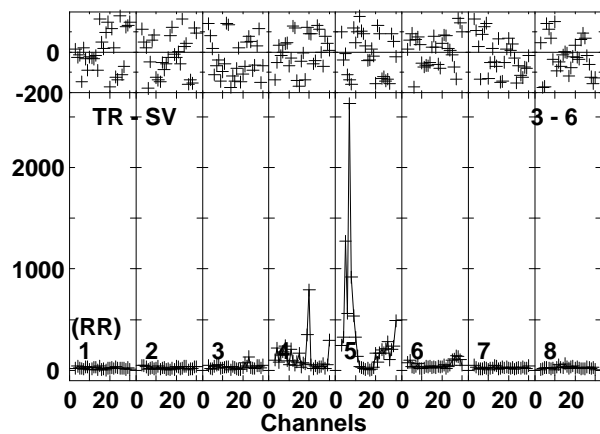
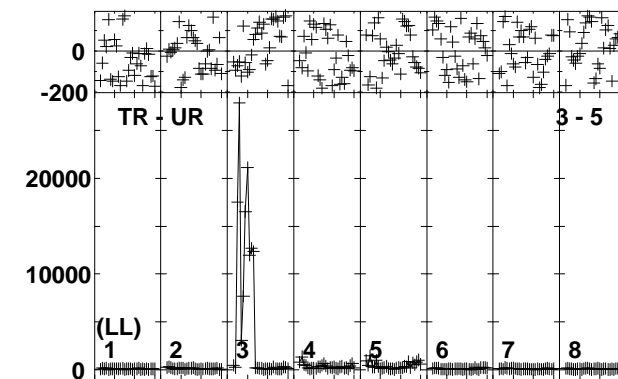
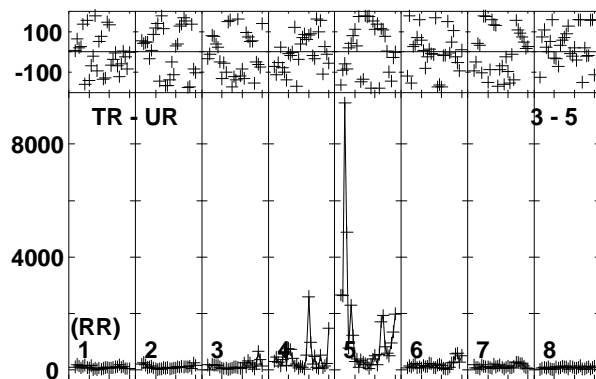
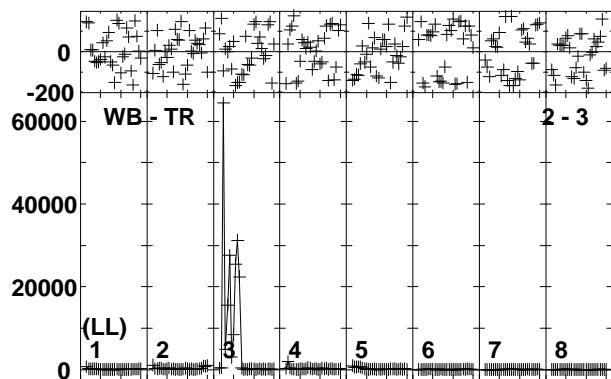
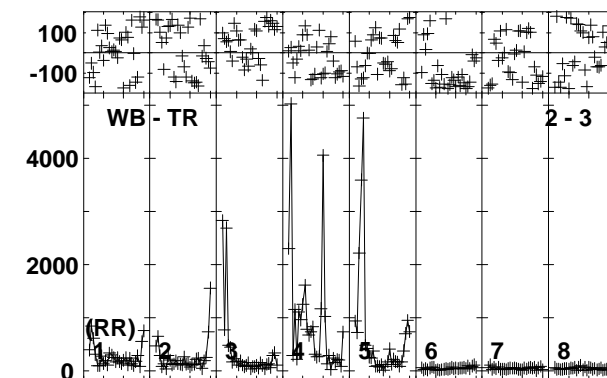
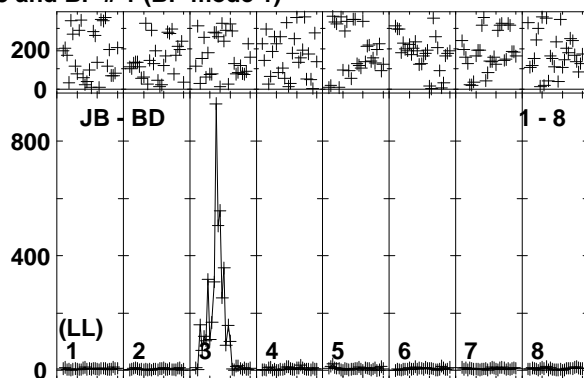
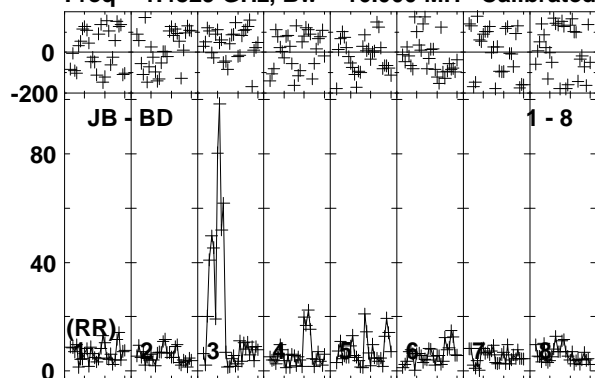

Lower frame: Milli Ampl Jy Top frame: Phas deg
Vector averaged cross-power spectrum Baseline: JB (01) - BD (08)
Timerange: 00/04:35:01 to 00/04:38:29

Plot file version 36 created 21-JUN-2019 11:53:33

IRAS12112 EP111A 1.UVDATA.1

Freq = 1.4829 GHz, Bw = 16.000 MH Calibrated with CL # 3 and BP # 1 (BP mode 1)

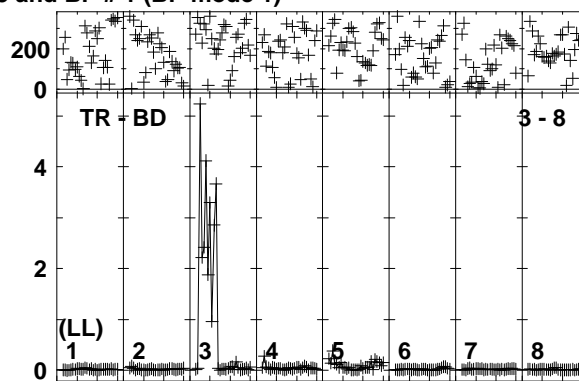
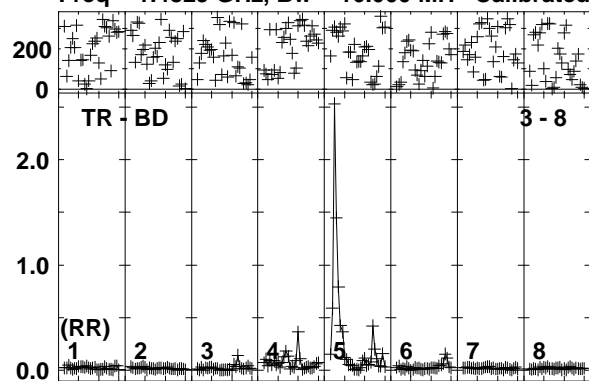

Lower frame: Ampl Jy Top frame: Phas deg
Vector averaged cross-power spectrum Baseline: TR (03) - BD (08)
Timerange: 00/04:35:01 to 00/04:38:29

Plot file version 37 created 21-JUN-2019 11:53:33

J1222+0413 EP111A 1.UVDATA.1

Freq = 1.4829 GHz, Bw = 16.000 MH Calibrated with CL # 3 and BP # 1 (BP mode 1)

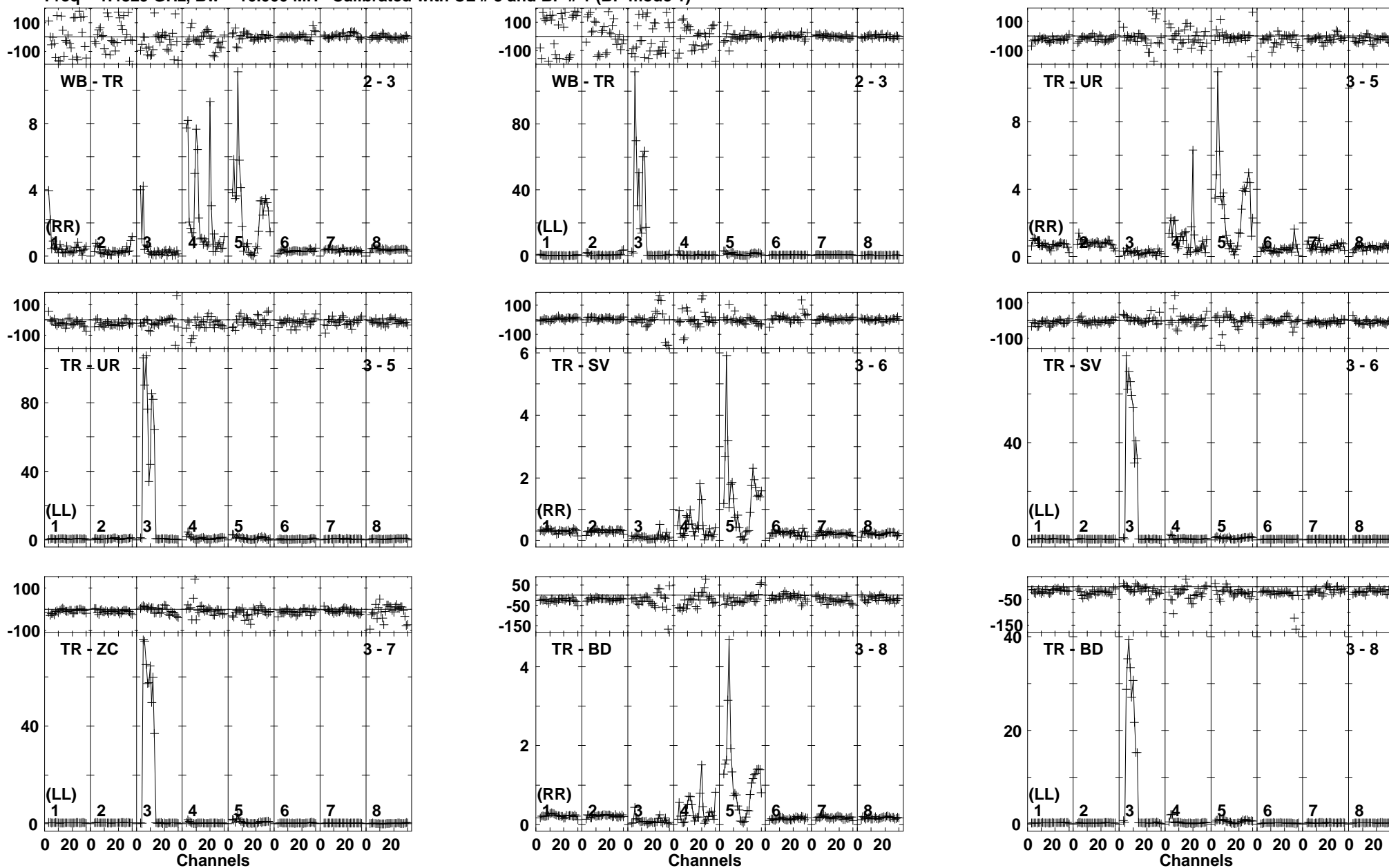

Lower frame: Ampl Jy Top frame: Phas deg
Vector averaged cross-power spectrum Baseline: WB (02) - TR (03)
Timerange: 00/04:38:31 to 00/04:39:59

Plot file version 38 created 21-JUN-2019 11:53:34
 IRAS12112 EP111A 1.UVDATA.1
 Freq = 1.4829 GHz, Bw = 16.000 MH Calibrated with CL # 3 and BP # 1 (BP mode 1)

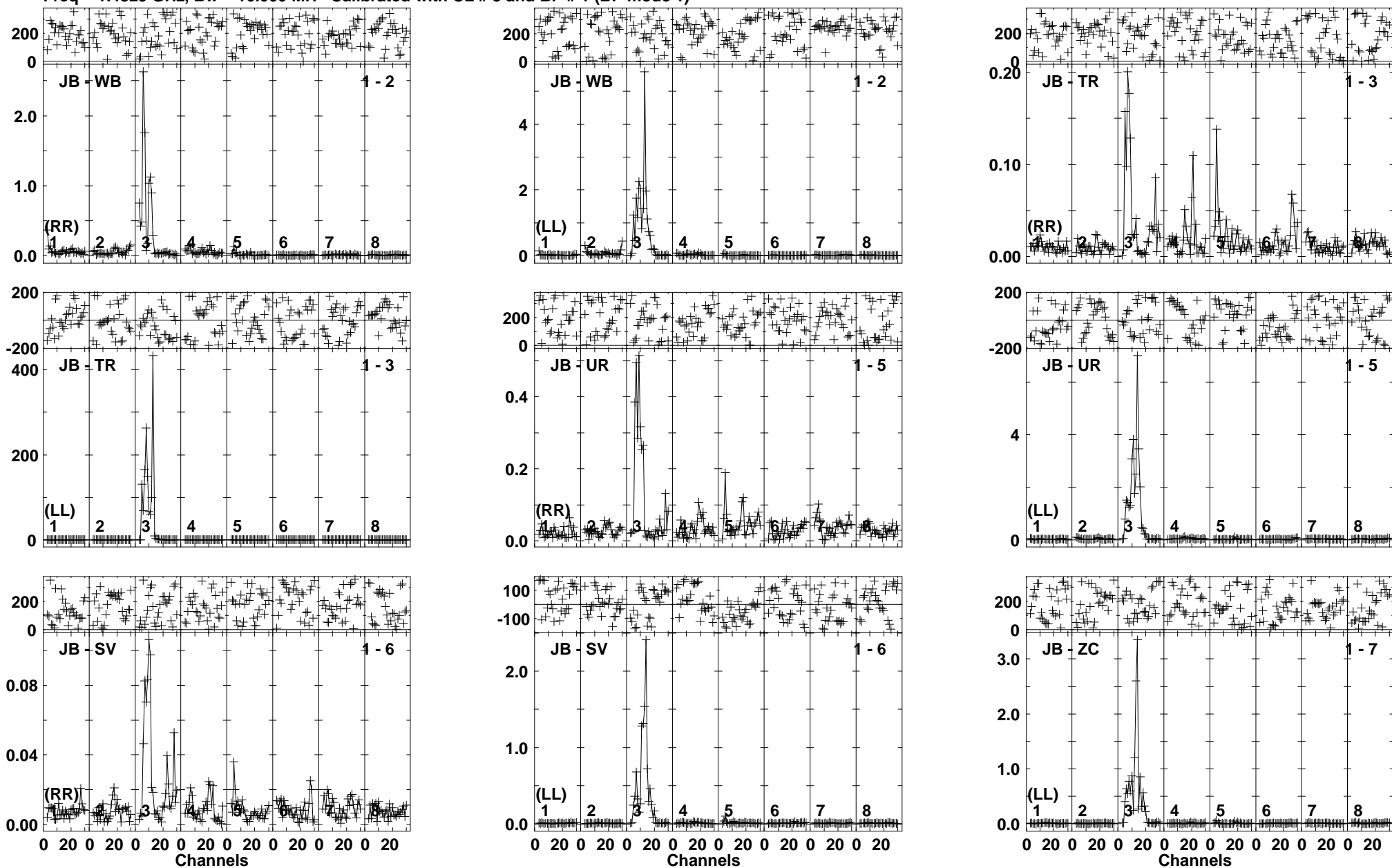

Lower frame: Ampl Jy Top frame: Phas deg
 Vector averaged cross-power spectrum Baseline: JB (01) - WB (02)
 Timerange: 00/04:40:01 to 00/04:43:29

Plot file version 39 created 21-JUN-2019 11:53:34

IRAS12112 EP111A 1.UVDATA.1

Freq = 1.4829 GHz, Bw = 16.000 MH Calibrated with CL # 3 and BP # 1 (BP mode 1)

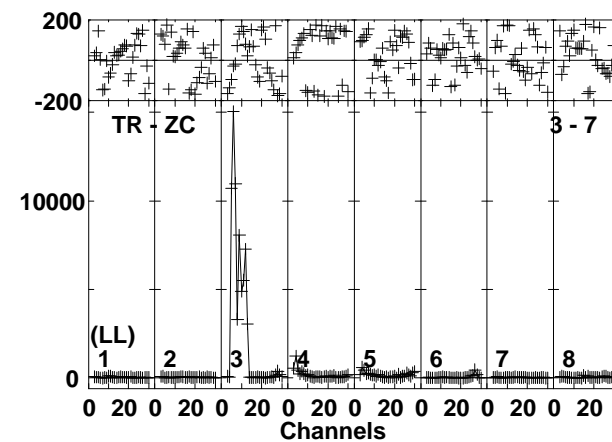
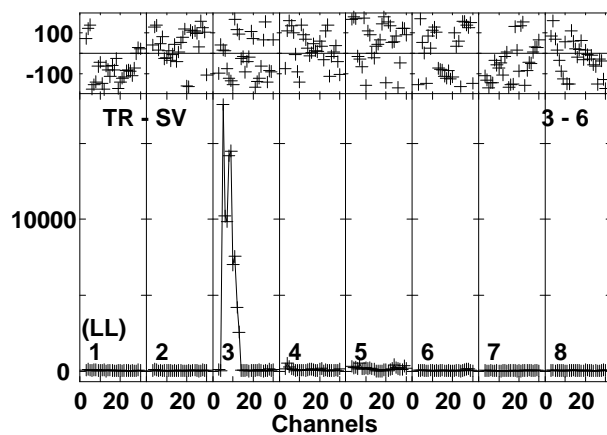
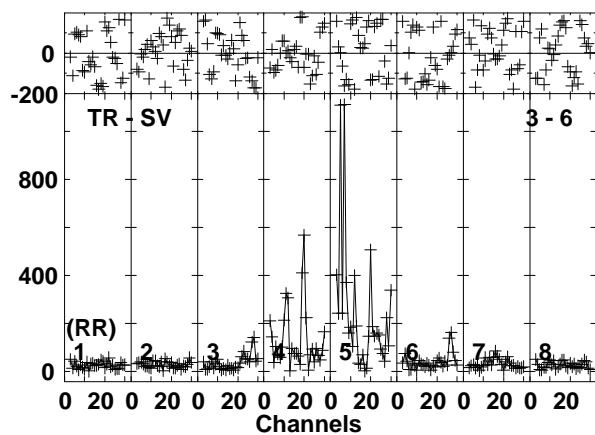
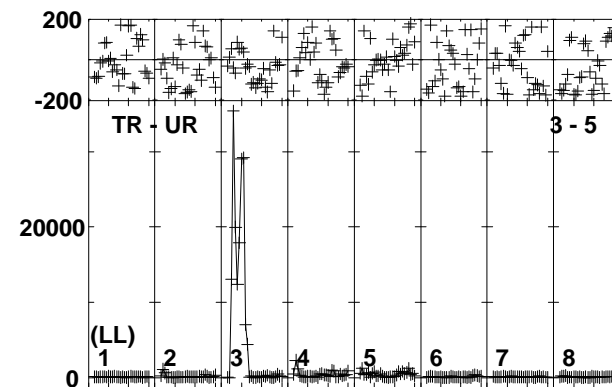
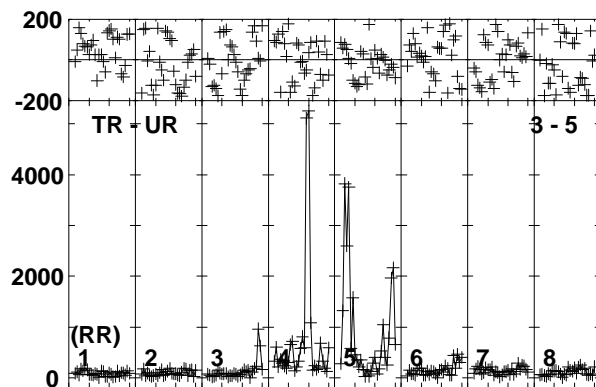
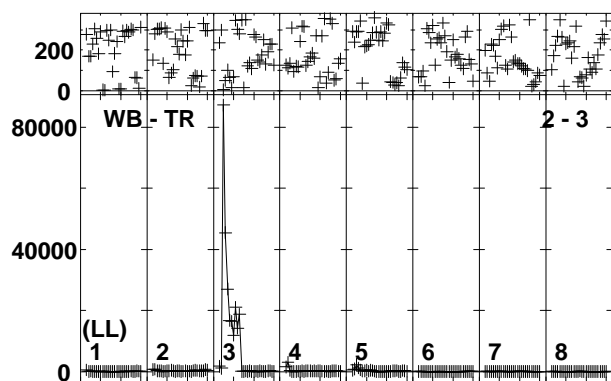
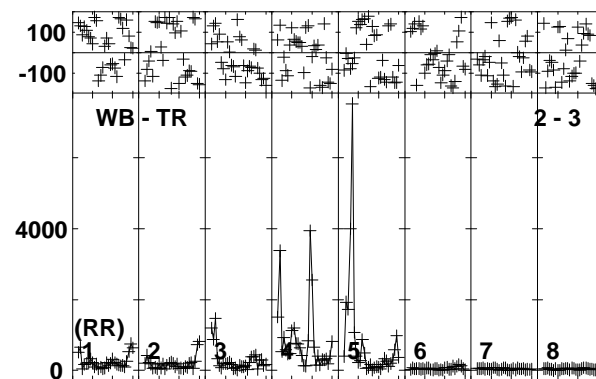
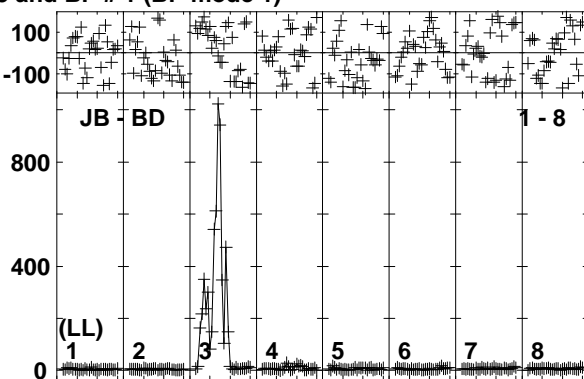
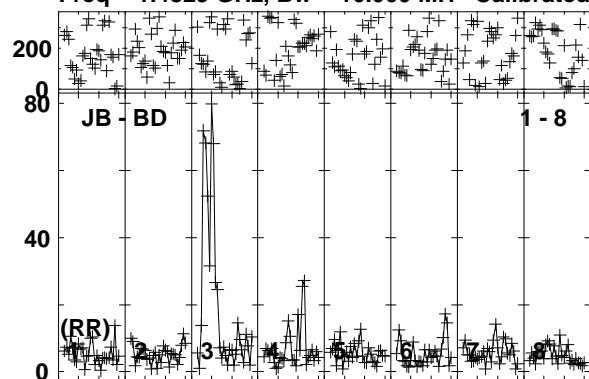

Lower frame: Milli Ampl Jy Top frame: Phas deg
Vector averaged cross-power spectrum Baseline: JB (01) - BD (08)
Timerange: 00/04:40:01 to 00/04:43:29

Plot file version 40 created 21-JUN-2019 11:53:35

IRAS12112 EP111A 1.UVDATA.1

Freq = 1.4829 GHz, Bw = 16.000 MH Calibrated with CL # 3 and BP # 1 (BP mode 1)

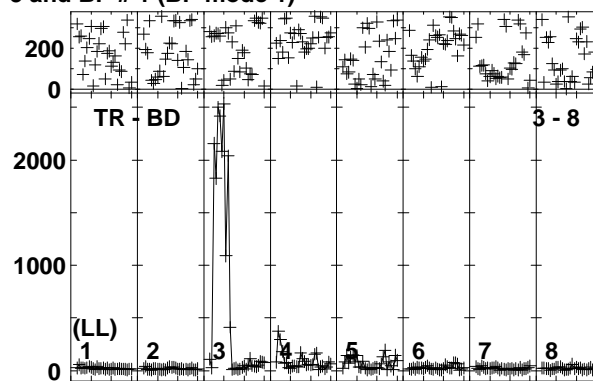
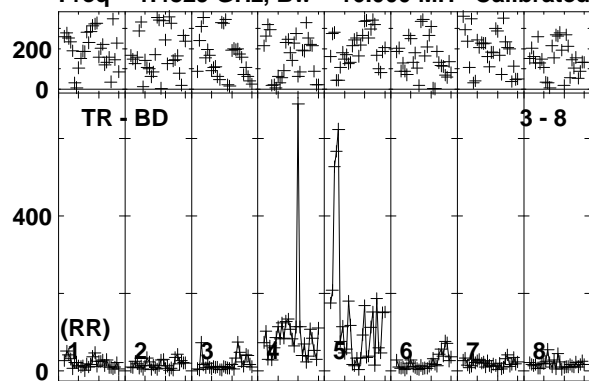

Lower frame: Milli Ampl Jy Top frame: Phas deg
Vector averaged cross-power spectrum Baseline: TR (03) - BD (08)
Timerange: 00/04:40:01 to 00/04:43:29

Plot file version 41 created 21-JUN-2019 11:53:35

J1222+0413 EP111A 1.UVDATA.1

Freq = 1.4829 GHz, Bw = 16.000 MH Calibrated with CL # 3 and BP # 1 (BP mode 1)

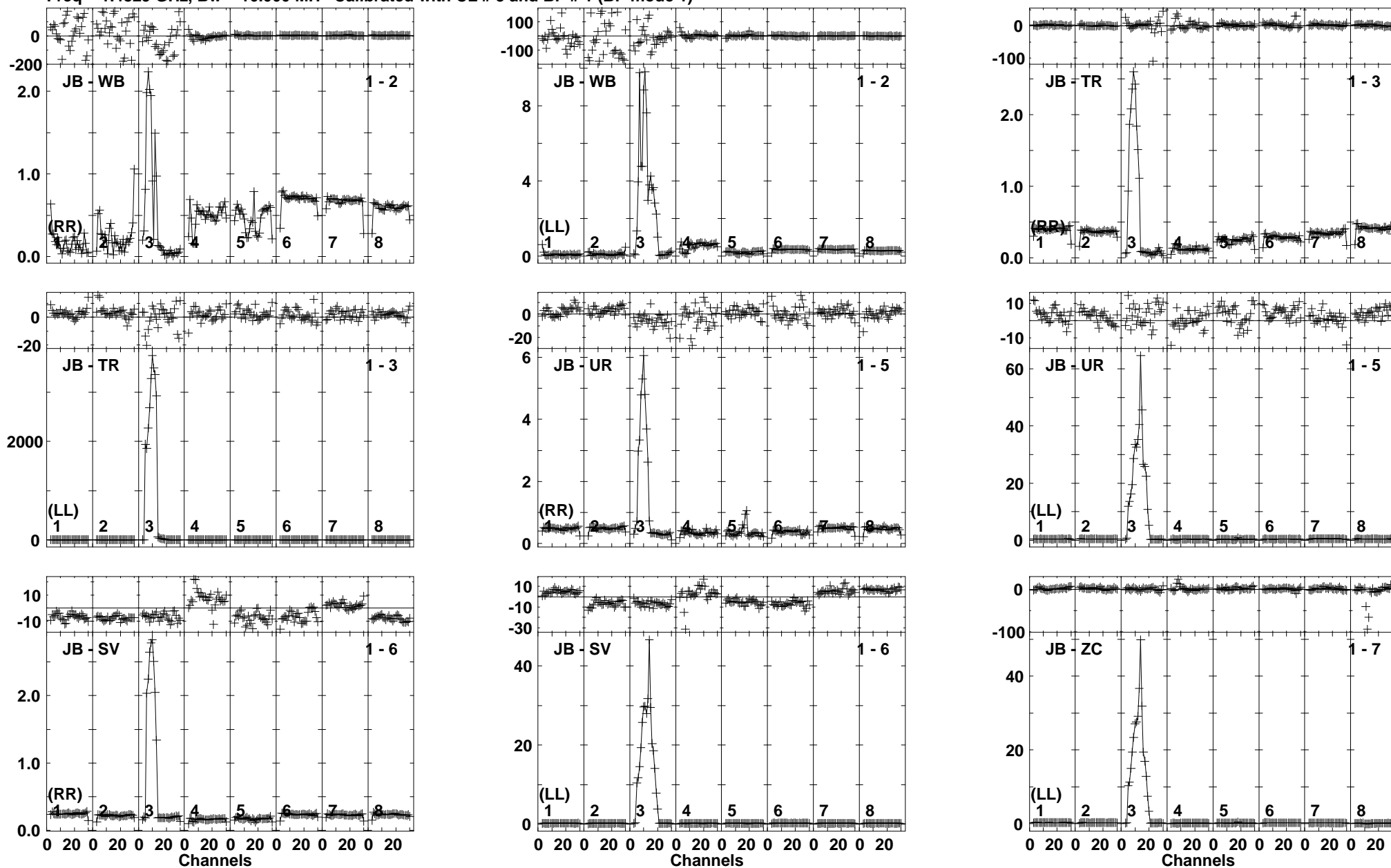

Lower frame: Ampl Jy Top frame: Phas deg
Vector averaged cross-power spectrum Baseline: JB (01) - WB (02)
Timerange: 00/04:44:11 to 00/04:45:39

Plot file version 42 created 21-JUN-2019 11:53:35

J1222+0413 EP111A 1.UVDATA.1

Freq = 1.4829 GHz, Bw = 16.000 MH Calibrated with CL # 3 and BP # 1 (BP mode 1)

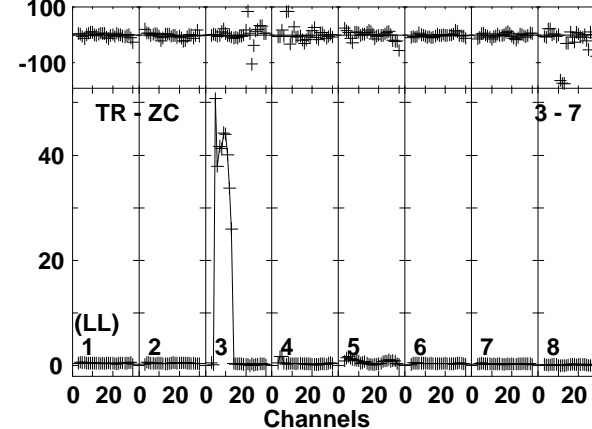
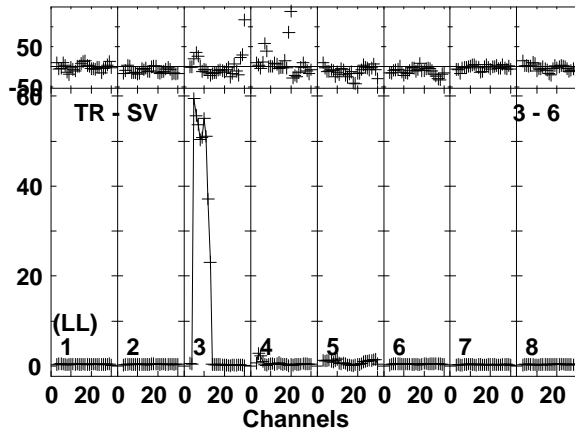
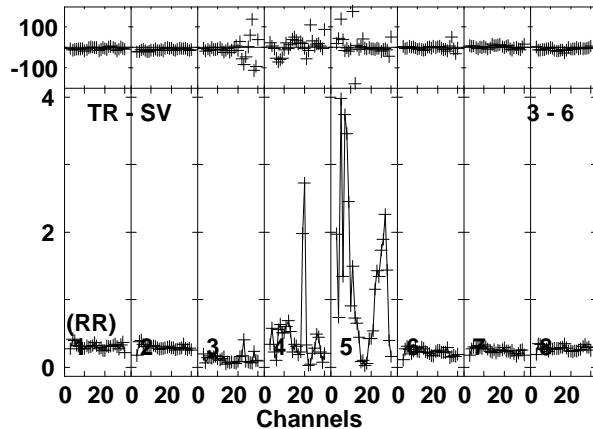
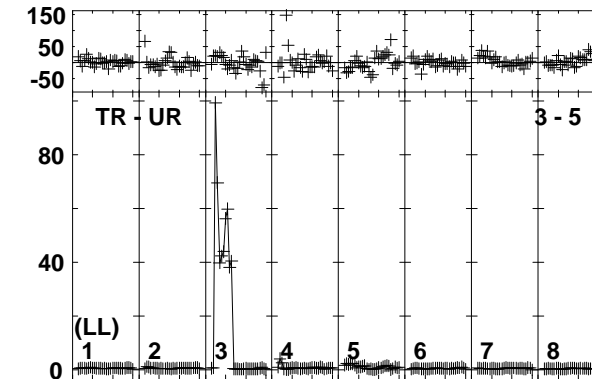
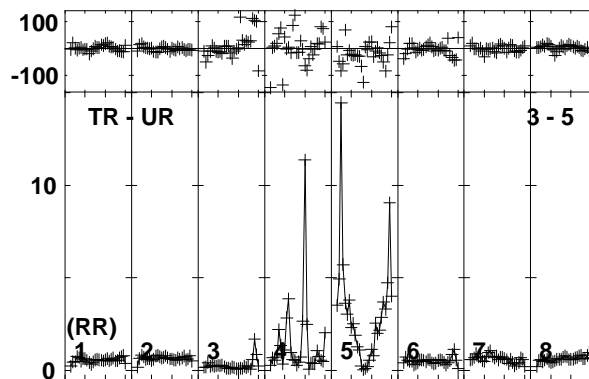
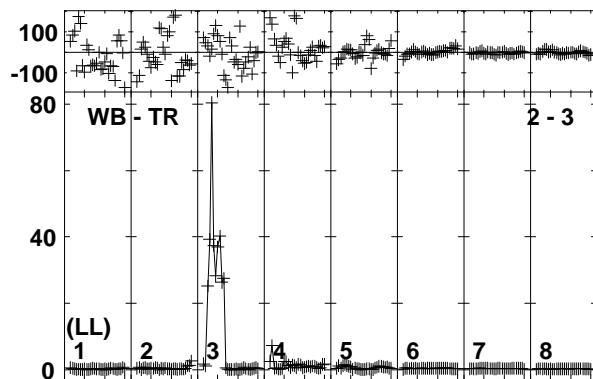
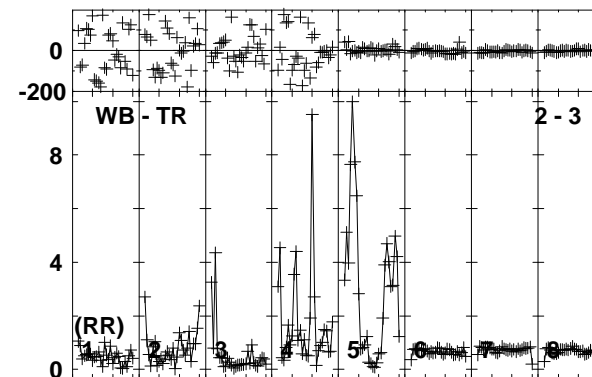
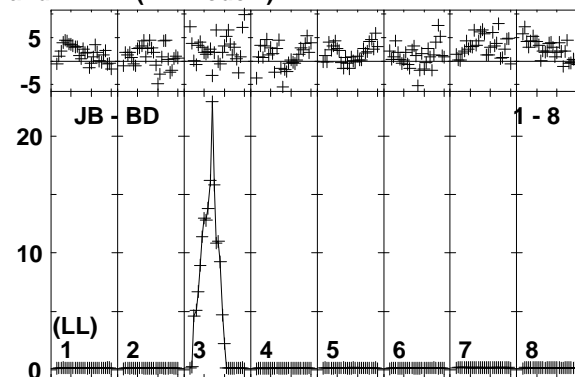
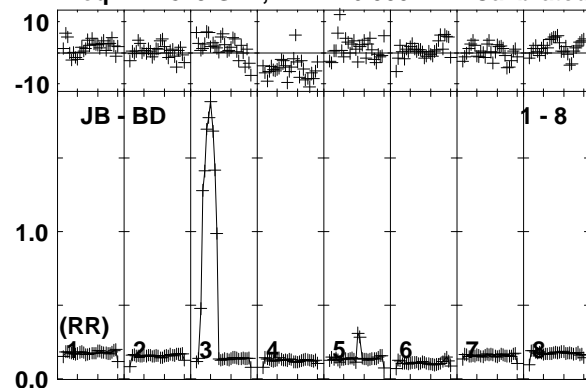

Lower frame: Ampl Jy Top frame: Phas deg
Vector averaged cross-power spectrum Baseline: JB (01) - BD (08)
Timerange: 00/04:44:11 to 00/04:45:39

Plot file version 43 created 21-JUN-2019 11:53:36

J1222+0413 EP111A 1.UVDATA.1

Freq = 1.4829 GHz, Bw = 16.000 MH Calibrated with CL # 3 and BP # 1 (BP mode 1)

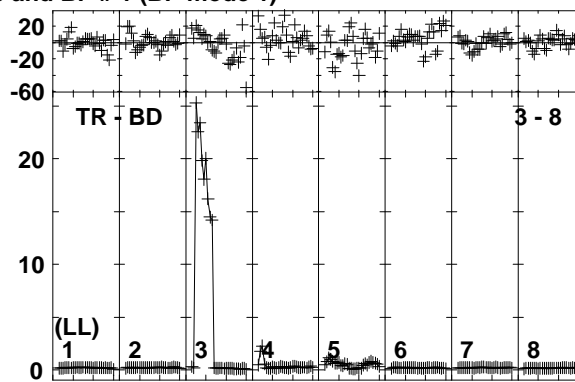
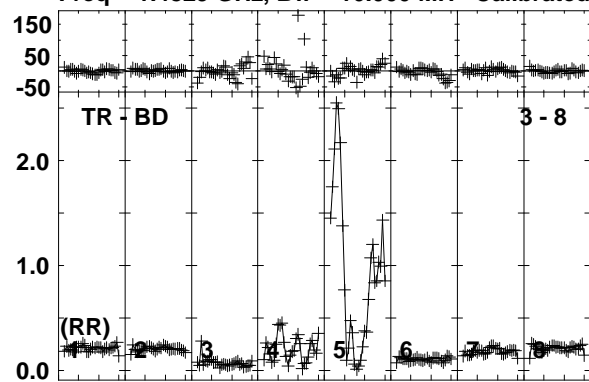

Lower frame: Ampl Jy Top frame: Phas deg
Vector averaged cross-power spectrum Baseline: TR (03) - BD (08)
Timerange: 00/04:44:11 to 00/04:45:39

Plot file version 44 created 21-JUN-2019 11:53:36

IRAS12112 EP111A 1.UVDATA.1

Freq = 1.4829 GHz, Bw = 16.000 MH Calibrated with CL # 3 and BP # 1 (BP mode 1)

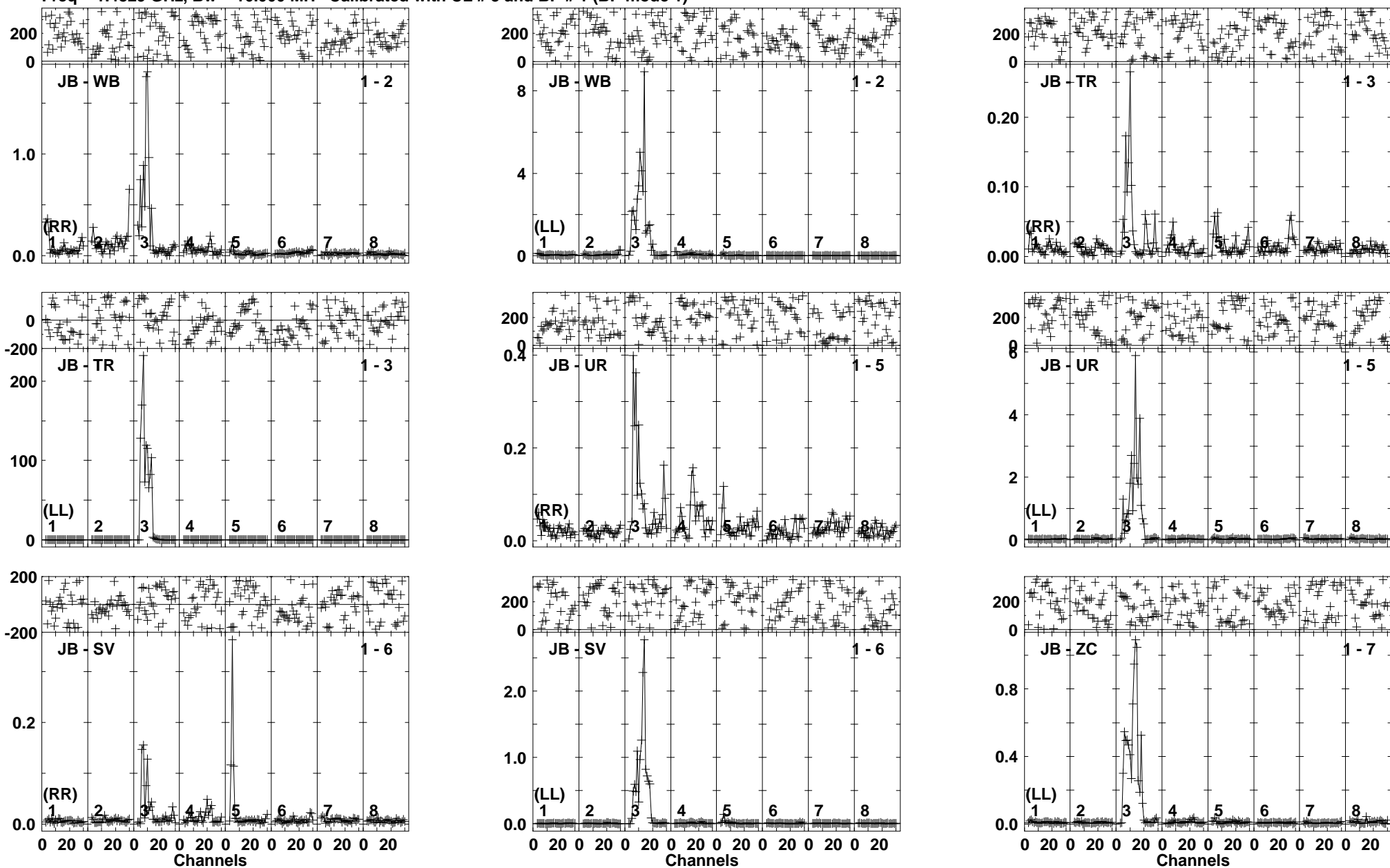

Lower frame: Ampl Jy Top frame: Phas deg
Vector averaged cross-power spectrum Baseline: JB (01) - WB (02)
Timerange: 00/04:45:41 to 00/04:50:23

Plot file version 45 created 21-JUN-2019 11:53:36

IRAS12112 EP111A 1.UVDATA.1

Freq = 1.4829 GHz, Bw = 16.000 MH Calibrated with CL # 3 and BP # 1 (BP mode 1)

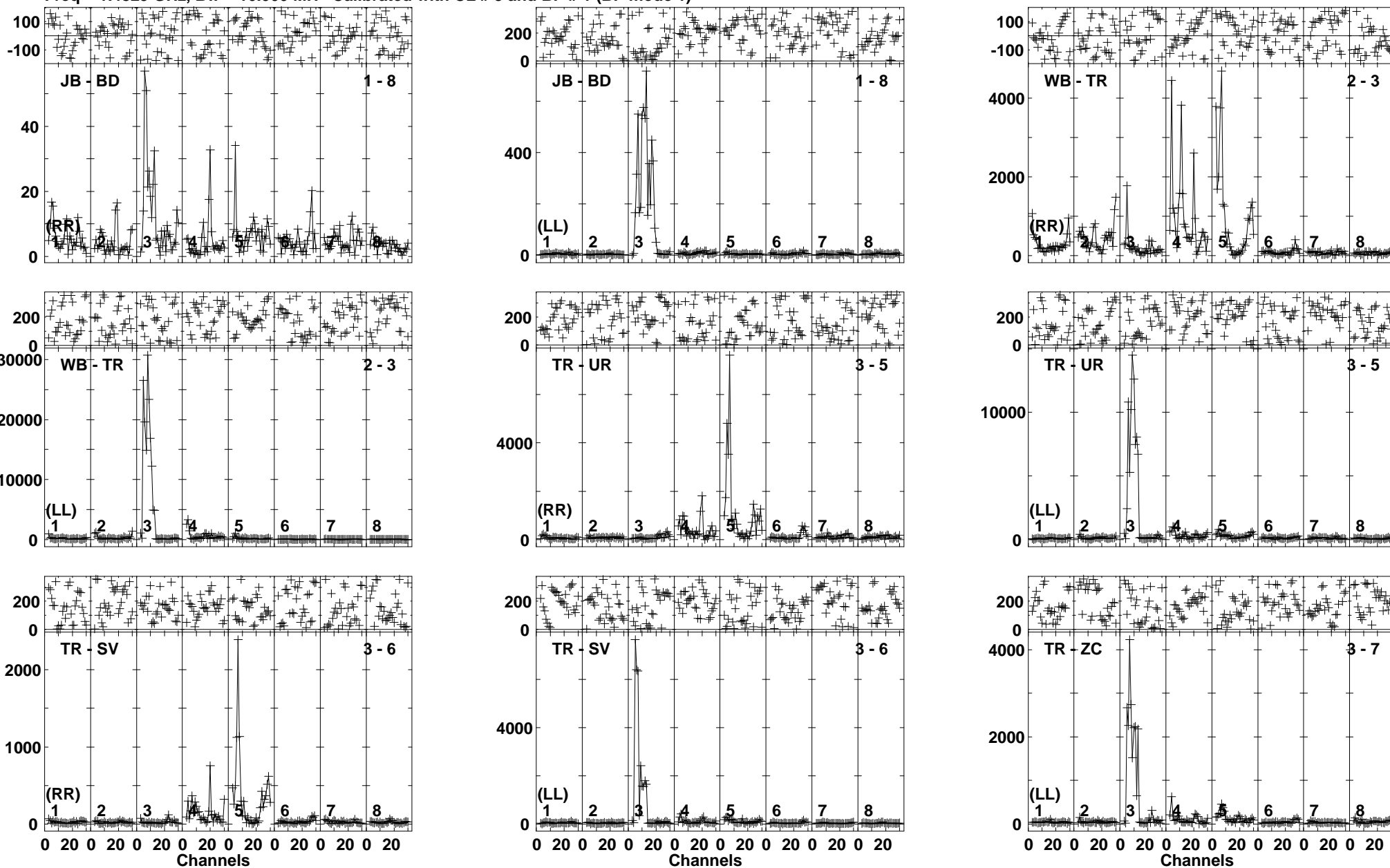

Lower frame: Milli Ampl Jy Top frame: Phas deg
Vector averaged cross-power spectrum Baseline: JB (01) - BD (08)
Timerange: 00/04:45:41 to 00/04:50:23

Plot file version 46 created 21-JUN-2019 11:53:37

IRAS12112 EP111A 1.UVDATA.1

Freq = 1.4829 GHz, Bw = 16.000 MH Calibrated with CL # 3 and BP # 1 (BP mode 1)

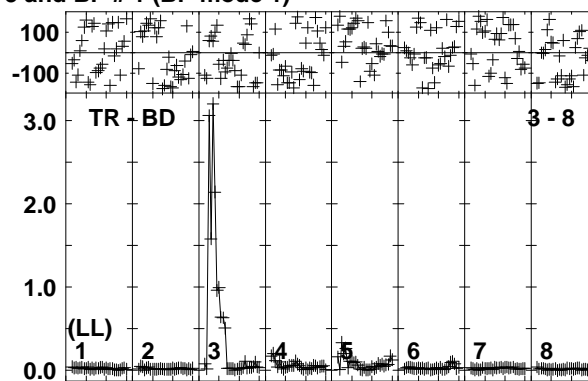
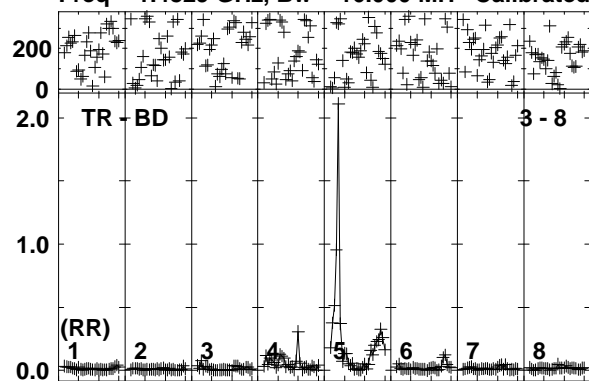

Lower frame: Ampl Jy Top frame: Phas deg
Vector averaged cross-power spectrum Baseline: TR (03) - BD (08)
Timerange: 00/04:45:41 to 00/04:50:23

Plot file version 47 created 21-JUN-2019 11:53:37

J1222+0413 EP111A 1.UVDATA.1

Freq = 1.4829 GHz, Bw = 16.000 MH Calibrated with CL # 3 and BP # 1 (BP mode 1)

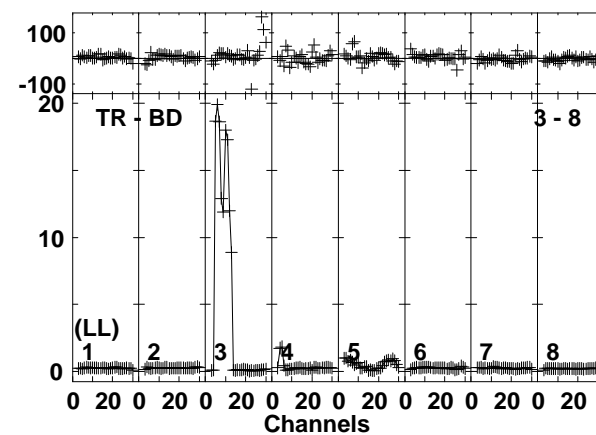
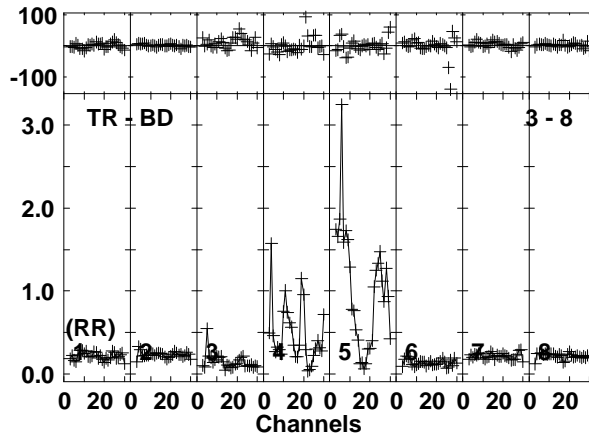
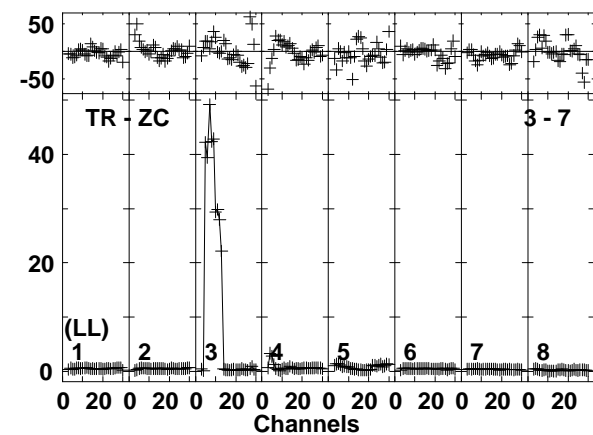
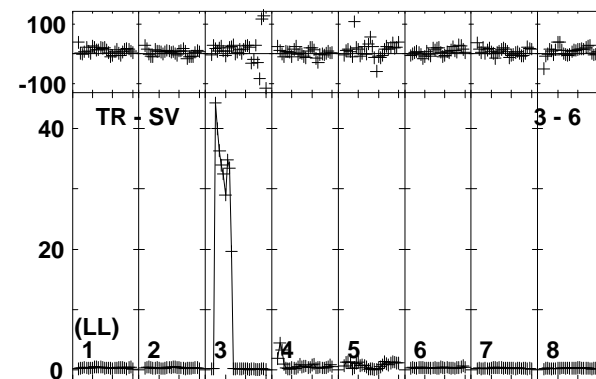
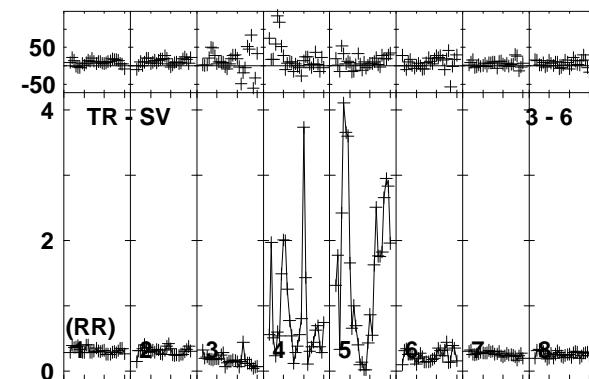
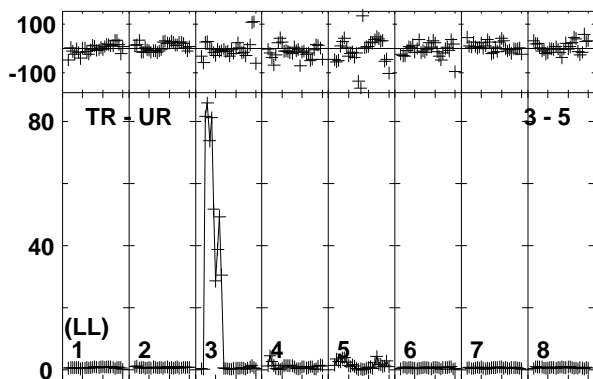
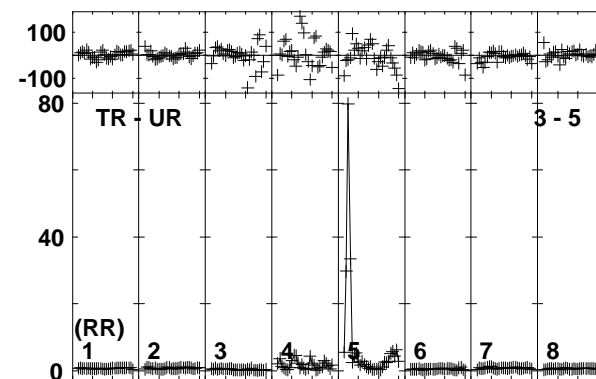
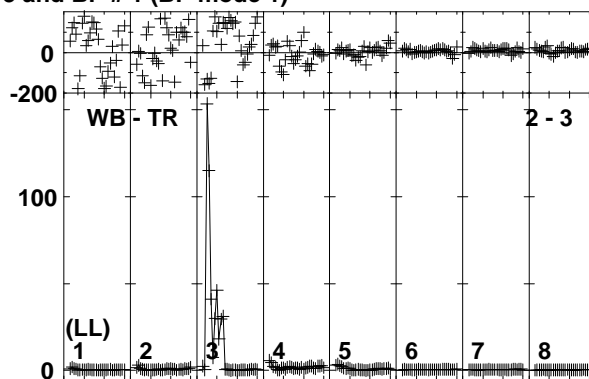
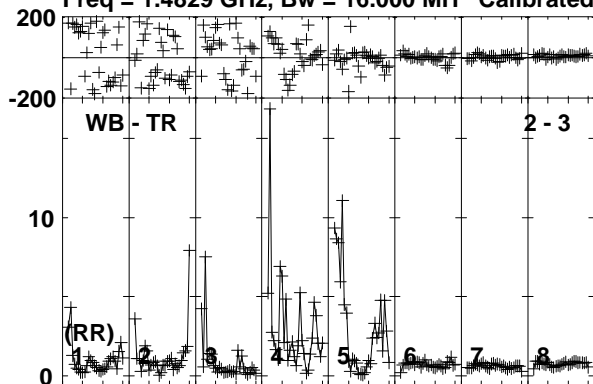

Lower frame: Ampl Jy Top frame: Phas deg
Vector averaged cross-power spectrum Baseline: WB (02) - TR (03)
Timerange: 00/04:50:26 to 00/04:51:54

Plot file version 48 created 21-JUN-2019 11:53:38

IRAS12112 EP111A 1.UVDATA.1

Freq = 1.4829 GHz, Bw = 16.000 MH Calibrated with CL # 3 and BP # 1 (BP mode 1)

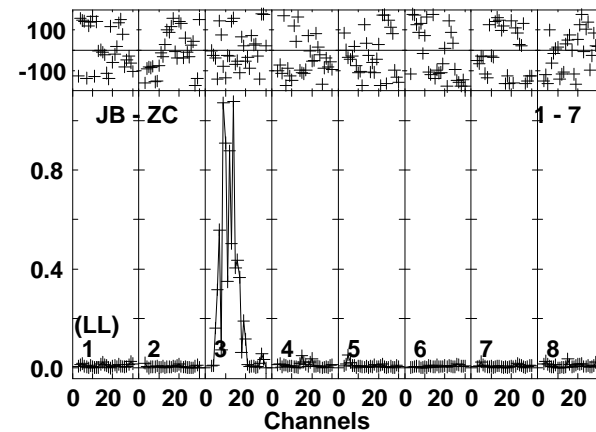
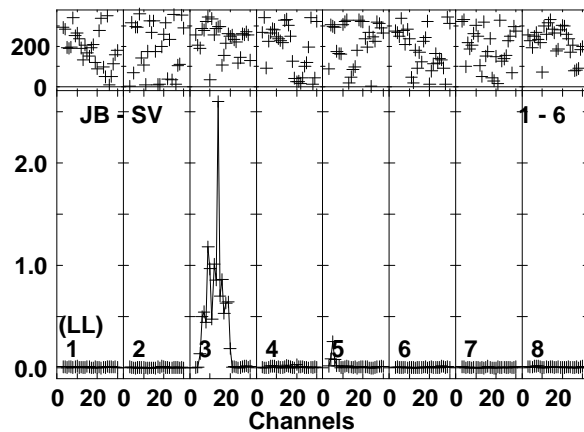
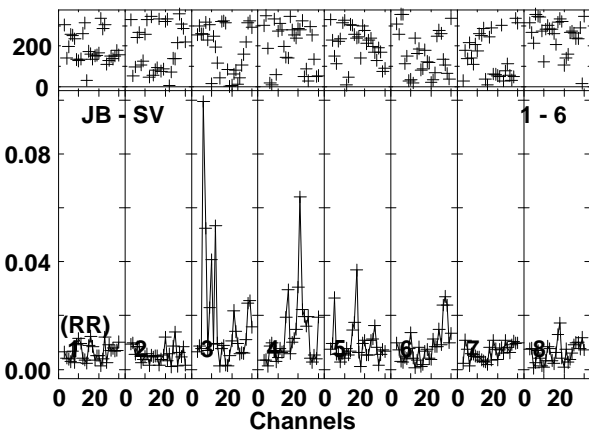
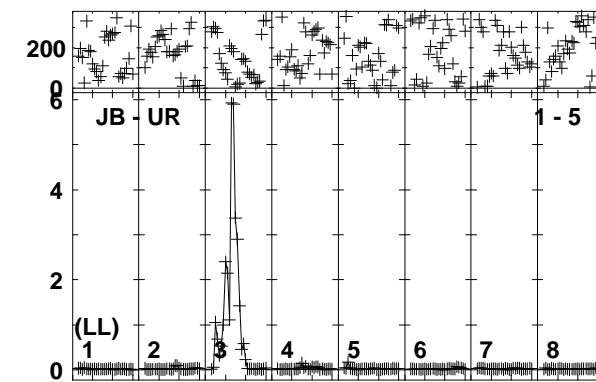
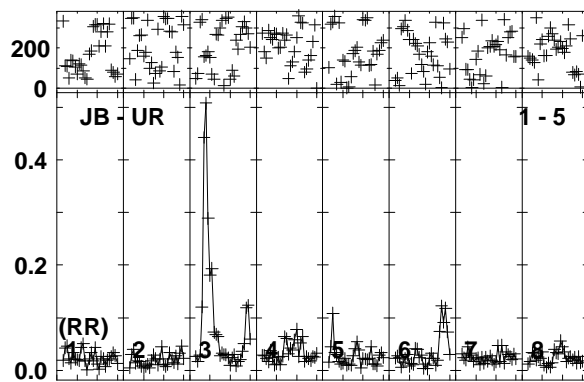
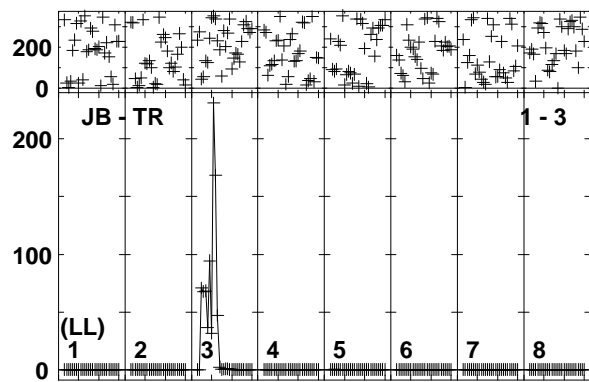
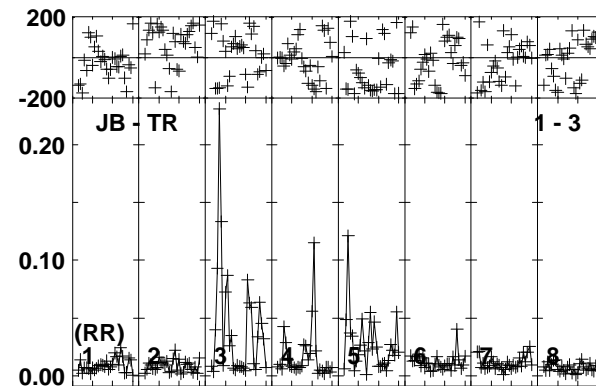
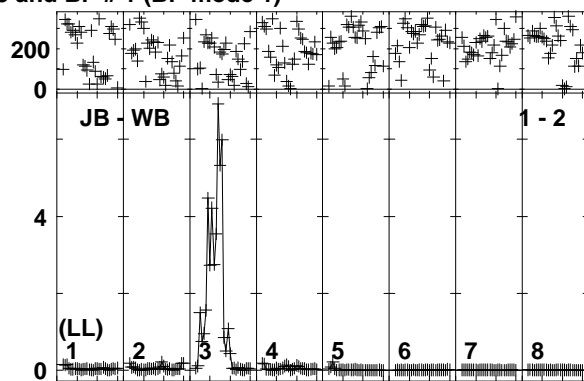
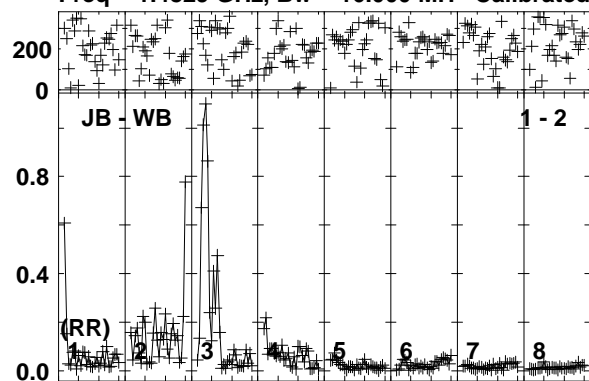

Lower frame: Ampl Jy Top frame: Phas deg
Vector averaged cross-power spectrum Baseline: JB (01) - WB (02)
Timerange: 00/04:51:56 to 00/04:56:38

Plot file version 49 created 21-JUN-2019 11:53:38

IRAS12112 EP111A 1.UVDATA.1

Freq = 1.4829 GHz, Bw = 16.000 MH Calibrated with CL # 3 and BP # 1 (BP mode 1)

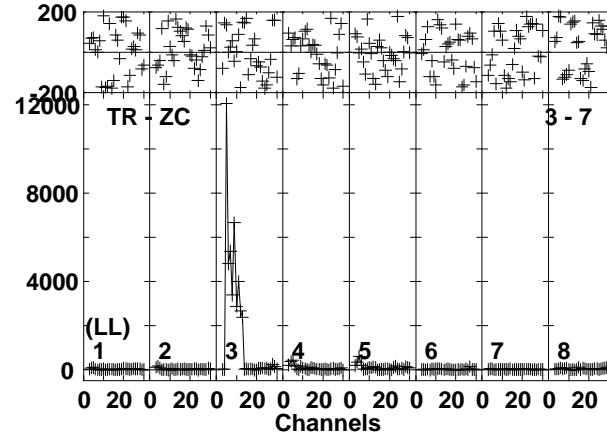
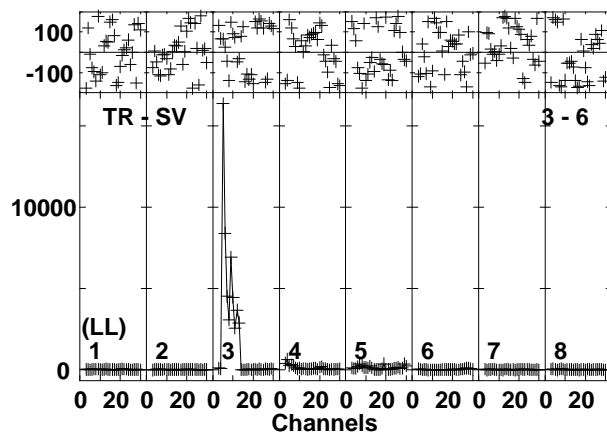
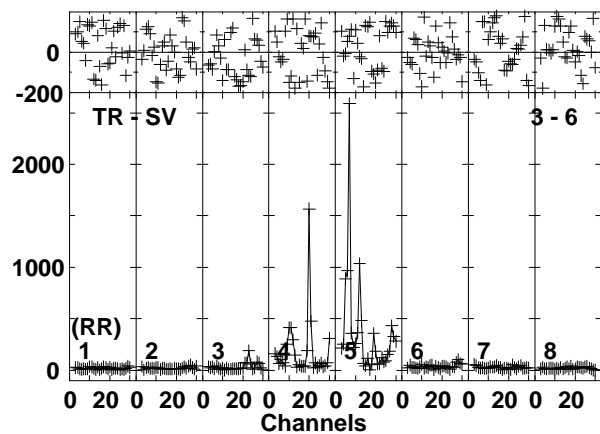
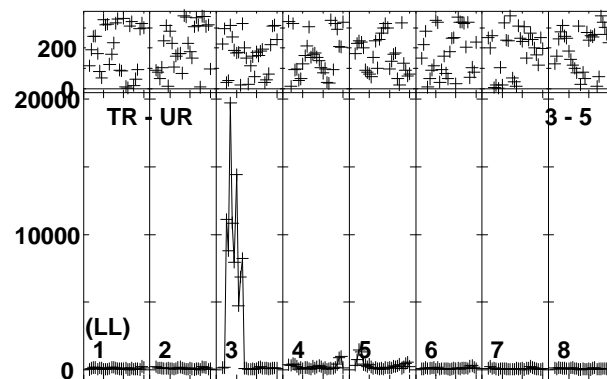
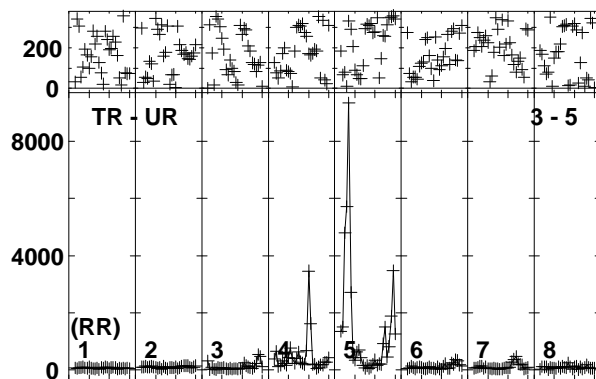
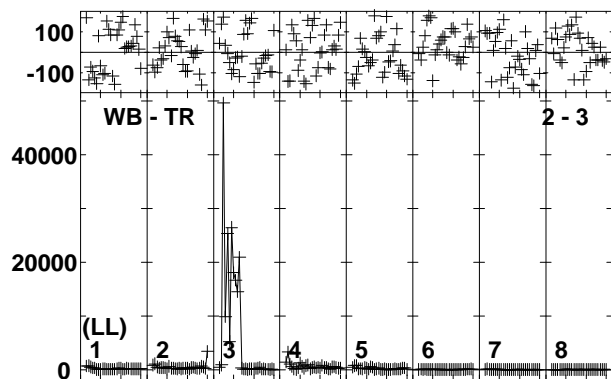
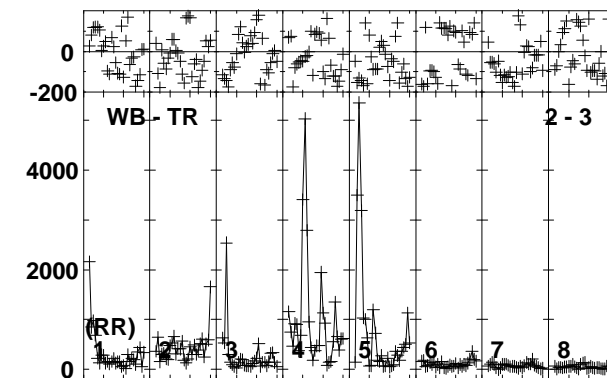
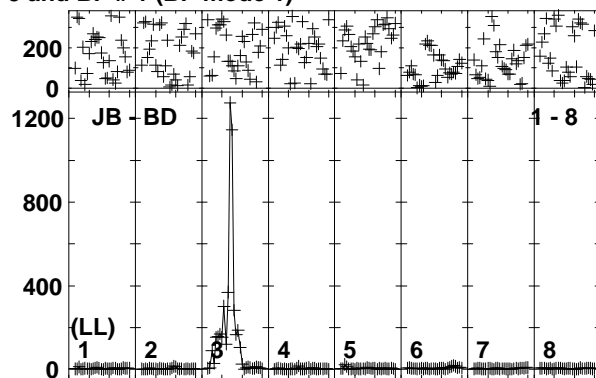
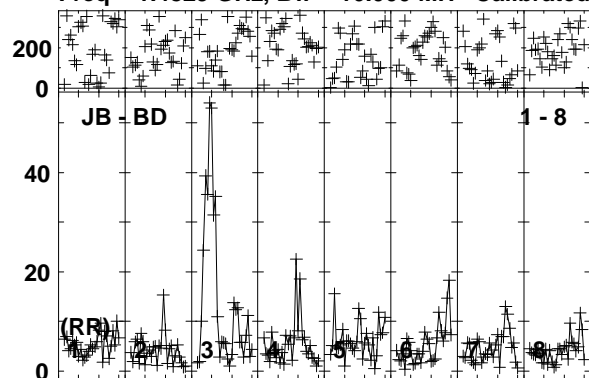

Lower frame: Milli Ampl Jy Top frame: Phas deg
Vector averaged cross-power spectrum Baseline: JB (01) - BD (08)
Timerange: 00/04:51:56 to 00/04:56:38

Plot file version 50 created 21-JUN-2019 11:53:39

IRAS12112 EP111A 1.UVDATA.1

Freq = 1.4829 GHz, Bw = 16.000 MH Calibrated with CL # 3 and BP # 1 (BP mode 1)

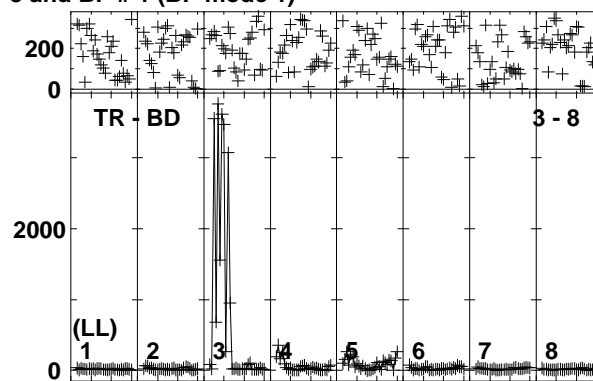
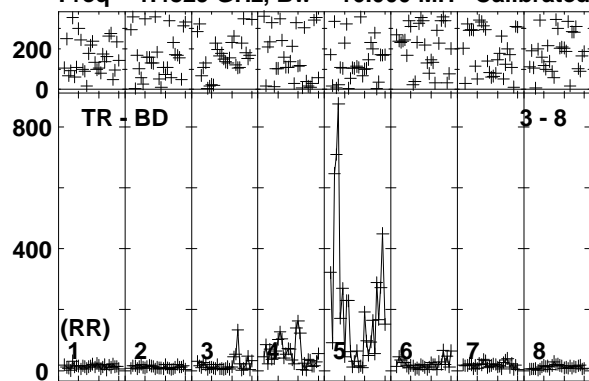

Lower frame: Milli Ampl Jy Top frame: Phas deg
Vector averaged cross-power spectrum Baseline: TR (03) - BD (08)
Timerange: 00/04:51:56 to 00/04:56:38

Plot file version 51 created 21-JUN-2019 11:53:39

J1222+0413 EP111A 1.UVDATA.1

Freq = 1.4829 GHz, Bw = 16.000 MH Calibrated with CL # 3 and BP # 1 (BP mode 1)

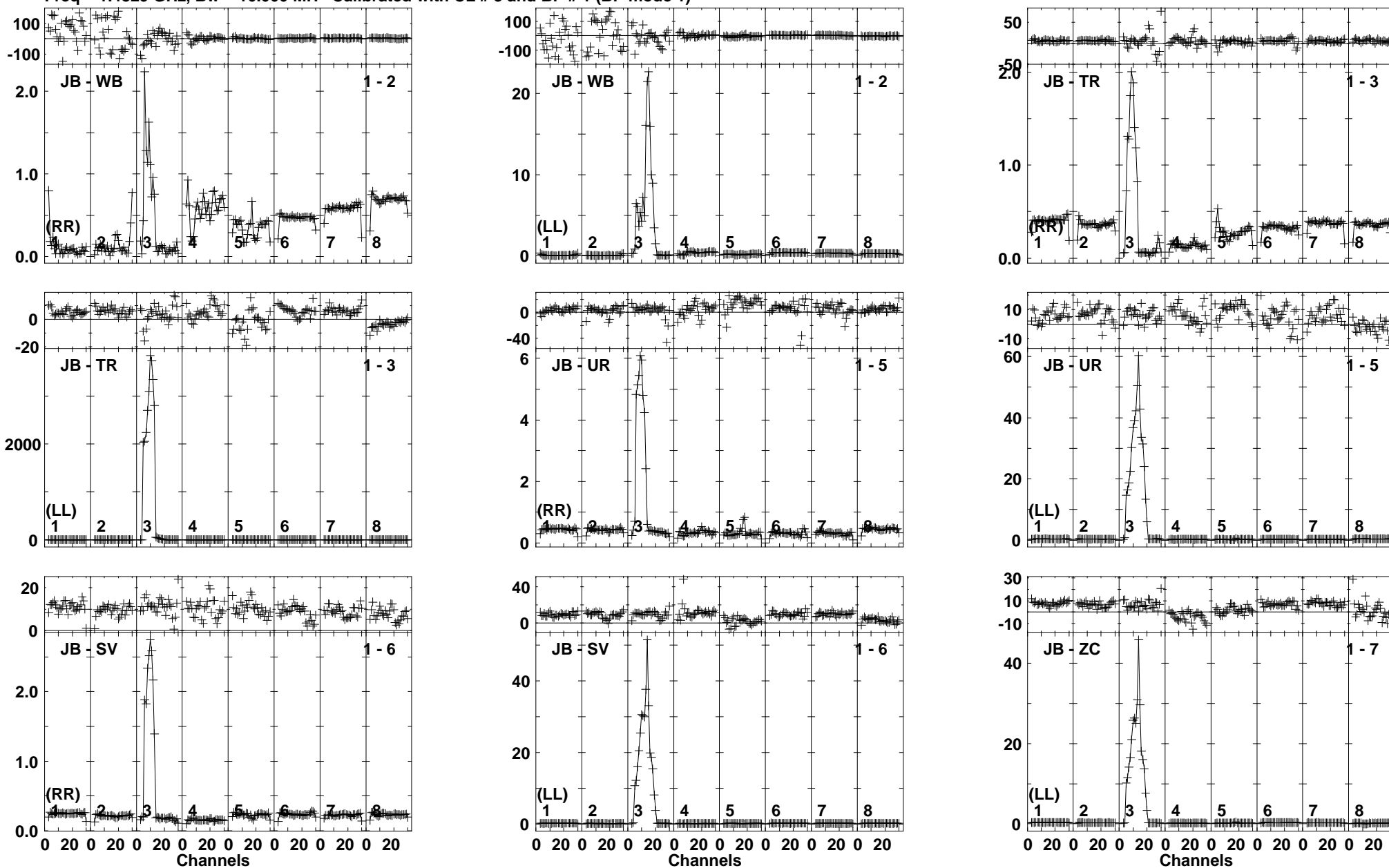

Lower frame: Ampl Jy Top frame: Phas deg
Vector averaged cross-power spectrum Baseline: JB (01) - WB (02)
Timerange: 00/04:57:21 to 00/04:58:49

Plot file version 52 created 21-JUN-2019 11:53:39

J1222+0413 EP111A 1.UVDATA.1

Freq = 1.4829 GHz, Bw = 16.000 MH Calibrated with CL # 3 and BP # 1 (BP mode 1)

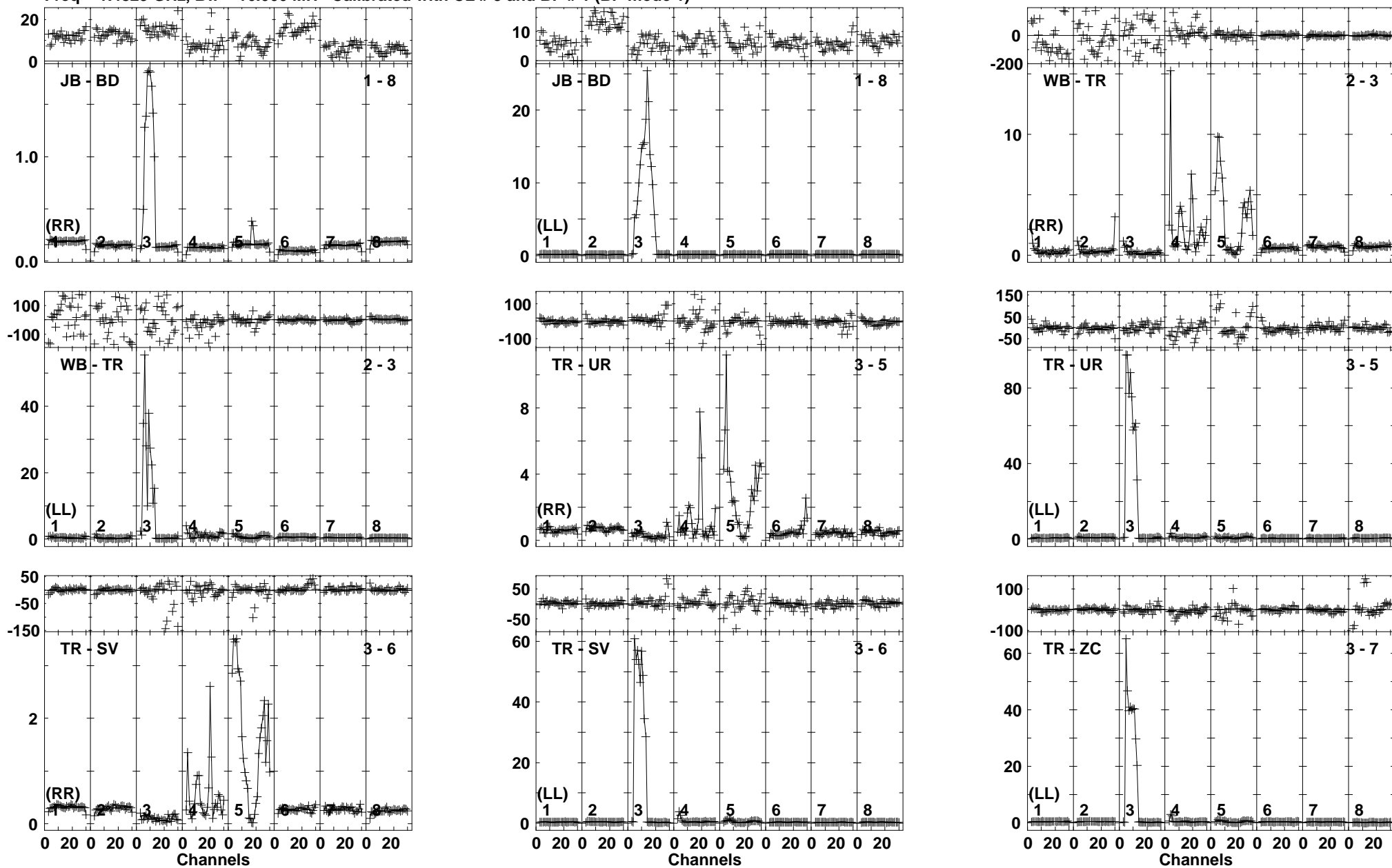

Lower frame: Ampl Jy Top frame: Phas deg
Vector averaged cross-power spectrum Baseline: JB (01) - BD (08)
Timerange: 00/04:57:21 to 00/04:58:49

Plot file version 53 created 21-JUN-2019 11:53:40

J1222+0413 EP111A 1.UVDATA.1

Freq = 1.4829 GHz, Bw = 16.000 MH Calibrated with CL # 3 and BP # 1 (BP mode 1)

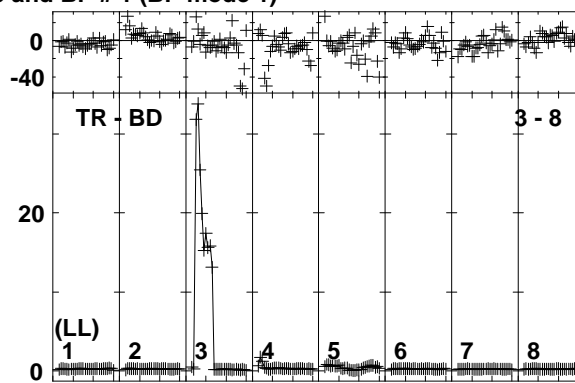
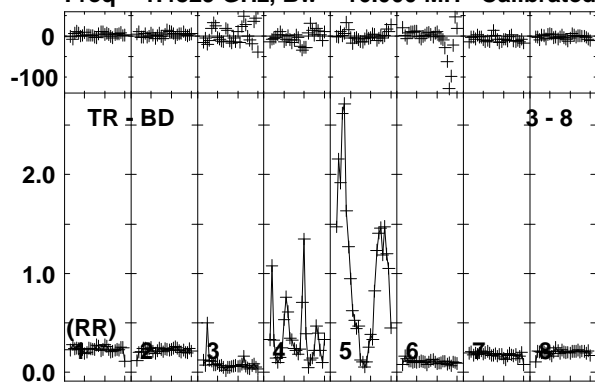

Lower frame: Ampl Jy Top frame: Phas deg
Vector averaged cross-power spectrum Baseline: TR (03) - BD (08)
Timerange: 00/04:57:21 to 00/04:58:49

Plot file version 54 created 21-JUN-2019 11:53:40

J1152-0841 EP111A 1.UVDATA.1

Freq = 1.4829 GHz, Bw = 16.000 MH Calibrated with CL # 3 and BP # 1 (BP mode 1)

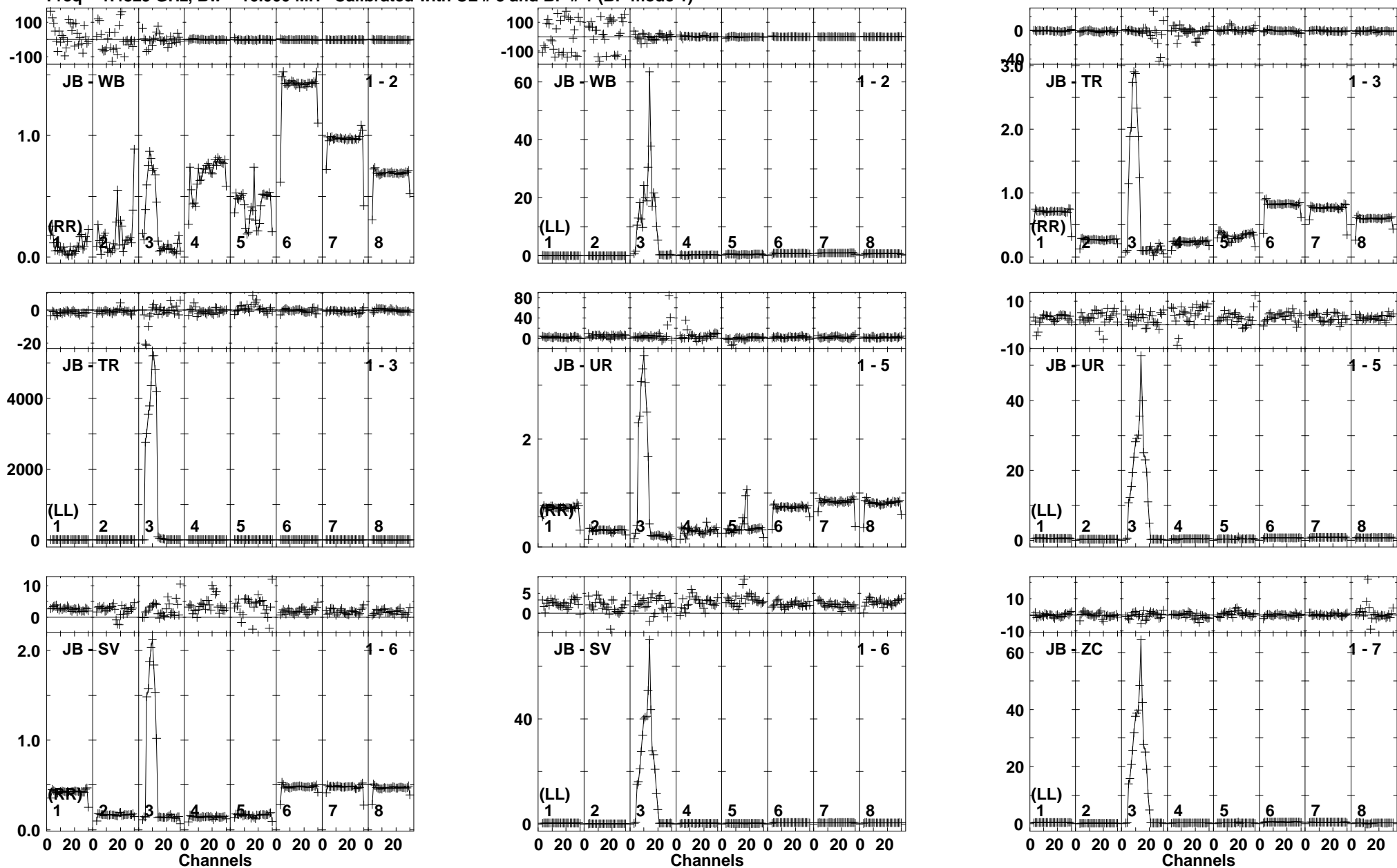

Lower frame: Ampl Jy Top frame: Phas deg
Vector averaged cross-power spectrum Baseline: JB (01) - WB (02)
Timerange: 00/05:00:16 to 00/05:04:14

Plot file version 55 created 21-JUN-2019 11:53:40

J1152-0841 EP111A 1.UVDATA.1

Freq = 1.4829 GHz, Bw = 16.000 MH Calibrated with CL # 3 and BP # 1 (BP mode 1)

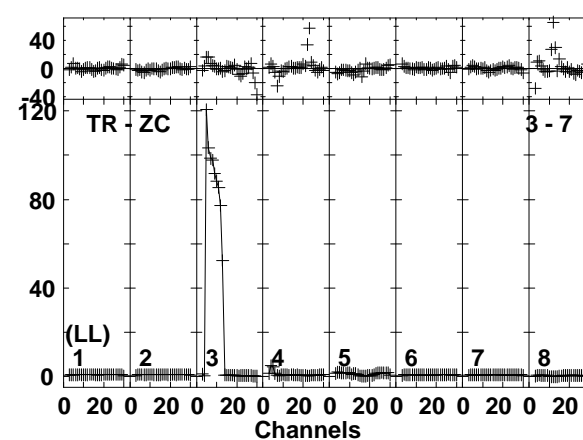
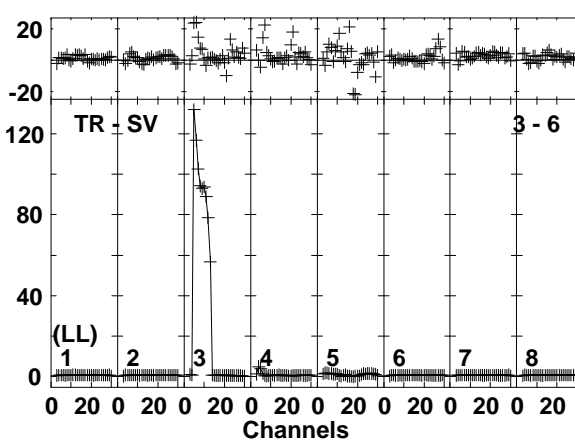
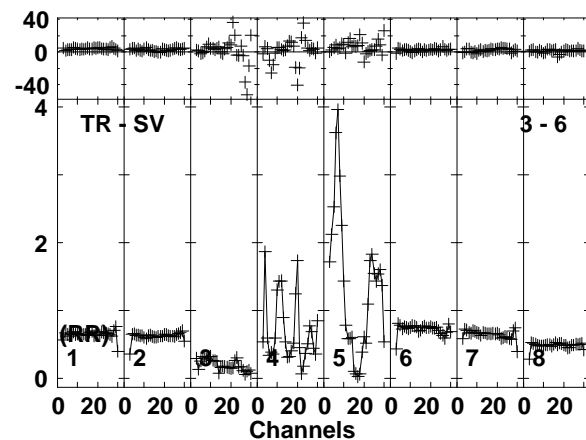
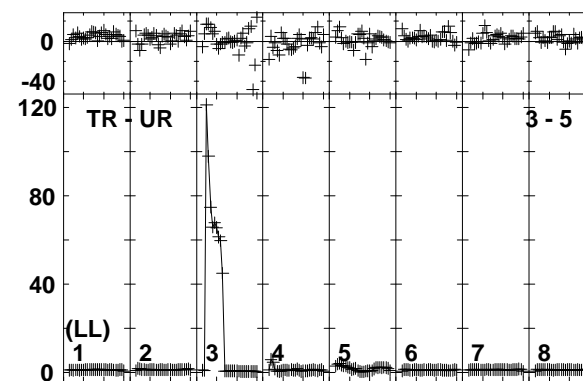
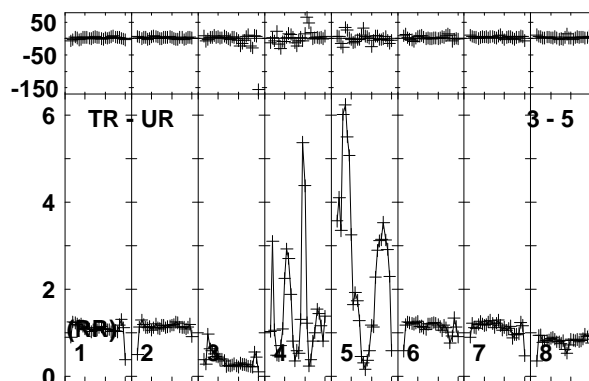
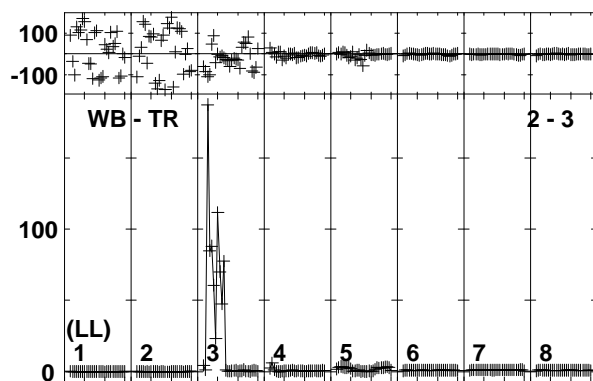
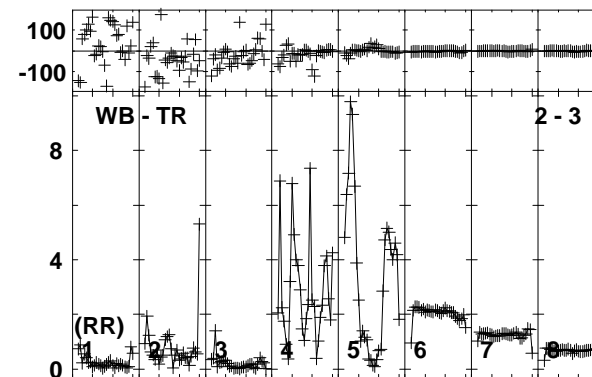
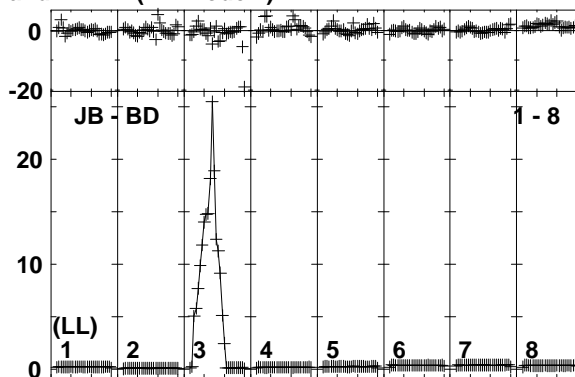
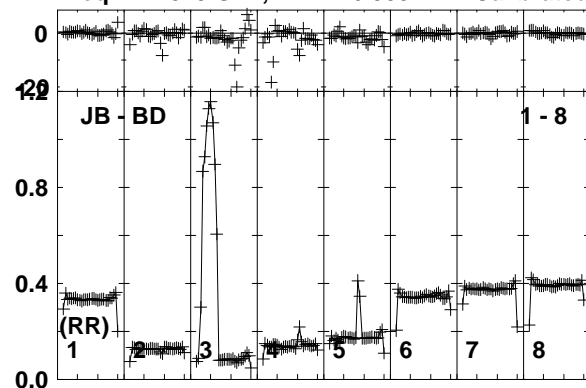

Lower frame: Ampl Jy Top frame: Phas deg
Vector averaged cross-power spectrum Baseline: JB (01) - BD (08)
Timerange: 00/05:00:16 to 00/05:04:14

Plot file version 56 created 21-JUN-2019 11:53:41

J1152-0841 EP1111A 1.UVDATA.1

Freq = 1.4829 GHz, Bw = 16.000 MH Calibrated with CL # 3 and BP # 1 (BP mode 1)

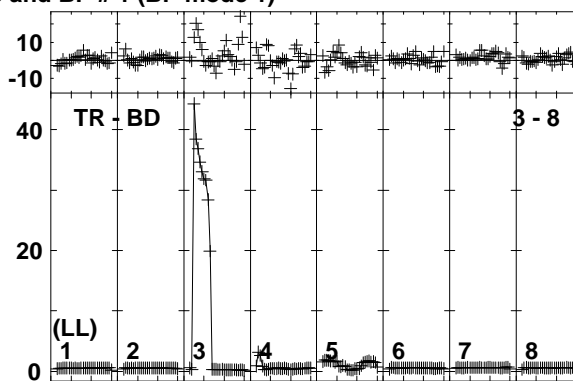
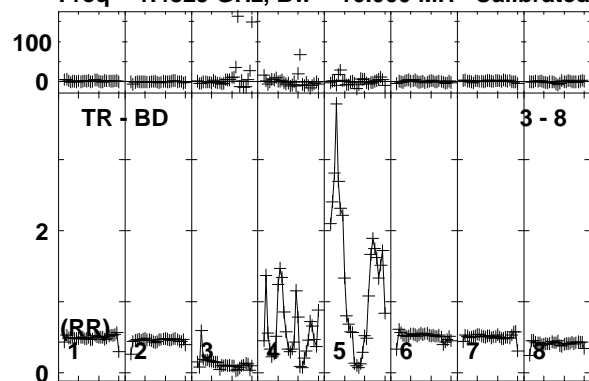

Lower frame: Ampl Jy Top frame: Phas deg
Vector averaged cross-power spectrum Baseline: TR (03) - BD (08)
Timerange: 00/05:00:16 to 00/05:04:14

Plot file version 57 created 21-JUN-2019 11:53:41

J1222+0413 EP111A 1.UVDATA.1

Freq = 1.4829 GHz, Bw = 16.000 MH Calibrated with CL # 3 and BP # 1 (BP mode 1)

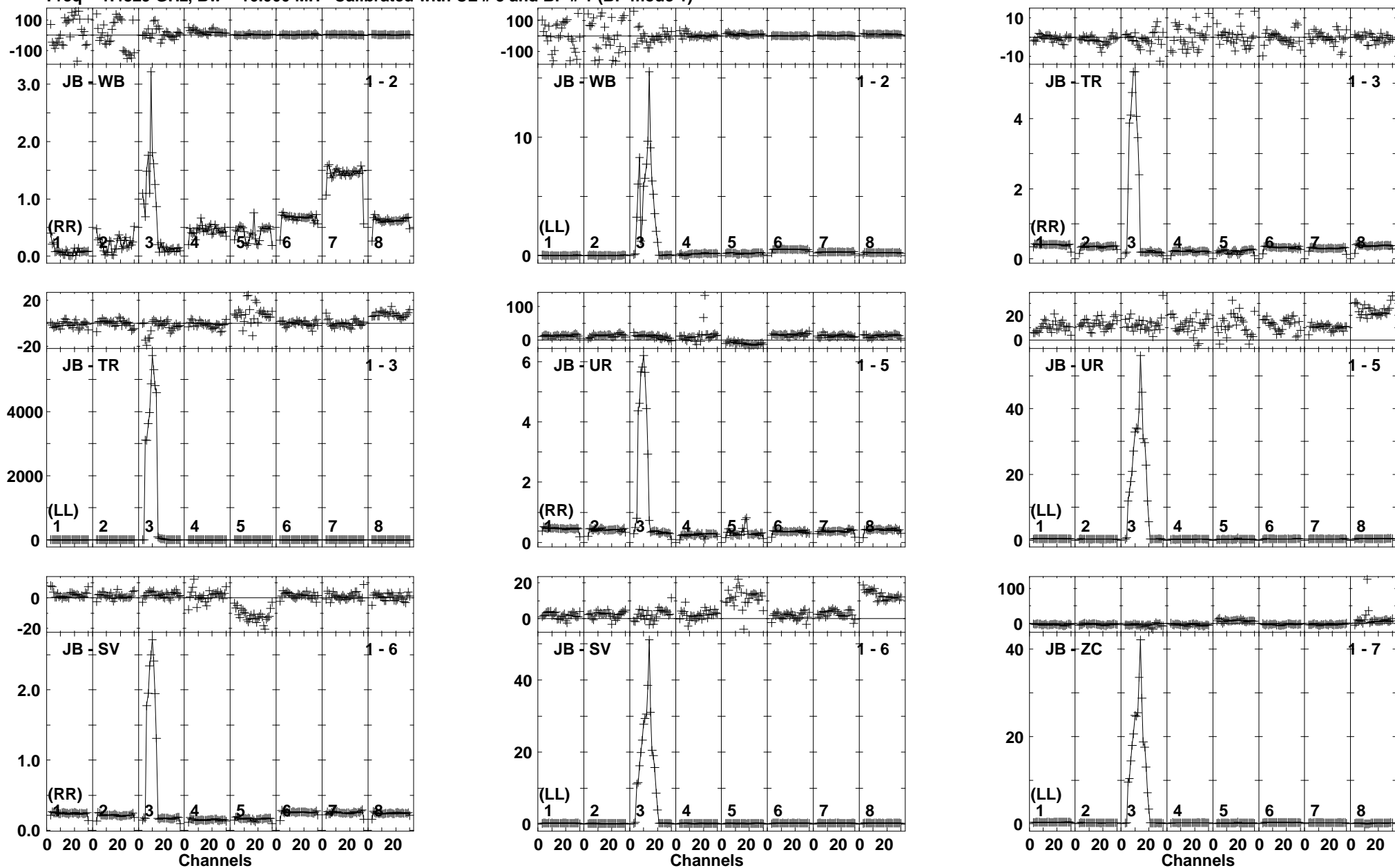

Lower frame: Ampl Jy Top frame: Phas deg
Vector averaged cross-power spectrum Baseline: JB (01) - WB (02)
Timerange: 00/05:05:36 to 00/05:07:34

Plot file version 58 created 21-JUN-2019 11:53:42

J1222+0413 EP111A 1.UVDATA.1

Freq = 1.4829 GHz, Bw = 16.000 MH Calibrated with CL # 3 and BP # 1 (BP mode 1)

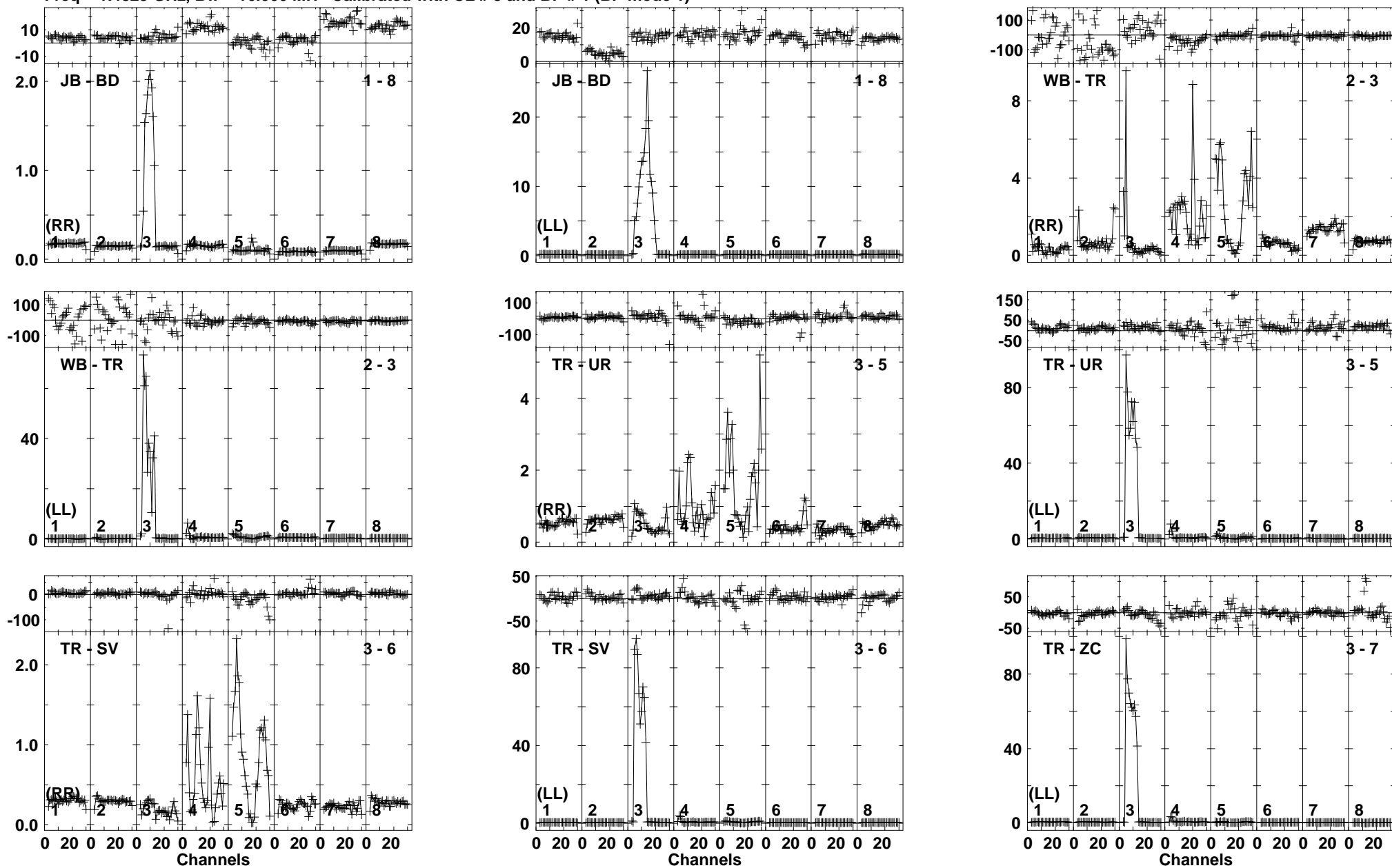

Lower frame: Ampl Jy Top frame: Phas deg
Vector averaged cross-power spectrum Baseline: JB (01) - BD (08)
Timerange: 00/05:05:36 to 00/05:07:34

Plot file version 59 created 21-JUN-2019 11:53:42

J1222+0413 EP111A 1.UVDATA.1

Freq = 1.4829 GHz, Bw = 16.000 MH Calibrated with CL # 3 and BP # 1 (BP mode 1)

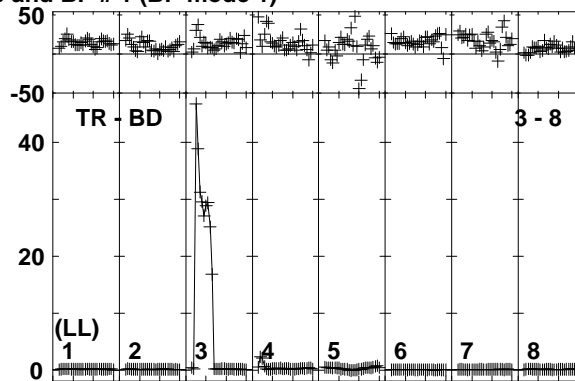
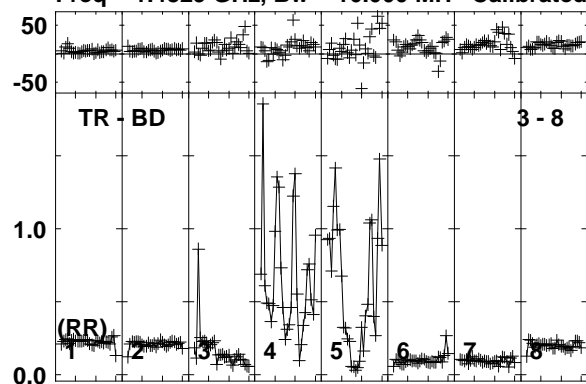

Lower frame: Ampl Jy Top frame: Phas deg
Vector averaged cross-power spectrum Baseline: TR (03) - BD (08)
Timerange: 00/05:05:36 to 00/05:07:34

Plot file version 60 created 21-JUN-2019 11:53:42
 IRAS12112 EP111A 1.UVDATA.1
 Freq = 1.4829 GHz, Bw = 16.000 MH Calibrated with CL # 3 and BP # 1 (BP mode 1)

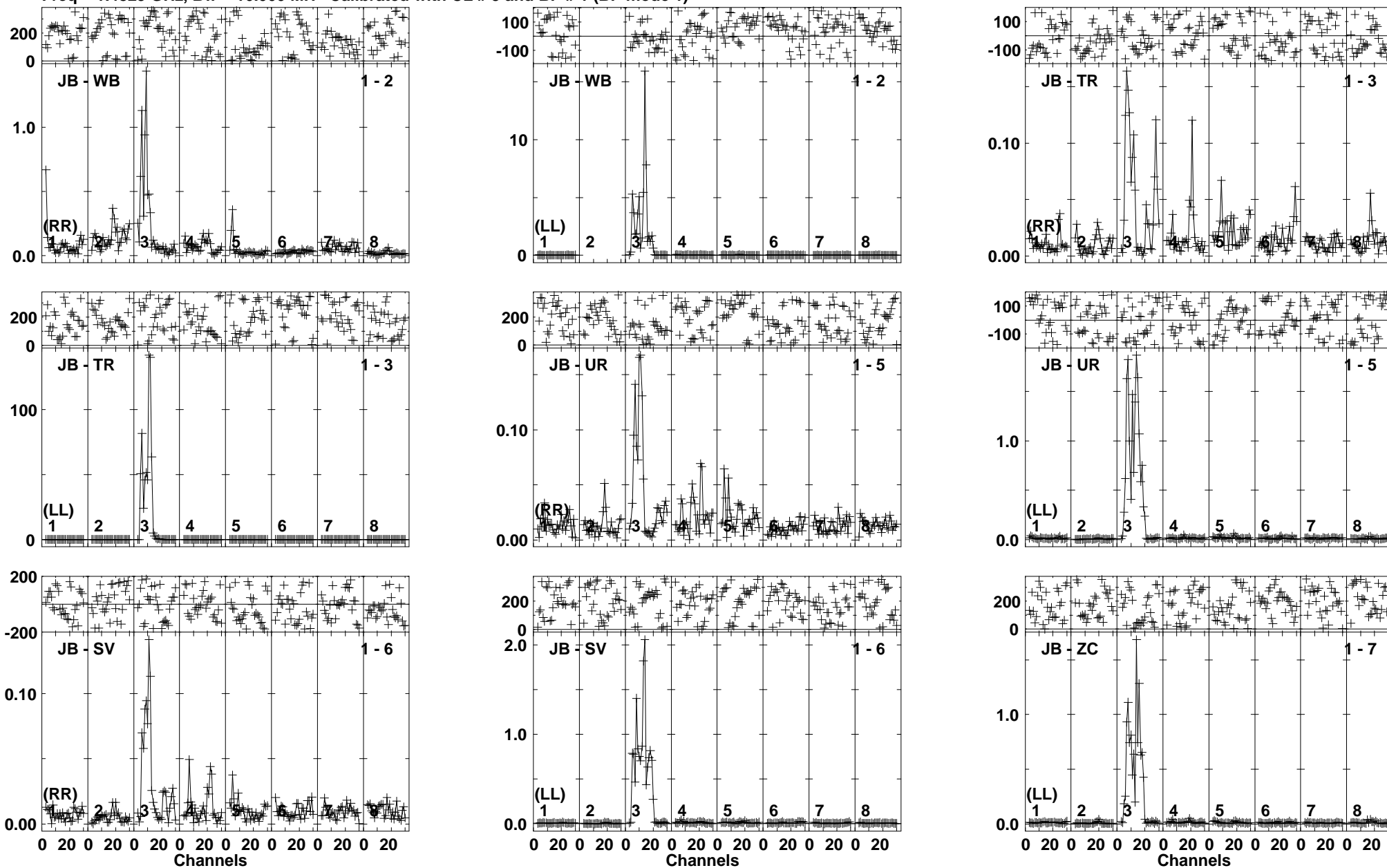

Lower frame: Ampl Jy Top frame: Phas deg
 Vector averaged cross-power spectrum Baseline: JB (01) - WB (02)
 Timerange: 00/05:07:36 to 00/05:11:04

Plot file version 61 created 21-JUN-2019 11:53:43

IRAS12112 EP111A 1.UVDATA.1

Freq = 1.4829 GHz, Bw = 16.000 MH Calibrated with CL # 3 and BP # 1 (BP mode 1)

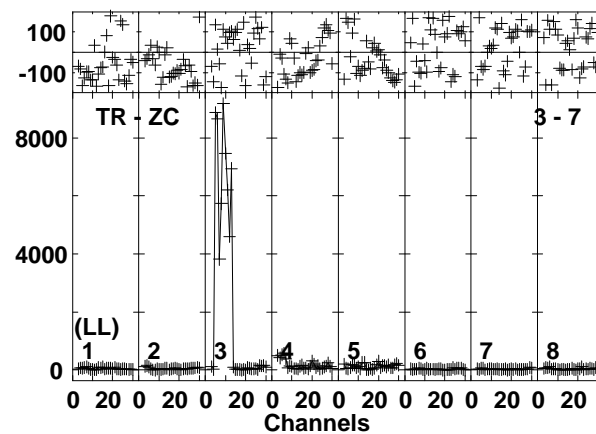
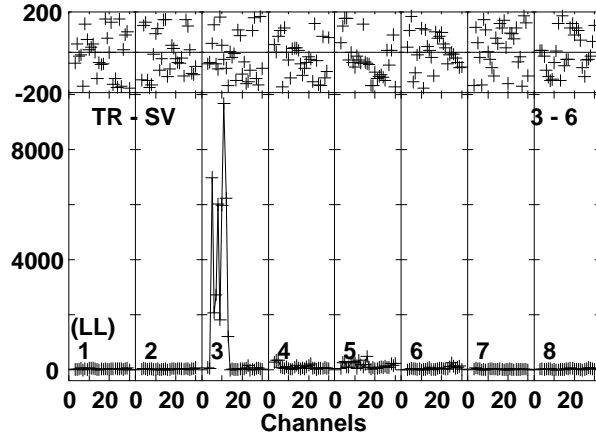
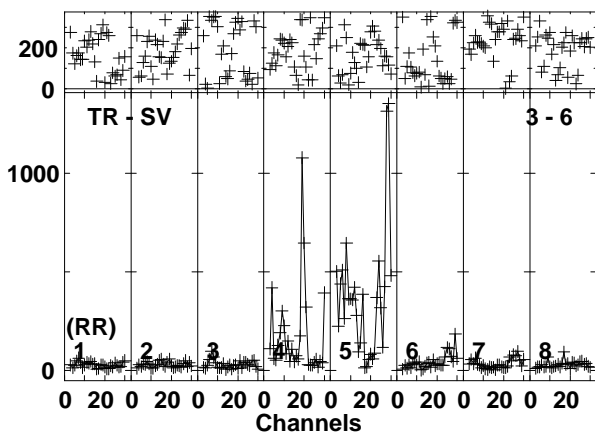
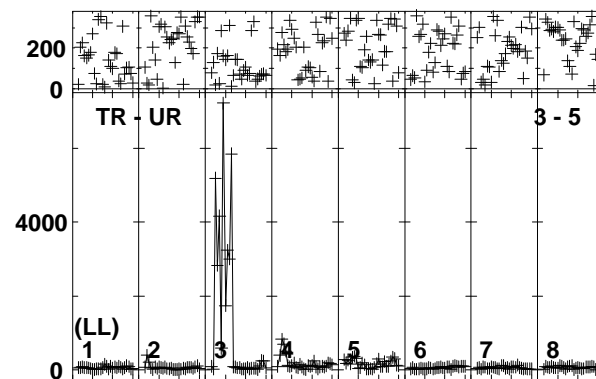
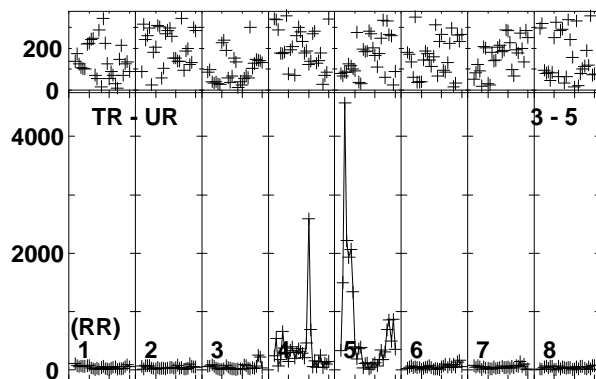
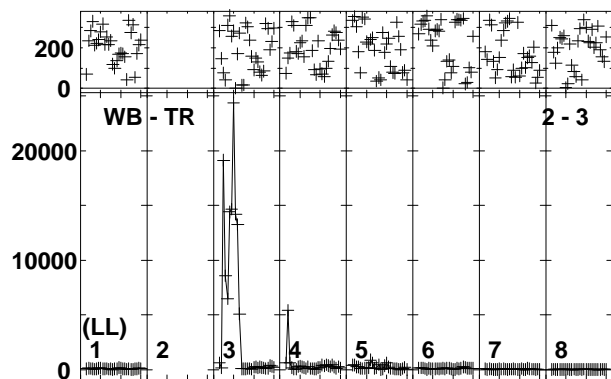
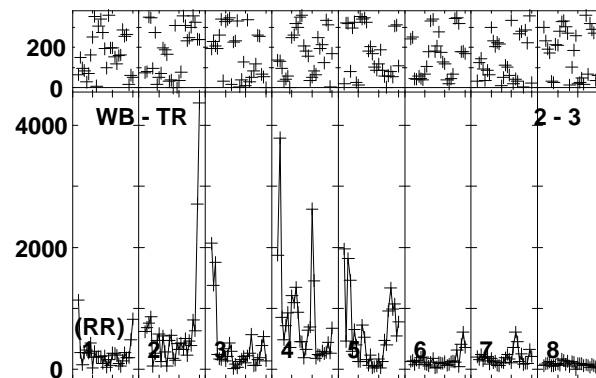
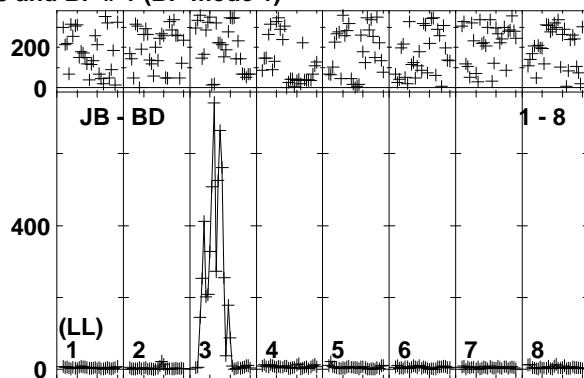
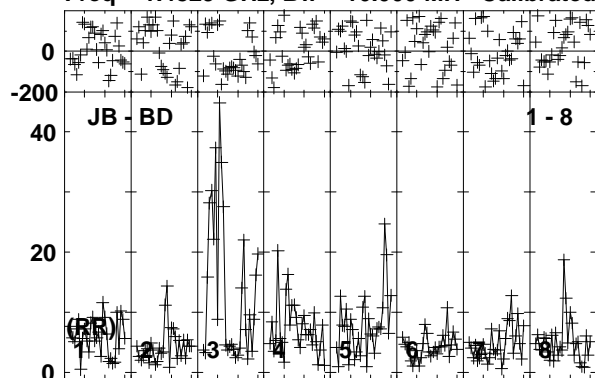

Lower frame: Milli Ampl Jy Top frame: Phas deg
Vector averaged cross-power spectrum Baseline: JB (01) - BD (08)
Timerange: 00/05:07:36 to 00/05:11:04

Plot file version 62 created 21-JUN-2019 11:53:43

IRAS12112 EP111A 1.UVDATA.1

Freq = 1.4829 GHz, Bw = 16.000 MH Calibrated with CL # 3 and BP # 1 (BP mode 1)

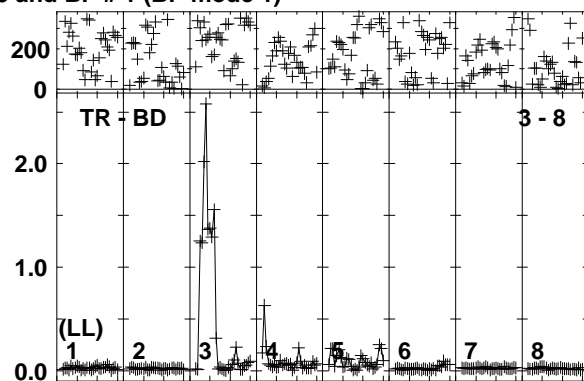
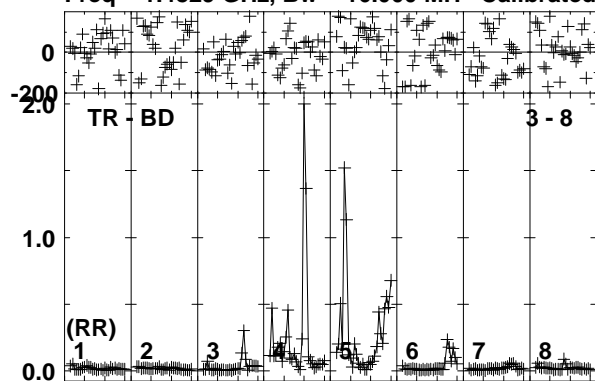

Lower frame: Ampl Jy Top frame: Phas deg
Vector averaged cross-power spectrum Baseline: TR (03) - BD (08)
Timerange: 00/05:07:36 to 00/05:11:04

Plot file version 63 created 21-JUN-2019 11:53:44

J1222+0413 EP111A 1.UVDATA.1

Freq = 1.4829 GHz, Bw = 16.000 MH Calibrated with CL # 3 and BP # 1 (BP mode 1)

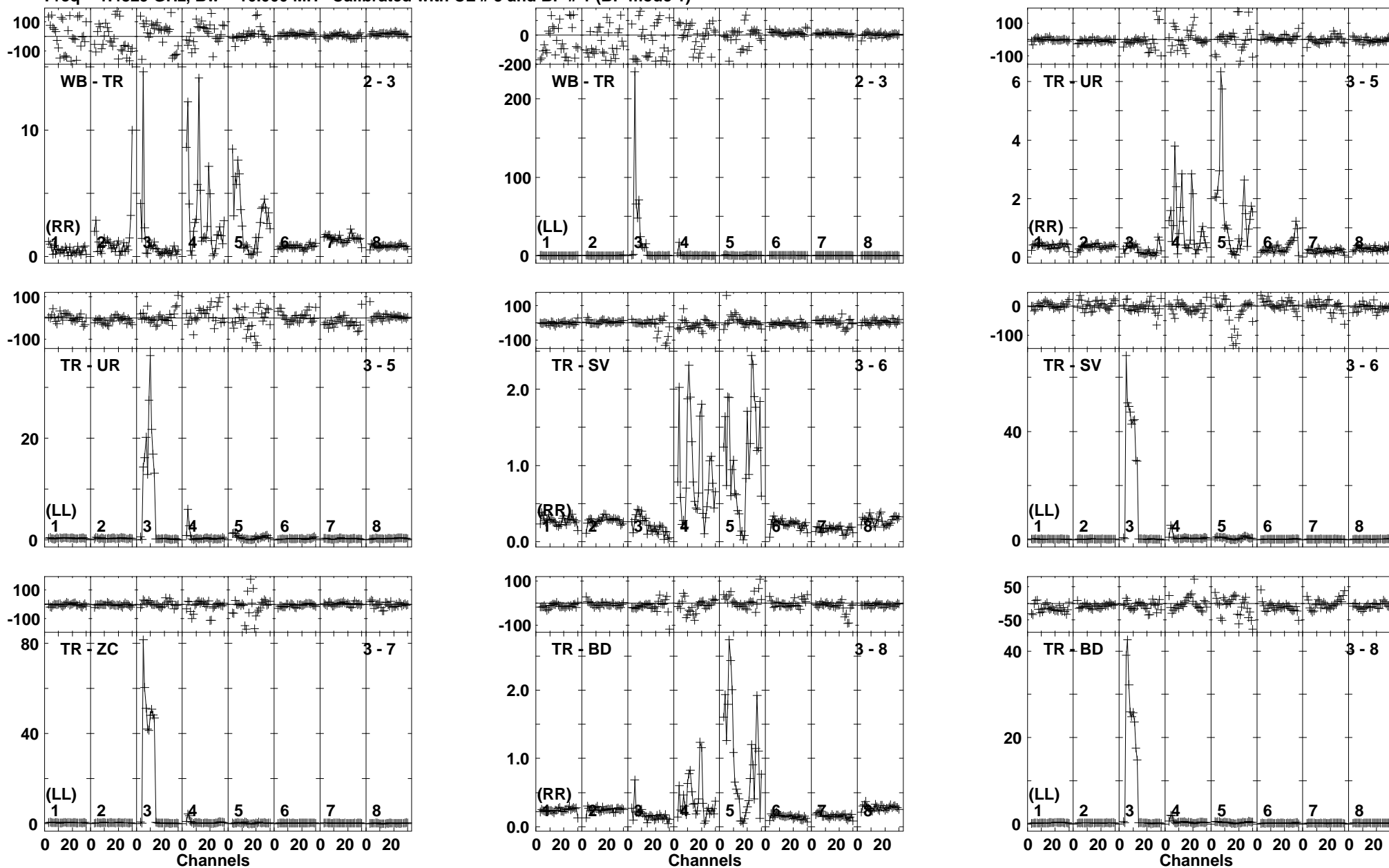

Lower frame: Ampl Jy Top frame: Phas deg
Vector averaged cross-power spectrum Baseline: WB (02) - TR (03)
Timerange: 00/05:11:06 to 00/05:12:34

Plot file version 64 created 21-JUN-2019 11:53:44

IRAS12112 EP111A 1.UVDATA.1

Freq = 1.4829 GHz, Bw = 16.000 MH Calibrated with CL # 3 and BP # 1 (BP mode 1)

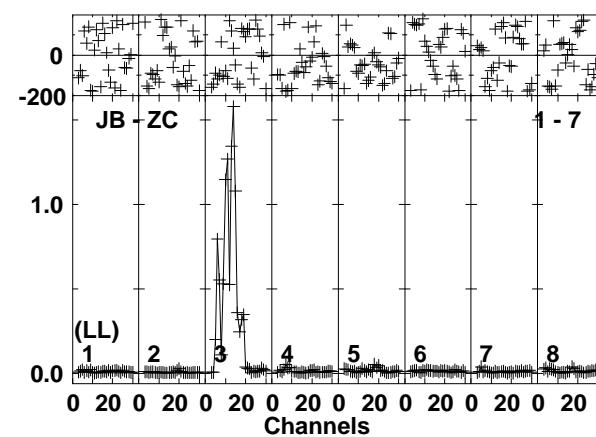
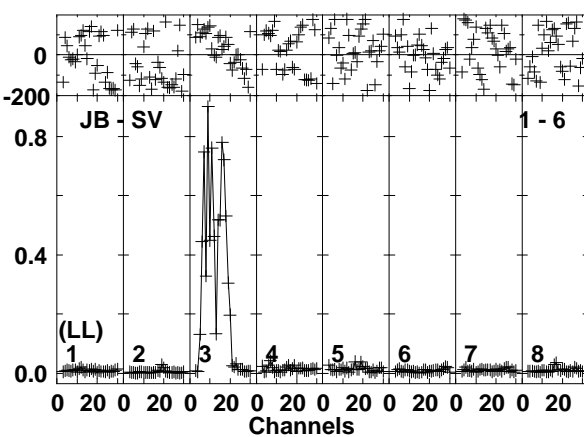
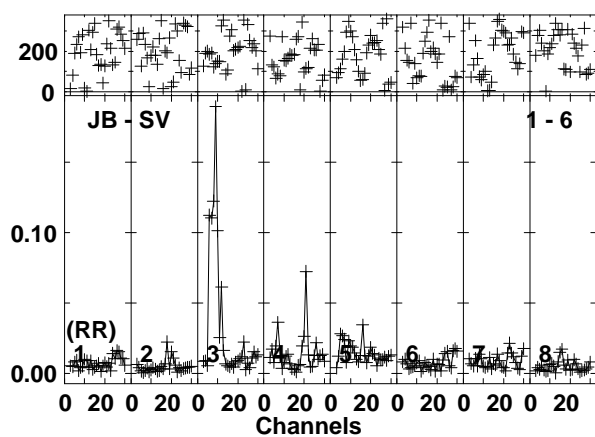
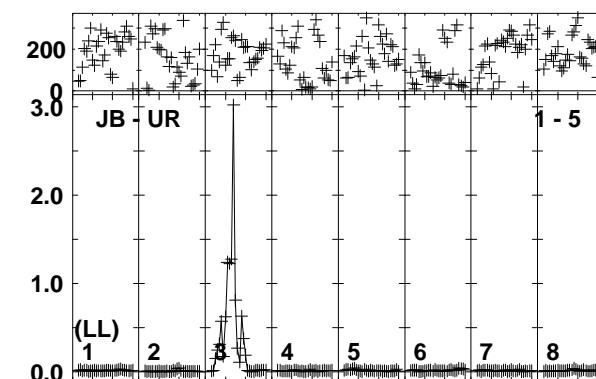
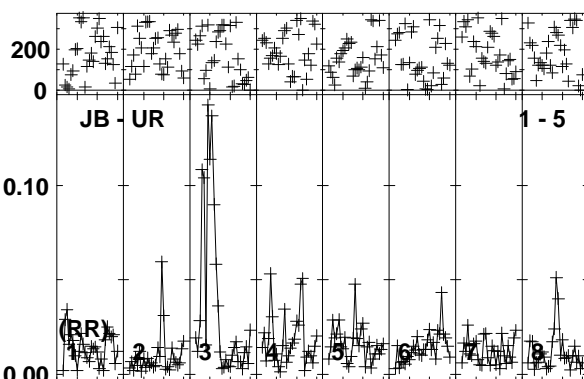
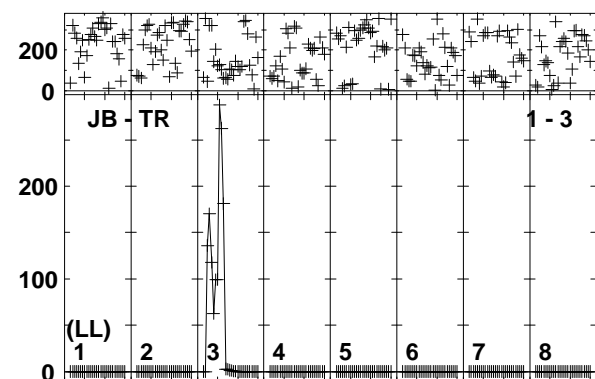
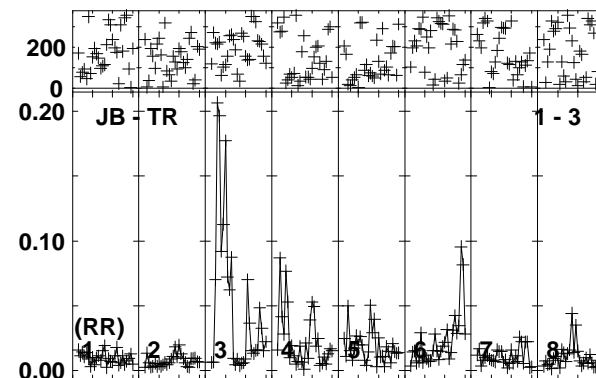
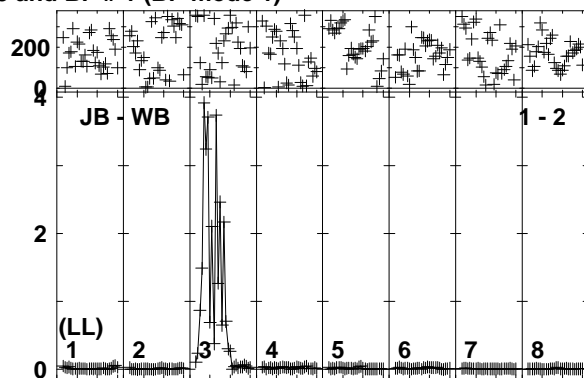
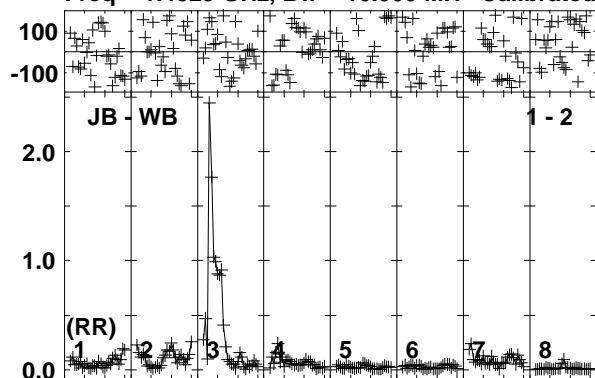

Lower frame: Ampl Jy Top frame: Phas deg
Vector averaged cross-power spectrum Baseline: JB (01) - WB (02)
Timerange: 00/05:12:36 to 00/05:16:04

Plot file version 65 created 21-JUN-2019 11:53:44

IRAS12112 EP111A 1.UVDATA.1

Freq = 1.4829 GHz, Bw = 16.000 MH Calibrated with CL # 3 and BP # 1 (BP mode 1)

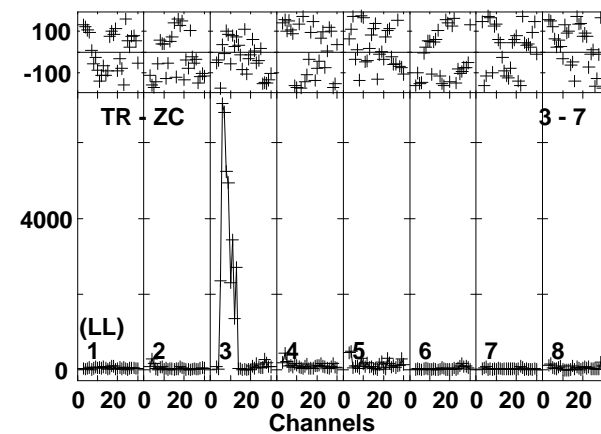
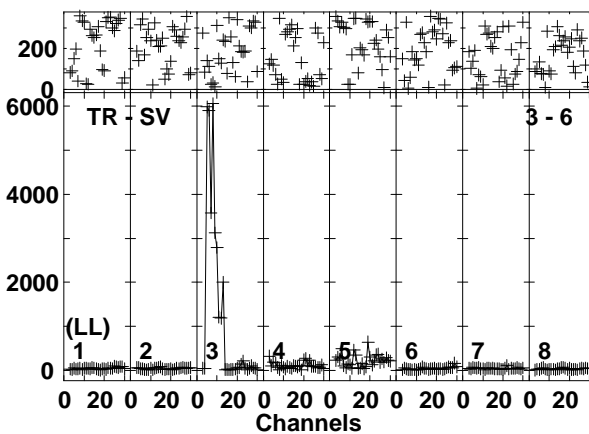
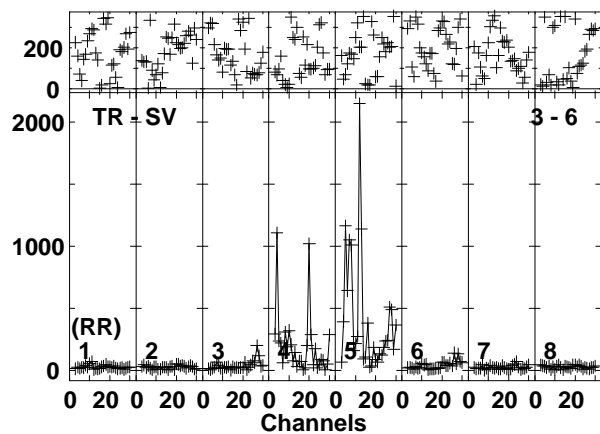
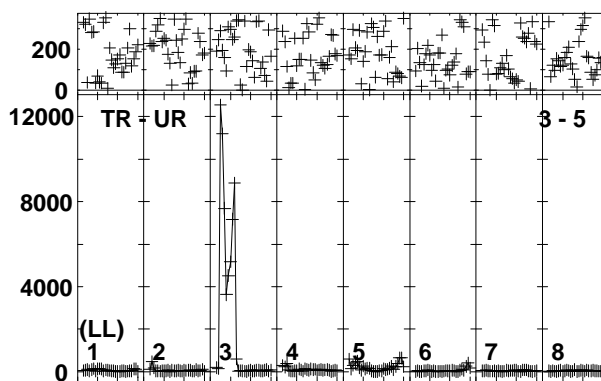
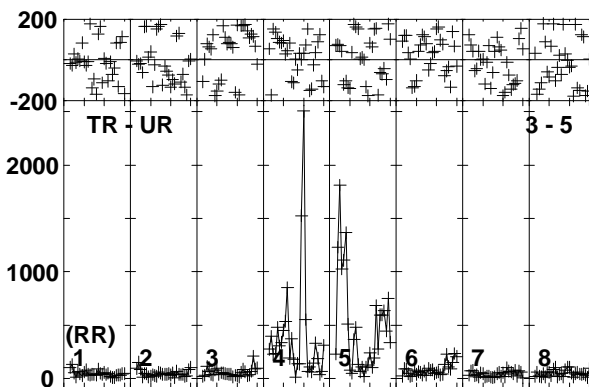
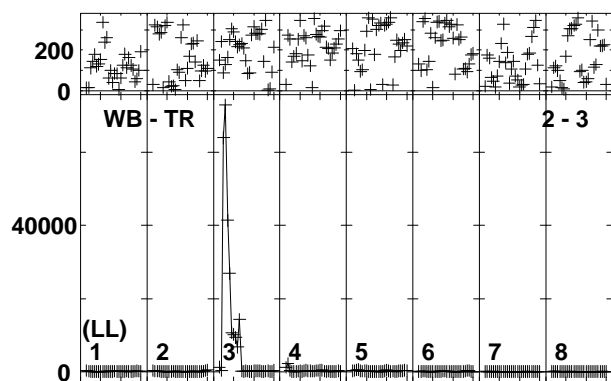
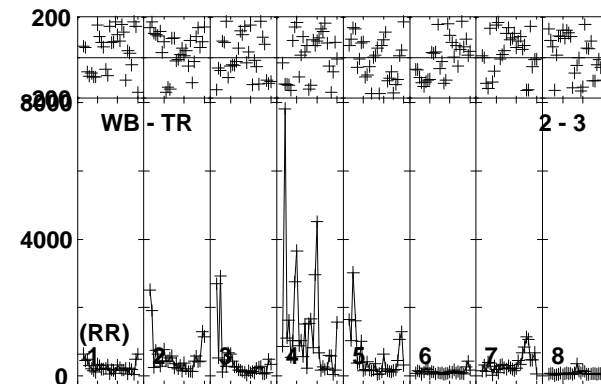
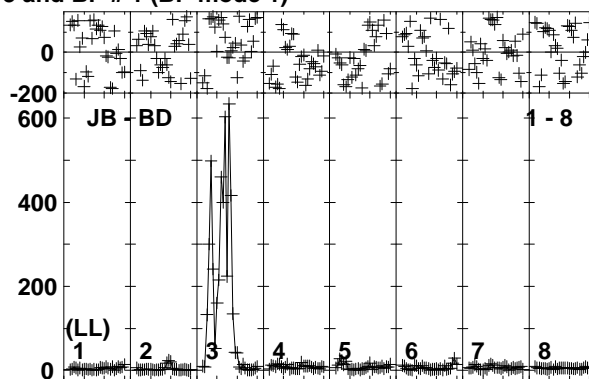
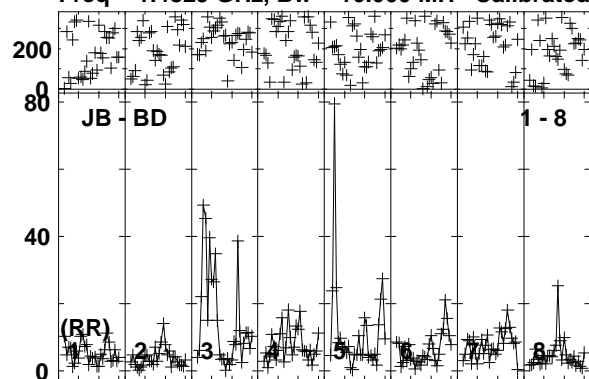

Lower frame: Milli Ampl Jy Top frame: Phas deg
Vector averaged cross-power spectrum Baseline: JB (01) - BD (08)
Timerange: 00/05:12:36 to 00/05:16:04

Plot file version 66 created 21-JUN-2019 11:53:45

IRAS12112 EP111A 1.UVDATA.1

Freq = 1.4829 GHz, Bw = 16.000 MH Calibrated with CL # 3 and BP # 1 (BP mode 1)

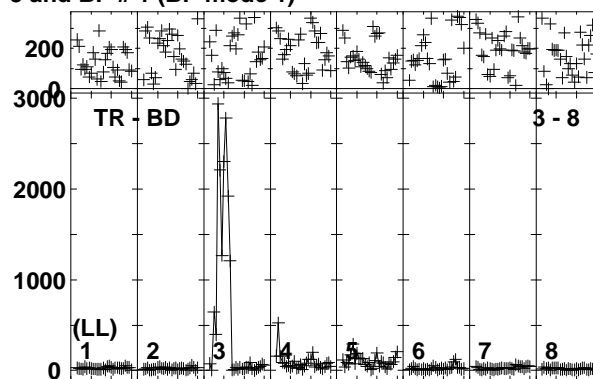
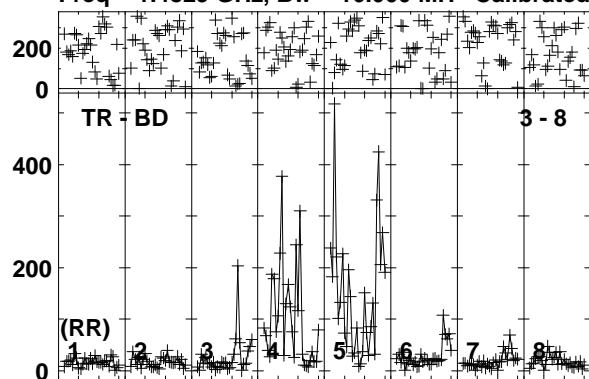

Lower frame: Milli Ampl Jy Top frame: Phas deg
Vector averaged cross-power spectrum Baseline: TR (03) - BD (08)
Timerange: 00/05:12:36 to 00/05:16:04

Plot file version 67 created 21-JUN-2019 11:53:45

J1222+0413 EP111A 1.UVDATA.1

Freq = 1.4829 GHz, Bw = 16.000 MH Calibrated with CL # 3 and BP # 1 (BP mode 1)

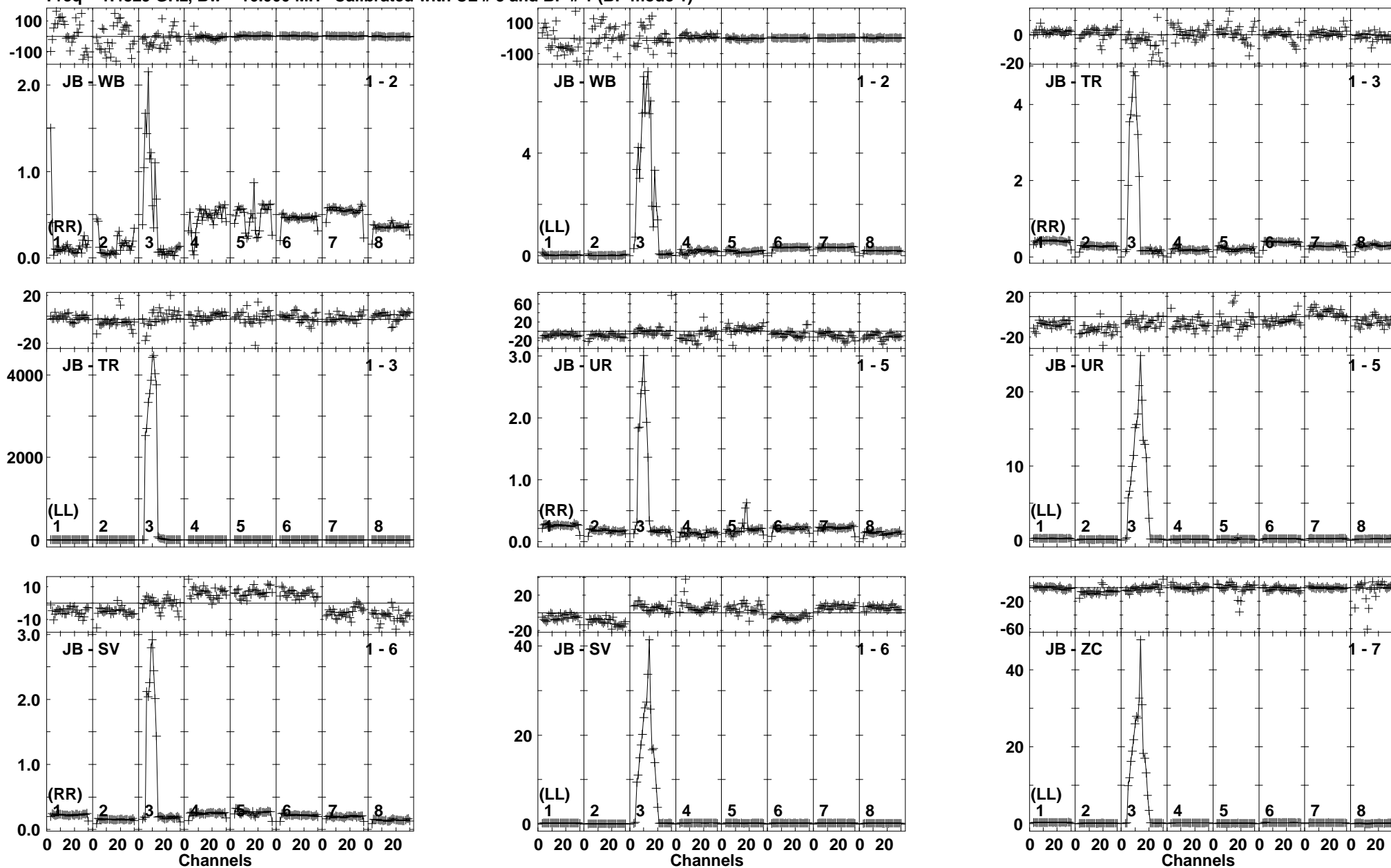

Lower frame: Ampl Jy Top frame: Phas deg
Vector averaged cross-power spectrum Baseline: JB (01) - WB (02)
Timerange: 00/05:16:46 to 00/05:18:14

Plot file version 68 created 21-JUN-2019 11:53:45

J1222+0413 EP111A 1.UVDATA.1

Freq = 1.4829 GHz, Bw = 16.000 MH Calibrated with CL # 3 and BP # 1 (BP mode 1)

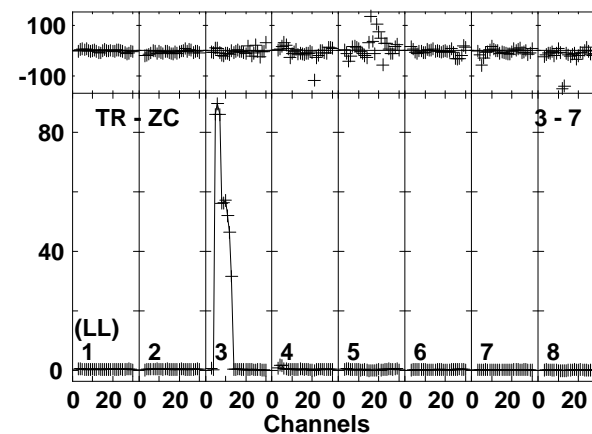
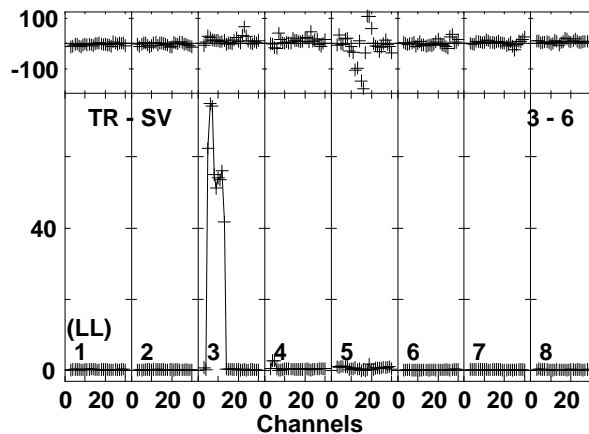
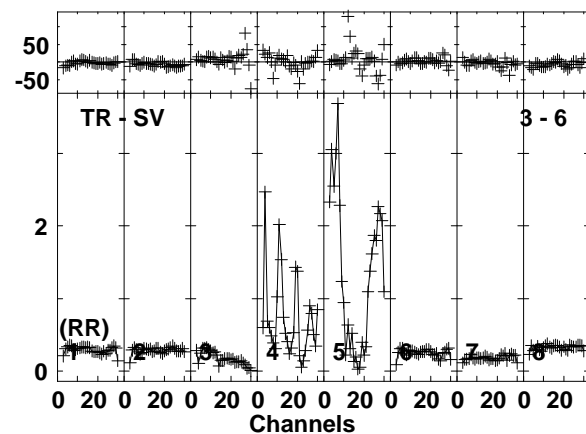
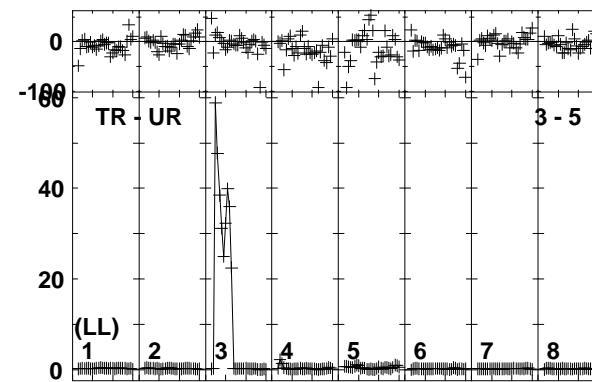
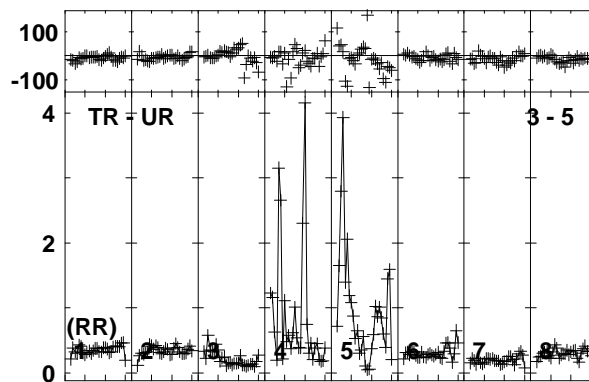
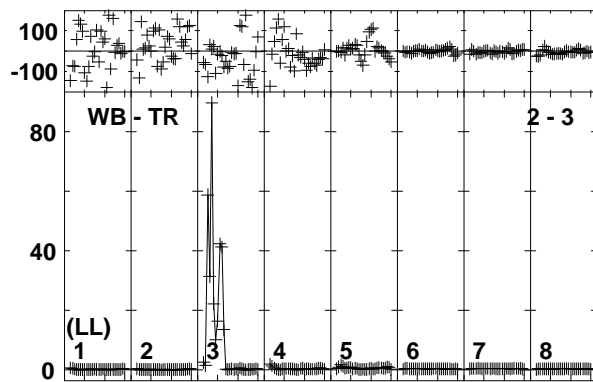
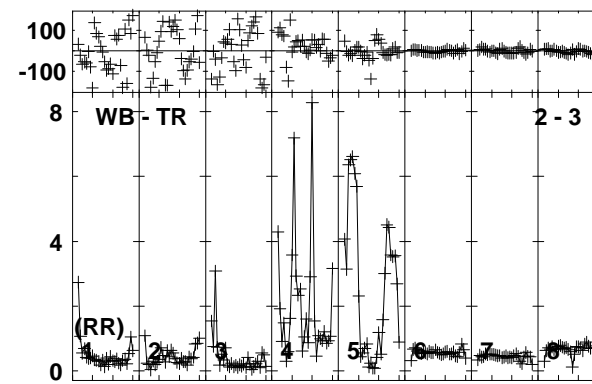
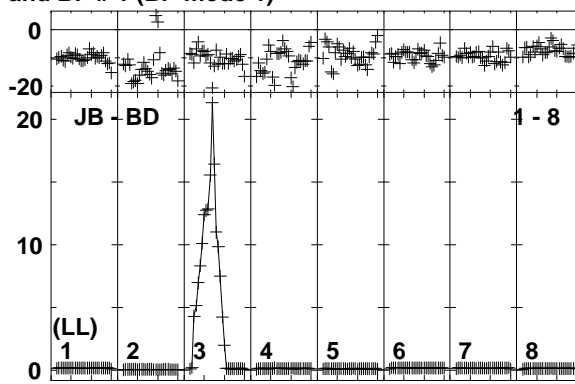
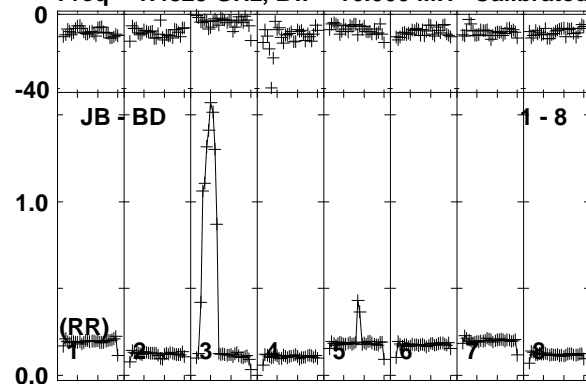

Lower frame: Ampl Jy Top frame: Phas deg
Vector averaged cross-power spectrum Baseline: JB (01) - BD (08)
Timerange: 00/05:16:46 to 00/05:18:14

Plot file version 69 created 21-JUN-2019 11:53:46

J1222+0413 EP1111A 1.UVDATA.1

Freq = 1.4829 GHz, Bw = 16.000 MH Calibrated with CL # 3 and BP # 1 (BP mode 1)

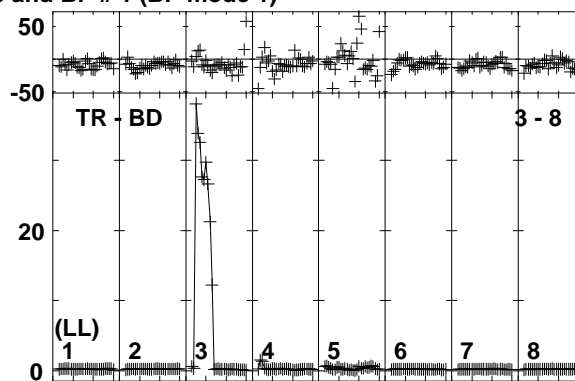
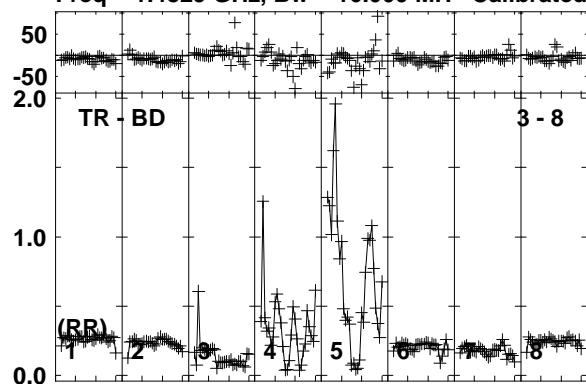

Lower frame: Ampl Jy Top frame: Phas deg
Vector averaged cross-power spectrum Baseline: TR (03) - BD (08)
Timerange: 00/05:16:46 to 00/05:18:14

Plot file version 70 created 21-JUN-2019 11:53:46
 IRAS12112 EP111A 1.UVDATA.1
 Freq = 1.4829 GHz, Bw = 16.000 MH Calibrated with CL # 3 and BP # 1 (BP mode 1)

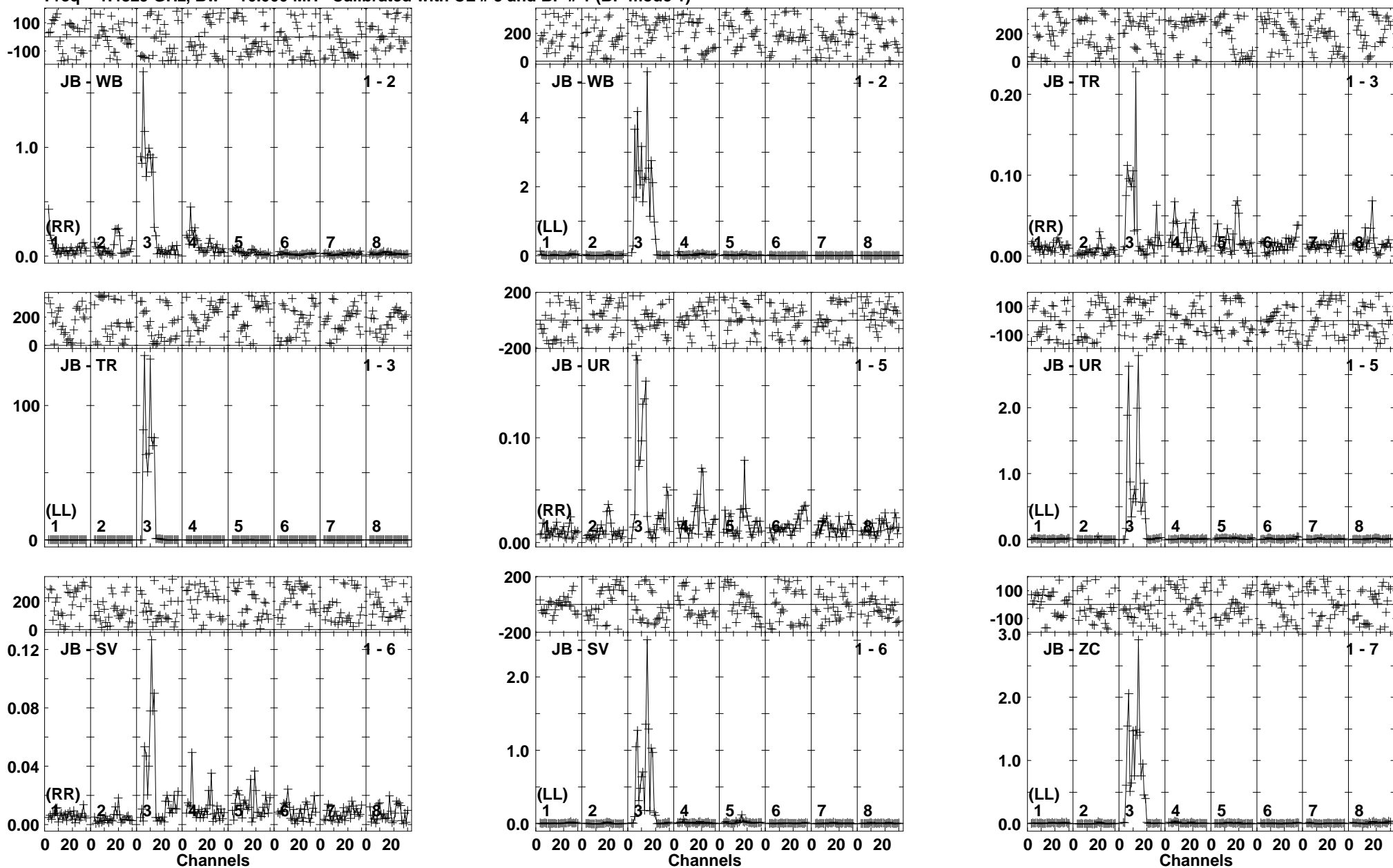

Lower frame: Ampl Jy Top frame: Phas deg
 Vector averaged cross-power spectrum Baseline: JB (01) - WB (02)
 Timerange: 00/05:18:16 to 00/05:21:44

Plot file version 71 created 21-JUN-2019 11:53:47

IRAS12112 EP111A 1.UVDATA.1

Freq = 1.4829 GHz, Bw = 16.000 MH Calibrated with CL # 3 and BP # 1 (BP mode 1)

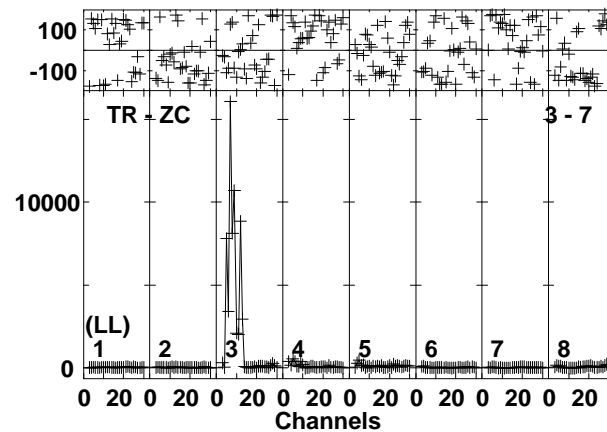
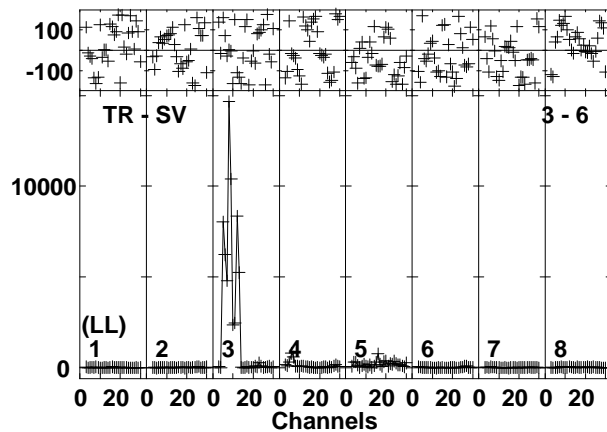
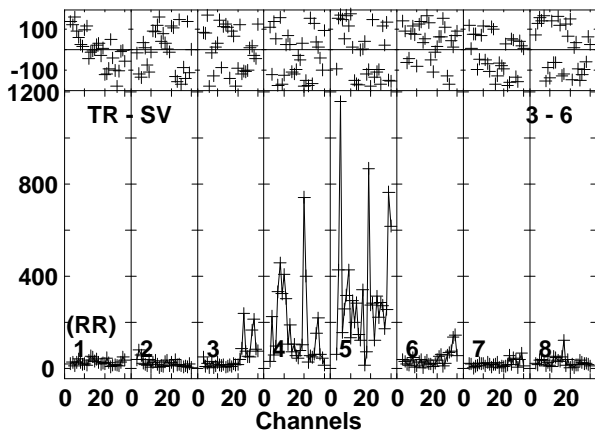
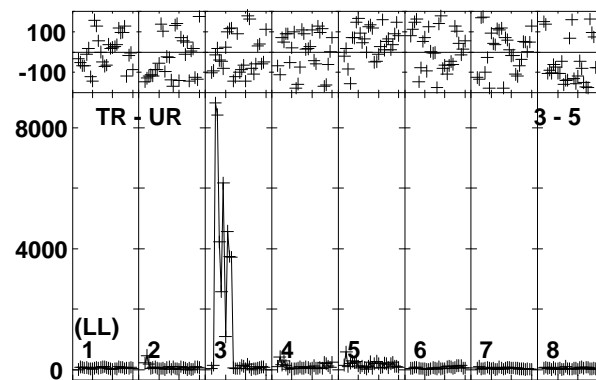
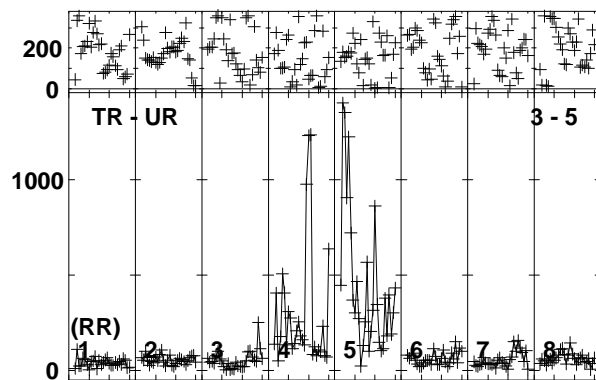
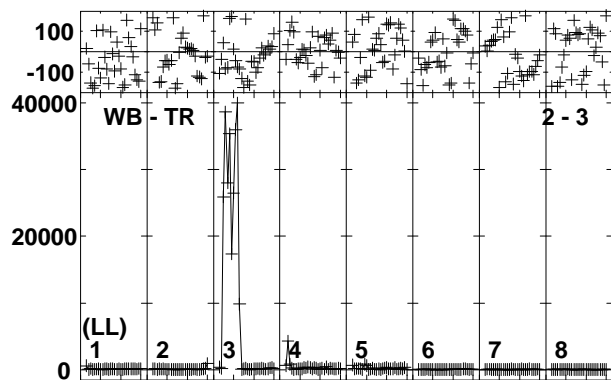
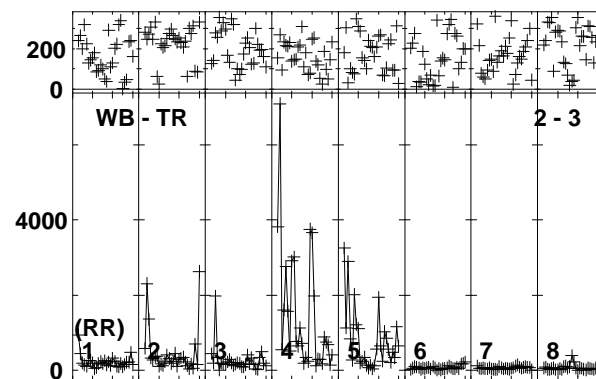
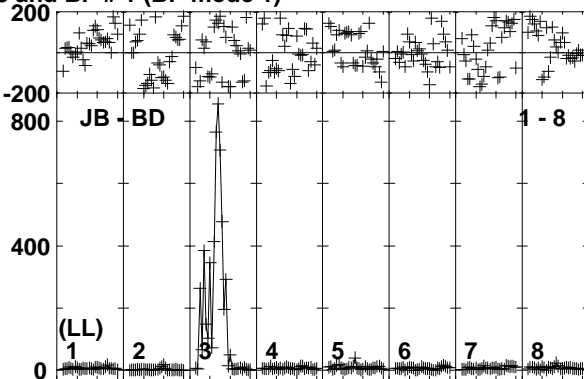
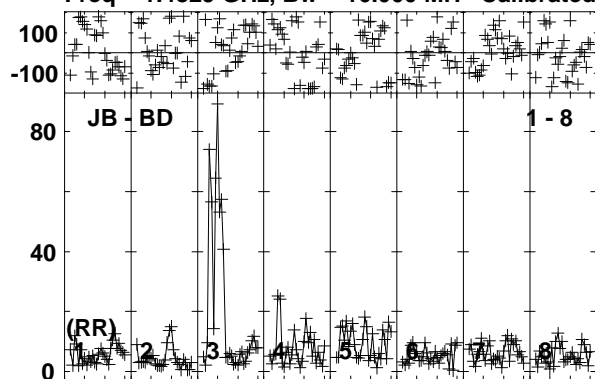

Lower frame: Milli Ampl Jy Top frame: Phas deg
Vector averaged cross-power spectrum Baseline: JB (01) - BD (08)
Timerange: 00/05:18:16 to 00/05:21:44

Plot file version 72 created 21-JUN-2019 11:53:47

IRAS12112 EP111A 1.UVDATA.1

Freq = 1.4829 GHz, Bw = 16.000 MH Calibrated with CL # 3 and BP # 1 (BP mode 1)

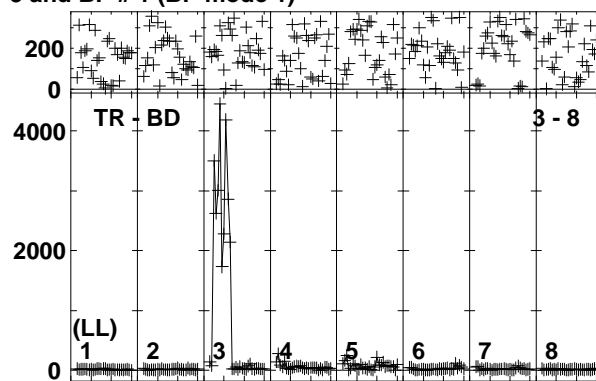
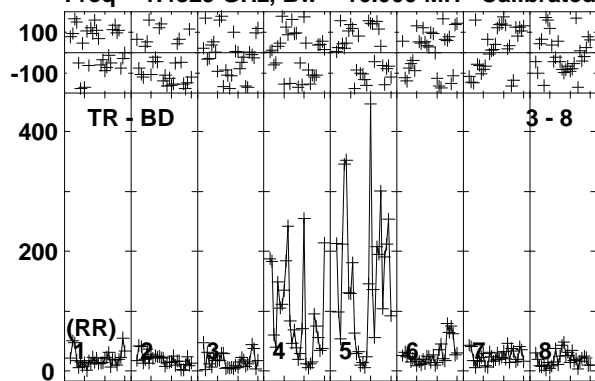

Lower frame: Milli Ampl Jy Top frame: Phas deg
Vector averaged cross-power spectrum Baseline: TR (03) - BD (08)
Timerange: 00/05:18:16 to 00/05:21:44

Plot file version 73 created 21-JUN-2019 11:53:48

J1222+0413 EP111A 1.UVDATA.1

Freq = 1.4829 GHz, Bw = 16.000 MH Calibrated with CL # 3 and BP # 1 (BP mode 1)

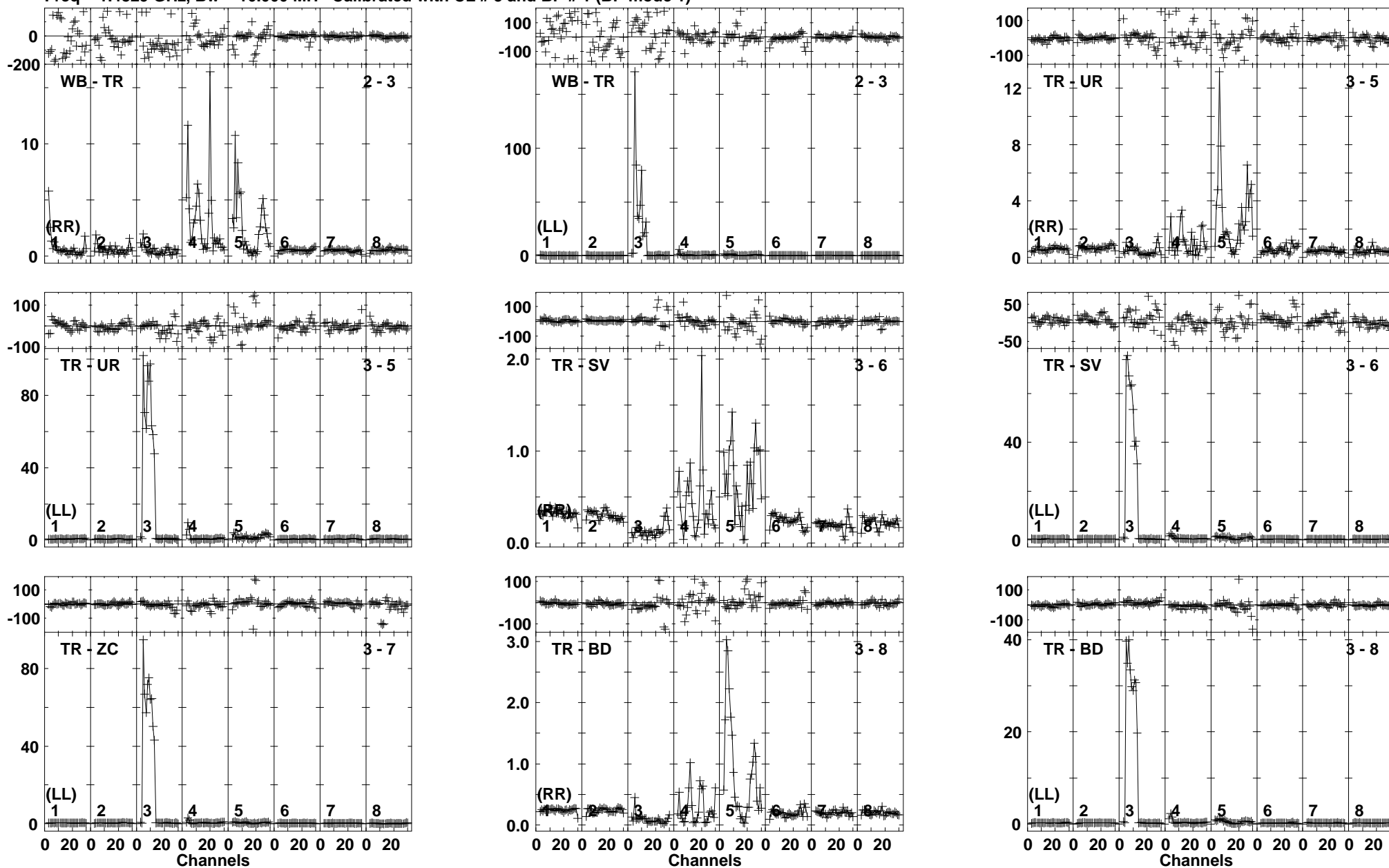

Lower frame: Ampl Jy Top frame: Phas deg
Vector averaged cross-power spectrum Baseline: WB (02) - TR (03)
Timerange: 00/05:21:46 to 00/05:23:14

Plot file version 74 created 21-JUN-2019 11:53:48

IRAS12112 EP111A 1.UVDATA.1

Freq = 1.4829 GHz, Bw = 16.000 MH Calibrated with CL # 3 and BP # 1 (BP mode 1)

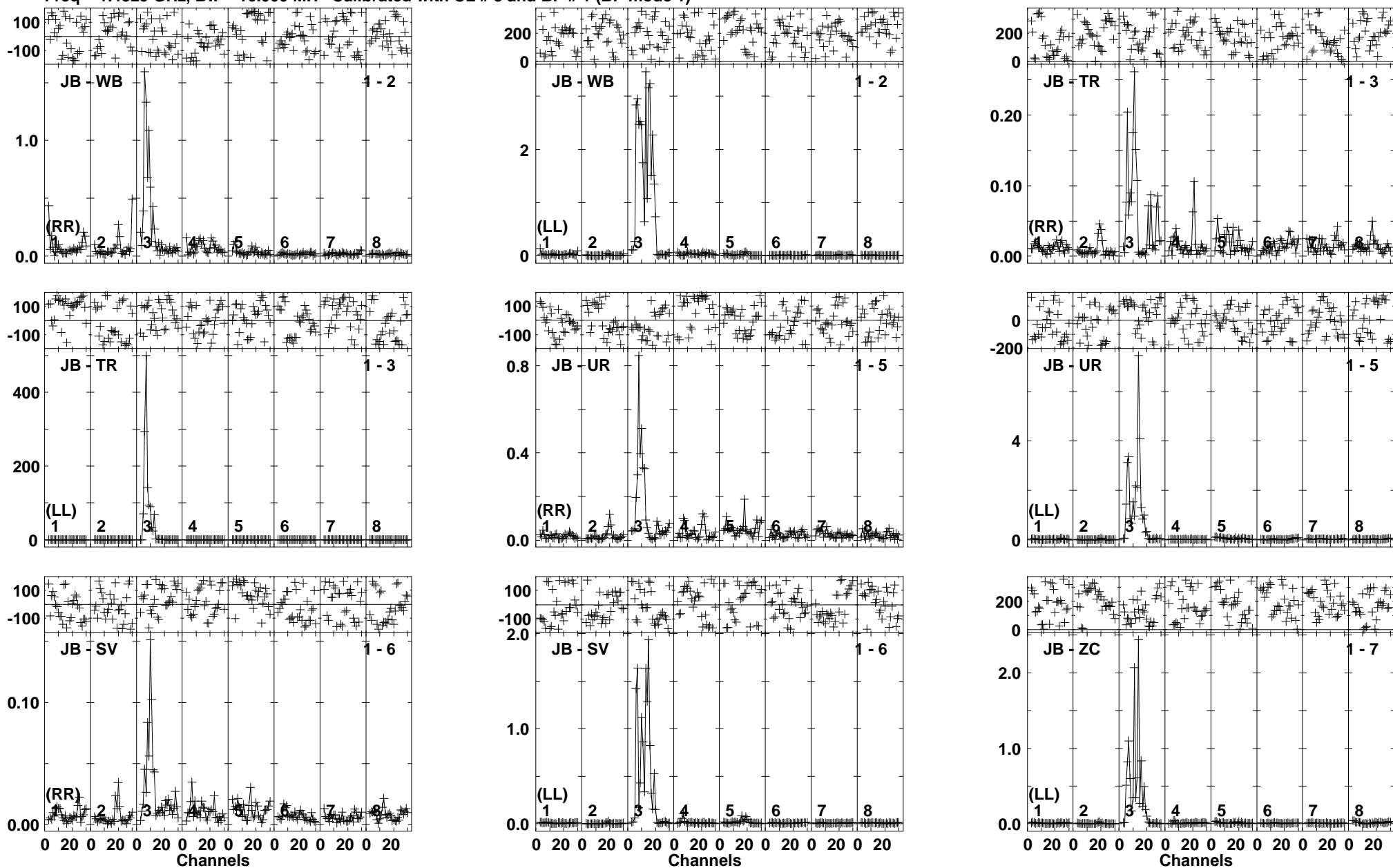

Lower frame: Ampl Jy Top frame: Phas deg
Vector averaged cross-power spectrum Baseline: JB (01) - WB (02)
Timerange: 00/05:23:16 to 00/05:26:44

Plot file version 75 created 21-JUN-2019 11:53:49

IRAS12112 EP111A 1.UVDATA.1

Freq = 1.4829 GHz, Bw = 16.000 MH Calibrated with CL # 3 and BP # 1 (BP mode 1)

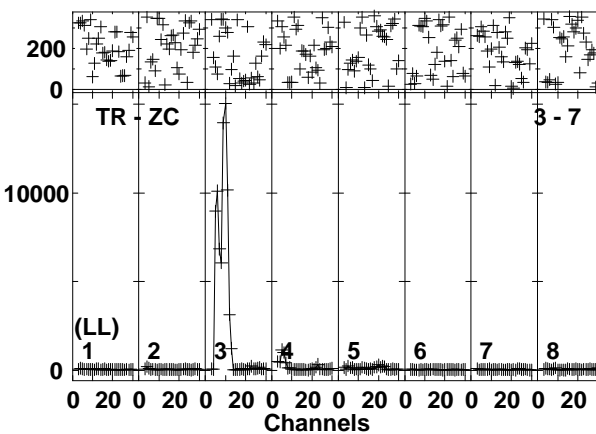
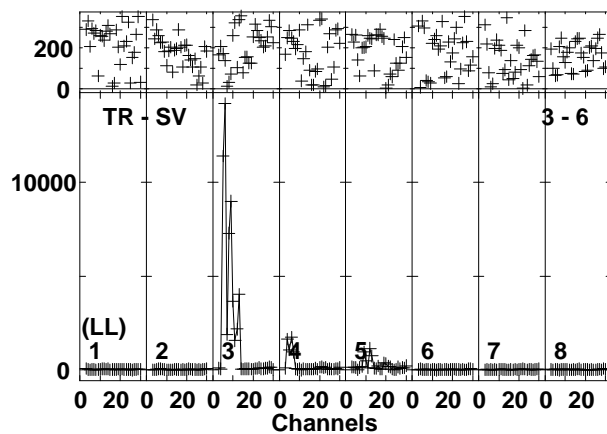
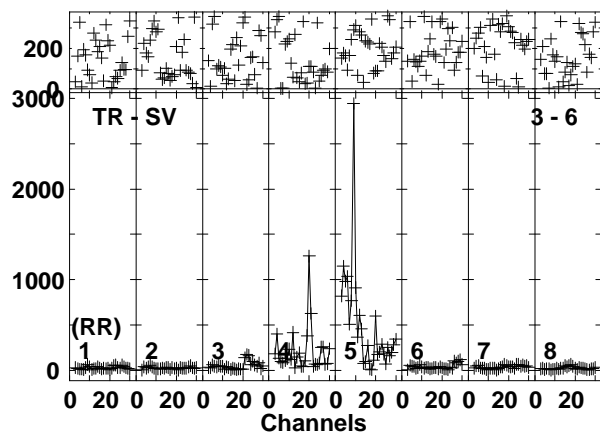
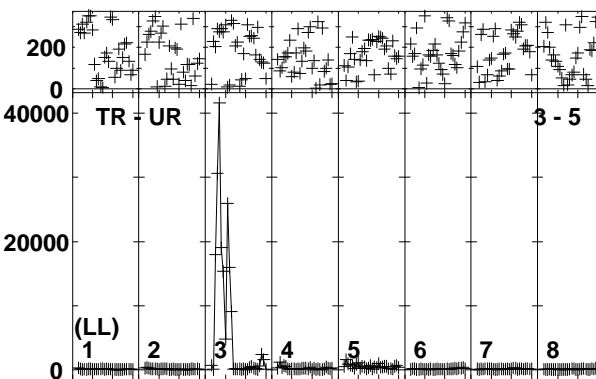
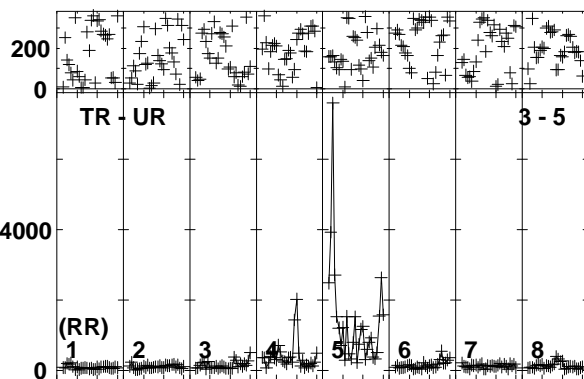
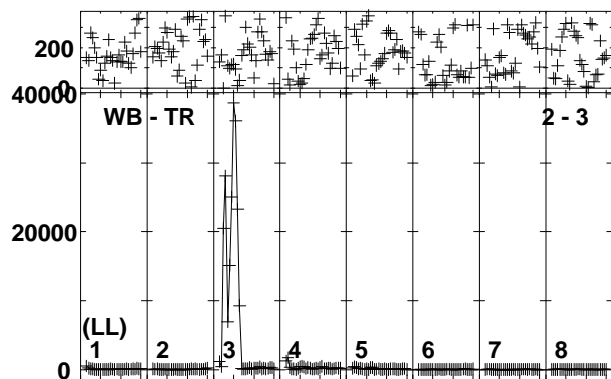
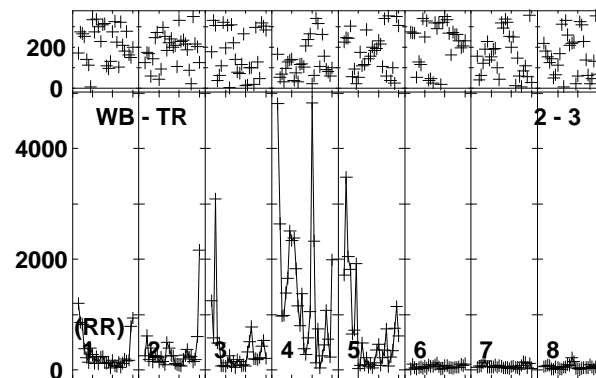
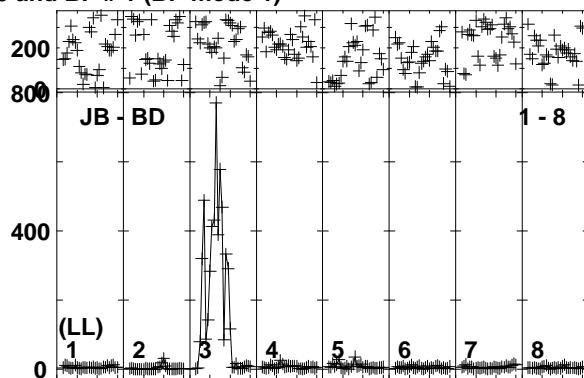
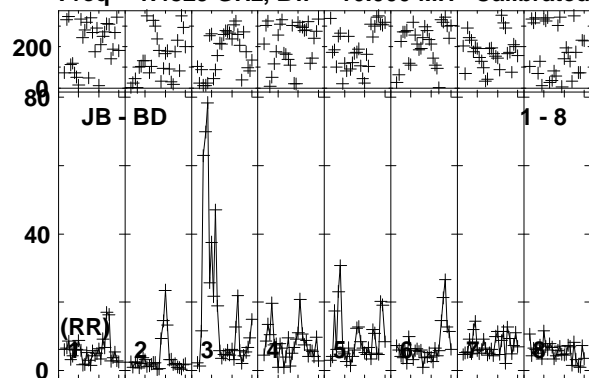

Lower frame: Milli Ampl Jy Top frame: Phas deg
Vector averaged cross-power spectrum Baseline: JB (01) - BD (08)
Timerange: 00/05:23:16 to 00/05:26:44

Plot file version 76 created 21-JUN-2019 11:53:49

IRAS12112 EP111A 1.UVDATA.1

Freq = 1.4829 GHz, Bw = 16.000 MH Calibrated with CL # 3 and BP # 1 (BP mode 1)

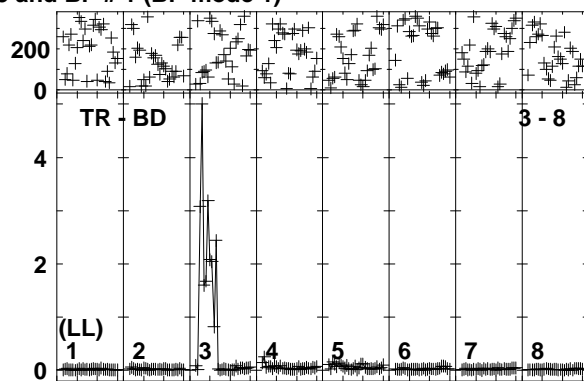
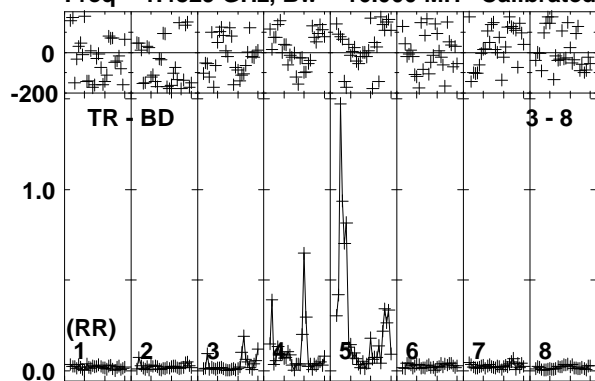

Lower frame: Ampl Jy Top frame: Phas deg
Vector averaged cross-power spectrum Baseline: TR (03) - BD (08)
Timerange: 00/05:23:16 to 00/05:26:44

Plot file version 77 created 21-JUN-2019 11:53:50

J1222+0413 EP111A 1.UVDATA.1

Freq = 1.4829 GHz, Bw = 16.000 MH Calibrated with CL # 3 and BP # 1 (BP mode 1)

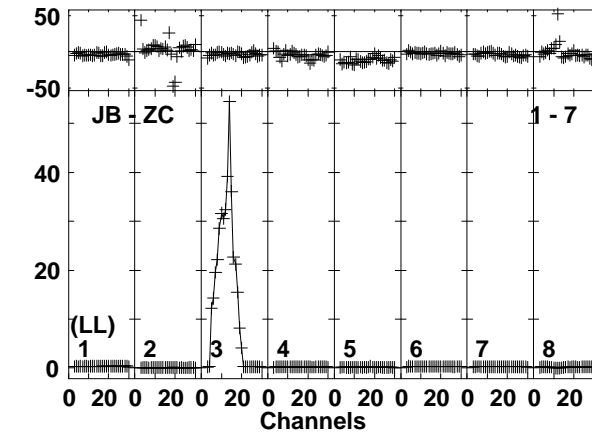
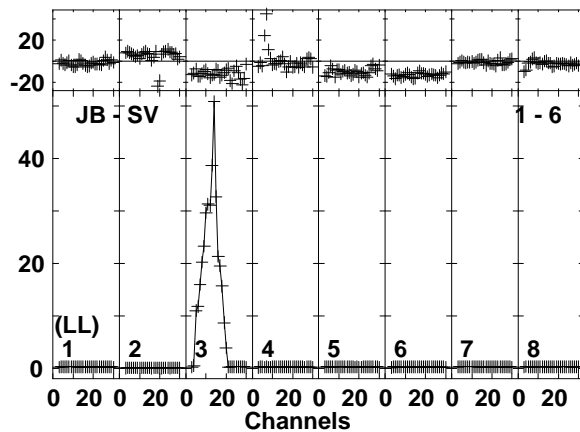
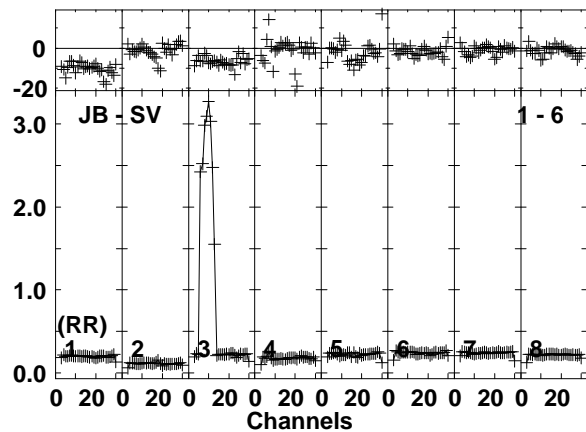
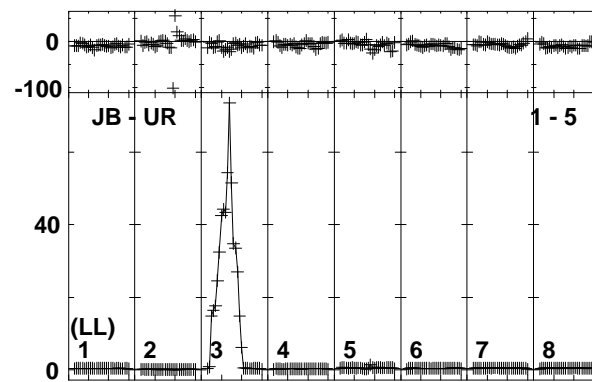
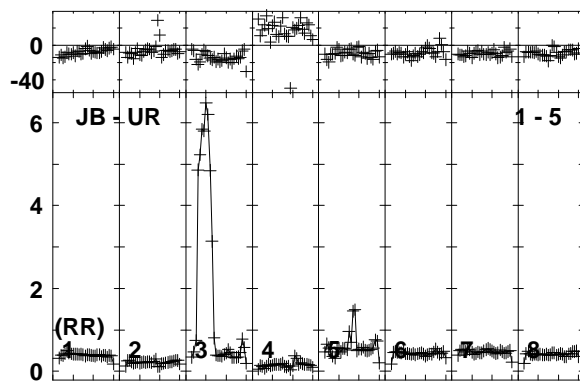
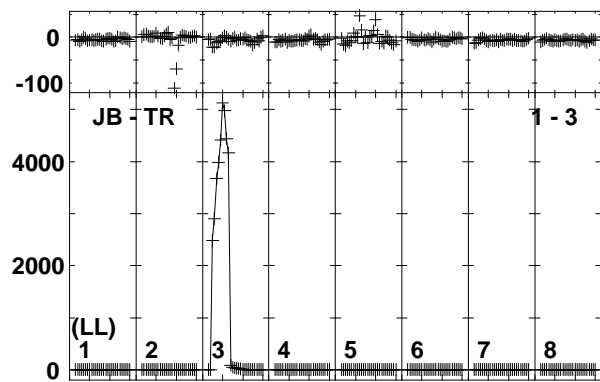
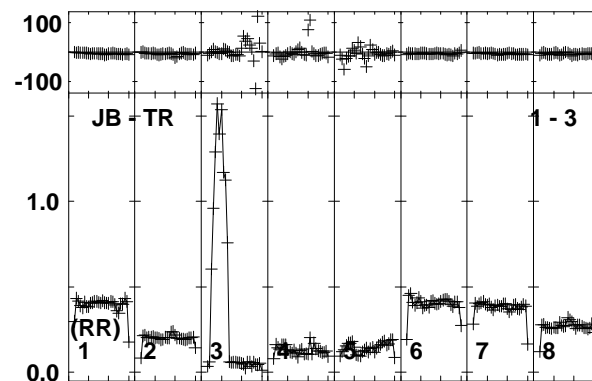
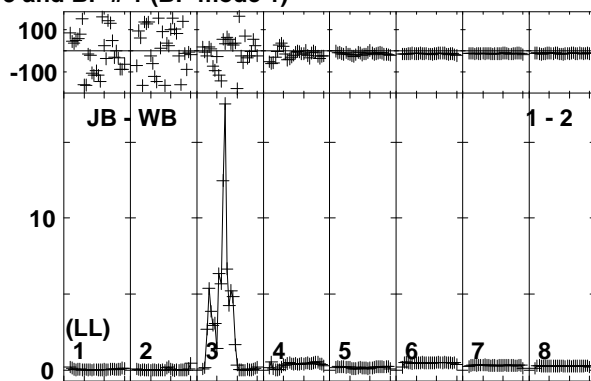
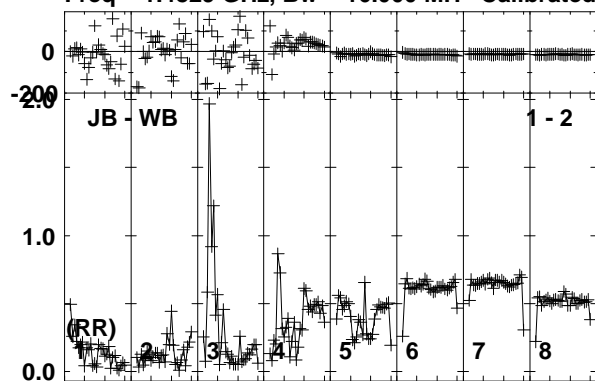

Lower frame: Ampl Jy Top frame: Phas deg
Vector averaged cross-power spectrum Baseline: JB (01) - WB (02)
Timerange: 00/05:27:26 to 00/05:28:54

Plot file version 78 created 21-JUN-2019 11:53:50

J1222+0413 EP111A 1.UVDATA.1

Freq = 1.4829 GHz, Bw = 16.000 MH Calibrated with CL # 3 and BP # 1 (BP mode 1)

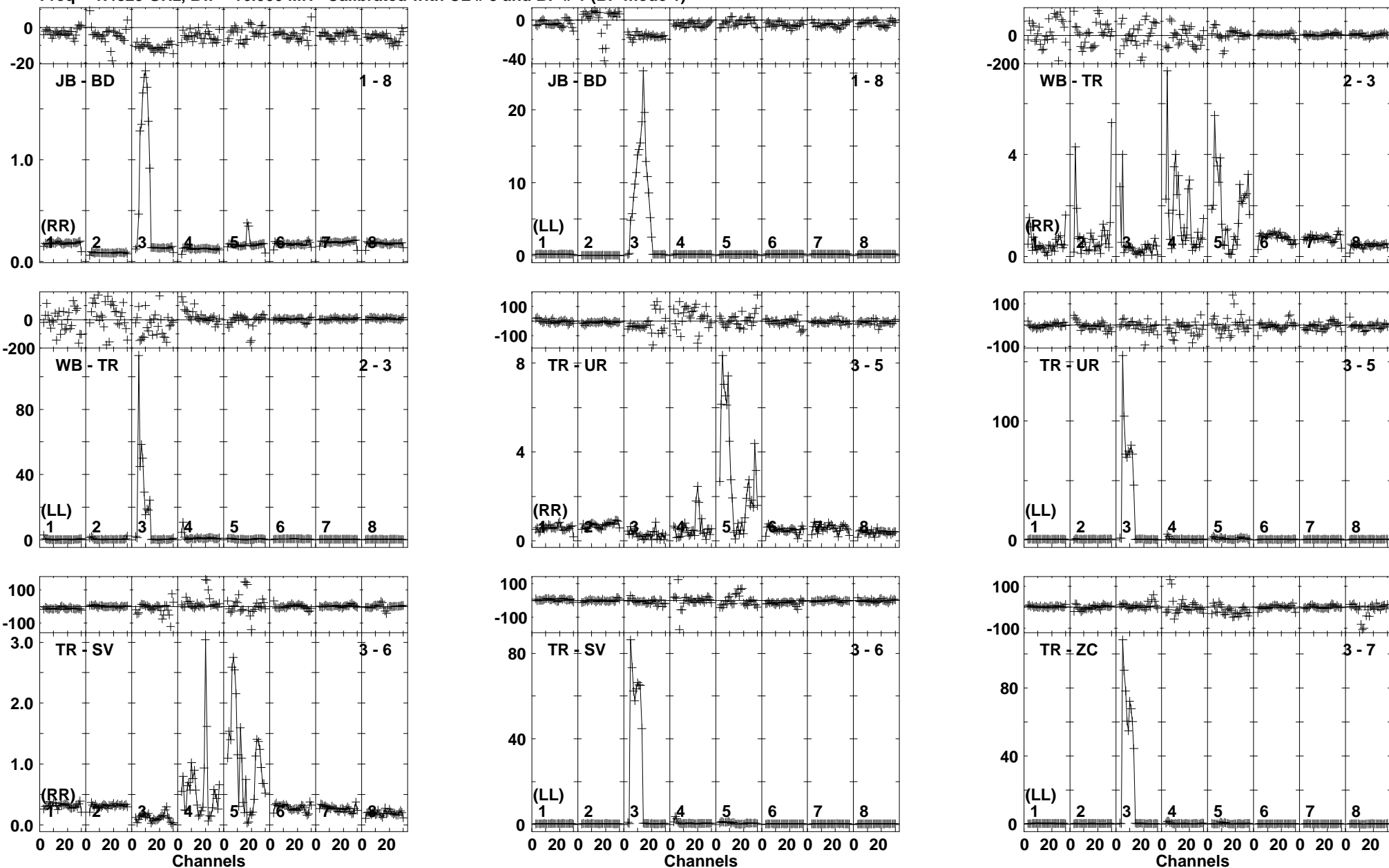

Lower frame: Ampl Jy Top frame: Phas deg
Vector averaged cross-power spectrum Baseline: JB (01) - BD (08)
Timerange: 00/05:27:26 to 00/05:28:54

Plot file version 79 created 21-JUN-2019 11:53:50

J1222+0413 EP111A 1.UVDATA.1

Freq = 1.4829 GHz, Bw = 16.000 MH Calibrated with CL # 3 and BP # 1 (BP mode 1)

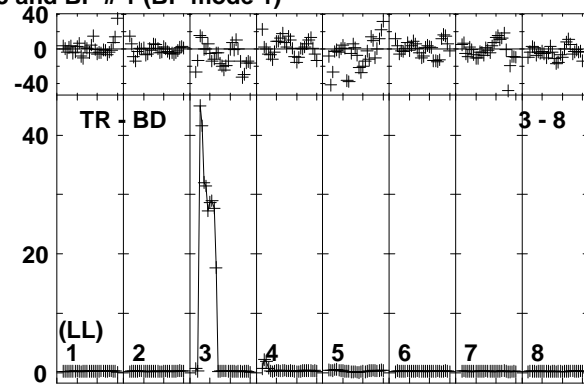
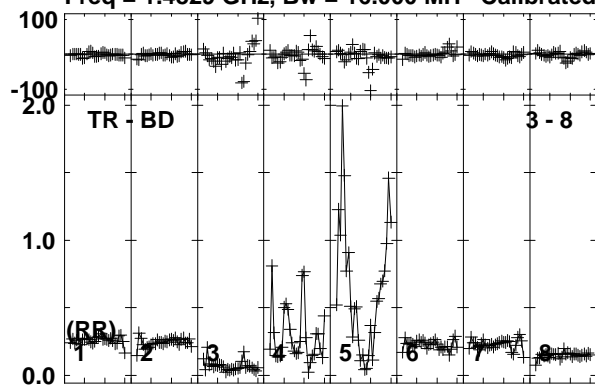

Lower frame: Ampl Jy Top frame: Phas deg
Vector averaged cross-power spectrum Baseline: TR (03) - BD (08)
Timerange: 00/05:27:26 to 00/05:28:54

Plot file version 80 created 21-JUN-2019 11:53:51

IRAS12112 EP111A 1.UVDATA.1

Freq = 1.4829 GHz, Bw = 16.000 MH Calibrated with CL # 3 and BP # 1 (BP mode 1)

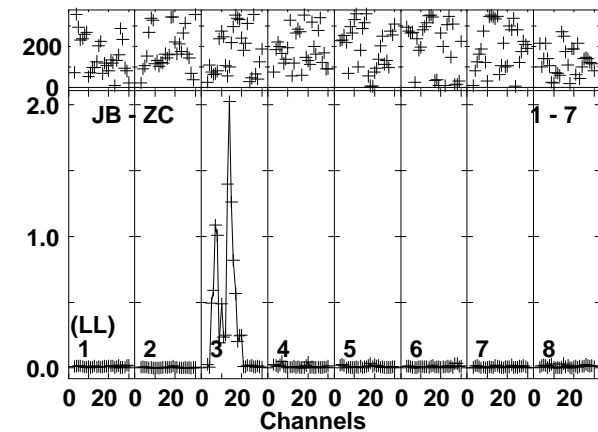
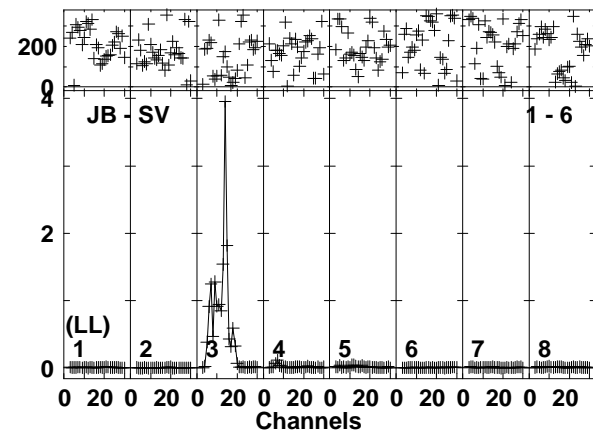
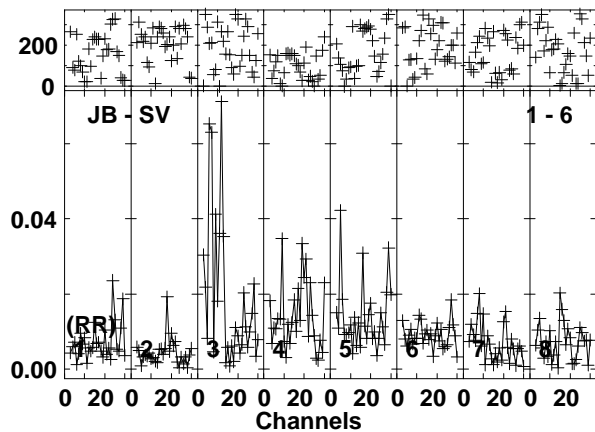
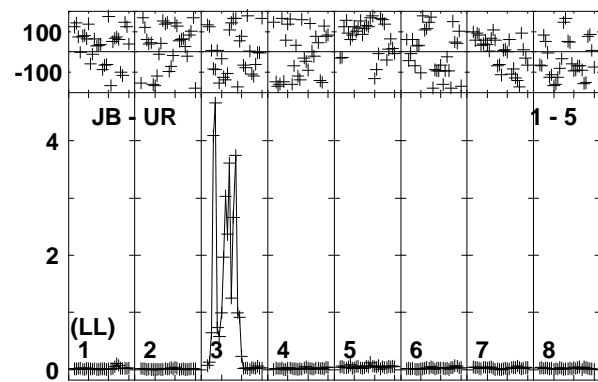
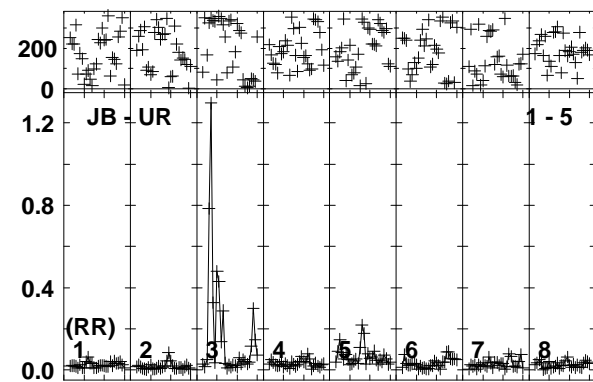
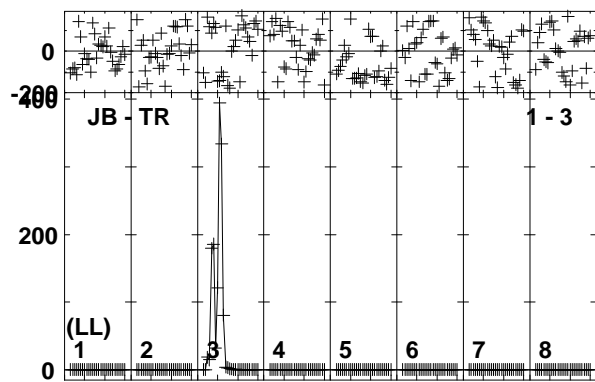
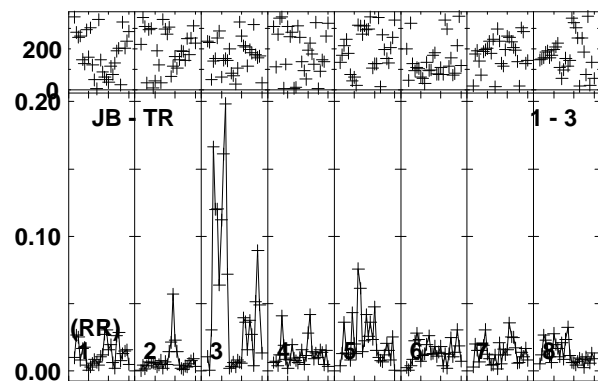
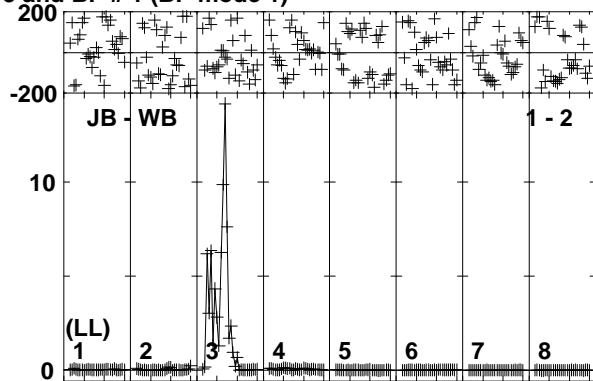
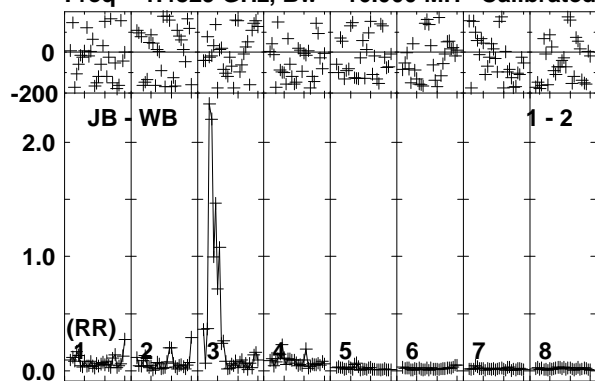

Lower frame: Ampl Jy Top frame: Phas deg
Vector averaged cross-power spectrum Baseline: JB (01) - WB (02)
Timerange: 00/05:28:56 to 00/05:32:24

Plot file version 81 created 21-JUN-2019 11:53:51

IRAS12112 EP111A 1.UVDATA.1

Freq = 1.4829 GHz, Bw = 16.000 MH Calibrated with CL # 3 and BP # 1 (BP mode 1)

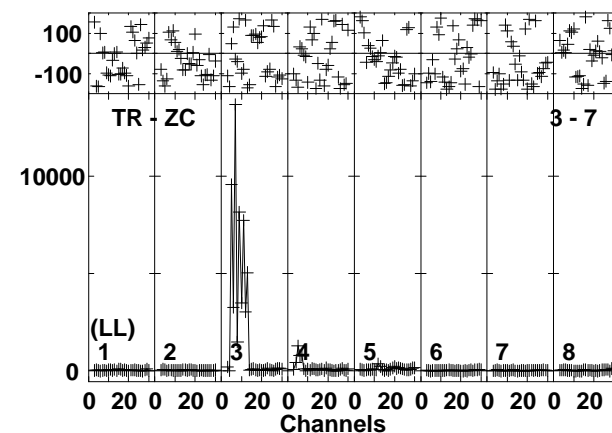
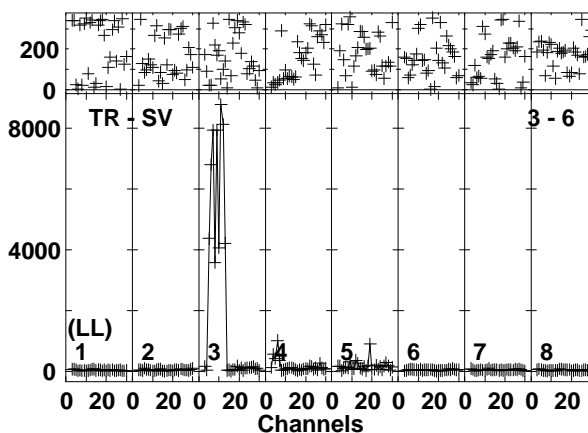
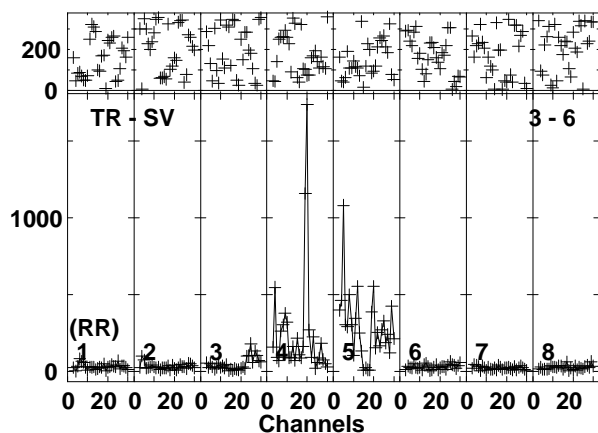
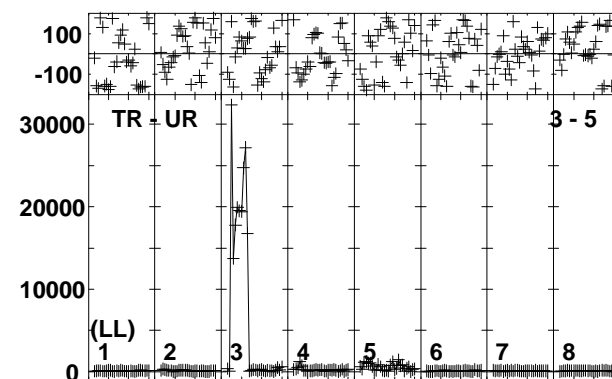
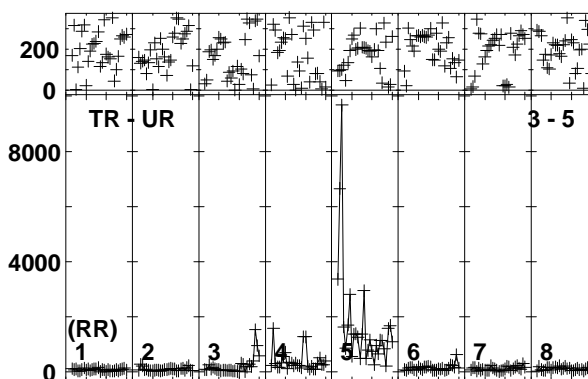
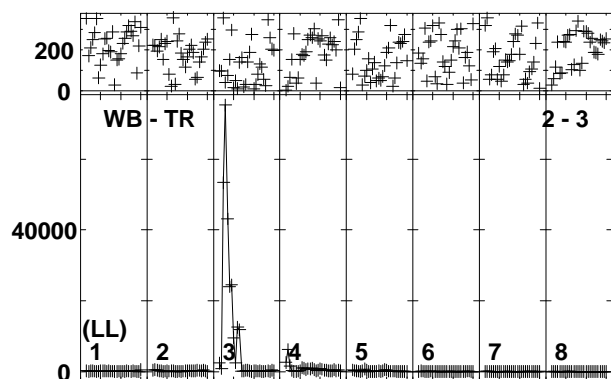
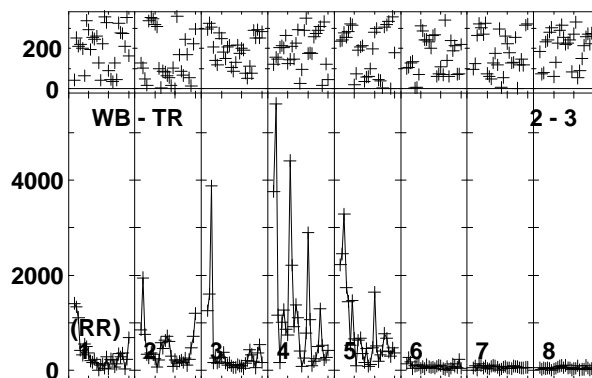
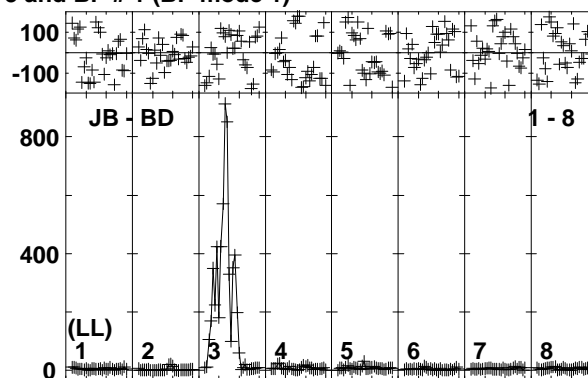
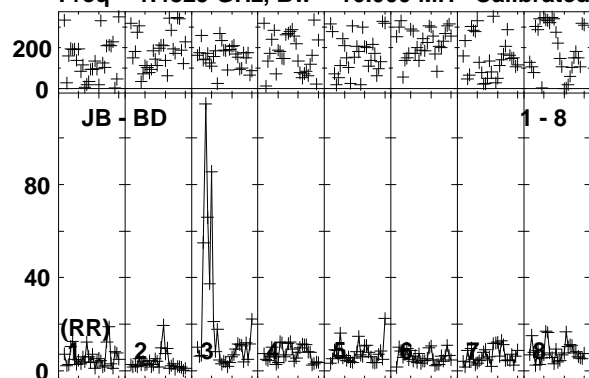

Lower frame: Milli Ampl Jy Top frame: Phas deg
Vector averaged cross-power spectrum Baseline: JB (01) - BD (08)
Timerange: 00/05:28:56 to 00/05:32:24

Plot file version 82 created 21-JUN-2019 11:53:51

IRAS12112 EP111A 1.UVDATA.1

Freq = 1.4829 GHz, Bw = 16.000 MH Calibrated with CL # 3 and BP # 1 (BP mode 1)

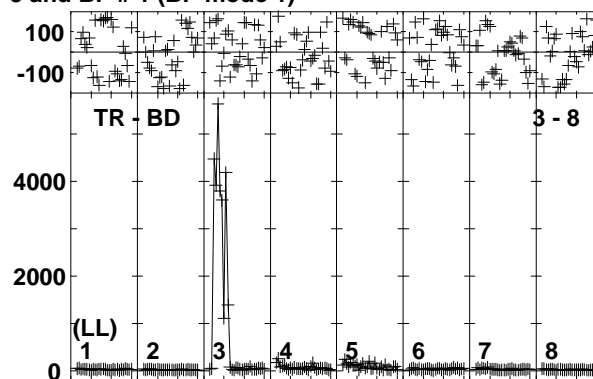
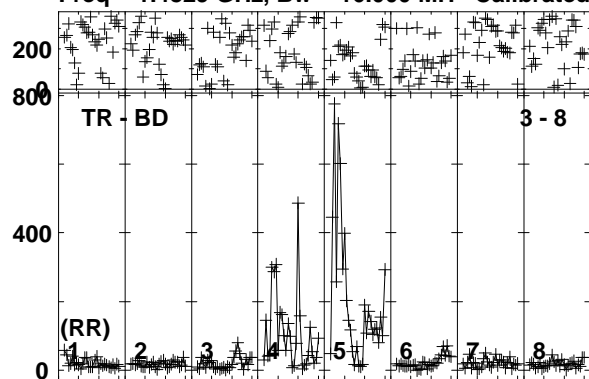

Lower frame: Milli Ampl Jy Top frame: Phas deg
Vector averaged cross-power spectrum Baseline: TR (03) - BD (08)
Timerange: 00/05:28:56 to 00/05:32:24

Plot file version 83 created 21-JUN-2019 11:53:52

J1222+0413 EP111A 1.UVDATA.1

Freq = 1.4829 GHz, Bw = 16.000 MH Calibrated with CL # 3 and BP # 1 (BP mode 1)

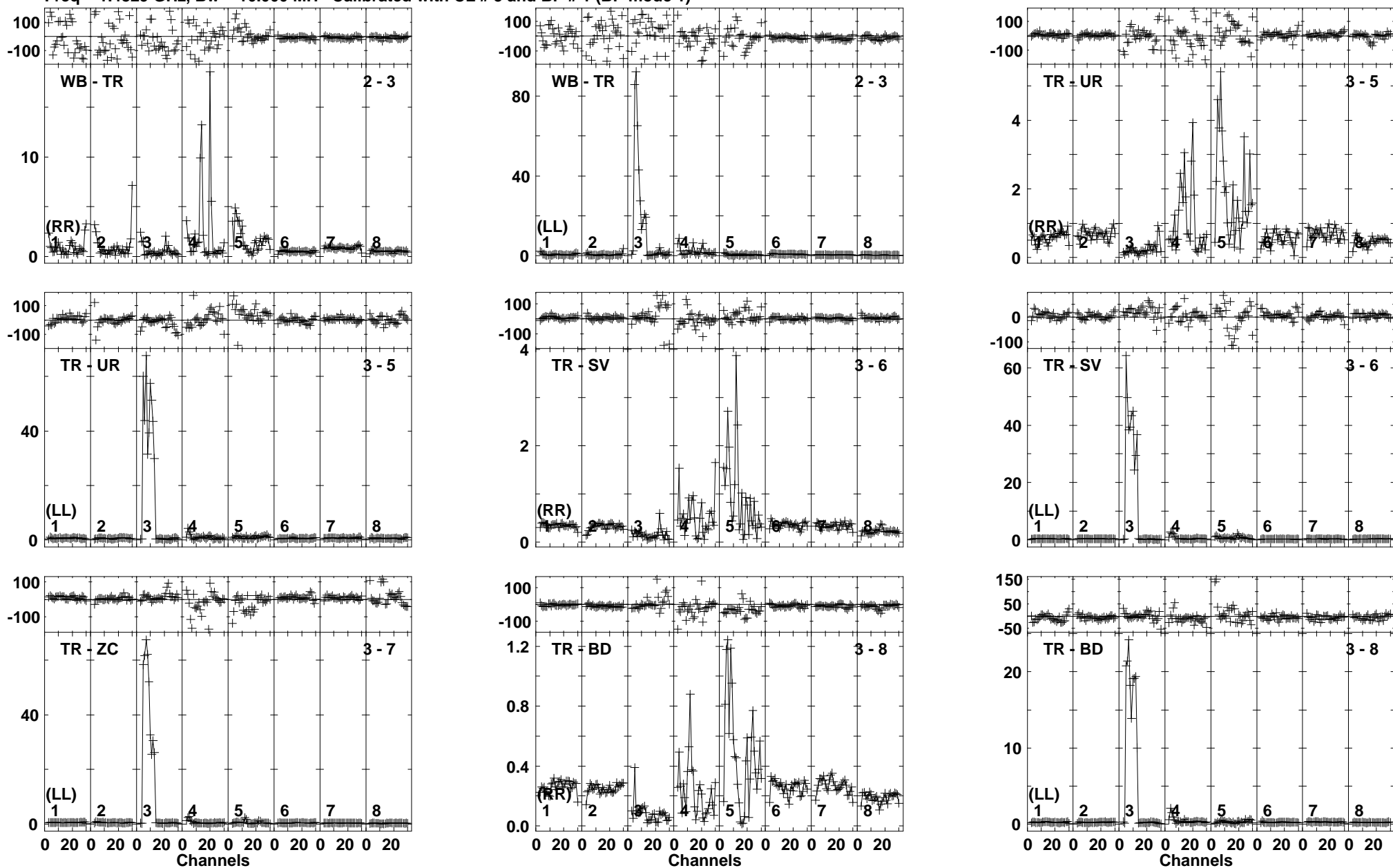

Lower frame: Ampl Jy Top frame: Phas deg
Vector averaged cross-power spectrum Baseline: WB (02) - TR (03)
Timerange: 00/05:32:26 to 00/05:33:54

Plot file version 84 created 21-JUN-2019 11:53:52

IRAS12112 EP111A 1.UVDATA.1

Freq = 1.4829 GHz, Bw = 16.000 MH Calibrated with CL # 3 and BP # 1 (BP mode 1)

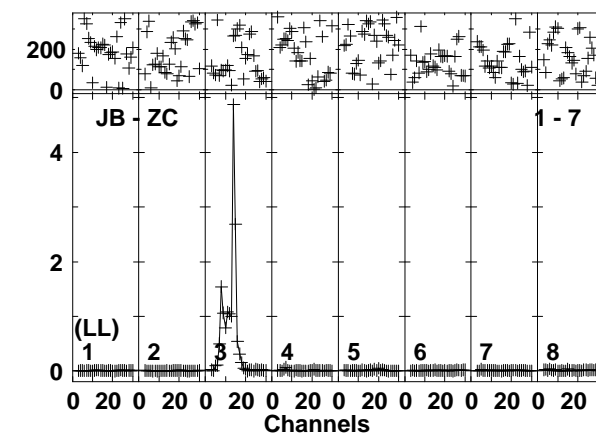
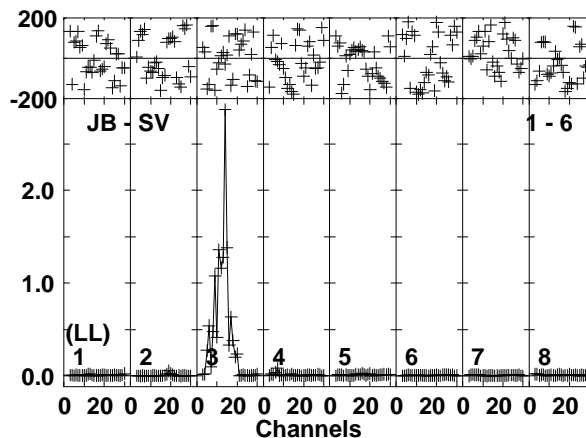
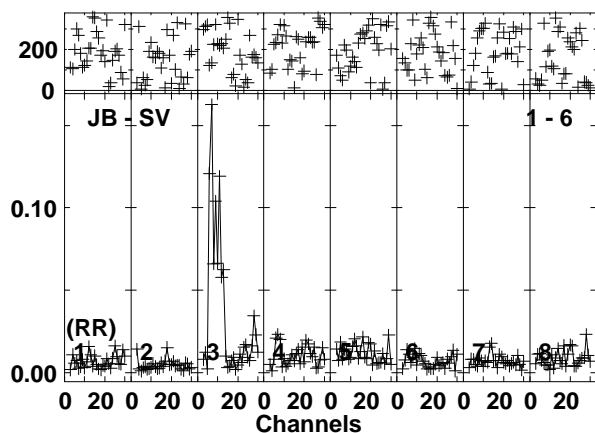
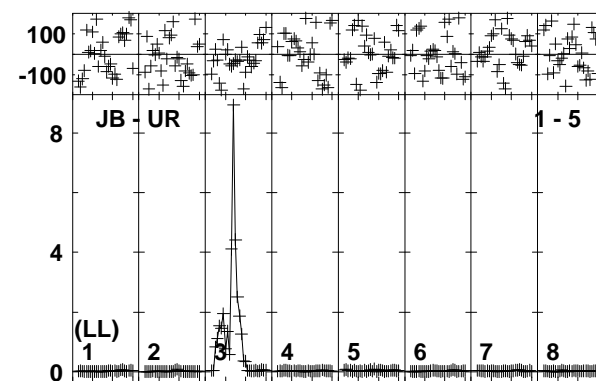
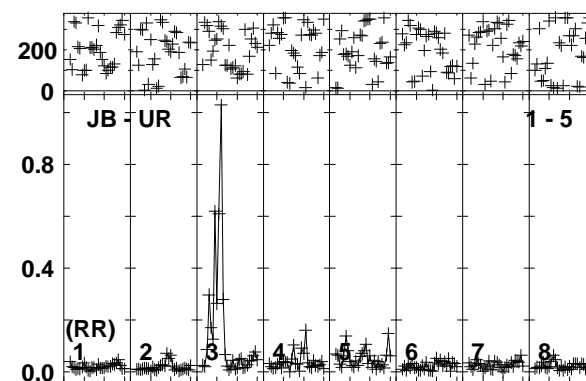
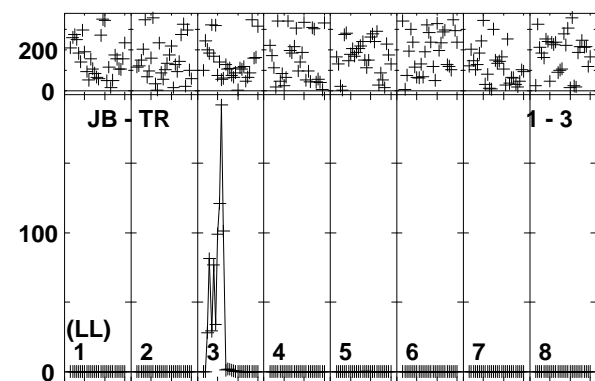
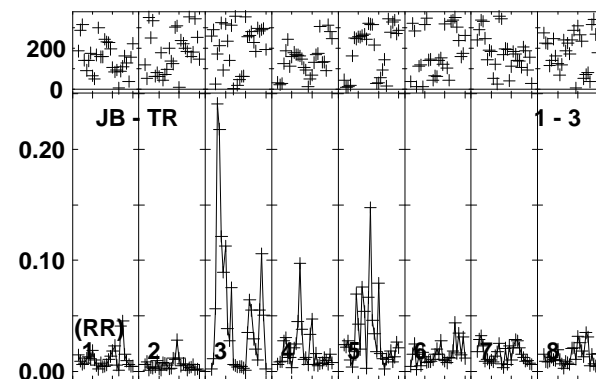
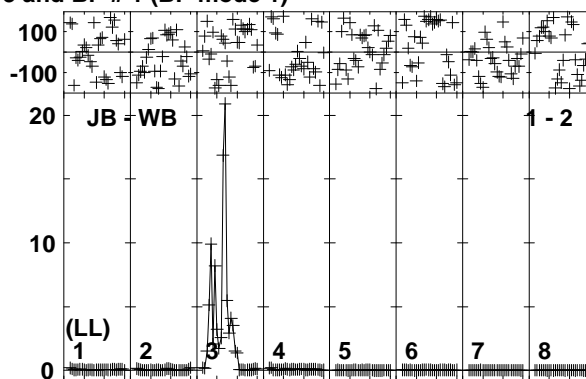
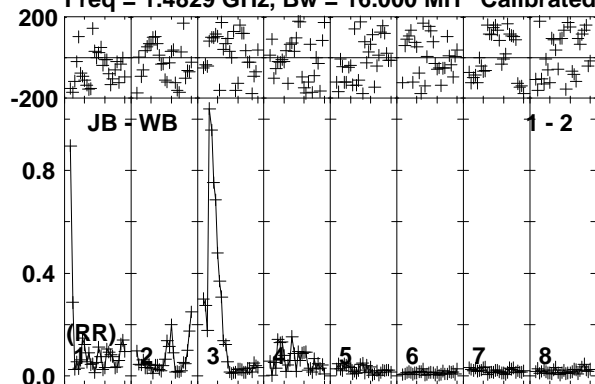

Lower frame: Ampl Jy Top frame: Phas deg
Vector averaged cross-power spectrum Baseline: JB (01) - WB (02)
Timerange: 00/05:33:56 to 00/05:37:24

Plot file version 85 created 21-JUN-2019 11:53:53

IRAS12112 EP111A 1.UVDATA.1

Freq = 1.4829 GHz, Bw = 16.000 MH Calibrated with CL # 3 and BP # 1 (BP mode 1)

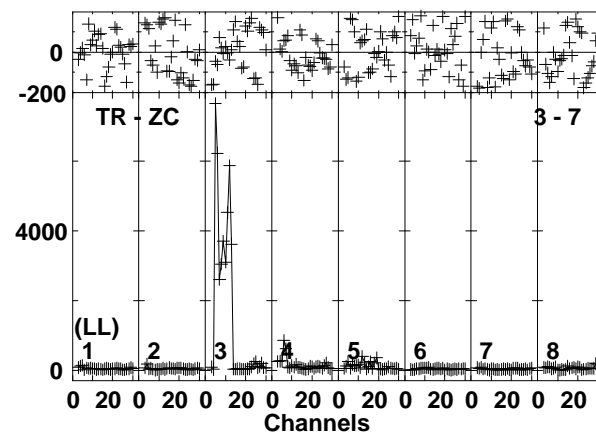
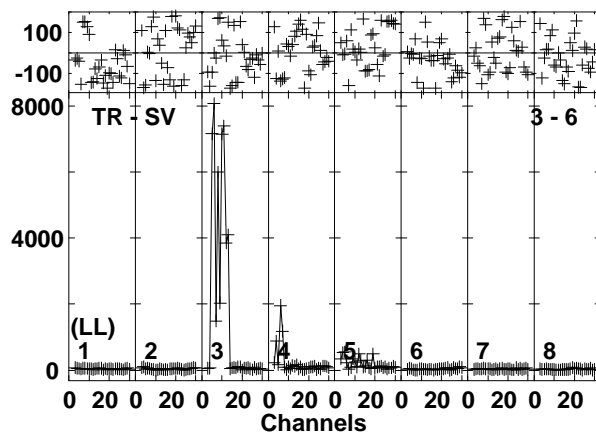
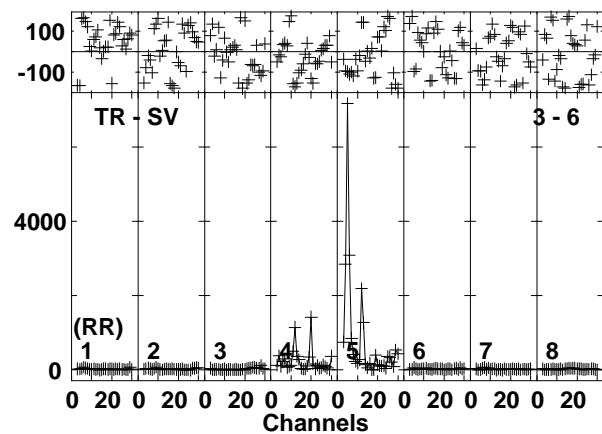
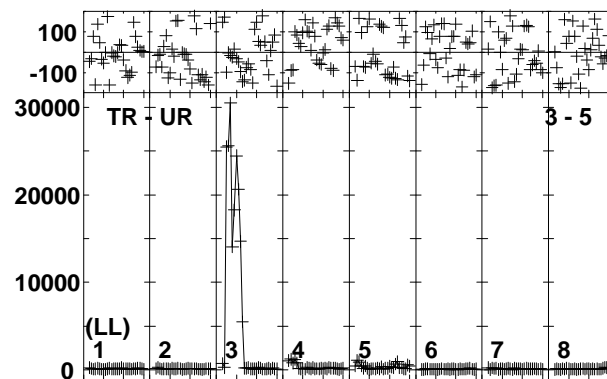
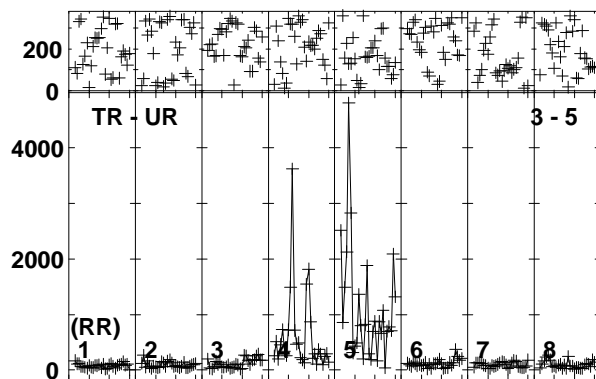
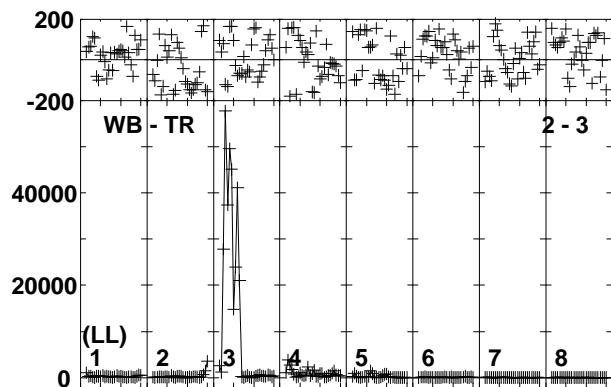
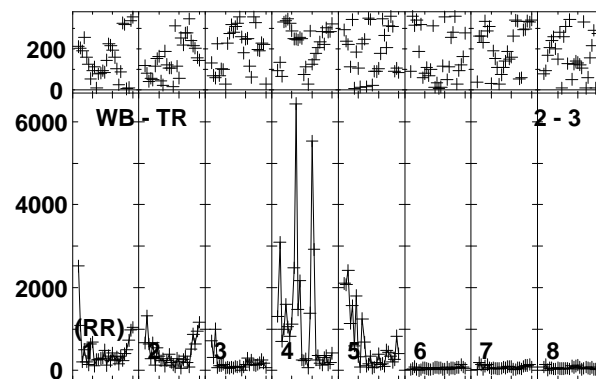
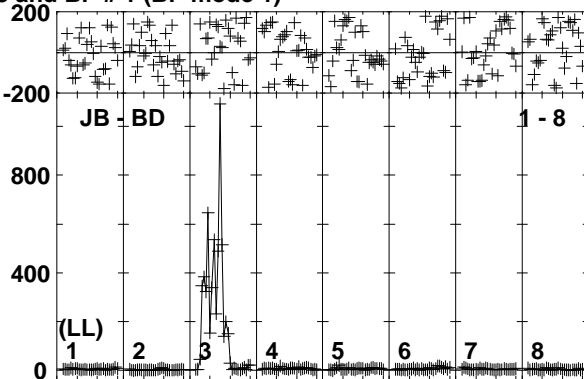
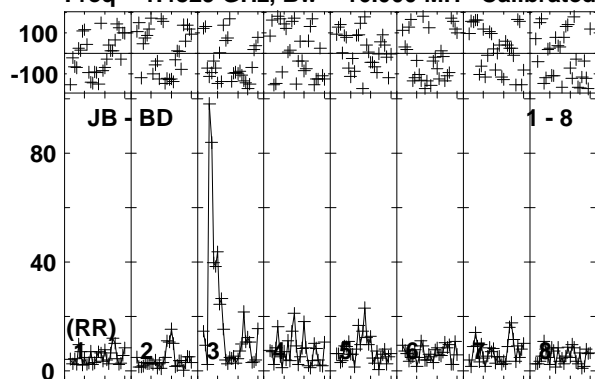

Lower frame: Milli Ampl Jy Top frame: Phas deg
Vector averaged cross-power spectrum Baseline: JB (01) - BD (08)
Timerange: 00/05:33:56 to 00/05:37:24

Plot file version 86 created 21-JUN-2019 11:53:53

IRAS12112 EP111A 1.UVDATA.1

Freq = 1.4829 GHz, Bw = 16.000 MH Calibrated with CL # 3 and BP # 1 (BP mode 1)

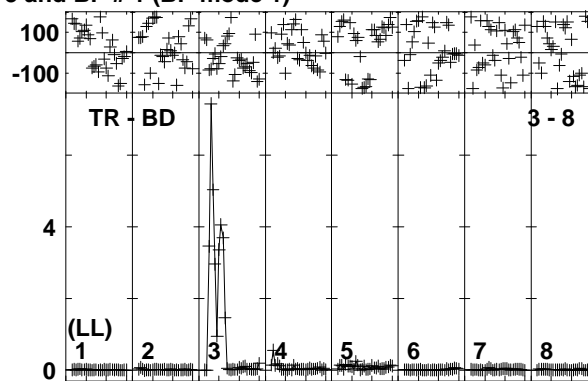
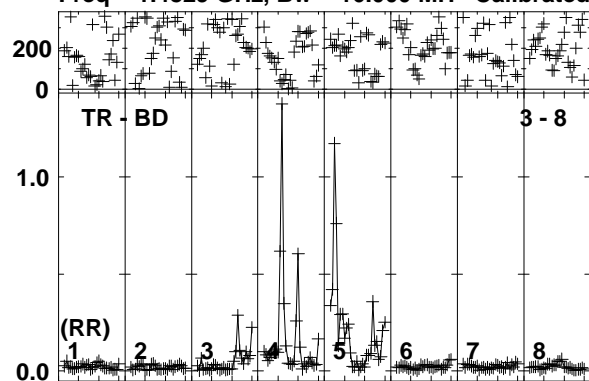

Lower frame: Ampl Jy Top frame: Phas deg
Vector averaged cross-power spectrum Baseline: TR (03) - BD (08)
Timerange: 00/05:33:56 to 00/05:37:24

Plot file version 87 created 21-JUN-2019 11:53:53

J1222+0413 EP111A 1.UVDATA.1

Freq = 1.4829 GHz, Bw = 16.000 MH Calibrated with CL # 3 and BP # 1 (BP mode 1)

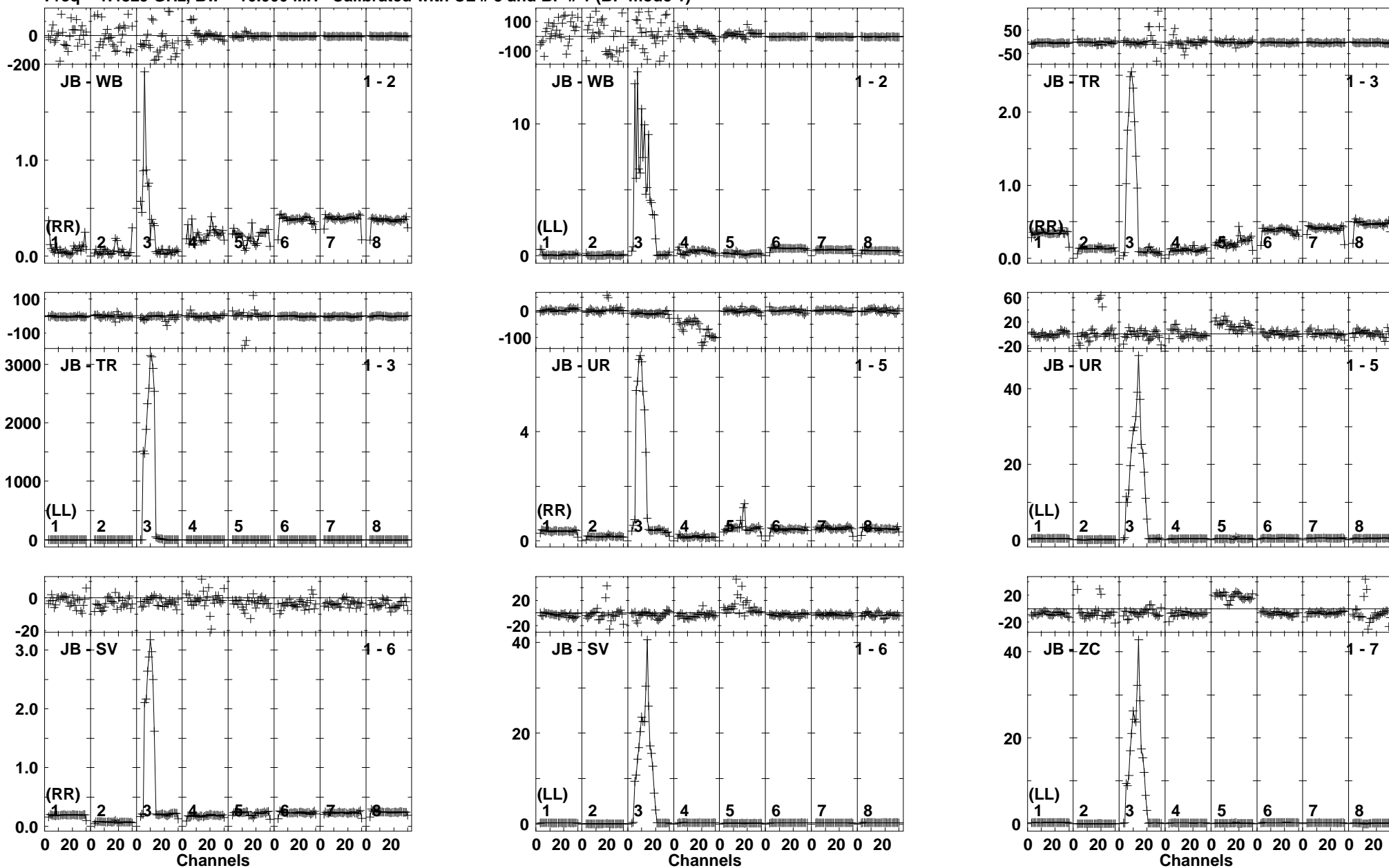

Lower frame: Ampl Jy Top frame: Phas deg
Vector averaged cross-power spectrum Baseline: JB (01) - WB (02)
Timerange: 00/05:38:06 to 00/05:39:34

Plot file version 88 created 21-JUN-2019 11:53:54

J1222+0413 EP111A 1.UVDATA.1

Freq = 1.4829 GHz, Bw = 16.000 MH Calibrated with CL # 3 and BP # 1 (BP mode 1)

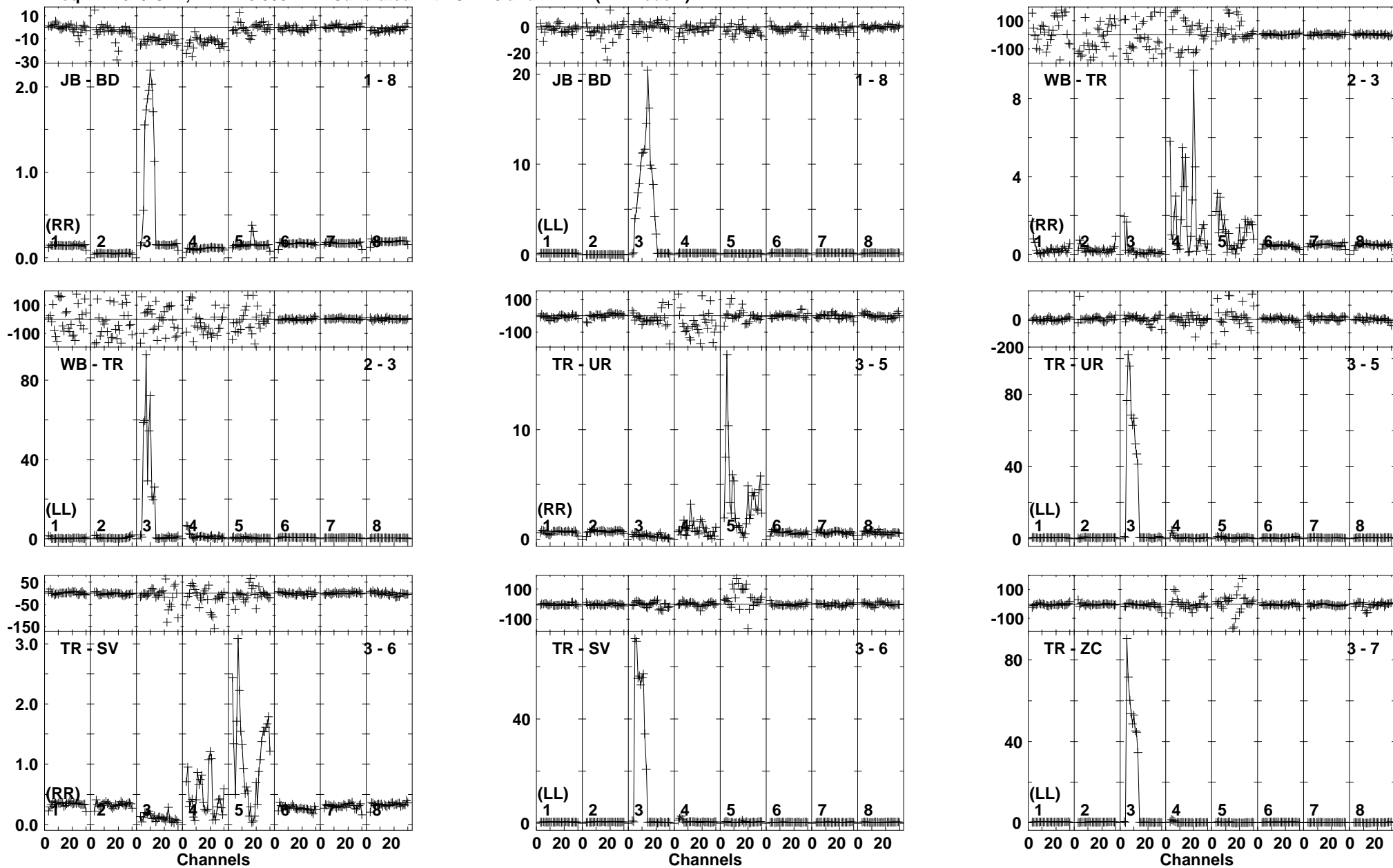

Plot file version 89 created 21-JUN-2019 11:53:54

J1222+0413 EP1111A 1.UVDATA.1

Freq = 1.4829 GHz, Bw = 16.000 MH Calibrated with CL # 3 and BP # 1 (BP mode 1)

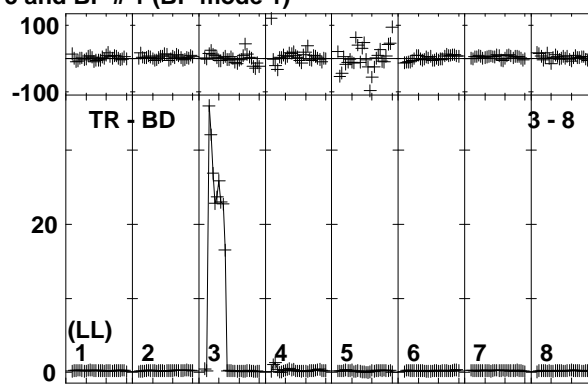
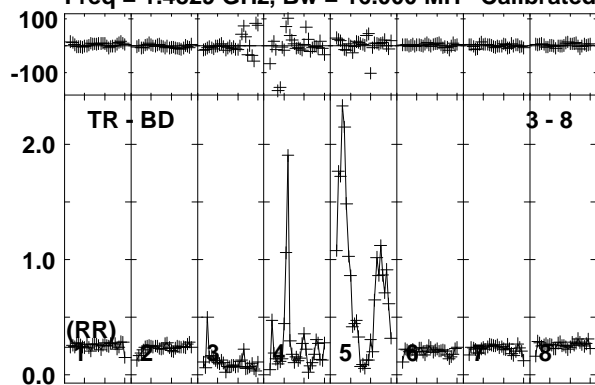

Lower frame: Ampl Jy Top frame: Phas deg
Vector averaged cross-power spectrum Baseline: TR (03) - BD (08)
Timerange: 00/05:38:06 to 00/05:39:34

Plot file version 90 created 21-JUN-2019 11:53:54
 IRAS12112 EP111A 1.UVDATA.1
 Freq = 1.4829 GHz, Bw = 16.000 MH Calibrated with CL # 3 and BP # 1 (BP mode 1)

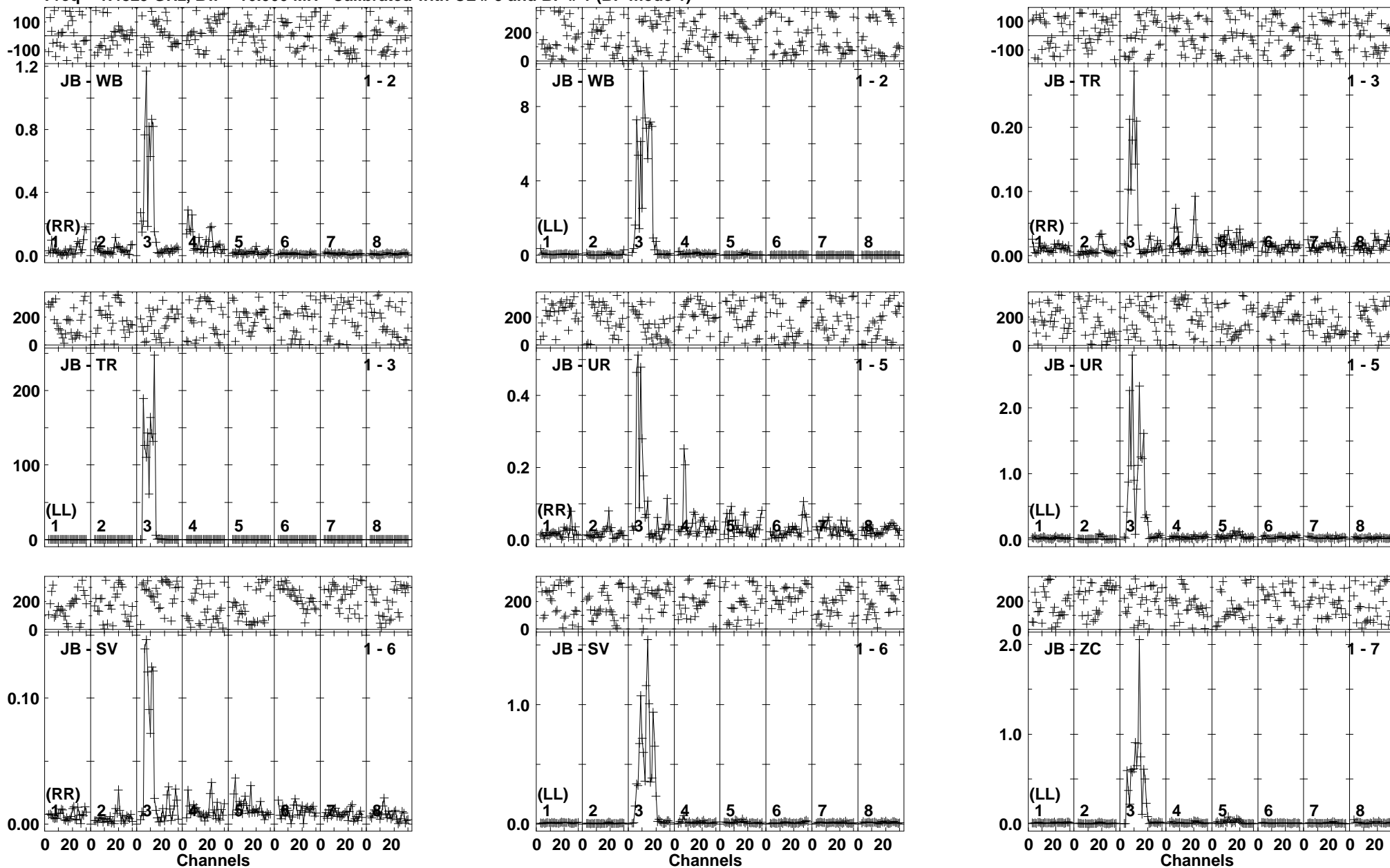

Lower frame: Ampl Jy Top frame: Phas deg
 Vector averaged cross-power spectrum Baseline: JB (01) - WB (02)
 Timerange: 00/05:39:36 to 00/05:43:04

Plot file version 91 created 21-JUN-2019 11:53:55

IRAS12112 EP111A 1.UVDATA.1

Freq = 1.4829 GHz, Bw = 16.000 MH Calibrated with CL # 3 and BP # 1 (BP mode 1)

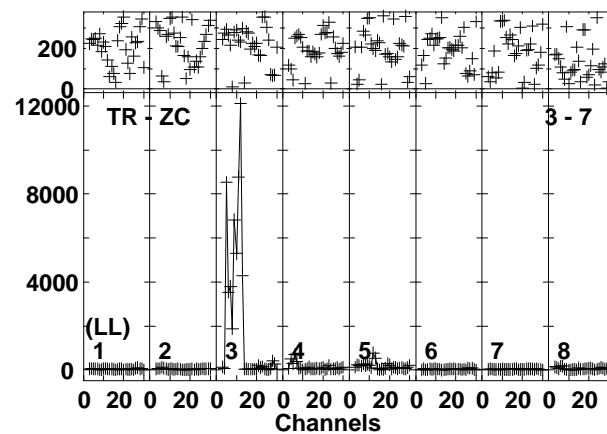
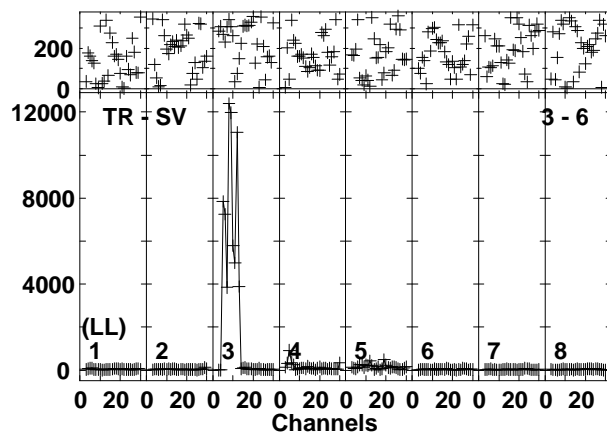
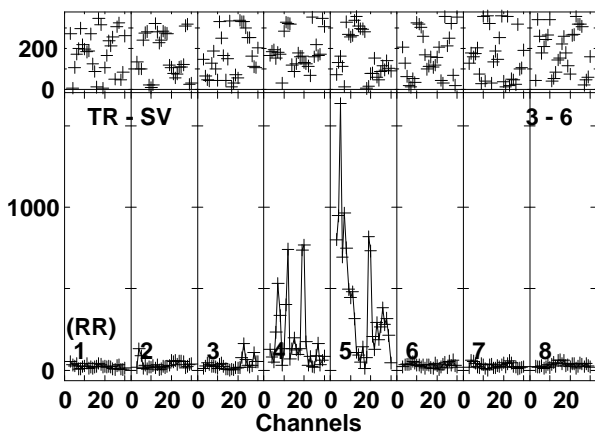
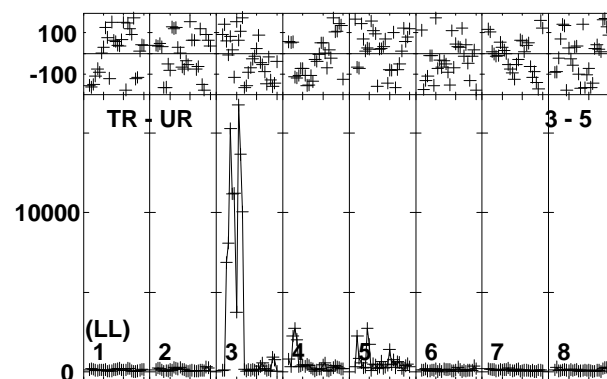
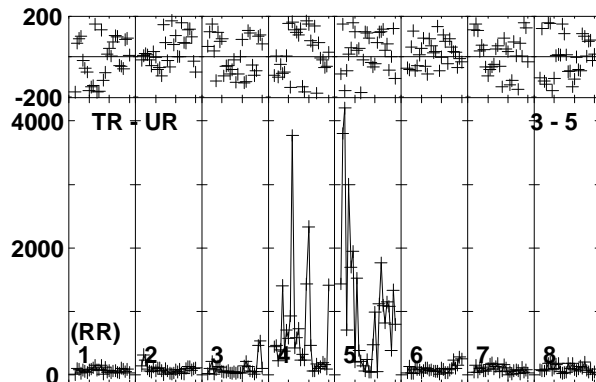
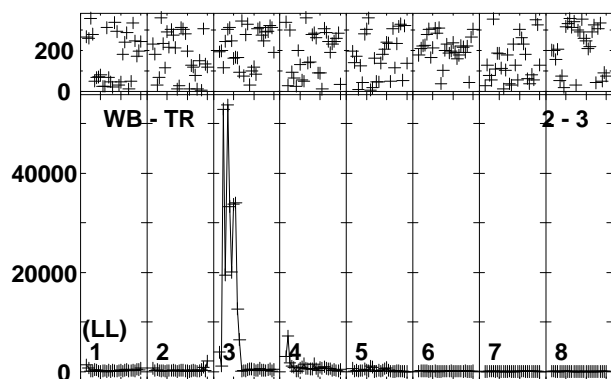
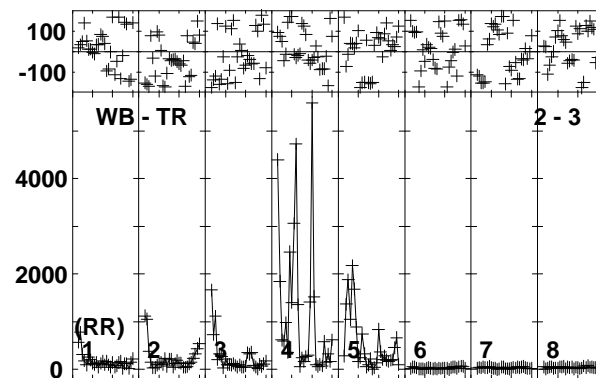
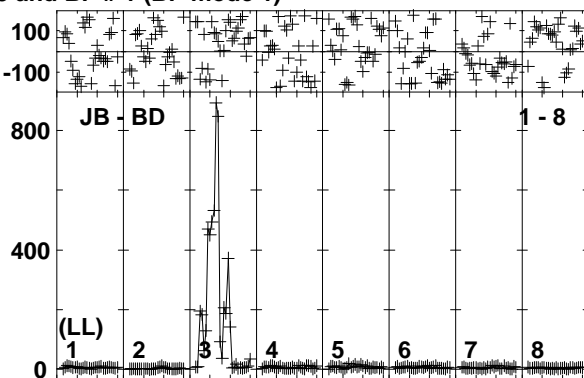
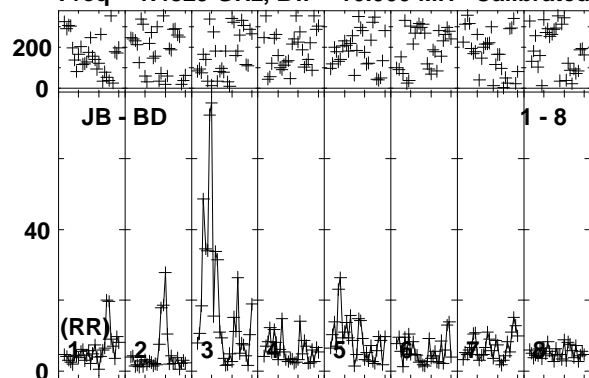

Lower frame: Milli Ampl Jy Top frame: Phas deg
Vector averaged cross-power spectrum Baseline: JB (01) - BD (08)
Timerange: 00/05:39:36 to 00/05:43:04

Plot file version 92 created 21-JUN-2019 11:53:55

IRAS12112 EP111A 1.UVDATA.1

Freq = 1.4829 GHz, Bw = 16.000 MH Calibrated with CL # 3 and BP # 1 (BP mode 1)

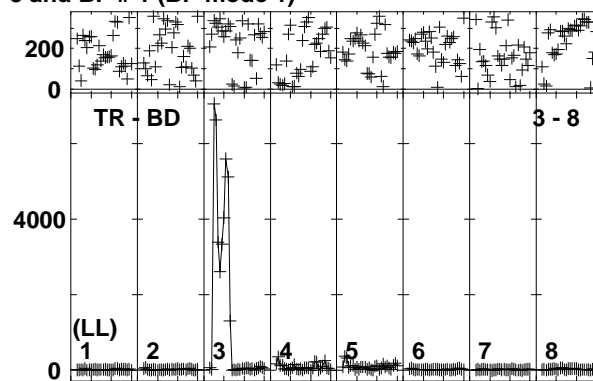
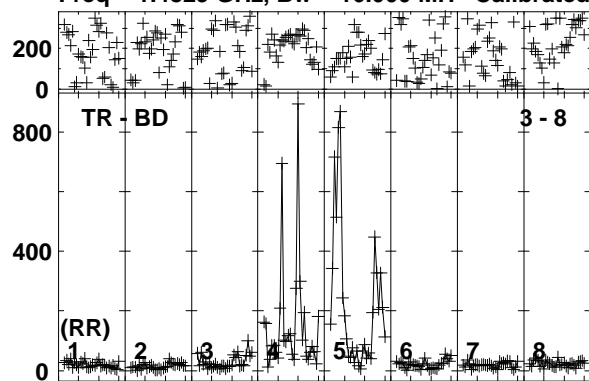

Lower frame: Milli Ampl Jy Top frame: Phas deg
Vector averaged cross-power spectrum Baseline: TR (03) - BD (08)
Timerange: 00/05:39:36 to 00/05:43:04

Plot file version 93 created 21-JUN-2019 11:53:56

J1222+0413 EP111A 1.UVDATA.1

Freq = 1.4829 GHz, Bw = 16.000 MH Calibrated with CL # 3 and BP # 1 (BP mode 1)

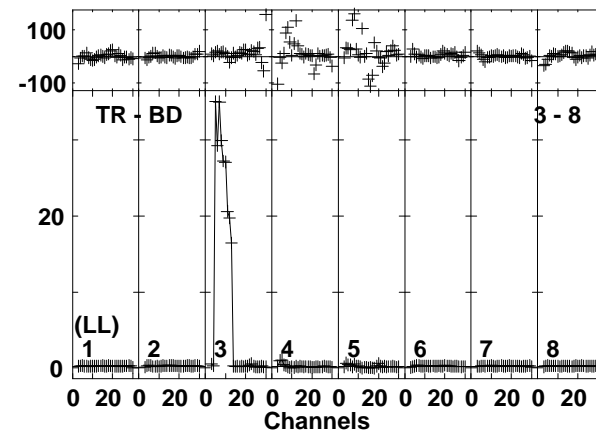
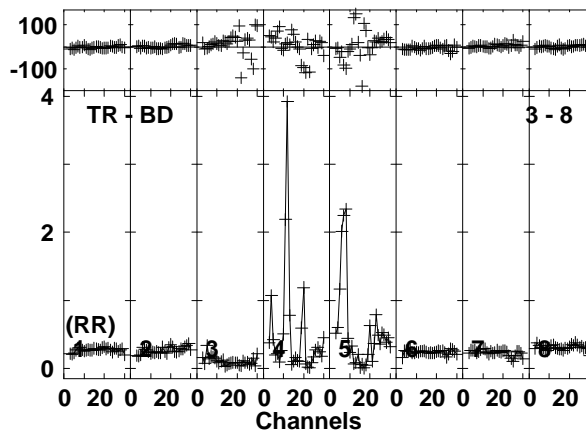
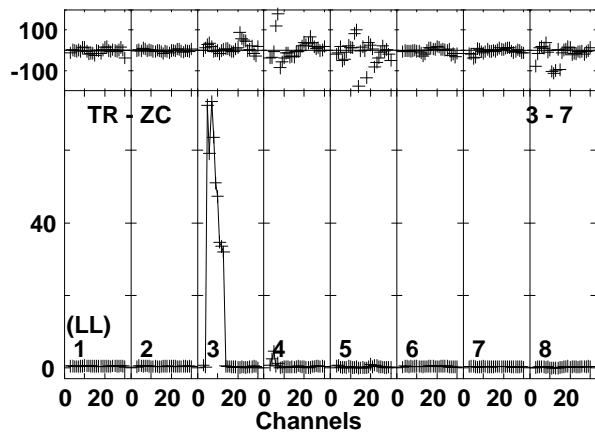
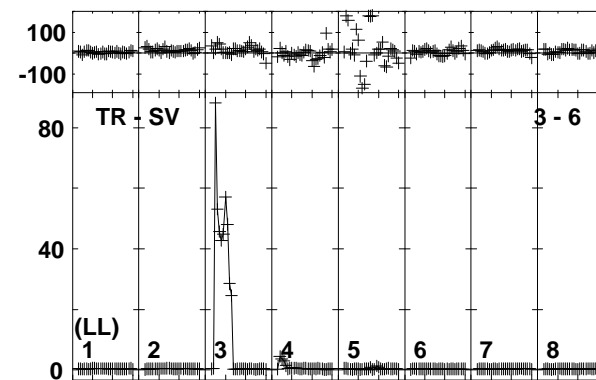
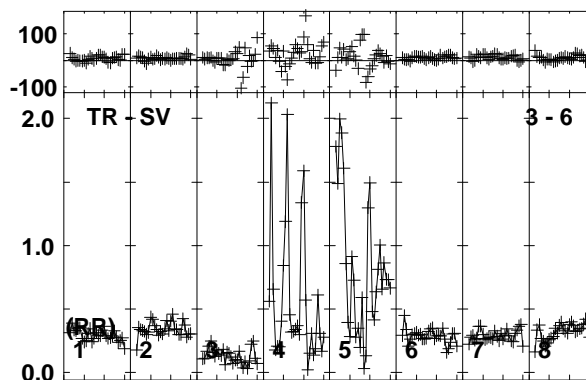
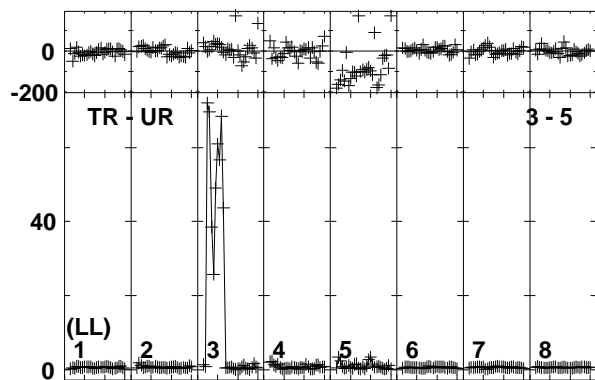
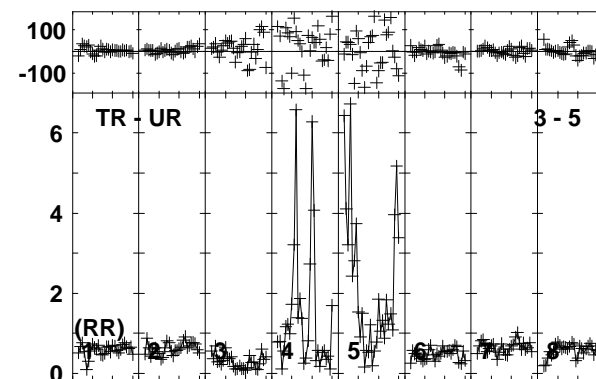
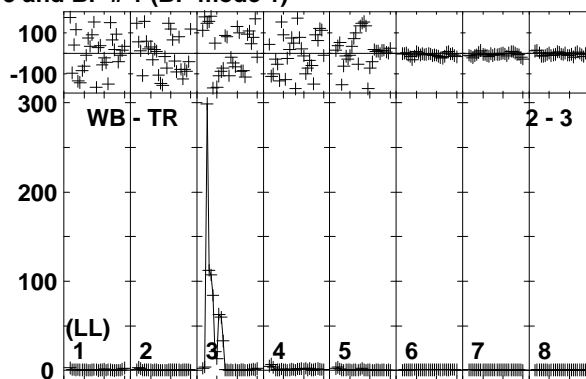
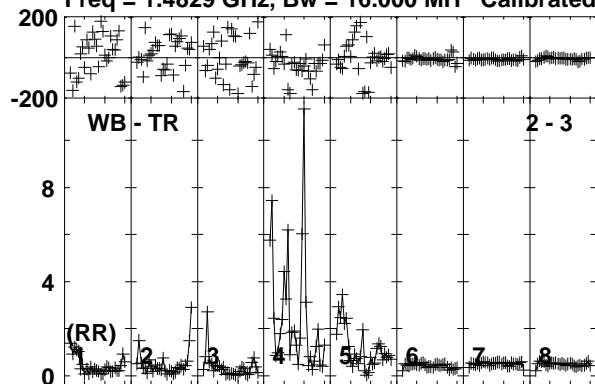

Lower frame: Ampl Jy Top frame: Phas deg
Vector averaged cross-power spectrum Baseline: WB (02) - TR (03)
Timerange: 00/05:43:06 to 00/05:44:34

Plot file version 94 created 21-JUN-2019 11:53:56

IRAS12112 EP111A 1.UVDATA.1

Freq = 1.4829 GHz, Bw = 16.000 MH Calibrated with CL # 3 and BP # 1 (BP mode 1)

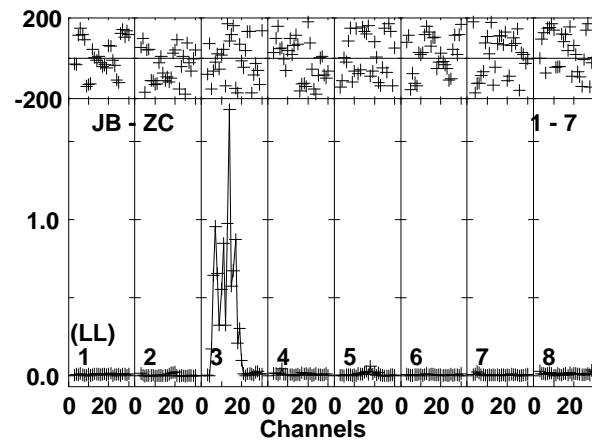
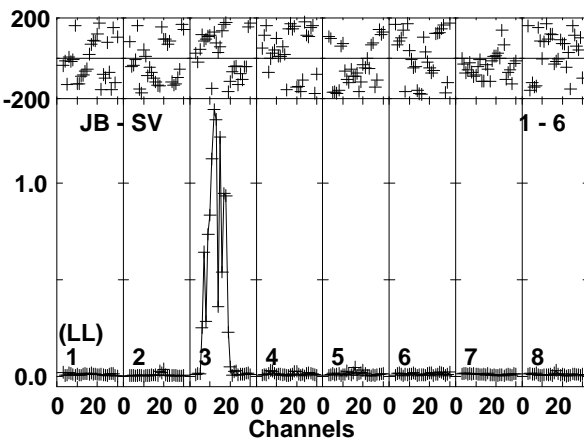
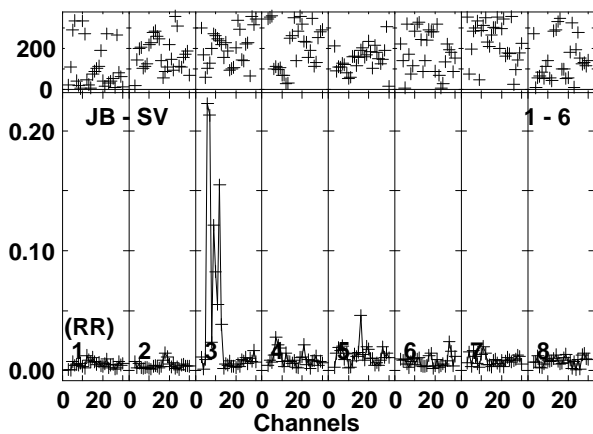
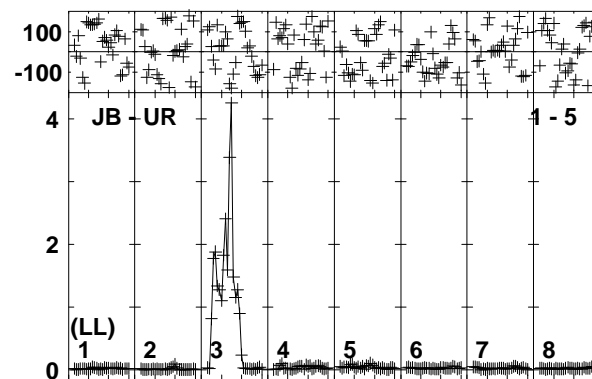
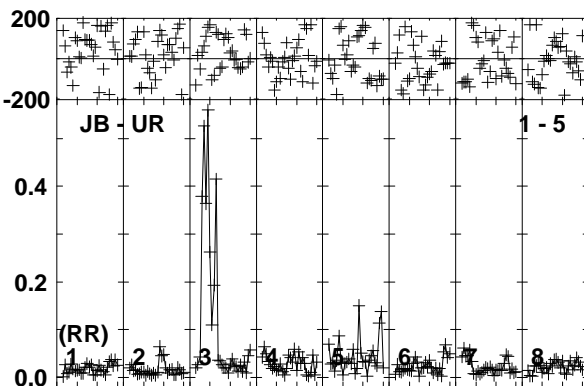
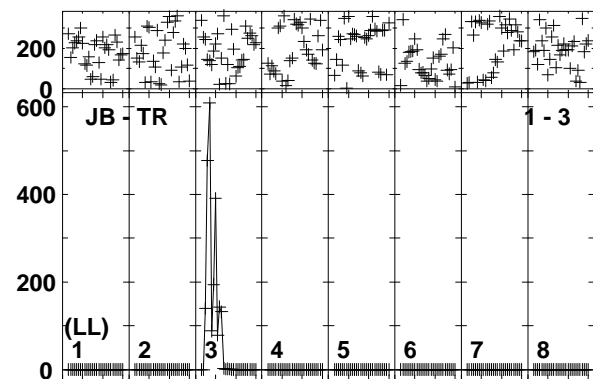
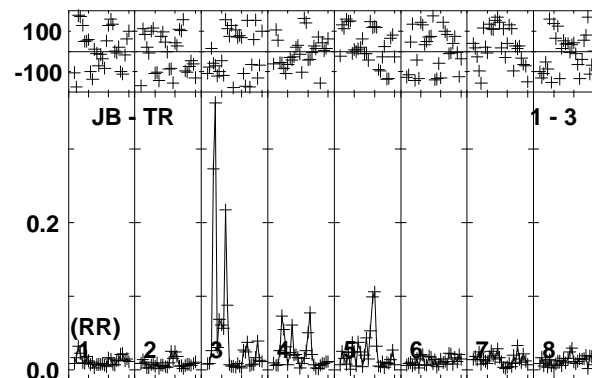
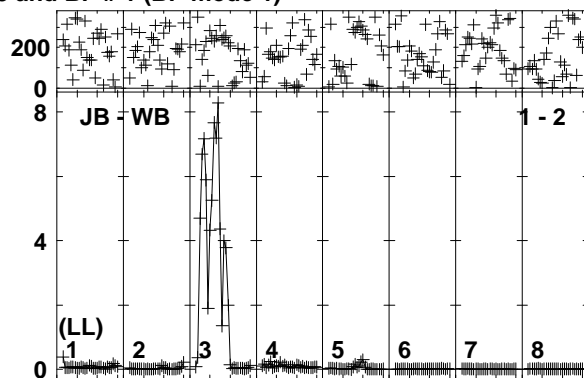
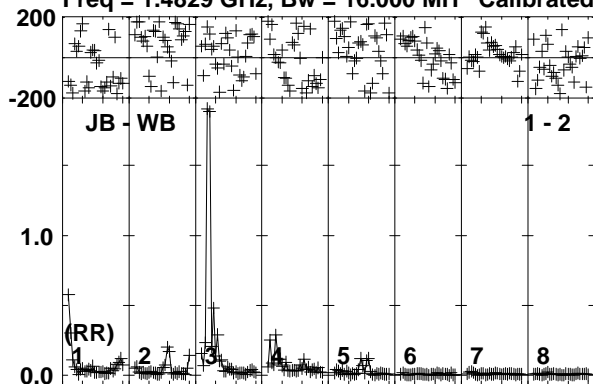

Lower frame: Ampl Jy Top frame: Phas deg
Vector averaged cross-power spectrum Baseline: JB (01) - WB (02)
Timerange: 00/05:44:36 to 00/05:48:04

Plot file version 95 created 21-JUN-2019 11:53:57

IRAS12112 EP111A 1.UVDATA.1

Freq = 1.4829 GHz, Bw = 16.000 MH Calibrated with CL # 3 and BP # 1 (BP mode 1)

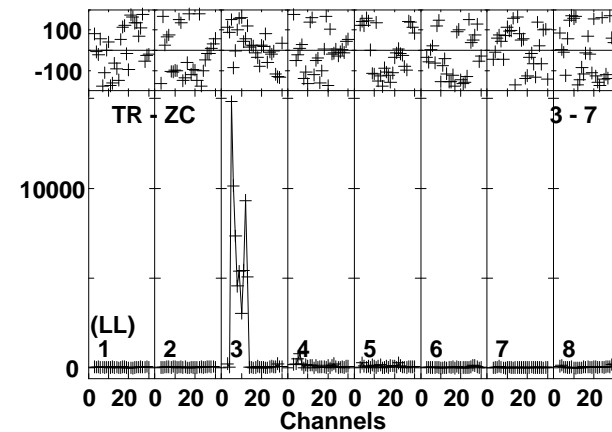
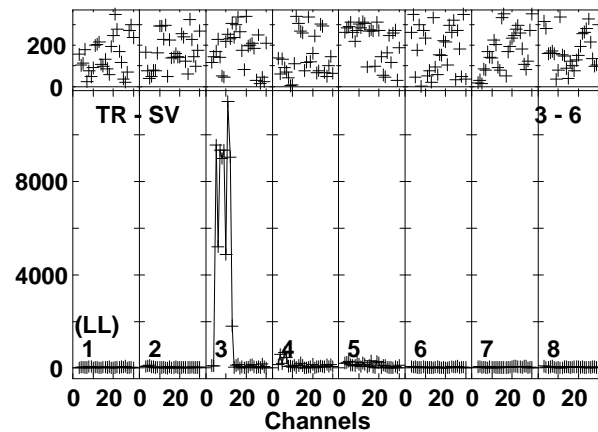
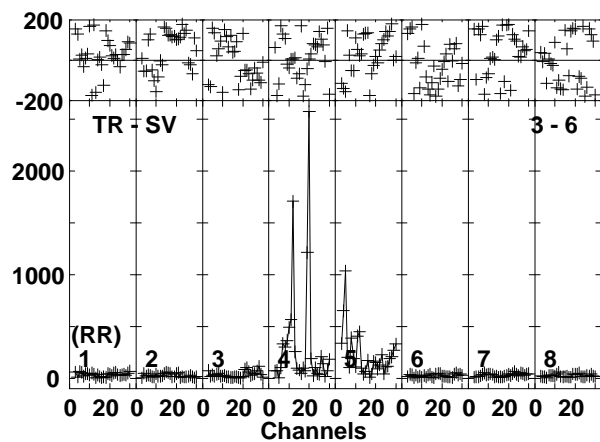
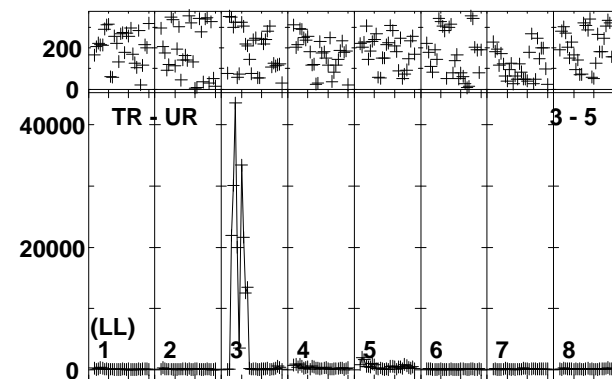
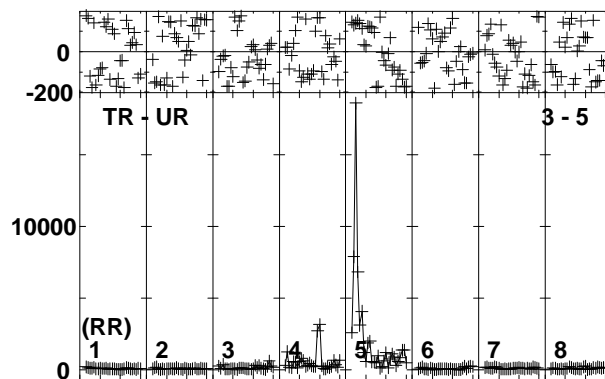
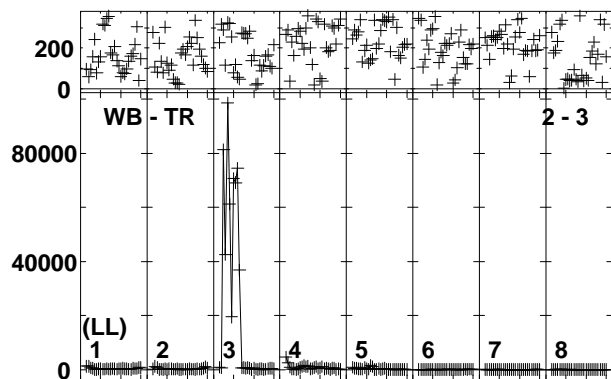
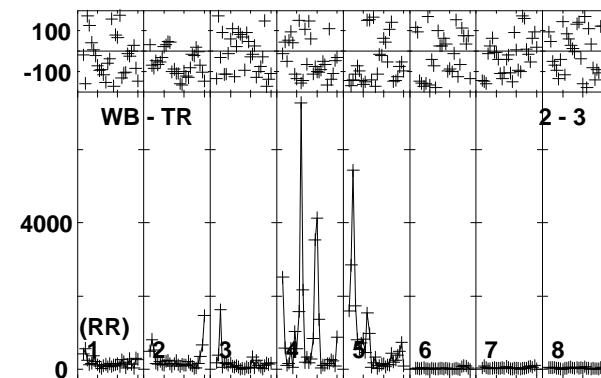
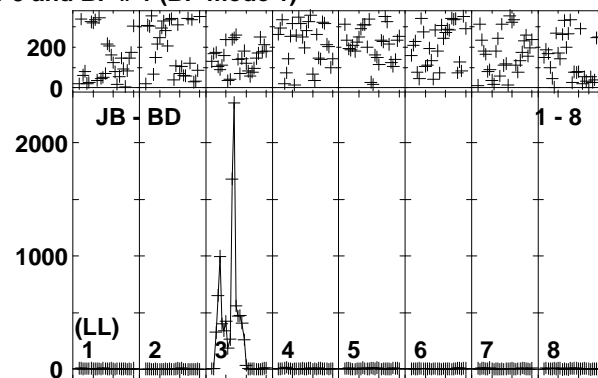
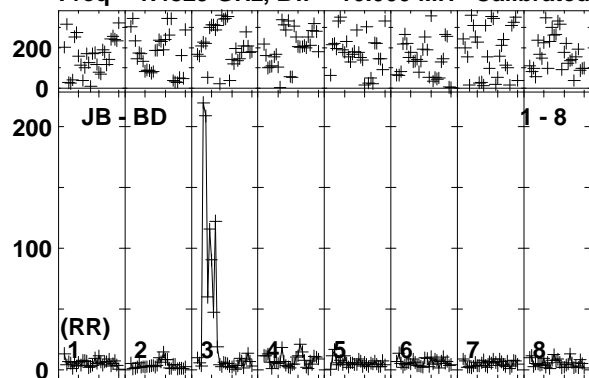

Lower frame: Milli Ampl Jy Top frame: Phas deg
Vector averaged cross-power spectrum Baseline: JB (01) - BD (08)
Timerange: 00/05:44:36 to 00/05:48:04

Plot file version 96 created 21-JUN-2019 11:53:57

IRAS12112 EP111A 1.UVDATA.1

Freq = 1.4829 GHz, Bw = 16.000 MH Calibrated with CL # 3 and BP # 1 (BP mode 1)

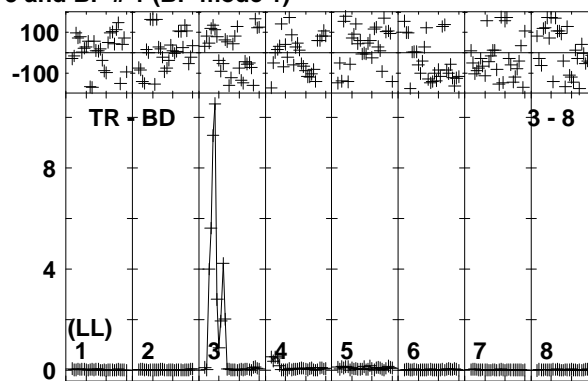
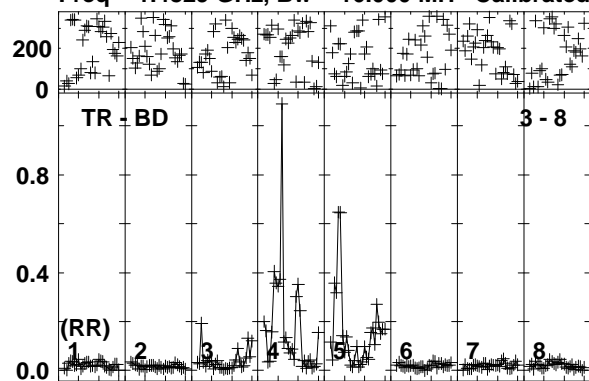

Lower frame: Ampl Jy Top frame: Phas deg
Vector averaged cross-power spectrum Baseline: TR (03) - BD (08)
Timerange: 00/05:44:36 to 00/05:48:04

Plot file version 97 created 21-JUN-2019 11:53:57

J1222+0413 EP111A 1.UVDATA.1

Freq = 1.4829 GHz, Bw = 16.000 MH Calibrated with CL # 3 and BP # 1 (BP mode 1)

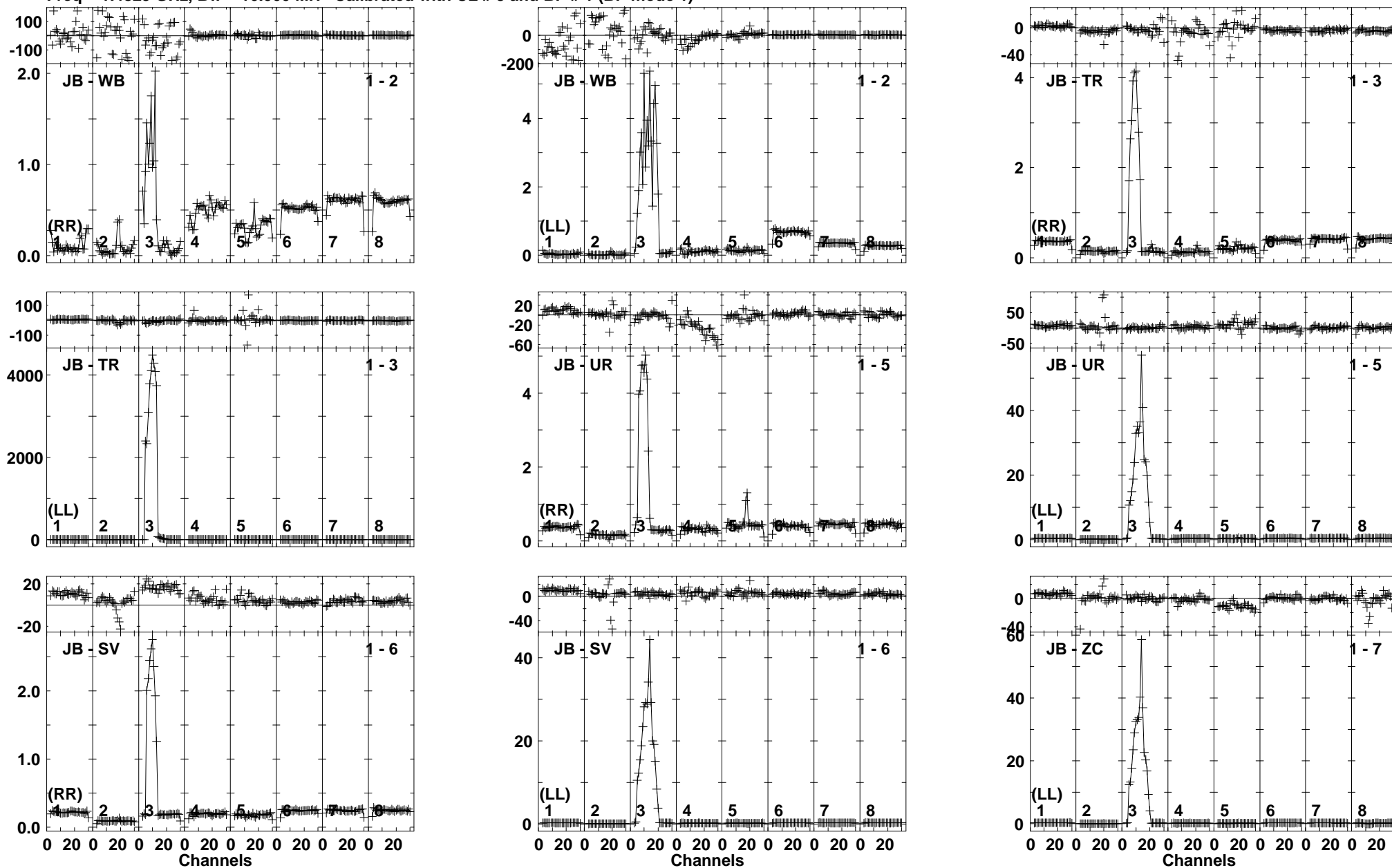

Lower frame: Ampl Jy Top frame: Phas deg
Vector averaged cross-power spectrum Baseline: JB (01) - WB (02)
Timerange: 00/05:48:46 to 00/05:50:14

Plot file version 98 created 21-JUN-2019 11:53:57

J1222+0413 EP111A 1.UVDATA.1

Freq = 1.4829 GHz, Bw = 16.000 MH Calibrated with CL # 3 and BP # 1 (BP mode 1)

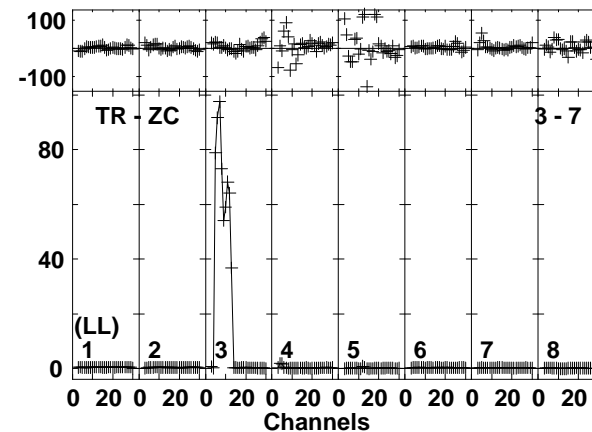
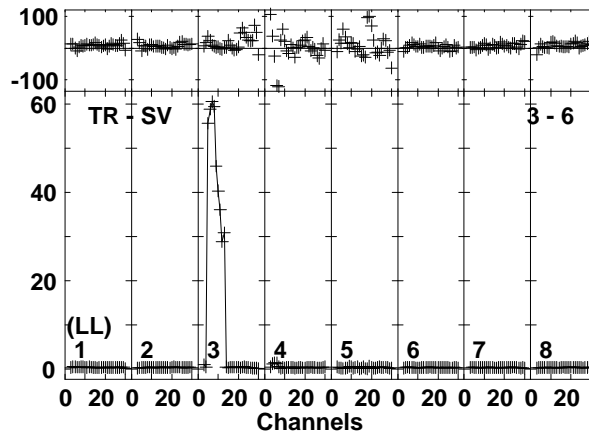
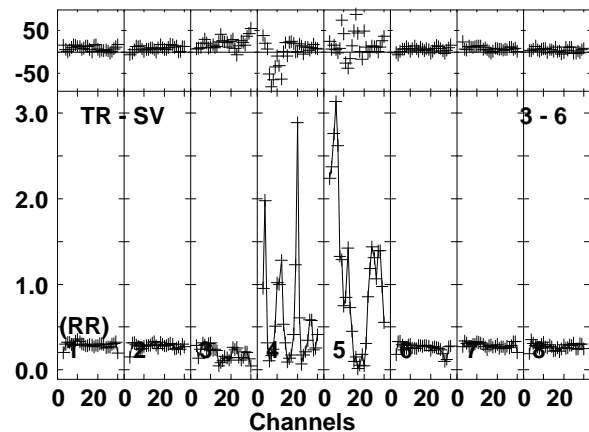
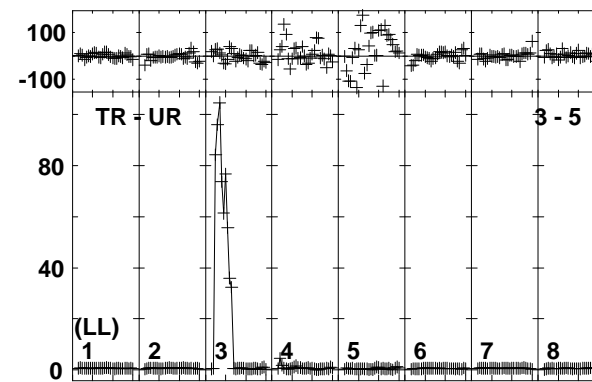
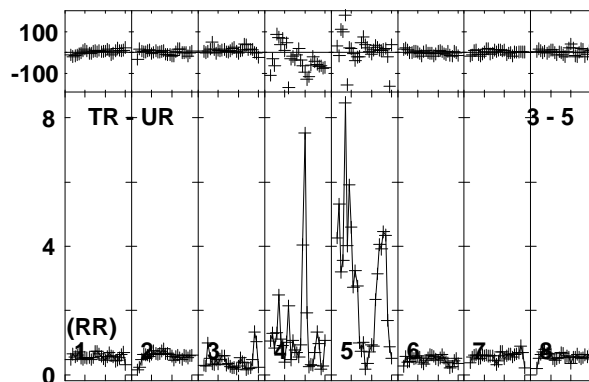
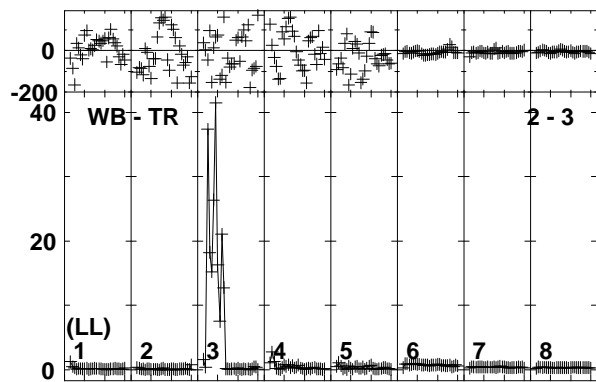
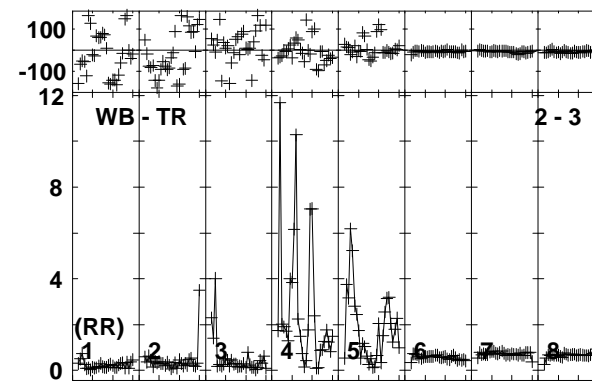
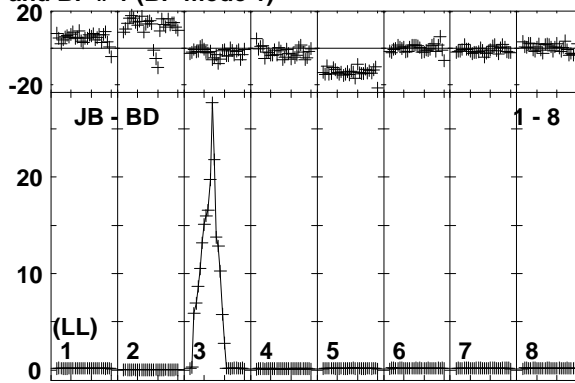
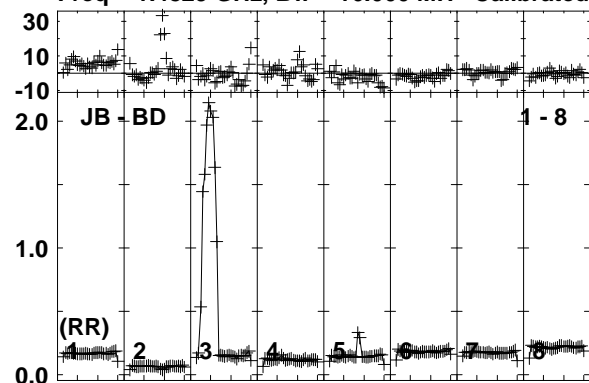

Lower frame: Ampl Jy Top frame: Phas deg
Vector averaged cross-power spectrum Baseline: JB (01) - BD (08)
Timerange: 00/05:48:46 to 00/05:50:14

Plot file version 99 created 21-JUN-2019 11:53:58

J1222+0413 EP111A 1.UVDATA.1

Freq = 1.4829 GHz, Bw = 16.000 MH Calibrated with CL # 3 and BP # 1 (BP mode 1)

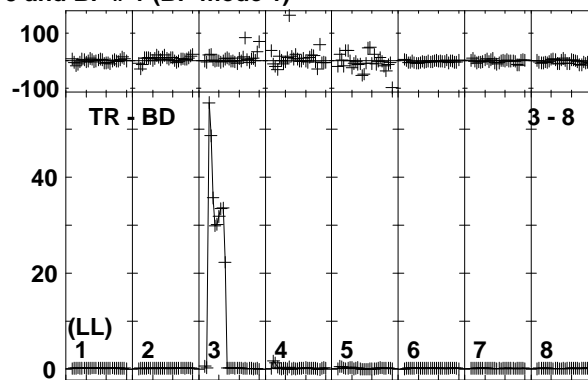
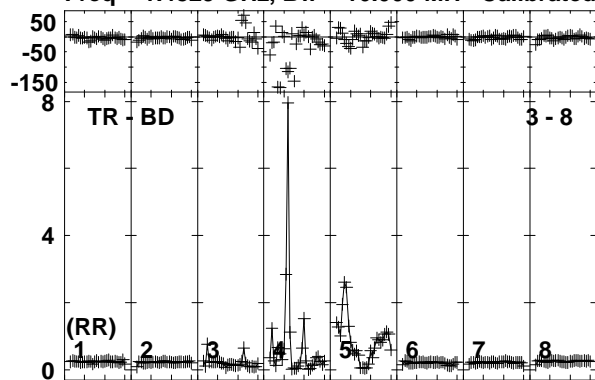

Lower frame: Ampl Jy Top frame: Phas deg
Vector averaged cross-power spectrum Baseline: TR (03) - BD (08)
Timerange: 00/05:48:46 to 00/05:50:14

Plot file version 100 created 21-JUN-2019 11:53:58

IRAS12112 EP111A 1.UVDATA.1

Freq = 1.4829 GHz, Bw = 16.000 MH Calibrated with CL # 3 and BP # 1 (BP mode 1)

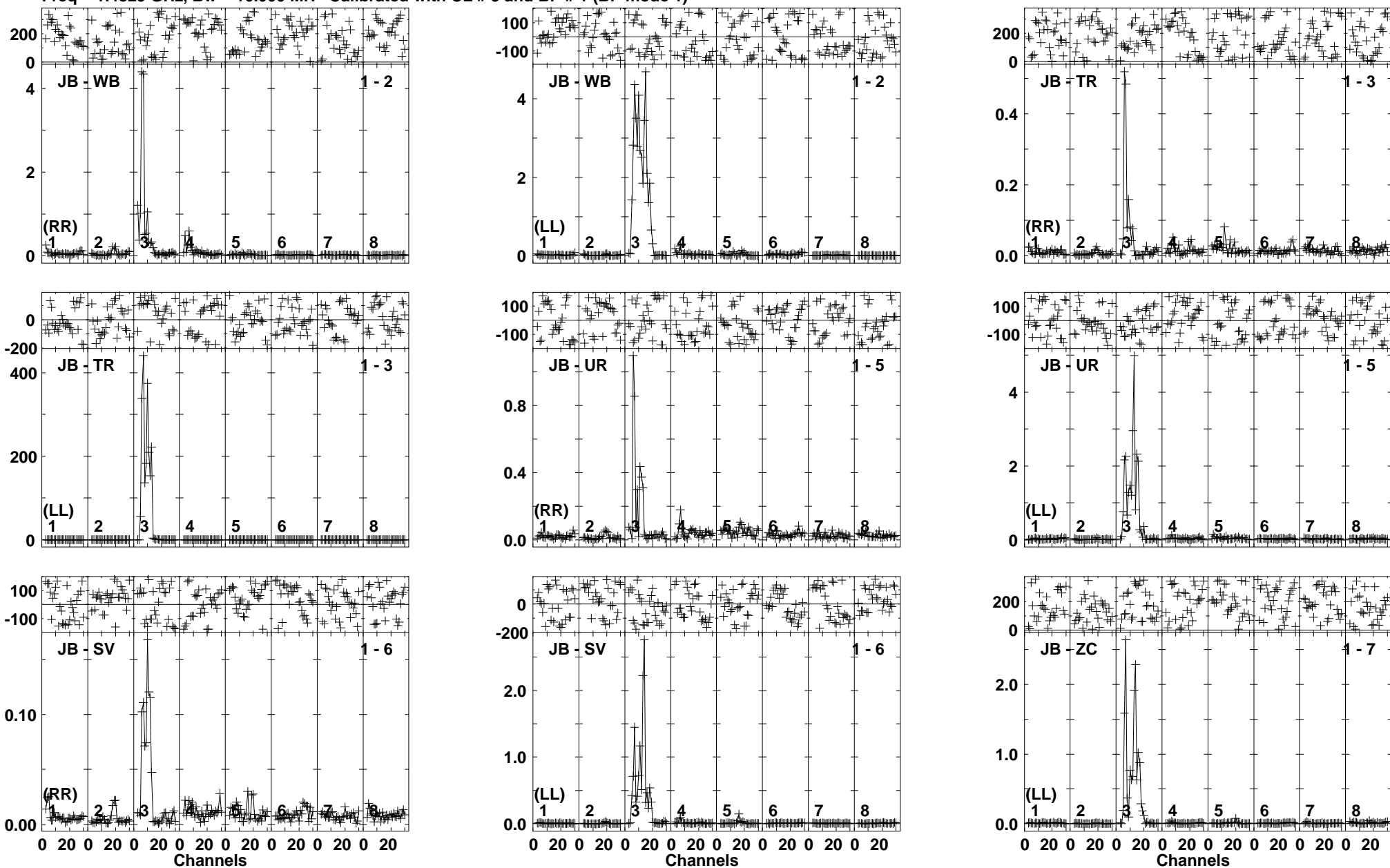

Lower frame: Ampl Jy Top frame: Phas deg
Vector averaged cross-power spectrum Baseline: JB (01) - WB (02)
Timerange: 00/05:50:16 to 00/05:53:44

Plot file version 101 created 21-JUN-2019 11:53:58

IRAS12112 EP111A 1.UVDATA.1

Freq = 1.4829 GHz, Bw = 16.000 MH Calibrated with CL # 3 and BP # 1 (BP mode 1)

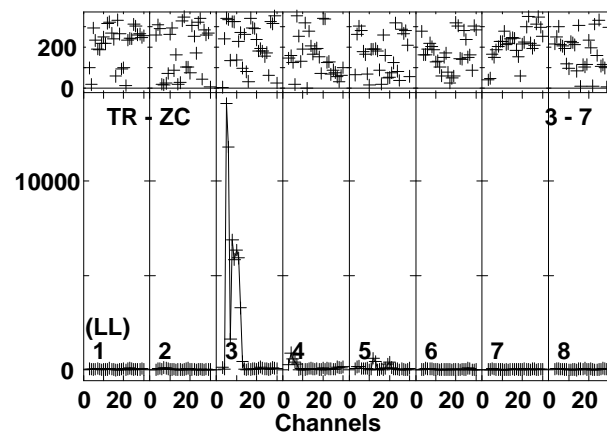
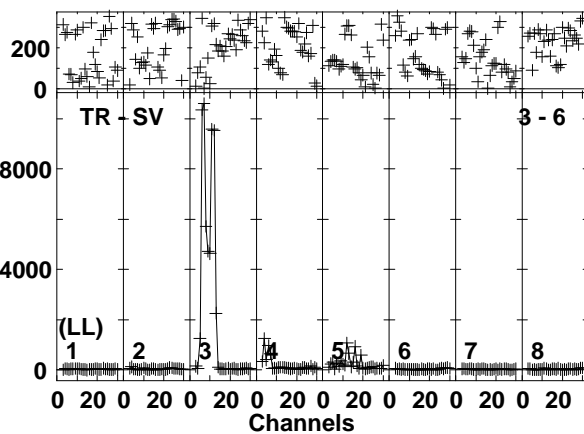
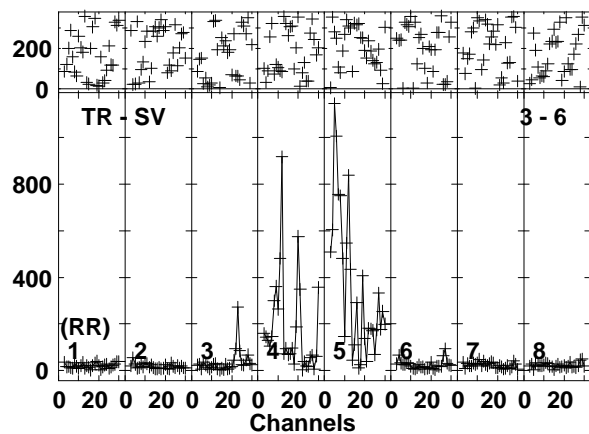
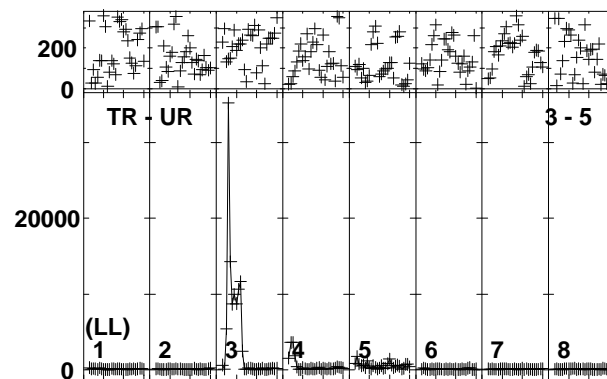
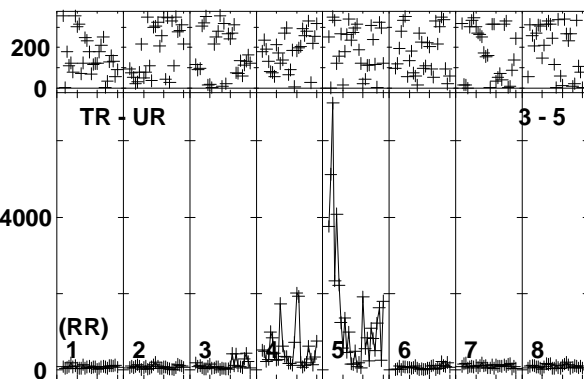
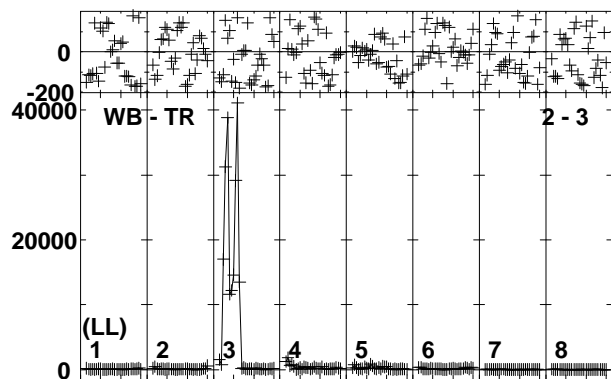
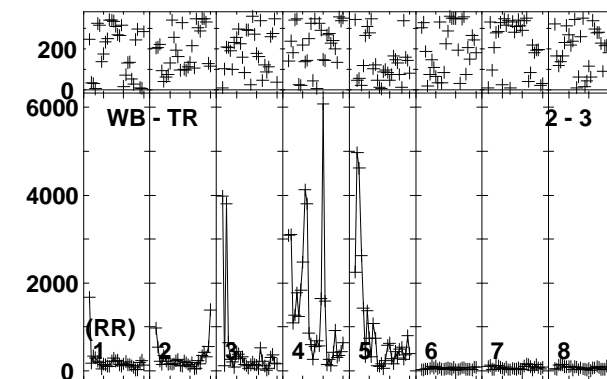
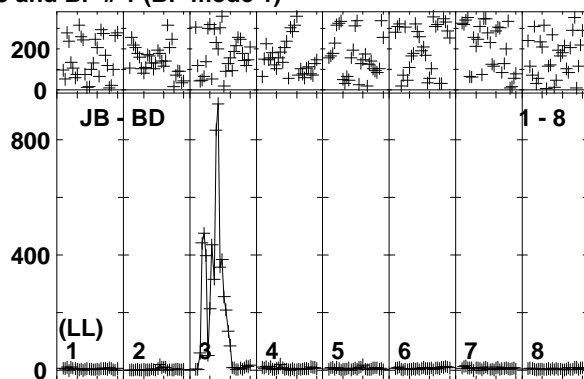
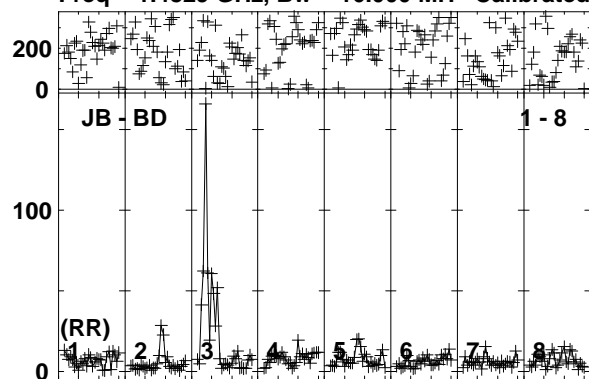

Lower frame: Milli Ampl Jy Top frame: Phas deg
Vector averaged cross-power spectrum Baseline: JB (01) - BD (08)
Timerange: 00/05:50:16 to 00/05:53:44

Plot file version 102 created 21-JUN-2019 11:53:59

IRAS12112 EP111A 1.UVDATA.1

Freq = 1.4829 GHz, Bw = 16.000 MH Calibrated with CL # 3 and BP # 1 (BP mode 1)

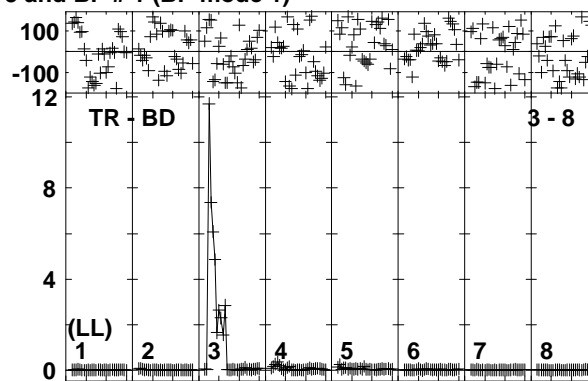
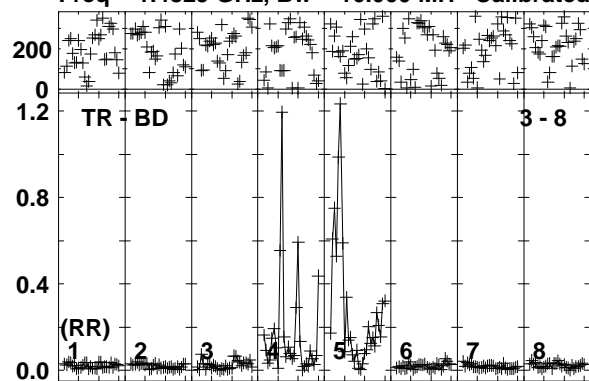

Lower frame: Ampl Jy Top frame: Phas deg
Vector averaged cross-power spectrum Baseline: TR (03) - BD (08)
Timerange: 00/05:50:16 to 00/05:53:44

Plot file version 103 created 21-JUN-2019 11:54:00

J1222+0413 EP111A 1.UVDATA.1

Freq = 1.4829 GHz, Bw = 16.000 MH Calibrated with CL # 3 and BP # 1 (BP mode 1)

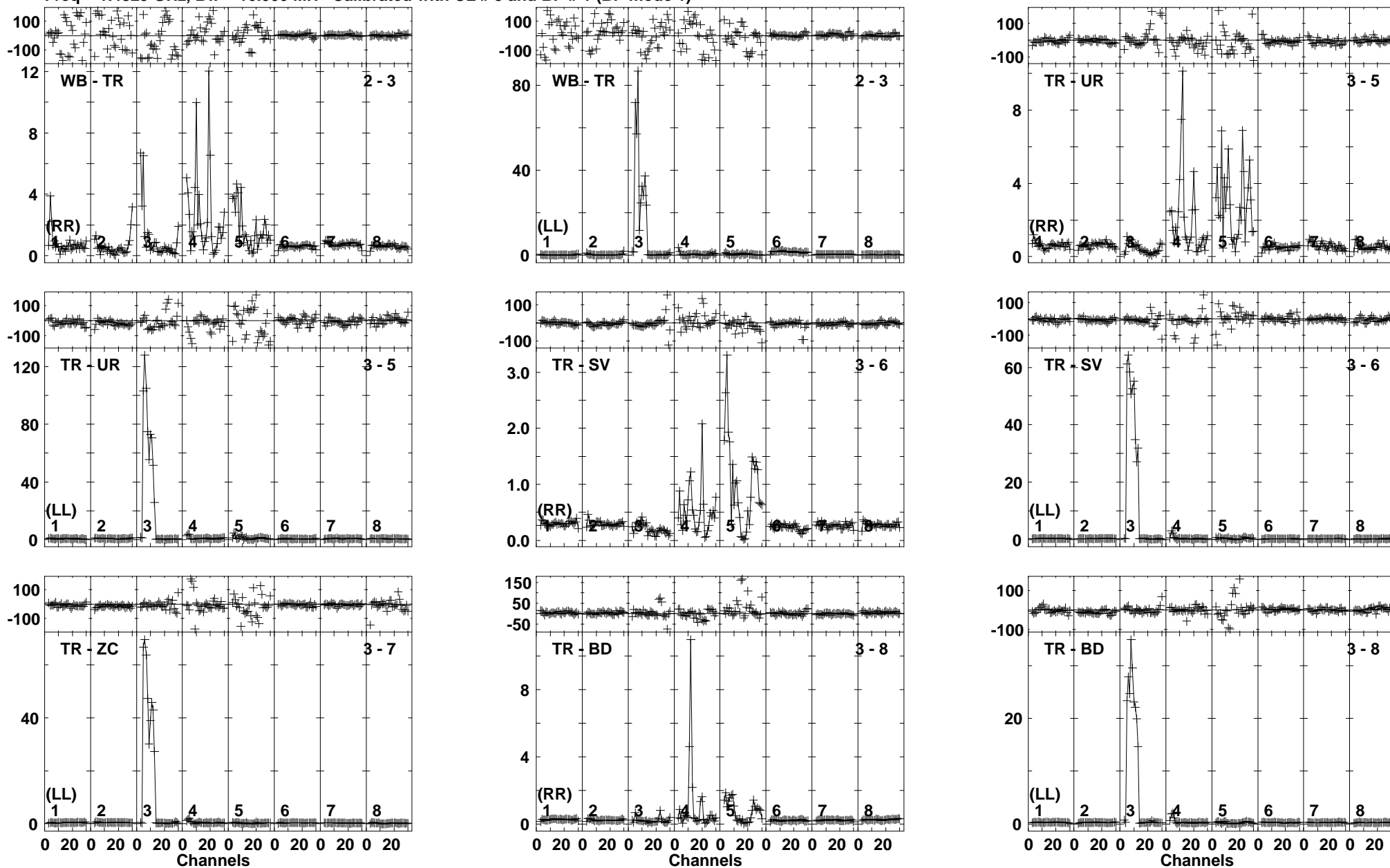

Lower frame: Ampl Jy Top frame: Phas deg
Vector averaged cross-power spectrum Baseline: WB (02) - TR (03)
Timerange: 00/05:53:46 to 00/05:55:14

Plot file version 104 created 21-JUN-2019 11:54:00

IRAS12112 EP111A 1.UVDATA.1

Freq = 1.4829 GHz, Bw = 16.000 MH Calibrated with CL # 3 and BP # 1 (BP mode 1)

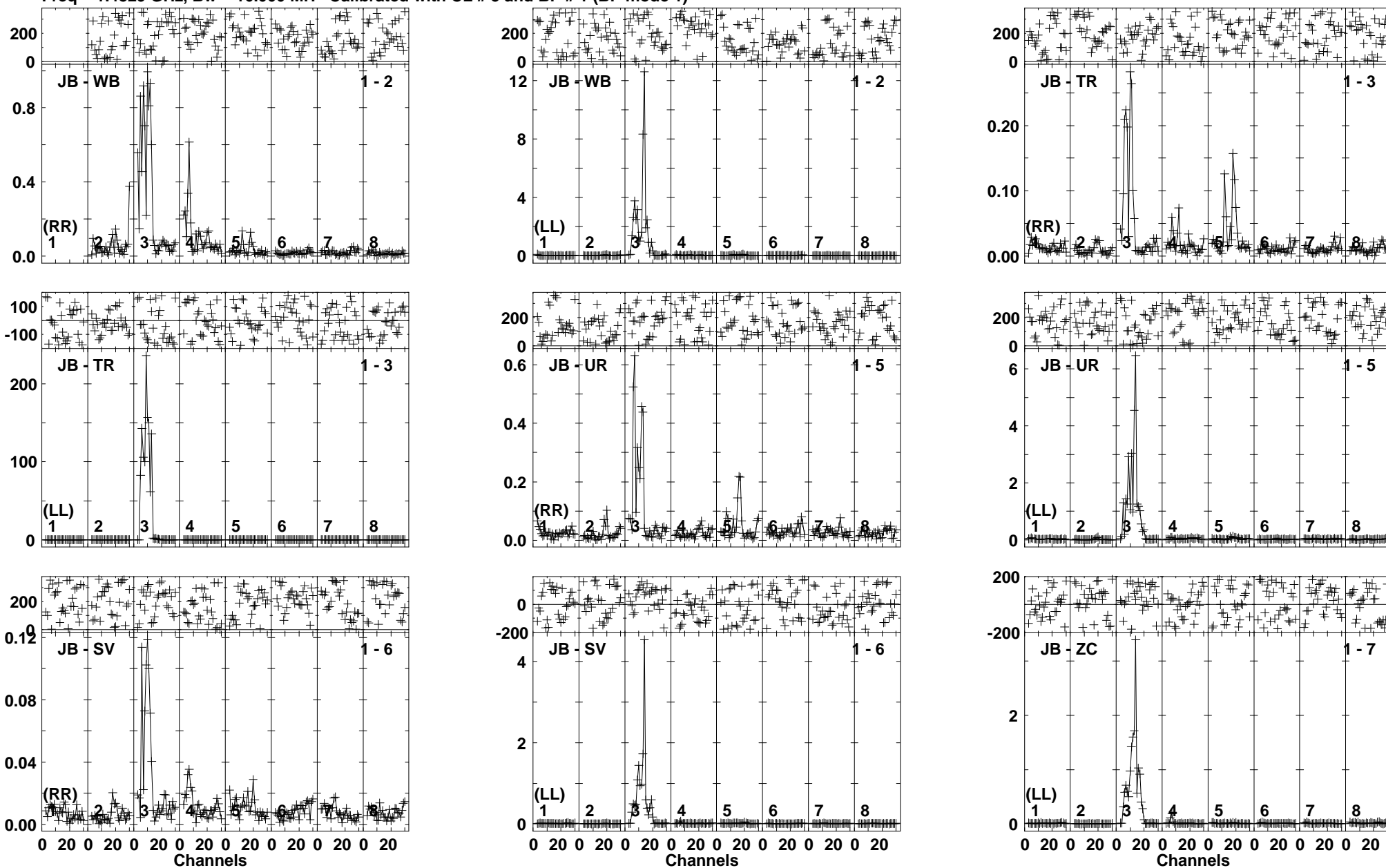

Lower frame: Ampl Jy Top frame: Phas deg
Vector averaged cross-power spectrum Baseline: JB (01) - WB (02)
Timerange: 00/05:55:16 to 00/05:58:44

Plot file version 105 created 21-JUN-2019 11:54:00

IRAS12112 EP111A 1.UVDATA.1

Freq = 1.4829 GHz, Bw = 16.000 MH Calibrated with CL # 3 and BP # 1 (BP mode 1)

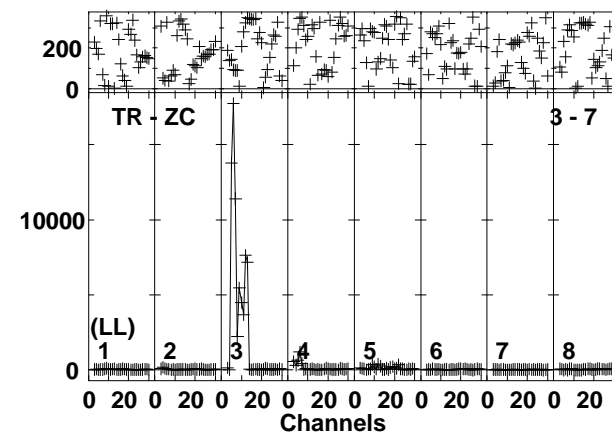
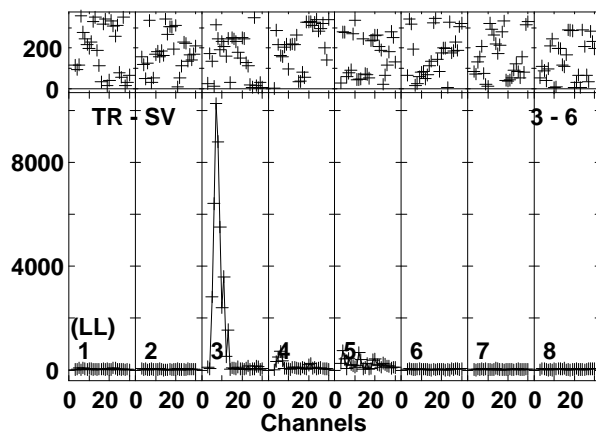
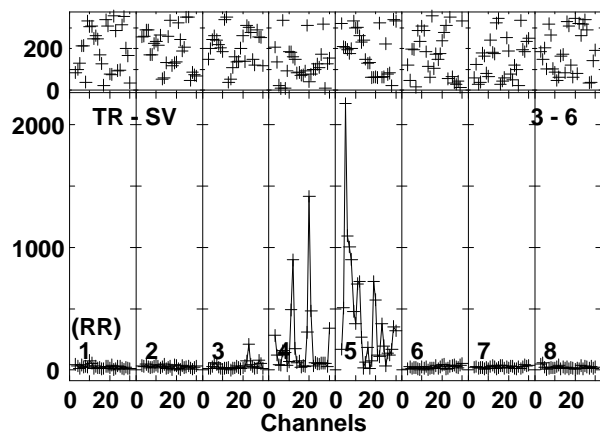
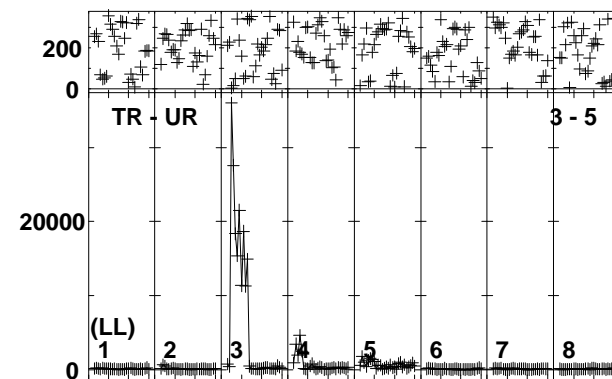
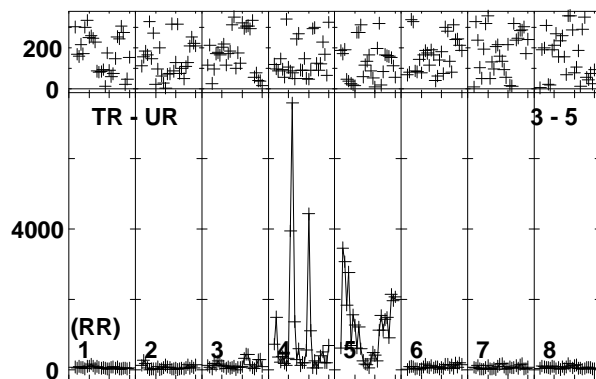
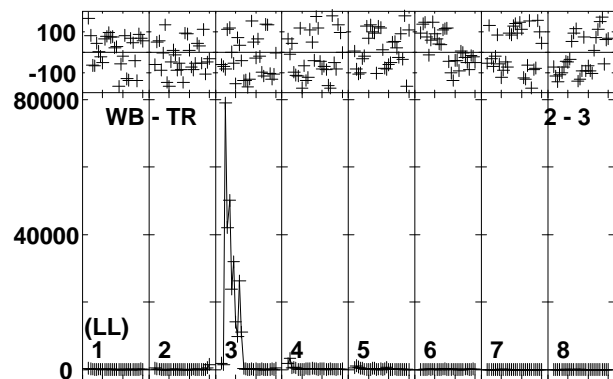
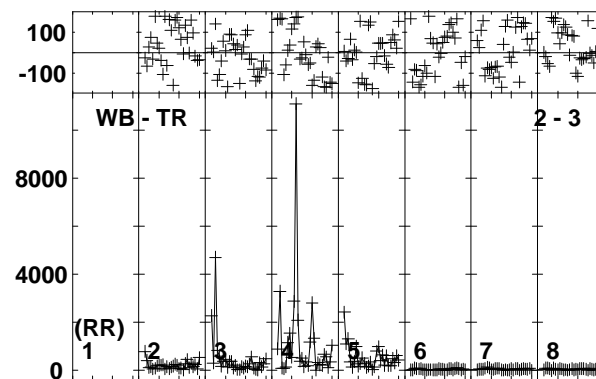
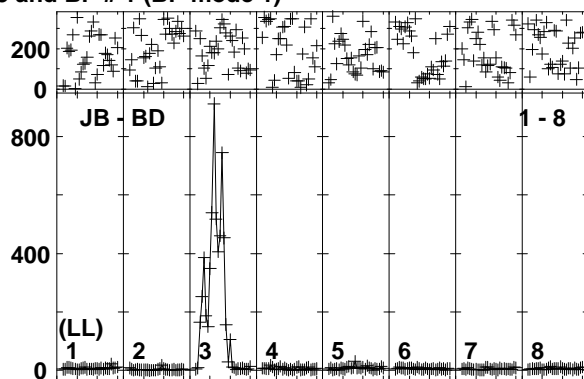
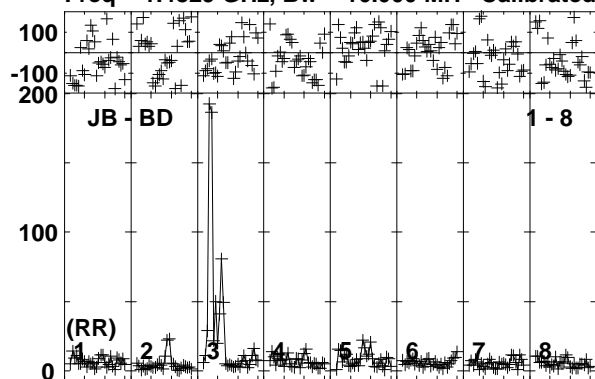

Lower frame: Milli Ampl Jy Top frame: Phas deg
Vector averaged cross-power spectrum Baseline: JB (01) - BD (08)
Timerange: 00/05:55:16 to 00/05:58:44

Plot file version 106 created 21-JUN-2019 11:54:01

IRAS12112 EP111A 1.UVDATA.1

Freq = 1.4829 GHz, Bw = 16.000 MH Calibrated with CL # 3 and BP # 1 (BP mode 1)

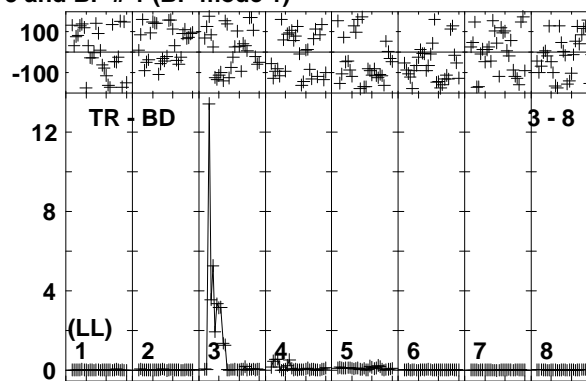
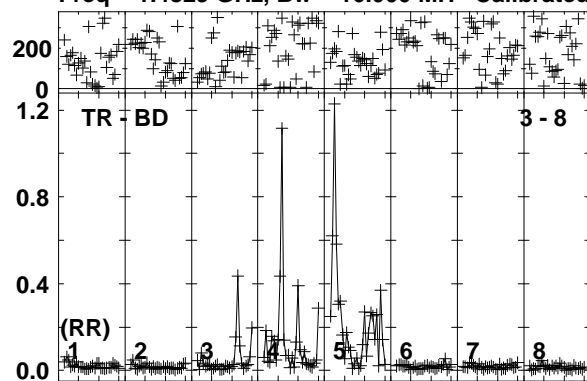

Lower frame: Ampl Jy Top frame: Phas deg
Vector averaged cross-power spectrum Baseline: TR (03) - BD (08)
Timerange: 00/05:55:16 to 00/05:58:44

Plot file version 107 created 21-JUN-2019 11:54:01

J1222+0413 EP111A 1.UVDATA.1

Freq = 1.4829 GHz, Bw = 16.000 MH Calibrated with CL # 3 and BP # 1 (BP mode 1)

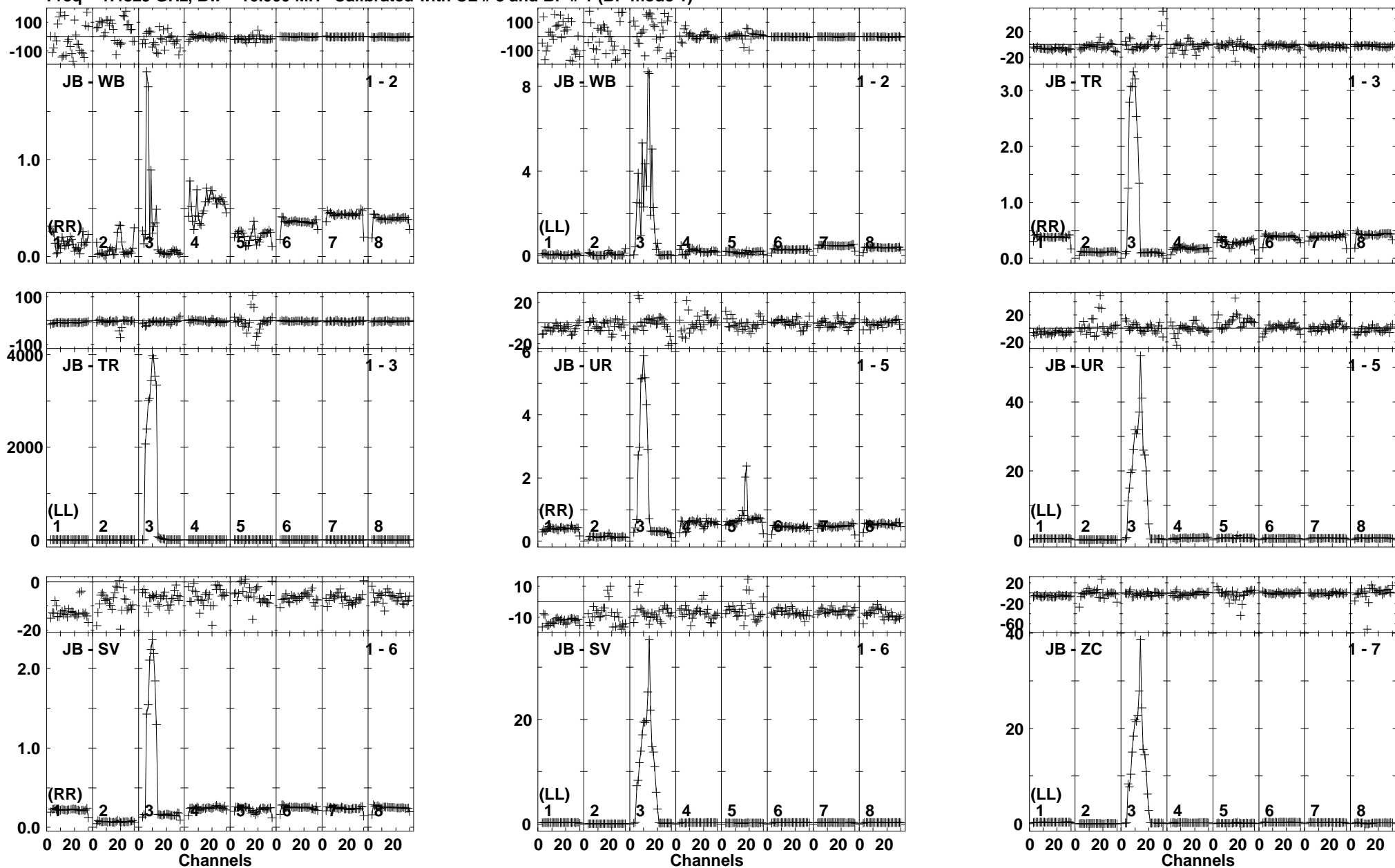

Lower frame: Ampl Jy Top frame: Phas deg
Vector averaged cross-power spectrum Baseline: JB (01) - WB (02)
Timerange: 00/05:59:26 to 00/06:00:54

Plot file version 109 created 21-JUN-2019 11:54:02

J1222+0413 EP1111A 1.UVDATA.1

Freq = 1.4829 GHz, Bw = 16.000 MH Calibrated with CL # 3 and BP # 1 (BP mode 1)

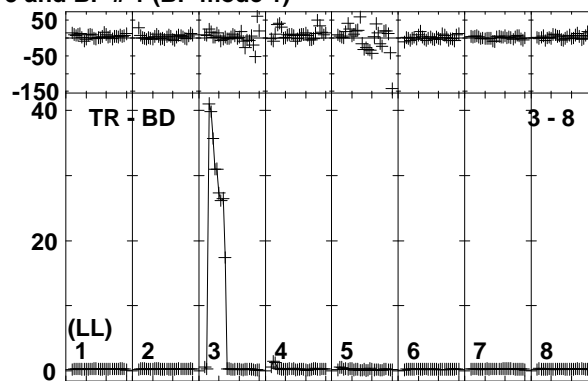
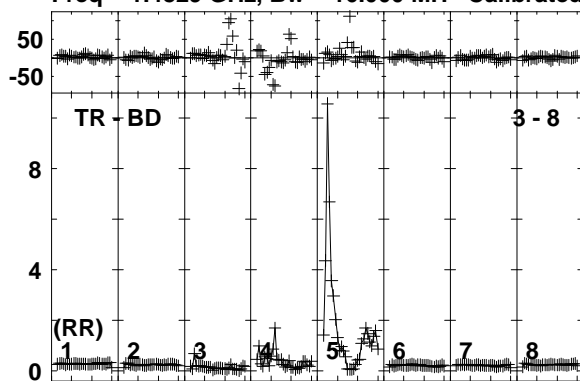

Lower frame: Ampl Jy Top frame: Phas deg
Vector averaged cross-power spectrum Baseline: TR (03) - BD (08)
Timerange: 00/05:59:26 to 00/06:00:54

Plot file version 110 created 21-JUN-2019 11:54:02

J1152-0841 EP111A 1.UVDATA.1

Freq = 1.4829 GHz, Bw = 16.000 MH Calibrated with CL # 3 and BP # 1 (BP mode 1)

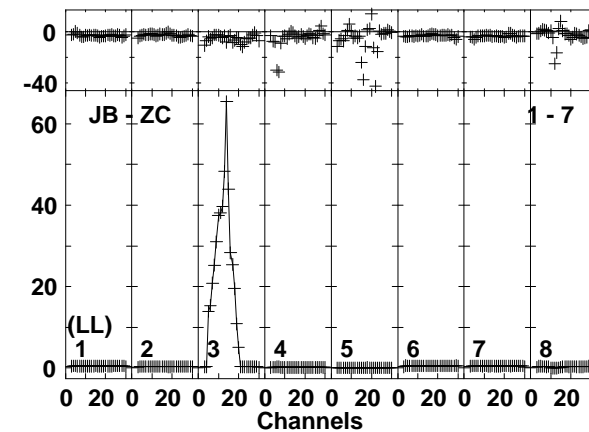
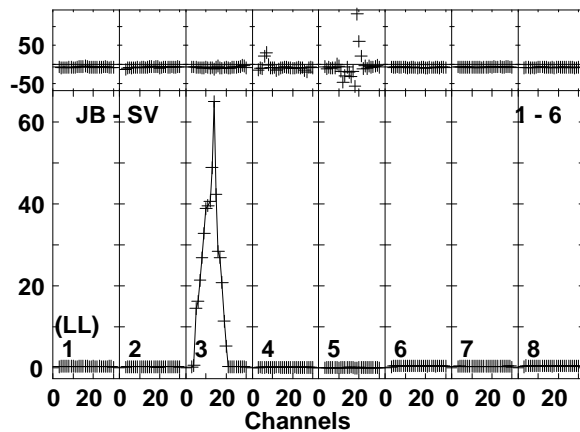
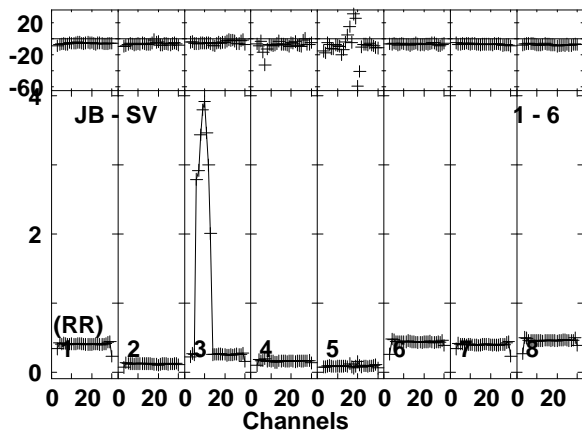
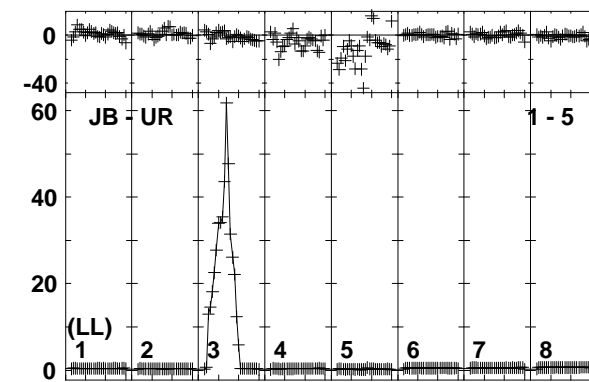
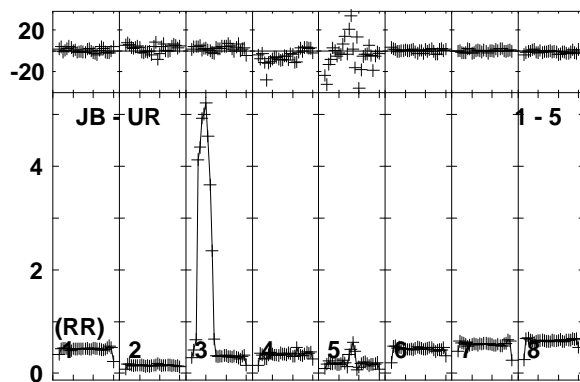
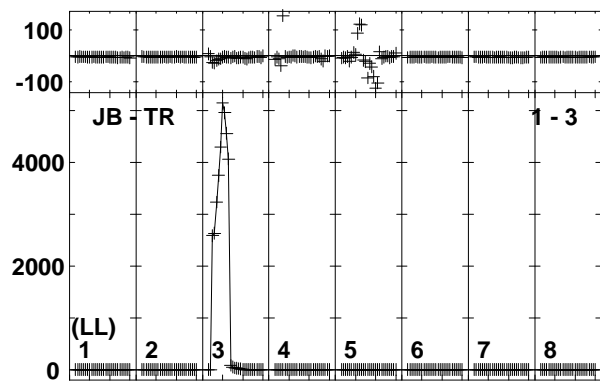
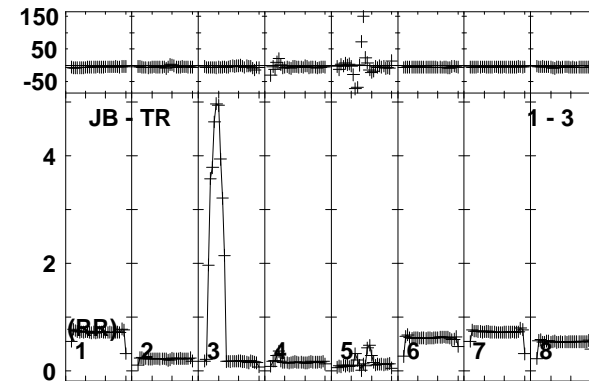
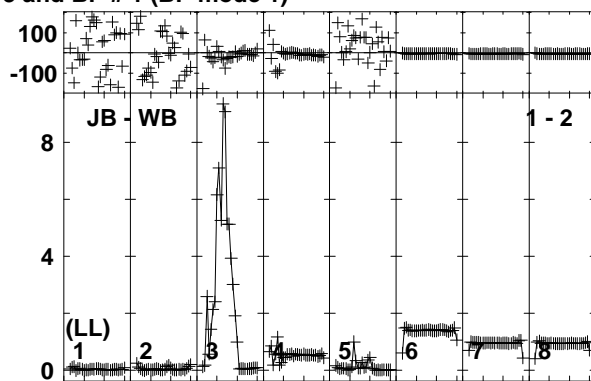
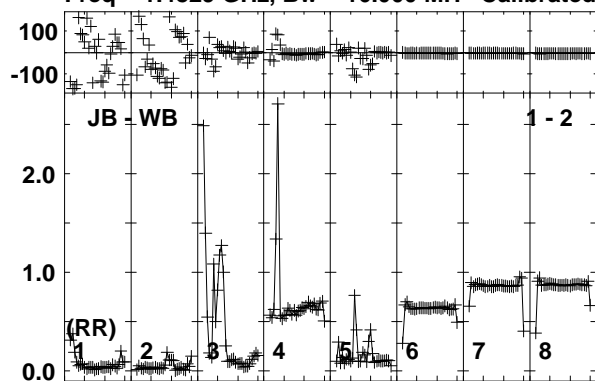

Lower frame: Ampl Jy Top frame: Phas deg
Vector averaged cross-power spectrum Baseline: JB (01) - WB (02)
Timerange: 00/06:02:21 to 00/06:06:19

Plot file version 111 created 21-JUN-2019 11:54:03

J1152-0841 EP111A 1.UVDATA.1

Freq = 1.4829 GHz, Bw = 16.000 MH Calibrated with CL # 3 and BP # 1 (BP mode 1)

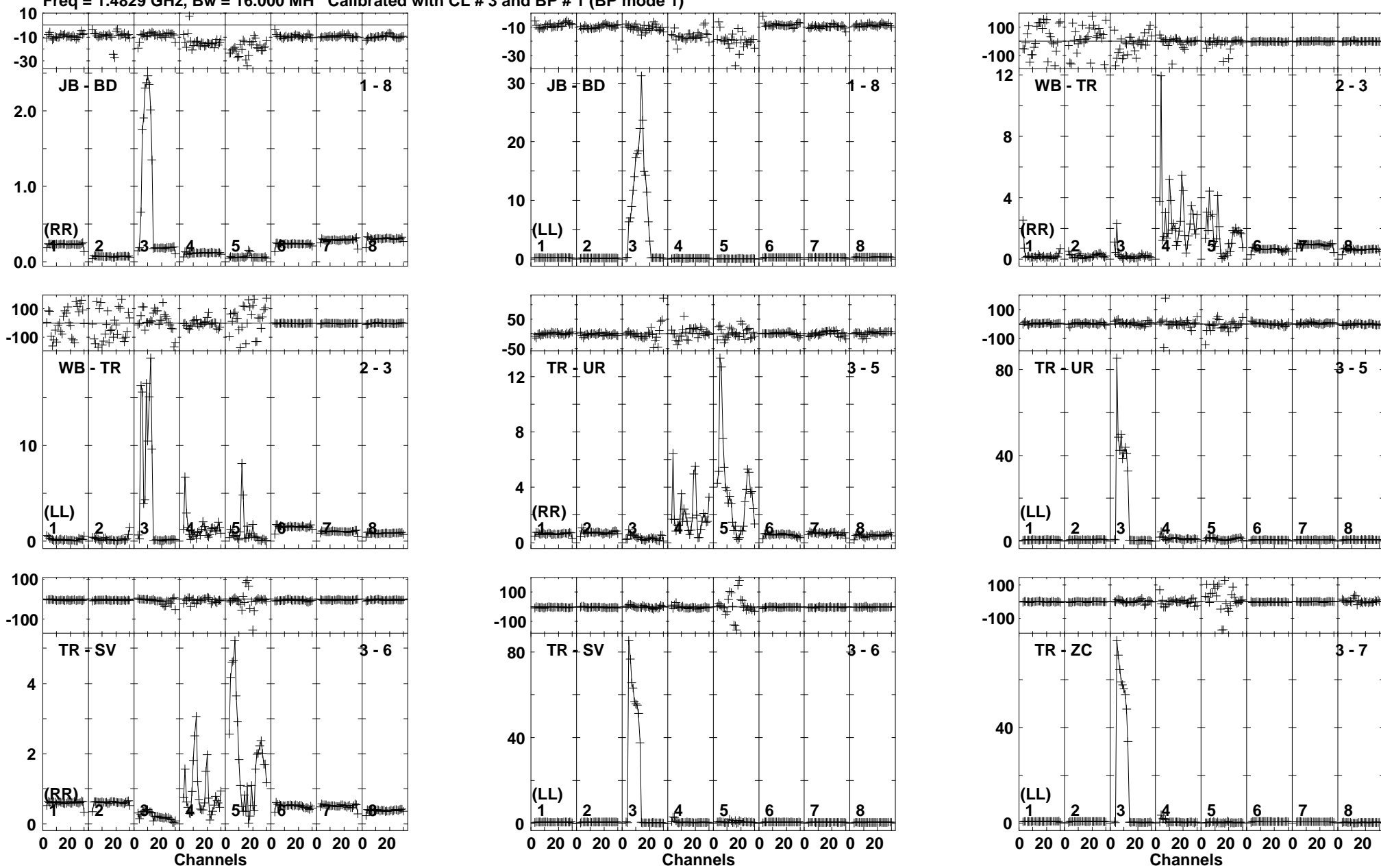

Lower frame: Ampl Jy Top frame: Phas deg
Vector averaged cross-power spectrum Baseline: JB (01) - BD (08)
Timerange: 00/06:02:21 to 00/06:06:19

Plot file version 112 created 21-JUN-2019 11:54:03

J1152-0841 EP1111A 1.UVDATA.1

Freq = 1.4829 GHz, Bw = 16.000 MH Calibrated with CL # 3 and BP # 1 (BP mode 1)

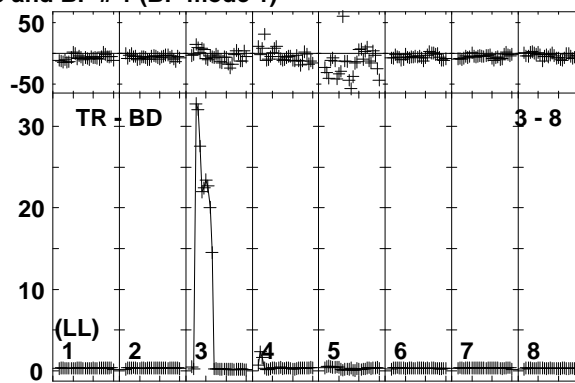
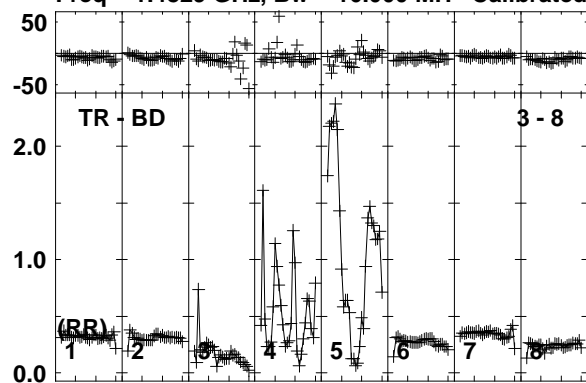

Lower frame: Ampl Jy Top frame: Phas deg
Vector averaged cross-power spectrum Baseline: TR (03) - BD (08)
Timerange: 00/06:02:21 to 00/06:06:19

Plot file version 113 created 21-JUN-2019 11:54:03

J1222+0413 EP111A 1.UVDATA.1

Freq = 1.4829 GHz, Bw = 16.000 MH Calibrated with CL # 3 and BP # 1 (BP mode 1)

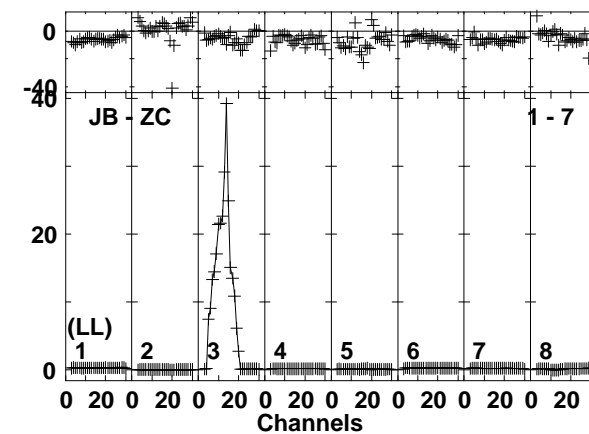
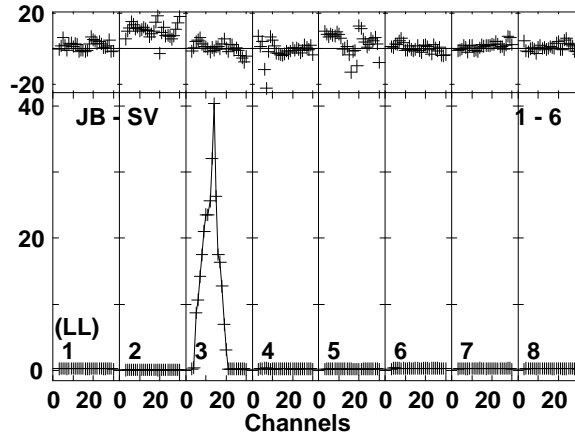
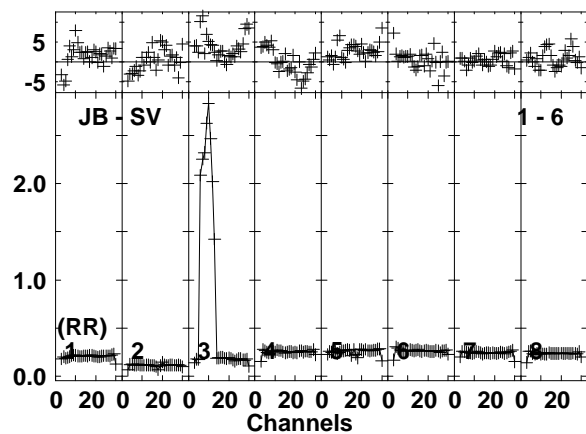
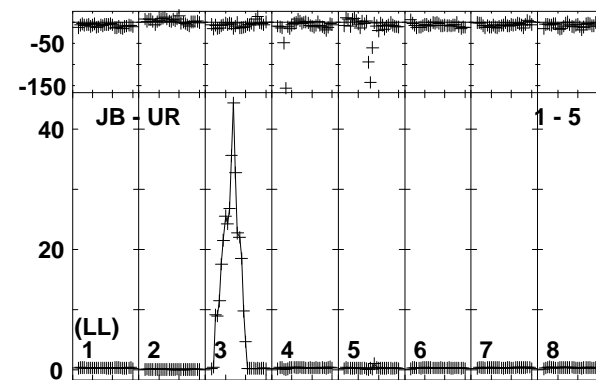
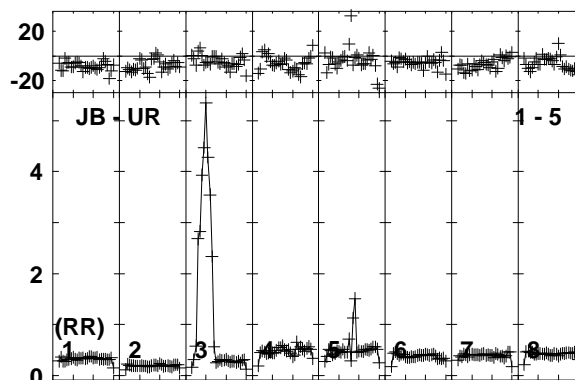
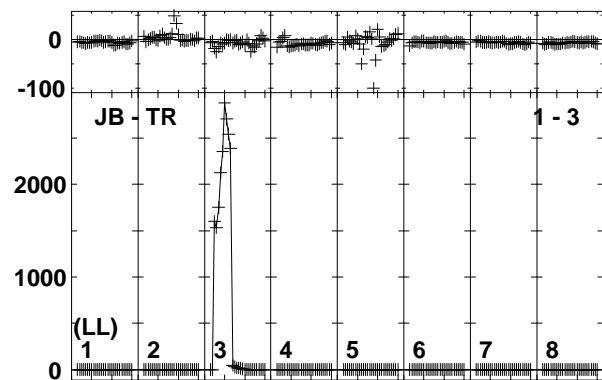
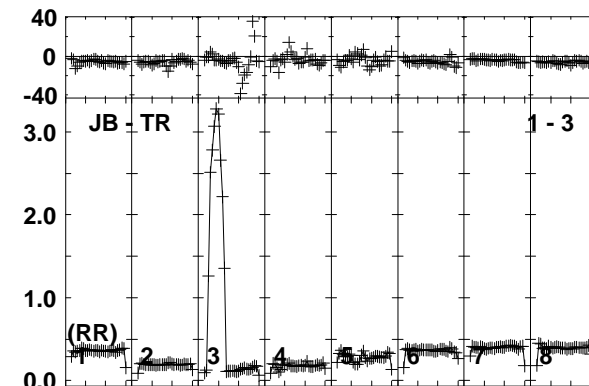
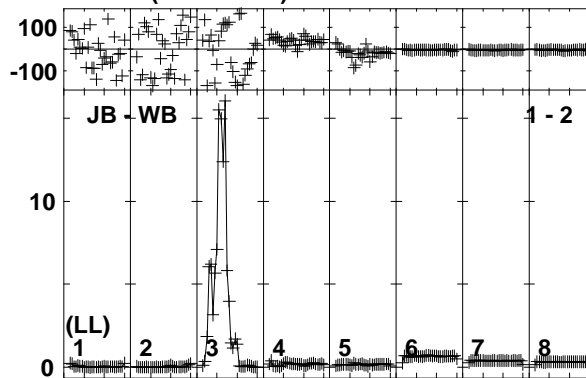
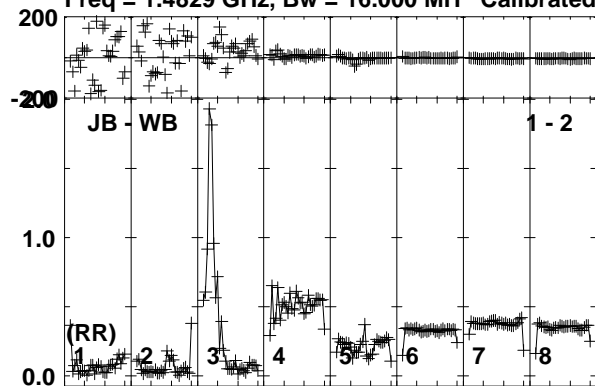

Lower frame: Ampl Jy Top frame: Phas deg
Vector averaged cross-power spectrum Baseline: JB (01) - WB (02)
Timerange: 00/06:07:41 to 00/06:09:39

Plot file version 114 created 21-JUN-2019 11:54:04

J1222+0413 EP111A 1.UVDATA.1

Freq = 1.4829 GHz, Bw = 16.000 MH Calibrated with CL # 3 and BP # 1 (BP mode 1)

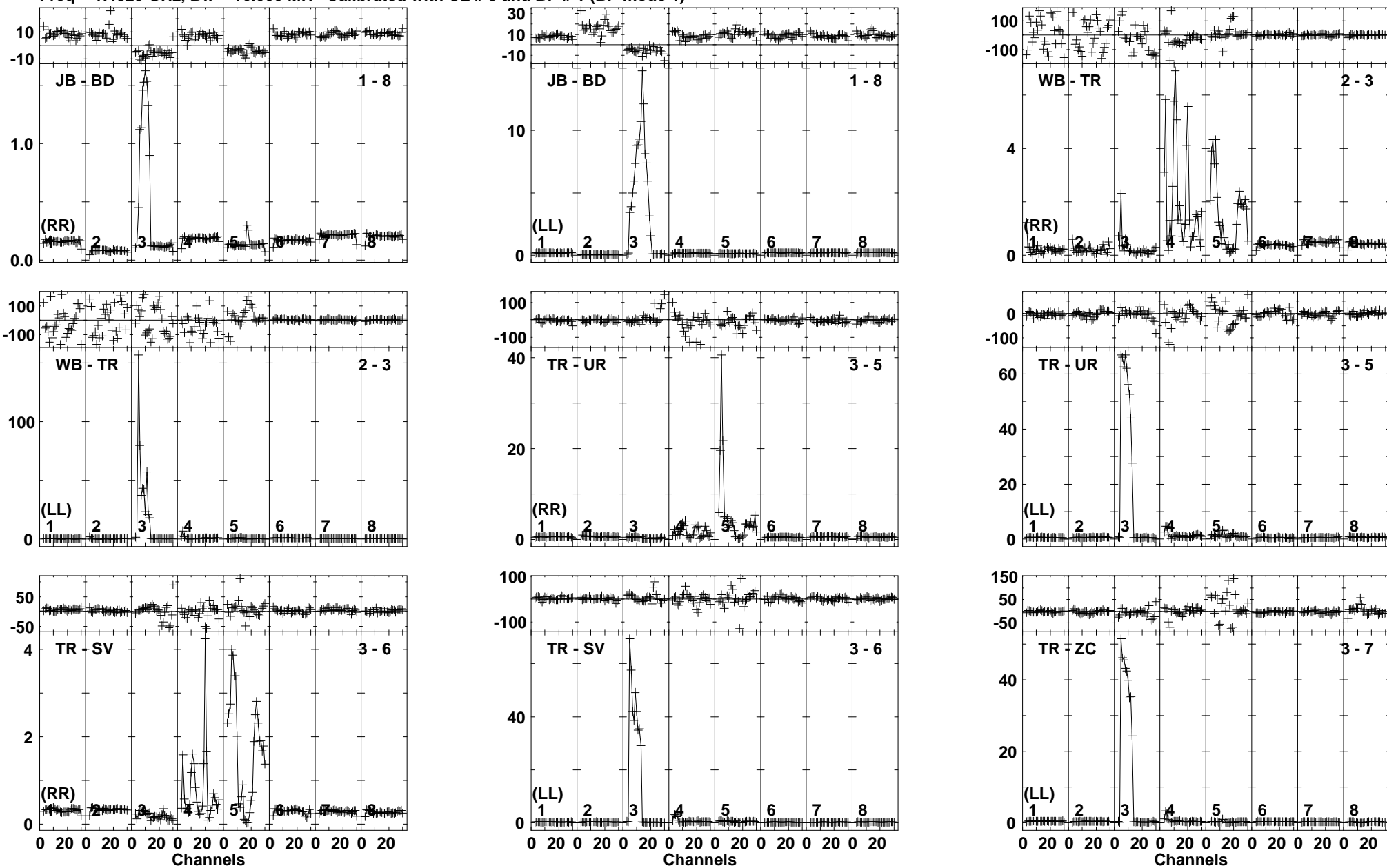

Lower frame: Ampl Jy Top frame: Phas deg
Vector averaged cross-power spectrum Baseline: JB (01) - BD (08)
Timerange: 00/06:07:41 to 00/06:09:39

Plot file version 115 created 21-JUN-2019 11:54:04

J1222+0413 EP111A 1.UVDATA.1

Freq = 1.4829 GHz, Bw = 16.000 MH Calibrated with CL # 3 and BP # 1 (BP mode 1)

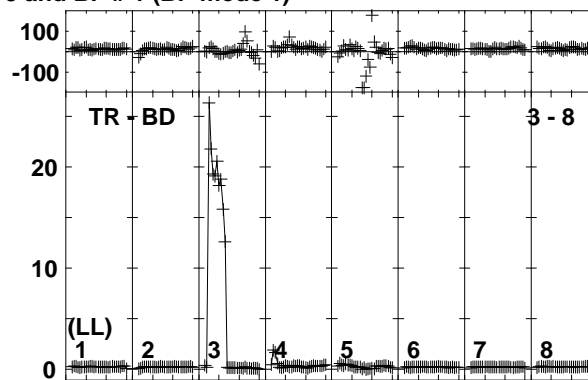
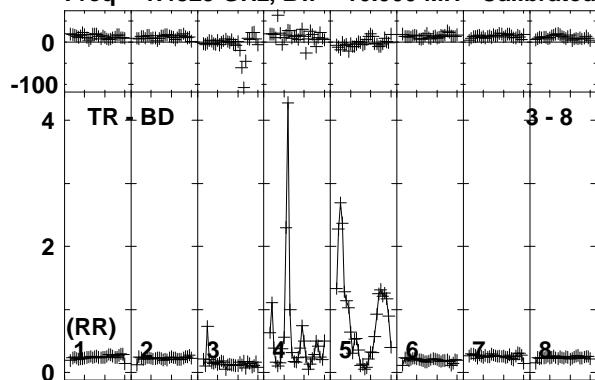

Lower frame: Ampl Jy Top frame: Phas deg
Vector averaged cross-power spectrum Baseline: TR (03) - BD (08)
Timerange: 00/06:07:41 to 00/06:09:39

Plot file version 116 created 21-JUN-2019 11:54:04

IRAS12112 EP111A 1.UVDATA.1

Freq = 1.4829 GHz, Bw = 16.000 MH Calibrated with CL # 3 and BP # 1 (BP mode 1)

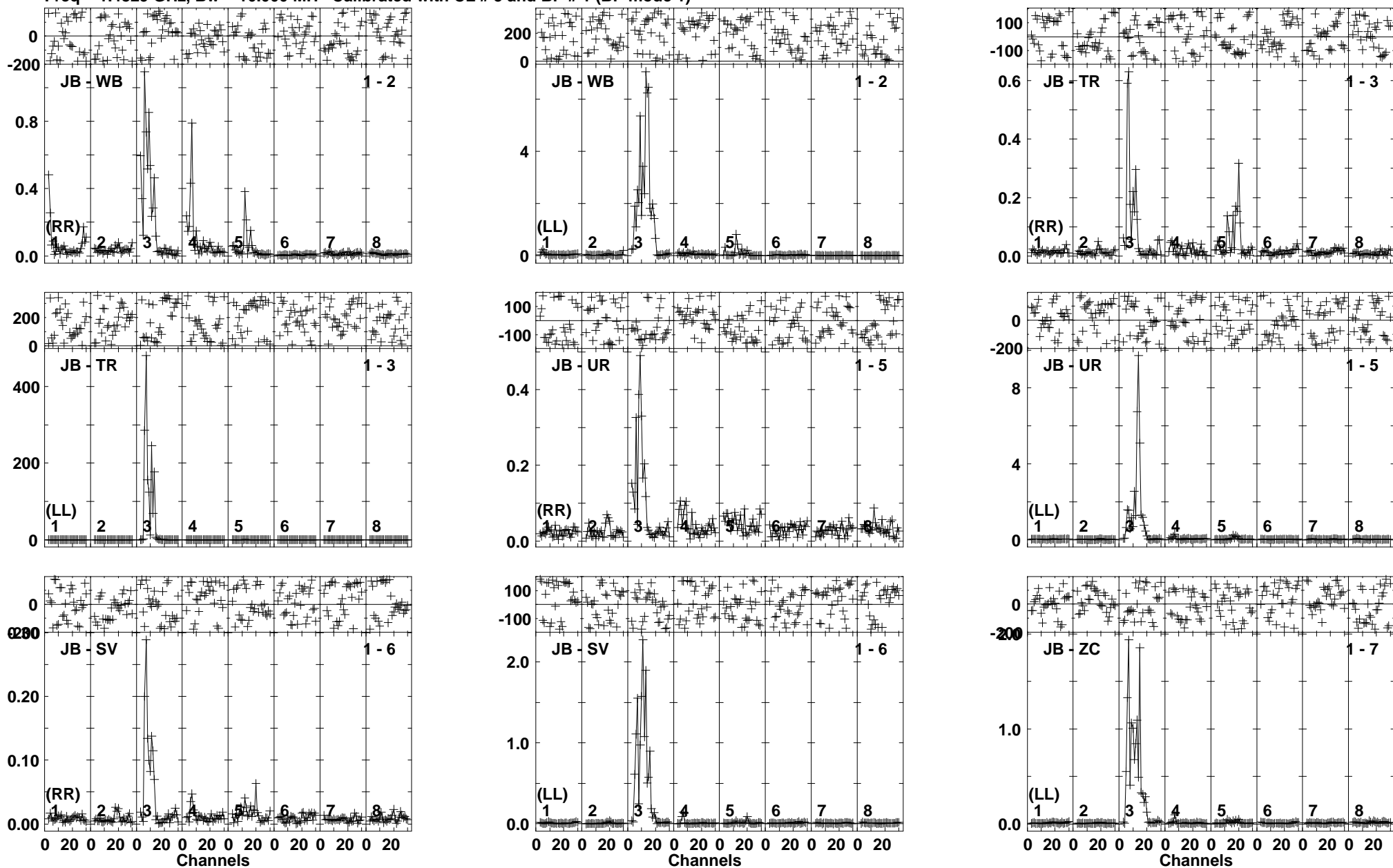

Lower frame: Ampl Jy Top frame: Phas deg
Vector averaged cross-power spectrum Baseline: JB (01) - WB (02)
Timerange: 00/06:09:41 to 00/06:13:09

Plot file version 117 created 21-JUN-2019 11:54:05

IRAS12112 EP111A 1.UVDATA.1

Freq = 1.4829 GHz, Bw = 16.000 MH Calibrated with CL # 3 and BP # 1 (BP mode 1)

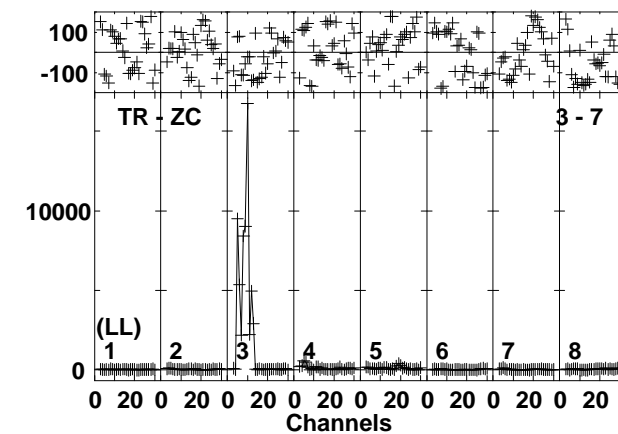
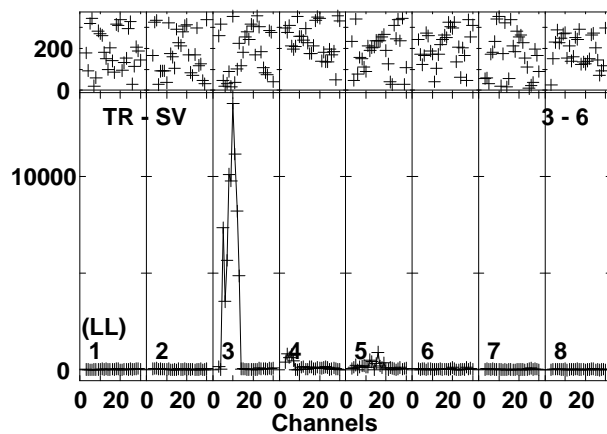
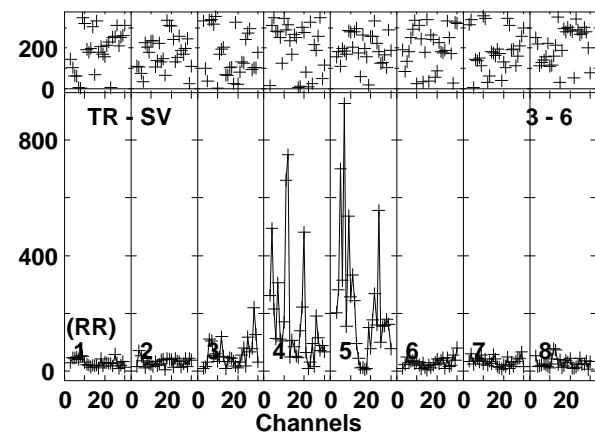
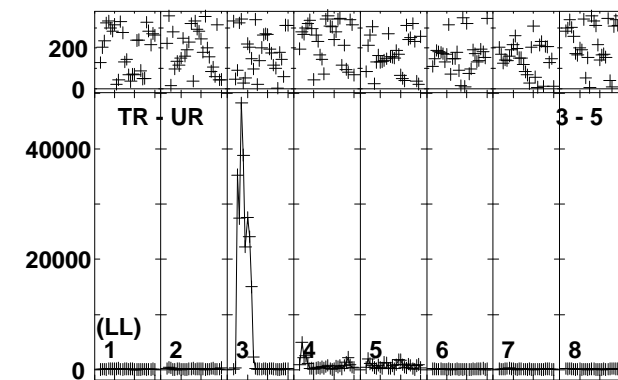
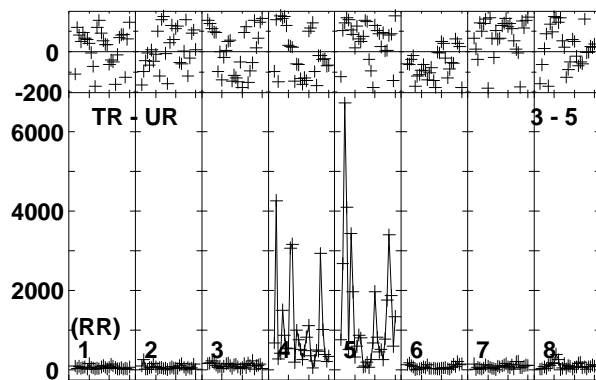
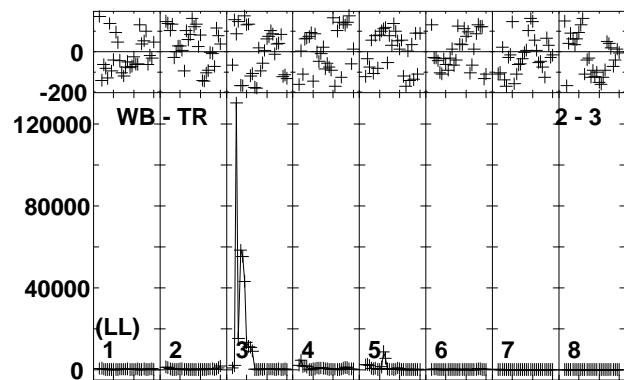
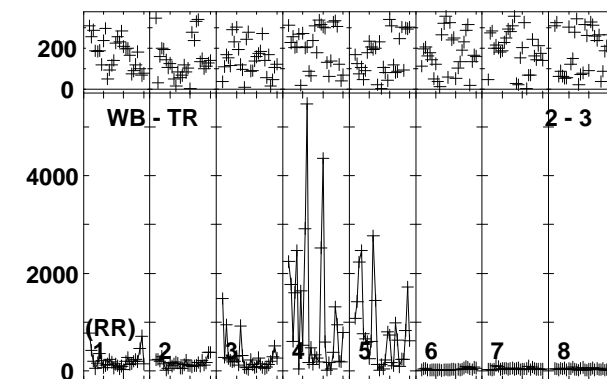
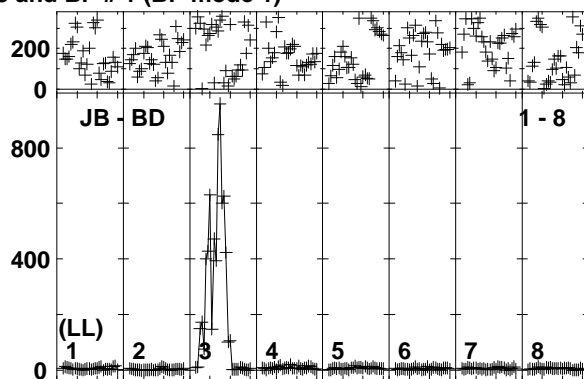
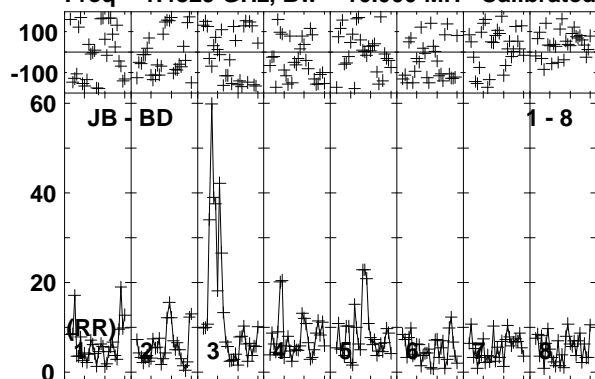

Lower frame: Milli Ampl Jy Top frame: Phas deg
Vector averaged cross-power spectrum Baseline: JB (01) - BD (08)
Timerange: 00/06:09:41 to 00/06:13:09

Plot file version 118 created 21-JUN-2019 11:54:05

IRAS12112 EP111A 1.UVDATA.1

Freq = 1.4829 GHz, Bw = 16.000 MH Calibrated with CL # 3 and BP # 1 (BP mode 1)

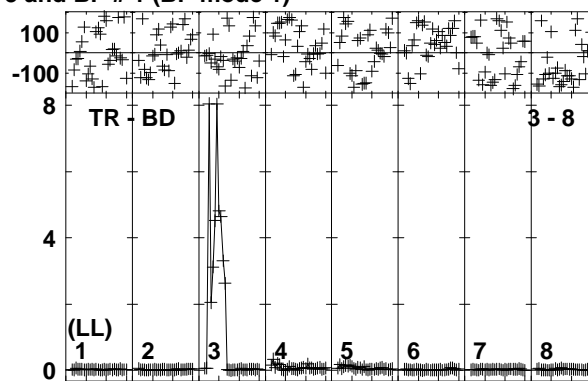
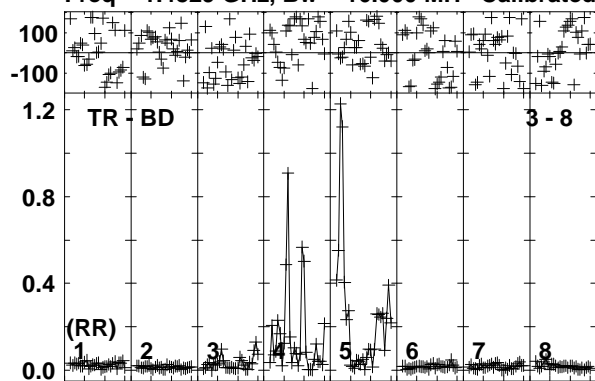

Lower frame: Ampl Jy Top frame: Phas deg
Vector averaged cross-power spectrum Baseline: TR (03) - BD (08)
Timerange: 00/06:09:41 to 00/06:13:09

Plot file version 119 created 21-JUN-2019 11:54:06

J1222+0413 EP111A 1.UVDATA.1

Freq = 1.4829 GHz, Bw = 16.000 MH Calibrated with CL # 3 and BP # 1 (BP mode 1)

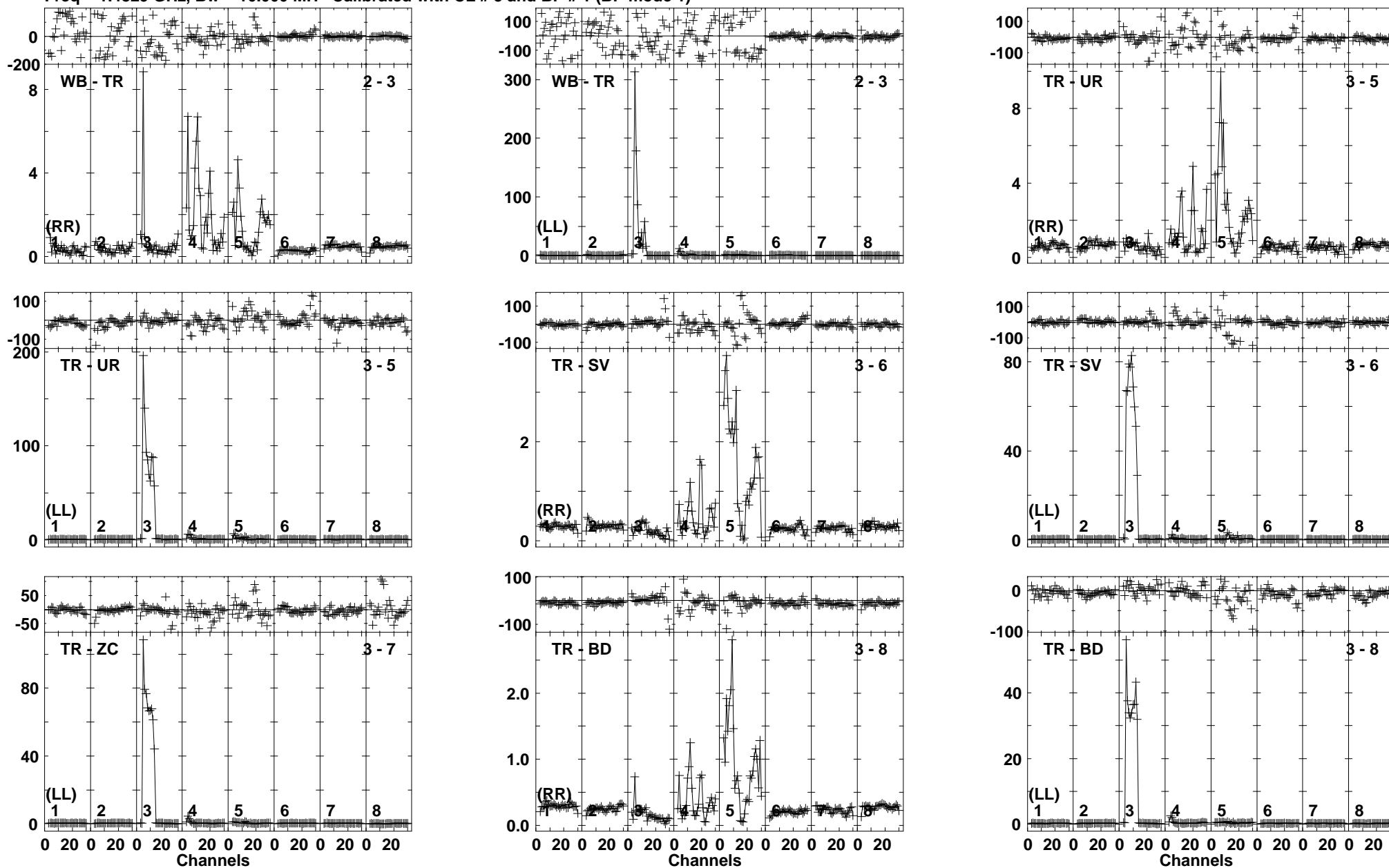

Lower frame: Ampl Jy Top frame: Phas deg
Vector averaged cross-power spectrum Baseline: WB (02) - TR (03)
Timerange: 00/06:13:11 to 00/06:14:39

Plot file version 120 created 21-JUN-2019 11:54:06

IRAS12112 EP111A 1.UVDATA.1

Freq = 1.4829 GHz, Bw = 16.000 MH Calibrated with CL # 3 and BP # 1 (BP mode 1)

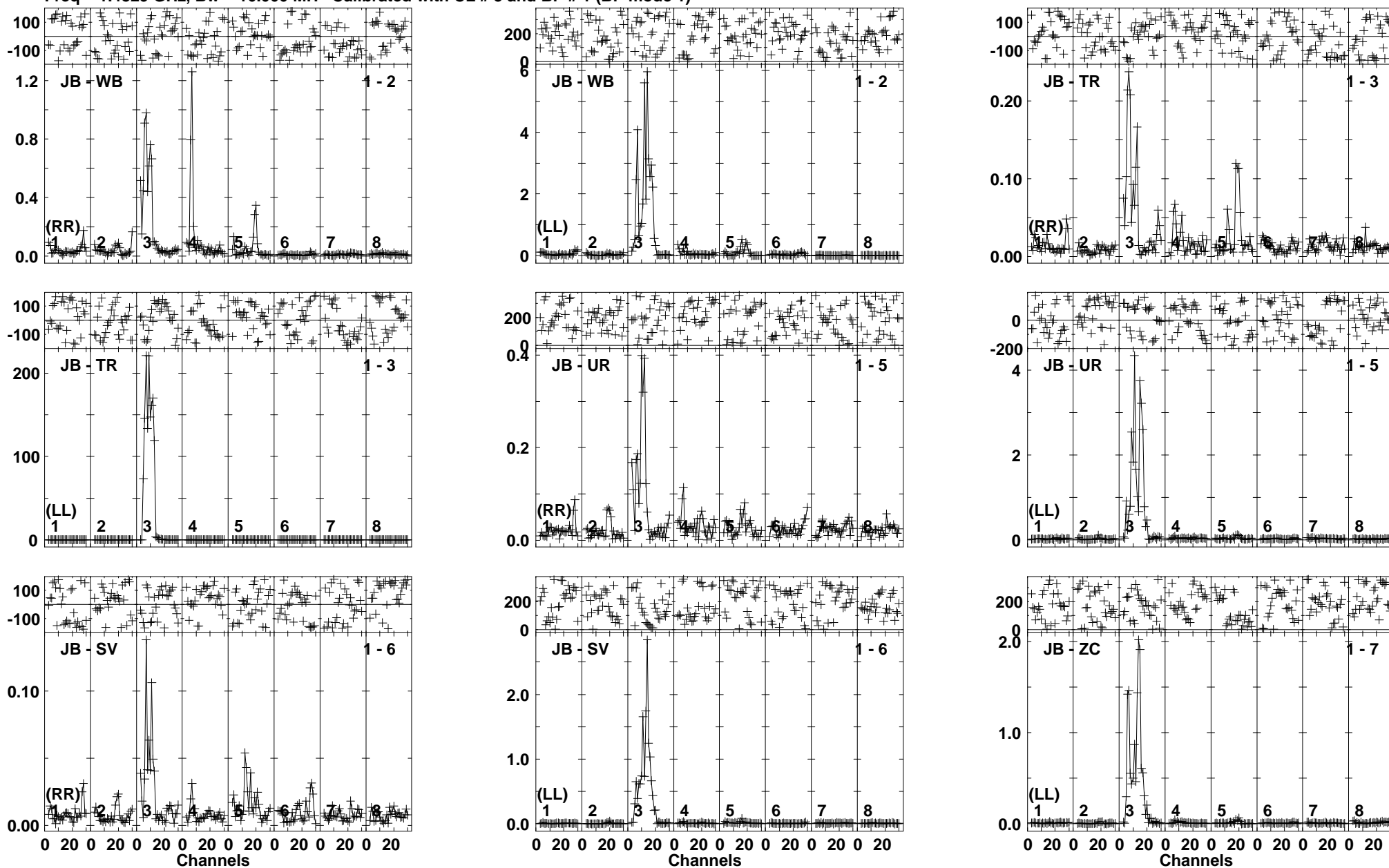

Lower frame: Ampl Jy Top frame: Phas deg
Vector averaged cross-power spectrum Baseline: JB (01) - WB (02)
Timerange: 00/06:14:41 to 00/06:18:09

Plot file version 121 created 21-JUN-2019 11:54:07

IRAS12112 EP111A 1.UVDATA.1

Freq = 1.4829 GHz, Bw = 16.000 MH Calibrated with CL # 3 and BP # 1 (BP mode 1)

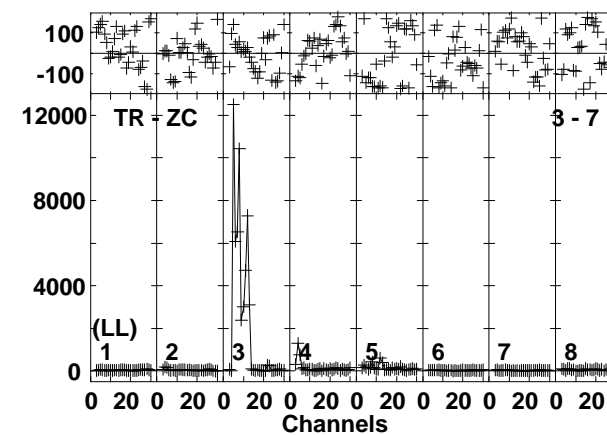
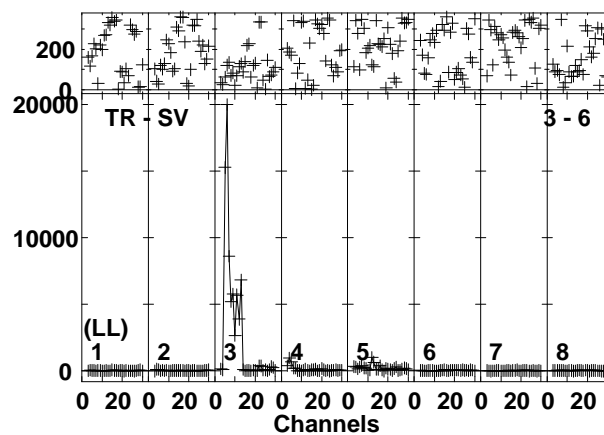
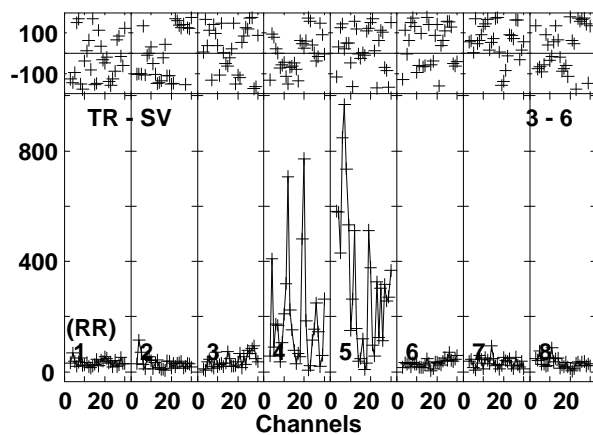
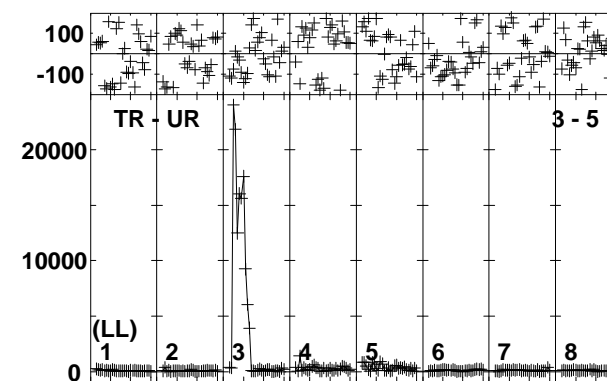
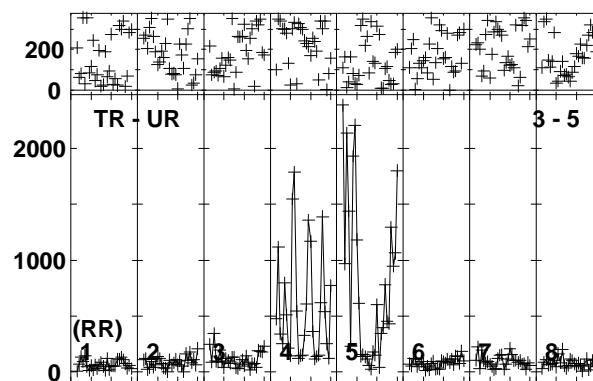
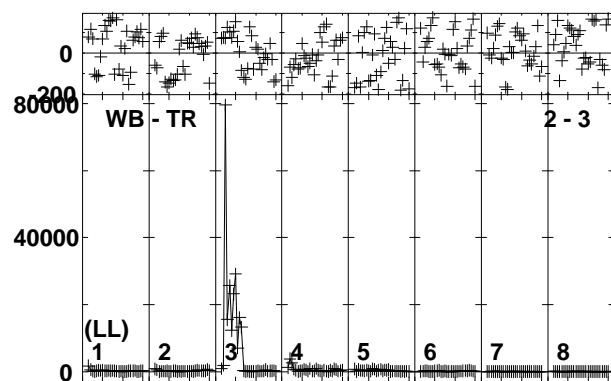
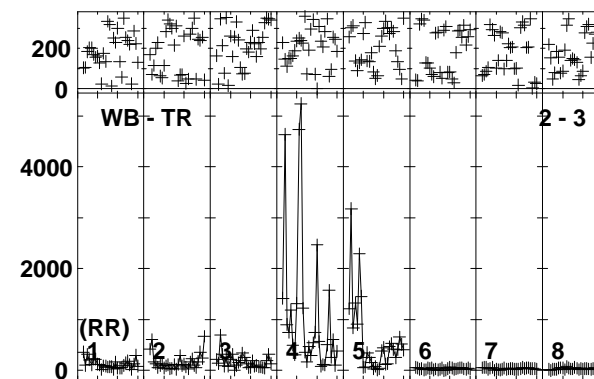
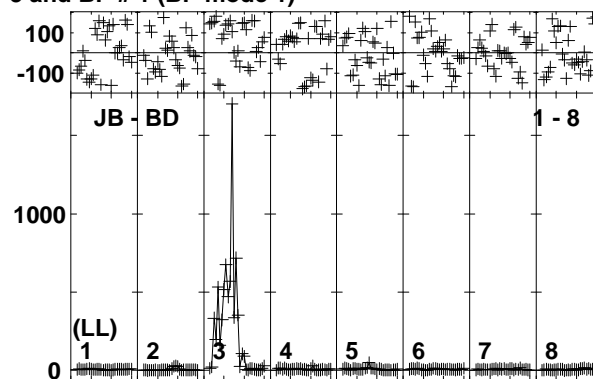
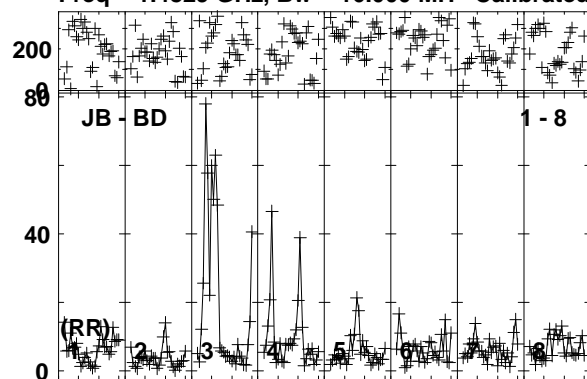

Lower frame: Milli Ampl Jy Top frame: Phas deg
Vector averaged cross-power spectrum Baseline: JB (01) - BD (08)
Timerange: 00/06:14:41 to 00/06:18:09

Plot file version 122 created 21-JUN-2019 11:54:07

IRAS12112 EP111A 1.UVDATA.1

Freq = 1.4829 GHz, Bw = 16.000 MH Calibrated with CL # 3 and BP # 1 (BP mode 1)

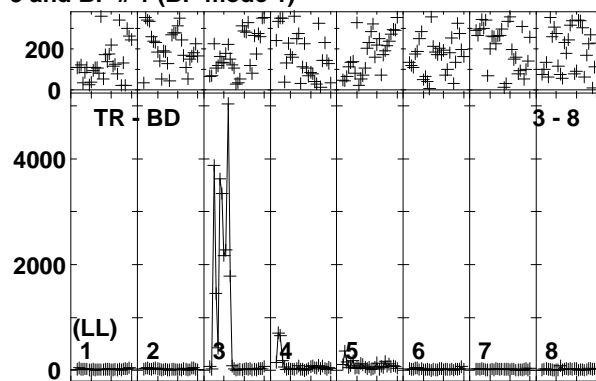
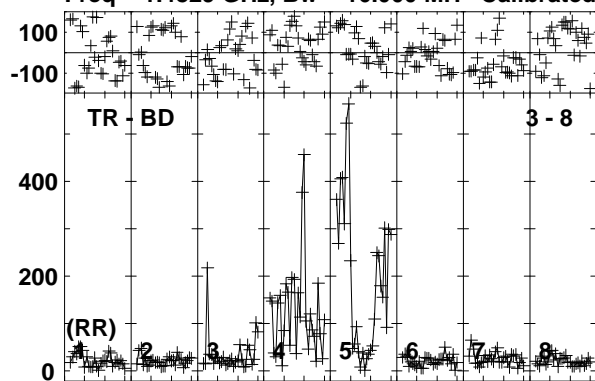

Lower frame: Milli Ampl Jy Top frame: Phas deg
Vector averaged cross-power spectrum Baseline: TR (03) - BD (08)
Timerange: 00/06:14:41 to 00/06:18:09

Plot file version 123 created 21-JUN-2019 11:54:07

J1222+0413 EP111A 1.UVDATA.1

Freq = 1.4829 GHz, Bw = 16.000 MH Calibrated with CL # 3 and BP # 1 (BP mode 1)

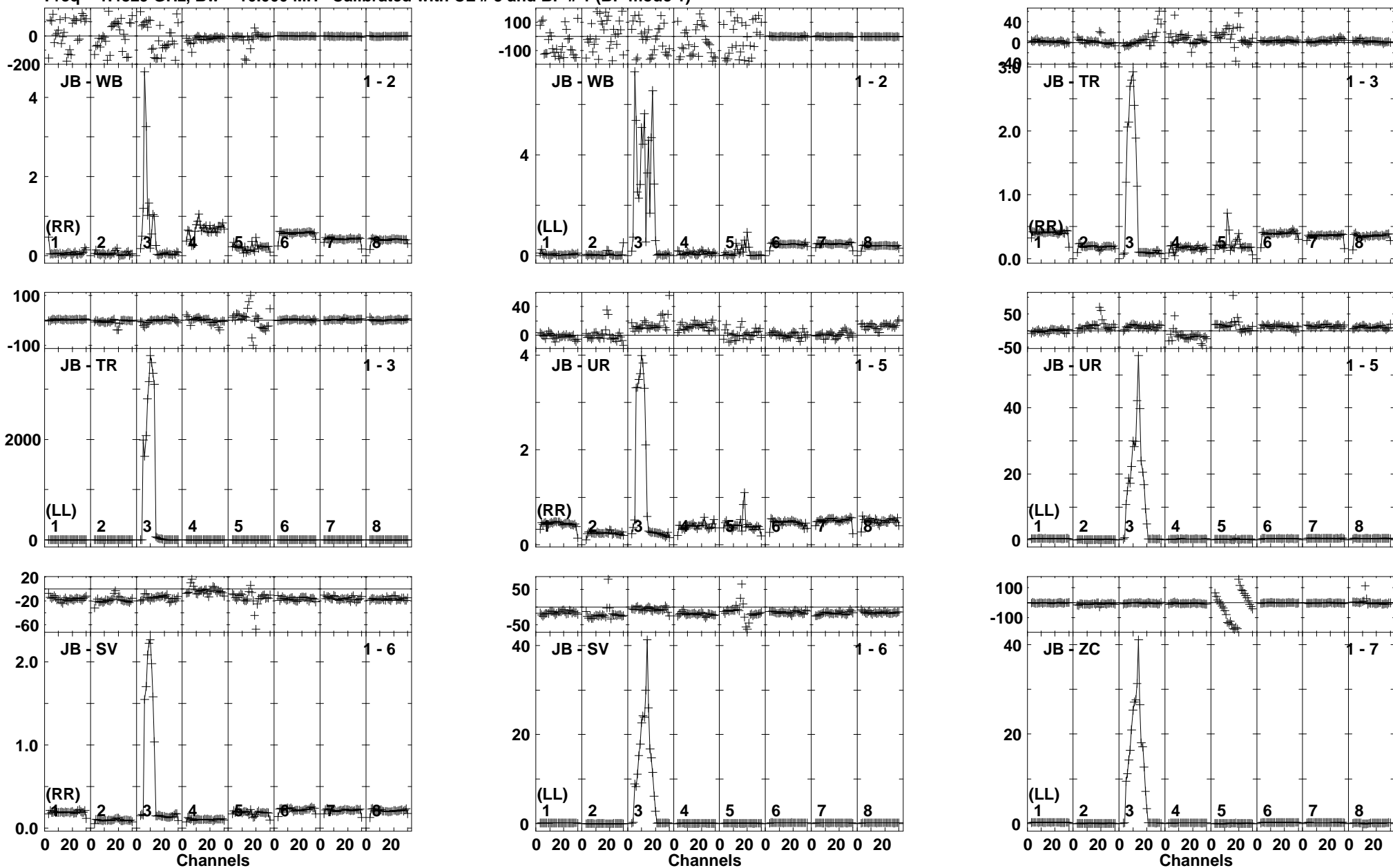

Lower frame: Ampl Jy Top frame: Phas deg
Vector averaged cross-power spectrum Baseline: JB (01) - WB (02)
Timerange: 00/06:18:51 to 00/06:20:19

Plot file version 124 created 21-JUN-2019 11:54:08

J1222+0413 EP111A 1.UVDATA.1

Freq = 1.4829 GHz, Bw = 16.000 MH Calibrated with CL # 3 and BP # 1 (BP mode 1)

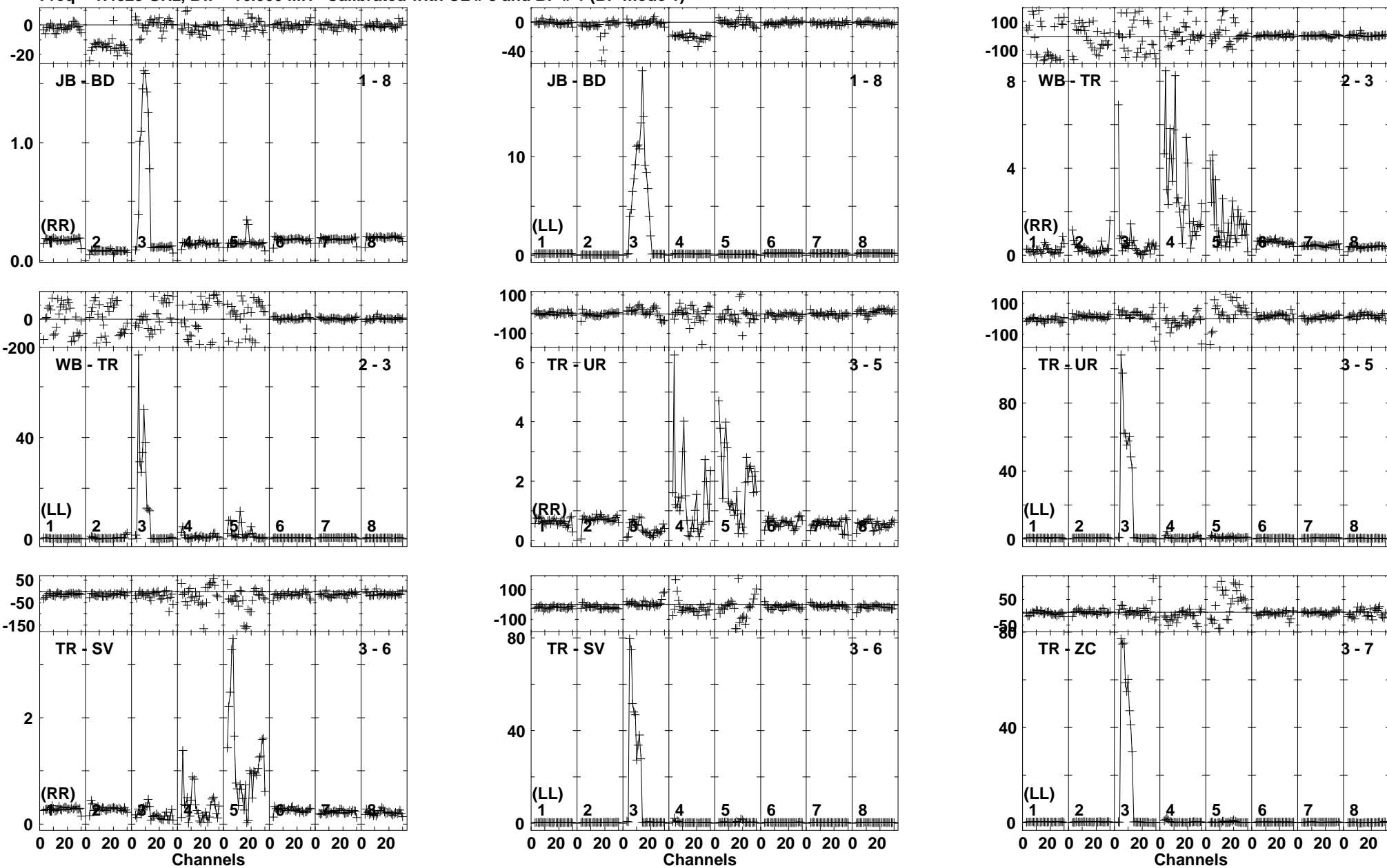

Lower frame: Ampl Jy Top frame: Phas deg
Vector averaged cross-power spectrum Baseline: JB (01) - BD (08)
Timerange: 00/06:18:51 to 00/06:20:19

Plot file version 125 created 21-JUN-2019 11:54:08
J1222+0413 EP1111A 1.UVDATA.1
Freq = 1.4829 GHz, Bw = 16.000 MH Calibrated with CL # 3 and BP # 1 (BP mode 1)

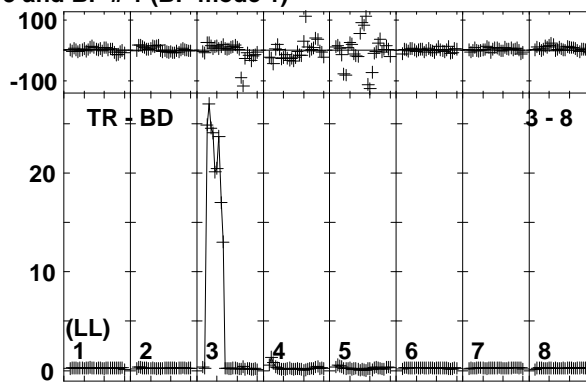
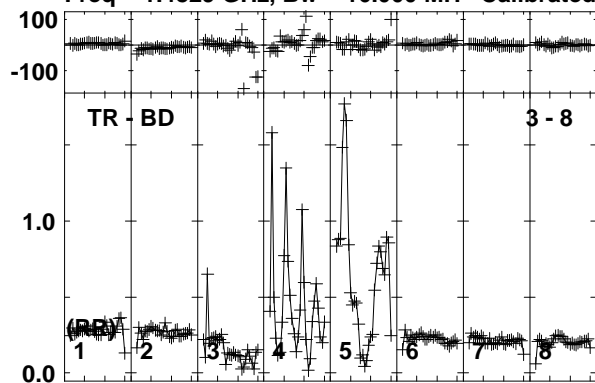

Lower frame: Ampl Jy Top frame: Phas deg
Vector averaged cross-power spectrum Baseline: TR (03) - BD (08)
Timerange: 00/06:18:51 to 00/06:20:19

Plot file version 126 created 21-JUN-2019 11:54:08

IRAS12112 EP111A 1.UVDATA.1

Freq = 1.4829 GHz, Bw = 16.000 MH Calibrated with CL # 3 and BP # 1 (BP mode 1)

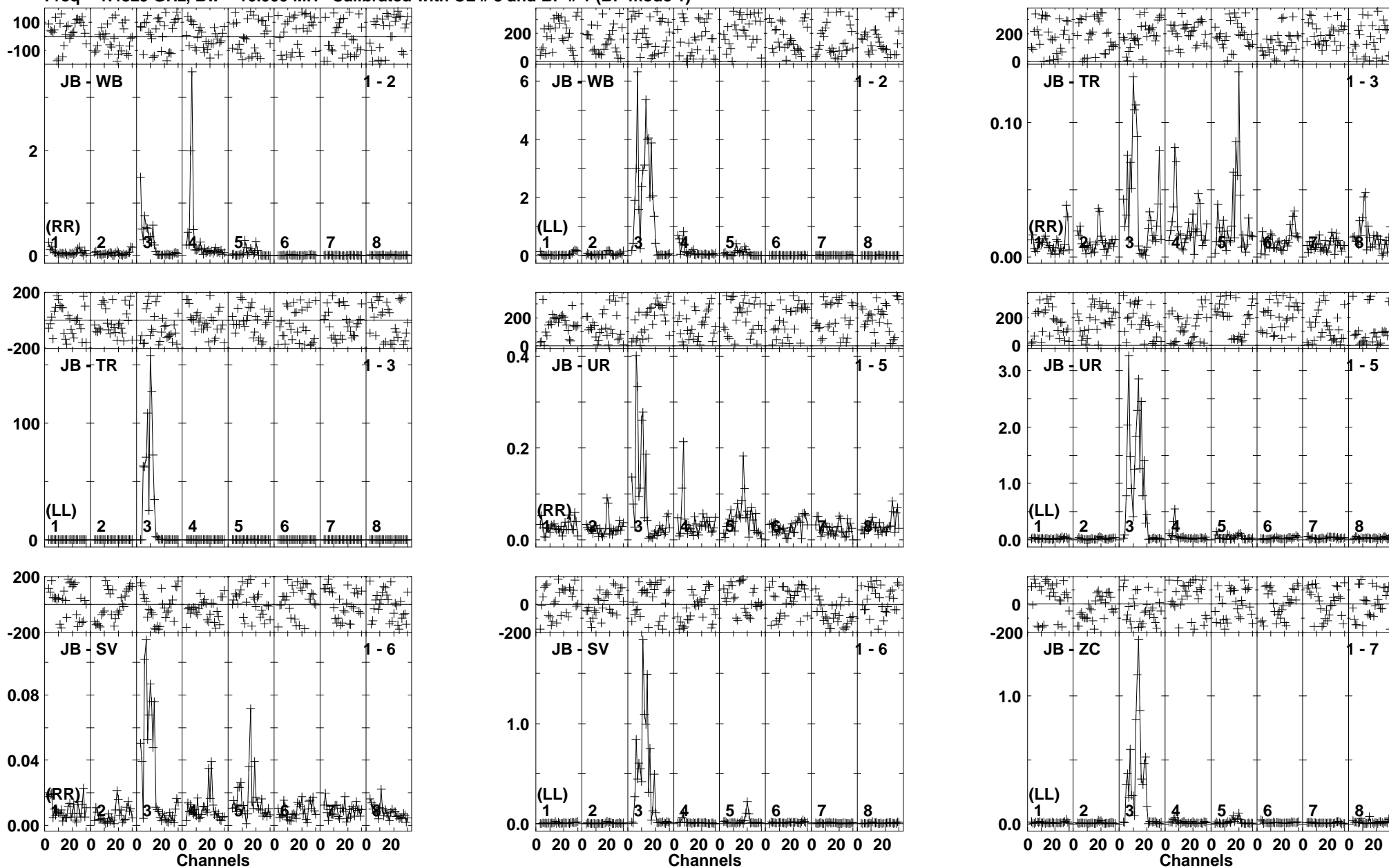

Lower frame: Ampl Jy Top frame: Phas deg
Vector averaged cross-power spectrum Baseline: JB (01) - WB (02)
Timerange: 00/06:20:21 to 00/06:23:49

Plot file version 127 created 21-JUN-2019 11:54:09

IRAS12112 EP111A 1.UVDATA.1

Freq = 1.4829 GHz, Bw = 16.000 MH Calibrated with CL # 3 and BP # 1 (BP mode 1)

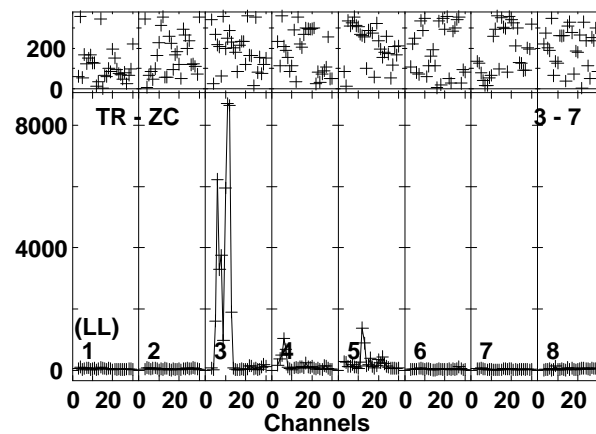
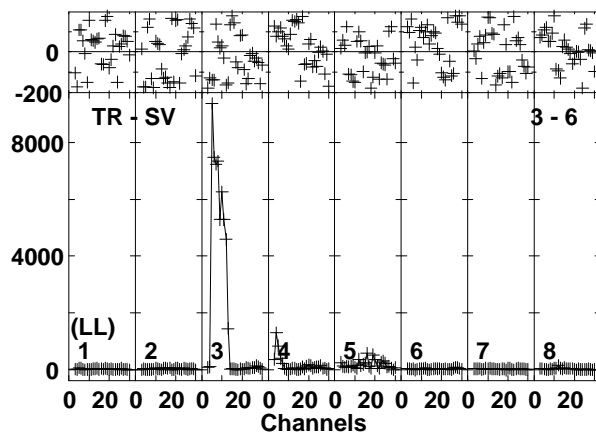
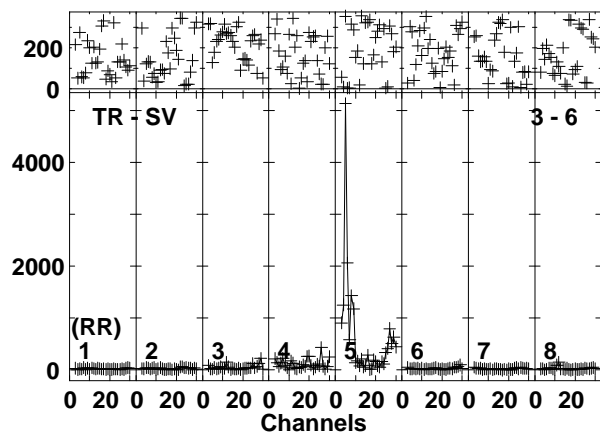
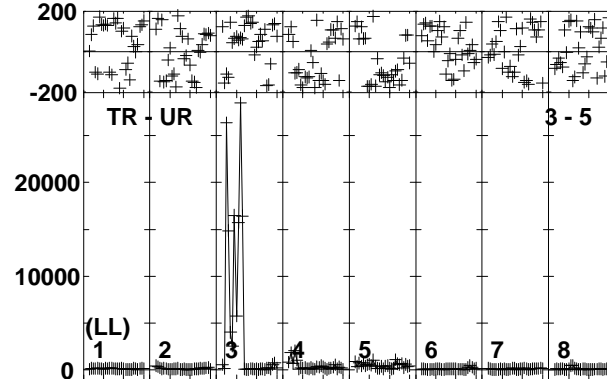
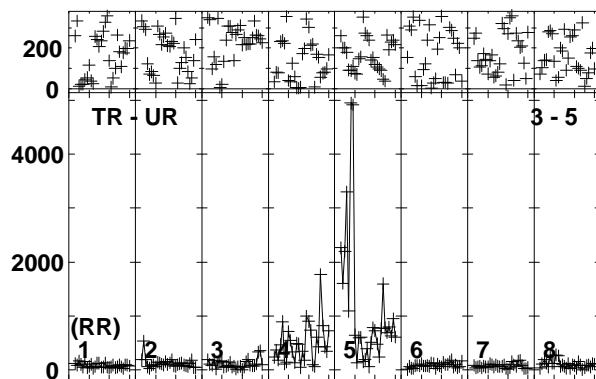
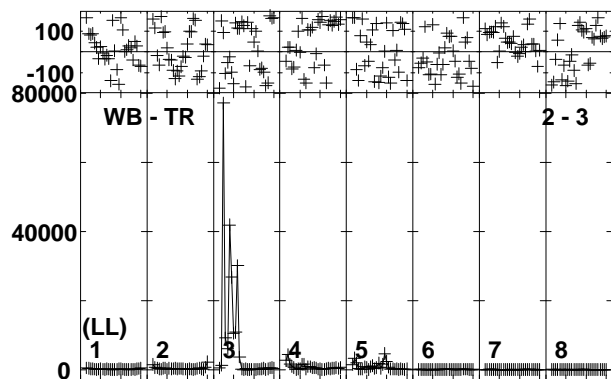
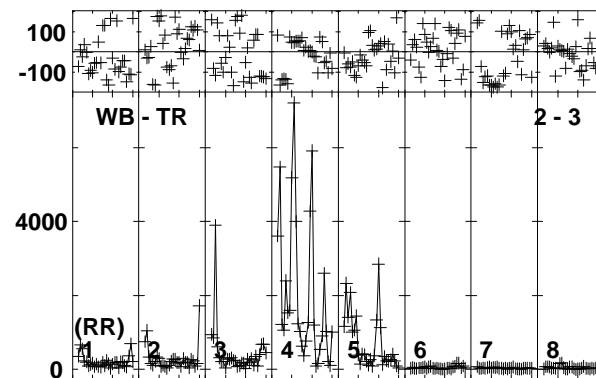
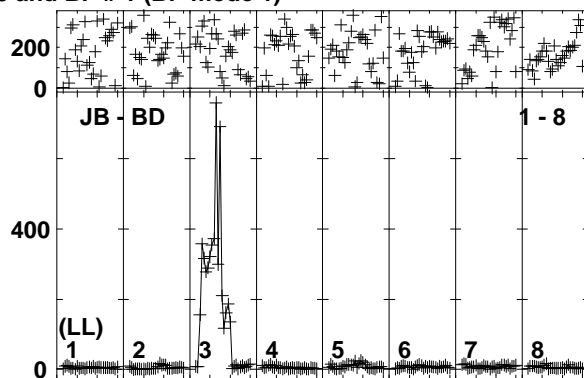
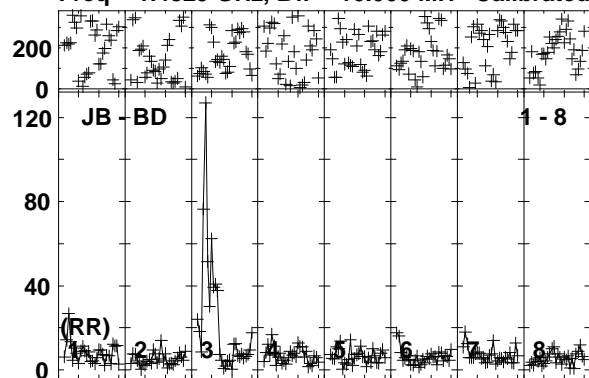

Lower frame: Milli Ampl Jy Top frame: Phas deg
Vector averaged cross-power spectrum Baseline: JB (01) - BD (08)
Timerange: 00/06:20:21 to 00/06:23:49

Plot file version 128 created 21-JUN-2019 11:54:09

IRAS12112 EP111A 1.UVDATA.1

Freq = 1.4829 GHz, Bw = 16.000 MH Calibrated with CL # 3 and BP # 1 (BP mode 1)

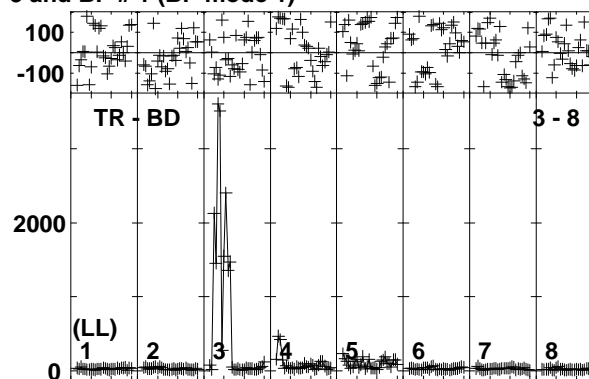
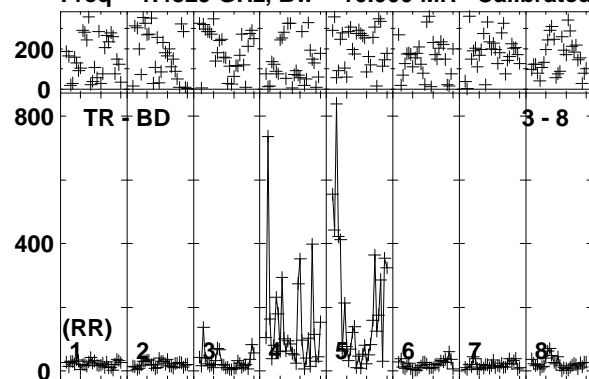

Lower frame: Milli Ampl Jy Top frame: Phas deg
Vector averaged cross-power spectrum Baseline: TR (03) - BD (08)
Timerange: 00/06:20:21 to 00/06:23:49

Plot file version 129 created 21-JUN-2019 11:54:10

J1222+0413 EP111A 1.UVDATA.1

Freq = 1.4829 GHz, Bw = 16.000 MH Calibrated with CL # 3 and BP # 1 (BP mode 1)

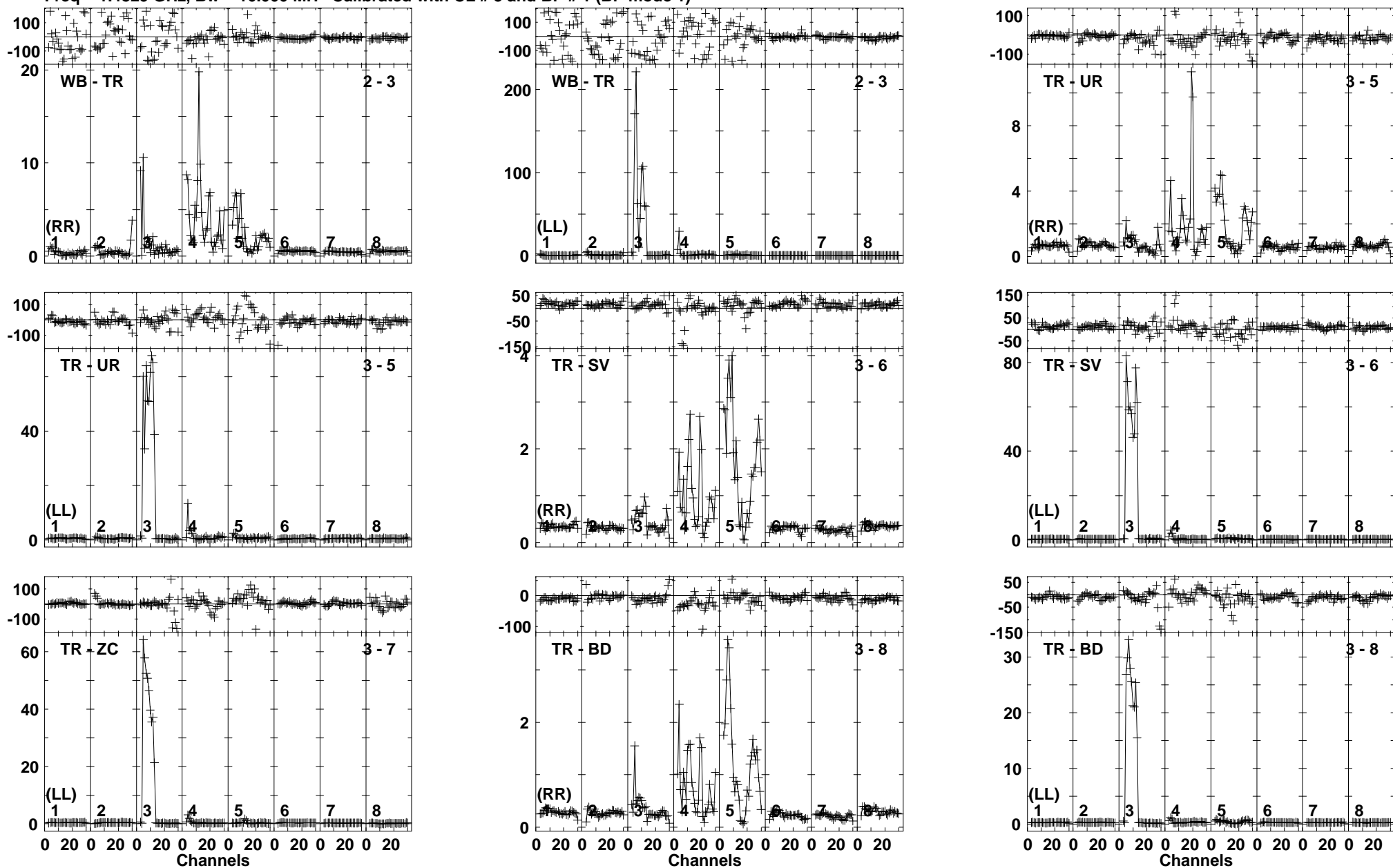

Lower frame: Ampl Jy Top frame: Phas deg
Vector averaged cross-power spectrum Baseline: WB (02) - TR (03)
Timerange: 00/06:23:51 to 00/06:25:19

Plot file version 130 created 21-JUN-2019 11:54:10

IRAS12112 EP111A 1.UVDATA.1

Freq = 1.4829 GHz, Bw = 16.000 MH Calibrated with CL # 3 and BP # 1 (BP mode 1)

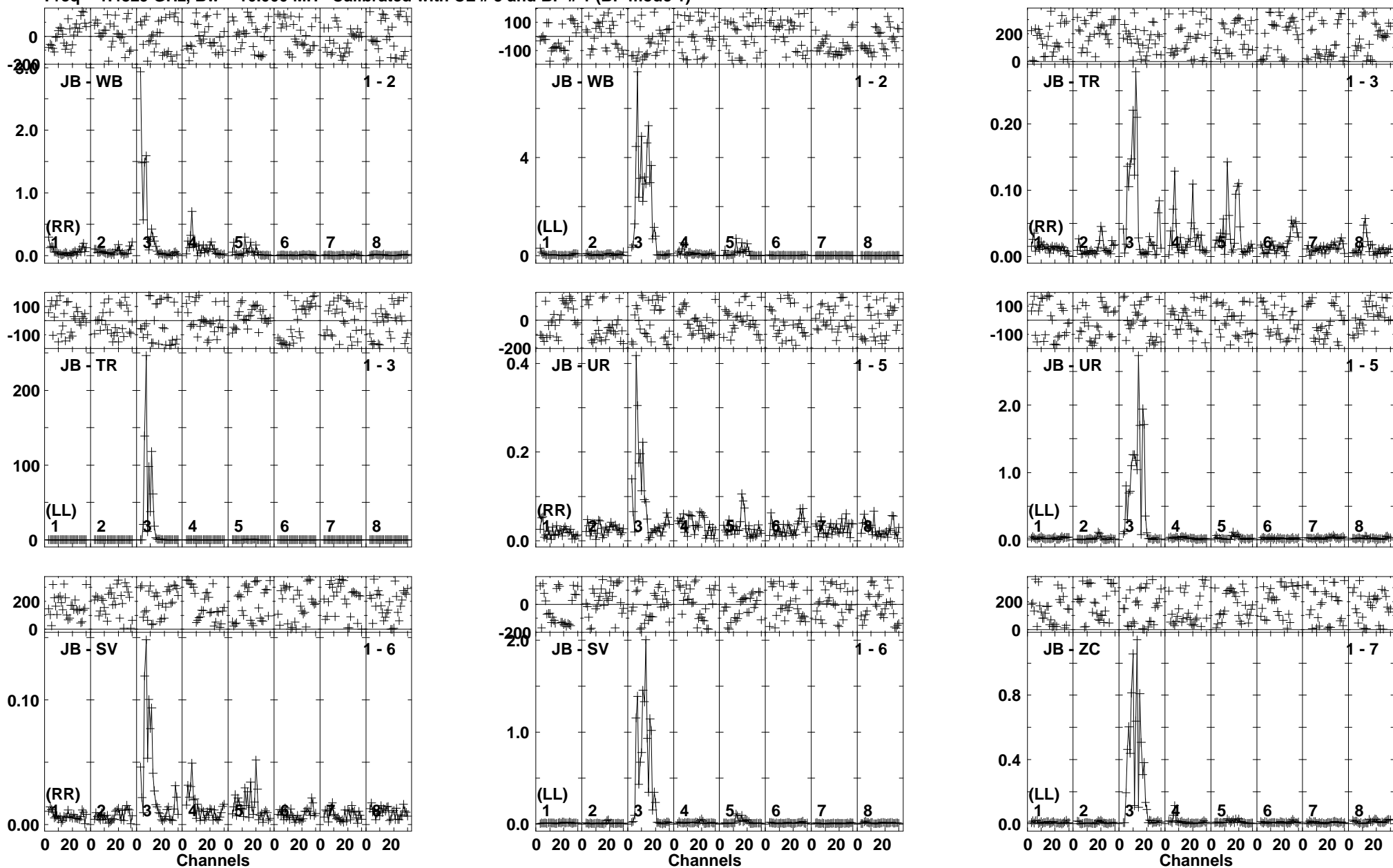

Lower frame: Ampl Jy Top frame: Phas deg
Vector averaged cross-power spectrum Baseline: JB (01) - WB (02)
Timerange: 00/06:25:21 to 00/06:28:49

Plot file version 131 created 21-JUN-2019 11:54:10

IRAS12112 EP111A 1.UVDATA.1

Freq = 1.4829 GHz, Bw = 16.000 MH Calibrated with CL # 3 and BP # 1 (BP mode 1)

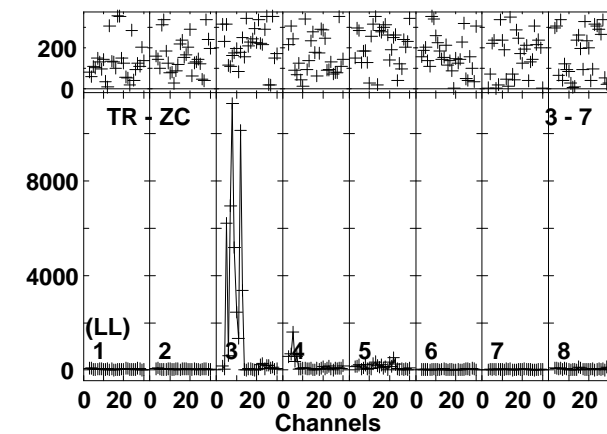
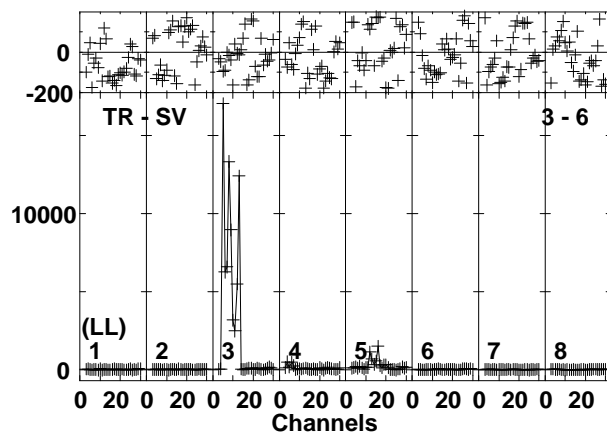
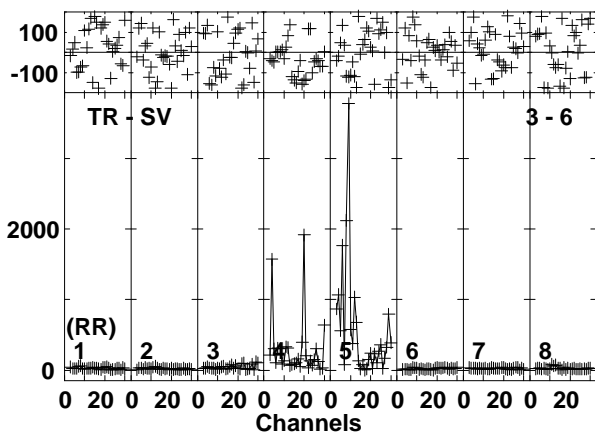
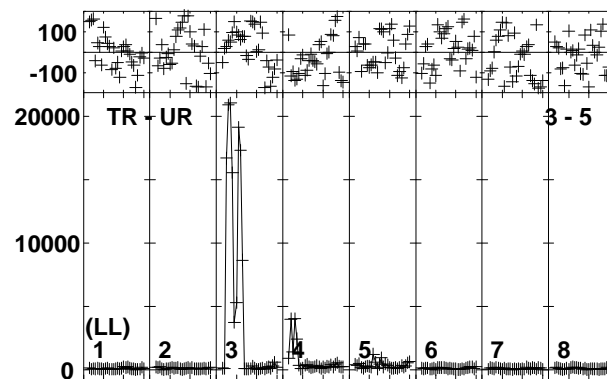
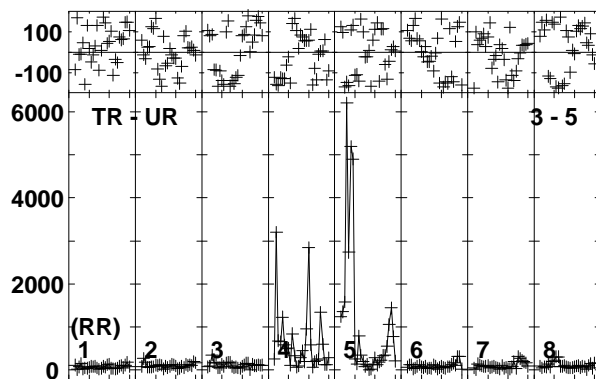
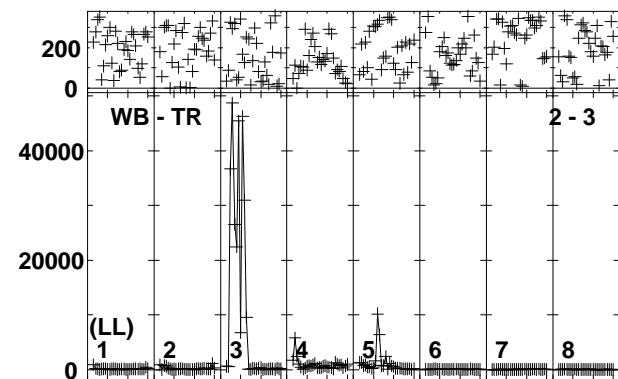
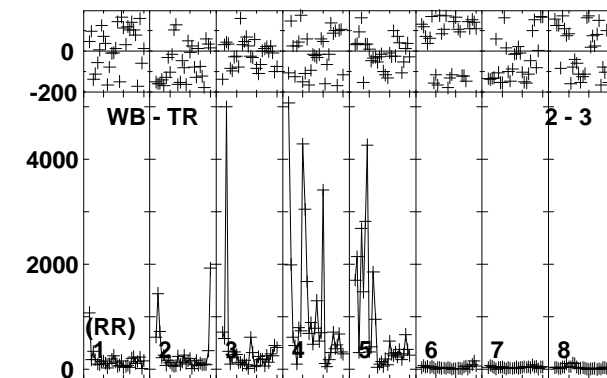
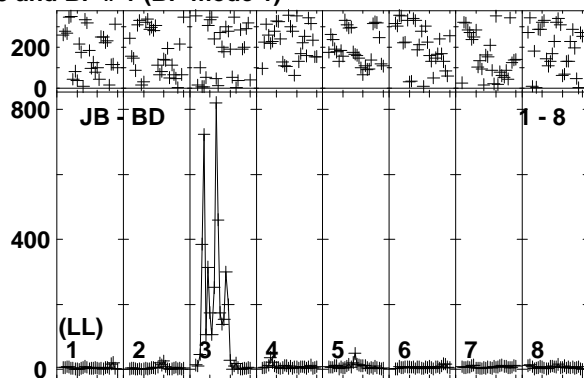
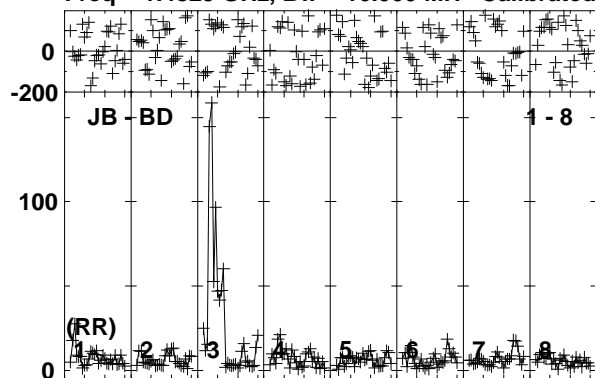

Lower frame: Milli Ampl Jy Top frame: Phas deg
Vector averaged cross-power spectrum Baseline: JB (01) - BD (08)
Timerange: 00/06:25:21 to 00/06:28:49

Plot file version 132 created 21-JUN-2019 11:54:11

IRAS12112 EP111A 1.UVDATA.1

Freq = 1.4829 GHz, Bw = 16.000 MH Calibrated with CL # 3 and BP # 1 (BP mode 1)

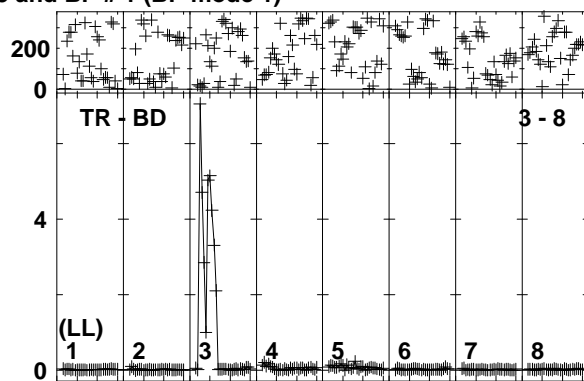
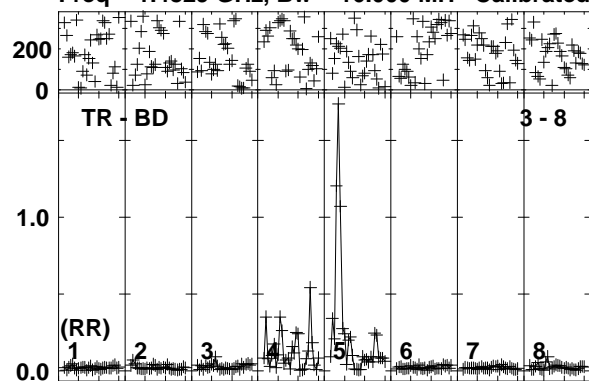

Lower frame: Ampl Jy Top frame: Phas deg
Vector averaged cross-power spectrum Baseline: TR (03) - BD (08)
Timerange: 00/06:25:21 to 00/06:28:49

Plot file version 133 created 21-JUN-2019 11:54:11

J1222+0413 EP111A 1.UVDATA.1

Freq = 1.4829 GHz, Bw = 16.000 MH Calibrated with CL # 3 and BP # 1 (BP mode 1)

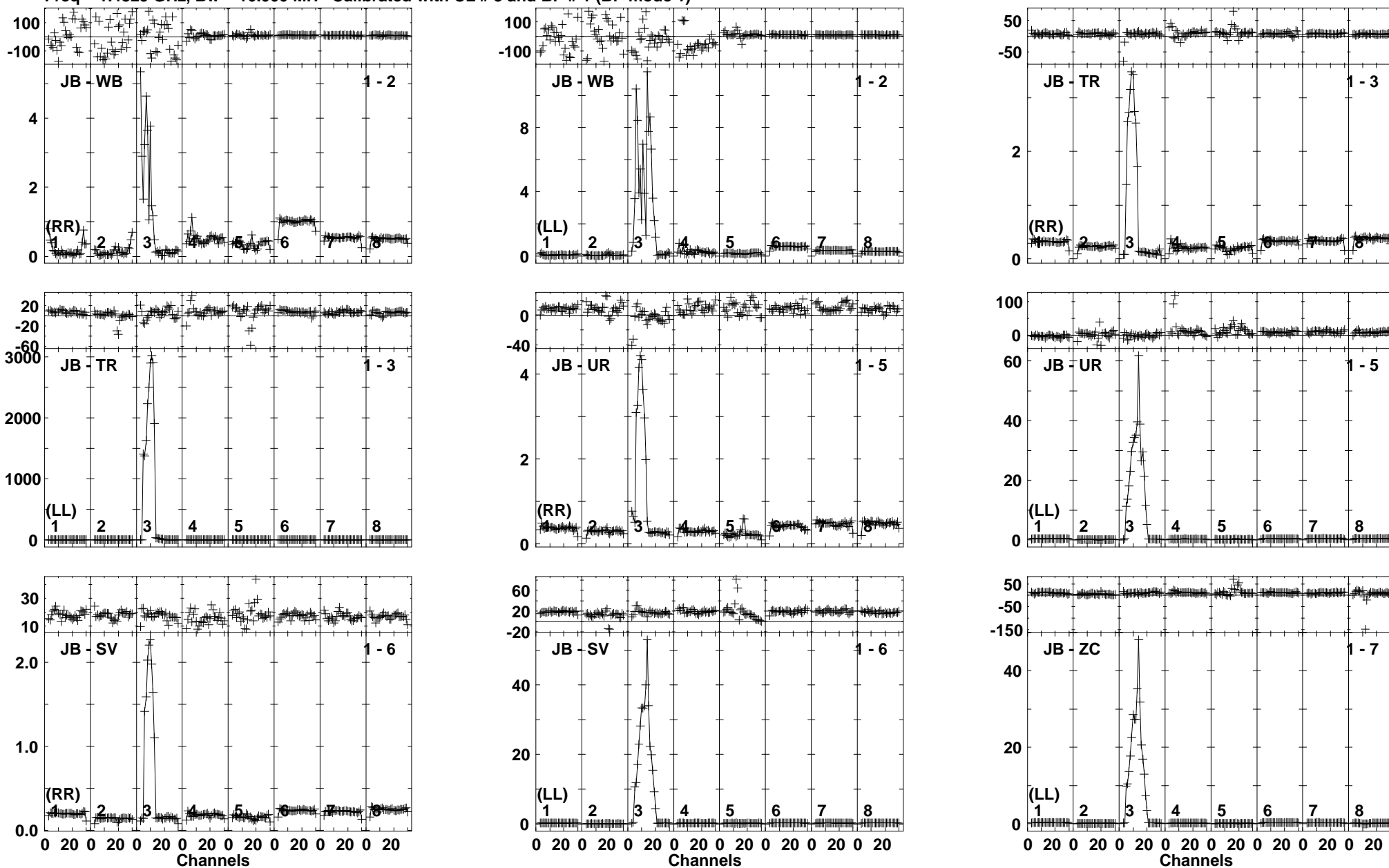

Lower frame: Ampl Jy Top frame: Phas deg
Vector averaged cross-power spectrum Baseline: JB (01) - WB (02)
Timerange: 00/06:29:31 to 00/06:30:59

Plot file version 134 created 21-JUN-2019 11:54:11

J1222+0413 EP111A 1.UVDATA.1

Freq = 1.4829 GHz, Bw = 16.000 MH Calibrated with CL # 3 and BP # 1 (BP mode 1)

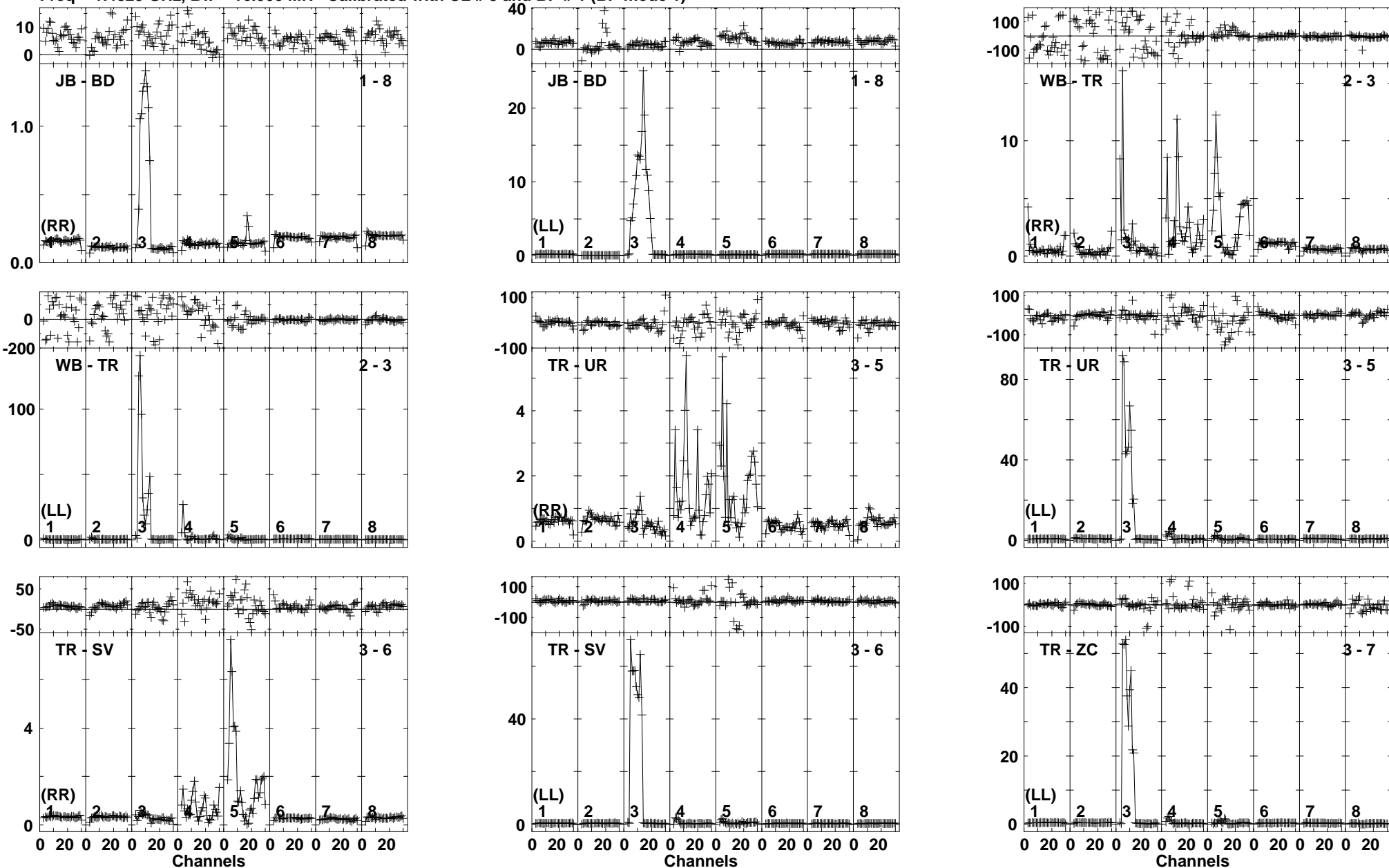

Lower frame: Ampl Jy Top frame: Phas deg
Vector averaged cross-power spectrum Baseline: JB (01) - BD (08)
Timerange: 00/06:29:31 to 00/06:30:59

Plot file version 135 created 21-JUN-2019 11:54:12

J1222+0413 EP111A 1.UVDATA.1

Freq = 1.4829 GHz, Bw = 16.000 MH Calibrated with CL # 3 and BP # 1 (BP mode 1)

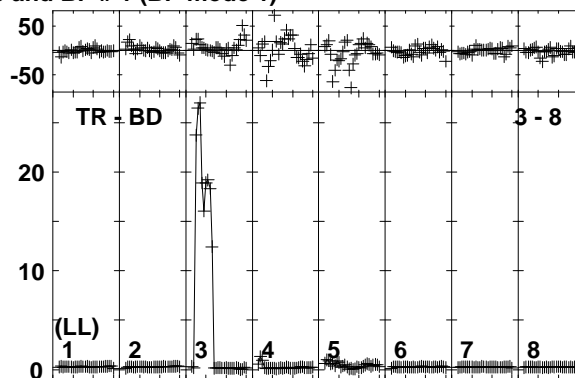
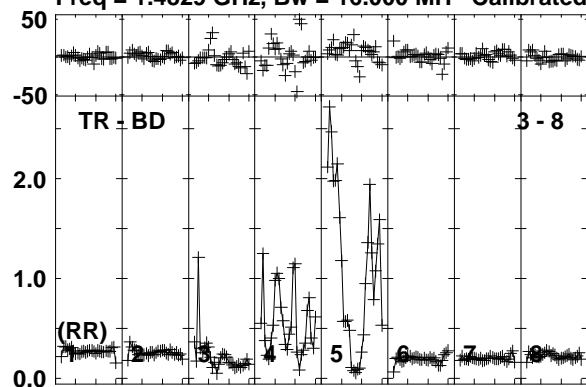

Lower frame: Ampl Jy Top frame: Phas deg
Vector averaged cross-power spectrum Baseline: TR (03) - BD (08)
Timerange: 00/06:29:31 to 00/06:30:59

Plot file version 136 created 21-JUN-2019 11:54:12

IRAS12112 EP111A 1.UVDATA.1

Freq = 1.4829 GHz, Bw = 16.000 MH Calibrated with CL # 3 and BP # 1 (BP mode 1)

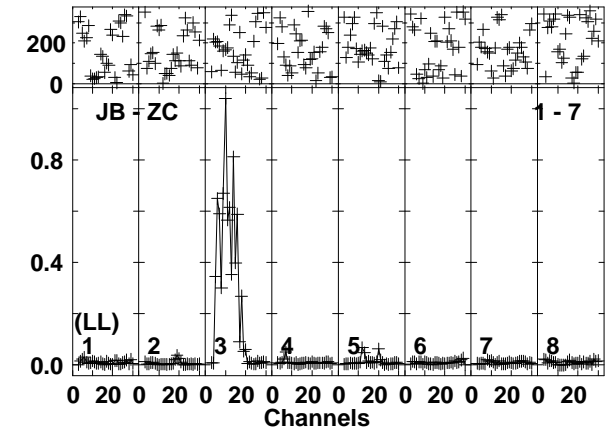
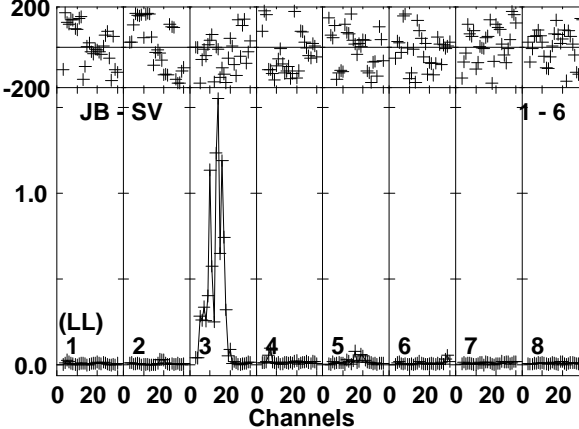
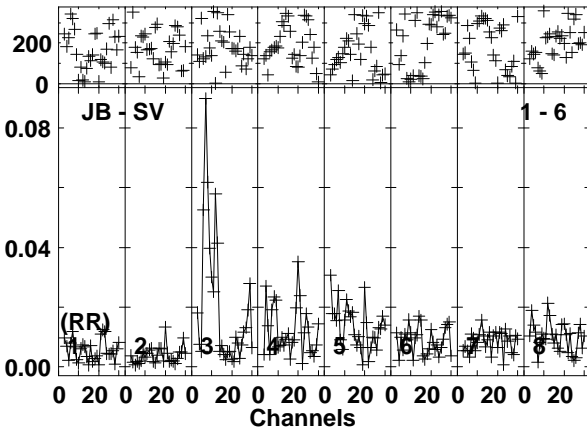
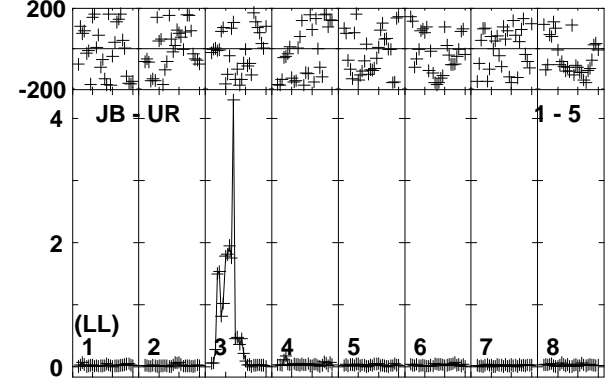
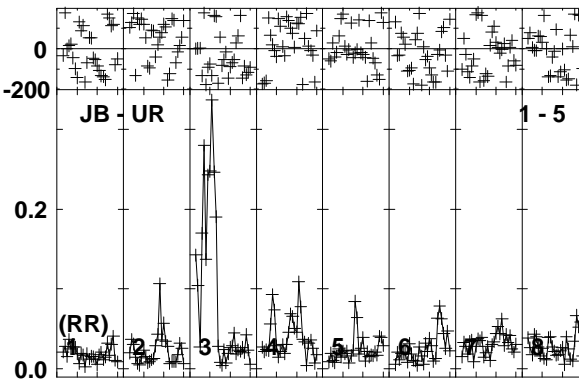
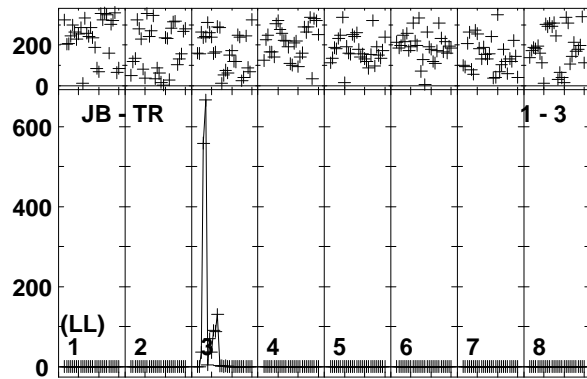
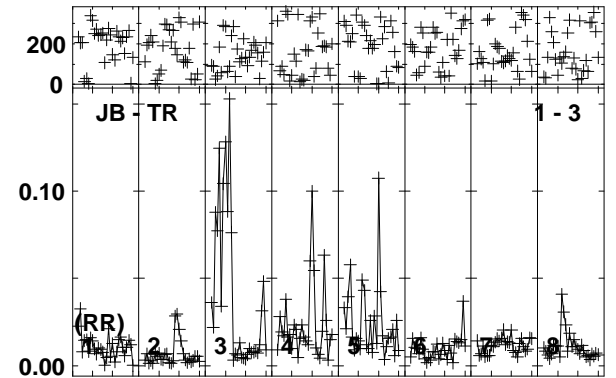
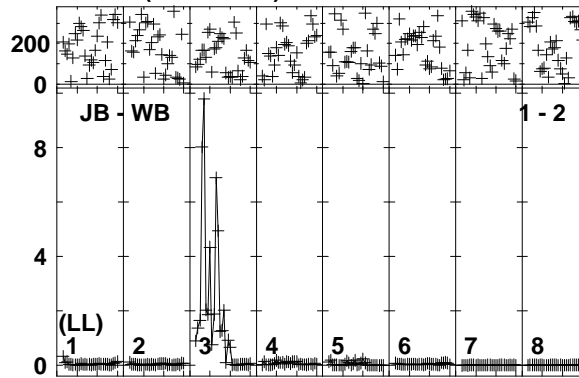
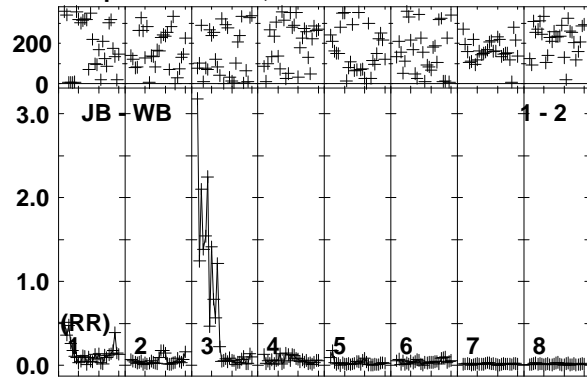

Lower frame: Ampl Jy Top frame: Phas deg
Vector averaged cross-power spectrum Baseline: JB (01) - WB (02)
Timerange: 00/06:31:01 to 00/06:34:29

Plot file version 137 created 21-JUN-2019 11:54:13

IRAS12112 EP111A 1.UVDATA.1

Freq = 1.4829 GHz, Bw = 16.000 MH Calibrated with CL # 3 and BP # 1 (BP mode 1)

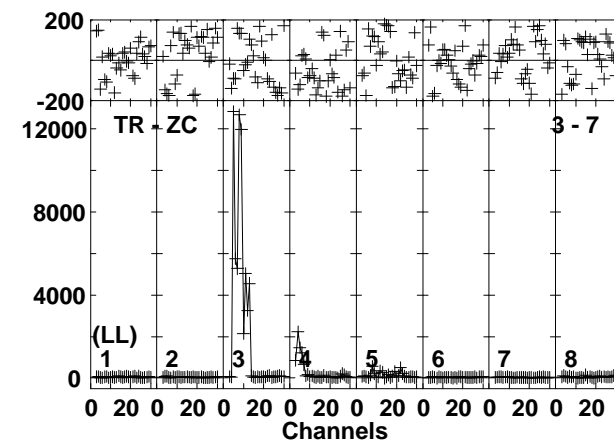
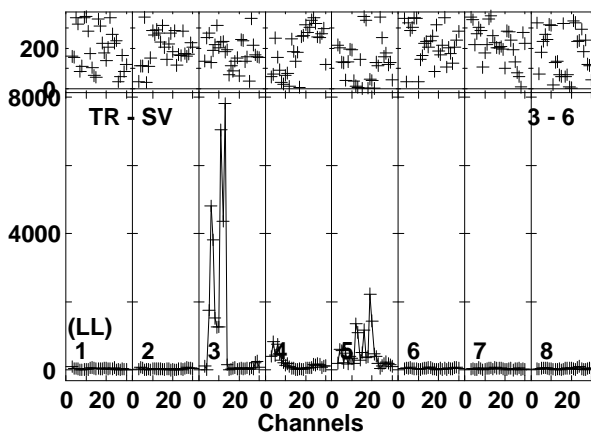
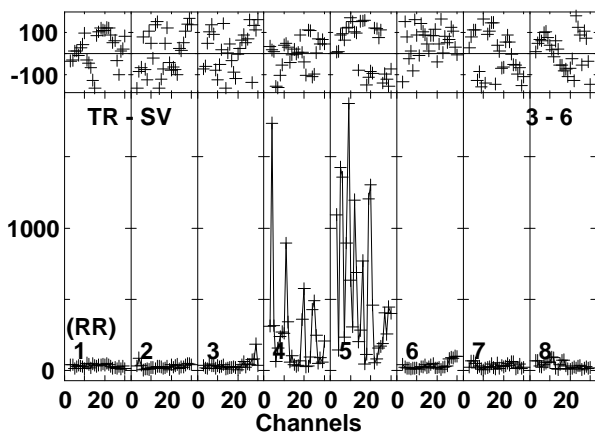
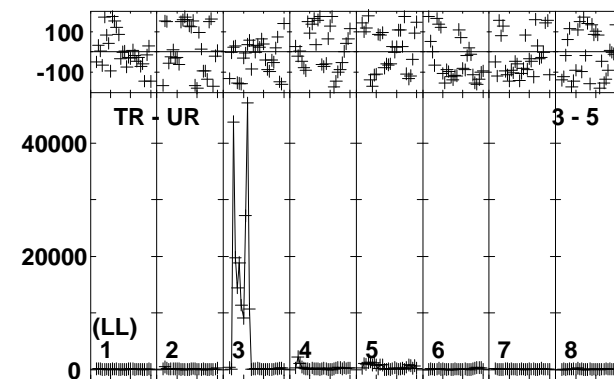
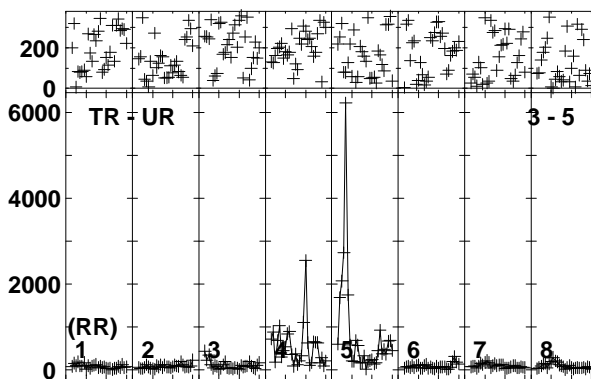
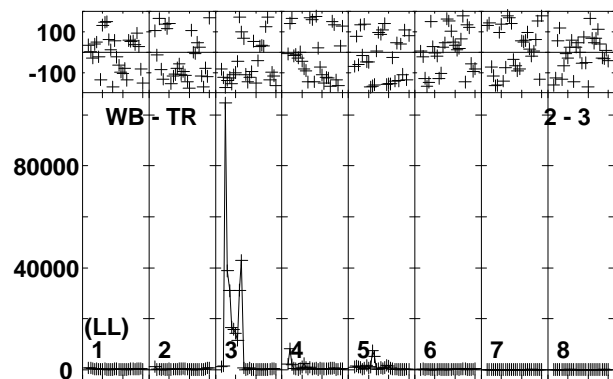
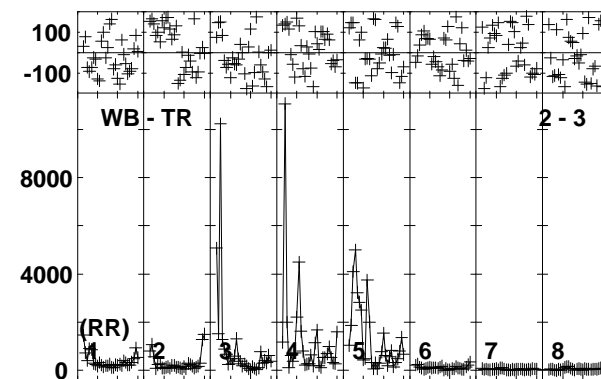
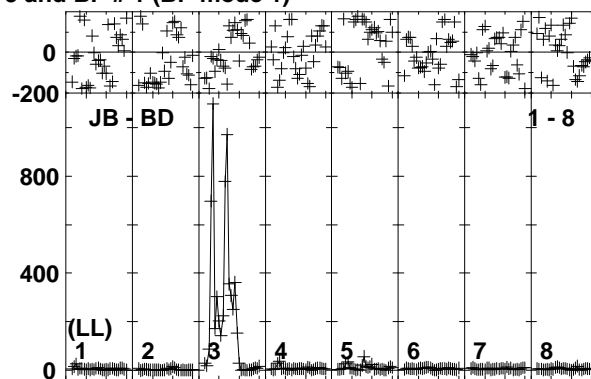
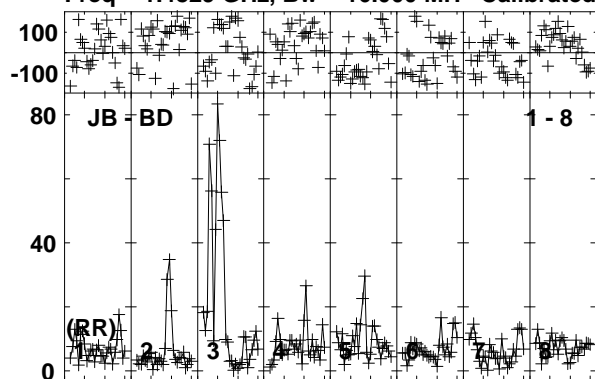

Lower frame: Milli Ampl Jy Top frame: Phas deg
Vector averaged cross-power spectrum Baseline: JB (01) - BD (08)
Timerange: 00/06:31:01 to 00/06:34:29

Plot file version 138 created 21-JUN-2019 11:54:13

IRAS12112 EP111A 1.UVDATA.1

Freq = 1.4829 GHz, Bw = 16.000 MH Calibrated with CL # 3 and BP # 1 (BP mode 1)

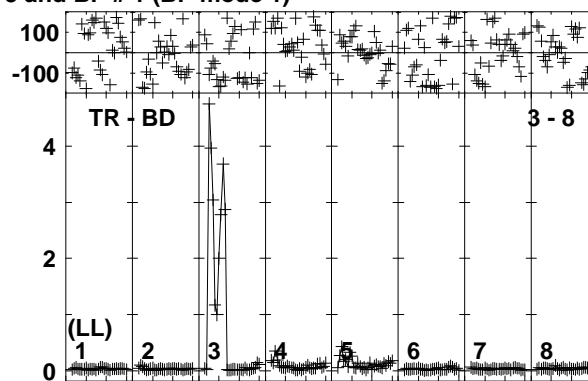
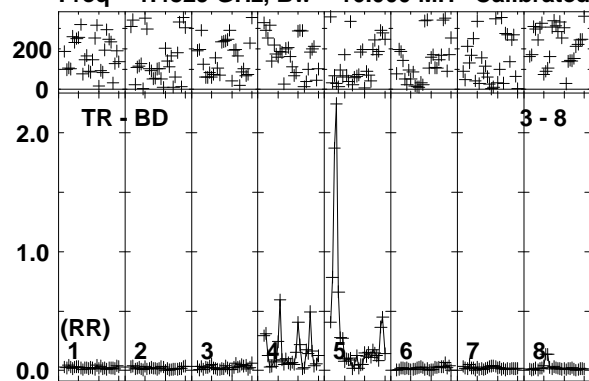

Lower frame: Ampl Jy Top frame: Phas deg
Vector averaged cross-power spectrum Baseline: TR (03) - BD (08)
Timerange: 00/06:31:01 to 00/06:34:29

Plot file version 139 created 21-JUN-2019 11:54:14
 J1222+0413 EP111A 1.UVDATA.1
 Freq = 1.4829 GHz, Bw = 16.000 MH Calibrated with CL # 3 and BP # 1 (BP mode 1)

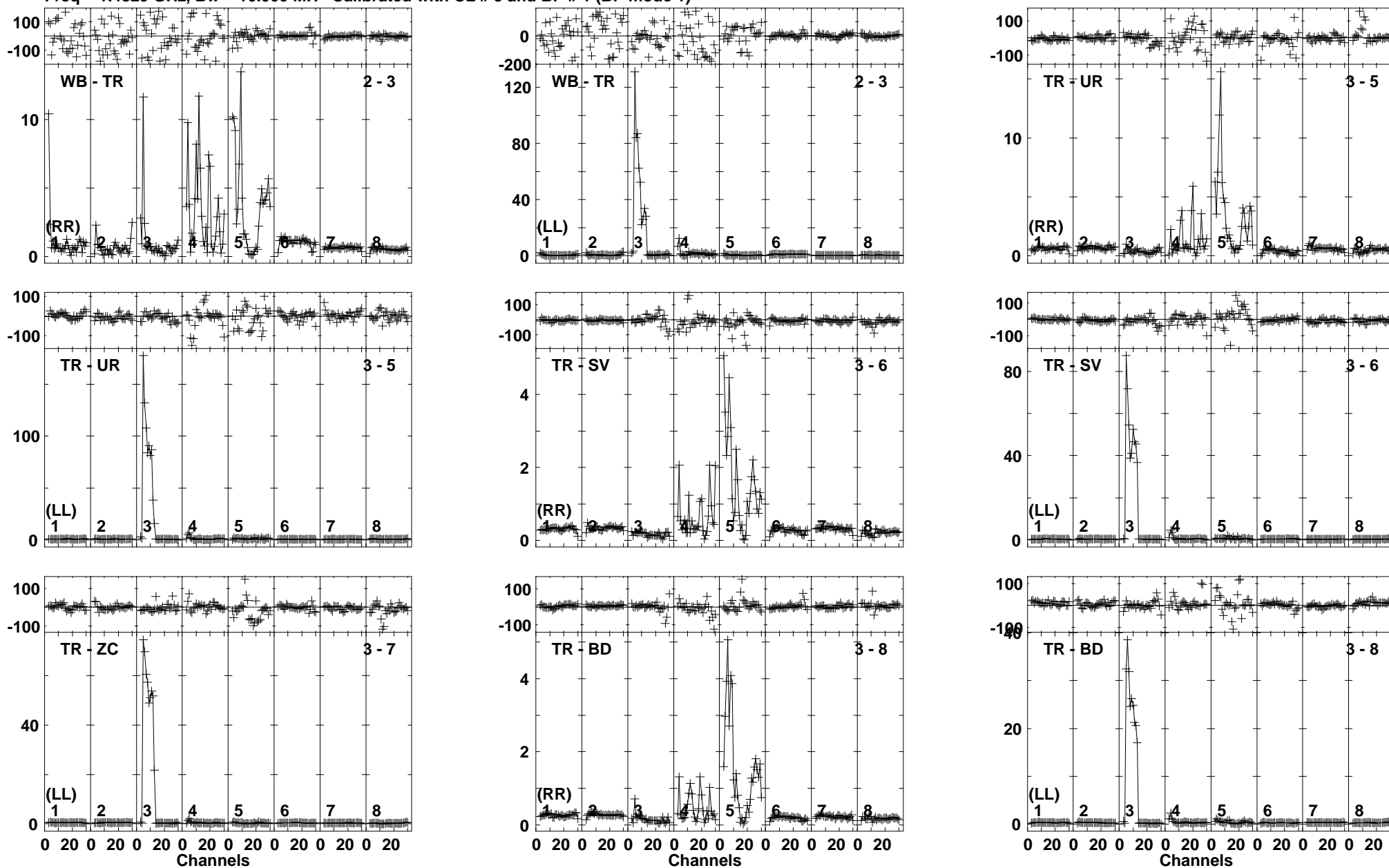

Lower frame: Ampl Jy Top frame: Phas deg
 Vector averaged cross-power spectrum Baseline: WB (02) - TR (03)
 Timerange: 00/06:34:31 to 00/06:35:59

Plot file version 140 created 21-JUN-2019 11:54:14
 IRAS12112 EP111A 1.UVDATA.1
 Freq = 1.4829 GHz, Bw = 16.000 MH Calibrated with CL # 3 and BP # 1 (BP mode 1)

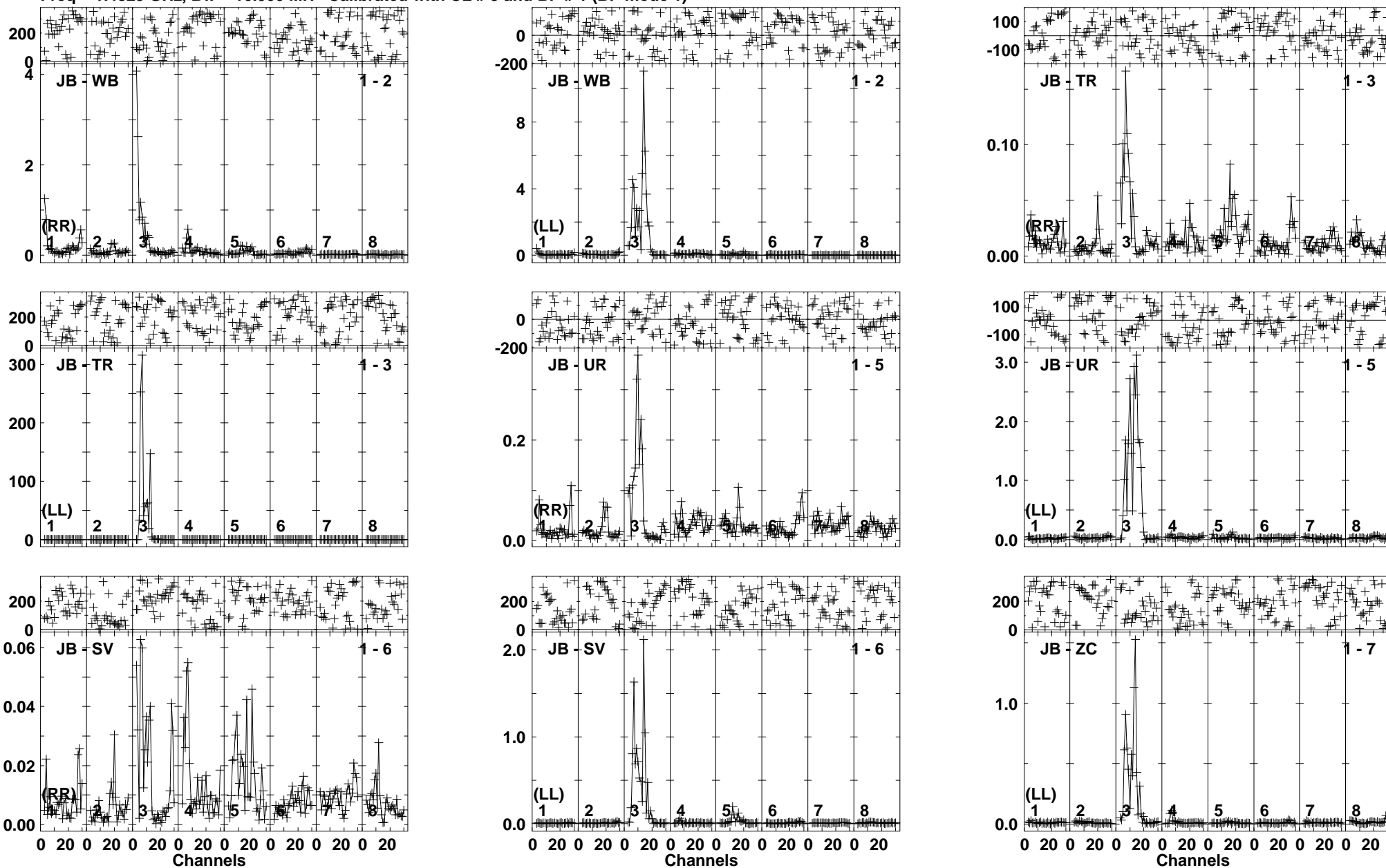

Lower frame: Ampl Jy Top frame: Phas deg
 Vector averaged cross-power spectrum Baseline: JB (01) - WB (02)
 Timerange: 00/06:36:01 to 00/06:39:29

Plot file version 141 created 21-JUN-2019 11:54:14

IRAS12112 EP111A 1.UVDATA.1

Freq = 1.4829 GHz, Bw = 16.000 MH Calibrated with CL # 3 and BP # 1 (BP mode 1)

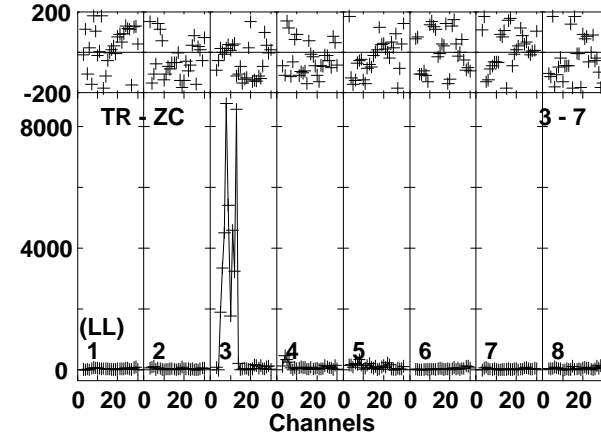
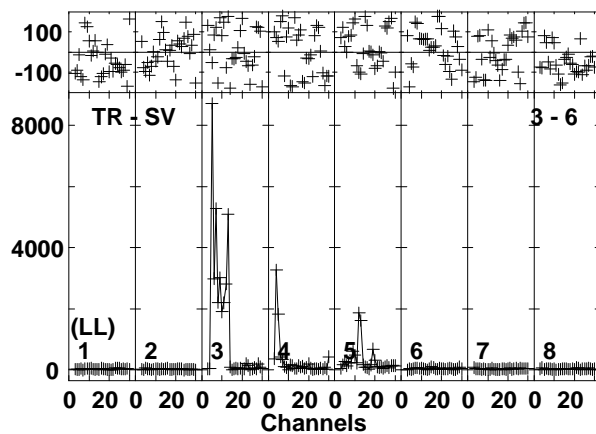
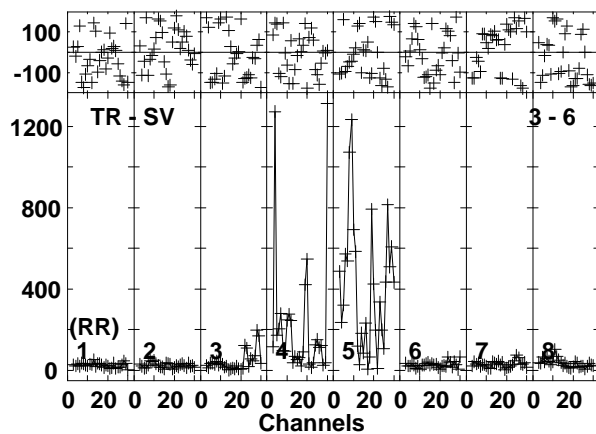
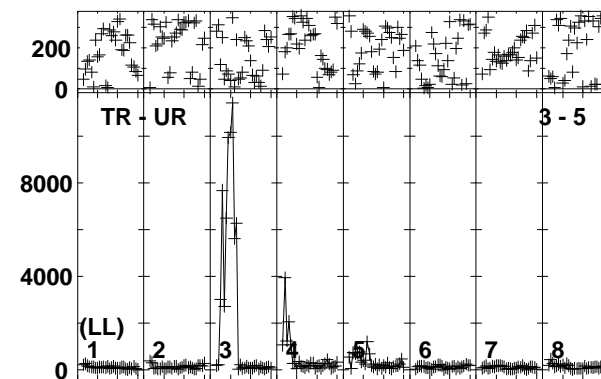
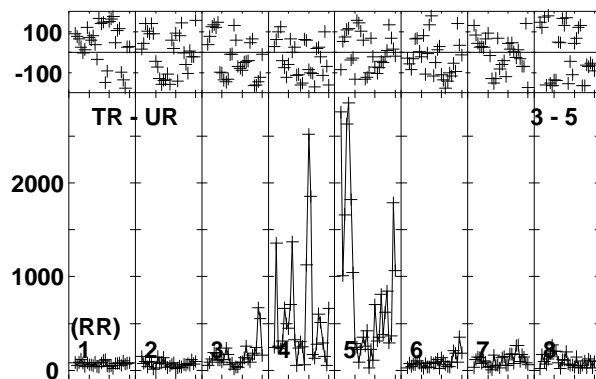
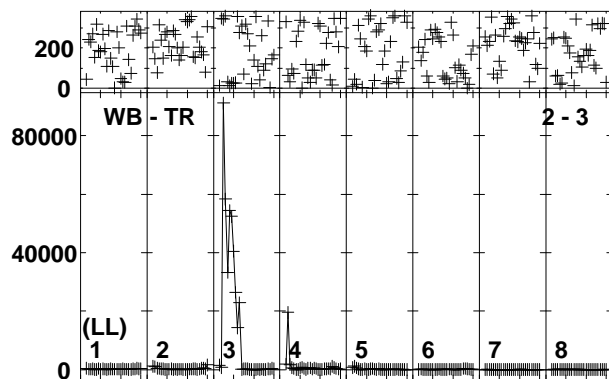
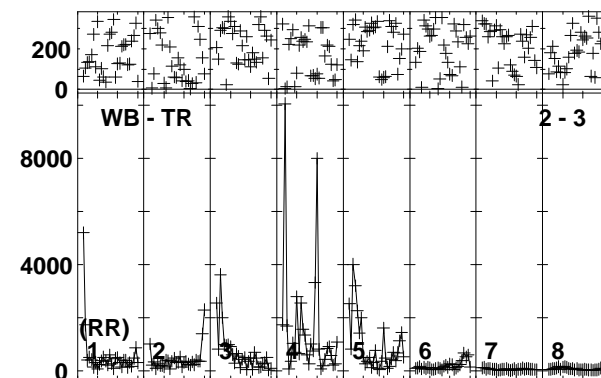
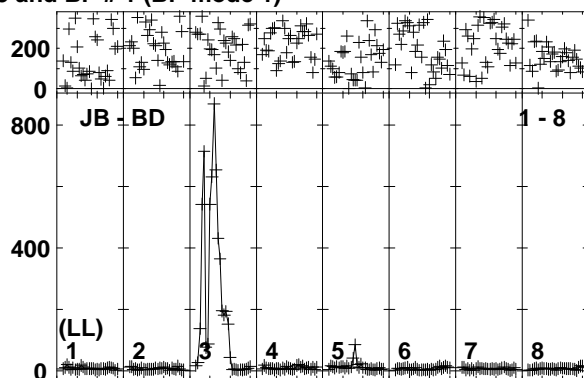
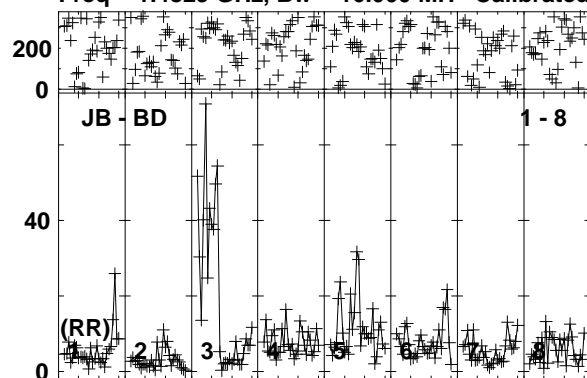

Lower frame: Milli Ampl Jy Top frame: Phas deg
Vector averaged cross-power spectrum Baseline: JB (01) - BD (08)
Timerange: 00/06:36:01 to 00/06:39:29

Plot file version 142 created 21-JUN-2019 11:54:15

IRAS12112 EP111A 1.UVDATA.1

Freq = 1.4829 GHz, Bw = 16.000 MH Calibrated with CL # 3 and BP # 1 (BP mode 1)

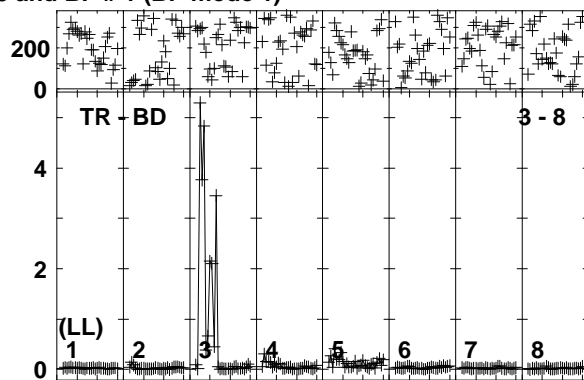
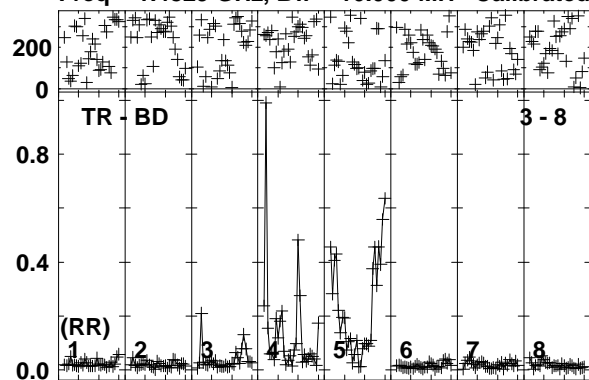

Lower frame: Ampl Jy Top frame: Phas deg
Vector averaged cross-power spectrum Baseline: TR (03) - BD (08)
Timerange: 00/06:36:01 to 00/06:39:29

Plot file version 143 created 21-JUN-2019 11:54:15

J1222+0413 EP111A 1.UVDATA.1

Freq = 1.4829 GHz, Bw = 16.000 MH Calibrated with CL # 3 and BP # 1 (BP mode 1)

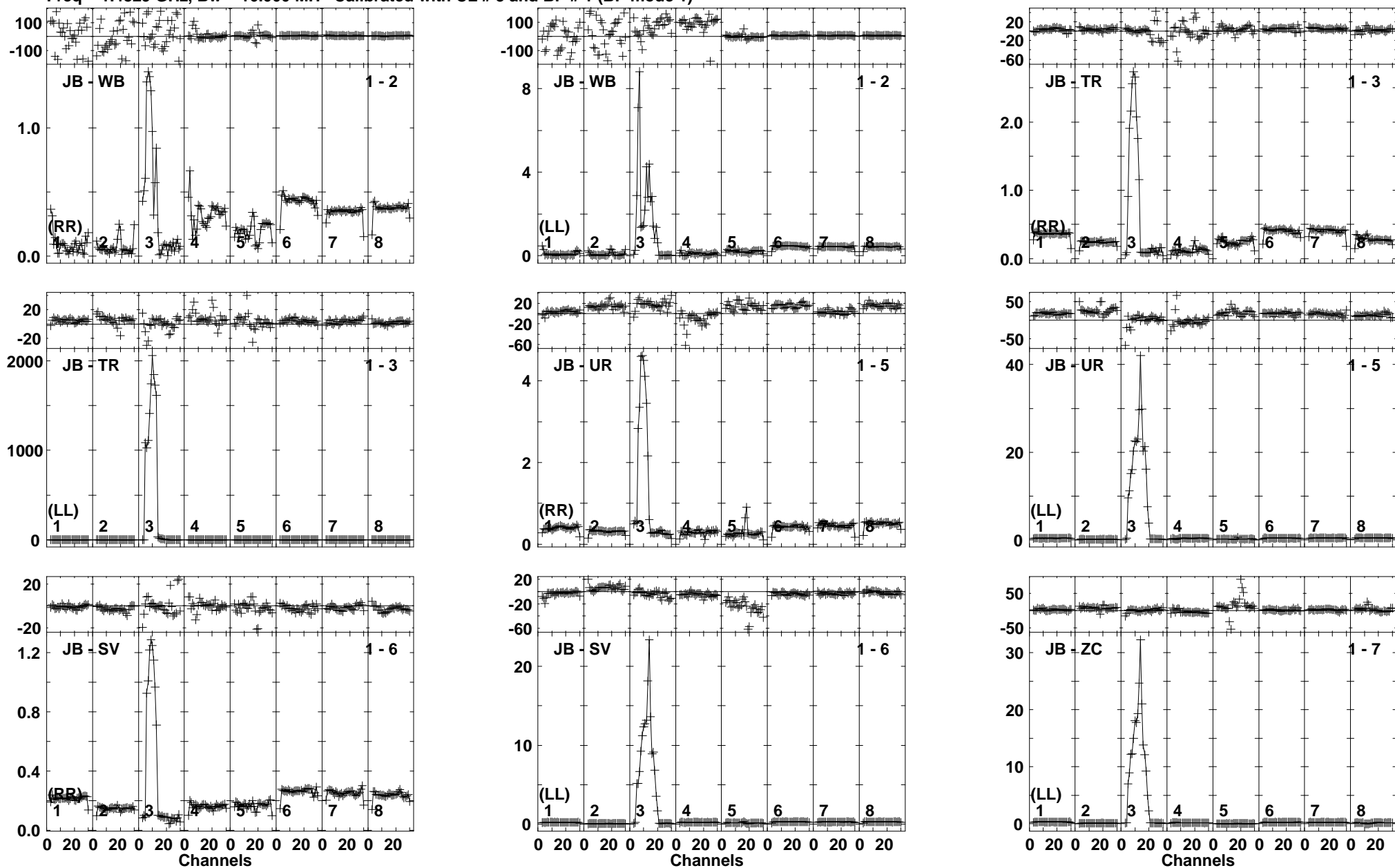

Lower frame: Ampl Jy Top frame: Phas deg
Vector averaged cross-power spectrum Baseline: JB (01) - WB (02)
Timerange: 00/06:40:11 to 00/06:41:39

Plot file version 144 created 21-JUN-2019 11:54:15

J1222+0413 EP111A 1.UVDATA.1

Freq = 1.4829 GHz, Bw = 16.000 MH Calibrated with CL # 3 and BP # 1 (BP mode 1)

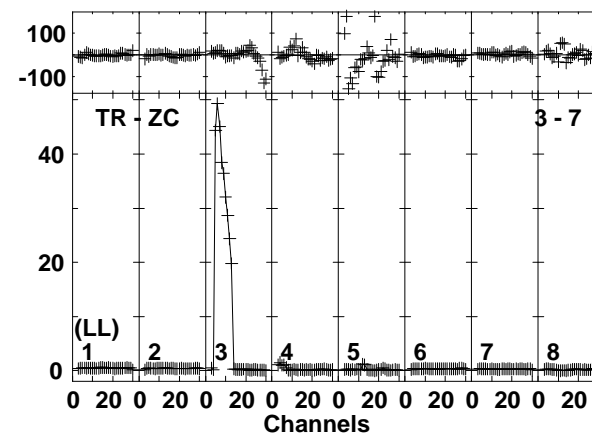
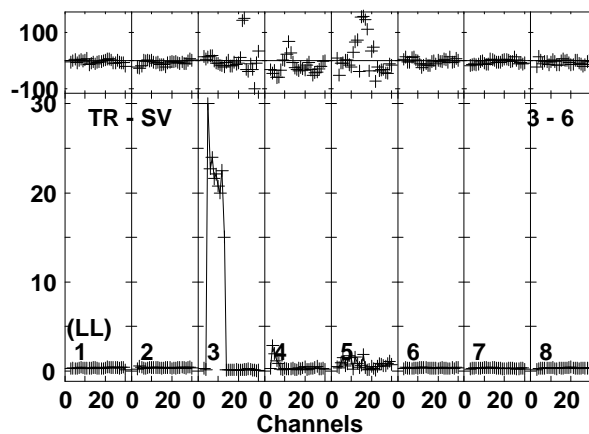
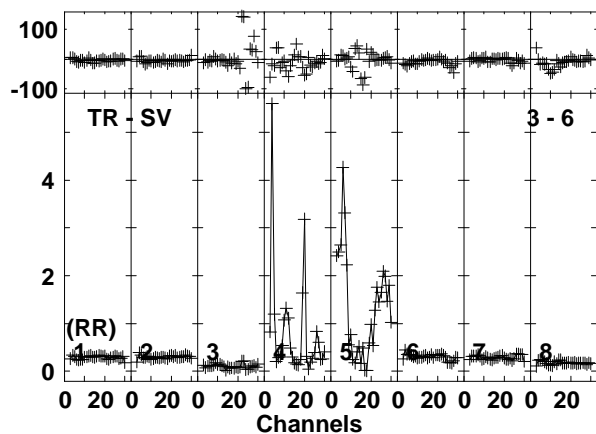
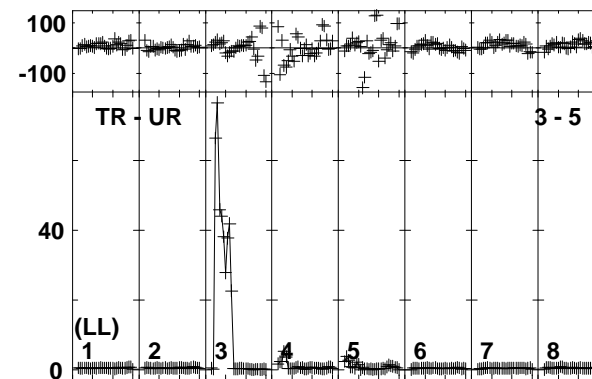
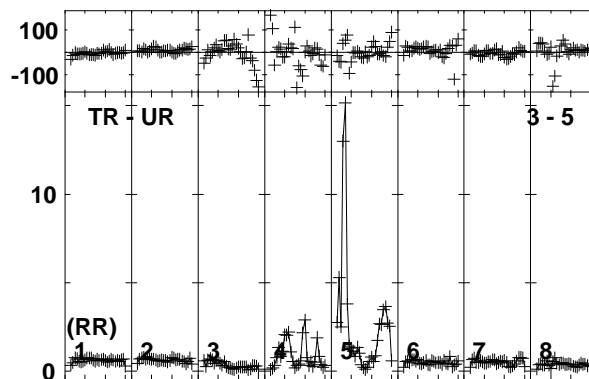
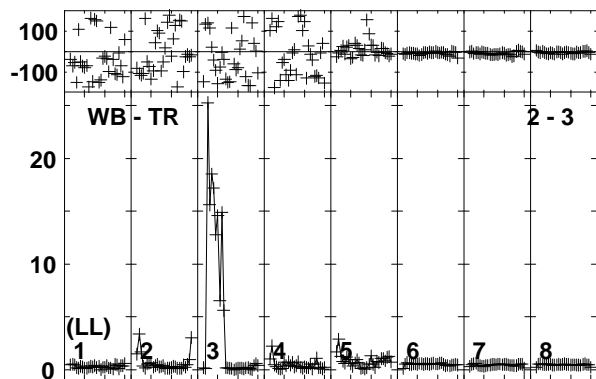
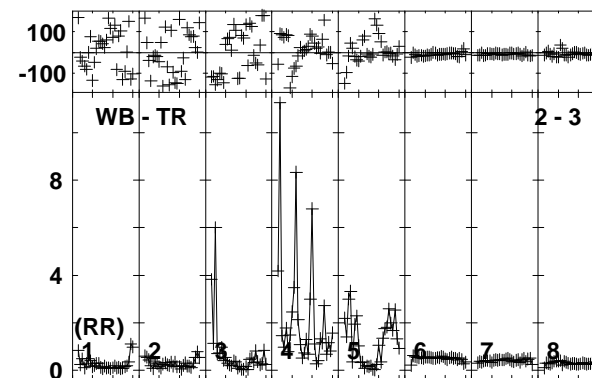
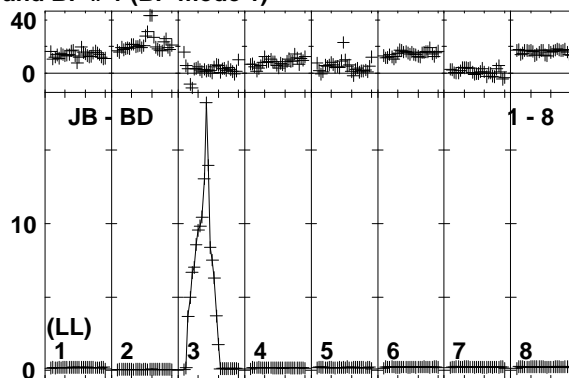
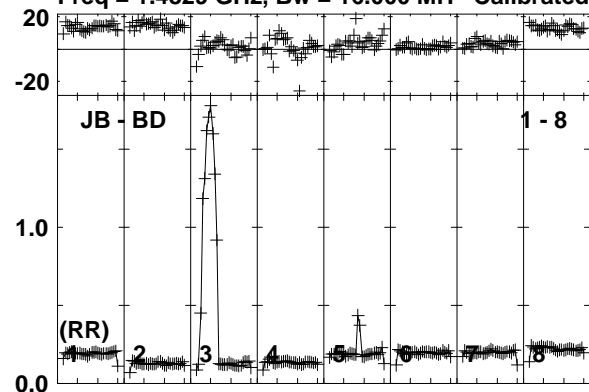

Lower frame: Ampl Jy Top frame: Phas deg
Vector averaged cross-power spectrum Baseline: JB (01) - BD (08)
Timerange: 00/06:40:11 to 00/06:41:39

Plot file version 145 created 21-JUN-2019 11:54:16

J1222+0413 EP111A 1.UVDATA.1

Freq = 1.4829 GHz, Bw = 16.000 MH Calibrated with CL # 3 and BP # 1 (BP mode 1)

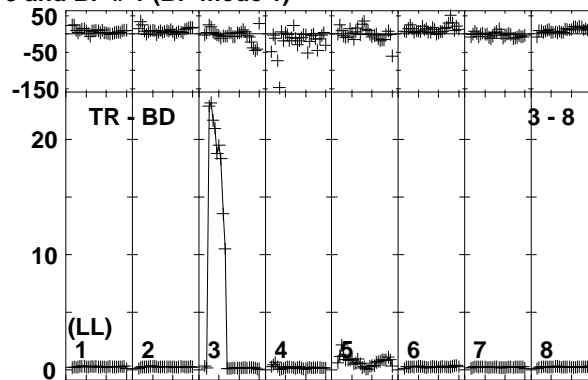
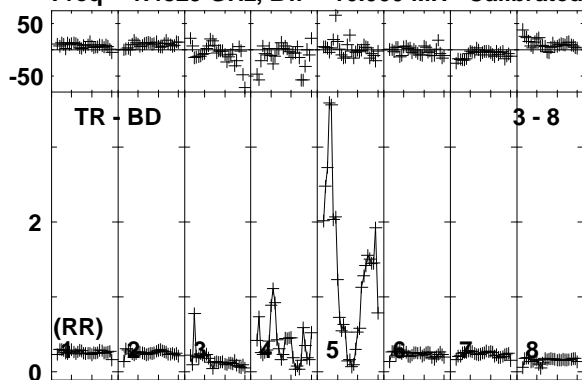

Lower frame: Ampl Jy Top frame: Phas deg
Vector averaged cross-power spectrum Baseline: TR (03) - BD (08)
Timerange: 00/06:40:11 to 00/06:41:39

Plot file version 146 created 21-JUN-2019 11:54:16

IRAS12112 EP111A 1.UVDATA.1

Freq = 1.4829 GHz, Bw = 16.000 MH Calibrated with CL # 3 and BP # 1 (BP mode 1)

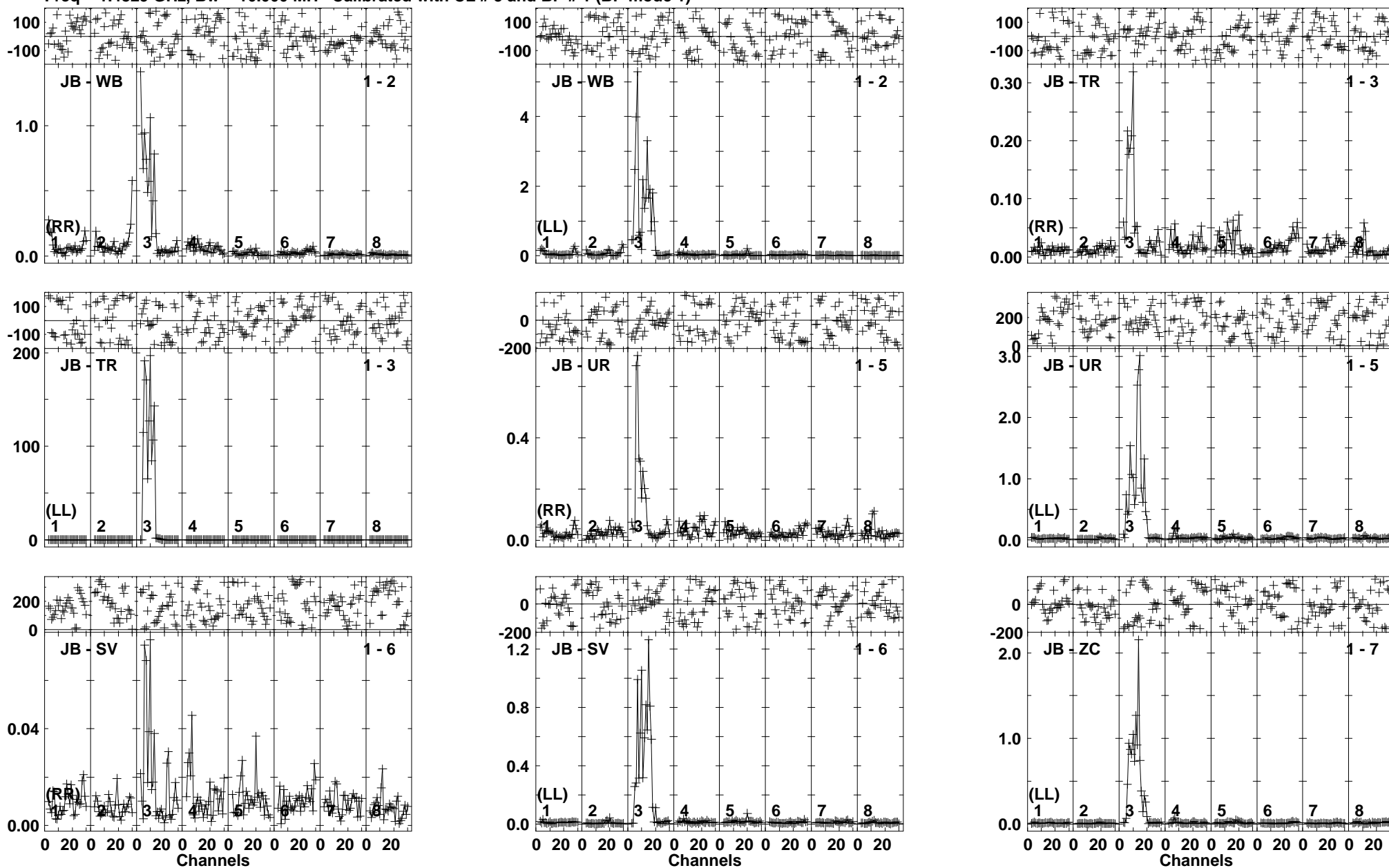

Lower frame: Ampl Jy Top frame: Phas deg
Vector averaged cross-power spectrum Baseline: JB (01) - WB (02)
Timerange: 00/06:41:41 to 00/06:45:09

Plot file version 147 created 21-JUN-2019 11:54:17

IRAS12112 EP111A 1.UVDATA.1

Freq = 1.4829 GHz, Bw = 16.000 MH Calibrated with CL # 3 and BP # 1 (BP mode 1)

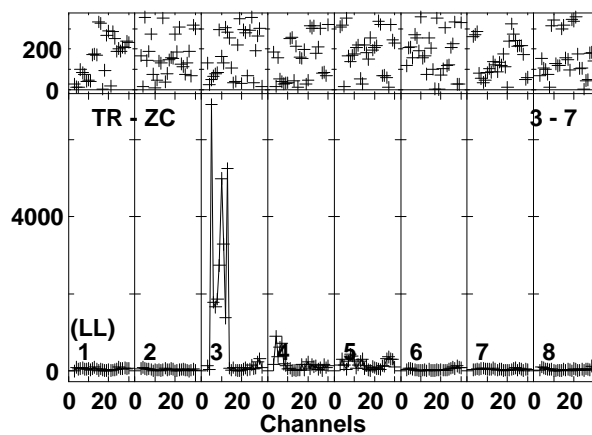
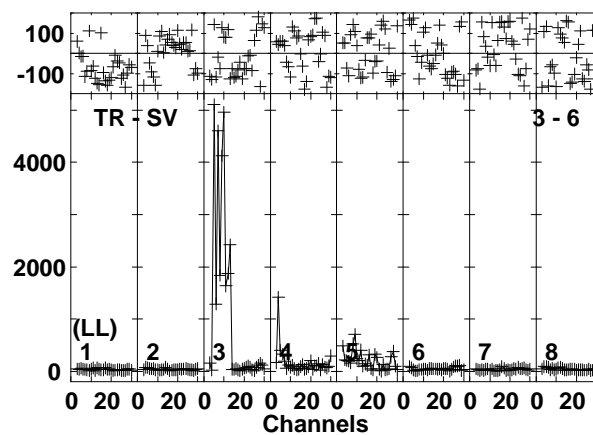
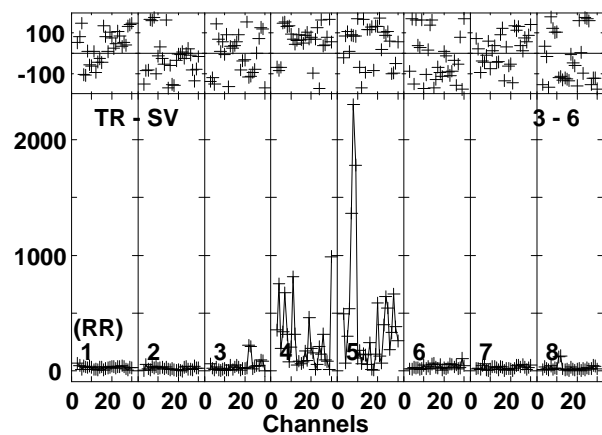
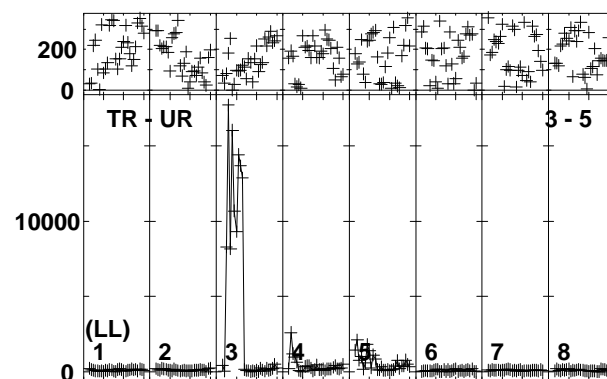
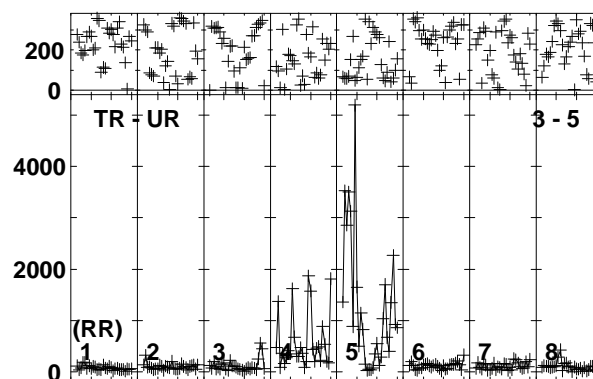
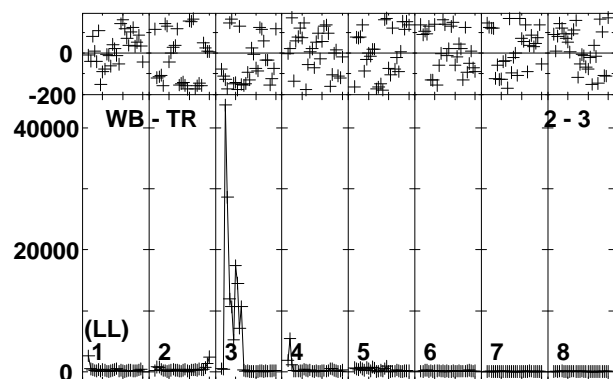
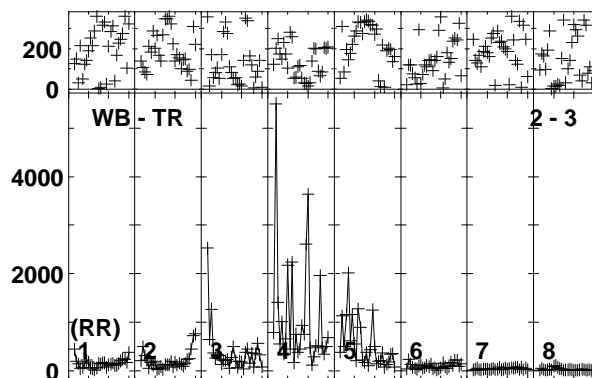
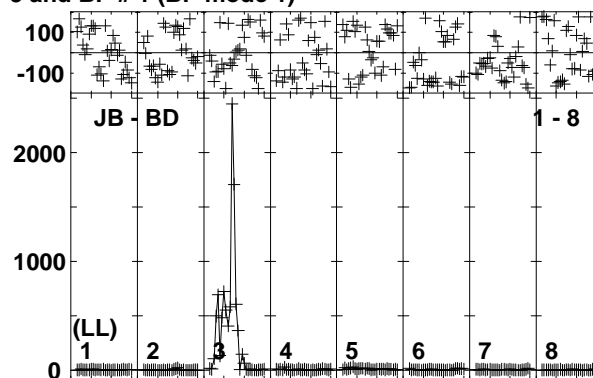
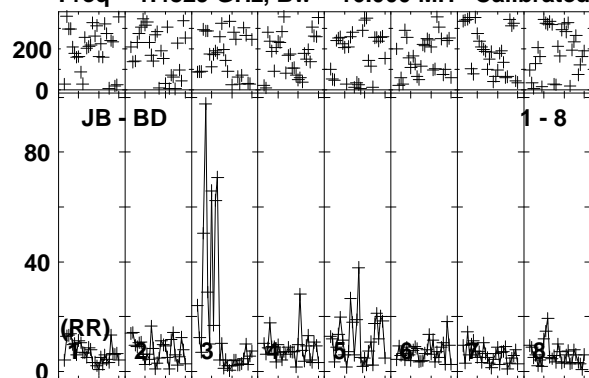

Lower frame: Milli Ampl Jy Top frame: Phas deg
Vector averaged cross-power spectrum Baseline: JB (01) - BD (08)
Timerange: 00/06:41:41 to 00/06:45:09

Plot file version 148 created 21-JUN-2019 11:54:17

IRAS12112 EP111A 1.UVDATA.1

Freq = 1.4829 GHz, Bw = 16.000 MH Calibrated with CL # 3 and BP # 1 (BP mode 1)

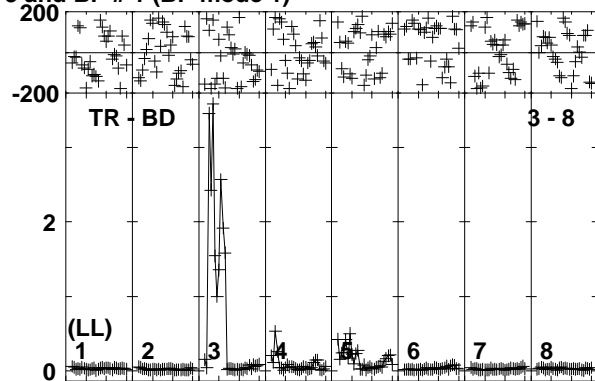
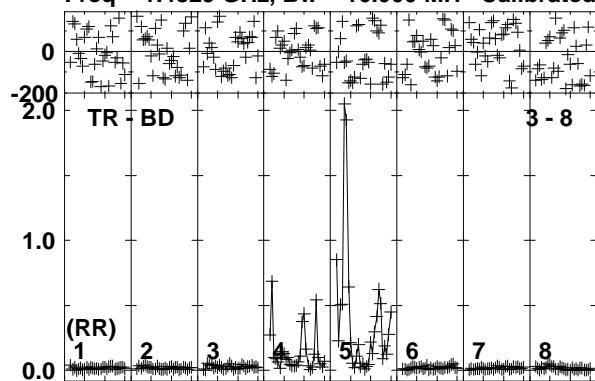

Lower frame: Ampl Jy Top frame: Phas deg
Vector averaged cross-power spectrum Baseline: TR (03) - BD (08)
Timerange: 00/06:41:41 to 00/06:45:09

Plot file version 149 created 21-JUN-2019 11:54:18

J1222+0413 EP111A 1.UVDATA.1

Freq = 1.4829 GHz, Bw = 16.000 MH Calibrated with CL # 3 and BP # 1 (BP mode 1)

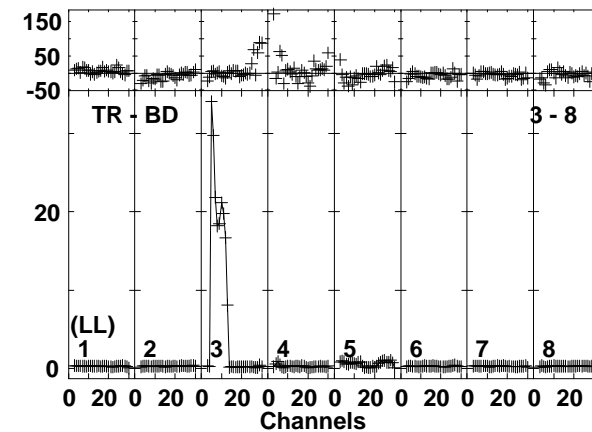
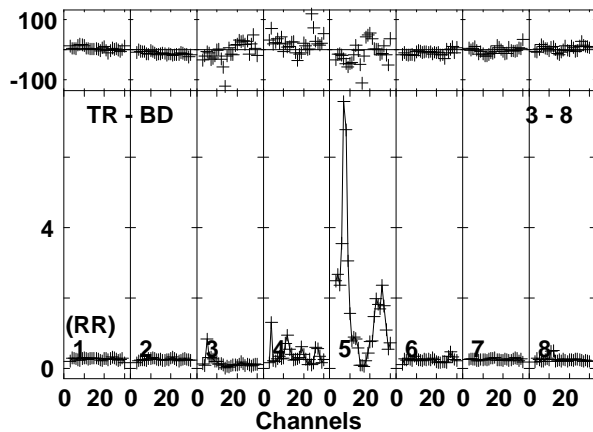
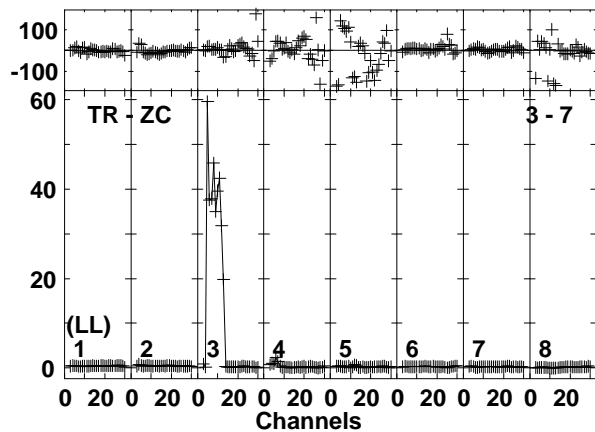
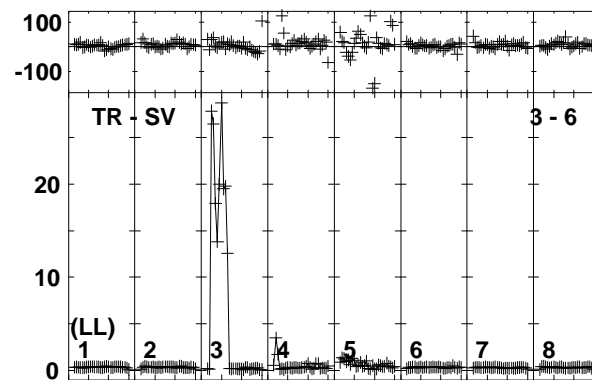
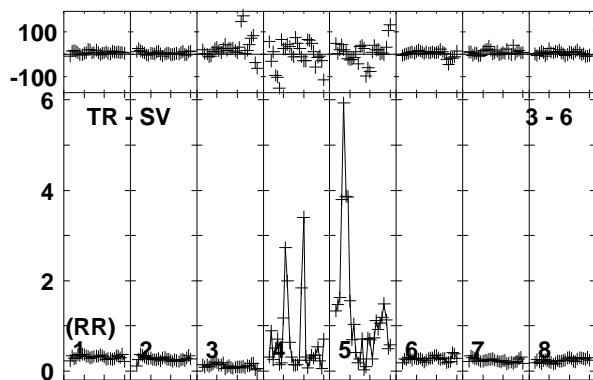
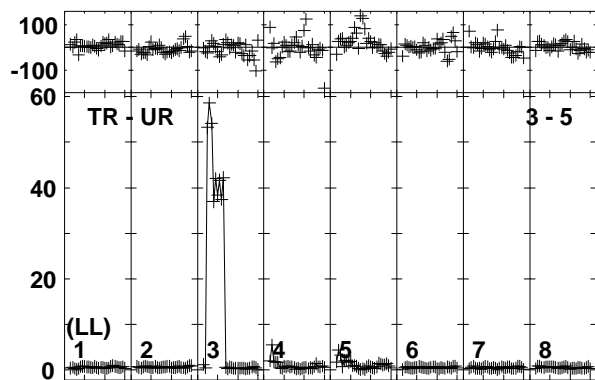
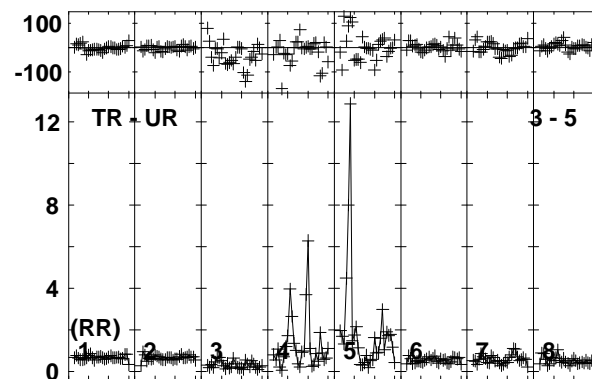
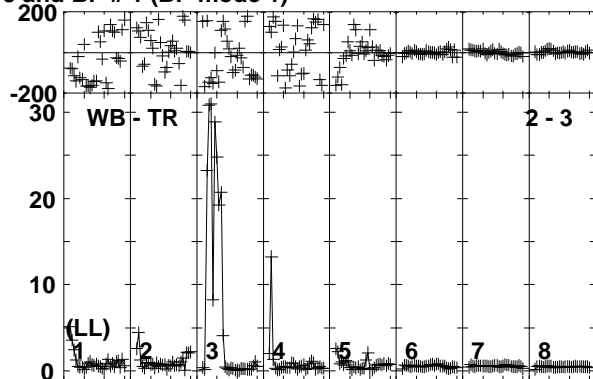
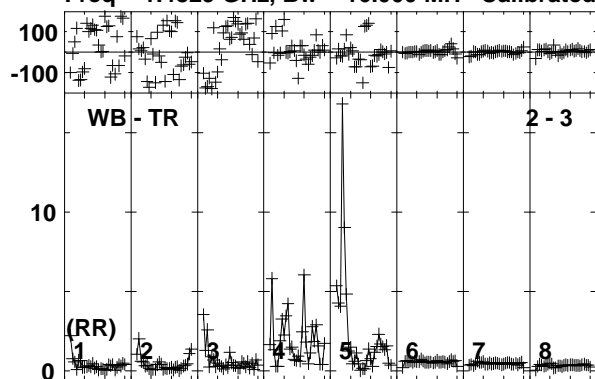

Lower frame: Ampl Jy Top frame: Phas deg
Vector averaged cross-power spectrum Baseline: WB (02) - TR (03)
Timerange: 00/06:45:11 to 00/06:46:39

Plot file version 150 created 21-JUN-2019 11:54:18
 IRAS12112 EP111A 1.UVDATA.1
 Freq = 1.4829 GHz, Bw = 16.000 MH Calibrated with CL # 3 and BP # 1 (BP mode 1)

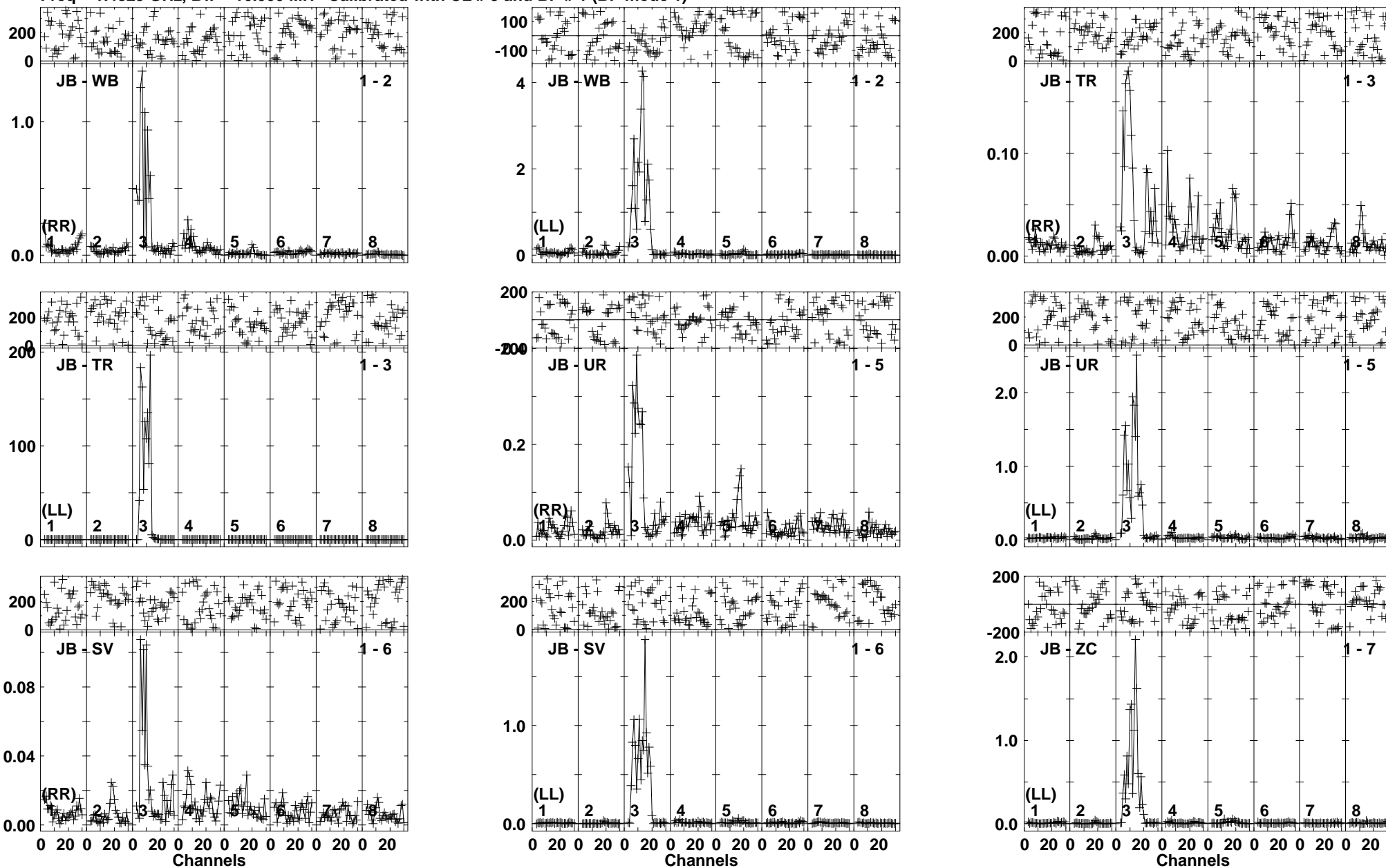

Lower frame: Ampl Jy Top frame: Phas deg
 Vector averaged cross-power spectrum Baseline: JB (01) - WB (02)
 Timerange: 00/06:46:41 to 00/06:50:09

Plot file version 151 created 21-JUN-2019 11:54:18

IRAS12112 EP111A 1.UVDATA.1

Freq = 1.4829 GHz, Bw = 16.000 MH Calibrated with CL # 3 and BP # 1 (BP mode 1)

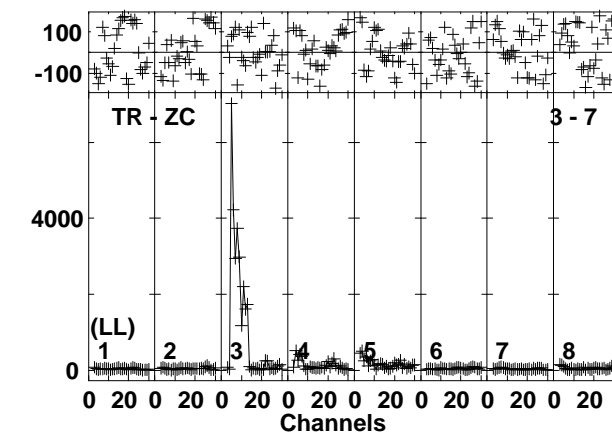
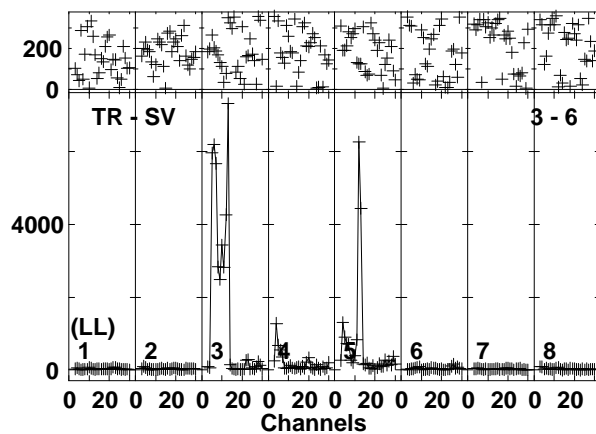
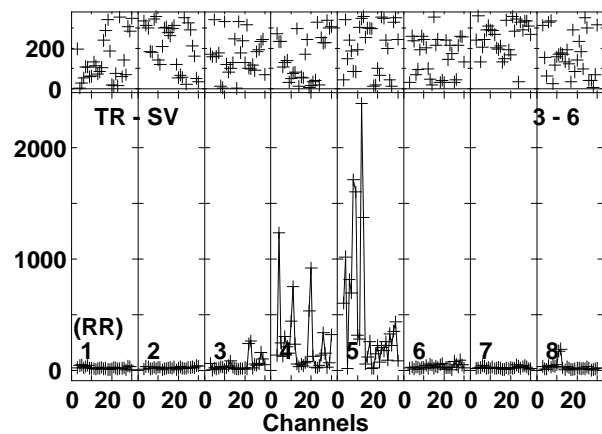
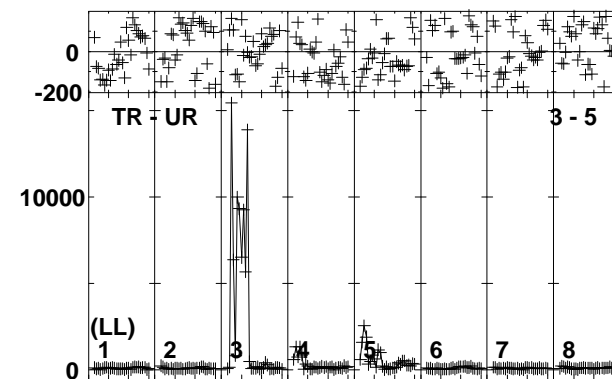
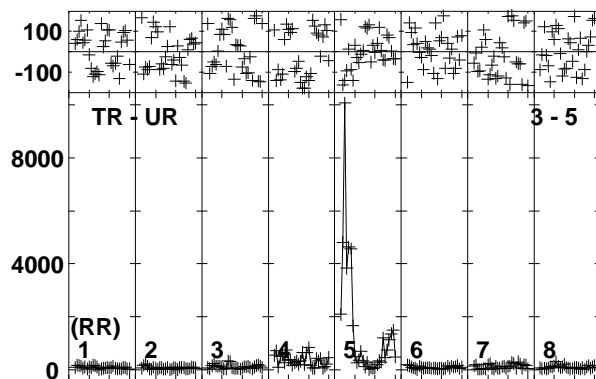
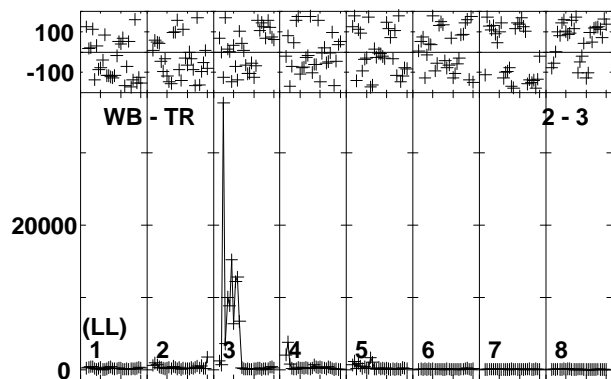
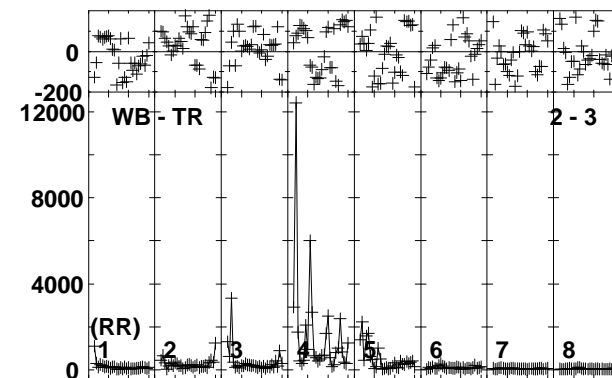
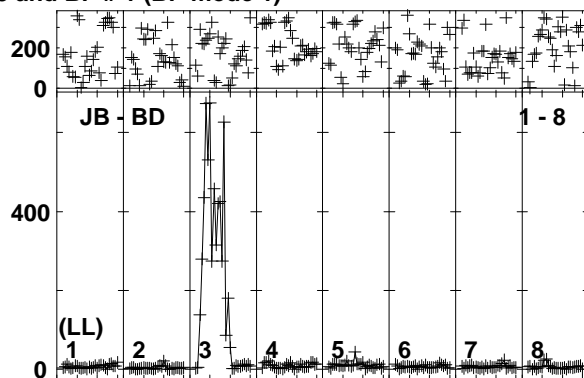
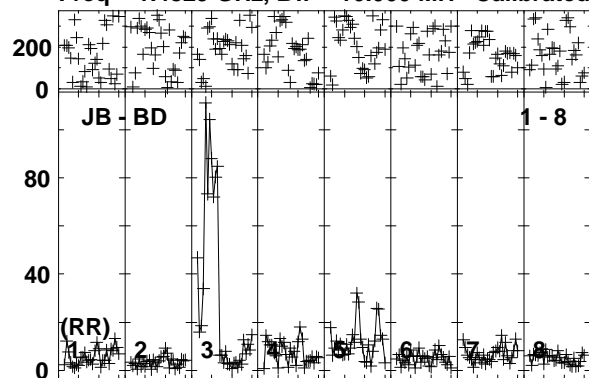

Lower frame: Milli Ampl Jy Top frame: Phas deg
Vector averaged cross-power spectrum Baseline: JB (01) - BD (08)
Timerange: 00/06:46:41 to 00/06:50:09

Plot file version 152 created 21-JUN-2019 11:54:19

IRAS12112 EP111A 1.UVDATA.1

Freq = 1.4829 GHz, Bw = 16.000 MH Calibrated with CL # 3 and BP # 1 (BP mode 1)

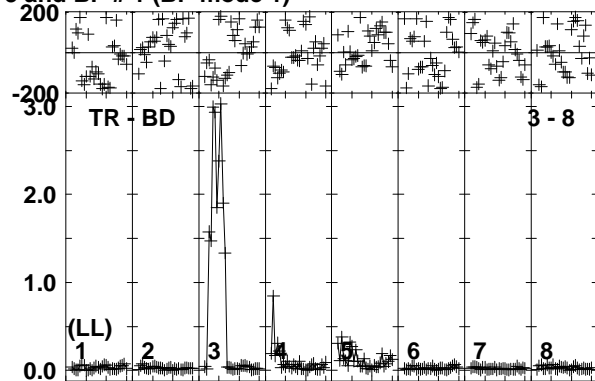
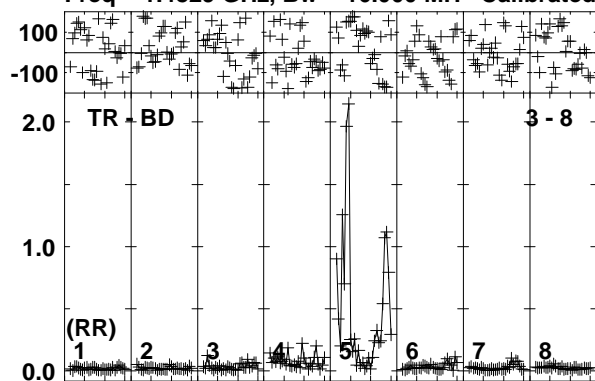

Lower frame: Ampl Jy Top frame: Phas deg
Vector averaged cross-power spectrum Baseline: TR (03) - BD (08)
Timerange: 00/06:46:41 to 00/06:50:09

Plot file version 153 created 21-JUN-2019 11:54:19

J1222+0413 EP111A 1.UVDATA.1

Freq = 1.4829 GHz, Bw = 16.000 MH Calibrated with CL # 3 and BP # 1 (BP mode 1)

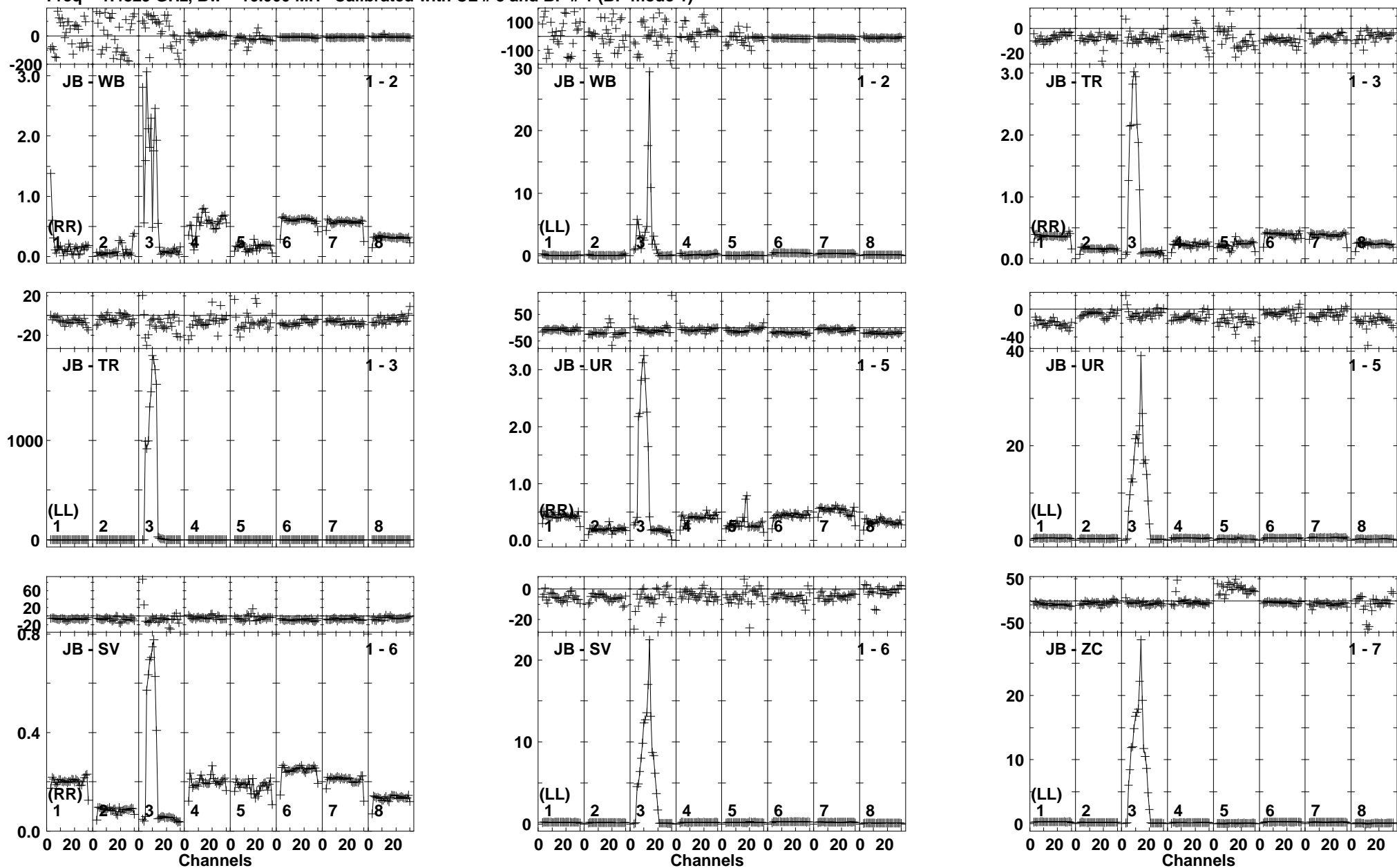

Lower frame: Ampl Jy Top frame: Phas deg
Vector averaged cross-power spectrum Baseline: JB (01) - WB (02)
Timerange: 00/06:50:51 to 00/06:52:19

Plot file version 155 created 21-JUN-2019 11:54:20

J1222+0413 EP111A 1.UVDATA.1

Freq = 1.4829 GHz, Bw = 16.000 MH Calibrated with CL # 3 and BP # 1 (BP mode 1)

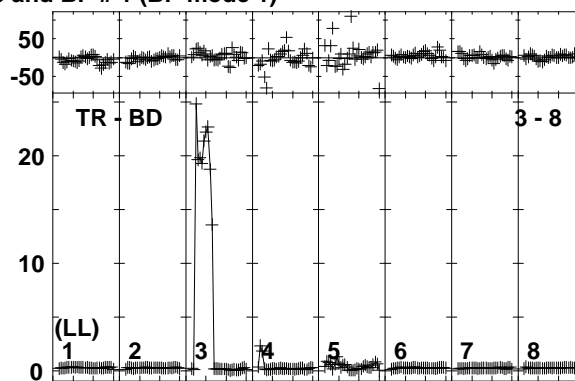
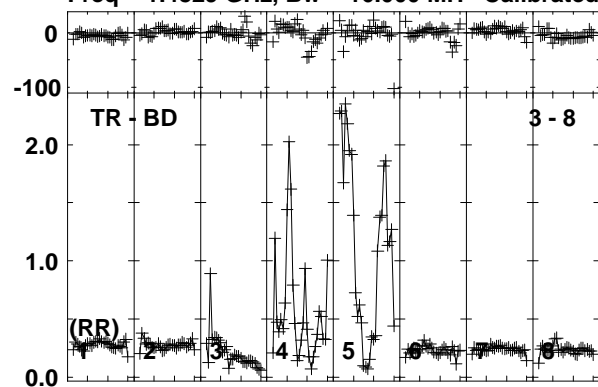

Lower frame: Ampl Jy Top frame: Phas deg
Vector averaged cross-power spectrum Baseline: TR (03) - BD (08)
Timerange: 00/06:50:51 to 00/06:52:19

Plot file version 156 created 21-JUN-2019 11:54:20

IRAS12112 EP111A 1.UVDATA.1

Freq = 1.4829 GHz, Bw = 16.000 MH Calibrated with CL # 3 and BP # 1 (BP mode 1)

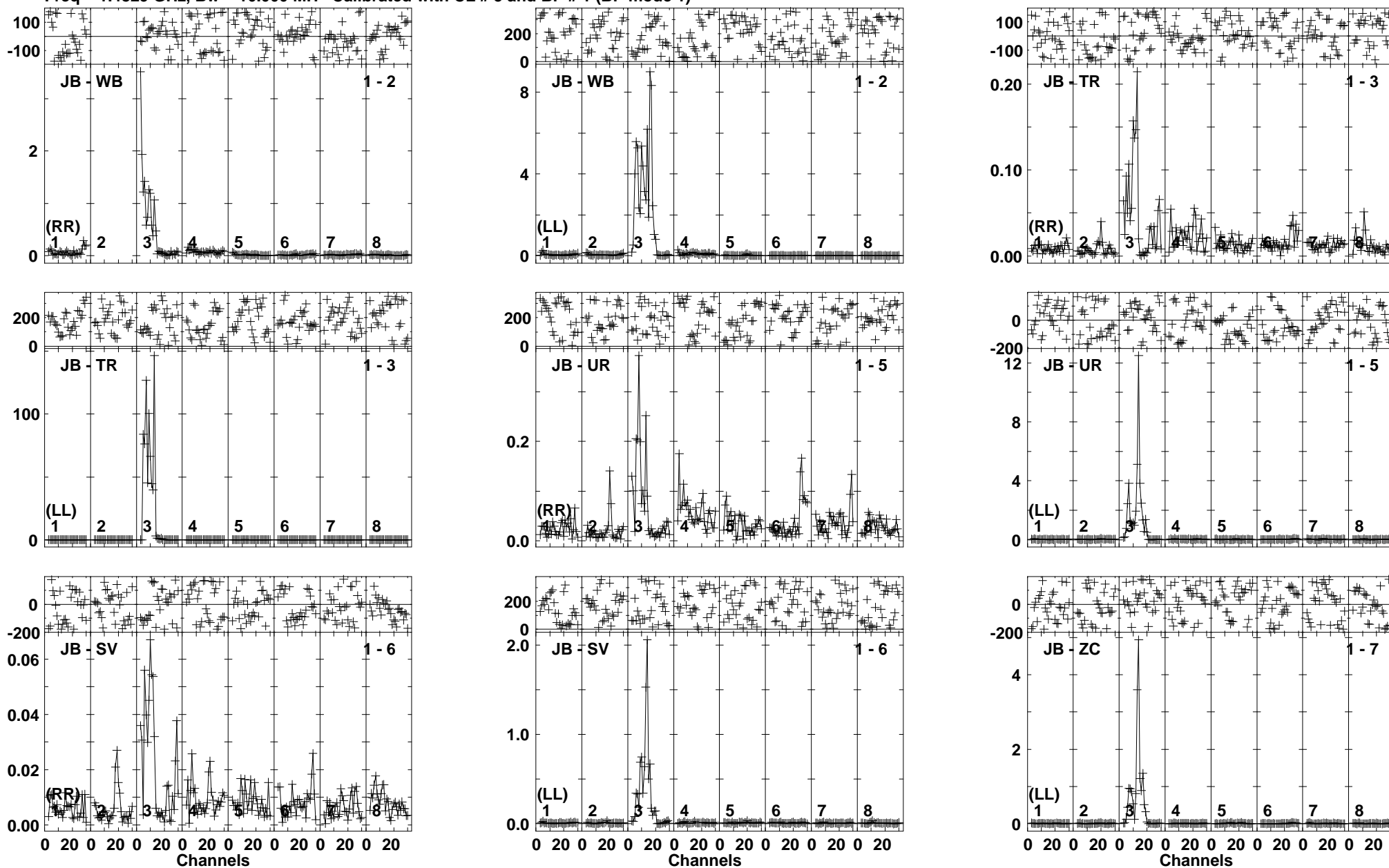

Lower frame: Ampl Jy Top frame: Phas deg
Vector averaged cross-power spectrum Baseline: JB (01) - WB (02)
Timerange: 00/06:52:21 to 00/06:55:49

Plot file version 157 created 21-JUN-2019 11:54:20

IRAS12112 EP111A 1.UVDATA.1

Freq = 1.4829 GHz, Bw = 16.000 MH Calibrated with CL # 3 and BP # 1 (BP mode 1)

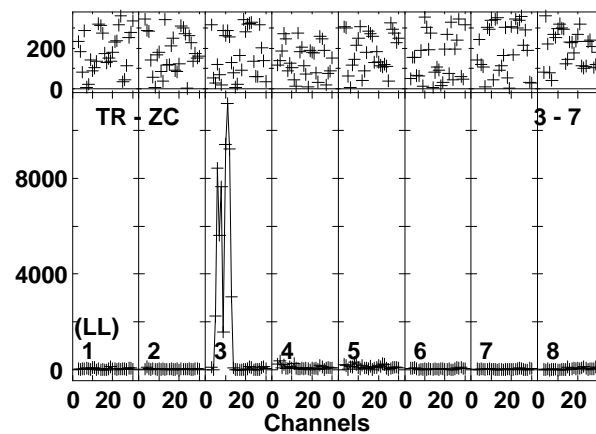
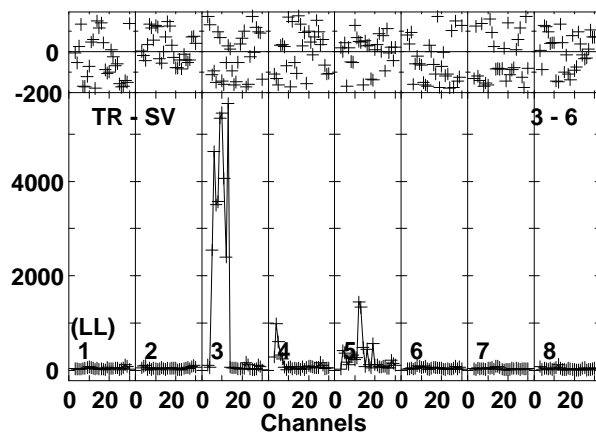
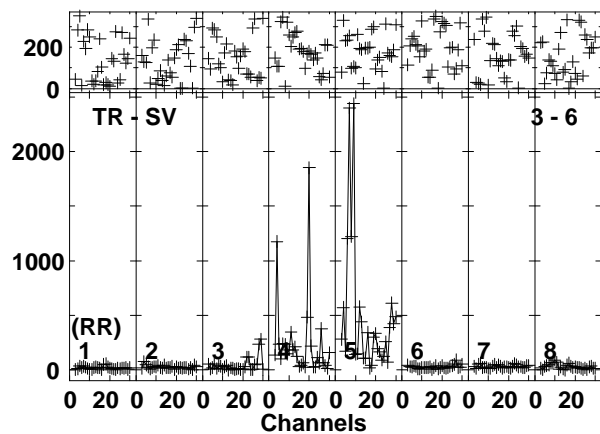
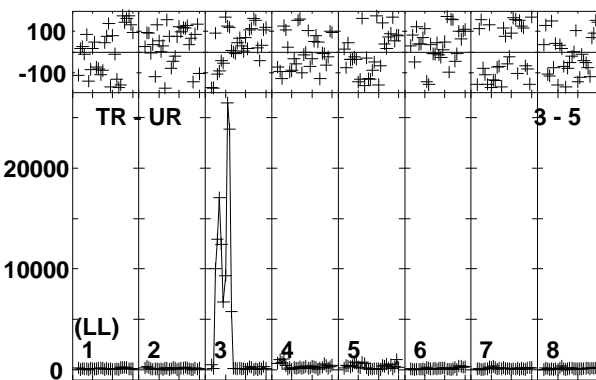
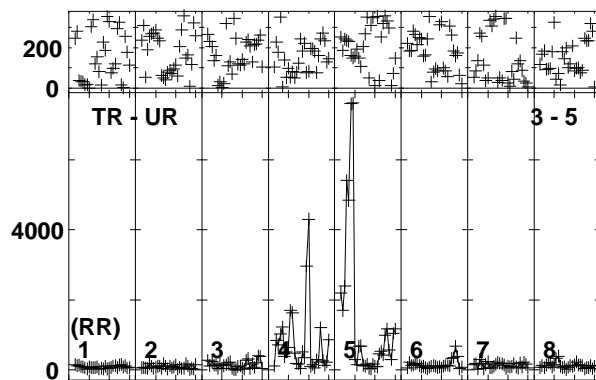
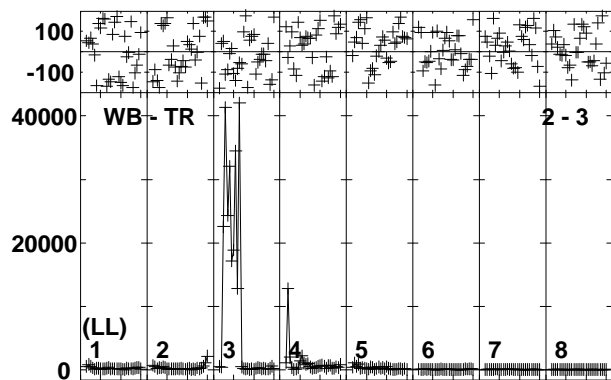
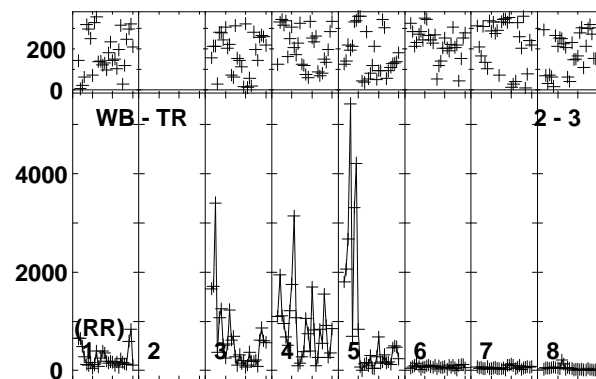
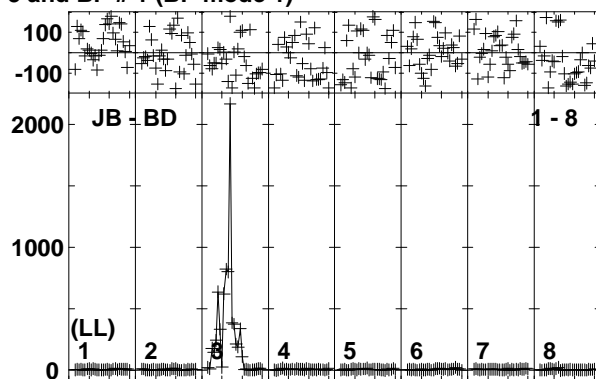
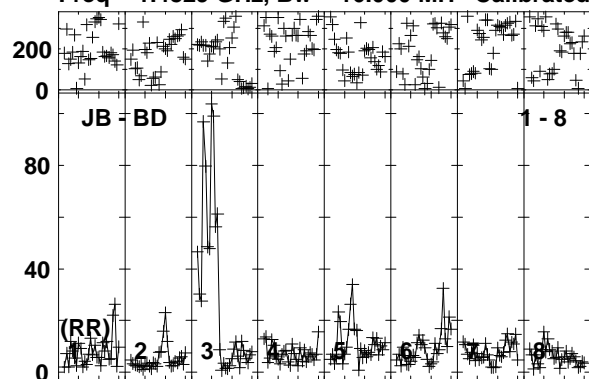

Lower frame: Milli Ampl Jy Top frame: Phas deg
Vector averaged cross-power spectrum Baseline: JB (01) - BD (08)
Timerange: 00/06:52:21 to 00/06:55:49

Plot file version 158 created 21-JUN-2019 11:54:21

IRAS12112 EP111A 1.UVDATA.1

Freq = 1.4829 GHz, Bw = 16.000 MH Calibrated with CL # 3 and BP # 1 (BP mode 1)

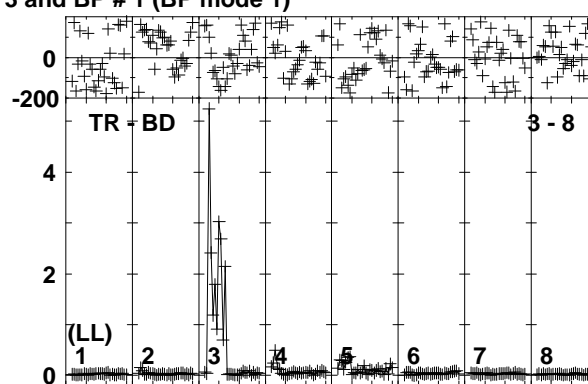
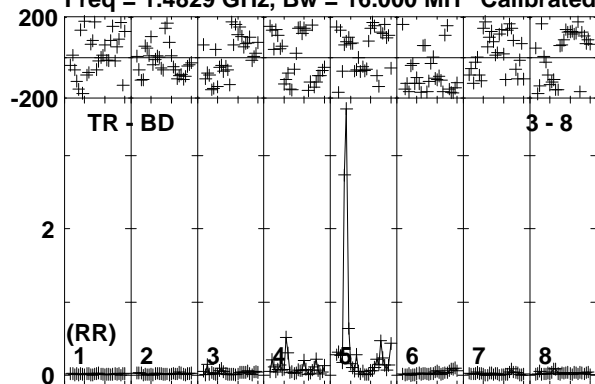

Lower frame: Ampl Jy Top frame: Phas deg
Vector averaged cross-power spectrum Baseline: TR (03) - BD (08)
Timerange: 00/06:52:21 to 00/06:55:49

Plot file version 159 created 21-JUN-2019 11:54:22

J1222+0413 EP111A 1.UVDATA.1

Freq = 1.4829 GHz, Bw = 16.000 MH Calibrated with CL # 3 and BP # 1 (BP mode 1)

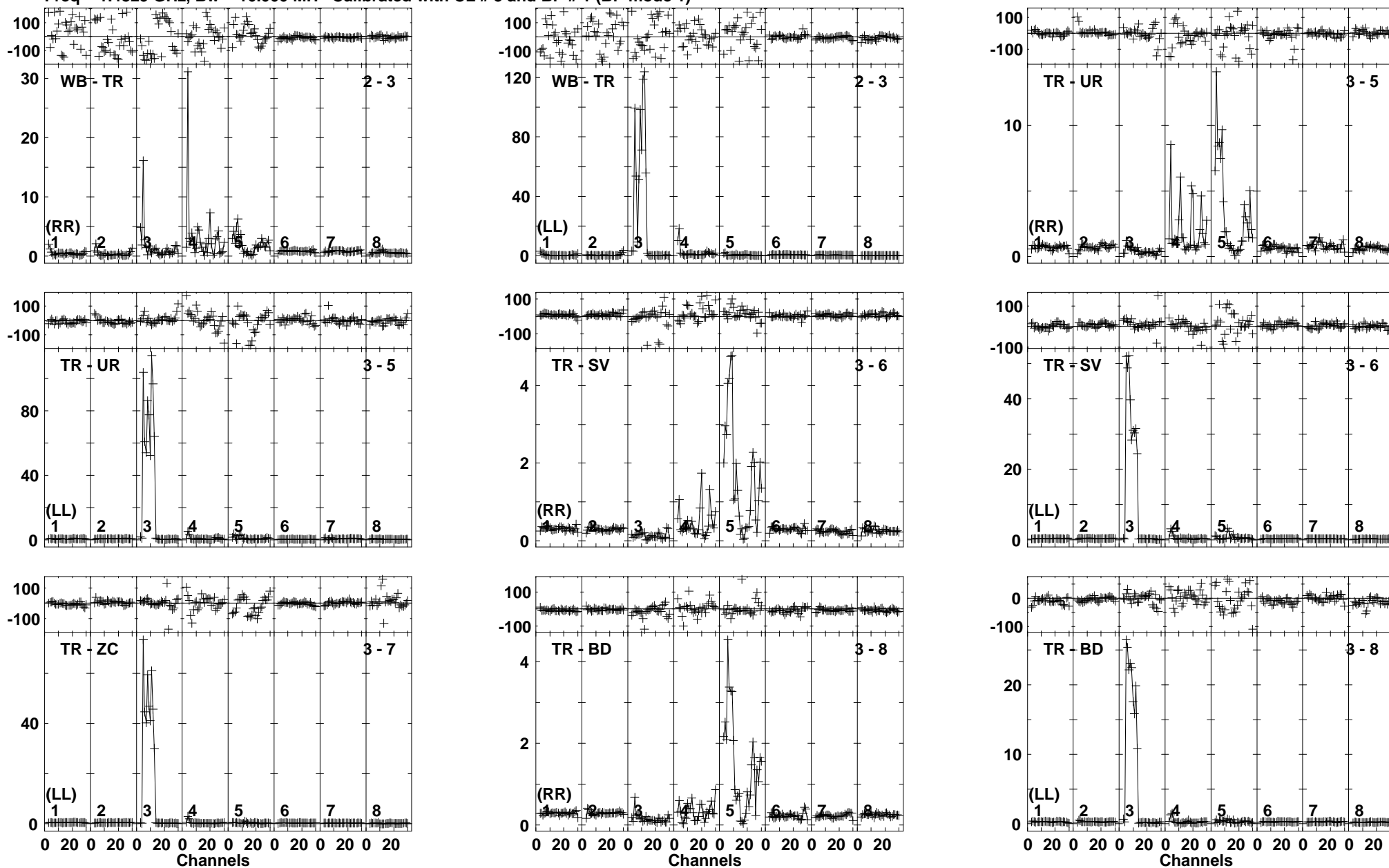

Lower frame: Ampl Jy Top frame: Phas deg
Vector averaged cross-power spectrum Baseline: WB (02) - TR (03)
Timerange: 00/06:55:51 to 00/06:57:19

Plot file version 160 created 21-JUN-2019 11:54:22

IRAS12112 EP111A 1.UVDATA.1

Freq = 1.4829 GHz, Bw = 16.000 MH Calibrated with CL # 3 and BP # 1 (BP mode 1)

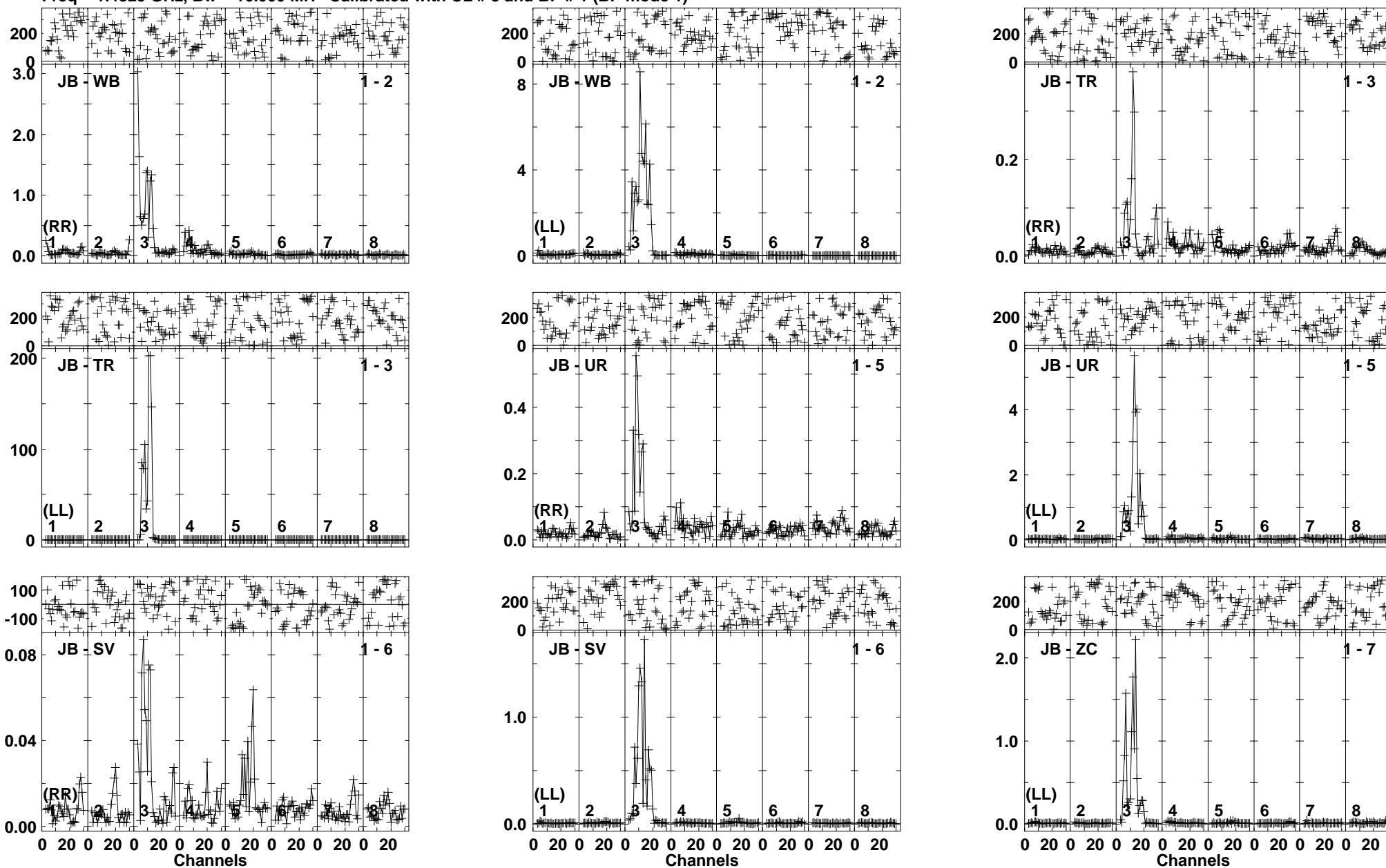

Lower frame: Ampl Jy Top frame: Phas deg
Vector averaged cross-power spectrum Baseline: JB (01) - WB (02)
Timerange: 00/06:57:21 to 00/07:00:49

Plot file version 161 created 21-JUN-2019 11:54:22

IRAS12112 EP111A 1.UVDATA.1

Freq = 1.4829 GHz, Bw = 16.000 MH Calibrated with CL # 3 and BP # 1 (BP mode 1)

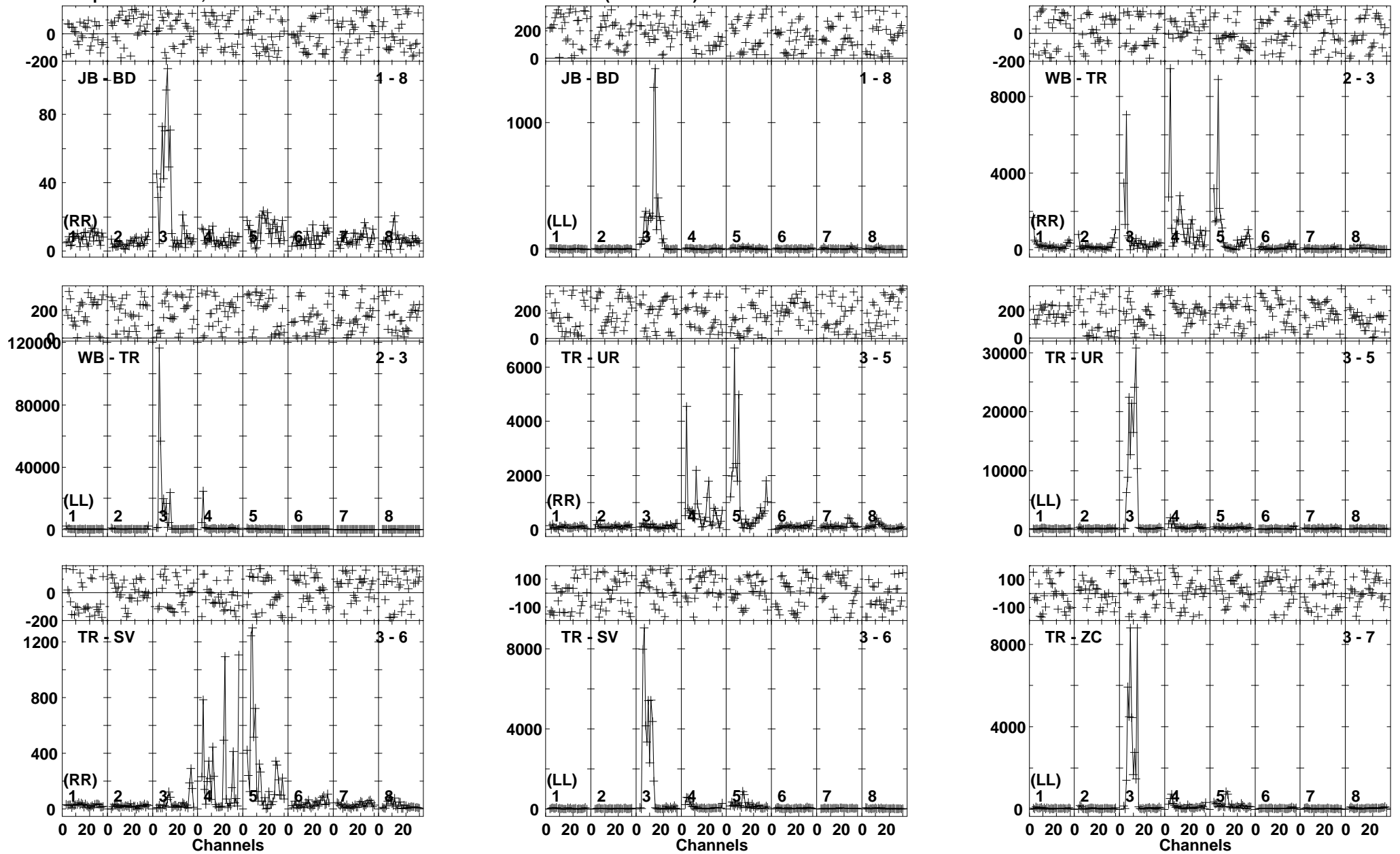

Lower frame: Milli Ampl Jy Top frame: Phas deg
Vector averaged cross-power spectrum Baseline: JB (01) - BD (08)
Timerange: 00/06:57:21 to 00/07:00:49

Plot file version 162 created 21-JUN-2019 11:54:23

IRAS12112 EP111A 1.UVDATA.1

Freq = 1.4829 GHz, Bw = 16.000 MH Calibrated with CL # 3 and BP # 1 (BP mode 1)

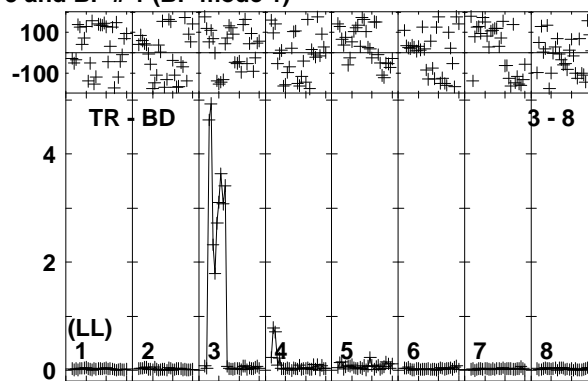
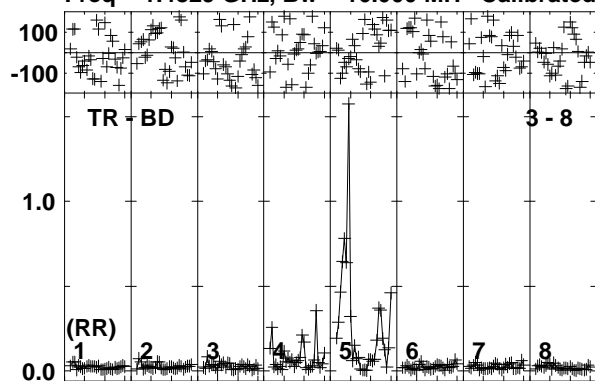

Lower frame: Ampl Jy Top frame: Phas deg
Vector averaged cross-power spectrum Baseline: TR (03) - BD (08)
Timerange: 00/06:57:21 to 00/07:00:49

Plot file version 163 created 21-JUN-2019 11:54:23

J1222+0413 EP111A 1.UVDATA.1

Freq = 1.4829 GHz, Bw = 16.000 MH Calibrated with CL # 3 and BP # 1 (BP mode 1)

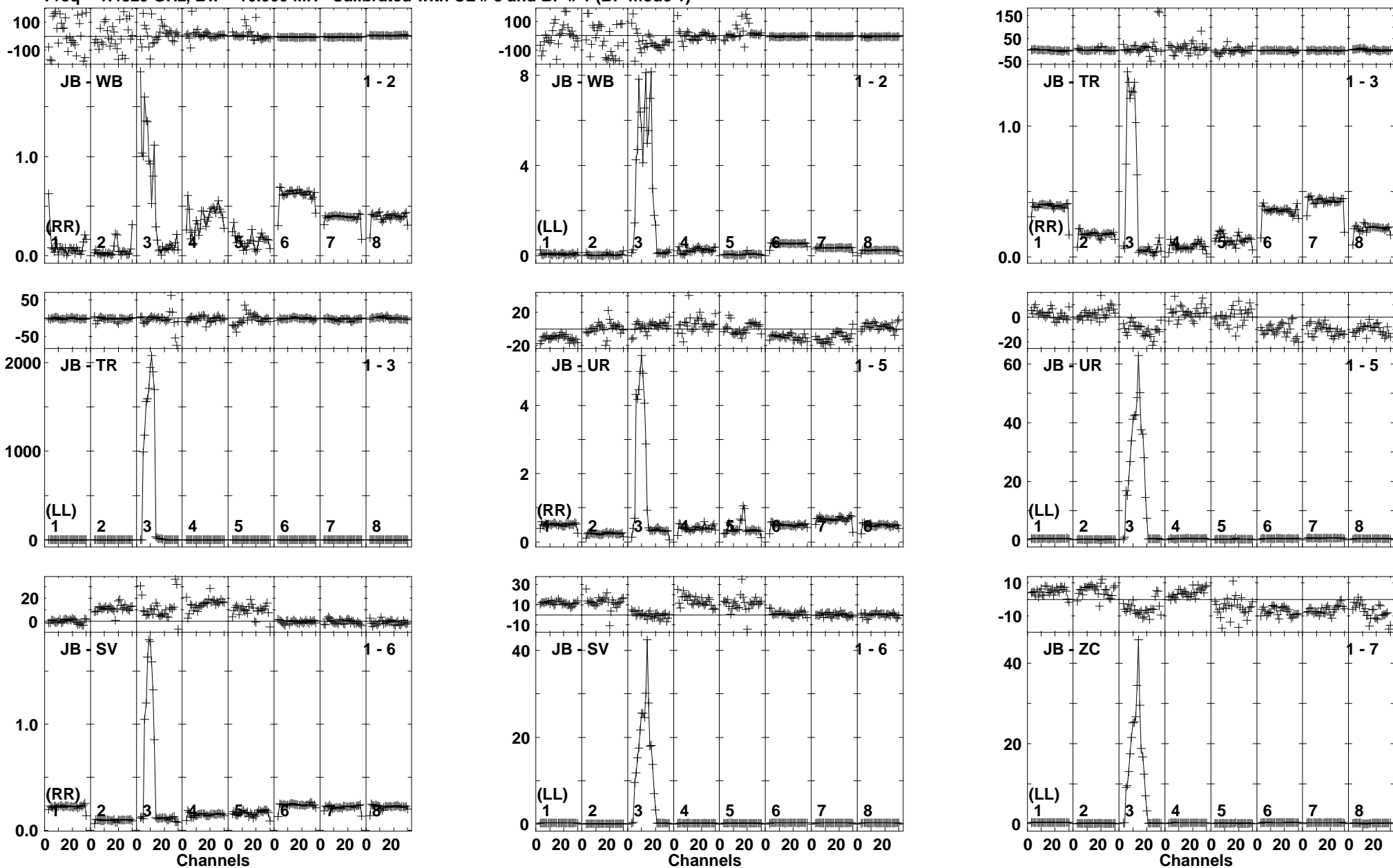

Lower frame: Ampl Jy Top frame: Phas deg
Vector averaged cross-power spectrum Baseline: JB (01) - WB (02)
Timerange: 00/07:01:31 to 00/07:02:59

Plot file version 164 created 21-JUN-2019 11:54:23

J1222+0413 EP111A 1.UVDATA.1

Freq = 1.4829 GHz, Bw = 16.000 MH Calibrated with CL # 3 and BP # 1 (BP mode 1)

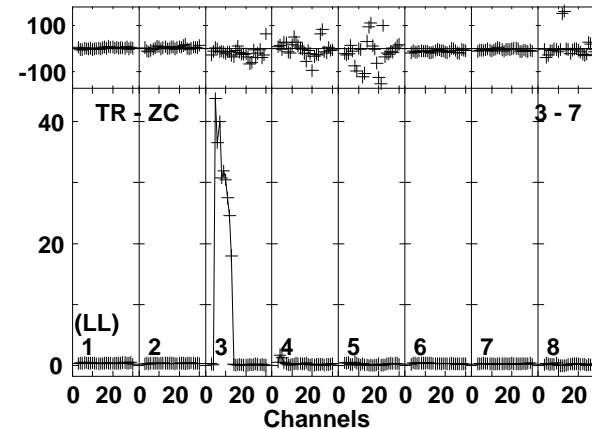
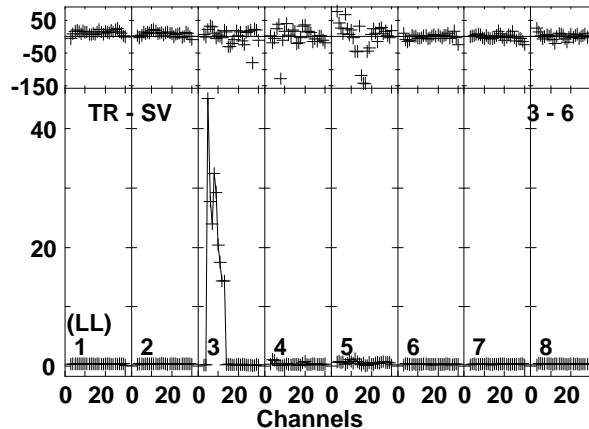
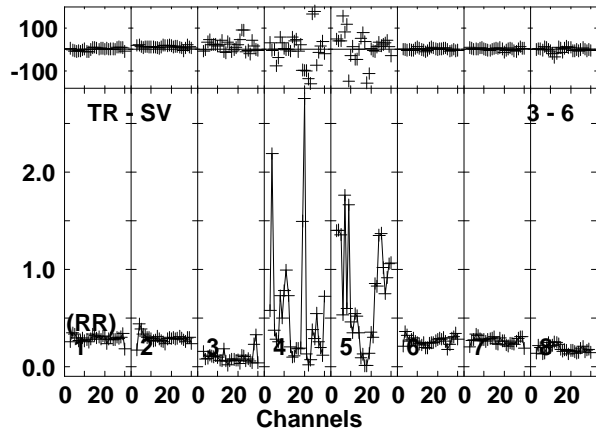
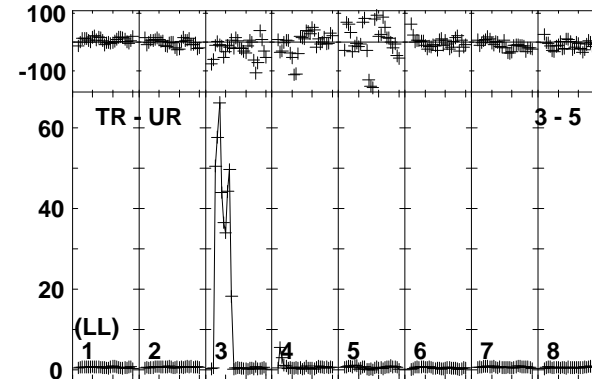
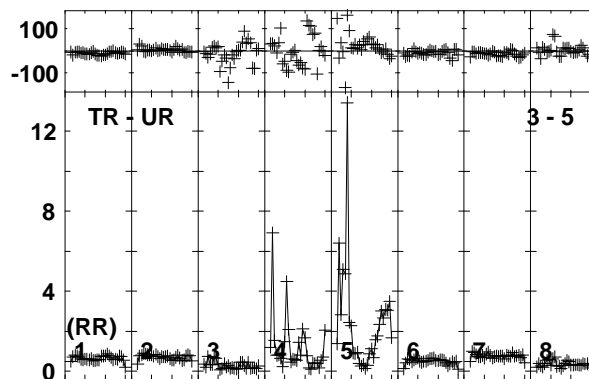
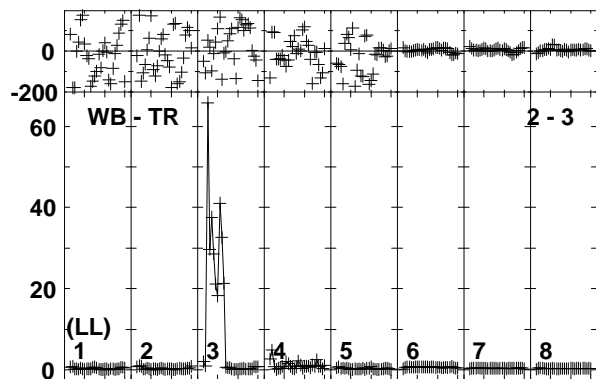
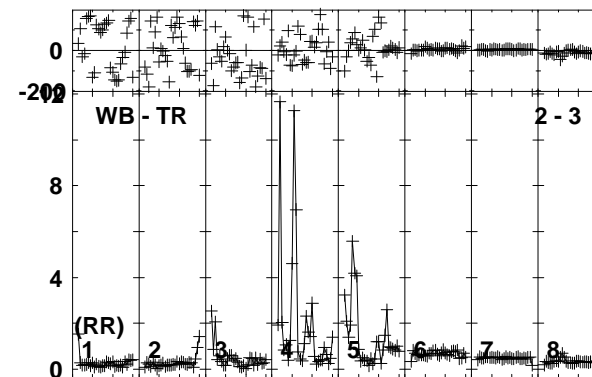
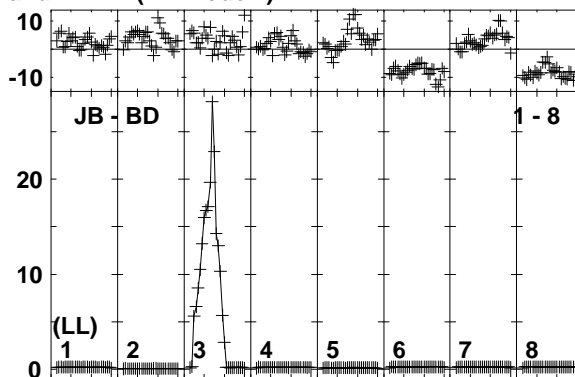
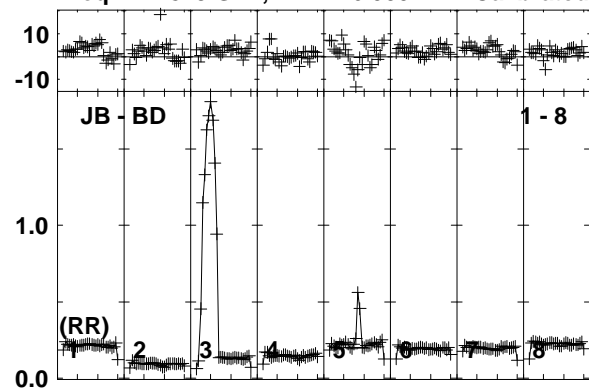

Lower frame: Ampl Jy Top frame: Phas deg
Vector averaged cross-power spectrum Baseline: JB (01) - BD (08)
Timerange: 00/07:01:31 to 00/07:02:59

Plot file version 165 created 21-JUN-2019 11:54:24

J1222+0413 EP1111A 1.UVDATA.1

Freq = 1.4829 GHz, Bw = 16.000 MH Calibrated with CL # 3 and BP # 1 (BP mode 1)

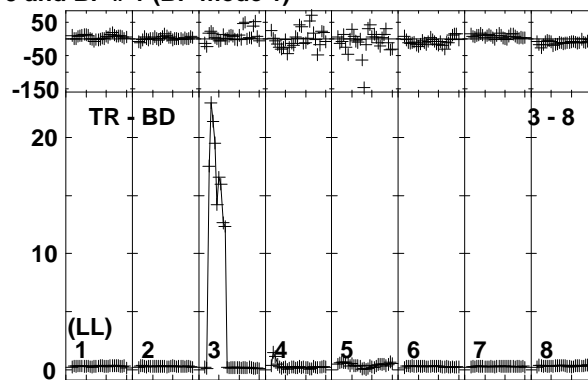
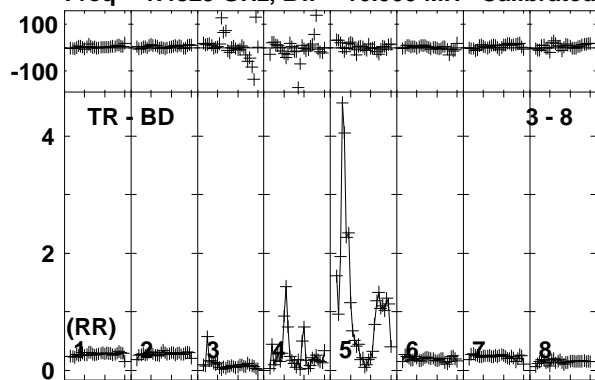

Lower frame: Ampl Jy Top frame: Phas deg
Vector averaged cross-power spectrum Baseline: TR (03) - BD (08)
Timerange: 00/07:01:31 to 00/07:02:59

Plot file version 166 created 21-JUN-2019 11:54:24
 IRAS12112 EP111A 1.UVDATA.1
 Freq = 1.4829 GHz, Bw = 16.000 MH Calibrated with CL # 3 and BP # 1 (BP mode 1)

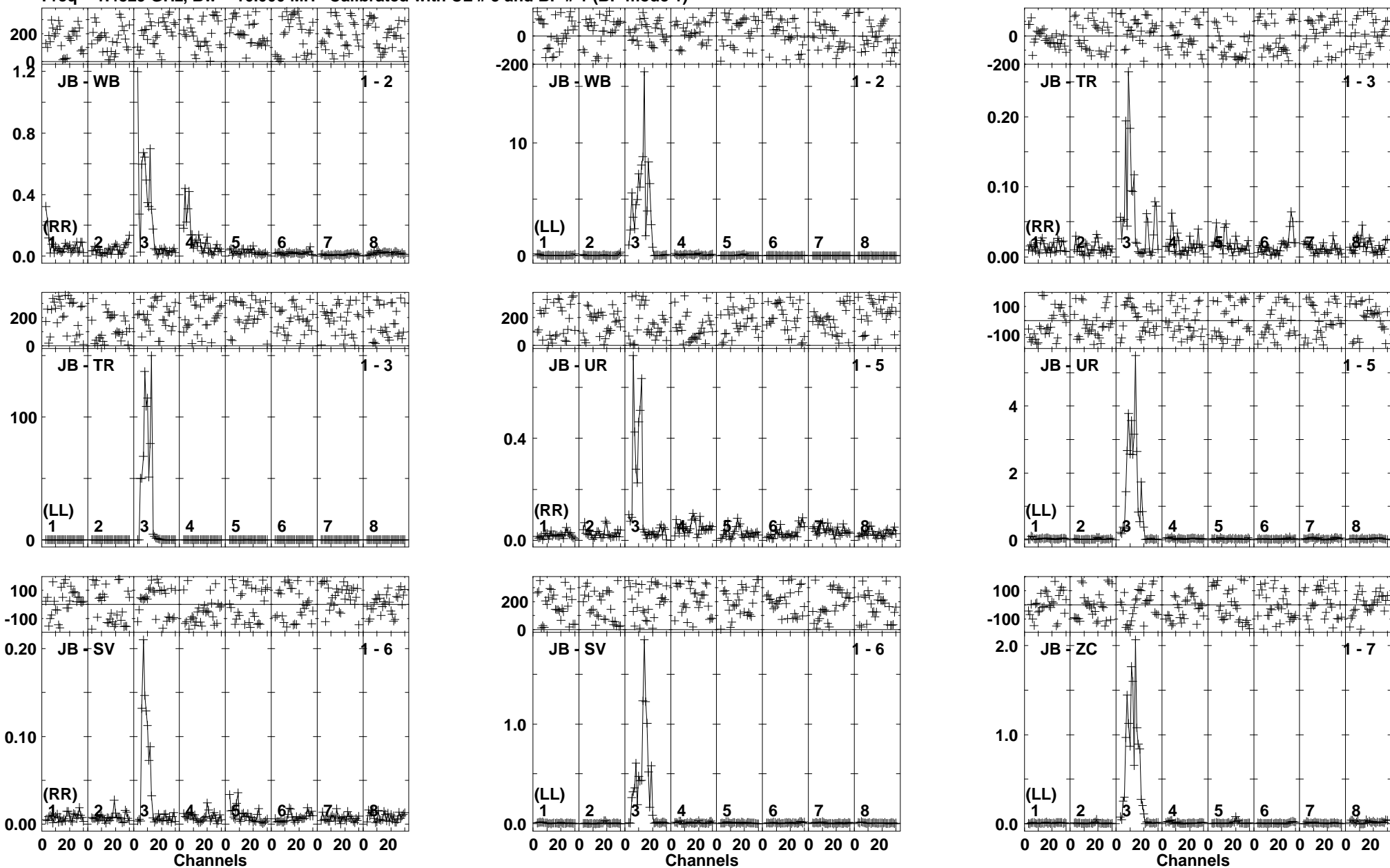

Lower frame: Ampl Jy Top frame: Phas deg
 Vector averaged cross-power spectrum Baseline: JB (01) - WB (02)
 Timerange: 00/07:03:01 to 00/07:06:29

Plot file version 167 created 21-JUN-2019 11:54:24
 IRAS12112 EP111A 1.UVDATA.1
 Freq = 1.4829 GHz, Bw = 16.000 MH Calibrated with CL # 3 and BP # 1 (BP mode 1)

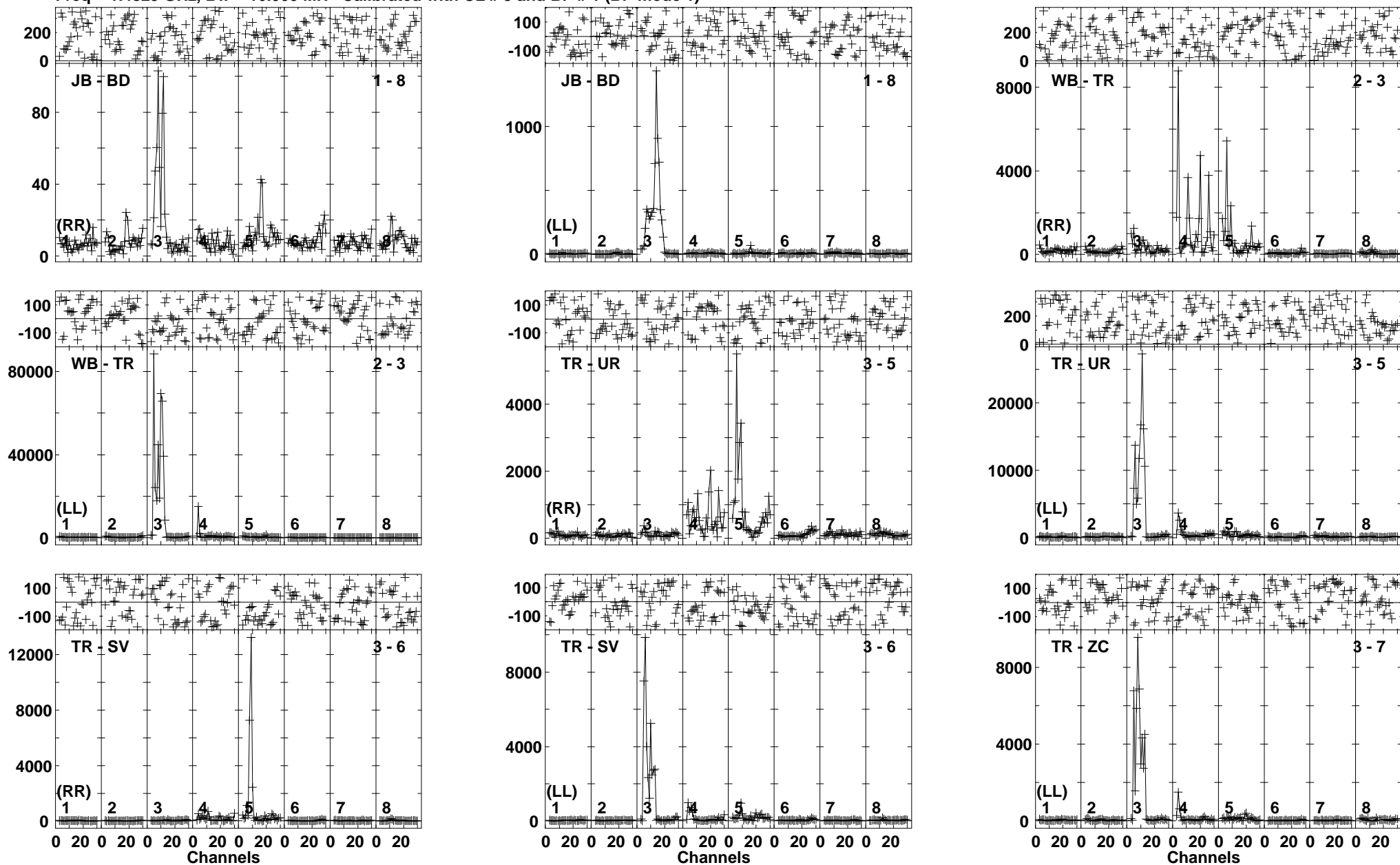

Lower frame: Milli Ampl Jy Top frame: Phas deg
 Vector averaged cross-power spectrum Baseline: JB (01) - BD (08)
 Timerange: 00/07:03:01 to 00/07:06:29

Plot file version 168 created 21-JUN-2019 11:54:25

IRAS12112 EP111A 1.UVDATA.1

Freq = 1.4829 GHz, Bw = 16.000 MH Calibrated with CL # 3 and BP # 1 (BP mode 1)

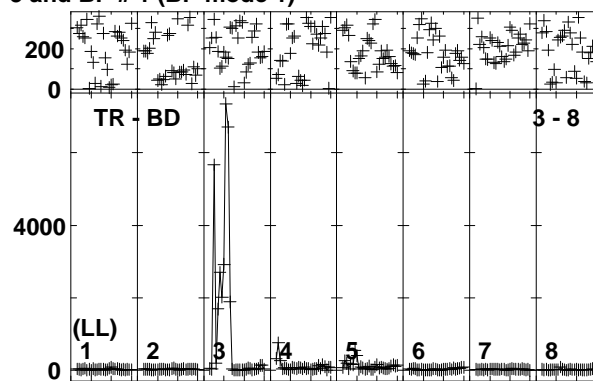
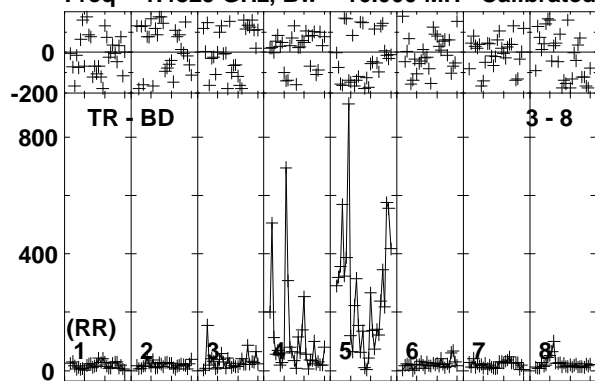

Lower frame: Milli Ampl Jy Top frame: Phas deg
Vector averaged cross-power spectrum Baseline: TR (03) - BD (08)
Timerange: 00/07:03:01 to 00/07:06:29

Plot file version 169 created 21-JUN-2019 11:54:26

J1222+0413 EP111A 1.UVDATA.1

Freq = 1.4829 GHz, Bw = 16.000 MH Calibrated with CL # 3 and BP # 1 (BP mode 1)

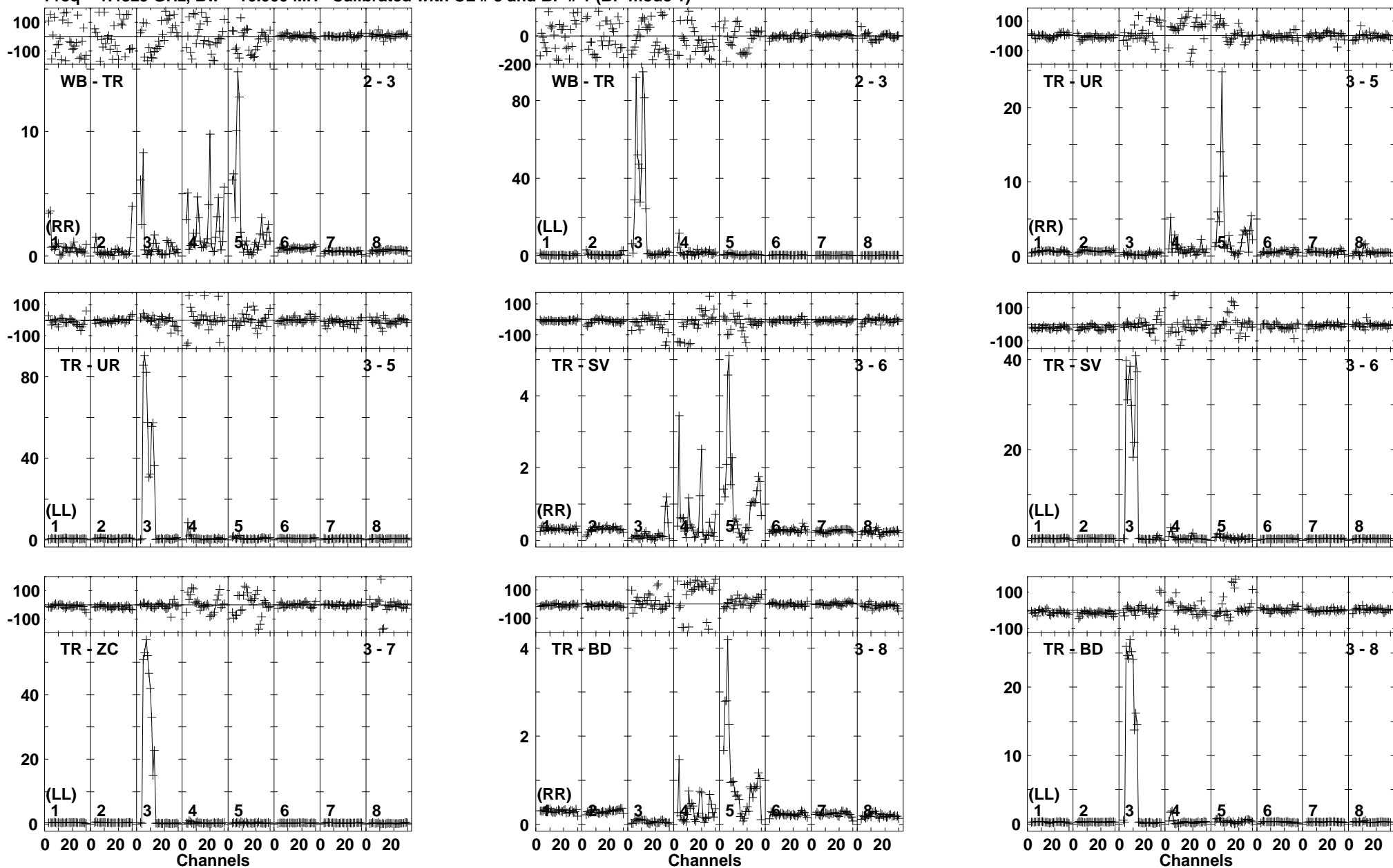

Lower frame: Ampl Jy Top frame: Phas deg
Vector averaged cross-power spectrum Baseline: WB (02) - TR (03)
Timerange: 00/07:06:31 to 00/07:07:59

Plot file version 170 created 21-JUN-2019 11:54:26

IRAS12112 EP111A 1.UVDATA.1

Freq = 1.4829 GHz, Bw = 16.000 MH Calibrated with CL # 3 and BP # 1 (BP mode 1)

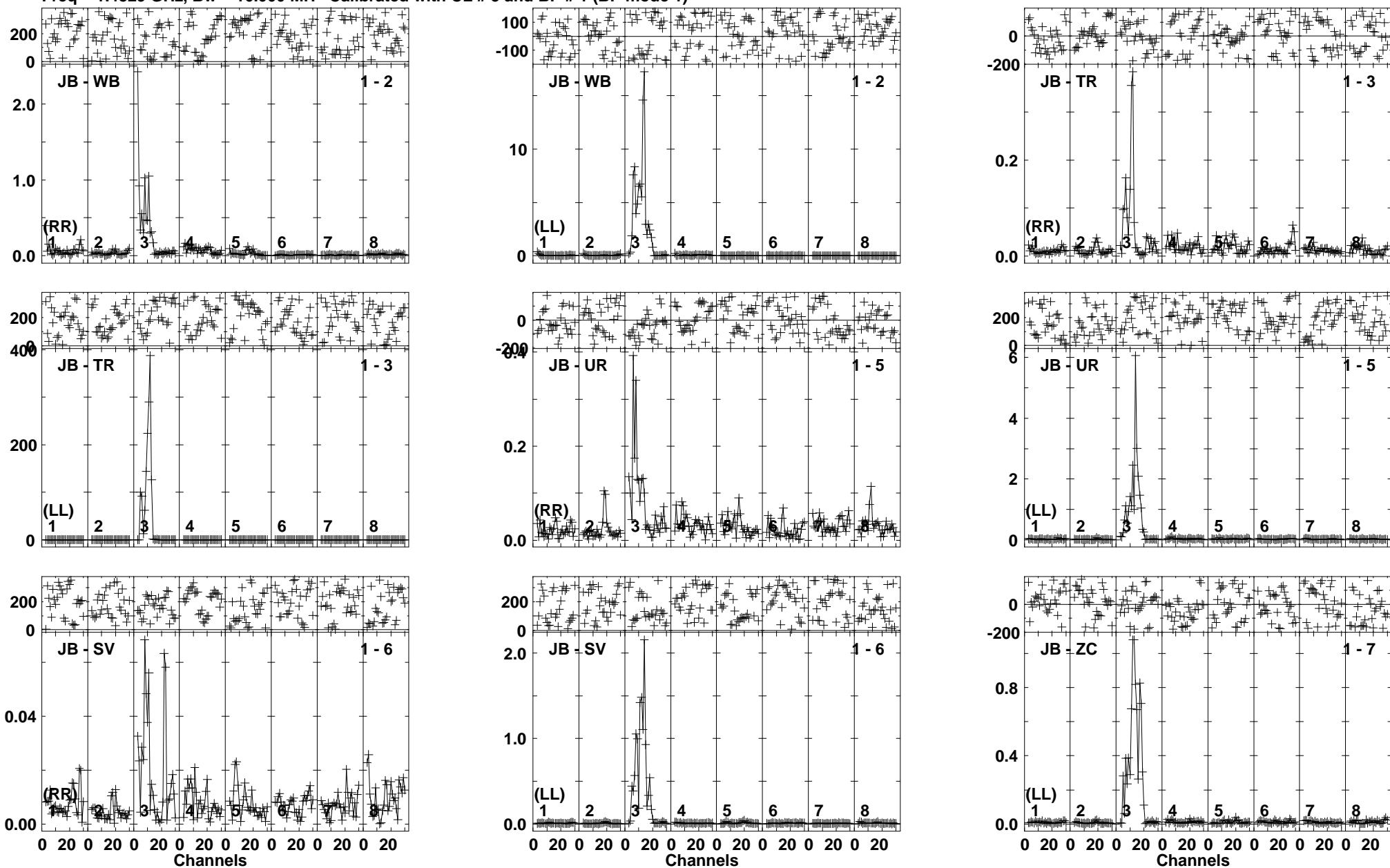

Lower frame: Ampl Jy Top frame: Phas deg
Vector averaged cross-power spectrum Baseline: JB (01) - WB (02)
Timerange: 00/07:08:01 to 00/07:11:29

Plot file version 171 created 21-JUN-2019 11:54:26

IRAS12112 EP111A 1.UVDATA.1

Freq = 1.4829 GHz, Bw = 16.000 MH Calibrated with CL # 3 and BP # 1 (BP mode 1)

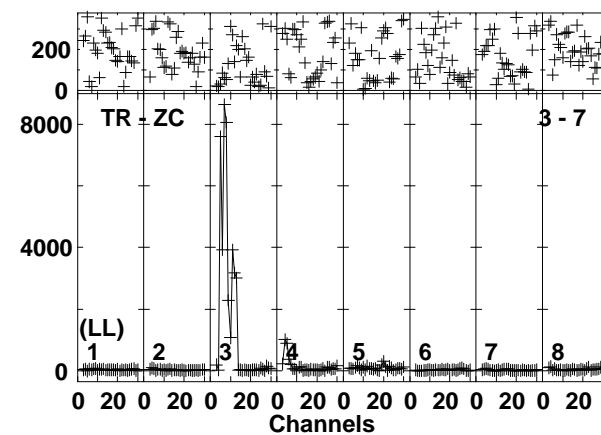
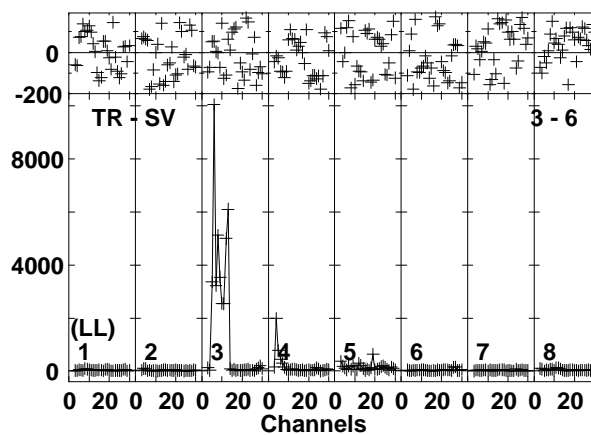
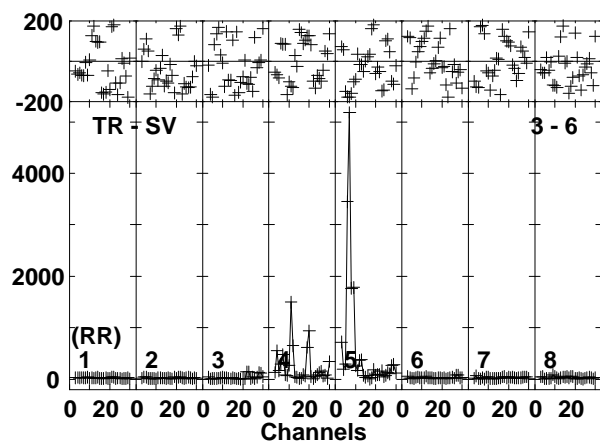
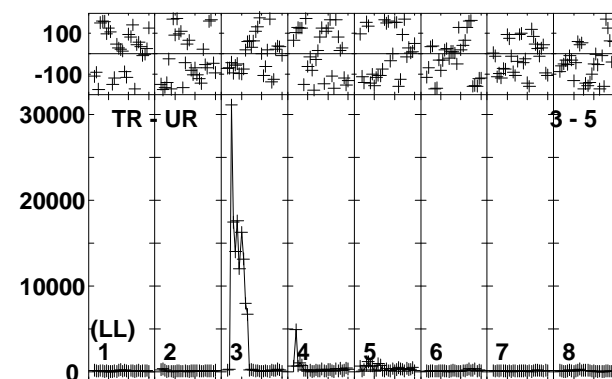
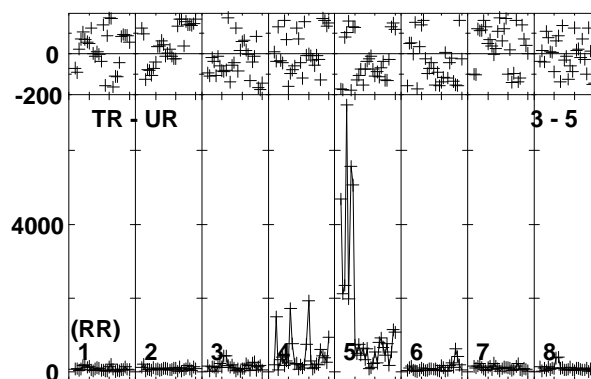
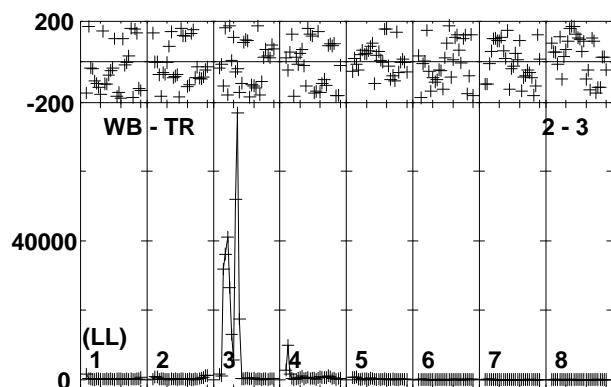
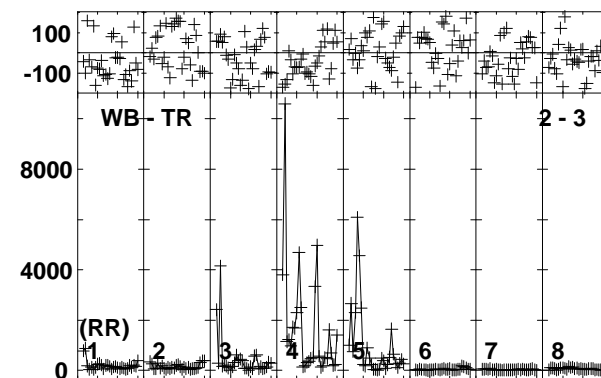
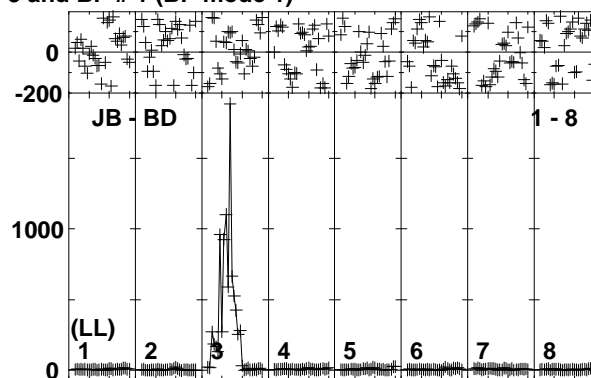
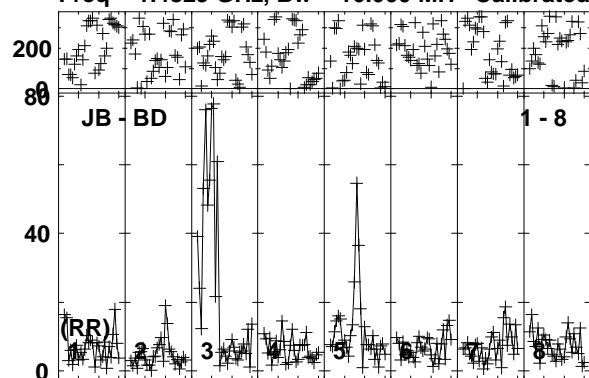

Lower frame: Milli Ampl Jy Top frame: Phas deg
Vector averaged cross-power spectrum Baseline: JB (01) - BD (08)
Timerange: 00/07:08:01 to 00/07:11:29

Plot file version 172 created 21-JUN-2019 11:54:27

IRAS12112 EP111A 1.UVDATA.1

Freq = 1.4829 GHz, Bw = 16.000 MH Calibrated with CL # 3 and BP # 1 (BP mode 1)

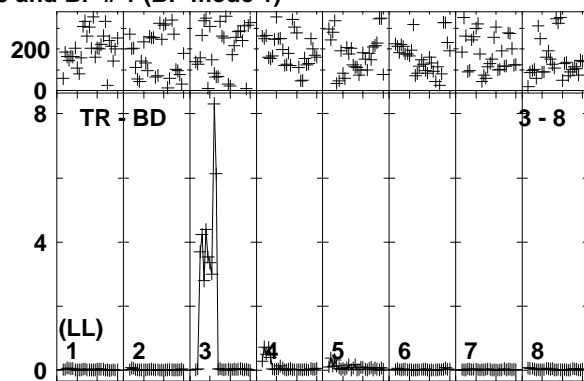
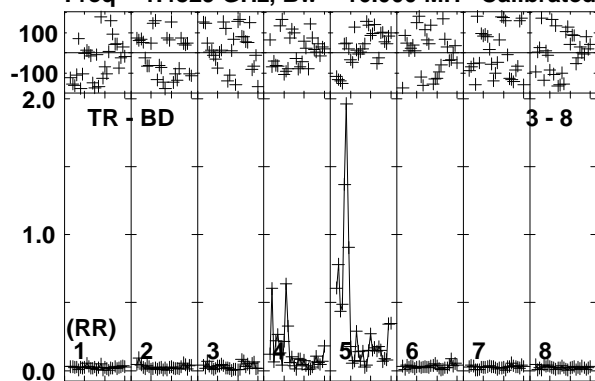

Lower frame: Ampl Jy Top frame: Phas deg
Vector averaged cross-power spectrum Baseline: TR (03) - BD (08)
Timerange: 00/07:08:01 to 00/07:11:29

Plot file version 173 created 21-JUN-2019 11:54:27

J1222+0413 EP111A 1.UVDATA.1

Freq = 1.4829 GHz, Bw = 16.000 MH Calibrated with CL # 3 and BP # 1 (BP mode 1)

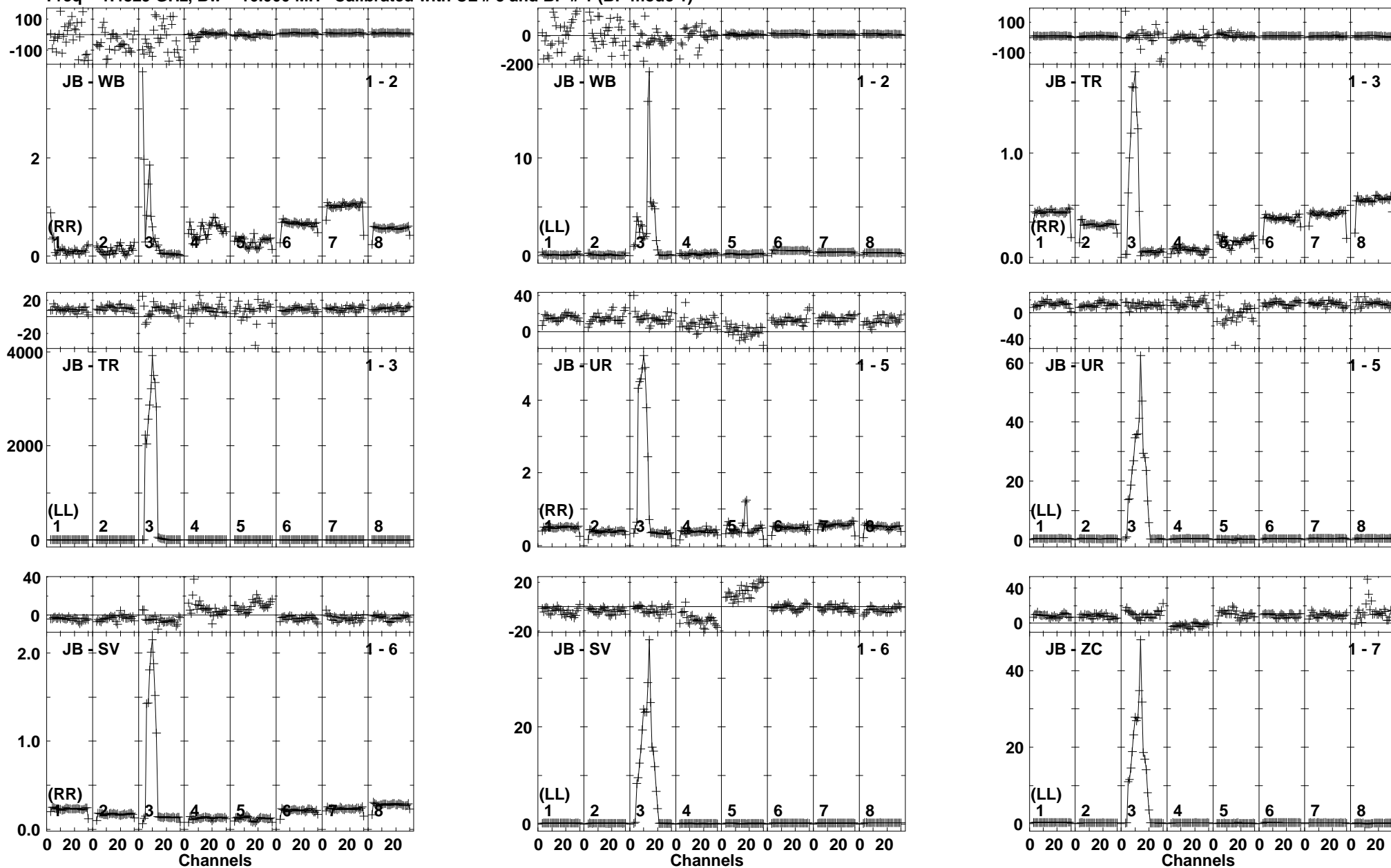

Lower frame: Ampl Jy Top frame: Phas deg
Vector averaged cross-power spectrum Baseline: JB (01) - WB (02)
Timerange: 00/07:12:11 to 00/07:13:39

Plot file version 174 created 21-JUN-2019 11:54:27

J1222+0413 EP111A 1.UVDATA.1

Freq = 1.4829 GHz, Bw = 16.000 MH Calibrated with CL # 3 and BP # 1 (BP mode 1)

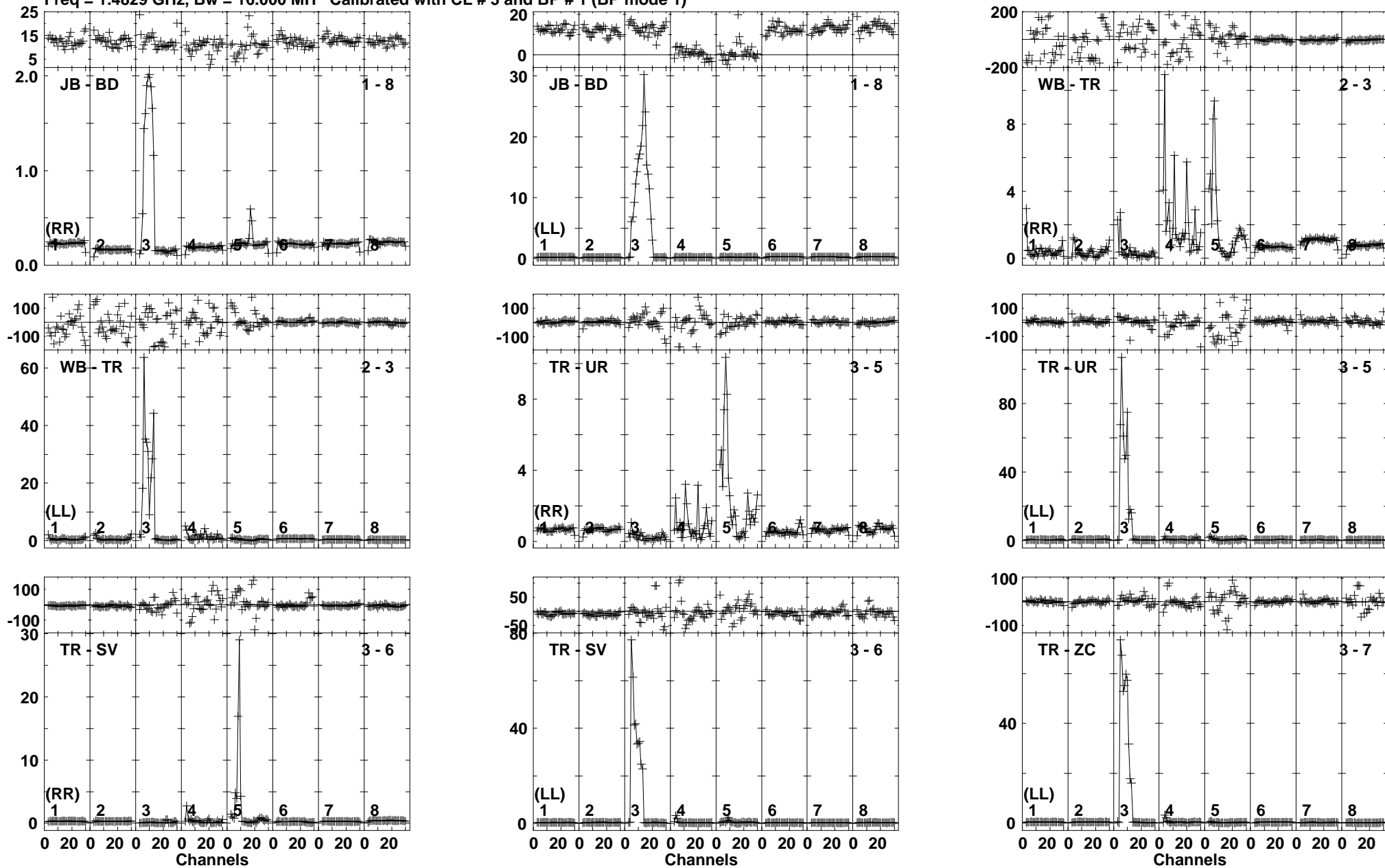

Lower frame: Ampl Jy Top frame: Phas deg
Vector averaged cross-power spectrum Baseline: JB (01) - BD (08)
Timerange: 00/07:12:11 to 00/07:13:39

Plot file version 175 created 21-JUN-2019 11:54:28
J1222+0413 EP111A 1.UVDATA.1
Freq = 1.4829 GHz, Bw = 16.000 MH Calibrated with CL # 3 and BP # 1 (BP mode 1)

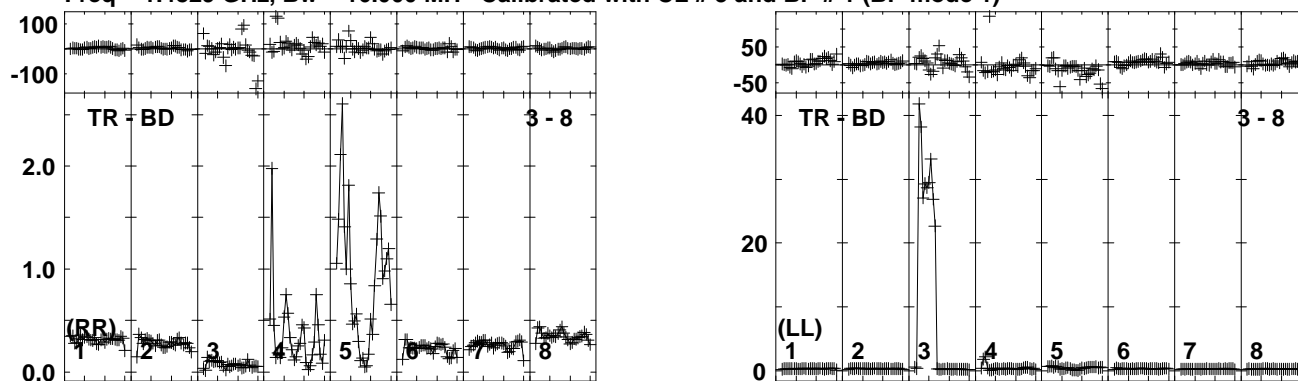

Lower frame: Ampl Jy Top frame: Phas deg
Vector averaged cross-power spectrum Baseline: TR (03) - BD (08)
Timerange: 00/07:12:11 to 00/07:13:39

Plot file version 176 created 21-JUN-2019 11:54:28
 IRAS12112 EP111A 1.UVDATA.1
 Freq = 1.4829 GHz, Bw = 16.000 MH Calibrated with CL # 3 and BP # 1 (BP mode 1)

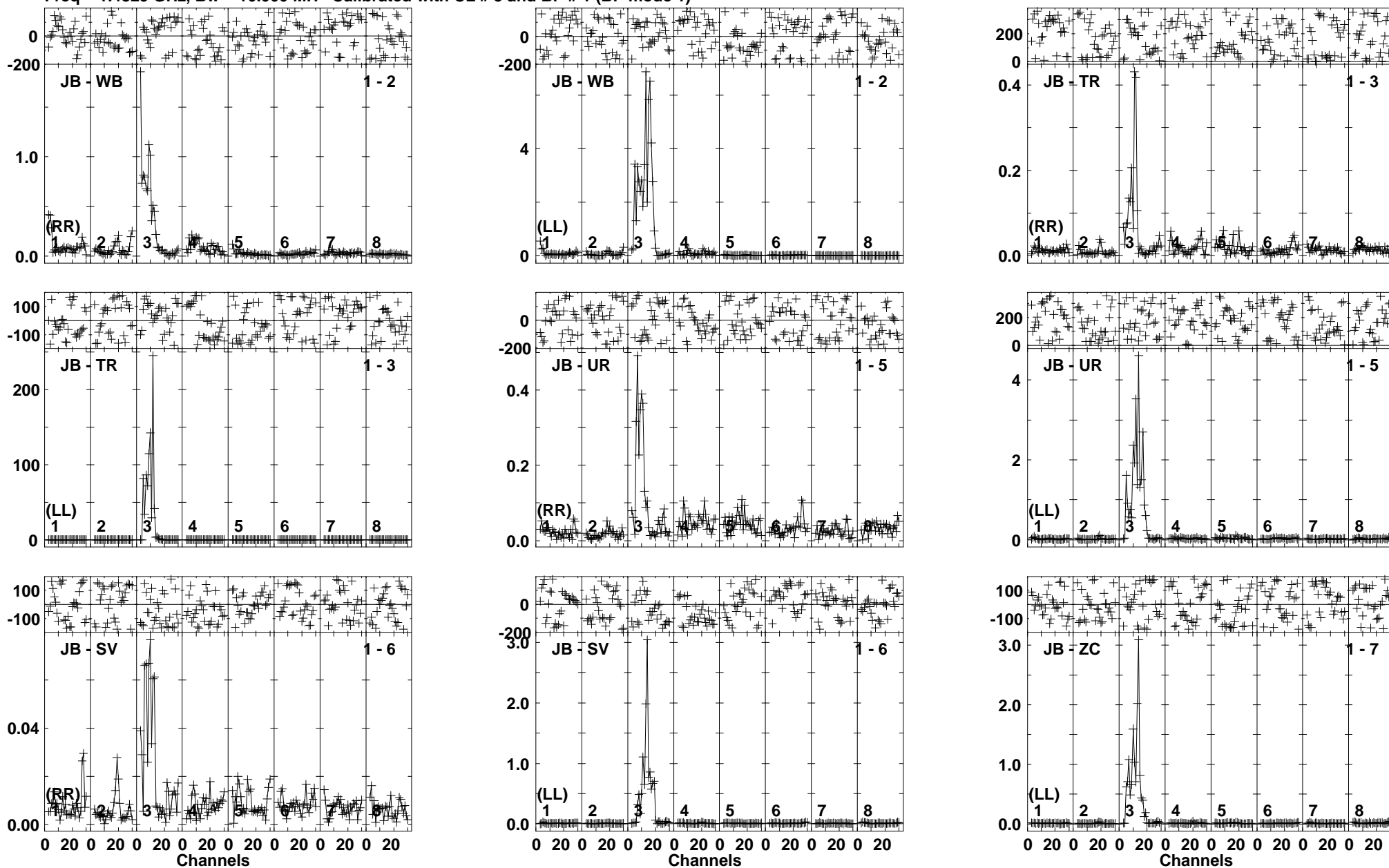

Lower frame: Ampl Jy Top frame: Phas deg
 Vector averaged cross-power spectrum Baseline: JB (01) - WB (02)
 Timerange: 00/07:13:41 to 00/07:17:09

Plot file version 177 created 21-JUN-2019 11:54:28

IRAS12112 EP111A 1.UVDATA.1

Freq = 1.4829 GHz, Bw = 16.000 MH Calibrated with CL # 3 and BP # 1 (BP mode 1)

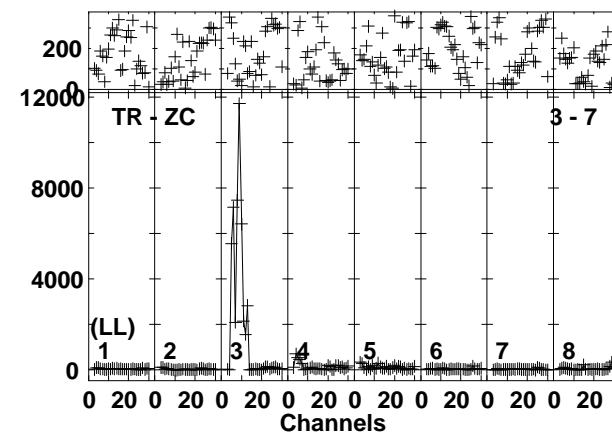
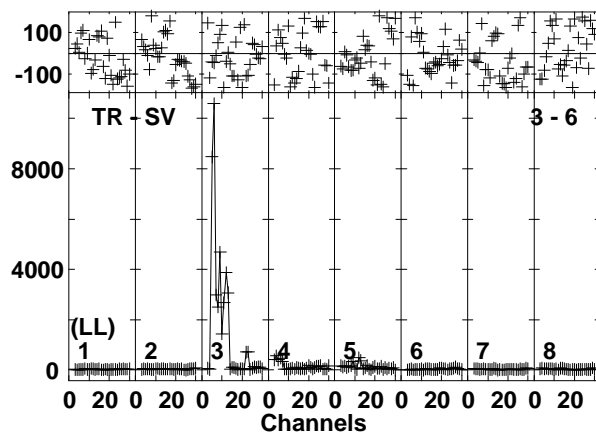
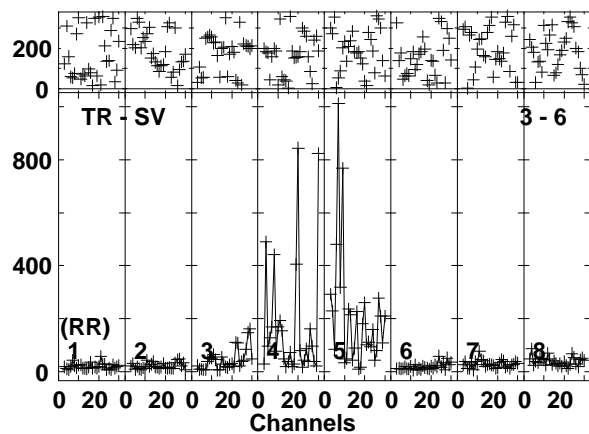
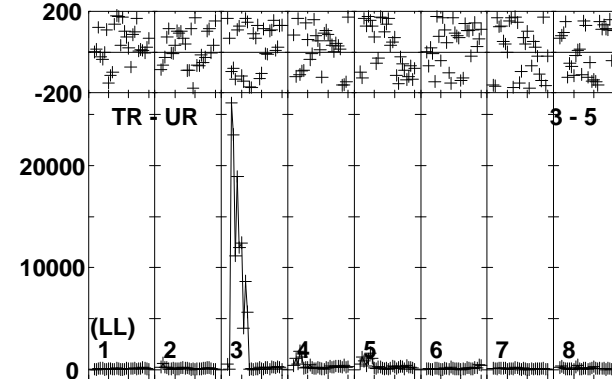
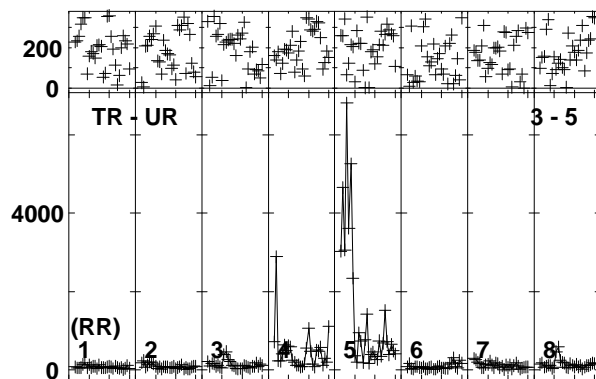
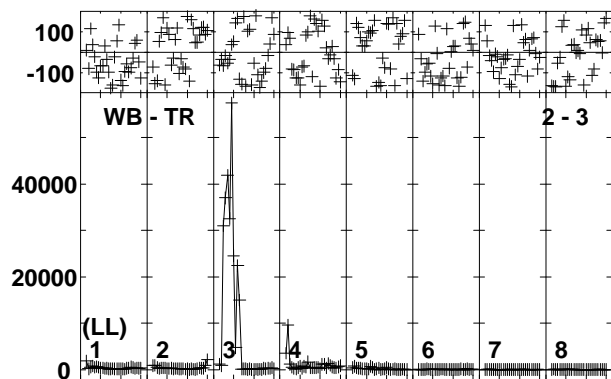
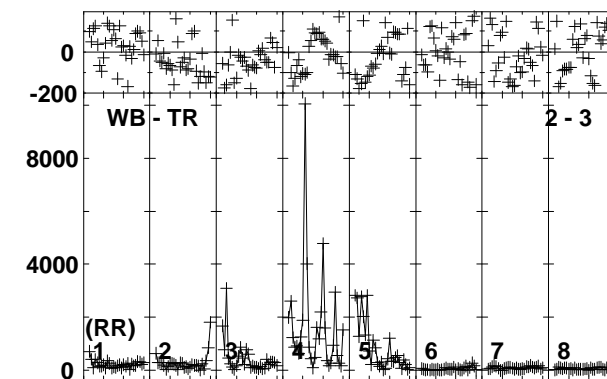
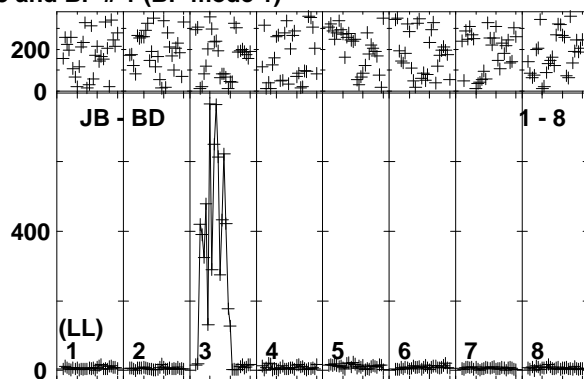
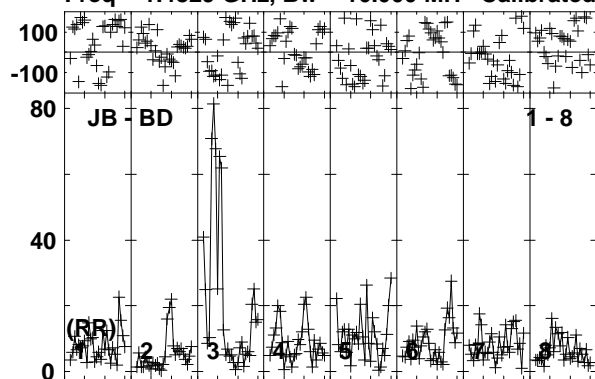

Lower frame: Milli Ampl Jy Top frame: Phas deg
Vector averaged cross-power spectrum Baseline: JB (01) - BD (08)
Timerange: 00/07:13:41 to 00/07:17:09

Plot file version 178 created 21-JUN-2019 11:54:29

IRAS12112 EP111A 1.UVDATA.1

Freq = 1.4829 GHz, Bw = 16.000 MH Calibrated with CL # 3 and BP # 1 (BP mode 1)

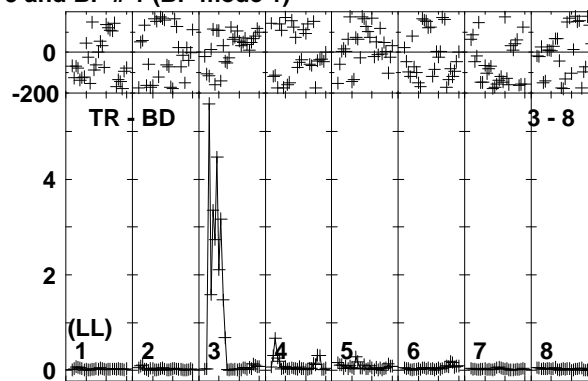
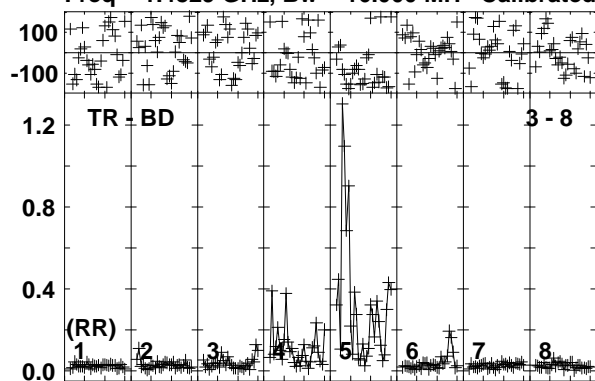

Lower frame: Ampl Jy Top frame: Phas deg
Vector averaged cross-power spectrum Baseline: TR (03) - BD (08)
Timerange: 00/07:13:41 to 00/07:17:09

Plot file version 179 created 21-JUN-2019 11:54:29

J1222+0413 EP111A 1.UVDATA.1

Freq = 1.4829 GHz, Bw = 16.000 MH Calibrated with CL # 3 and BP # 1 (BP mode 1)

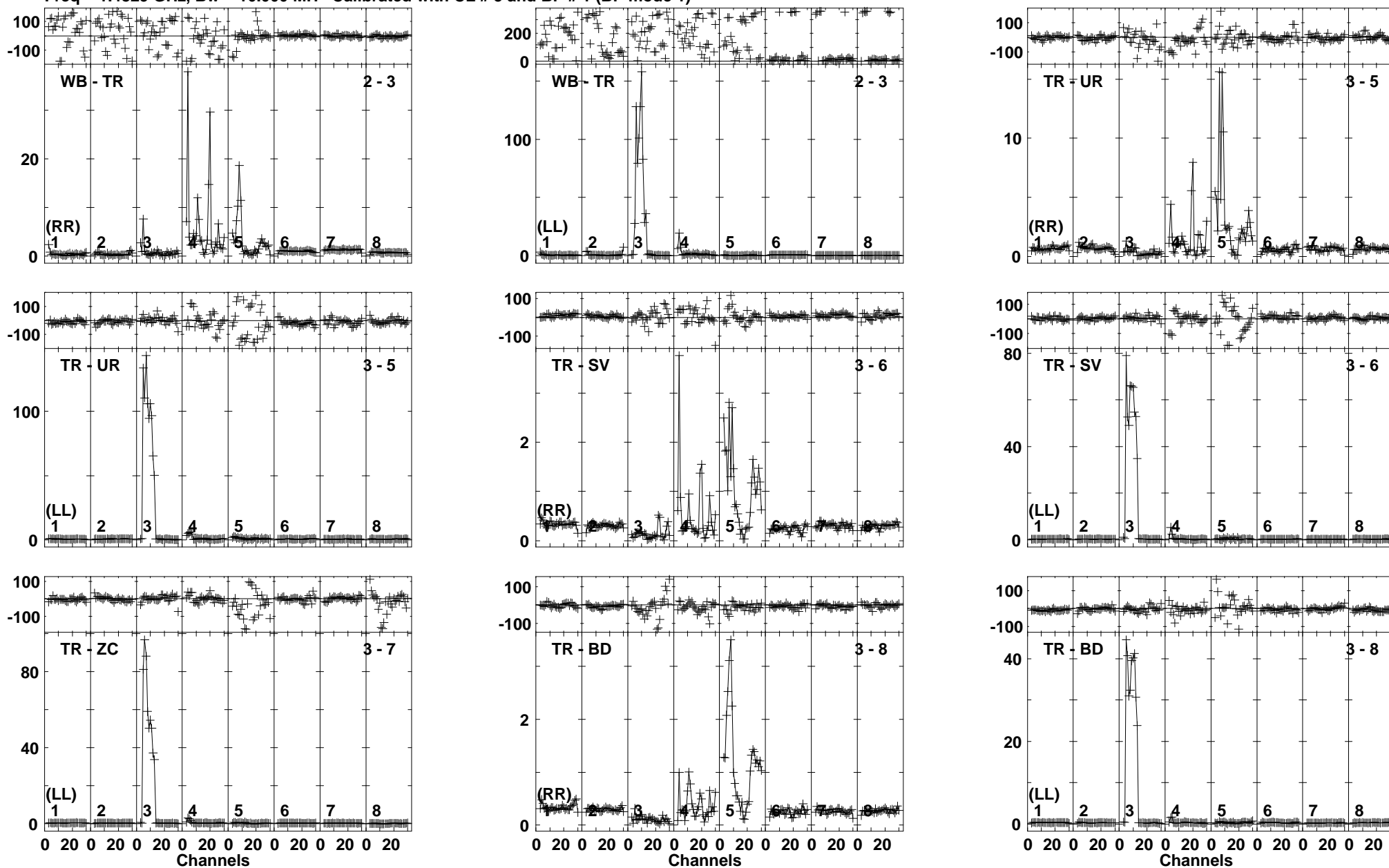

Lower frame: Ampl Jy Top frame: Phas deg
Vector averaged cross-power spectrum Baseline: WB (02) - TR (03)
Timerange: 00/07:17:11 to 00/07:18:39

Plot file version 180 created 21-JUN-2019 11:54:30

IRAS12112 EP111A 1.UVDATA.1

Freq = 1.4829 GHz, Bw = 16.000 MH Calibrated with CL # 3 and BP # 1 (BP mode 1)

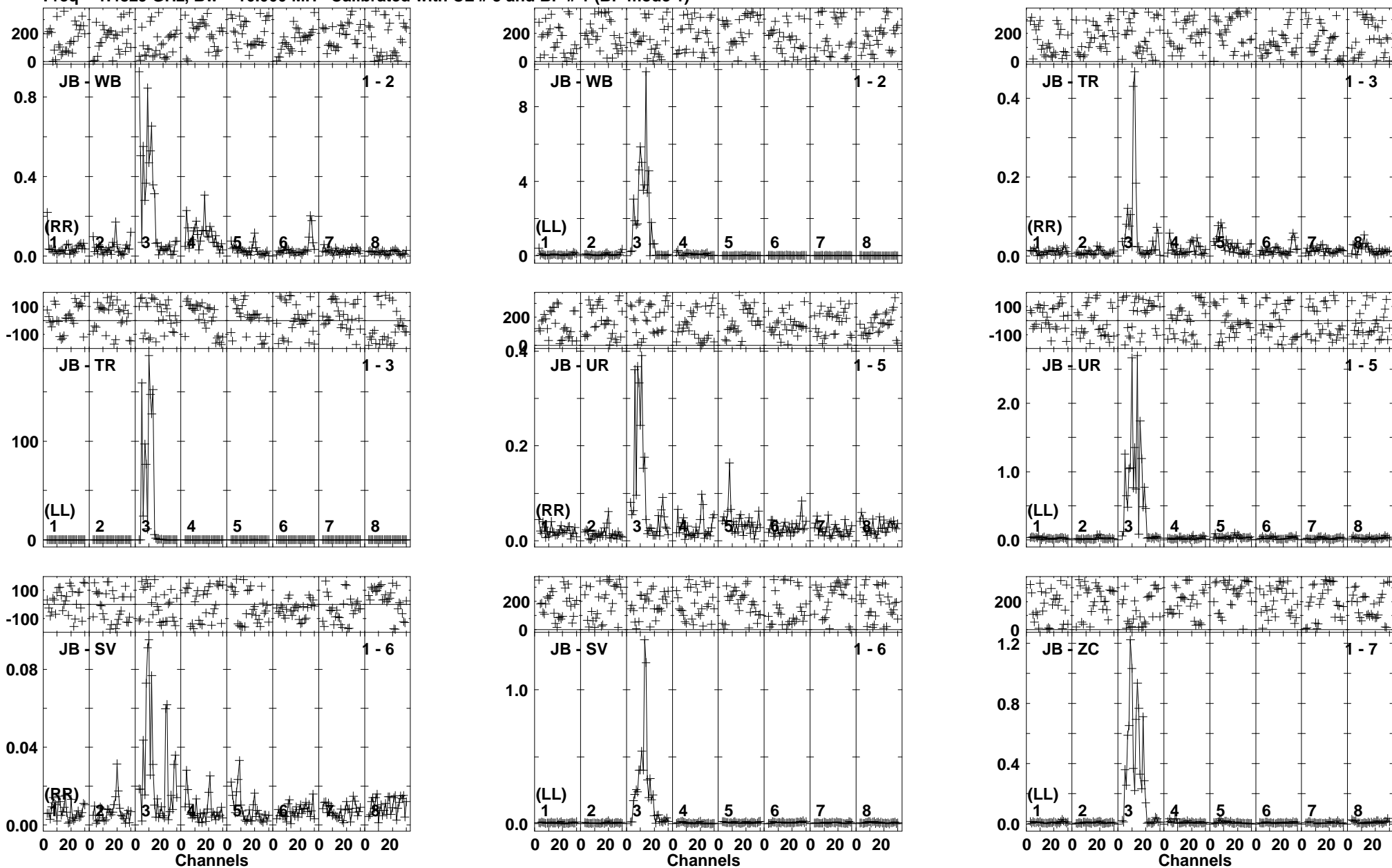

Lower frame: Ampl Jy Top frame: Phas deg
Vector averaged cross-power spectrum Baseline: JB (01) - WB (02)
Timerange: 00/07:18:41 to 00/07:22:09

Plot file version 181 created 21-JUN-2019 11:54:30

IRAS12112 EP111A 1.UVDATA.1

Freq = 1.4829 GHz, Bw = 16.000 MH Calibrated with CL # 3 and BP # 1 (BP mode 1)

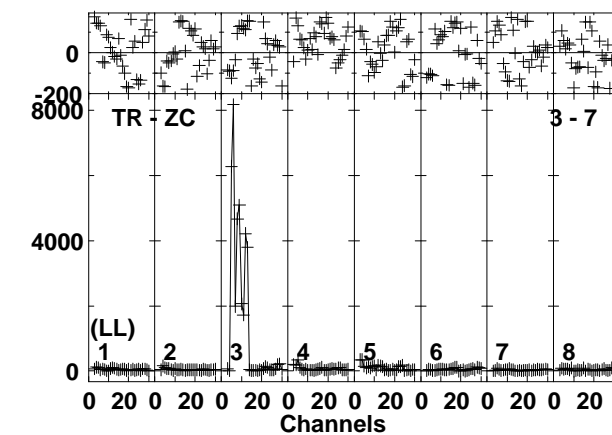
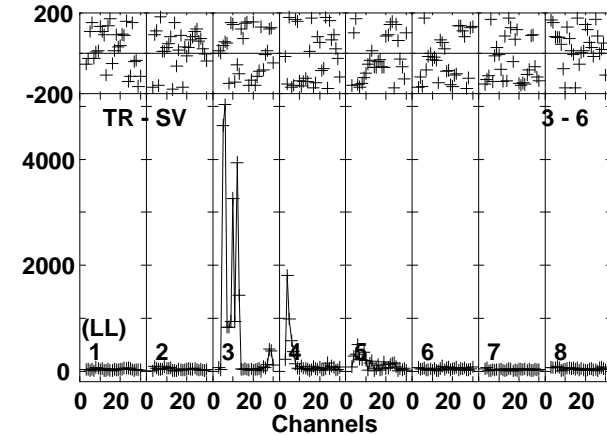
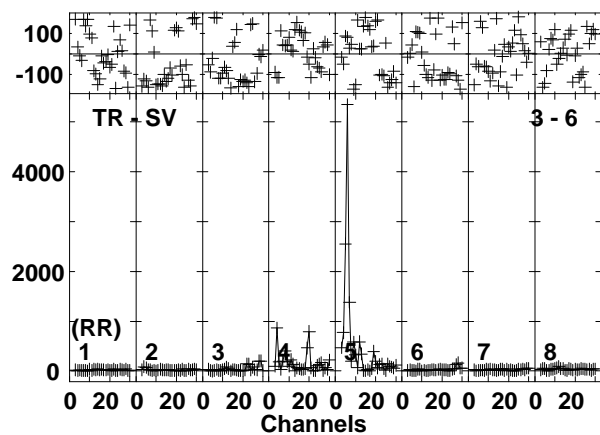
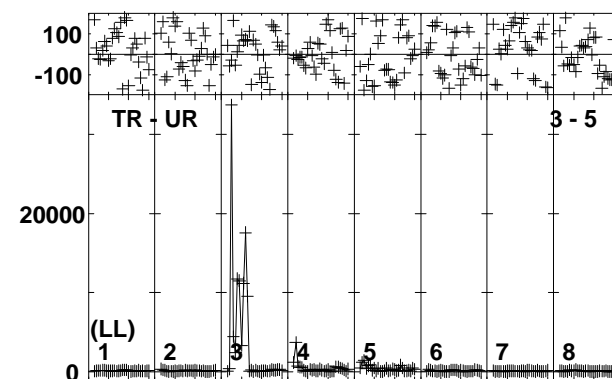
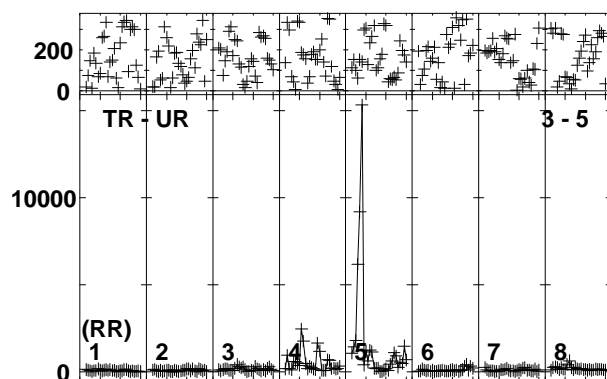
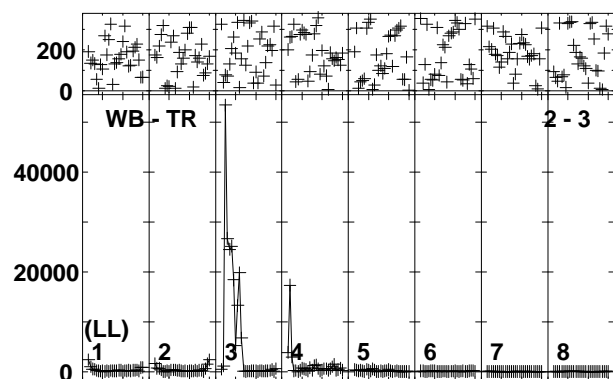
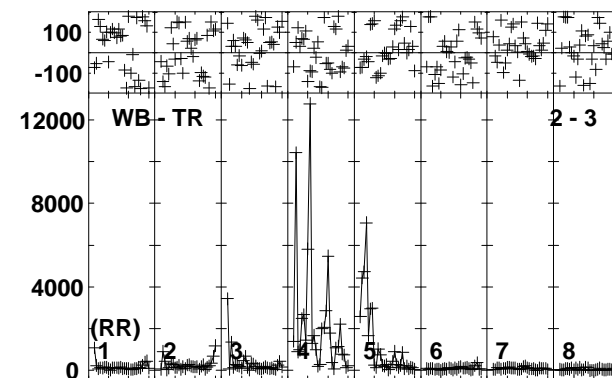
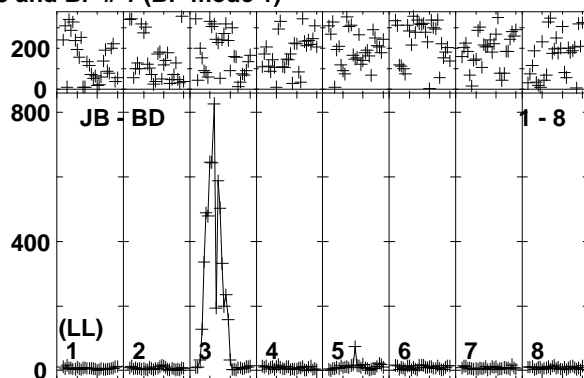
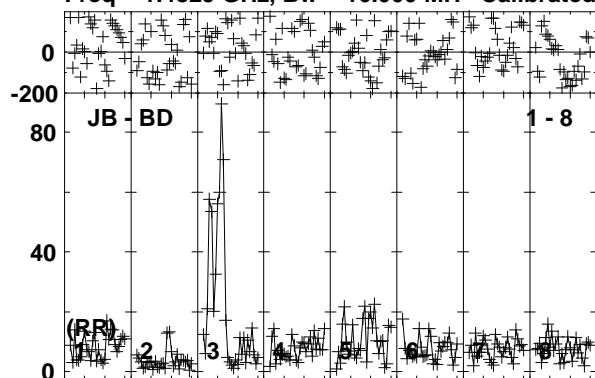

Lower frame: Milli Ampl Jy Top frame: Phas deg
Vector averaged cross-power spectrum Baseline: JB (01) - BD (08)
Timerange: 00/07:18:41 to 00/07:22:09

Plot file version 182 created 21-JUN-2019 11:54:31

IRAS12112 EP111A 1.UVDATA.1

Freq = 1.4829 GHz, Bw = 16.000 MH Calibrated with CL # 3 and BP # 1 (BP mode 1)

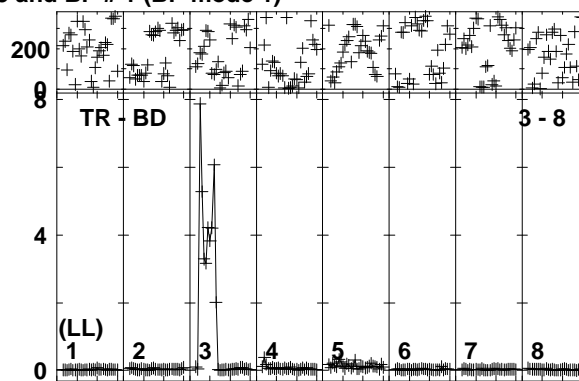
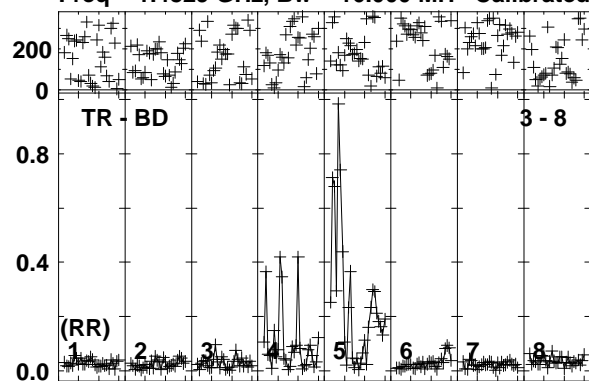

Lower frame: Ampl Jy Top frame: Phas deg
Vector averaged cross-power spectrum Baseline: TR (03) - BD (08)
Timerange: 00/07:18:41 to 00/07:22:09

Plot file version 183 created 21-JUN-2019 11:54:31

J1222+0413 EP111A 1.UVDATA.1

Freq = 1.4829 GHz, Bw = 16.000 MH Calibrated with CL # 3 and BP # 1 (BP mode 1)

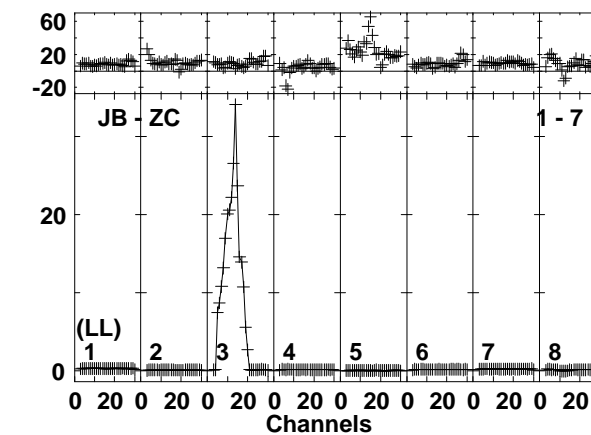
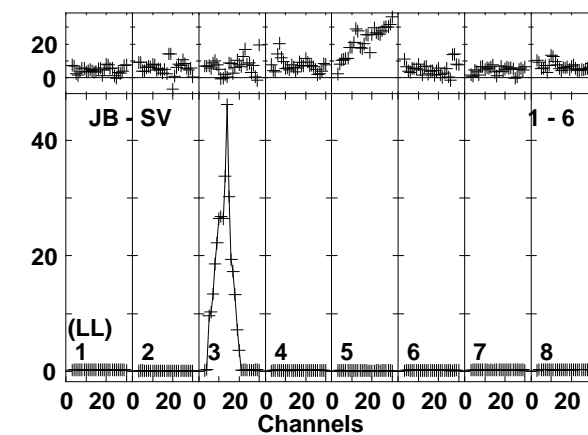
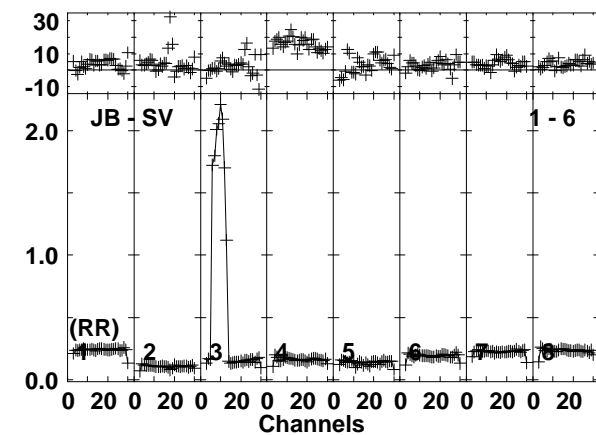
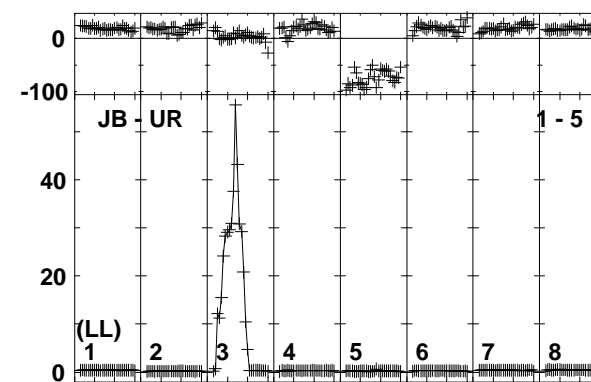
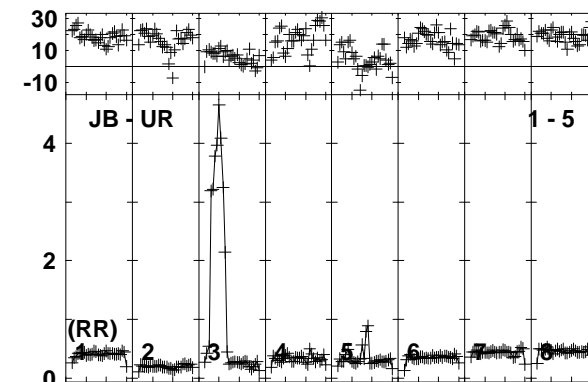
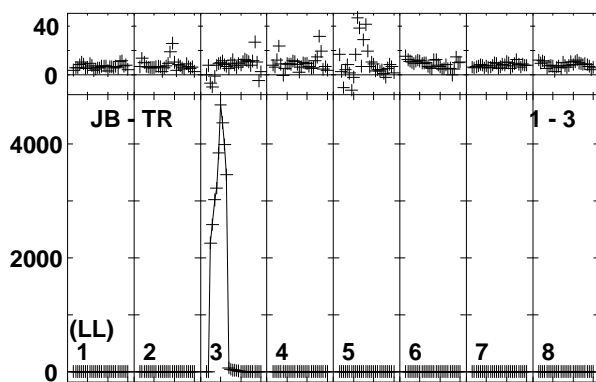
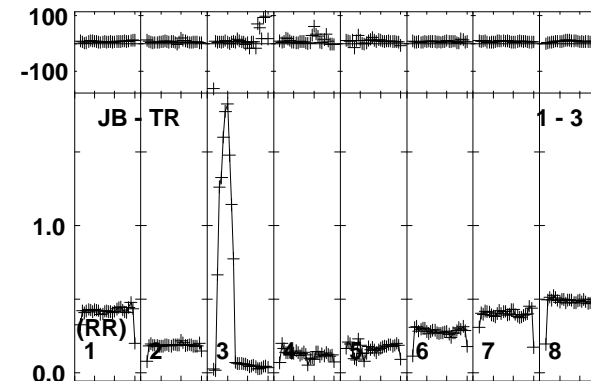
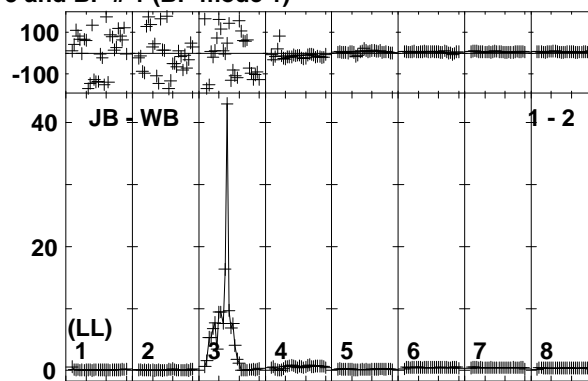
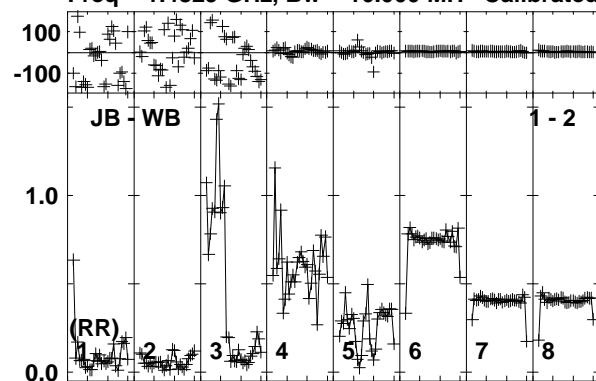

Lower frame: Ampl Jy Top frame: Phas deg
Vector averaged cross-power spectrum Baseline: JB (01) - WB (02)
Timerange: 00/07:22:51 to 00/07:24:19

Plot file version 184 created 21-JUN-2019 11:54:31

J1222+0413 EP111A 1.UVDATA.1

Freq = 1.4829 GHz, Bw = 16.000 MH Calibrated with CL # 3 and BP # 1 (BP mode 1)

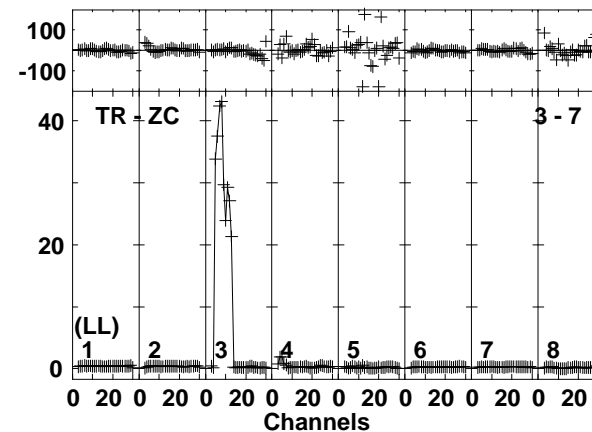
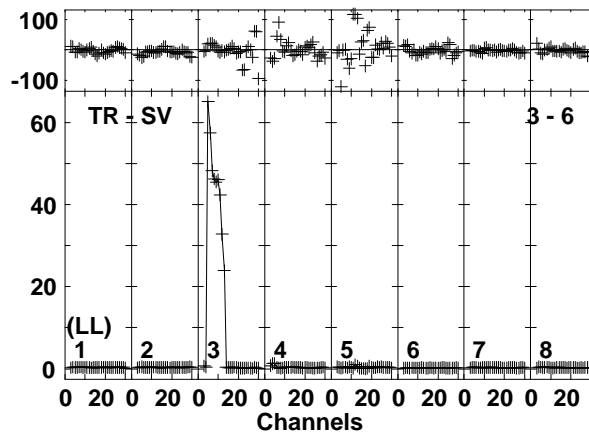
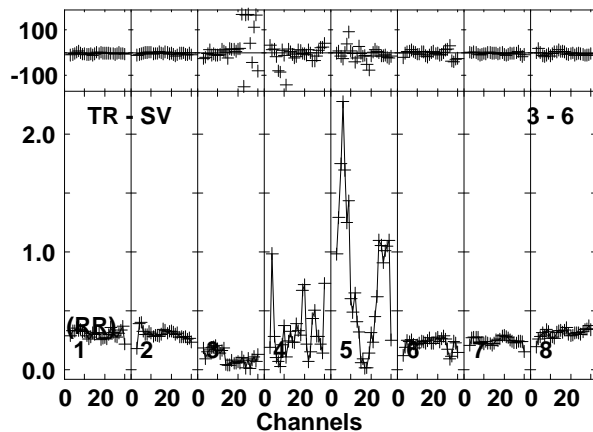
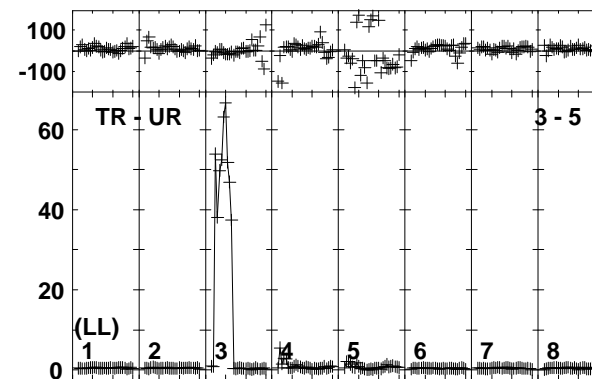
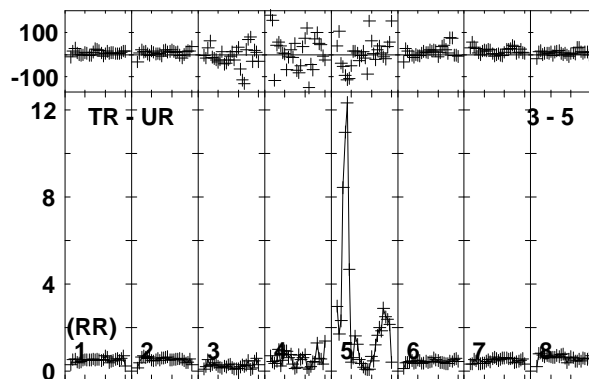
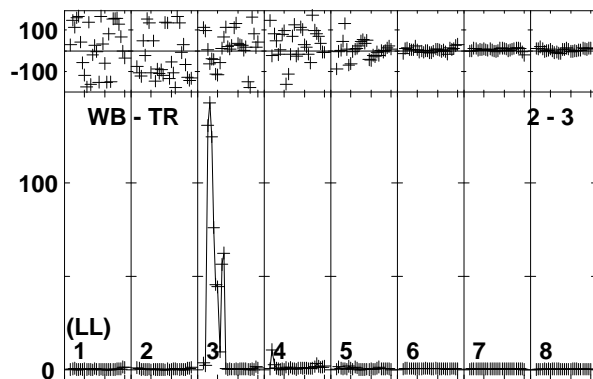
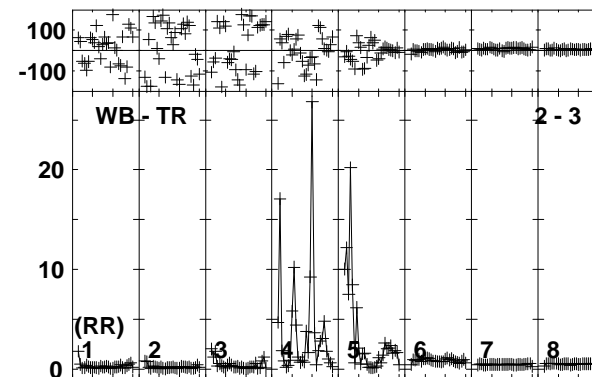
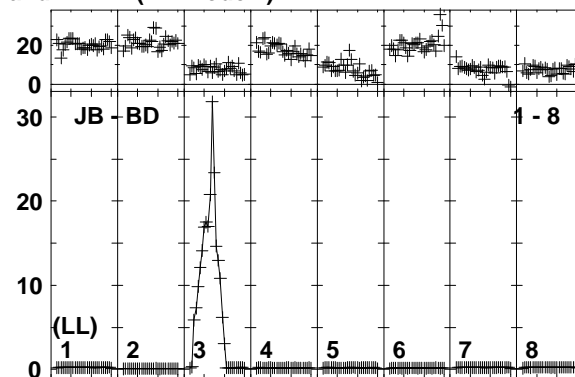
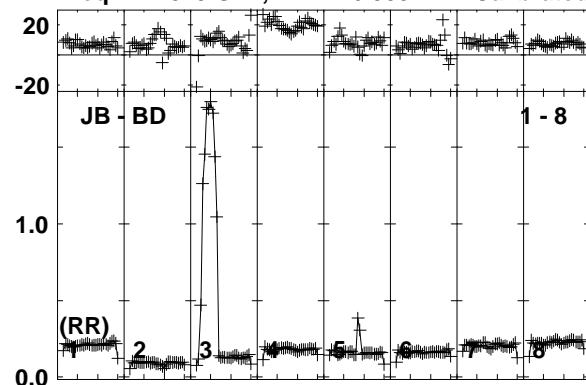

Lower frame: Ampl Jy Top frame: Phas deg
Vector averaged cross-power spectrum Baseline: JB (01) - BD (08)
Timerange: 00/07:22:51 to 00/07:24:19

Plot file version 185 created 21-JUN-2019 11:54:32

J1222+0413 EP111A 1.UVDATA.1

Freq = 1.4829 GHz, Bw = 16.000 MH Calibrated with CL # 3 and BP # 1 (BP mode 1)

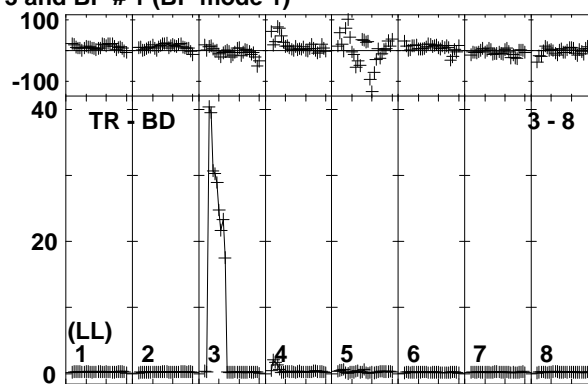
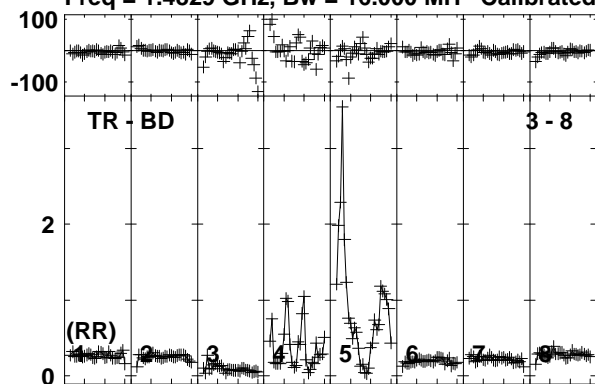

Lower frame: Ampl Jy Top frame: Phas deg
Vector averaged cross-power spectrum Baseline: TR (03) - BD (08)
Timerange: 00/07:22:51 to 00/07:24:19

Plot file version 186 created 21-JUN-2019 11:54:32

IRAS12112 EP111A 1.UVDATA.1

Freq = 1.4829 GHz, Bw = 16.000 MH Calibrated with CL # 3 and BP # 1 (BP mode 1)

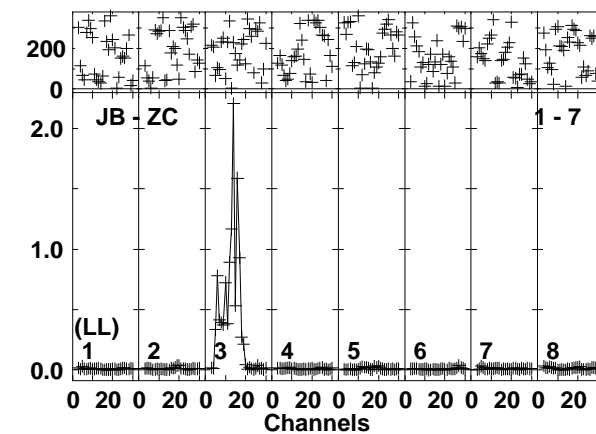
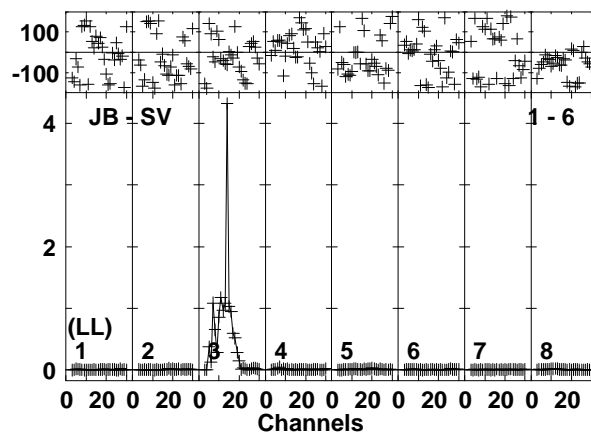
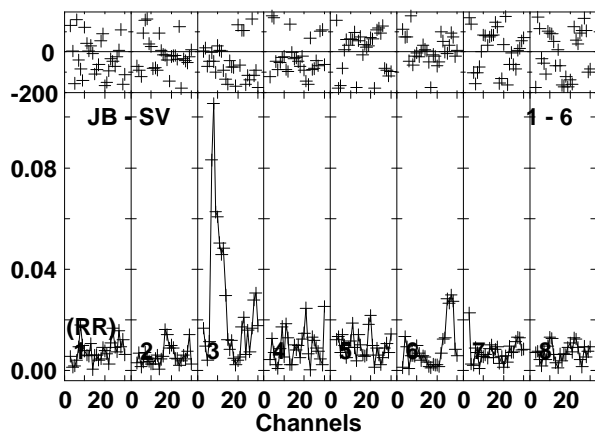
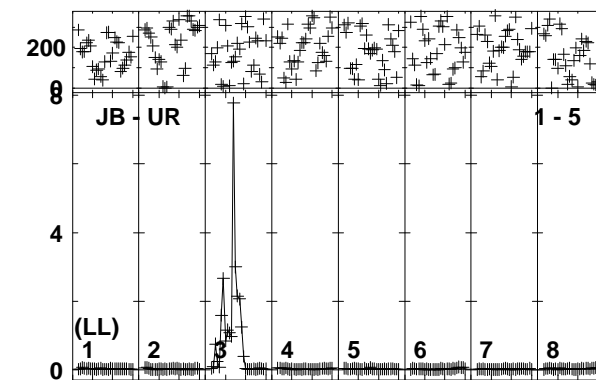
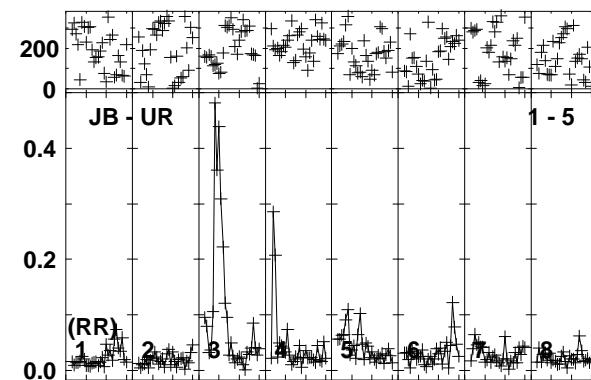
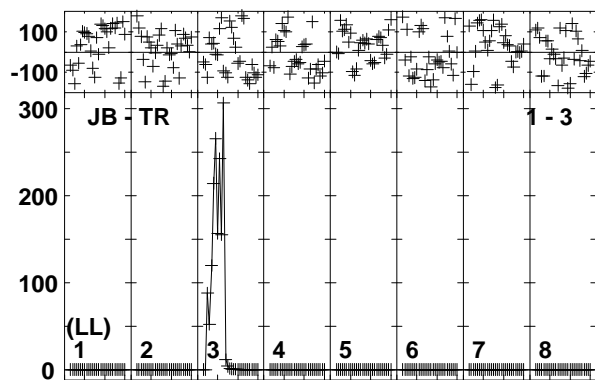
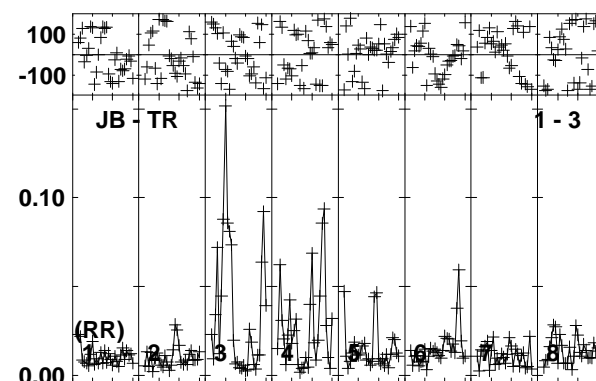
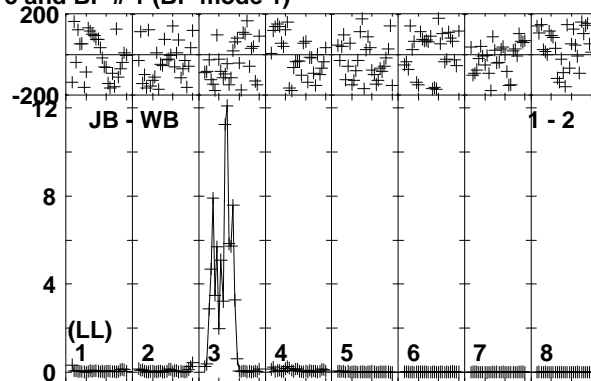
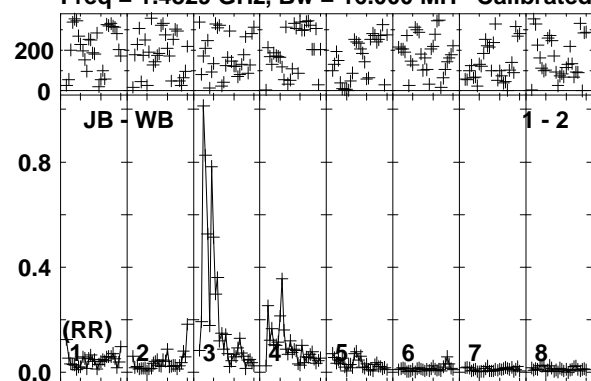

Lower frame: Ampl Jy Top frame: Phas deg
Vector averaged cross-power spectrum Baseline: JB (01) - WB (02)
Timerange: 00/07:24:21 to 00/07:27:49

Plot file version 187 created 21-JUN-2019 11:54:32

IRAS12112 EP111A 1.UVDATA.1

Freq = 1.4829 GHz, Bw = 16.000 MH Calibrated with CL # 3 and BP # 1 (BP mode 1)

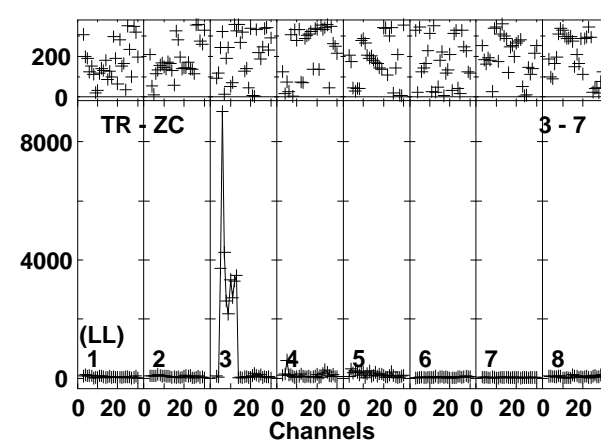
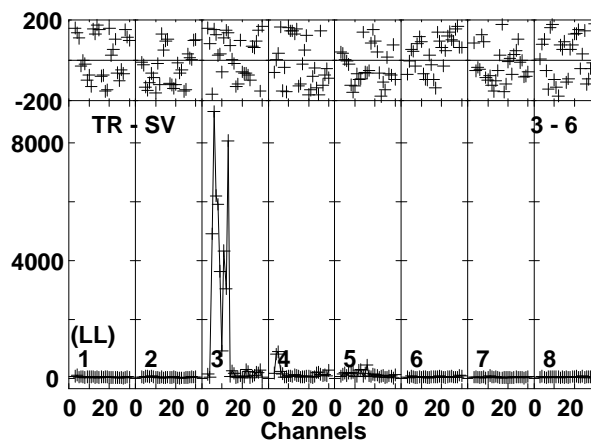
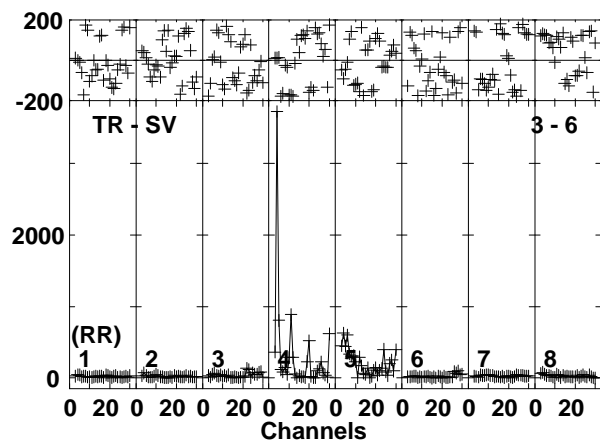
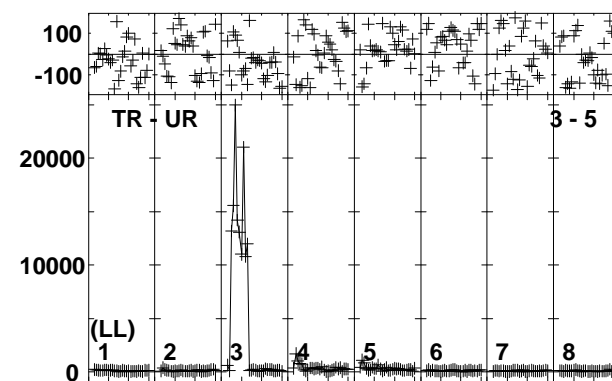
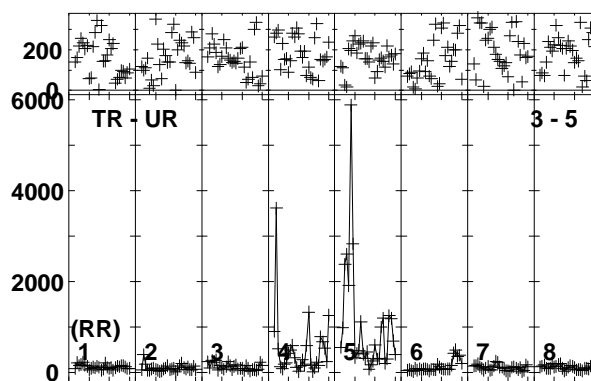
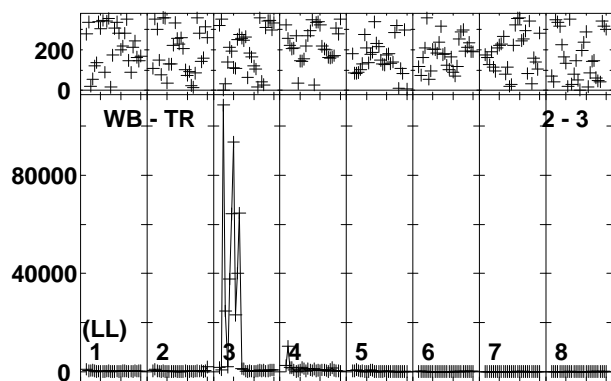
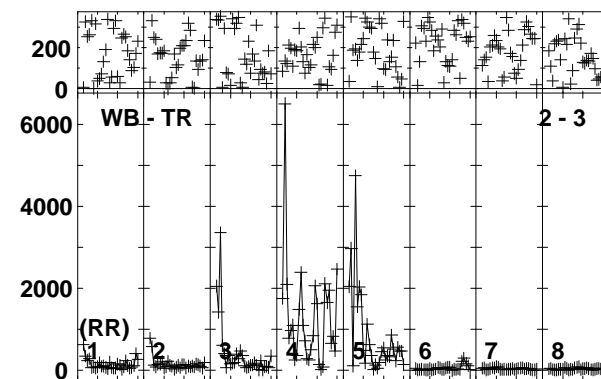
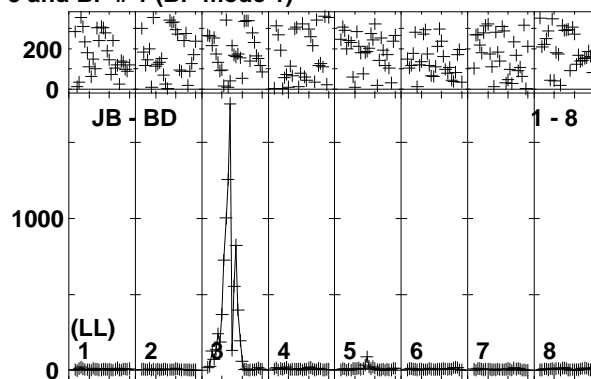
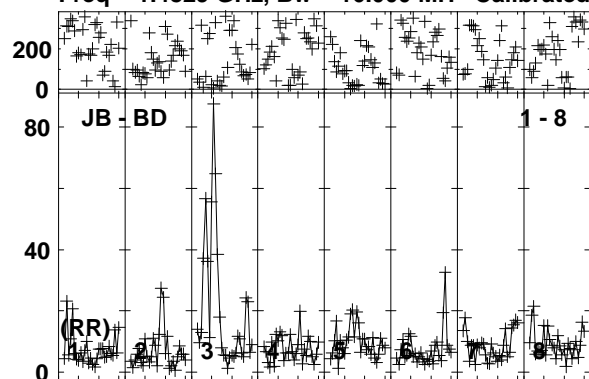

Lower frame: Milli Ampl Jy Top frame: Phas deg
Vector averaged cross-power spectrum Baseline: JB (01) - BD (08)
Timerange: 00/07:24:21 to 00/07:27:49

Plot file version 188 created 21-JUN-2019 11:54:33

IRAS12112 EP111A 1.UVDATA.1

Freq = 1.4829 GHz, Bw = 16.000 MH Calibrated with CL # 3 and BP # 1 (BP mode 1)

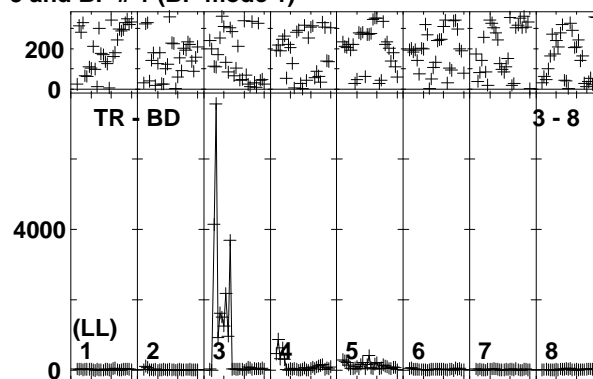
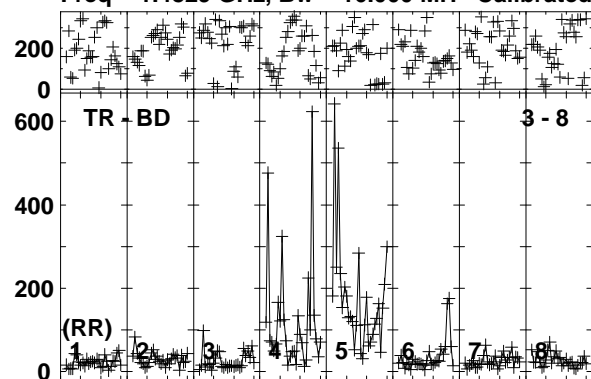

Lower frame: Milli Ampl Jy Top frame: Phas deg
Vector averaged cross-power spectrum Baseline: TR (03) - BD (08)
Timerange: 00/07:24:21 to 00/07:27:49

Plot file version 189 created 21-JUN-2019 11:54:33

J1222+0413 EP111A 1.UVDATA.1

Freq = 1.4829 GHz, Bw = 16.000 MH Calibrated with CL # 3 and BP # 1 (BP mode 1)

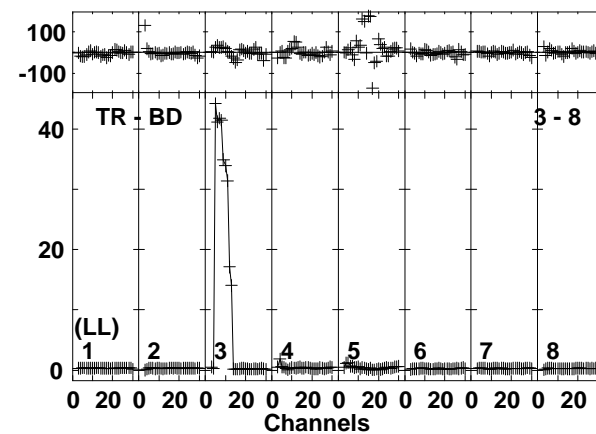
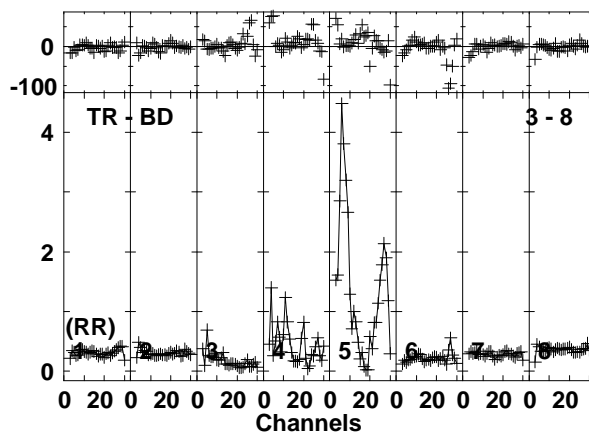
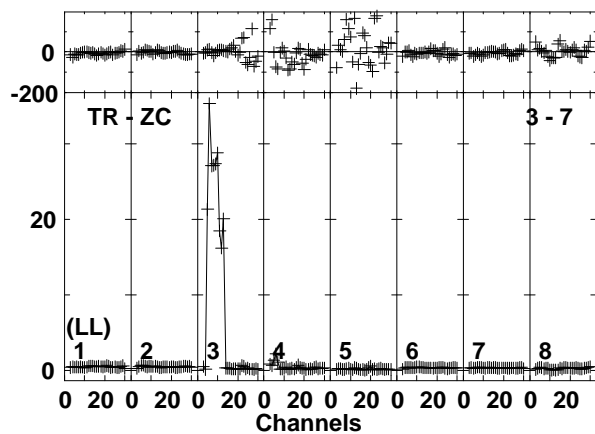
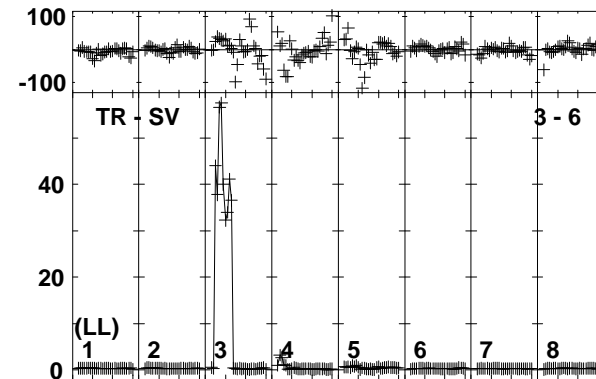
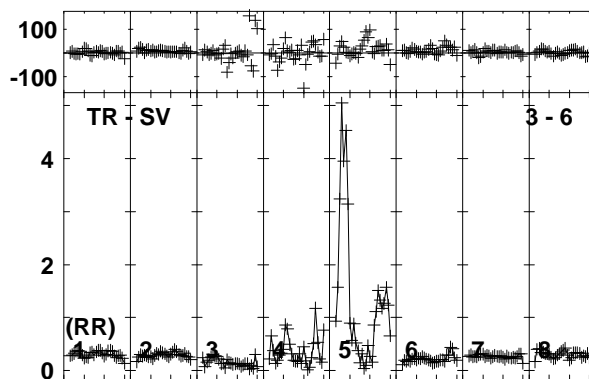
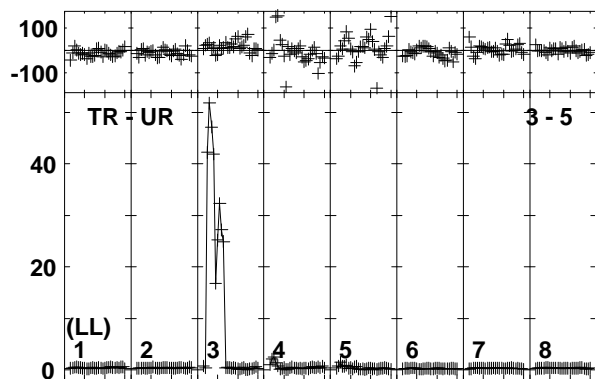
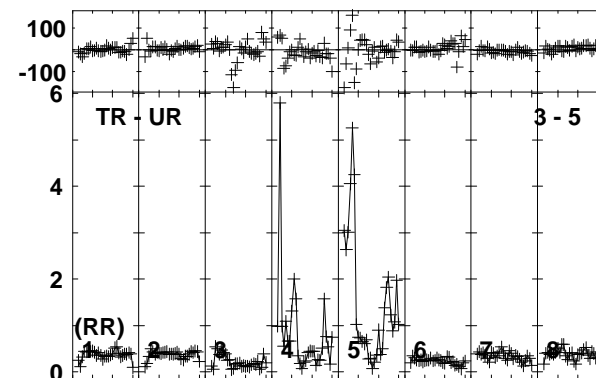
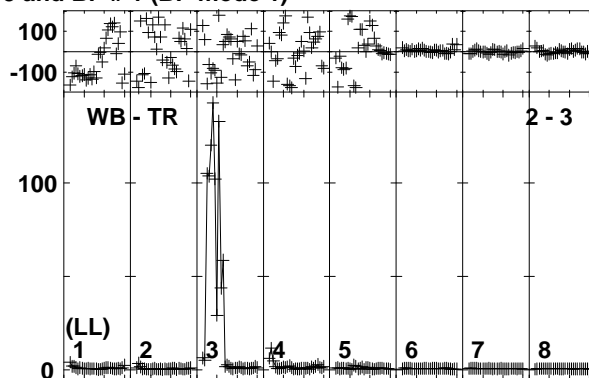
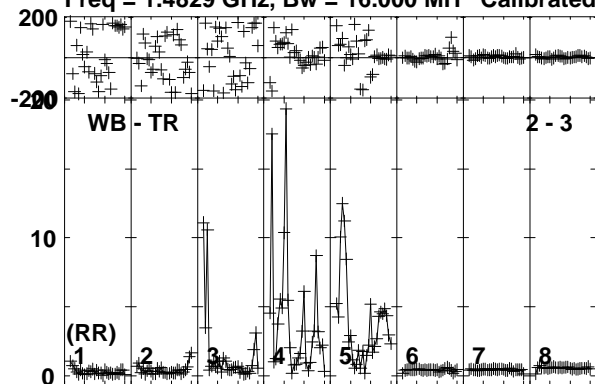

Lower frame: Ampl Jy Top frame: Phas deg
Vector averaged cross-power spectrum Baseline: WB (02) - TR (03)
Timerange: 00/07:27:51 to 00/07:29:19

Plot file version 190 created 21-JUN-2019 11:54:34

IRAS12112 EP111A 1.UVDATA.1

Freq = 1.4829 GHz, Bw = 16.000 MH Calibrated with CL # 3 and BP # 1 (BP mode 1)

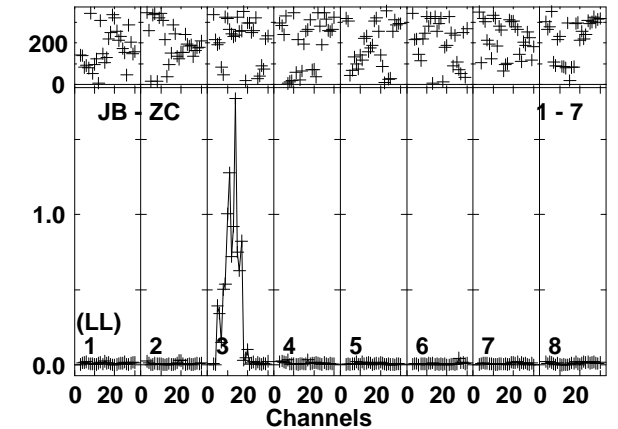
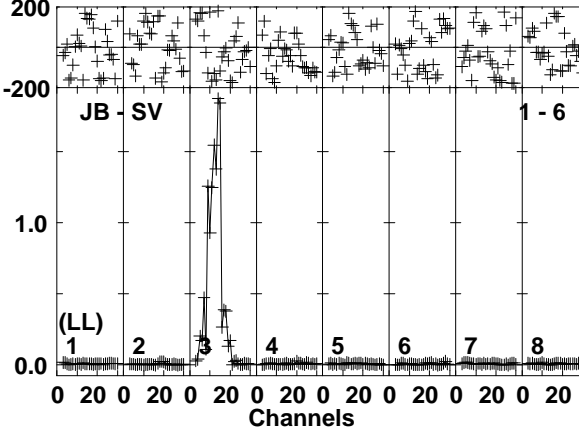
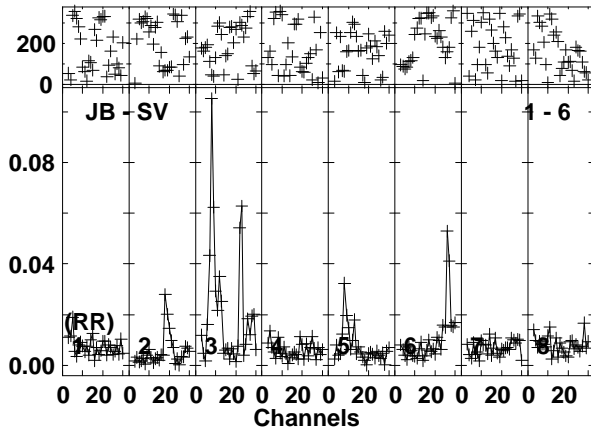
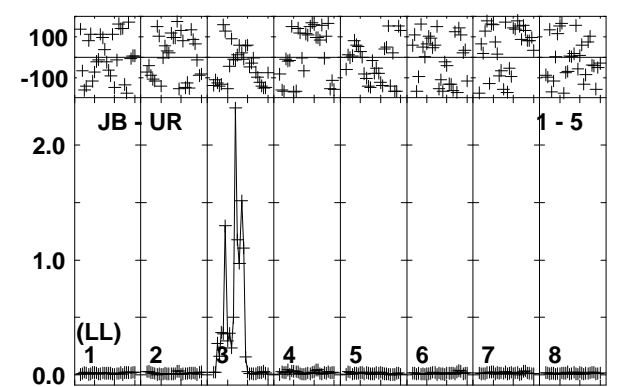
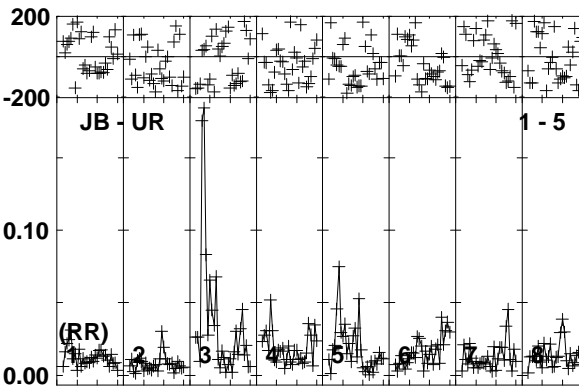
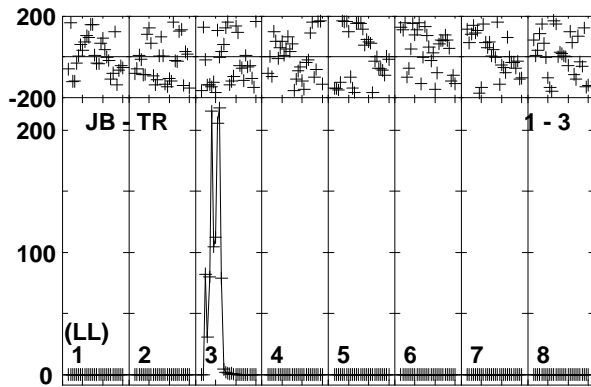
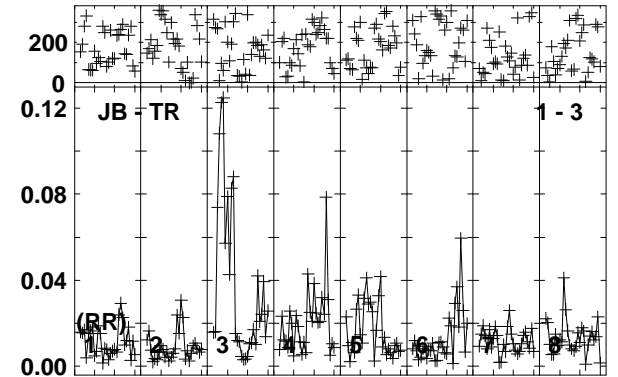
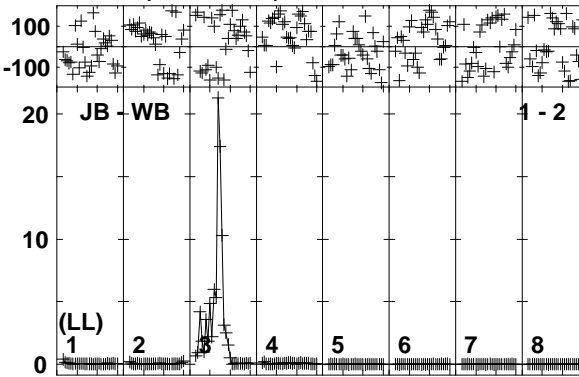
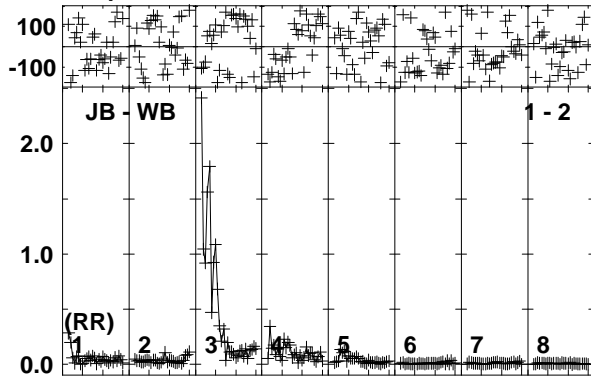

Lower frame: Ampl Jy Top frame: Phas deg
Vector averaged cross-power spectrum Baseline: JB (01) - WB (02)
Timerange: 00/07:29:21 to 00/07:32:49

Plot file version 191 created 21-JUN-2019 11:54:34

IRAS12112 EP111A 1.UVDATA.1

Freq = 1.4829 GHz, Bw = 16.000 MH Calibrated with CL # 3 and BP # 1 (BP mode 1)

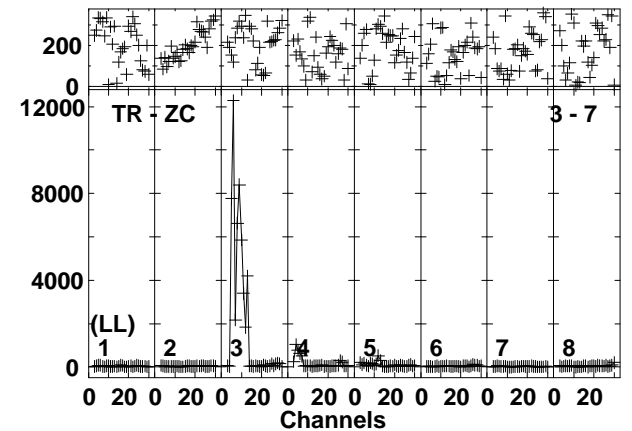
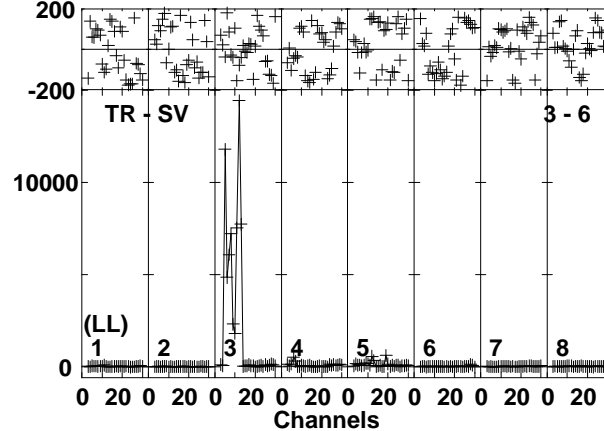
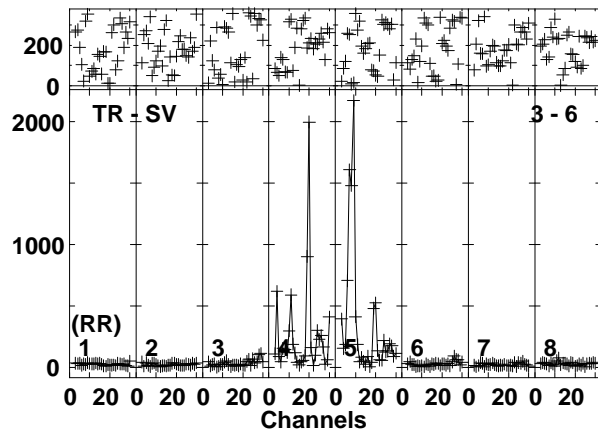
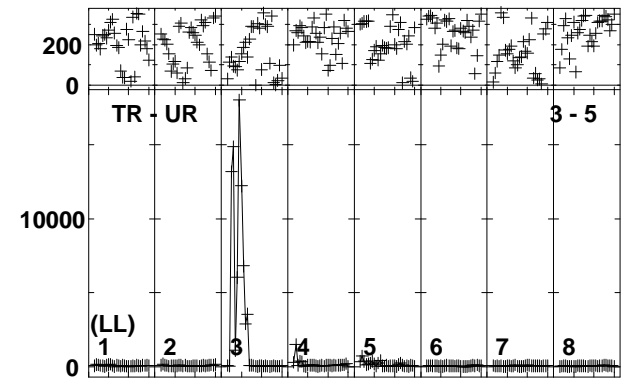
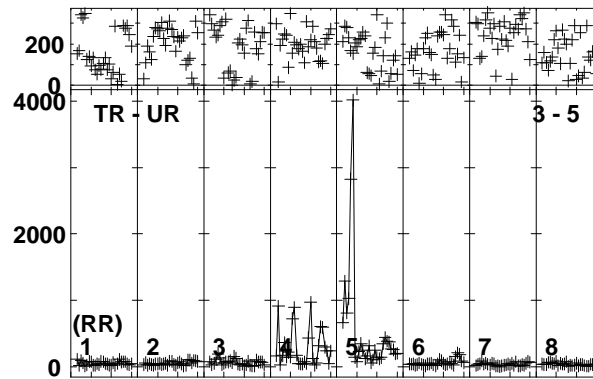
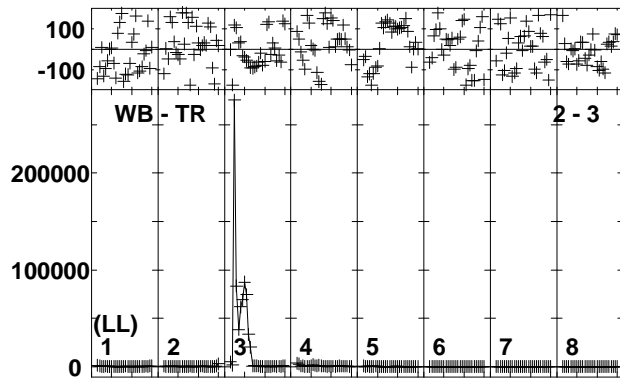
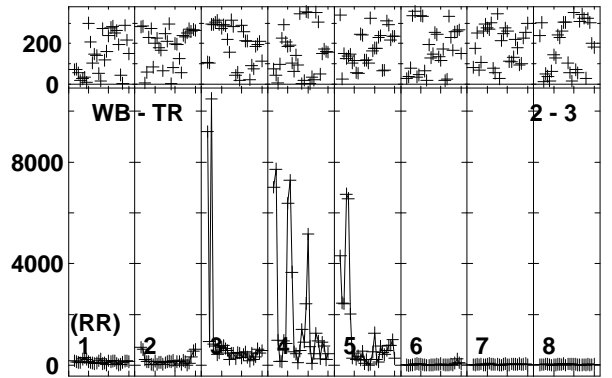
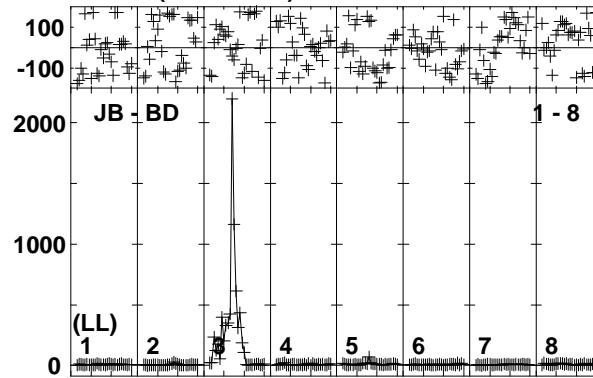
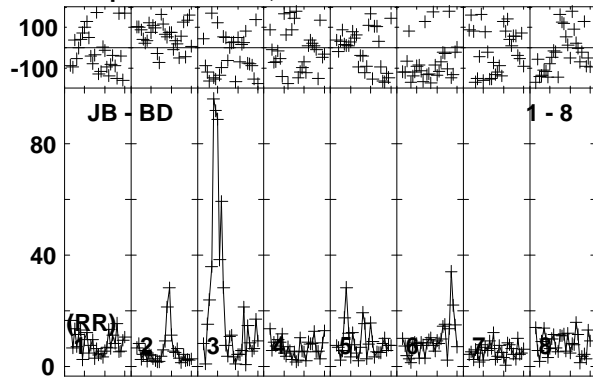

Lower frame: Milli Ampl Jy Top frame: Phas deg
Vector averaged cross-power spectrum Baseline: JB (01) - BD (08)
Timerange: 00/07:29:21 to 00/07:32:49

Plot file version 192 created 21-JUN-2019 11:54:35

IRAS12112 EP111A 1.UVDATA.1

Freq = 1.4829 GHz, Bw = 16.000 MH Calibrated with CL # 3 and BP # 1 (BP mode 1)

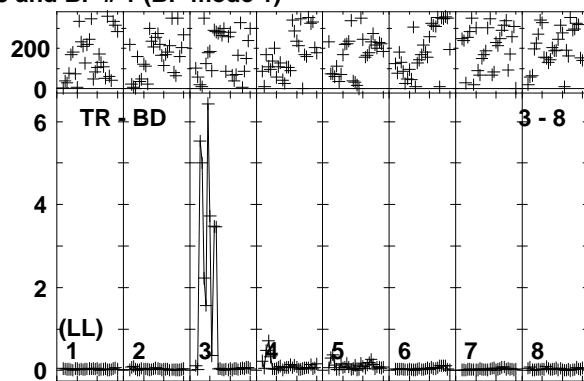
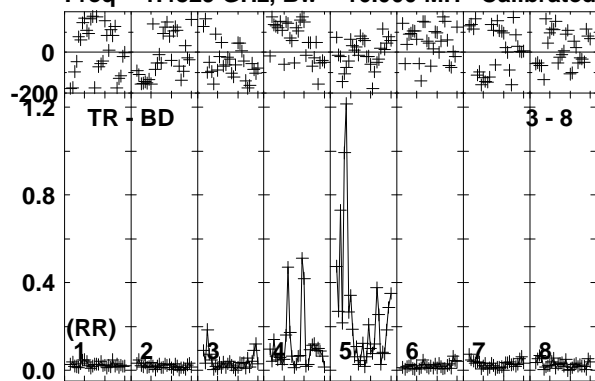

Lower frame: Ampl Jy Top frame: Phas deg
Vector averaged cross-power spectrum Baseline: TR (03) - BD (08)
Timerange: 00/07:29:21 to 00/07:32:49

Plot file version 193 created 21-JUN-2019 11:54:35

J1222+0413 EP111A 1.UVDATA.1

Freq = 1.4829 GHz, Bw = 16.000 MH Calibrated with CL # 3 and BP # 1 (BP mode 1)

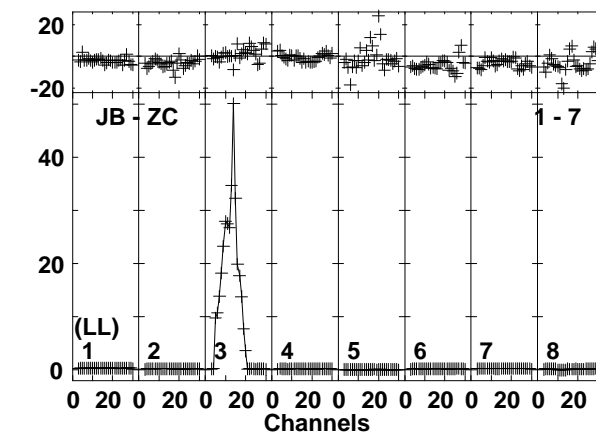
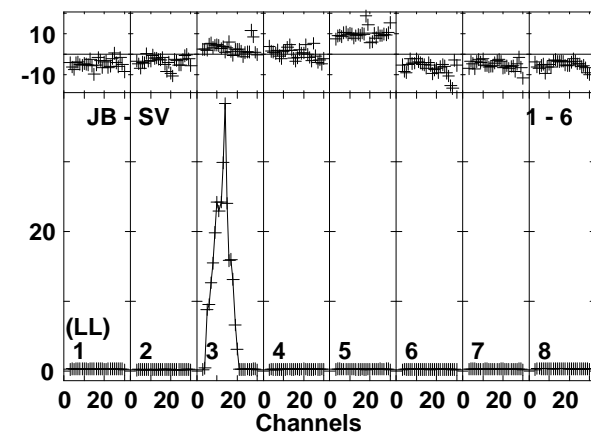
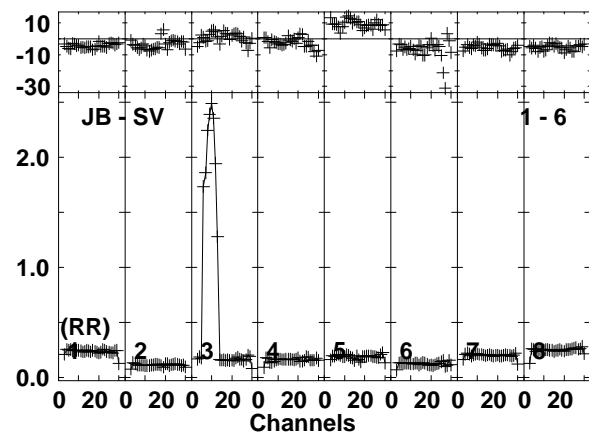
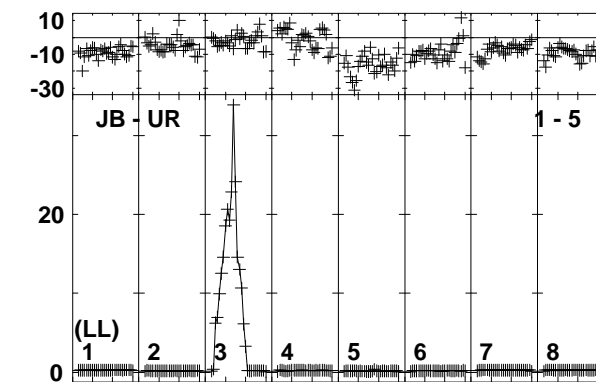
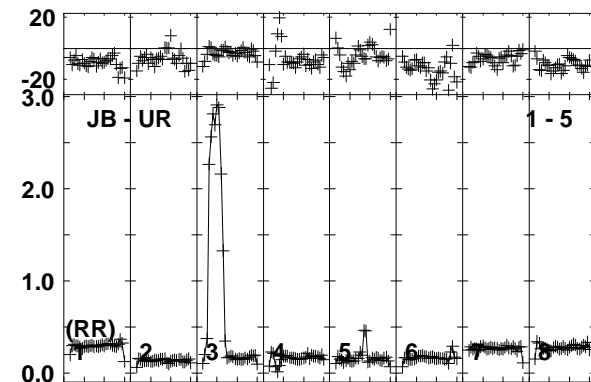
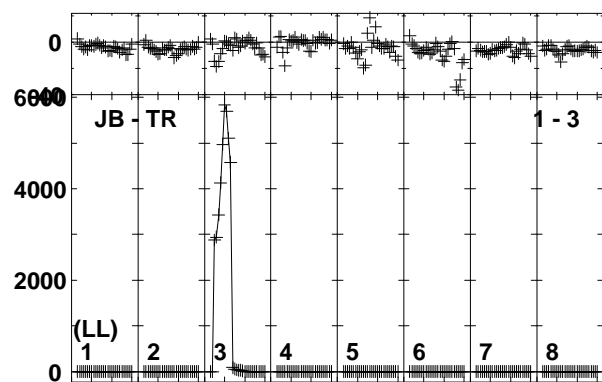
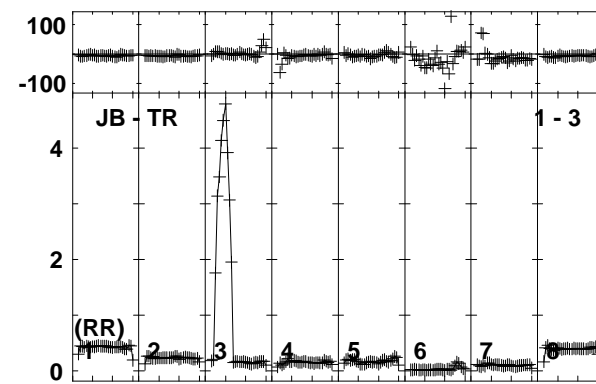
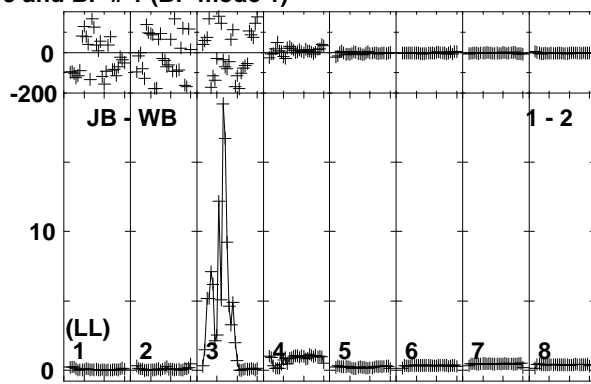
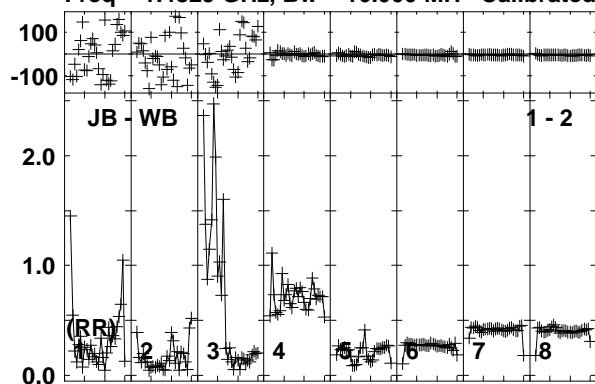

Lower frame: Ampl Jy Top frame: Phas deg
Vector averaged cross-power spectrum Baseline: JB (01) - WB (02)
Timerange: 00/07:33:31 to 00/07:34:59

Plot file version 194 created 21-JUN-2019 11:54:35

J1222+0413 EP111A 1.UVDATA.1

Freq = 1.4829 GHz, Bw = 16.000 MH Calibrated with CL # 3 and BP # 1 (BP mode 1)

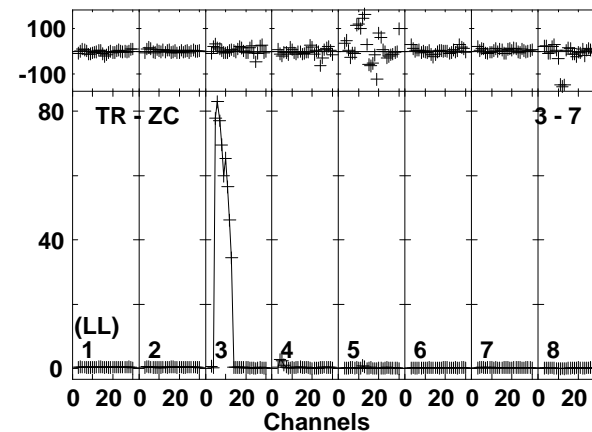
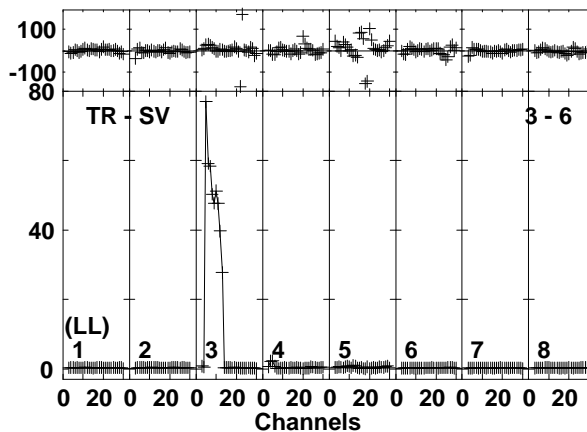
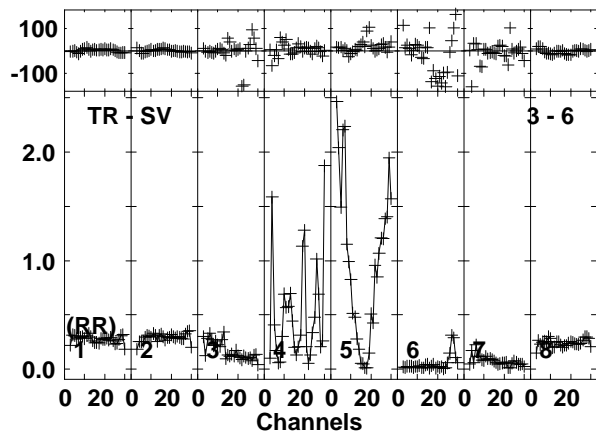
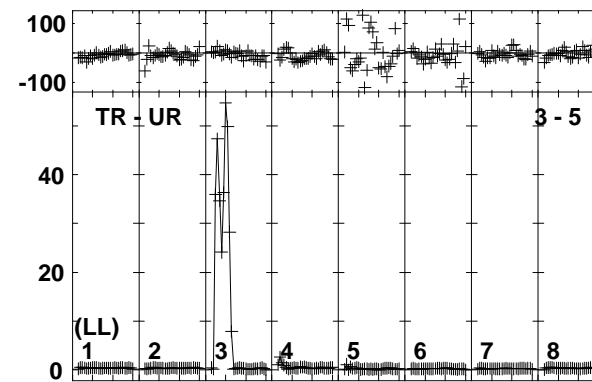
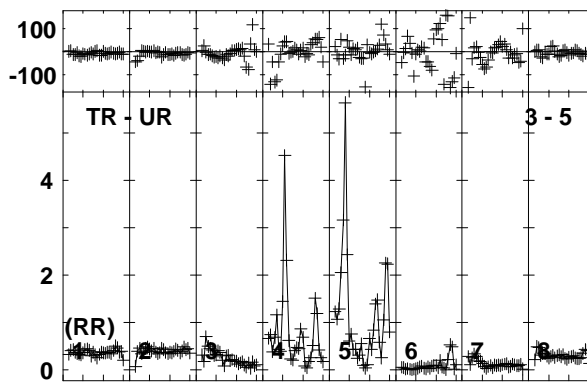
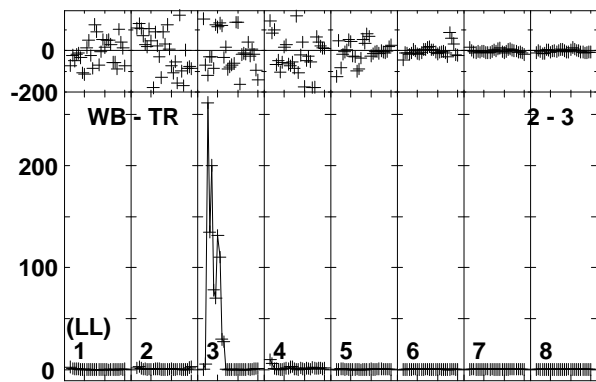
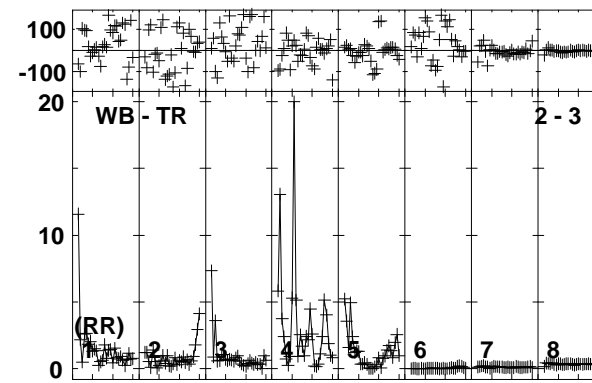
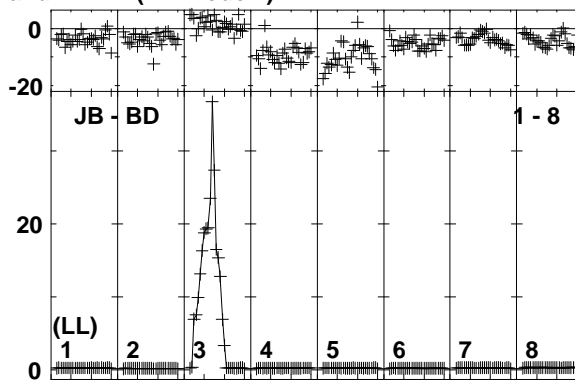
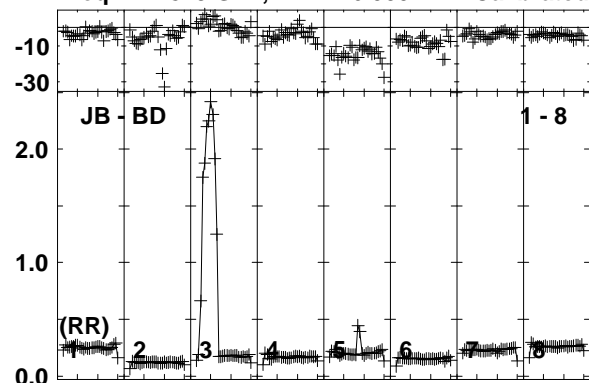

Lower frame: Ampl Jy Top frame: Phas deg
Vector averaged cross-power spectrum Baseline: JB (01) - BD (08)
Timerange: 00/07:33:31 to 00/07:34:59

Plot file version 195 created 21-JUN-2019 11:54:36

J1222+0413 EP111A 1.UVDATA.1

Freq = 1.4829 GHz, Bw = 16.000 MH Calibrated with CL # 3 and BP # 1 (BP mode 1)

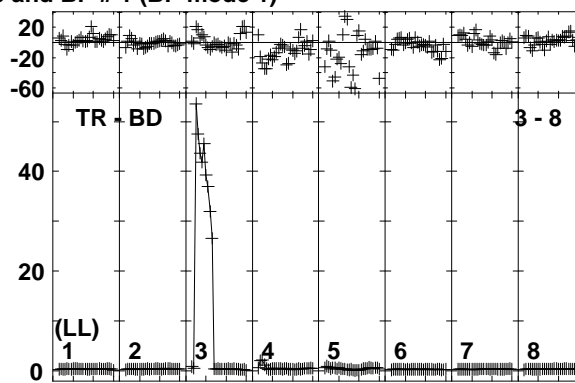
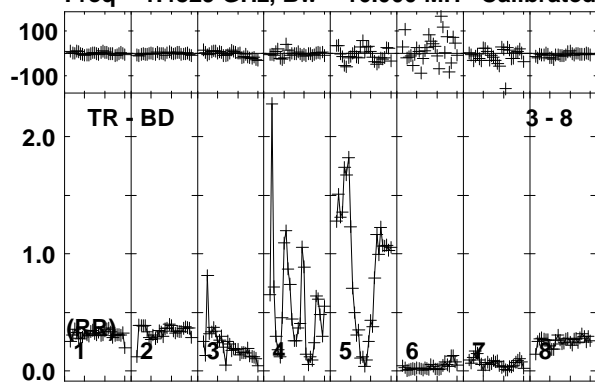

Lower frame: Ampl Jy Top frame: Phas deg
Vector averaged cross-power spectrum Baseline: TR (03) - BD (08)
Timerange: 00/07:33:31 to 00/07:34:59

Plot file version 196 created 21-JUN-2019 11:54:36
 IRAS12112 EP111A 1.UVDATA.1
 Freq = 1.4829 GHz, Bw = 16.000 MH Calibrated with CL # 3 and BP # 1 (BP mode 1)

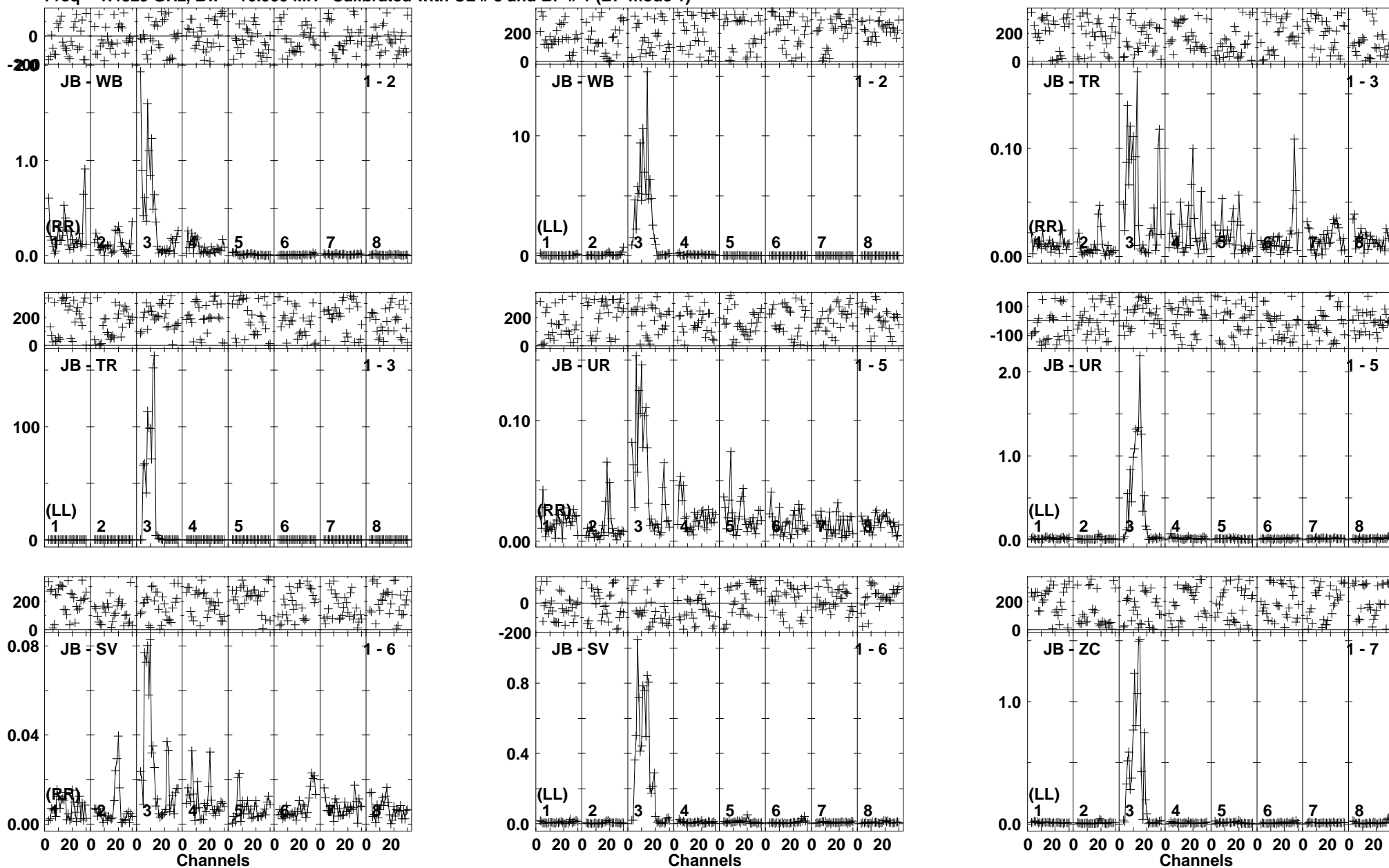

Lower frame: Ampl Jy Top frame: Phas deg
 Vector averaged cross-power spectrum Baseline: JB (01) - WB (02)
 Timerange: 00/07:35:01 to 00/07:38:29

Plot file version 197 created 21-JUN-2019 11:54:36

IRAS12112 EP111A 1.UVDATA.1

Freq = 1.4829 GHz, Bw = 16.000 MH Calibrated with CL # 3 and BP # 1 (BP mode 1)

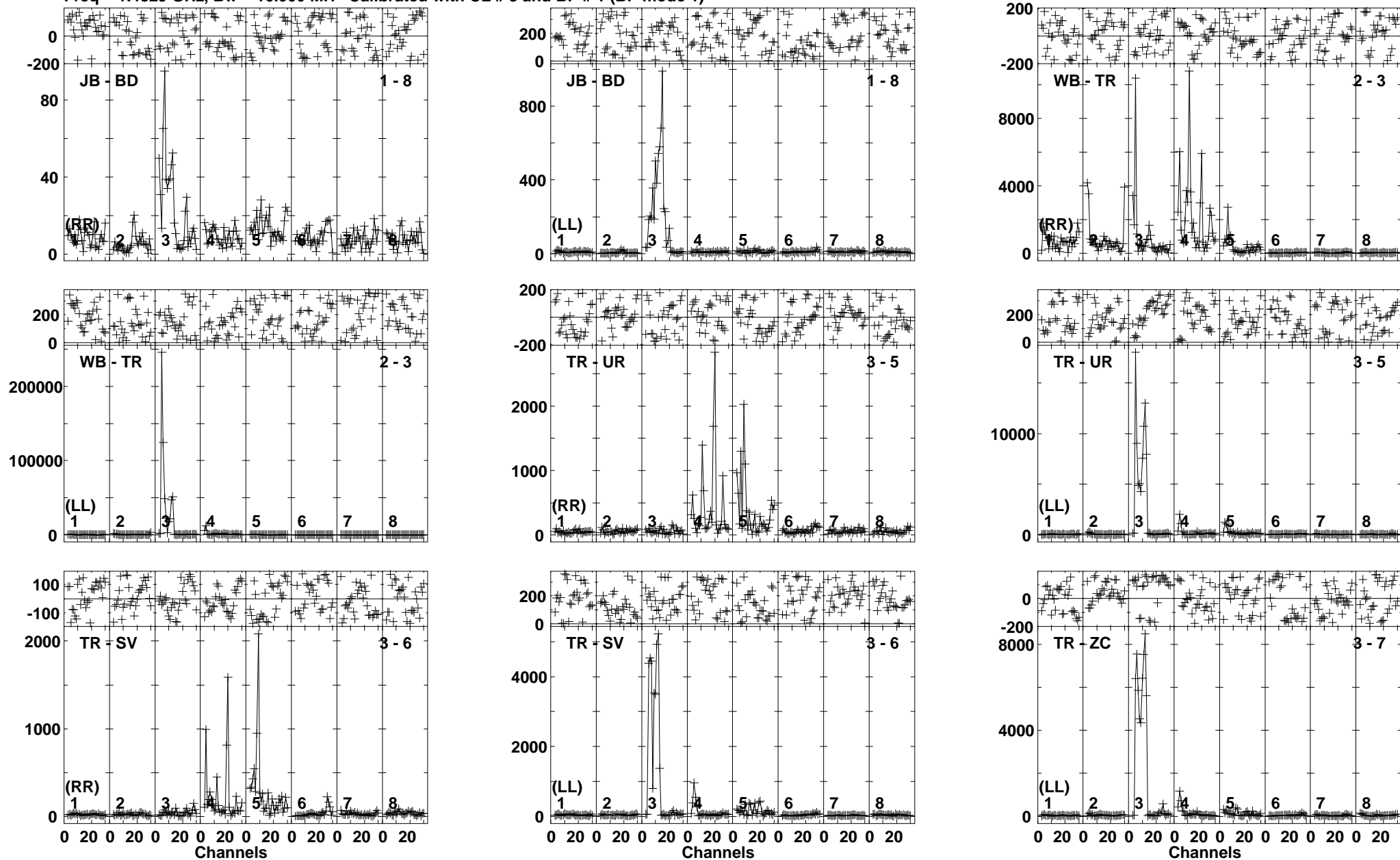

Plot file version 198 created 21-JUN-2019 11:54:37

IRAS12112 EP111A 1.UVDATA.1

Freq = 1.4829 GHz, Bw = 16.000 MH Calibrated with CL # 3 and BP # 1 (BP mode 1)

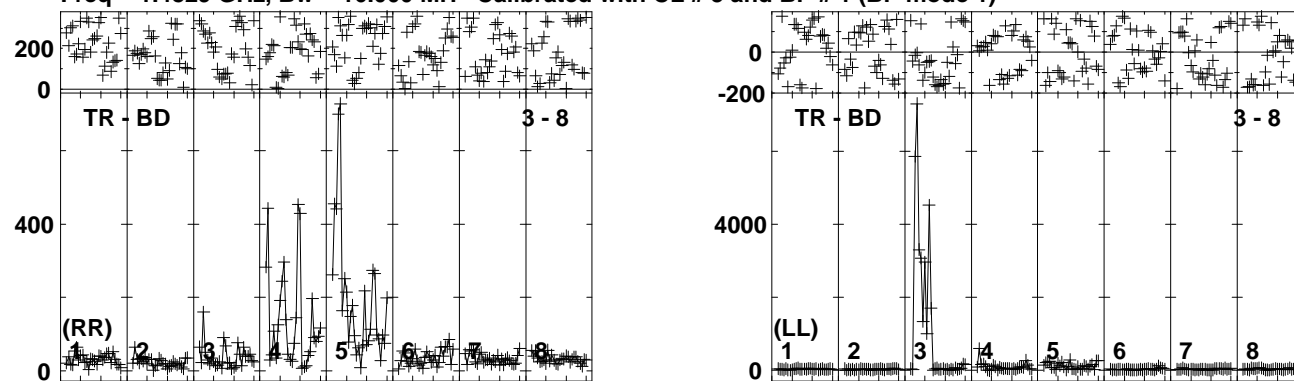

Lower frame: Milli Ampl Jy Top frame: Phas deg
Vector averaged cross-power spectrum Baseline: TR (03) - BD (08)
Timerange: 00/07:35:01 to 00/07:38:29

Plot file version 199 created 21-JUN-2019 11:54:37

J1222+0413 EP111A 1.UVDATA.1

Freq = 1.4829 GHz, Bw = 16.000 MH Calibrated with CL # 3 and BP # 1 (BP mode 1)

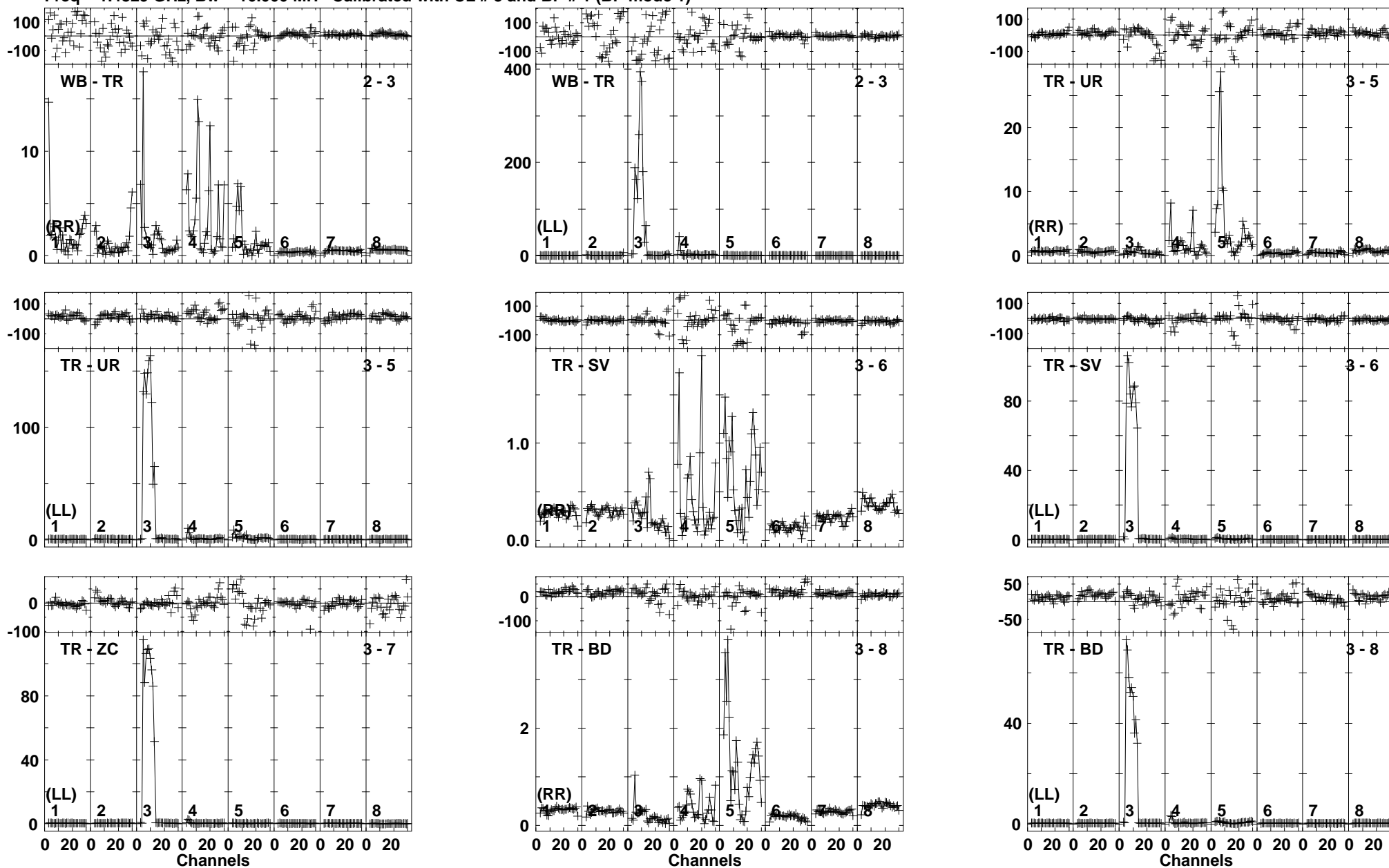

Lower frame: Ampl Jy Top frame: Phas deg
Vector averaged cross-power spectrum Baseline: WB (02) - TR (03)
Timerange: 00/07:38:31 to 00/07:39:59

Plot file version 200 created 21-JUN-2019 11:54:38

IRAS12112 EP111A 1.UVDATA.1

Freq = 1.4829 GHz, Bw = 16.000 MH Calibrated with CL # 3 and BP # 1 (BP mode 1)

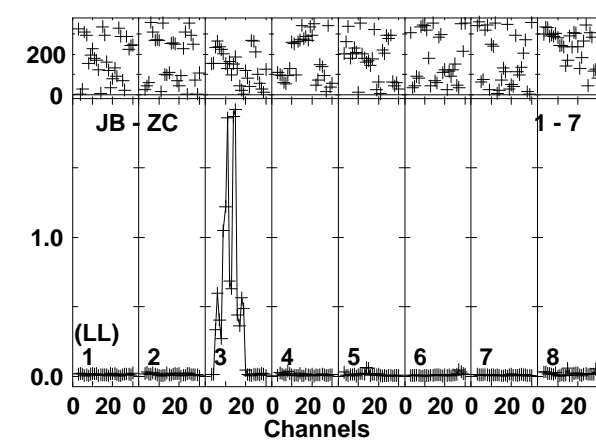
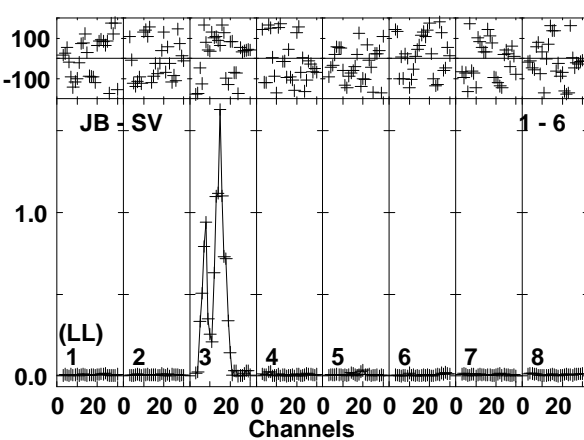
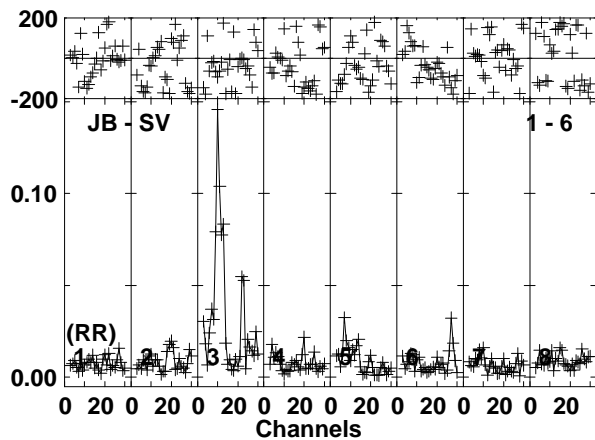
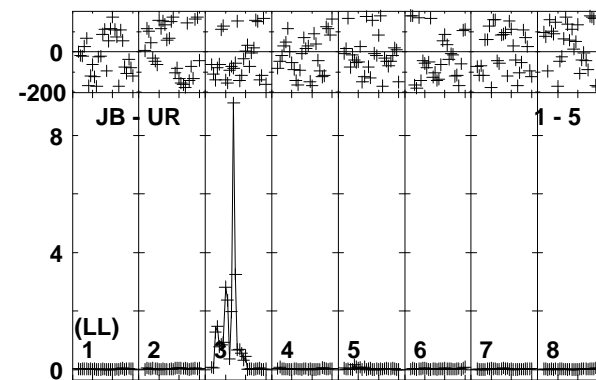
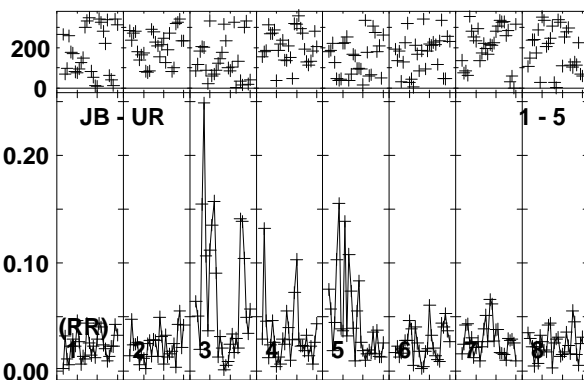
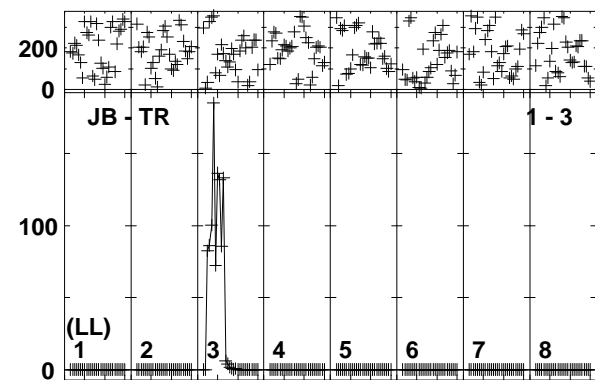
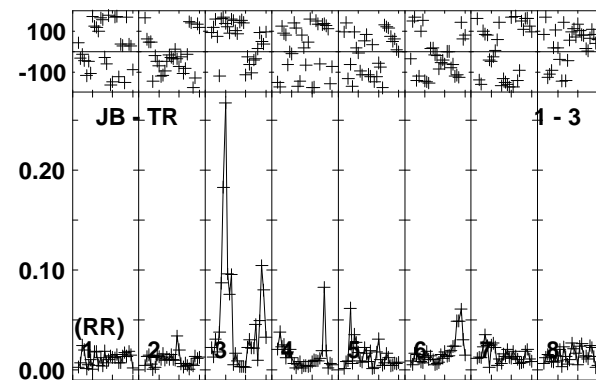
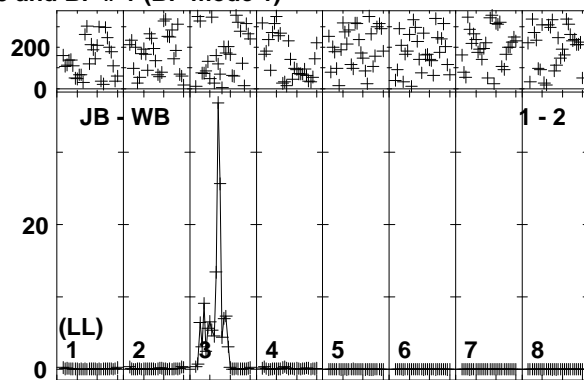
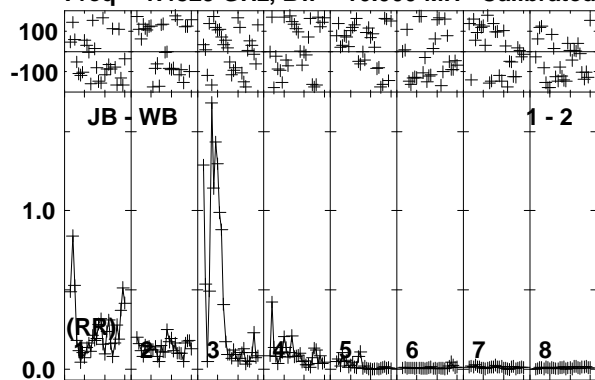

Lower frame: Ampl Jy Top frame: Phas deg
Vector averaged cross-power spectrum Baseline: JB (01) - WB (02)
Timerange: 00/07:40:01 to 00/07:43:29

Plot file version 201 created 21-JUN-2019 11:54:38

IRAS12112 EP111A 1.UVDATA.1

Freq = 1.4829 GHz, Bw = 16.000 MH Calibrated with CL # 3 and BP # 1 (BP mode 1)

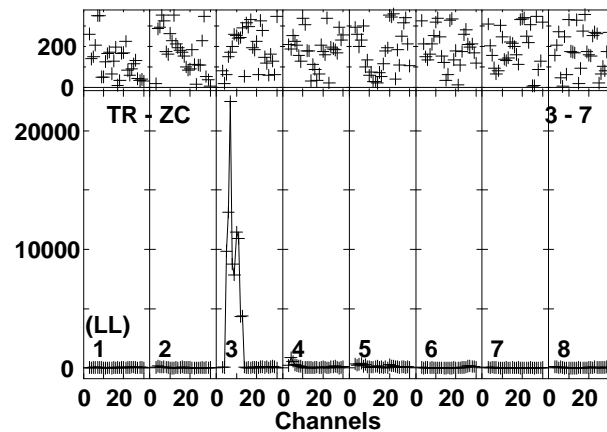
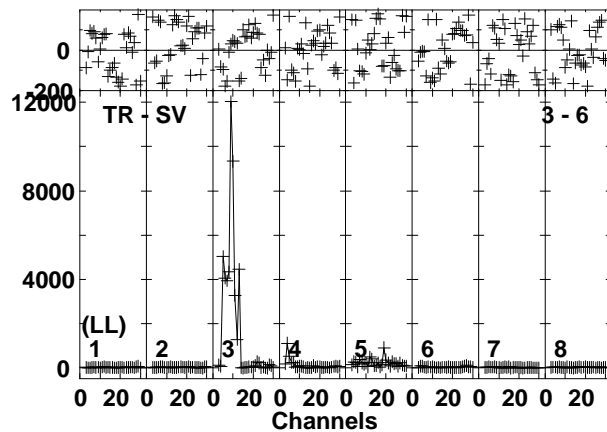
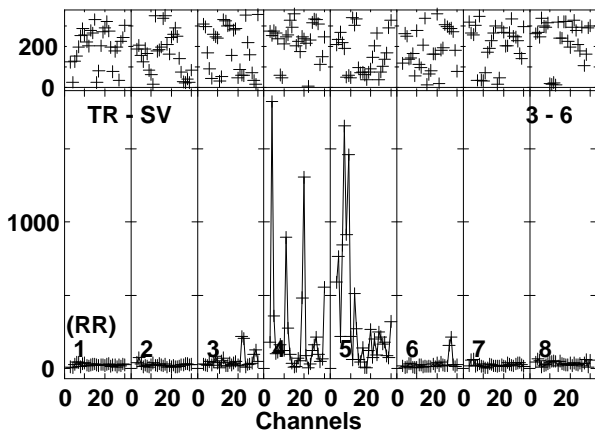
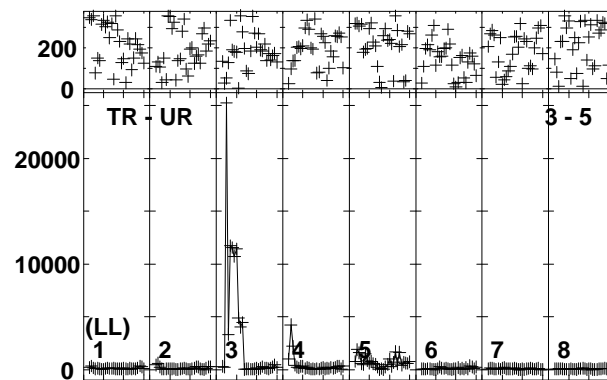
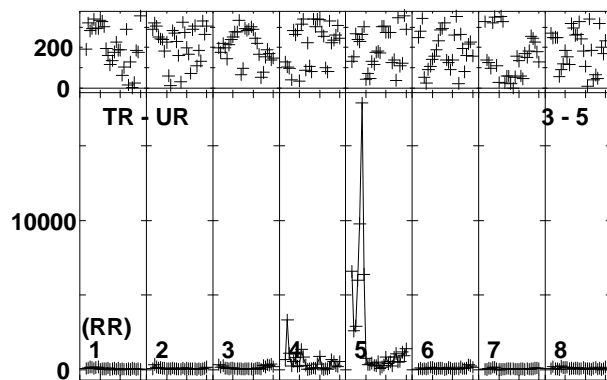
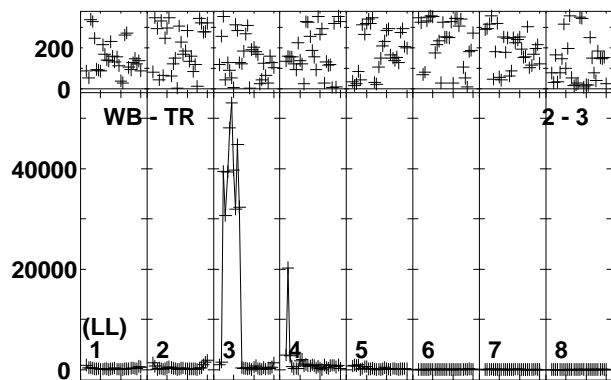
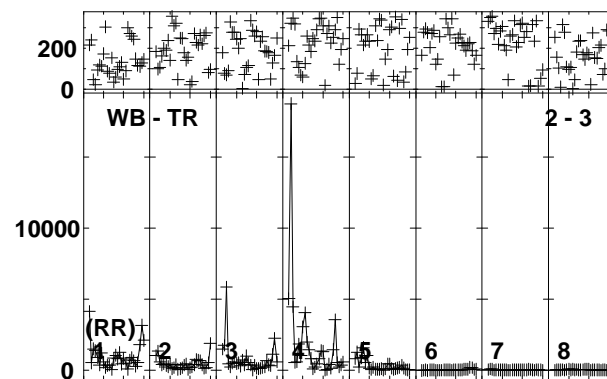
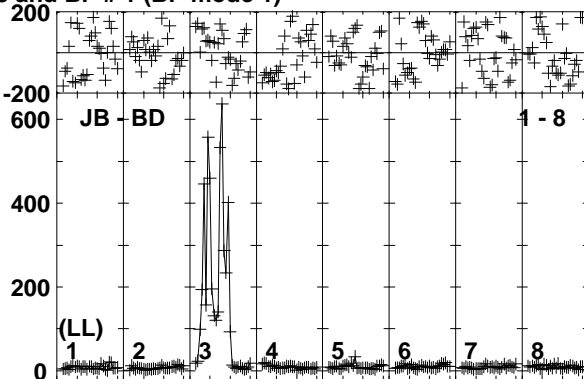
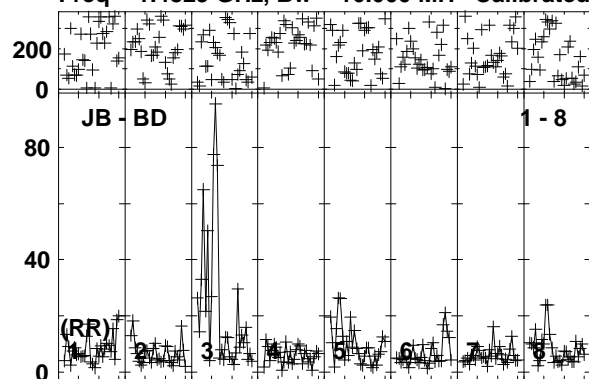

Lower frame: Milli Ampl Jy Top frame: Phas deg
Vector averaged cross-power spectrum Baseline: JB (01) - BD (08)
Timerange: 00/07:40:01 to 00/07:43:29

Plot file version 202 created 21-JUN-2019 11:54:39

IRAS12112 EP111A 1.UVDATA.1

Freq = 1.4829 GHz, Bw = 16.000 MH Calibrated with CL # 3 and BP # 1 (BP mode 1)

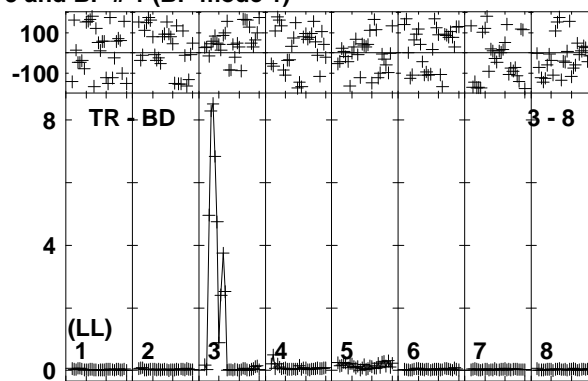
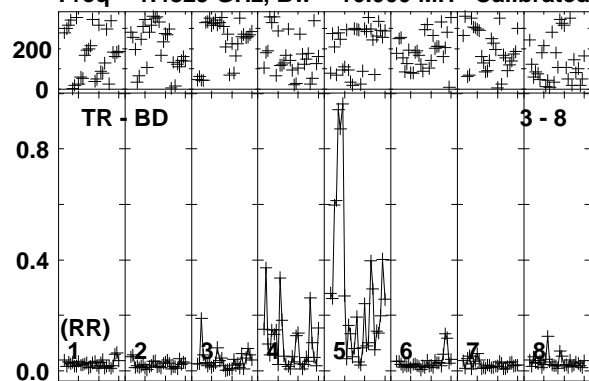

Lower frame: Ampl Jy Top frame: Phas deg
Vector averaged cross-power spectrum Baseline: TR (03) - BD (08)
Timerange: 00/07:40:01 to 00/07:43:29

Plot file version 203 created 21-JUN-2019 11:54:39

J1222+0413 EP111A 1.UVDATA.1

Freq = 1.4829 GHz, Bw = 16.000 MH Calibrated with CL # 3 and BP # 1 (BP mode 1)

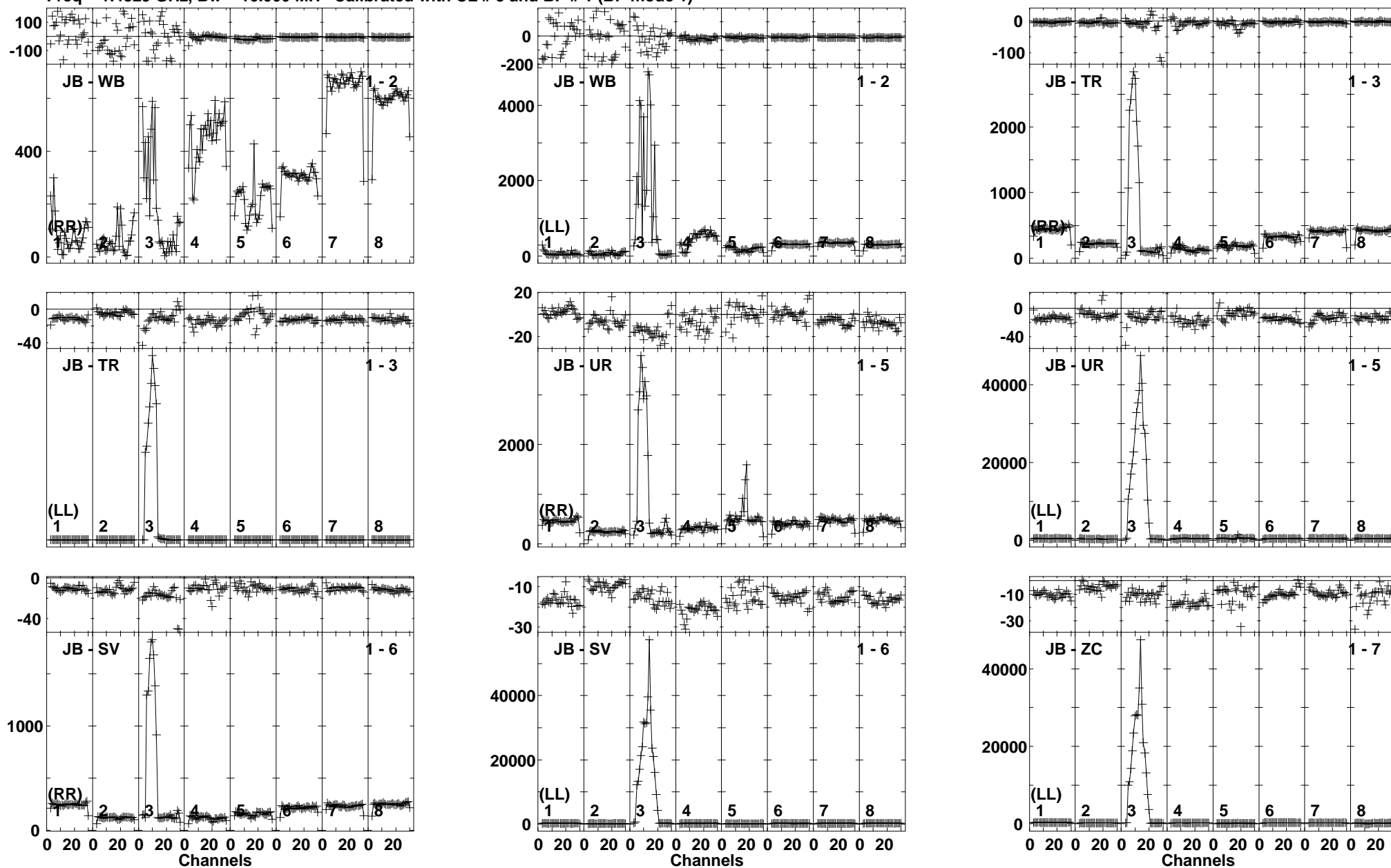

Lower frame: Milli Ampl Jy Top frame: Phas deg
Vector averaged cross-power spectrum Baseline: JB (01) - WB (02)
Timerange: 00/07:44:11 to 00/07:45:39

Plot file version 204 created 21-JUN-2019 11:54:39

J1222+0413 EP111A 1.UVDATA.1

Freq = 1.4829 GHz, Bw = 16.000 MH Calibrated with CL # 3 and BP # 1 (BP mode 1)

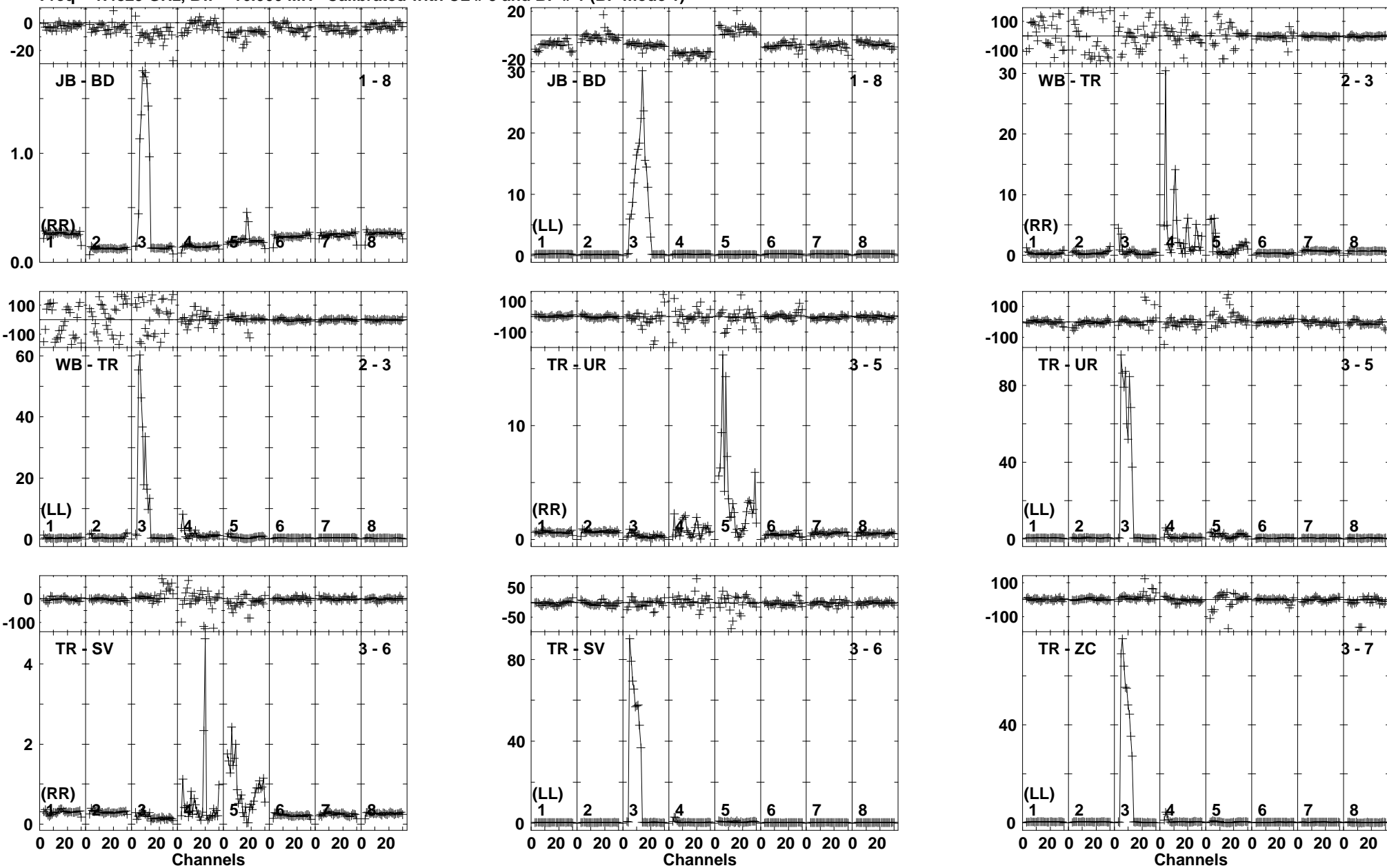

Lower frame: Ampl Jy Top frame: Phas deg
Vector averaged cross-power spectrum Baseline: JB (01) - BD (08)
Timerange: 00/07:44:11 to 00/07:45:39

Plot file version 205 created 21-JUN-2019 11:54:40

J1222+0413 EP111A 1.UVDATA.1

Freq = 1.4829 GHz, Bw = 16.000 MH Calibrated with CL # 3 and BP # 1 (BP mode 1)

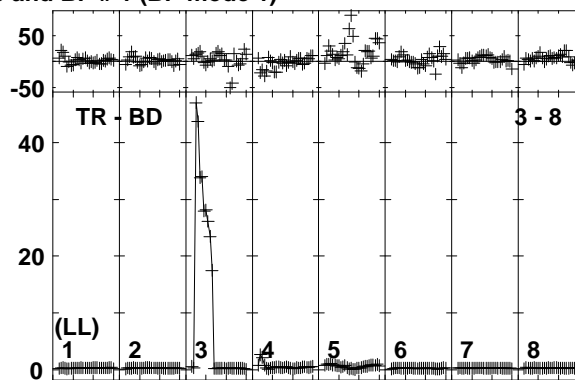
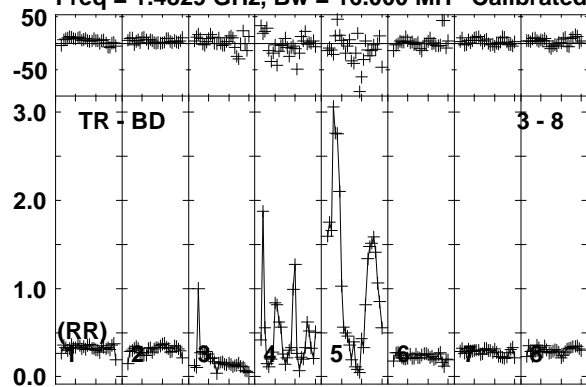

Lower frame: Ampl Jy Top frame: Phas deg
Vector averaged cross-power spectrum Baseline: TR (03) - BD (08)
Timerange: 00/07:44:11 to 00/07:45:39

Plot file version 206 created 21-JUN-2019 11:54:40

IRAS12112 EP111A 1.UVDATA.1

Freq = 1.4829 GHz, Bw = 16.000 MH Calibrated with CL # 3 and BP # 1 (BP mode 1)

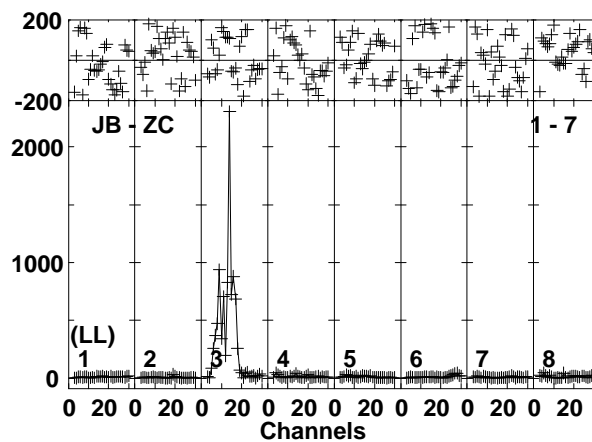
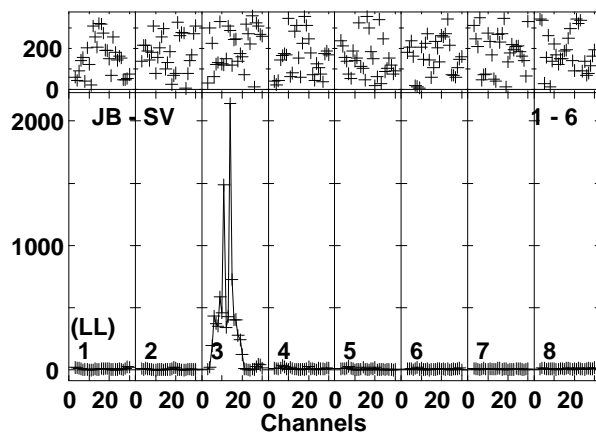
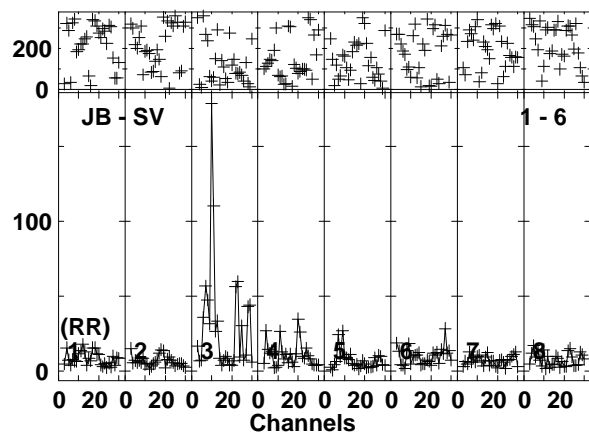
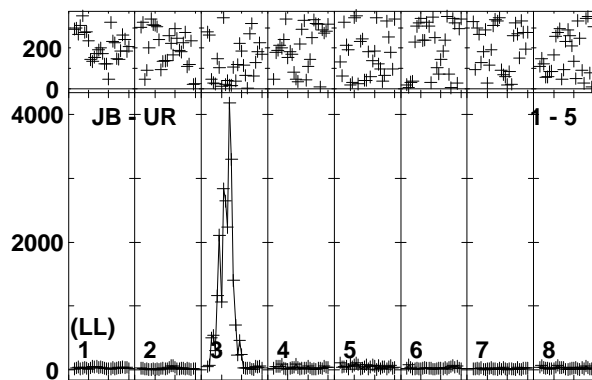
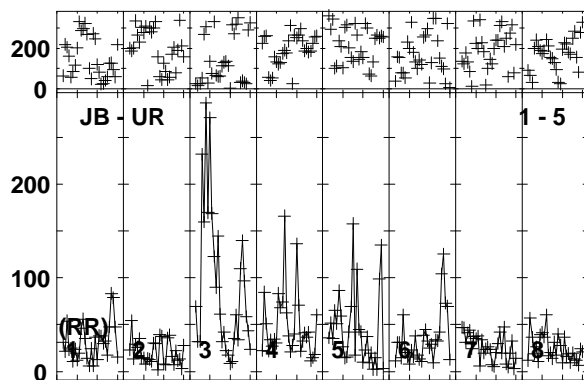
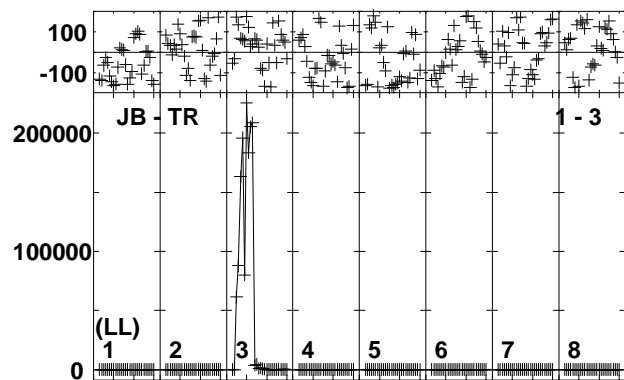
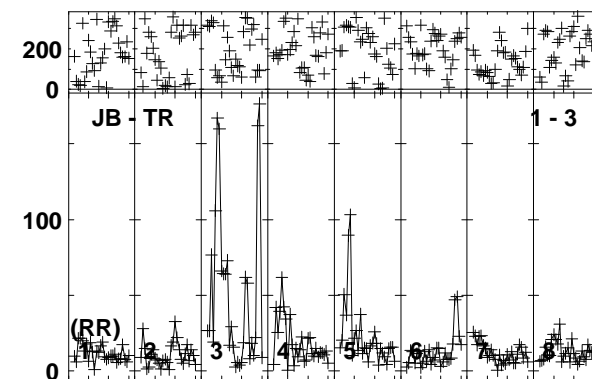
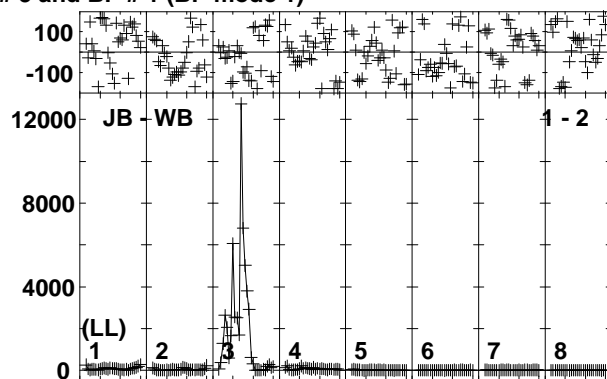
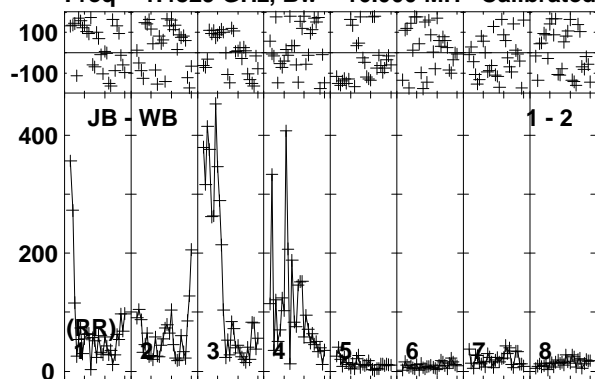

Lower frame: Milli Ampl Jy Top frame: Phas deg
Vector averaged cross-power spectrum Baseline: JB (01) - WB (02)
Timerange: 00/07:45:41 to 00/07:49:09

Plot file version 207 created 21-JUN-2019 11:54:40

IRAS12112 EP111A 1.UVDATA.1

Freq = 1.4829 GHz, Bw = 16.000 MH Calibrated with CL # 3 and BP # 1 (BP mode 1)

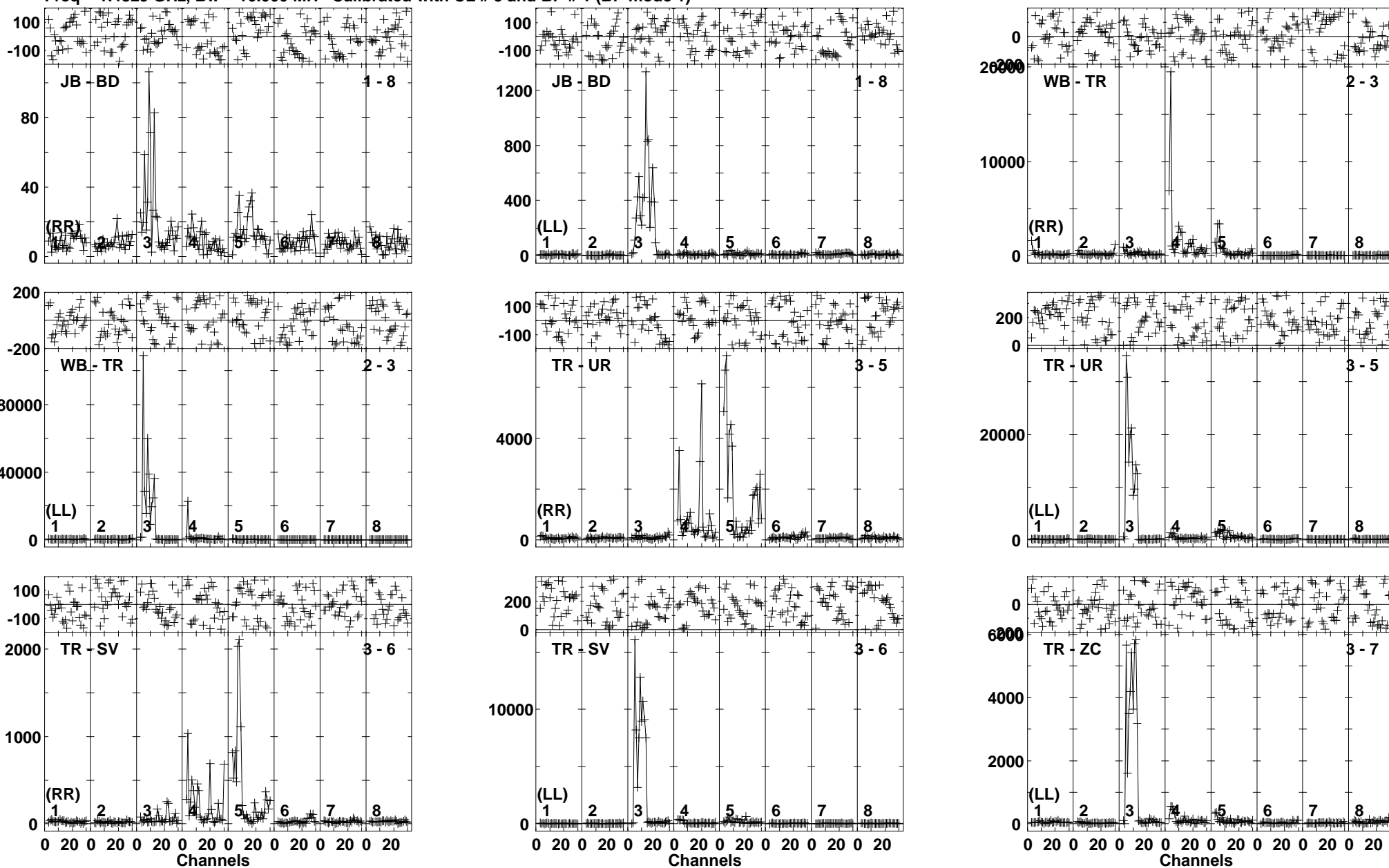

Lower frame: Milli Ampl Jy Top frame: Phas deg
Vector averaged cross-power spectrum Baseline: JB (01) - BD (08)
Timerange: 00/07:45:41 to 00/07:49:09

Plot file version 208 created 21-JUN-2019 11:54:41

IRAS12112 EP111A 1.UVDATA.1

Freq = 1.4829 GHz, Bw = 16.000 MH Calibrated with CL # 3 and BP # 1 (BP mode 1)

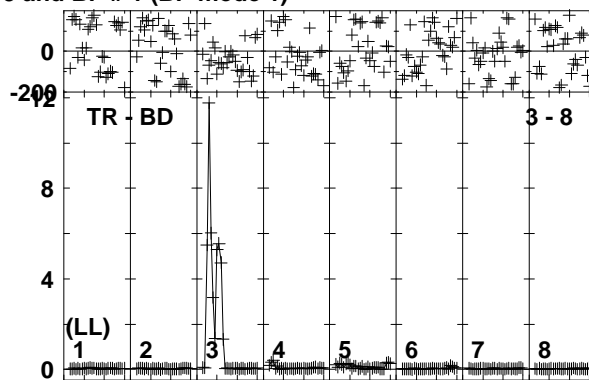
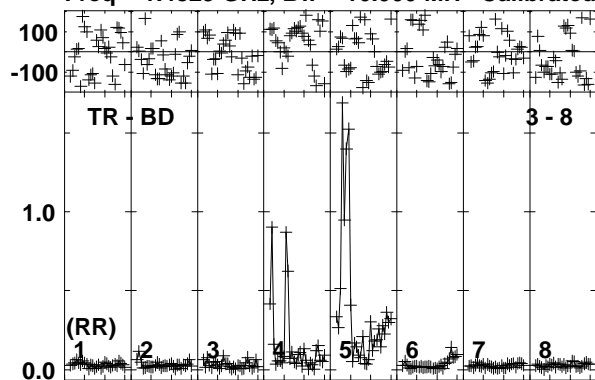

Lower frame: Ampl Jy Top frame: Phas deg
Vector averaged cross-power spectrum Baseline: TR (03) - BD (08)
Timerange: 00/07:45:41 to 00/07:49:09

Plot file version 209 created 21-JUN-2019 11:54:41

J1222+0413 EP111A 1.UVDATA.1

Freq = 1.4829 GHz, Bw = 16.000 MH Calibrated with CL # 3 and BP # 1 (BP mode 1)

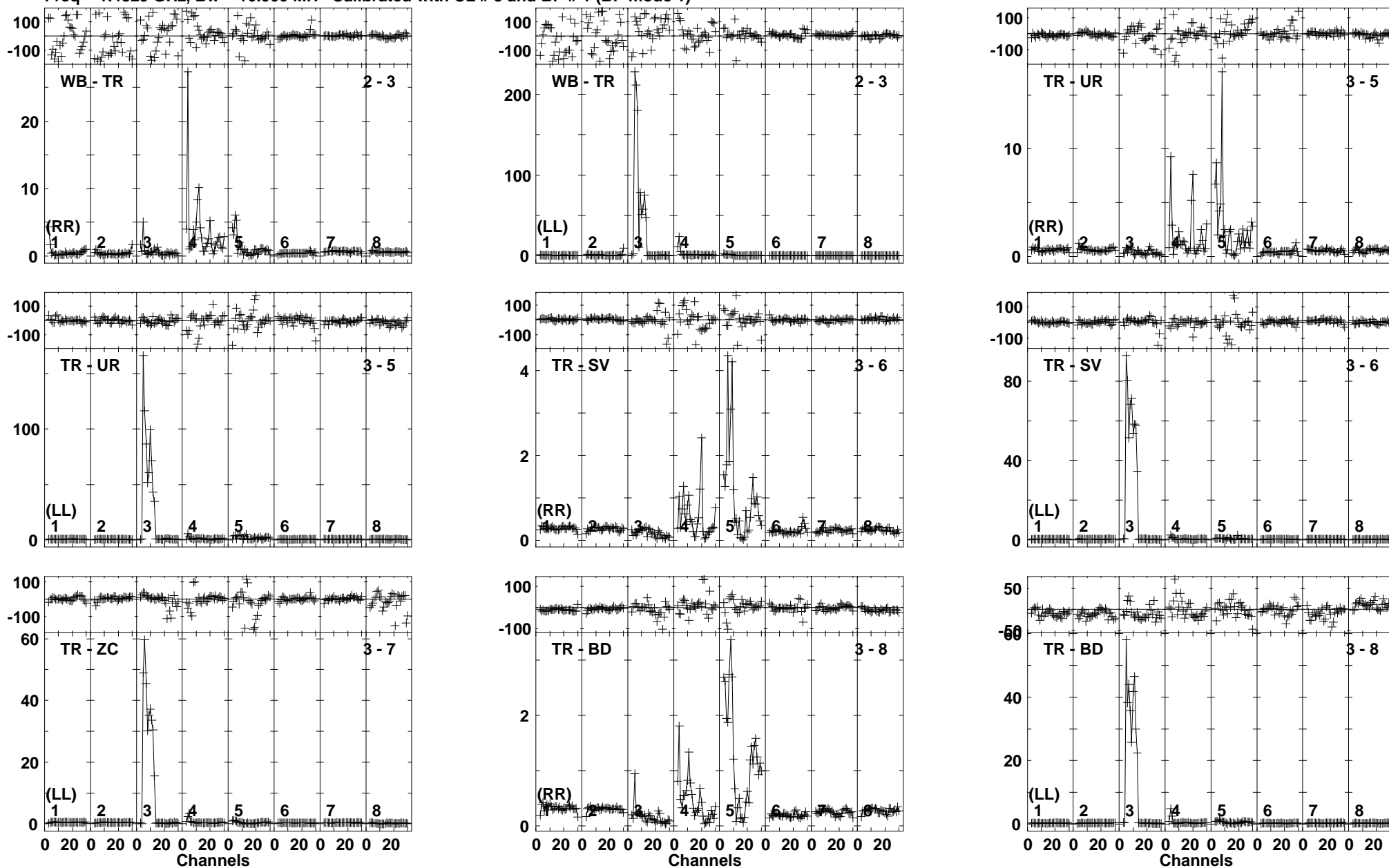

Lower frame: Ampl Jy Top frame: Phas deg
Vector averaged cross-power spectrum Baseline: WB (02) - TR (03)
Timerange: 00/07:49:11 to 00/07:50:39

Plot file version 210 created 21-JUN-2019 11:54:42

IRAS12112 EP111A 1.UVDATA.1

Freq = 1.4829 GHz, Bw = 16.000 MH Calibrated with CL # 3 and BP # 1 (BP mode 1)

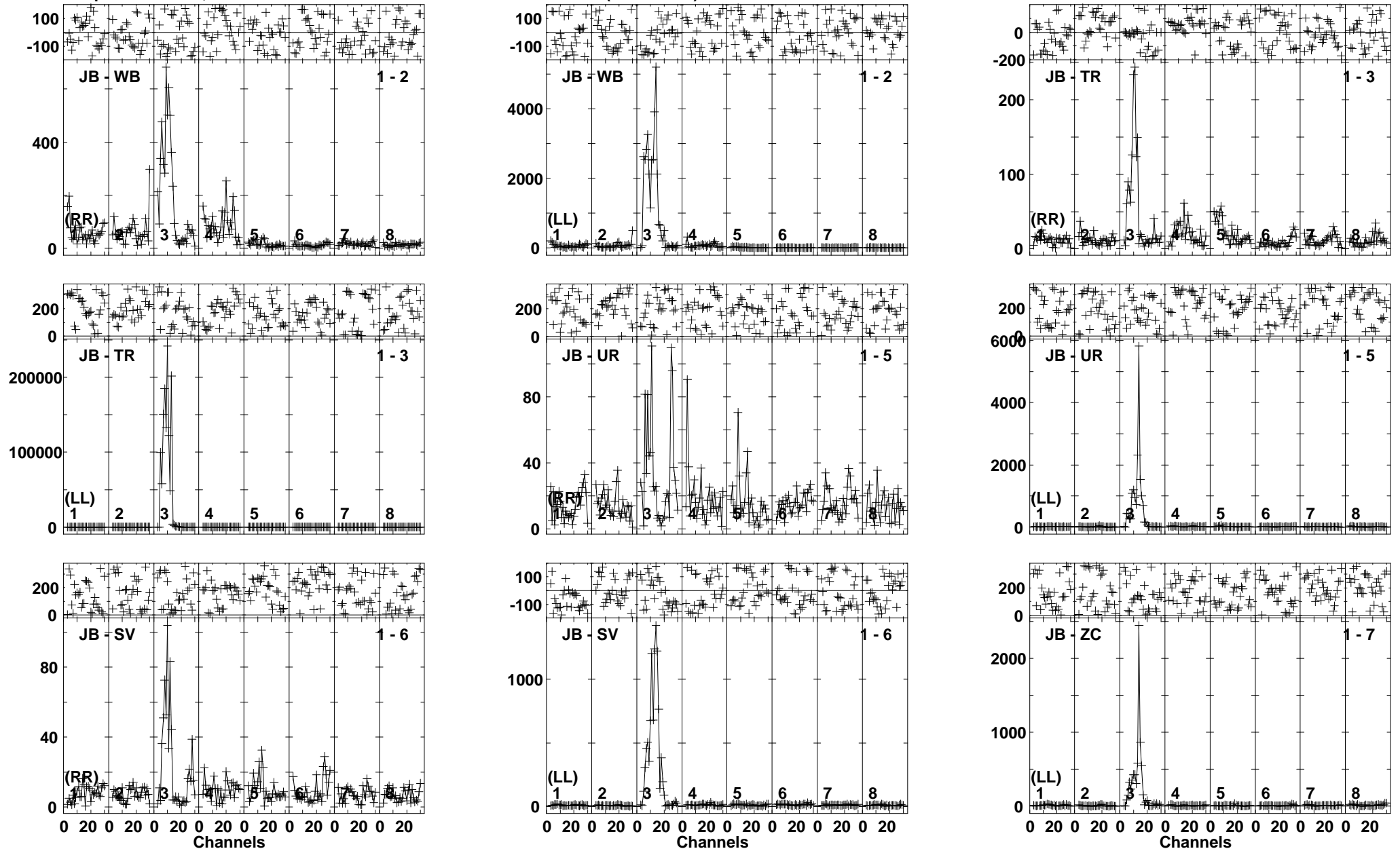

Lower frame: Milli Ampl Jy Top frame: Phas deg
Vector averaged cross-power spectrum Baseline: JB (01) - WB (02)
Timerange: 00/07:50:41 to 00/07:54:09

Plot file version 211 created 21-JUN-2019 11:54:42

IRAS12112 EP111A 1.UVDATA.1

Freq = 1.4829 GHz, Bw = 16.000 MH Calibrated with CL # 3 and BP # 1 (BP mode 1)

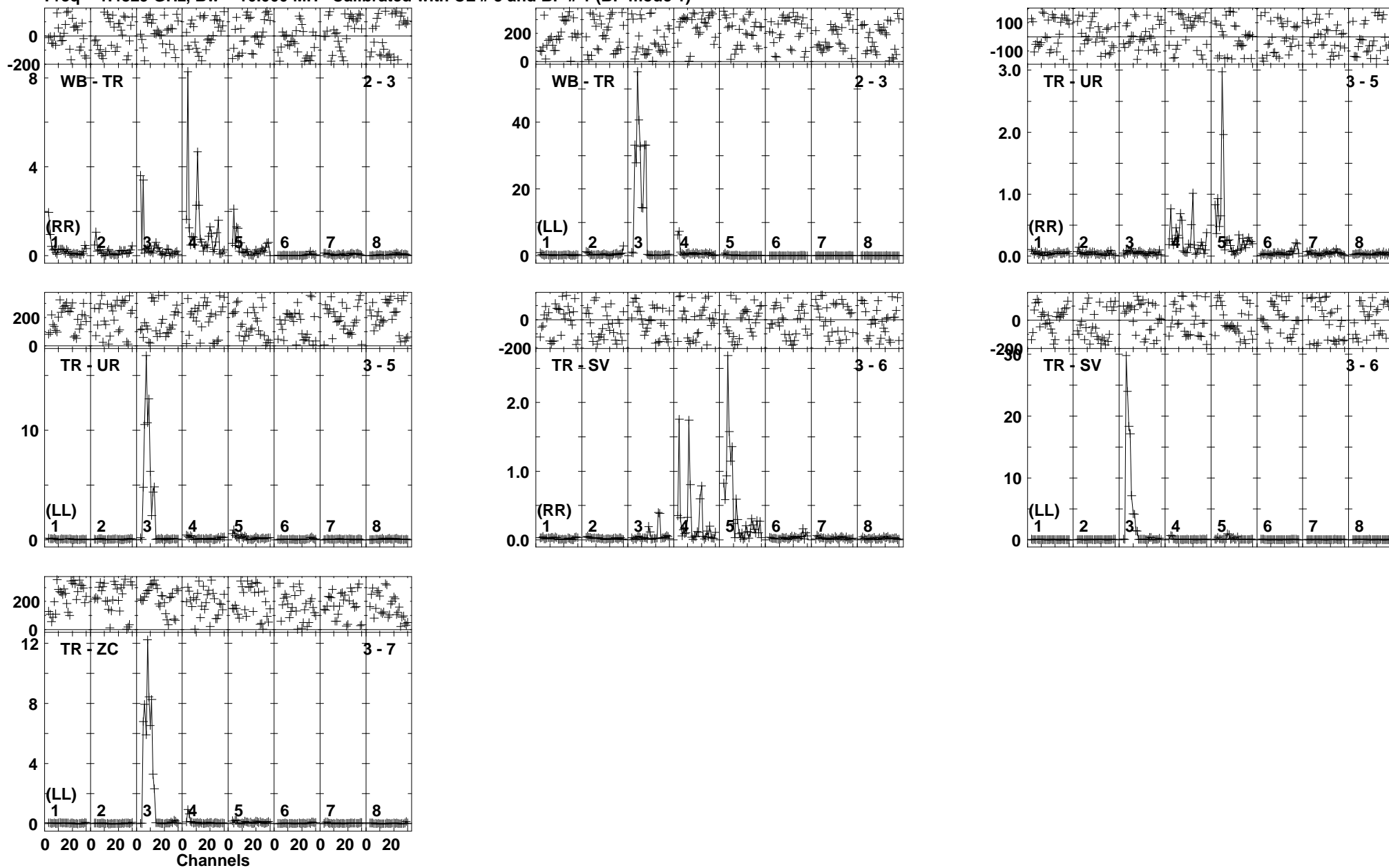

Lower frame: Ampl Jy Top frame: Phas deg
Vector averaged cross-power spectrum Baseline: WB (02) - TR (03)
Timerange: 00/07:50:41 to 00/07:54:09

Plot file version 212 created 21-JUN-2019 11:54:43
 J1222+0413 EP111A 1.UVDATA.1
 Freq = 1.4829 GHz, Bw = 16.000 MH Calibrated with CL # 3 and BP # 1 (BP mode 1)

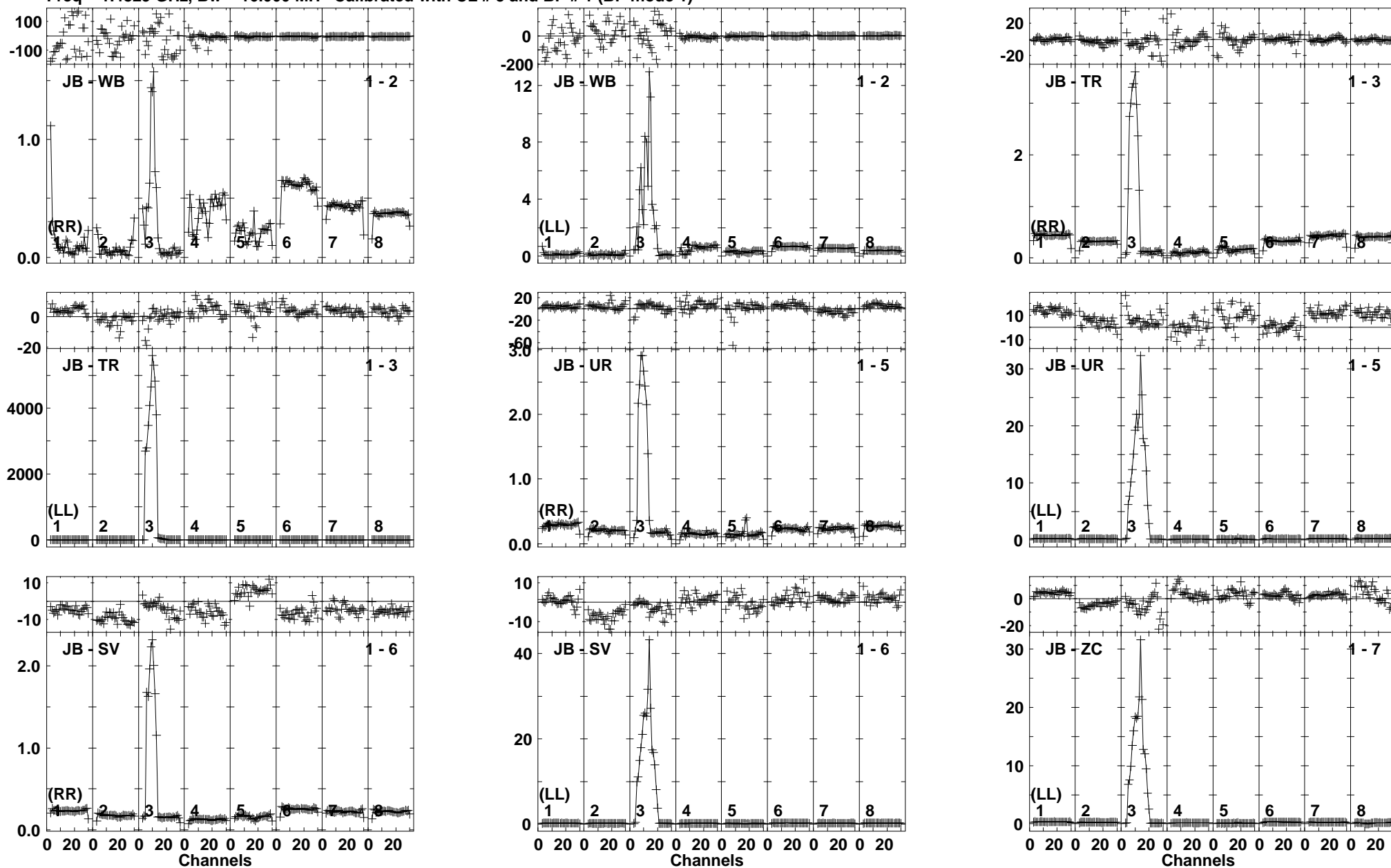

Lower frame: Ampl Jy Top frame: Phas deg
 Vector averaged cross-power spectrum Baseline: JB (01) - WB (02)
 Timerange: 00/07:54:51 to 00/07:56:19

Plot file version 213 created 21-JUN-2019 11:54:43

J1222+0413 EP111A 1.UVDATA.1

Freq = 1.4829 GHz, Bw = 16.000 MH Calibrated with CL # 3 and BP # 1 (BP mode 1)

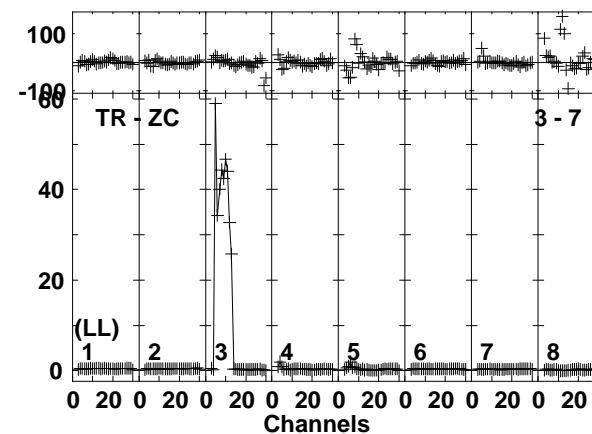
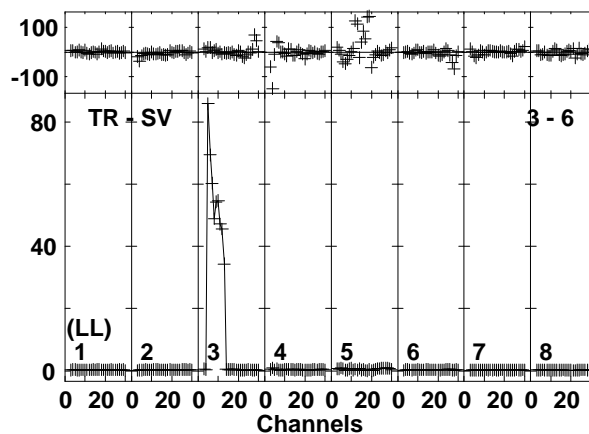
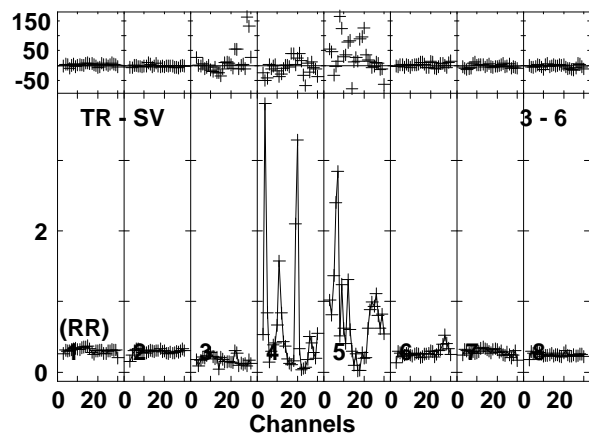
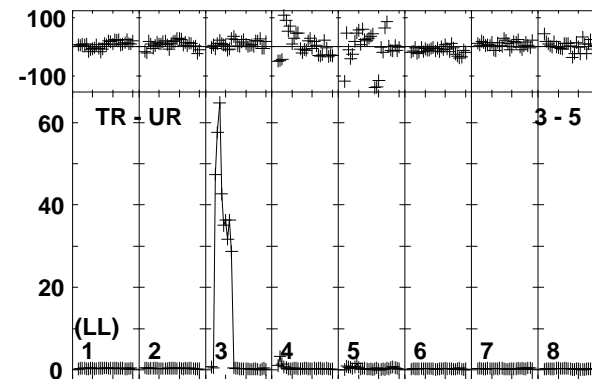
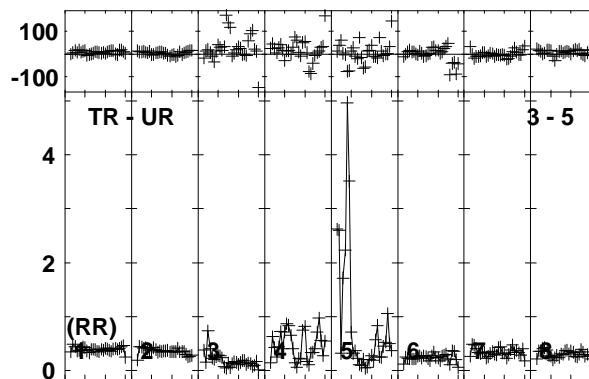
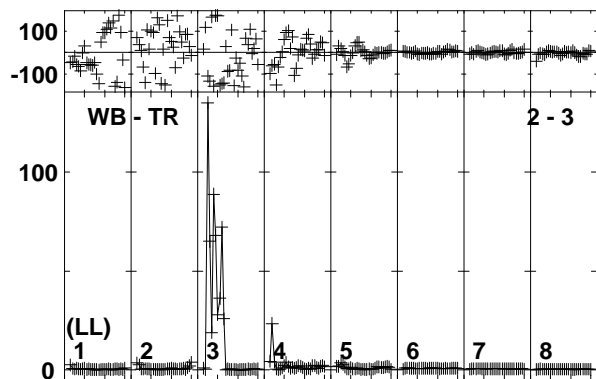
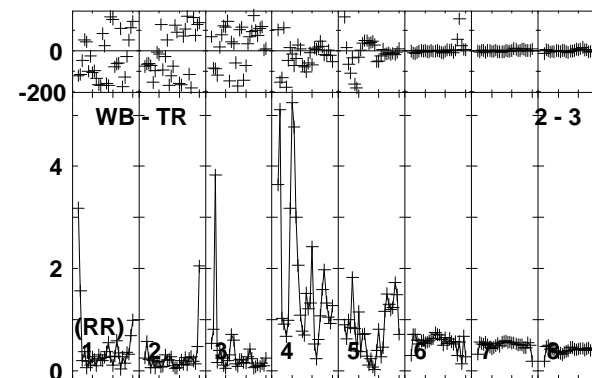
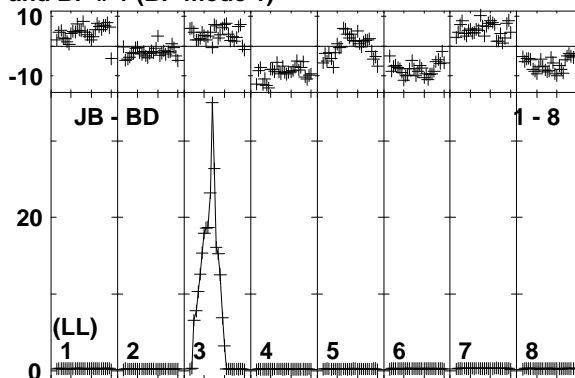
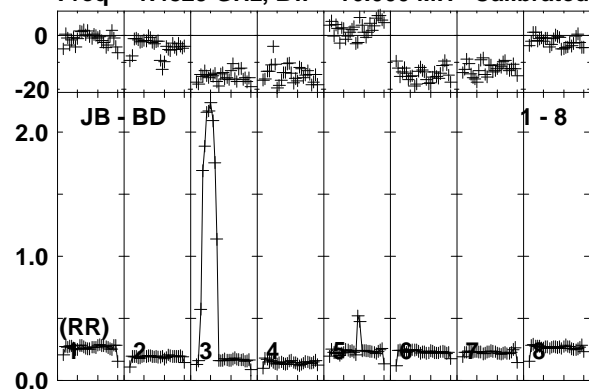

Lower frame: Ampl Jy Top frame: Phas deg
Vector averaged cross-power spectrum Baseline: JB (01) - BD (08)
Timerange: 00/07:54:51 to 00/07:56:19

Plot file version 214 created 21-JUN-2019 11:54:43

J1222+0413 EP111A 1.UVDATA.1

Freq = 1.4829 GHz, Bw = 16.000 MH Calibrated with CL # 3 and BP # 1 (BP mode 1)

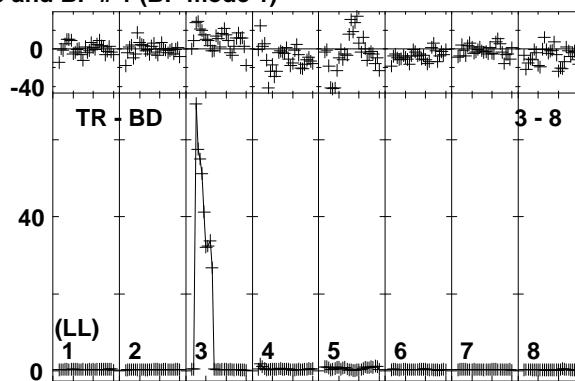
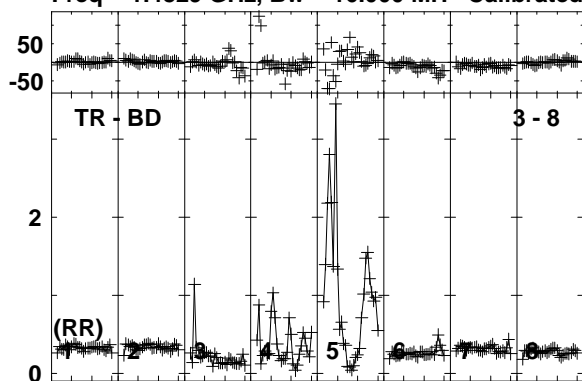

Lower frame: Ampl Jy Top frame: Phas deg
Vector averaged cross-power spectrum Baseline: TR (03) - BD (08)
Timerange: 00/07:54:51 to 00/07:56:19

Plot file version 215 created 21-JUN-2019 11:54:44

J1152-0841 EP111A 1.UVDATA.1

Freq = 1.4829 GHz, Bw = 16.000 MH Calibrated with CL # 3 and BP # 1 (BP mode 1)

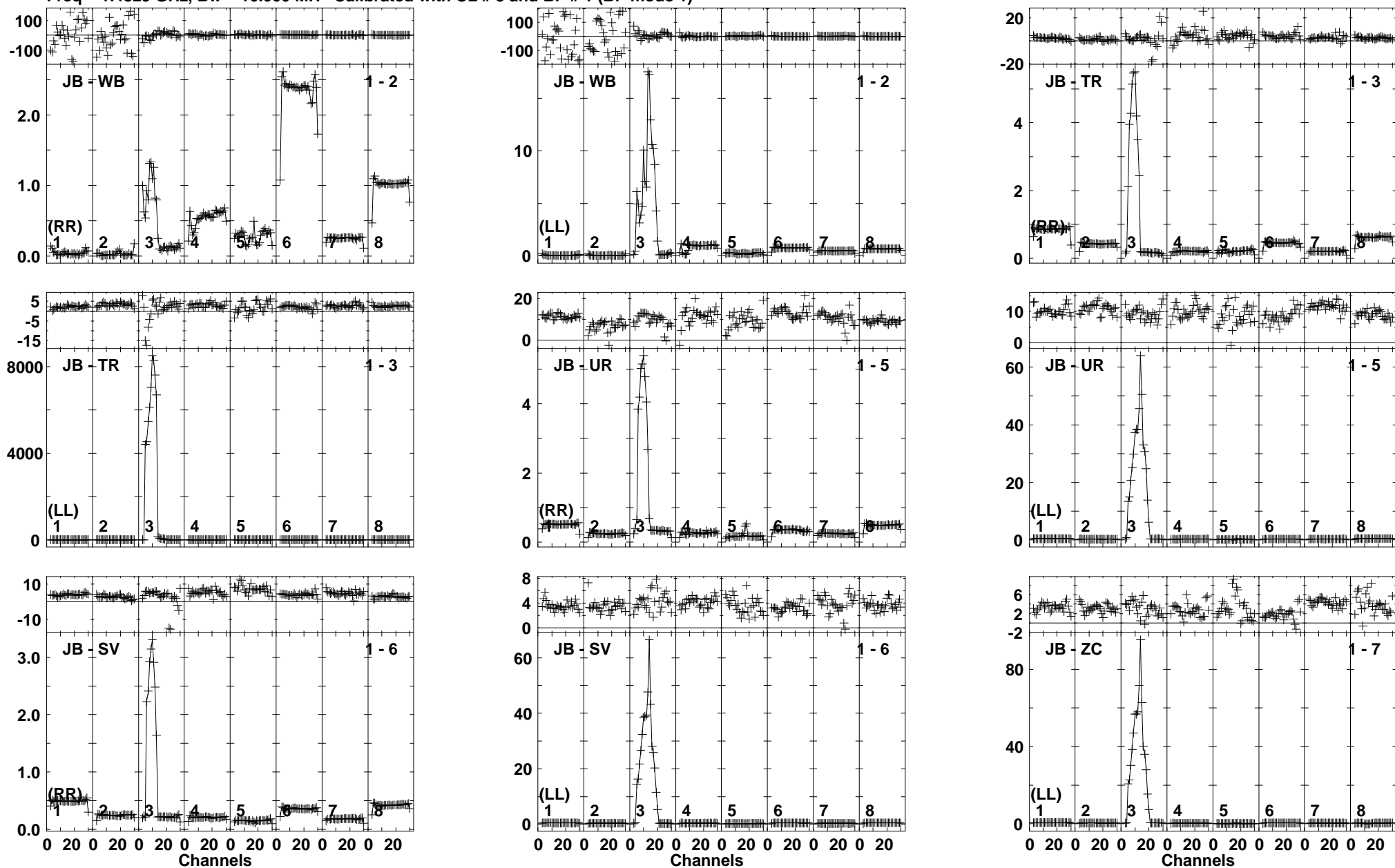

Lower frame: Ampl Jy Top frame: Phas deg
Vector averaged cross-power spectrum Baseline: JB (01) - WB (02)
Timerange: 00/07:58:01 to 00/08:01:49

Plot file version 216 created 21-JUN-2019 11:54:44

J1152-0841 EP111A 1.UVDATA.1

Freq = 1.4829 GHz, Bw = 16.000 MH Calibrated with CL # 3 and BP # 1 (BP mode 1)

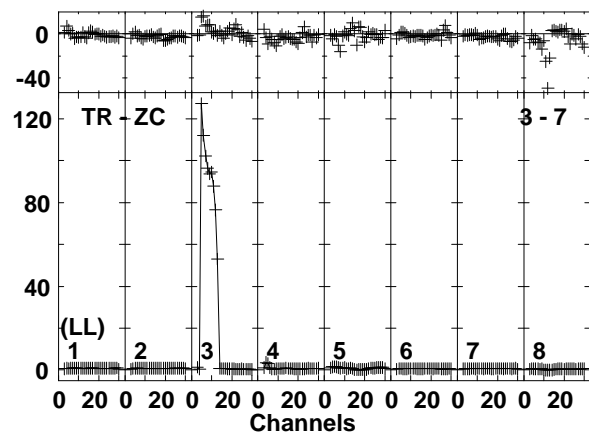
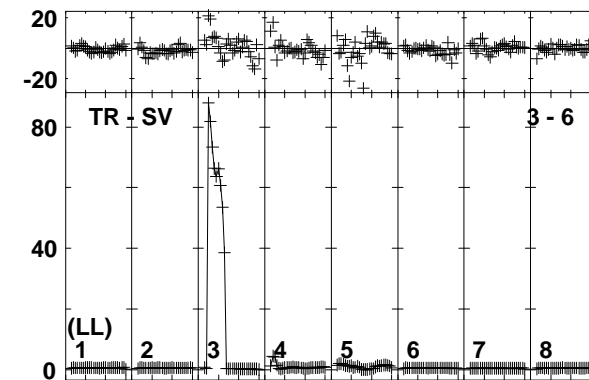
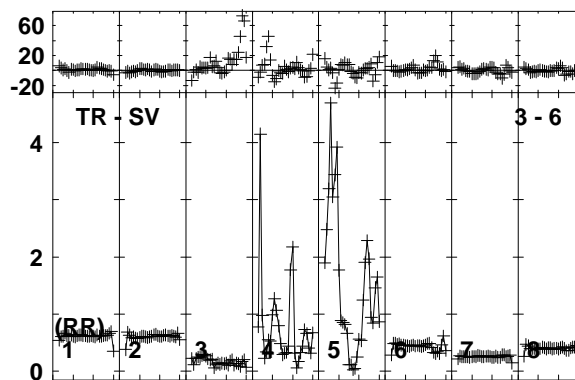
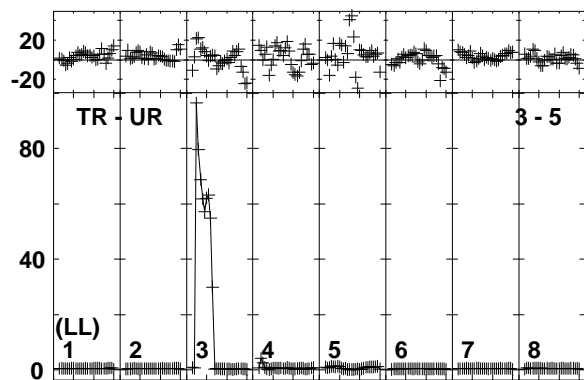
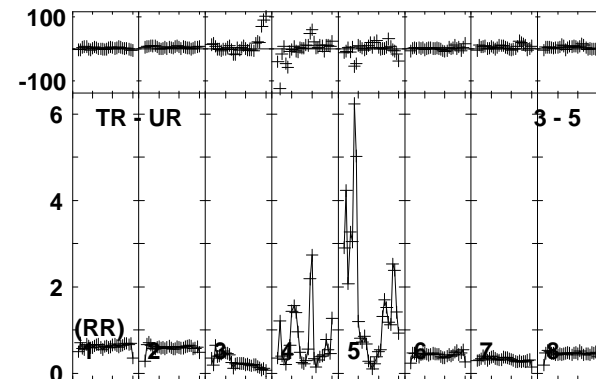
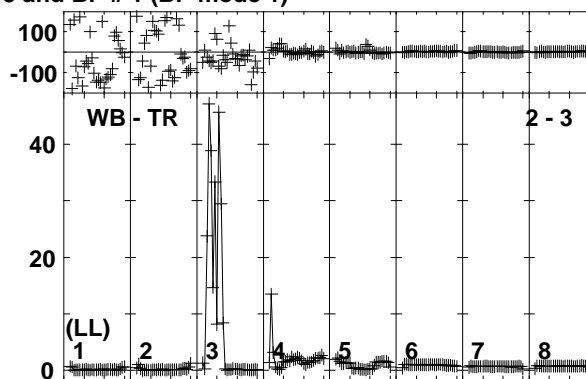
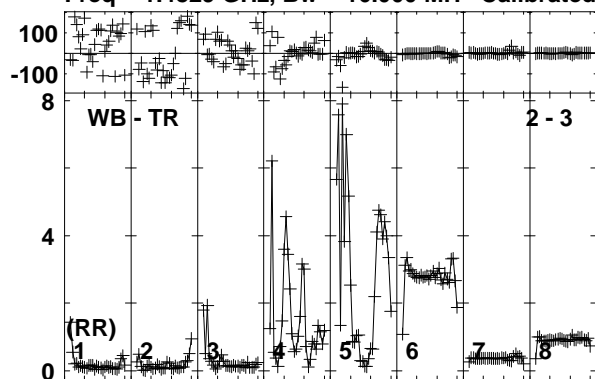

Lower frame: Ampl Jy Top frame: Phas deg
Vector averaged cross-power spectrum Baseline: WB (02) - TR (03)
Timerange: 00/07:58:01 to 00/08:01:49

Plot file version 217 created 21-JUN-2019 11:54:45

J1222+0413 EP111A 1.UVDATA.1

Freq = 1.4829 GHz, Bw = 16.000 MH Calibrated with CL # 3 and BP # 1 (BP mode 1)

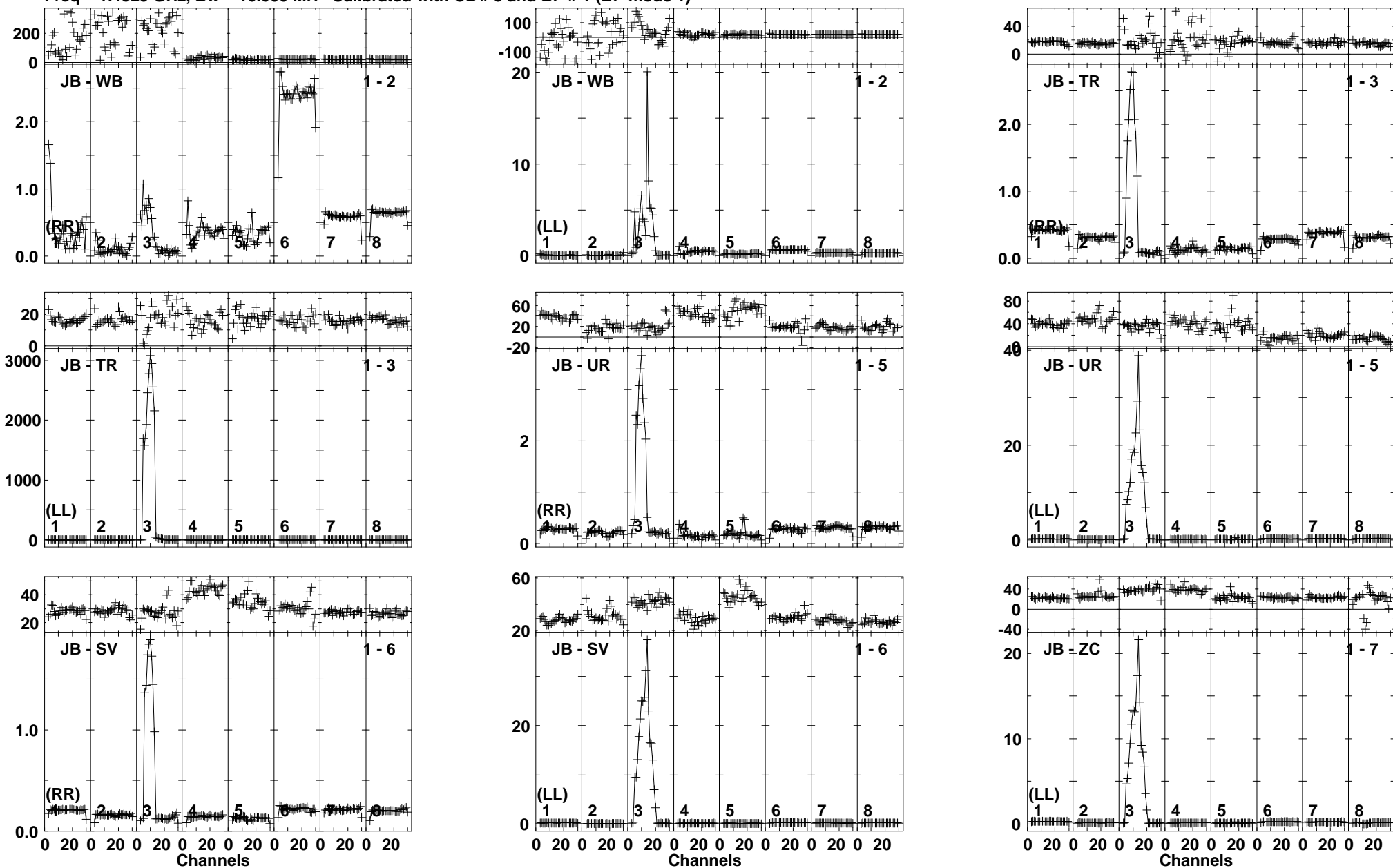

Lower frame: Ampl Jy Top frame: Phas deg
Vector averaged cross-power spectrum Baseline: JB (01) - WB (02)
Timerange: 00/08:03:36 to 00/08:05:34

Plot file version 218 created 21-JUN-2019 11:54:45

J1222+0413 EP111A 1.UVDATA.1

Freq = 1.4829 GHz, Bw = 16.000 MH Calibrated with CL # 3 and BP # 1 (BP mode 1)

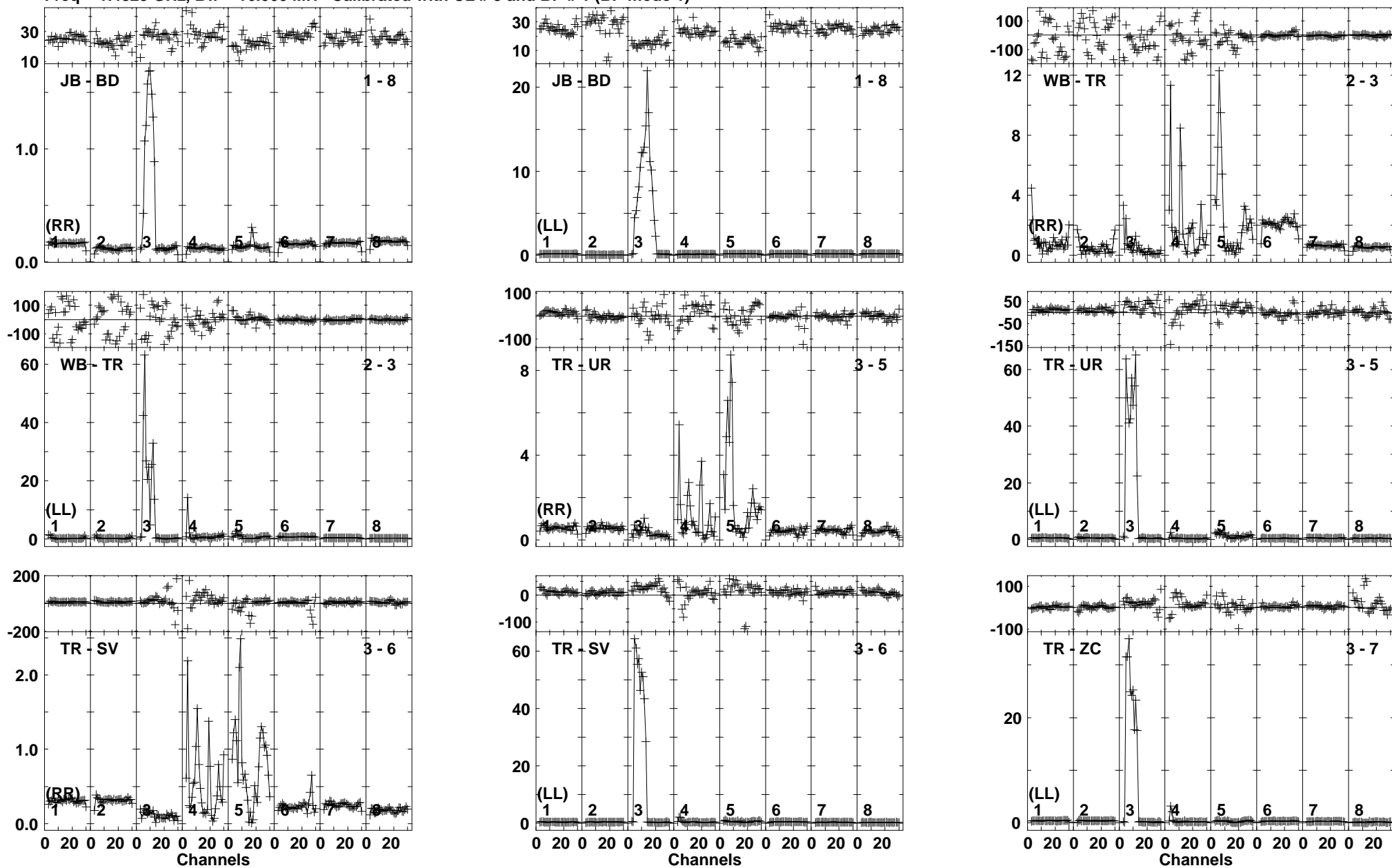

Lower frame: Ampl Jy Top frame: Phas deg
Vector averaged cross-power spectrum Baseline: JB (01) - BD (08)
Timerange: 00/08:03:36 to 00/08:05:34

Plot file version 219 created 21-JUN-2019 11:54:46

J1222+0413 EP111A 1.UVDATA.1

Freq = 1.4829 GHz, Bw = 16.000 MH Calibrated with CL # 3 and BP # 1 (BP mode 1)

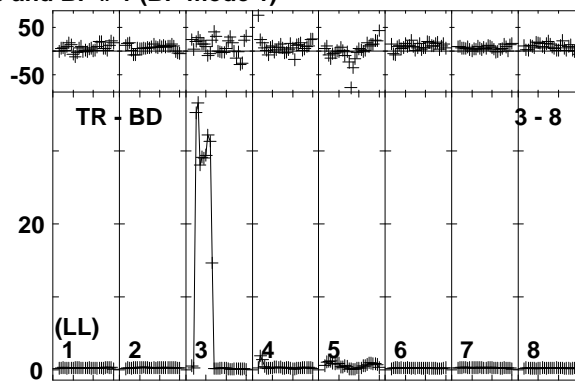
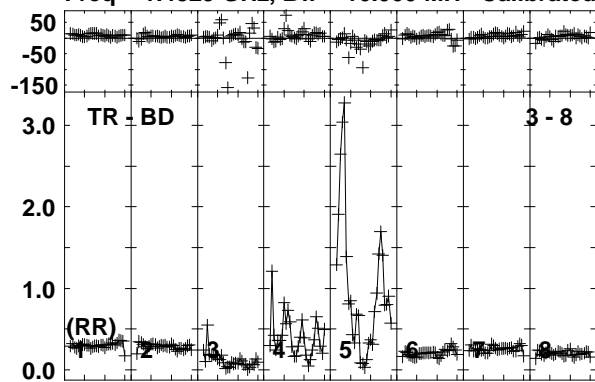

Lower frame: Ampl Jy Top frame: Phas deg
Vector averaged cross-power spectrum Baseline: TR (03) - BD (08)
Timerange: 00/08:03:36 to 00/08:05:34

Plot file version 220 created 21-JUN-2019 11:54:46

IRAS12112 EP111A 1.UVDATA.1

Freq = 1.4829 GHz, Bw = 16.000 MH Calibrated with CL # 3 and BP # 1 (BP mode 1)

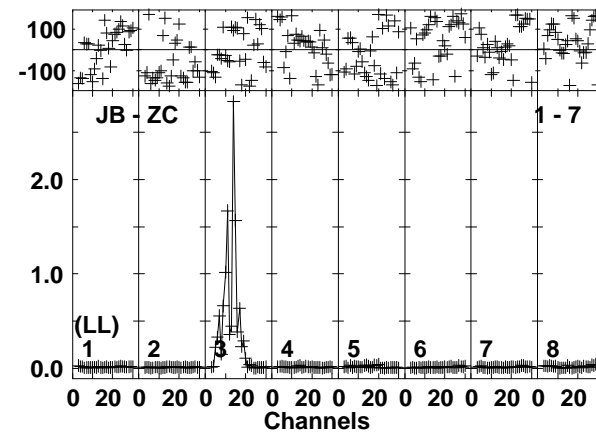
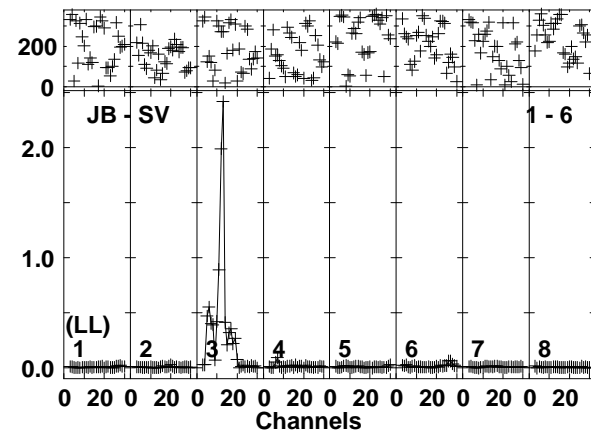
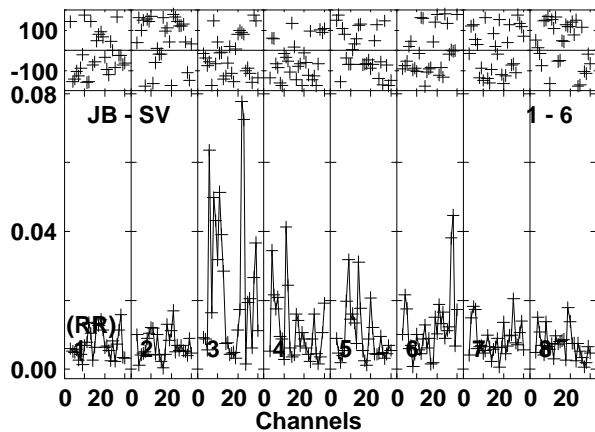
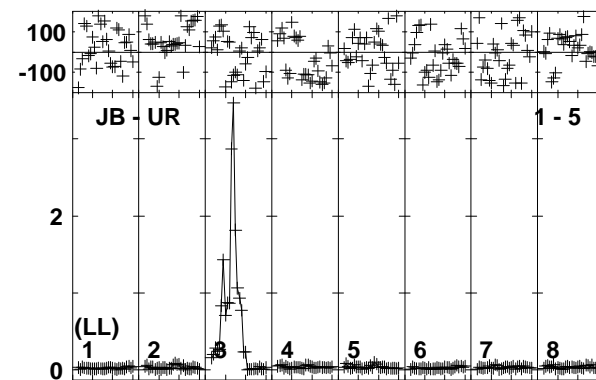
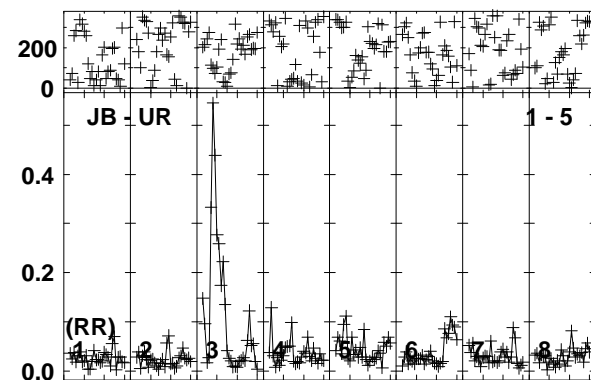
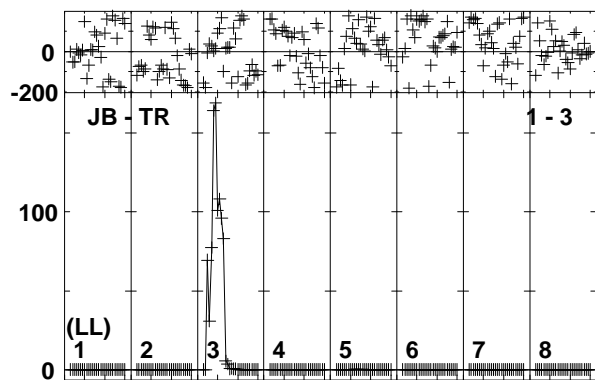
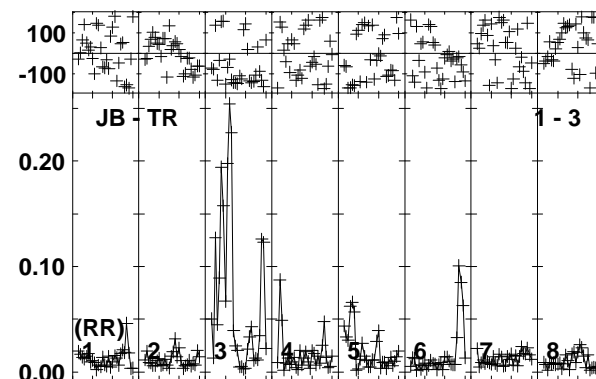
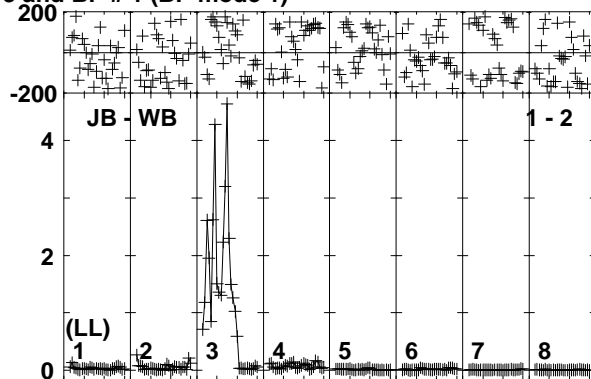
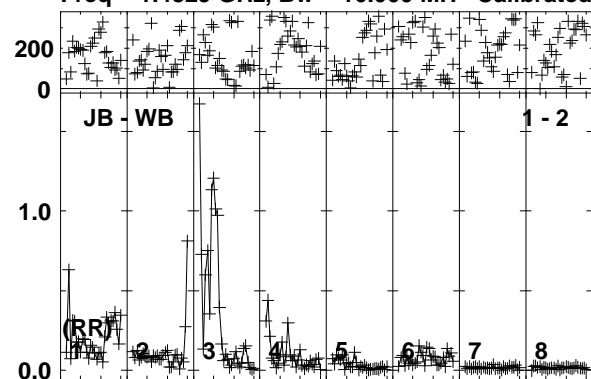

Lower frame: Ampl Jy Top frame: Phas deg
Vector averaged cross-power spectrum Baseline: JB (01) - WB (02)
Timerange: 00/08:05:36 to 00/08:09:04

Plot file version 221 created 21-JUN-2019 11:54:46

IRAS12112 EP111A 1.UVDATA.1

Freq = 1.4829 GHz, Bw = 16.000 MH Calibrated with CL # 3 and BP # 1 (BP mode 1)

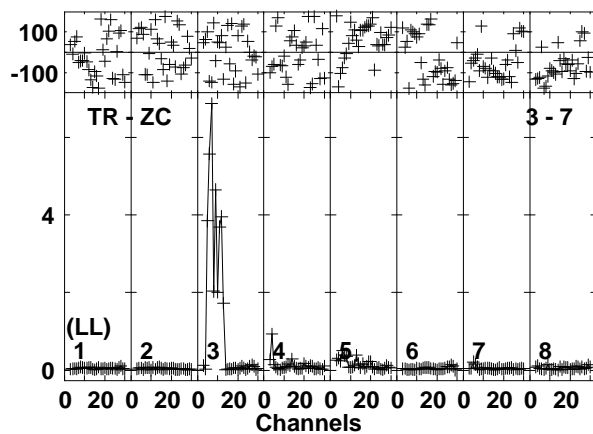
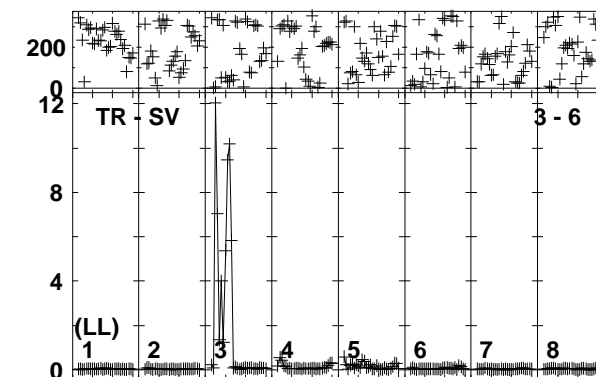
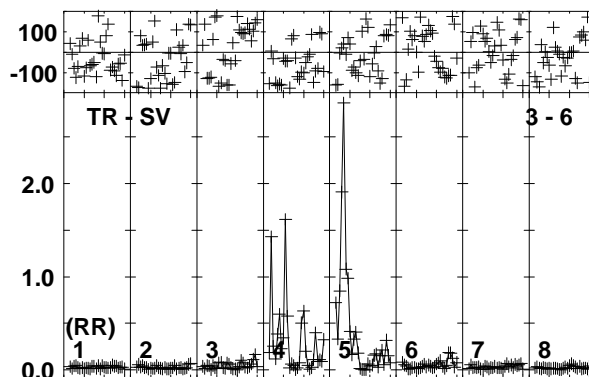
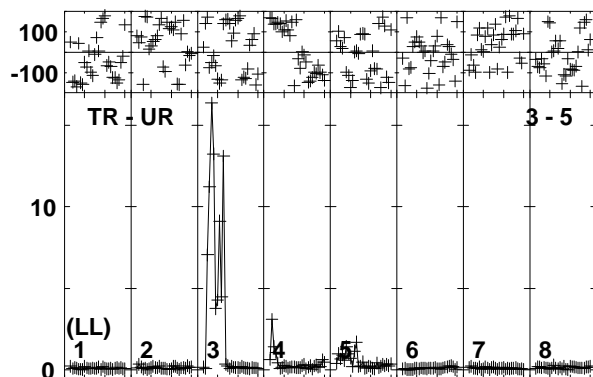
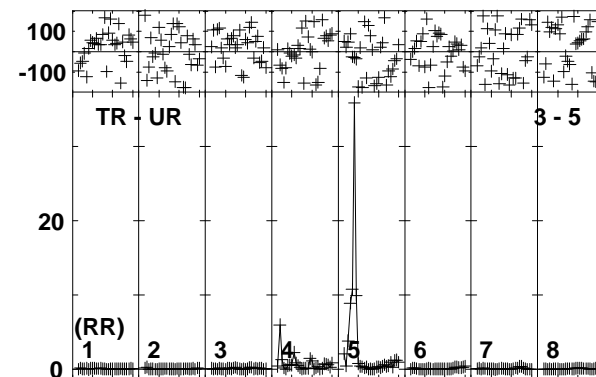
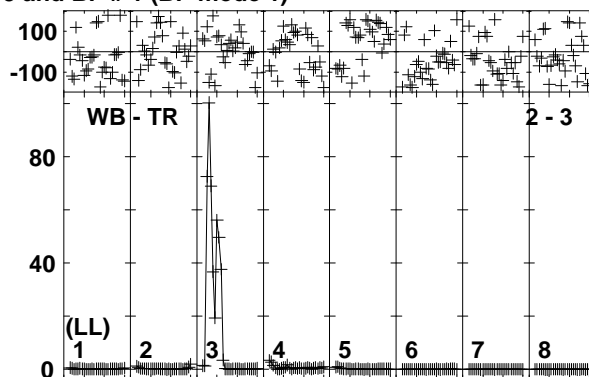
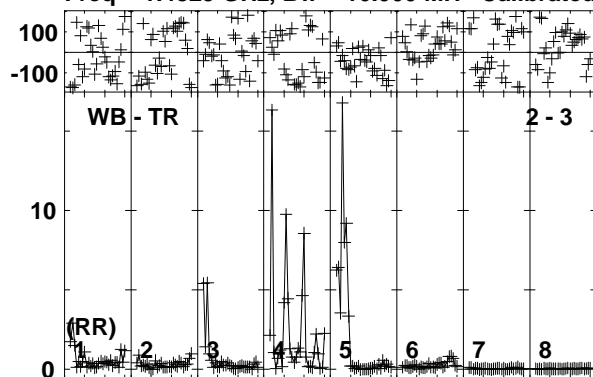

Lower frame: Ampl Jy Top frame: Phas deg
Vector averaged cross-power spectrum Baseline: WB (02) - TR (03)
Timerange: 00/08:05:36 to 00/08:09:04

Plot file version 222 created 21-JUN-2019 11:54:47

J1222+0413 EP111A 1.UVDATA.1

Freq = 1.4829 GHz, Bw = 16.000 MH Calibrated with CL # 3 and BP # 1 (BP mode 1)

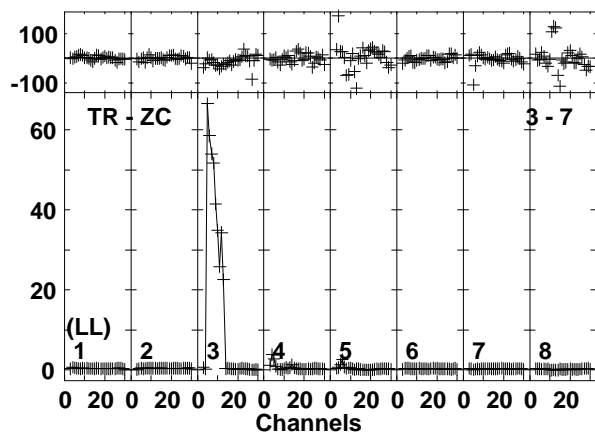
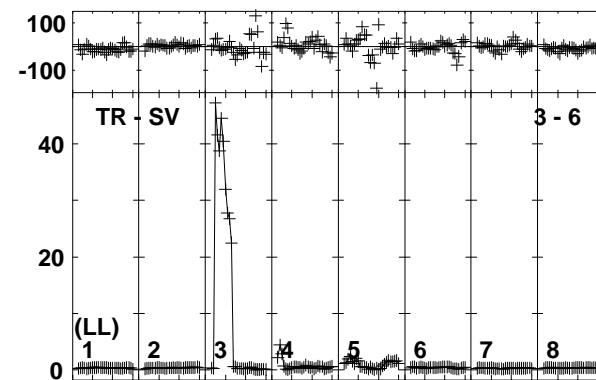
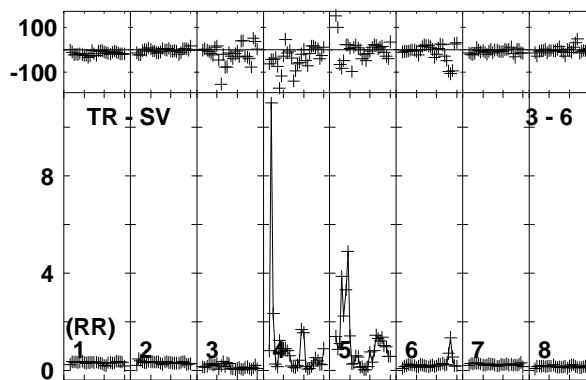
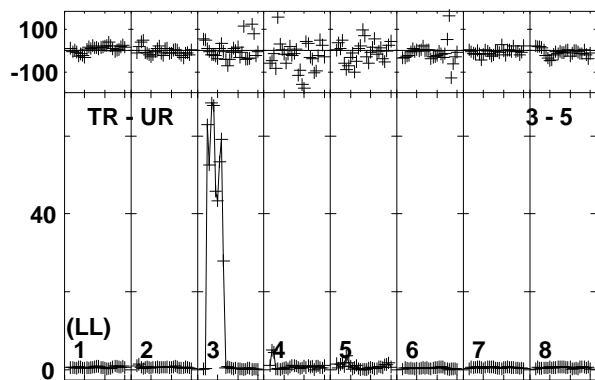
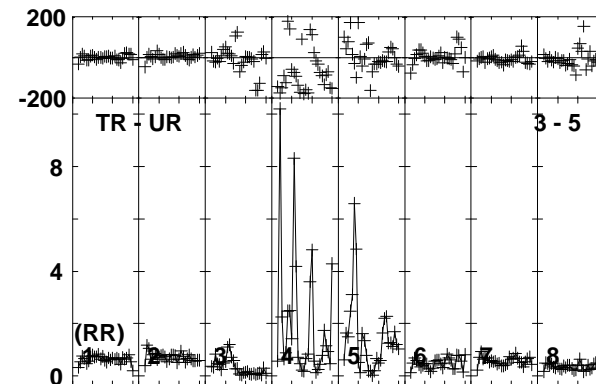
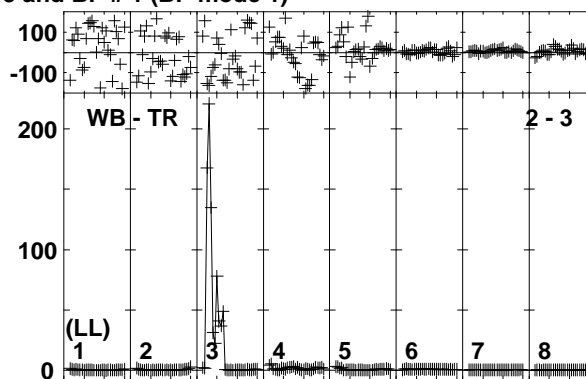
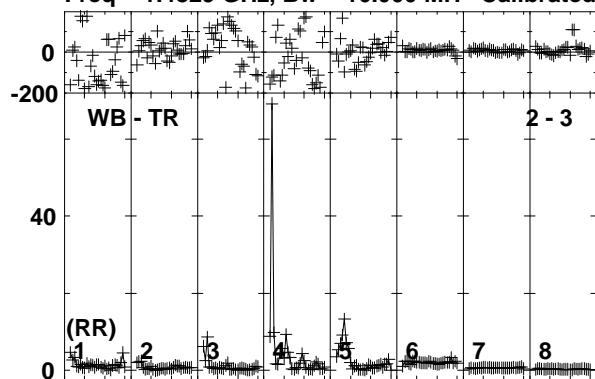

Lower frame: Ampl Jy Top frame: Phas deg
Vector averaged cross-power spectrum Baseline: WB (02) - TR (03)
Timerange: 00/08:09:06 to 00/08:10:34

Plot file version 223 created 21-JUN-2019 11:54:48

IRAS12112 EP111A 1.UVDATA.1

Freq = 1.4829 GHz, Bw = 16.000 MH Calibrated with CL # 3 and BP # 1 (BP mode 1)

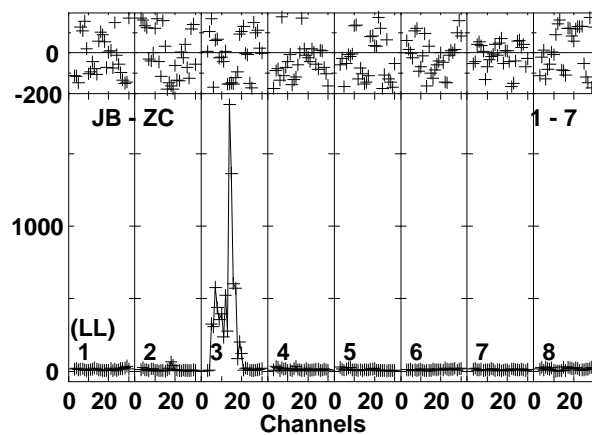
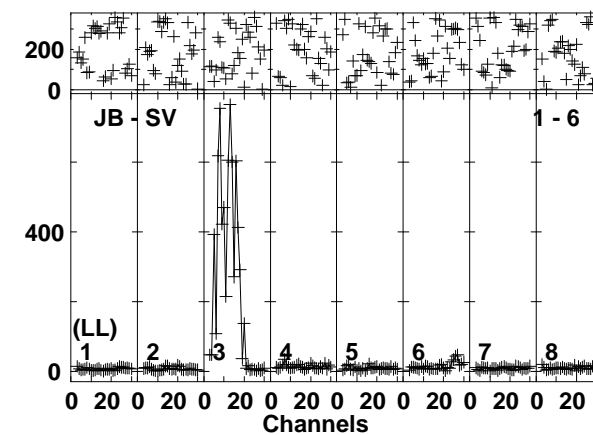
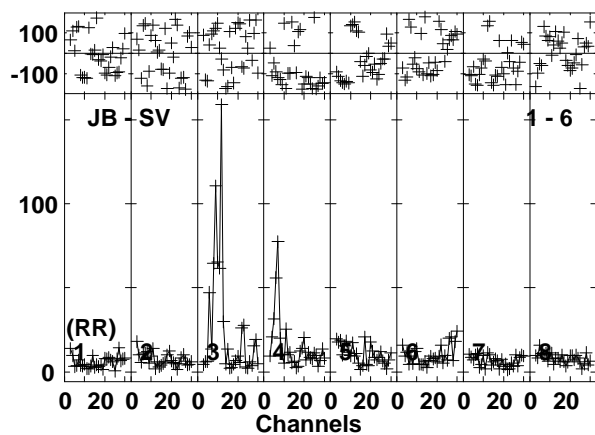
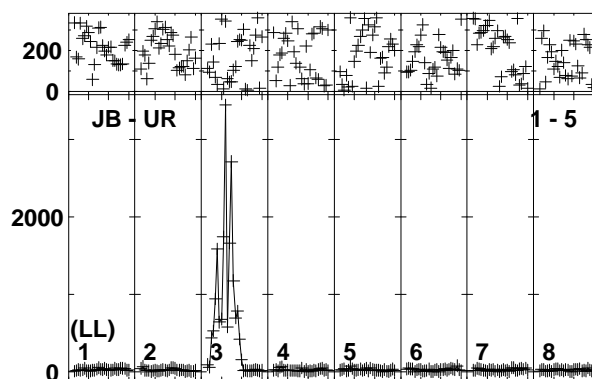
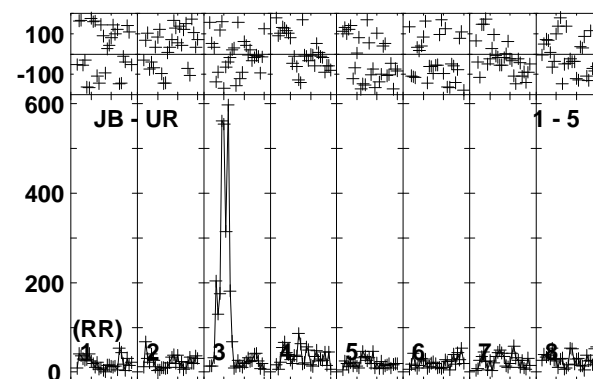
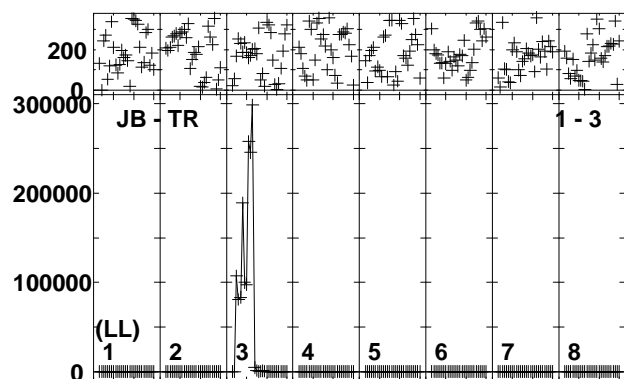
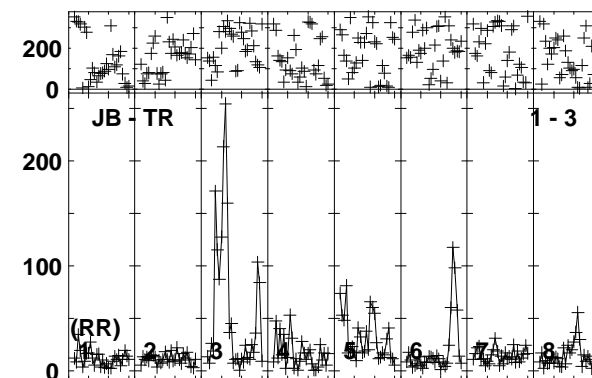
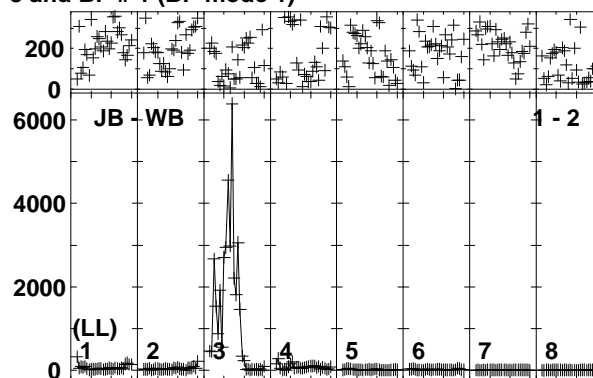
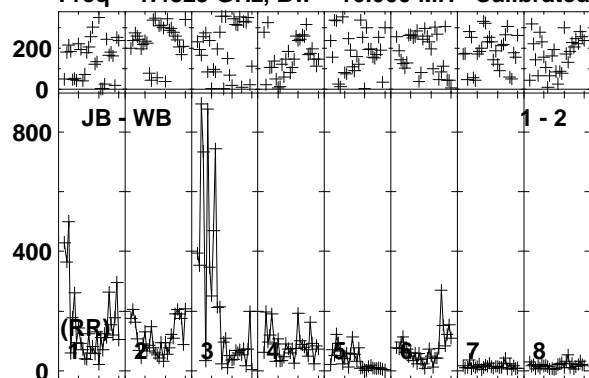

Lower frame: Milli Ampl Jy Top frame: Phas deg
Vector averaged cross-power spectrum Baseline: JB (01) - WB (02)
Timerange: 00/08:10:36 to 00/08:14:04

Plot file version 224 created 21-JUN-2019 11:54:48

IRAS12112 EP111A 1.UVDATA.1

Freq = 1.4829 GHz, Bw = 16.000 MH Calibrated with CL # 3 and BP # 1 (BP mode 1)

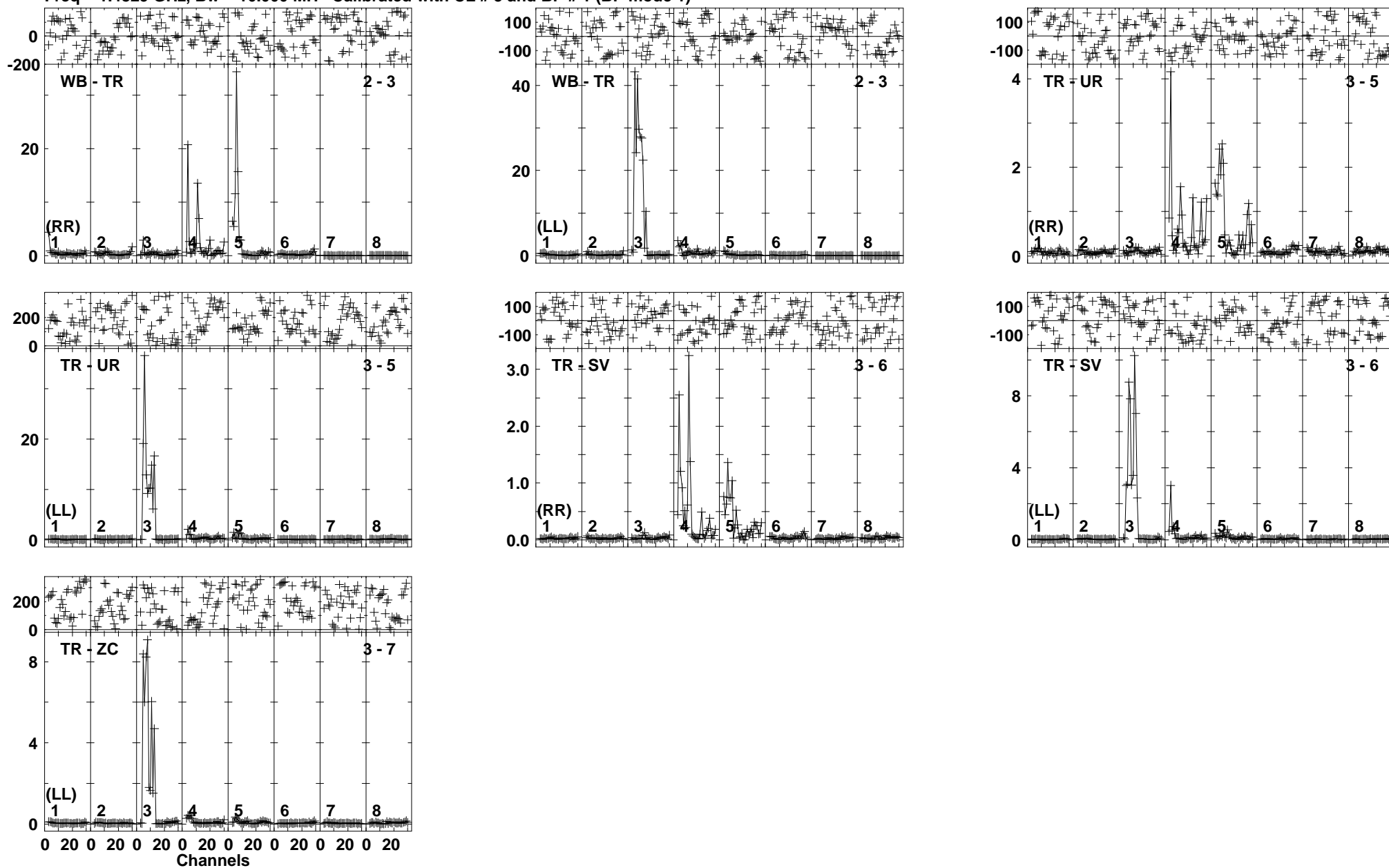

Lower frame: Ampl Jy Top frame: Phas deg
Vector averaged cross-power spectrum Baseline: WB (02) - TR (03)
Timerange: 00/08:10:36 to 00/08:14:04

Plot file version 225 created 21-JUN-2019 11:54:49

J1222+0413 EP111A 1.UVDATA.1

Freq = 1.4829 GHz, Bw = 16.000 MH Calibrated with CL # 3 and BP # 1 (BP mode 1)

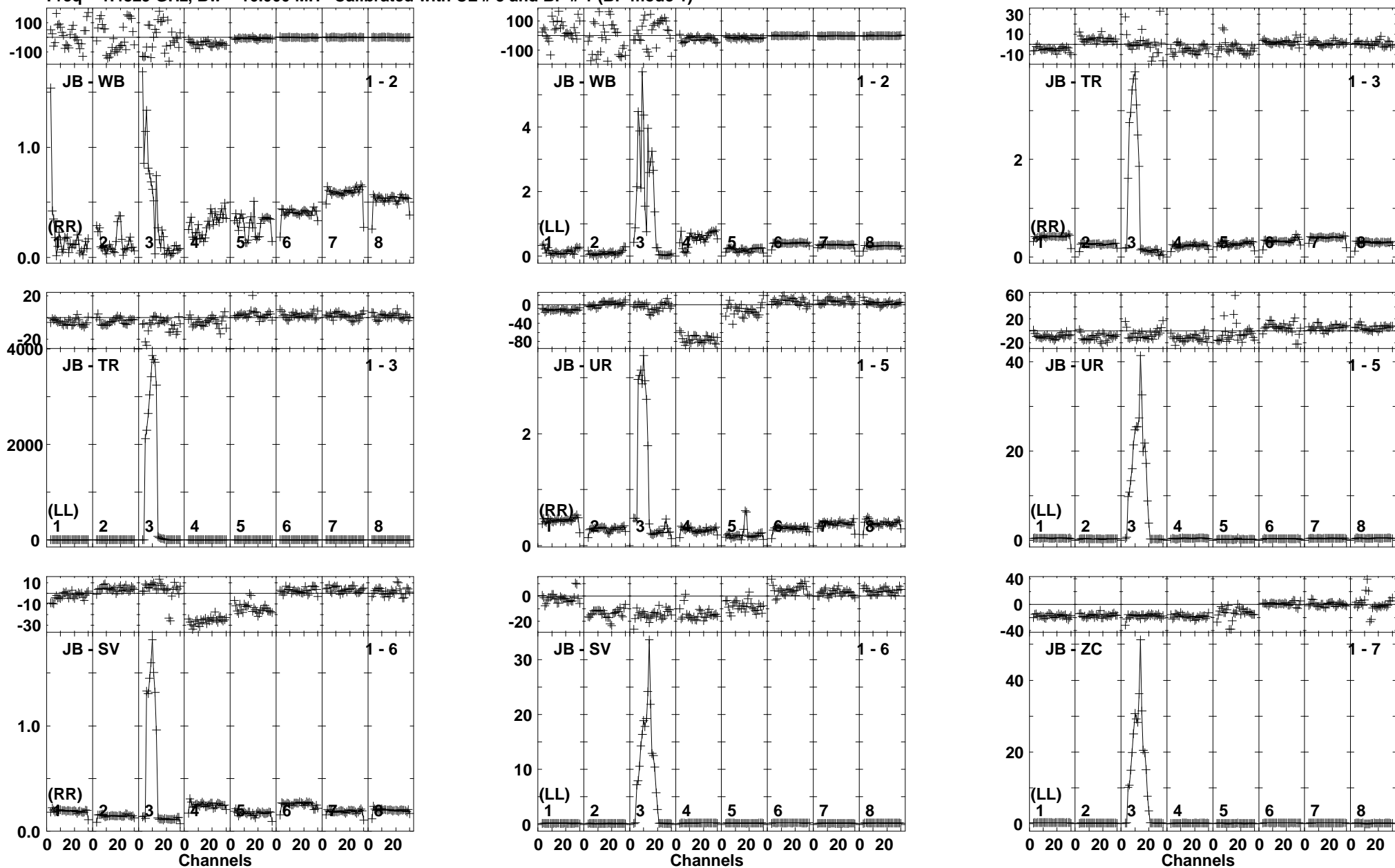

Lower frame: Ampl Jy Top frame: Phas deg
Vector averaged cross-power spectrum Baseline: JB (01) - WB (02)
Timerange: 00/08:14:46 to 00/08:16:14

Plot file version 226 created 21-JUN-2019 11:54:49

J1222+0413 EP111A 1.UVDATA.1

Freq = 1.4829 GHz, Bw = 16.000 MH Calibrated with CL # 3 and BP # 1 (BP mode 1)

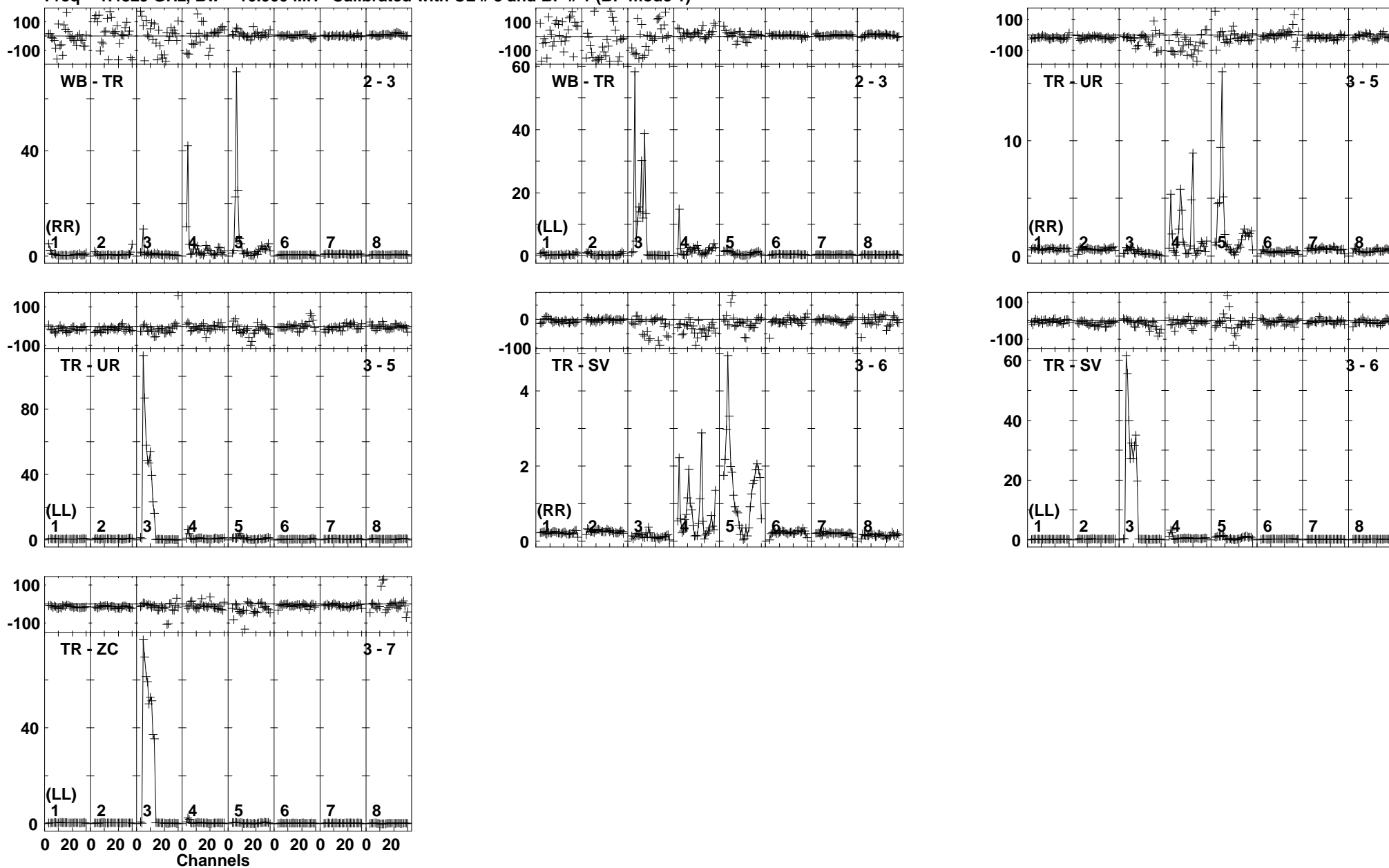

Lower frame: Ampl Jy Top frame: Phas deg
Vector averaged cross-power spectrum Baseline: WB (02) - TR (03)
Timerange: 00/08:14:46 to 00/08:16:14

Plot file version 227 created 21-JUN-2019 11:54:50
 IRAS12112 EP111A 1.UVDATA.1
 Freq = 1.4829 GHz, Bw = 16.000 MH Calibrated with CL # 3 and BP # 1 (BP mode 1)

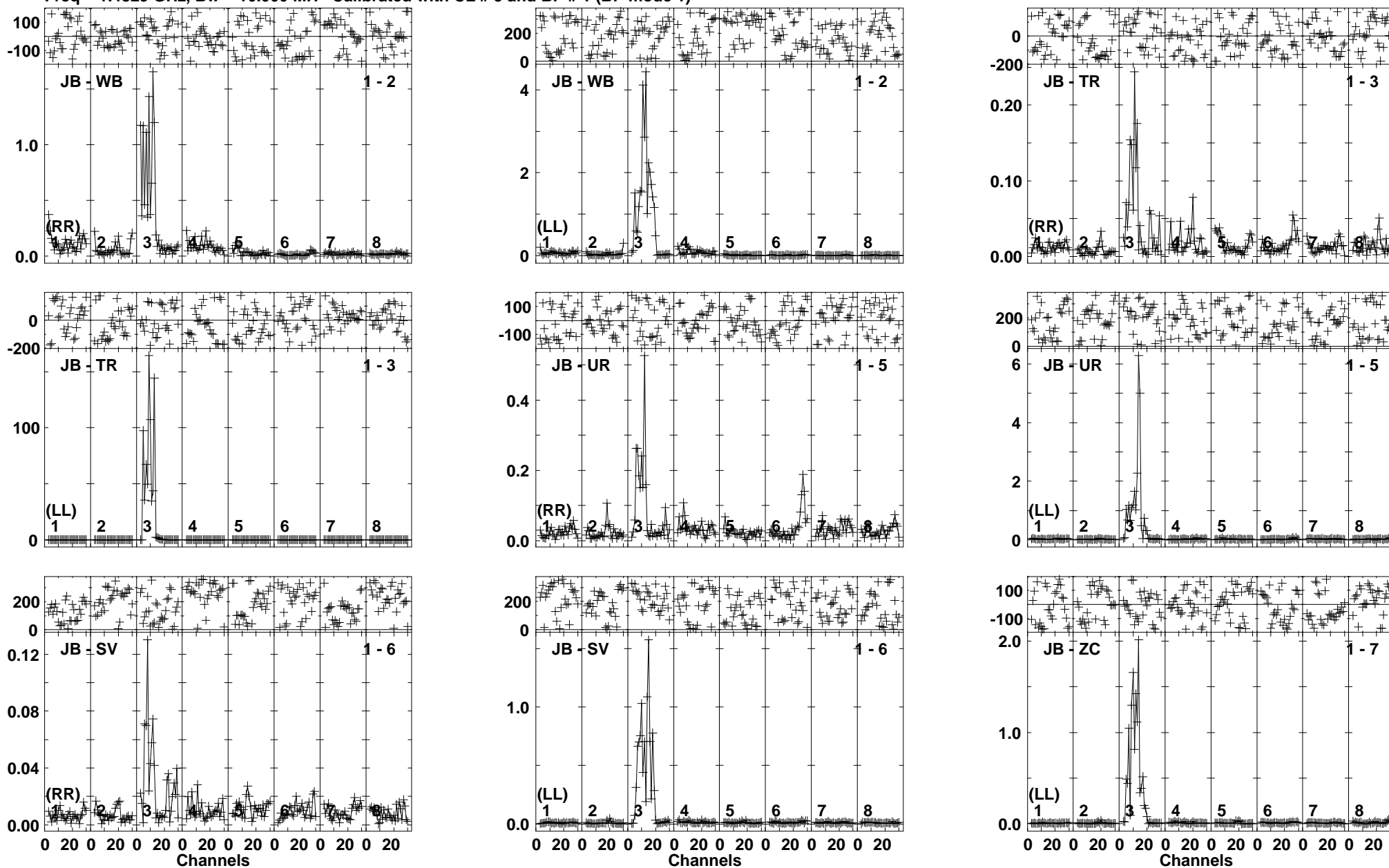

Lower frame: Ampl Jy Top frame: Phas deg
 Vector averaged cross-power spectrum Baseline: JB (01) - WB (02)
 Timerange: 00/08:16:16 to 00/08:19:44

Plot file version 228 created 21-JUN-2019 11:54:50

IRAS12112 EP111A 1.UVDATA.1

Freq = 1.4829 GHz, Bw = 16.000 MH Calibrated with CL # 3 and BP # 1 (BP mode 1)

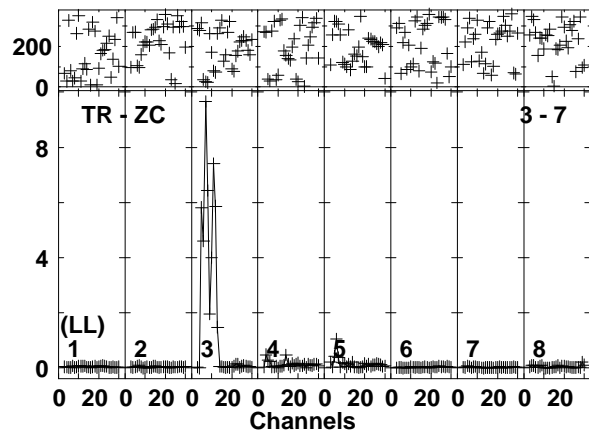
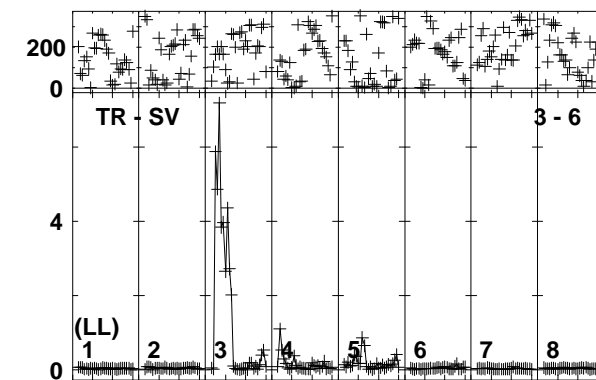
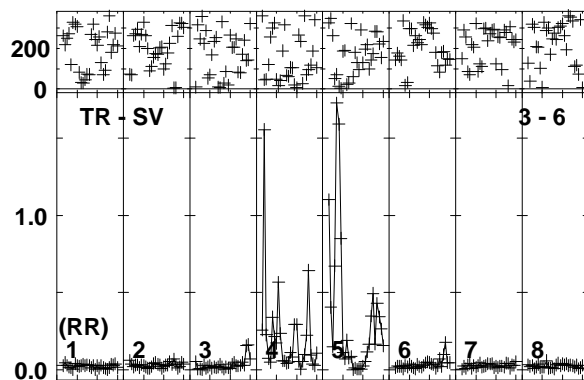
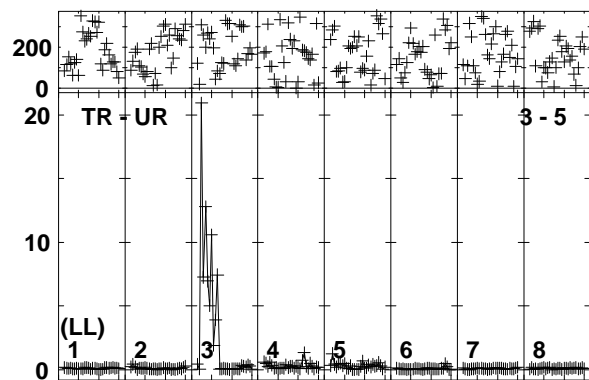
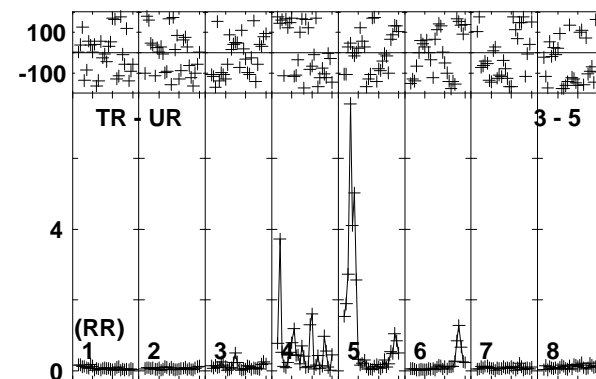
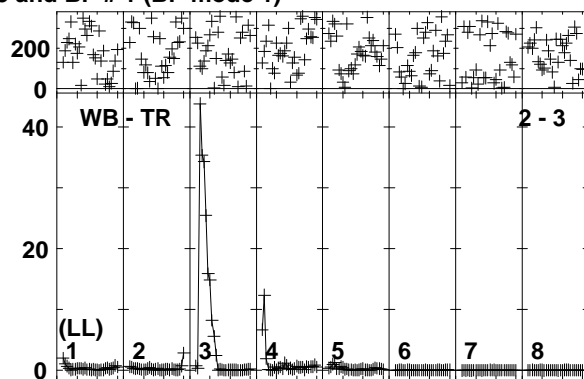
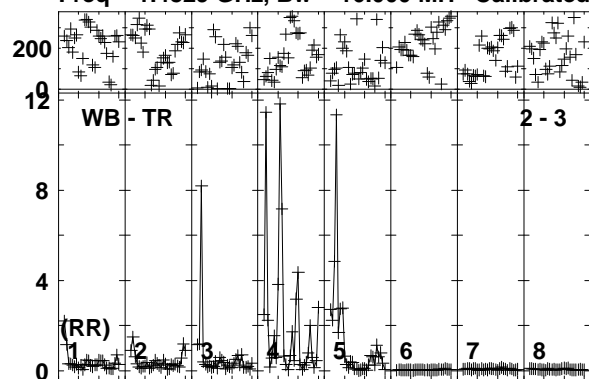

Lower frame: Ampl Jy Top frame: Phas deg
Vector averaged cross-power spectrum Baseline: WB (02) - TR (03)
Timerange: 00/08:16:16 to 00/08:19:44

Plot file version 229 created 21-JUN-2019 11:54:51

J1222+0413 EP111A 1.UVDATA.1

Freq = 1.4829 GHz, Bw = 16.000 MH Calibrated with CL # 3 and BP # 1 (BP mode 1)

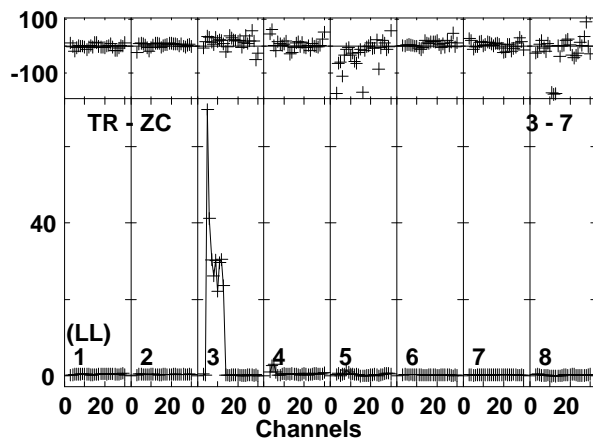
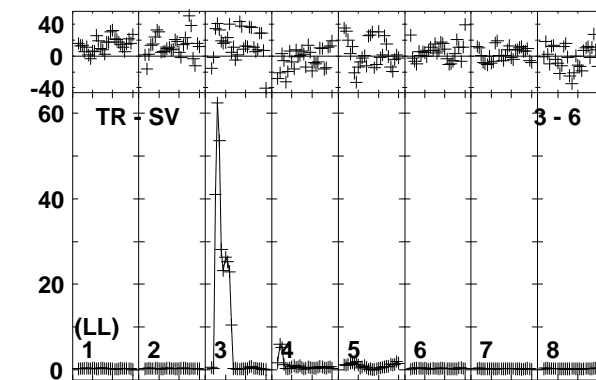
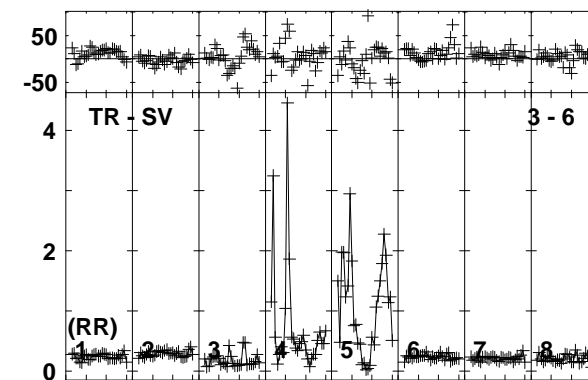
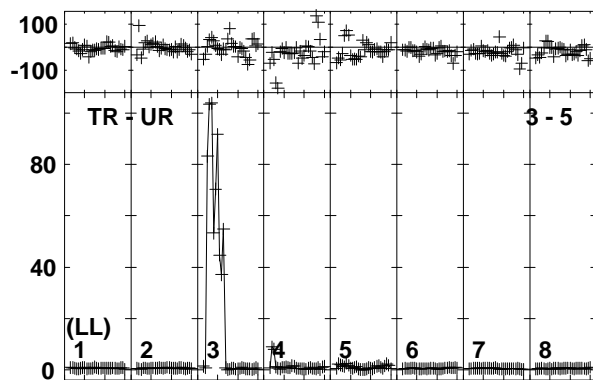
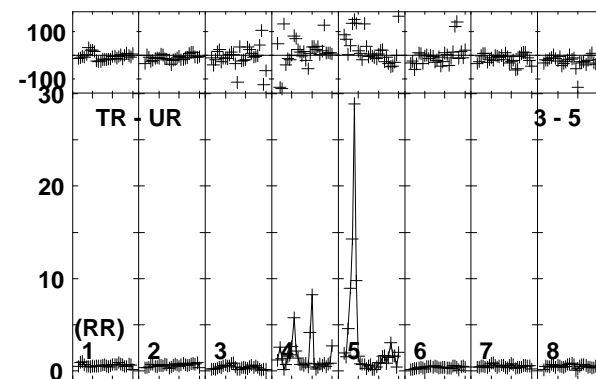
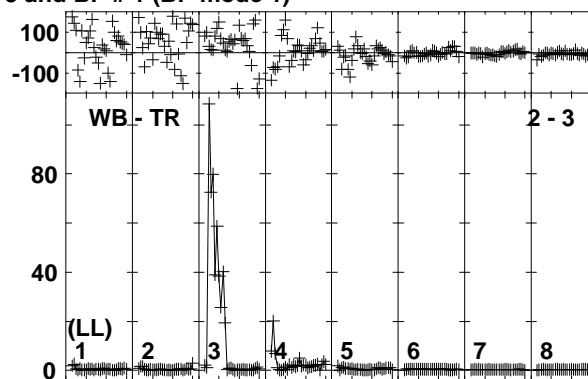
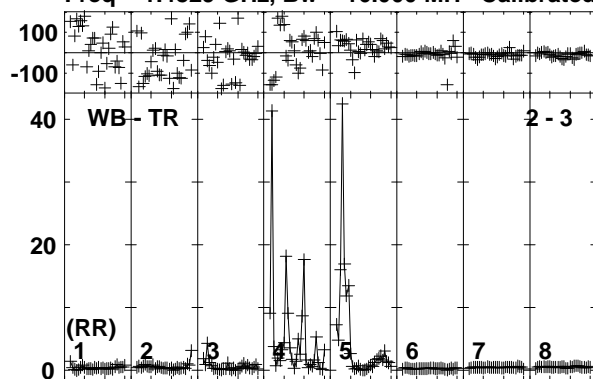

Lower frame: Ampl Jy Top frame: Phas deg
Vector averaged cross-power spectrum Baseline: WB (02) - TR (03)
Timerange: 00/08:19:46 to 00/08:21:14

Plot file version 230 created 21-JUN-2019 11:54:52
 IRAS12112 EP111A 1.UVDATA.1
 Freq = 1.4829 GHz, Bw = 16.000 MH Calibrated with CL # 3 and BP # 1 (BP mode 1)

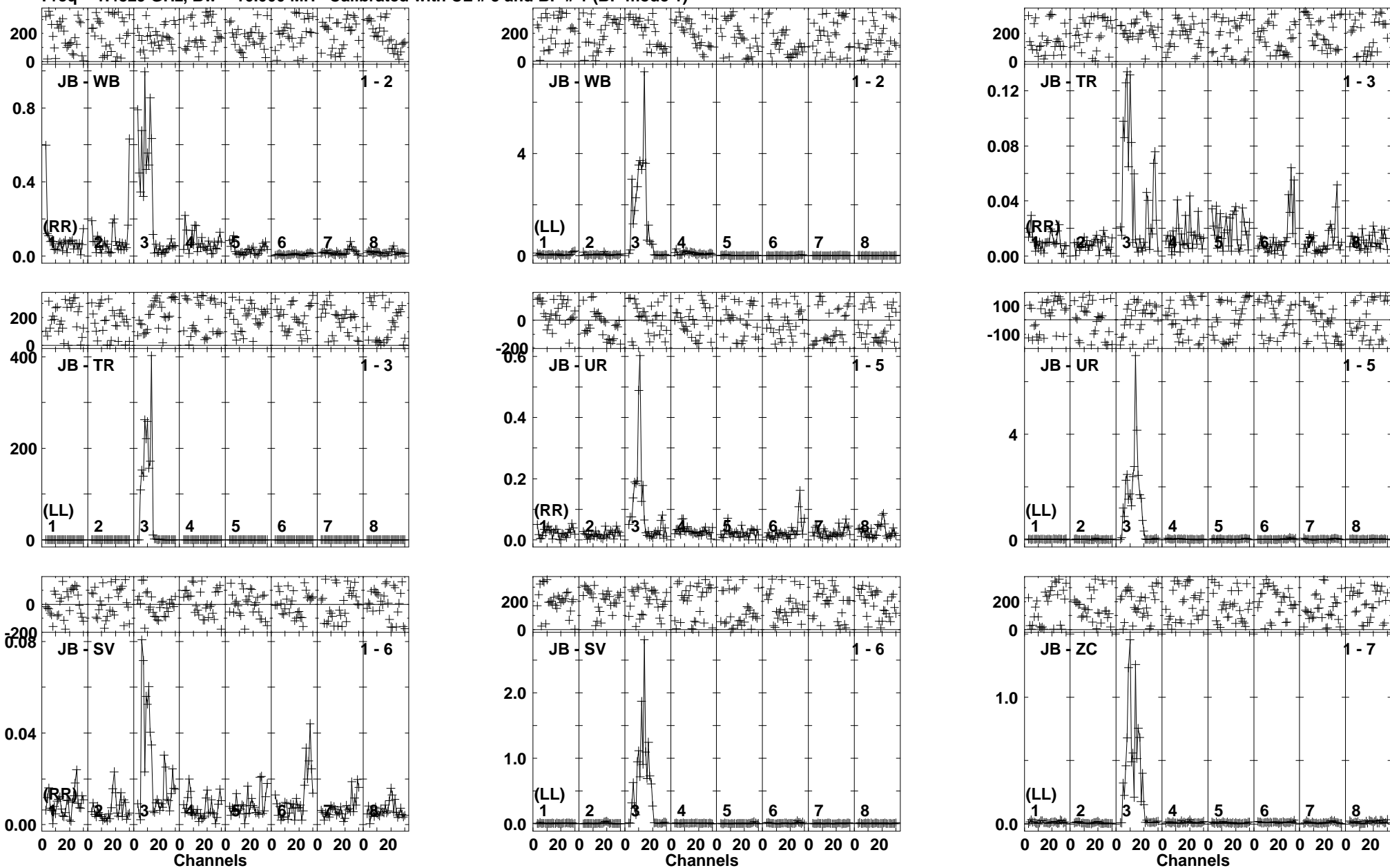

Lower frame: Ampl Jy Top frame: Phas deg
 Vector averaged cross-power spectrum Baseline: JB (01) - WB (02)
 Timerange: 00/08:21:16 to 00/08:24:44

Plot file version 231 created 21-JUN-2019 11:54:52

IRAS12112 EP111A 1.UVDATA.1

Freq = 1.4829 GHz, Bw = 16.000 MH Calibrated with CL # 3 and BP # 1 (BP mode 1)

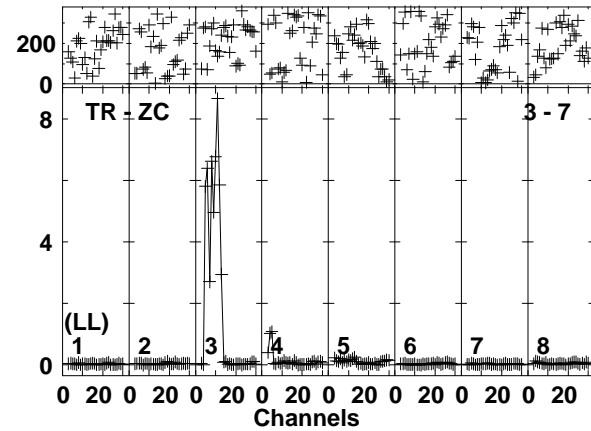
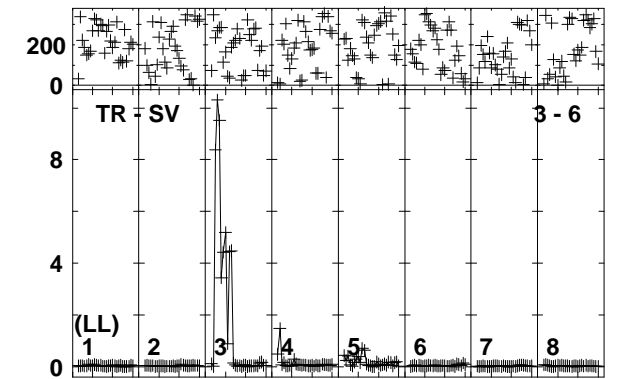
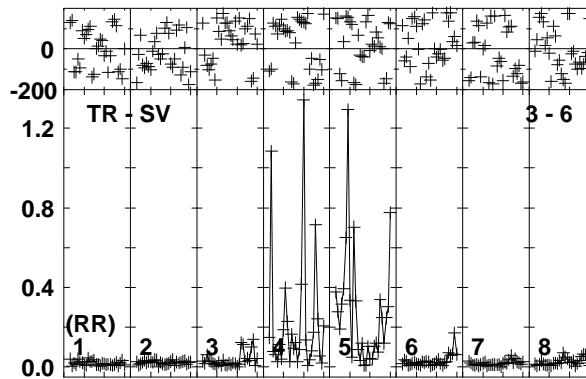
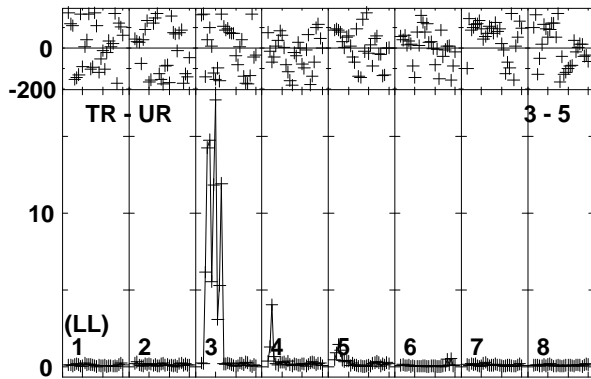
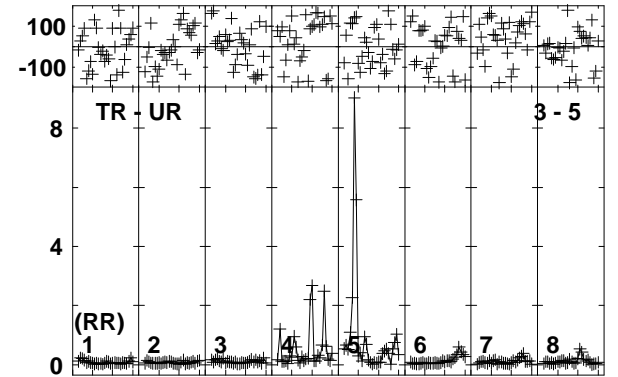
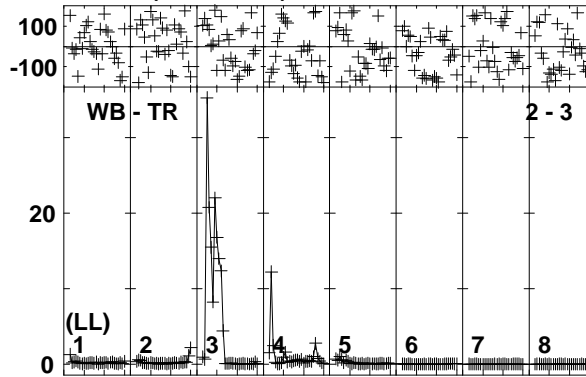
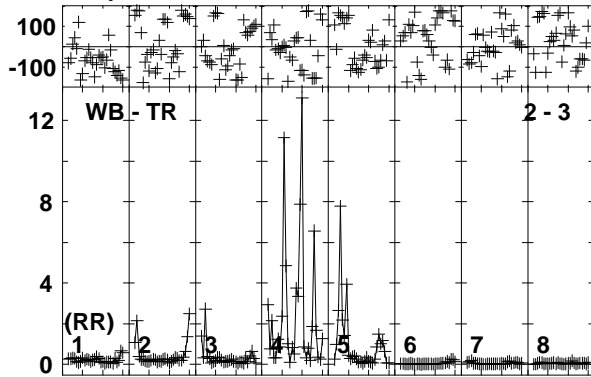

Lower frame: Ampl Jy Top frame: Phas deg
Vector averaged cross-power spectrum Baseline: WB (02) - TR (03)
Timerange: 00/08:21:16 to 00/08:24:44

Plot file version 232 created 21-JUN-2019 11:54:53

J1222+0413 EP111A 1.UVDATA.1

Freq = 1.4829 GHz, Bw = 16.000 MH Calibrated with CL # 3 and BP # 1 (BP mode 1)

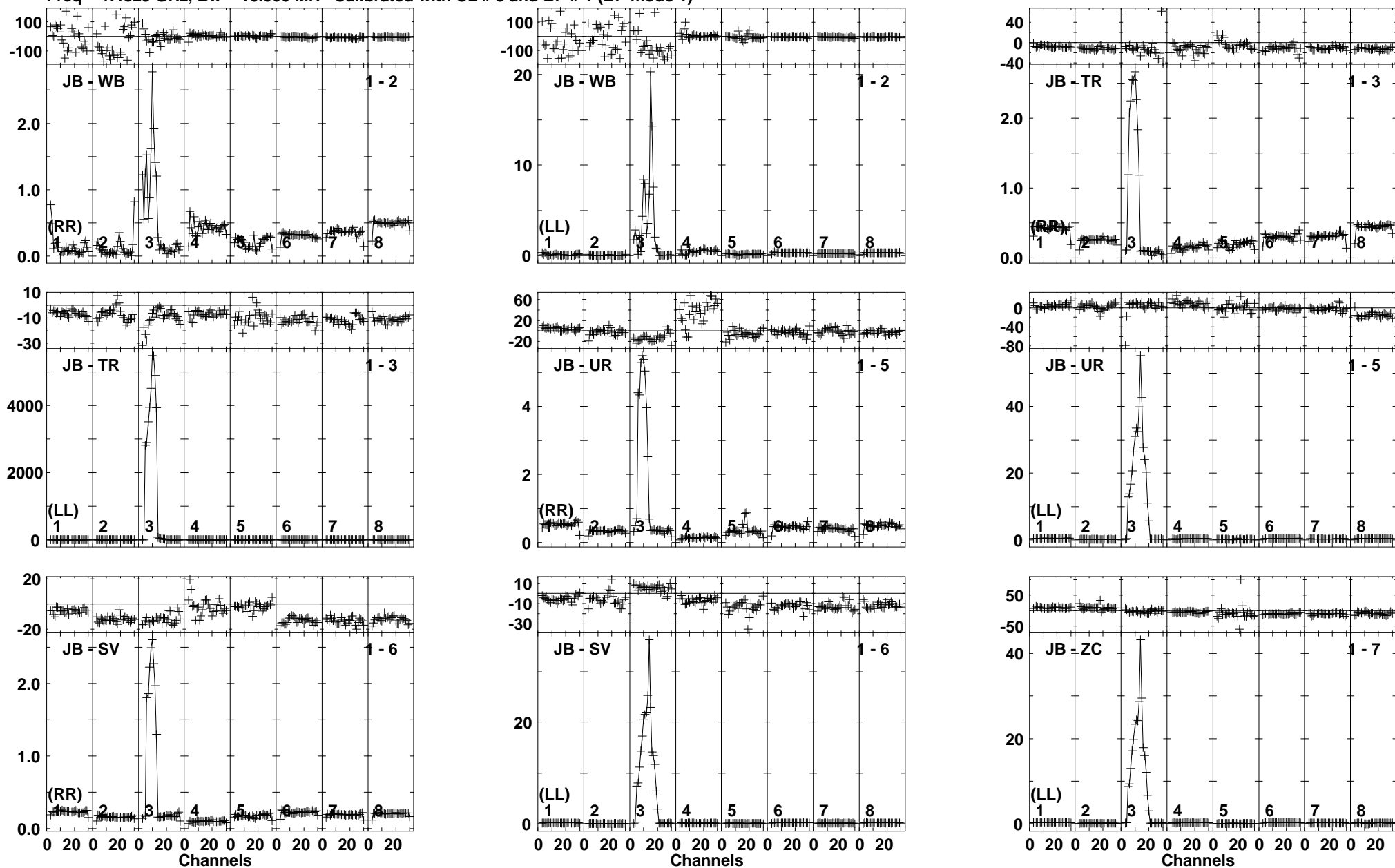

Lower frame: Ampl Jy Top frame: Phas deg
Vector averaged cross-power spectrum Baseline: JB (01) - WB (02)
Timerange: 00/08:25:26 to 00/08:26:54

Plot file version 234 created 21-JUN-2019 11:54:54

IRAS12112 EP111A 1.UVDATA.1

Freq = 1.4829 GHz, Bw = 16.000 MH Calibrated with CL # 3 and BP # 1 (BP mode 1)

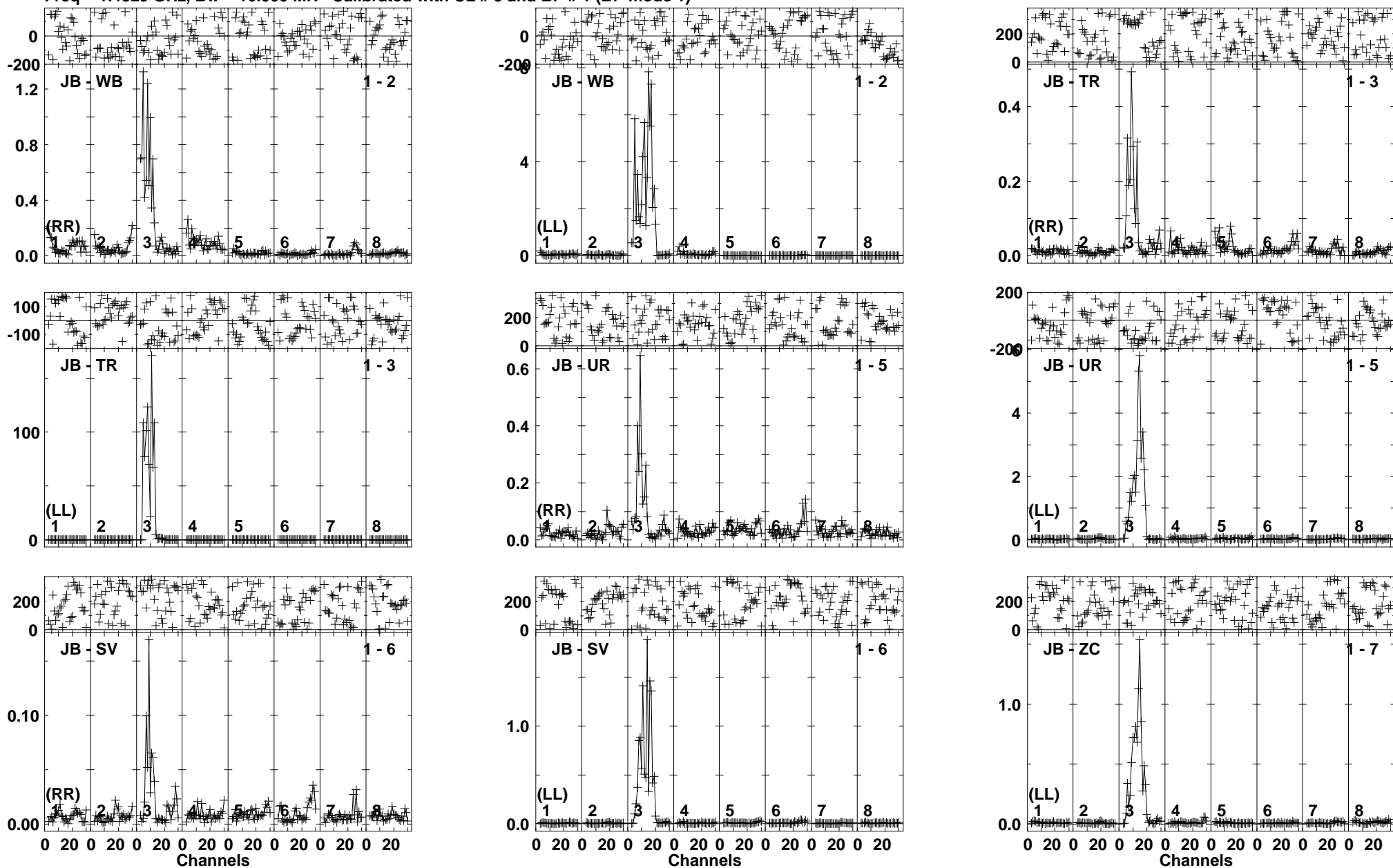

Lower frame: Ampl Jy Top frame: Phas deg
Vector averaged cross-power spectrum Baseline: JB (01) - WB (02)
Timerange: 00/08:26:56 to 00/08:30:24

Plot file version 236 created 21-JUN-2019 11:54:55

J1222+0413 EP111A 1.UVDATA.1

Freq = 1.4829 GHz, Bw = 16.000 MH Calibrated with CL # 3 and BP # 1 (BP mode 1)

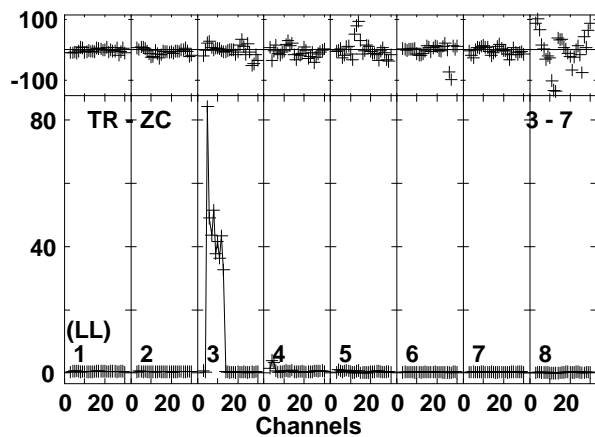
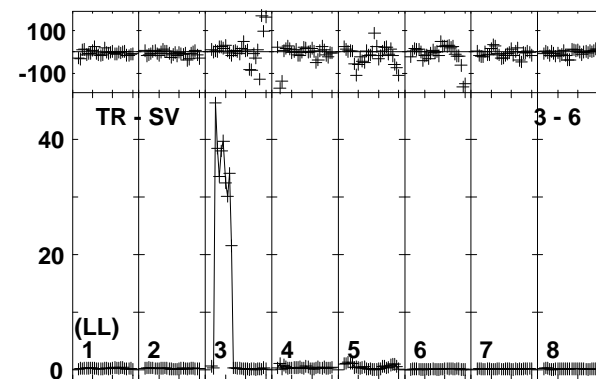
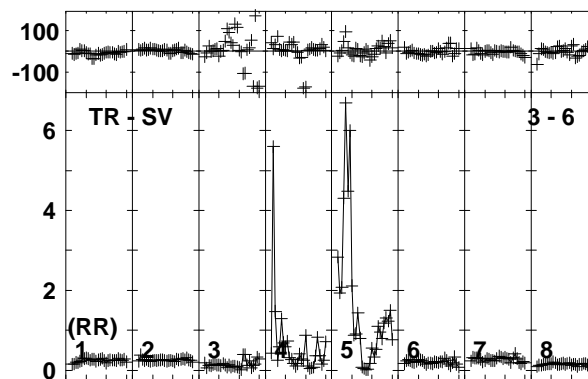
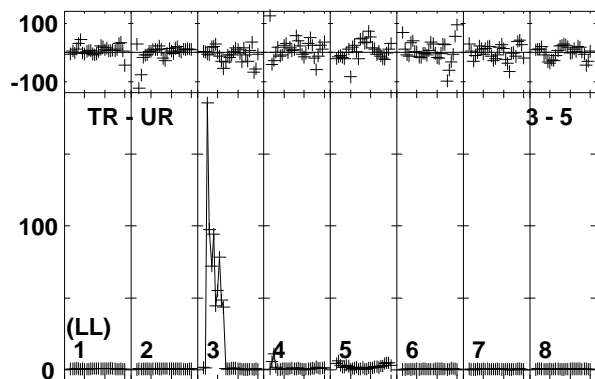
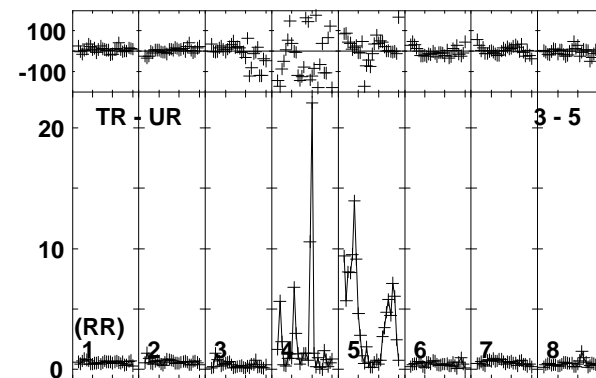
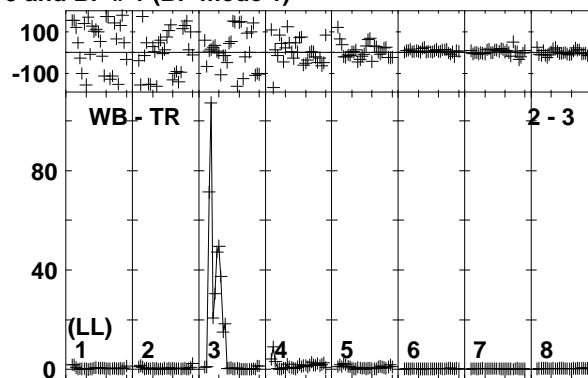
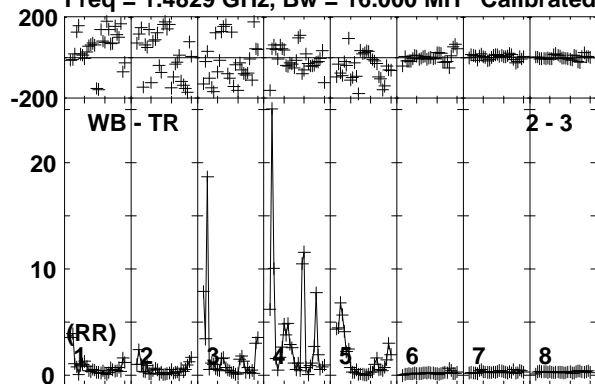

Lower frame: Ampl Jy Top frame: Phas deg
Vector averaged cross-power spectrum Baseline: WB (02) - TR (03)
Timerange: 00/08:30:26 to 00/08:31:54

Plot file version 237 created 21-JUN-2019 11:54:56

IRAS12112 EP111A 1.UVDATA.1

Freq = 1.4829 GHz, Bw = 16.000 MH Calibrated with CL # 3 and BP # 1 (BP mode 1)

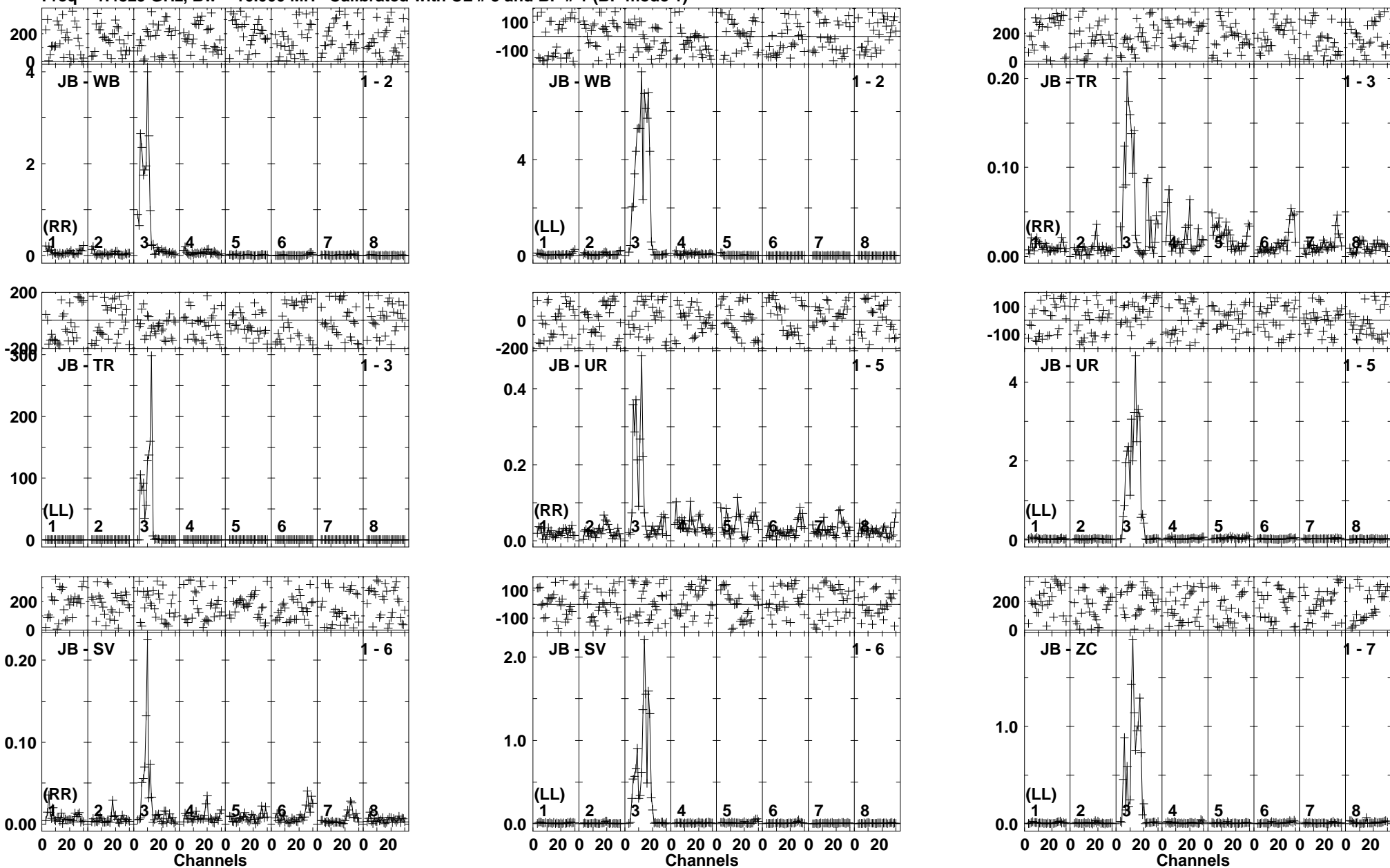

Lower frame: Ampl Jy Top frame: Phas deg
Vector averaged cross-power spectrum Baseline: JB (01) - WB (02)
Timerange: 00/08:31:56 to 00/08:35:24

Plot file version 238 created 21-JUN-2019 11:54:56

IRAS12112 EP111A 1.UVDATA.1

Freq = 1.4829 GHz, Bw = 16.000 MH Calibrated with CL # 3 and BP # 1 (BP mode 1)

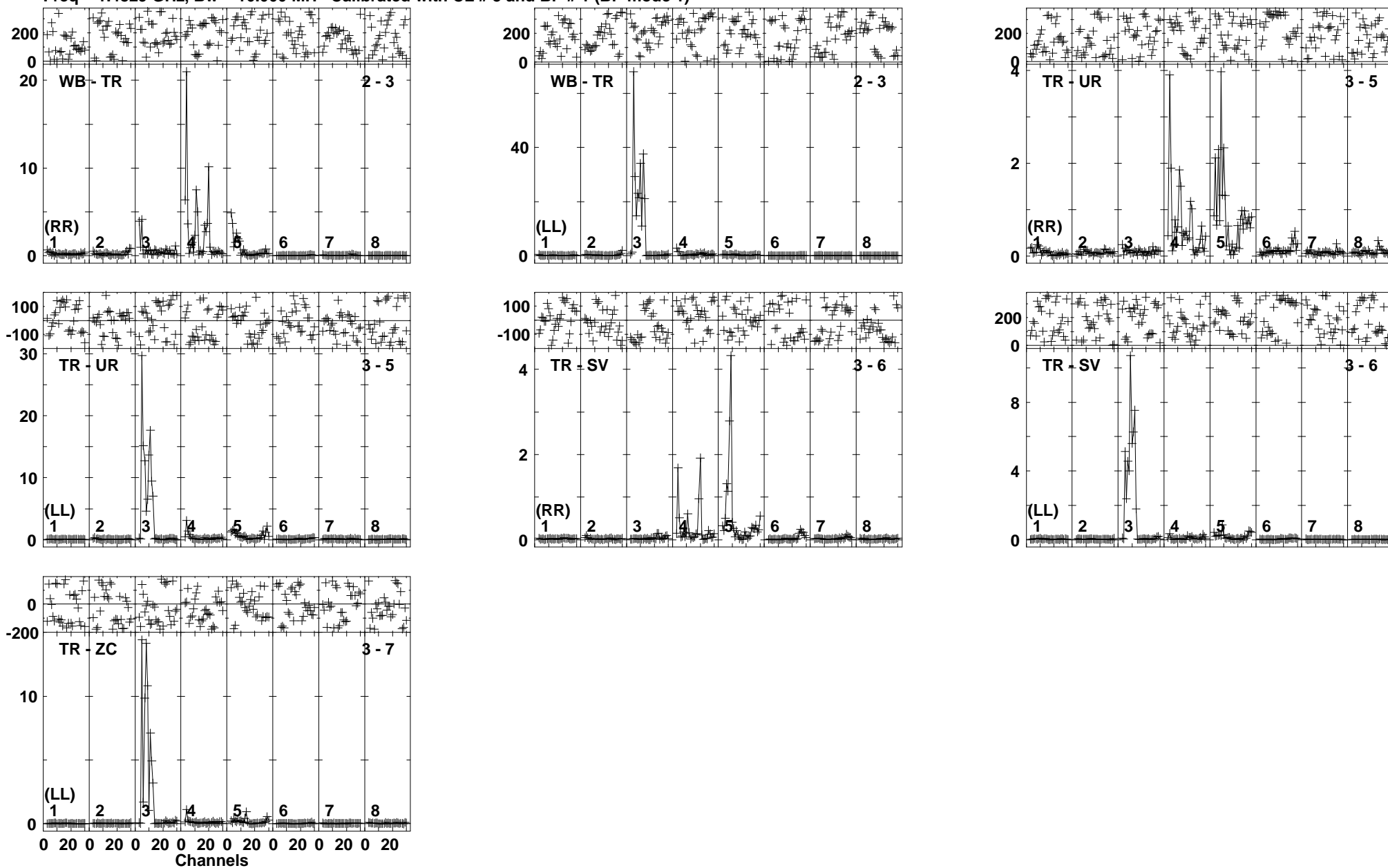

Lower frame: Ampl Jy Top frame: Phas deg
Vector averaged cross-power spectrum Baseline: WB (02) - TR (03)
Timerange: 00/08:31:56 to 00/08:35:24

Plot file version 239 created 21-JUN-2019 11:54:56

J1222+0413 EP111A 1.UVDATA.1

Freq = 1.4829 GHz, Bw = 16.000 MH Calibrated with CL # 3 and BP # 1 (BP mode 1)

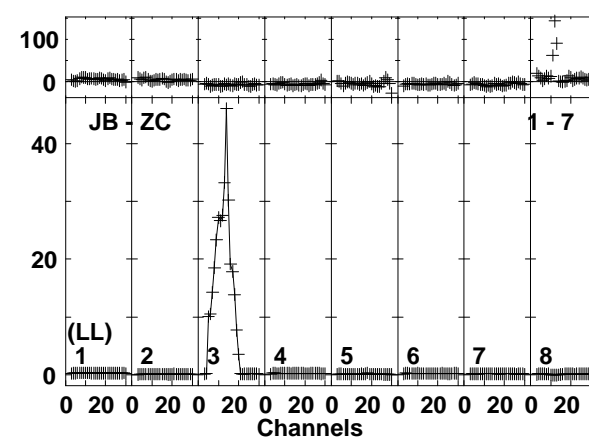
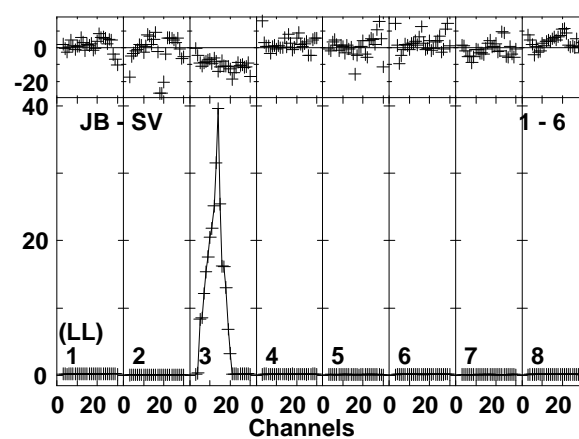
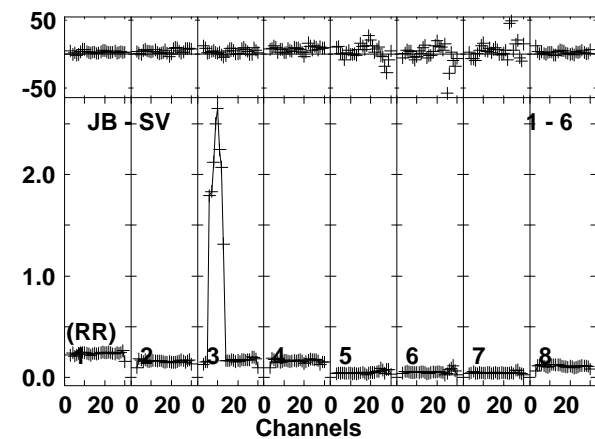
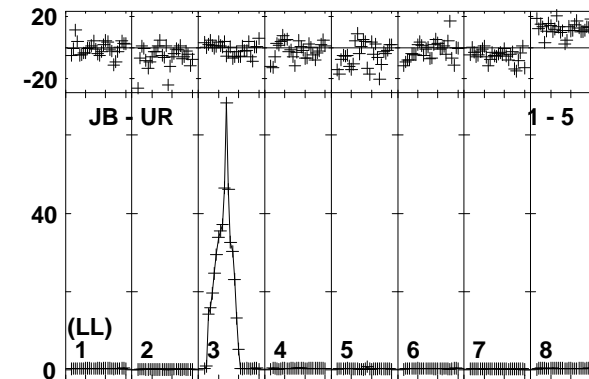
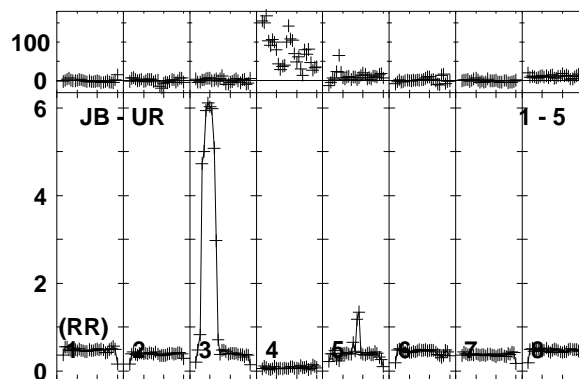
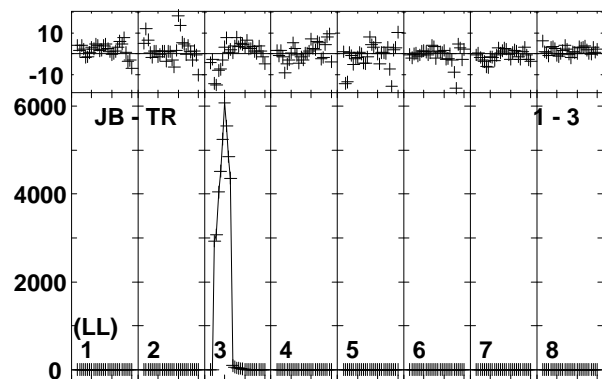
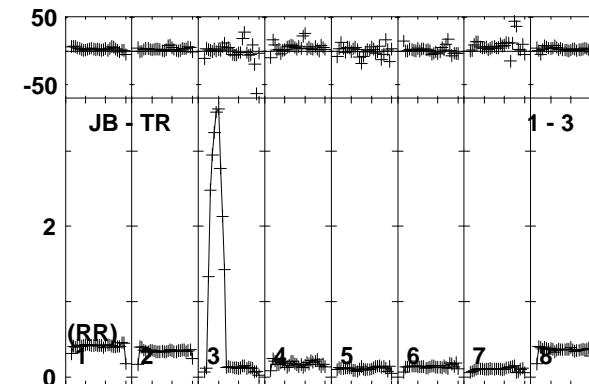
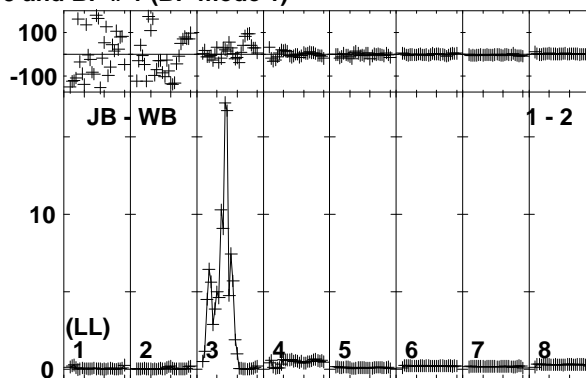
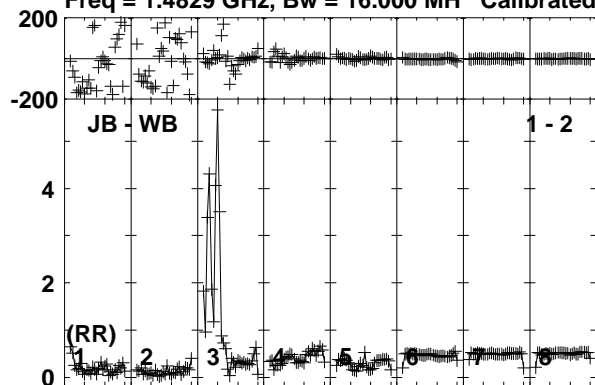

Lower frame: Ampl Jy Top frame: Phas deg
Vector averaged cross-power spectrum Baseline: JB (01) - WB (02)
Timerange: 00/08:36:06 to 00/08:37:34

Plot file version 240 created 21-JUN-2019 11:54:57

J1222+0413 EP111A 1.UVDATA.1

Freq = 1.4829 GHz, Bw = 16.000 MH Calibrated with CL # 3 and BP # 1 (BP mode 1)

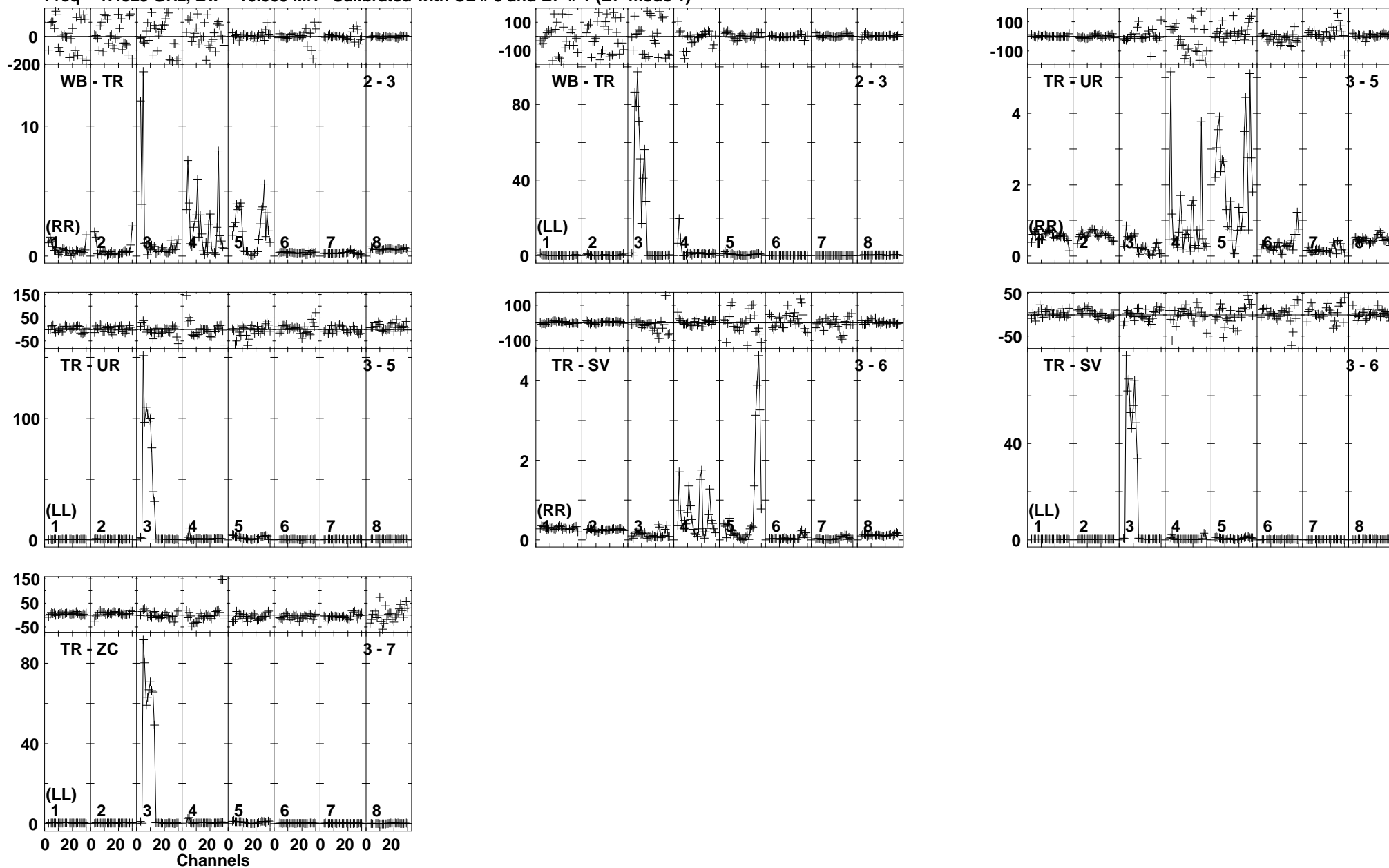

Lower frame: Ampl Jy Top frame: Phas deg
Vector averaged cross-power spectrum Baseline: WB (02) - TR (03)
Timerange: 00/08:36:06 to 00/08:37:34

Plot file version 241 created 21-JUN-2019 11:54:57

IRAS12112 EP111A 1.UVDATA.1

Freq = 1.4829 GHz, Bw = 16.000 MH Calibrated with CL # 3 and BP # 1 (BP mode 1)

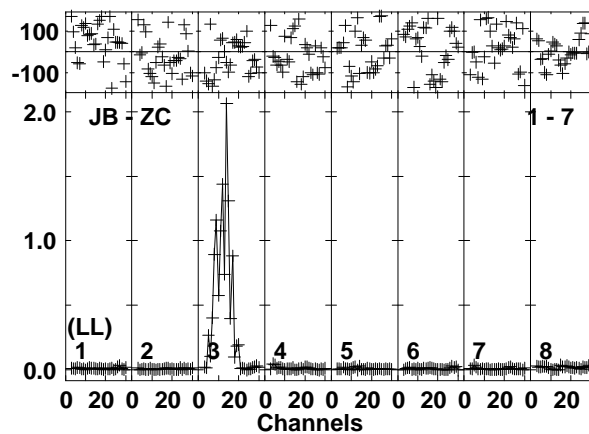
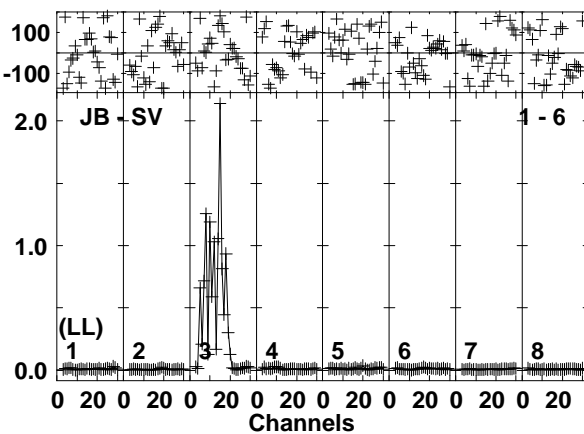
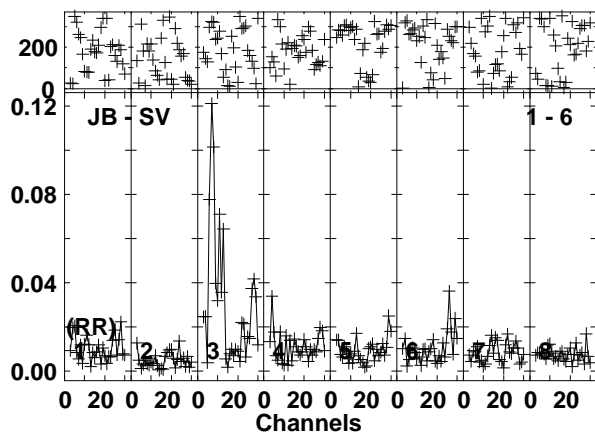
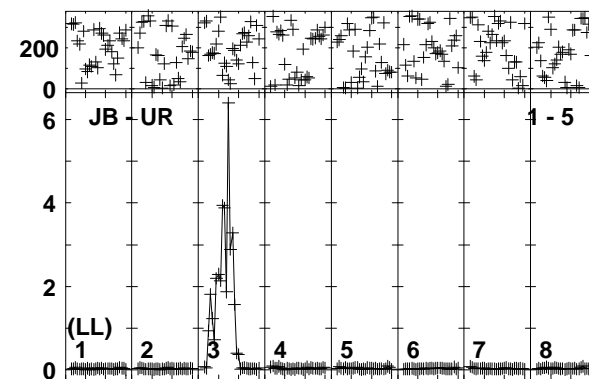
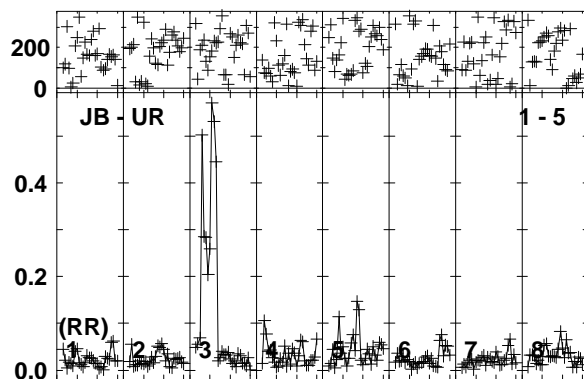
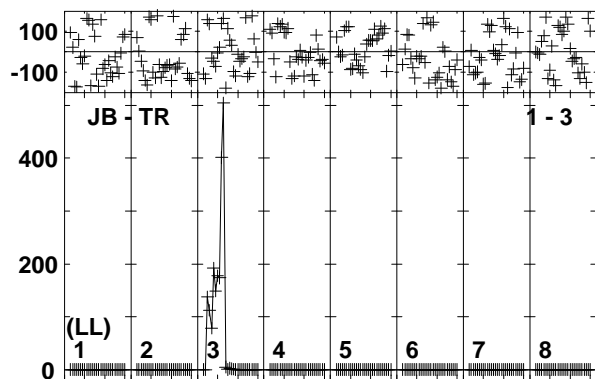
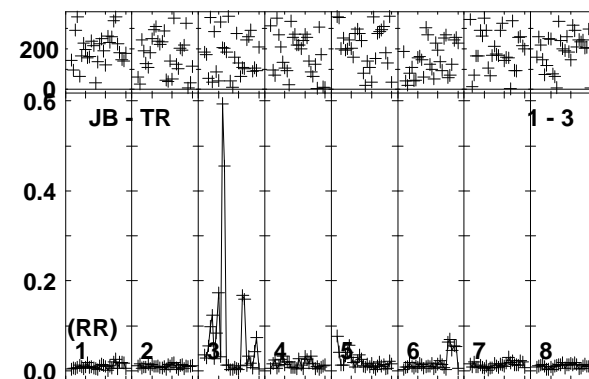
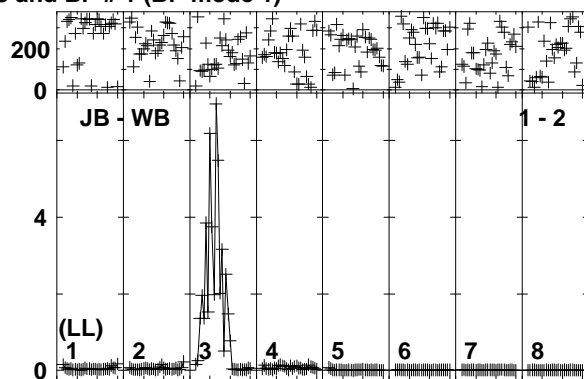
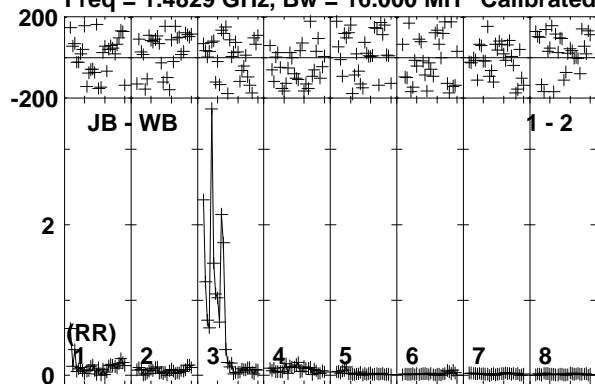

Lower frame: Ampl Jy Top frame: Phas deg
Vector averaged cross-power spectrum Baseline: JB (01) - WB (02)
Timerange: 00/08:37:36 to 00/08:41:04

Plot file version 242 created 21-JUN-2019 11:54:58

IRAS12112 EP111A 1.UVDATA.1

Freq = 1.4829 GHz, Bw = 16.000 MH Calibrated with CL # 3 and BP # 1 (BP mode 1)

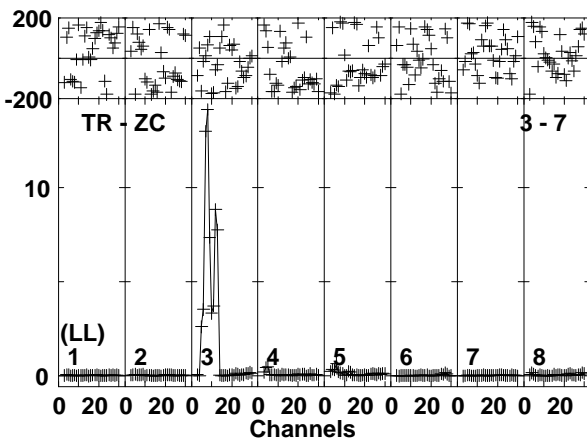
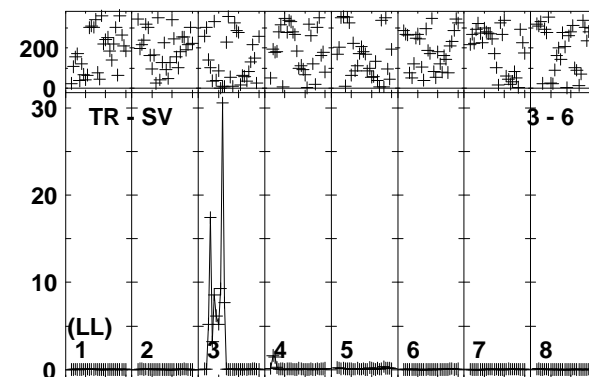
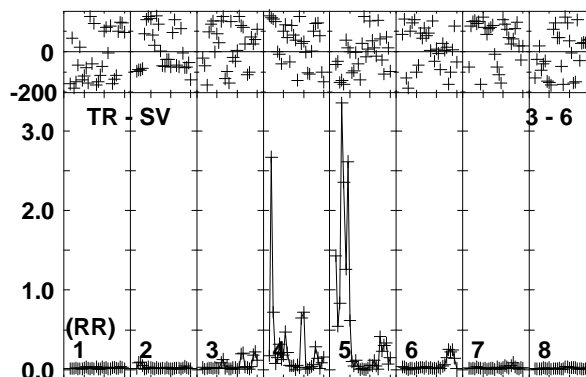
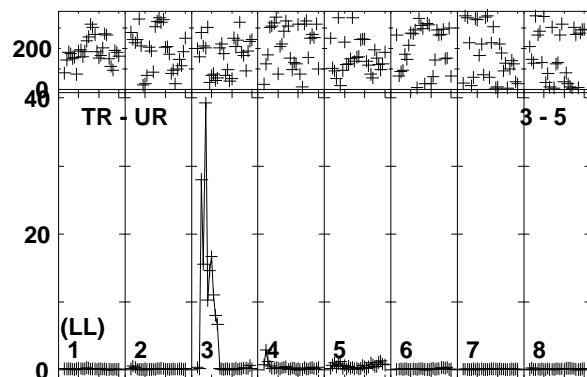
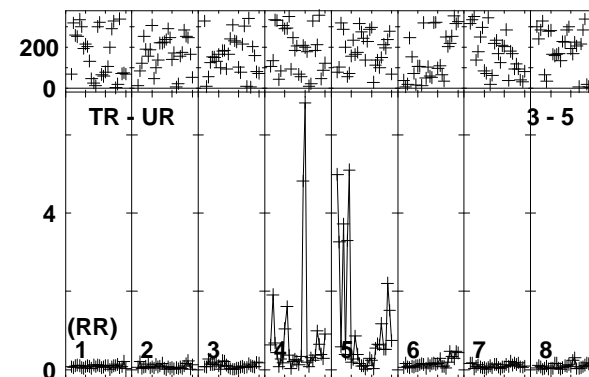
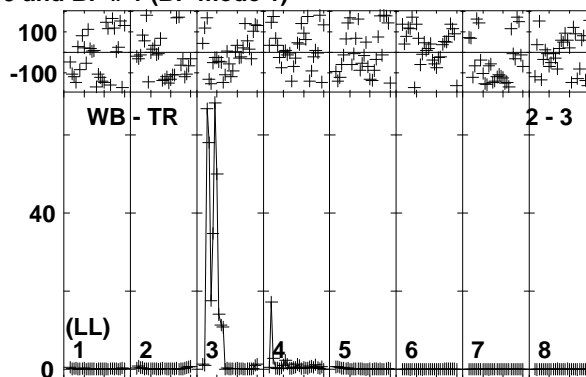
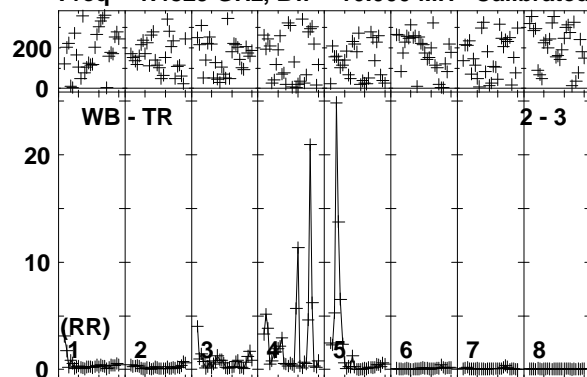

Lower frame: Ampl Jy Top frame: Phas deg
Vector averaged cross-power spectrum Baseline: WB (02) - TR (03)
Timerange: 00/08:37:36 to 00/08:41:04

Plot file version 244 created 21-JUN-2019 11:54:59

IRAS12112 EP111A 1.UVDATA.1

Freq = 1.4829 GHz, Bw = 16.000 MH Calibrated with CL # 3 and BP # 1 (BP mode 1)

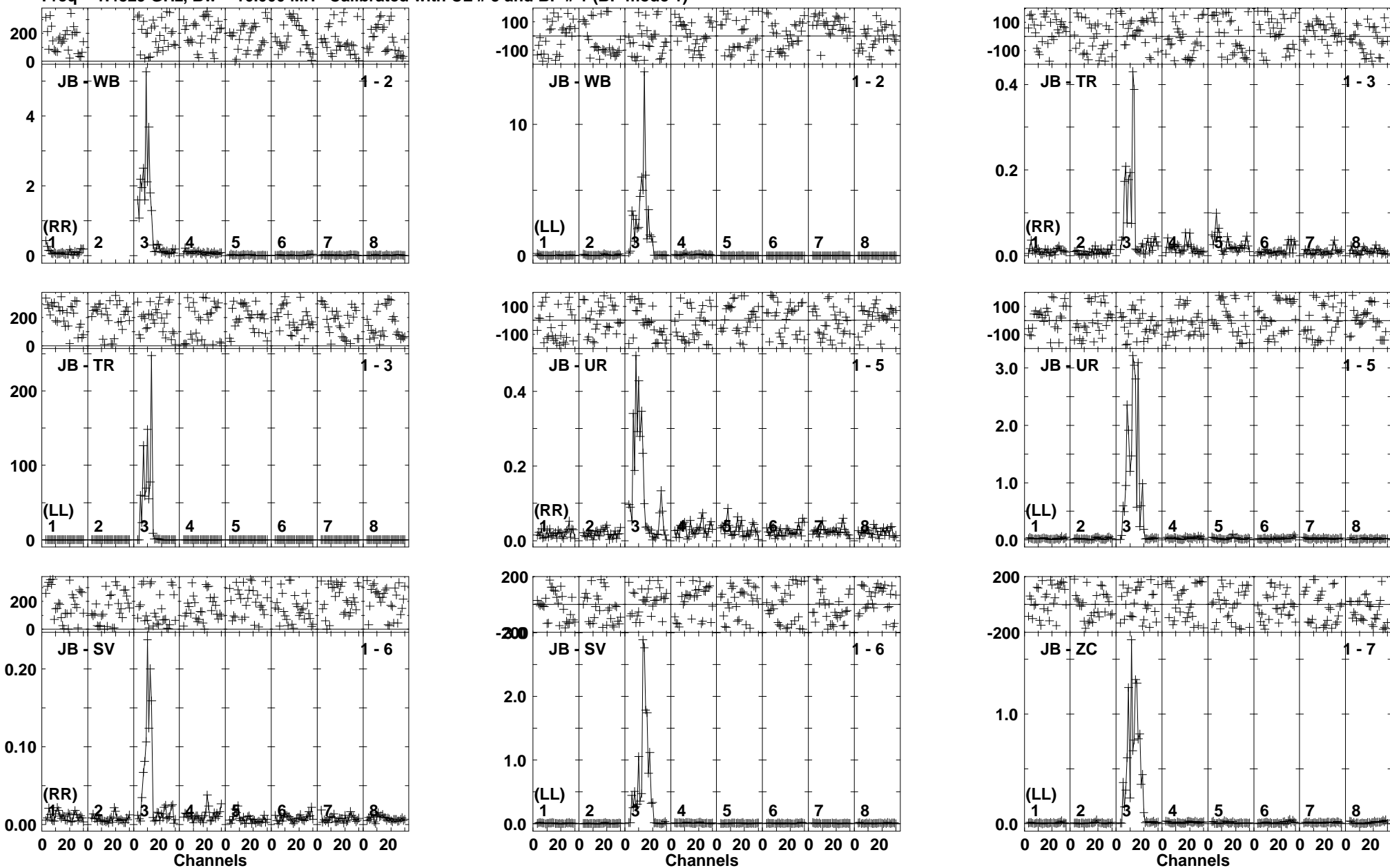

Lower frame: Ampl Jy Top frame: Phas deg
Vector averaged cross-power spectrum Baseline: JB (01) - WB (02)
Timerange: 00/08:42:36 to 00/08:46:04

Plot file version 245 created 21-JUN-2019 11:55:00

IRAS12112 EP111A 1.UVDATA.1

Freq = 1.4829 GHz, Bw = 16.000 MH Calibrated with CL # 3 and BP # 1 (BP mode 1)

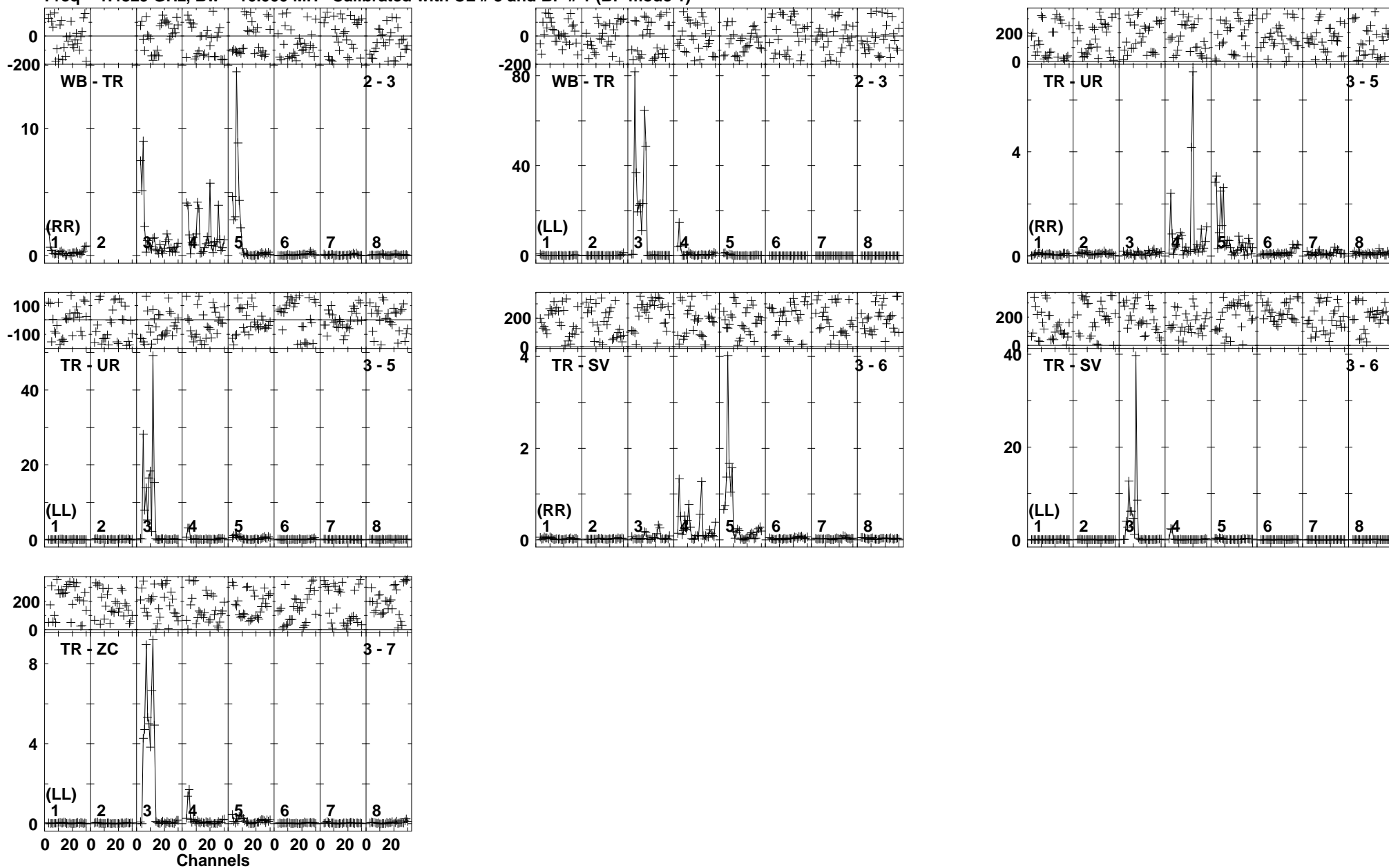

Lower frame: Ampl Jy Top frame: Phas deg
Vector averaged cross-power spectrum Baseline: WB (02) - TR (03)
Timerange: 00/08:42:36 to 00/08:46:04

Plot file version 246 created 21-JUN-2019 11:55:00

J1222+0413 EP111A 1.UVDATA.1

Freq = 1.4829 GHz, Bw = 16.000 MH Calibrated with CL # 3 and BP # 1 (BP mode 1)

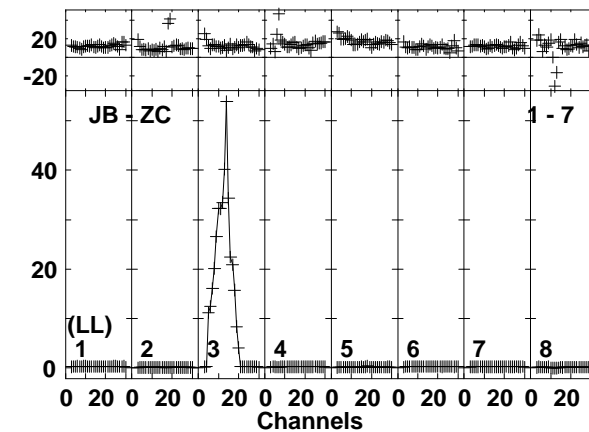
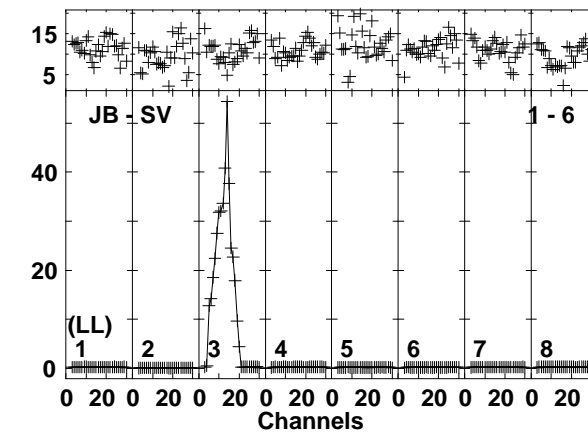
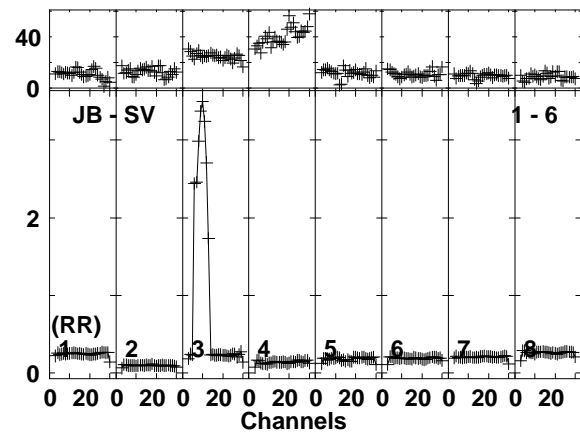
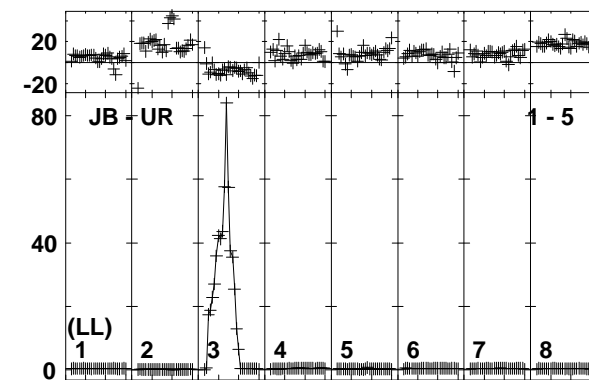
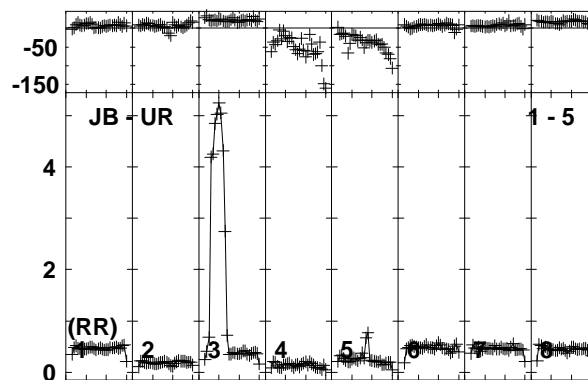
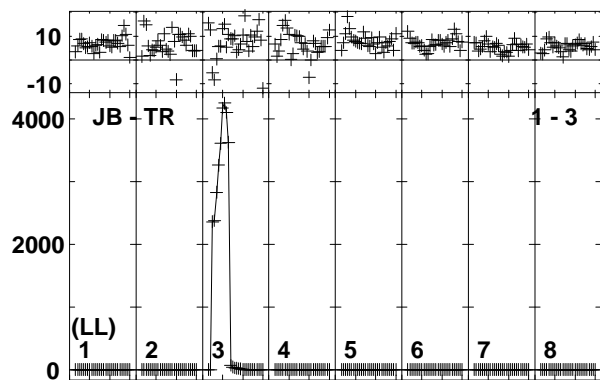
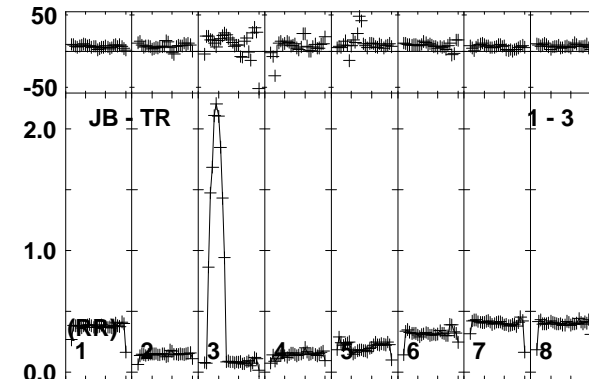
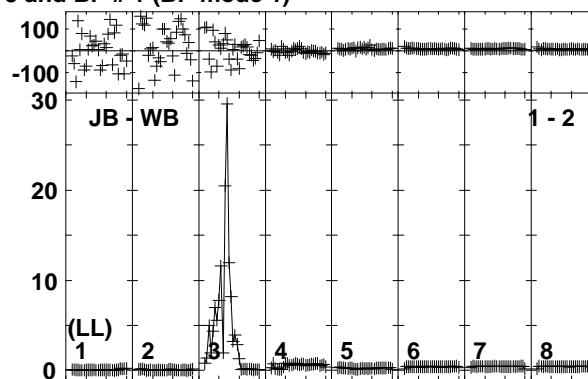
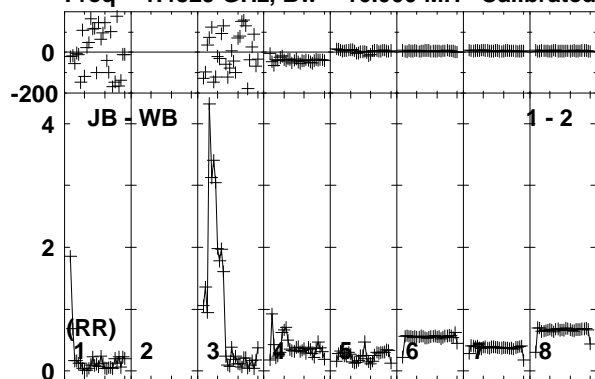

Lower frame: Ampl Jy Top frame: Phas deg
Vector averaged cross-power spectrum Baseline: JB (01) - WB (02)
Timerange: 00/08:46:46 to 00/08:48:14

Plot file version 247 created 21-JUN-2019 11:55:01

J1222+0413 EP111A 1.UVDATA.1

Freq = 1.4829 GHz, Bw = 16.000 MH Calibrated with CL # 3 and BP # 1 (BP mode 1)

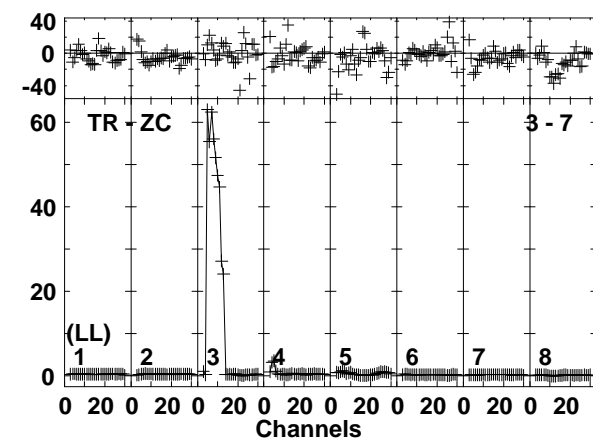
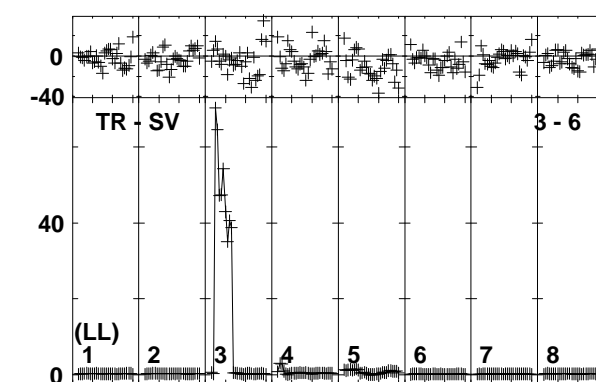
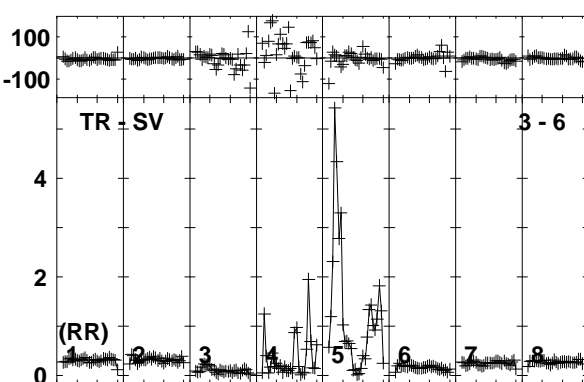
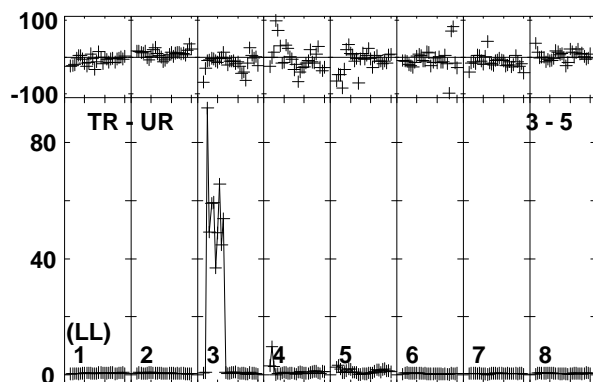
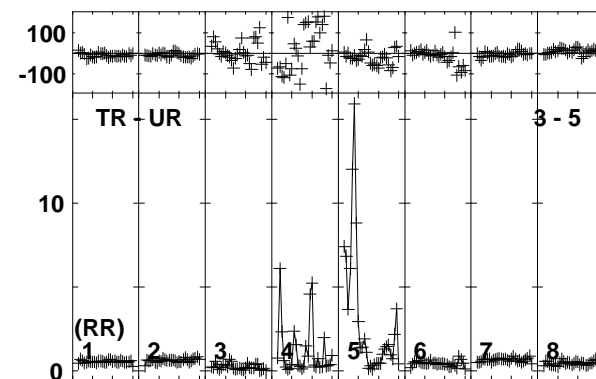
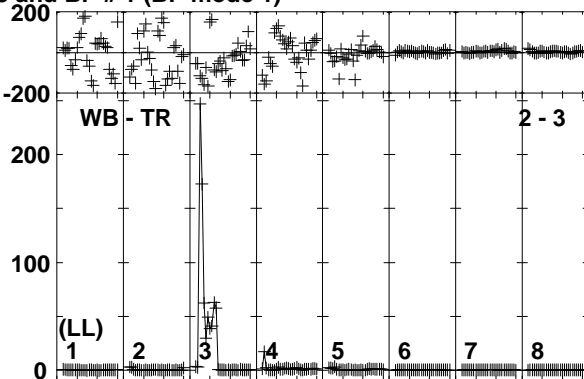
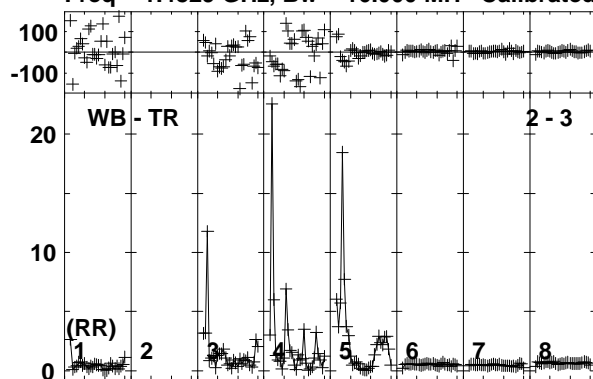

Lower frame: Ampl Jy Top frame: Phas deg
Vector averaged cross-power spectrum Baseline: WB (02) - TR (03)
Timerange: 00/08:46:46 to 00/08:48:14

Plot file version 248 created 21-JUN-2019 11:55:01

IRAS12112 EP111A 1.UVDATA.1

Freq = 1.4829 GHz, Bw = 16.000 MH Calibrated with CL # 3 and BP # 1 (BP mode 1)

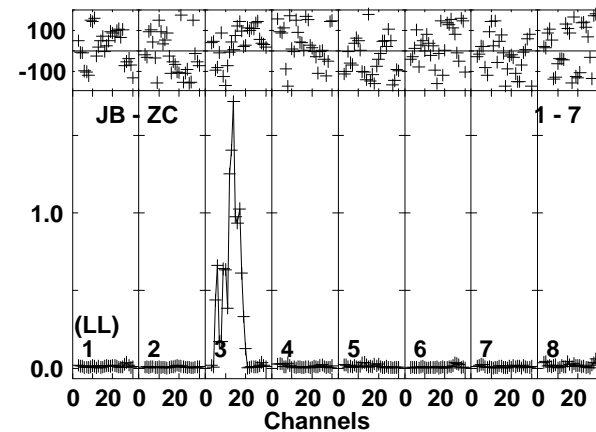
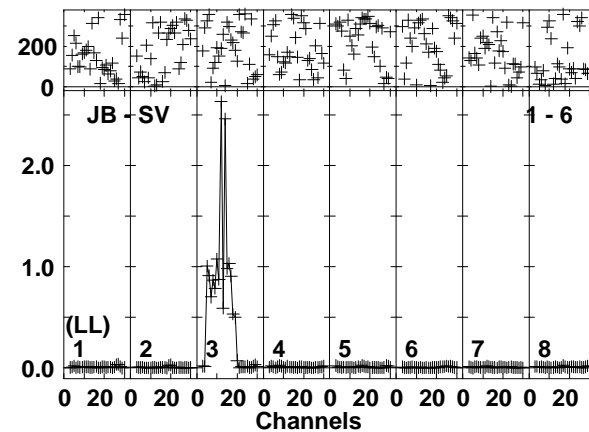
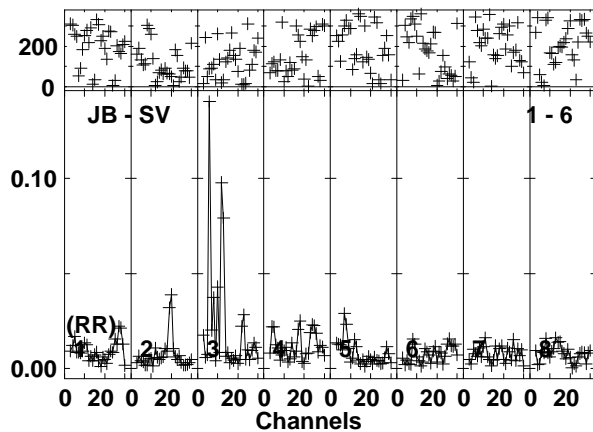
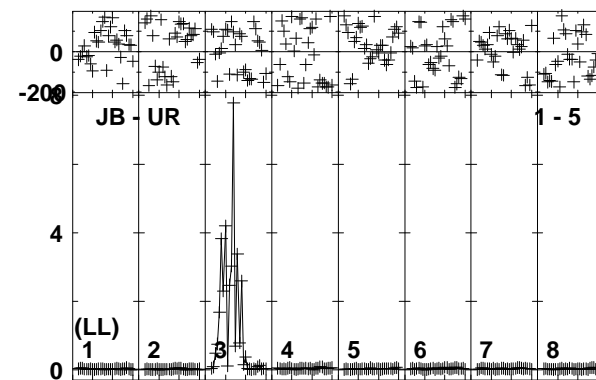
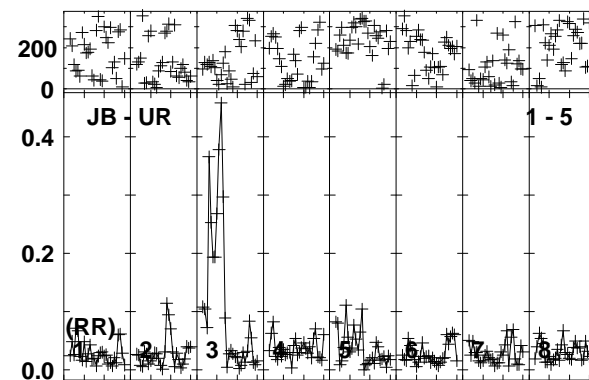
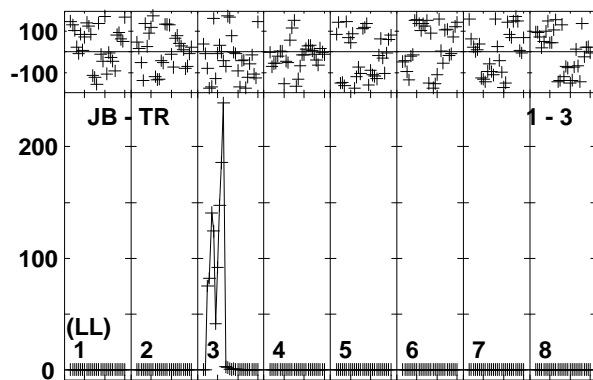
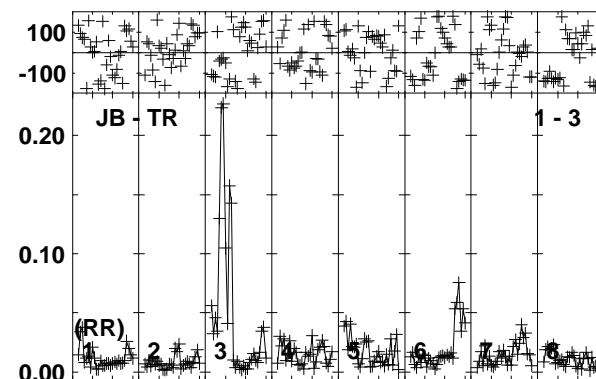
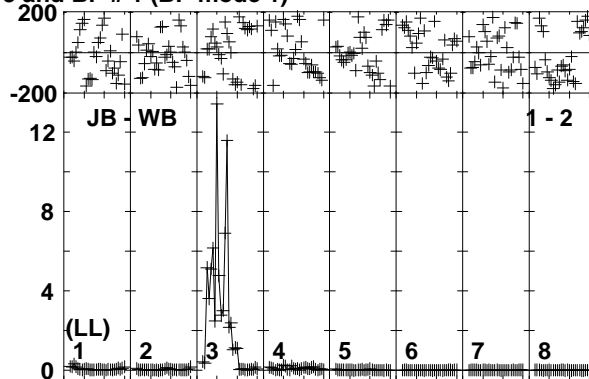
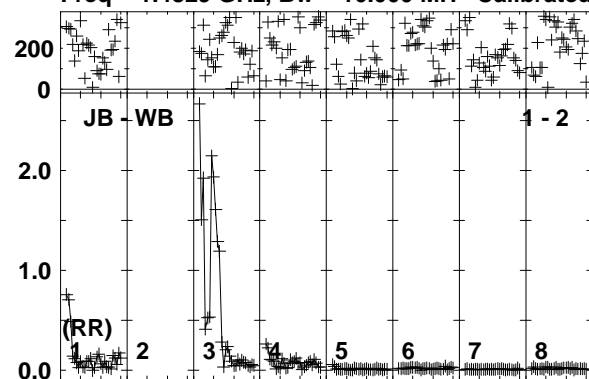

Lower frame: Ampl Jy Top frame: Phas deg
Vector averaged cross-power spectrum Baseline: JB (01) - WB (02)
Timerange: 00/08:48:16 to 00/08:51:44

Plot file version 249 created 21-JUN-2019 11:55:02

IRAS12112 EP111A 1.UVDATA.1

Freq = 1.4829 GHz, Bw = 16.000 MH Calibrated with CL # 3 and BP # 1 (BP mode 1)

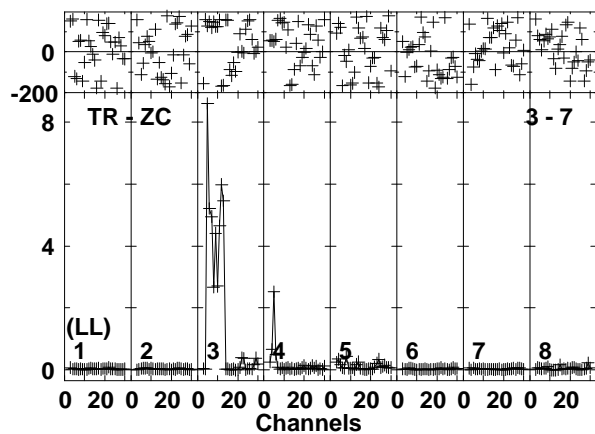
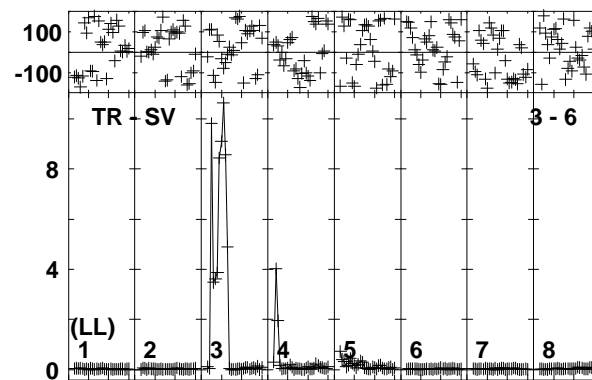
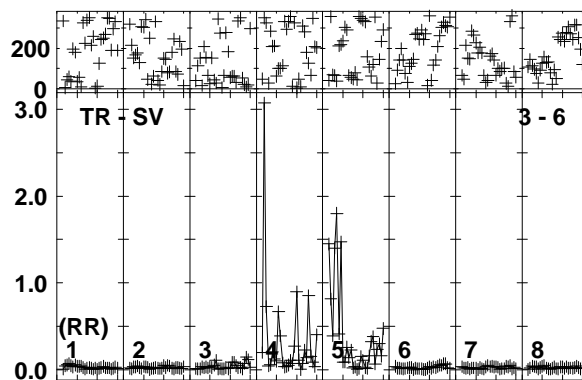
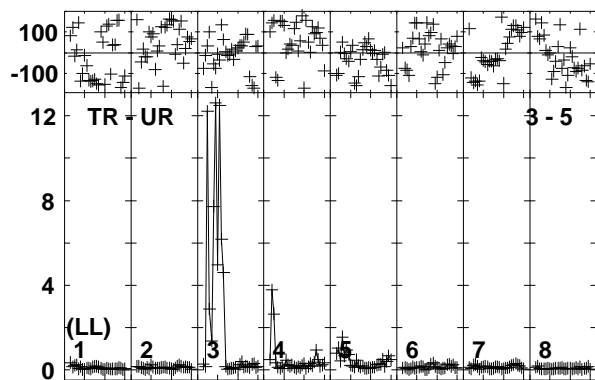
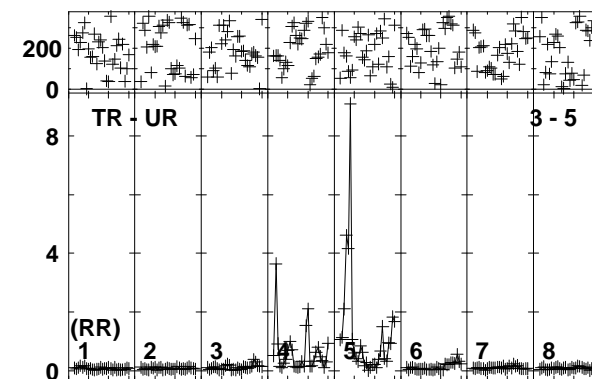
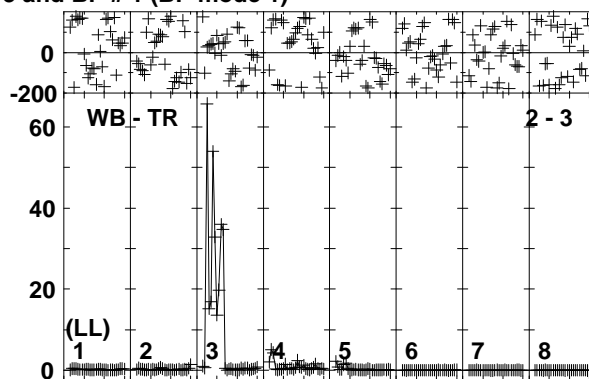
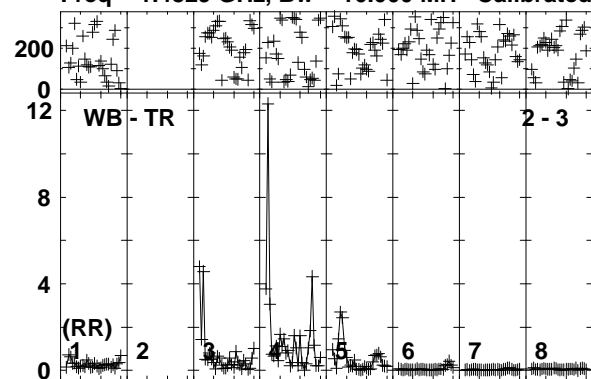

Lower frame: Ampl Jy Top frame: Phas deg
Vector averaged cross-power spectrum Baseline: WB (02) - TR (03)
Timerange: 00/08:48:16 to 00/08:51:44

Plot file version 250 created 21-JUN-2019 11:55:03

J1222+0413 EP111A 1.UVDATA.1

Freq = 1.4829 GHz, Bw = 16.000 MH Calibrated with CL # 3 and BP # 1 (BP mode 1)

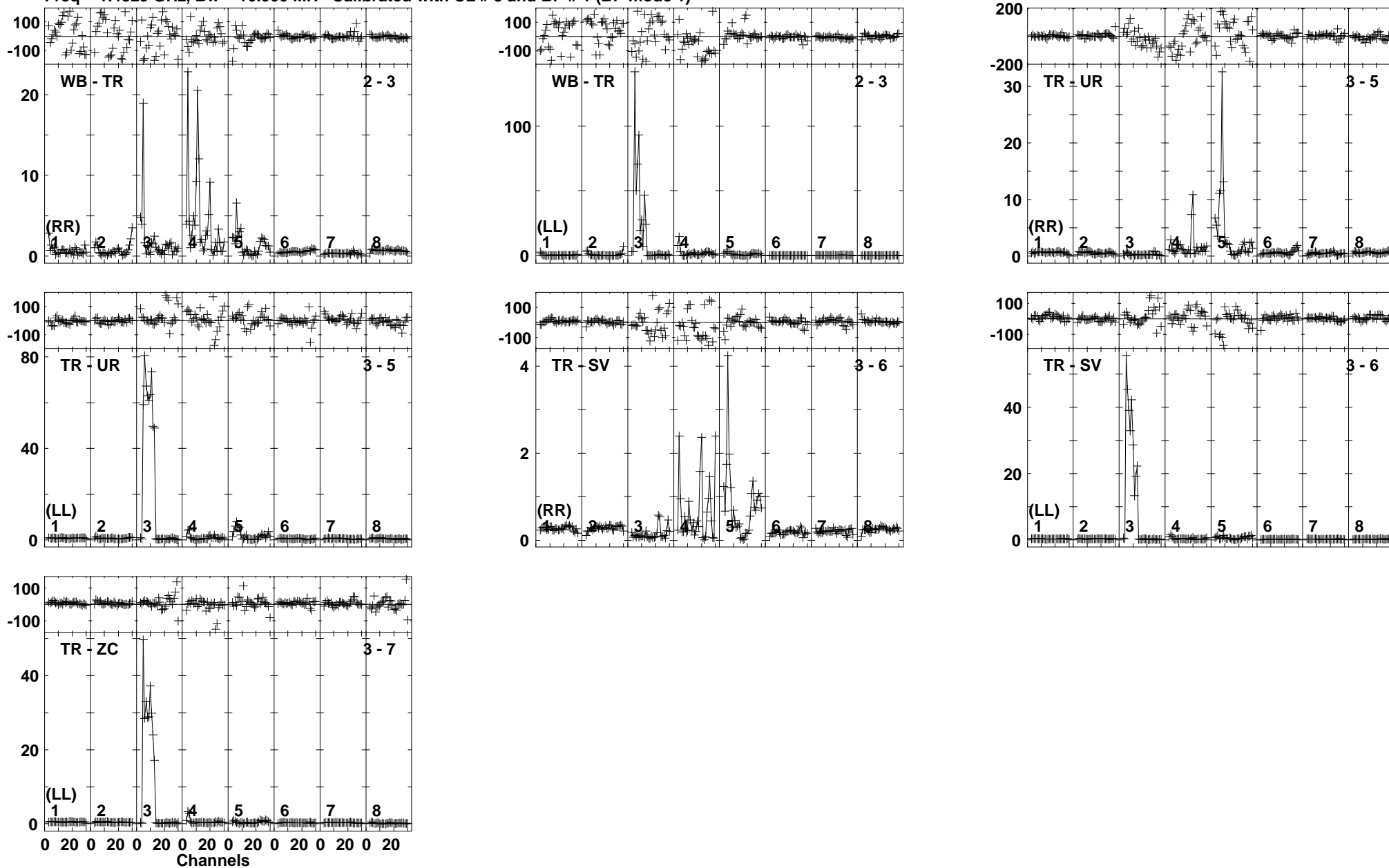

Lower frame: Ampl Jy Top frame: Phas deg
Vector averaged cross-power spectrum Baseline: WB (02) - TR (03)
Timerange: 00/08:51:46 to 00/08:53:14

Plot file version 251 created 21-JUN-2019 11:55:03

IRAS12112 EP111A 1.UVDATA.1

Freq = 1.4829 GHz, Bw = 16.000 MH Calibrated with CL # 3 and BP # 1 (BP mode 1)

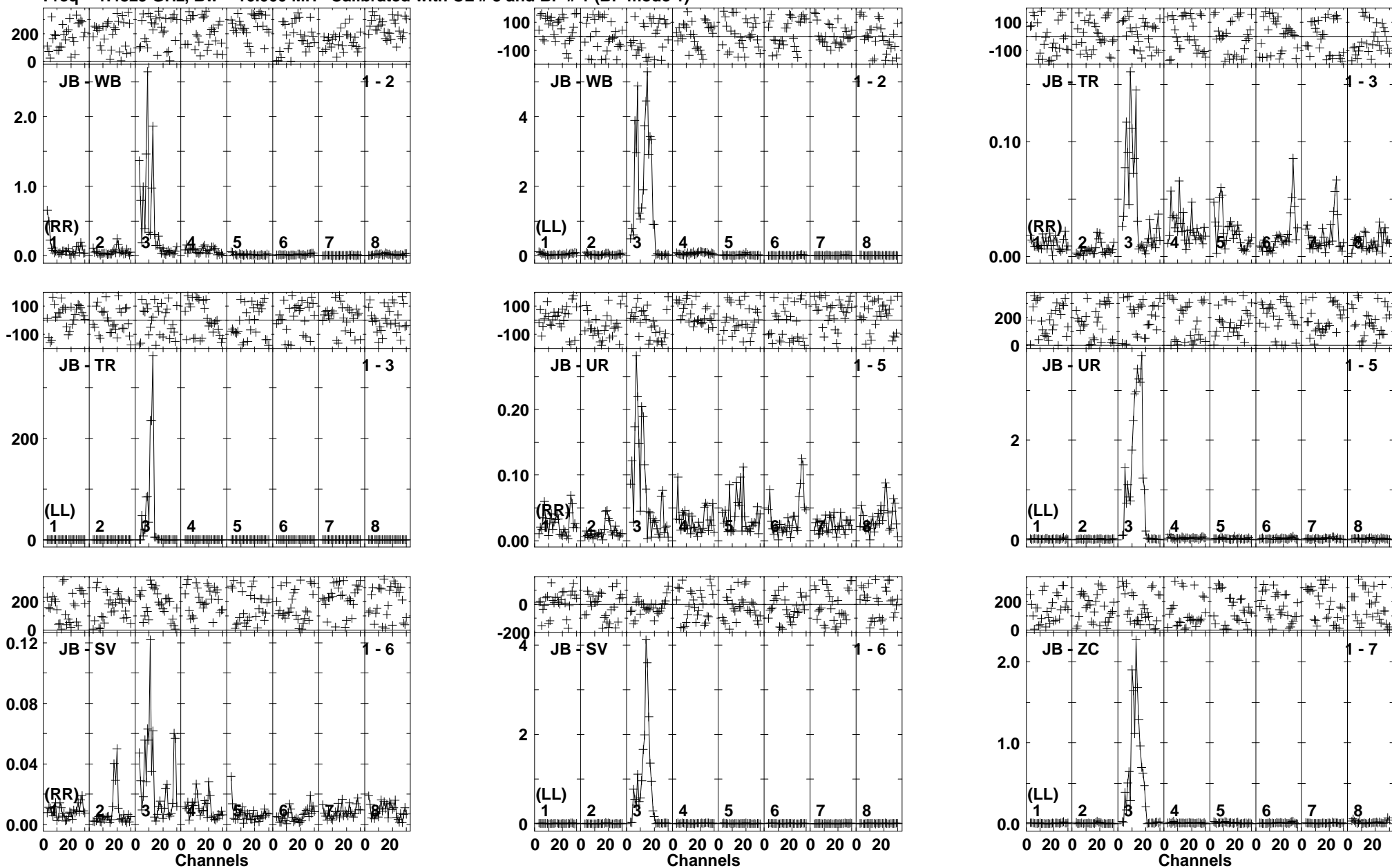

Lower frame: Ampl Jy Top frame: Phas deg
Vector averaged cross-power spectrum Baseline: JB (01) - WB (02)
Timerange: 00/08:53:16 to 00/08:56:44

Plot file version 252 created 21-JUN-2019 11:55:03

IRAS12112 EP111A 1.UVDATA.1

Freq = 1.4829 GHz, Bw = 16.000 MH Calibrated with CL # 3 and BP # 1 (BP mode 1)

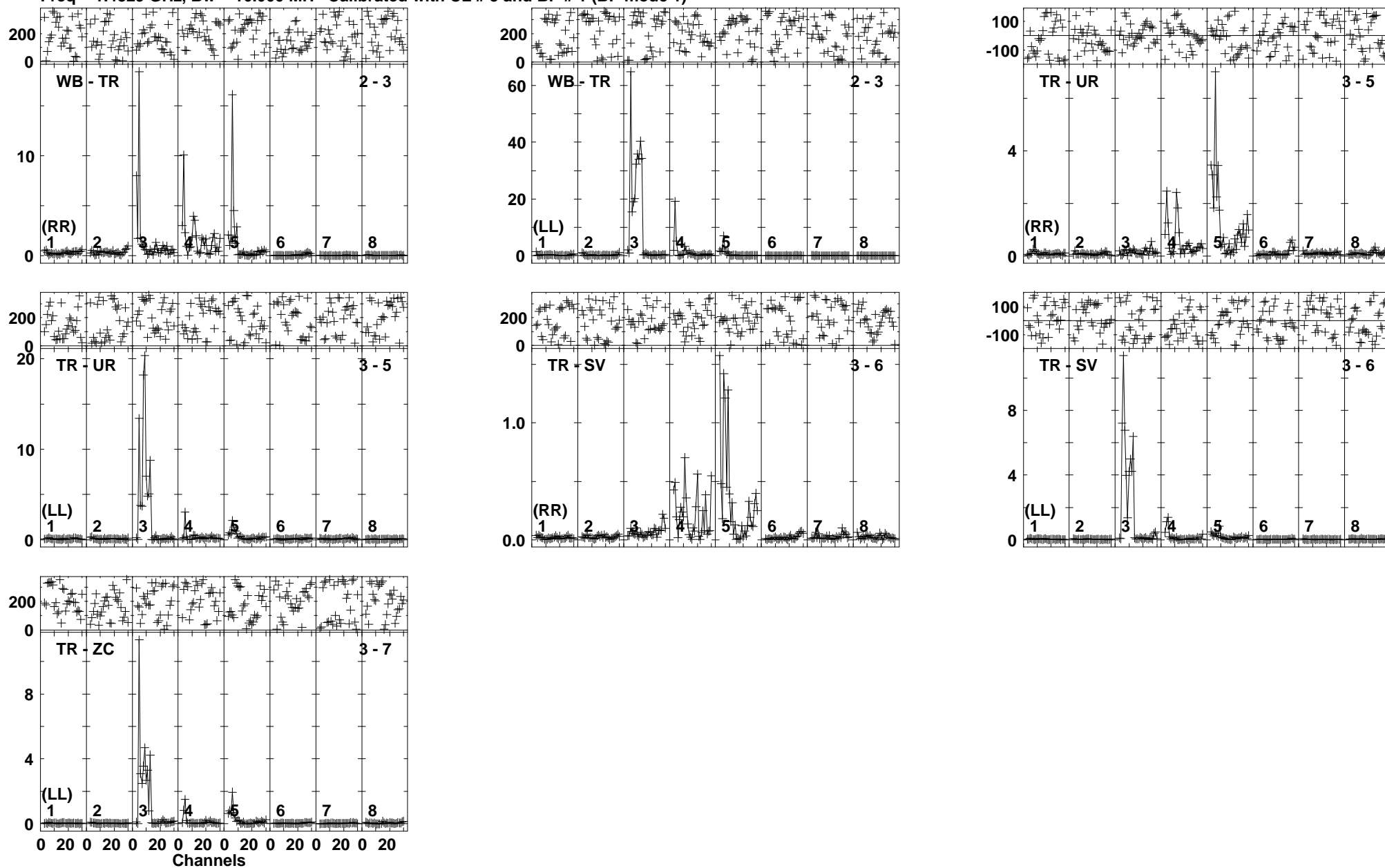

Lower frame: Ampl Jy Top frame: Phas deg
Vector averaged cross-power spectrum Baseline: WB (02) - TR (03)
Timerange: 00/08:53:16 to 00/08:56:44

Plot file version 253 created 21-JUN-2019 11:55:04

J1222+0413 EP111A 1.UVDATA.1

Freq = 1.4829 GHz, Bw = 16.000 MH Calibrated with CL # 3 and BP # 1 (BP mode 1)

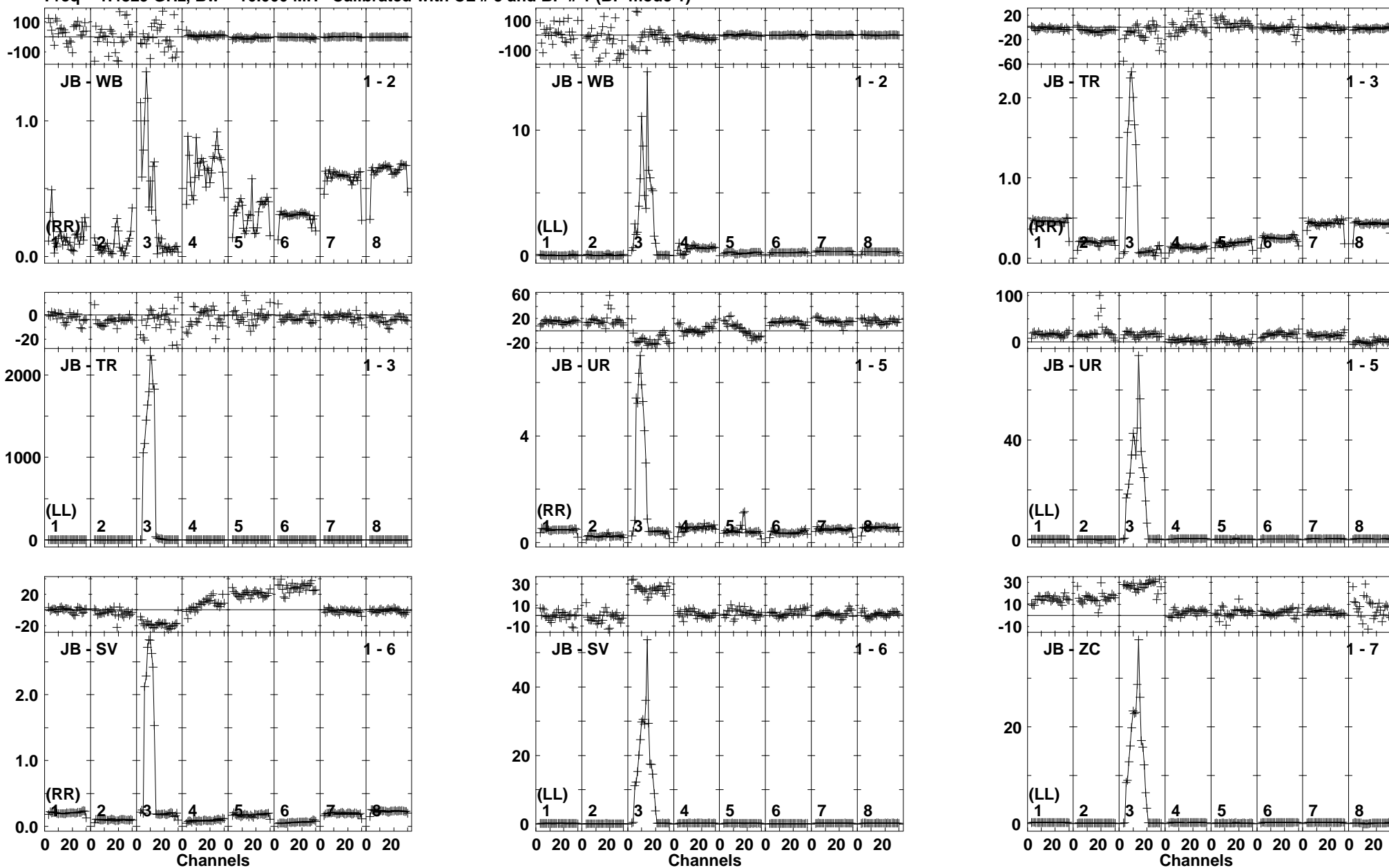

Lower frame: Ampl Jy Top frame: Phas deg
Vector averaged cross-power spectrum Baseline: JB (01) - WB (02)
Timerange: 00/08:57:26 to 00/08:58:54

Plot file version 255 created 21-JUN-2019 11:55:05

IRAS12112 EP111A 1.UVDATA.1

Freq = 1.4829 GHz, Bw = 16.000 MH Calibrated with CL # 3 and BP # 1 (BP mode 1)

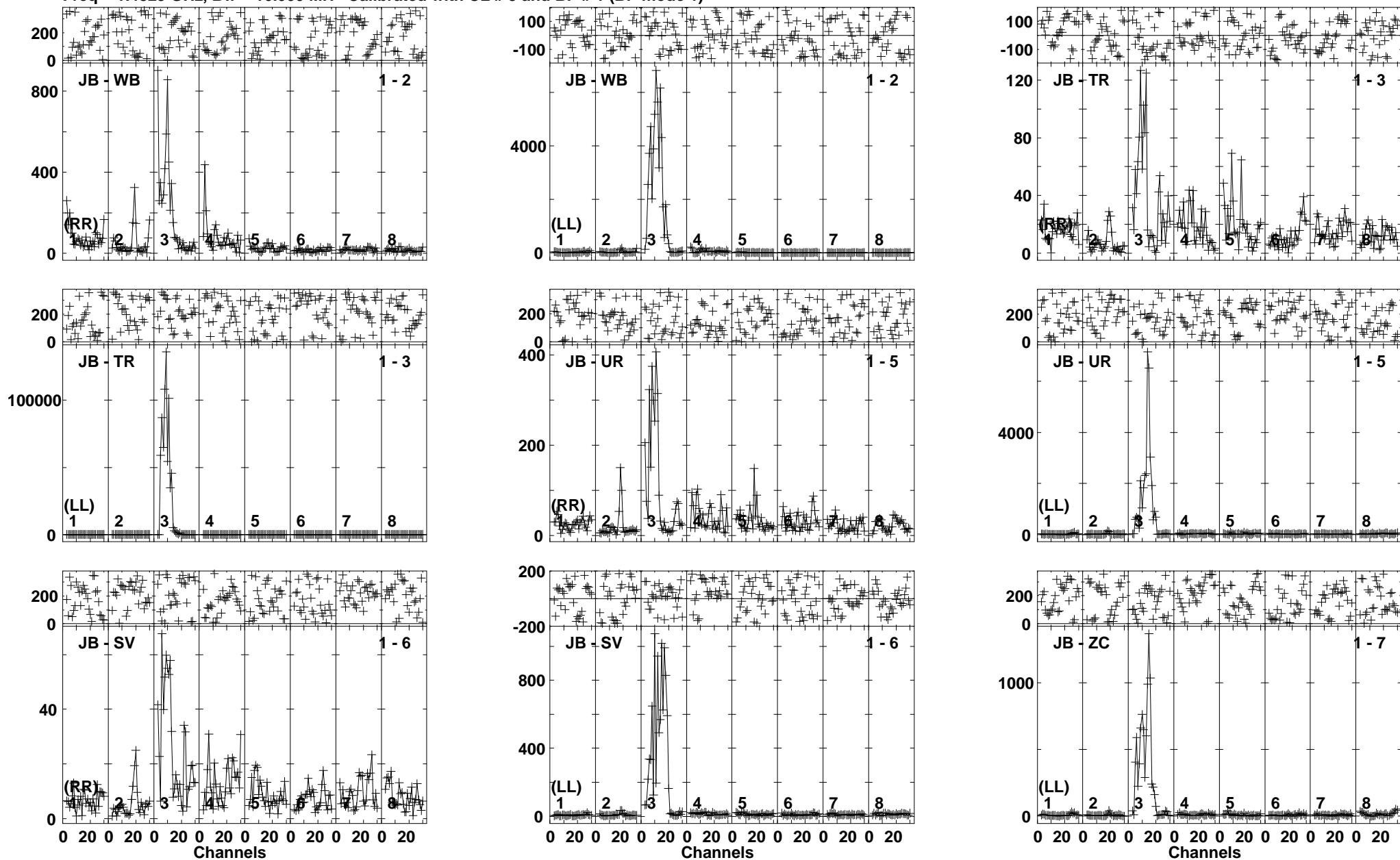

Lower frame: Milli Ampl Jy Top frame: Phas deg
Vector averaged cross-power spectrum Baseline: JB (01) - WB (02)
Timerange: 00/08:58:56 to 00/09:02:24

Plot file version 257 created 21-JUN-2019 11:55:06

J1222+0413 EP111A 1.UVDATA.1

Freq = 1.4829 GHz, Bw = 16.000 MH Calibrated with CL # 3 and BP # 1 (BP mode 1)

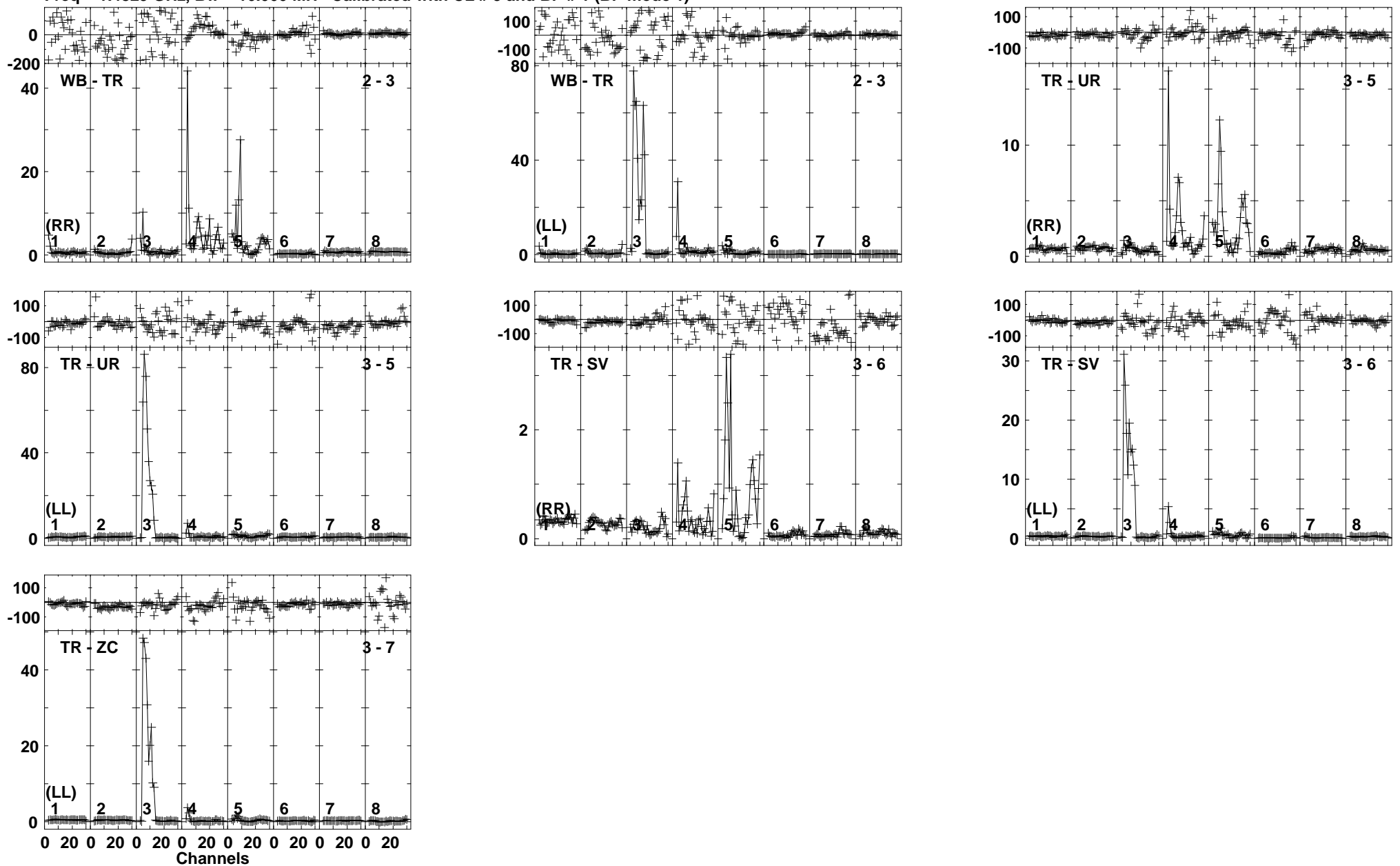

Lower frame: Ampl Jy Top frame: Phas deg
Vector averaged cross-power spectrum Baseline: WB (02) - TR (03)
Timerange: 00/09:02:26 to 00/09:03:54

Plot file version 258 created 21-JUN-2019 11:55:07

IRAS12112 EP111A 1.UVDATA.1

Freq = 1.4829 GHz, Bw = 16.000 MH Calibrated with CL # 3 and BP # 1 (BP mode 1)

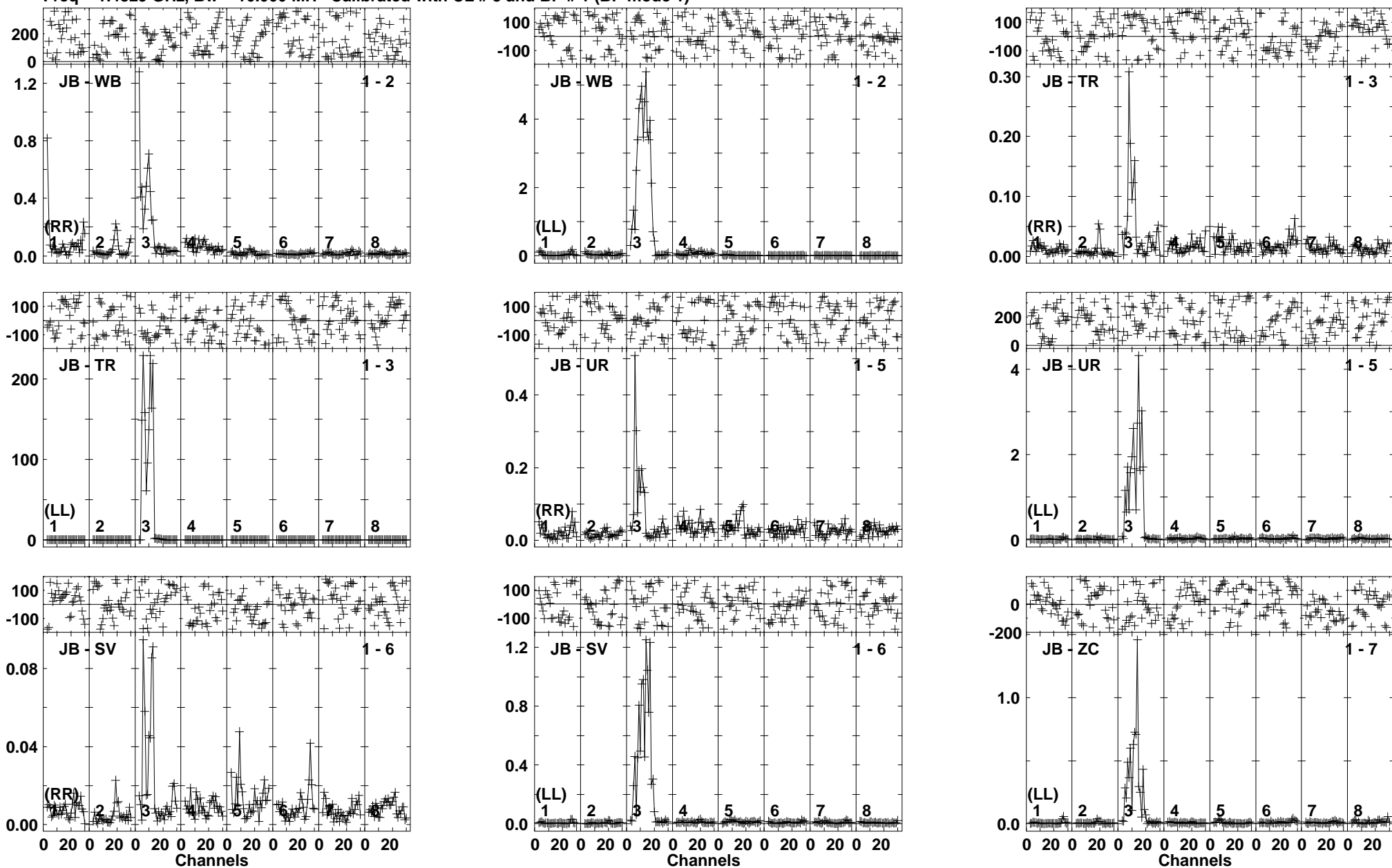

Lower frame: Ampl Jy Top frame: Phas deg
Vector averaged cross-power spectrum Baseline: JB (01) - WB (02)
Timerange: 00/09:03:56 to 00/09:07:24

Plot file version 260 created 21-JUN-2019 11:55:08

J1222+0413 EP111A 1.UVDATA.1

Freq = 1.4829 GHz, Bw = 16.000 MH Calibrated with CL # 3 and BP # 1 (BP mode 1)

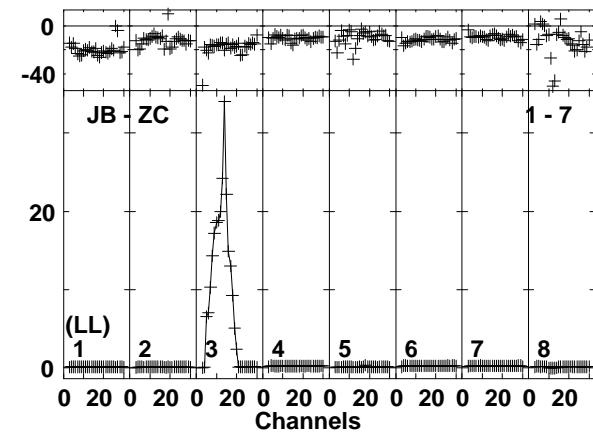
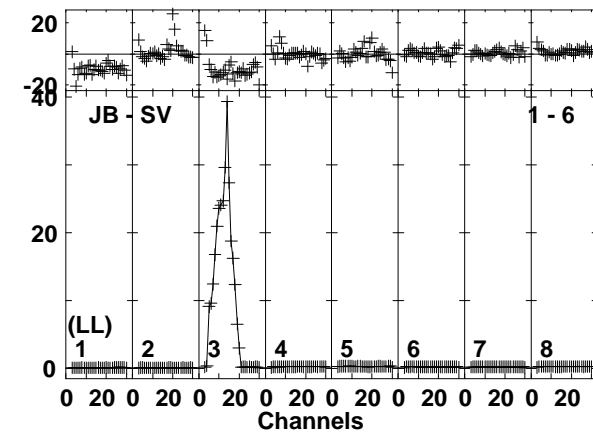
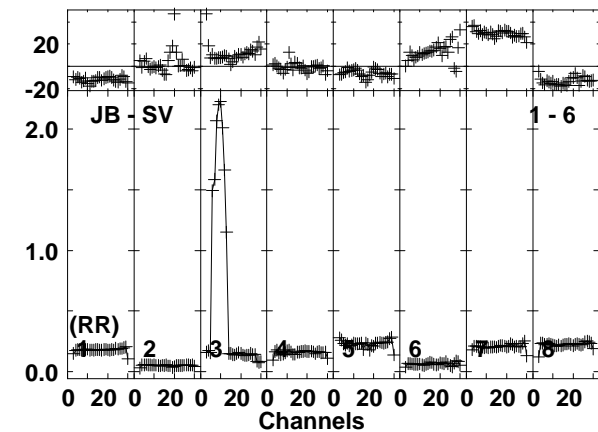
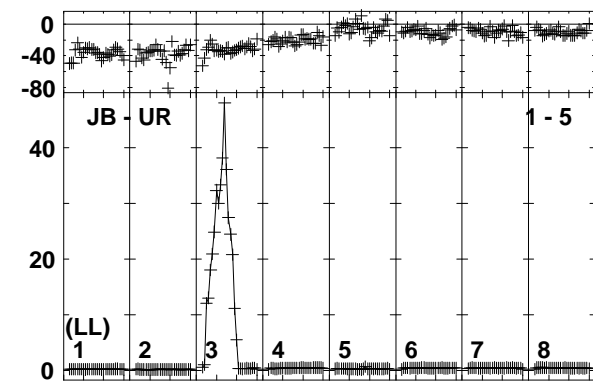
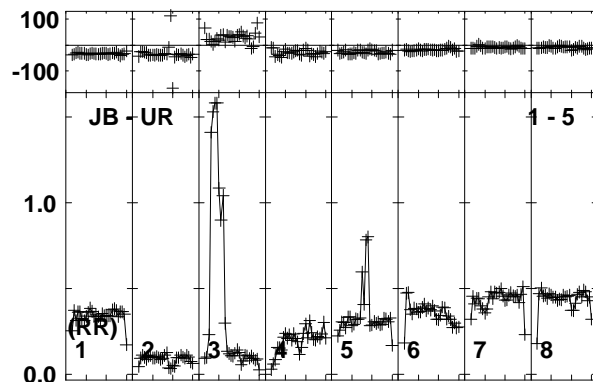
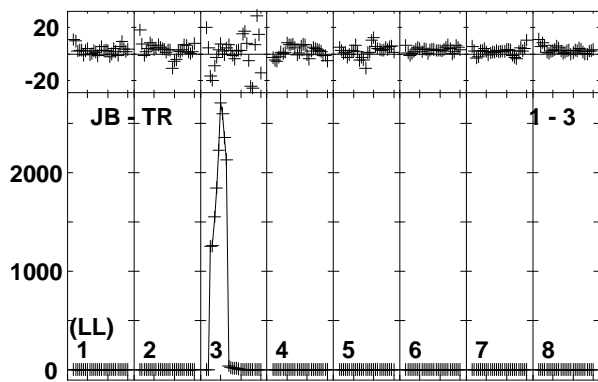
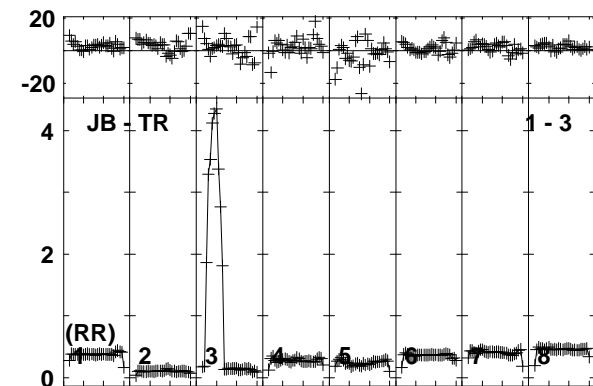
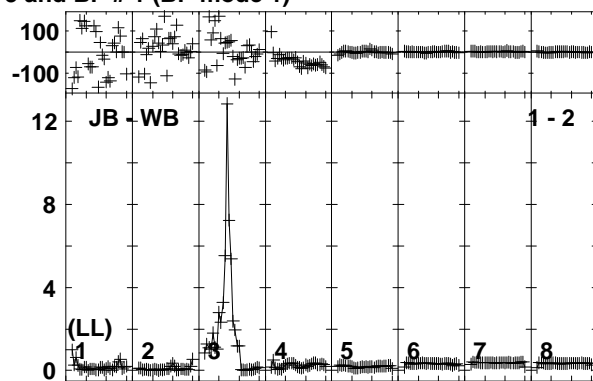
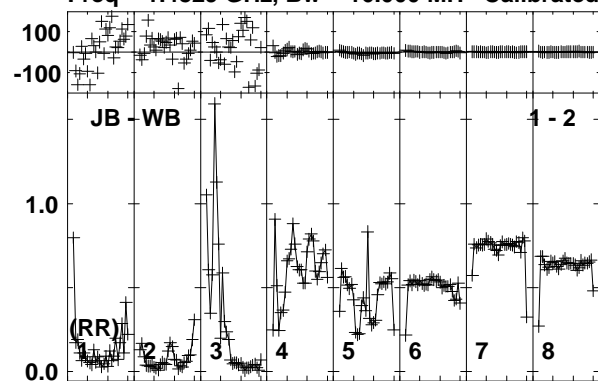

Lower frame: Ampl Jy Top frame: Phas deg
Vector averaged cross-power spectrum Baseline: JB (01) - WB (02)
Timerange: 00/09:08:06 to 00/09:09:34

Plot file version 261 created 21-JUN-2019 11:55:08

J1222+0413 EP111A 1.UVDATA.1

Freq = 1.4829 GHz, Bw = 16.000 MH Calibrated with CL # 3 and BP # 1 (BP mode 1)

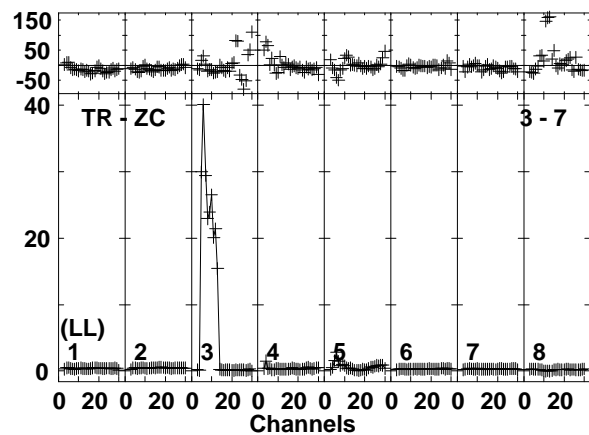
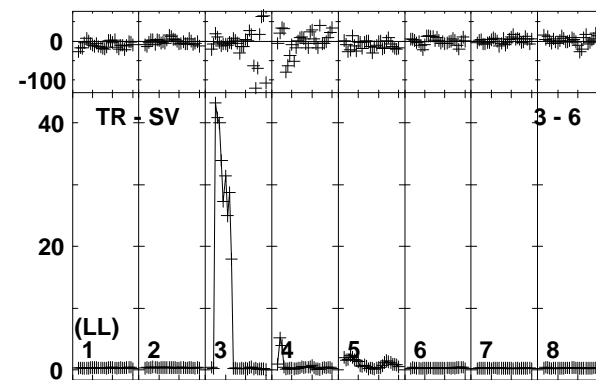
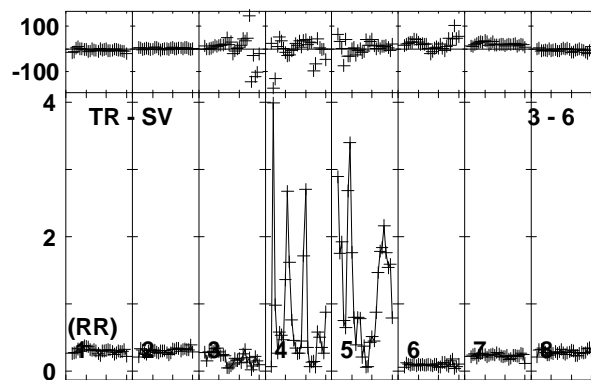
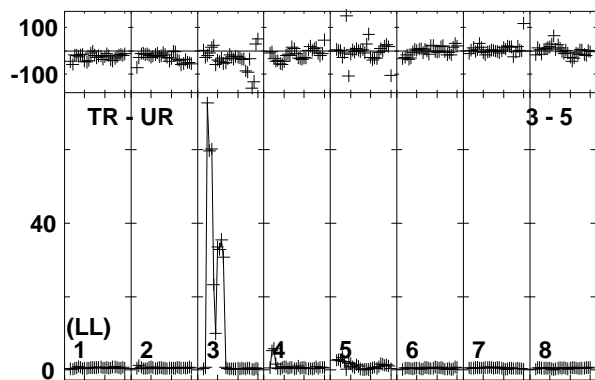
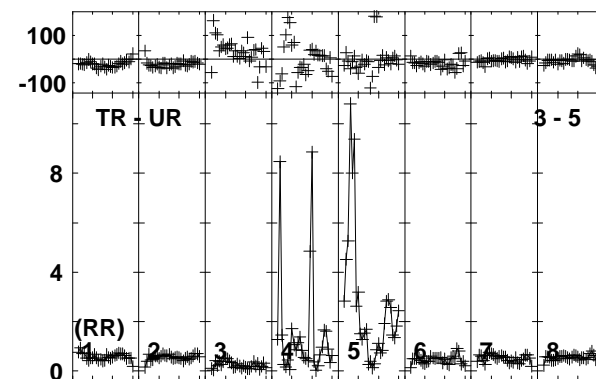
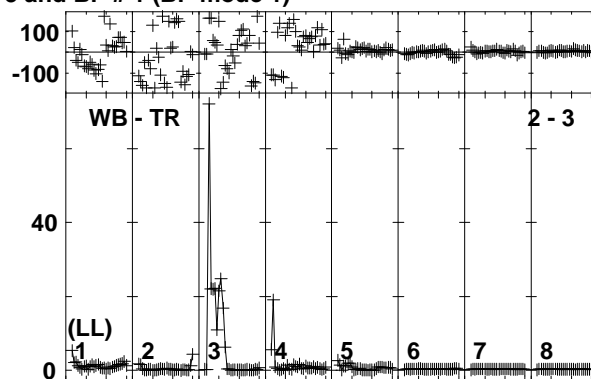
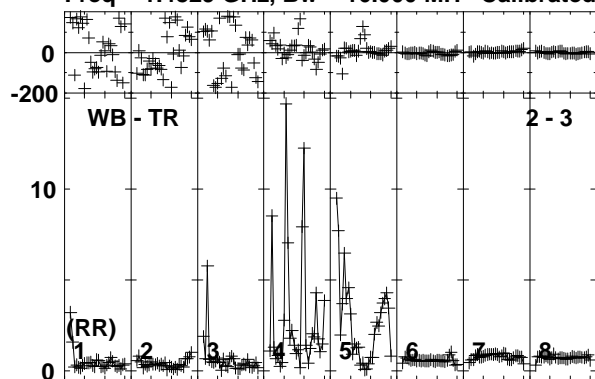

Lower frame: Ampl Jy Top frame: Phas deg
Vector averaged cross-power spectrum Baseline: WB (02) - TR (03)
Timerange: 00/09:08:06 to 00/09:09:34

Plot file version 262 created 21-JUN-2019 11:55:09

IRAS12112 EP111A 1.UVDATA.1

Freq = 1.4829 GHz, Bw = 16.000 MH Calibrated with CL # 3 and BP # 1 (BP mode 1)

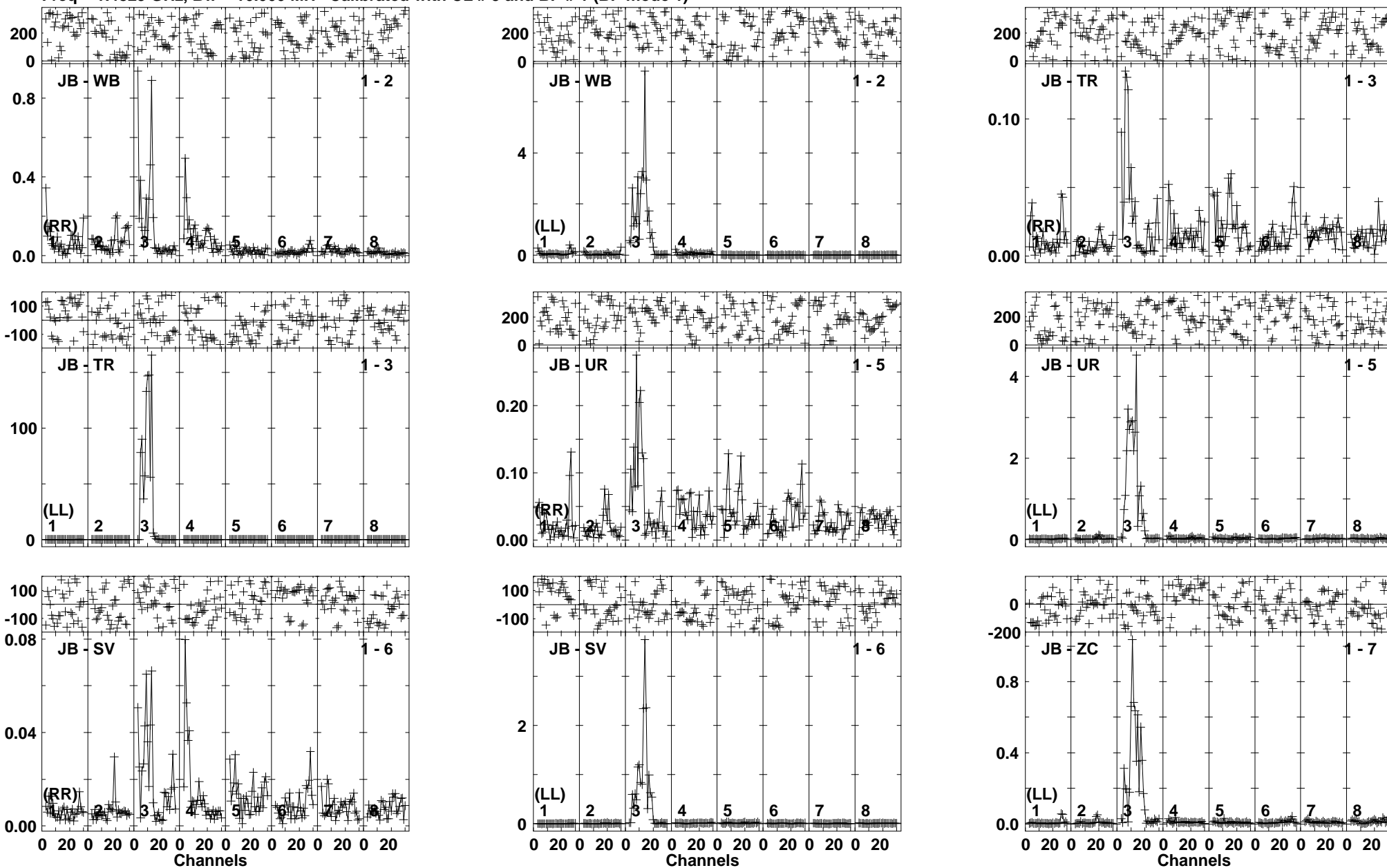

Plot file version 264 created 21-JUN-2019 11:55:10

J1222+0413 EP111A 1.UVDATA.1

Freq = 1.4829 GHz, Bw = 16.000 MH Calibrated with CL # 3 and BP # 1 (BP mode 1)

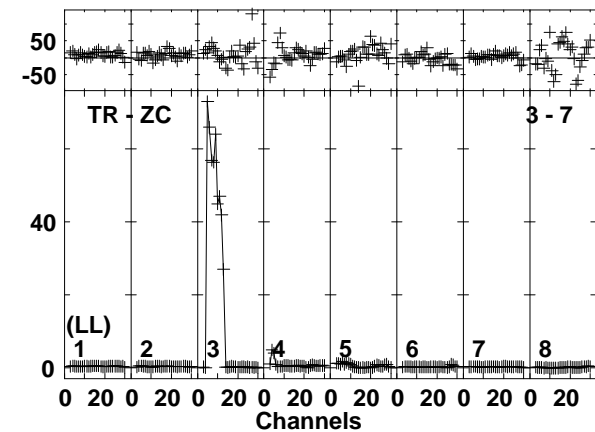
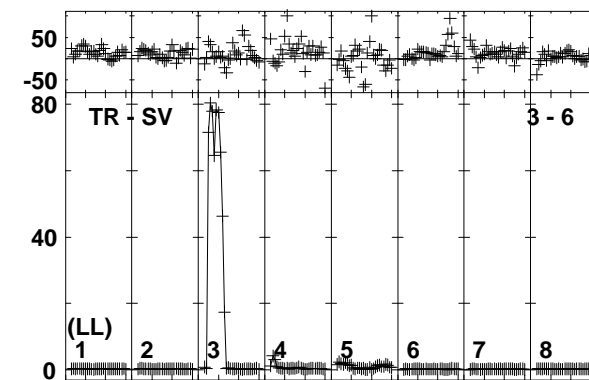
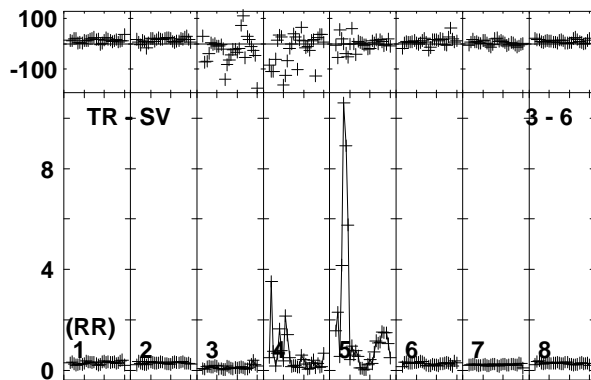
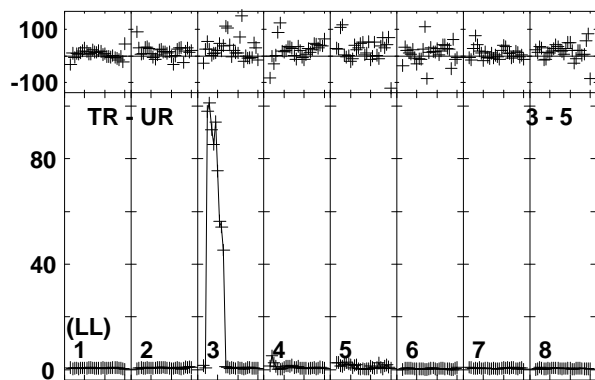
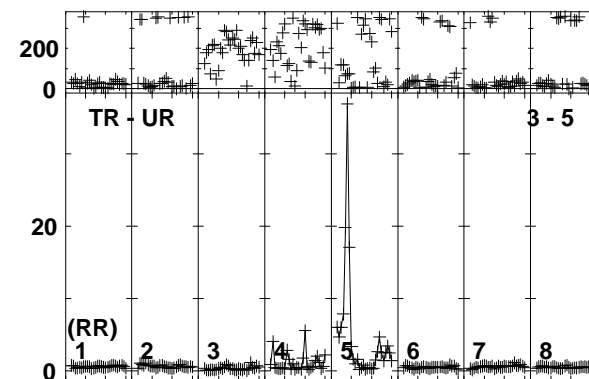
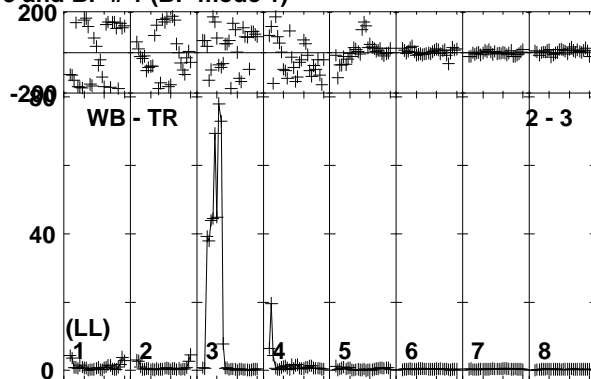
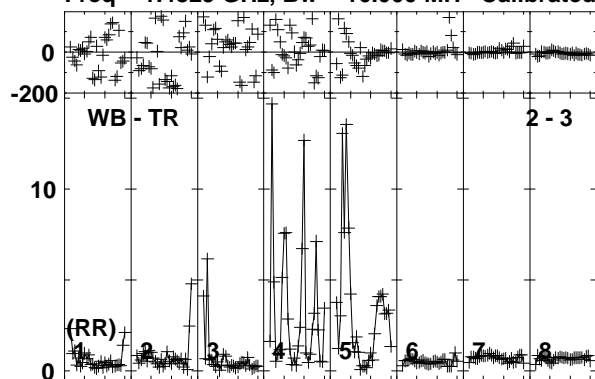

Lower frame: Ampl Jy Top frame: Phas deg
Vector averaged cross-power spectrum Baseline: WB (02) - TR (03)
Timerange: 00/09:13:08 to 00/09:14:34

Plot file version 265 created 21-JUN-2019 11:55:10

IRAS12112 EP111A 1.UVDATA.1

Freq = 1.4829 GHz, Bw = 16.000 MH Calibrated with CL # 3 and BP # 1 (BP mode 1)

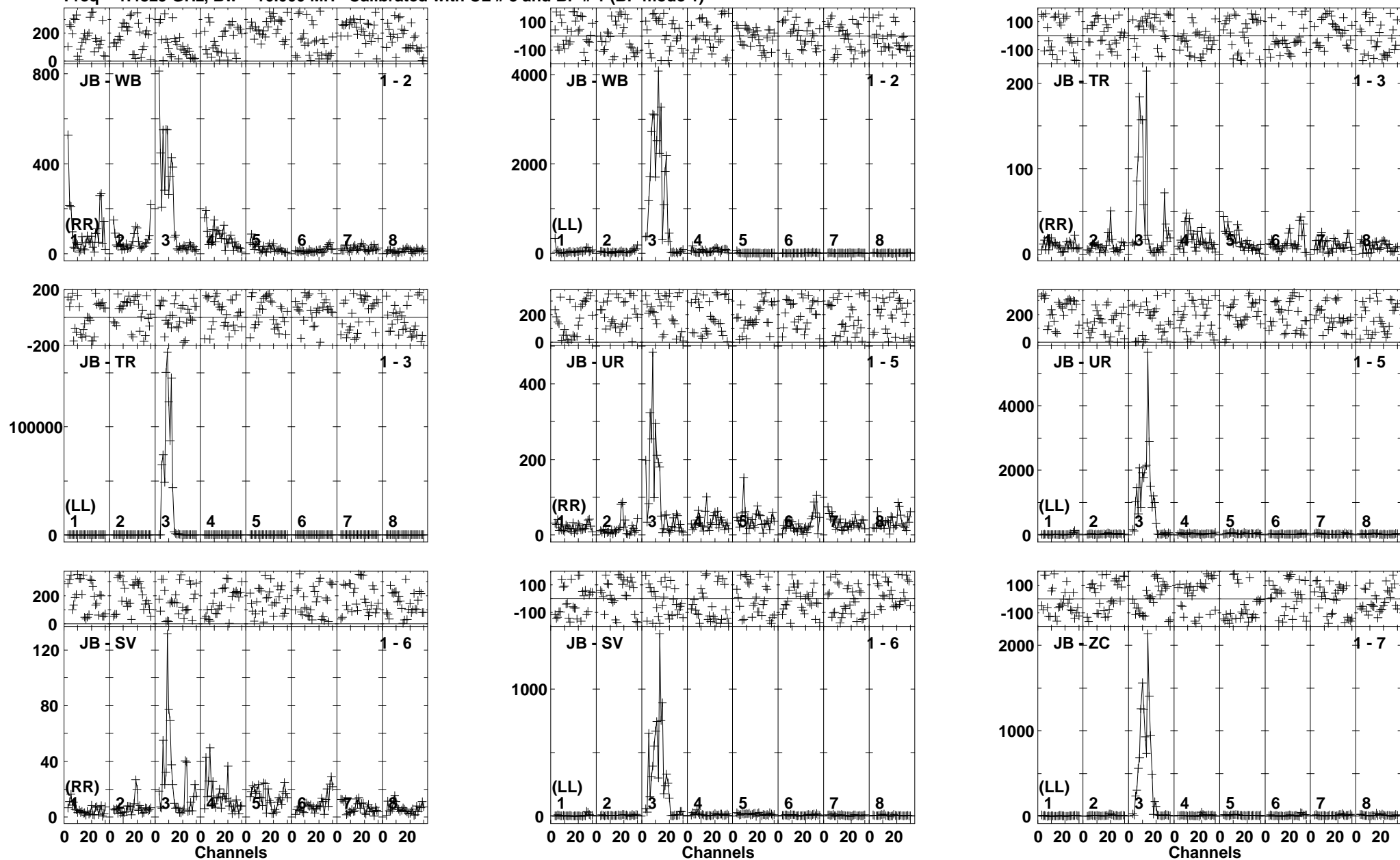

Lower frame: Milli Ampl Jy Top frame: Phas deg
Vector averaged cross-power spectrum Baseline: JB (01) - WB (02)
Timerange: 00/09:14:36 to 00/09:18:04

Plot file version 266 created 21-JUN-2019 11:55:11

IRAS12112 EP111A 1.UVDATA.1

Freq = 1.4829 GHz, Bw = 16.000 MH Calibrated with CL # 3 and BP # 1 (BP mode 1)

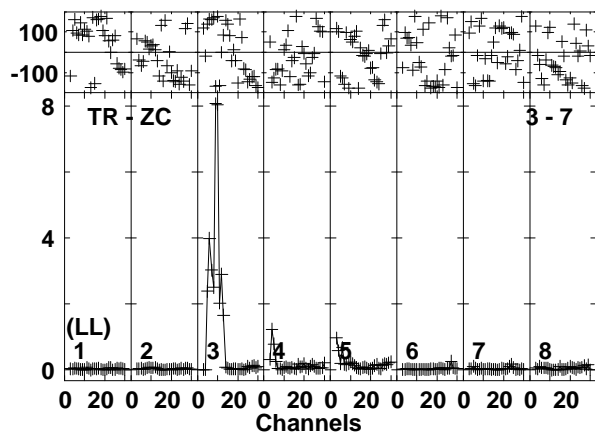
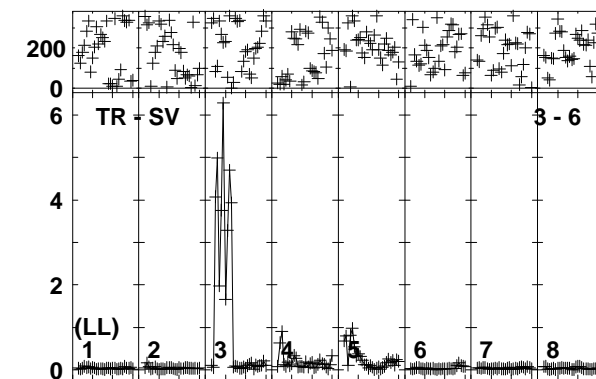
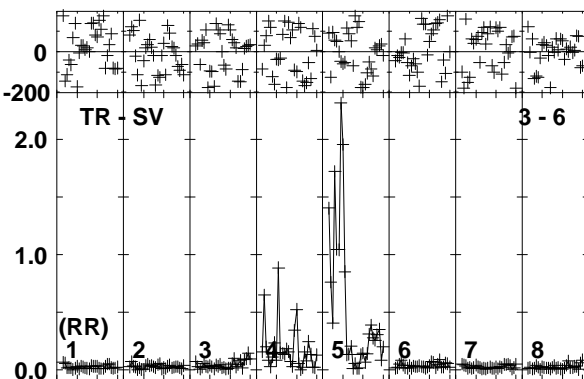
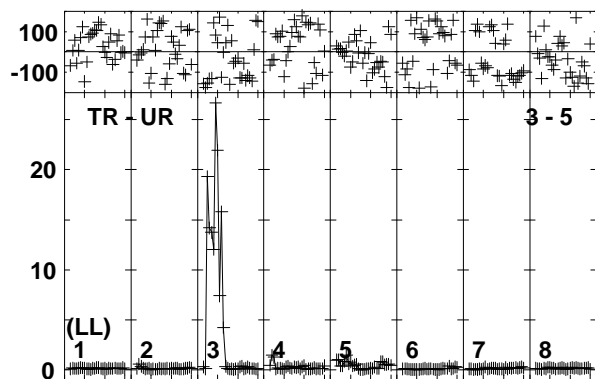
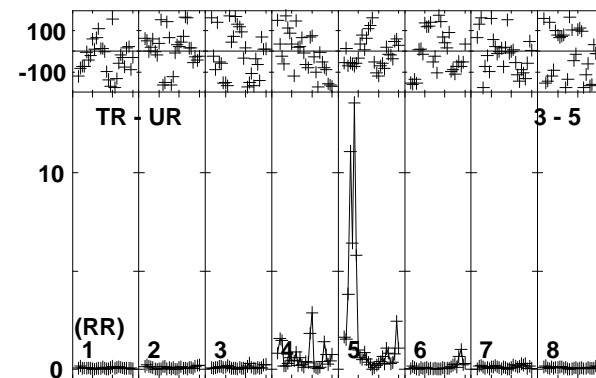
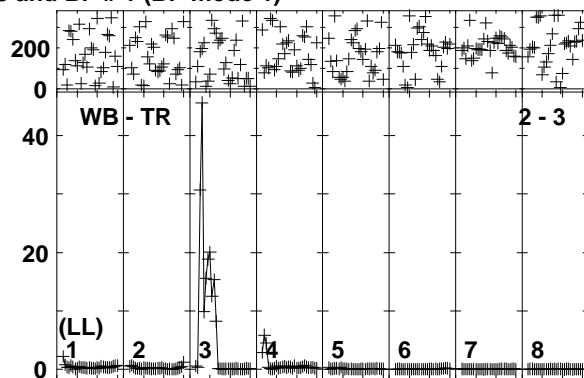
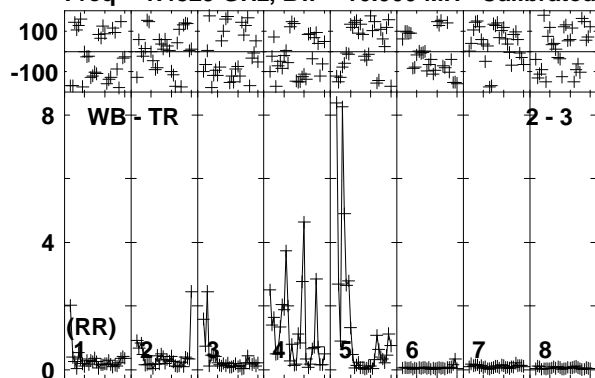

Lower frame: Ampl Jy Top frame: Phas deg
Vector averaged cross-power spectrum Baseline: WB (02) - TR (03)
Timerange: 00/09:14:36 to 00/09:18:04

Plot file version 268 created 21-JUN-2019 11:55:12

J1222+0413 EP111A 1.UVDATA.1

Freq = 1.4829 GHz, Bw = 16.000 MH Calibrated with CL # 3 and BP # 1 (BP mode 1)

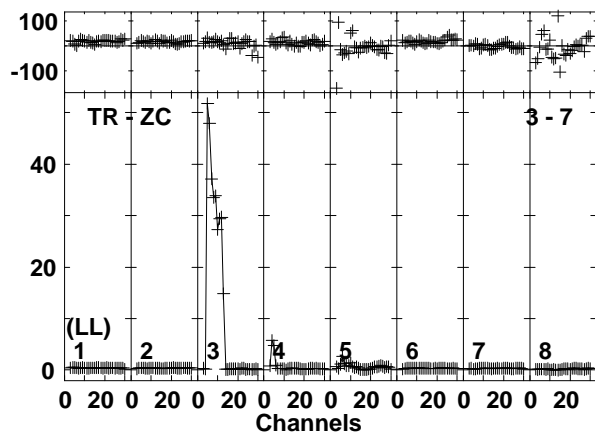
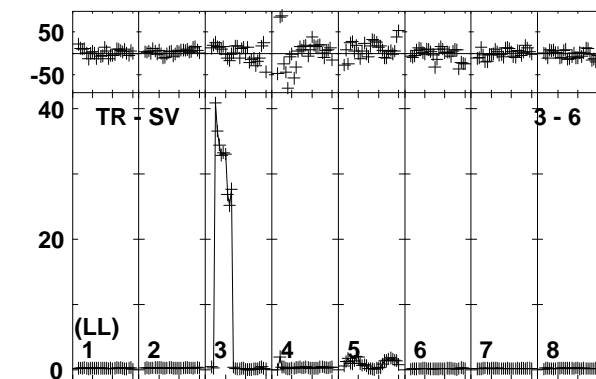
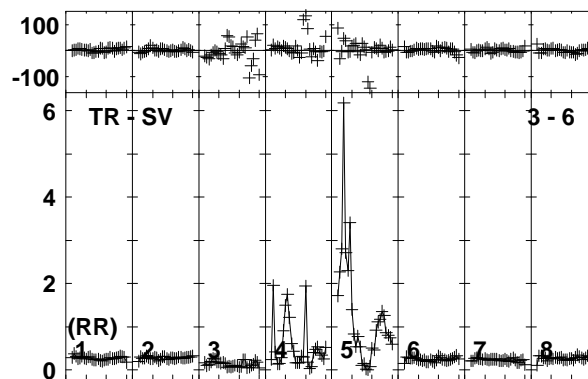
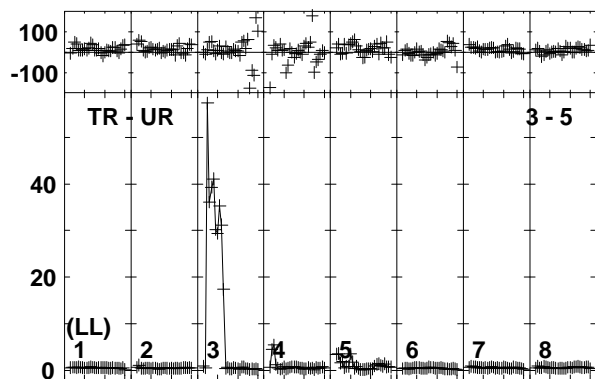
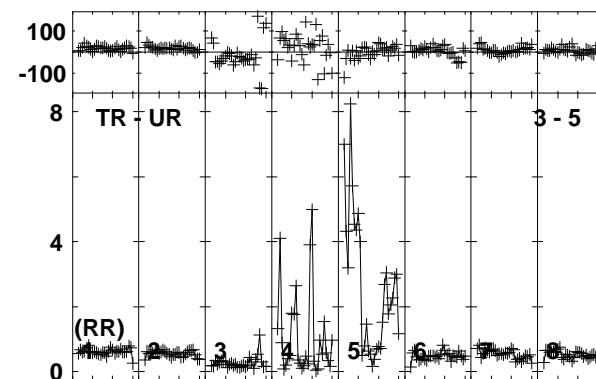
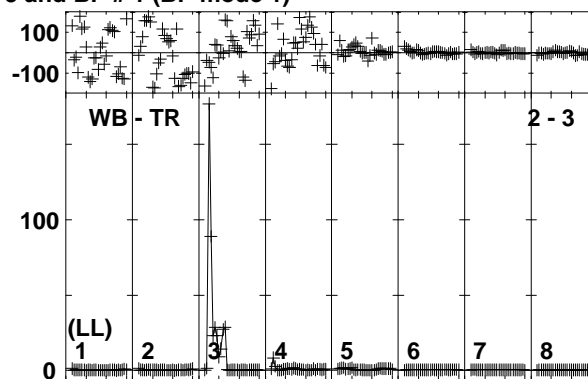
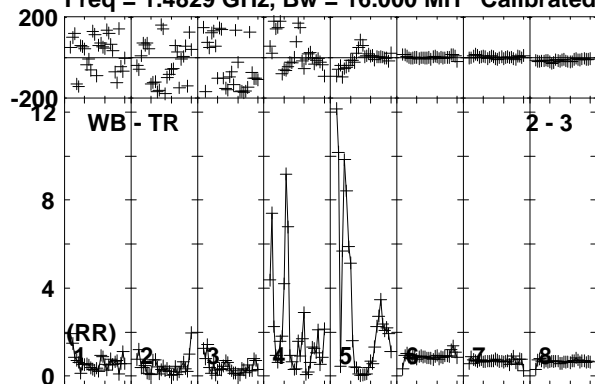

Lower frame: Ampl Jy Top frame: Phas deg
Vector averaged cross-power spectrum Baseline: WB (02) - TR (03)
Timerange: 00/09:18:46 to 00/09:20:14

Plot file version 269 created 21-JUN-2019 11:55:12
 IRAS12112 EP111A 1.UVDATA.1
 Freq = 1.4829 GHz, Bw = 16.000 MH Calibrated with CL # 3 and BP # 1 (BP mode 1)

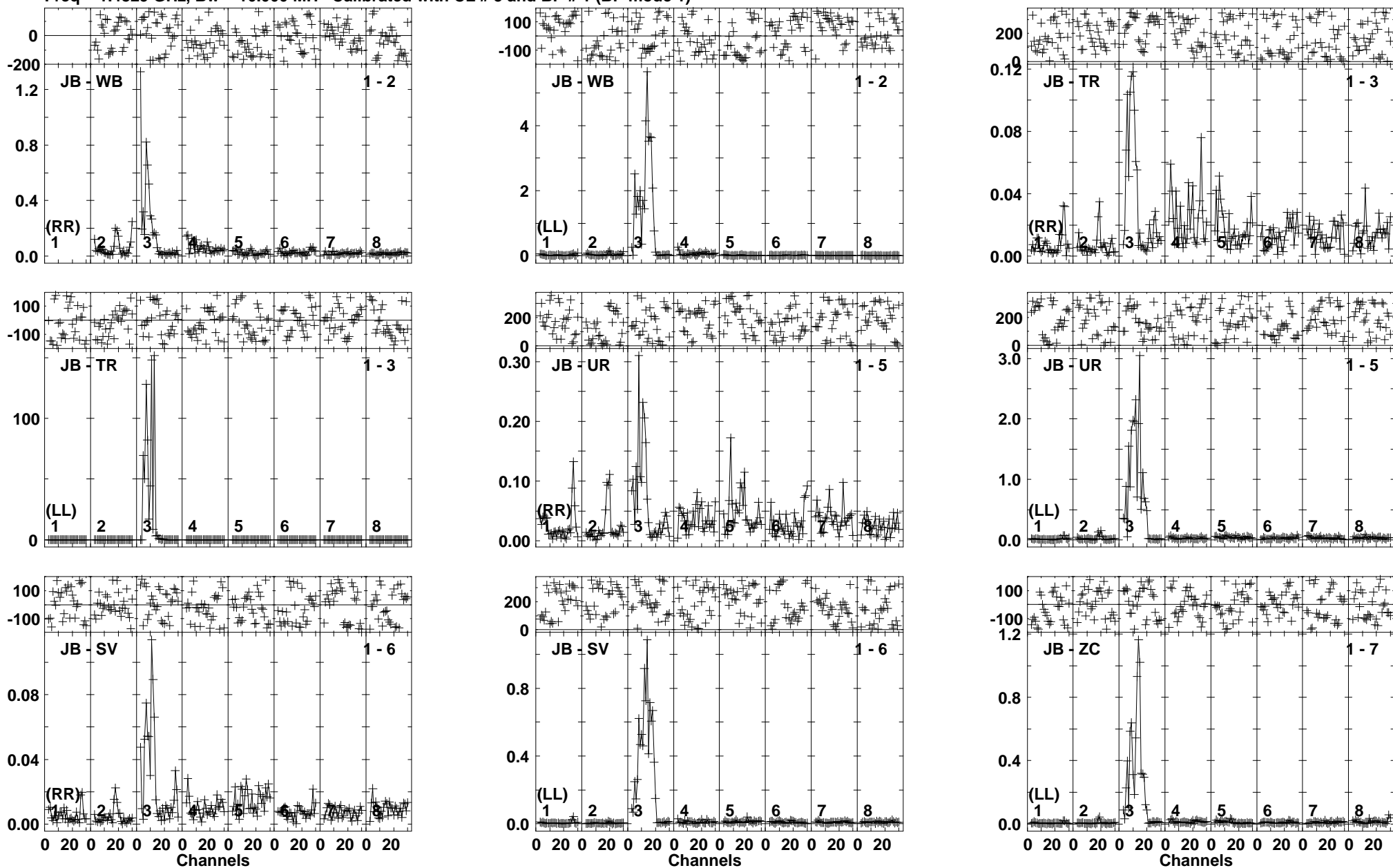

Lower frame: Ampl Jy Top frame: Phas deg
 Vector averaged cross-power spectrum Baseline: JB (01) - WB (02)
 Timerange: 00/09:20:16 to 00/09:23:44

Plot file version 270 created 21-JUN-2019 11:55:13

IRAS12112 EP111A 1.UVDATA.1

Freq = 1.4829 GHz, Bw = 16.000 MH Calibrated with CL # 3 and BP # 1 (BP mode 1)

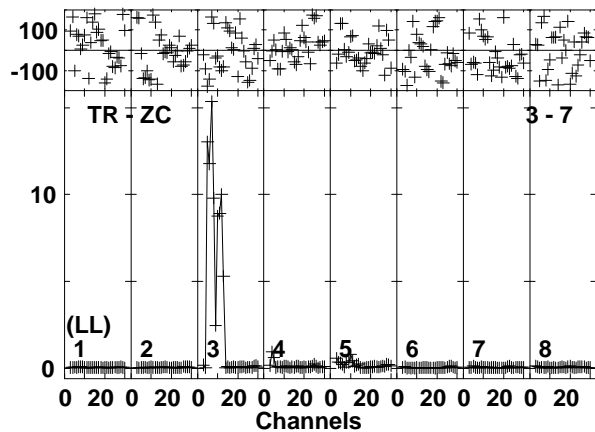
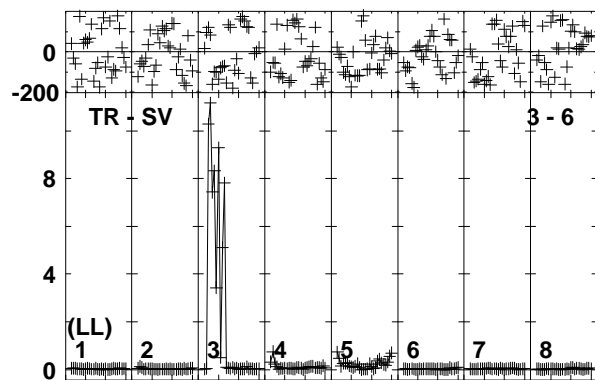
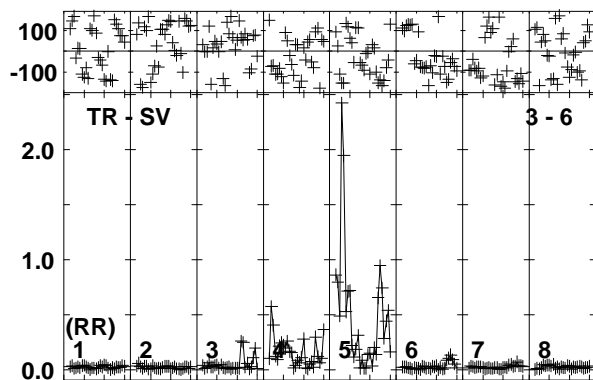
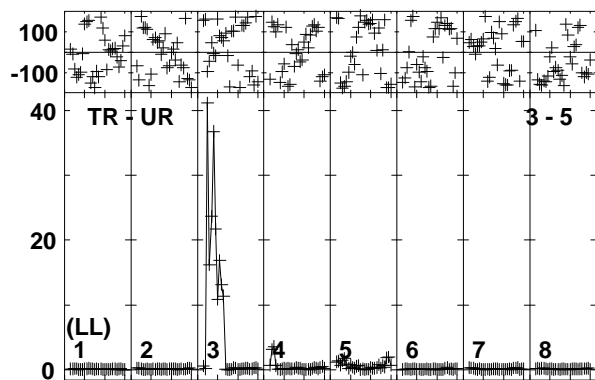
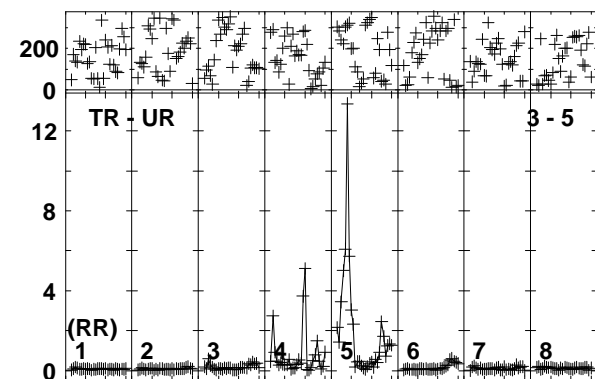
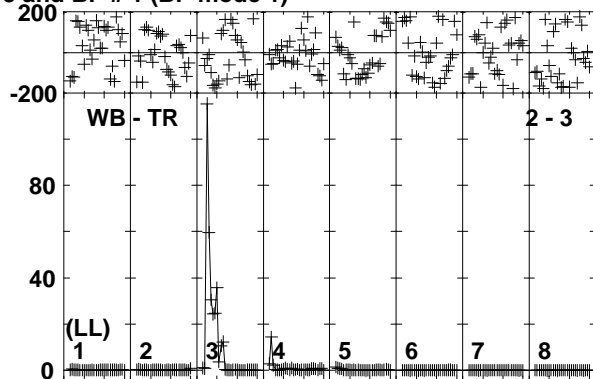
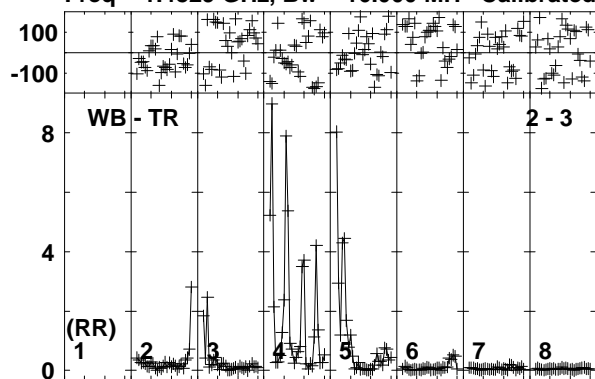

Lower frame: Ampl Jy Top frame: Phas deg
Vector averaged cross-power spectrum Baseline: WB (02) - TR (03)
Timerange: 00/09:20:16 to 00/09:23:44

Plot file version 271 created 21-JUN-2019 11:55:14

J1222+0413 EP111A 1.UVDATA.1

Freq = 1.4829 GHz, Bw = 16.000 MH Calibrated with CL # 3 and BP # 1 (BP mode 1)

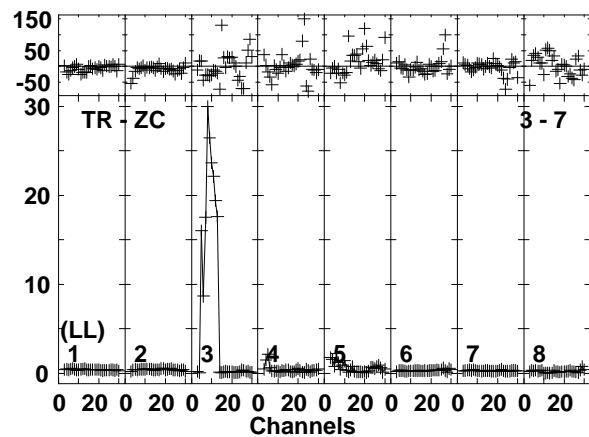
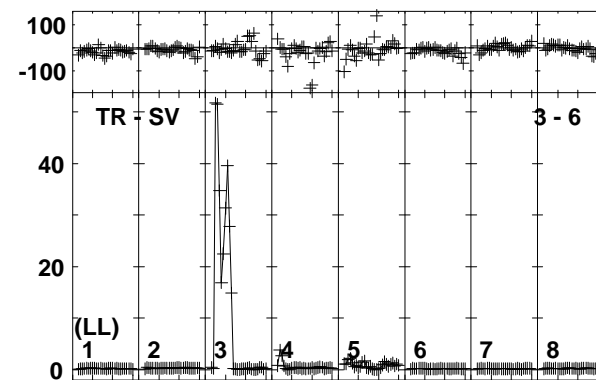
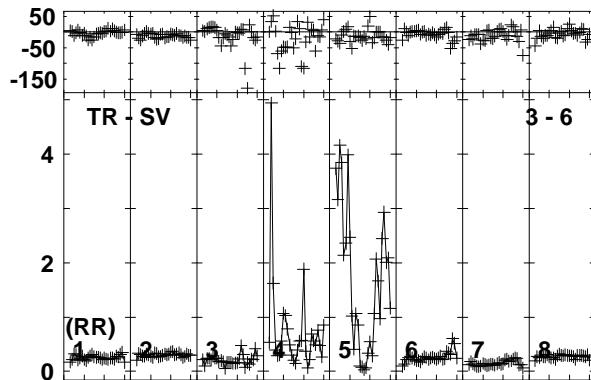
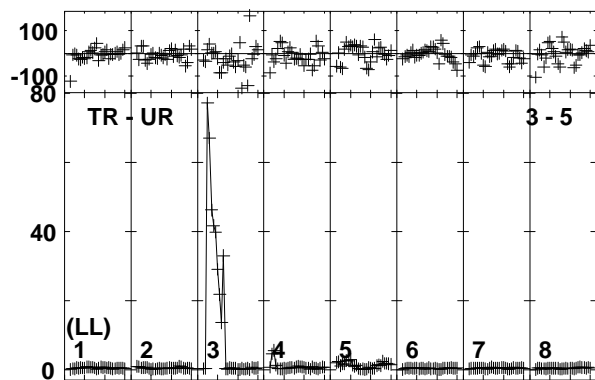
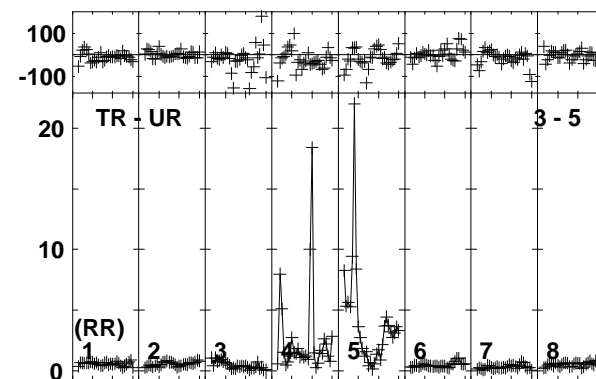
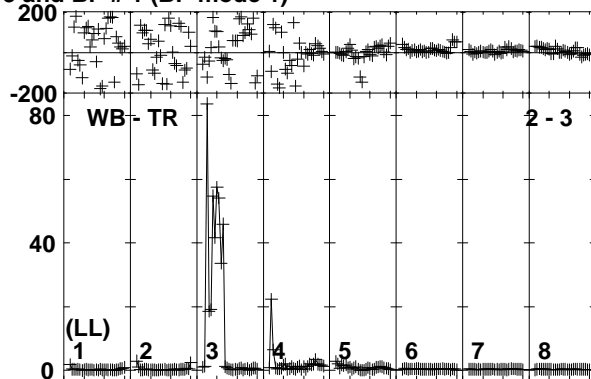
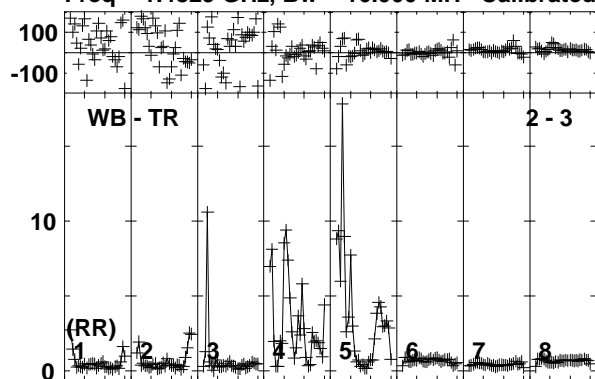

Lower frame: Ampl Jy Top frame: Phas deg
Vector averaged cross-power spectrum Baseline: WB (02) - TR (03)
Timerange: 00/09:23:48 to 00/09:25:14

Plot file version 272 created 21-JUN-2019 11:55:14

IRAS12112 EP111A 1.UVDATA.1

Freq = 1.4829 GHz, Bw = 16.000 MH Calibrated with CL # 3 and BP # 1 (BP mode 1)

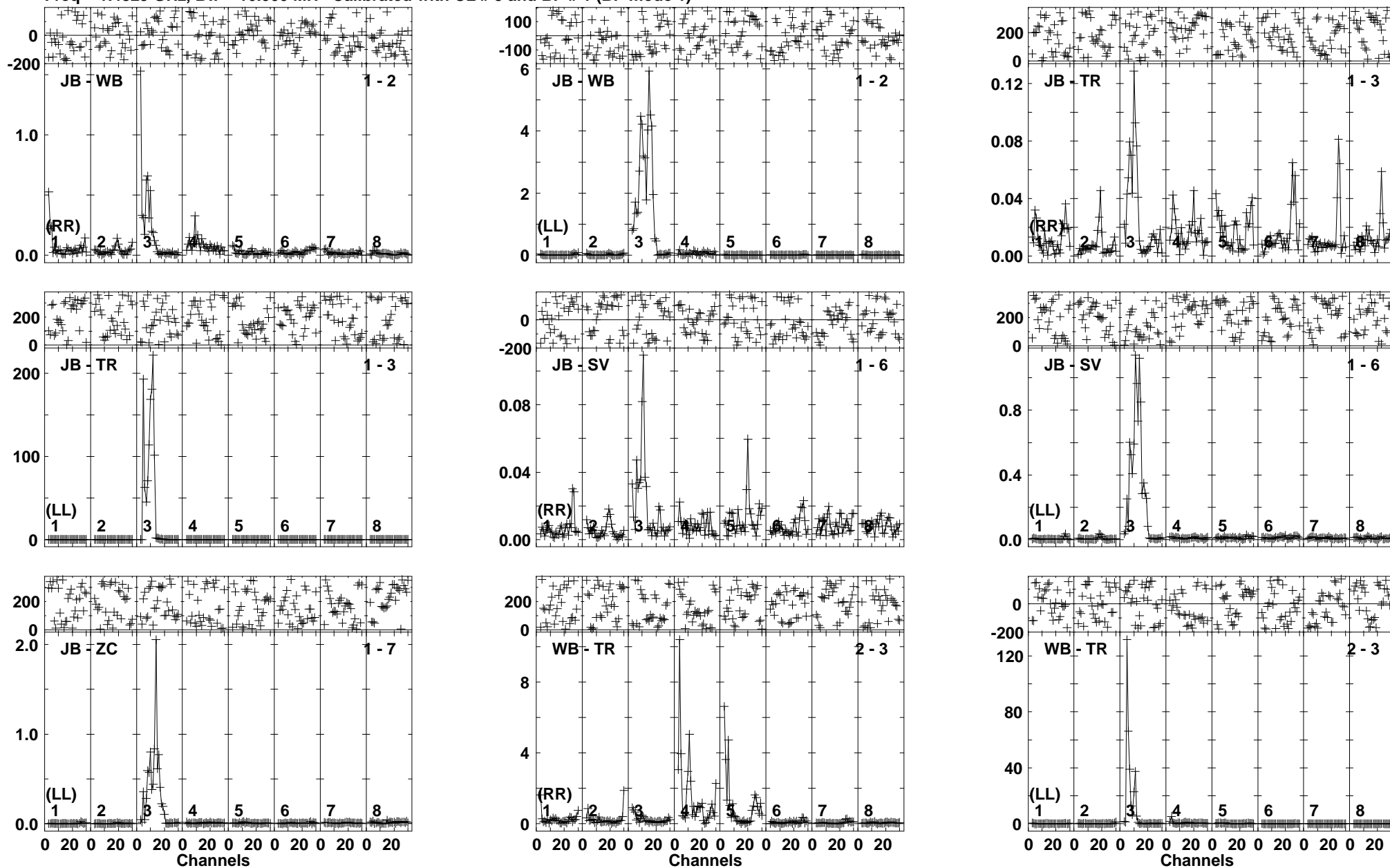

Lower frame: Ampl Jy Top frame: Phas deg
Vector averaged cross-power spectrum Baseline: JB (01) - WB (02)
Timerange: 00/09:25:16 to 00/09:28:44

Plot file version 273 created 21-JUN-2019 11:55:15

IRAS12112 EP111A 1.UVDATA.1

Freq = 1.4829 GHz, Bw = 16.000 MH Calibrated with CL # 3 and BP # 1 (BP mode 1)

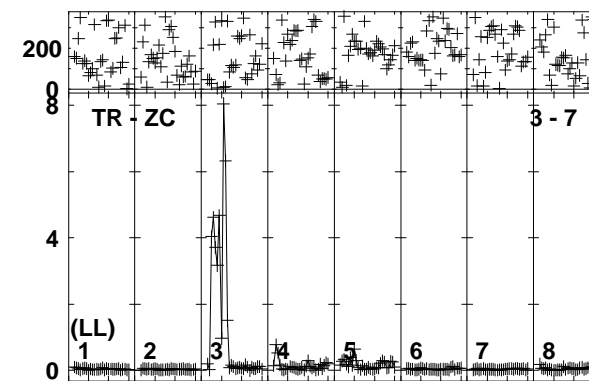
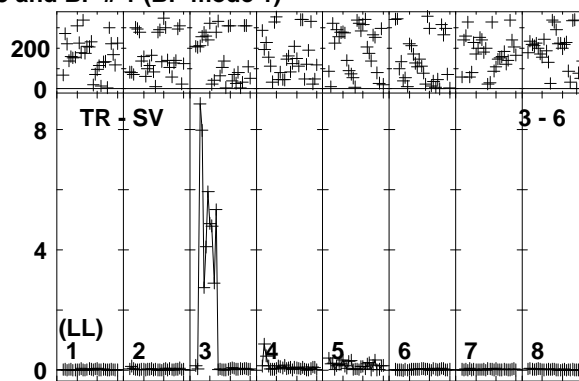
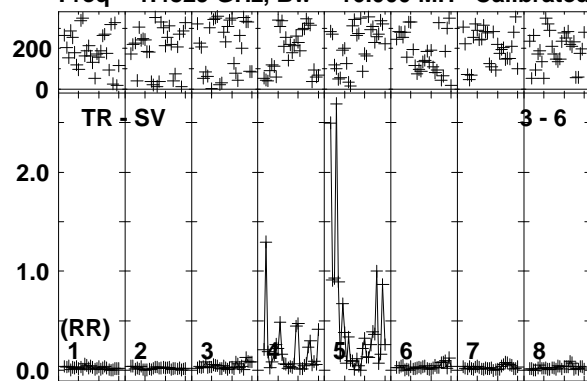

Lower frame: Ampl Jy Top frame: Phas deg
Vector averaged cross-power spectrum Baseline: TR (03) - SV (06)
Timerange: 00/09:25:16 to 00/09:28:44

Plot file version 274 created 21-JUN-2019 11:55:15

J1222+0413 EP111A 1.UVDATA.1

Freq = 1.4829 GHz, Bw = 16.000 MH Calibrated with CL # 3 and BP # 1 (BP mode 1)

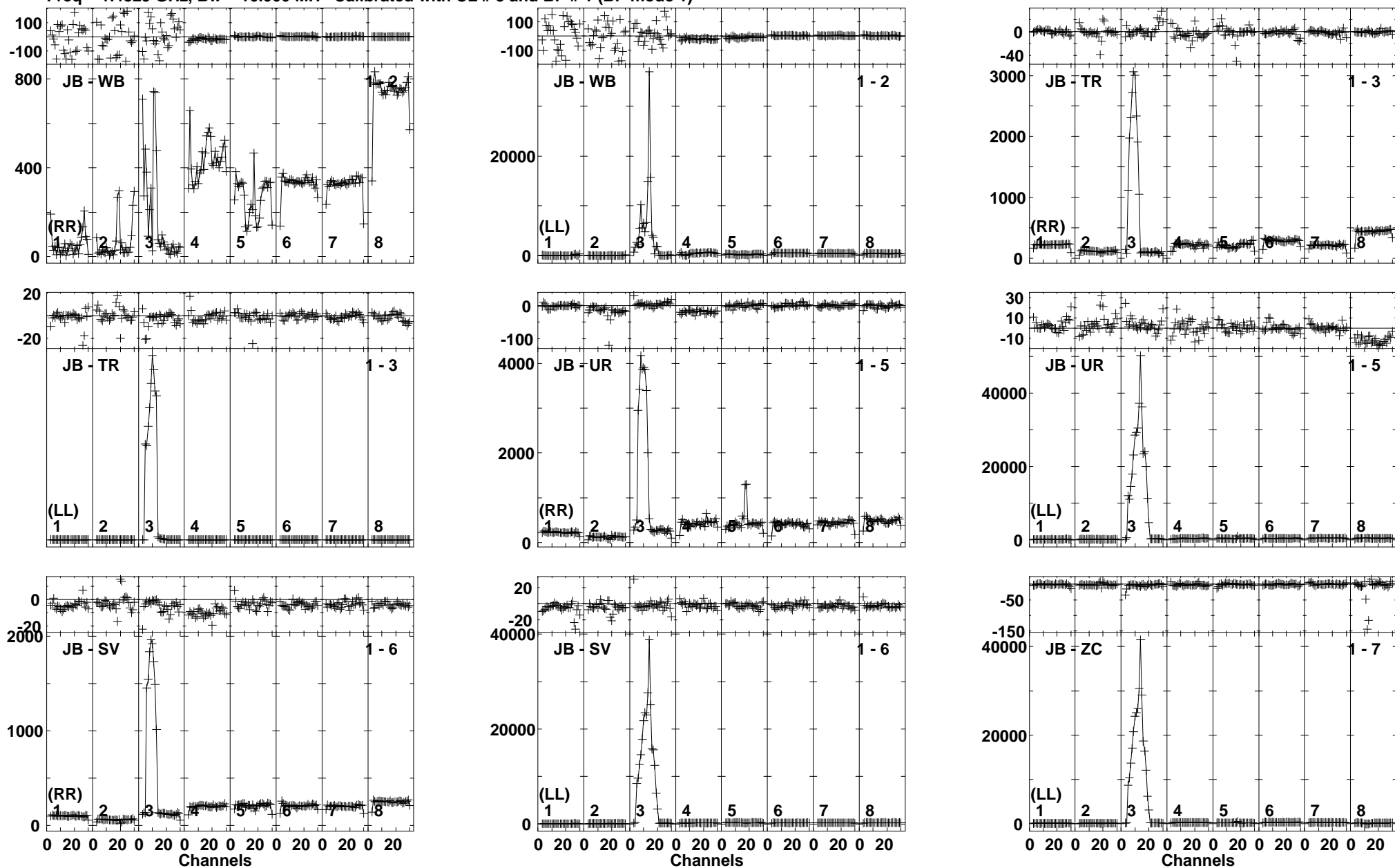

Lower frame: Milli Ampl Jy Top frame: Phas deg
Vector averaged cross-power spectrum Baseline: JB (01) - WB (02)
Timerange: 00/09:29:26 to 00/09:30:54

Plot file version 275 created 21-JUN-2019 11:55:16

J1222+0413 EP111A 1.UVDATA.1

Freq = 1.4829 GHz, Bw = 16.000 MH Calibrated with CL # 3 and BP # 1 (BP mode 1)

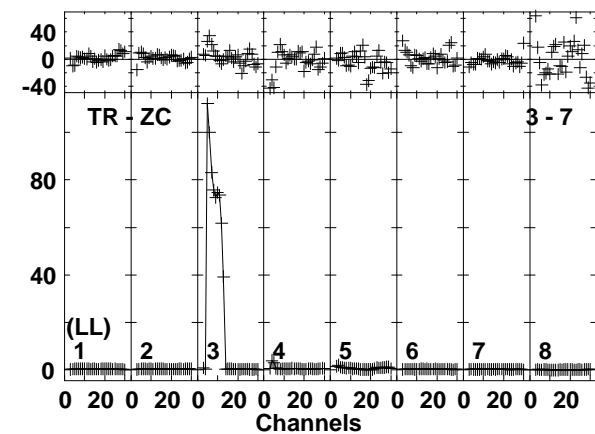
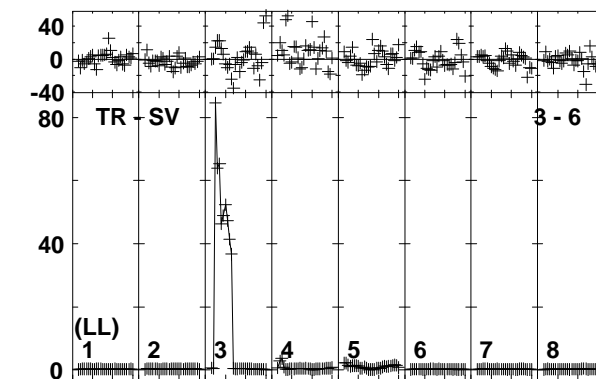
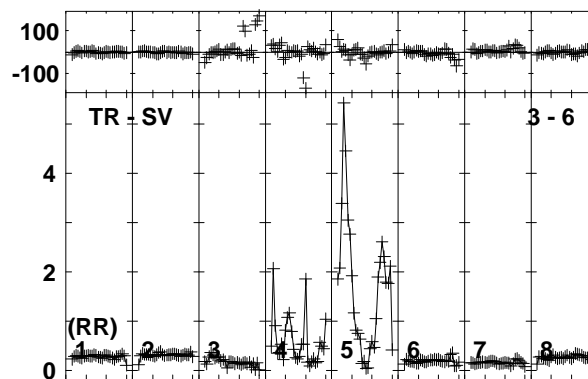
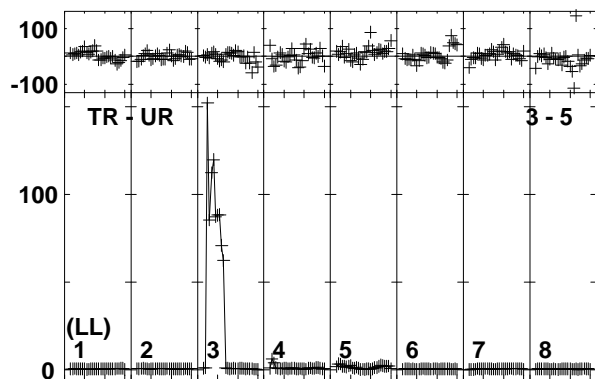
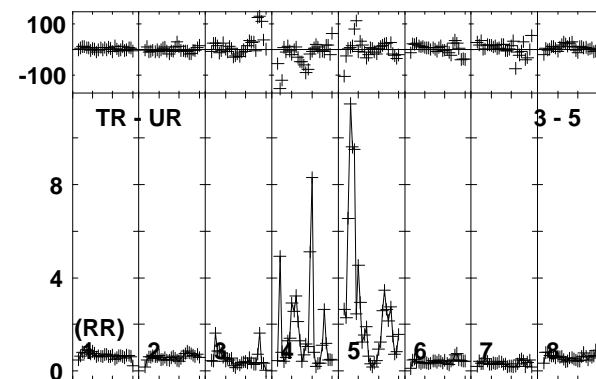
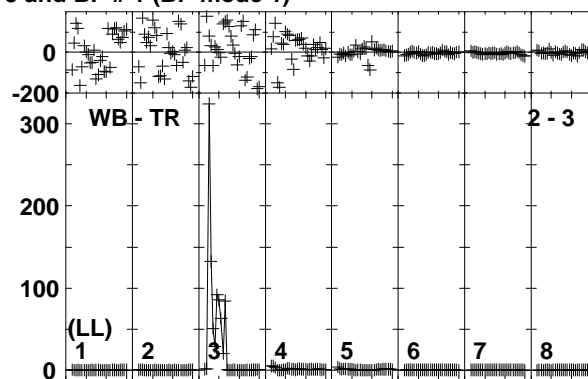
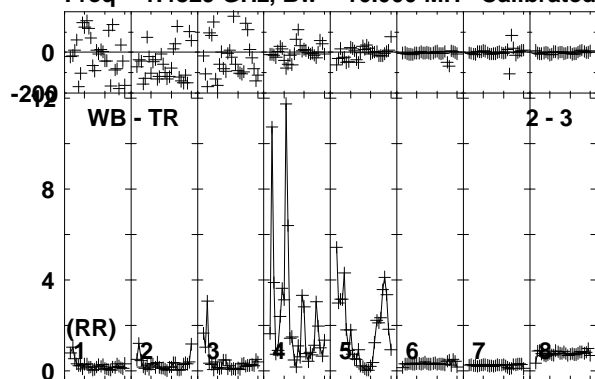

Lower frame: Ampl Jy Top frame: Phas deg
Vector averaged cross-power spectrum Baseline: WB (02) - TR (03)
Timerange: 00/09:29:26 to 00/09:30:54

Plot file version 276 created 21-JUN-2019 11:55:16

IRAS12112 EP111A 1.UVDATA.1

Freq = 1.4829 GHz, Bw = 16.000 MH Calibrated with CL # 3 and BP # 1 (BP mode 1)

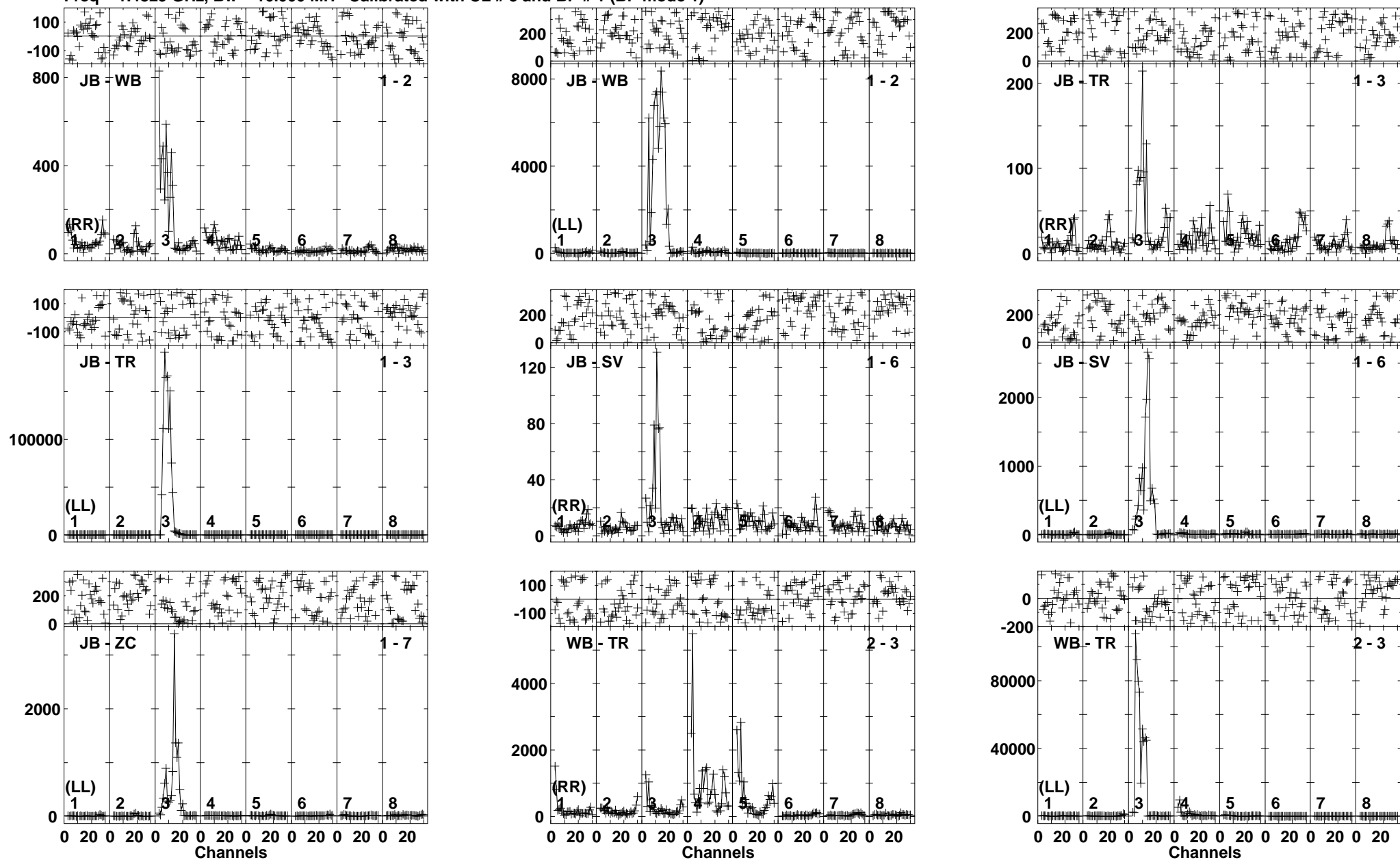

Lower frame: Milli Ampl Jy Top frame: Phas deg
Vector averaged cross-power spectrum Baseline: JB (01) - WB (02)
Timerange: 00/09:30:56 to 00/09:34:24

Plot file version 277 created 21-JUN-2019 11:55:17

IRAS12112 EP111A 1.UVDATA.1

Freq = 1.4829 GHz, Bw = 16.000 MH Calibrated with CL # 3 and BP # 1 (BP mode 1)

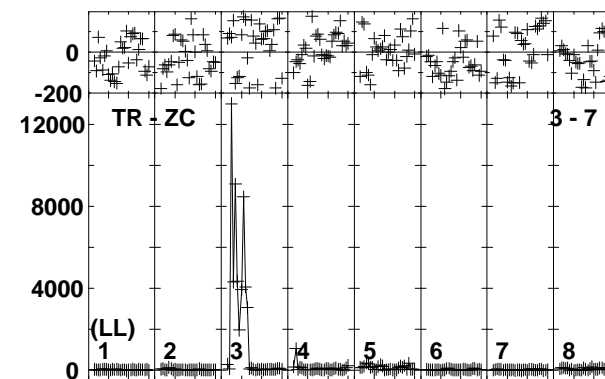
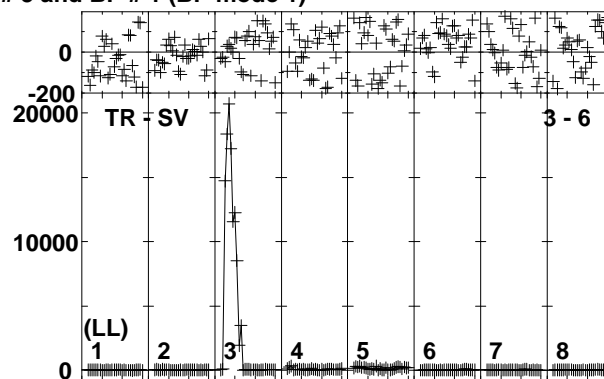
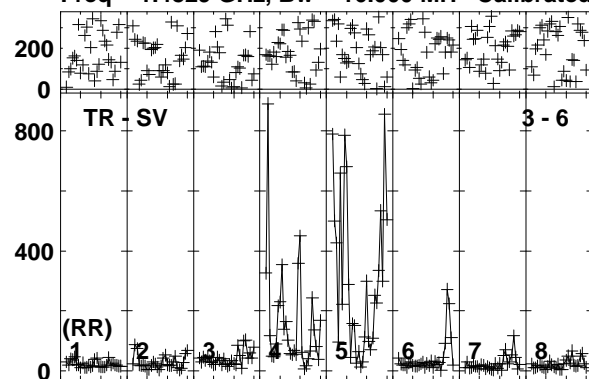

Lower frame: Milli Ampl Jy Top frame: Phas deg
Vector averaged cross-power spectrum Baseline: TR (03) - SV (06)
Timerange: 00/09:30:56 to 00/09:34:24

Plot file version 278 created 21-JUN-2019 11:55:18

J1222+0413 EP111A 1.UVDATA.1

Freq = 1.4829 GHz, Bw = 16.000 MH Calibrated with CL # 3 and BP # 1 (BP mode 1)

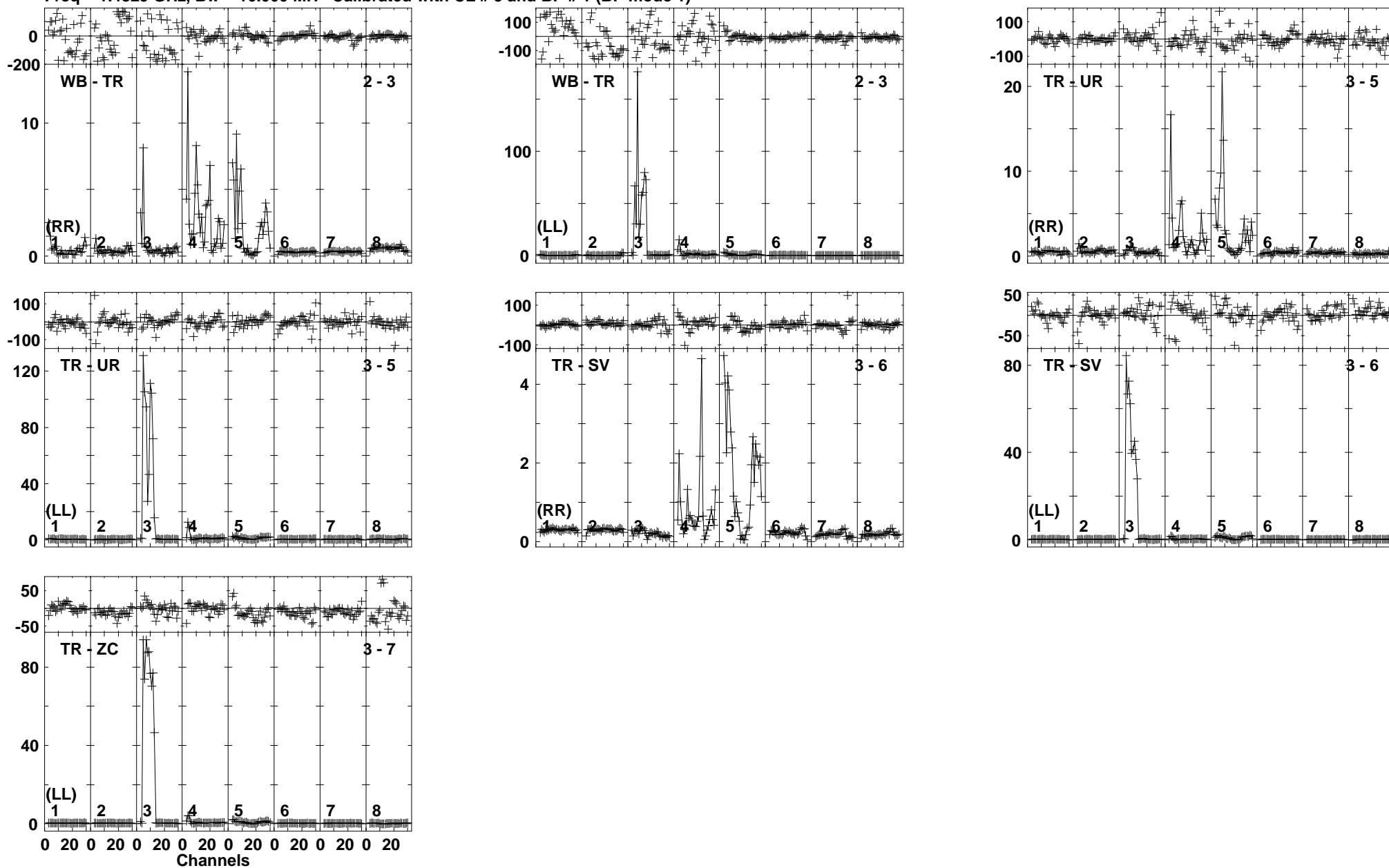

Lower frame: Ampl Jy Top frame: Phas deg
Vector averaged cross-power spectrum Baseline: WB (02) - TR (03)
Timerange: 00/09:34:26 to 00/09:35:54

Plot file version 279 created 21-JUN-2019 11:55:18
 IRAS12112 EP111A 1.UVDATA.1
 Freq = 1.4829 GHz, Bw = 16.000 MH Calibrated with CL # 3 and BP # 1 (BP mode 1)

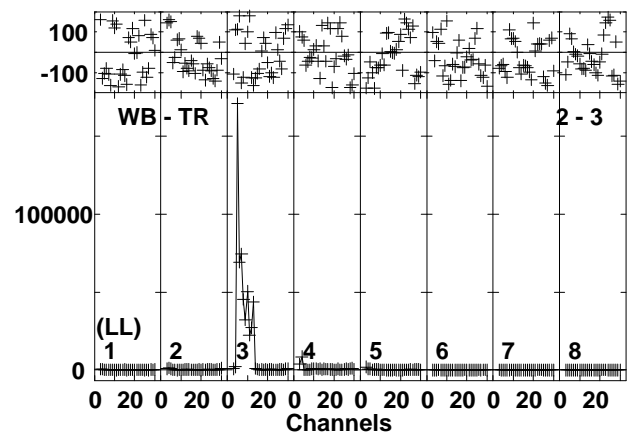
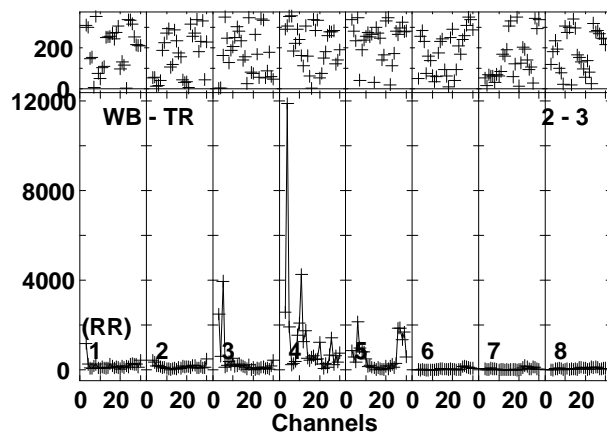
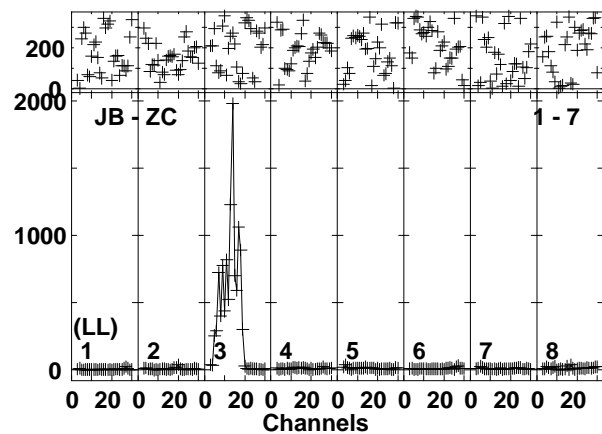
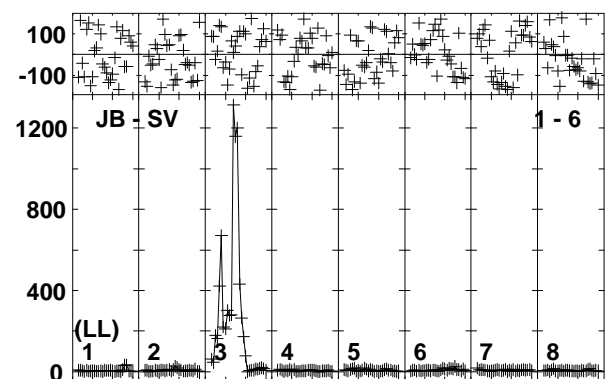
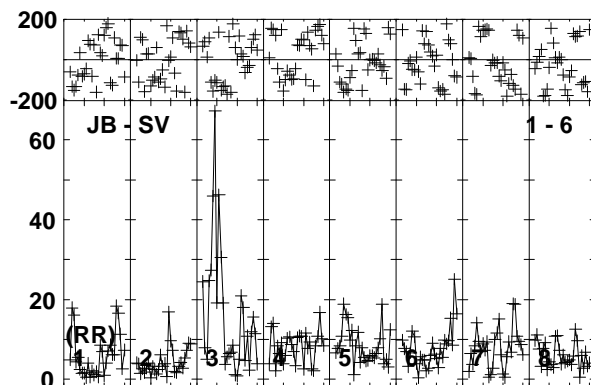
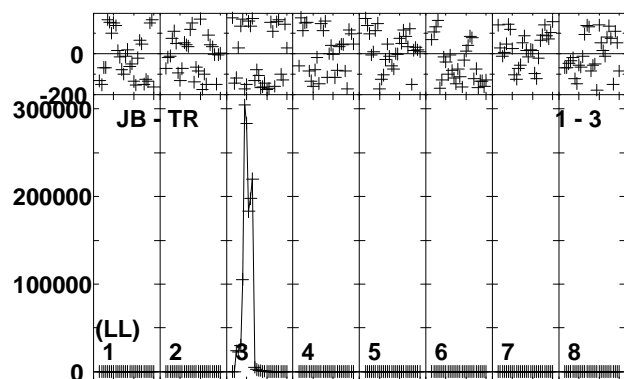
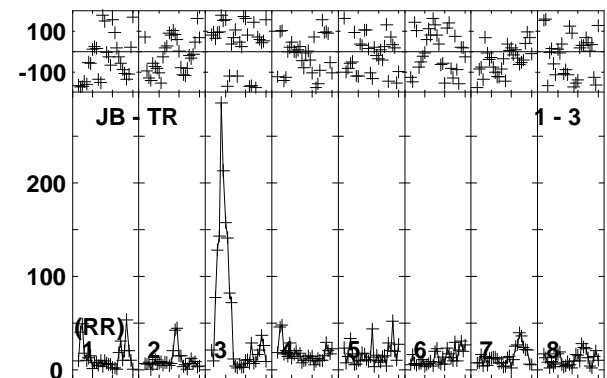
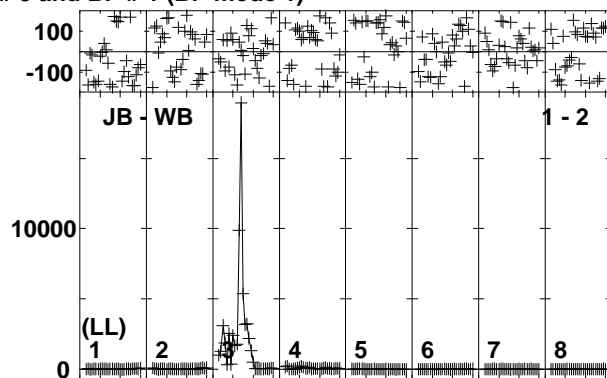
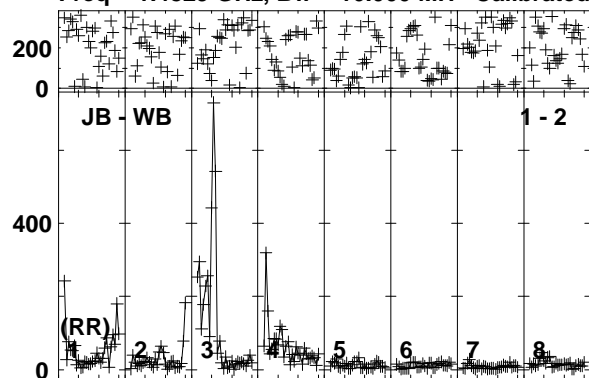

Lower frame: Milli Ampl Jy Top frame: Phas deg
 Vector averaged cross-power spectrum Baseline: JB (01) - WB (02)
 Timerange: 00/09:35:56 to 00/09:39:24

Plot file version 280 created 21-JUN-2019 11:55:19

IRAS12112 EP111A 1.UVDATA.1

Freq = 1.4829 GHz, Bw = 16.000 MH Calibrated with CL # 3 and BP # 1 (BP mode 1)

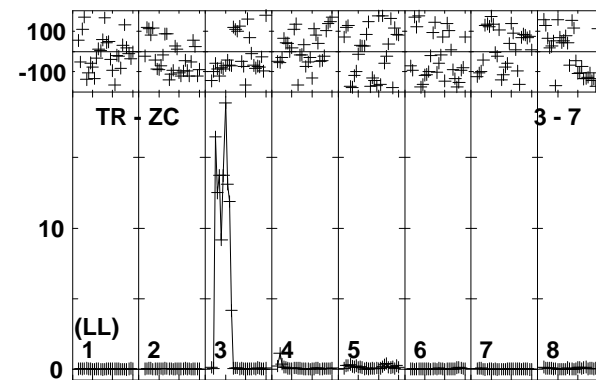
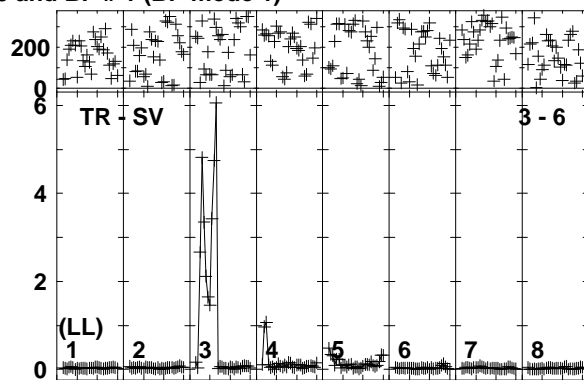
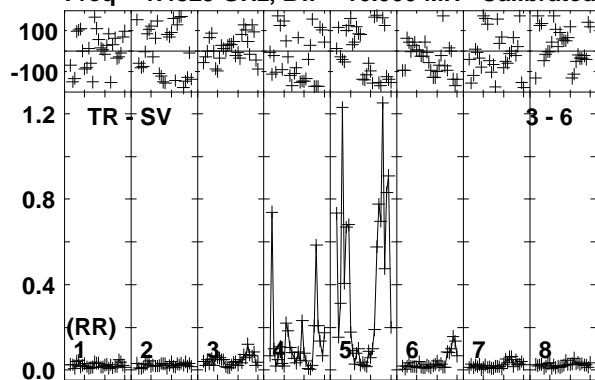

Lower frame: Ampl Jy Top frame: Phas deg
Vector averaged cross-power spectrum Baseline: TR (03) - SV (06)
Timerange: 00/09:35:56 to 00/09:39:24

Plot file version 281 created 21-JUN-2019 11:55:19

J1222+0413 EP111A 1.UVDATA.1

Freq = 1.4829 GHz, Bw = 16.000 MH Calibrated with CL # 3 and BP # 1 (BP mode 1)

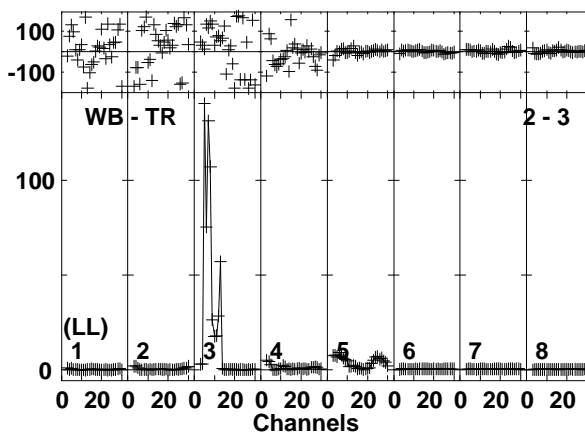
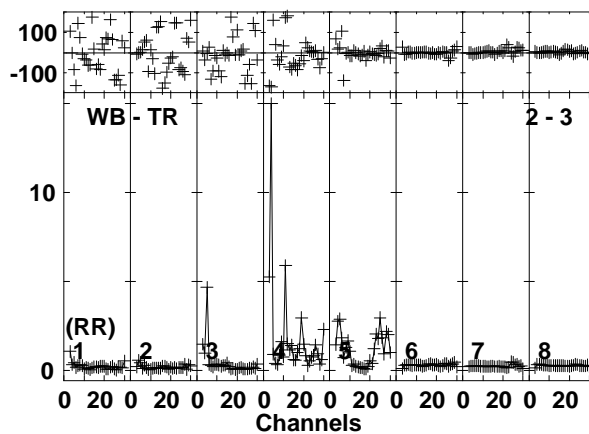
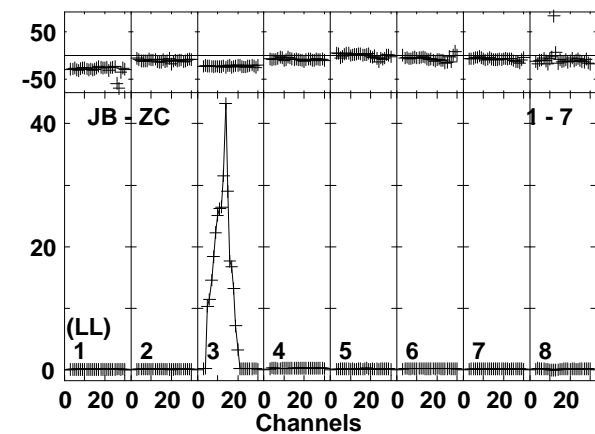
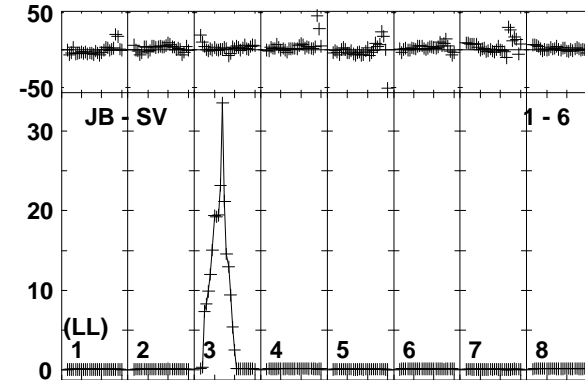
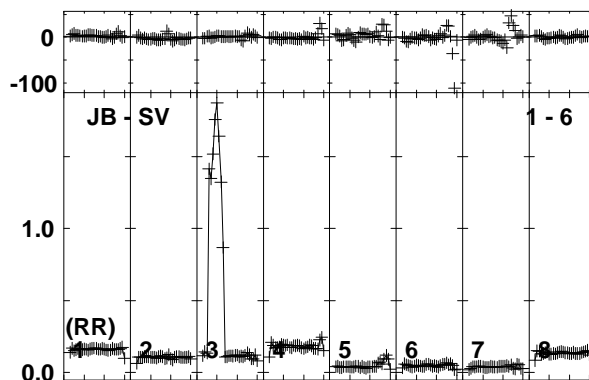
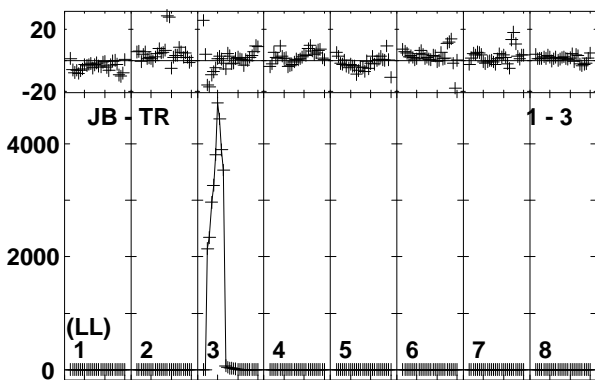
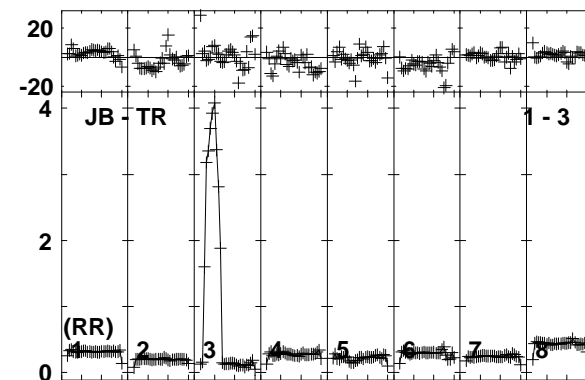
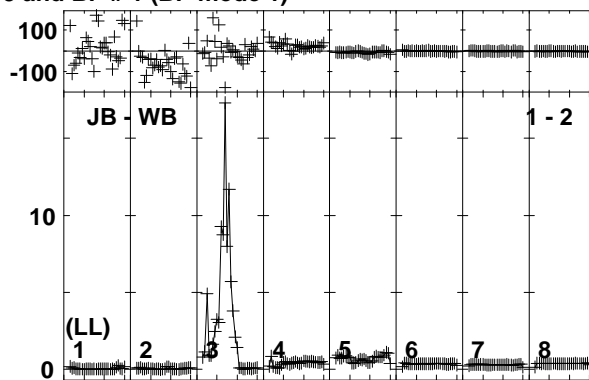
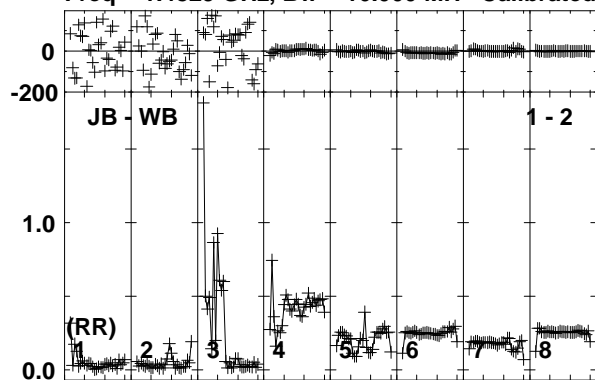

Lower frame: Ampl Jy Top frame: Phas deg
Vector averaged cross-power spectrum Baseline: JB (01) - WB (02)
Timerange: 00/09:40:06 to 00/09:41:34

Plot file version 282 created 21-JUN-2019 11:55:19
J1222+0413 EP111A 1.UVDATA.1
Freq = 1.4829 GHz, Bw = 16.000 MH Calibrated with CL # 3 and BP # 1 (BP mode 1)

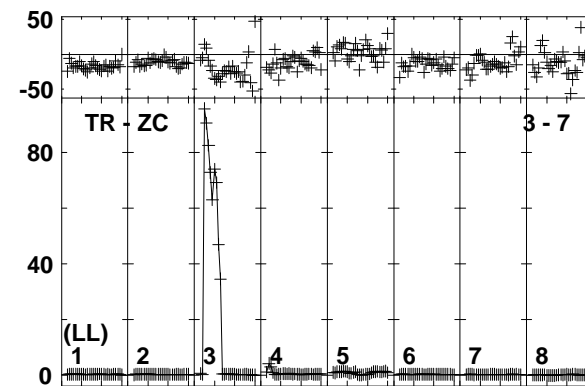
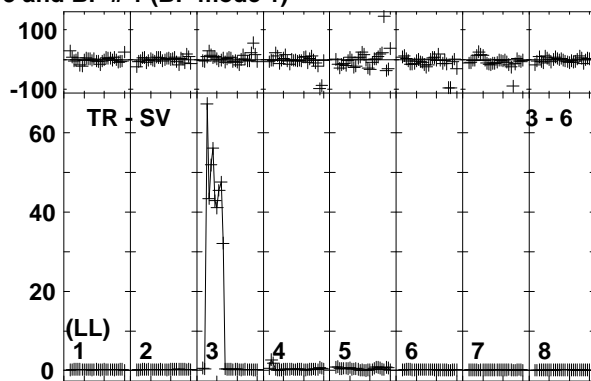
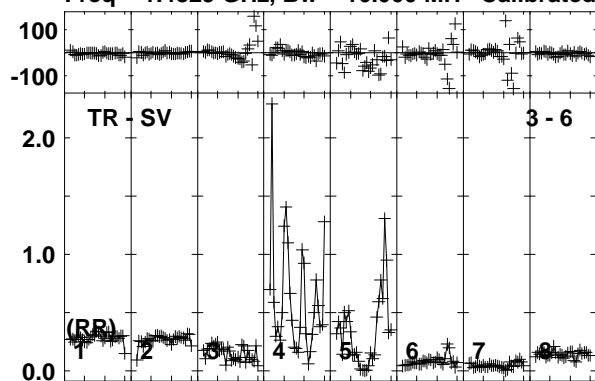

Lower frame: Ampl Jy Top frame: Phas deg
Vector averaged cross-power spectrum Baseline: TR (03) - SV (06)
Timerange: 00/09:40:06 to 00/09:41:34

Plot file version 283 created 21-JUN-2019 11:55:20

IRAS12112 EP111A 1.UVDATA.1

Freq = 1.4829 GHz, Bw = 16.000 MH Calibrated with CL # 3 and BP # 1 (BP mode 1)

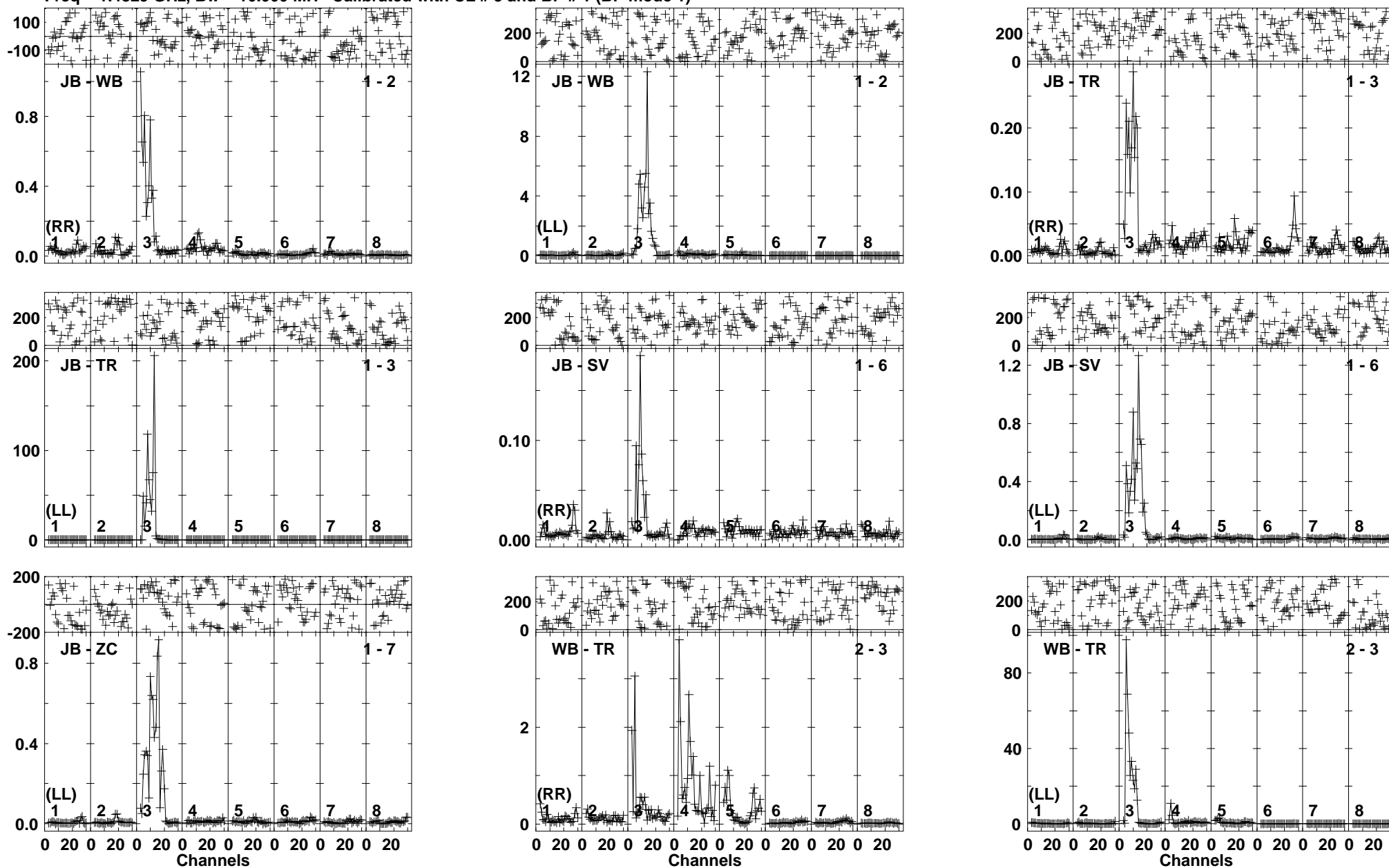

Lower frame: Ampl Jy Top frame: Phas deg
Vector averaged cross-power spectrum Baseline: JB (01) - WB (02)
Timerange: 00/09:41:36 to 00/09:45:04

Plot file version 284 created 21-JUN-2019 11:55:20

IRAS12112 EP111A 1.UVDATA.1

Freq = 1.4829 GHz, Bw = 16.000 MH Calibrated with CL # 3 and BP # 1 (BP mode 1)

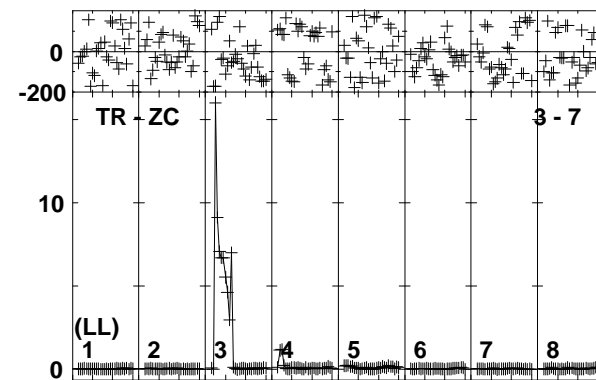
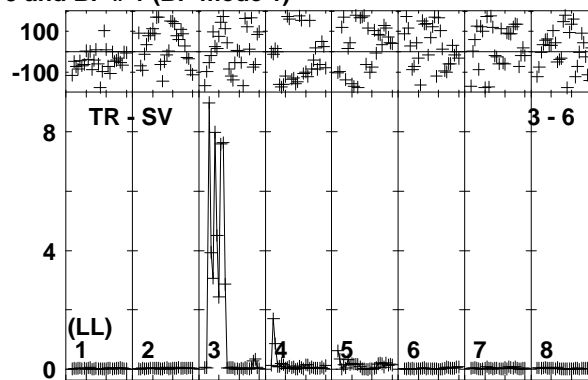
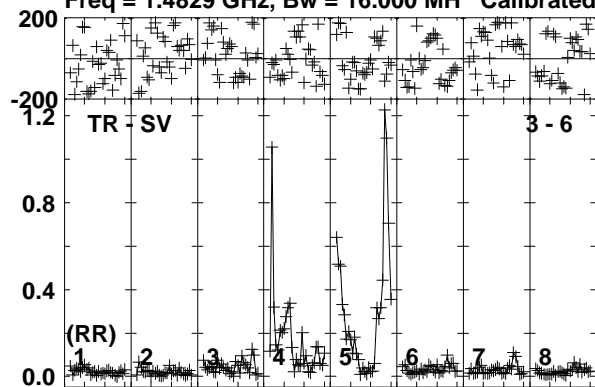

Lower frame: Ampl Jy Top frame: Phas deg
Vector averaged cross-power spectrum Baseline: TR (03) - SV (06)
Timerange: 00/09:41:36 to 00/09:45:04

Plot file version 285 created 21-JUN-2019 11:55:21

J1222+0413 EP111A 1.UVDATA.1

Freq = 1.4829 GHz, Bw = 16.000 MH Calibrated with CL # 3 and BP # 1 (BP mode 1)

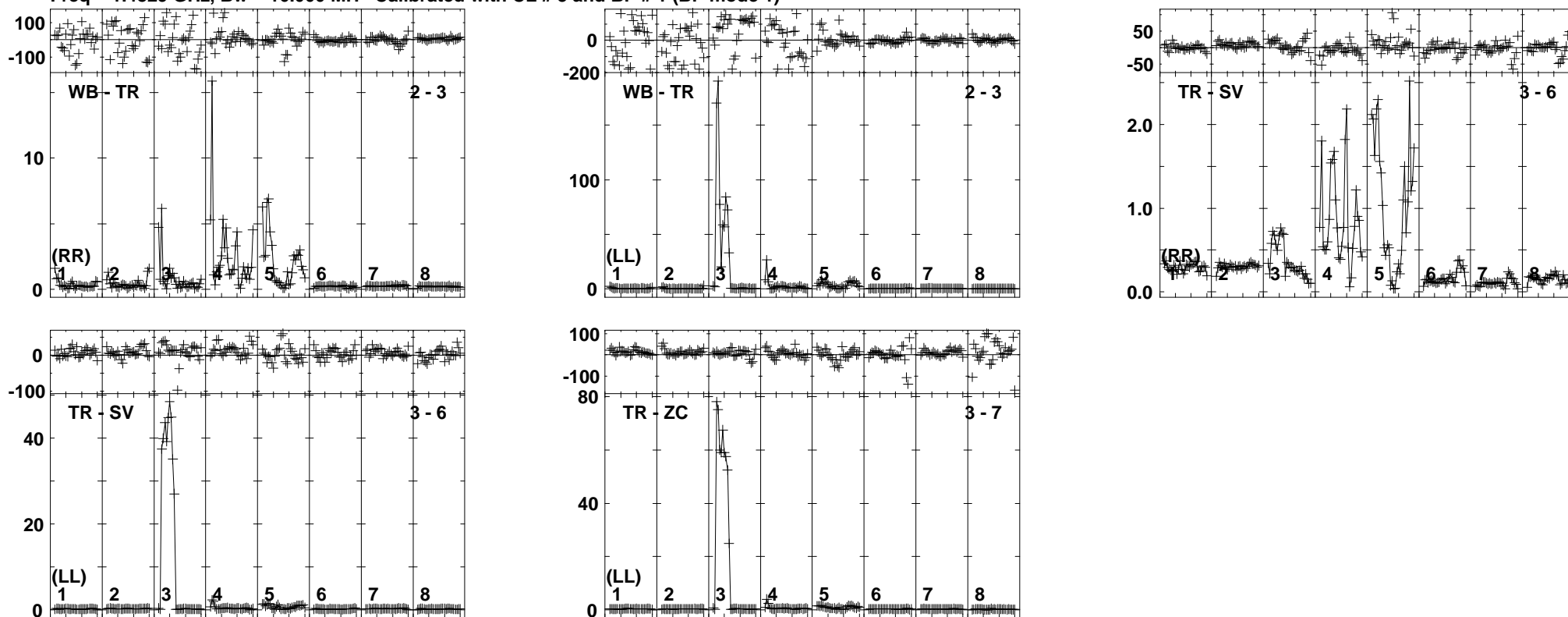

Lower frame: Ampl Jy Top frame: Phas deg
Vector averaged cross-power spectrum Baseline: WB (02) - TR (03)
Timerange: 00/09:45:06 to 00/09:46:34

Plot file version 286 created 21-JUN-2019 11:55:22

IRAS12112 EP111A 1.UVDATA.1

Freq = 1.4829 GHz, Bw = 16.000 MH Calibrated with CL # 3 and BP # 1 (BP mode 1)

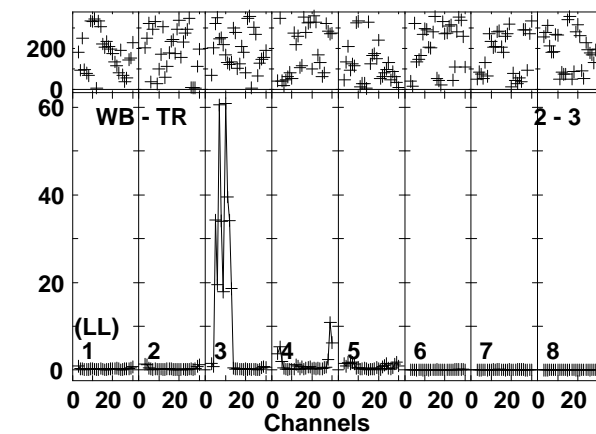
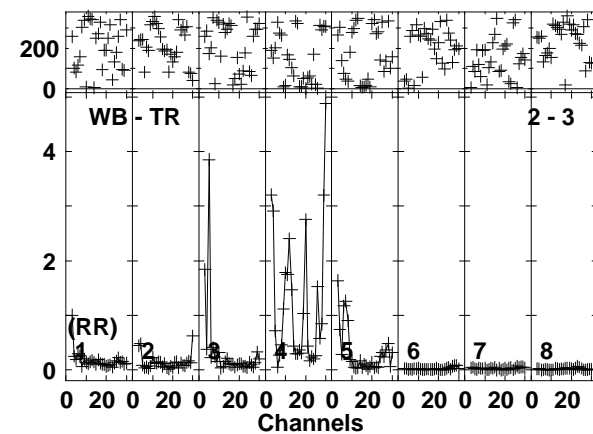
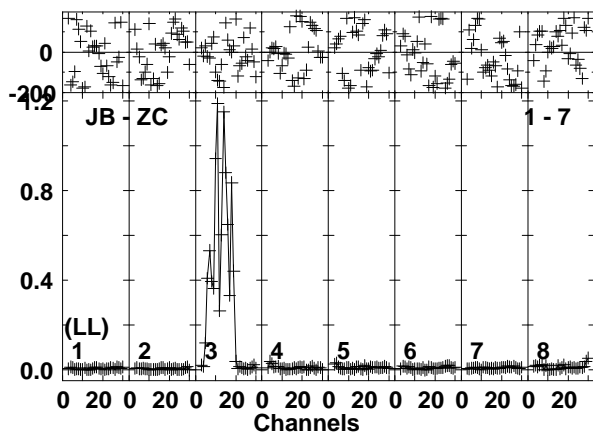
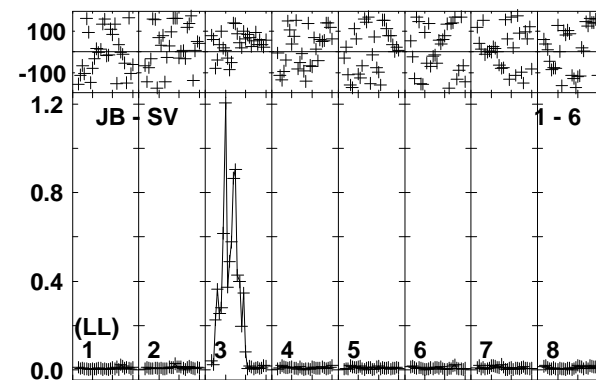
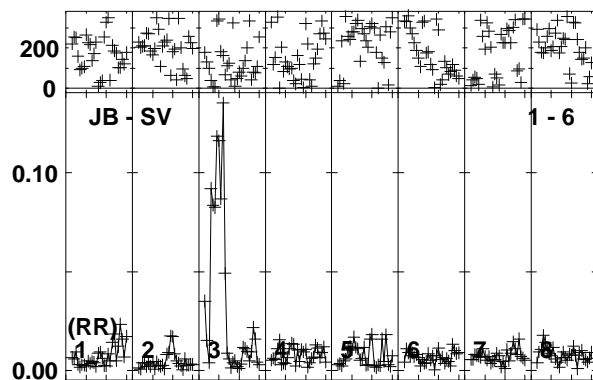
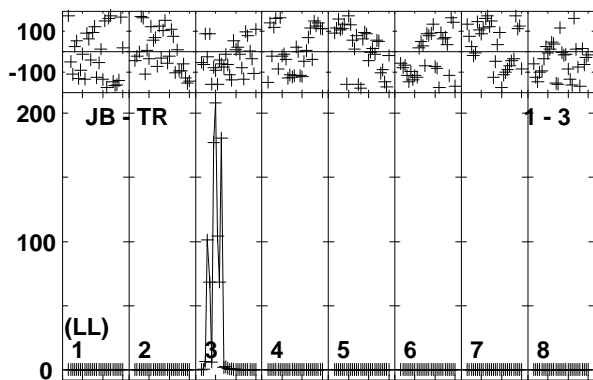
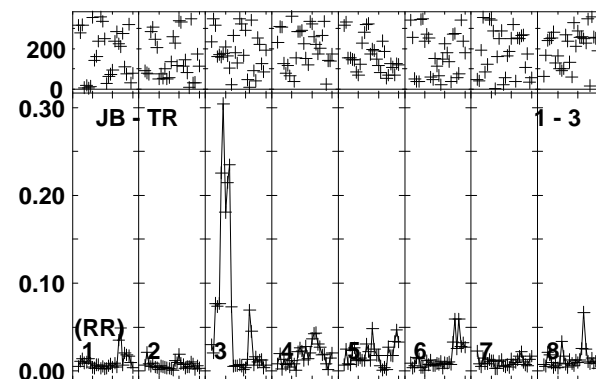
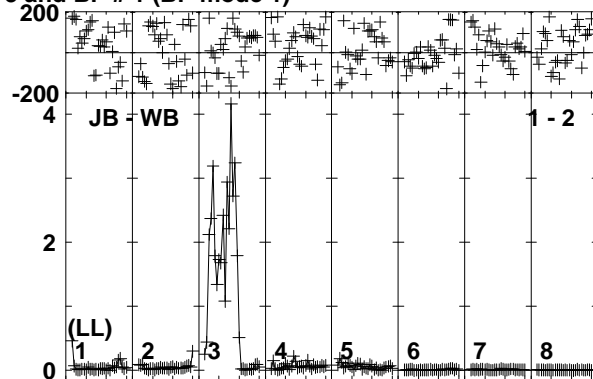
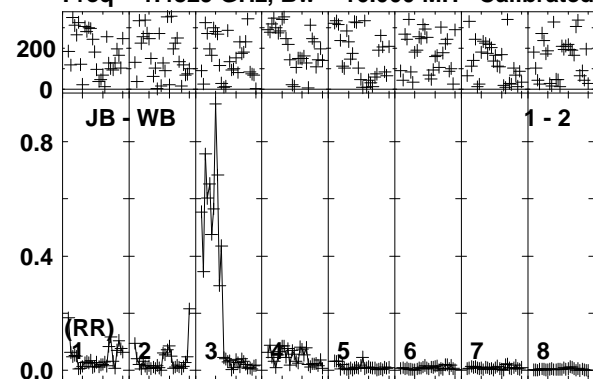

Lower frame: Ampl Jy Top frame: Phas deg
Vector averaged cross-power spectrum Baseline: JB (01) - WB (02)
Timerange: 00/09:46:36 to 00/09:50:04

Plot file version 287 created 21-JUN-2019 11:55:22

IRAS12112 EP111A 1.UVDATA.1

Freq = 1.4829 GHz, Bw = 16.000 MH Calibrated with CL # 3 and BP # 1 (BP mode 1)

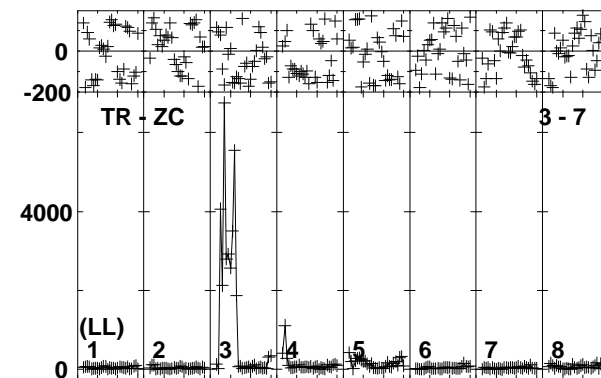
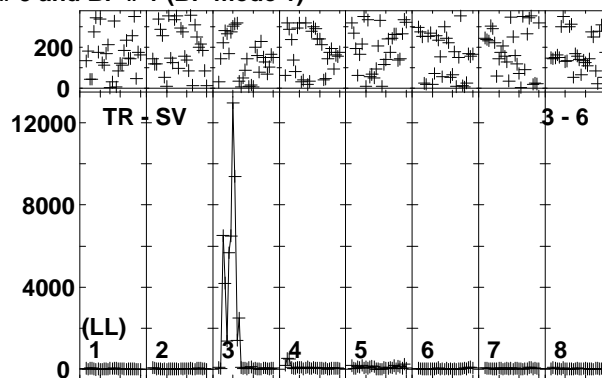
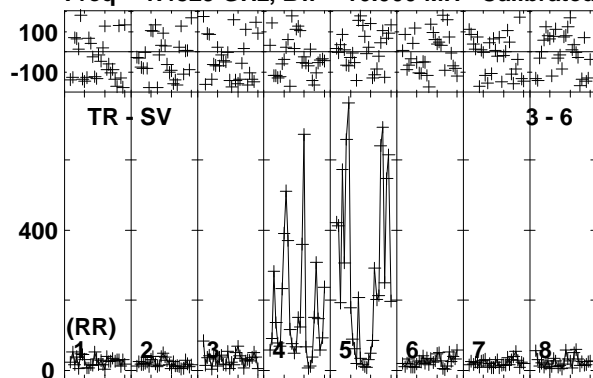

Lower frame: Milli Ampl Jy Top frame: Phas deg
Vector averaged cross-power spectrum Baseline: TR (03) - SV (06)
Timerange: 00/09:46:36 to 00/09:50:04

Plot file version 288 created 21-JUN-2019 11:55:23

J1222+0413 EP111A 1.UVDATA.1

Freq = 1.4829 GHz, Bw = 16.000 MH Calibrated with CL # 3 and BP # 1 (BP mode 1)

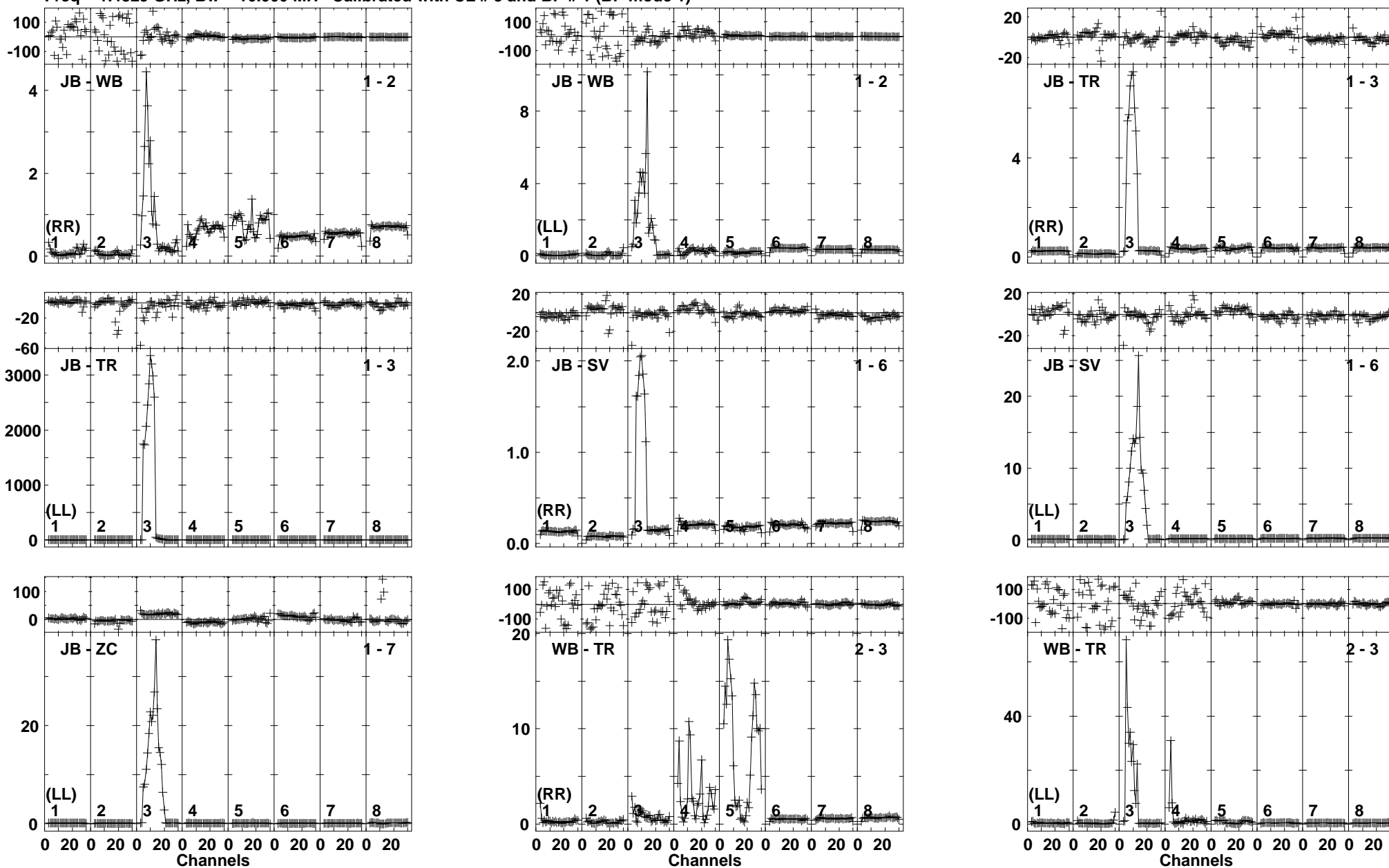

Lower frame: Ampl Jy Top frame: Phas deg
Vector averaged cross-power spectrum Baseline: JB (01) - WB (02)
Timerange: 00/09:50:46 to 00/09:52:14

Plot file version 289 created 21-JUN-2019 11:55:23
J1222+0413 EP1111A 1.UVDATA.1
Freq = 1.4829 GHz, Bw = 16.000 MH Calibrated with CL # 3 and BP # 1 (BP mode 1)

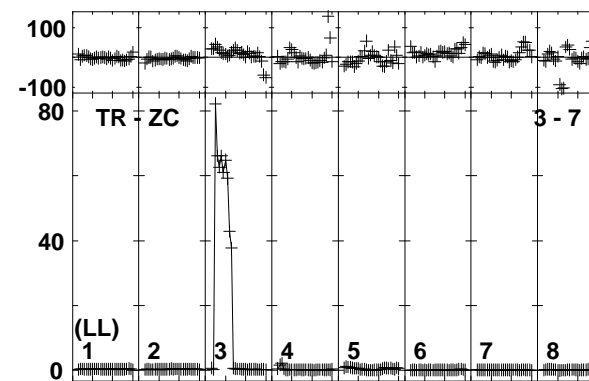
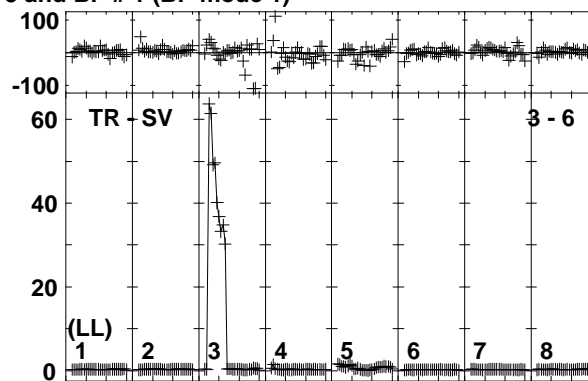
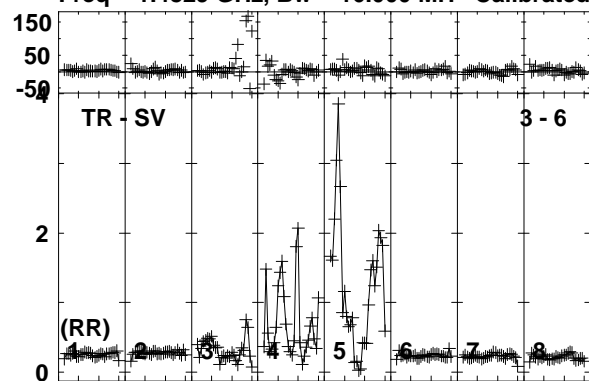

Lower frame: Ampl Jy Top frame: Phas deg
Vector averaged cross-power spectrum Baseline: TR (03) - SV (06)
Timerange: 00/09:50:46 to 00/09:52:14

Plot file version 290 created 21-JUN-2019 11:55:23
 IRAS12112 EP111A 1.UVDATA.1
 Freq = 1.4829 GHz, Bw = 16.000 MH Calibrated with CL # 3 and BP # 1 (BP mode 1)

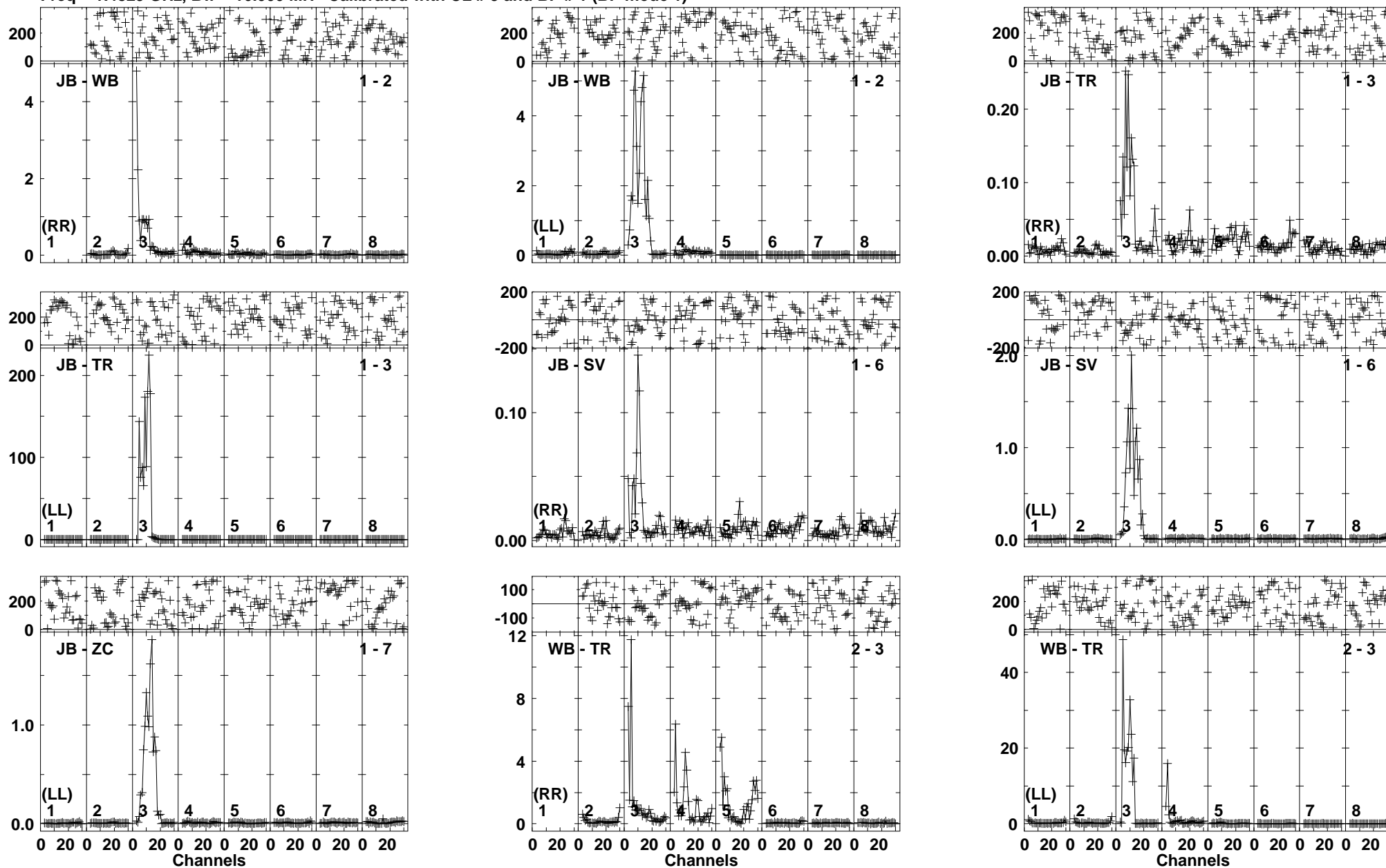

Lower frame: Ampl Jy Top frame: Phas deg
 Vector averaged cross-power spectrum Baseline: JB (01) - WB (02)
 Timerange: 00/09:52:16 to 00/09:55:44

Plot file version 291 created 21-JUN-2019 11:55:24

IRAS12112 EP111A 1.UVDATA.1

Freq = 1.4829 GHz, Bw = 16.000 MH Calibrated with CL # 3 and BP # 1 (BP mode 1)

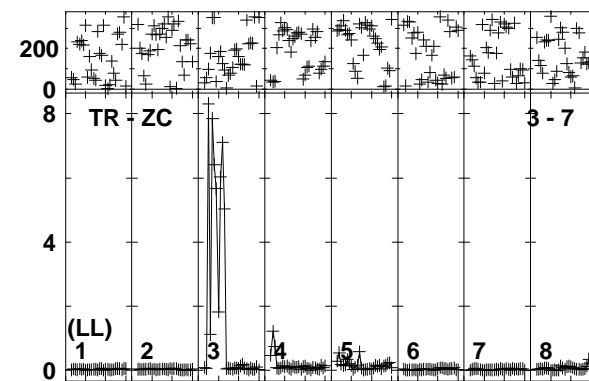
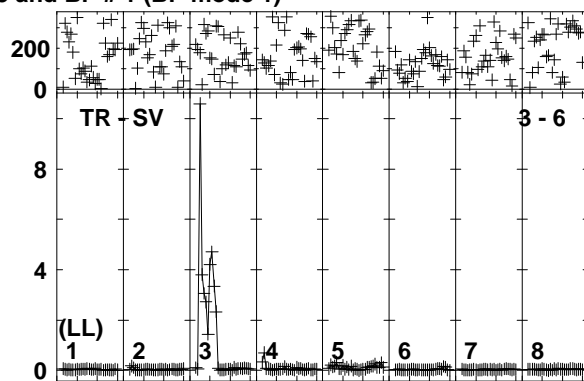
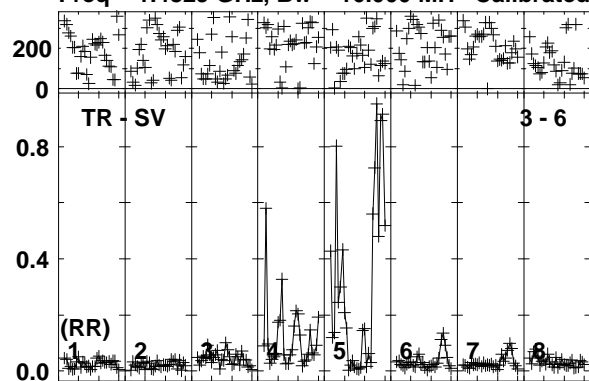

Lower frame: Ampl Jy Top frame: Phas deg
Vector averaged cross-power spectrum Baseline: TR (03) - SV (06)
Timerange: 00/09:52:16 to 00/09:55:44

Plot file version 292 created 21-JUN-2019 11:55:25

J1222+0413 EP111A 1.UVDATA.1

Freq = 1.4829 GHz, Bw = 16.000 MH Calibrated with CL # 3 and BP # 1 (BP mode 1)

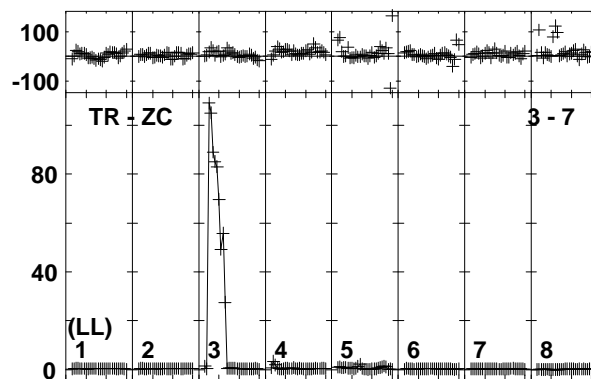
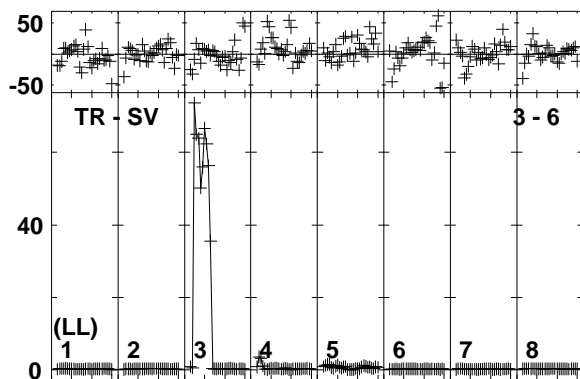
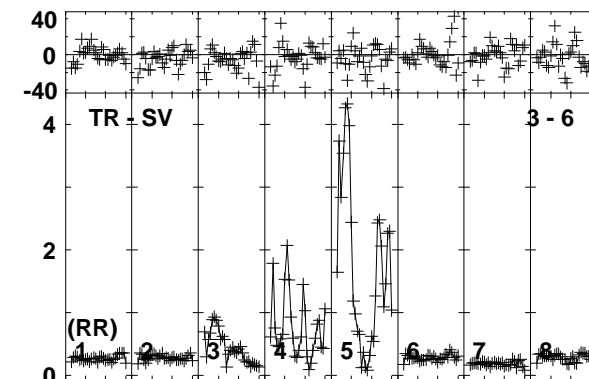
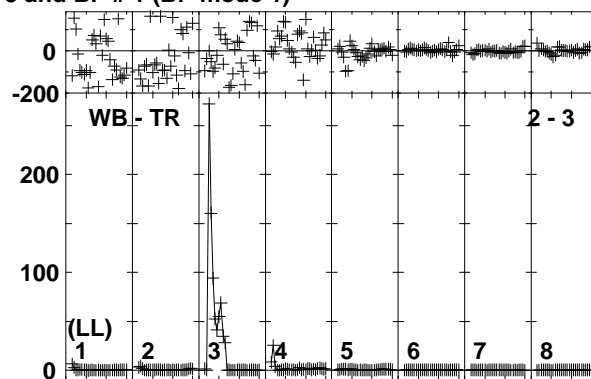
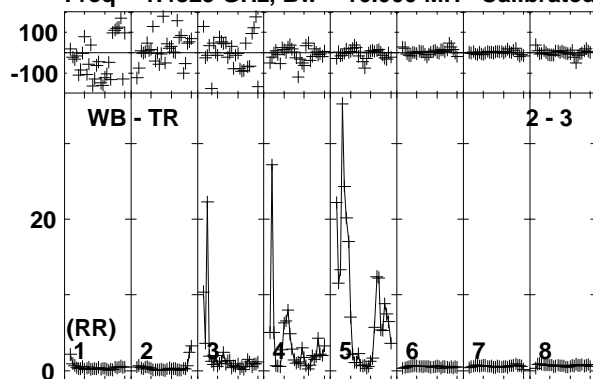

Lower frame: Ampl Jy Top frame: Phas deg
Vector averaged cross-power spectrum Baseline: WB (02) - TR (03)
Timerange: 00/09:55:46 to 00/09:57:14

Plot file version 293 created 21-JUN-2019 11:55:25

IRAS12112 EP111A 1.UVDATA.1

Freq = 1.4829 GHz, Bw = 16.000 MH Calibrated with CL # 3 and BP # 1 (BP mode 1)

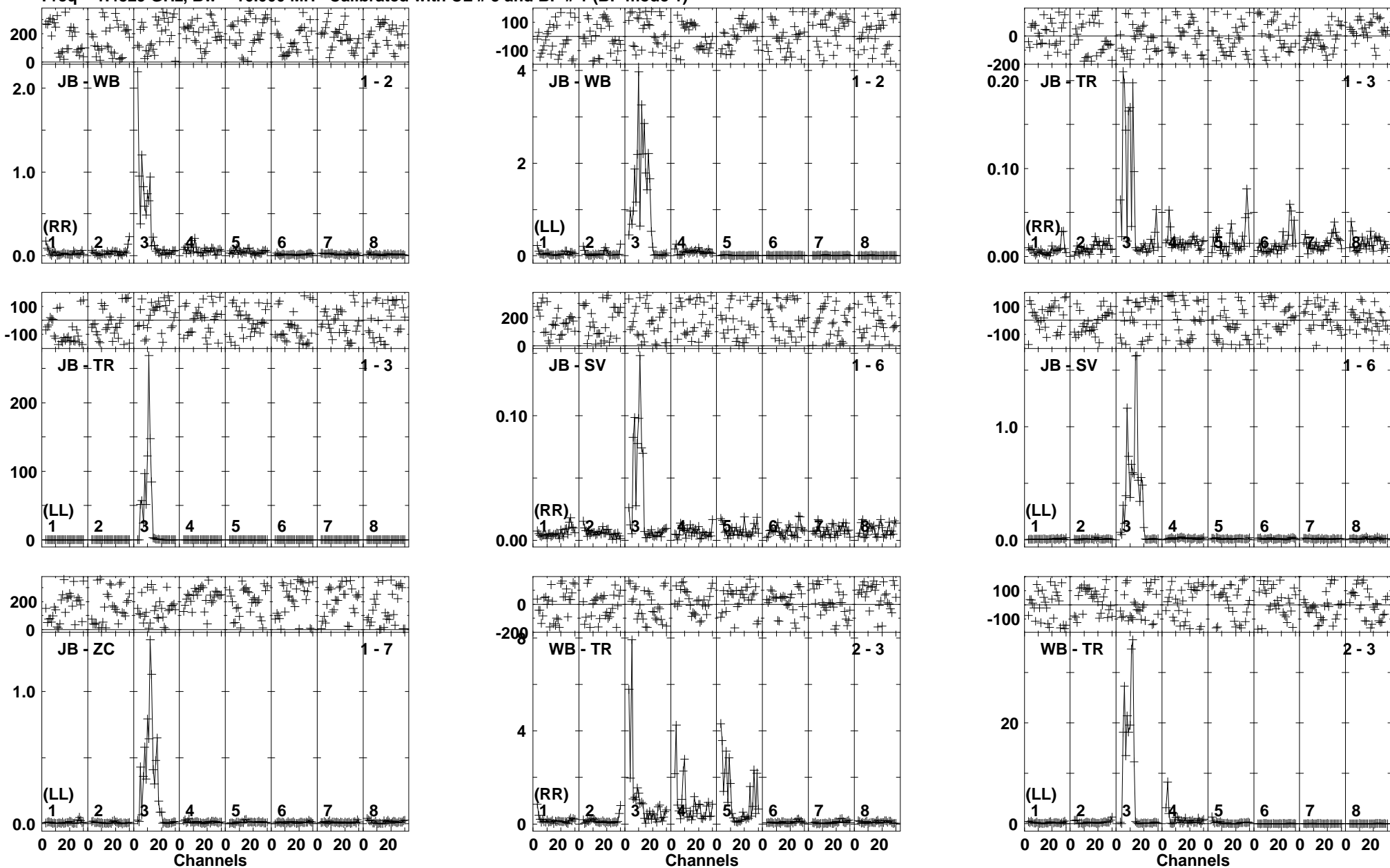

Lower frame: Ampl Jy Top frame: Phas deg
Vector averaged cross-power spectrum Baseline: JB (01) - WB (02)
Timerange: 00/09:57:16 to 00/10:00:44

Plot file version 294 created 21-JUN-2019 11:55:26

IRAS12112 EP111A 1.UVDATA.1

Freq = 1.4829 GHz, Bw = 16.000 MH Calibrated with CL # 3 and BP # 1 (BP mode 1)

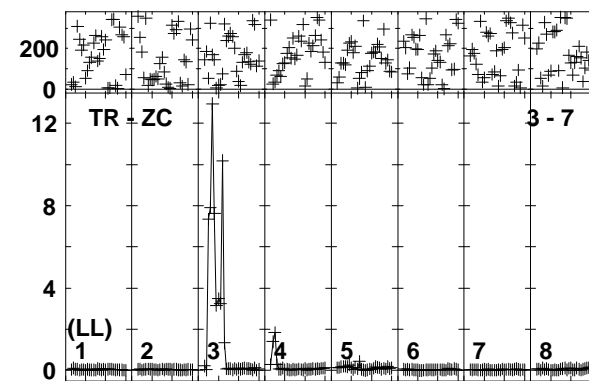
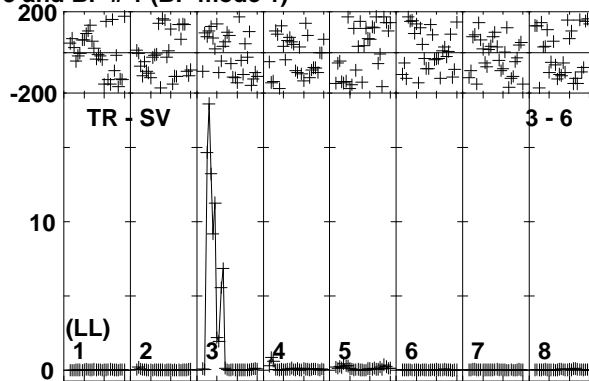
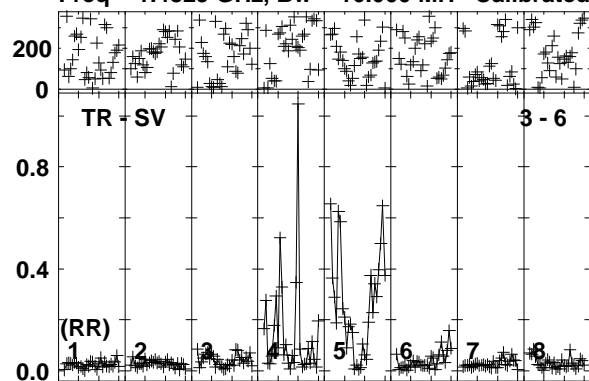

Lower frame: Ampl Jy Top frame: Phas deg
Vector averaged cross-power spectrum Baseline: TR (03) - SV (06)
Timerange: 00/09:57:16 to 00/10:00:44

Plot file version 295 created 21-JUN-2019 11:55:26

J1222+0413 EP111A 1.UVDATA.1

Freq = 1.4829 GHz, Bw = 16.000 MH Calibrated with CL # 3 and BP # 1 (BP mode 1)

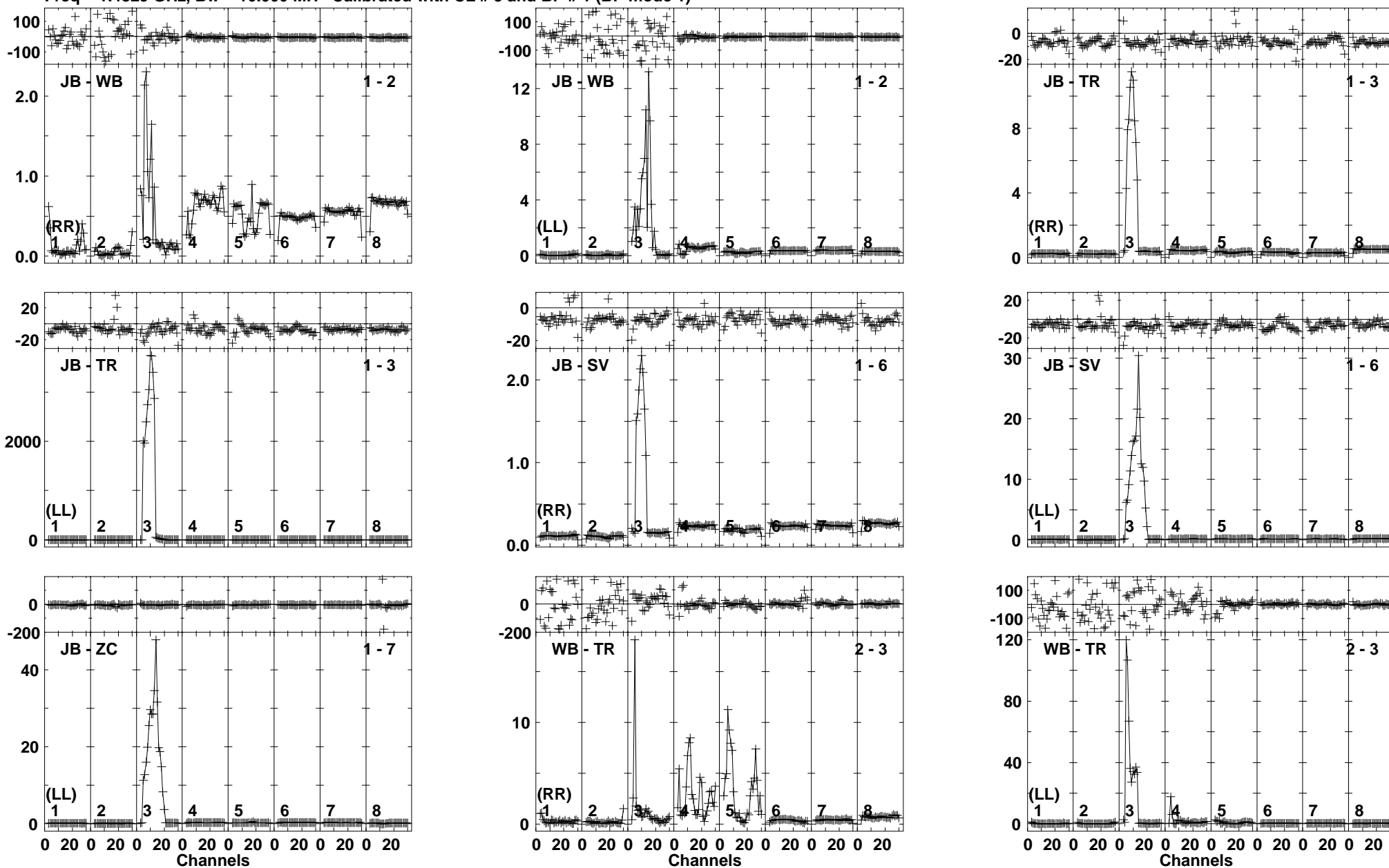

Lower frame: Ampl Jy Top frame: Phas deg
Vector averaged cross-power spectrum Baseline: JB (01) - WB (02)
Timerange: 00/10/01:26 to 00/10/02:54

Plot file version 296 created 21-JUN-2019 11:55:27

J1222+0413 EP111A 1.UVDATA.1

Freq = 1.4829 GHz, Bw = 16.000 MH Calibrated with CL # 3 and BP # 1 (BP mode 1)

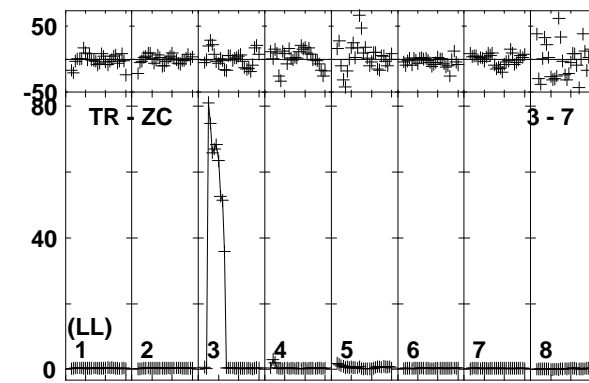
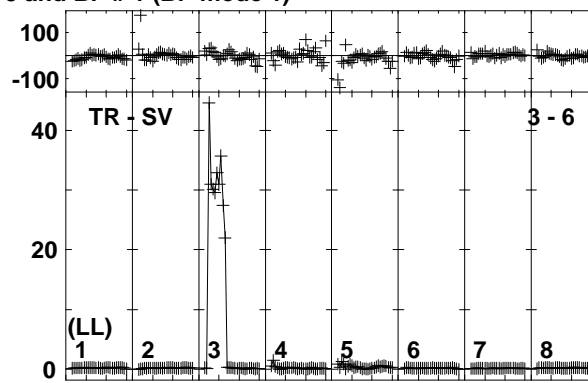
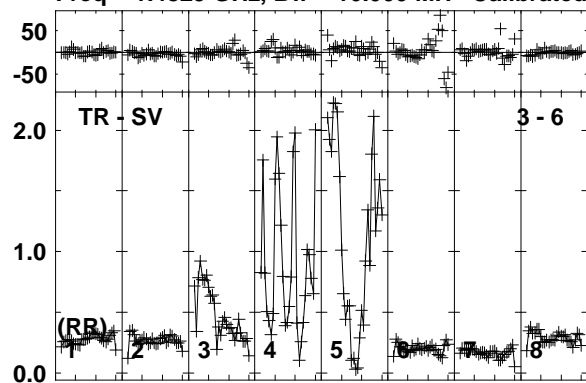

Lower frame: Ampl Jy Top frame: Phas deg
Vector averaged cross-power spectrum Baseline: TR (03) - SV (06)
Timerange: 00/10:01:26 to 00/10:02:54

Plot file version 297 created 21-JUN-2019 11:55:27

IRAS12112 EP111A 1.UVDATA.1

Freq = 1.4829 GHz, Bw = 16.000 MH Calibrated with CL # 3 and BP # 1 (BP mode 1)

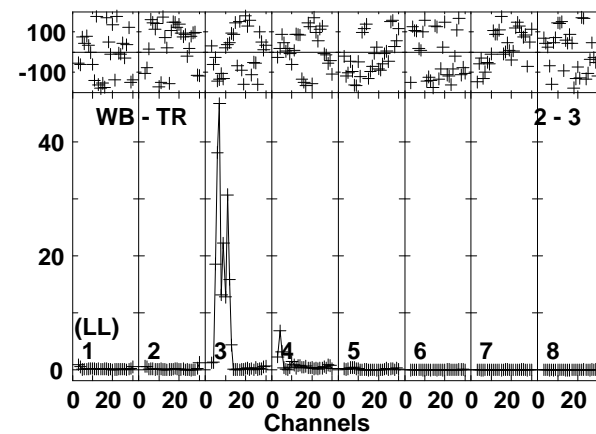
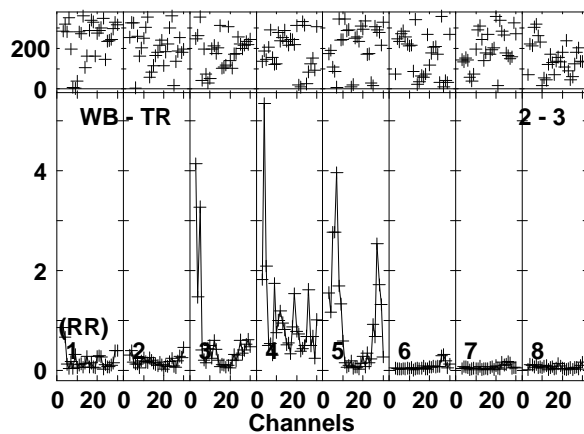
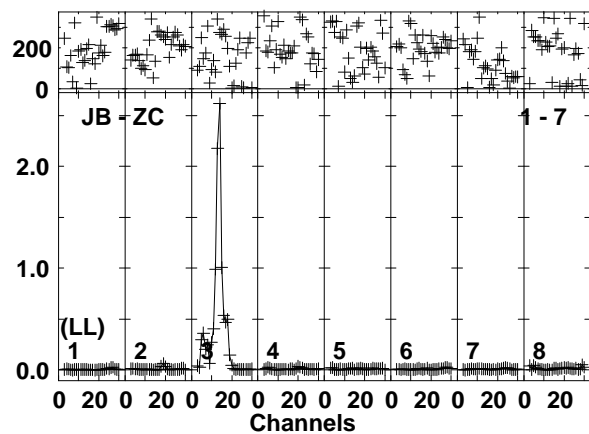
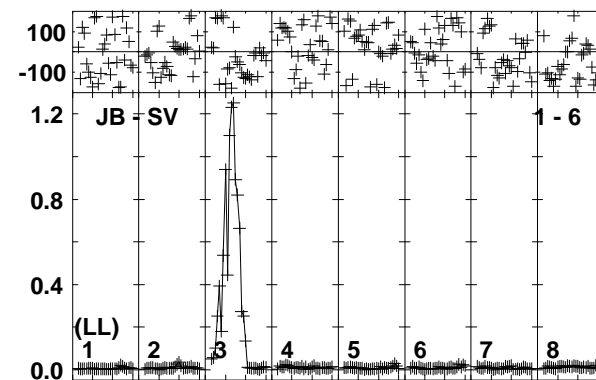
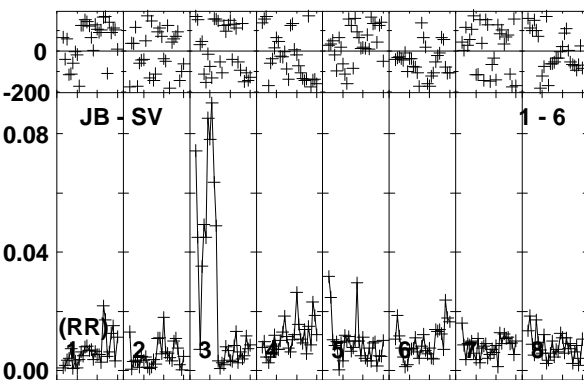
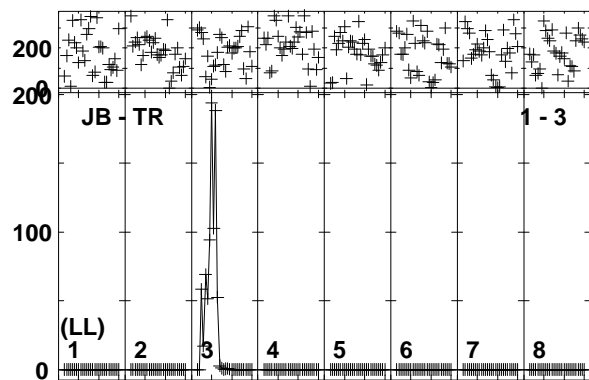
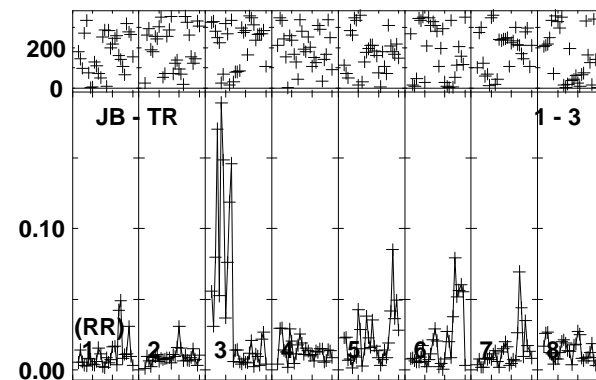
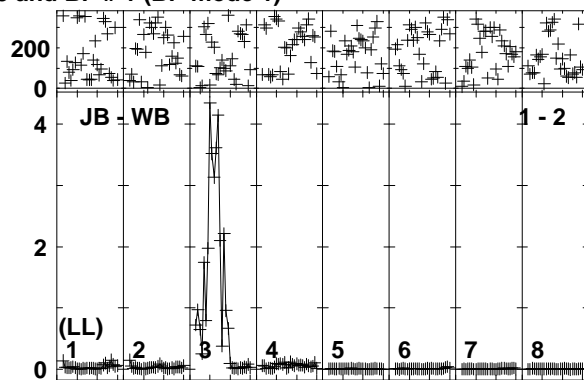
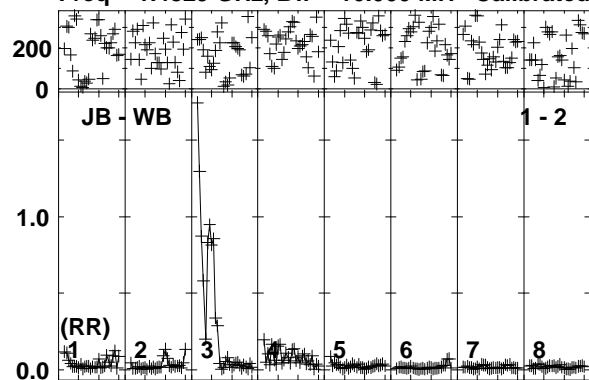

Lower frame: Ampl Jy Top frame: Phas deg
Vector averaged cross-power spectrum Baseline: JB (01) - WB (02)
Timerange: 00/10:02:56 to 00/10:06:24

Plot file version 298 created 21-JUN-2019 11:55:28

IRAS12112 EP111A 1.UVDATA.1

Freq = 1.4829 GHz, Bw = 16.000 MH Calibrated with CL # 3 and BP # 1 (BP mode 1)

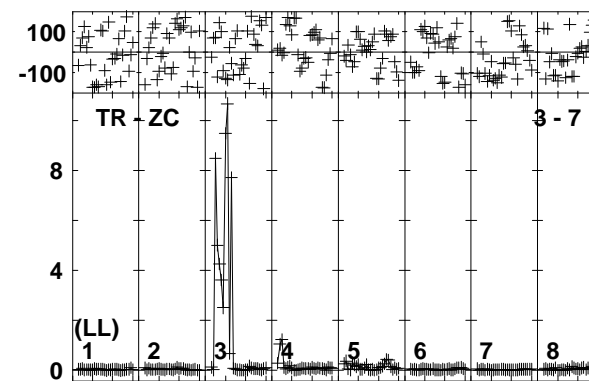
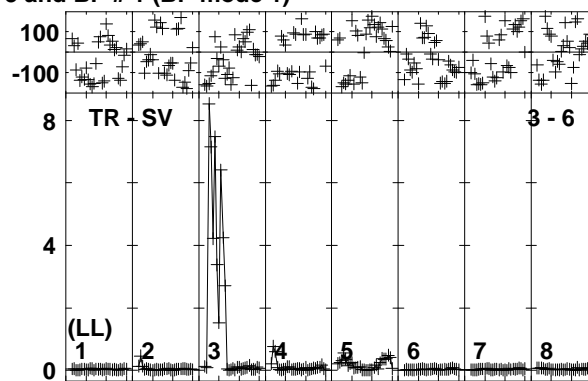
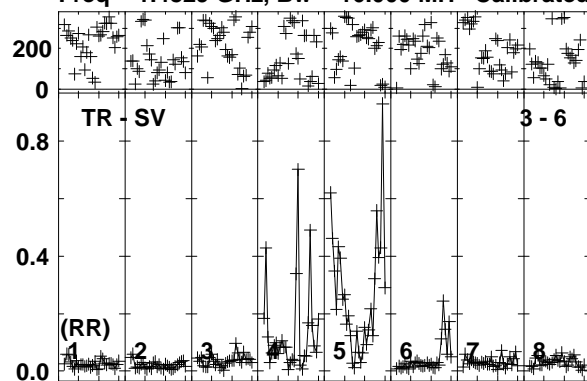

Lower frame: Ampl Jy Top frame: Phas deg
Vector averaged cross-power spectrum Baseline: TR (03) - SV (06)
Timerange: 00/10:02:56 to 00/10:06:24

Plot file version 299 created 21-JUN-2019 11:55:28

J1222+0413 EP111A 1.UVDATA.1

Freq = 1.4829 GHz, Bw = 16.000 MH Calibrated with CL # 3 and BP # 1 (BP mode 1)

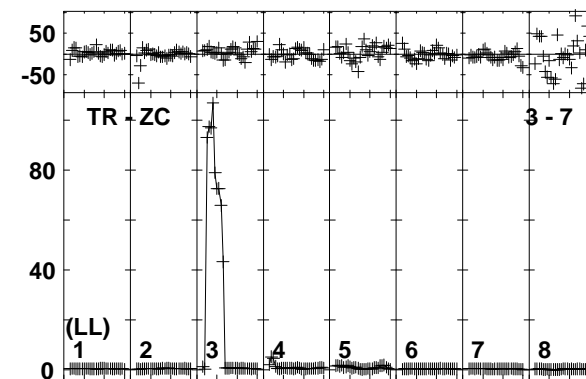
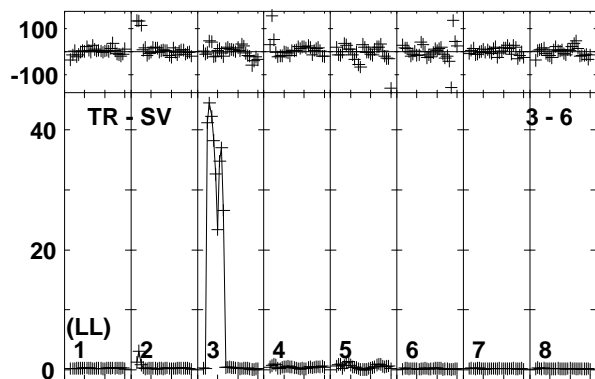
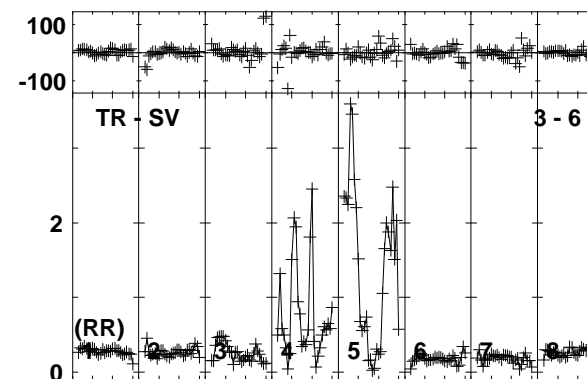
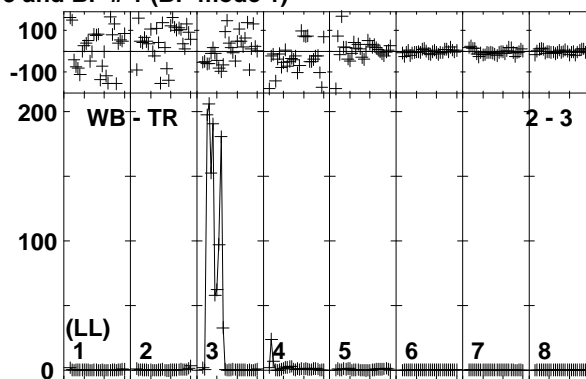
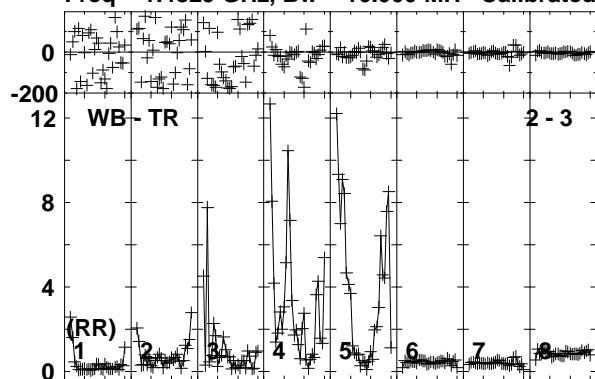

Lower frame: Ampl Jy Top frame: Phas deg
Vector averaged cross-power spectrum Baseline: WB (02) - TR (03)
Timerange: 00/10:06:26 to 00/10:07:54

Plot file version 300 created 21-JUN-2019 11:55:29
 IRAS12112 EP111A 1.UVDATA.1
 Freq = 1.4829 GHz, Bw = 16.000 MH Calibrated with CL # 3 and BP # 1 (BP mode 1)

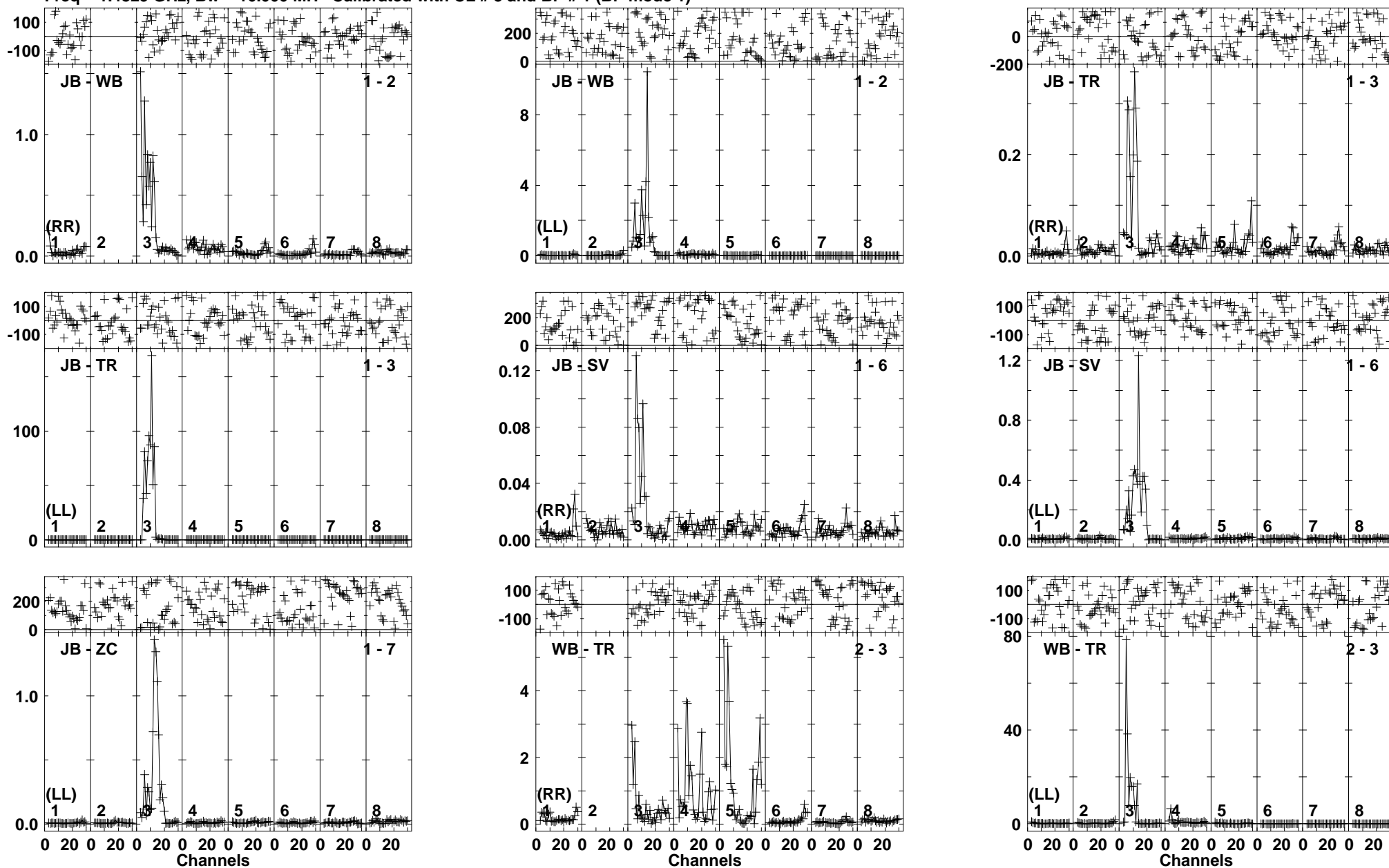

Lower frame: Ampl Jy Top frame: Phas deg
 Vector averaged cross-power spectrum Baseline: JB (01) - WB (02)
 Timerange: 00/10/07:56 to 00/10/11:24

Plot file version 301 created 21-JUN-2019 11:55:29

IRAS12112 EP111A 1.UVDATA.1

Freq = 1.4829 GHz, Bw = 16.000 MH Calibrated with CL # 3 and BP # 1 (BP mode 1)

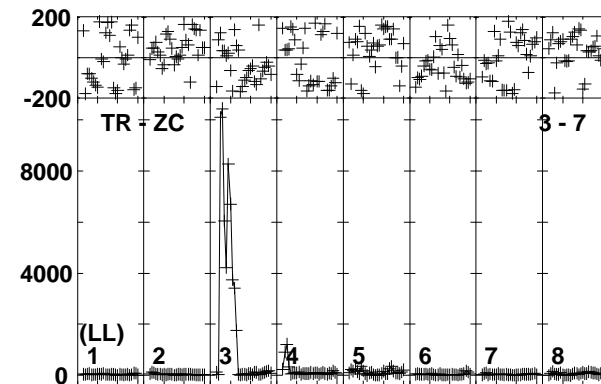
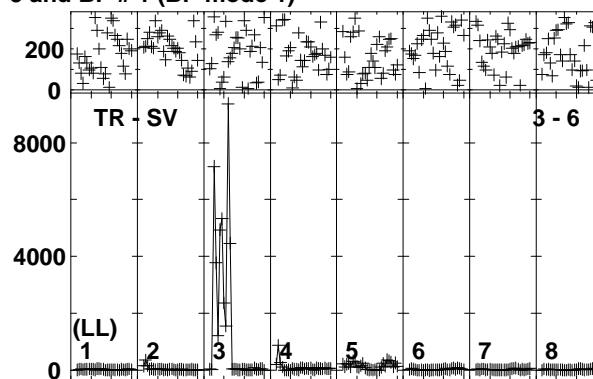
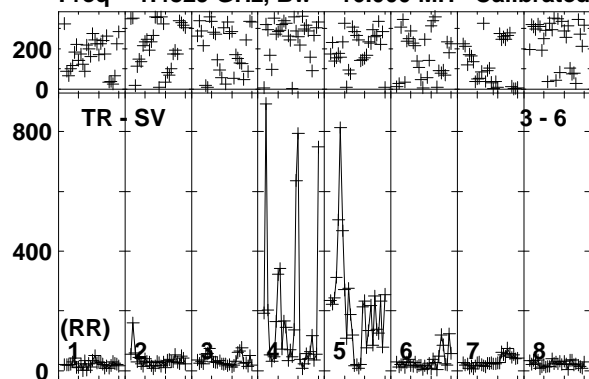

Lower frame: Milli Ampl Jy Top frame: Phas deg
Vector averaged cross-power spectrum Baseline: TR (03) - SV (06)
Timerange: 00/10:07:56 to 00/10:11:24

Plot file version 302 created 21-JUN-2019 11:55:30

J1222+0413 EP111A 1.UVDATA.1

Freq = 1.4829 GHz, Bw = 16.000 MH Calibrated with CL # 3 and BP # 1 (BP mode 1)

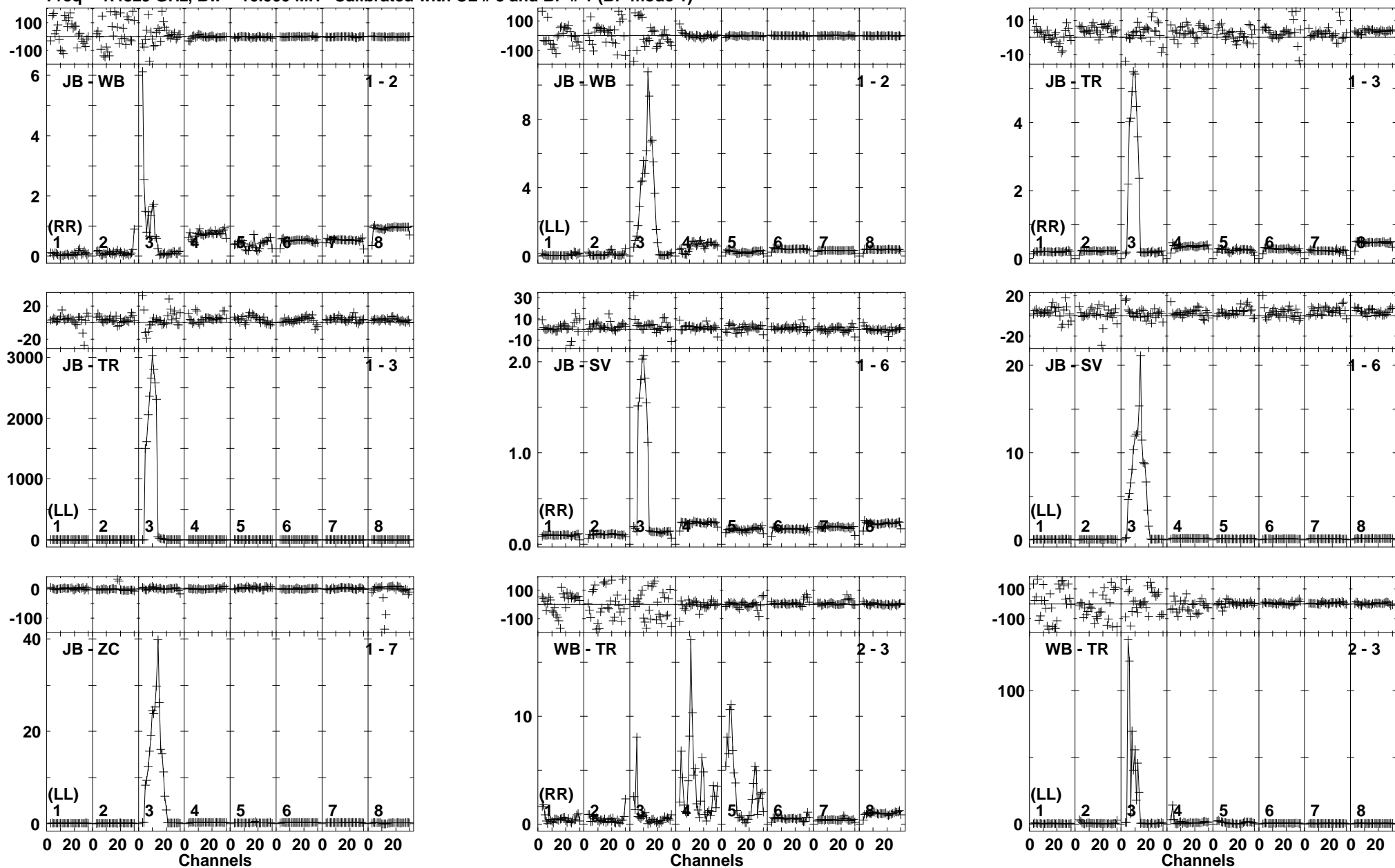

Lower frame: Ampl Jy Top frame: Phas deg
Vector averaged cross-power spectrum Baseline: JB (01) - WB (02)
Timerange: 00/10:12:06 to 00/10:13:34

Plot file version 303 created 21-JUN-2019 11:55:30
 J1222+0413 EP1111A 1.UVDATA.1
 Freq = 1.4829 GHz, Bw = 16.000 MH Calibrated with CL # 3 and BP # 1 (BP mode 1)

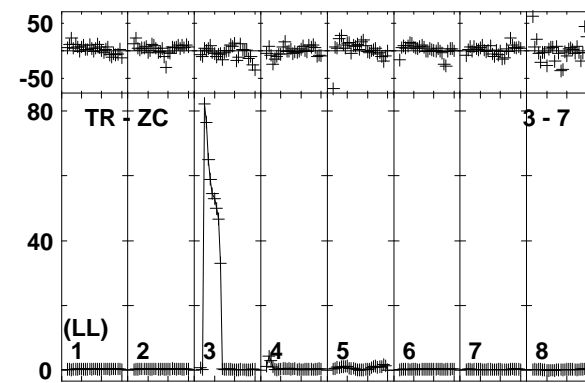
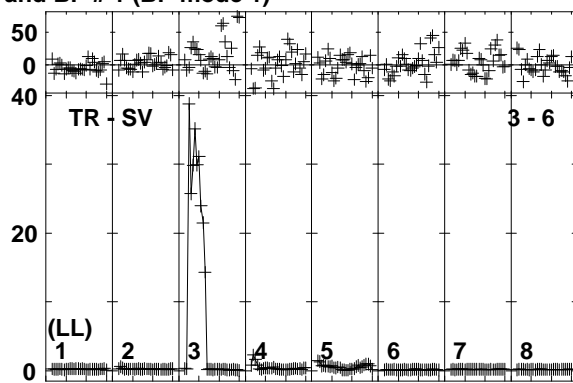
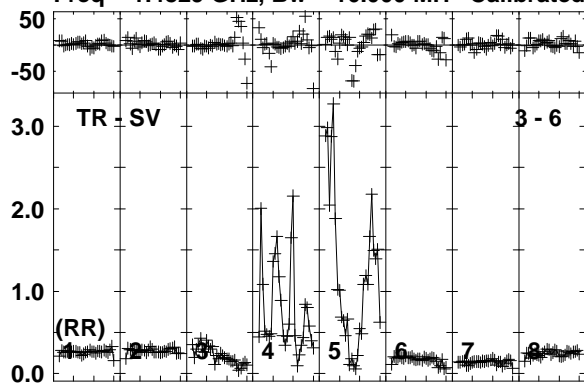

Lower frame: Ampl Jy Top frame: Phas deg
 Vector averaged cross-power spectrum Baseline: TR (03) - SV (06)
 Timerange: 00/10:12:06 to 00/10:13:34

Plot file version 304 created 21-JUN-2019 11:55:31

IRAS12112 EP111A 1.UVDATA.1

Freq = 1.4829 GHz, Bw = 16.000 MH Calibrated with CL # 3 and BP # 1 (BP mode 1)

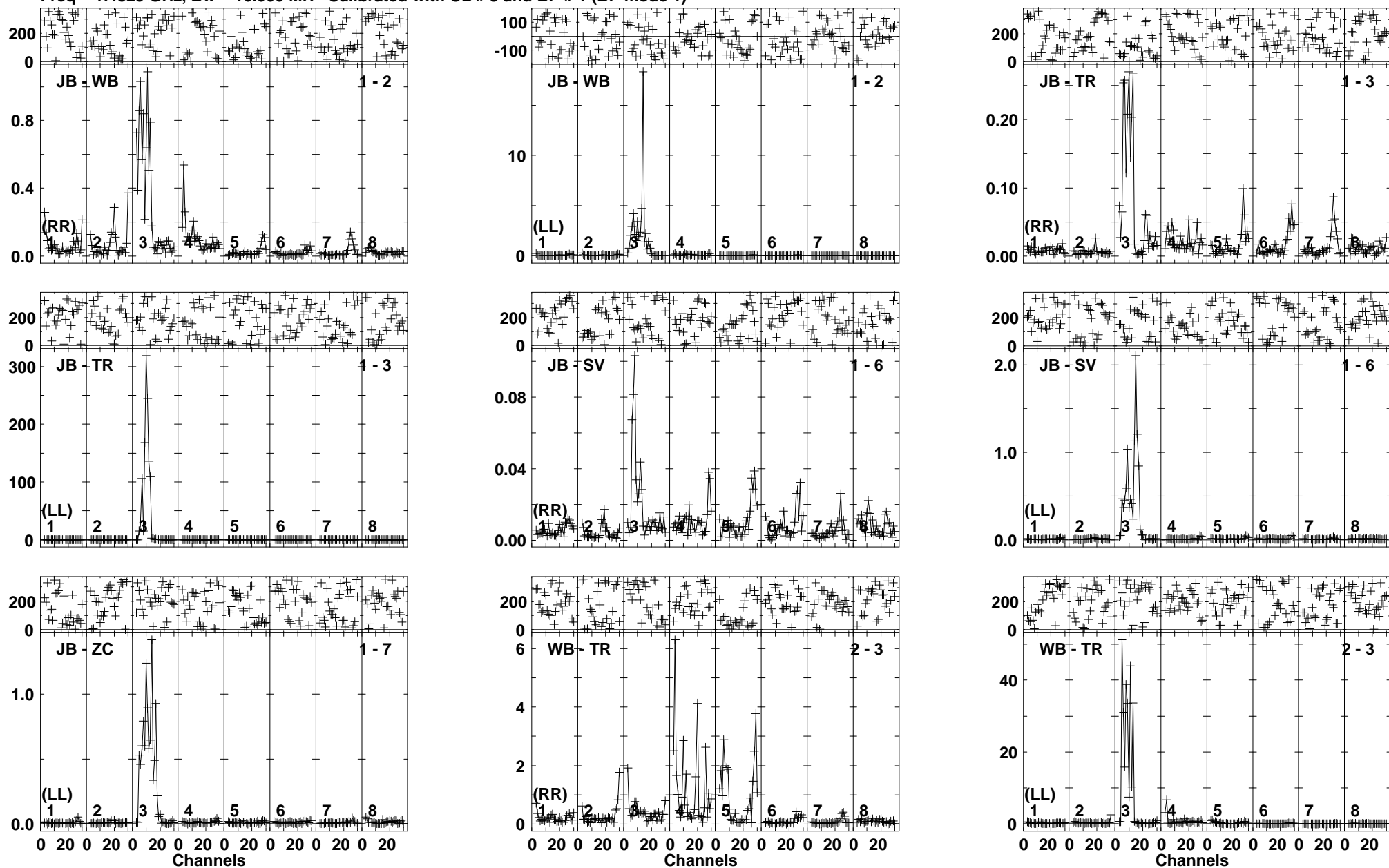

Lower frame: Ampl Jy Top frame: Phas deg
Vector averaged cross-power spectrum Baseline: JB (01) - WB (02)
Timerange: 00/10:13:36 to 00/10:17:04

Plot file version 305 created 21-JUN-2019 11:55:31

IRAS12112 EP111A 1.UVDATA.1

Freq = 1.4829 GHz, Bw = 16.000 MH Calibrated with CL # 3 and BP # 1 (BP mode 1)

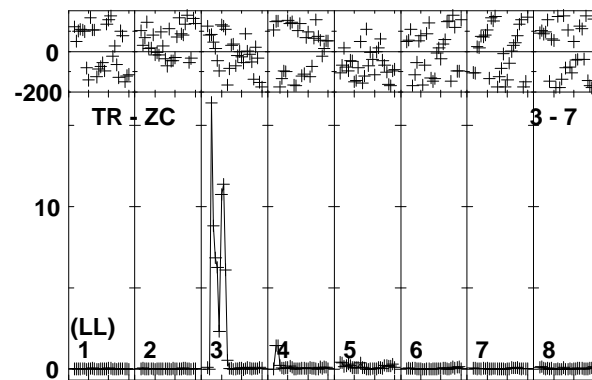
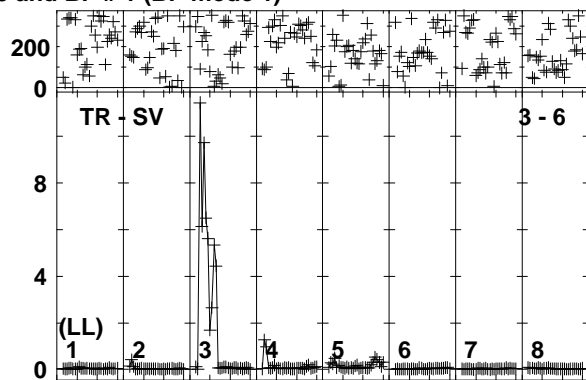
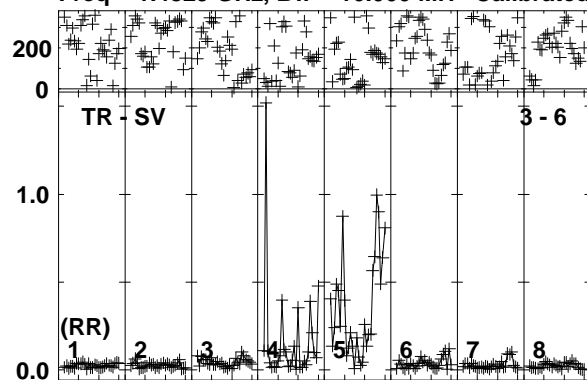

Lower frame: Ampl Jy Top frame: Phas deg
Vector averaged cross-power spectrum Baseline: TR (03) - SV (06)
Timerange: 00/10:13:36 to 00/10:17:04

Plot file version 306 created 21-JUN-2019 11:55:32

J1222+0413 EP111A 1.UVDATA.1

Freq = 1.4829 GHz, Bw = 16.000 MH Calibrated with CL # 3 and BP # 1 (BP mode 1)

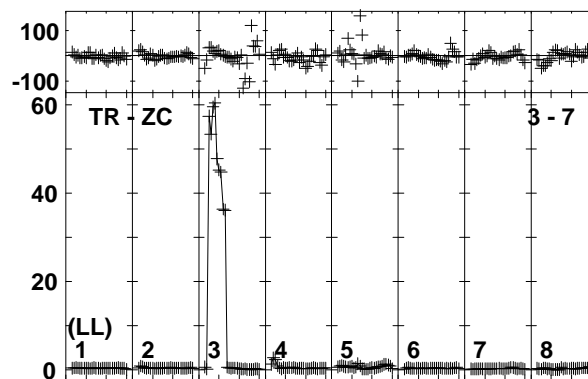
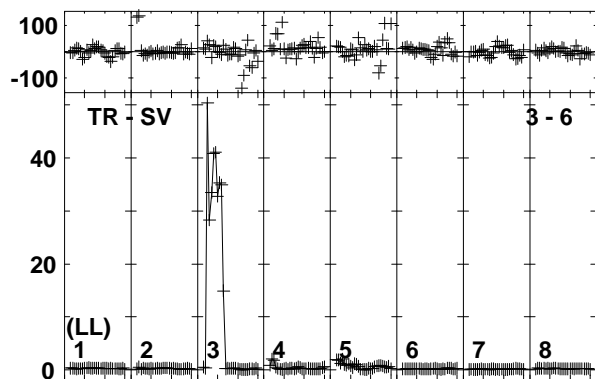
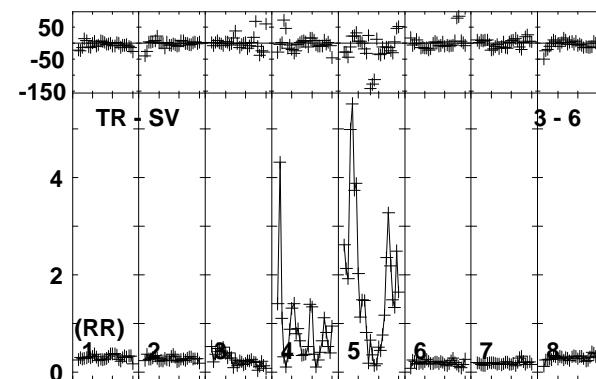
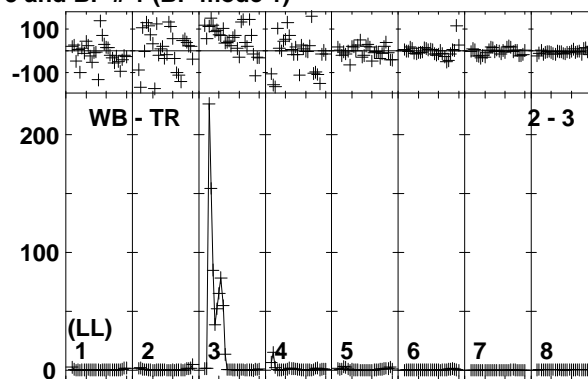
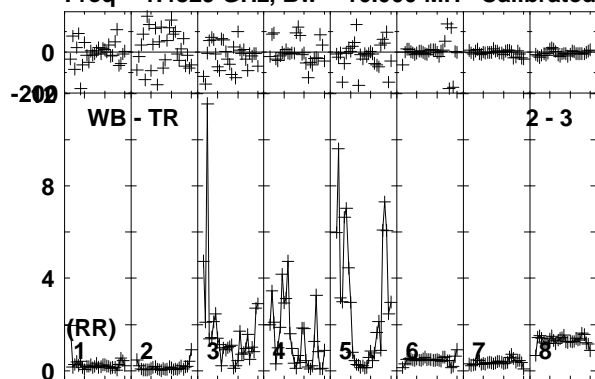

Lower frame: Ampl Jy Top frame: Phas deg
Vector averaged cross-power spectrum Baseline: WB (02) - TR (03)
Timerange: 00/10:17:06 to 00/10:18:34

Plot file version 307 created 21-JUN-2019 11:55:32
 IRAS12112 EP111A 1.UVDATA.1
 Freq = 1.4829 GHz, Bw = 16.000 MH Calibrated with CL # 3 and BP # 1 (BP mode 1)

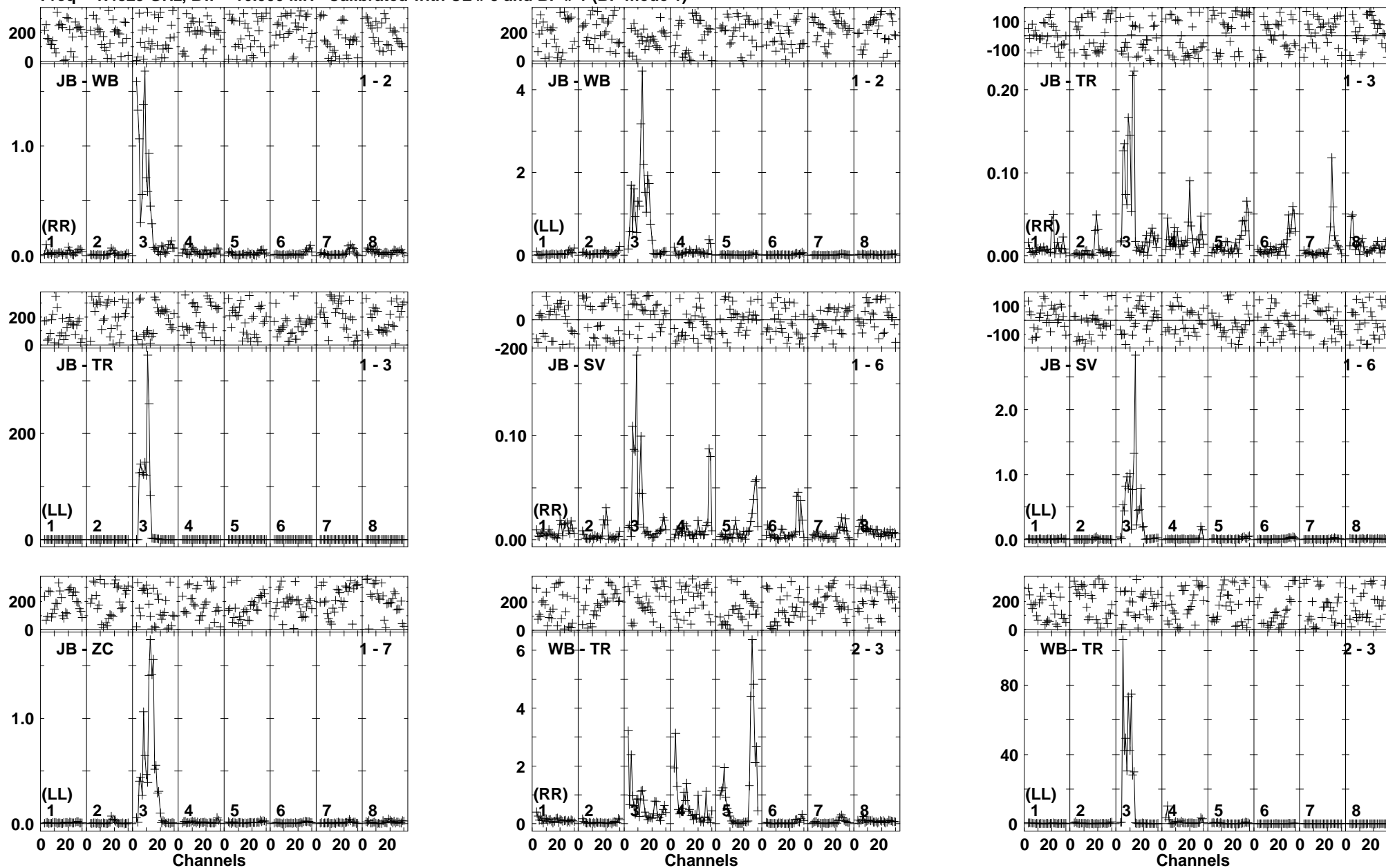

Lower frame: Ampl Jy Top frame: Phas deg
 Vector averaged cross-power spectrum Baseline: JB (01) - WB (02)
 Timerange: 00/10:18:36 to 00/10:22:04

Plot file version 308 created 21-JUN-2019 11:55:33

IRAS12112 EP111A 1.UVDATA.1

Freq = 1.4829 GHz, Bw = 16.000 MH Calibrated with CL # 3 and BP # 1 (BP mode 1)

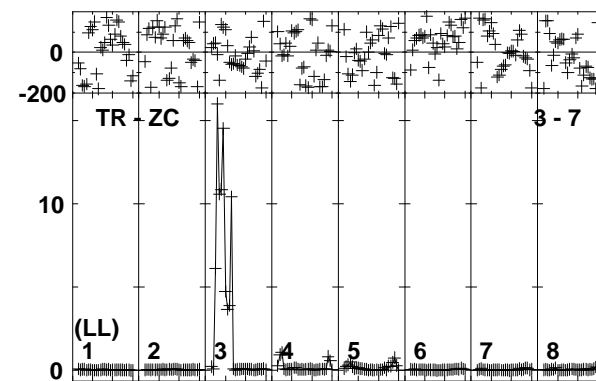
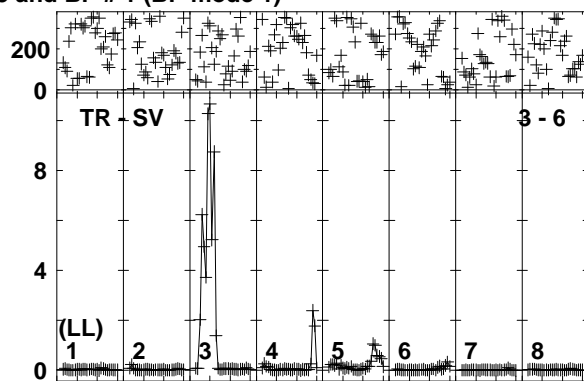
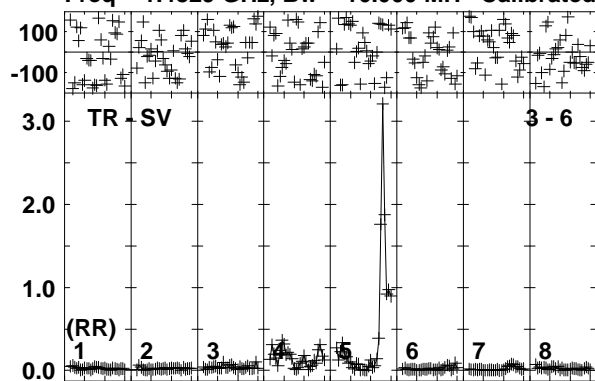

Lower frame: Ampl Jy Top frame: Phas deg
Vector averaged cross-power spectrum Baseline: TR (03) - SV (06)
Timerange: 00/10:18:36 to 00/10:22:04

Plot file version 309 created 21-JUN-2019 11:55:33
 J1222+0413 EP111A 1.UVDATA.1
 Freq = 1.4829 GHz, Bw = 16.000 MH Calibrated with CL # 3 and BP # 1 (BP mode 1)

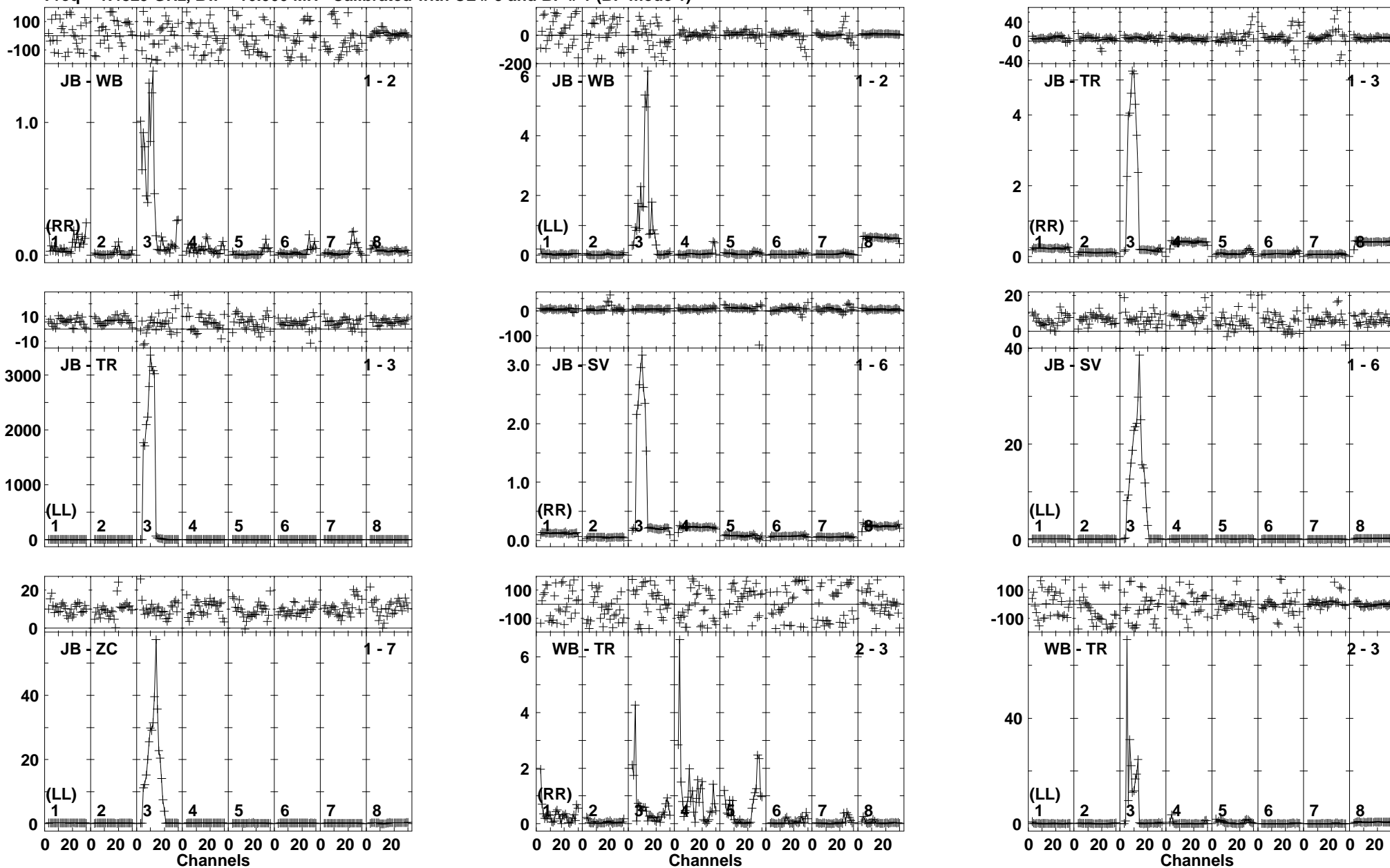

Lower frame: Ampl Jy Top frame: Phas deg
 Vector averaged cross-power spectrum Baseline: JB (01) - WB (02)
 Timerange: 00/10/22:46 to 00/10/24:14

Plot file version 310 created 21-JUN-2019 11:55:34
J1222+0413 EP111A 1.UVDATA.1
Freq = 1.4829 GHz, Bw = 16.000 MH Calibrated with CL # 3 and BP # 1 (BP mode 1)

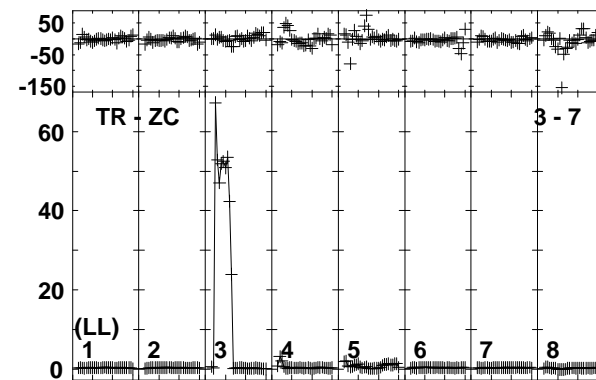
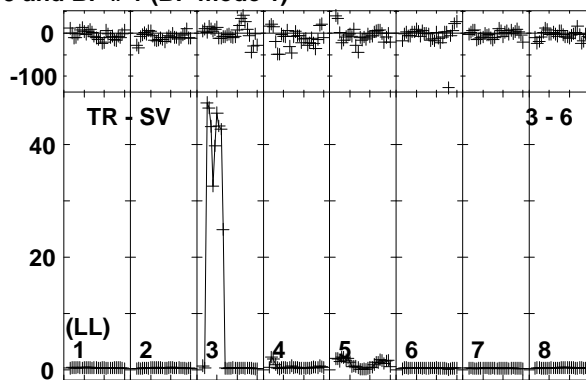
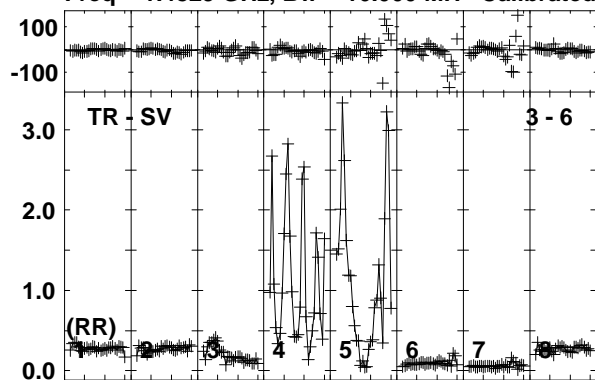

Lower frame: Ampl Jy Top frame: Phas deg
Vector averaged cross-power spectrum Baseline: TR (03) - SV (06)
Timerange: 00/10:22:46 to 00/10:24:14

Plot file version 311 created 21-JUN-2019 11:55:34

J1152-0841 EP111A 1.UVDATA.1

Freq = 1.4829 GHz, Bw = 16.000 MH Calibrated with CL # 3 and BP # 1 (BP mode 1)

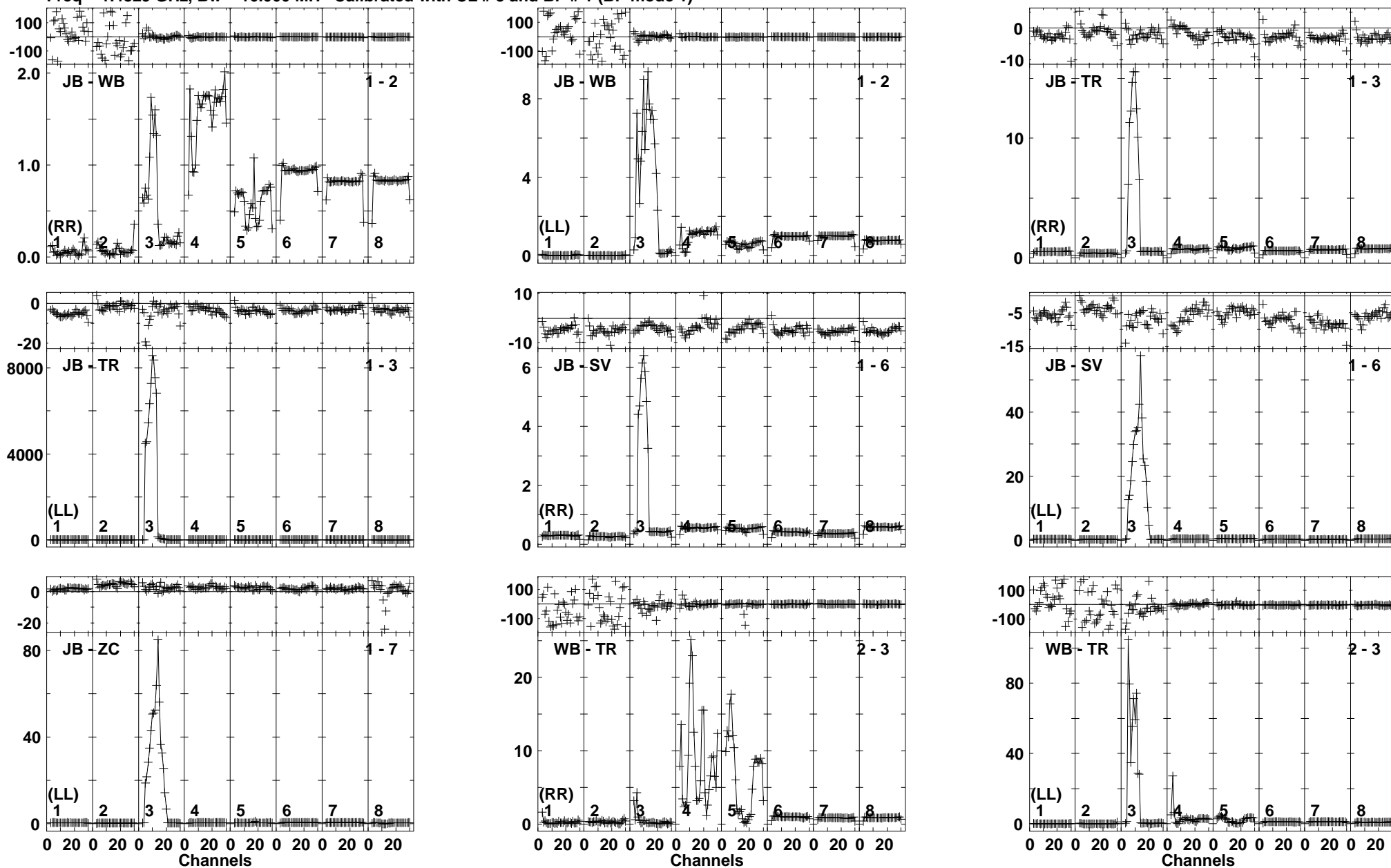

Lower frame: Ampl Jy Top frame: Phas deg
Vector averaged cross-power spectrum Baseline: JB (01) - WB (02)
Timerange: 00/10:26:26 to 00/10:29:54

Plot file version 312 created 21-JUN-2019 11:55:35
J1152-0841 EP1111A 1.UVDATA.1
Freq = 1.4829 GHz, Bw = 16.000 MH Calibrated with CL # 3 and BP # 1 (BP mode 1)

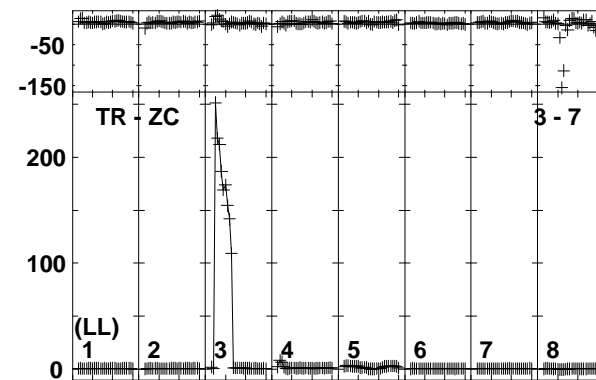
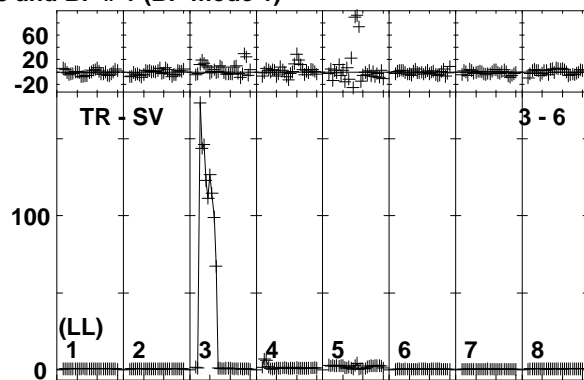
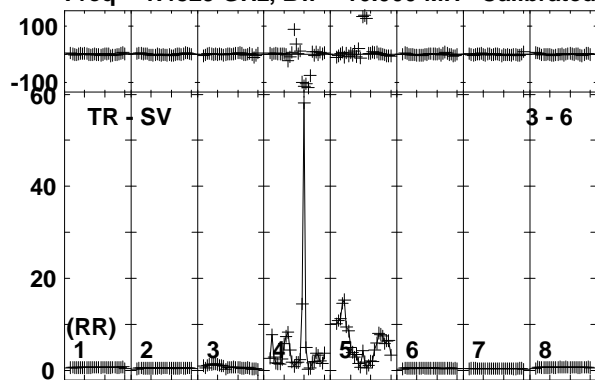

Lower frame: Ampl Jy Top frame: Phas deg
Vector averaged cross-power spectrum Baseline: TR (03) - SV (06)
Timerange: 00/10:26:26 to 00/10:29:54

Plot file version 313 created 21-JUN-2019 11:55:35

J1222+0413 EP111A 1.UVDATA.1

Freq = 1.4829 GHz, Bw = 16.000 MH Calibrated with CL # 3 and BP # 1 (BP mode 1)

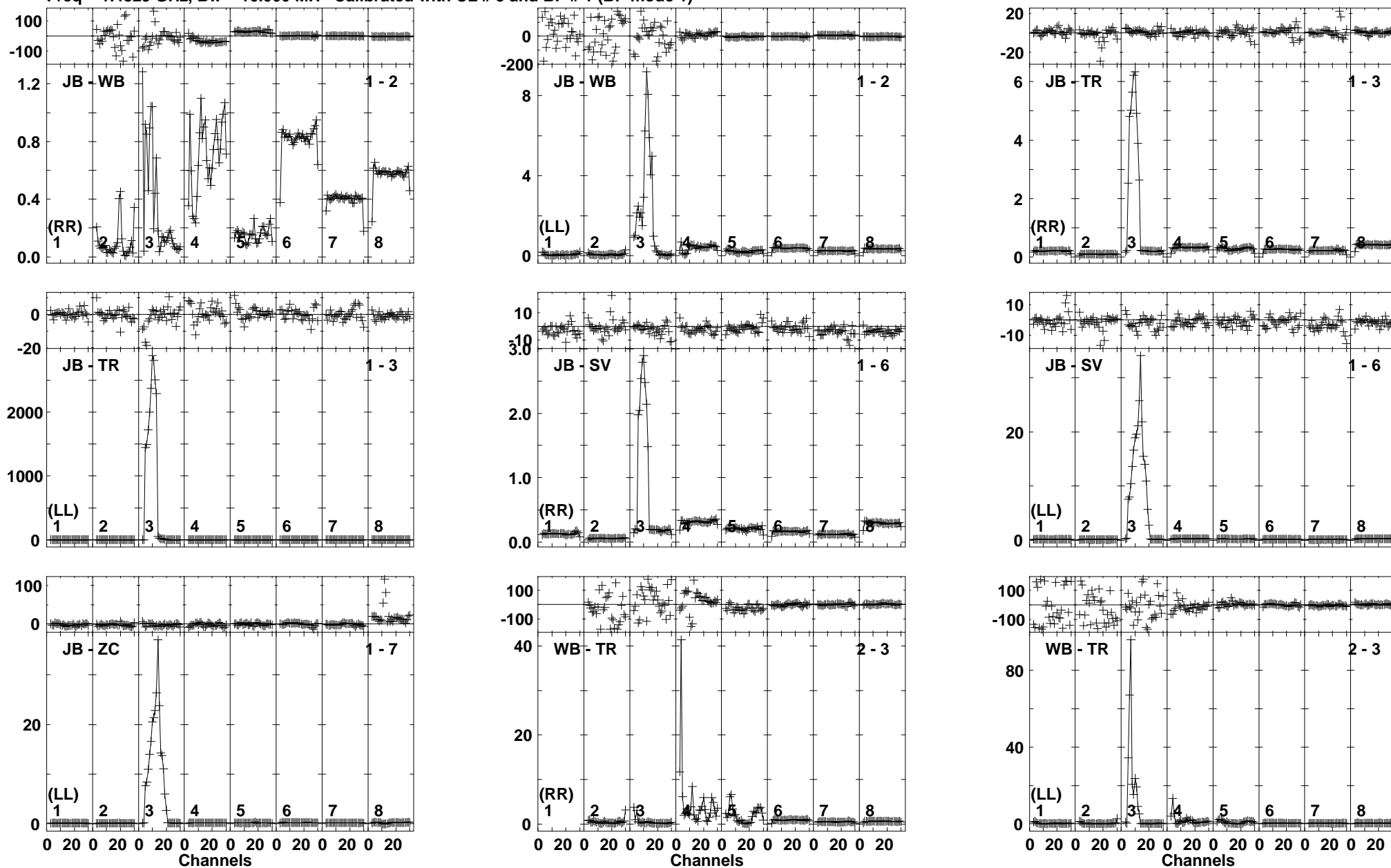

Plot file version 314 created 21-JUN-2019 11:55:36

J1222+0413 EP1111A 1.UVDATA.1

Freq = 1.4829 GHz, Bw = 16.000 MH Calibrated with CL # 3 and BP # 1 (BP mode 1)

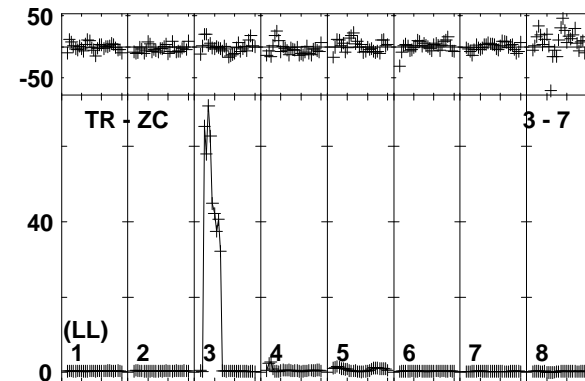
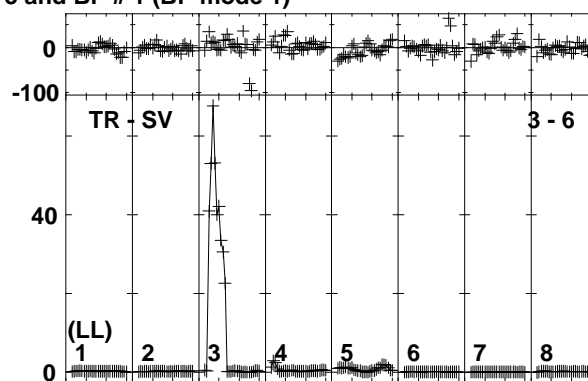
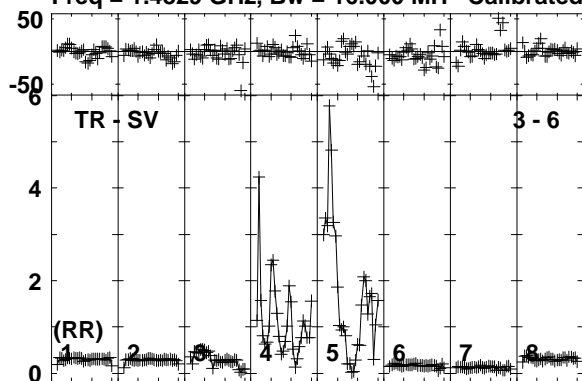

Lower frame: Ampl Jy Top frame: Phas deg
Vector averaged cross-power spectrum Baseline: TR (03) - SV (06)
Timerange: 00/10:32:06 to 00/10:34:04

Plot file version 315 created 21-JUN-2019 11:55:36

IRAS12112 EP111A 1.UVDATA.1

Freq = 1.4829 GHz, Bw = 16.000 MH Calibrated with CL # 3 and BP # 1 (BP mode 1)

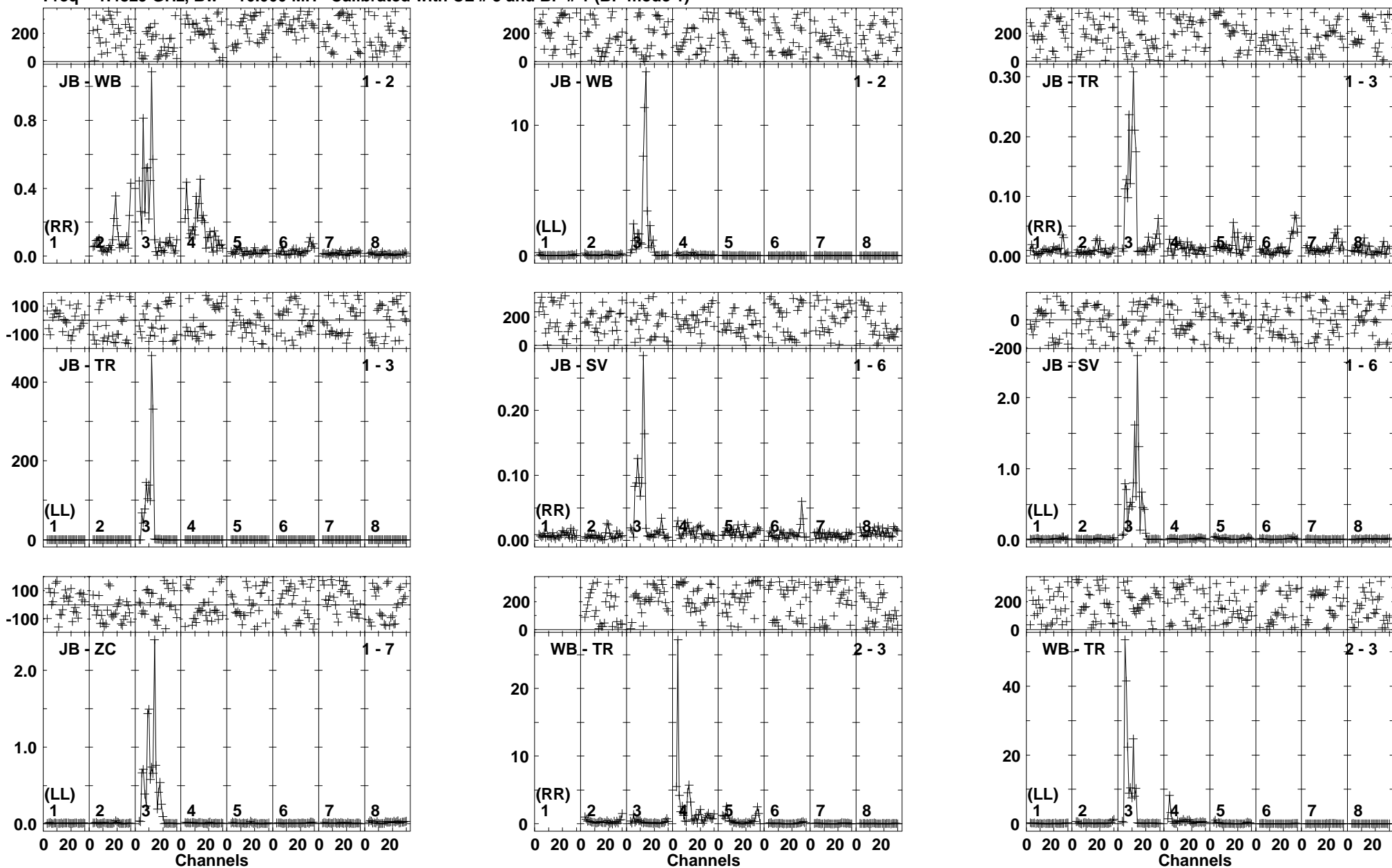

Lower frame: Ampl Jy Top frame: Phas deg
Vector averaged cross-power spectrum Baseline: JB (01) - WB (02)
Timerange: 00/10:34:06 to 00/10:37:34

Plot file version 316 created 21-JUN-2019 11:55:37

IRAS12112 EP111A 1.UVDATA.1

Freq = 1.4829 GHz, Bw = 16.000 MH Calibrated with CL # 3 and BP # 1 (BP mode 1)

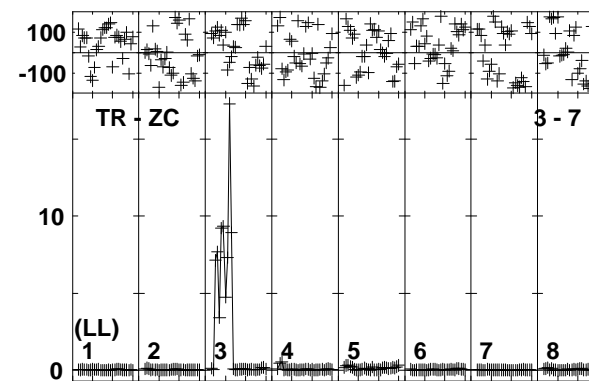
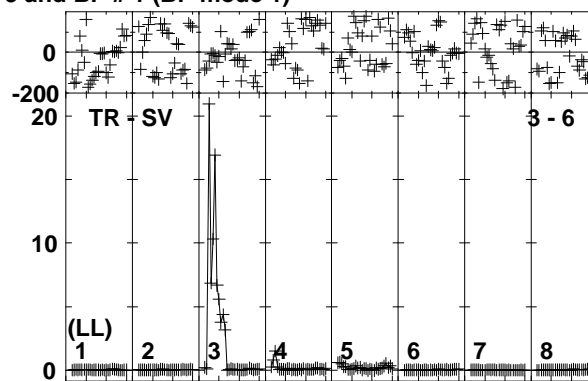
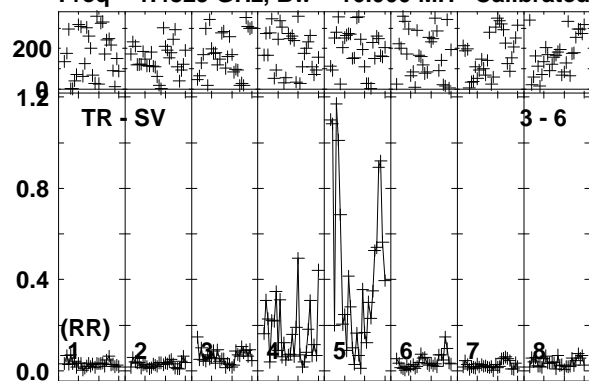

Lower frame: Ampl Jy Top frame: Phas deg
Vector averaged cross-power spectrum Baseline: TR (03) - SV (06)
Timerange: 00/10:34:06 to 00/10:37:34

Plot file version 317 created 21-JUN-2019 11:55:37

J1222+0413 EP111A 1.UVDATA.1

Freq = 1.4829 GHz, Bw = 16.000 MH Calibrated with CL # 3 and BP # 1 (BP mode 1)

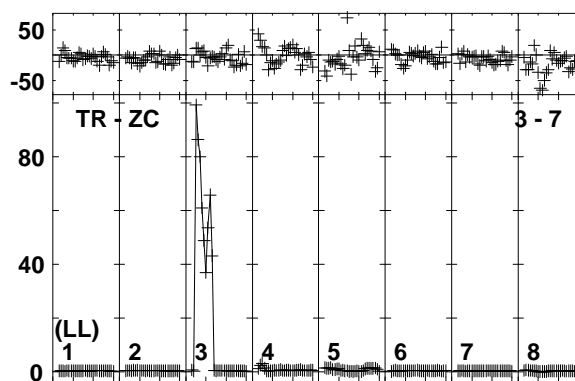
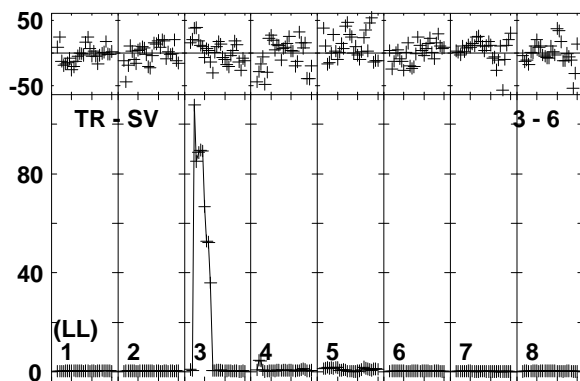
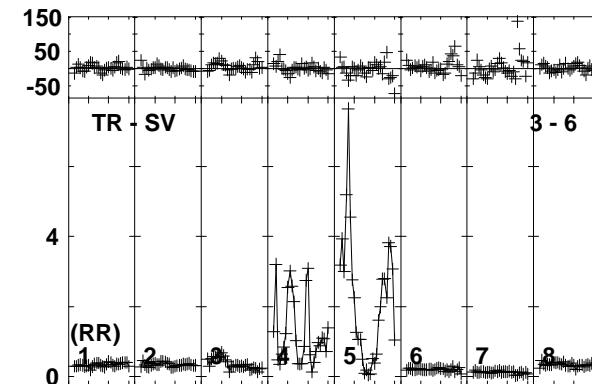
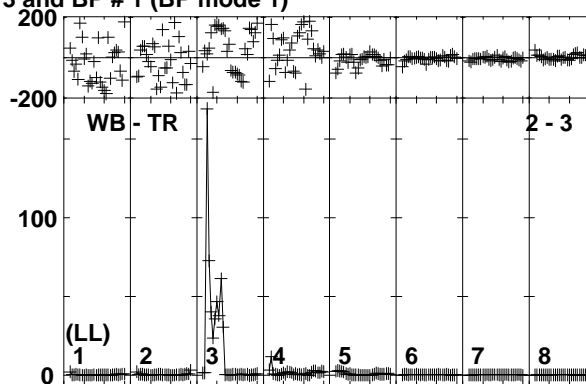
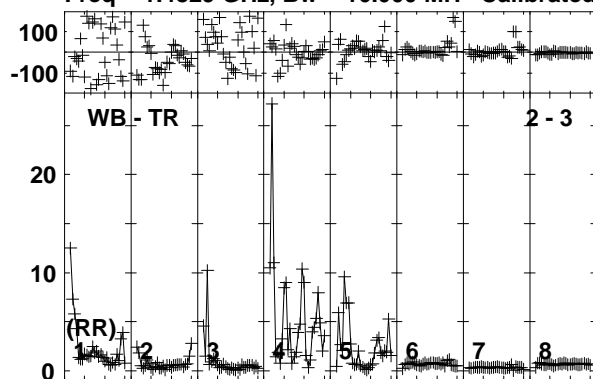

Lower frame: Ampl Jy Top frame: Phas deg
Vector averaged cross-power spectrum Baseline: WB (02) - TR (03)
Timerange: 00/10:37:36 to 00/10:39:04

Plot file version 318 created 21-JUN-2019 11:55:38

IRAS12112 EP111A 1.UVDATA.1

Freq = 1.4829 GHz, Bw = 16.000 MH Calibrated with CL # 3 and BP # 1 (BP mode 1)

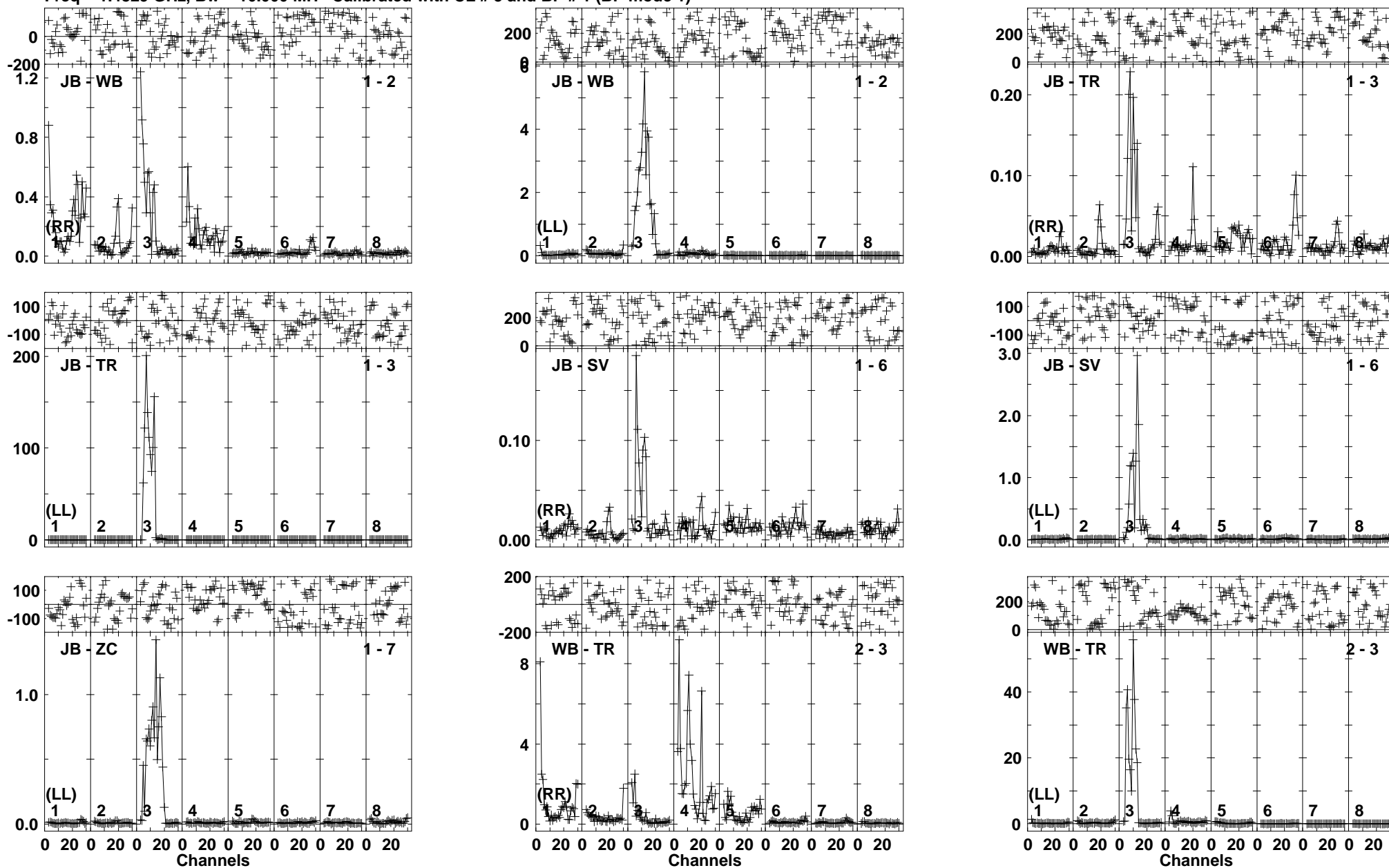

Lower frame: Ampl Jy Top frame: Phas deg
Vector averaged cross-power spectrum Baseline: JB (01) - WB (02)
Timerange: 00/10:39:06 to 00/10:42:34

Plot file version 319 created 21-JUN-2019 11:55:38

IRAS12112 EP111A 1.UVDATA.1

Freq = 1.4829 GHz, Bw = 16.000 MH Calibrated with CL # 3 and BP # 1 (BP mode 1)

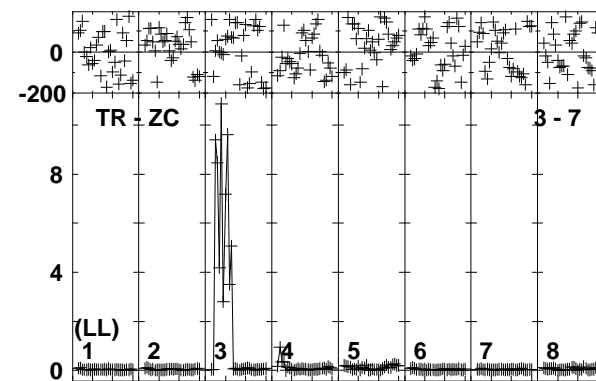
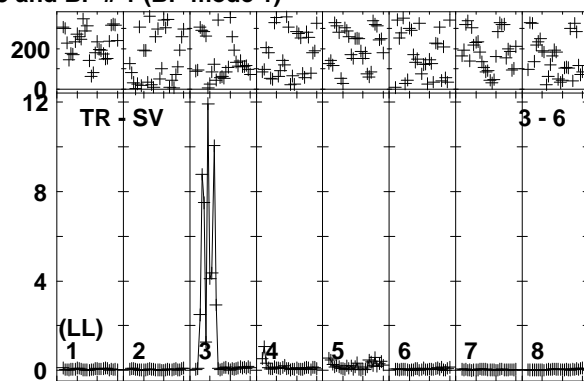
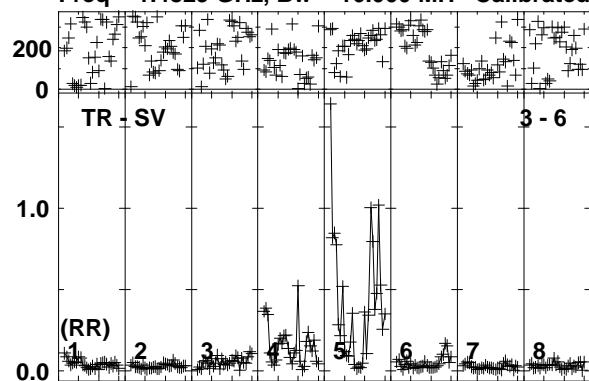

Lower frame: Ampl Jy Top frame: Phas deg
Vector averaged cross-power spectrum Baseline: TR (03) - SV (06)
Timerange: 00/10:39:06 to 00/10:42:34

Plot file version 320 created 21-JUN-2019 11:55:39

J1222+0413 EP111A 1.UVDATA.1

Freq = 1.4829 GHz, Bw = 16.000 MH Calibrated with CL # 3 and BP # 1 (BP mode 1)

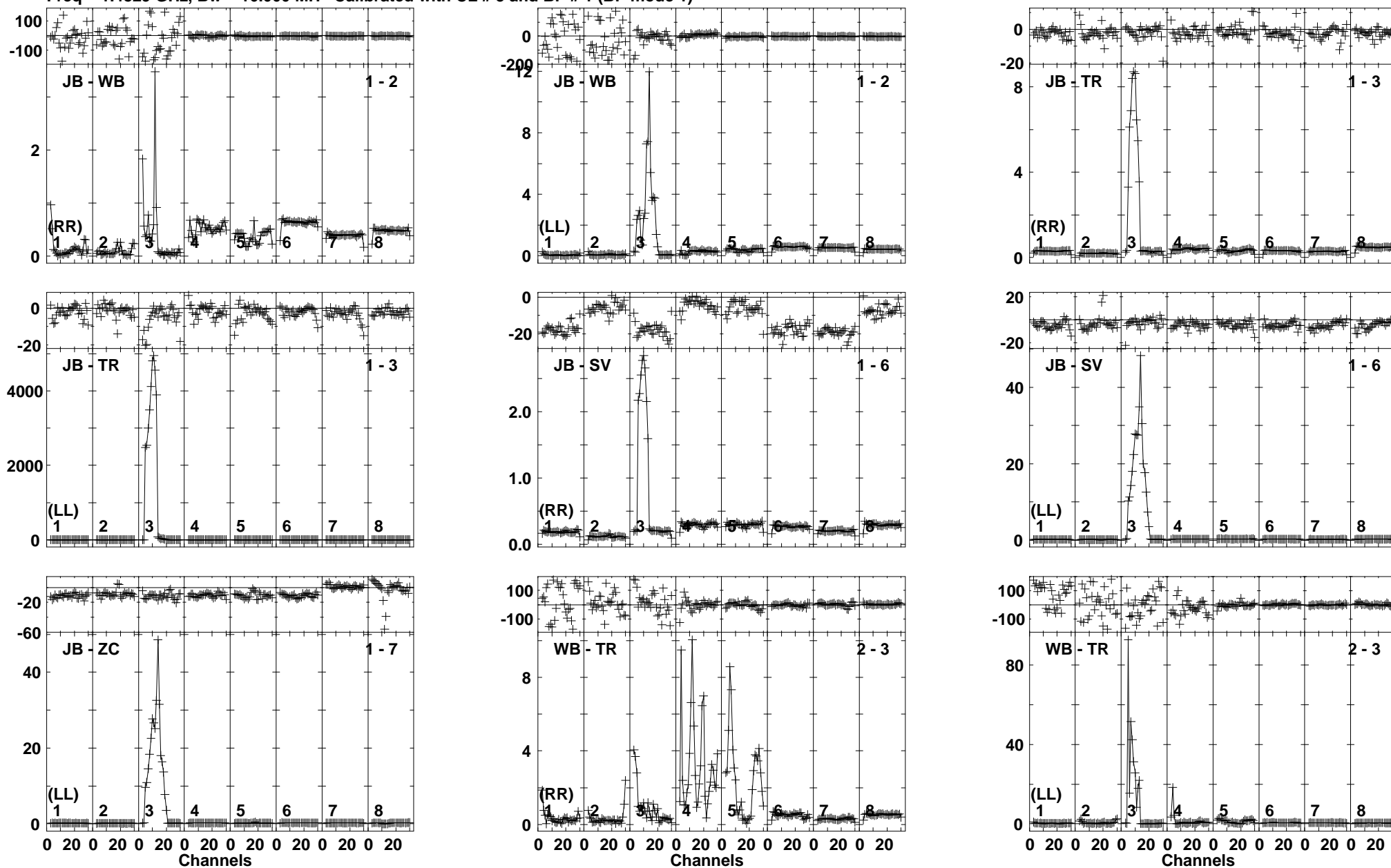

Lower frame: Ampl Jy Top frame: Phas deg
Vector averaged cross-power spectrum Baseline: JB (01) - WB (02)
Timerange: 00/10:43:16 to 00/10:44:44

Plot file version 321 created 21-JUN-2019 11:55:39

J1222+0413 EP1111A 1.UVDATA.1

Freq = 1.4829 GHz, Bw = 16.000 MH Calibrated with CL # 3 and BP # 1 (BP mode 1)

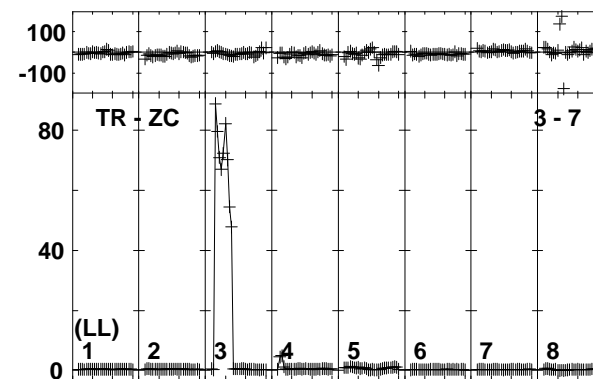
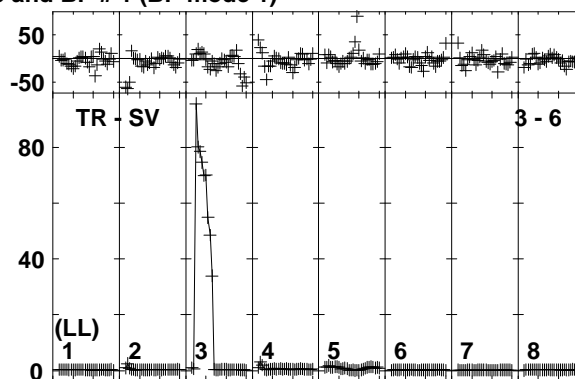
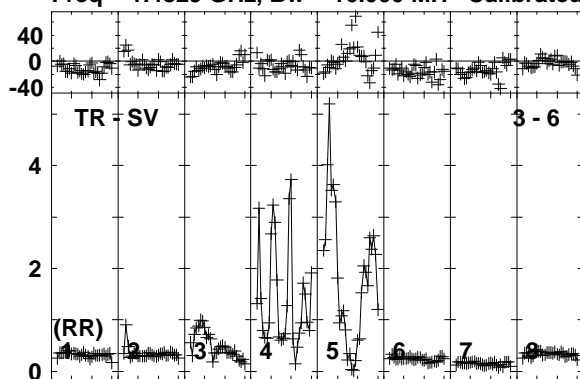

Lower frame: Ampl Jy Top frame: Phas deg
Vector averaged cross-power spectrum Baseline: TR (03) - SV (06)
Timerange: 00/10:43:16 to 00/10:44:44

Plot file version 322 created 21-JUN-2019 11:55:40
 IRAS12112 EP111A 1.UVDATA.1
 Freq = 1.4829 GHz, Bw = 16.000 MH Calibrated with CL # 3 and BP # 1 (BP mode 1)

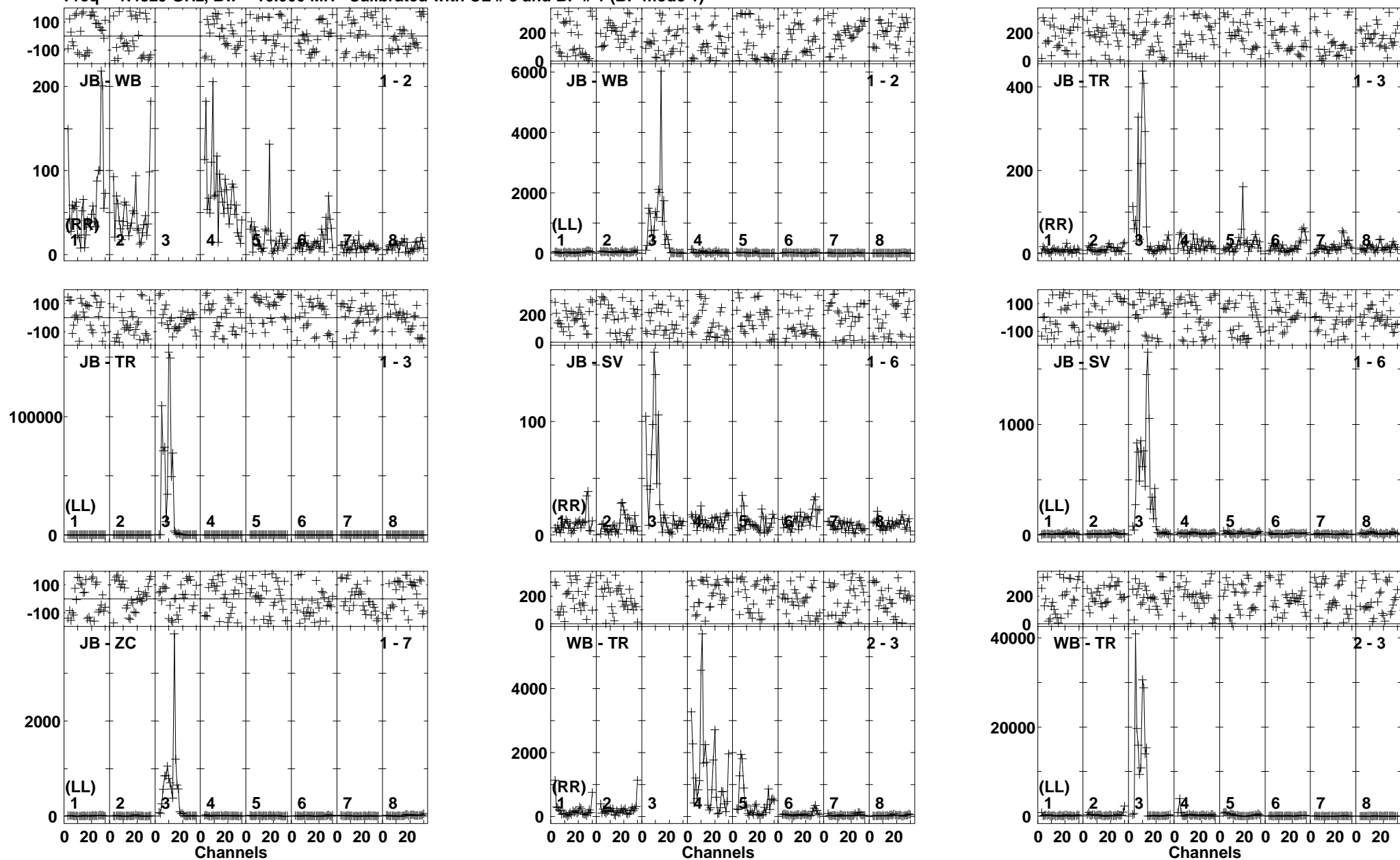

Lower frame: Milli Ampl Jy Top frame: Phas deg
 Vector averaged cross-power spectrum Baseline: JB (01) - WB (02)
 Timerange: 00/10:44:46 to 00/10:48:14

Plot file version 323 created 21-JUN-2019 11:55:40

IRAS12112 EP111A 1.UVDATA.1

Freq = 1.4829 GHz, Bw = 16.000 MH Calibrated with CL # 3 and BP # 1 (BP mode 1)

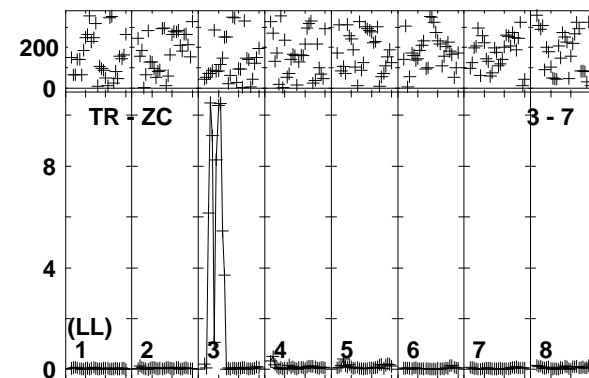
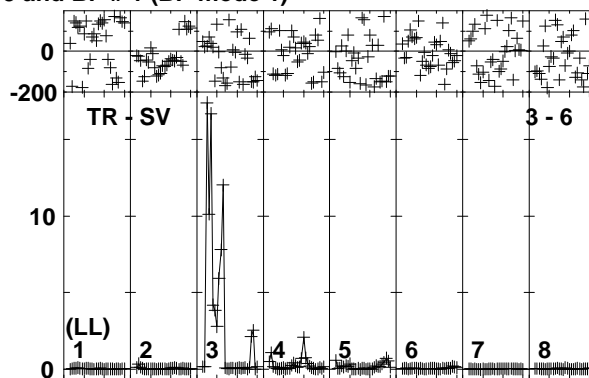
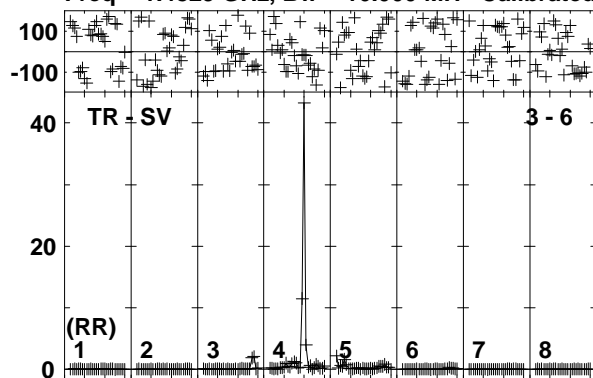

Lower frame: Ampl Jy Top frame: Phas deg
Vector averaged cross-power spectrum Baseline: TR (03) - SV (06)
Timerange: 00/10:44:46 to 00/10:48:14

Plot file version 324 created 21-JUN-2019 11:55:41

J1222+0413 EP111A 1.UVDATA.1

Freq = 1.4829 GHz, Bw = 16.000 MH Calibrated with CL # 3 and BP # 1 (BP mode 1)

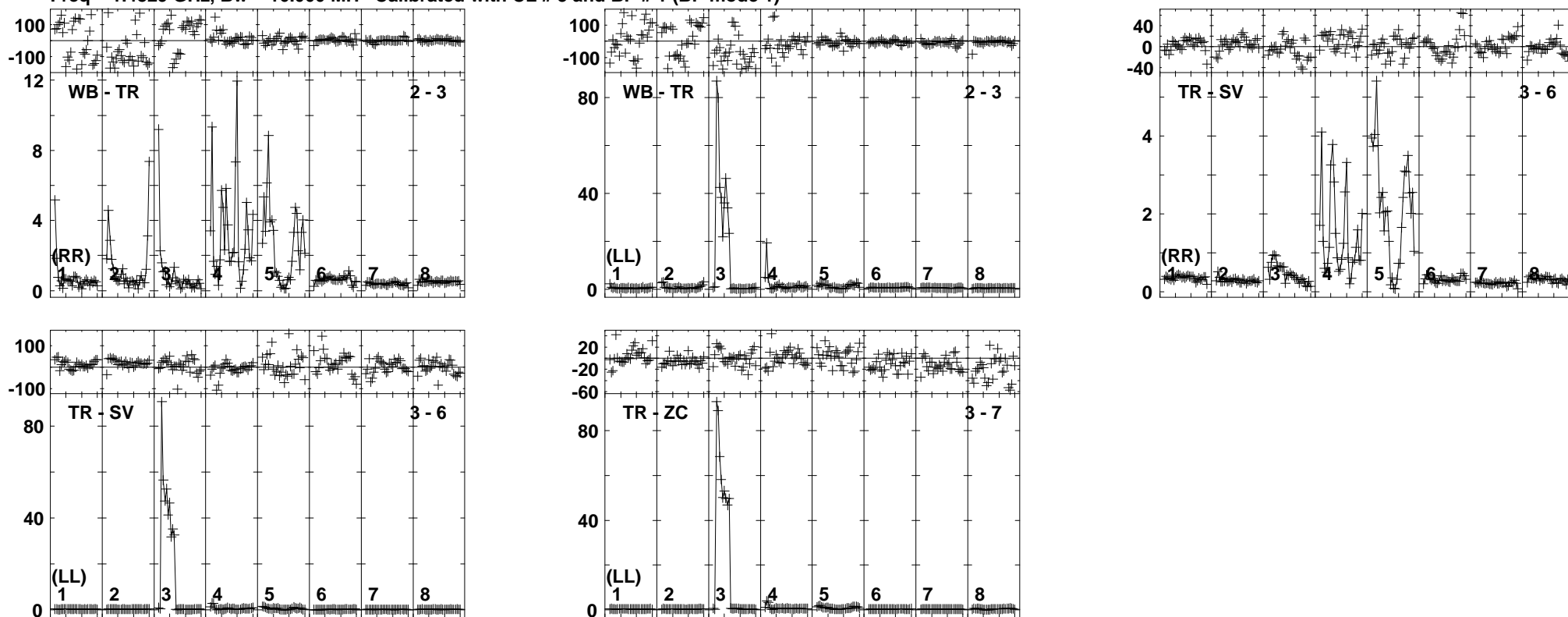

Lower frame: Ampl Jy Top frame: Phas deg
Vector averaged cross-power spectrum Baseline: WB (02) - TR (03)
Timerange: 00/10:48:16 to 00/10:49:44

Plot file version 325 created 21-JUN-2019 11:55:41

IRAS12112 EP111A 1.UVDATA.1

Freq = 1.4829 GHz, Bw = 16.000 MH Calibrated with CL # 3 and BP # 1 (BP mode 1)

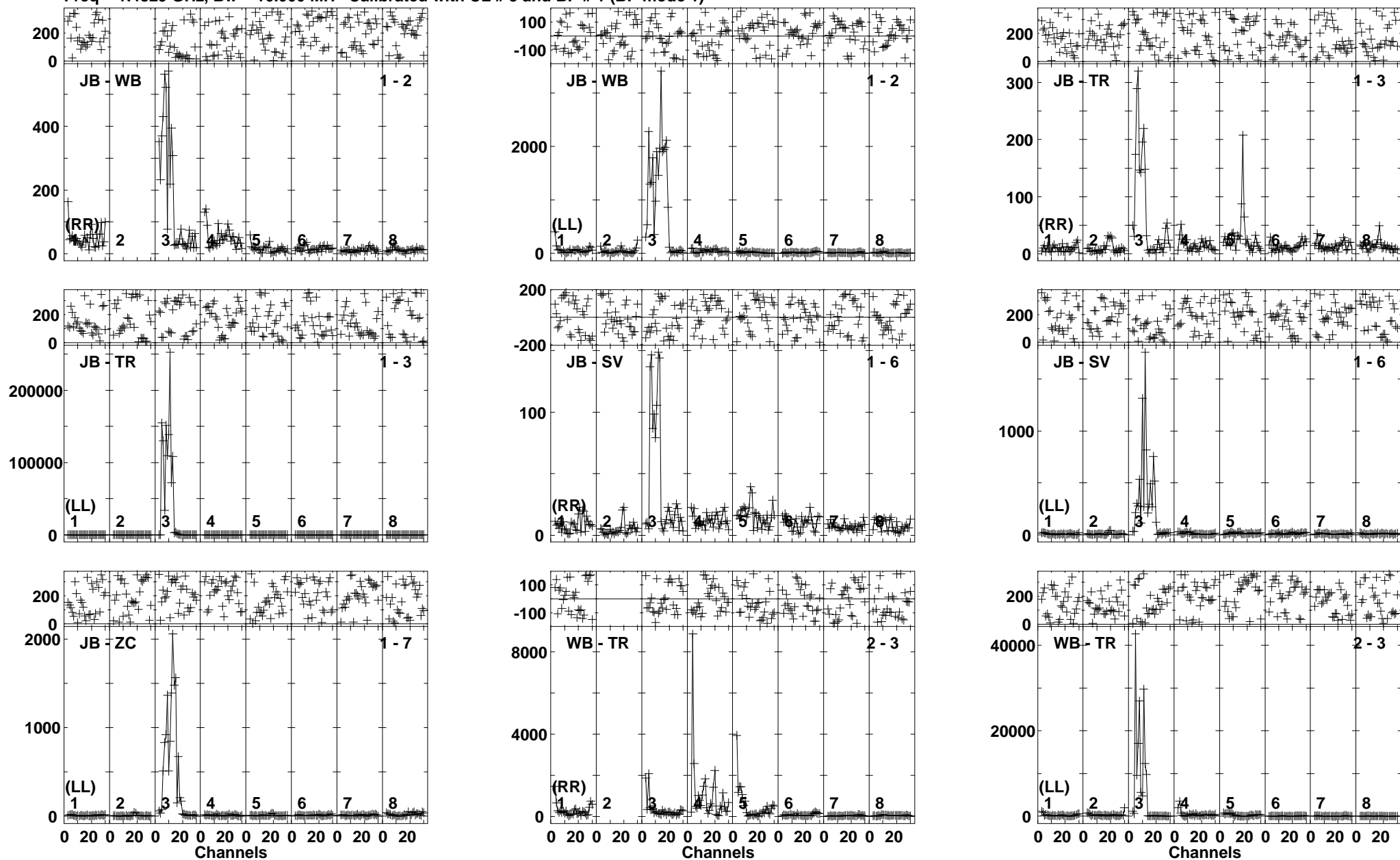

Lower frame: Milli Ampl Jy Top frame: Phas deg
Vector averaged cross-power spectrum Baseline: JB (01) - WB (02)
Timerange: 00/10:49:46 to 00/10:53:14

Plot file version 326 created 21-JUN-2019 11:55:42

IRAS12112 EP111A 1.UVDATA.1

Freq = 1.4829 GHz, Bw = 16.000 MH Calibrated with CL # 3 and BP # 1 (BP mode 1)

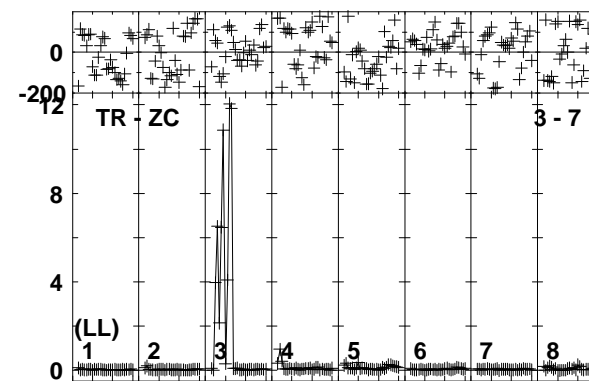
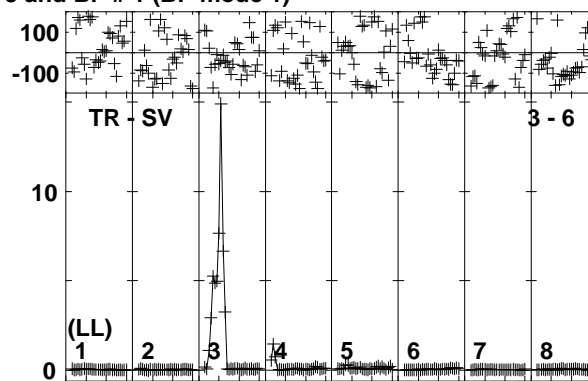
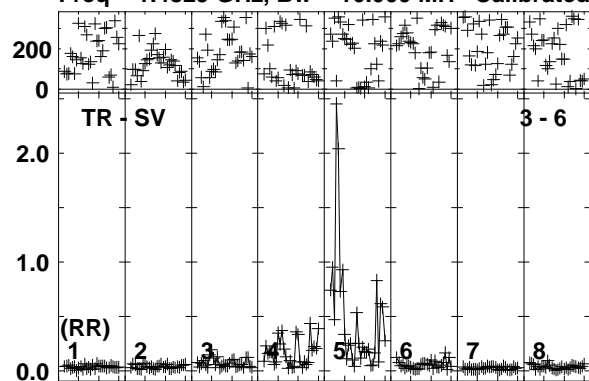

Lower frame: Ampl Jy Top frame: Phas deg
Vector averaged cross-power spectrum Baseline: TR (03) - SV (06)
Timerange: 00/10:49:46 to 00/10:53:14

Plot file version 327 created 21-JUN-2019 11:55:42

J1222+0413 EP111A 1.UVDATA.1

Freq = 1.4829 GHz, Bw = 16.000 MH Calibrated with CL # 3 and BP # 1 (BP mode 1)

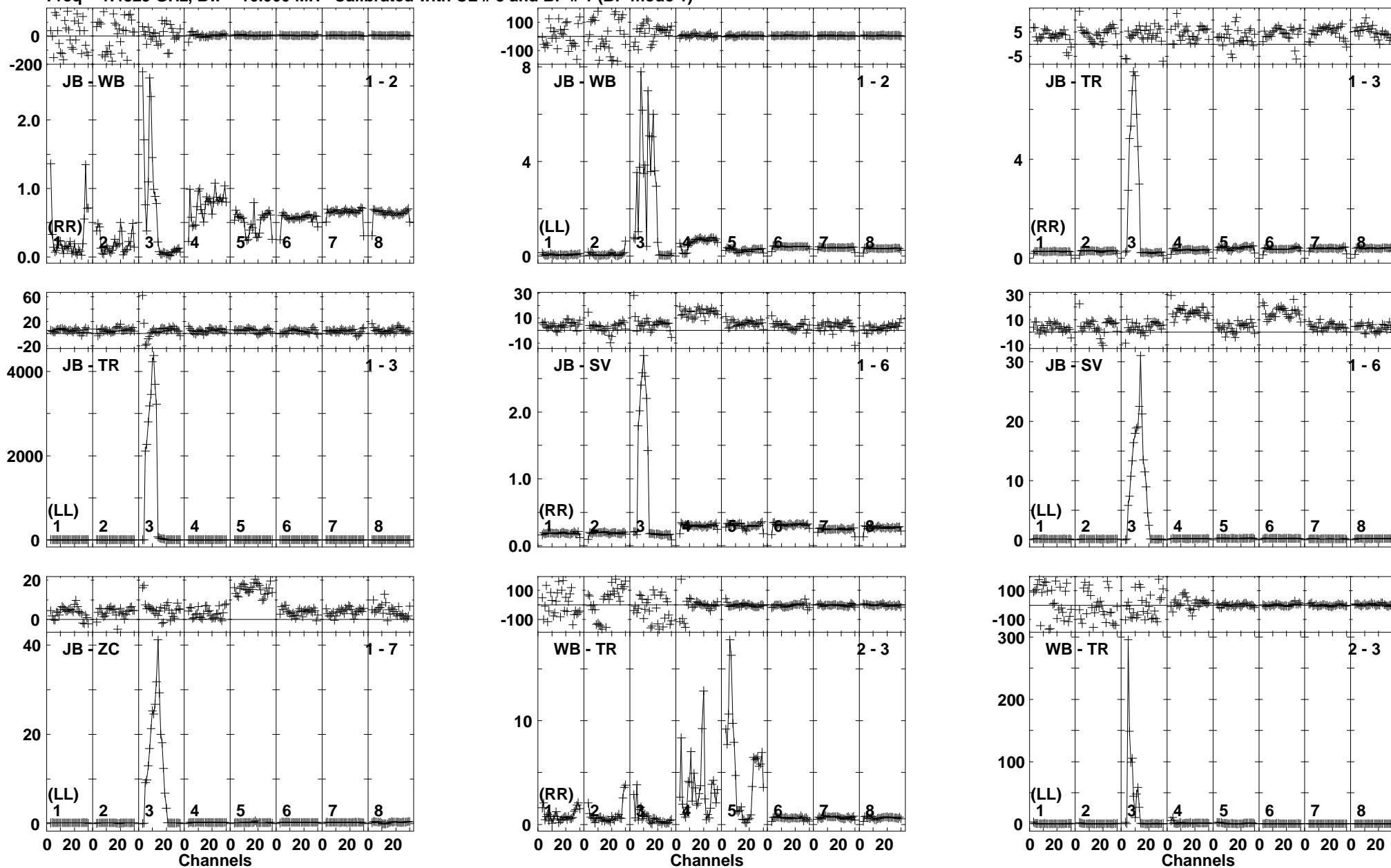

Lower frame: Ampl Jy Top frame: Phas deg
Vector averaged cross-power spectrum Baseline: JB (01) - WB (02)
Timerange: 00/10:53:56 to 00/10:55:24

Plot file version 328 created 21-JUN-2019 11:55:43

J1222+0413 EP1111A 1.UVDATA.1

Freq = 1.4829 GHz, Bw = 16.000 MH Calibrated with CL # 3 and BP # 1 (BP mode 1)

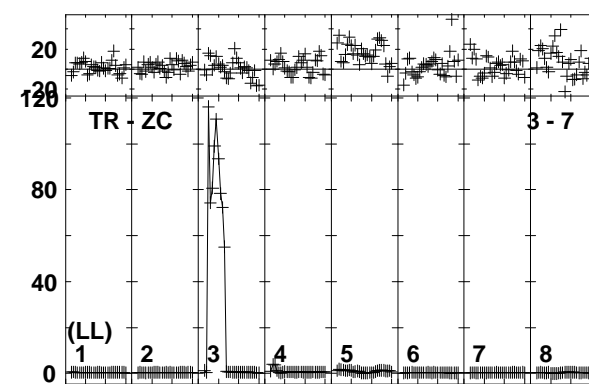
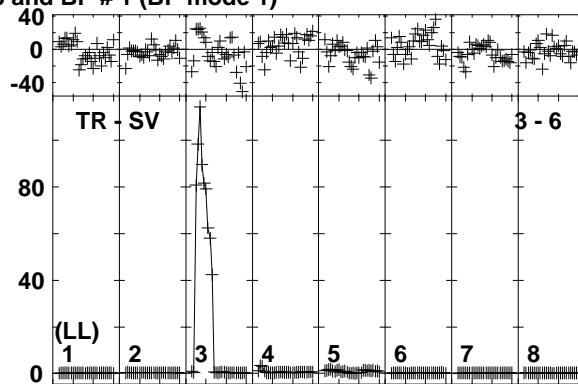
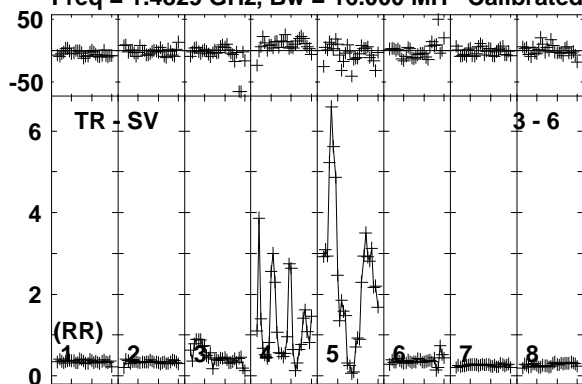

Lower frame: Ampl Jy Top frame: Phas deg
Vector averaged cross-power spectrum Baseline: TR (03) - SV (06)
Timerange: 00/10:53:56 to 00/10:55:24

Plot file version 329 created 21-JUN-2019 11:55:43

IRAS12112 EP111A 1.UVDATA.1

Freq = 1.4829 GHz, Bw = 16.000 MH Calibrated with CL # 3 and BP # 1 (BP mode 1)

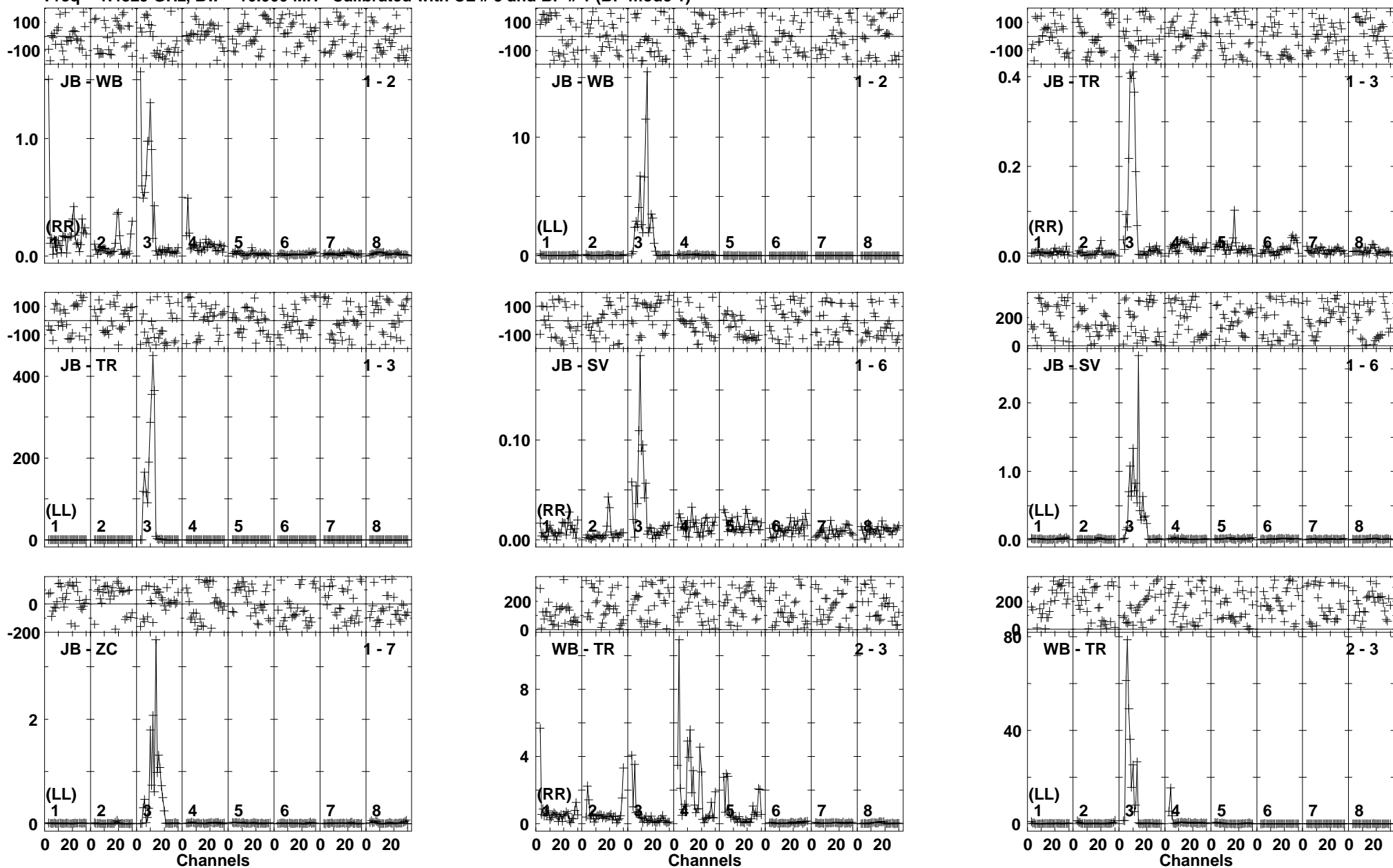

Lower frame: Ampl Jy Top frame: Phas deg
Vector averaged cross-power spectrum Baseline: JB (01) - WB (02)
Timerange: 00/10:55:26 to 00/10:58:54

Plot file version 330 created 21-JUN-2019 11:55:44

IRAS12112 EP111A 1.UVDATA.1

Freq = 1.4829 GHz, Bw = 16.000 MH Calibrated with CL # 3 and BP # 1 (BP mode 1)

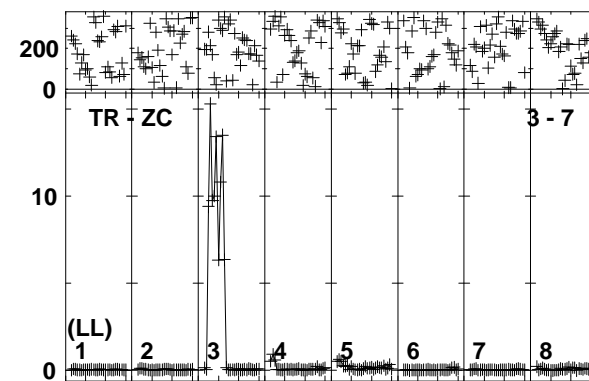
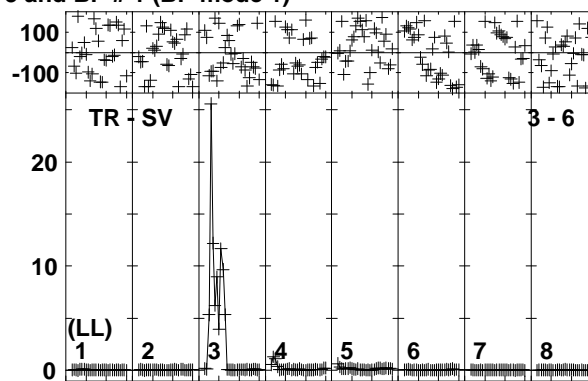
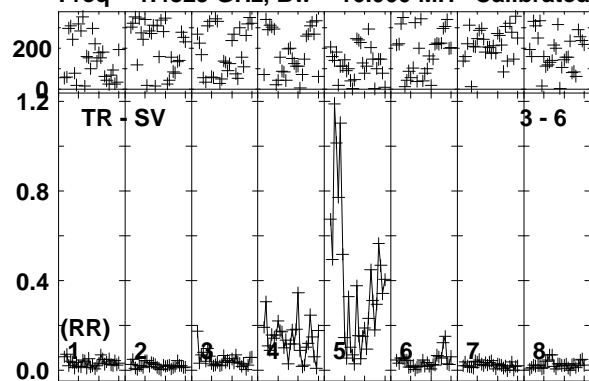

Lower frame: Ampl Jy Top frame: Phas deg
Vector averaged cross-power spectrum Baseline: TR (03) - SV (06)
Timerange: 00/10:55:26 to 00/10:58:54

Plot file version 331 created 21-JUN-2019 11:55:44

J1222+0413 EP111A 1.UVDATA.1

Freq = 1.4829 GHz, Bw = 16.000 MH Calibrated with CL # 3 and BP # 1 (BP mode 1)

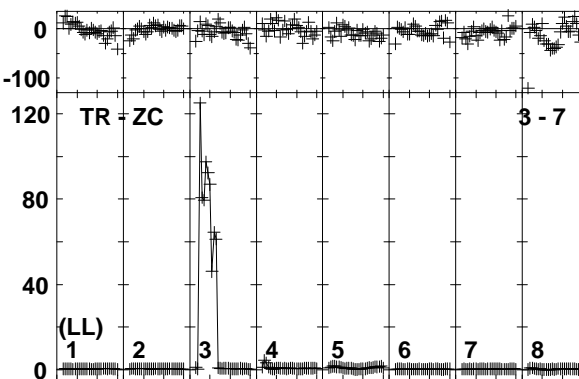
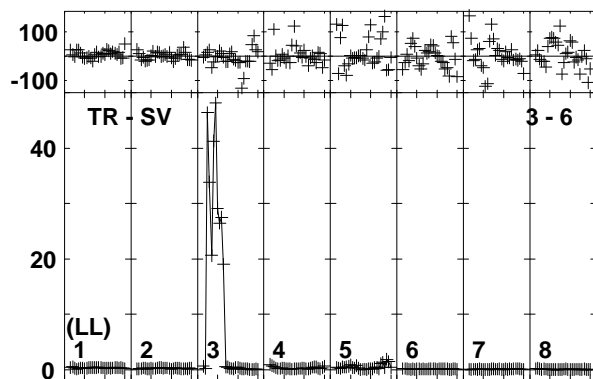
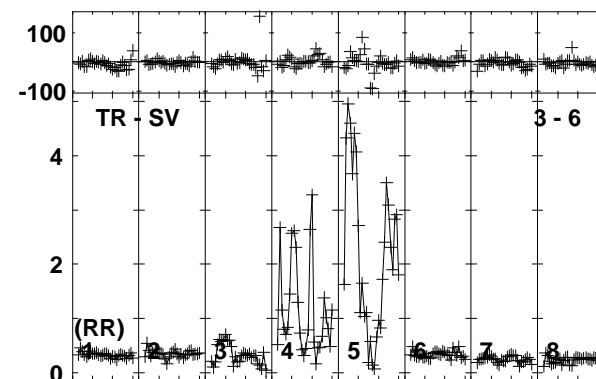
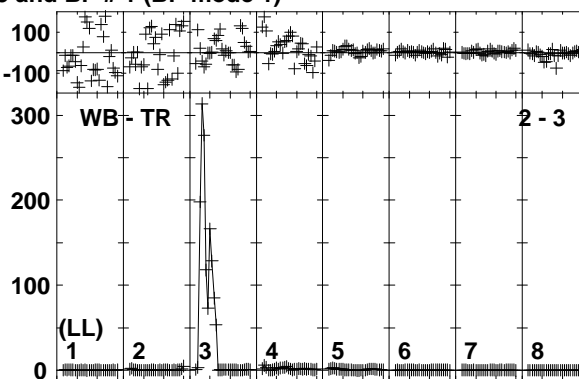
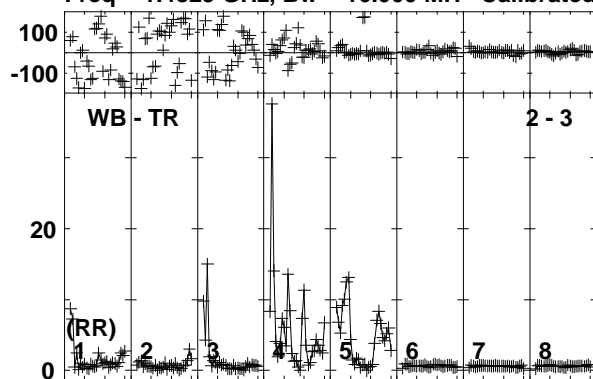

Lower frame: Ampl Jy Top frame: Phas deg
Vector averaged cross-power spectrum Baseline: WB (02) - TR (03)
Timerange: 00/10:58:56 to 00/11:00:24

Plot file version 332 created 21-JUN-2019 11:55:45

IRAS12112 EP111A 1.UVDATA.1

Freq = 1.4829 GHz, Bw = 16.000 MH Calibrated with CL # 3 and BP # 1 (BP mode 1)

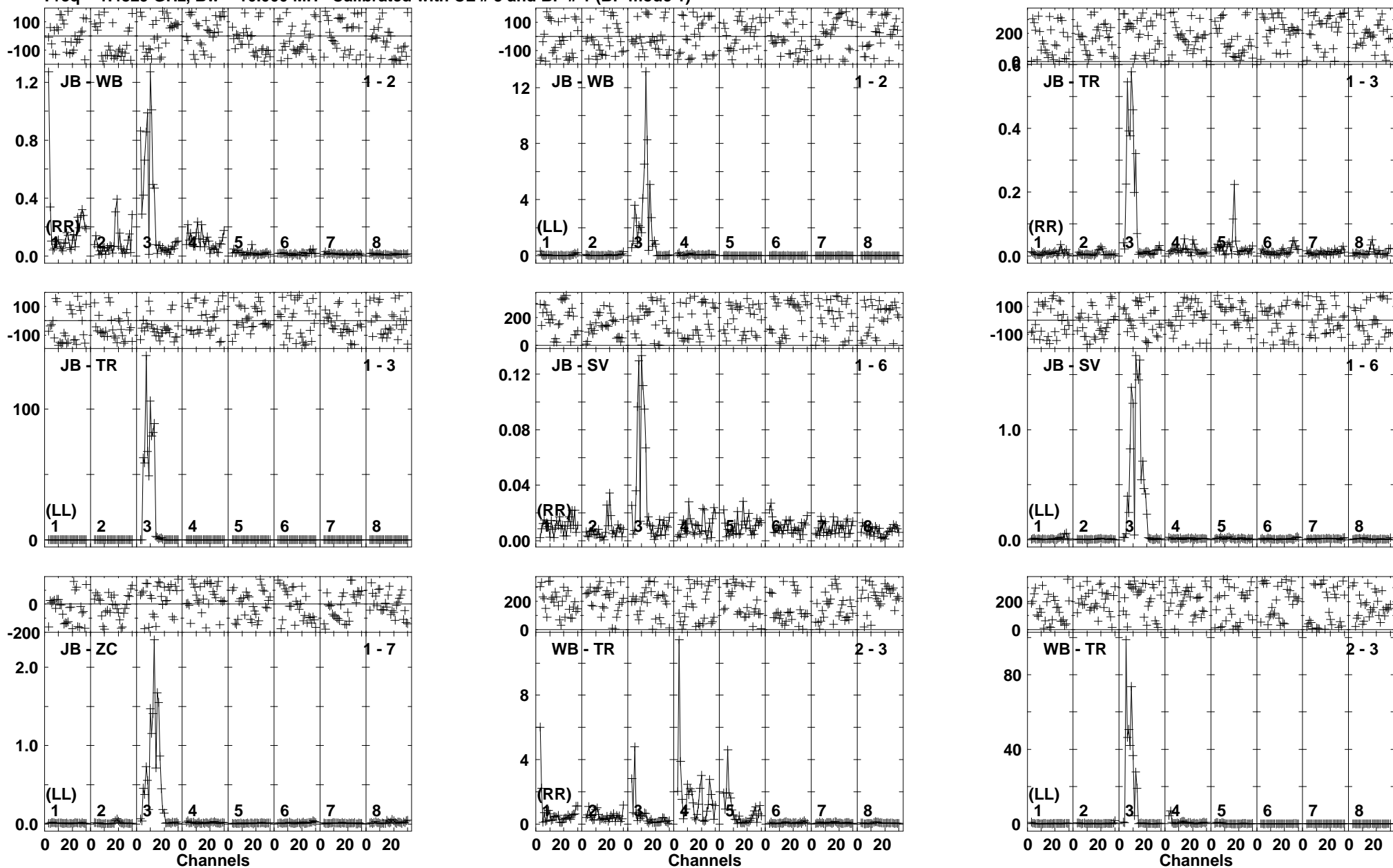

Lower frame: Ampl Jy Top frame: Phas deg
Vector averaged cross-power spectrum Baseline: JB (01) - WB (02)
Timerange: 00/11:00:26 to 00/11:03:54

Plot file version 333 created 21-JUN-2019 11:55:46

IRAS12112 EP111A 1.UVDATA.1

Freq = 1.4829 GHz, Bw = 16.000 MH Calibrated with CL # 3 and BP # 1 (BP mode 1)

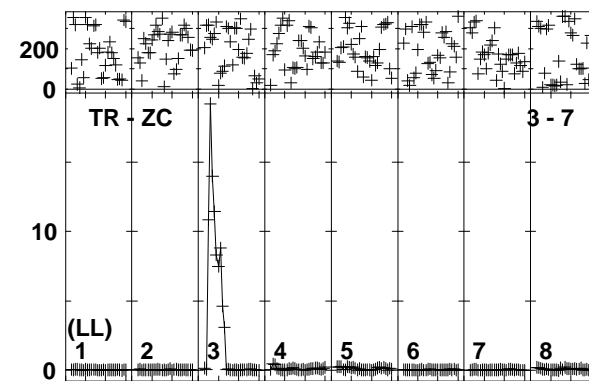
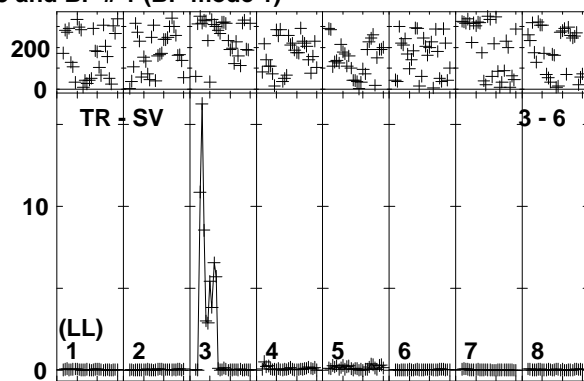
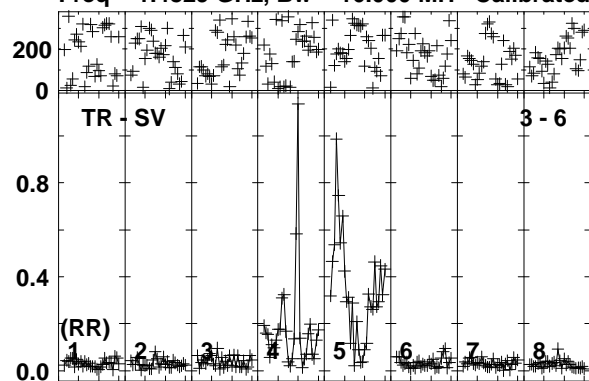

Lower frame: Ampl Jy Top frame: Phas deg
Vector averaged cross-power spectrum Baseline: TR (03) - SV (06)
Timerange: 00/11:00:26 to 00/11:03:54

Plot file version 334 created 21-JUN-2019 11:55:46

J1222+0413 EP111A 1.UVDATA.1

Freq = 1.4829 GHz, Bw = 16.000 MH Calibrated with CL # 3 and BP # 1 (BP mode 1)

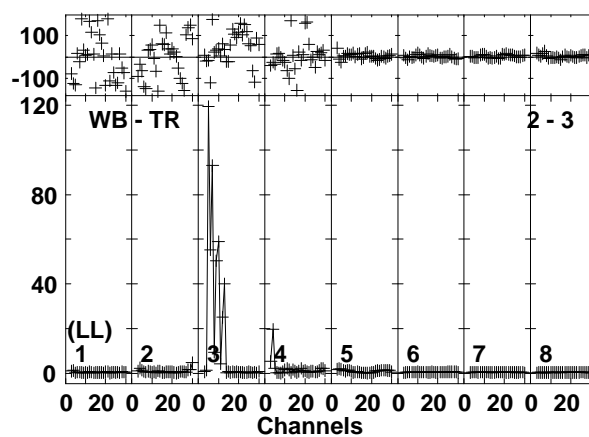
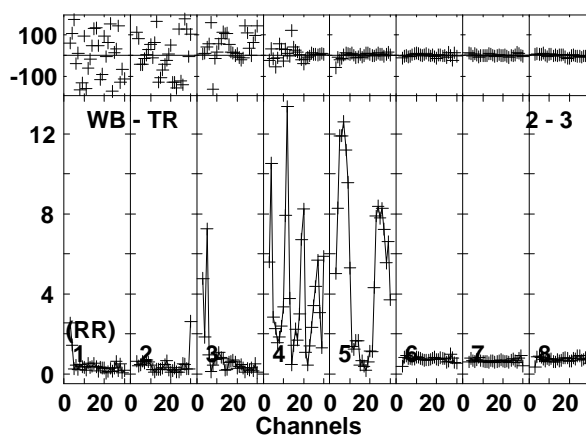
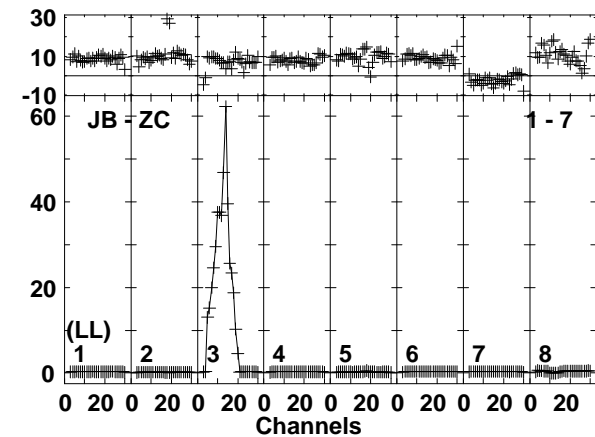
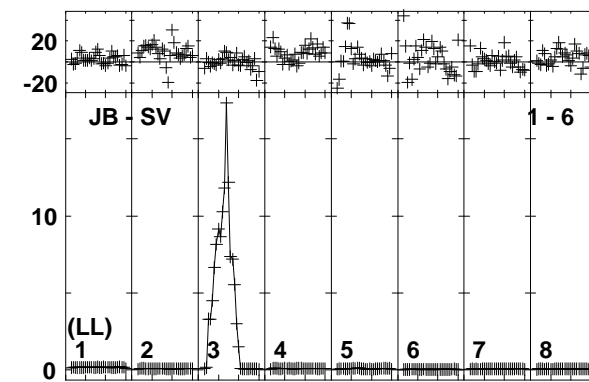
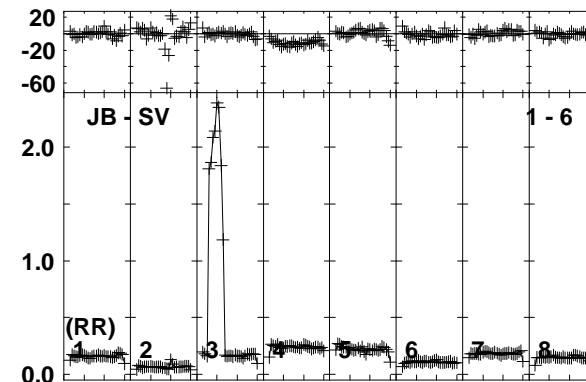
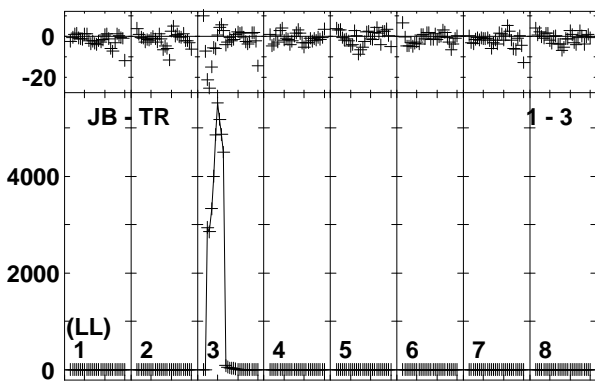
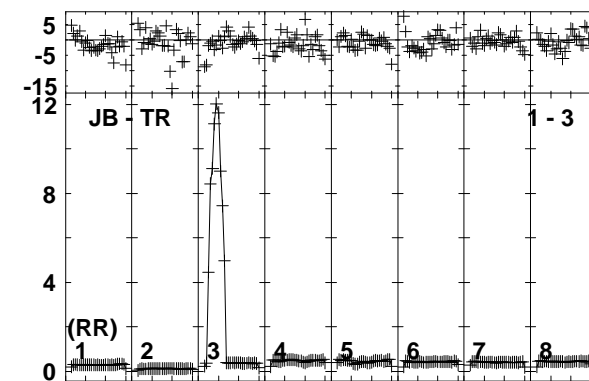
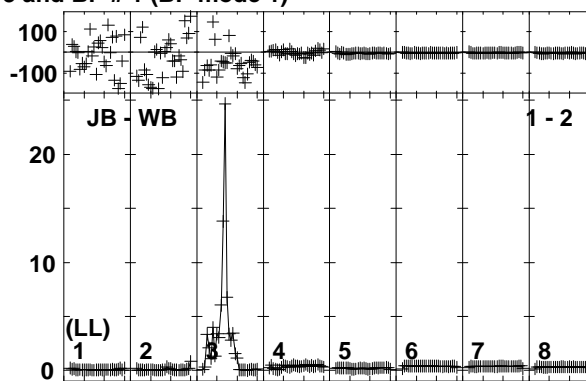
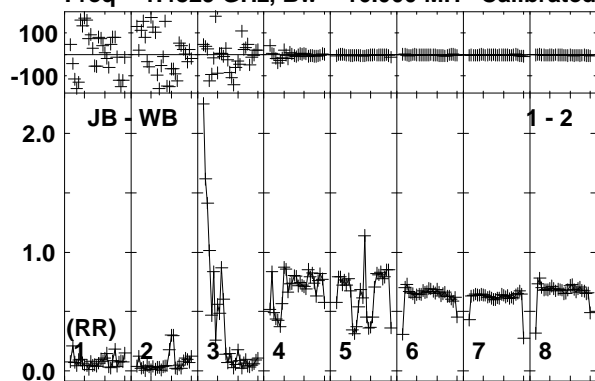

Lower frame: Ampl Jy Top frame: Phas deg
Vector averaged cross-power spectrum Baseline: JB (01) - WB (02)
Timerange: 00/11:04:36 to 00/11:06:04

Plot file version 335 created 21-JUN-2019 11:55:47

J1222+0413 EP1111A 1.UVDATA.1

Freq = 1.4829 GHz, Bw = 16.000 MH Calibrated with CL # 3 and BP # 1 (BP mode 1)

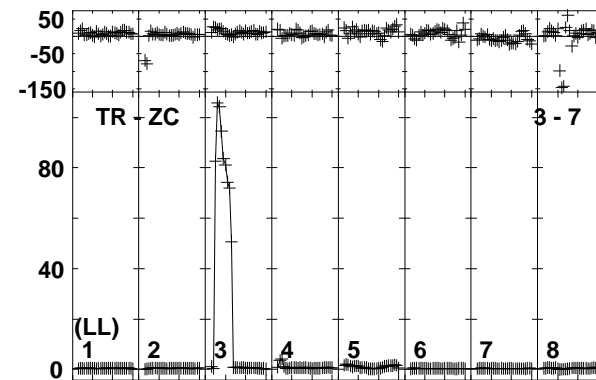
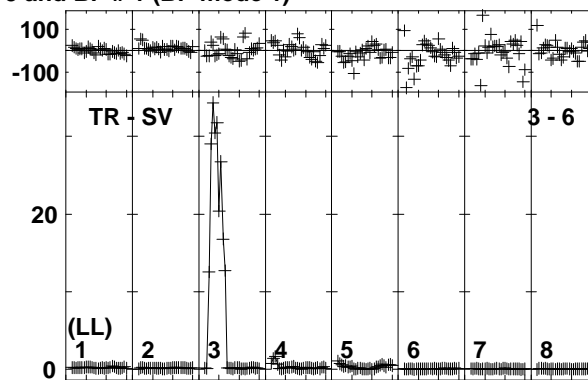
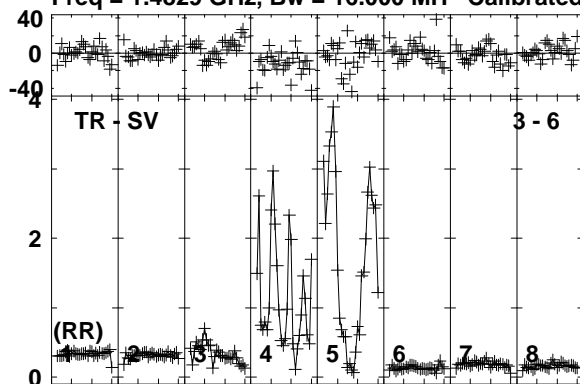

Lower frame: Ampl Jy Top frame: Phas deg
Vector averaged cross-power spectrum Baseline: TR (03) - SV (06)
Timerange: 00/11:04:36 to 00/11:06:04

Plot file version 336 created 21-JUN-2019 11:55:47

IRAS12112 EP111A 1.UVDATA.1

Freq = 1.4829 GHz, Bw = 16.000 MH Calibrated with CL # 3 and BP # 1 (BP mode 1)

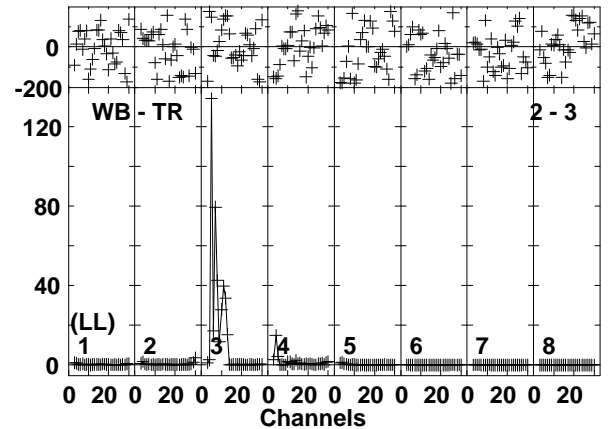
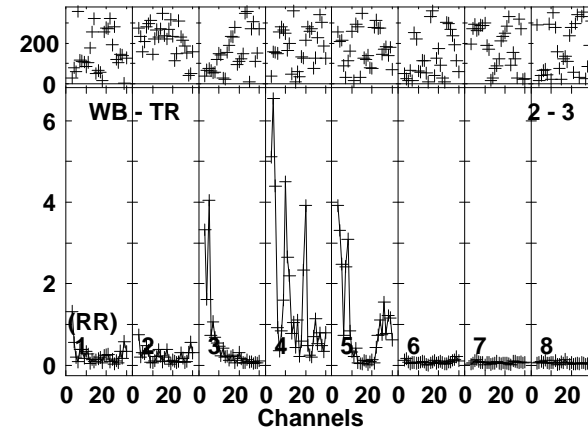
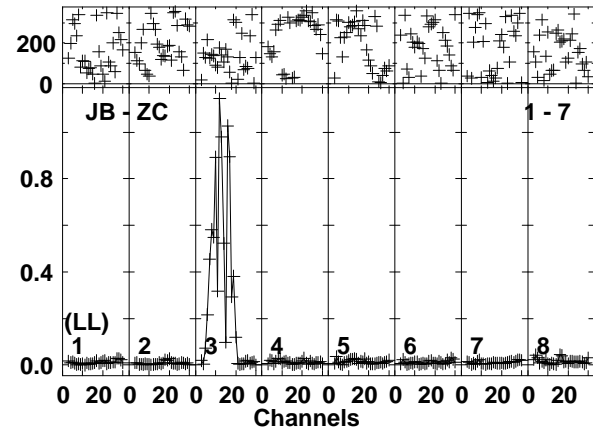
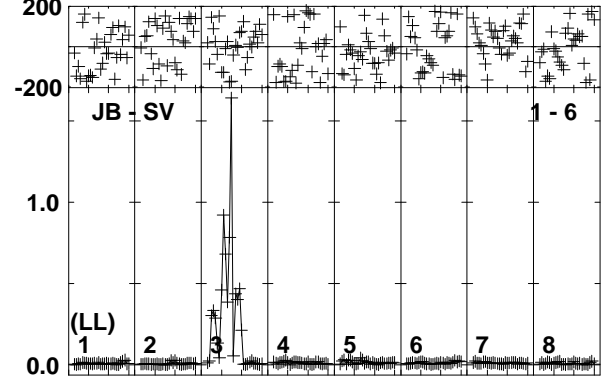
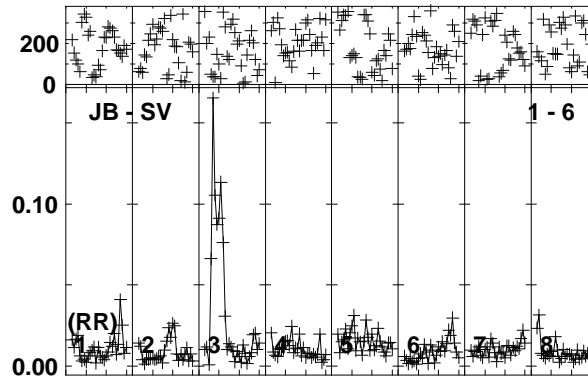
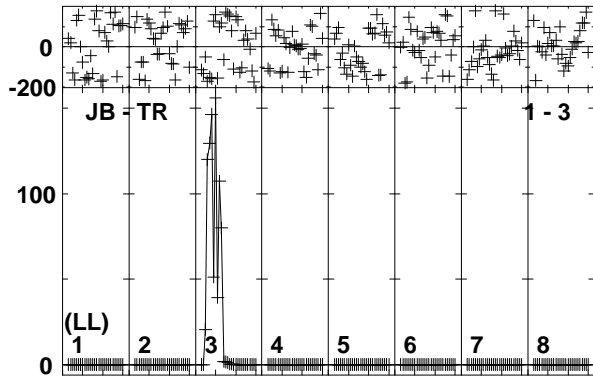
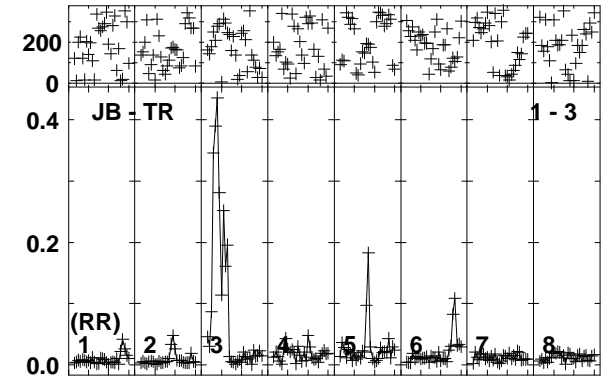
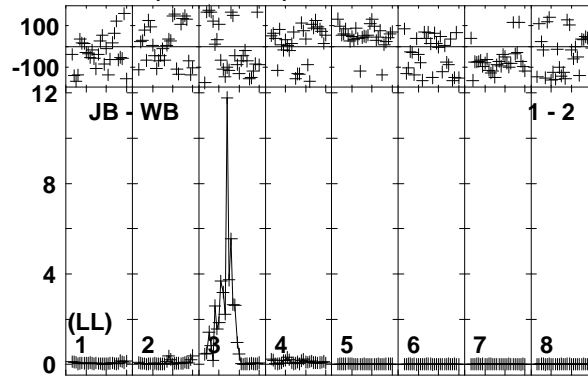
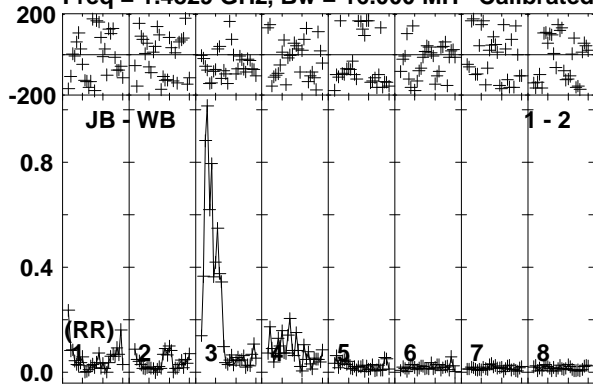

Lower frame: Ampl Jy Top frame: Phas deg
Vector averaged cross-power spectrum Baseline: JB (01) - WB (02)
Timerange: 00/11:06:06 to 00/11:09:34

Plot file version 337 created 21-JUN-2019 11:55:48

IRAS12112 EP111A 1.UVDATA.1

Freq = 1.4829 GHz, Bw = 16.000 MH Calibrated with CL # 3 and BP # 1 (BP mode 1)

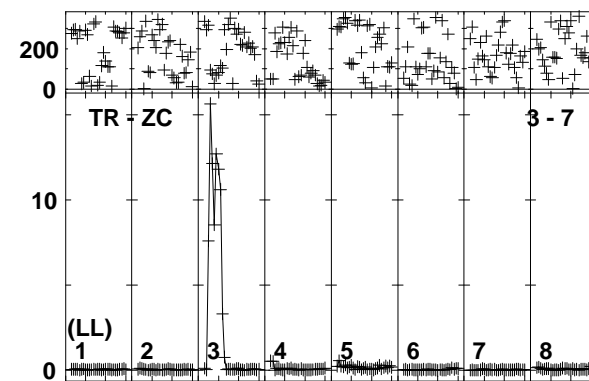
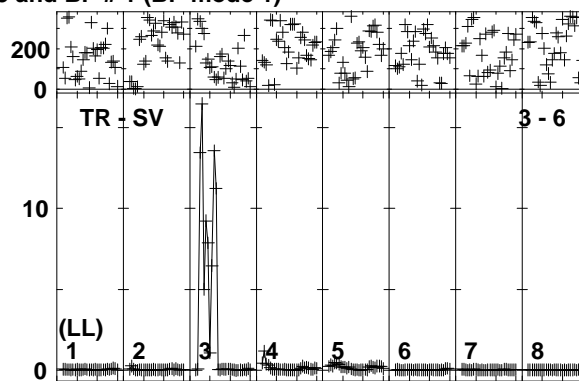
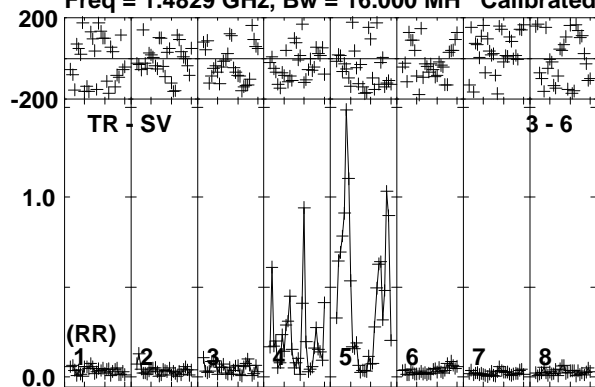

Lower frame: Ampl Jy Top frame: Phas deg
Vector averaged cross-power spectrum Baseline: TR (03) - SV (06)
Timerange: 00/11:06:06 to 00/11:09:34

Plot file version 338 created 21-JUN-2019 11:55:48

J1222+0413 EP111A 1.UVDATA.1

Freq = 1.4829 GHz, Bw = 16.000 MH Calibrated with CL # 3 and BP # 1 (BP mode 1)

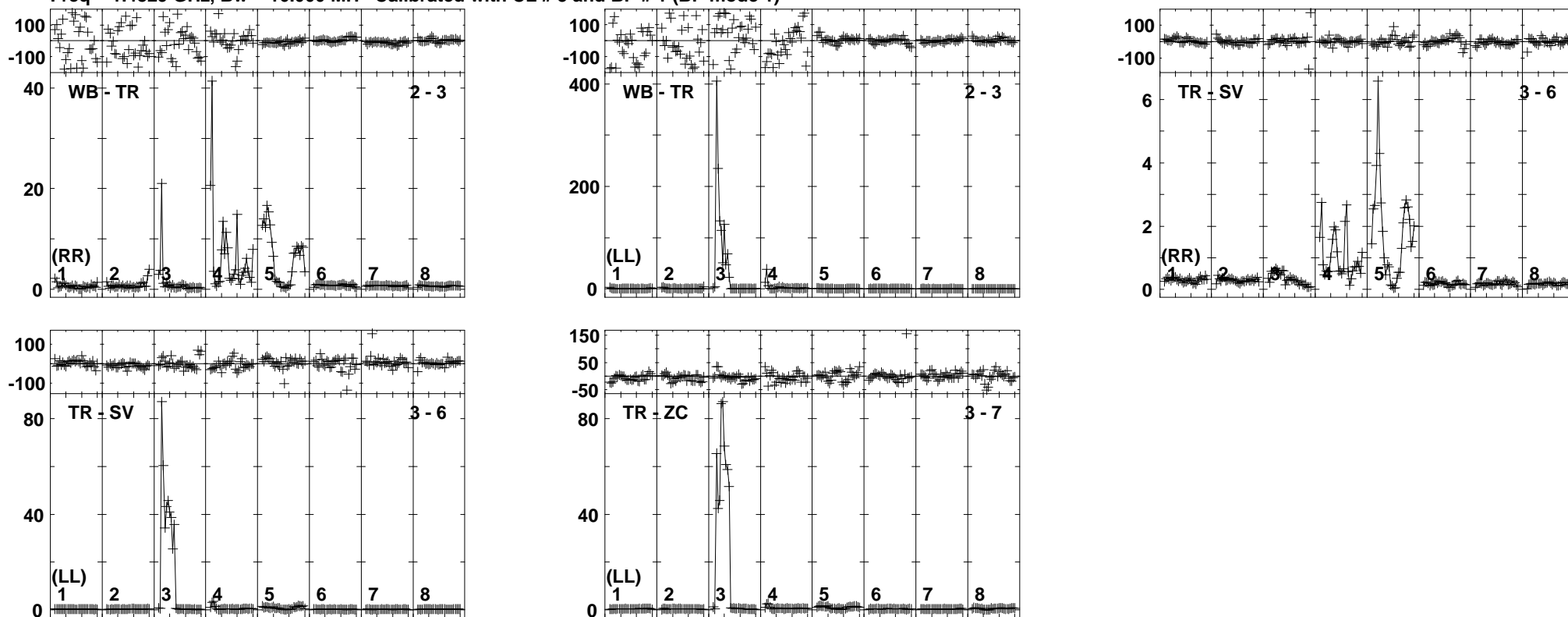

Lower frame: Ampl Jy Top frame: Phas deg
Vector averaged cross-power spectrum Baseline: WB (02) - TR (03)
Timerange: 00/11:09:36 to 00/11:11:04

Plot file version 339 created 21-JUN-2019 11:55:49

IRAS12112 EP111A 1.UVDATA.1

Freq = 1.4829 GHz, Bw = 16.000 MH Calibrated with CL # 3 and BP # 1 (BP mode 1)

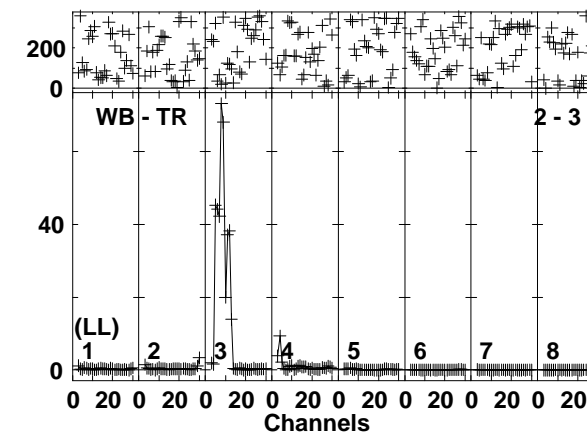
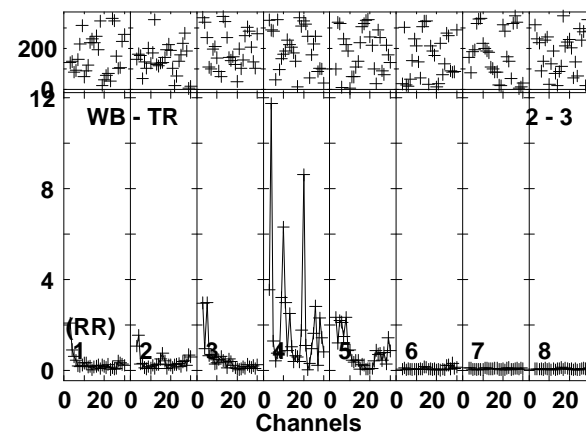
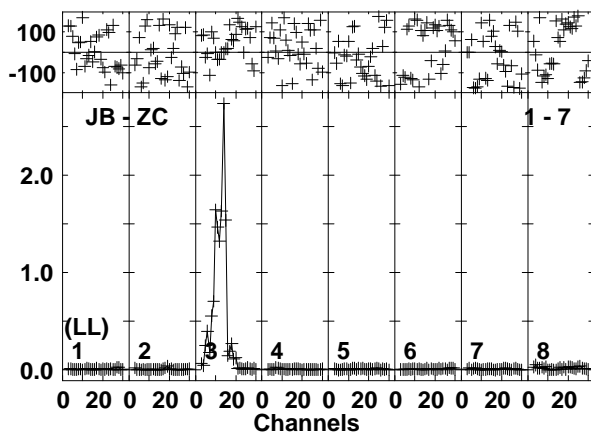
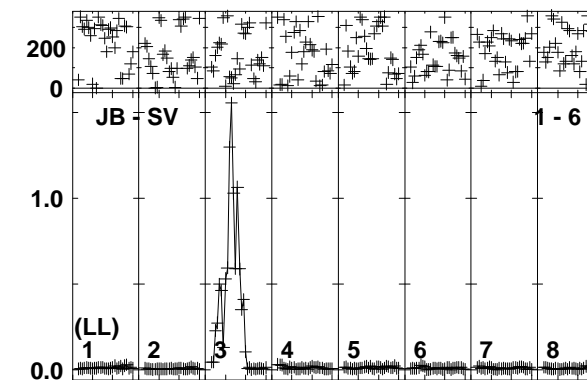
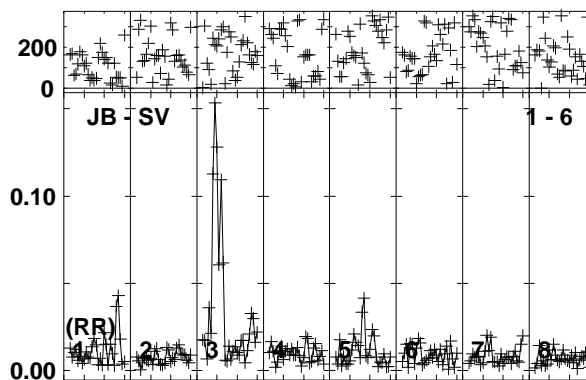
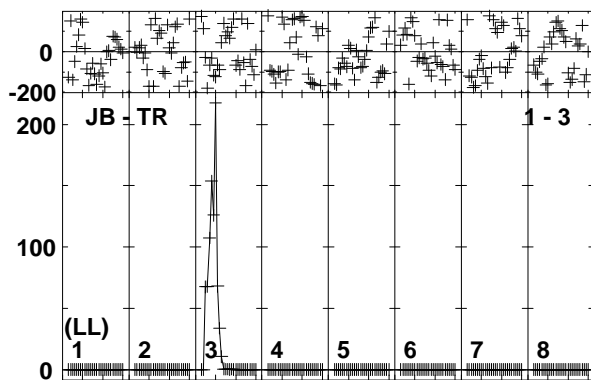
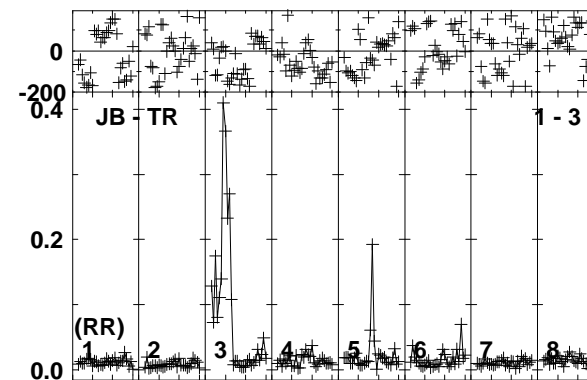
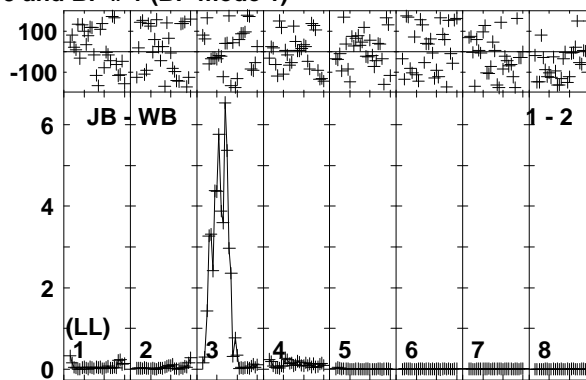
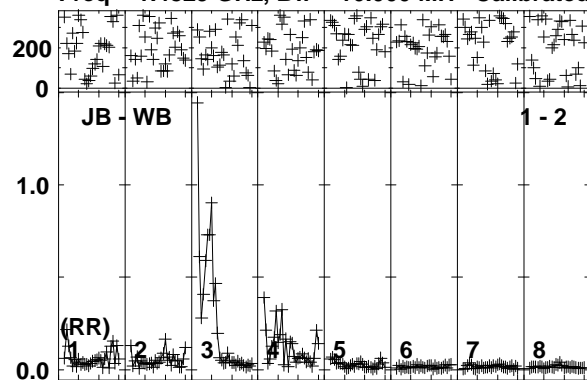

Lower frame: Ampl Jy Top frame: Phas deg
Vector averaged cross-power spectrum Baseline: JB (01) - WB (02)
Timerange: 00/11:11:06 to 00/11:14:34

Plot file version 340 created 21-JUN-2019 11:55:49
IRAS12112 EP111A 1.UVDATA.1
Freq = 1.4829 GHz, Bw = 16.000 MH Calibrated with CL # 3 and BP # 1 (BP mode 1)

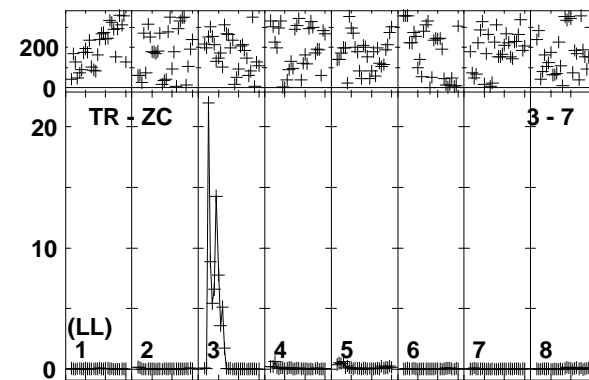
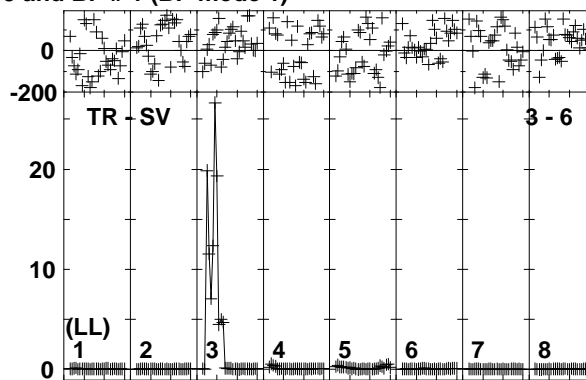
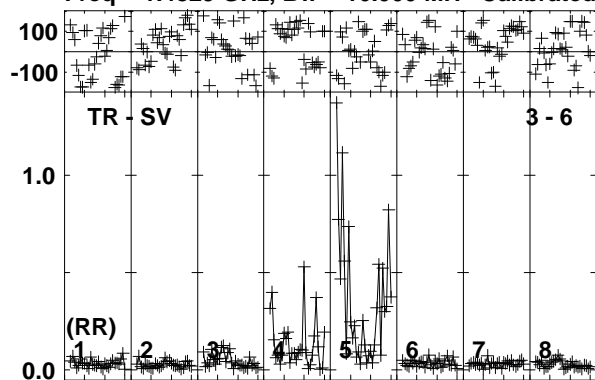

Lower frame: Ampl Jy Top frame: Phas deg
Vector averaged cross-power spectrum Baseline: TR (03) - SV (06)
Timerange: 00/11:11:06 to 00/11:14:34

Plot file version 341 created 21-JUN-2019 11:55:50

J1222+0413 EP111A 1.UVDATA.1

Freq = 1.4829 GHz, Bw = 16.000 MH Calibrated with CL # 3 and BP # 1 (BP mode 1)

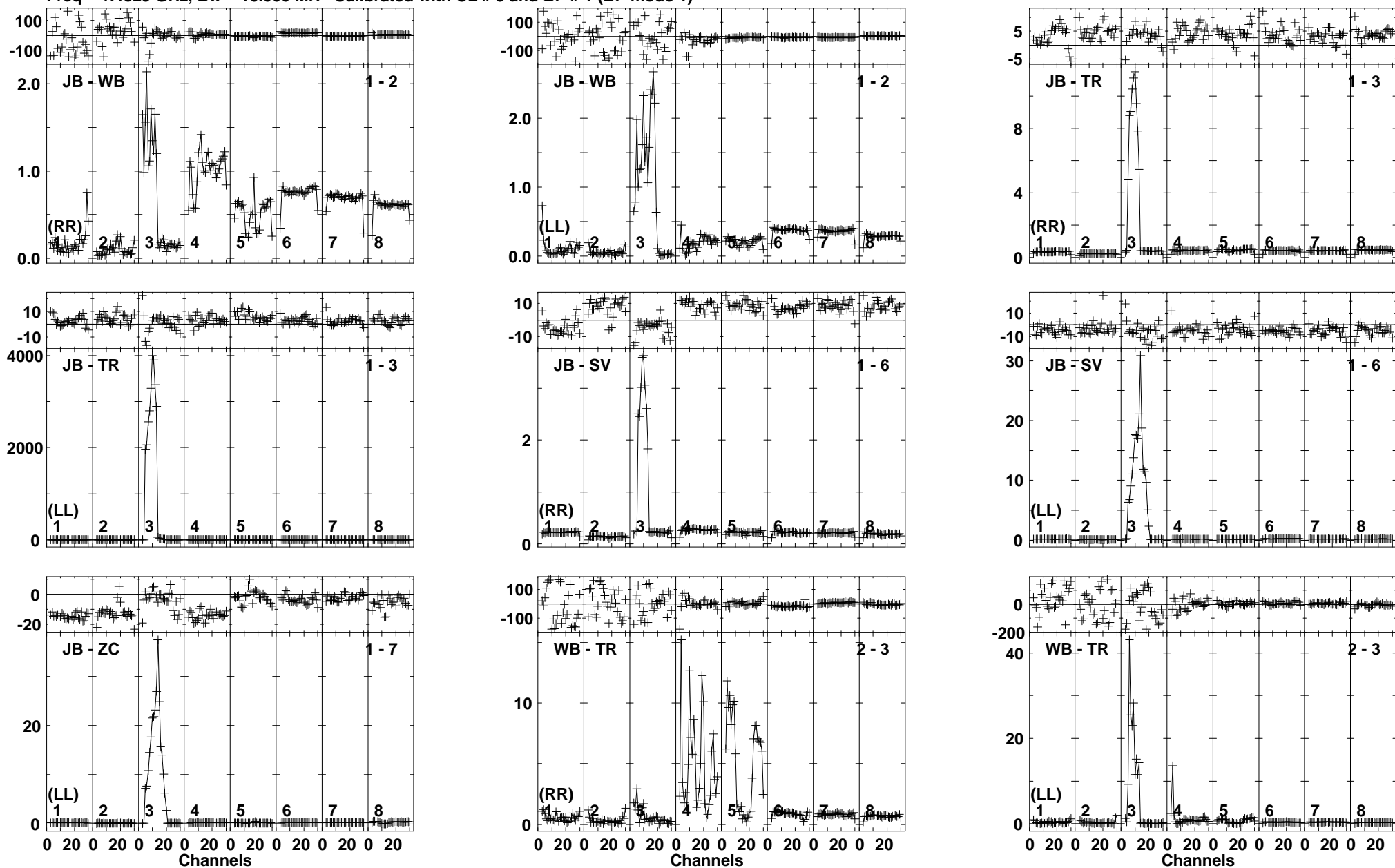

Lower frame: Ampl Jy Top frame: Phas deg
Vector averaged cross-power spectrum Baseline: JB (01) - WB (02)
Timerange: 00/11:15:16 to 00/11:16:44

Plot file version 342 created 21-JUN-2019 11:55:50
J1222+0413 EP1111A 1.UVDATA.1
Freq = 1.4829 GHz, Bw = 16.000 MH Calibrated with CL # 3 and BP # 1 (BP mode 1)

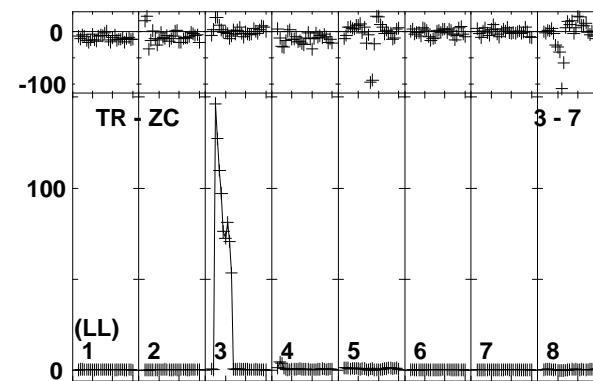
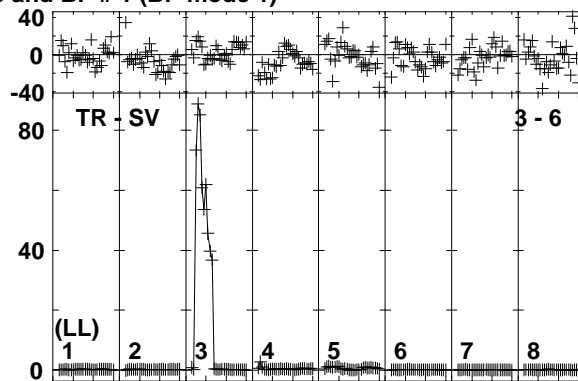
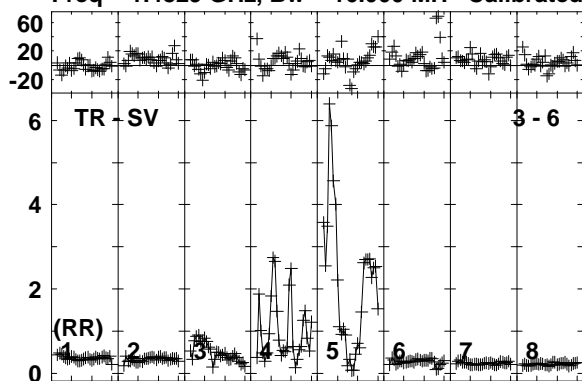

Lower frame: Ampl Jy Top frame: Phas deg
Vector averaged cross-power spectrum Baseline: TR (03) - SV (06)
Timerange: 00/11:15:16 to 00/11:16:44

Plot file version 343 created 21-JUN-2019 11:55:51

IRAS12112 EP111A 1.UVDATA.1

Freq = 1.4829 GHz, Bw = 16.000 MH Calibrated with CL # 3 and BP # 1 (BP mode 1)

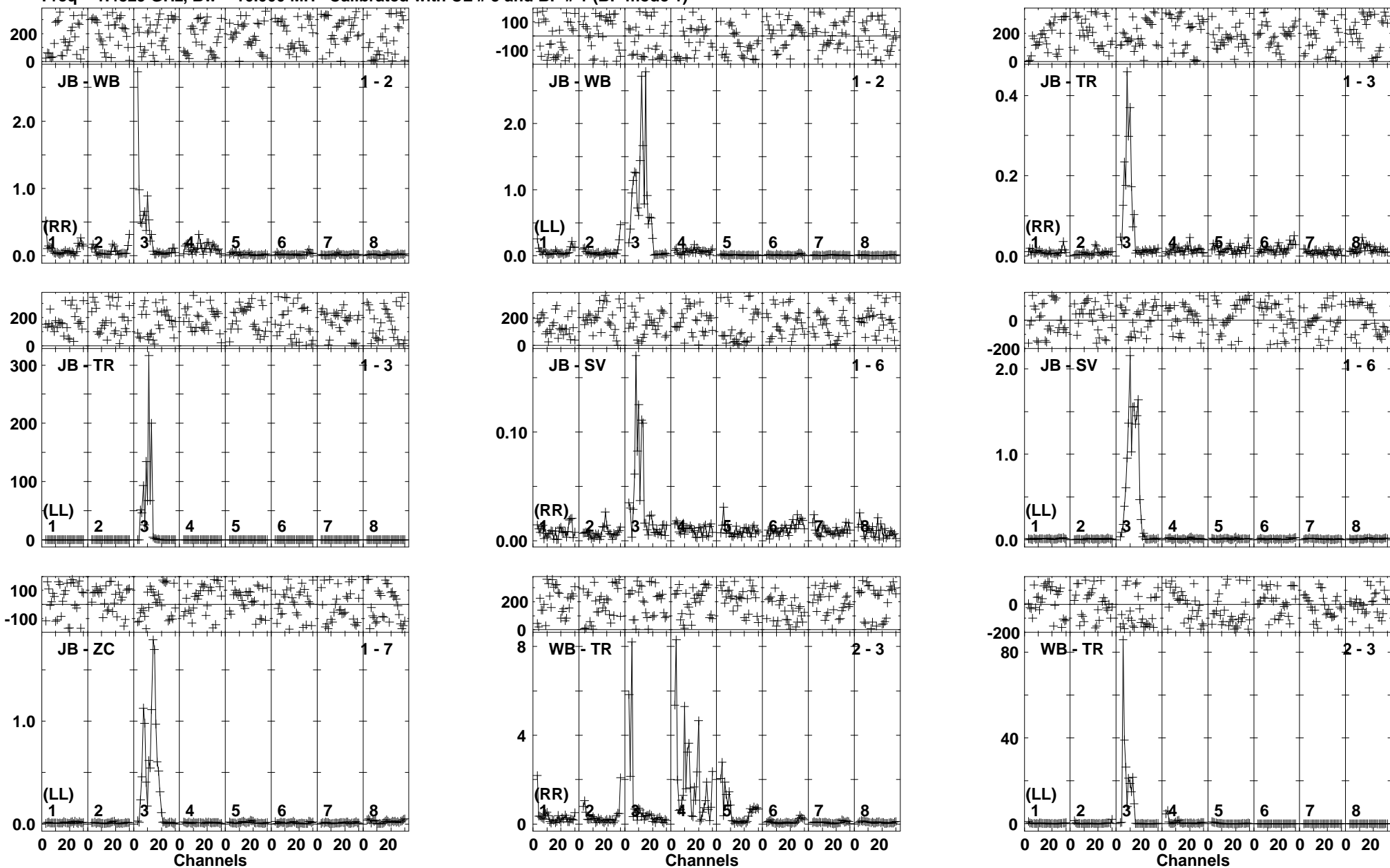

Lower frame: Ampl Jy Top frame: Phas deg
Vector averaged cross-power spectrum Baseline: JB (01) - WB (02)
Timerange: 00/11:16:46 to 00/11:20:14

Plot file version 344 created 21-JUN-2019 11:55:51

IRAS12112 EP111A 1.UVDATA.1

Freq = 1.4829 GHz, Bw = 16.000 MH Calibrated with CL # 3 and BP # 1 (BP mode 1)

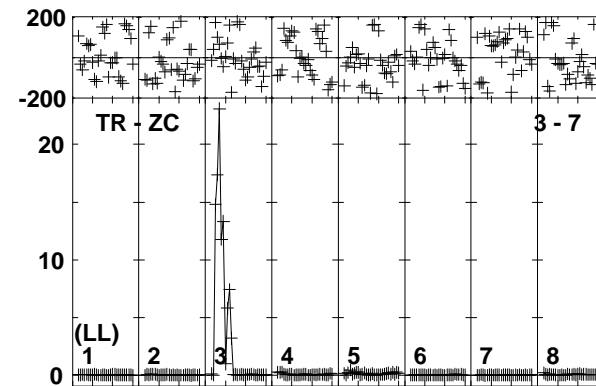
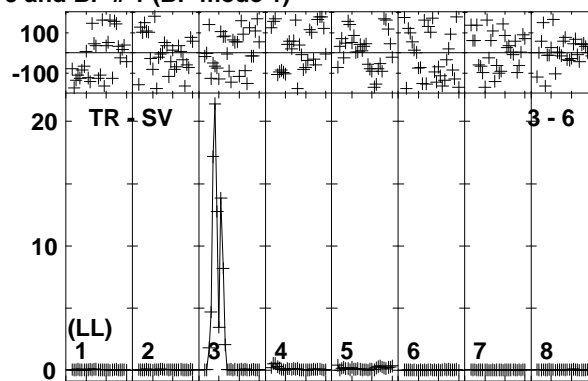
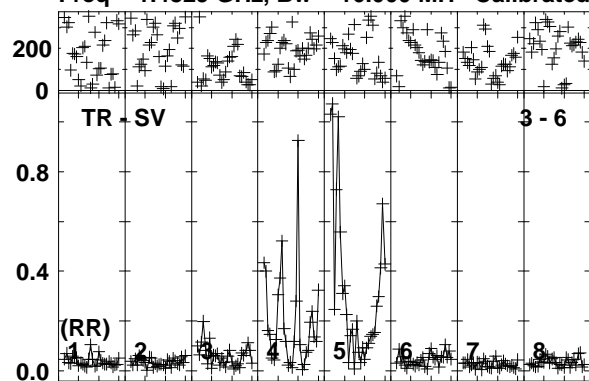

Lower frame: Ampl Jy Top frame: Phas deg
Vector averaged cross-power spectrum Baseline: TR (03) - SV (06)
Timerange: 00/11:16:46 to 00/11:20:14

Plot file version 345 created 21-JUN-2019 11:55:52

J1222+0413 EP111A 1.UVDATA.1

Freq = 1.4829 GHz, Bw = 16.000 MH Calibrated with CL # 3 and BP # 1 (BP mode 1)

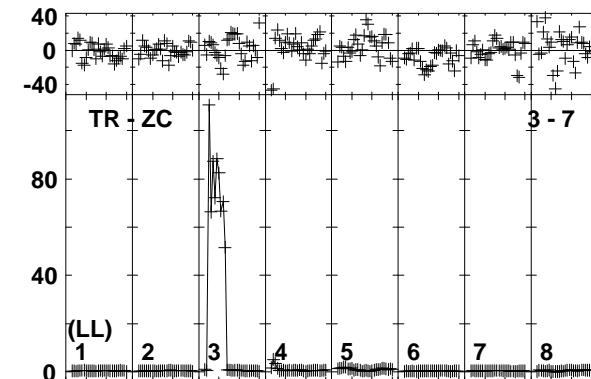
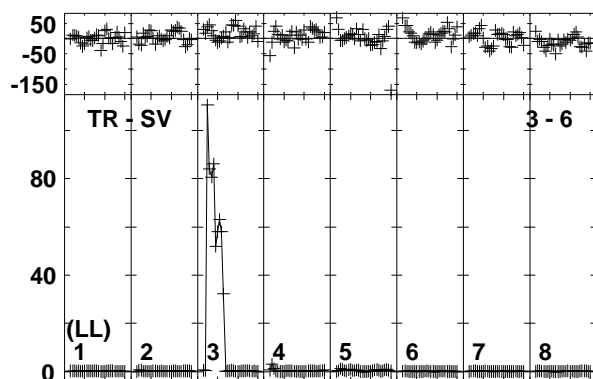
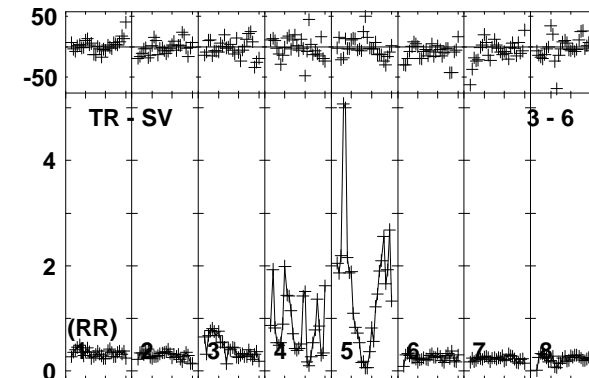
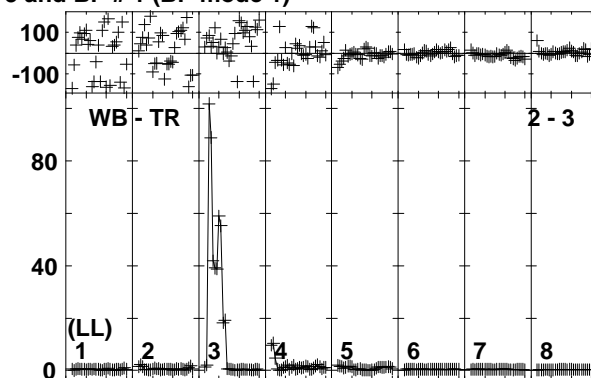
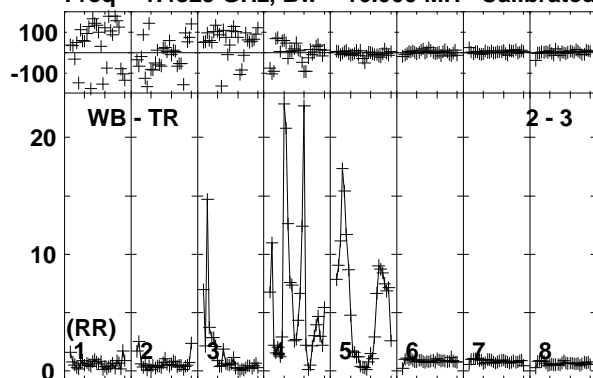

Lower frame: Ampl Jy Top frame: Phas deg
Vector averaged cross-power spectrum Baseline: WB (02) - TR (03)
Timerange: 00/11:20:16 to 00/11:21:44

Plot file version 346 created 21-JUN-2019 11:55:52
 IRAS12112 EP111A 1.UVDATA.1
 Freq = 1.4829 GHz, Bw = 16.000 MH Calibrated with CL # 3 and BP # 1 (BP mode 1)

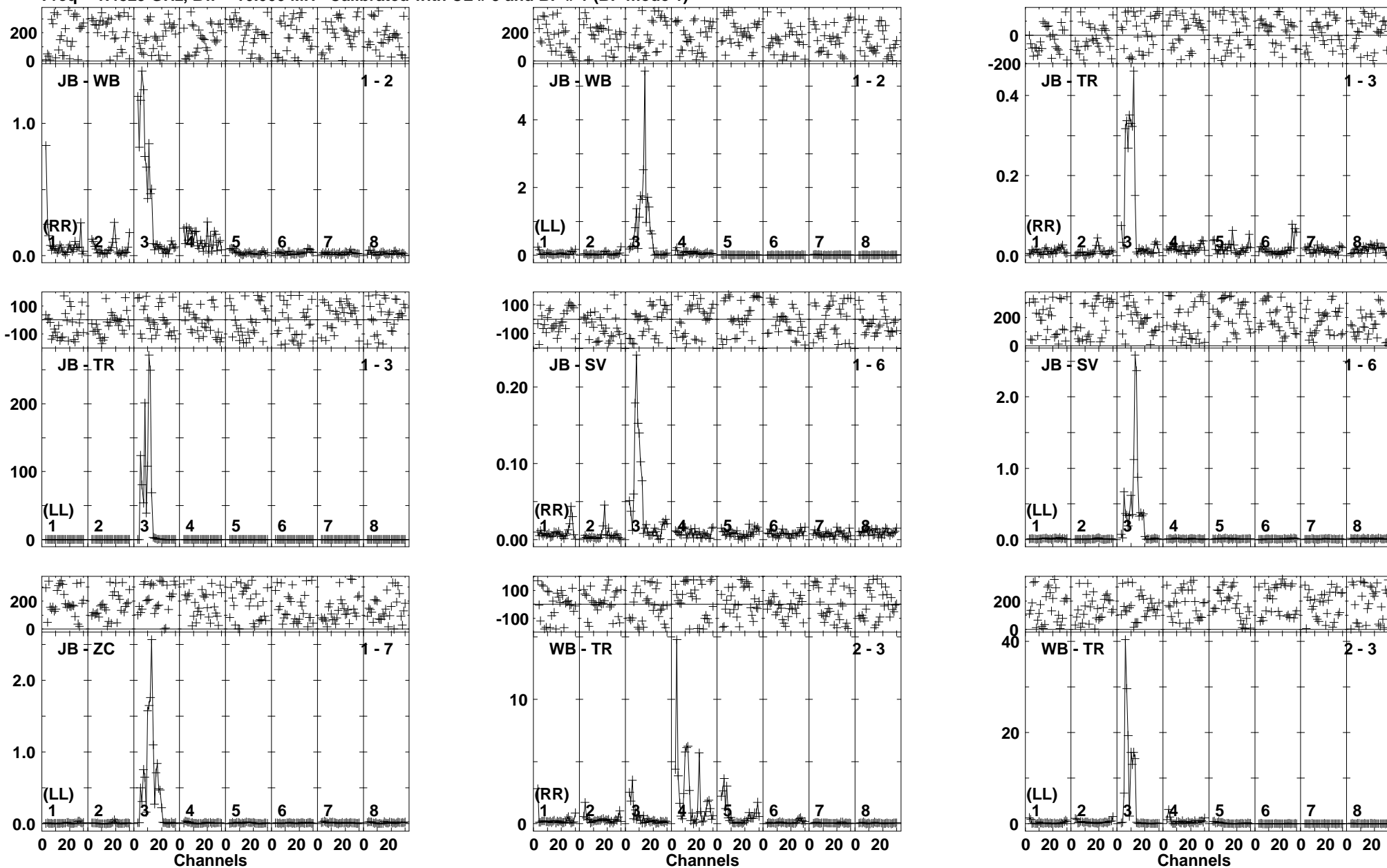

Lower frame: Ampl Jy Top frame: Phas deg
 Vector averaged cross-power spectrum Baseline: JB (01) - WB (02)
 Timerange: 00/11:21:46 to 00/11:25:14

Plot file version 347 created 21-JUN-2019 11:55:53

IRAS12112 EP111A 1.UVDATA.1

Freq = 1.4829 GHz, Bw = 16.000 MH Calibrated with CL # 3 and BP # 1 (BP mode 1)

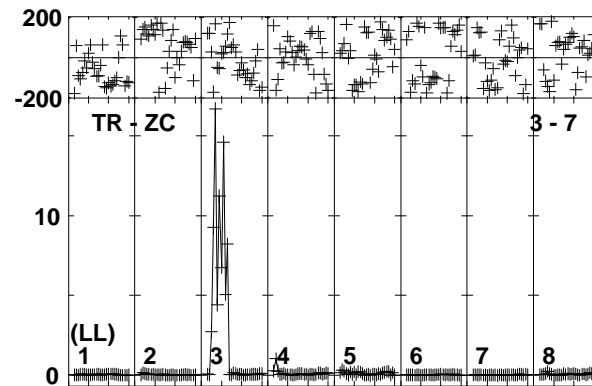
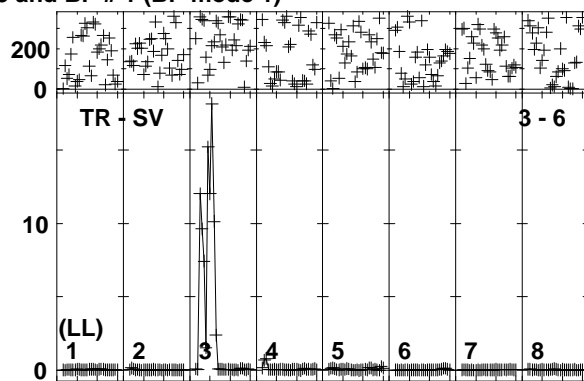
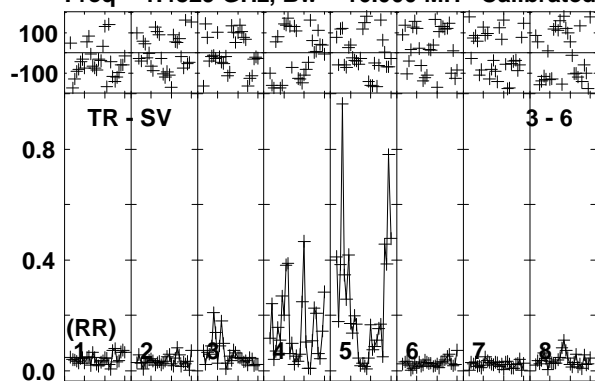

Lower frame: Ampl Jy Top frame: Phas deg
Vector averaged cross-power spectrum Baseline: TR (03) - SV (06)
Timerange: 00/11:21:46 to 00/11:25:14

Plot file version 348 created 21-JUN-2019 11:55:53

J1222+0413 EP111A 1.UVDATA.1

Freq = 1.4829 GHz, Bw = 16.000 MH Calibrated with CL # 3 and BP # 1 (BP mode 1)

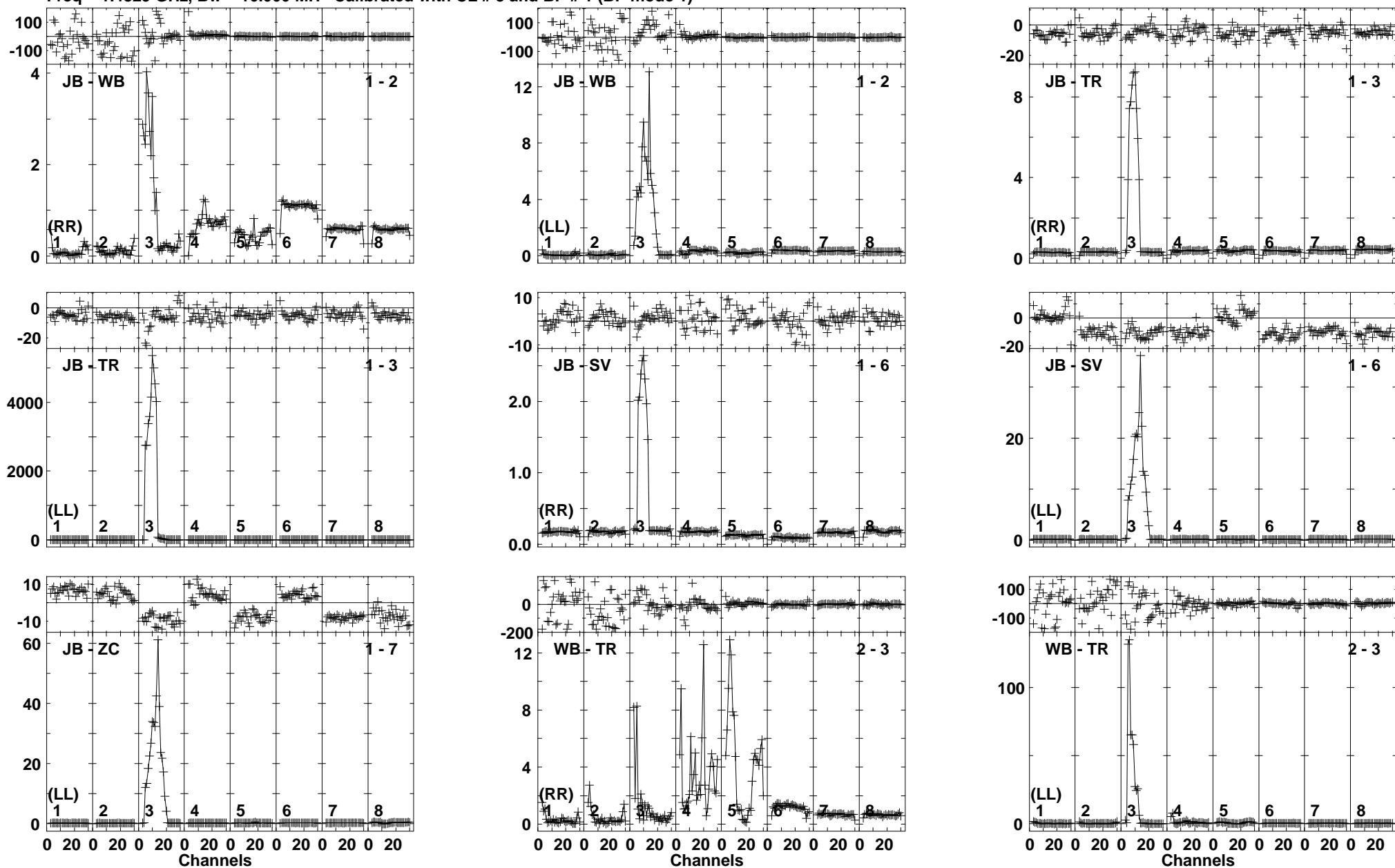

Lower frame: Ampl Jy Top frame: Phas deg
Vector averaged cross-power spectrum Baseline: JB (01) - WB (02)
Timerange: 00/11:25:56 to 00/11:27:24

Plot file version 349 created 21-JUN-2019 11:55:54
J1222+0413 EP1111A 1.UVDATA.1
Freq = 1.4829 GHz, Bw = 16.000 MH Calibrated with CL # 3 and BP # 1 (BP mode 1)

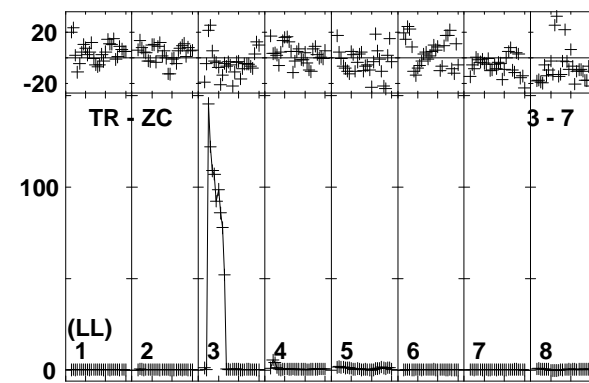
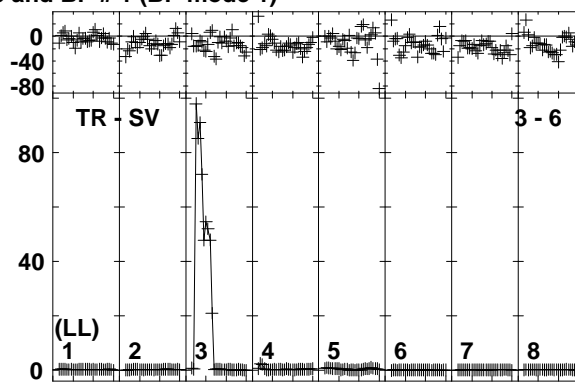
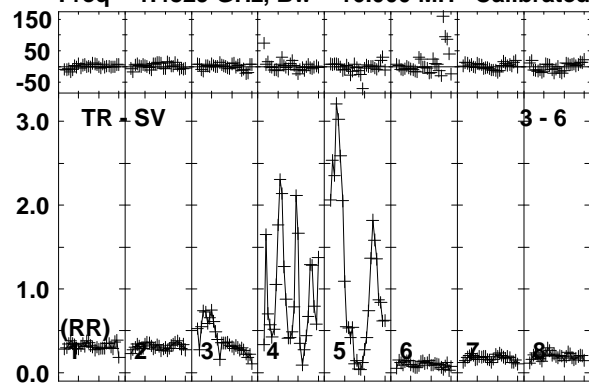

Lower frame: Ampl Jy Top frame: Phas deg
Vector averaged cross-power spectrum Baseline: TR (03) - SV (06)
Timerange: 00/11:25:56 to 00/11:27:24

Plot file version 350 created 21-JUN-2019 11:55:54

IRAS12112 EP111A 1.UVDATA.1

Freq = 1.4829 GHz, Bw = 16.000 MH Calibrated with CL # 3 and BP # 1 (BP mode 1)

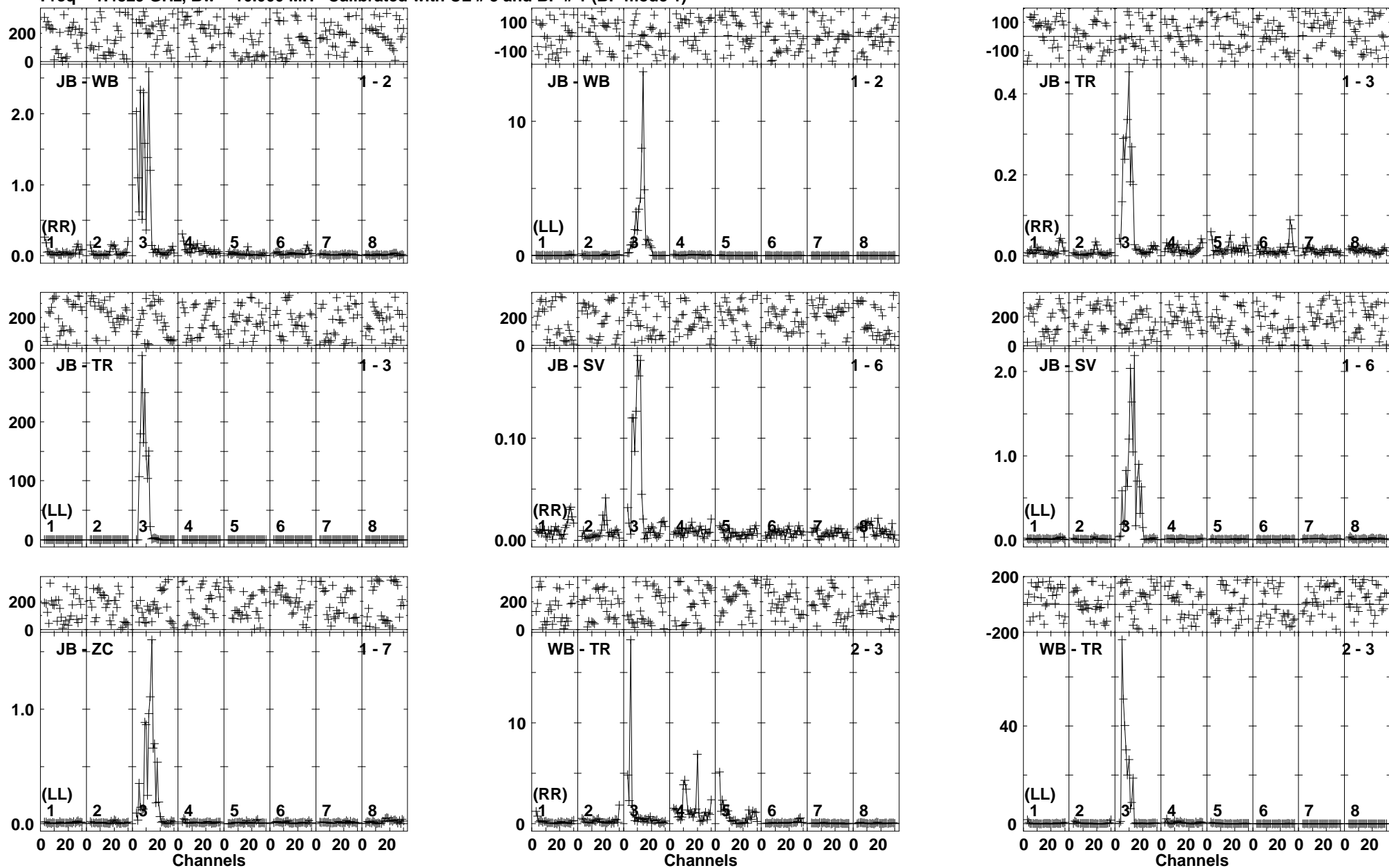

Lower frame: Ampl Jy Top frame: Phas deg
Vector averaged cross-power spectrum Baseline: JB (01) - WB (02)
Timerange: 00/11:27:26 to 00/11:30:54

Plot file version 351 created 21-JUN-2019 11:55:55

IRAS12112 EP111A 1.UVDATA.1

Freq = 1.4829 GHz, Bw = 16.000 MH Calibrated with CL # 3 and BP # 1 (BP mode 1)

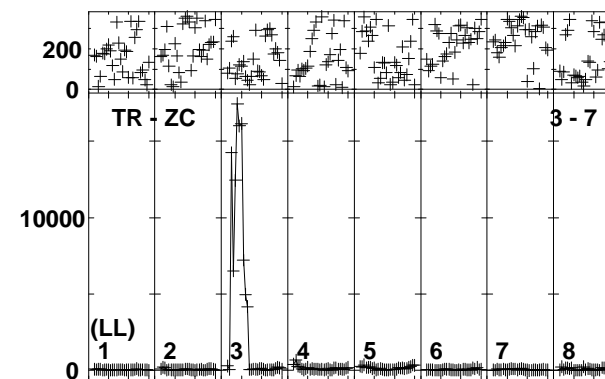
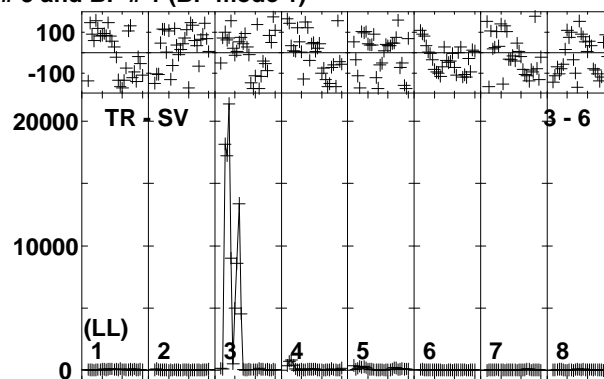
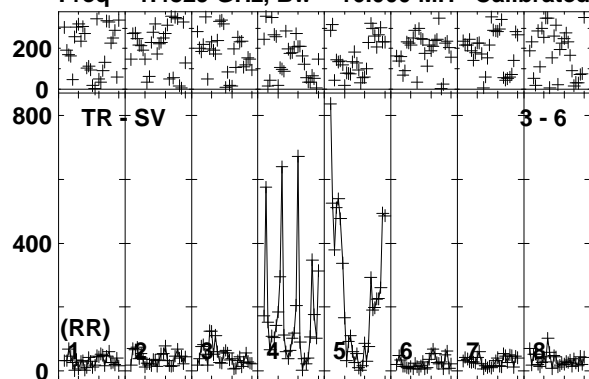

Lower frame: Milli Ampl Jy Top frame: Phas deg
Vector averaged cross-power spectrum Baseline: TR (03) - SV (06)
Timerange: 00/11:27:26 to 00/11:30:54

Plot file version 352 created 21-JUN-2019 11:55:56

J1222+0413 EP111A 1.UVDATA.1

Freq = 1.4829 GHz, Bw = 16.000 MH Calibrated with CL # 3 and BP # 1 (BP mode 1)

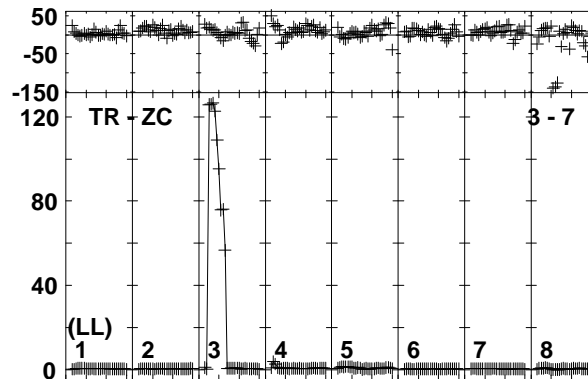
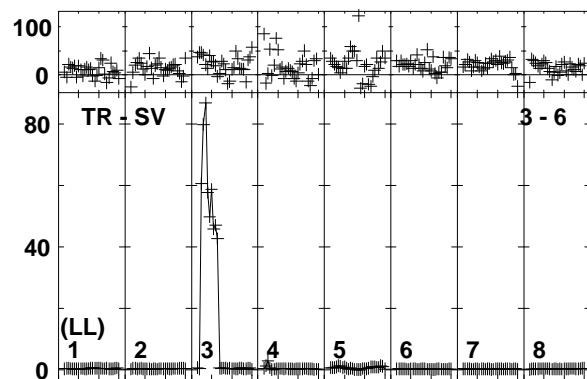
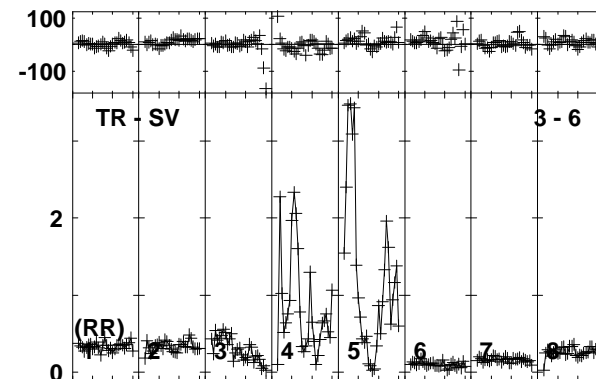
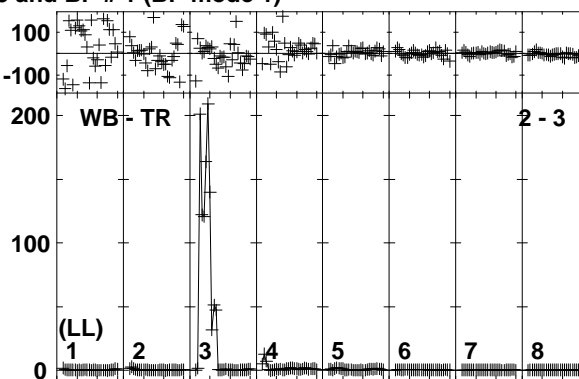
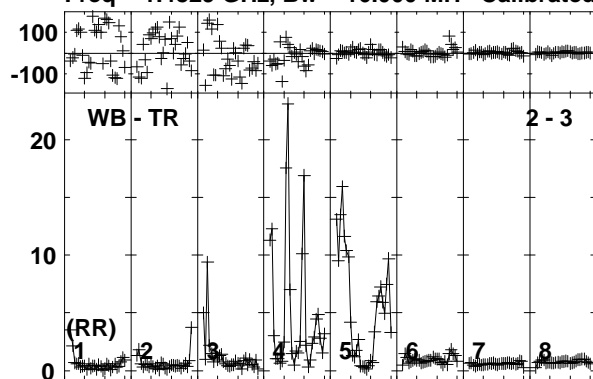

Lower frame: Ampl Jy Top frame: Phas deg
Vector averaged cross-power spectrum Baseline: WB (02) - TR (03)
Timerange: 00/11:30:56 to 00/11:32:24

Plot file version 353 created 21-JUN-2019 11:55:56

IRAS12112 EP111A 1.UVDATA.1

Freq = 1.4829 GHz, Bw = 16.000 MH Calibrated with CL # 3 and BP # 1 (BP mode 1)

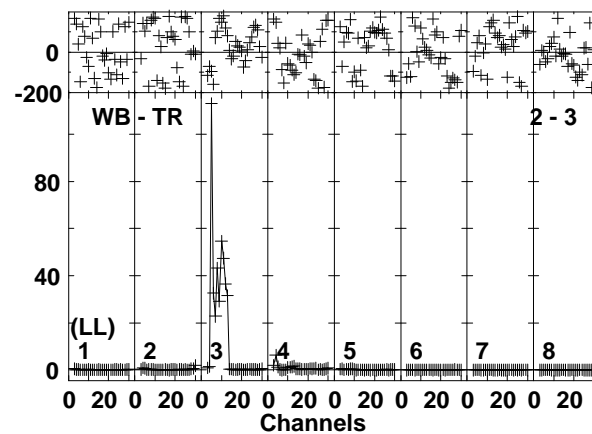
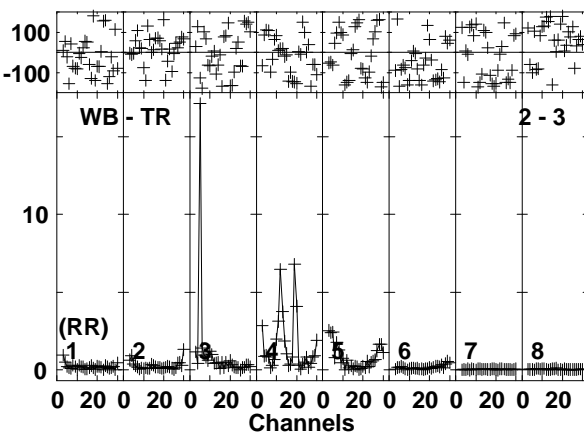
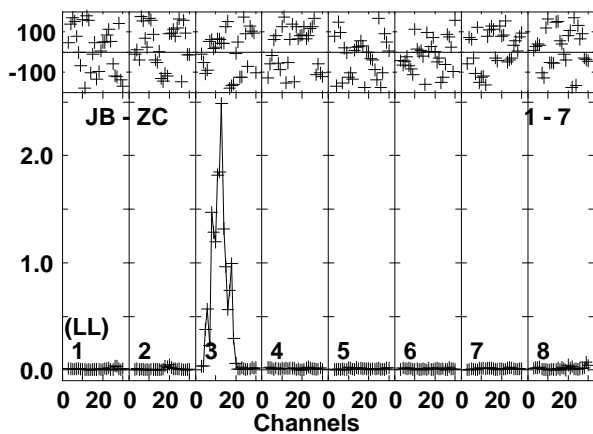
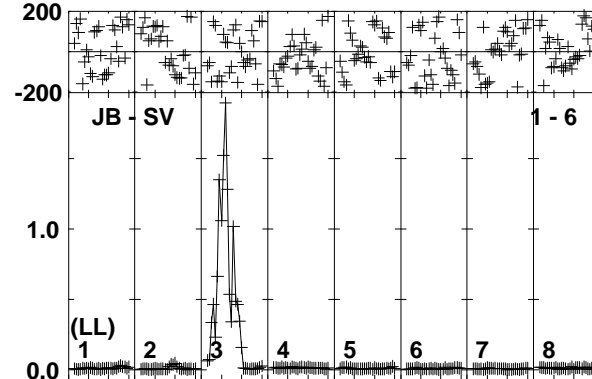
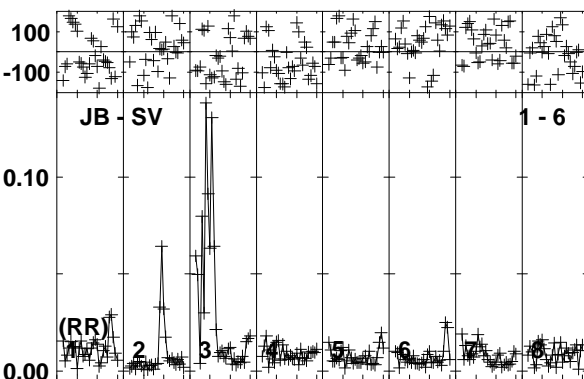
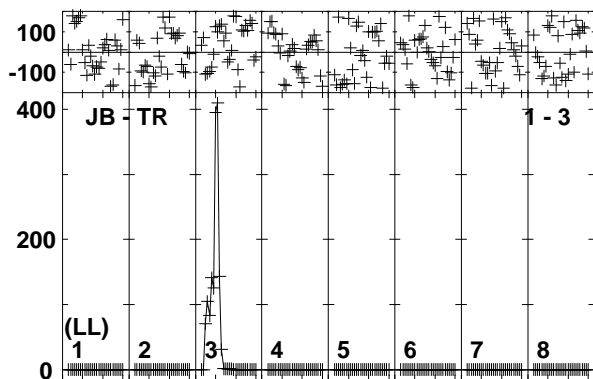
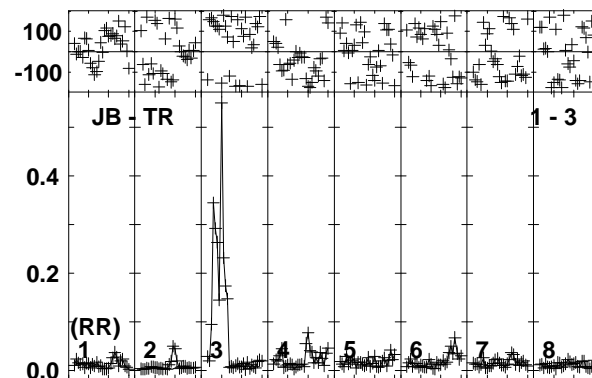
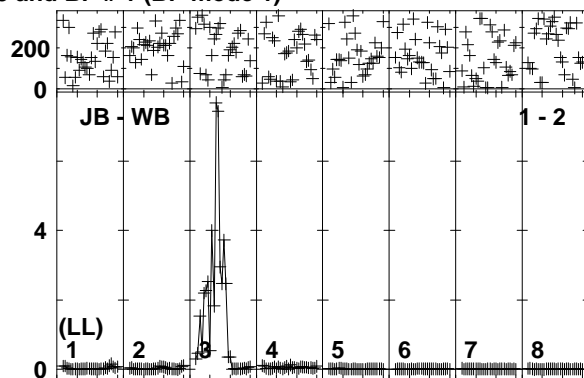
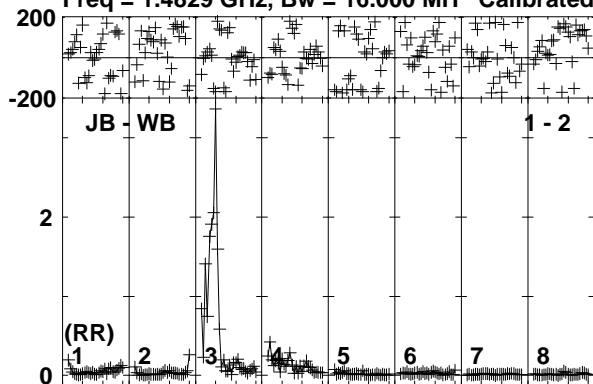

Lower frame: Ampl Jy Top frame: Phas deg
Vector averaged cross-power spectrum Baseline: JB (01) - WB (02)
Timerange: 00/11:32:26 to 00/11:35:54

Plot file version 354 created 21-JUN-2019 11:55:57

IRAS12112 EP111A 1.UVDATA.1

Freq = 1.4829 GHz, Bw = 16.000 MH Calibrated with CL # 3 and BP # 1 (BP mode 1)

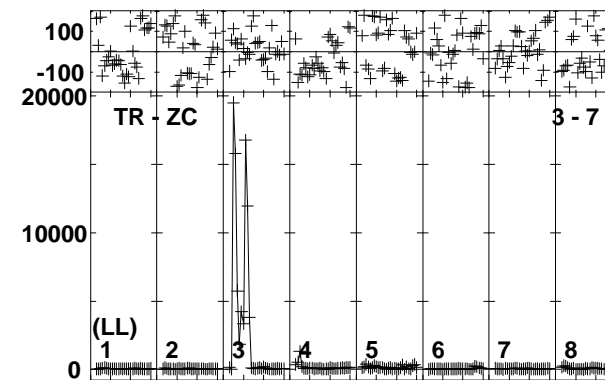
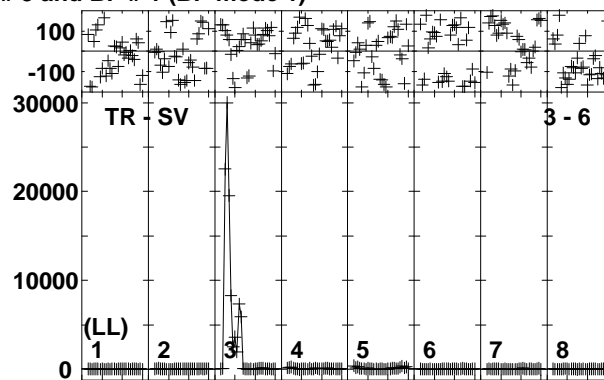
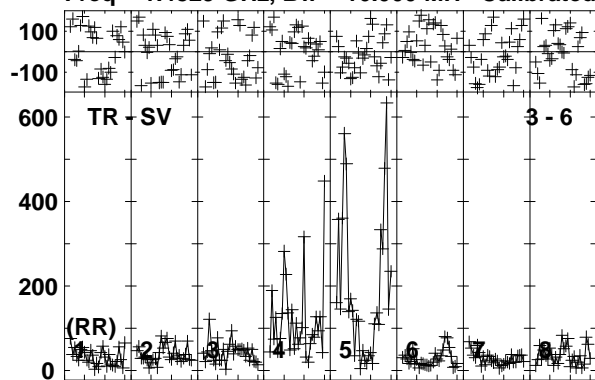

Lower frame: Milli Ampl Jy Top frame: Phas deg
Vector averaged cross-power spectrum Baseline: TR (03) - SV (06)
Timerange: 00/11:32:26 to 00/11:35:54

Plot file version 355 created 21-JUN-2019 11:55:57

J1222+0413 EP111A 1.UVDATA.1

Freq = 1.4829 GHz, Bw = 16.000 MH Calibrated with CL # 3 and BP # 1 (BP mode 1)

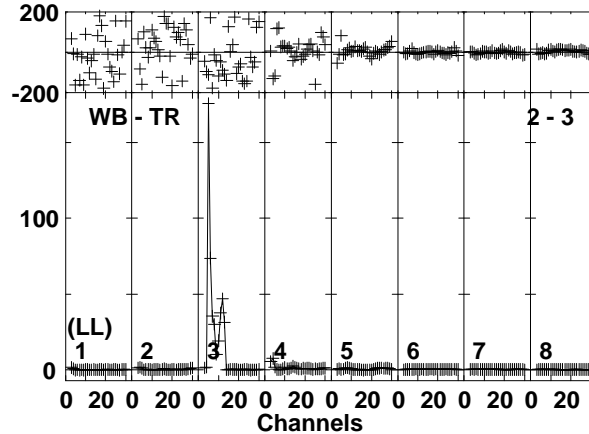
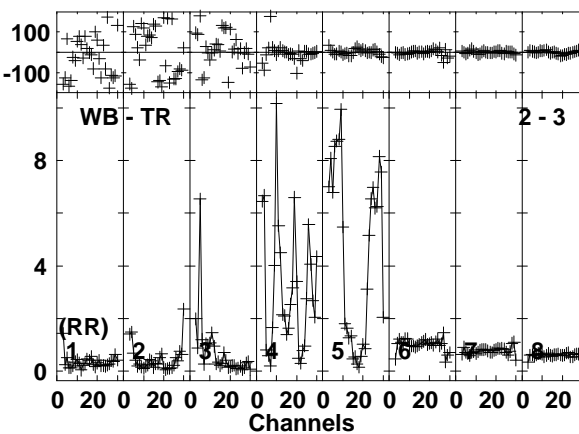
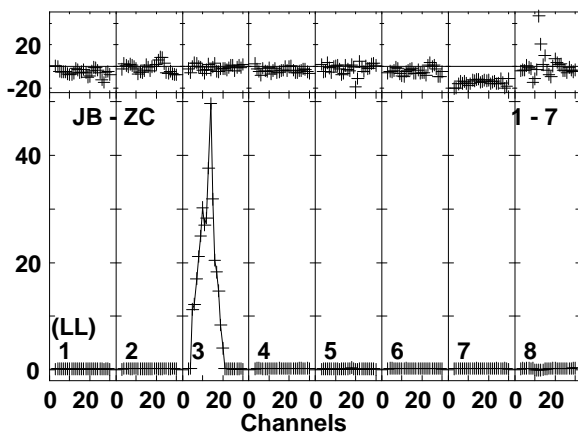
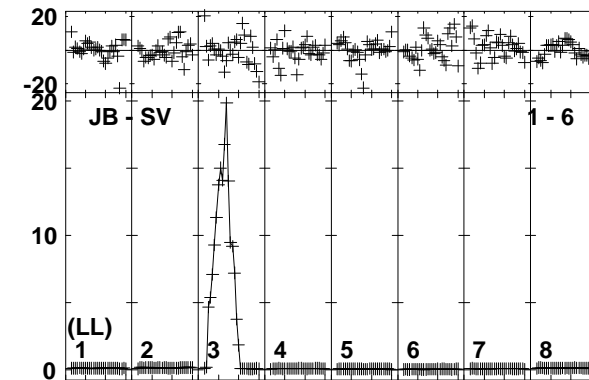
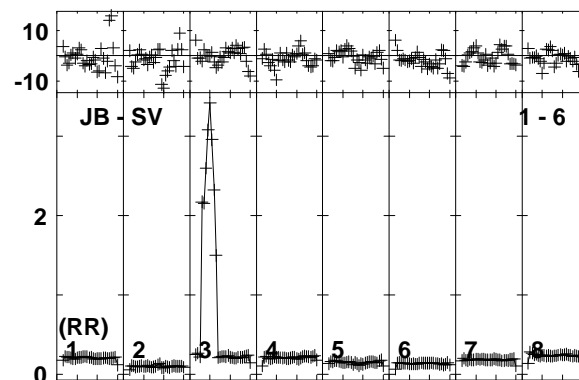
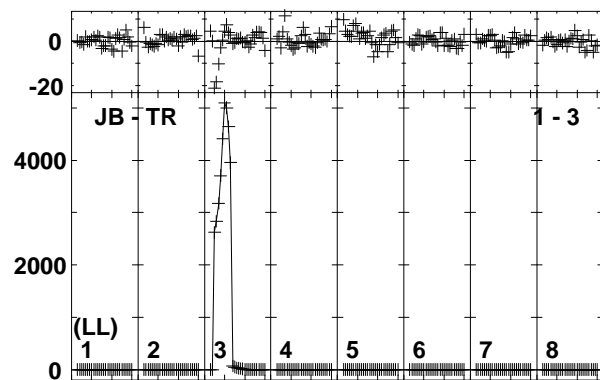
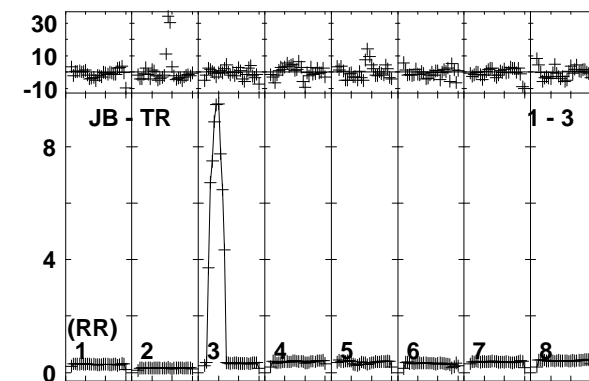
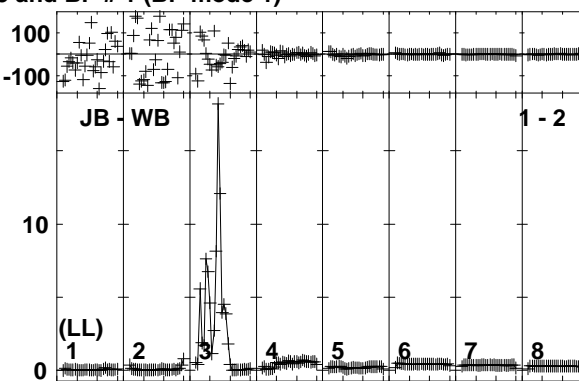
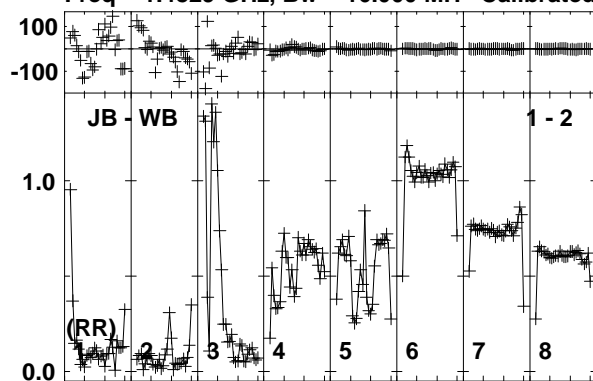

Lower frame: Ampl Jy Top frame: Phas deg
Vector averaged cross-power spectrum Baseline: JB (01) - WB (02)
Timerange: 00/11:36:36 to 00/11:38:04

Plot file version 356 created 21-JUN-2019 11:55:57
J1222+0413 EP111A 1.UVDATA.1
Freq = 1.4829 GHz, Bw = 16.000 MH Calibrated with CL # 3 and BP # 1 (BP mode 1)

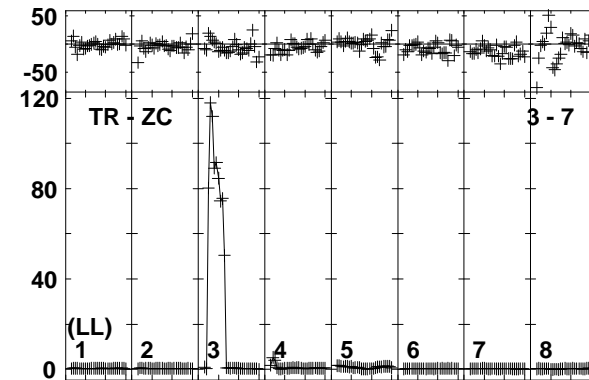
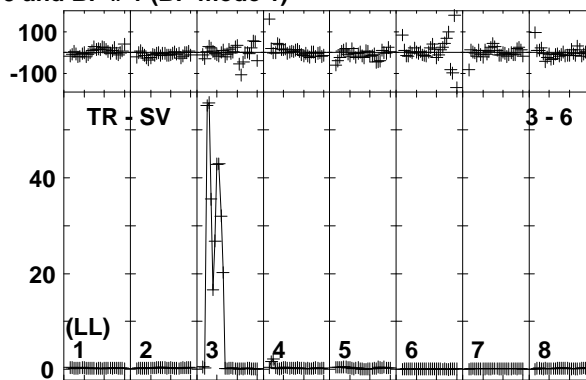
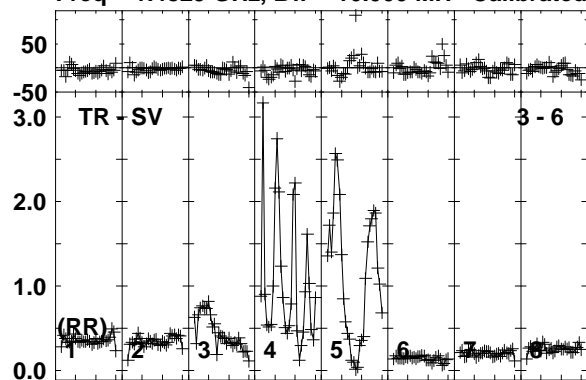

Lower frame: Ampl Jy Top frame: Phas deg
Vector averaged cross-power spectrum Baseline: TR (03) - SV (06)
Timerange: 00/11:36:36 to 00/11:38:04

Plot file version 357 created 21-JUN-2019 11:55:58

IRAS12112 EP111A 1.UVDATA.1

Freq = 1.4829 GHz, Bw = 16.000 MH Calibrated with CL # 3 and BP # 1 (BP mode 1)

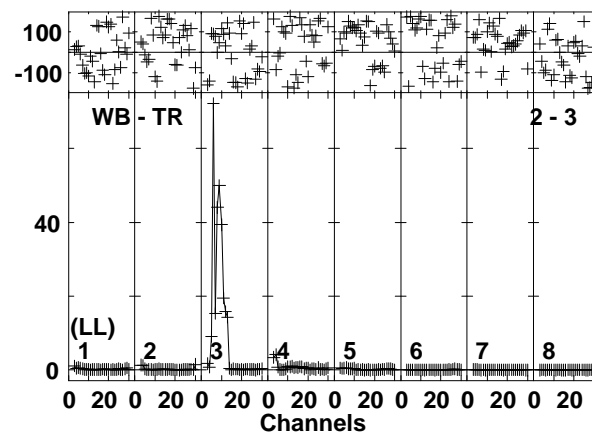
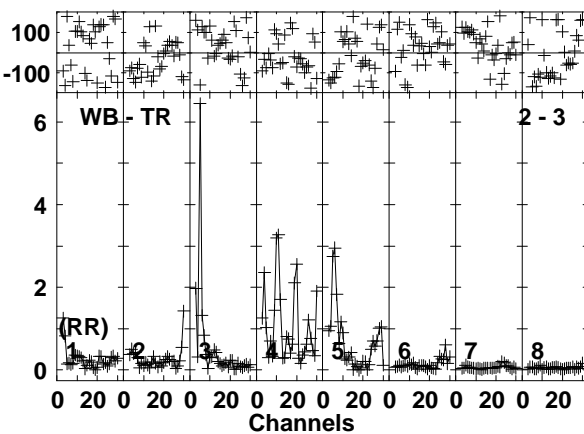
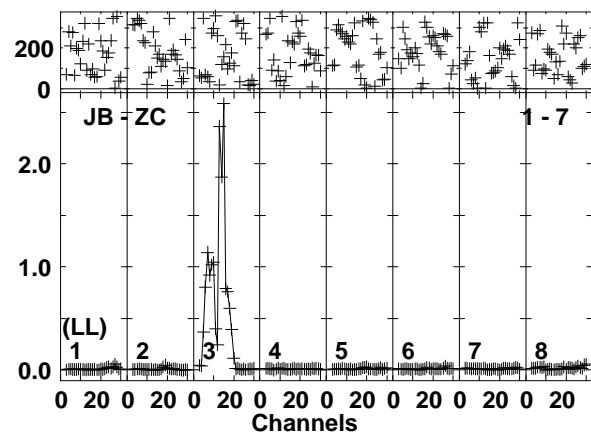
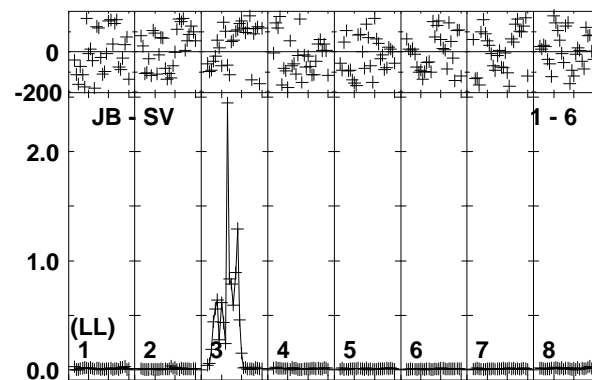
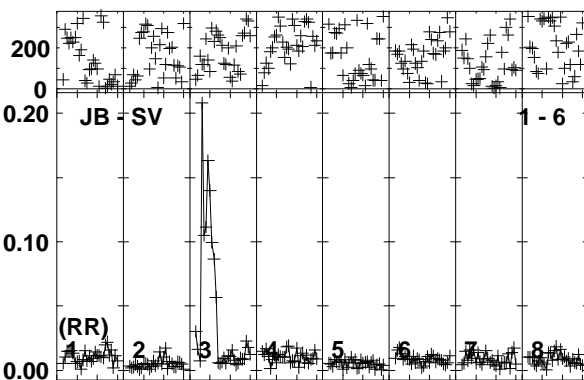
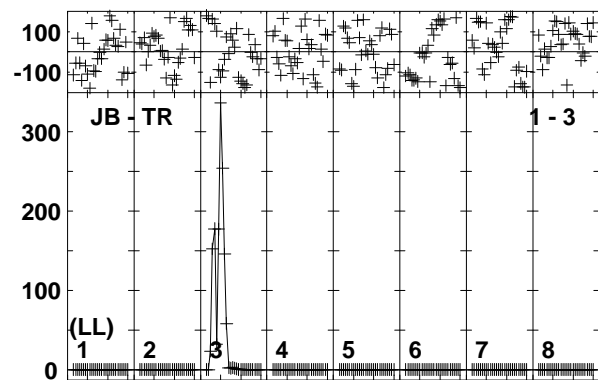
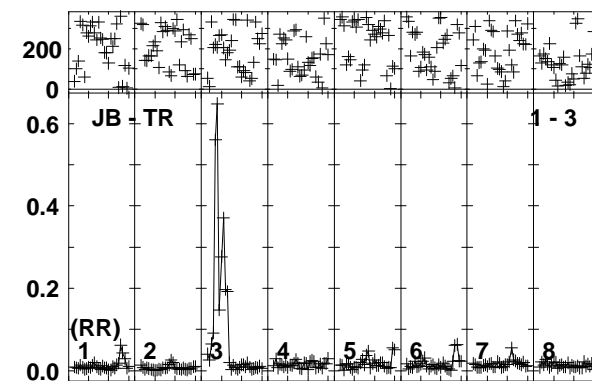
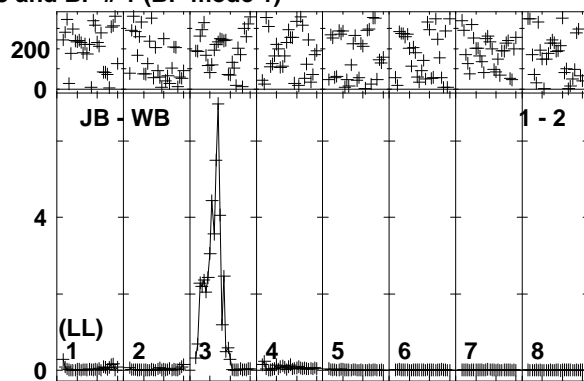
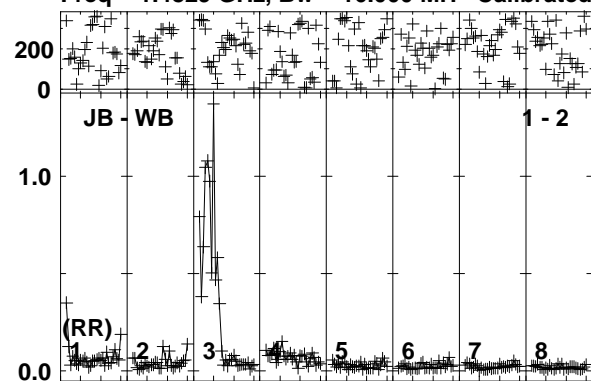

Lower frame: Ampl Jy Top frame: Phas deg
Vector averaged cross-power spectrum Baseline: JB (01) - WB (02)
Timerange: 00/11:38:06 to 00/11:41:34

Plot file version 358 created 21-JUN-2019 11:55:58

IRAS12112 EP111A 1.UVDATA.1

Freq = 1.4829 GHz, Bw = 16.000 MH Calibrated with CL # 3 and BP # 1 (BP mode 1)

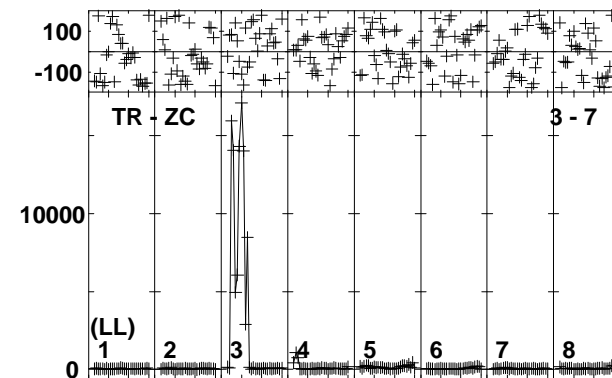
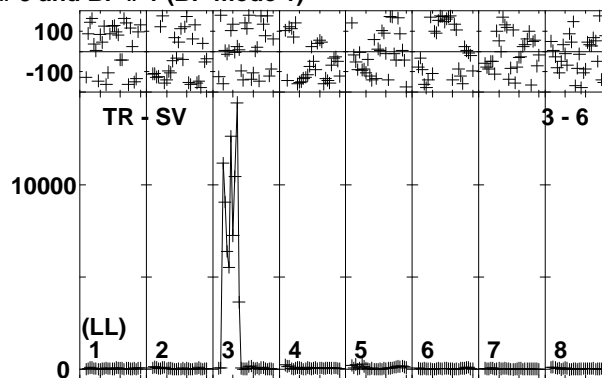
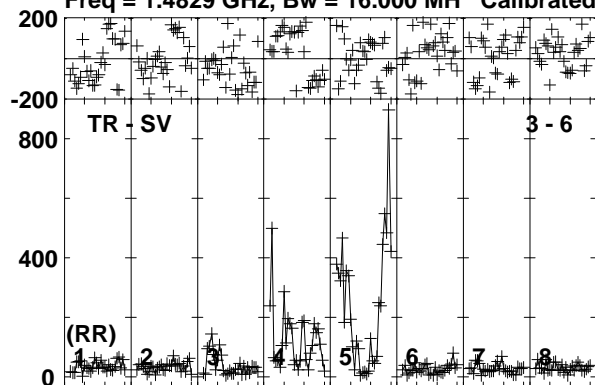

Lower frame: Milli Ampl Jy Top frame: Phas deg
Vector averaged cross-power spectrum Baseline: TR (03) - SV (06)
Timerange: 00/11:38:06 to 00/11:41:34

Plot file version 359 created 21-JUN-2019 11:55:59

J1222+0413 EP111A 1.UVDATA.1

Freq = 1.4829 GHz, Bw = 16.000 MH Calibrated with CL # 3 and BP # 1 (BP mode 1)

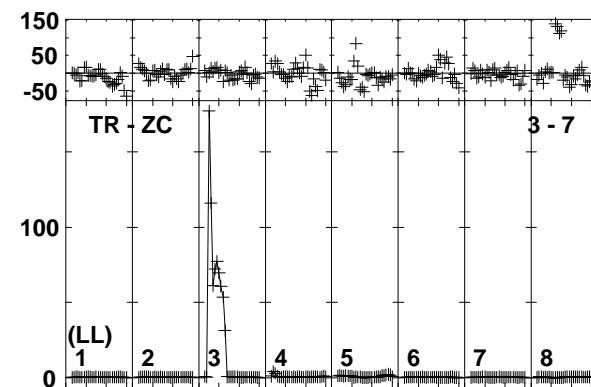
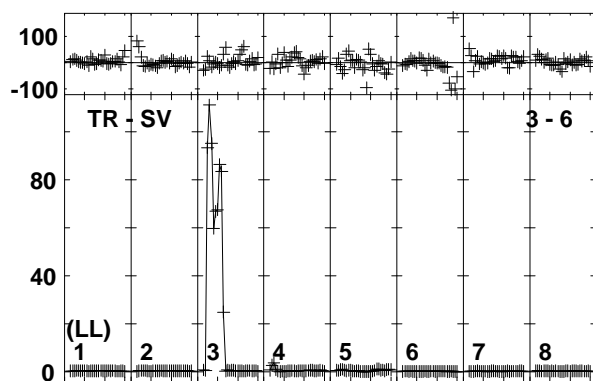
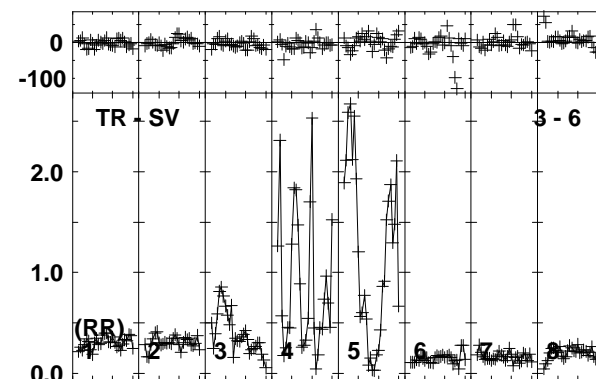
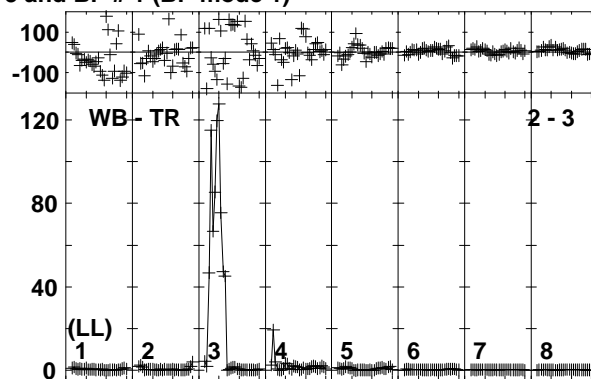
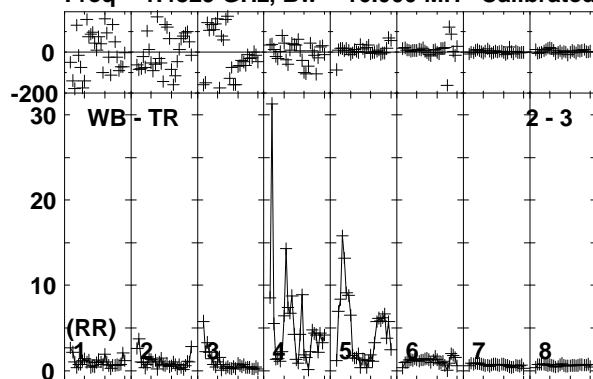

Lower frame: Ampl Jy Top frame: Phas deg
Vector averaged cross-power spectrum Baseline: WB (02) - TR (03)
Timerange: 00/11:41:36 to 00/11:43:04

Plot file version 360 created 21-JUN-2019 11:55:59

IRAS12112 EP111A 1.UVDATA.1

Freq = 1.4829 GHz, Bw = 16.000 MH Calibrated with CL # 3 and BP # 1 (BP mode 1)

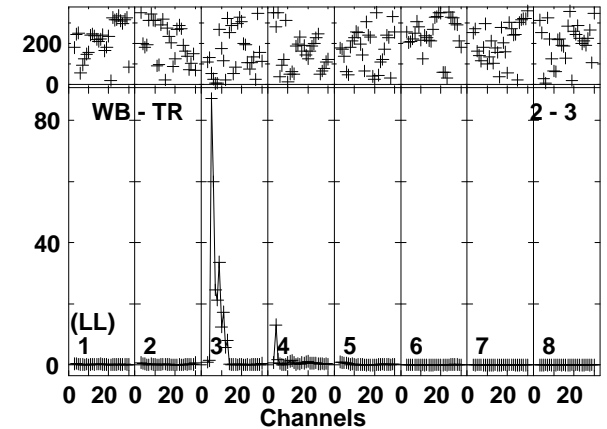
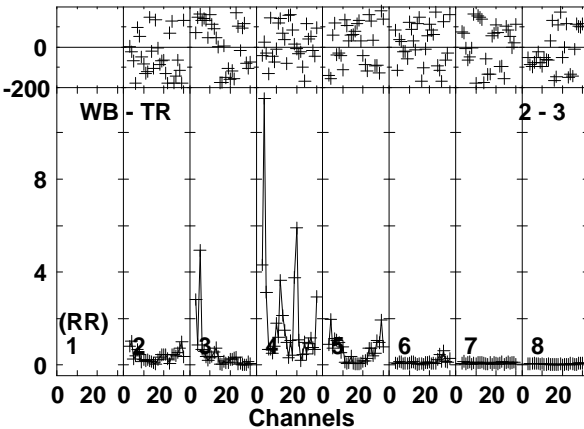
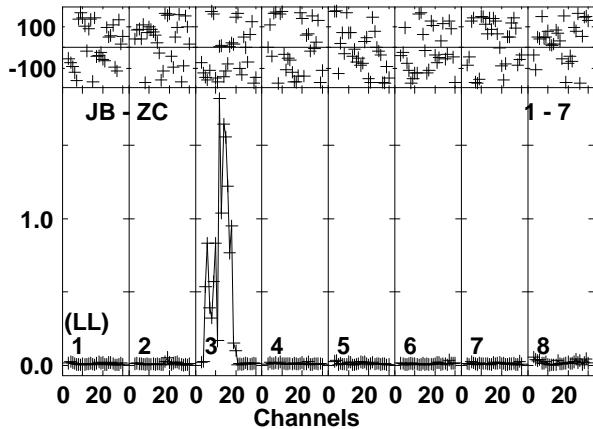
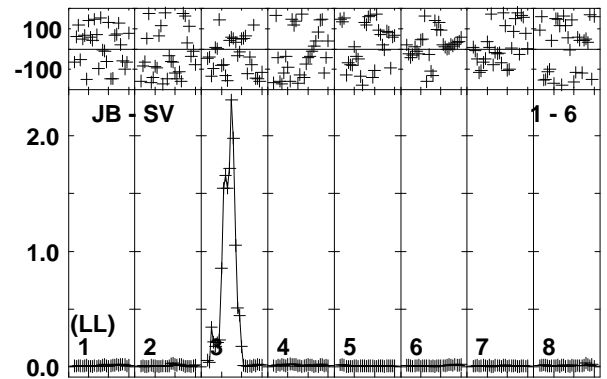
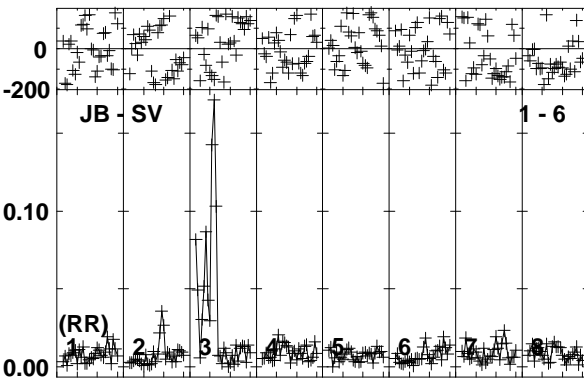
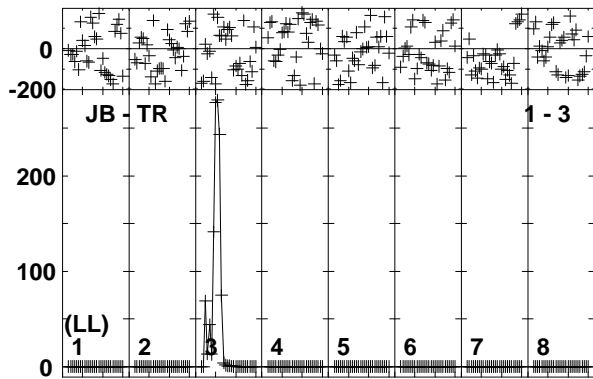
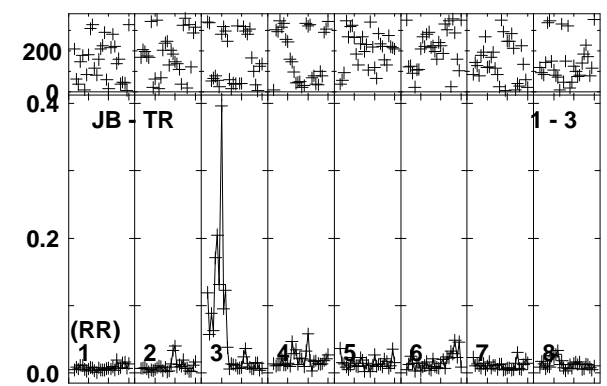
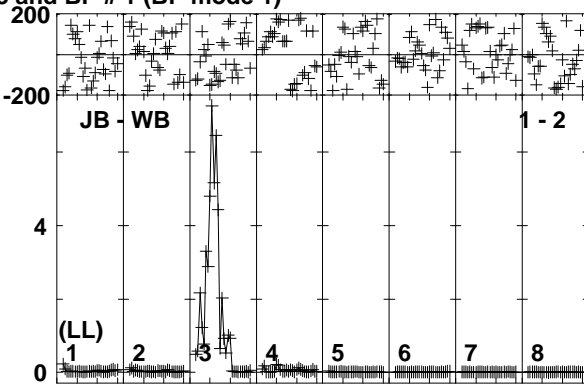
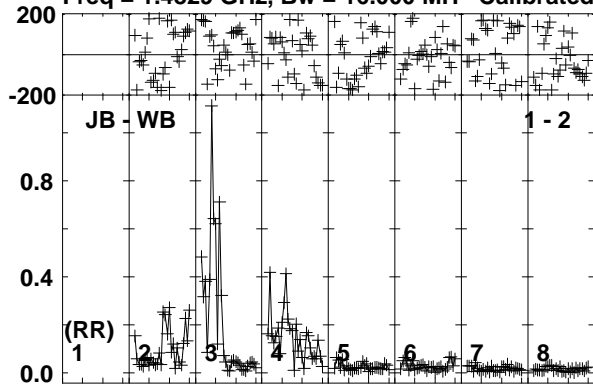

Lower frame: Ampl Jy Top frame: Phas deg
Vector averaged cross-power spectrum Baseline: JB (01) - WB (02)
Timerange: 00/11:43:06 to 00/11:46:34

Plot file version 361 created 21-JUN-2019 11:56:00

IRAS12112 EP111A 1.UVDATA.1

Freq = 1.4829 GHz, Bw = 16.000 MH Calibrated with CL # 3 and BP # 1 (BP mode 1)

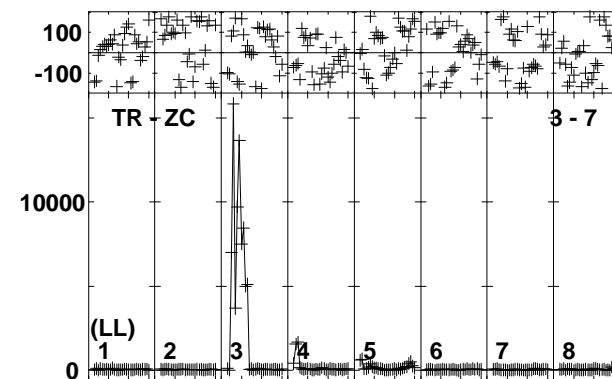
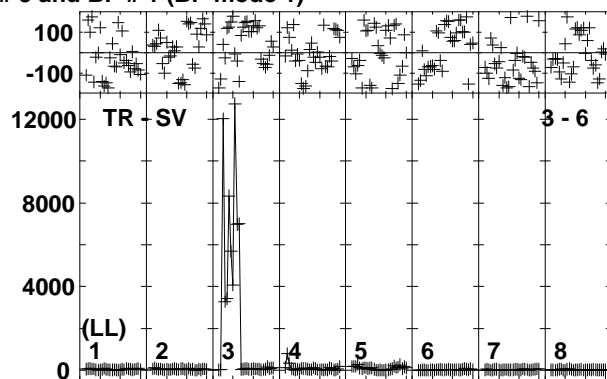
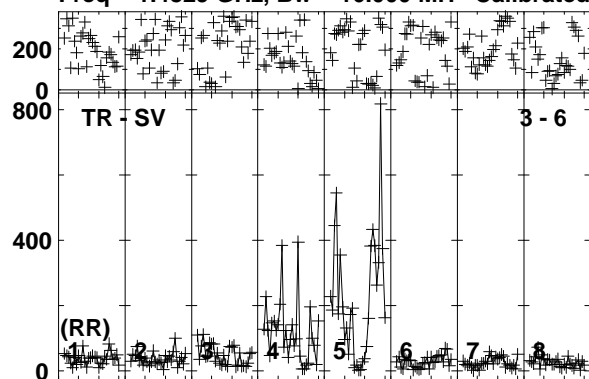

Lower frame: Milli Ampl Jy Top frame: Phas deg
Vector averaged cross-power spectrum Baseline: TR (03) - SV (06)
Timerange: 00/11:43:06 to 00/11:46:34

Plot file version 362 created 21-JUN-2019 11:56:00

J1222+0413 EP111A 1.UVDATA.1

Freq = 1.4829 GHz, Bw = 16.000 MH Calibrated with CL # 3 and BP # 1 (BP mode 1)

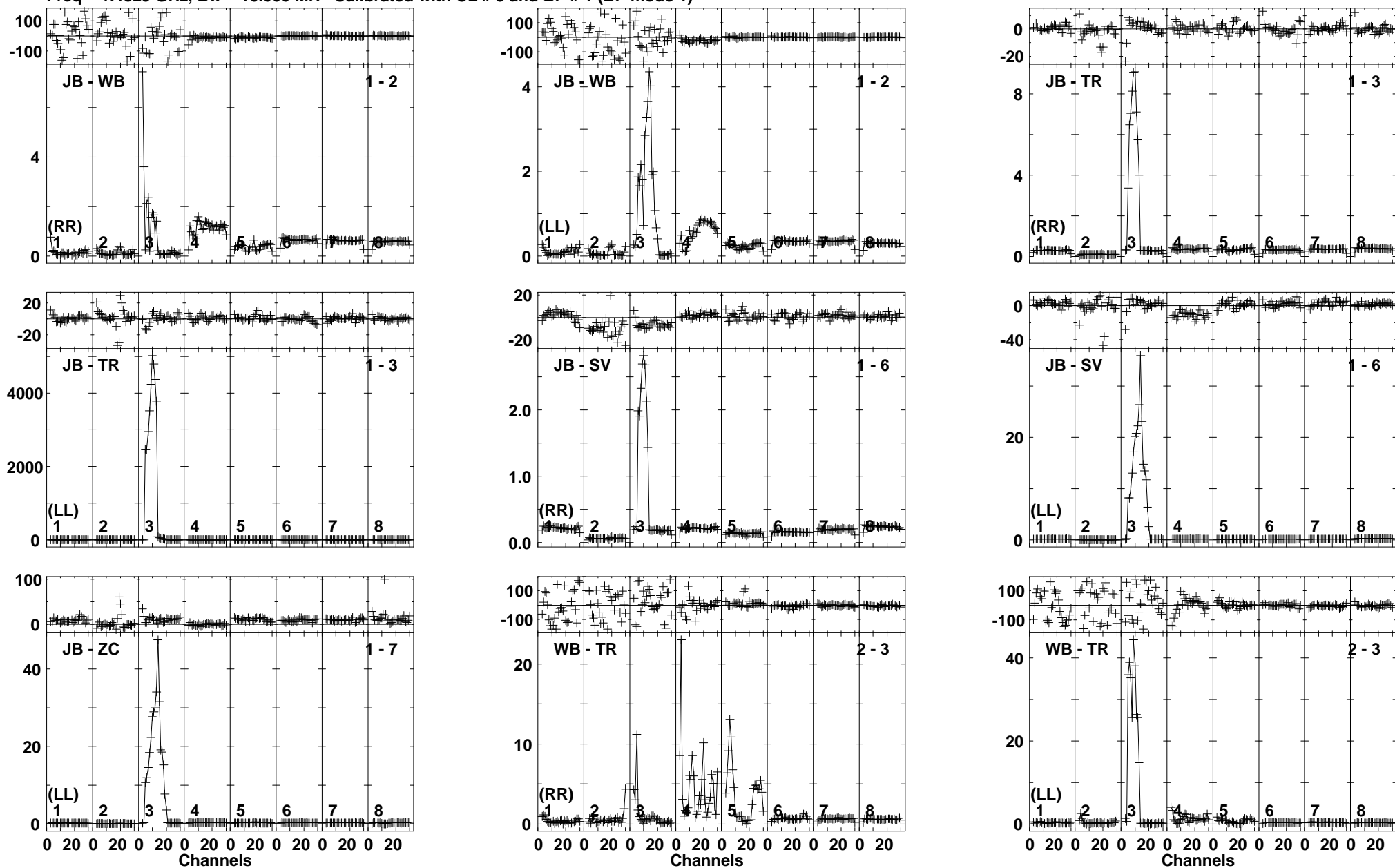

Lower frame: Ampl Jy Top frame: Phas deg
Vector averaged cross-power spectrum Baseline: JB (01) - WB (02)
Timerange: 00/11:47:16 to 00/11:48:44

Plot file version 363 created 21-JUN-2019 11:56:01
J1222+0413 EP111A 1.UVDATA.1
Freq = 1.4829 GHz, Bw = 16.000 MH Calibrated with CL # 3 and BP # 1 (BP mode 1)

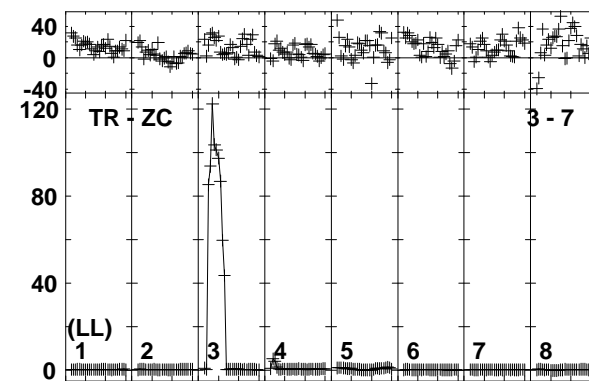
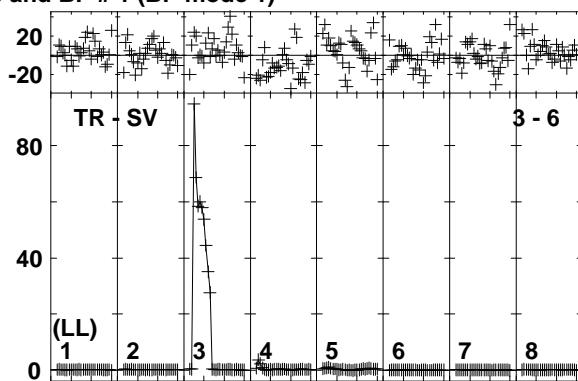
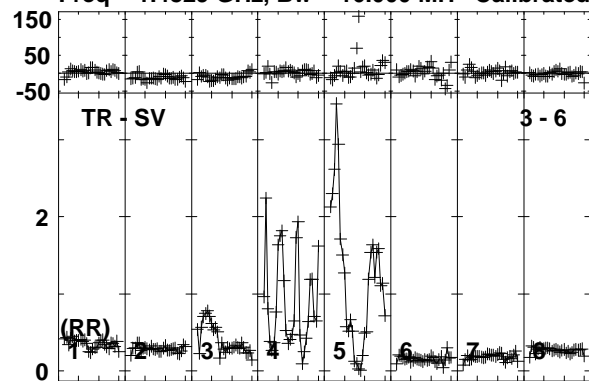

Lower frame: Ampl Jy Top frame: Phas deg
Vector averaged cross-power spectrum Baseline: TR (03) - SV (06)
Timerange: 00/11:47:16 to 00/11:48:44

Plot file version 364 created 21-JUN-2019 11:56:01

IRAS12112 EP111A 1.UVDATA.1

Freq = 1.4829 GHz, Bw = 16.000 MH Calibrated with CL # 3 and BP # 1 (BP mode 1)

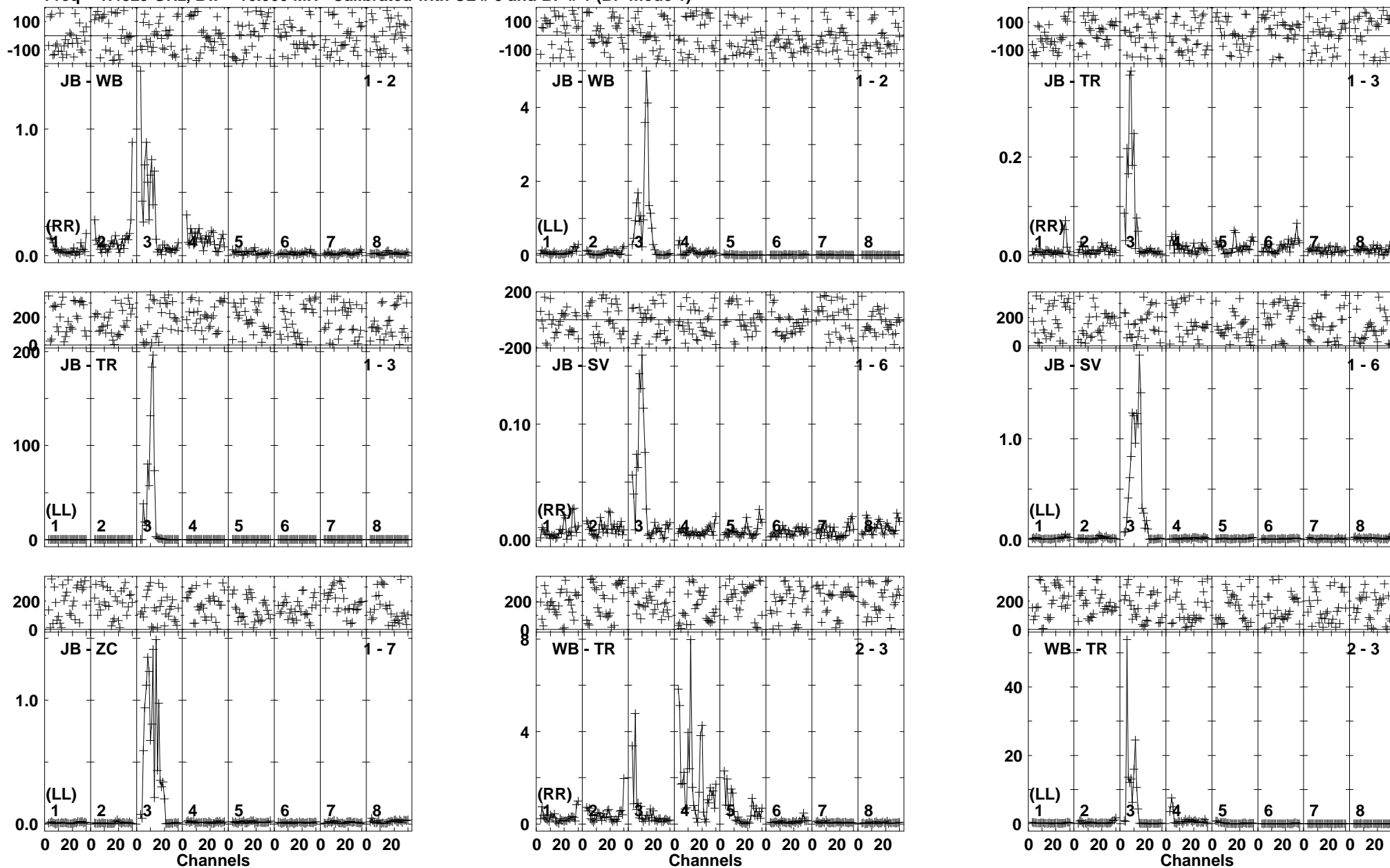

Lower frame: Ampl Jy Top frame: Phas deg
Vector averaged cross-power spectrum Baseline: JB (01) - WB (02)
Timerange: 00/11:48:46 to 00/11:52:14

Plot file version 365 created 21-JUN-2019 11:56:02

IRAS12112 EP111A 1.UVDATA.1

Freq = 1.4829 GHz, Bw = 16.000 MH Calibrated with CL # 3 and BP # 1 (BP mode 1)

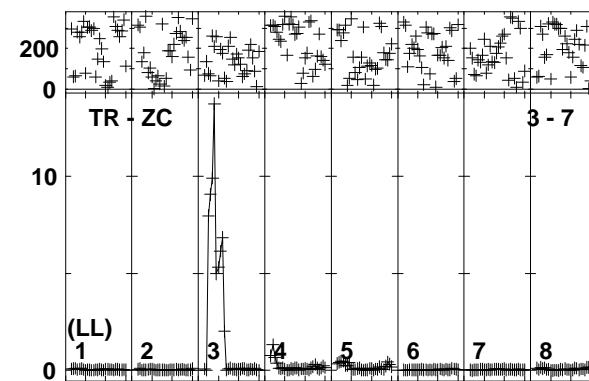
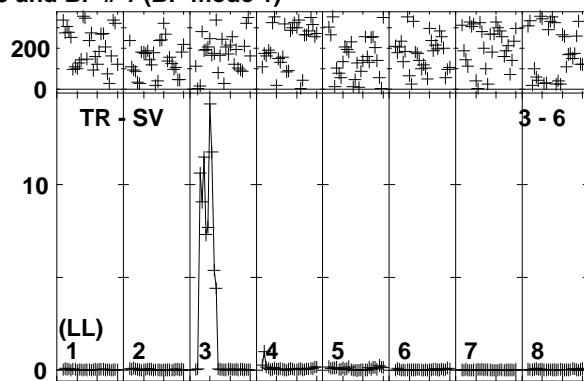
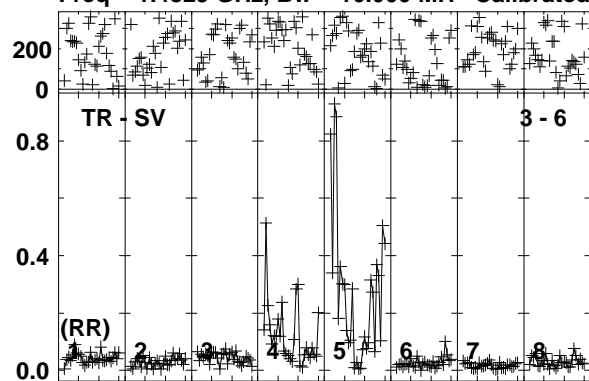

Lower frame: Ampl Jy Top frame: Phas deg
Vector averaged cross-power spectrum Baseline: TR (03) - SV (06)
Timerange: 00/11:48:46 to 00/11:52:14

Plot file version 366 created 21-JUN-2019 11:56:03

J1222+0413 EP111A 1.UVDATA.1

Freq = 1.4829 GHz, Bw = 16.000 MH Calibrated with CL # 3 and BP # 1 (BP mode 1)

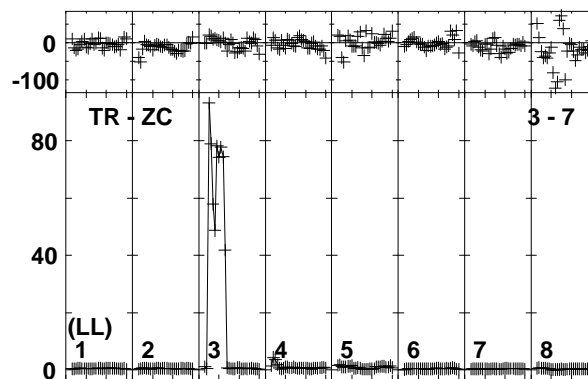
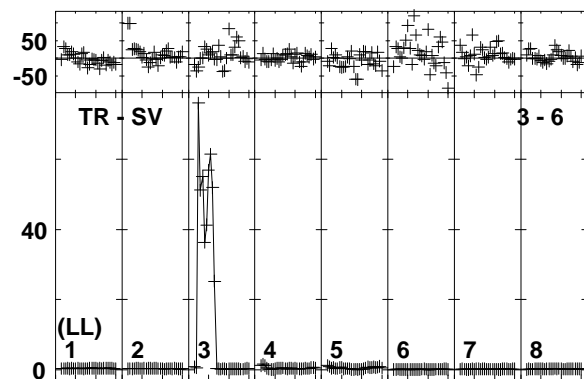
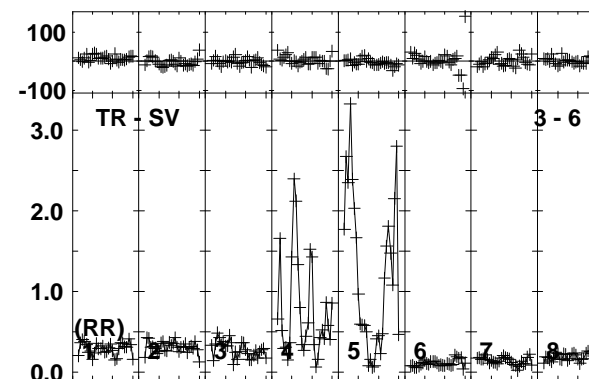
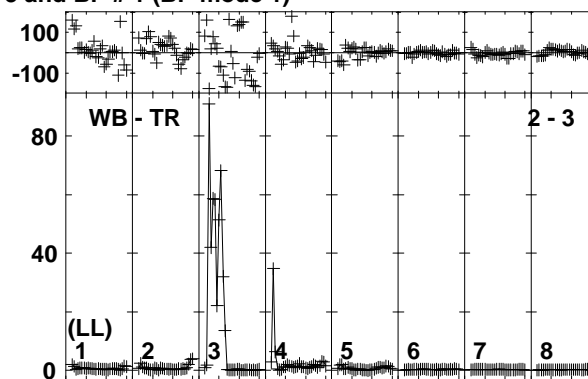
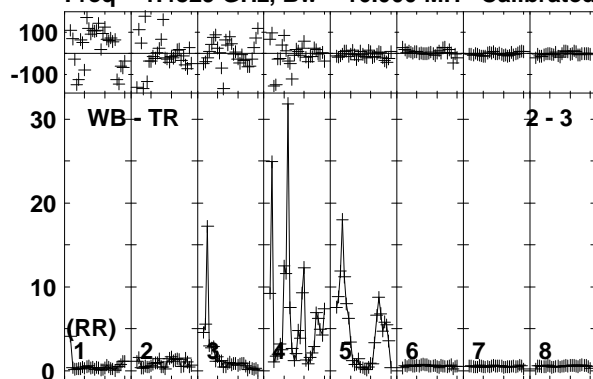

Lower frame: Ampl Jy Top frame: Phas deg
Vector averaged cross-power spectrum Baseline: WB (02) - TR (03)
Timerange: 00/11:52:16 to 00/11:53:44

Plot file version 367 created 21-JUN-2019 11:56:03

IRAS12112 EP111A 1.UVDATA.1

Freq = 1.4829 GHz, Bw = 16.000 MH Calibrated with CL # 3 and BP # 1 (BP mode 1)

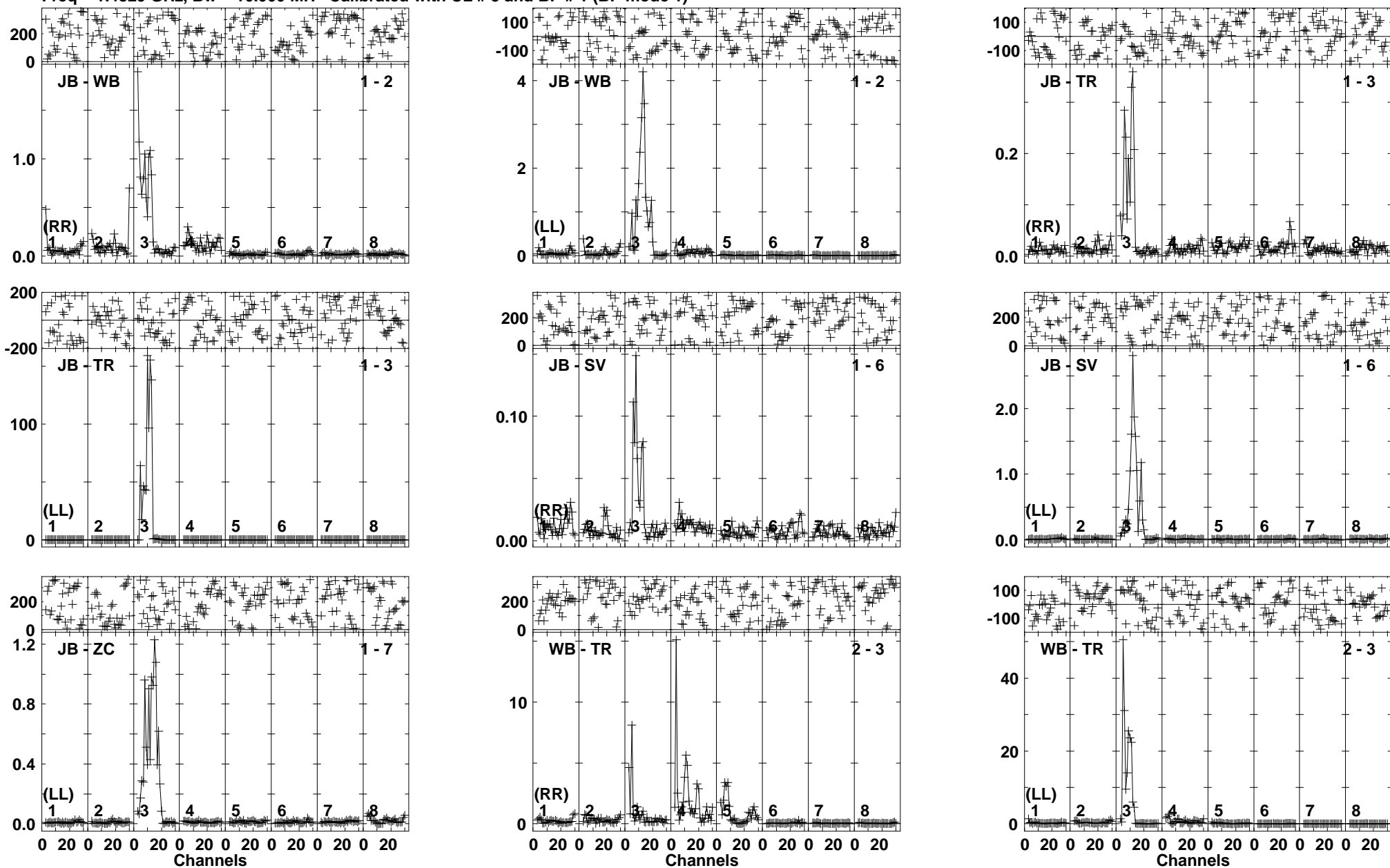

Lower frame: Ampl Jy Top frame: Phas deg
Vector averaged cross-power spectrum Baseline: JB (01) - WB (02)
Timerange: 00/11:53:46 to 00/11:57:14

Plot file version 368 created 21-JUN-2019 11:56:04

IRAS12112 EP111A 1.UVDATA.1

Freq = 1.4829 GHz, Bw = 16.000 MH Calibrated with CL # 3 and BP # 1 (BP mode 1)

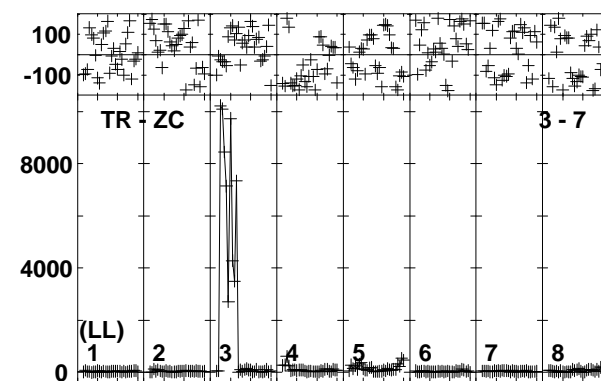
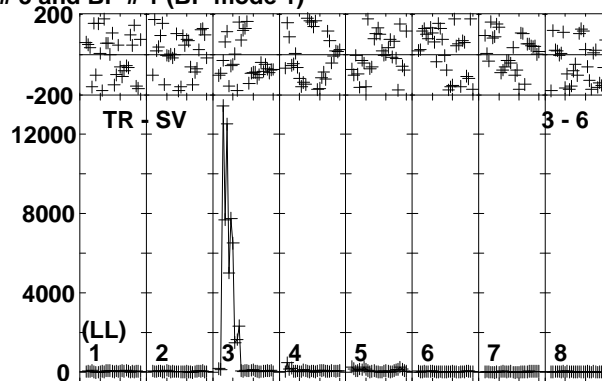
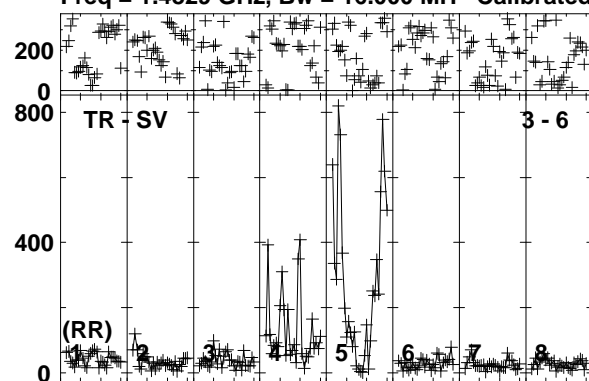

Lower frame: Milli Ampl Jy Top frame: Phas deg
Vector averaged cross-power spectrum Baseline: TR (03) - SV (06)
Timerange: 00/11:53:46 to 00/11:57:14

Plot file version 369 created 21-JUN-2019 11:56:04

J1222+0413 EP111A 1.UVDATA.1

Freq = 1.4829 GHz, Bw = 16.000 MH Calibrated with CL # 3 and BP # 1 (BP mode 1)

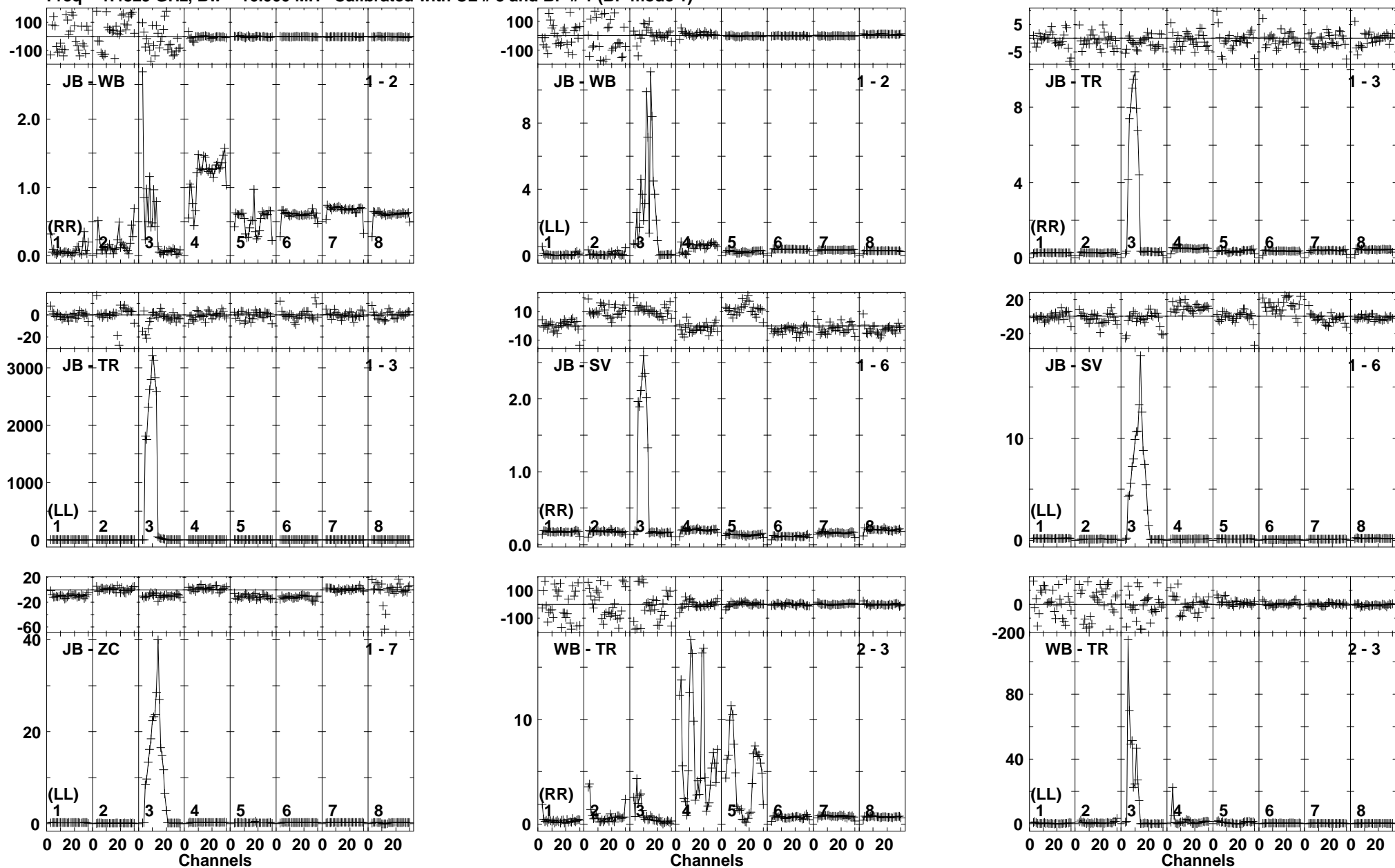

Lower frame: Ampl Jy Top frame: Phas deg
Vector averaged cross-power spectrum Baseline: JB (01) - WB (02)
Timerange: 00/11:57:56 to 00/11:59:24

Plot file version 370 created 21-JUN-2019 11:56:05

J1222+0413 EP1111A 1.UVDATA.1

Freq = 1.4829 GHz, Bw = 16.000 MH Calibrated with CL # 3 and BP # 1 (BP mode 1)

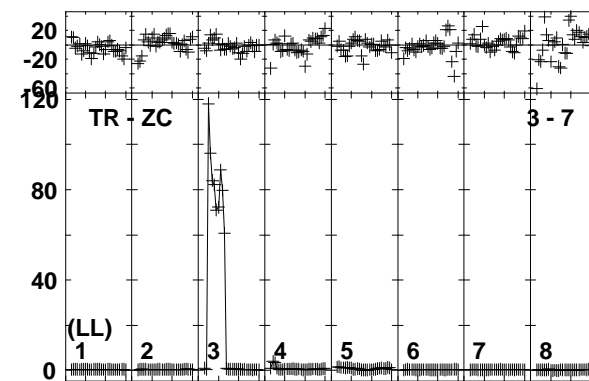
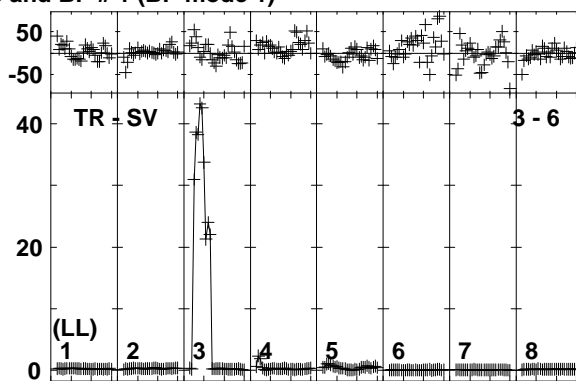
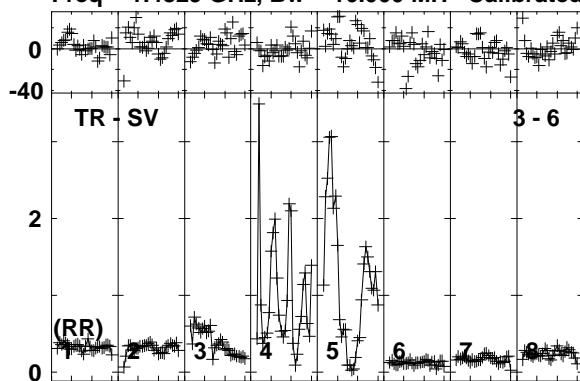

Lower frame: Ampl Jy Top frame: Phas deg
Vector averaged cross-power spectrum Baseline: TR (03) - SV (06)
Timerange: 00/11:57:56 to 00/11:59:24

Plot file version 371 created 21-JUN-2019 11:56:05

IRAS12112 EP111A 1.UVDATA.1

Freq = 1.4829 GHz, Bw = 16.000 MH Calibrated with CL # 3 and BP # 1 (BP mode 1)

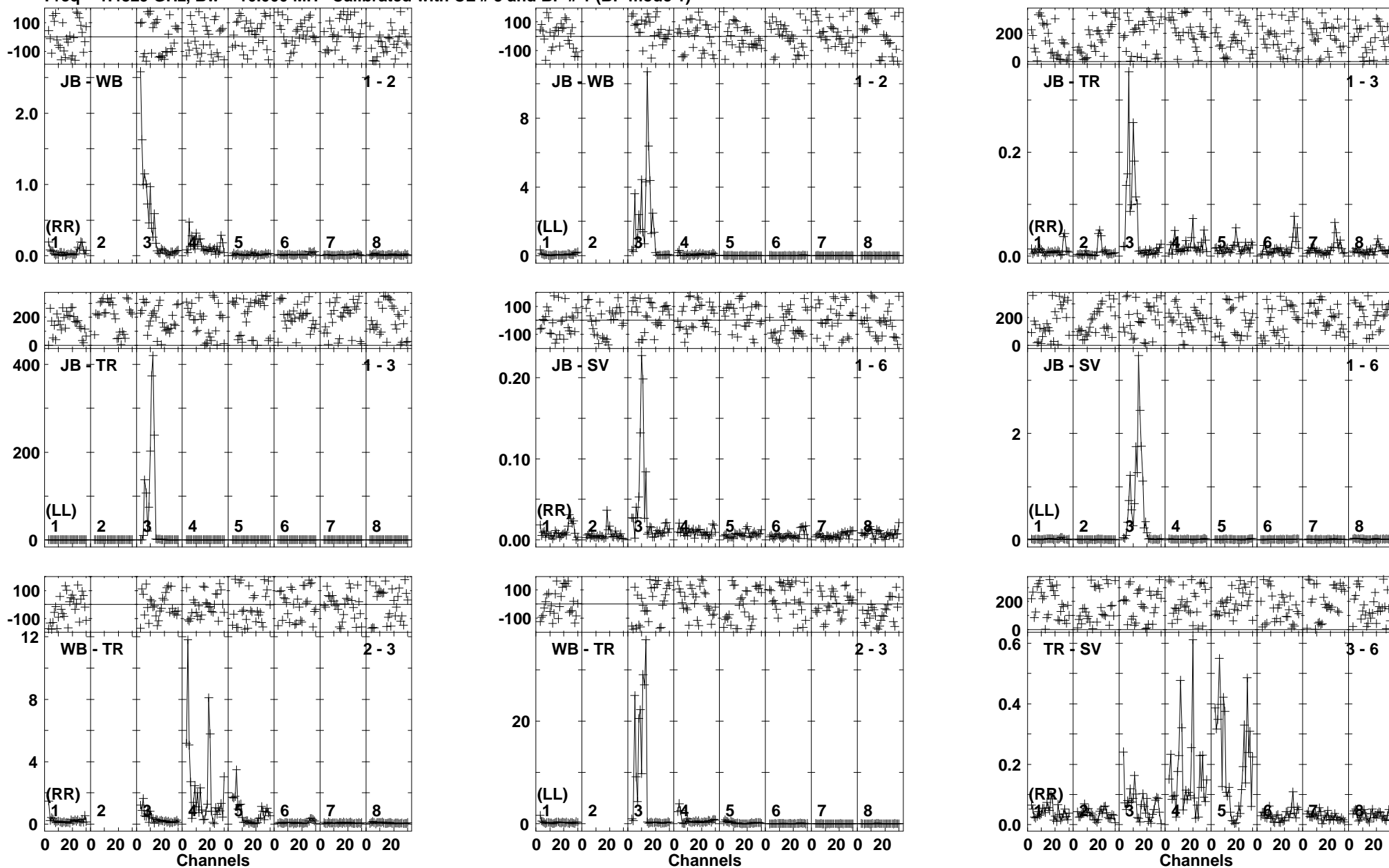

Lower frame: Ampl Jy Top frame: Phas deg
Vector averaged cross-power spectrum Baseline: JB (01) - WB (02)
Timerange: 00/11:59:26 to 00/12:02:54

Plot file version 372 created 21-JUN-2019 11:56:06
IRAS12112 EP111A 1.UVDATA.1
Freq = 1.4829 GHz, Bw = 16.000 MH Calibrated with CL # 3 and BP # 1 (BP mode 1)

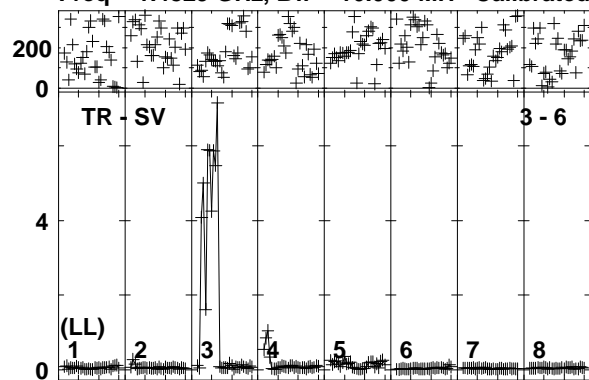

Lower frame: Ampl Jy Top frame: Phas deg
Vector averaged cross-power spectrum Baseline: TR (03) - SV (06)
Timerange: 00/11:59:26 to 00/12:02:54

Plot file version 373 created 21-JUN-2019 11:56:06

J1222+0413 EP111A 1.UVDATA.1

Freq = 1.4829 GHz, Bw = 16.000 MH Calibrated with CL # 3 and BP # 1 (BP mode 1)

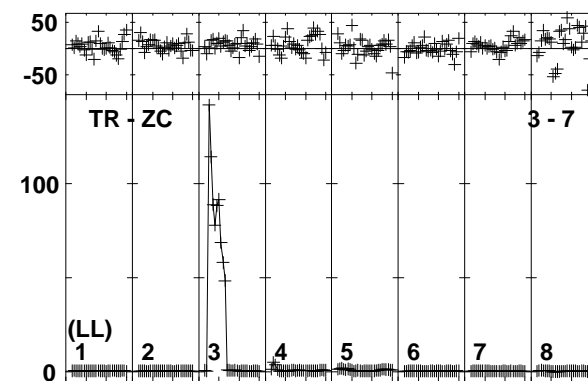
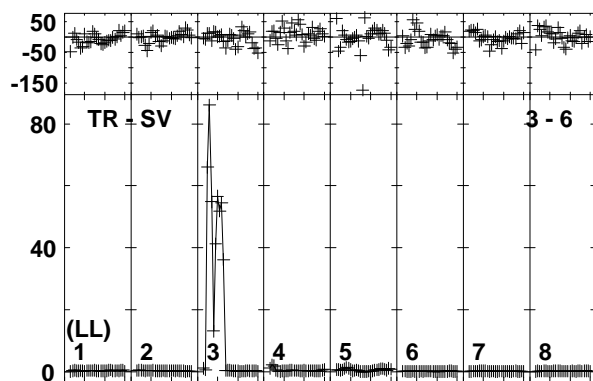
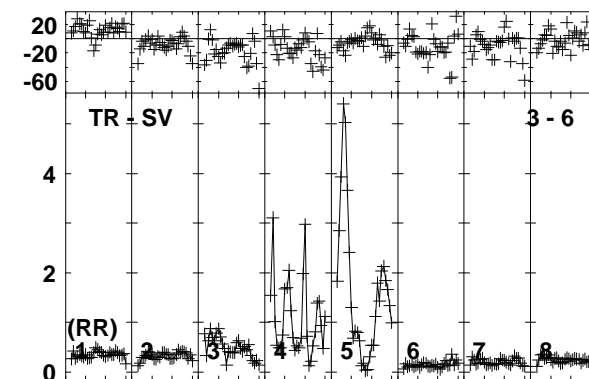
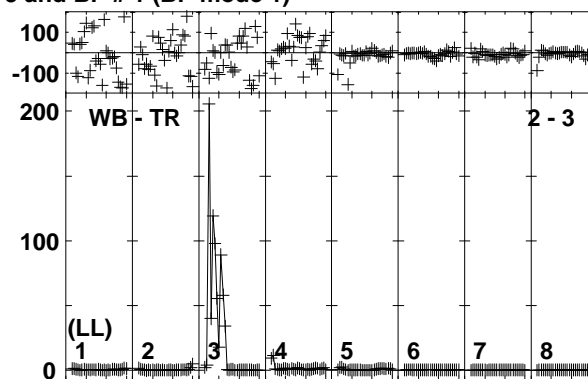
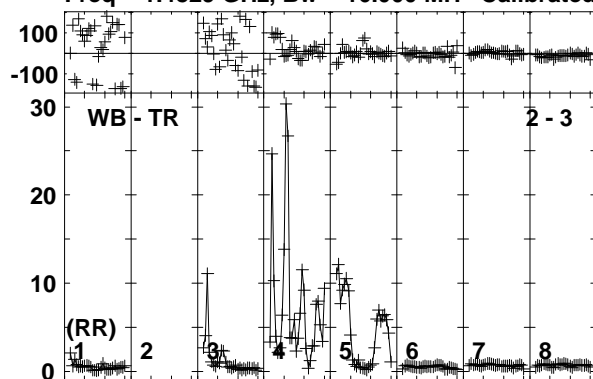

Lower frame: Ampl Jy Top frame: Phas deg
Vector averaged cross-power spectrum Baseline: WB (02) - TR (03)
Timerange: 00/12:02:56 to 00/12:04:24

Plot file version 374 created 21-JUN-2019 11:56:07

IRAS12112 EP111A 1.UVDATA.1

Freq = 1.4829 GHz, Bw = 16.000 MH Calibrated with CL # 3 and BP # 1 (BP mode 1)

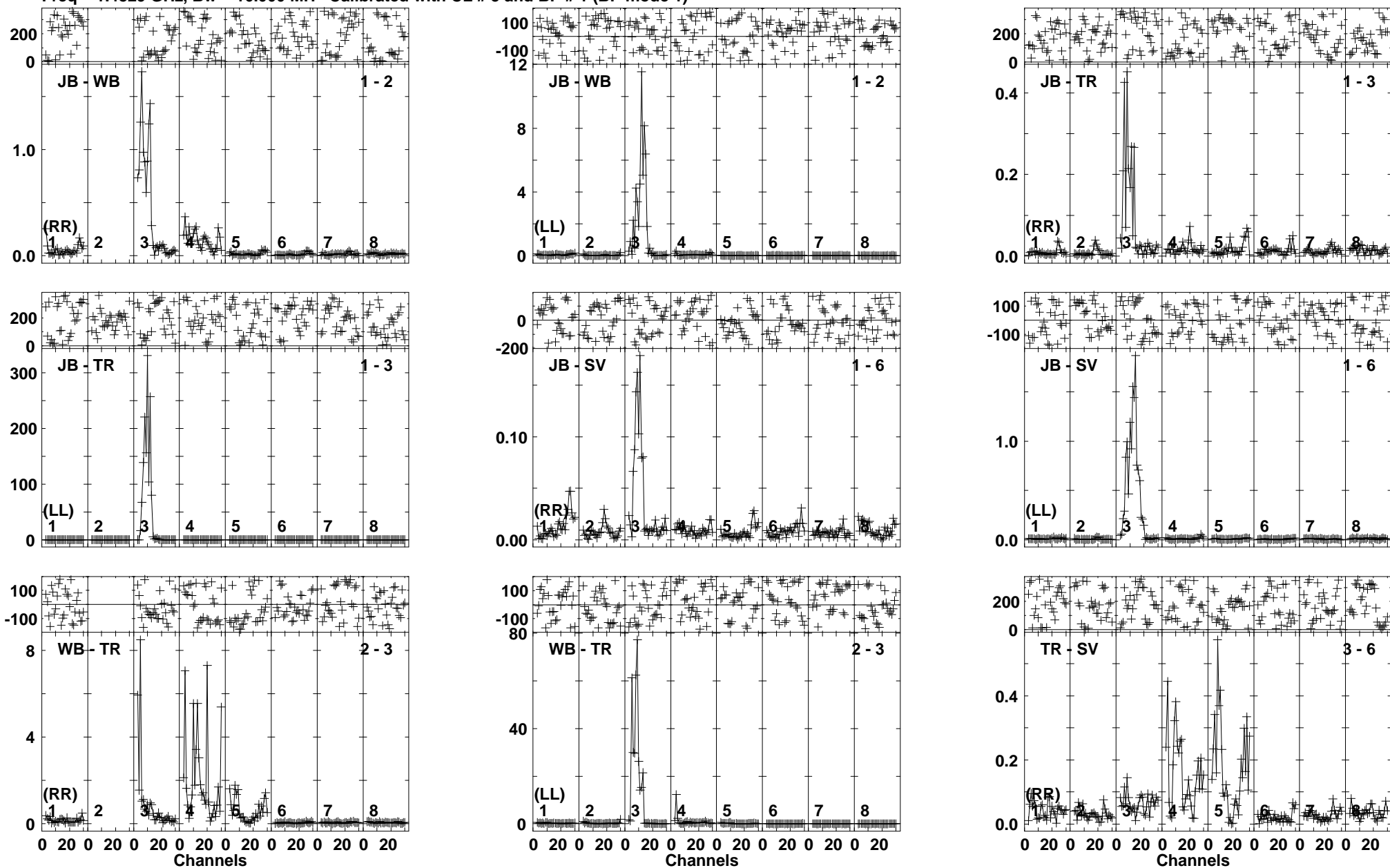

Lower frame: Ampl Jy Top frame: Phas deg
Vector averaged cross-power spectrum Baseline: JB (01) - WB (02)
Timerange: 00/12:04:26 to 00/12:07:54

Plot file version 375 created 21-JUN-2019 11:56:07
IRAS12112 EP111A 1.UVDATA.1
Freq = 1.4829 GHz, Bw = 16.000 MH Calibrated with CL # 3 and BP # 1 (BP mode 1)

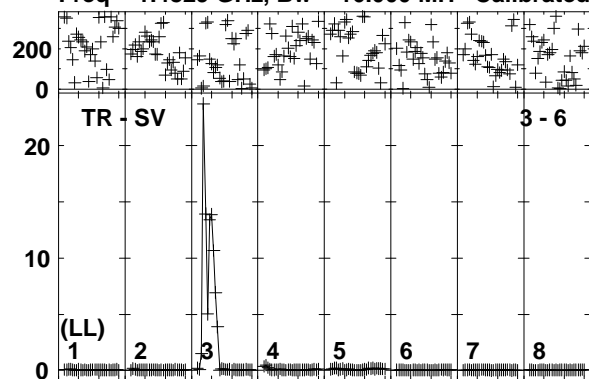

Lower frame: Ampl Jy Top frame: Phas deg
Vector averaged cross-power spectrum Baseline: TR (03) - SV (06)
Timerange: 00/12:04:26 to 00/12:07:54

Plot file version 376 created 21-JUN-2019 11:56:08

J1222+0413 EP111A 1.UVDATA.1

Freq = 1.4829 GHz, Bw = 16.000 MH Calibrated with CL # 3 and BP # 1 (BP mode 1)

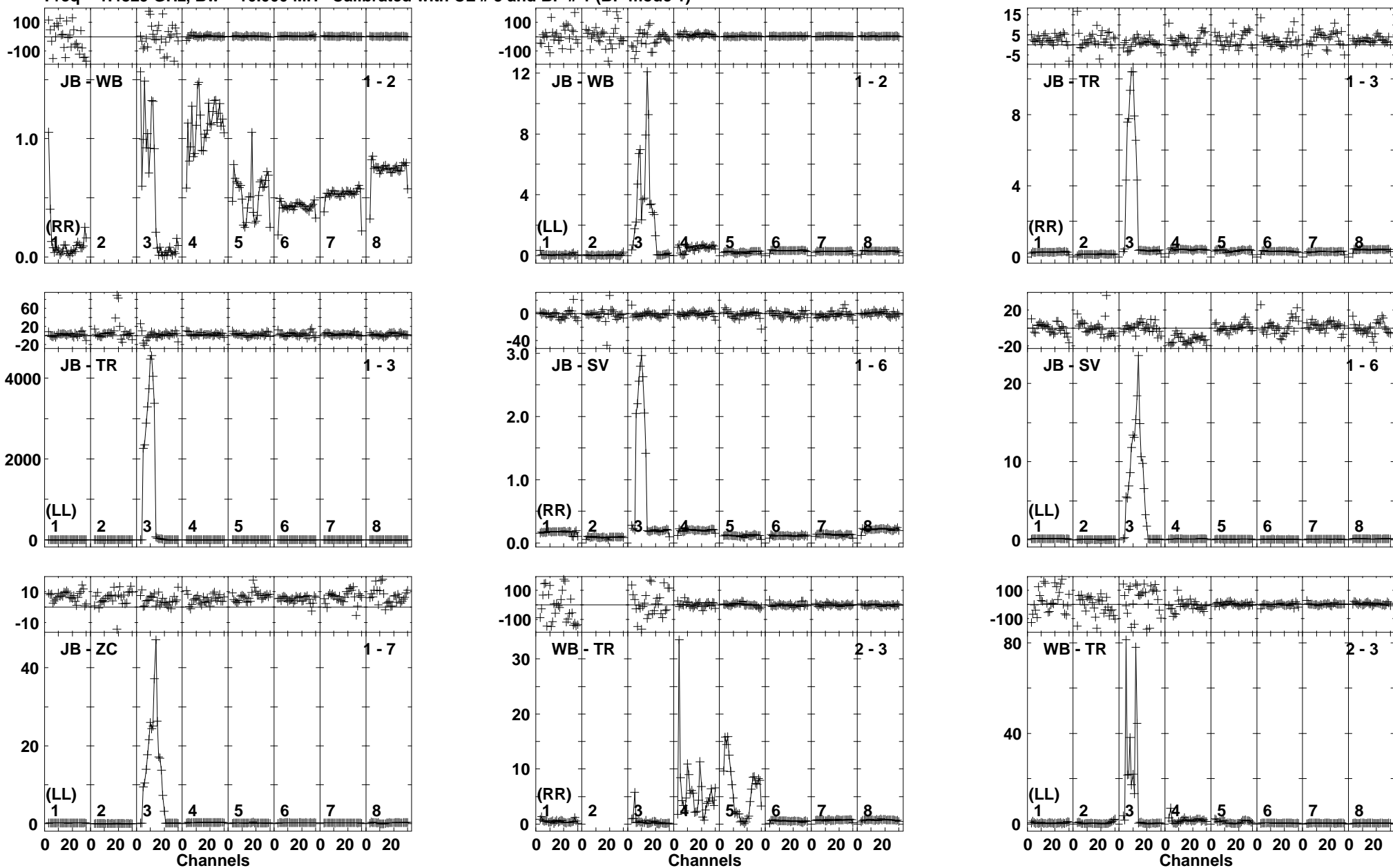

Lower frame: Ampl Jy Top frame: Phas deg
Vector averaged cross-power spectrum Baseline: JB (01) - WB (02)
Timerange: 00:12:08:36 to 00:12:10:04

Plot file version 377 created 21-JUN-2019 11:56:08

J1222+0413 EP111A 1.UVDATA.1

Freq = 1.4829 GHz, Bw = 16.000 MH Calibrated with CL # 3 and BP # 1 (BP mode 1)

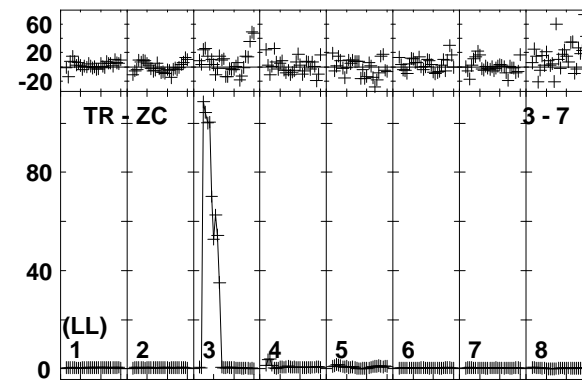
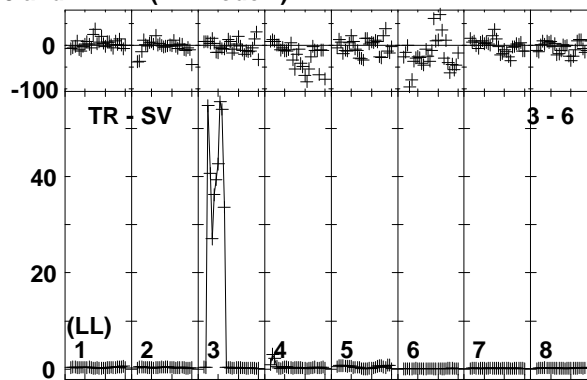
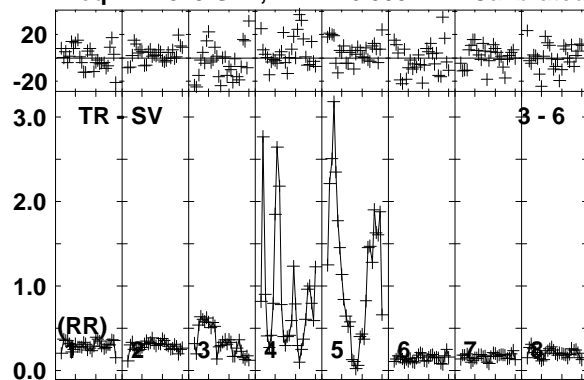

Lower frame: Ampl Jy Top frame: Phas deg
Vector averaged cross-power spectrum Baseline: TR (03) - SV (06)
Timerange: 00/12:08:36 to 00/12:10:04

Plot file version 378 created 21-JUN-2019 11:56:08

IRAS12112 EP111A 1.UVDATA.1

Freq = 1.4829 GHz, Bw = 16.000 MH Calibrated with CL # 3 and BP # 1 (BP mode 1)

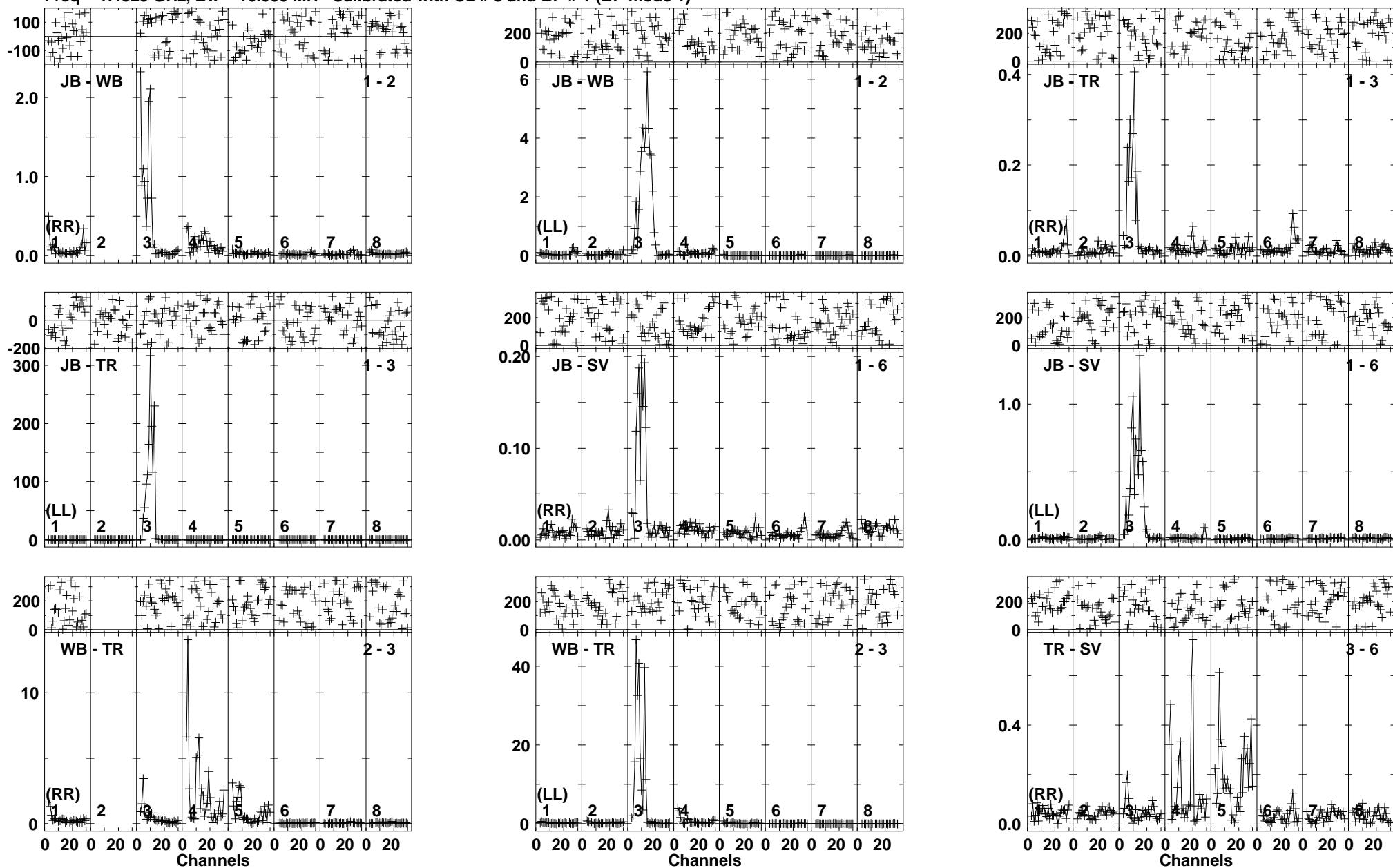

Lower frame: Ampl Jy Top frame: Phas deg
Vector averaged cross-power spectrum Baseline: JB (01) - WB (02)
Timerange: 00/12:10:06 to 00/12:13:34

Plot file version 379 created 21-JUN-2019 11:56:09
IRAS12112 EP111A 1.UVDATA.1
Freq = 1.4829 GHz, Bw = 16.000 MH Calibrated with CL # 3 and BP # 1 (BP mode 1)

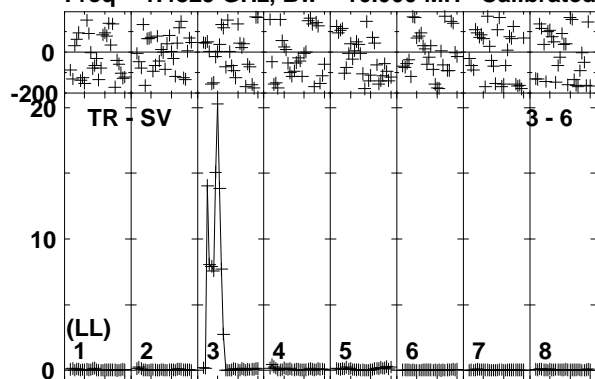

Lower frame: Ampl Jy Top frame: Phas deg
Vector averaged cross-power spectrum Baseline: TR (03) - SV (06)
Timerange: 00/12:10:06 to 00/12:13:34

Plot file version 380 created 21-JUN-2019 11:56:10

J1222+0413 EP111A 1.UVDATA.1

Freq = 1.4829 GHz, Bw = 16.000 MH Calibrated with CL # 3 and BP # 1 (BP mode 1)

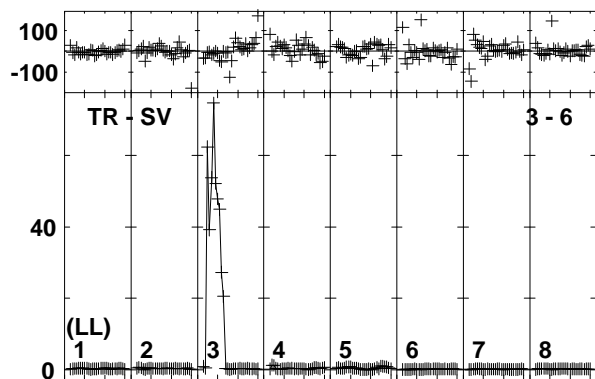
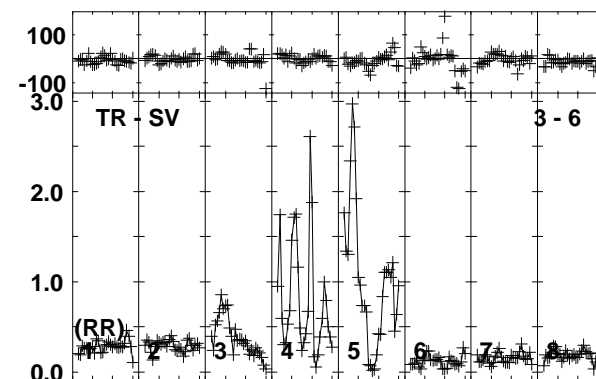
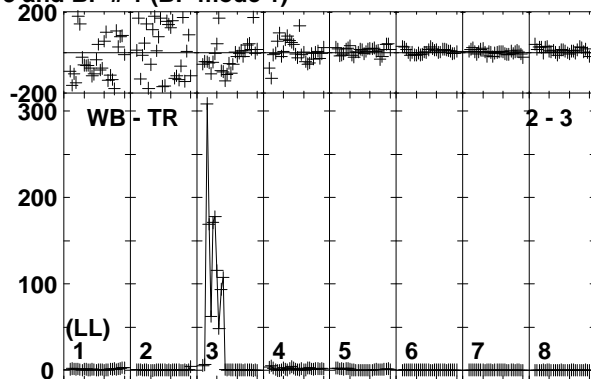
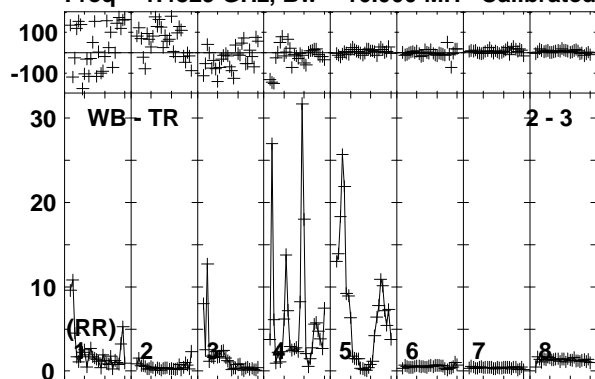

Lower frame: Ampl Jy Top frame: Phas deg
Vector averaged cross-power spectrum Baseline: WB (02) - TR (03)
Timerange: 00:12:13:36 to 00:12:15:04

Plot file version 381 created 21-JUN-2019 11:56:10

IRAS12112 EP111A 1.UVDATA.1

Freq = 1.4829 GHz, Bw = 16.000 MH Calibrated with CL # 3 and BP # 1 (BP mode 1)

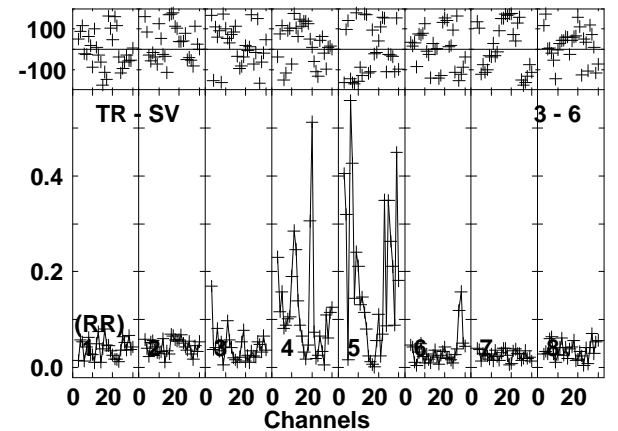
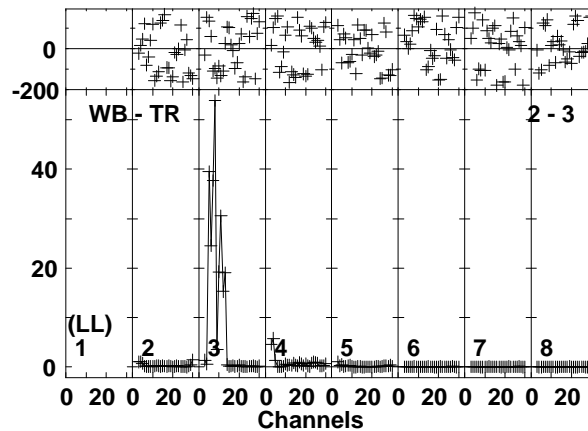
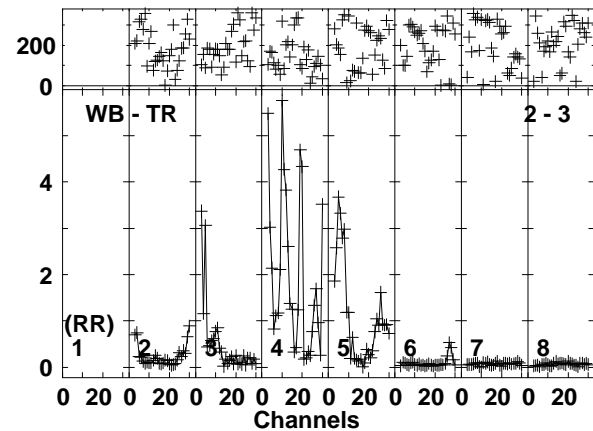
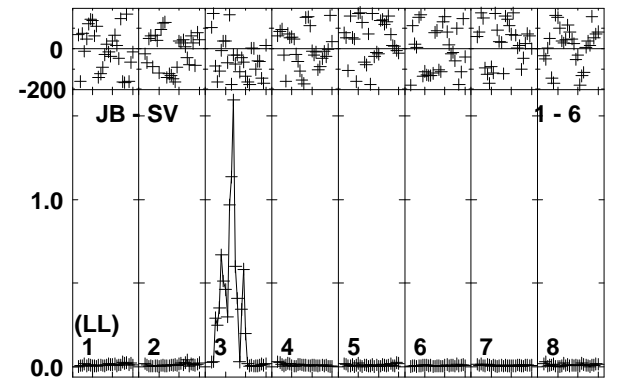
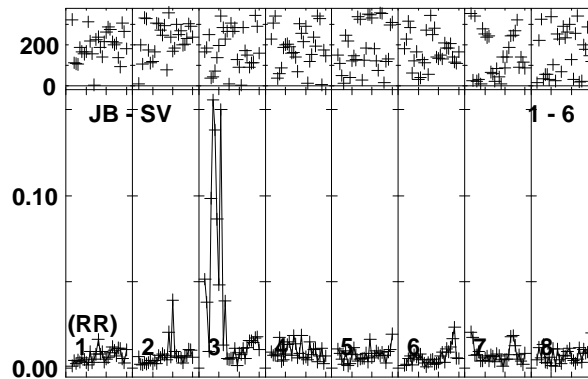
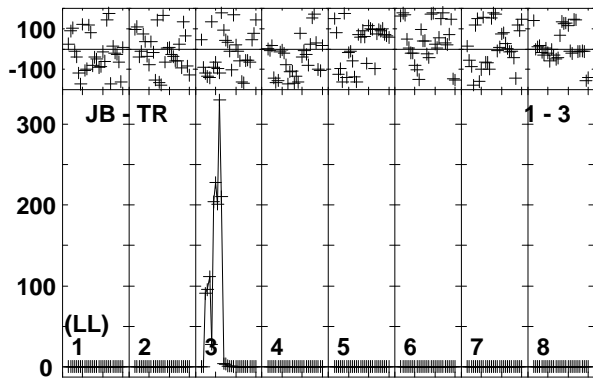
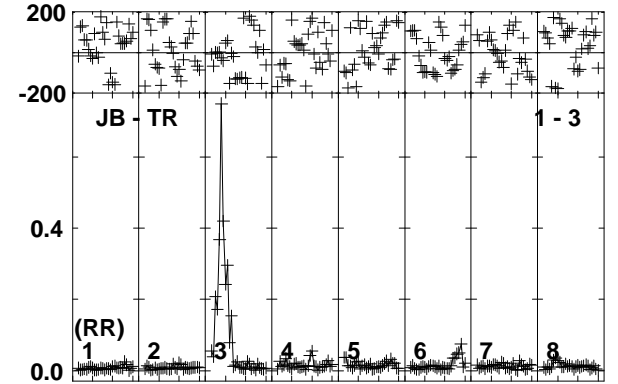
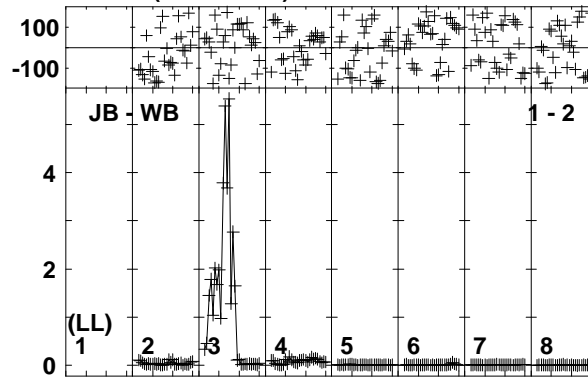
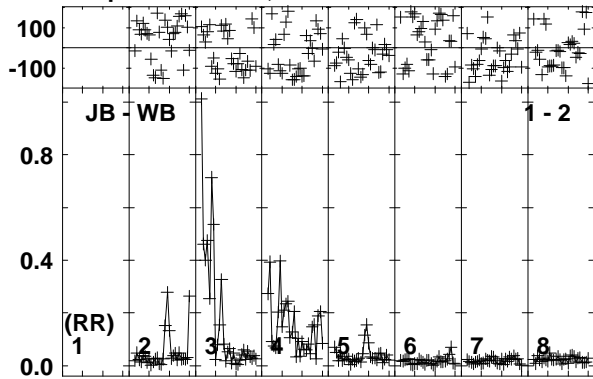

Lower frame: Ampl Jy Top frame: Phas deg
Vector averaged cross-power spectrum Baseline: JB (01) - WB (02)
Timerange: 00/12:15:06 to 00/12:18:34

Plot file version 382 created 21-JUN-2019 11:56:11
IRAS12112 EP111A 1.UVDATA.1
Freq = 1.4829 GHz, Bw = 16.000 MH Calibrated with CL # 3 and BP # 1 (BP mode 1)

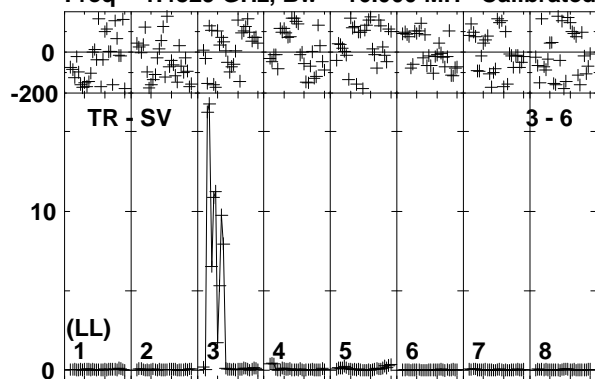

Lower frame: Ampl Jy Top frame: Phas deg
Vector averaged cross-power spectrum Baseline: TR (03) - SV (06)
Timerange: 00/12:15:06 to 00/12:18:34

Plot file version 383 created 21-JUN-2019 11:56:11

J1222+0413 EP111A 1.UVDATA.1

Freq = 1.4829 GHz, Bw = 16.000 MH Calibrated with CL # 3 and BP # 1 (BP mode 1)

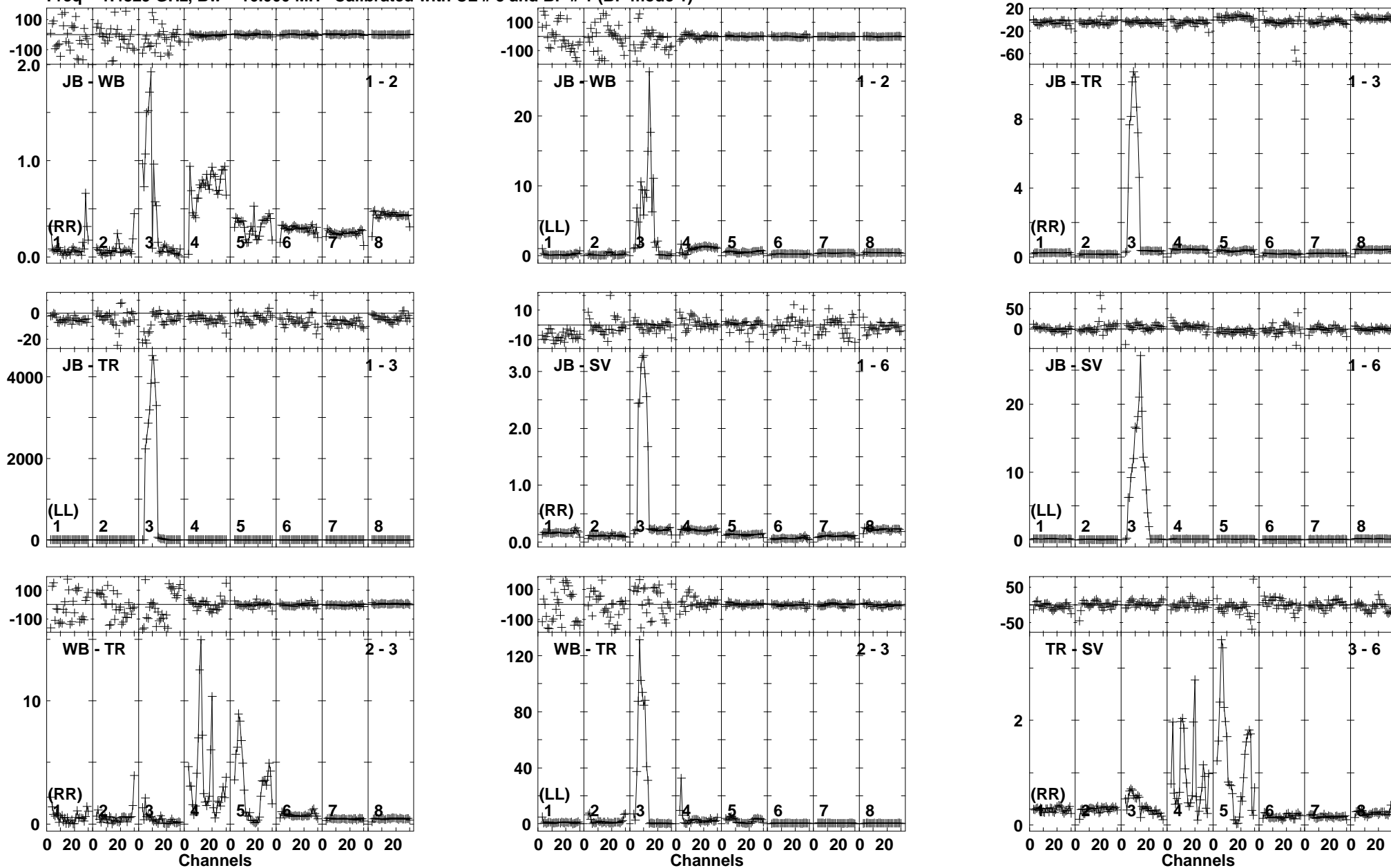

Lower frame: Ampl Jy Top frame: Phas deg
Vector averaged cross-power spectrum Baseline: JB (01) - WB (02)
Timerange: 00:12:19:16 to 00:12:20:44

Plot file version 384 created 21-JUN-2019 11:56:12
J1222+0413 EP111A 1.UVDATA.1
Freq = 1.4829 GHz, Bw = 16.000 MH Calibrated with CL # 3 and BP # 1 (BP mode 1)

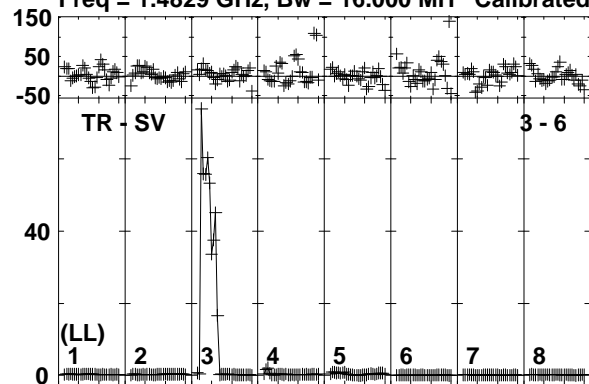

Lower frame: Ampl Jy Top frame: Phas deg
Vector averaged cross-power spectrum Baseline: TR (03) - SV (06)
Timerange: 00/12:19:16 to 00/12:20:44

Plot file version 385 created 21-JUN-2019 11:56:12

J1152-0841 EP111A 1.UVDATA.1

Freq = 1.4829 GHz, Bw = 16.000 MH Calibrated with CL # 3 and BP # 1 (BP mode 1)

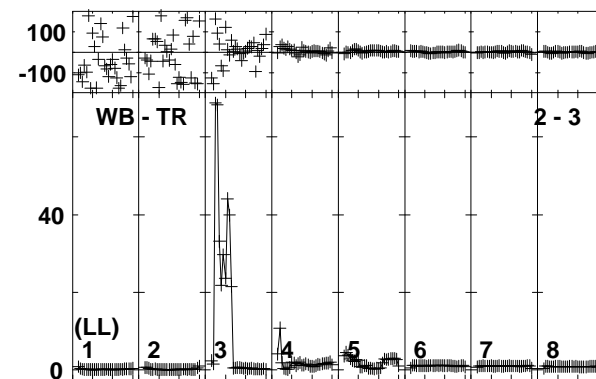
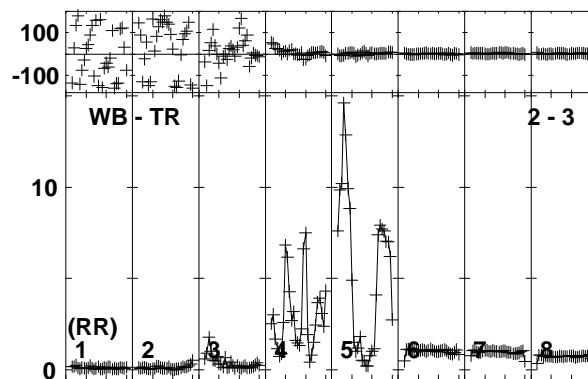
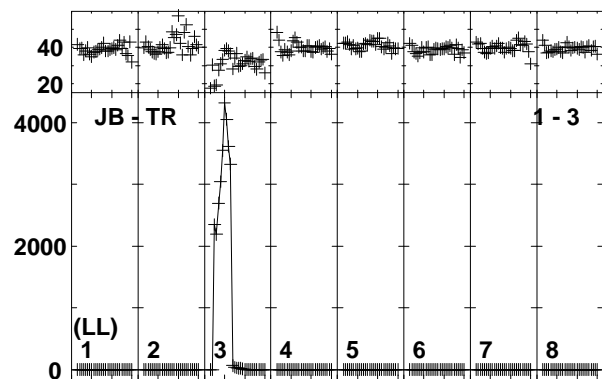
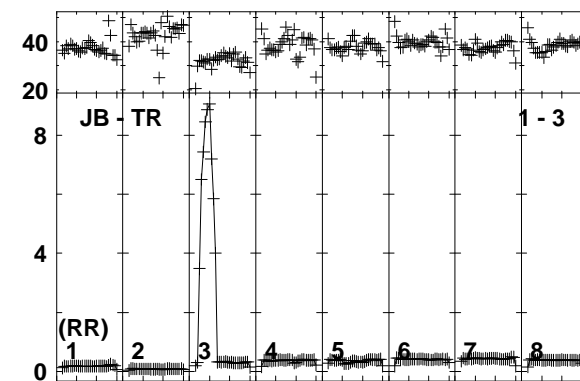
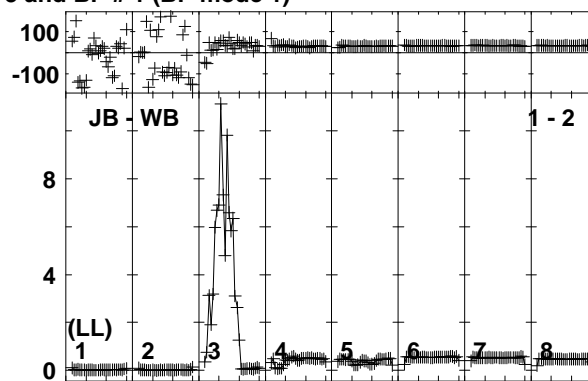
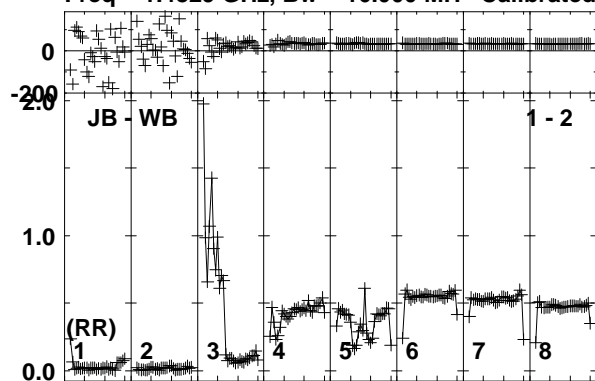

Lower frame: Ampl Jy Top frame: Phas deg
Vector averaged cross-power spectrum Baseline: JB (01) - WB (02)
Timerange: 00/12:23:01 to 00/12:26:23

Plot file version 386 created 21-JUN-2019 11:56:13

J1222+0413 EP111A 1.UVDATA.1

Freq = 1.4829 GHz, Bw = 16.000 MH Calibrated with CL # 3 and BP # 1 (BP mode 1)

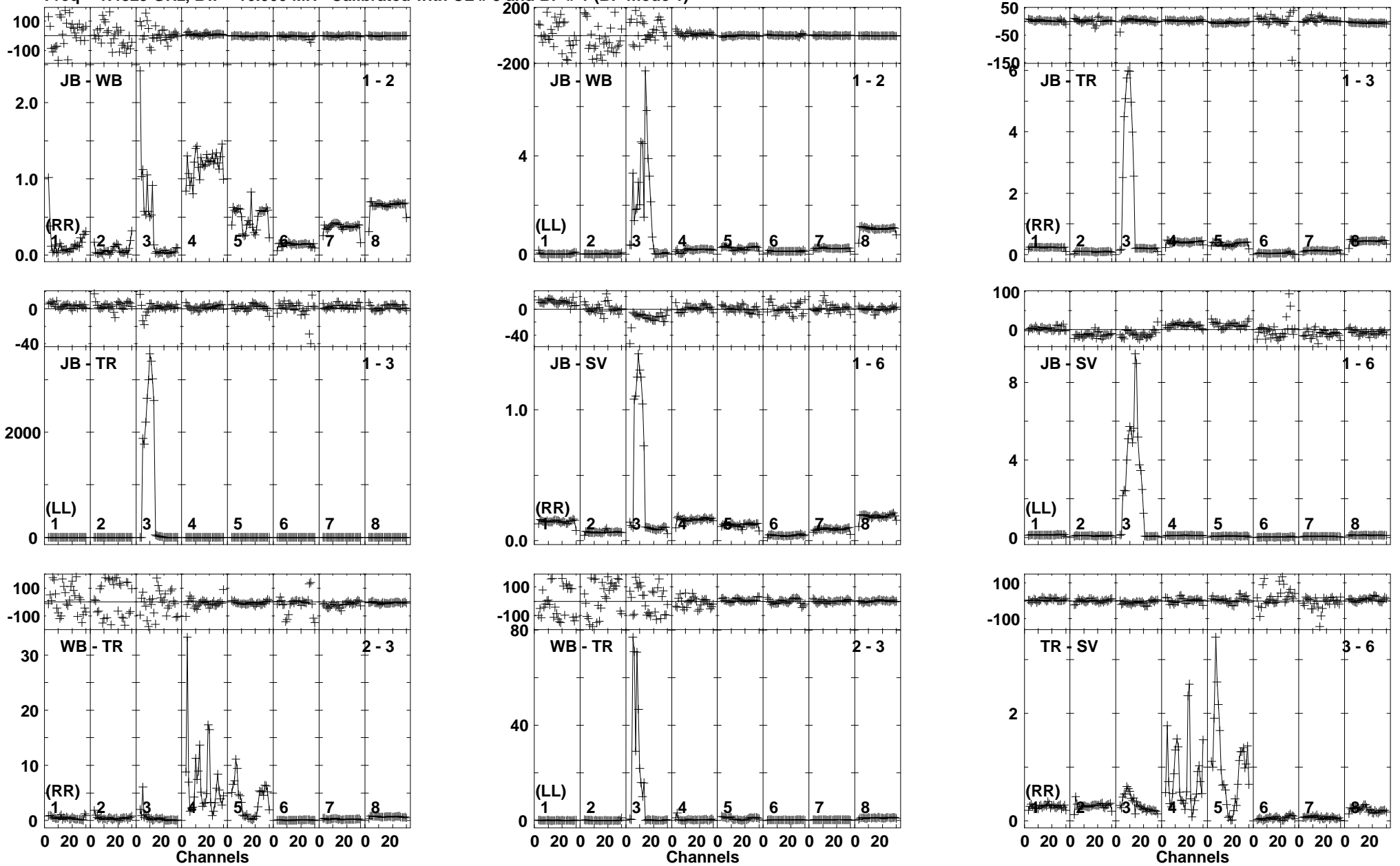

Lower frame: Ampl Jy Top frame: Phas deg
Vector averaged cross-power spectrum Baseline: JB (01) - WB (02)
Timerange: 00:12:28:41 to 00:12:30:39

Plot file version 387 created 21-JUN-2019 11:56:13
J1222+0413 EP111A 1.UVDATA.1
Freq = 1.4829 GHz, Bw = 16.000 MH Calibrated with CL # 3 and BP # 1 (BP mode 1)

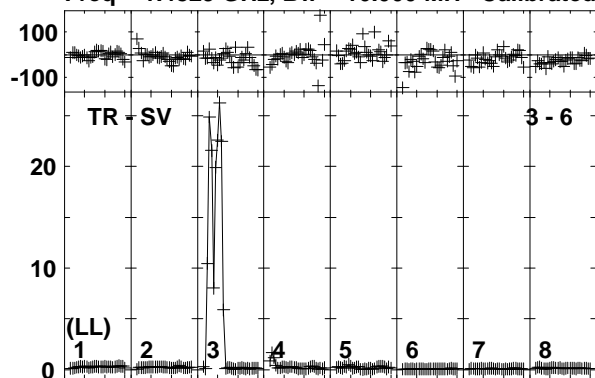

Lower frame: Ampl Jy Top frame: Phas deg
Vector averaged cross-power spectrum Baseline: TR (03) - SV (06)
Timerange: 00/12:28:41 to 00/12:30:39

Plot file version 388 created 21-JUN-2019 11:56:14
 IRAS12112 EP111A 1.UVDATA.1
 Freq = 1.4829 GHz, Bw = 16.000 MH Calibrated with CL # 3 and BP # 1 (BP mode 1)

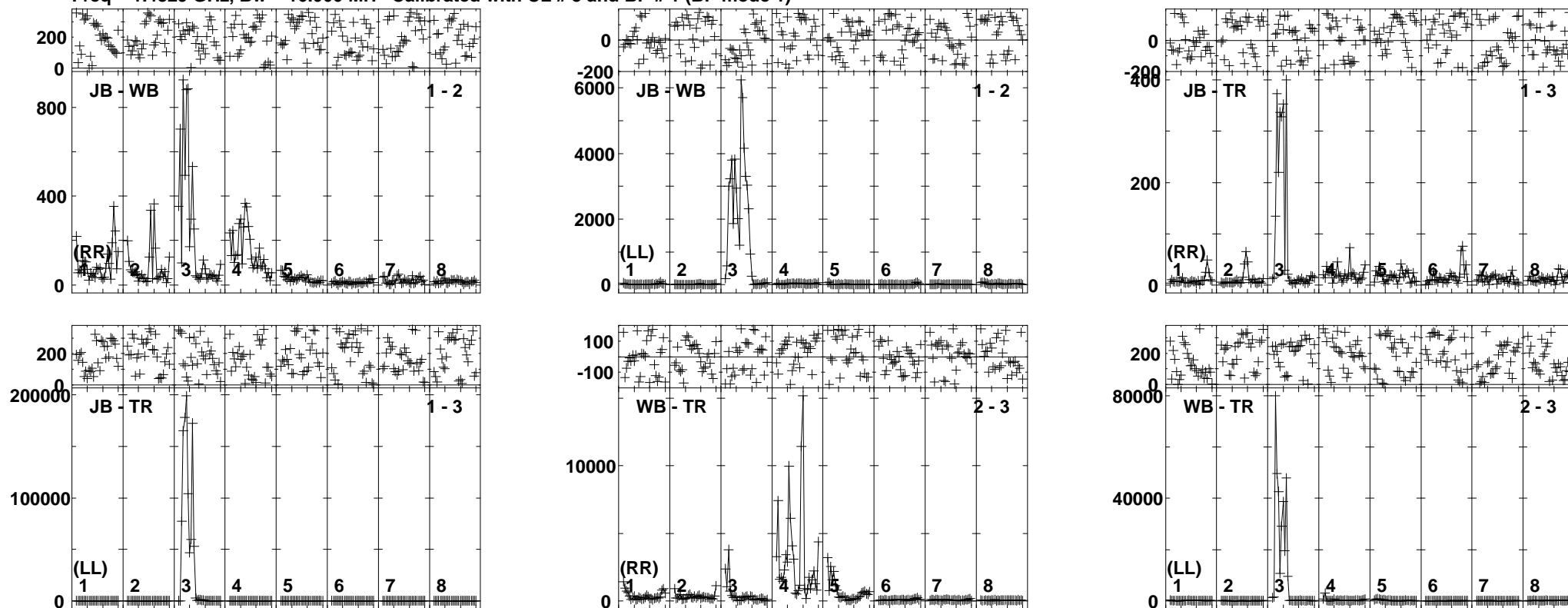

Lower frame: Milli Ampl Jy Top frame: Phas deg
 Vector averaged cross-power spectrum Baseline: JB (01) - WB (02)
 Timerange: 00/12:30:41 to 00/12:34:09

Plot file version 389 created 21-JUN-2019 11:56:15

J1222+0413 EP111A 1.UVDATA.1

Freq = 1.4829 GHz, Bw = 16.000 MH Calibrated with CL # 3 and BP # 1 (BP mode 1)

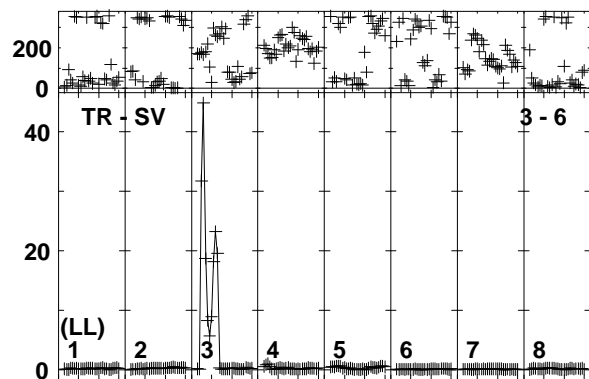
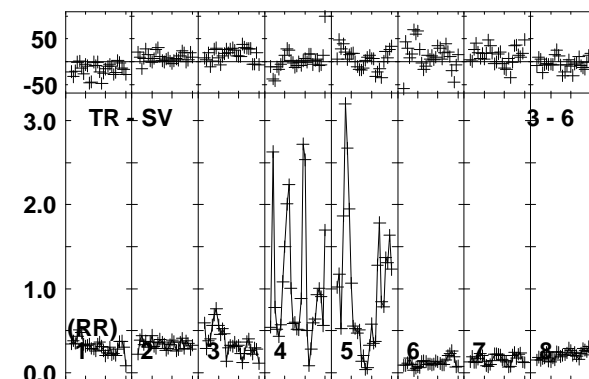
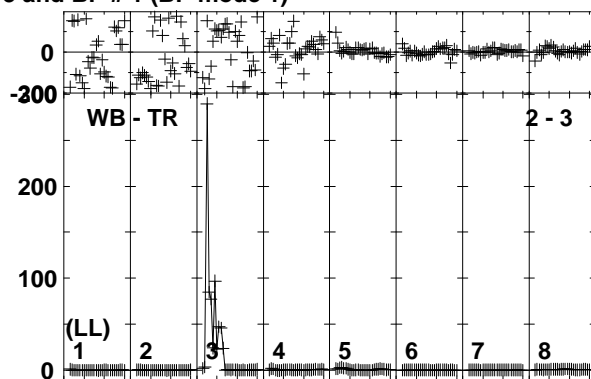
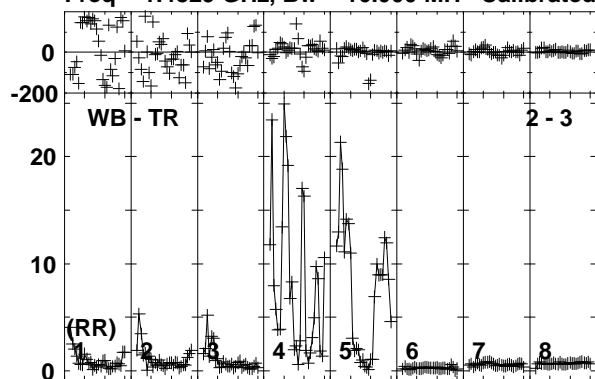

Lower frame: Ampl Jy Top frame: Phas deg
Vector averaged cross-power spectrum Baseline: WB (02) - TR (03)
Timerange: 00/12:34:11 to 00/12:35:39

Plot file version 390 created 21-JUN-2019 11:56:15

IRAS12112 EP111A 1.UVDATA.1

Freq = 1.4829 GHz, Bw = 16.000 MH Calibrated with CL # 3 and BP # 1 (BP mode 1)

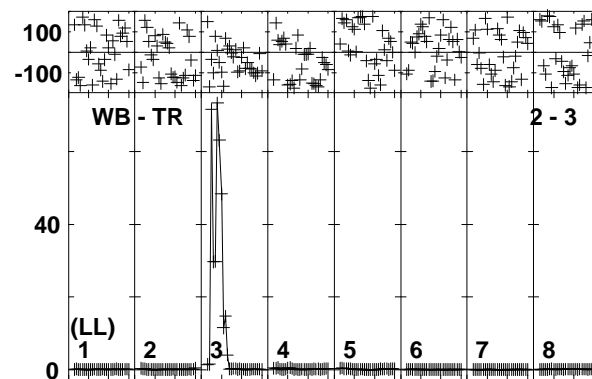
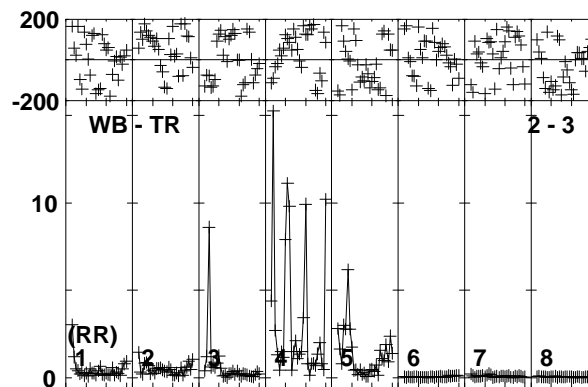
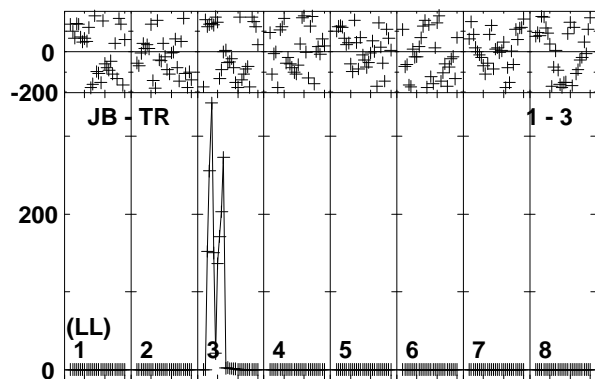
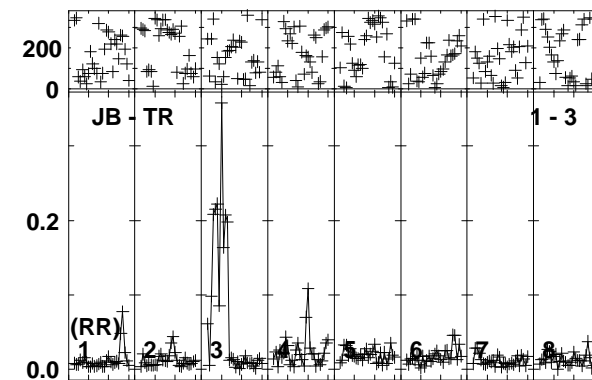
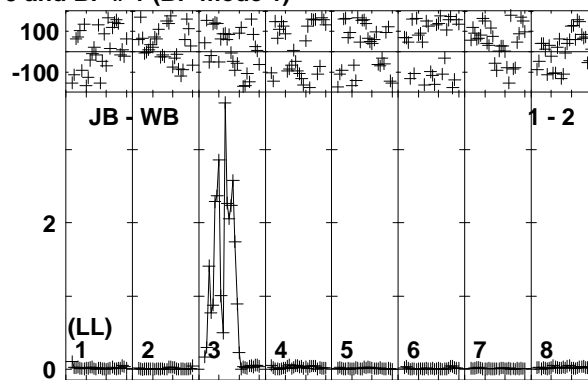
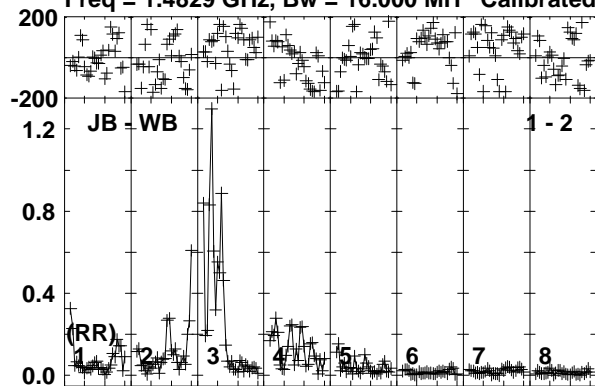

Lower frame: Ampl Jy Top frame: Phas deg
Vector averaged cross-power spectrum Baseline: JB (01) - WB (02)
Timerange: 00/12:35:41 to 00/12:39:09

Plot file version 391 created 21-JUN-2019 11:56:16

J1222+0413 EP111A 1.UVDATA.1

Freq = 1.4829 GHz, Bw = 16.000 MH Calibrated with CL # 3 and BP # 1 (BP mode 1)

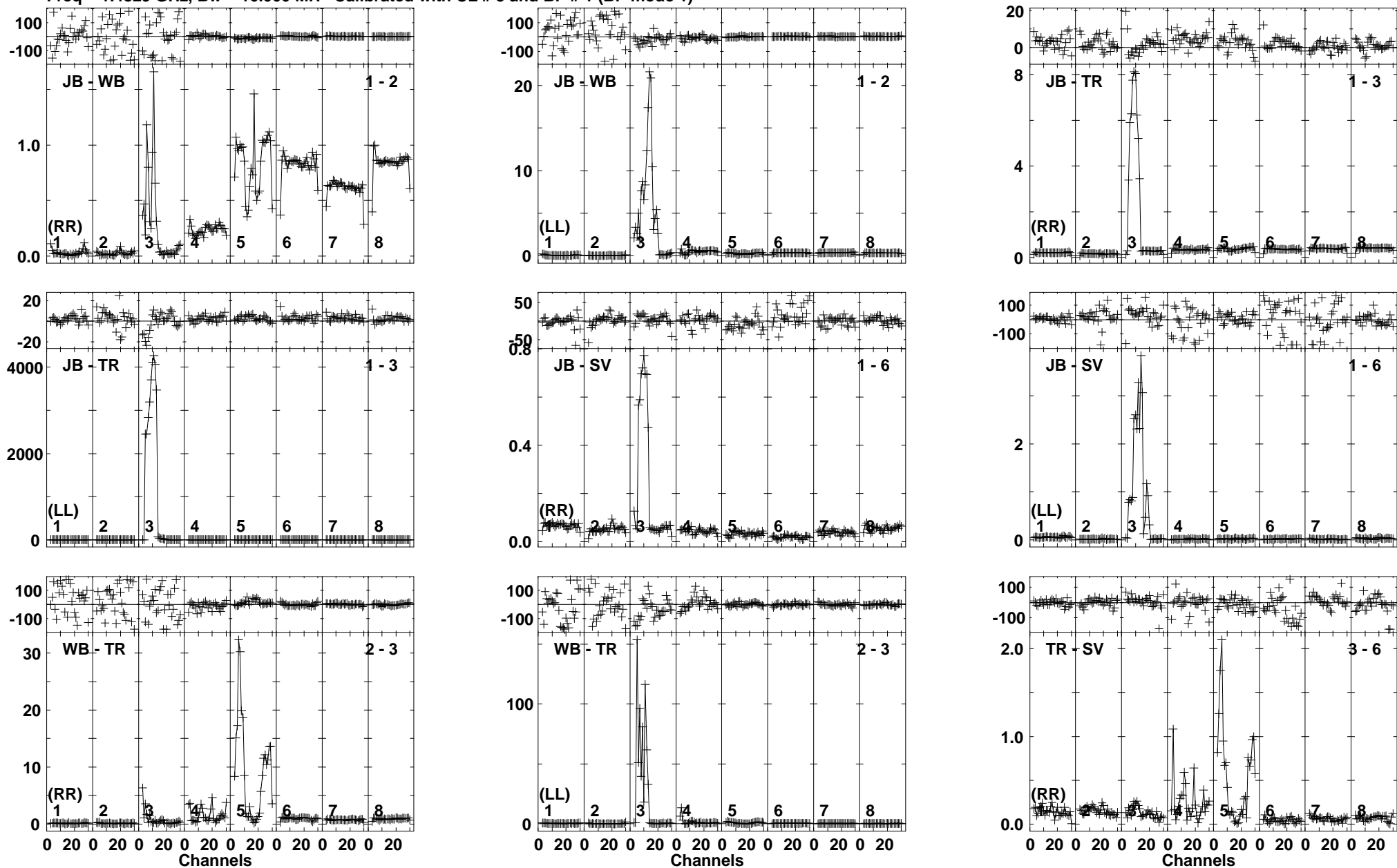

Lower frame: Ampl Jy Top frame: Phas deg
Vector averaged cross-power spectrum Baseline: JB (01) - WB (02)
Timerange: 00:12:39:51 to 00:12:41:19

Plot file version 392 created 21-JUN-2019 11:56:17
J1222+0413 EP111A 1.UVDATA.1
Freq = 1.4829 GHz, Bw = 16.000 MH Calibrated with CL # 3 and BP # 1 (BP mode 1)

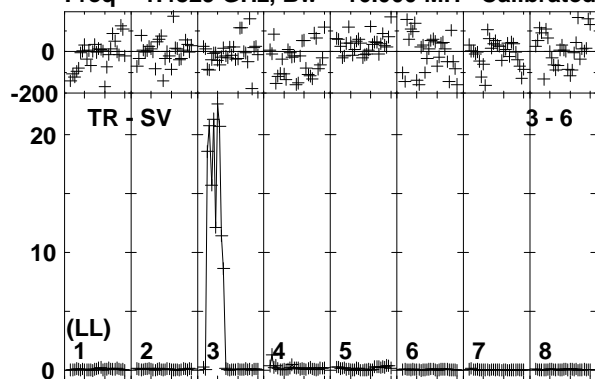

Lower frame: Ampl Jy Top frame: Phas deg
Vector averaged cross-power spectrum Baseline: TR (03) - SV (06)
Timerange: 00/12:39:51 to 00/12:41:19

Plot file version 393 created 21-JUN-2019 11:56:17

IRAS12112 EP111A 1.UVDATA.1

Freq = 1.4829 GHz, Bw = 16.000 MH Calibrated with CL # 3 and BP # 1 (BP mode 1)

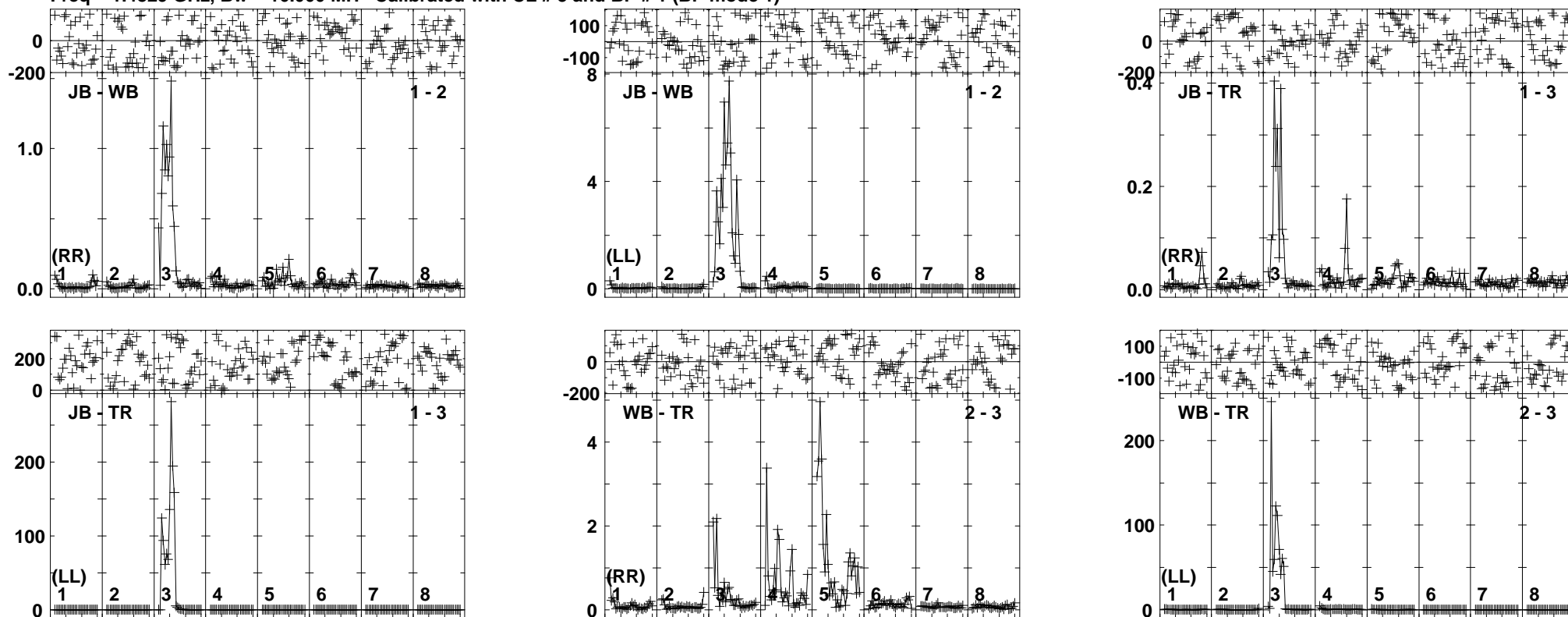

Lower frame: Ampl Jy Top frame: Phas deg
Vector averaged cross-power spectrum Baseline: JB (01) - WB (02)
Timerange: 00/12:41:21 to 00/12:44:49

Plot file version 394 created 21-JUN-2019 11:56:18
J1222+0413 EP111A 1.UVDATA.1
Freq = 1.4829 GHz, Bw = 16.000 MH Calibrated with CL # 3 and BP # 1 (BP mode 1)

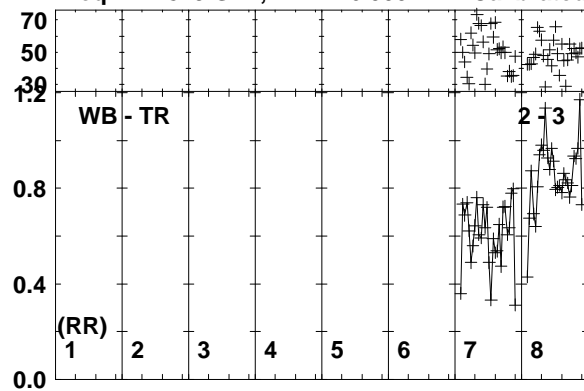

Lower frame: Ampl Jy Top frame: Phas deg
Vector averaged cross-power spectrum Baseline: WB (02) - TR (03)
Timerange: 00/12:44:51 to 00/12:46:19

Plot file version 395 created 21-JUN-2019 11:56:19

IRAS12112 EP111A 1.UVDATA.1

Freq = 1.4829 GHz, Bw = 16.000 MH Calibrated with CL # 3 and BP # 1 (BP mode 1)

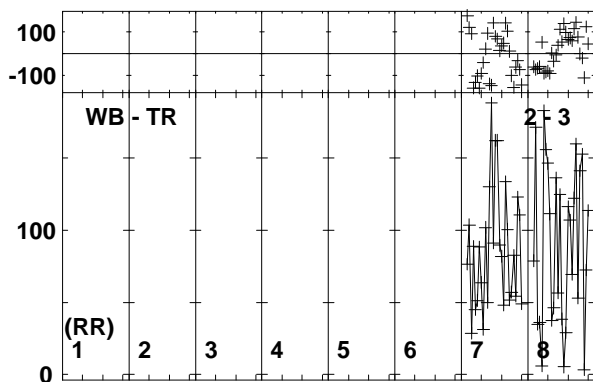
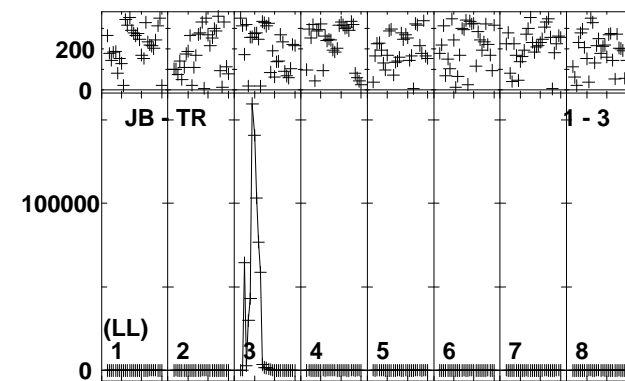
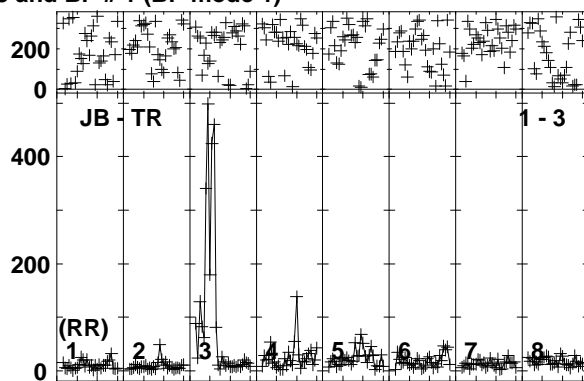
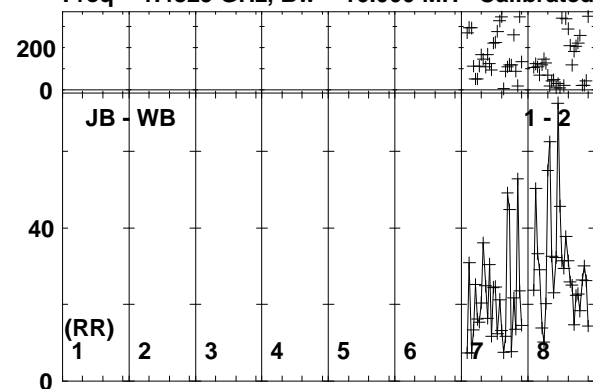

Lower frame: Milli Ampl Jy Top frame: Phas deg
Vector averaged cross-power spectrum Baseline: JB (01) - WB (02)
Timerange: 00/12:46:21 to 00/12:49:49

Plot file version 396 created 21-JUN-2019 11:56:20

J1222+0413 EP111A 1.UVDATA.1

Freq = 1.4829 GHz, Bw = 16.000 MH Calibrated with CL # 3 and BP # 1 (BP mode 1)

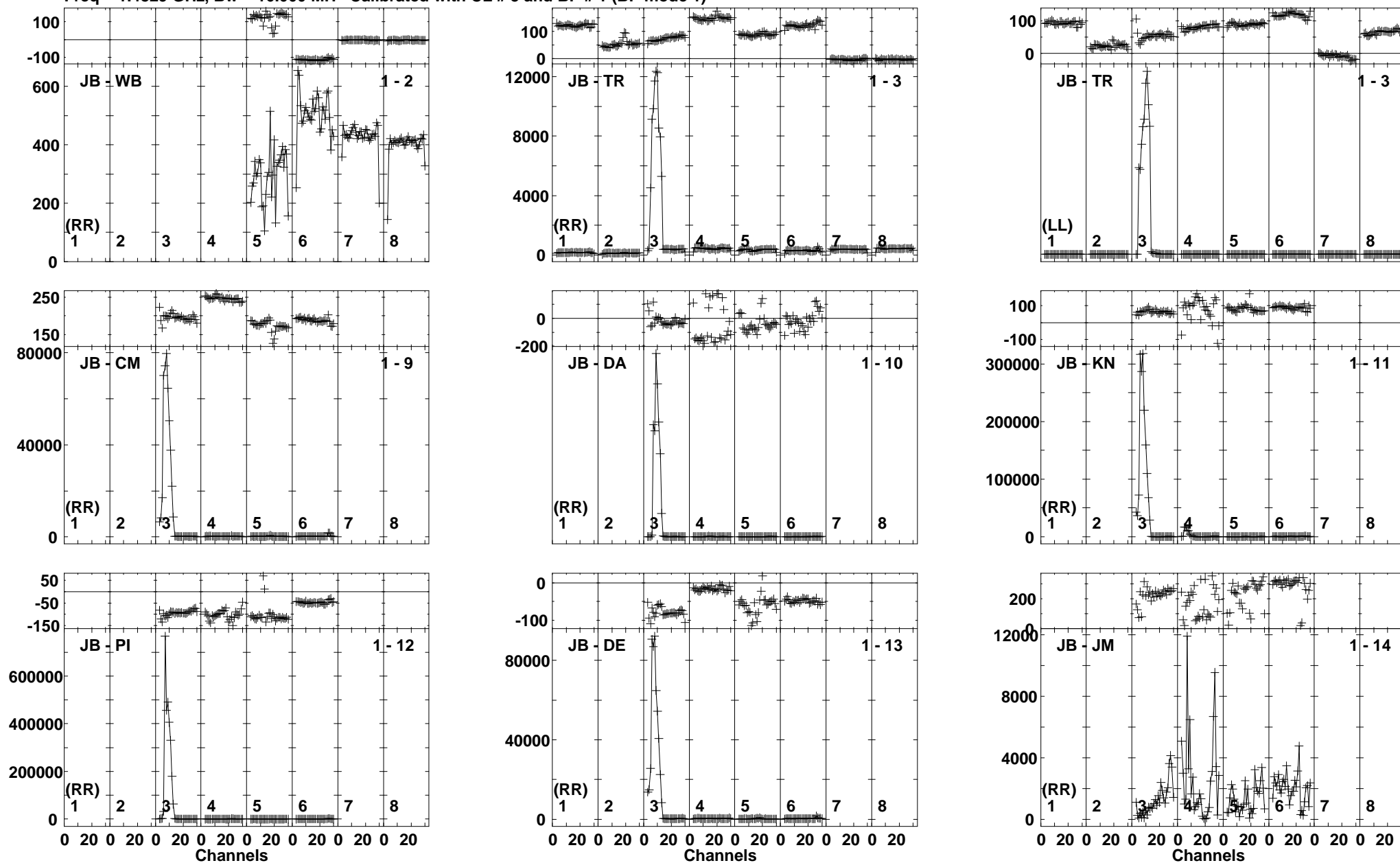

Lower frame: Milli Ampl Jy Top frame: Phas deg
Vector averaged cross-power spectrum Baseline: JB (01) - WB (02)
Timerange: 00:12:50:31 to 00:12:51:59

Plot file version 397 created 21-JUN-2019 11:56:20

J1222+0413 EP111A 1.UVDATA.1

Freq = 1.4829 GHz, Bw = 16.000 MH Calibrated with CL # 3 and BP # 1 (BP mode 1)

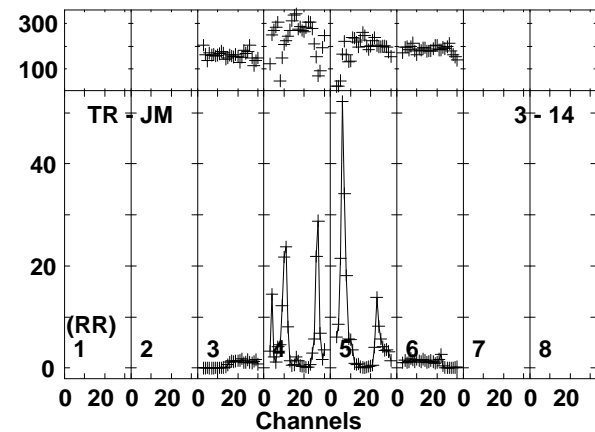
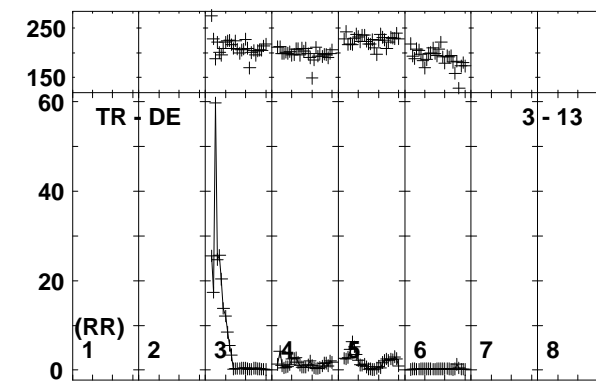
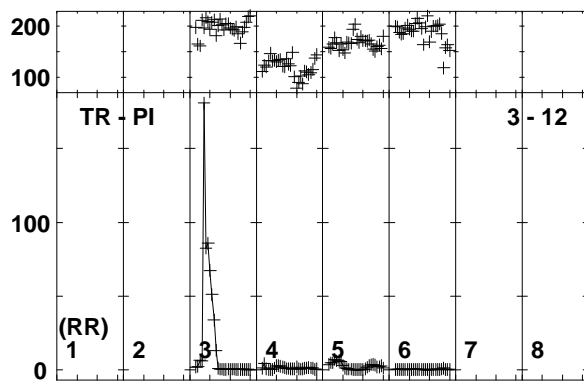
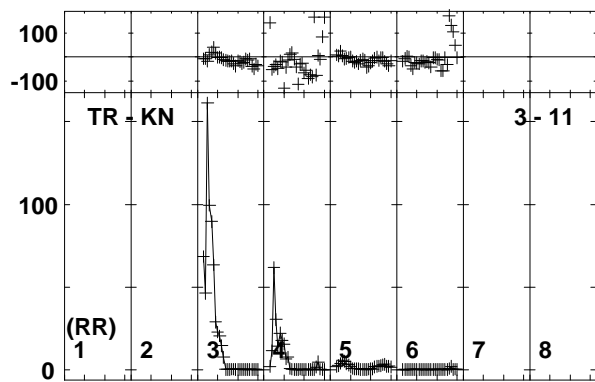
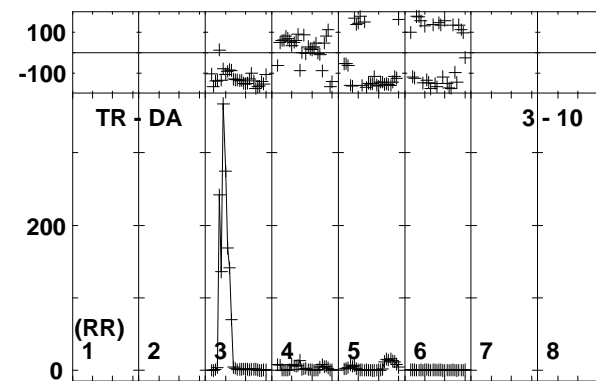
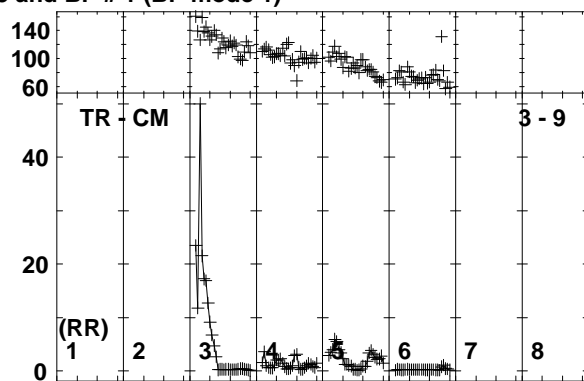
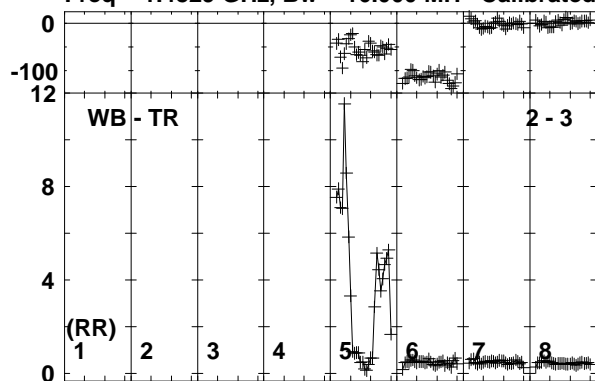

Lower frame: Ampl Jy Top frame: Phas deg
Vector averaged cross-power spectrum Baseline: WB (02) - TR (03)
Timerange: 00/12:50:31 to 00/12:51:59

Plot file version 398 created 21-JUN-2019 11:56:21
 IRAS12112 EP111A 1.UVDATA.1
 Freq = 1.4829 GHz, Bw = 16.000 MH Calibrated with CL # 3 and BP # 1 (BP mode 1)

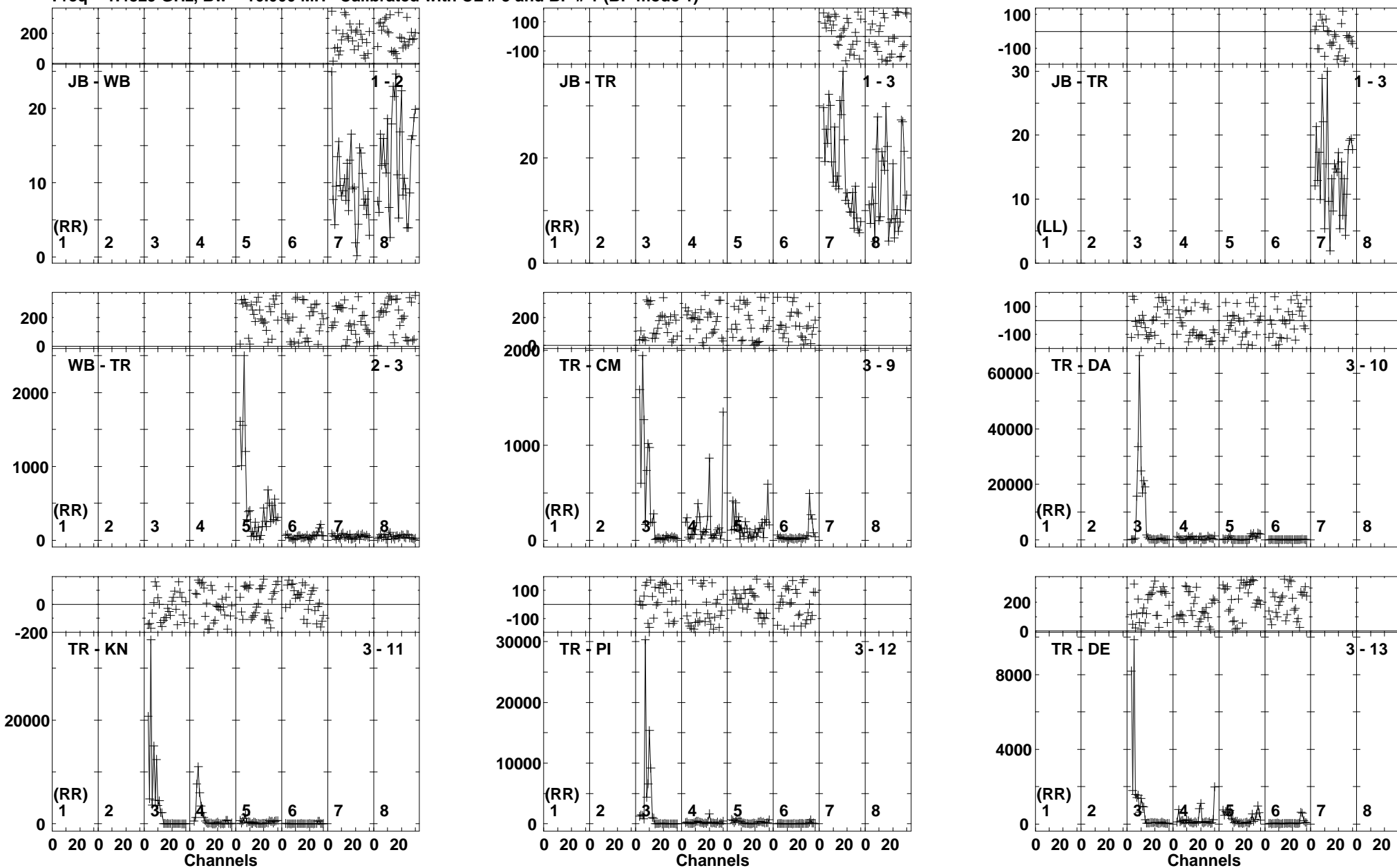

Lower frame: Milli Ampl Jy Top frame: Phas deg
 Vector averaged cross-power spectrum Baseline: JB (01) - WB (02)
 Timerange: 00/12:52:01 to 00/12:55:29

Plot file version 399 created 21-JUN-2019 11:56:22
IRAS12112 EP111A 1.UVDATA.1
Freq = 1.4829 GHz, Bw = 16.000 MH Calibrated with CL # 3 and BP # 1 (BP mode 1)

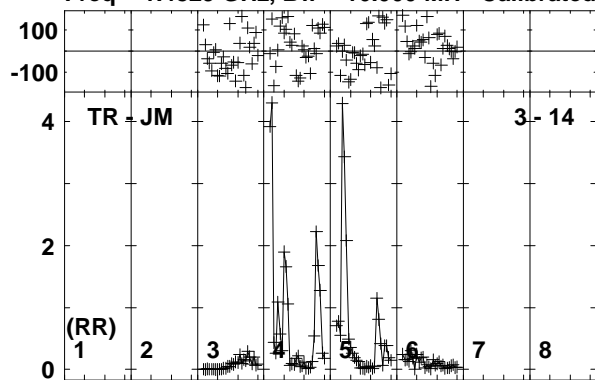

Lower frame: Ampl Jy Top frame: Phas deg
Vector averaged cross-power spectrum Baseline: TR (03) - JM (14)
Timerange: 00/12:52:01 to 00/12:55:29

Plot file version 400 created 21-JUN-2019 11:56:23

J1222+0413 EP111A 1.UVDATA.1

Freq = 1.4829 GHz, Bw = 16.000 MH Calibrated with CL # 3 and BP # 1 (BP mode 1)

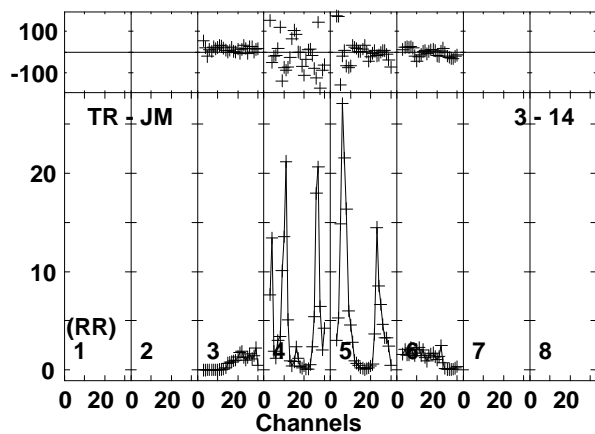
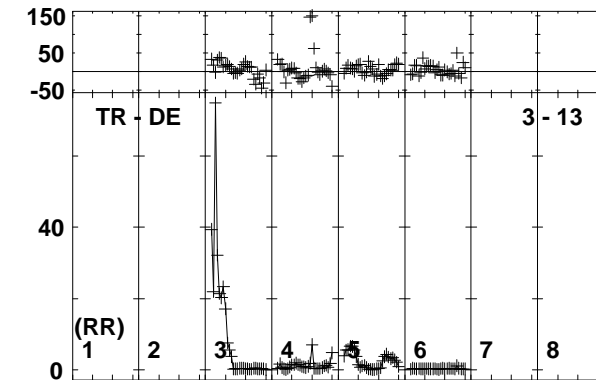
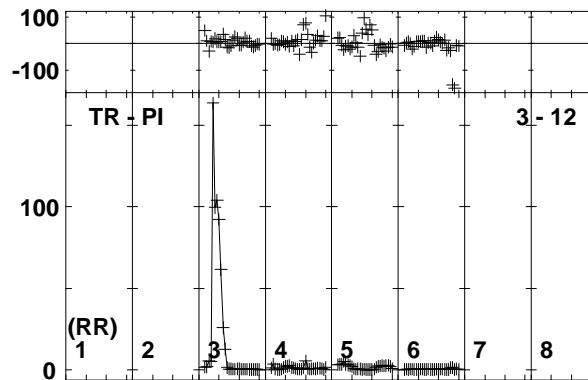
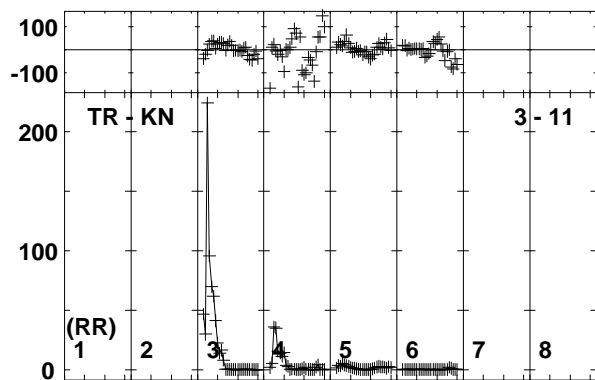
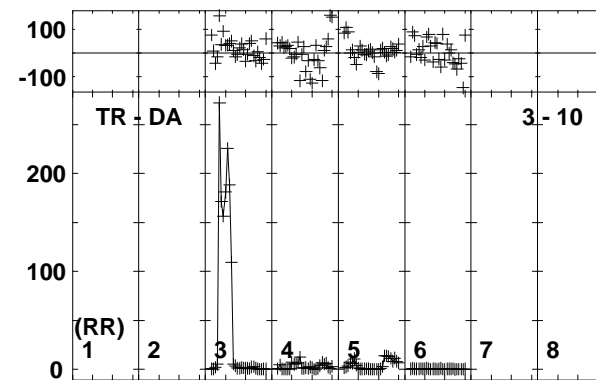
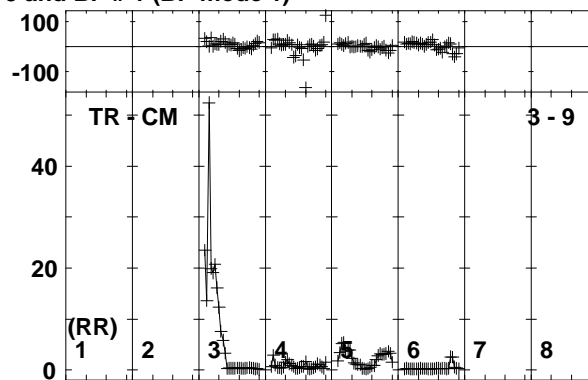
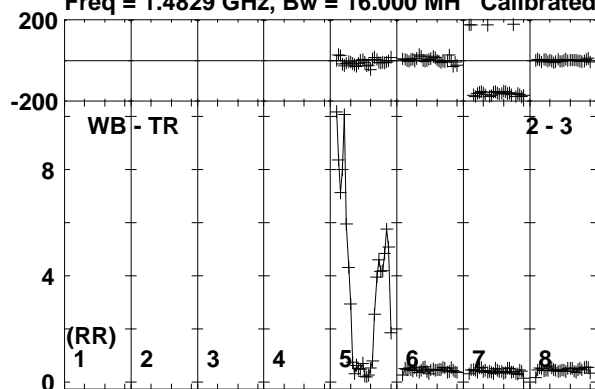

Lower frame: Ampl Jy Top frame: Phas deg
Vector averaged cross-power spectrum Baseline: WB (02) - TR (03)
Timerange: 00/12:55:31 to 00/12:56:59

Plot file version 401 created 21-JUN-2019 11:56:23

IRAS12112 EP111A 1.UVDATA.1

Freq = 1.4829 GHz, Bw = 16.000 MH Calibrated with CL # 3 and BP # 1 (BP mode 1)

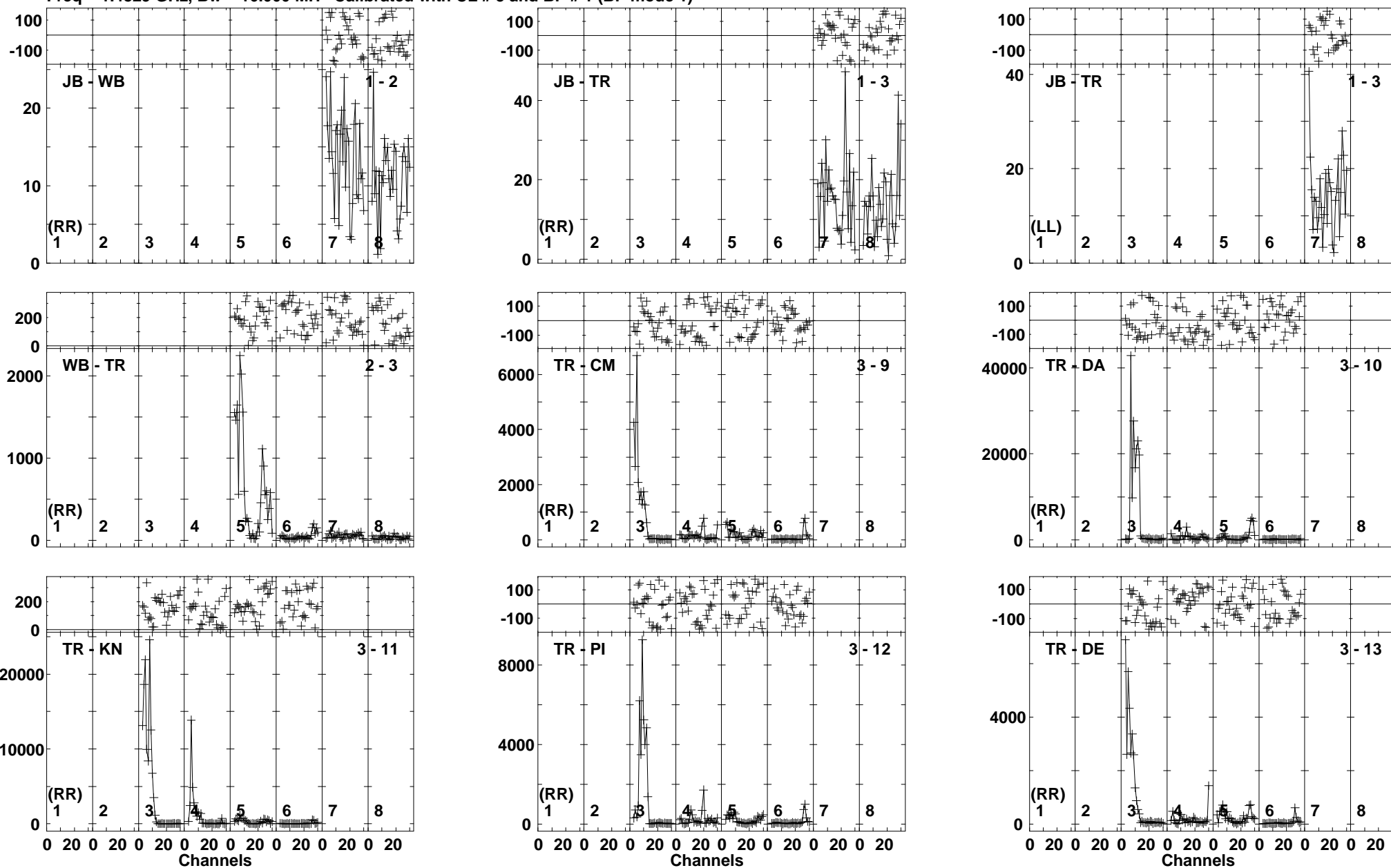

Lower frame: Milli Ampl Jy Top frame: Phas deg
Vector averaged cross-power spectrum Baseline: JB (01) - WB (02)
Timerange: 00/12:57:01 to 00/13:00:29

Plot file version 402 created 21-JUN-2019 11:56:24
IRAS12112 EP111A 1.UVDATA.1
Freq = 1.4829 GHz, Bw = 16.000 MH Calibrated with CL # 3 and BP # 1 (BP mode 1)

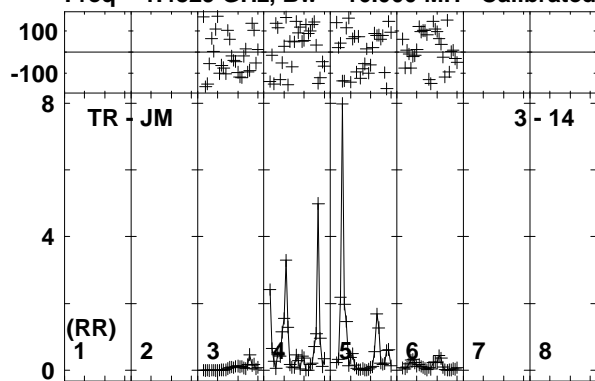

Lower frame: Ampl Jy Top frame: Phas deg
Vector averaged cross-power spectrum Baseline: TR (03) - JM (14)
Timerange: 00/12:57:01 to 00/13:00:29

Plot file version 403 created 21-JUN-2019 11:56:24

J1222+0413 EP111A 1.UVDATA.1

Freq = 1.4829 GHz, Bw = 16.000 MH Calibrated with CL # 3 and BP # 1 (BP mode 1)

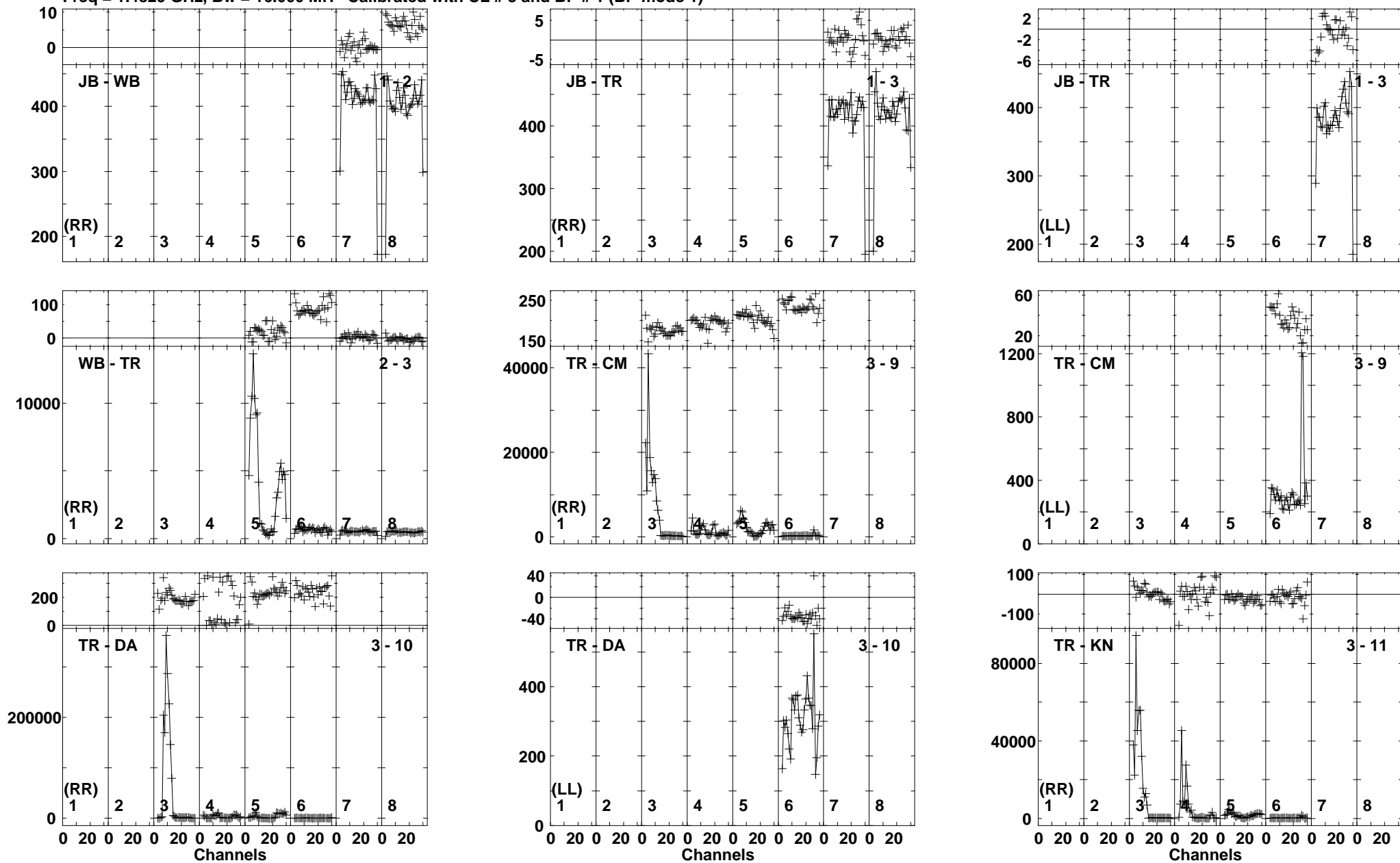

Lower frame: Milli Ampl Jy Top frame: Phas deg
Vector averaged cross-power spectrum Baseline: JB (01) - WB (02)
Timerange: 00/13:01:11 to 00/13:02:39

Plot file version 404 created 21-JUN-2019 11:56:25
 J1222+0413 EP111A 1.UVDATA.1
 Freq = 1.4829 GHz, Bw = 16.000 MH Calibrated with CL # 3 and BP # 1 (BP mode 1)

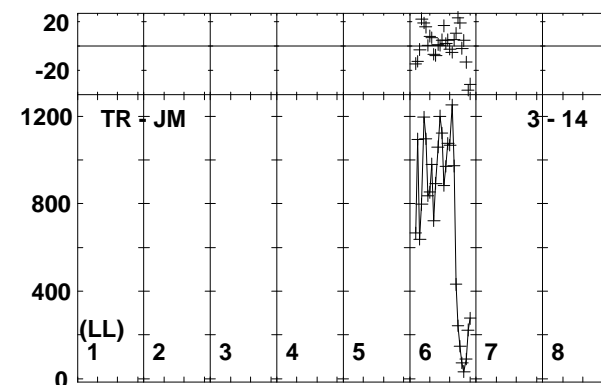
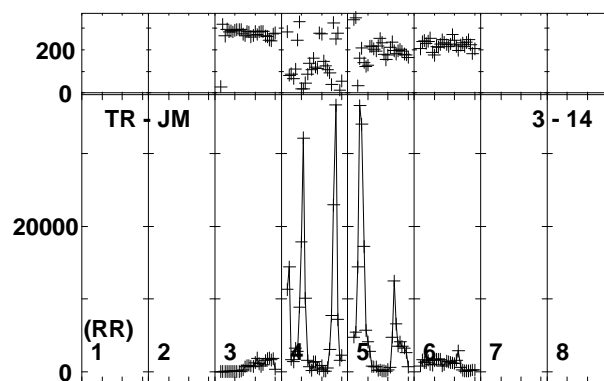
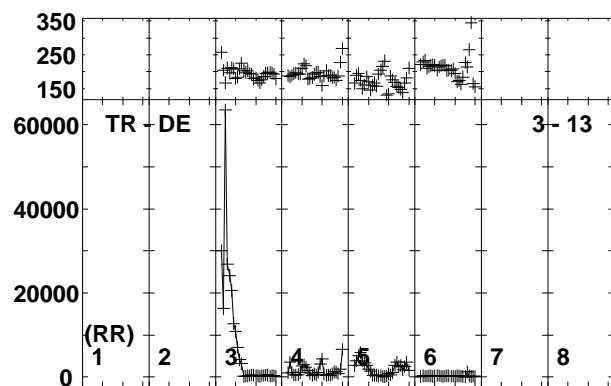
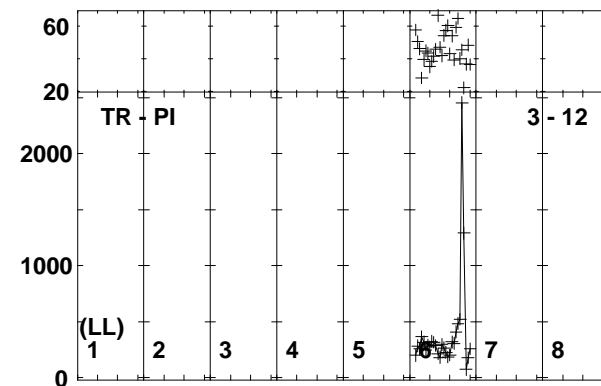
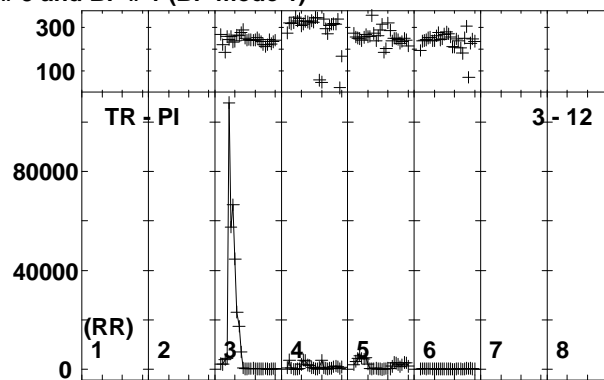
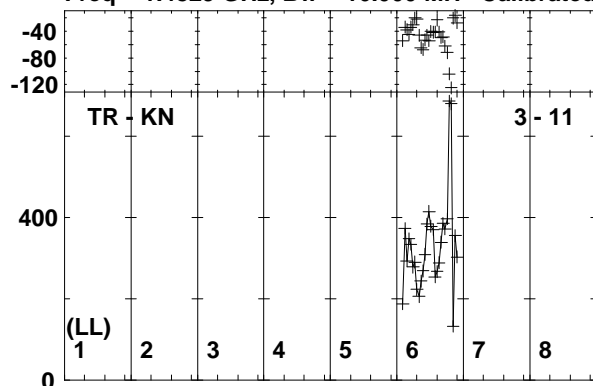

Lower frame: Milli Ampl Jy Top frame: Phas deg
 Vector averaged cross-power spectrum Baseline: TR (03) - KN (11)
 Timerange: 00/13:01:11 to 00/13:02:39

Plot file version 406 created 21-JUN-2019 11:56:27

J1222+0413 EP111A 1.UVDATA.1

Freq = 1.4829 GHz, Bw = 16.000 MH Calibrated with CL # 3 and BP # 1 (BP mode 1)

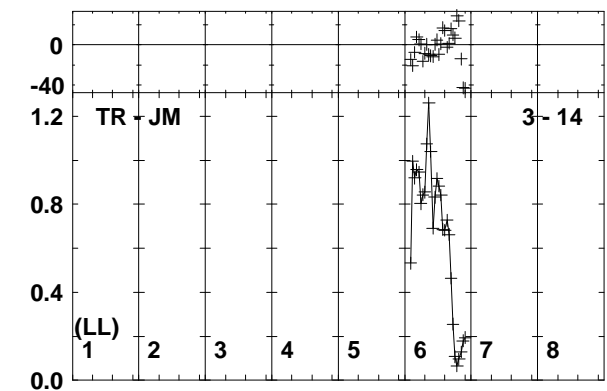
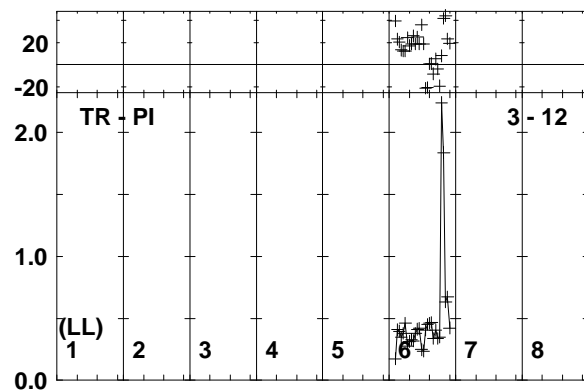
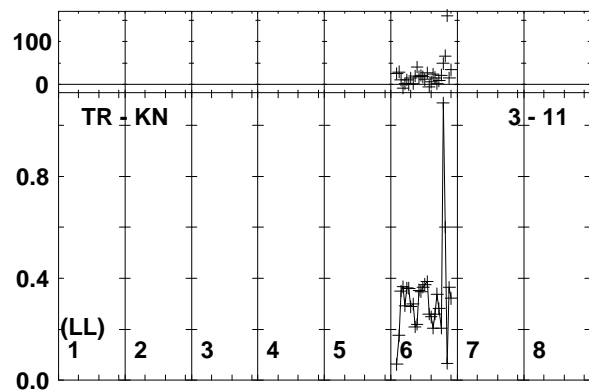
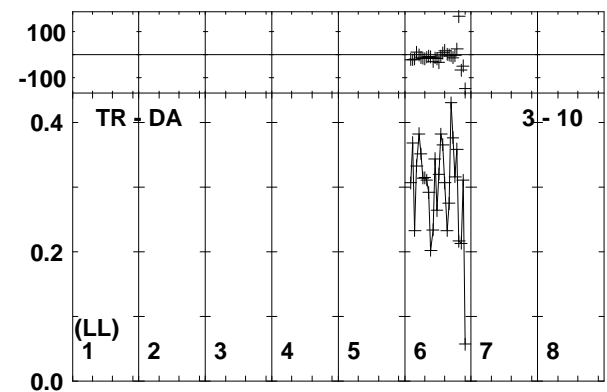
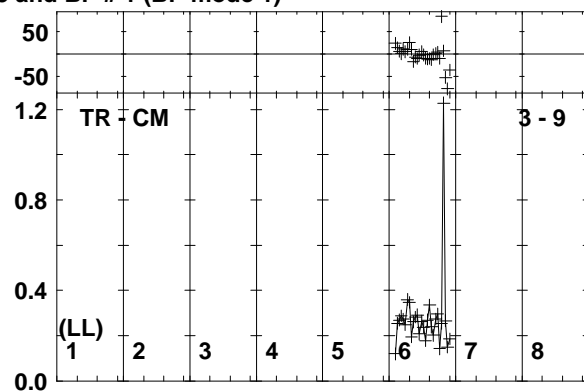
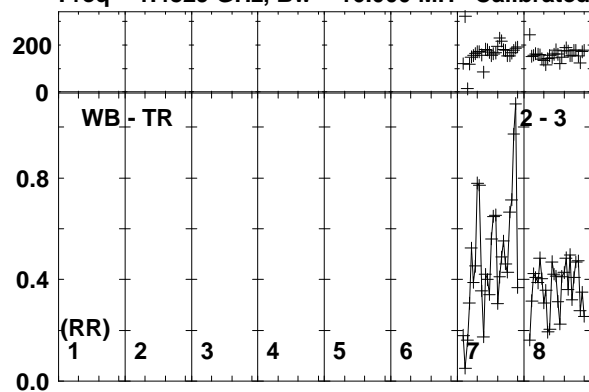

Lower frame: Ampl Jy Top frame: Phas deg
Vector averaged cross-power spectrum Baseline: WB (02) - TR (03)
Timerange: 00/13:06:11 to 00/13:07:39

Plot file version 407 created 21-JUN-2019 11:56:27

IRAS12112 EP111A 1.UVDATA.1

Freq = 1.4829 GHz, Bw = 16.000 MH Calibrated with CL # 3 and BP # 1 (BP mode 1)

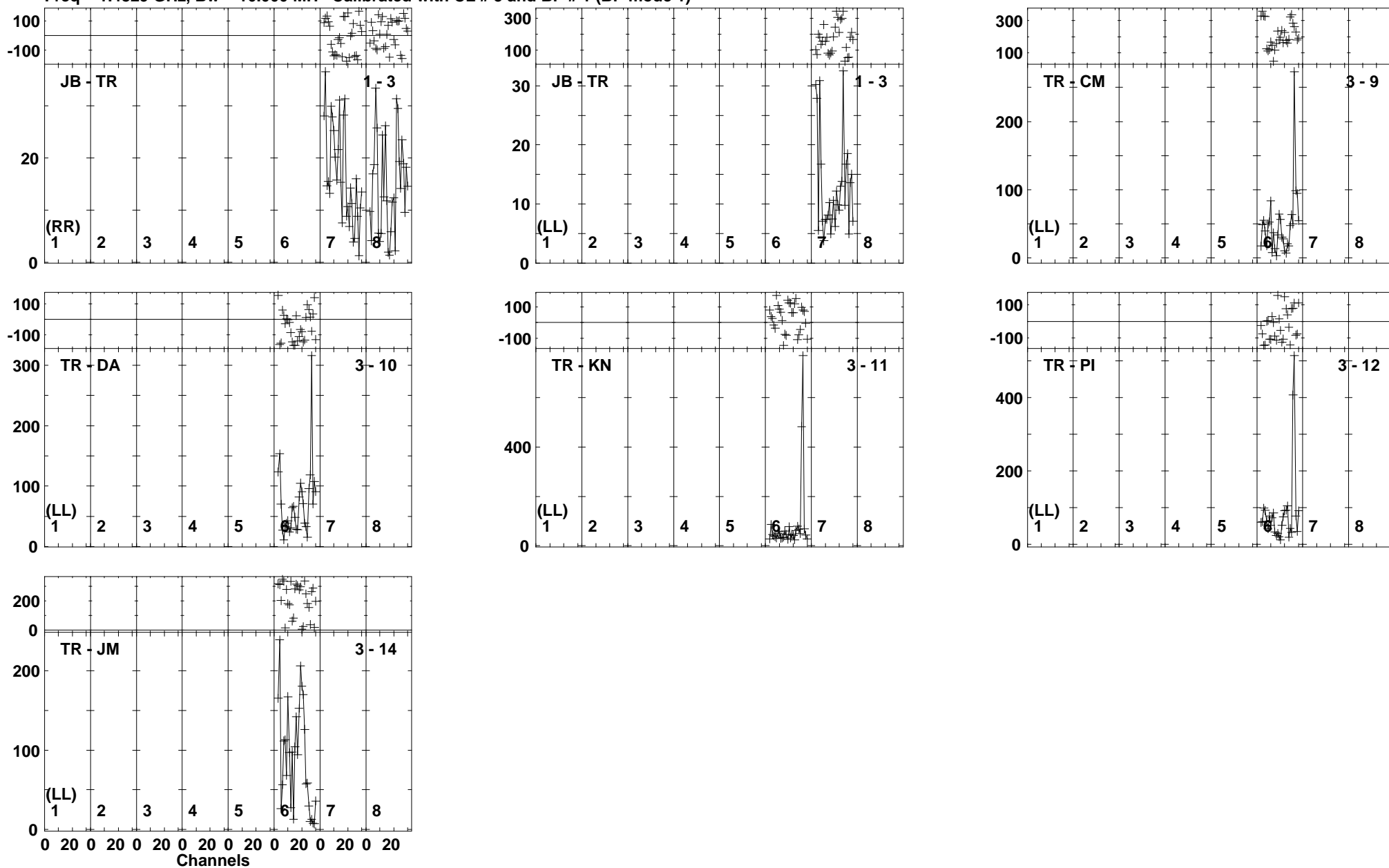

Lower frame: Milli Ampl Jy Top frame: Phas deg
Vector averaged cross-power spectrum Baseline: JB (01) - TR (03)
Timerange: 00/13:07:41 to 00/13:11:09

Plot file version 408 created 21-JUN-2019 11:56:28

J1222+0413 EP111A 1.UVDATA.1

Freq = 1.4829 GHz, Bw = 16.000 MH Calibrated with CL # 3 and BP # 1 (BP mode 1)

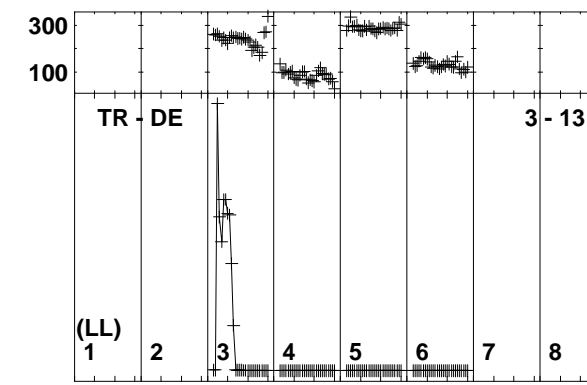
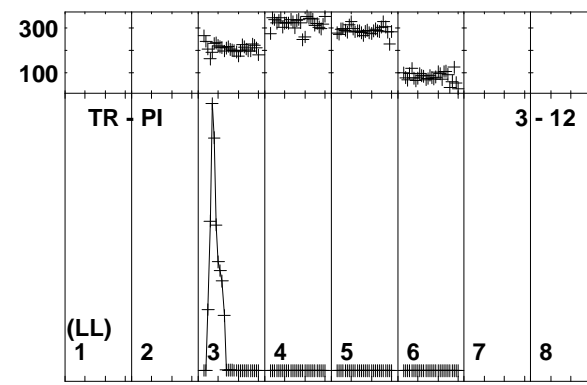
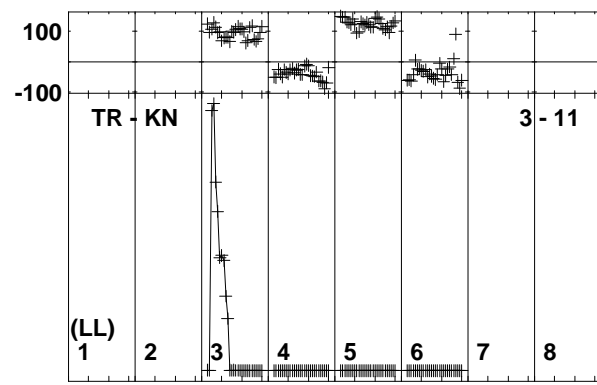
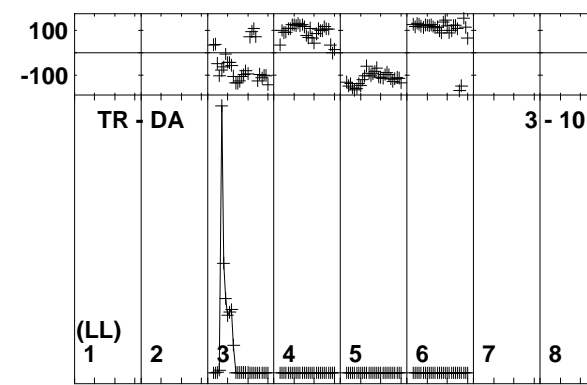
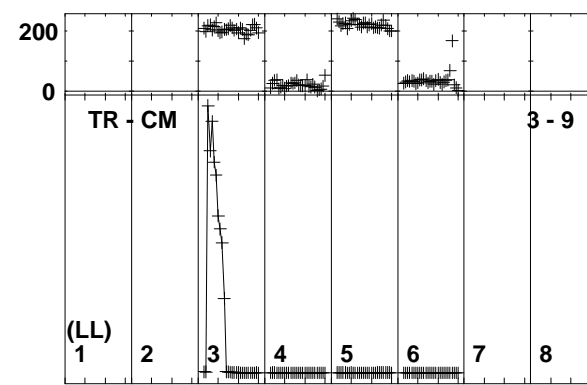
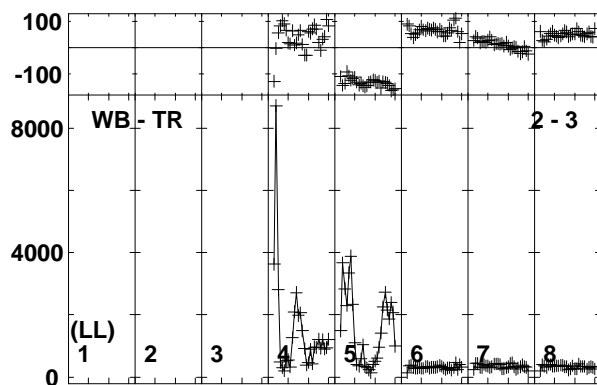
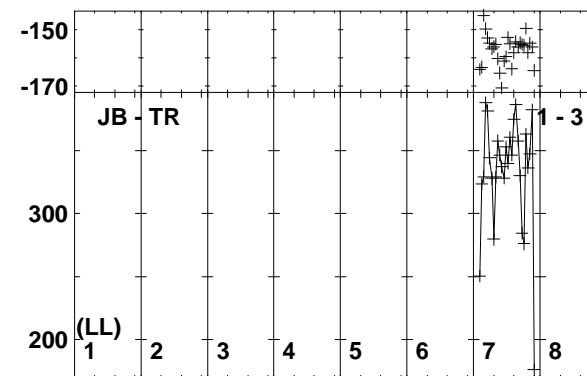
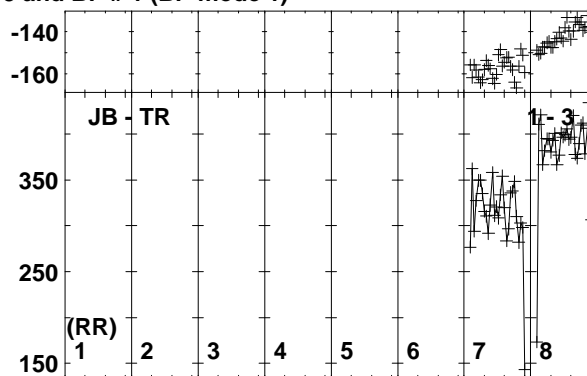
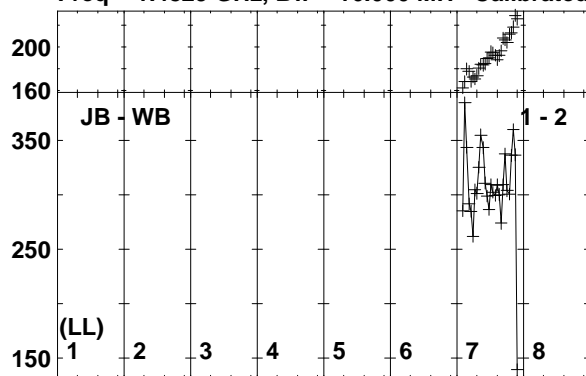

Lower frame: Milli Ampl Jy Top frame: Phas deg
Vector averaged cross-power spectrum Baseline: JB (01) - WB (02)
Timerange: 00/13:11:51 to 00/13:13:19

Plot file version 409 created 21-JUN-2019 11:56:29
J1222+0413 EP111A 1.UVDATA.1
Freq = 1.4829 GHz, Bw = 16.000 MH Calibrated with CL # 3 and BP # 1 (BP mode 1)

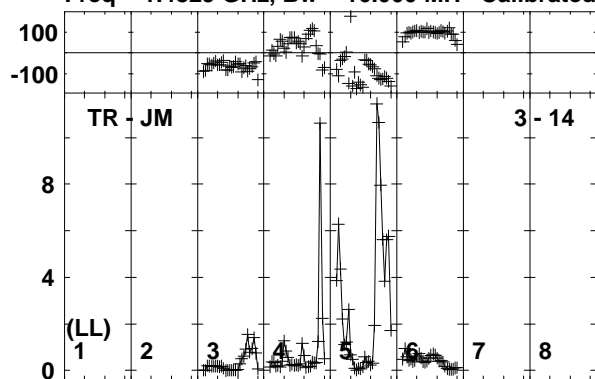

Lower frame: Ampl Jy Top frame: Phas deg
Vector averaged cross-power spectrum Baseline: TR (03) - JM (14)
Timerange: 00/13:11:51 to 00/13:13:19

Plot file version 412 created 21-JUN-2019 11:56:32

IRAS12112 EP111A 1.UVDATA.1

Freq = 1.4829 GHz, Bw = 16.000 MH Calibrated with CL # 3 and BP # 1 (BP mode 1)

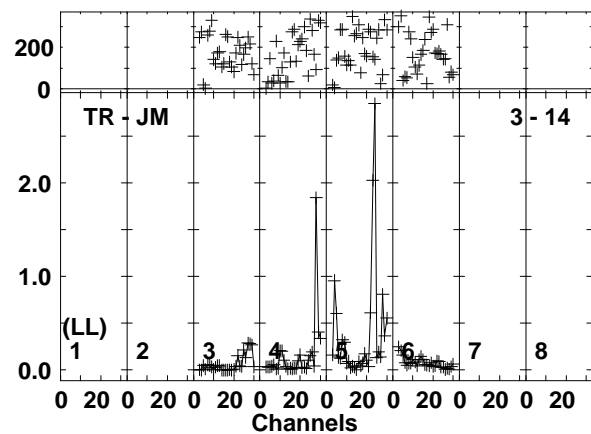
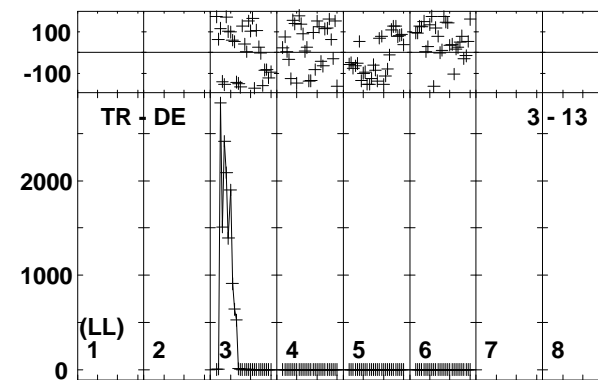
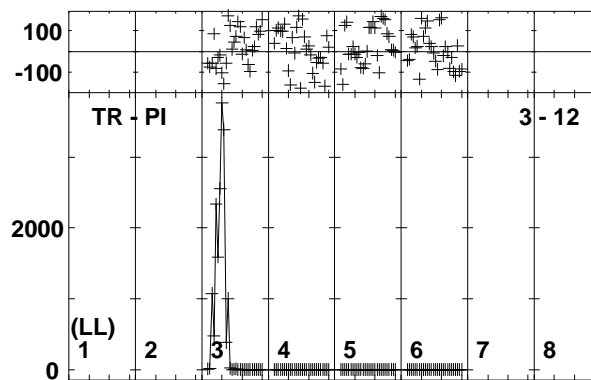
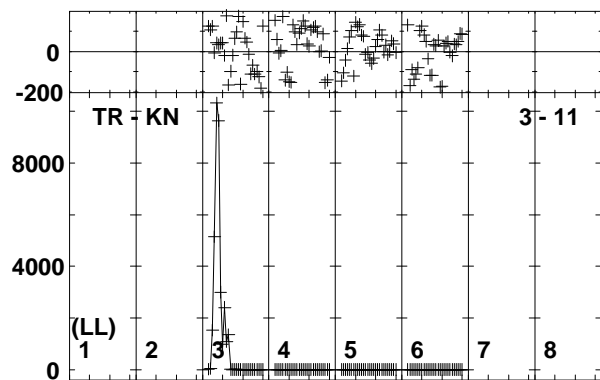
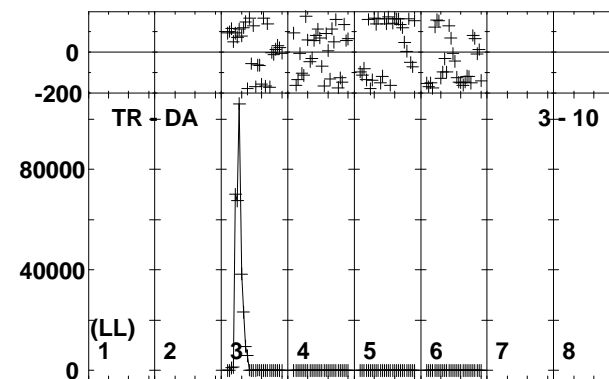
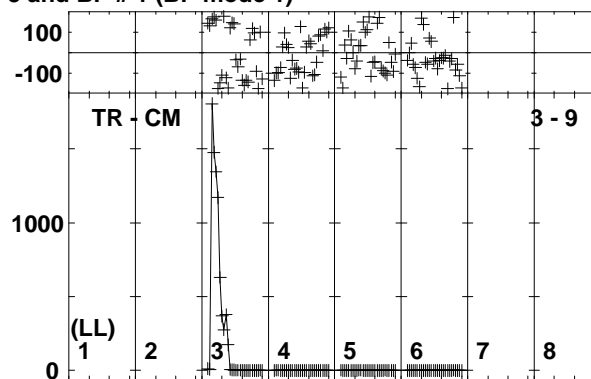
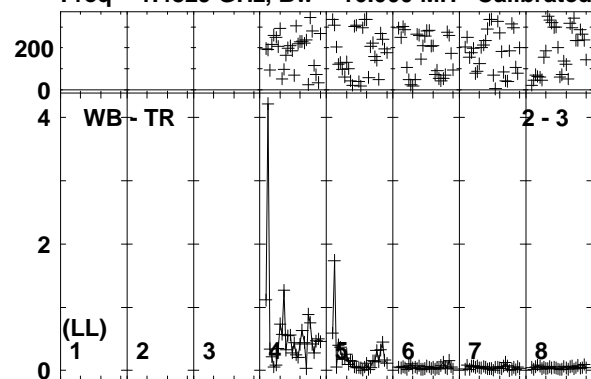

Lower frame: Ampl Jy Top frame: Phas deg
Vector averaged cross-power spectrum Baseline: WB (02) - TR (03)
Timerange: 00/13:18:21 to 00/13:21:49

Plot file version 413 created 21-JUN-2019 11:56:32

J1222+0413 EP111A 1.UVDATA.1

Freq = 1.4829 GHz, Bw = 16.000 MH Calibrated with CL # 3 and BP # 1 (BP mode 1)

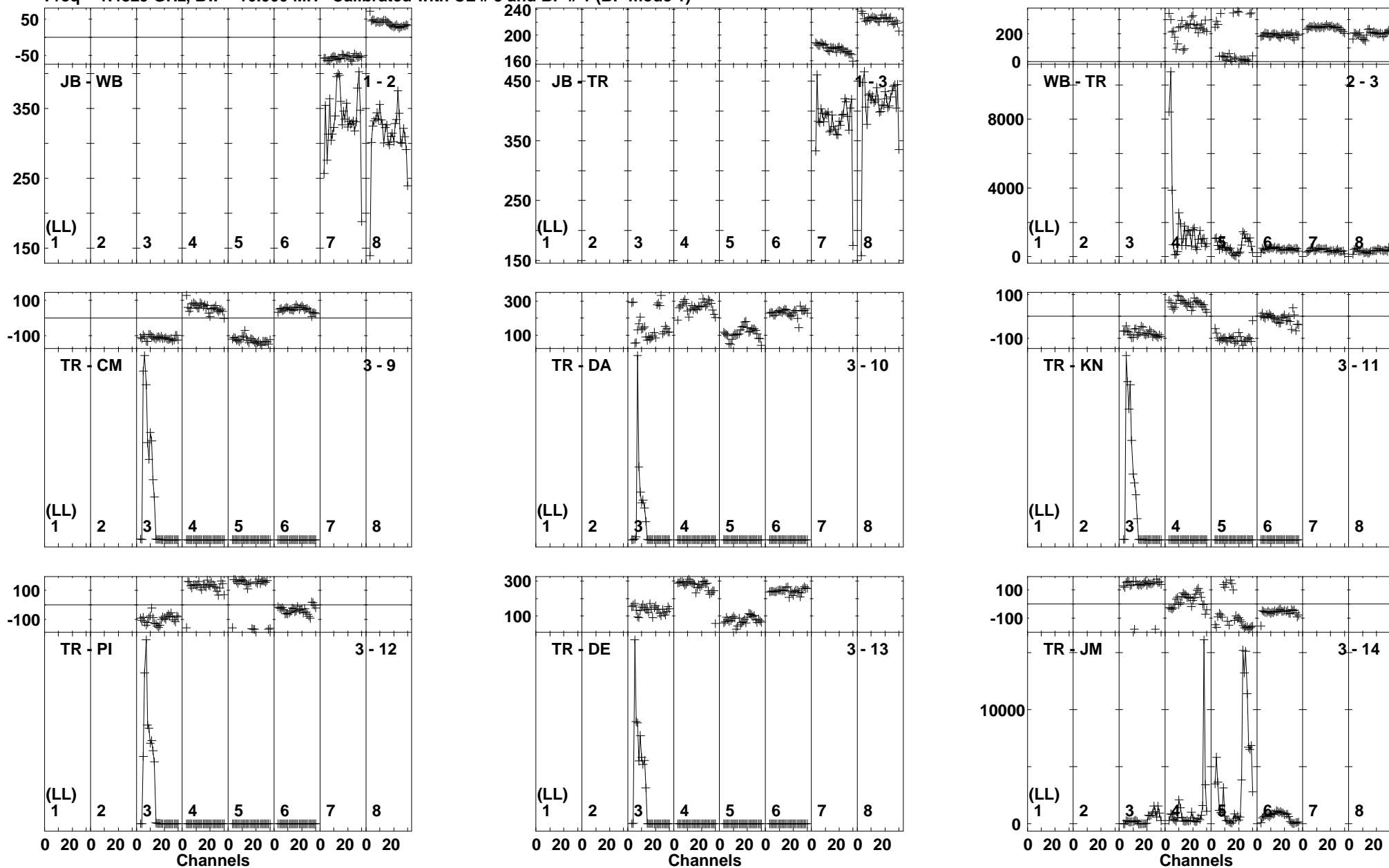

Lower frame: Milli Ampl Jy Top frame: Phas deg
Vector averaged cross-power spectrum Baseline: JB (01) - WB (02)
Timerange: 00/13:22:31 to 00/13:23:59

Plot file version 414 created 21-JUN-2019 11:56:33
IRAS12112 EP111A 1.UVDATA.1
Freq = 1.4829 GHz, Bw = 16.000 MH Calibrated with CL # 3 and BP # 1 (BP mode 1)

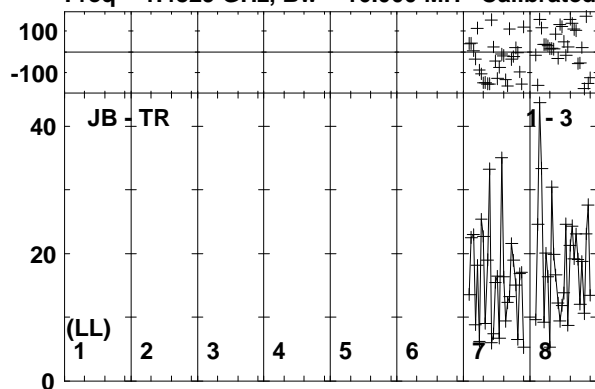

Lower frame: Milli Ampl Jy Top frame: Phas deg
Vector averaged cross-power spectrum Baseline: JB (01) - TR (03)
Timerange: 00/13:24:01 to 00/13:27:29

Plot file version 415 created 21-JUN-2019 11:56:35
J1222+0413 EP111A 1.UVDATA.1
Freq = 1.4829 GHz, Bw = 16.000 MH Calibrated with CL # 3 and BP # 1 (BP mode 1)

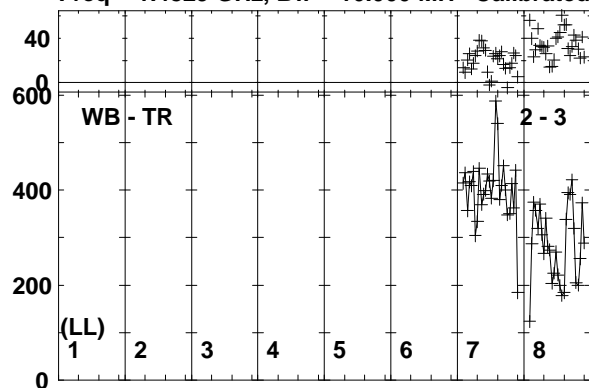

Lower frame: Milli Ampl Jy Top frame: Phas deg
Vector averaged cross-power spectrum Baseline: WB (02) - TR (03)
Timerange: 00/13:27:31 to 00/13:28:59

Plot file version 416 created 21-JUN-2019 11:56:35
IRAS12112 EP111A 1.UVDATA.1
Freq = 1.4829 GHz, Bw = 16.000 MH Calibrated with CL # 3 and BP # 1 (BP mode 1)

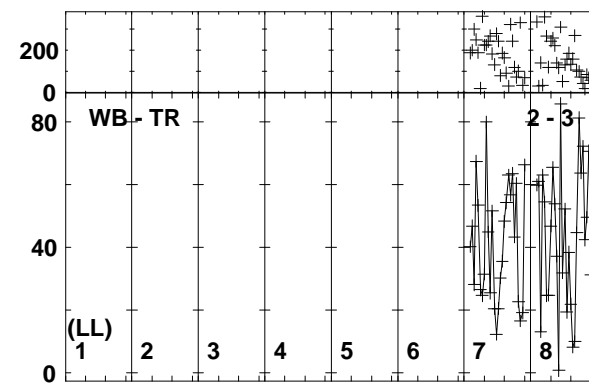
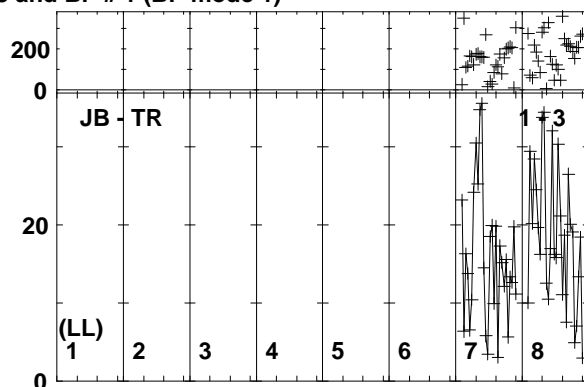
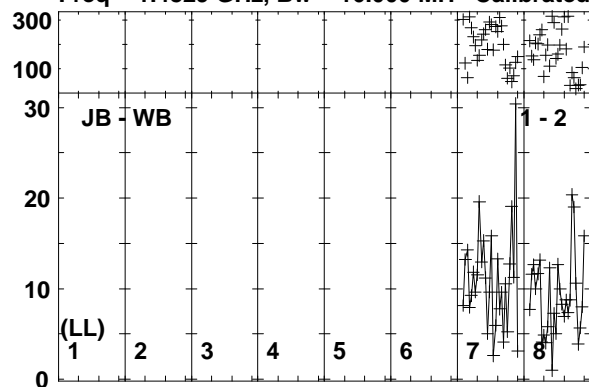

Lower frame: Milli Ampl Jy Top frame: Phas deg
Vector averaged cross-power spectrum Baseline: JB (01) - WB (02)
Timerange: 00/13:29:01 to 00/13:32:29

Plot file version 417 created 21-JUN-2019 11:56:37

J1222+0413 EP111A 1.UVDATA.1

Freq = 1.4829 GHz, Bw = 16.000 MH Calibrated with CL # 3 and BP # 1 (BP mode 1)

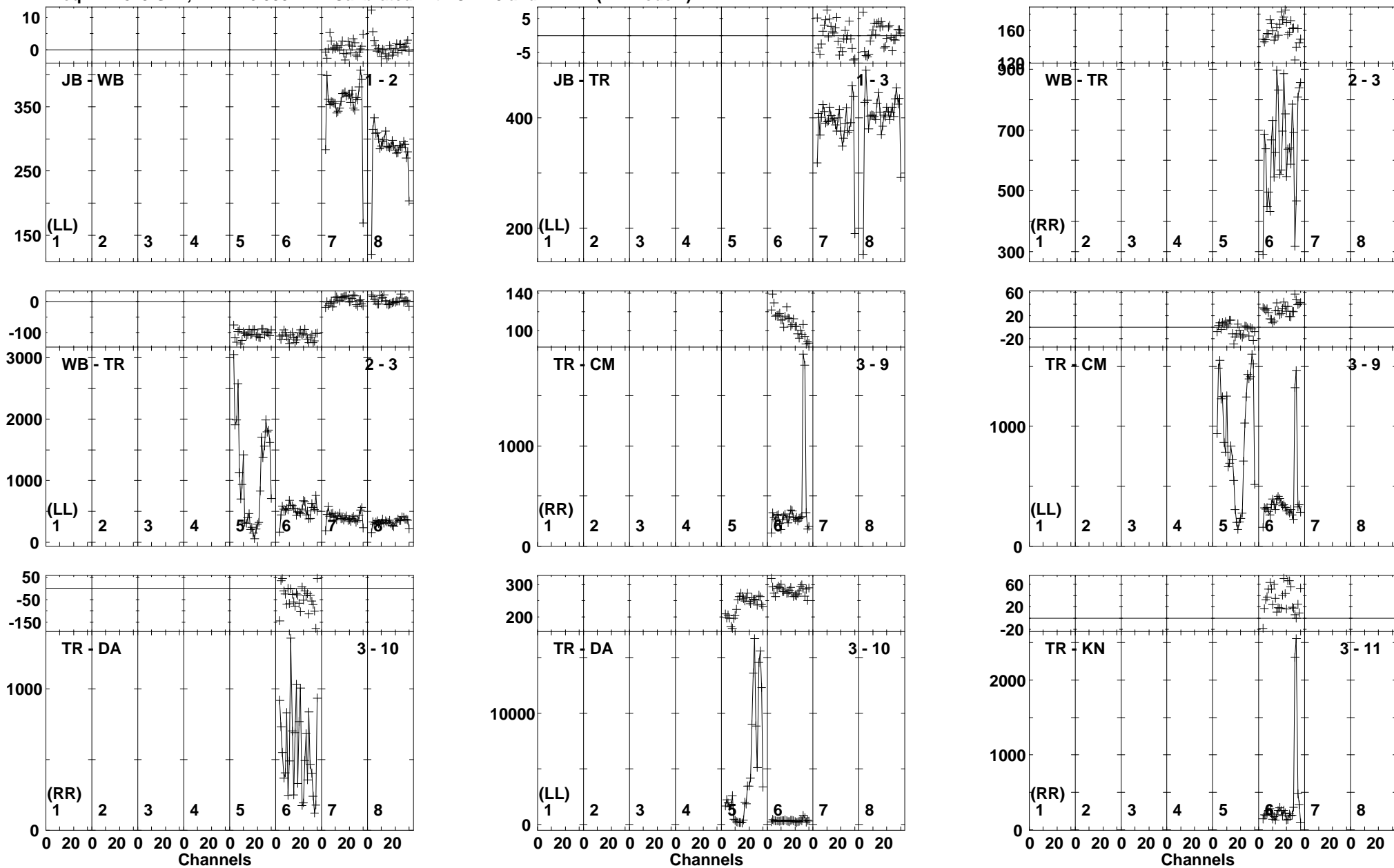

Lower frame: Milli Ampl Jy Top frame: Phas deg
Vector averaged cross-power spectrum Baseline: JB (01) - WB (02)
Timerange: 00/13:33:11 to 00/13:34:39

Plot file version 418 created 21-JUN-2019 11:56:37

J1222+0413 EP111A 1.UVDATA.1

Freq = 1.4829 GHz, Bw = 16.000 MH Calibrated with CL # 3 and BP # 1 (BP mode 1)

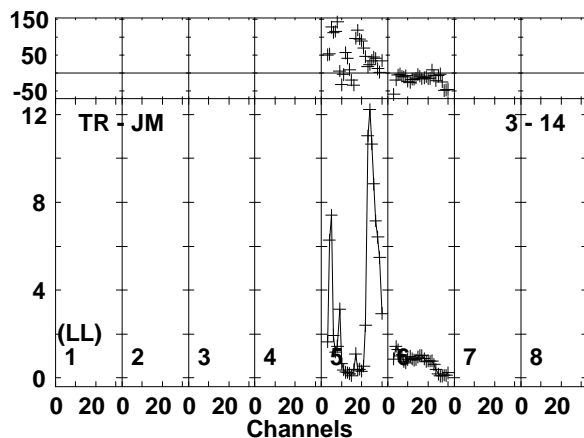
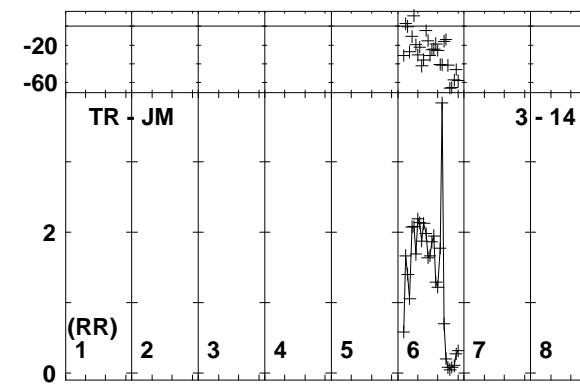
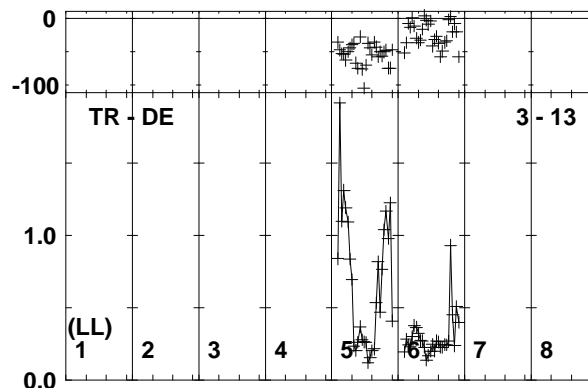
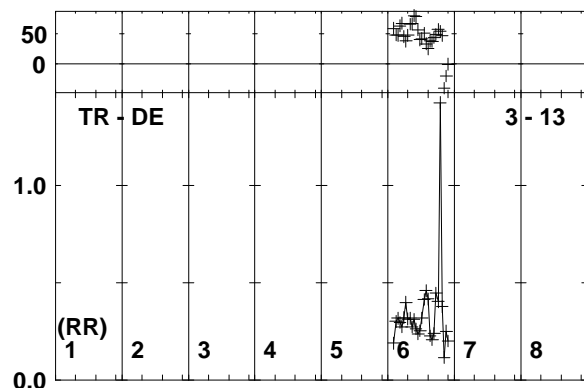
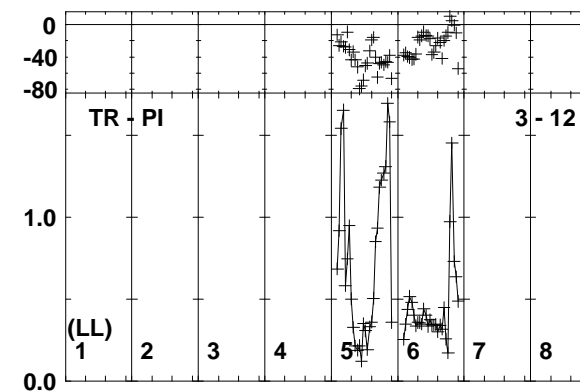
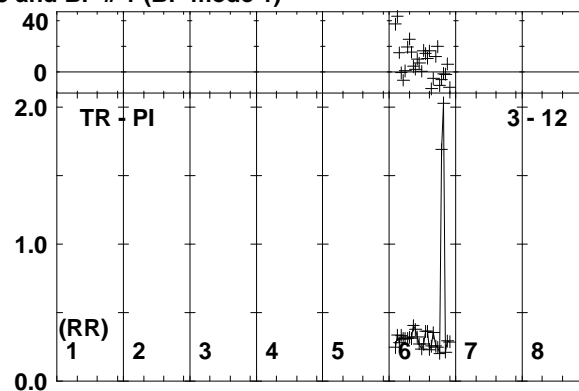
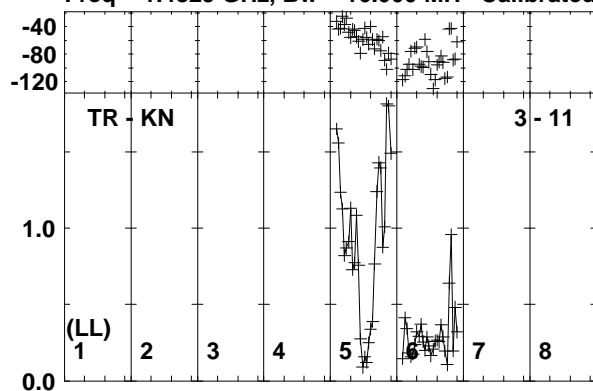

Lower frame: Ampl Jy Top frame: Phas deg
Vector averaged cross-power spectrum Baseline: TR (03) - KN (11)
Timerange: 00/13:33:11 to 00/13:34:39

Plot file version 419 created 21-JUN-2019 11:56:38
 IRAS12112 EP111A 1.UVDATA.1
 Freq = 1.4829 GHz, Bw = 16.000 MH Calibrated with CL # 3 and BP # 1 (BP mode 1)

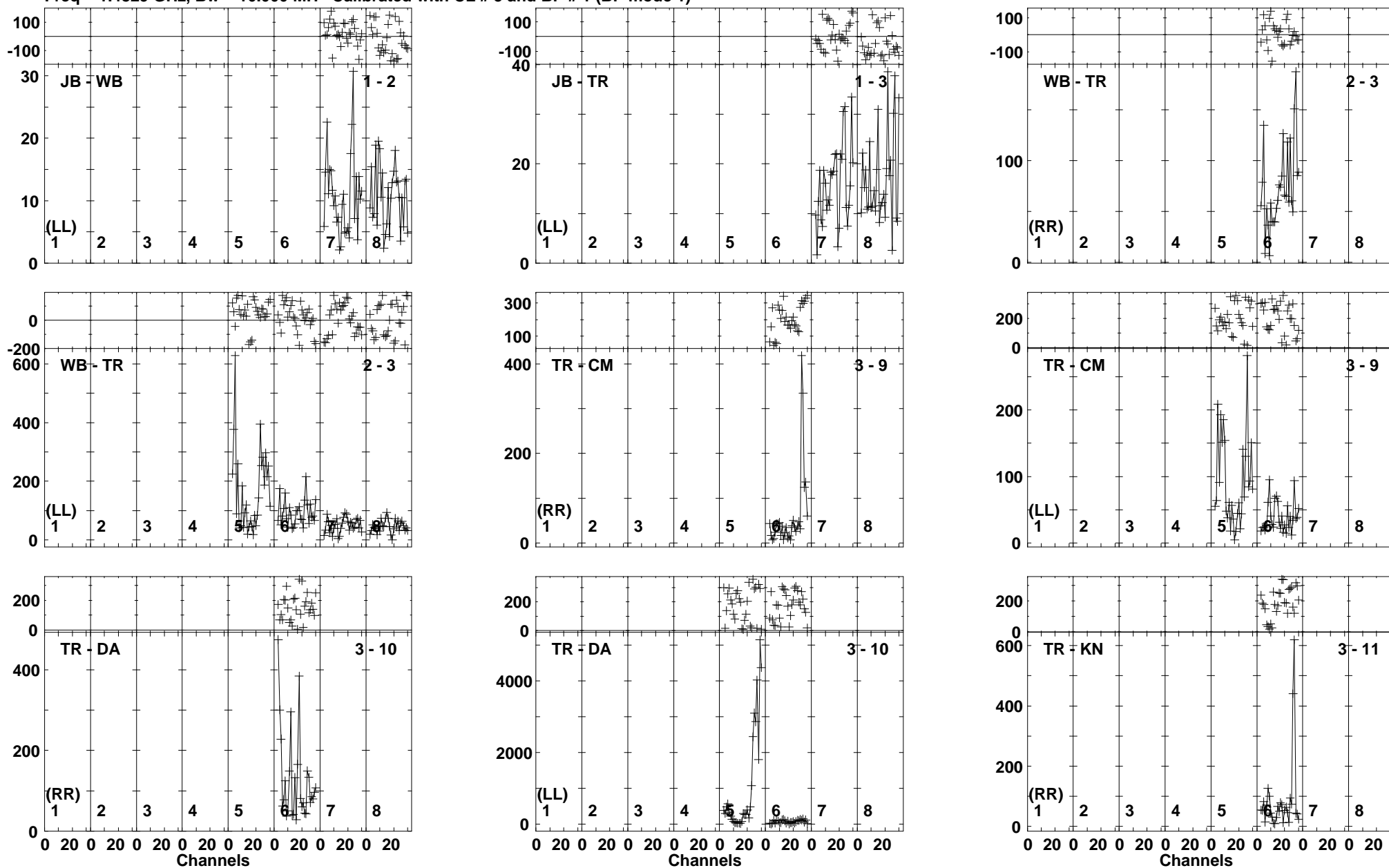

Lower frame: Milli Ampl Jy Top frame: Phas deg
 Vector averaged cross-power spectrum Baseline: JB (01) - WB (02)
 Timerange: 00/13:34:41 to 00/13:38:09

Plot file version 420 created 21-JUN-2019 11:56:39

IRAS12112 EP111A 1.UVDATA.1

Freq = 1.4829 GHz, Bw = 16.000 MH Calibrated with CL # 3 and BP # 1 (BP mode 1)

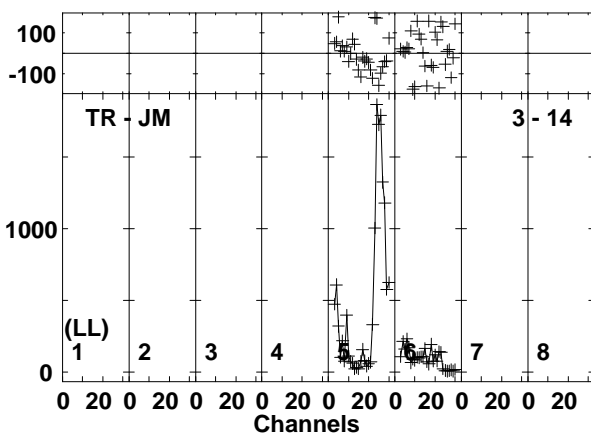
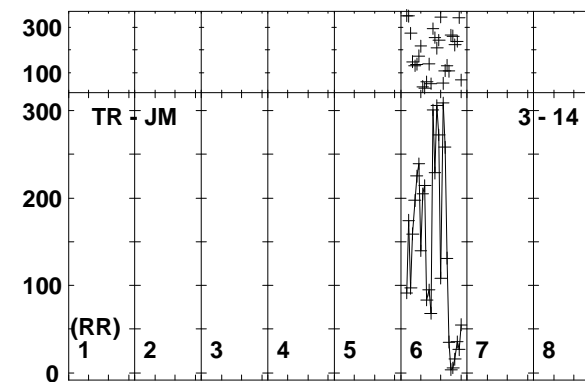
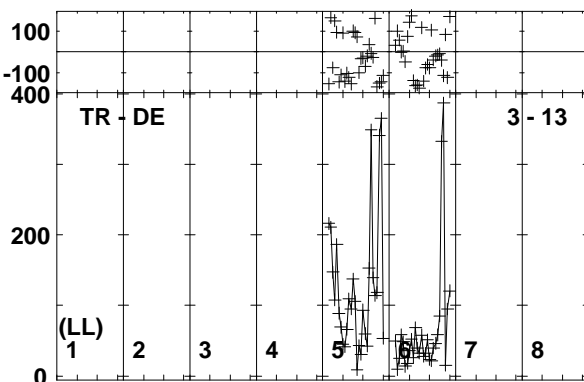
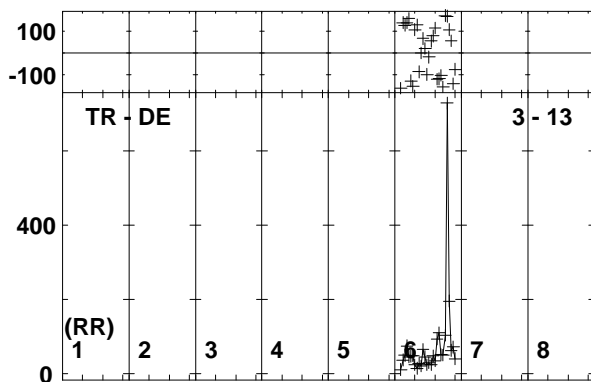
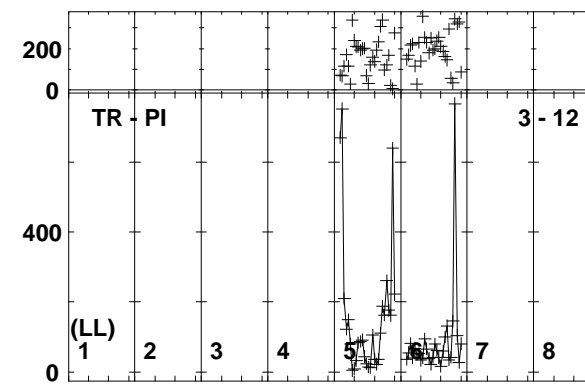
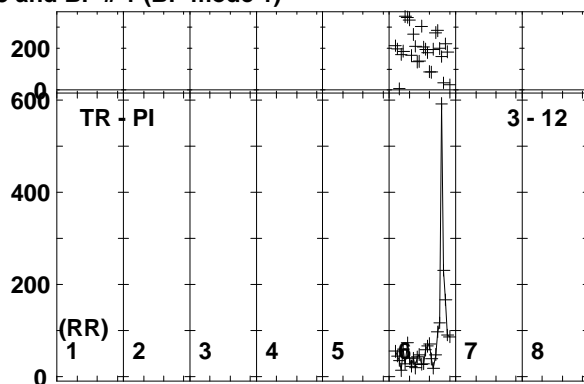
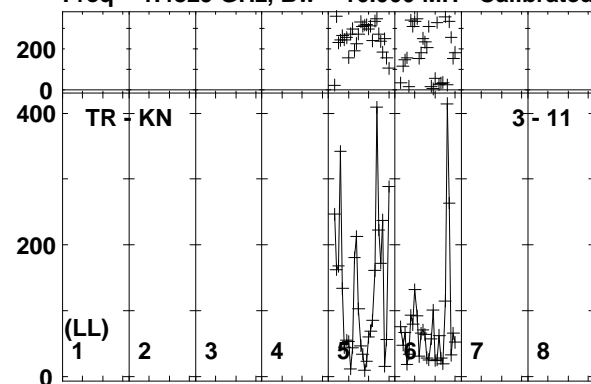

Lower frame: Milli Ampl Jy Top frame: Phas deg
Vector averaged cross-power spectrum Baseline: TR (03) - KN (11)
Timerange: 00/13:34:41 to 00/13:38:09

Plot file version 421 created 21-JUN-2019 11:56:39

J1222+0413 EP111A 1.UVDATA.1

Freq = 1.4829 GHz, Bw = 16.000 MH Calibrated with CL # 3 and BP # 1 (BP mode 1)

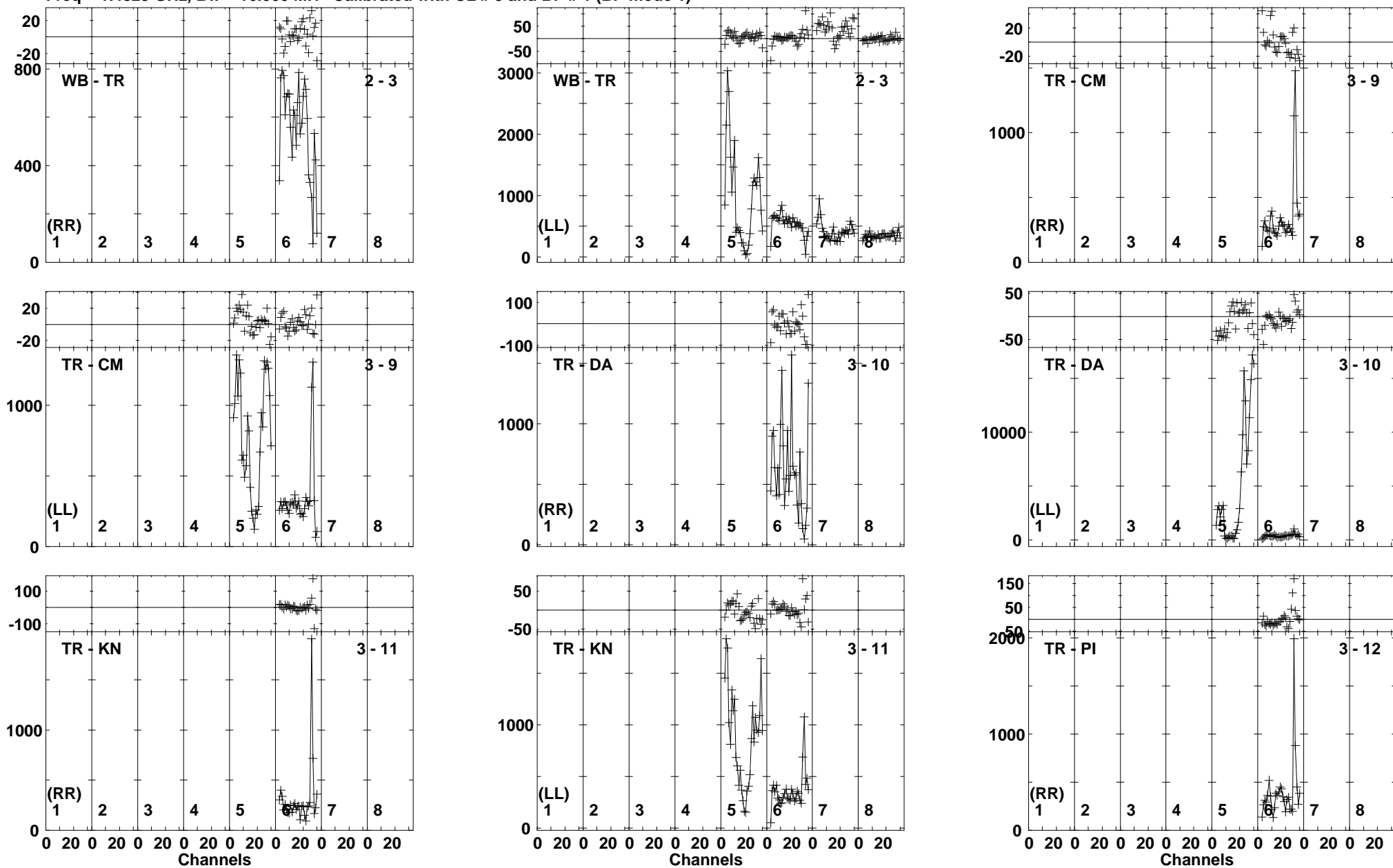

Lower frame: Milli Ampl Jy Top frame: Phas deg
Vector averaged cross-power spectrum Baseline: WB (02) - TR (03)
Timerange: 00/13:38:11 to 00/13:39:39

Plot file version 422 created 21-JUN-2019 11:56:40
 J1222+0413 EP111A 1.UVDATA.1
 Freq = 1.4829 GHz, Bw = 16.000 MH Calibrated with CL # 3 and BP # 1 (BP mode 1)

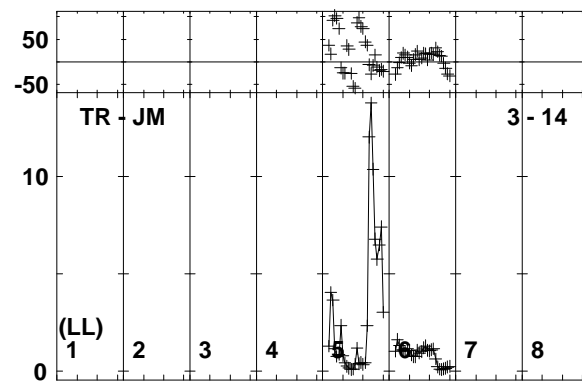
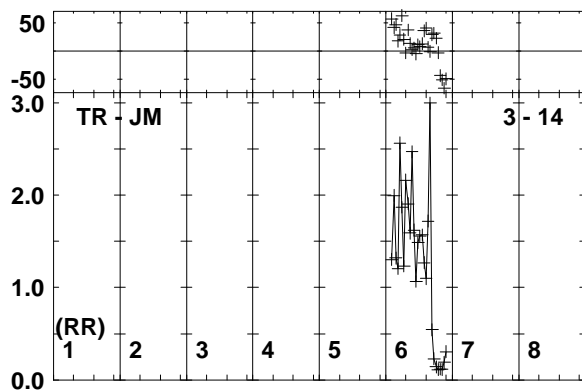
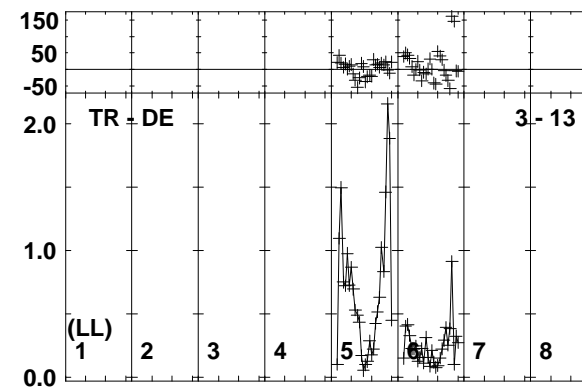
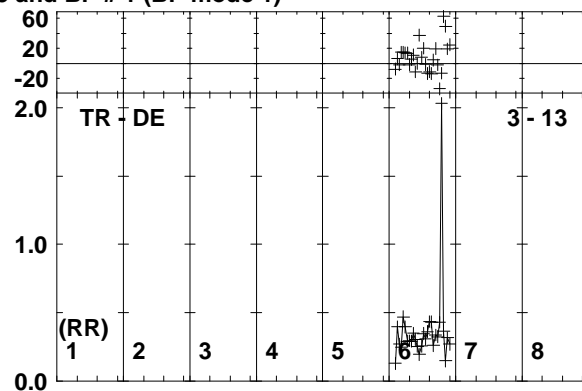
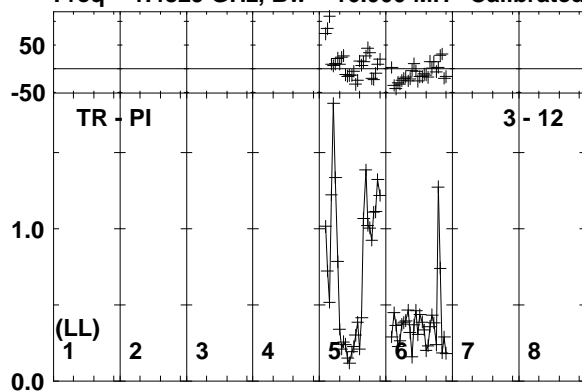

Lower frame: Ampl Jy Top frame: Phas deg
 Vector averaged cross-power spectrum Baseline: TR (03) - PI (12)
 Timerange: 00/13:38:11 to 00/13:39:39

Plot file version 423 created 21-JUN-2019 11:56:40
 IRAS12112 EP111A 1.UVDATA.1
 Freq = 1.4829 GHz, Bw = 16.000 MH Calibrated with CL # 3 and BP # 1 (BP mode 1)

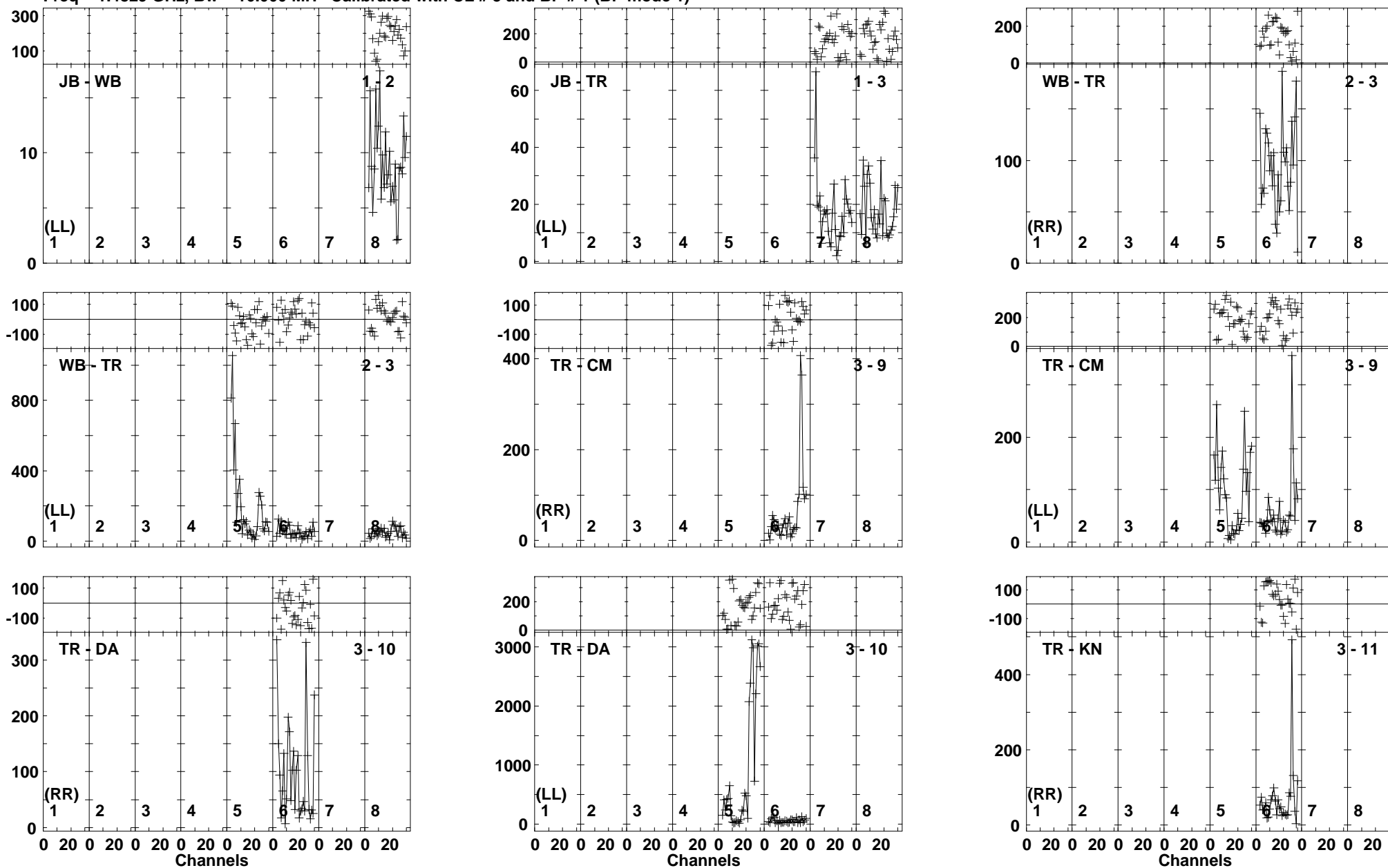

Lower frame: Milli Ampl Jy Top frame: Phas deg
 Vector averaged cross-power spectrum Baseline: JB (01) - WB (02)
 Timerange: 00/13:39:41 to 00/13:43:09

Plot file version 424 created 21-JUN-2019 11:56:41

IRAS12112 EP111A 1.UVDATA.1

Freq = 1.4829 GHz, Bw = 16.000 MH Calibrated with CL # 3 and BP # 1 (BP mode 1)

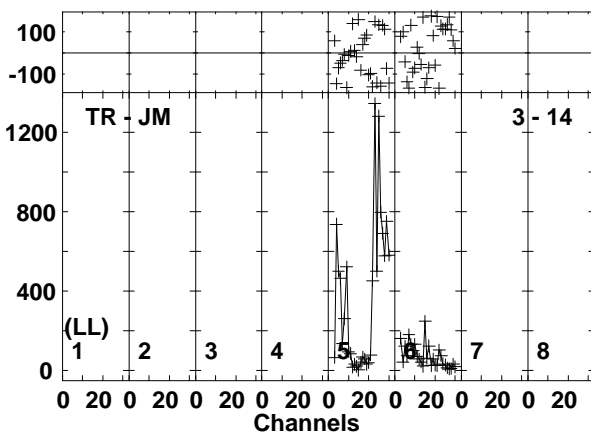
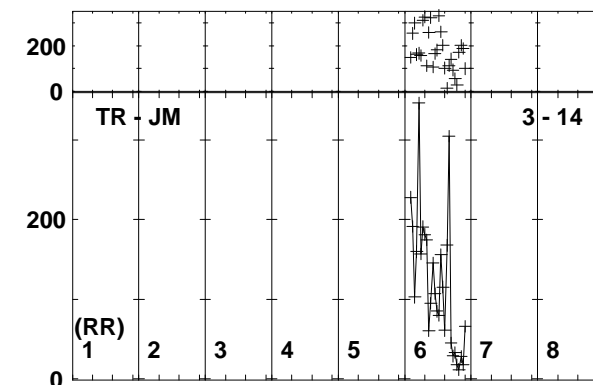
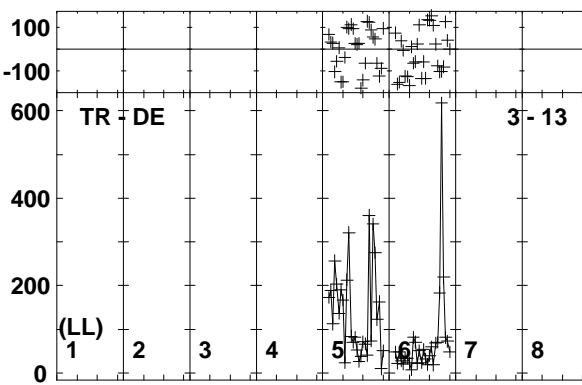
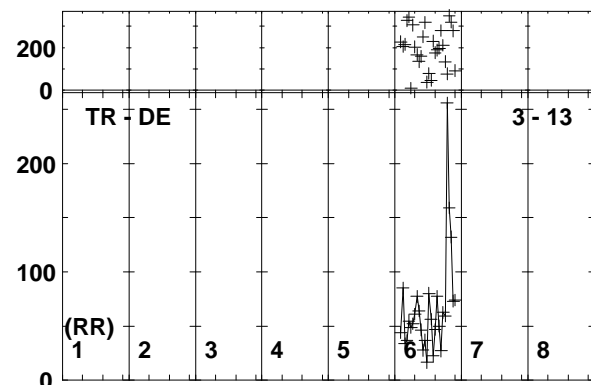
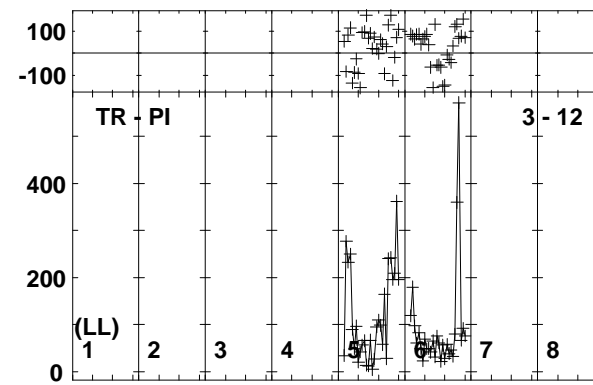
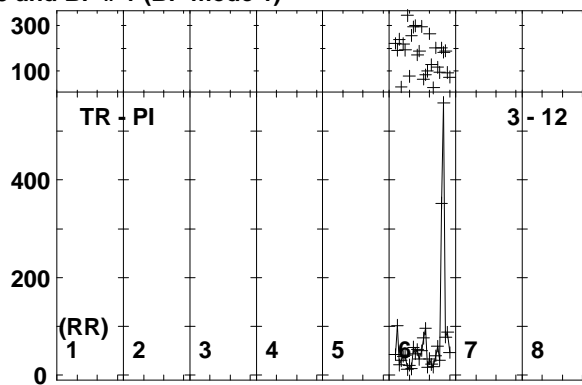
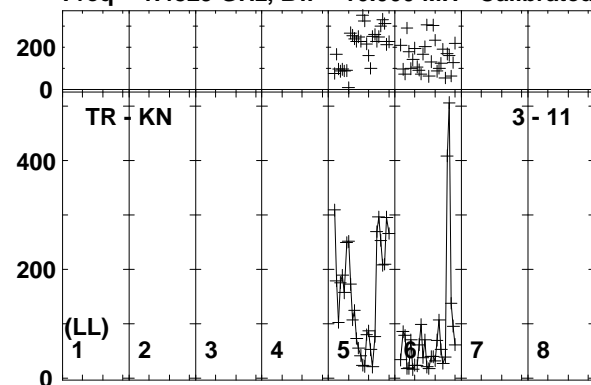

Lower frame: Milli Ampl Jy Top frame: Phas deg
Vector averaged cross-power spectrum Baseline: TR (03) - KN (11)
Timerange: 00/13:39:41 to 00/13:43:09

Plot file version 425 created 21-JUN-2019 11:56:41

J1222+0413 EP111A 1.UVDATA.1

Freq = 1.4829 GHz, Bw = 16.000 MH Calibrated with CL # 3 and BP # 1 (BP mode 1)

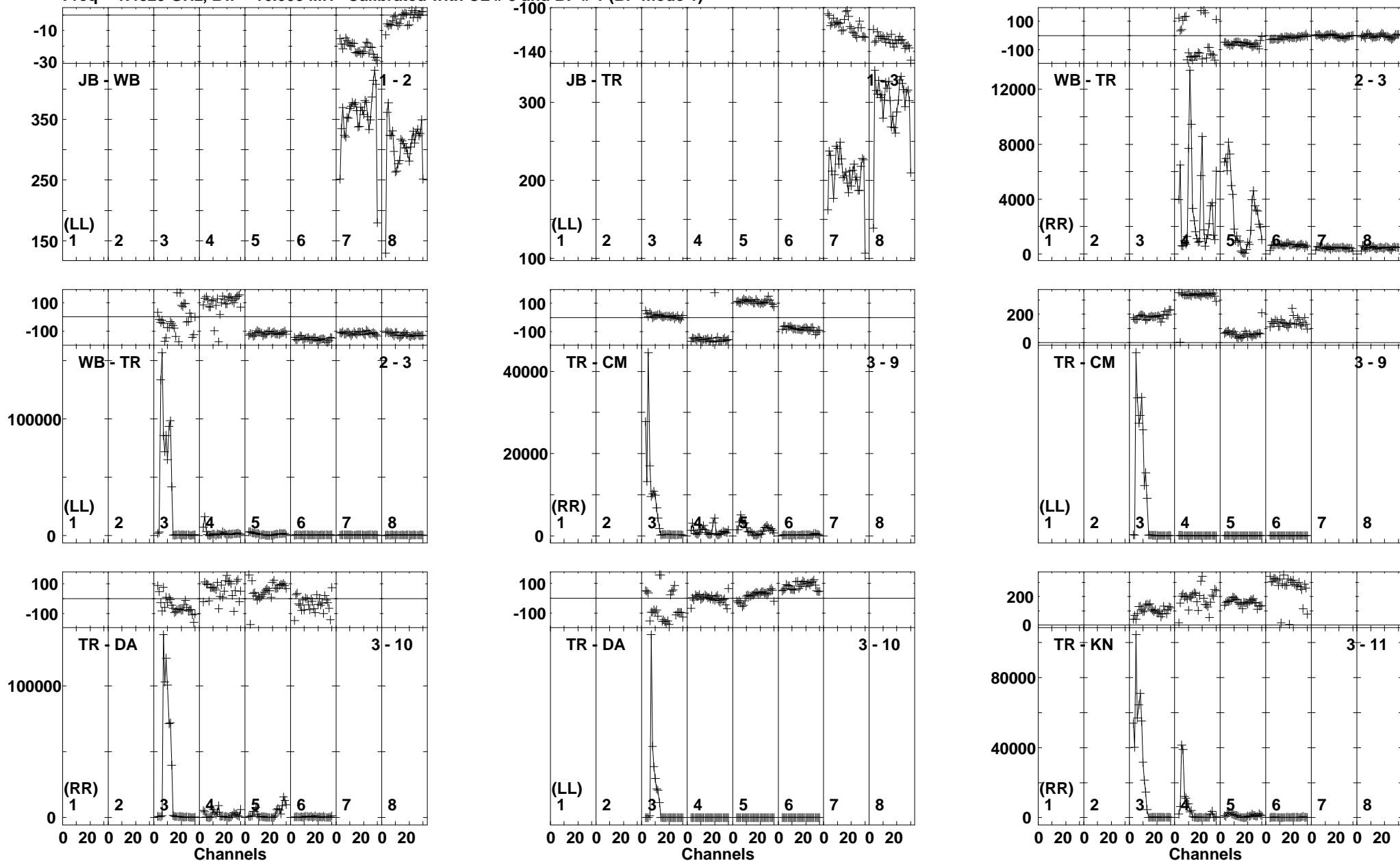

Lower frame: Milli Ampl Jy Top frame: Phas deg
Vector averaged cross-power spectrum Baseline: JB (01) - WB (02)
Timerange: 00/13:43:51 to 00/13:45:19

Plot file version 426 created 21-JUN-2019 11:56:42
 J1222+0413 EP111A 1.UVDATA.1
 Freq = 1.4829 GHz, Bw = 16.000 MH Calibrated with CL # 3 and BP # 1 (BP mode 1)

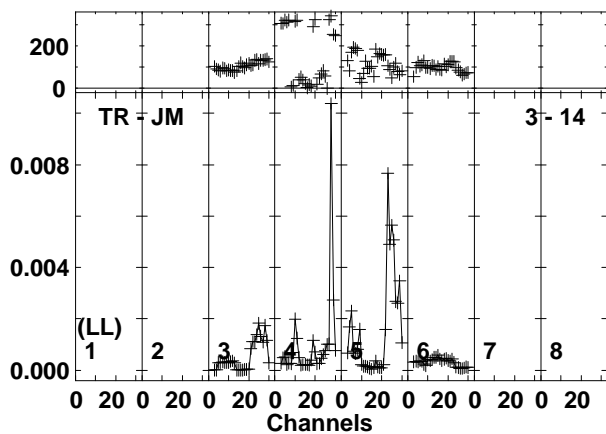
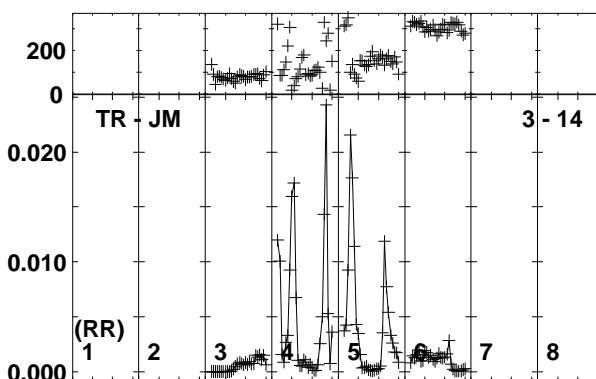
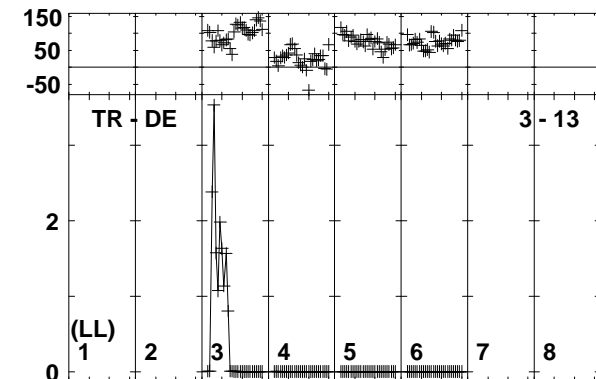
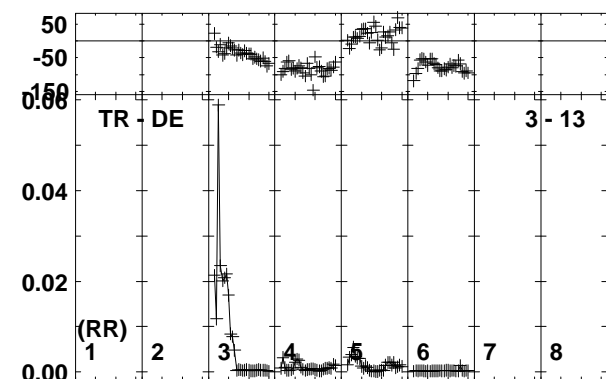
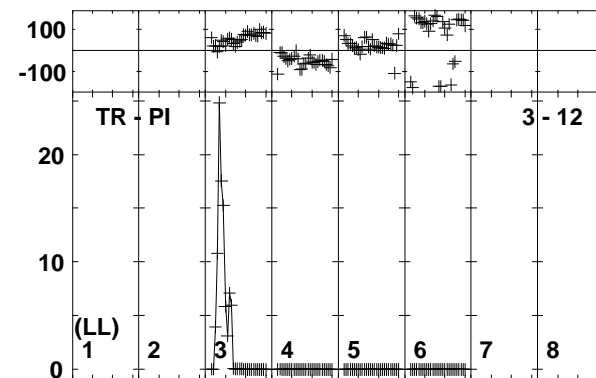
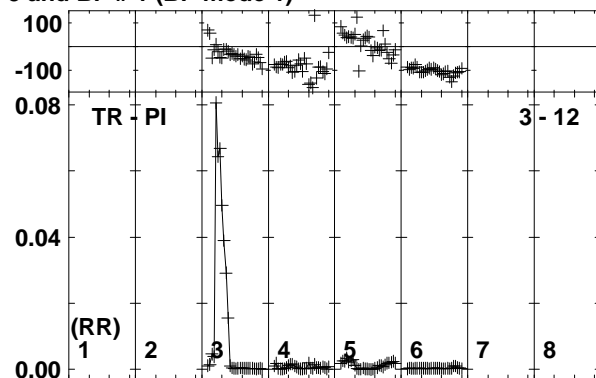
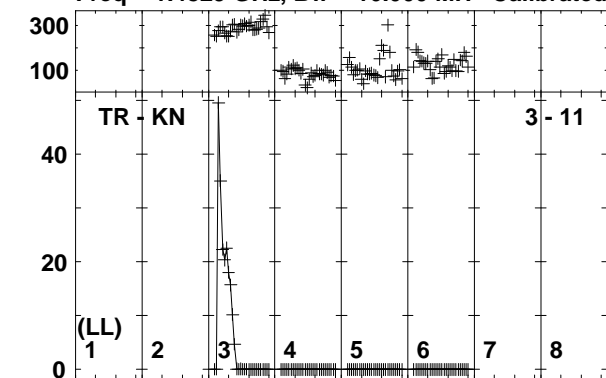

Lower frame: Kilo Ampl Jy Top frame: Phas deg
 Vector averaged cross-power spectrum Baseline: TR (03) - KN (11)
 Timerange: 00/13:43:51 to 00/13:45:19

Plot file version 427 created 21-JUN-2019 11:56:42

IRAS12112 EP111A 1.UVDATA.1

Freq = 1.4829 GHz, Bw = 16.000 MH Calibrated with CL # 3 and BP # 1 (BP mode 1)

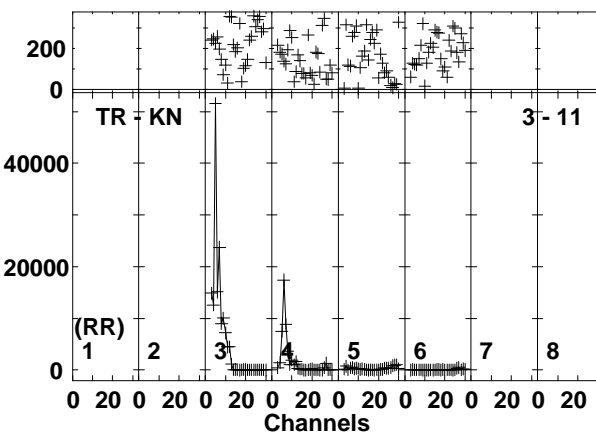
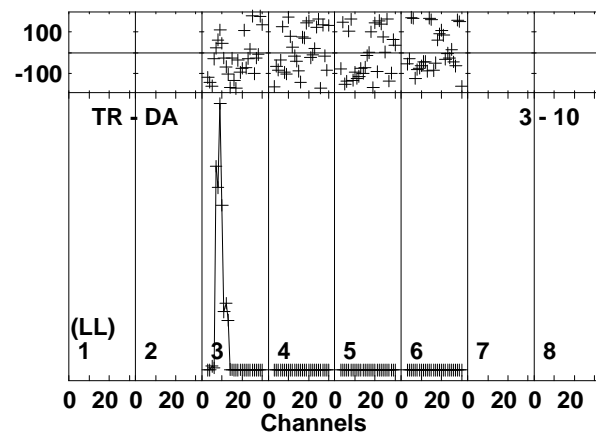
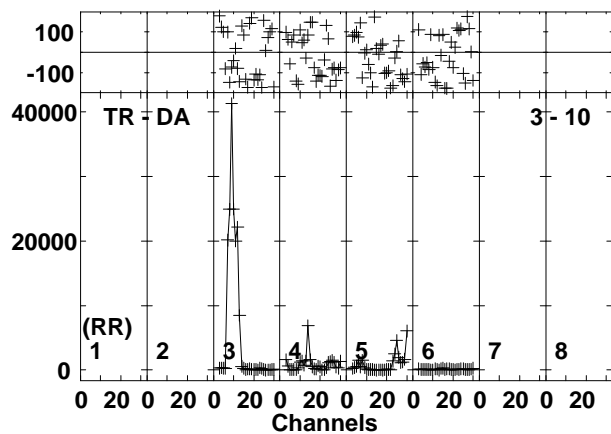
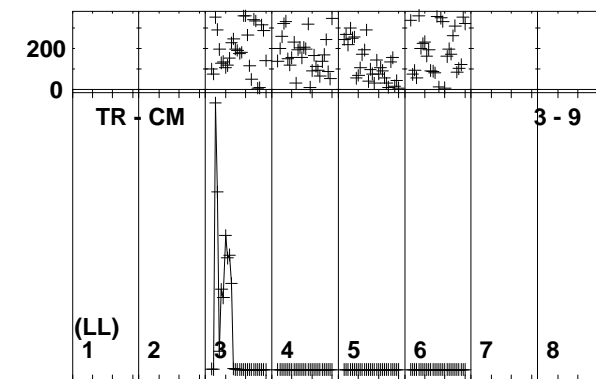
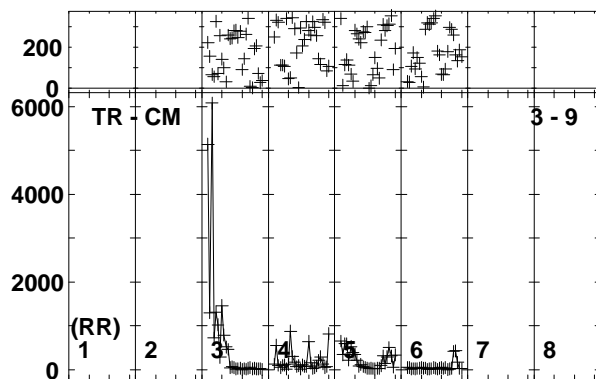
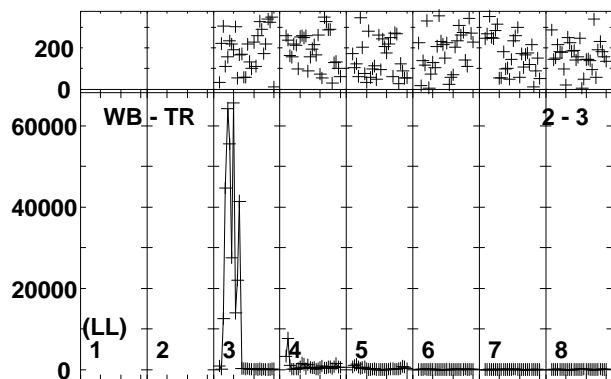
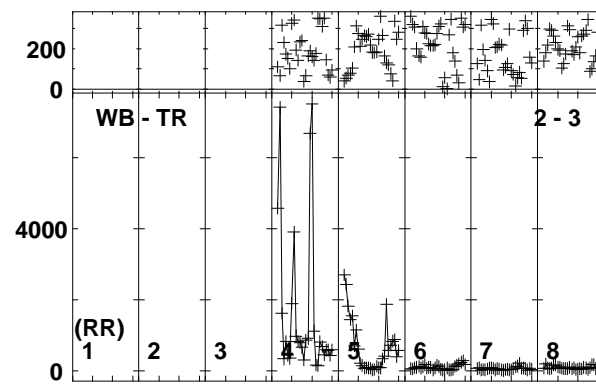
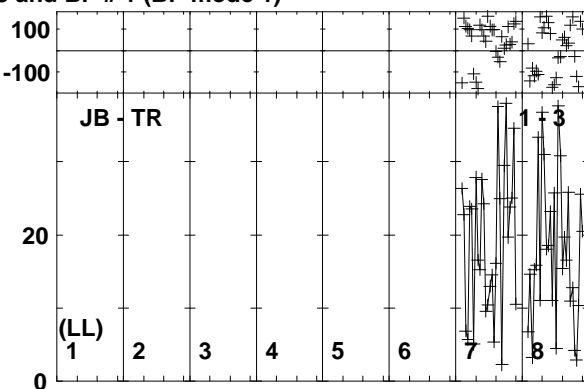
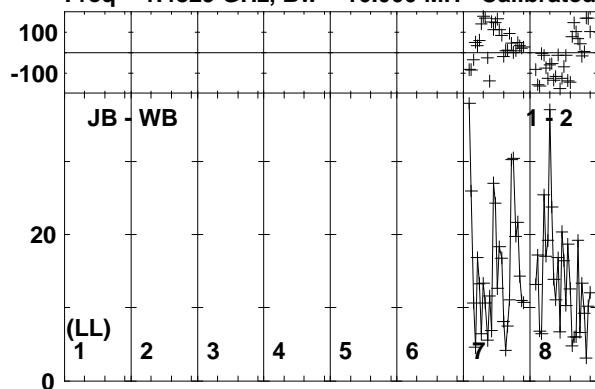

Lower frame: Milli Ampl Jy Top frame: Phas deg
Vector averaged cross-power spectrum Baseline: JB (01) - WB (02)
Timerange: 00/13:45:21 to 00/13:48:49

Plot file version 428 created 21-JUN-2019 11:56:43
 IRAS12112 EP111A 1.UVDATA.1
 Freq = 1.4829 GHz, Bw = 16.000 MH Calibrated with CL # 3 and BP # 1 (BP mode 1)

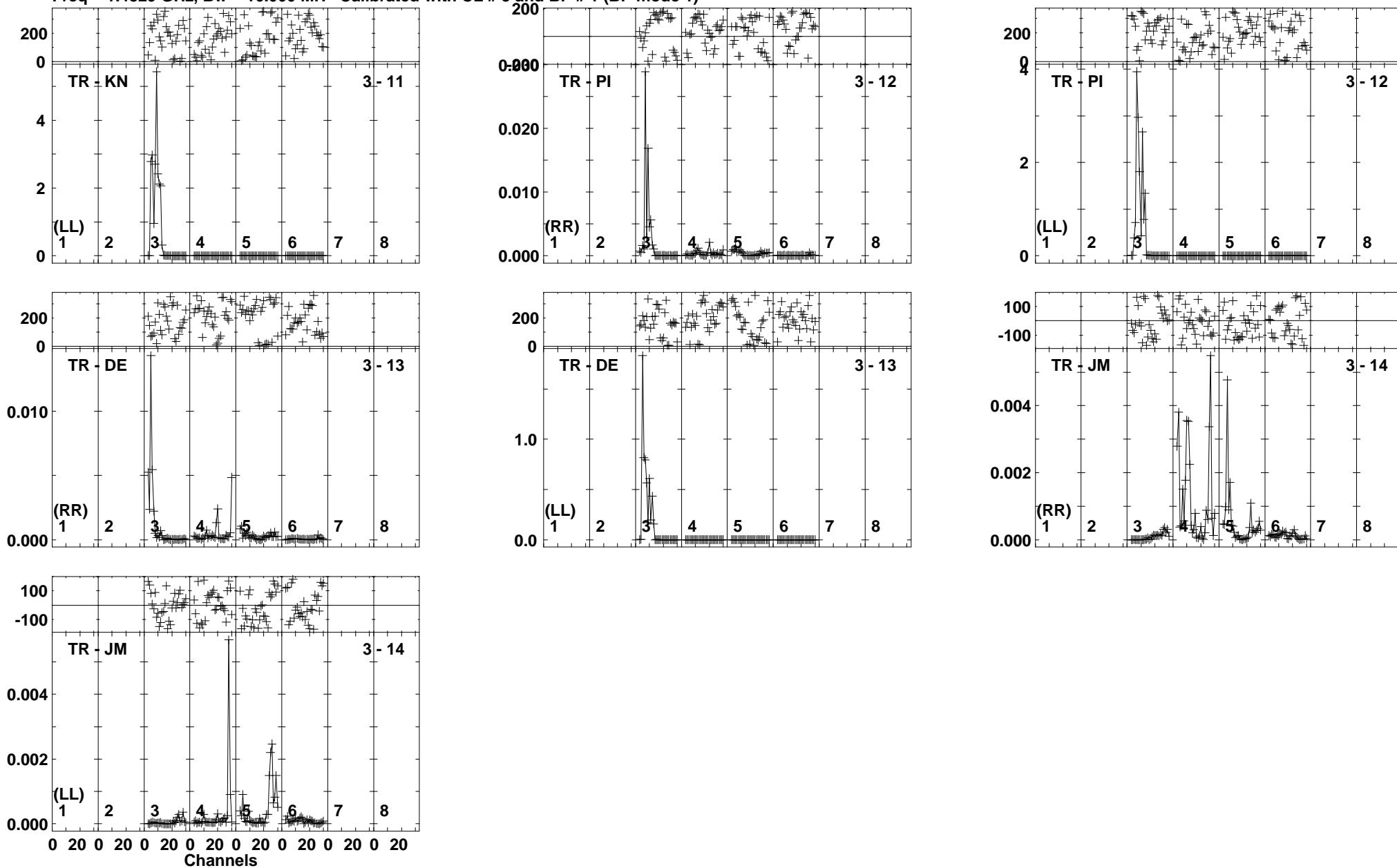

Lower frame: Kilo Ampl Jy Top frame: Phas deg
 Vector averaged cross-power spectrum Baseline: TR (03) - KN (11)
 Timerange: 00/13:45:21 to 00/13:48:49

Plot file version 429 created 21-JUN-2019 11:56:44

J1222+0413 EP111A 1.UVDATA.1

Freq = 1.4829 GHz, Bw = 16.000 MH Calibrated with CL # 3 and BP # 1 (BP mode 1)

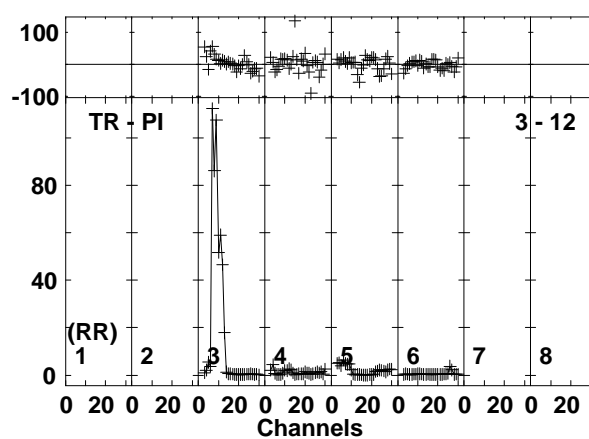
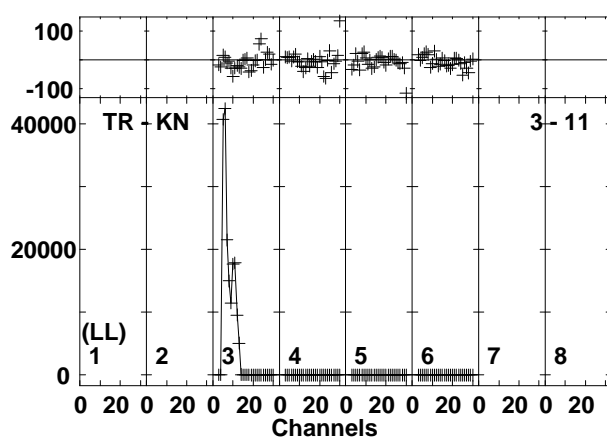
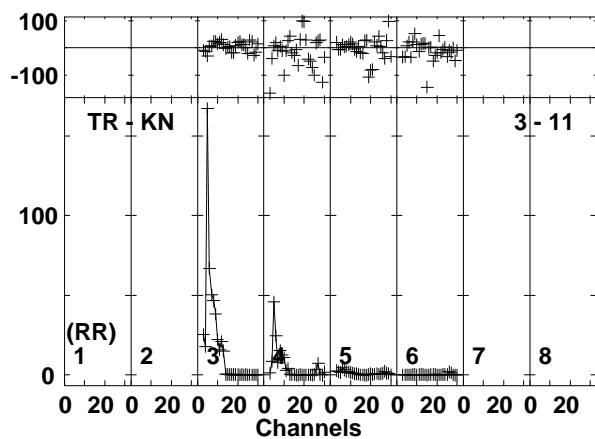
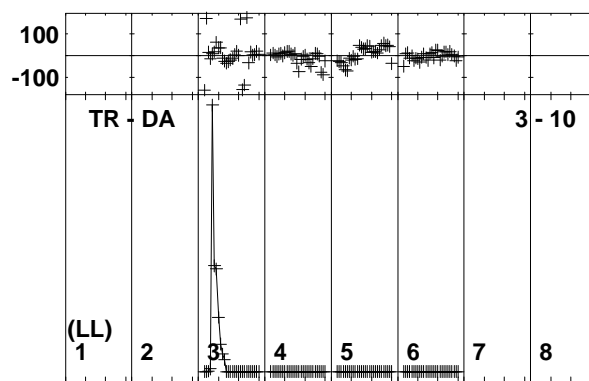
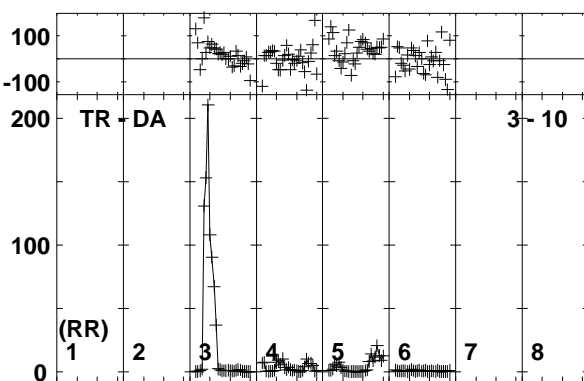
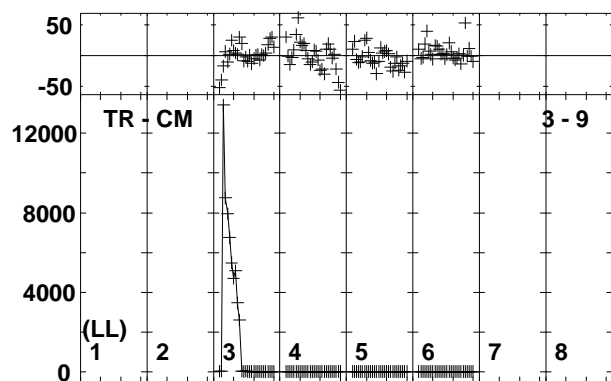
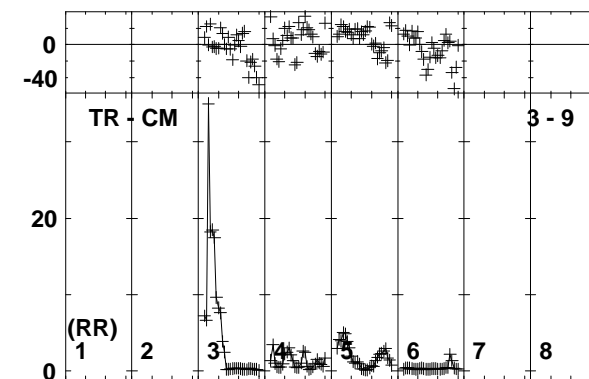
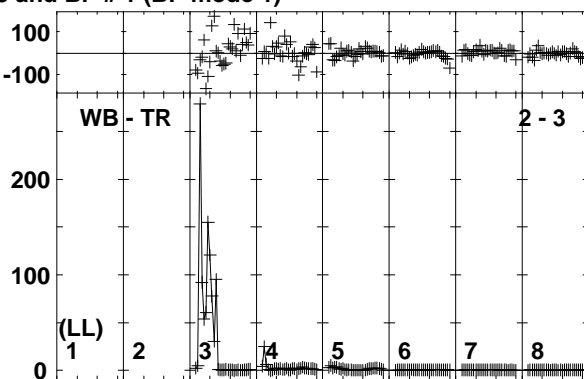
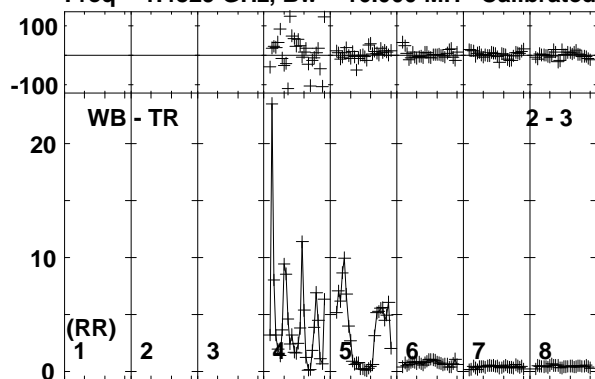

Lower frame: Ampl Jy Top frame: Phas deg
Vector averaged cross-power spectrum Baseline: WB (02) - TR (03)
Timerange: 00/13:48:51 to 00/13:50:19

Plot file version 430 created 21-JUN-2019 11:56:44
J1222+0413 EP111A 1.UVDATA.1
Freq = 1.4829 GHz, Bw = 16.000 MH Calibrated with CL # 3 and BP # 1 (BP mode 1)

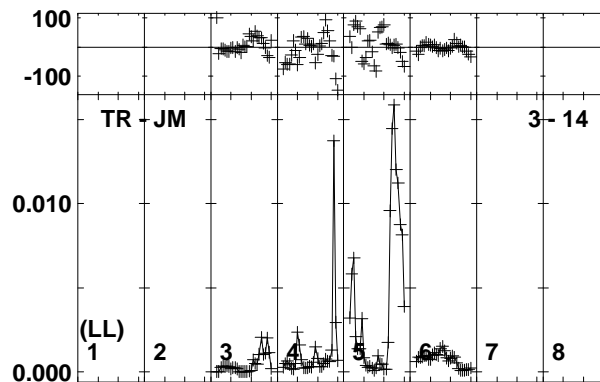
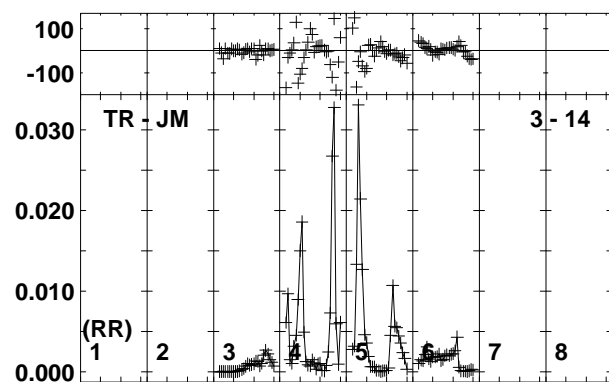
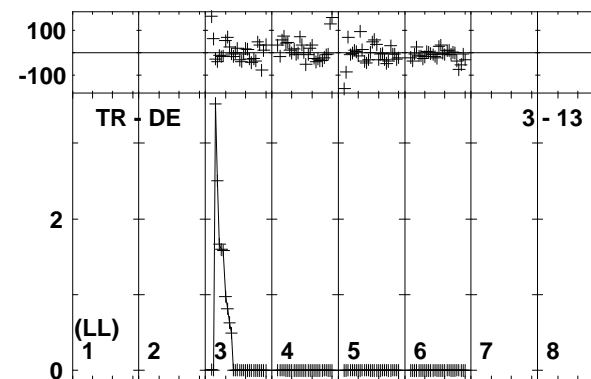
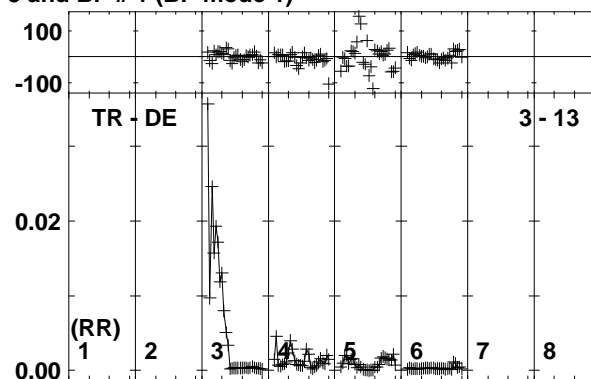
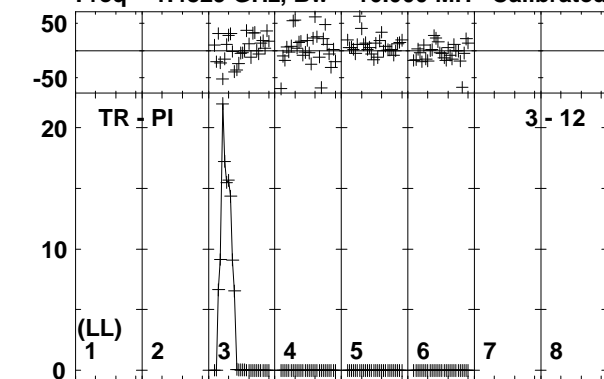

Lower frame: Kilo Ampl Jy Top frame: Phas deg
Vector averaged cross-power spectrum Baseline: TR (03) - PI (12)
Timerange: 00/13:48:51 to 00/13:50:19

Plot file version 431 created 21-JUN-2019 11:56:44
 IRAS12112 EP111A 1.UVDATA.1
 Freq = 1.4829 GHz, Bw = 16.000 MH Calibrated with CL # 3 and BP # 1 (BP mode 1)

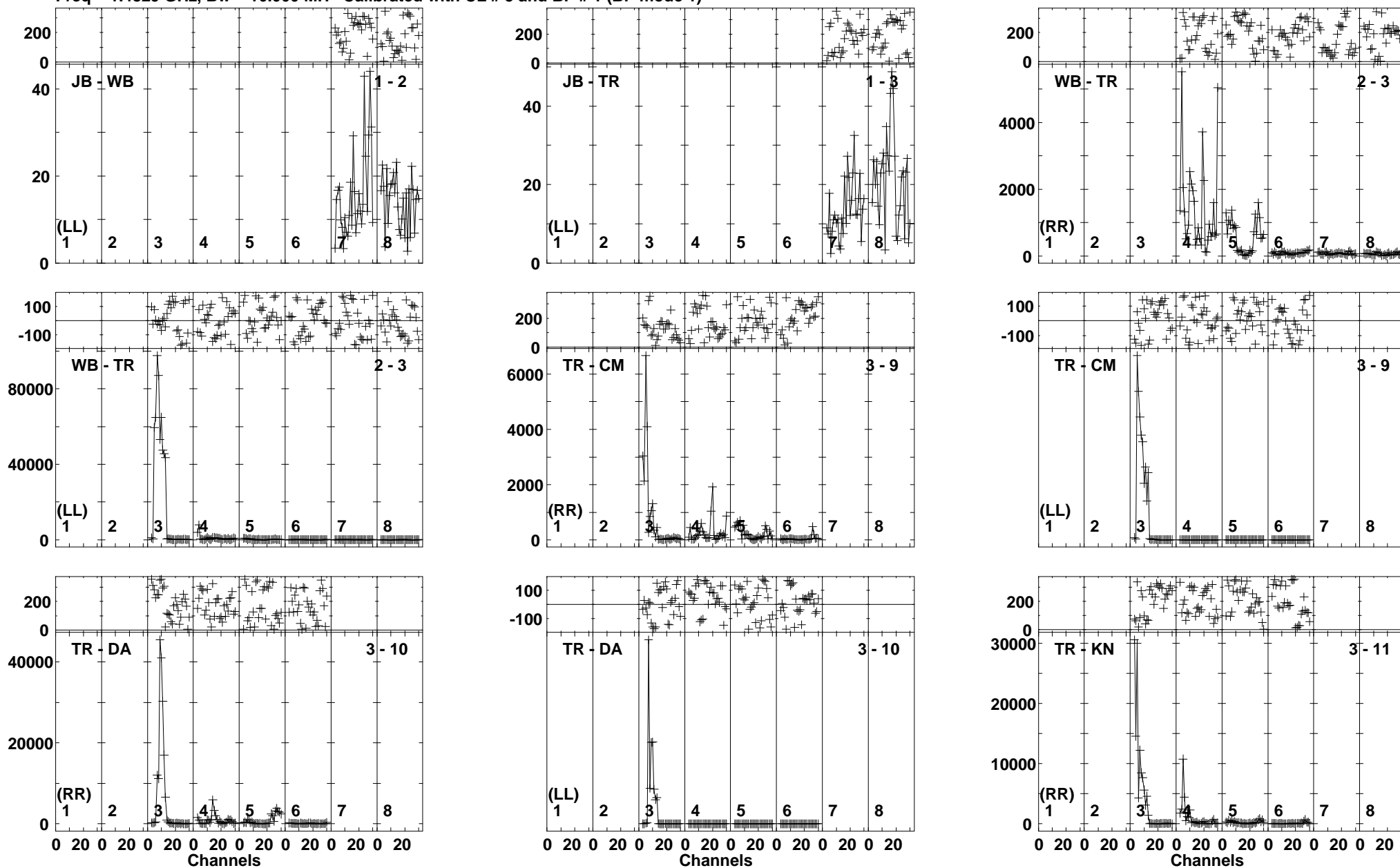

Lower frame: Milli Ampl Jy Top frame: Phas deg
 Vector averaged cross-power spectrum Baseline: JB (01) - WB (02)
 Timerange: 00/13:50:21 to 00/13:53:49

Plot file version 433 created 21-JUN-2019 11:56:45

J1222+0413 EP111A 1.UVDATA.1

Freq = 1.4829 GHz, Bw = 16.000 MH Calibrated with CL # 3 and BP # 1 (BP mode 1)

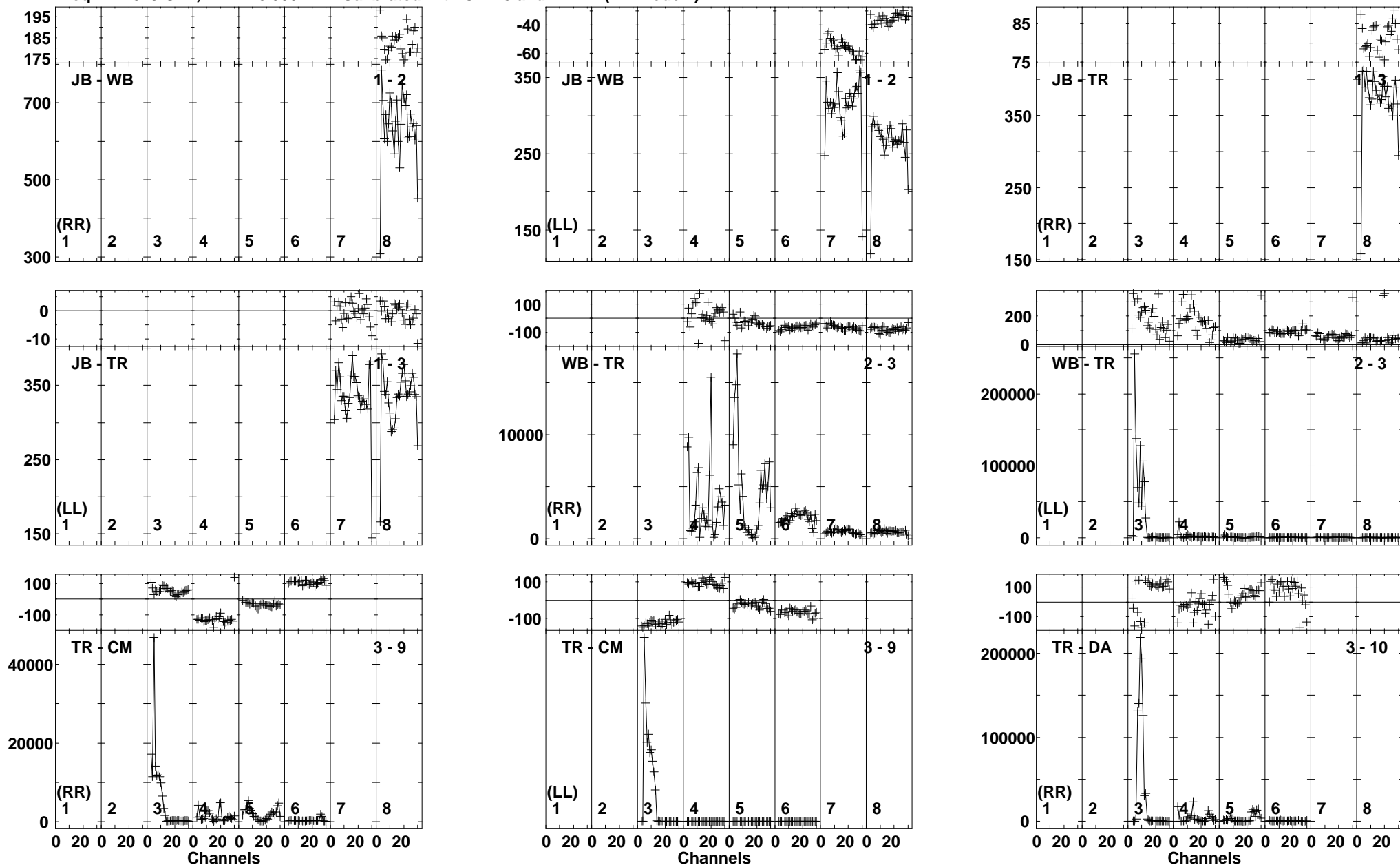

Lower frame: Milli Ampl Jy Top frame: Phas deg
Vector averaged cross-power spectrum Baseline: JB (01) - WB (02)
Timerange: 00/13:54:31 to 00/13:55:59

Plot file version 434 created 21-JUN-2019 11:56:46
 J1222+0413 EP111A 1.UVDATA.1
 Freq = 1.4829 GHz, Bw = 16.000 MH Calibrated with CL # 3 and BP # 1 (BP mode 1)

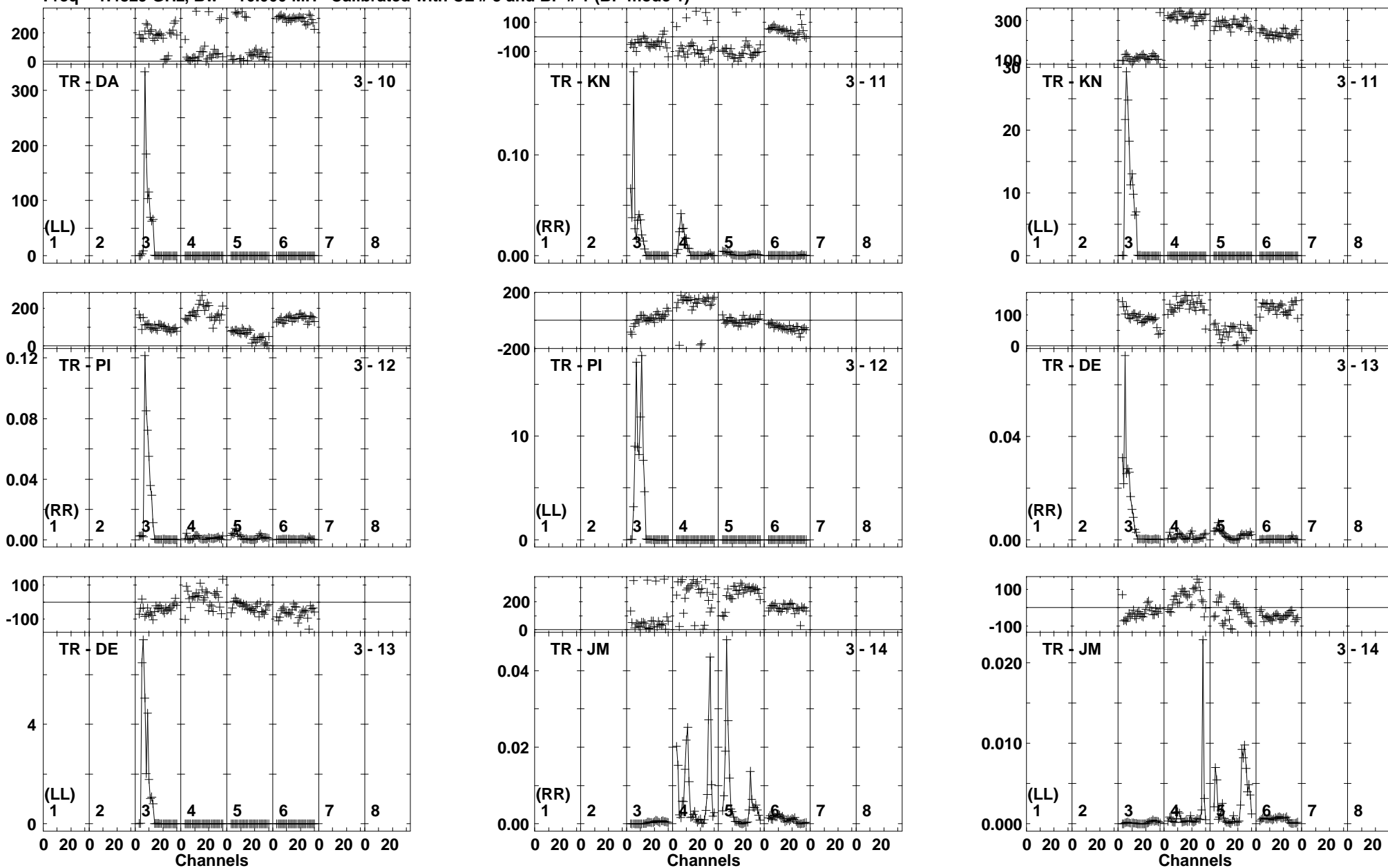

Lower frame: Kilo Ampl Jy Top frame: Phas deg
 Vector averaged cross-power spectrum Baseline: TR (03) - DA (10)
 Timerange: 00/13:54:31 to 00/13:55:59

Plot file version 435 created 21-JUN-2019 11:56:46

IRAS12112 EP111A 1.UVDATA.1

Freq = 1.4829 GHz, Bw = 16.000 MH Calibrated with CL # 3 and BP # 1 (BP mode 1)

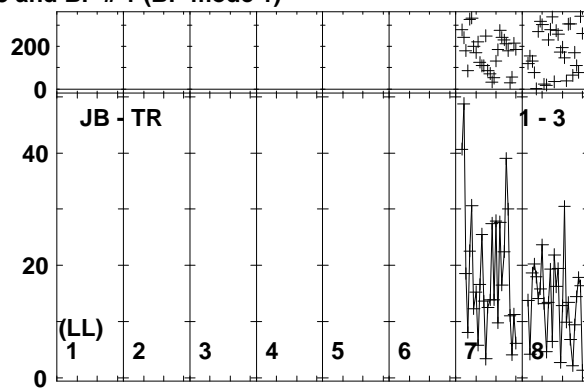
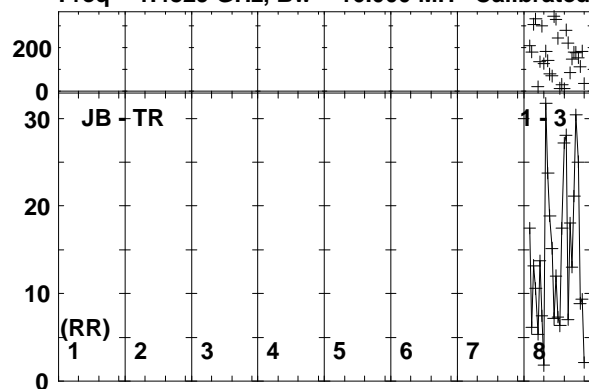

Lower frame: Milli Ampl Jy Top frame: Phas deg
Vector averaged cross-power spectrum Baseline: JB (01) - TR (03)
Timerange: 00/13:56:01 to 00/13:59:29

Plot file version 436 created 21-JUN-2019 11:56:48

IRAS12112 EP111A 1.UVDATA.1

Freq = 1.4829 GHz, Bw = 16.000 MH Calibrated with CL # 3 and BP # 1 (BP mode 1)

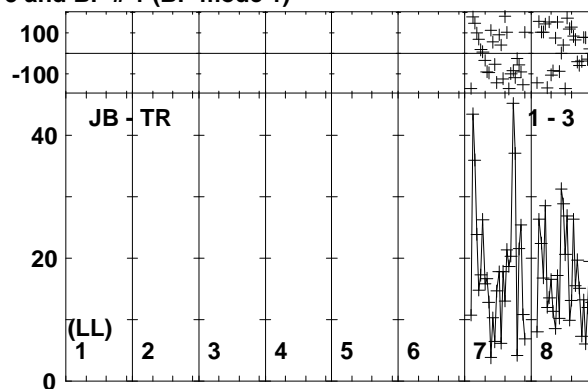
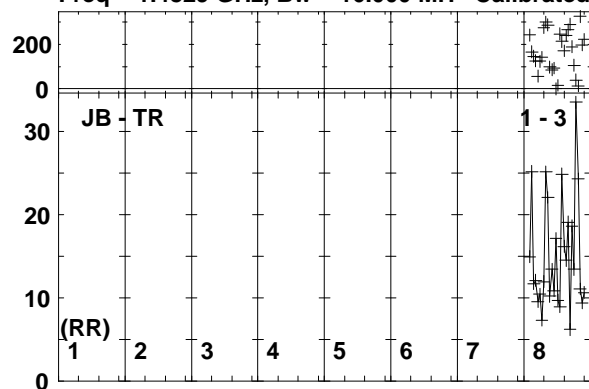

Lower frame: Milli Ampl Jy Top frame: Phas deg
Vector averaged cross-power spectrum Baseline: JB (01) - TR (03)
Timerange: 00/14:01:01 to 00/14:04:29

Plot file version 437 created 21-JUN-2019 11:56:49

J1222+0413 EP111A 1.UVDATA.1

Freq = 1.4829 GHz, Bw = 16.000 MH Calibrated with CL # 3 and BP # 1 (BP mode 1)

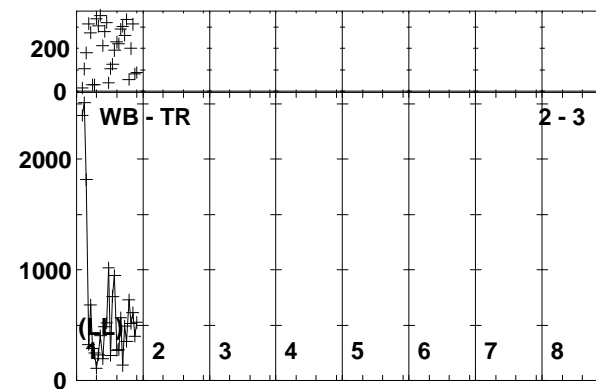
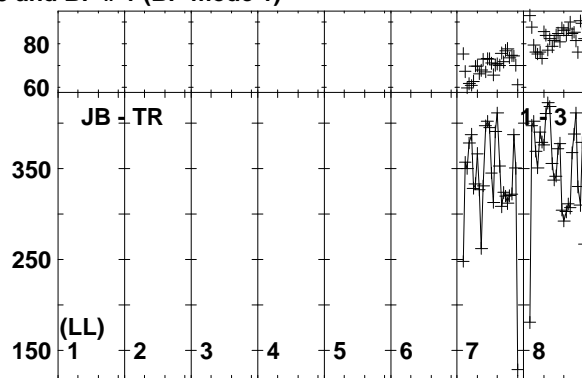
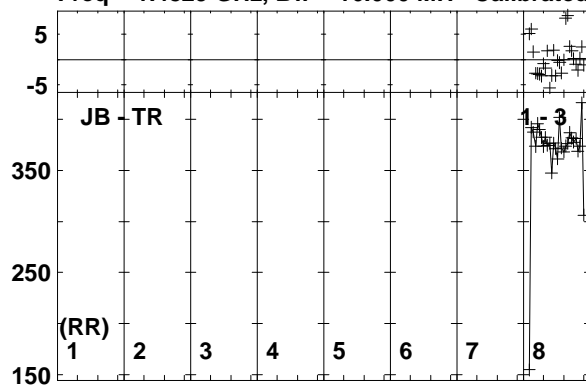

Lower frame: Milli Ampl Jy Top frame: Phas deg
Vector averaged cross-power spectrum Baseline: JB (01) - TR (03)
Timerange: 00/14:05:11 to 00/14:06:39

Plot file version 438 created 21-JUN-2019 11:56:50

IRAS12112 EP111A 1.UVDATA.1

Freq = 1.4829 GHz, Bw = 16.000 MH Calibrated with CL # 3 and BP # 1 (BP mode 1)

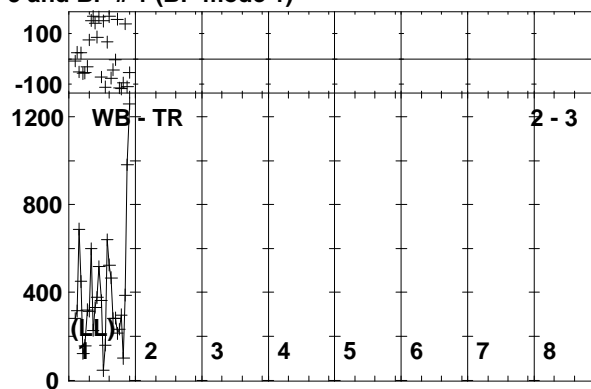
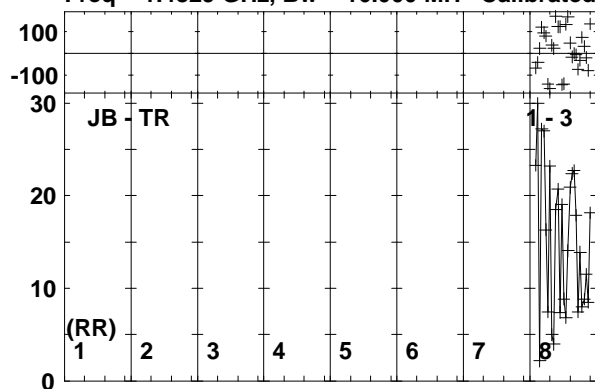

Lower frame: Milli Ampl Jy Top frame: Phas deg
Vector averaged cross-power spectrum Baseline: JB (01) - TR (03)
Timerange: 00/14:06:41 to 00/14:10:09

Plot file version 439 created 21-JUN-2019 11:56:52
J1222+0413 EP111A 1.UVDATA.1
Freq = 1.4829 GHz, Bw = 16.000 MH Calibrated with CL # 3 and BP # 1 (BP mode 1)

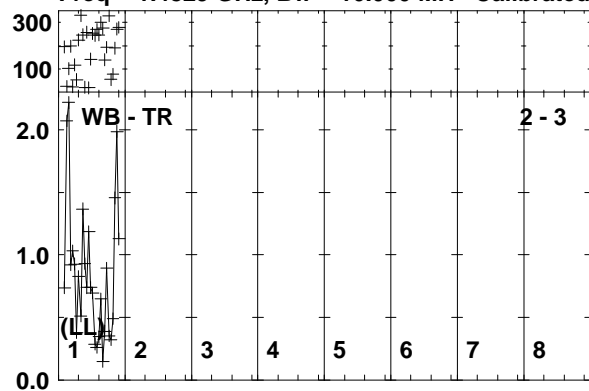

Lower frame: Ampl Jy Top frame: Phas deg
Vector averaged cross-power spectrum Baseline: WB (02) - TR (03)
Timerange: 00/14:10:11 to 00/14:11:39

Plot file version 440 created 21-JUN-2019 11:56:53

J1222+0413 EP111A 1.UVDATA.1

Freq = 1.4829 GHz, Bw = 16.000 MH Calibrated with CL # 3 and BP # 1 (BP mode 1)

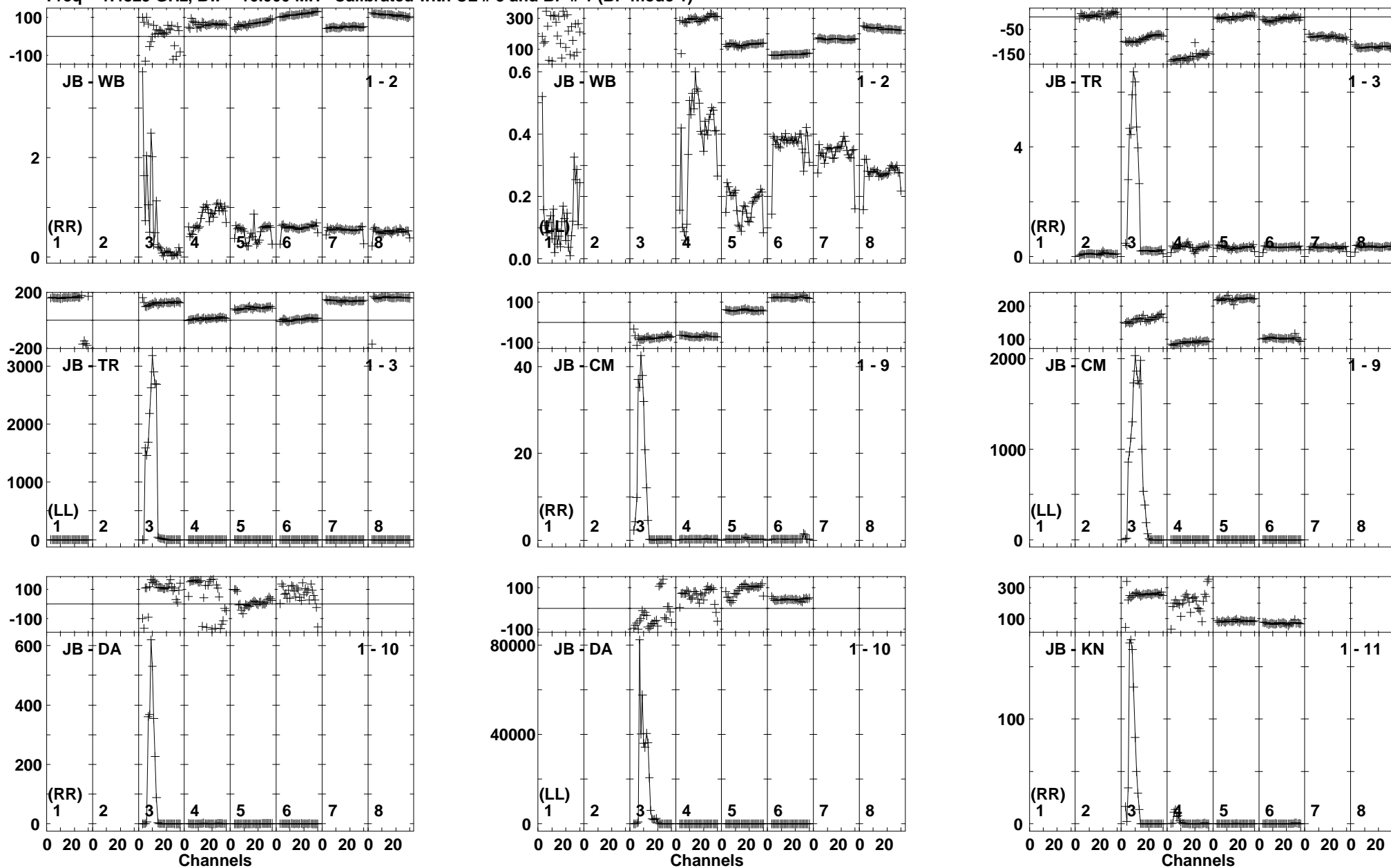

Lower frame: Ampl Jy Top frame: Phas deg
Vector averaged cross-power spectrum Baseline: JB (01) - WB (02)
Timerange: 00/14:15:51 to 00/14:17:19

Plot file version 441 created 21-JUN-2019 11:56:54

J1222+0413 EP111A 1.UVDATA.1

Freq = 1.4829 GHz, Bw = 16.000 MH Calibrated with CL # 3 and BP # 1 (BP mode 1)

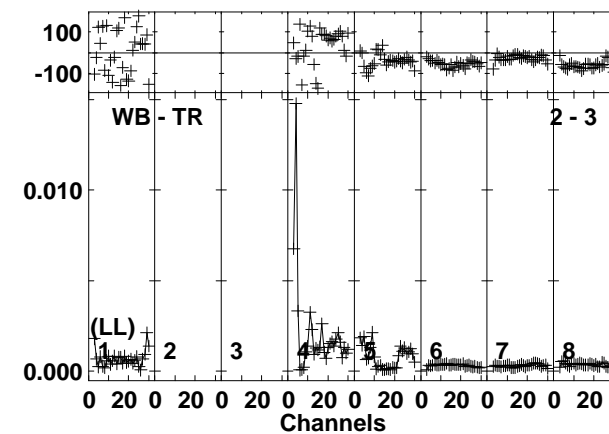
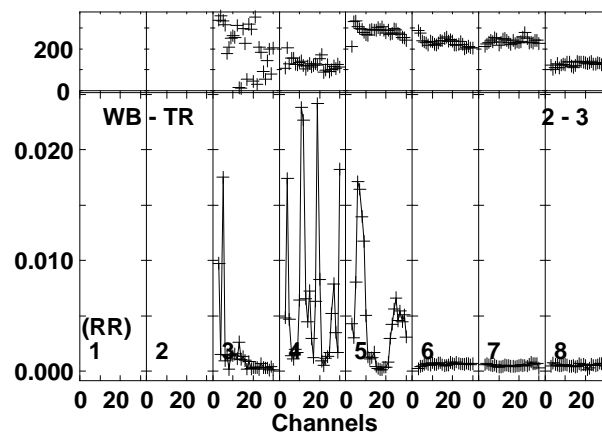
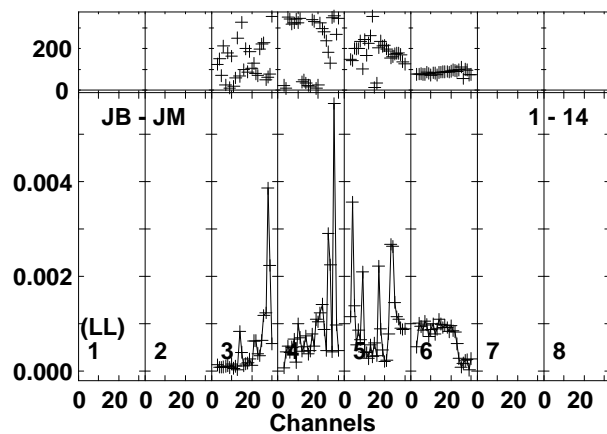
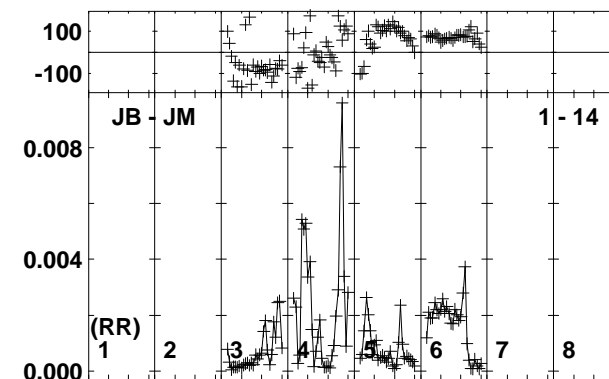
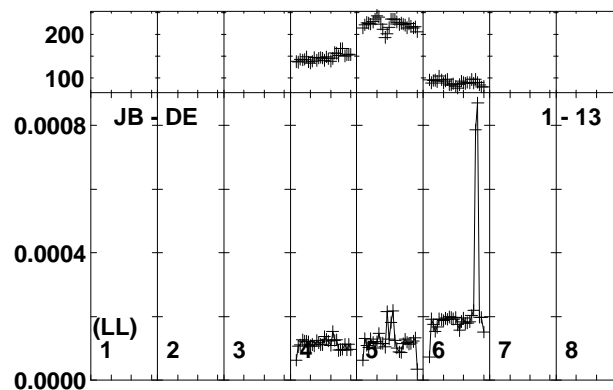
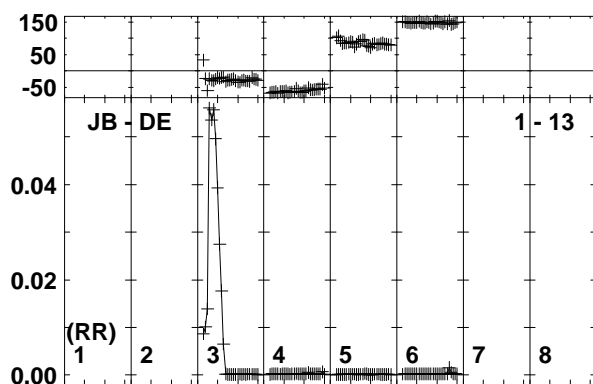
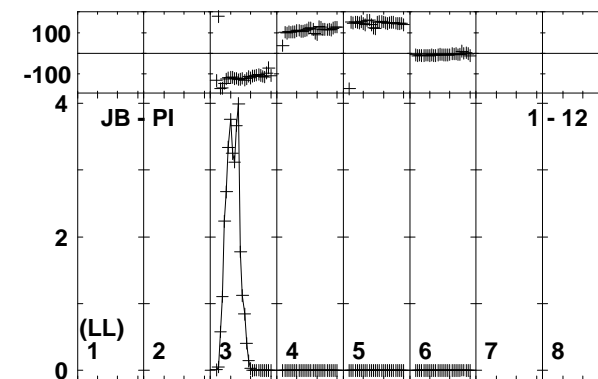
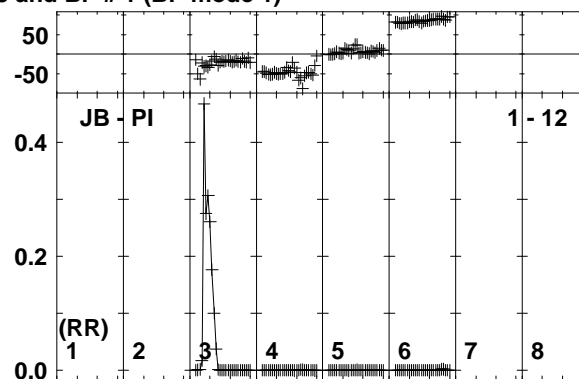
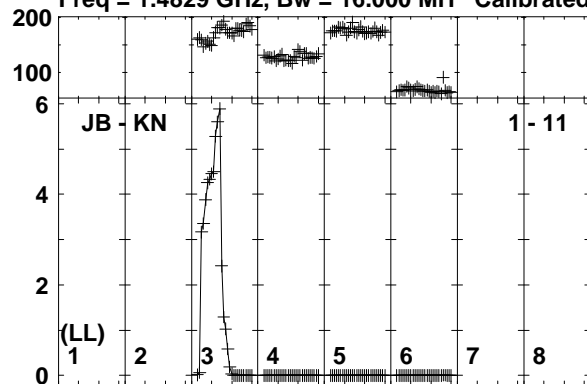

Lower frame: Kilo Ampl Jy Top frame: Phas deg
Vector averaged cross-power spectrum Baseline: JB (01) - KN (11)
Timerange: 00/14:15:51 to 00/14:17:19

Plot file version 442 created 21-JUN-2019 11:56:54
 J1222+0413 EP111A 1.UVDATA.1
 Freq = 1.4829 GHz, Bw = 16.000 MH Calibrated with CL # 3 and BP # 1 (BP mode 1)

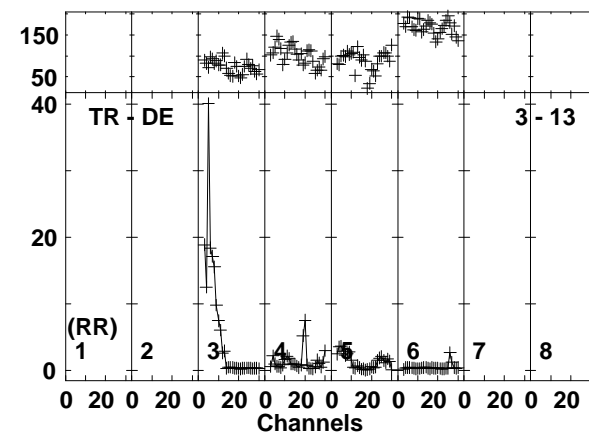
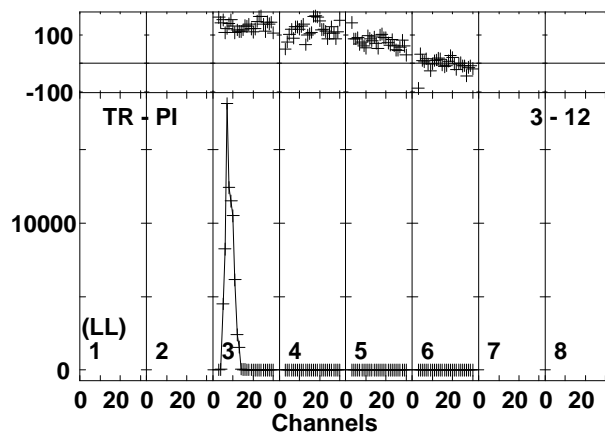
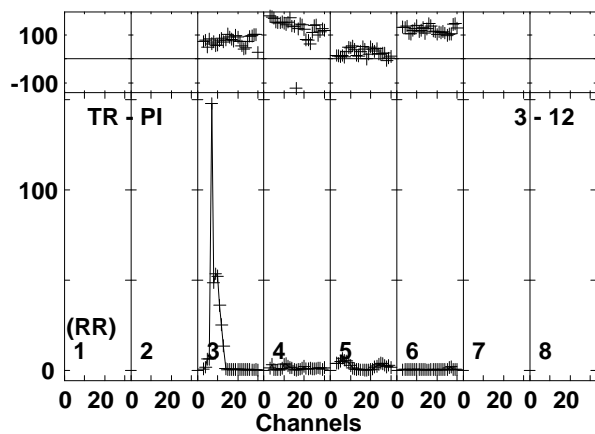
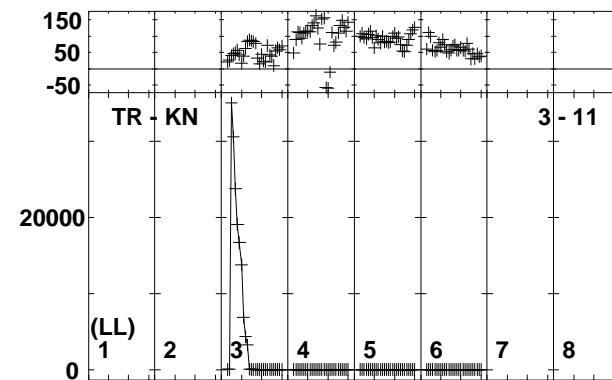
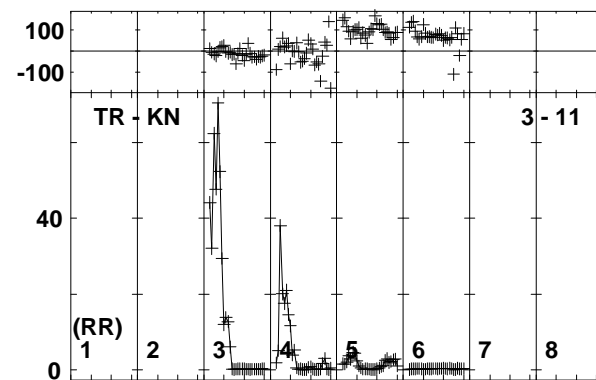
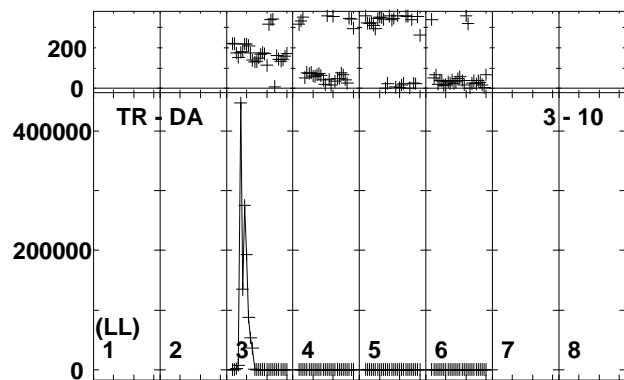
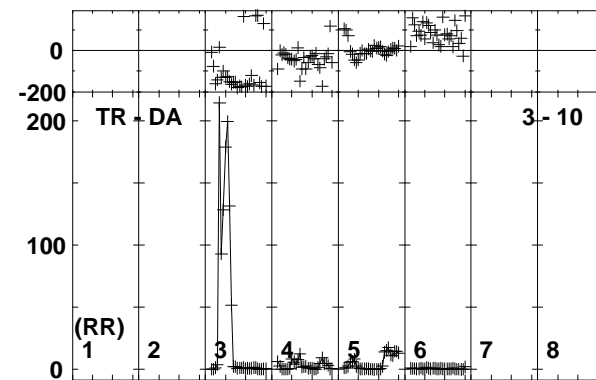
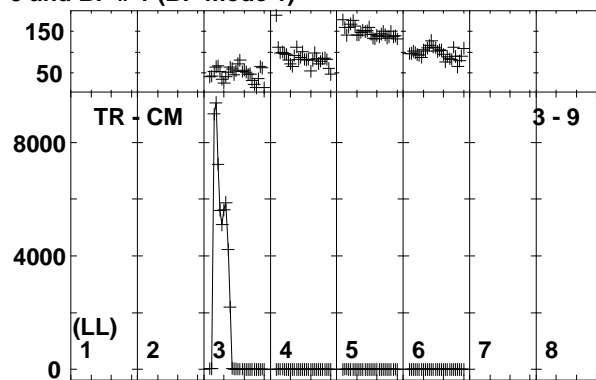
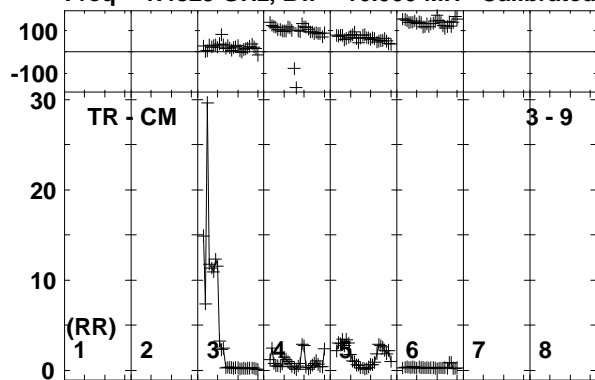

Lower frame: Ampl Jy Top frame: Phas deg
 Vector averaged cross-power spectrum Baseline: TR (03) - CM (09)
 Timerange: 00/14:15:51 to 00/14:17:19

Plot file version 443 created 21-JUN-2019 11:56:54
J1222+0413 EP1111A 1.UVDATA.1
Freq = 1.4829 GHz, Bw = 16.000 MH Calibrated with CL # 3 and BP # 1 (BP mode 1)

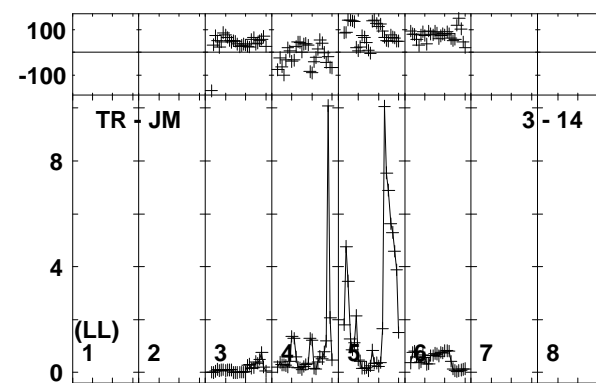
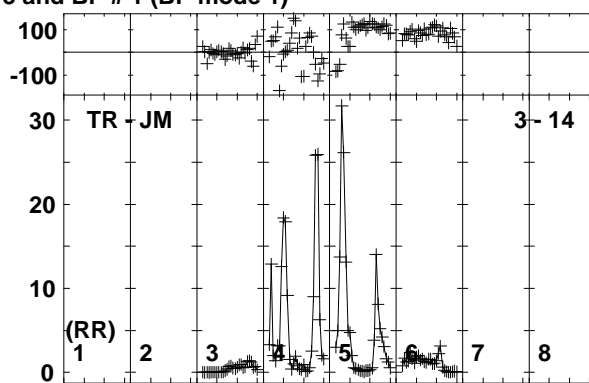
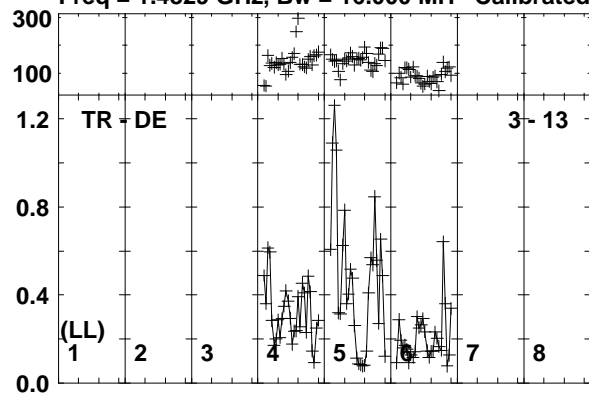

Lower frame: Ampl Jy Top frame: Phas deg
Vector averaged cross-power spectrum Baseline: TR (03) - DE (13)
Timerange: 00/14:15:51 to 00/14:17:19

Plot file version 444 created 21-JUN-2019 11:56:54
 IRAS12112 EP111A 1.UVDATA.1
 Freq = 1.4829 GHz, Bw = 16.000 MH Calibrated with CL # 3 and BP # 1 (BP mode 1)

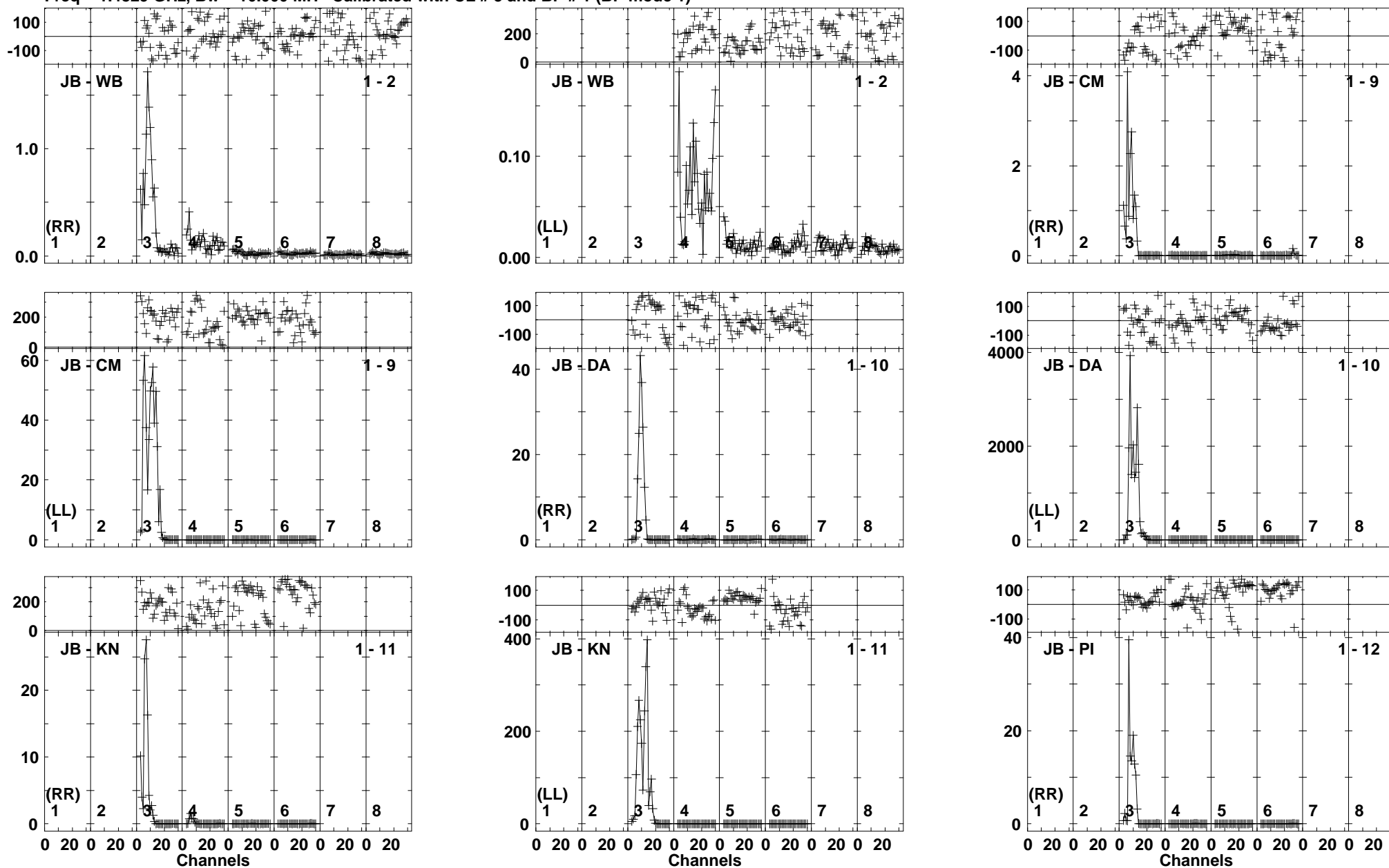

Lower frame: Ampl Jy Top frame: Phas deg
 Vector averaged cross-power spectrum Baseline: JB (01) - WB (02)
 Timerange: 00/14:17:21 to 00/14:20:49

Plot file version 445 created 21-JUN-2019 11:56:55
 IRAS12112 EP111A 1.UVDATA.1
 Freq = 1.4829 GHz, Bw = 16.000 MH Calibrated with CL # 3 and BP # 1 (BP mode 1)

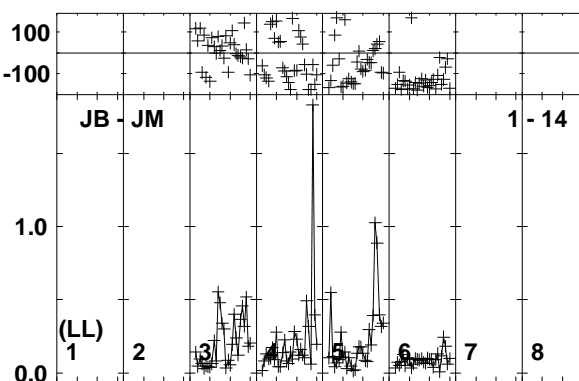
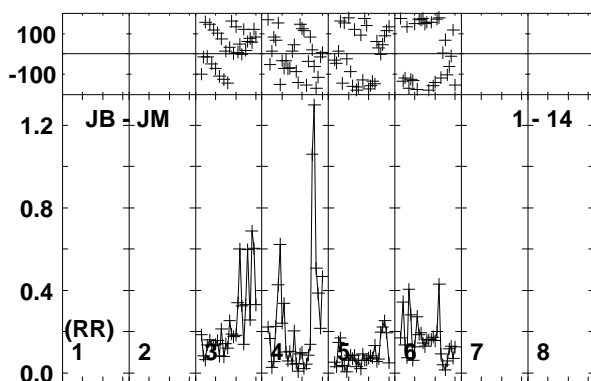
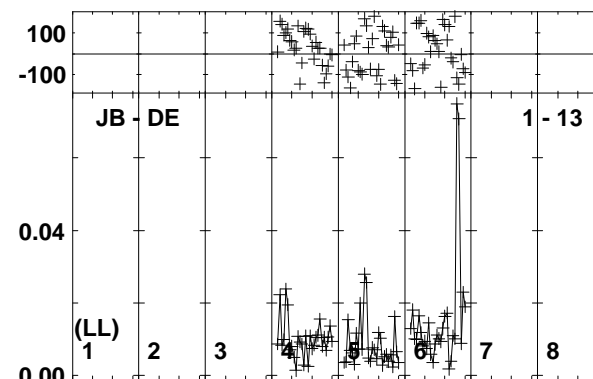
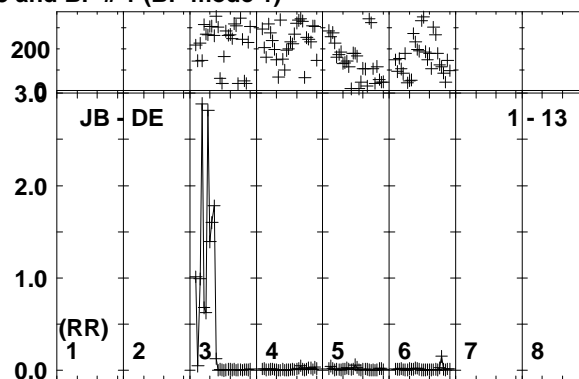
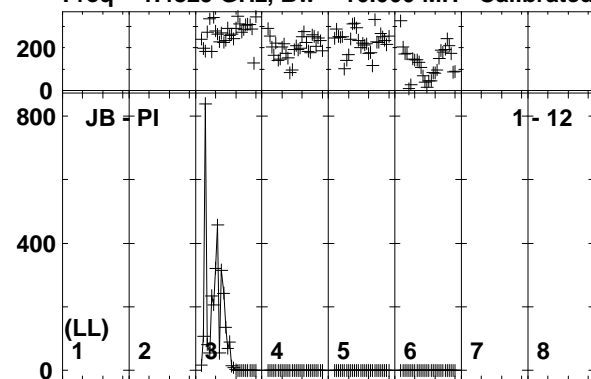

Lower frame: Ampl Jy Top frame: Phas deg
 Vector averaged cross-power spectrum Baseline: JB (01) - PI (12)
 Timerange: 00/14:17:21 to 00/14:20:49

Plot file version 446 created 21-JUN-2019 11:56:56

J1222+0413 EP111A 1.UVDATA.1

Freq = 1.4829 GHz, Bw = 16.000 MH Calibrated with CL # 3 and BP # 1 (BP mode 1)

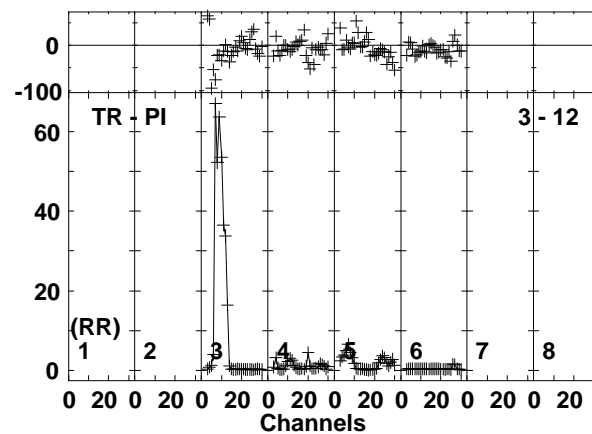
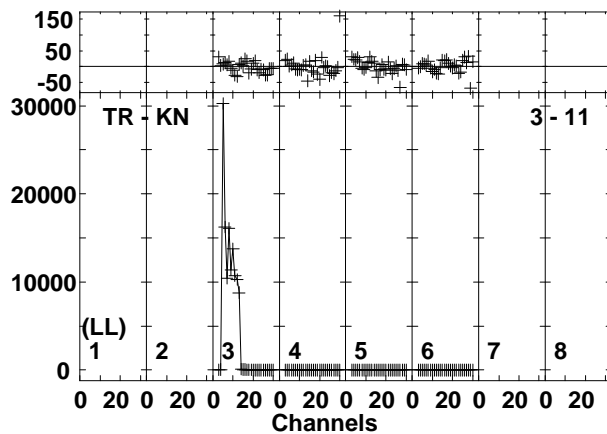
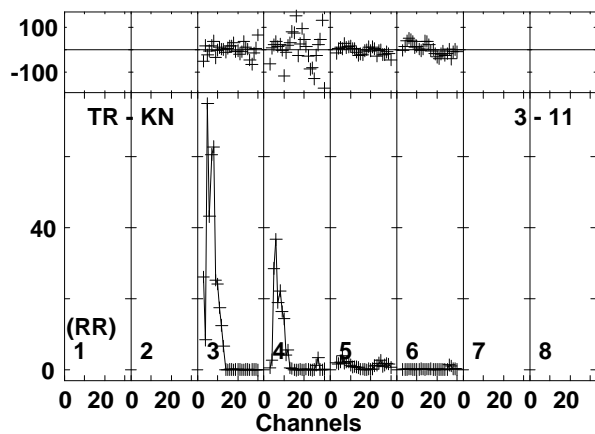
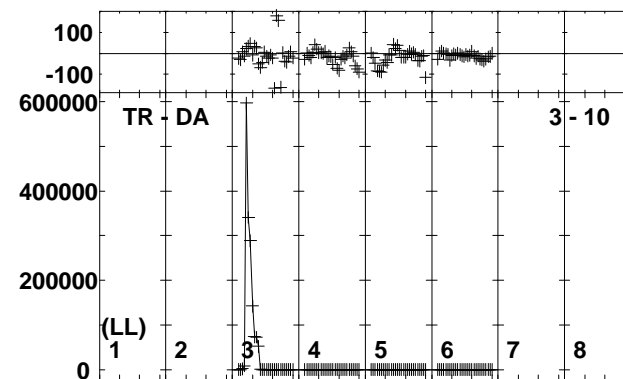
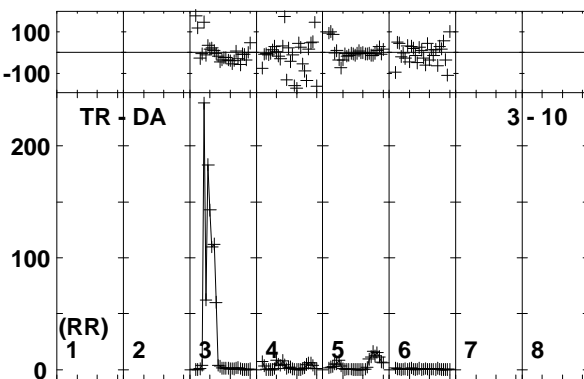
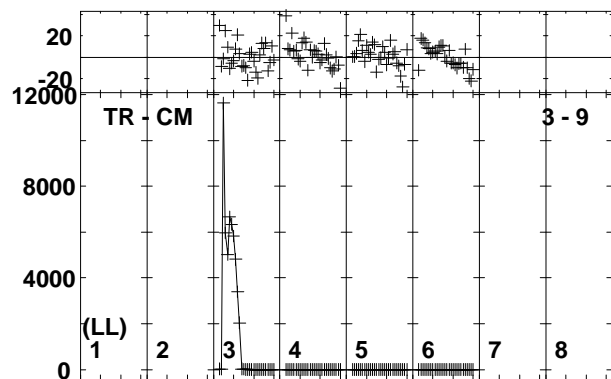
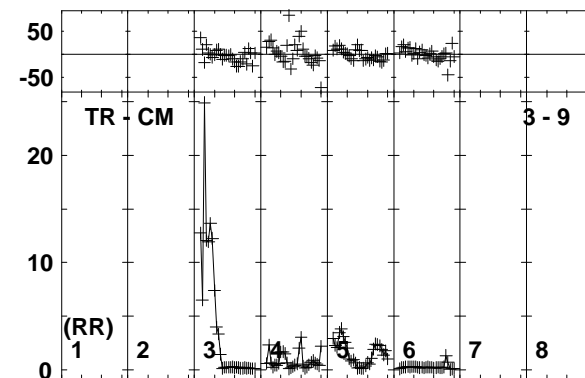
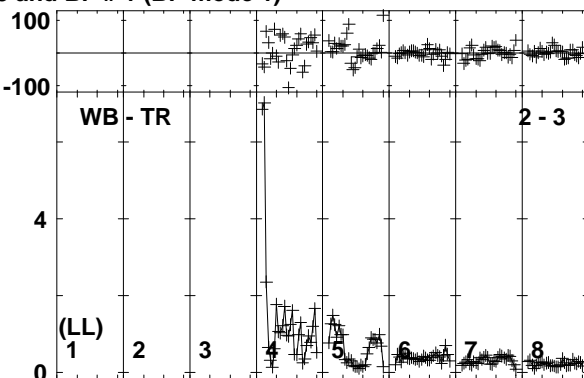
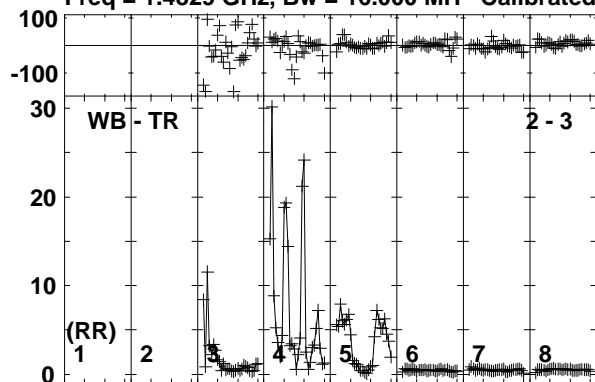

Lower frame: Ampl Jy Top frame: Phas deg
Vector averaged cross-power spectrum Baseline: WB (02) - TR (03)
Timerange: 00/14:20:51 to 00/14:22:19

Plot file version 447 created 21-JUN-2019 11:56:56
 J1222+0413 EP111A 1.UVDATA.1
 Freq = 1.4829 GHz, Bw = 16.000 MH Calibrated with CL # 3 and BP # 1 (BP mode 1)

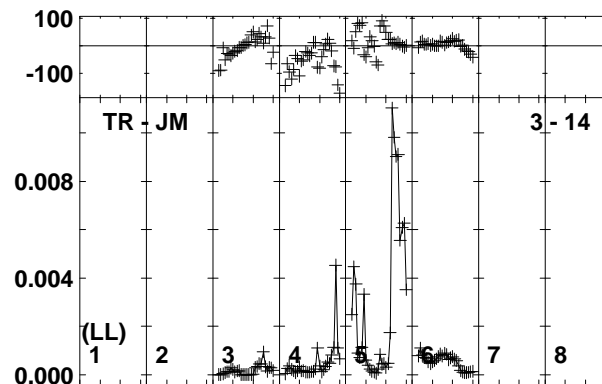
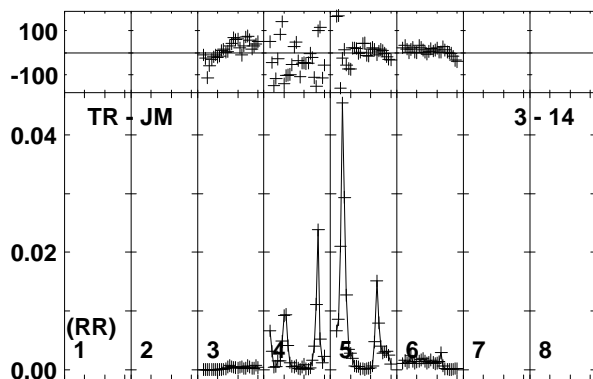
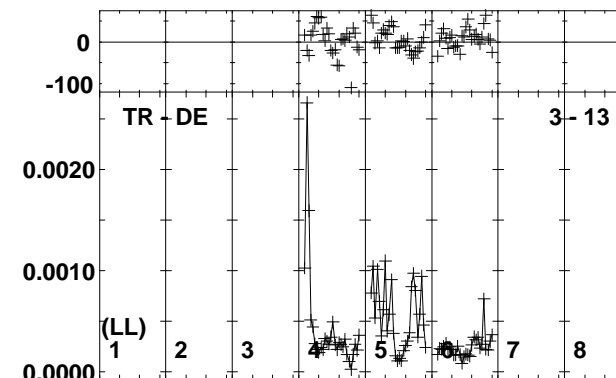
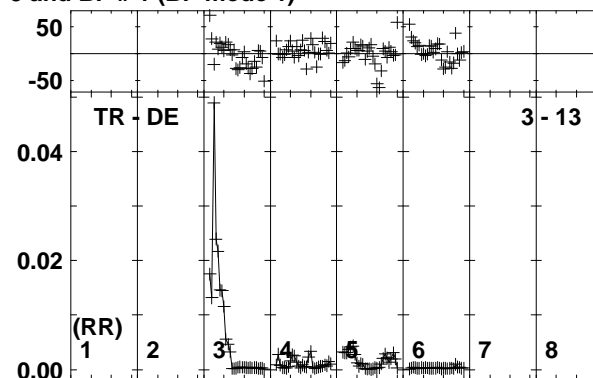
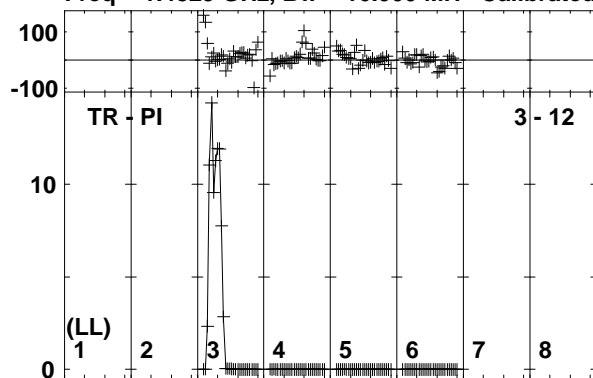

Lower frame: Kilo Ampl Jy Top frame: Phas deg
 Vector averaged cross-power spectrum Baseline: TR (03) - PI (12)
 Timerange: 00/14:20:51 to 00/14:22:19

Plot file version 448 created 21-JUN-2019 11:56:57

IRAS12112 EP111A 1.UVDATA.1

Freq = 1.4829 GHz, Bw = 16.000 MH Calibrated with CL # 3 and BP # 1 (BP mode 1)

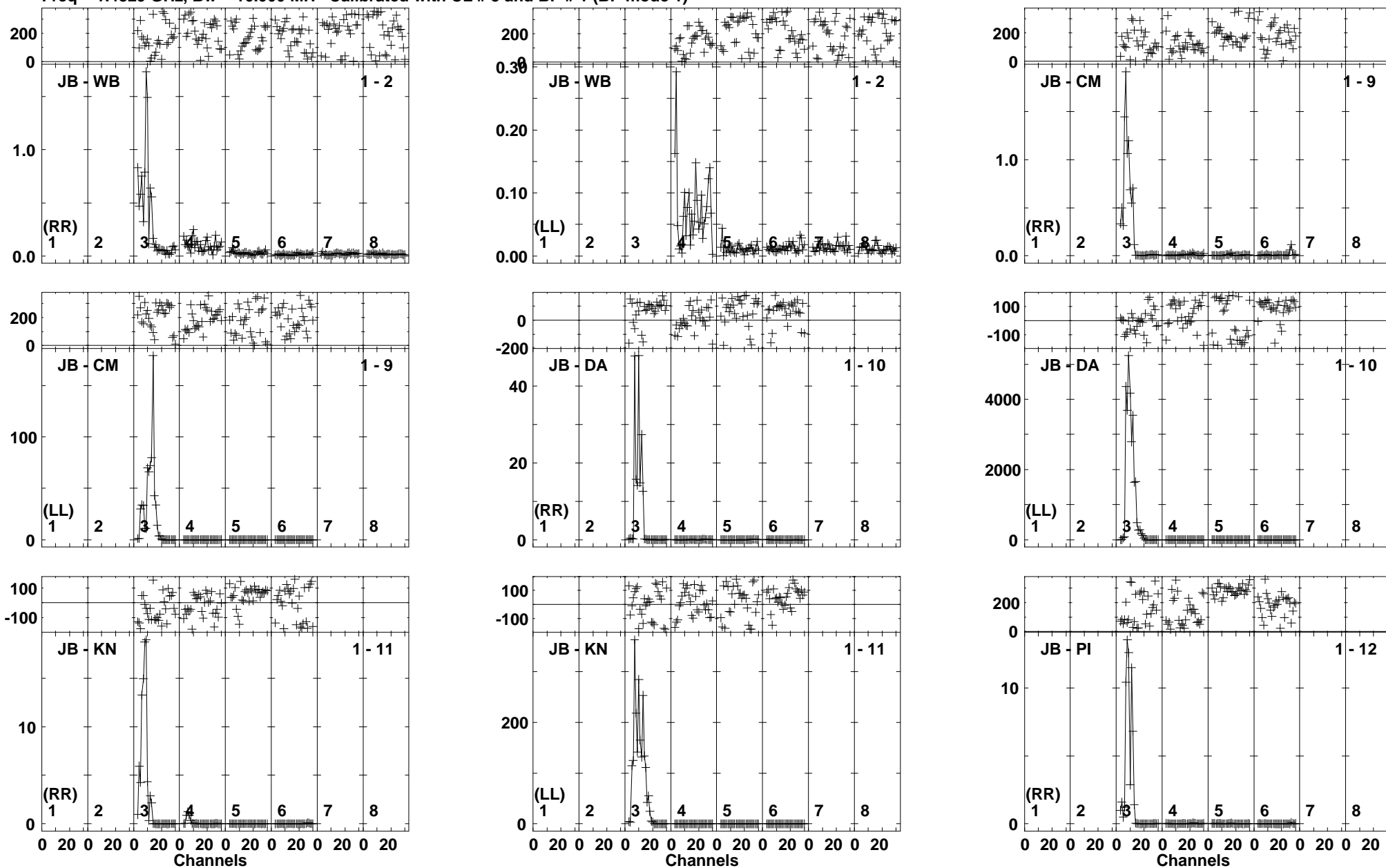

Lower frame: Ampl Jy Top frame: Phas deg
Vector averaged cross-power spectrum Baseline: JB (01) - WB (02)
Timerange: 00/14:22:21 to 00/14:25:49

Plot file version 449 created 21-JUN-2019 11:56:57

IRAS12112 EP111A 1.UVDATA.1

Freq = 1.4829 GHz, Bw = 16.000 MH Calibrated with CL # 3 and BP # 1 (BP mode 1)

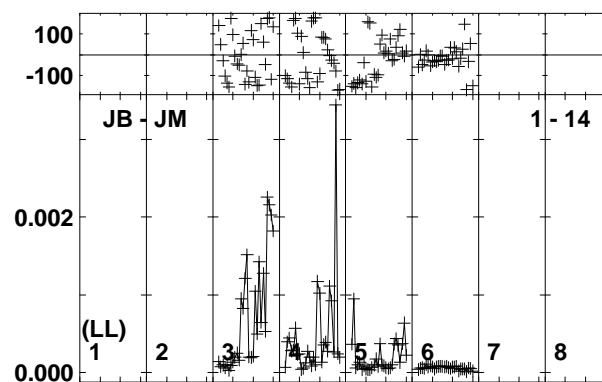
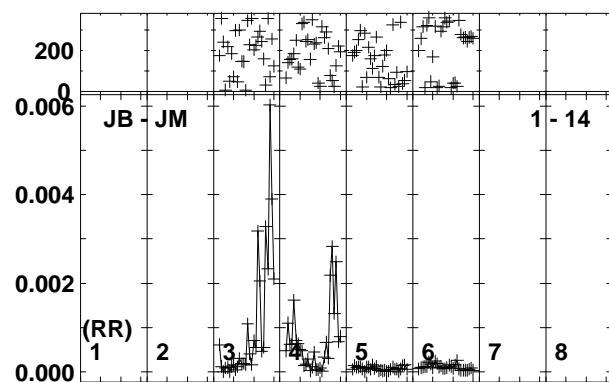
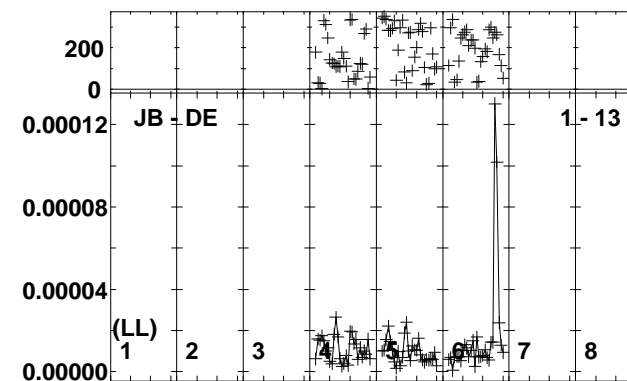
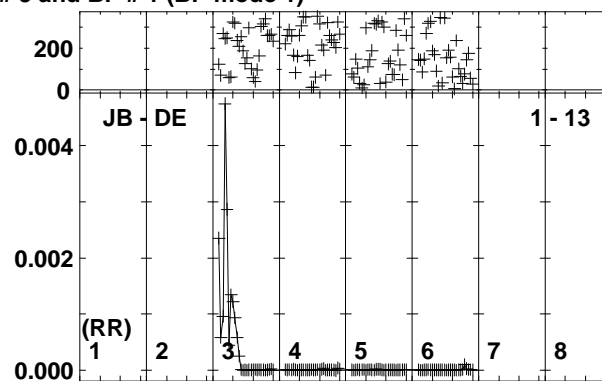
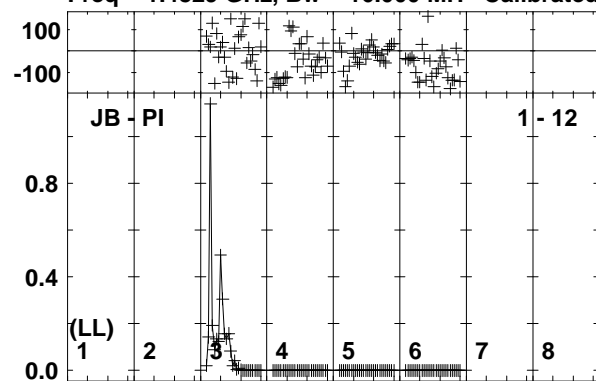

Lower frame: Kilo Ampl Jy Top frame: Phas deg
Vector averaged cross-power spectrum Baseline: JB (01) - PI (12)
Timerange: 00/14:22:21 to 00/14:25:49

Plot file version 450 created 21-JUN-2019 11:56:58

J1222+0413 EP111A 1.UVDATA.1

Freq = 1.4829 GHz, Bw = 16.000 MH Calibrated with CL # 3 and BP # 1 (BP mode 1)

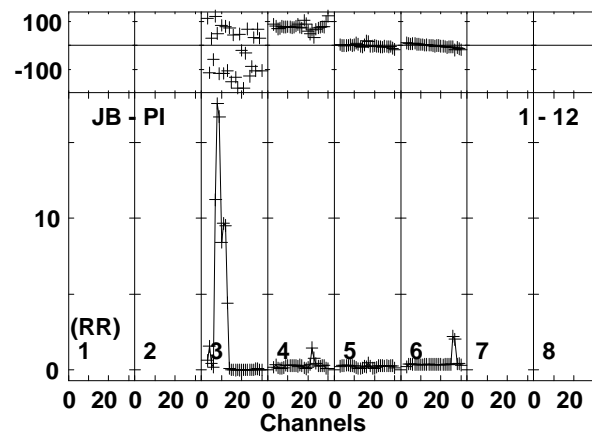
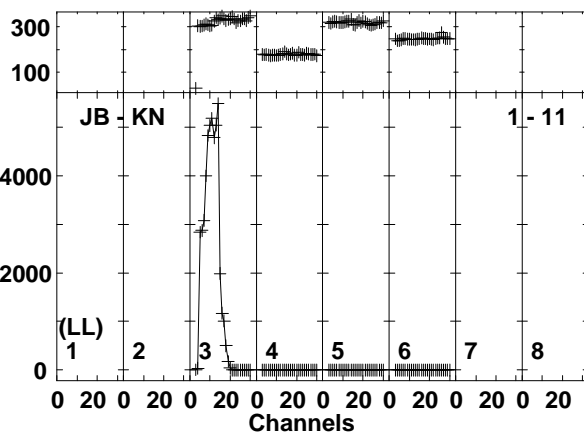
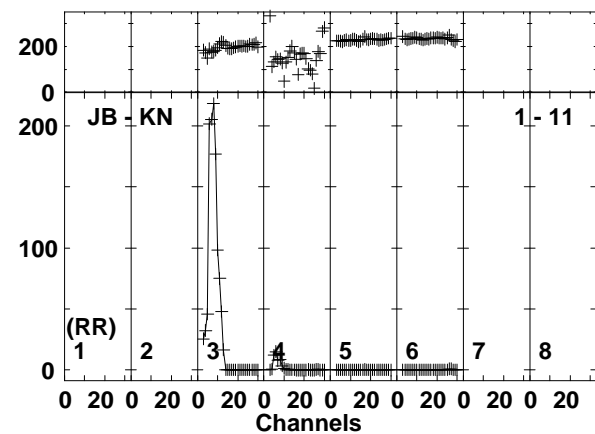
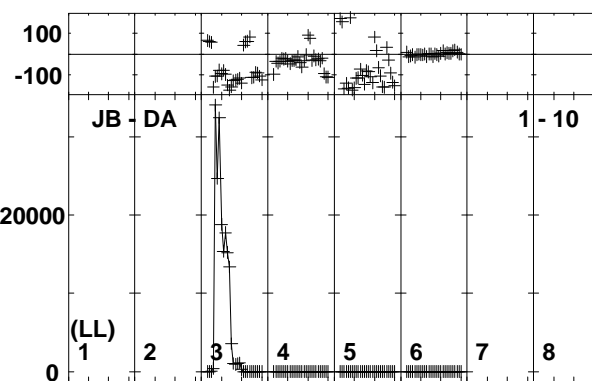
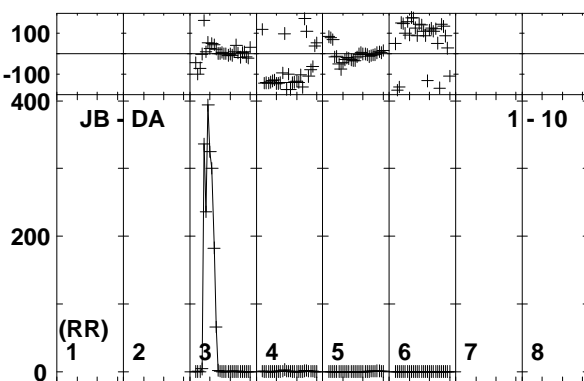
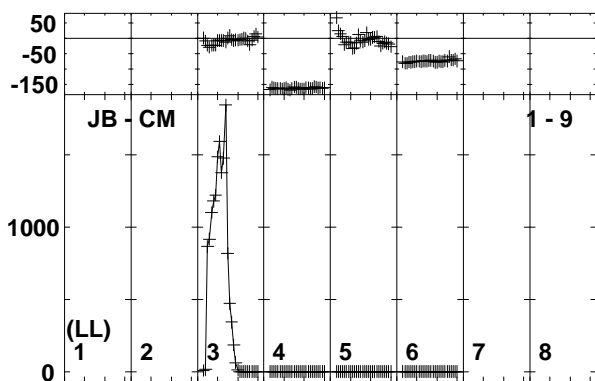
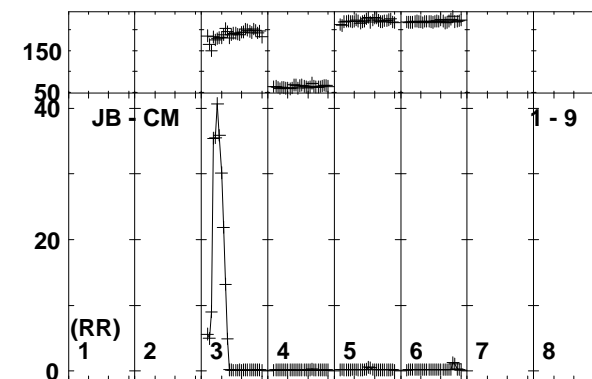
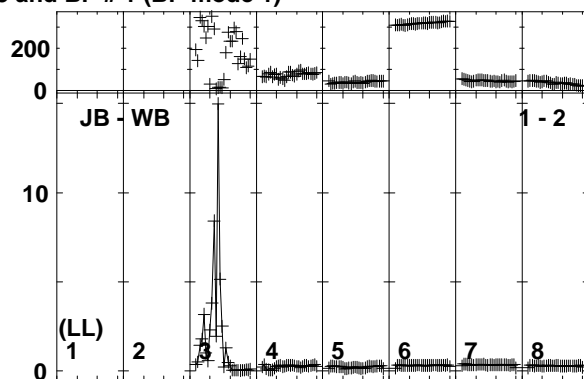
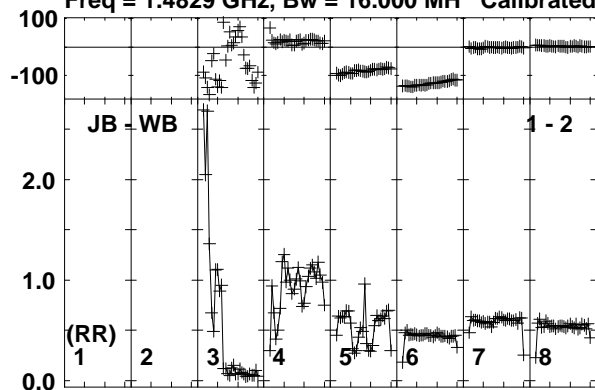

Lower frame: Ampl Jy Top frame: Phas deg
Vector averaged cross-power spectrum Baseline: JB (01) - WB (02)
Timerange: 00/14:26:31 to 00/14:27:59

Plot file version 451 created 21-JUN-2019 11:56:58
 J1222+0413 EP111A 1.UVDATA.1
 Freq = 1.4829 GHz, Bw = 16.000 MH Calibrated with CL # 3 and BP # 1 (BP mode 1)

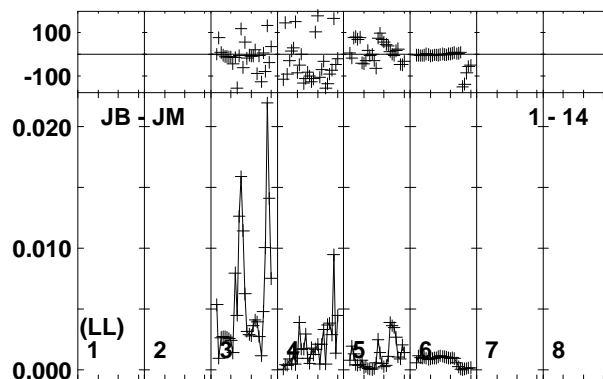
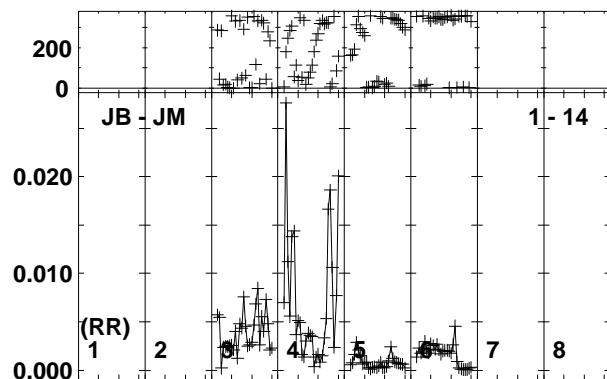
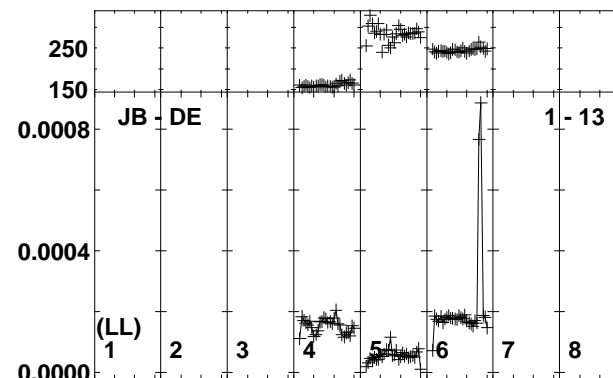
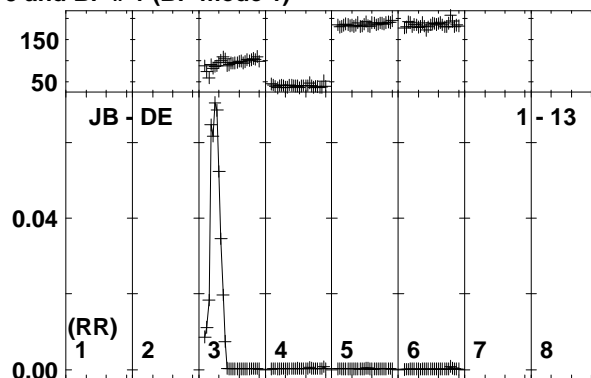
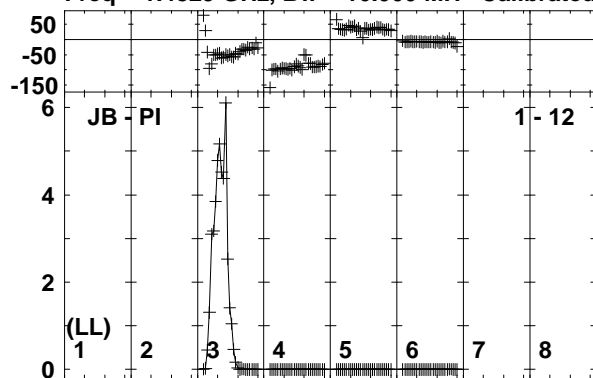

Lower frame: Kilo Ampl Jy Top frame: Phas deg
 Vector averaged cross-power spectrum Baseline: JB (01) - PI (12)
 Timerange: 00/14:26:31 to 00/14:27:59

Plot file version 452 created 21-JUN-2019 11:56:59

IRAS12112 EP111A 1.UVDATA.1

Freq = 1.4829 GHz, Bw = 16.000 MH Calibrated with CL # 3 and BP # 1 (BP mode 1)

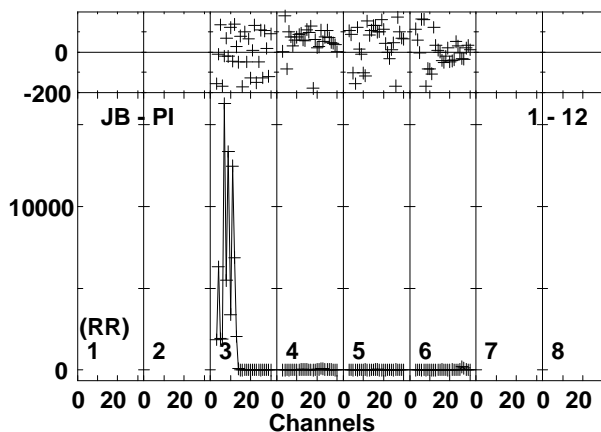
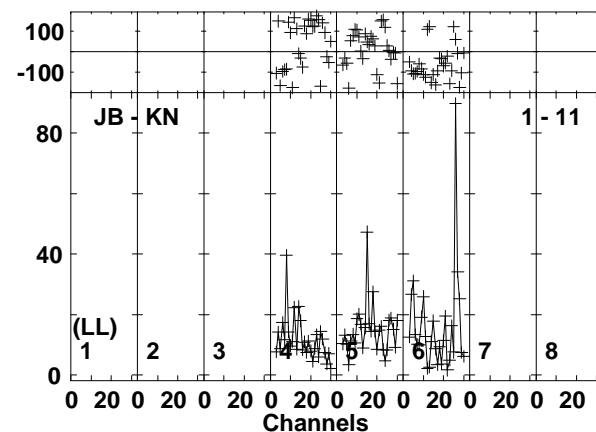
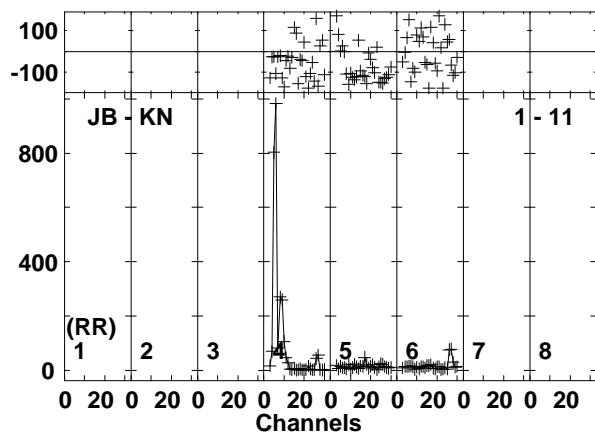
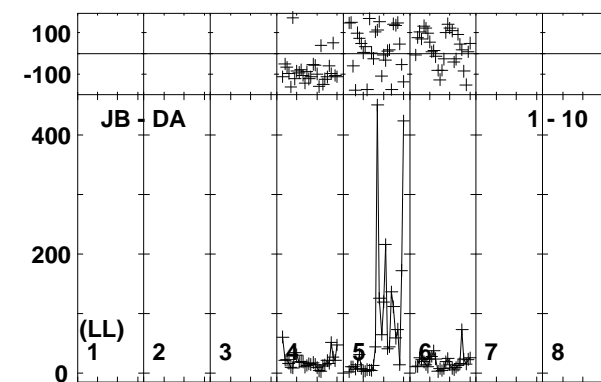
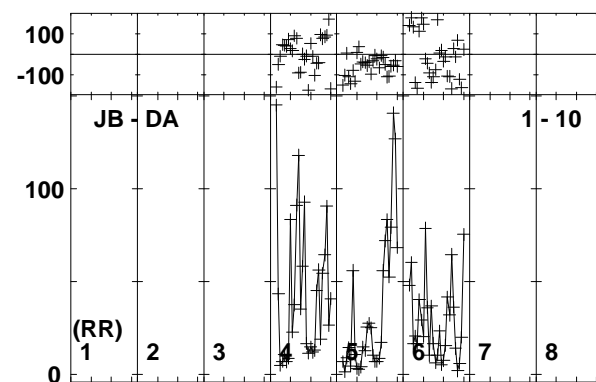
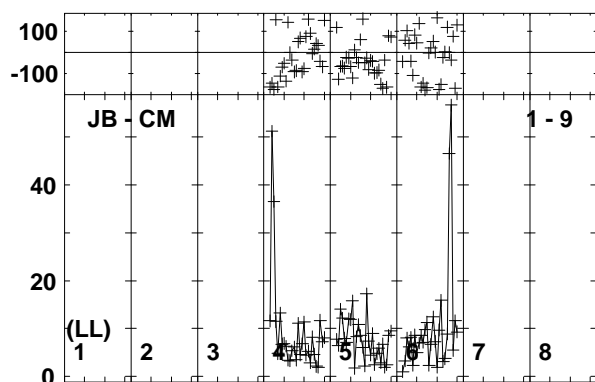
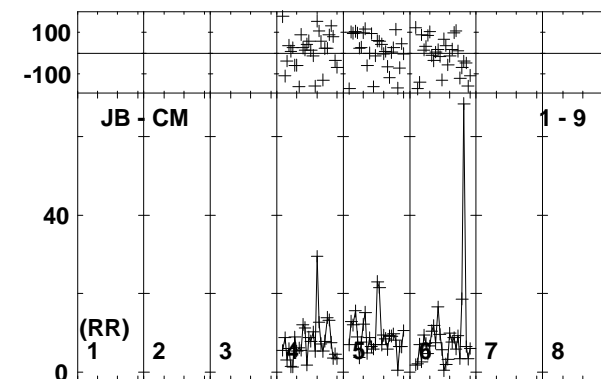
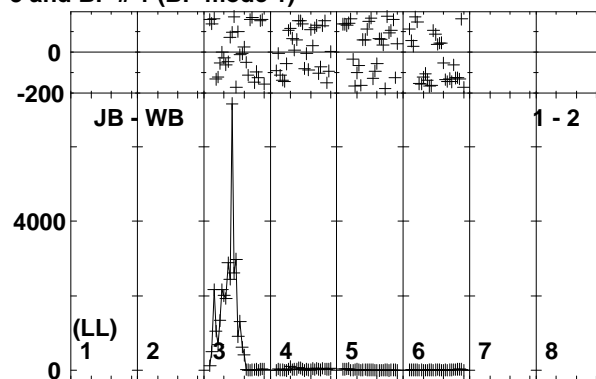
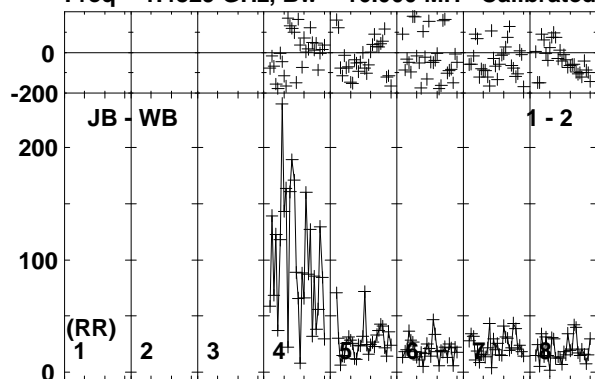

Lower frame: Milli Ampl Jy Top frame: Phas deg
Vector averaged cross-power spectrum Baseline: JB (01) - WB (02)
Timerange: 00/14:28:01 to 00/14:31:29

Plot file version 453 created 21-JUN-2019 11:56:59

IRAS12112 EP111A 1.UVDATA.1

Freq = 1.4829 GHz, Bw = 16.000 MH Calibrated with CL # 3 and BP # 1 (BP mode 1)

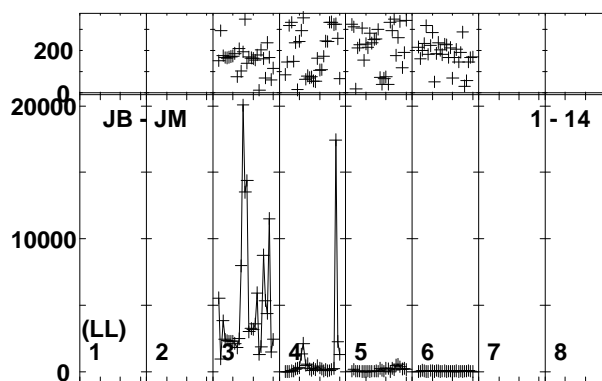
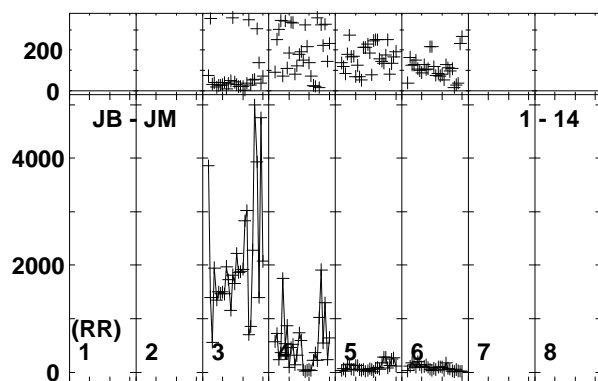
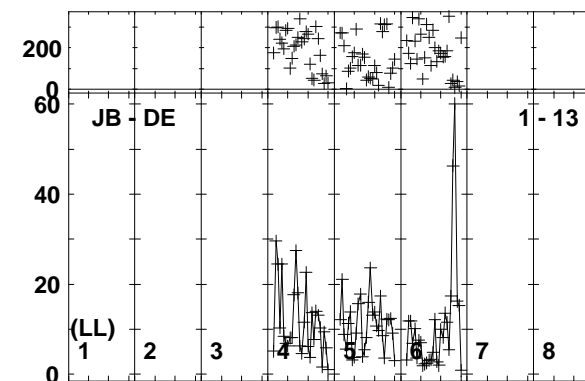
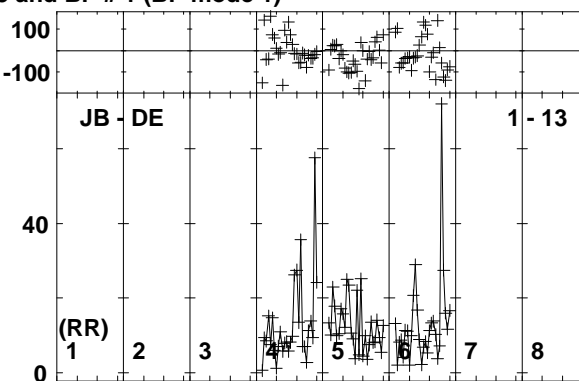
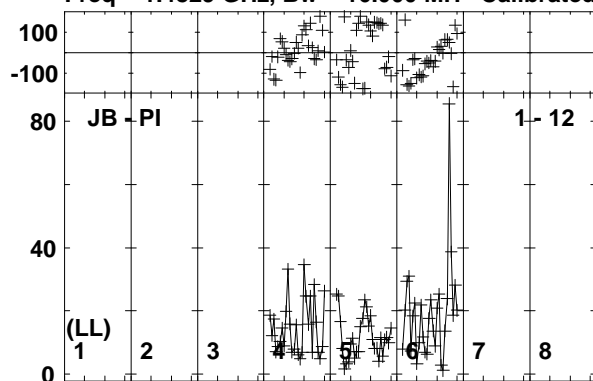

Lower frame: Milli Ampl Jy Top frame: Phas deg
Vector averaged cross-power spectrum Baseline: JB (01) - PI (12)
Timerange: 00/14:28:01 to 00/14:31:29

Plot file version 454 created 21-JUN-2019 11:57:00
 IRAS12112 EP111A 1.UVDATA.1
 Freq = 1.4829 GHz, Bw = 16.000 MH Calibrated with CL # 3 and BP # 1 (BP mode 1)

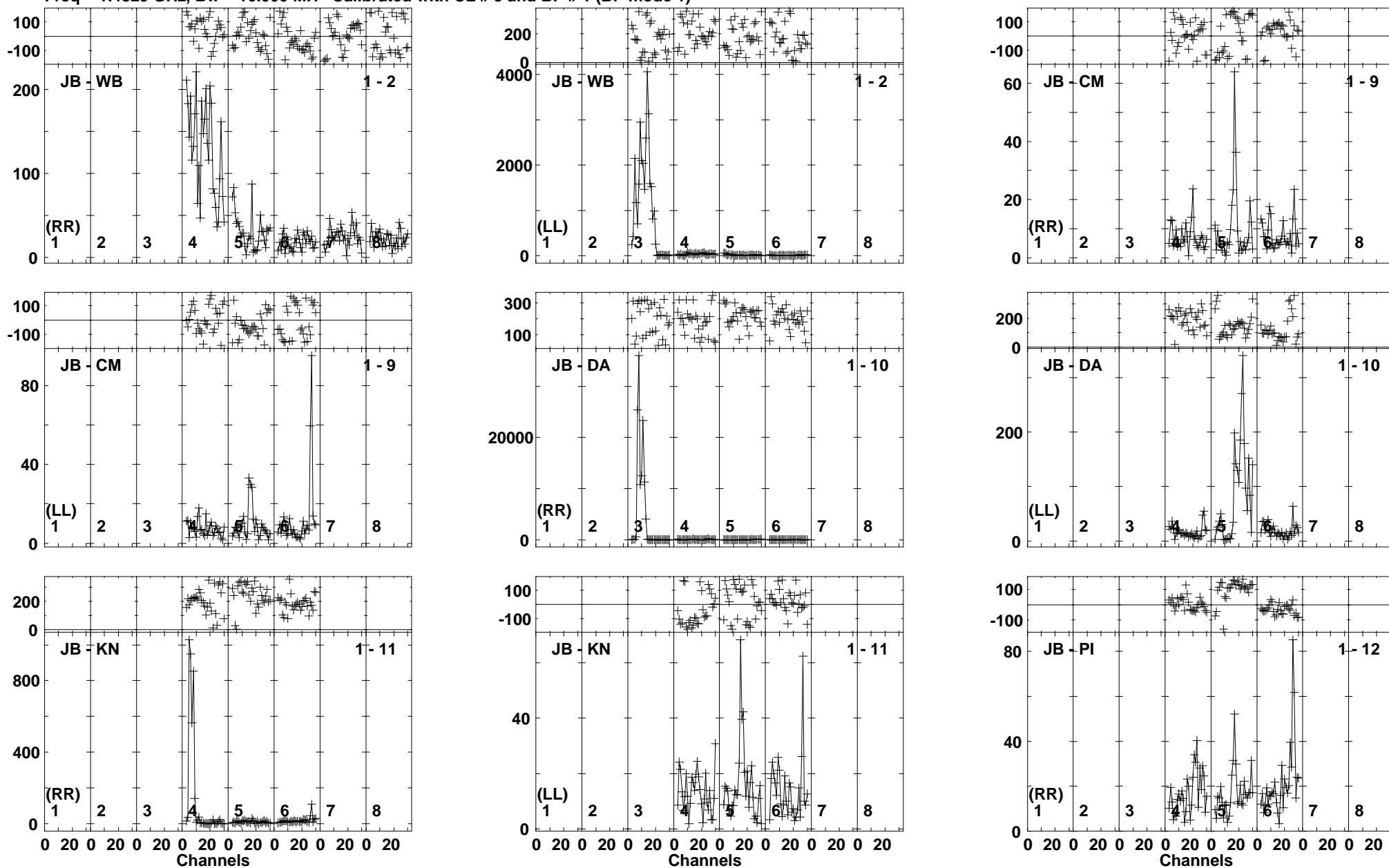

Lower frame: Milli Ampl Jy Top frame: Phas deg
 Vector averaged cross-power spectrum Baseline: JB (01) - WB (02)
 Timerange: 00/14:33:01 to 00/14:36:29

Plot file version 455 created 21-JUN-2019 11:57:01

IRAS12112 EP111A 1.UVDATA.1

Freq = 1.4829 GHz, Bw = 16.000 MH Calibrated with CL # 3 and BP # 1 (BP mode 1)

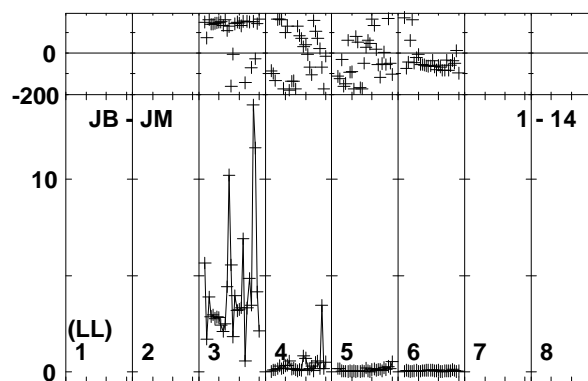
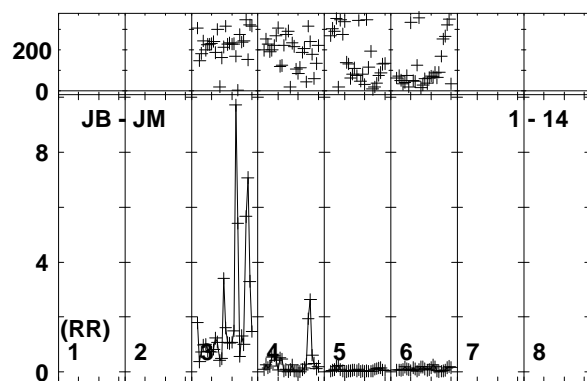
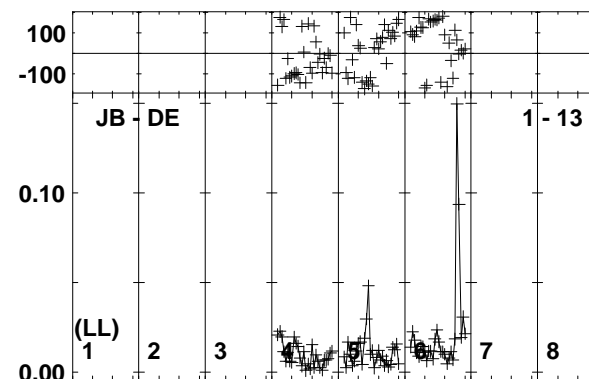
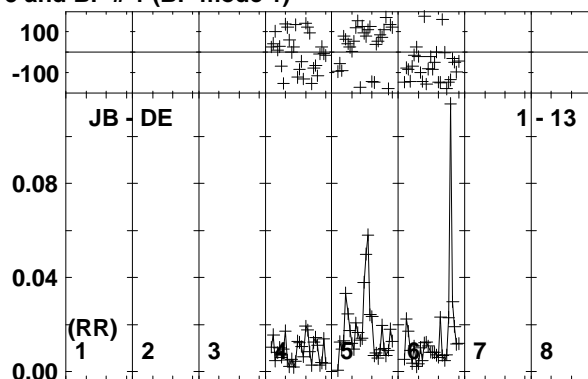
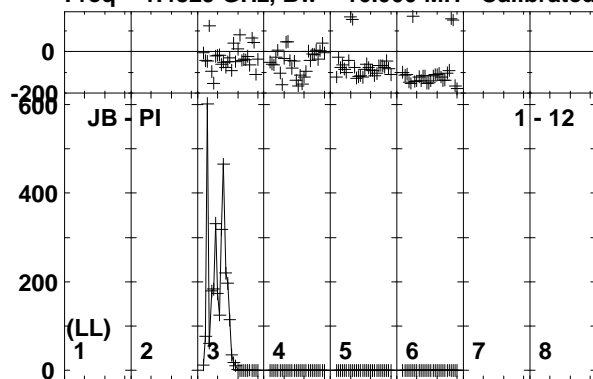

Lower frame: Ampl Jy Top frame: Phas deg
Vector averaged cross-power spectrum Baseline: JB (01) - PI (12)
Timerange: 00/14:33:01 to 00/14:36:29

Plot file version 456 created 21-JUN-2019 11:57:02

J1222+0413 EP111A 1.UVDATA.1

Freq = 1.4829 GHz, Bw = 16.000 MH Calibrated with CL # 3 and BP # 1 (BP mode 1)

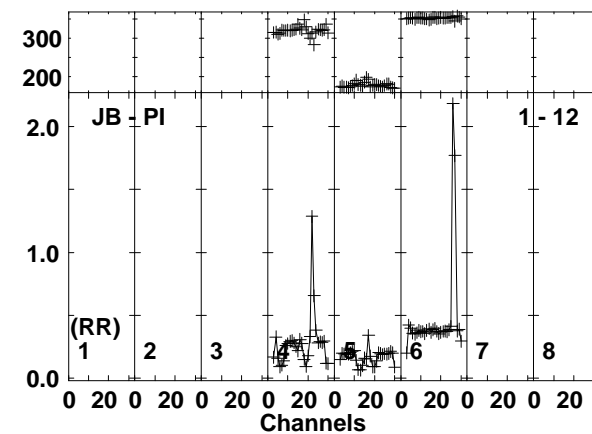
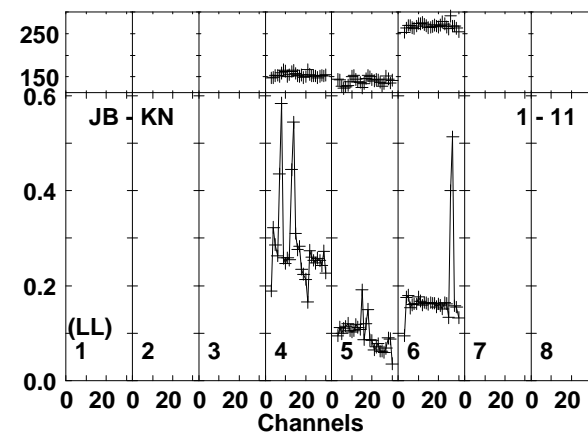
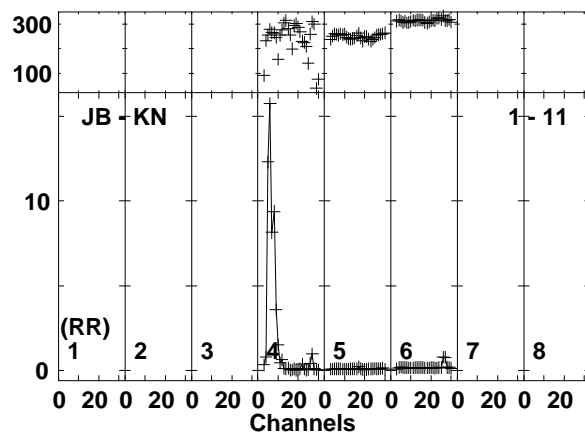
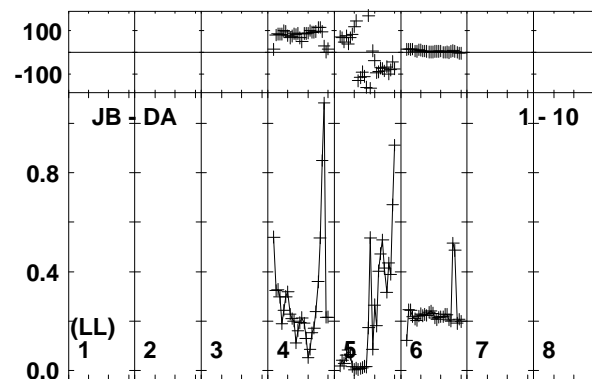
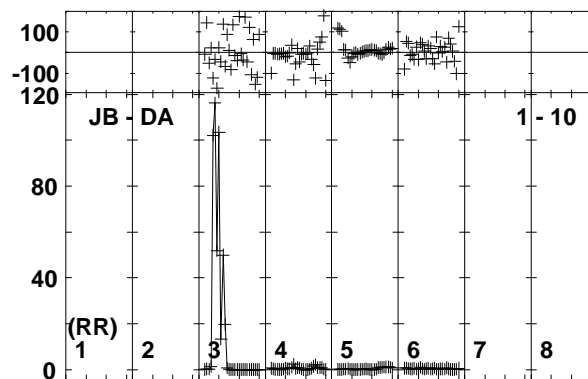
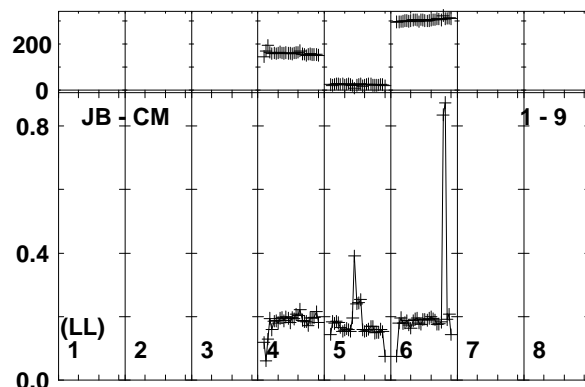
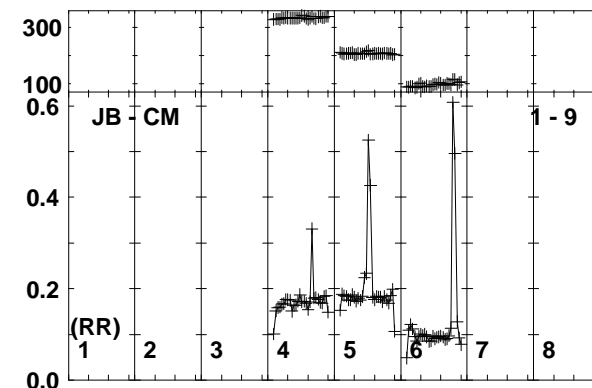
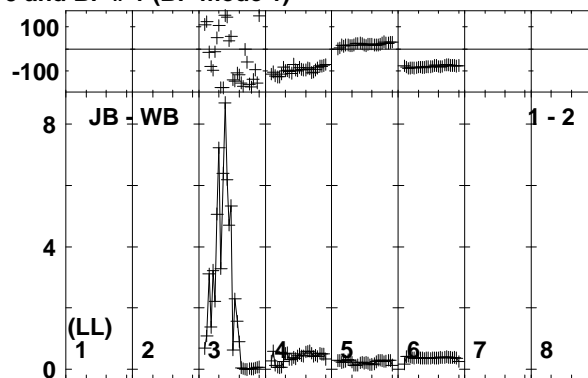
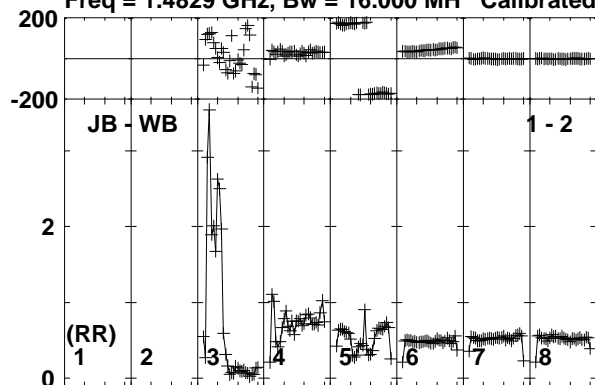

Lower frame: Ampl Jy Top frame: Phas deg
Vector averaged cross-power spectrum Baseline: JB (01) - WB (02)
Timerange: 00/14:37:11 to 00/14:38:39

Plot file version 457 created 21-JUN-2019 11:57:02
 J1222+0413 EP111A 1.UVDATA.1
 Freq = 1.4829 GHz, Bw = 16.000 MH Calibrated with CL # 3 and BP # 1 (BP mode 1)

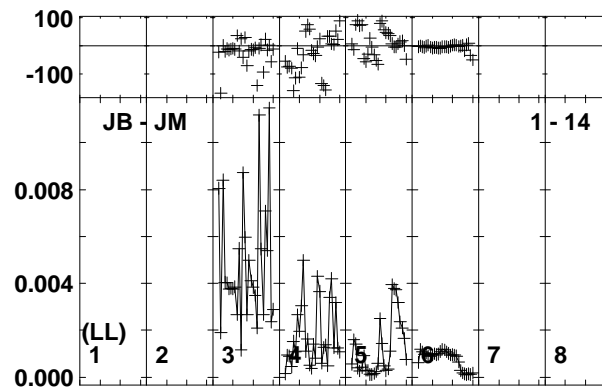
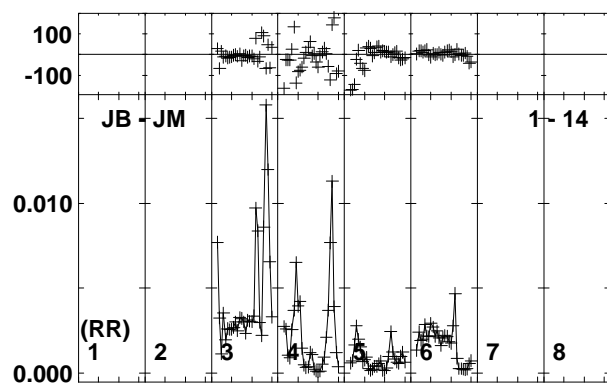
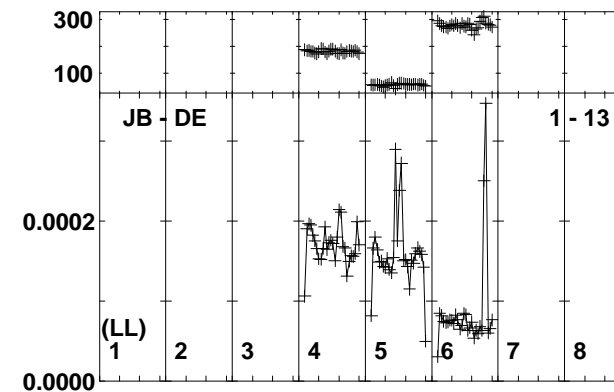
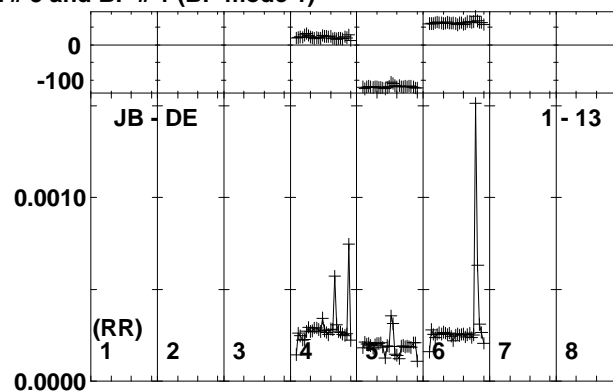
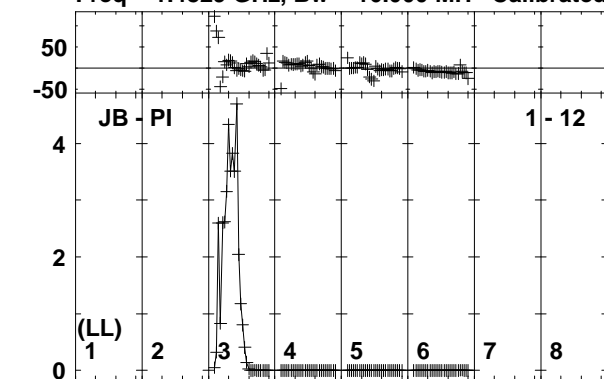

Lower frame: Kilo Ampl Jy Top frame: Phas deg
 Vector averaged cross-power spectrum Baseline: JB (01) - PI (12)
 Timerange: 00/14:37:11 to 00/14:38:39

Plot file version 458 created 21-JUN-2019 11:57:03
 IRAS12112 EP111A 1.UVDATA.1
 Freq = 1.4829 GHz, Bw = 16.000 MH Calibrated with CL # 3 and BP # 1 (BP mode 1)

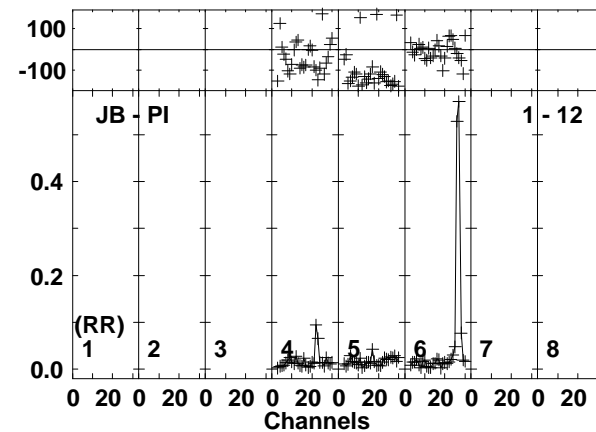
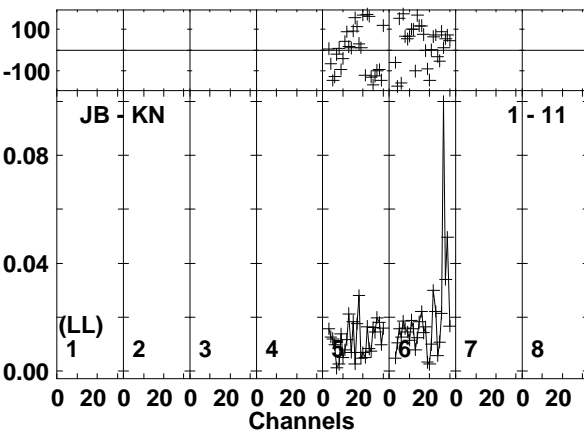
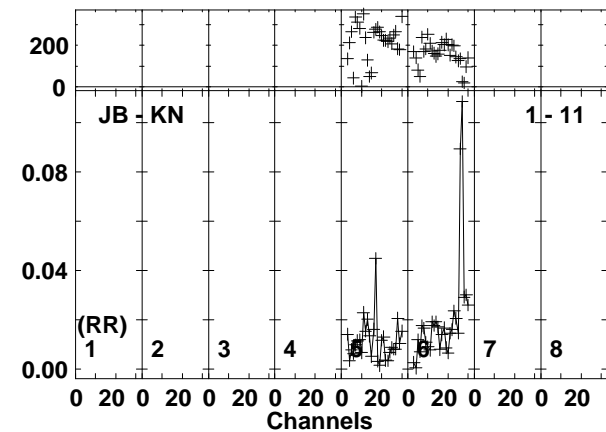
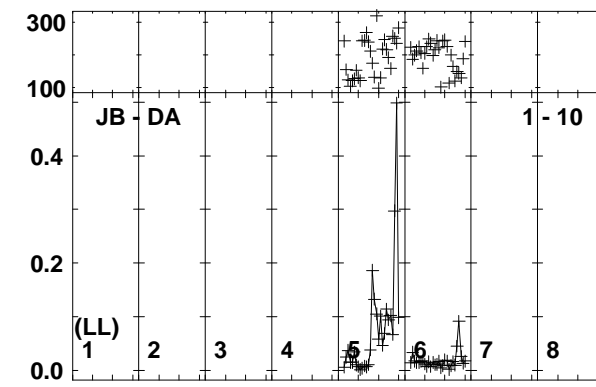
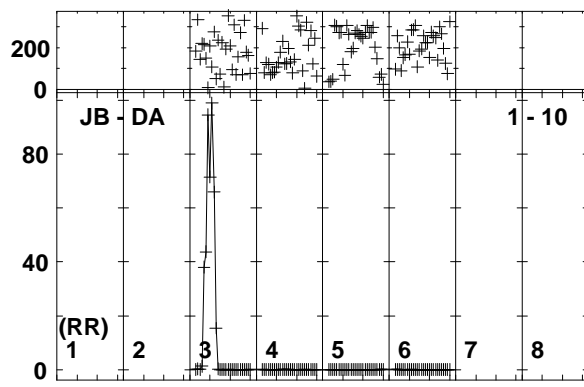
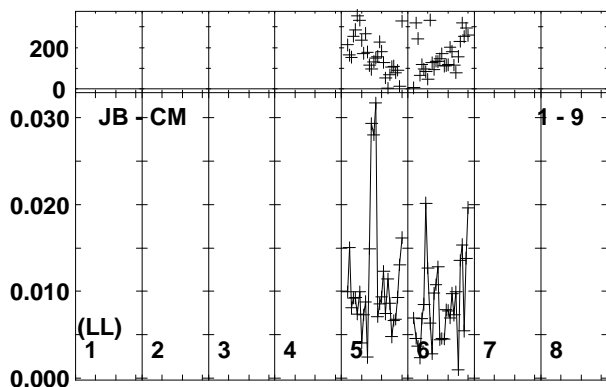
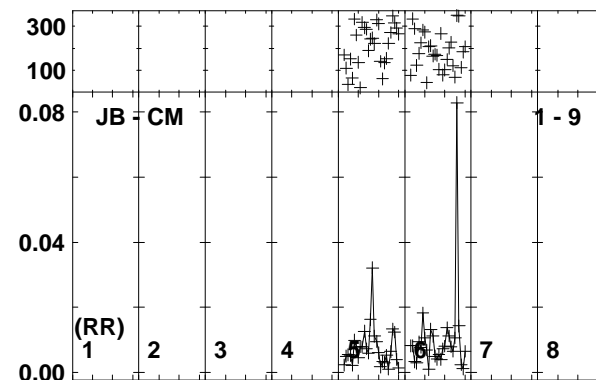
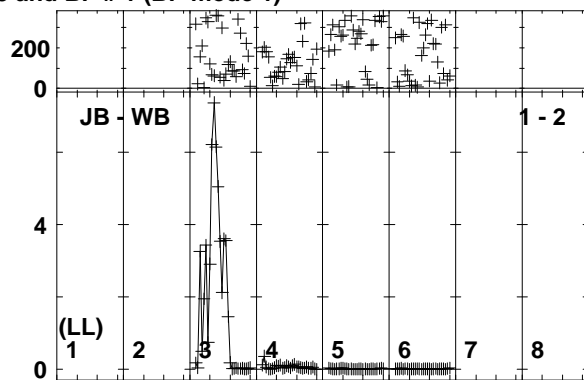
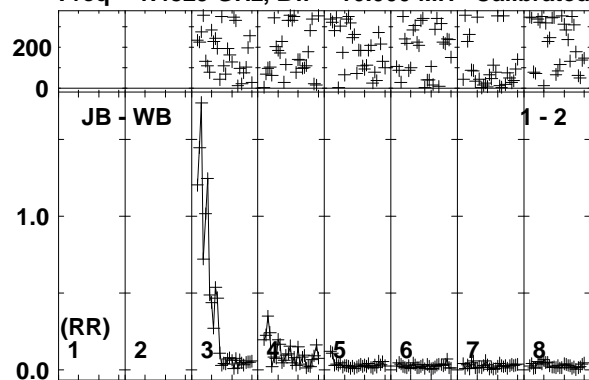

Lower frame: Ampl Jy Top frame: Phas deg
 Vector averaged cross-power spectrum Baseline: JB (01) - WB (02)
 Timerange: 00/14:38:41 to 00/14:42:09

Plot file version 459 created 21-JUN-2019 11:57:03

IRAS12112 EP111A 1.UVDATA.1

Freq = 1.4829 GHz, Bw = 16.000 MH Calibrated with CL # 3 and BP # 1 (BP mode 1)

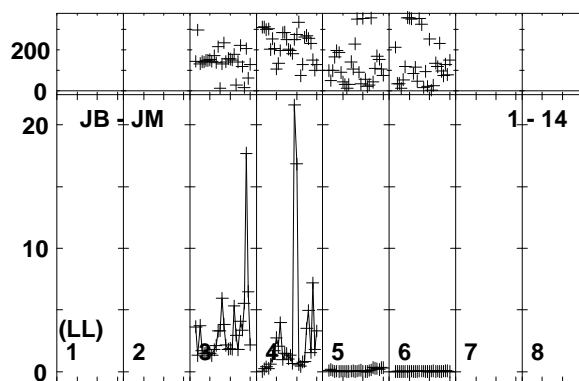
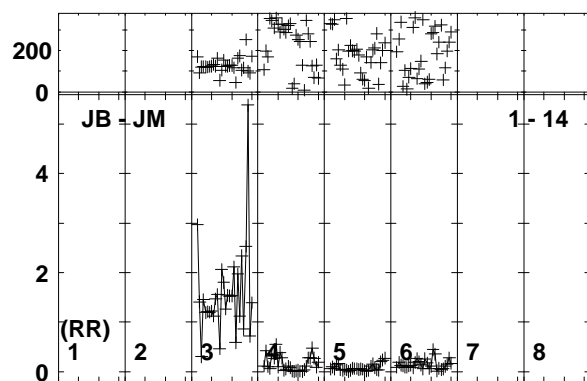
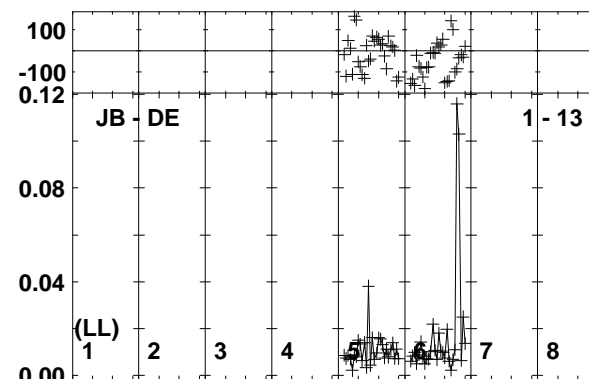
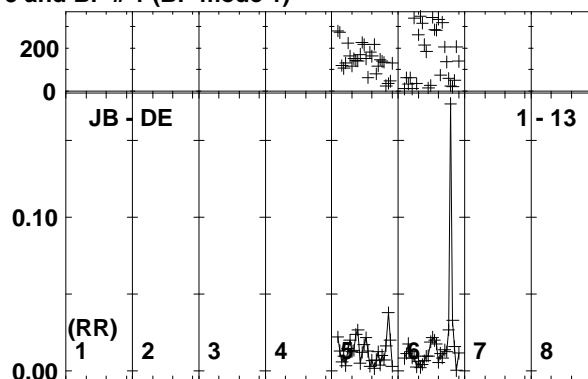
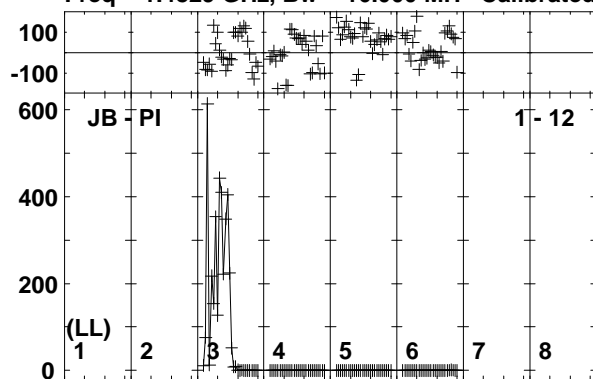

Lower frame: Ampl Jy Top frame: Phas deg
Vector averaged cross-power spectrum Baseline: JB (01) - PI (12)
Timerange: 00/14:38:41 to 00/14:42:09

Plot file version 460 created 21-JUN-2019 11:57:04
 IRAS12112 EP111A 1.UVDATA.1
 Freq = 1.4829 GHz, Bw = 16.000 MH Calibrated with CL # 3 and BP # 1 (BP mode 1)

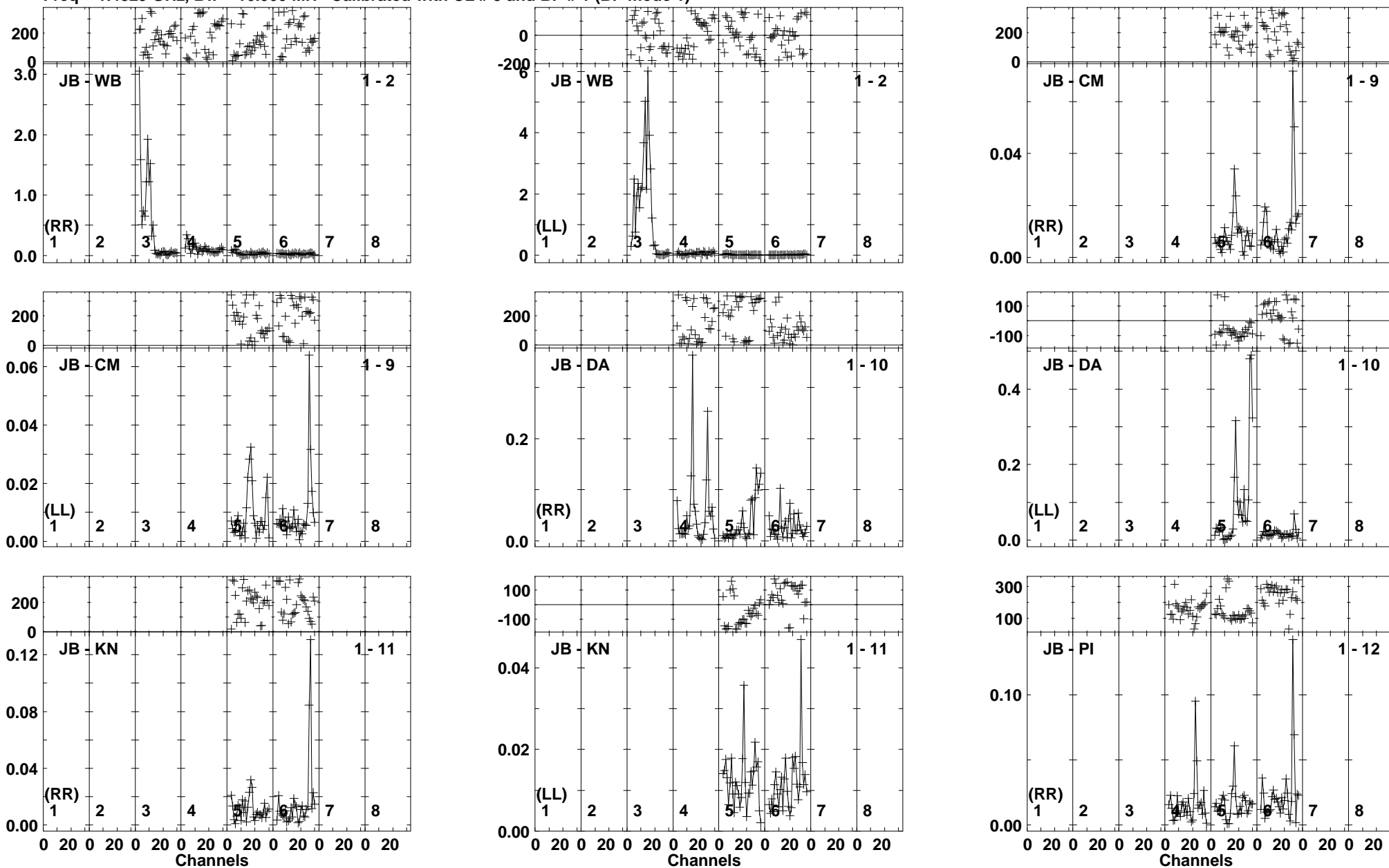

Lower frame: Ampl Jy Top frame: Phas deg
 Vector averaged cross-power spectrum Baseline: JB (01) - WB (02)
 Timerange: 00/14:43:41 to 00/14:47:09

Plot file version 461 created 21-JUN-2019 11:57:05
 IRAS12112 EP111A 1.UVDATA.1
 Freq = 1.4829 GHz, Bw = 16.000 MH Calibrated with CL # 3 and BP # 1 (BP mode 1)

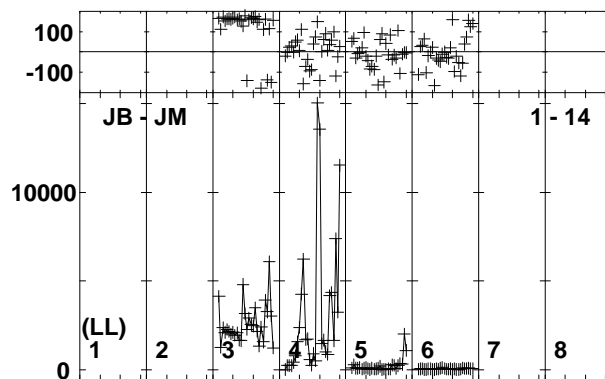
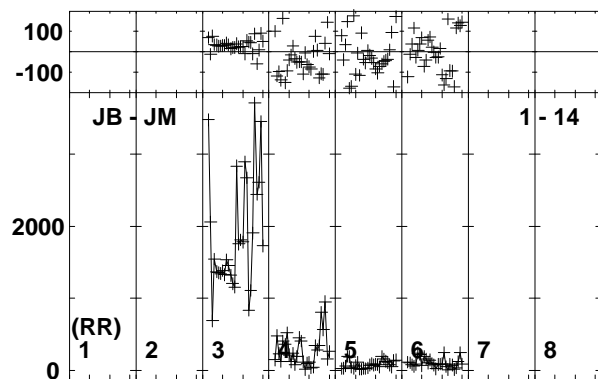
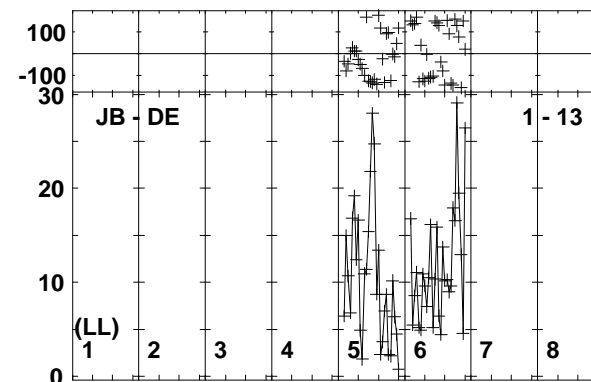
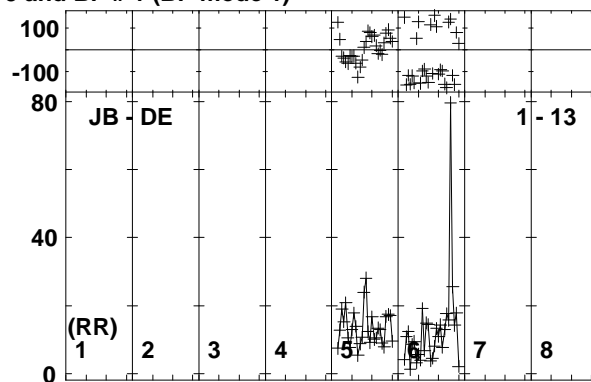
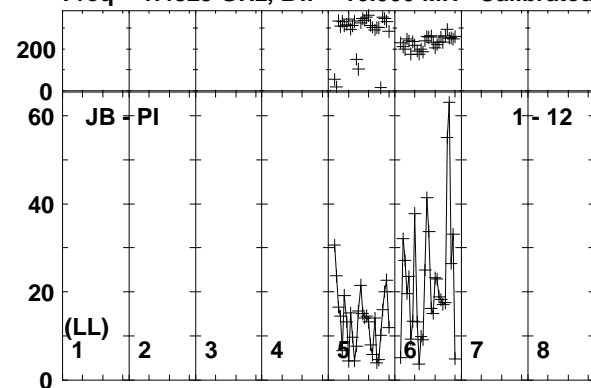

Lower frame: Milli Ampl Jy Top frame: Phas deg
 Vector averaged cross-power spectrum Baseline: JB (01) - PI (12)
 Timerange: 00/14:43:41 to 00/14:47:09

Plot file version 462 created 21-JUN-2019 11:57:05
 J1222+0413 EP111A 1.UVDATA.1
 Freq = 1.4829 GHz, Bw = 16.000 MH Calibrated with CL # 3 and BP # 1 (BP mode 1)

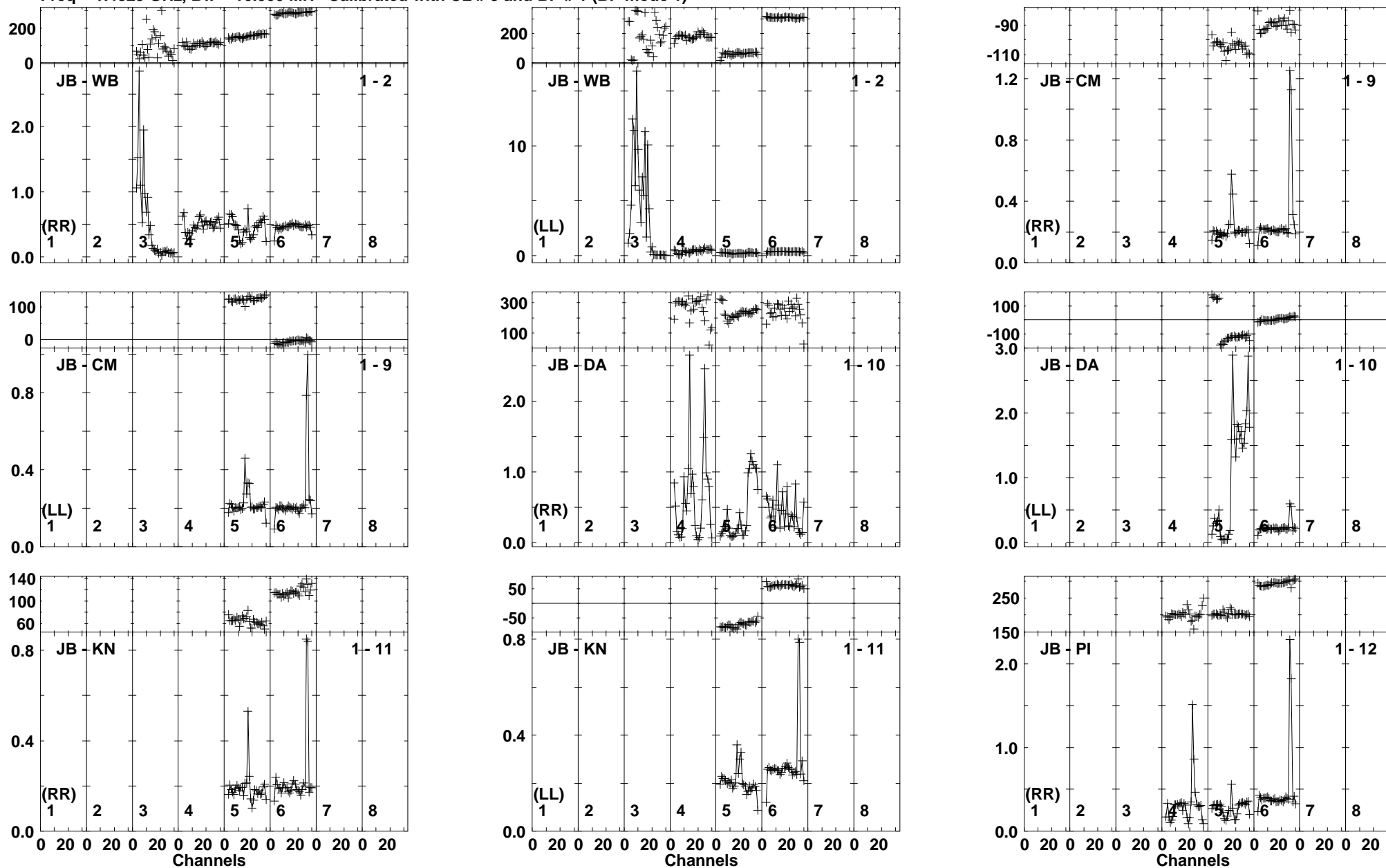

Lower frame: Ampl Jy Top frame: Phas deg
 Vector averaged cross-power spectrum Baseline: JB (01) - WB (02)
 Timerange: 00/14:47:51 to 00/14:49:19

Plot file version 463 created 21-JUN-2019 11:57:06
 J1222+0413 EP111A 1.UVDATA.1
 Freq = 1.4829 GHz, Bw = 16.000 MH Calibrated with CL # 3 and BP # 1 (BP mode 1)

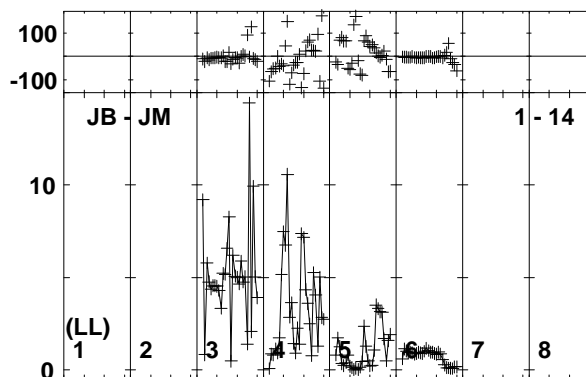
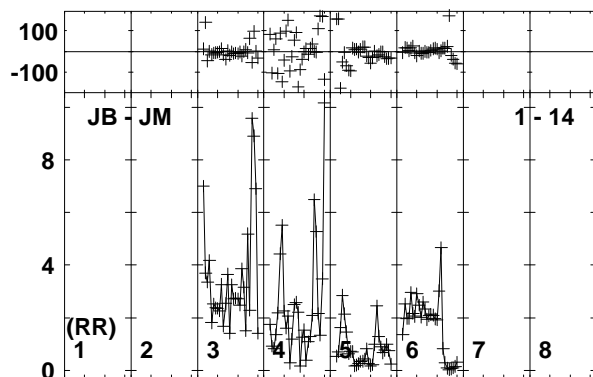
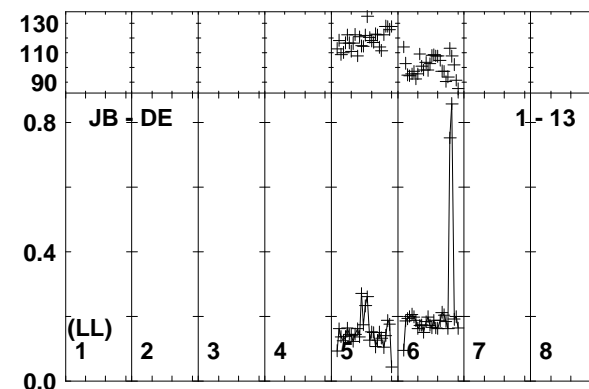
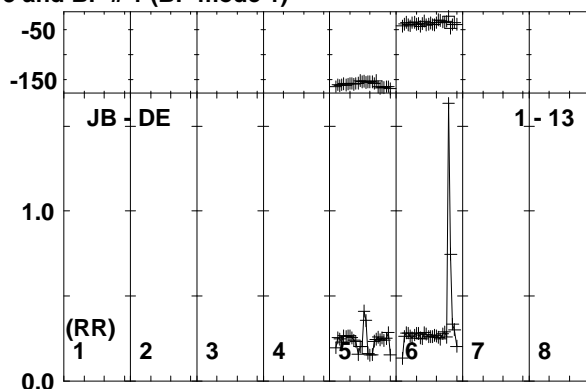
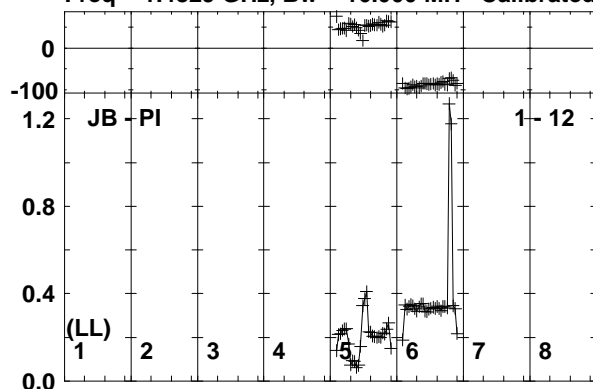

Lower frame: Ampl Jy Top frame: Phas deg
 Vector averaged cross-power spectrum Baseline: JB (01) - PI (12)
 Timerange: 00/14:47:51 to 00/14:49:19

Plot file version 464 created 21-JUN-2019 11:57:07

IRAS12112 EP111A 1.UVDATA.1

Freq = 1.4829 GHz, Bw = 16.000 MH Calibrated with CL # 3 and BP # 1 (BP mode 1)

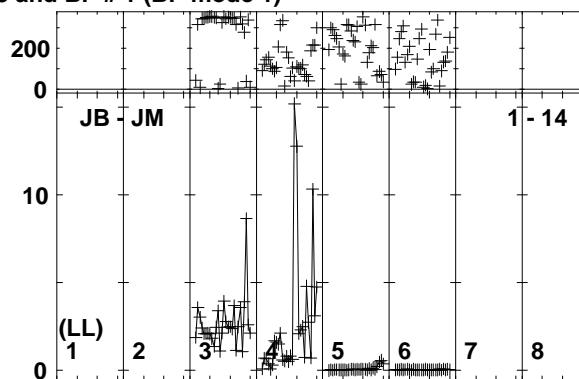
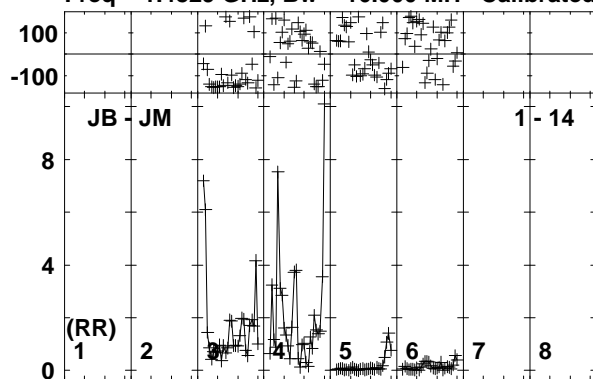

Lower frame: Ampl Jy Top frame: Phas deg
Vector averaged cross-power spectrum Baseline: JB (01) - JM (14)
Timerange: 00/14:49:21 to 00/14:52:49