

Plot file version 1 created 10-APR-2012 15:41:38

1127-185 ER026C 5.UVDATA.1

Freq = 6.6132 GHz, Bw = 8.000 MH No calibration applied and no bandpass applied

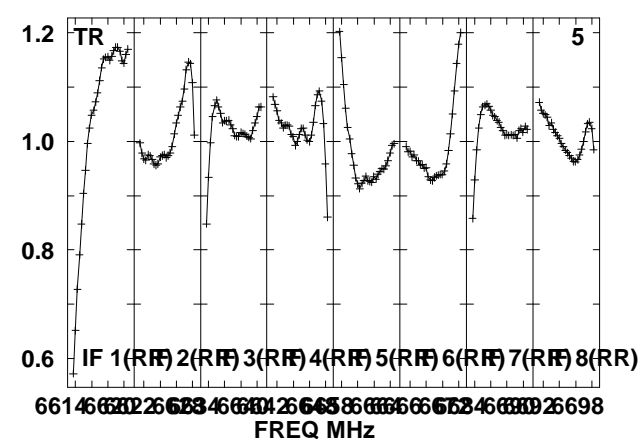
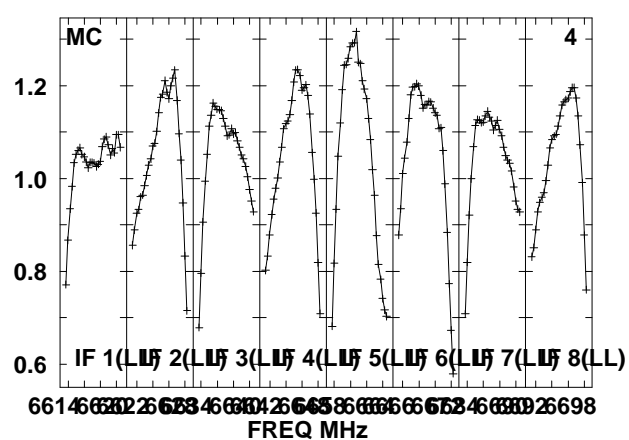
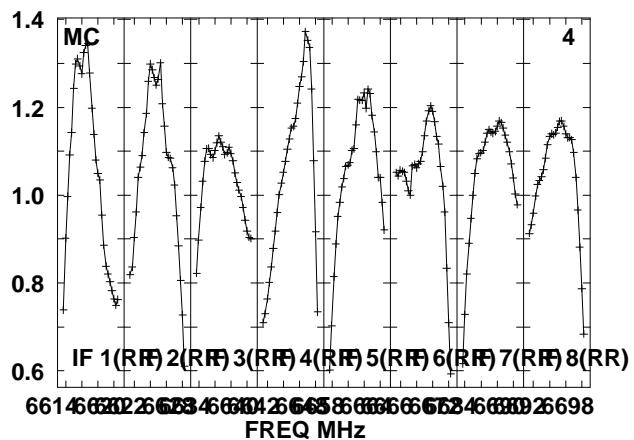
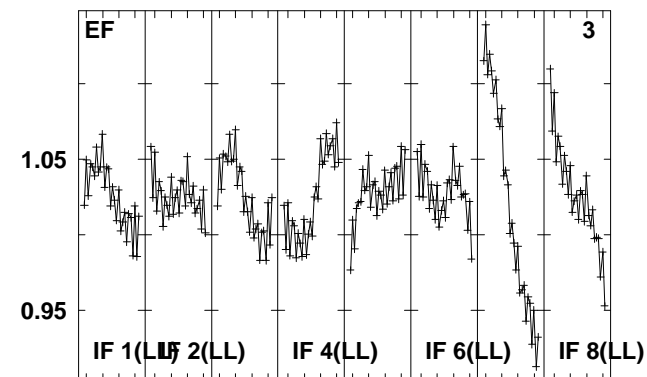
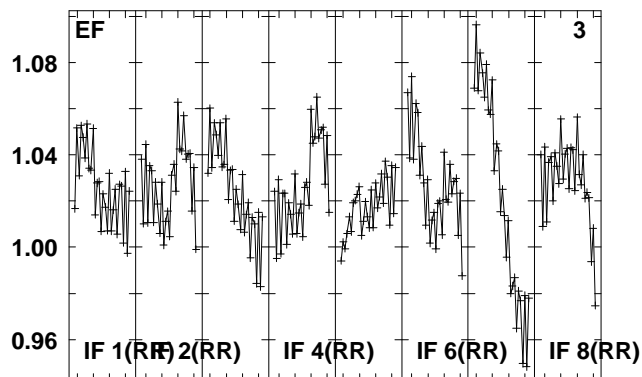
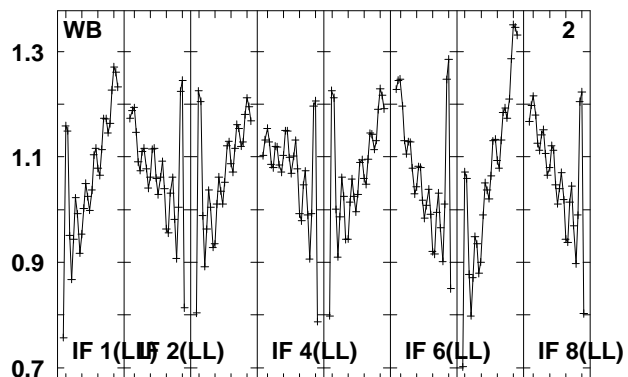
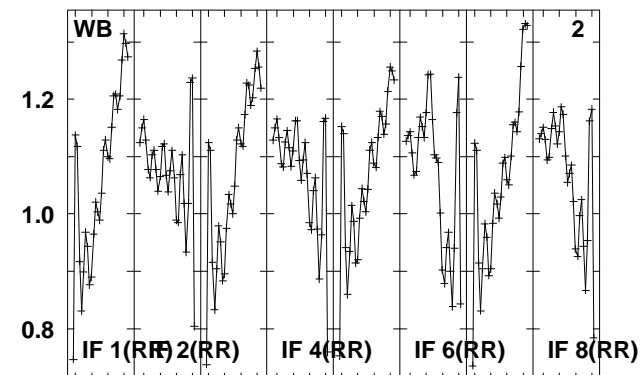
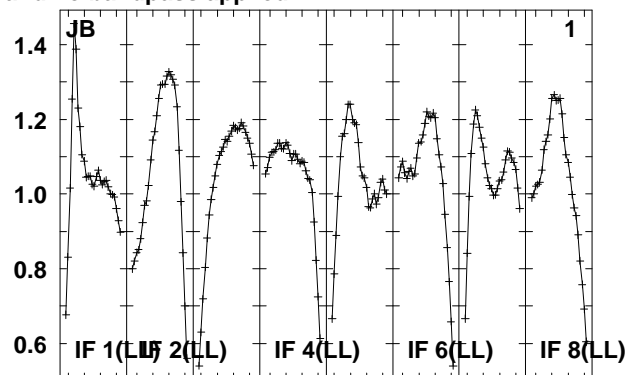
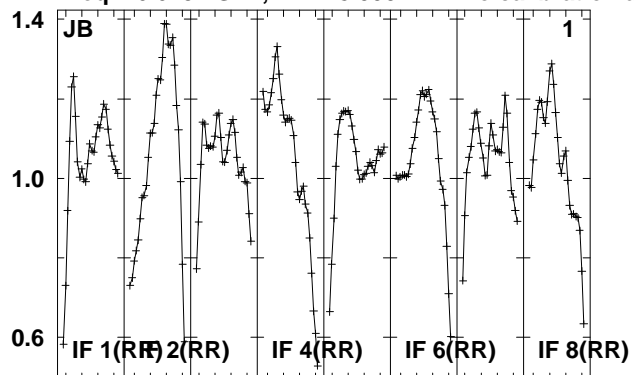

Lower frame: Real Jy  
Total-power spectrum Antenna: \*  
Timerange: 00/11:30:03 to 00/11:31:29

Plot file version 2 created 10-APR-2012 15:41:38

1127-185 ER026C 5.UVDATA.1

Freq = 6.6132 GHz, Bw = 8.000 MH No calibration applied and no bandpass applied

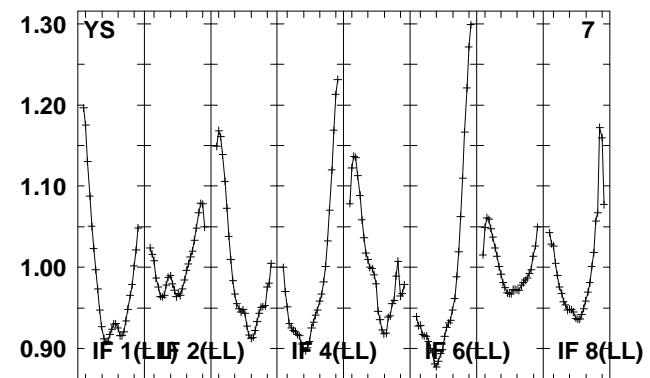
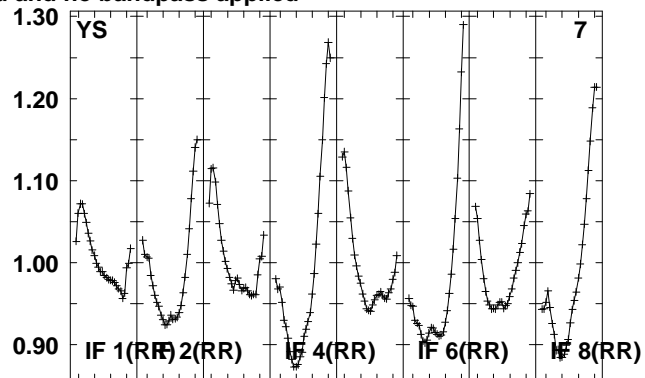
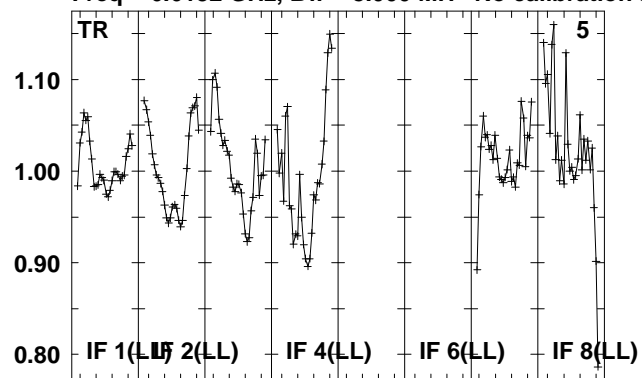

Lower frame: Real Jy  
Total-power spectrum Antenna: \*  
Timerange: 00/11:30:03 to 00/11:31:29

Plot file version 3 created 10-APR-2012 15:41:38

1159+291 ER026C 5.UVDATA.1

Freq = 6.6132 GHz, Bw = 8.000 MH No calibration applied and no bandpass applied

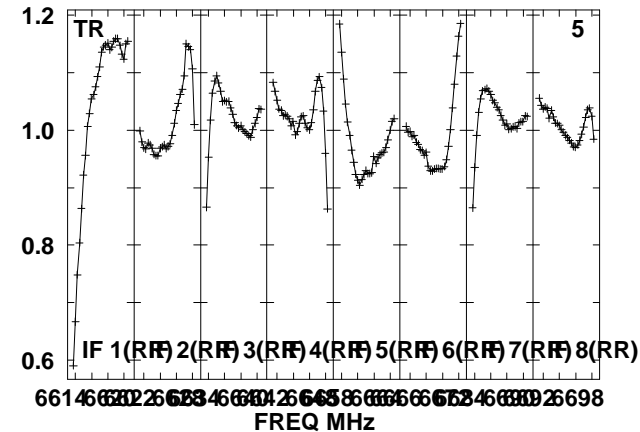
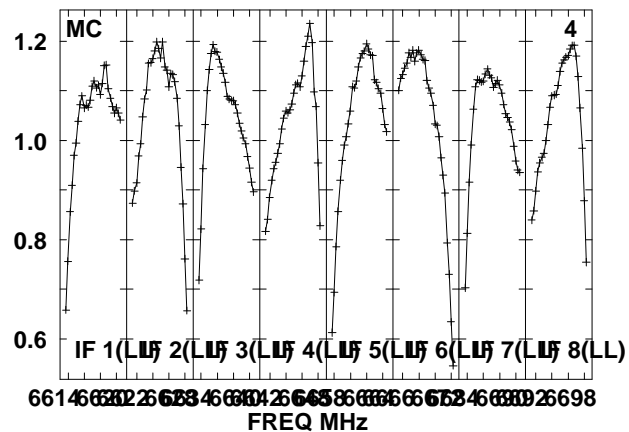
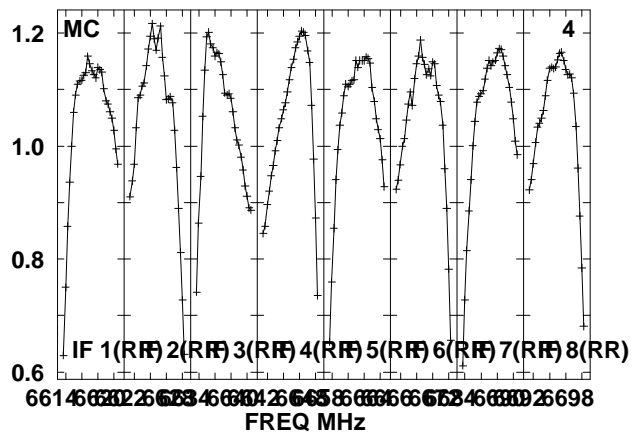
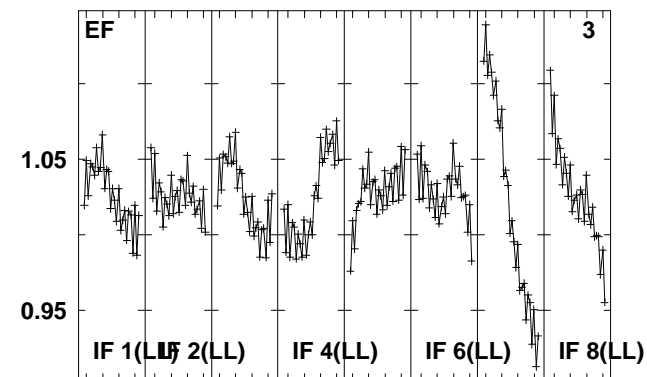
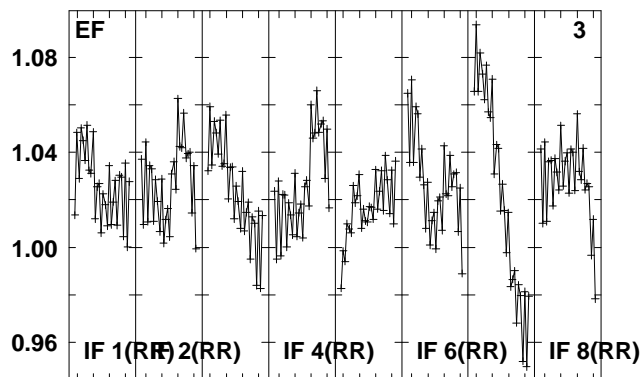
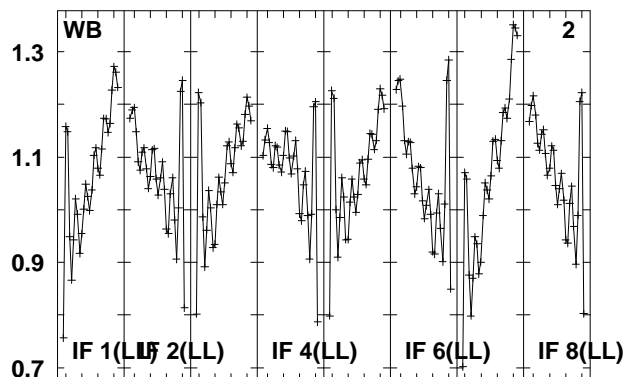
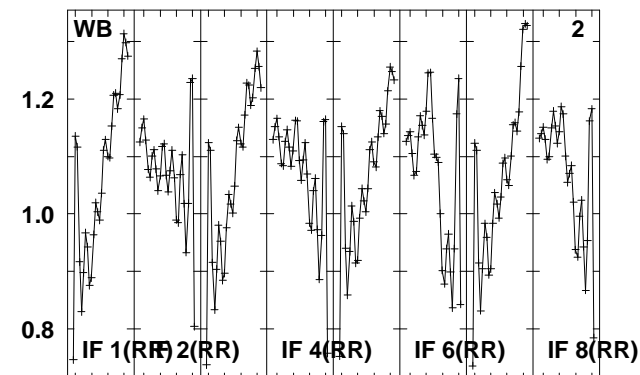
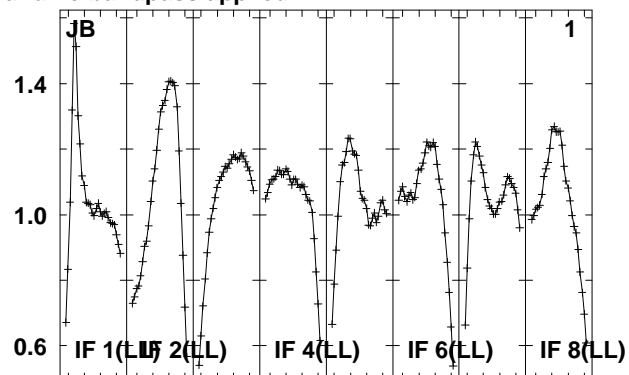
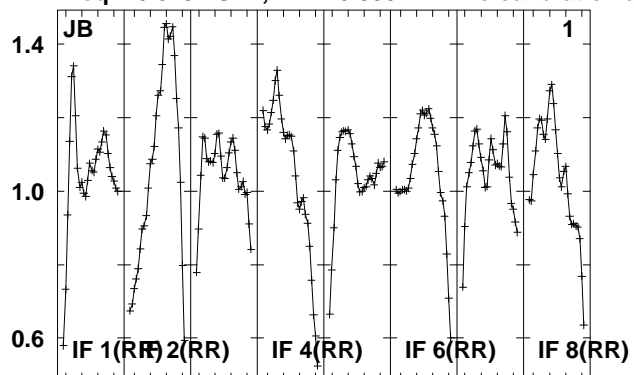

Lower frame: Real Jy  
Total-power spectrum Antenna: \*  
Timerange: 00/11:34:59 to 00/11:36:25

Plot file version 4 created 10-APR-2012 15:41:38

1159+291 ER026C 5.UVDATA.1

Freq = 6.6132 GHz, Bw = 8.000 MH No calibration applied and no bandpass applied

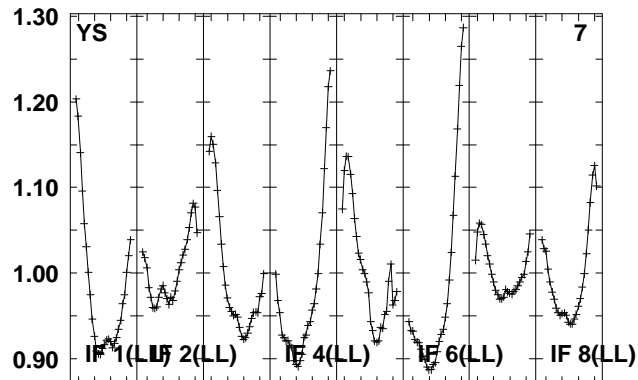
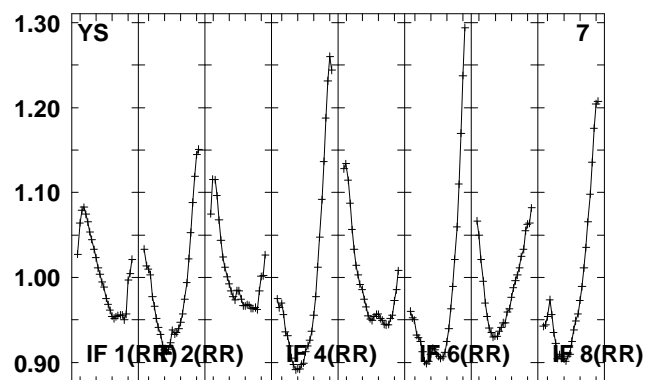
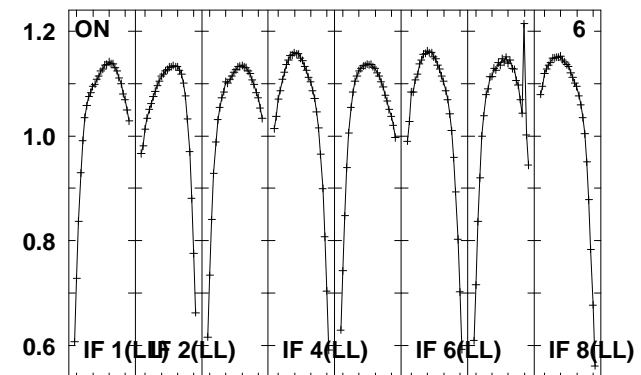
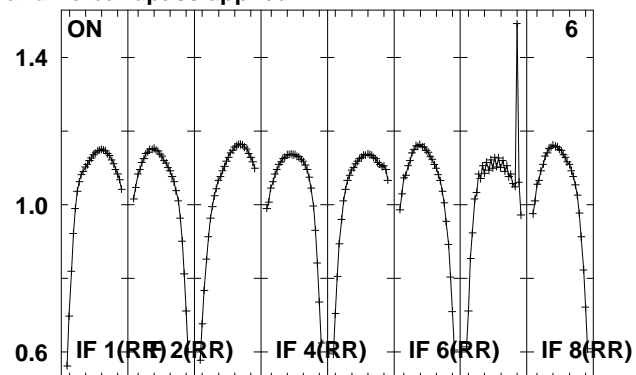
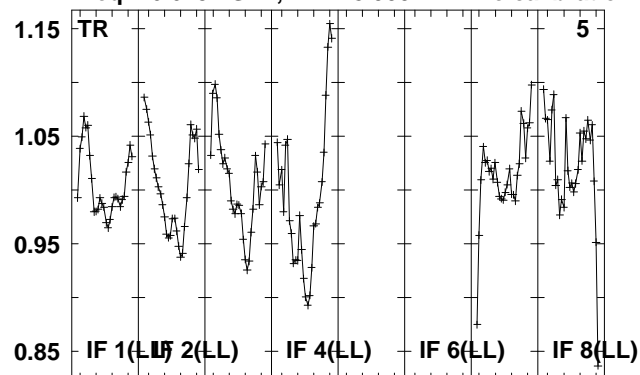

Lower frame: Real Jy  
Total-power spectrum Antenna: \*  
Timerange: 00/11:34:59 to 00/11:36:25

Plot file version 5 created 10-APR-2012 15:41:38

1302+574 ER026C 5.UVDATA.1

Freq = 6.6132 GHz, Bw = 8.000 MH No calibration applied and no bandpass applied

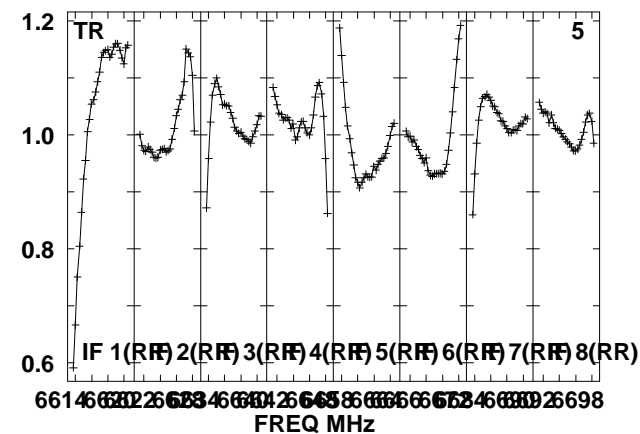
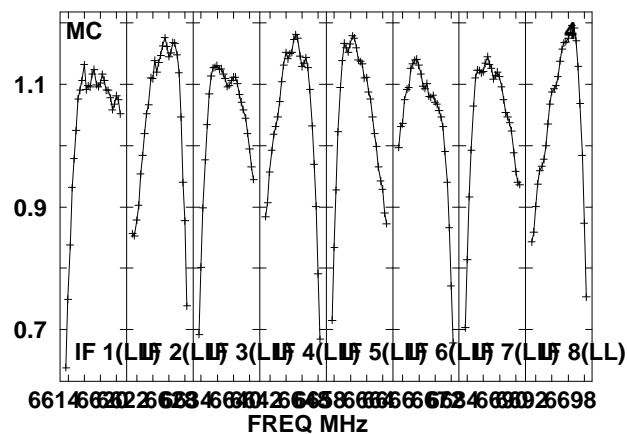
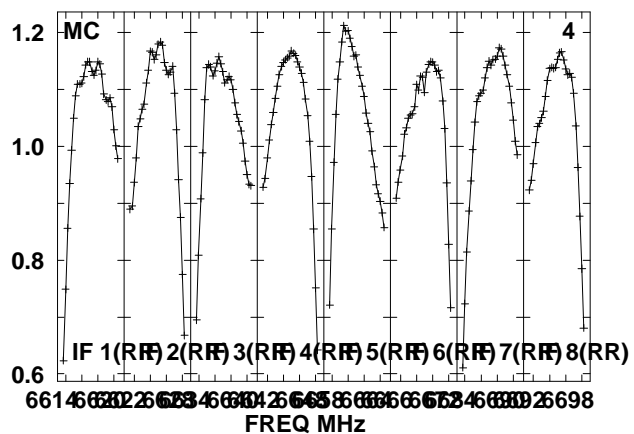
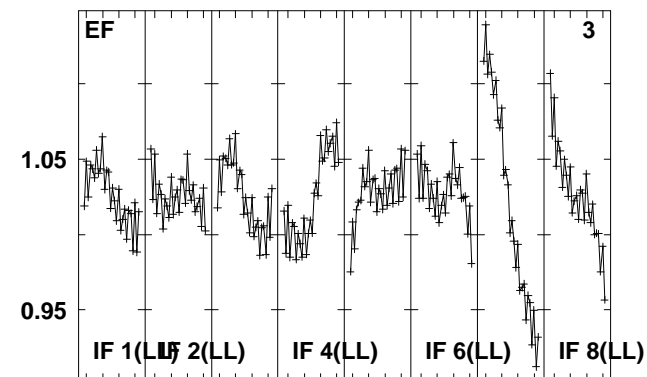
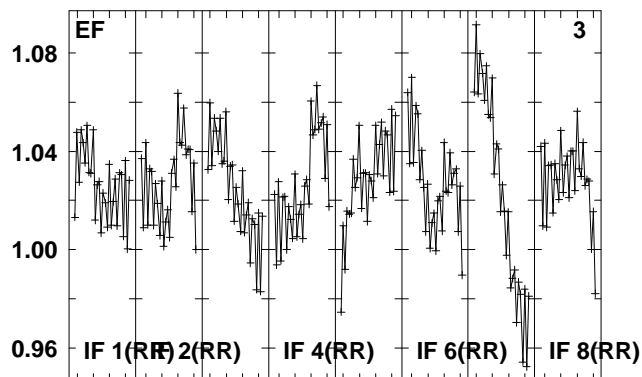
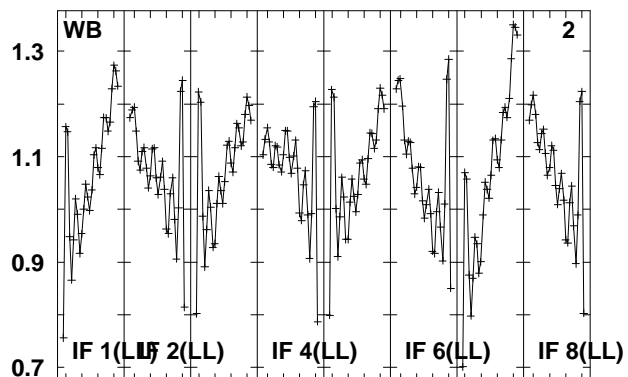
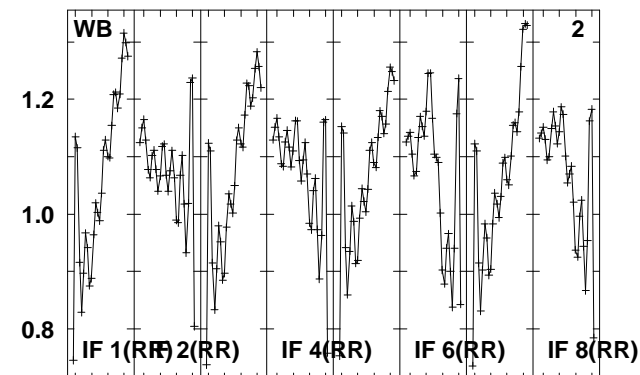
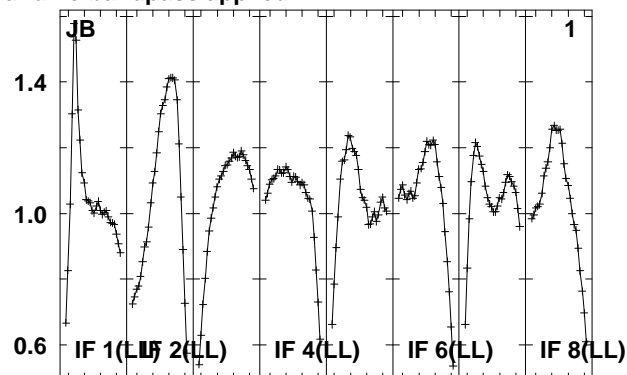
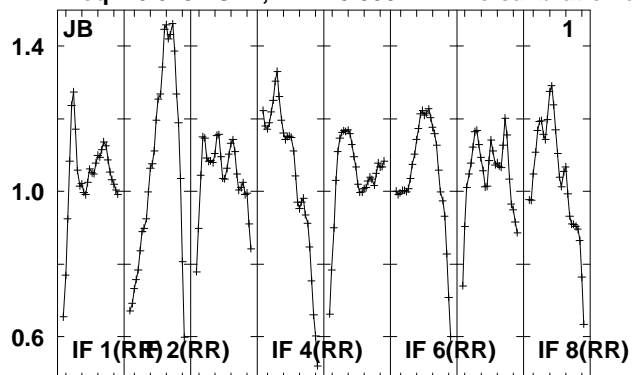

Lower frame: Real Jy  
Total-power spectrum Antenna: \*  
Timerange: 00/11:40:35 to 00/11:42:01

Plot file version 6 created 10-APR-2012 15:41:39

1302+574 ER026C 5.UVDATA.1

Freq = 6.6132 GHz, Bw = 8.000 MH No calibration applied and no bandpass applied

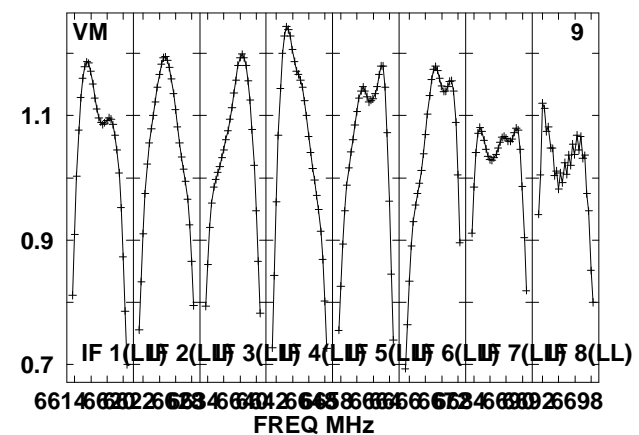
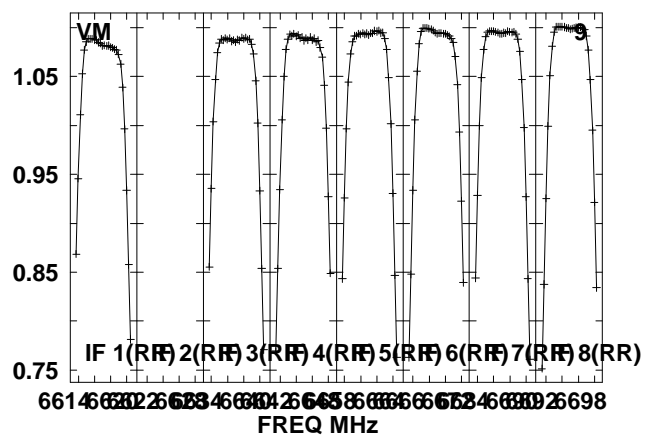
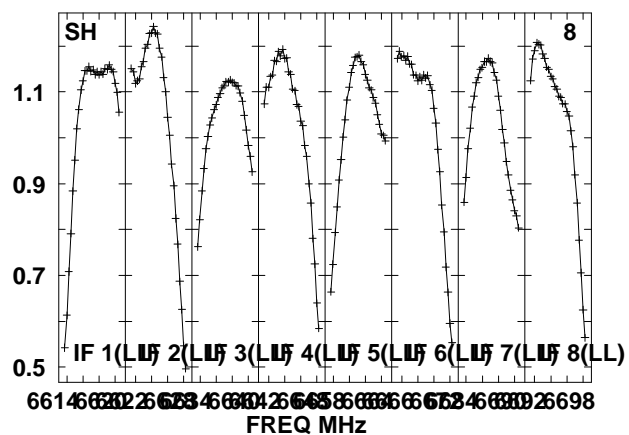
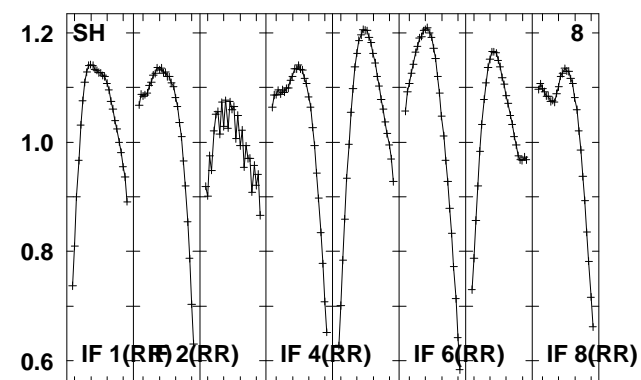
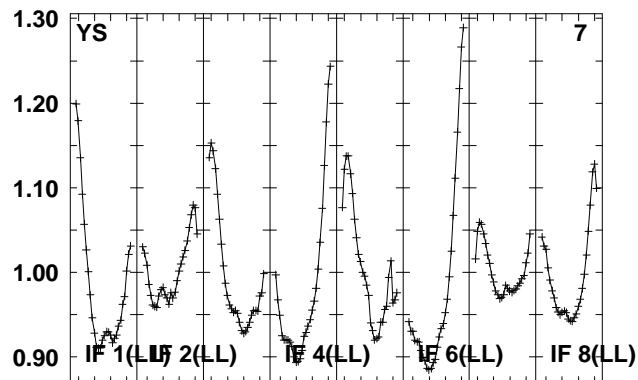
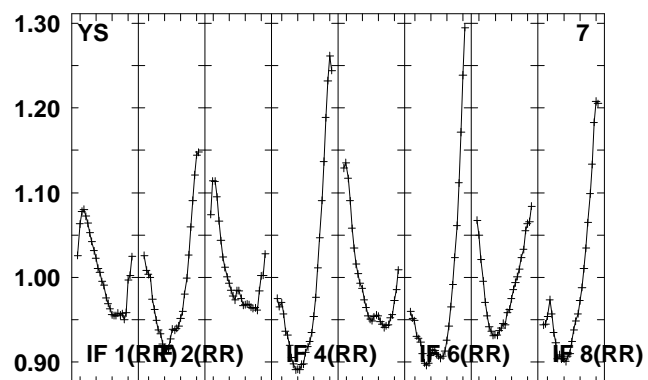
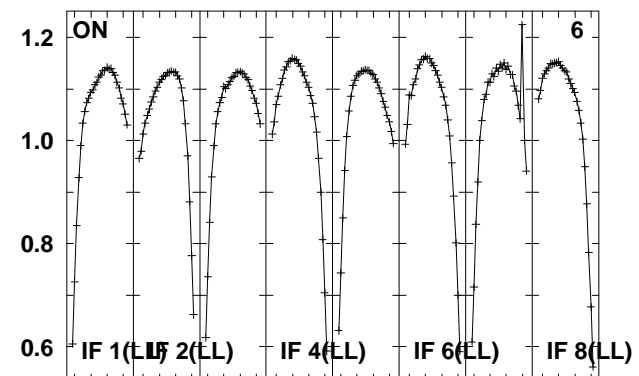
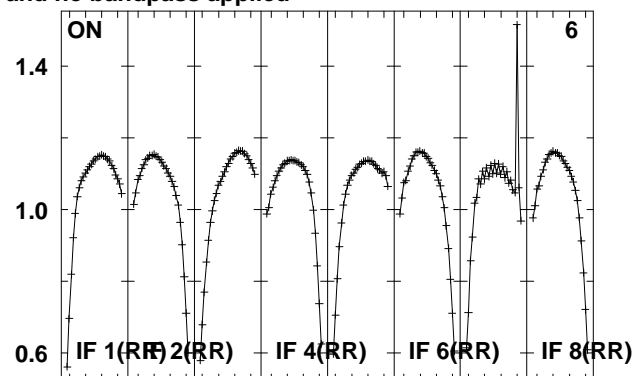
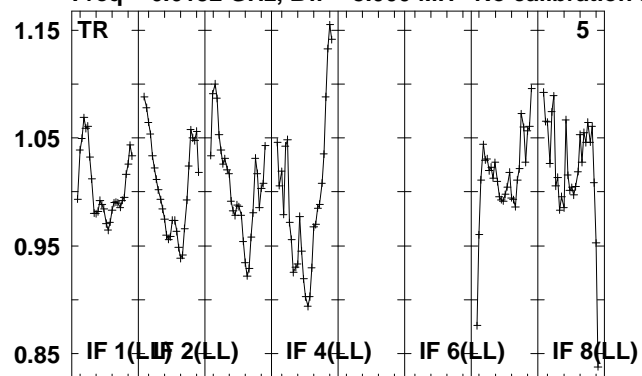

Lower frame: Real Jy

Total-power spectrum Antenna: \*

Timerange: 00/11:40:35 to 00/11:42:01

Plot file version 7 created 10-APR-2012 15:41:39

1638+572 ER026C 5.UVDATA.1

Freq = 6.6132 GHz, Bw = 8.000 MH No calibration applied and no bandpass applied

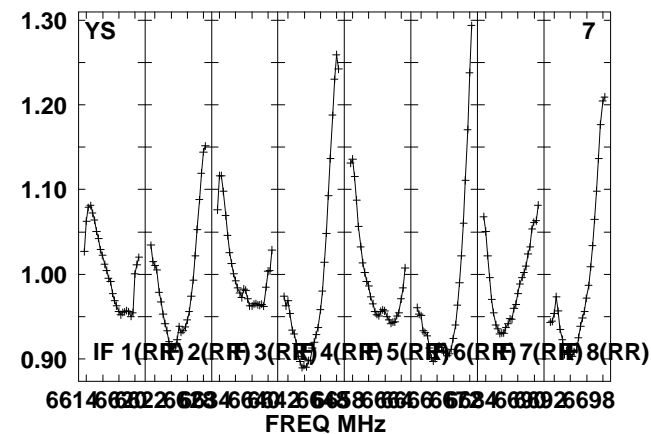
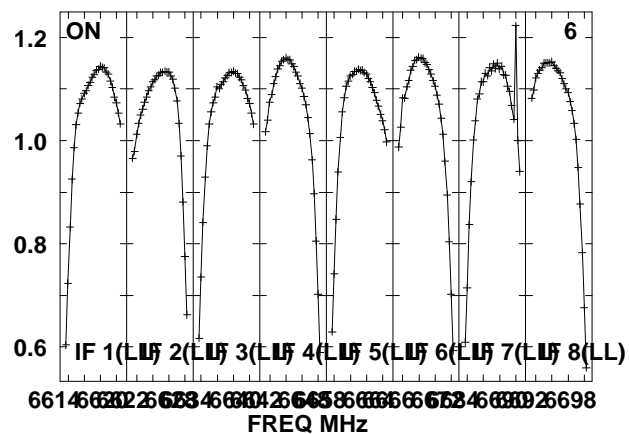
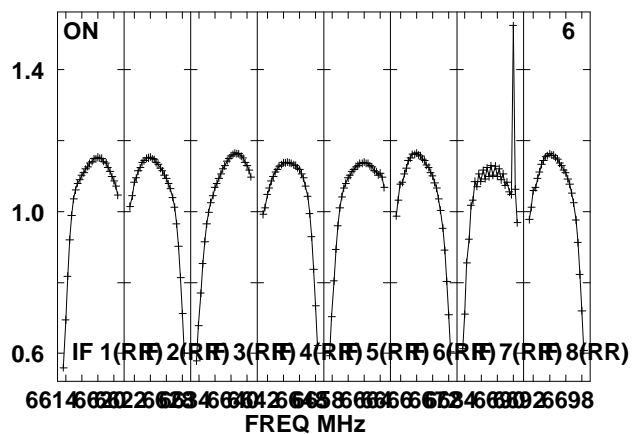
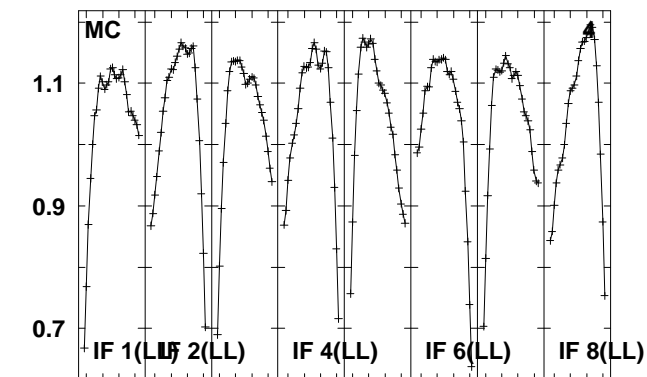
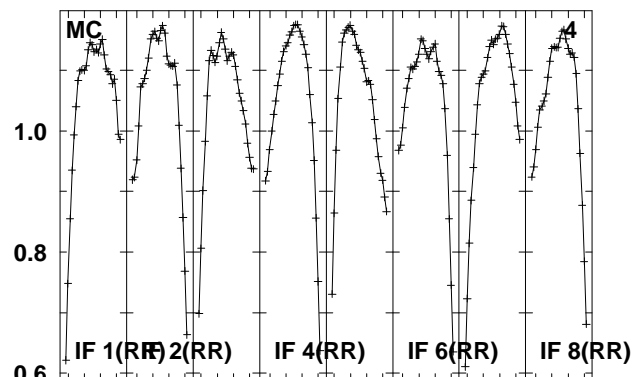
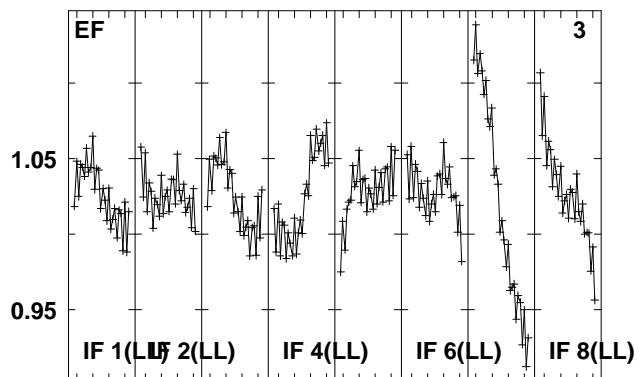
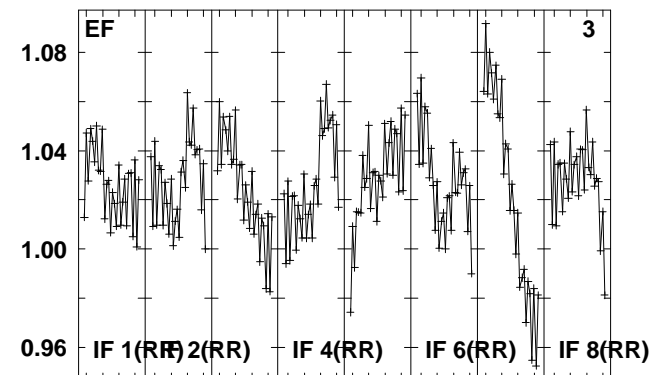
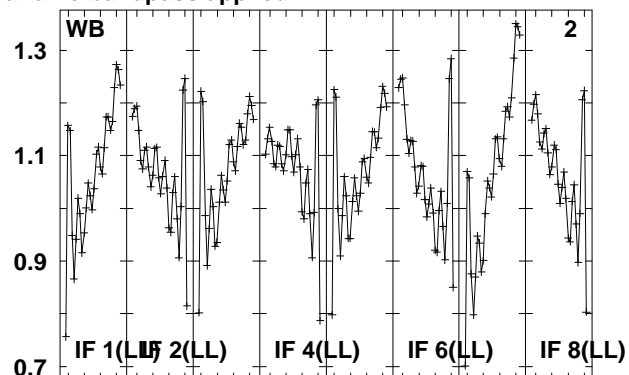
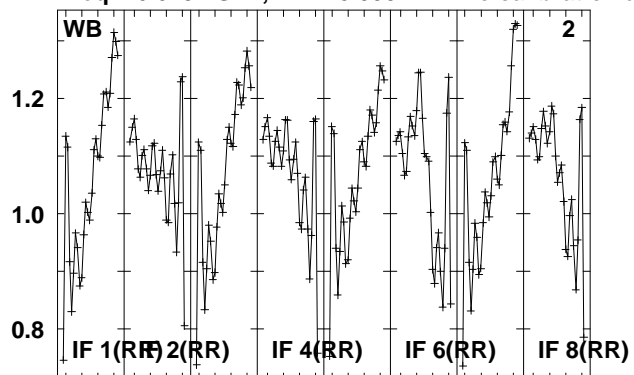

Lower frame: Real Jy  
Total-power spectrum Antenna: \*  
Timerange: 00/11:46:57 to 00/11:48:23

Plot file version 8 created 10-APR-2012 15:41:39

1638+572 ER026C 5.UVDATA.1

Freq = 6.6132 GHz, Bw = 8.000 MH No calibration applied and no bandpass applied

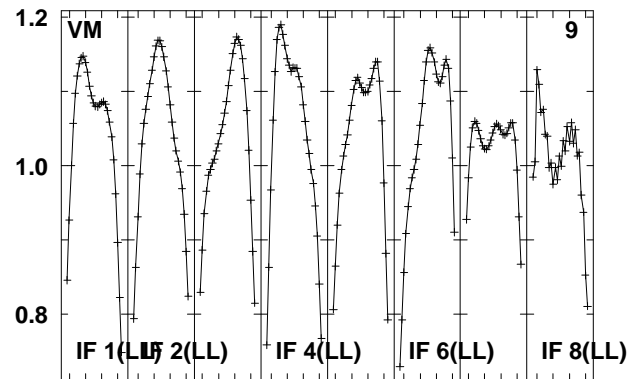
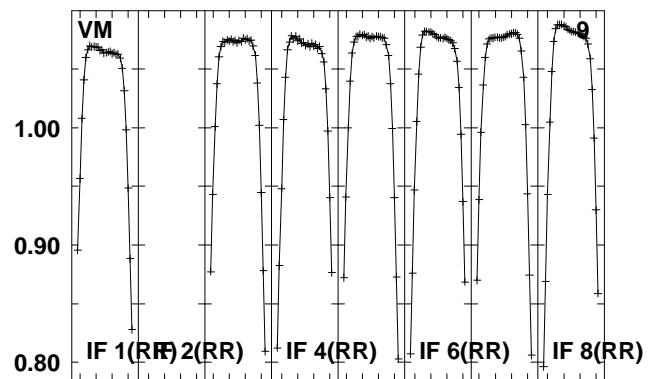
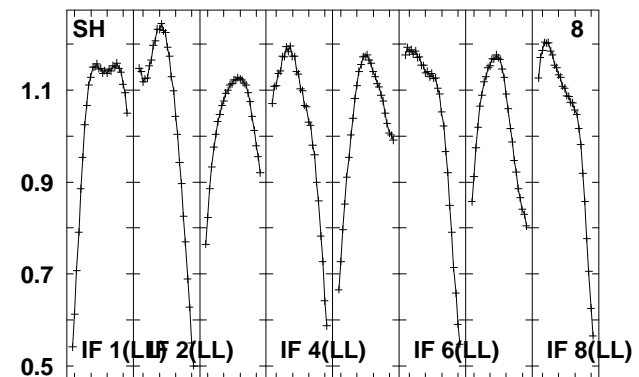
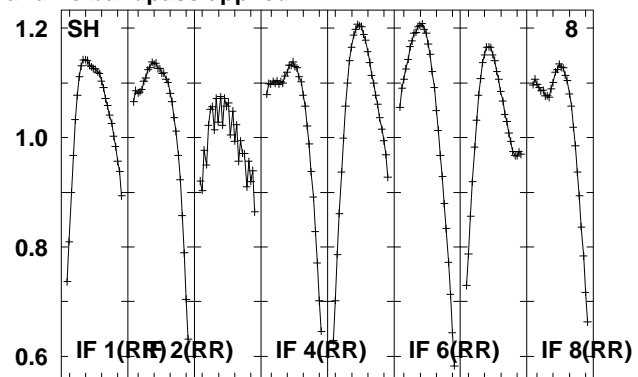
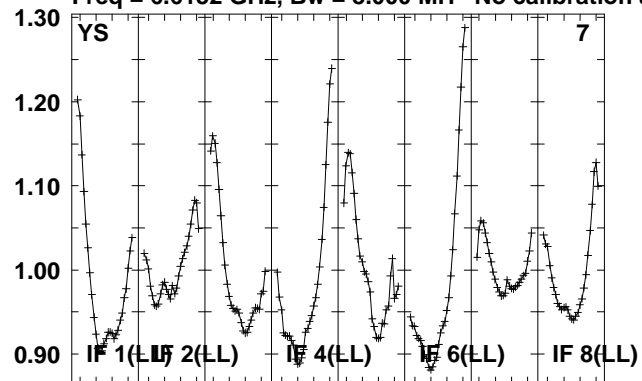

Lower frame: Real Jy  
Total-power spectrum Antenna: \*  
Timerange: 00/11:46:57 to 00/11:48:23



Plot file version 9 created 10-APR-2012 15:41:39

1740+521 ER026C 5.UVDATA.1

Freq = 6.6132 GHz, Bw = 8.000 MH No calibration applied and no bandpass applied

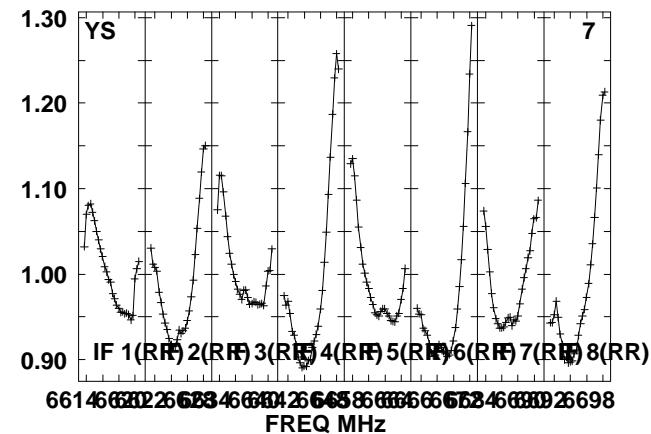
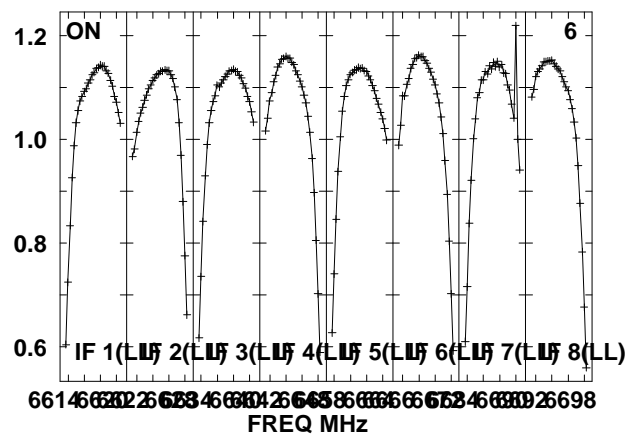
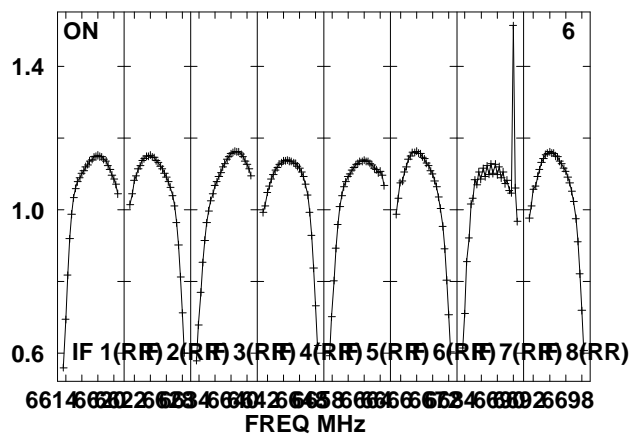
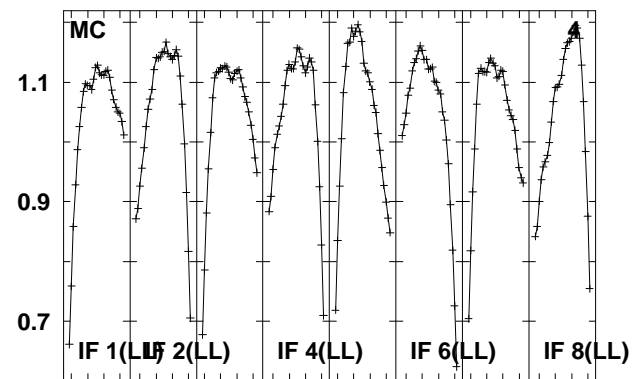
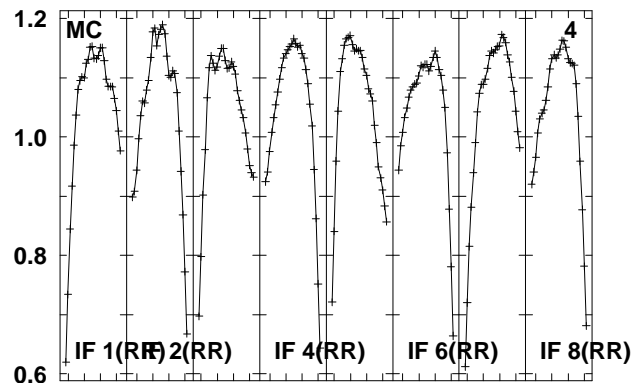
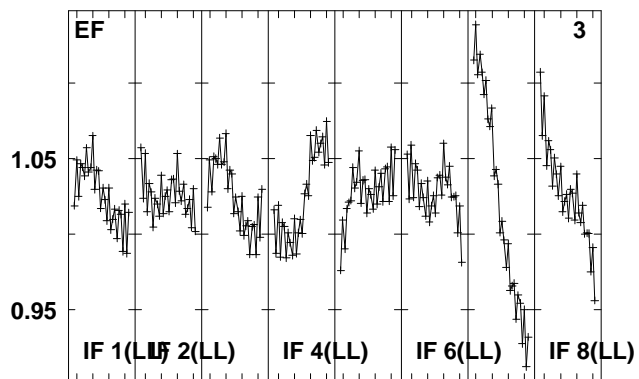
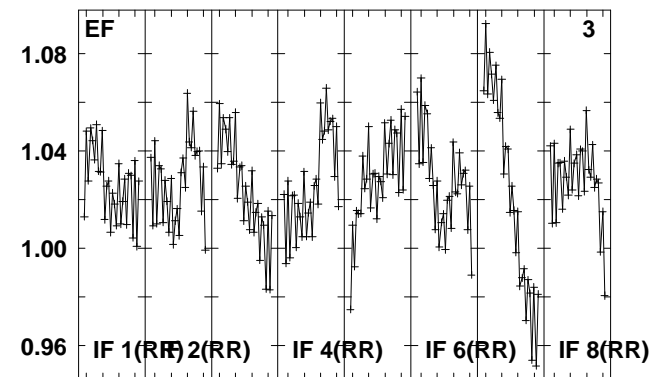
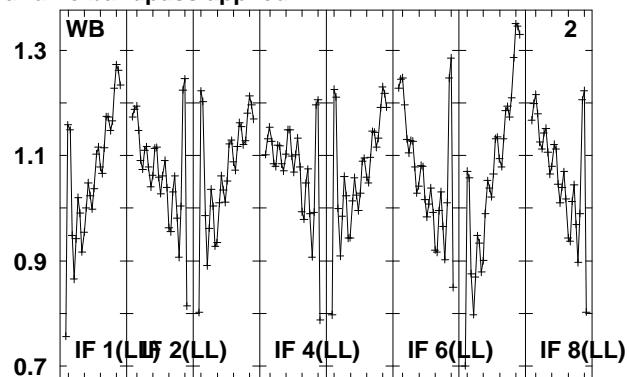
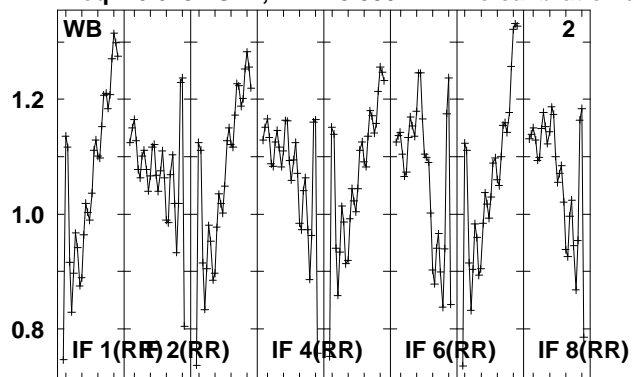

Lower frame: Real Jy  
Total-power spectrum Antenna: \*  
Timerange: 00/11:49:31 to 00/11:50:57

Plot file version 10 created 10-APR-2012 15:41:39

1740+521 ER026C 5.UVDATA.1

Freq = 6.6132 GHz, Bw = 8.000 MH No calibration applied and no bandpass applied

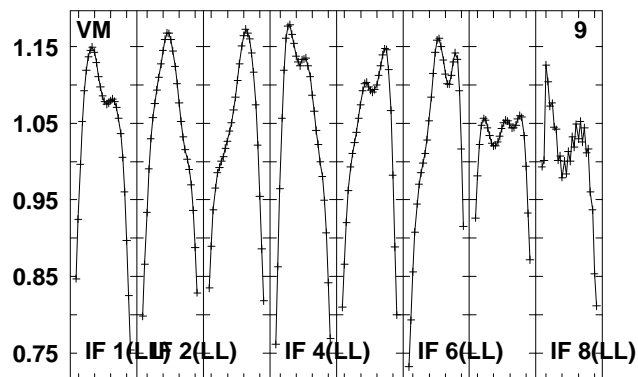
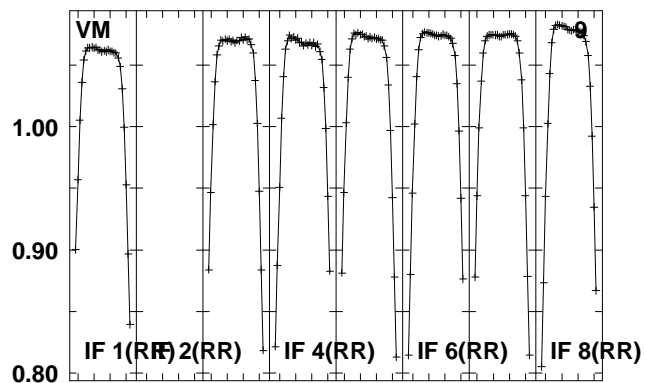
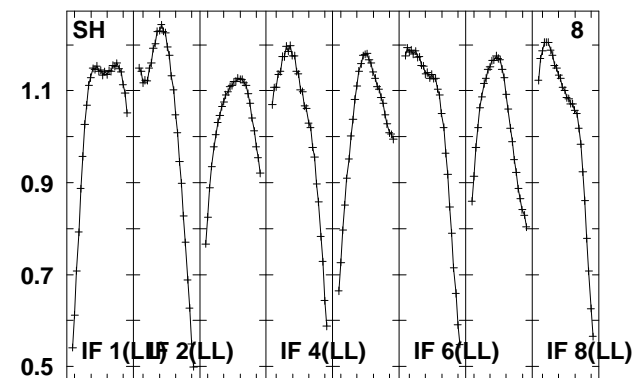
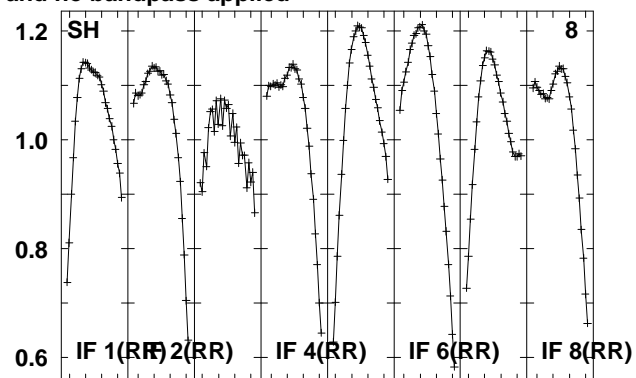
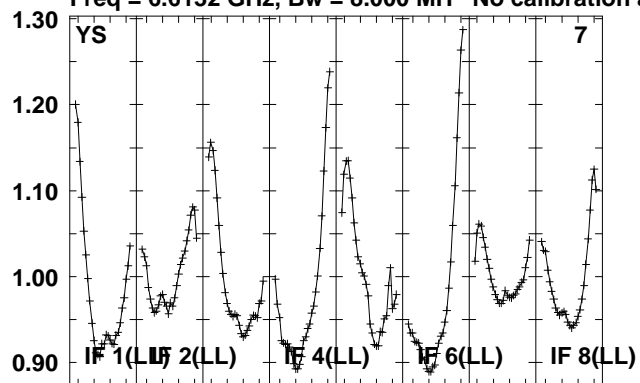

Lower frame: Real Jy  
Total-power spectrum Antenna: \*  
Timerange: 00/11:49:31 to 00/11:50:57

Plot file version 11 created 10-APR-2012 15:41:40

0102+582 ER026C 5.UVDATA.1

Freq = 6.6132 GHz, Bw = 8.000 MH No calibration applied and no bandpass applied

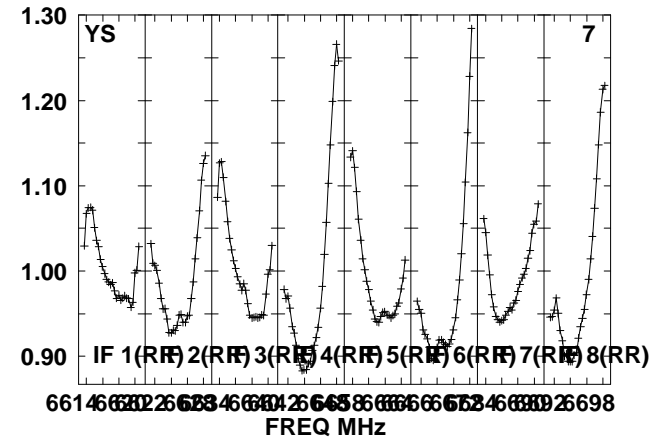
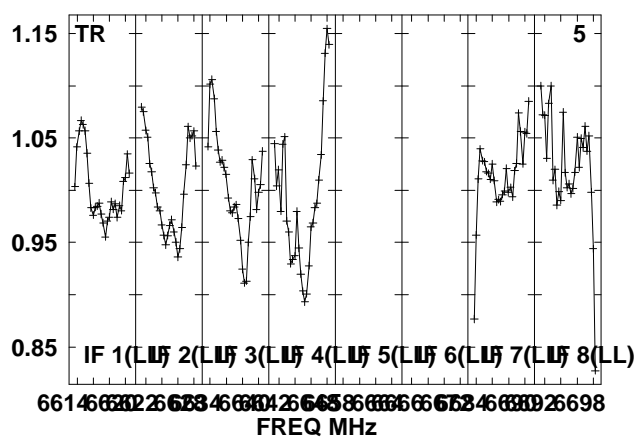
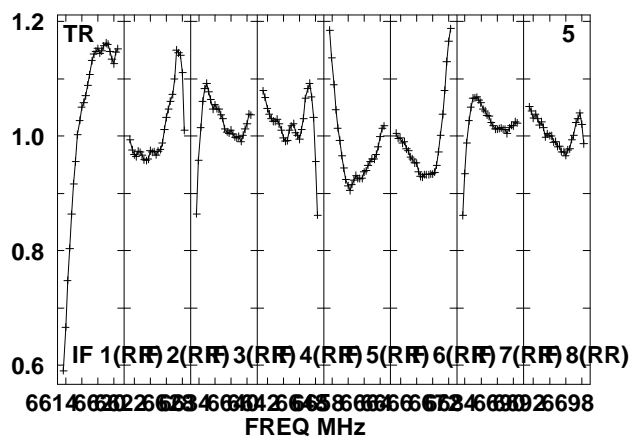
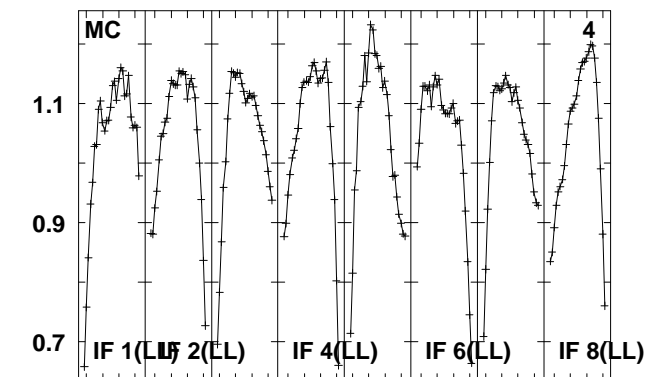
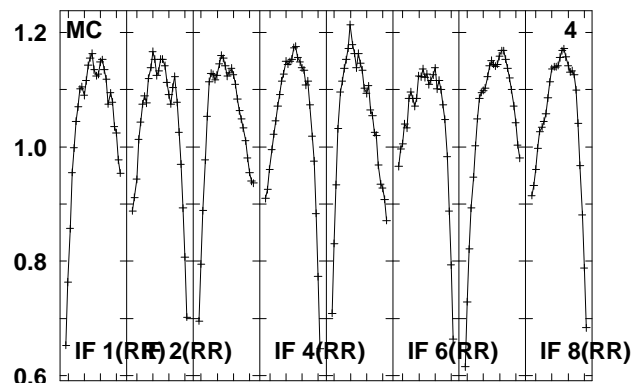
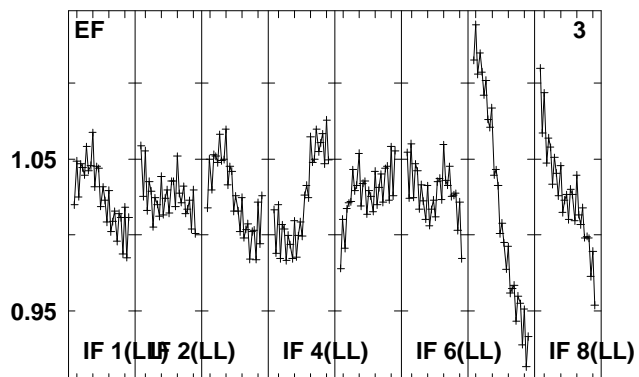
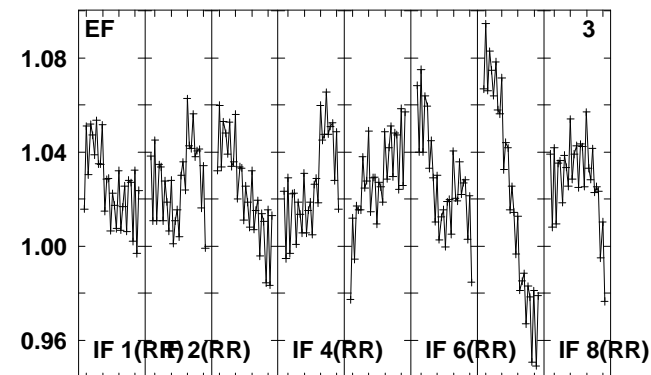
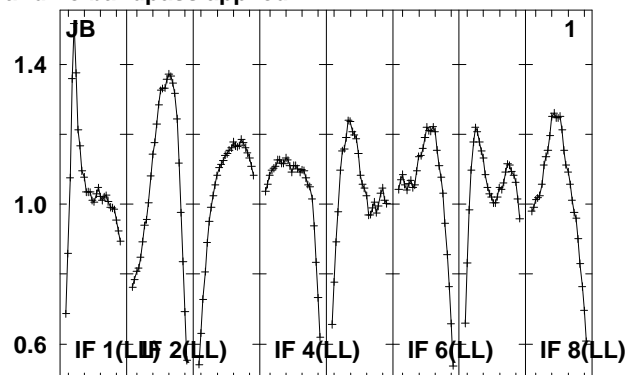
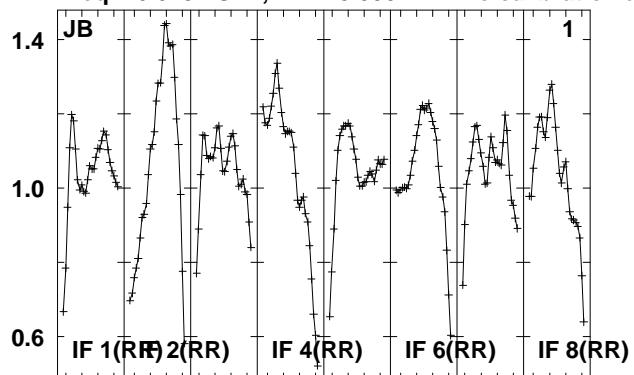

Lower frame: Real Jy  
Total-power spectrum Antenna: \*  
Timerange: 00/11:57:13 to 00/11:58:39

Plot file version 12 created 10-APR-2012 15:41:40

0102+582 ER026C 5.UVDATA.1

Freq = 6.6132 GHz, Bw = 8.000 MH No calibration applied and no bandpass applied

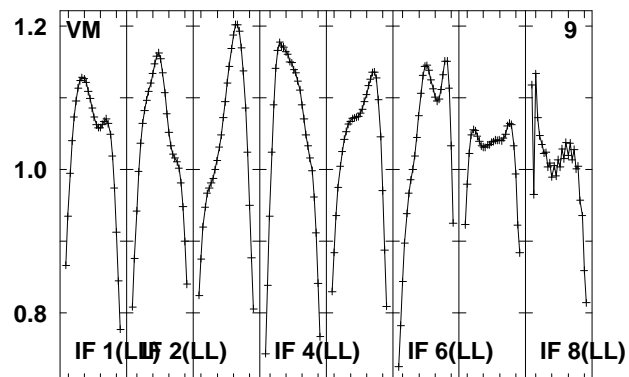
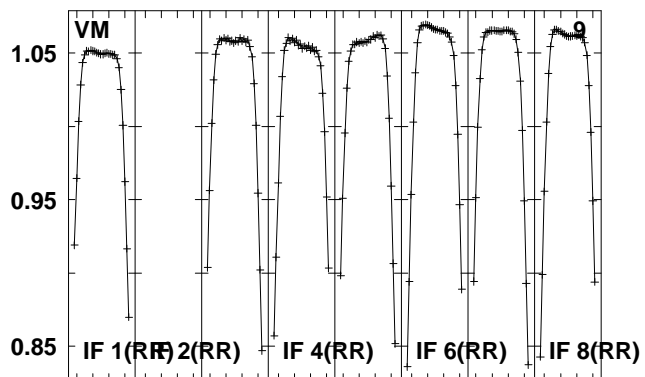
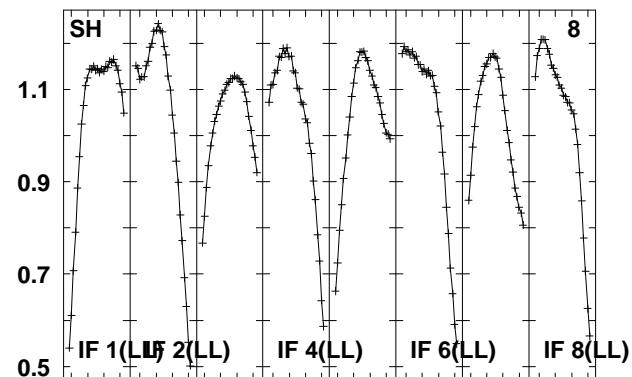
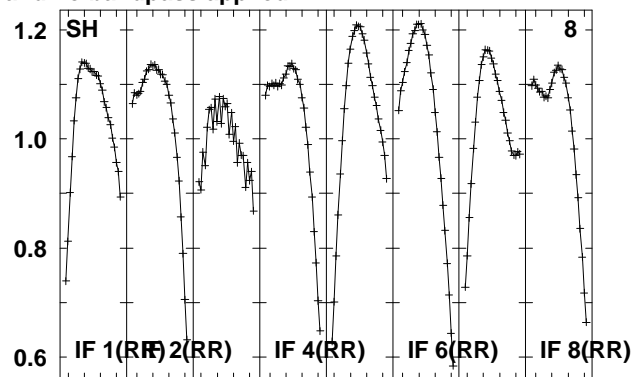
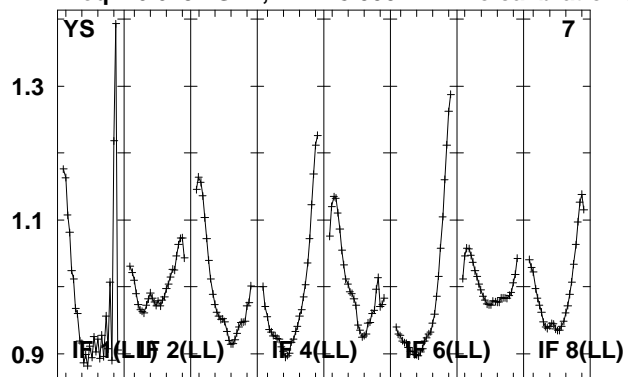

Lower frame: Real Jy  
Total-power spectrum Antenna: \*  
Timerange: 00/11:57:13 to 00/11:58:39

Plot file version 13 created 10-APR-2012 15:41:40

0646+445 ER026C 5.UVDATA.1

Freq = 6.6132 GHz, Bw = 8.000 MH No calibration applied and no bandpass applied

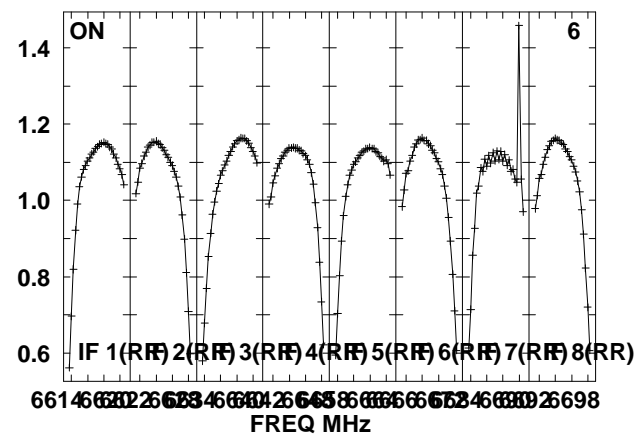
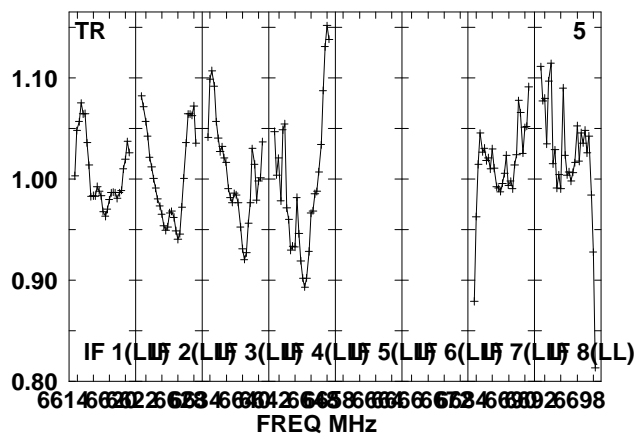
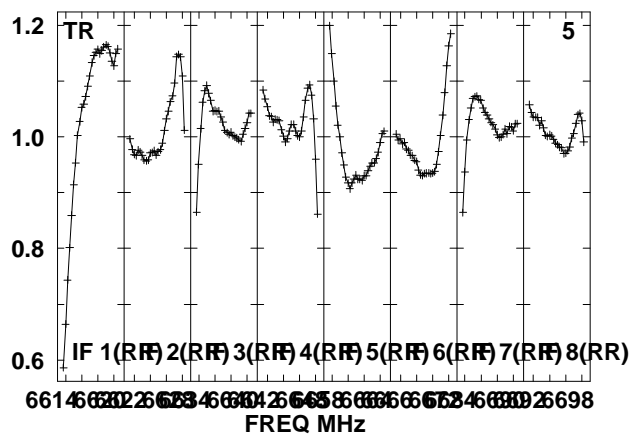
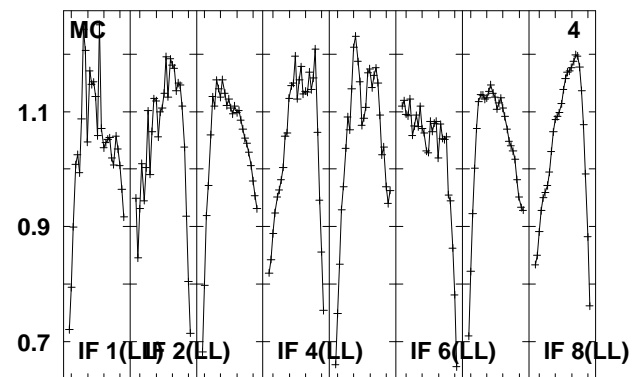
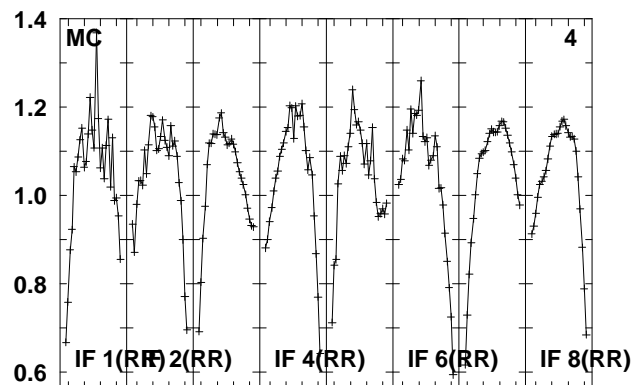
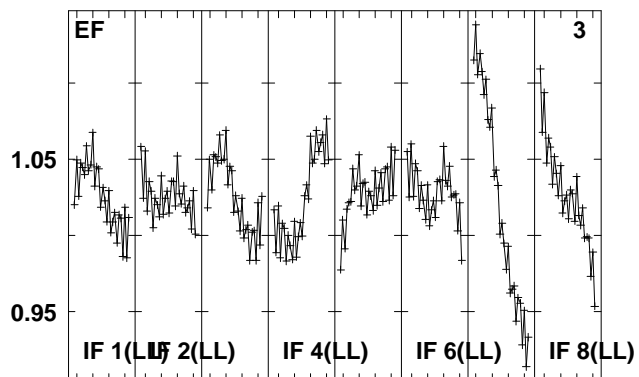
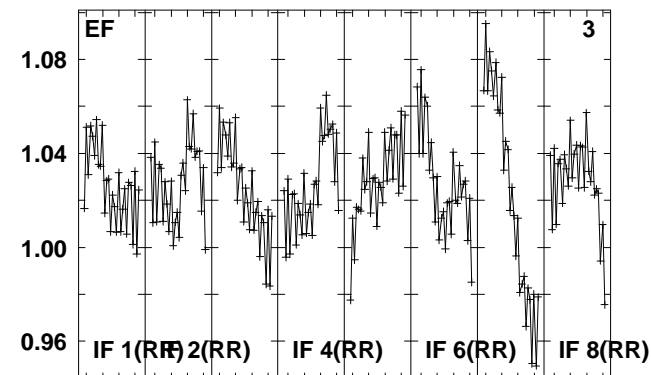
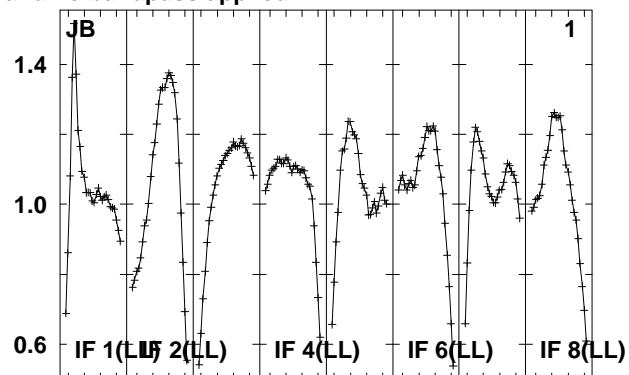
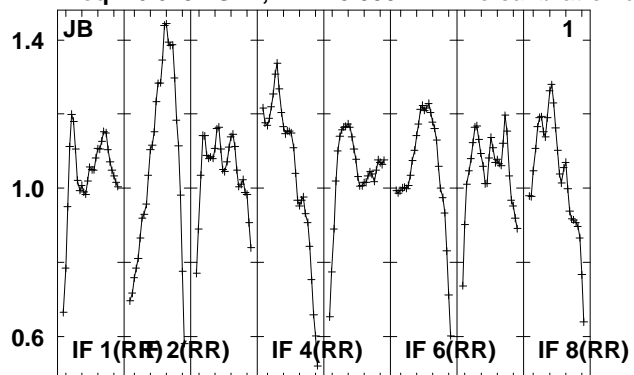

Lower frame: Real Jy  
Total-power spectrum Antenna: \*  
Timerange: 00/12:01:53 to 00/12:03:19

Plot file version 14 created 10-APR-2012 15:41:40

0646+445 ER026C 5.UVDATA.1

Freq = 6.6132 GHz, Bw = 8.000 MH No calibration applied and no bandpass applied

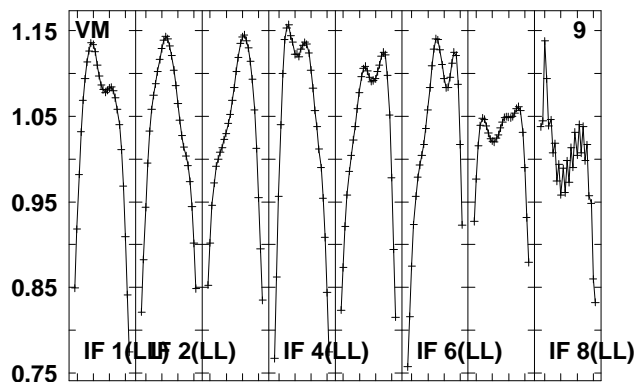
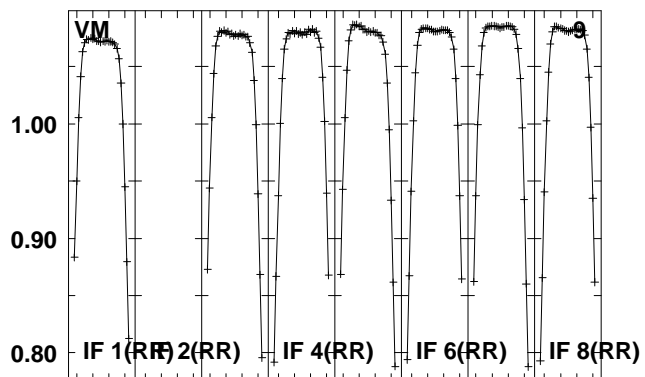
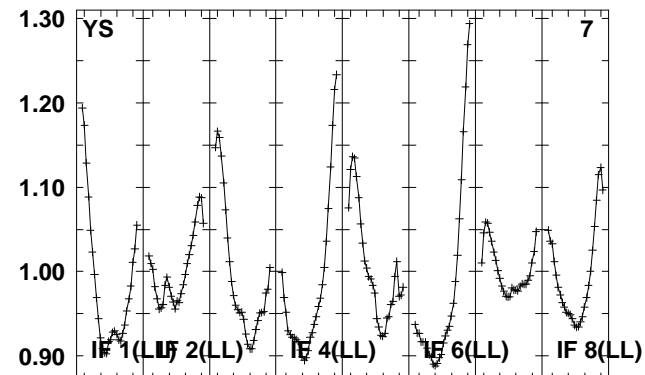
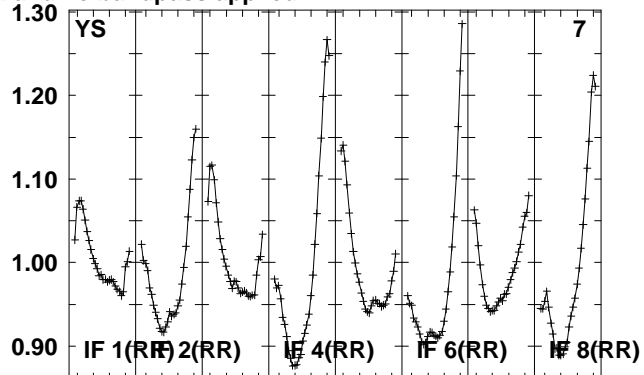
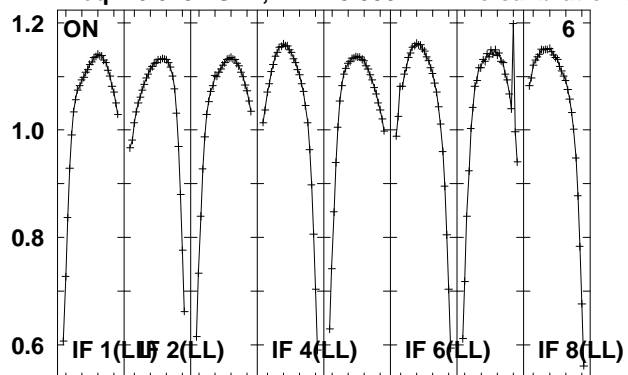

Lower frame: Real Jy  
Total-power spectrum Antenna: \*  
Timerange: 00/12:01:53 to 00/12:03:19

Plot file version 15 created 10-APR-2012 15:41:40

0726+791 ER026C 5.UVDATA.1

Freq = 6.6132 GHz, Bw = 8.000 MH No calibration applied and no bandpass applied

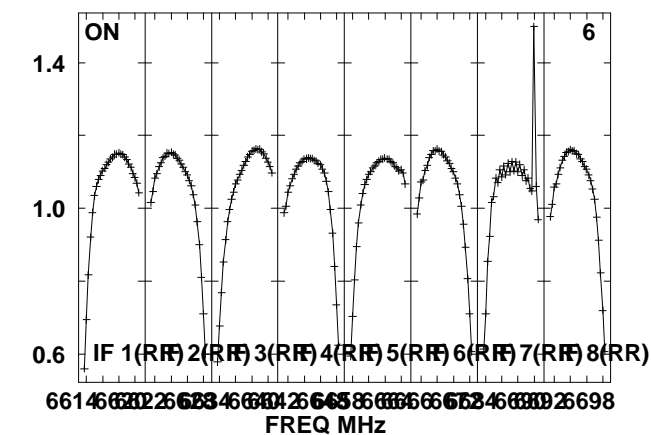
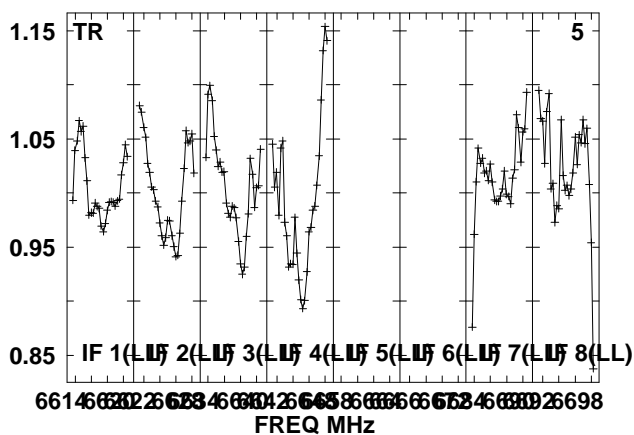
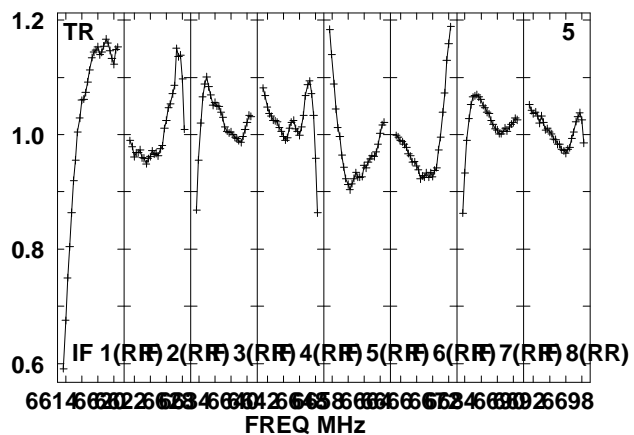
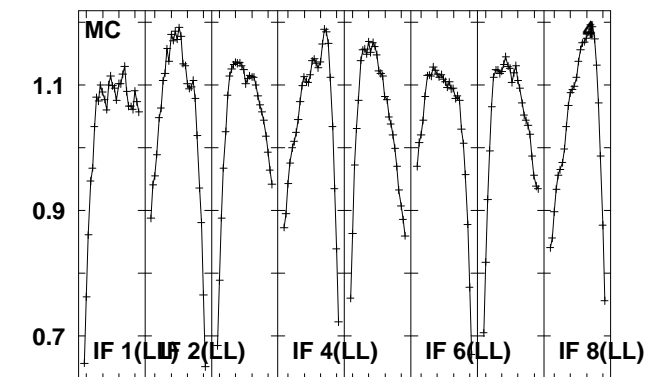
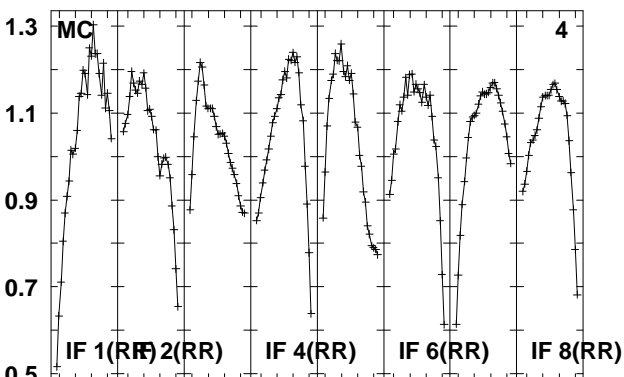
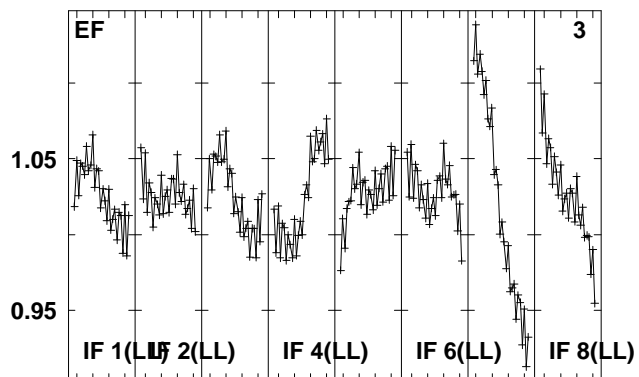
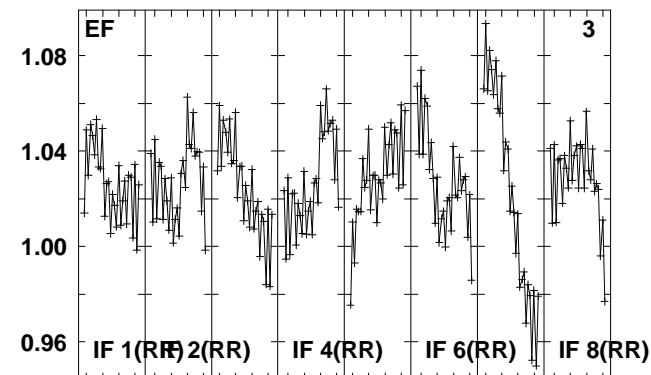
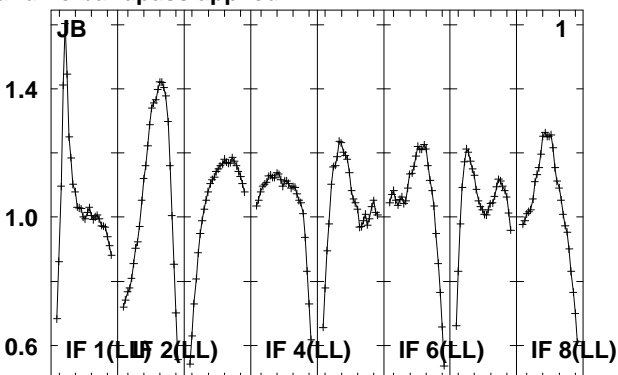
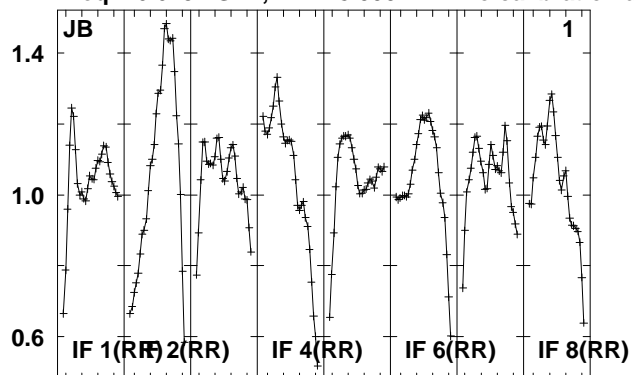

Lower frame: Real Jy  
Total-power spectrum Antenna: \*  
Timerange: 00/12:05:53 to 00/12:07:19

Plot file version 16 created 10-APR-2012 15:41:41

0726+791 ER026C 5.UVDATA.1

Freq = 6.6132 GHz, Bw = 8.000 MH No calibration applied and no bandpass applied

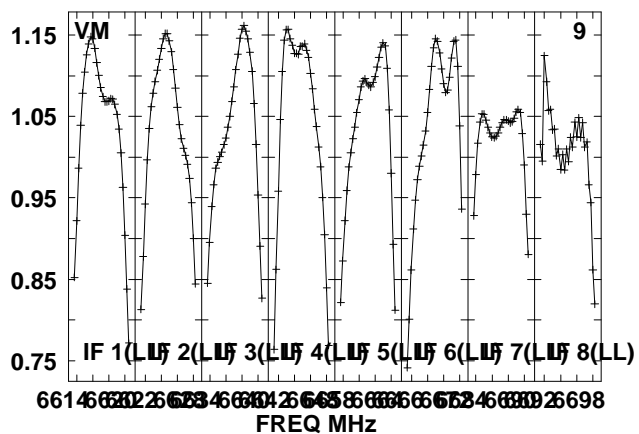
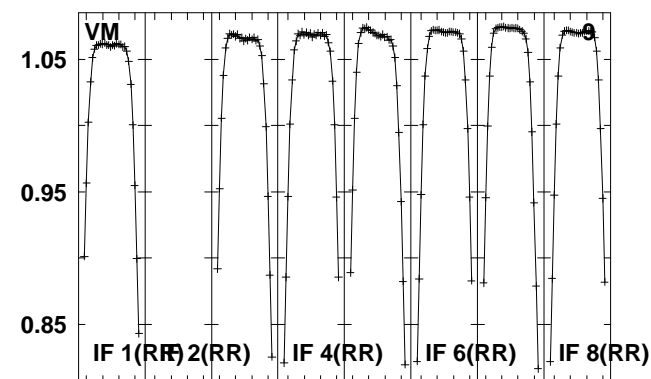
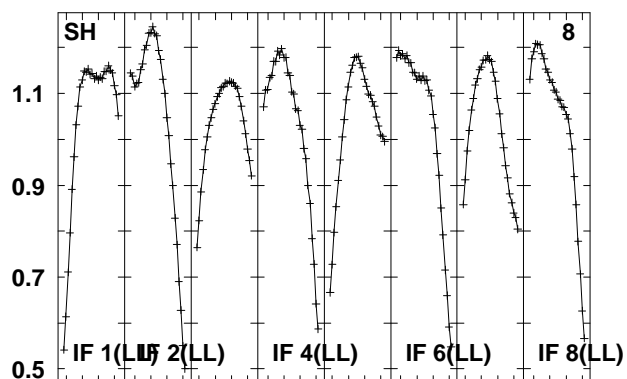
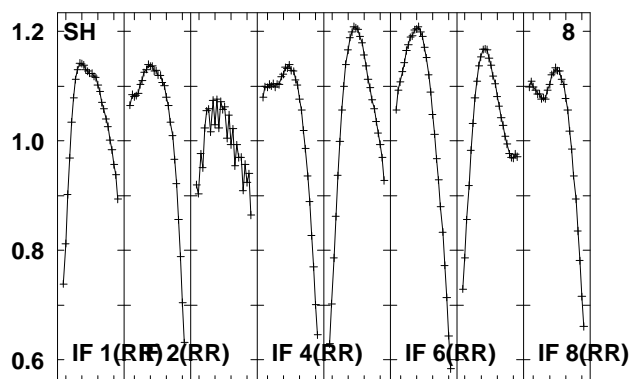
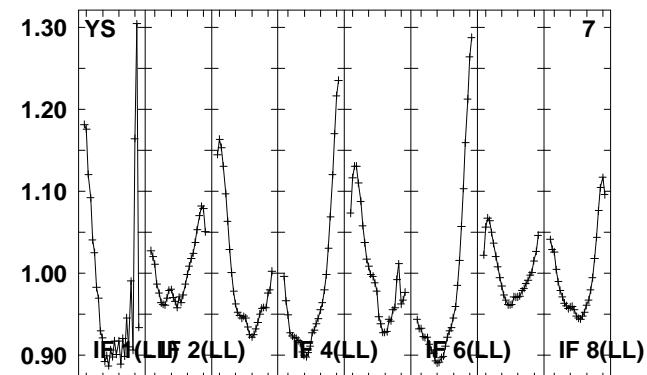
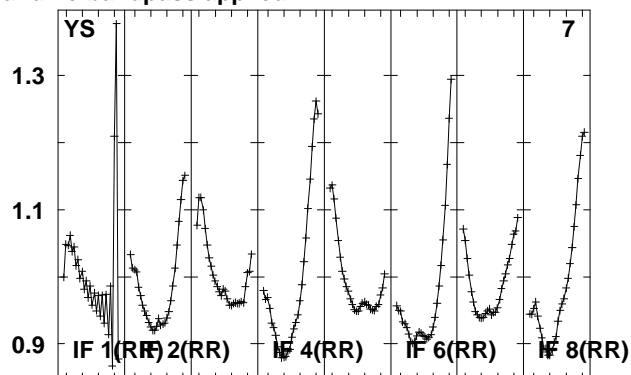
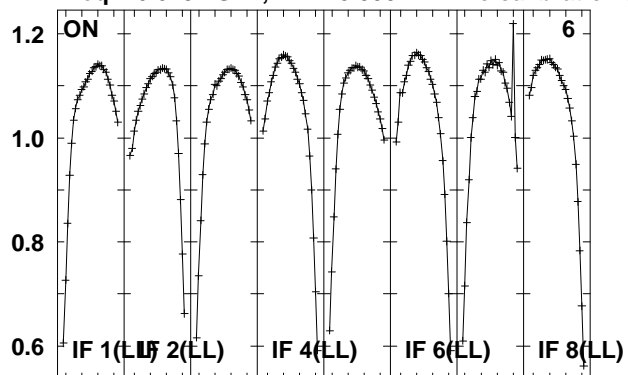

Lower frame: Real Jy

Total-power spectrum Antenna: \*

Timerange: 00/12:05:53 to 00/12:07:19



Plot file version 17 created 10-APR-2012 15:41:41

0818+422 ER026C 5.UVDATA.1

Freq = 6.6132 GHz, Bw = 8.000 MH No calibration applied and no bandpass applied

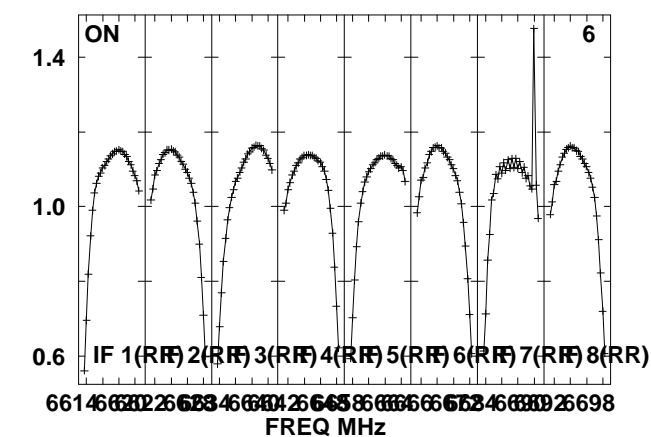
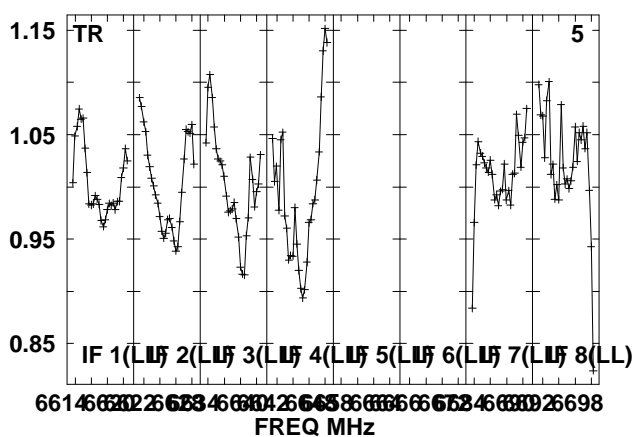
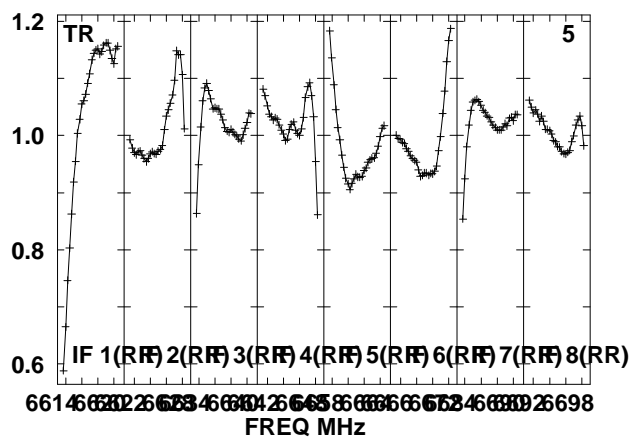
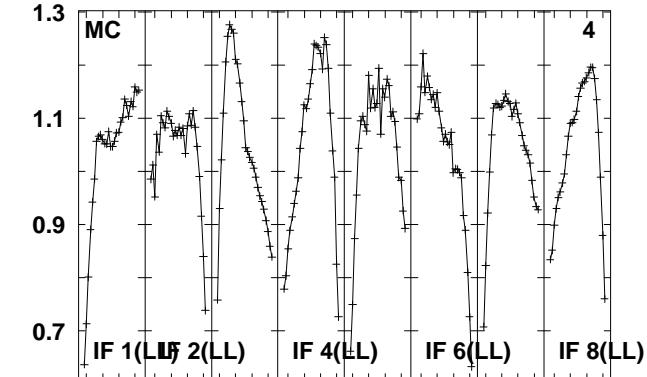
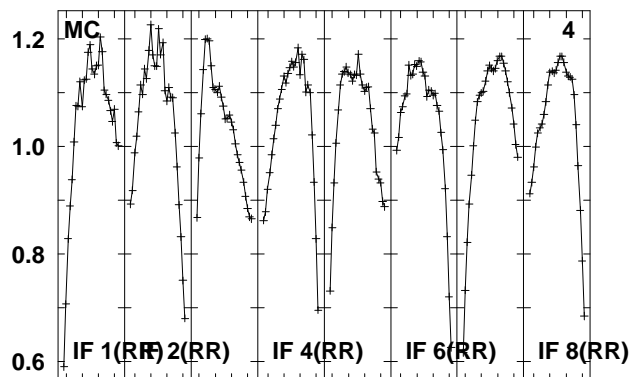
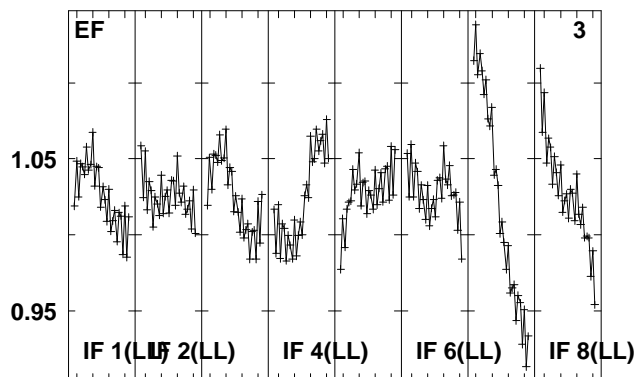
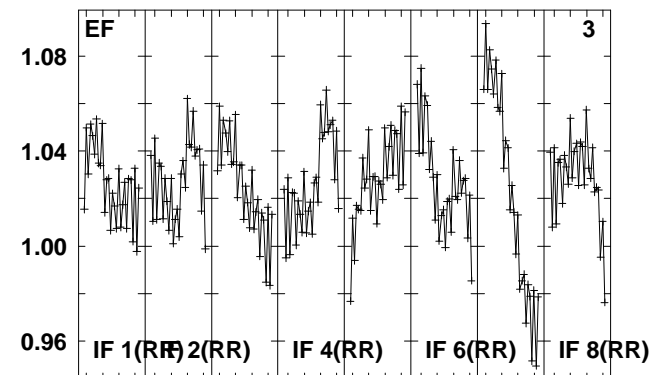
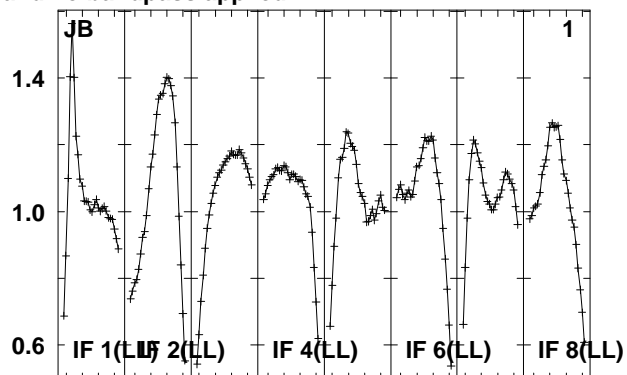
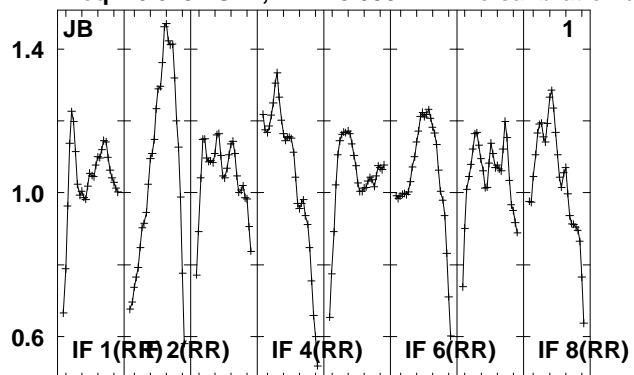

Lower frame: Real Jy  
Total-power spectrum Antenna: \*  
Timerange: 00/12:10:03 to 00/12:11:29

Plot file version 18 created 10-APR-2012 15:41:41

0818+422 ER026C 5.UVDATA.1

Freq = 6.6132 GHz, Bw = 8.000 MH No calibration applied and no bandpass applied

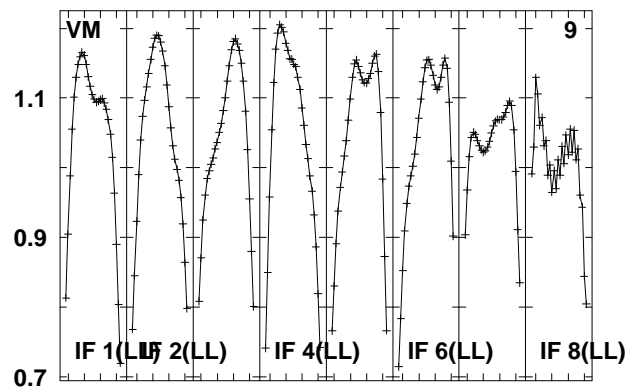
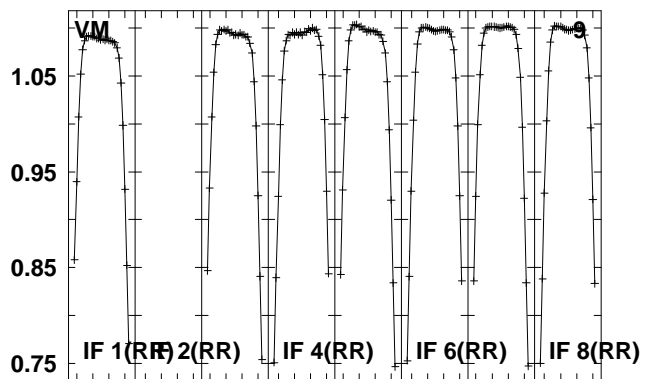
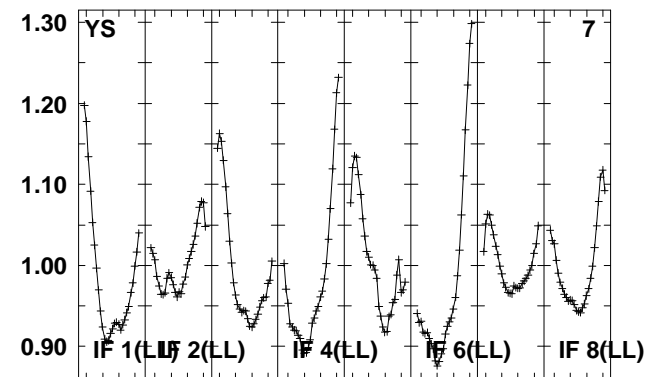
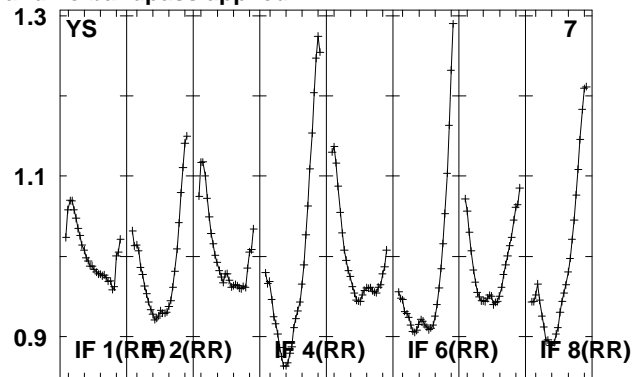
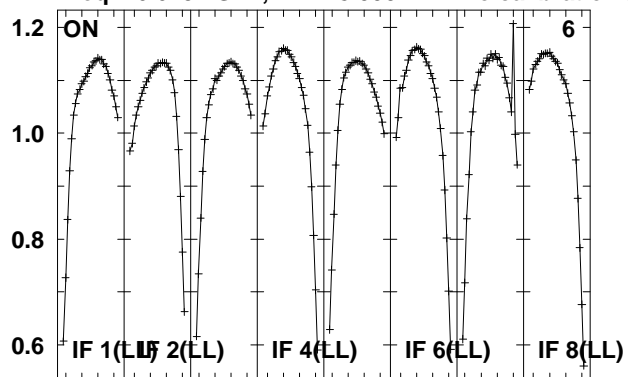

Lower frame: Real Jy  
Total-power spectrum Antenna: \*  
Timerange: 00/12:10:03 to 00/12:11:29

Plot file version 19 created 10-APR-2012 15:41:41

0854+200 ER026C 5.UVDATA.1

Freq = 6.6132 GHz, Bw = 8.000 MH No calibration applied and no bandpass applied

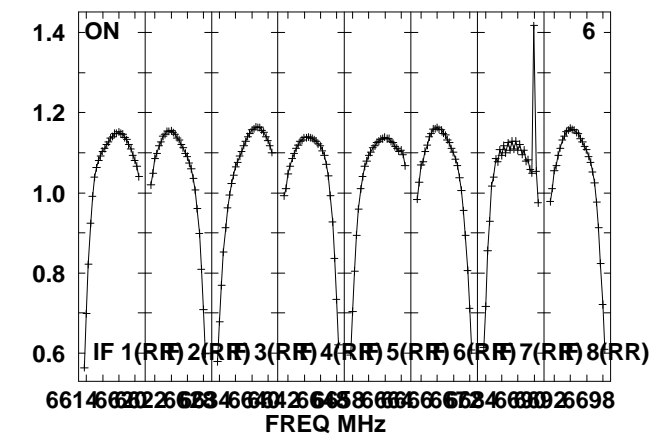
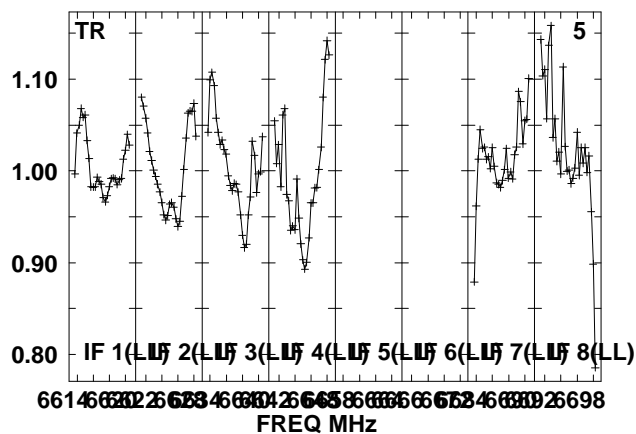
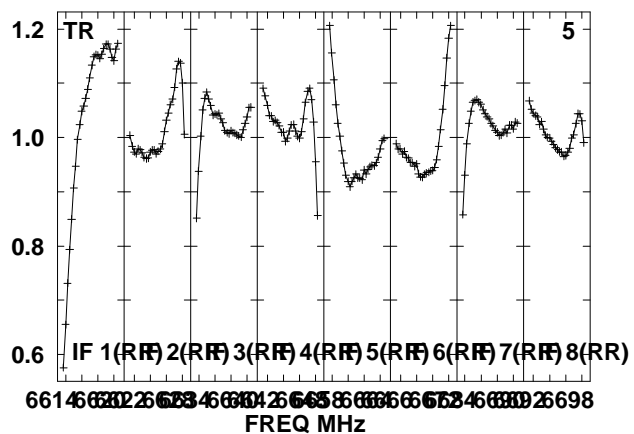
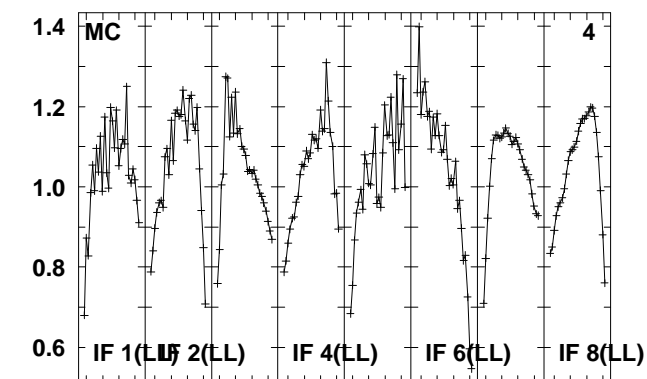
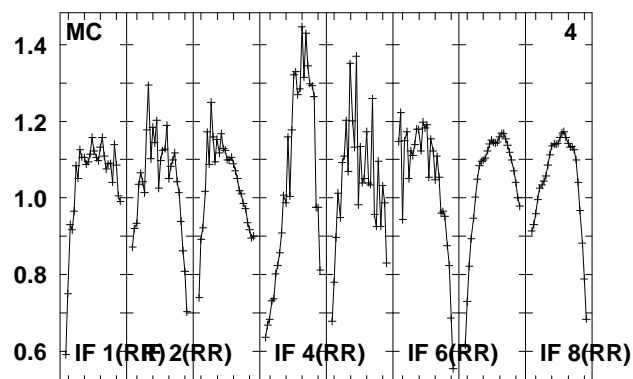
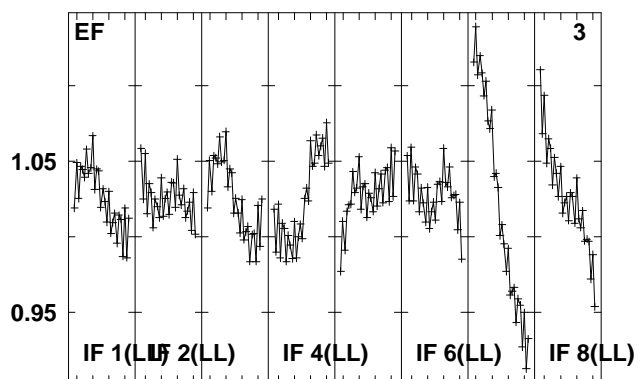
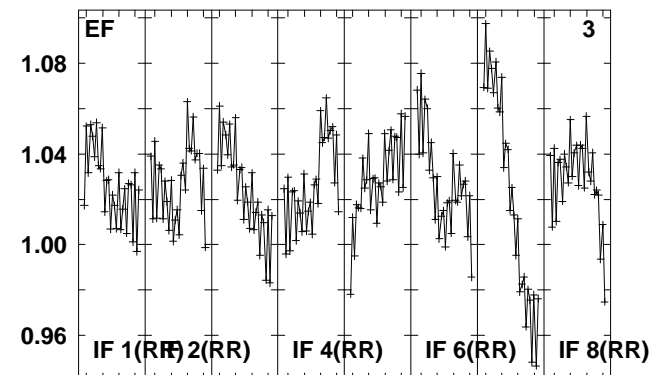
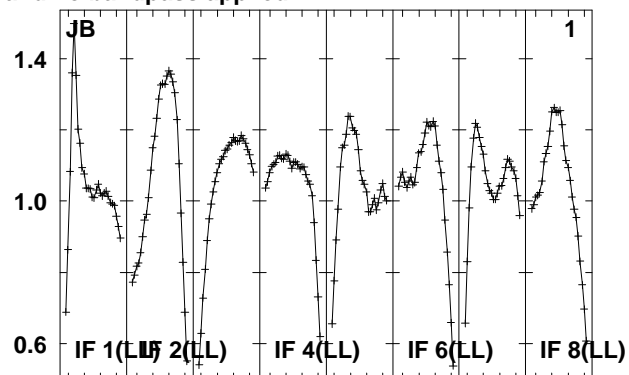
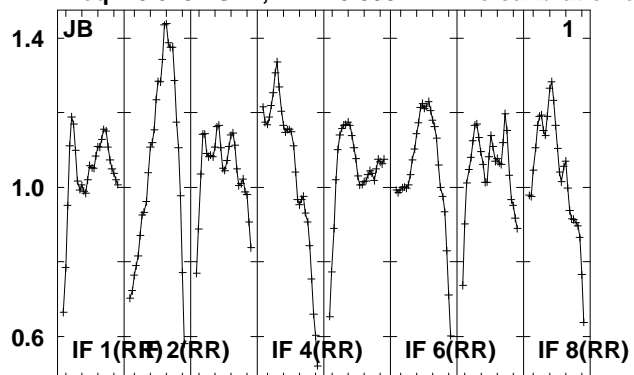

Lower frame: Real Jy

Total-power spectrum Antenna: \*

Timerange: 00/12:13:15 to 00/12:14:41

Plot file version 20 created 10-APR-2012 15:41:41

0854+200 ER026C 5.UVDATA.1

Freq = 6.6132 GHz, Bw = 8.000 MH No calibration applied and no bandpass applied

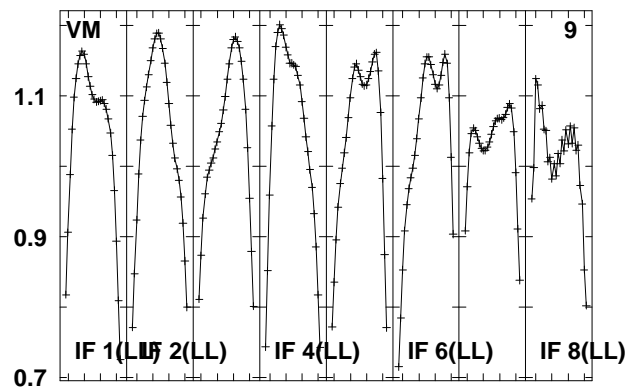
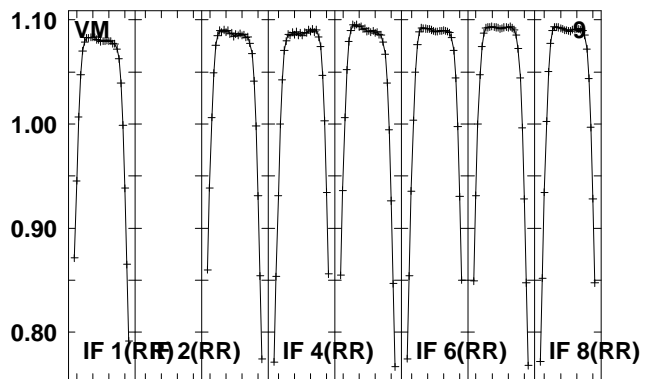
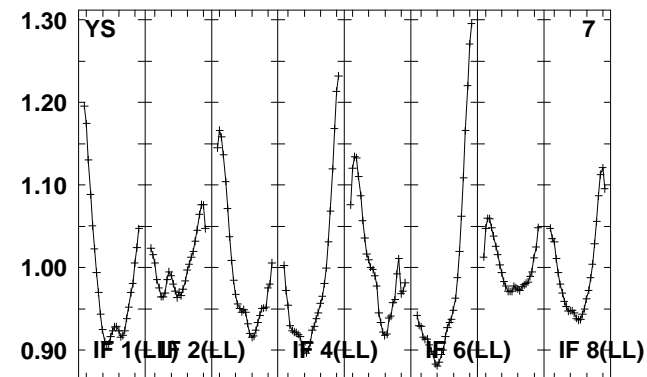
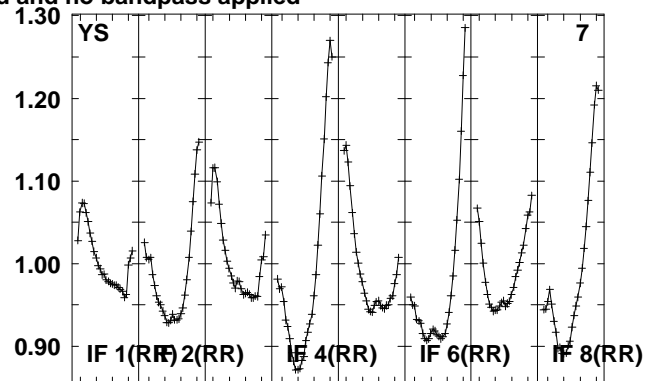
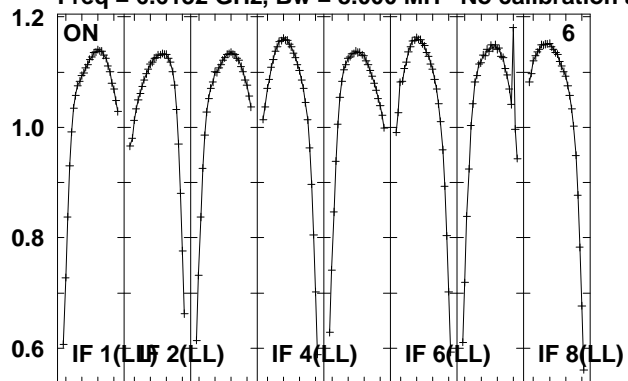

Lower frame: Real Jy  
Total-power spectrum Antenna: \*  
Timerange: 00/12:13:15 to 00/12:14:41

Plot file version 21 created 10-APR-2012 15:41:41

0927+390 ER026C 5.UVDATA.1

Freq = 6.6132 GHz, Bw = 8.000 MH No calibration applied and no bandpass applied

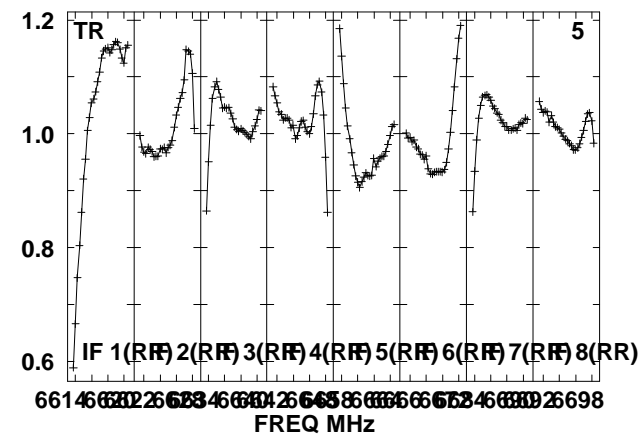
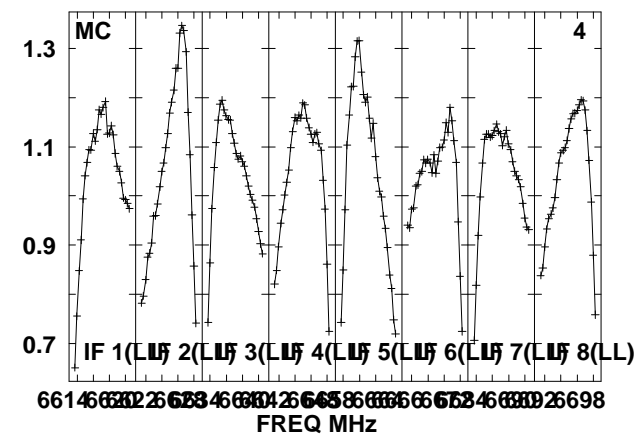
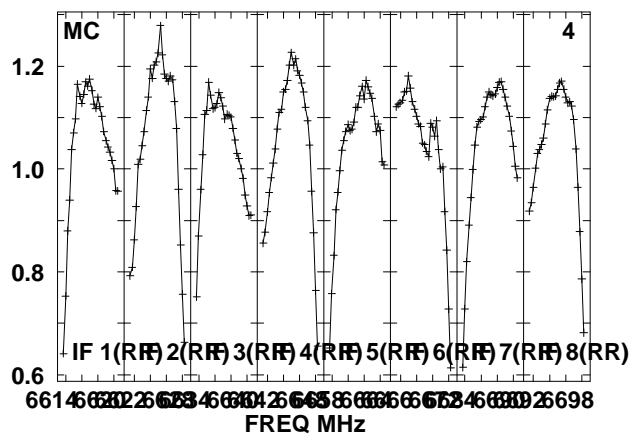
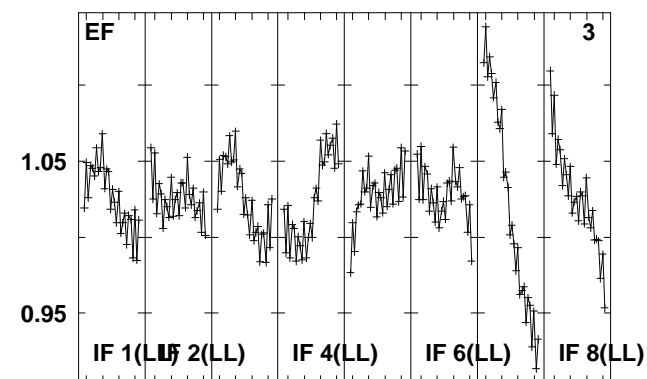
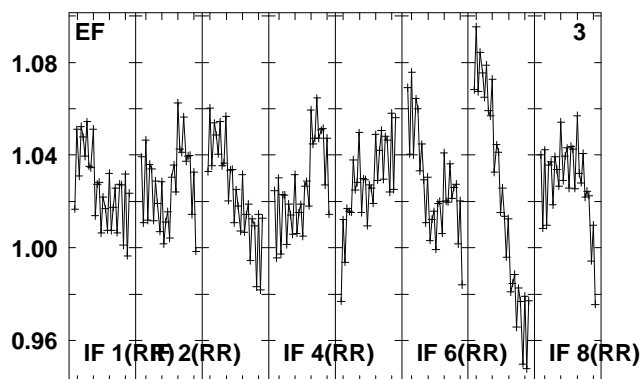
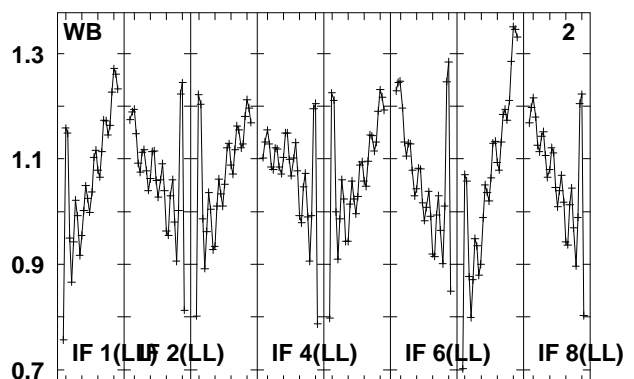
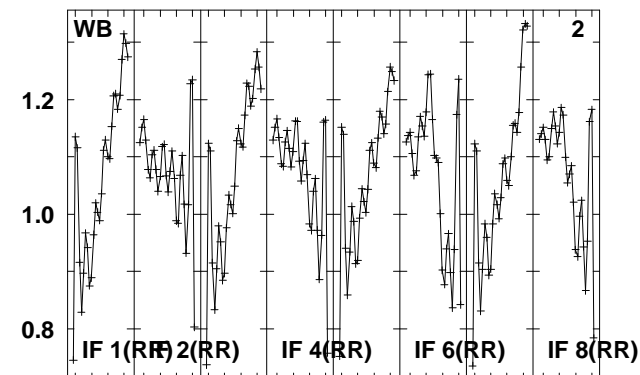
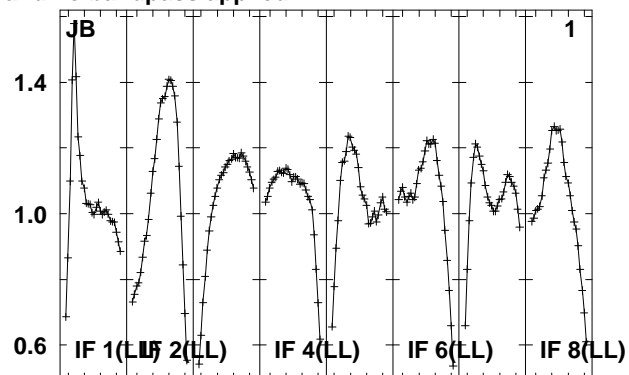
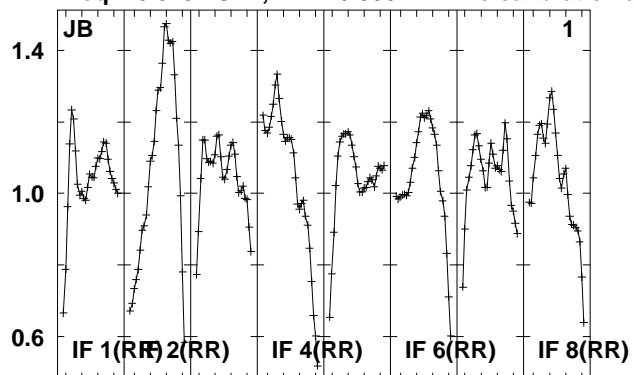

Lower frame: Real Jy  
Total-power spectrum Antenna: \*  
Timerange: 00/12:16:19 to 00/12:17:45

Plot file version 22 created 10-APR-2012 15:41:42

0927+390 ER026C 5.UVDATA.1

Freq = 6.6132 GHz, Bw = 8.000 MH No calibration applied and no bandpass applied

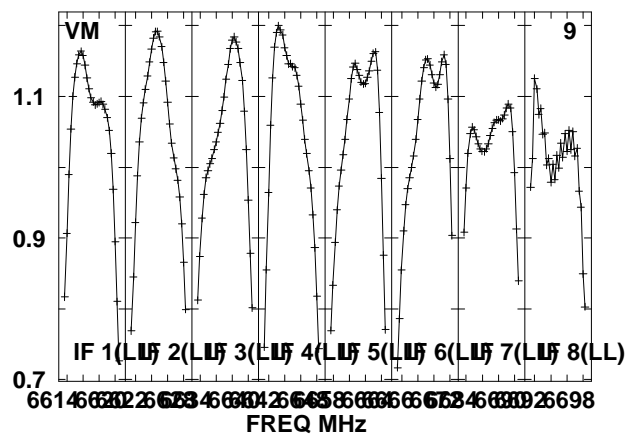
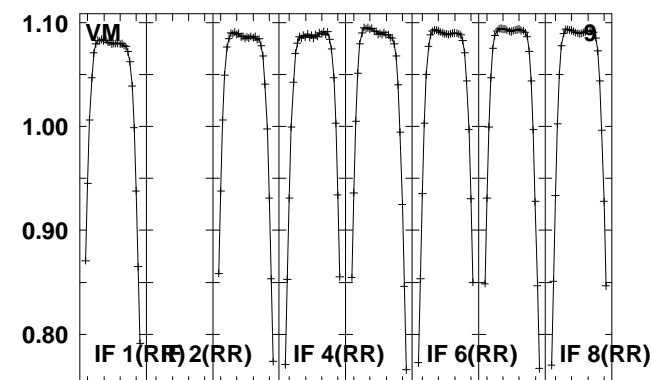
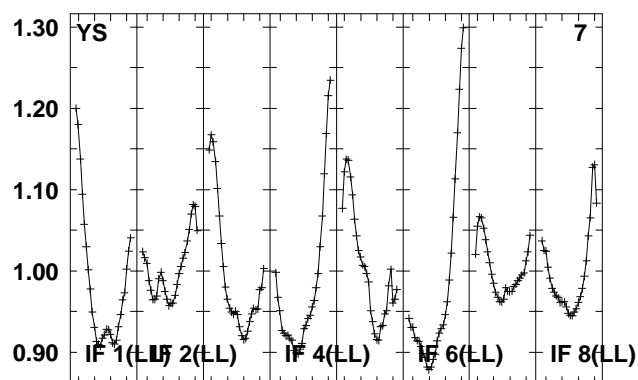
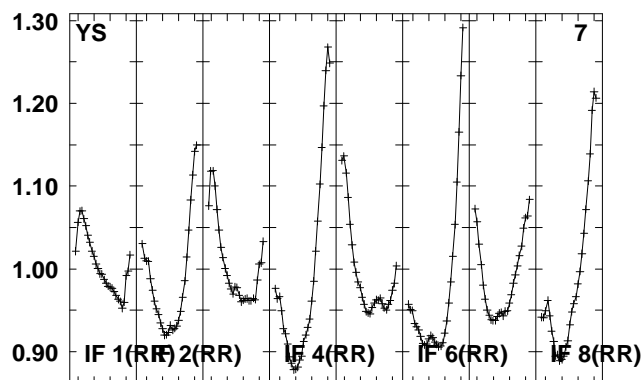
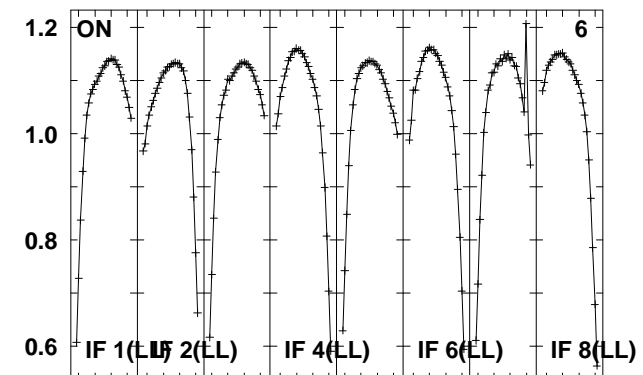
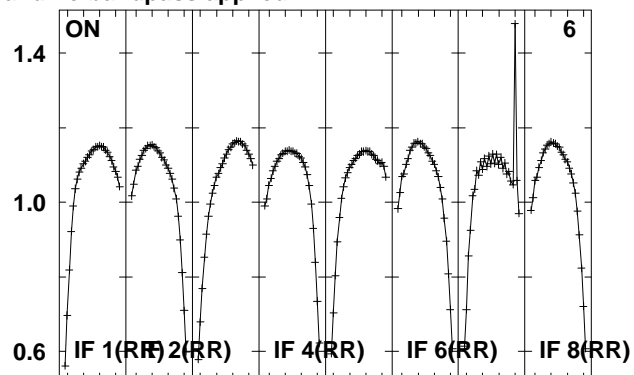
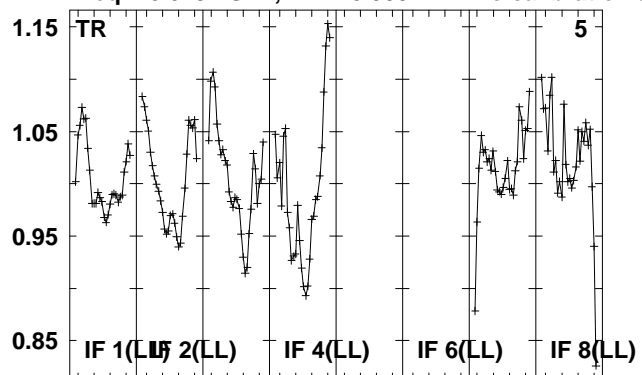

Lower frame: Real Jy

Total-power spectrum Antenna: \*

Timerange: 00/12:16:19 to 00/12:17:45

Plot file version 23 created 10-APR-2012 15:41:42

3C345 ER026C 5.UVDATA.1

Freq = 6.6132 GHz, Bw = 8.000 MH No calibration applied and no bandpass applied

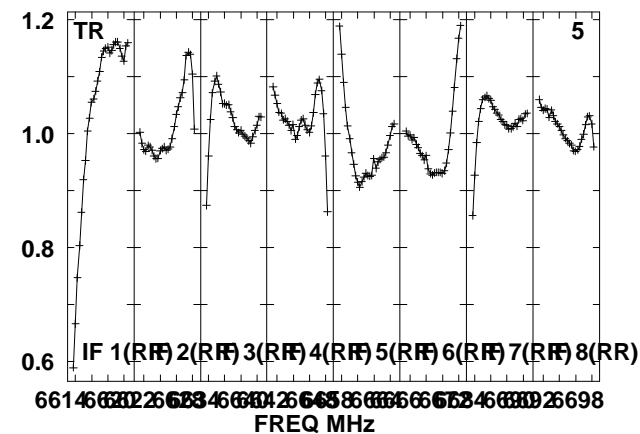
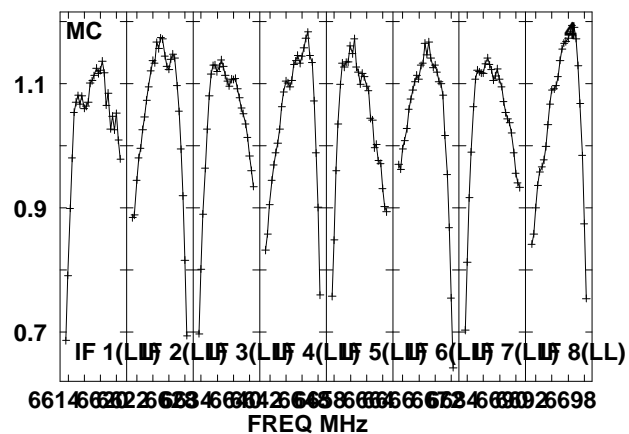
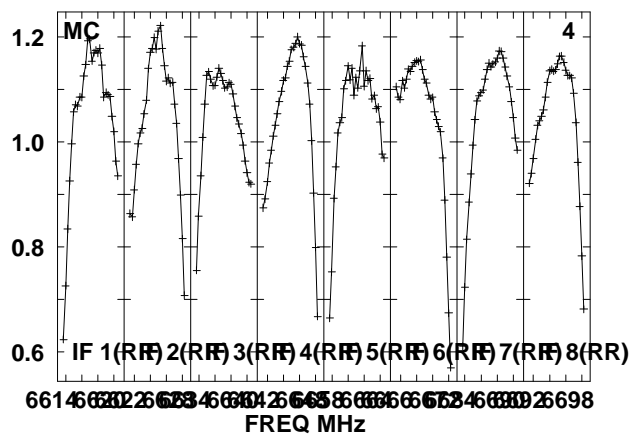
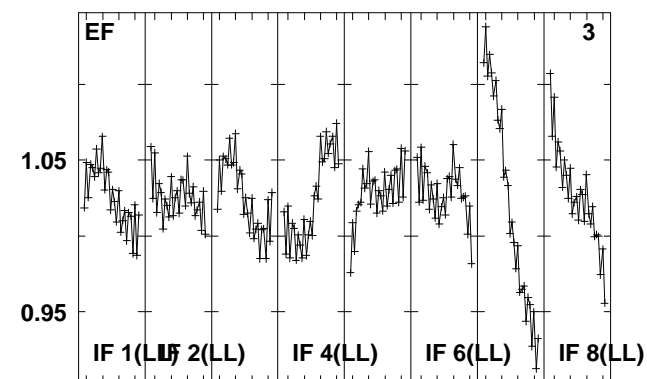
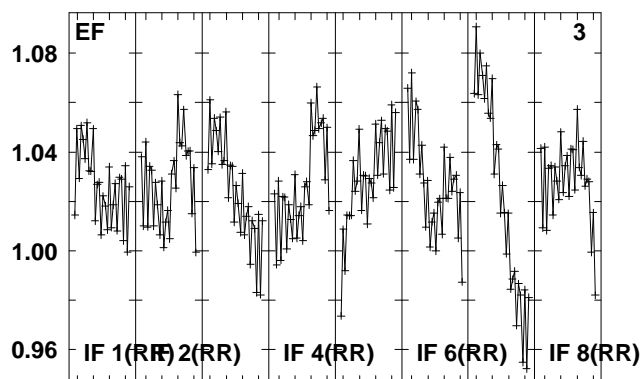
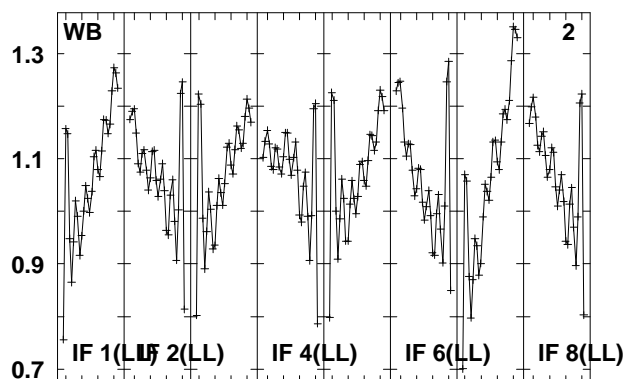
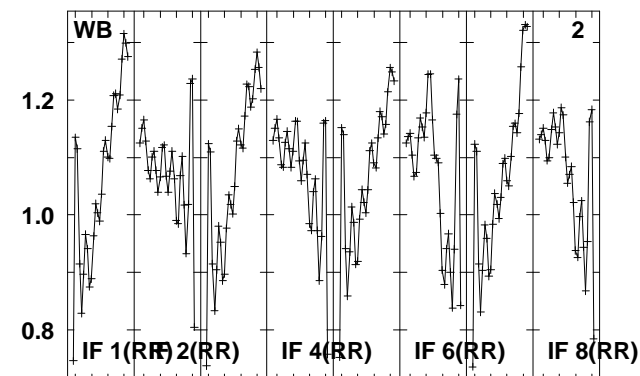
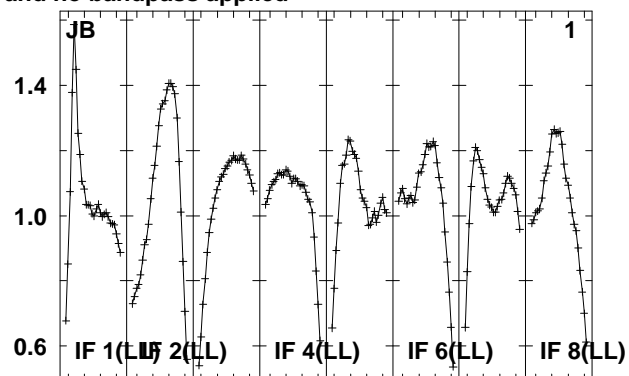
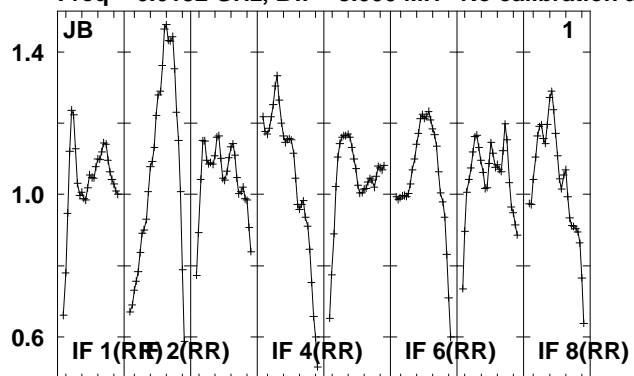

Lower frame: Real Jy

Total-power spectrum Antenna: \*

Timerange: 00/12:27:25 to 00/12:28:51

Plot file version 24 created 10-APR-2012 15:41:42

3C345 ER026C 5.UVDATA.1

Freq = 6.6132 GHz, Bw = 8.000 MH No calibration applied and no bandpass applied

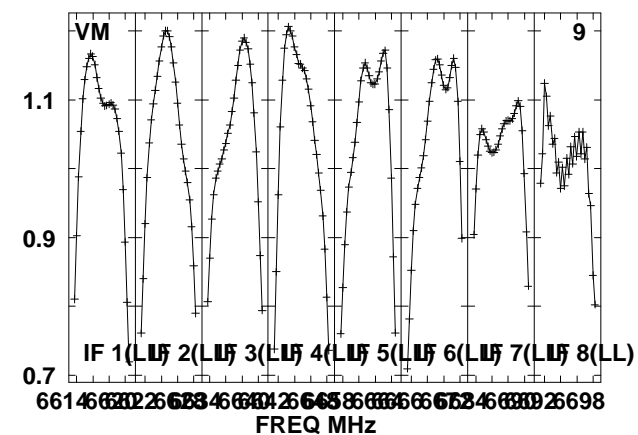
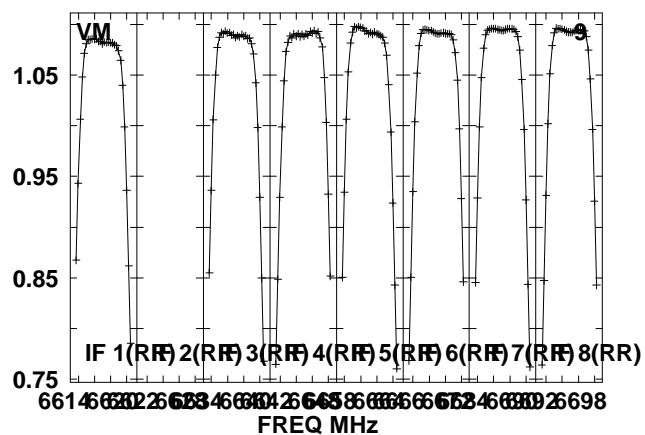
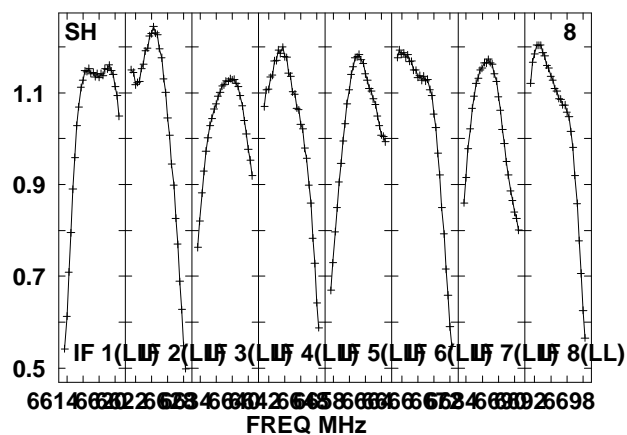
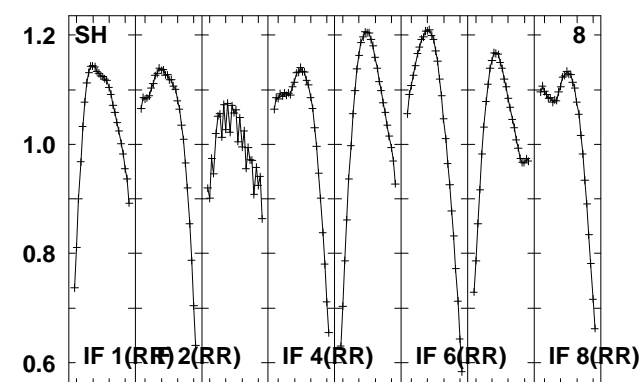
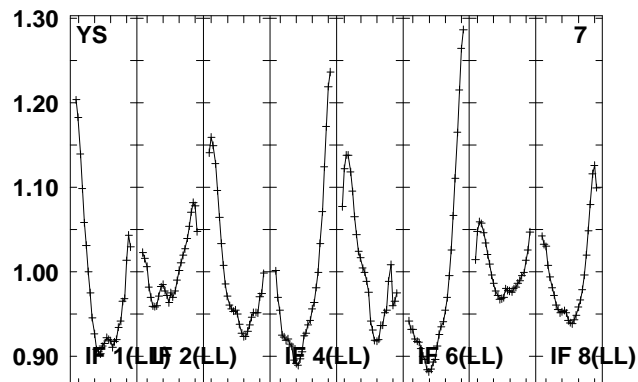
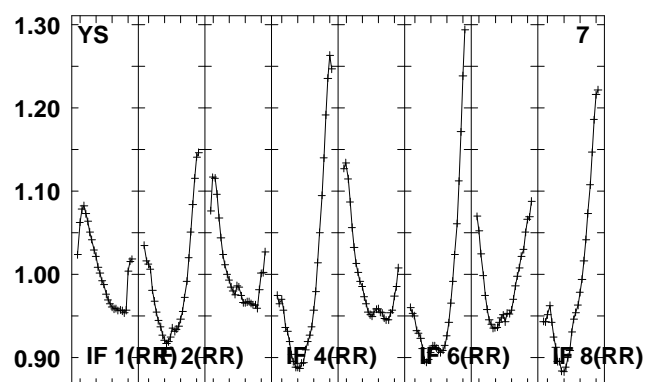
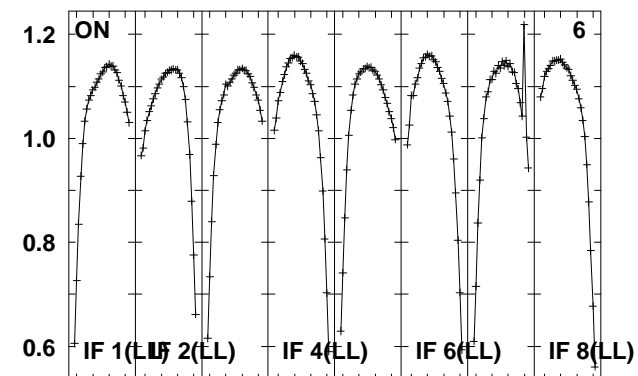
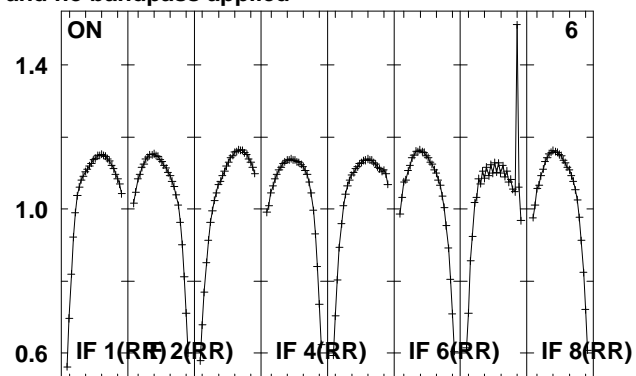
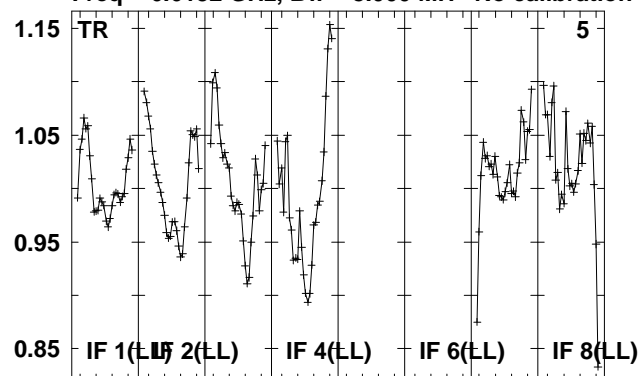

Lower frame: Real Jy

Total-power spectrum Antenna: \*

Timerange: 00/12:27:25 to 00/12:28:51



Plot file version 25 created 10-APR-2012 15:41:42  
 J2038+51 ER026C 5.UVDATA.1  
 Freq = 6.6132 GHz, Bw = 8.000 MH No calibration applied and no bandpass applied

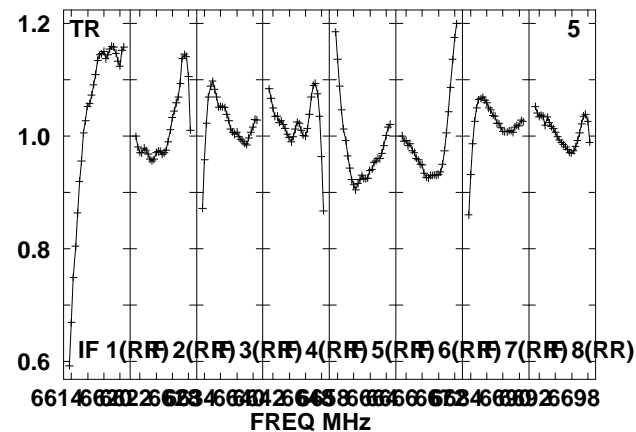
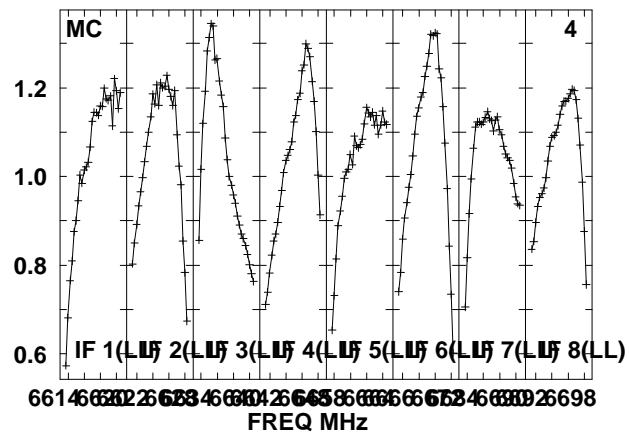
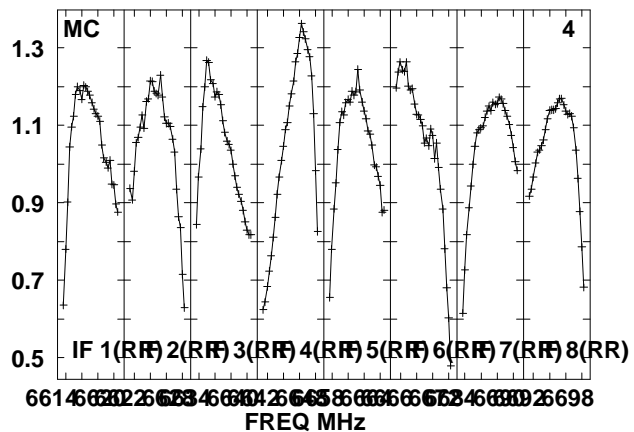
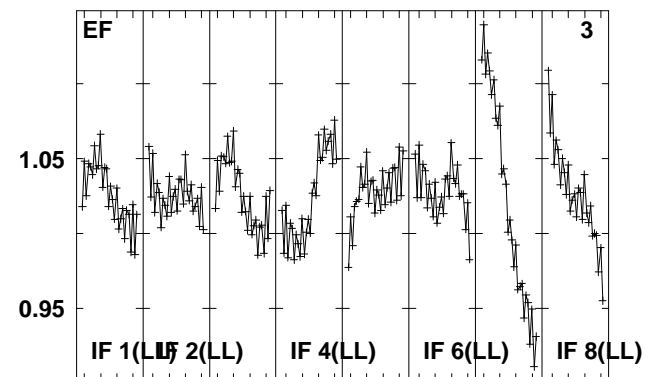
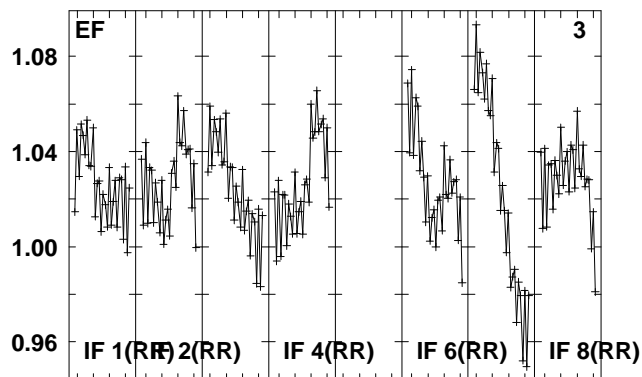
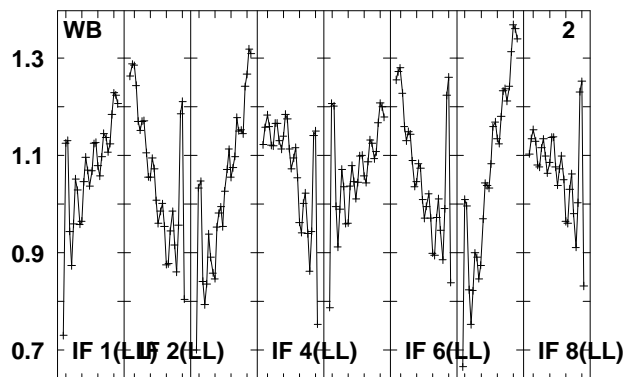
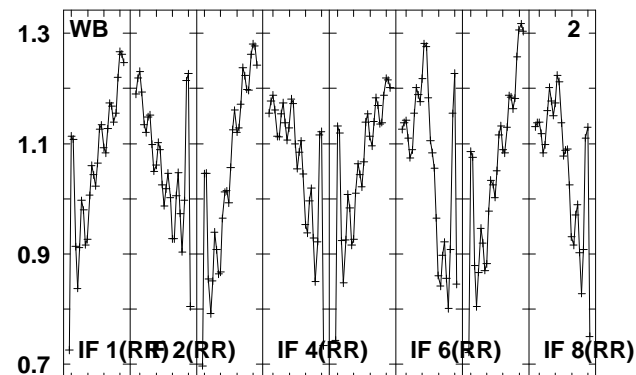
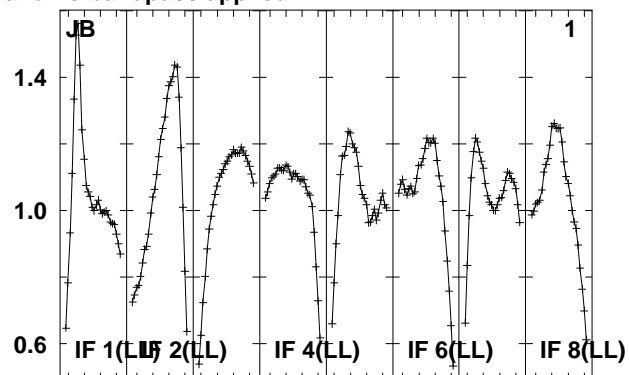
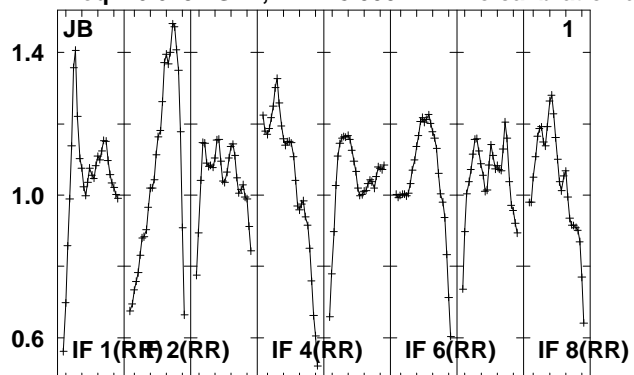

Lower frame: Real Jy  
 Total-power spectrum Antenna: \*  
 Timerange: 00/22:30:34 to 00/22:32:00

Plot file version 26 created 10-APR-2012 15:41:42

J2038+51 ER026C 5.UVDATA.1

Freq = 6.6132 GHz, Bw = 8.000 MH No calibration applied and no bandpass applied

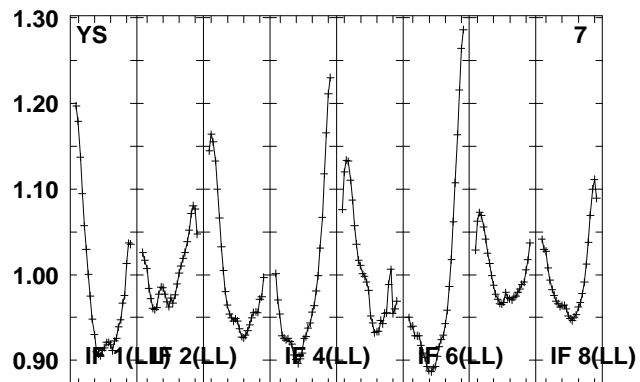
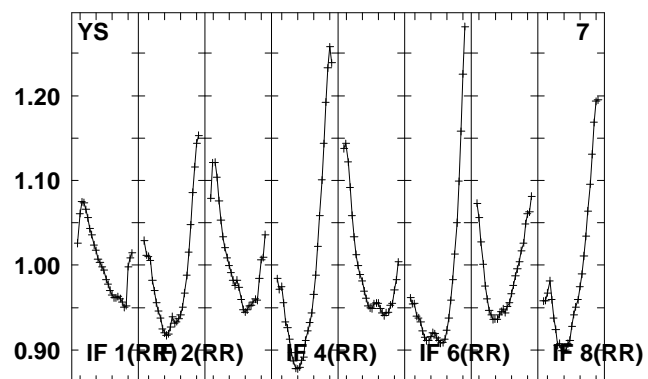
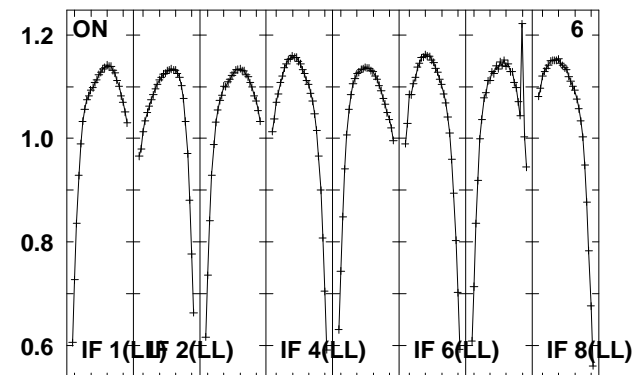
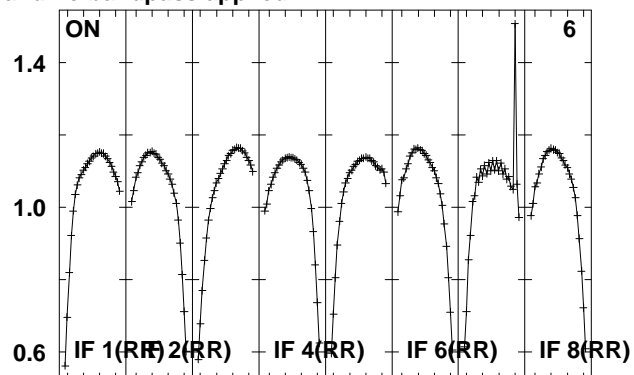
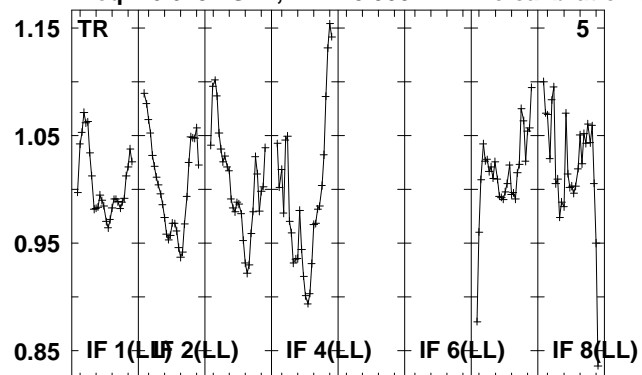

Lower frame: Real Jy  
Total-power spectrum Antenna: \*  
Timerange: 00/22:30:34 to 00/22:32:00

Plot file version 27 created 10-APR-2012 15:41:43

1638+572 ER026C 5.UVDATA.1

Freq = 6.6132 GHz, Bw = 8.000 MH No calibration applied and no bandpass applied

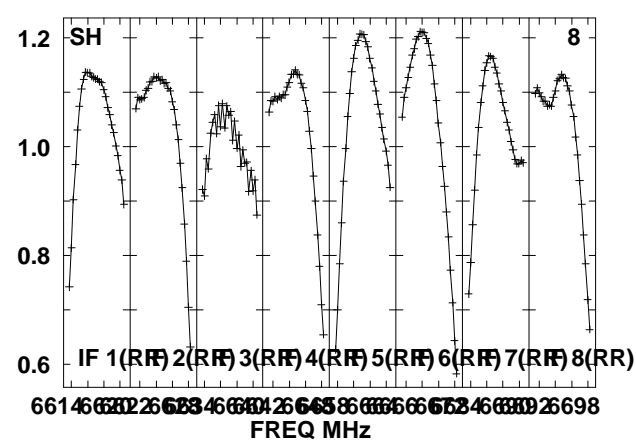
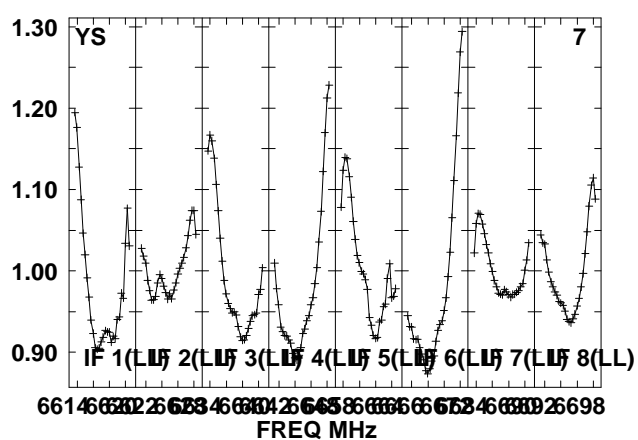
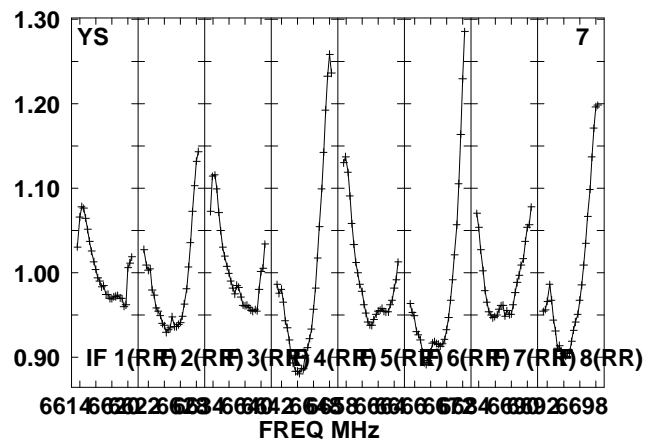
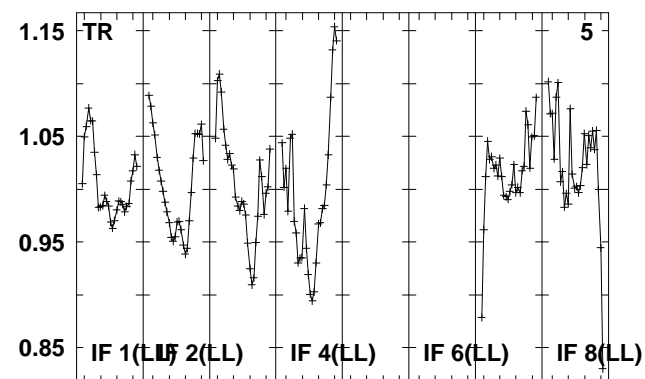
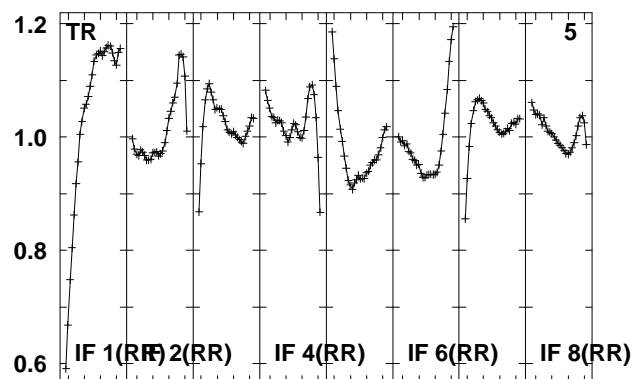
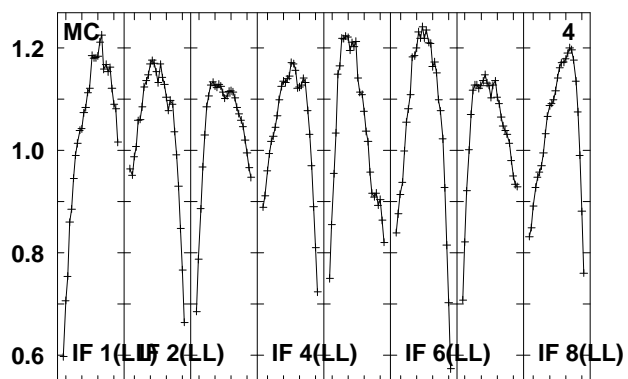
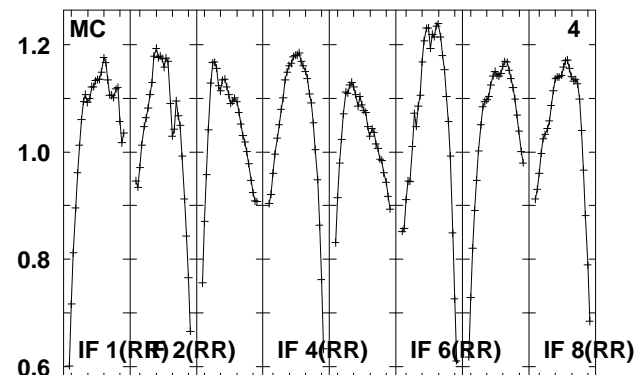
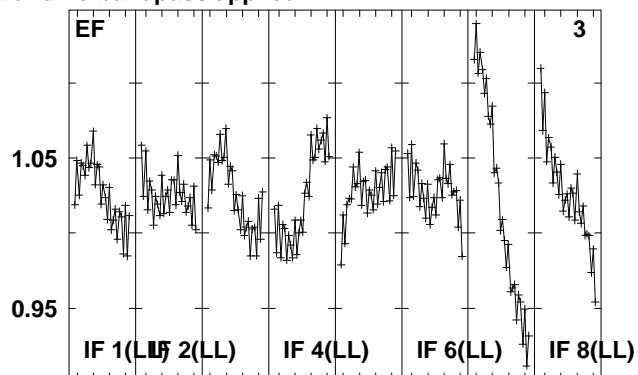
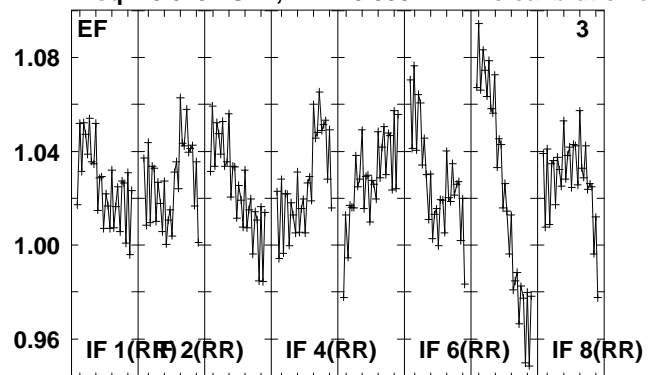

Lower frame: Real Jy  
Total-power spectrum Antenna: \*  
Timerange: 00/22:34:14 to 00/22:35:40

Plot file version 28 created 10-APR-2012 15:41:43  
1638+572 ER026C 5.UVDATA.1  
Freq = 6.6132 GHz, Bw = 8.000 MH No calibration applied and no bandpass applied

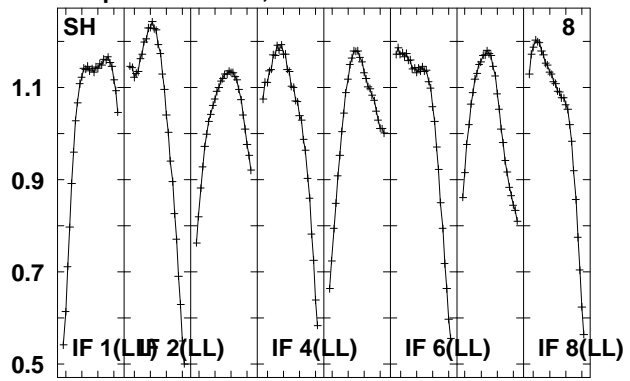

Lower frame: Real Jy  
Total-power spectrum Antenna: \*  
Timerange: 00/22:34:14 to 00/22:35:40

Plot file version 29 created 10-APR-2012 15:41:43

1640+394 ER026C 5.UVDATA.1

Freq = 6.6132 GHz, Bw = 8.000 MH No calibration applied and no bandpass applied

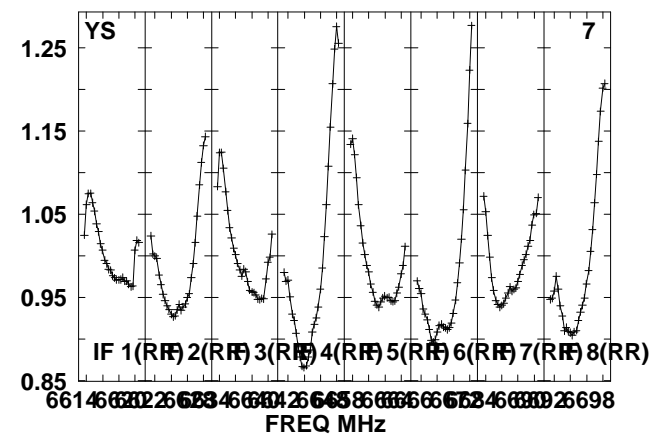
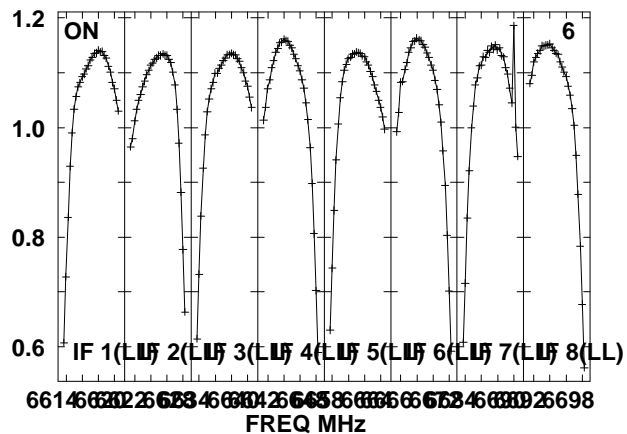
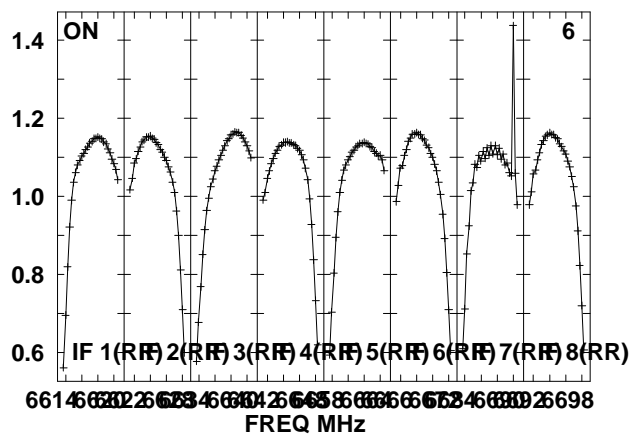
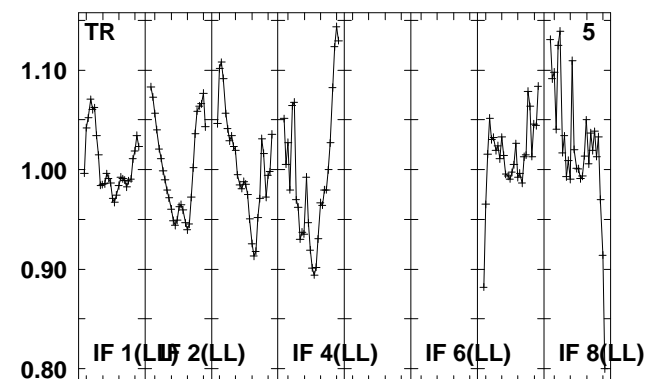
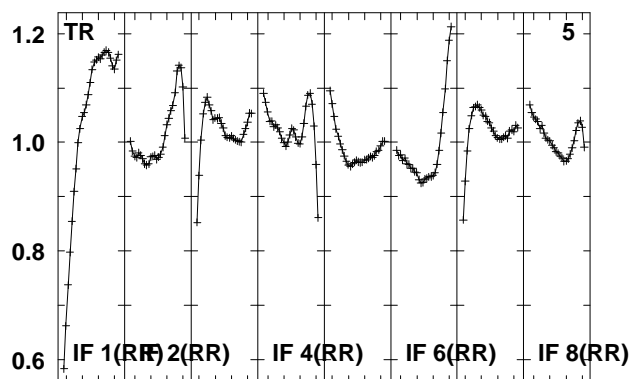
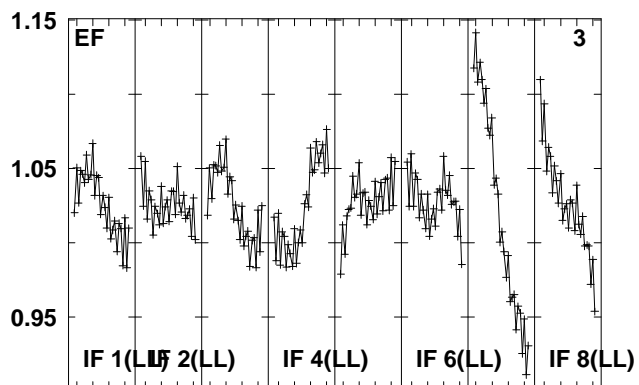
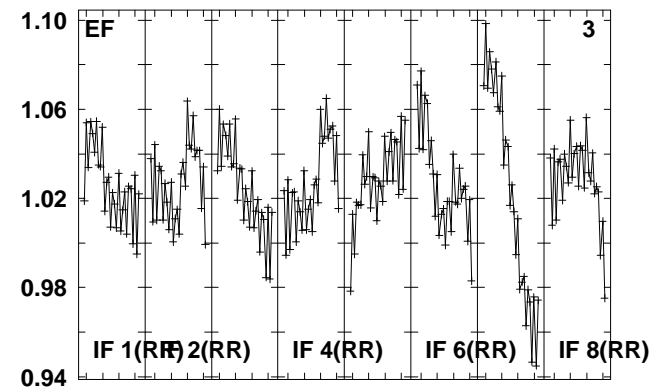
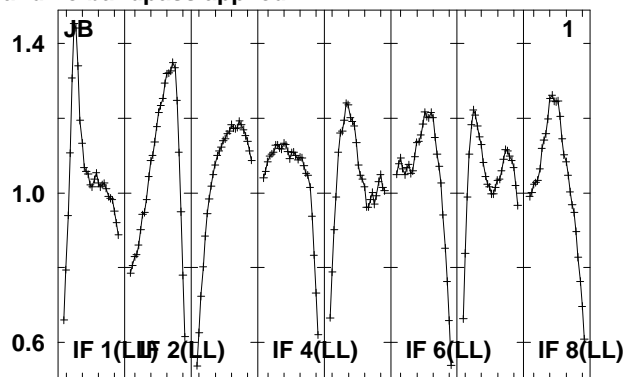
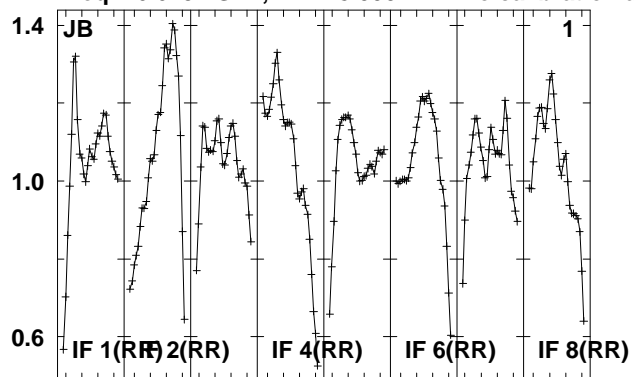

Lower frame: Real Jy  
Total-power spectrum Antenna: \*  
Timerange: 00/22:36:59 to 00/22:38:25

Plot file version 30 created 10-APR-2012 15:41:43  
1640+394 ER026C 5.UVDATA.1  
Freq = 6.6132 GHz, Bw = 8.000 MH No calibration applied and no bandpass applied

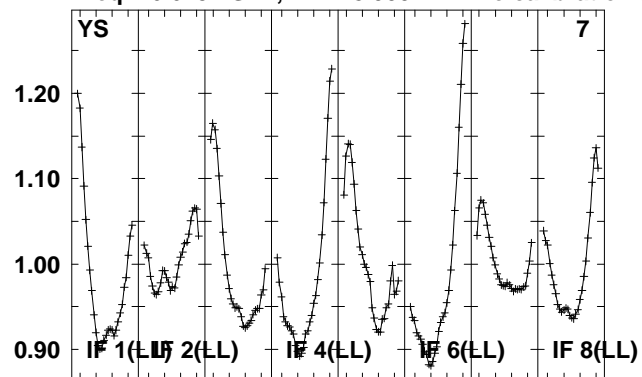

Lower frame: Real Jy  
Total-power spectrum Antenna: \*  
Timerange: 00/22:36:59 to 00/22:38:25

Plot file version 31 created 10-APR-2012 15:41:43

1746+622 ER026C 5.UVDATA.1

Freq = 6.6132 GHz, Bw = 8.000 MH No calibration applied and no bandpass applied

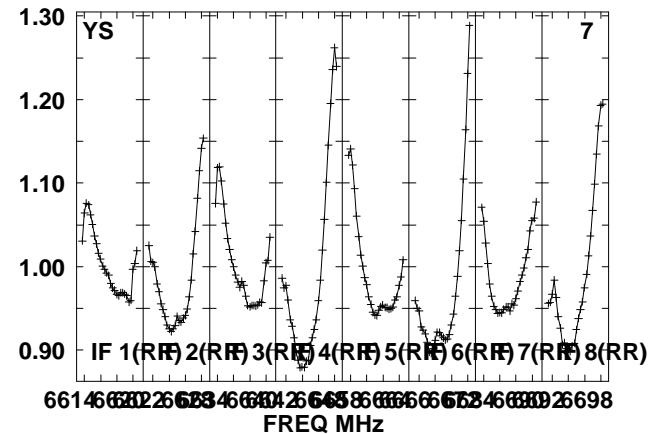
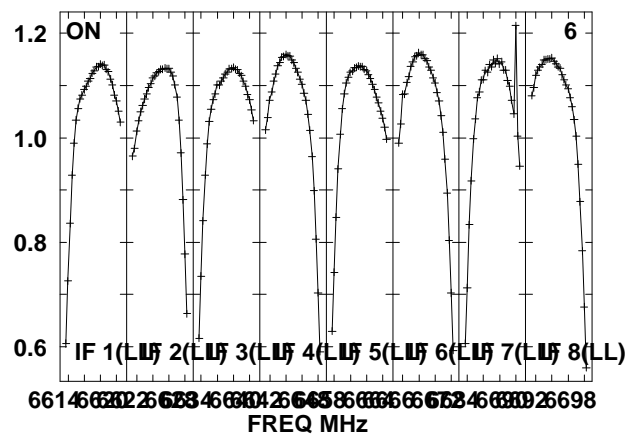
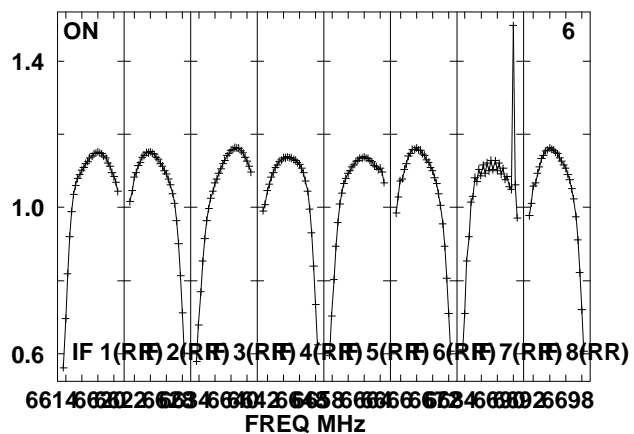
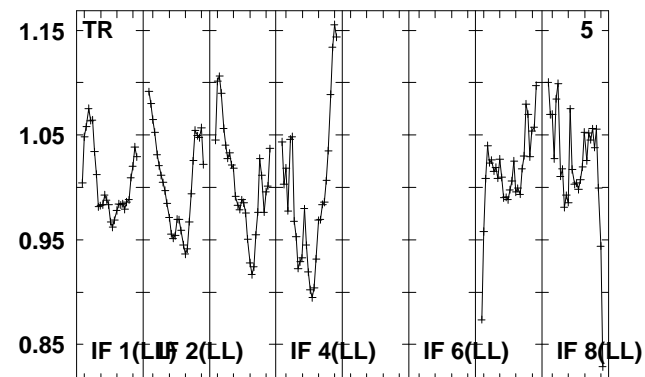
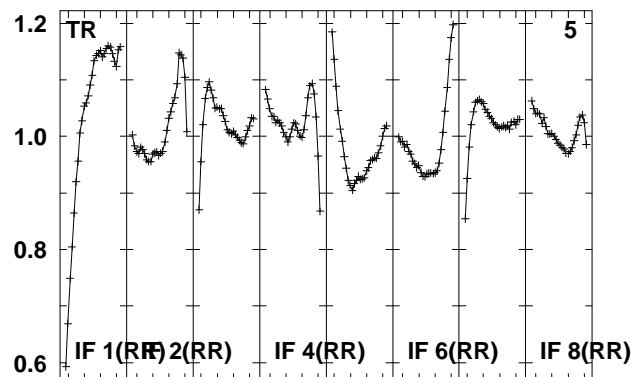
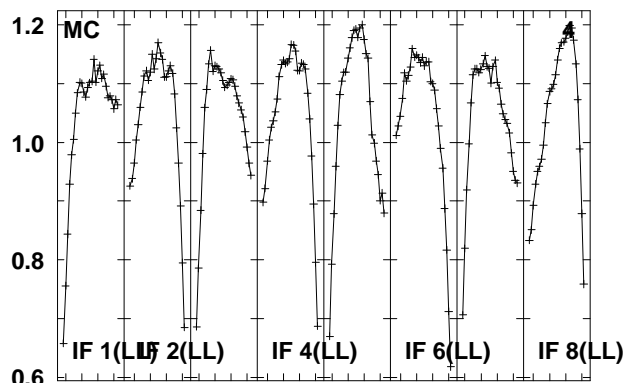
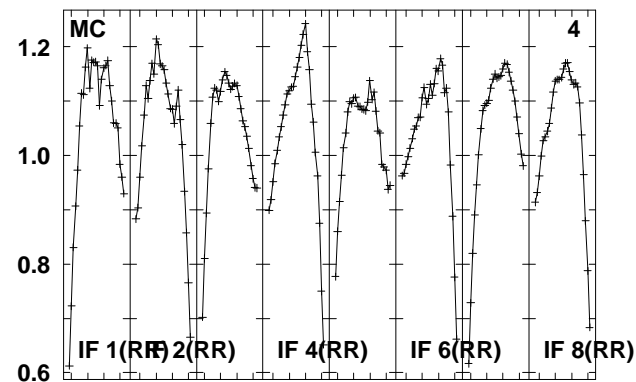
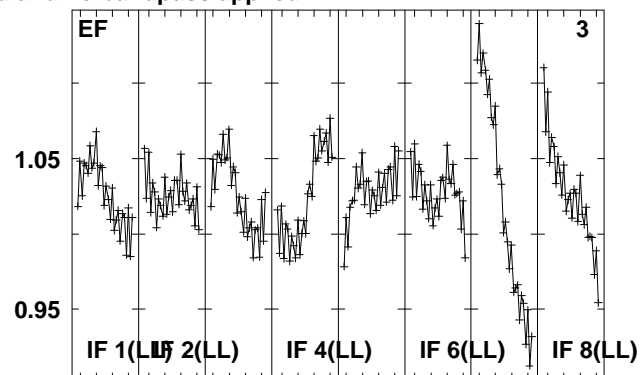
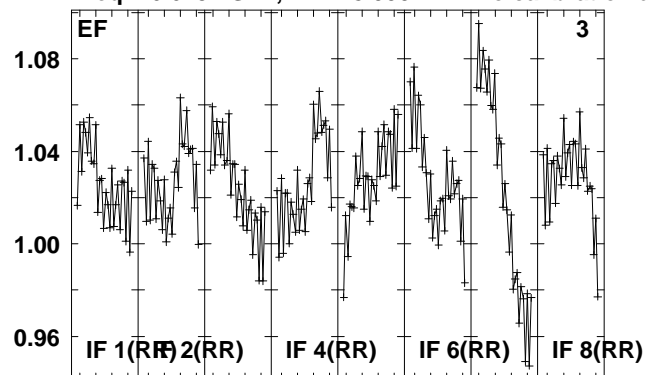

Lower frame: Real Jy  
Total-power spectrum Antenna: \*  
Timerange: 00/22:40:27 to 00/22:41:53

Plot file version 32 created 10-APR-2012 15:41:44

1746+622 ER026C 5.UVDATA.1

Freq = 6.6132 GHz, Bw = 8.000 MH No calibration applied and no bandpass applied

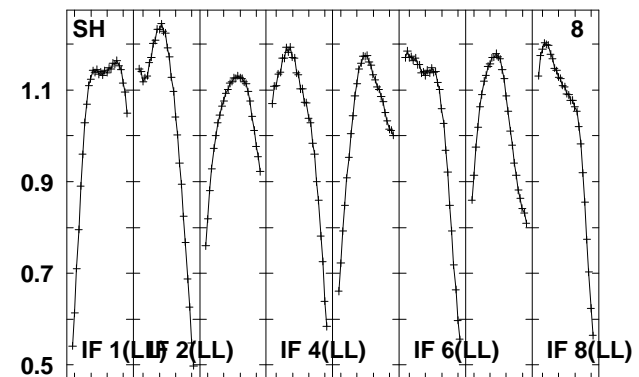
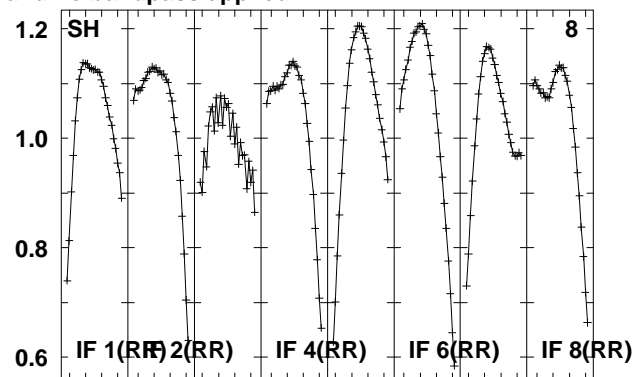
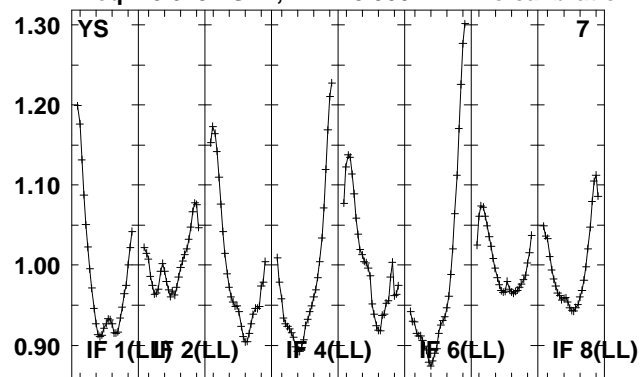

Lower frame: Real Jy  
Total-power spectrum Antenna: \*  
Timerange: 00/22:40:27 to 00/22:41:53



Plot file version 33 created 10-APR-2012 15:41:44

2148+065 ER026C 5.UVDATA.1

Freq = 6.6132 GHz, Bw = 8.000 MH No calibration applied and no bandpass applied

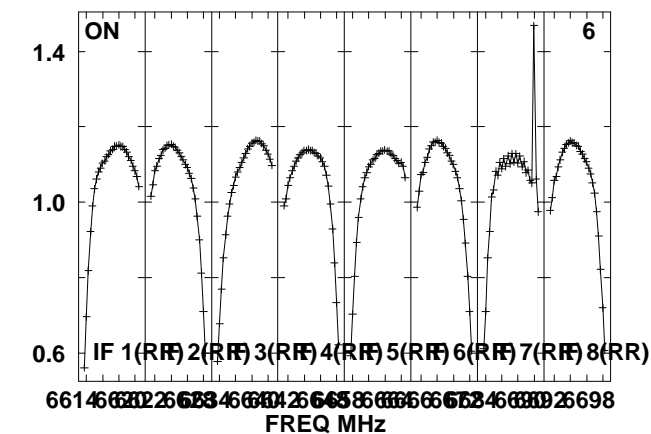
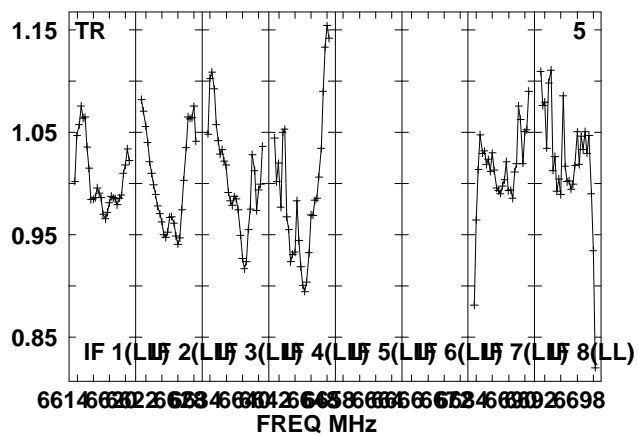
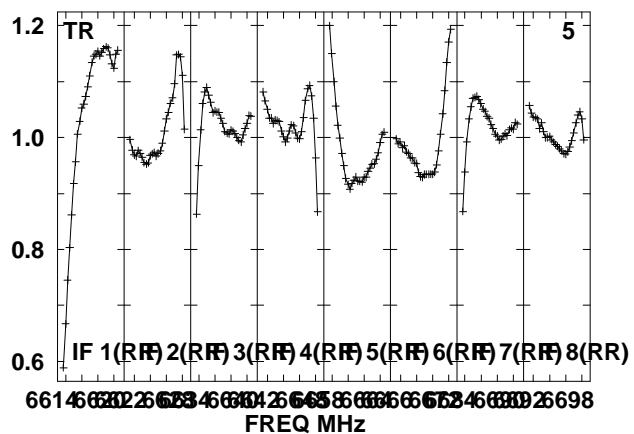
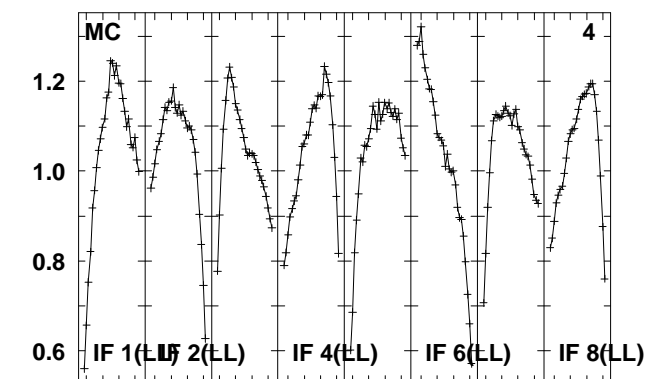
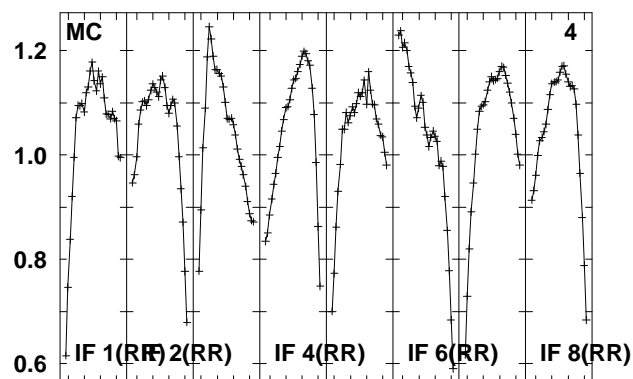
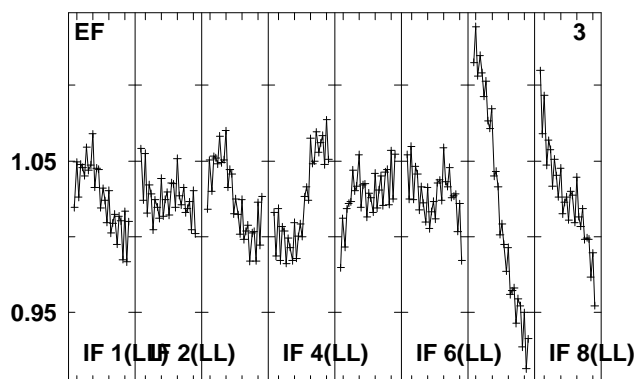
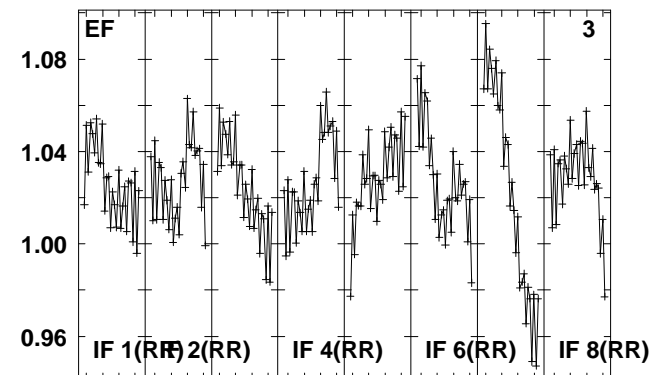
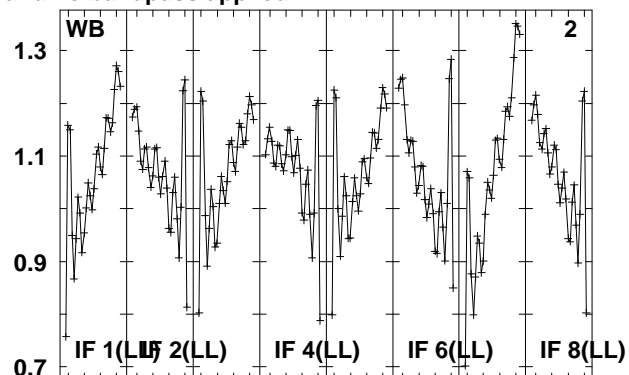
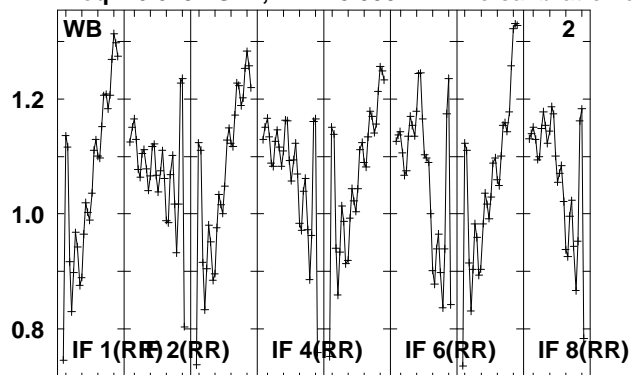

Lower frame: Real Jy  
Total-power spectrum Antenna: \*  
Timerange: 00/22:45:53 to 00/22:47:19

Plot file version 34 created 10-APR-2012 15:41:44

2148+065 ER026C 5.UVDATA.1

Freq = 6.6132 GHz, Bw = 8.000 MH No calibration applied and no bandpass applied

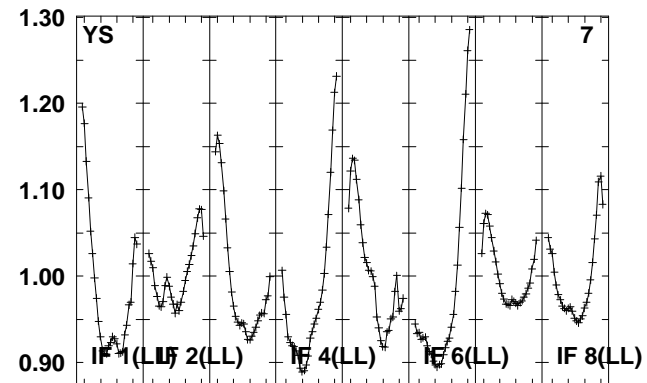
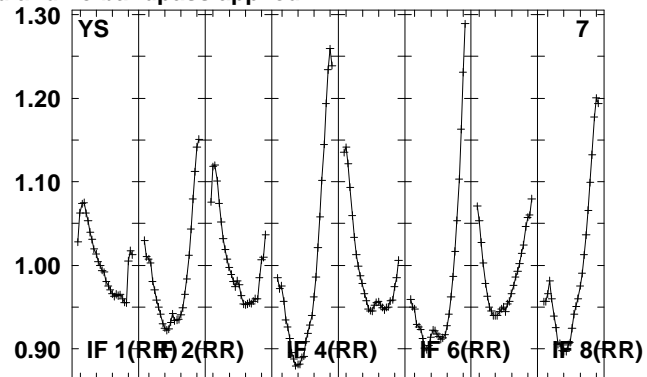
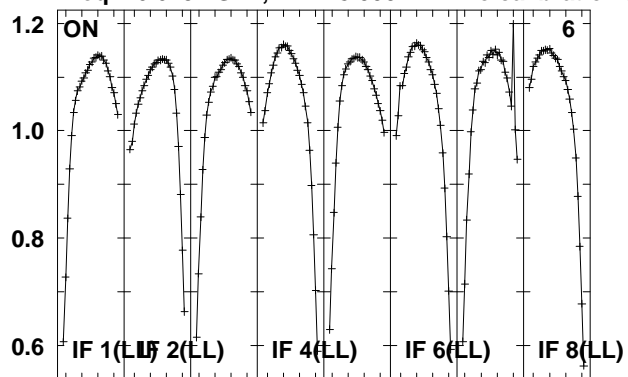

Lower frame: Real Jy  
Total-power spectrum Antenna: \*  
Timerange: 00/22:45:53 to 00/22:47:19

Plot file version 35 created 10-APR-2012 15:41:44

2225-045 ER026C 5.UVDATA.1

Freq = 6.6132 GHz, Bw = 8.000 MH No calibration applied and no bandpass applied

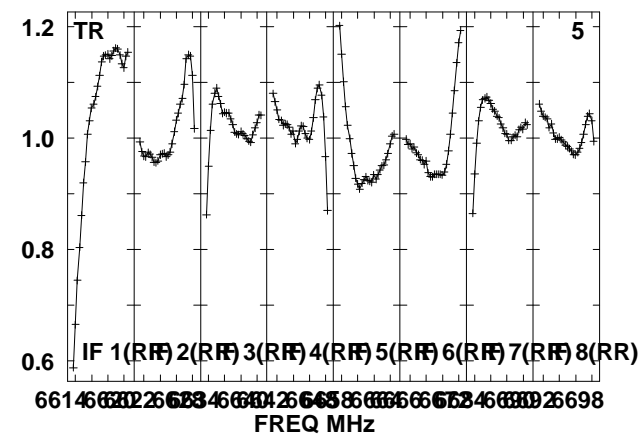
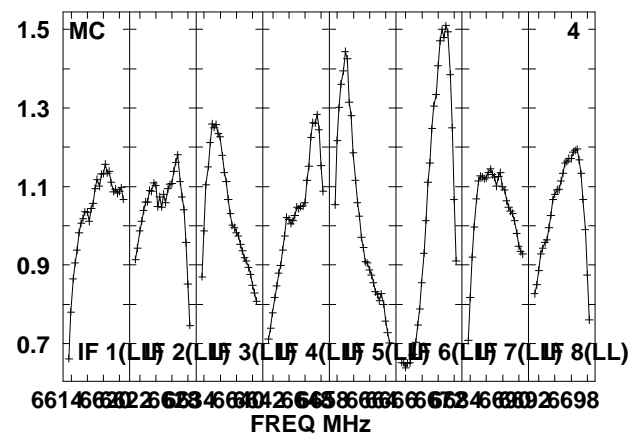
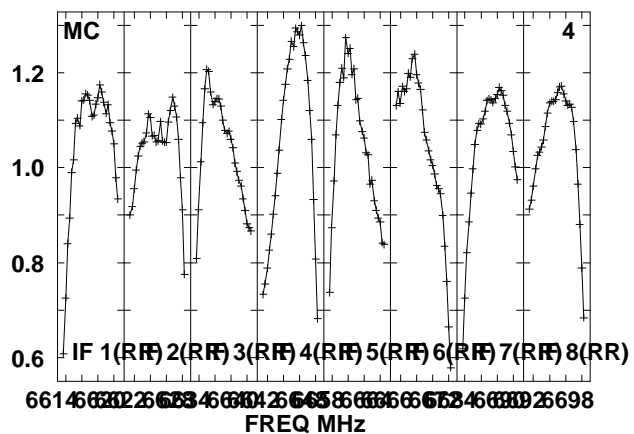
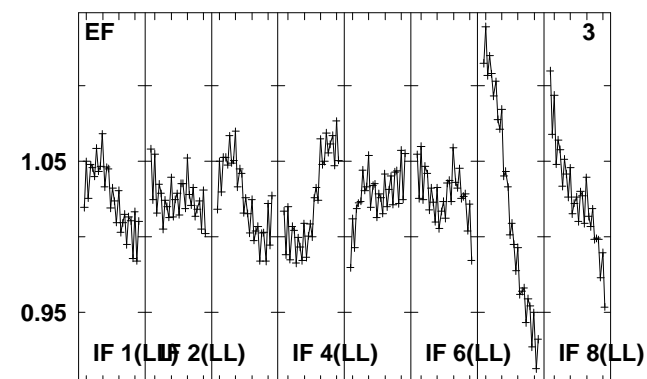
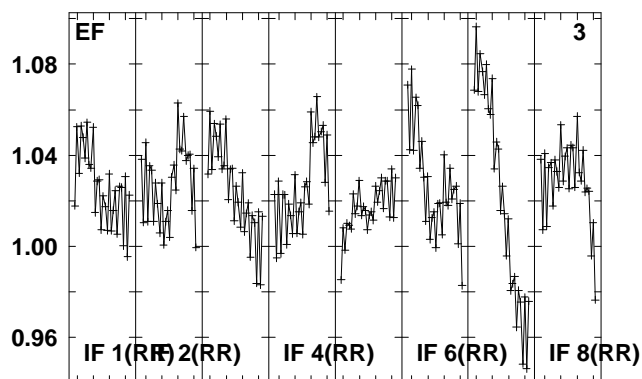
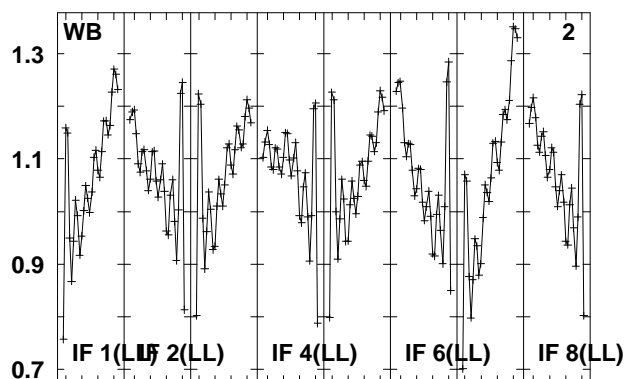
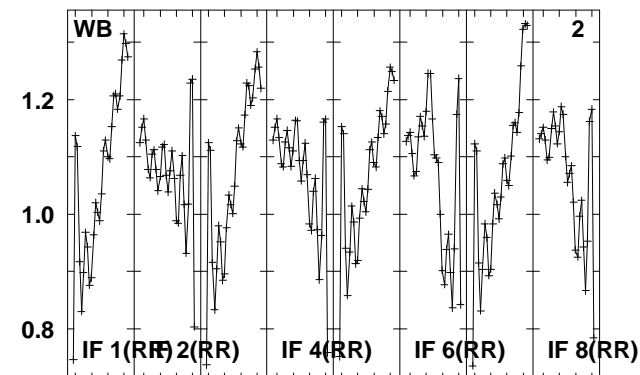
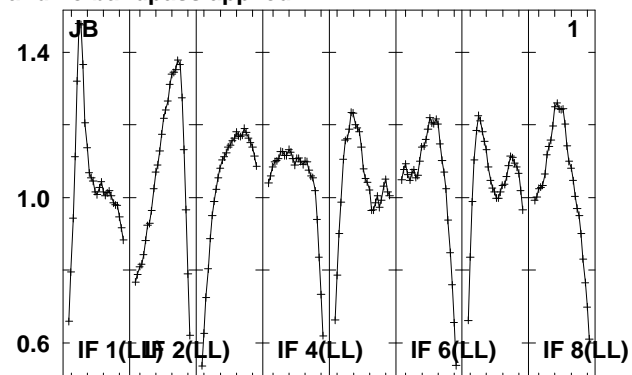
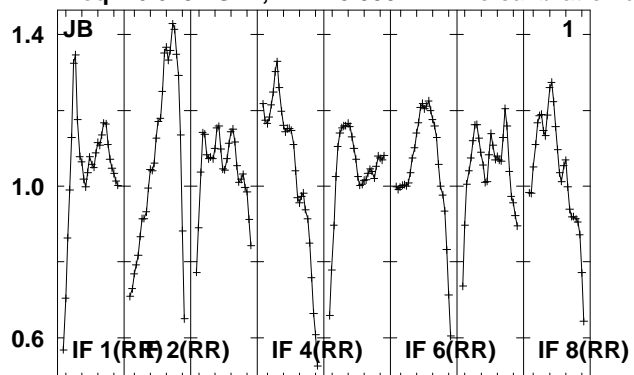

Lower frame: Real Jy  
Total-power spectrum Antenna: \*  
Timerange: 00/22:48:30 to 00/22:49:56

Plot file version 36 created 10-APR-2012 15:41:44

2225-045 ER026C 5.UVDATA.1

Freq = 6.6132 GHz, Bw = 8.000 MH No calibration applied and no bandpass applied

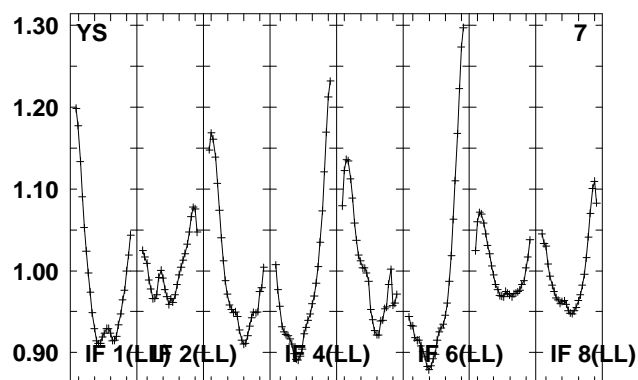
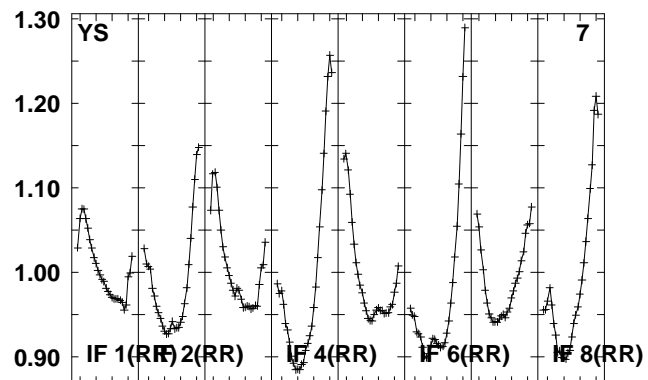
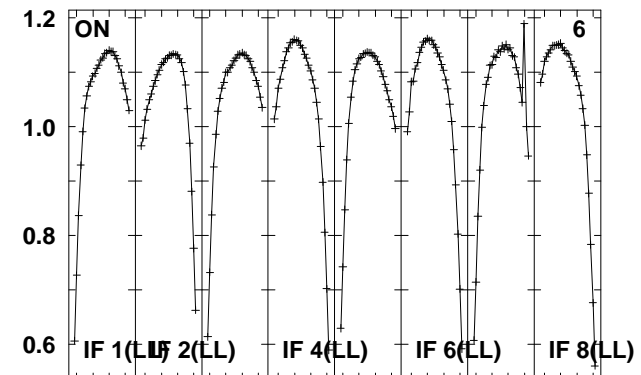
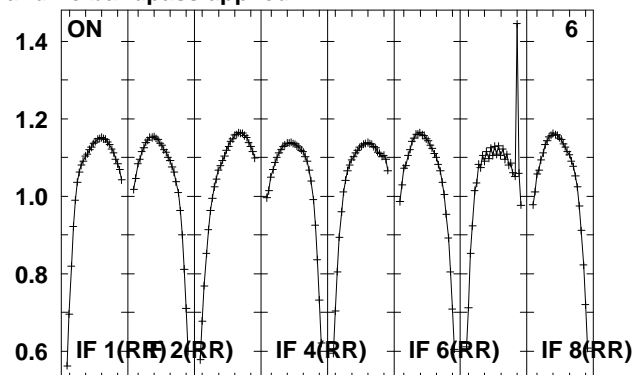
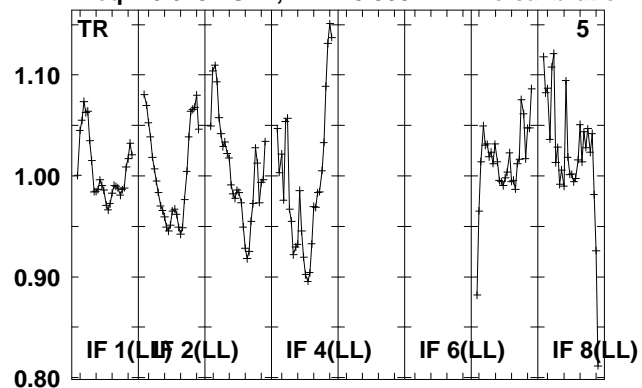

Lower frame: Real Jy  
Total-power spectrum Antenna: \*  
Timerange: 00/22:48:30 to 00/22:49:56

Plot file version 37 created 10-APR-2012 15:41:44

0121+114 ER026C 5.UVDATA.1

Freq = 6.6132 GHz, Bw = 8.000 MH No calibration applied and no bandpass applied

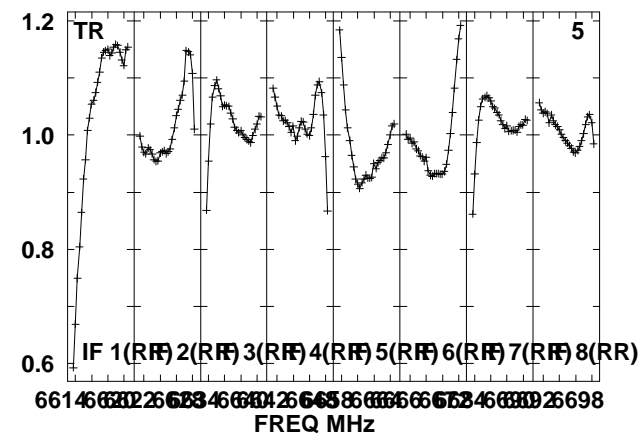
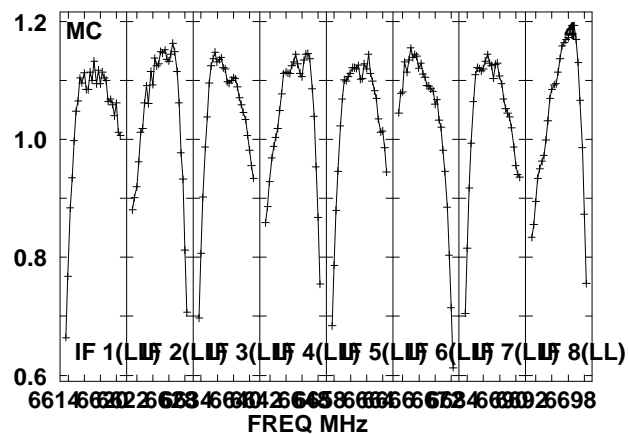
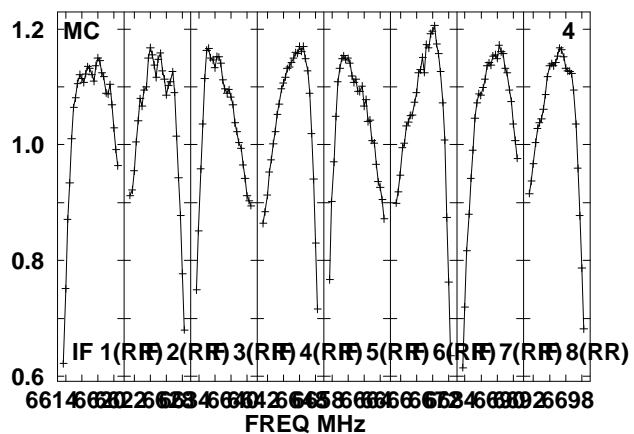
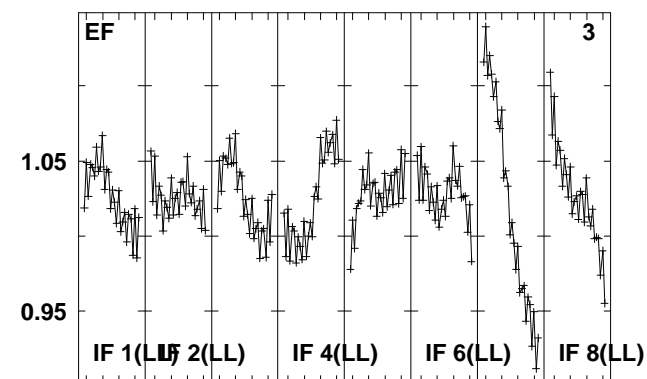
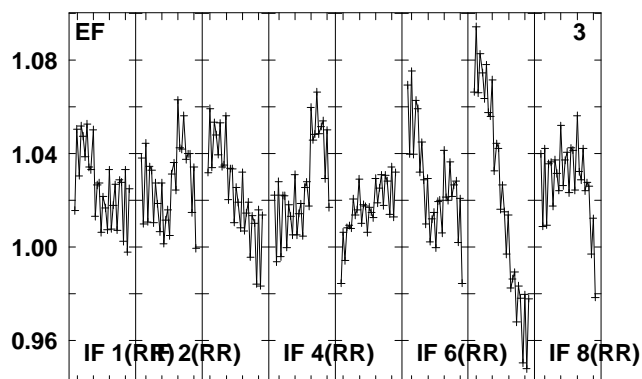
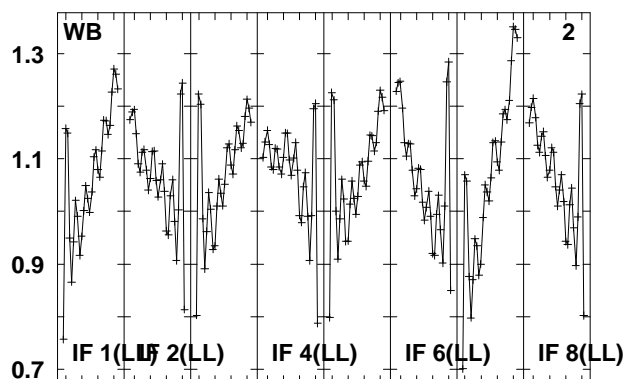
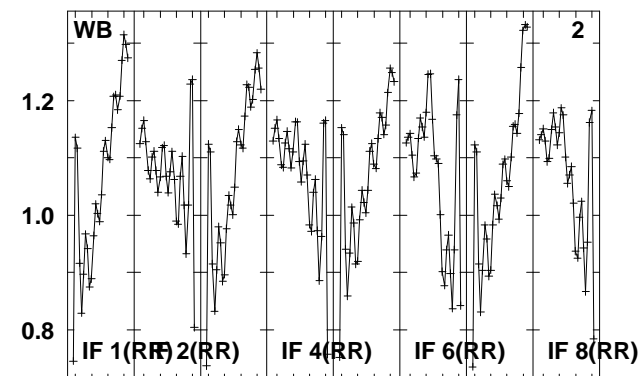
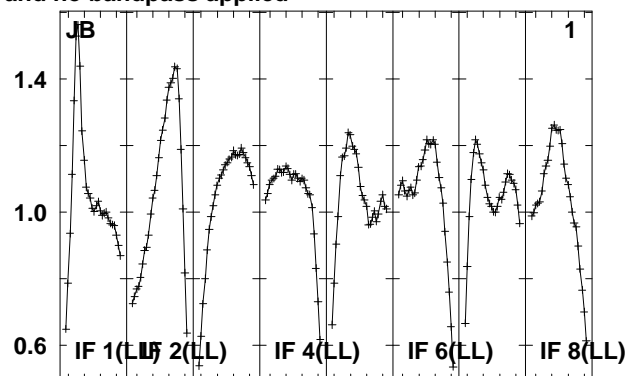
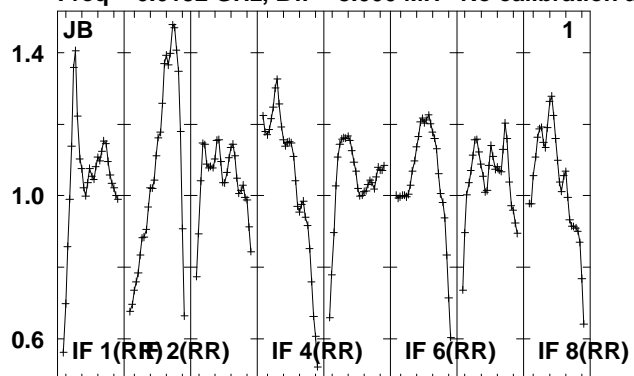

Lower frame: Real Jy  
Total-power spectrum Antenna: \*  
Timerange: 00/22:52:48 to 00/22:54:14

Plot file version 38 created 10-APR-2012 15:41:45

0121+114 ER026C 5.UVDATA.1

Freq = 6.6132 GHz, Bw = 8.000 MH No calibration applied and no bandpass applied

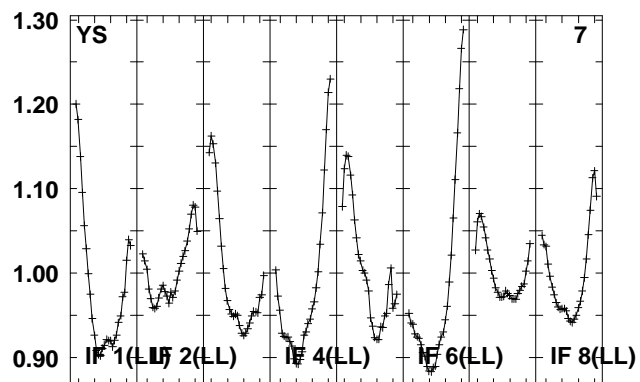
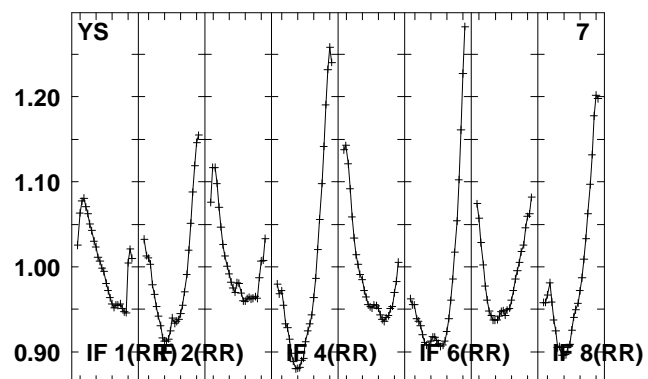
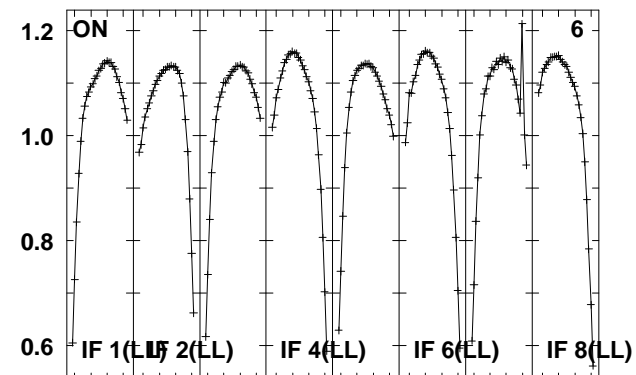
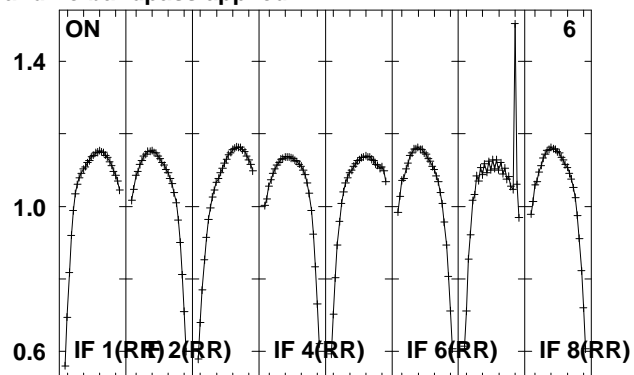
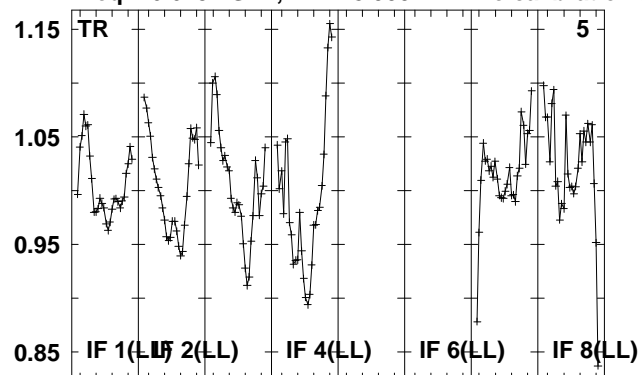

Lower frame: Real Jy  
Total-power spectrum Antenna: \*  
Timerange: 00/22:52:48 to 00/22:54:14

Plot file version 39 created 10-APR-2012 15:41:45

0136+475 ER026C 5.UVDATA.1

Freq = 6.6132 GHz, Bw = 8.000 MH No calibration applied and no bandpass applied

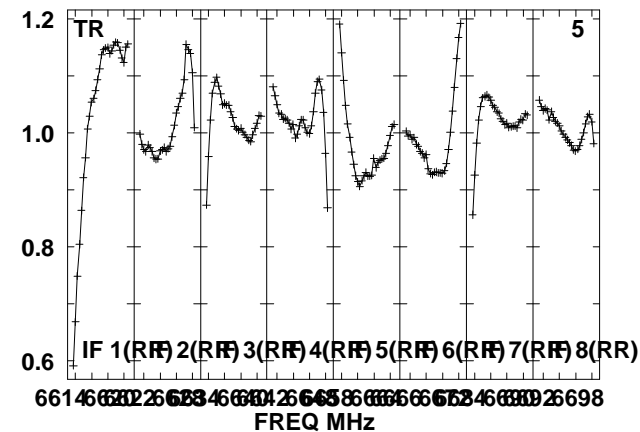
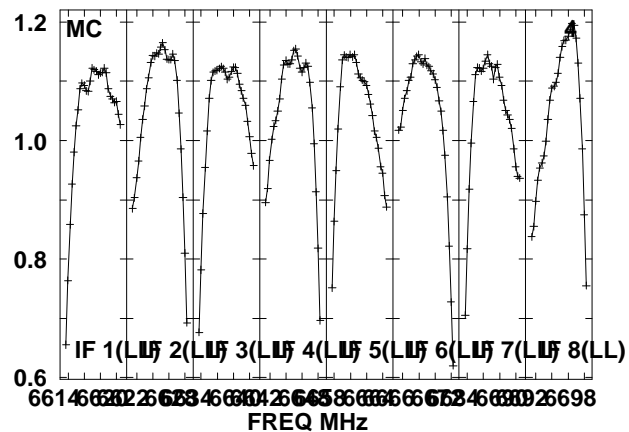
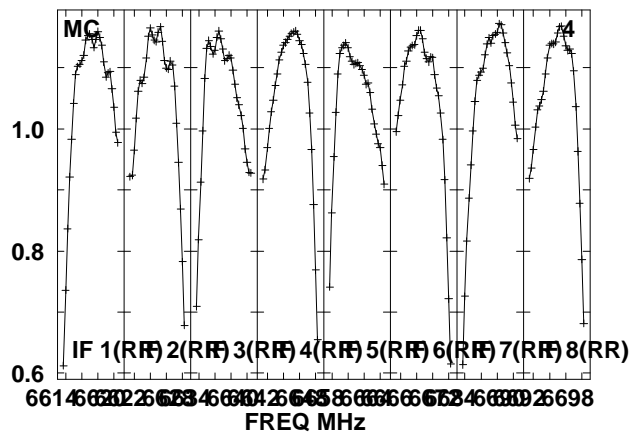
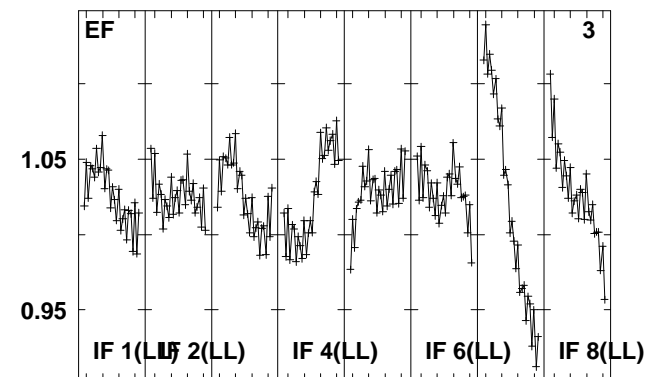
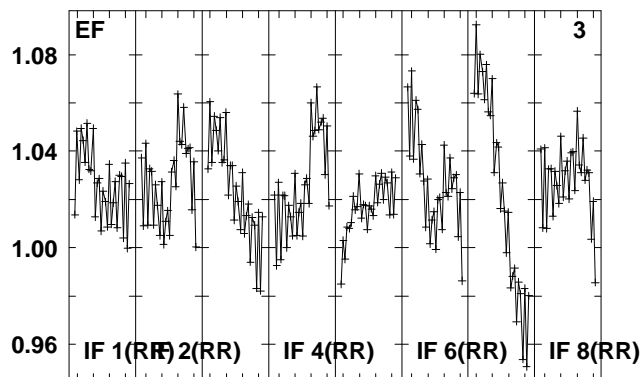
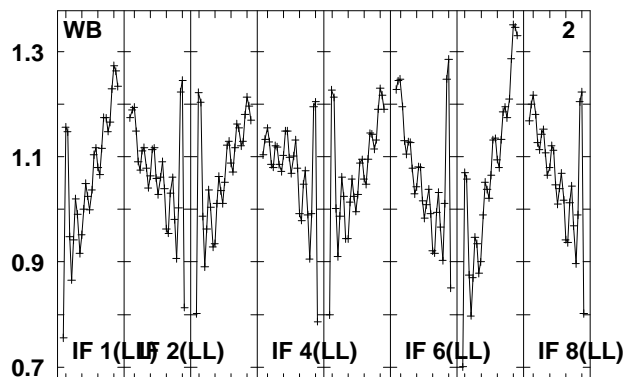
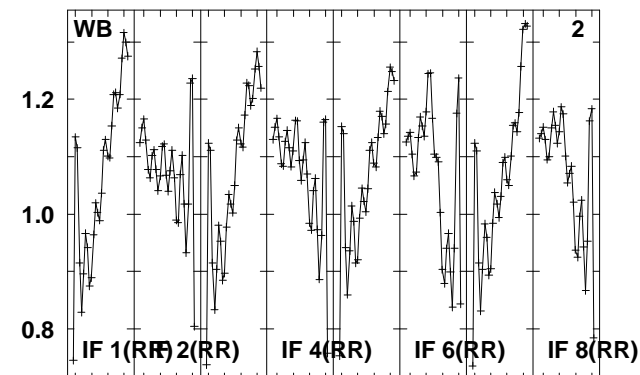
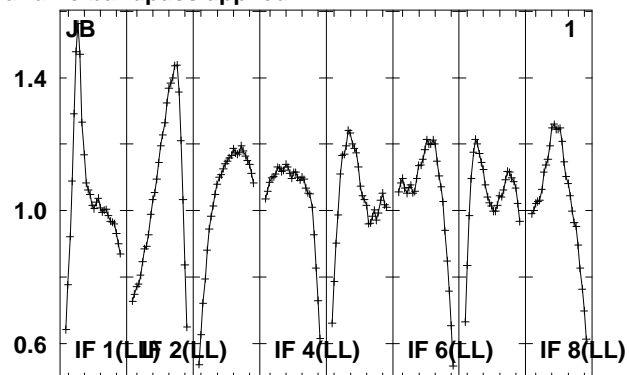
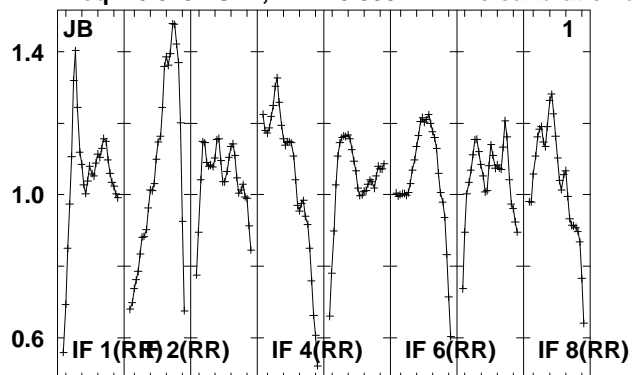

Lower frame: Real Jy  
Total-power spectrum Antenna: \*  
Timerange: 00/22:57:02 to 00/22:58:28

Plot file version 40 created 10-APR-2012 15:41:45

0136+475 ER026C 5.UVDATA.1

Freq = 6.6132 GHz, Bw = 8.000 MH No calibration applied and no bandpass applied

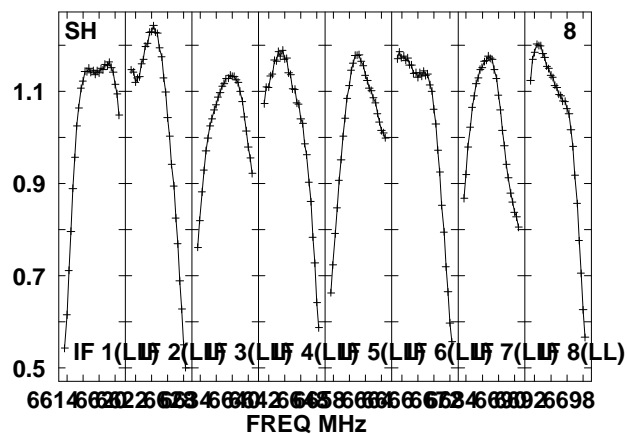
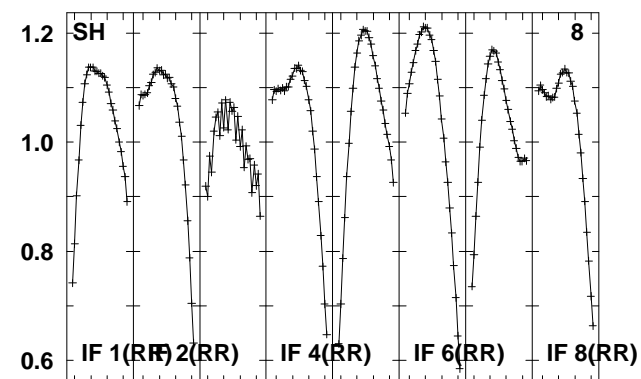
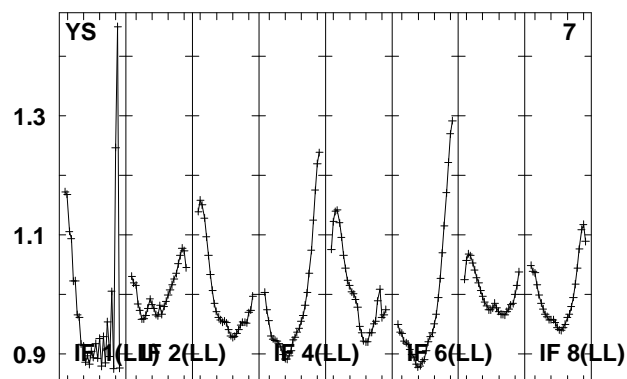
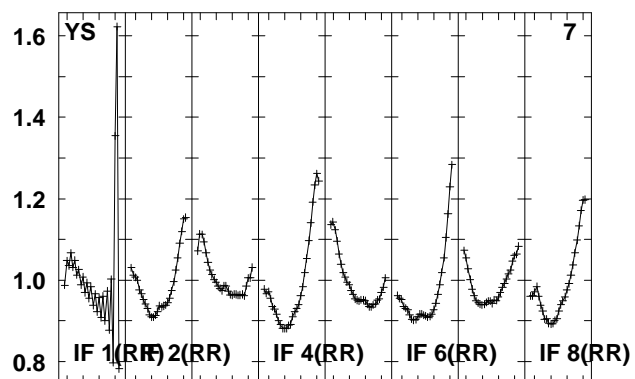
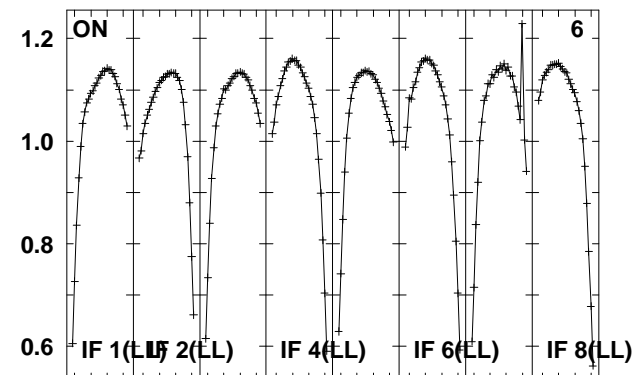
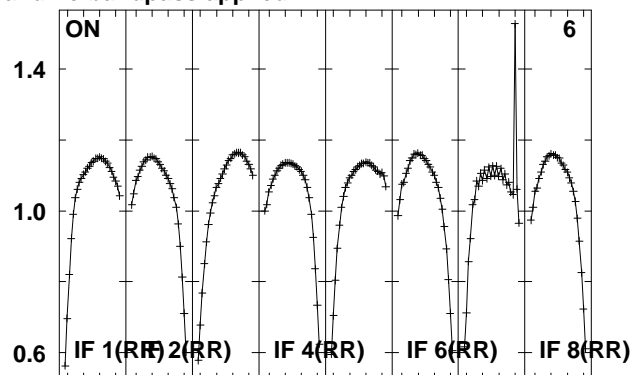
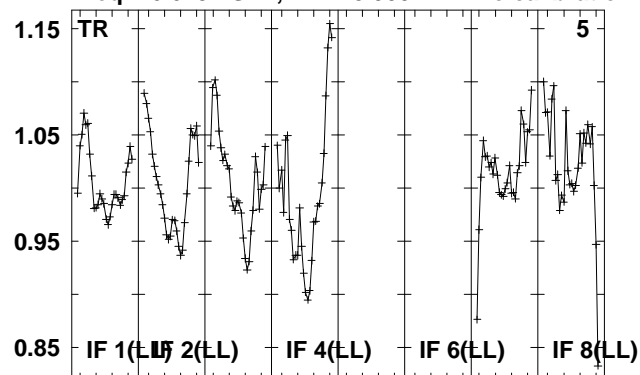

Lower frame: Real Jy

Total-power spectrum Antenna: \*

Timerange: 00/22:57:02 to 00/22:58:28



Plot file version 41 created 10-APR-2012 15:41:45

0303+471 ER026C 5.UVDATA.1

Freq = 6.6132 GHz, Bw = 8.000 MH No calibration applied and no bandpass applied

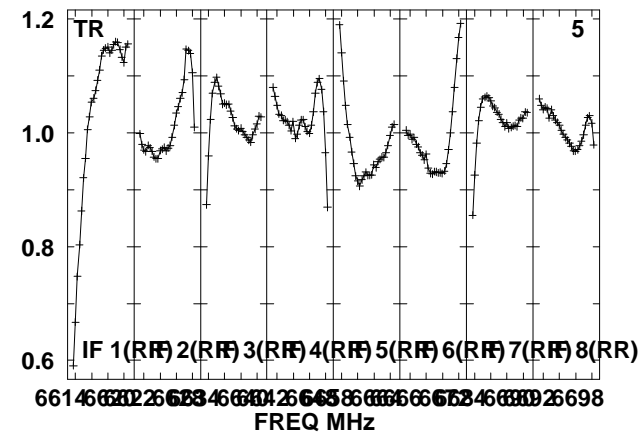
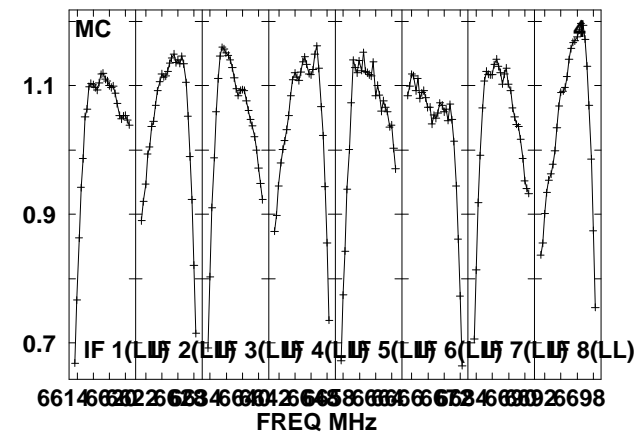
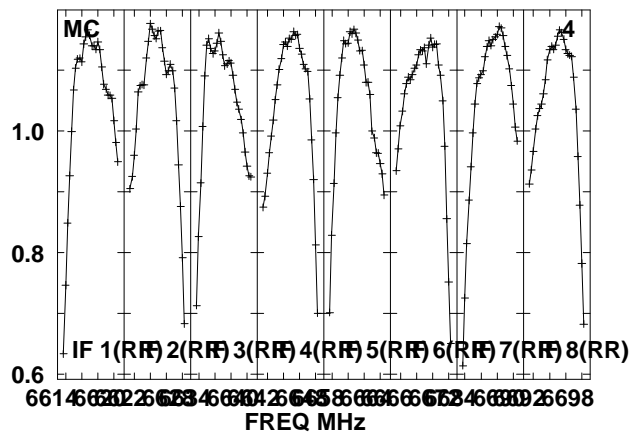
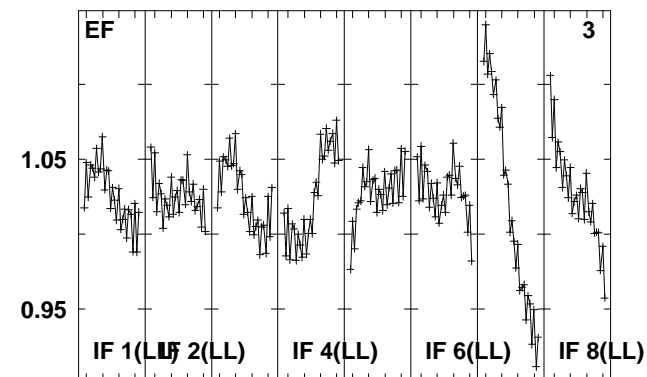
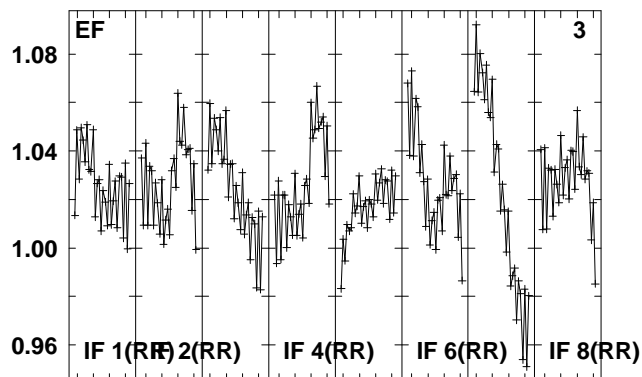
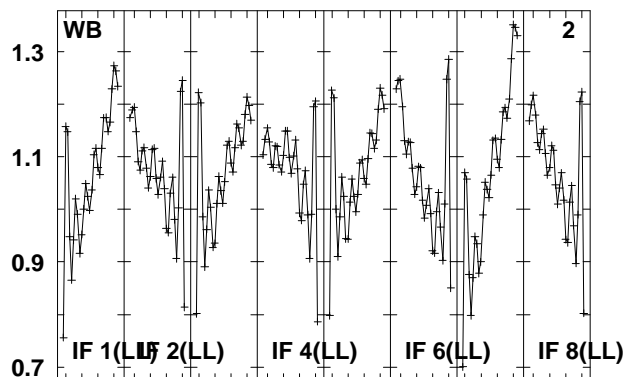
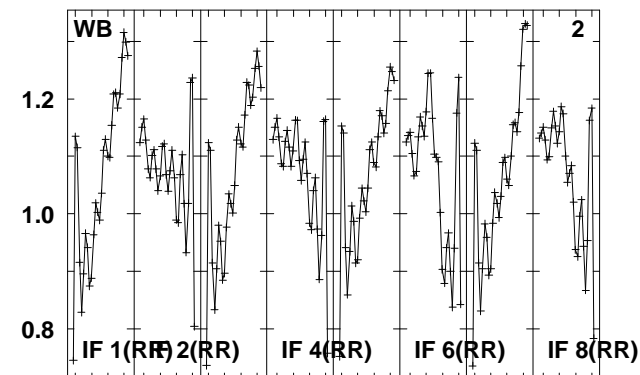
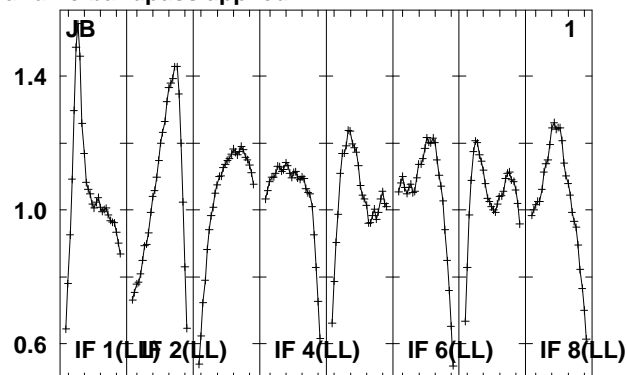
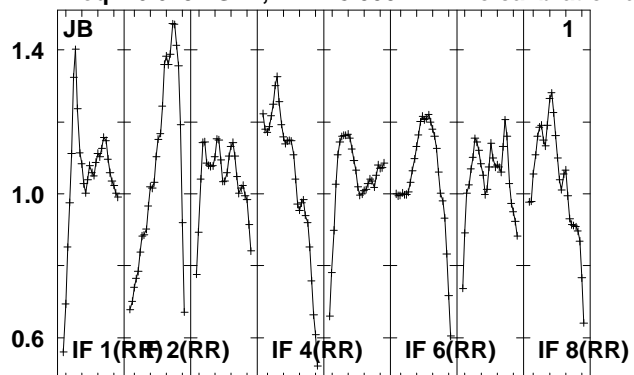

Lower frame: Real Jy  
Total-power spectrum Antenna: \*  
Timerange: 00/23:04:04 to 00/23:05:30

Plot file version 42 created 10-APR-2012 15:41:45

0303+471 ER026C 5.UVDATA.1

Freq = 6.6132 GHz, Bw = 8.000 MH No calibration applied and no bandpass applied

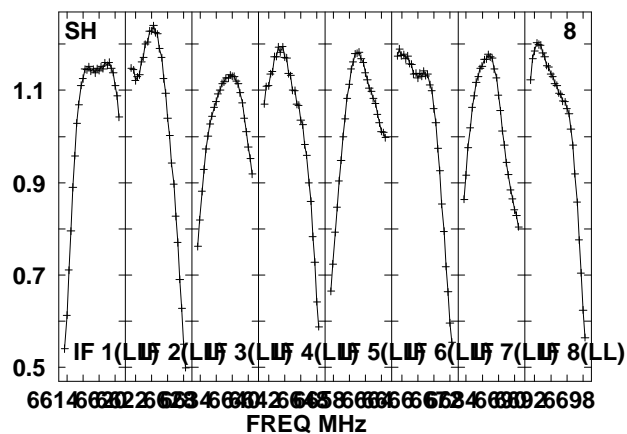
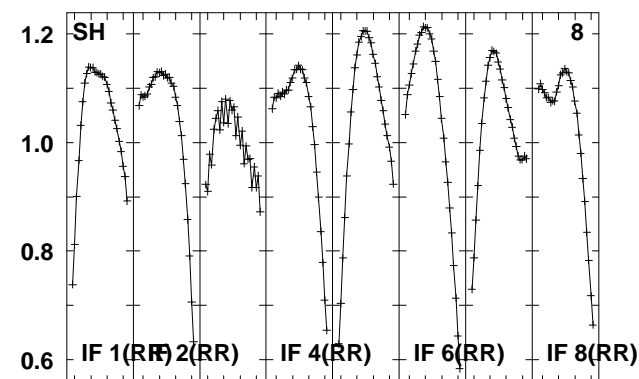
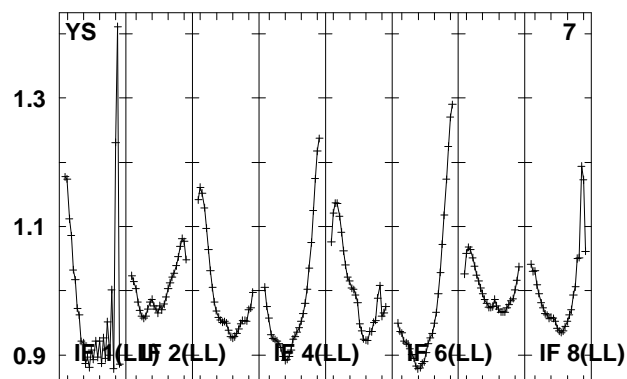
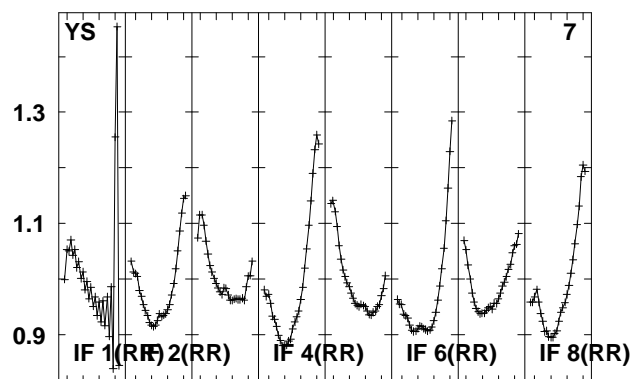
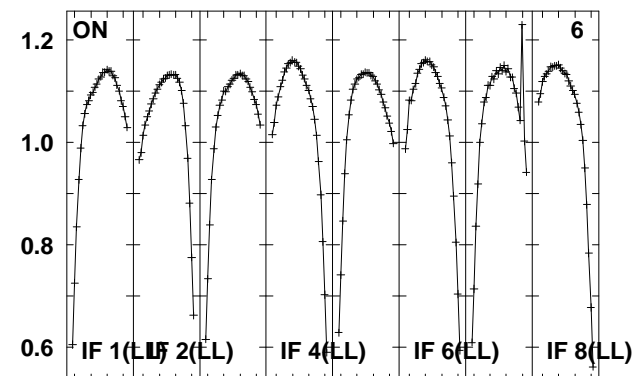
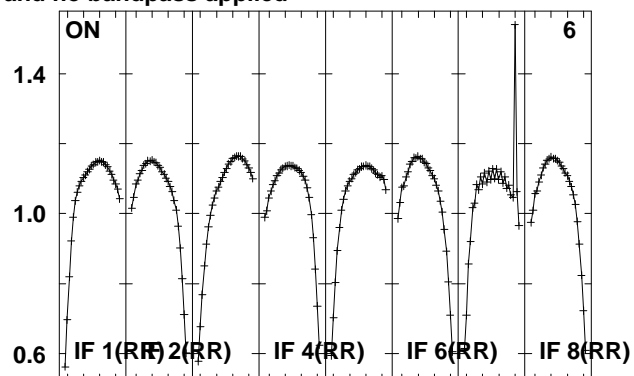
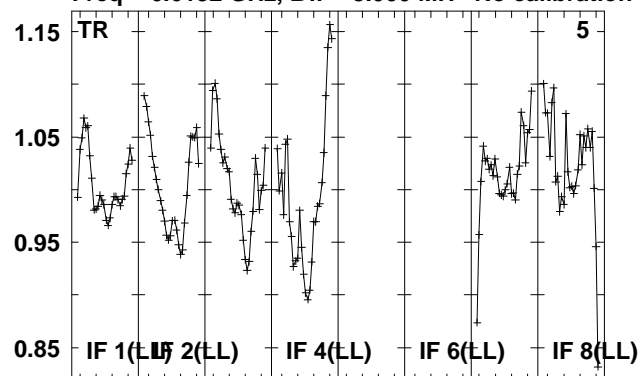

661466226623466304266358663666724668026698

FREQ MHz

Lower frame: Real Jy

Total-power spectrum Antenna: \*

Timerange: 00/23:04:04 to 00/23:05:30

Plot file version 43 created 10-APR-2012 15:41:46

0501-015 ER026C 5.UVDATA.1

Freq = 6.6132 GHz, Bw = 8.000 MH No calibration applied and no bandpass applied

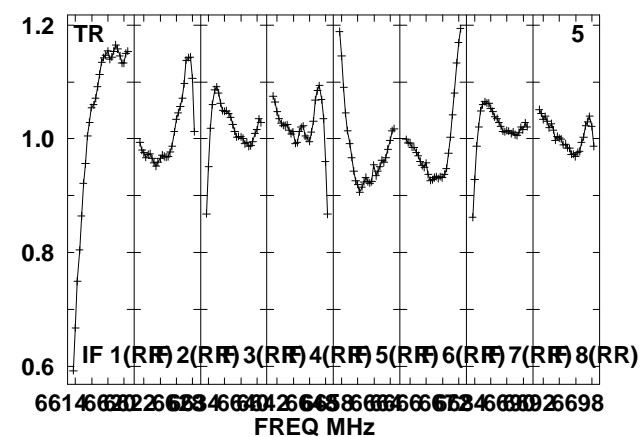
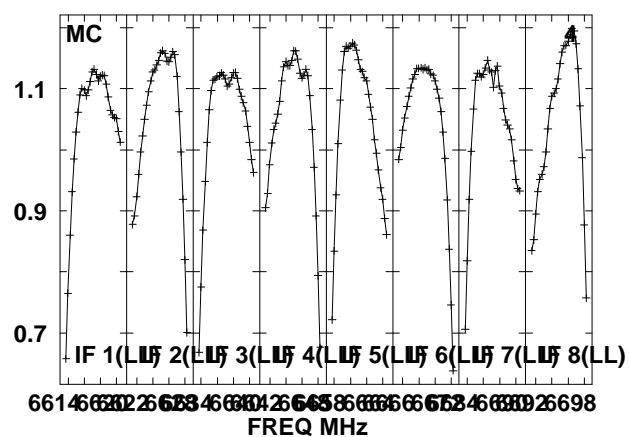
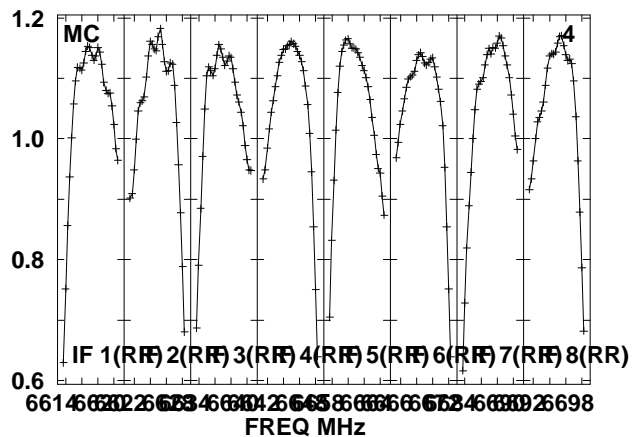
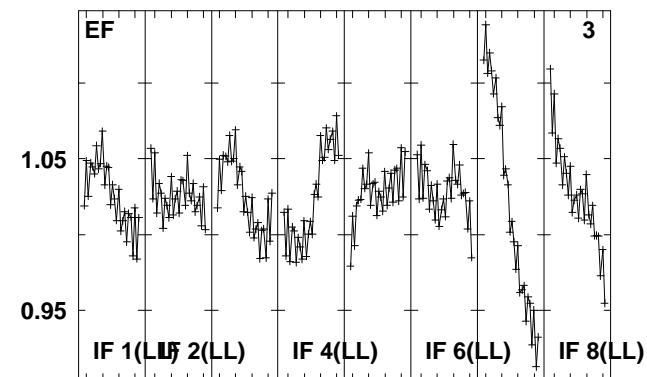
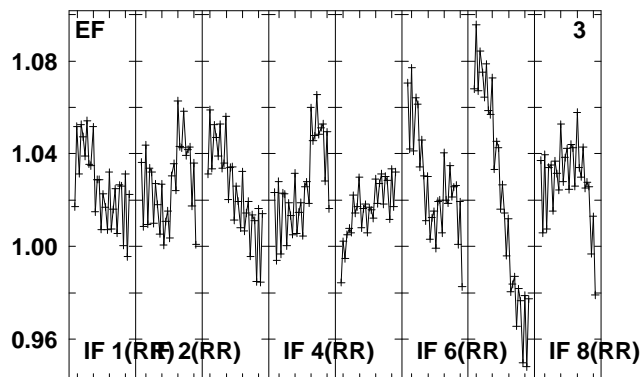
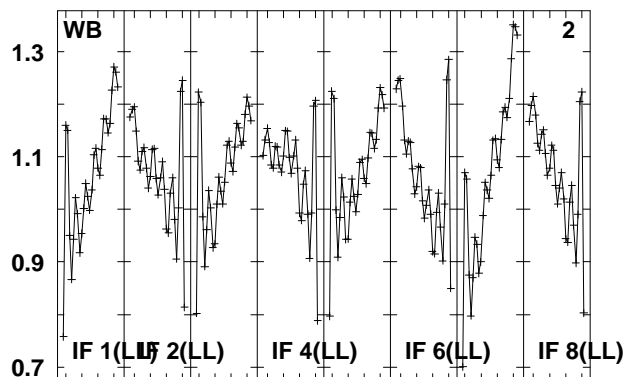
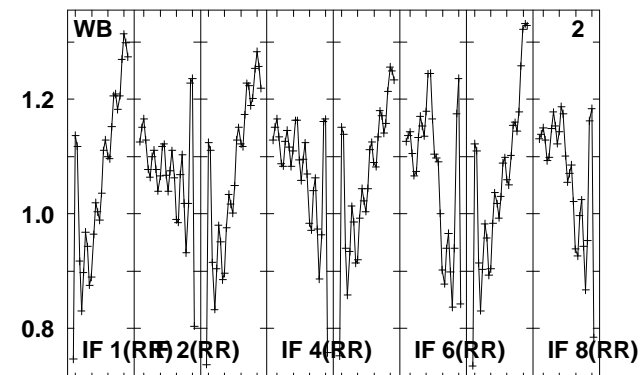
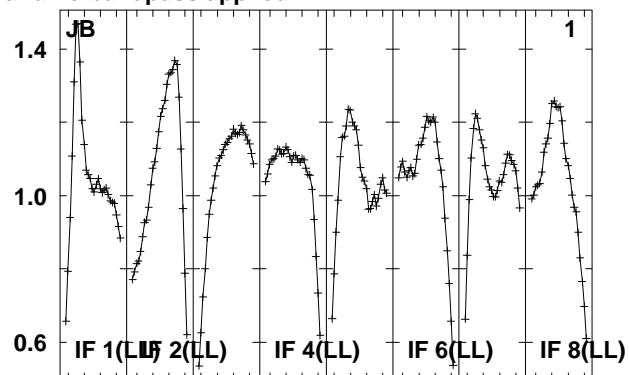
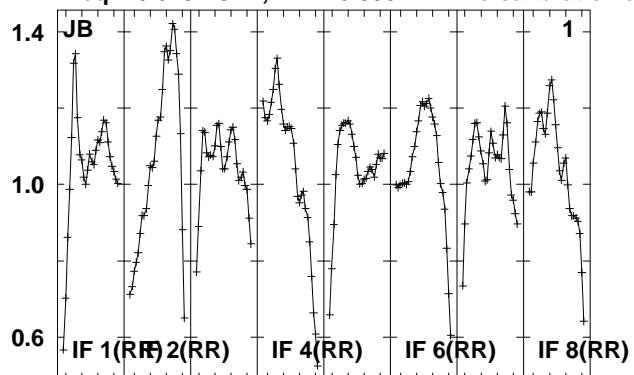

Lower frame: Real Jy

Total-power spectrum Antenna: \*

Timerange: 00/23:12:10 to 00/23:13:36

Plot file version 44 created 10-APR-2012 15:41:46  
 0501-015 ER026C 5.UVDATA.1  
 Freq = 6.6132 GHz, Bw = 8.000 MH No calibration applied and no bandpass applied

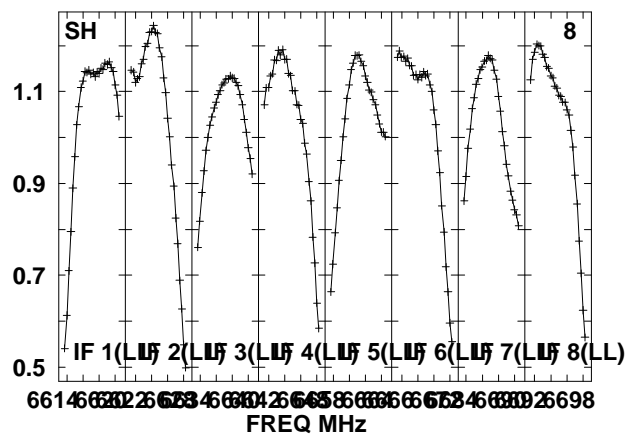
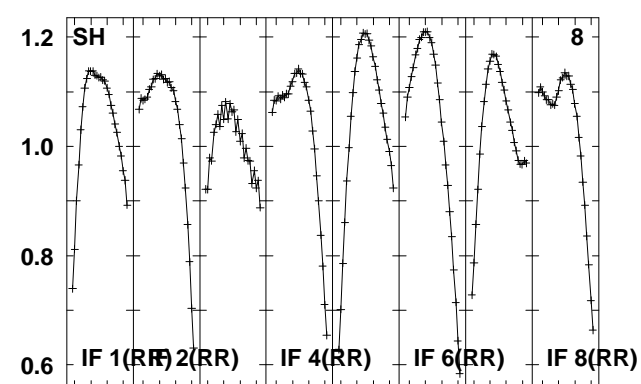
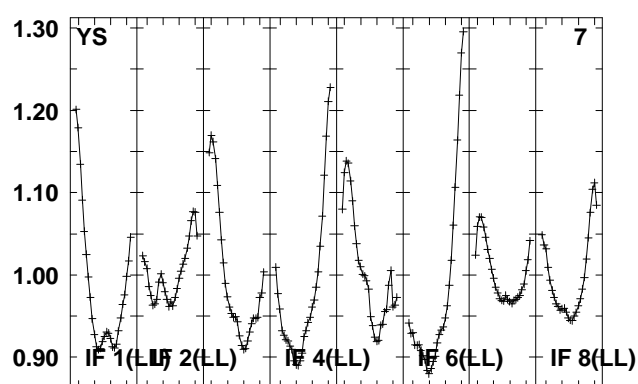
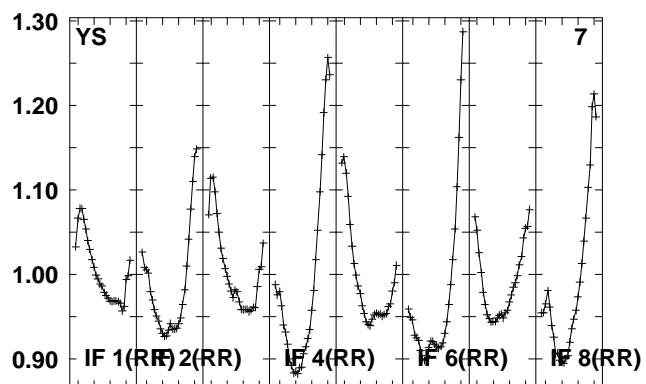
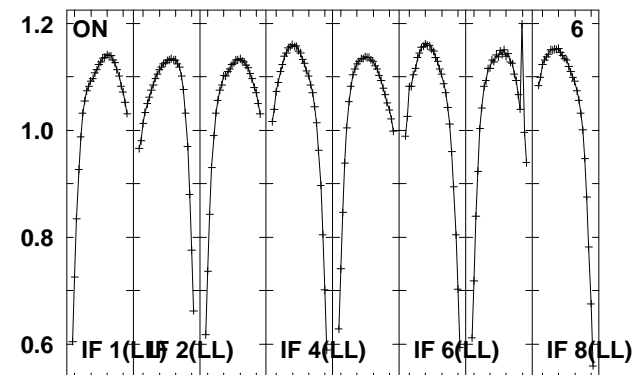
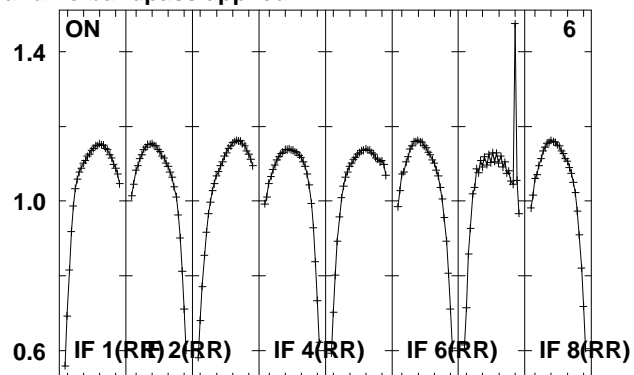
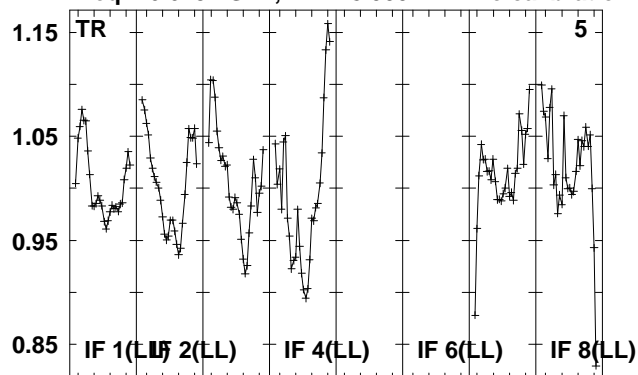

Lower frame: Real Jy  
 Total-power spectrum Antenna: \*  
 Timerange: 00/23:12:10 to 00/23:13:36

Plot file version 45 created 10-APR-2012 15:41:46

0530+133 ER026C 5.UVDATA.1

Freq = 6.6132 GHz, Bw = 8.000 MH No calibration applied and no bandpass applied

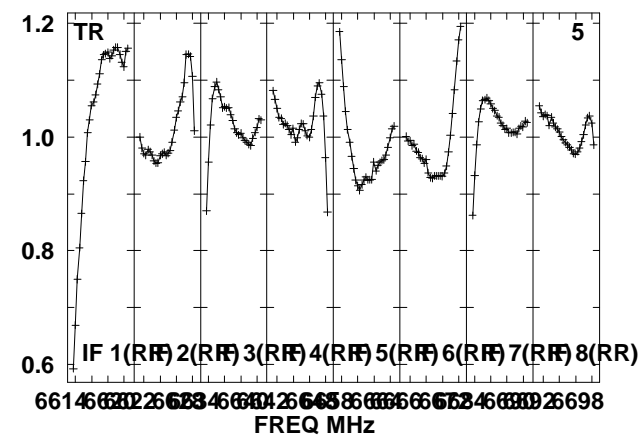
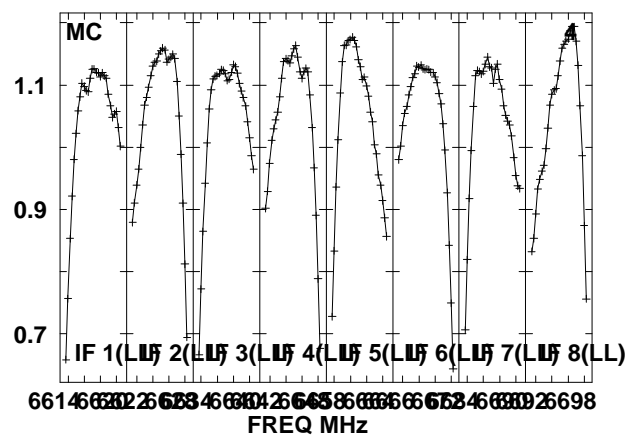
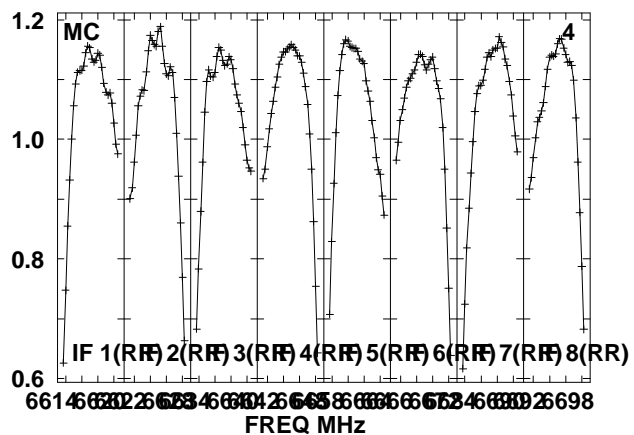
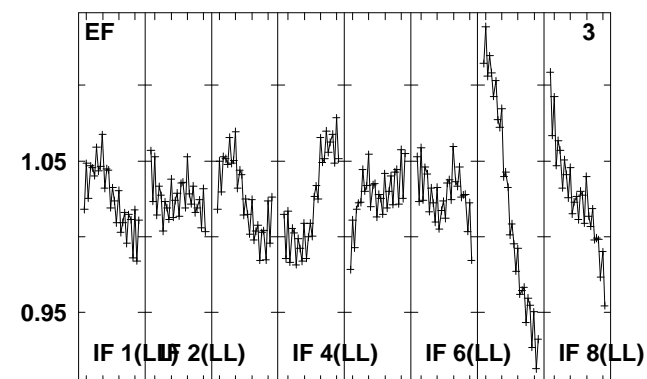
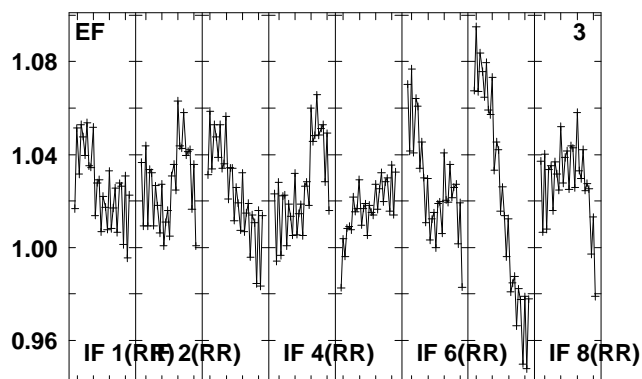
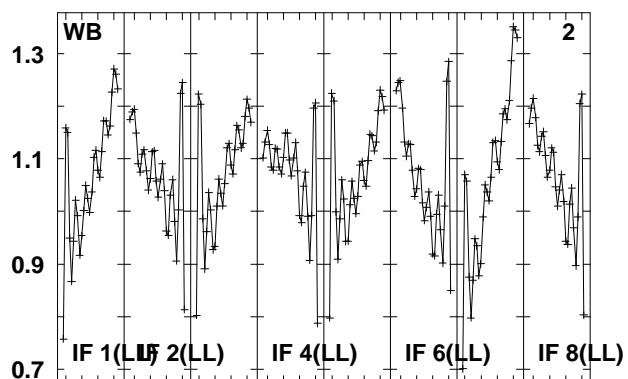
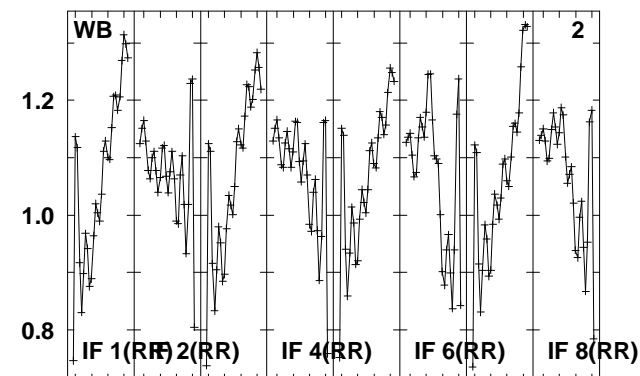
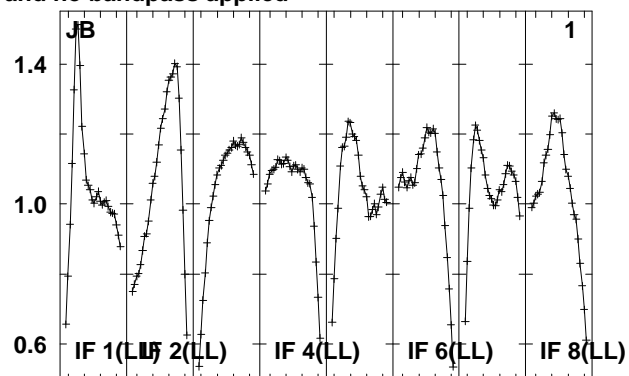
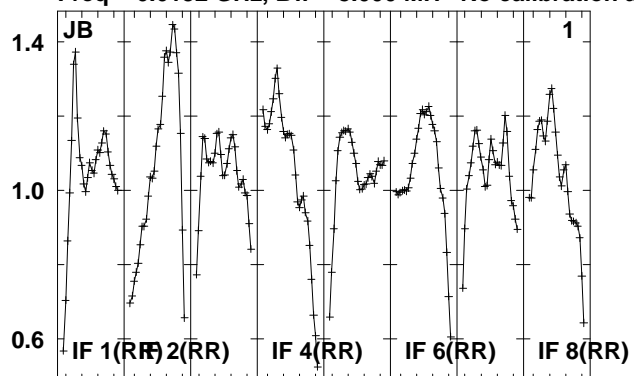

Lower frame: Real Jy

Total-power spectrum Antenna: \*

Timerange: 00/23:14:54 to 00/23:16:20

Plot file version 46 created 10-APR-2012 15:41:46

0530+133 ER026C 5.UVDATA.1

Freq = 6.6132 GHz, Bw = 8.000 MH No calibration applied and no bandpass applied

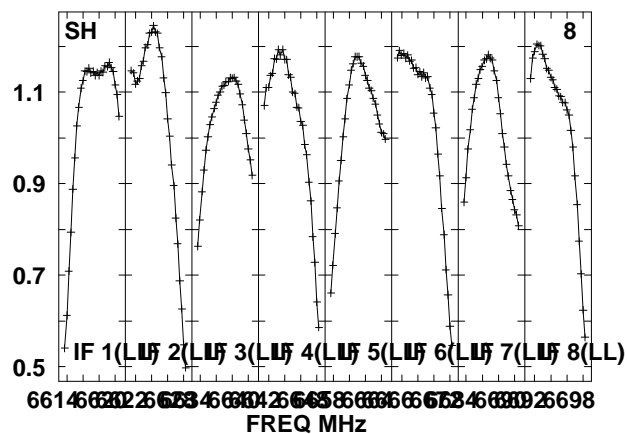
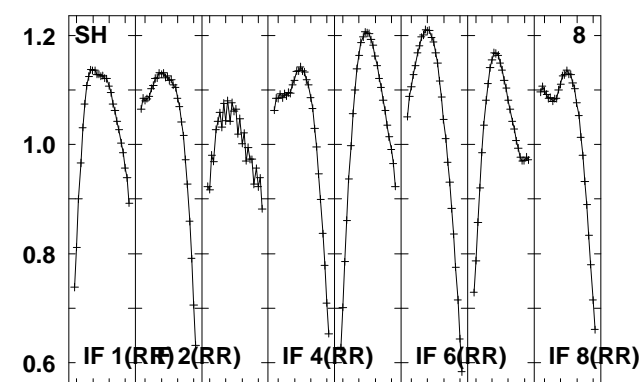
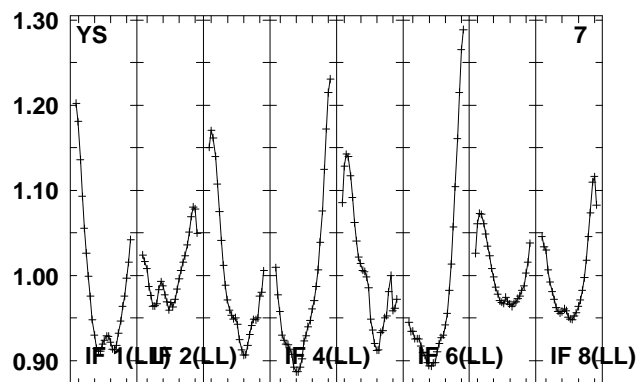
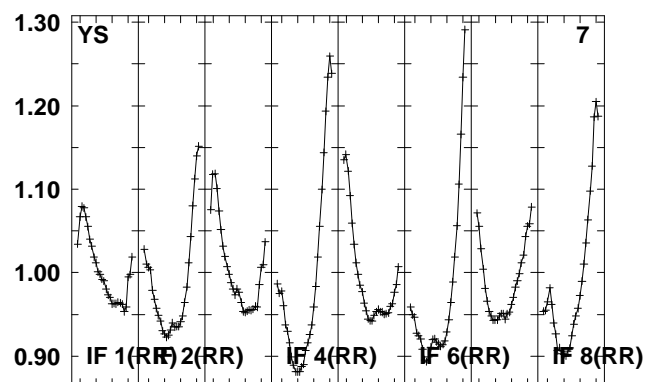
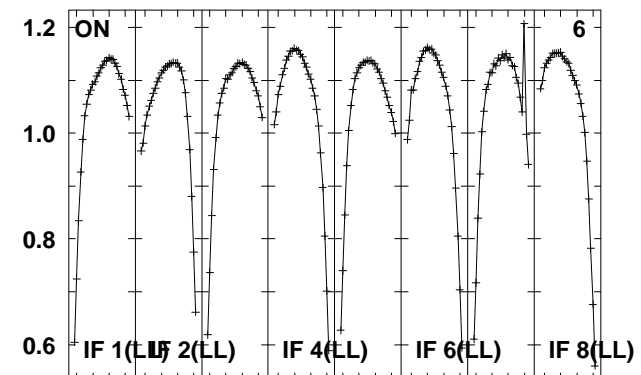
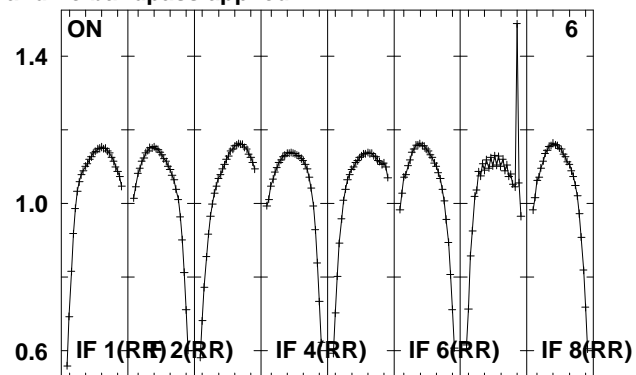
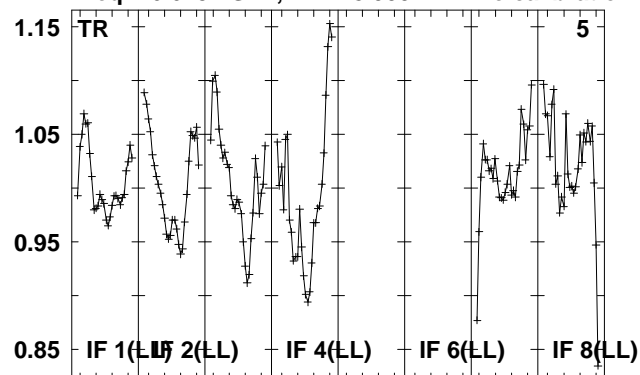

Lower frame: Real Jy

Total-power spectrum Antenna: \*

Timerange: 00/23:14:54 to 00/23:16:20

Plot file version 47 created 10-APR-2012 15:41:47

0808+405 ER026C 5.UVDATA.1

Freq = 6.6132 GHz, Bw = 8.000 MH No calibration applied and no bandpass applied

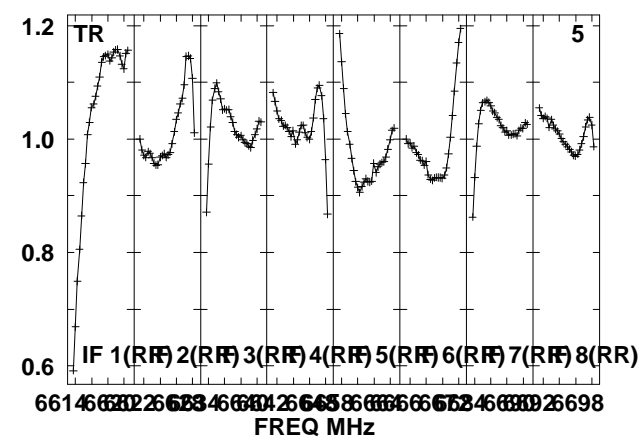
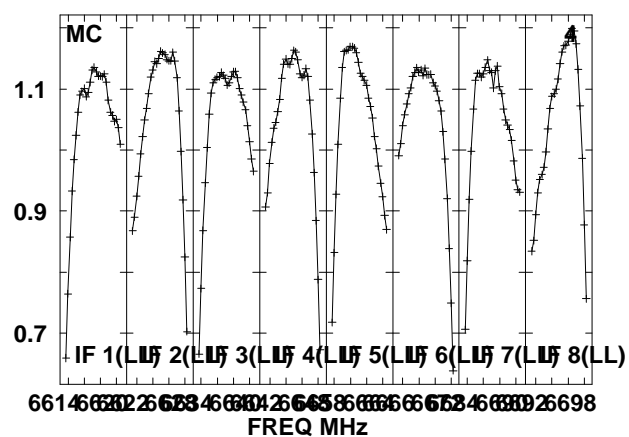
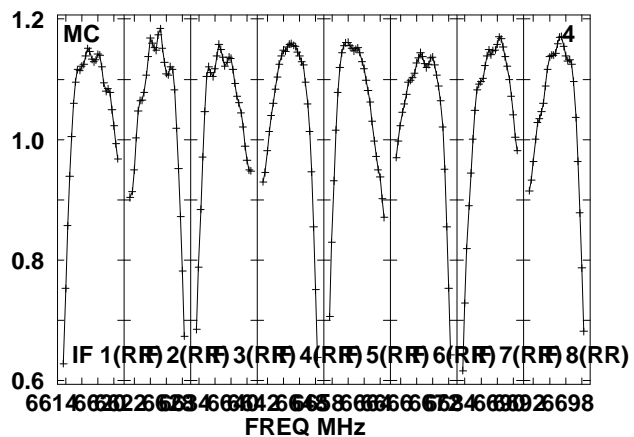
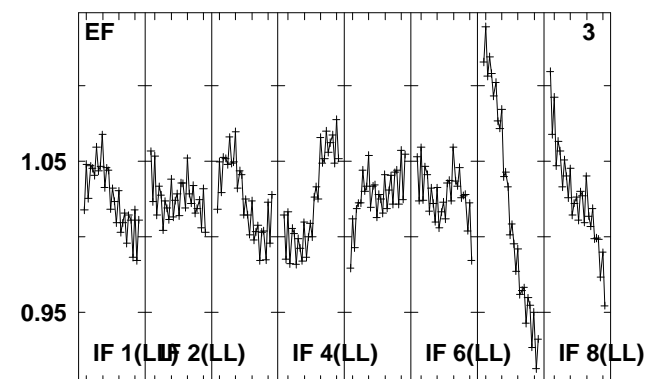
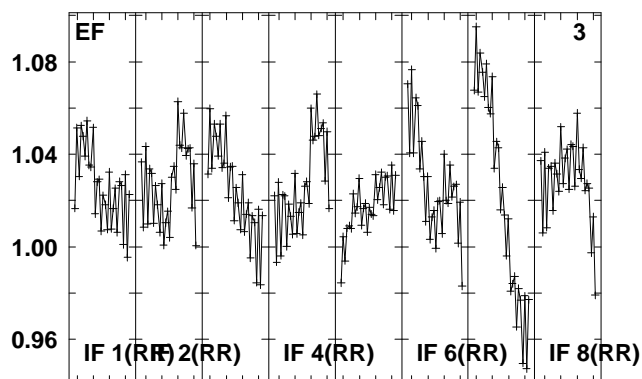
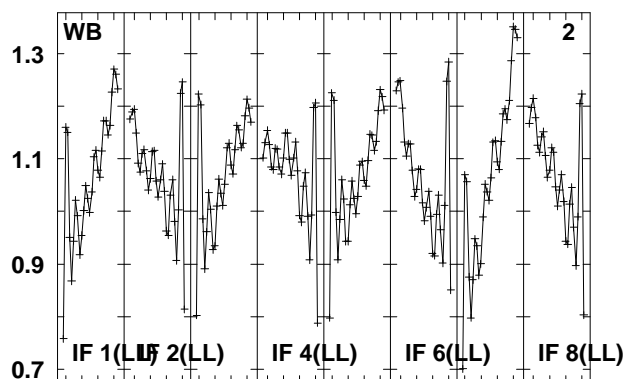
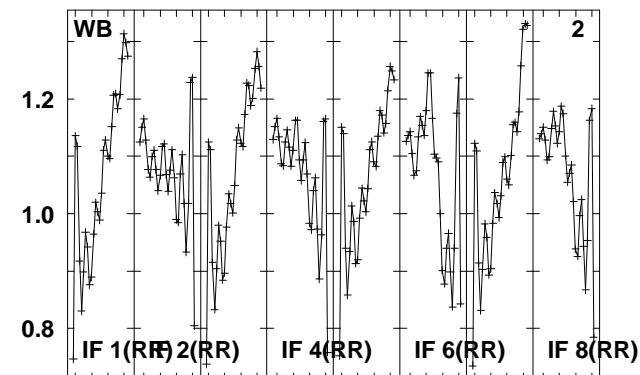
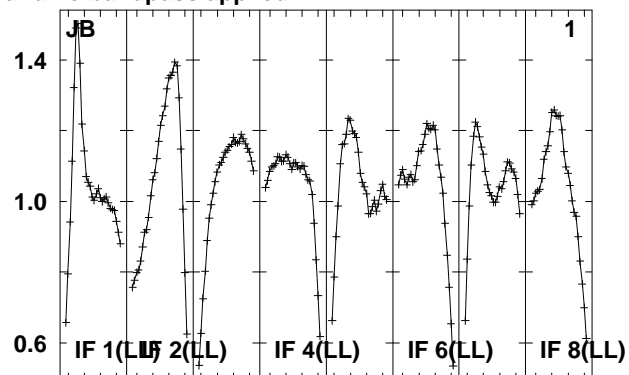
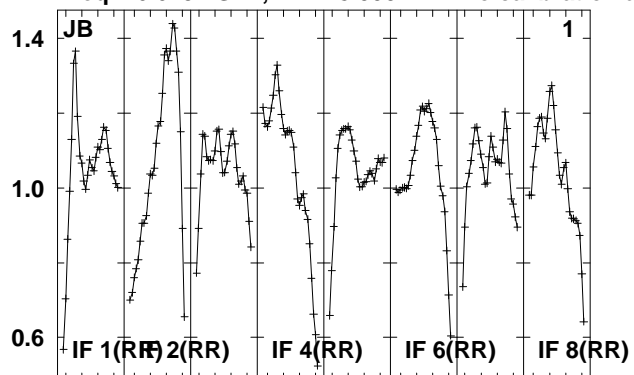

Lower frame: Real Jy  
Total-power spectrum Antenna: \*  
Timerange: 00/23:19:14 to 00/23:20:40

Plot file version 48 created 10-APR-2012 15:41:47

0808+405 ER026C 5.UVDATA.1

Freq = 6.6132 GHz, Bw = 8.000 MH No calibration applied and no bandpass applied

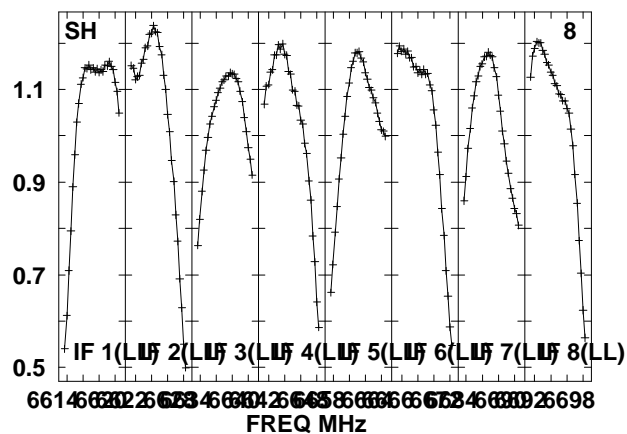
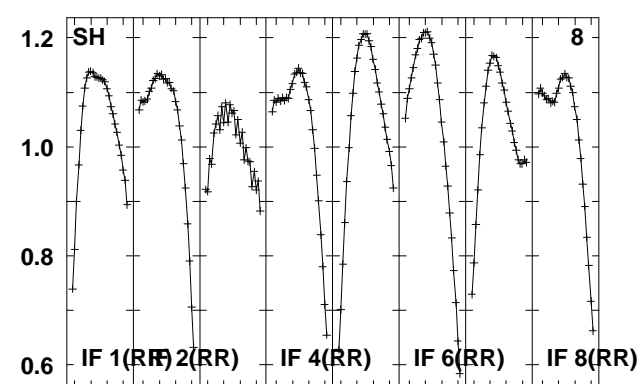
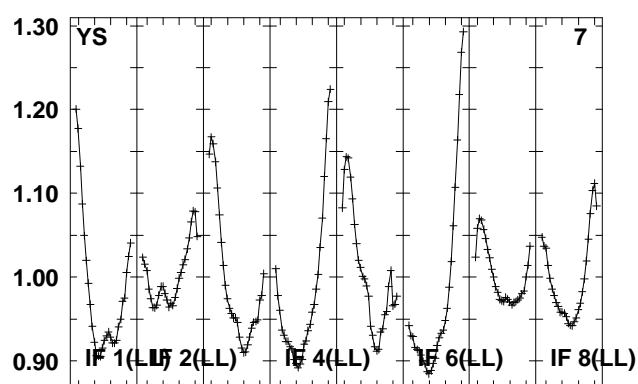
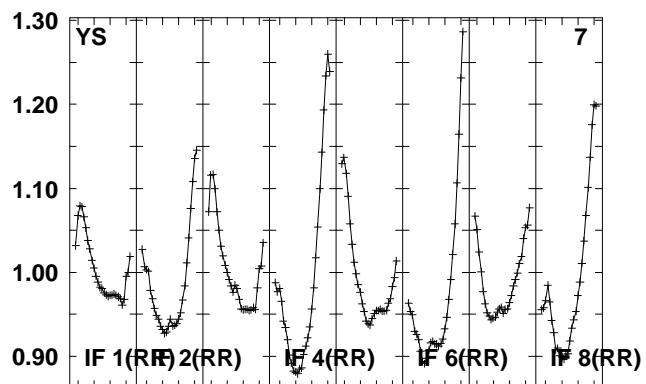
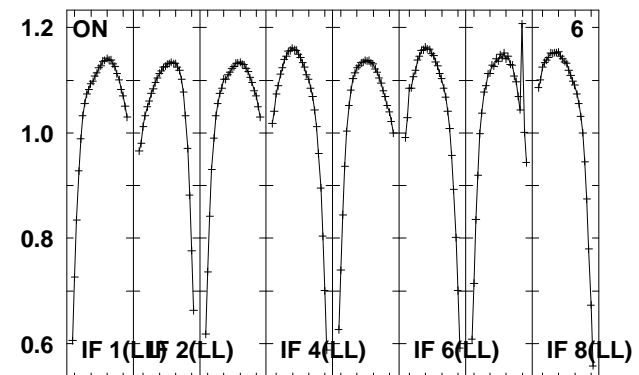
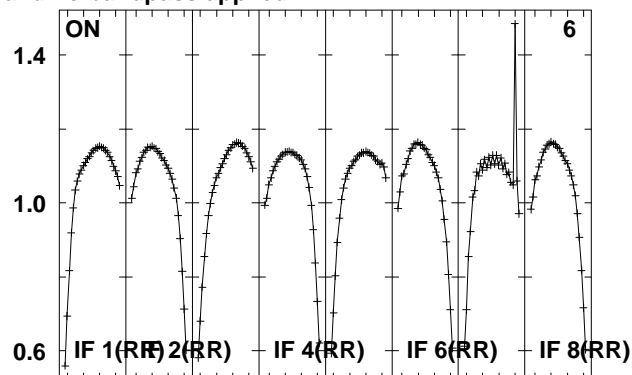
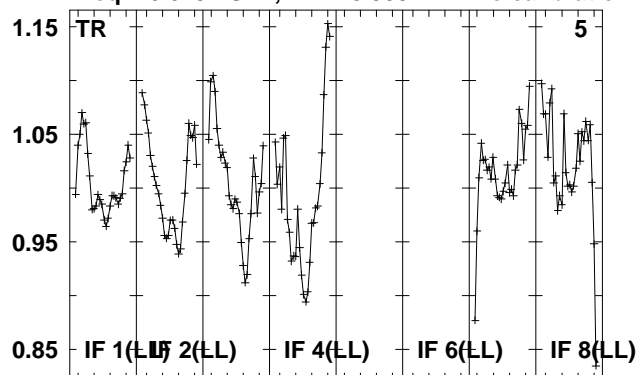

Lower frame: Real Jy

Total-power spectrum Antenna: \*

Timerange: 00/23:19:14 to 00/23:20:40



Plot file version 49 created 10-APR-2012 15:41:47

0646+445 ER026C 5.UVDATA.1

Freq = 6.6132 GHz, Bw = 8.000 MH No calibration applied and no bandpass applied

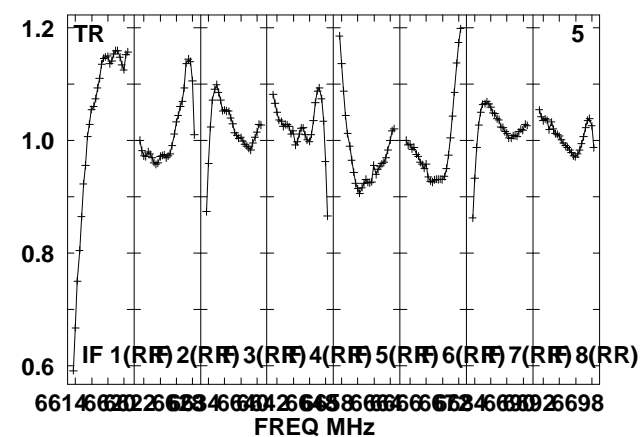
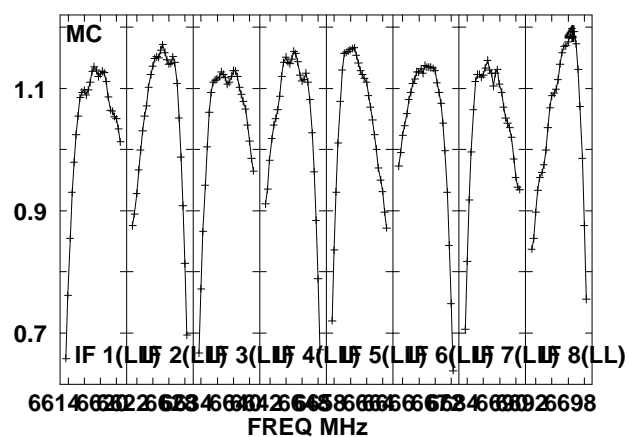
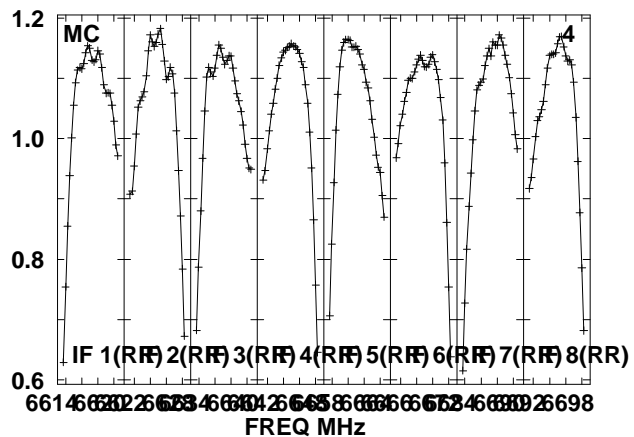
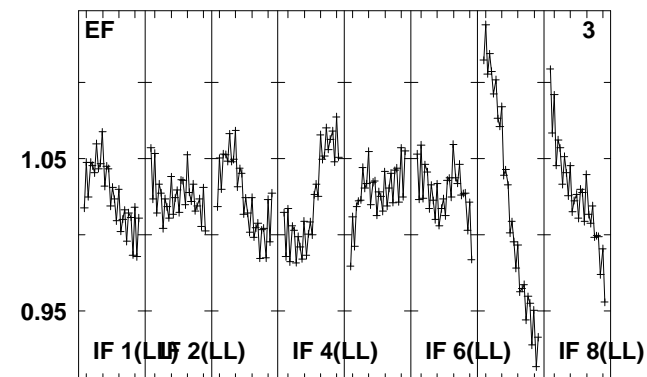
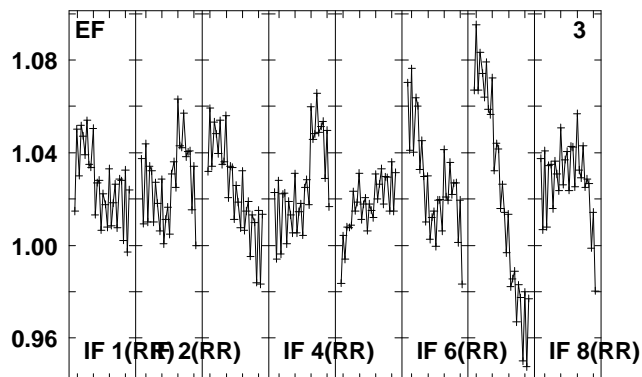
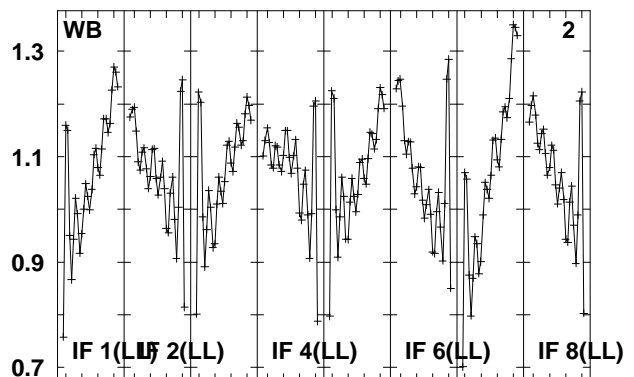
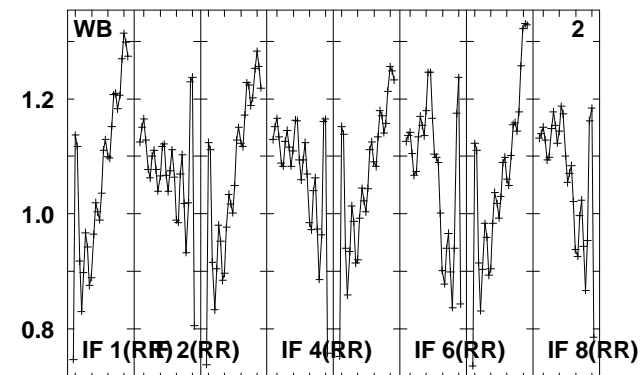
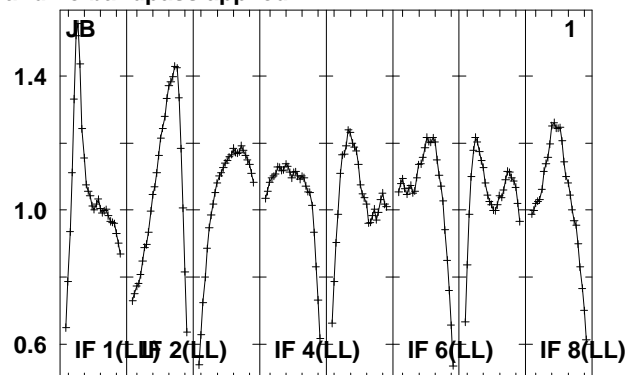
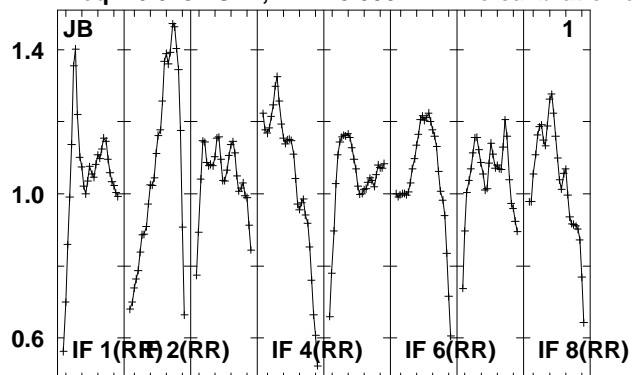

Lower frame: Real Jy

Total-power spectrum Antenna: \*

Timerange: 00/23:22:08 to 00/23:23:34

Plot file version 50 created 10-APR-2012 15:41:47

0646+445 ER026C 5.UVDATA.1

Freq = 6.6132 GHz, Bw = 8.000 MH No calibration applied and no bandpass applied

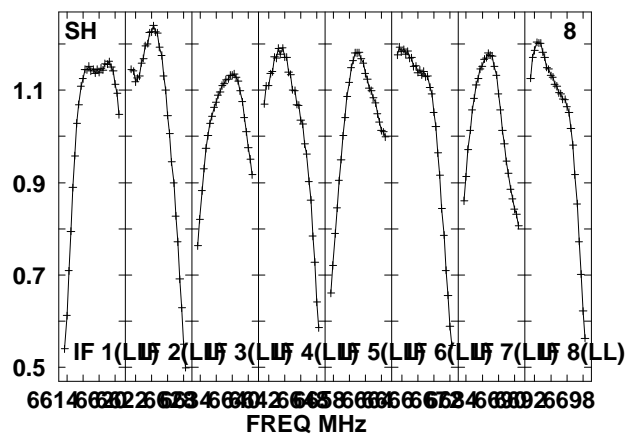
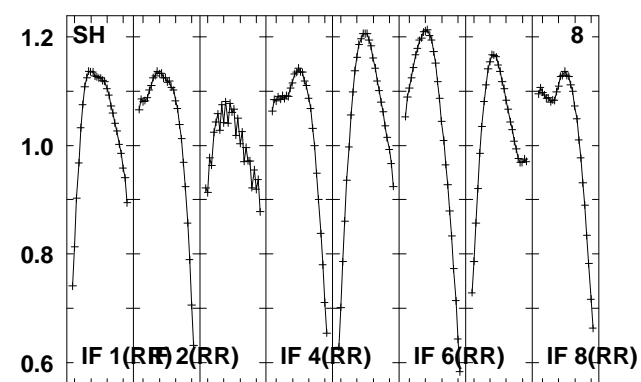
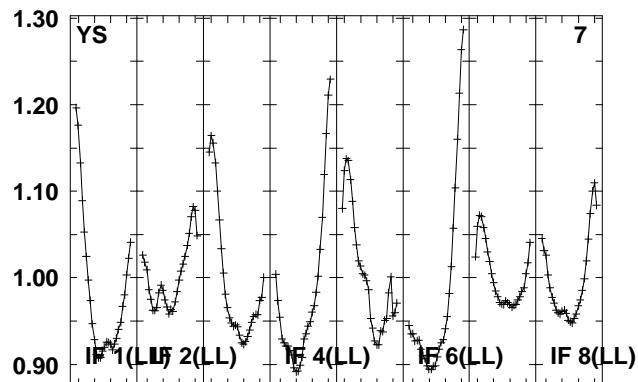
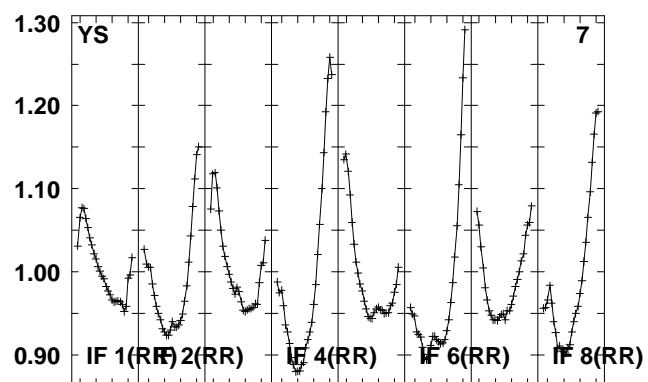
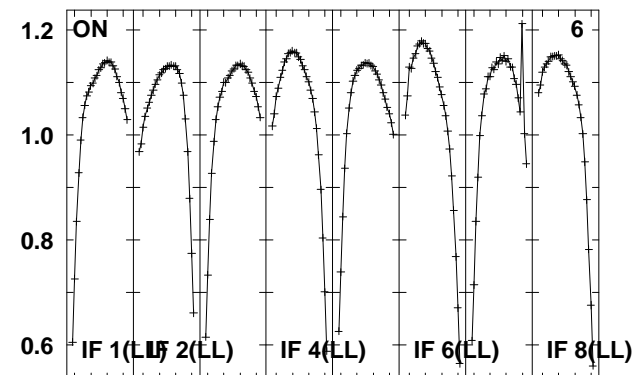
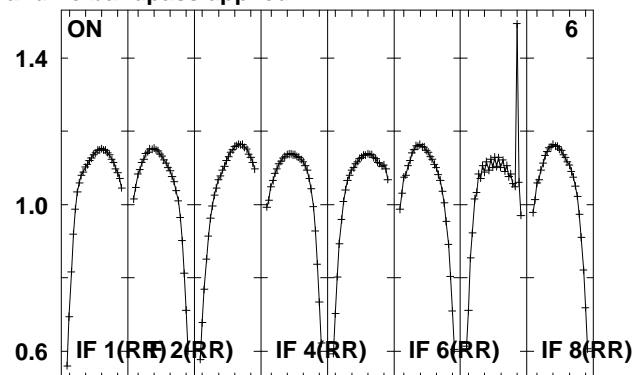
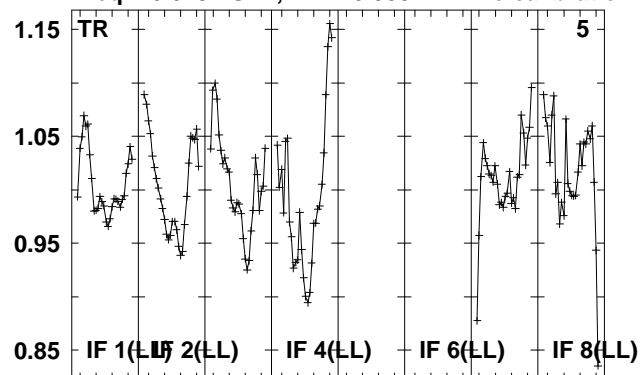

66146632 2662346604266458663666724668026698

FREQ MHz

Lower frame: Real Jy

Total-power spectrum Antenna: \*

Timerange: 00/23:22:08 to 00/23:23:34

Plot file version 51 created 10-APR-2012 15:41:47

0555+394 ER026C 5.UVDATA.1

Freq = 6.6132 GHz, Bw = 8.000 MH No calibration applied and no bandpass applied

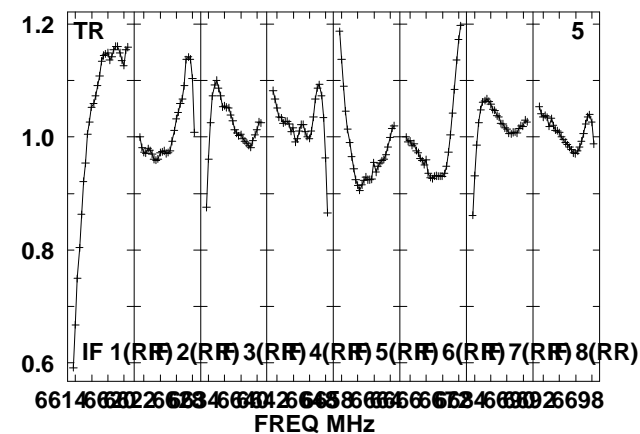
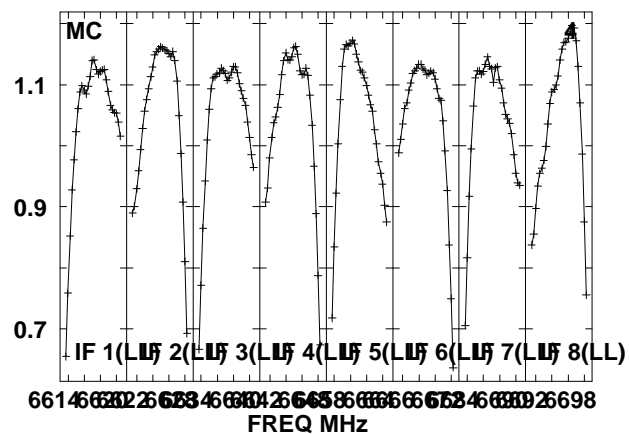
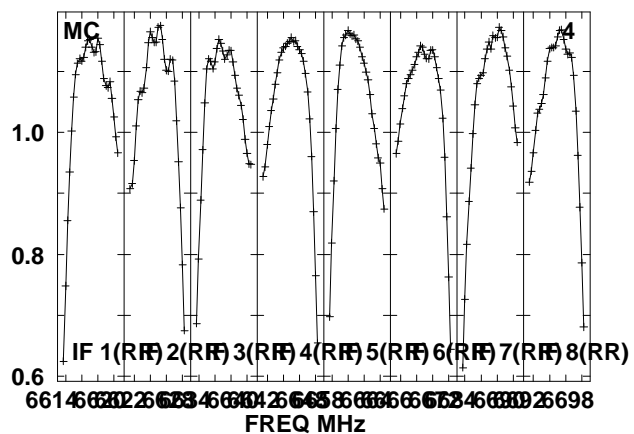
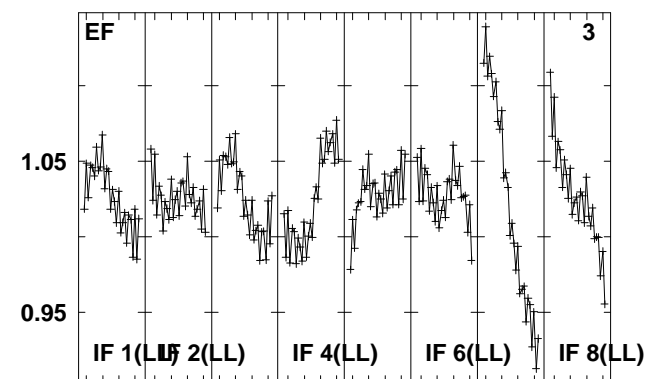
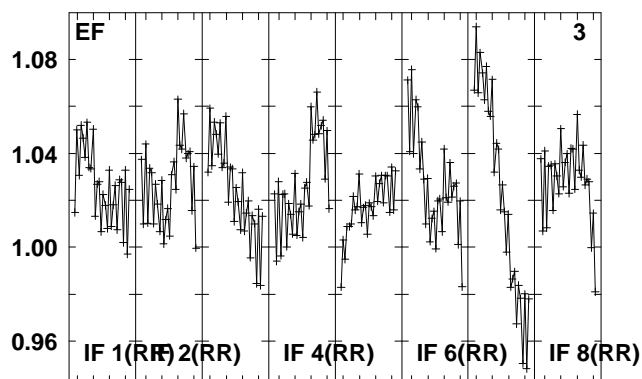
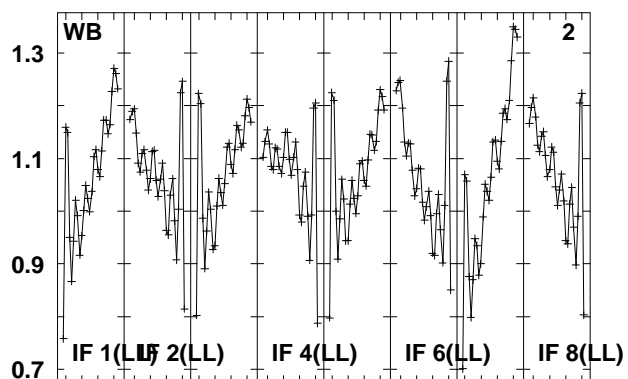
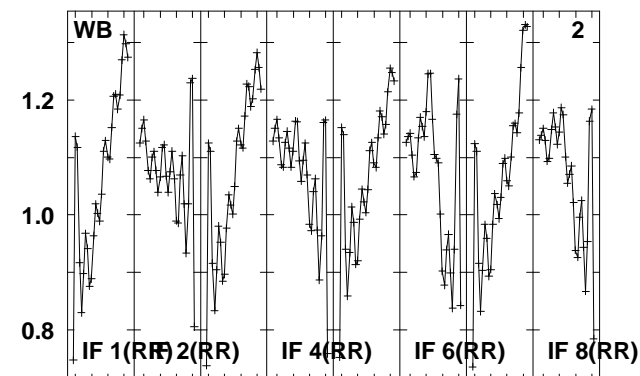
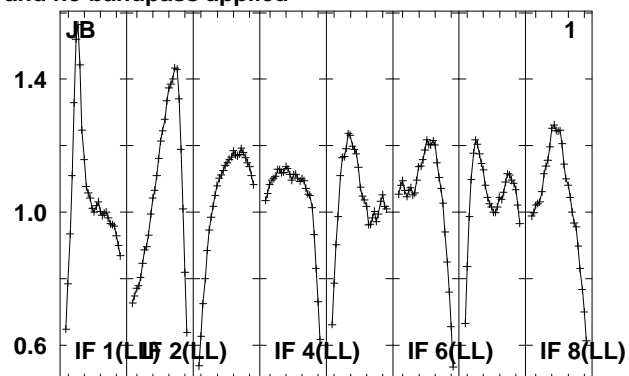
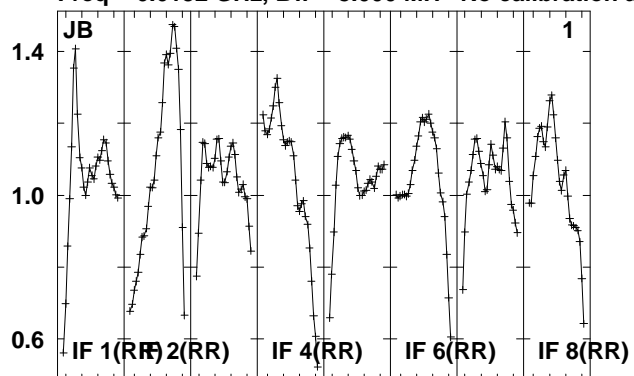

Lower frame: Real Jy

Total-power spectrum Antenna: \*

Timerange: 00/23:24:42 to 00/23:26:08

Plot file version 52 created 10-APR-2012 15:41:48

0555+394 ER026C 5.UVDATA.1

Freq = 6.6132 GHz, Bw = 8.000 MH No calibration applied and no bandpass applied

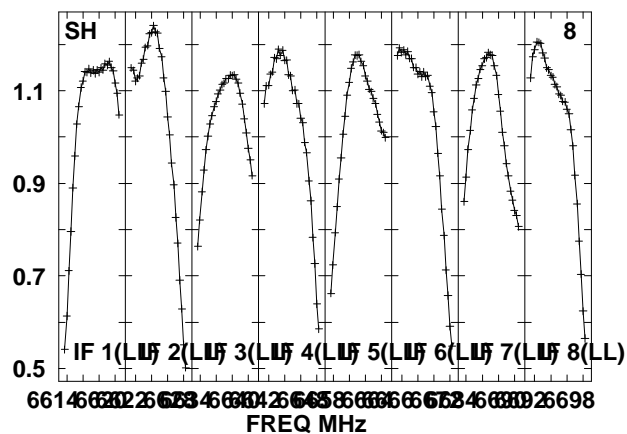
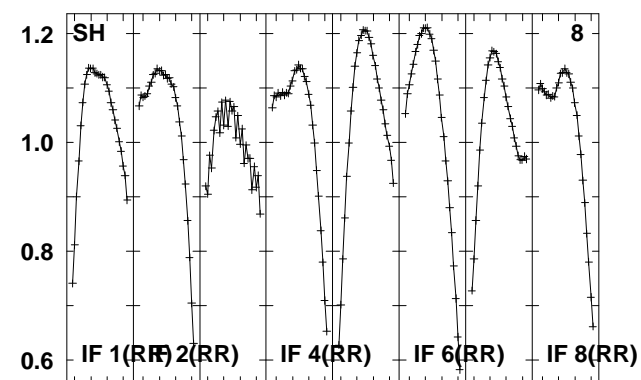
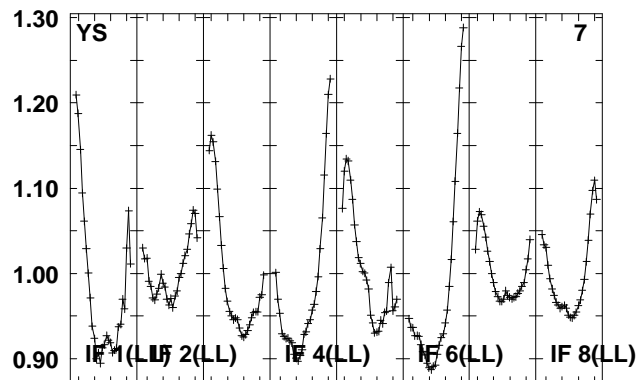
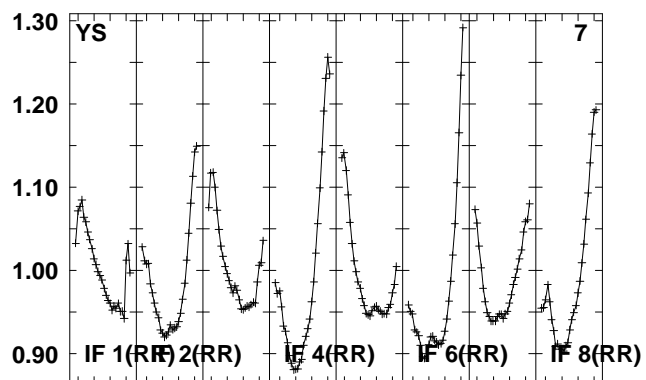
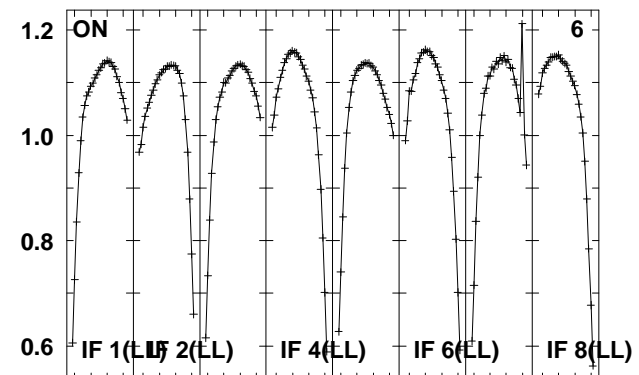
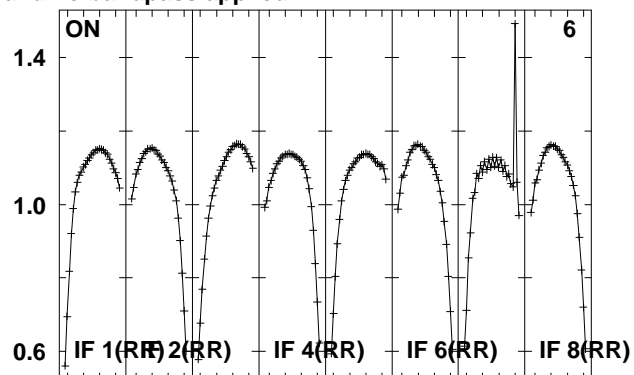
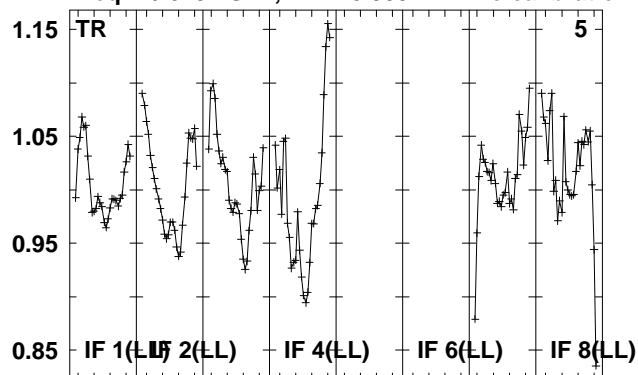

Lower frame: Real Jy

Total-power spectrum Antenna: \*

Timerange: 00/23:24:42 to 00/23:26:08

Plot file version 53 created 10-APR-2012 15:41:48

0530+133 ER026C 5.UVDATA.1

Freq = 6.6132 GHz, Bw = 8.000 MH No calibration applied and no bandpass applied

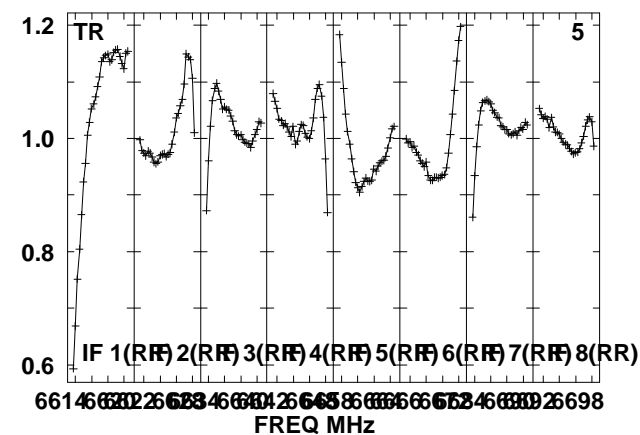
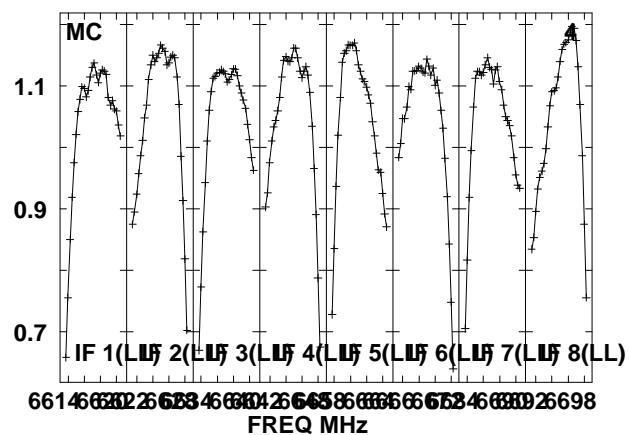
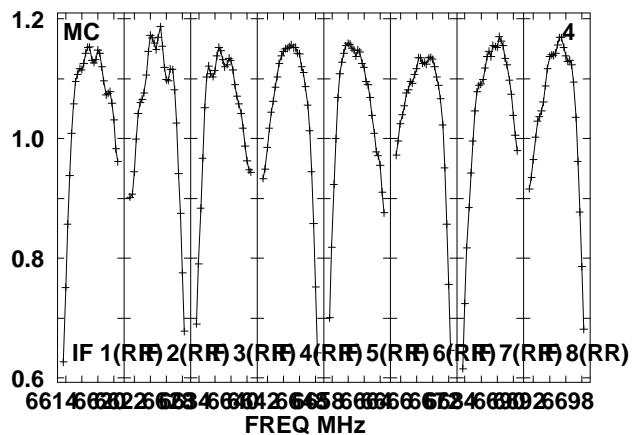
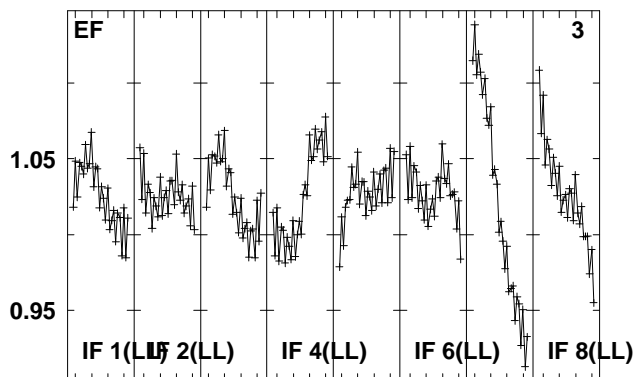
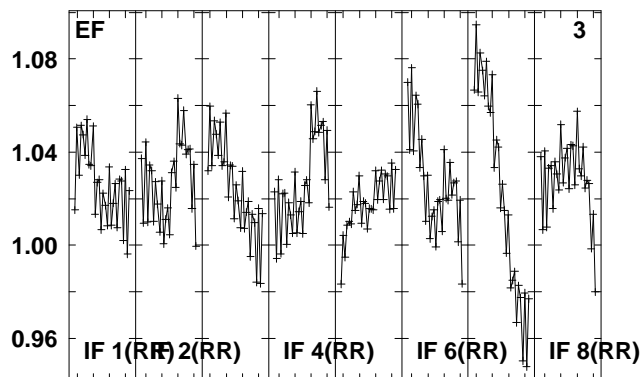
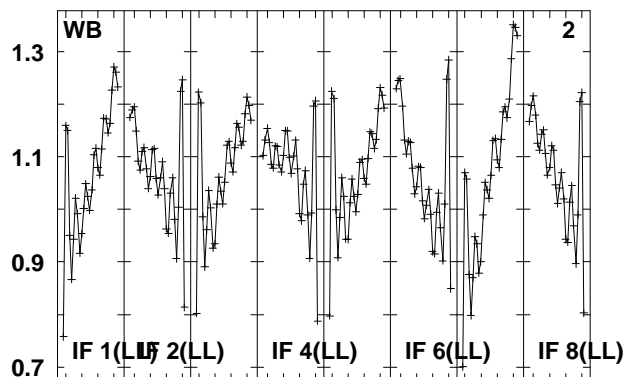
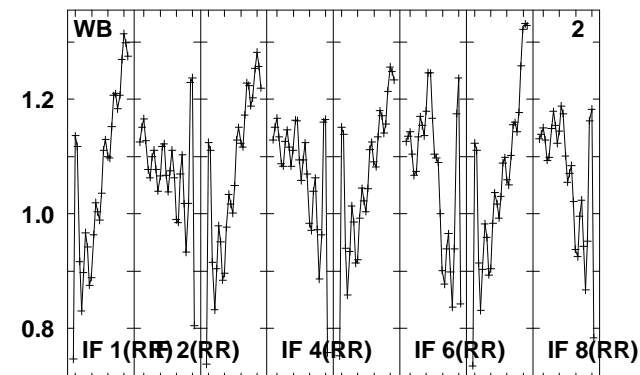
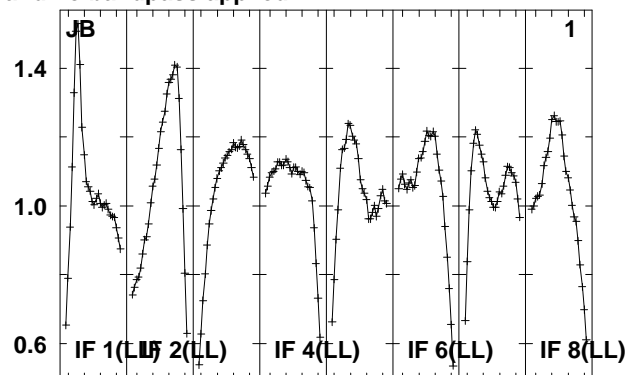
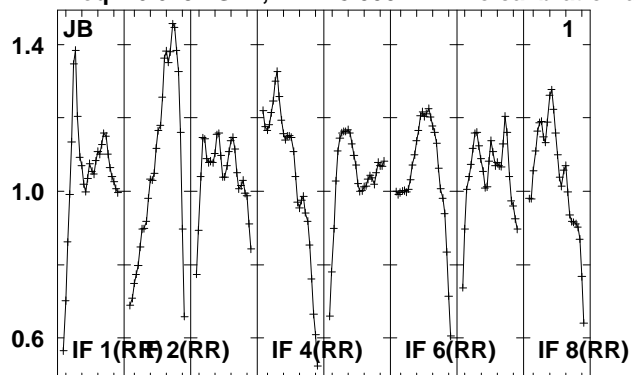

Lower frame: Real Jy  
Total-power spectrum Antenna: \*  
Timerange: 00/23:28:08 to 00/23:29:34

Plot file version 54 created 10-APR-2012 15:41:48

0530+133 ER026C 5.UVDATA.1

Freq = 6.6132 GHz, Bw = 8.000 MH No calibration applied and no bandpass applied

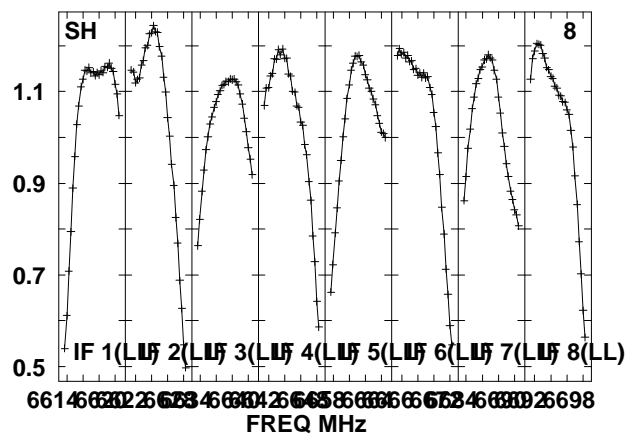
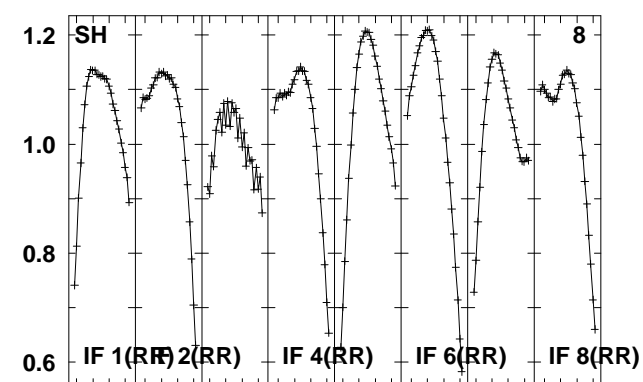
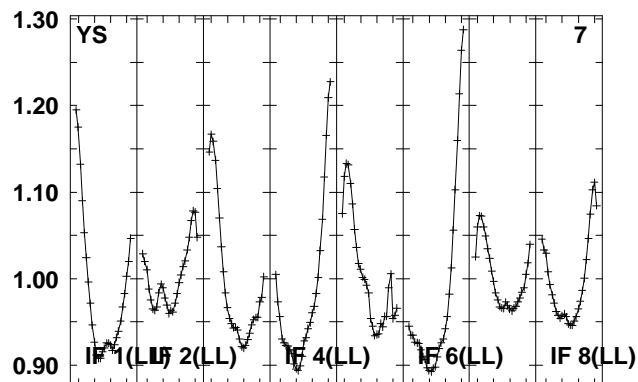
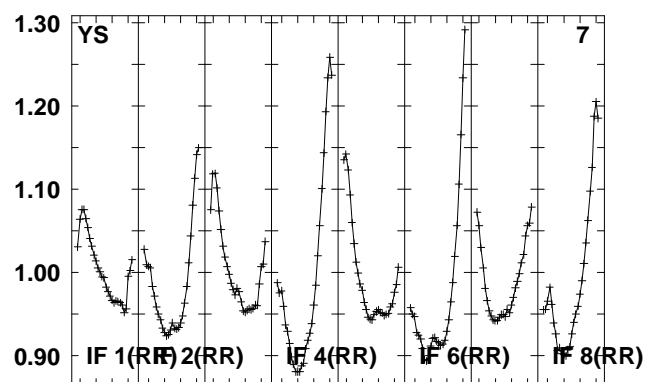
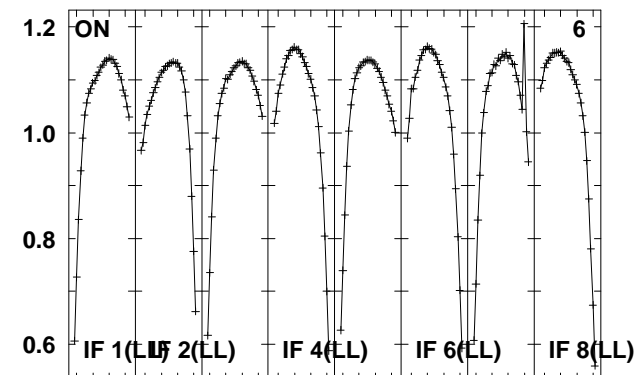
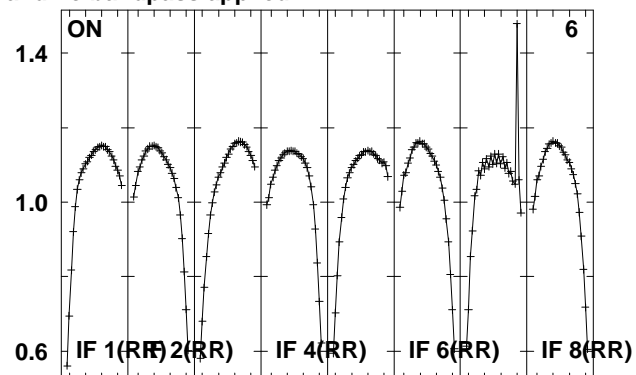
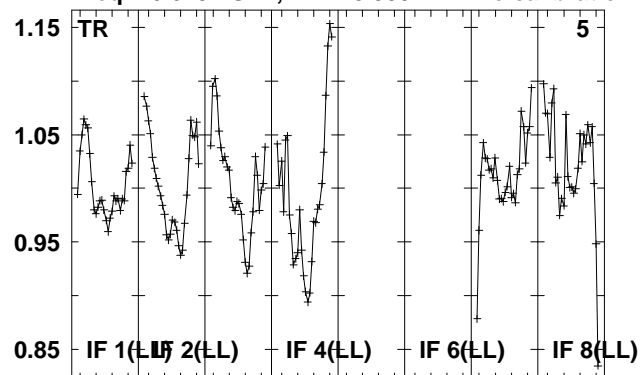

Lower frame: Real Jy

Total-power spectrum Antenna: \*

Timerange: 00/23:28:08 to 00/23:29:34