

Plot file version 1 created 20-MAR-2014 17:07:51

J1159+2914 ER030C.UVDATA.1

Freq = 1.5950 GHz, Bw = 16.000 MH No calibration applied and no bandpass applied

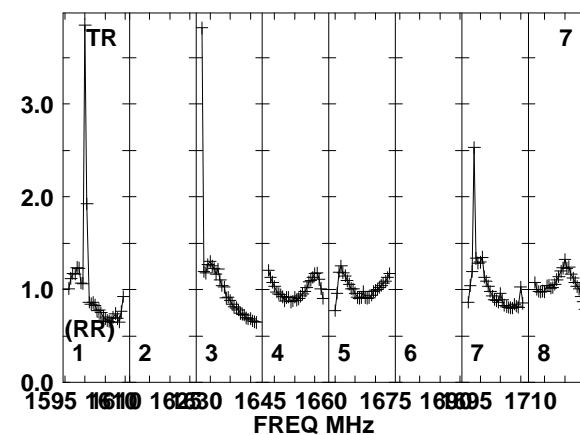
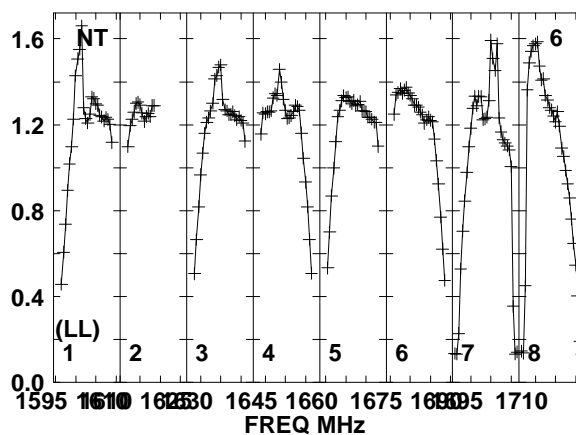
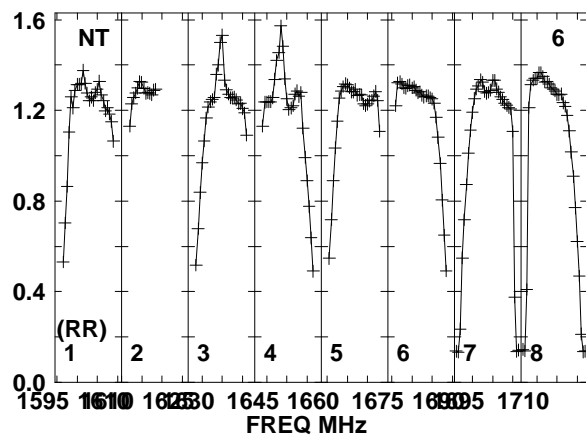
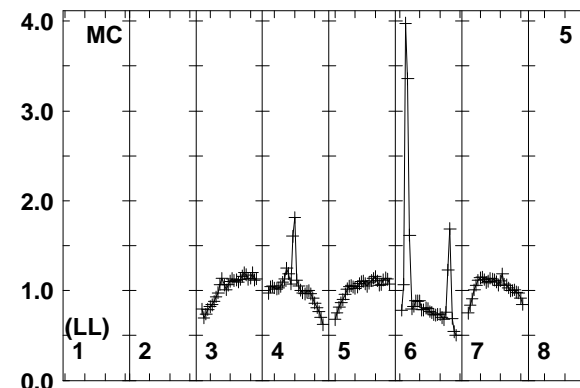
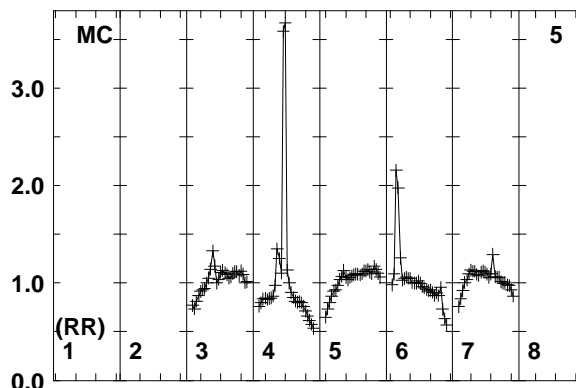
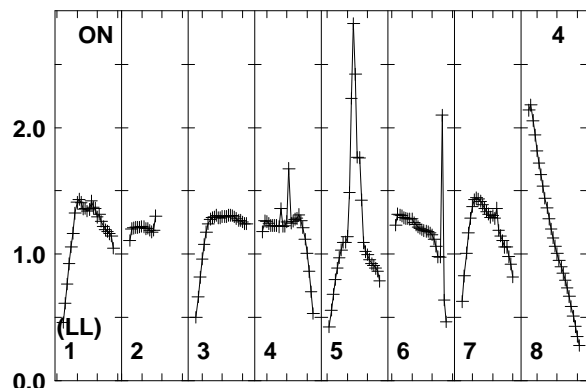
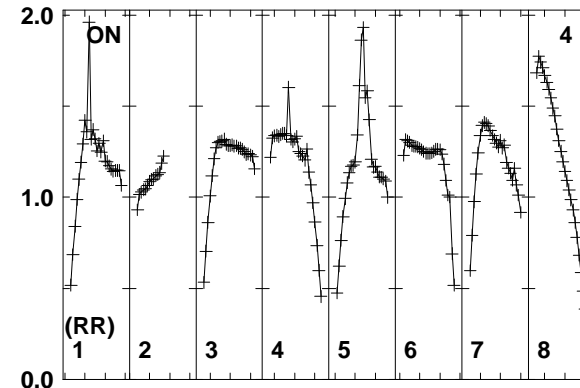
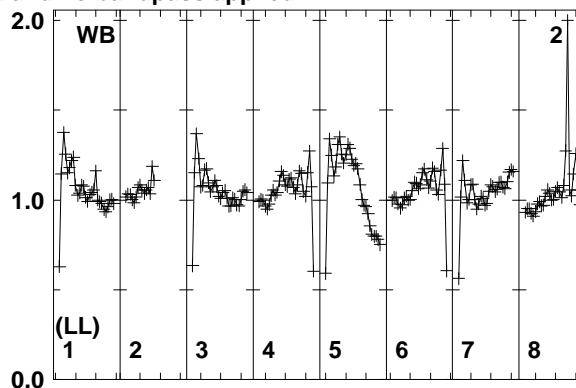
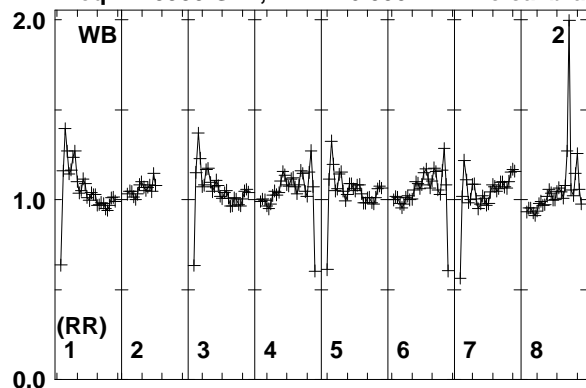

Lower frame: Real Jy
Total-power spectrum Antenna: WB (02)
Timerange: 00/05:30:01 to 00/05:33:59

Plot file version 2 created 20-MAR-2014 17:07:51

J1159+2914 ER030C.UVDATA.1

Freq = 1.5950 GHz, Bw = 16.000 MH No calibration applied and no bandpass applied

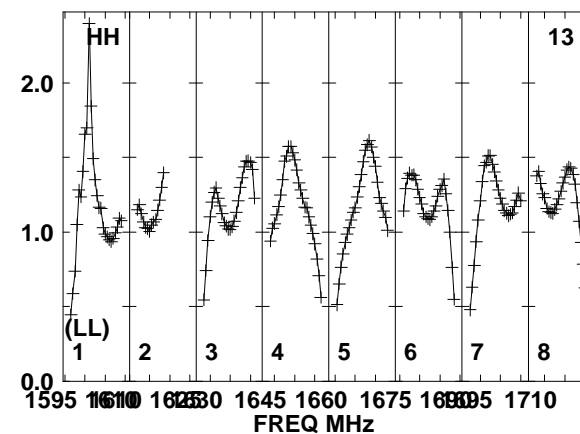
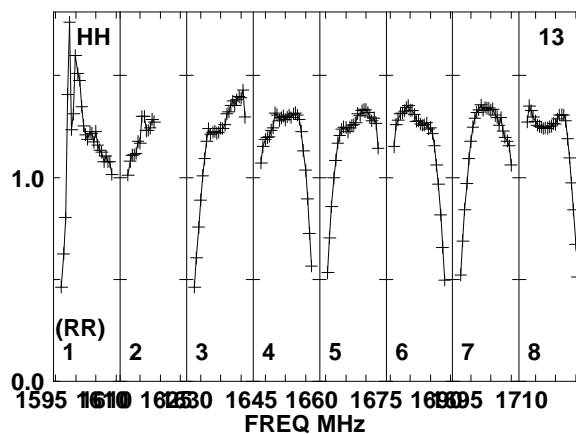
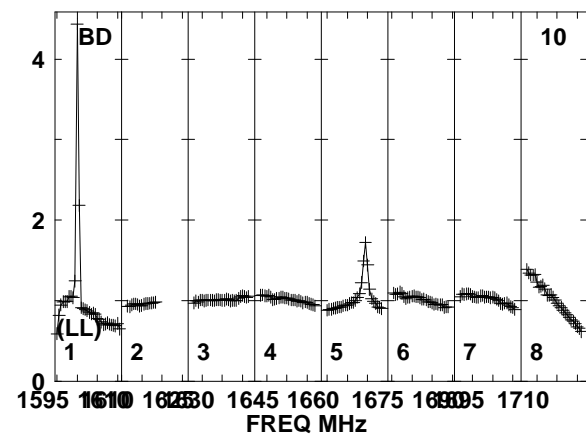
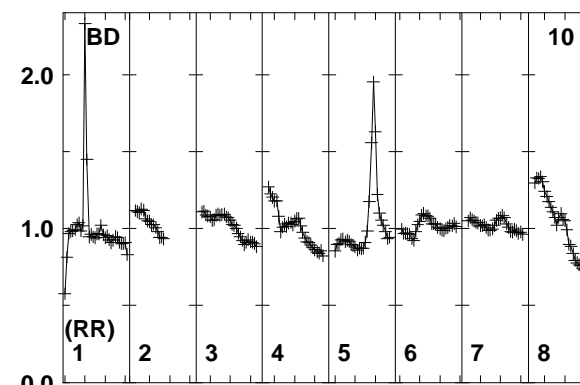
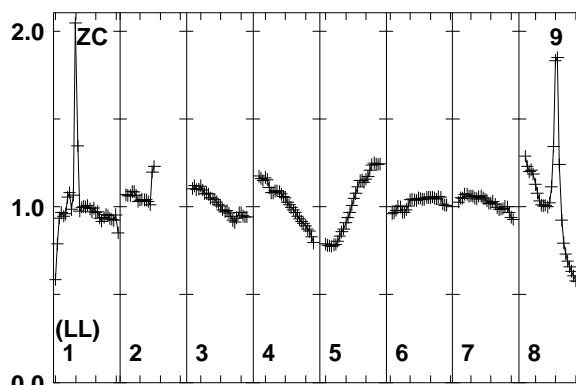
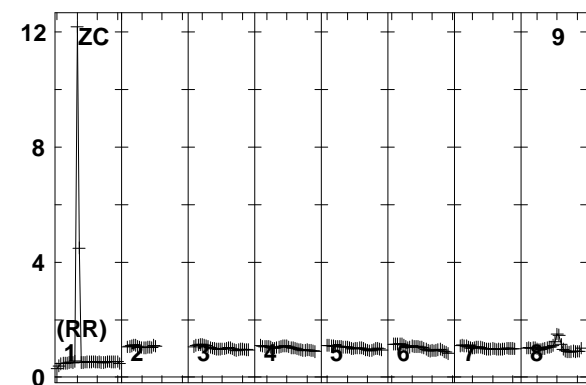
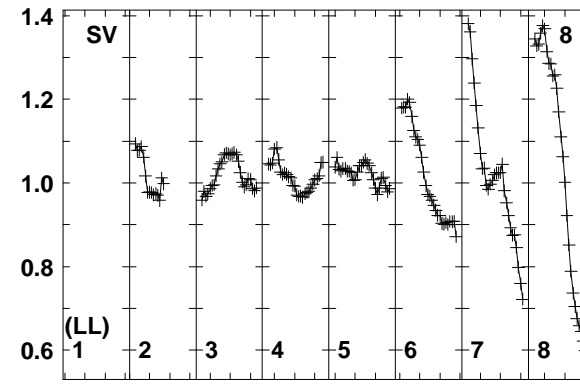
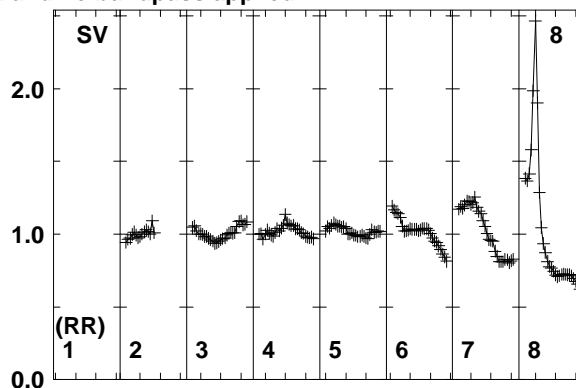
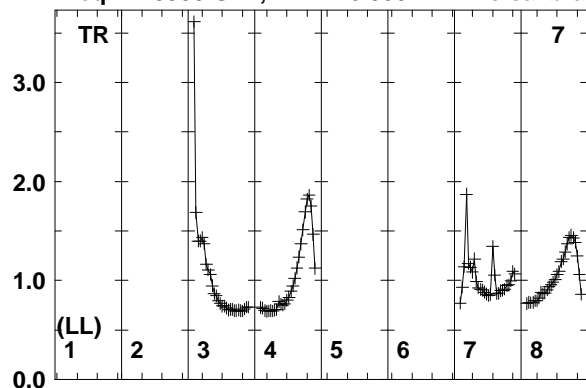

Lower frame: Real Jy
Total-power spectrum Antenna: TR (07)
Timerange: 00/05:30:01 to 00/05:33:59

Plot file version 3 created 20-MAR-2014 17:07:51

J1317+3425 ER030C.UVDATA.1

Freq = 1.5950 GHz, Bw = 16.000 MH No calibration applied and no bandpass applied

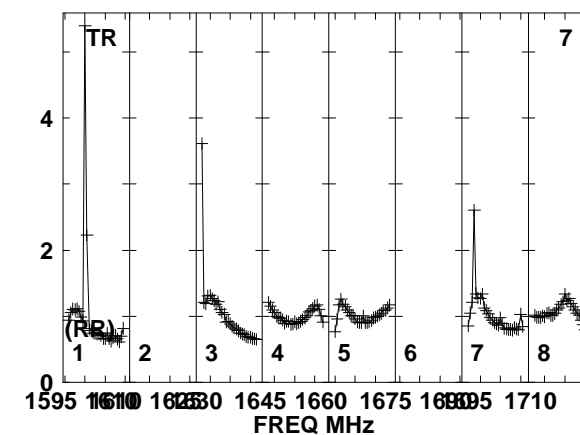
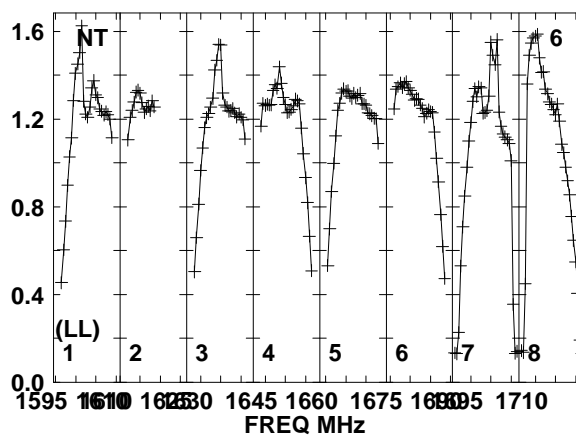
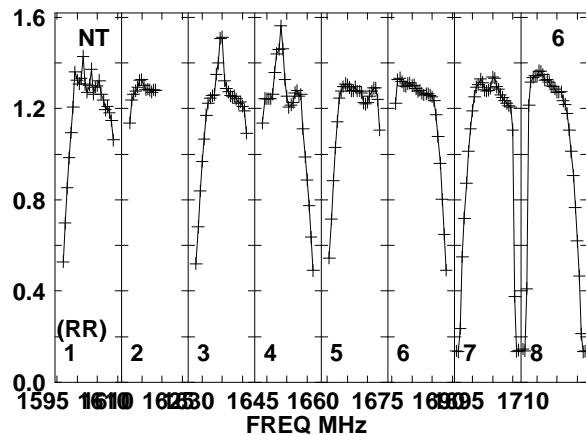
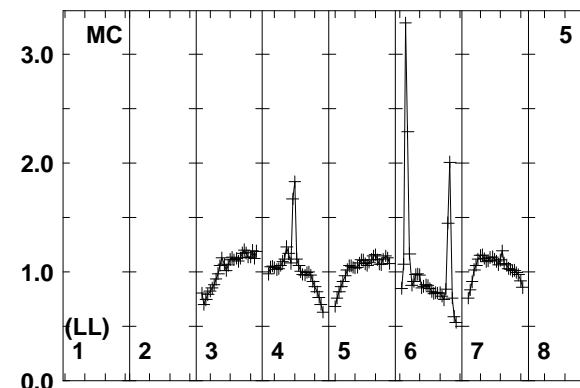
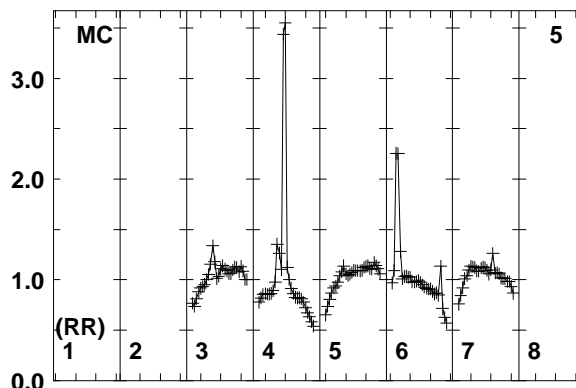
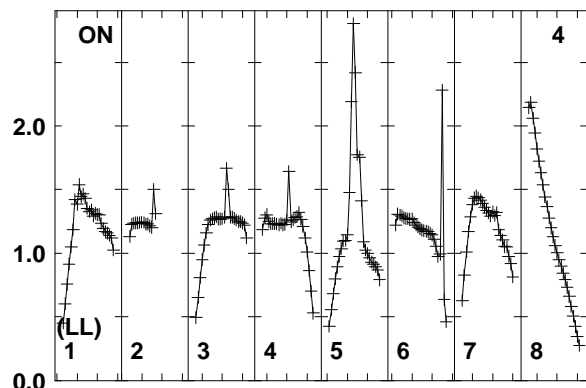
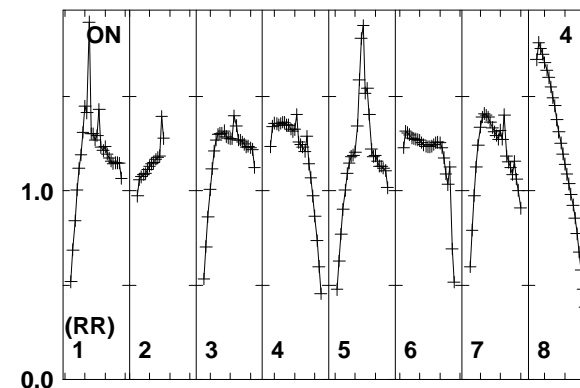
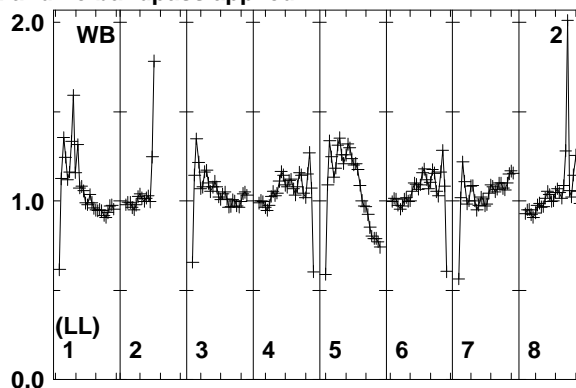
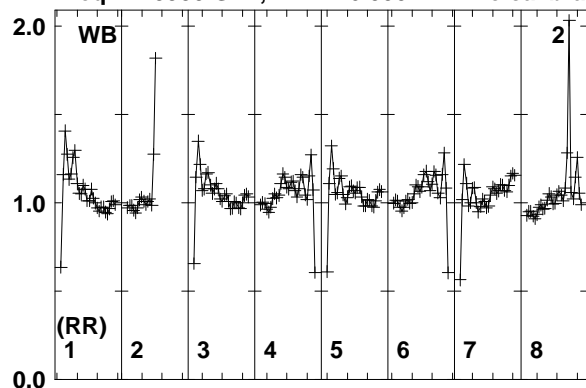

Lower frame: Real Jy
Total-power spectrum Antenna: WB (02)
Timerange: 00/05:36:01 to 00/05:36:59

Plot file version 4 created 20-MAR-2014 17:07:51

J1317+3425 ER030C.UVDATA.1

Freq = 1.5950 GHz, Bw = 16.000 MH No calibration applied and no bandpass applied

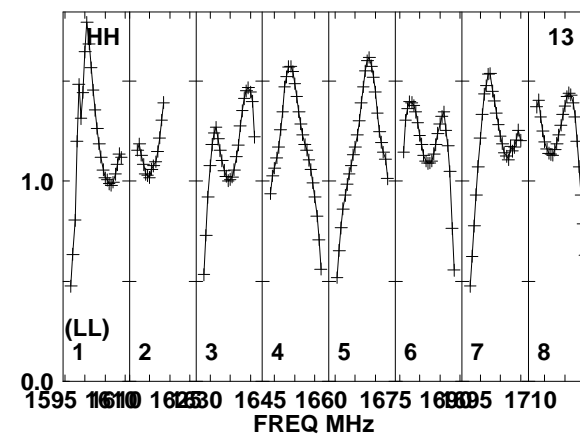
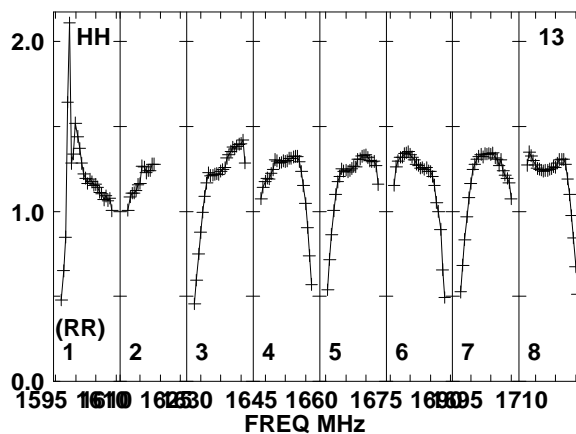
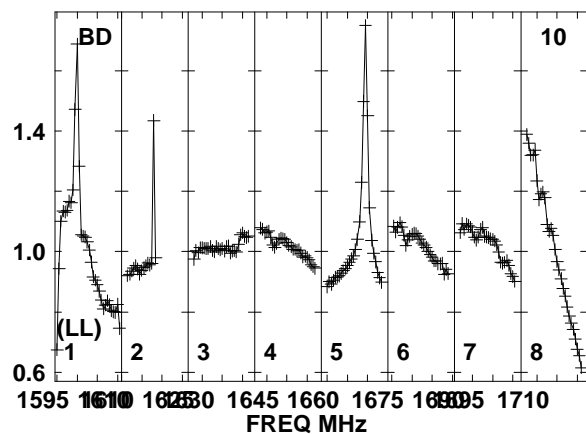
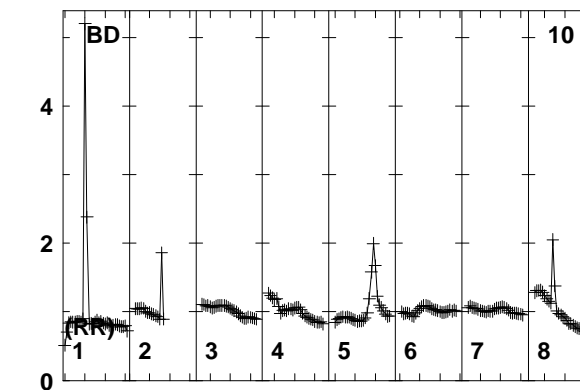
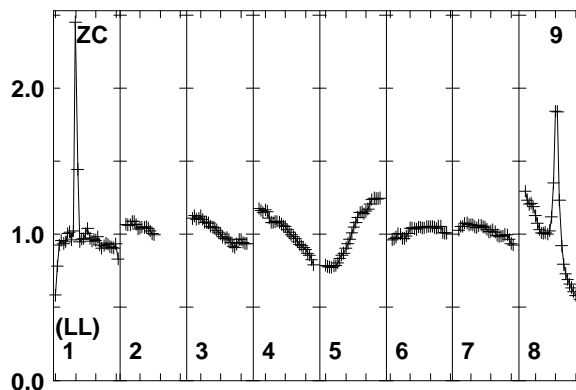
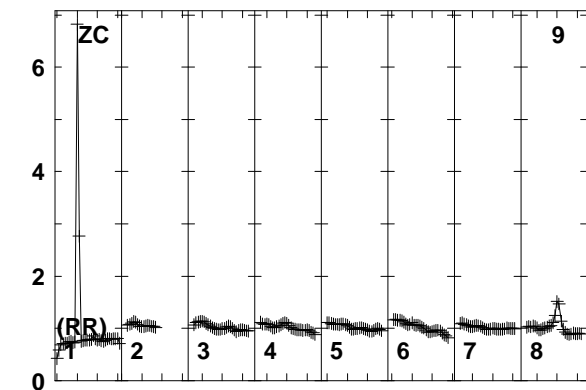
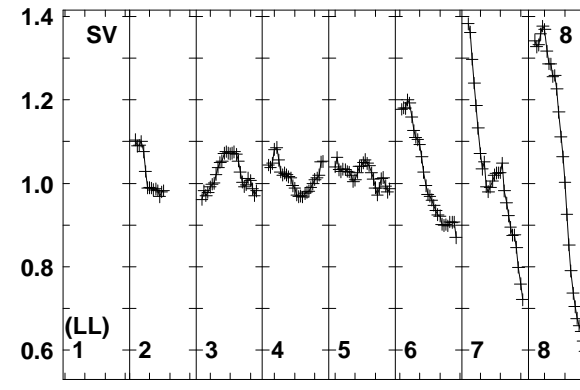
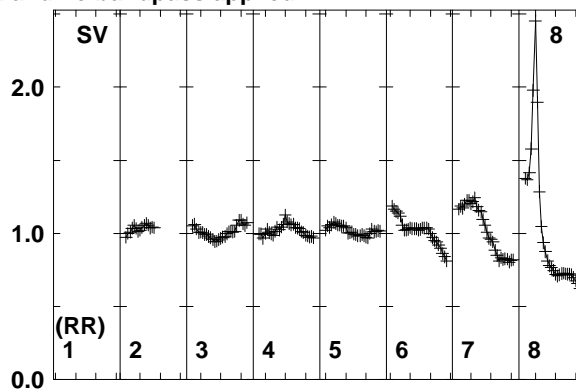
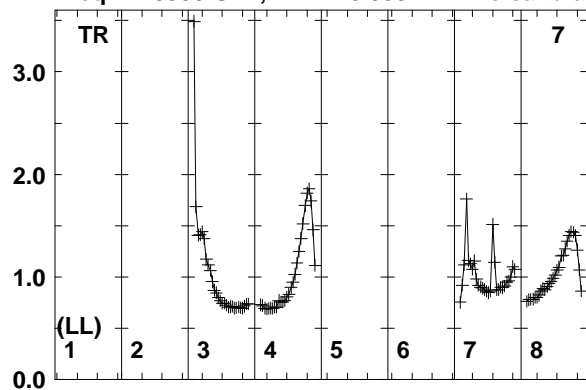

Lower frame: Real Jy
Total-power spectrum Antenna: TR (07)
Timerange: 00/05:36:01 to 00/05:36:59

Plot file version 5 created 20-MAR-2014 17:07:51

IC883 ER030C.UVDATA.1

Freq = 1.5950 GHz, Bw = 16.000 MH No calibration applied and no bandpass applied

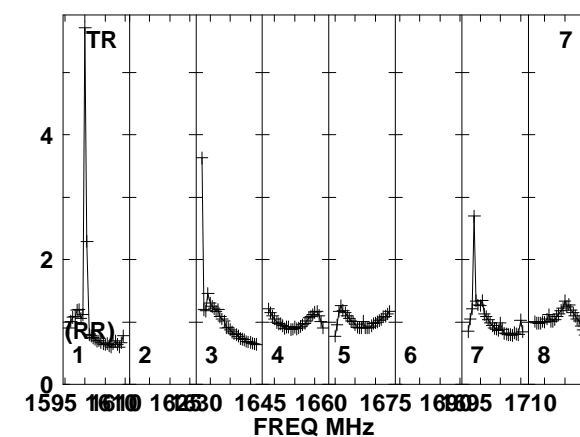
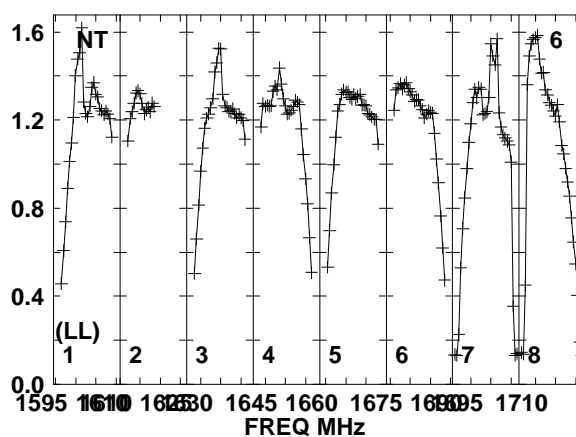
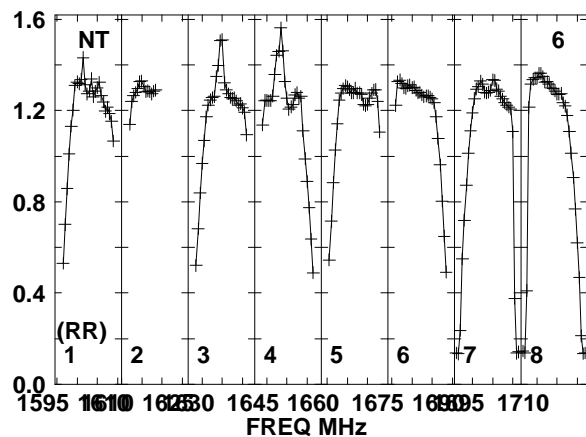
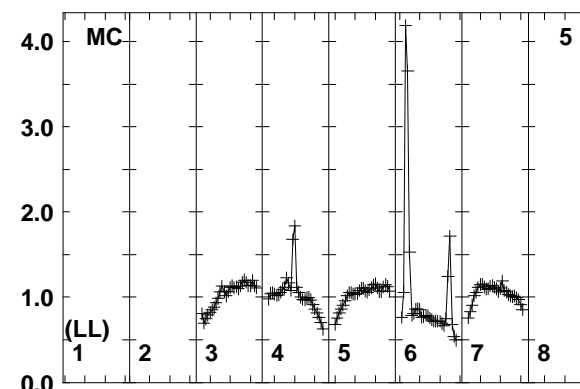
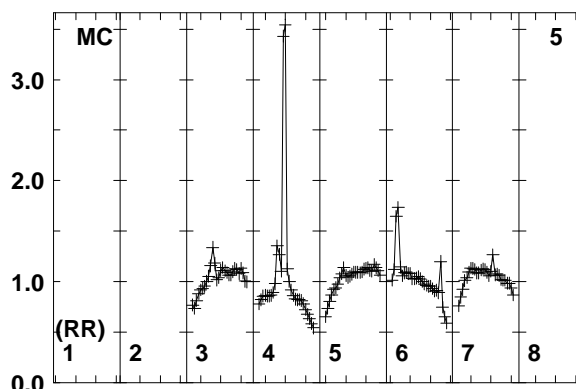
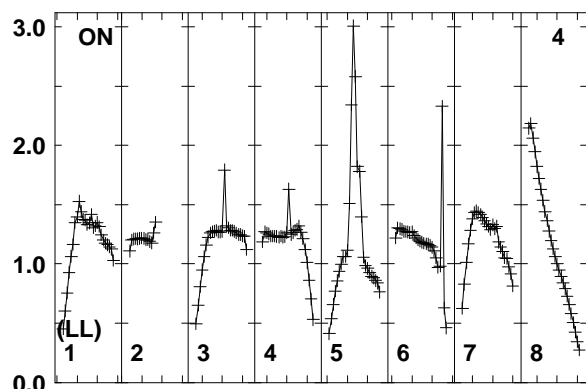
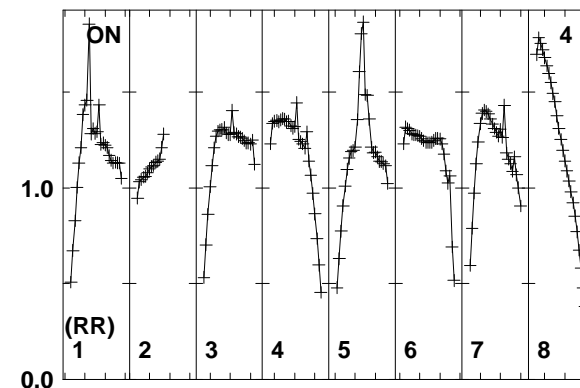
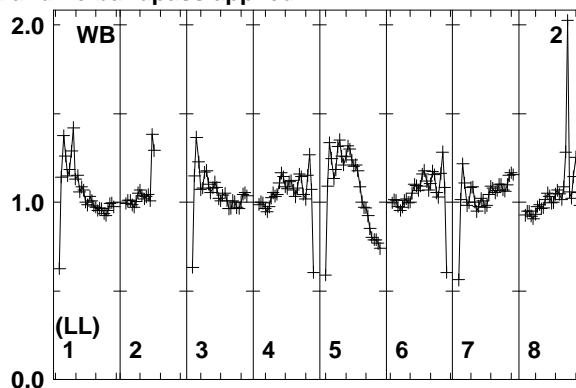
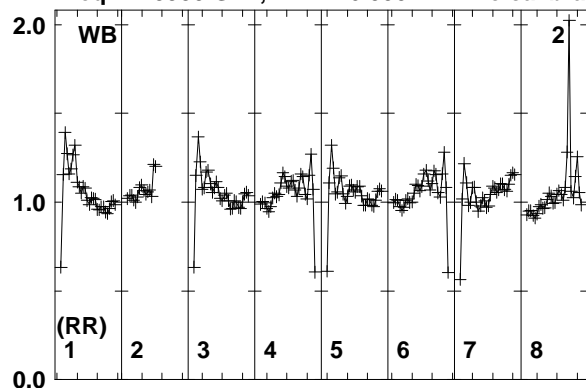

Lower frame: Real Jy
Total-power spectrum Antenna: WB (02)
Timerange: 00/05:37:03 to 00/05:39:59

Plot file version 6 created 20-MAR-2014 17:07:51

IC883 ER030C.UVDATA.1

Freq = 1.5950 GHz, Bw = 16.000 MH No calibration applied and no bandpass applied

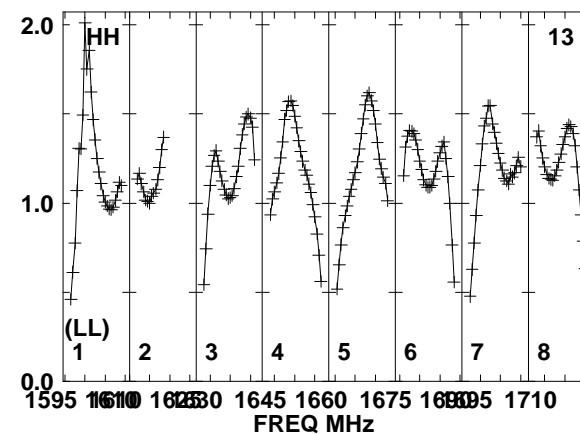
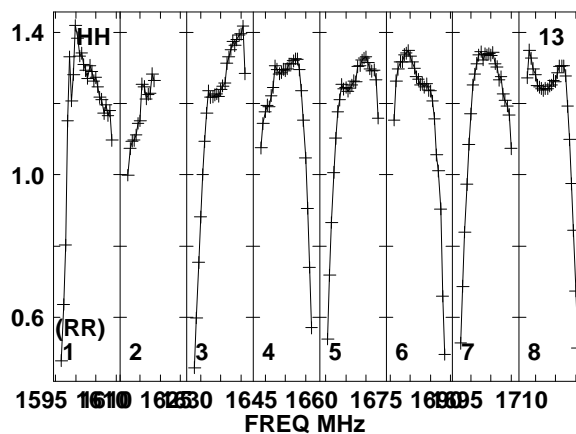
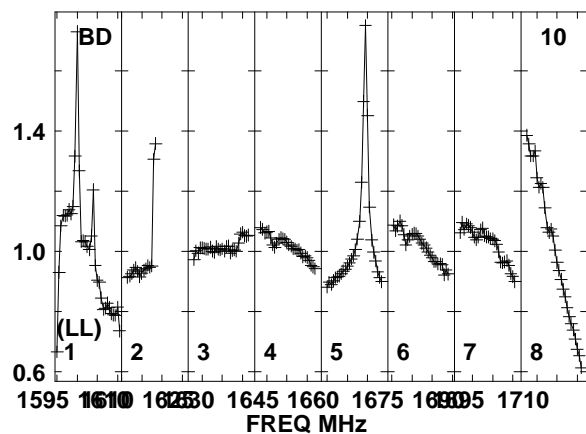
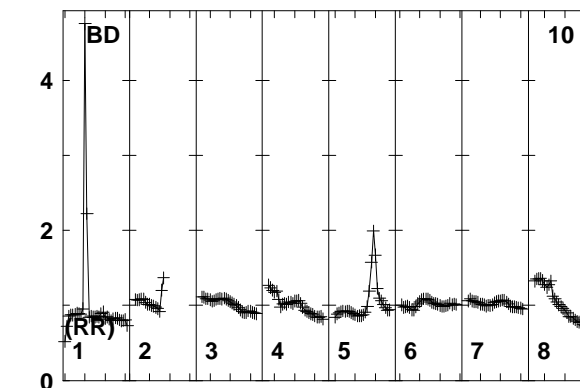
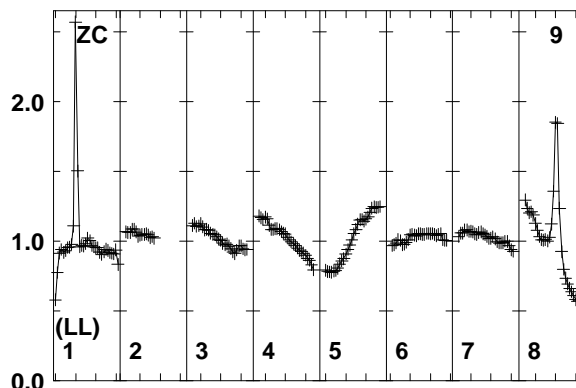
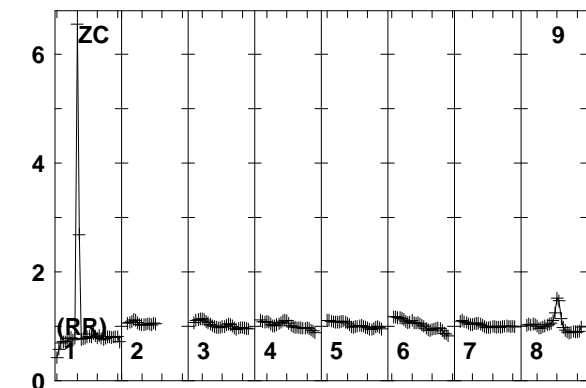
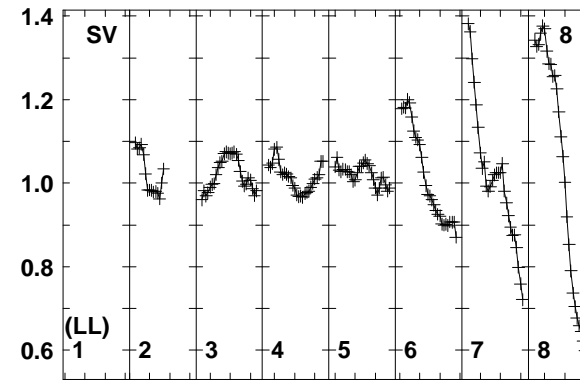
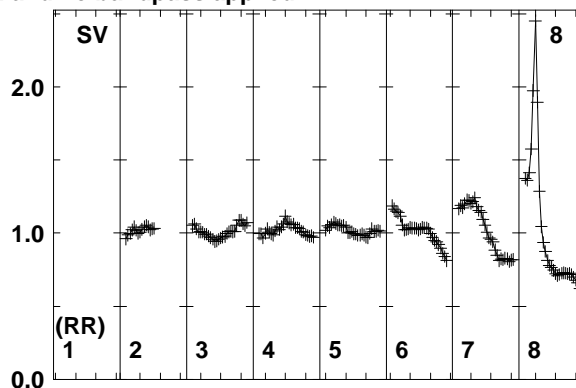
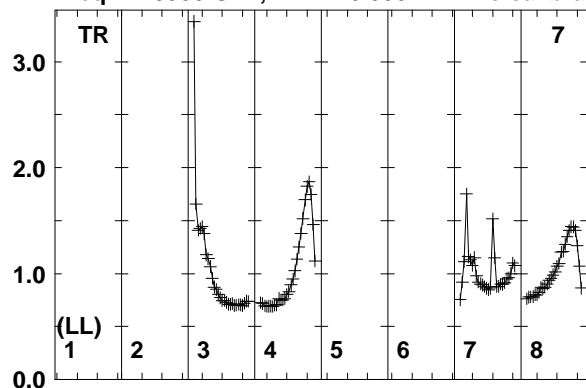

Lower frame: Real Jy
Total-power spectrum Antenna: TR (07)
Timerange: 00/05:37:03 to 00/05:39:59

Plot file version 7 created 20-MAR-2014 17:07:51

J1317+3425 ER030C.UVDATA.1

Freq = 1.5950 GHz, Bw = 16.000 MH No calibration applied and no bandpass applied

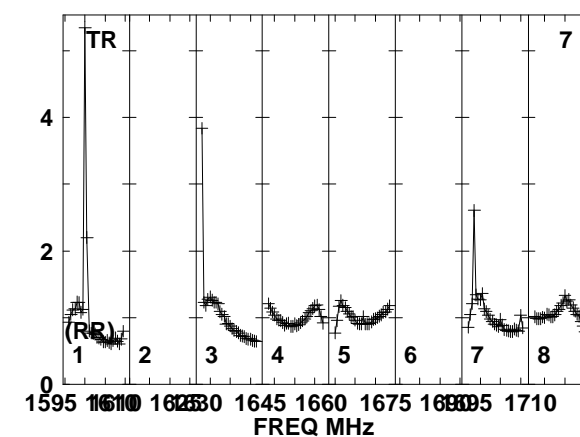
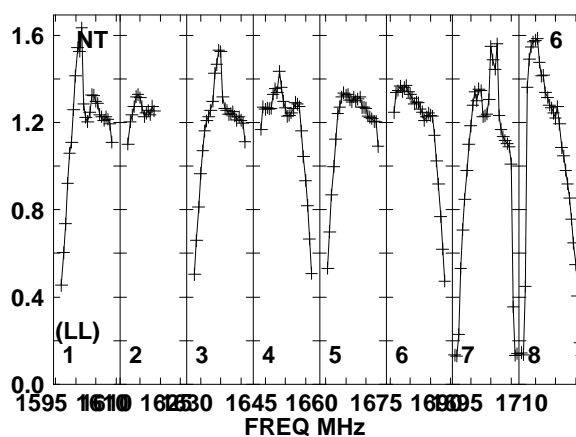
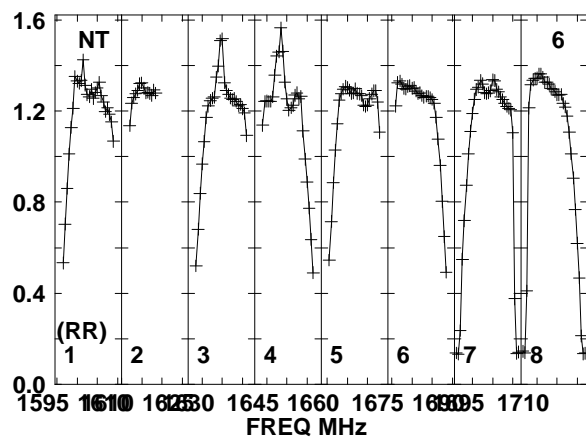
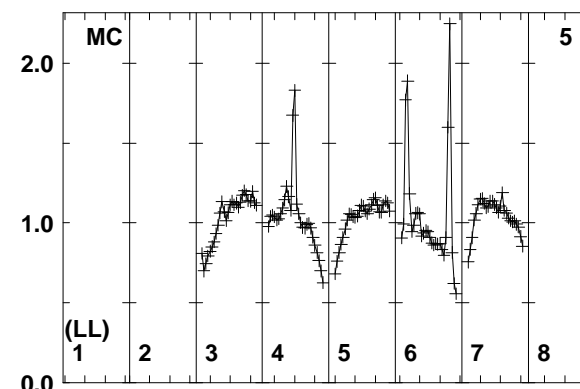
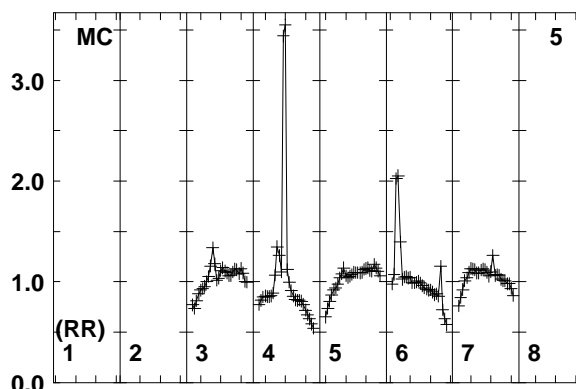
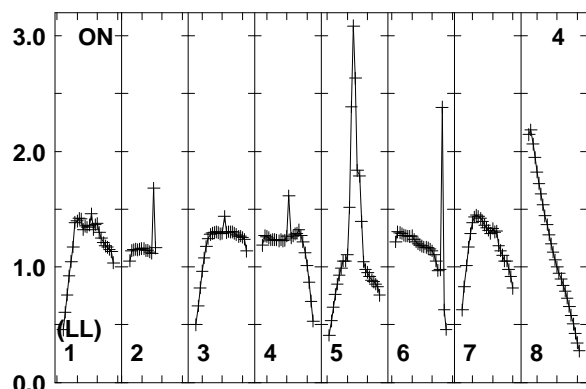
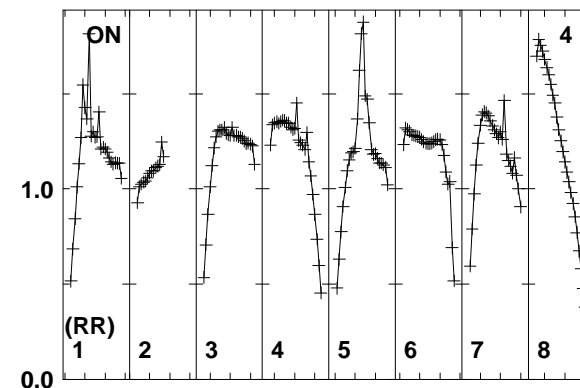
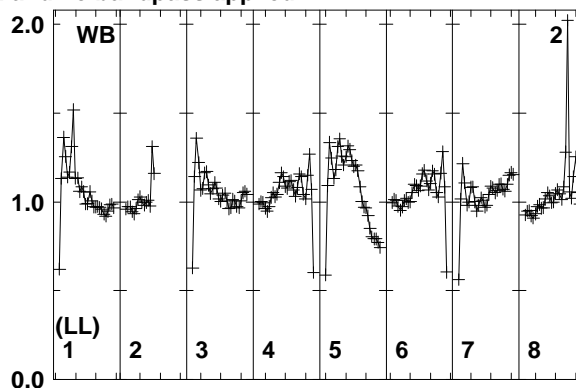
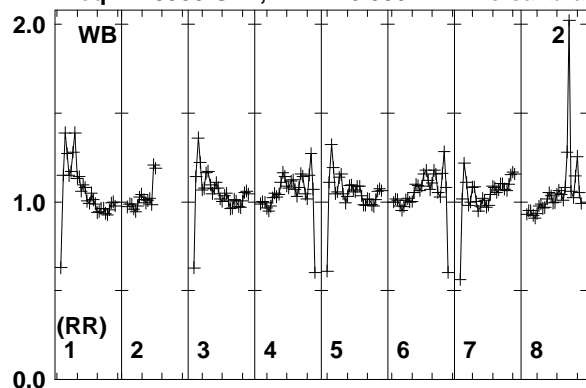

Lower frame: Real Jy
Total-power spectrum Antenna: WB (02)
Timerange: 00/05:40:03 to 00/05:41:19

Plot file version 8 created 20-MAR-2014 17:07:51

J1317+3425 ER030C.UVDATA.1

Freq = 1.5950 GHz, Bw = 16.000 MH No calibration applied and no bandpass applied

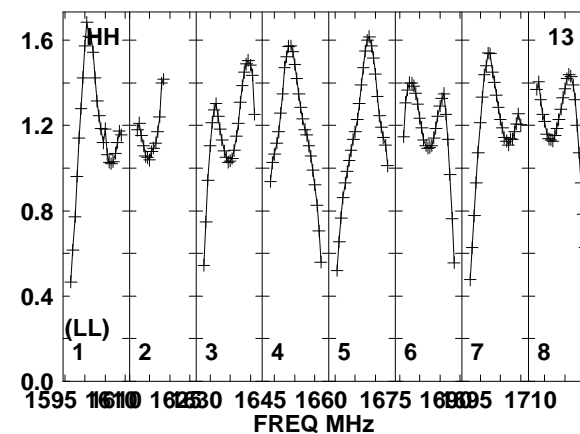
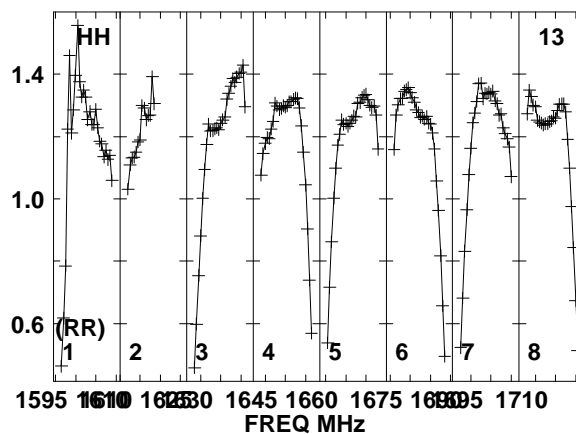
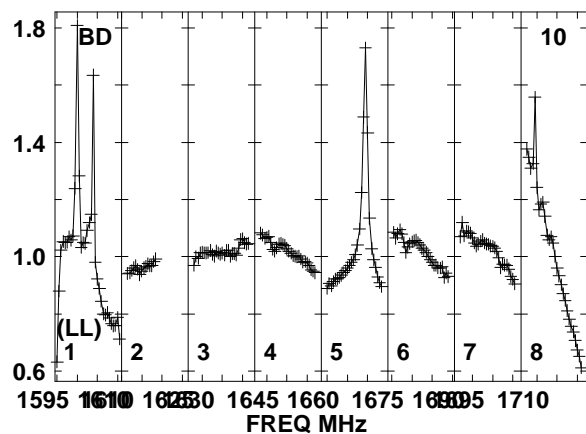
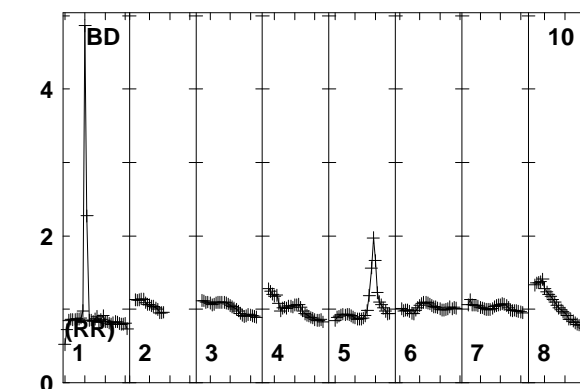
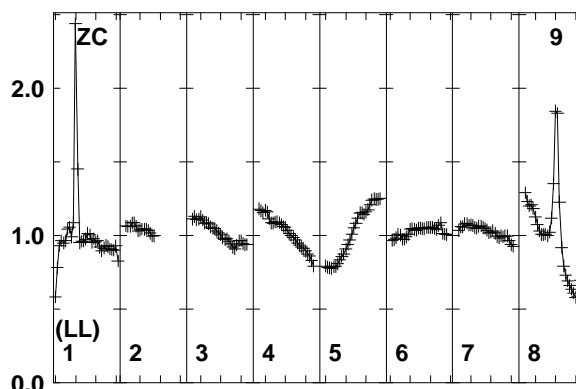
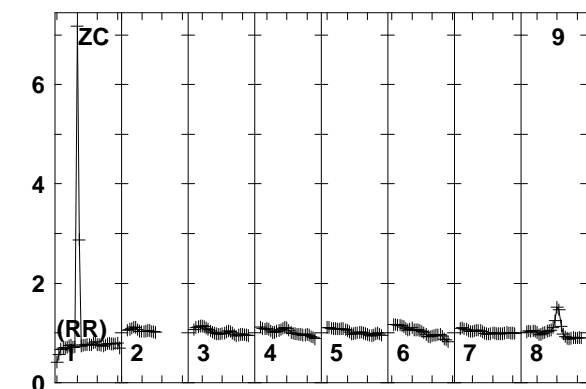
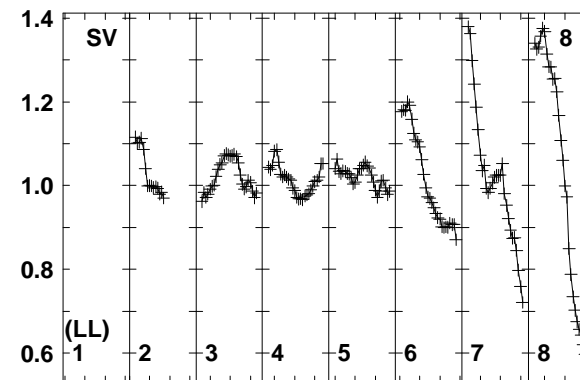
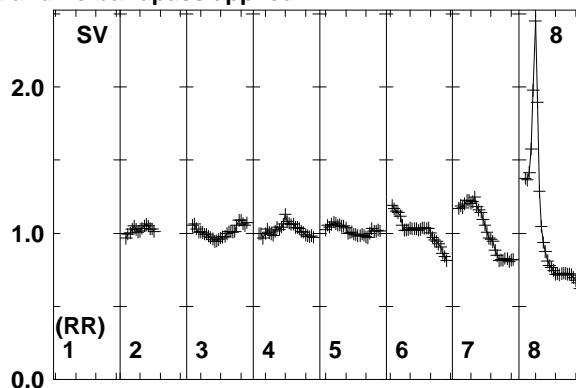
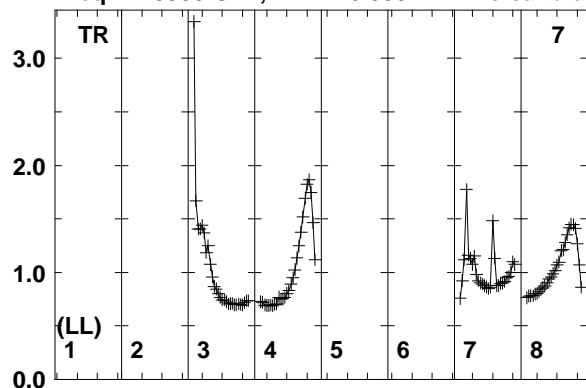

Lower frame: Real Jy
Total-power spectrum Antenna: TR (07)
Timerange: 00/05:40:03 to 00/05:41:19

Plot file version 9 created 20-MAR-2014 17:07:52

IC883 ER030C.UVDATA.1

Freq = 1.5950 GHz, Bw = 16.000 MH No calibration applied and no bandpass applied

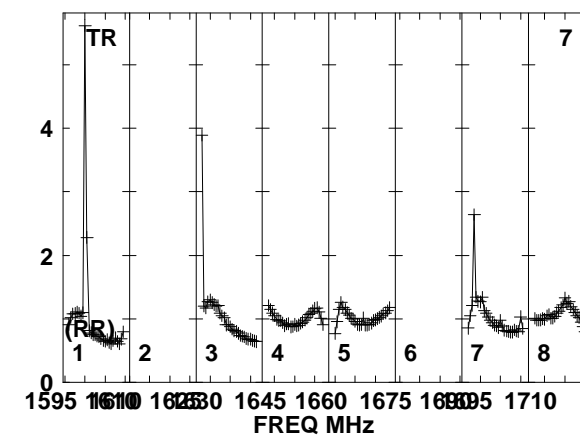
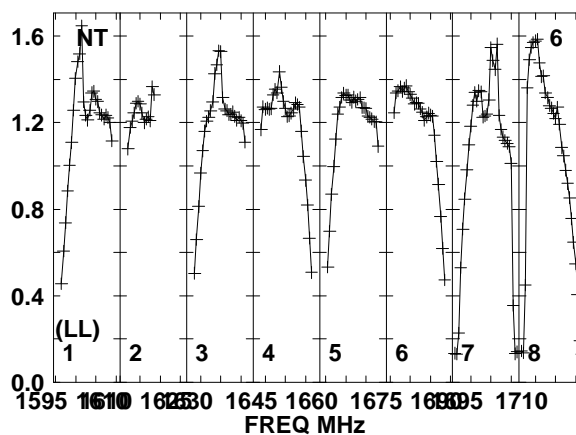
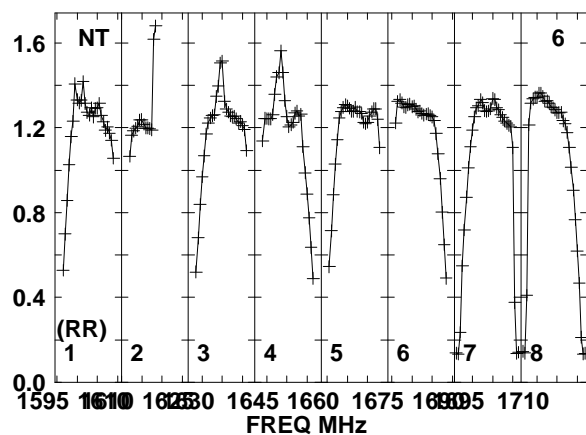
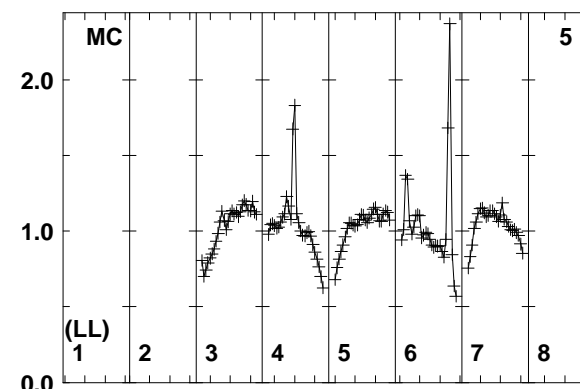
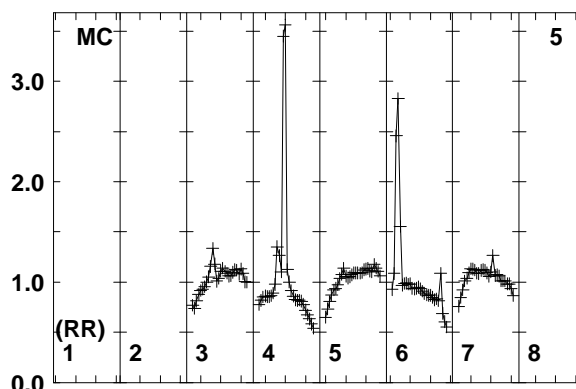
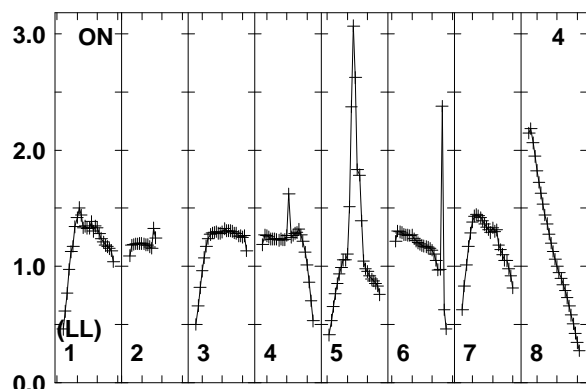
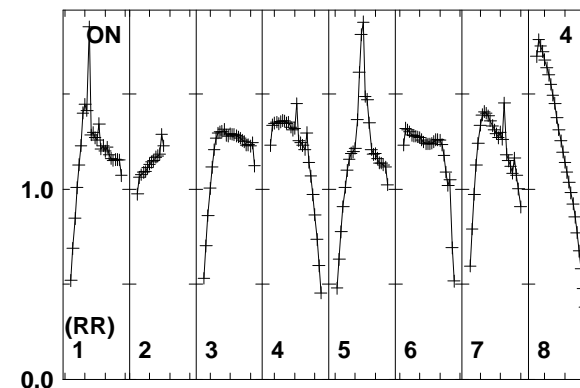
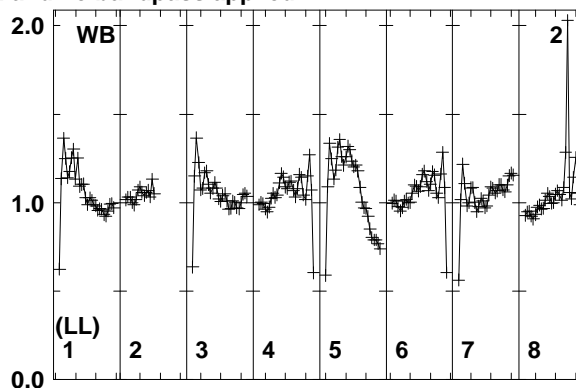
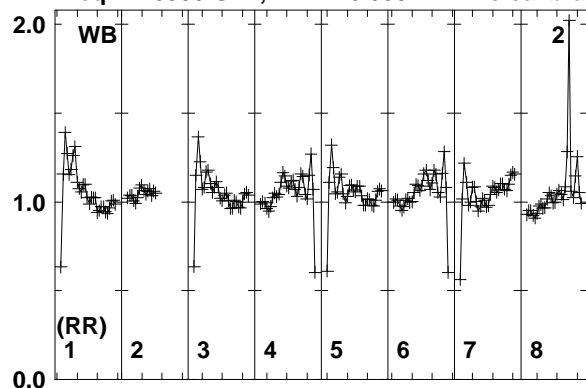

Lower frame: Real Jy
Total-power spectrum Antenna: WB (02)
Timerange: 00/05:41:21 to 00/05:45:09

Plot file version 10 created 20-MAR-2014 17:07:52

IC883 ER030C.UVDATA.1

Freq = 1.5950 GHz, Bw = 16.000 MH No calibration applied and no bandpass applied

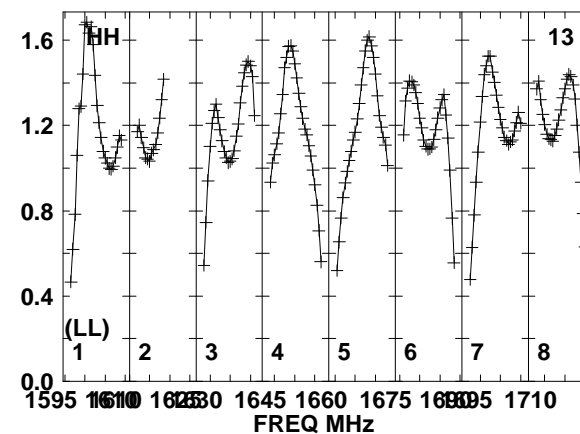
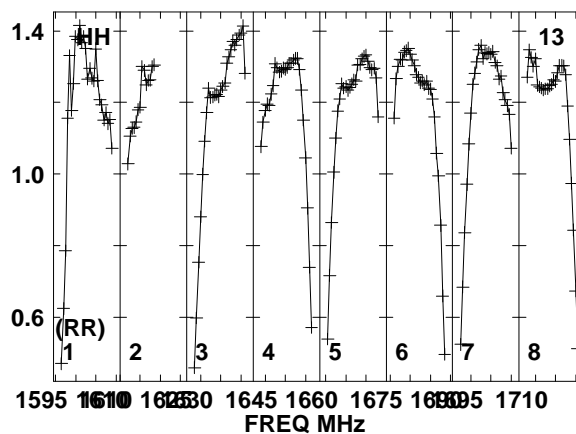
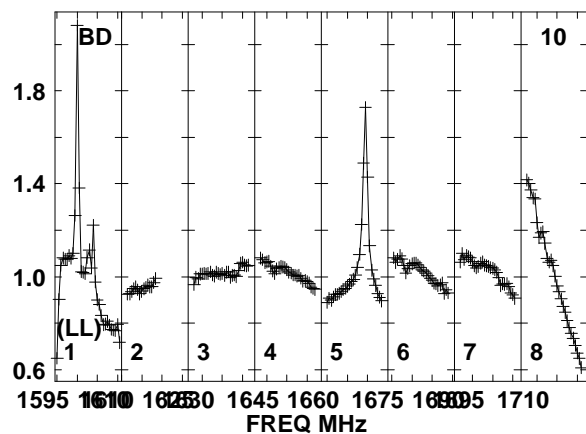
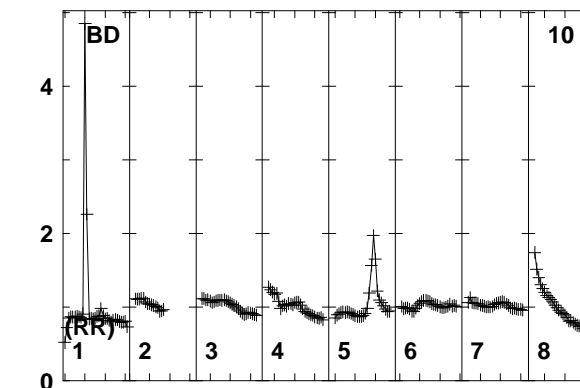
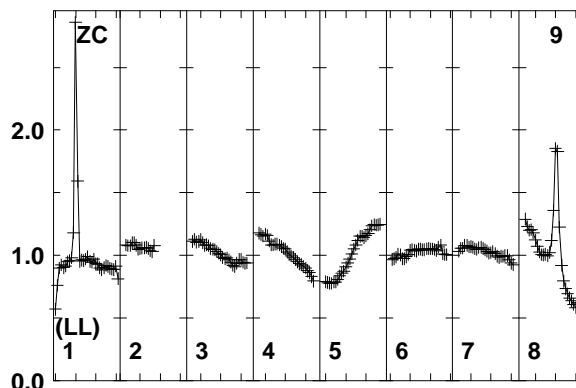
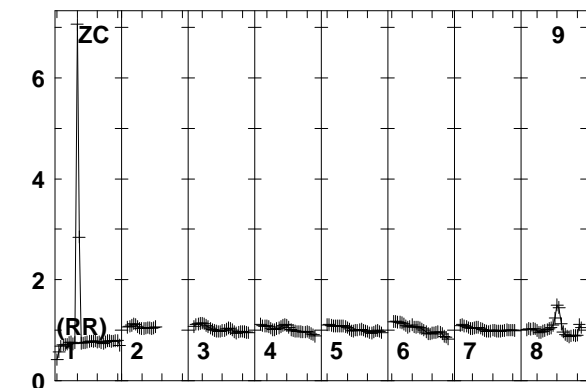
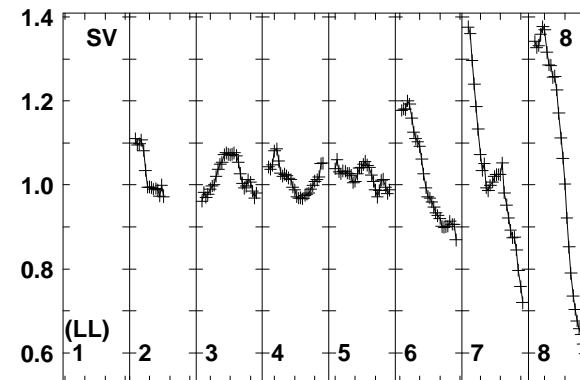
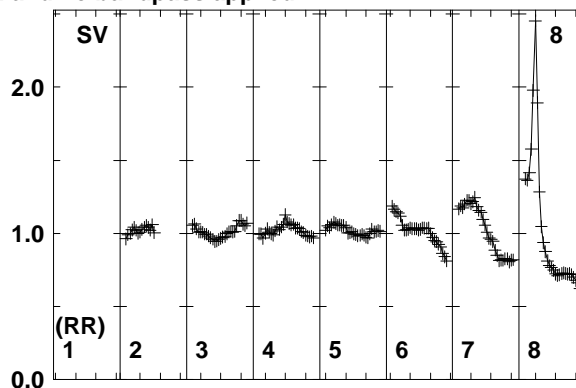
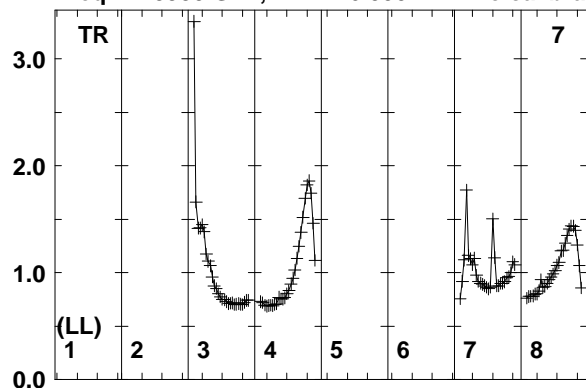

Lower frame: Real Jy
Total-power spectrum Antenna: TR (07)
Timerange: 00/05:41:21 to 00/05:45:09

Plot file version 11 created 20-MAR-2014 17:07:52

J1317+3425 ER030C.UVDATA.1

Freq = 1.5950 GHz, Bw = 16.000 MH No calibration applied and no bandpass applied

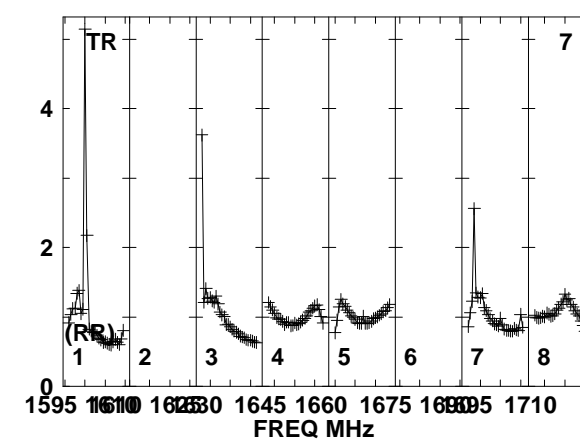
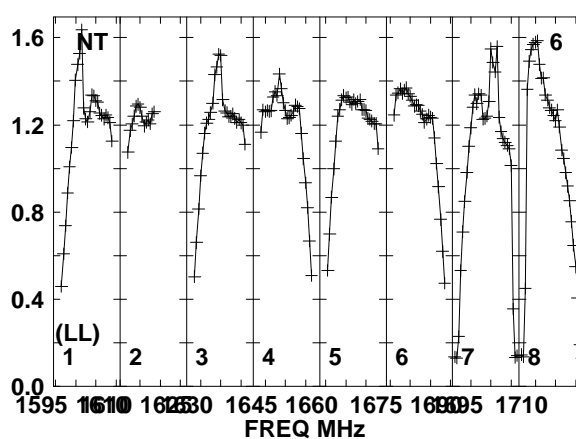
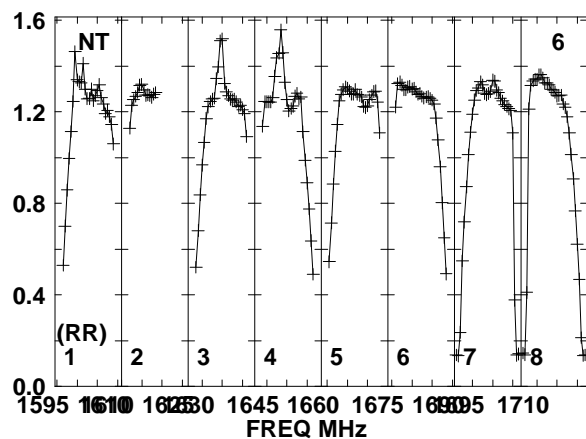
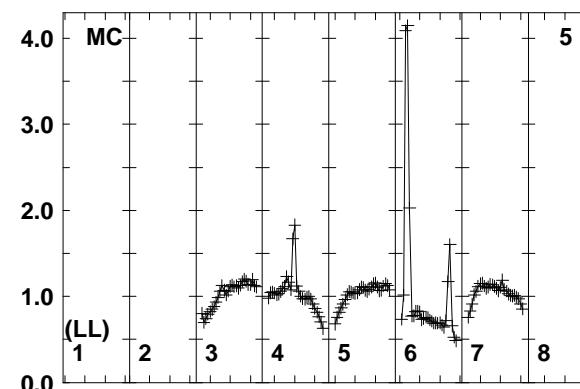
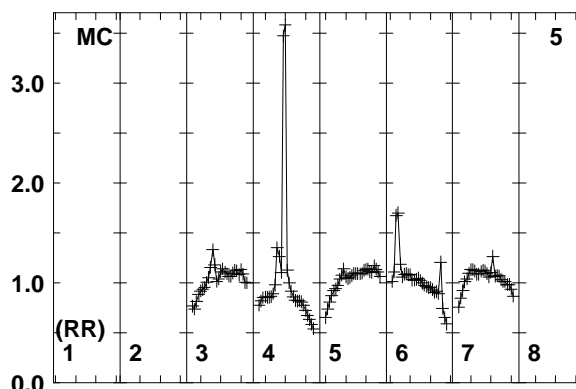
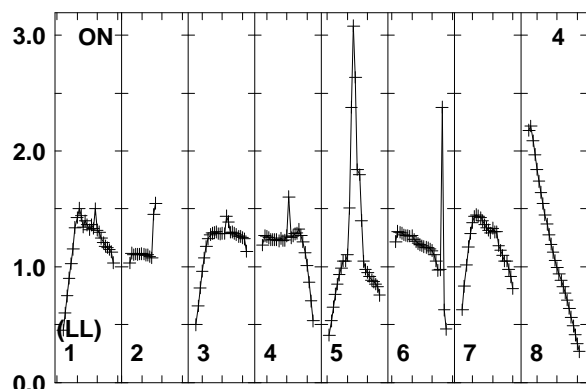
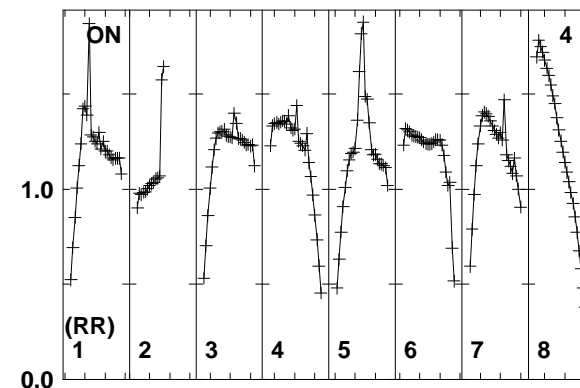
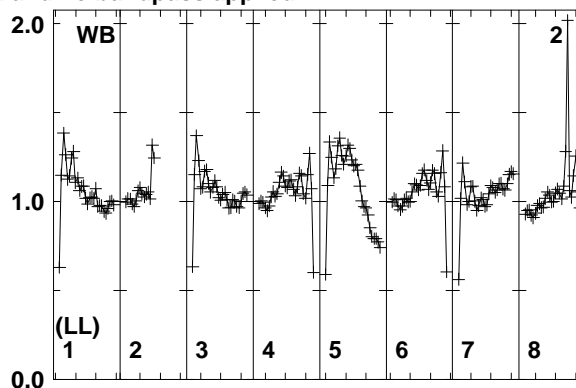
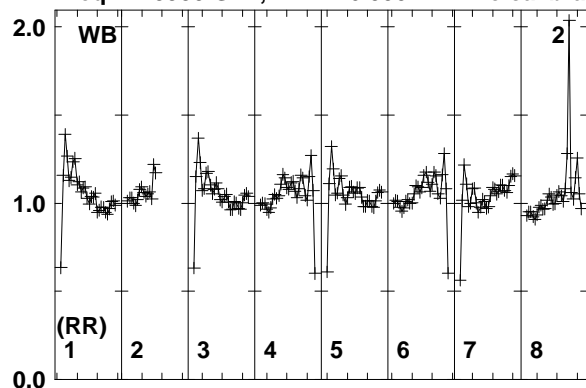

Lower frame: Real Jy
Total-power spectrum Antenna: WB (02)
Timerange: 00/05:45:51 to 00/05:46:49

Plot file version 12 created 20-MAR-2014 17:07:52

J1317+3425 ER030C.UVDATA.1

Freq = 1.5950 GHz, Bw = 16.000 MH No calibration applied and no bandpass applied

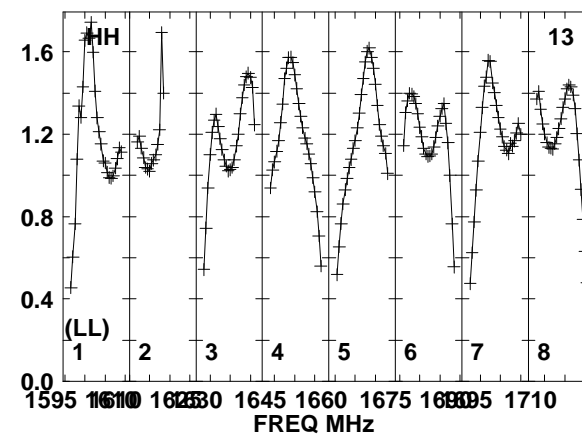
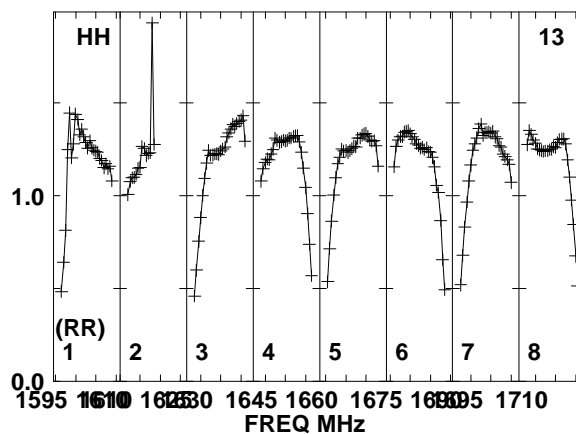
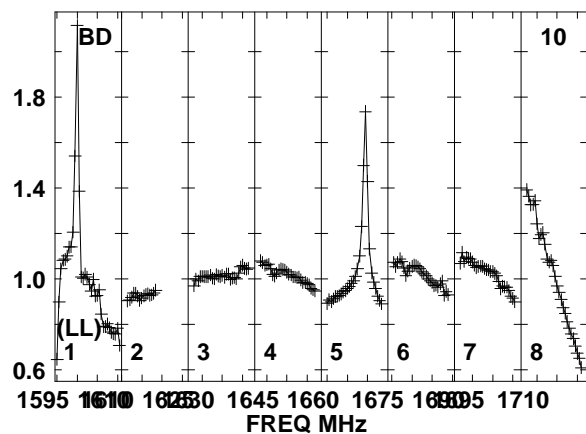
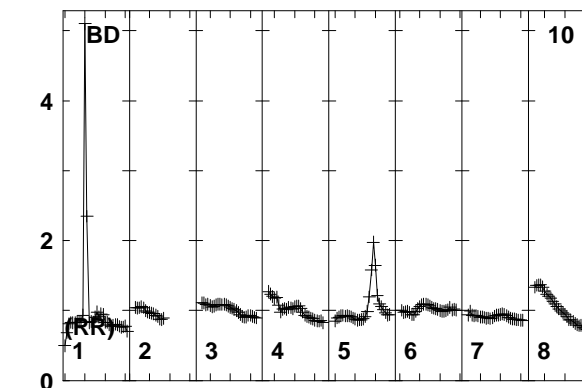
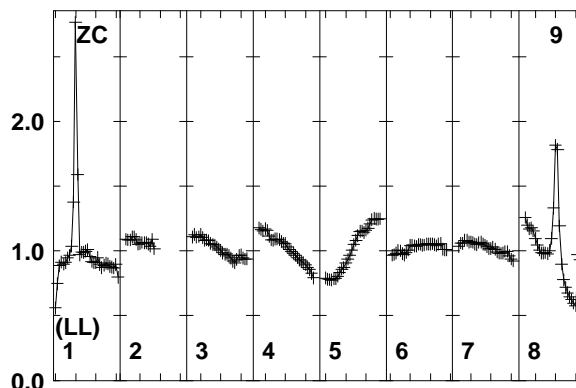
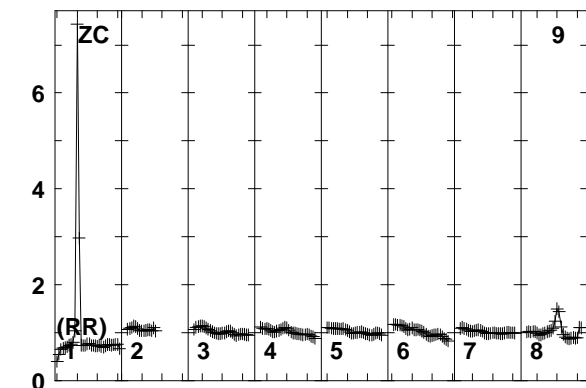
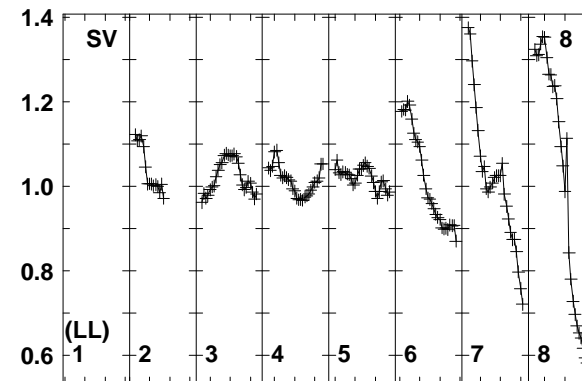
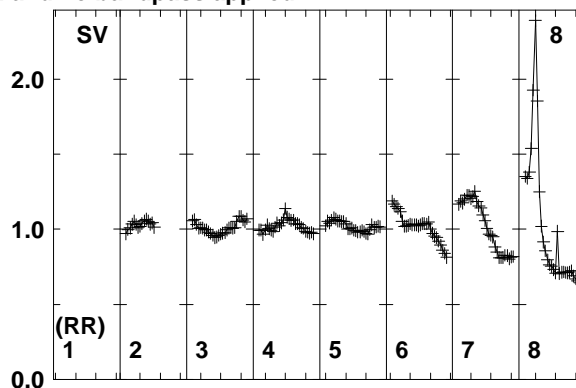
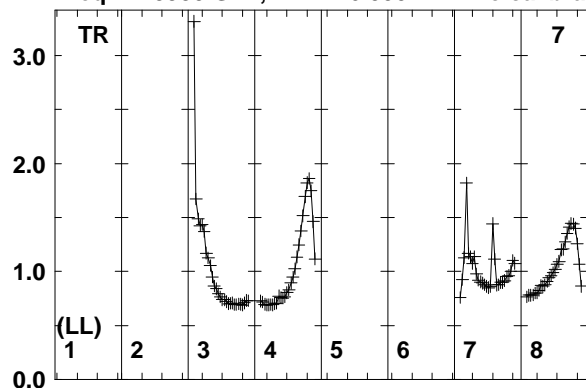

Lower frame: Real Jy
Total-power spectrum Antenna: TR (07)
Timerange: 00/05:45:51 to 00/05:46:49

Plot file version 13 created 20-MAR-2014 17:07:52

IC883 ER030C.UVDATA.1

Freq = 1.5950 GHz, Bw = 16.000 MH No calibration applied and no bandpass applied

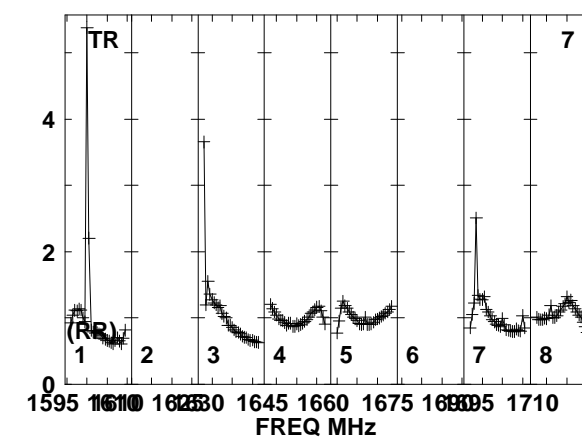
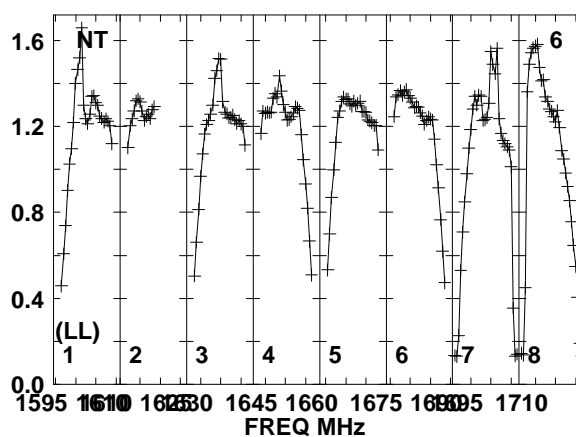
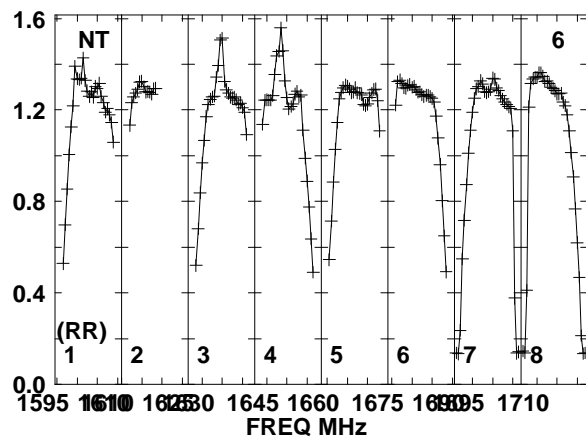
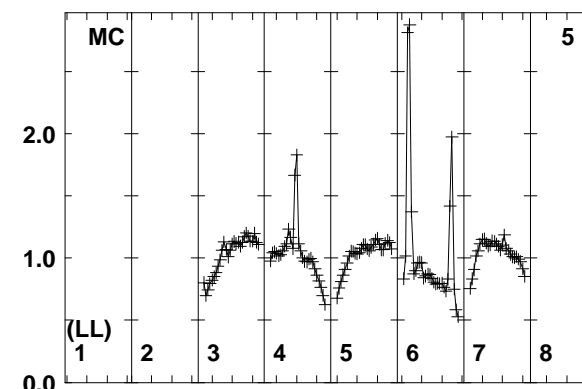
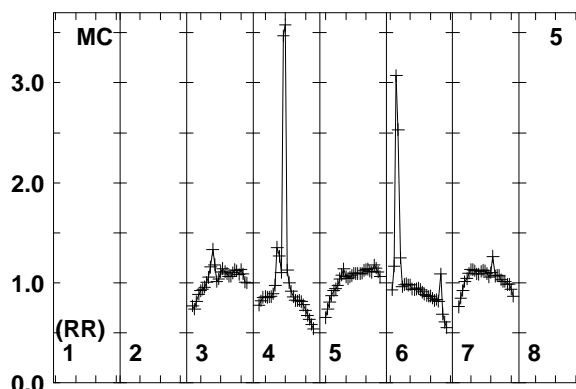
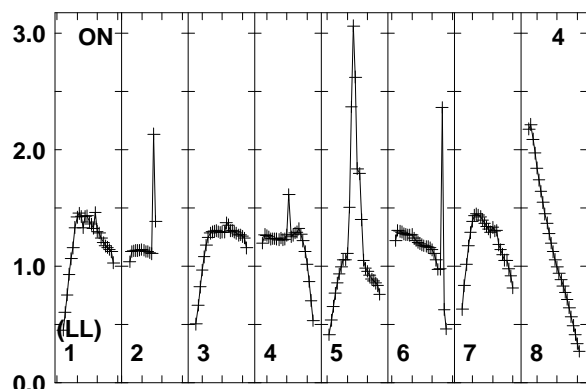
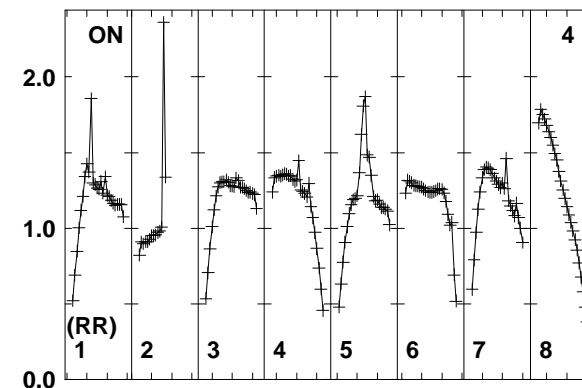
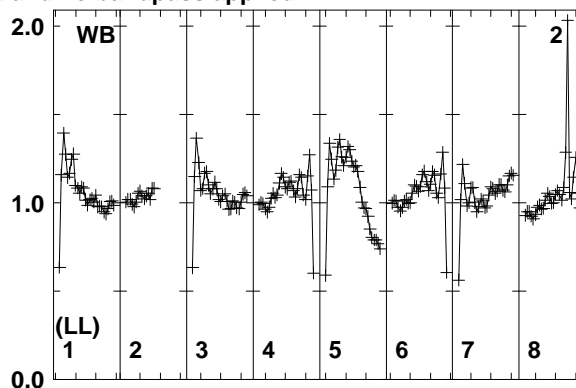
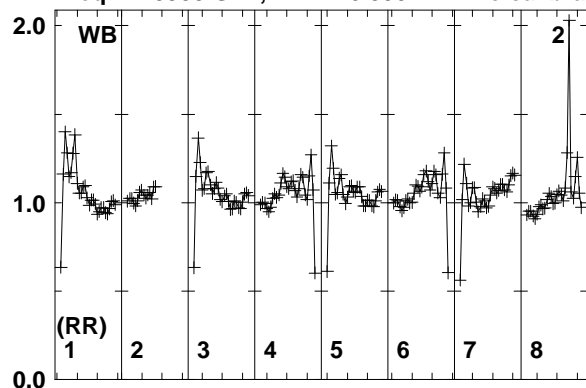

Lower frame: Real Jy
Total-power spectrum Antenna: WB (02)
Timerange: 00/05:46:53 to 00/05:50:39

Plot file version 14 created 20-MAR-2014 17:07:52

IC883 ER030C.UVDATA.1

Freq = 1.5950 GHz, Bw = 16.000 MH No calibration applied and no bandpass applied

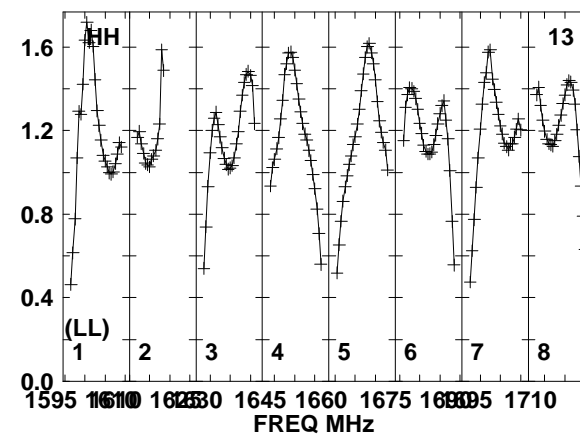
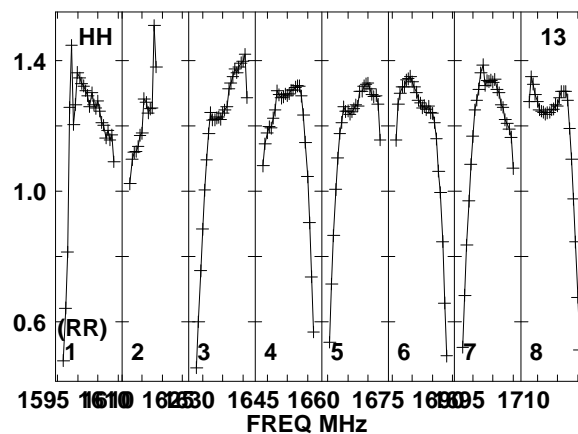
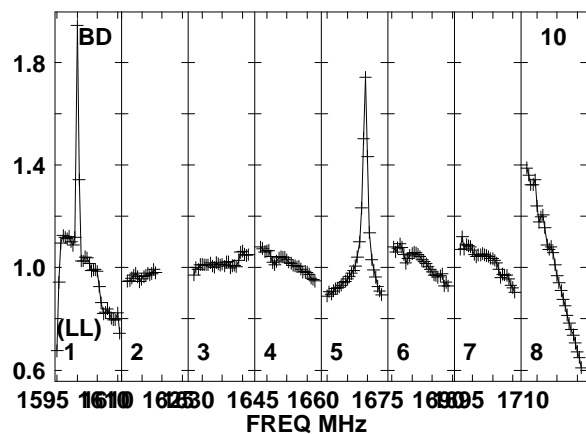
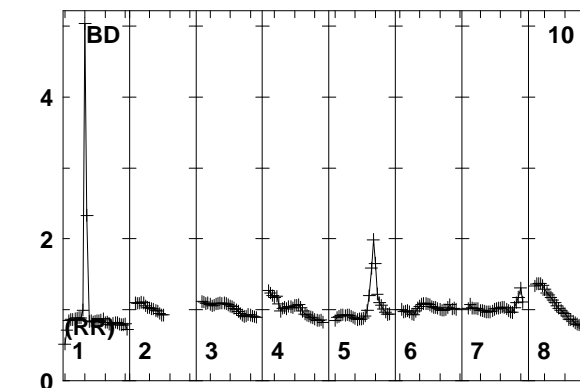
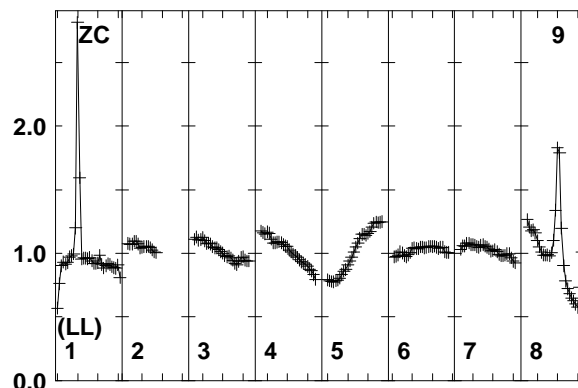
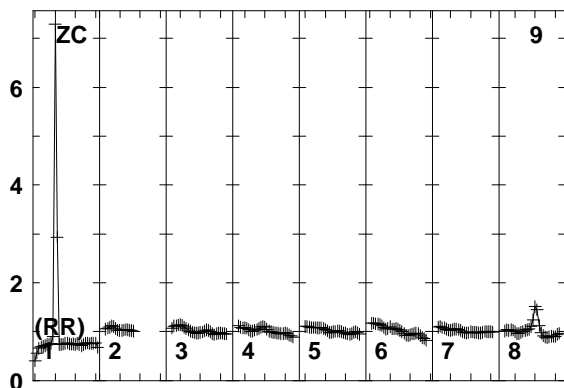
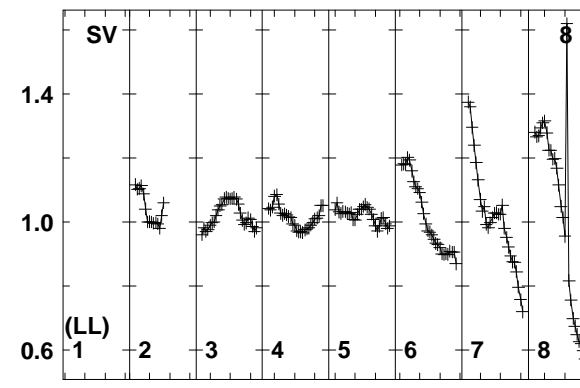
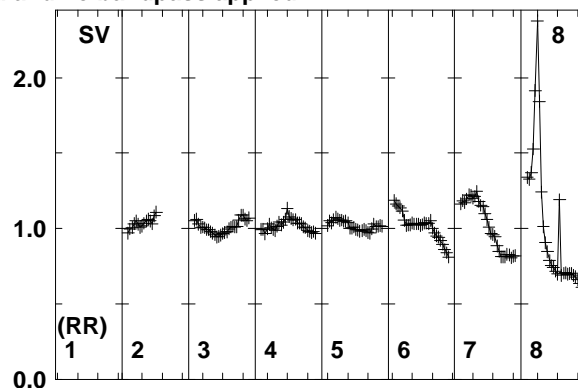
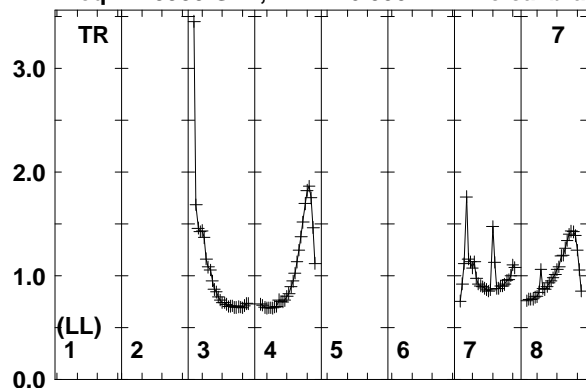

Lower frame: Real Jy
Total-power spectrum Antenna: TR (07)
Timerange: 00/05:46:53 to 00/05:50:39

Plot file version 15 created 20-MAR-2014 17:07:52

J1317+3425 ER030C.UVDATA.1

Freq = 1.5950 GHz, Bw = 16.000 MH No calibration applied and no bandpass applied

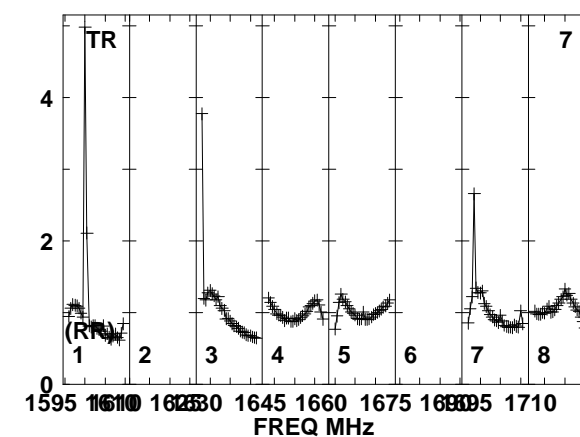
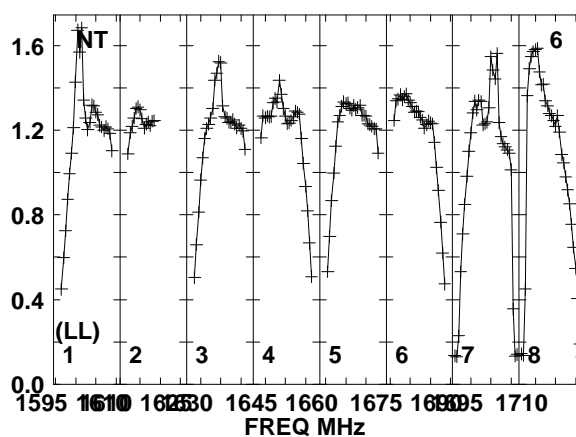
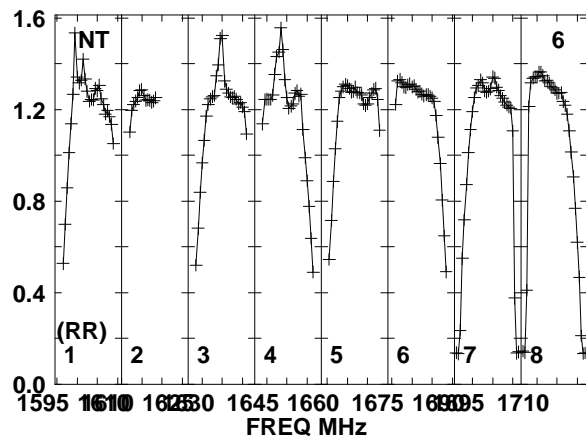
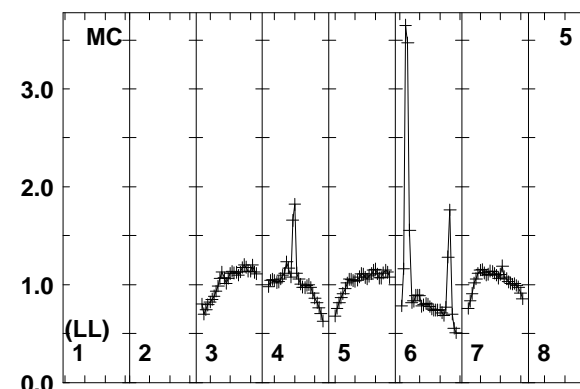
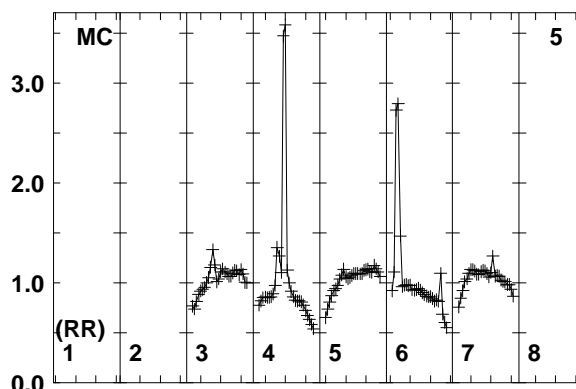
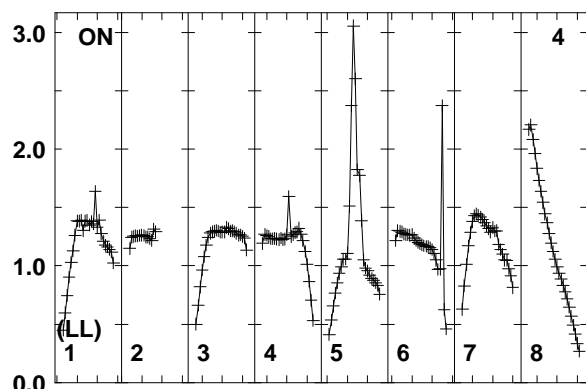
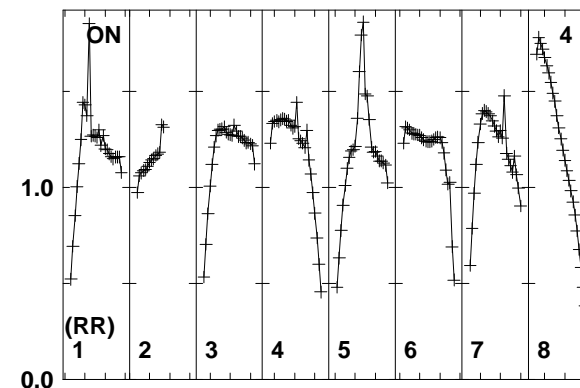
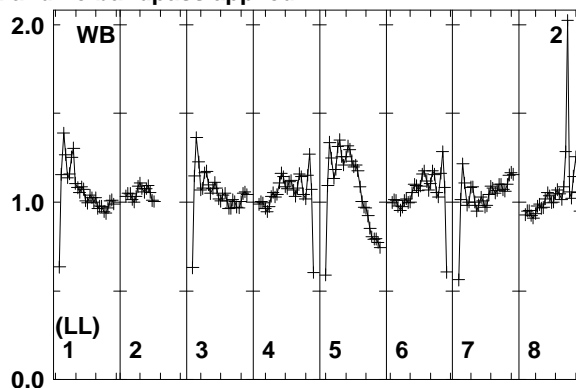
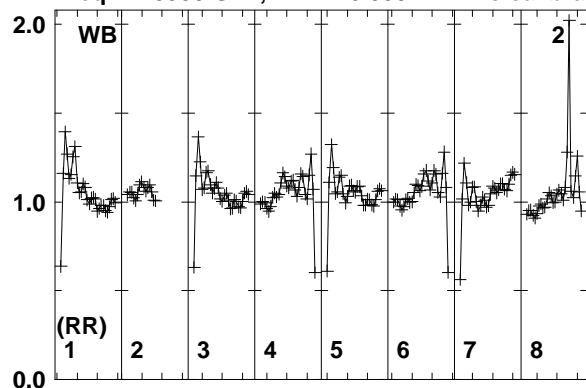

Lower frame: Real Jy
Total-power spectrum Antenna: WB (02)
Timerange: 00/05:50:43 to 00/05:51:59

Plot file version 16 created 20-MAR-2014 17:07:52

J1317+3425 ER030C.UVDATA.1

Freq = 1.5950 GHz, Bw = 16.000 MH No calibration applied and no bandpass applied

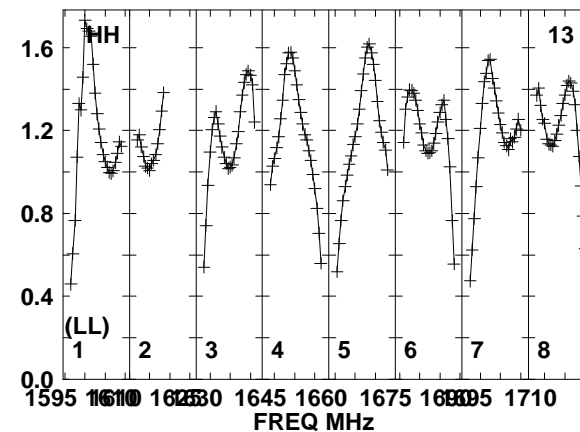
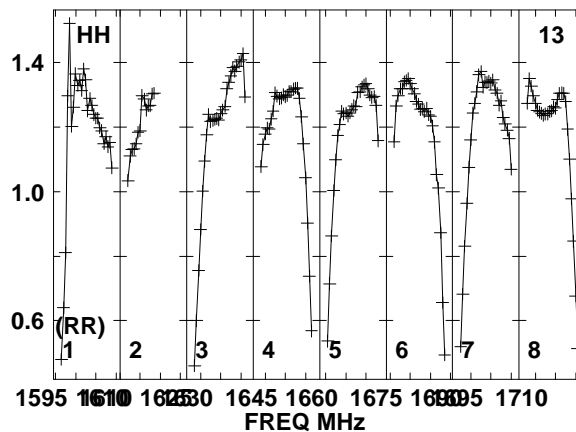
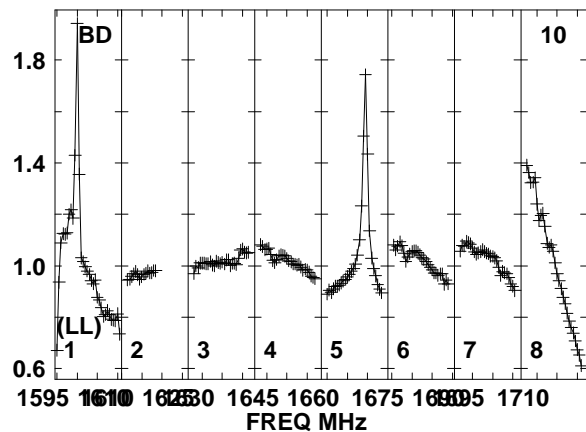
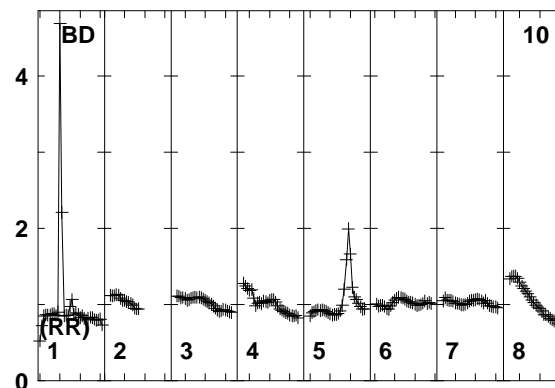
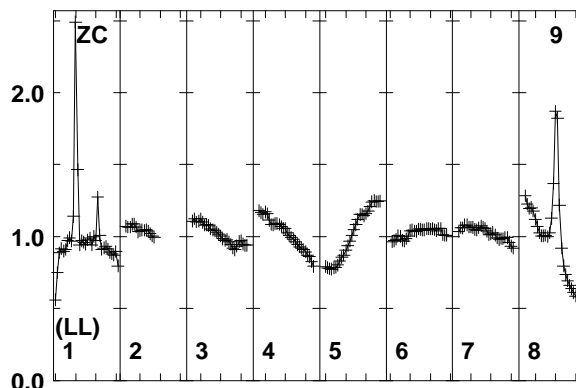
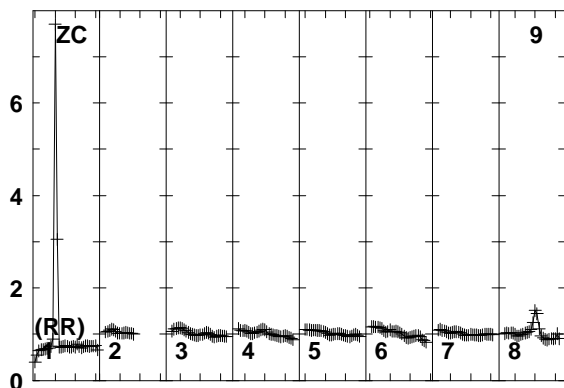
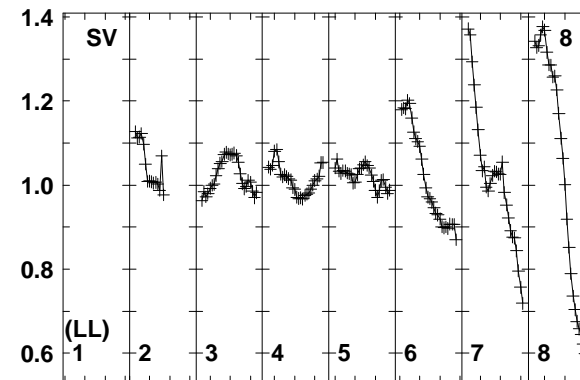
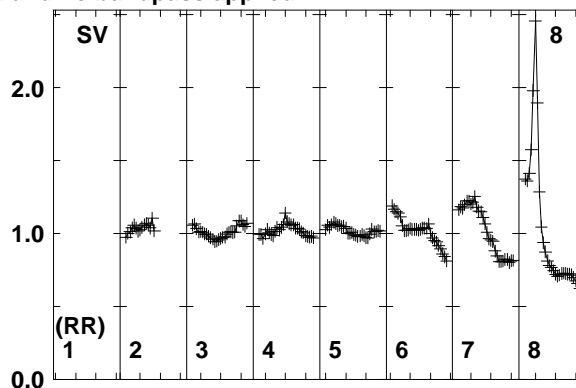
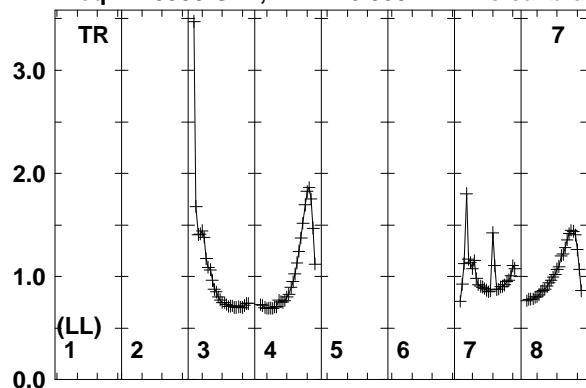

Lower frame: Real Jy
Total-power spectrum Antenna: TR (07)
Timerange: 00/05:50:43 to 00/05:51:59

Plot file version 17 created 20-MAR-2014 17:07:52

IC883 ER030C.UVDATA.1

Freq = 1.5950 GHz, Bw = 16.000 MH No calibration applied and no bandpass applied

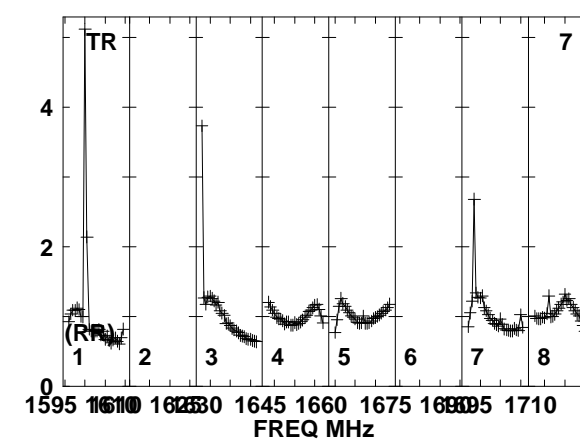
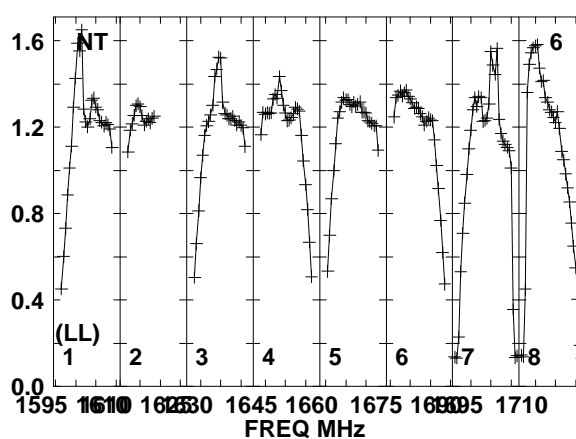
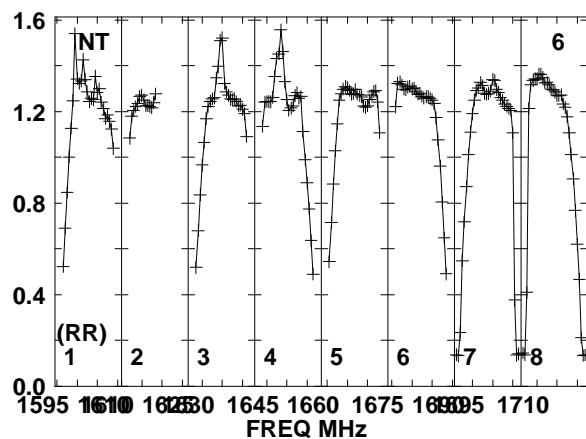
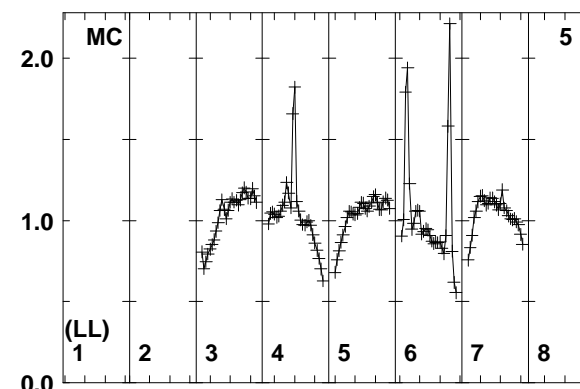
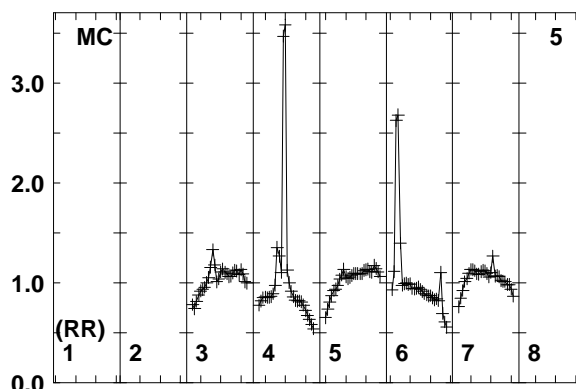
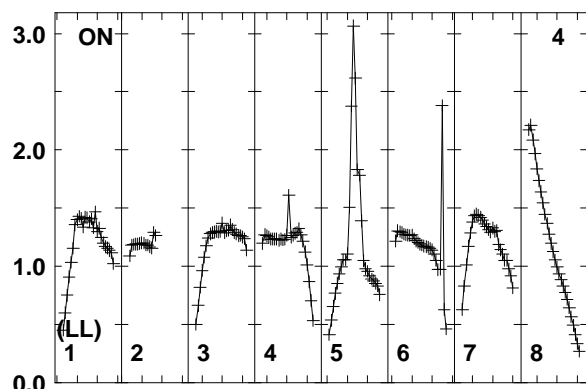
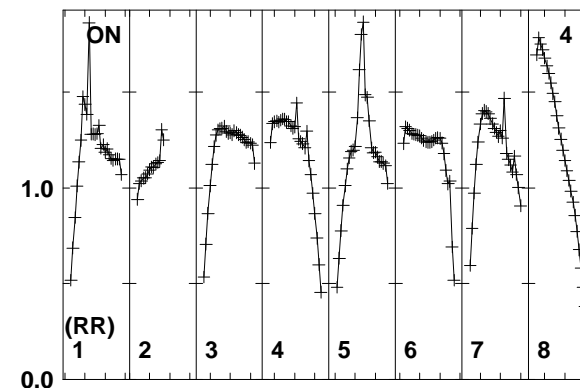
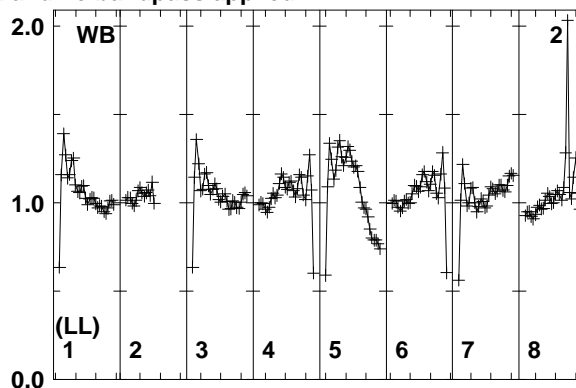
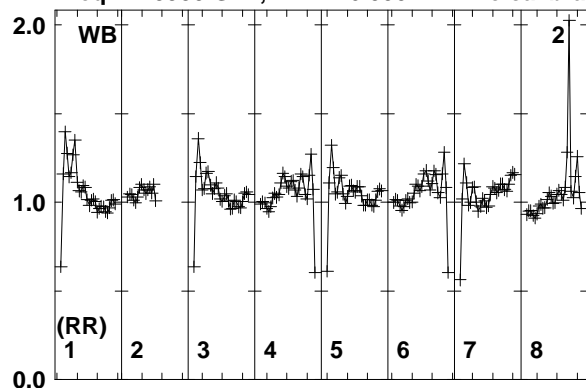

Lower frame: Real Jy
Total-power spectrum Antenna: WB (02)
Timerange: 00/05:52:01 to 00/05:55:49

Plot file version 18 created 20-MAR-2014 17:07:52

IC883 ER030C.UVDATA.1

Freq = 1.5950 GHz, Bw = 16.000 MH No calibration applied and no bandpass applied

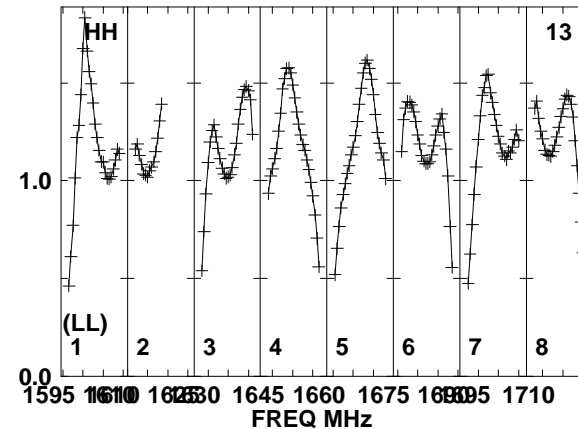
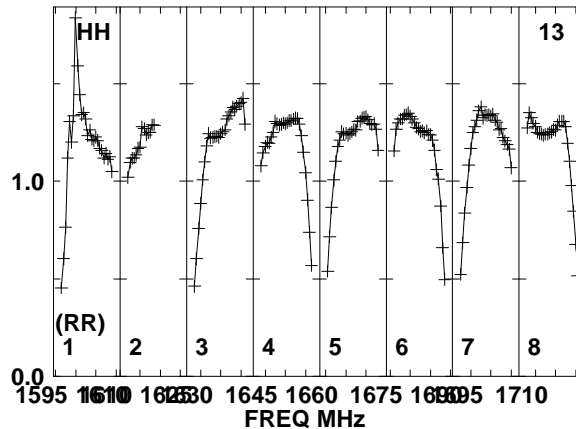
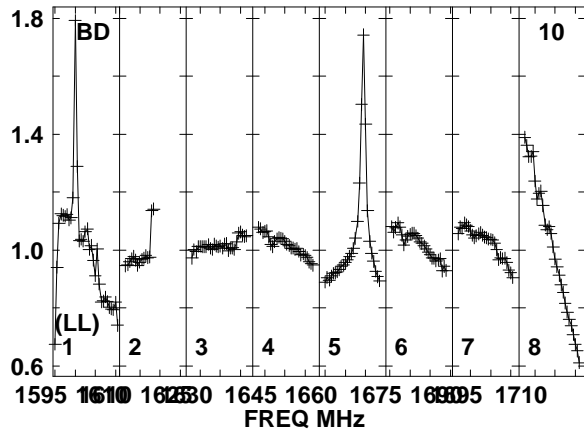
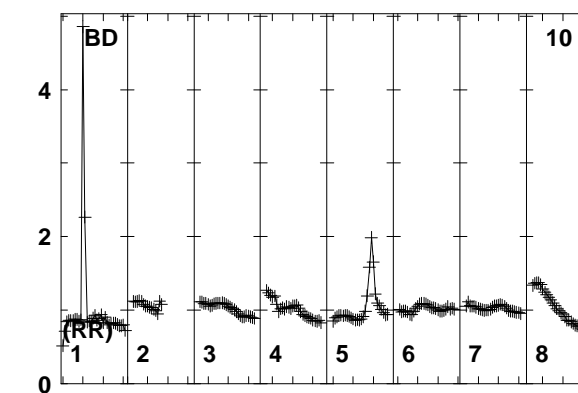
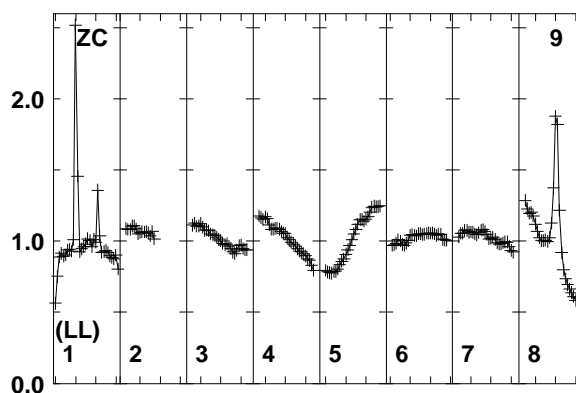
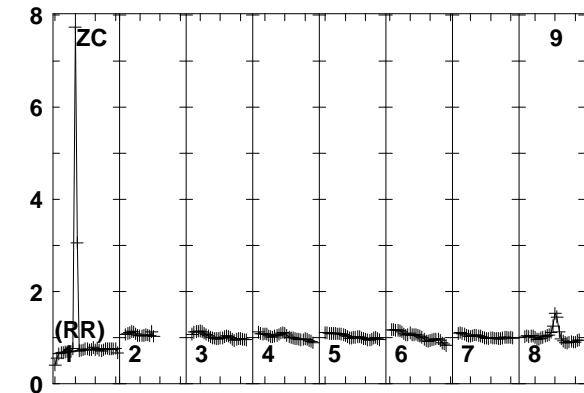
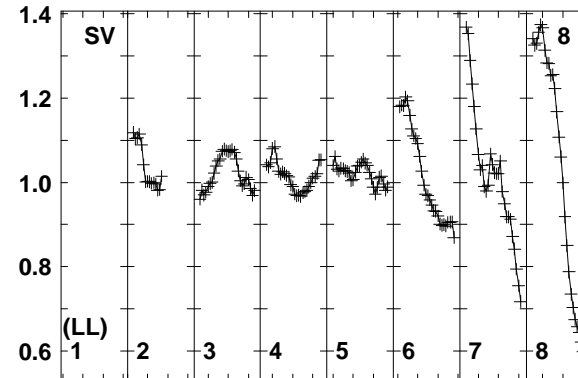
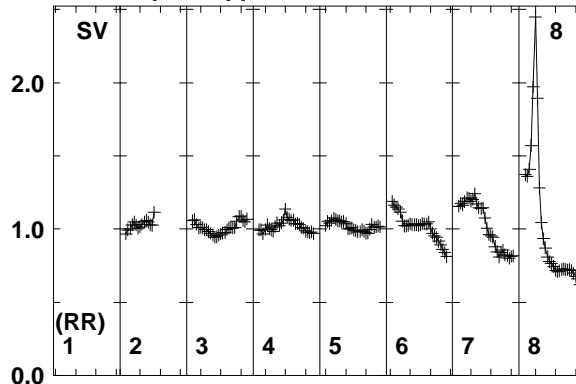
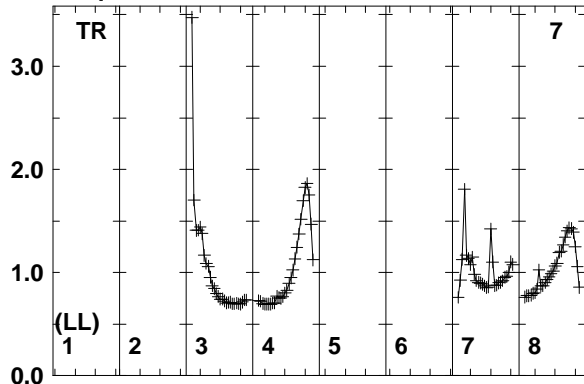

Lower frame: Real Jy
Total-power spectrum Antenna: TR (07)
Timerange: 00/05:52:01 to 00/05:55:49

Plot file version 19 created 20-MAR-2014 17:07:53

J1317+3425 ER030C.UVDATA.1

Freq = 1.5950 GHz, Bw = 16.000 MH No calibration applied and no bandpass applied

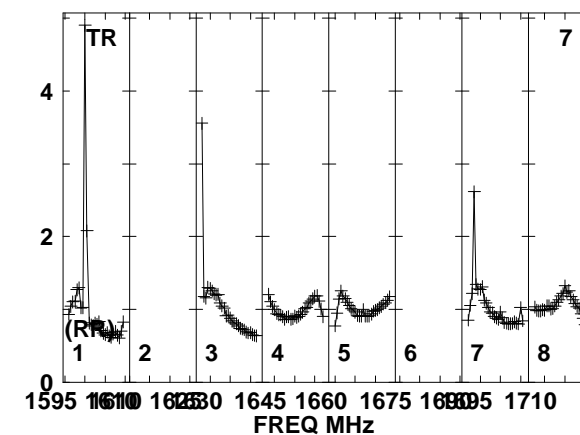
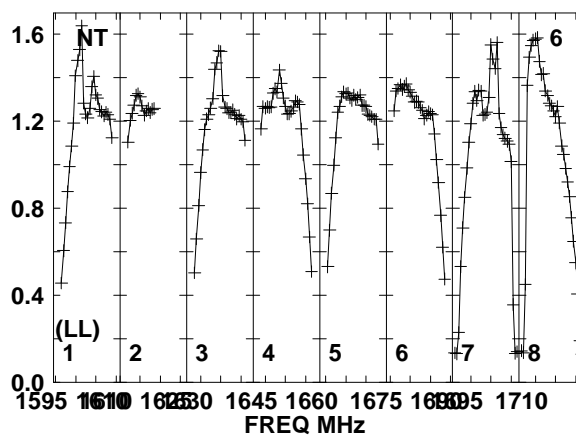
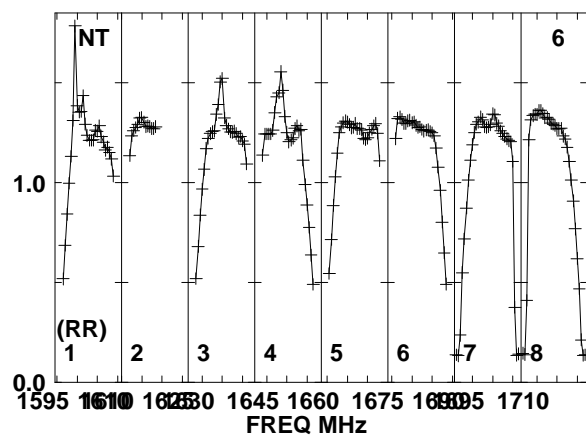
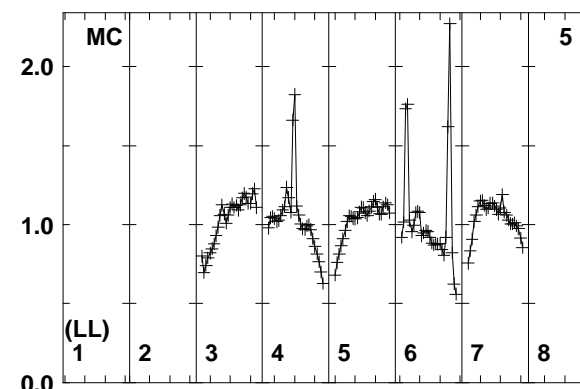
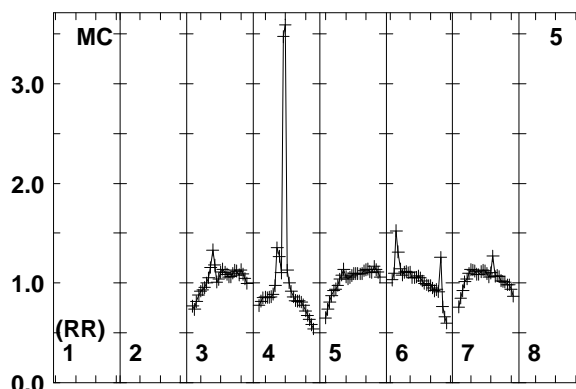
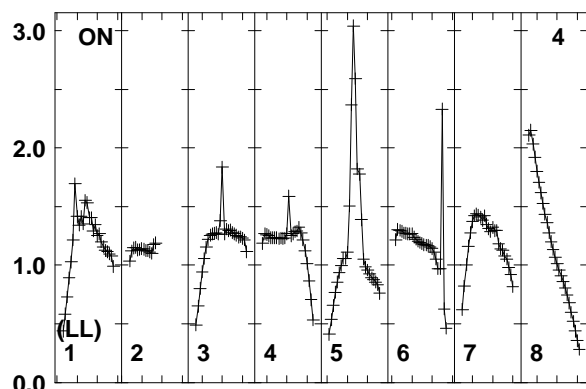
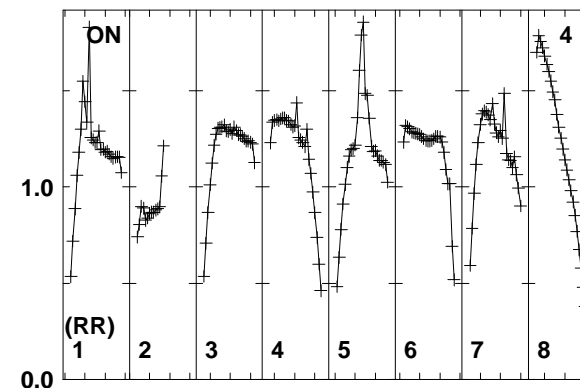
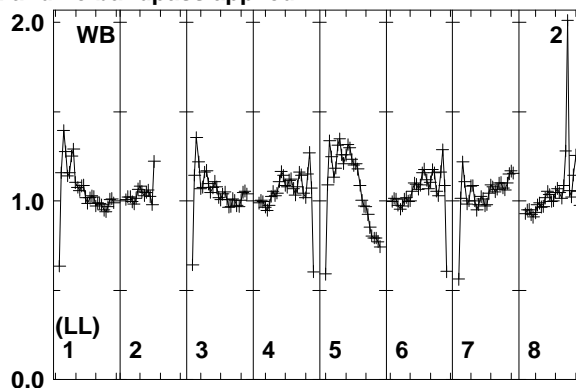
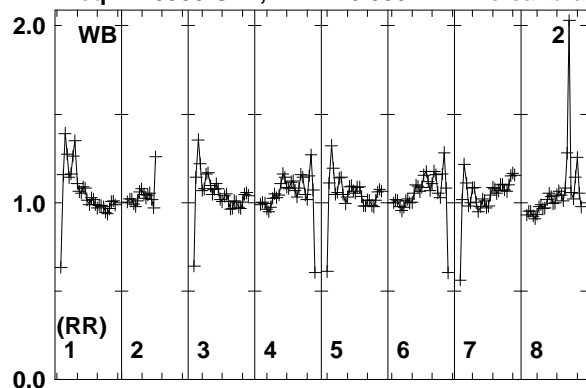

Lower frame: Real Jy
Total-power spectrum Antenna: WB (02)
Timerange: 00/05:56:31 to 00/05:57:29

Plot file version 20 created 20-MAR-2014 17:07:53

J1317+3425 ER030C.UVDATA.1

Freq = 1.5950 GHz, Bw = 16.000 MH No calibration applied and no bandpass applied

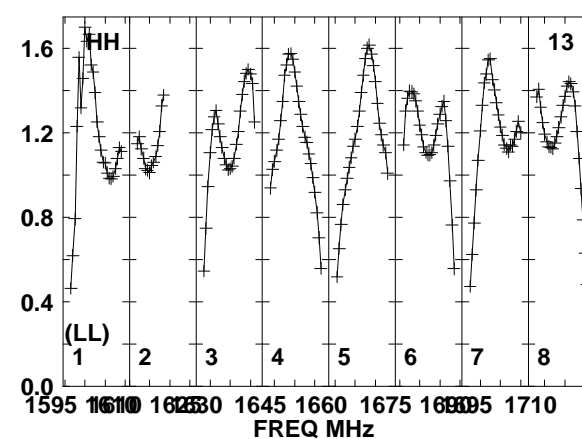
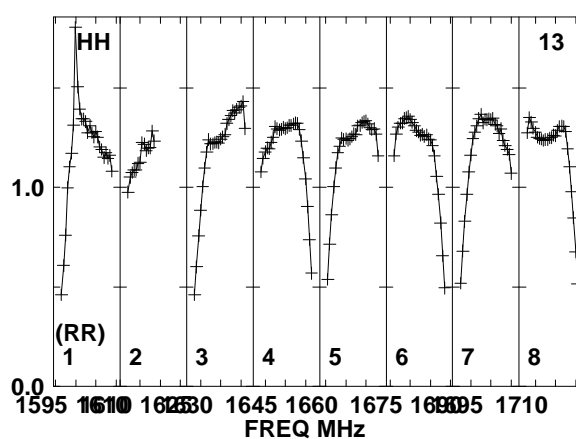
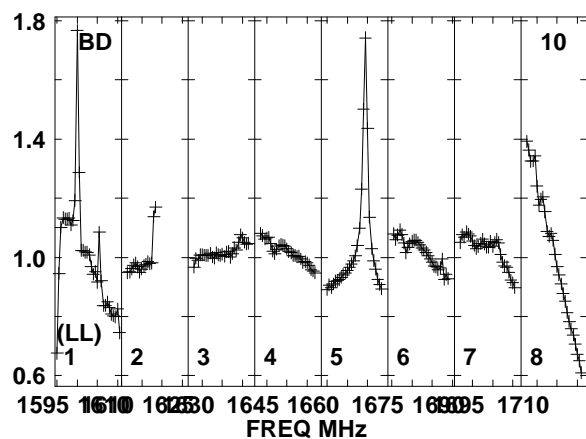
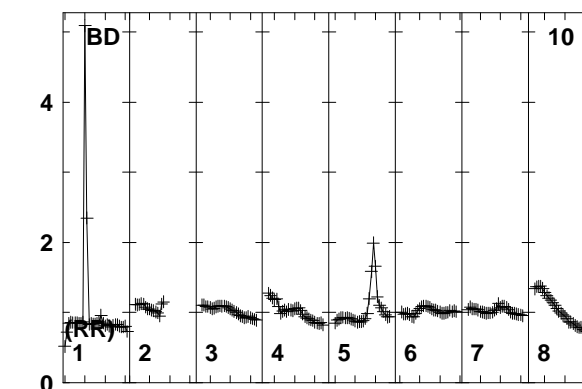
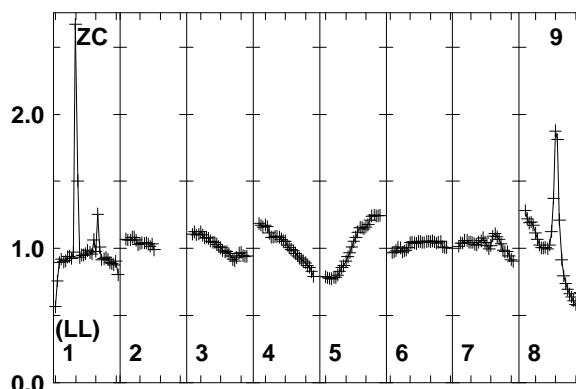
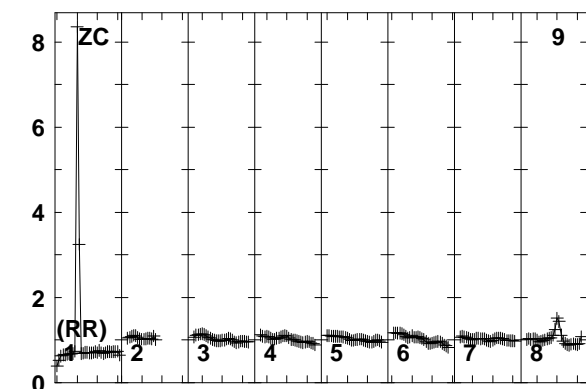
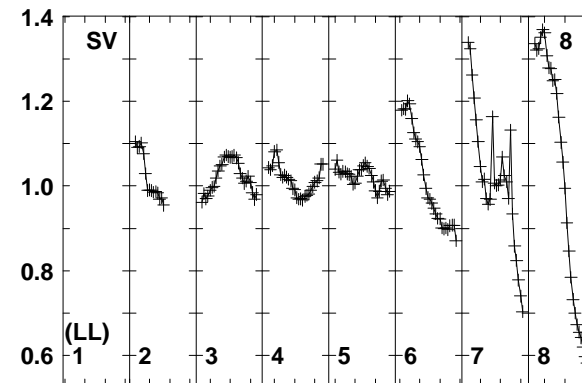
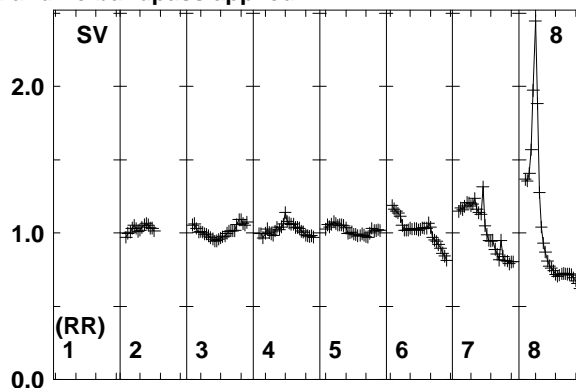
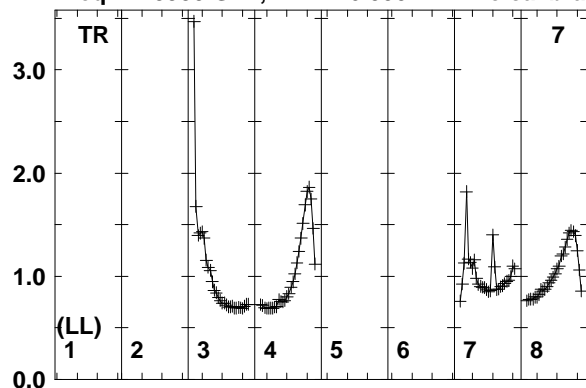

Lower frame: Real Jy
Total-power spectrum Antenna: TR (07)
Timerange: 00/05:56:31 to 00/05:57:29

Plot file version 21 created 20-MAR-2014 17:07:53

IC883 ER030C.UVDATA.1

Freq = 1.5950 GHz, Bw = 16.000 MH No calibration applied and no bandpass applied

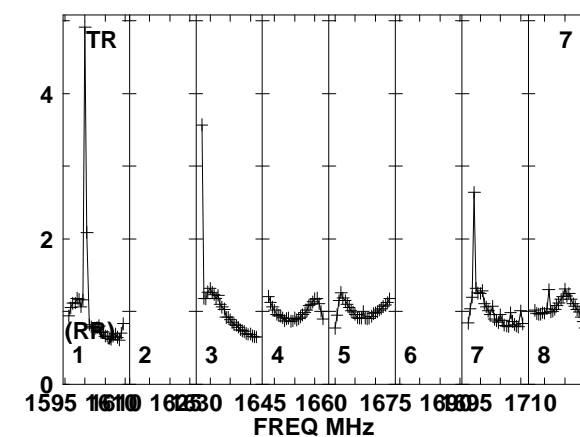
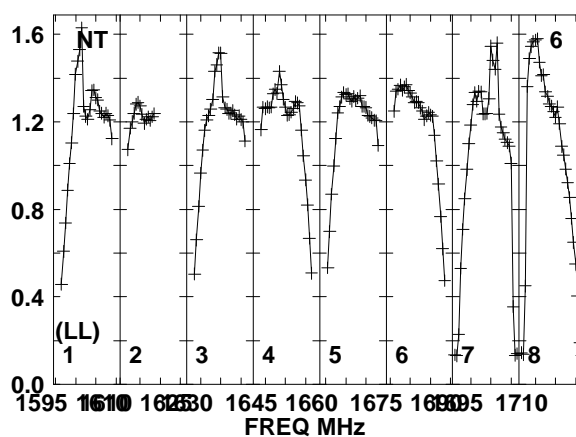
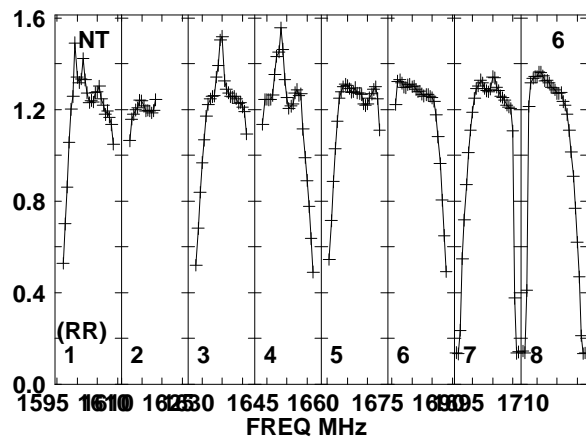
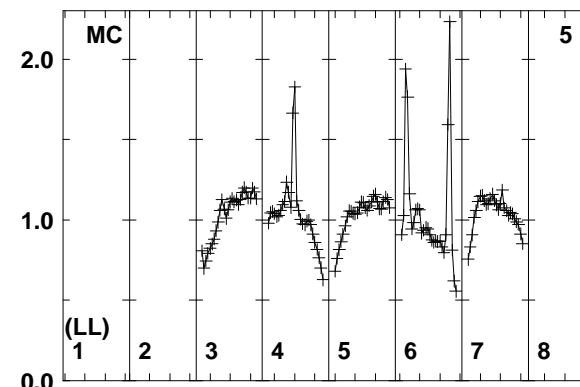
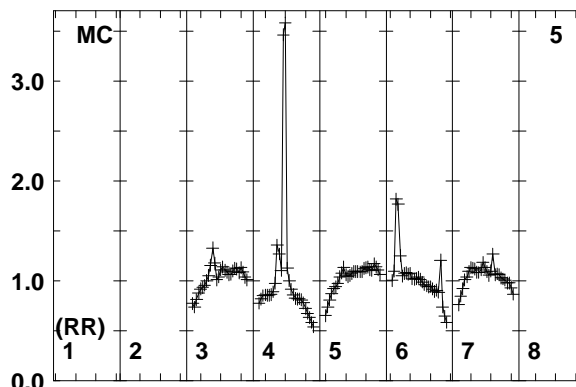
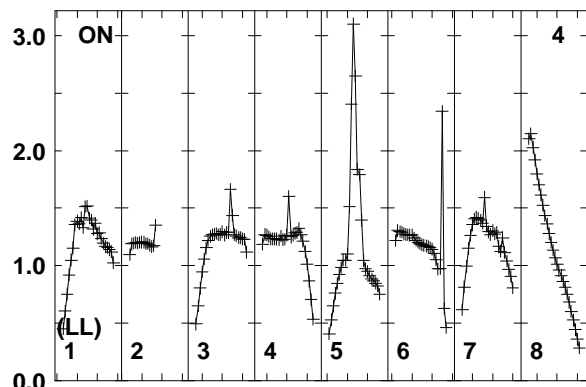
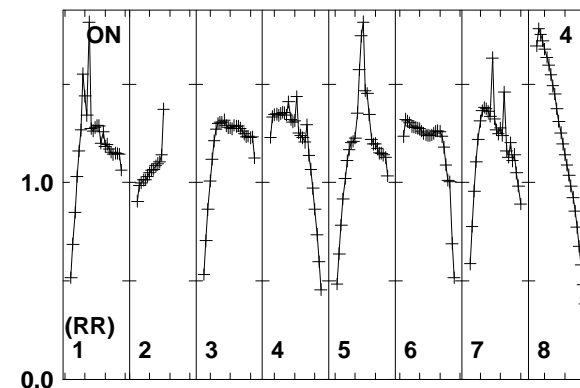
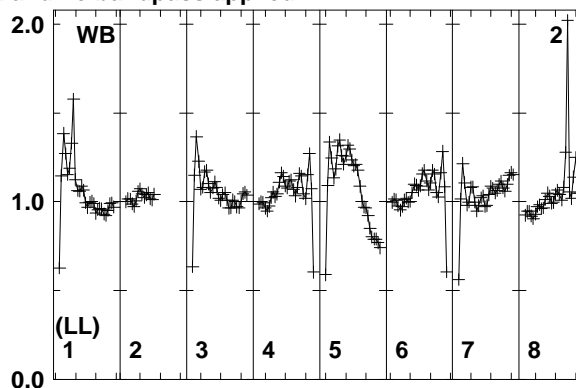
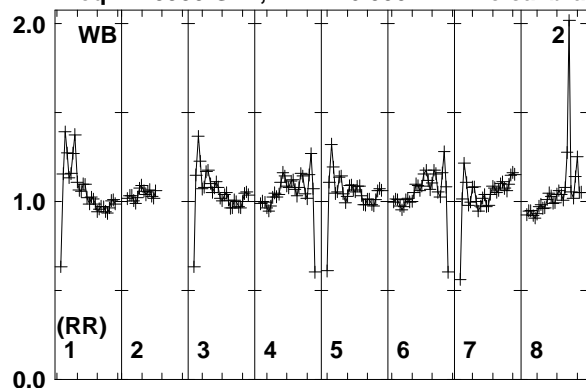

Lower frame: Real Jy
Total-power spectrum Antenna: WB (02)
Timerange: 00/05:57:33 to 00/06:01:19

Plot file version 22 created 20-MAR-2014 17:07:53

IC883 ER030C.UVDATA.1

Freq = 1.5950 GHz, Bw = 16.000 MH No calibration applied and no bandpass applied

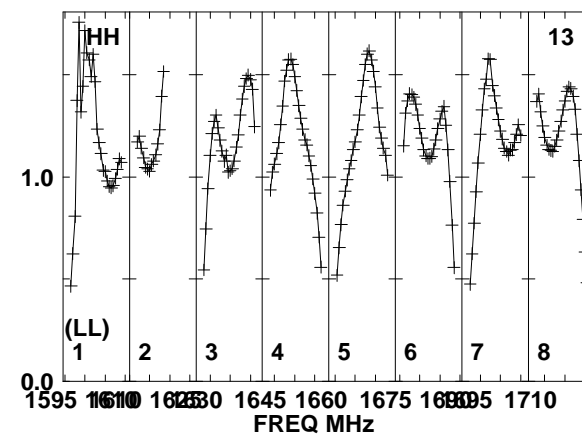
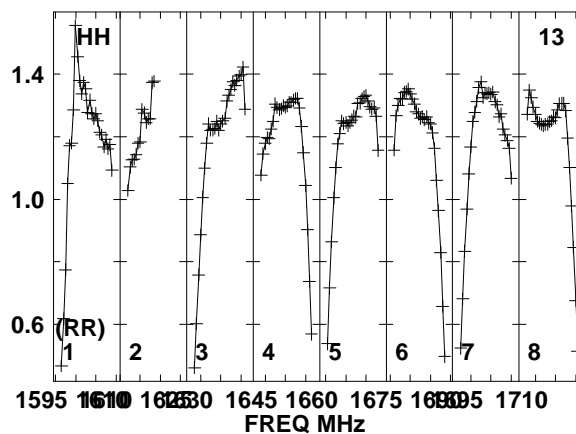
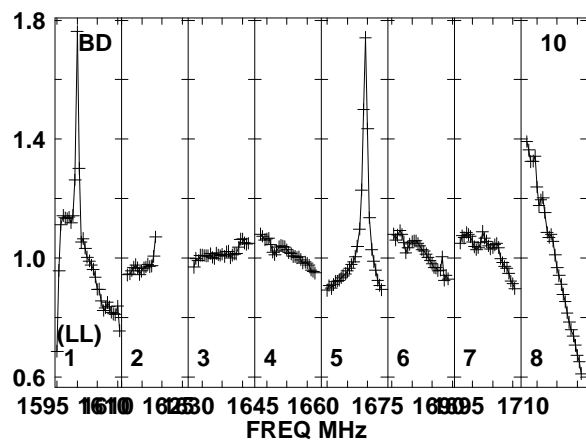
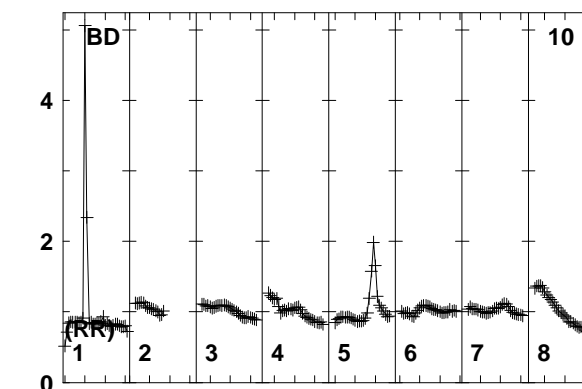
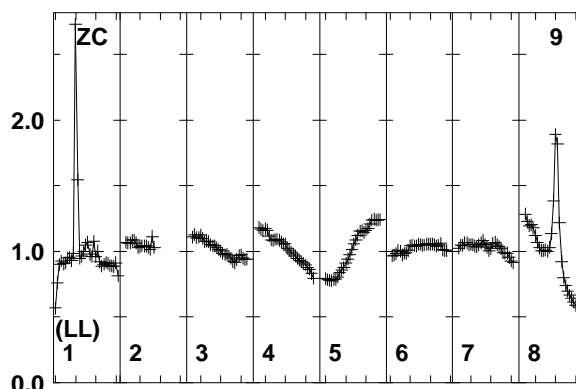
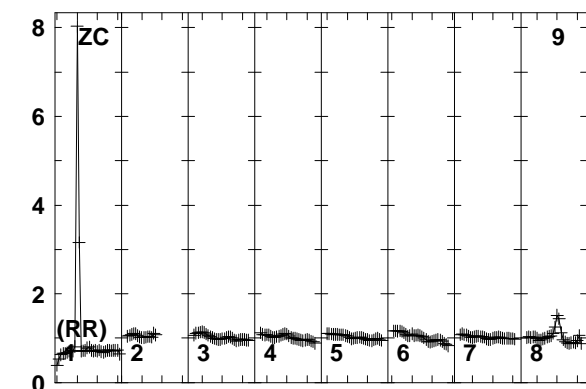
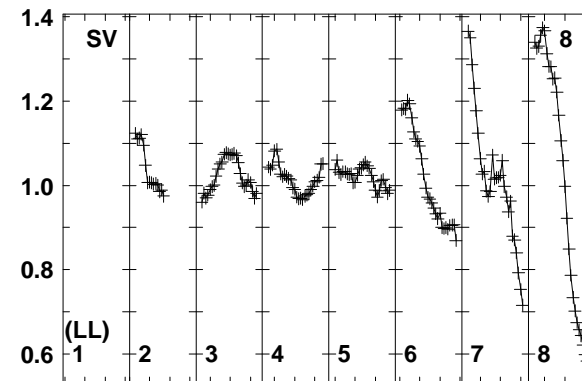
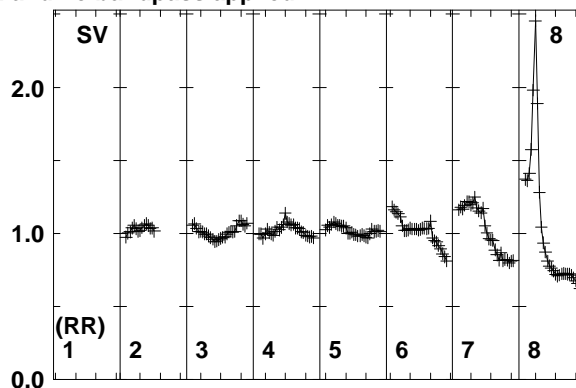
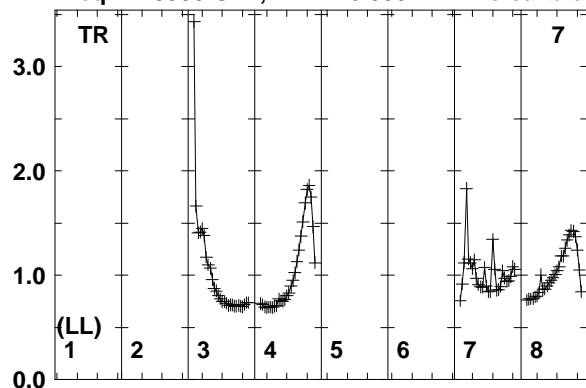

Lower frame: Real Jy
Total-power spectrum Antenna: TR (07)
Timerange: 00/05:57:33 to 00/06:01:19

Plot file version 23 created 20-MAR-2014 17:07:53

J1317+3425 ER030C.UVDATA.1

Freq = 1.5950 GHz, Bw = 16.000 MH No calibration applied and no bandpass applied

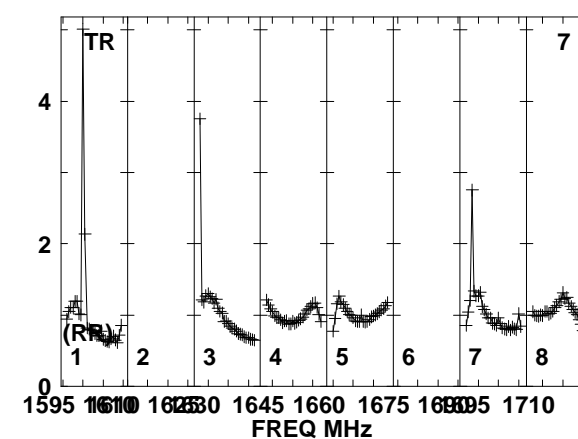
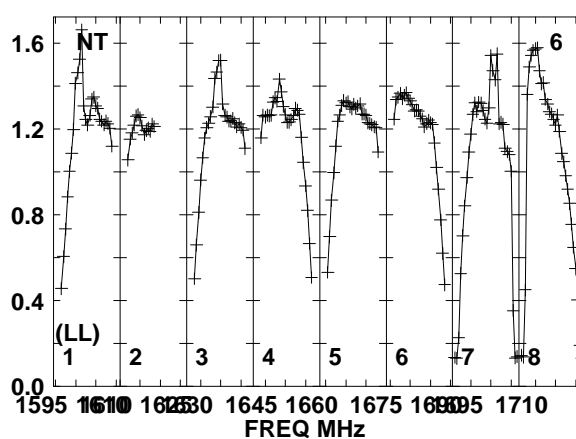
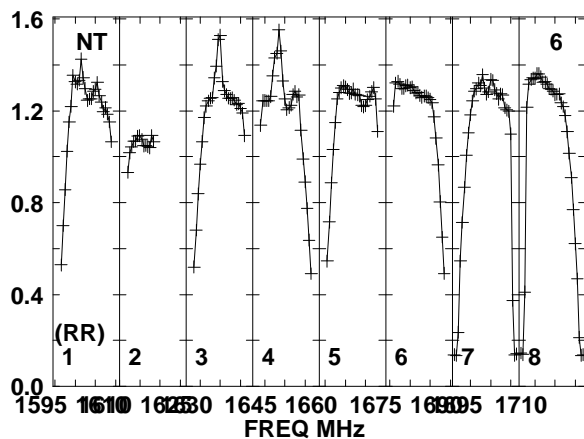
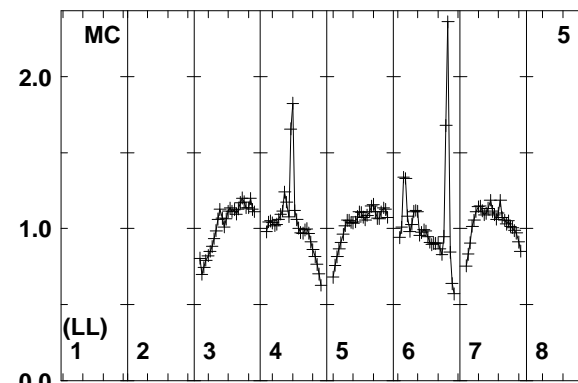
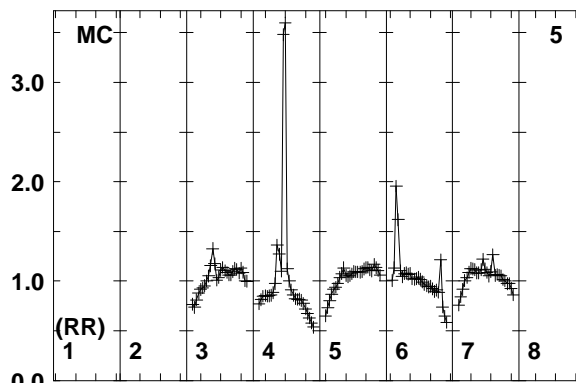
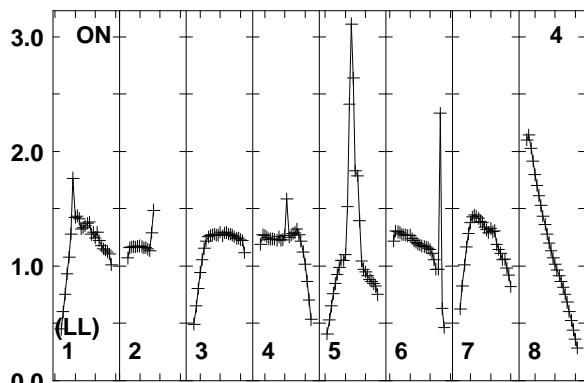
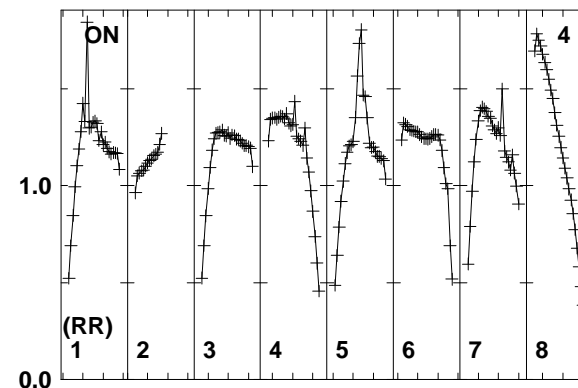
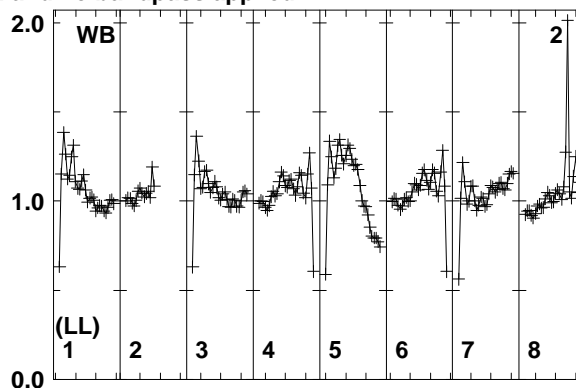
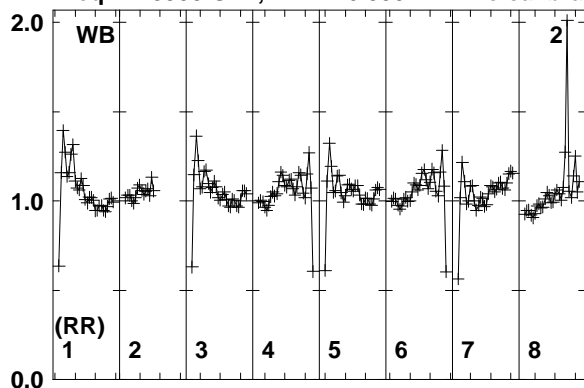

Lower frame: Real Jy
Total-power spectrum Antenna: WB (02)
Timerange: 00/06:01:23 to 00/06:02:39

Plot file version 24 created 20-MAR-2014 17:07:53

J1317+3425 ER030C.UVDATA.1

Freq = 1.5950 GHz, Bw = 16.000 MH No calibration applied and no bandpass applied

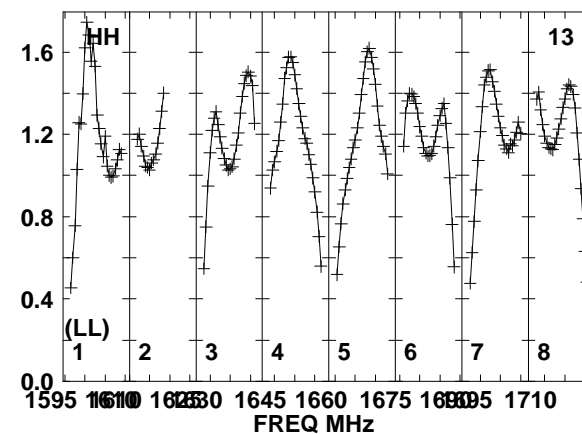
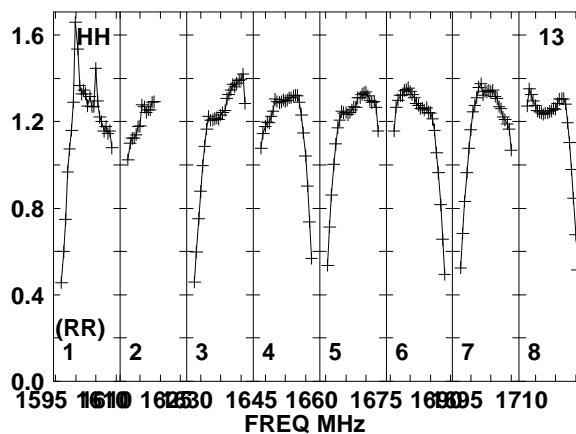
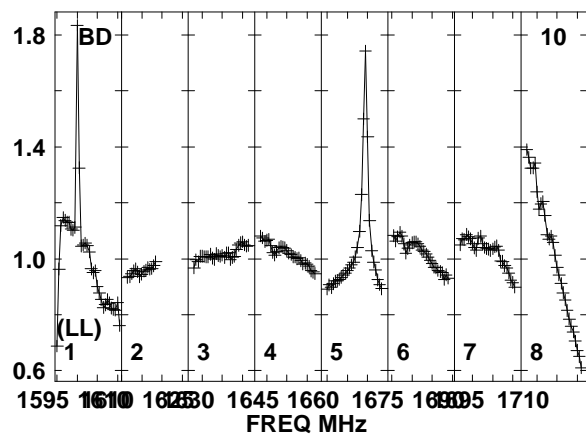
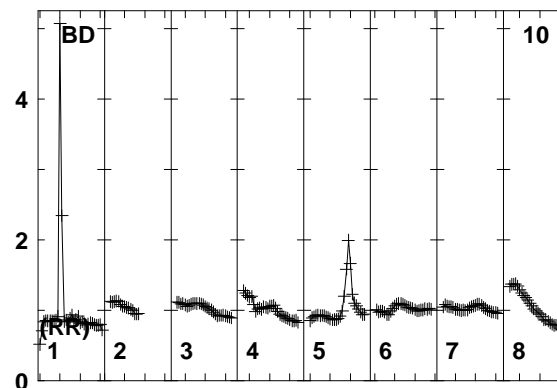
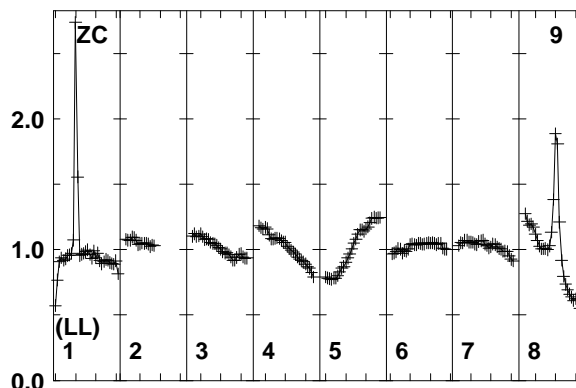
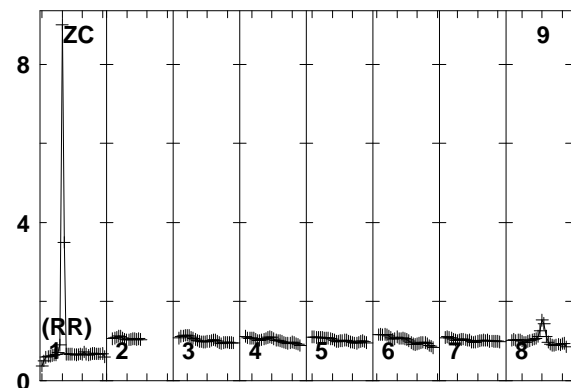
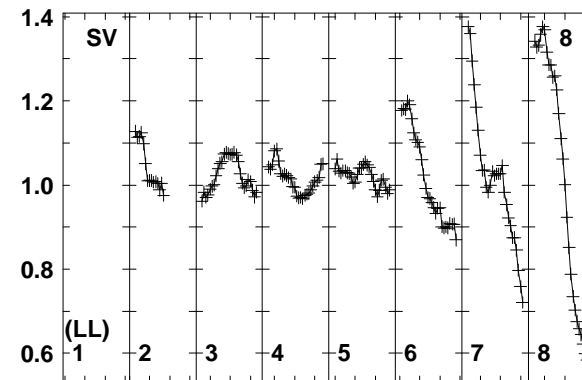
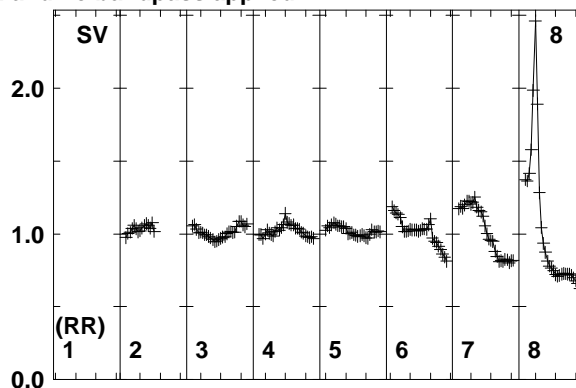
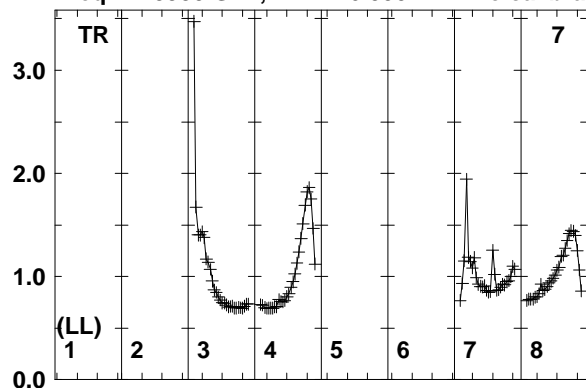

Lower frame: Real Jy
Total-power spectrum Antenna: TR (07)
Timerange: 00/06:01:23 to 00/06:02:39

Plot file version 25 created 20-MAR-2014 17:07:53

IC883 ER030C.UVDATA.1

Freq = 1.5950 GHz, Bw = 16.000 MH No calibration applied and no bandpass applied

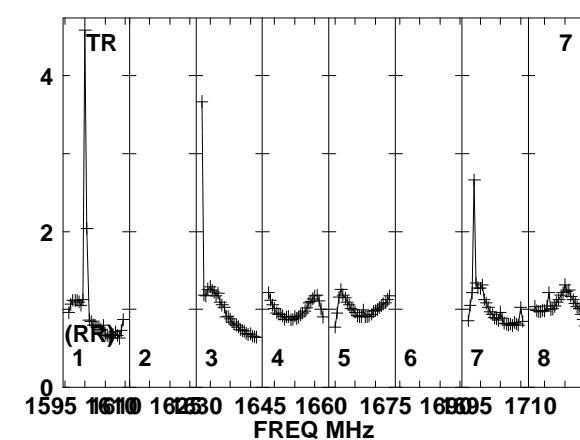
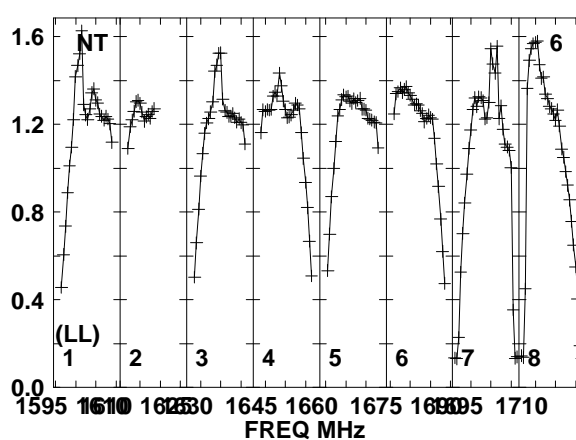
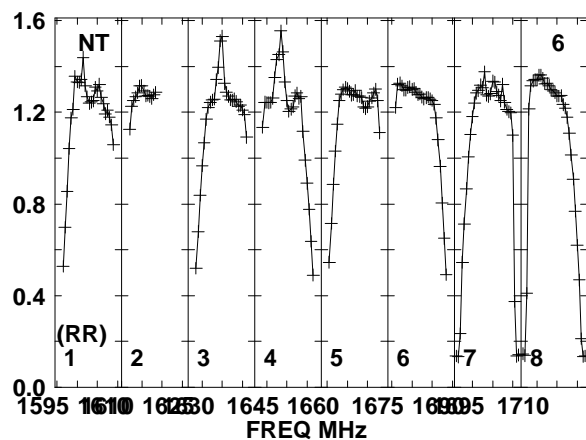
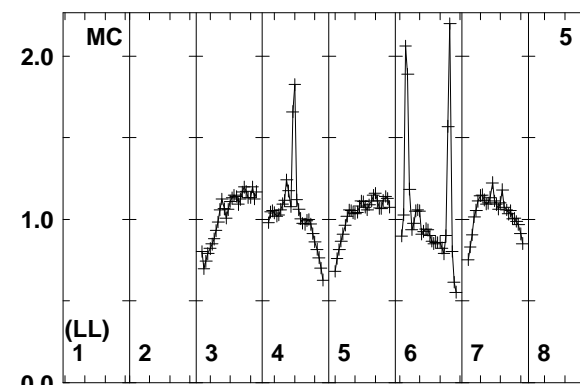
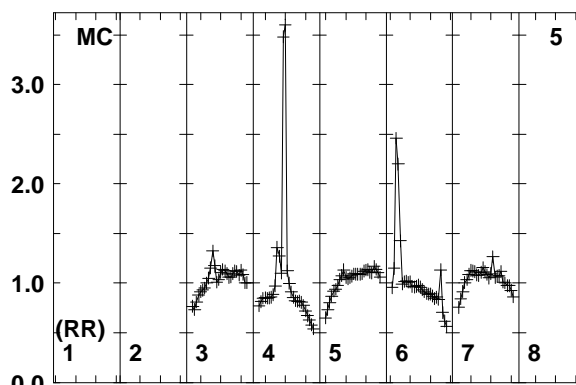
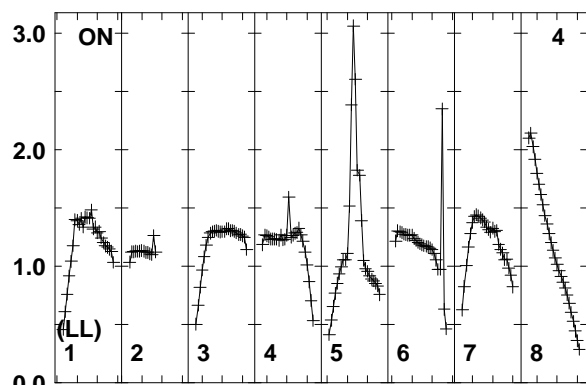
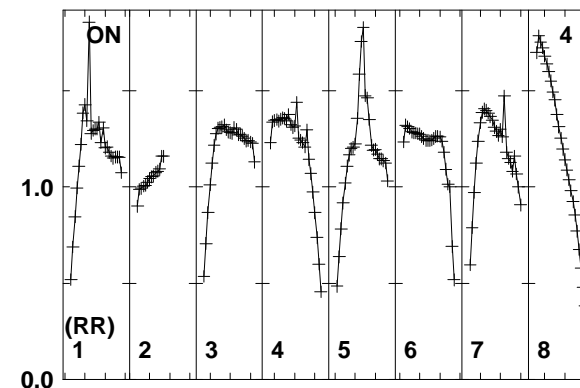
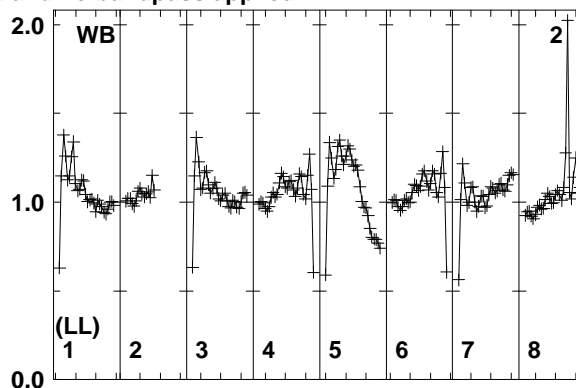
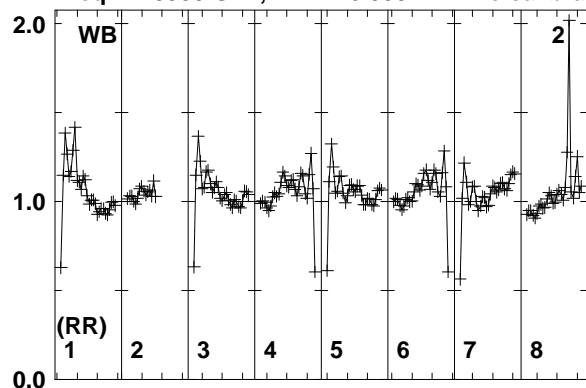

Lower frame: Real Jy
Total-power spectrum Antenna: WB (02)
Timerange: 00/06:02:41 to 00/06:06:29

Plot file version 26 created 20-MAR-2014 17:07:53

IC883 ER030C.UVDATA.1

Freq = 1.5950 GHz, Bw = 16.000 MH No calibration applied and no bandpass applied

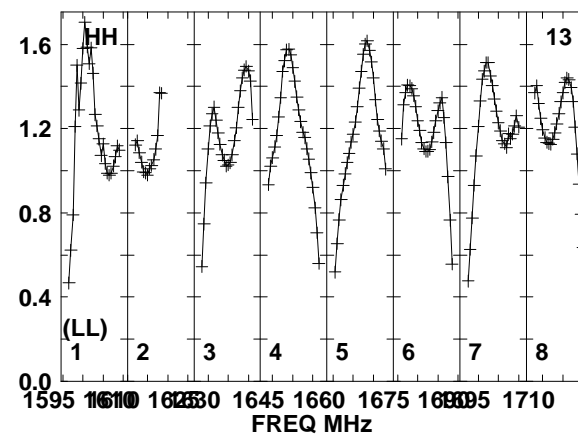
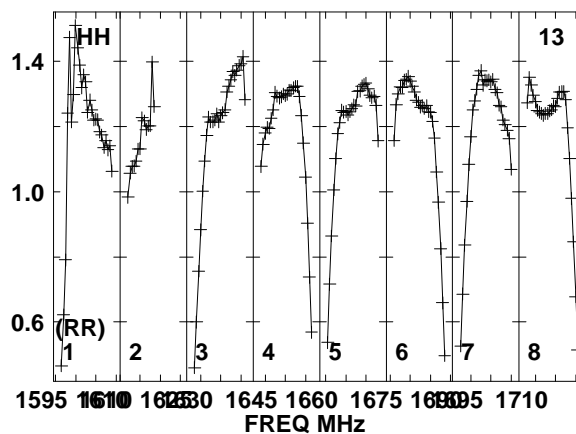
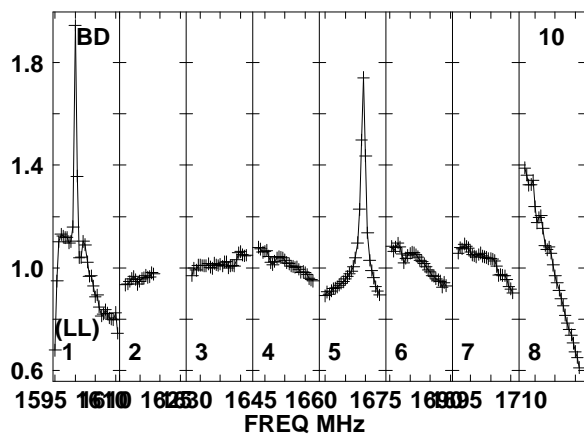
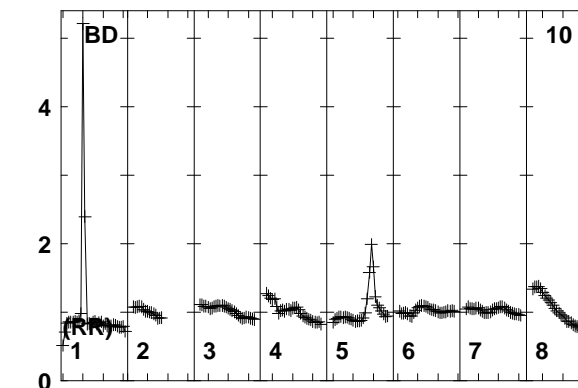
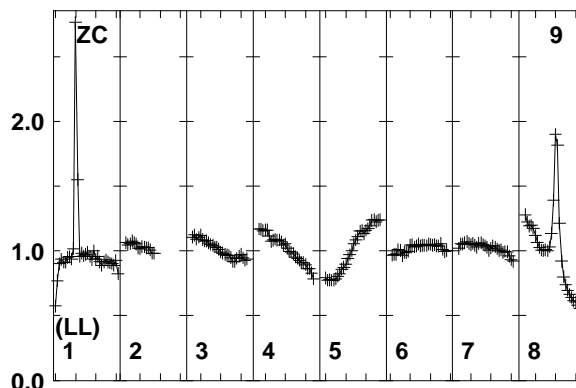
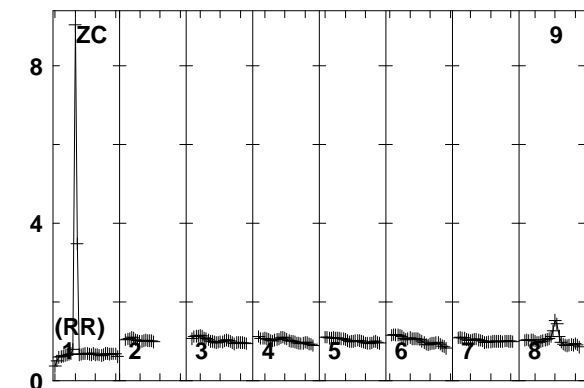
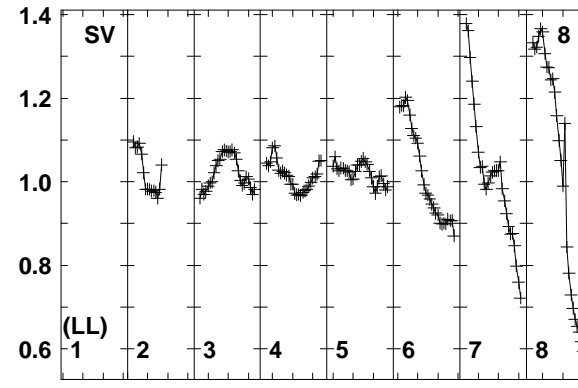
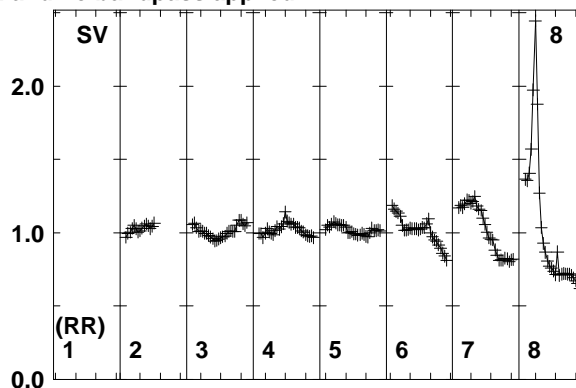
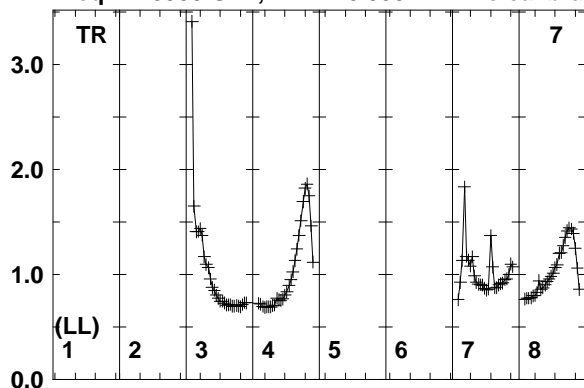

Lower frame: Real Jy
Total-power spectrum Antenna: TR (07)
Timerange: 00/06:02:41 to 00/06:06:29

Plot file version 27 created 20-MAR-2014 17:07:53

J1317+3425 ER030C.UVDATA.1

Freq = 1.5950 GHz, Bw = 16.000 MH No calibration applied and no bandpass applied

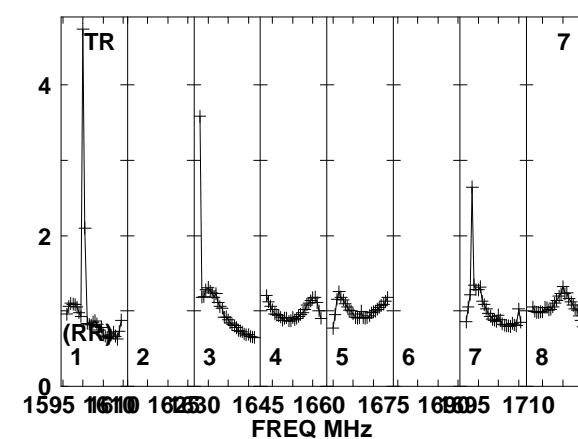
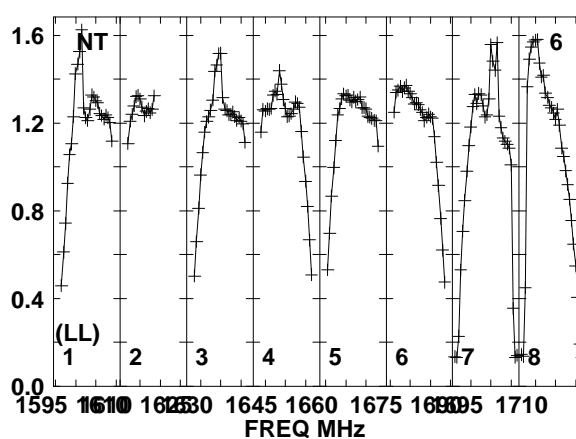
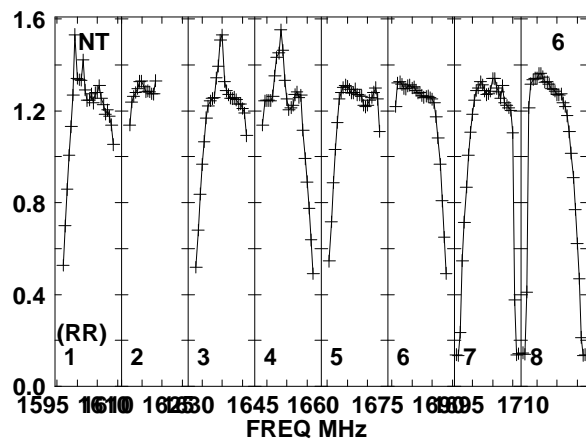
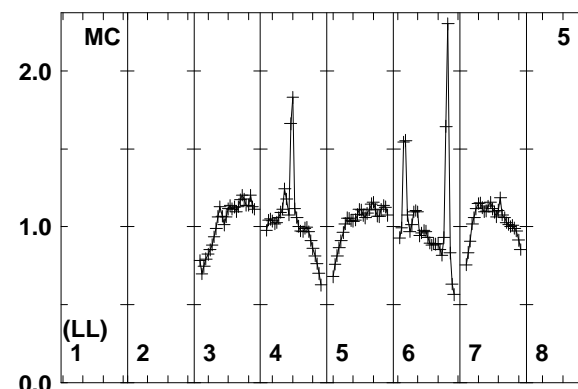
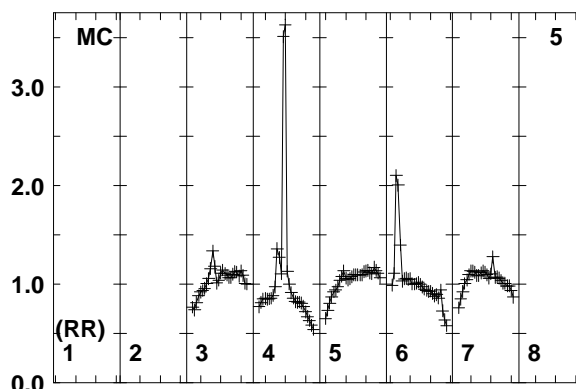
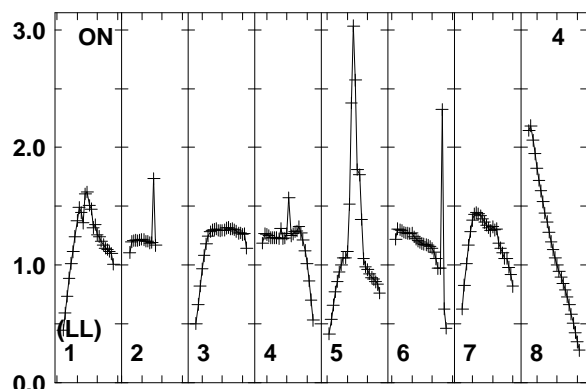
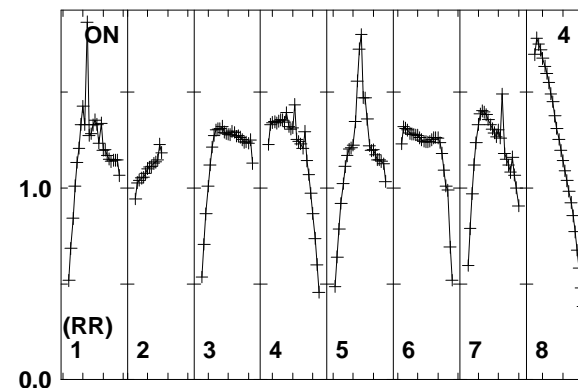
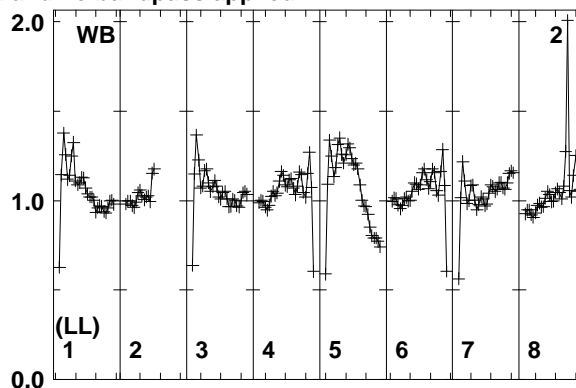
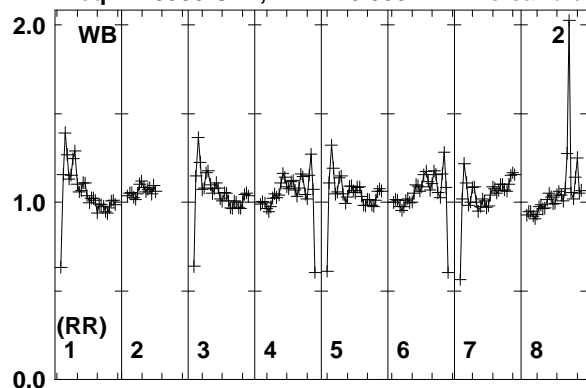

Lower frame: Real Jy
Total-power spectrum Antenna: WB (02)
Timerange: 00/06:07:11 to 00/06:08:09

Plot file version 28 created 20-MAR-2014 17:07:53

J1317+3425 ER030C.UVDATA.1

Freq = 1.5950 GHz, Bw = 16.000 MH No calibration applied and no bandpass applied

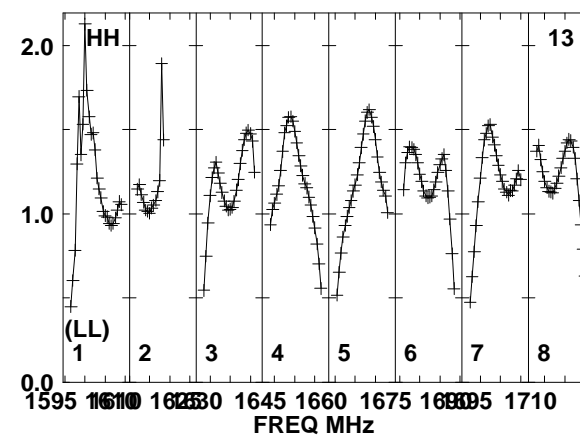
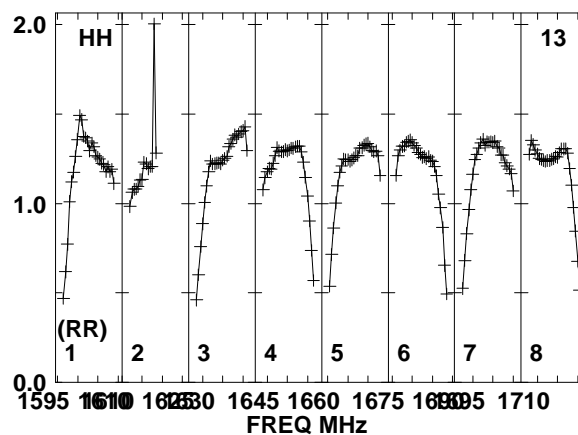
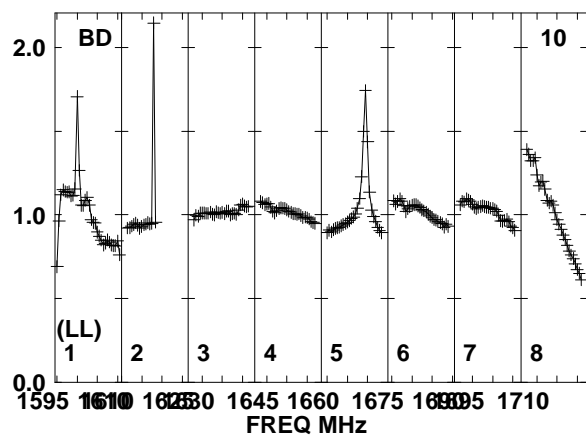
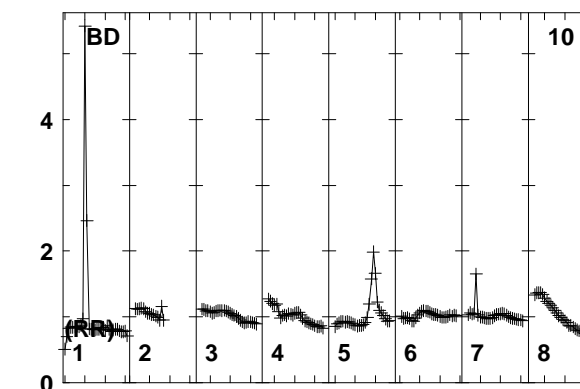
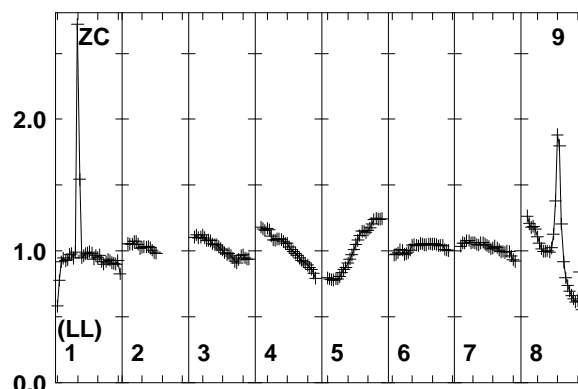
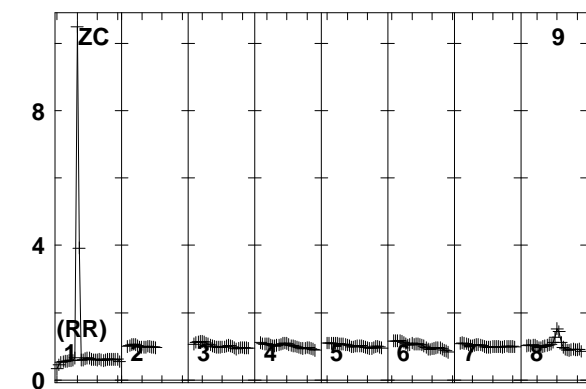
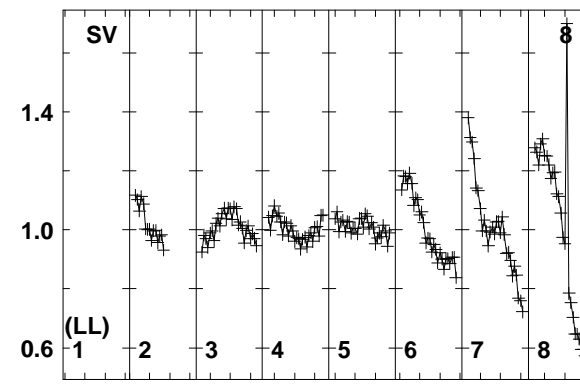
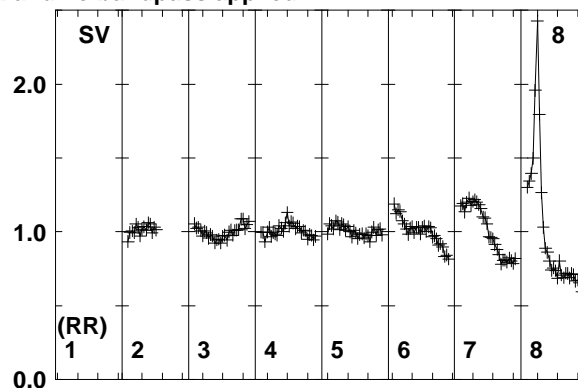
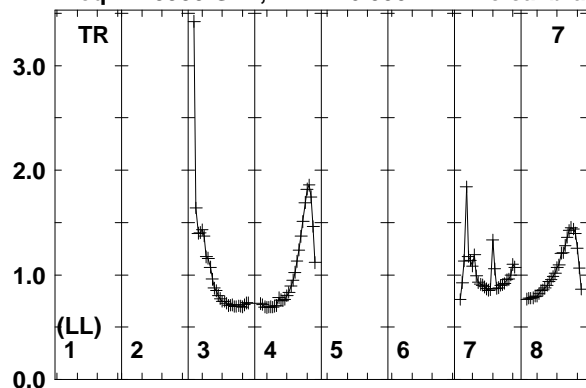

Lower frame: Real Jy
Total-power spectrum Antenna: TR (07)
Timerange: 00/06:07:11 to 00/06:08:09

Plot file version 29 created 20-MAR-2014 17:07:53

IC883 ER030C.UVDATA.1

Freq = 1.5950 GHz, Bw = 16.000 MH No calibration applied and no bandpass applied

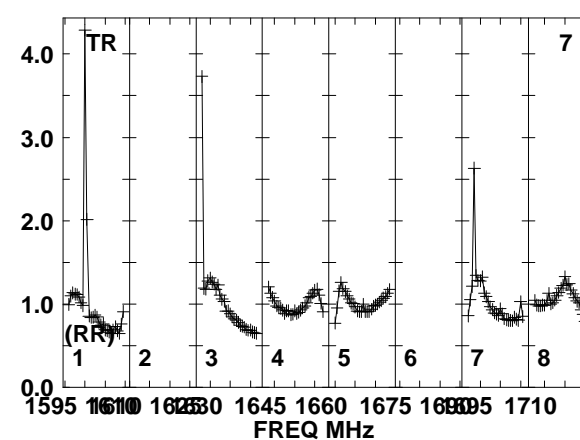
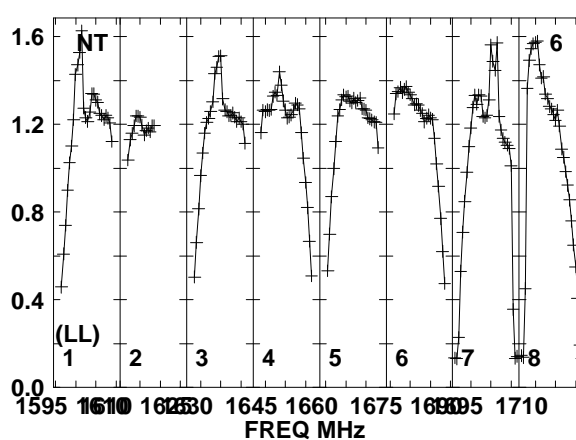
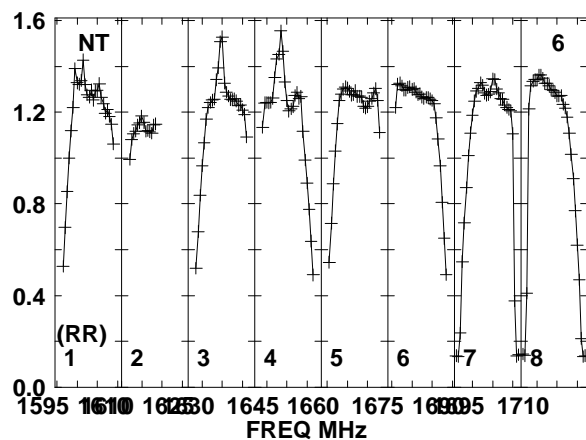
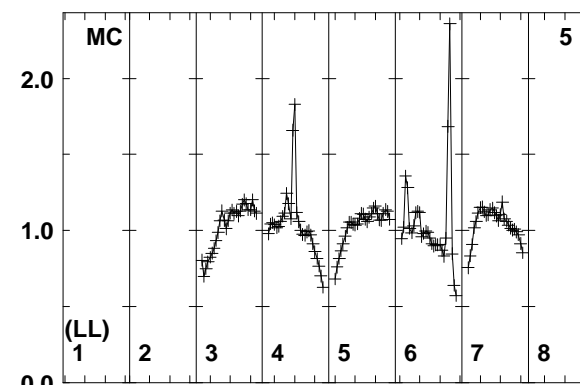
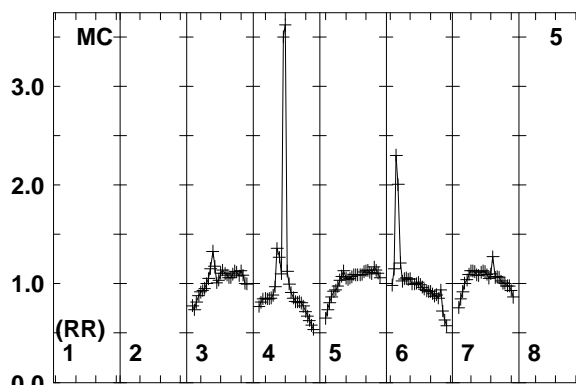
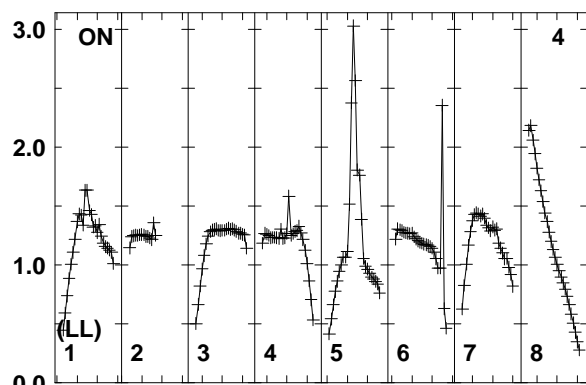
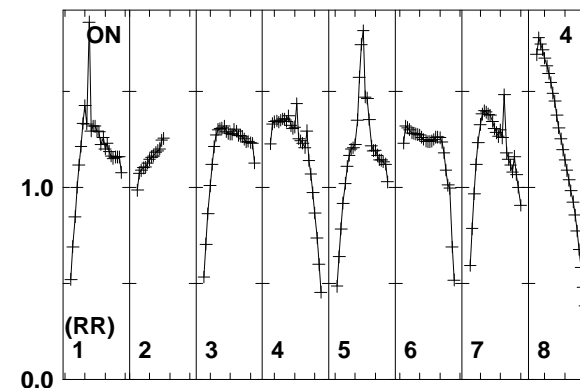
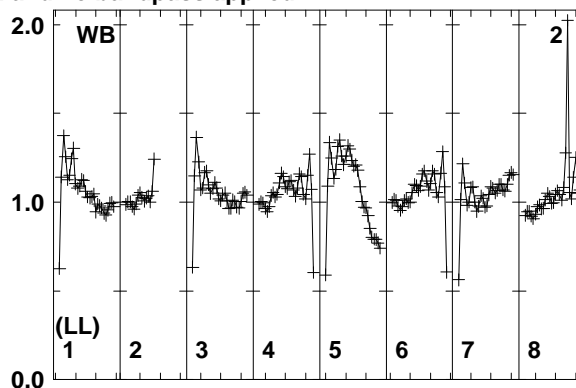
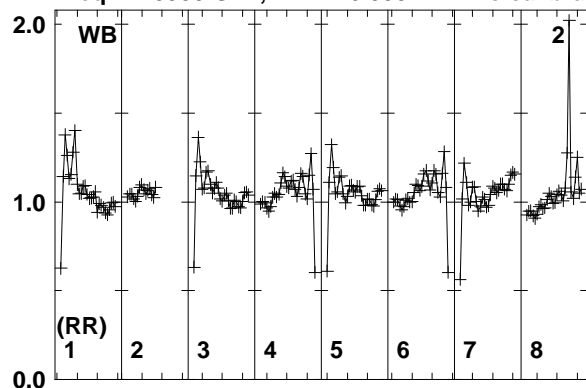

Lower frame: Real Jy
Total-power spectrum Antenna: WB (02)
Timerange: 00/06:08:13 to 00/06:11:59

Plot file version 30 created 20-MAR-2014 17:07:54

IC883 ER030C.UVDATA.1

Freq = 1.5950 GHz, Bw = 16.000 MH No calibration applied and no bandpass applied

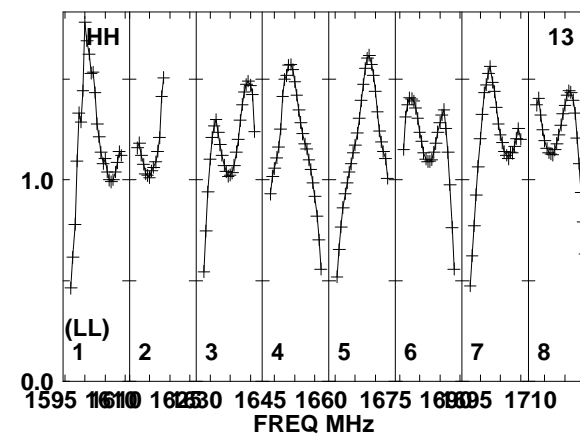
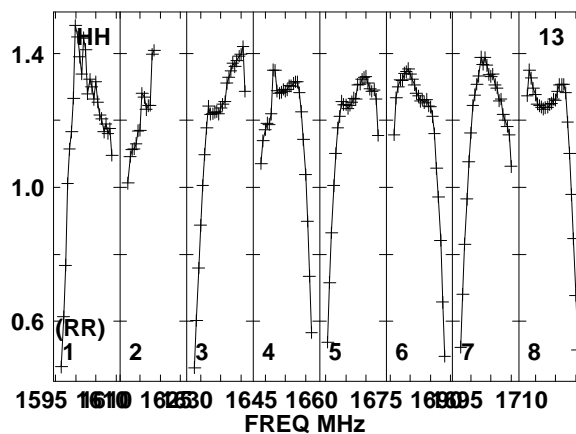
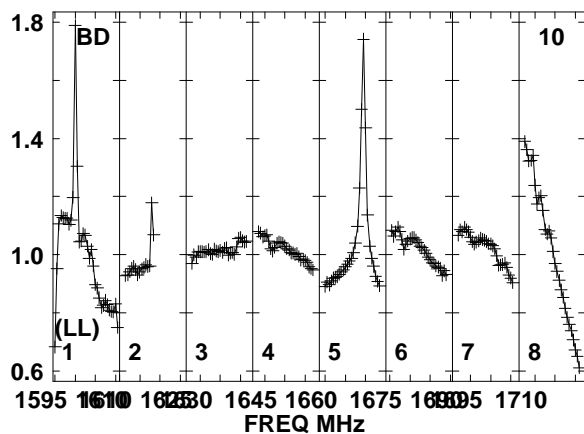
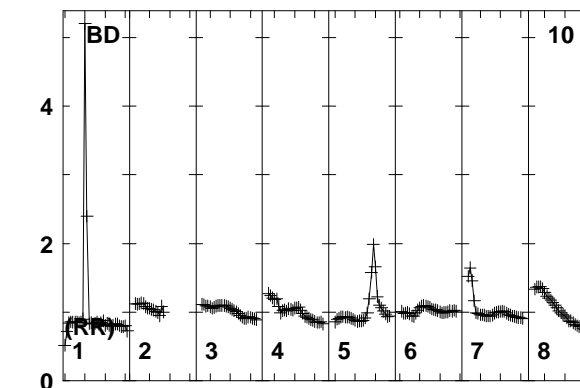
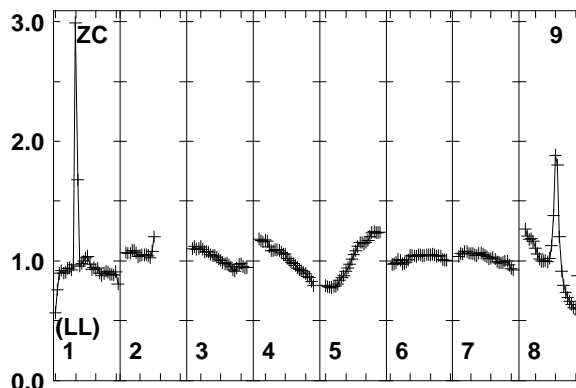
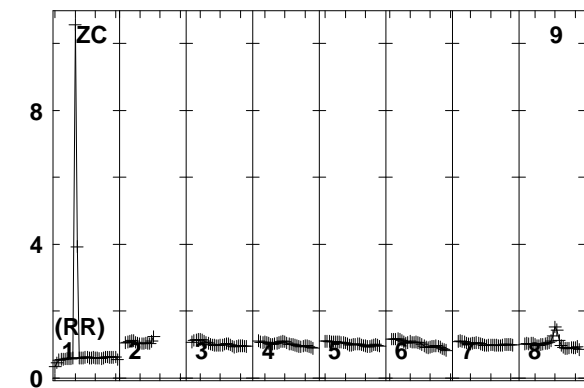
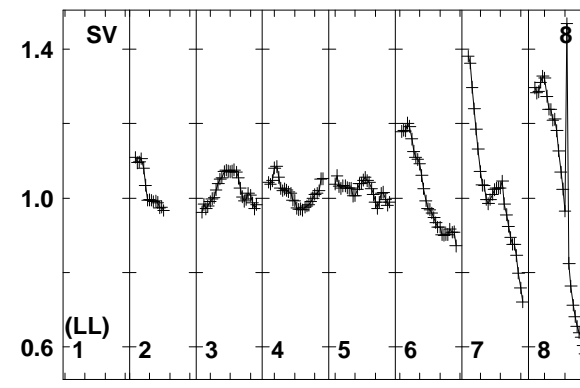
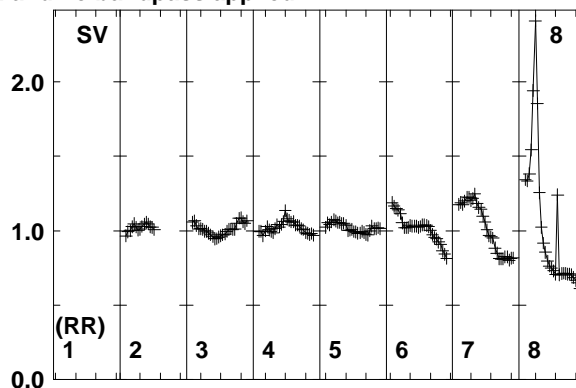
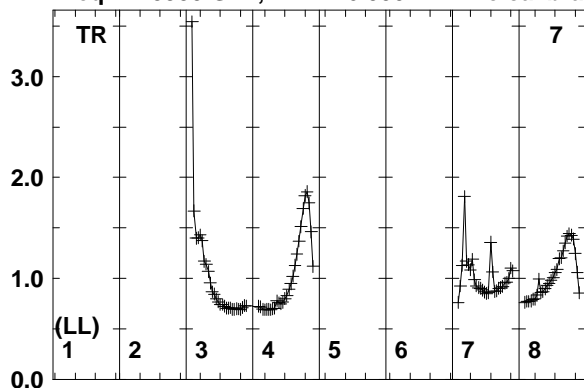

Lower frame: Real Jy
Total-power spectrum Antenna: TR (07)
Timerange: 00/06:08:13 to 00/06:11:59

Plot file version 31 created 20-MAR-2014 17:07:54

J1317+3425 ER030C.UVDATA.1

Freq = 1.5950 GHz, Bw = 16.000 MH No calibration applied and no bandpass applied

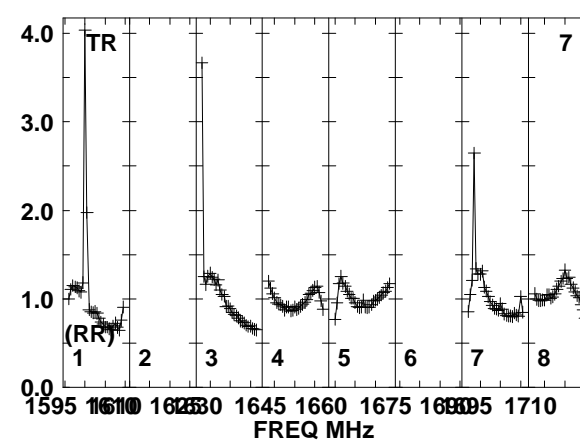
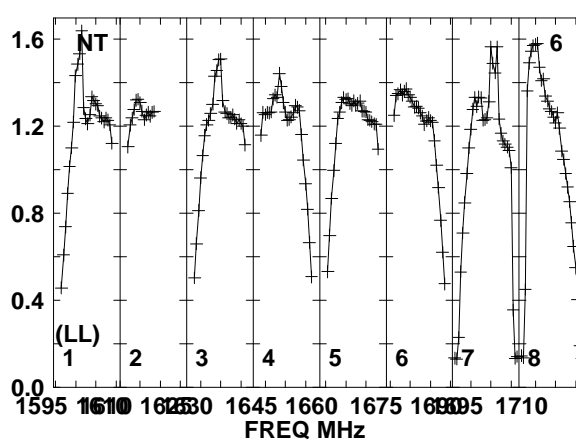
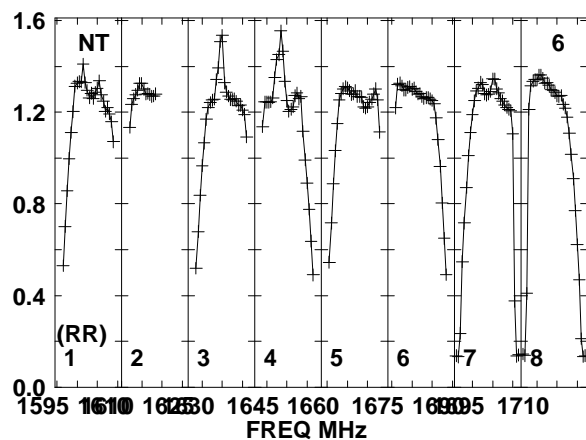
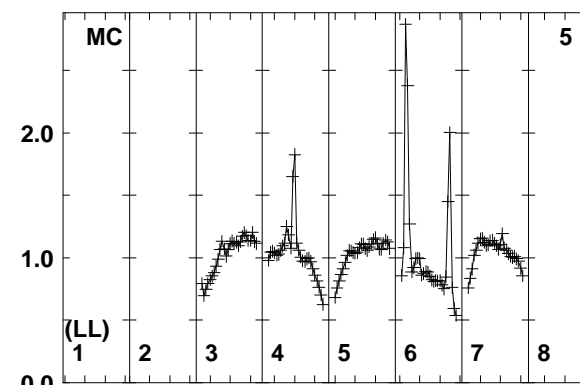
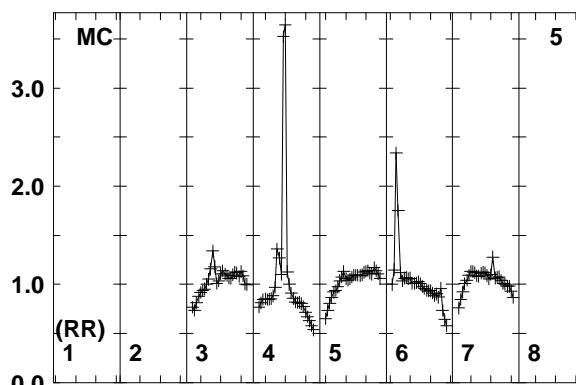
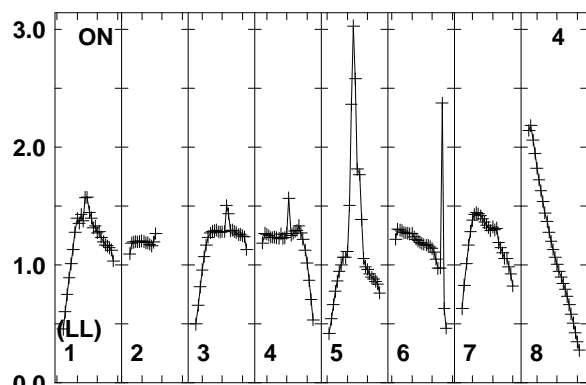
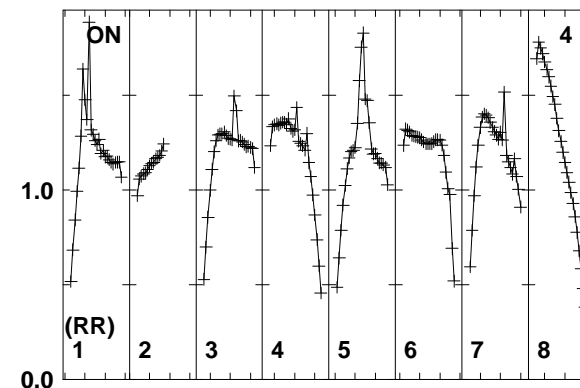
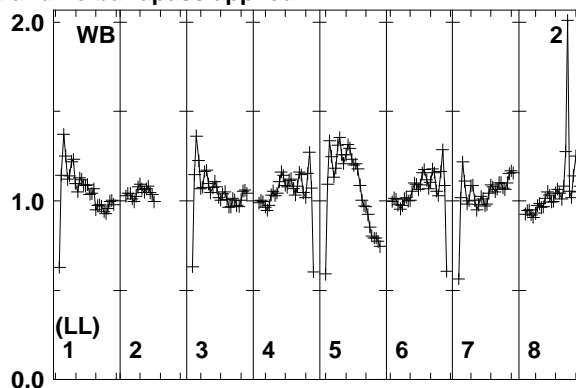
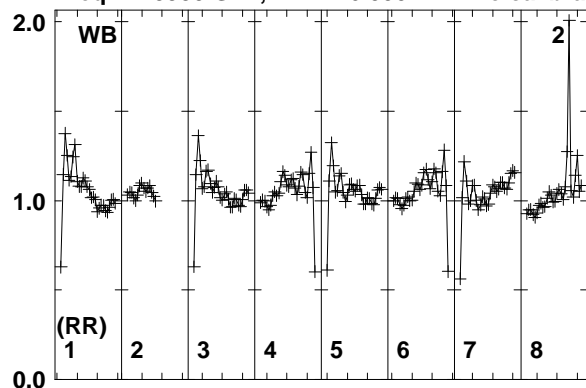

Lower frame: Real Jy
Total-power spectrum Antenna: WB (02)
Timerange: 00/06:12:03 to 00/06:13:19

Plot file version 32 created 20-MAR-2014 17:07:54

J1317+3425 ER030C.UVDATA.1

Freq = 1.5950 GHz, Bw = 16.000 MH No calibration applied and no bandpass applied

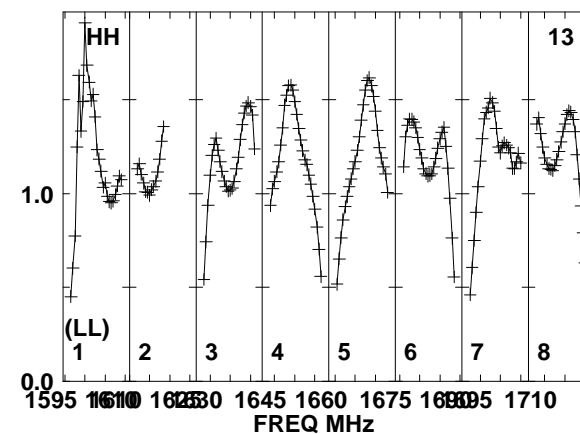
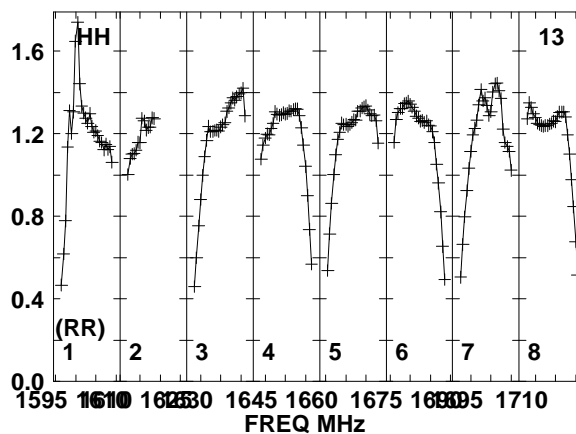
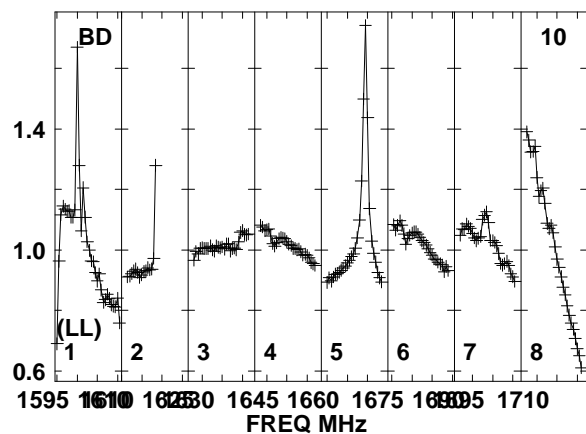
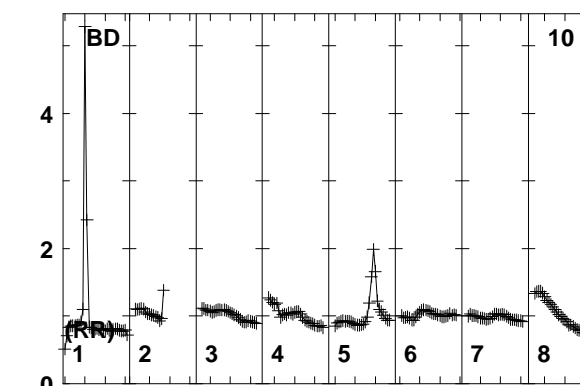
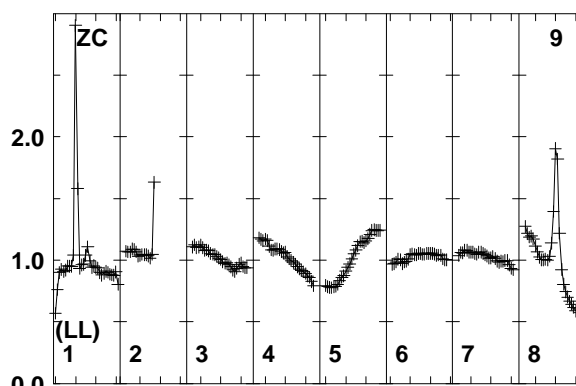
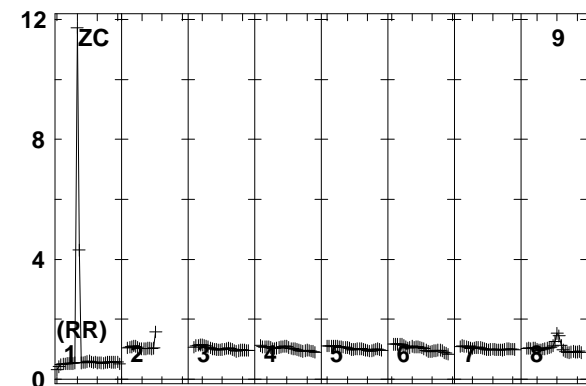
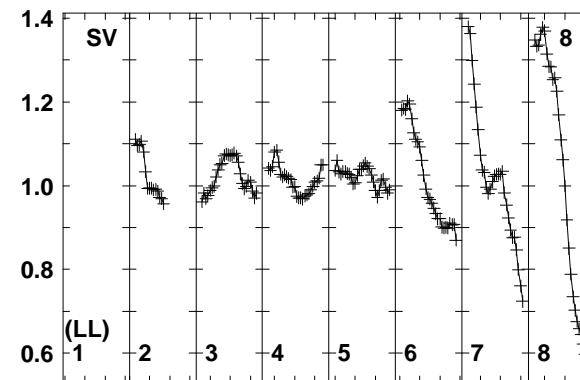
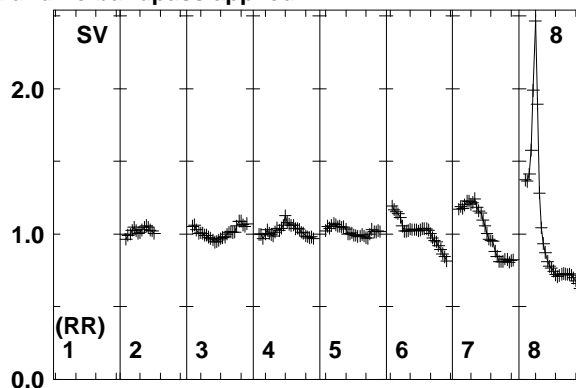
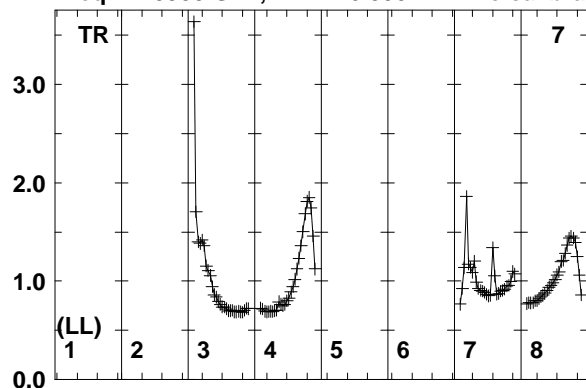

Lower frame: Real Jy
Total-power spectrum Antenna: TR (07)
Timerange: 00/06:12:03 to 00/06:13:19

Plot file version 33 created 20-MAR-2014 17:07:54

IC883 ER030C.UVDATA.1

Freq = 1.5950 GHz, Bw = 16.000 MH No calibration applied and no bandpass applied

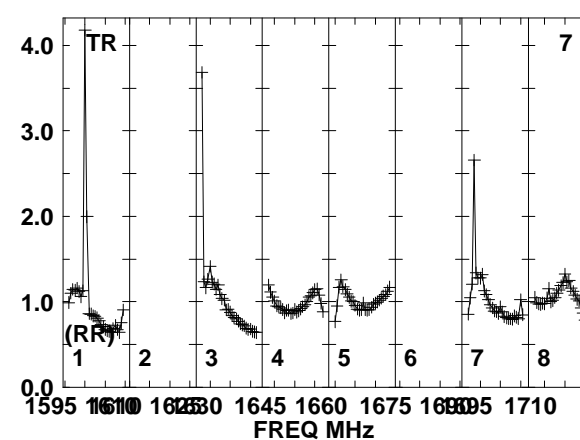
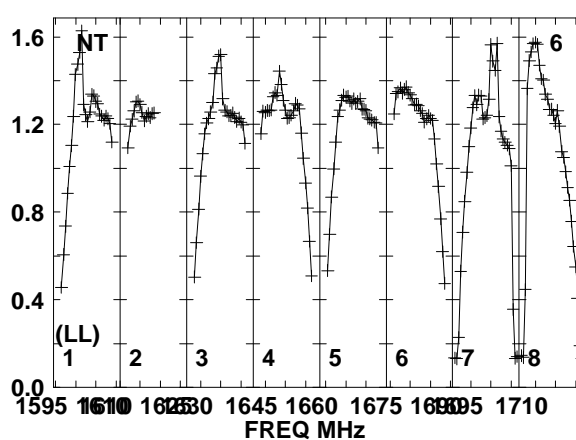
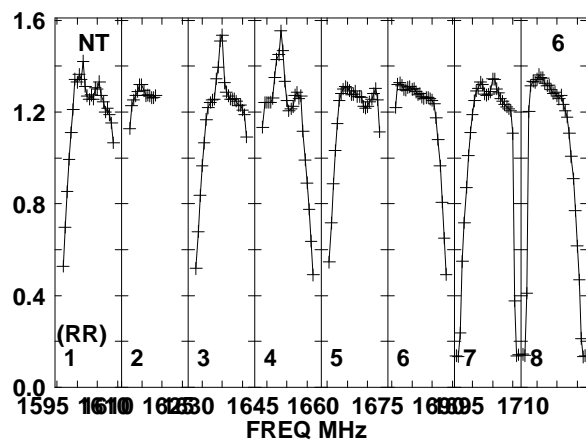
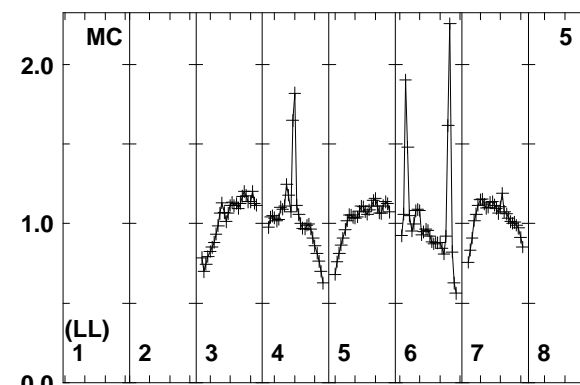
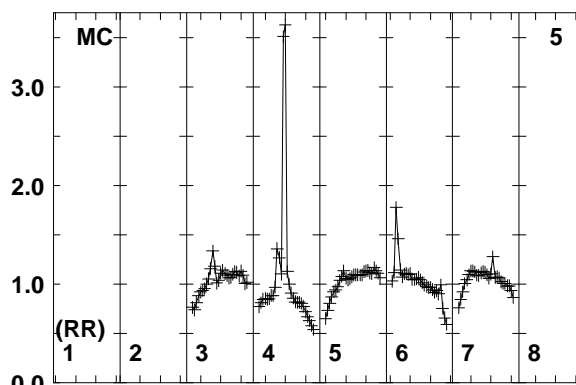
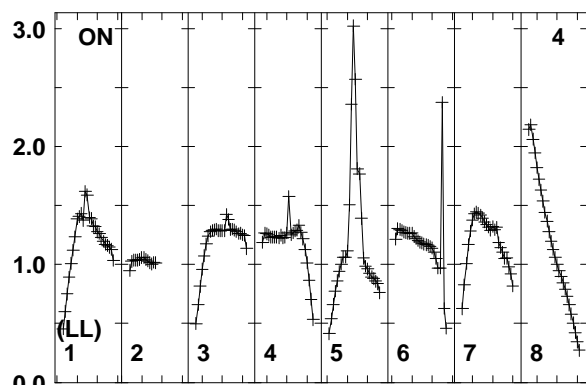
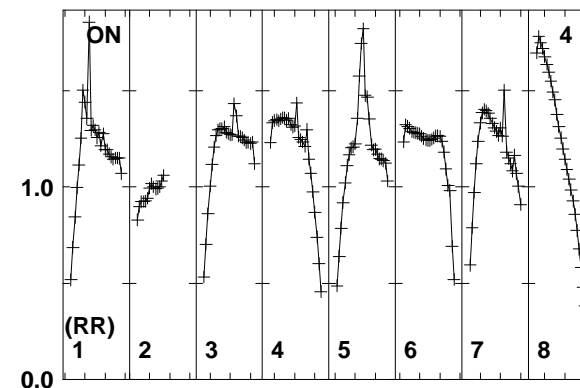
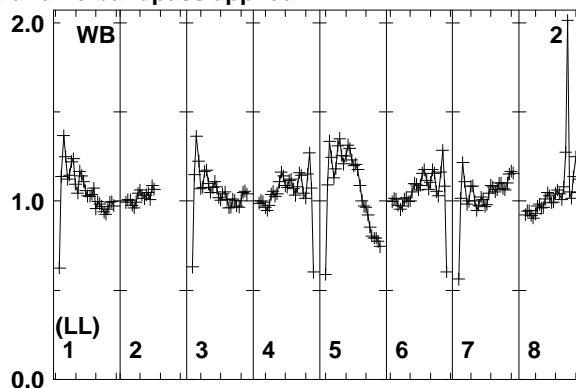
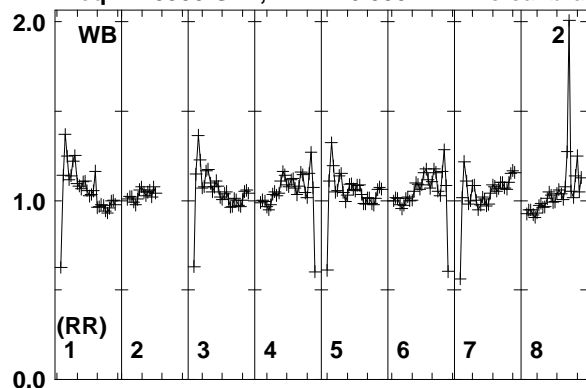

Lower frame: Real Jy
Total-power spectrum Antenna: WB (02)
Timerange: 00/06:13:21 to 00/06:17:09

Plot file version 34 created 20-MAR-2014 17:07:54

IC883 ER030C.UVDATA.1

Freq = 1.5950 GHz, Bw = 16.000 MH No calibration applied and no bandpass applied

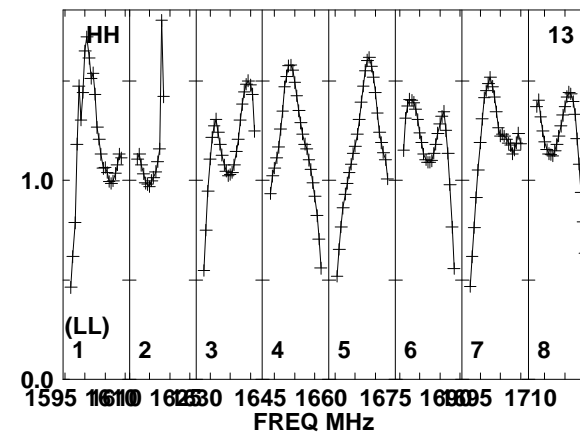
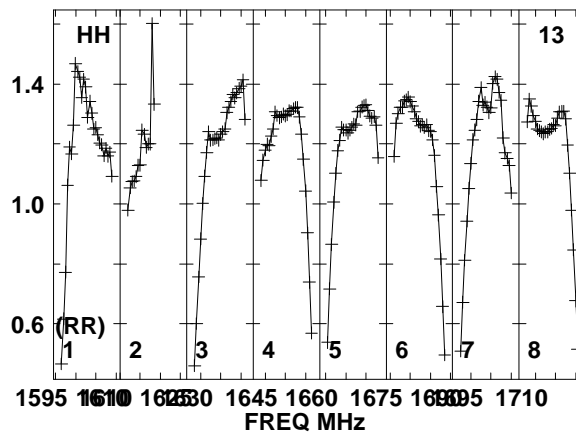
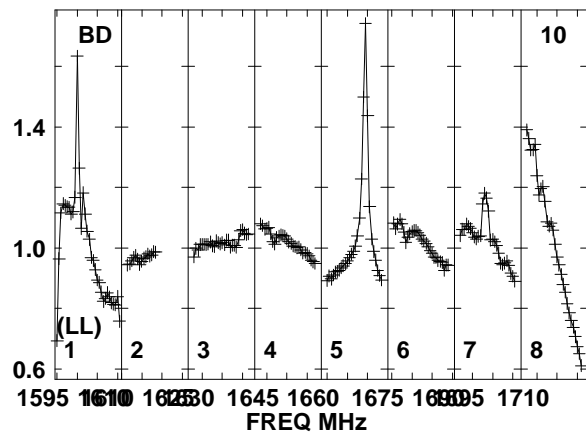
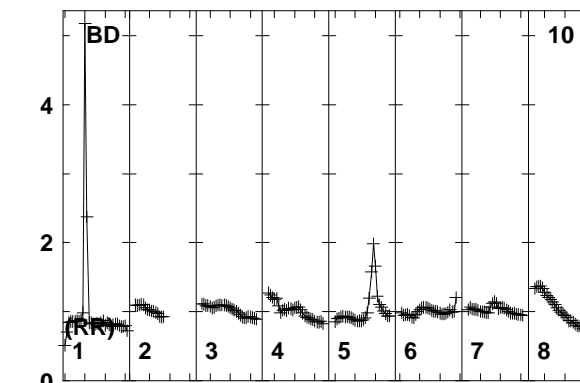
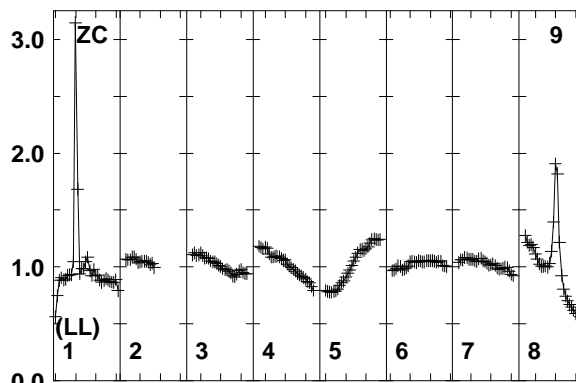
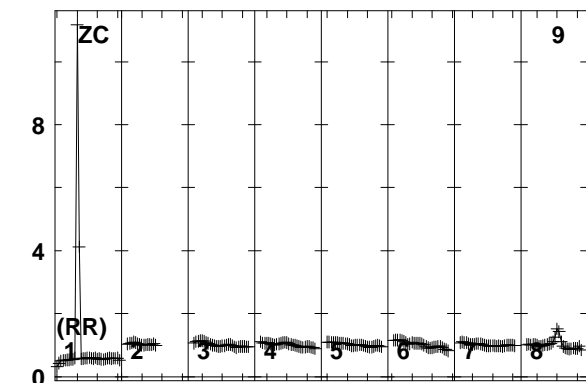
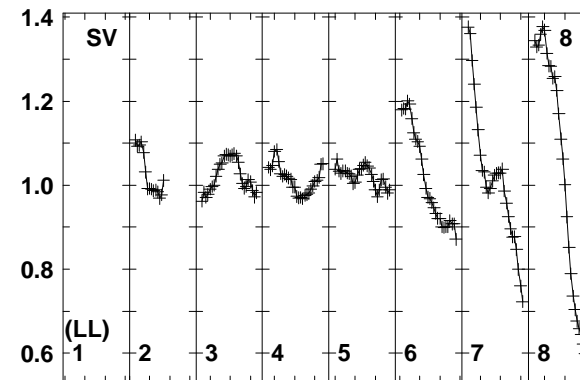
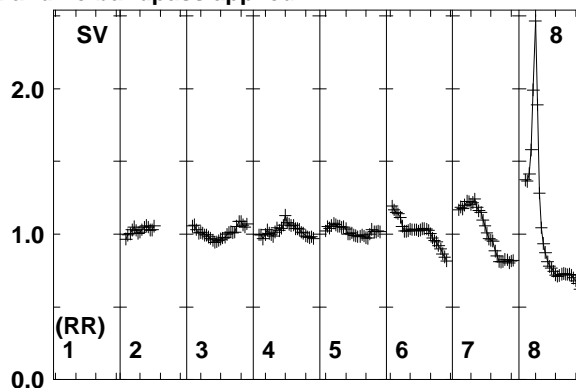
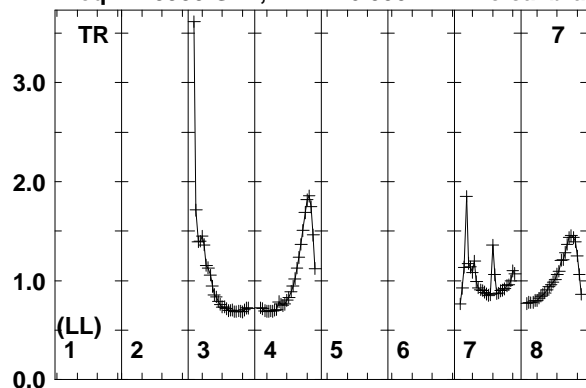

Lower frame: Real Jy
Total-power spectrum Antenna: TR (07)
Timerange: 00/06:13:21 to 00/06:17:09

Plot file version 35 created 20-MAR-2014 17:07:54

J1317+3425 ER030C.UVDATA.1

Freq = 1.5950 GHz, Bw = 16.000 MH No calibration applied and no bandpass applied

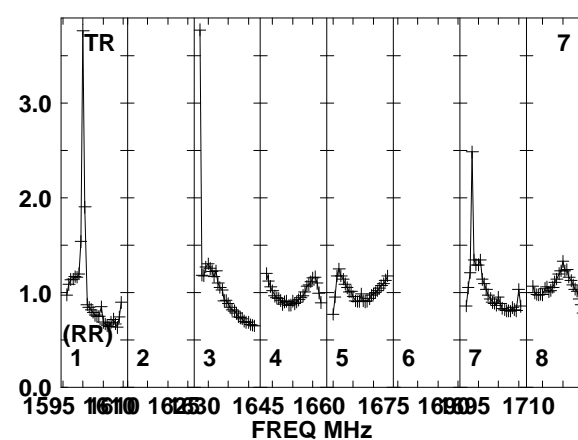
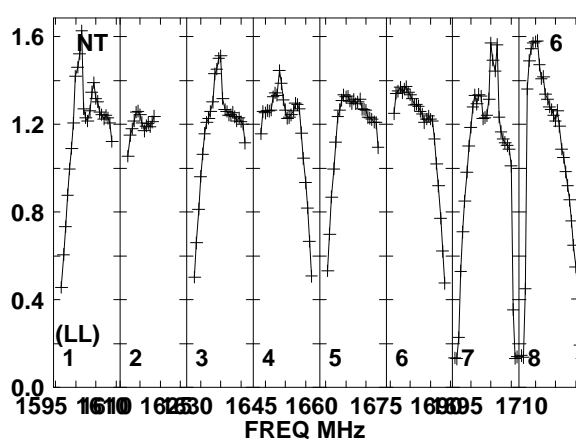
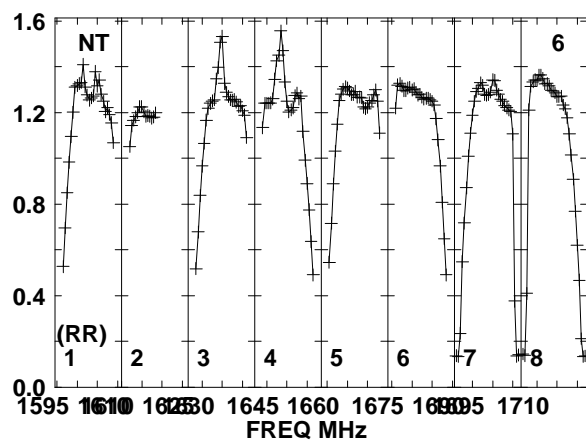
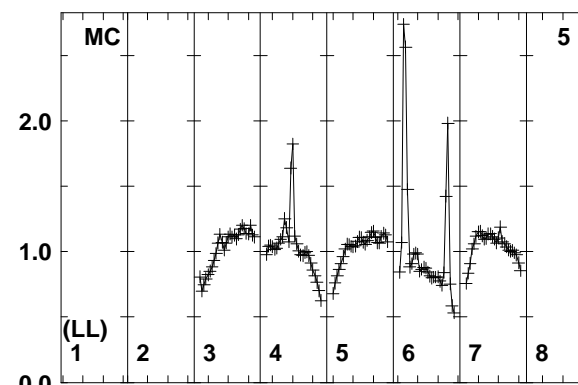
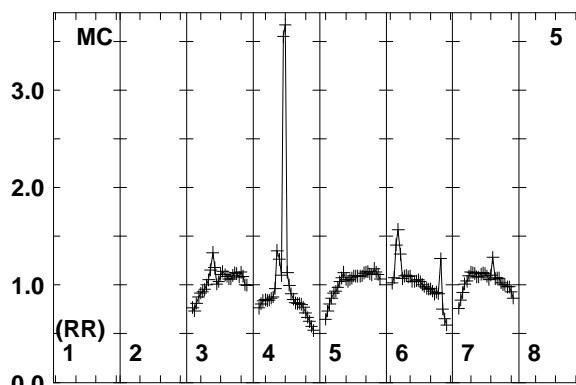
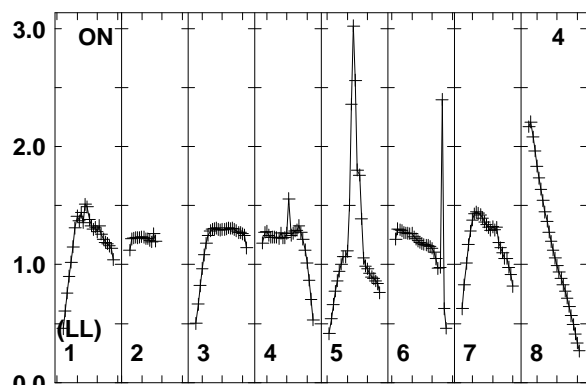
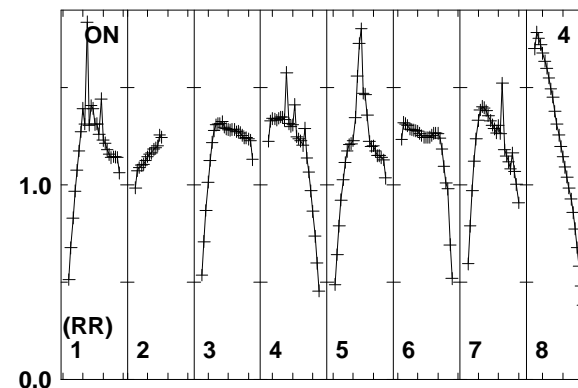
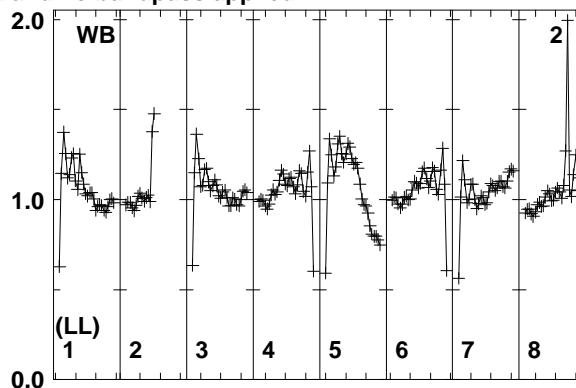
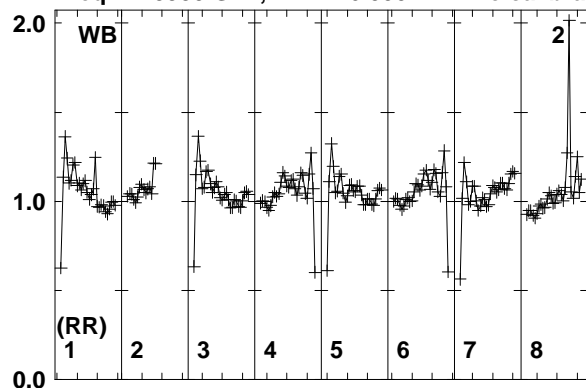

Lower frame: Real Jy
Total-power spectrum Antenna: WB (02)
Timerange: 00/06:17:51 to 00/06:18:49

Plot file version 36 created 20-MAR-2014 17:07:54

J1317+3425 ER030C.UVDATA.1

Freq = 1.5950 GHz, Bw = 16.000 MH No calibration applied and no bandpass applied

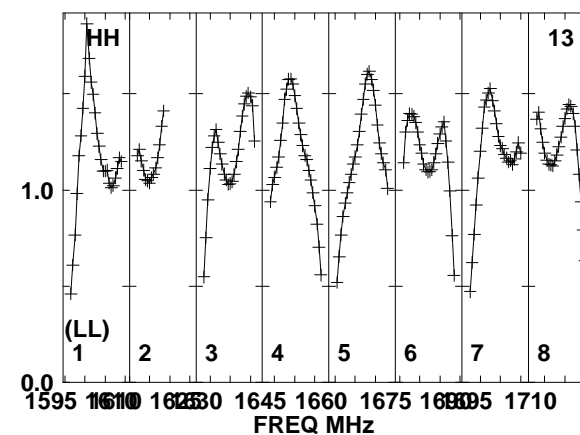
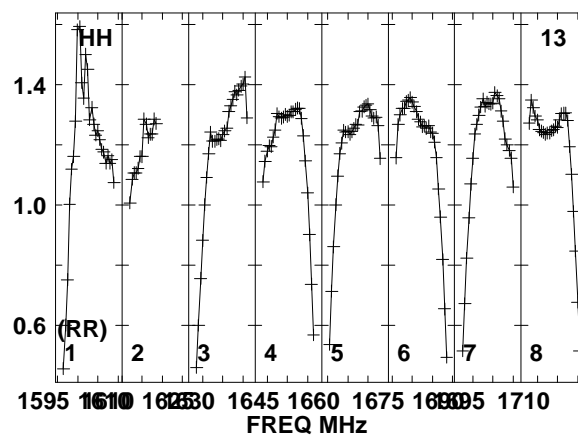
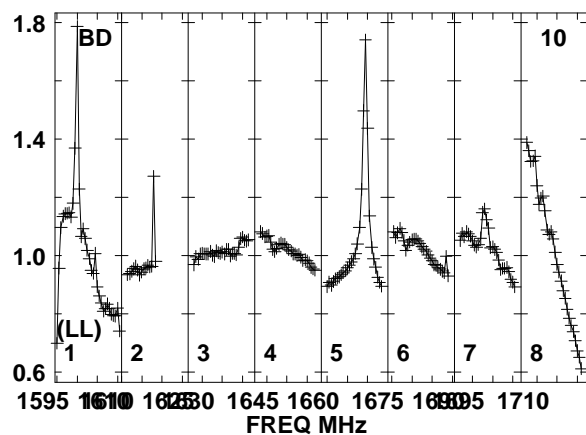
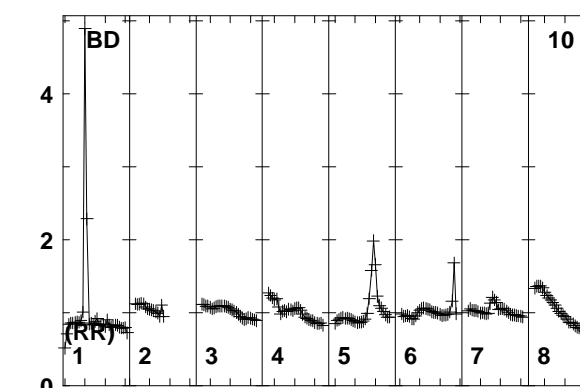
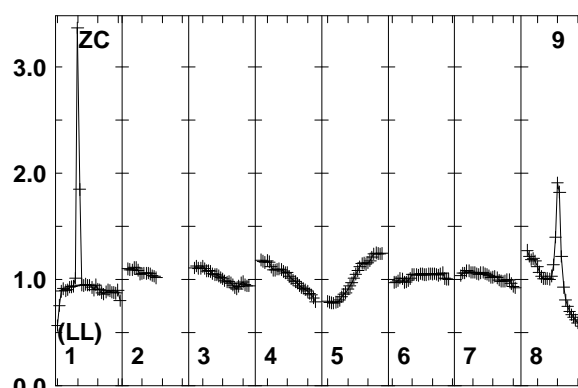
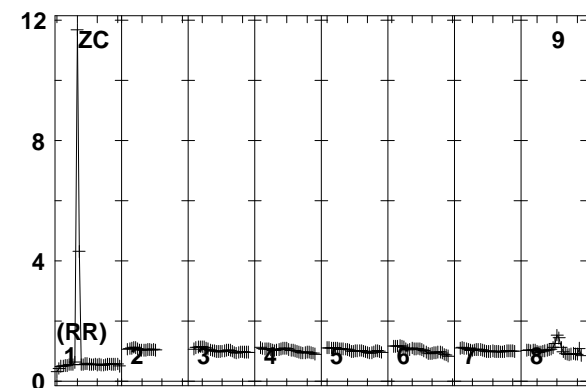
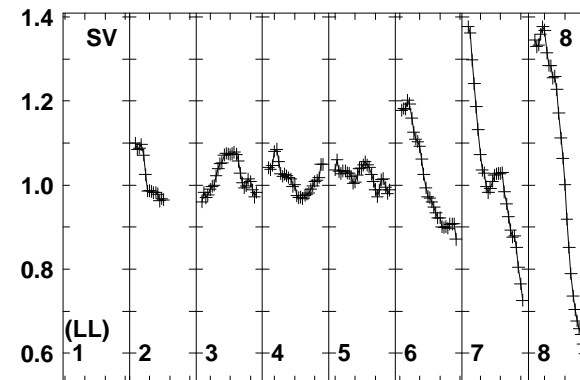
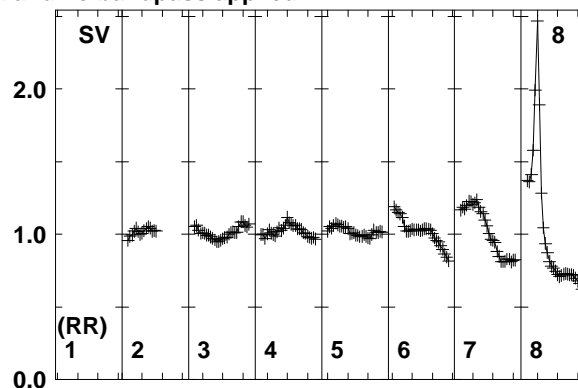
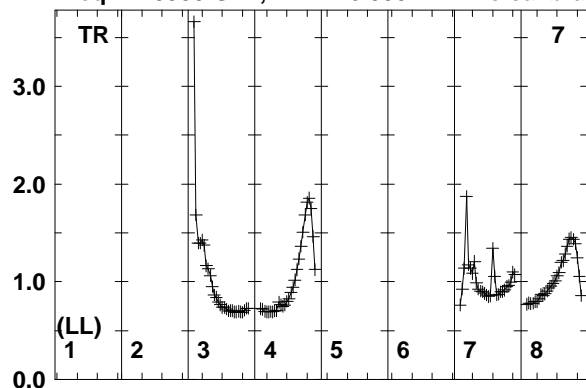

Lower frame: Real Jy
Total-power spectrum Antenna: TR (07)
Timerange: 00/06:17:51 to 00/06:18:49

Plot file version 37 created 20-MAR-2014 17:07:54

IC883 ER030C.UVDATA.1

Freq = 1.5950 GHz, Bw = 16.000 MH No calibration applied and no bandpass applied

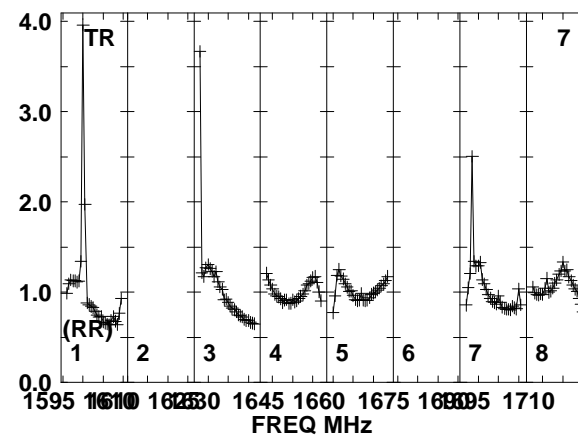
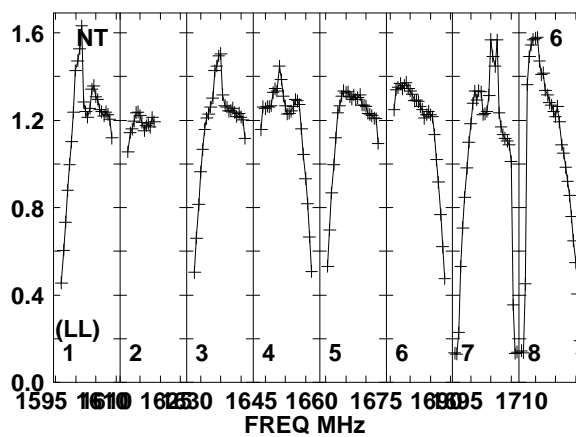
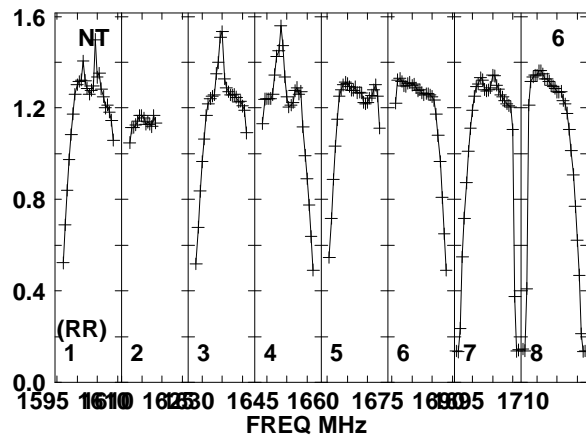
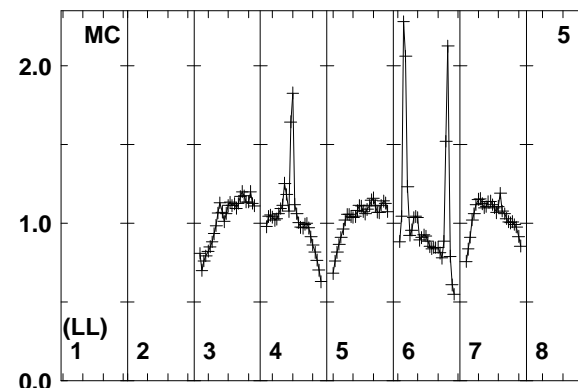
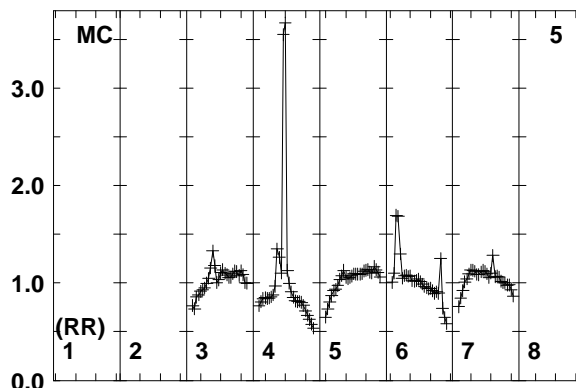
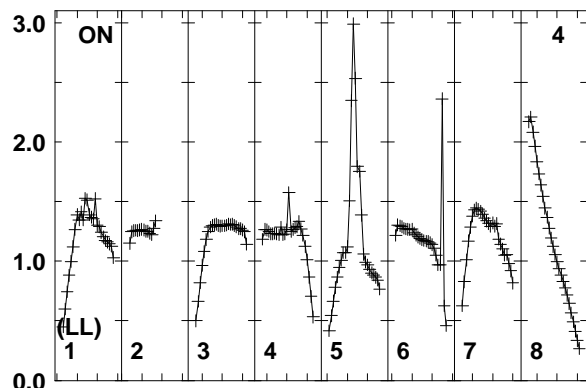
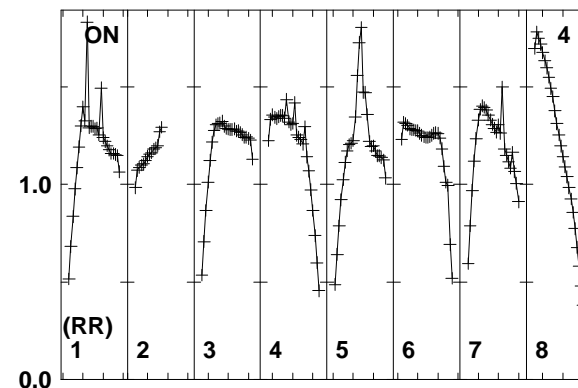
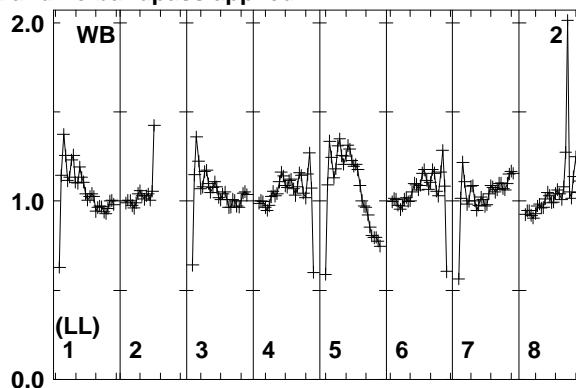
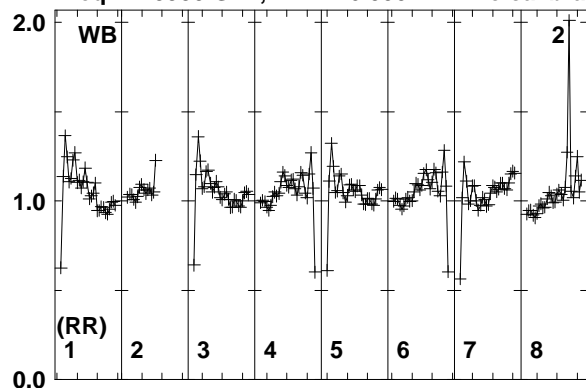

Lower frame: Real Jy
Total-power spectrum Antenna: WB (02)
Timerange: 00/06:18:53 to 00/06:22:39

Plot file version 38 created 20-MAR-2014 17:07:54

IC883 ER030C.UVDATA.1

Freq = 1.5950 GHz, Bw = 16.000 MH No calibration applied and no bandpass applied

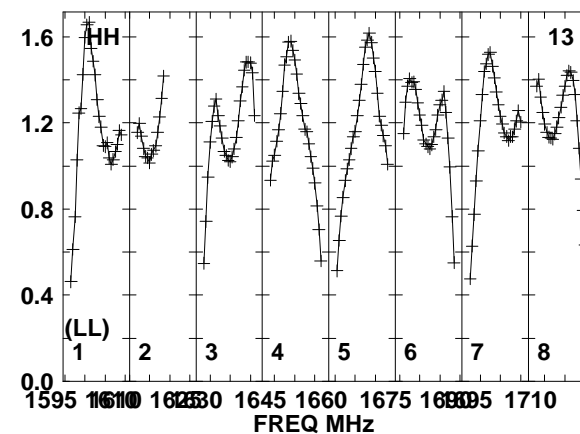
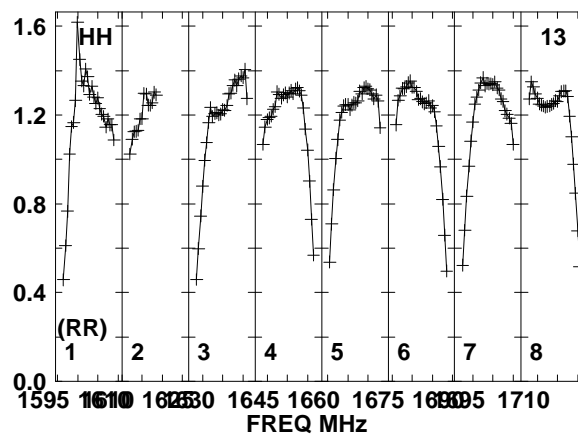
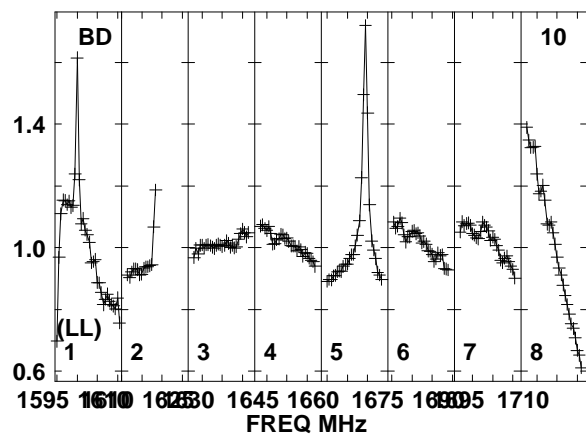
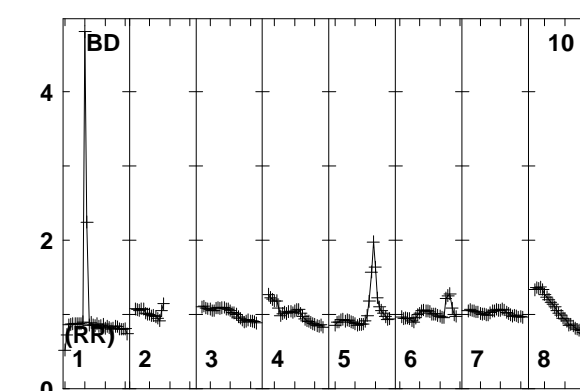
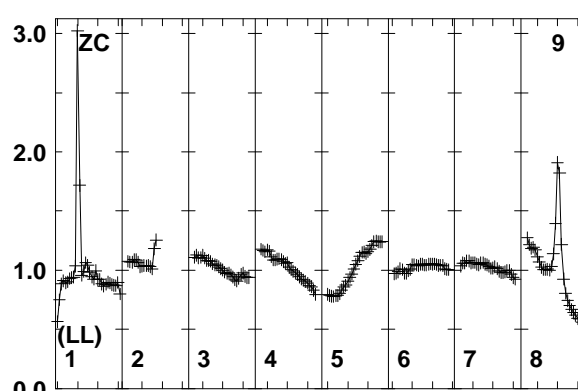
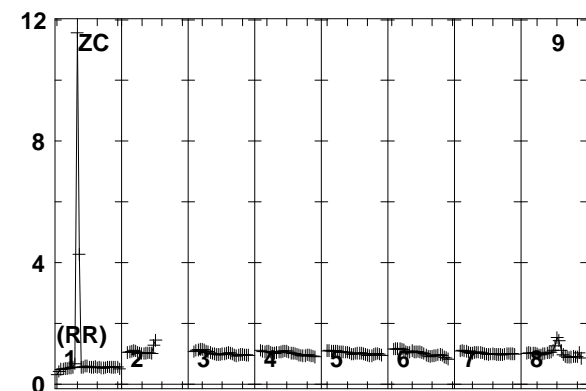
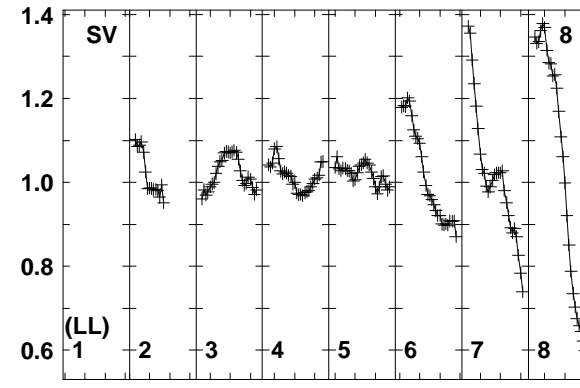
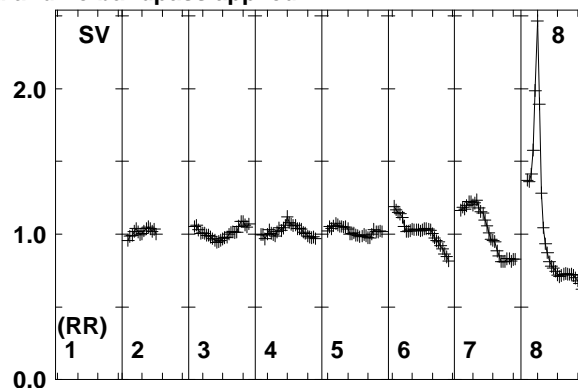
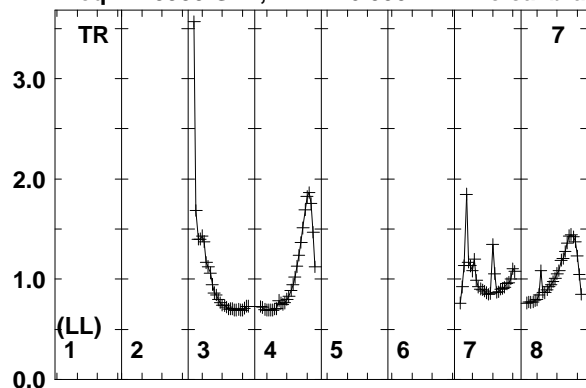

Lower frame: Real Jy
Total-power spectrum Antenna: TR (07)
Timerange: 00/06:18:53 to 00/06:22:39

Plot file version 39 created 20-MAR-2014 17:07:54

J1317+3425 ER030C.UVDATA.1

Freq = 1.5950 GHz, Bw = 16.000 MH No calibration applied and no bandpass applied

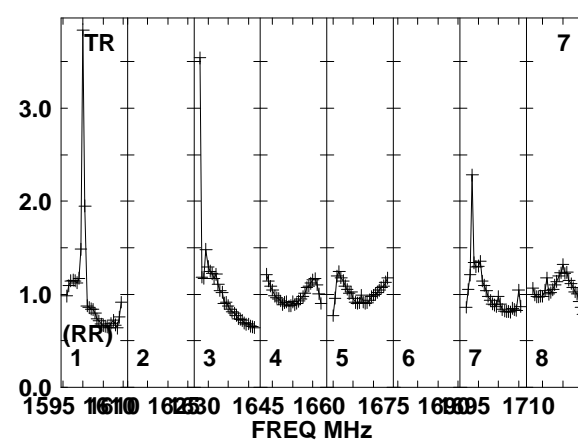
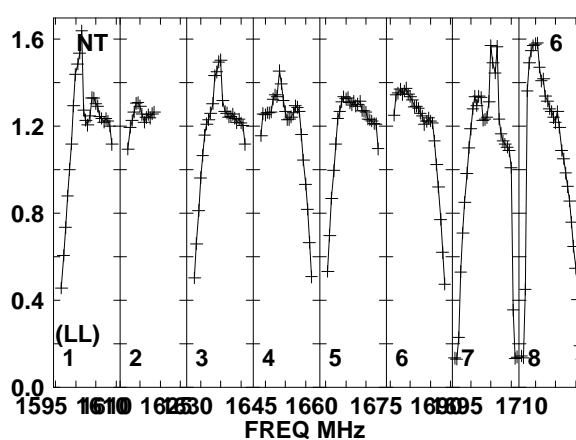
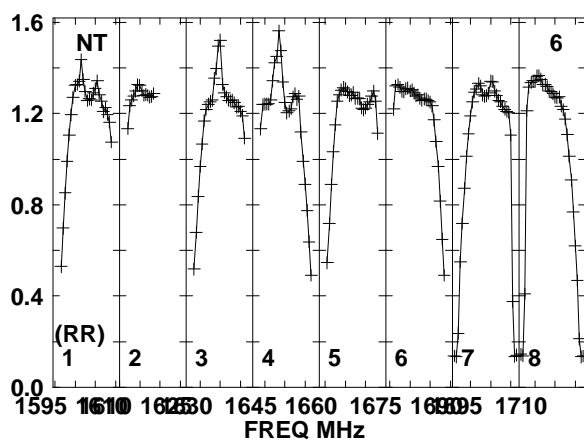
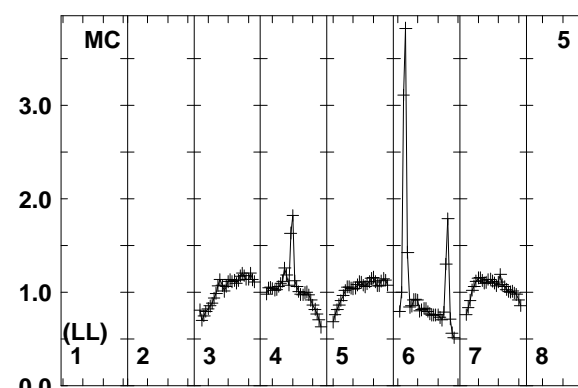
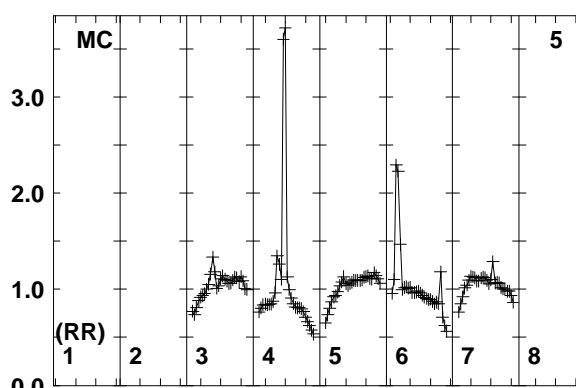
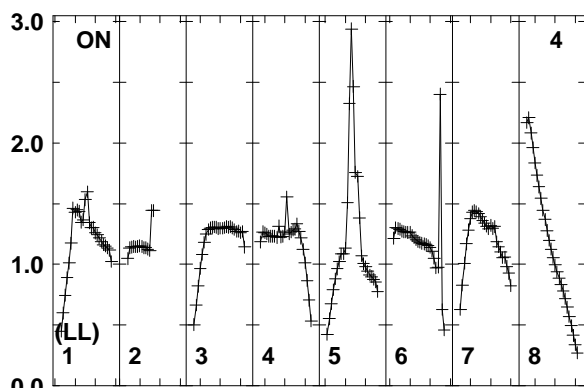
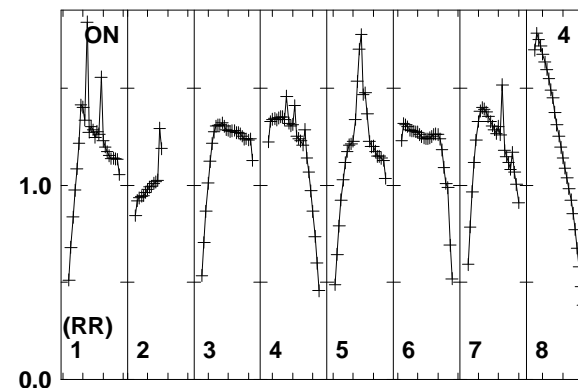
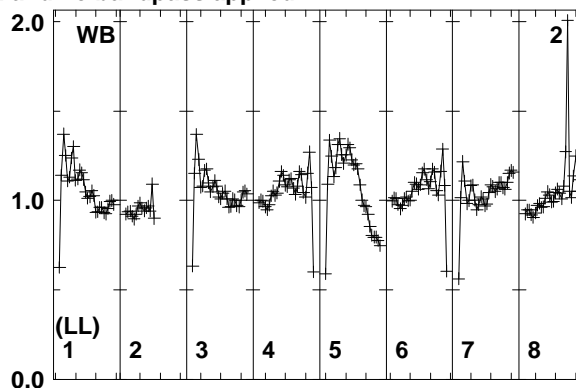
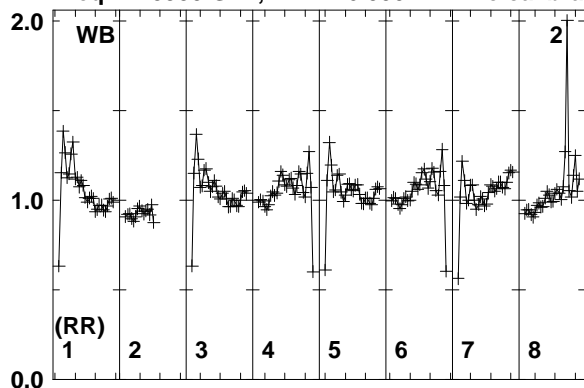

Lower frame: Real Jy
Total-power spectrum Antenna: WB (02)
Timerange: 00/06:22:43 to 00/06:23:59

Plot file version 40 created 20-MAR-2014 17:07:55
 J1317+3425 ER030C.UVDATA.1
 Freq = 1.5950 GHz, Bw = 16.000 MH No calibration applied and no bandpass applied

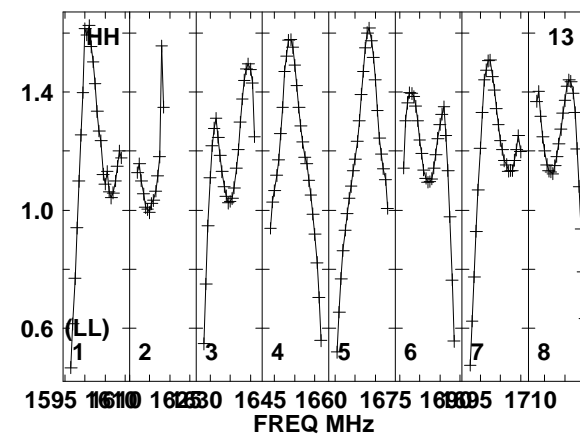
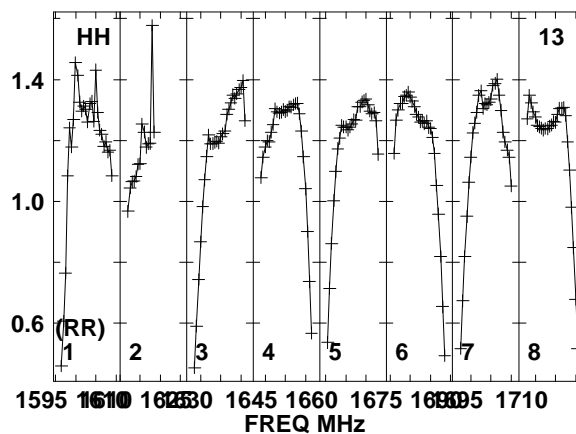
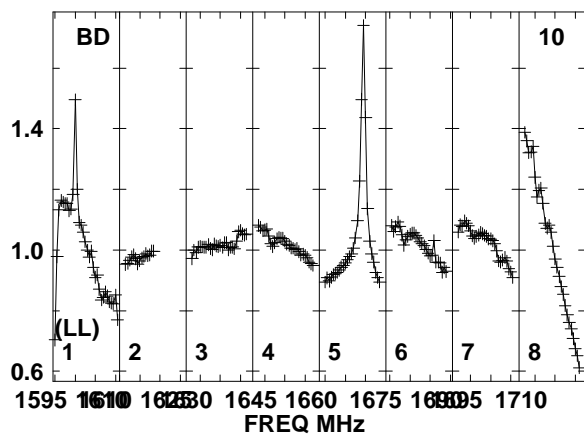
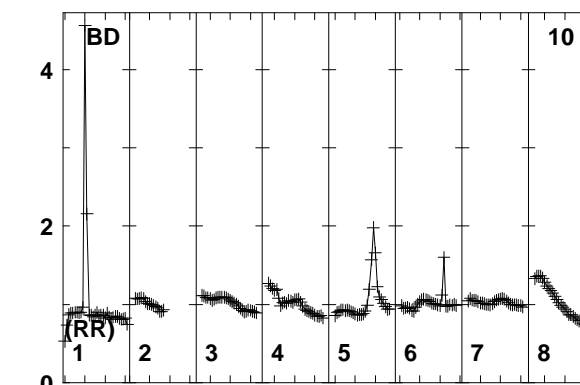
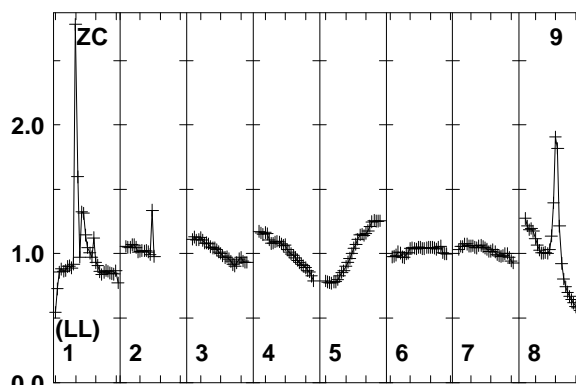
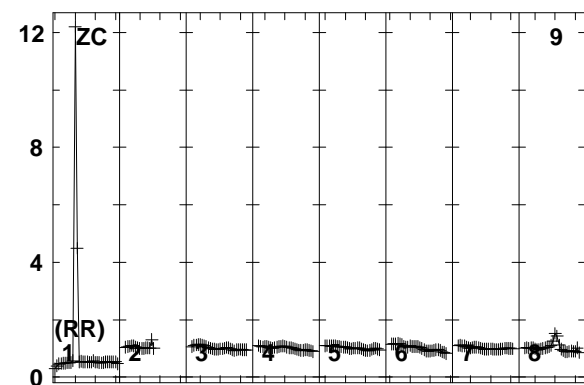
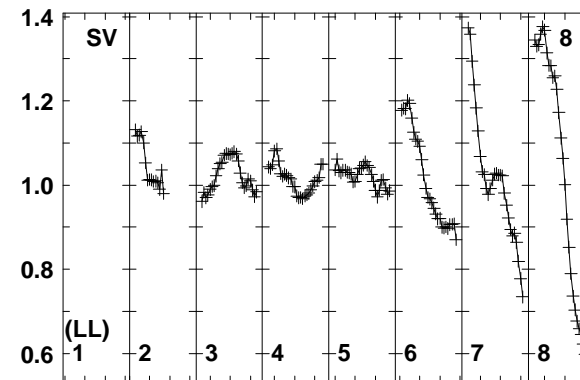
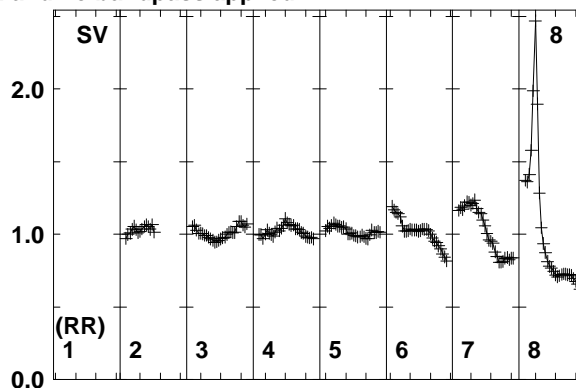
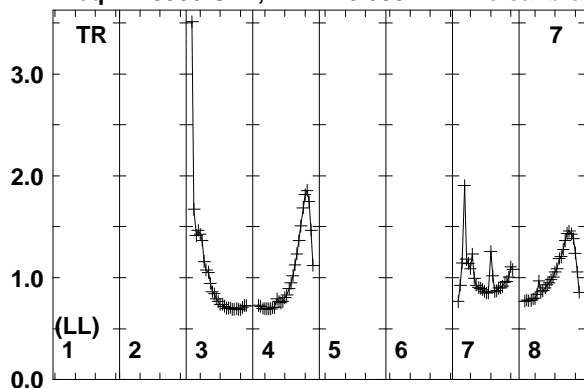

Lower frame: Real Jy
 Total-power spectrum Antenna: TR (07)
 Timerange: 00/06:22:43 to 00/06:23:59

Plot file version 41 created 20-MAR-2014 17:07:55

IC883 ER030C.UVDATA.1

Freq = 1.5950 GHz, Bw = 16.000 MH No calibration applied and no bandpass applied

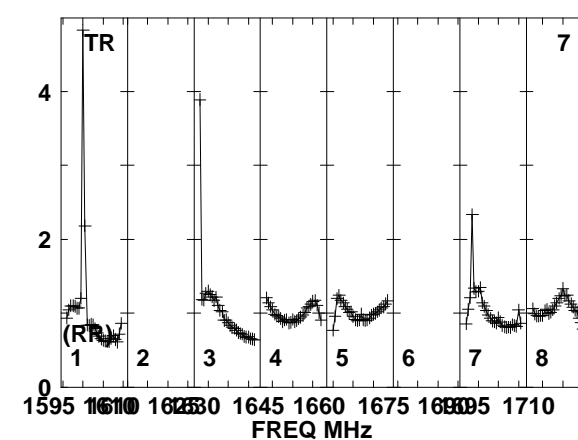
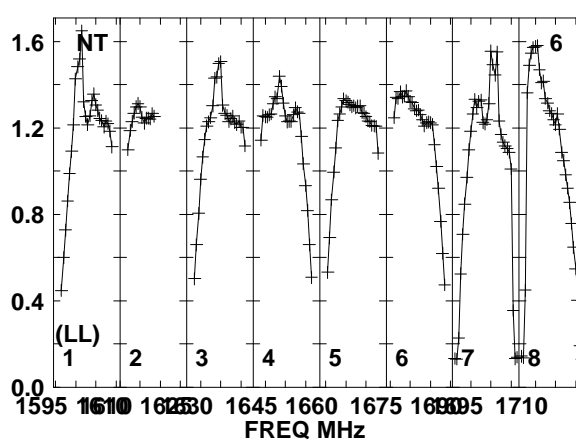
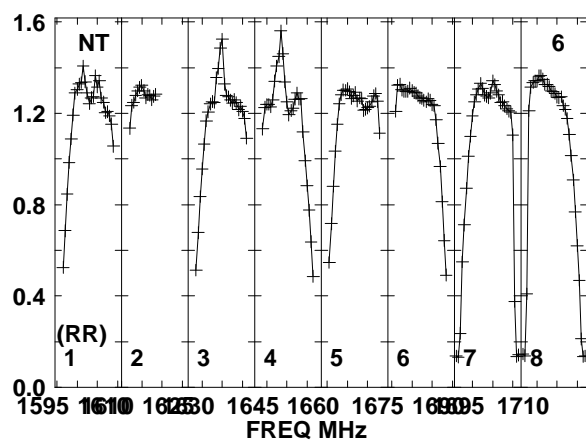
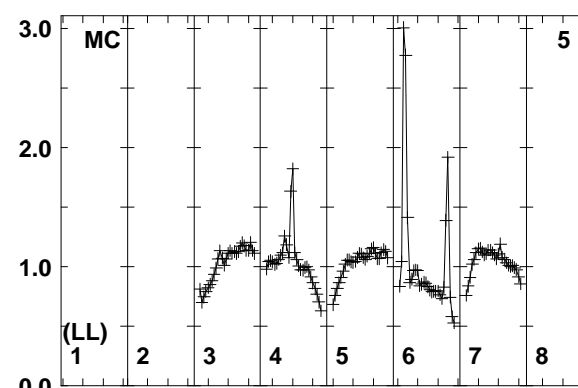
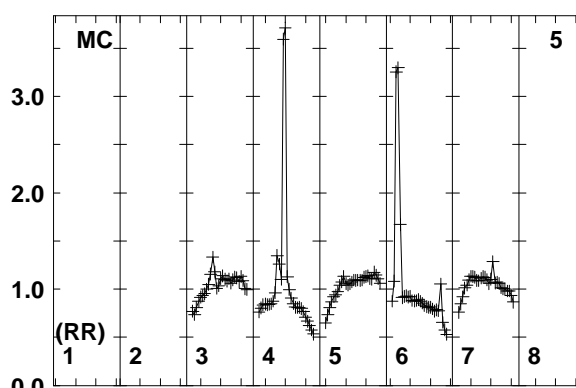
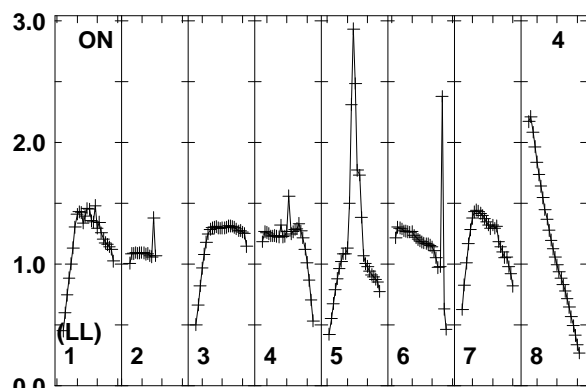
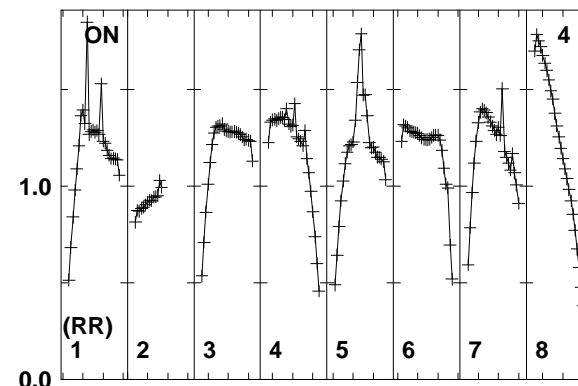
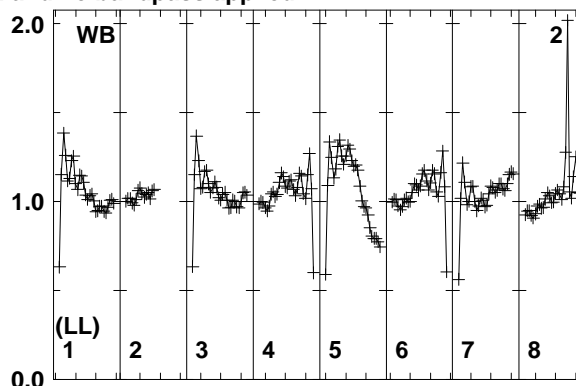
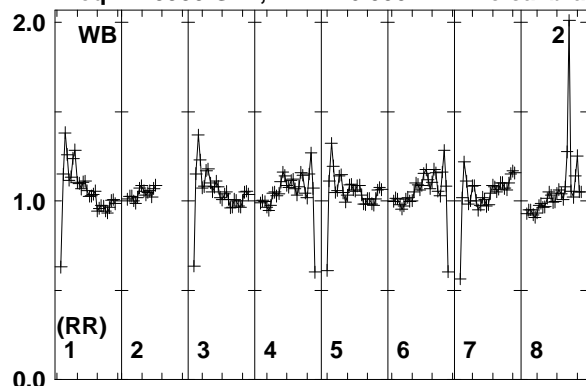

Lower frame: Real Jy
Total-power spectrum Antenna: WB (02)
Timerange: 00/06:24:01 to 00/06:27:49

Plot file version 42 created 20-MAR-2014 17:07:55

IC883 ER030C.UVDATA.1

Freq = 1.5950 GHz, Bw = 16.000 MH No calibration applied and no bandpass applied

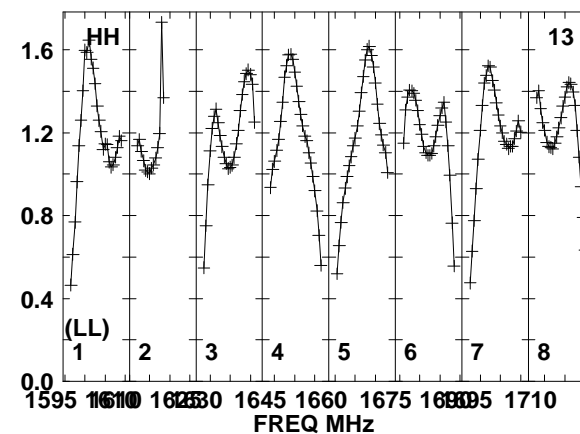
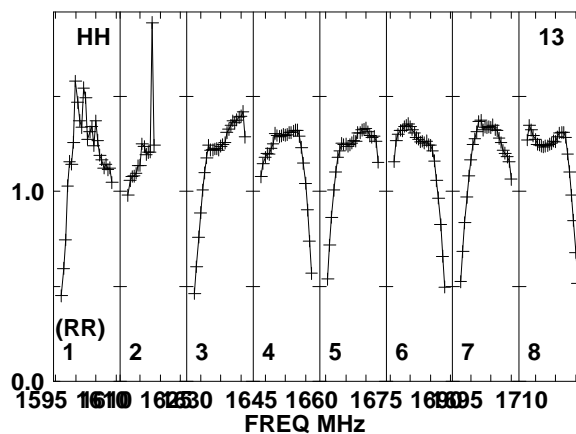
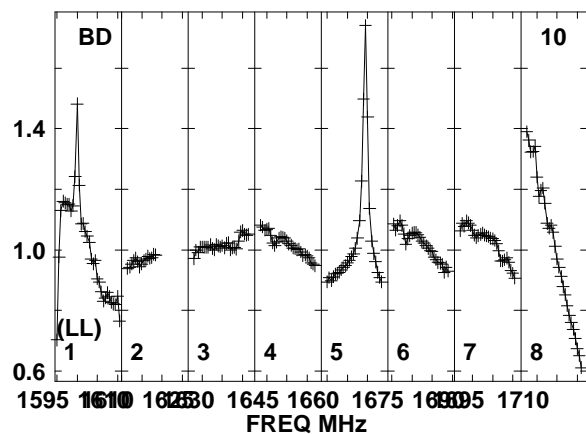
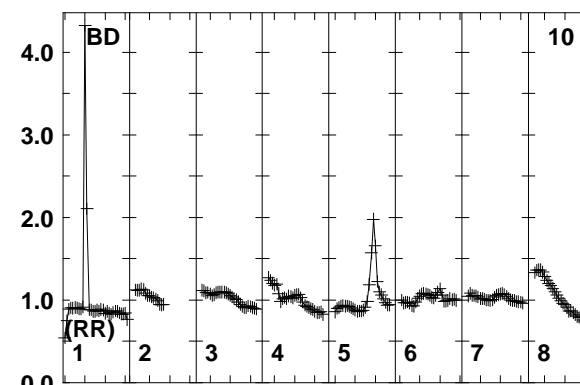
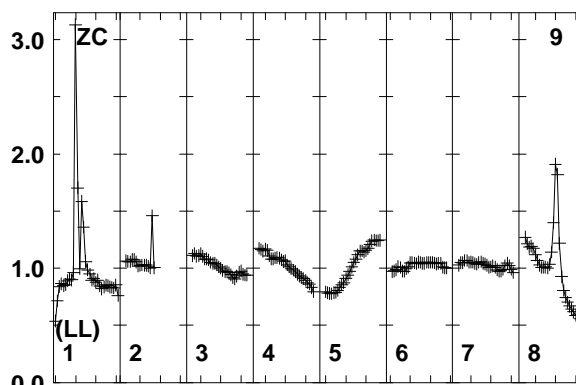
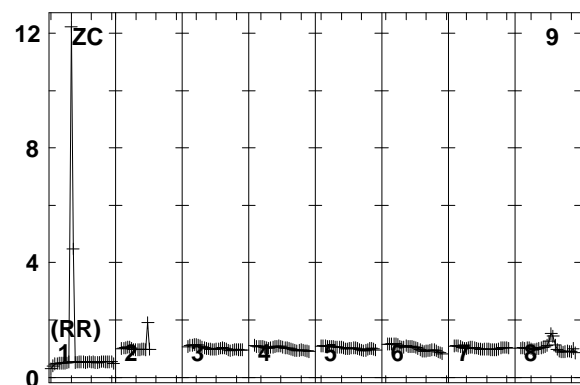
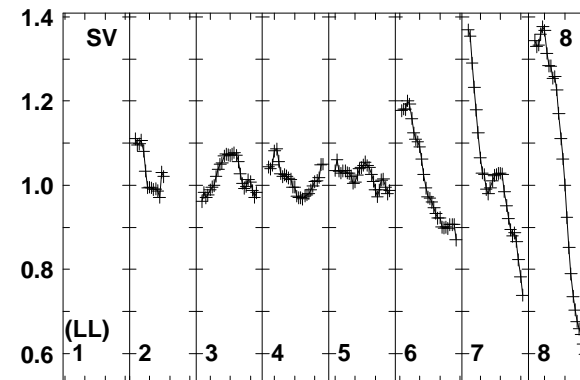
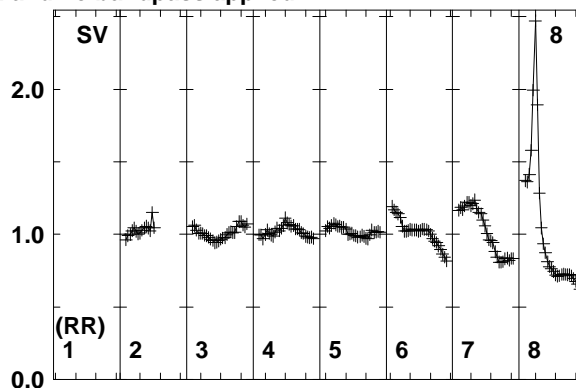
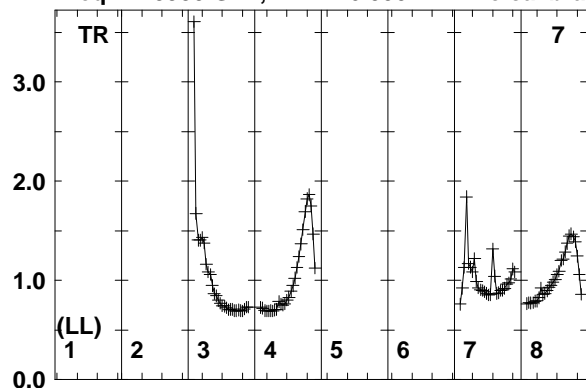

Lower frame: Real Jy
Total-power spectrum Antenna: TR (07)
Timerange: 00/06:24:01 to 00/06:27:49

Plot file version 43 created 20-MAR-2014 17:07:55

J1317+3425 ER030C.UVDATA.1

Freq = 1.5950 GHz, Bw = 16.000 MH No calibration applied and no bandpass applied

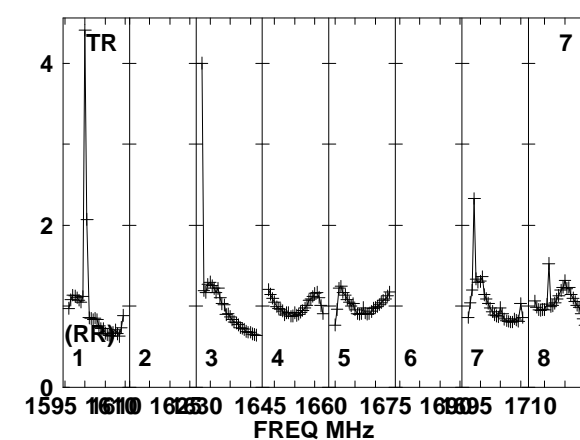
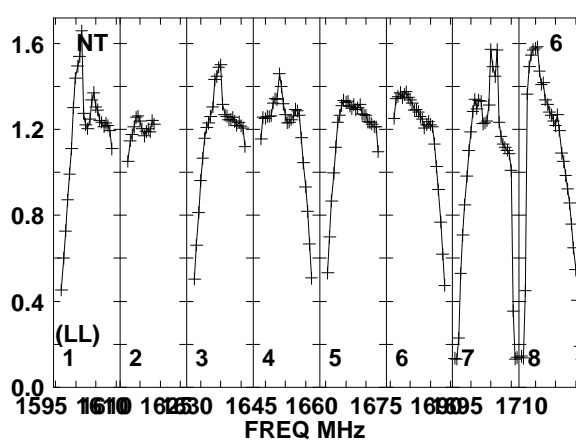
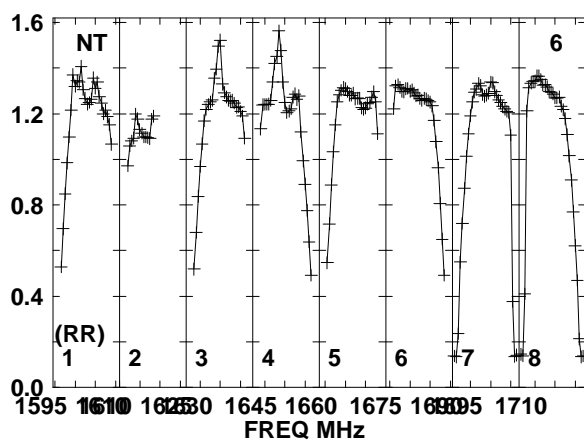
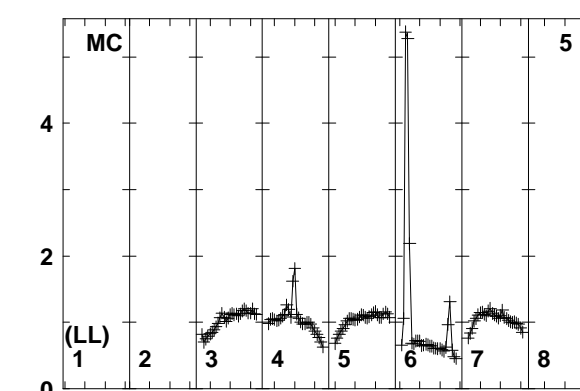
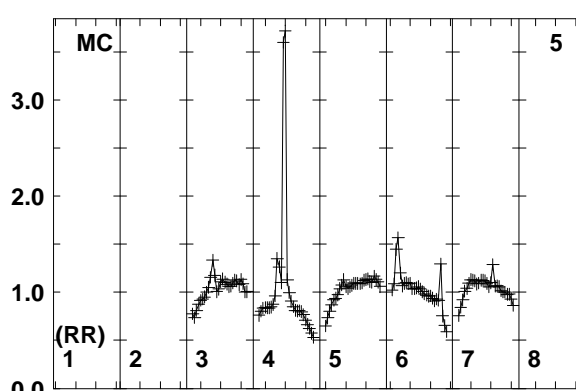
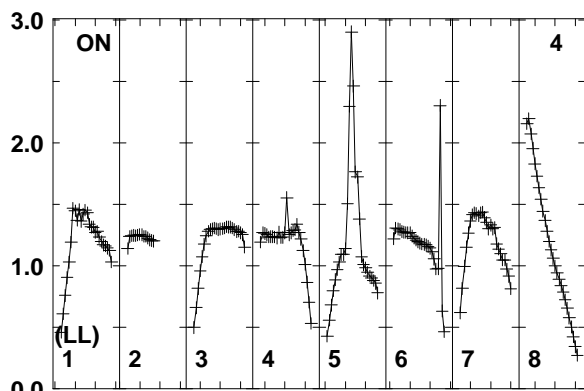
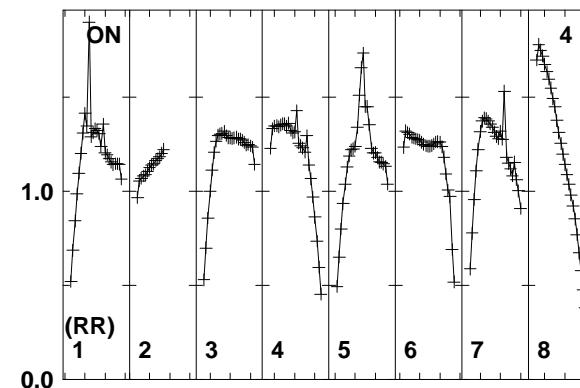
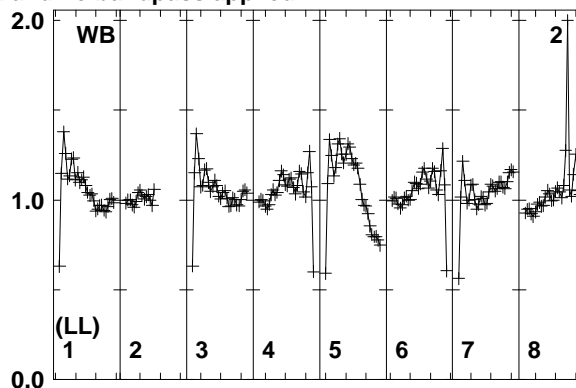
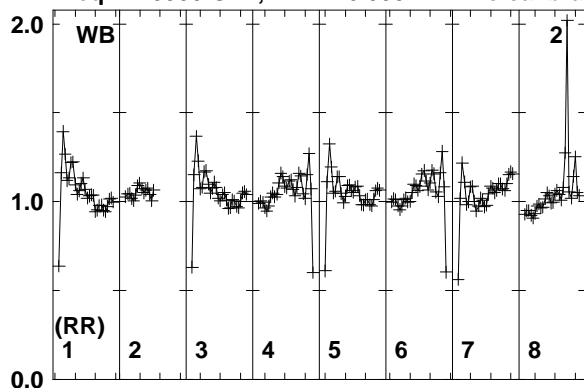

Lower frame: Real Jy
Total-power spectrum Antenna: WB (02)
Timerange: 00/06:28:31 to 00/06:29:29

Plot file version 44 created 20-MAR-2014 17:07:55

J1317+3425 ER030C.UVDATA.1

Freq = 1.5950 GHz, Bw = 16.000 MH No calibration applied and no bandpass applied

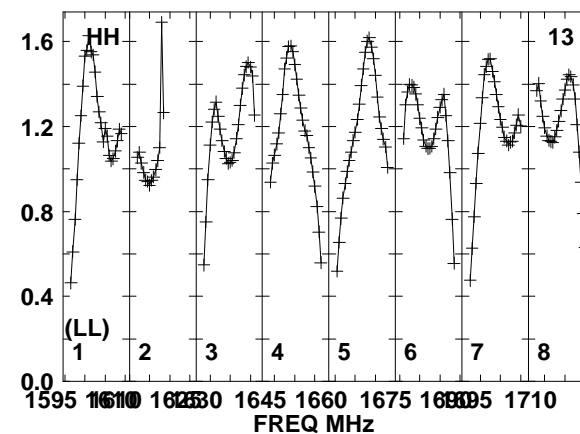
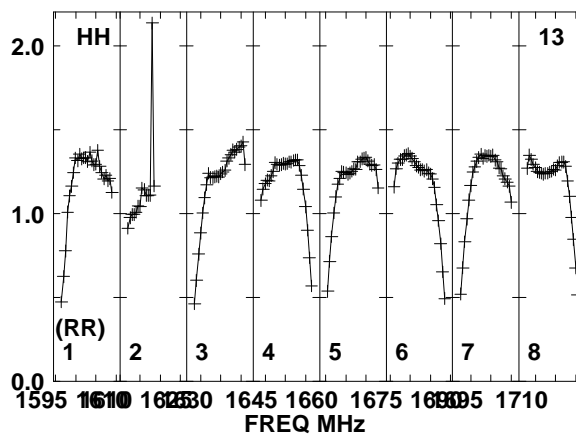
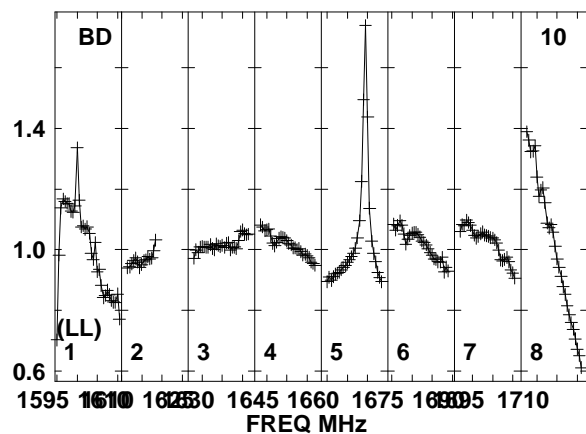
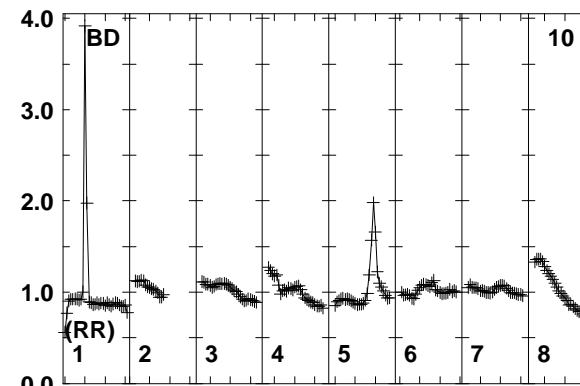
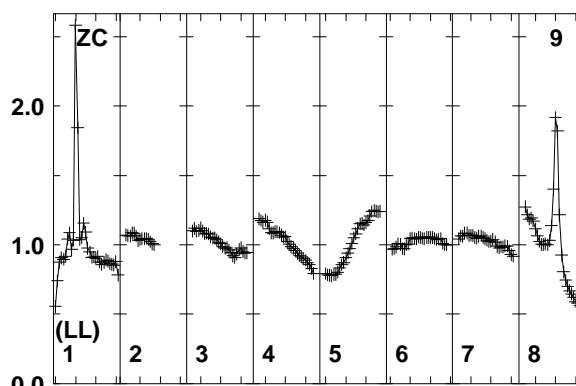
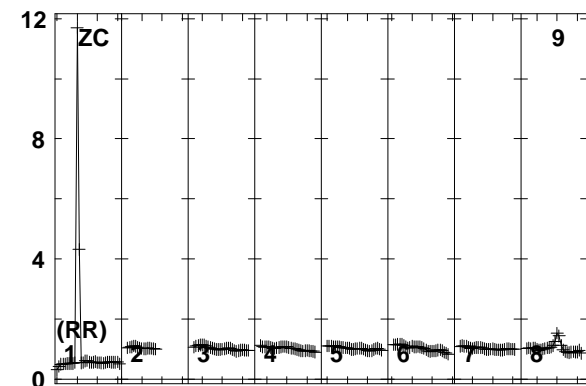
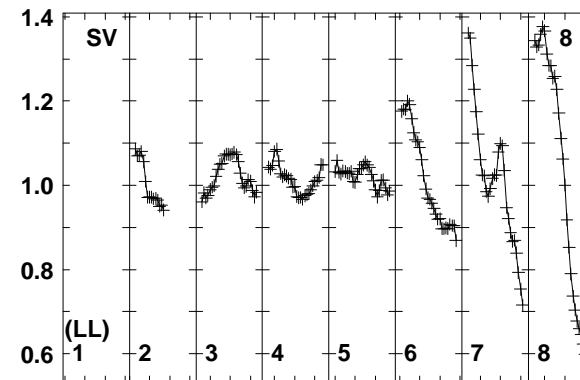
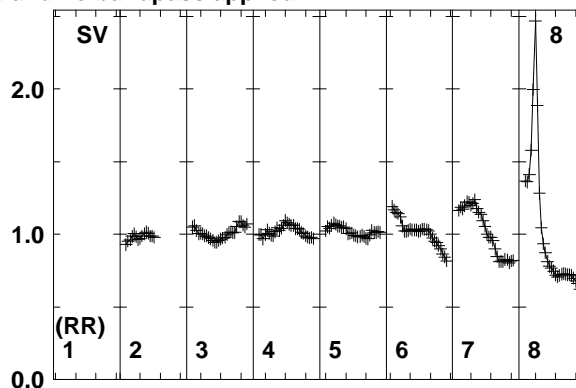
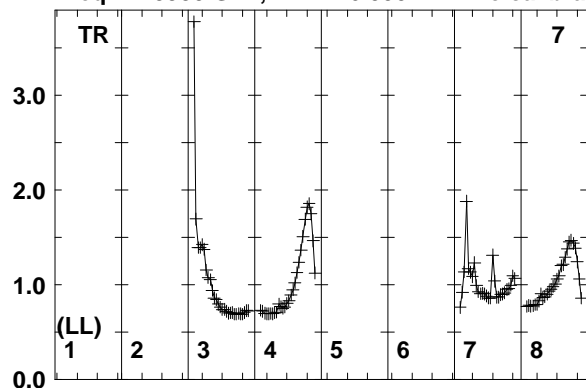

Lower frame: Real Jy
Total-power spectrum Antenna: TR (07)
Timerange: 00/06:28:31 to 00/06:29:29

Plot file version 45 created 20-MAR-2014 17:07:55

IC883 ER030C.UVDATA.1

Freq = 1.5950 GHz, Bw = 16.000 MH No calibration applied and no bandpass applied

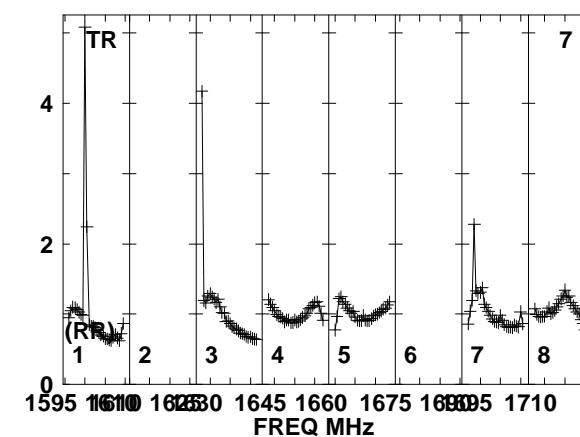
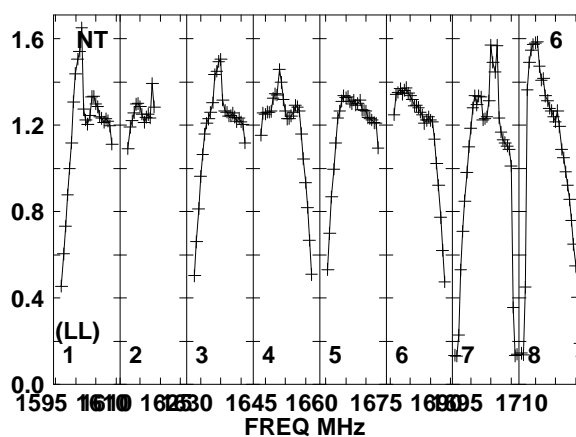
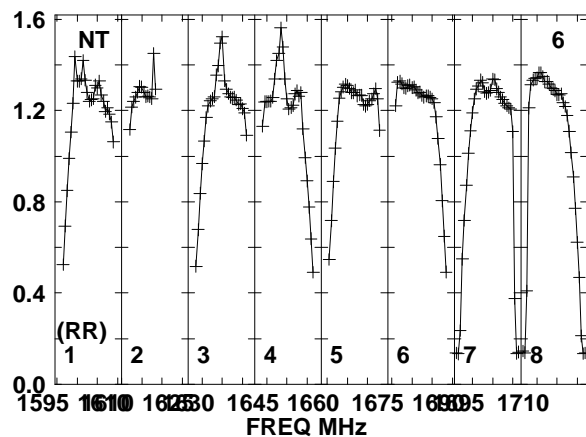
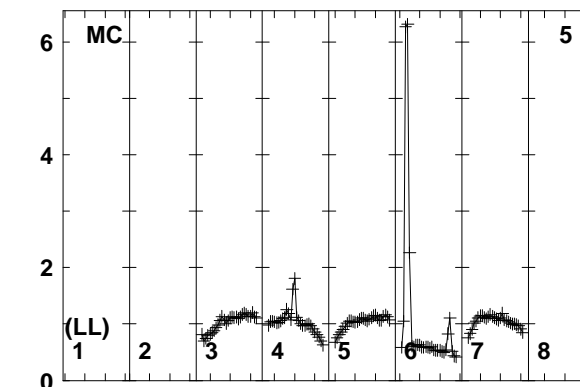
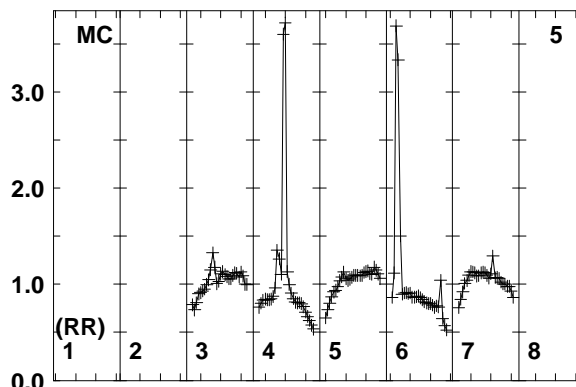
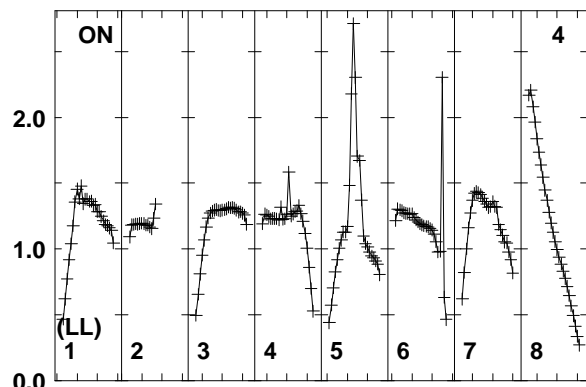
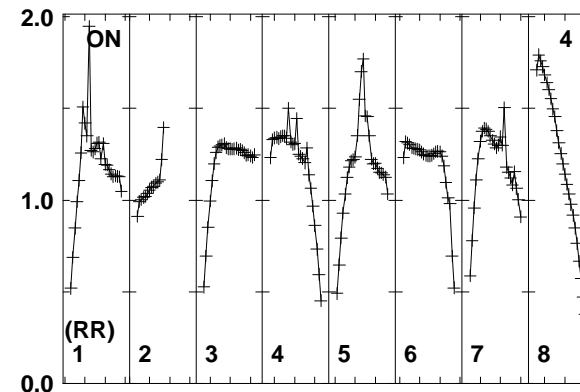
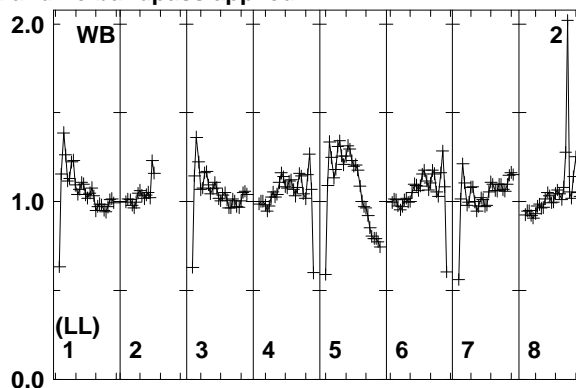
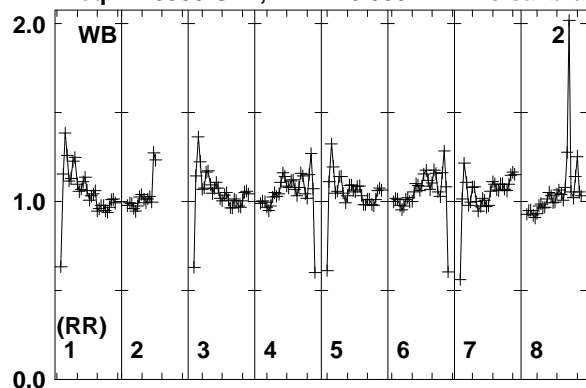

Lower frame: Real Jy
Total-power spectrum Antenna: WB (02)
Timerange: 00/06:29:35 to 00/06:33:19

Plot file version 46 created 20-MAR-2014 17:07:55

IC883 ER030C.UVDATA.1

Freq = 1.5950 GHz, Bw = 16.000 MH No calibration applied and no bandpass applied

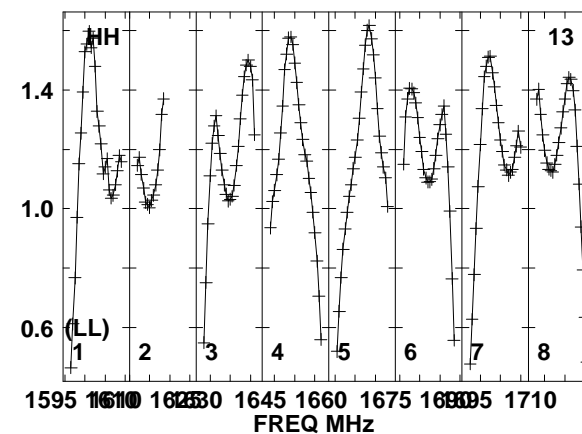
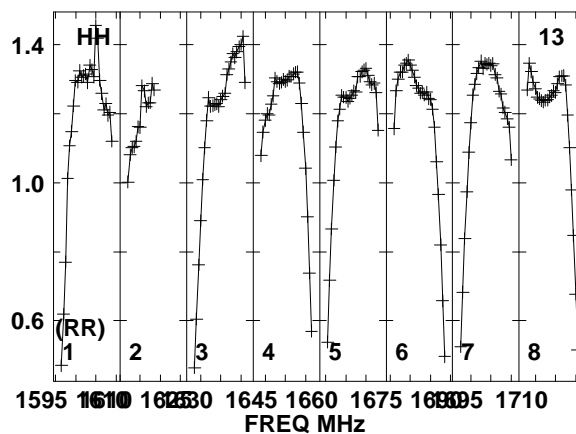
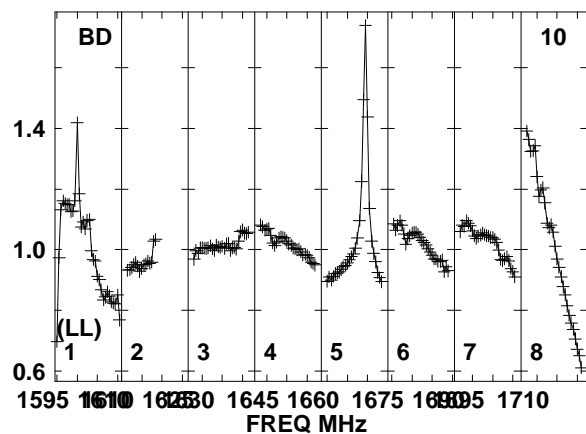
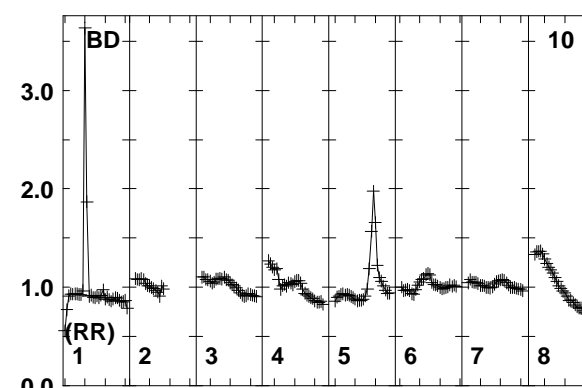
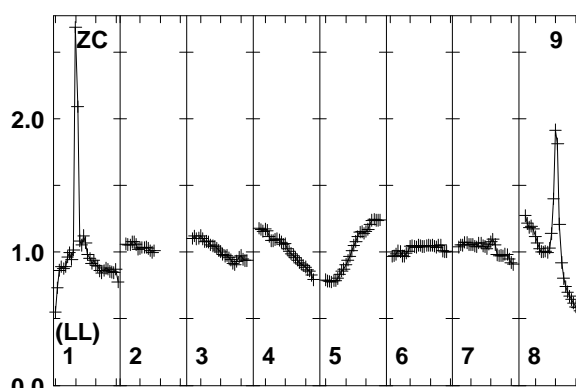
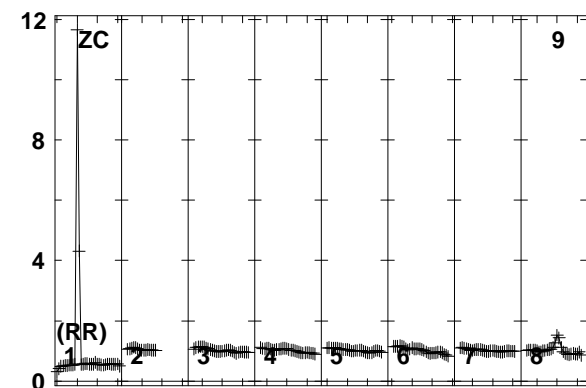
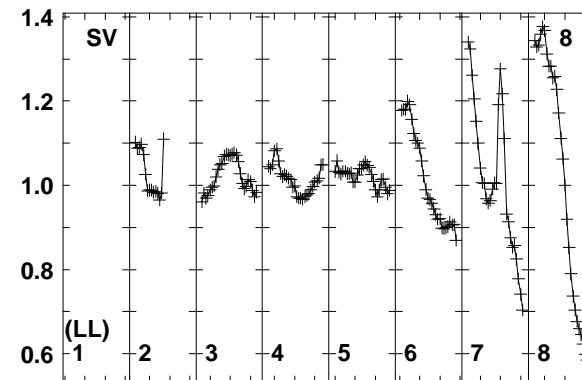
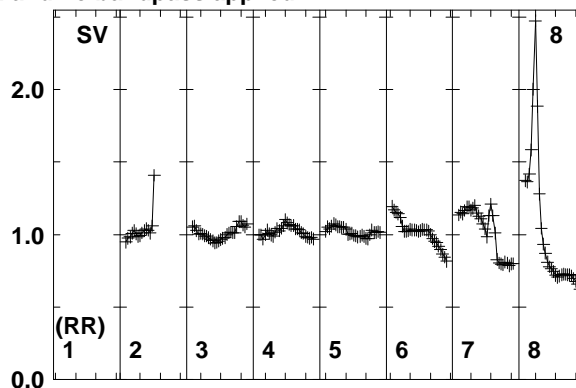
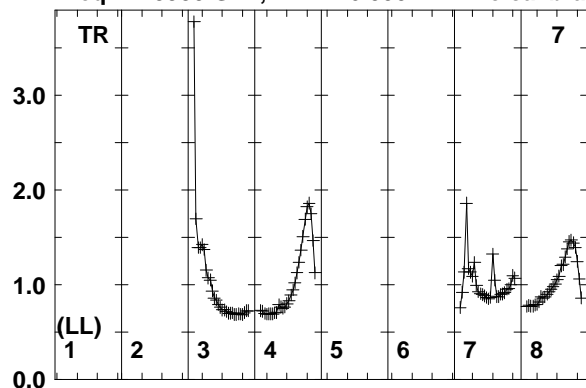

Lower frame: Real Jy
Total-power spectrum Antenna: TR (07)
Timerange: 00/06:29:35 to 00/06:33:19

Plot file version 47 created 20-MAR-2014 17:07:55

J1317+3425 ER030C.UVDATA.1

Freq = 1.5950 GHz, Bw = 16.000 MH No calibration applied and no bandpass applied

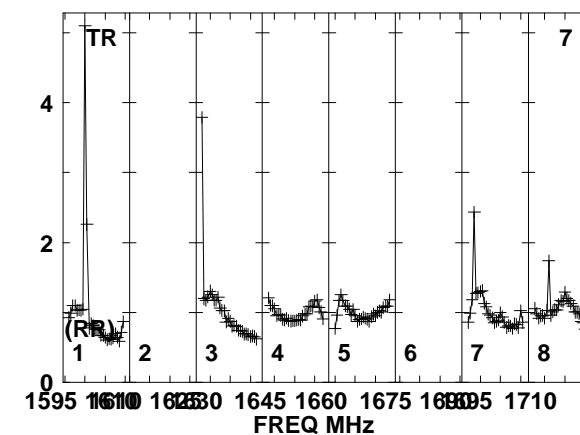
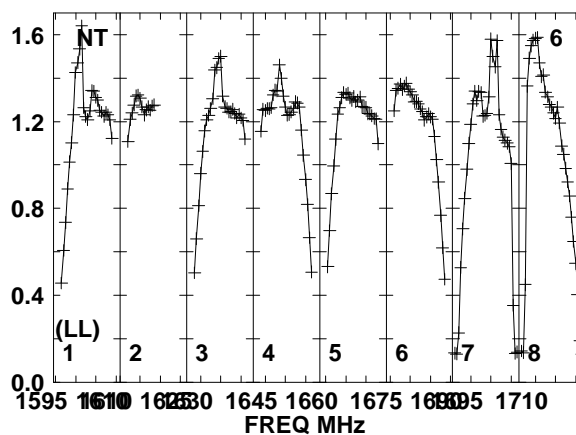
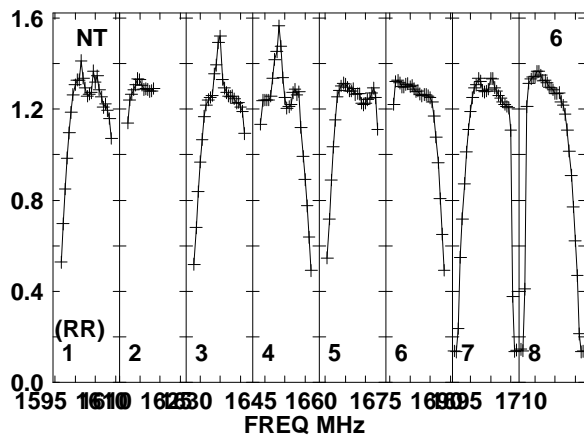
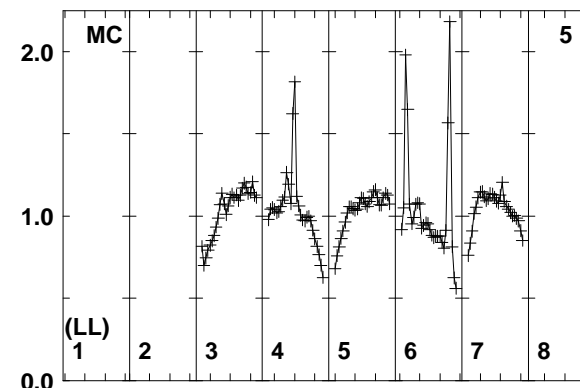
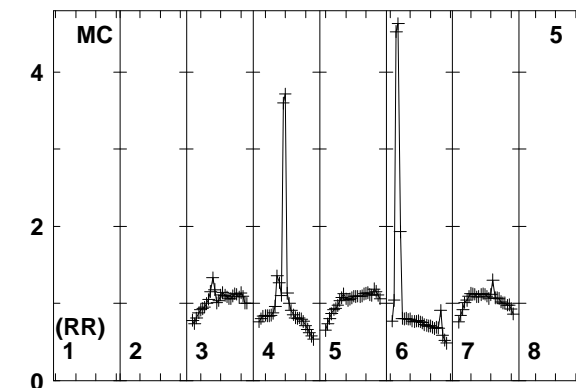
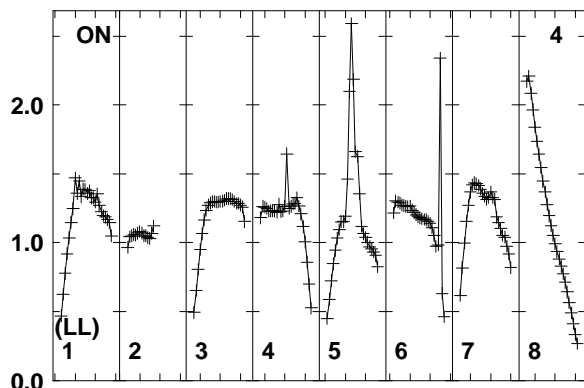
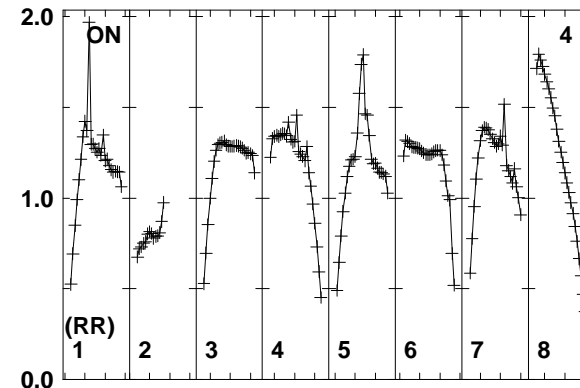
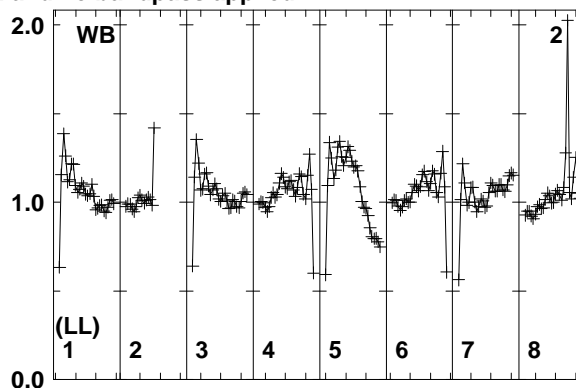
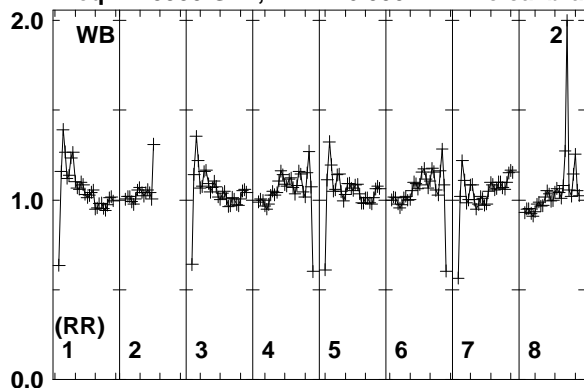

Lower frame: Real Jy
Total-power spectrum Antenna: WB (02)
Timerange: 00/06:33:23 to 00/06:34:39

Plot file version 48 created 20-MAR-2014 17:07:55

J1317+3425 ER030C.UVDATA.1

Freq = 1.5950 GHz, Bw = 16.000 MH No calibration applied and no bandpass applied

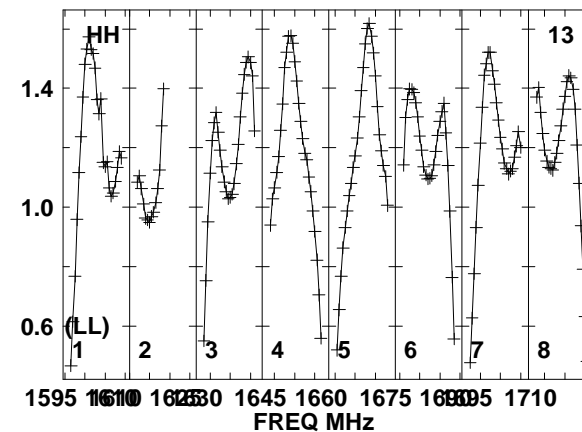
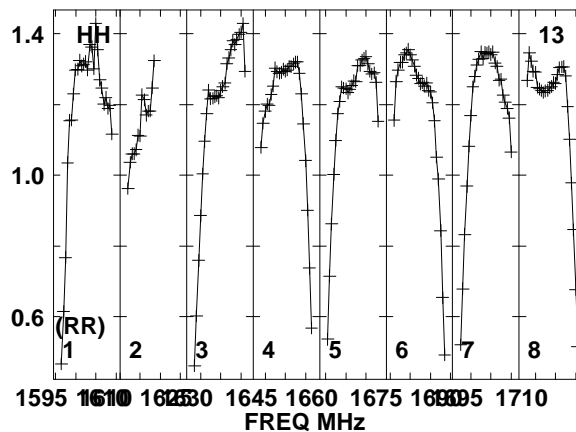
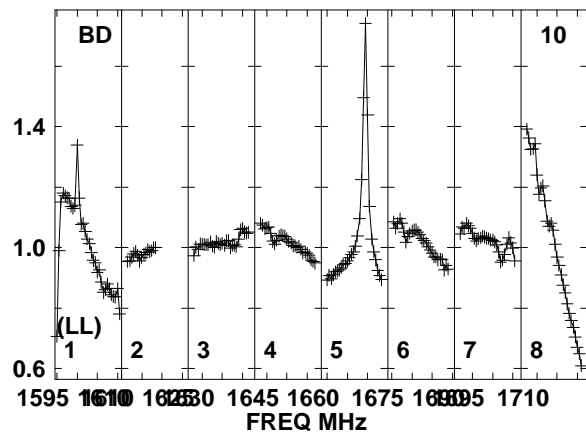
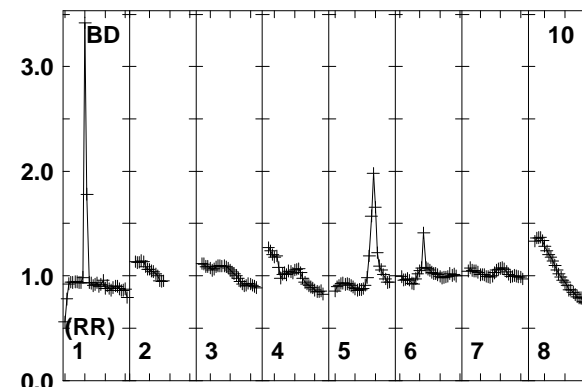
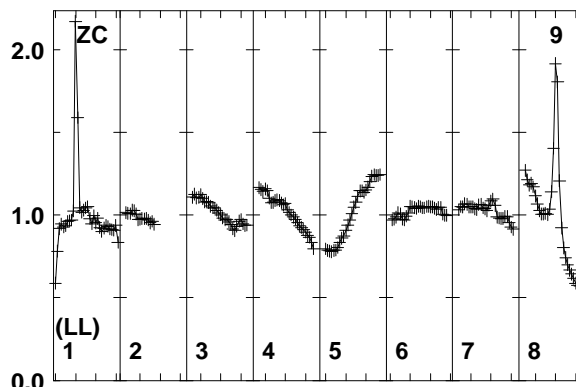
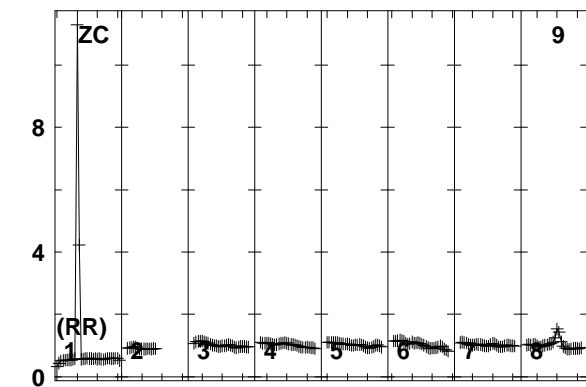
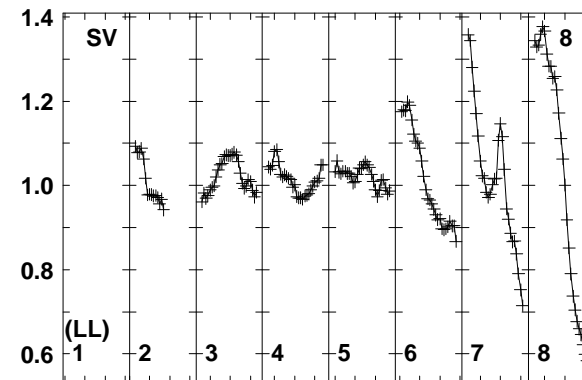
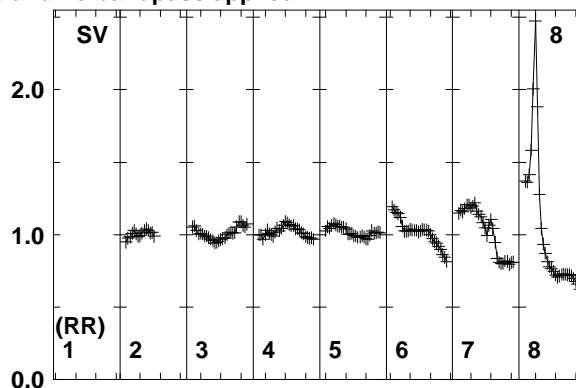
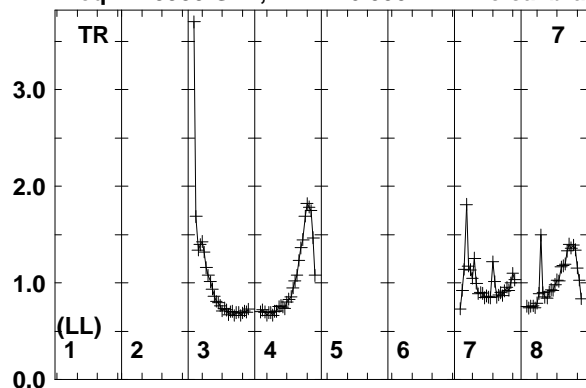

Lower frame: Real Jy
Total-power spectrum Antenna: TR (07)
Timerange: 00/06:33:23 to 00/06:34:39

Plot file version 49 created 20-MAR-2014 17:07:55

J1159+2914 ER030C.UVDATA.1

Freq = 1.5950 GHz, Bw = 16.000 MH No calibration applied and no bandpass applied

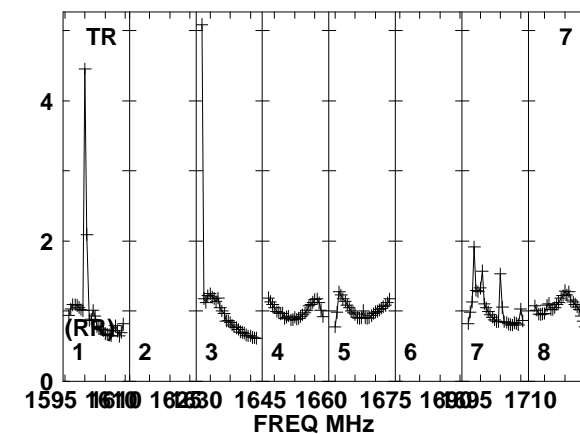
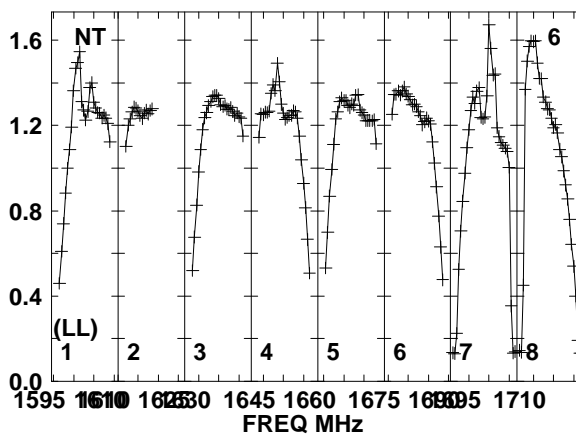
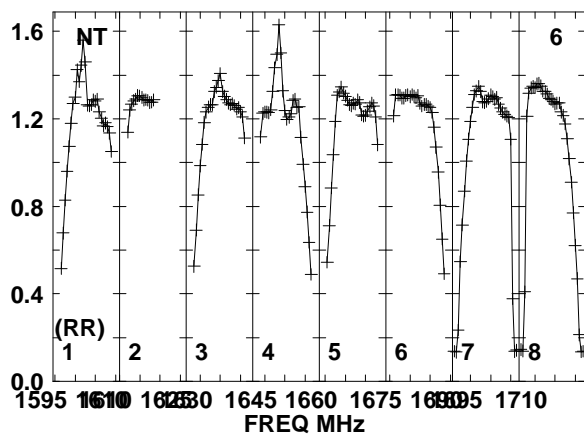
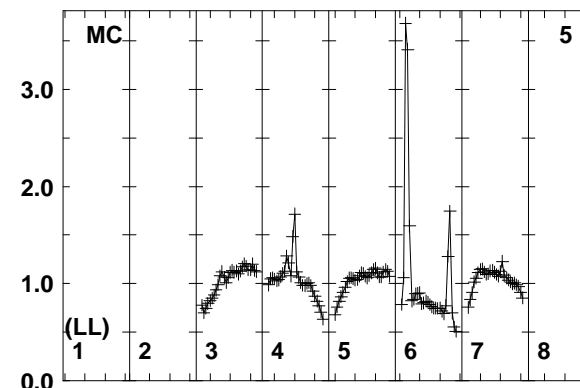
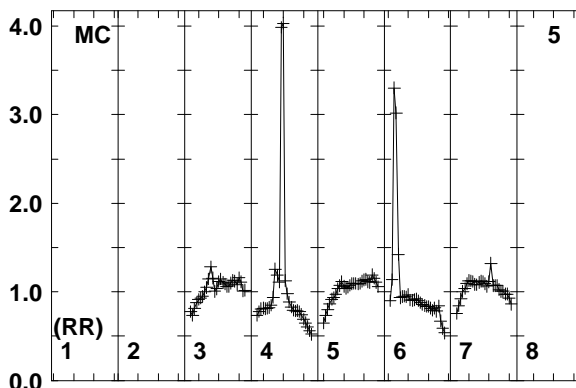
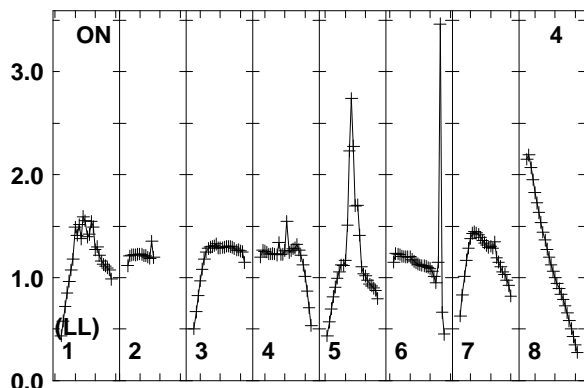
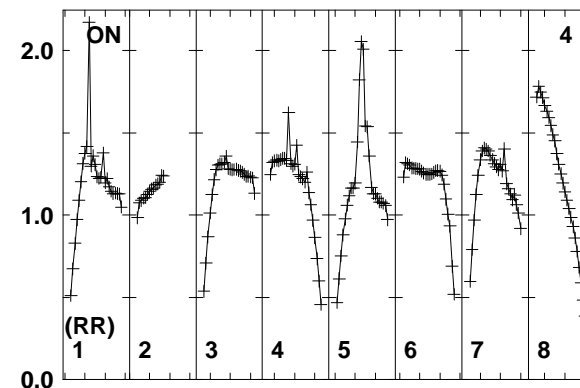
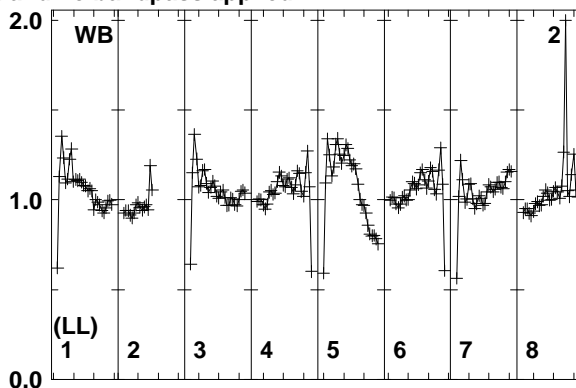
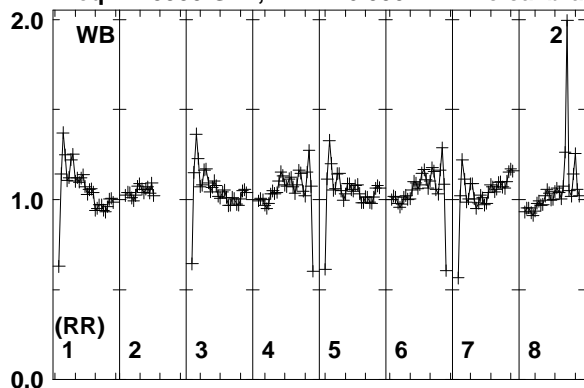

Lower frame: Real Jy
Total-power spectrum Antenna: WB (02)
Timerange: 00/06:36:41 to 00/06:42:39

Plot file version 50 created 20-MAR-2014 17:07:56

J1159+2914 ER030C.UVDATA.1

Freq = 1.5950 GHz, Bw = 16.000 MH No calibration applied and no bandpass applied

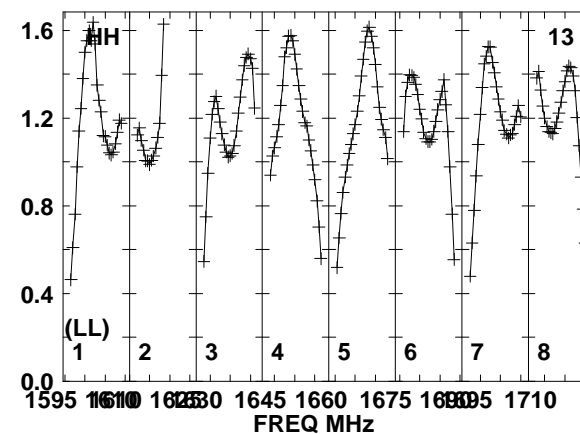
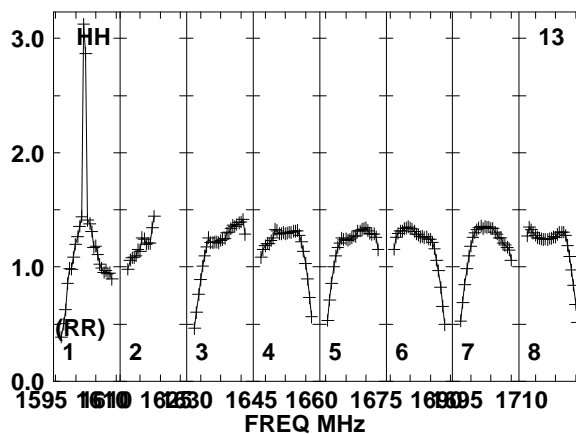
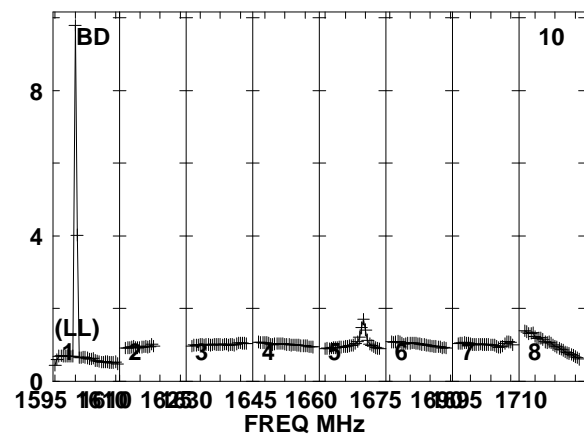
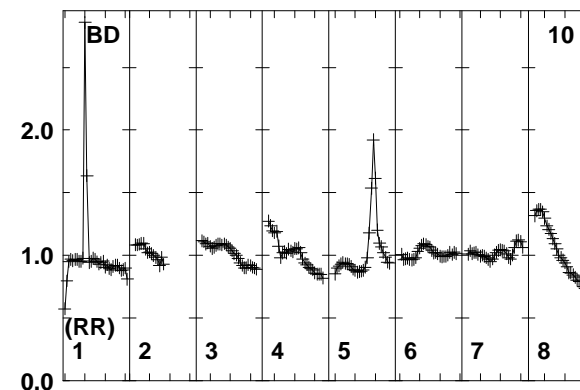
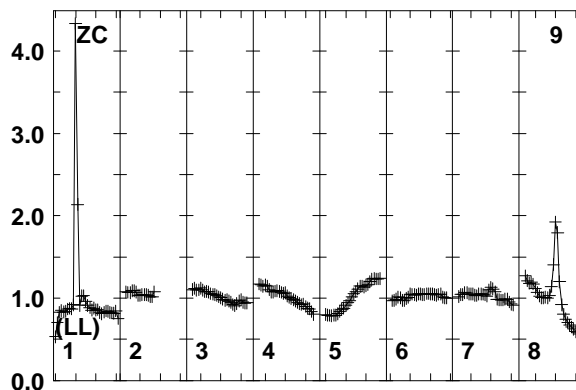
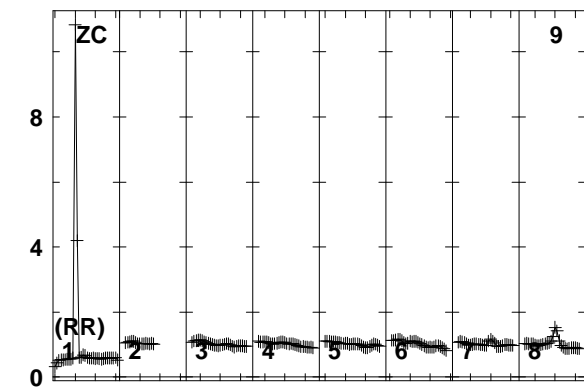
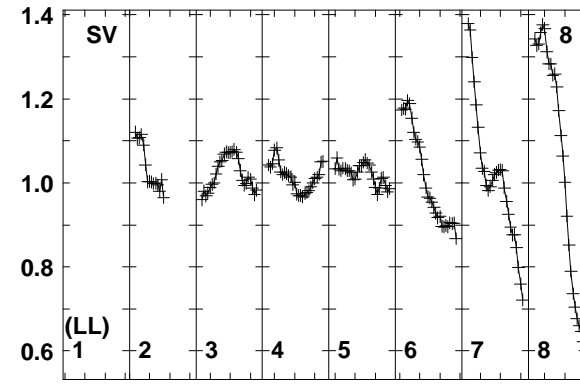
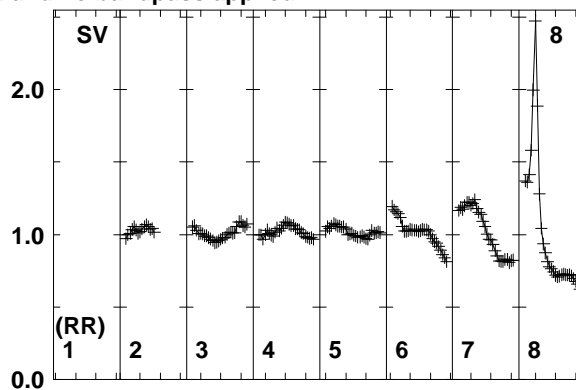
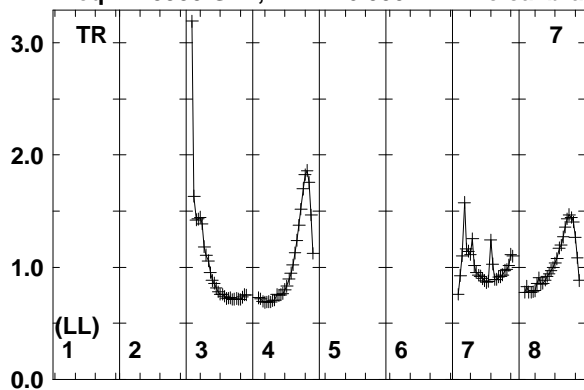

Lower frame: Real Jy
Total-power spectrum Antenna: TR (07)
Timerange: 00/06:36:41 to 00/06:42:39

Plot file version 51 created 20-MAR-2014 17:07:56

J1317+3425 ER030C.UVDATA.1

Freq = 1.5950 GHz, Bw = 16.000 MH No calibration applied and no bandpass applied

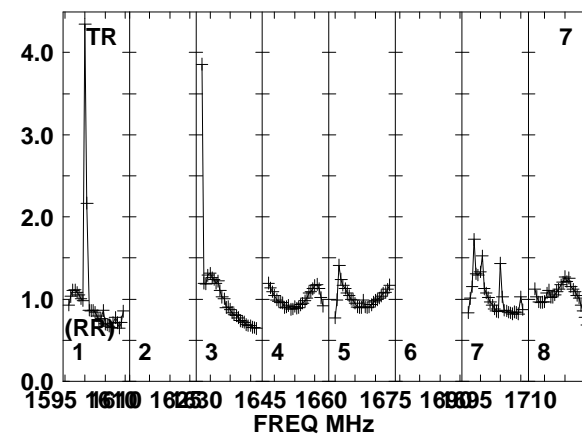
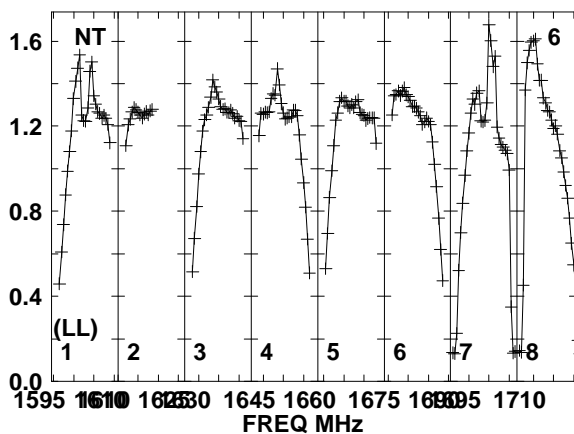
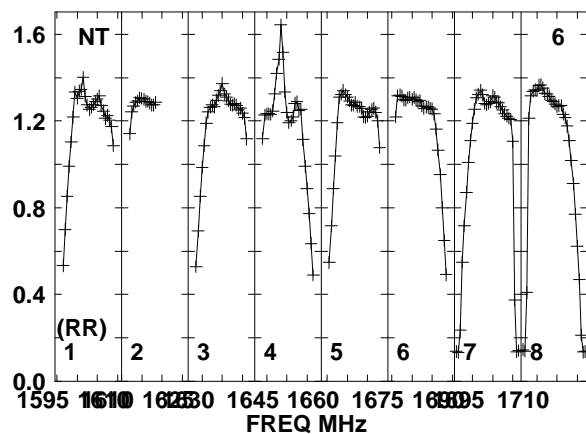
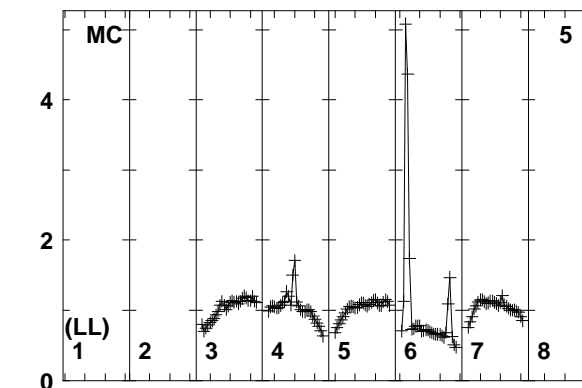
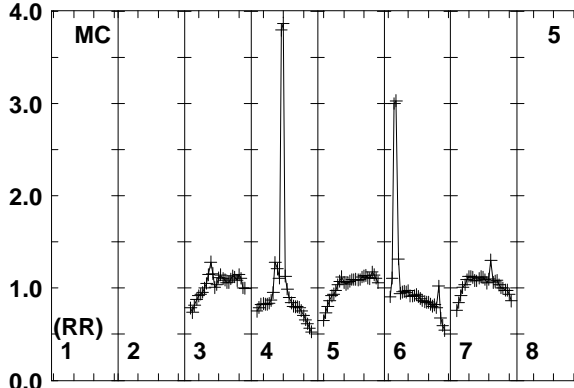
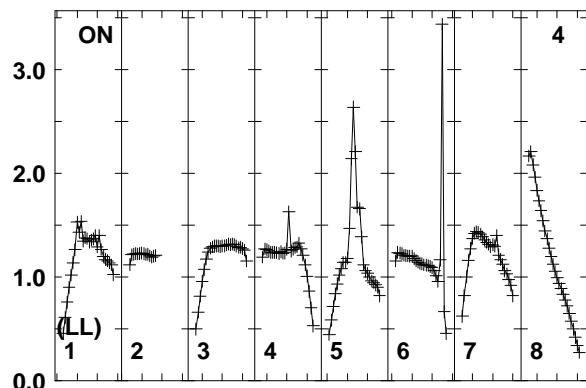
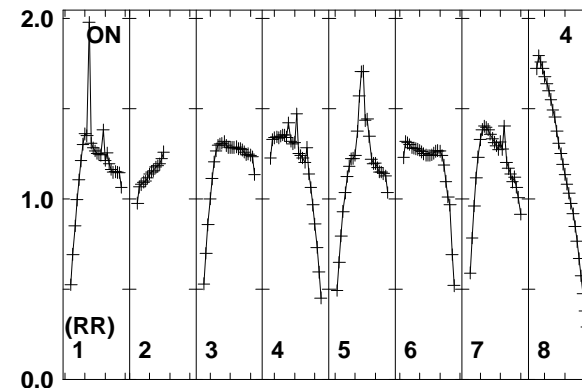
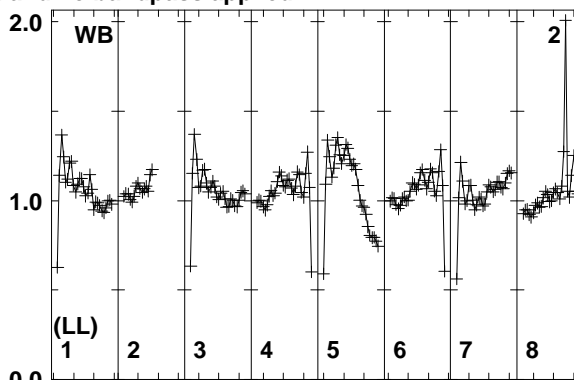
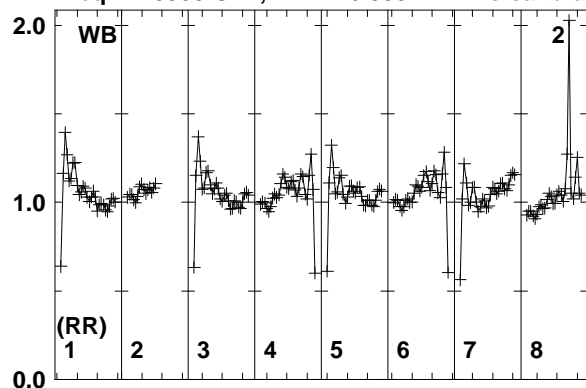

Lower frame: Real Jy
Total-power spectrum Antenna: WB (02)
Timerange: 00/06:44:41 to 00/06:45:39

Plot file version 52 created 20-MAR-2014 17:07:56

J1317+3425 ER030C.UVDATA.1

Freq = 1.5950 GHz, Bw = 16.000 MH No calibration applied and no bandpass applied

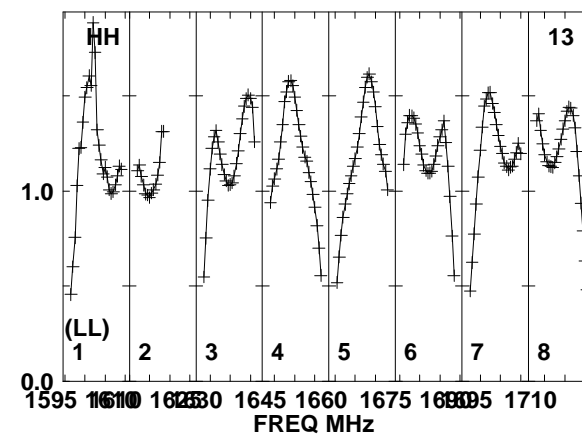
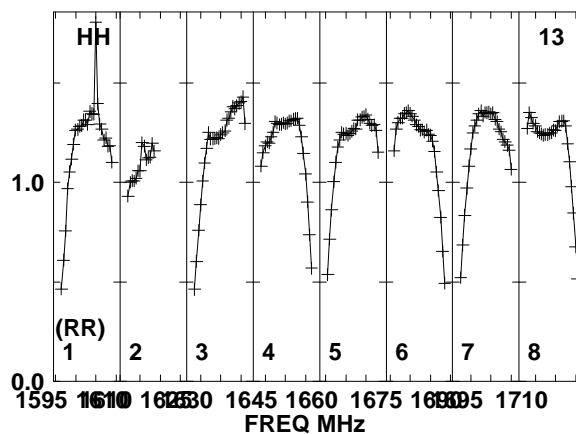
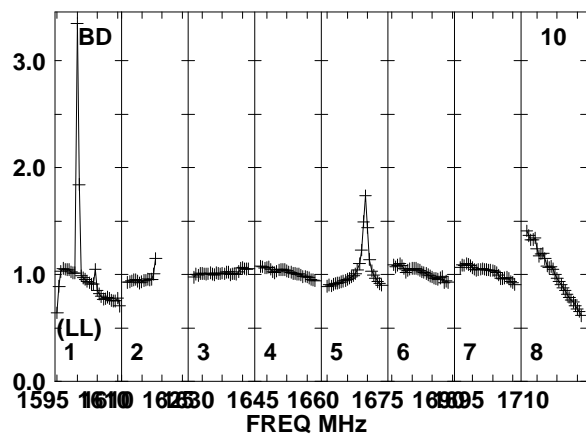
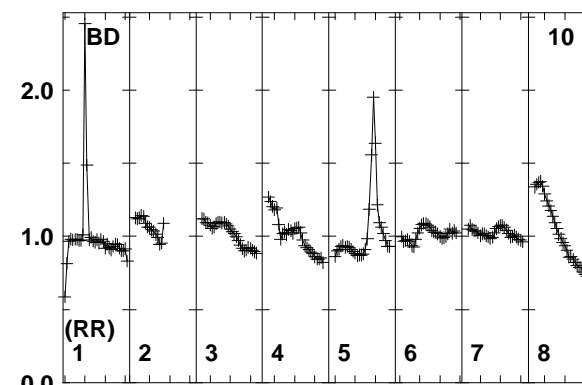
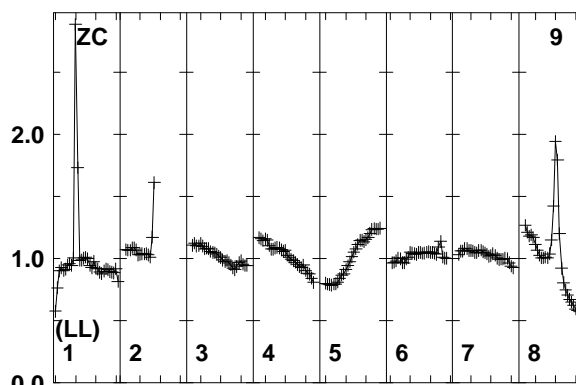
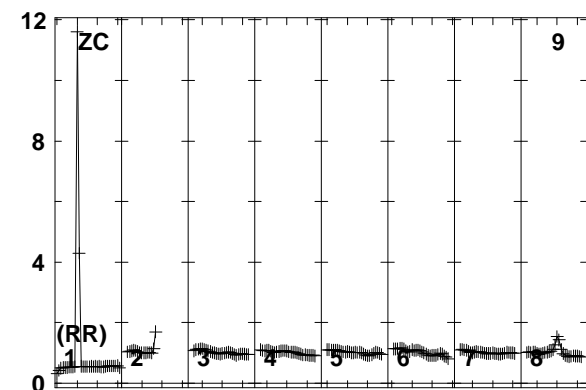
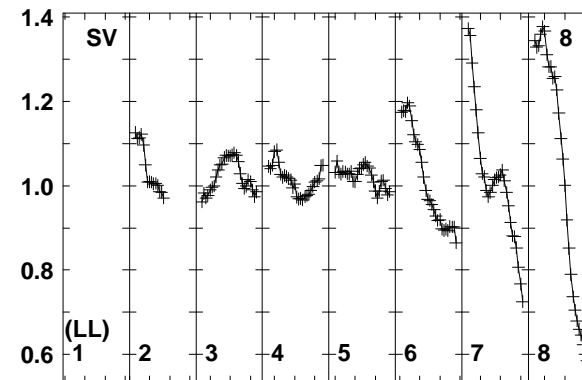
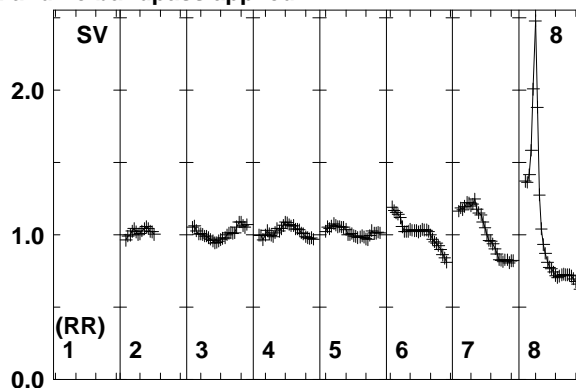
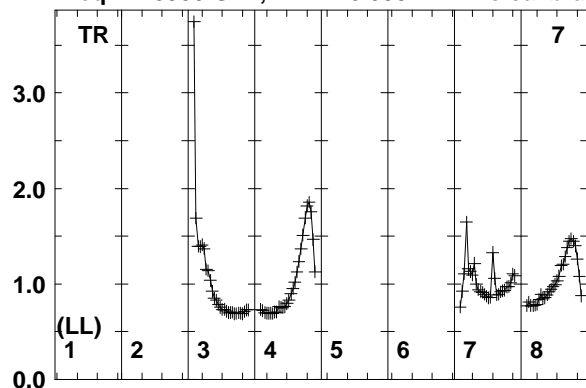

Lower frame: Real Jy
Total-power spectrum Antenna: TR (07)
Timerange: 00/06:44:41 to 00/06:45:39

Plot file version 53 created 20-MAR-2014 17:07:56

IC883 ER030C.UVDATA.1

Freq = 1.5950 GHz, Bw = 16.000 MH No calibration applied and no bandpass applied

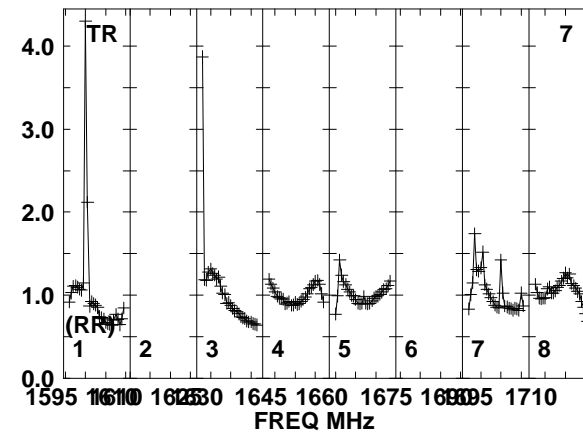
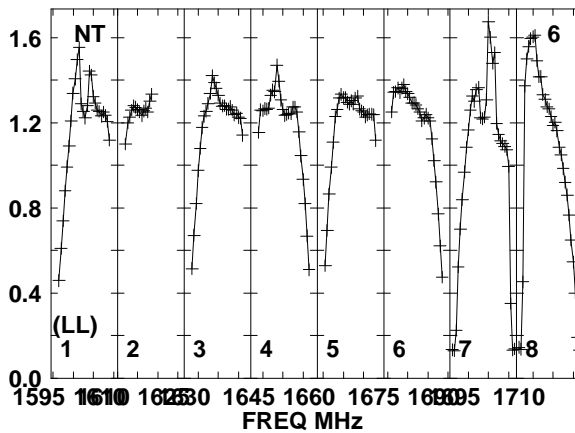
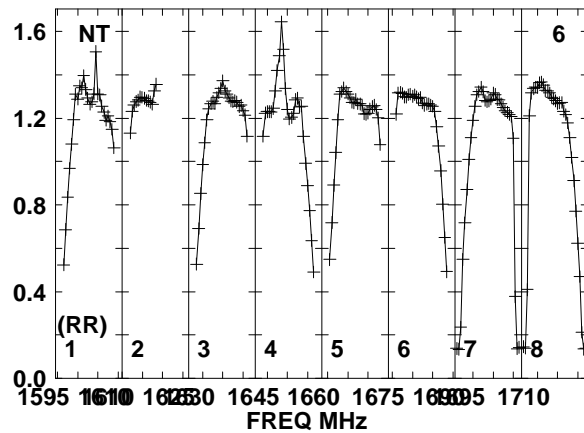
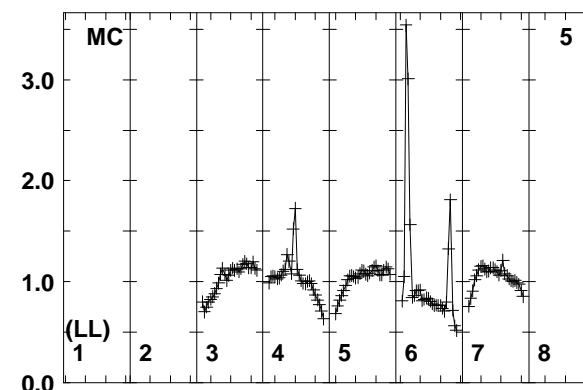
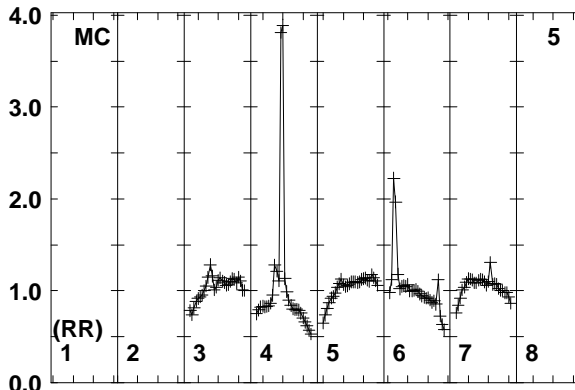
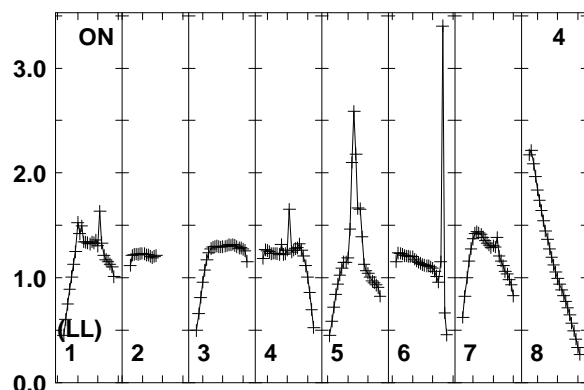
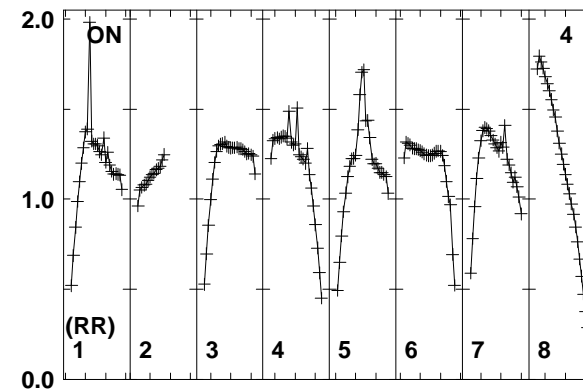
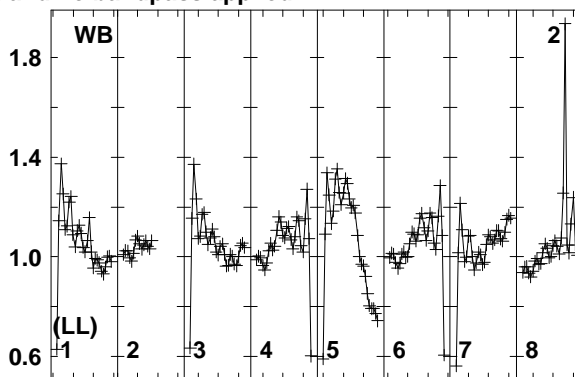
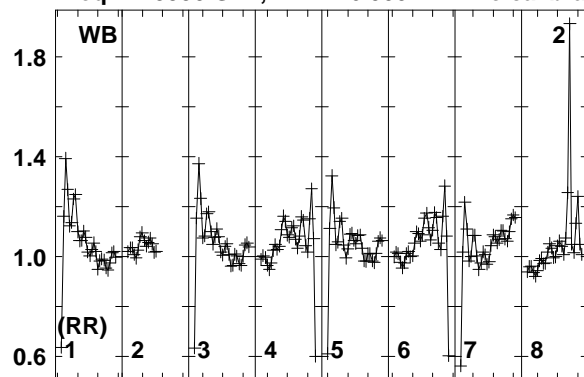

Lower frame: Real Jy
Total-power spectrum Antenna: WB (02)
Timerange: 00/06:45:43 to 00/06:48:39

Plot file version 54 created 20-MAR-2014 17:07:56

IC883 ER030C.UVDATA.1

Freq = 1.5950 GHz, Bw = 16.000 MH No calibration applied and no bandpass applied

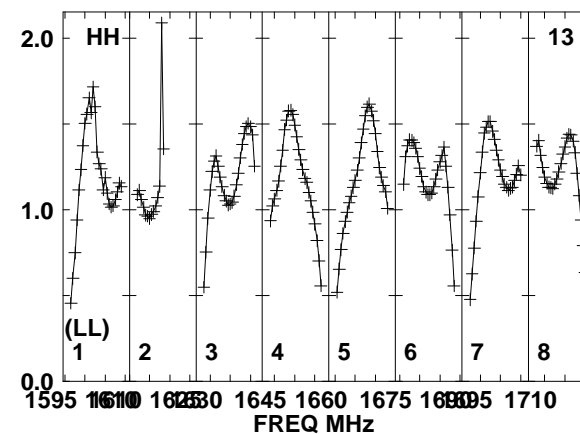
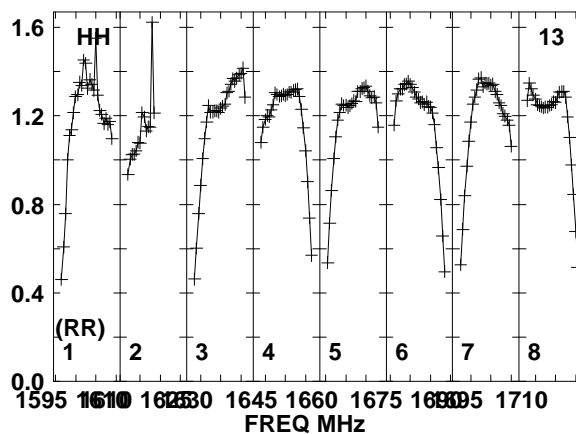
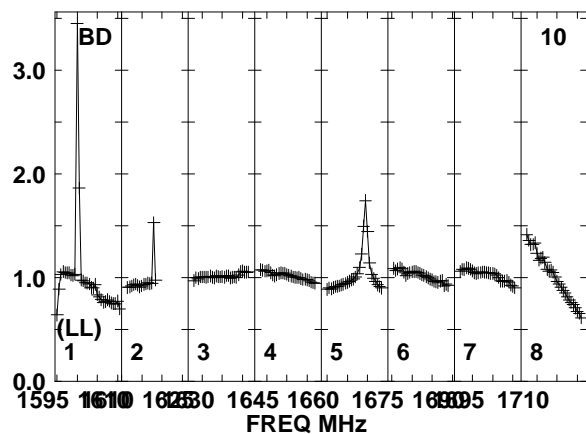
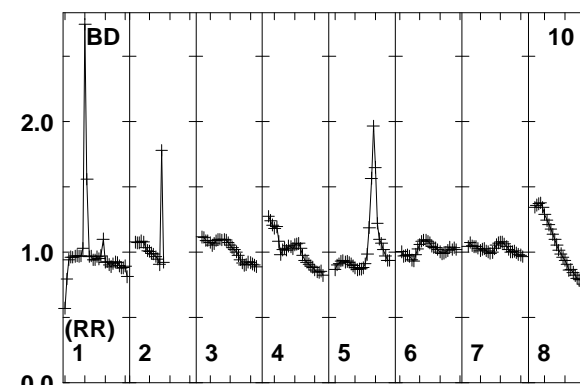
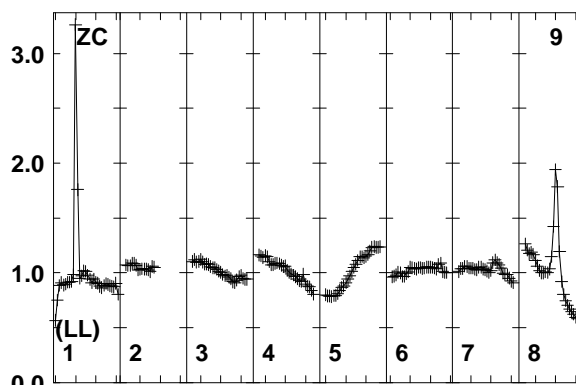
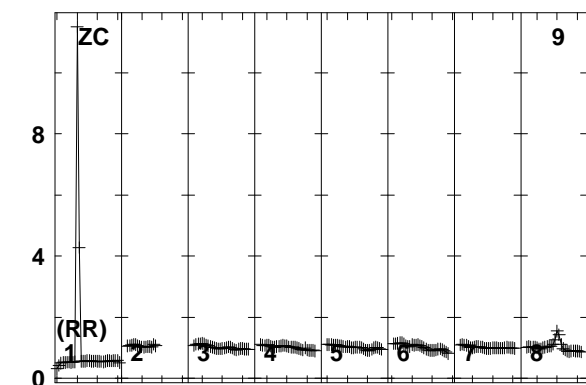
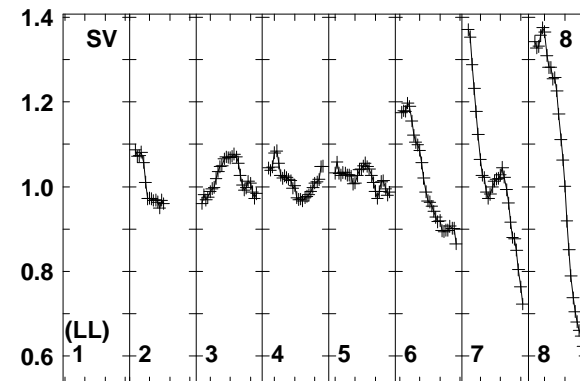
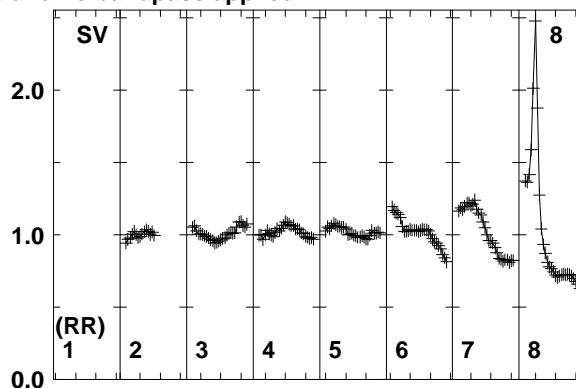
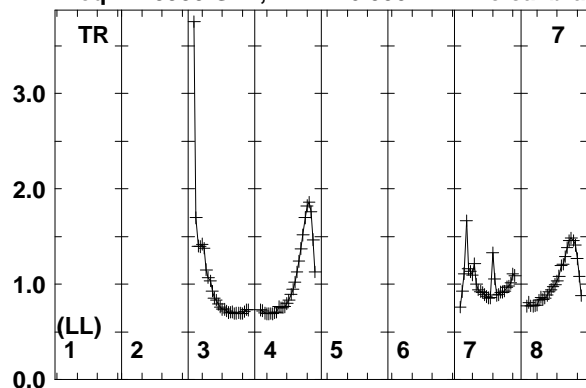

Lower frame: Real Jy
Total-power spectrum Antenna: TR (07)
Timerange: 00/06:45:43 to 00/06:48:39

Plot file version 55 created 20-MAR-2014 17:07:56

J1317+3425 ER030C.UVDATA.1

Freq = 1.5950 GHz, Bw = 16.000 MH No calibration applied and no bandpass applied

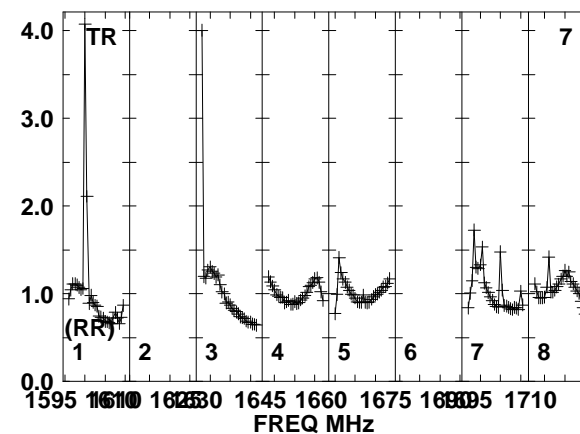
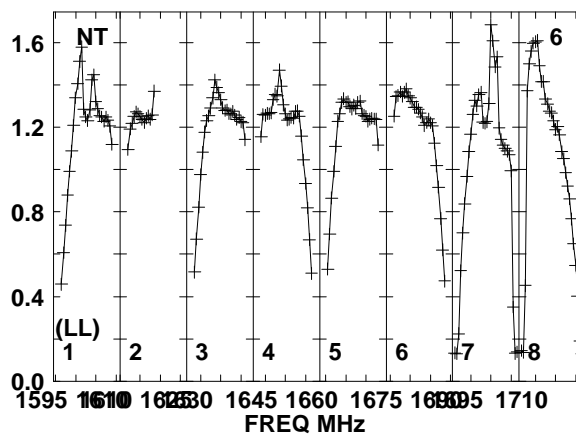
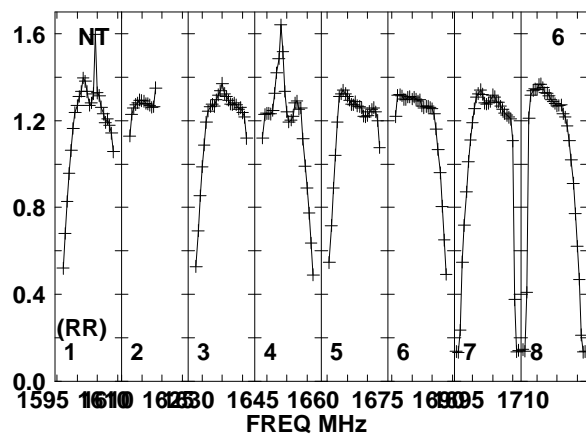
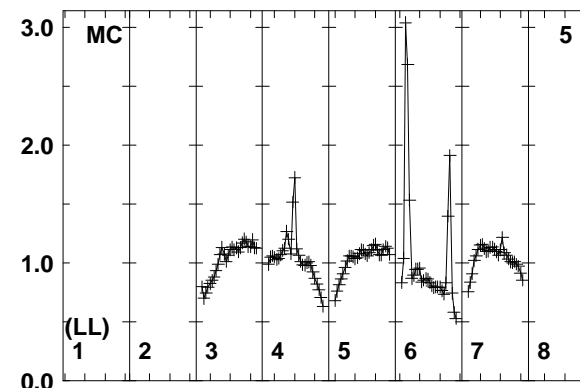
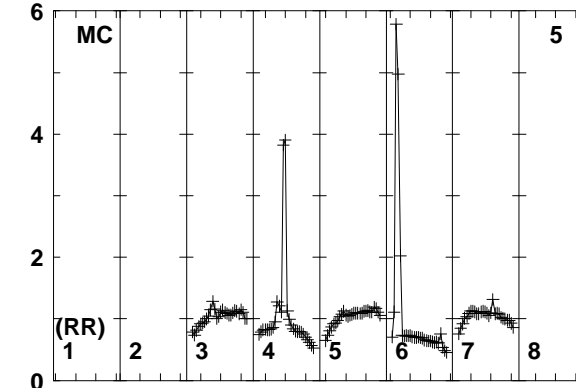
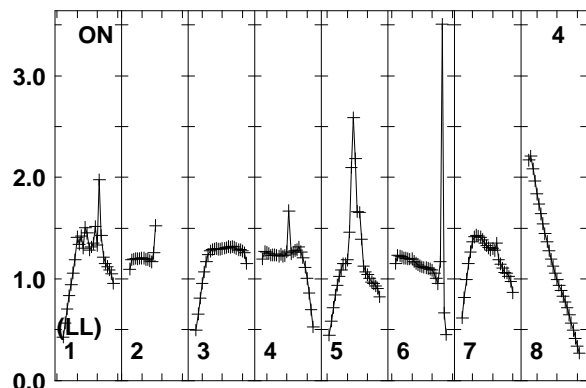
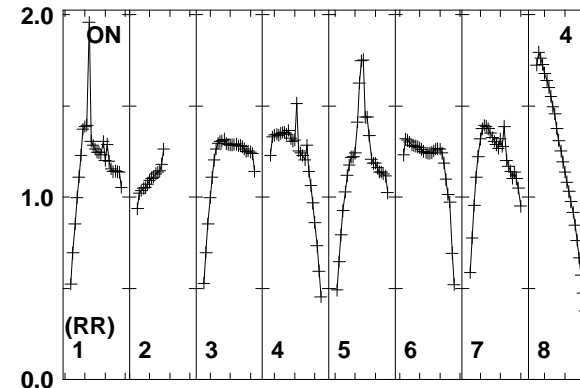
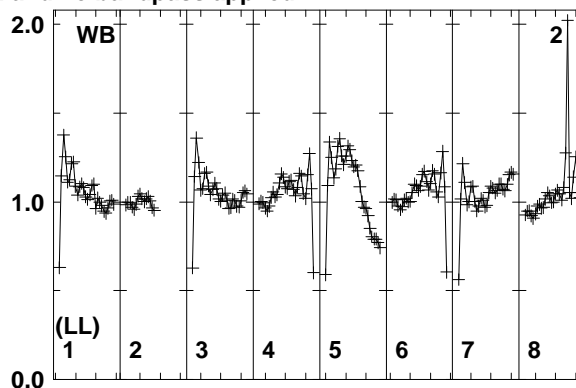
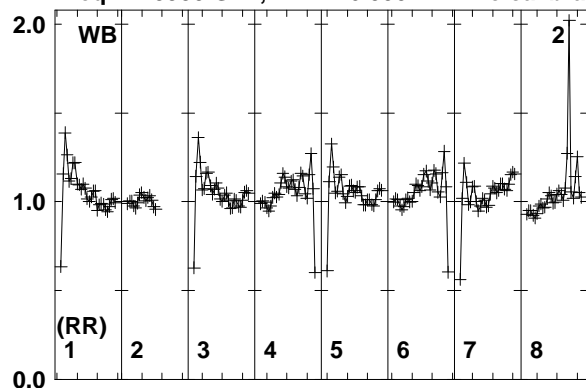

Lower frame: Real Jy
Total-power spectrum Antenna: WB (02)
Timerange: 00/06:48:43 to 00/06:49:59

Plot file version 56 created 20-MAR-2014 17:07:56

J1317+3425 ER030C.UVDATA.1

Freq = 1.5950 GHz, Bw = 16.000 MH No calibration applied and no bandpass applied

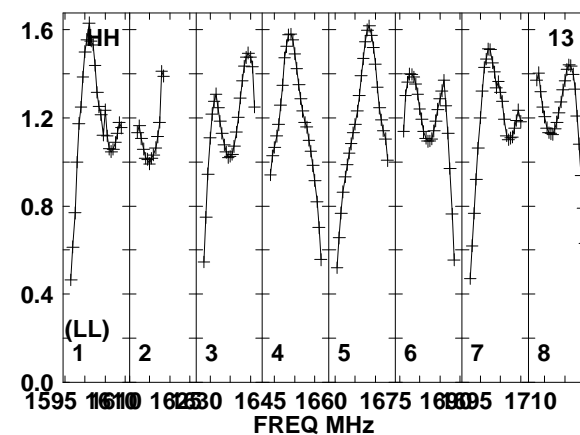
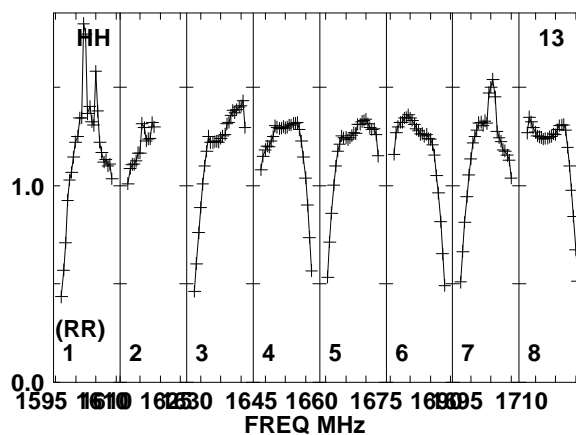
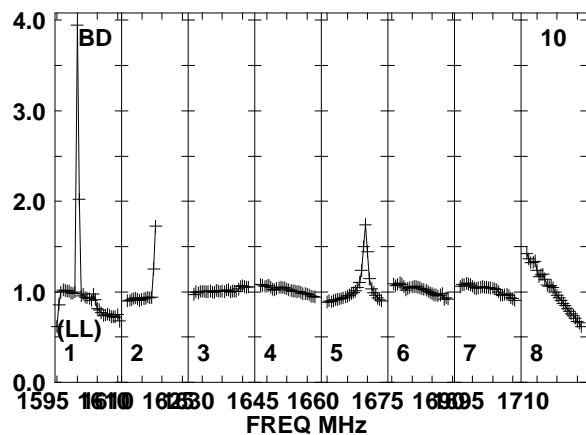
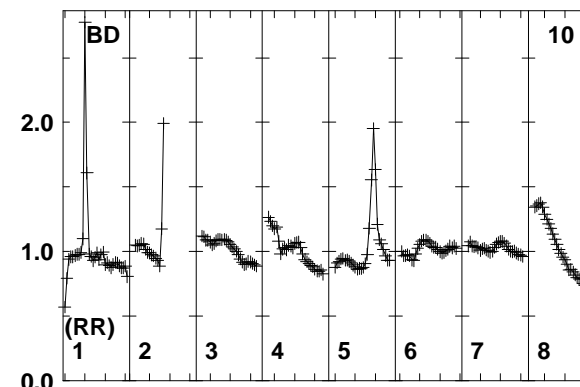
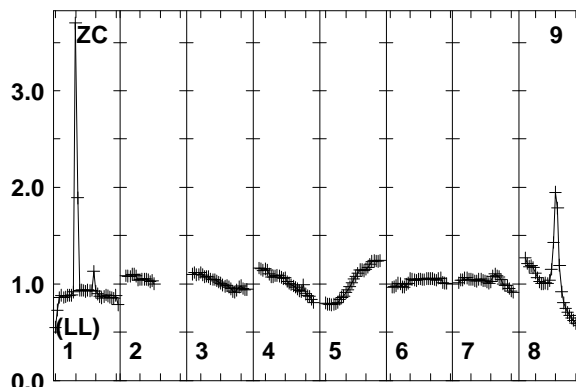
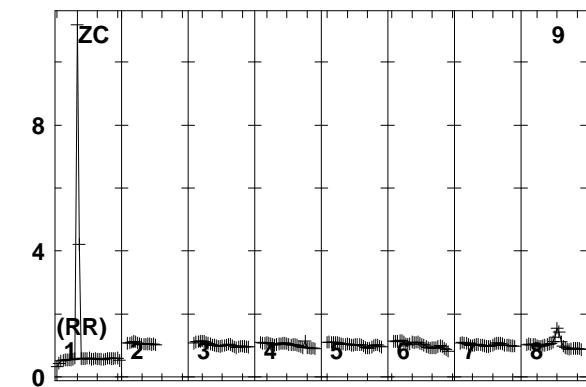
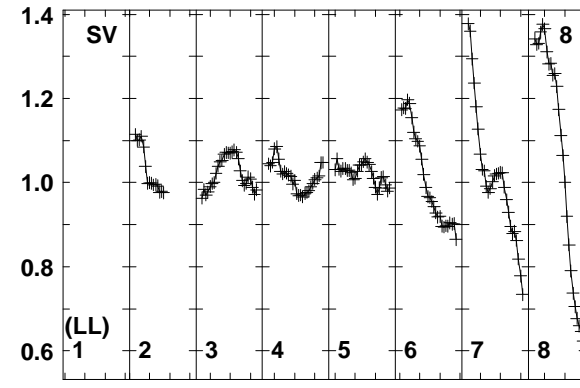
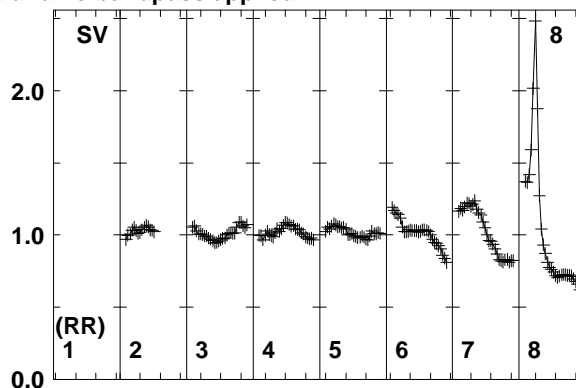
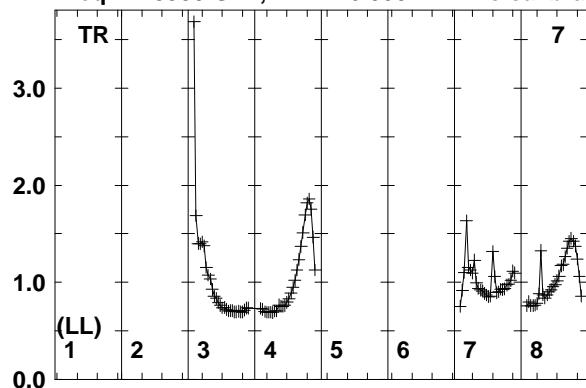

Lower frame: Real Jy
Total-power spectrum Antenna: TR (07)
Timerange: 00/06:48:43 to 00/06:49:59

Plot file version 57 created 20-MAR-2014 17:07:56

IC883 ER030C.UVDATA.1

Freq = 1.5950 GHz, Bw = 16.000 MH No calibration applied and no bandpass applied

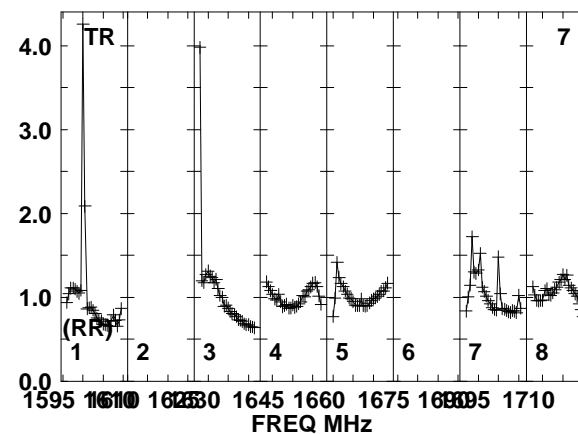
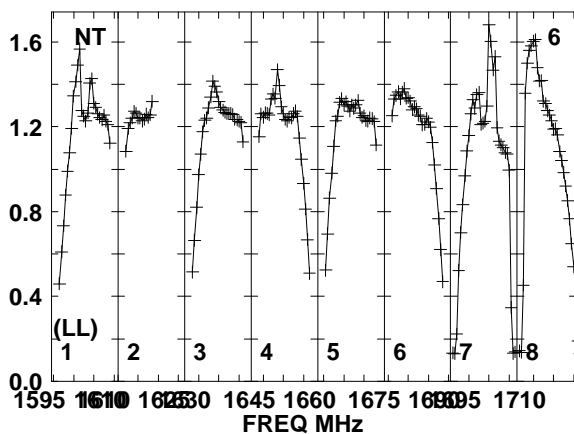
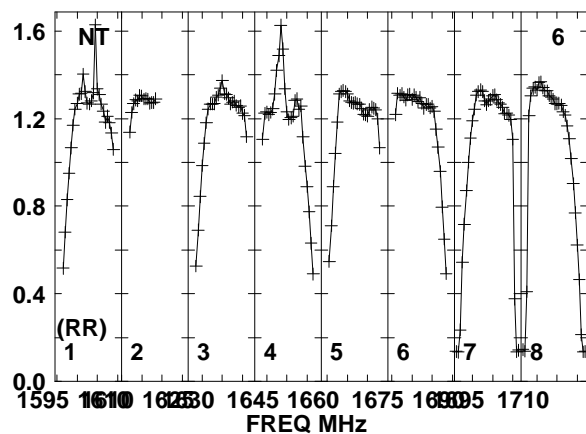
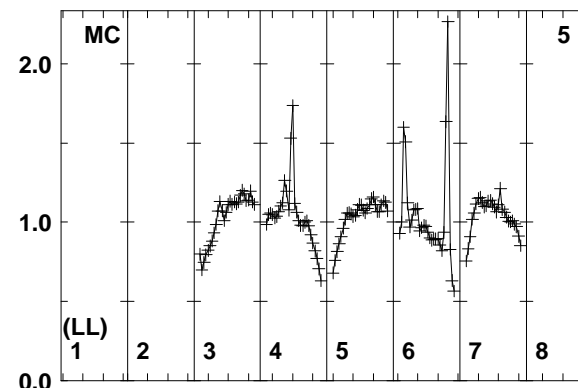
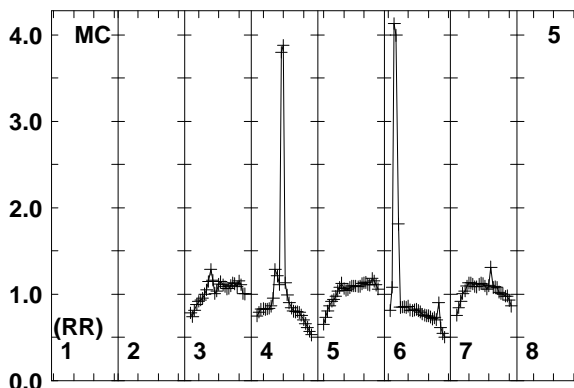
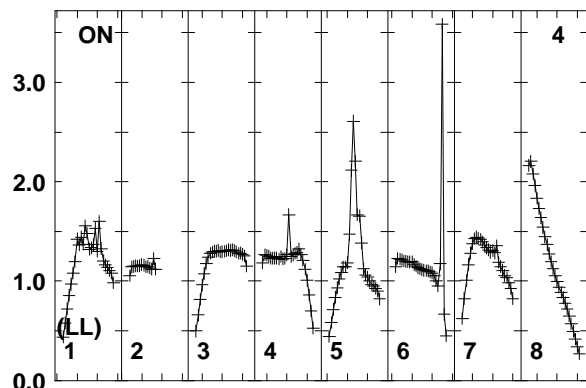
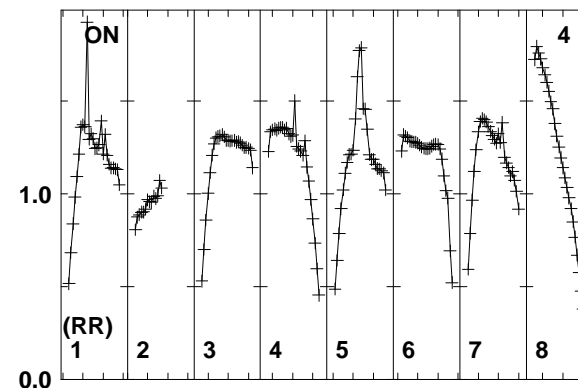
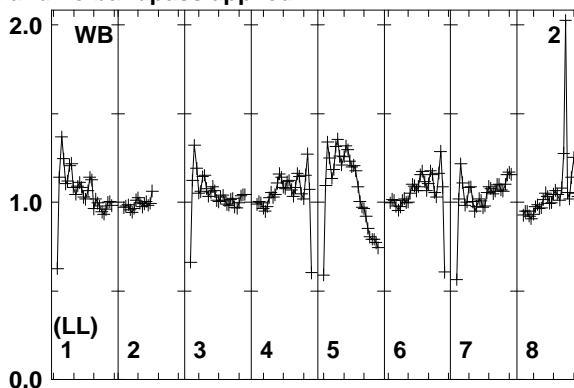
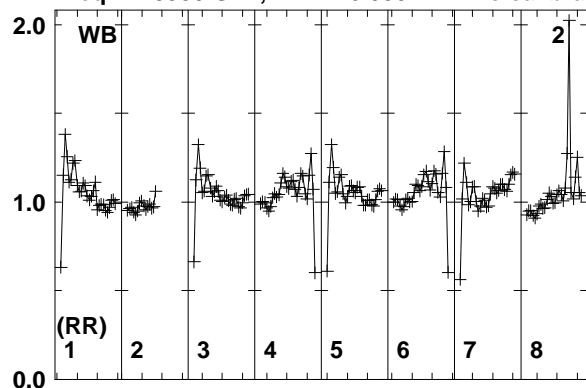

Lower frame: Real Jy
Total-power spectrum Antenna: WB (02)
Timerange: 00/06:50:01 to 00/06:53:49

Plot file version 58 created 20-MAR-2014 17:07:56

IC883 ER030C.UVDATA.1

Freq = 1.5950 GHz, Bw = 16.000 MH No calibration applied and no bandpass applied

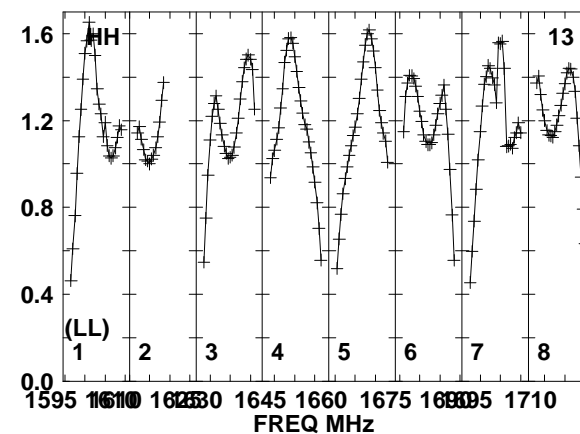
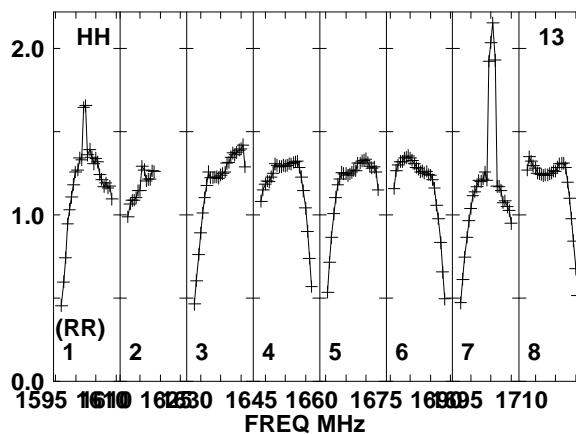
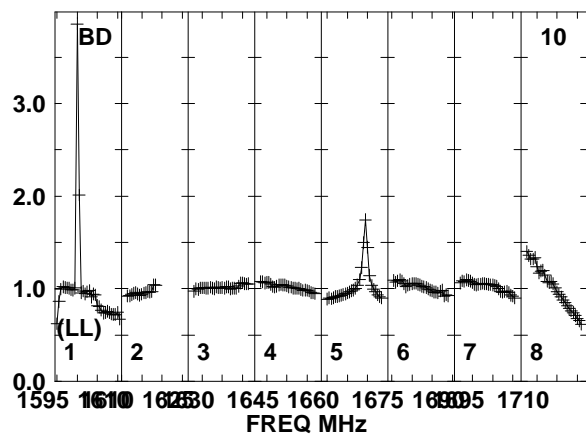
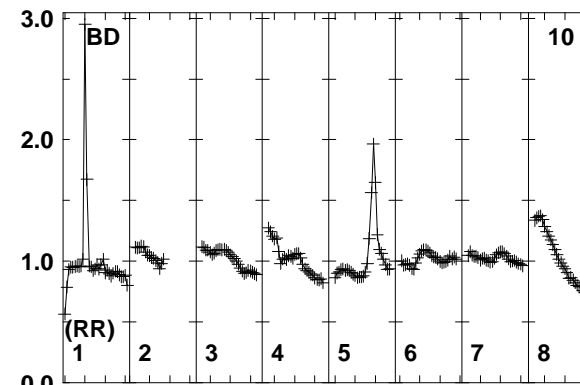
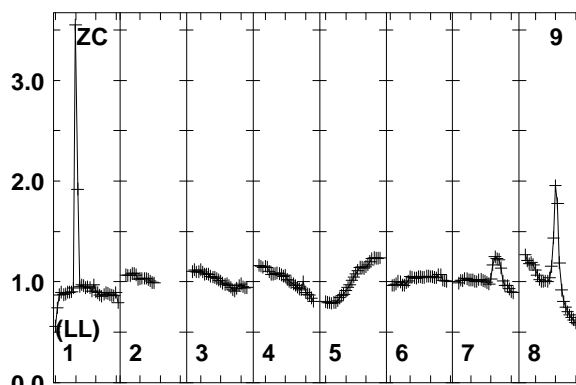
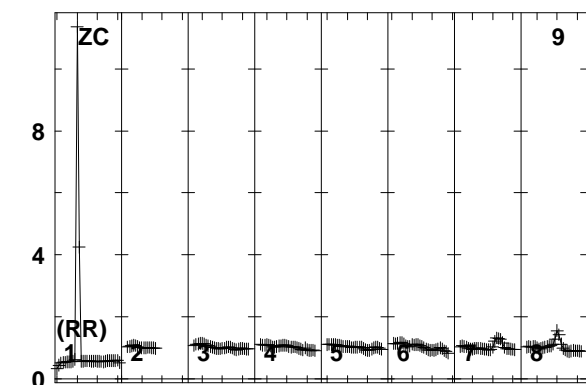
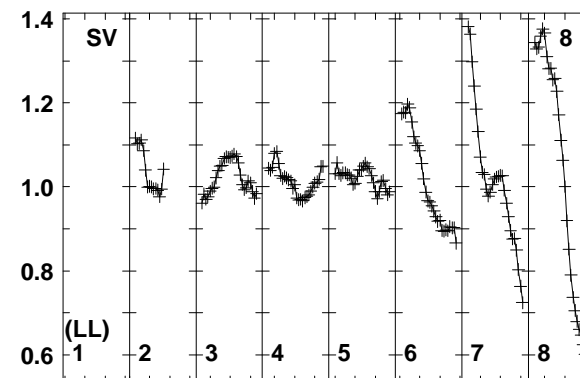
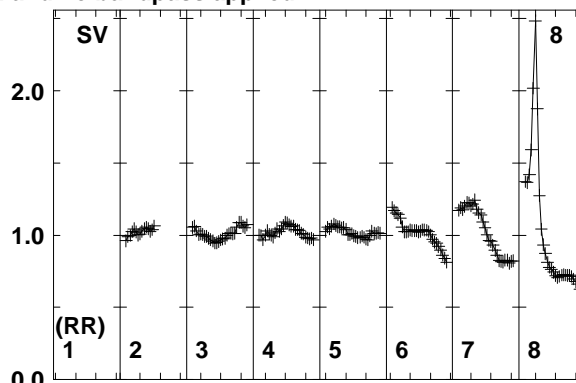
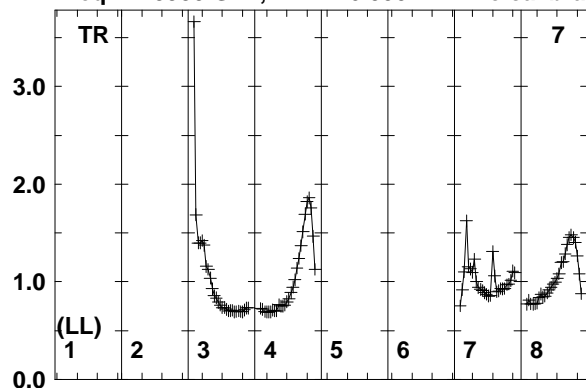

Lower frame: Real Jy
Total-power spectrum Antenna: TR (07)
Timerange: 00/06:50:01 to 00/06:53:49

Plot file version 59 created 20-MAR-2014 17:07:57

J1317+3425 ER030C.UVDATA.1

Freq = 1.5950 GHz, Bw = 16.000 MH No calibration applied and no bandpass applied

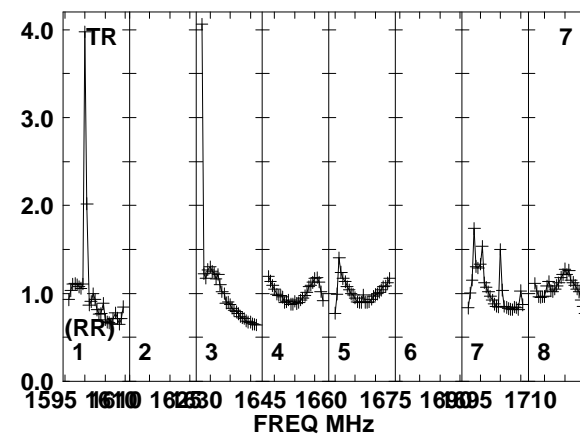
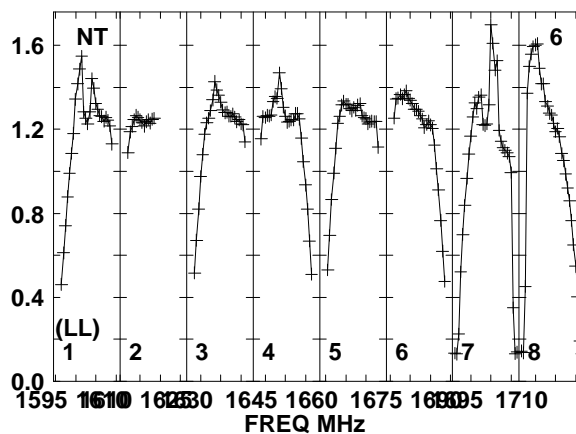
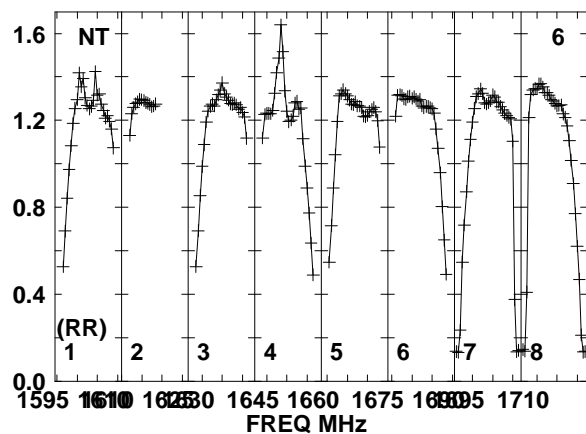
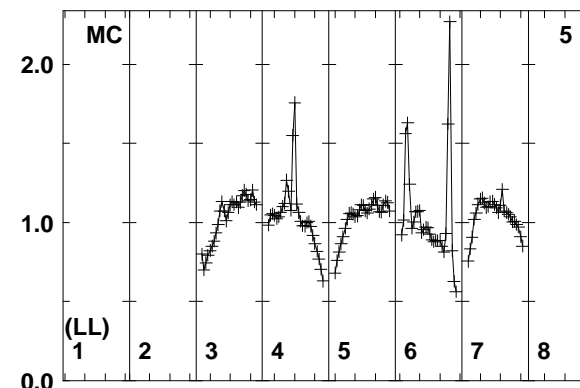
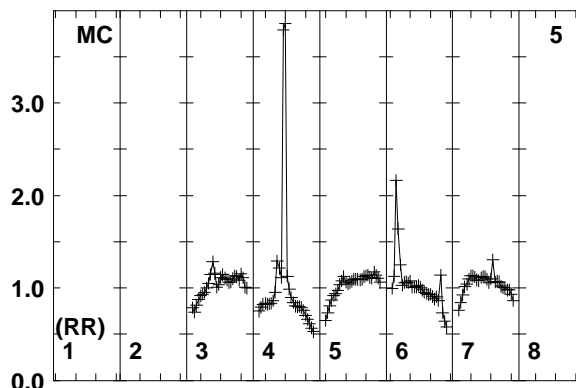
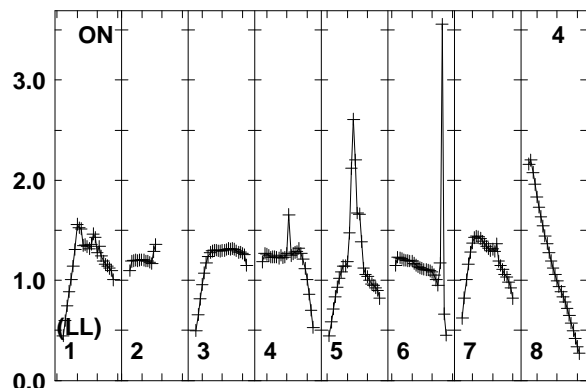
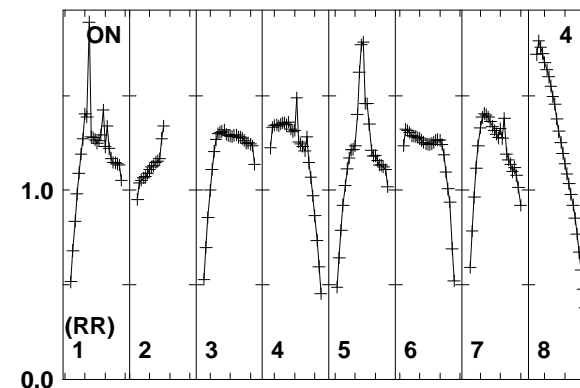
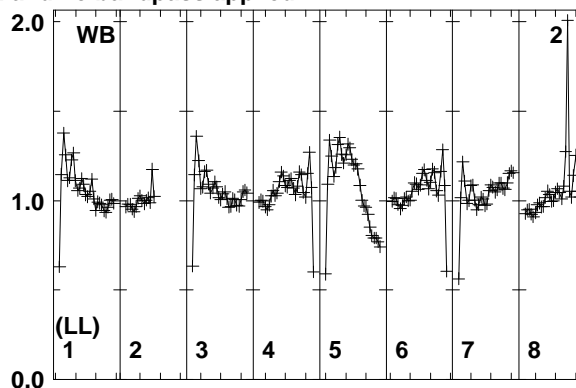
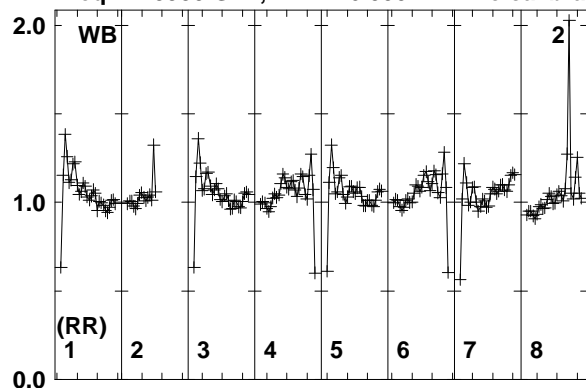

Lower frame: Real Jy
Total-power spectrum Antenna: WB (02)
Timerange: 00/06:54:31 to 00/06:55:29

Plot file version 60 created 20-MAR-2014 17:07:57

J1317+3425 ER030C.UVDATA.1

Freq = 1.5950 GHz, Bw = 16.000 MH No calibration applied and no bandpass applied

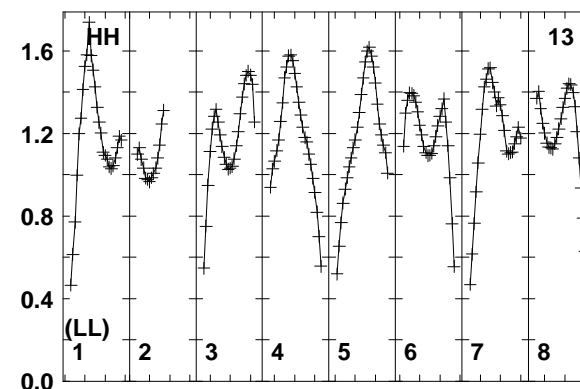
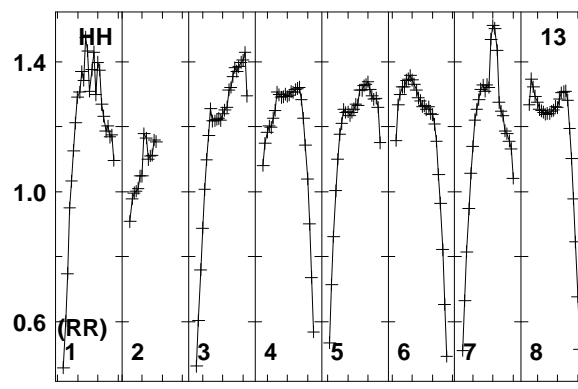
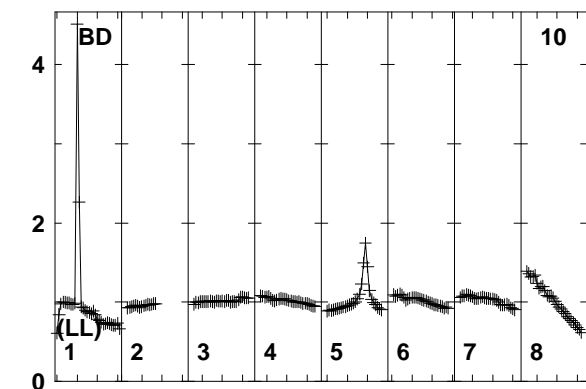
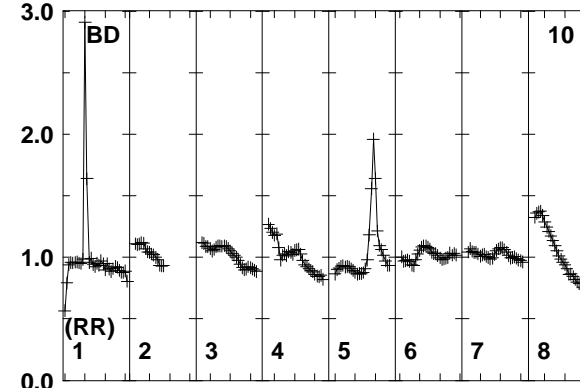
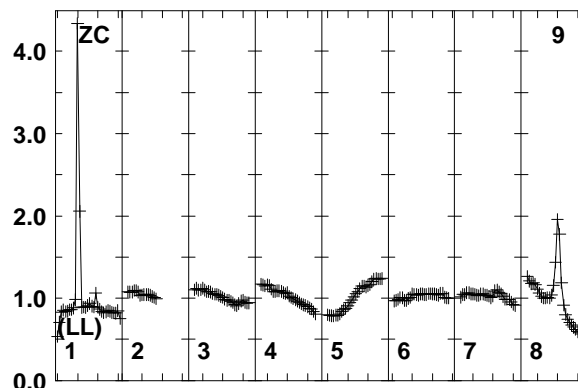
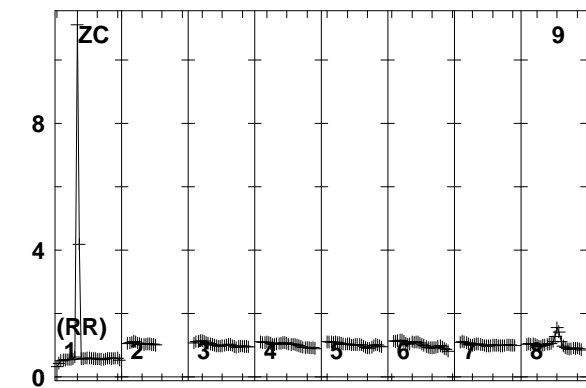
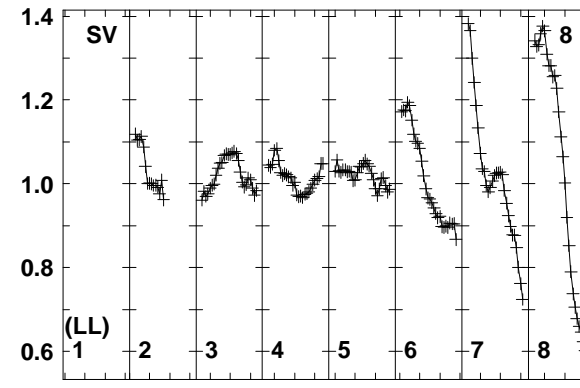
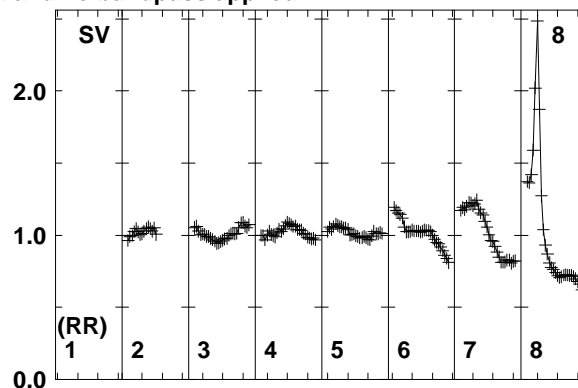
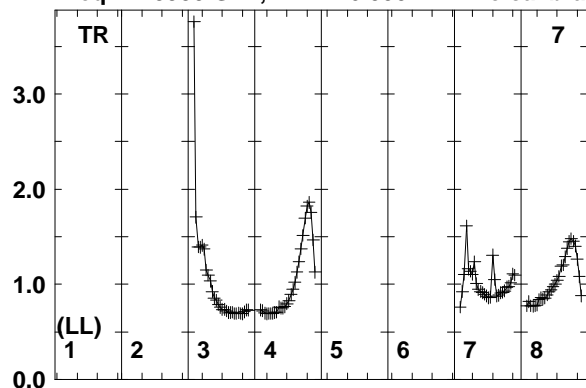

1595 1610 1625 1640 1655 1670 1685 1700 1715
FREQ MHz

1595 1610 1625 1640 1655 1670 1685 1700 1715
FREQ MHz

1595 1610 1625 1640 1655 1670 1685 1700 1715
FREQ MHz

Lower frame: Real Jy
Total-power spectrum Antenna: TR (07)
Timerange: 00/06:54:31 to 00/06:55:29

Plot file version 61 created 20-MAR-2014 17:07:57

IC883 ER030C.UVDATA.1

Freq = 1.5950 GHz, Bw = 16.000 MH No calibration applied and no bandpass applied

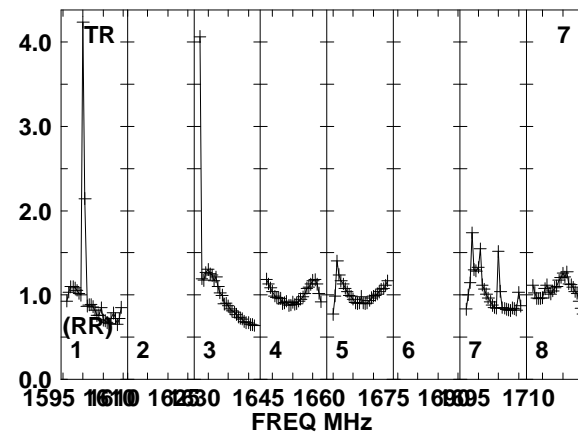
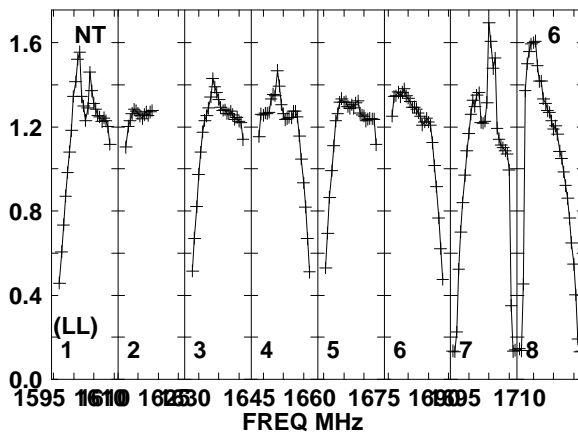
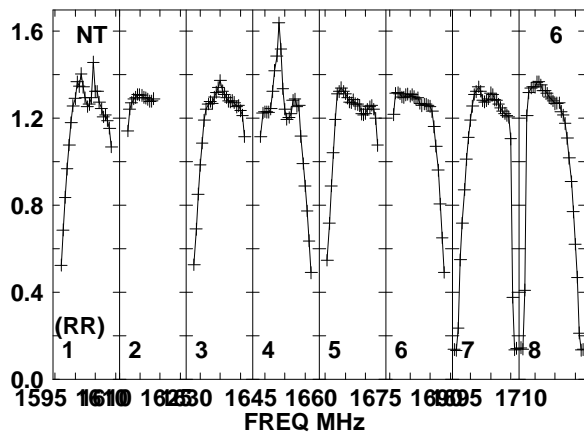
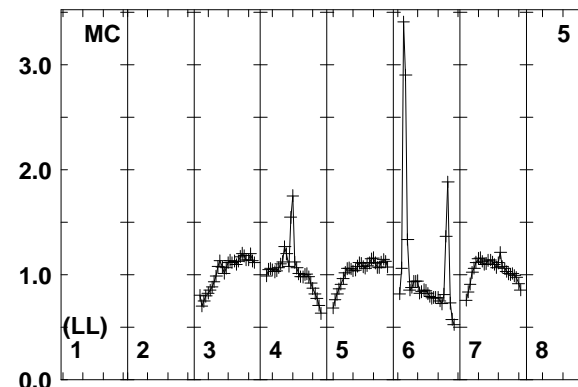
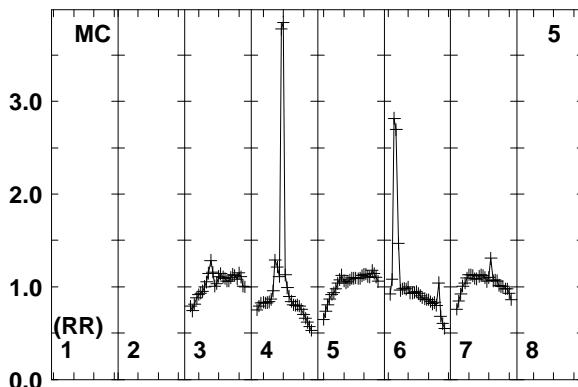
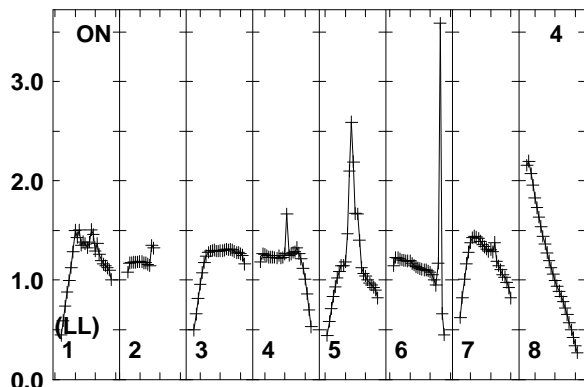
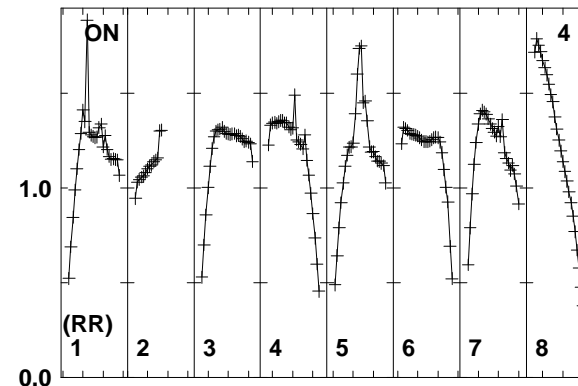
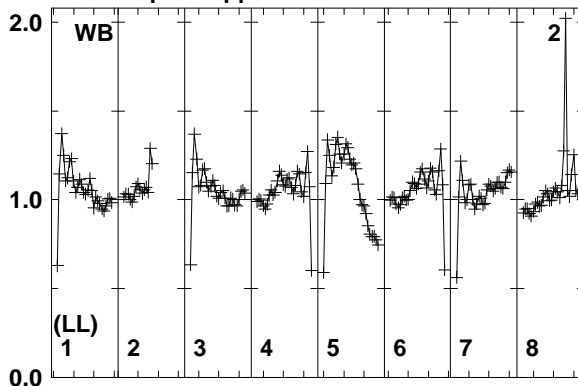
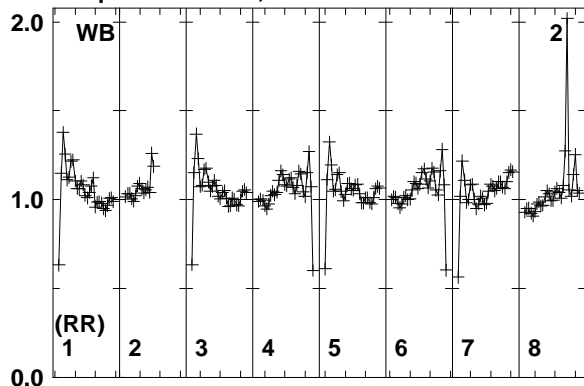

Lower frame: Real Jy
Total-power spectrum Antenna: WB (02)
Timerange: 00/06:55:33 to 00/06:59:19

Plot file version 62 created 20-MAR-2014 17:07:57

IC883 ER030C.UVDATA.1

Freq = 1.5950 GHz, Bw = 16.000 MH No calibration applied and no bandpass applied

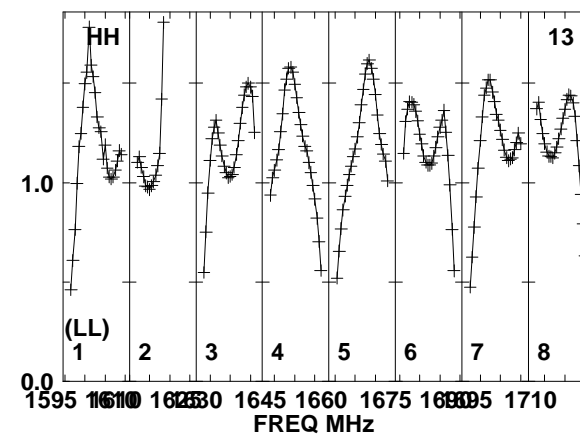
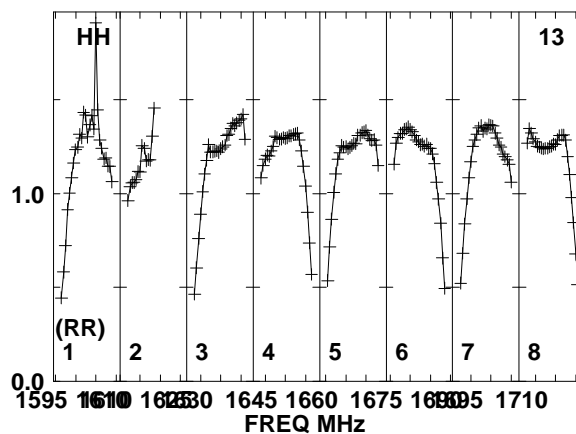
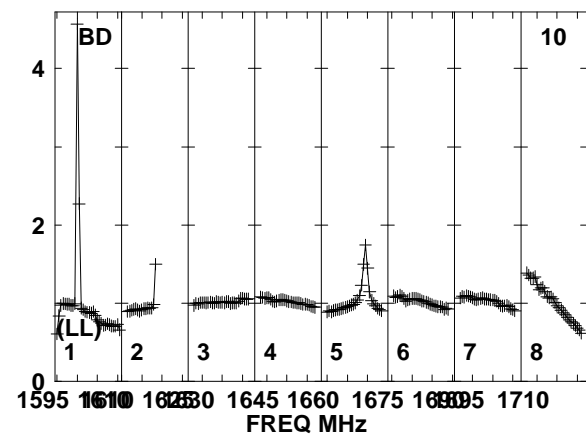
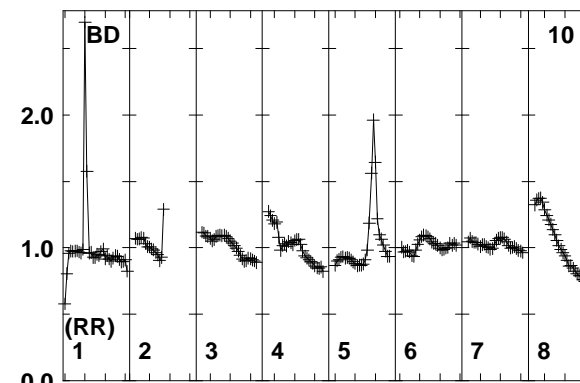
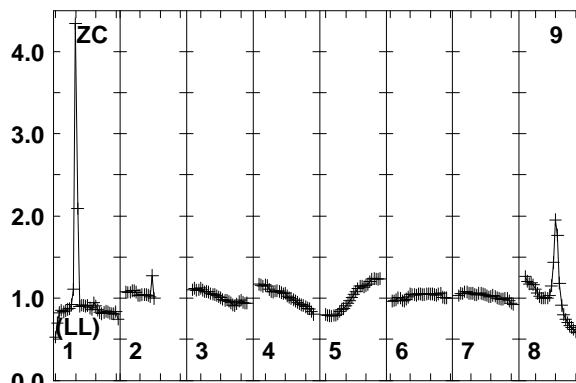
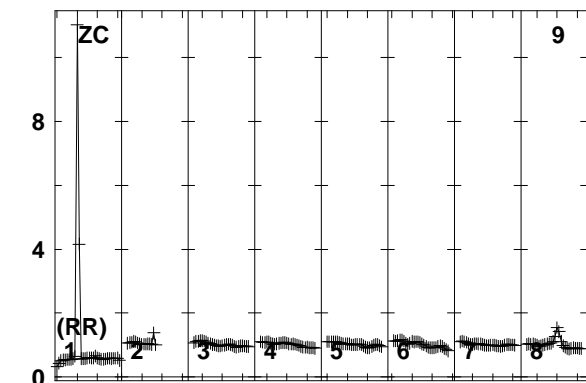
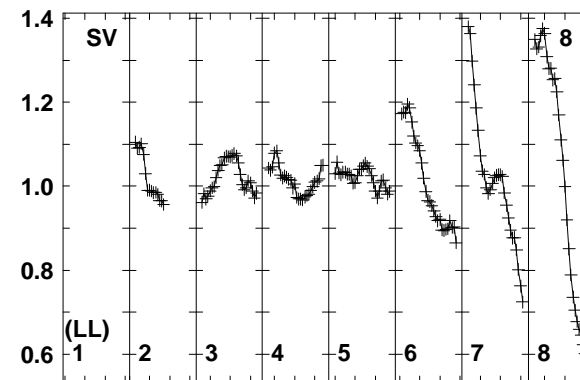
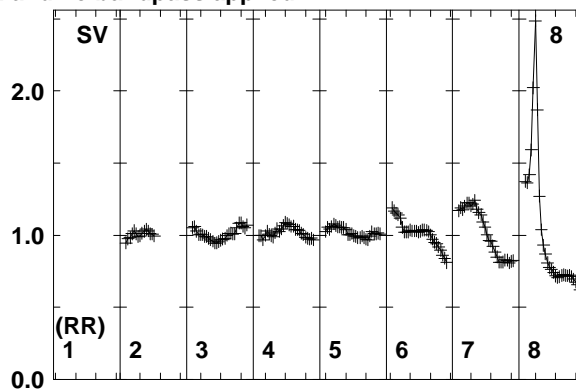
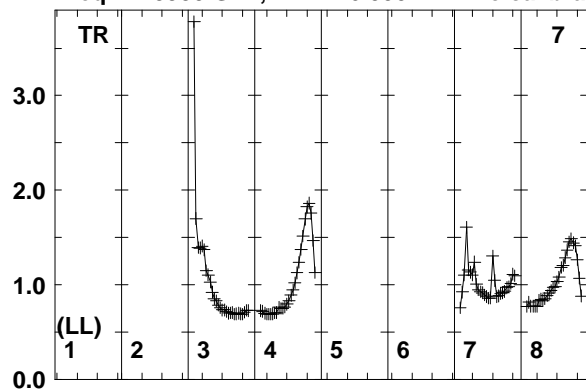

Lower frame: Real Jy
Total-power spectrum Antenna: TR (07)
Timerange: 00/06:55:33 to 00/06:59:19

Plot file version 63 created 20-MAR-2014 17:07:57

J1317+3425 ER030C.UVDATA.1

Freq = 1.5950 GHz, Bw = 16.000 MH No calibration applied and no bandpass applied

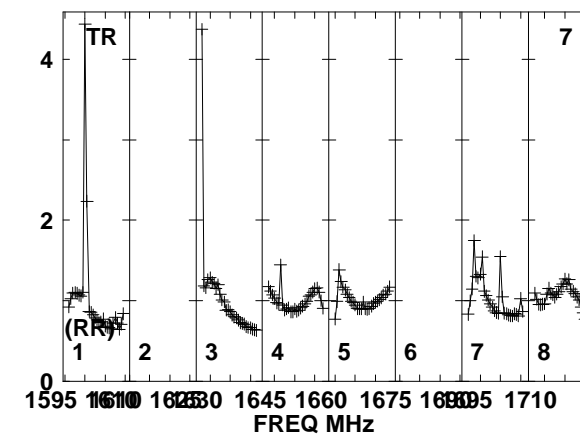
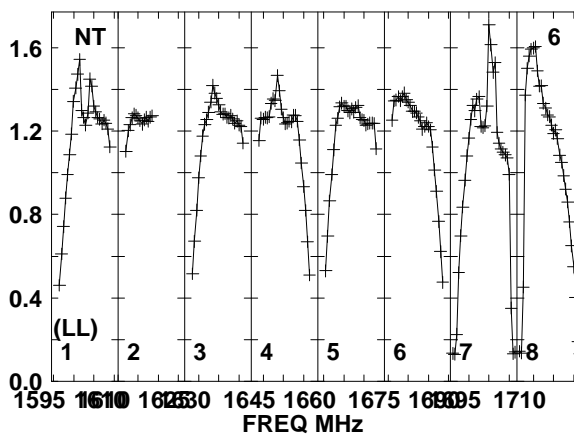
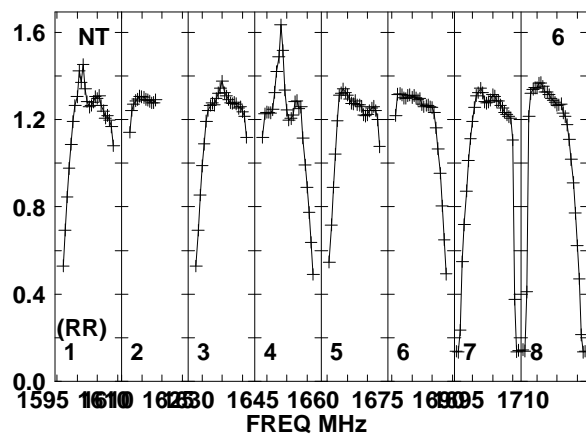
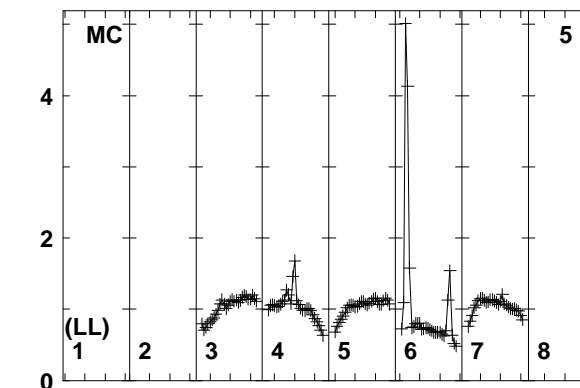
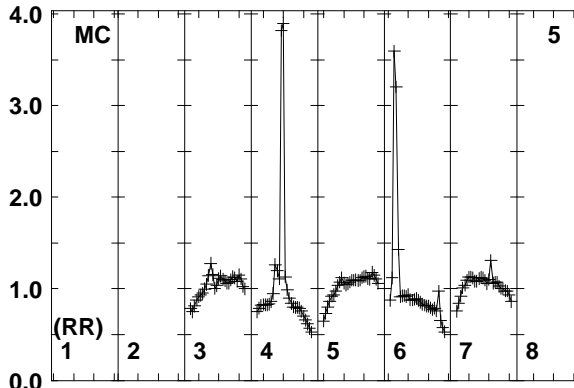
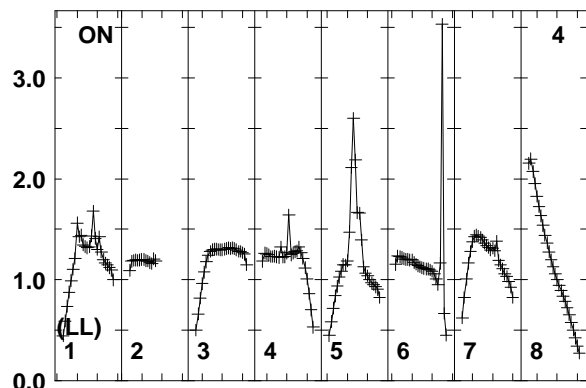
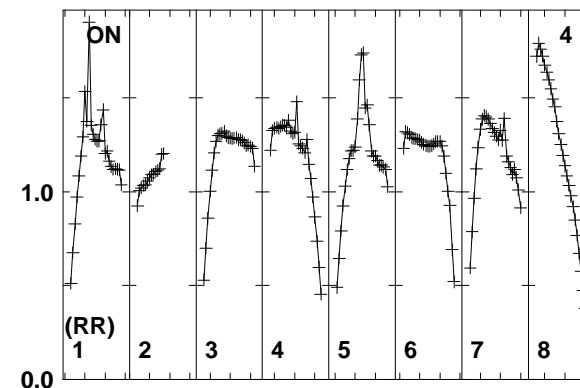
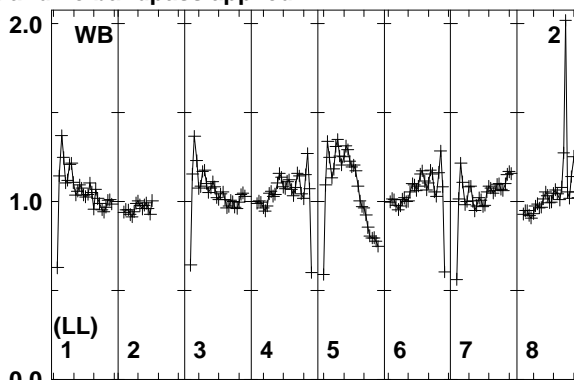
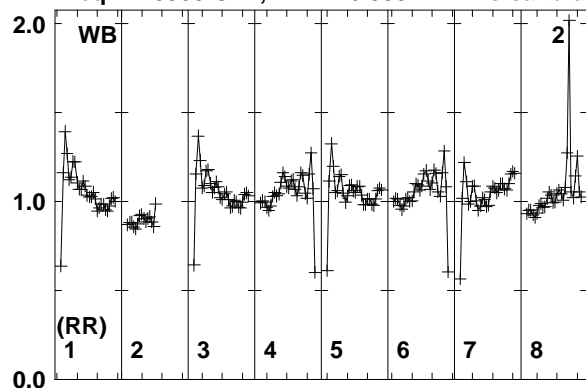

Lower frame: Real Jy
Total-power spectrum Antenna: WB (02)
Timerange: 00/06:59:23 to 00/07:00:39

Plot file version 64 created 20-MAR-2014 17:07:57

J1317+3425 ER030C.UVDATA.1

Freq = 1.5950 GHz, Bw = 16.000 MH No calibration applied and no bandpass applied

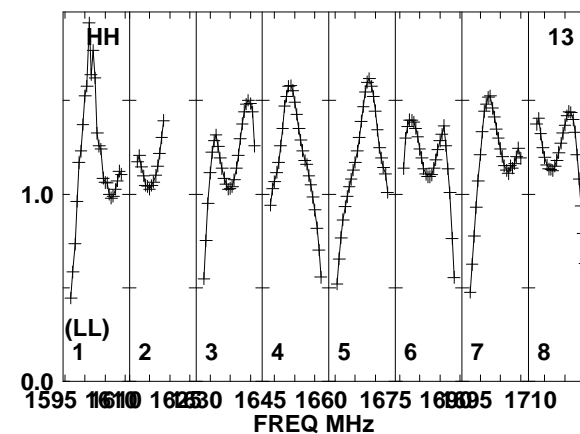
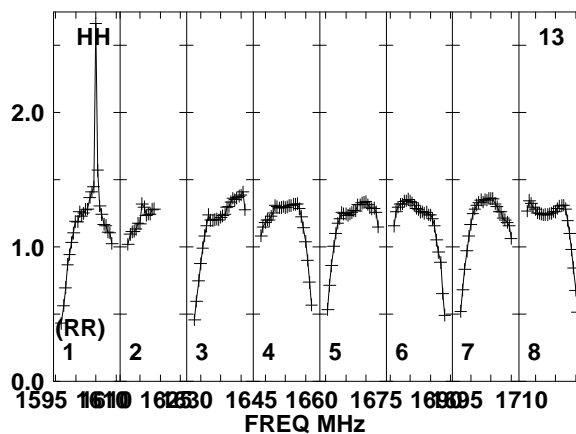
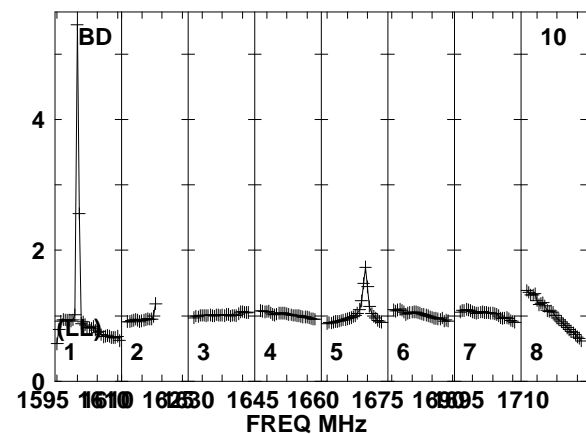
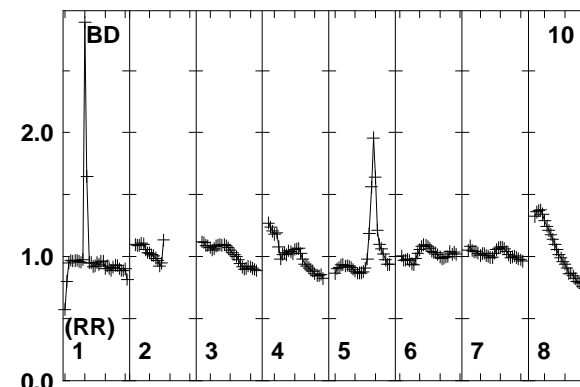
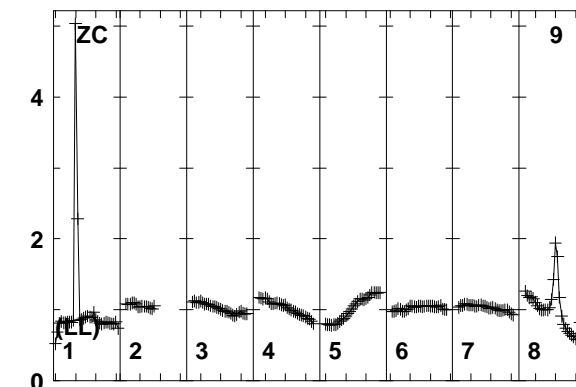
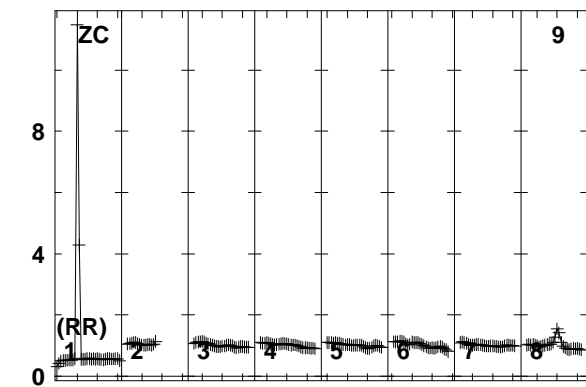
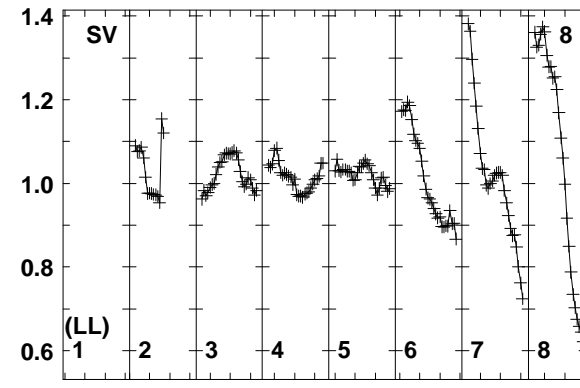
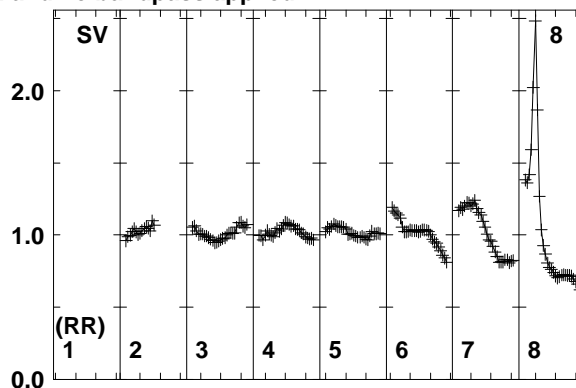
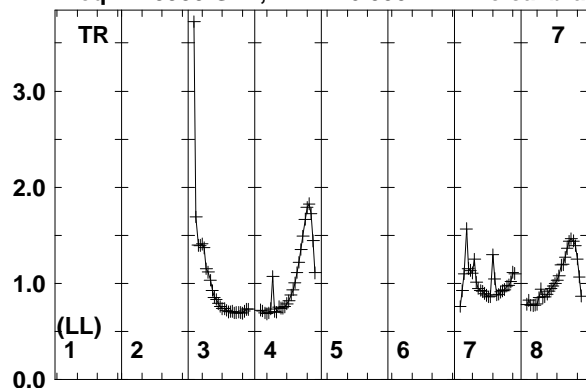

Lower frame: Real Jy
Total-power spectrum Antenna: TR (07)
Timerange: 00/06:59:23 to 00/07:00:39

Plot file version 65 created 20-MAR-2014 17:07:57

IC883 ER030C.UVDATA.1

Freq = 1.5950 GHz, Bw = 16.000 MH No calibration applied and no bandpass applied

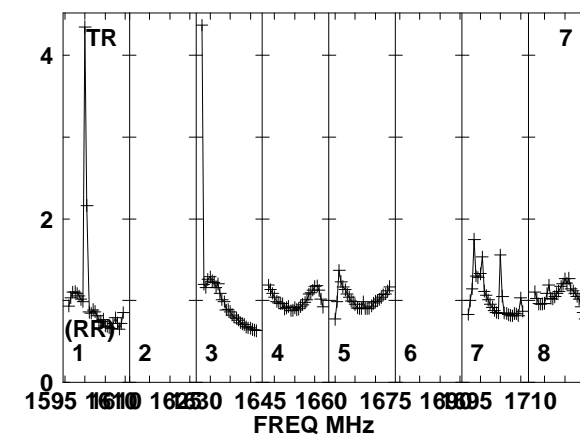
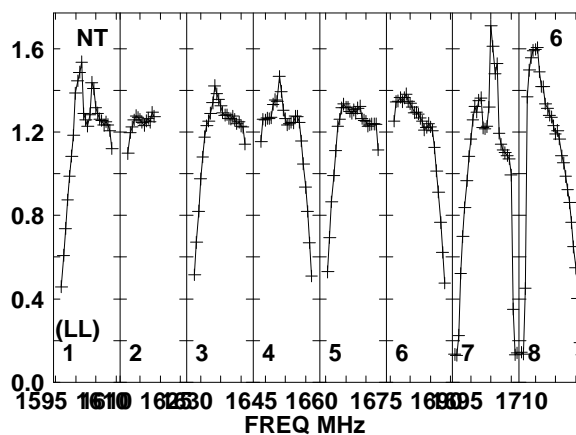
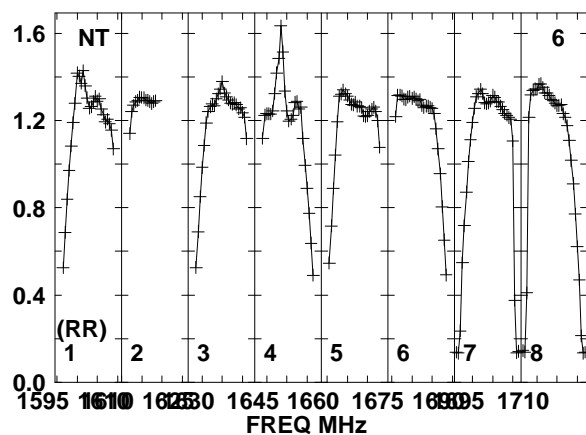
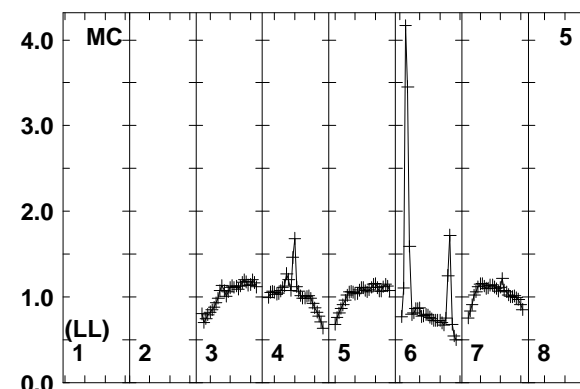
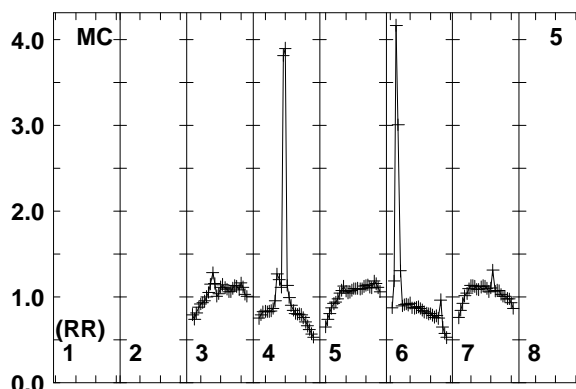
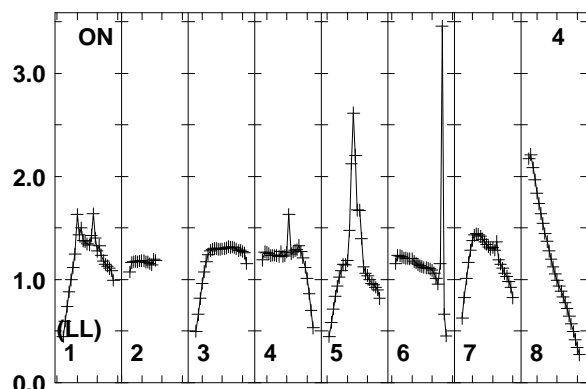
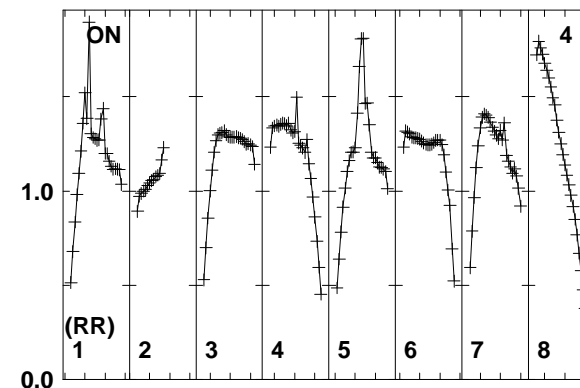
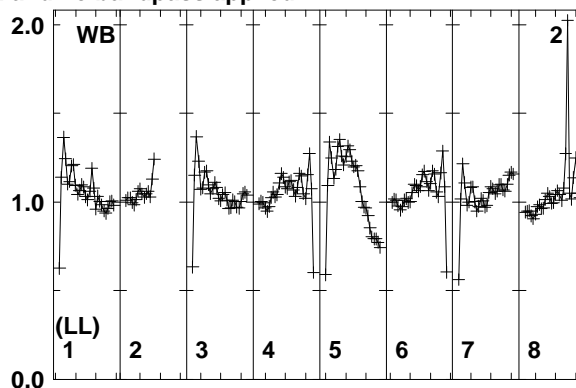
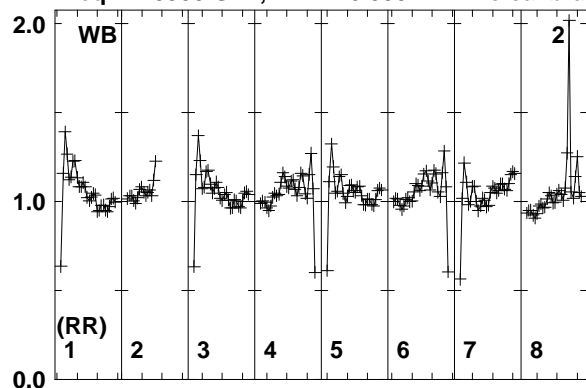

Lower frame: Real Jy
Total-power spectrum Antenna: WB (02)
Timerange: 00/07:00:41 to 00/07:04:29

Plot file version 66 created 20-MAR-2014 17:07:57

IC883 ER030C.UVDATA.1

Freq = 1.5950 GHz, Bw = 16.000 MH No calibration applied and no bandpass applied

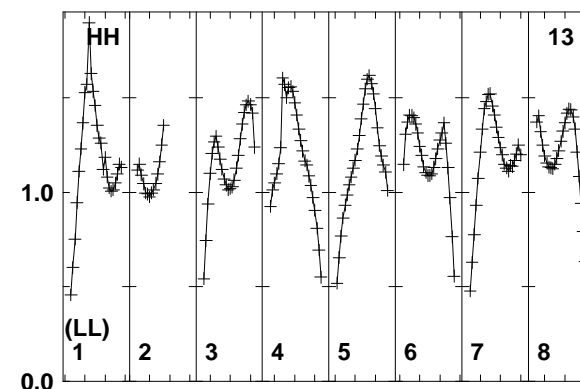
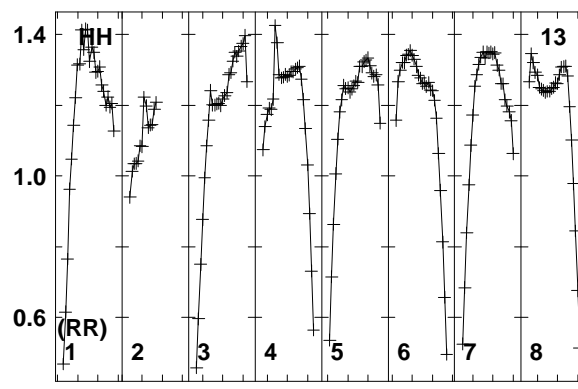
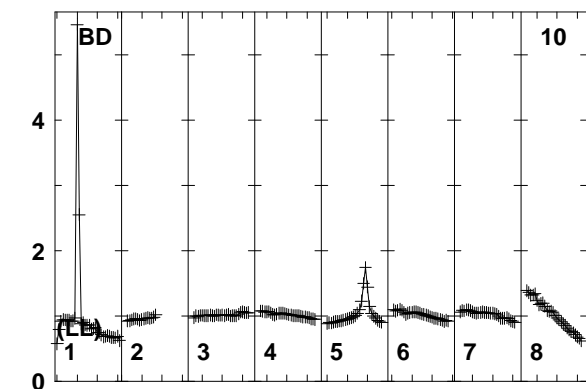
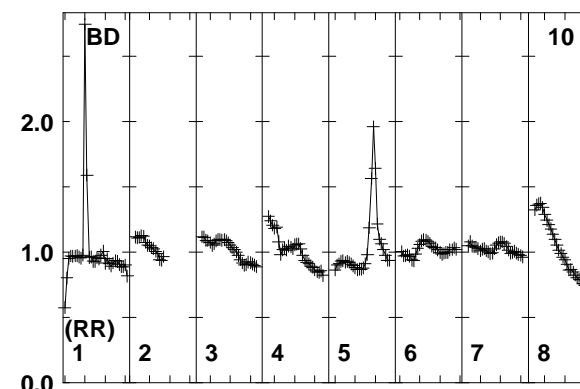
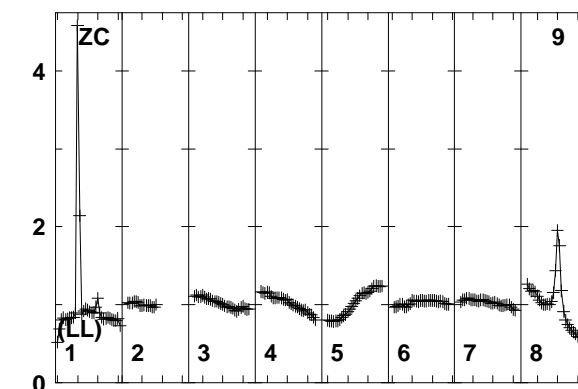
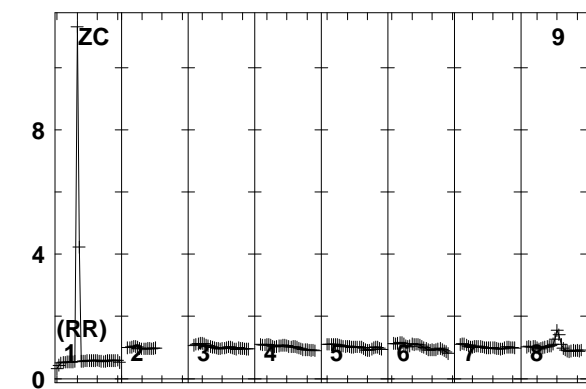
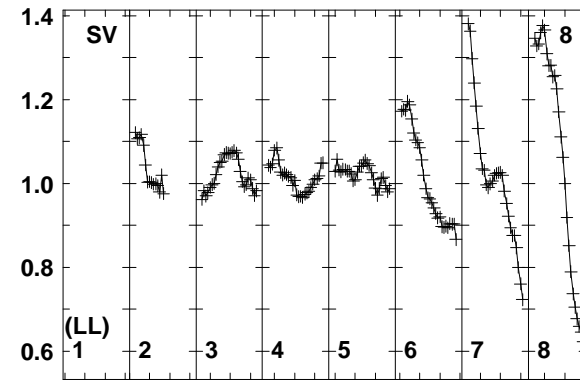
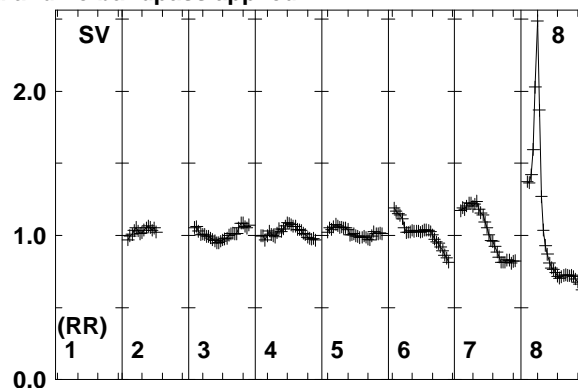
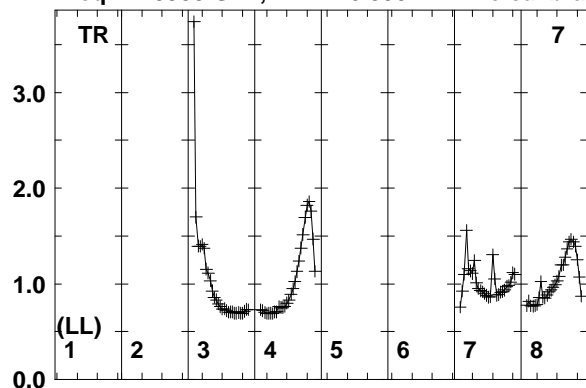

1595 1610 1625 1645 1660 1675 1695 1710
FREQ MHz

1595 1610 1625 1645 1660 1675 1695 1710
FREQ MHz

1595 1610 1625 1645 1660 1675 1695 1710
FREQ MHz

Lower frame: Real Jy
Total-power spectrum Antenna: TR (07)
Timerange: 00/07:00:41 to 00/07:04:29

Plot file version 67 created 20-MAR-2014 17:07:57

J1317+3425 ER030C.UVDATA.1

Freq = 1.5950 GHz, Bw = 16.000 MH No calibration applied and no bandpass applied

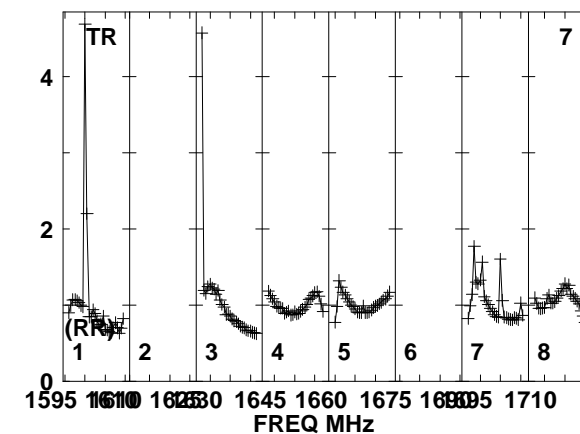
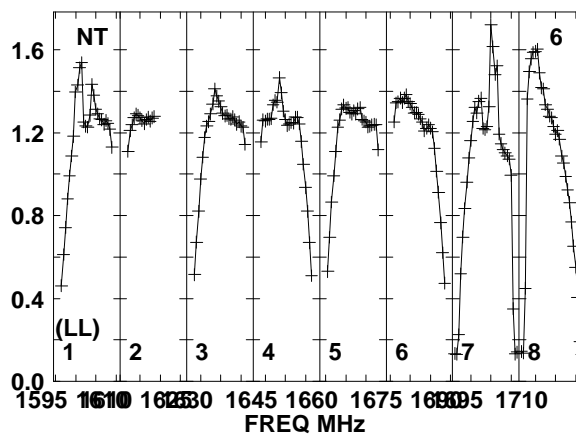
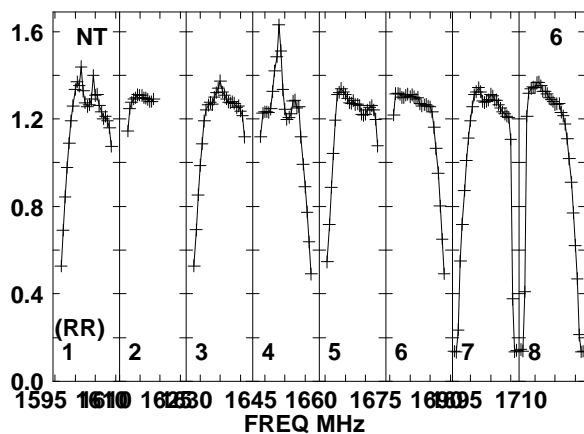
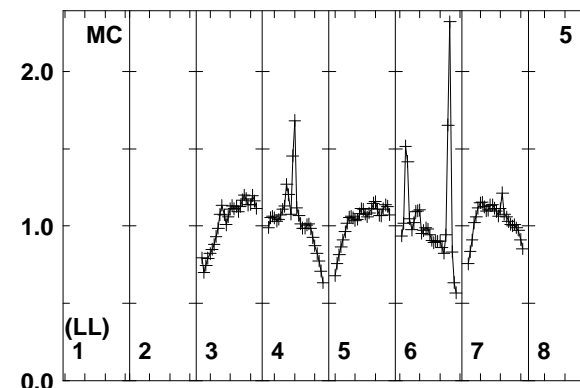
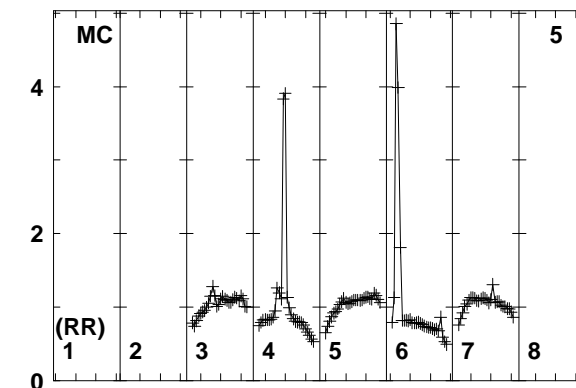
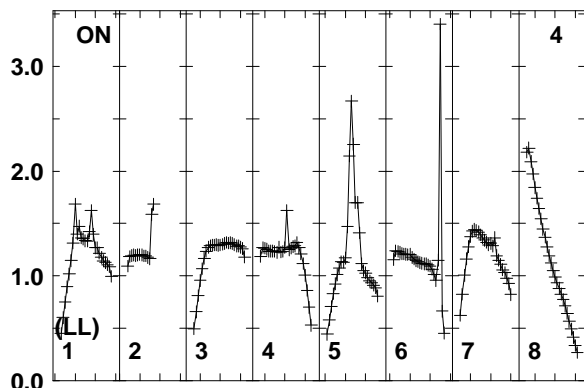
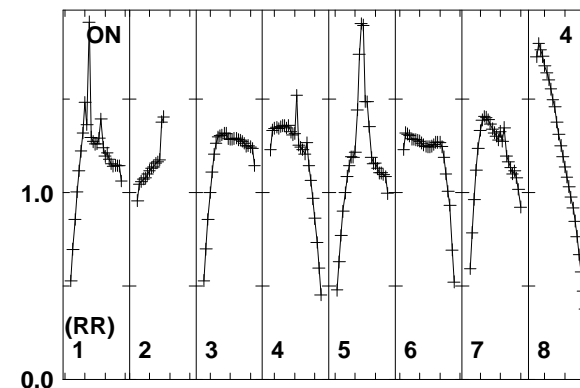
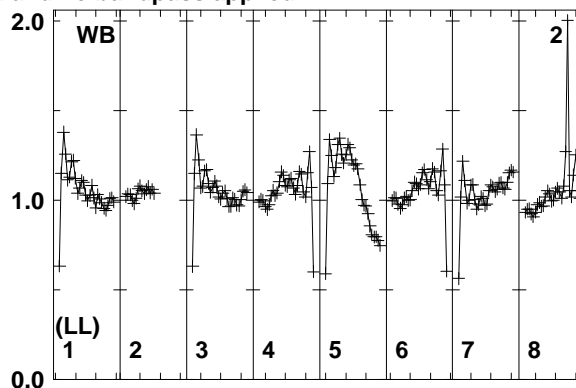
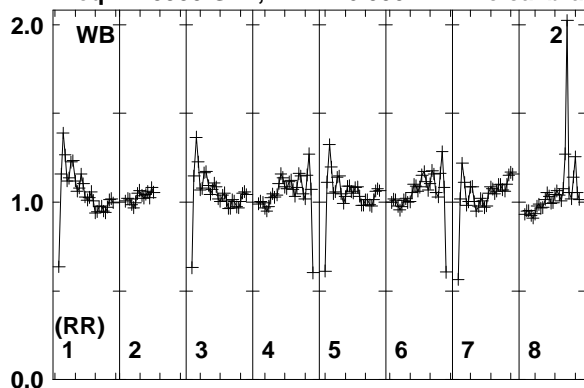

Lower frame: Real Jy
Total-power spectrum Antenna: WB (02)
Timerange: 00/07:05:11 to 00/07:06:09

Plot file version 68 created 20-MAR-2014 17:07:57

J1317+3425 ER030C.UVDATA.1

Freq = 1.5950 GHz, Bw = 16.000 MH No calibration applied and no bandpass applied

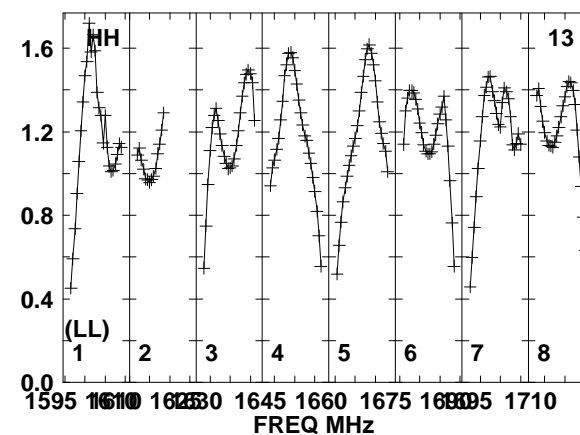
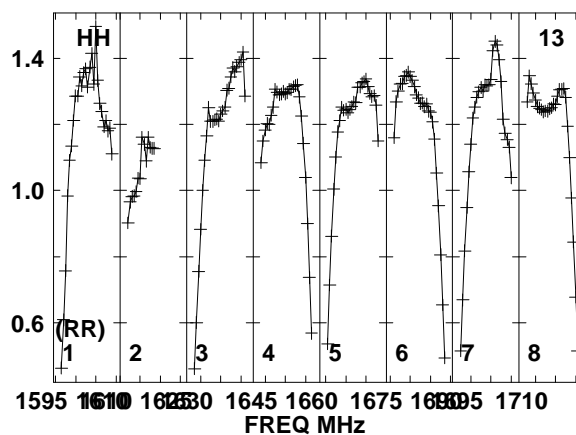
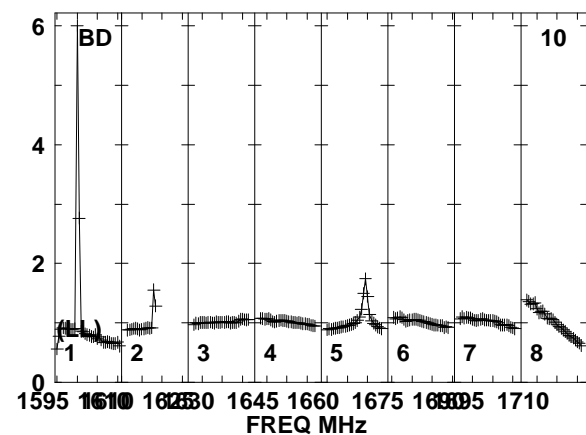
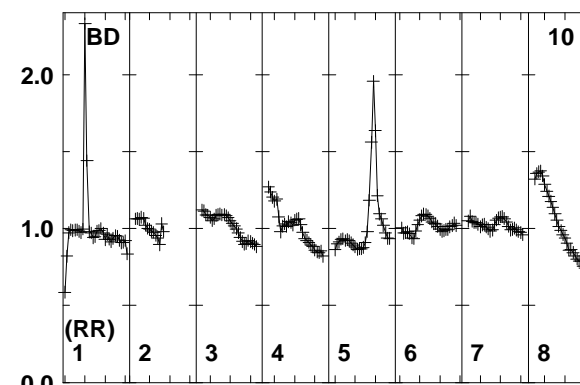
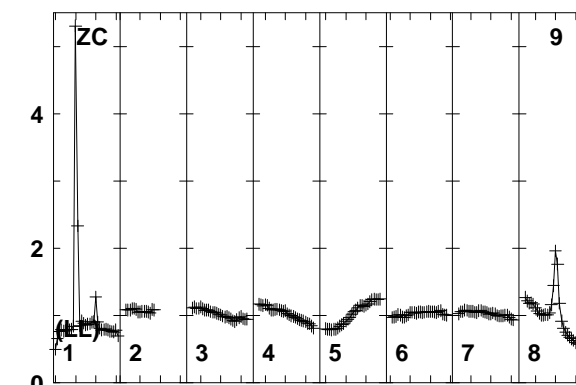
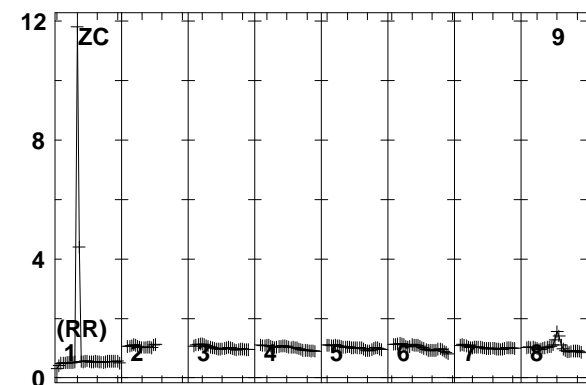
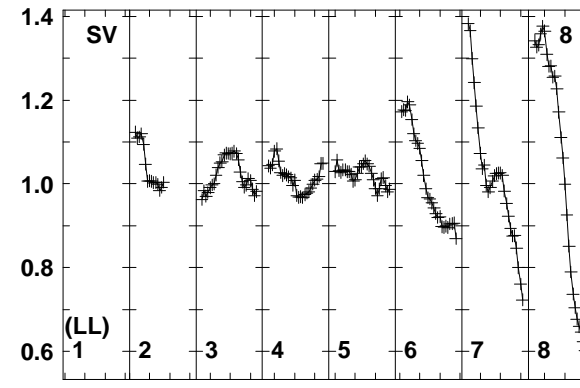
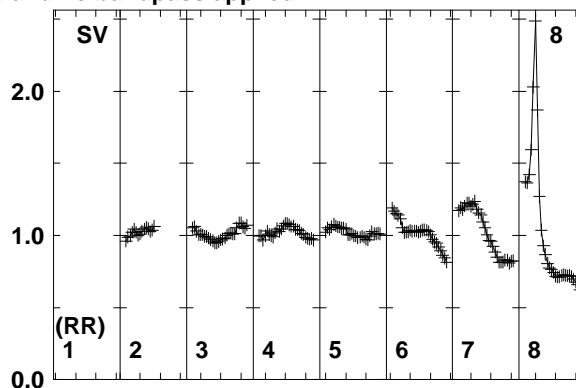
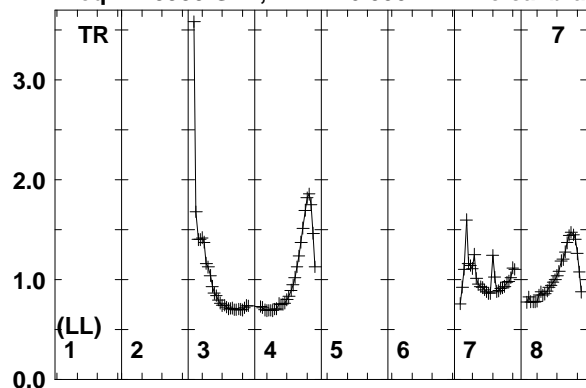

Lower frame: Real Jy
Total-power spectrum Antenna: TR (07)
Timerange: 00/07:05:11 to 00/07:06:09

Plot file version 69 created 20-MAR-2014 17:07:57

IC883 ER030C.UVDATA.1

Freq = 1.5950 GHz, Bw = 16.000 MH No calibration applied and no bandpass applied

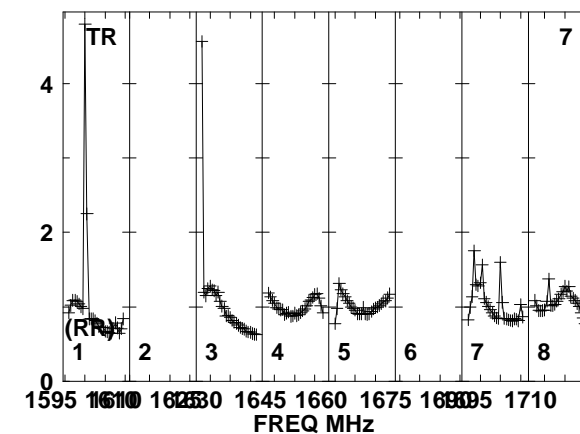
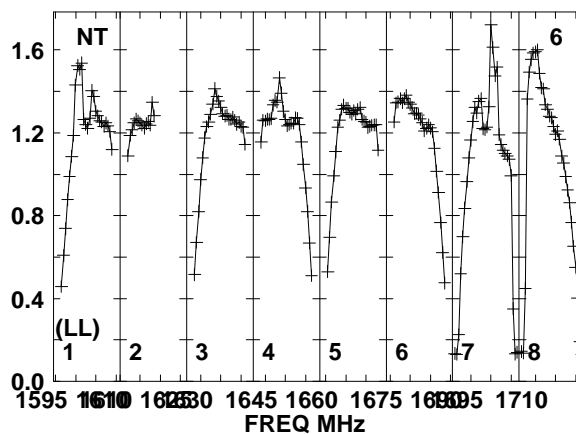
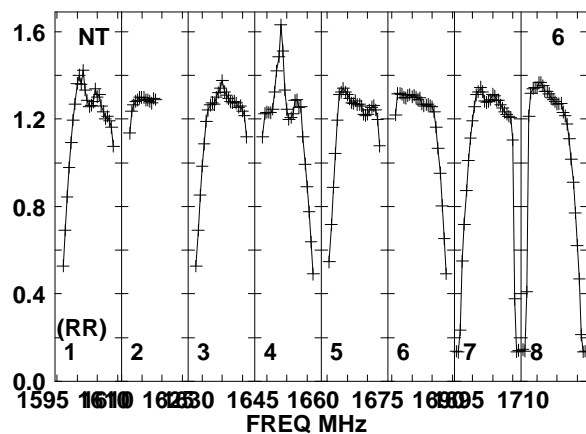
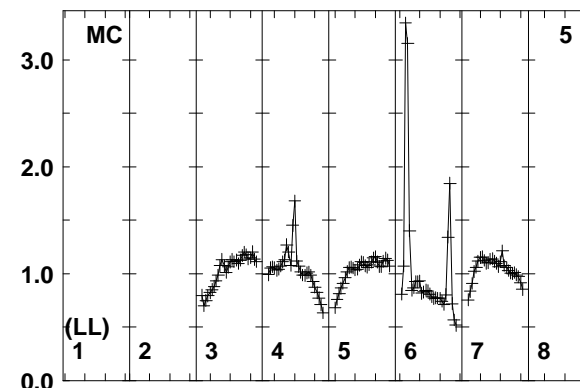
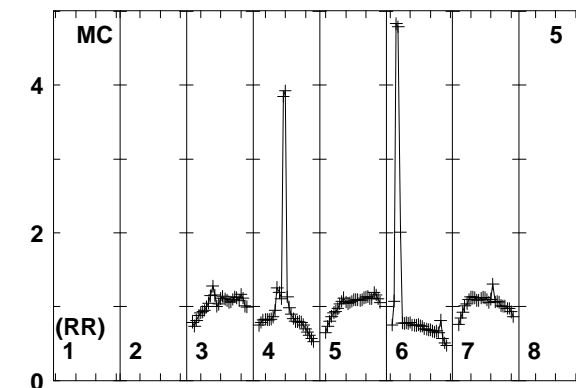
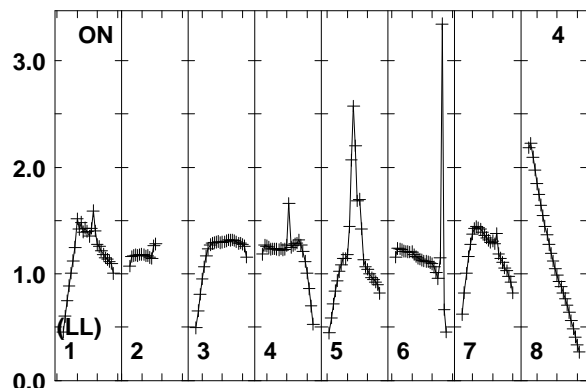
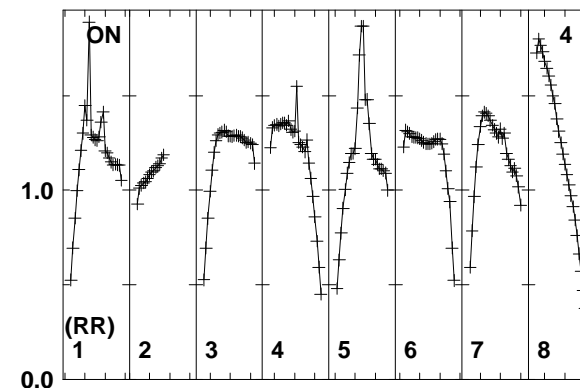
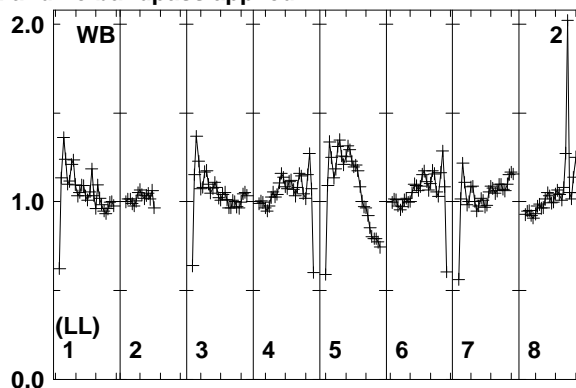
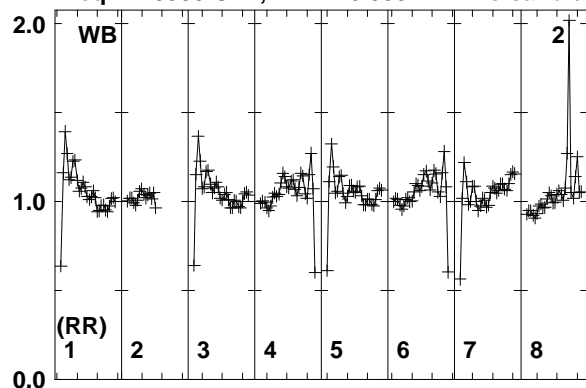

Lower frame: Real Jy
Total-power spectrum Antenna: WB (02)
Timerange: 00/07:06:13 to 00/07:09:59

Plot file version 70 created 20-MAR-2014 17:07:58

IC883 ER030C.UVDATA.1

Freq = 1.5950 GHz, Bw = 16.000 MH No calibration applied and no bandpass applied

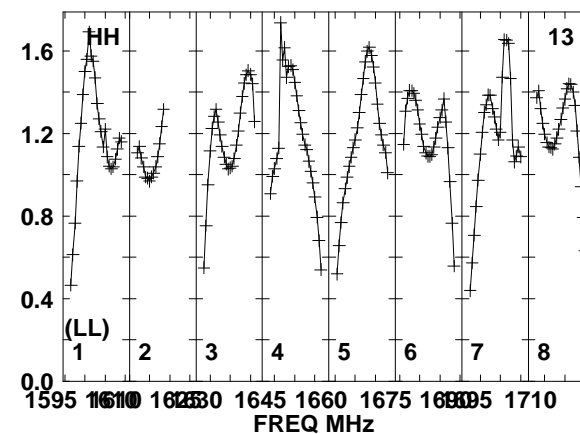
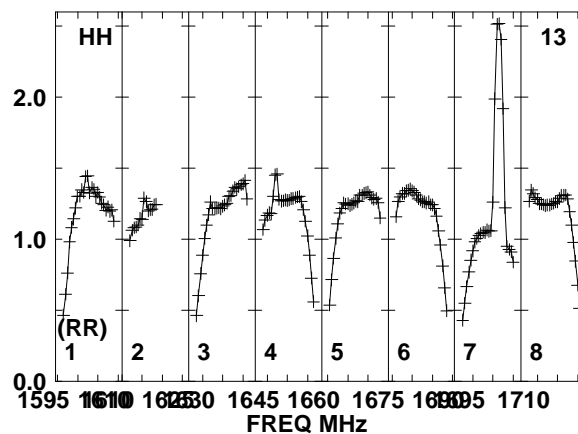
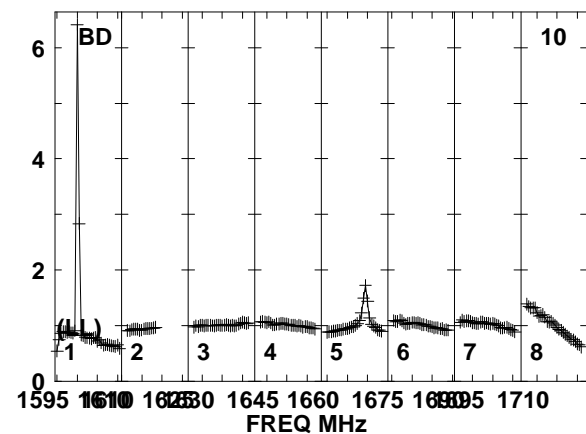
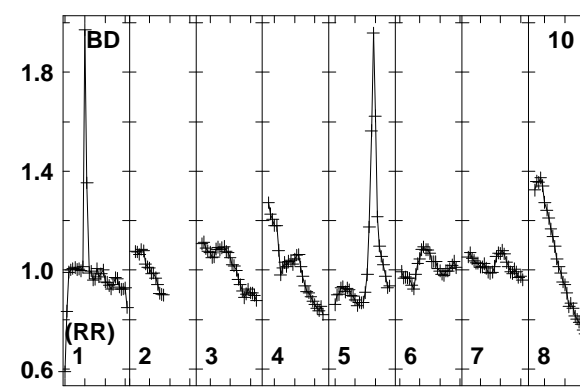
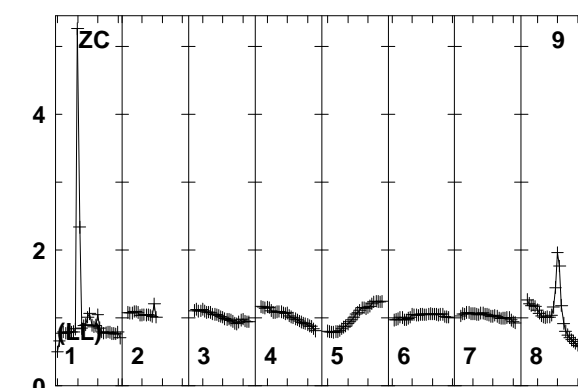
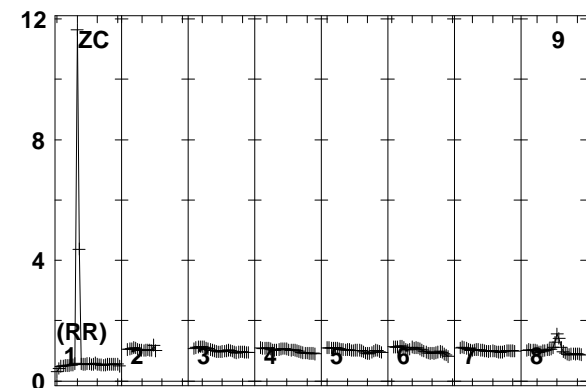
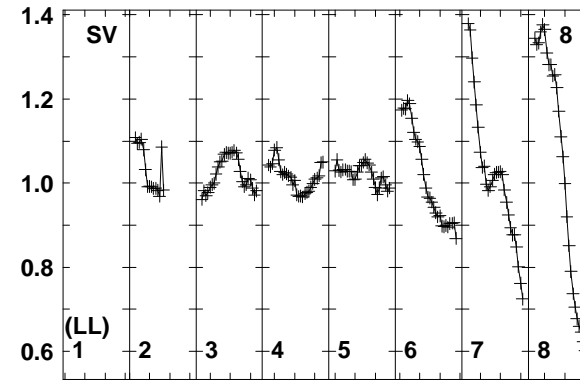
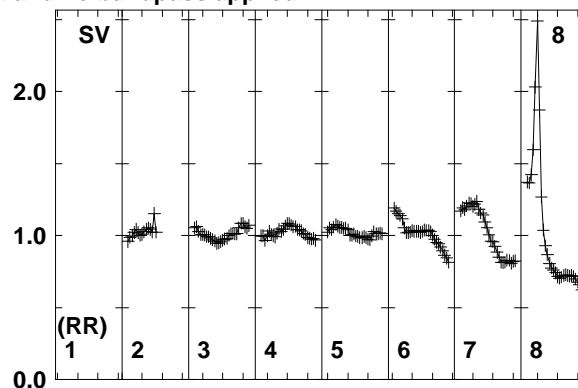
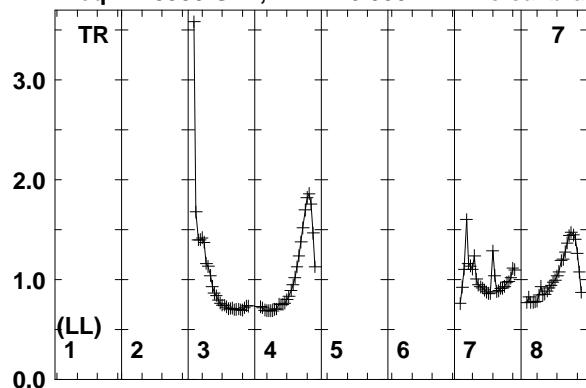

Lower frame: Real Jy
Total-power spectrum Antenna: TR (07)
Timerange: 00/07:06:13 to 00/07:09:59

Plot file version 71 created 20-MAR-2014 17:07:58

J1317+3425 ER030C.UVDATA.1

Freq = 1.5950 GHz, Bw = 16.000 MH No calibration applied and no bandpass applied

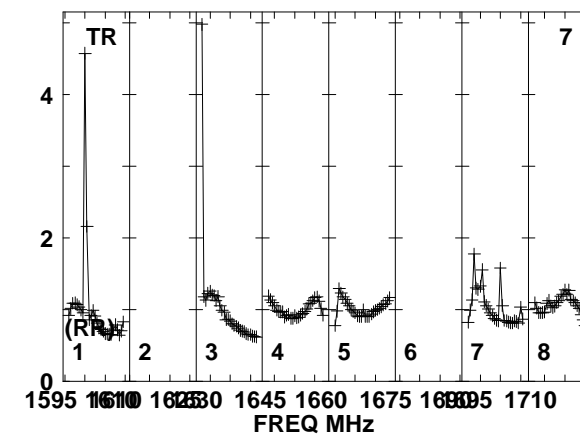
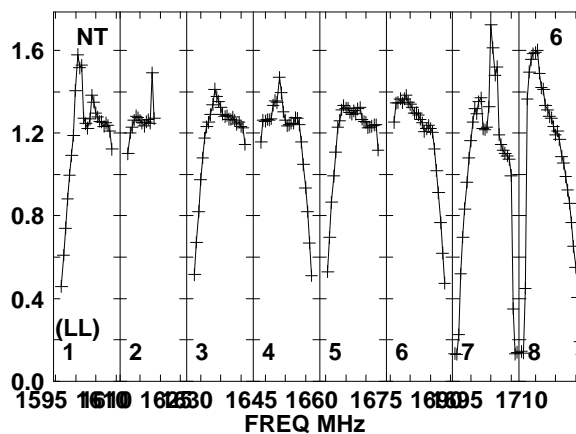
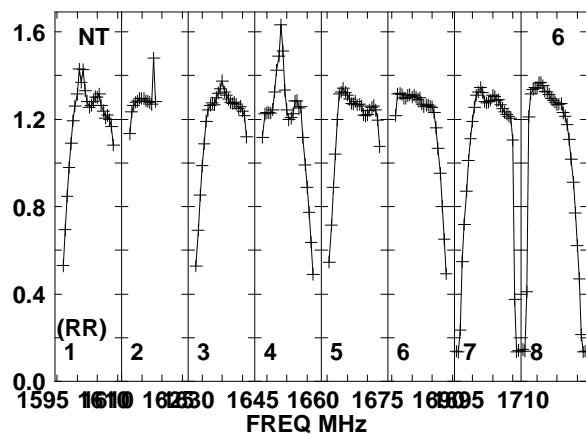
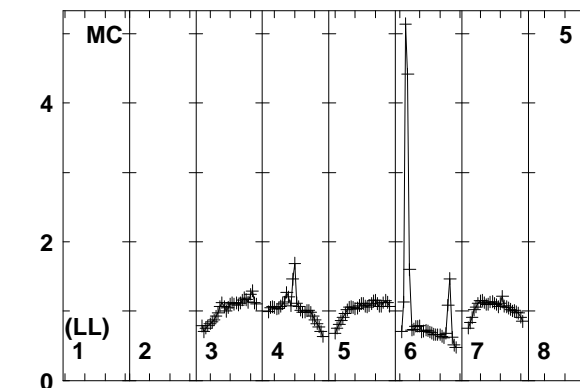
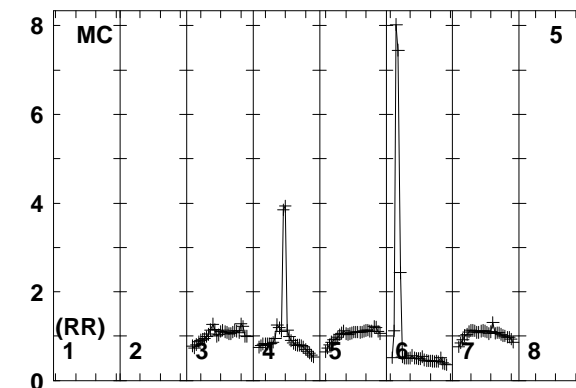
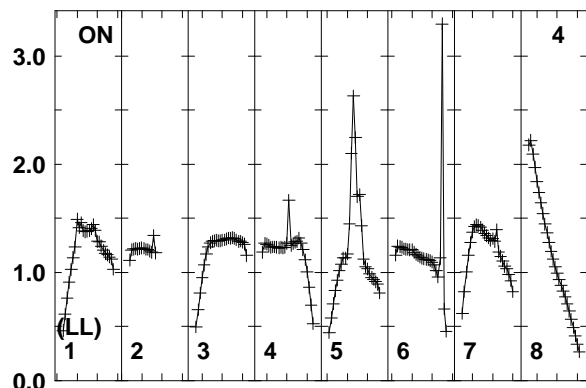
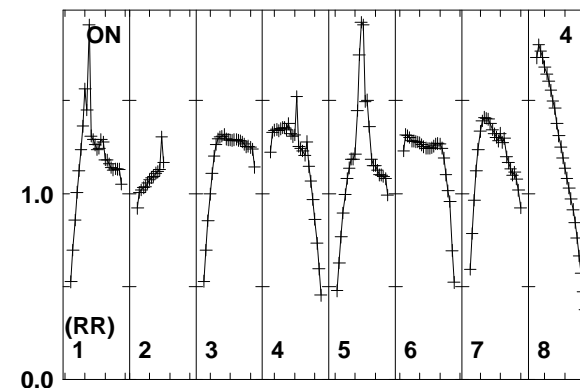
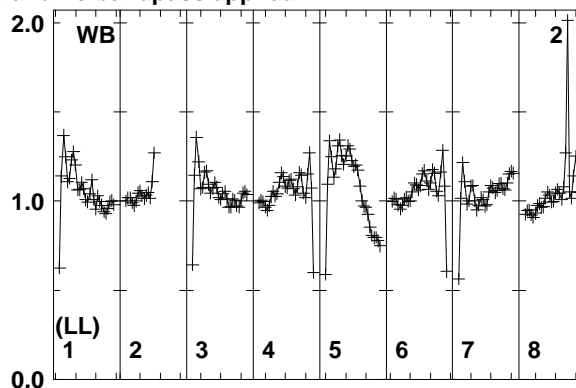
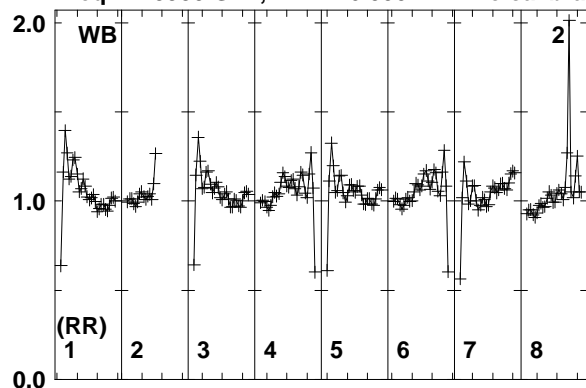

Lower frame: Real Jy
Total-power spectrum Antenna: WB (02)
Timerange: 00/07:10:03 to 00/07:11:19

Plot file version 72 created 20-MAR-2014 17:07:58

J1317+3425 ER030C.UVDATA.1

Freq = 1.5950 GHz, Bw = 16.000 MH No calibration applied and no bandpass applied

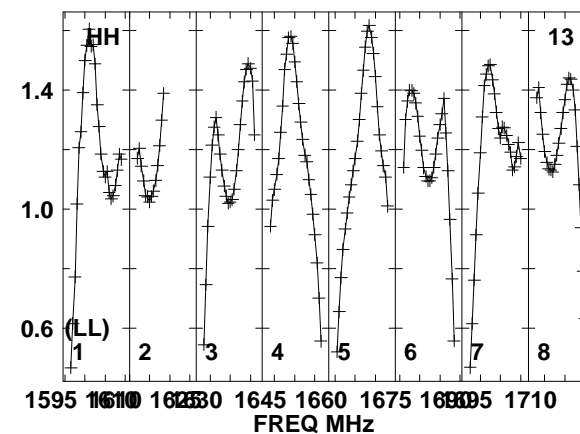
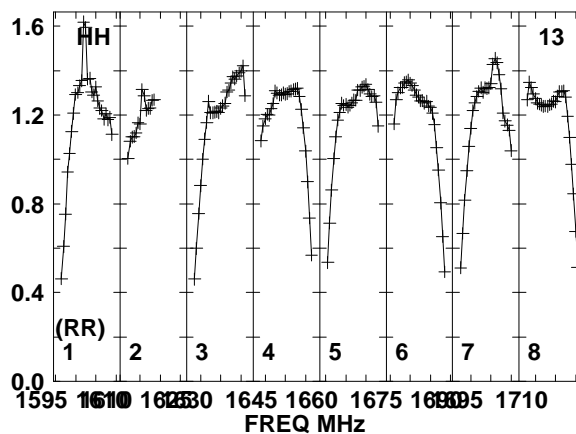
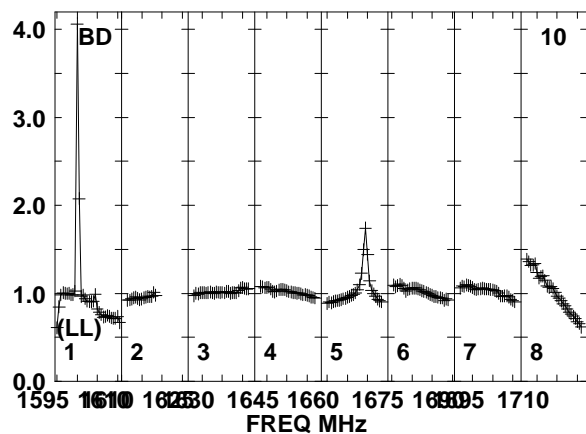
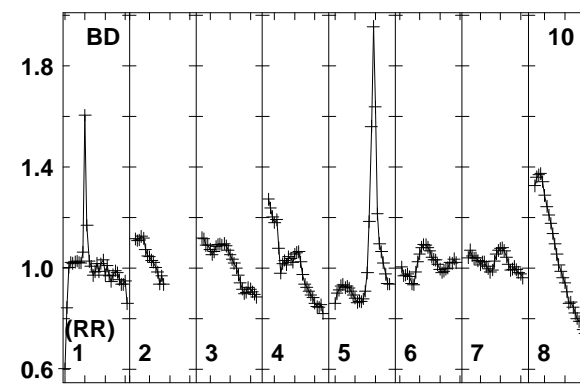
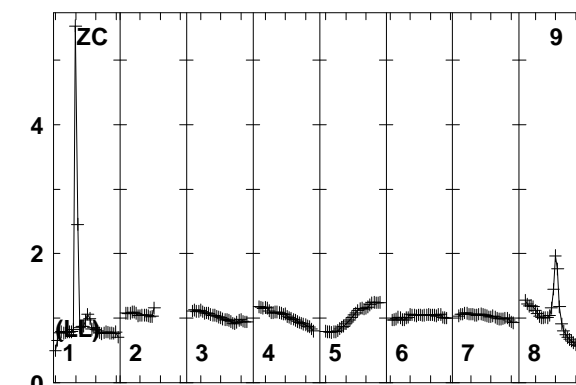
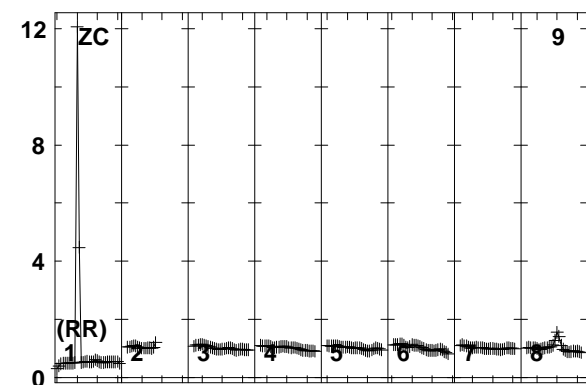
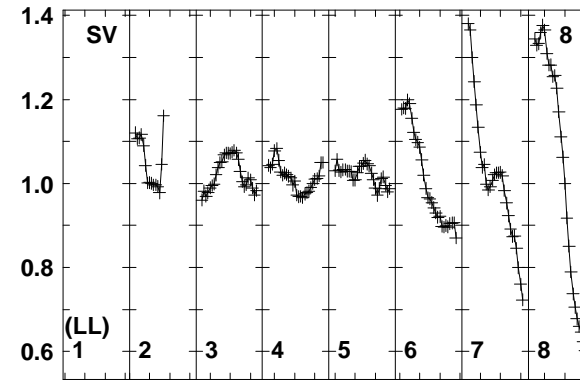
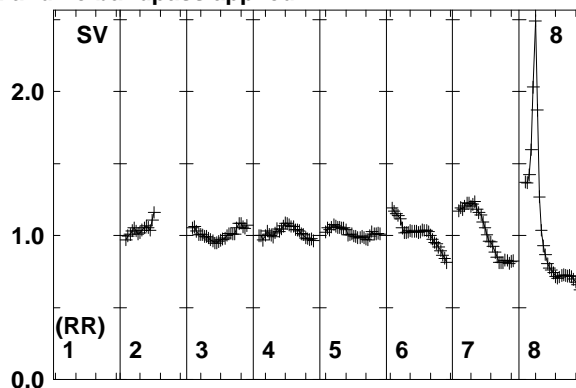
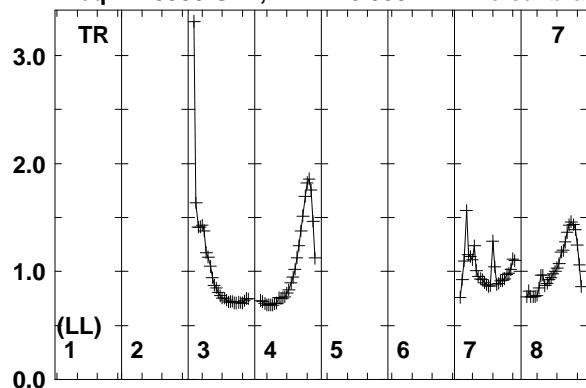

Lower frame: Real Jy
Total-power spectrum Antenna: TR (07)
Timerange: 00/07:10:03 to 00/07:11:19

Plot file version 73 created 20-MAR-2014 17:07:58

IC883 ER030C.UVDATA.1

Freq = 1.5950 GHz, Bw = 16.000 MH No calibration applied and no bandpass applied

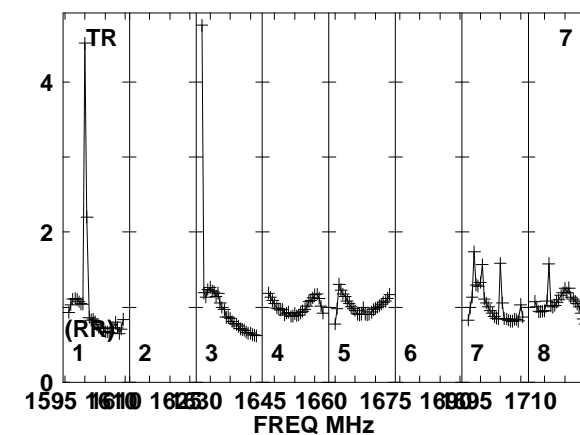
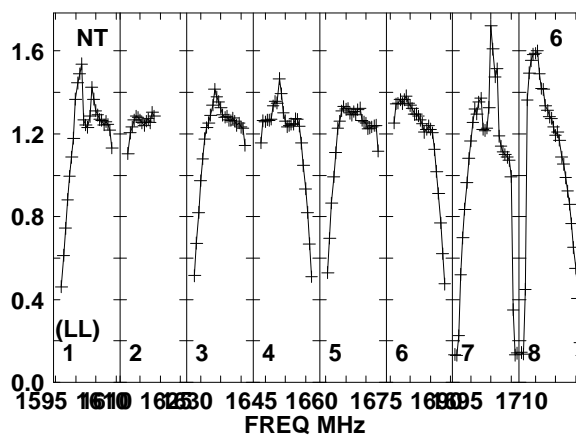
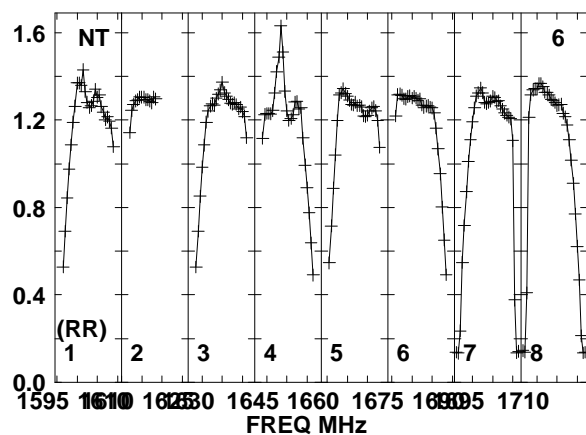
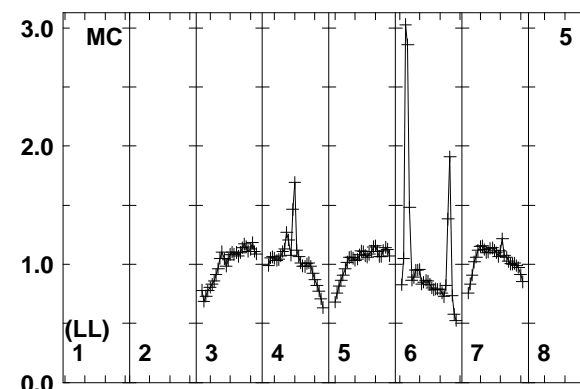
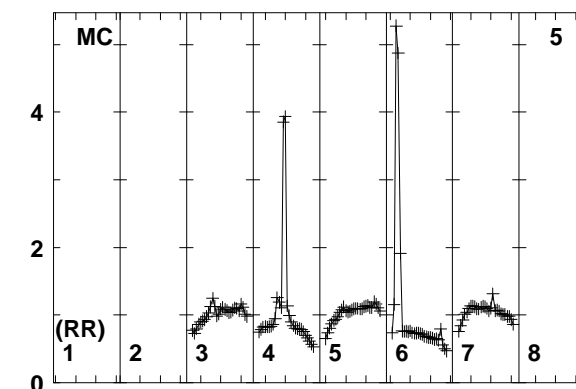
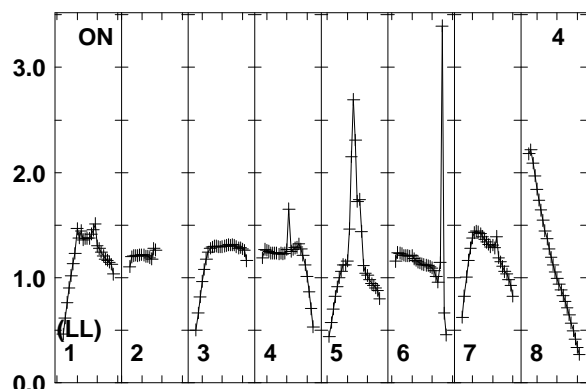
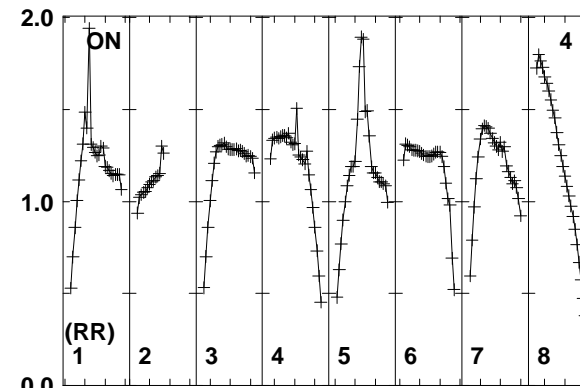
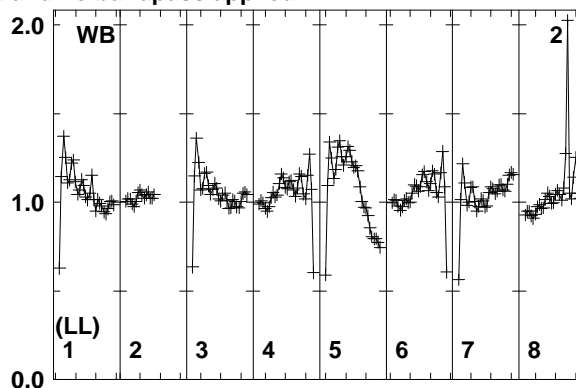
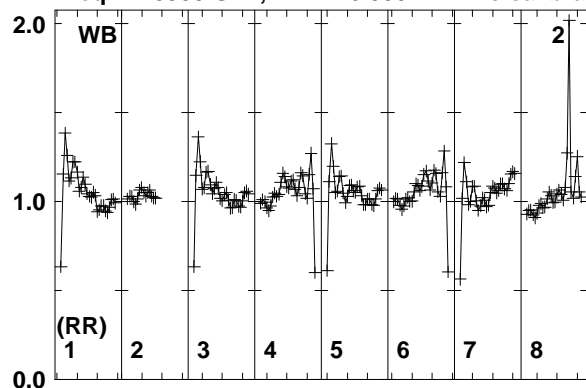

Lower frame: Real Jy
Total-power spectrum Antenna: WB (02)
Timerange: 00/07:11:21 to 00/07:15:09

Plot file version 74 created 20-MAR-2014 17:07:58

IC883 ER030C.UVDATA.1

Freq = 1.5950 GHz, Bw = 16.000 MH No calibration applied and no bandpass applied

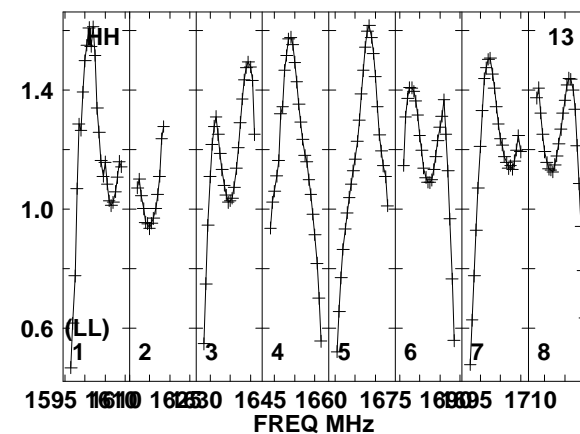
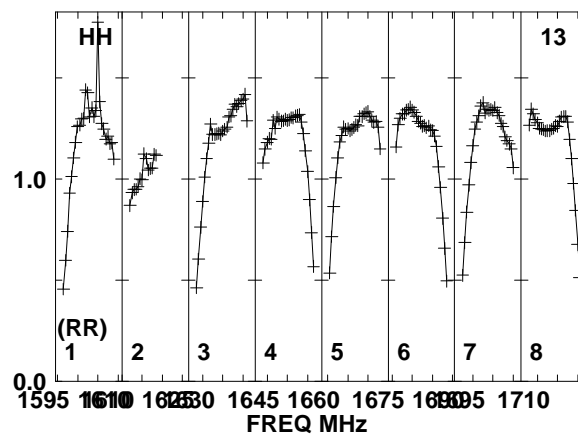
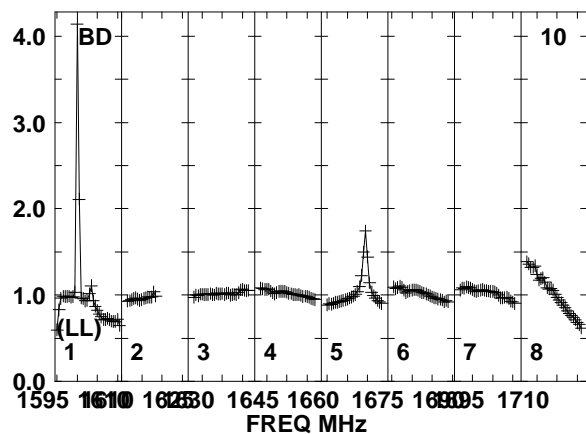
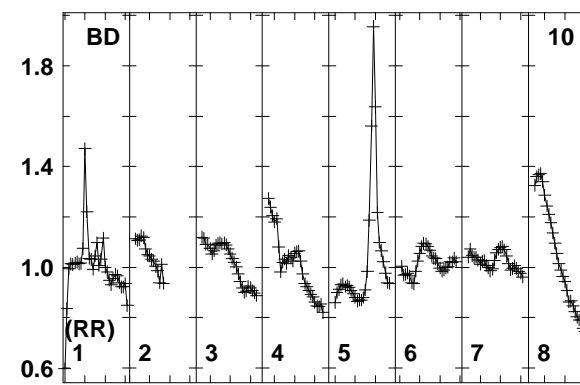
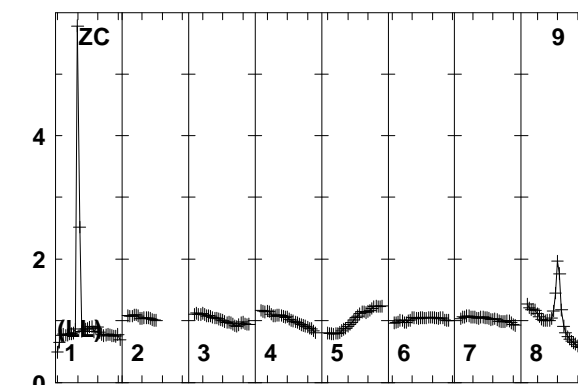
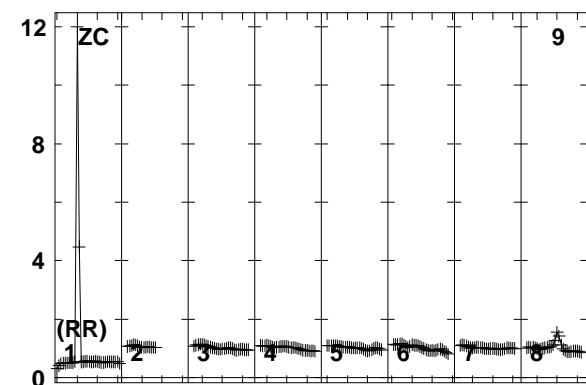
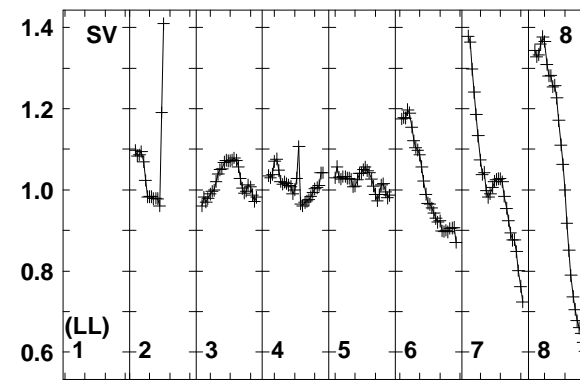
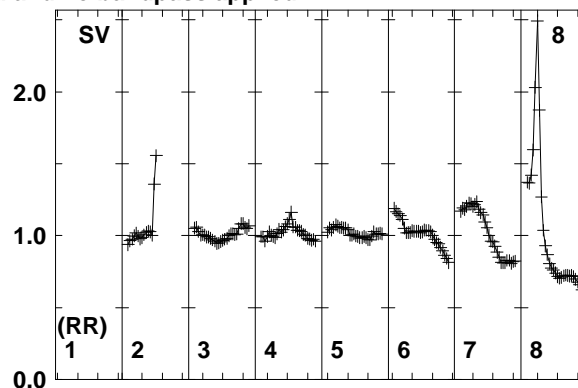
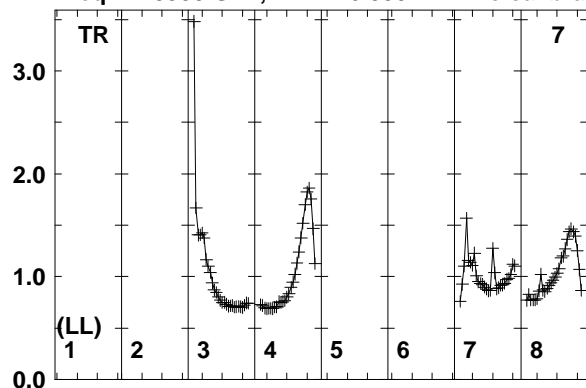

Lower frame: Real Jy
Total-power spectrum Antenna: TR (07)
Timerange: 00/07:11:21 to 00/07:15:09

Plot file version 75 created 20-MAR-2014 17:07:58

J1317+3425 ER030C.UVDATA.1

Freq = 1.5950 GHz, Bw = 16.000 MH No calibration applied and no bandpass applied

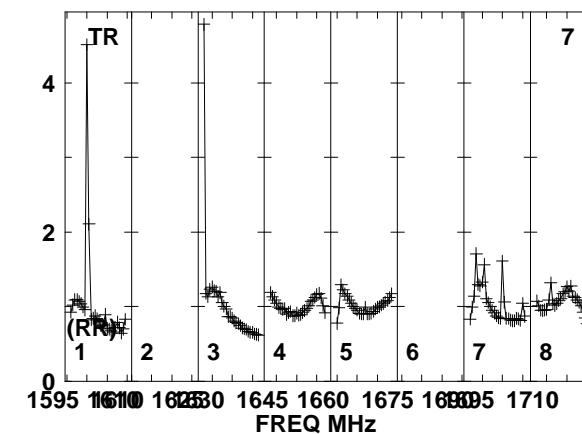
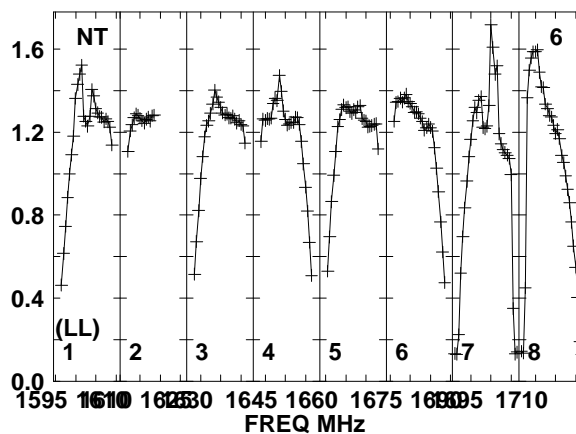
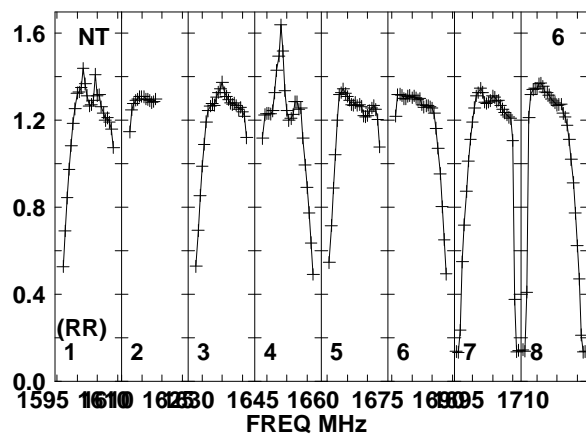
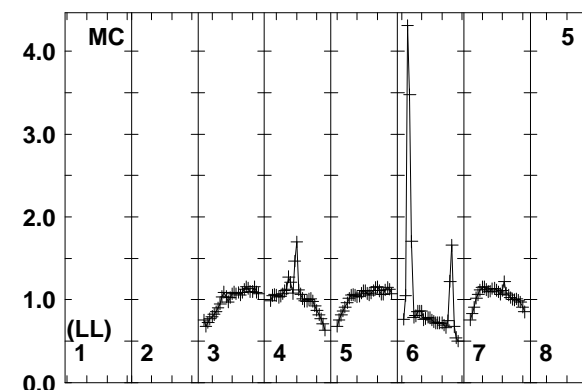
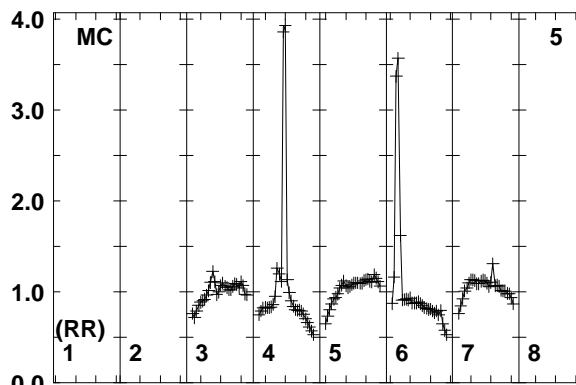
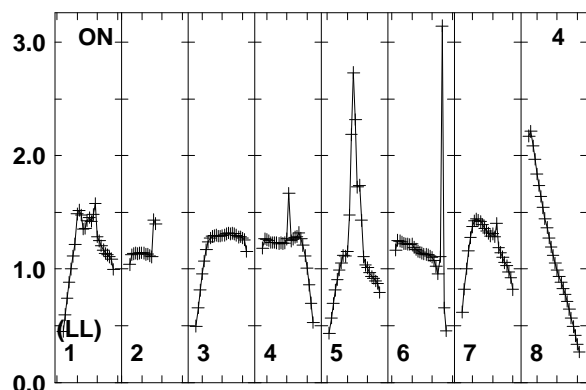
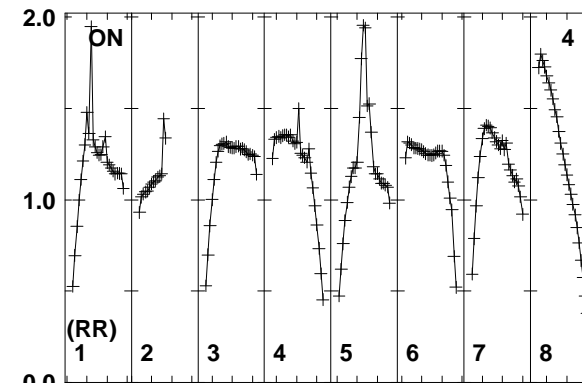
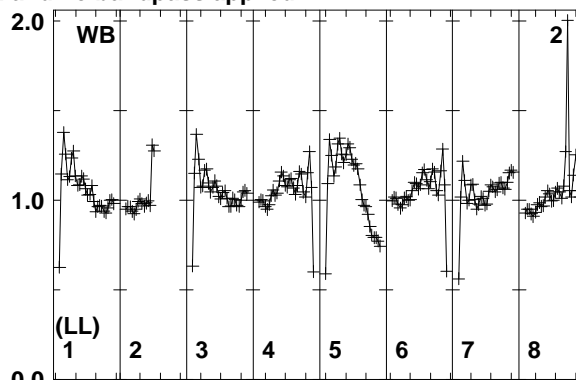
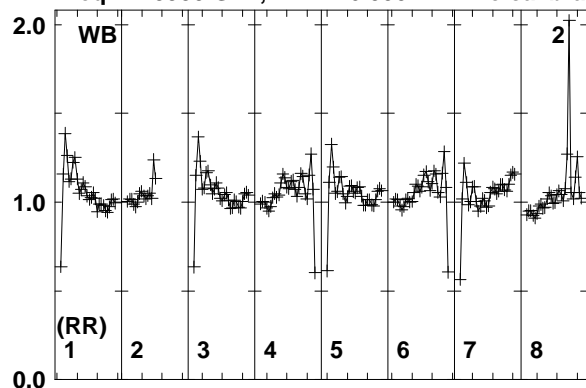

Lower frame: Real Jy
Total-power spectrum Antenna: WB (02)
Timerange: 00/07:15:51 to 00/07:16:49

Plot file version 76 created 20-MAR-2014 17:07:58

J1317+3425 ER030C.UVDATA.1

Freq = 1.5950 GHz, Bw = 16.000 MH No calibration applied and no bandpass applied

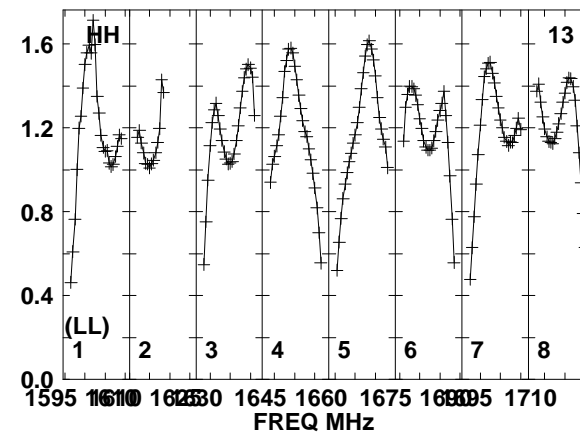
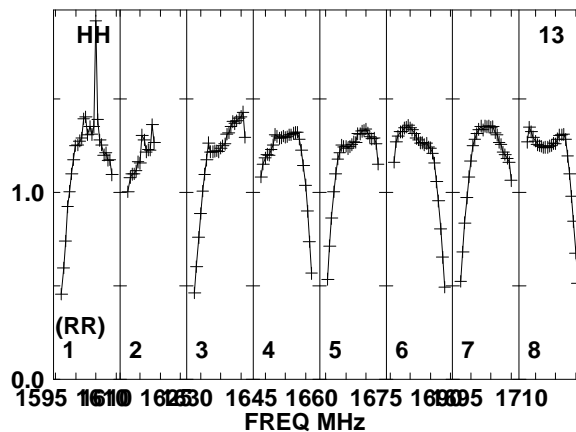
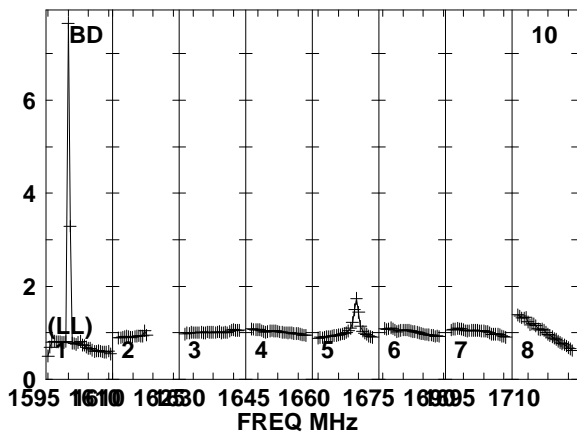
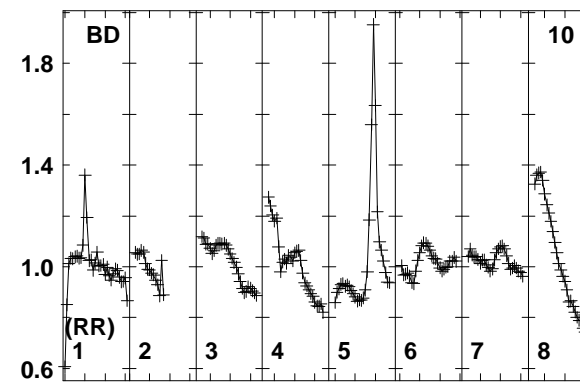
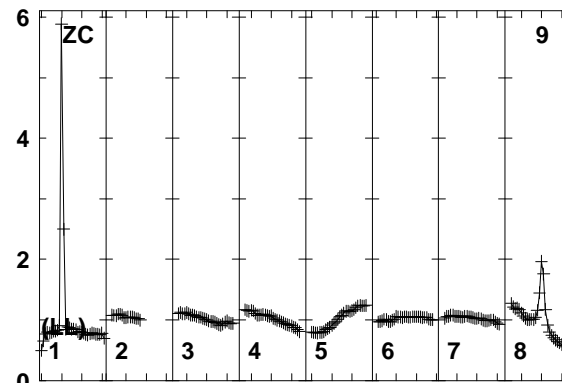
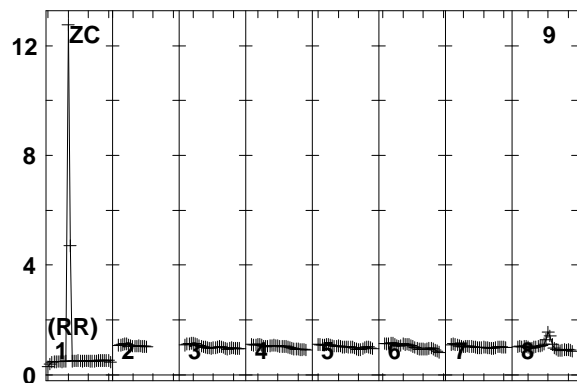
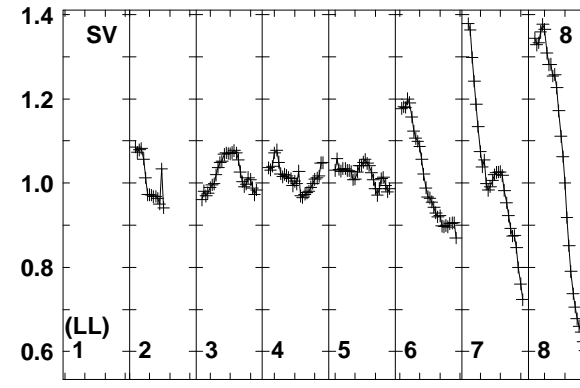
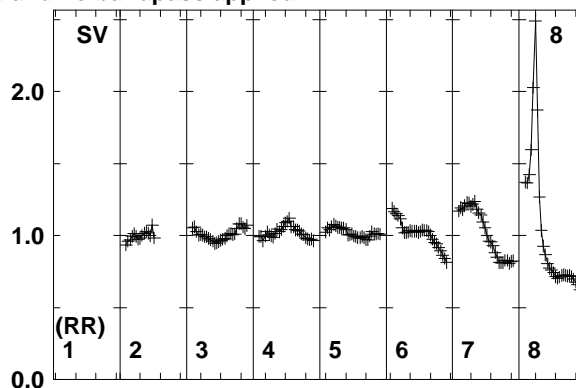
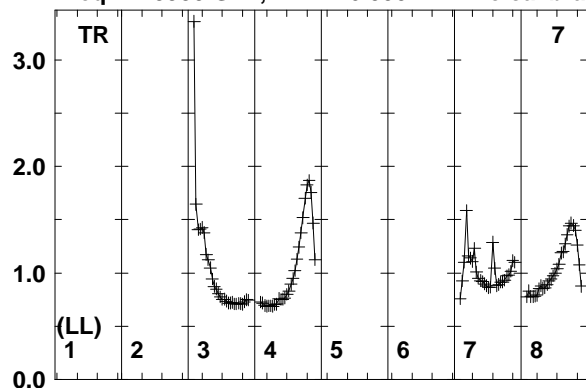

Lower frame: Real Jy
Total-power spectrum Antenna: TR (07)
Timerange: 00/07:15:51 to 00/07:16:49

Plot file version 77 created 20-MAR-2014 17:07:58

IC883 ER030C.UVDATA.1

Freq = 1.5950 GHz, Bw = 16.000 MH No calibration applied and no bandpass applied

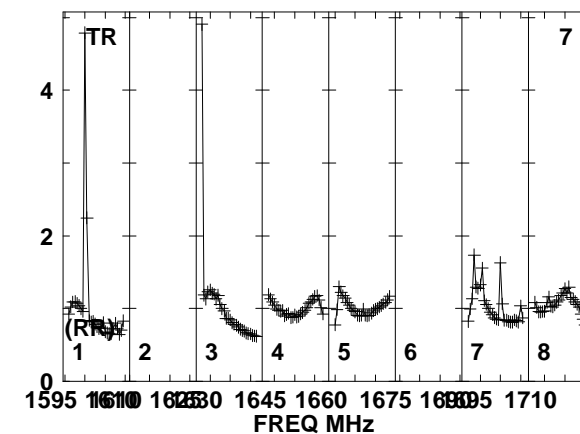
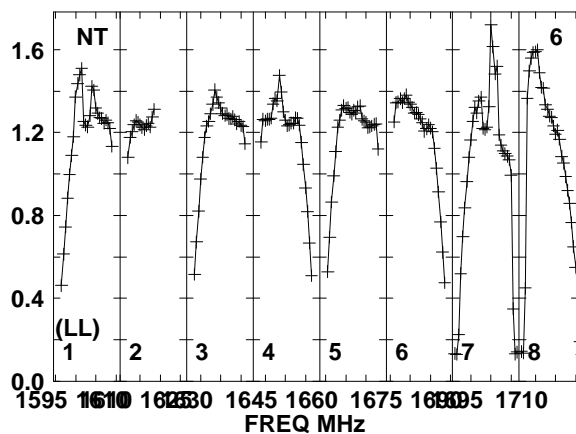
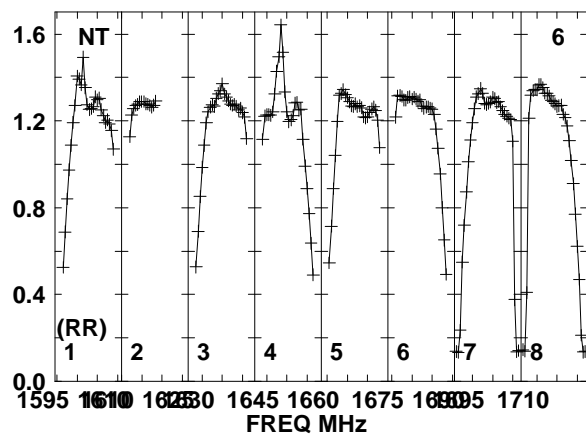
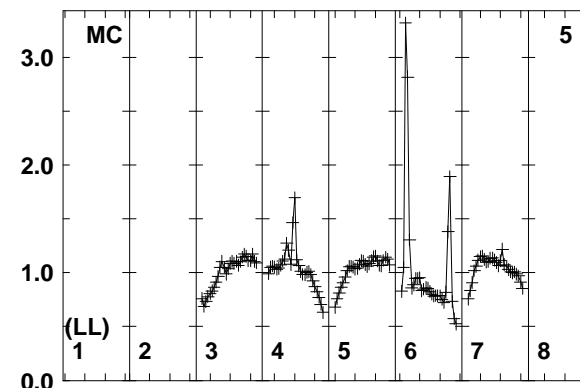
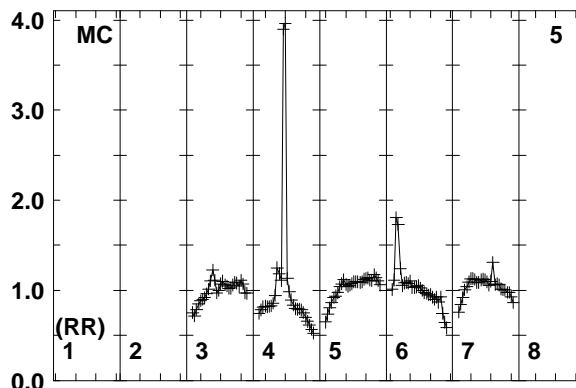
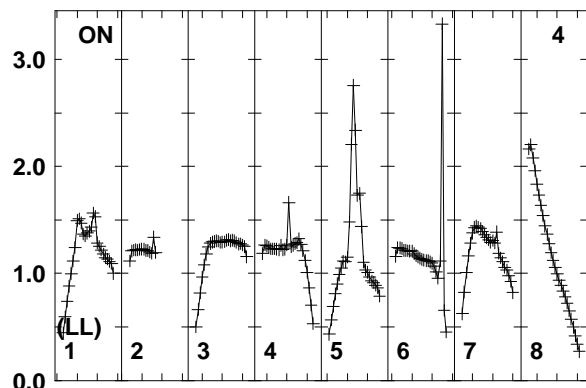
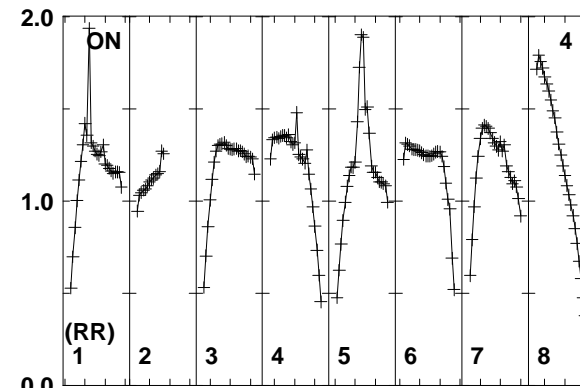
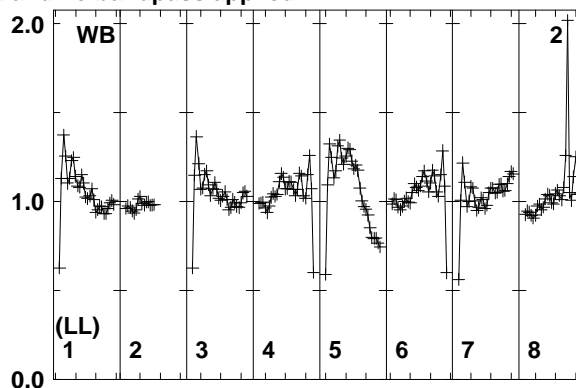
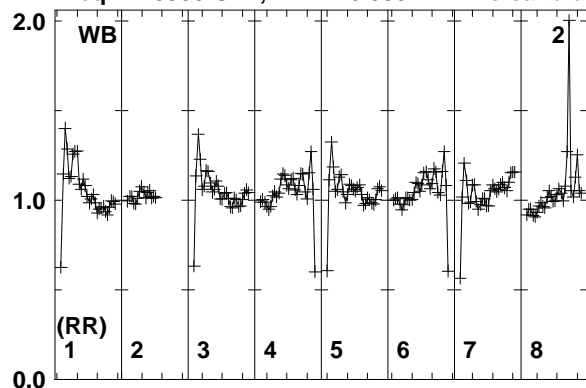

Lower frame: Real Jy
Total-power spectrum Antenna: WB (02)
Timerange: 00/07:16:53 to 00/07:20:39

Plot file version 78 created 20-MAR-2014 17:07:58

IC883 ER030C.UVDATA.1

Freq = 1.5950 GHz, Bw = 16.000 MH No calibration applied and no bandpass applied

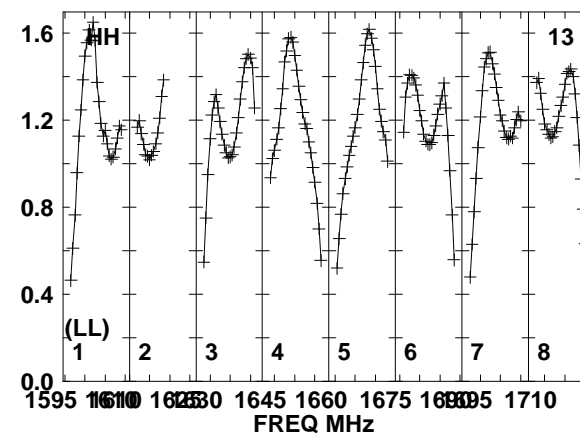
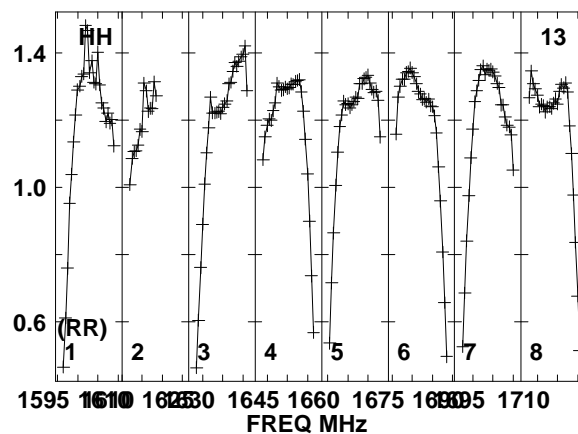
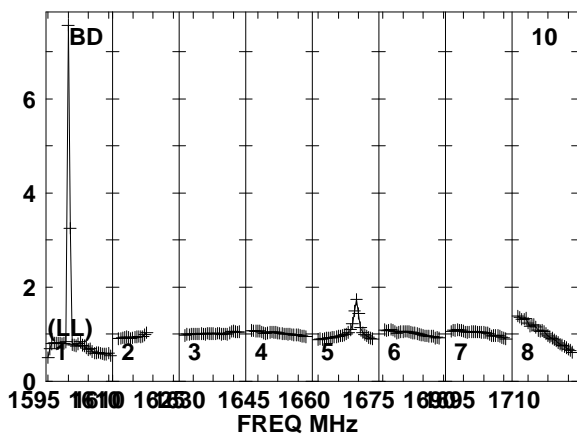
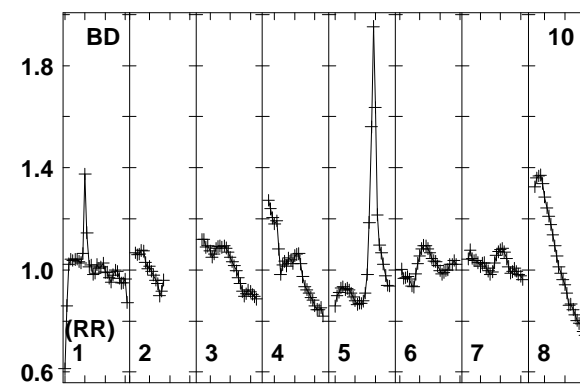
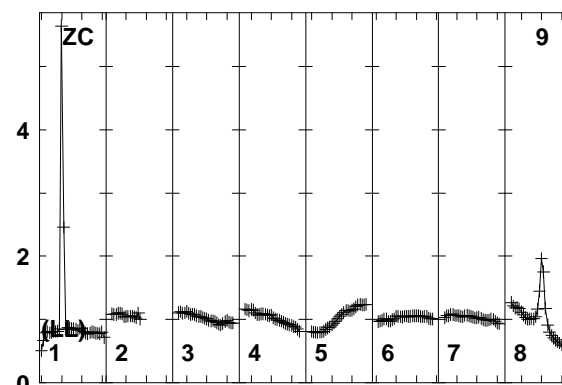
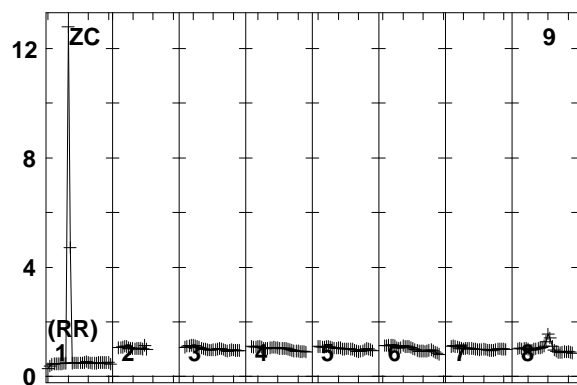
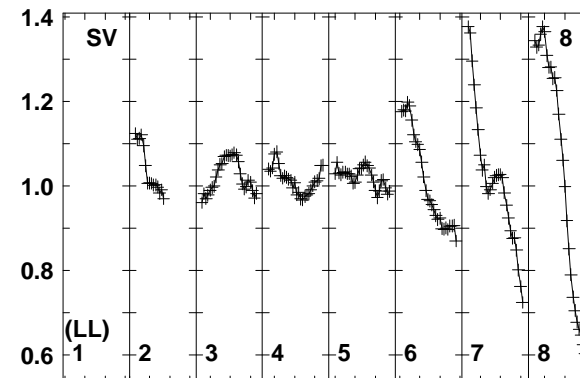
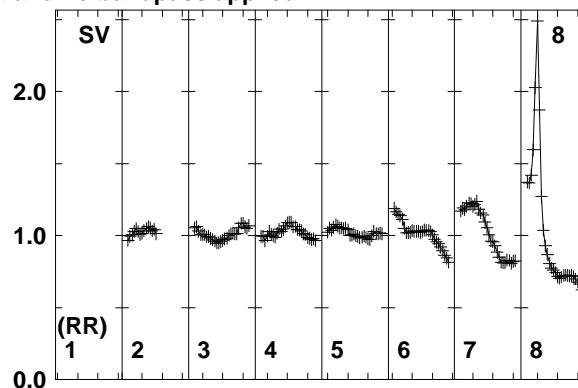
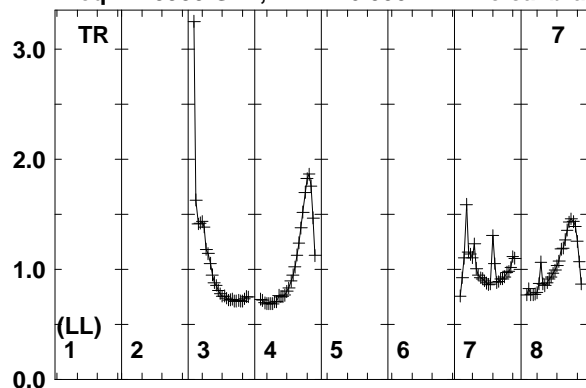

1595 1610 1625 1645 1660 1675 1695 1710
FREQ MHz
Lower frame: Real Jy
Total-power spectrum Antenna: TR (07)
Timerange: 00/07:16:53 to 00/07:20:39

Plot file version 79 created 20-MAR-2014 17:07:59

J1317+3425 ER030C.UVDATA.1

Freq = 1.5950 GHz, Bw = 16.000 MH No calibration applied and no bandpass applied

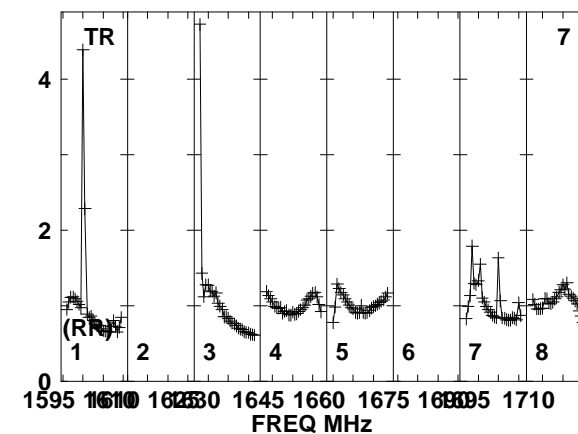
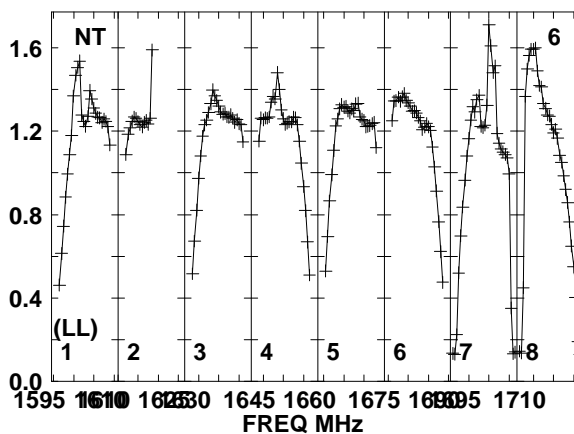
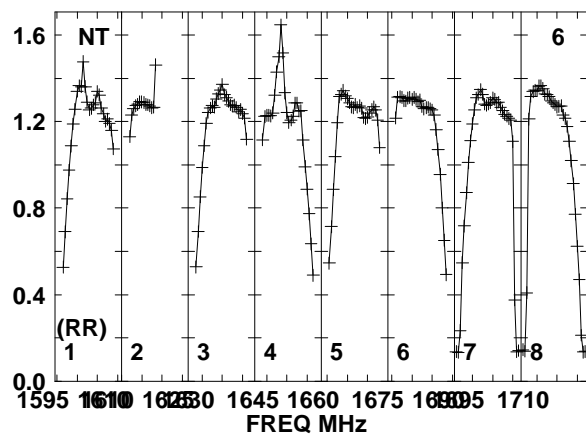
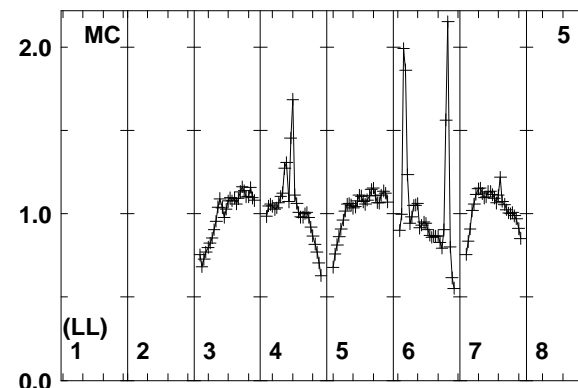
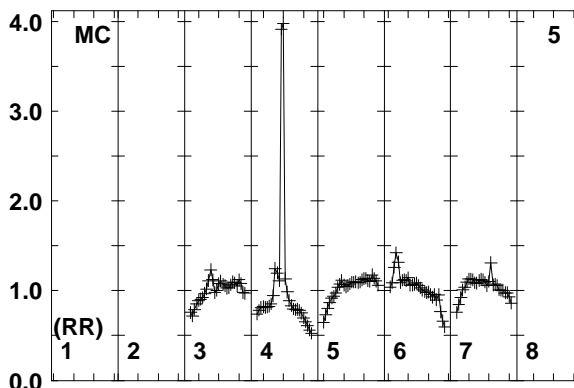
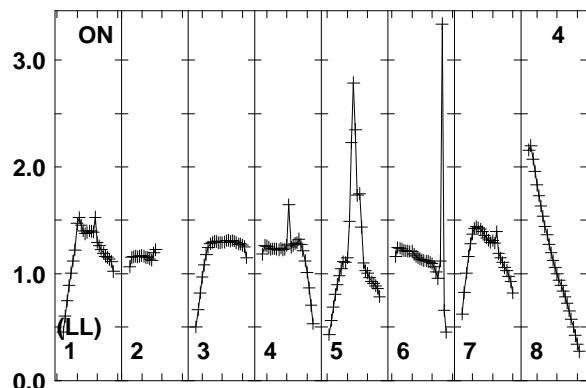
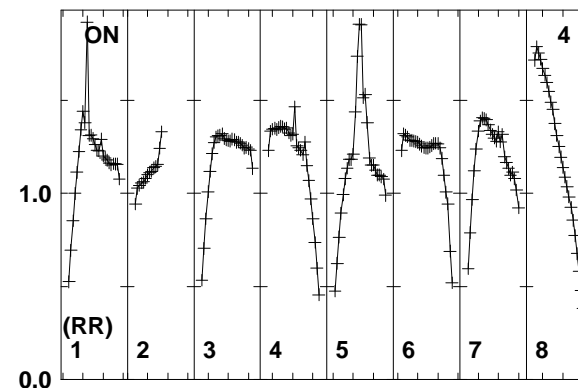
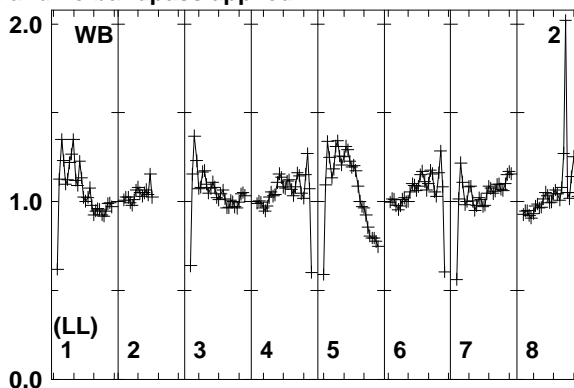
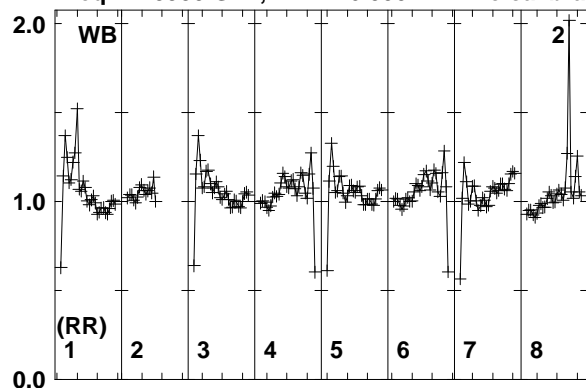

Lower frame: Real Jy
Total-power spectrum Antenna: WB (02)
Timerange: 00/07:20:43 to 00/07:21:59

Plot file version 80 created 20-MAR-2014 17:07:59

J1317+3425 ER030C.UVDATA.1

Freq = 1.5950 GHz, Bw = 16.000 MH No calibration applied and no bandpass applied

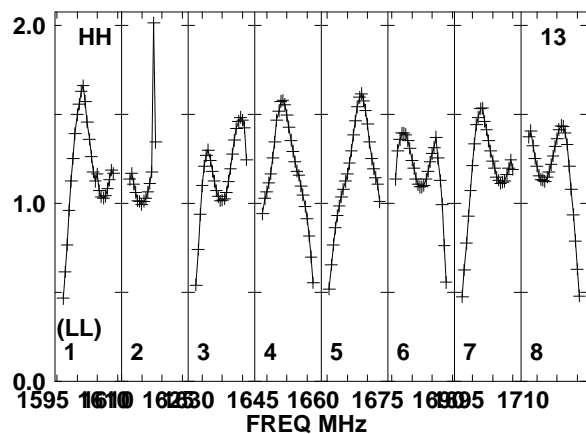
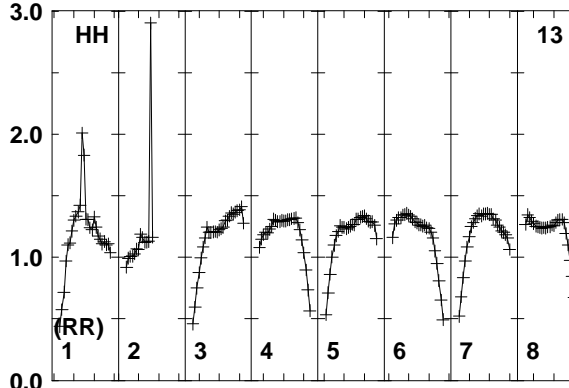
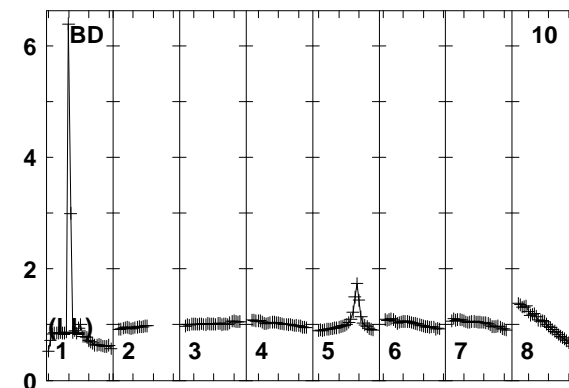
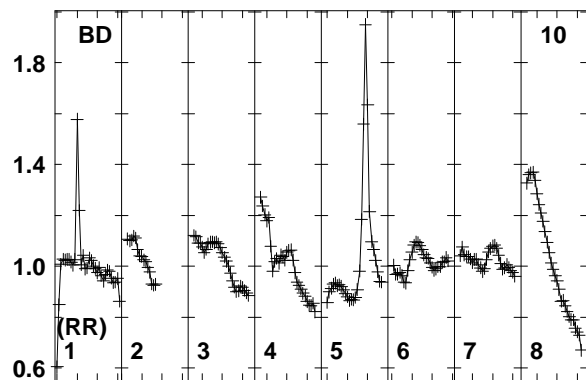
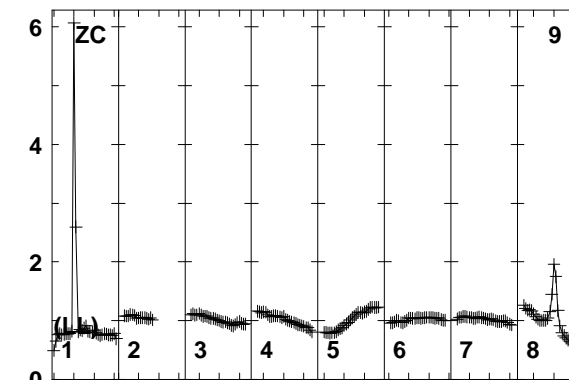
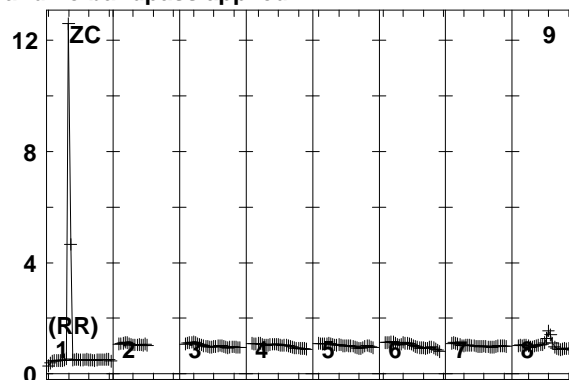
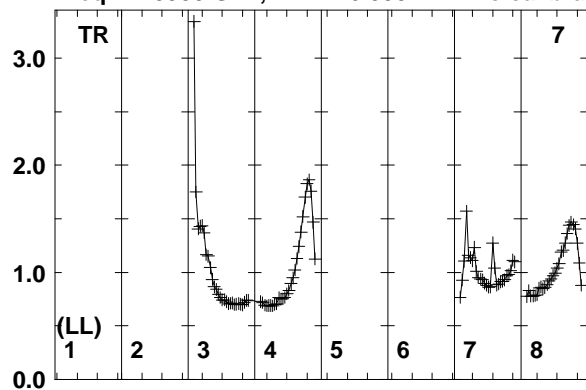

1595 1610 1625 1640 1645 1660 1675 1690 1710
FREQ MHz

Lower frame: Real Jy
Total-power spectrum Antenna: TR (07)
Timerange: 00/07:20:43 to 00/07:21:59

Plot file version 81 created 20-MAR-2014 17:07:59

IC883 ER030C.UVDATA.1

Freq = 1.5950 GHz, Bw = 16.000 MH No calibration applied and no bandpass applied

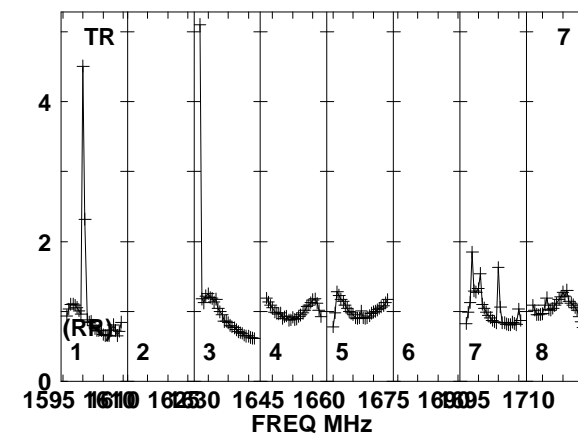
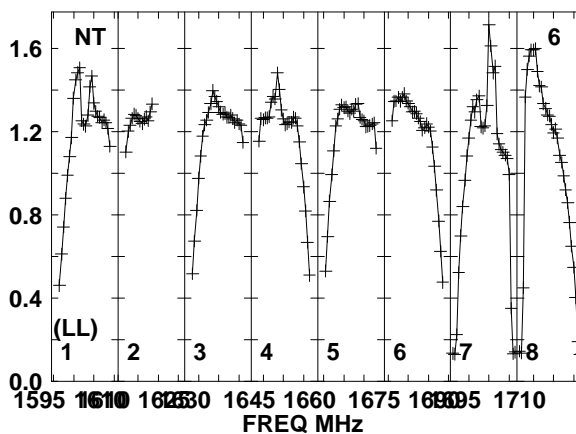
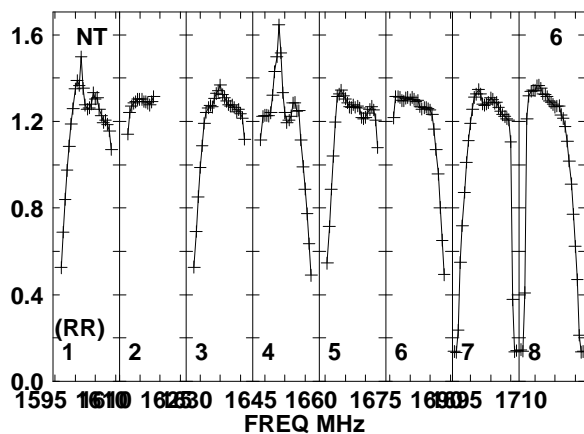
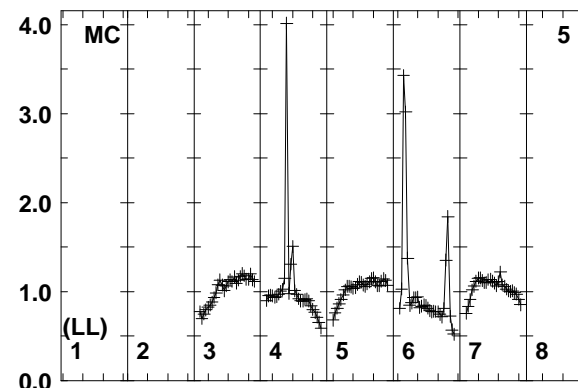
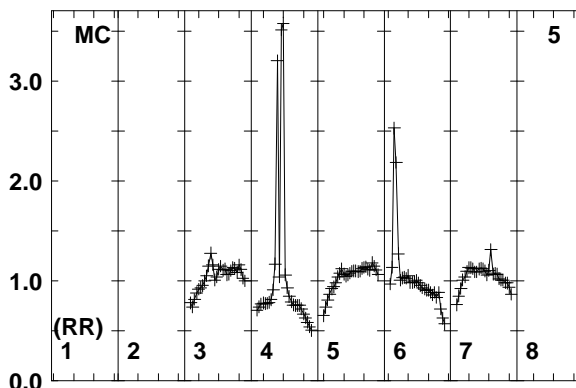
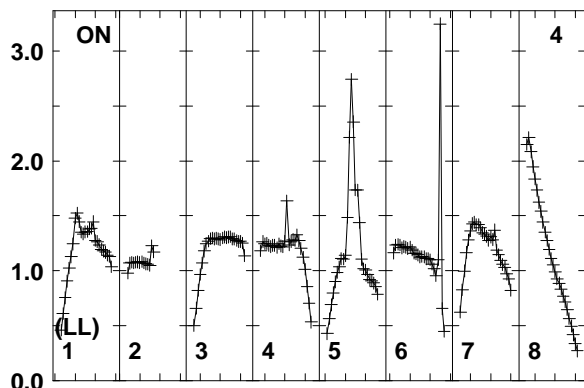
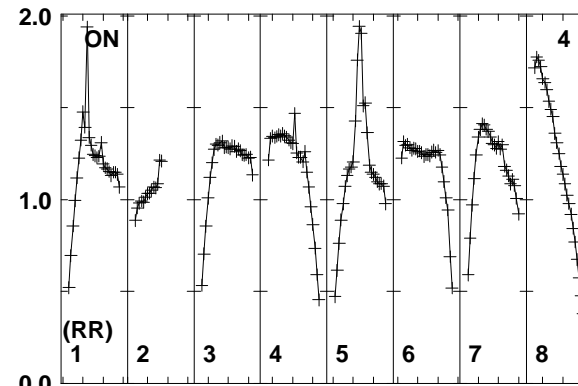
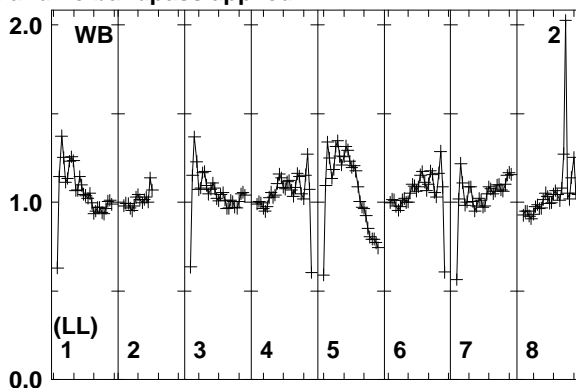
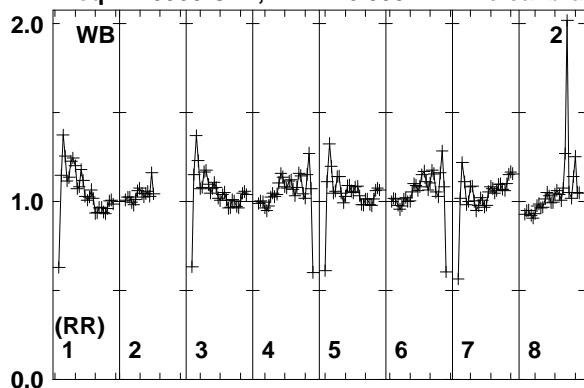

Lower frame: Real Jy
Total-power spectrum Antenna: WB (02)
Timerange: 00/07:22:01 to 00/07:25:49

Plot file version 82 created 20-MAR-2014 17:07:59

IC883 ER030C.UVDATA.1

Freq = 1.5950 GHz, Bw = 16.000 MH No calibration applied and no bandpass applied

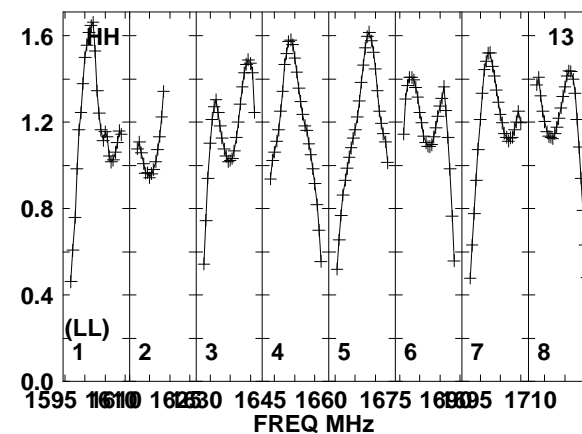
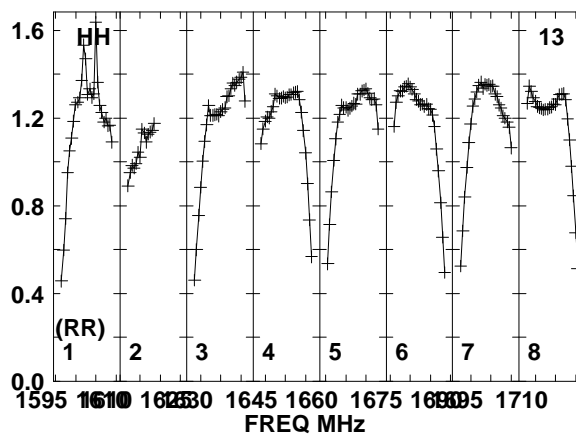
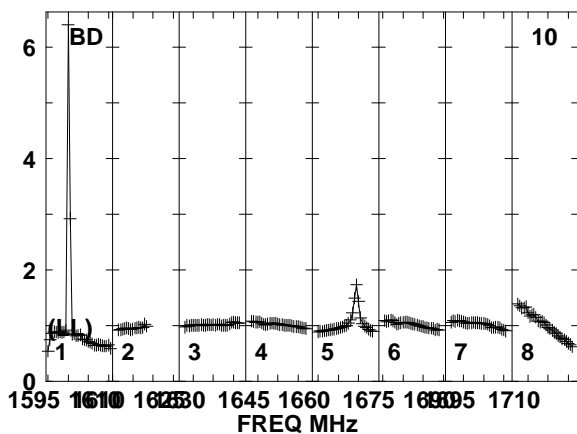
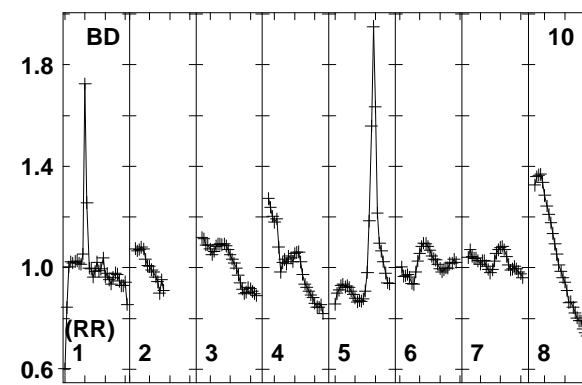
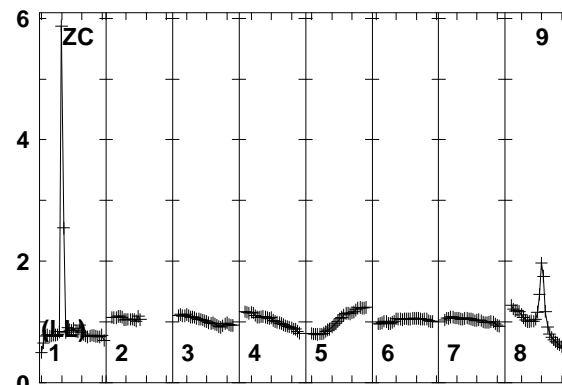
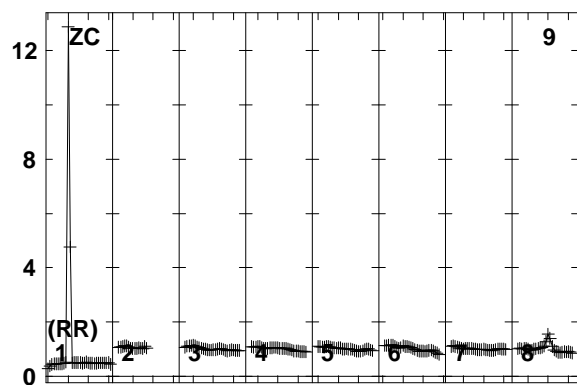
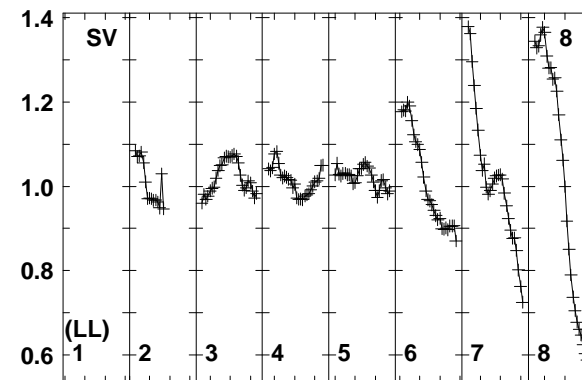
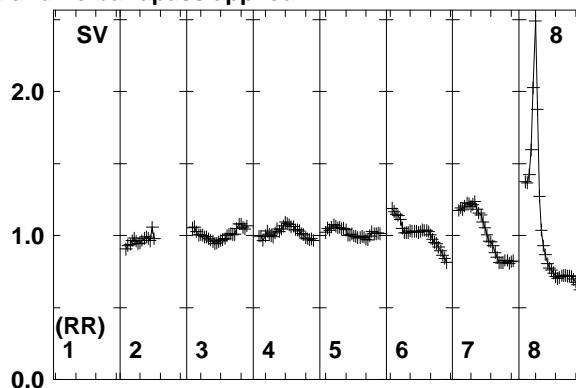
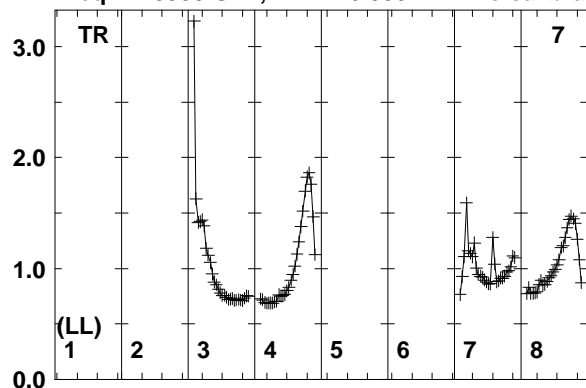

Lower frame: Real Jy
Total-power spectrum Antenna: TR (07)
Timerange: 00/07:22:01 to 00/07:25:49

Plot file version 83 created 20-MAR-2014 17:07:59

J1317+3425 ER030C.UVDATA.1

Freq = 1.5950 GHz, Bw = 16.000 MH No calibration applied and no bandpass applied

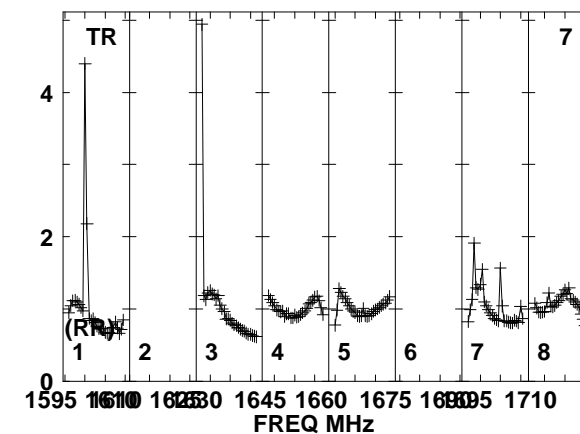
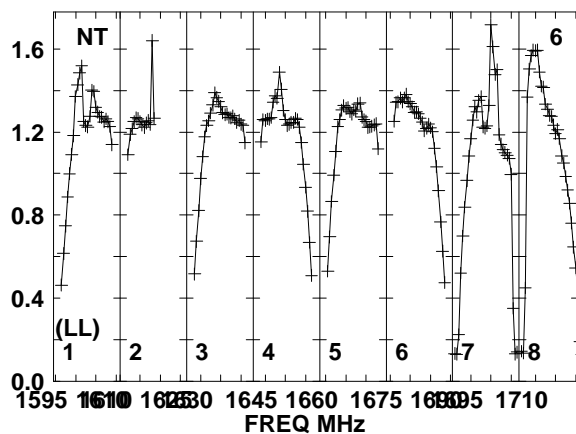
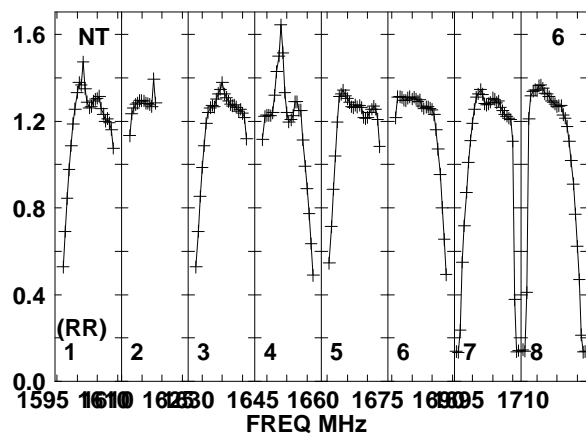
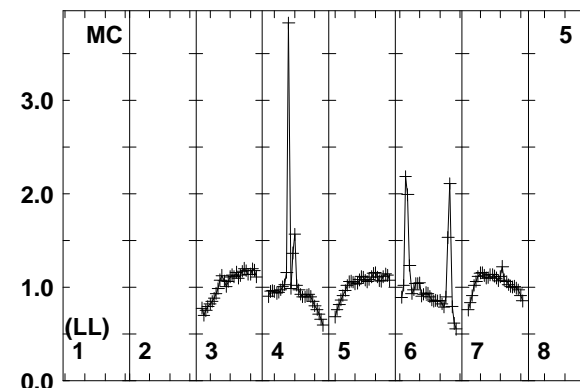
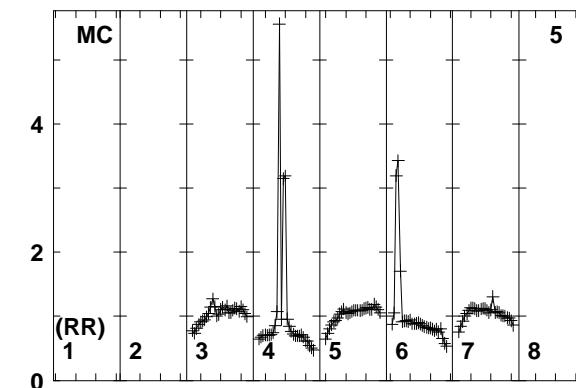
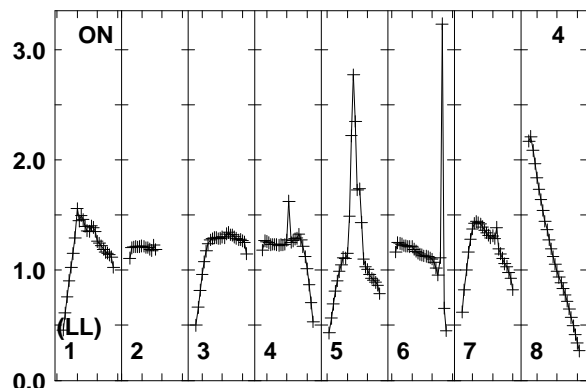
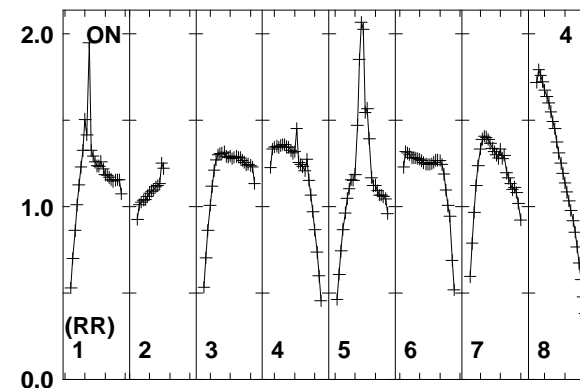
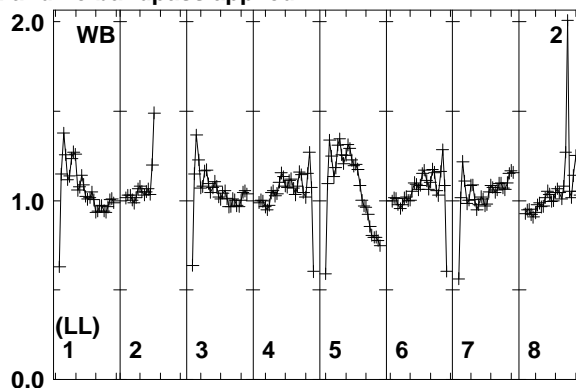
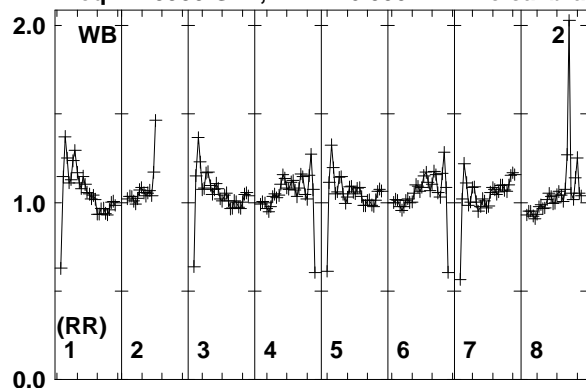

Lower frame: Real Jy
Total-power spectrum Antenna: WB (02)
Timerange: 00/07:26:31 to 00/07:27:29

Plot file version 84 created 20-MAR-2014 17:07:59

J1317+3425 ER030C.UVDATA.1

Freq = 1.5950 GHz, Bw = 16.000 MH No calibration applied and no bandpass applied

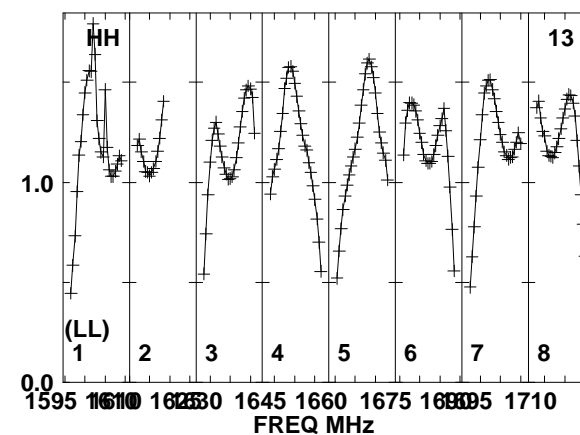
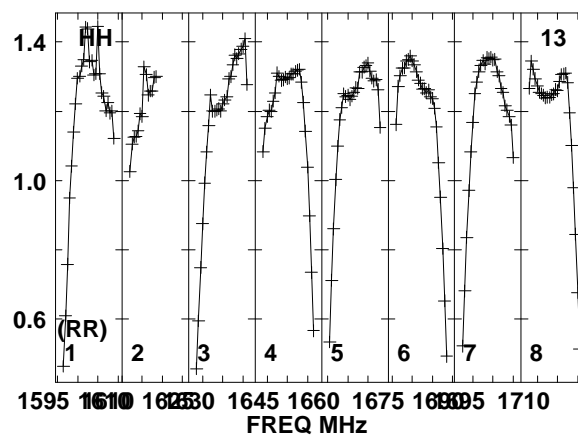
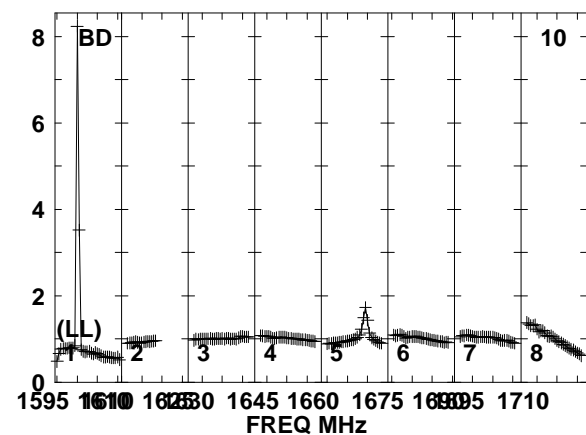
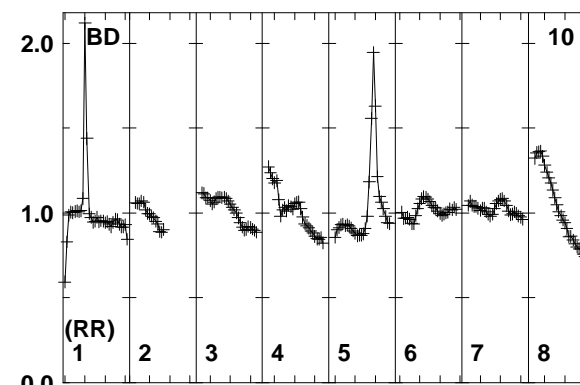
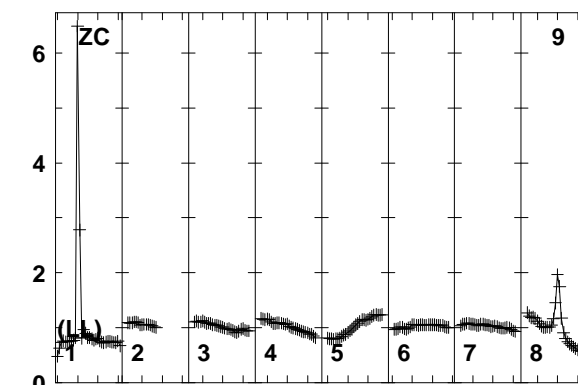
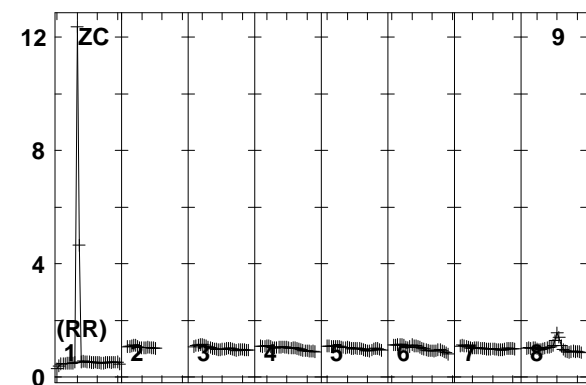
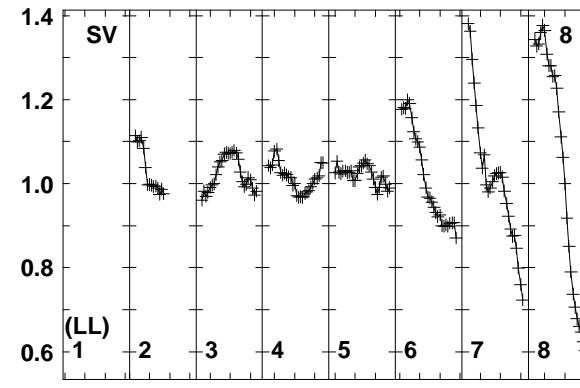
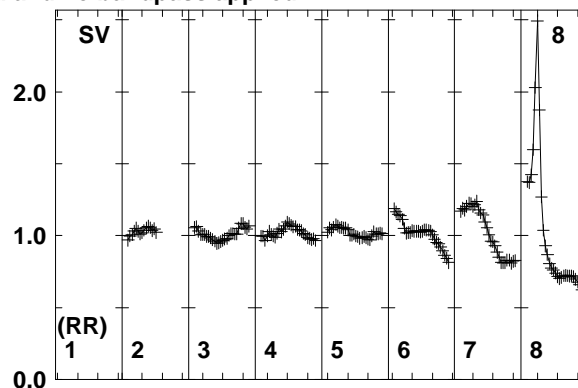
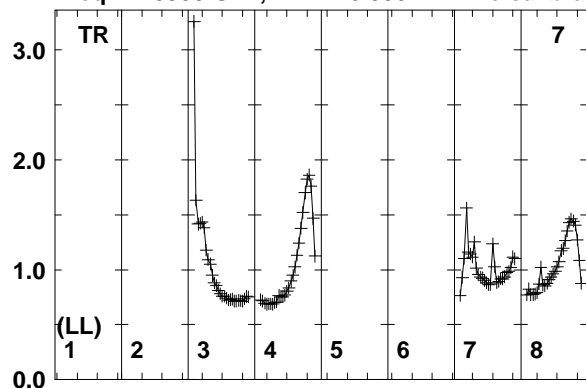

1595 1610 1625 1645 1660 1675 1695 1710
FREQ MHz

1595 1610 1625 1645 1660 1675 1695 1710
FREQ MHz

1595 1610 1625 1645 1660 1675 1695 1710
FREQ MHz

Lower frame: Real Jy
Total-power spectrum Antenna: TR (07)
Timerange: 00/07:26:31 to 00/07:27:29

Plot file version 85 created 20-MAR-2014 17:07:59

IC883 ER030C.UVDATA.1

Freq = 1.5950 GHz, Bw = 16.000 MH No calibration applied and no bandpass applied

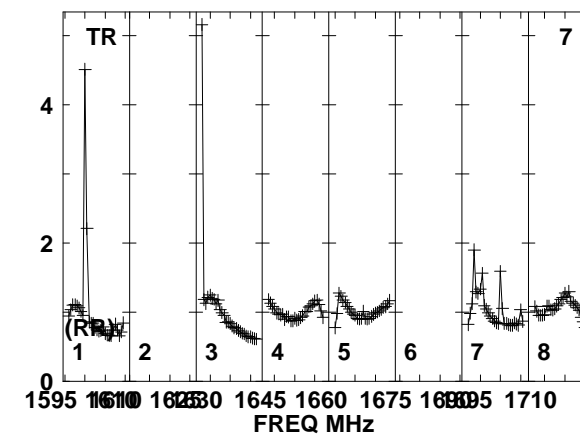
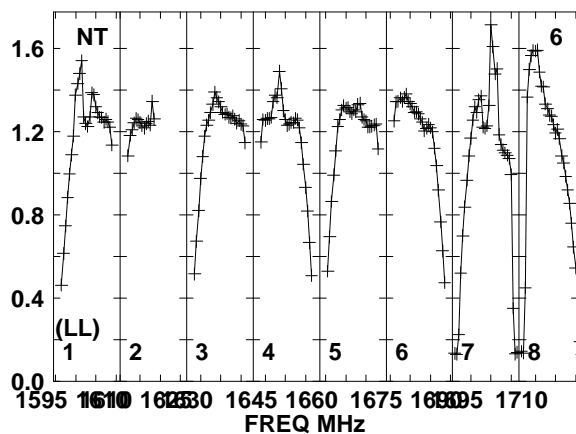
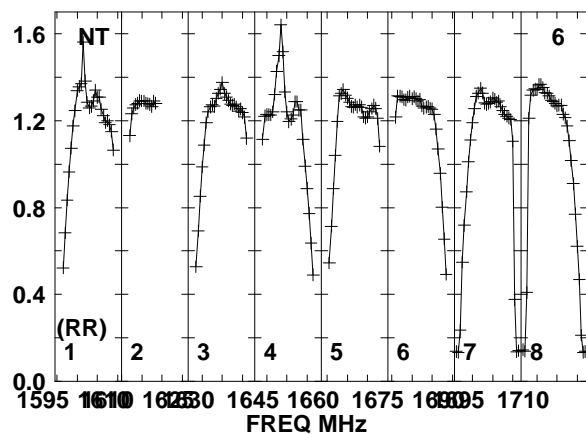
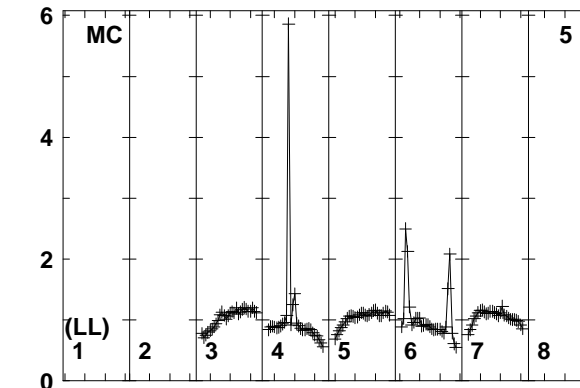
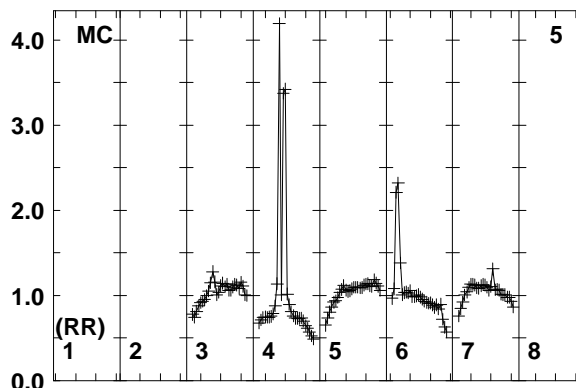
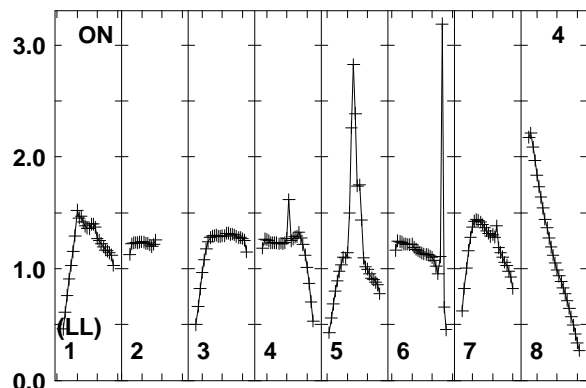
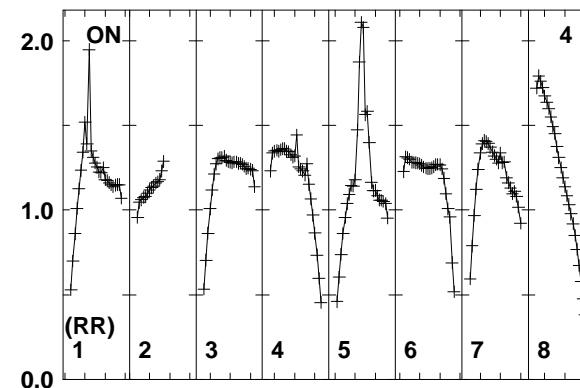
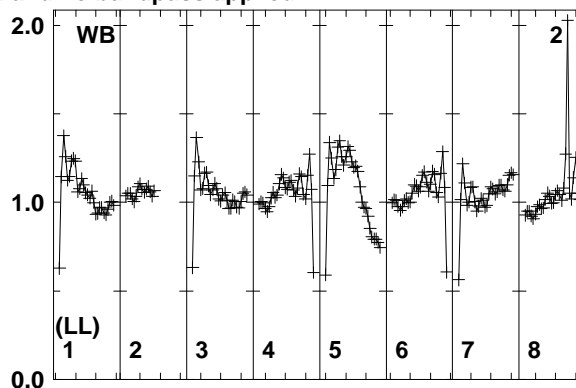
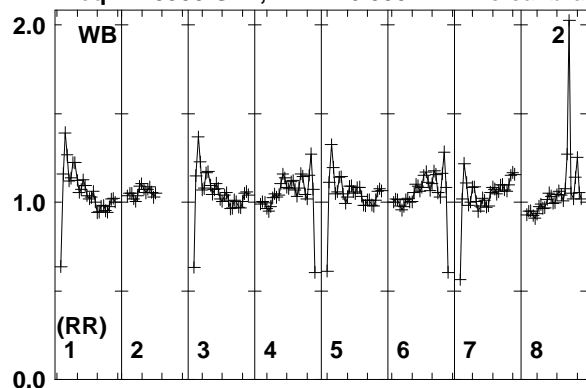

Lower frame: Real Jy
Total-power spectrum Antenna: WB (02)
Timerange: 00/07:27:33 to 00/07:31:19

Plot file version 86 created 20-MAR-2014 17:07:59

IC883 ER030C.UVDATA.1

Freq = 1.5950 GHz, Bw = 16.000 MH No calibration applied and no bandpass applied

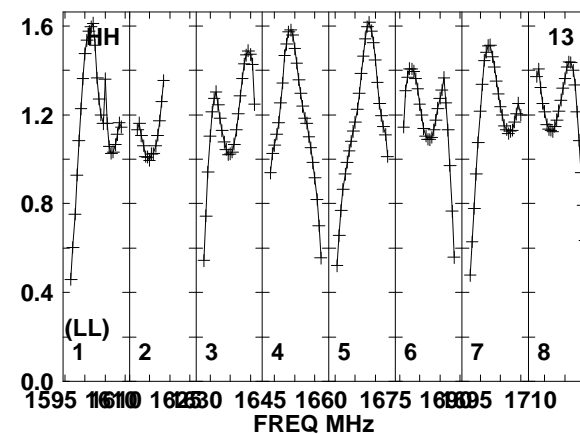
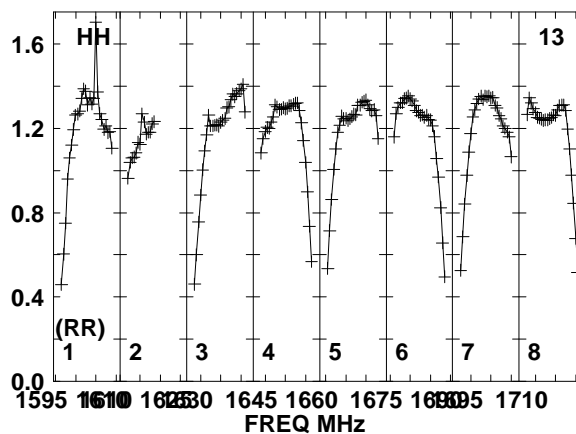
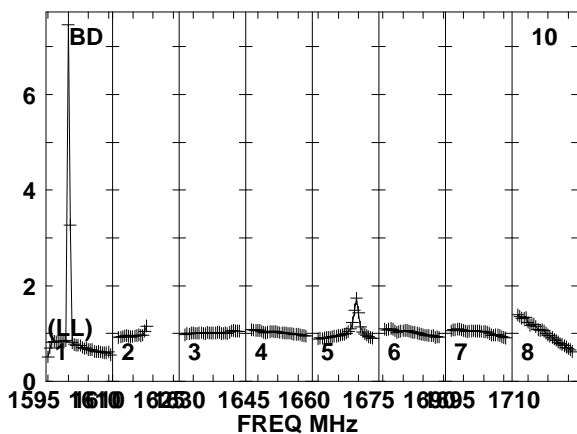
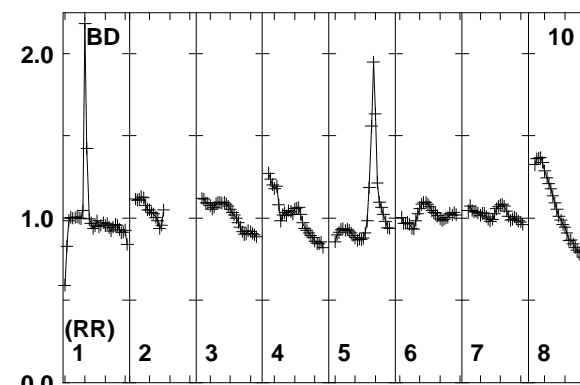
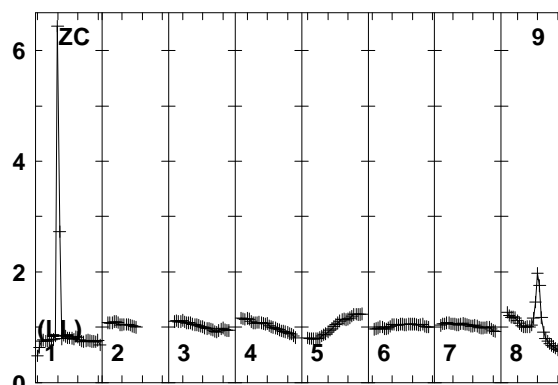
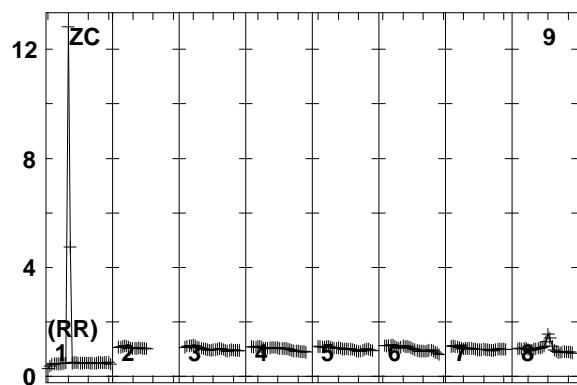
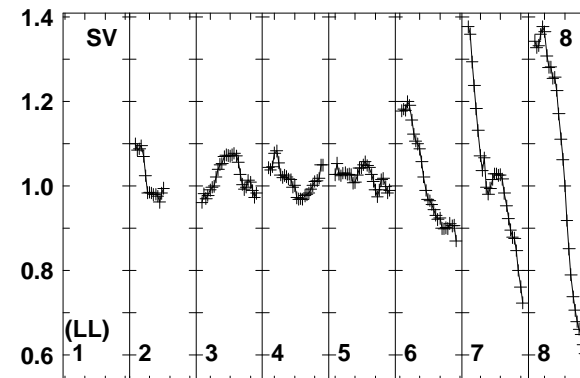
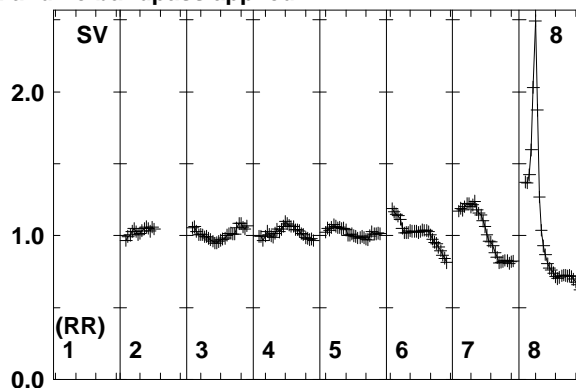
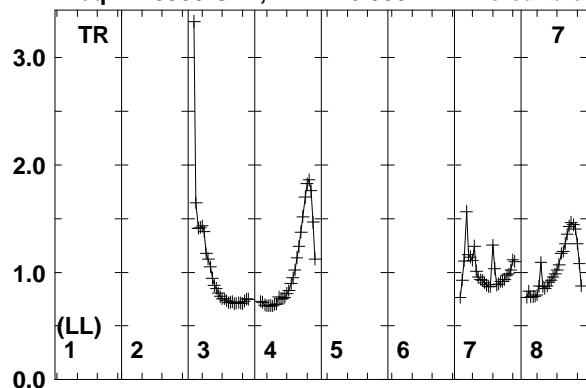

Lower frame: Real Jy
Total-power spectrum Antenna: TR (07)
Timerange: 00/07:27:33 to 00/07:31:19

Plot file version 87 created 20-MAR-2014 17:07:59

J1317+3425 ER030C.UVDATA.1

Freq = 1.5950 GHz, Bw = 16.000 MH No calibration applied and no bandpass applied

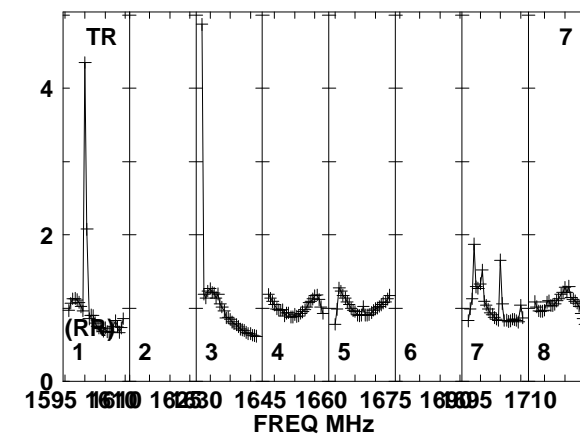
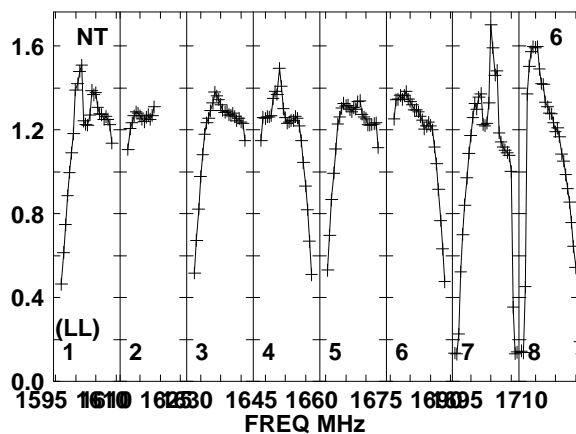
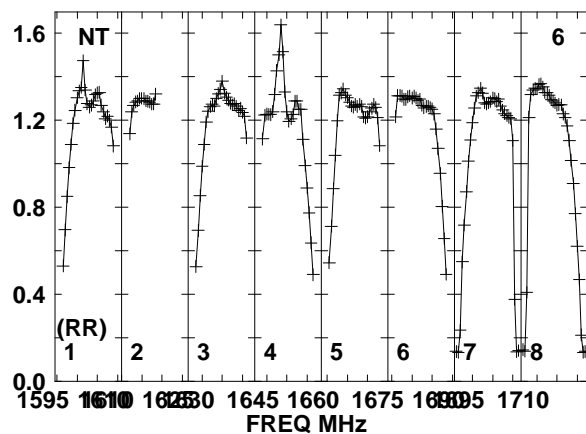
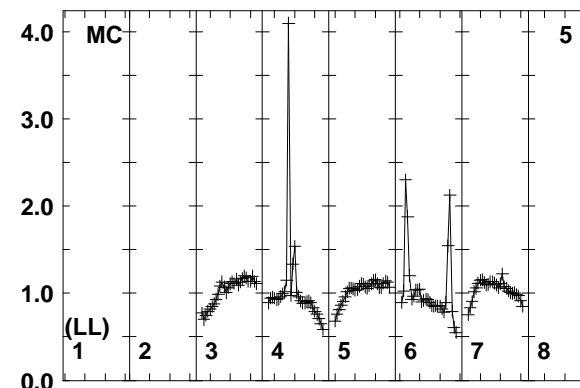
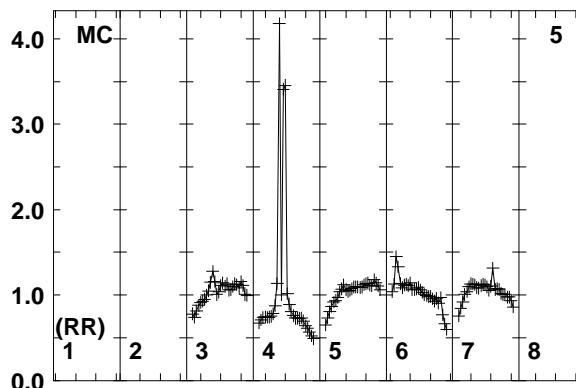
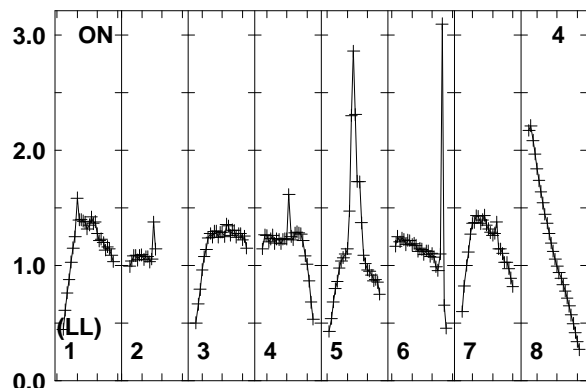
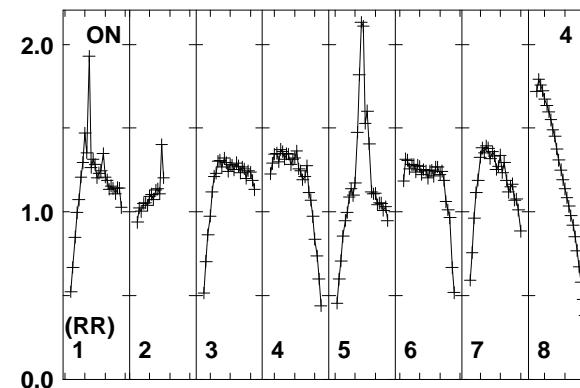
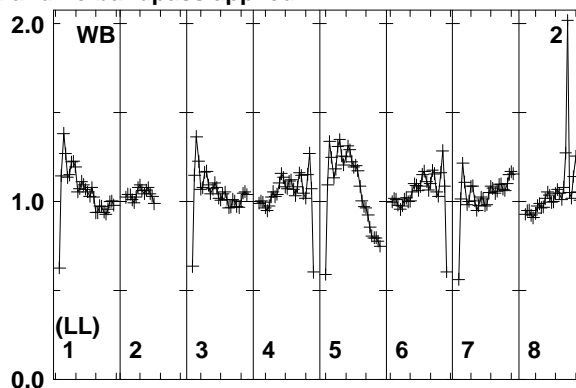
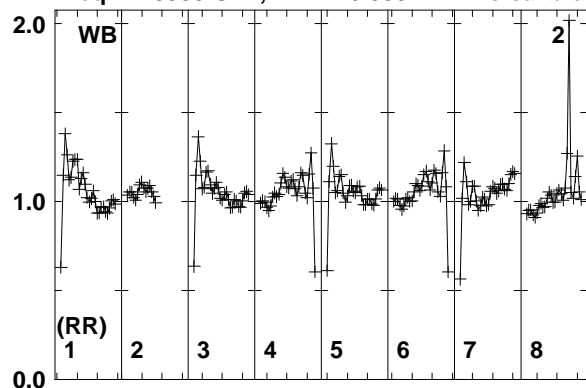

Lower frame: Real Jy
Total-power spectrum Antenna: WB (02)
Timerange: 00/07:31:23 to 00/07:32:39

Plot file version 88 created 20-MAR-2014 17:07:59

J1317+3425 ER030C.UVDATA.1

Freq = 1.5950 GHz, Bw = 16.000 MH No calibration applied and no bandpass applied

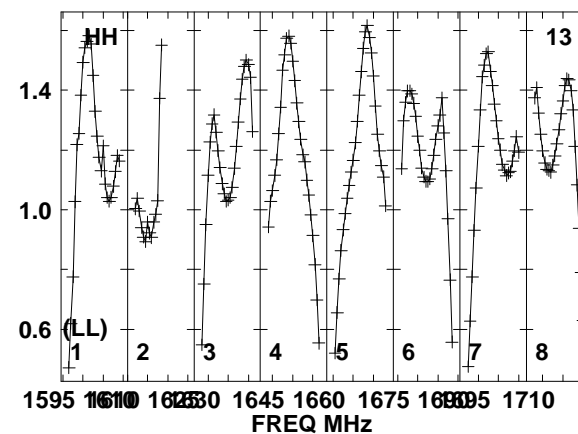
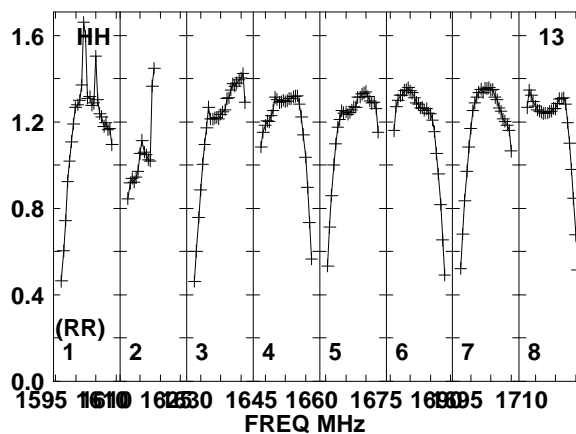
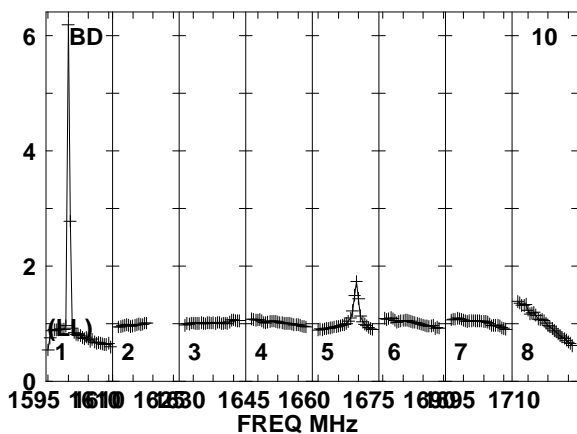
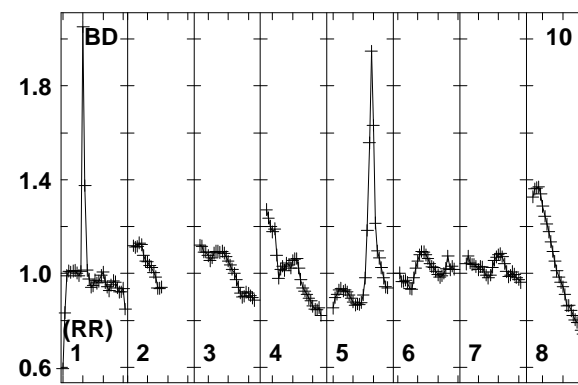
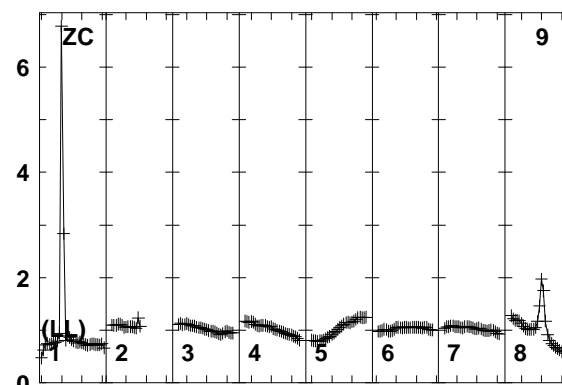
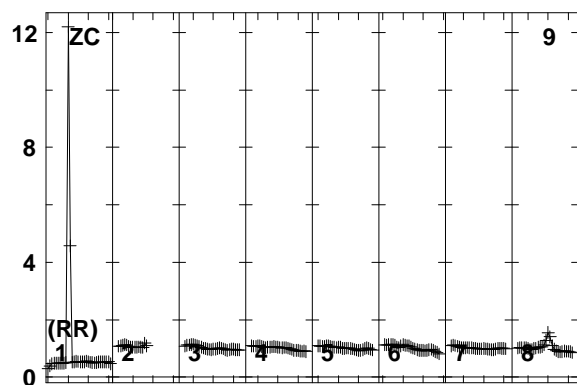
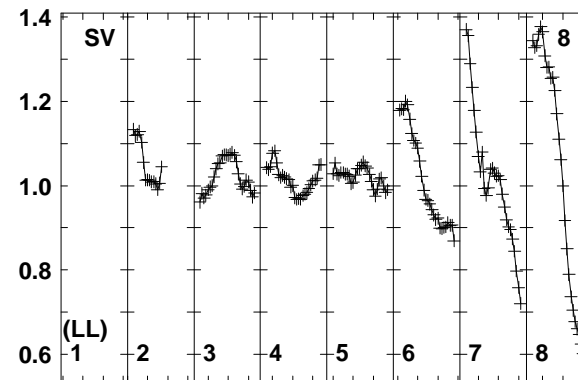
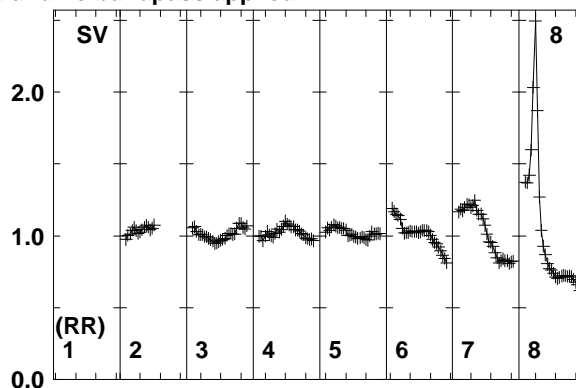
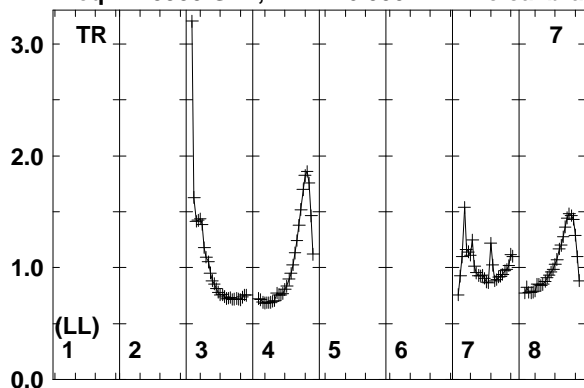

Lower frame: Real Jy
Total-power spectrum Antenna: TR (07)
Timerange: 00/07:31:23 to 00/07:32:39

Plot file version 89 created 20-MAR-2014 17:07:59

IC883 ER030C.UVDATA.1

Freq = 1.5950 GHz, Bw = 16.000 MH No calibration applied and no bandpass applied

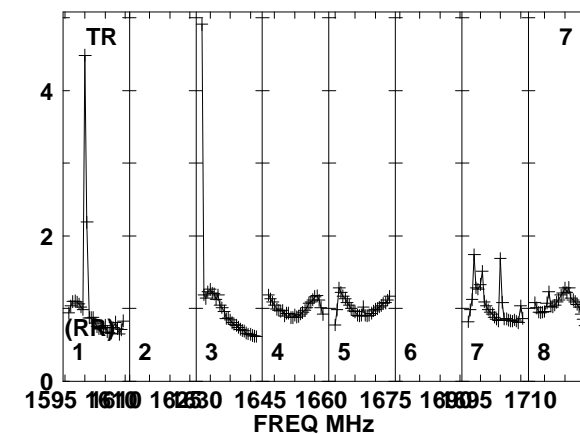
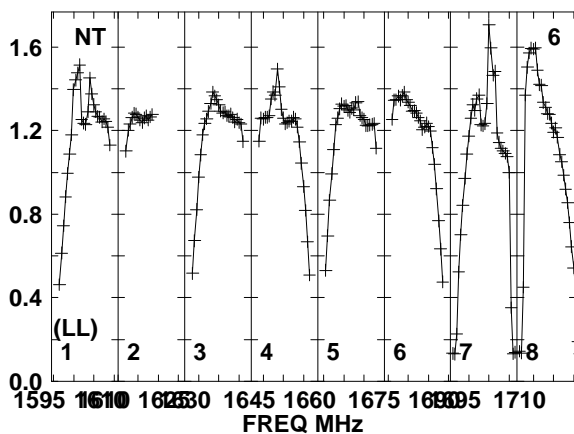
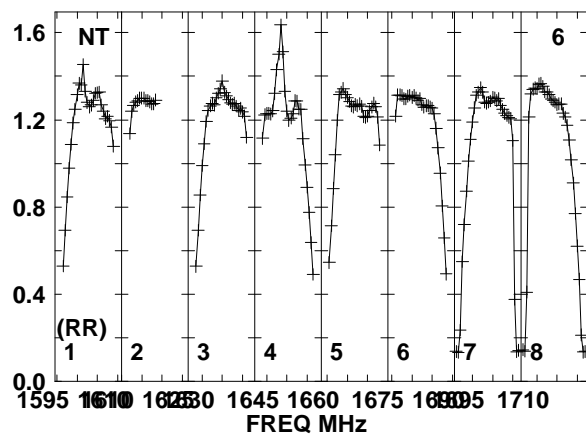
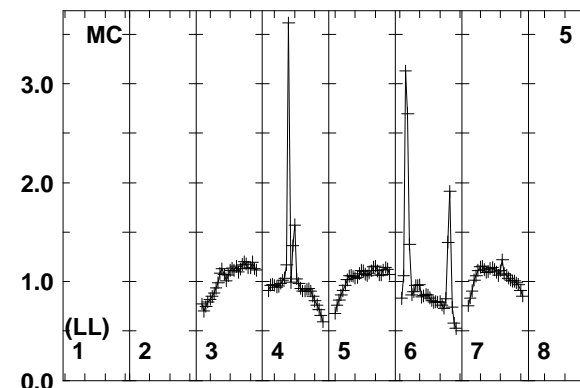
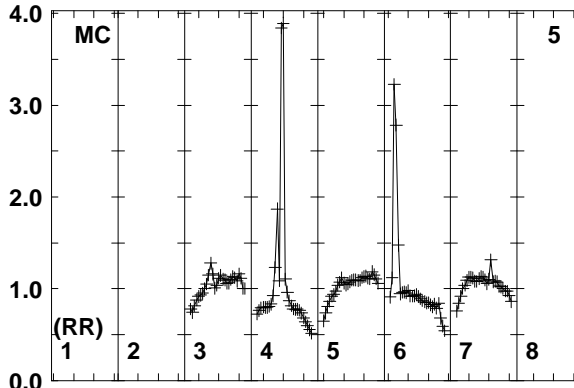
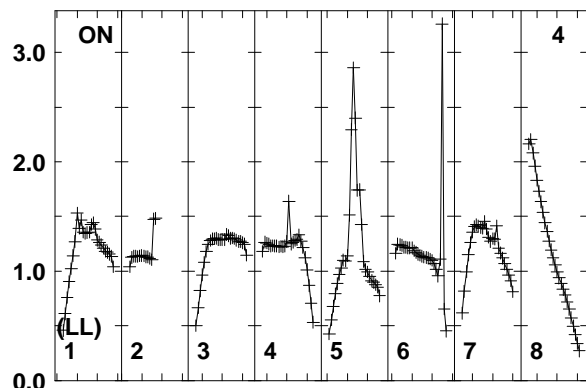
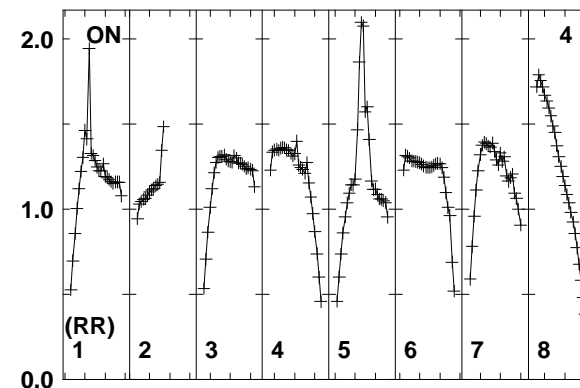
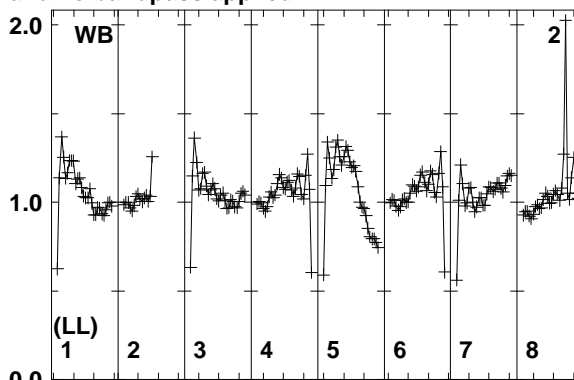
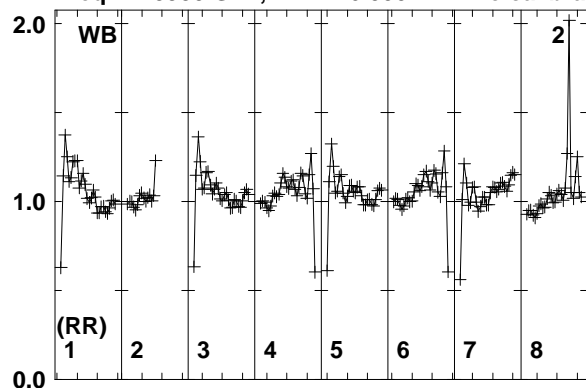

Lower frame: Real Jy
Total-power spectrum Antenna: WB (02)
Timerange: 00/07:32:41 to 00/07:36:29

Plot file version 90 created 20-MAR-2014 17:08:00

IC883 ER030C.UVDATA.1

Freq = 1.5950 GHz, Bw = 16.000 MH No calibration applied and no bandpass applied

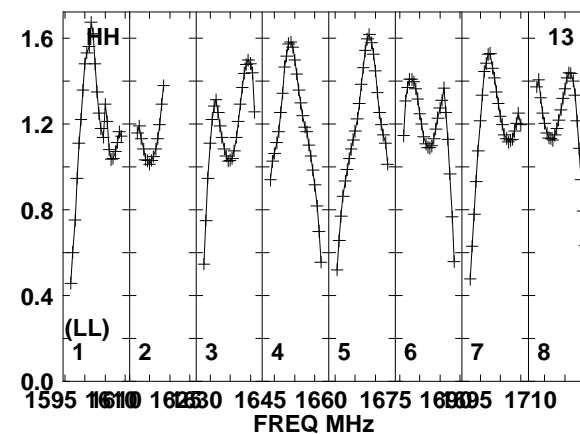
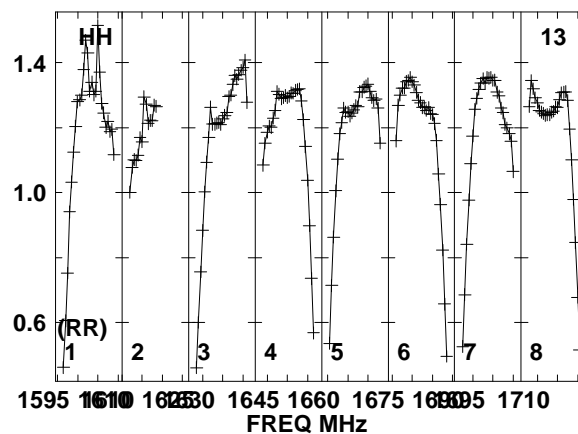
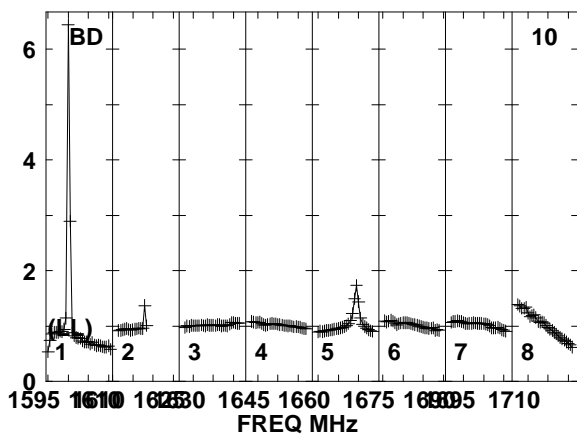
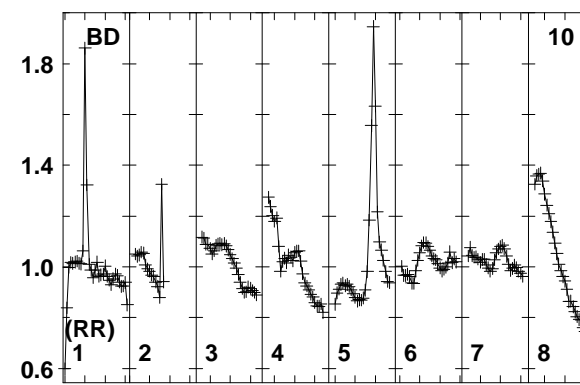
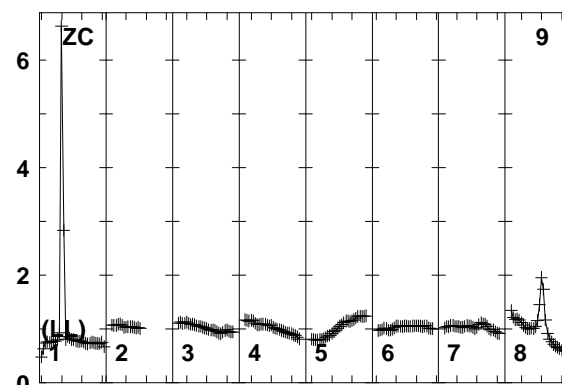
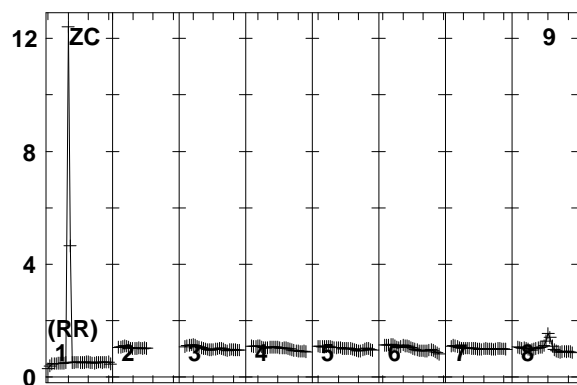
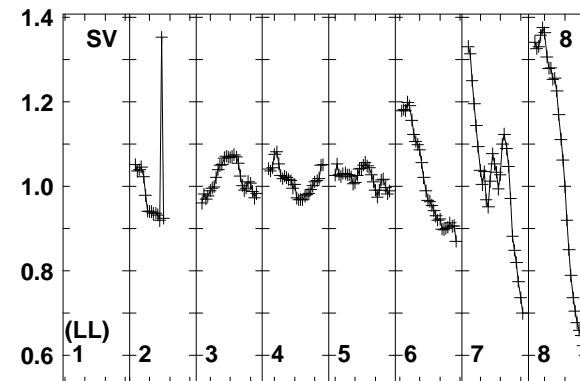
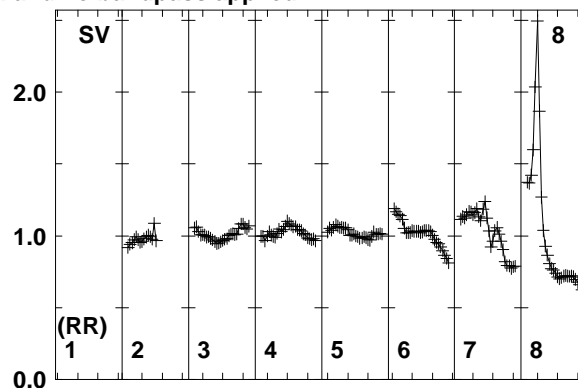
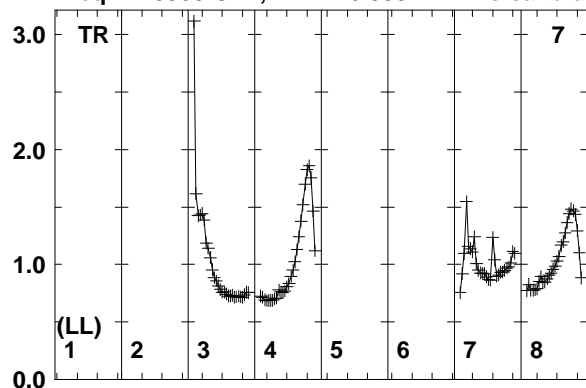

Lower frame: Real Jy
Total-power spectrum Antenna: TR (07)
Timerange: 00/07:32:41 to 00/07:36:29

Plot file version 91 created 20-MAR-2014 17:08:00

J1317+3425 ER030C.UVDATA.1

Freq = 1.5950 GHz, Bw = 16.000 MH No calibration applied and no bandpass applied

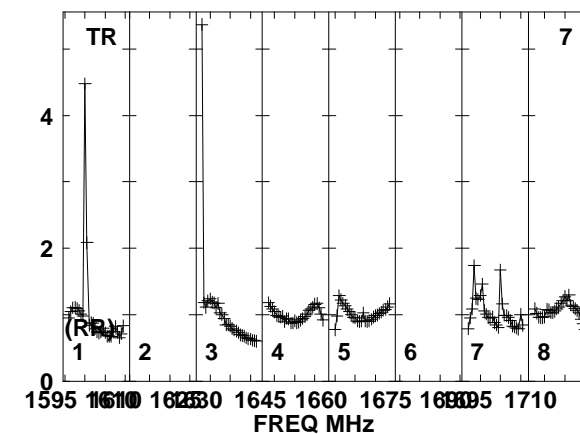
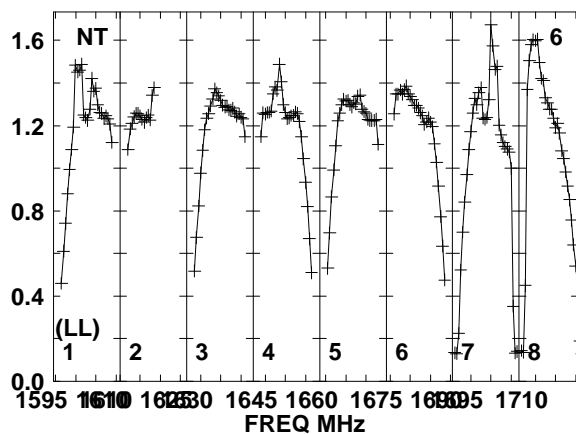
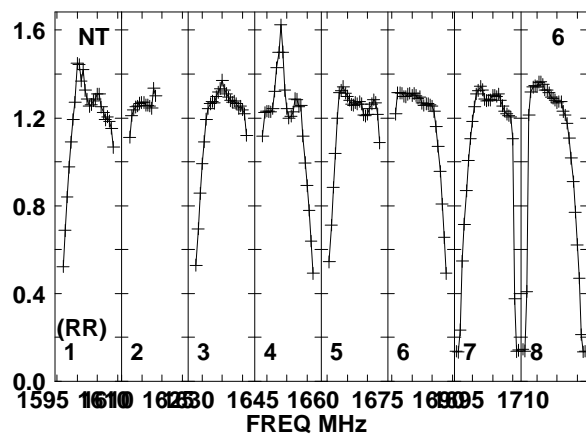
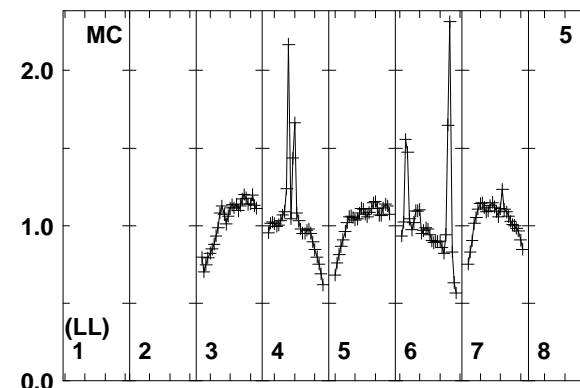
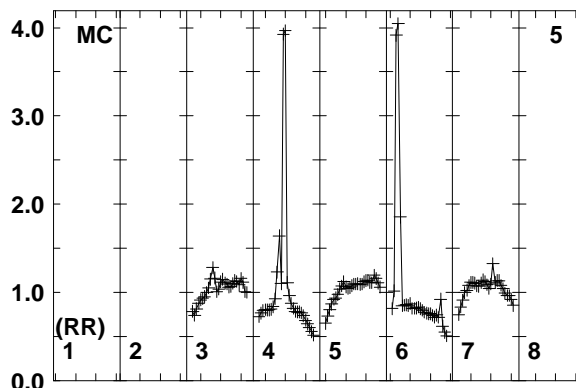
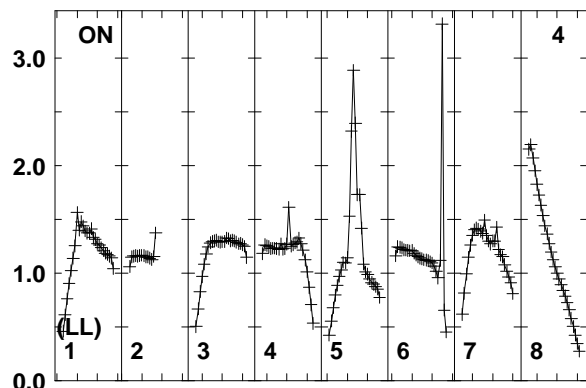
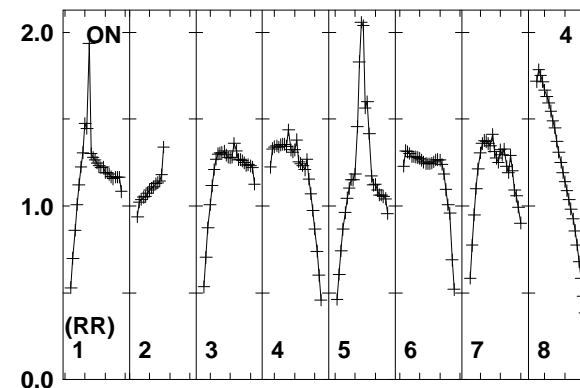
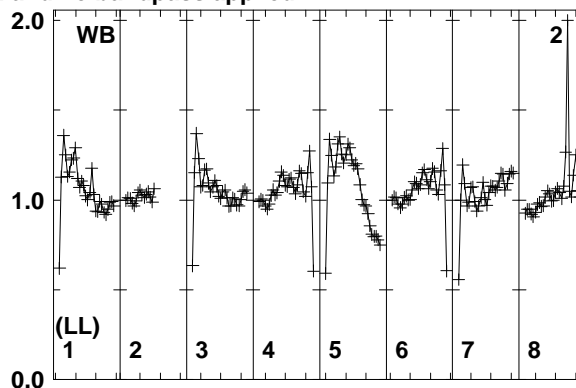
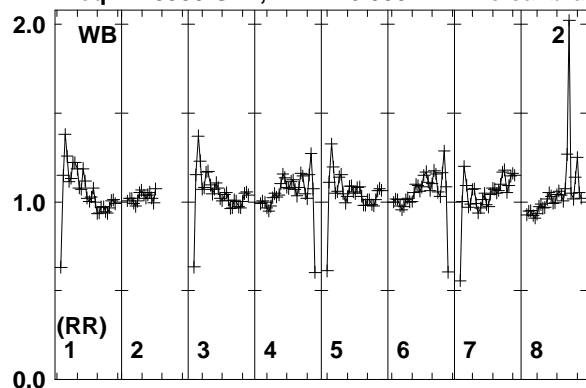

Lower frame: Real Jy
Total-power spectrum Antenna: WB (02)
Timerange: 00/07:37:11 to 00/07:38:09

Plot file version 92 created 20-MAR-2014 17:08:00

J1317+3425 ER030C.UVDATA.1

Freq = 1.5950 GHz, Bw = 16.000 MH No calibration applied and no bandpass applied

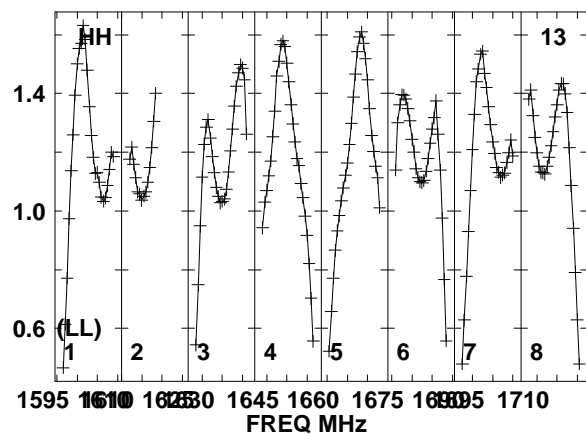
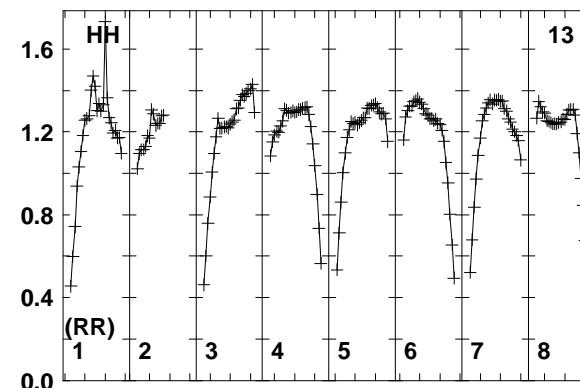
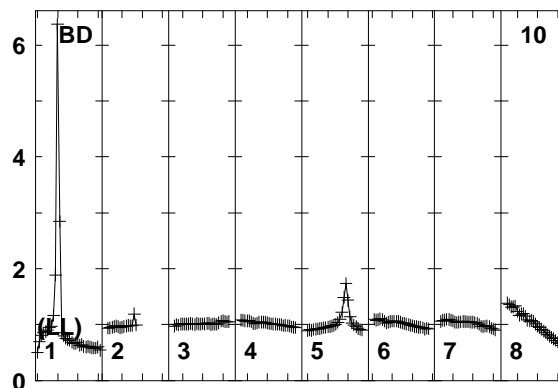
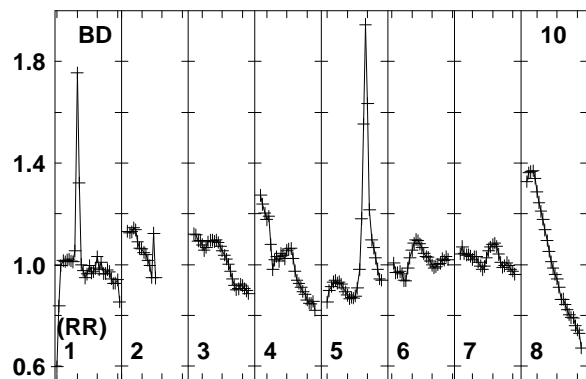
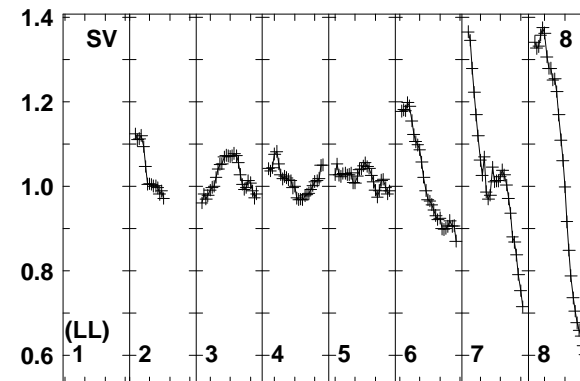
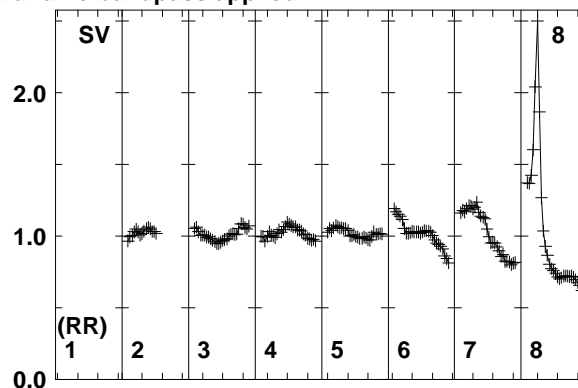
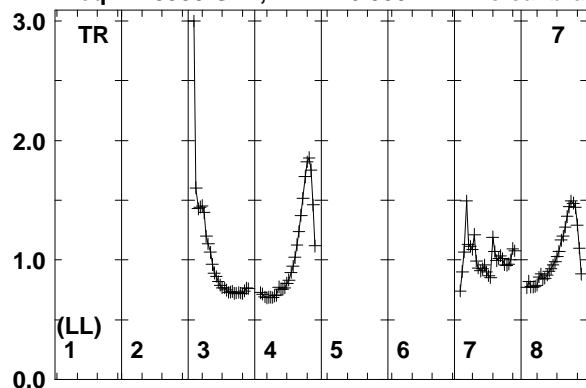

1595 1610 1625 1640 1655 1670 1685 1700 1715
FREQ MHz

Lower frame: Real Jy
Total-power spectrum Antenna: TR (07)
Timerange: 00/07:37:11 to 00/07:38:09

Plot file version 93 created 20-MAR-2014 17:08:00

IC883 ER030C.UVDATA.1

Freq = 1.5950 GHz, Bw = 16.000 MH No calibration applied and no bandpass applied

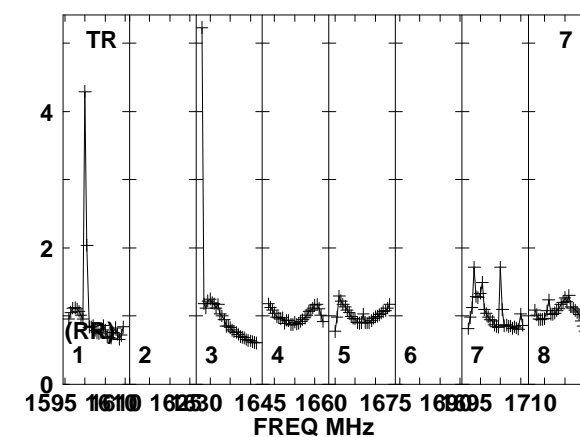
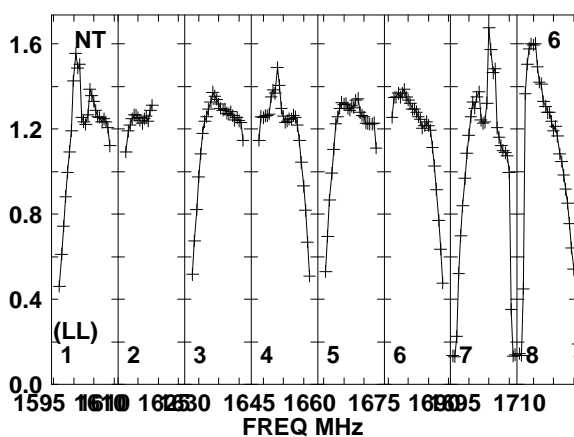
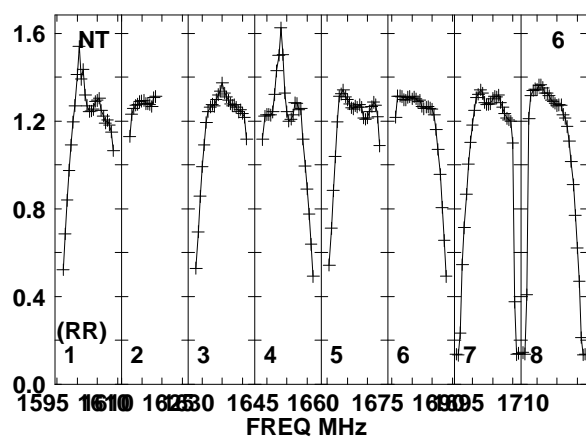
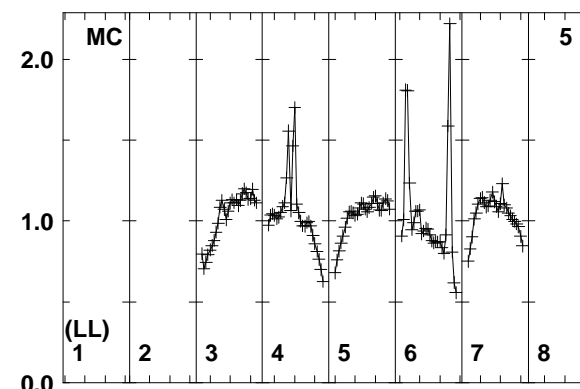
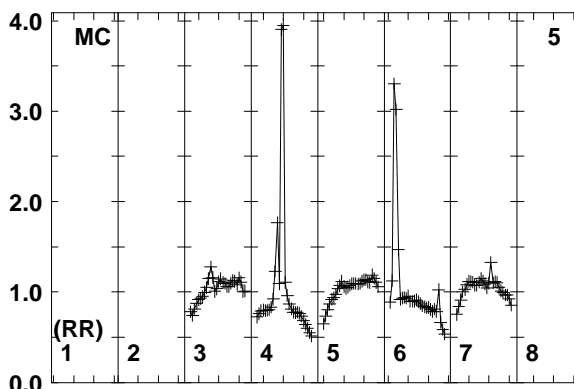
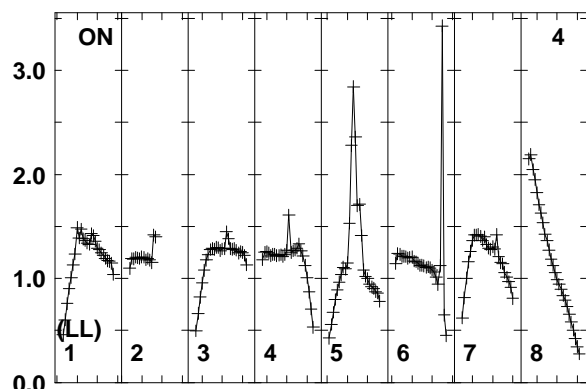
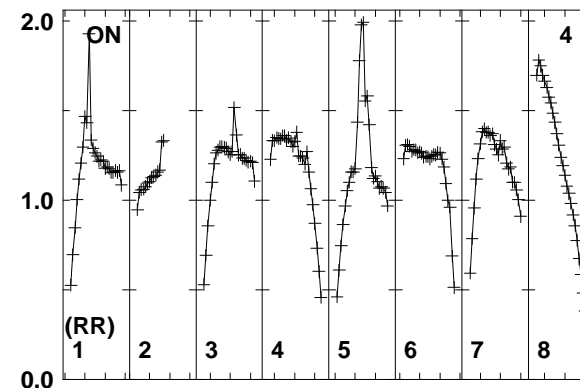
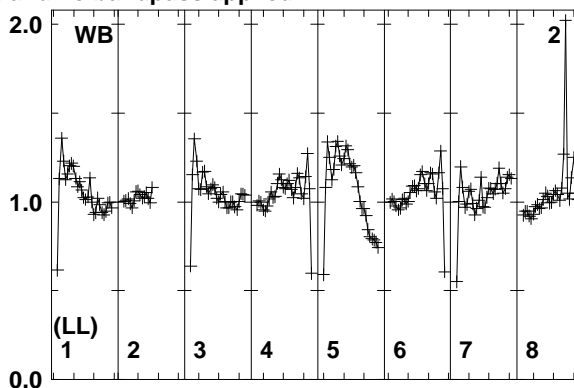
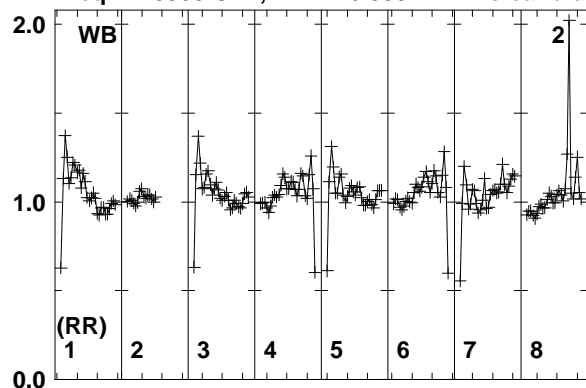

Lower frame: Real Jy
Total-power spectrum Antenna: WB (02)
Timerange: 00/07:38:13 to 00/07:41:59

Plot file version 94 created 20-MAR-2014 17:08:00

IC883 ER030C.UVDATA.1

Freq = 1.5950 GHz, Bw = 16.000 MH No calibration applied and no bandpass applied

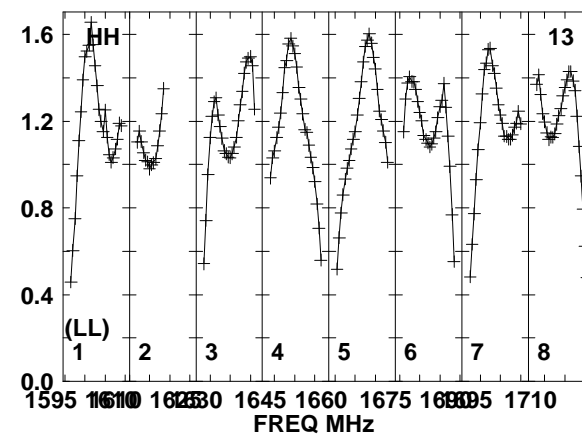
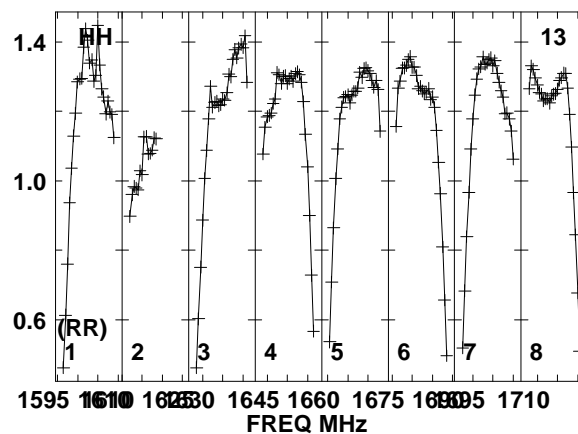
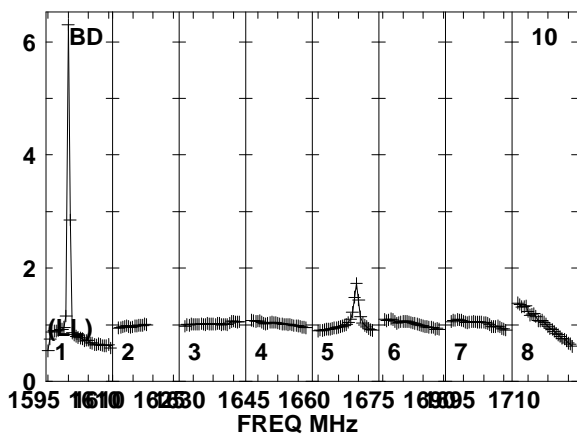
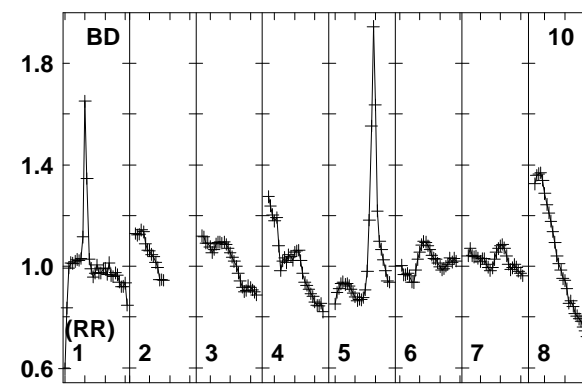
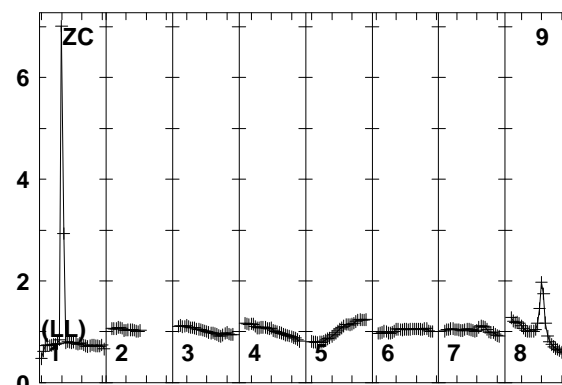
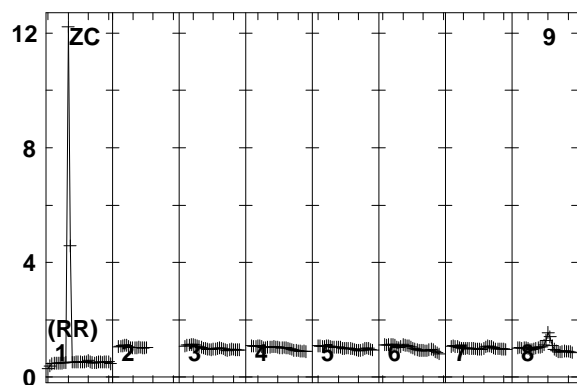
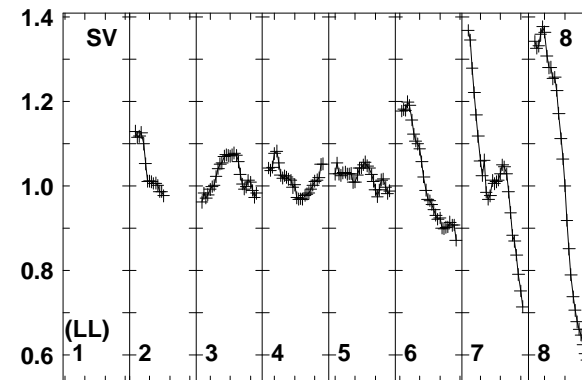
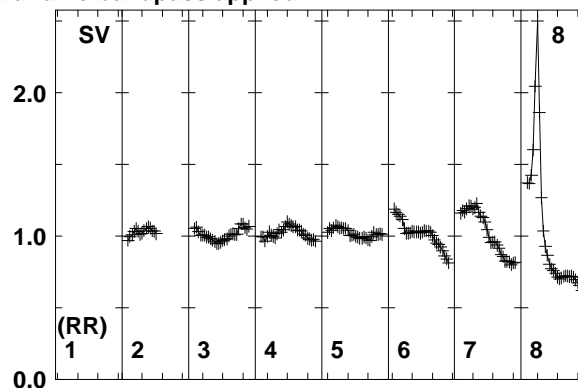
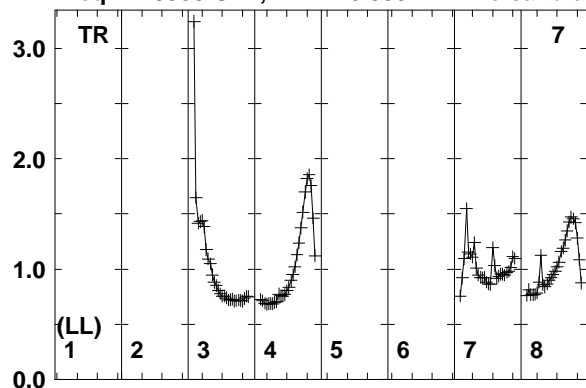

Lower frame: Real Jy
Total-power spectrum Antenna: TR (07)
Timerange: 00/07:38:13 to 00/07:41:59

Plot file version 95 created 20-MAR-2014 17:08:00

J1317+3425 ER030C.UVDATA.1

Freq = 1.5950 GHz, Bw = 16.000 MH No calibration applied and no bandpass applied

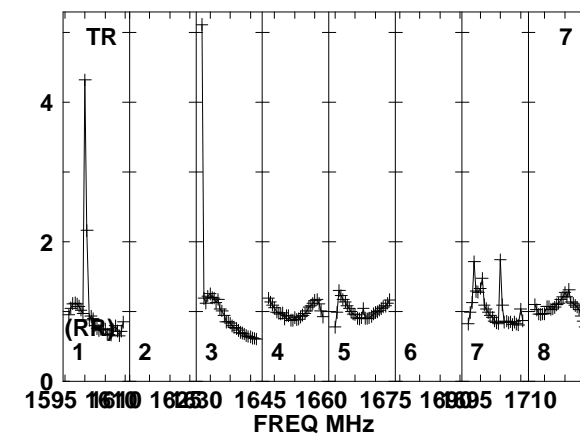
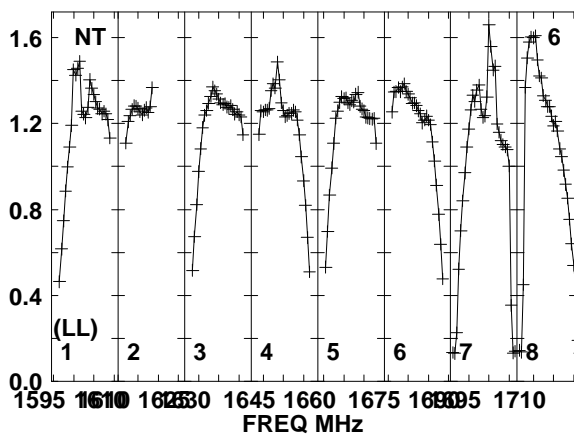
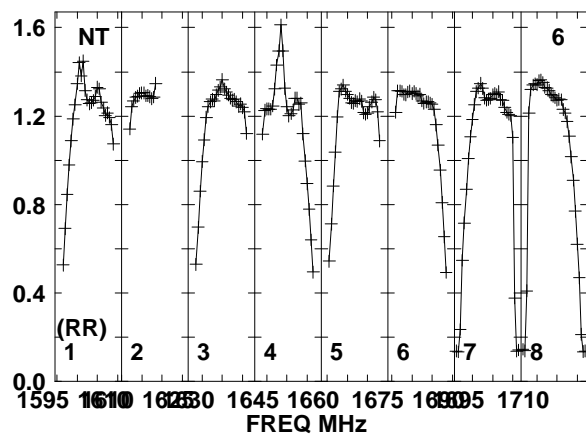
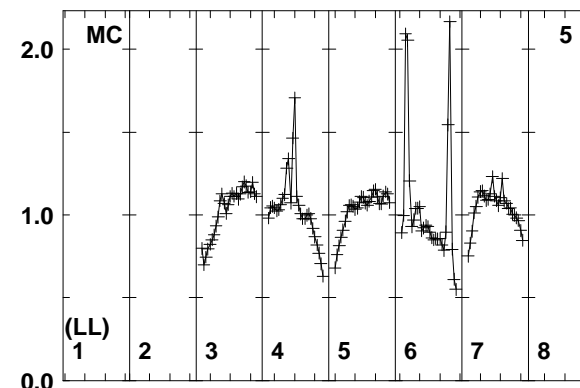
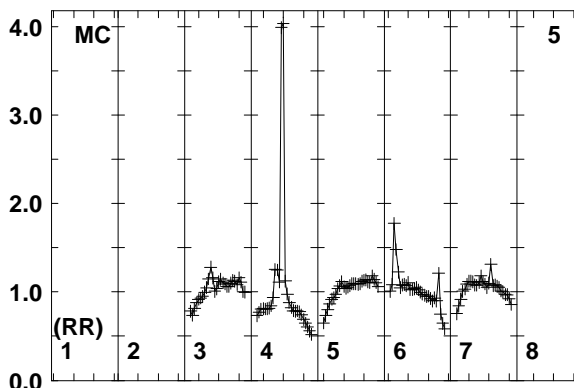
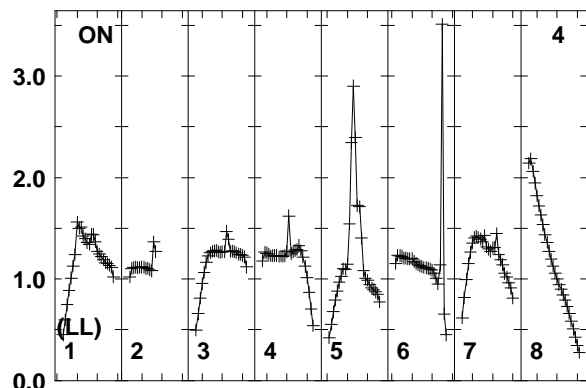
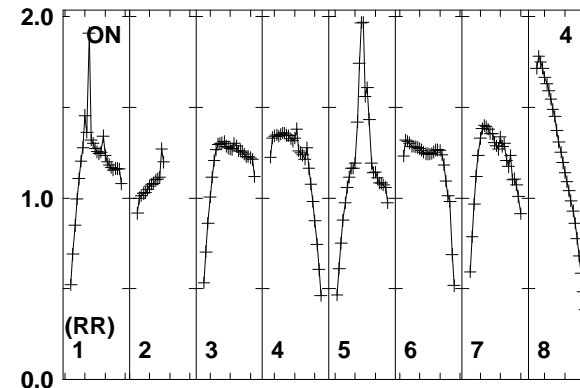
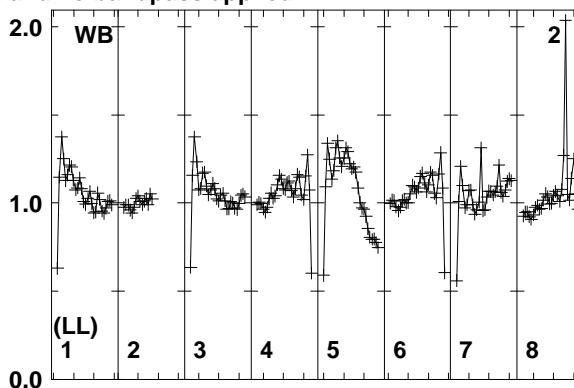
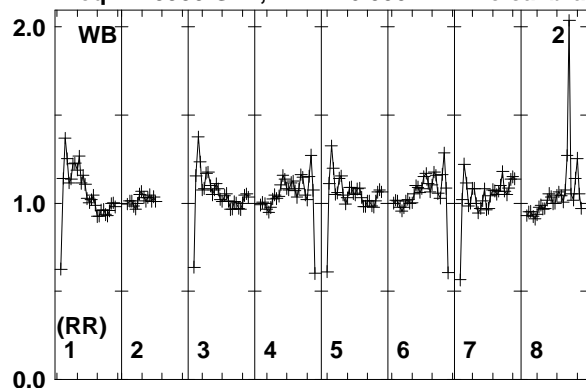

Lower frame: Real Jy
Total-power spectrum Antenna: WB (02)
Timerange: 00/07:42:03 to 00/07:43:19

Plot file version 96 created 20-MAR-2014 17:08:00

J1317+3425 ER030C.UVDATA.1

Freq = 1.5950 GHz, Bw = 16.000 MH No calibration applied and no bandpass applied

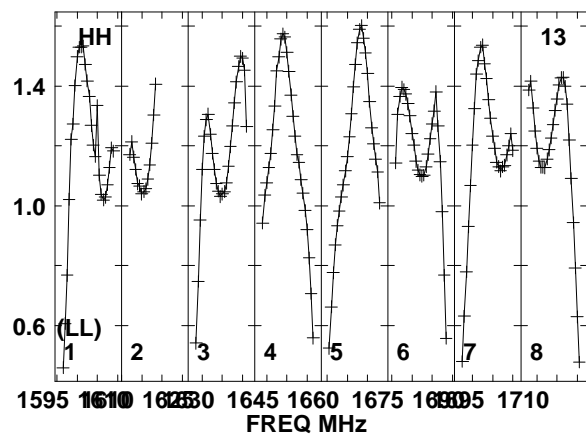
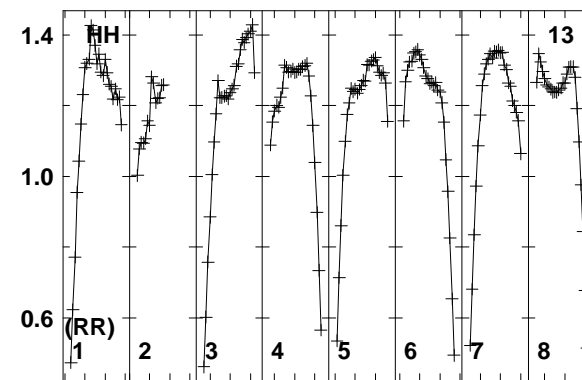
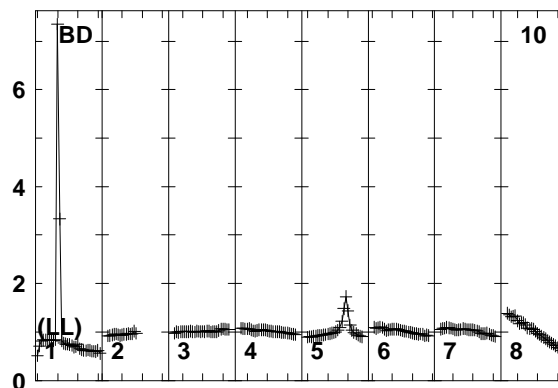
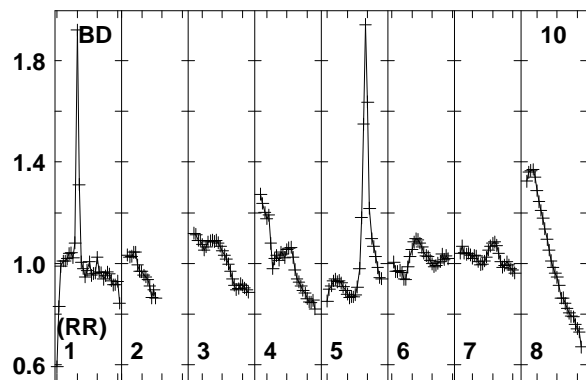
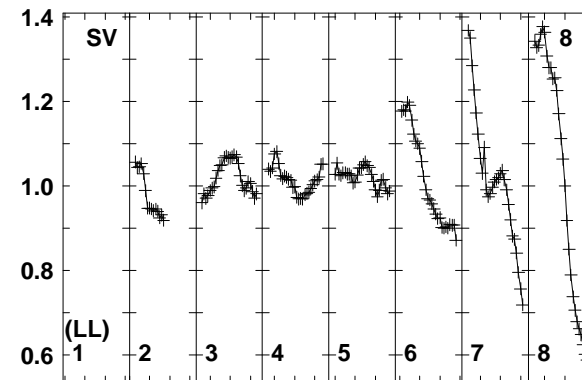
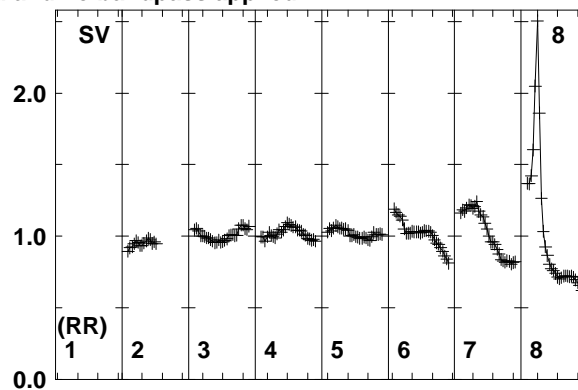
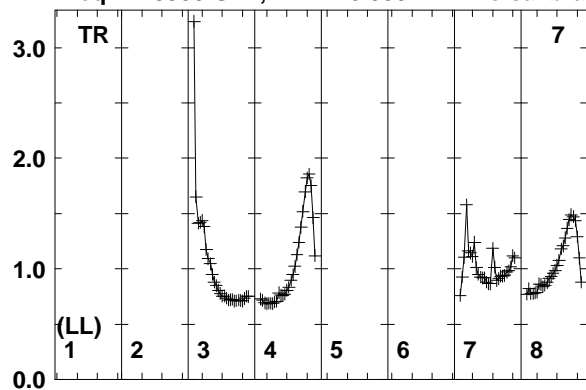

1595 1610 1625 1640 1655 1670 1685 1700 1710
FREQ MHz

Lower frame: Real Jy
Total-power spectrum Antenna: TR (07)
Timerange: 00/07:42:03 to 00/07:43:19

Plot file version 97 created 20-MAR-2014 17:08:00

IC883 ER030C.UVDATA.1

Freq = 1.5950 GHz, Bw = 16.000 MH No calibration applied and no bandpass applied

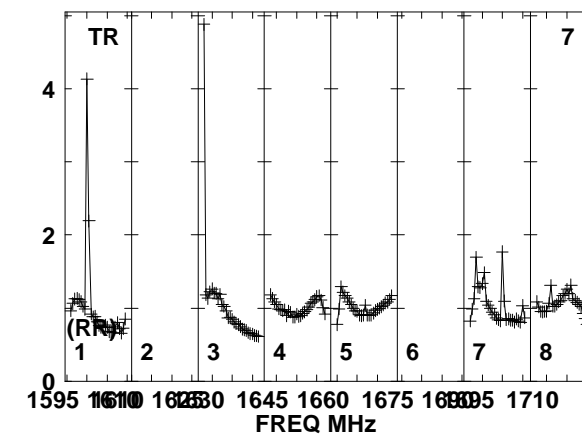
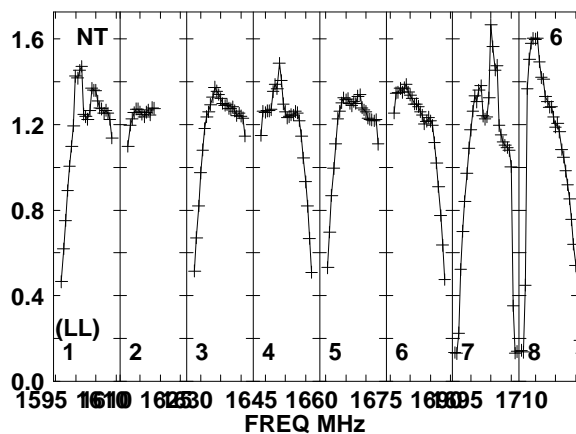
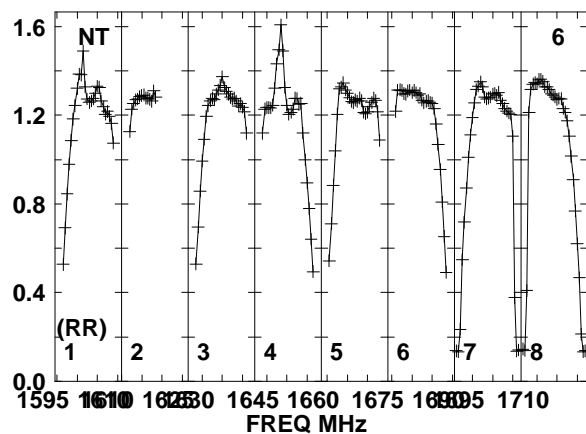
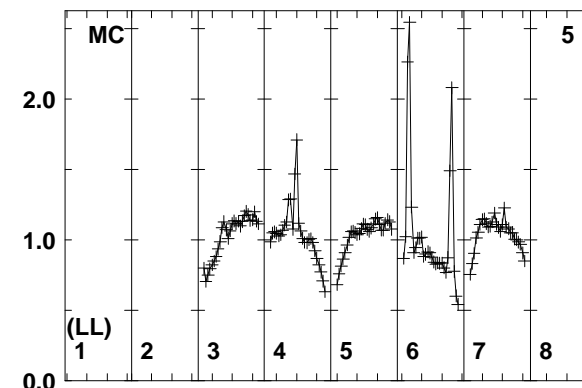
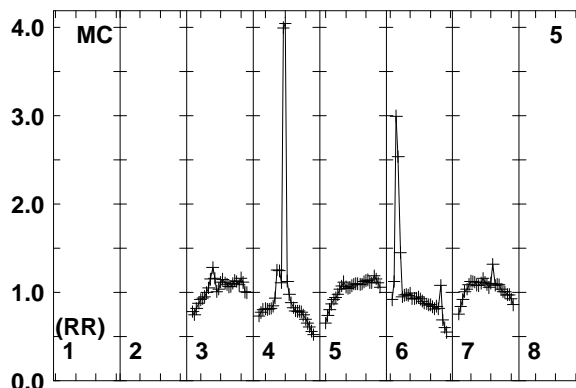
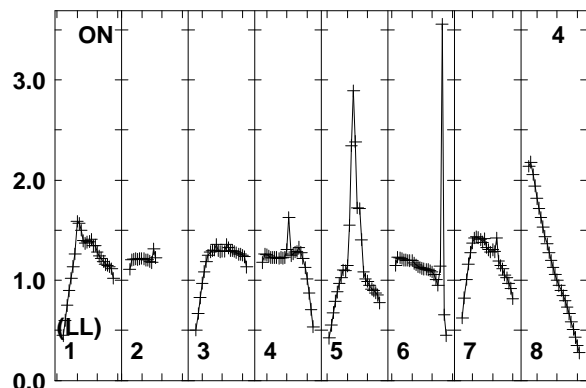
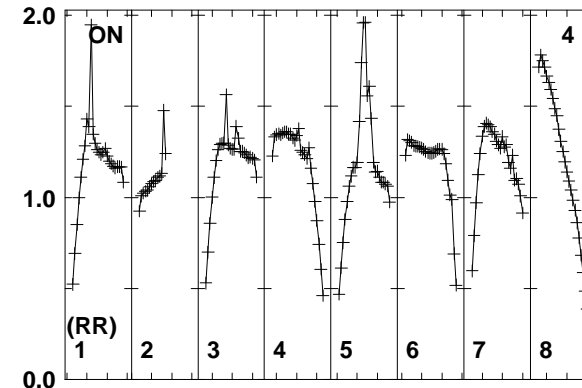
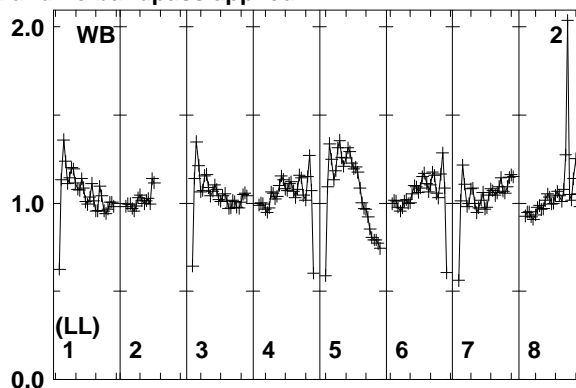
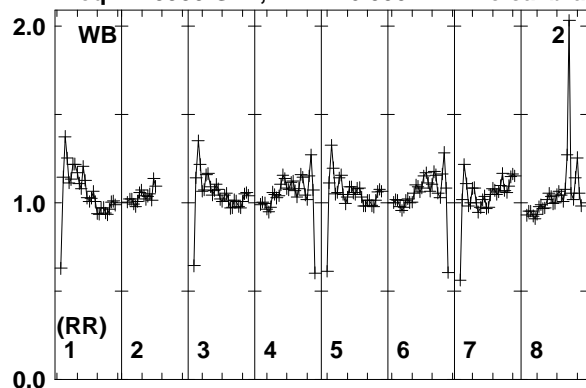

Lower frame: Real Jy
Total-power spectrum Antenna: WB (02)
Timerange: 00/07:43:21 to 00/07:47:09

Plot file version 98 created 20-MAR-2014 17:08:00

IC883 ER030C.UVDATA.1

Freq = 1.5950 GHz, Bw = 16.000 MH No calibration applied and no bandpass applied

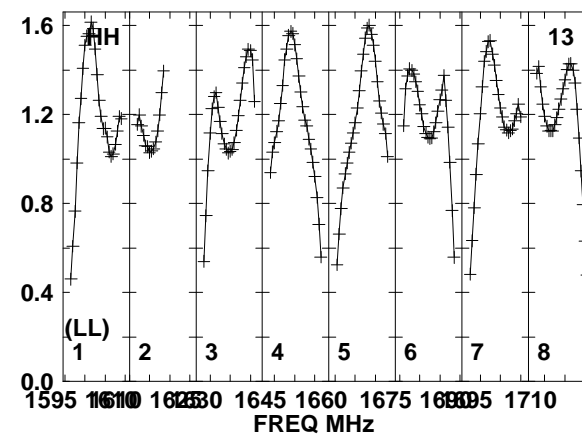
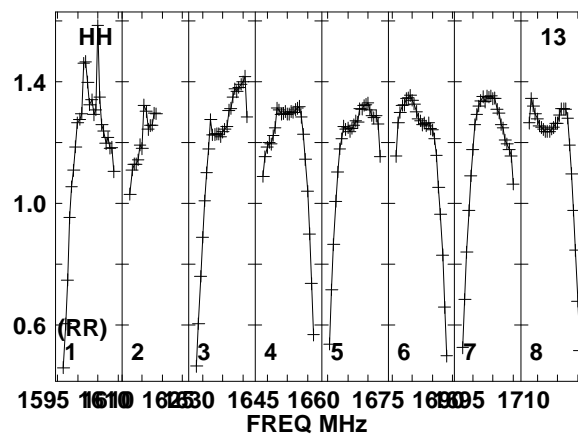
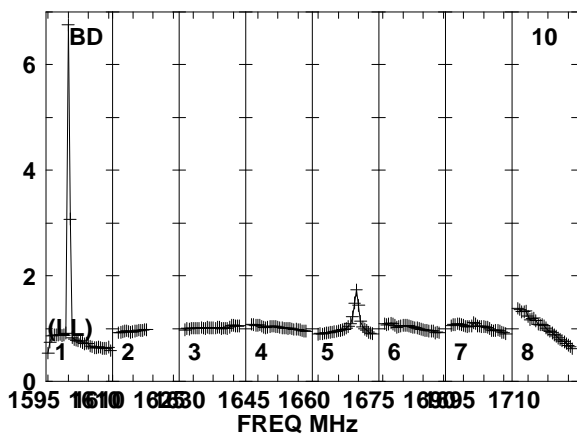
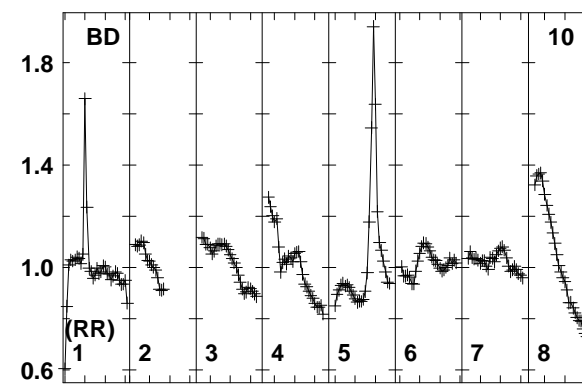
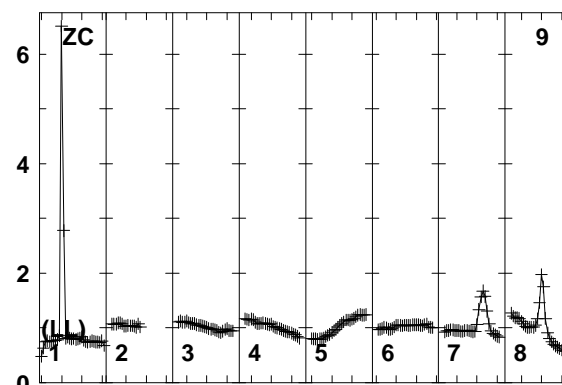
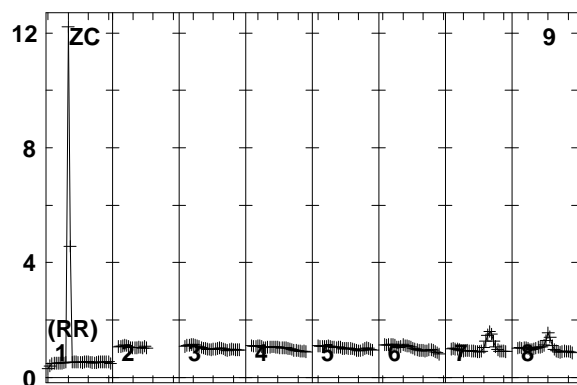
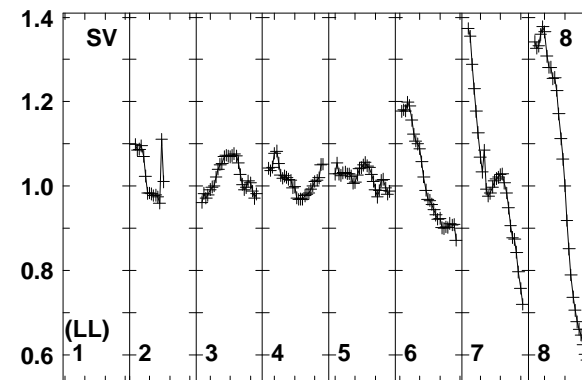
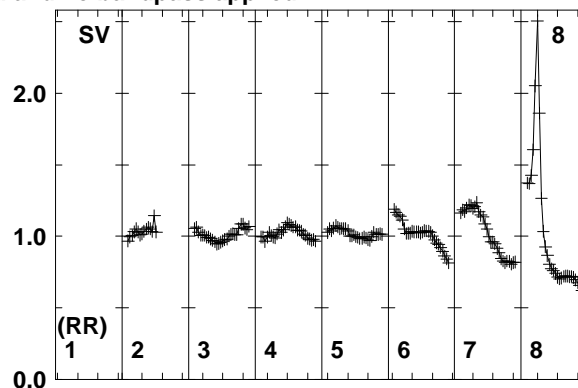
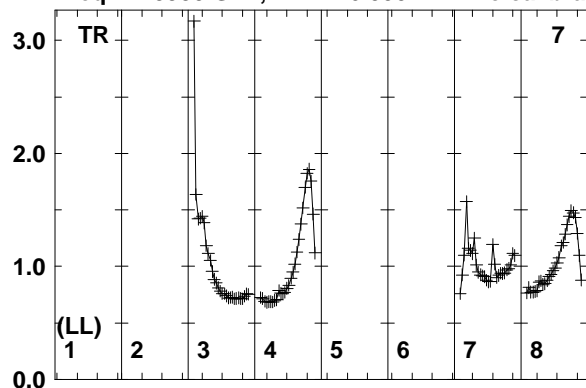

1595 1610 1625 1640 1655 1670 1685 1700 1715
FREQ MHz

1595 1610 1625 1640 1655 1670 1685 1700 1715
FREQ MHz

1595 1610 1625 1640 1655 1670 1685 1700 1715
FREQ MHz

Lower frame: Real Jy
Total-power spectrum Antenna: TR (07)
Timerange: 00/07:43:21 to 00/07:47:09

Plot file version 99 created 20-MAR-2014 17:08:00

J1317+3425 ER030C.UVDATA.1

Freq = 1.5950 GHz, Bw = 16.000 MH No calibration applied and no bandpass applied

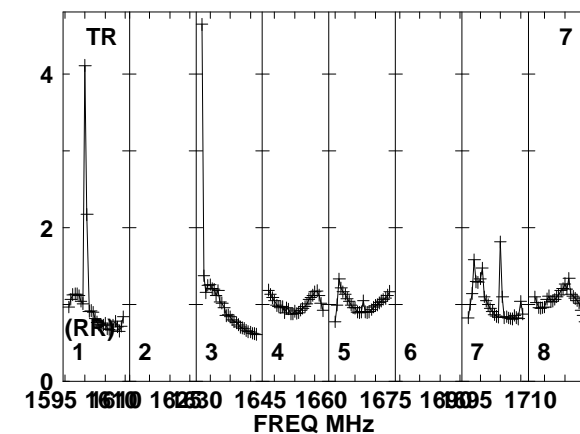
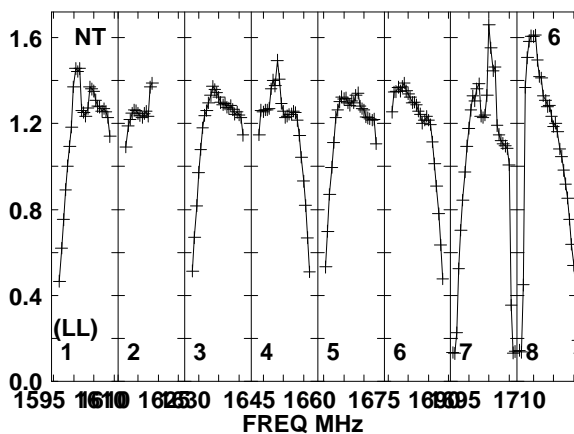
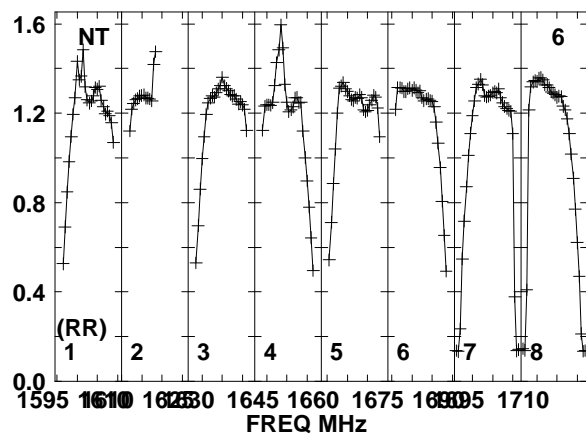
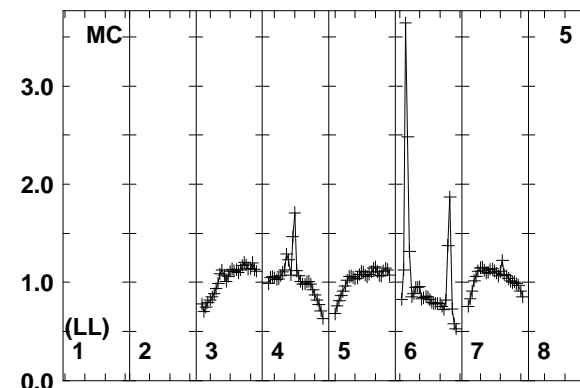
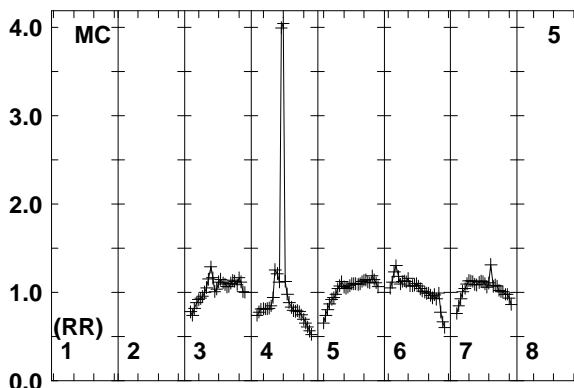
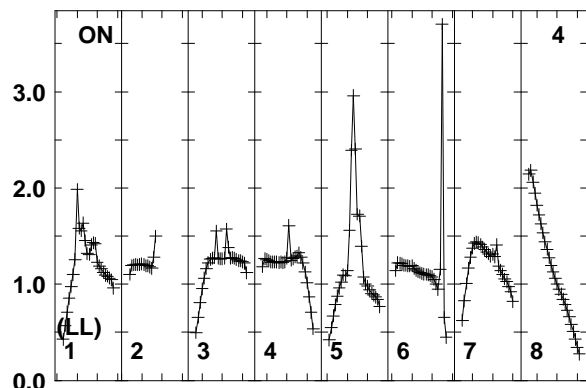
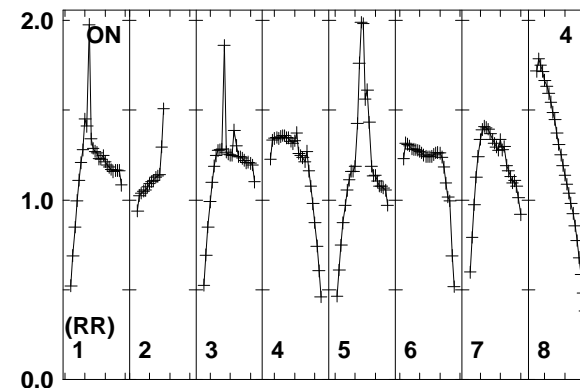
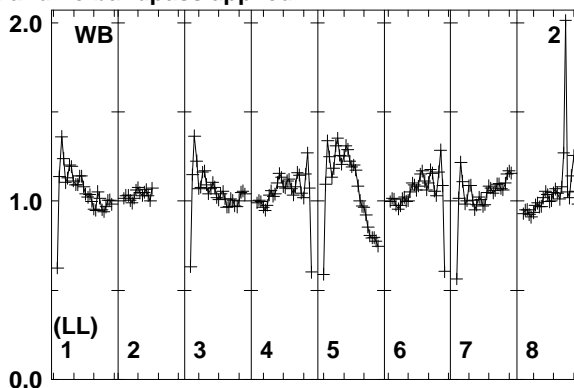
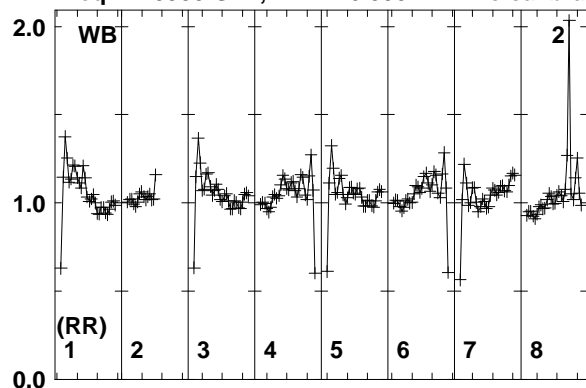

Lower frame: Real Jy
Total-power spectrum Antenna: WB (02)
Timerange: 00/07:47:51 to 00/07:48:49

Plot file version 100 created 20-MAR-2014 17:08:00

J1317+3425 ER030C.UVDATA.1

Freq = 1.5950 GHz, Bw = 16.000 MH No calibration applied and no bandpass applied

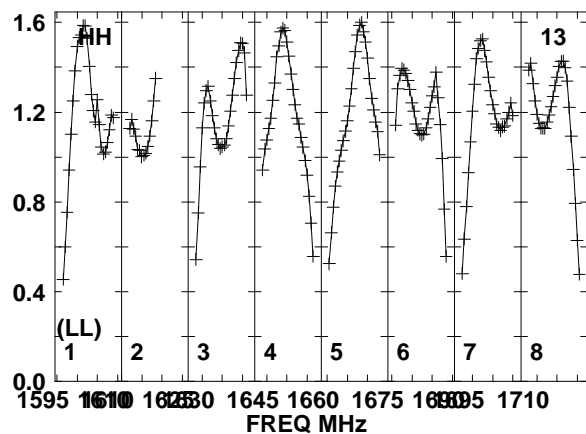
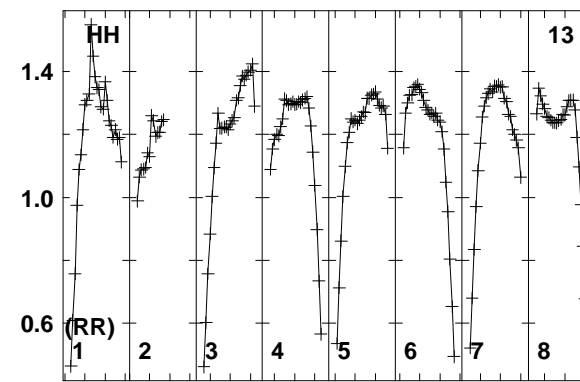
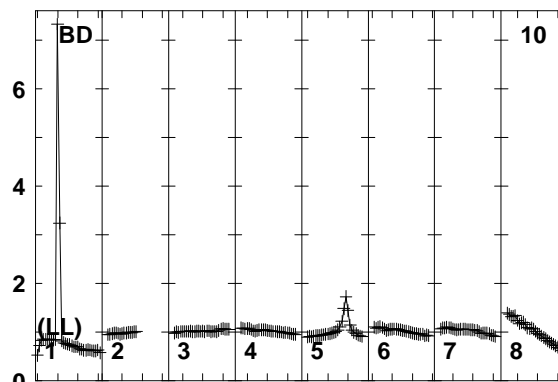
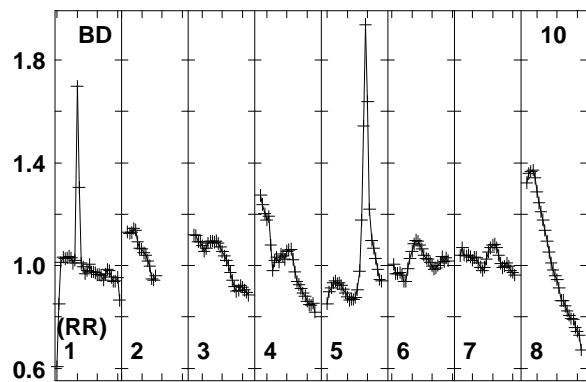
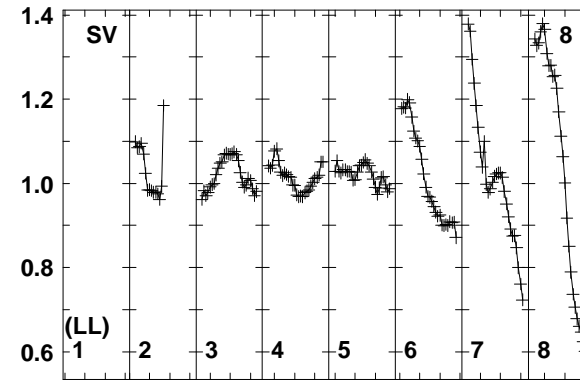
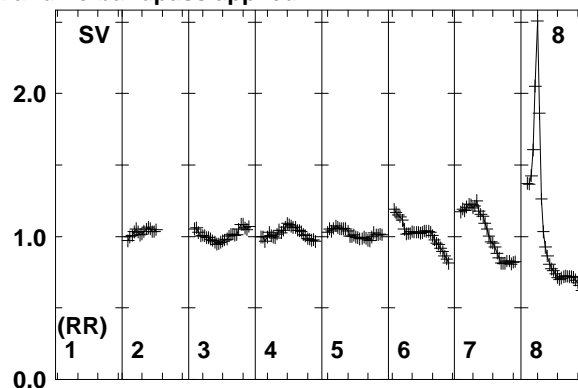
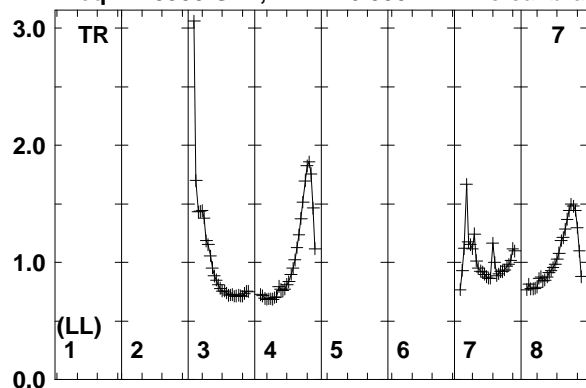

1595 1610 1625 1640 1655 1670 1685 1700 1715
FREQ MHz

Lower frame: Real Jy
Total-power spectrum Antenna: TR (07)
Timerange: 00/07:47:51 to 00/07:48:49

Plot file version 101 created 20-MAR-2014 17:08:01

IC883 ER030C.UVDATA.1

Freq = 1.5950 GHz, Bw = 16.000 MH No calibration applied and no bandpass applied

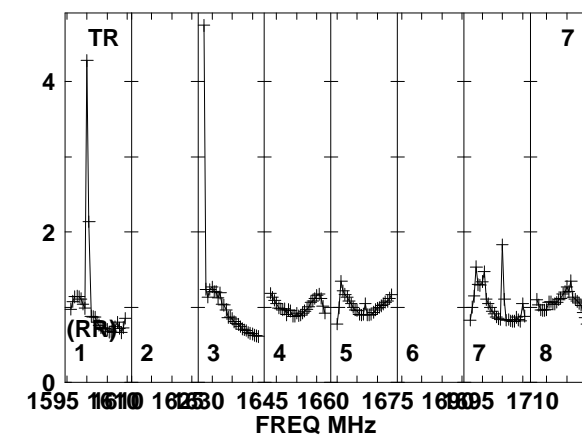
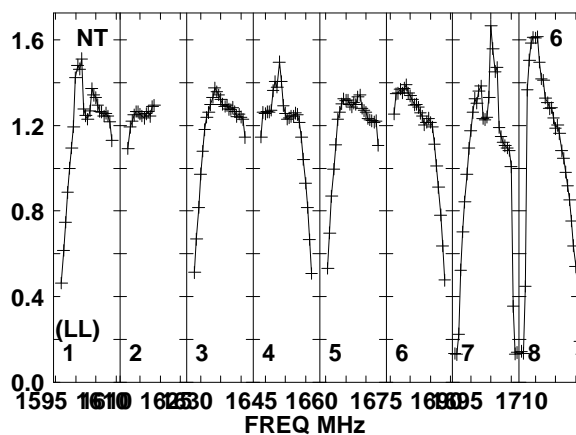
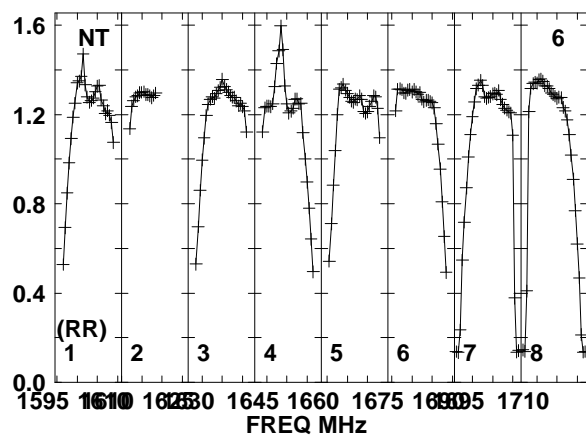
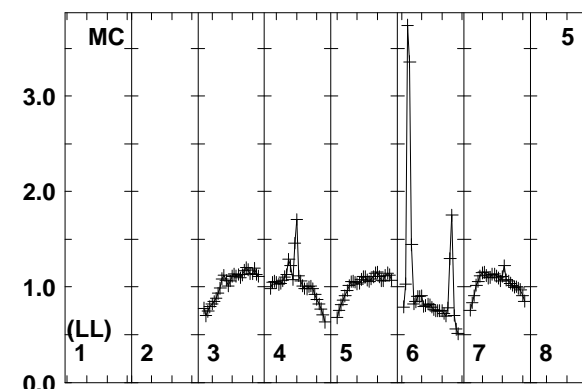
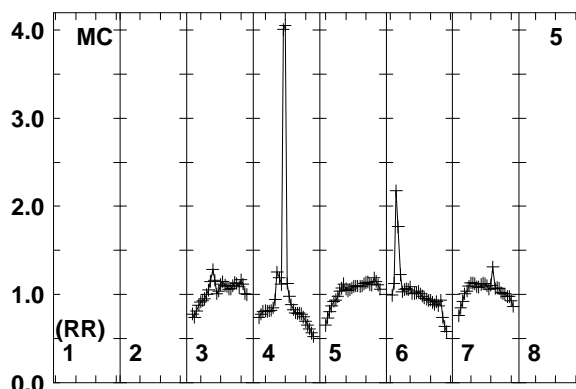
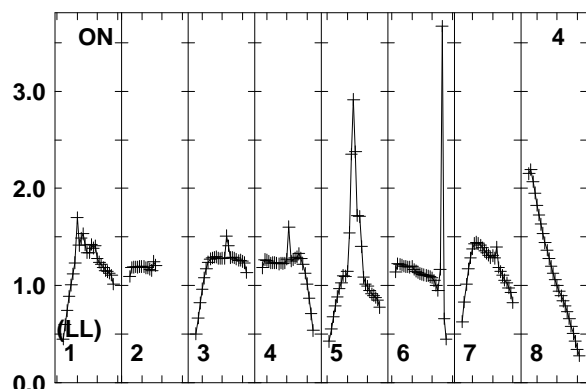
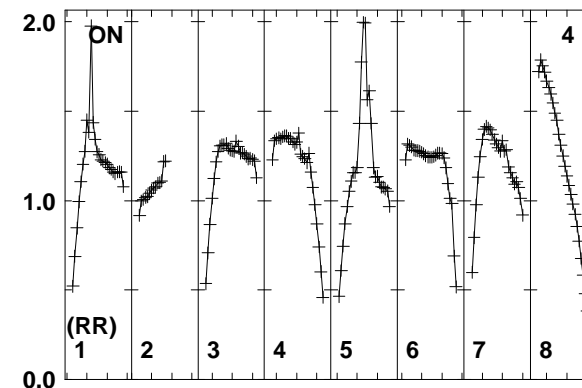
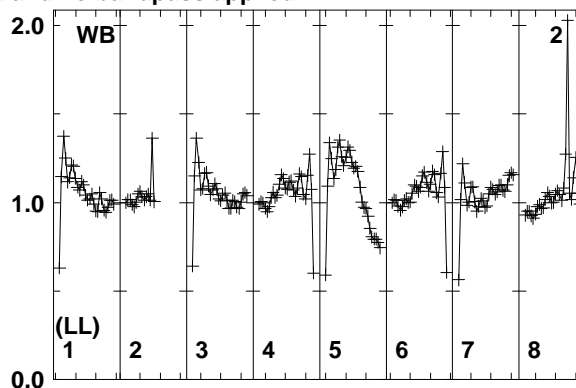
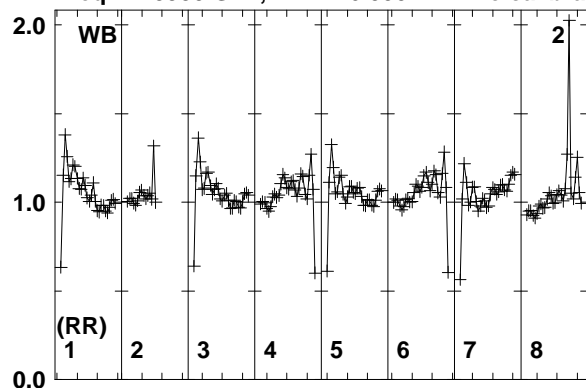

Lower frame: Real Jy
Total-power spectrum Antenna: WB (02)
Timerange: 00/07:48:55 to 00/07:52:39

Plot file version 102 created 20-MAR-2014 17:08:01

IC883 ER030C.UVDATA.1

Freq = 1.5950 GHz, Bw = 16.000 MH No calibration applied and no bandpass applied

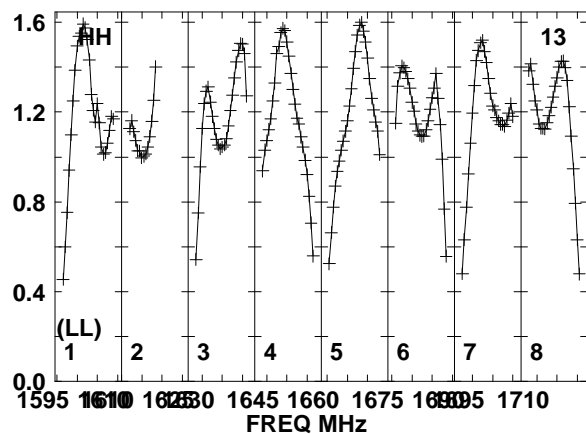
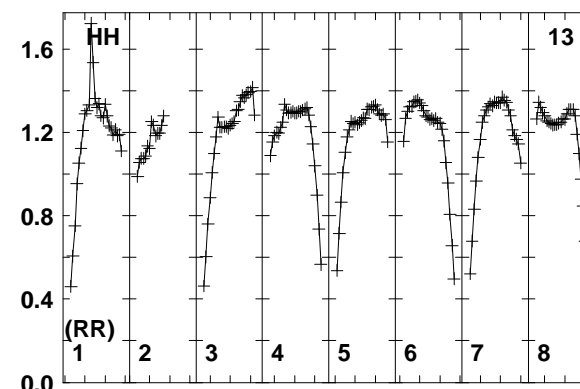
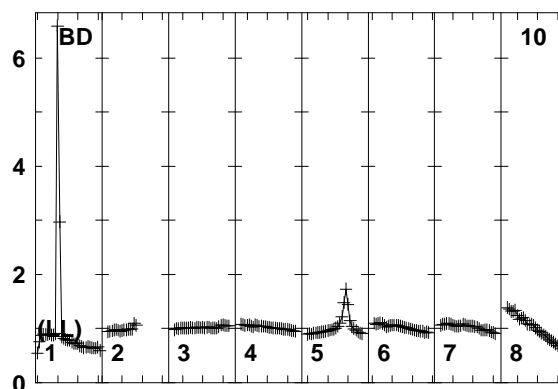
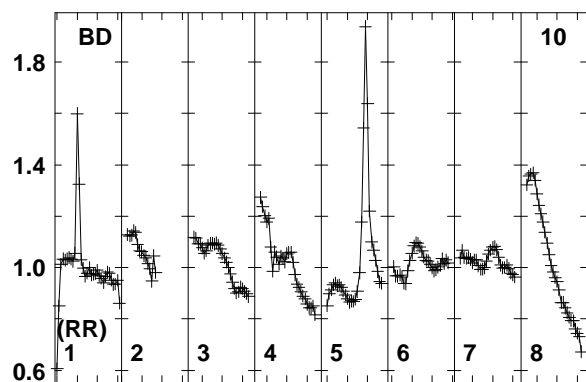
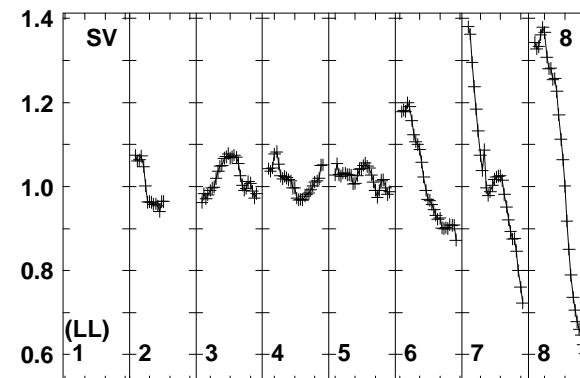
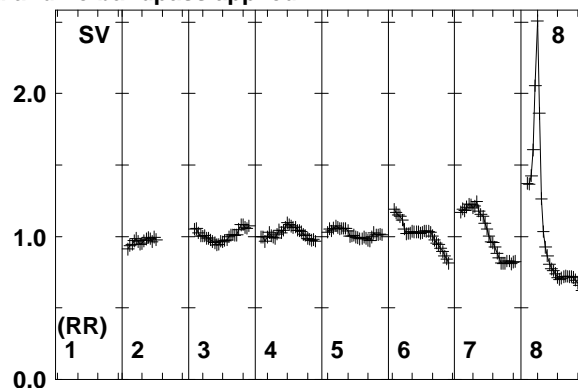
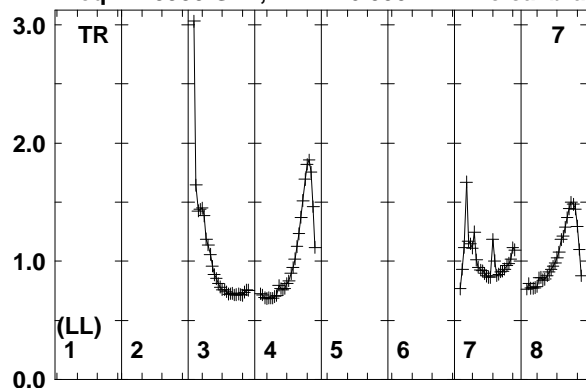

1595 1610 1625 1640 1655 1670 1685 1700 1715
FREQ MHz

Lower frame: Real Jy
Total-power spectrum Antenna: TR (07)
Timerange: 00/07:48:55 to 00/07:52:39

Plot file version 103 created 20-MAR-2014 17:08:01

J1317+3425 ER030C.UVDATA.1

Freq = 1.5950 GHz, Bw = 16.000 MH No calibration applied and no bandpass applied

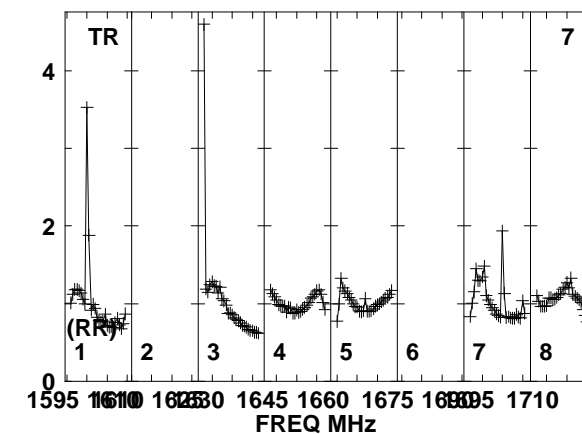
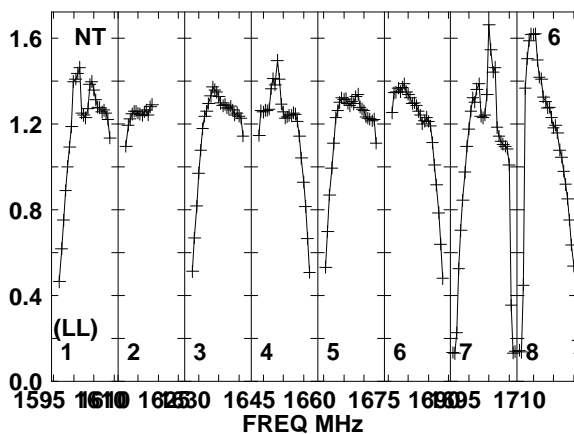
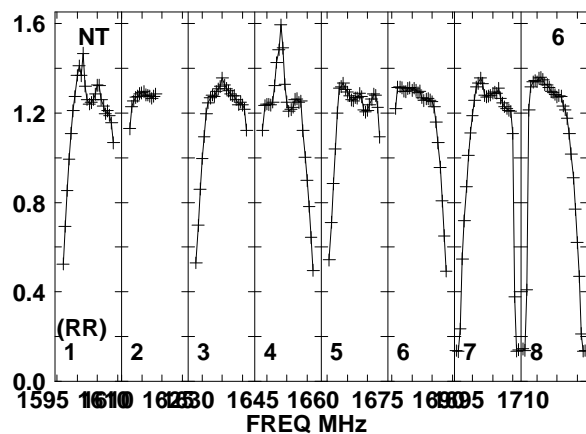
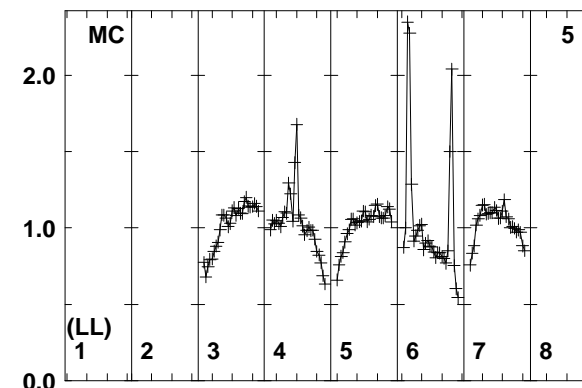
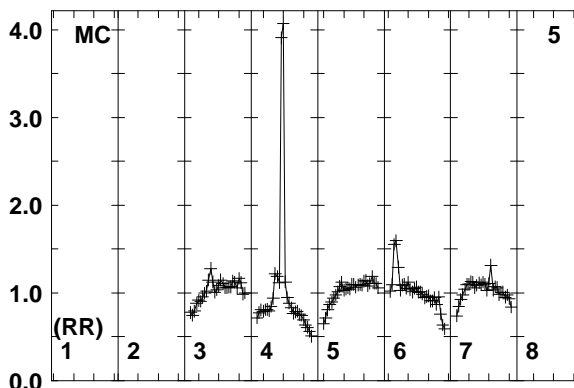
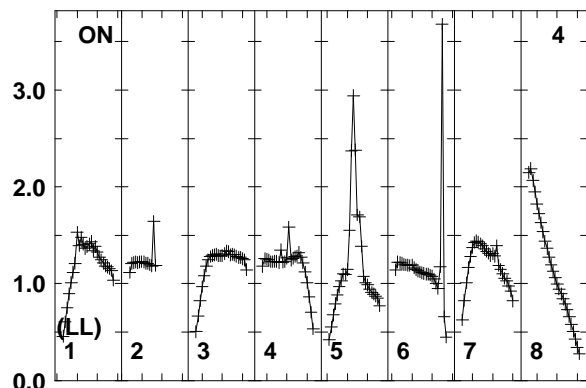
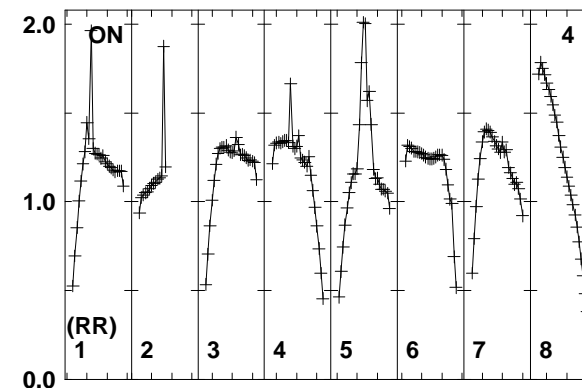
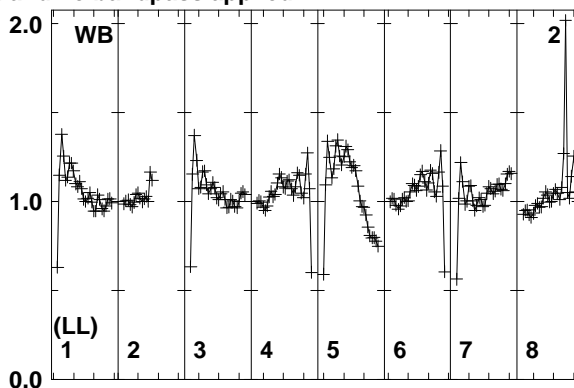
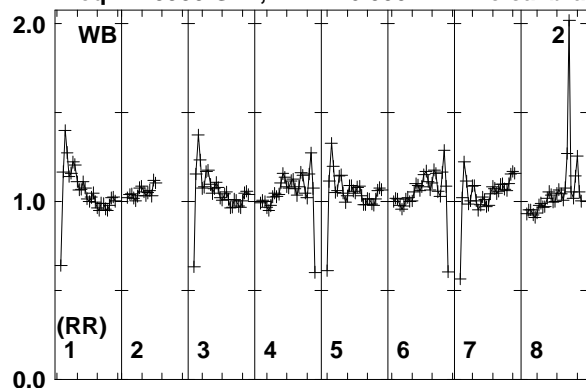

Lower frame: Real Jy
Total-power spectrum Antenna: WB (02)
Timerange: 00/07:52:43 to 00/07:53:59

Plot file version 104 created 20-MAR-2014 17:08:01

J1317+3425 ER030C.UVDATA.1

Freq = 1.5950 GHz, Bw = 16.000 MH No calibration applied and no bandpass applied

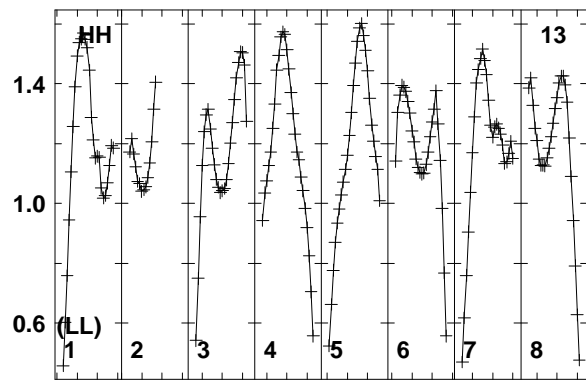
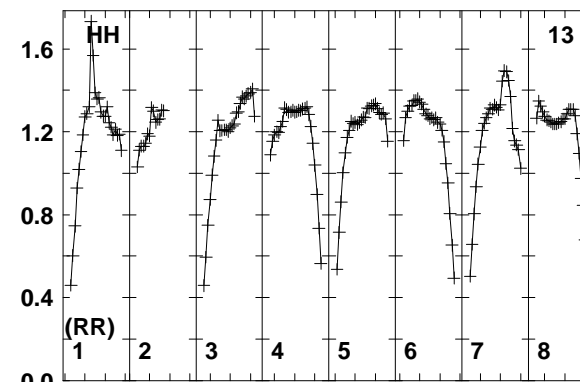
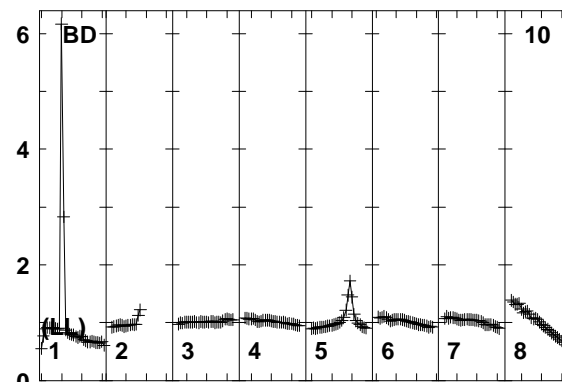
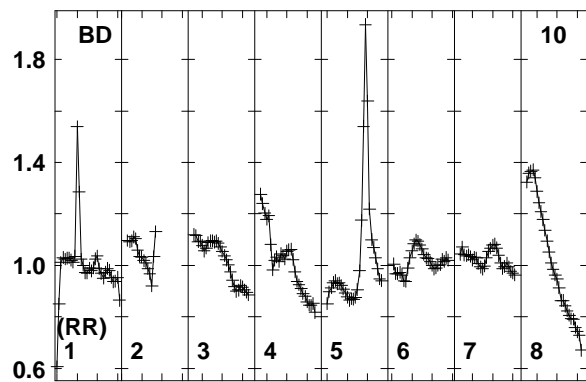
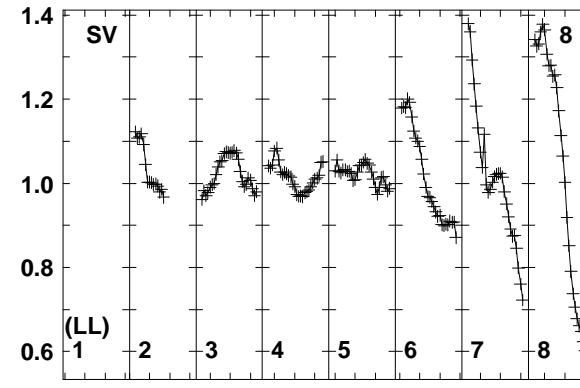
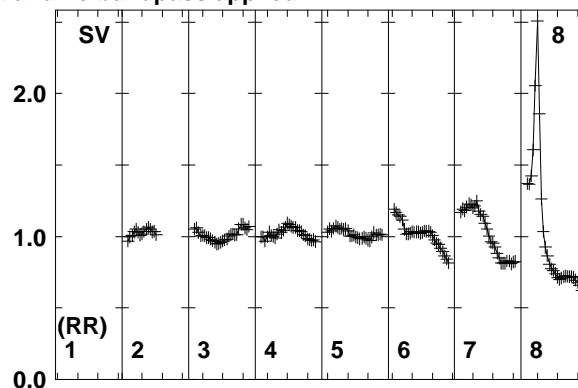
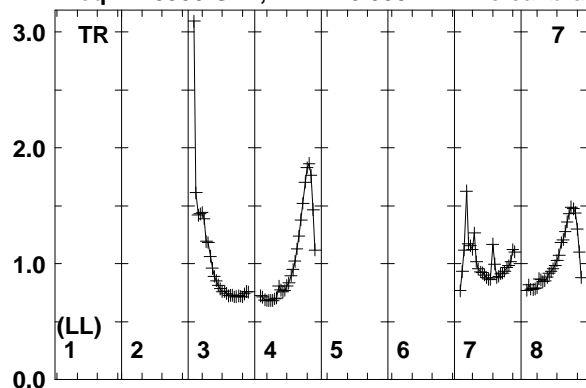

1595 1610 1625 1640 1655 1670 1685 1700 1710
FREQ MHz

Lower frame: Real Jy
Total-power spectrum Antenna: TR (07)
Timerange: 00/07:52:43 to 00/07:53:59

Plot file version 105 created 20-MAR-2014 17:08:01

IC883 ER030C.UVDATA.1

Freq = 1.5950 GHz, Bw = 16.000 MH No calibration applied and no bandpass applied

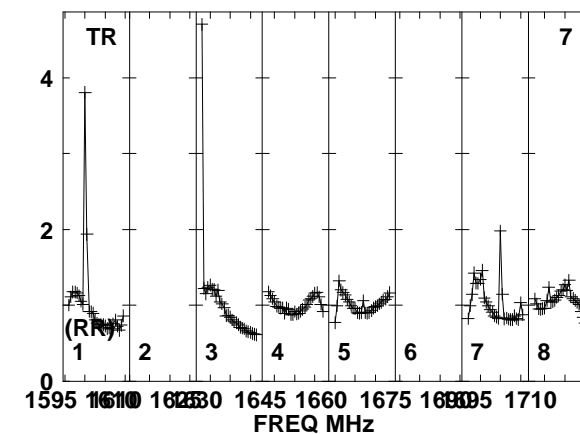
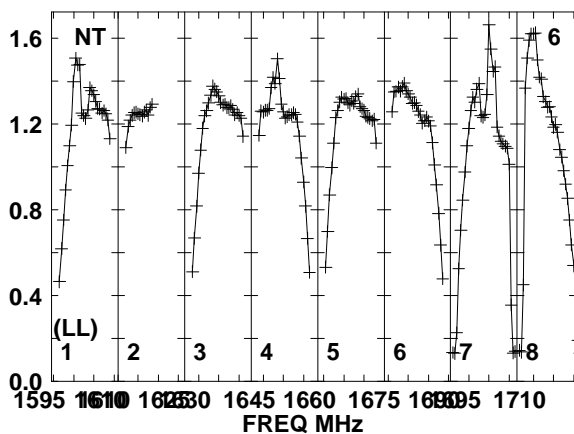
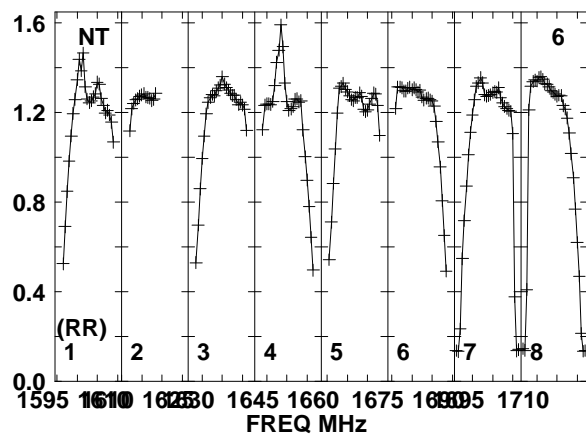
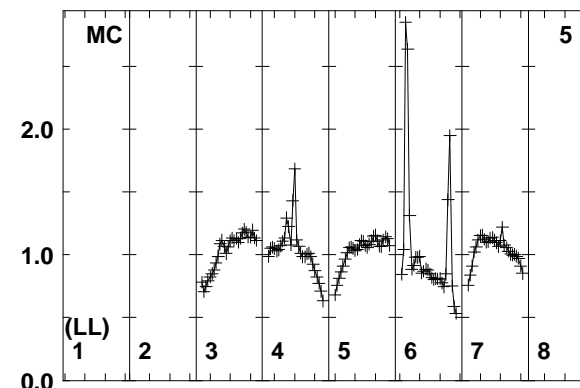
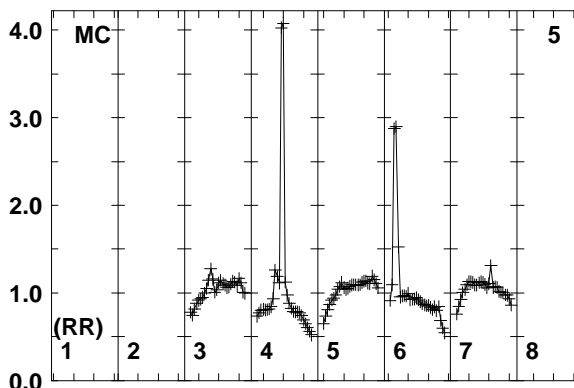
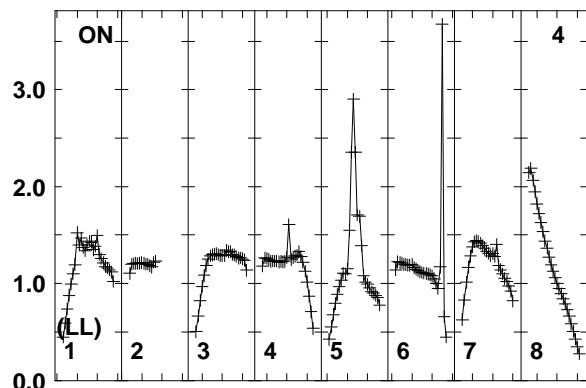
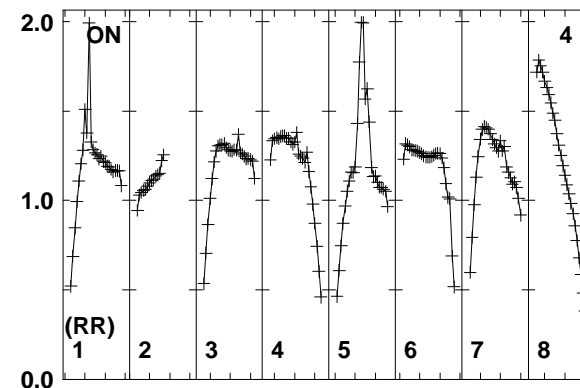
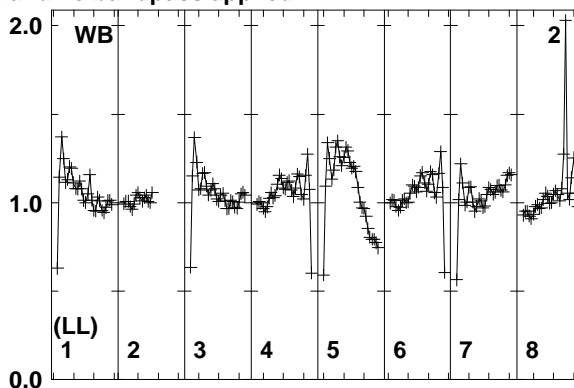
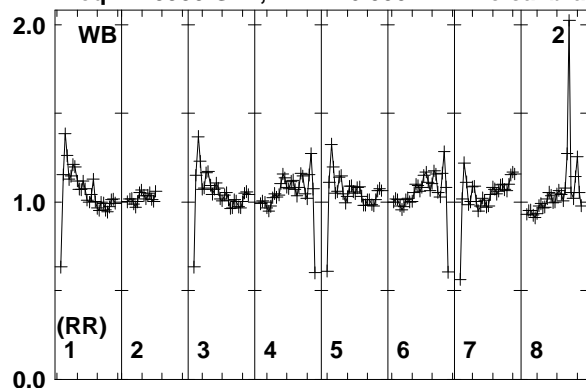

Lower frame: Real Jy
Total-power spectrum Antenna: WB (02)
Timerange: 00/07:54:01 to 00/07:57:49

Plot file version 106 created 20-MAR-2014 17:08:01

IC883 ER030C.UVDATA.1

Freq = 1.5950 GHz, Bw = 16.000 MH No calibration applied and no bandpass applied

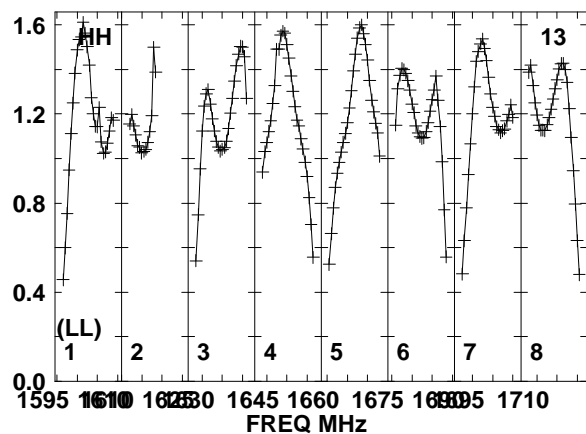
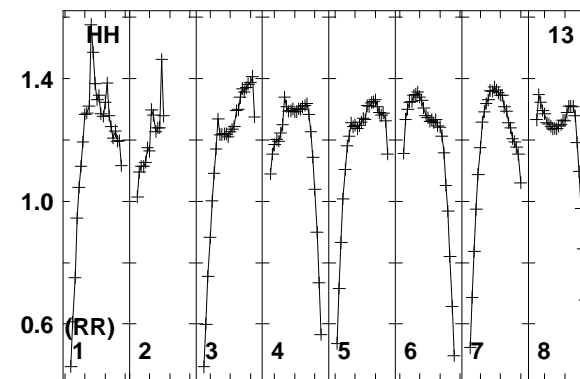
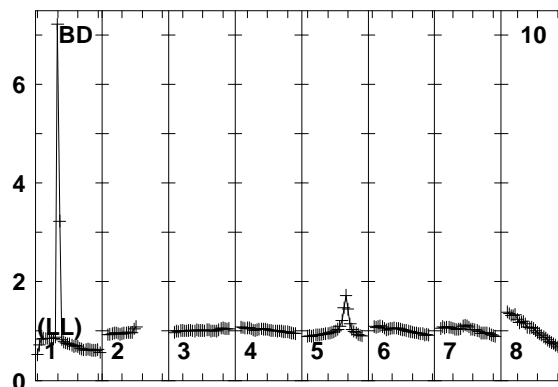
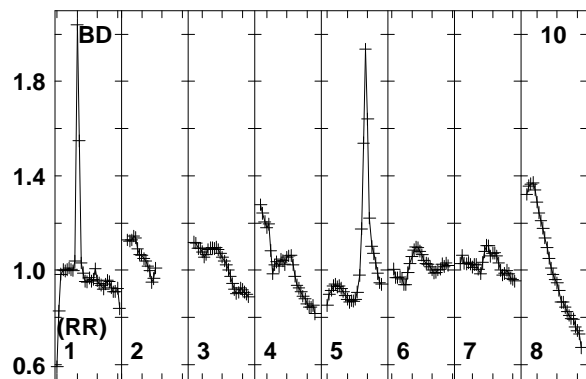
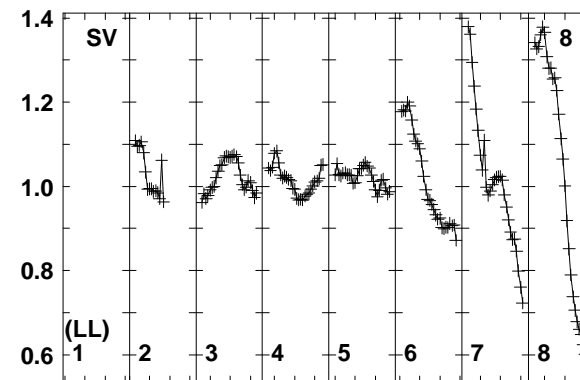
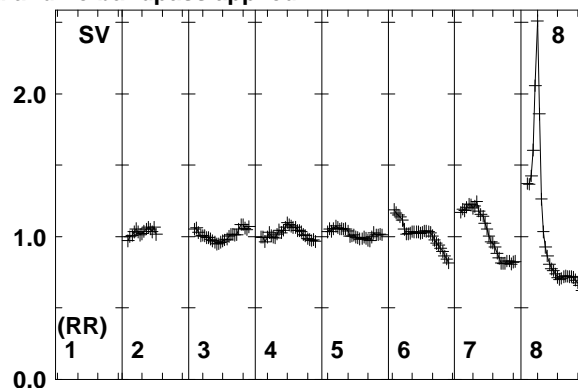
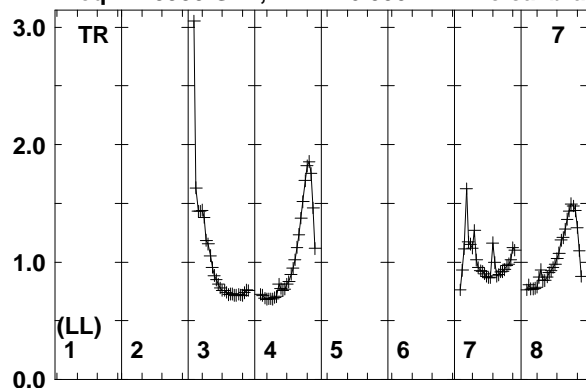

1595 1610 1625 1640 1655 1670 1685 1700 1715
FREQ MHz

Lower frame: Real Jy
Total-power spectrum Antenna: TR (07)
Timerange: 00/07:54:01 to 00/07:57:49

Plot file version 107 created 20-MAR-2014 17:08:01

J1317+3425 ER030C.UVDATA.1

Freq = 1.5950 GHz, Bw = 16.000 MH No calibration applied and no bandpass applied

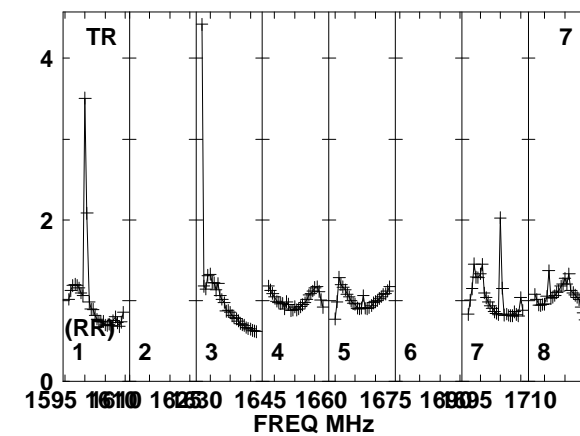
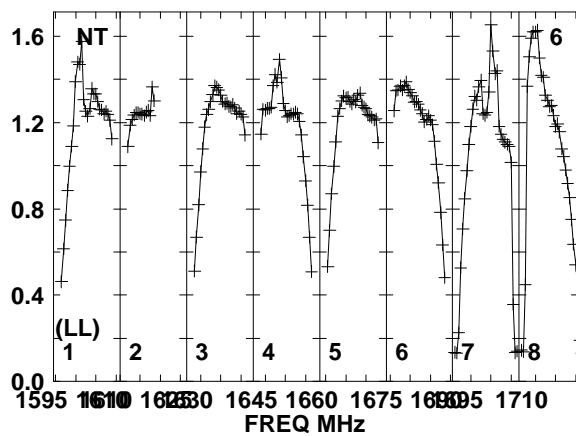
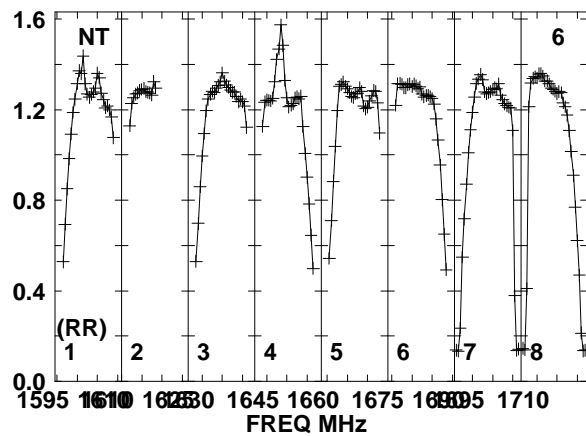
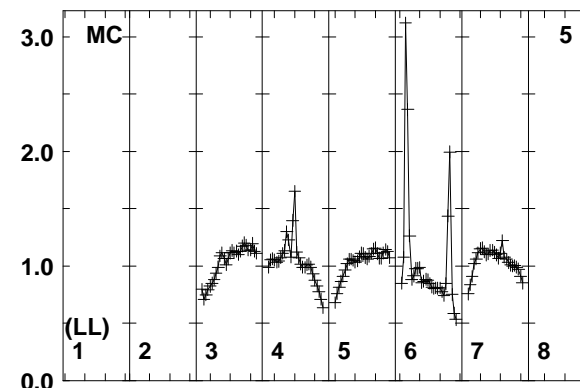
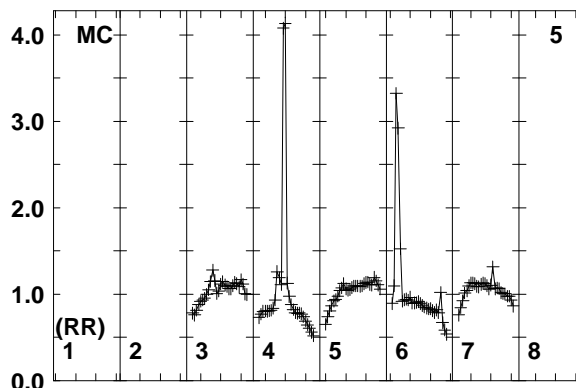
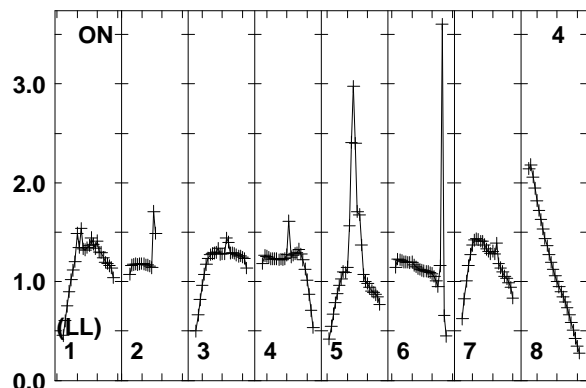
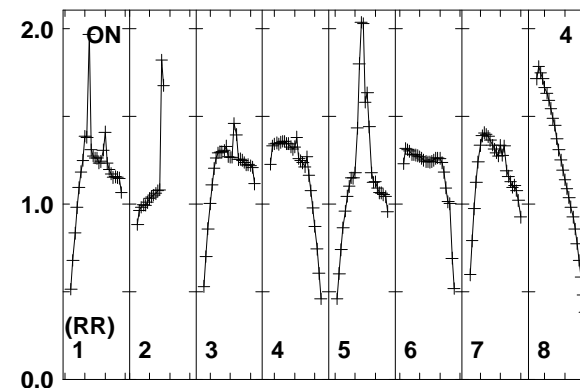
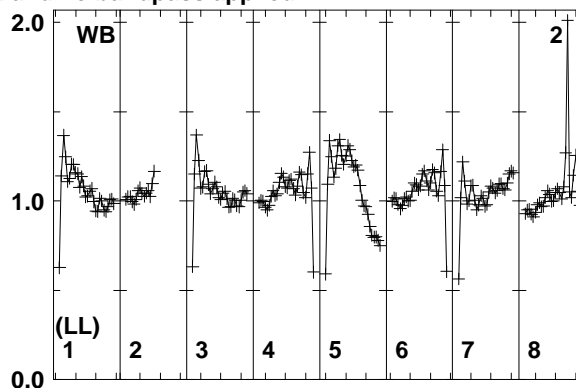
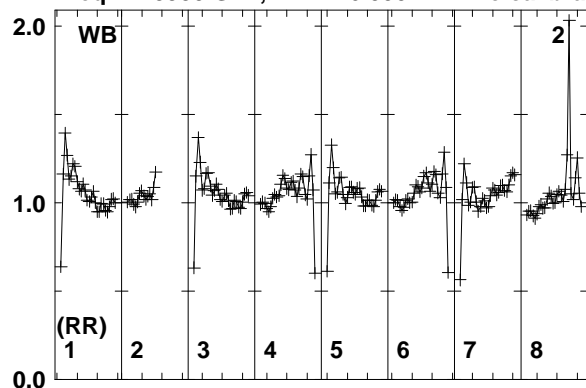

Lower frame: Real Jy
Total-power spectrum Antenna: WB (02)
Timerange: 00/07:58:31 to 00/07:59:29

Plot file version 108 created 20-MAR-2014 17:08:01

J1317+3425 ER030C.UVDATA.1

Freq = 1.5950 GHz, Bw = 16.000 MH No calibration applied and no bandpass applied

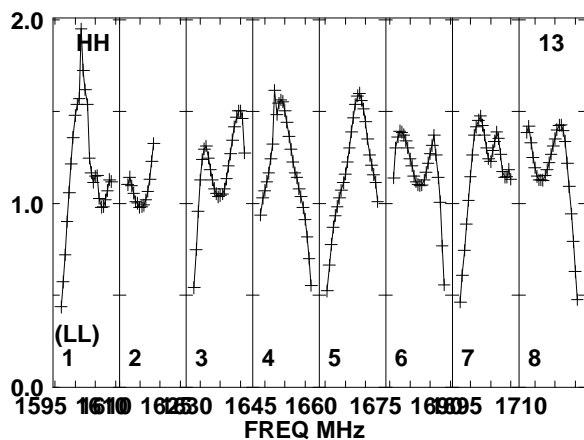
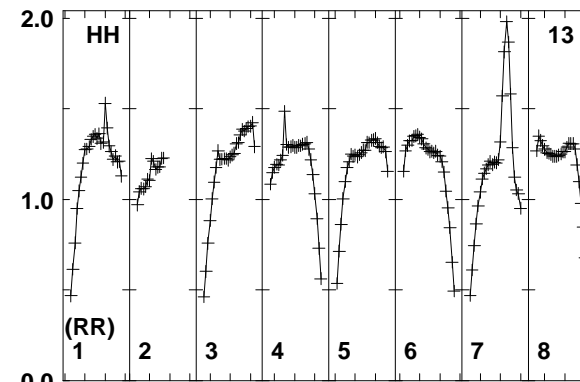
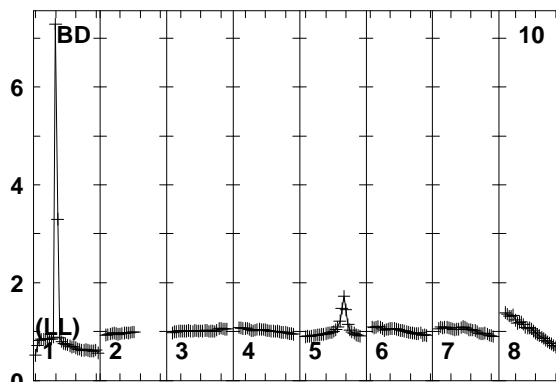
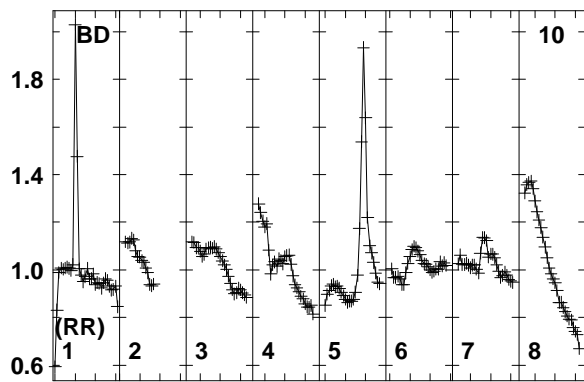
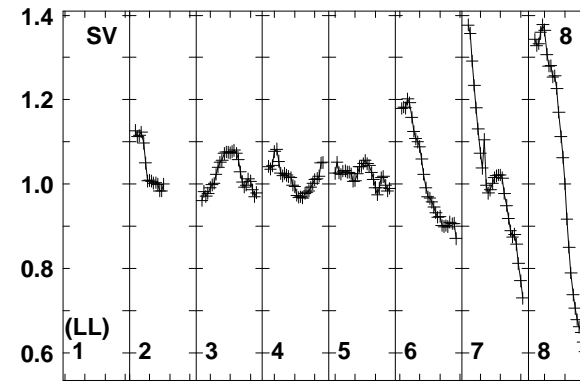
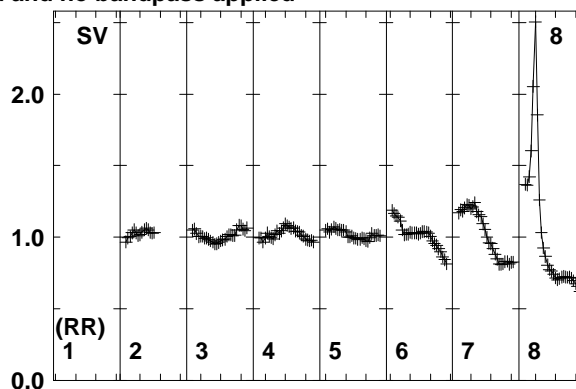
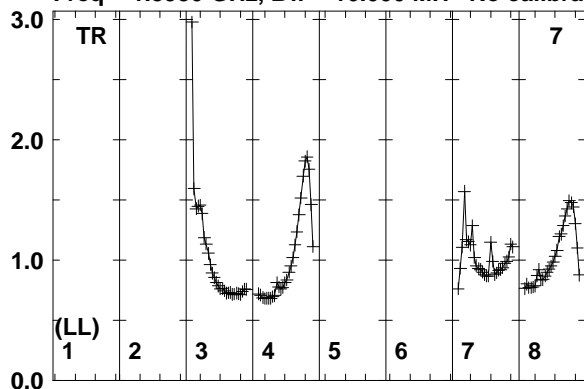

1595 1610 1625 1640 1650 1660 1675 1690 1710
FREQ MHz

Lower frame: Real Jy
Total-power spectrum Antenna: TR (07)
Timerange: 00/07:58:31 to 00/07:59:29

Plot file version 109 created 20-MAR-2014 17:08:01

IC883 ER030C.UVDATA.1

Freq = 1.5950 GHz, Bw = 16.000 MH No calibration applied and no bandpass applied

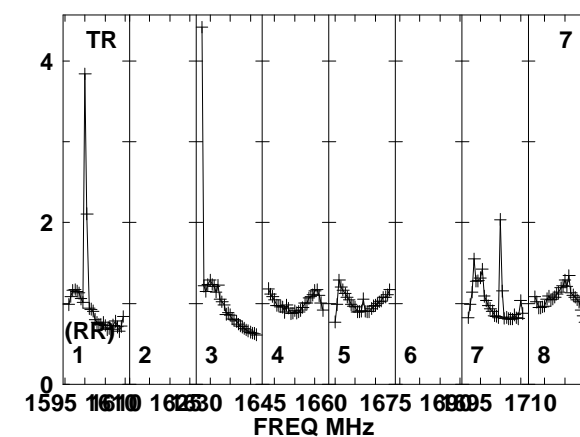
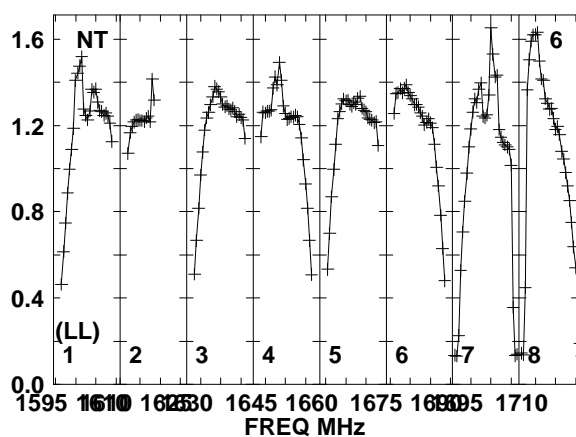
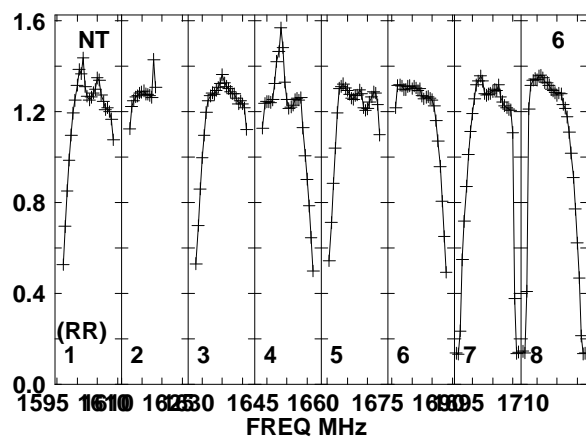
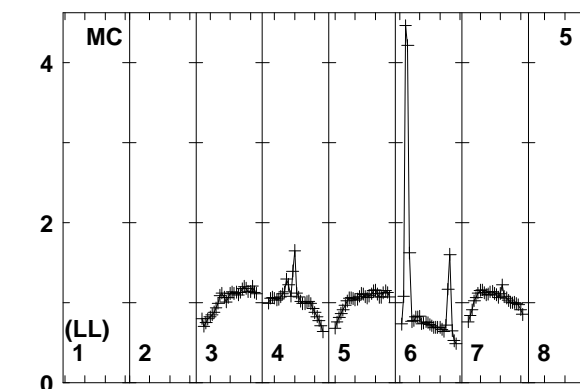
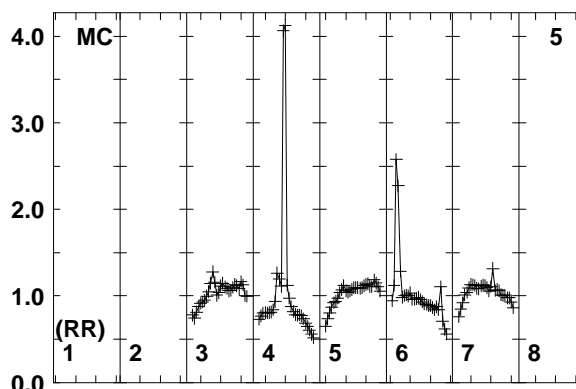
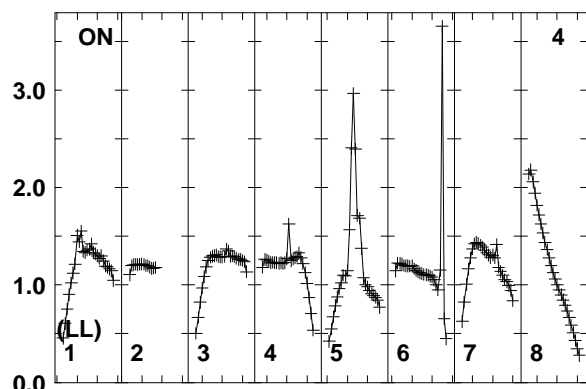
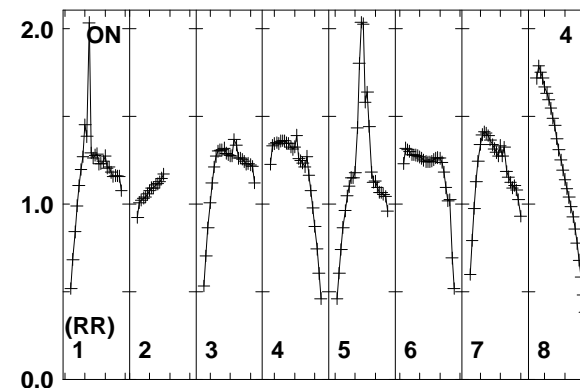
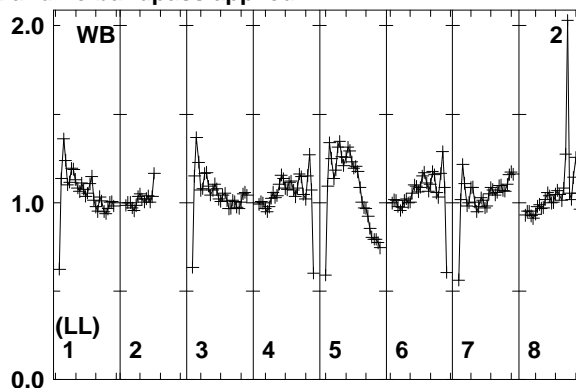
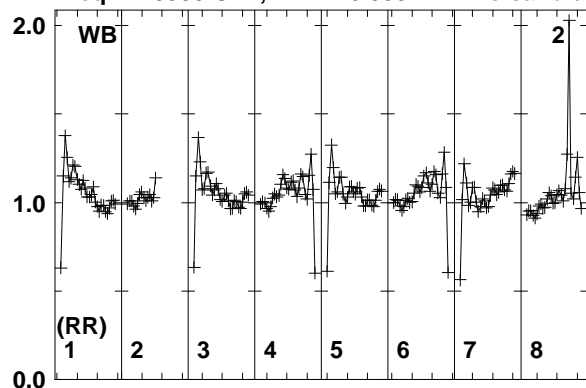

Lower frame: Real Jy
Total-power spectrum Antenna: WB (02)
Timerange: 00/07:59:33 to 00/08:03:19

Plot file version 110 created 20-MAR-2014 17:08:01

IC883 ER030C.UVDATA.1

Freq = 1.5950 GHz, Bw = 16.000 MH No calibration applied and no bandpass applied

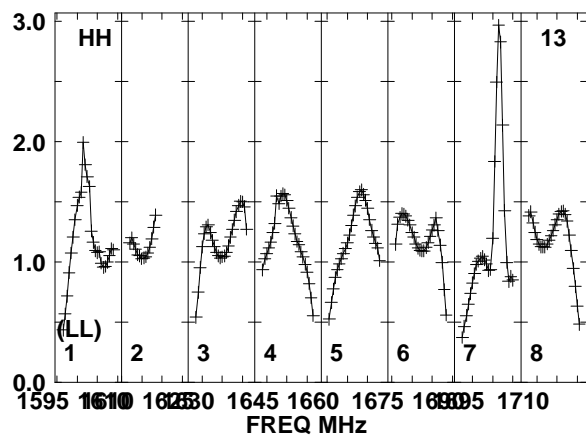
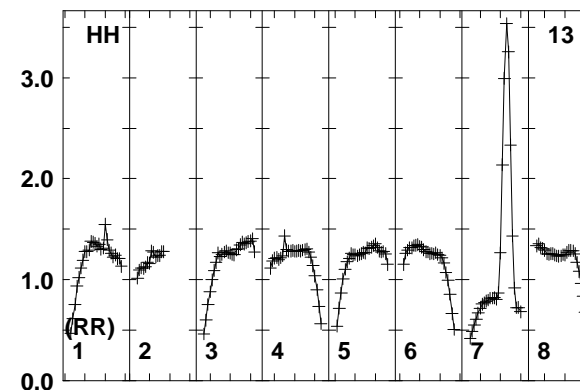
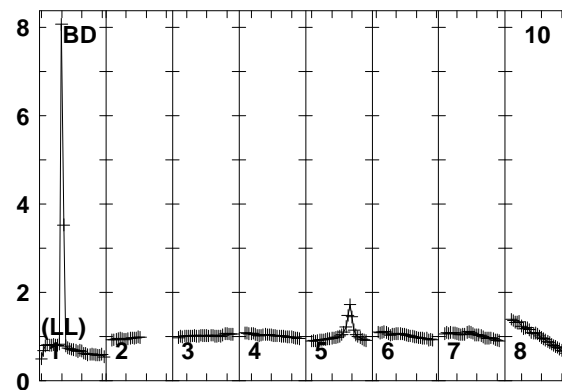
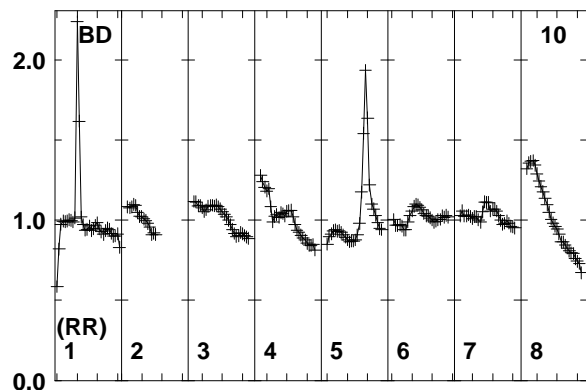
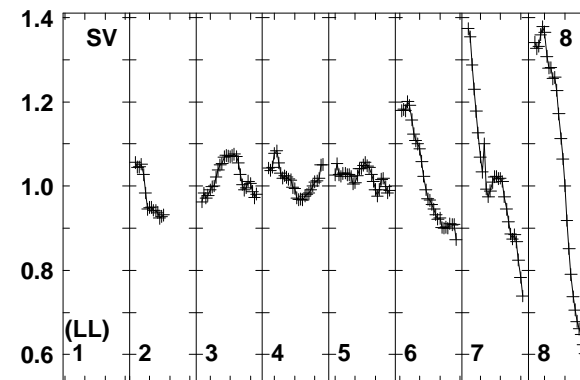
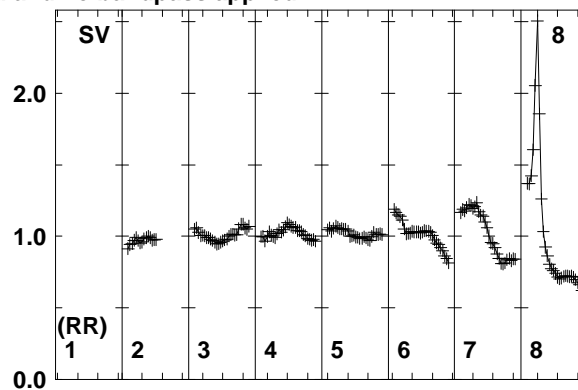
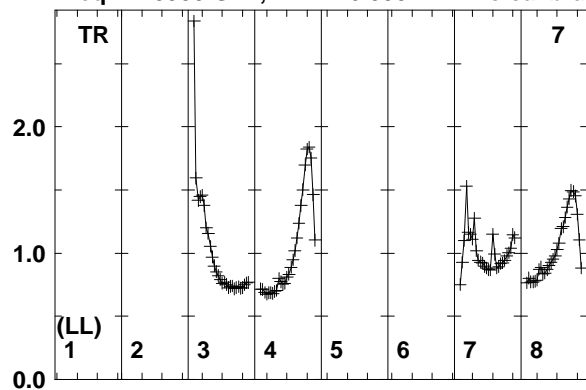

1595 1610 1625 1640 1655 1670 1685 1700 1715
FREQ MHz

Lower frame: Real Jy
Total-power spectrum Antenna: TR (07)
Timerange: 00/07:59:33 to 00/08:03:19

Plot file version 111 created 20-MAR-2014 17:08:01

J1317+3425 ER030C.UVDATA.1

Freq = 1.5950 GHz, Bw = 16.000 MH No calibration applied and no bandpass applied

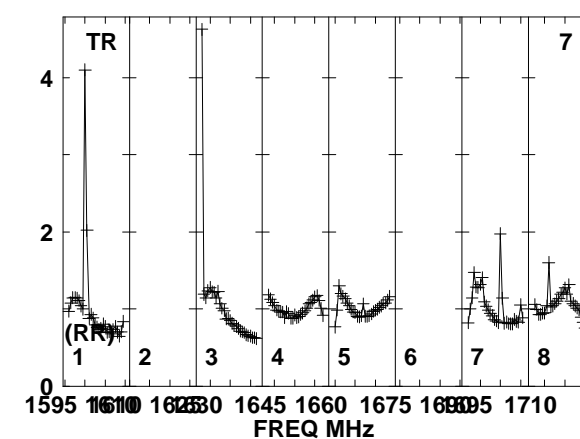
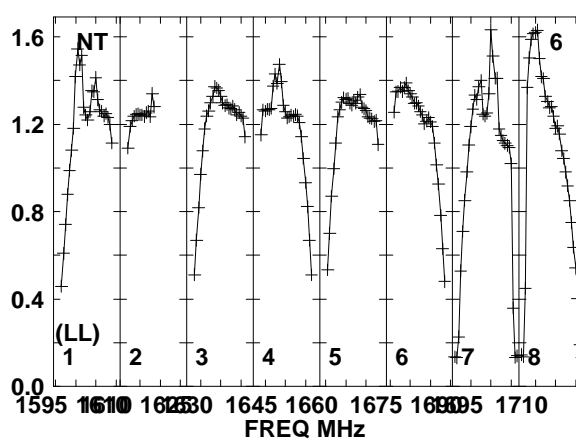
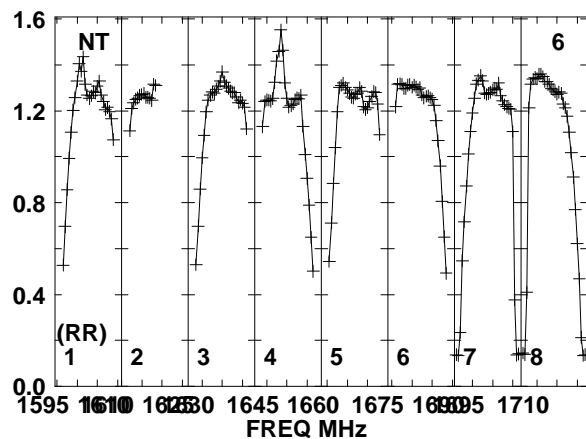
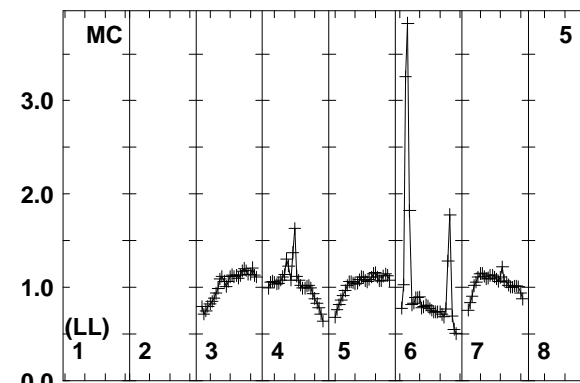
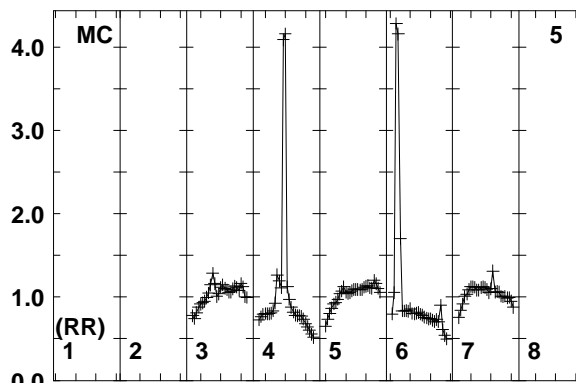
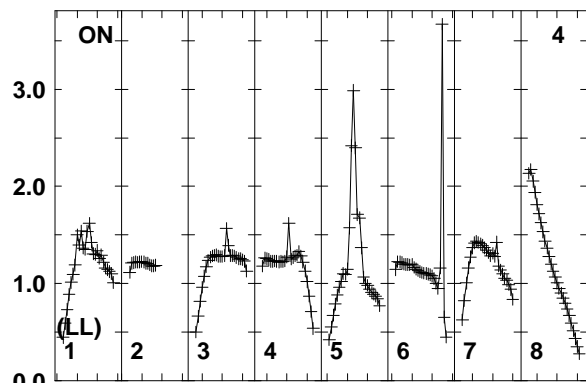
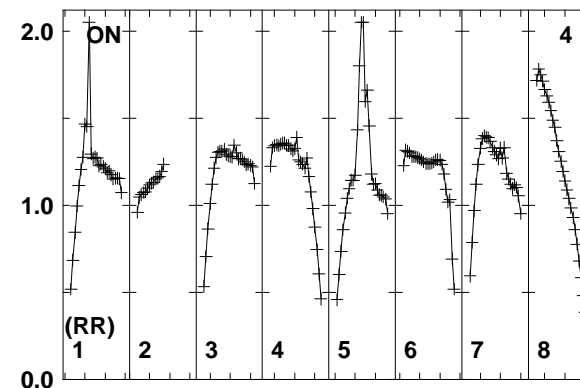
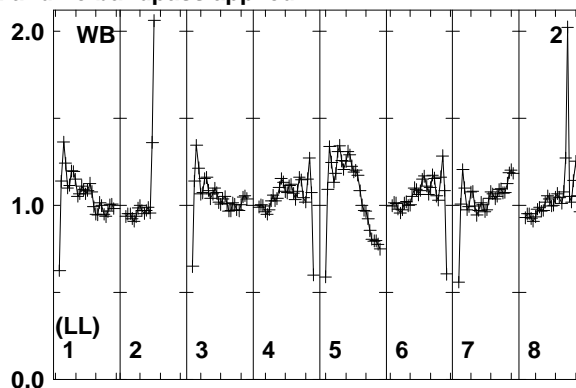
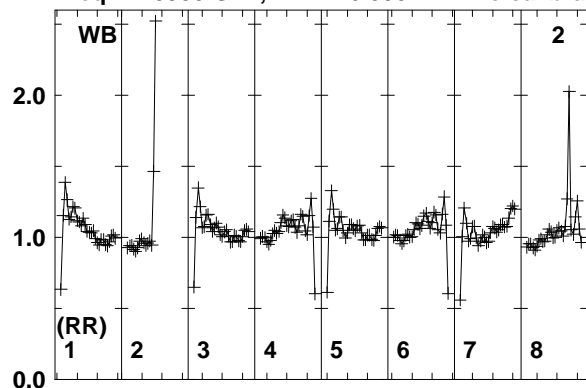

Lower frame: Real Jy
Total-power spectrum Antenna: WB (02)
Timerange: 00/08:03:23 to 00/08:04:39

Plot file version 112 created 20-MAR-2014 17:08:01

J1317+3425 ER030C.UVDATA.1

Freq = 1.5950 GHz, Bw = 16.000 MH No calibration applied and no bandpass applied

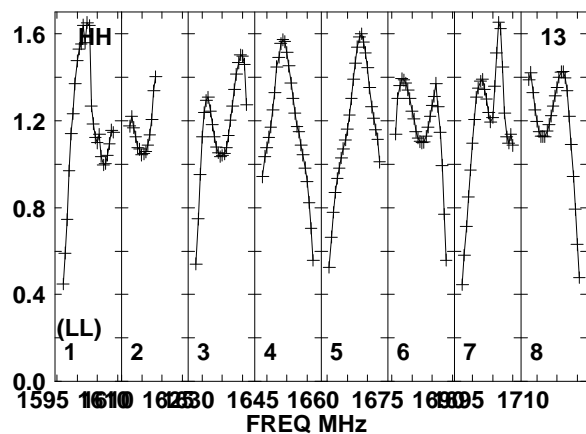
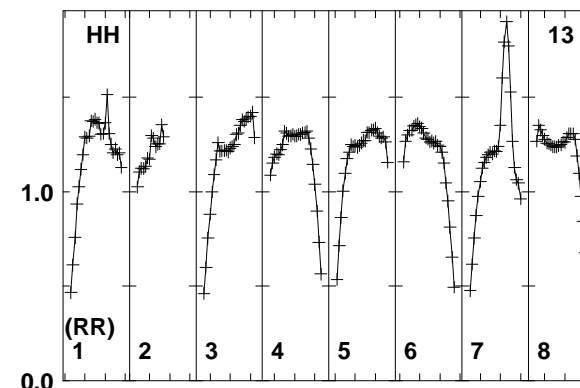
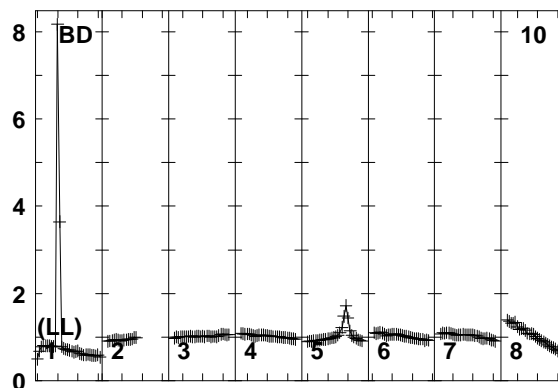
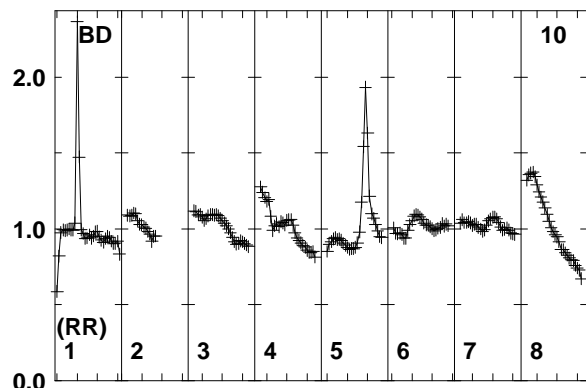
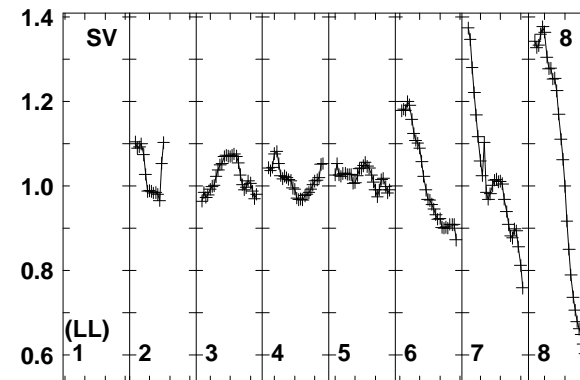
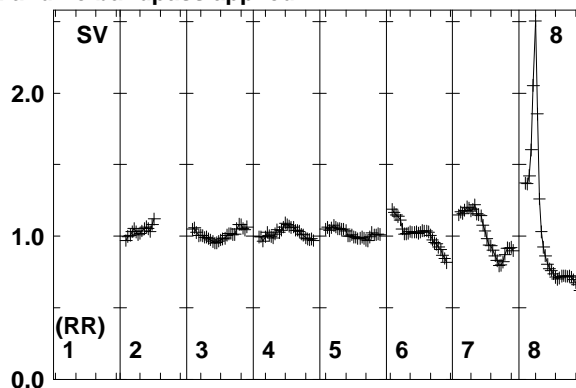
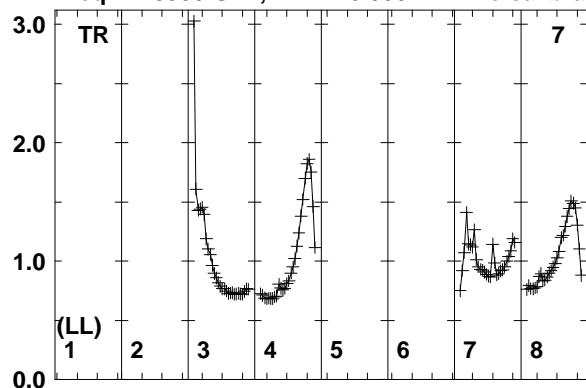

Lower frame: Real Jy
Total-power spectrum Antenna: TR (07)
Timerange: 00/08:03:23 to 00/08:04:39

Plot file version 113 created 20-MAR-2014 17:08:02

IC883 ER030C.UVDATA.1

Freq = 1.5950 GHz, Bw = 16.000 MH No calibration applied and no bandpass applied

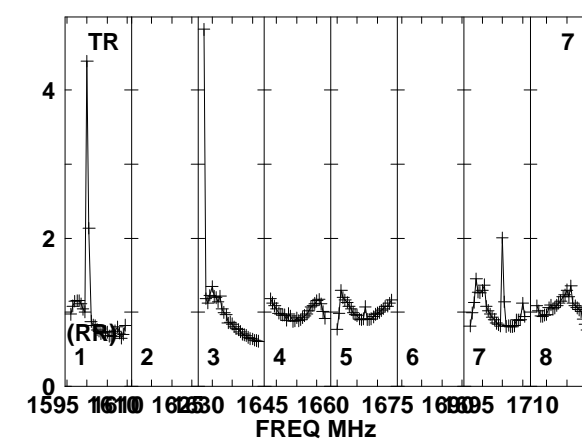
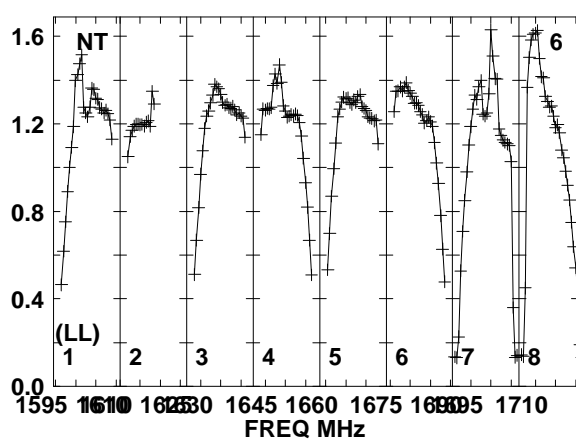
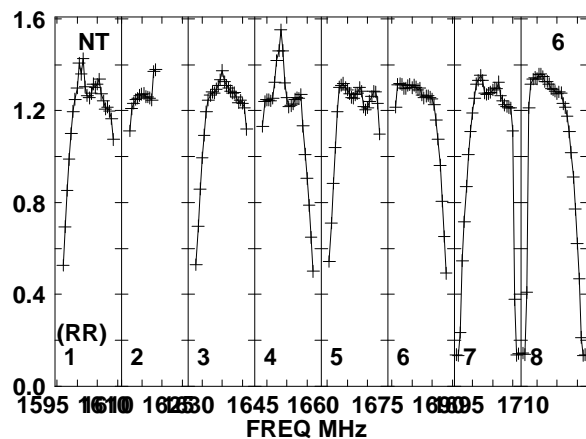
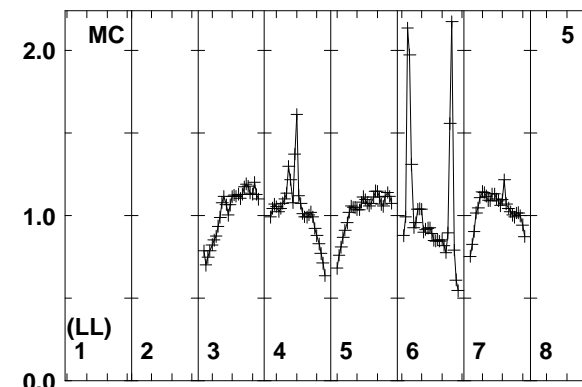
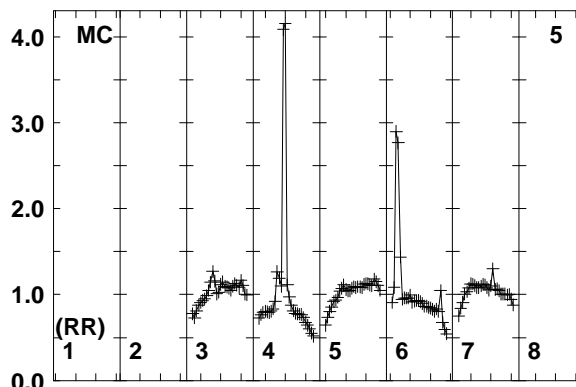
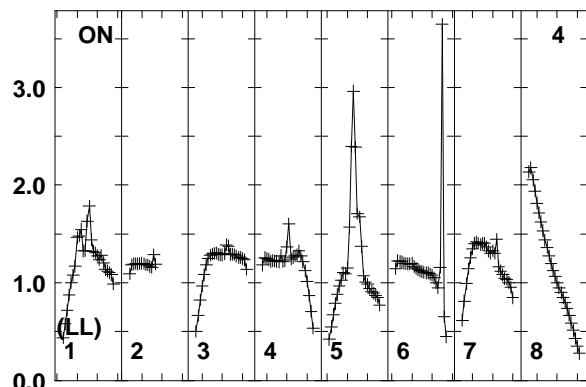
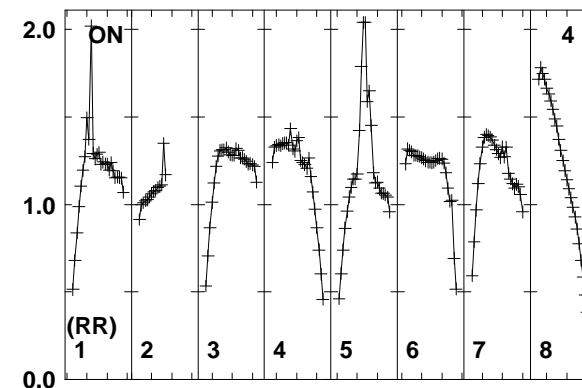
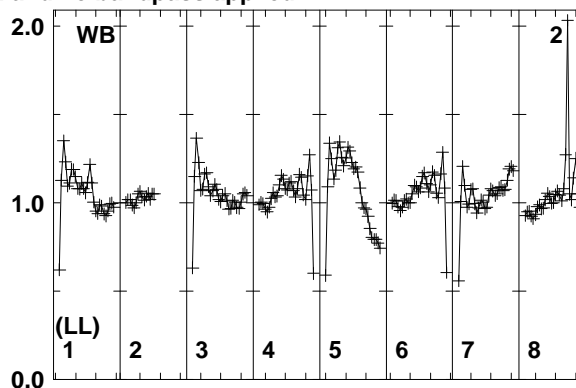
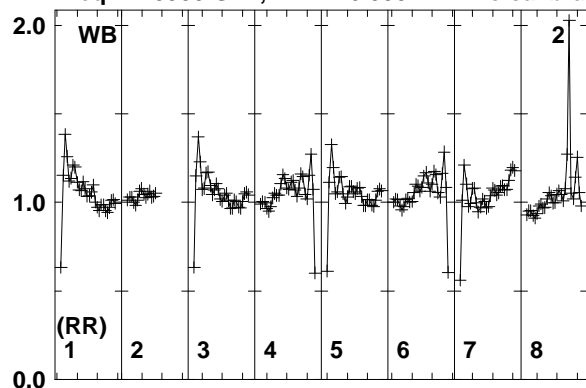

Lower frame: Real Jy
Total-power spectrum Antenna: WB (02)
Timerange: 00/08:04:41 to 00/08:08:29

Plot file version 114 created 20-MAR-2014 17:08:02

IC883 ER030C.UVDATA.1

Freq = 1.5950 GHz, Bw = 16.000 MH No calibration applied and no bandpass applied

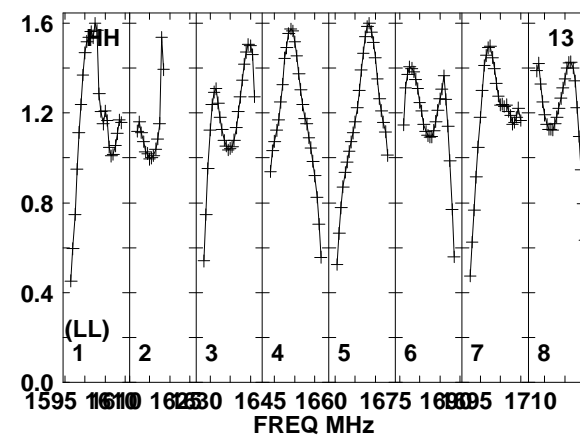
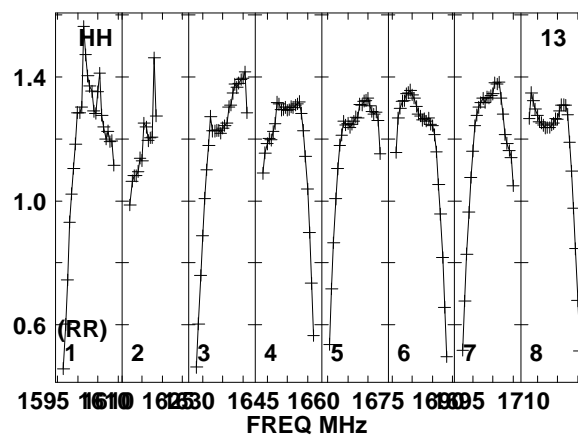
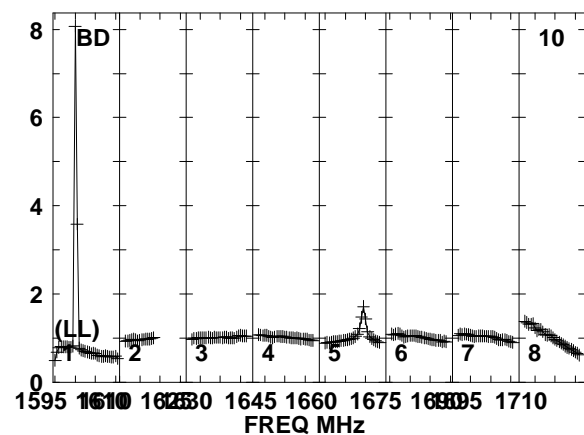
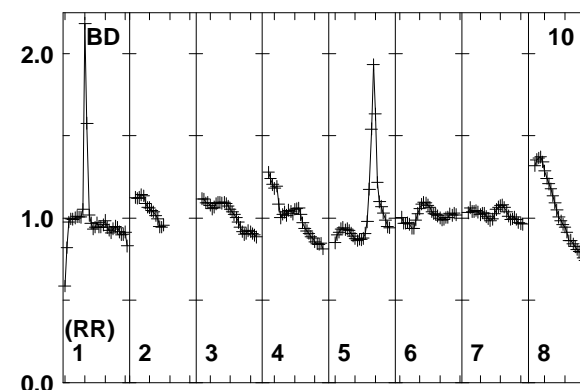
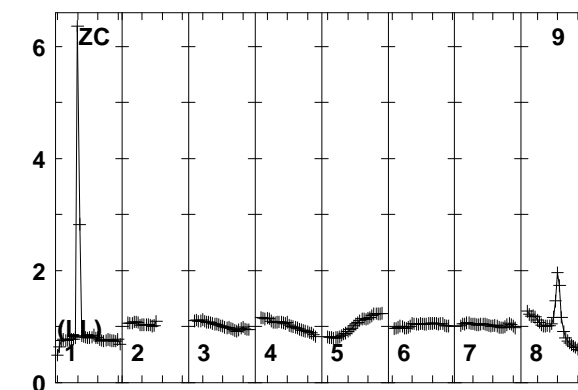
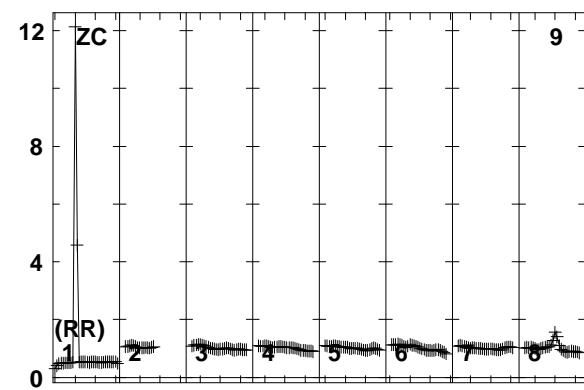
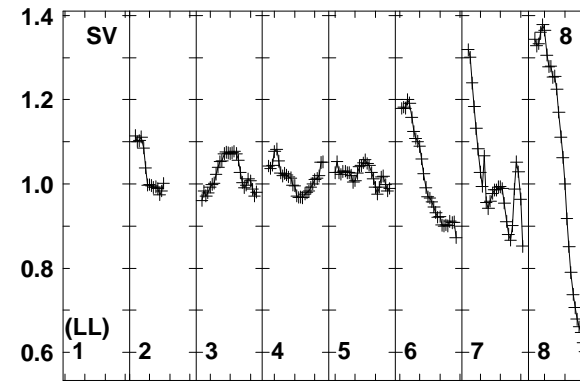
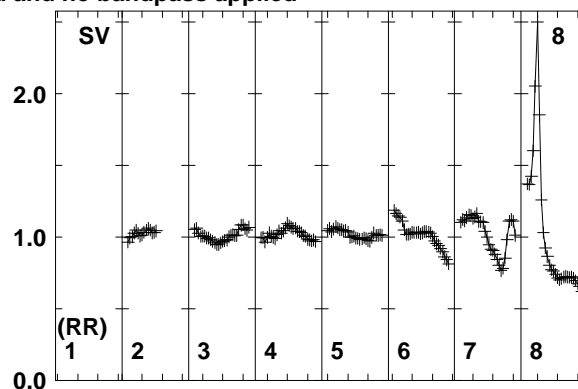
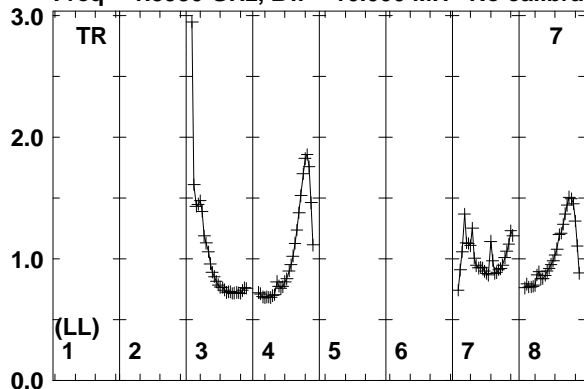

Lower frame: Real Jy
Total-power spectrum Antenna: TR (07)
Timerange: 00/08:04:41 to 00/08:08:29

Plot file version 115 created 20-MAR-2014 17:08:02

J1317+3425 ER030C.UVDATA.1

Freq = 1.5950 GHz, Bw = 16.000 MH No calibration applied and no bandpass applied

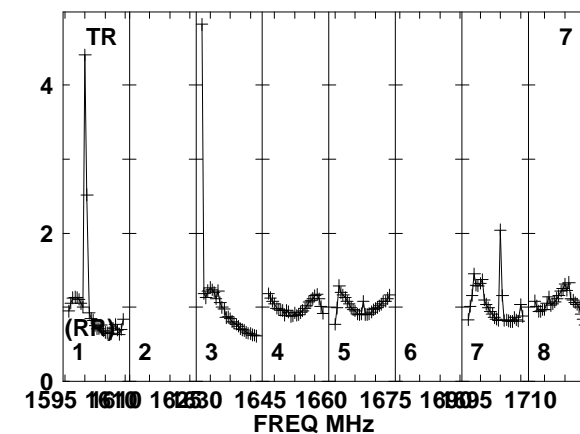
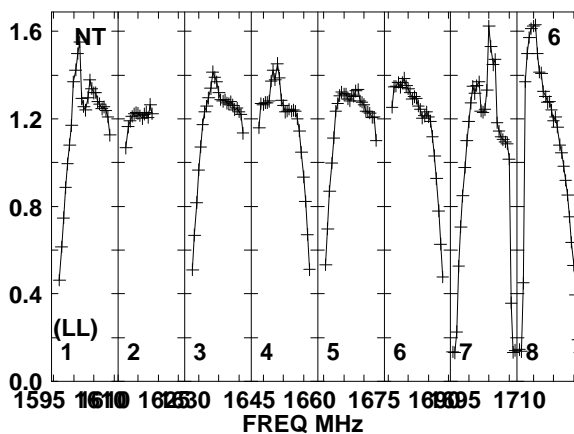
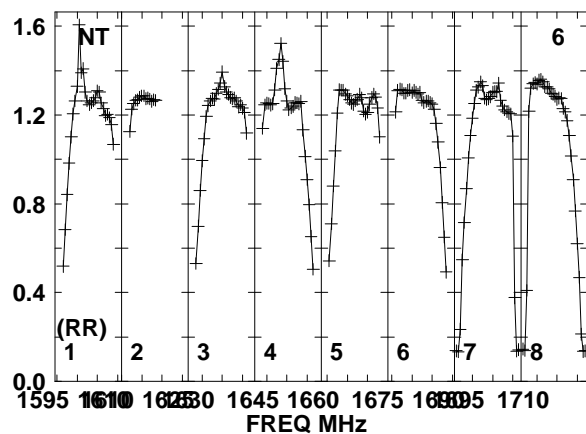
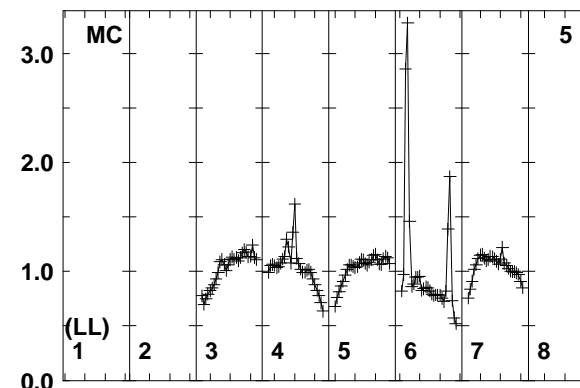
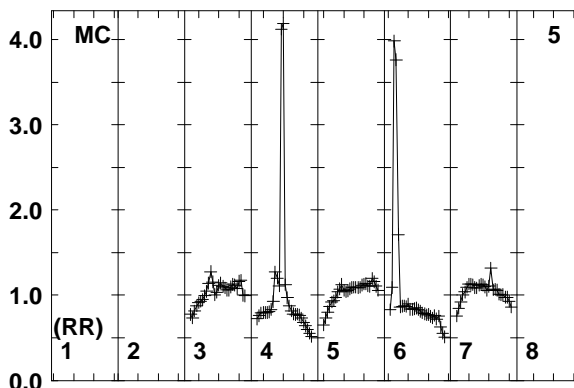
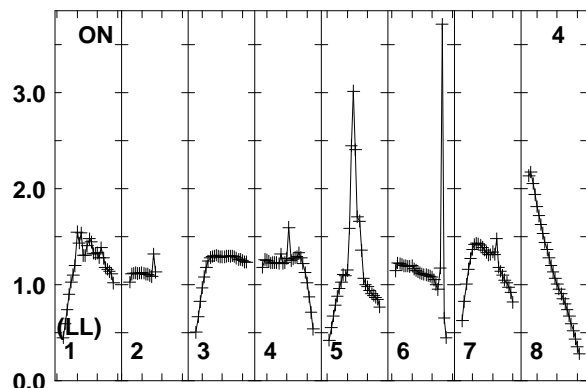
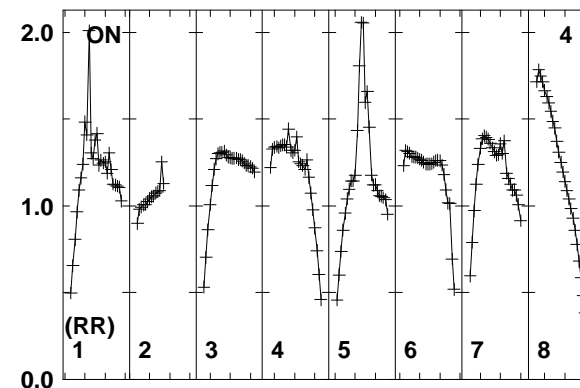
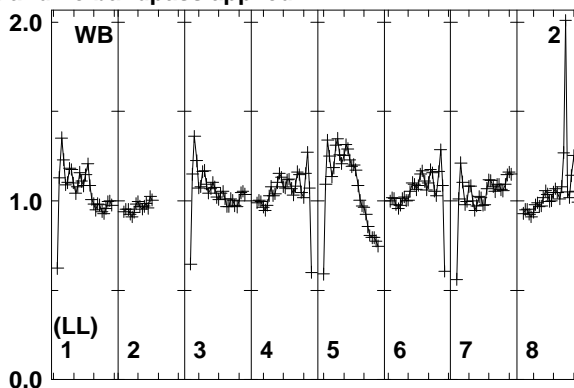
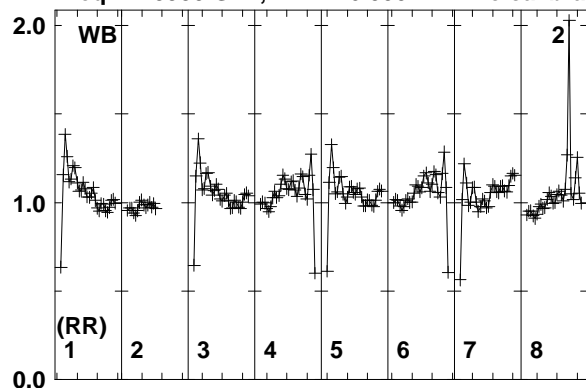

Lower frame: Real Jy
Total-power spectrum Antenna: WB (02)
Timerange: 00/08:09:11 to 00/08:10:09

Plot file version 116 created 20-MAR-2014 17:08:02

J1317+3425 ER030C.UVDATA.1

Freq = 1.5950 GHz, Bw = 16.000 MH No calibration applied and no bandpass applied

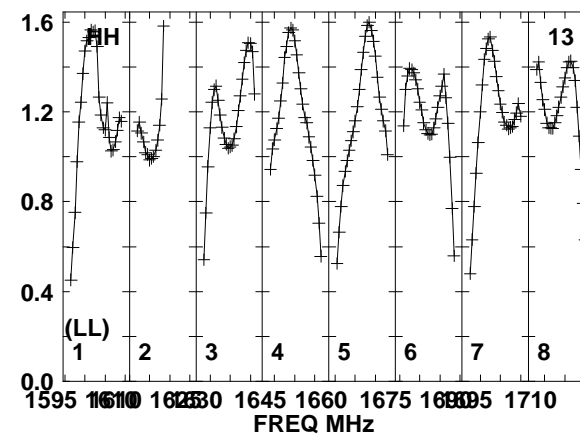
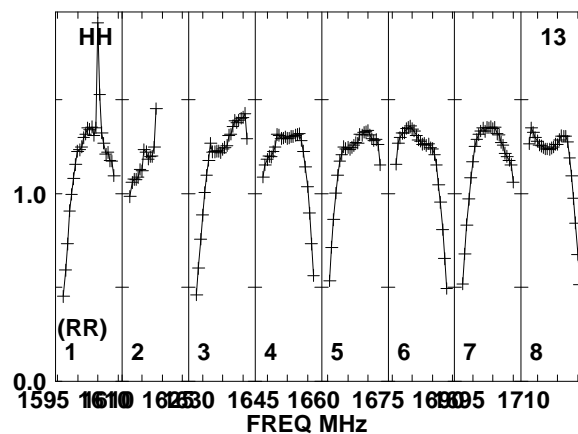
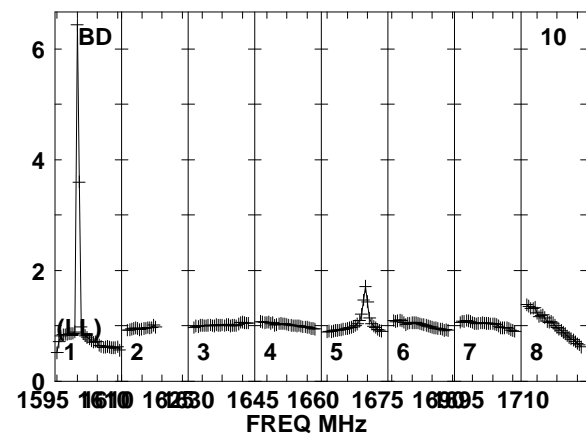
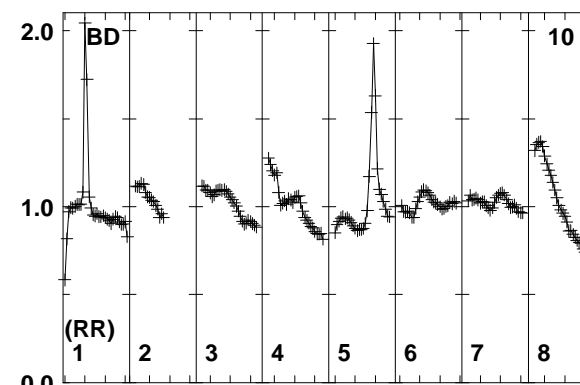
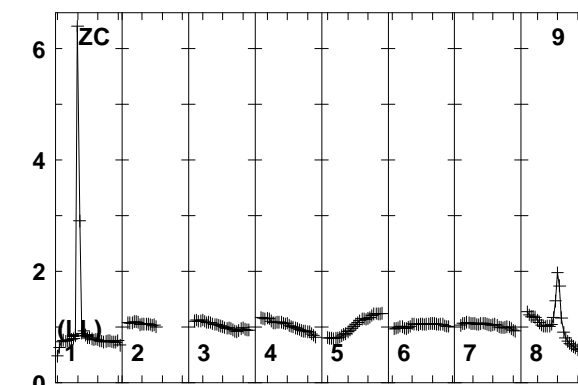
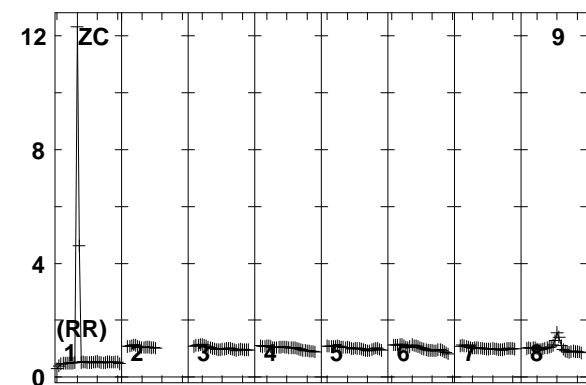
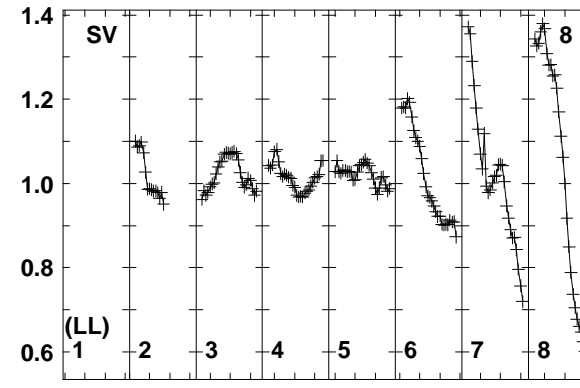
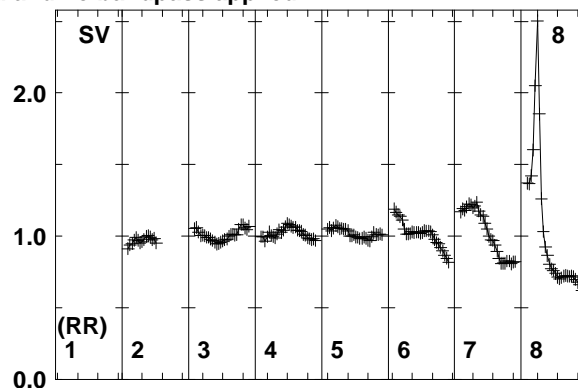
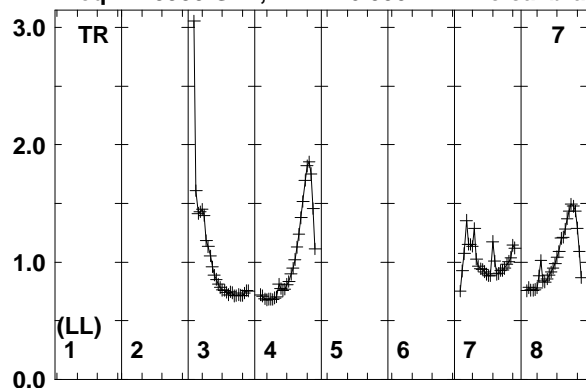

Lower frame: Real Jy
Total-power spectrum Antenna: TR (07)
Timerange: 00/08:09:11 to 00/08:10:09

Plot file version 117 created 20-MAR-2014 17:08:02

IC883 ER030C.UVDATA.1

Freq = 1.5950 GHz, Bw = 16.000 MH No calibration applied and no bandpass applied

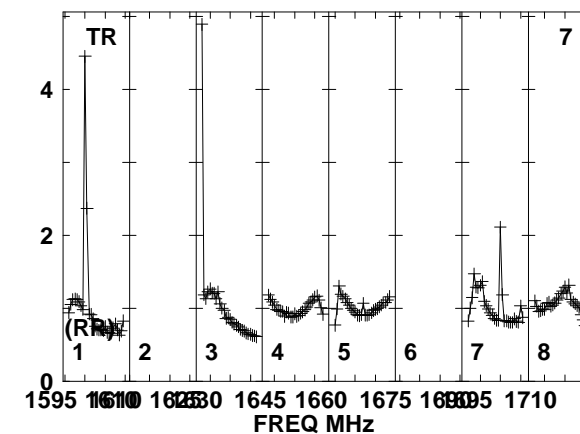
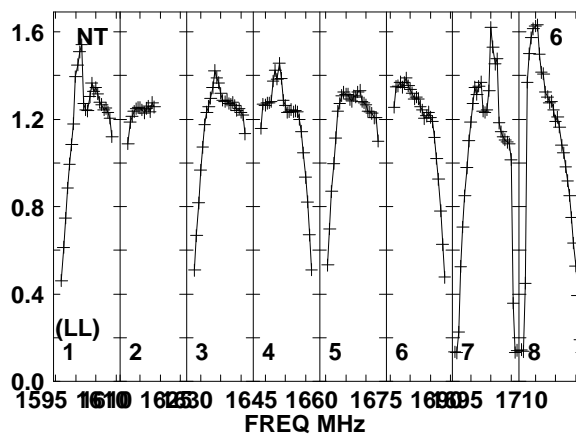
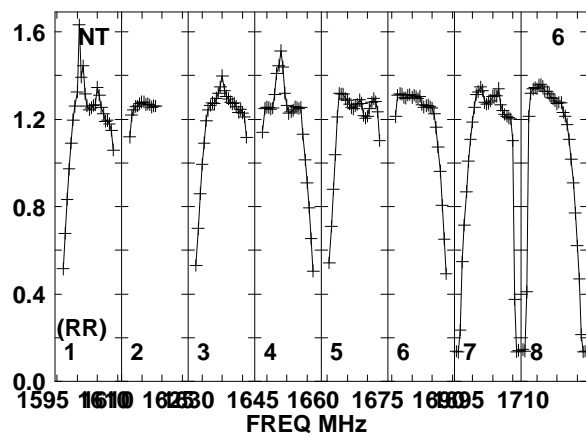
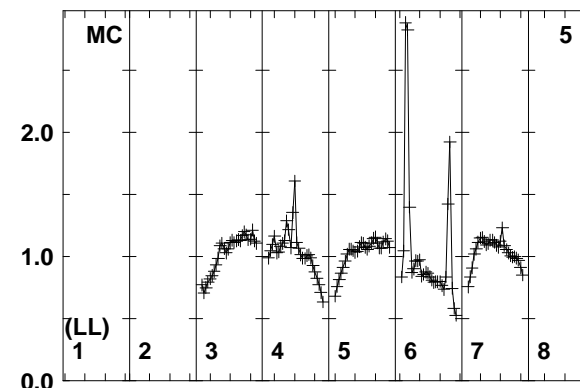
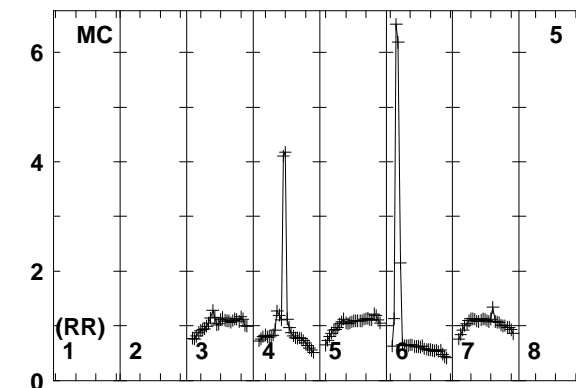
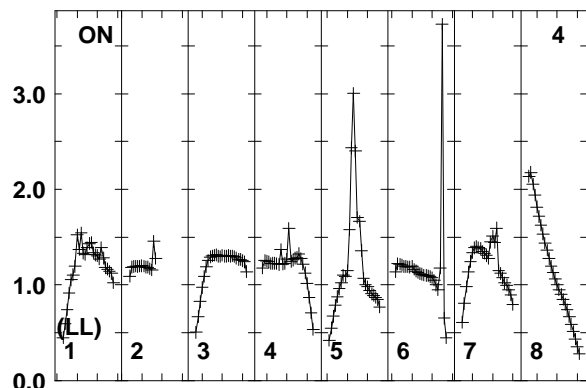
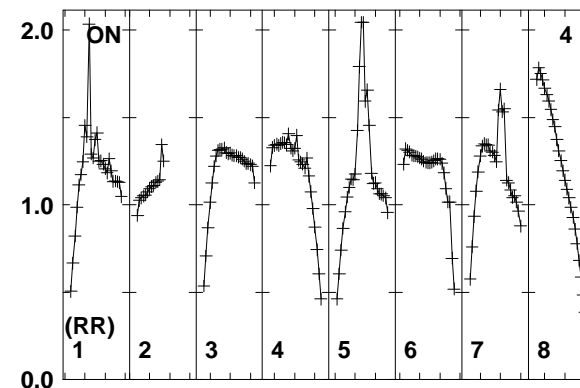
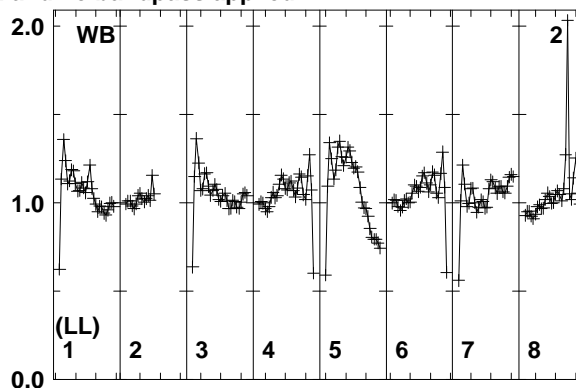
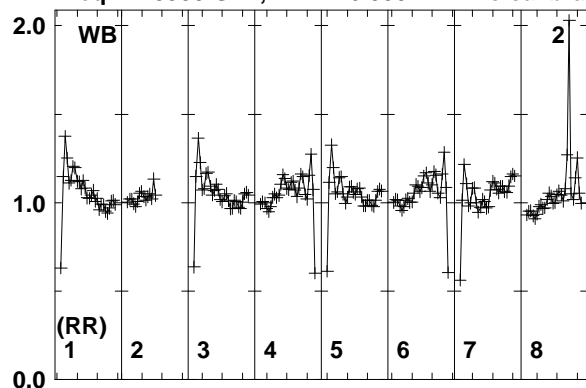

Lower frame: Real Jy
Total-power spectrum Antenna: WB (02)
Timerange: 00/08:10:13 to 00/08:13:59

Plot file version 118 created 20-MAR-2014 17:08:02

IC883 ER030C.UVDATA.1

Freq = 1.5950 GHz, Bw = 16.000 MH No calibration applied and no bandpass applied

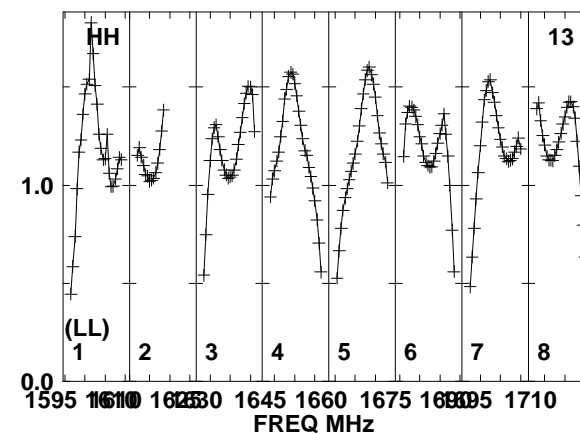
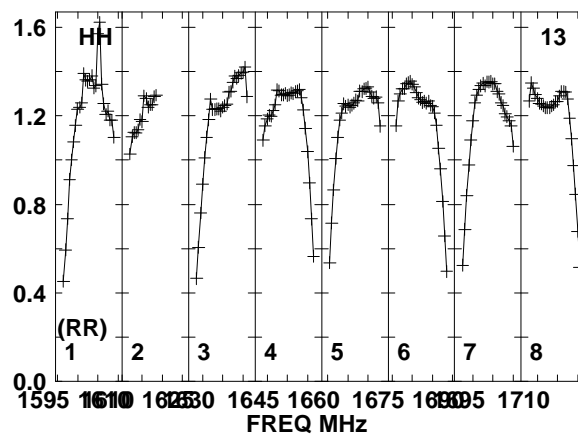
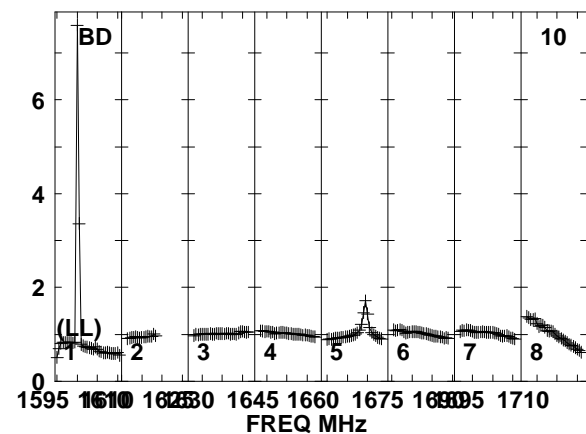
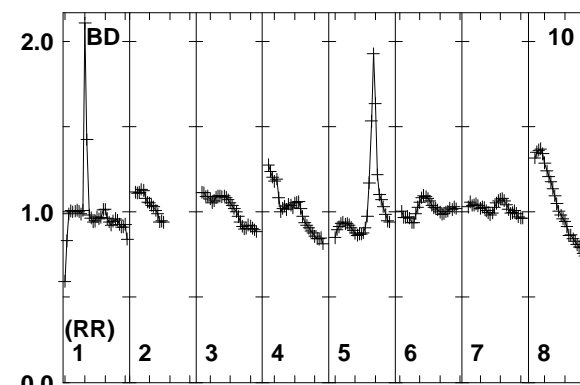
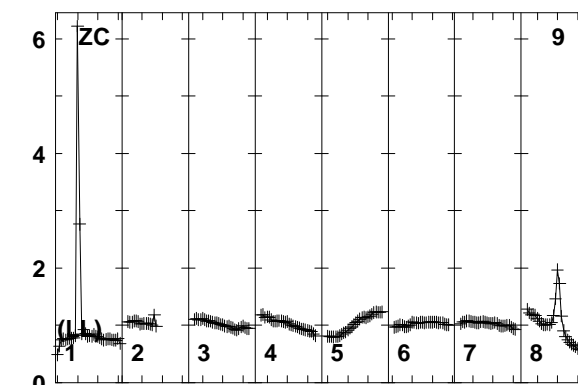
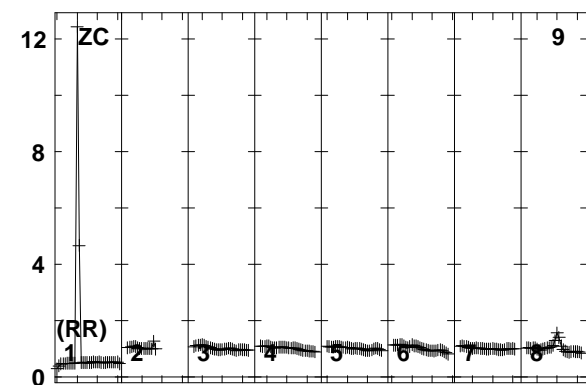
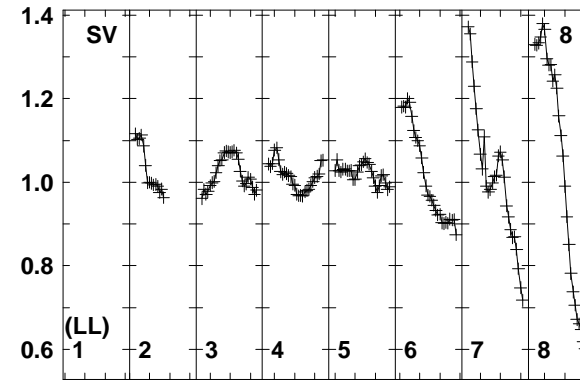
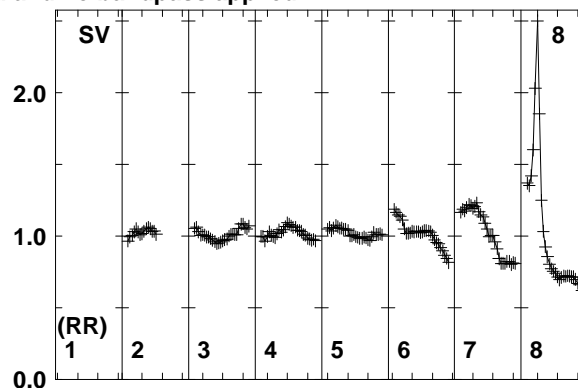
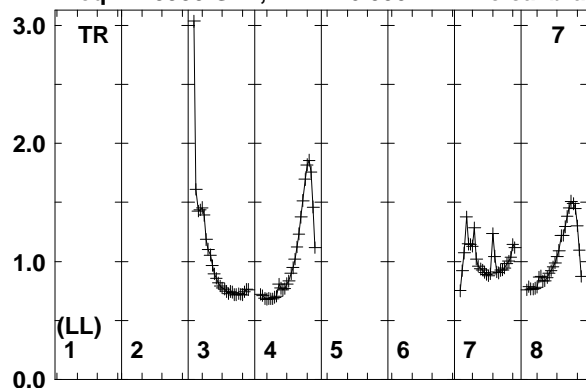

Lower frame: Real Jy
Total-power spectrum Antenna: TR (07)
Timerange: 00/08:10:13 to 00/08:13:59

Plot file version 119 created 20-MAR-2014 17:08:02

J1317+3425 ER030C.UVDATA.1

Freq = 1.5950 GHz, Bw = 16.000 MH No calibration applied and no bandpass applied

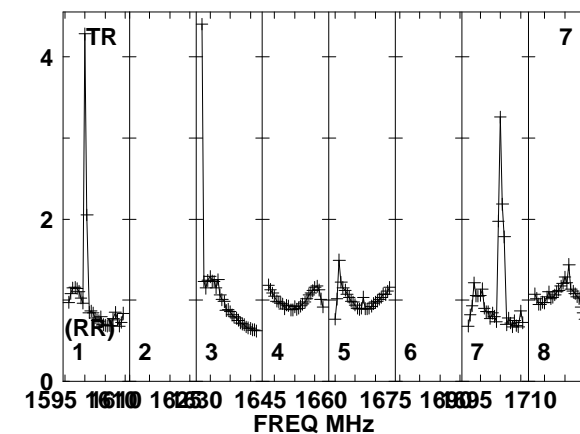
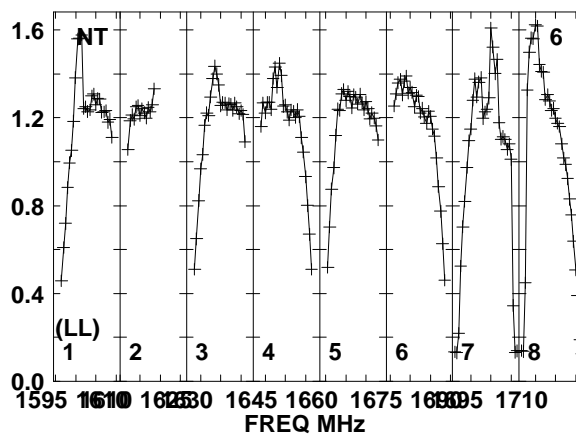
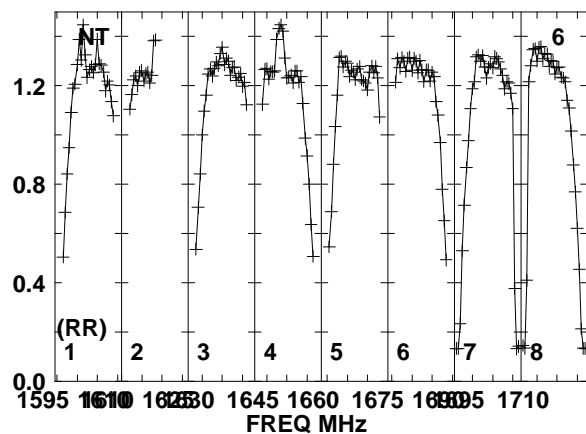
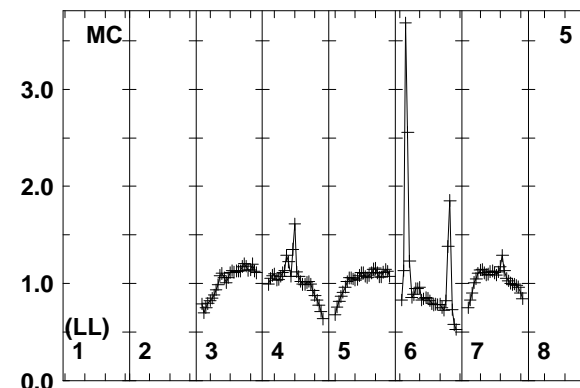
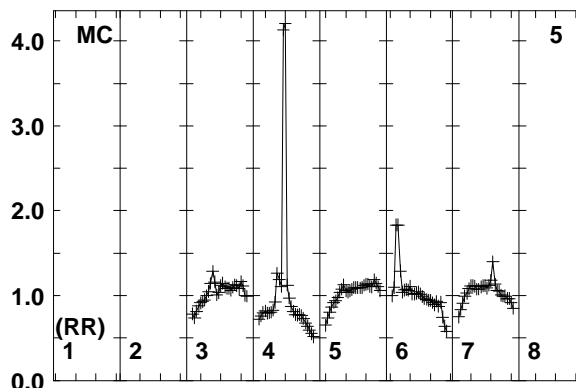
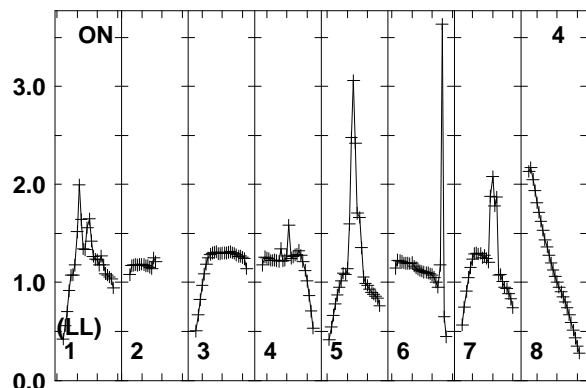
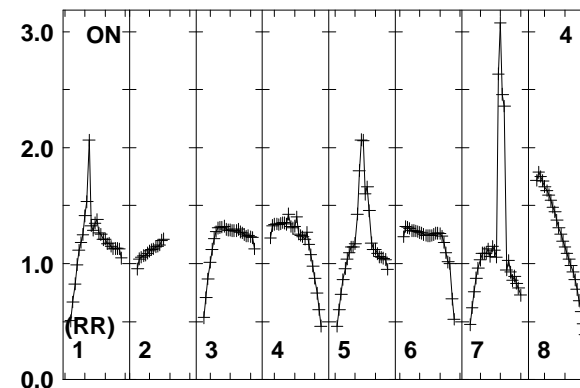
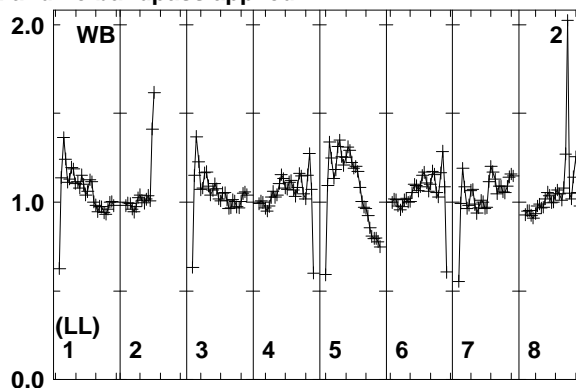
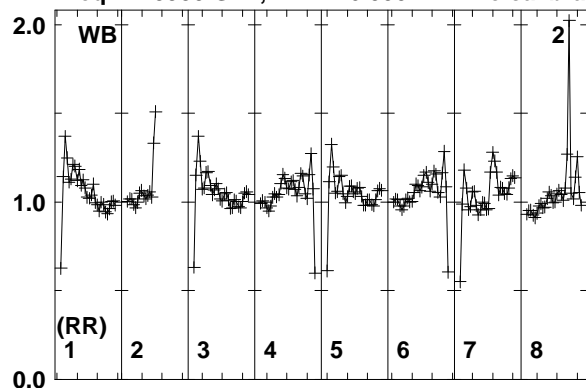

Lower frame: Real Jy
Total-power spectrum Antenna: WB (02)
Timerange: 00/08:14:03 to 00/08:15:19

Plot file version 120 created 20-MAR-2014 17:08:02

J1317+3425 ER030C.UVDATA.1

Freq = 1.5950 GHz, Bw = 16.000 MH No calibration applied and no bandpass applied

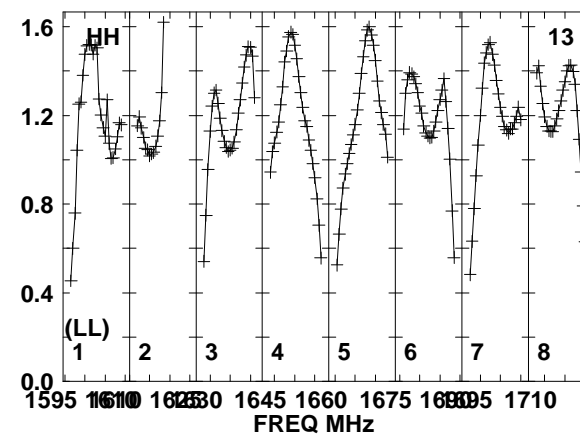
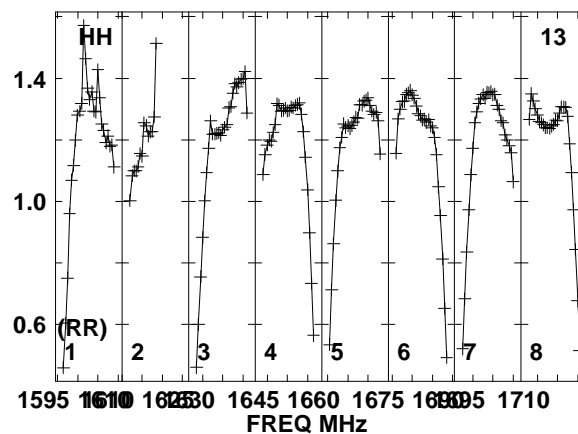
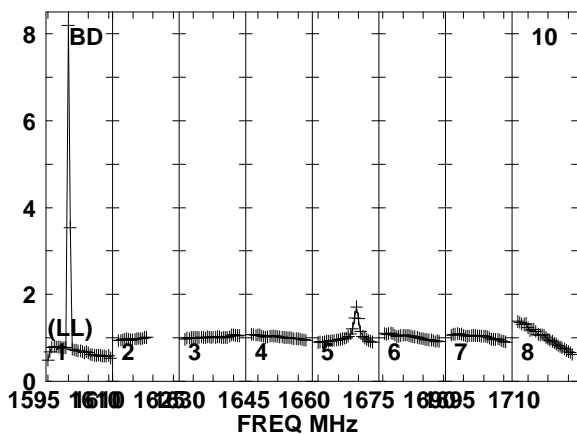
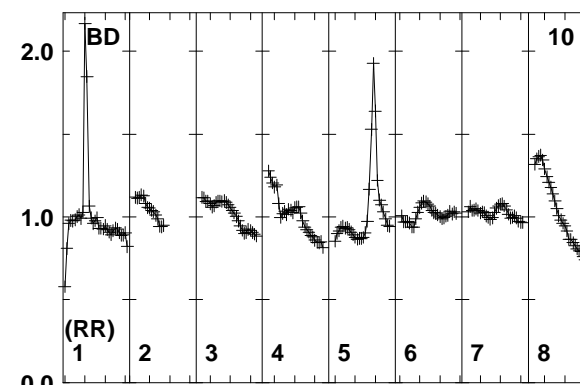
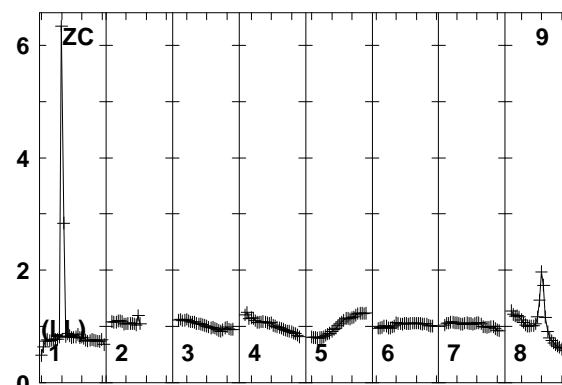
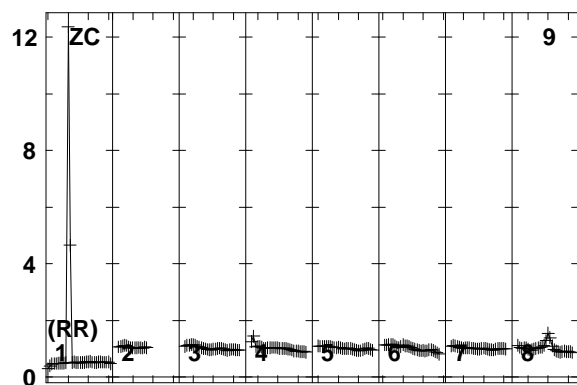
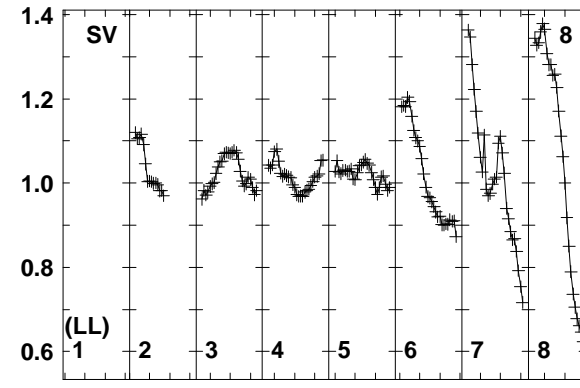
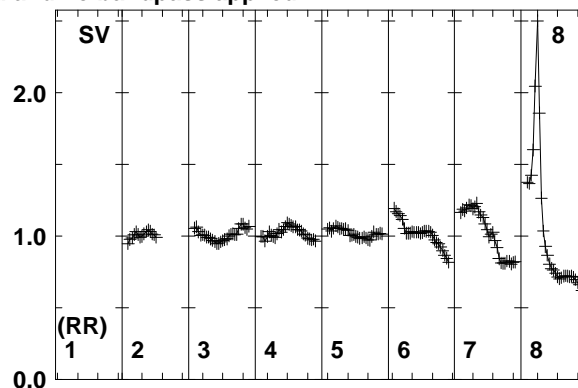
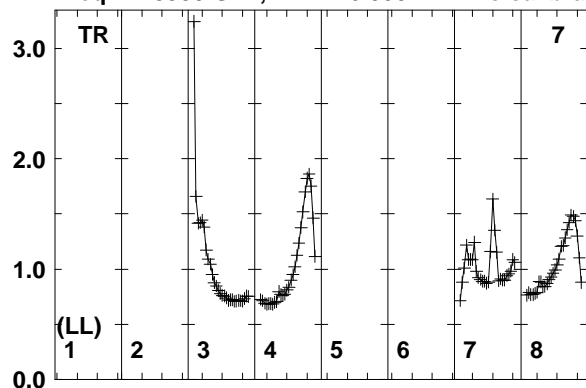

Lower frame: Real Jy
Total-power spectrum Antenna: TR (07)
Timerange: 00/08:14:03 to 00/08:15:19

Plot file version 121 created 20-MAR-2014 17:08:02

IC883 ER030C.UVDATA.1

Freq = 1.5950 GHz, Bw = 16.000 MH No calibration applied and no bandpass applied

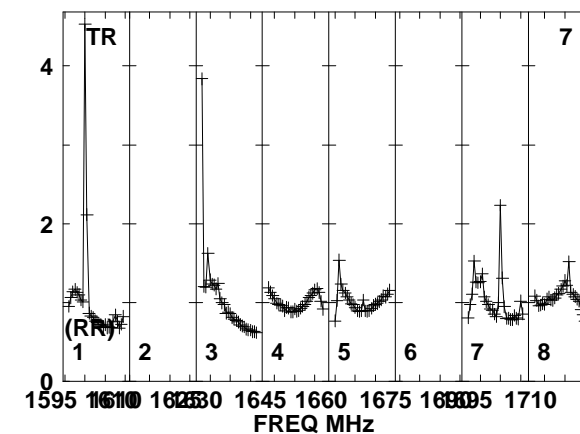
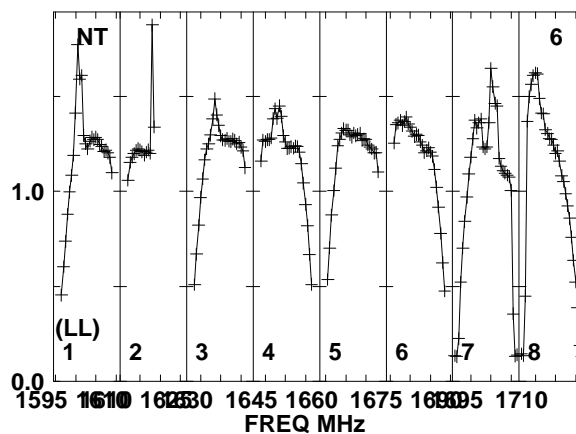
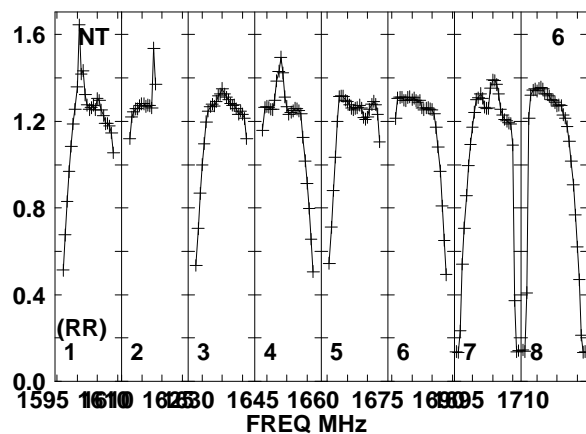
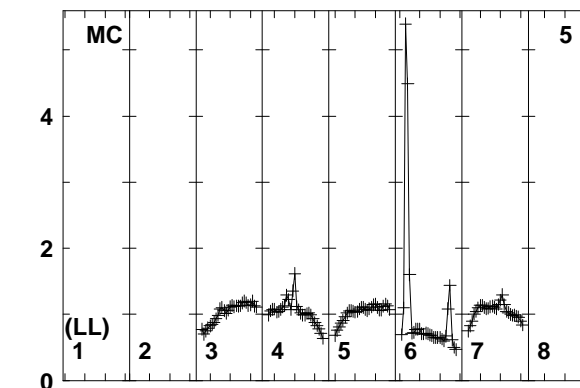
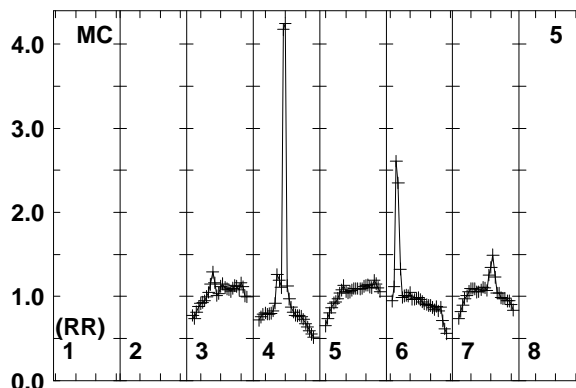
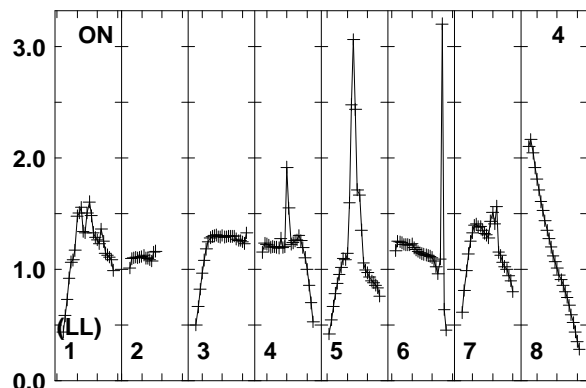
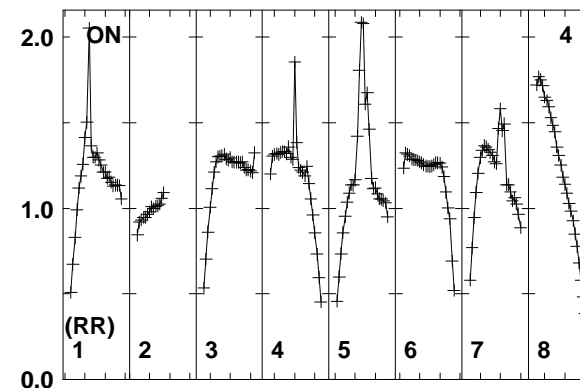
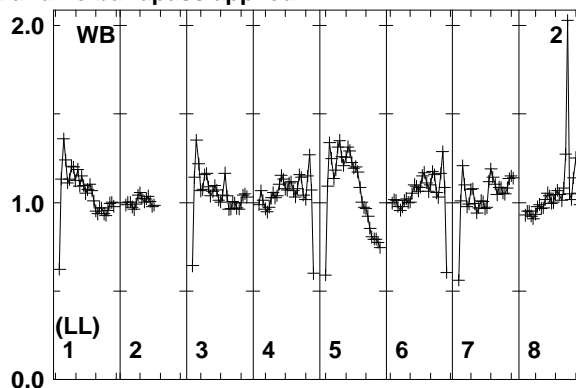
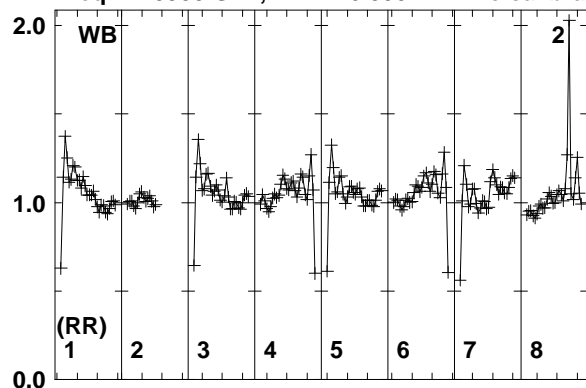

Lower frame: Real Jy
Total-power spectrum Antenna: WB (02)
Timerange: 00/08:15:21 to 00/08:19:09

Plot file version 122 created 20-MAR-2014 17:08:02

IC883 ER030C.UVDATA.1

Freq = 1.5950 GHz, Bw = 16.000 MH No calibration applied and no bandpass applied

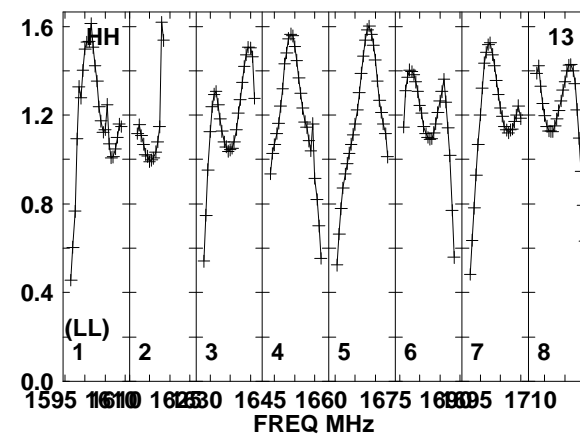
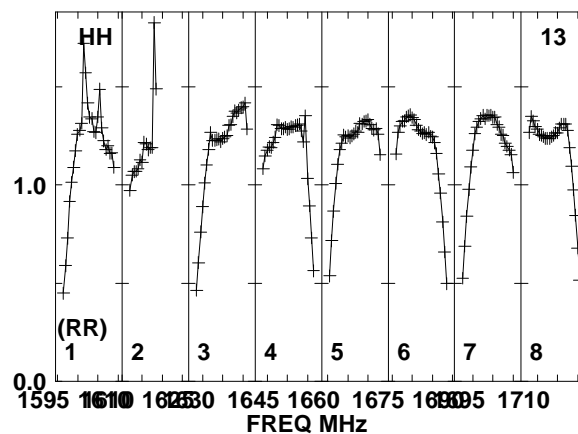
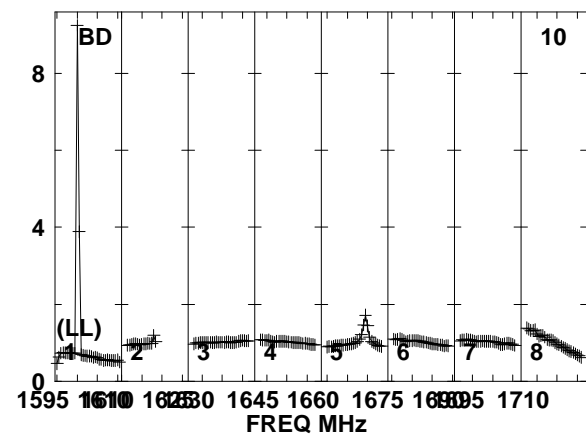
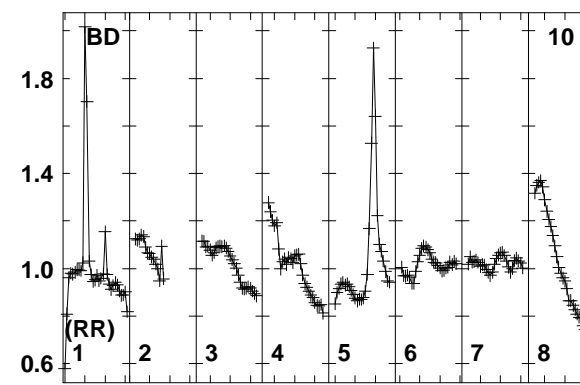
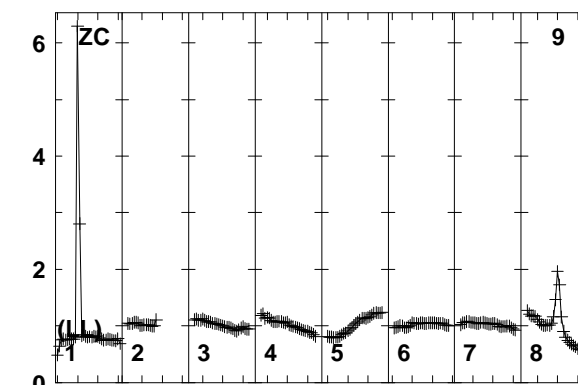
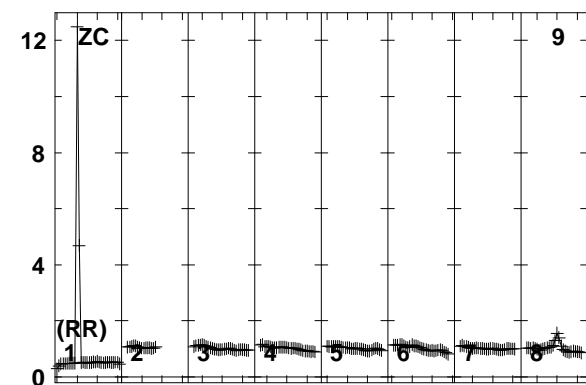
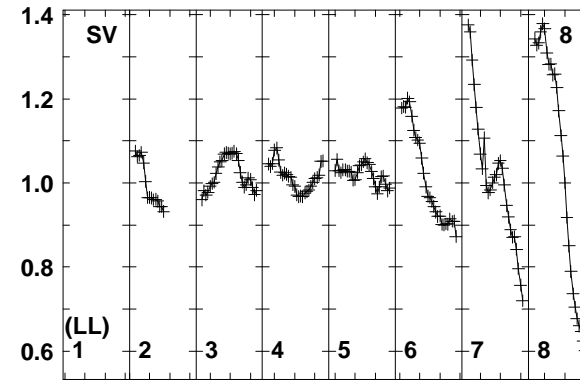
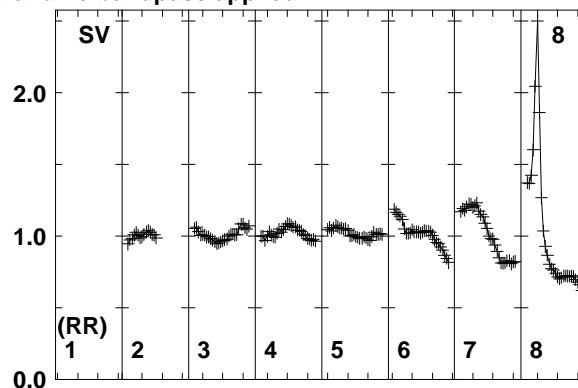
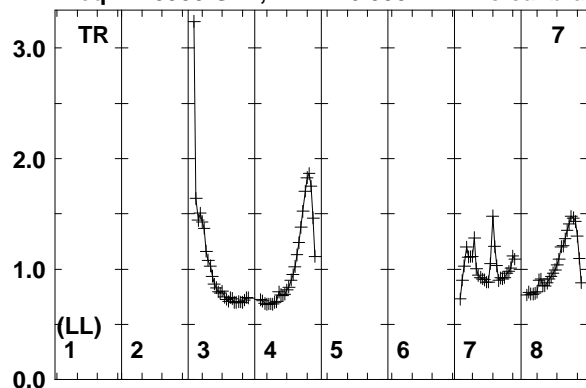

Lower frame: Real Jy
Total-power spectrum Antenna: TR (07)
Timerange: 00/08:15:21 to 00/08:19:09

Plot file version 123 created 20-MAR-2014 17:08:03

J1317+3425 ER030C.UVDATA.1

Freq = 1.5950 GHz, Bw = 16.000 MH No calibration applied and no bandpass applied

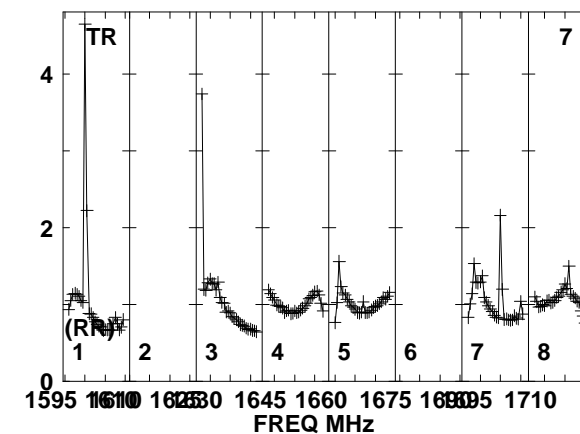
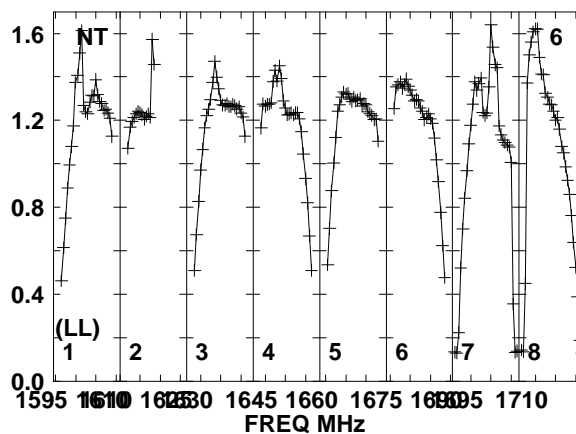
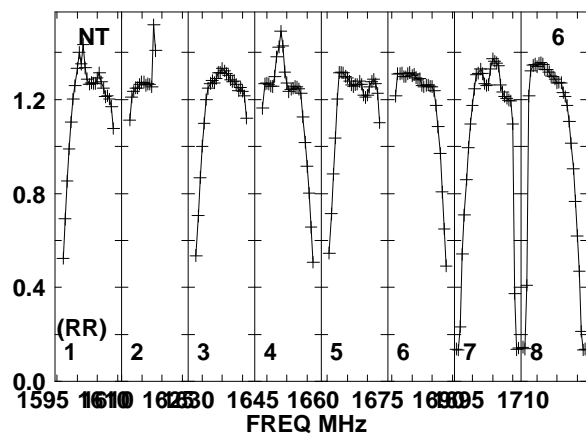
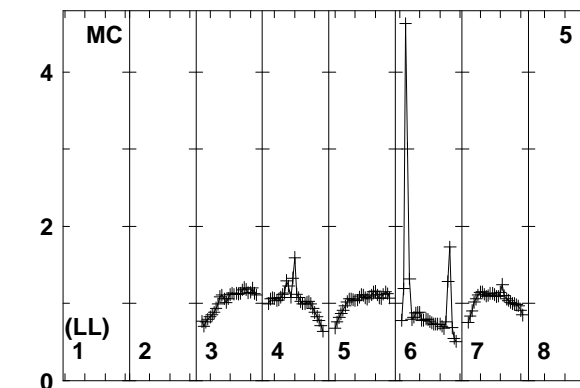
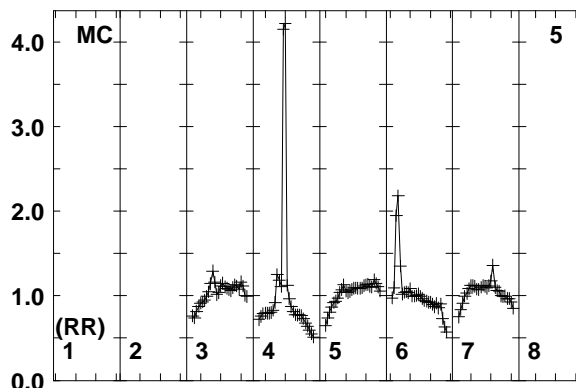
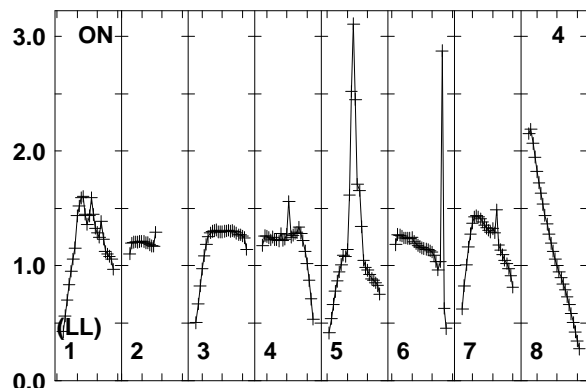
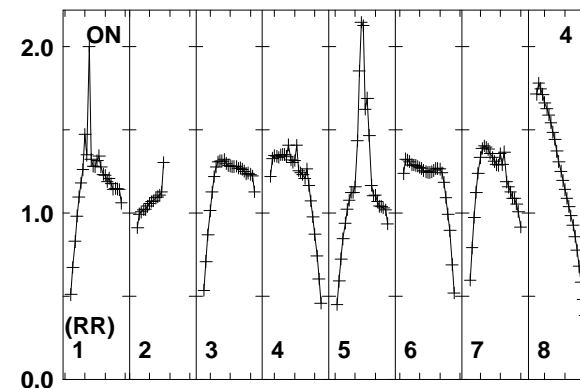
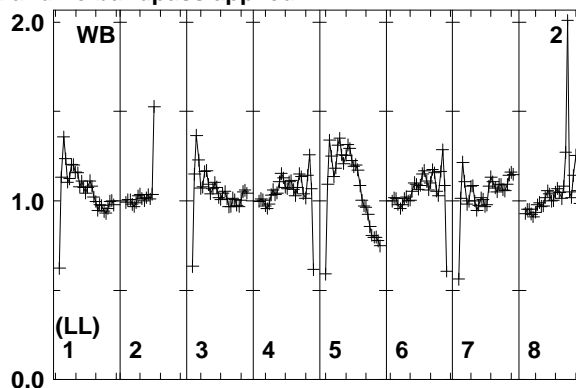
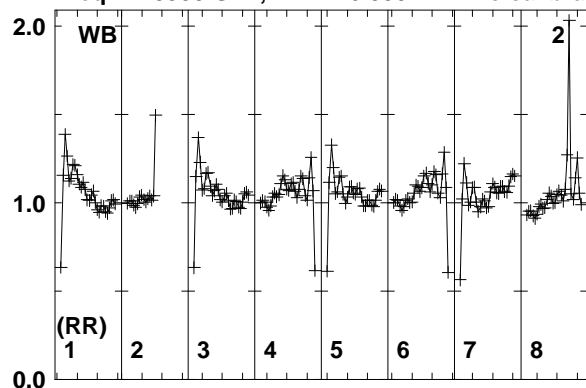

Lower frame: Real Jy
Total-power spectrum Antenna: WB (02)
Timerange: 00/08:19:51 to 00/08:20:49

Plot file version 124 created 20-MAR-2014 17:08:03

J1317+3425 ER030C.UVDATA.1

Freq = 1.5950 GHz, Bw = 16.000 MH No calibration applied and no bandpass applied

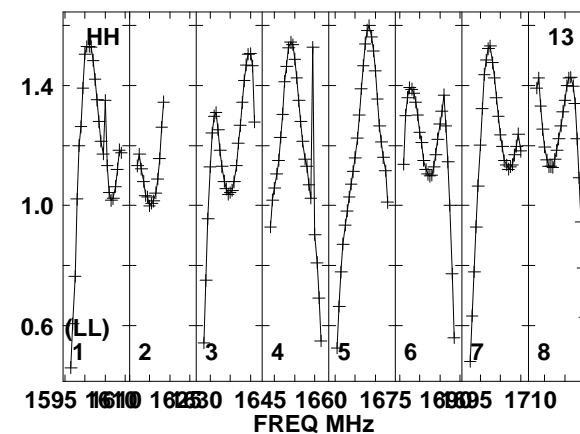
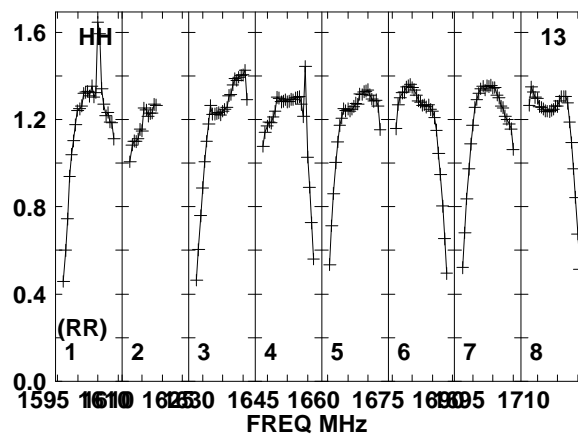
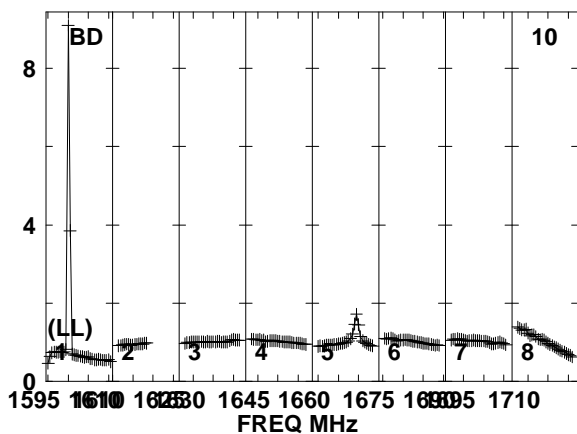
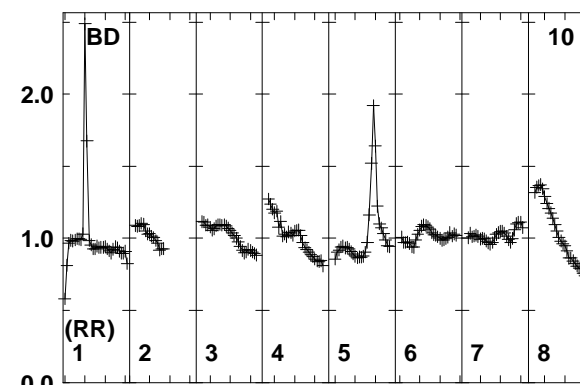
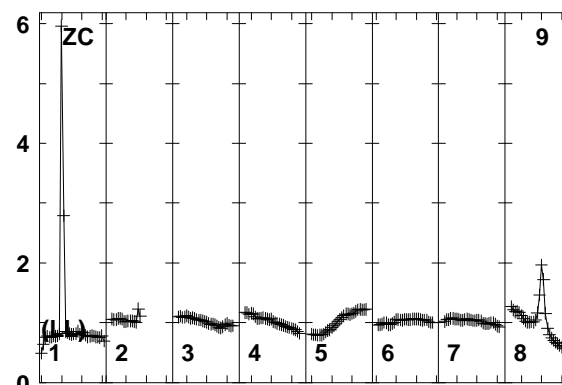
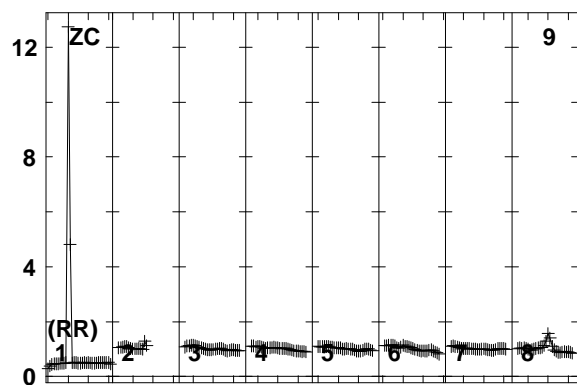
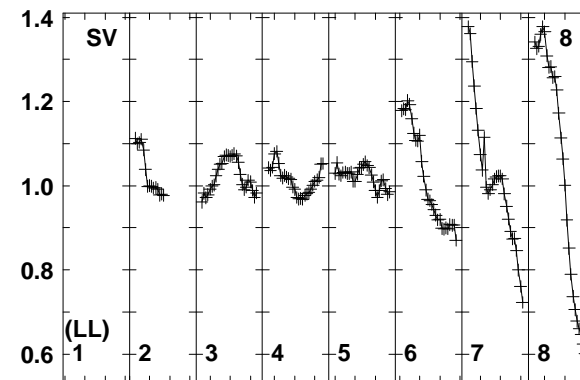
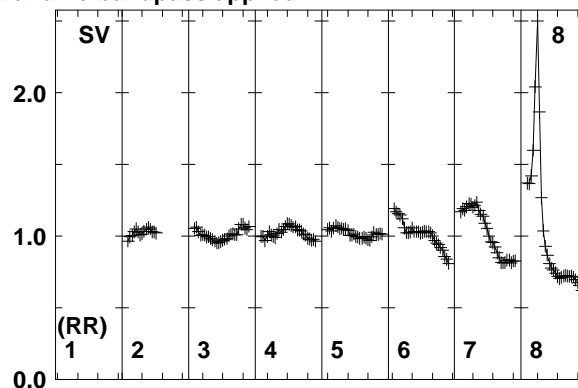
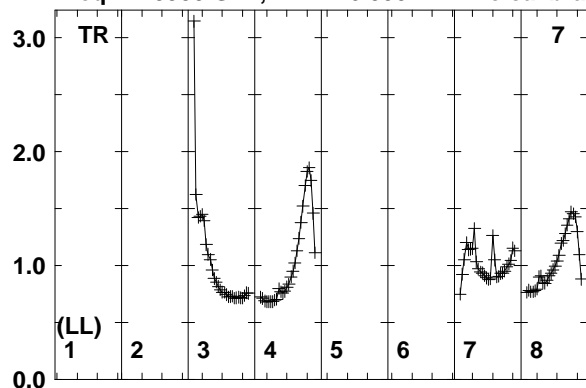

Lower frame: Real Jy
Total-power spectrum Antenna: TR (07)
Timerange: 00/08:19:51 to 00/08:20:49

Plot file version 125 created 20-MAR-2014 17:08:03

IC883 ER030C.UVDATA.1

Freq = 1.5950 GHz, Bw = 16.000 MH No calibration applied and no bandpass applied

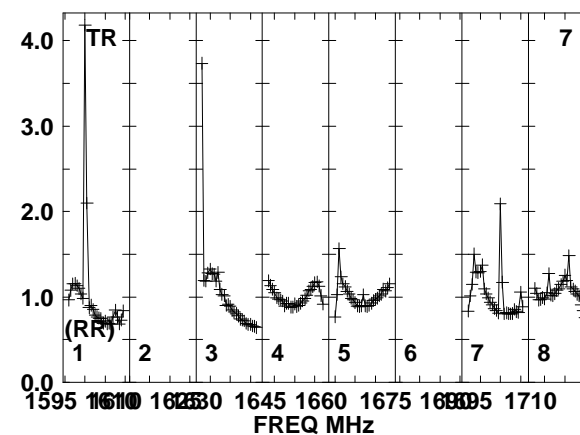
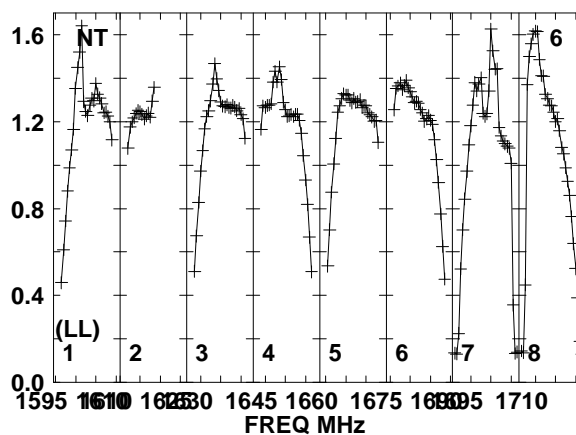
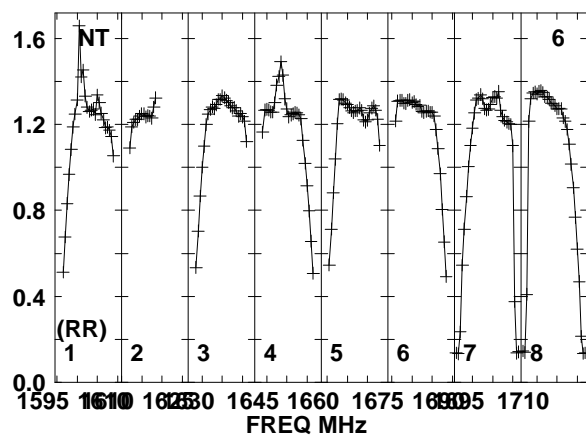
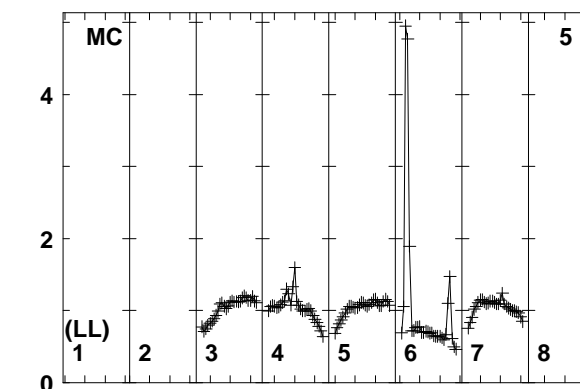
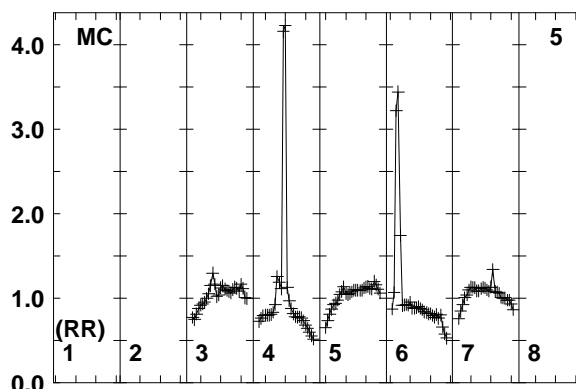
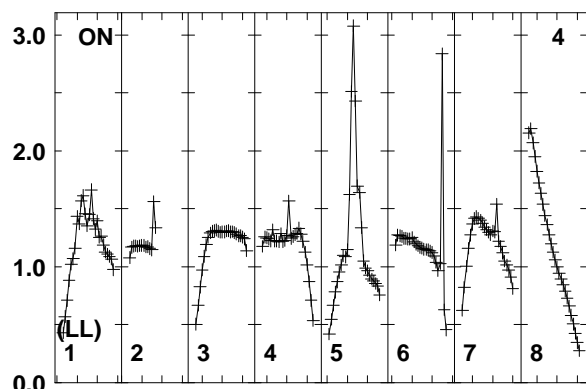
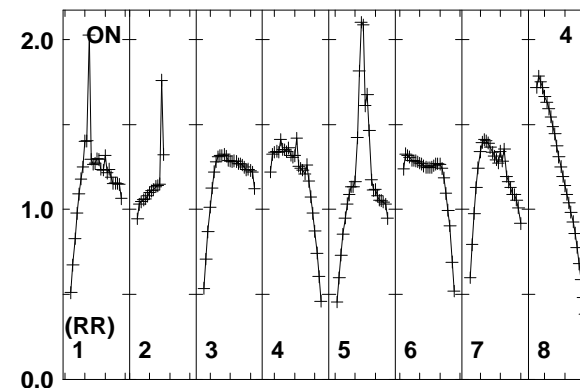
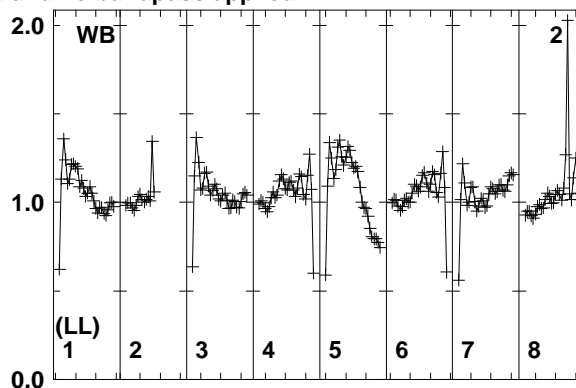
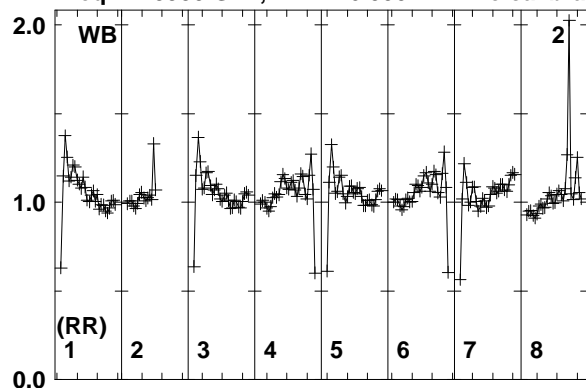

Lower frame: Real Jy
Total-power spectrum Antenna: WB (02)
Timerange: 00/08:20:53 to 00/08:24:39

Plot file version 126 created 20-MAR-2014 17:08:03

IC883 ER030C.UVDATA.1

Freq = 1.5950 GHz, Bw = 16.000 MH No calibration applied and no bandpass applied

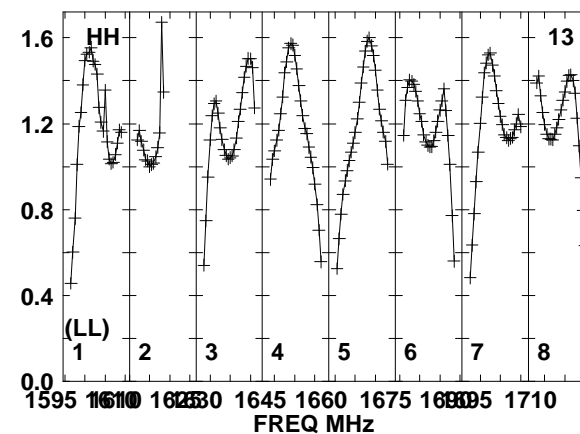
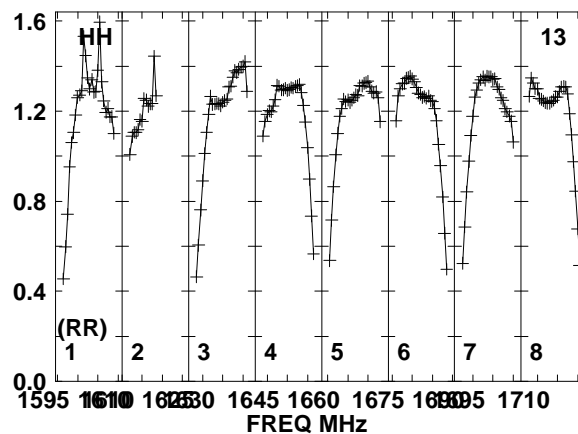
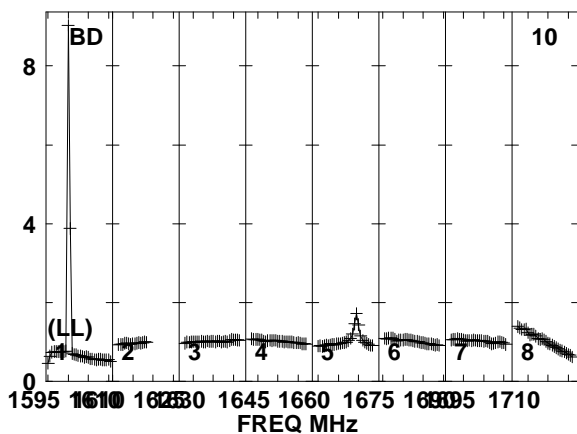
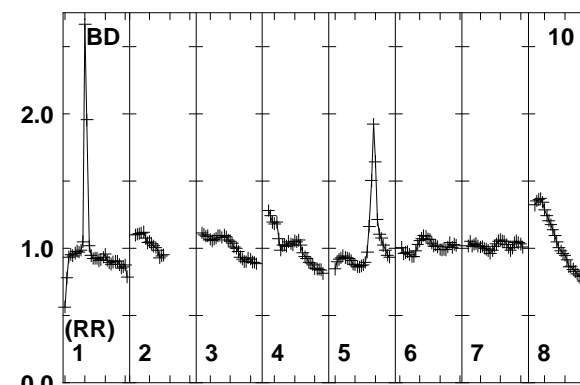
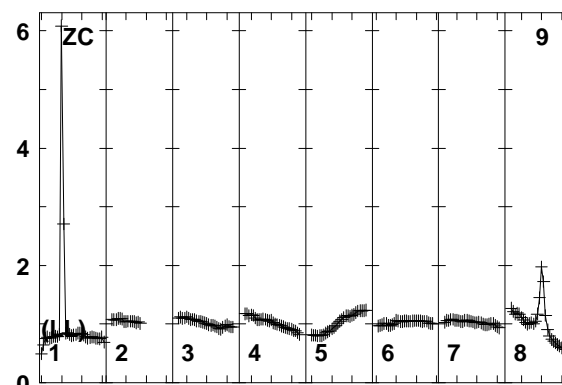
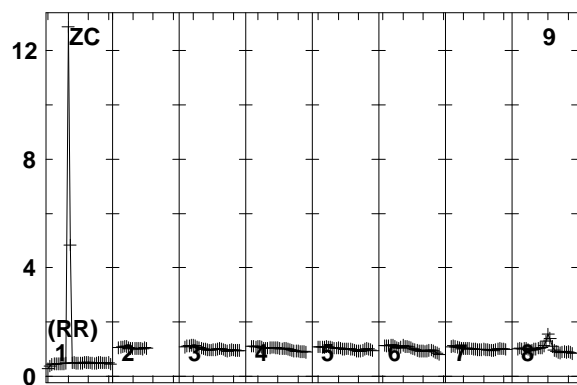
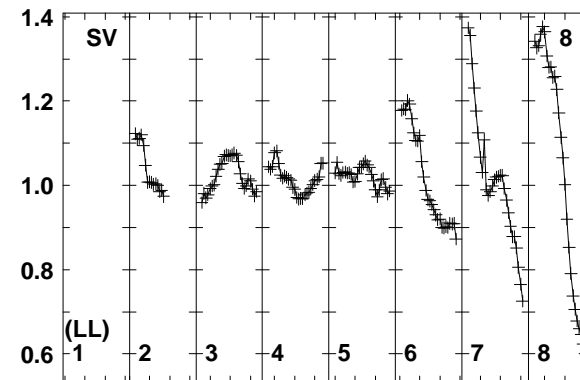
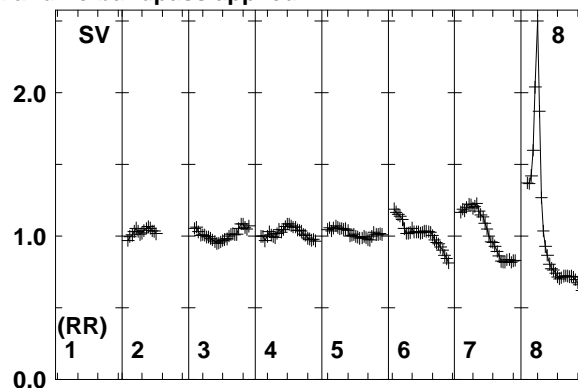
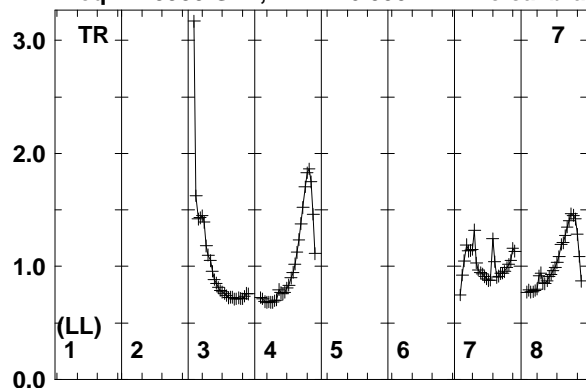

Lower frame: Real Jy
Total-power spectrum Antenna: TR (07)
Timerange: 00/08:20:53 to 00/08:24:39

Plot file version 127 created 20-MAR-2014 17:08:03

J1317+3425 ER030C.UVDATA.1

Freq = 1.5950 GHz, Bw = 16.000 MH No calibration applied and no bandpass applied

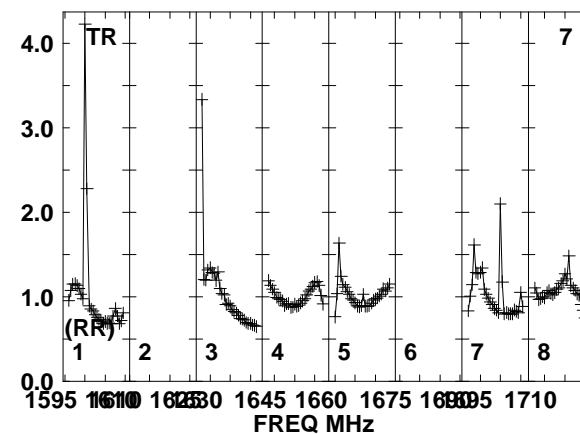
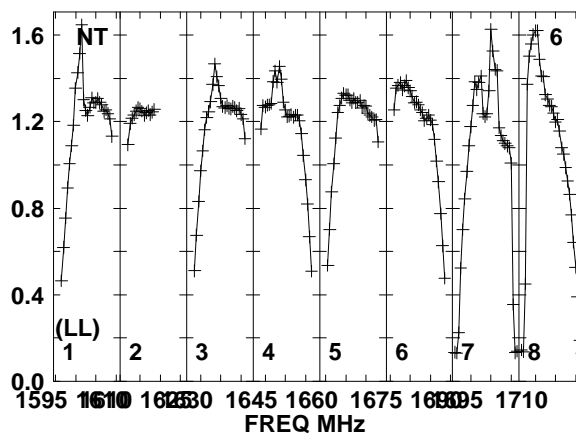
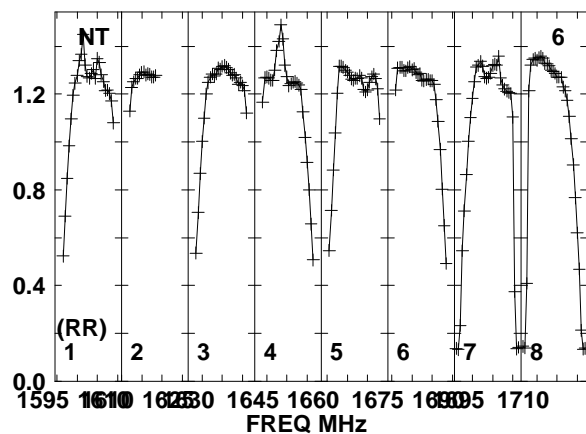
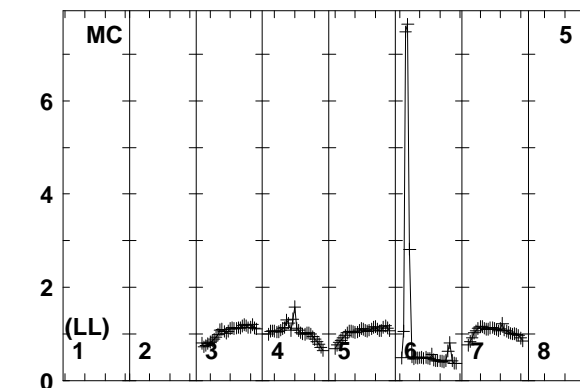
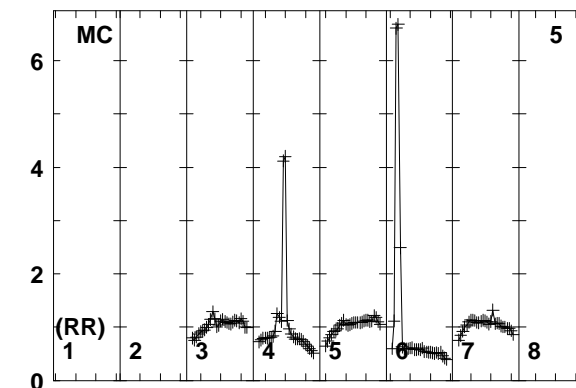
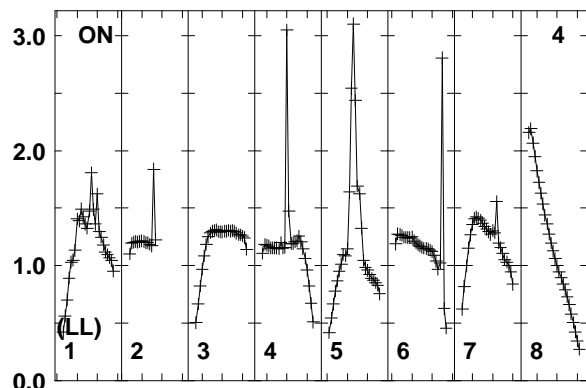
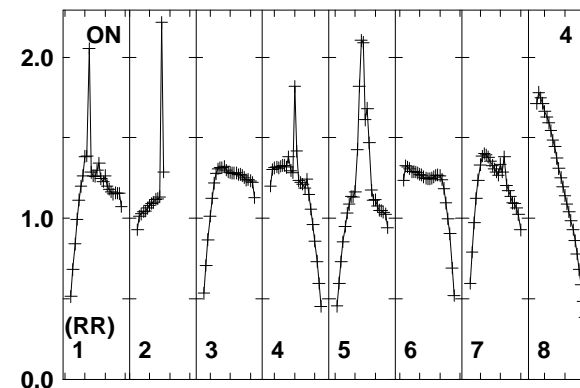
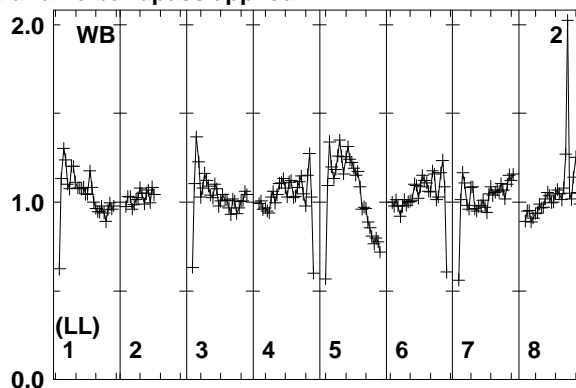
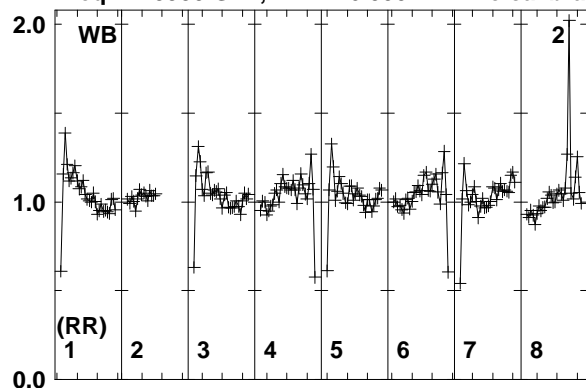

Lower frame: Real Jy
Total-power spectrum Antenna: WB (02)
Timerange: 00/08:24:43 to 00/08:25:59

Plot file version 128 created 20-MAR-2014 17:08:03

J1317+3425 ER030C.UVDATA.1

Freq = 1.5950 GHz, Bw = 16.000 MH No calibration applied and no bandpass applied

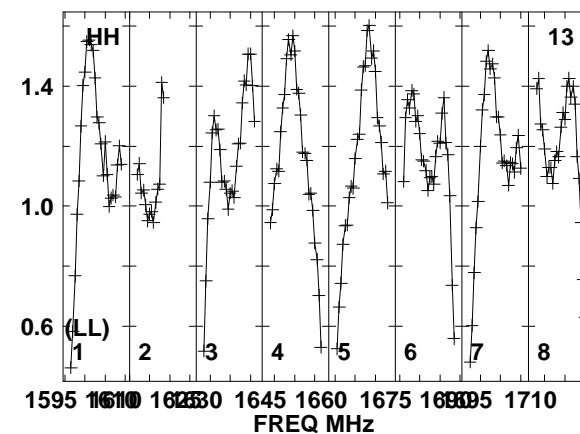
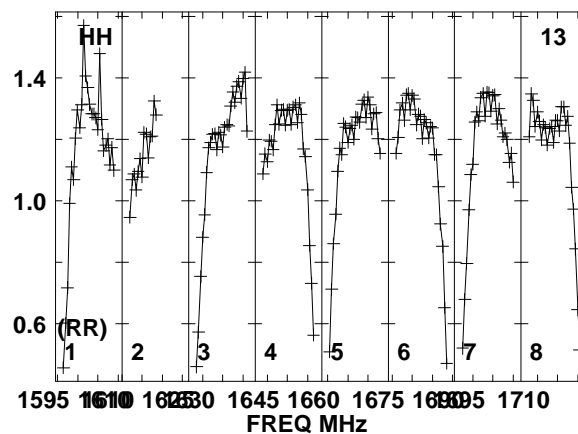
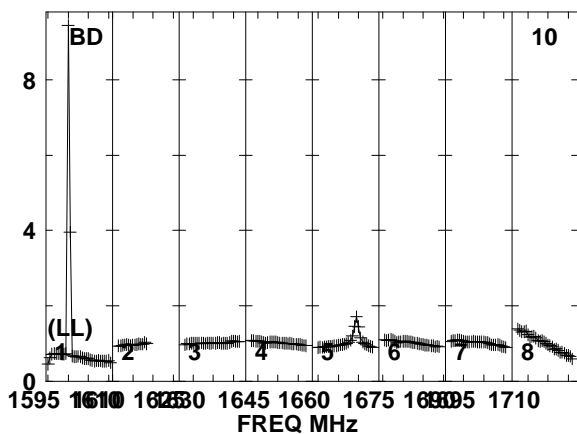
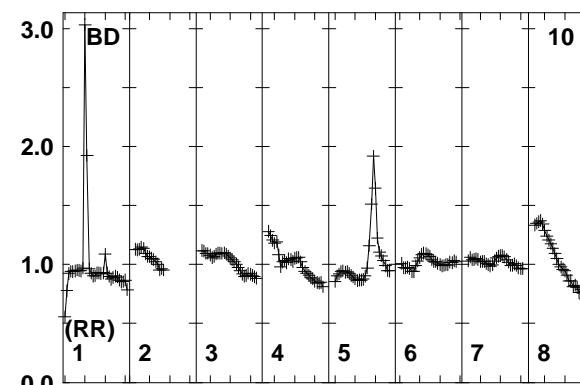
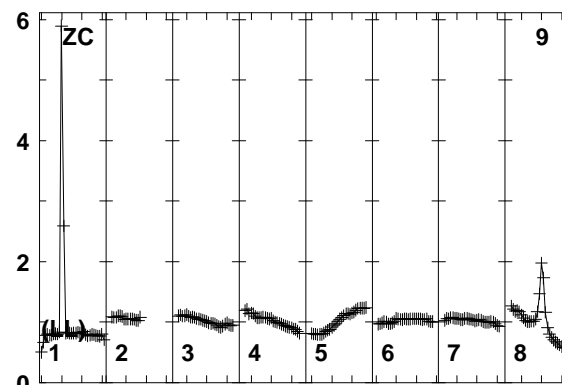
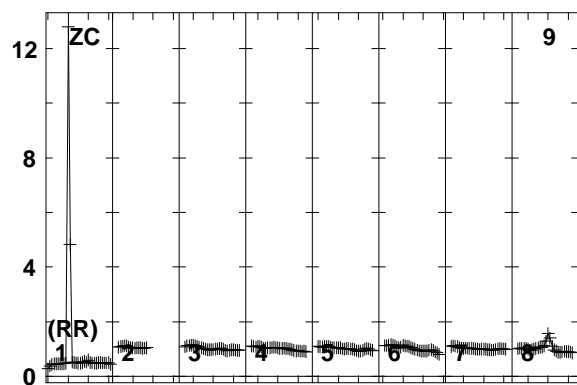
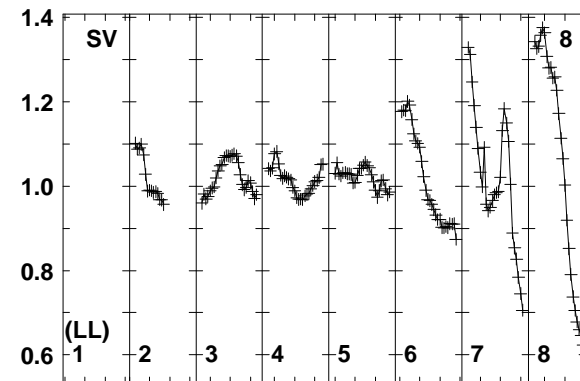
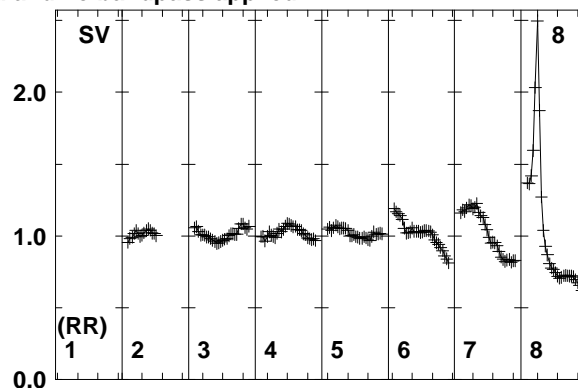
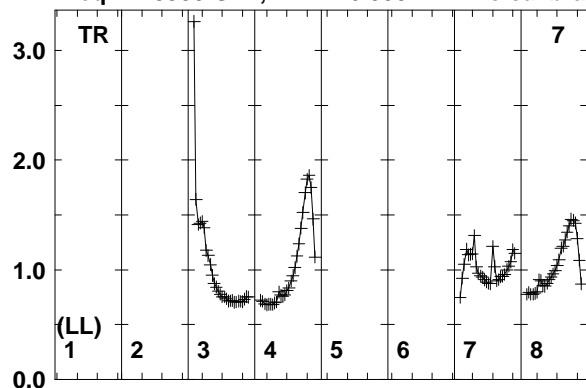

Lower frame: Real Jy
Total-power spectrum Antenna: TR (07)
Timerange: 00/08:24:43 to 00/08:25:59

Plot file version 129 created 20-MAR-2014 17:08:03

IC883 ER030C.UVDATA.1

Freq = 1.5950 GHz, Bw = 16.000 MH No calibration applied and no bandpass applied

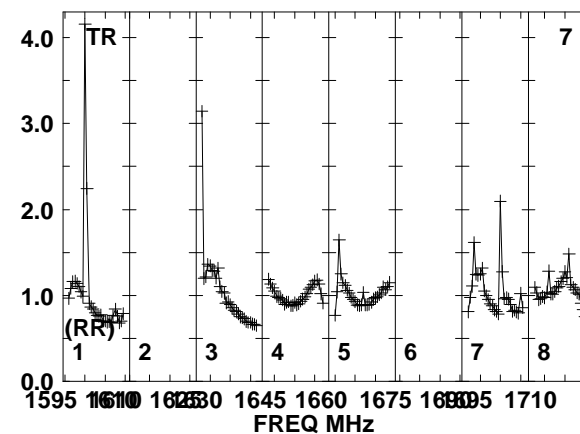
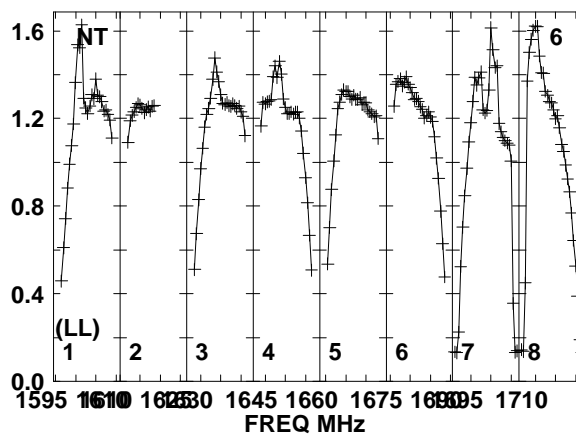
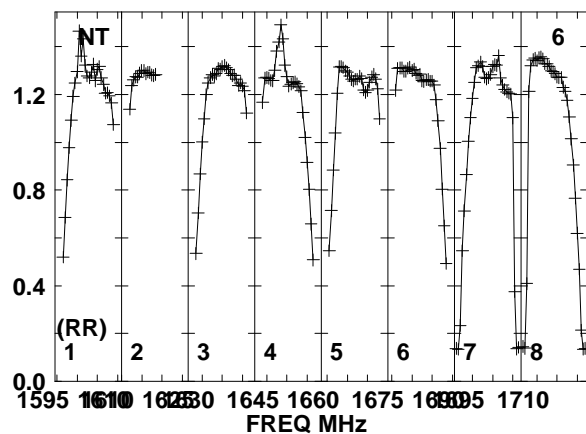
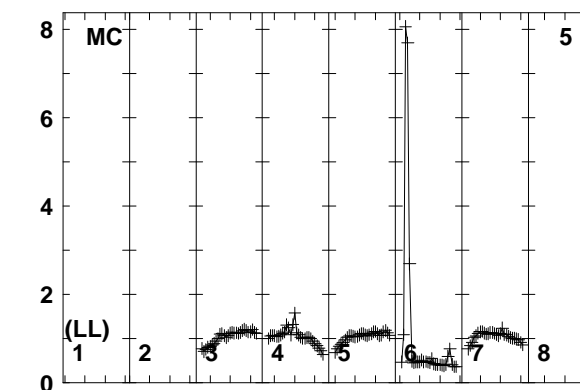
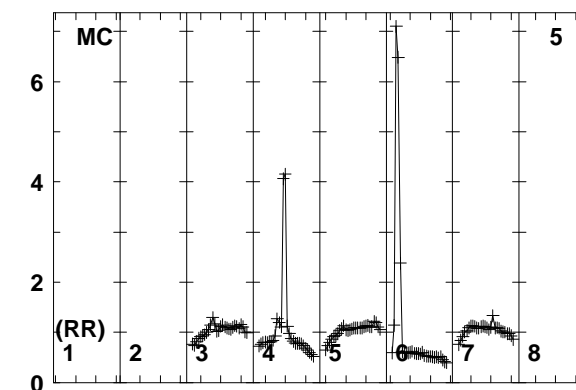
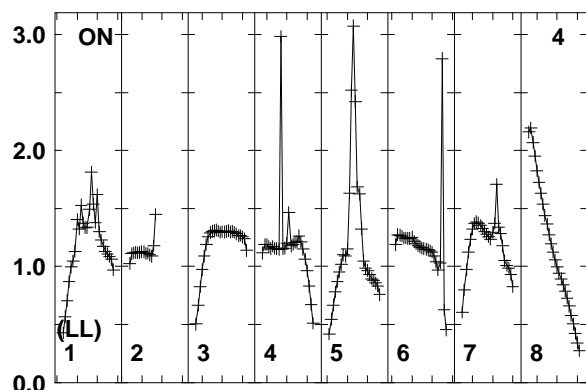
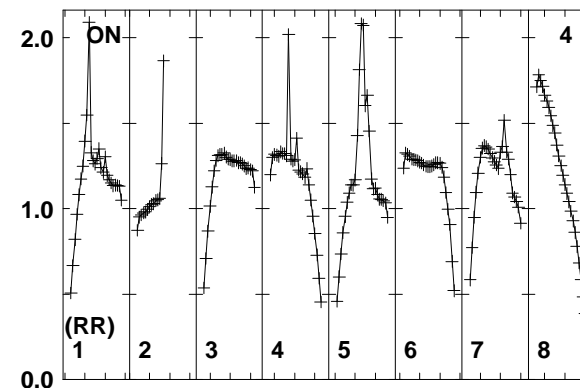
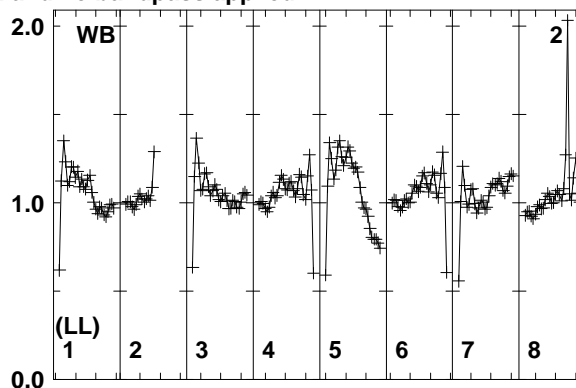
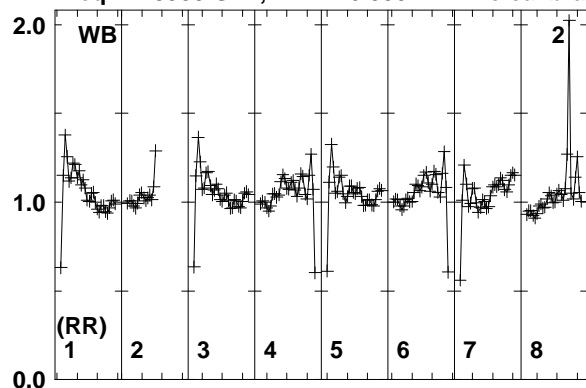

Lower frame: Real Jy
Total-power spectrum Antenna: WB (02)
Timerange: 00/08:26:01 to 00/08:29:49

Plot file version 130 created 20-MAR-2014 17:08:03

IC883 ER030C.UVDATA.1

Freq = 1.5950 GHz, Bw = 16.000 MH No calibration applied and no bandpass applied

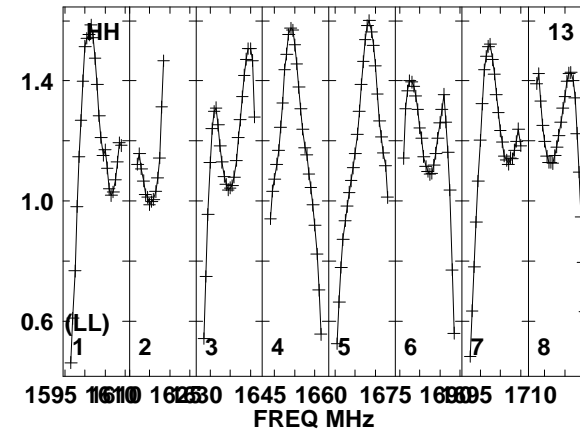
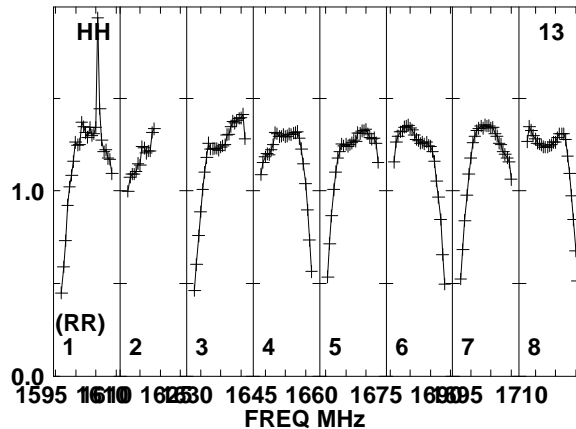
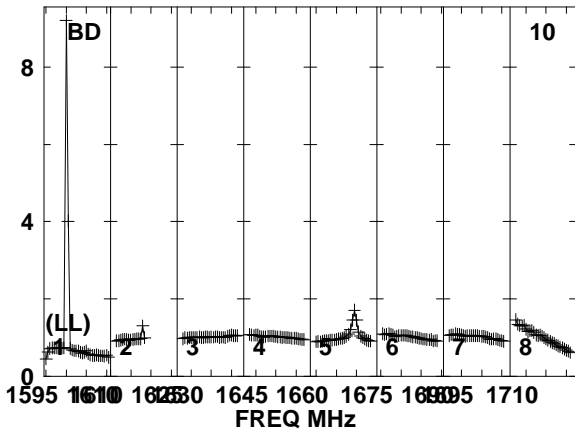
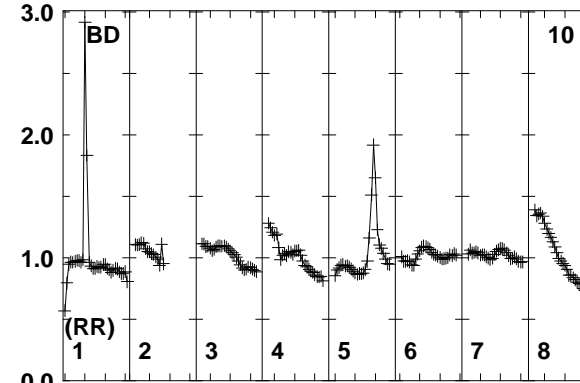
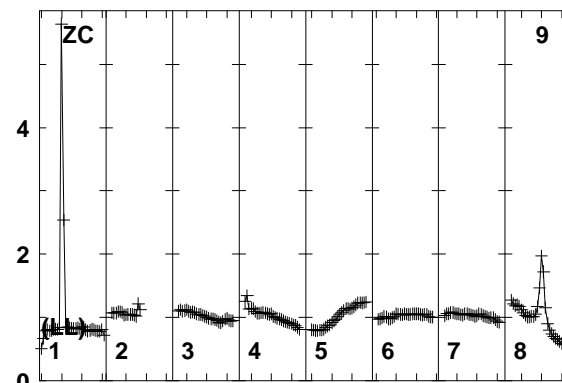
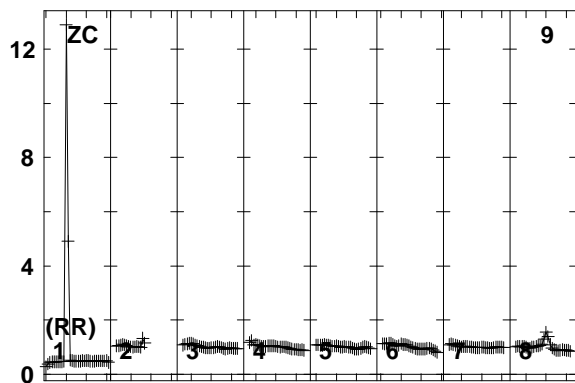
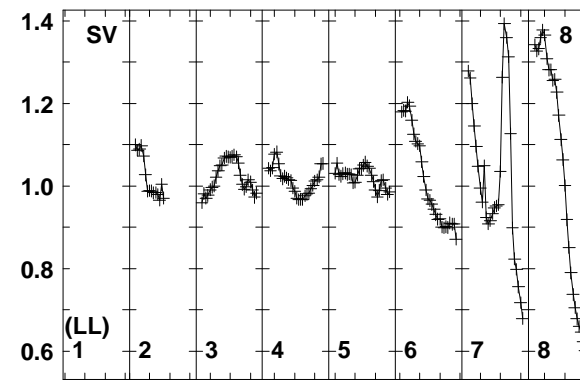
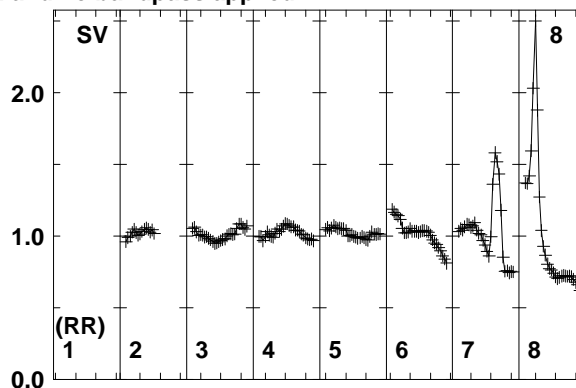
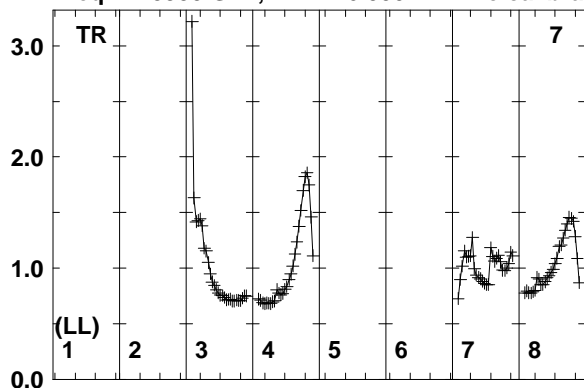

Lower frame: Real Jy
Total-power spectrum Antenna: TR (07)
Timerange: 00/08:26:01 to 00/08:29:49

Plot file version 131 created 20-MAR-2014 17:08:03

J1317+3425 ER030C.UVDATA.1

Freq = 1.5950 GHz, Bw = 16.000 MH No calibration applied and no bandpass applied

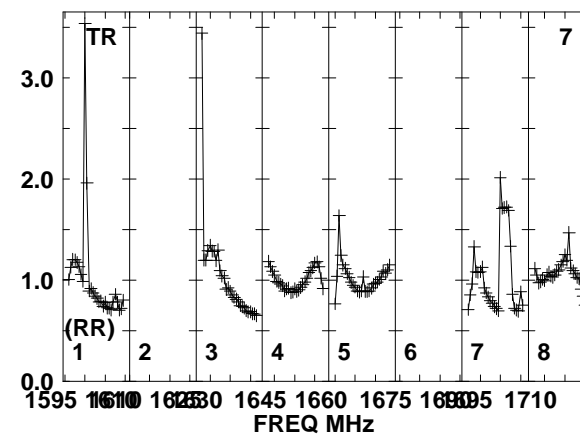
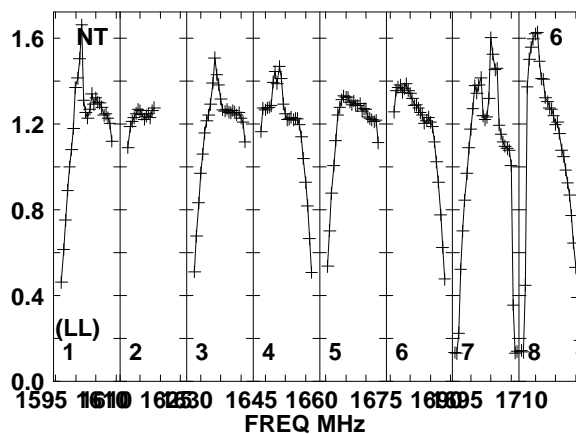
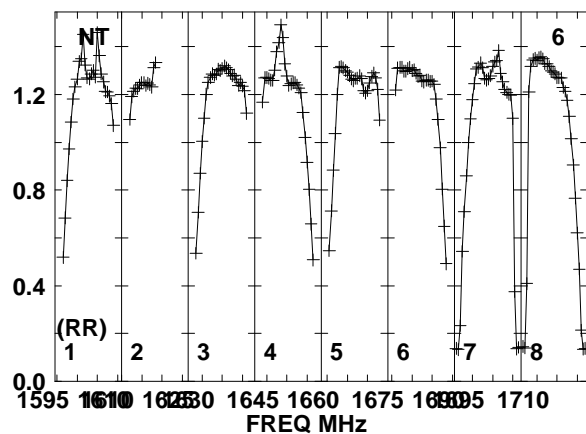
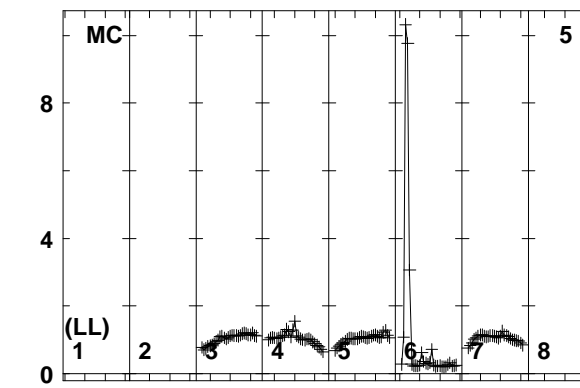
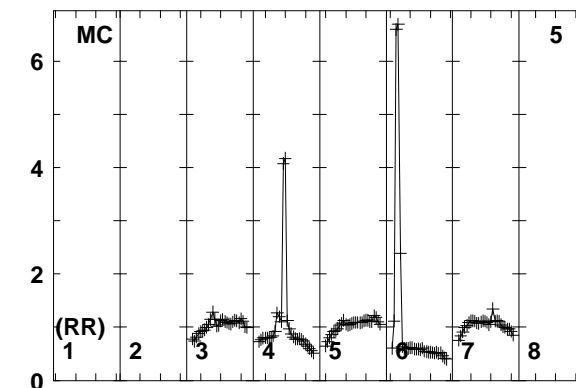
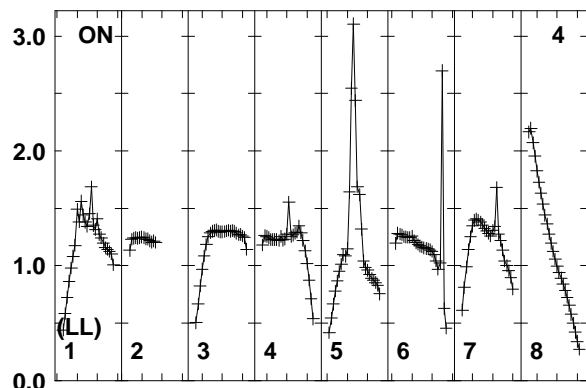
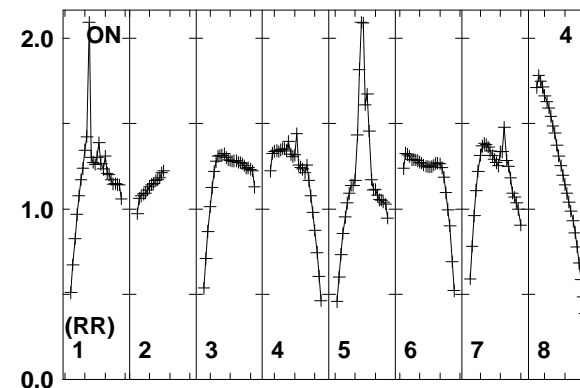
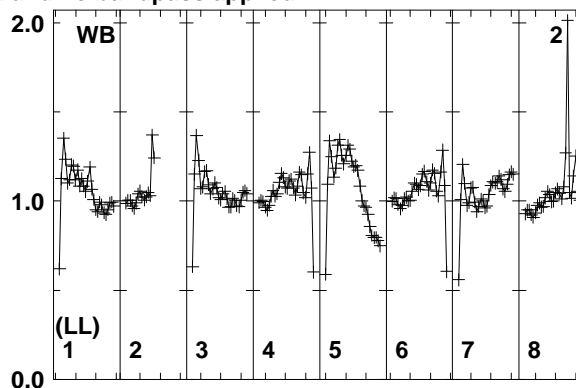
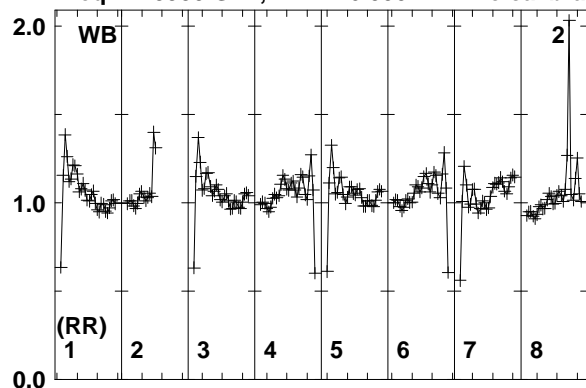

Lower frame: Real Jy
Total-power spectrum Antenna: WB (02)
Timerange: 00/08:30:31 to 00/08:31:29

Plot file version 132 created 20-MAR-2014 17:08:03

J1317+3425 ER030C.UVDATA.1

Freq = 1.5950 GHz, Bw = 16.000 MH No calibration applied and no bandpass applied

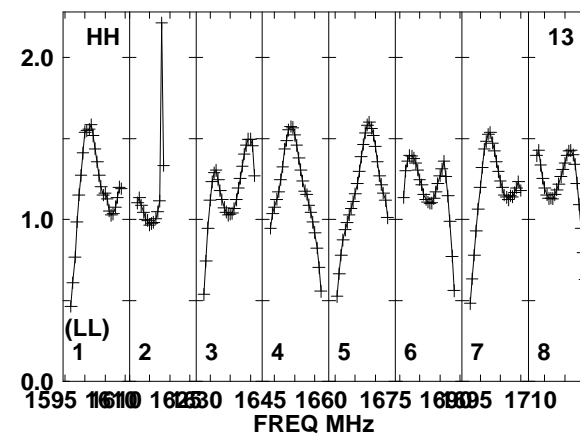
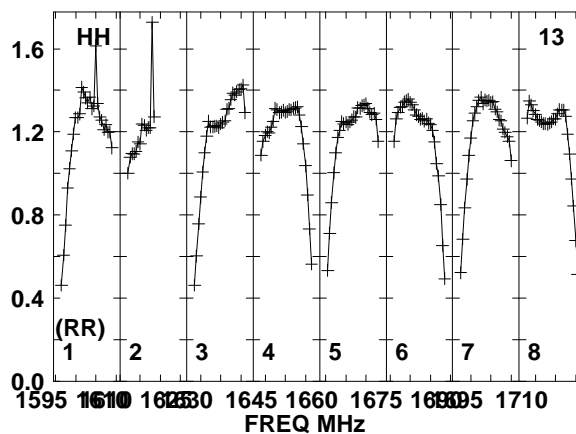
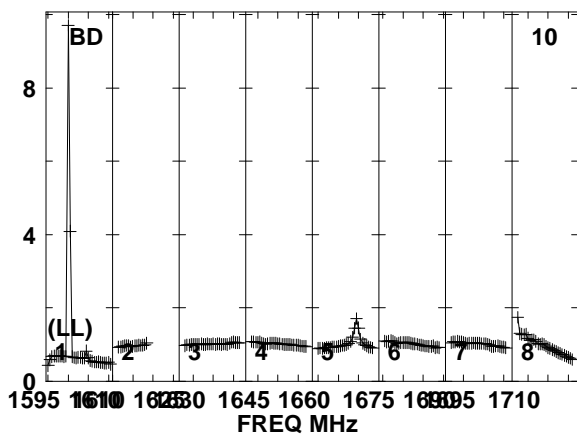
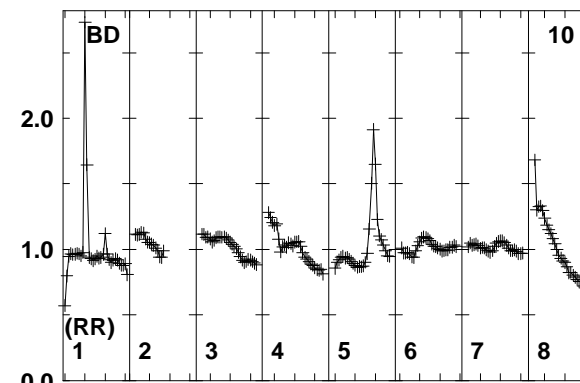
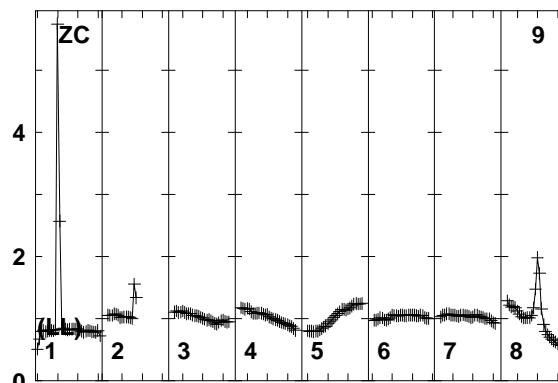
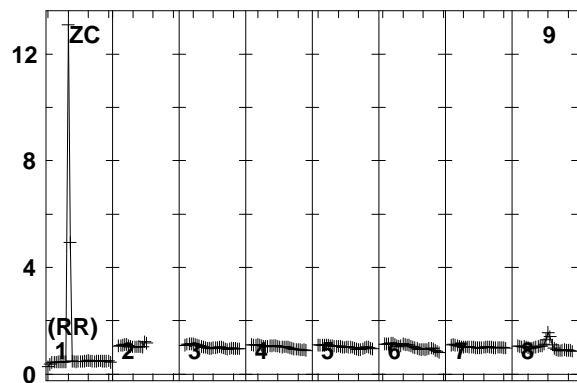
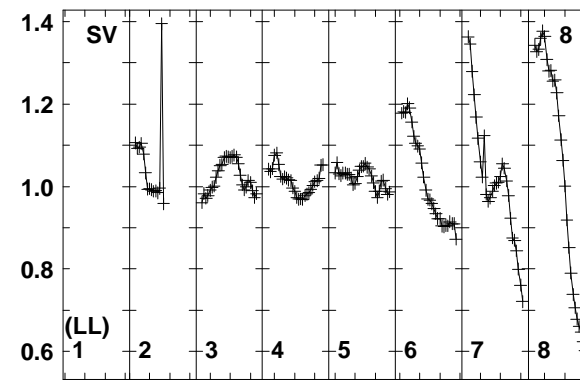
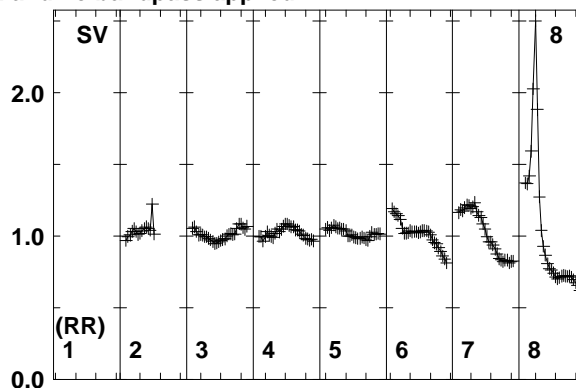
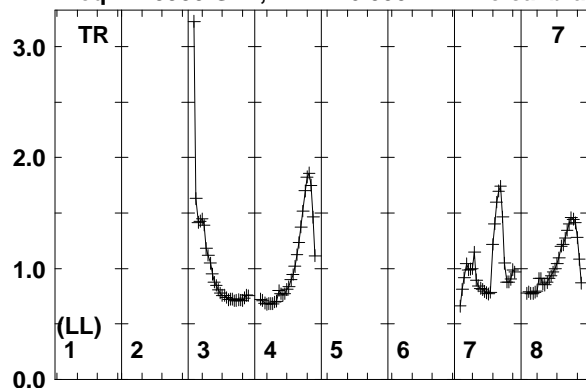

Lower frame: Real Jy
Total-power spectrum Antenna: TR (07)
Timerange: 00/08:30:31 to 00/08:31:29

Plot file version 133 created 20-MAR-2014 17:08:03

IC883 ER030C.UVDATA.1

Freq = 1.5950 GHz, Bw = 16.000 MH No calibration applied and no bandpass applied

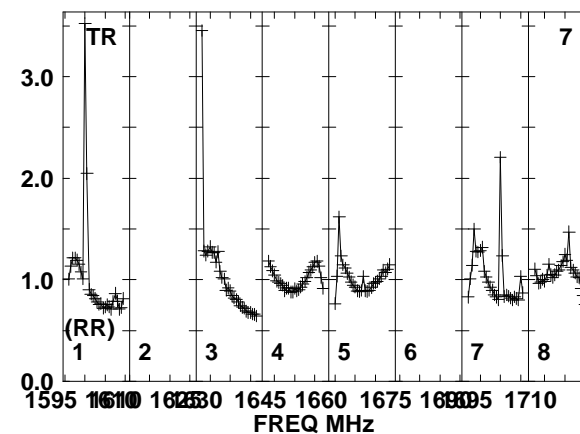
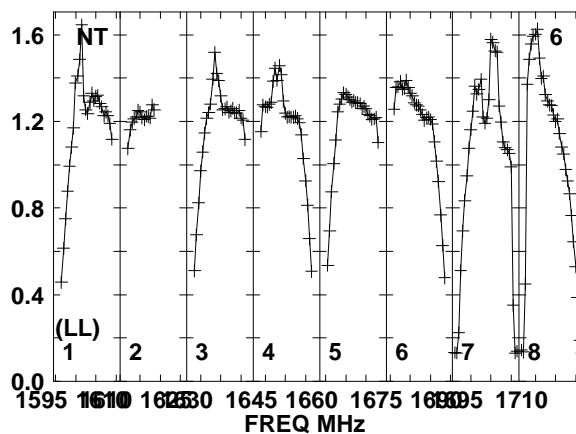
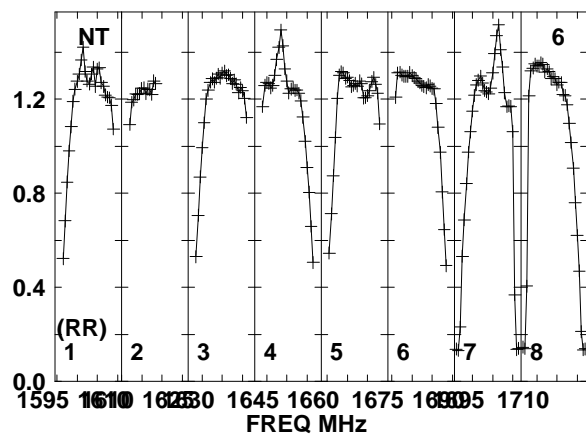
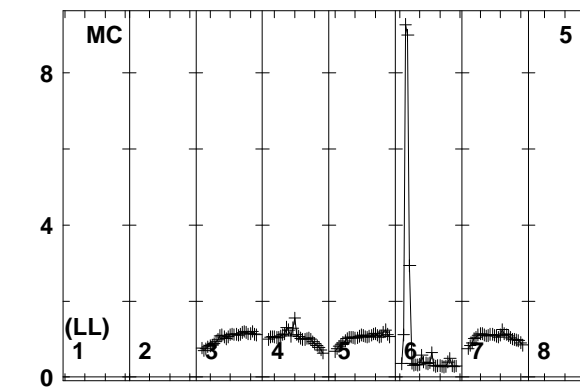
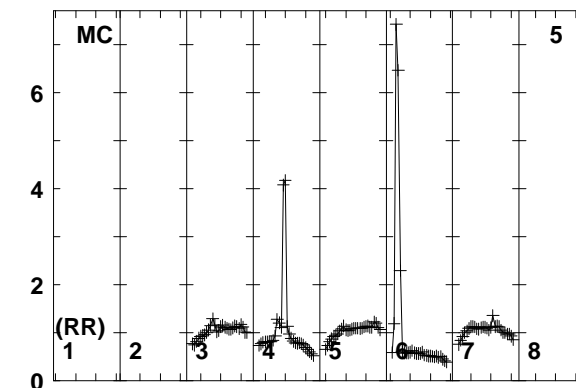
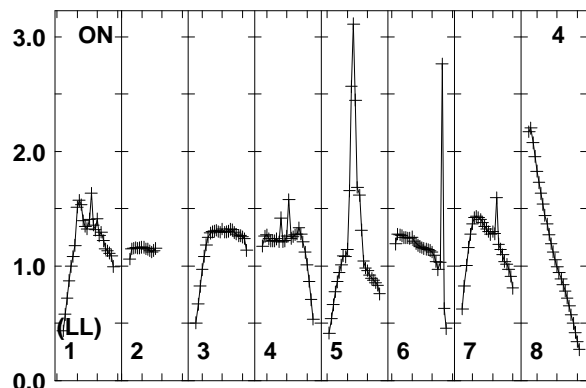
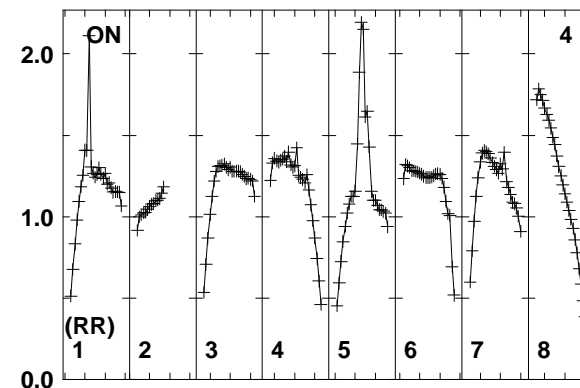
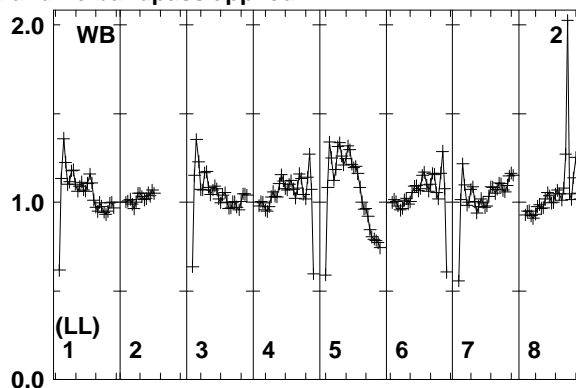
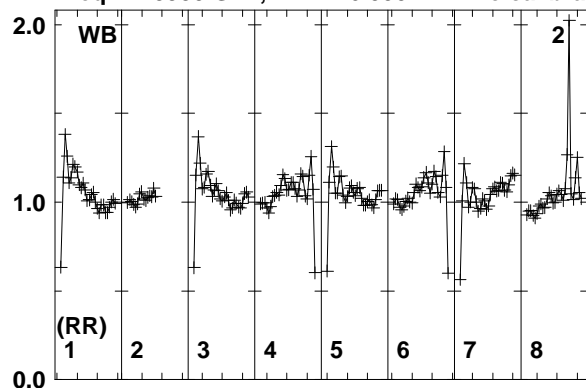

Lower frame: Real Jy
Total-power spectrum Antenna: WB (02)
Timerange: 00/08:31:33 to 00/08:35:19

Plot file version 134 created 20-MAR-2014 17:08:03

IC883 ER030C.UVDATA.1

Freq = 1.5950 GHz, Bw = 16.000 MH No calibration applied and no bandpass applied

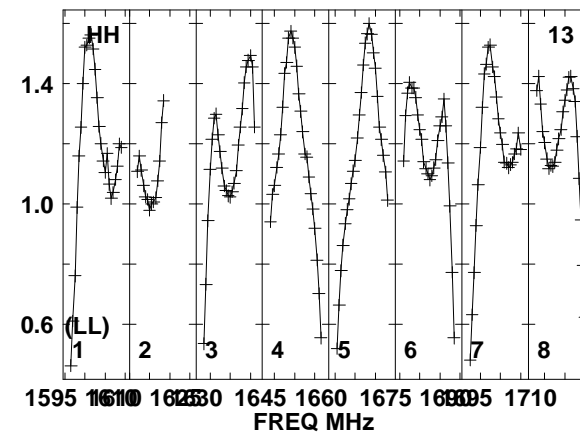
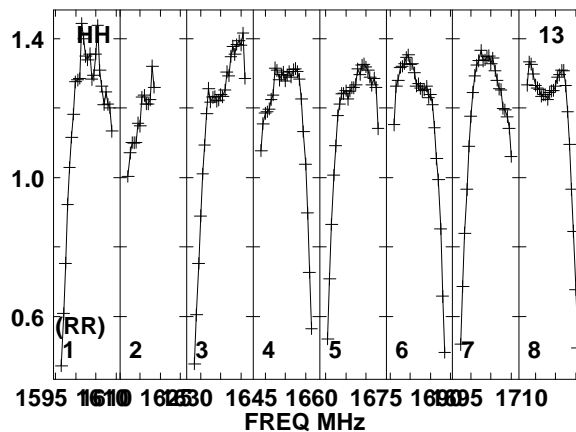
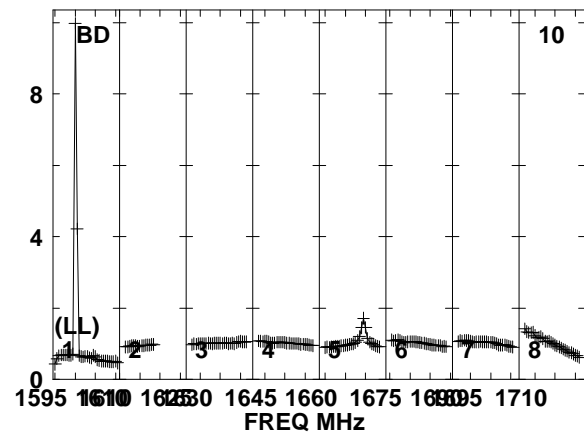
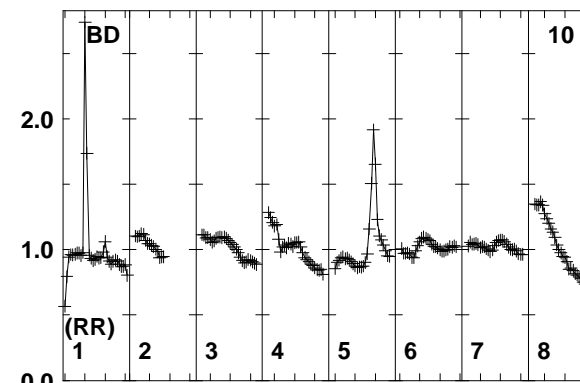
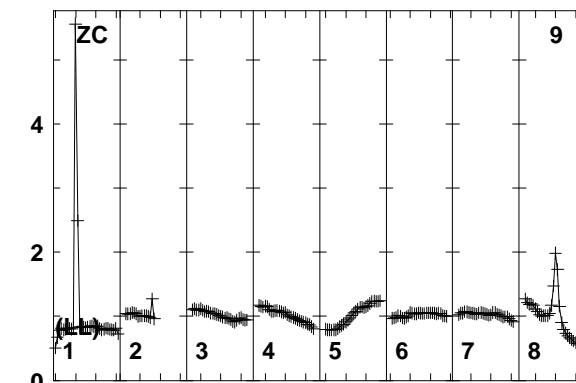
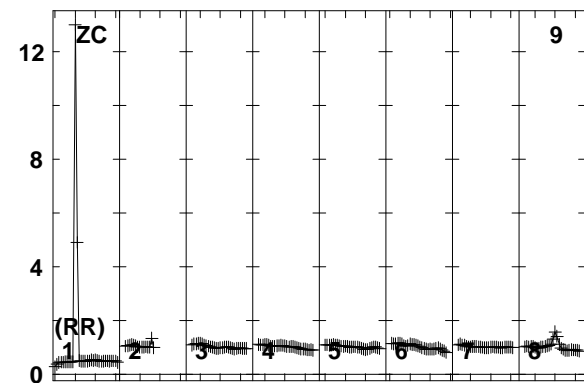
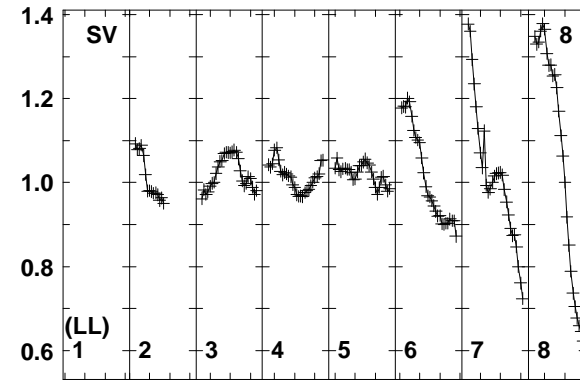
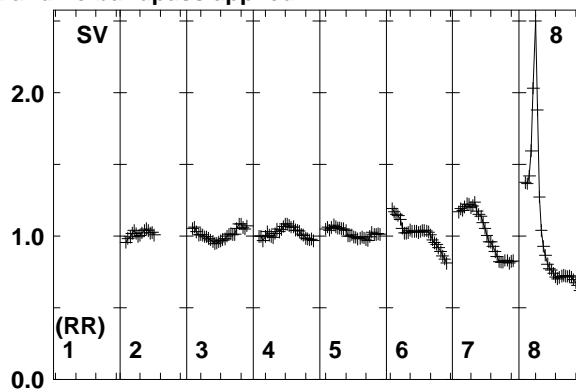
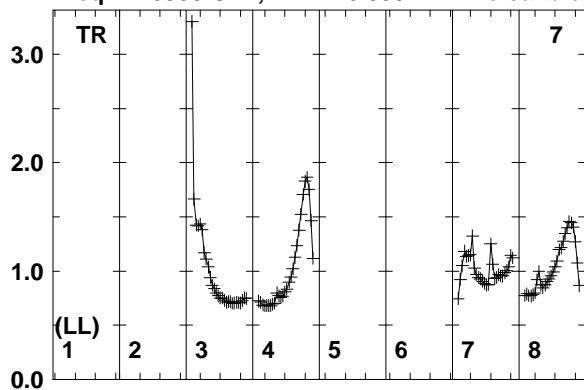

1595 1610 1625 1640 1655 1670 1685 1700 1715
FREQ MHz

1595 1610 1625 1640 1655 1670 1685 1700 1715
FREQ MHz

1595 1610 1625 1640 1655 1670 1685 1700 1715
FREQ MHz

Lower frame: Real Jy
Total-power spectrum Antenna: TR (07)
Timerange: 00/08:31:33 to 00/08:35:19

Plot file version 135 created 20-MAR-2014 17:08:04

J1317+3425 ER030C.UVDATA.1

Freq = 1.5950 GHz, Bw = 16.000 MH No calibration applied and no bandpass applied

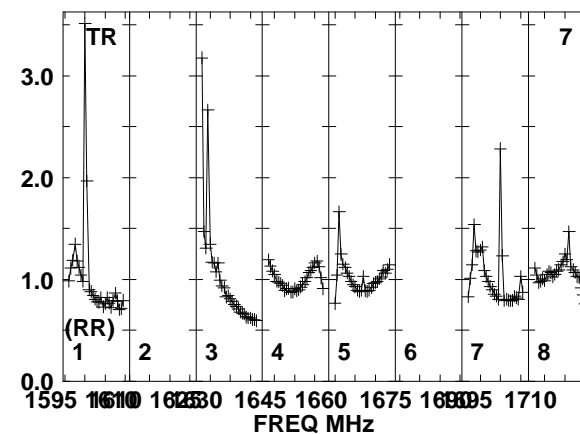
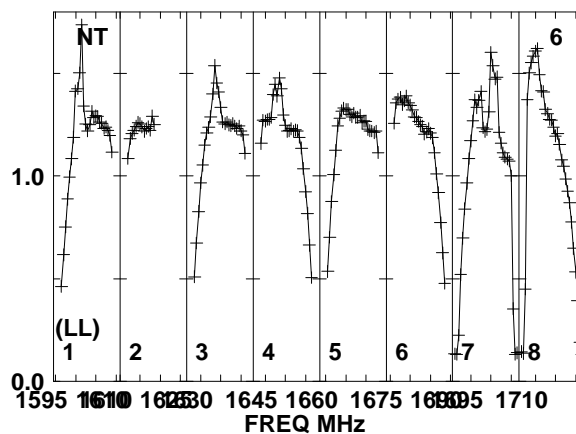
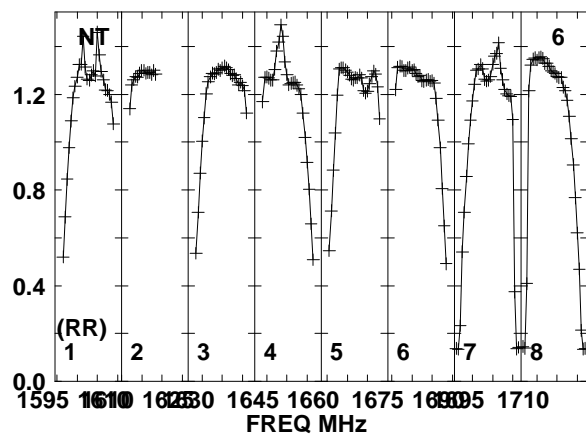
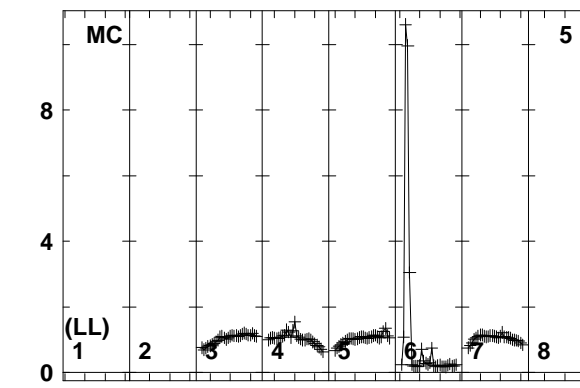
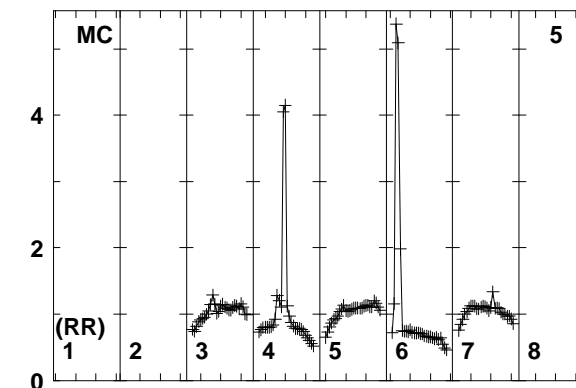
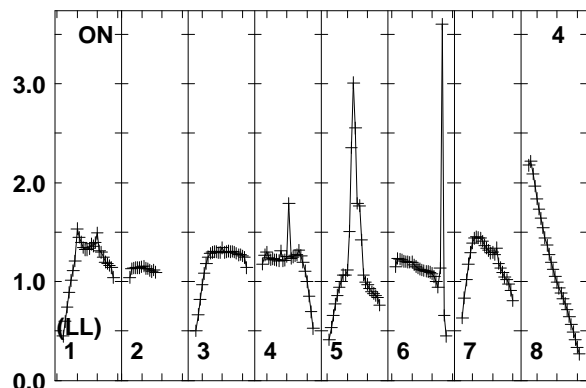
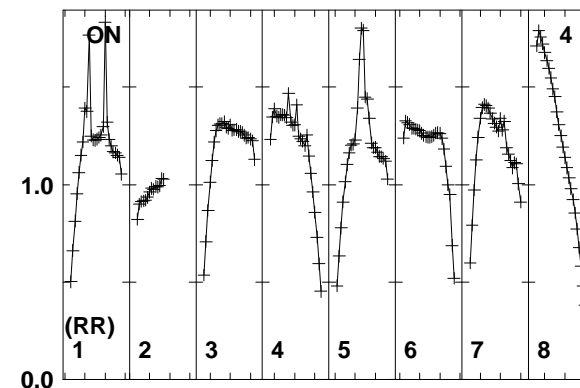
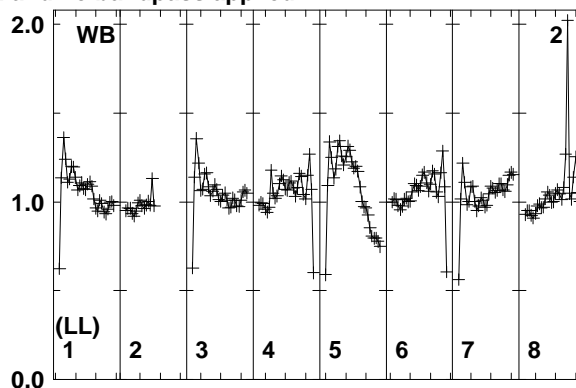
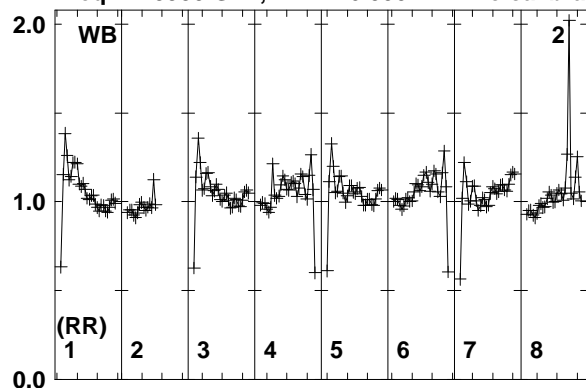

Lower frame: Real Jy
Total-power spectrum Antenna: WB (02)
Timerange: 00/08:35:23 to 00/08:36:39

Plot file version 136 created 20-MAR-2014 17:08:04

J1317+3425 ER030C.UVDATA.1

Freq = 1.5950 GHz, Bw = 16.000 MH No calibration applied and no bandpass applied

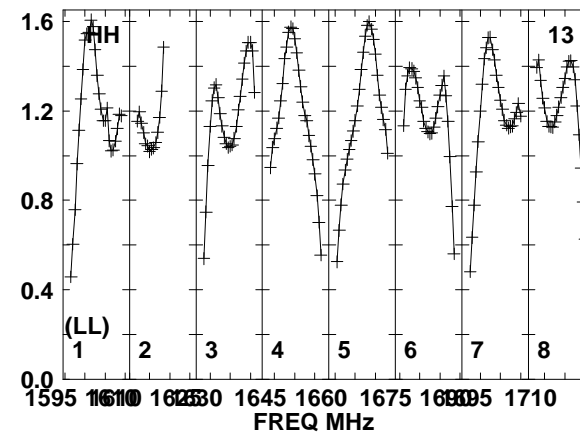
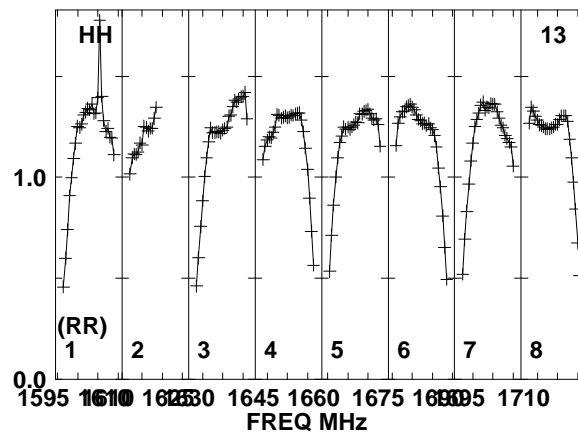
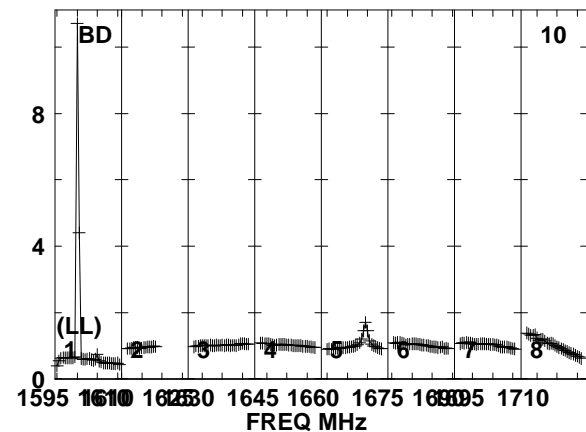
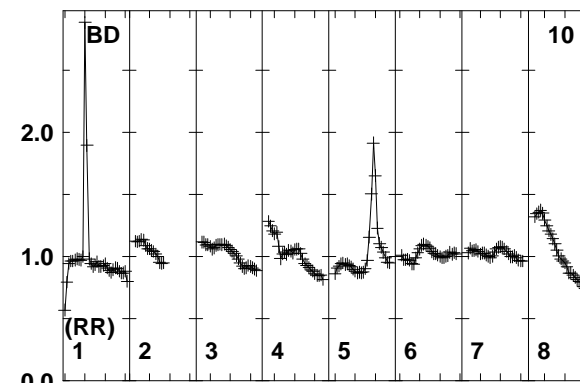
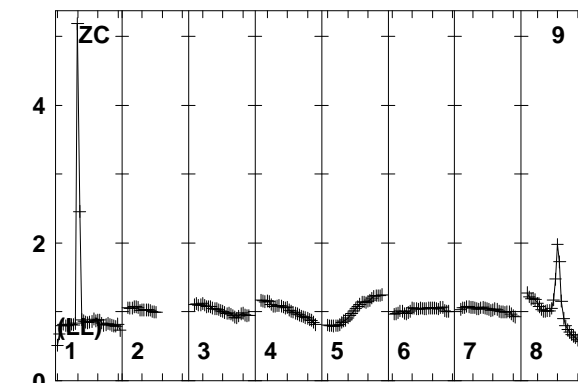
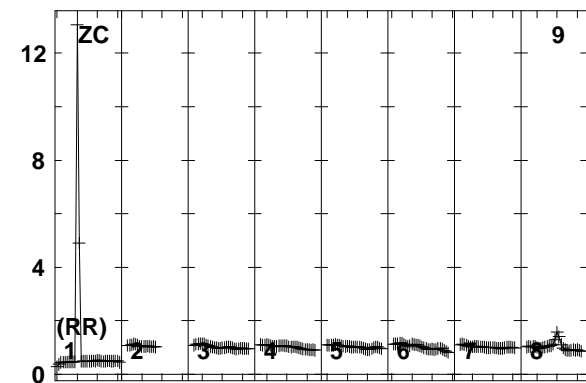
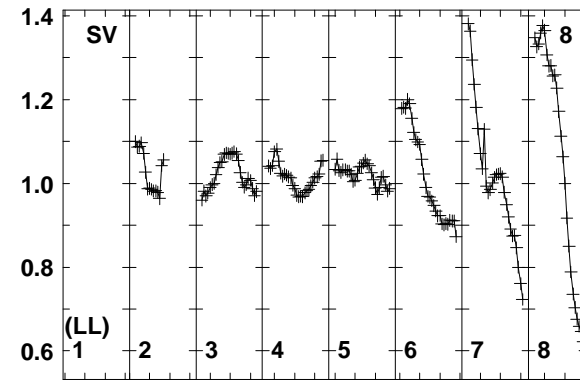
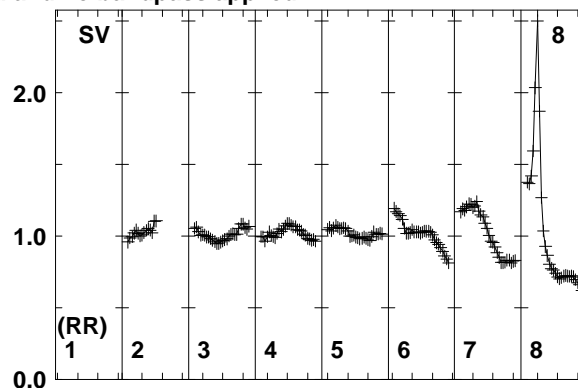
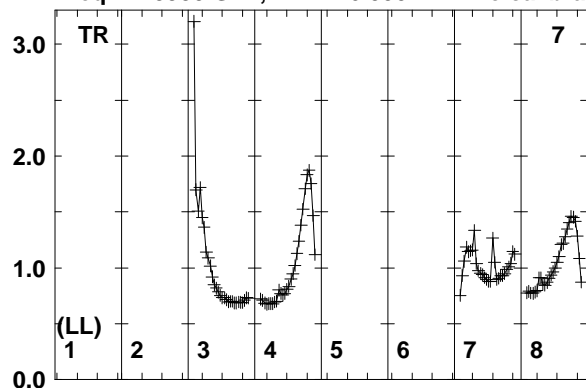

Lower frame: Real Jy
Total-power spectrum Antenna: TR (07)
Timerange: 00/08:35:23 to 00/08:36:39

Plot file version 137 created 20-MAR-2014 17:08:04

IC883 ER030C.UVDATA.1

Freq = 1.5950 GHz, Bw = 16.000 MH No calibration applied and no bandpass applied

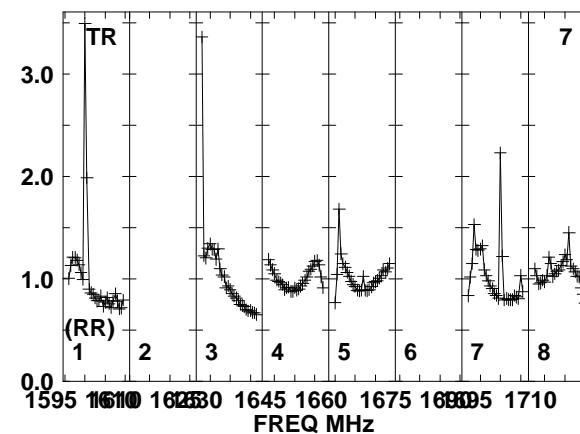
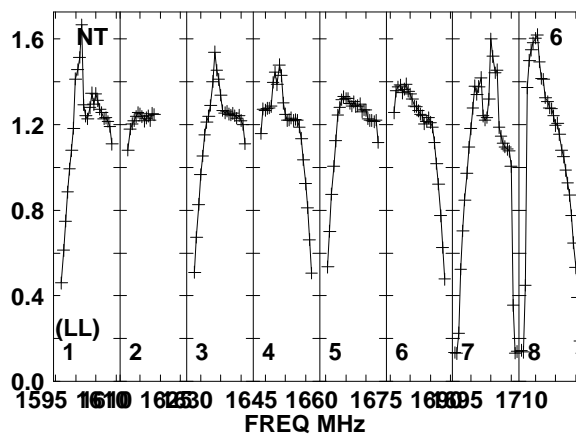
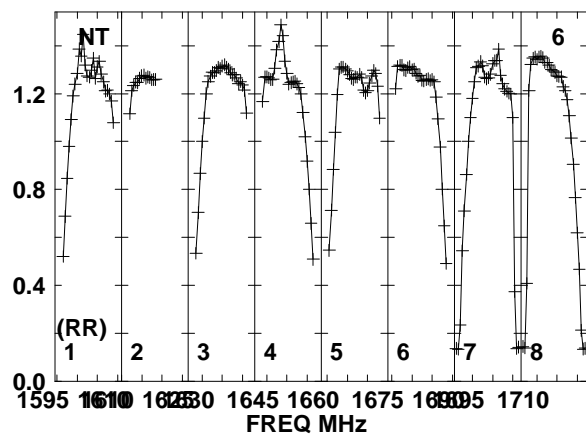
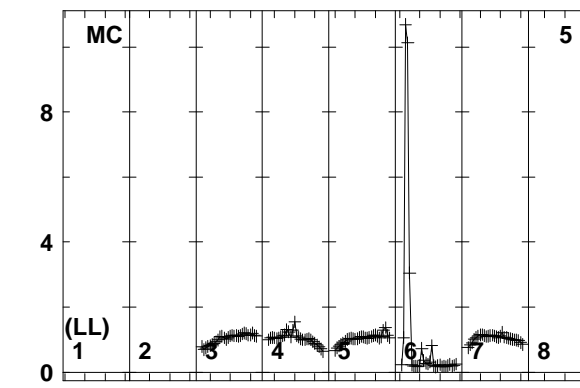
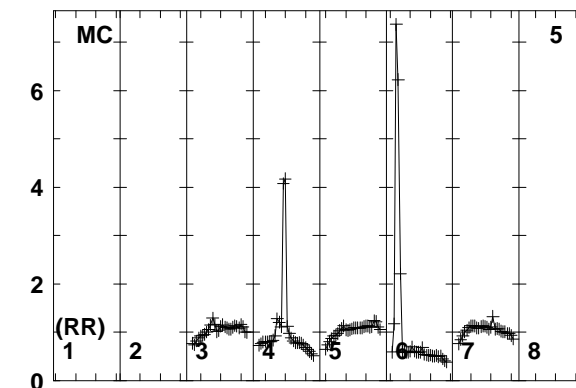
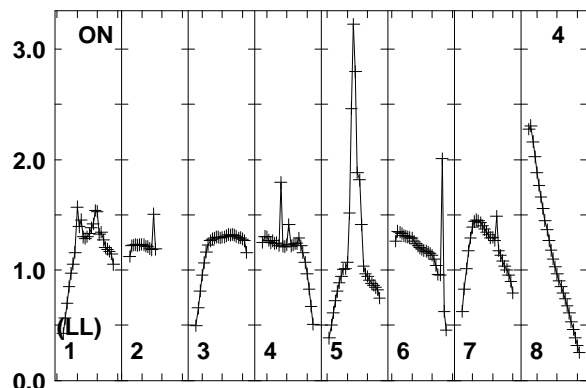
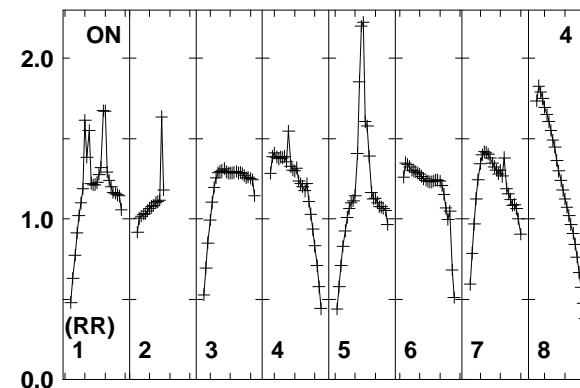
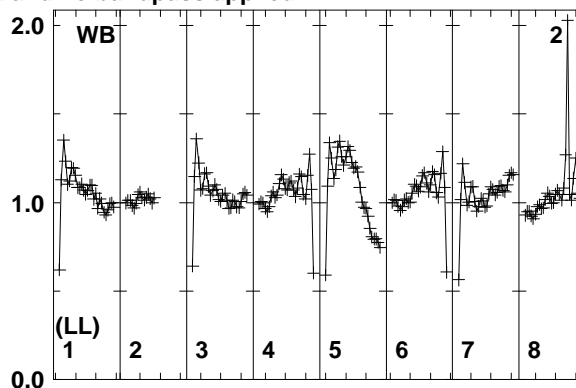
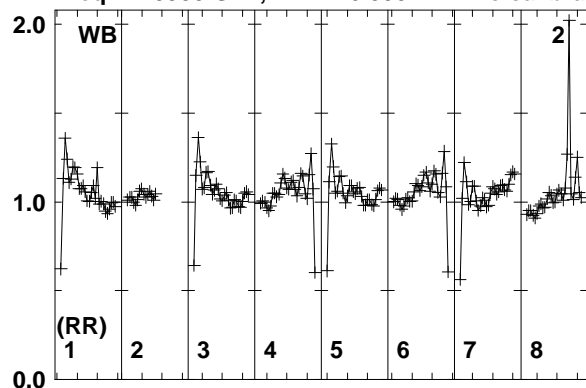

Lower frame: Real Jy
Total-power spectrum Antenna: WB (02)
Timerange: 00/08:36:41 to 00/08:40:29

Plot file version 138 created 20-MAR-2014 17:08:04

IC883 ER030C.UVDATA.1

Freq = 1.5950 GHz, Bw = 16.000 MH No calibration applied and no bandpass applied

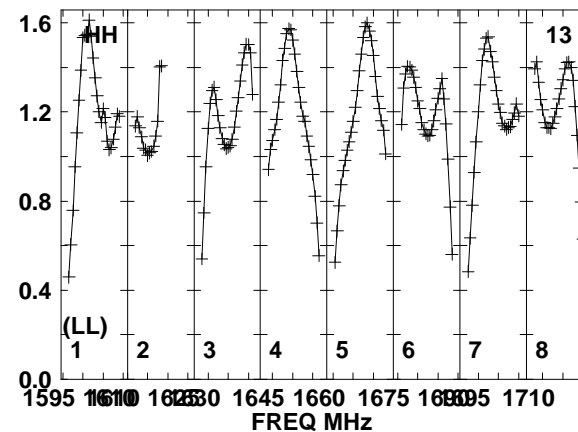
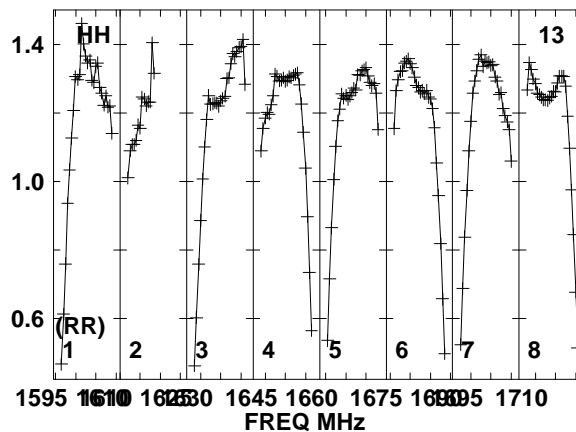
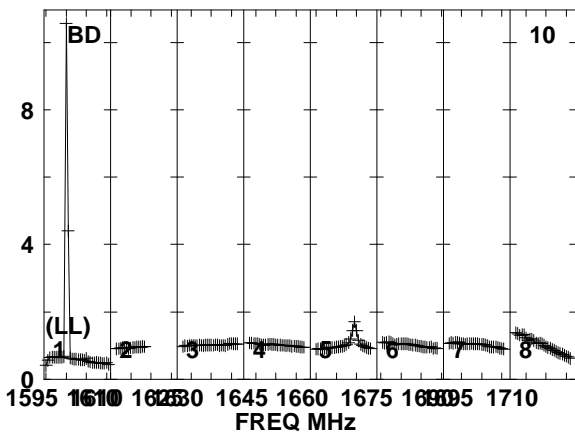
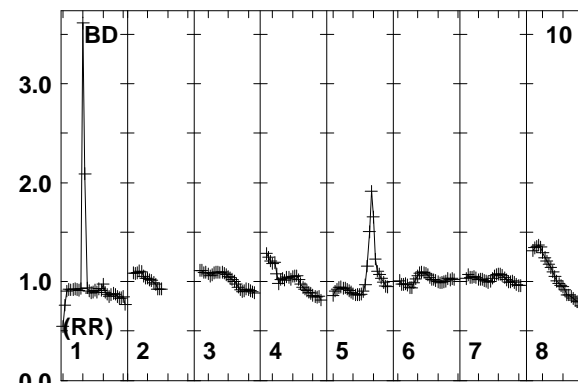
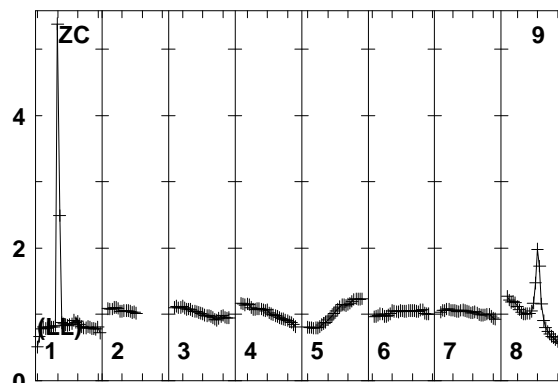
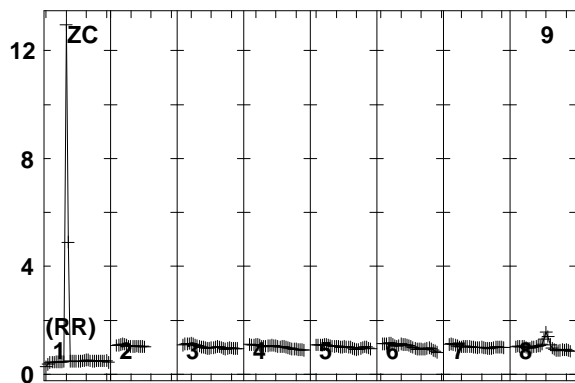
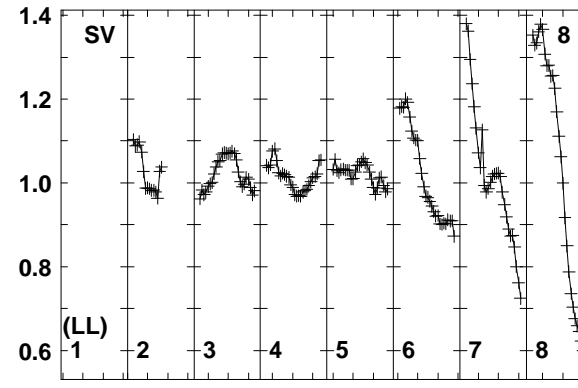
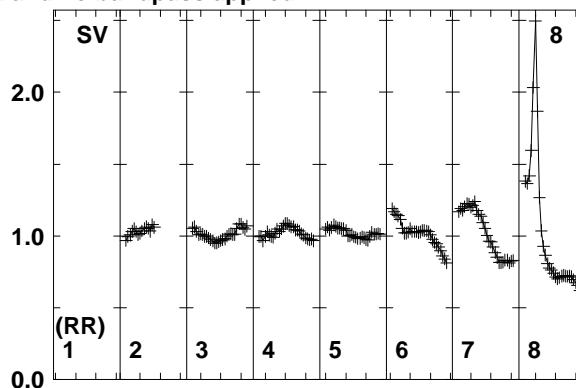
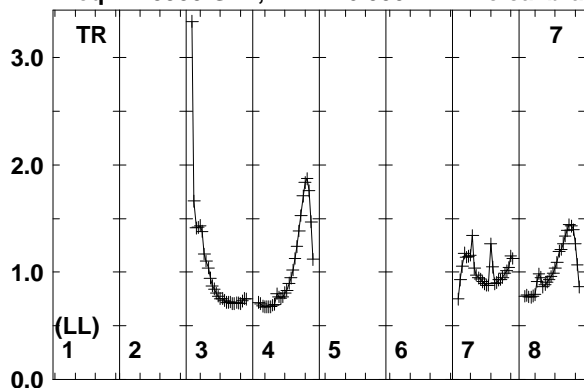

Lower frame: Real Jy
Total-power spectrum Antenna: TR (07)
Timerange: 00/08:36:41 to 00/08:40:29

Plot file version 139 created 20-MAR-2014 17:08:04

J1317+3425 ER030C.UVDATA.1

Freq = 1.5950 GHz, Bw = 16.000 MH No calibration applied and no bandpass applied

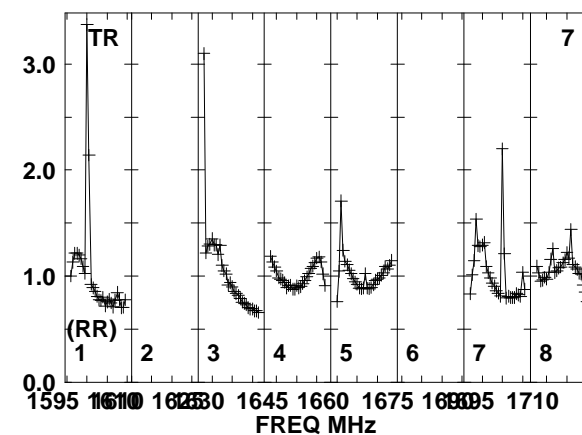
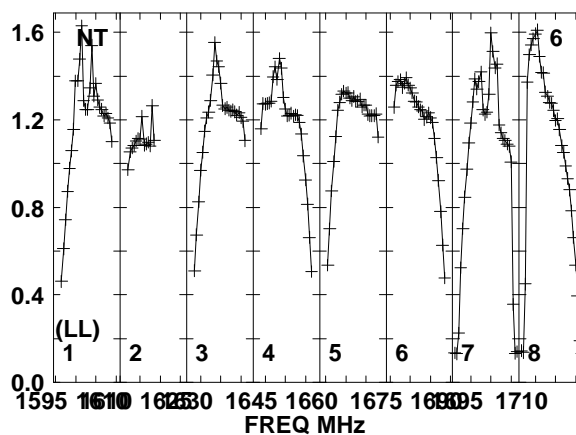
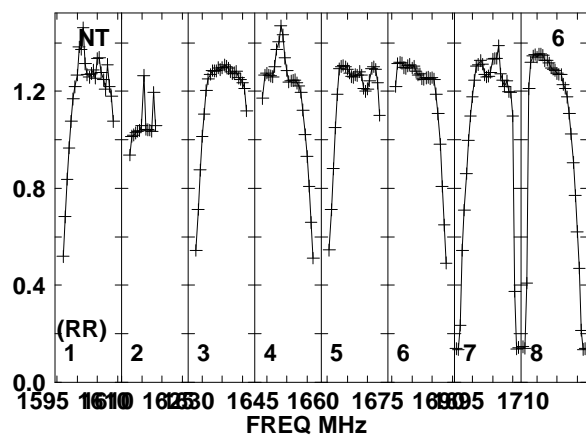
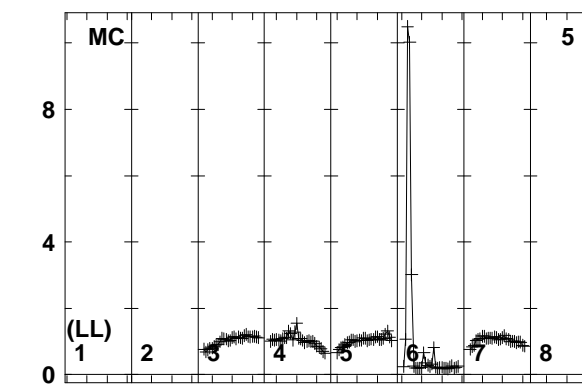
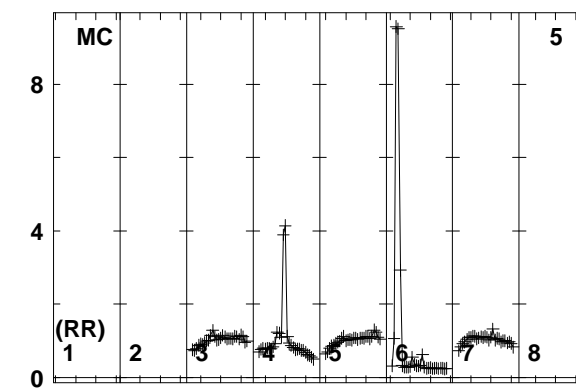
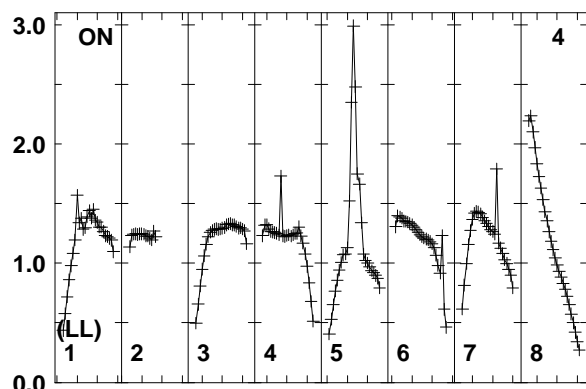
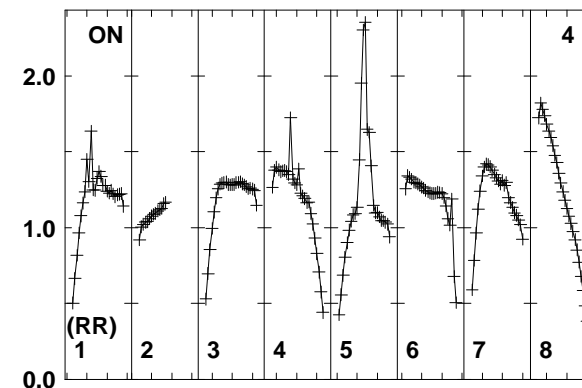
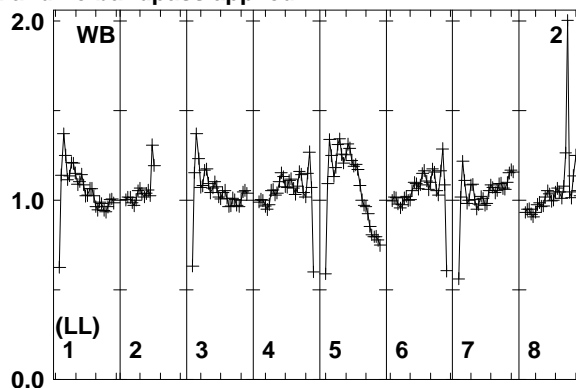
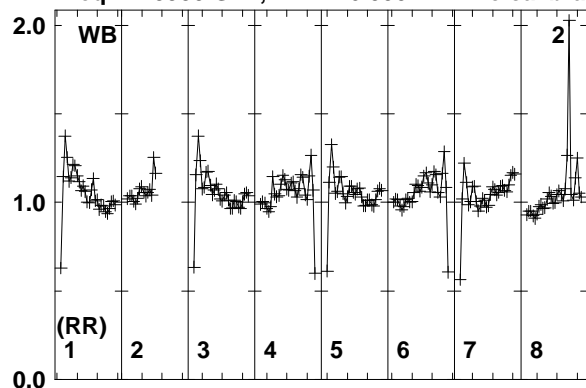

Lower frame: Real Jy
Total-power spectrum Antenna: WB (02)
Timerange: 00/08:41:11 to 00/08:42:09

Plot file version 140 created 20-MAR-2014 17:08:04

J1317+3425 ER030C.UVDATA.1

Freq = 1.5950 GHz, Bw = 16.000 MH No calibration applied and no bandpass applied

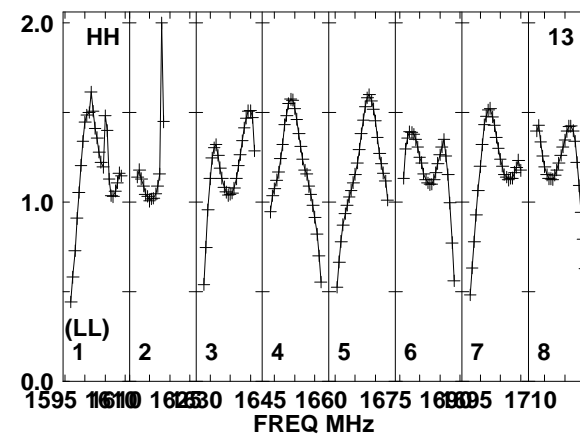
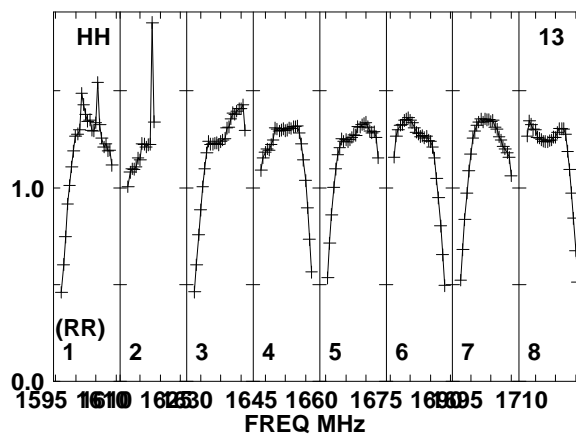
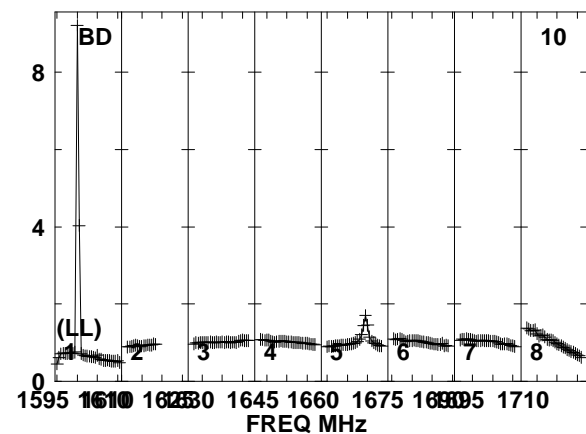
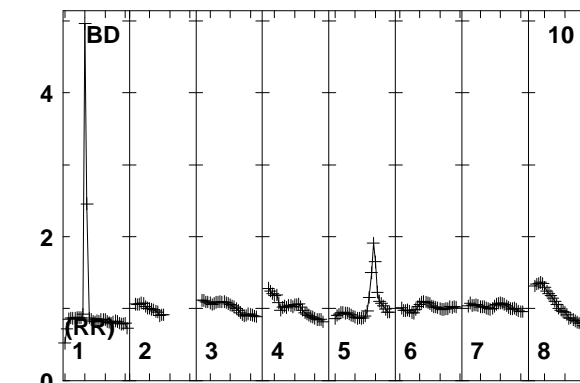
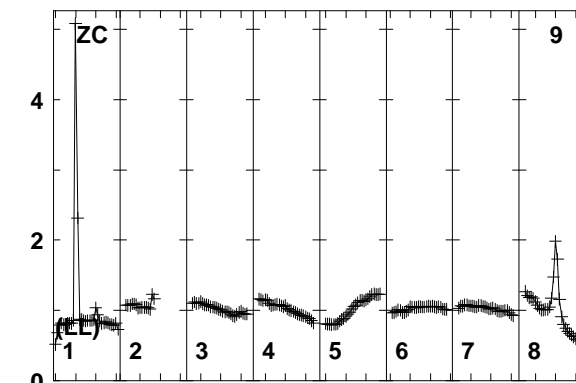
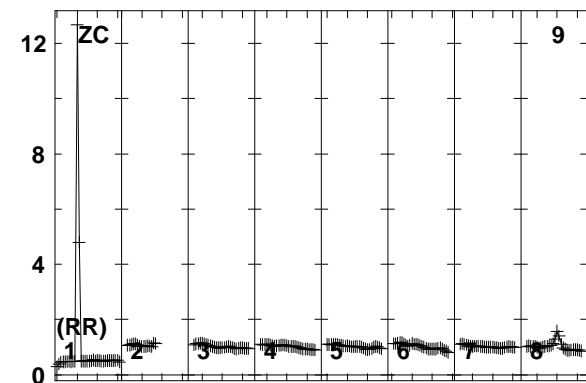
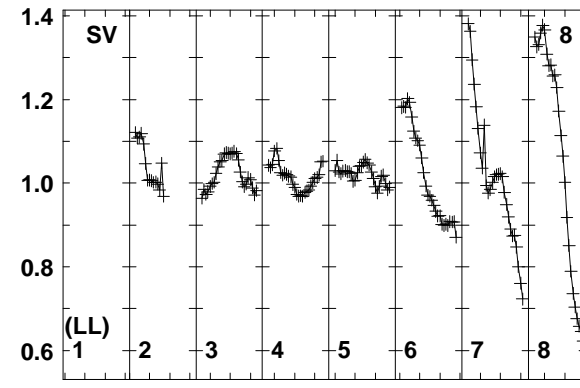
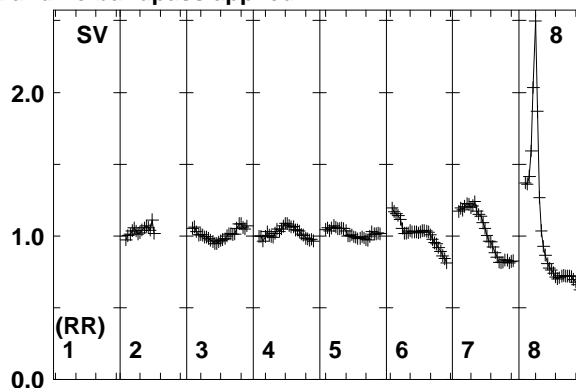
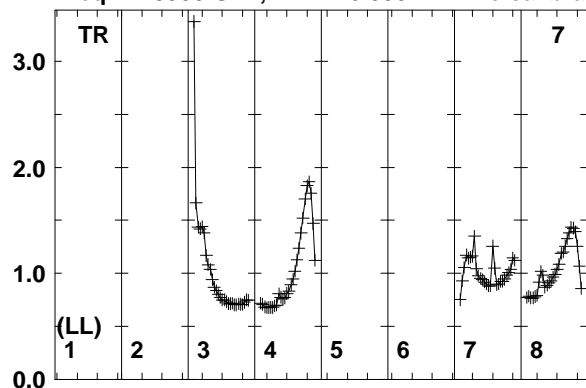

Lower frame: Real Jy
Total-power spectrum Antenna: TR (07)
Timerange: 00/08:41:11 to 00/08:42:09

Plot file version 141 created 20-MAR-2014 17:08:04

IC883 ER030C.UVDATA.1

Freq = 1.5950 GHz, Bw = 16.000 MH No calibration applied and no bandpass applied

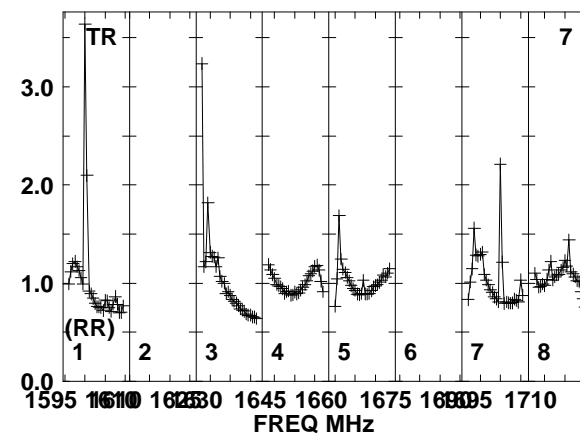
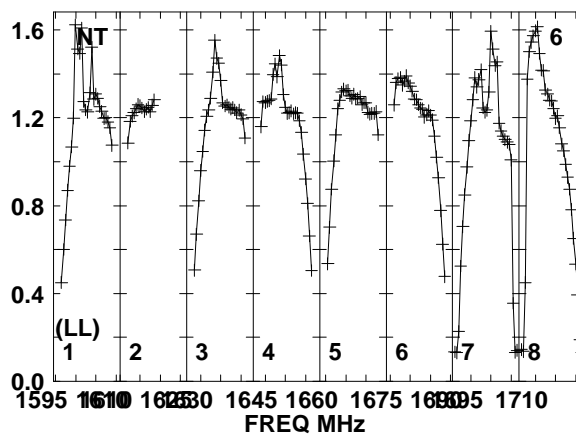
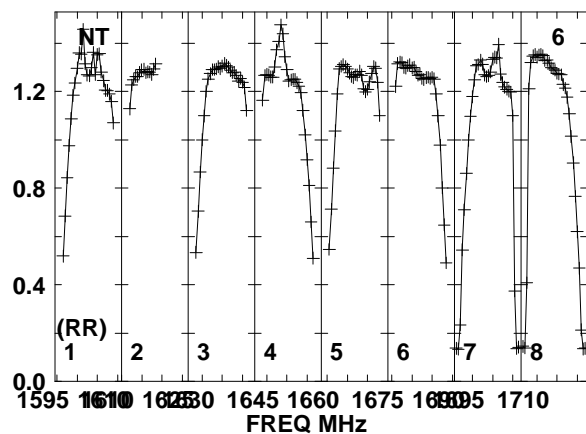
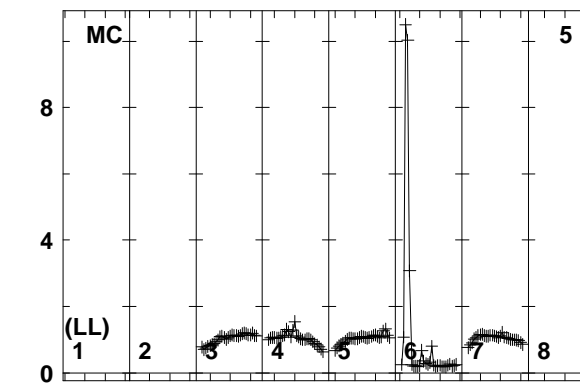
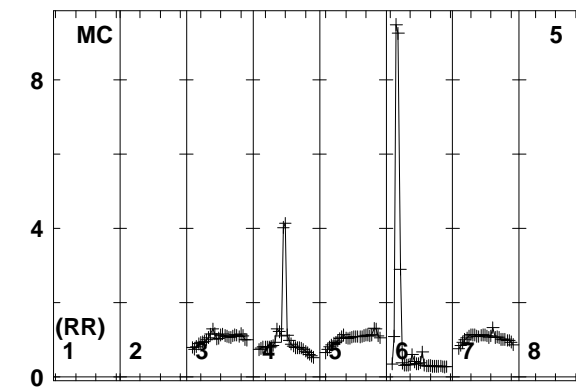
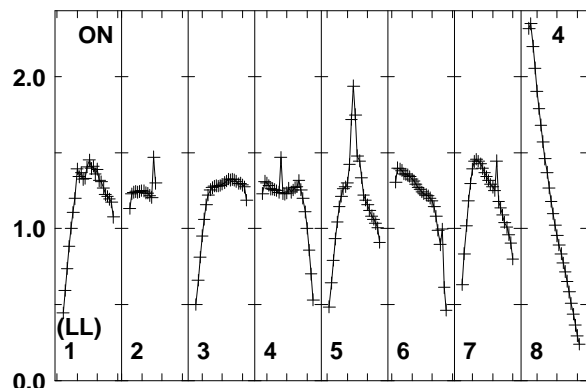
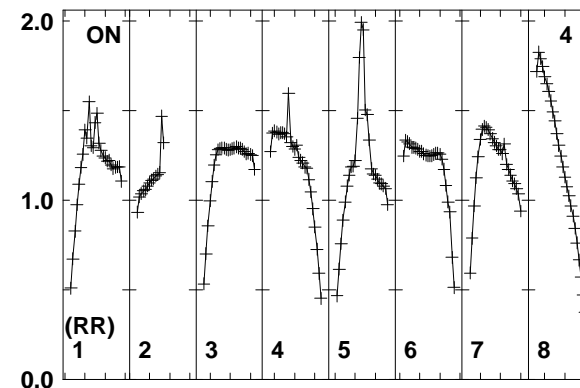
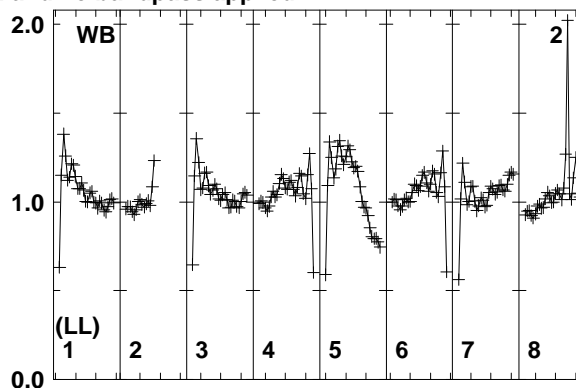
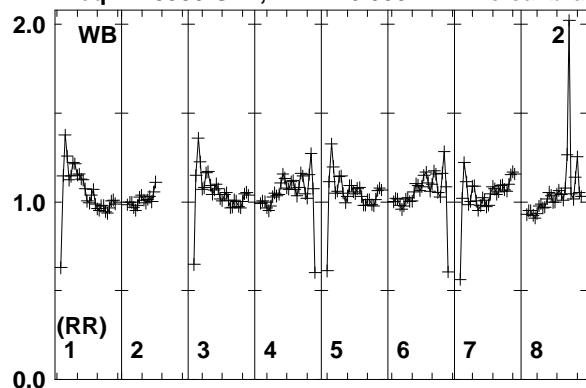

Lower frame: Real Jy
Total-power spectrum Antenna: WB (02)
Timerange: 00/08:42:13 to 00/08:45:59

Plot file version 142 created 20-MAR-2014 17:08:04

IC883 ER030C.UVDATA.1

Freq = 1.5950 GHz, Bw = 16.000 MH No calibration applied and no bandpass applied

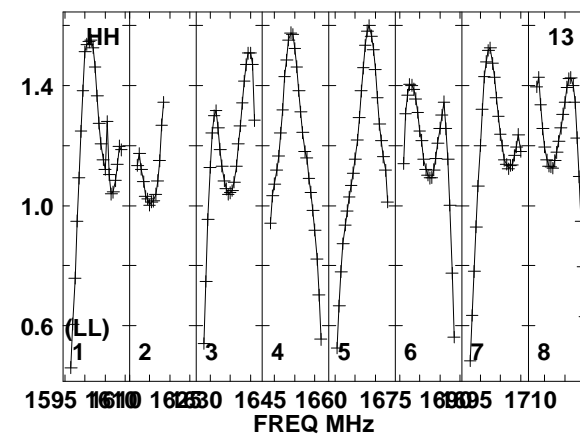
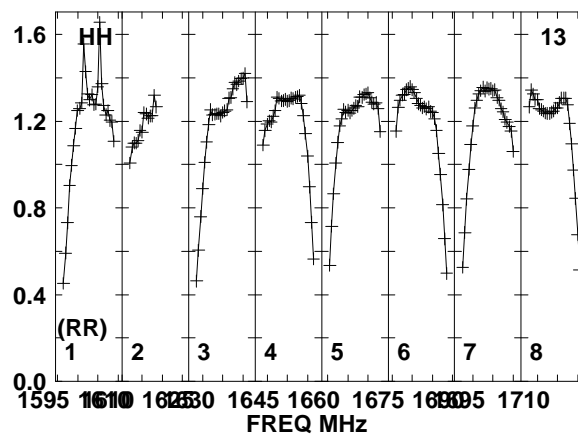
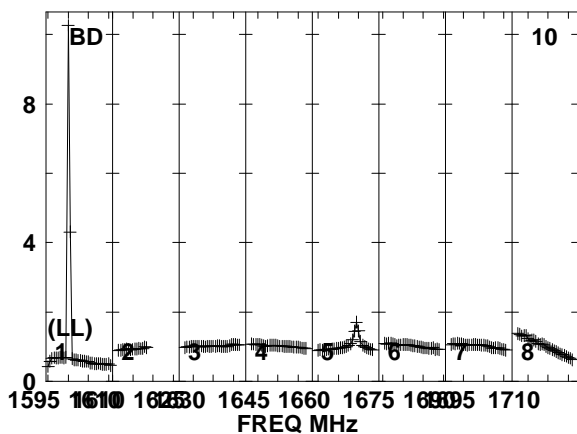
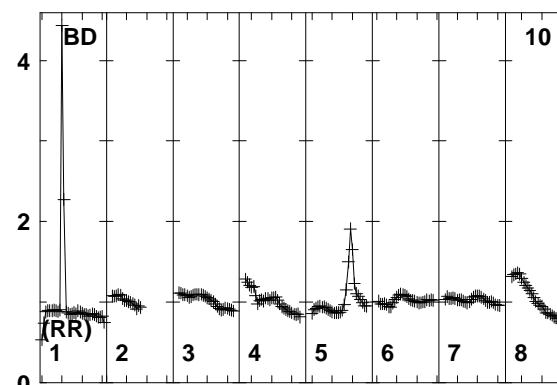
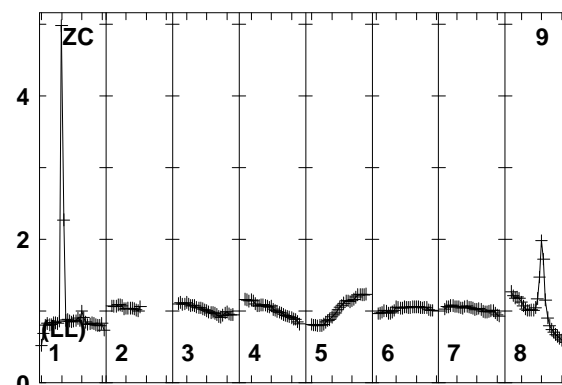
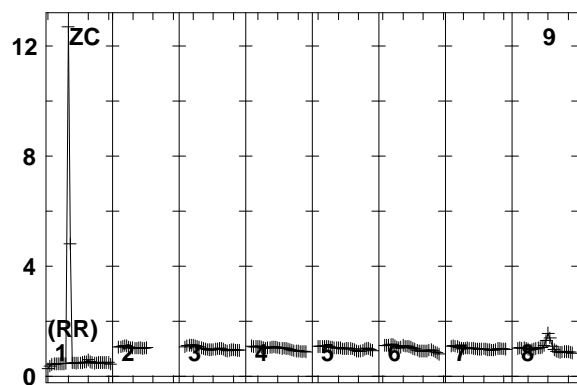
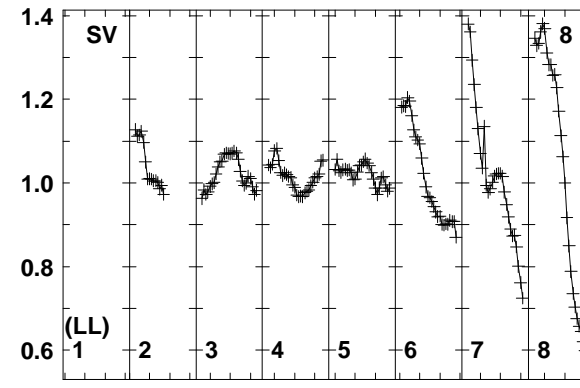
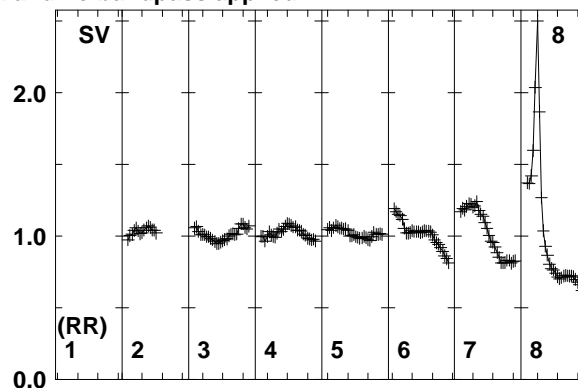
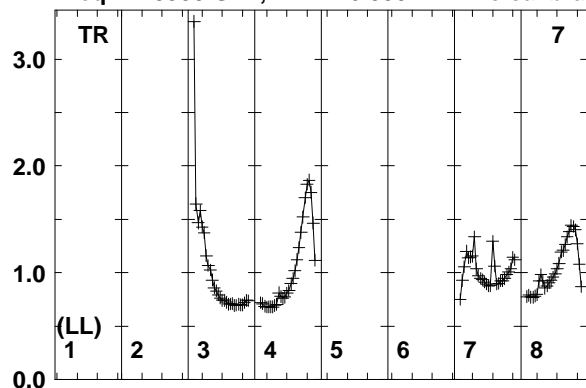

Lower frame: Real Jy
Total-power spectrum Antenna: TR (07)
Timerange: 00/08:42:13 to 00/08:45:59

Plot file version 143 created 20-MAR-2014 17:08:04

J1317+3425 ER030C.UVDATA.1

Freq = 1.5950 GHz, Bw = 16.000 MH No calibration applied and no bandpass applied

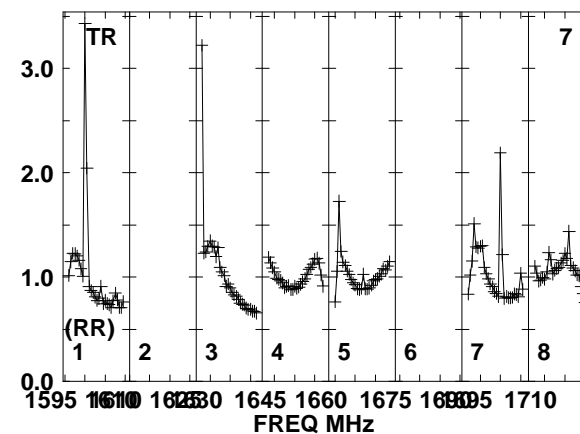
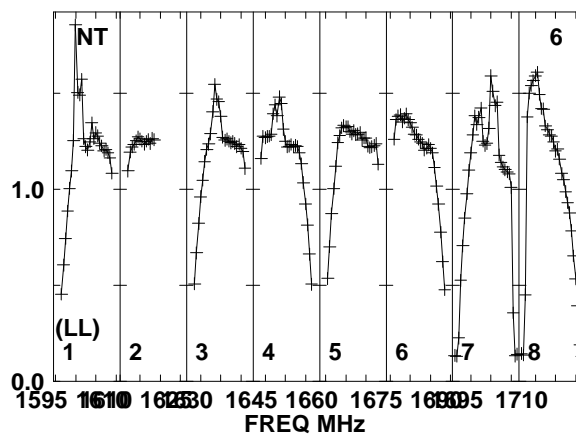
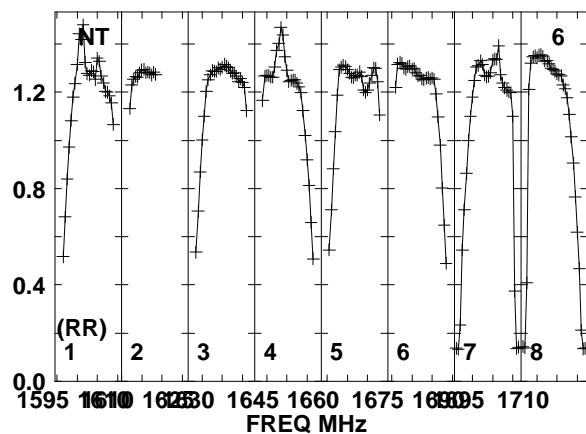
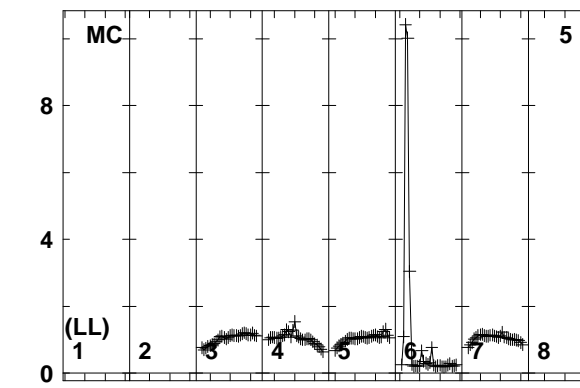
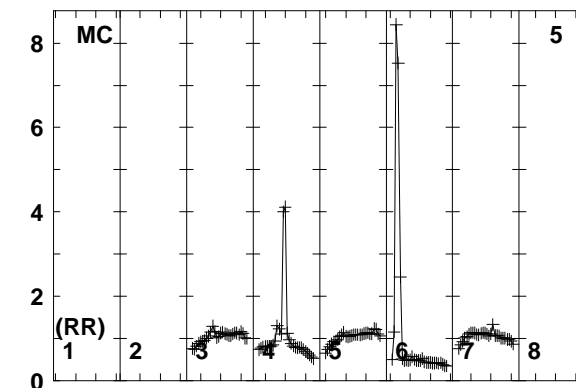
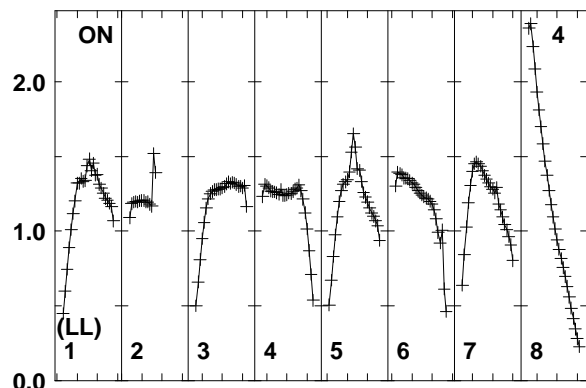
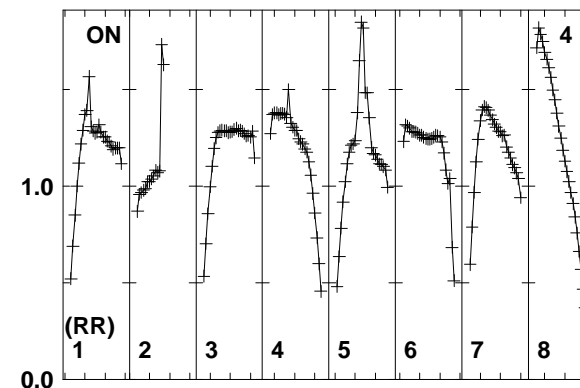
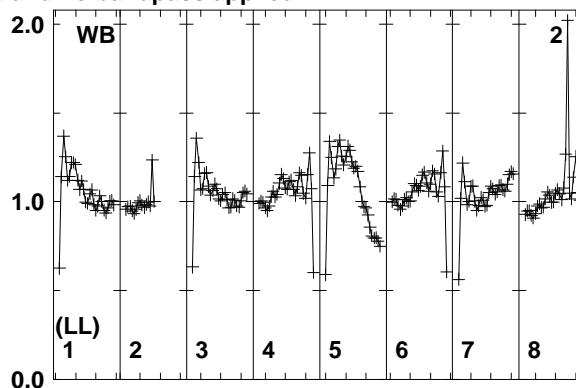
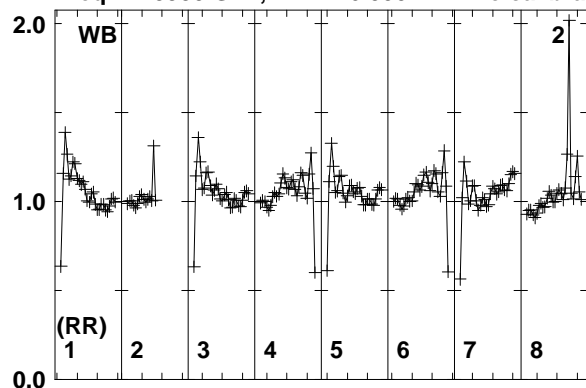

Lower frame: Real Jy
Total-power spectrum Antenna: WB (02)
Timerange: 00/08:46:03 to 00/08:47:19

Plot file version 144 created 20-MAR-2014 17:08:04

J1317+3425 ER030C.UVDATA.1

Freq = 1.5950 GHz, Bw = 16.000 MH No calibration applied and no bandpass applied

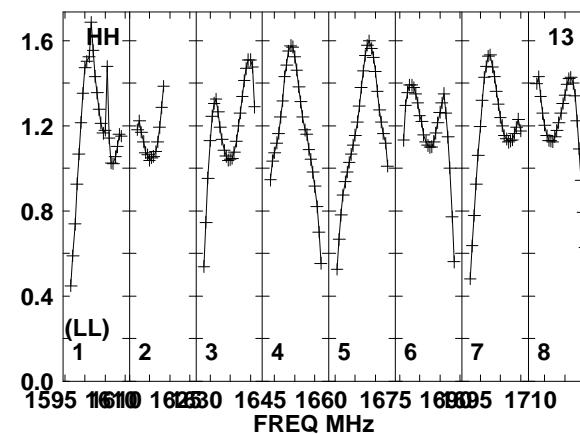
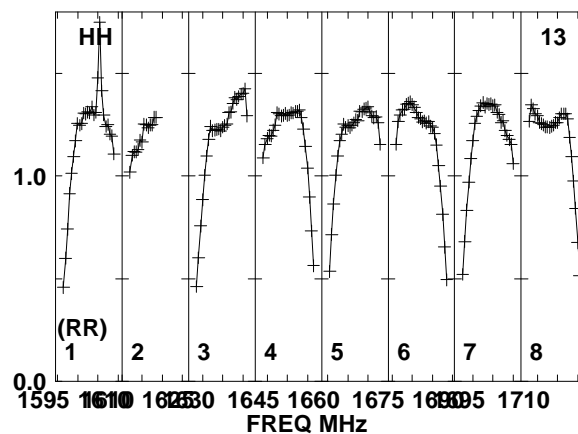
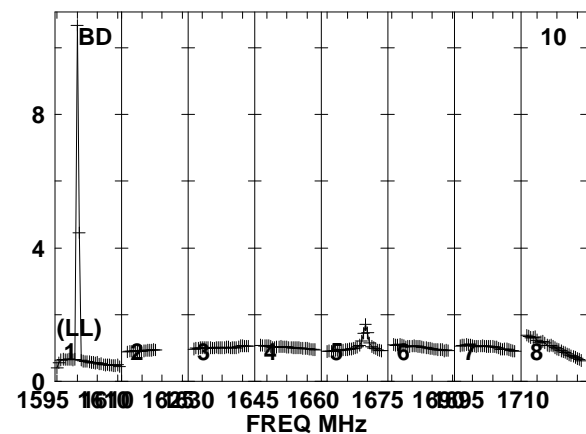
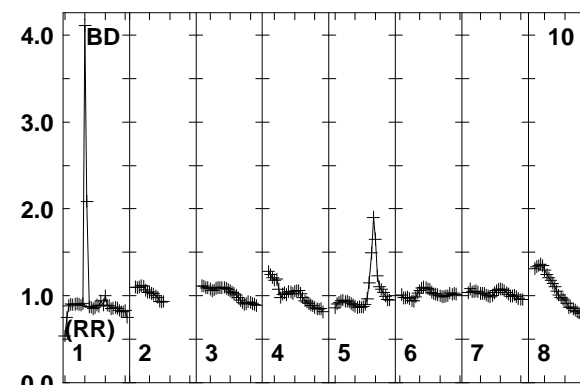
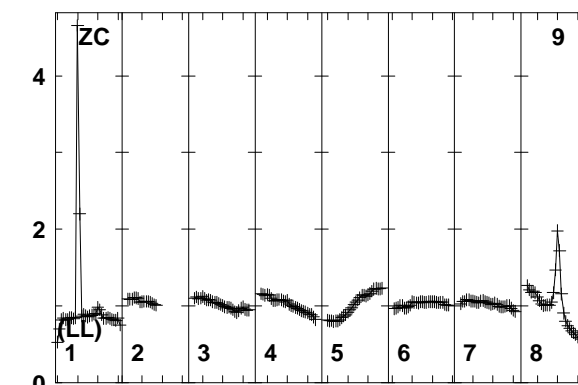
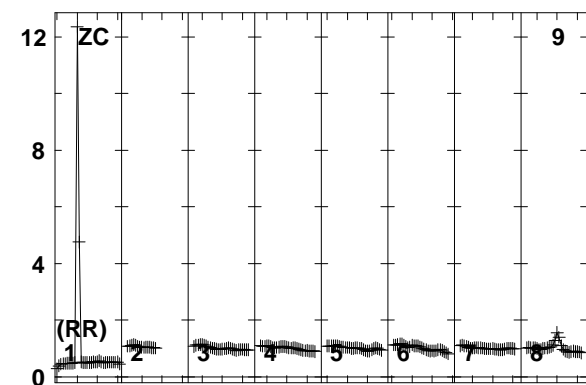
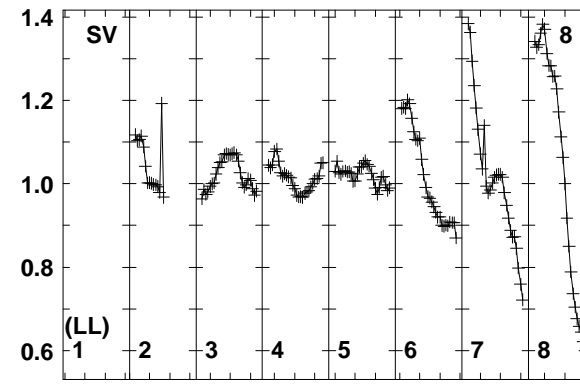
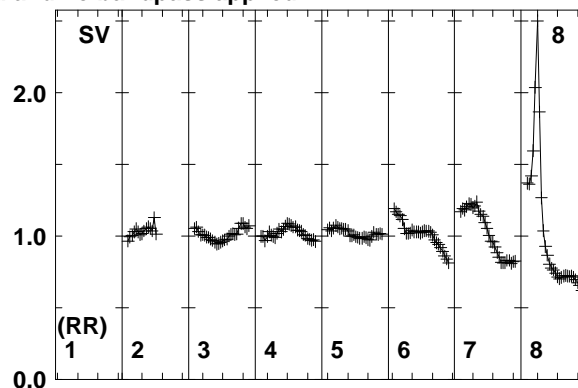
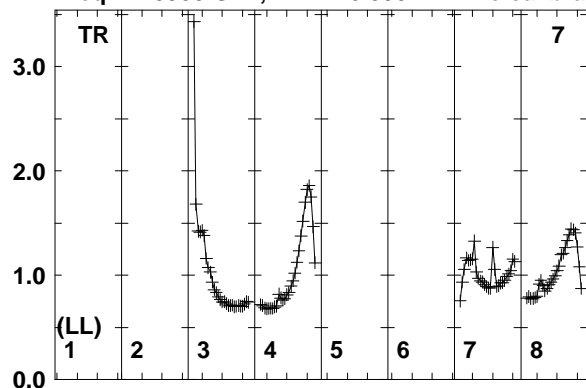

Lower frame: Real Jy
Total-power spectrum Antenna: TR (07)
Timerange: 00/08:46:03 to 00/08:47:19

Plot file version 145 created 20-MAR-2014 17:08:04

IC883 ER030C.UVDATA.1

Freq = 1.5950 GHz, Bw = 16.000 MH No calibration applied and no bandpass applied

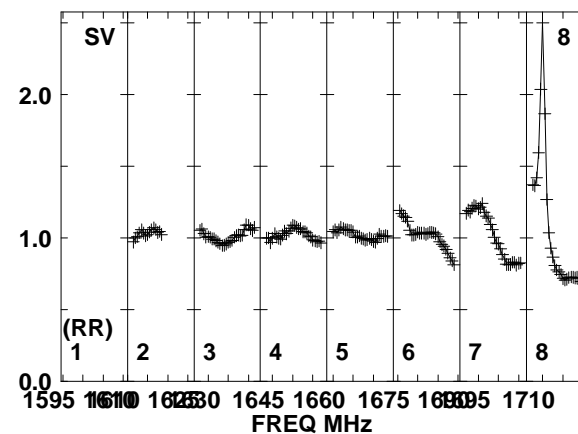
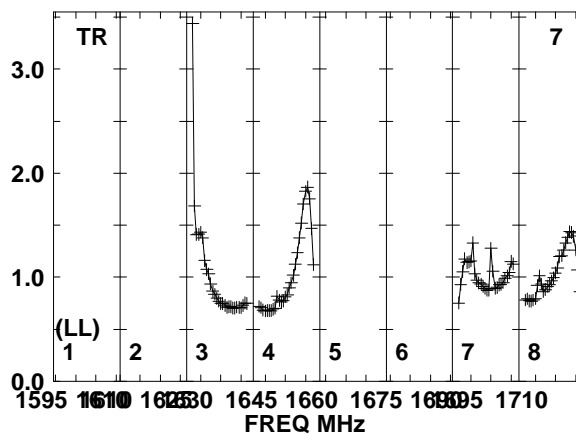
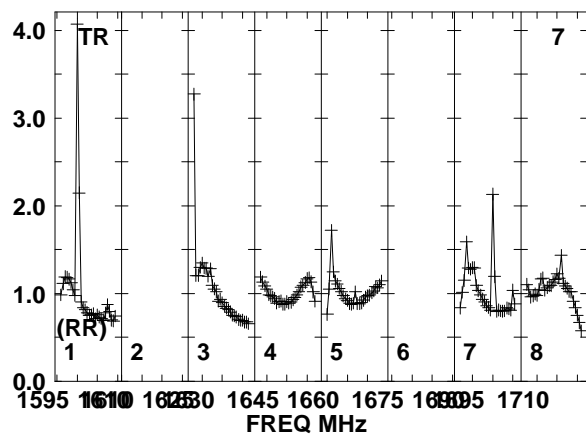
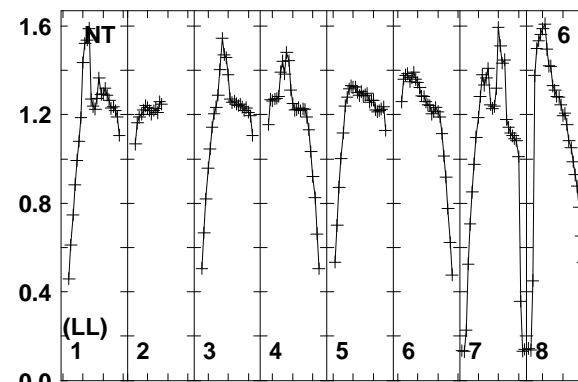
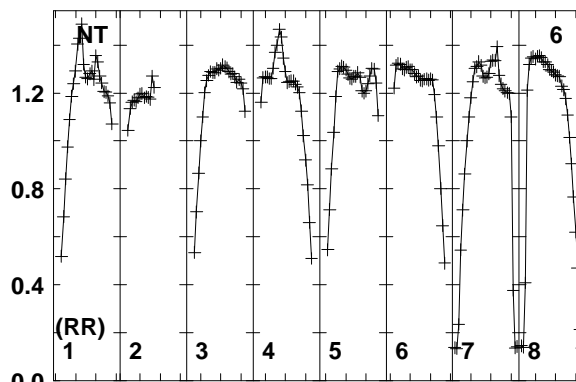
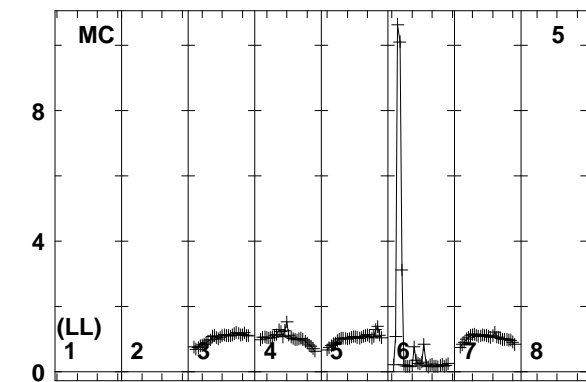
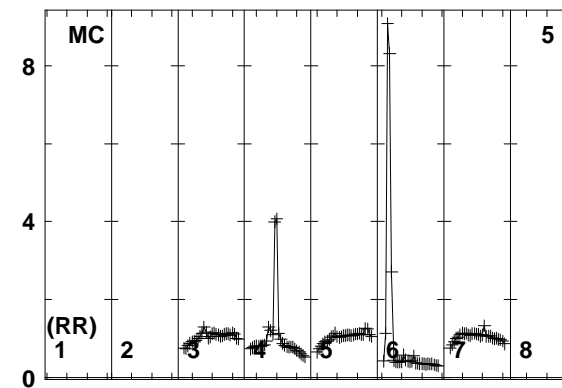
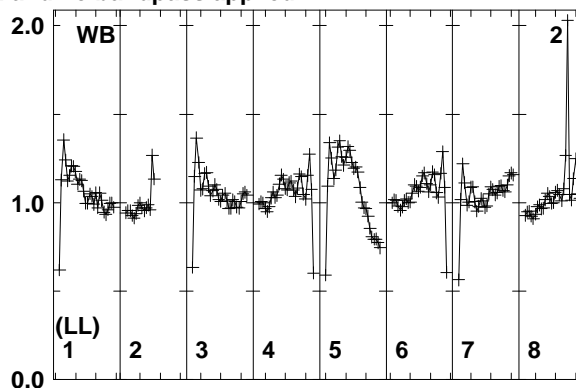
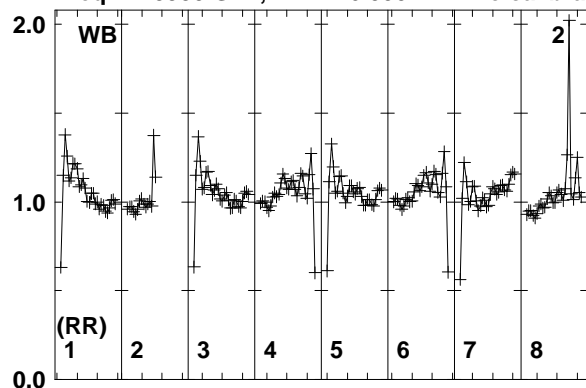

Lower frame: Real Jy
Total-power spectrum Antenna: WB (02)
Timerange: 00/08:47:21 to 00/08:51:09

Plot file version 146 created 20-MAR-2014 17:08:04

IC883 ER030C.UVDATA.1

Freq = 1.5950 GHz, Bw = 16.000 MH No calibration applied and no bandpass applied

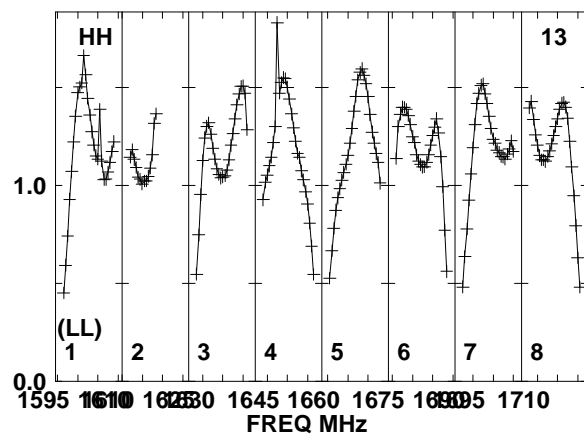
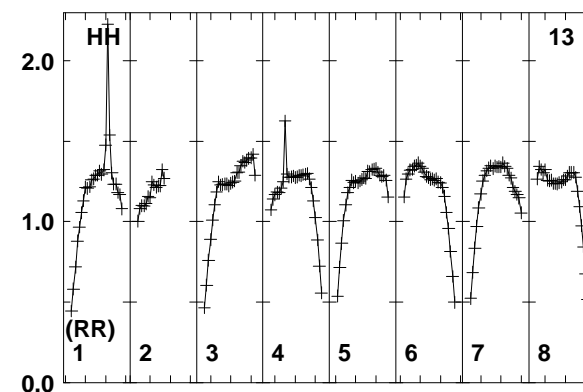
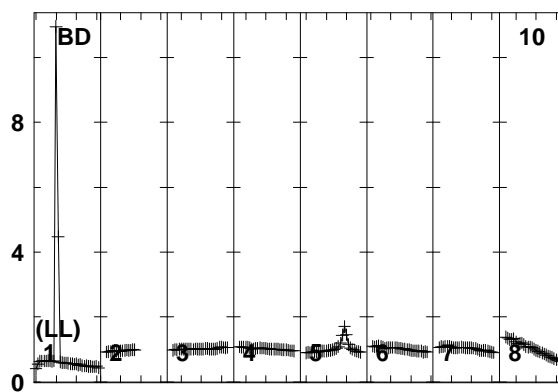
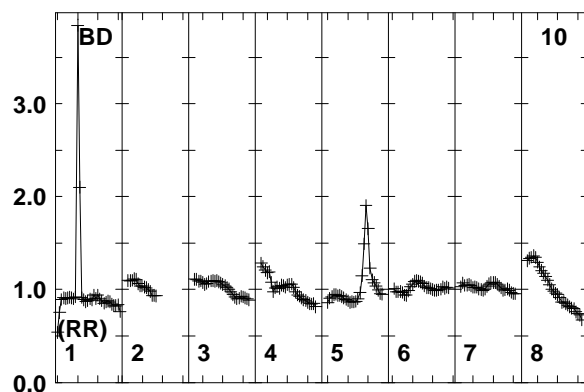
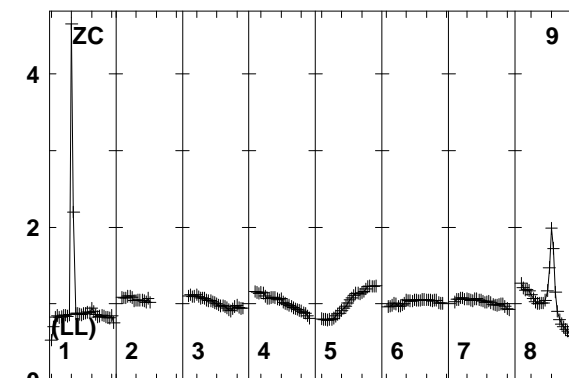
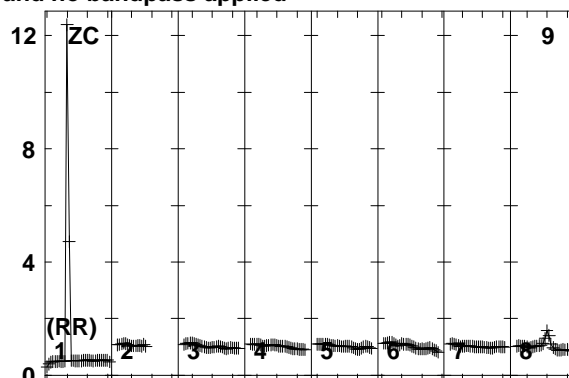
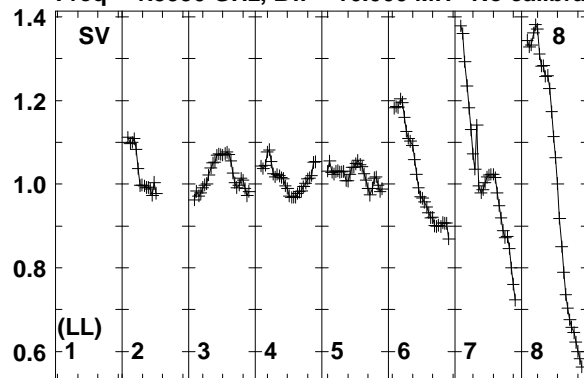

Lower frame: Real Jy
Total-power spectrum Antenna: SV (08)
Timerange: 00/08:47:21 to 00/08:51:09

Plot file version 147 created 20-MAR-2014 17:08:05

J1317+3425 ER030C.UVDATA.1

Freq = 1.5950 GHz, Bw = 16.000 MH No calibration applied and no bandpass applied

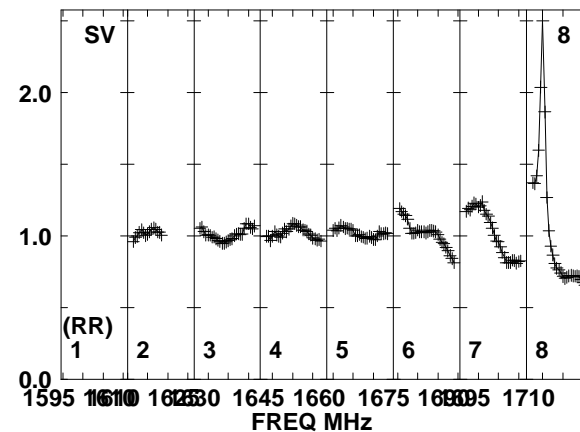
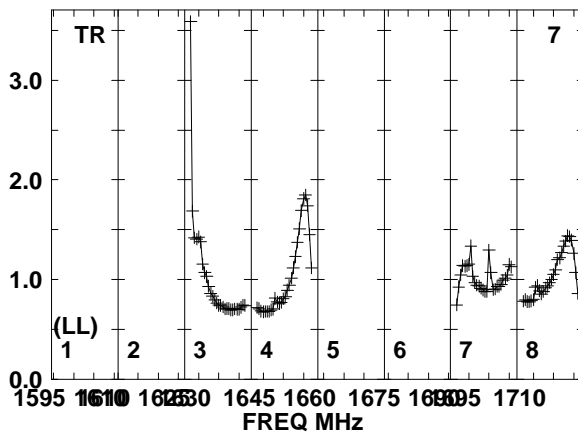
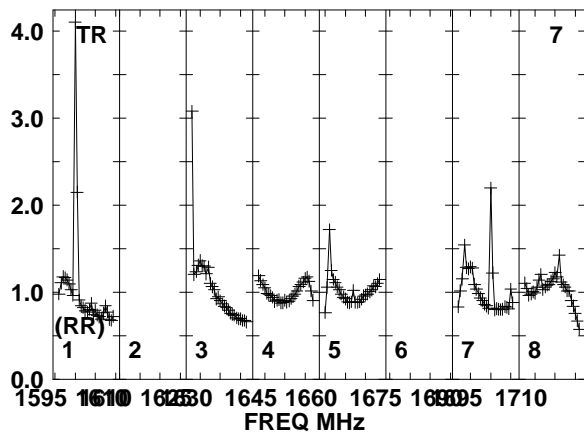
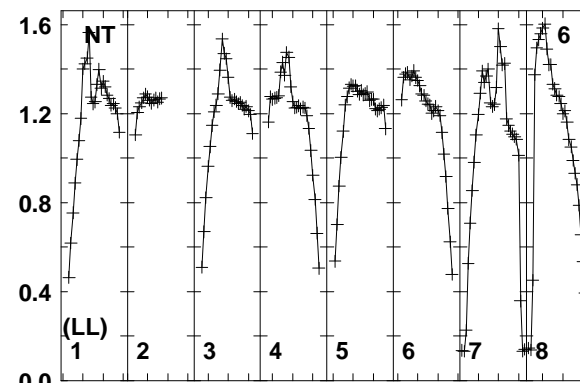
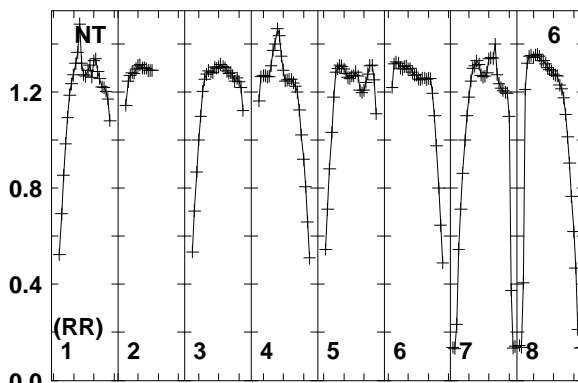
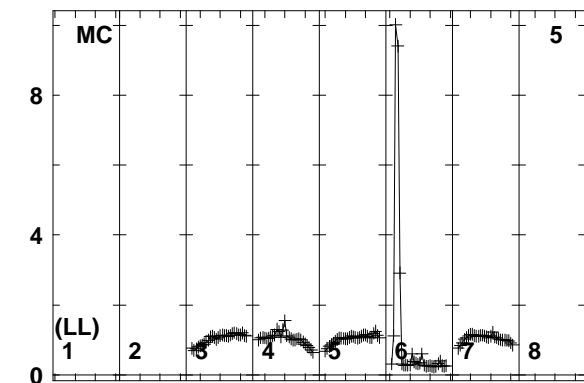
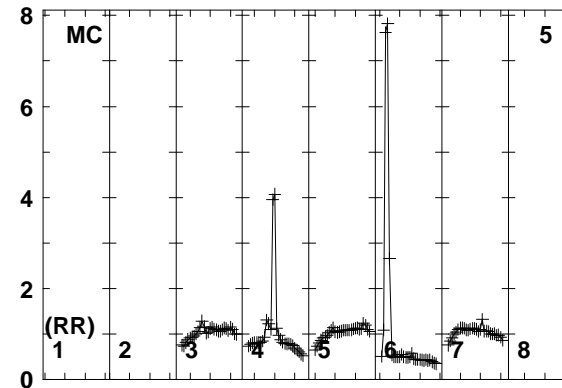
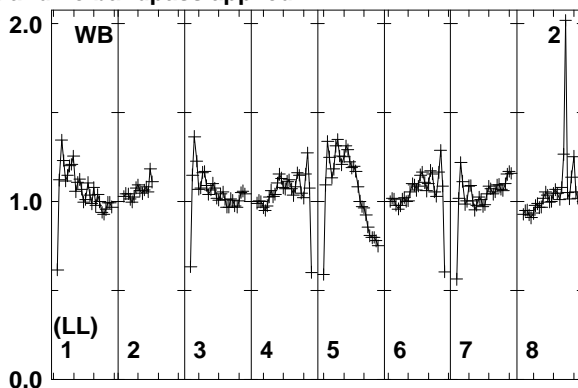
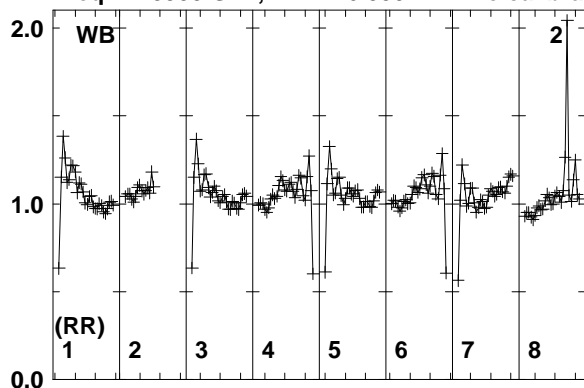

Lower frame: Real Jy
Total-power spectrum Antenna: WB (02)
Timerange: 00/08:51:51 to 00/08:52:49

Plot file version 148 created 20-MAR-2014 17:08:05

J1317+3425 ER030C.UVDATA.1

Freq = 1.5950 GHz, Bw = 16.000 MH No calibration applied and no bandpass applied

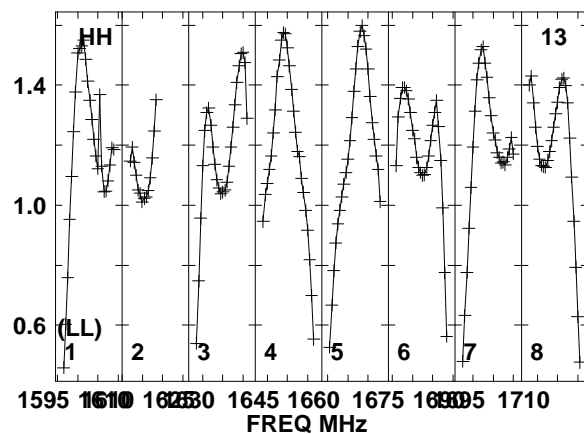
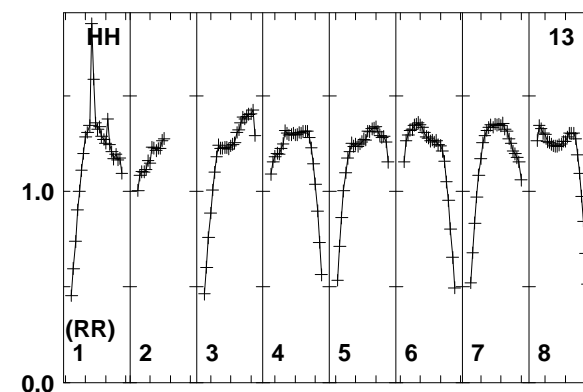
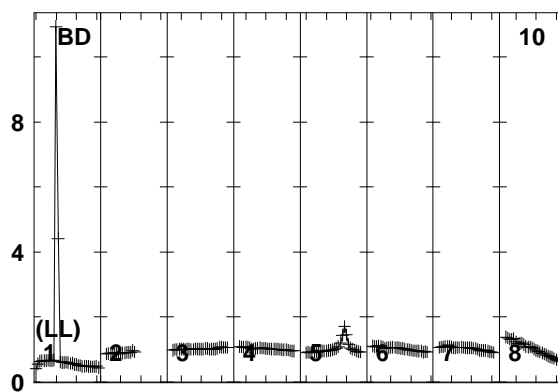
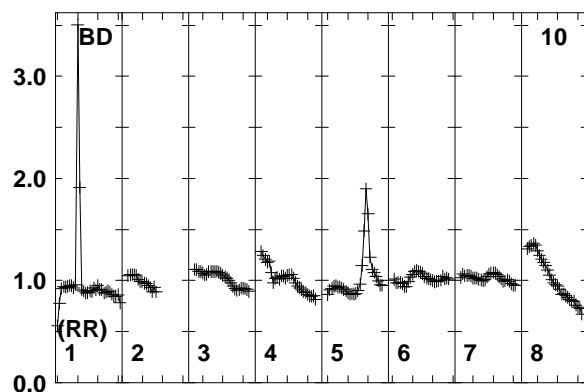
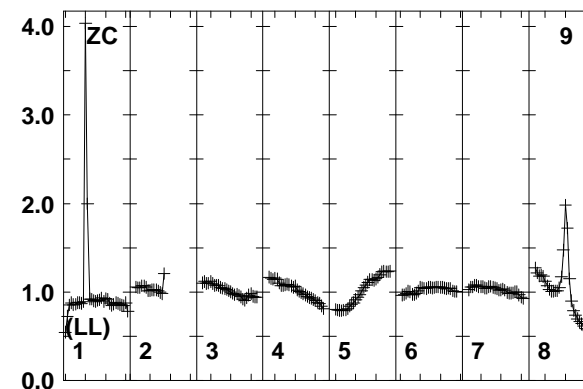
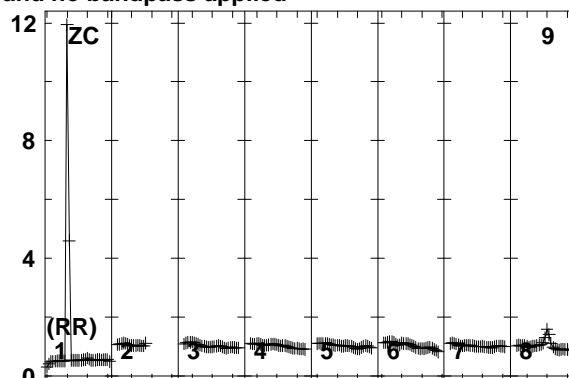
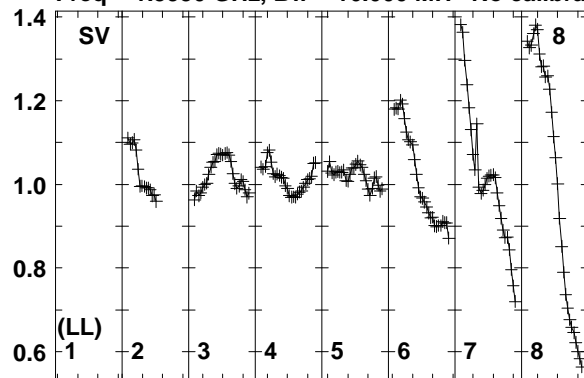

Lower frame: Real Jy
Total-power spectrum Antenna: SV (08)
Timerange: 00/08:51:51 to 00/08:52:49

Plot file version 149 created 20-MAR-2014 17:08:05

IC883 ER030C.UVDATA.1

Freq = 1.5950 GHz, Bw = 16.000 MH No calibration applied and no bandpass applied

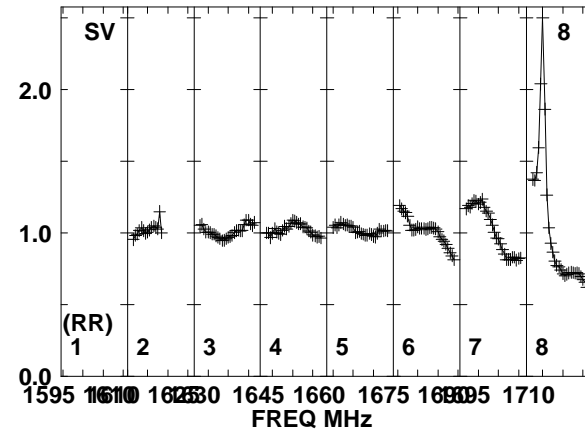
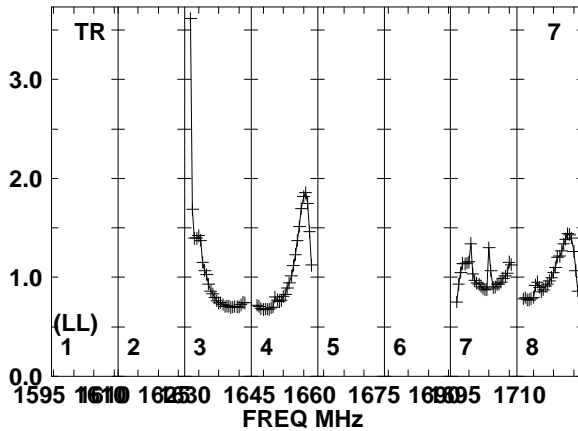
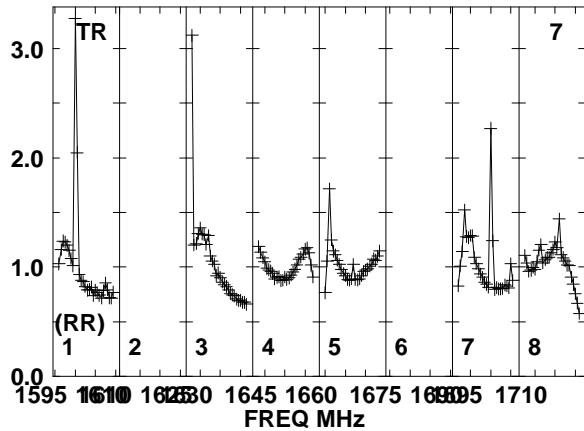
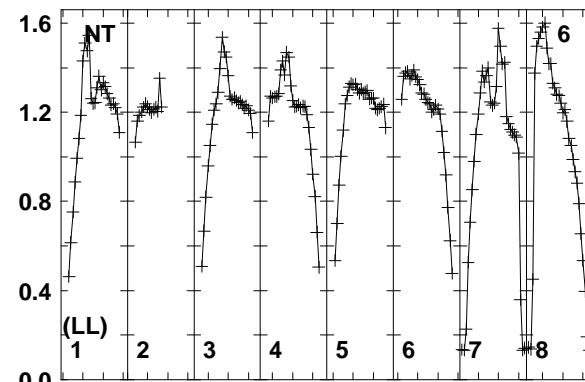
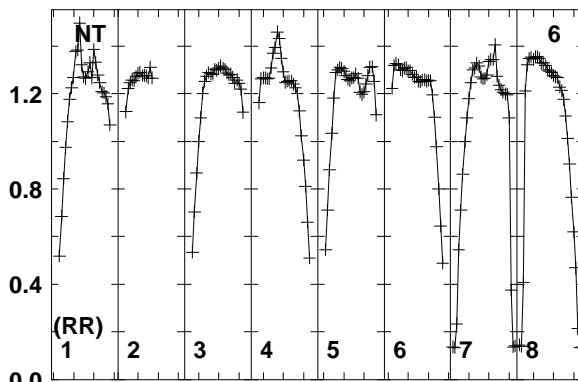
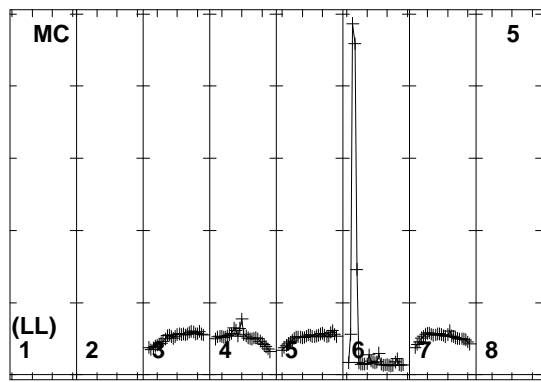
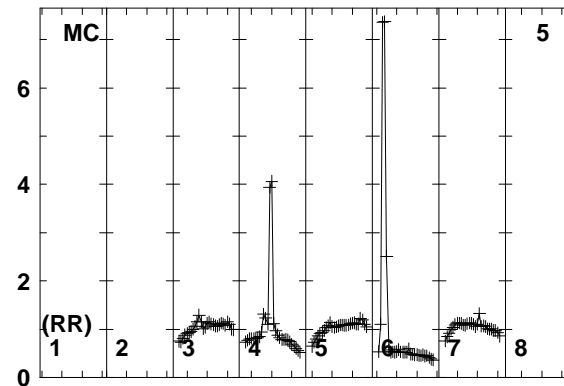
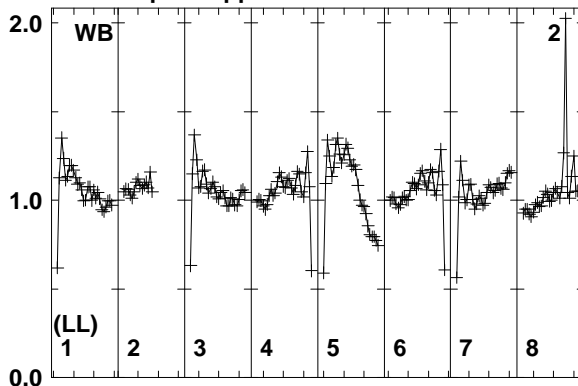
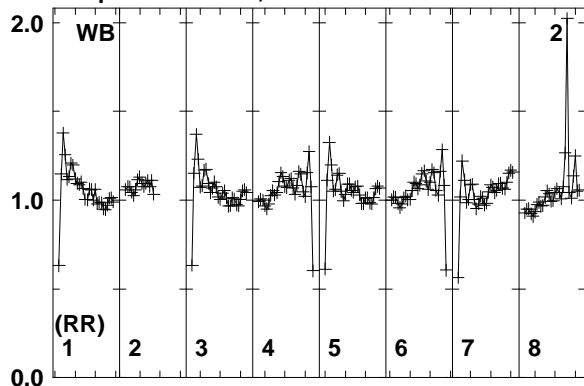

Lower frame: Real Jy
Total-power spectrum Antenna: WB (02)
Timerange: 00/08:52:53 to 00/08:56:39

Plot file version 150 created 20-MAR-2014 17:08:05

IC883 ER030C.UVDATA.1

Freq = 1.5950 GHz, Bw = 16.000 MH No calibration applied and no bandpass applied

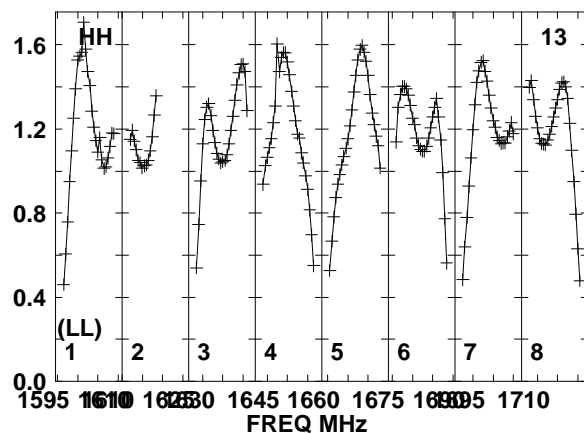
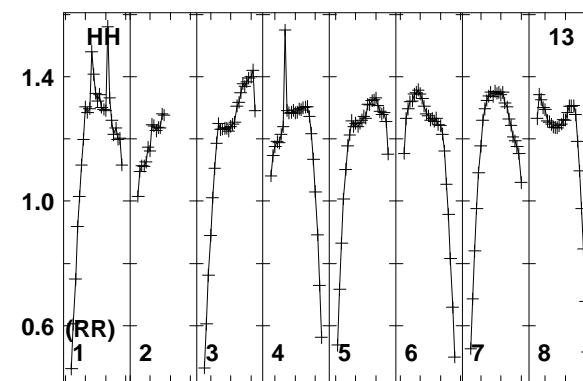
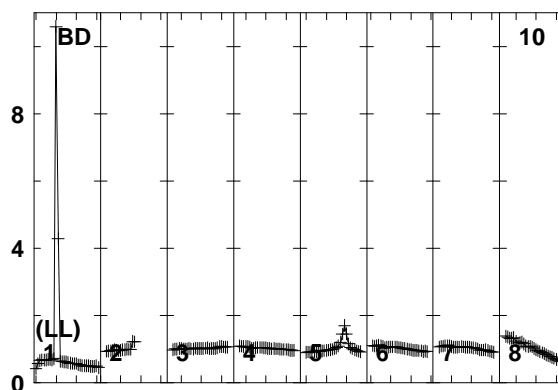
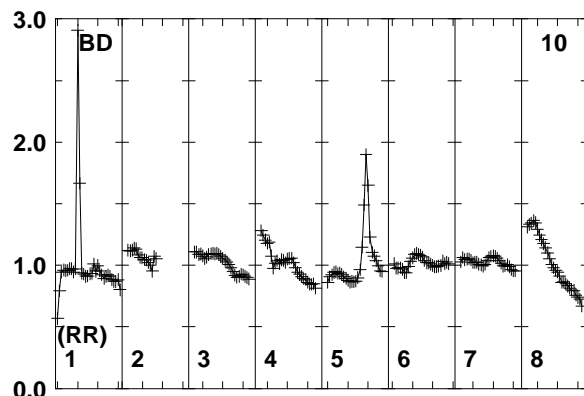
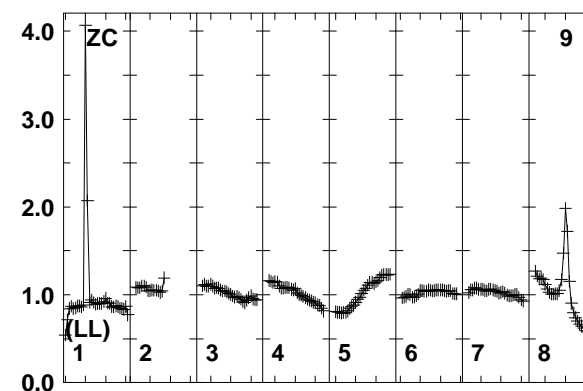
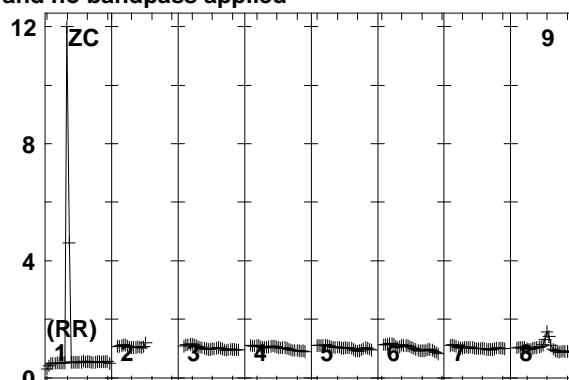
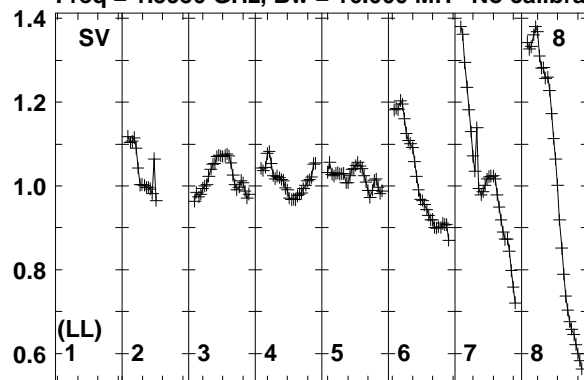

Lower frame: Real Jy
Total-power spectrum Antenna: SV (08)
Timerange: 00/08:52:53 to 00/08:56:39

Plot file version 151 created 20-MAR-2014 17:08:05

J1317+3425 ER030C.UVDATA.1

Freq = 1.5950 GHz, Bw = 16.000 MH No calibration applied and no bandpass applied

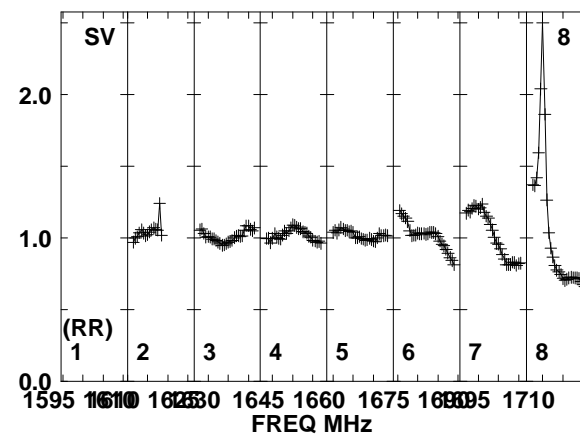
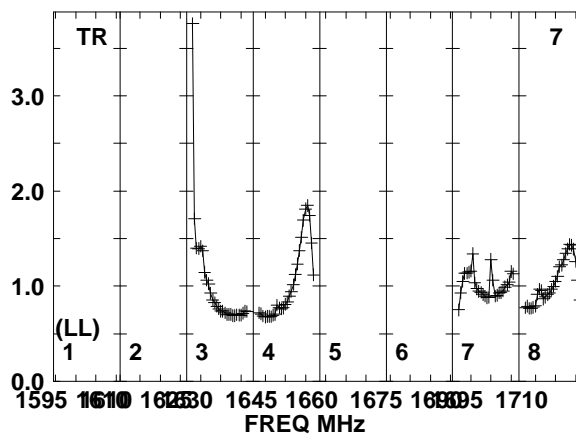
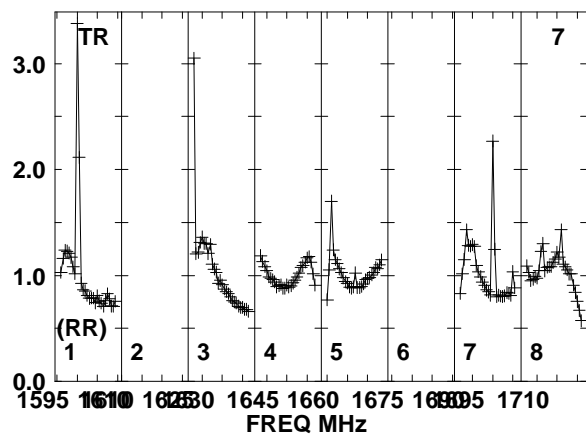
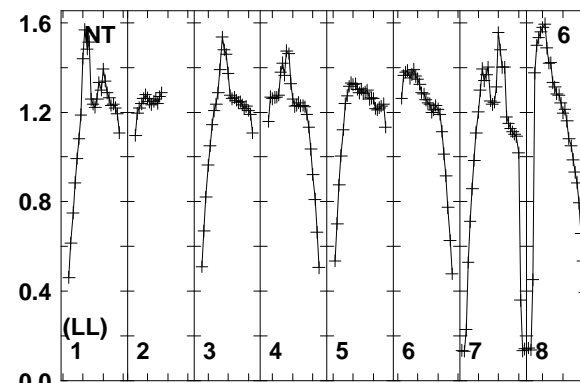
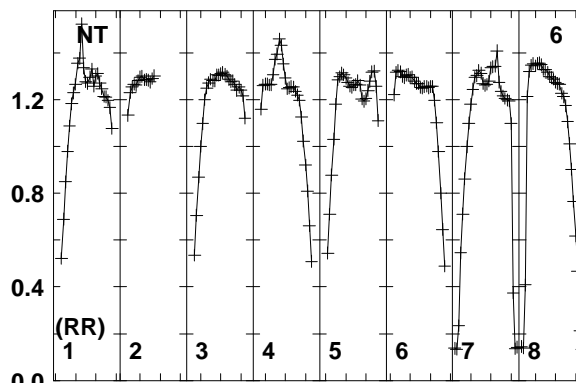
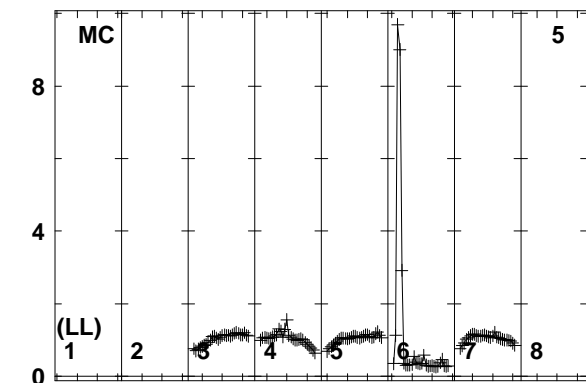
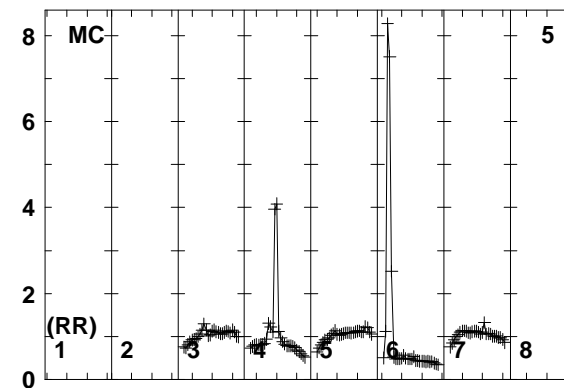
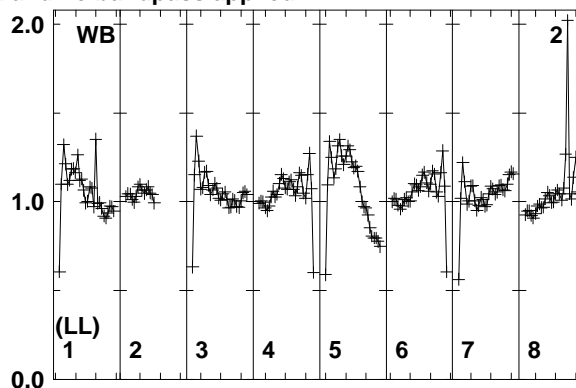
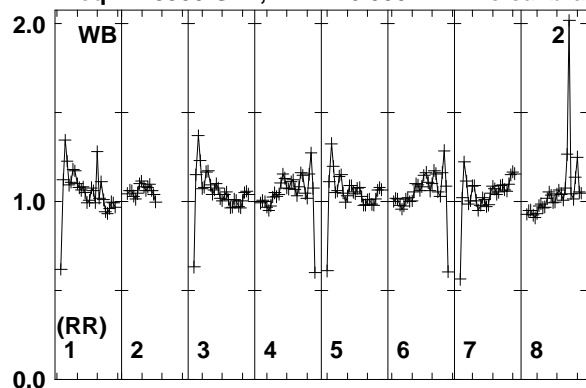

Lower frame: Real Jy
Total-power spectrum Antenna: WB (02)
Timerange: 00/08:56:43 to 00/08:57:59

Plot file version 152 created 20-MAR-2014 17:08:05

J1317+3425 ER030C.UVDATA.1

Freq = 1.5950 GHz, Bw = 16.000 MH No calibration applied and no bandpass applied

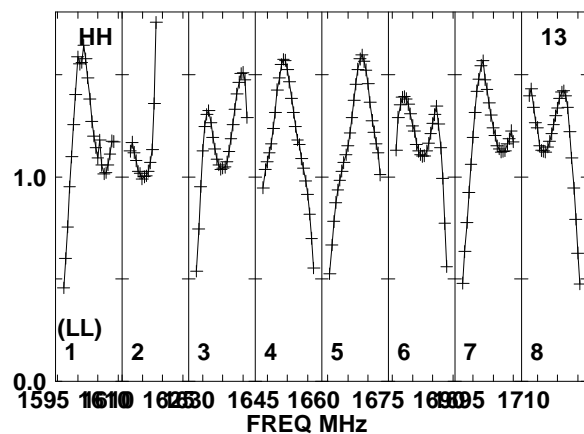
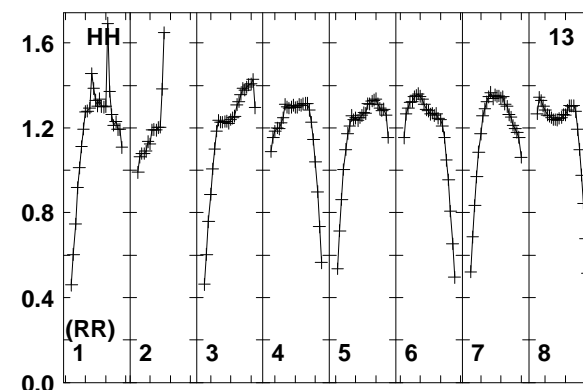
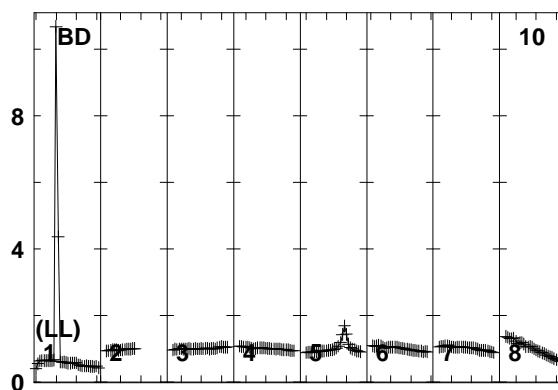
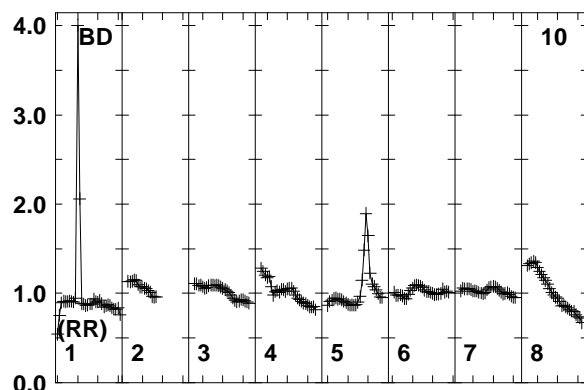
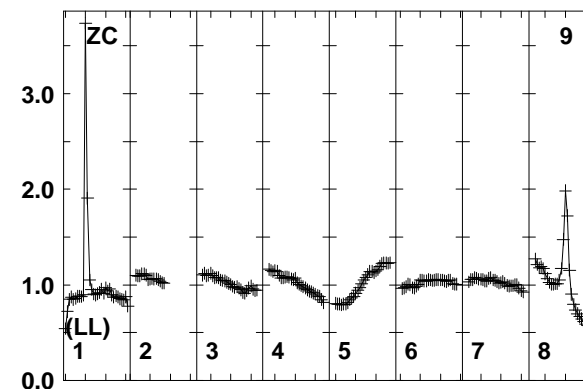
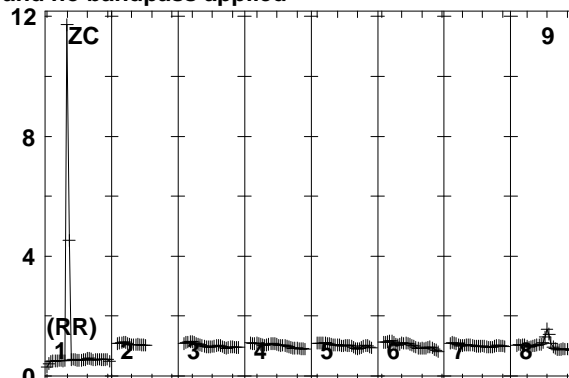
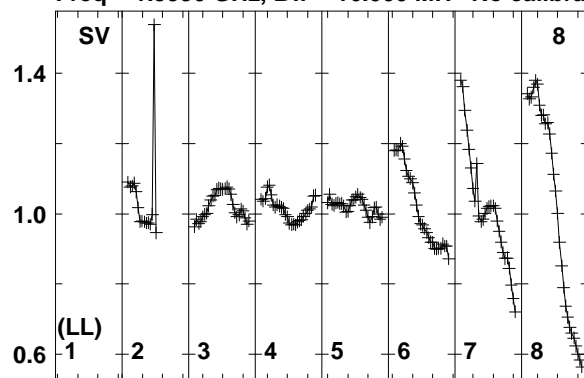

Lower frame: Real Jy
Total-power spectrum Antenna: SV (08)
Timerange: 00/08:56:43 to 00/08:57:59

Plot file version 153 created 20-MAR-2014 17:08:05

IC883 ER030C.UVDATA.1

Freq = 1.5950 GHz, Bw = 16.000 MH No calibration applied and no bandpass applied

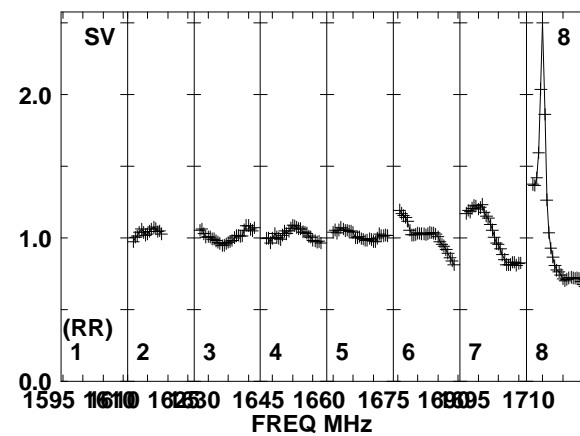
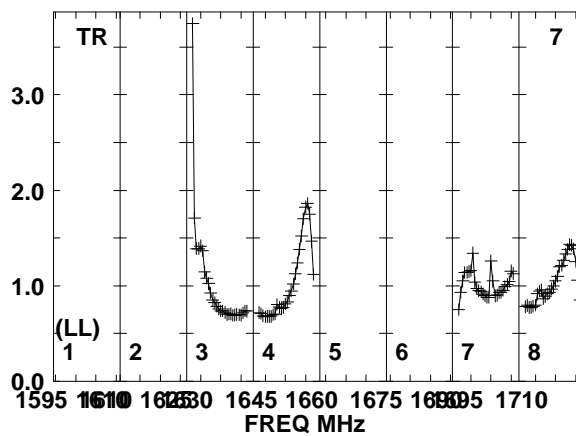
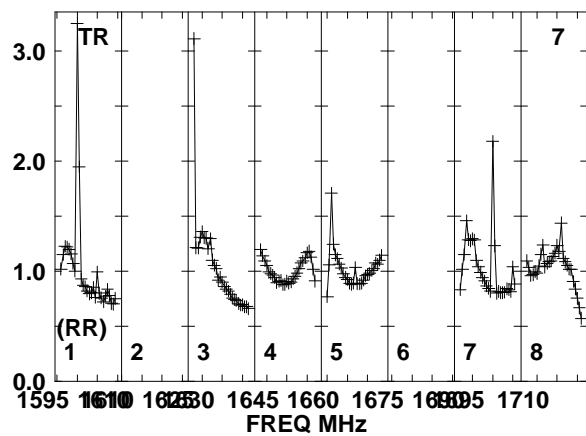
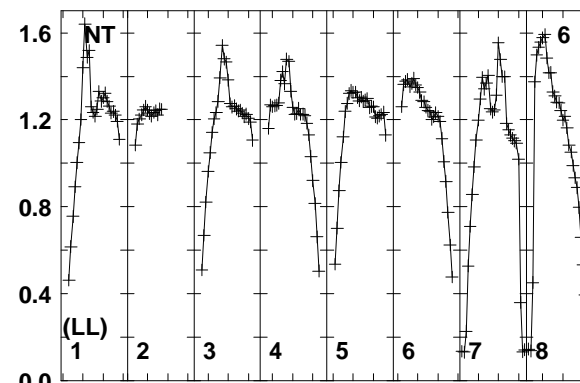
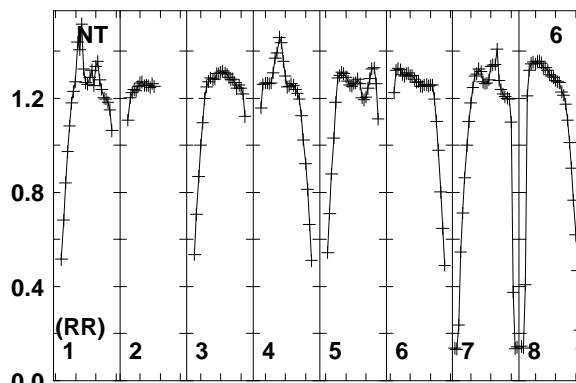
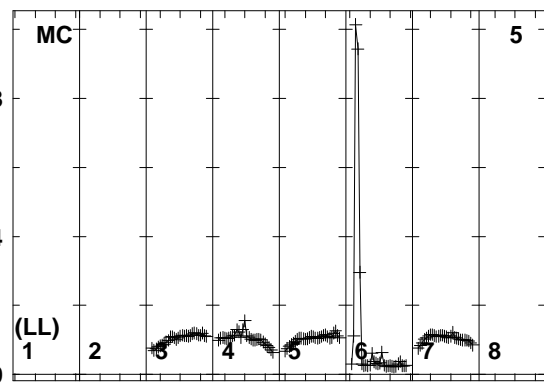
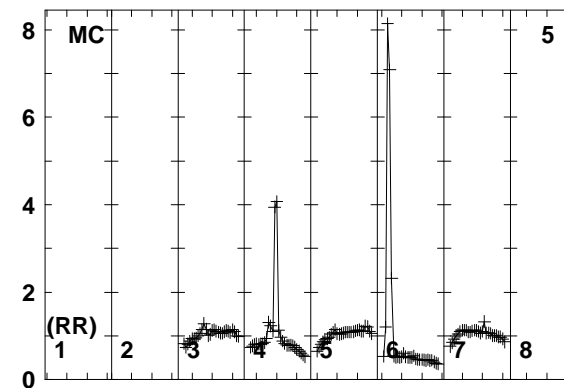
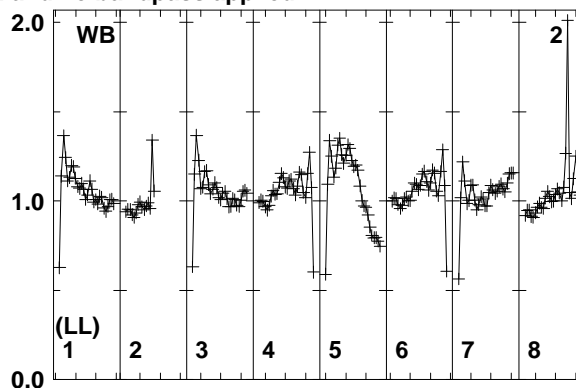
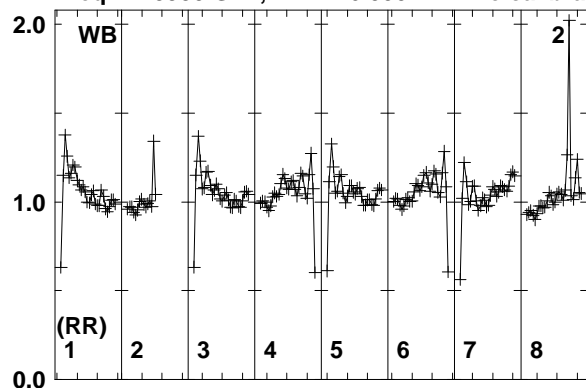

Lower frame: Real Jy
Total-power spectrum Antenna: WB (02)
Timerange: 00/08:58:01 to 00/09:01:49

Plot file version 154 created 20-MAR-2014 17:08:05

IC883 ER030C.UVDATA.1

Freq = 1.5950 GHz, Bw = 16.000 MH No calibration applied and no bandpass applied

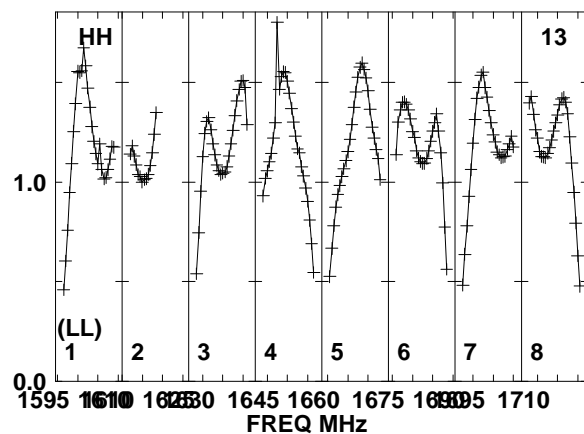
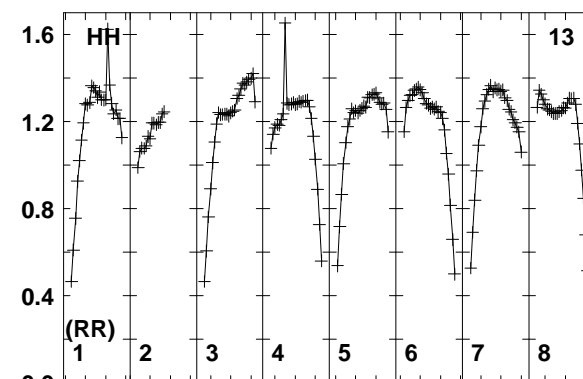
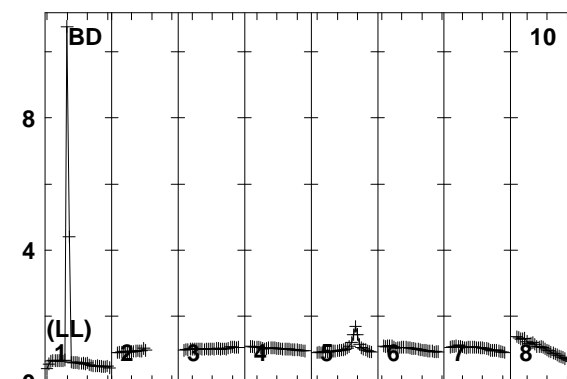
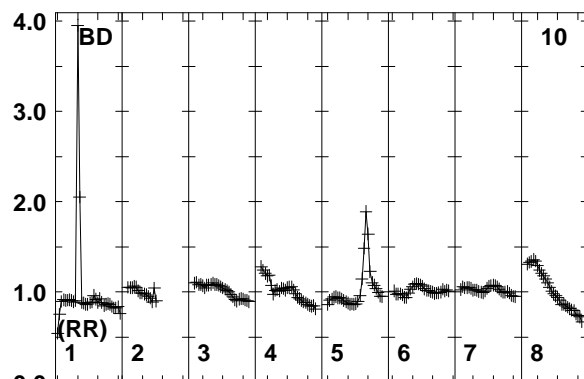
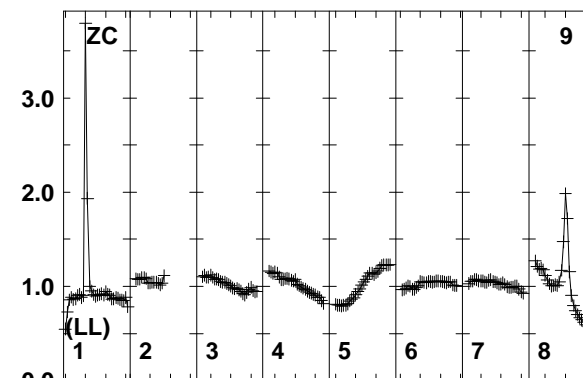
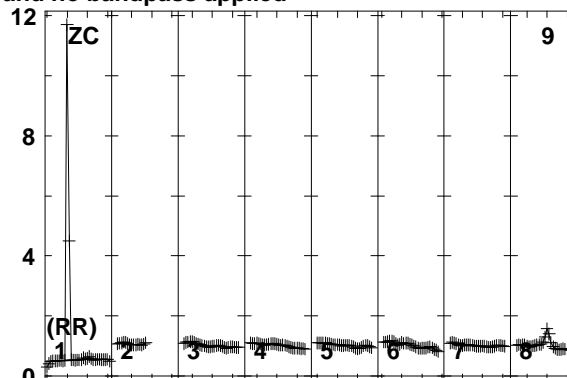
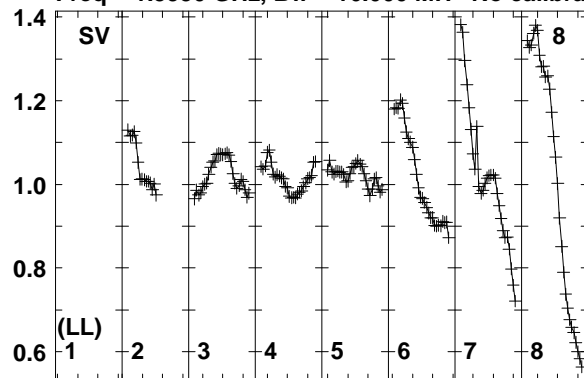

1595 1610 1625 1640 1655 1670 1685 1700 1710
FREQ MHz
Lower frame: Real Jy
Total-power spectrum Antenna: SV (08)
Timerange: 00/08:58:01 to 00/09:01:49

Plot file version 155 created 20-MAR-2014 17:08:05

J1317+3425 ER030C.UVDATA.1

Freq = 1.5950 GHz, Bw = 16.000 MH No calibration applied and no bandpass applied

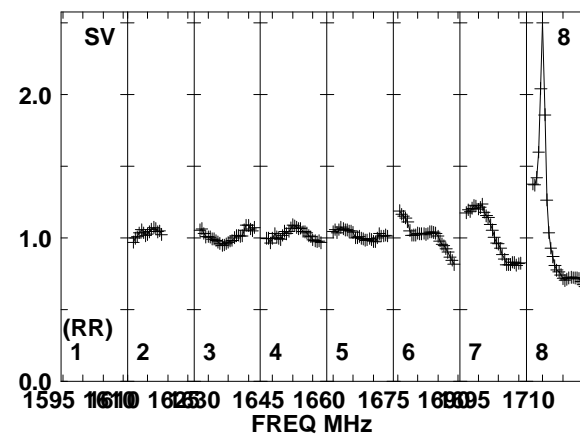
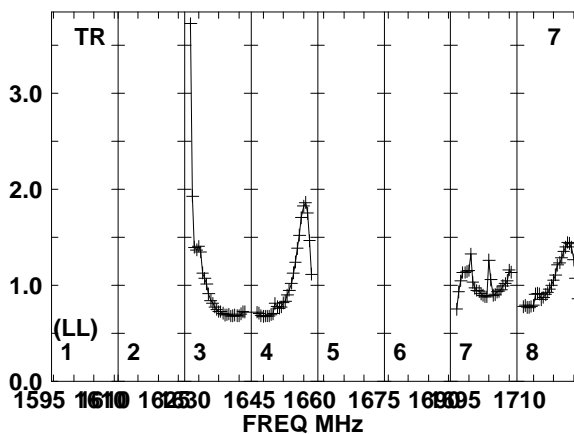
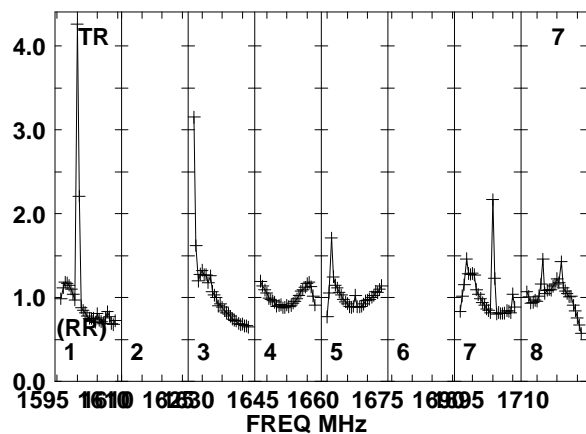
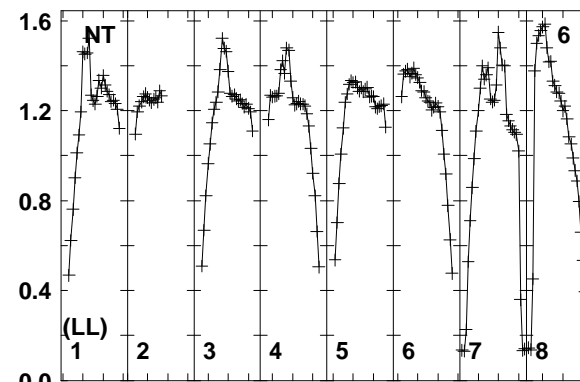
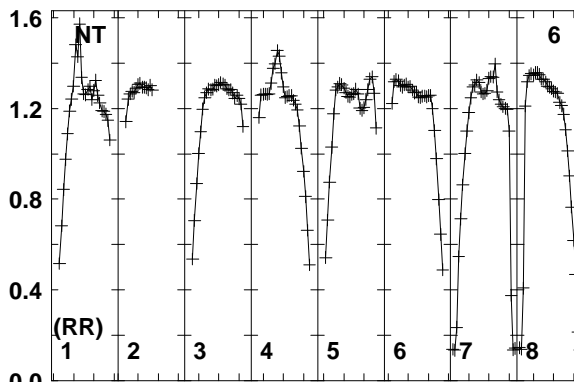
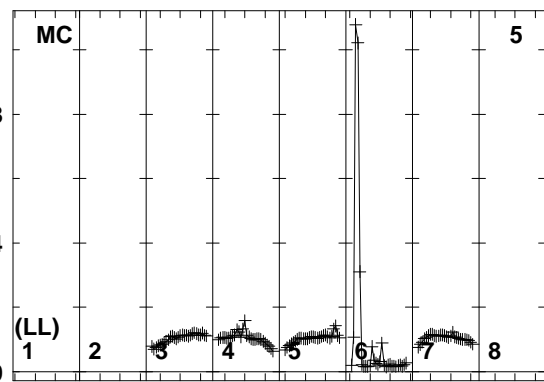
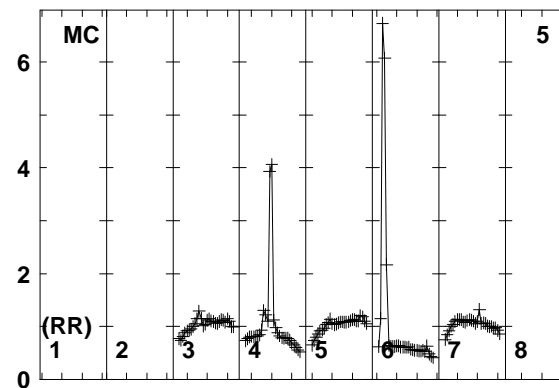
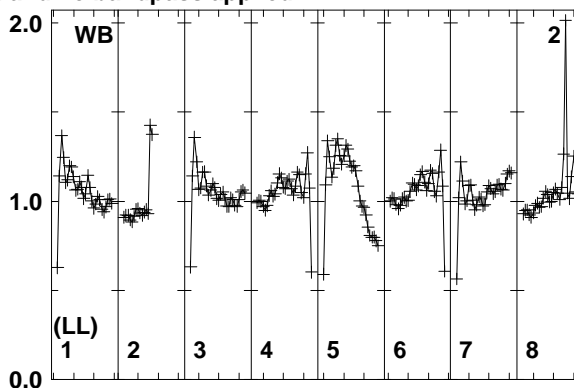
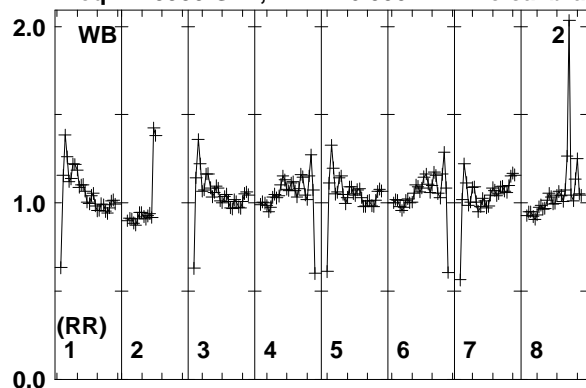

Lower frame: Real Jy
Total-power spectrum Antenna: WB (02)
Timerange: 00/09:02:31 to 00/09:03:29

Plot file version 156 created 20-MAR-2014 17:08:05

J1317+3425 ER030C.UVDATA.1

Freq = 1.5950 GHz, Bw = 16.000 MH No calibration applied and no bandpass applied

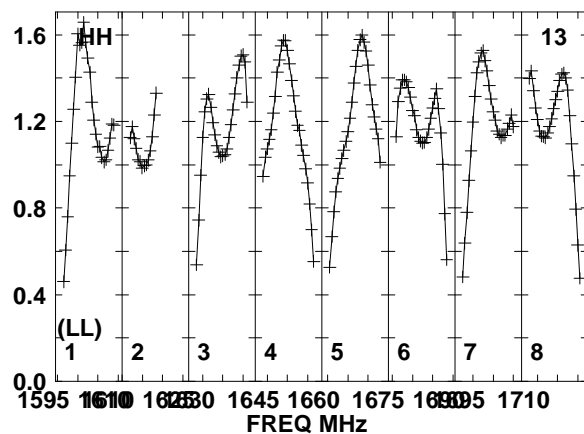
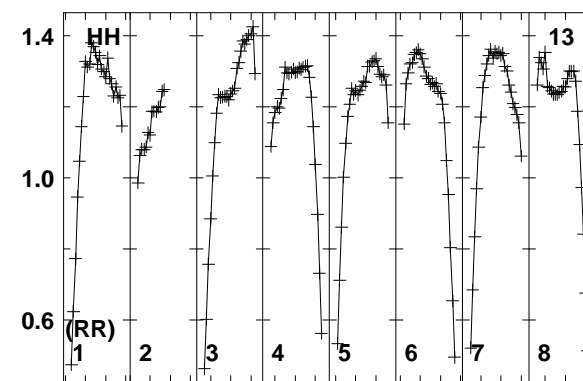
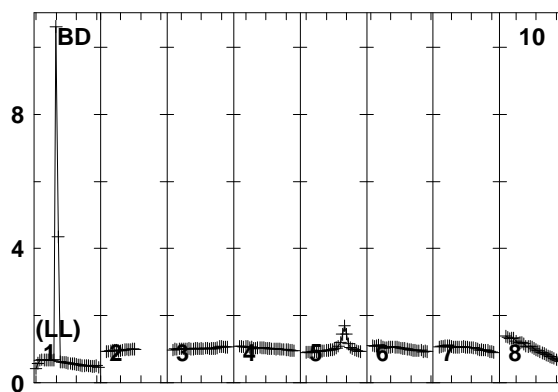
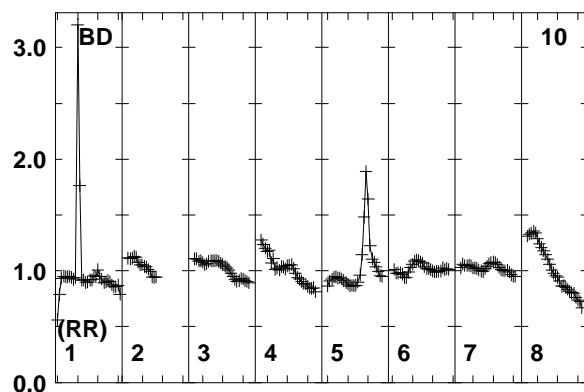
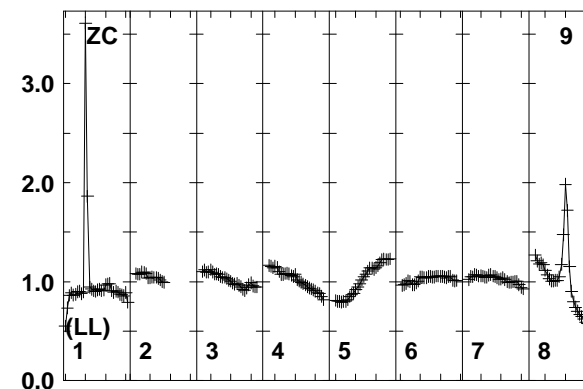
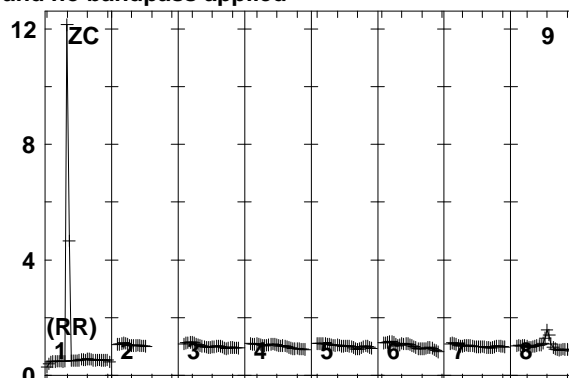
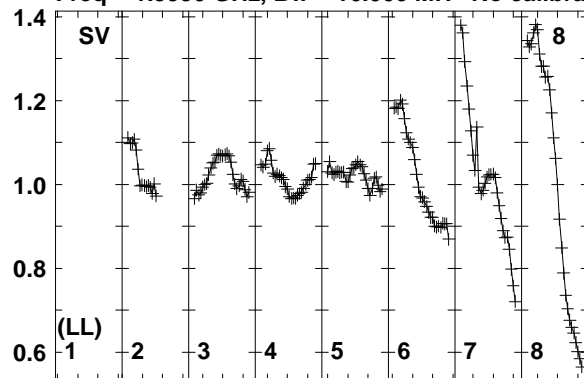

Lower frame: Real Jy
Total-power spectrum Antenna: SV (08)
Timerange: 00/09:02:31 to 00/09:03:29

Plot file version 157 created 20-MAR-2014 17:08:05

IC883 ER030C.UVDATA.1

Freq = 1.5950 GHz, Bw = 16.000 MH No calibration applied and no bandpass applied

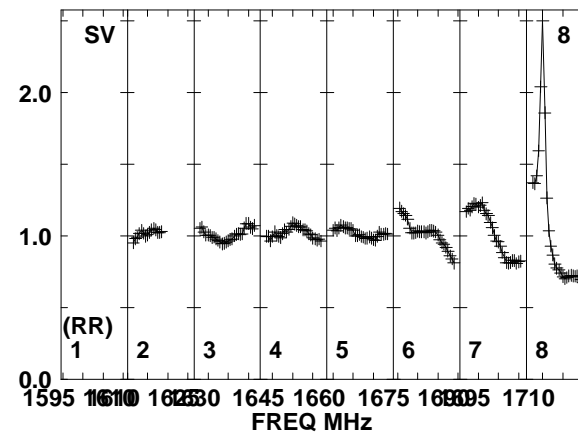
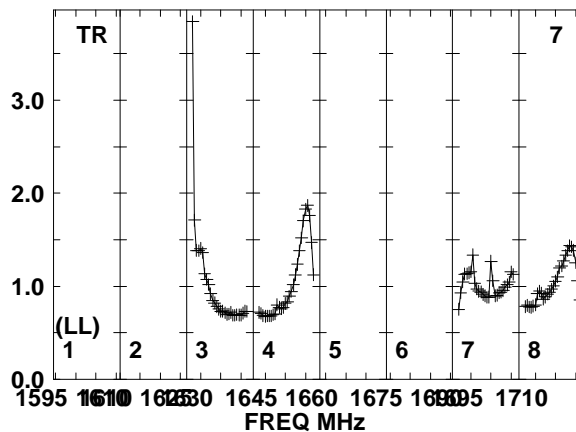
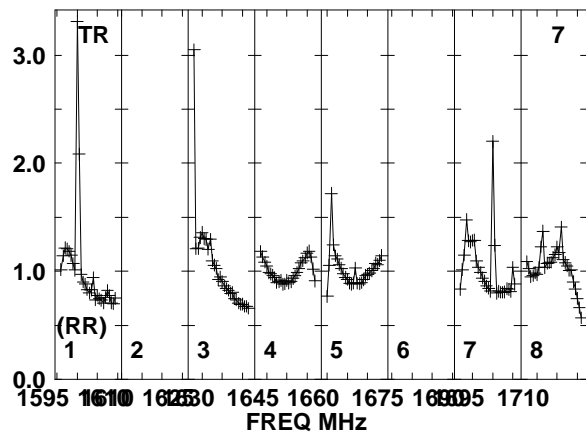
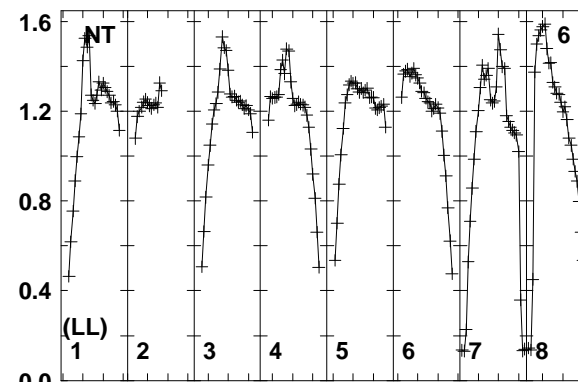
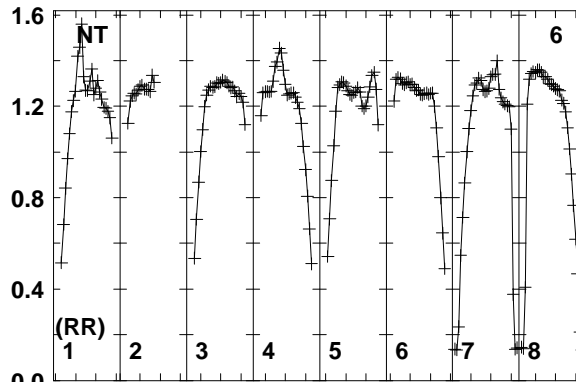
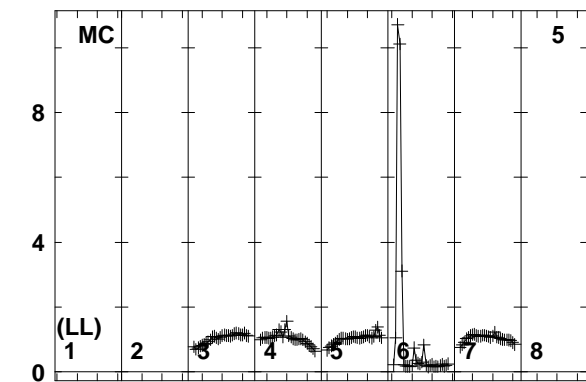
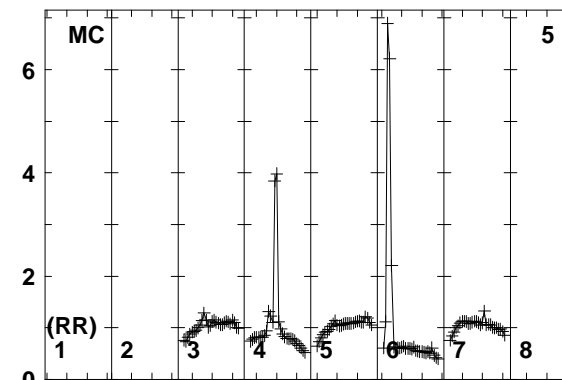
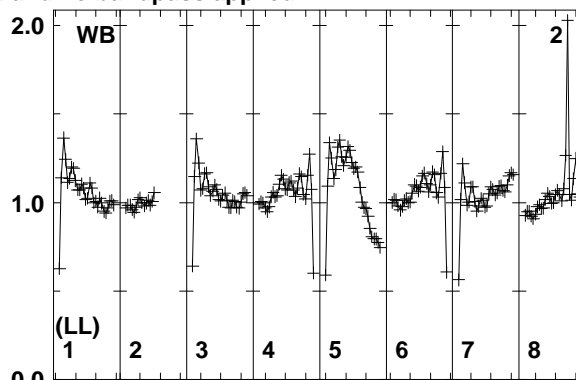
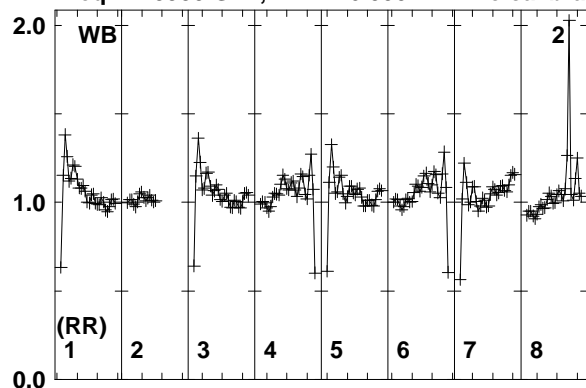

Lower frame: Real Jy
Total-power spectrum Antenna: WB (02)
Timerange: 00/09:03:33 to 00/09:07:19

Plot file version 158 created 20-MAR-2014 17:08:05

IC883 ER030C.UVDATA.1

Freq = 1.5950 GHz, Bw = 16.000 MH No calibration applied and no bandpass applied

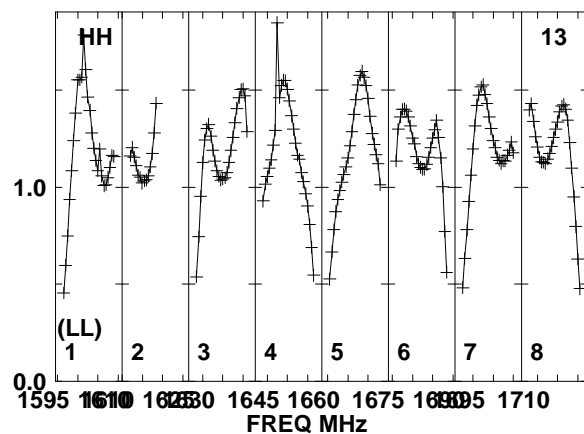
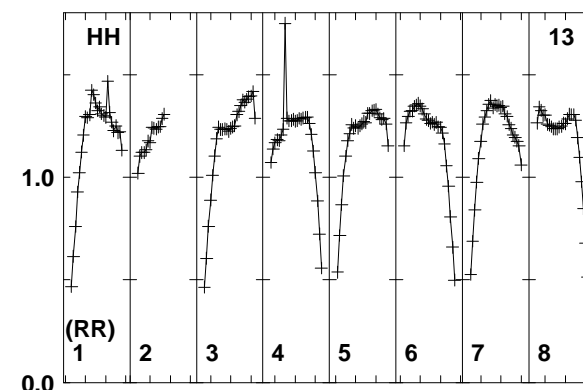
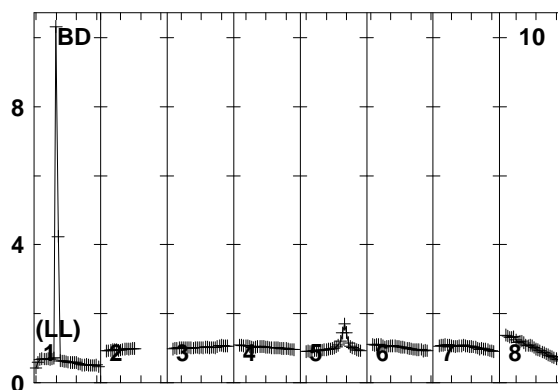
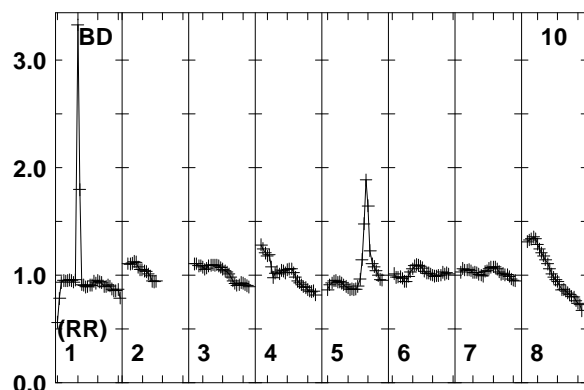
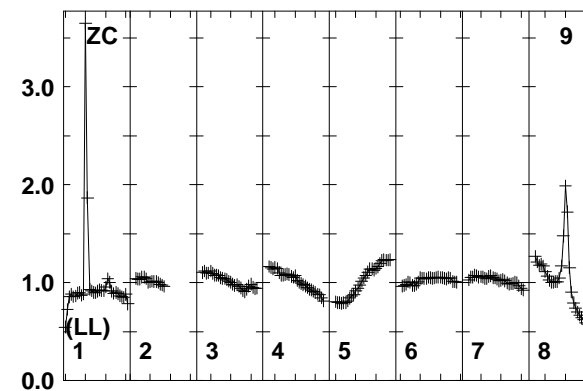
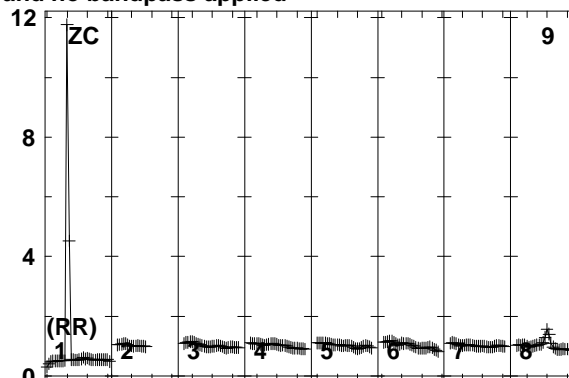
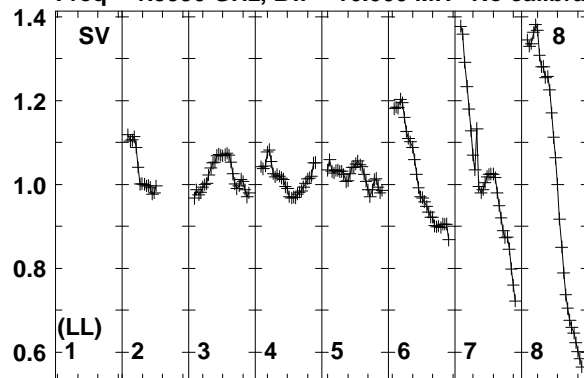

1595 1610 1625 1640 1655 1670 1685 1700 1710
FREQ MHz

Lower frame: Real Jy
Total-power spectrum Antenna: SV (08)
Timerange: 00/09:03:33 to 00/09:07:19

Plot file version 159 created 20-MAR-2014 17:08:05

J1317+3425 ER030C.UVDATA.1

Freq = 1.5950 GHz, Bw = 16.000 MH No calibration applied and no bandpass applied

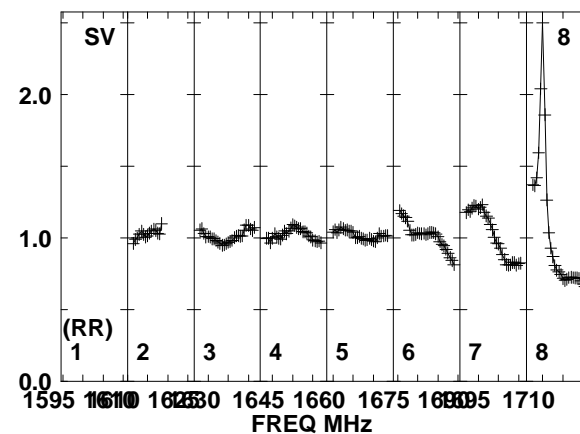
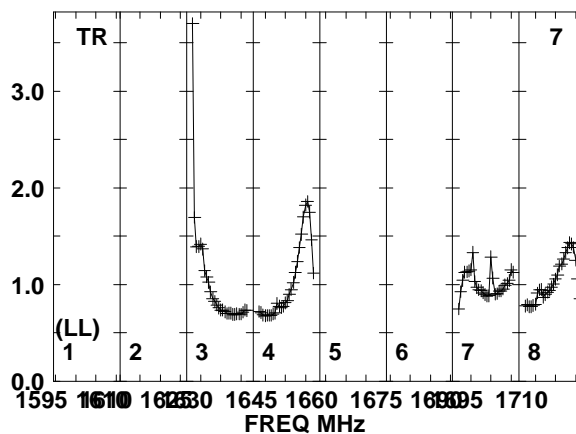
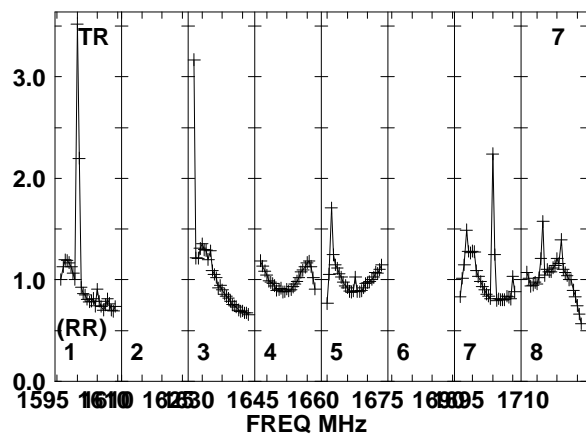
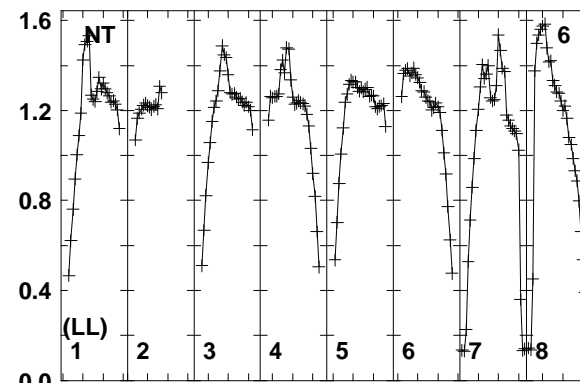
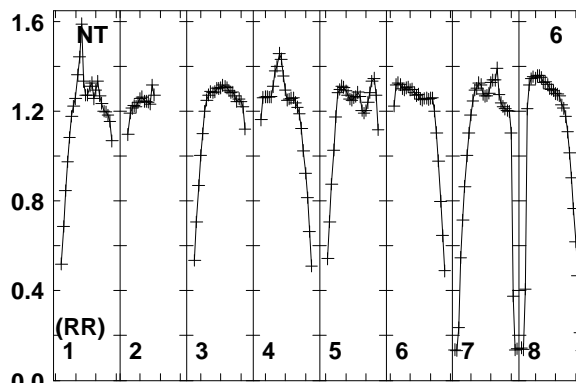
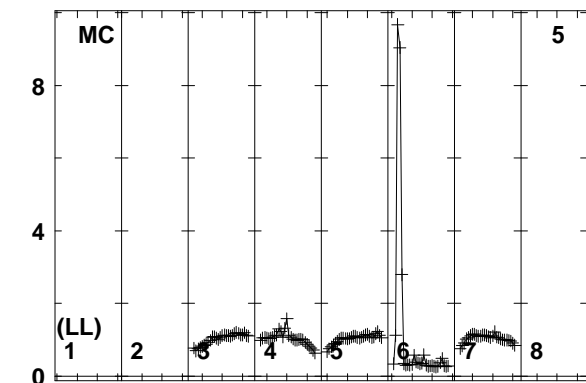
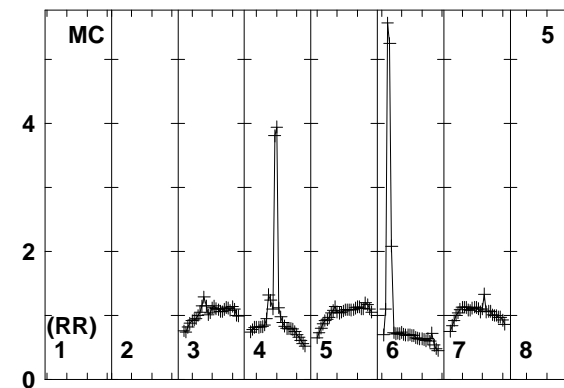
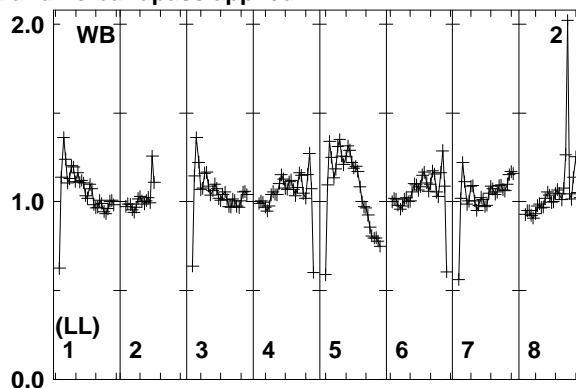
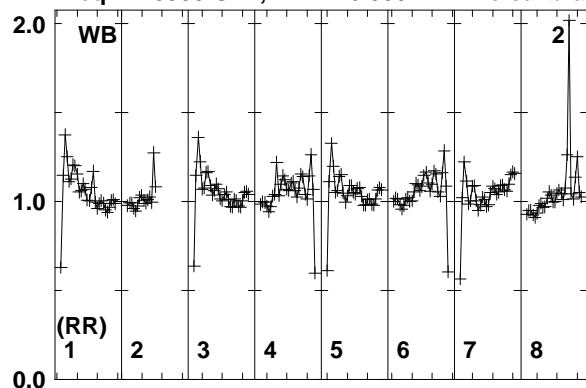

Lower frame: Real Jy
Total-power spectrum Antenna: WB (02)
Timerange: 00/09:07:23 to 00/09:08:39

Plot file version 160 created 20-MAR-2014 17:08:06

J1317+3425 ER030C.UVDATA.1

Freq = 1.5950 GHz, Bw = 16.000 MH No calibration applied and no bandpass applied

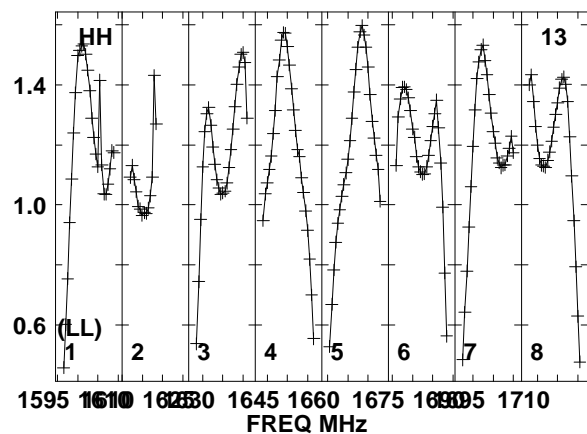
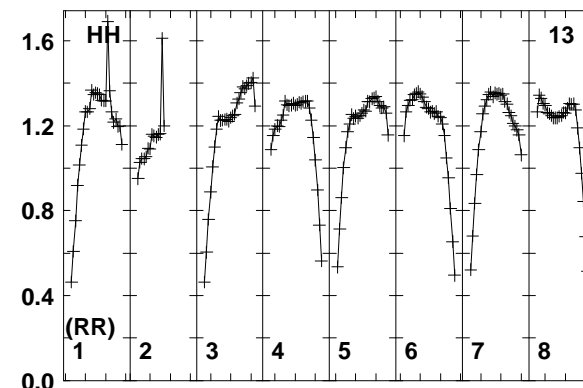
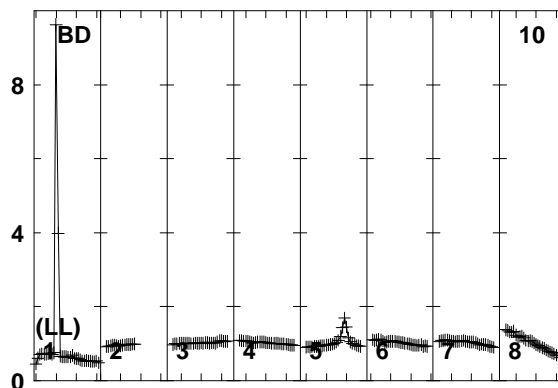
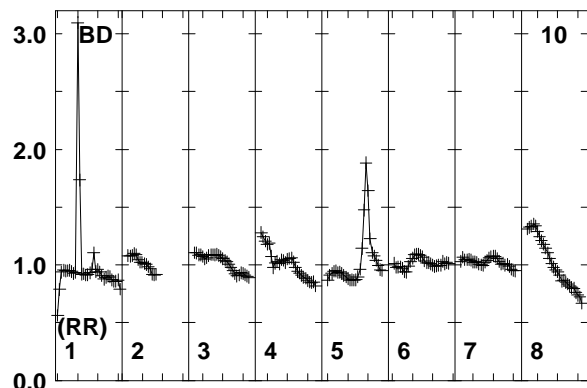
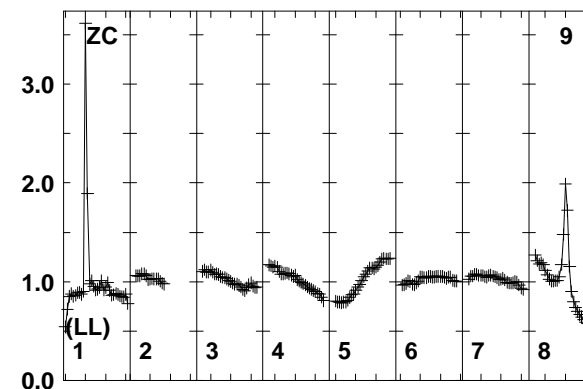
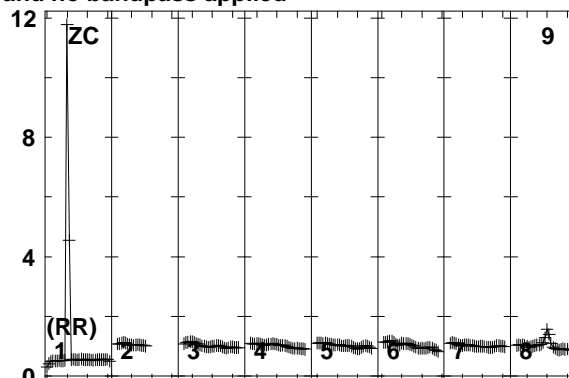
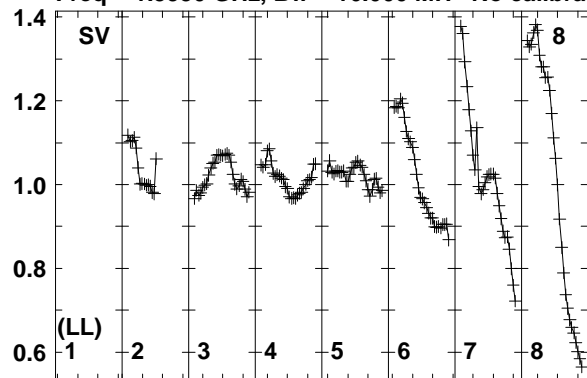

Lower frame: Real Jy
Total-power spectrum Antenna: SV (08)
Timerange: 00/09:07:23 to 00/09:08:39

Plot file version 161 created 20-MAR-2014 17:08:06

IC883 ER030C.UVDATA.1

Freq = 1.5950 GHz, Bw = 16.000 MH No calibration applied and no bandpass applied

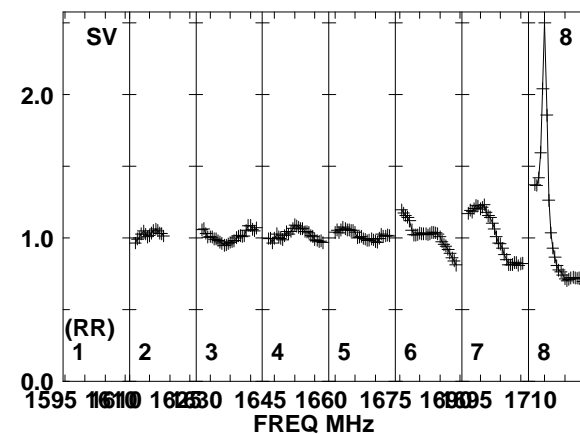
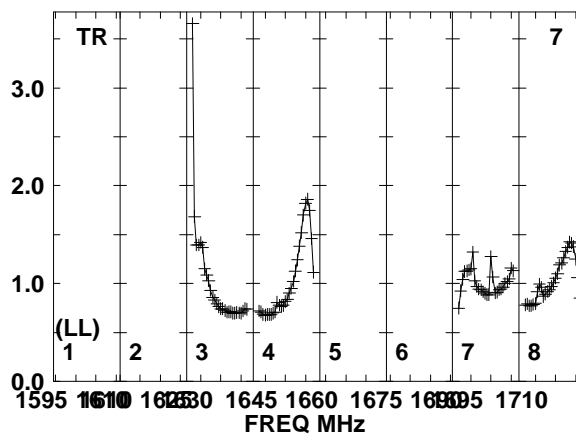
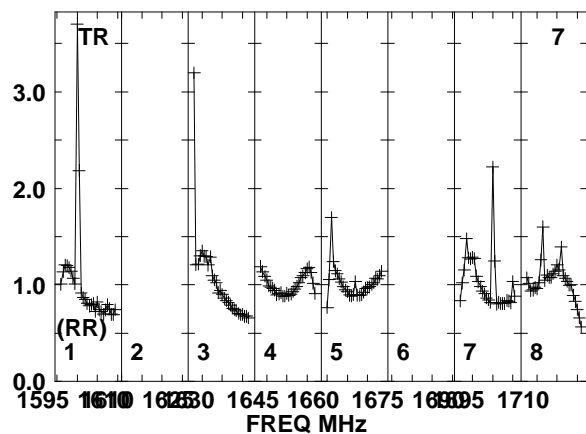
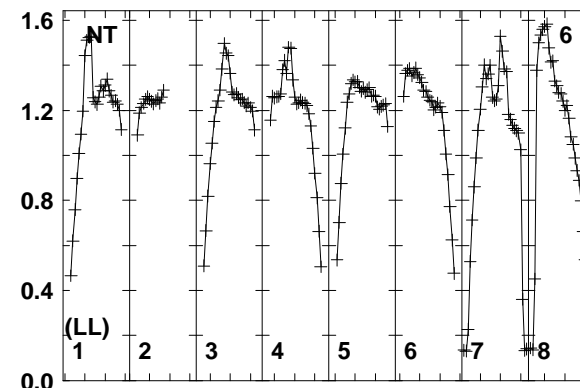
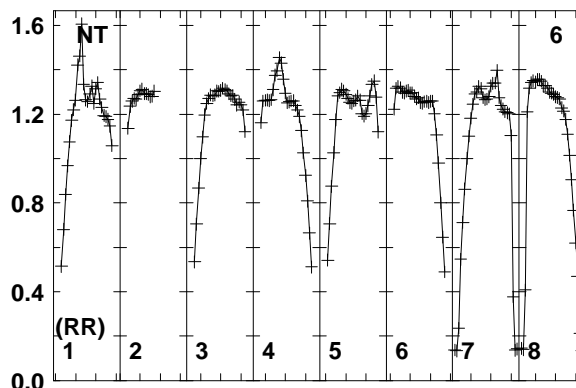
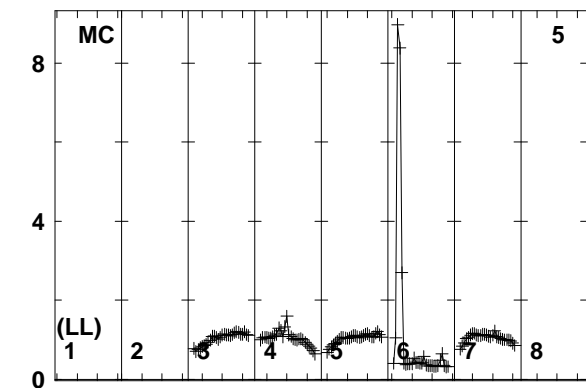
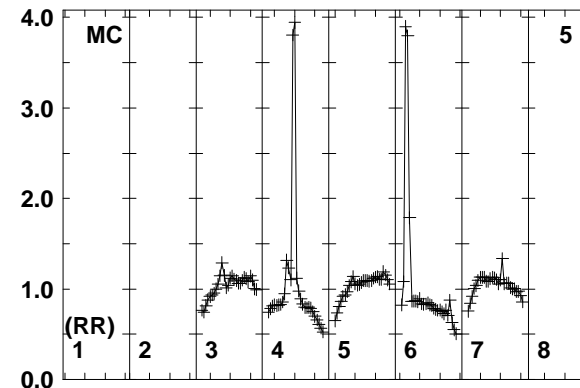
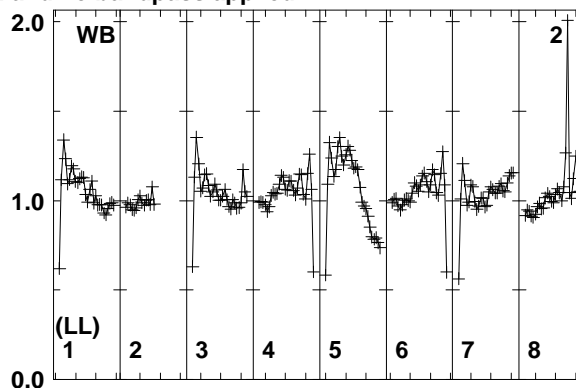
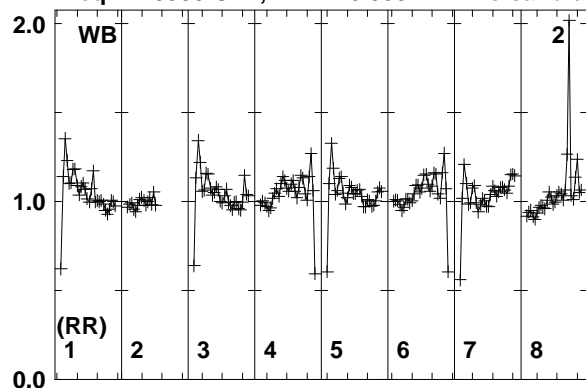

Lower frame: Real Jy
Total-power spectrum Antenna: WB (02)
Timerange: 00/09:08:41 to 00/09:12:29

Plot file version 162 created 20-MAR-2014 17:08:06

IC883 ER030C.UVDATA.1

Freq = 1.5950 GHz, Bw = 16.000 MH No calibration applied and no bandpass applied

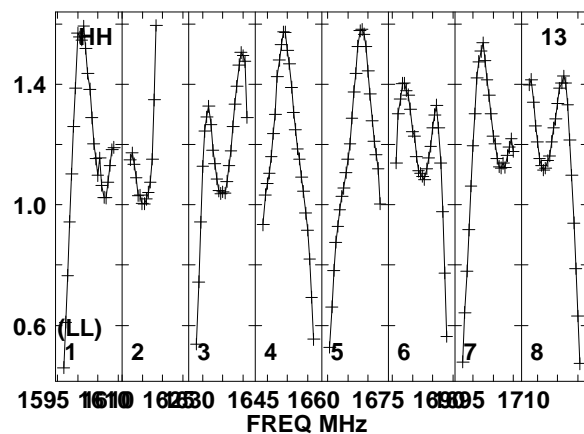
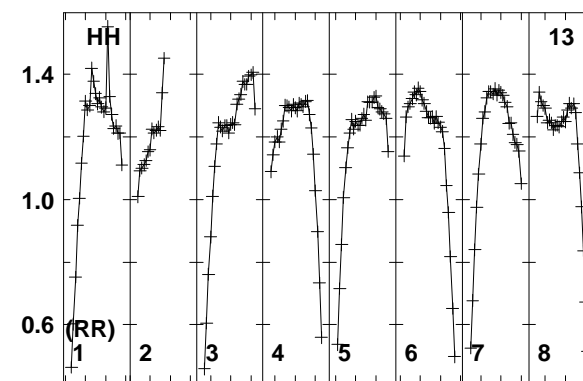
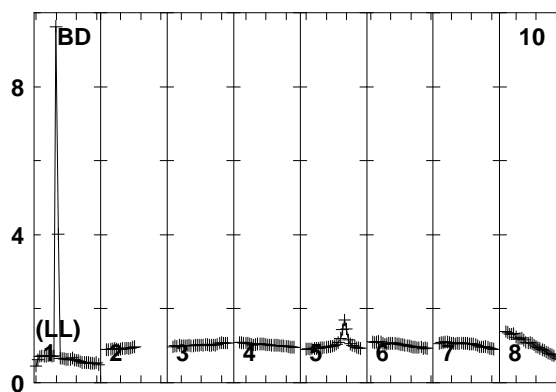
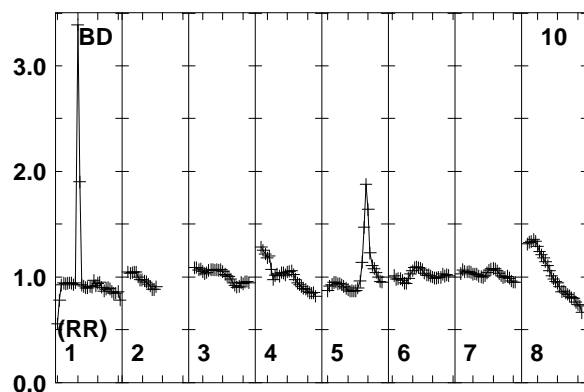
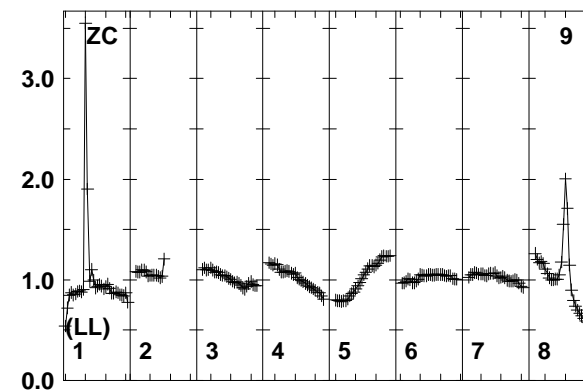
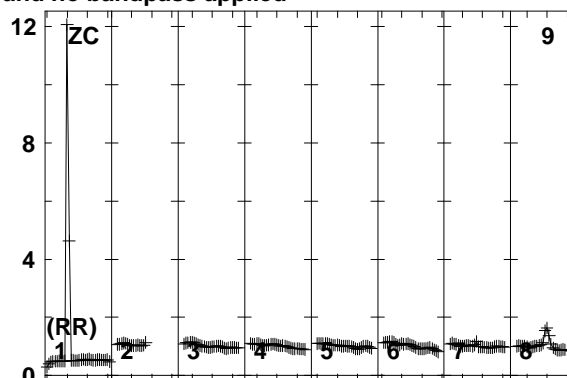
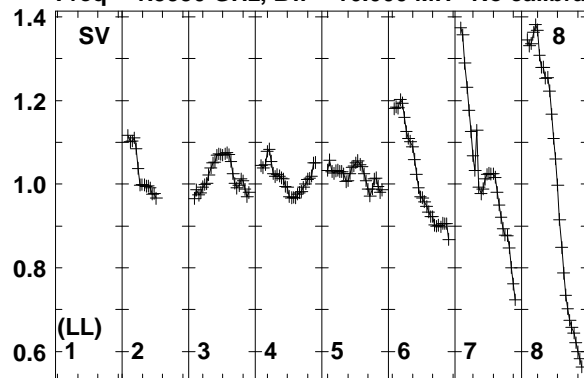

1595 1610 1625 1640 1655 1670 1685 1700 1710
FREQ MHz

Lower frame: Real Jy
Total-power spectrum Antenna: SV (08)
Timerange: 00/09:08:41 to 00/09:12:29

Plot file version 163 created 20-MAR-2014 17:08:06

J1317+3425 ER030C.UVDATA.1

Freq = 1.5950 GHz, Bw = 16.000 MH No calibration applied and no bandpass applied

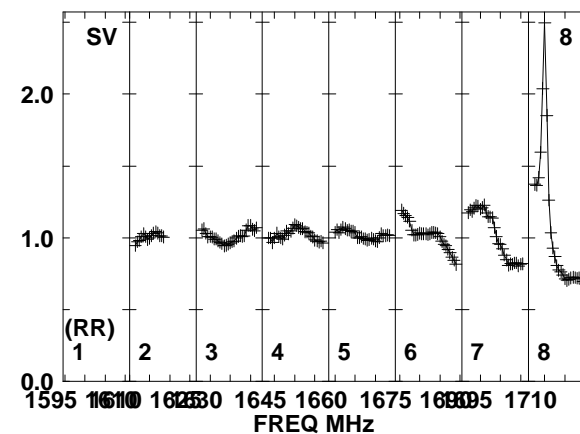
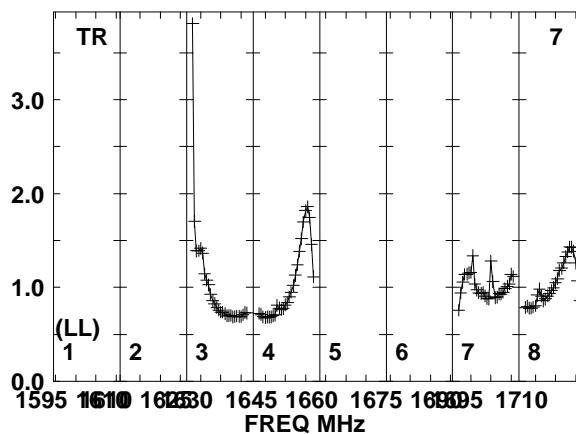
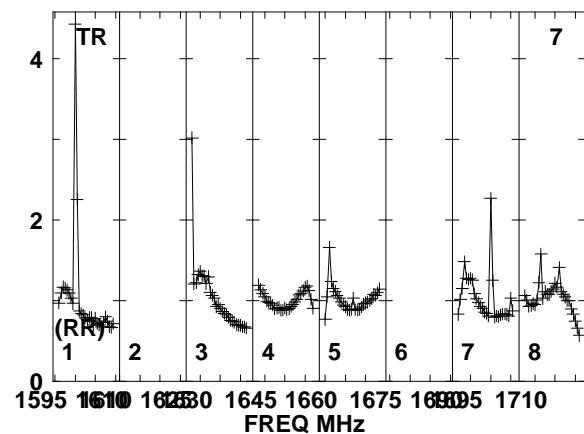
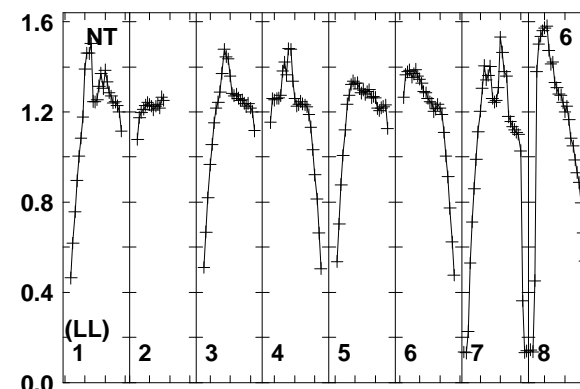
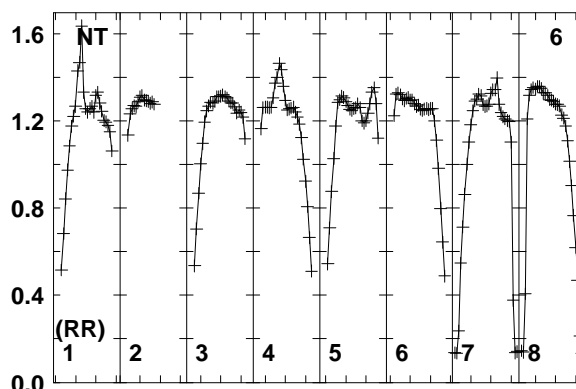
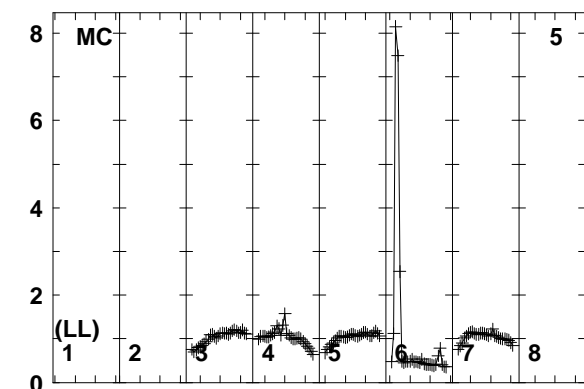
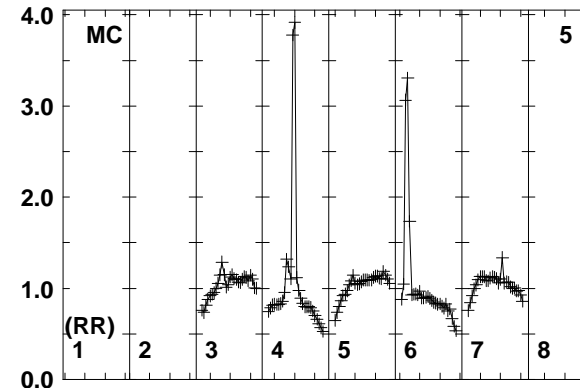
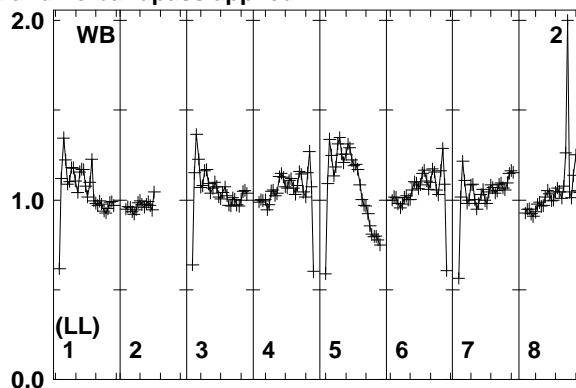
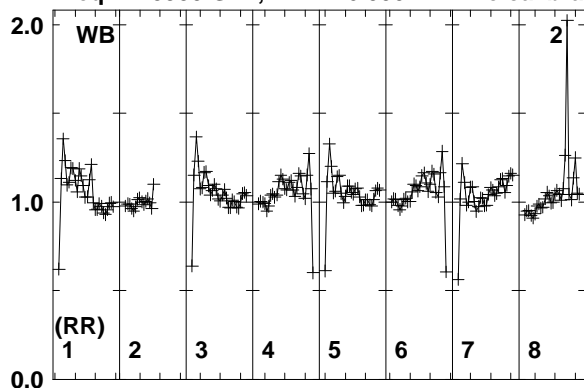

1595 1610 1625 1645 1660 1675 1695 1710
FREQ MHz

1595 1610 1625 1645 1660 1675 1695 1710
FREQ MHz

1595 1610 1625 1645 1660 1675 1695 1710
FREQ MHz

Lower frame: Real Jy
Total-power spectrum Antenna: WB (02)
Timerange: 00/09:13:11 to 00/09:14:09

Plot file version 164 created 20-MAR-2014 17:08:06

J1317+3425 ER030C.UVDATA.1

Freq = 1.5950 GHz, Bw = 16.000 MH No calibration applied and no bandpass applied

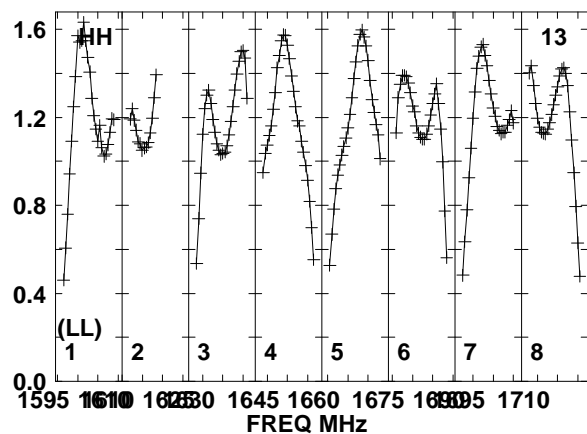
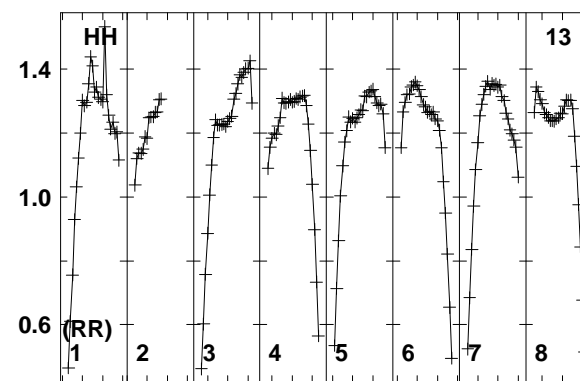
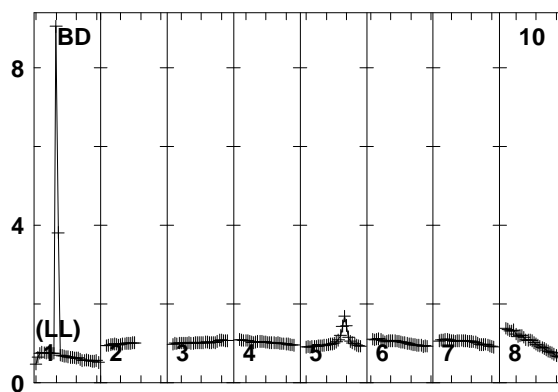
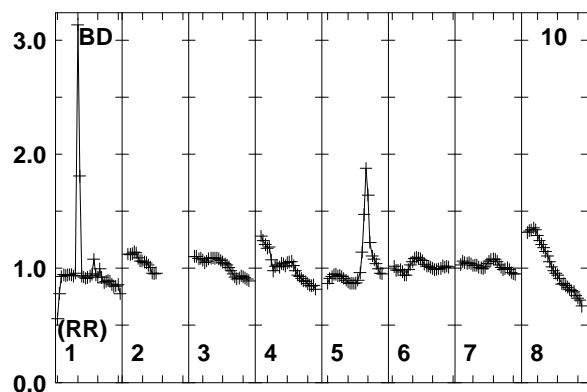
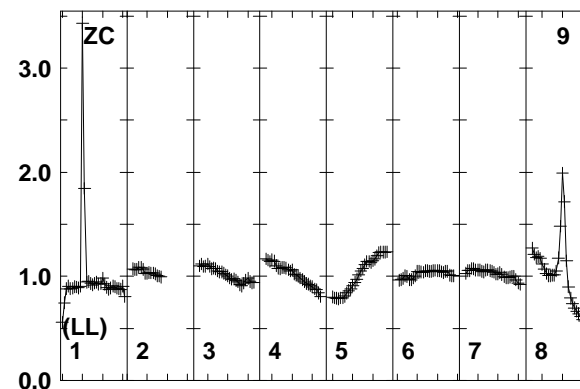
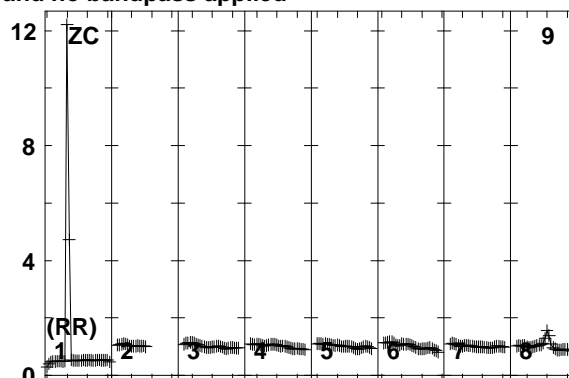
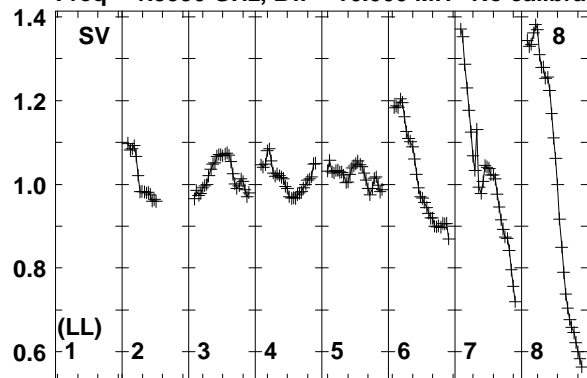

Lower frame: Real Jy
Total-power spectrum Antenna: SV (08)
Timerange: 00/09:13:11 to 00/09:14:09

Plot file version 165 created 20-MAR-2014 17:08:06

IC883 ER030C.UVDATA.1

Freq = 1.5950 GHz, Bw = 16.000 MH No calibration applied and no bandpass applied

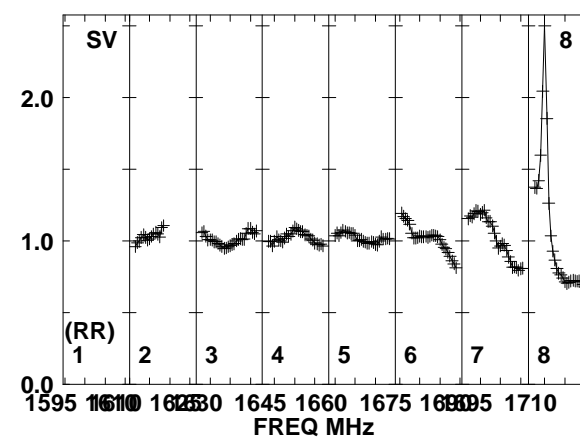
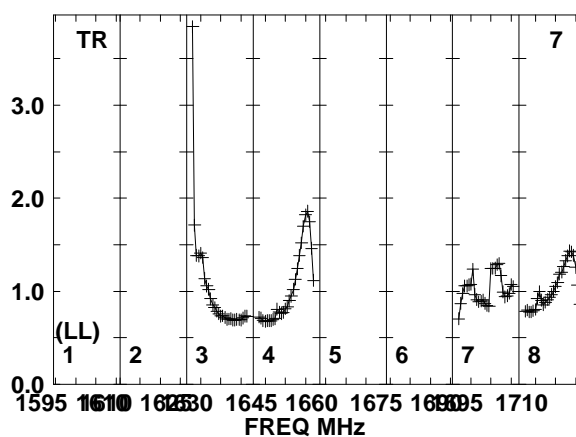
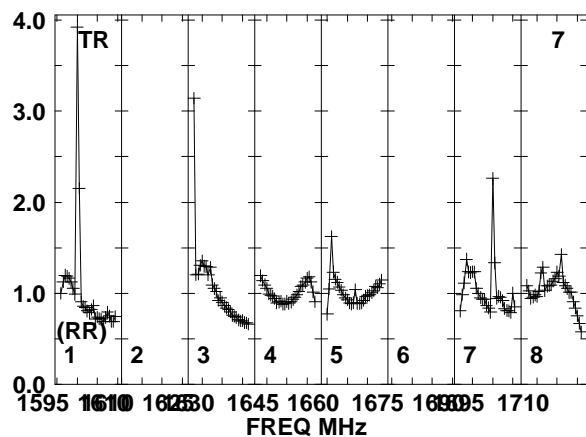
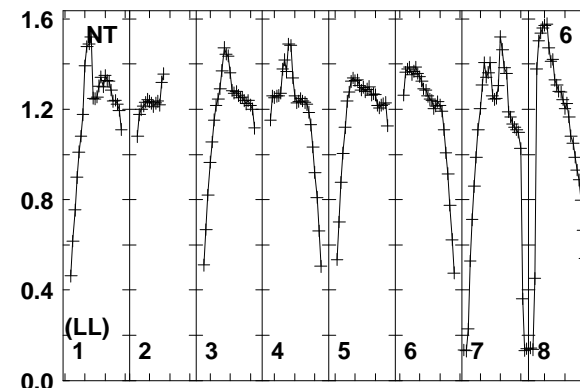
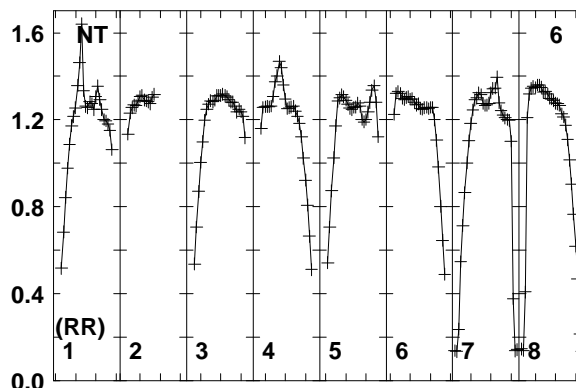
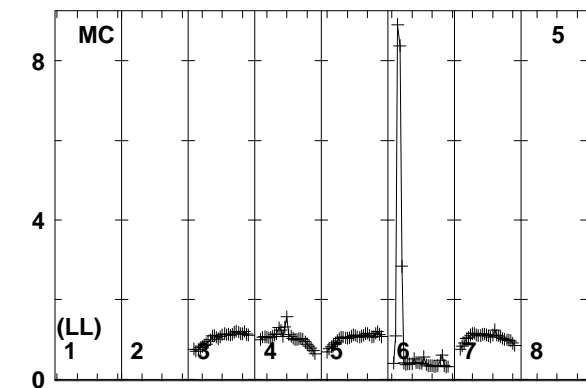
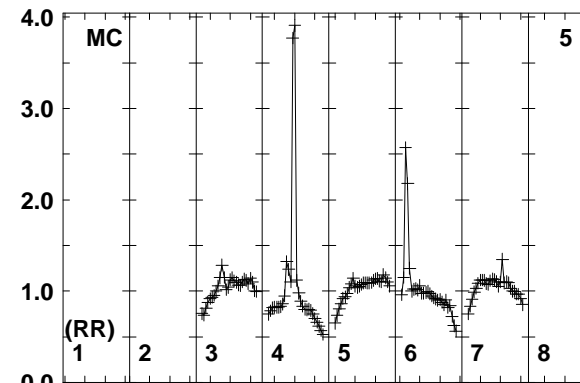
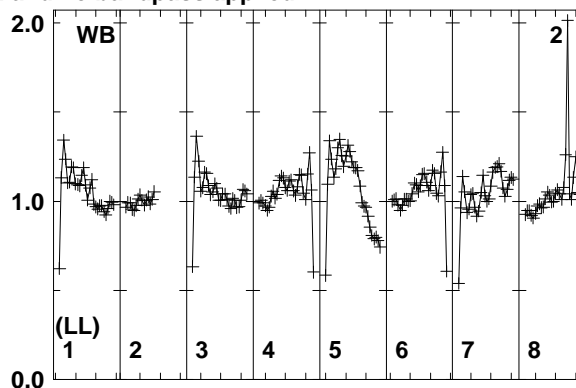
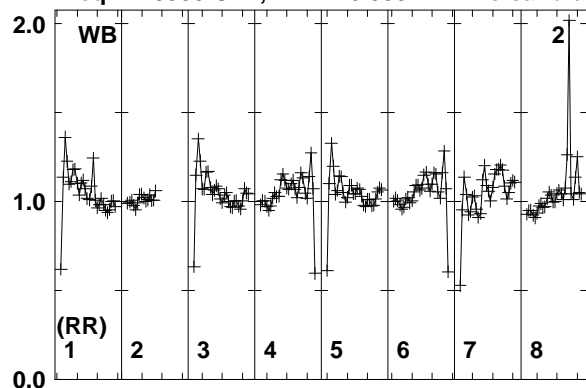

Lower frame: Real Jy
Total-power spectrum Antenna: WB (02)
Timerange: 00/09:14:13 to 00/09:17:59

Plot file version 166 created 20-MAR-2014 17:08:06

IC883 ER030C.UVDATA.1

Freq = 1.5950 GHz, Bw = 16.000 MH No calibration applied and no bandpass applied

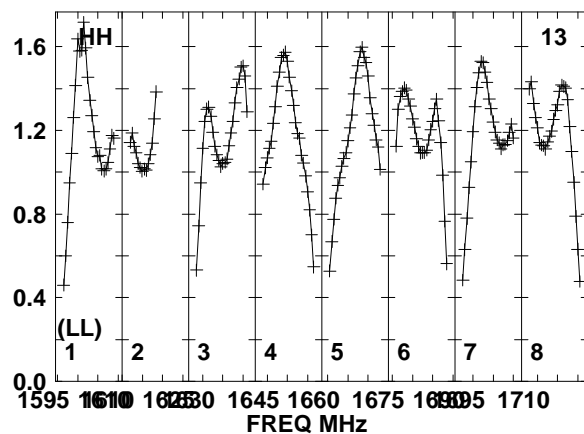
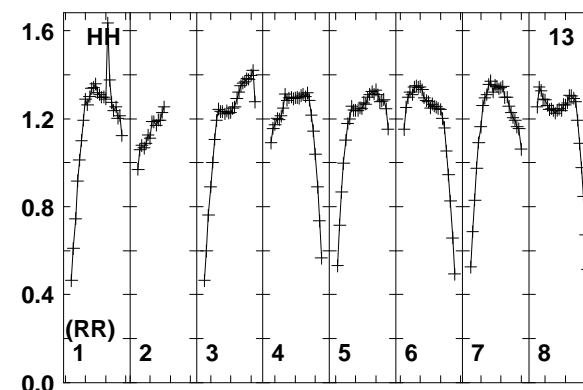
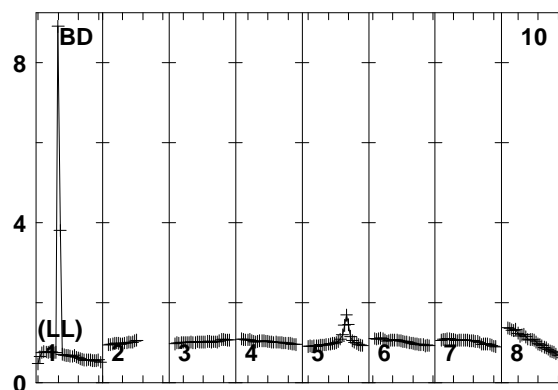
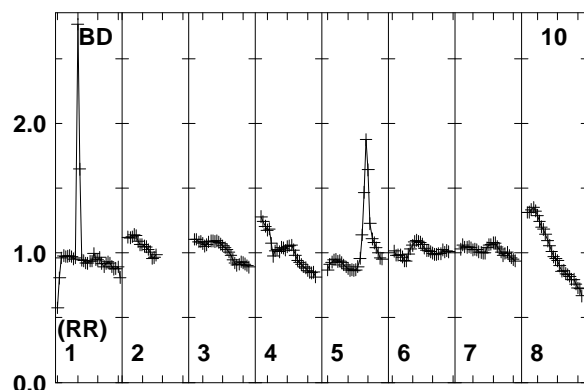
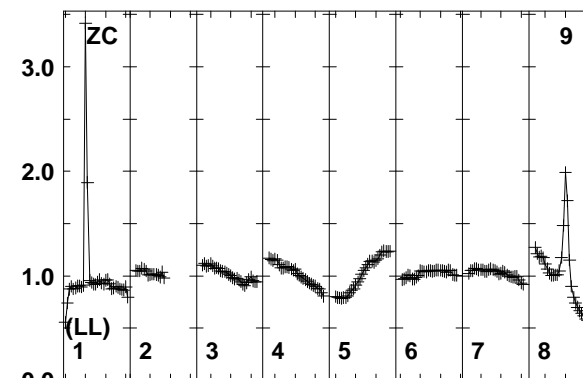
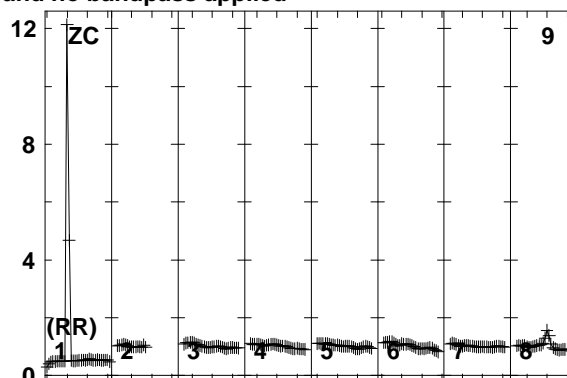
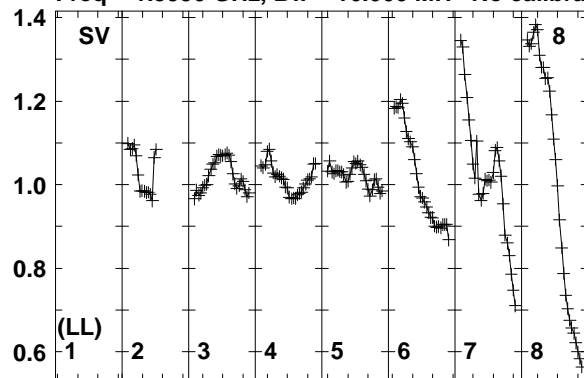

Lower frame: Real Jy
Total-power spectrum Antenna: SV (08)
Timerange: 00/09:14:13 to 00/09:17:59

Plot file version 167 created 20-MAR-2014 17:08:06

J1317+3425 ER030C.UVDATA.1

Freq = 1.5950 GHz, Bw = 16.000 MH No calibration applied and no bandpass applied

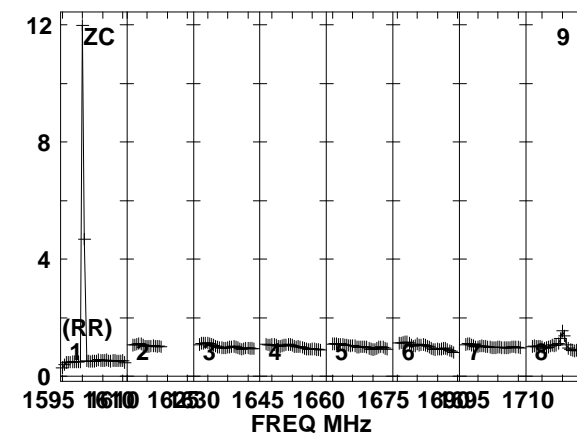
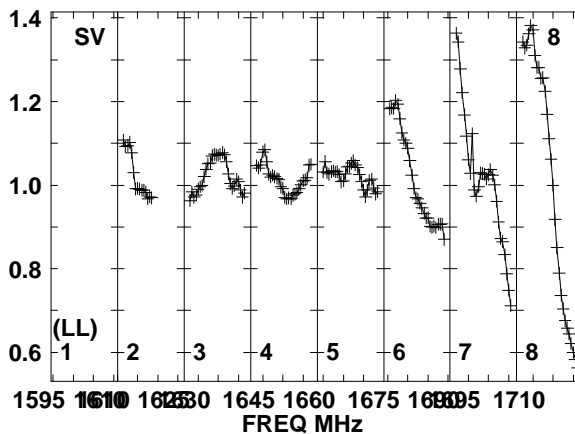
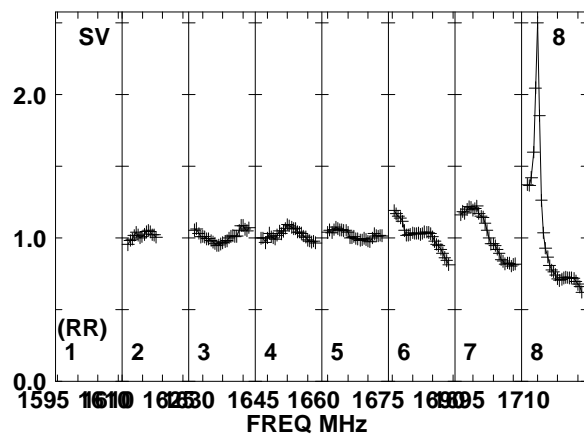
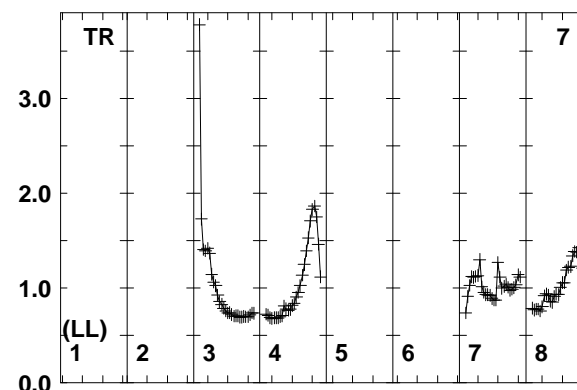
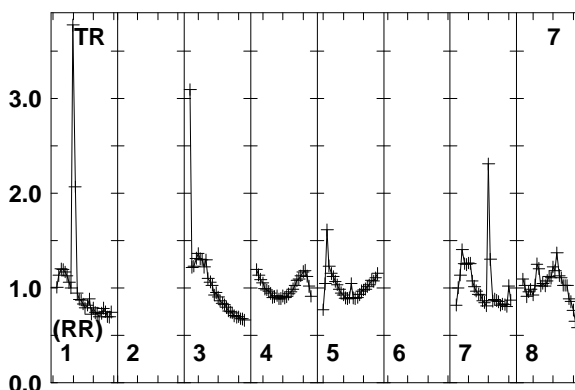
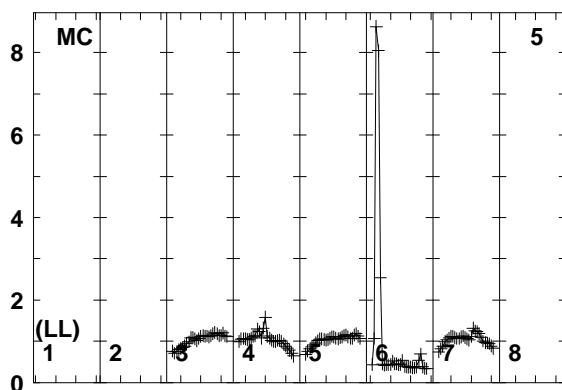
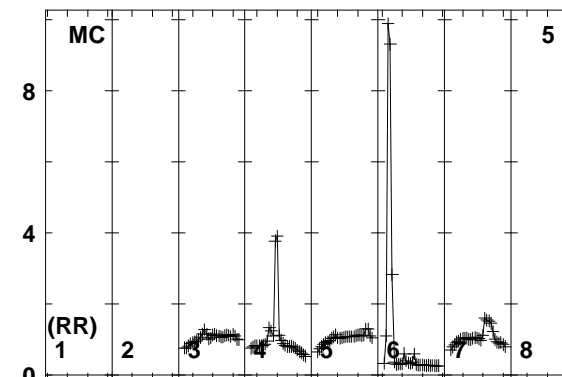
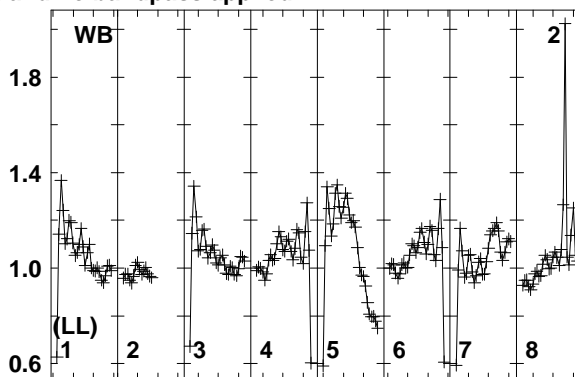
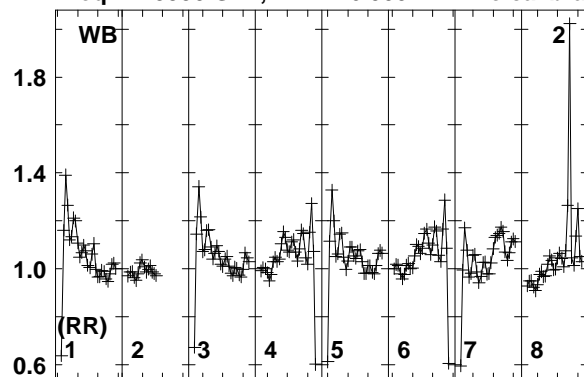

Lower frame: Real Jy
Total-power spectrum Antenna: WB (02)
Timerange: 00/09:18:07 to 00/09:19:19

Plot file version 168 created 20-MAR-2014 17:08:06

J1317+3425 ER030C.UVDATA.1

Freq = 1.5950 GHz, Bw = 16.000 MH No calibration applied and no bandpass applied

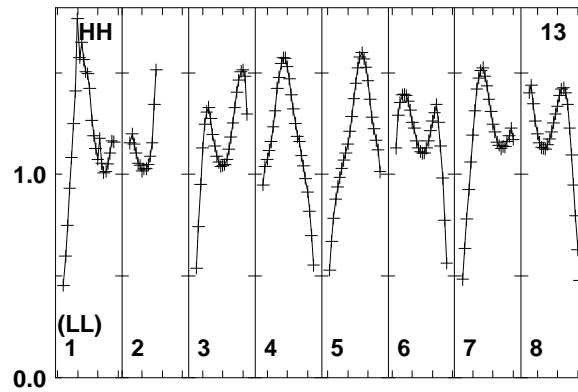
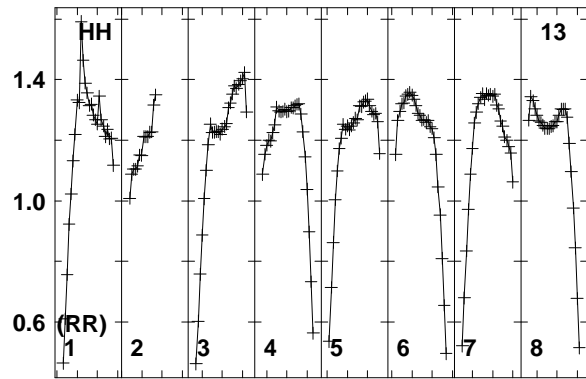
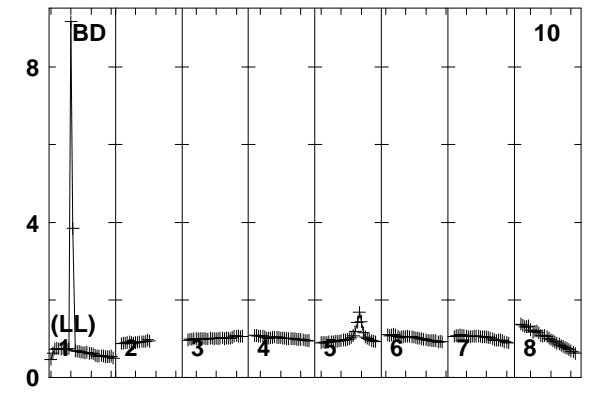
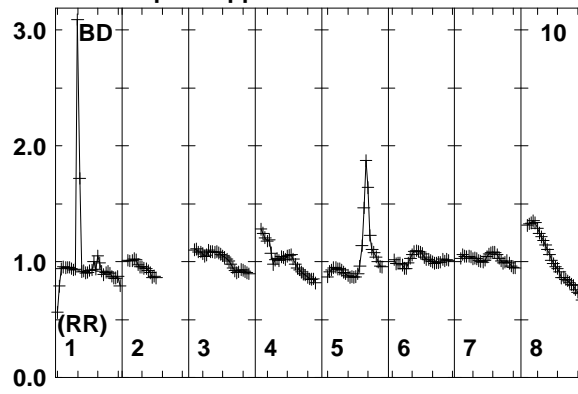
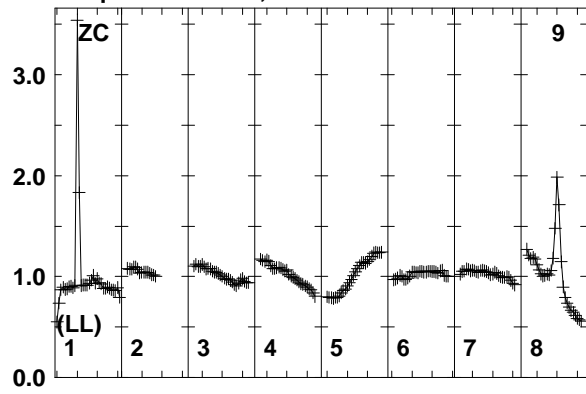

Lower frame: Real Jy
Total-power spectrum Antenna: ZC (09)
Timerange: 00/09:18:07 to 00/09:19:19

Plot file version 169 created 20-MAR-2014 17:08:06

IC883 ER030C.UVDATA.1

Freq = 1.5950 GHz, Bw = 16.000 MH No calibration applied and no bandpass applied

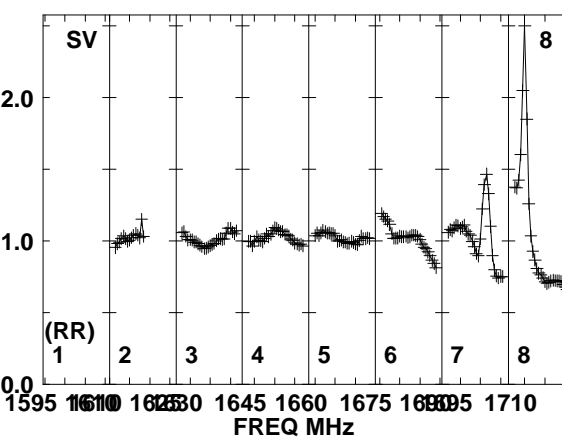
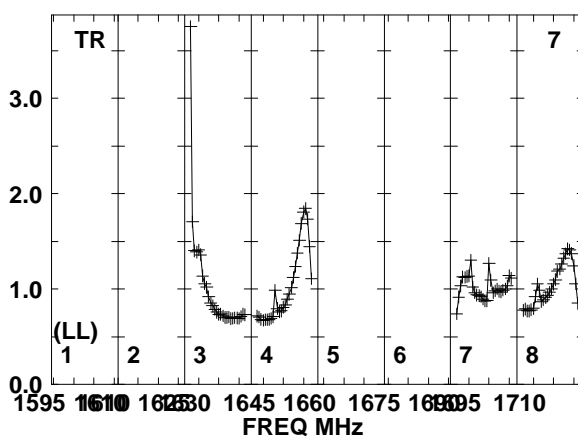
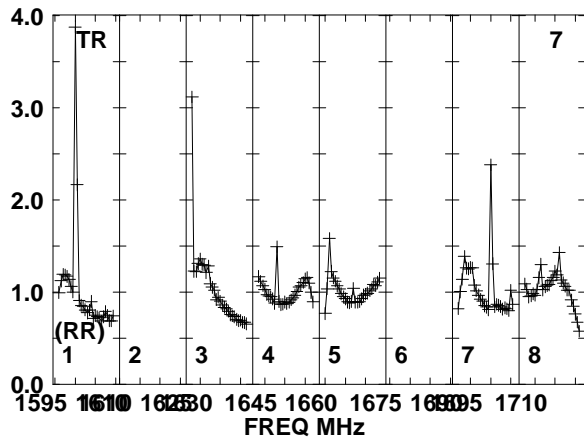
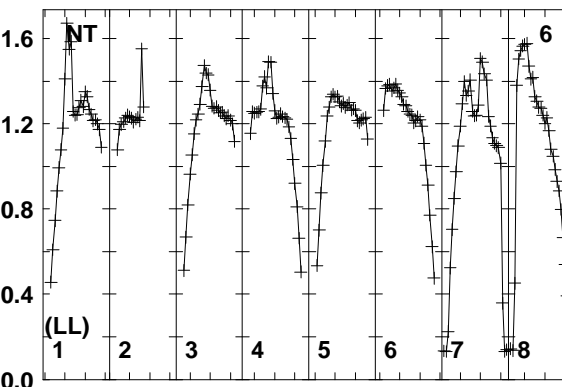
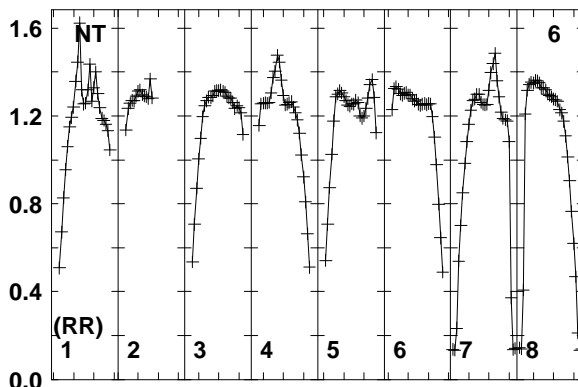
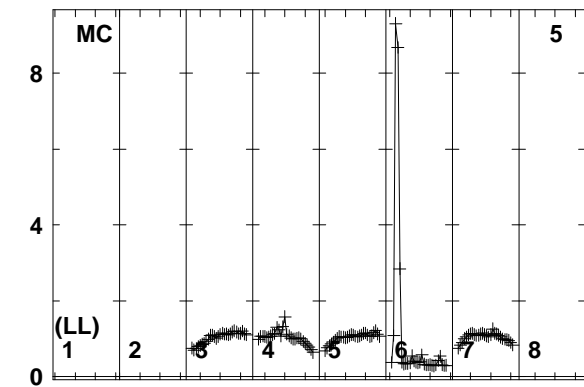
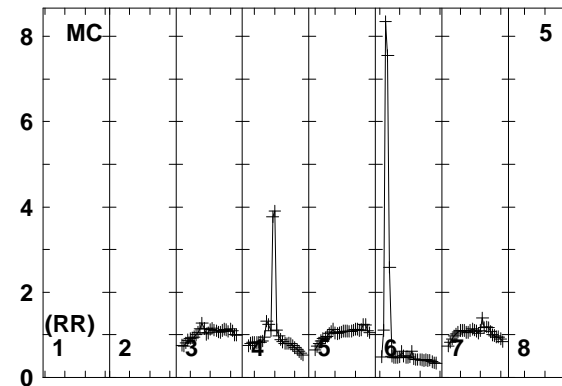
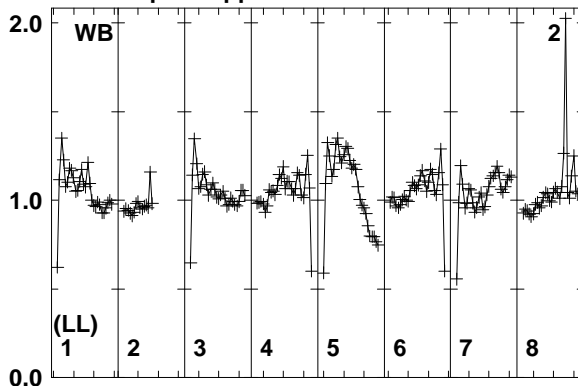
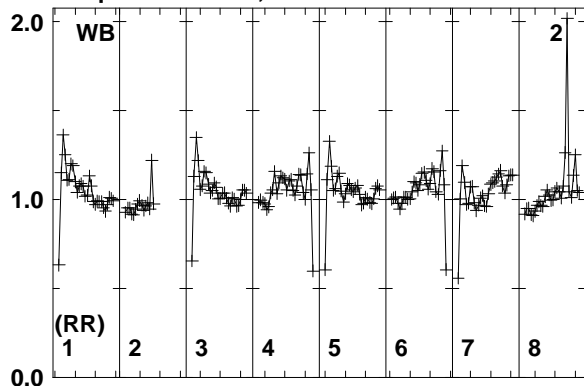

Lower frame: Real Jy
Total-power spectrum Antenna: WB (02)
Timerange: 00/09:19:21 to 00/09:23:09

Plot file version 170 created 20-MAR-2014 17:08:06

IC883 ER030C.UVDATA.1

Freq = 1.5950 GHz, Bw = 16.000 MH No calibration applied and no bandpass applied

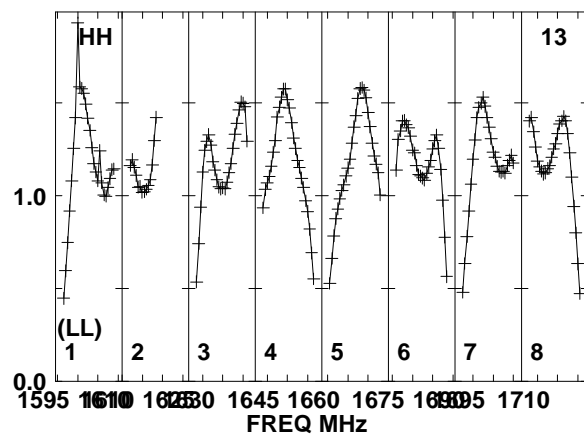
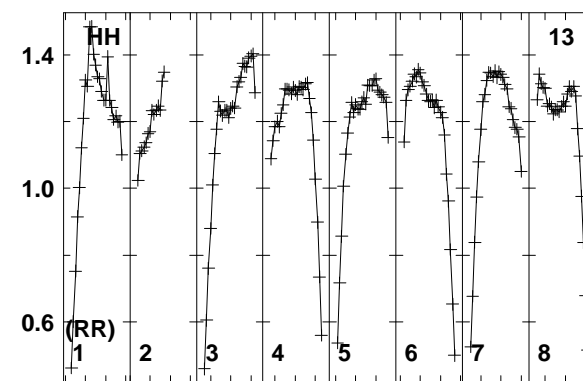
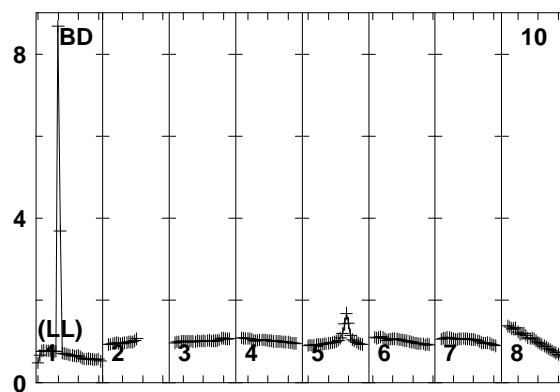
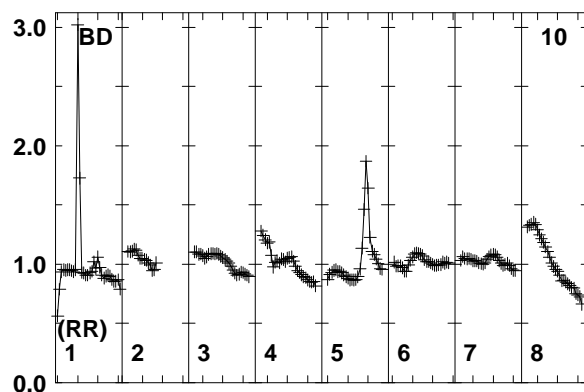
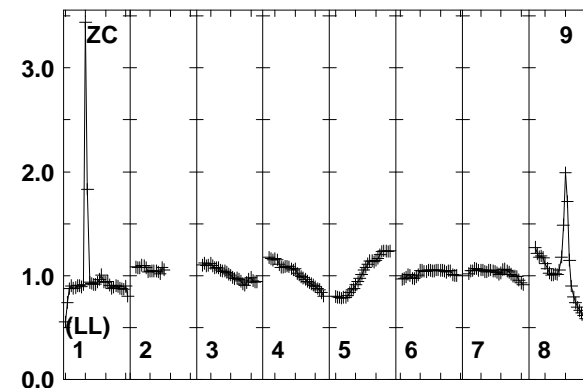
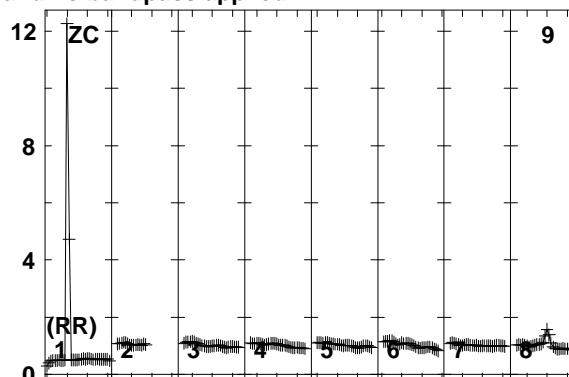
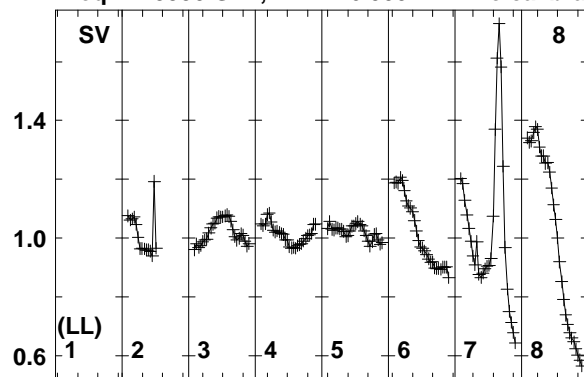

Lower frame: Real Jy
Total-power spectrum Antenna: SV (08)
Timerange: 00/09:19:21 to 00/09:23:09

Plot file version 171 created 20-MAR-2014 17:08:06

J1317+3425 ER030C.UVDATA.1

Freq = 1.5950 GHz, Bw = 16.000 MH No calibration applied and no bandpass applied

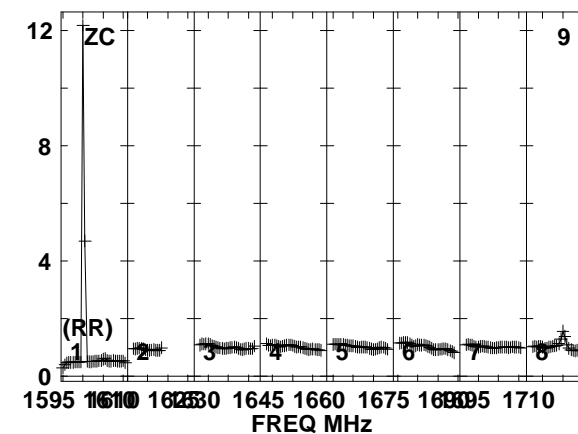
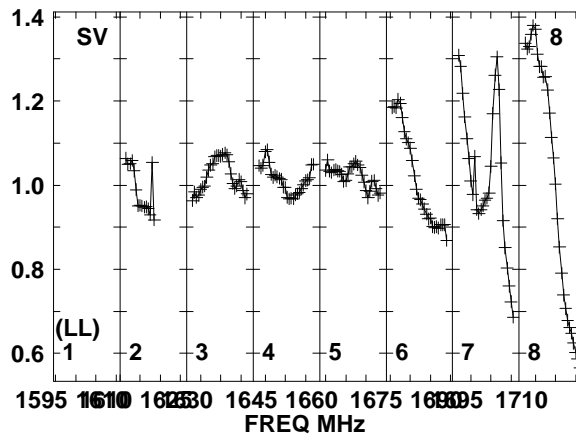
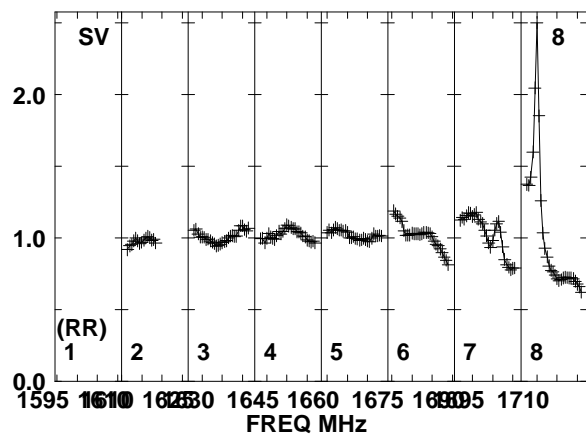
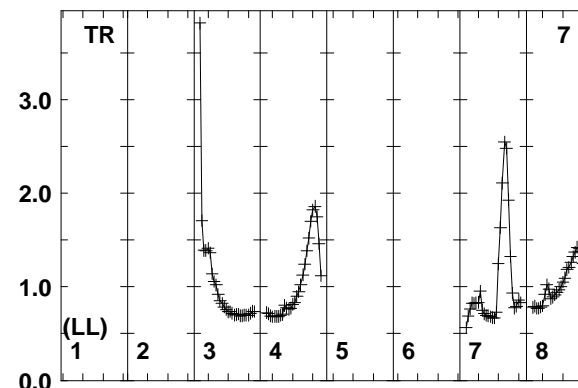
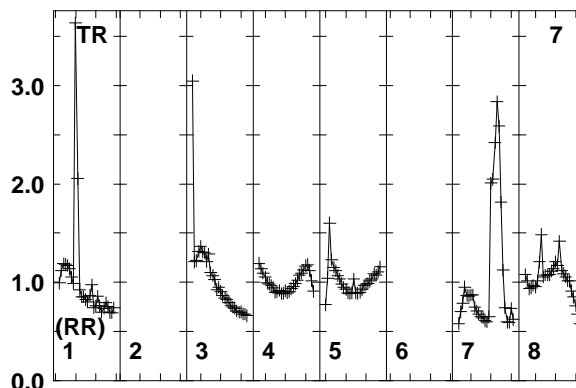
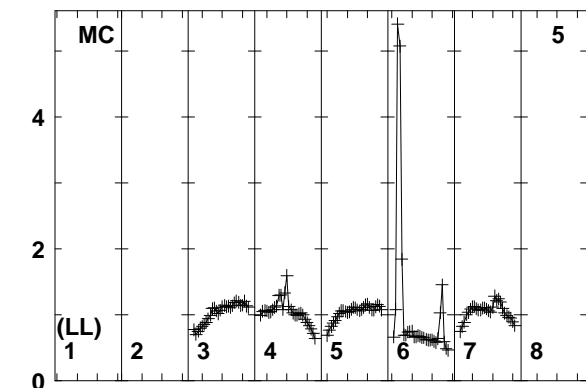
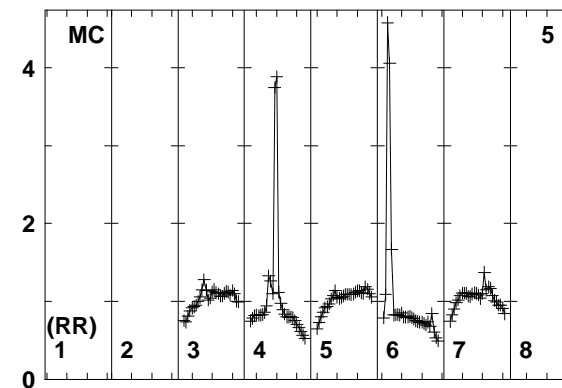
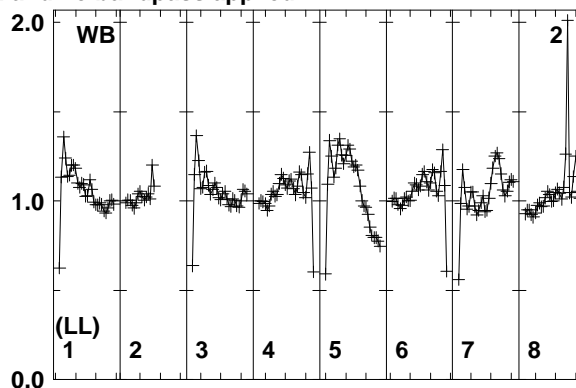
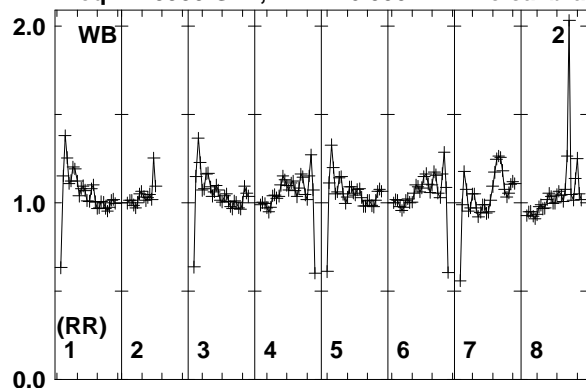

Lower frame: Real Jy
Total-power spectrum Antenna: WB (02)
Timerange: 00/09:23:51 to 00/09:24:49

Plot file version 172 created 20-MAR-2014 17:08:06

J1317+3425 ER030C.UVDATA.1

Freq = 1.5950 GHz, Bw = 16.000 MH No calibration applied and no bandpass applied

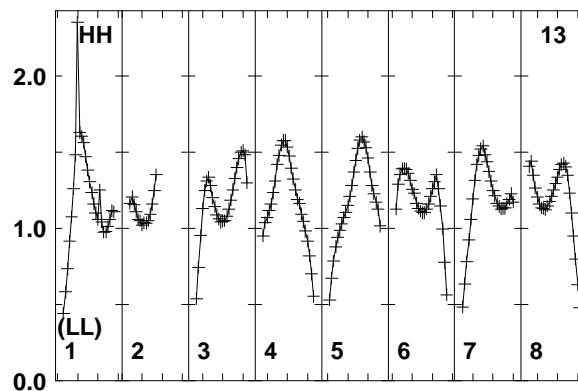
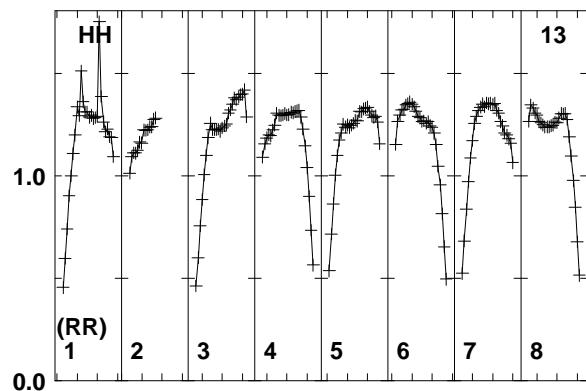
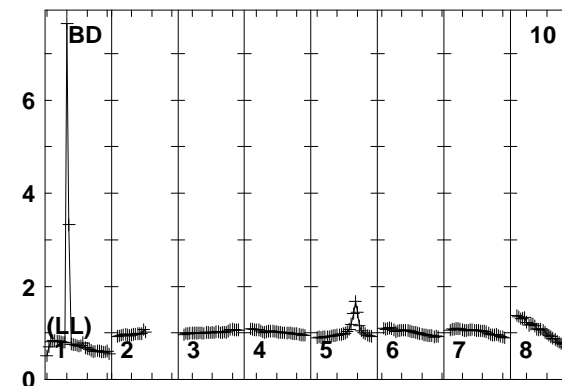
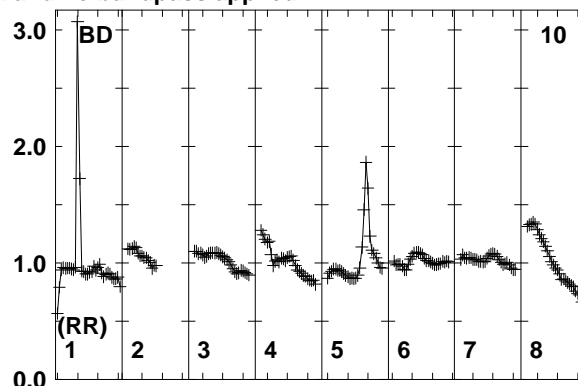
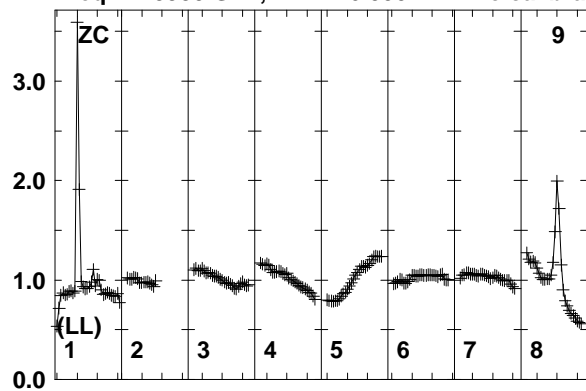

Lower frame: Real Jy
Total-power spectrum Antenna: ZC (09)
Timerange: 00/09:23:51 to 00/09:24:49

Plot file version 173 created 20-MAR-2014 17:08:06

IC883 ER030C.UVDATA.1

Freq = 1.5950 GHz, Bw = 16.000 MH No calibration applied and no bandpass applied

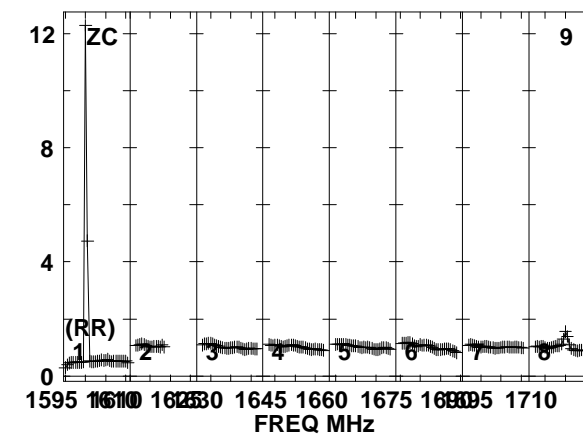
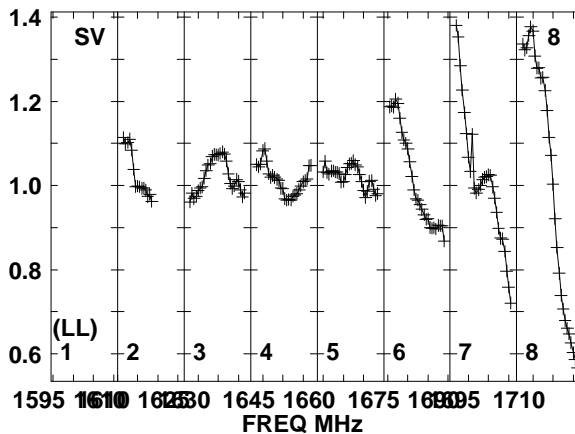
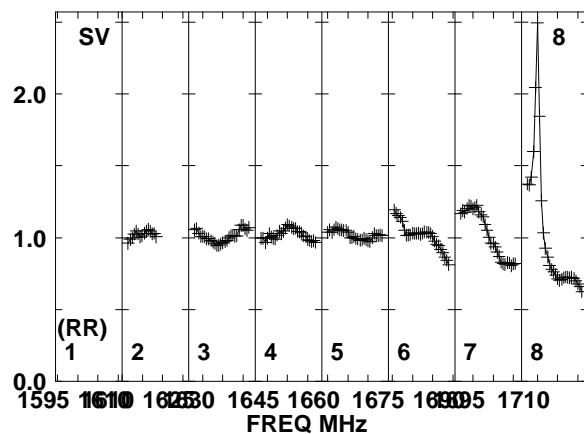
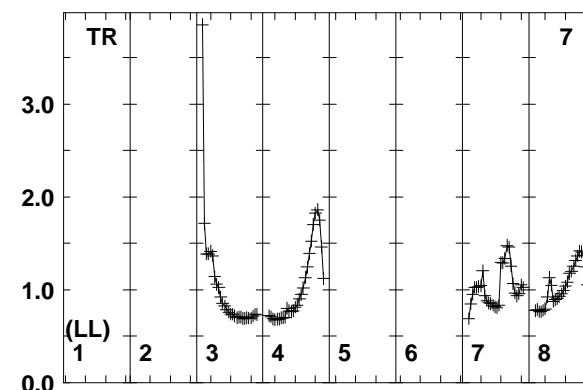
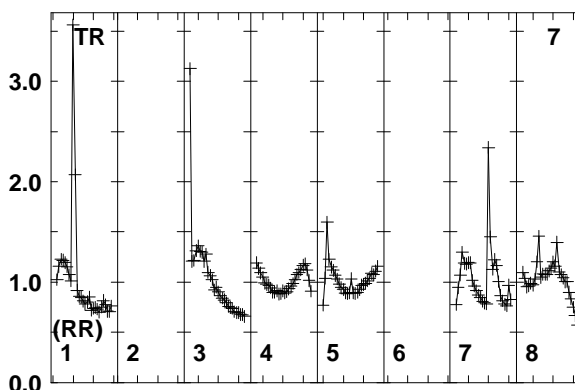
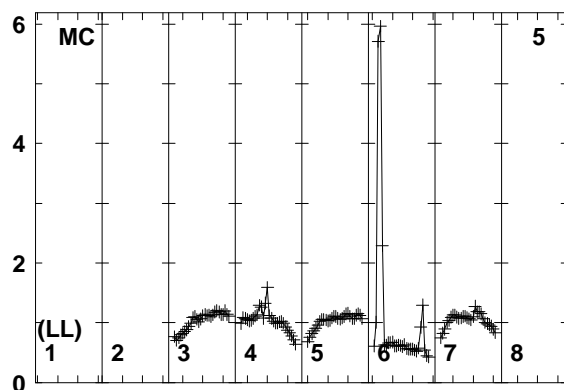
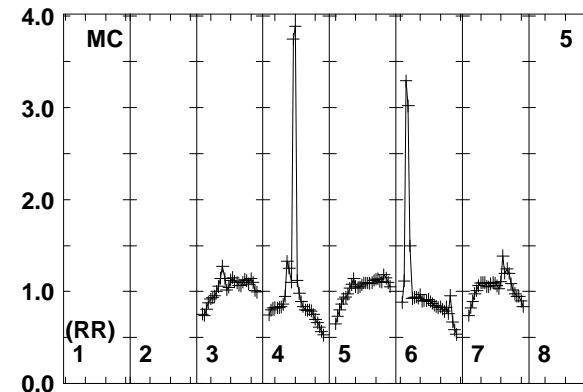
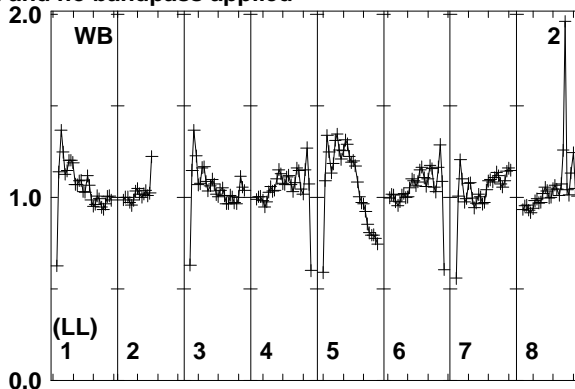
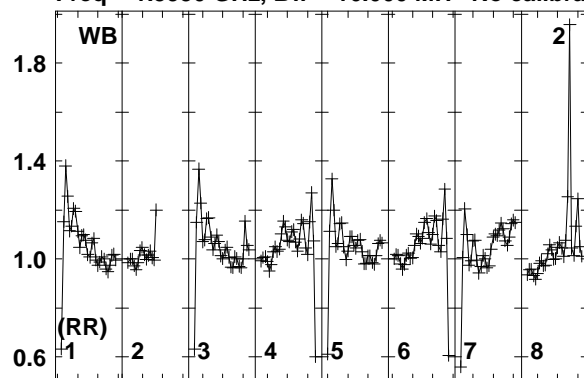

Lower frame: Real Jy
Total-power spectrum Antenna: WB (02)
Timerange: 00/09:24:57 to 00/09:28:39

Plot file version 174 created 20-MAR-2014 17:08:07

IC883 ER030C.UVDATA.1

Freq = 1.5950 GHz, Bw = 16.000 MH No calibration applied and no bandpass applied

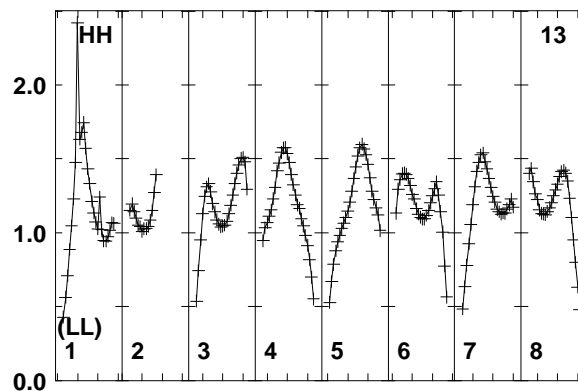
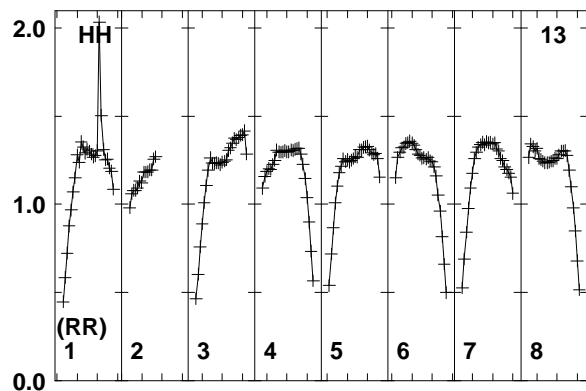
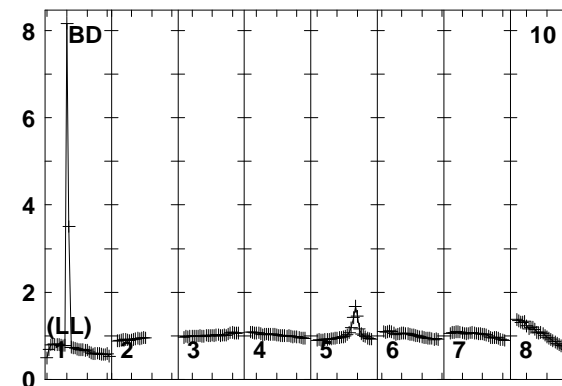
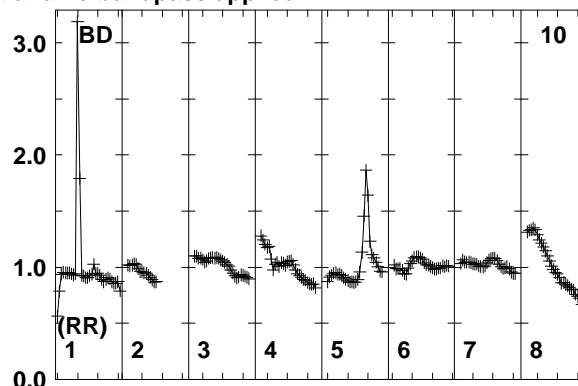
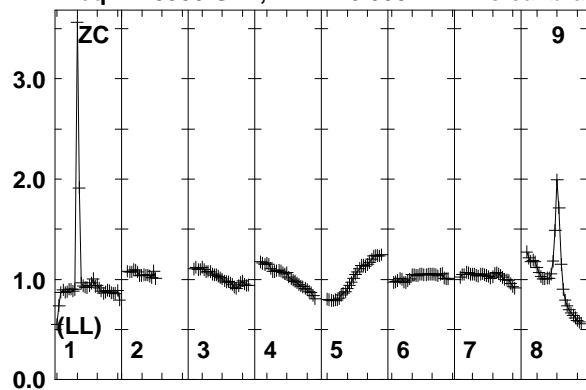

Lower frame: Real Jy
Total-power spectrum Antenna: ZC (09)
Timerange: 00/09:24:57 to 00/09:28:39

Plot file version 175 created 20-MAR-2014 17:08:07

J1317+3425 ER030C.UVDATA.1

Freq = 1.5950 GHz, Bw = 16.000 MH No calibration applied and no bandpass applied

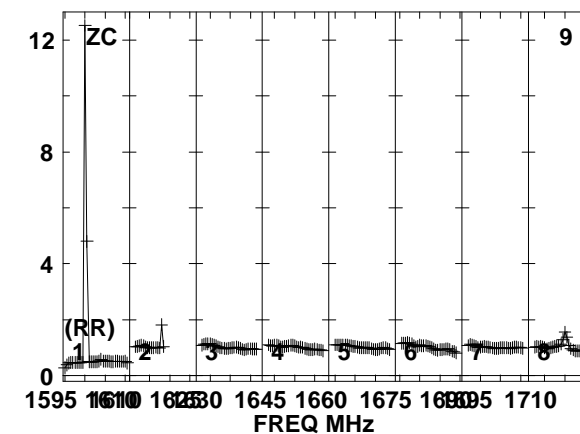
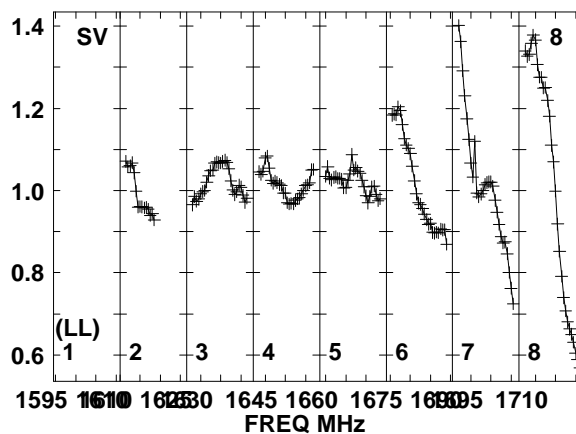
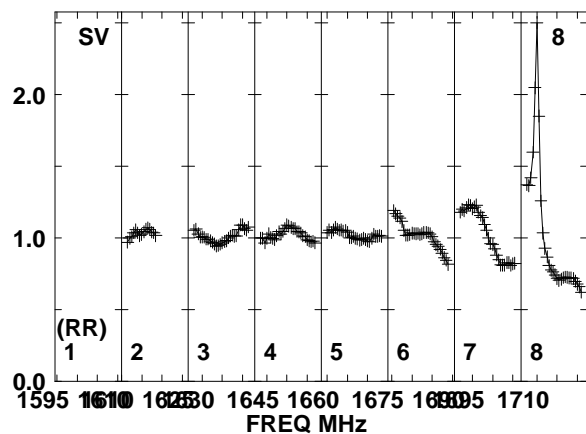
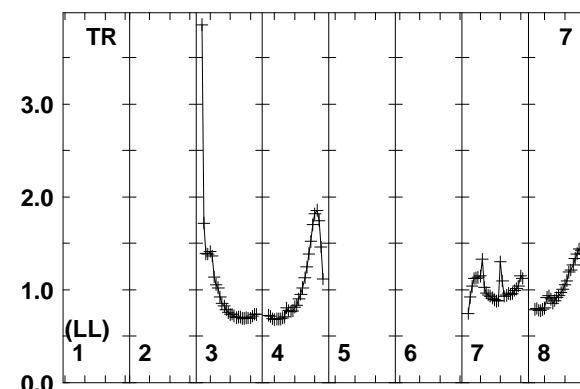
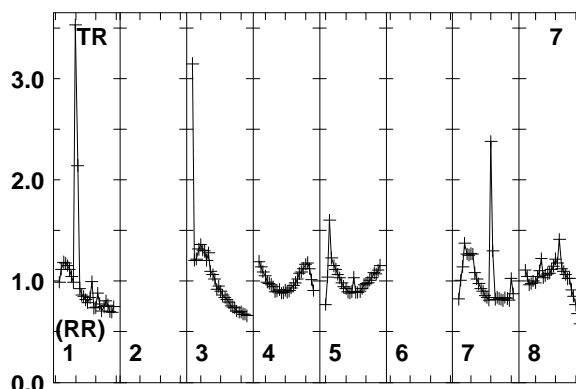
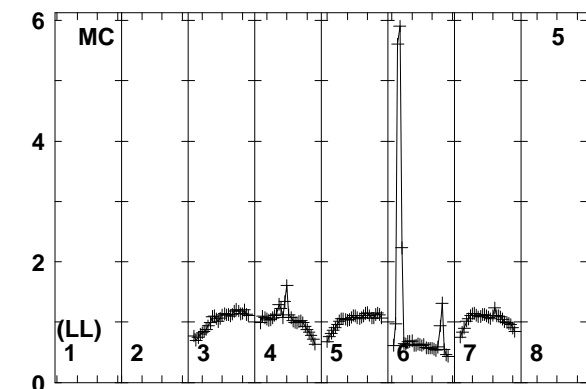
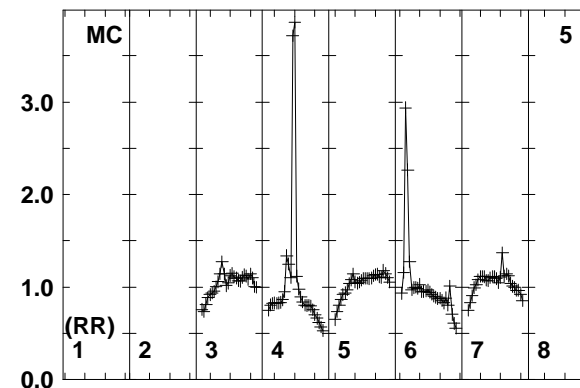
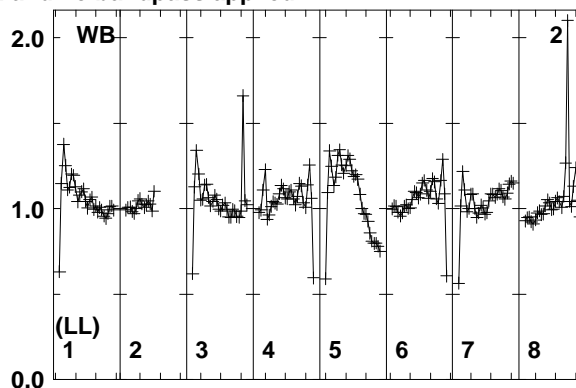
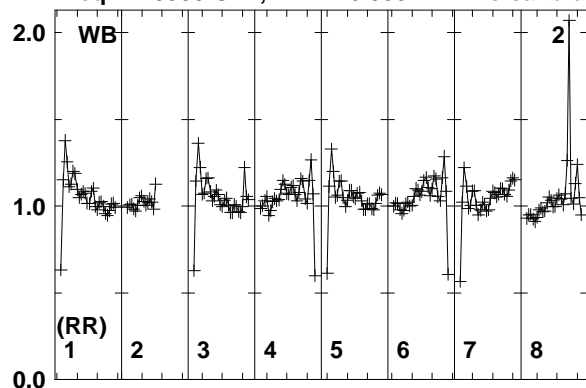

Lower frame: Real Jy
Total-power spectrum Antenna: WB (02)
Timerange: 00/09:28:47 to 00/09:29:59

Plot file version 176 created 20-MAR-2014 17:08:07

J1317+3425 ER030C.UVDATA.1

Freq = 1.5950 GHz, Bw = 16.000 MH No calibration applied and no bandpass applied

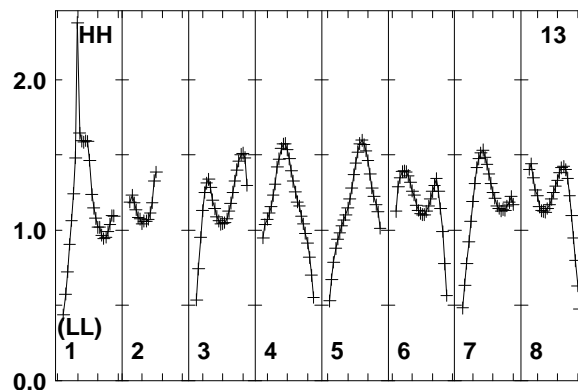
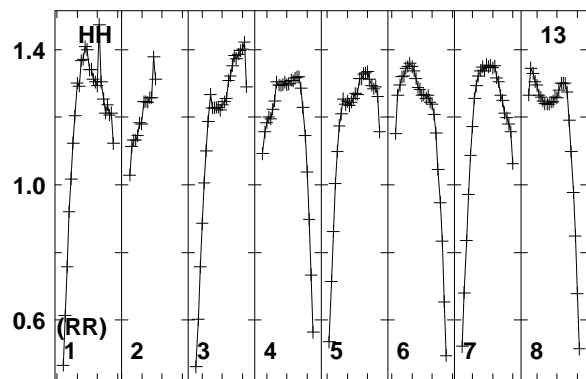
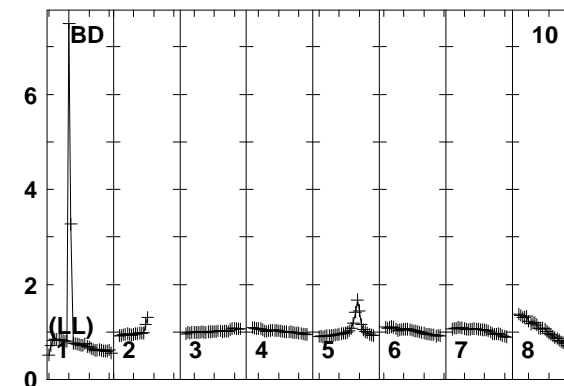
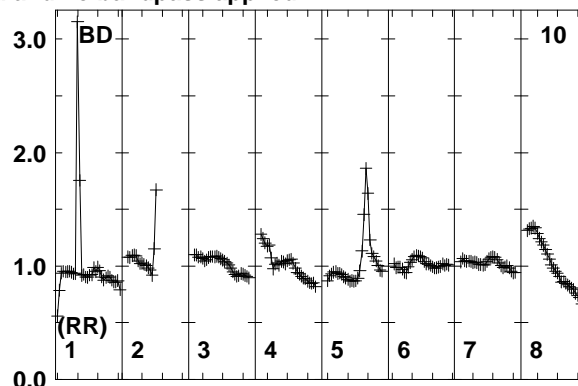
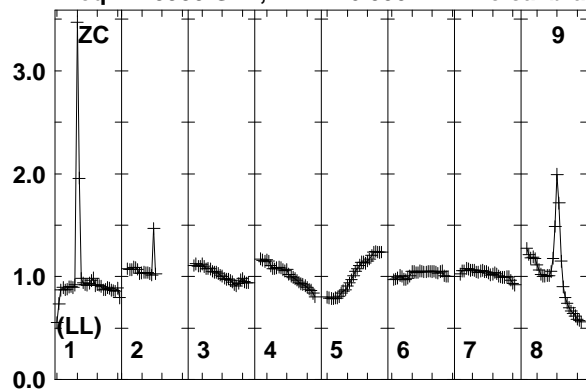

Lower frame: Real Jy
Total-power spectrum Antenna: ZC (09)
Timerange: 00/09:28:47 to 00/09:29:59