

Plot file version 1 created 19-OCT-2017 15:35:54

J1602+3326 ES081C.UVDATA.1

Freq = 4.7990 GHz, Bw = 32.000 MH No calibration applied and no bandpass applied

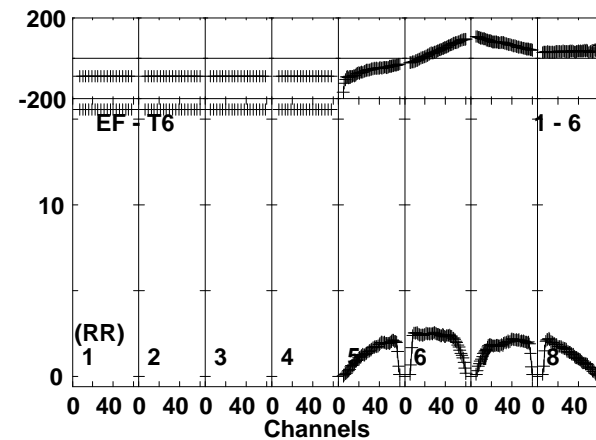
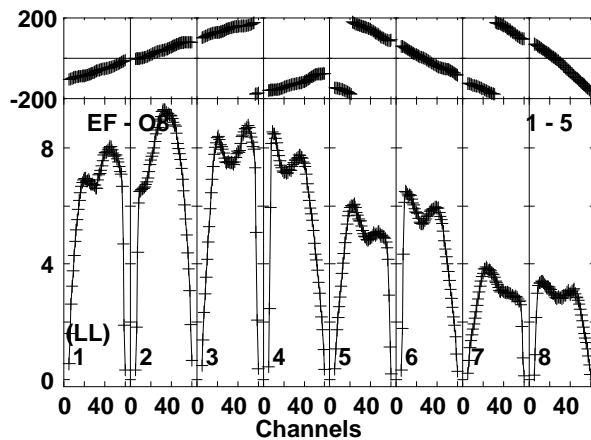
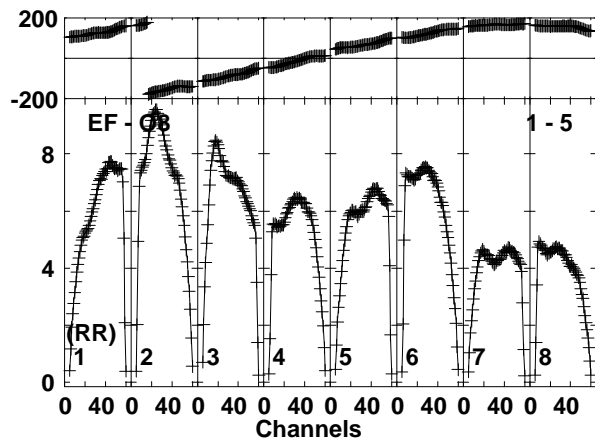
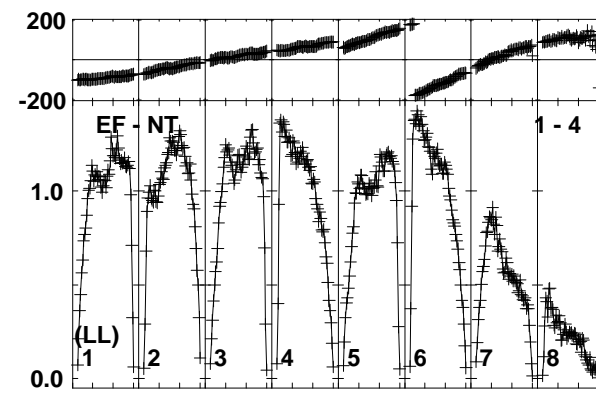
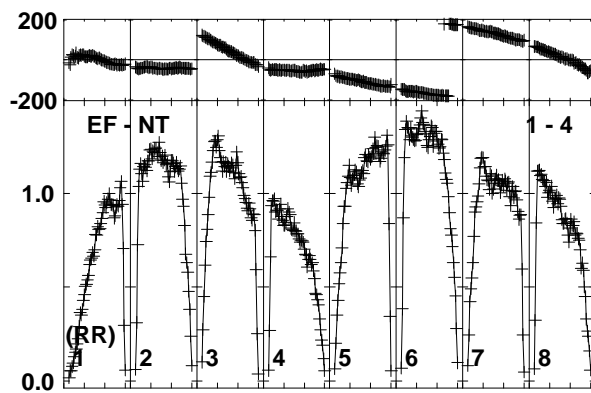
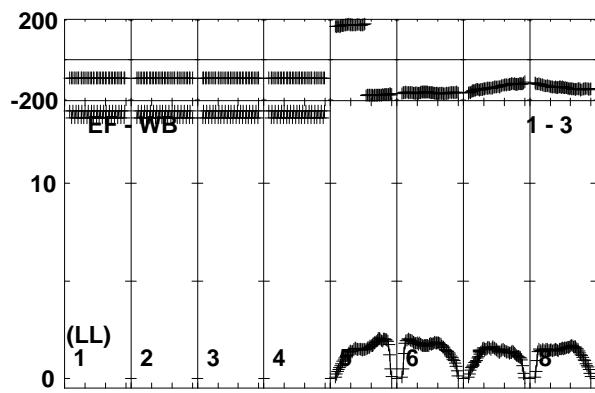
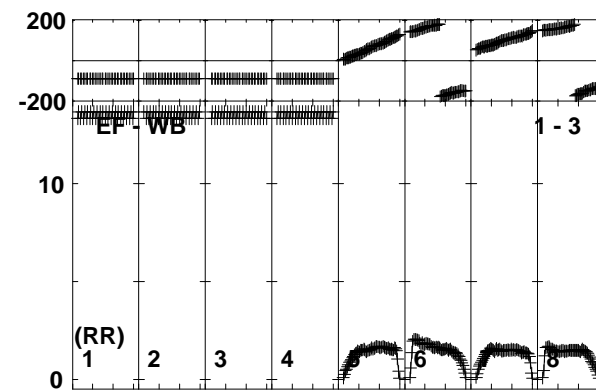
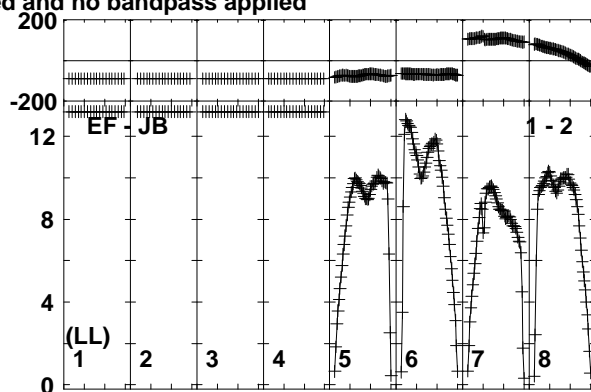
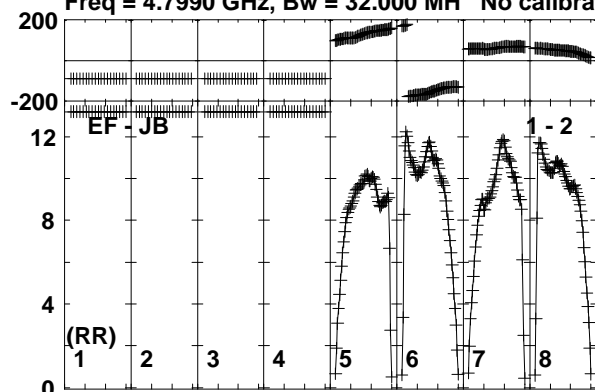

Lower frame: Milli Ampl Jy Top frame: Phas deg
Vector averaged cross-power spectrum Baseline: EF (01) - JB (02)
Timerange: 00/13:12:54 to 00/13:24:58

Plot file version 2 created 19-OCT-2017 15:35:55

J1602+3326 ES081C.UVDATA.1

Freq = 4.7990 GHz, Bw = 32.000 MH No calibration applied and no bandpass applied

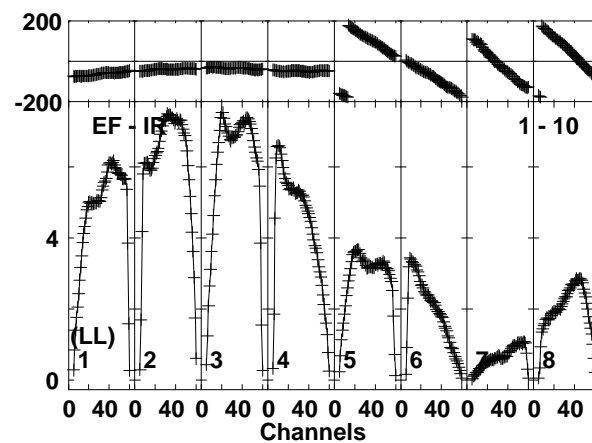
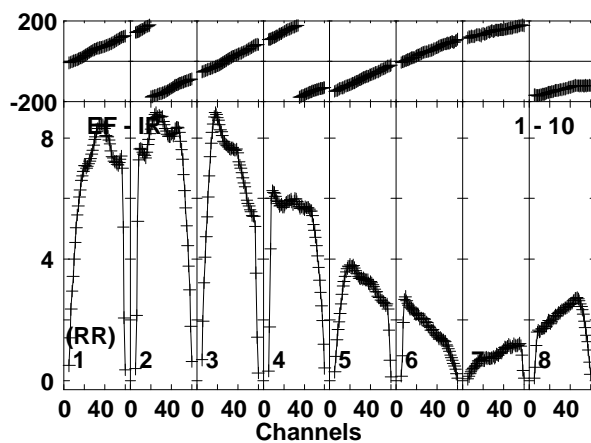
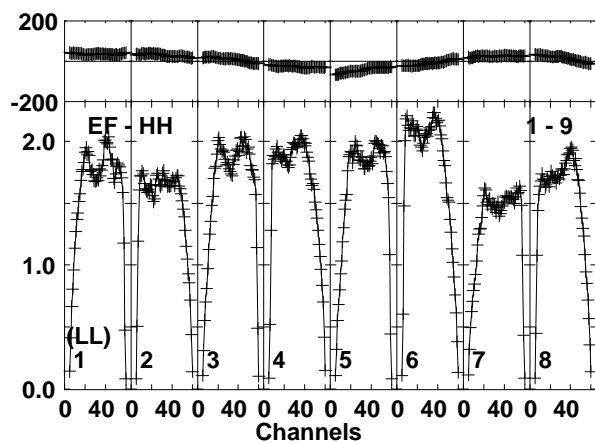
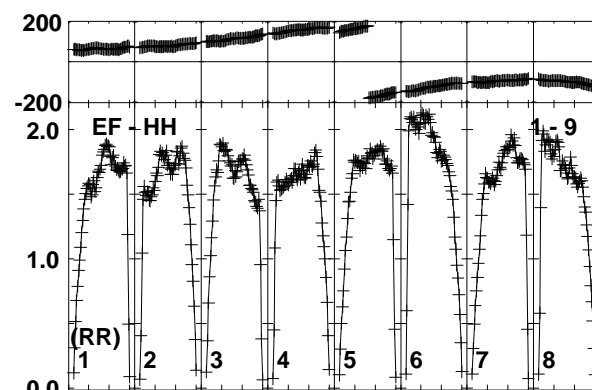
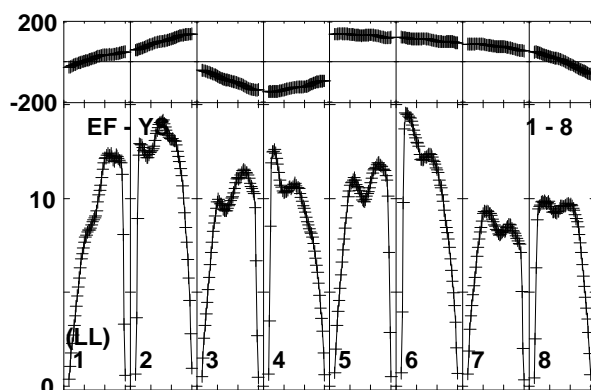
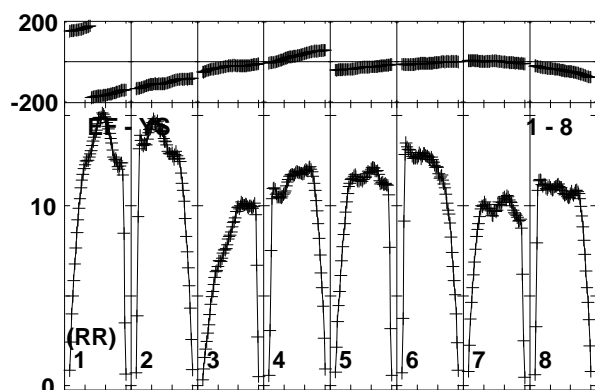
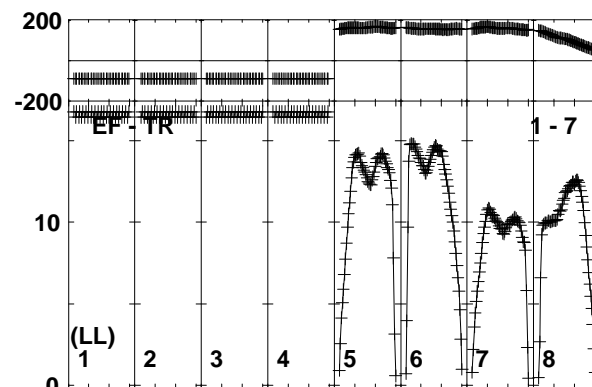
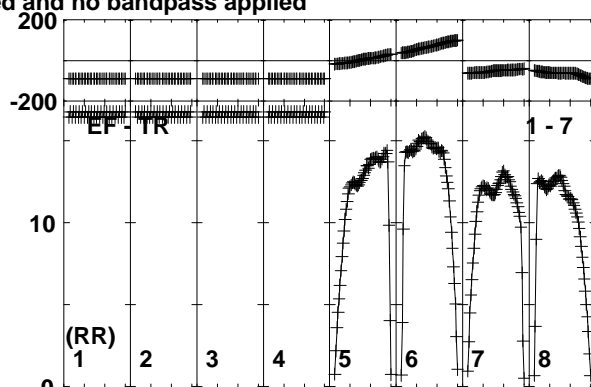
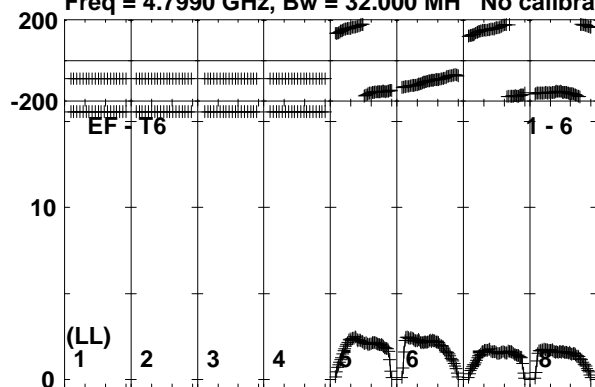

Lower frame: Milli Ampl Jy Top frame: Phas deg
Vector averaged cross-power spectrum Baseline: EF (01) - T6 (06)
Timerange: 00/13:12:54 to 00/13:24:58

Plot file version 3 created 19-OCT-2017 15:35:55

J1504+1029 ES081C.UVDATA.1

Freq = 4.7990 GHz, Bw = 32.000 MH No calibration applied and no bandpass applied

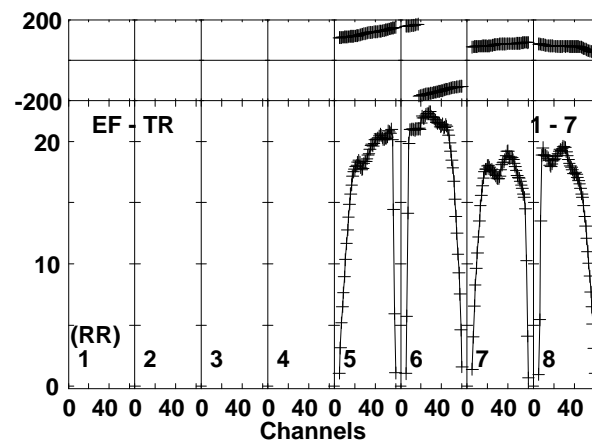
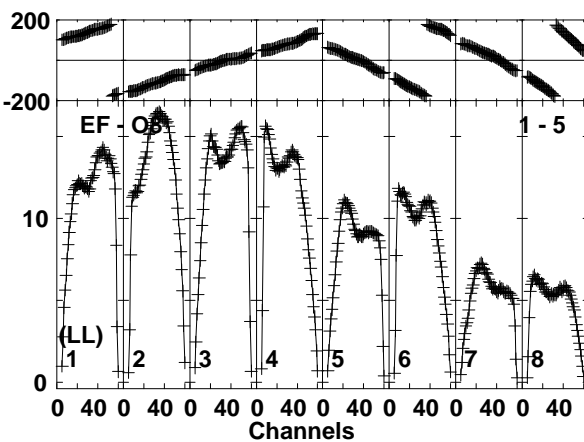
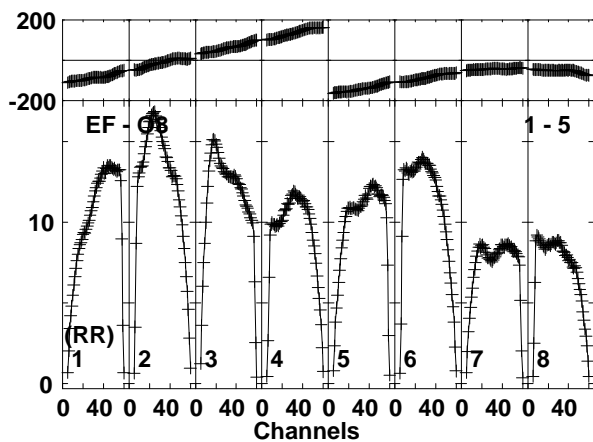
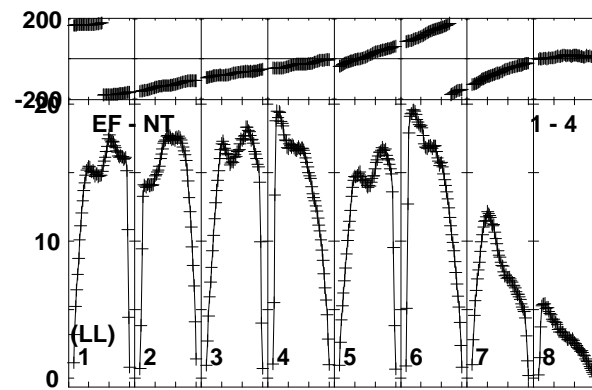
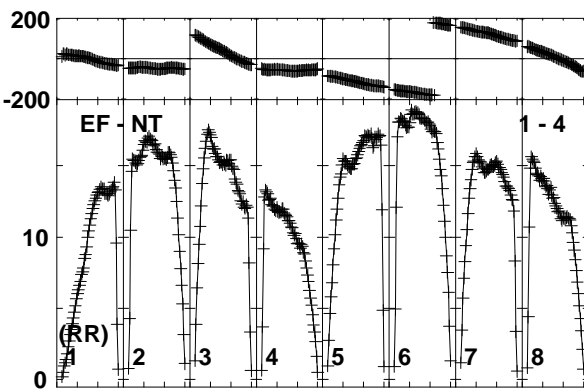
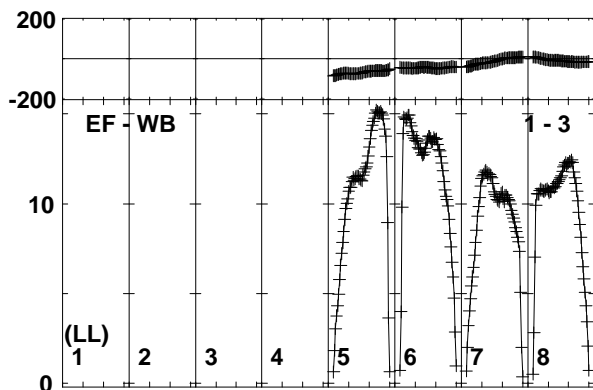
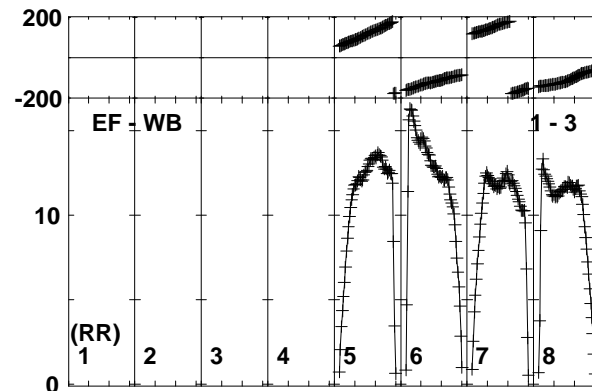
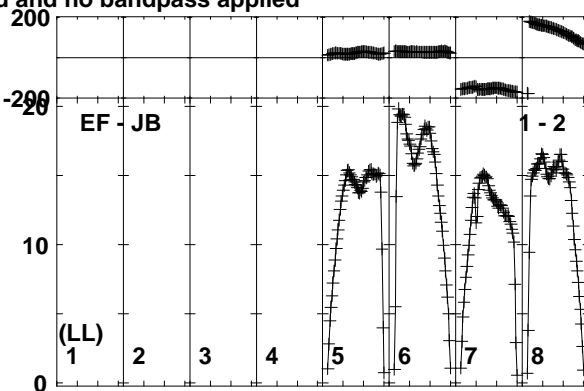
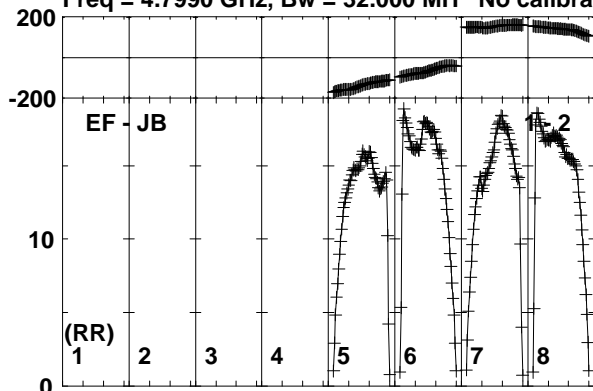

Lower frame: Milli Ampl Jy Top frame: Phas deg
Vector averaged cross-power spectrum Baseline: EF (01) - JB (02)
Timerange: 00:13:27:02 to 00:13:29:08

Plot file version 4 created 19-OCT-2017 15:35:55

J1504+1029 ES081C.UVDATA.1

Freq = 4.7990 GHz, Bw = 32.000 MH No calibration applied and no bandpass applied

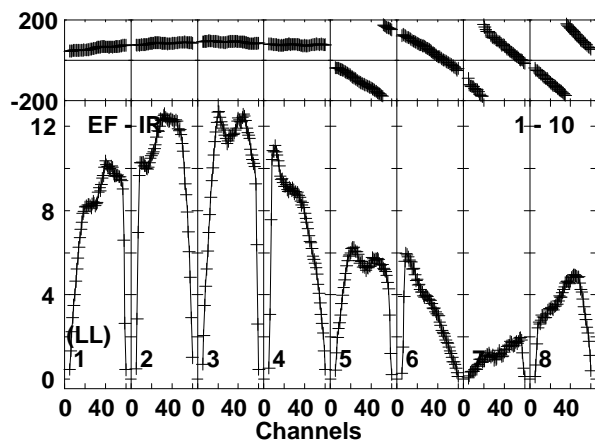
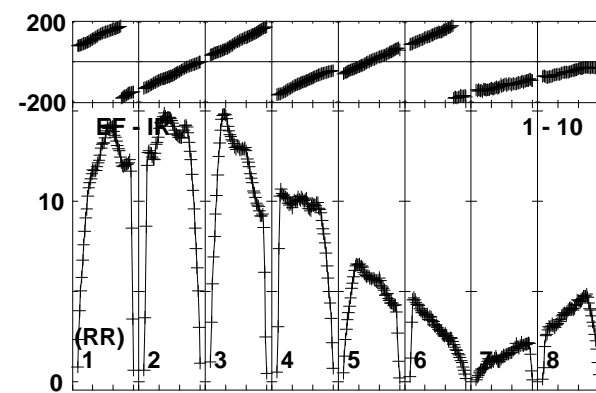
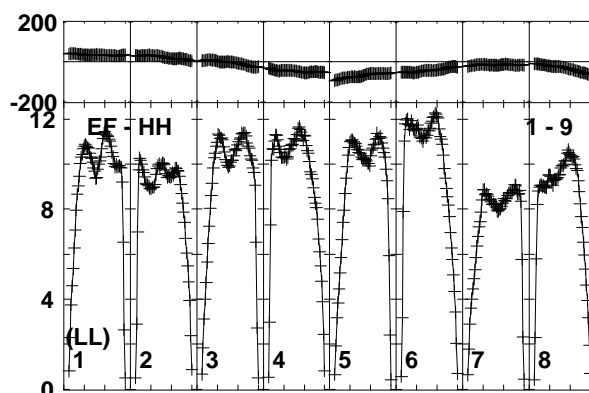
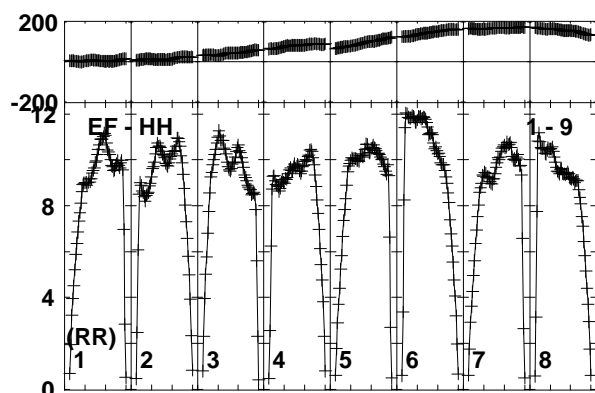
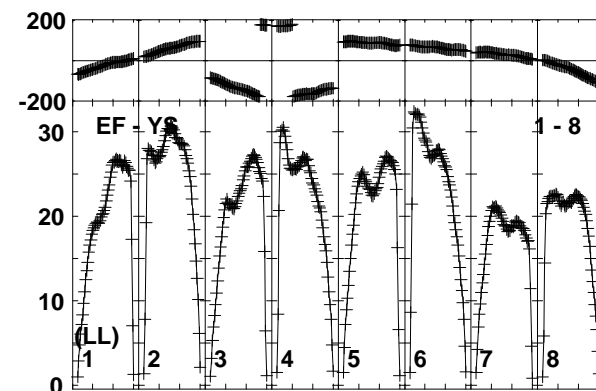
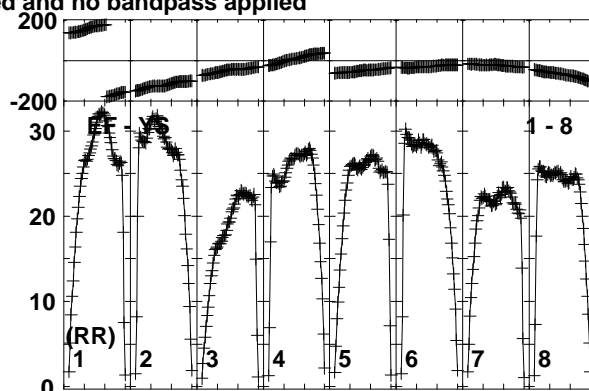
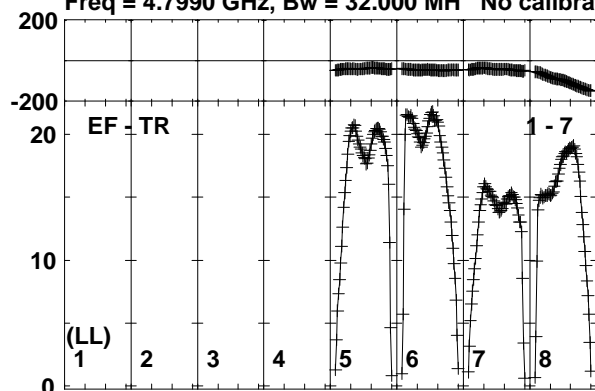

Lower frame: Milli Ampl Jy Top frame: Phas deg
Vector averaged cross-power spectrum Baseline: EF (01) - TR (07)
Timerange: 00/13:27:02 to 00/13:29:08

Plot file version 5 created 19-OCT-2017 15:35:56

J1504+1029 ES081C.UVDATA.1

Freq = 4.7990 GHz, Bw = 32.000 MH No calibration applied and no bandpass applied

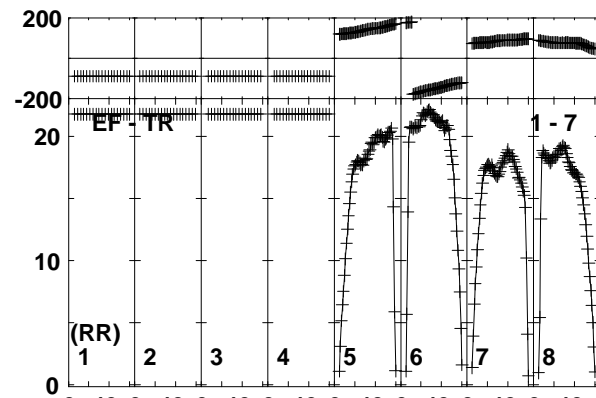
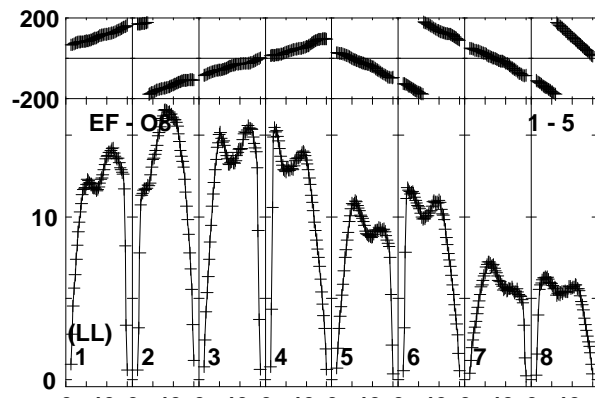
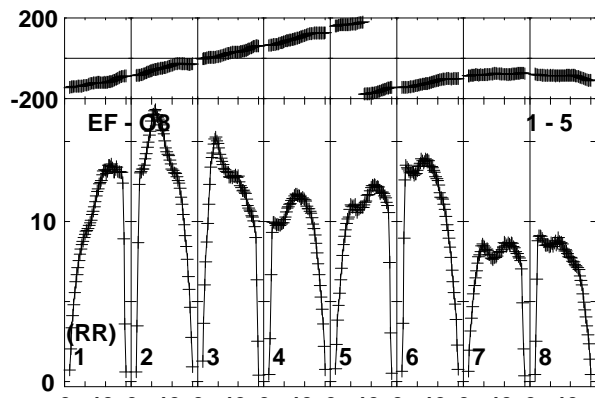
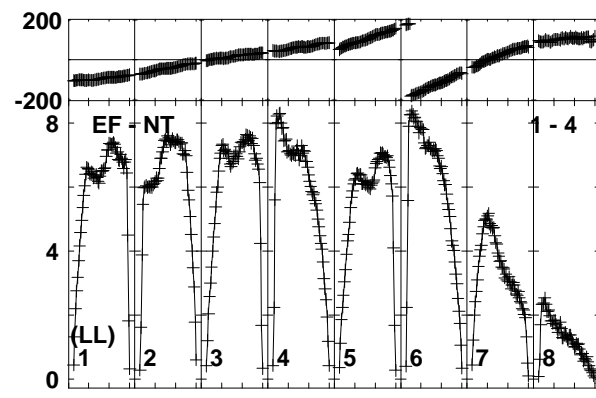
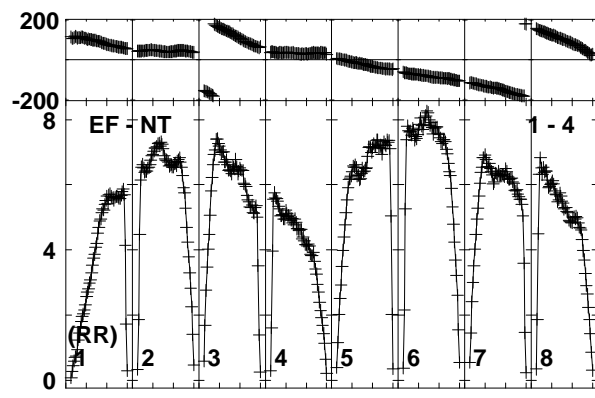
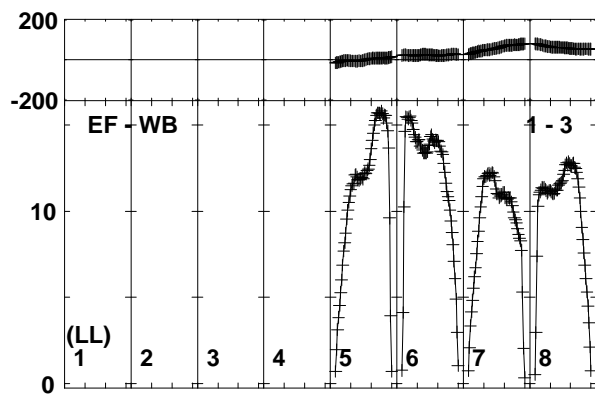
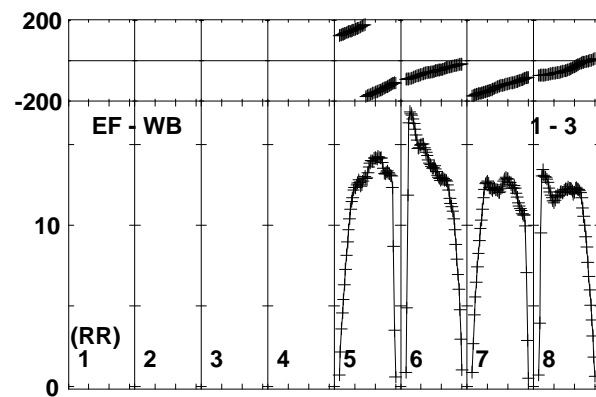
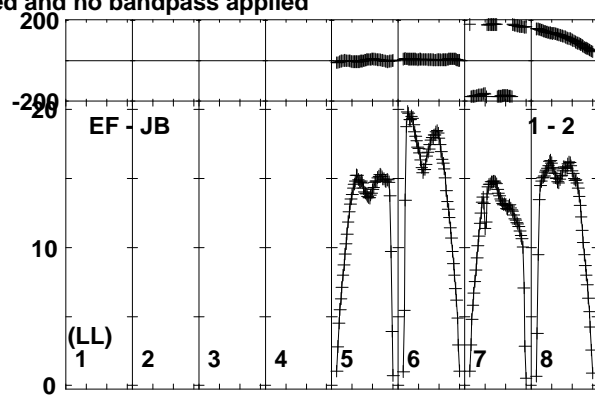
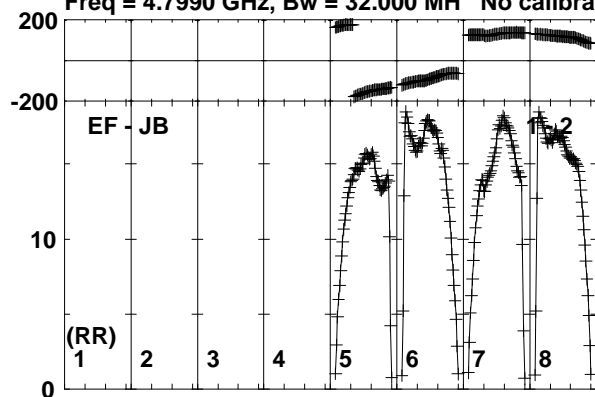

Lower frame: Milli Ampl Jy Top frame: Phas deg
Vector averaged cross-power spectrum Baseline: EF (01) - JB (02)
Timerange: 00/13:29:32 to 00/13:31:28

Plot file version 6 created 19-OCT-2017 15:35:56
 J1504+1029 ES081C.UVDATA.1

Freq = 4.7990 GHz, Bw = 32.000 MH No calibration applied and no bandpass applied

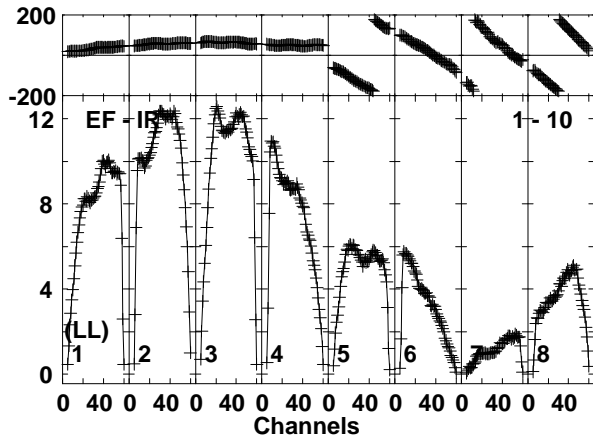
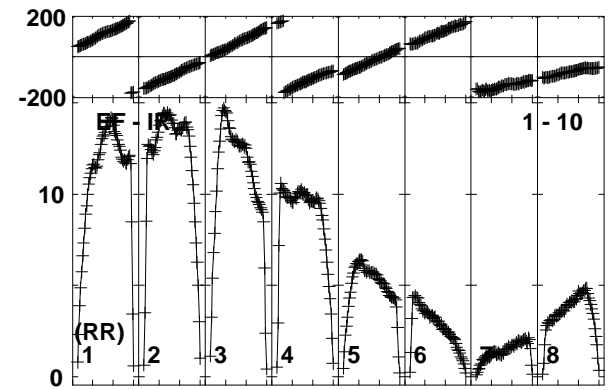
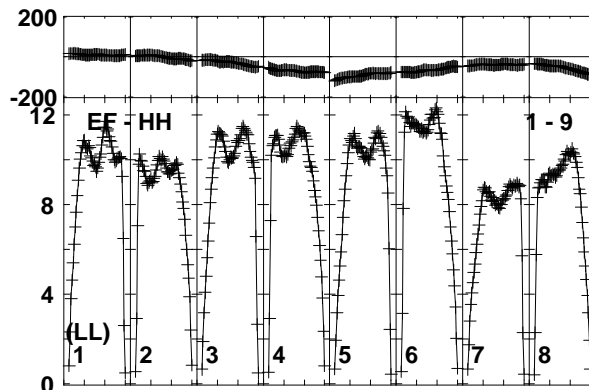
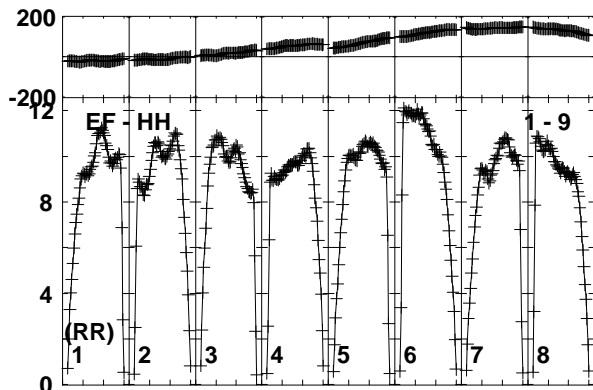
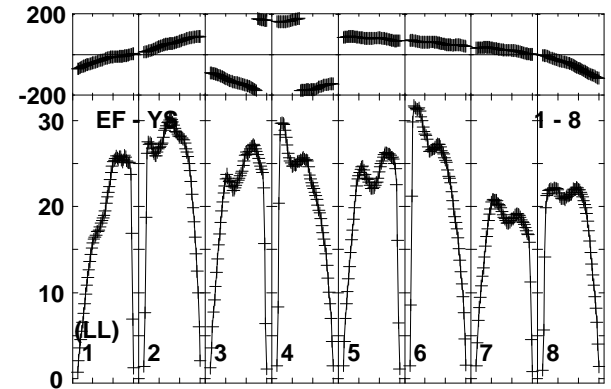
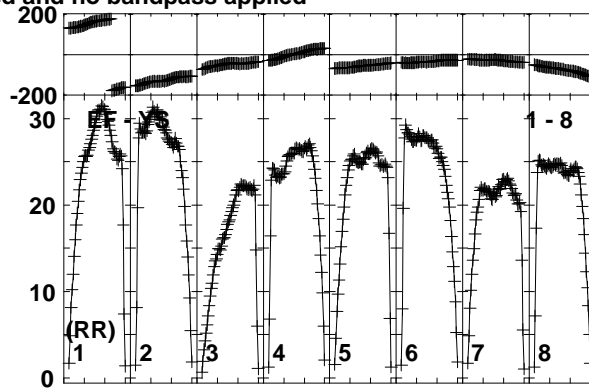
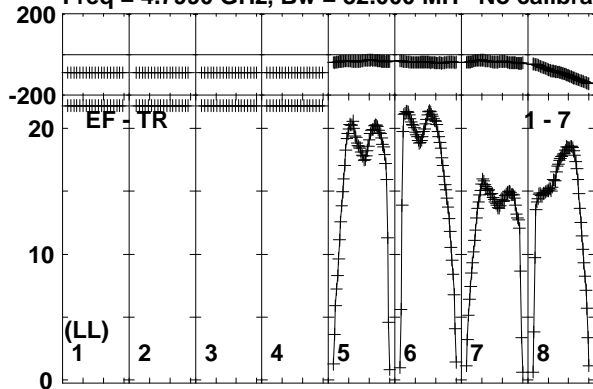

Lower frame: Milli Ampl Jy Top frame: Phas deg
 Vector averaged cross-power spectrum Baseline: EF (01) - TR (07)
 Timerange: 00/13:29:32 to 00/13:31:28

Plot file version 7 created 19-OCT-2017 15:35:56
 MRK841 ES081C.UVDATA.1
 Freq = 4.7990 GHz, Bw = 32.000 MH No calibration applied and no bandpass applied

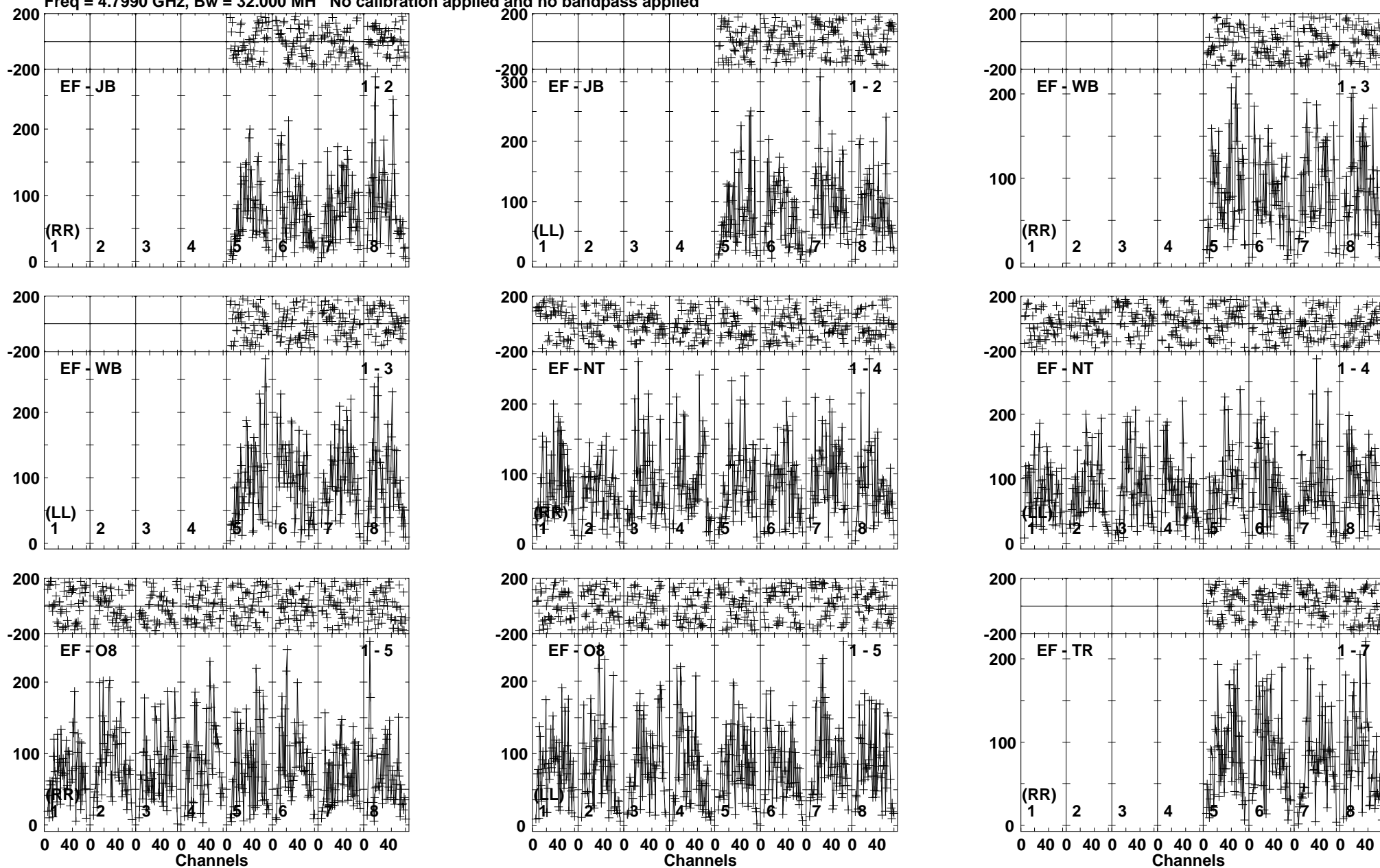

Lower frame: Micro Ampl Jy Top frame: Phas deg
 Vector averaged cross-power spectrum Baseline: EF (01) - JB (02)
 Timerange: 00/13:31:32 to 00/13:34:58

Plot file version 8 created 19-OCT-2017 15:35:56

MRK841 ES081C.UVDATA.1

Freq = 4.7990 GHz, Bw = 32.000 MH No calibration applied and no bandpass applied

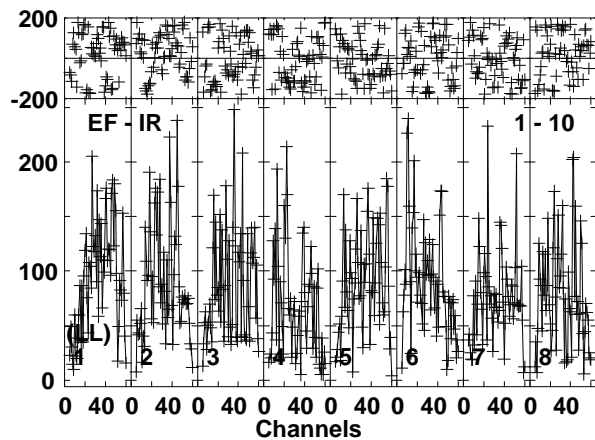
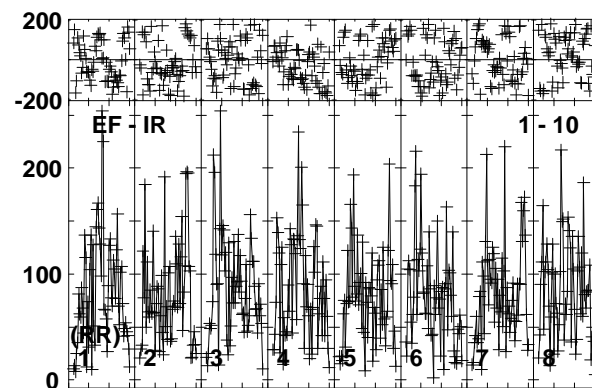
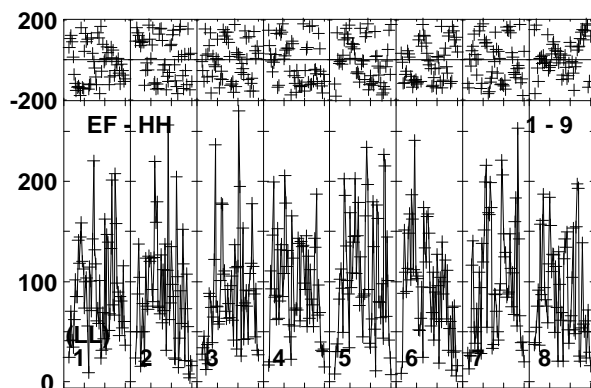
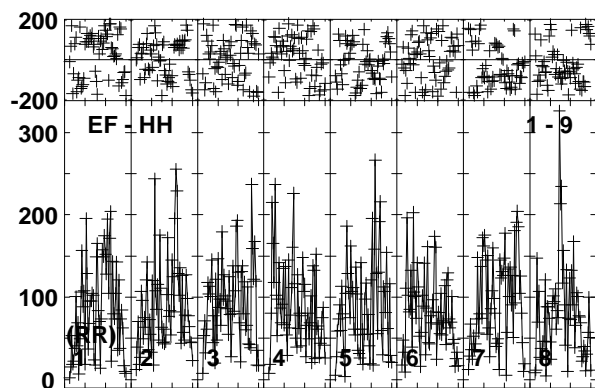
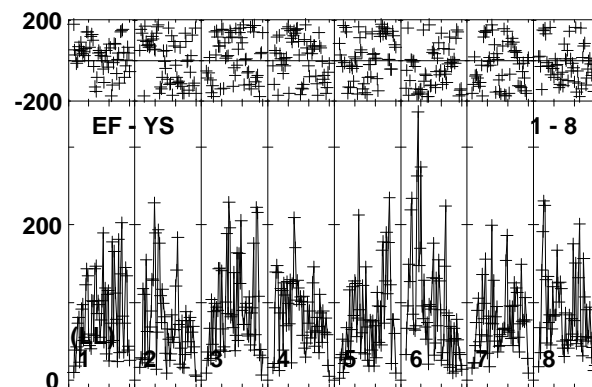
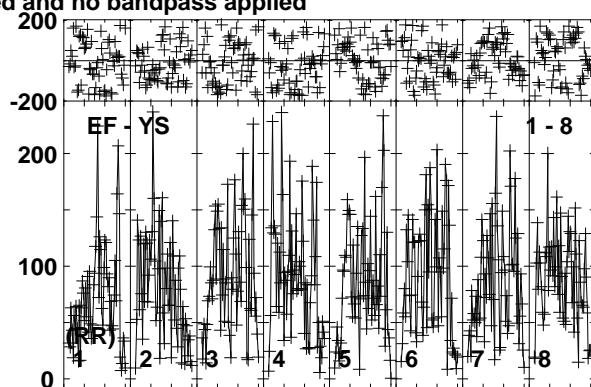
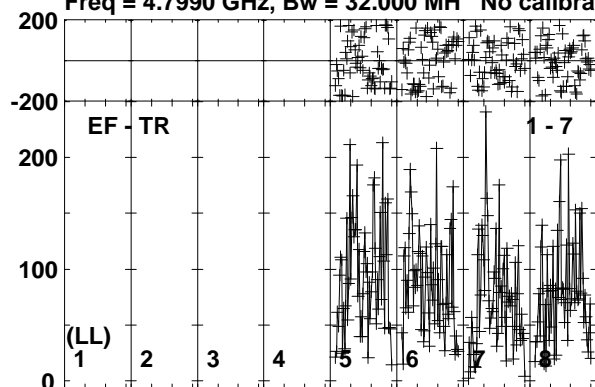

Lower frame: Micro Ampl Jy Top frame: Phas deg
Vector averaged cross-power spectrum Baseline: EF (01) - TR (07)
Timerange: 00/13:31:32 to 00/13:34:58

Plot file version 9 created 19-OCT-2017 15:35:56

J1504+1029 ES081C.UVDATA.1

Freq = 4.7990 GHz, Bw = 32.000 MH No calibration applied and no bandpass applied

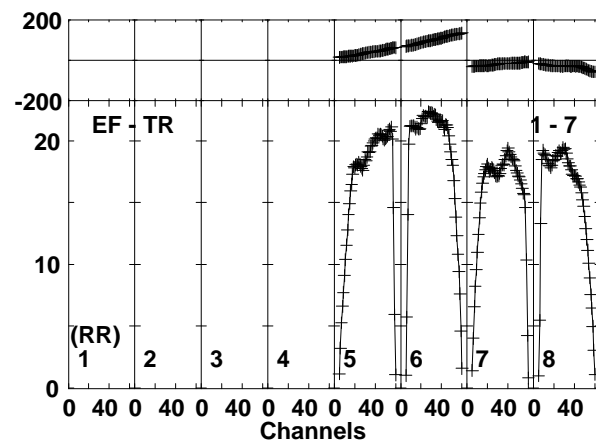
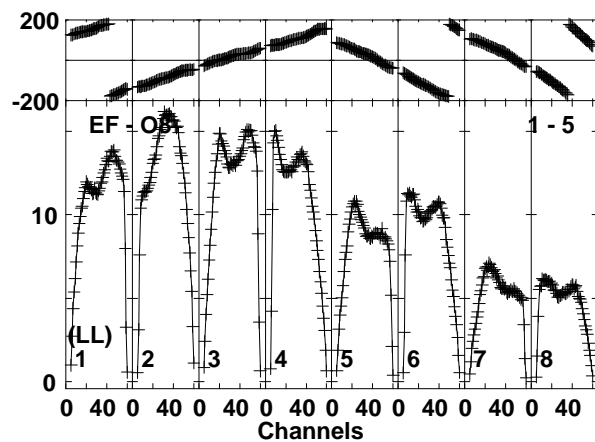
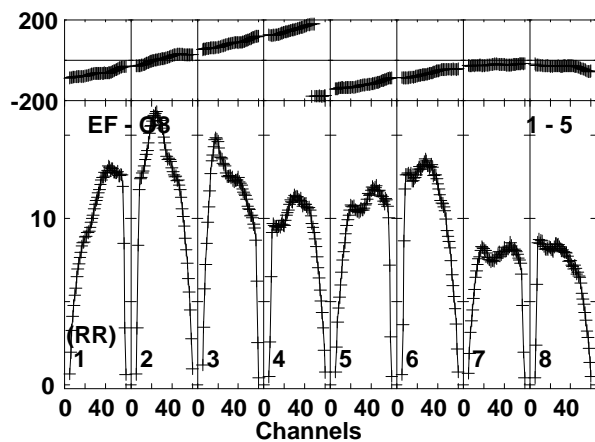
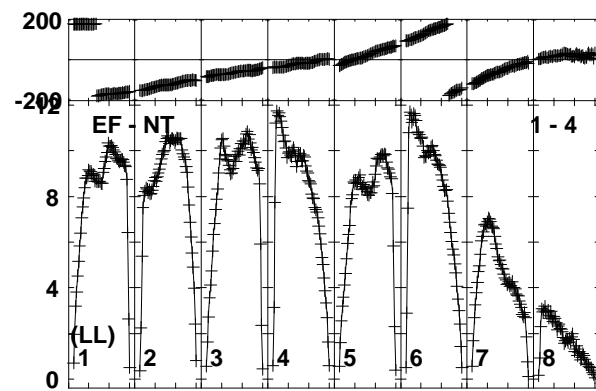
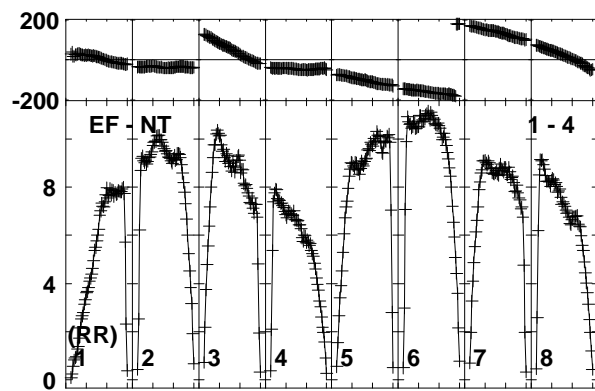
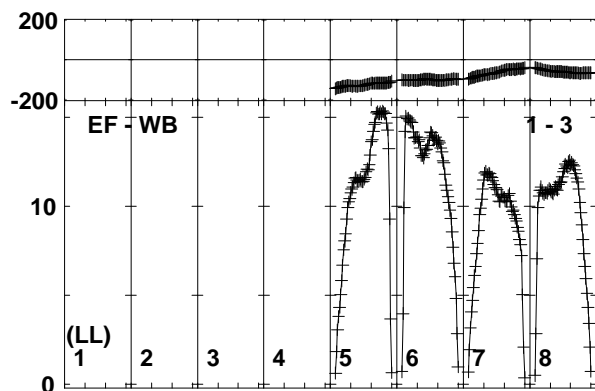
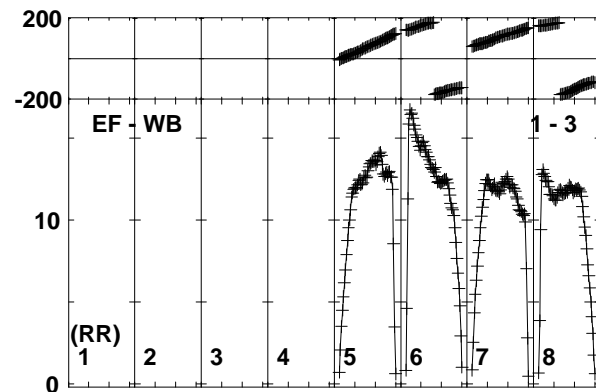
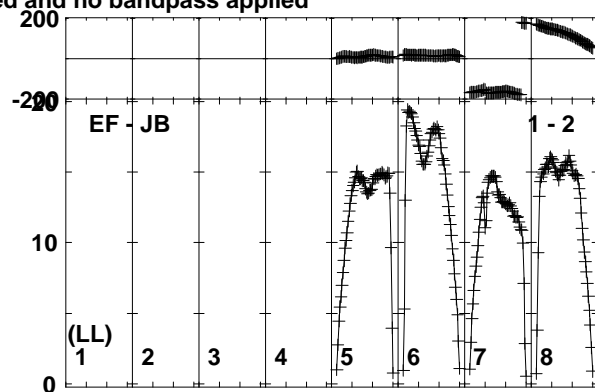
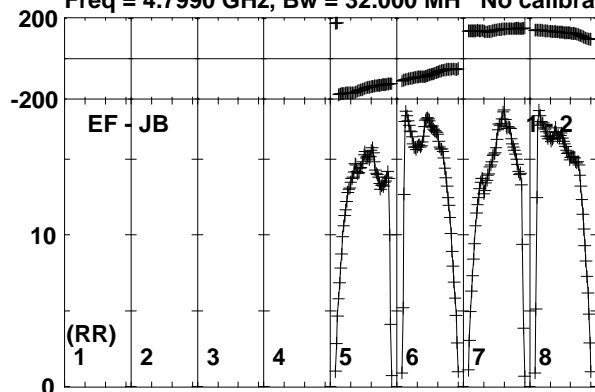

Lower frame: Milli Ampl Jy Top frame: Phas deg
Vector averaged cross-power spectrum Baseline: EF (01) - JB (02)
Timerange: 00/13:35:02 to 00/13:36:28

Plot file version 10 created 19-OCT-2017 15:35:56

J1504+1029 ES081C.UVDATA.1

Freq = 4.7990 GHz, Bw = 32.000 MH No calibration applied and no bandpass applied

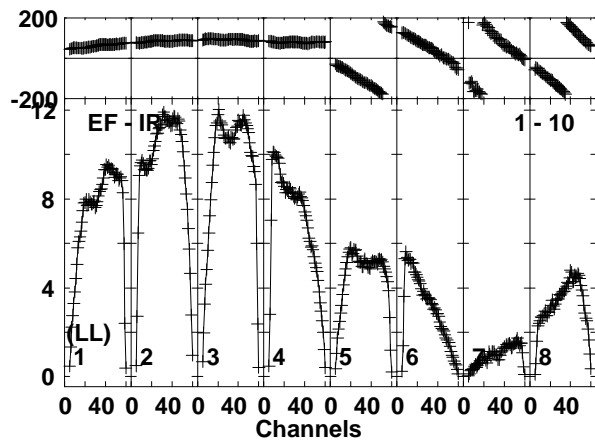
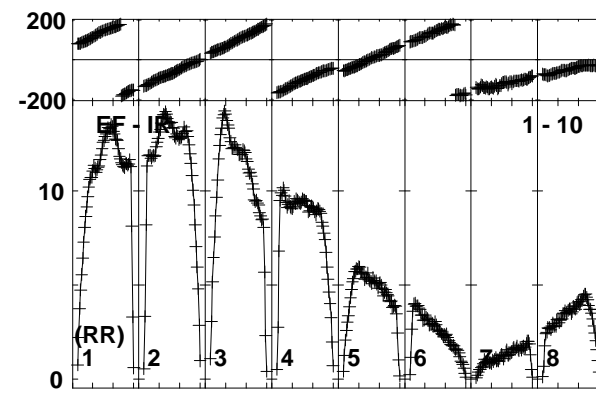
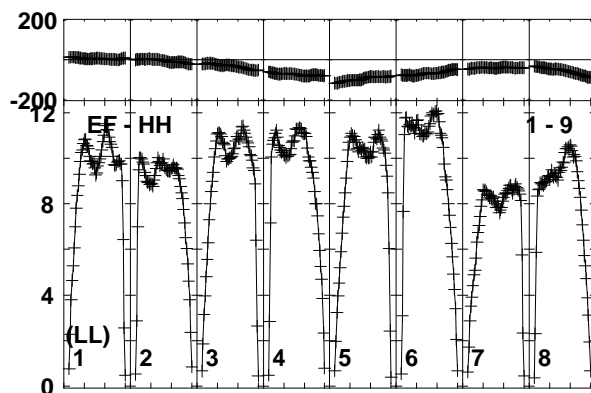
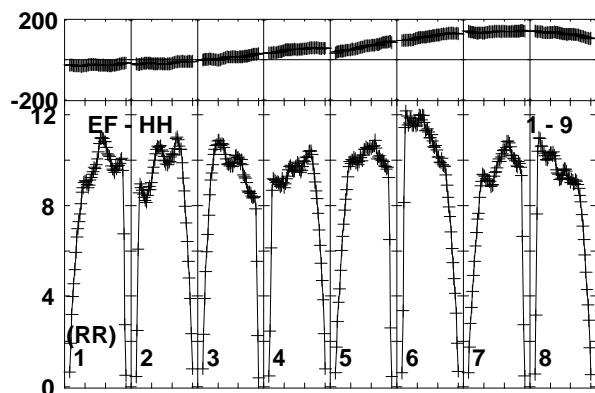
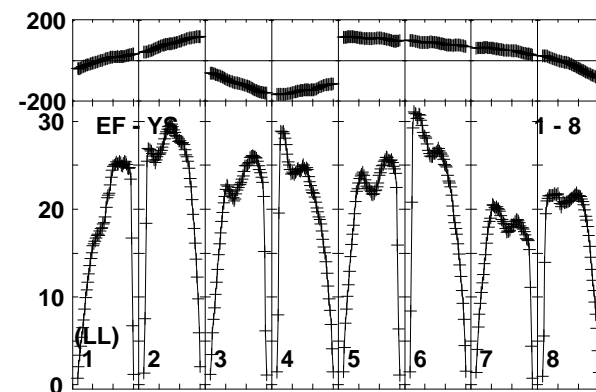
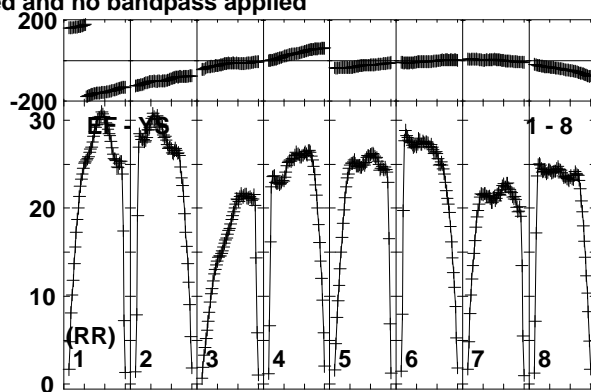
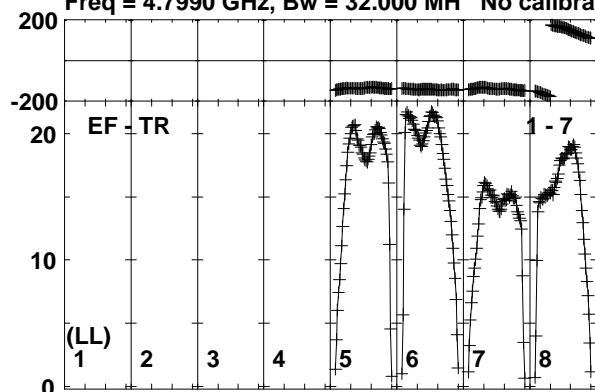

Lower frame: Milli Ampl Jy Top frame: Phas deg
Vector averaged cross-power spectrum Baseline: EF (01) - TR (07)
Timerange: 00/13:35:02 to 00/13:36:28

Plot file version 11 created 19-OCT-2017 15:35:56

MRK841 ES081C.UVDATA.1

Freq = 4.7990 GHz, Bw = 32.000 MH No calibration applied and no bandpass applied

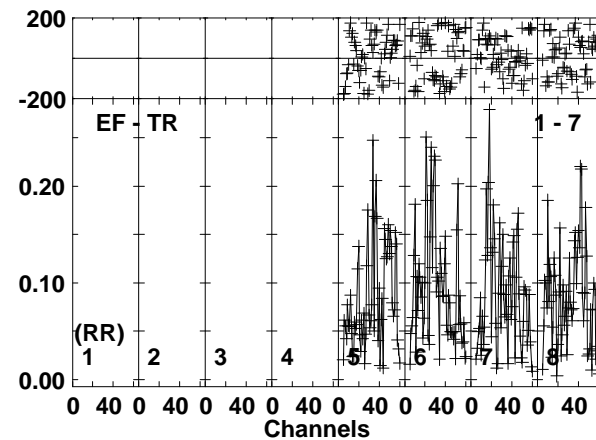
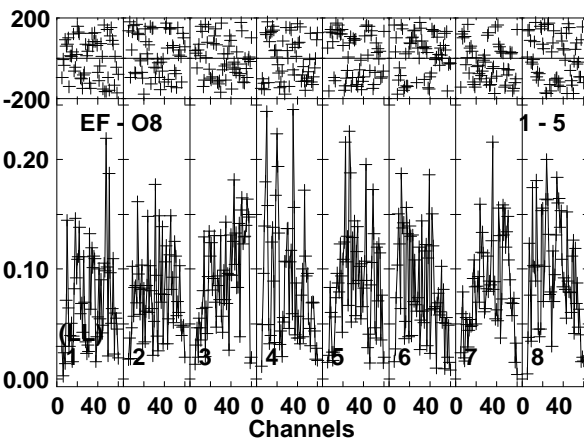
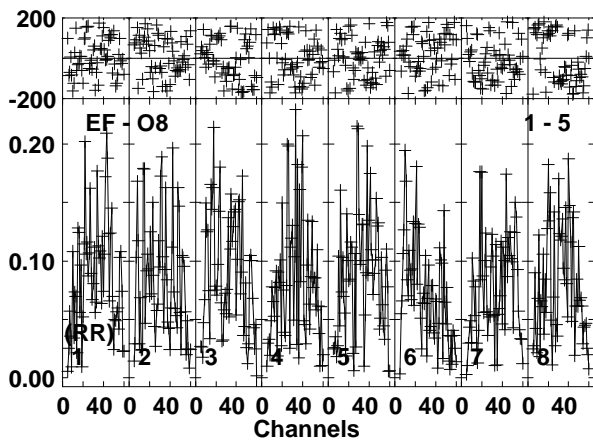
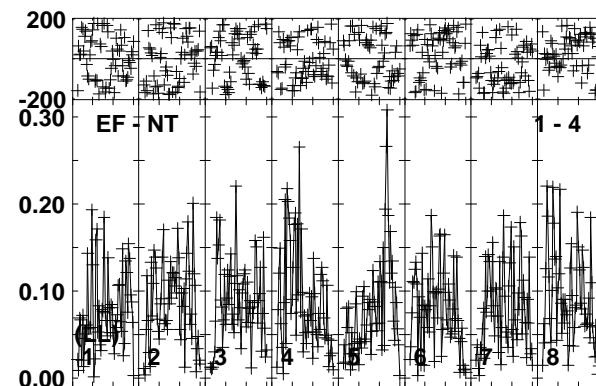
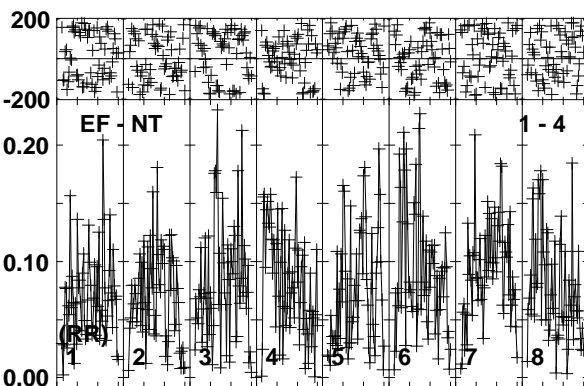
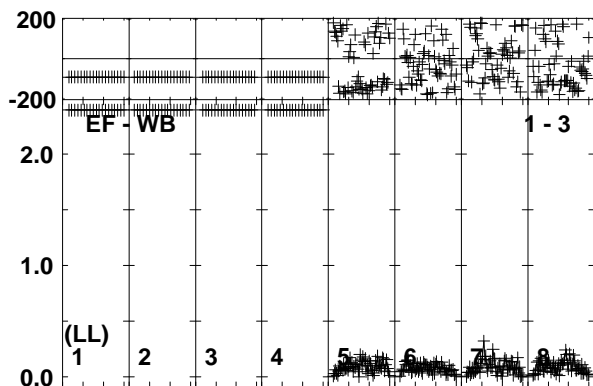
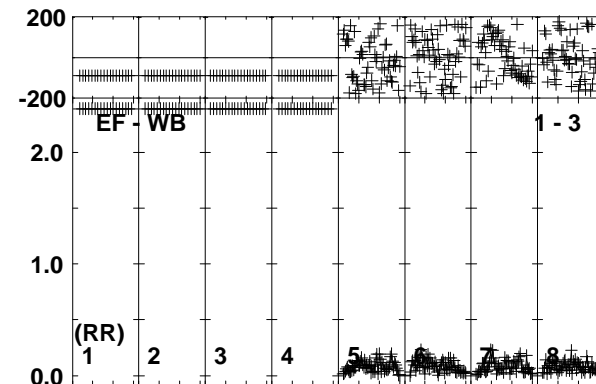
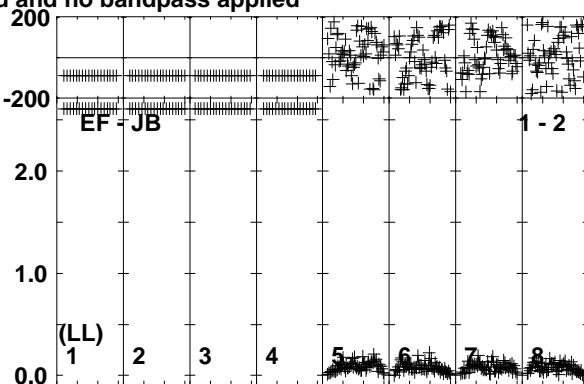
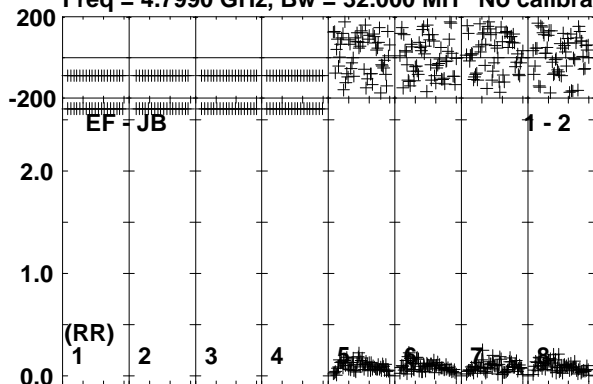

Lower frame: Milli Ampl Jy Top frame: Phas deg
Vector averaged cross-power spectrum Baseline: EF (01) - JB (02)
Timerange: 00/13:36:32 to 00/13:39:58

Plot file version 12 created 19-OCT-2017 15:35:57

MRK841 ES081C.UVDATA.1

Freq = 4.7990 GHz, Bw = 32.000 MH No calibration applied and no bandpass applied

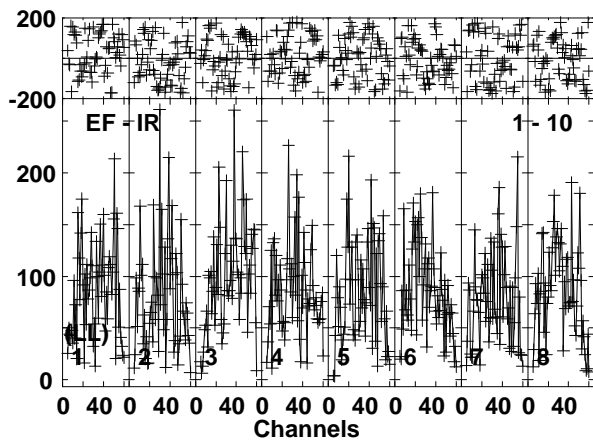
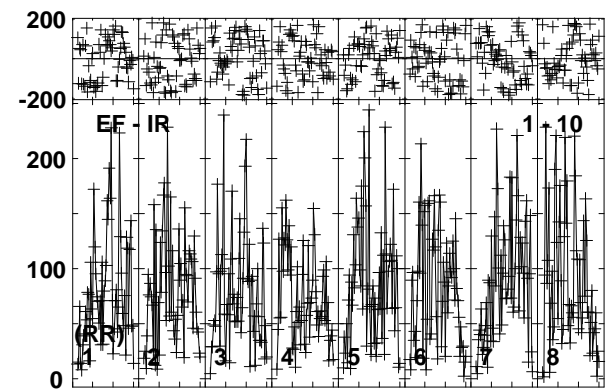
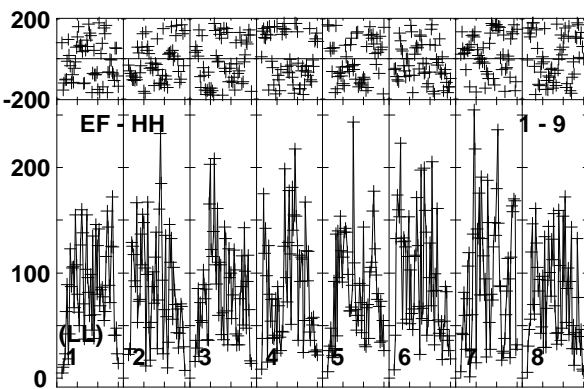
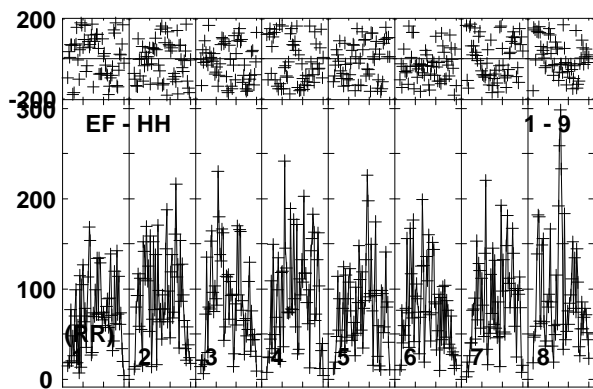
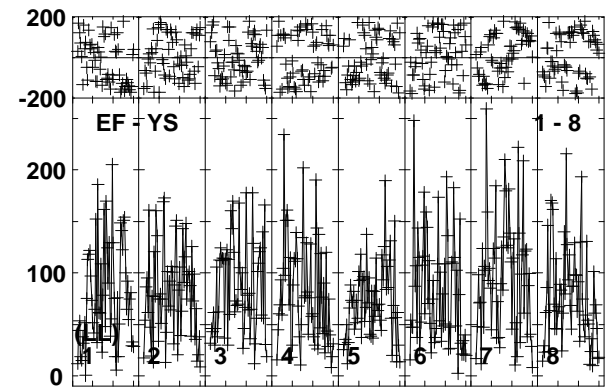
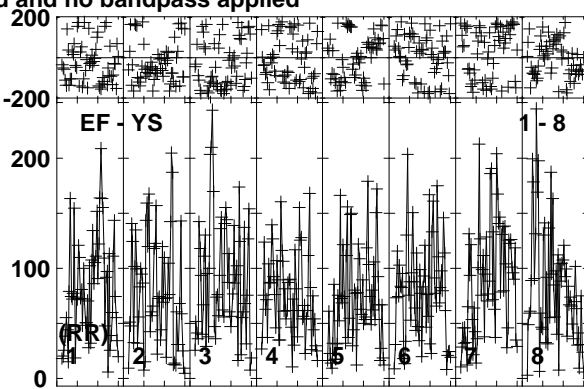
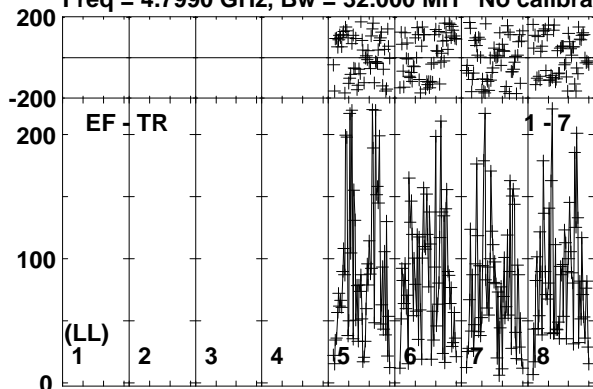

Lower frame: Micro Ampl Jy Top frame: Phas deg
Vector averaged cross-power spectrum Baseline: EF (01) - TR (07)
Timerange: 00/13:36:32 to 00/13:39:58

Plot file version 13 created 19-OCT-2017 15:35:57

J1504+1029 ES081C.UVDATA.1

Freq = 4.7990 GHz, Bw = 32.000 MH No calibration applied and no bandpass applied

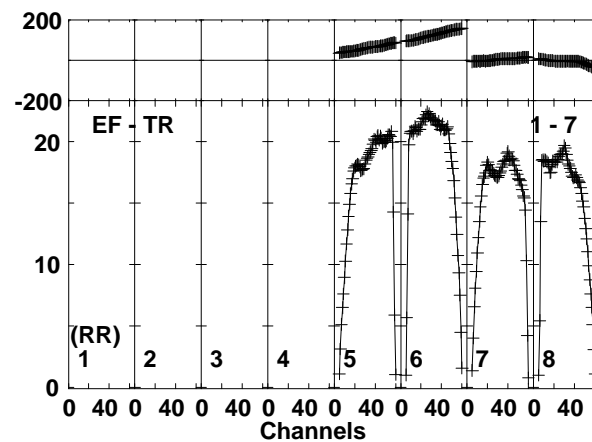
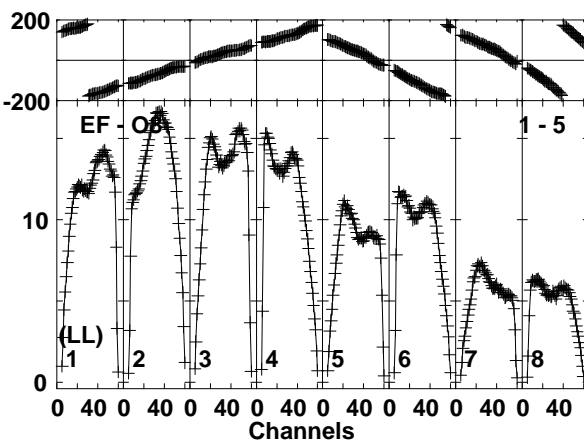
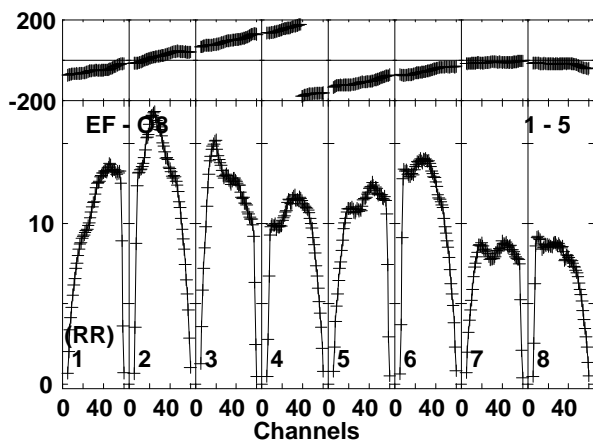
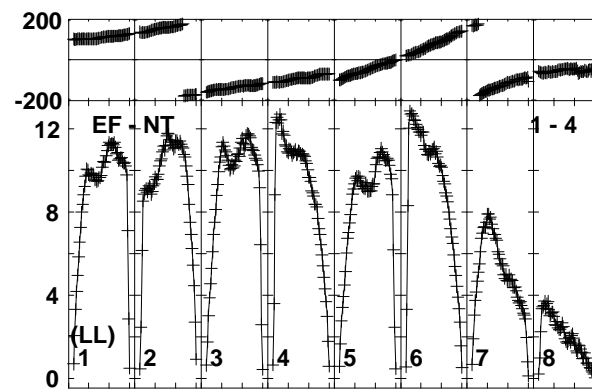
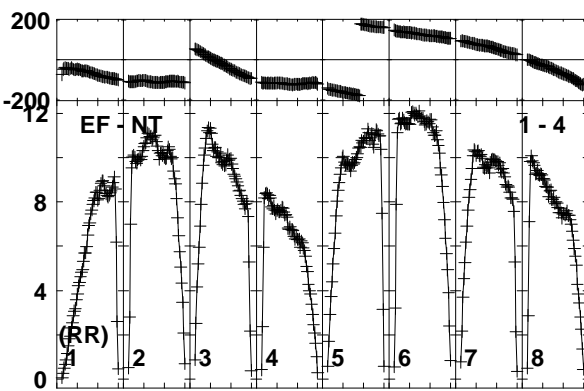
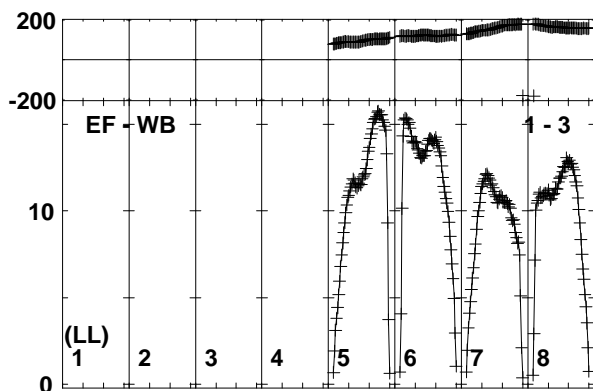
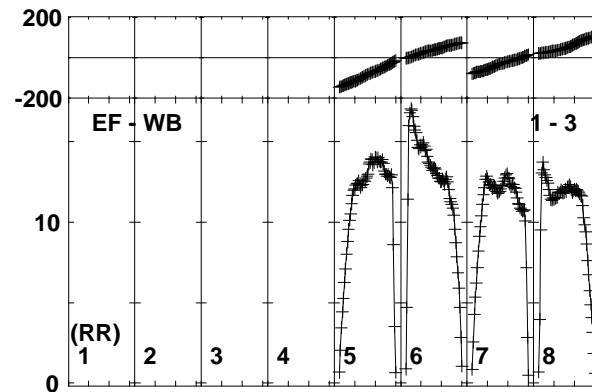
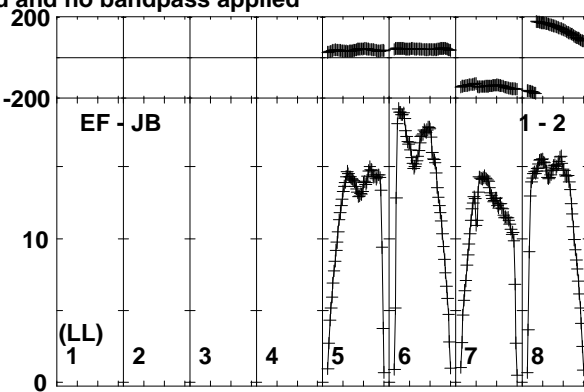
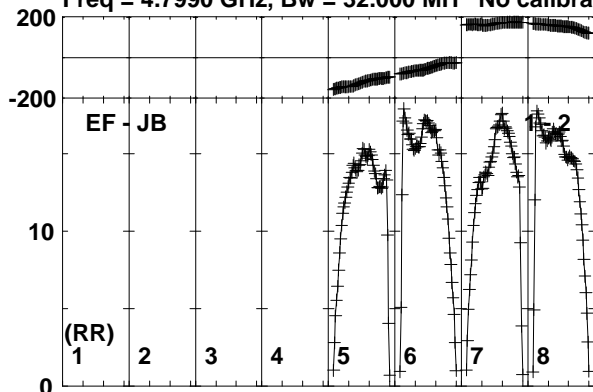

Lower frame: Milli Ampl Jy Top frame: Phas deg
Vector averaged cross-power spectrum Baseline: EF (01) - JB (02)
Timerange: 00:13:40:32 to 00:13:41:28

Plot file version 14 created 19-OCT-2017 15:35:57

J1504+1029 ES081C.UVDATA.1

Freq = 4.7990 GHz, Bw = 32.000 MH No calibration applied and no bandpass applied

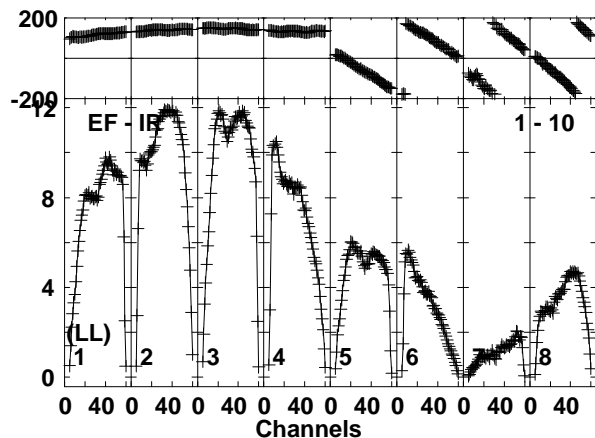
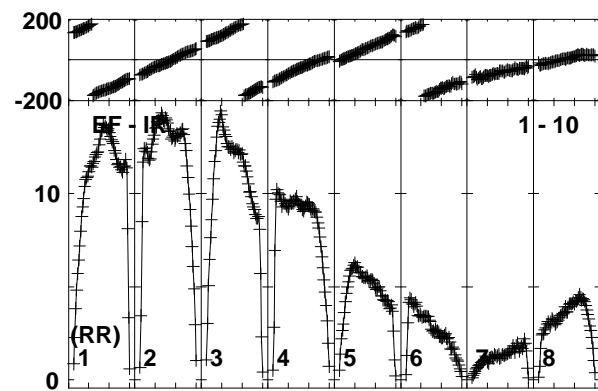
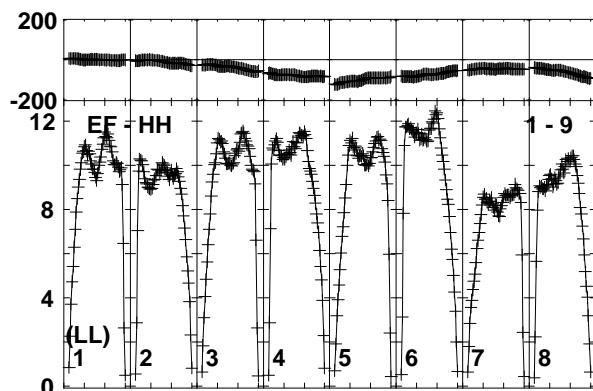
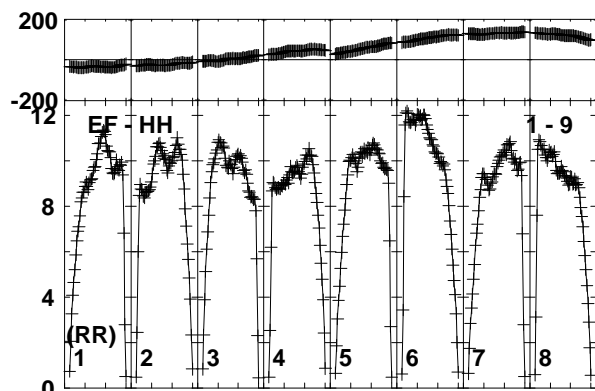
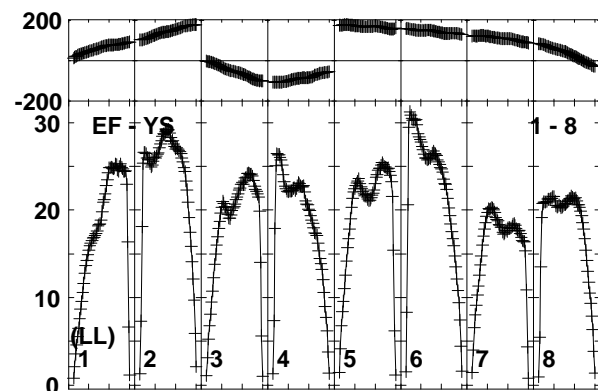
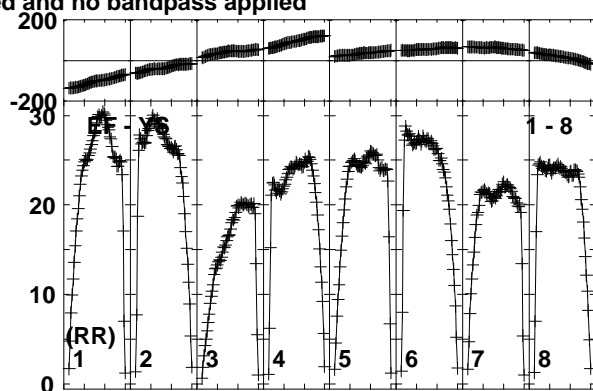
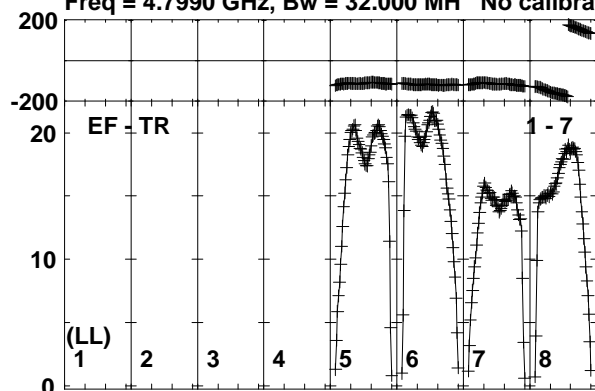

Lower frame: Milli Ampl Jy Top frame: Phas deg
Vector averaged cross-power spectrum Baseline: EF (01) - TR (07)
Timerange: 00/13:40:32 to 00/13:41:28

Plot file version 15 created 19-OCT-2017 15:35:57

MRK841 ES081C.UVDATA.1

Freq = 4.7990 GHz, Bw = 32.000 MH No calibration applied and no bandpass applied

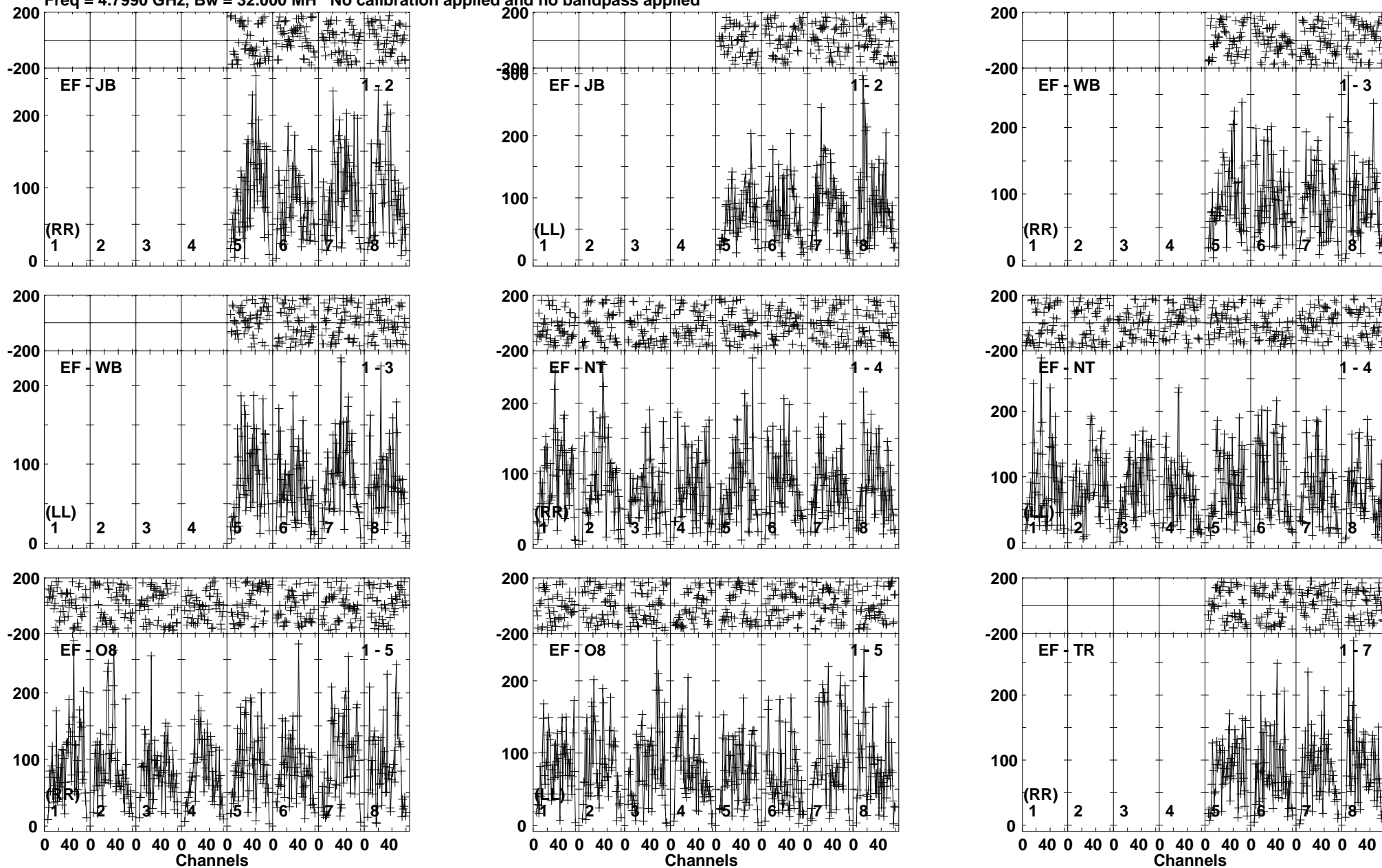

Lower frame: Micro Ampl Jy Top frame: Phas deg
Vector averaged cross-power spectrum Baseline: EF (01) - JB (02)
Timerange: 00/13:41:32 to 00/13:44:58

Plot file version 16 created 19-OCT-2017 15:35:57

MRK841 ES081C.UVDATA.1

Freq = 4.7990 GHz, Bw = 32.000 MH No calibration applied and no bandpass applied

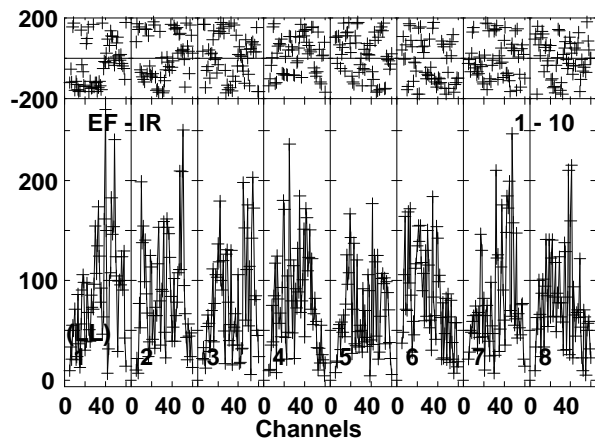
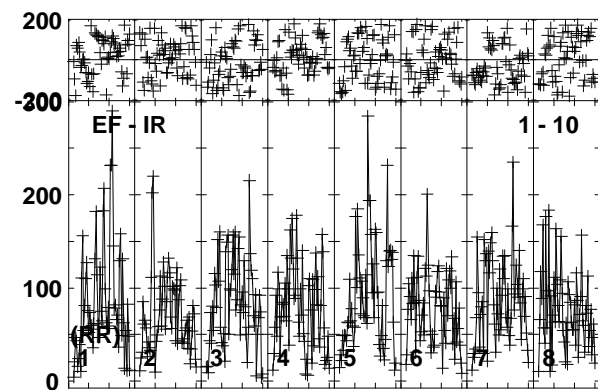
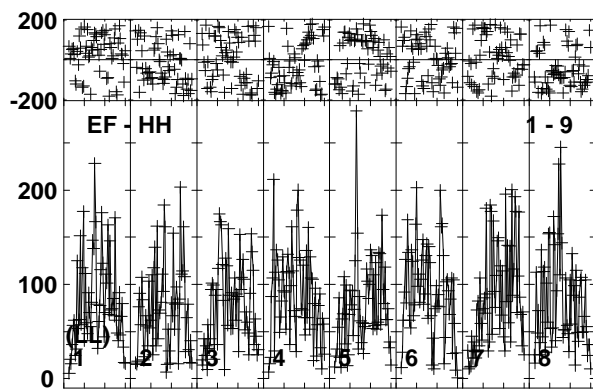
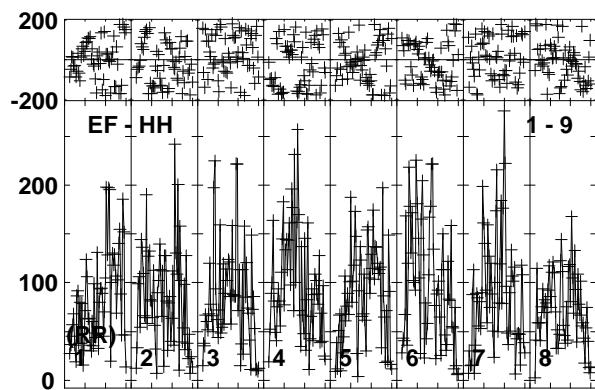
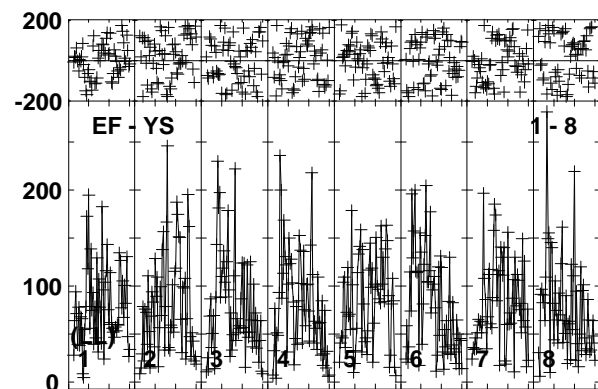
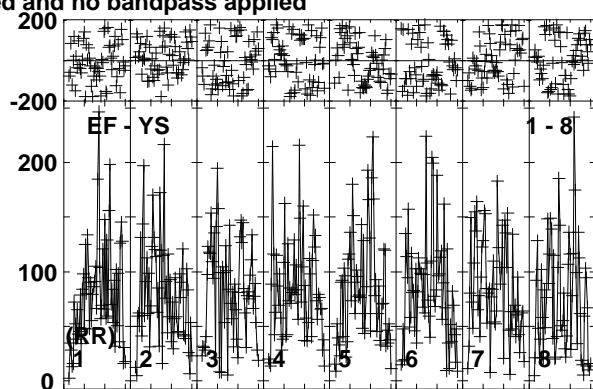
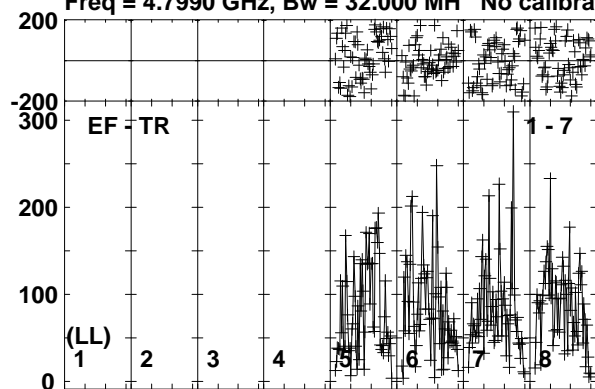

Lower frame: Micro Ampl Jy Top frame: Phas deg
Vector averaged cross-power spectrum Baseline: EF (01) - TR (07)
Timerange: 00/13:41:32 to 00/13:44:58

Plot file version 17 created 19-OCT-2017 15:35:57

J1504+1029 ES081C.UVDATA.1

Freq = 4.7990 GHz, Bw = 32.000 MH No calibration applied and no bandpass applied

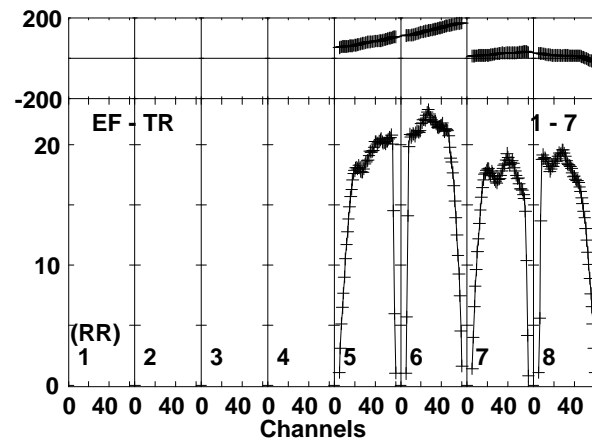
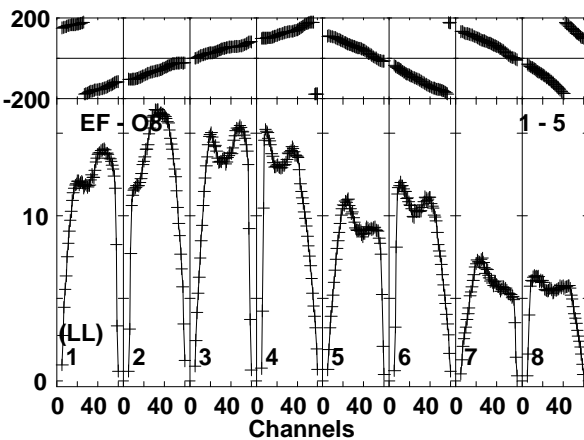
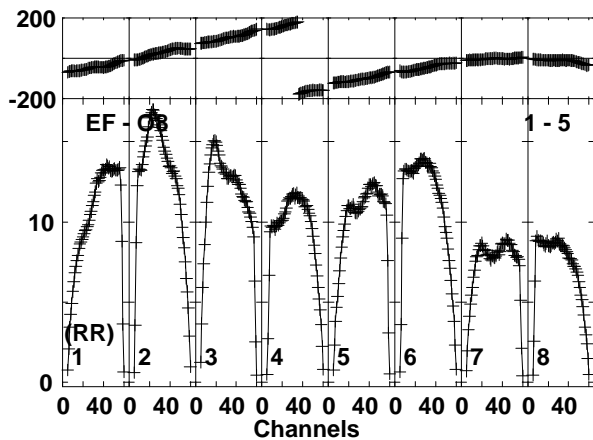
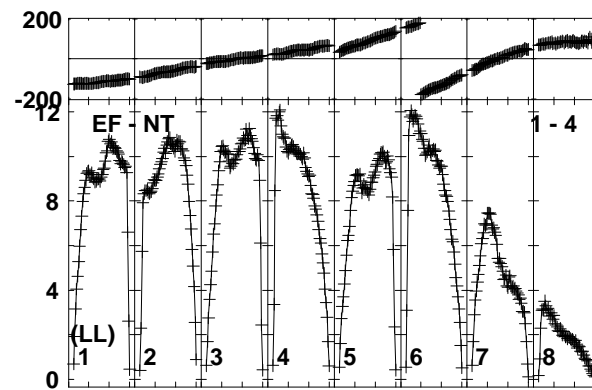
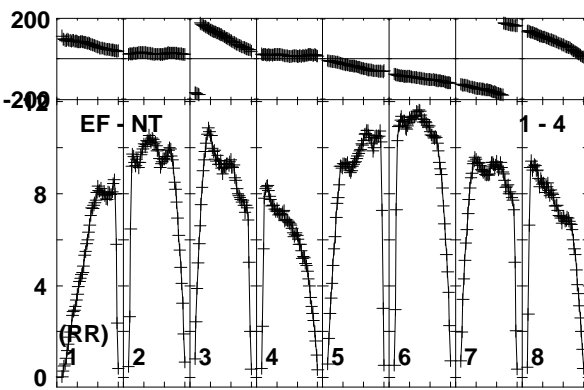
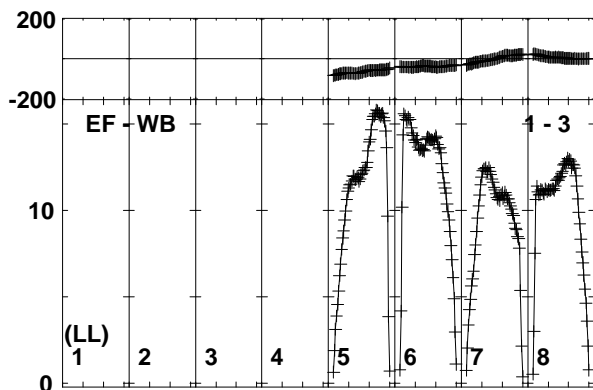
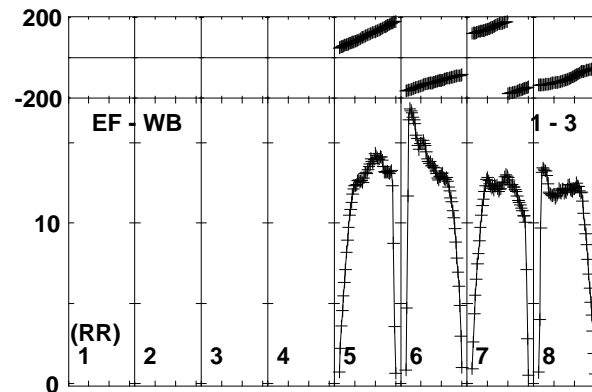
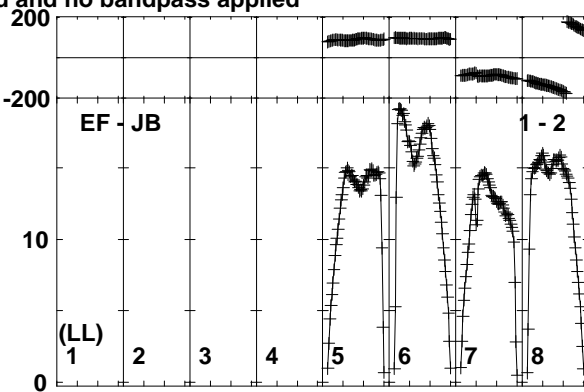
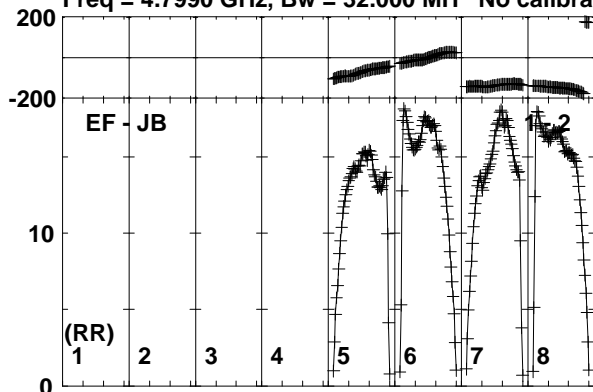

Lower frame: Milli Ampl Jy Top frame: Phas deg
Vector averaged cross-power spectrum Baseline: EF (01) - JB (02)
Timerange: 00:13:45:02 to 00:13:46:28

Plot file version 18 created 19-OCT-2017 15:35:57

J1504+1029 ES081C.UVDATA.1

Freq = 4.7990 GHz, Bw = 32.000 MH No calibration applied and no bandpass applied

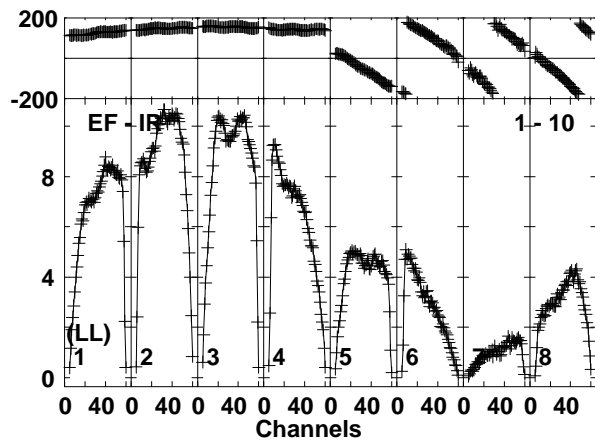
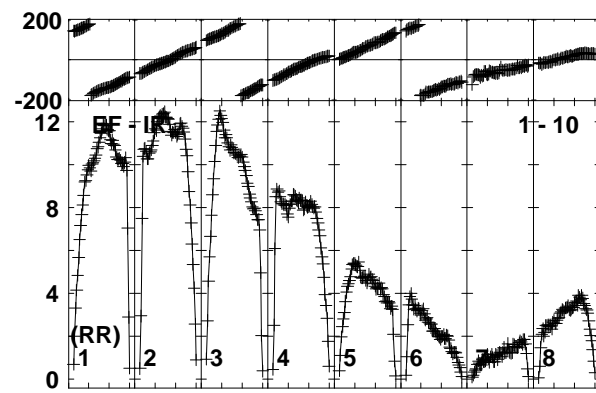
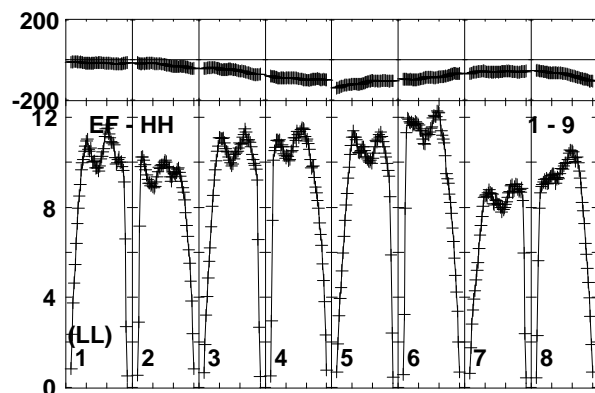
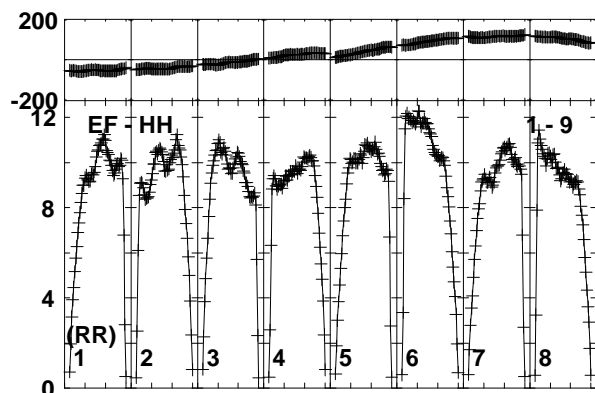
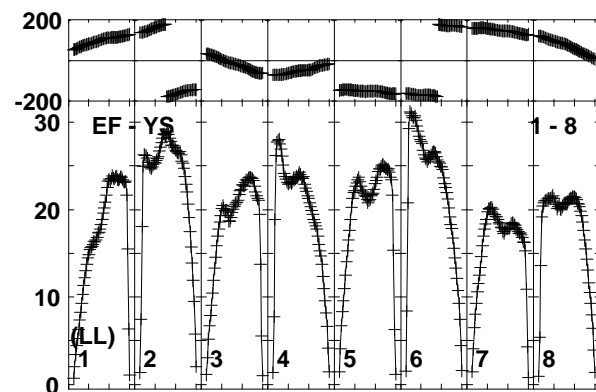
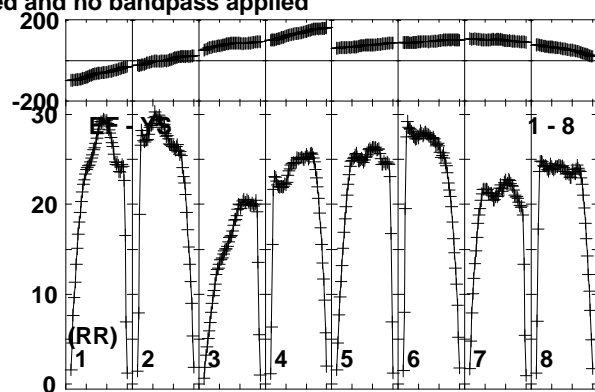
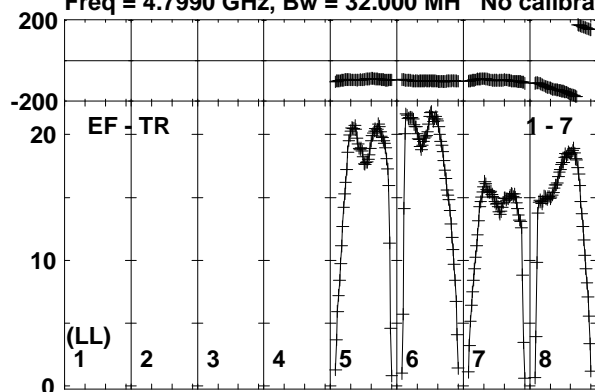

Lower frame: Milli Ampl Jy Top frame: Phas deg
Vector averaged cross-power spectrum Baseline: EF (01) - TR (07)
Timerange: 00/13:45:02 to 00/13:46:28

Plot file version 19 created 19-OCT-2017 15:35:57

MRK841 ES081C.UVDATA.1

Freq = 4.7990 GHz, Bw = 32.000 MH No calibration applied and no bandpass applied

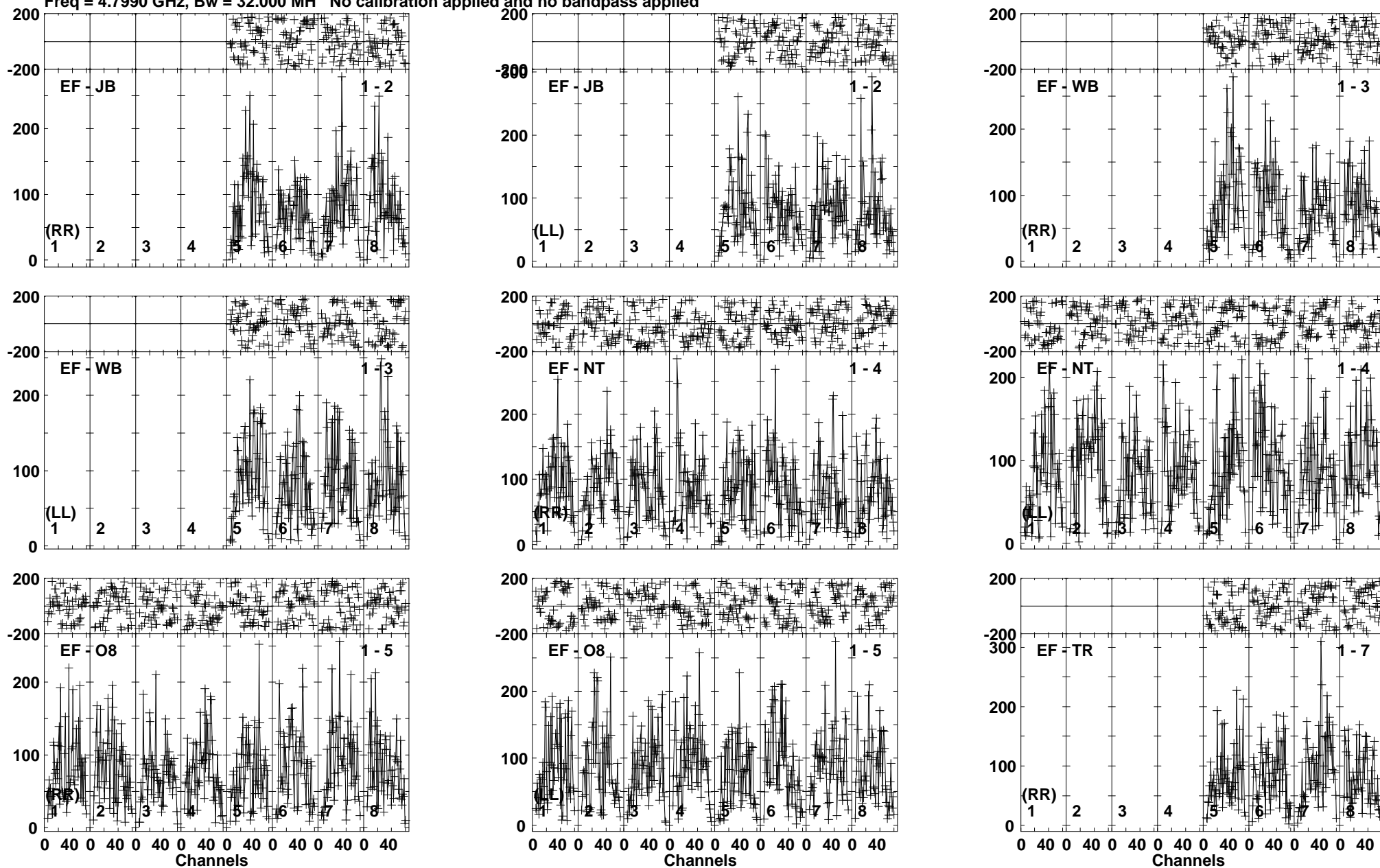

Lower frame: Micro Ampl Jy Top frame: Phas deg
Vector averaged cross-power spectrum Baseline: EF (01) - JB (02)
Timerange: 00/13:46:32 to 00/13:49:58

Plot file version 20 created 19-OCT-2017 15:35:58

MRK841 ES081C.UVDATA.1

Freq = 4.7990 GHz, Bw = 32.000 MH No calibration applied and no bandpass applied

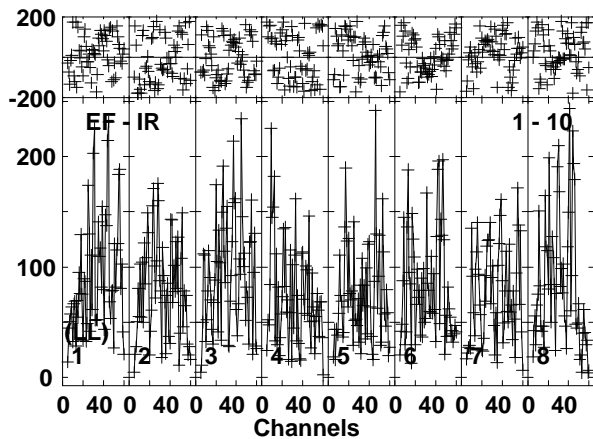
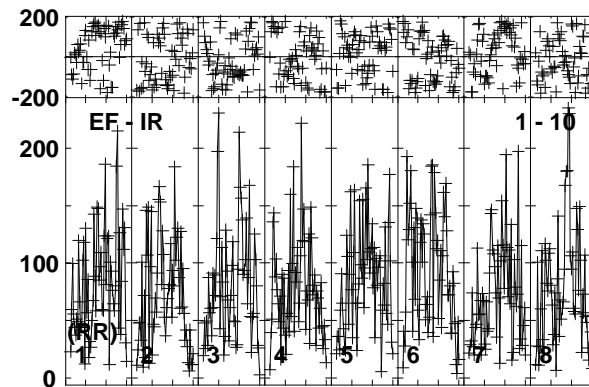
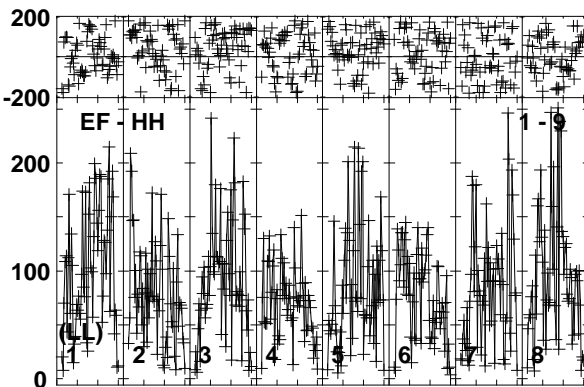
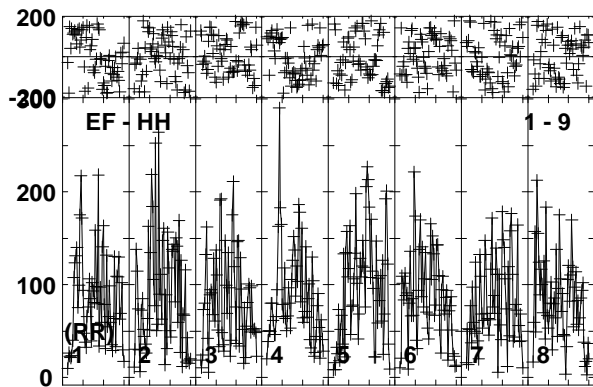
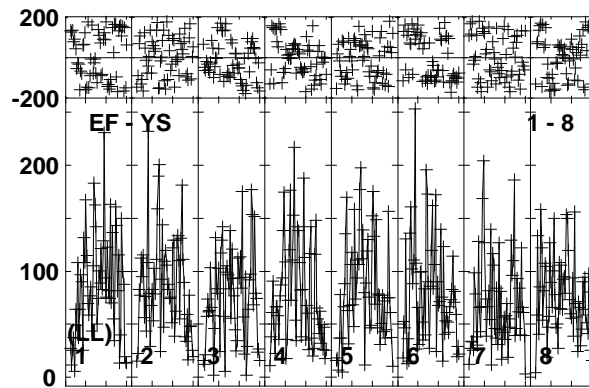
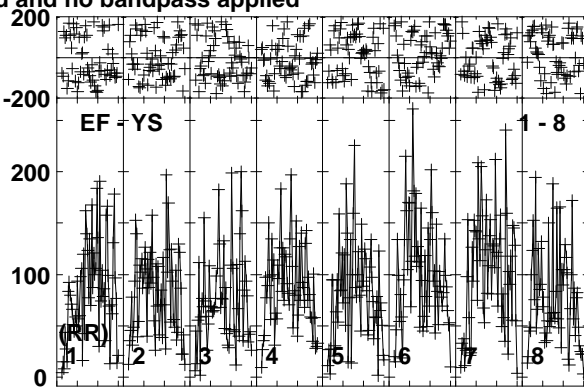
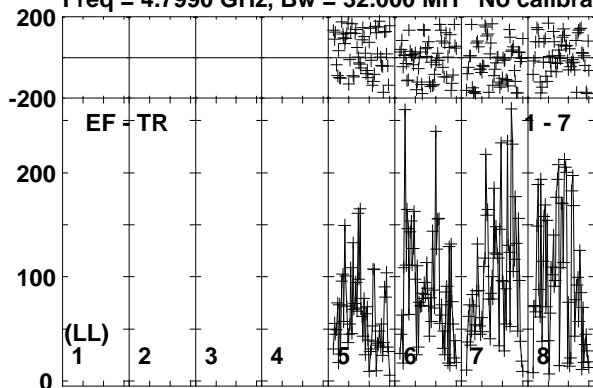

Lower frame: Micro Ampl Jy Top frame: Phas deg
Vector averaged cross-power spectrum Baseline: EF (01) - TR (07)
Timerange: 00/13:46:32 to 00/13:49:58

Plot file version 21 created 19-OCT-2017 15:35:58

J1504+1029 ES081C.UVDATA.1

Freq = 4.7990 GHz, Bw = 32.000 MH No calibration applied and no bandpass applied

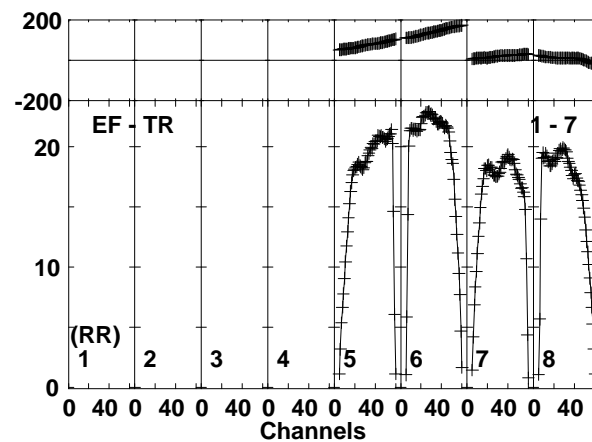
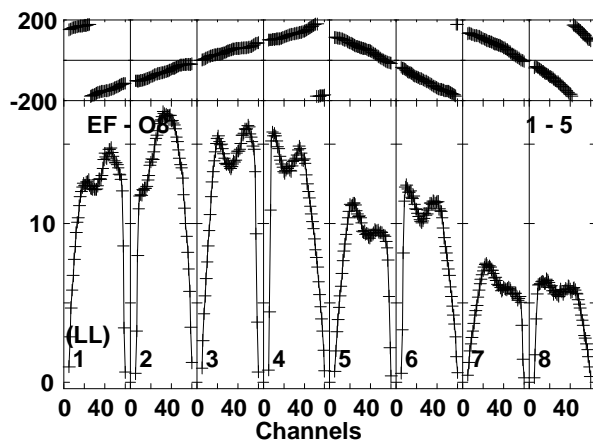
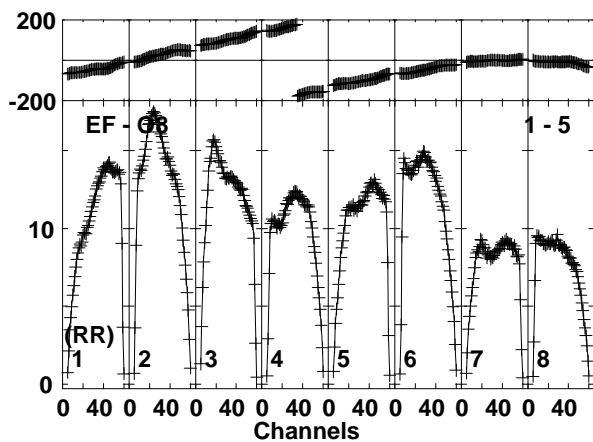
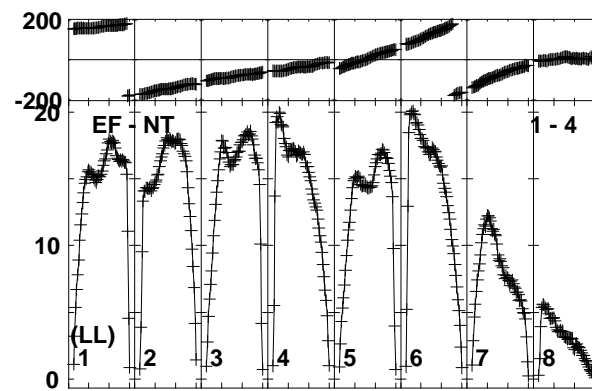
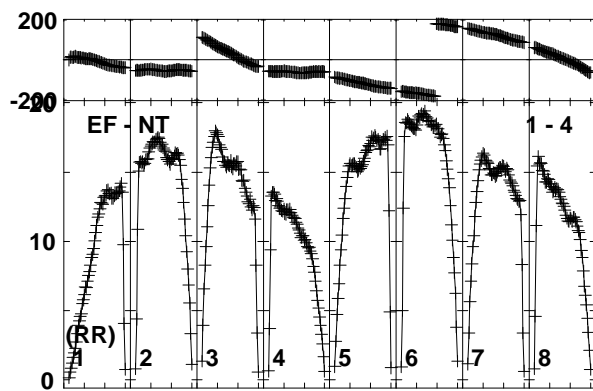
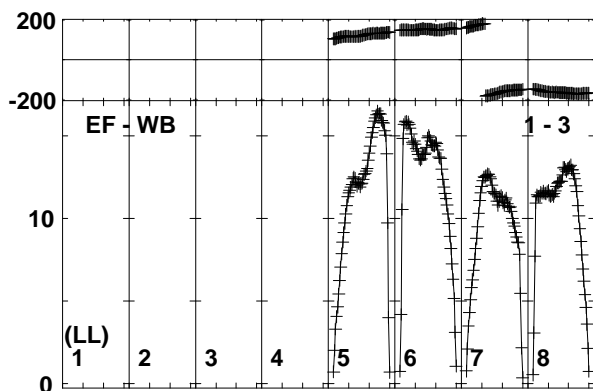
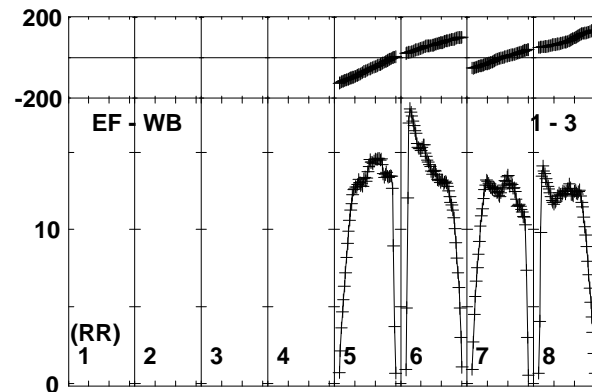
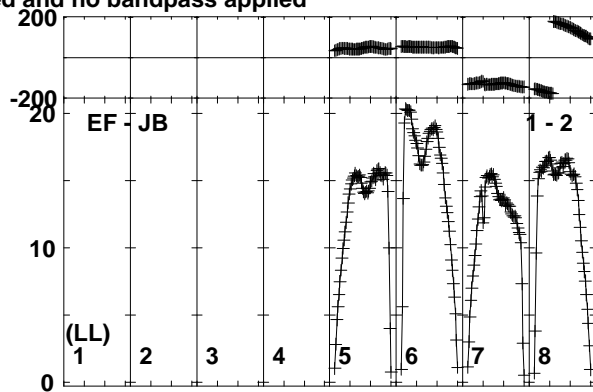
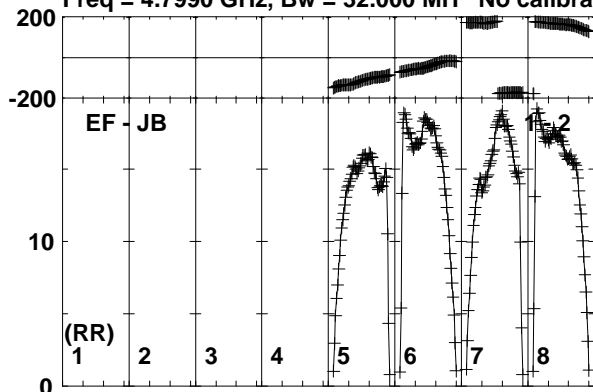

Lower frame: Milli Ampl Jy Top frame: Phas deg
Vector averaged cross-power spectrum Baseline: EF (01) - JB (02)
Timerange: 00:13:50:32 to 00:13:51:28

Plot file version 22 created 19-OCT-2017 15:35:58

J1504+1029 ES081C.UVDATA.1

Freq = 4.7990 GHz, Bw = 32.000 MH No calibration applied and no bandpass applied

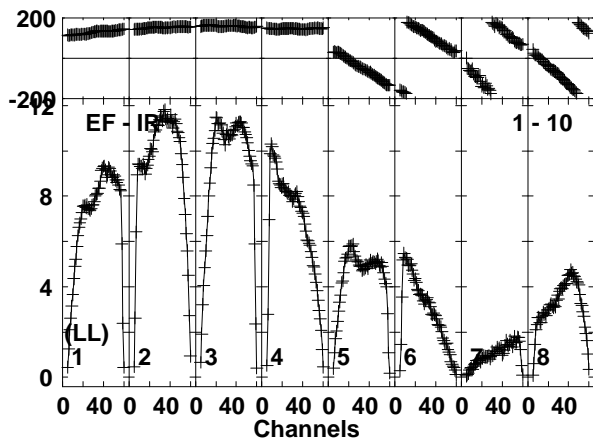
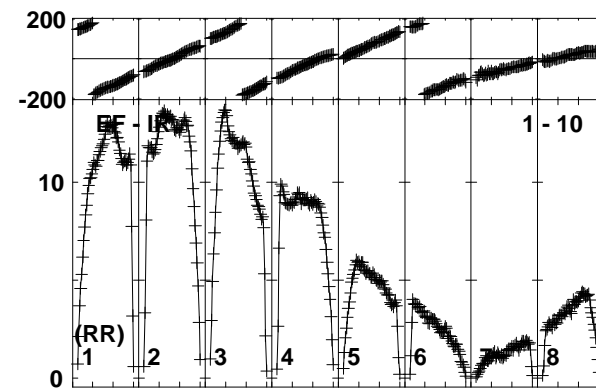
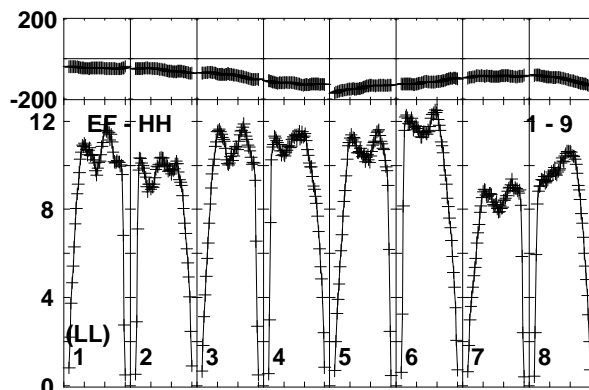
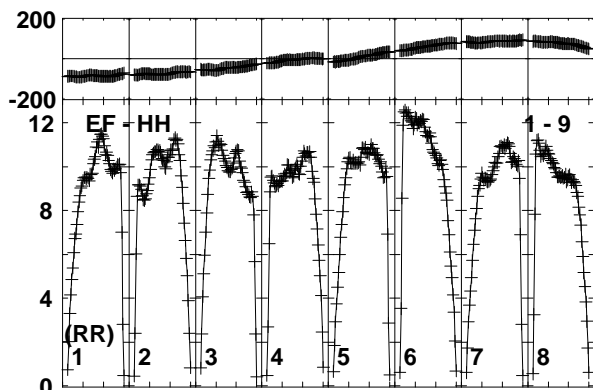
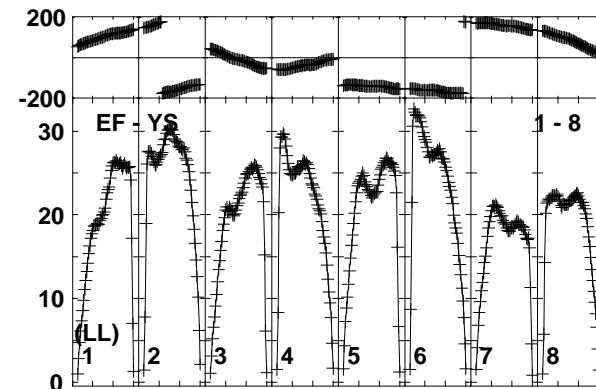
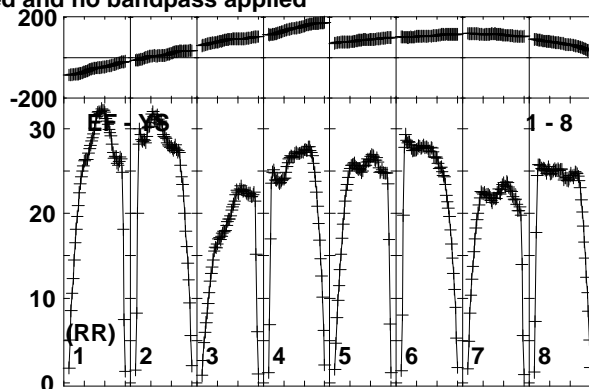
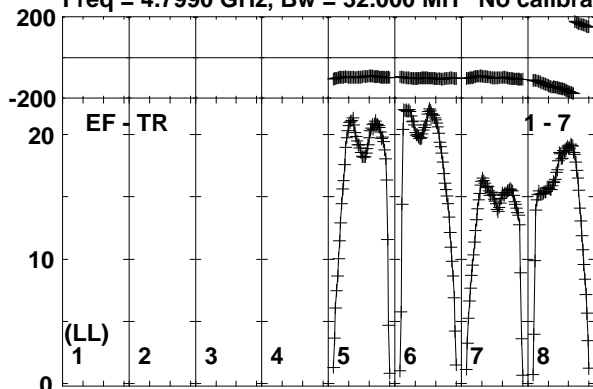

Lower frame: Milli Ampl Jy Top frame: Phas deg
Vector averaged cross-power spectrum Baseline: EF (01) - TR (07)
Timerange: 00/13:50:32 to 00/13:51:28

Plot file version 23 created 19-OCT-2017 15:35:58

MRK841 ES081C.UVDATA.1

Freq = 4.7990 GHz, Bw = 32.000 MH No calibration applied and no bandpass applied

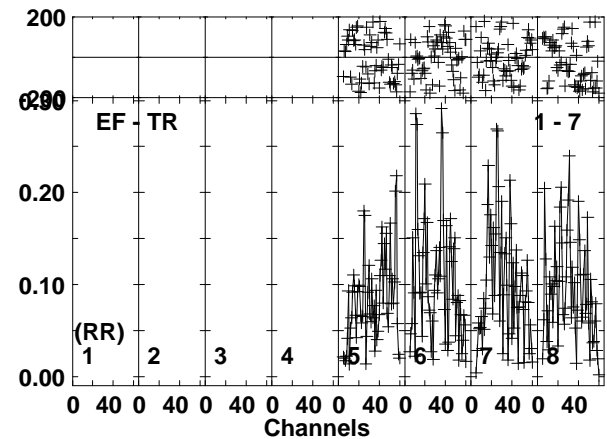
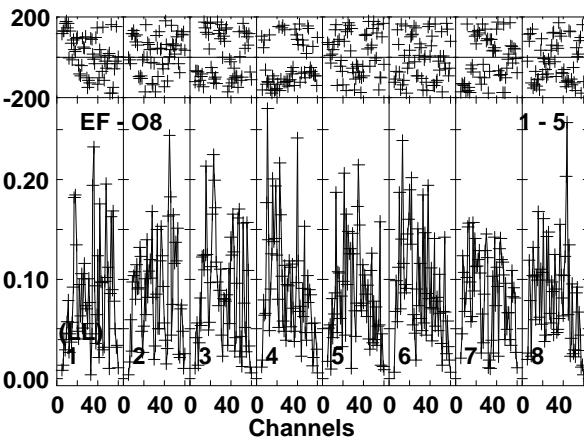
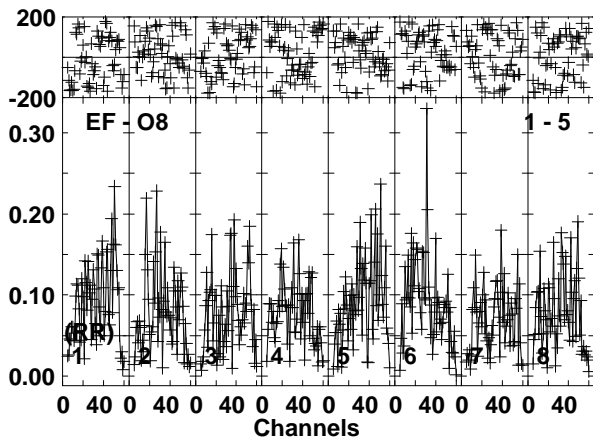
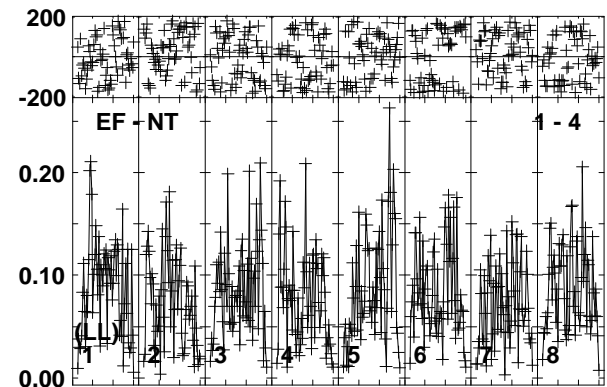
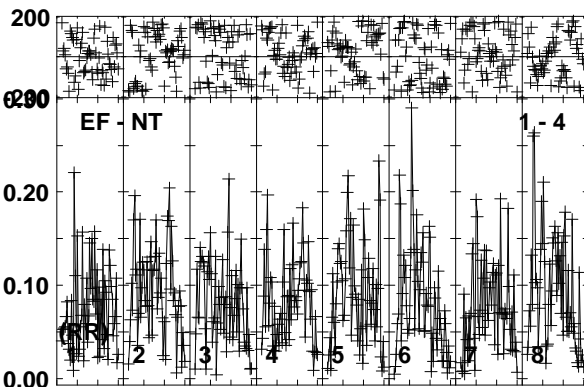
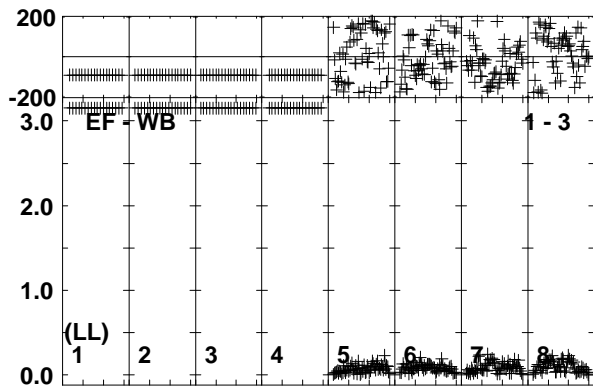
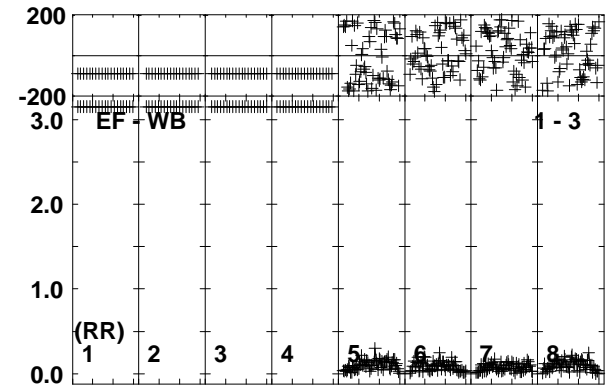
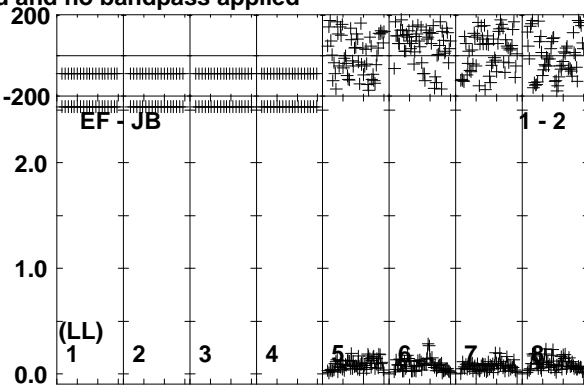
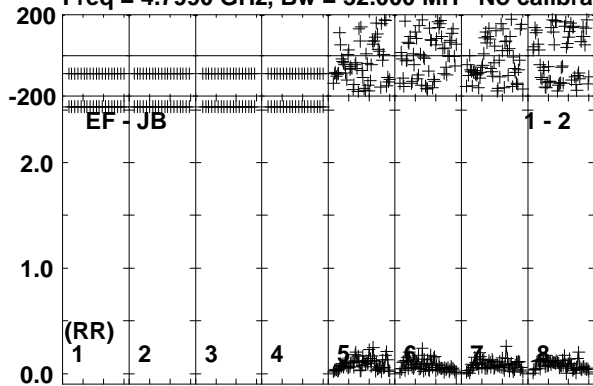

Lower frame: Milli Ampl Jy Top frame: Phas deg
Vector averaged cross-power spectrum Baseline: EF (01) - JB (02)
Timerange: 00/13:51:32 to 00/13:54:58

Plot file version 24 created 19-OCT-2017 15:35:58

MRK841 ES081C.UVDATA.1

Freq = 4.7990 GHz, Bw = 32.000 MH No calibration applied and no bandpass applied

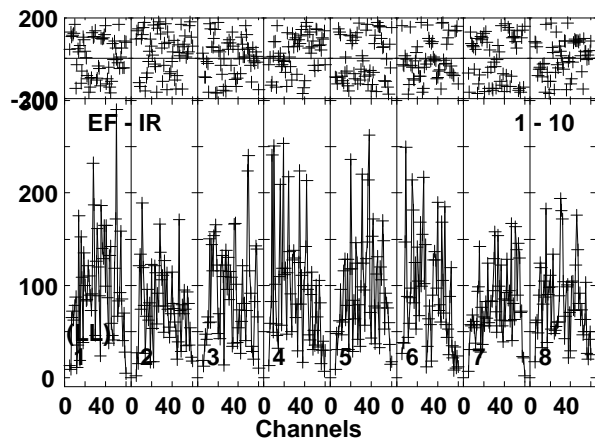
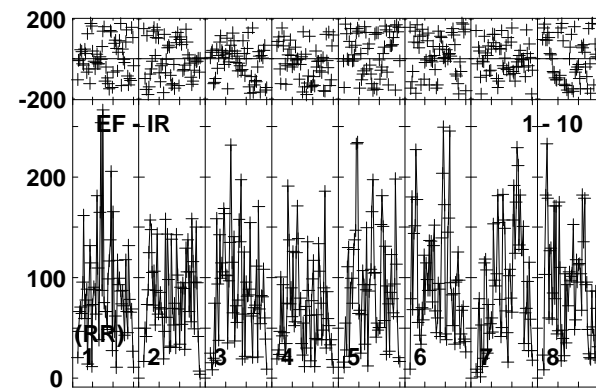
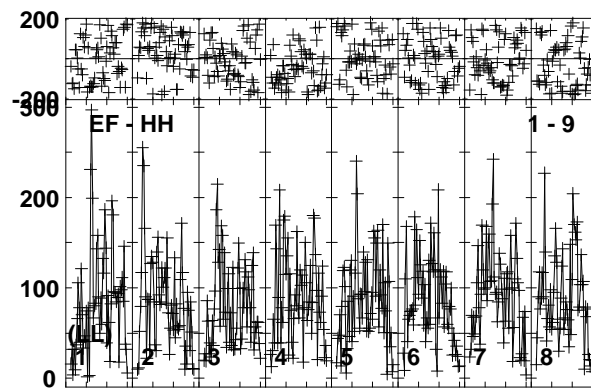
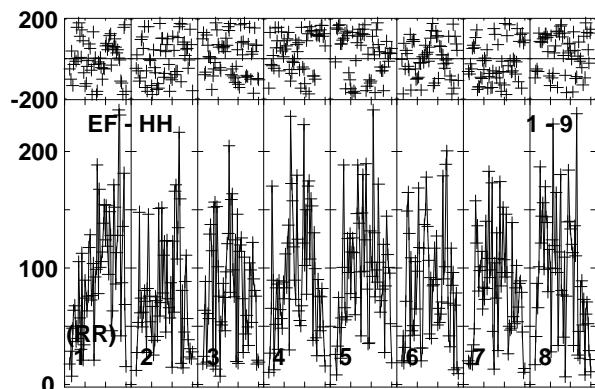
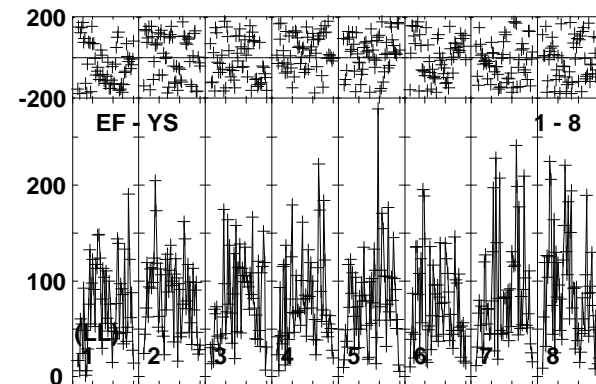
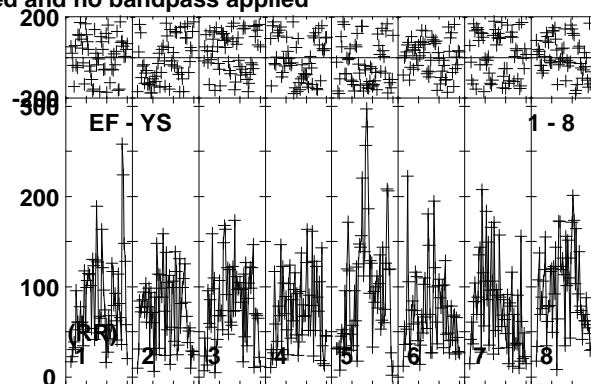
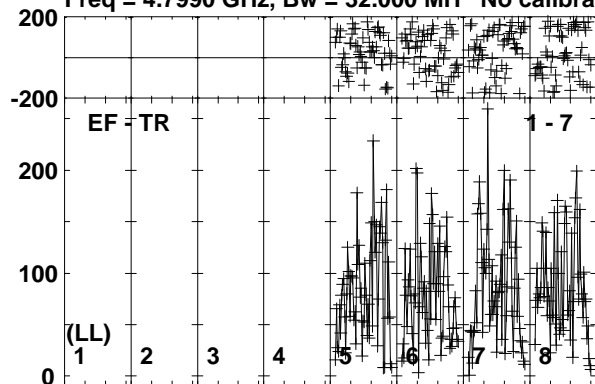

Lower frame: Micro Ampl Jy Top frame: Phas deg
Vector averaged cross-power spectrum Baseline: EF (01) - TR (07)
Timerange: 00/13:51:32 to 00/13:54:58

Plot file version 25 created 19-OCT-2017 15:35:58

J1504+1029 ES081C.UVDATA.1

Freq = 4.7990 GHz, Bw = 32.000 MH No calibration applied and no bandpass applied

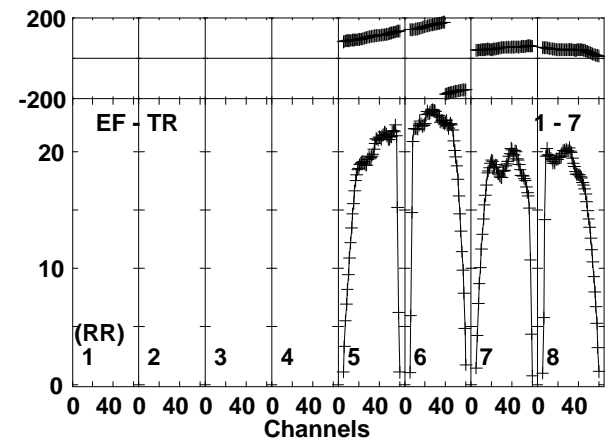
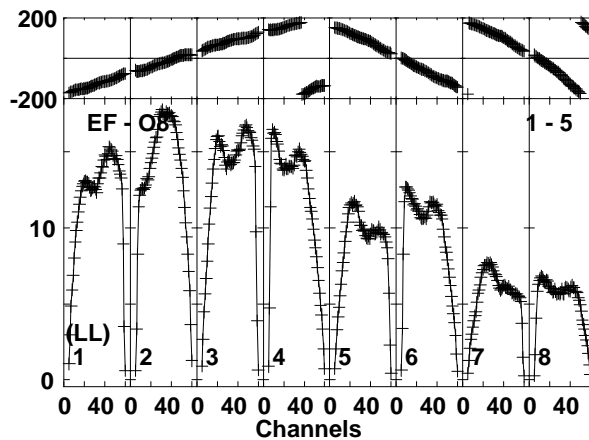
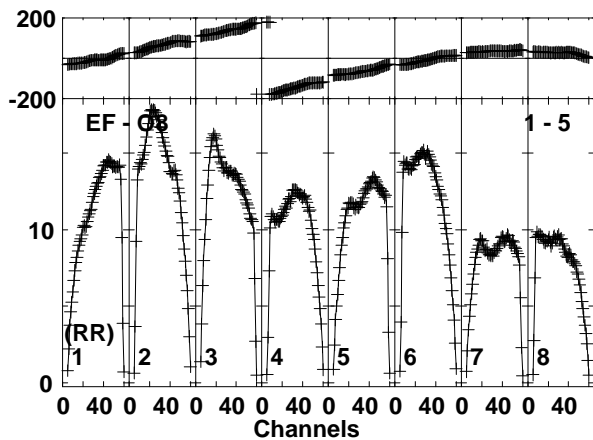
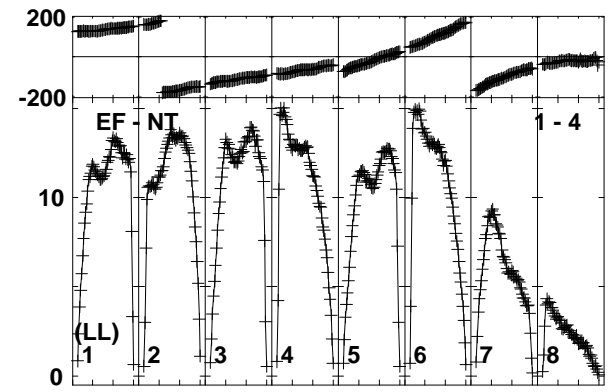
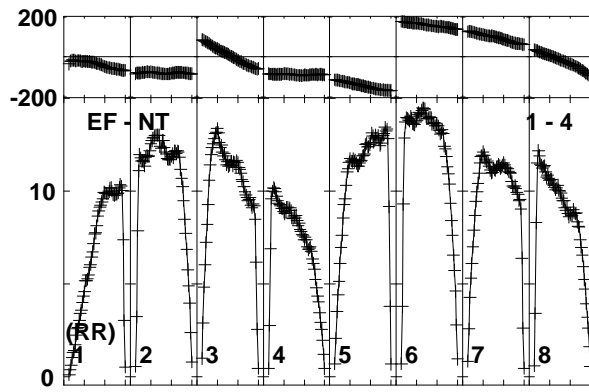
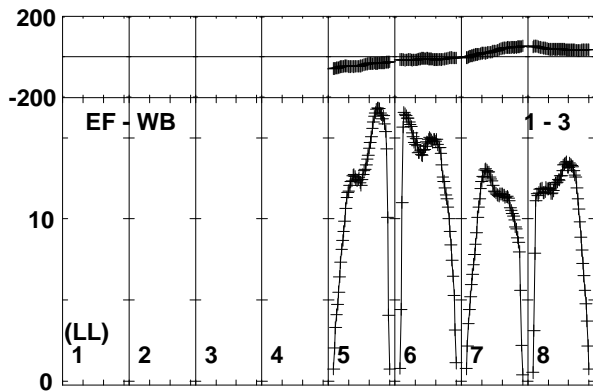
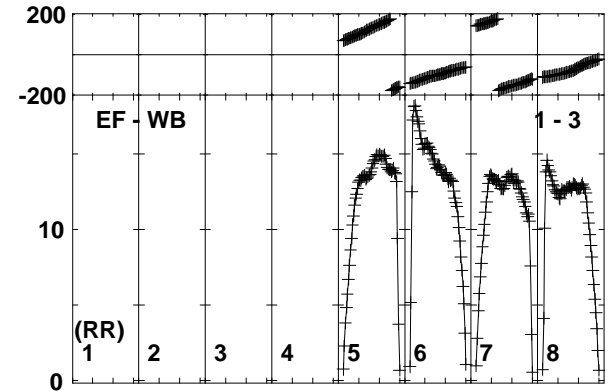
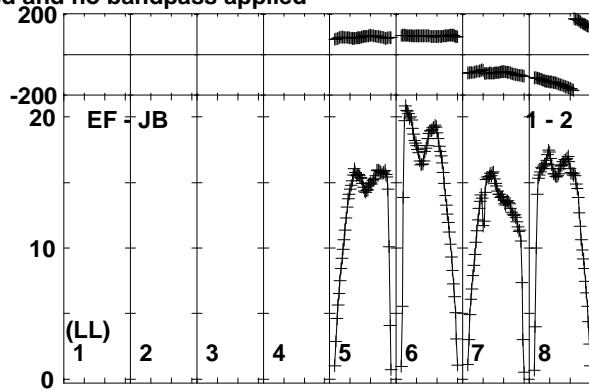
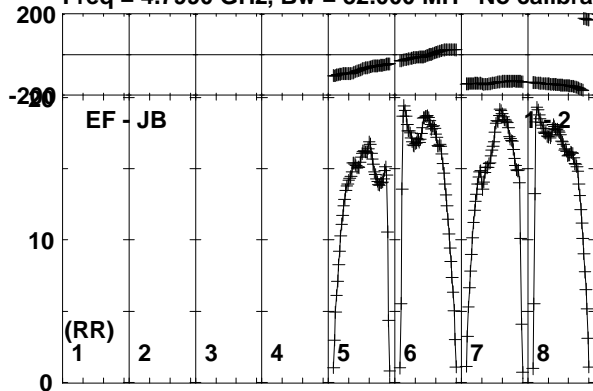

Lower frame: Milli Ampl Jy Top frame: Phas deg
Vector averaged cross-power spectrum Baseline: EF (01) - JB (02)
Timerange: 00/13:55:02 to 00/13:56:28

Plot file version 26 created 19-OCT-2017 15:35:58

J1504+1029 ES081C.UVDATA.1

Freq = 4.7990 GHz, Bw = 32.000 MH No calibration applied and no bandpass applied

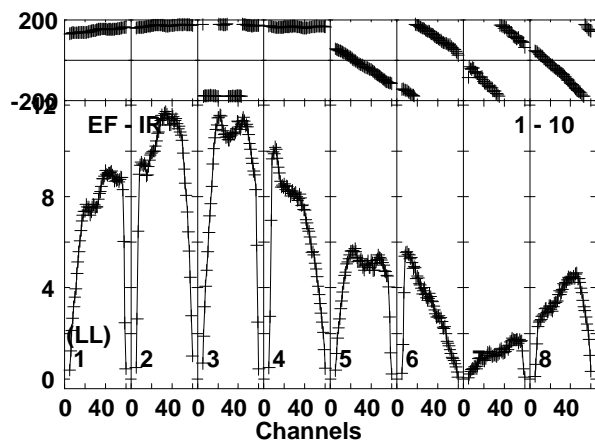
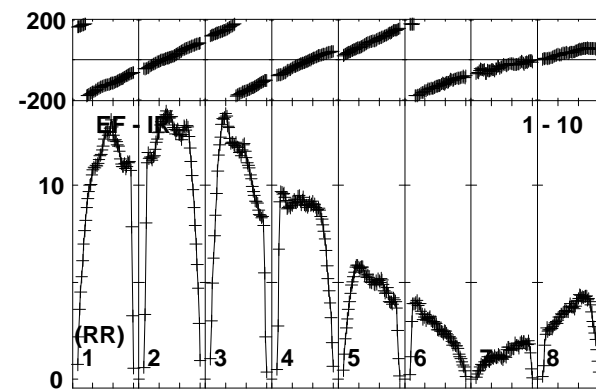
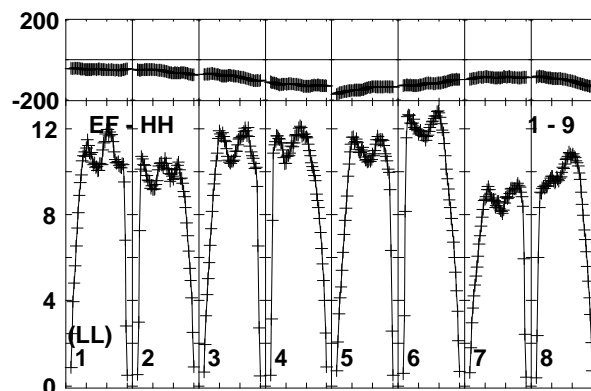
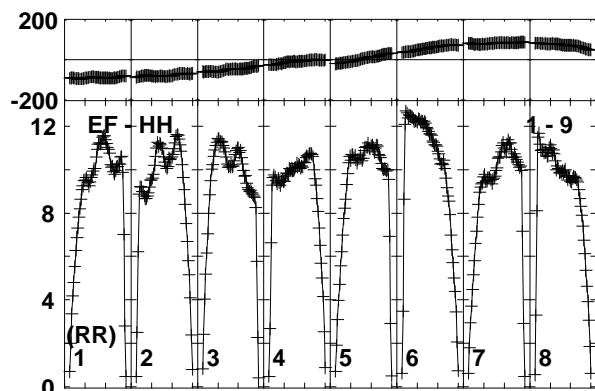
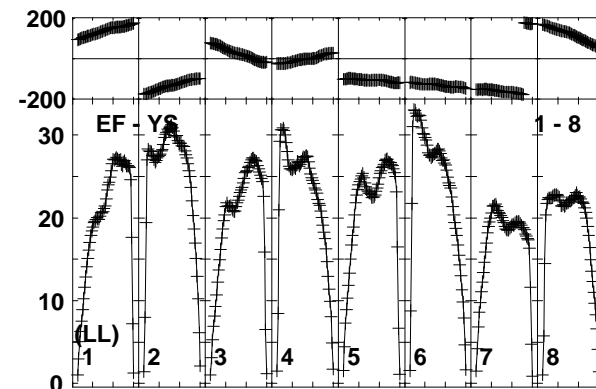
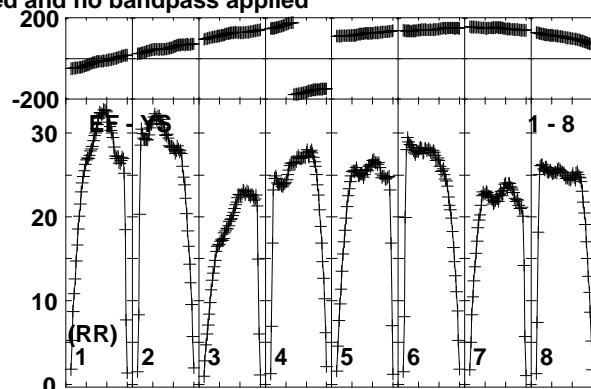
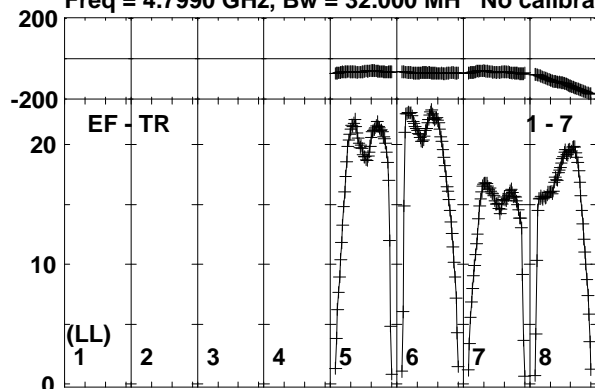

Lower frame: Milli Ampl Jy Top frame: Phas deg
Vector averaged cross-power spectrum Baseline: EF (01) - TR (07)
Timerange: 00/13:55:02 to 00/13:56:28

Plot file version 27 created 19-OCT-2017 15:35:58

MRK841 ES081C.UVDATA.1

Freq = 4.7990 GHz, Bw = 32.000 MH No calibration applied and no bandpass applied

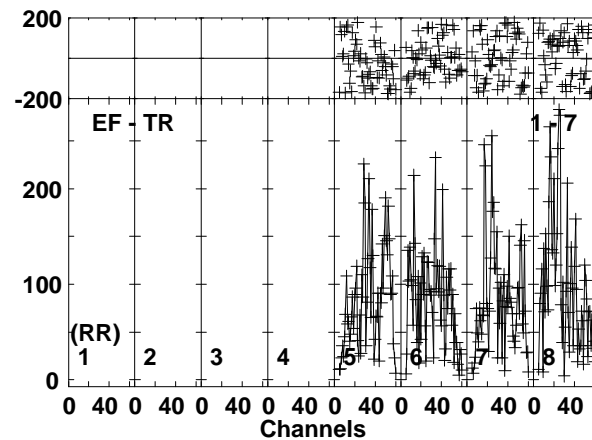
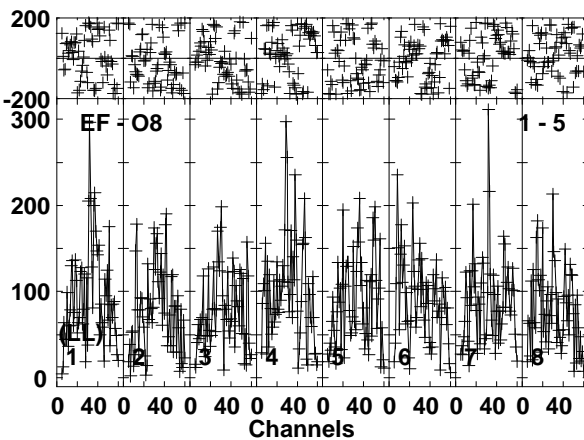
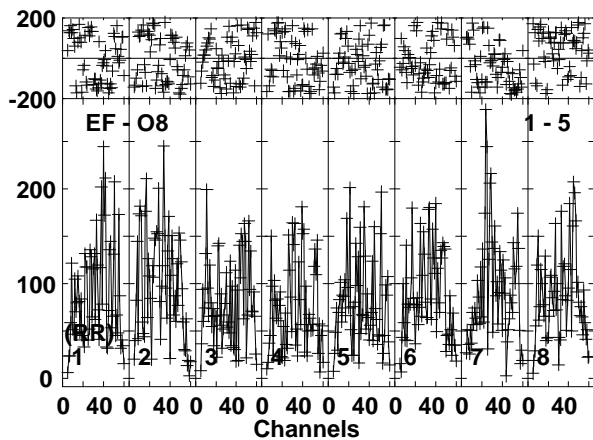
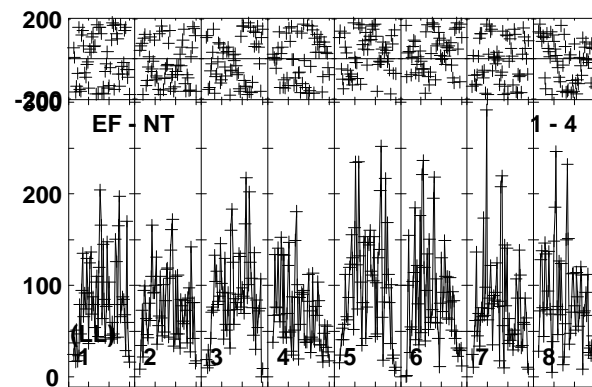
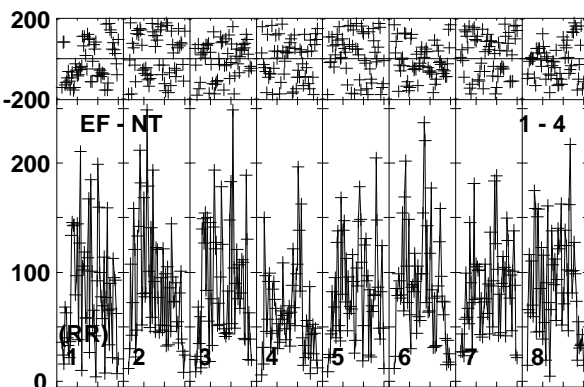
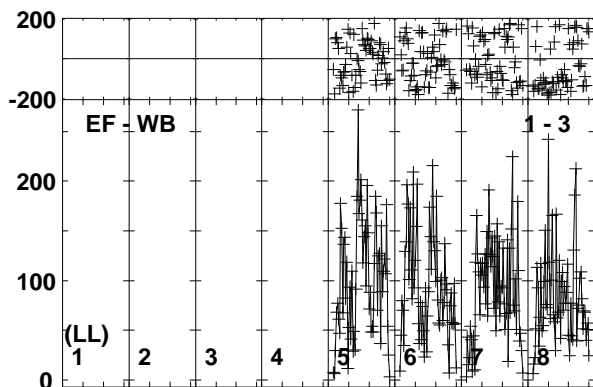
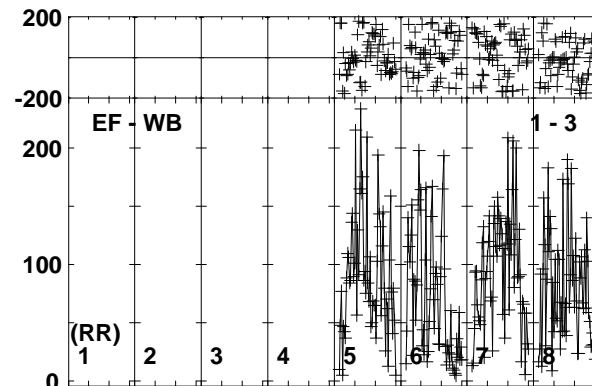
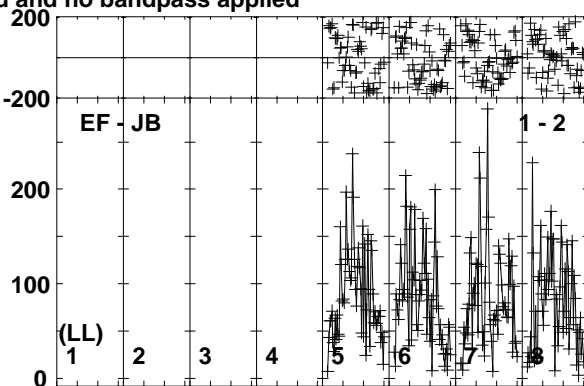
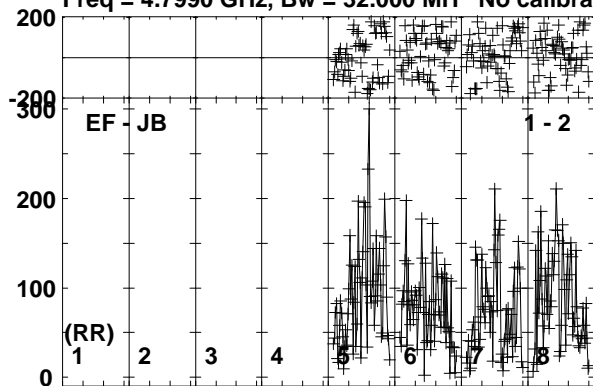

Lower frame: Micro Ampl Jy Top frame: Phas deg
Vector averaged cross-power spectrum Baseline: EF (01) - JB (02)
Timerange: 00/13:56:32 to 00/13:59:58

Plot file version 28 created 19-OCT-2017 15:35:58

MRK841 ES081C.UVDATA.1

Freq = 4.7990 GHz, Bw = 32.000 MH No calibration applied and no bandpass applied

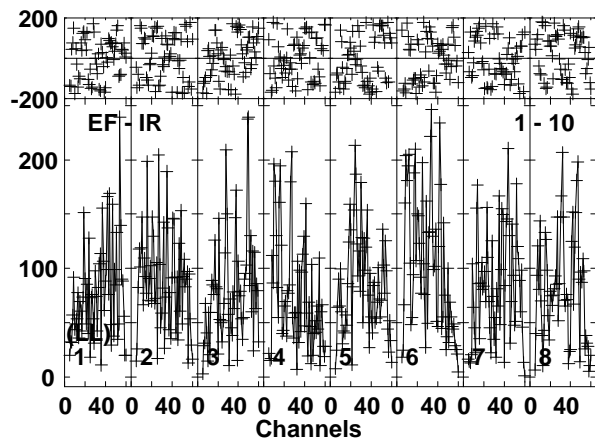
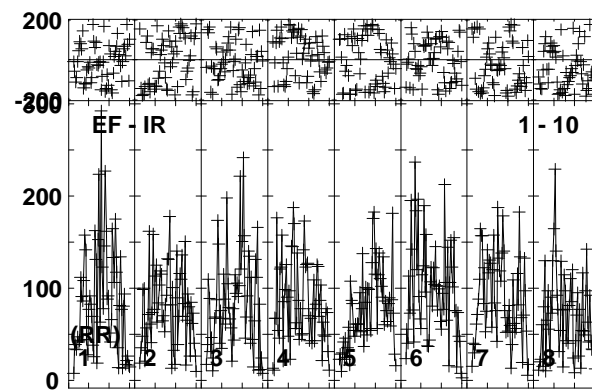
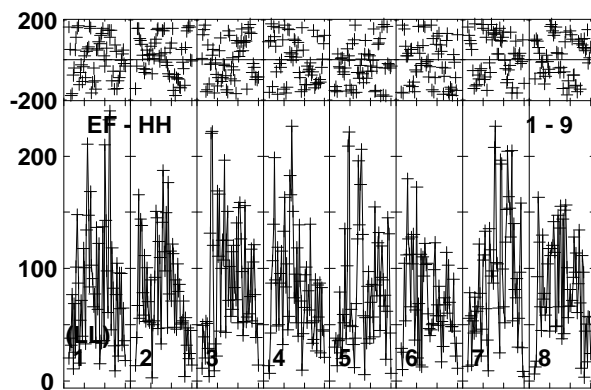
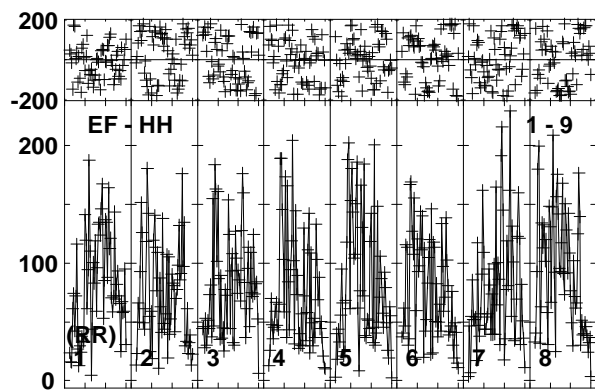
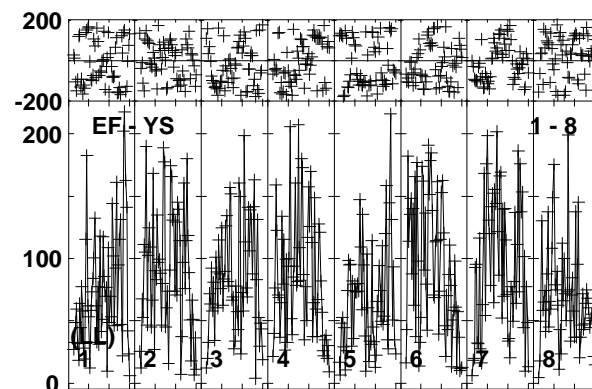
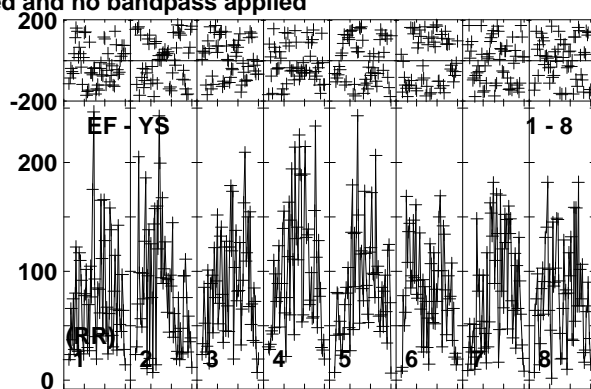
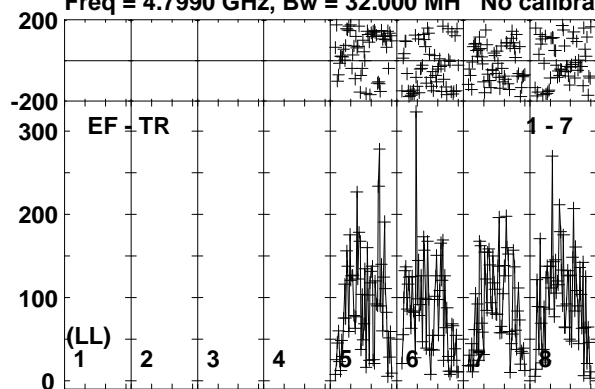

Lower frame: Micro Ampl Jy Top frame: Phas deg
Vector averaged cross-power spectrum Baseline: EF (01) - TR (07)
Timerange: 00/13:56:32 to 00/13:59:58

Plot file version 29 created 19-OCT-2017 15:35:59
 J1504+1029 ES081C.UVDATA.1
 Freq = 4.7990 GHz, Bw = 32.000 MH No calibration applied and no bandpass applied

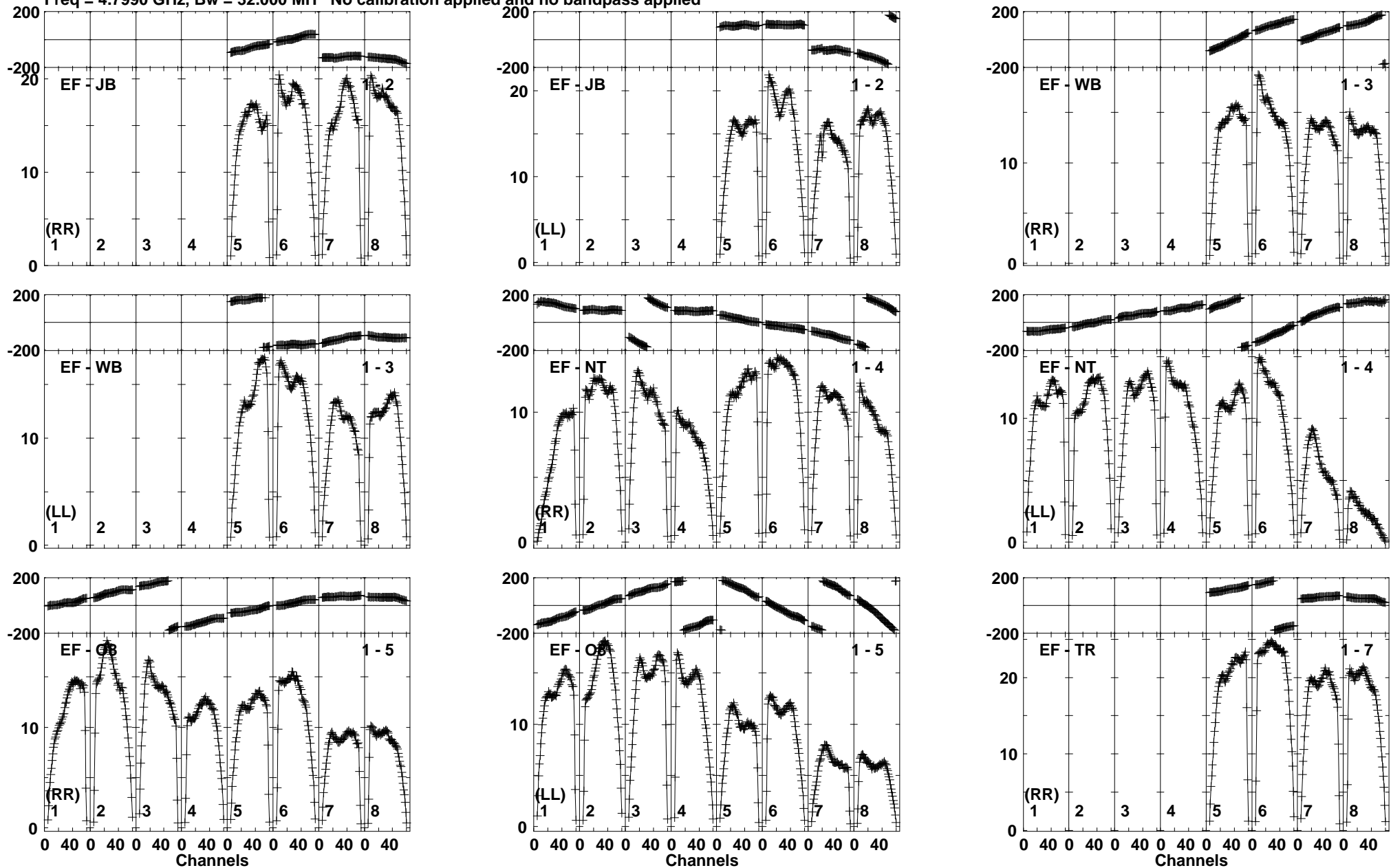

Lower frame: Milli Ampl Jy Top frame: Phas deg
 Vector averaged cross-power spectrum Baseline: EF (01) - JB (02)
 Timerange: 00/14:00:32 to 00/14:01:28

Plot file version 30 created 19-OCT-2017 15:35:59

J1504+1029 ES081C.UVDATA.1

Freq = 4.7990 GHz, Bw = 32.000 MH No calibration applied and no bandpass applied

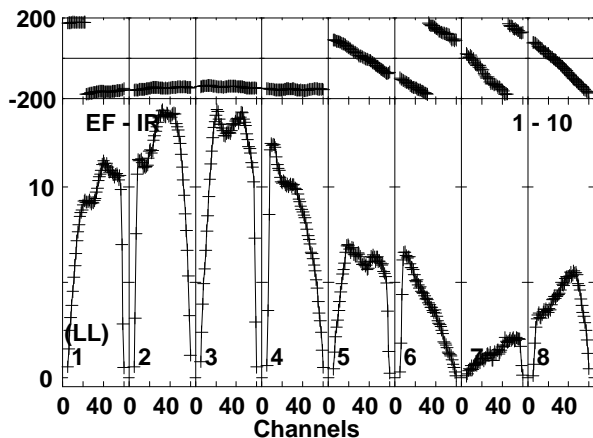
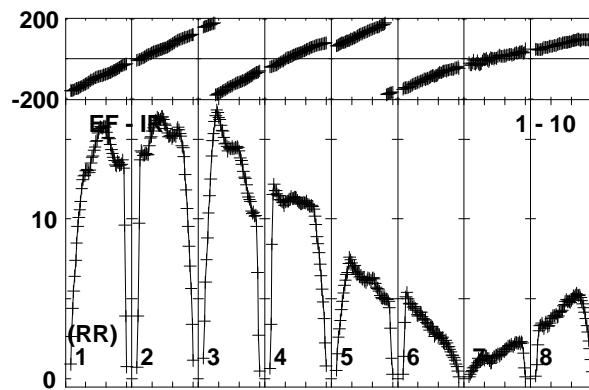
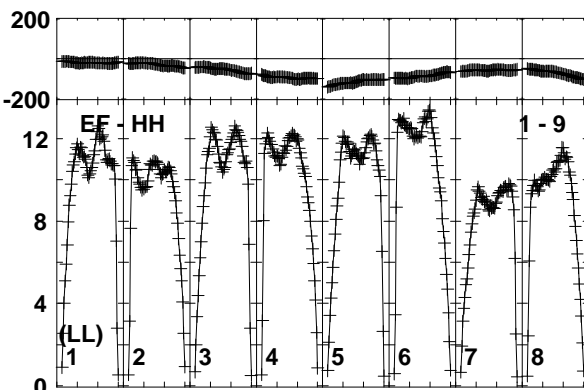
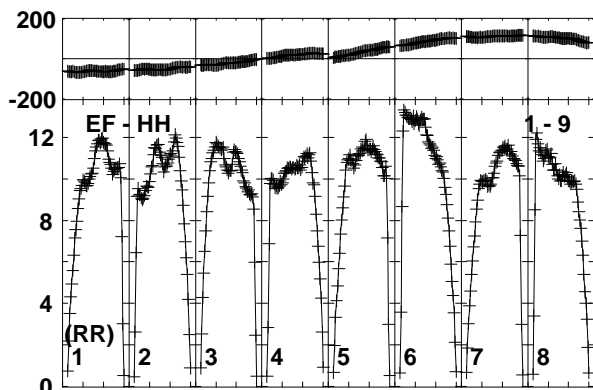
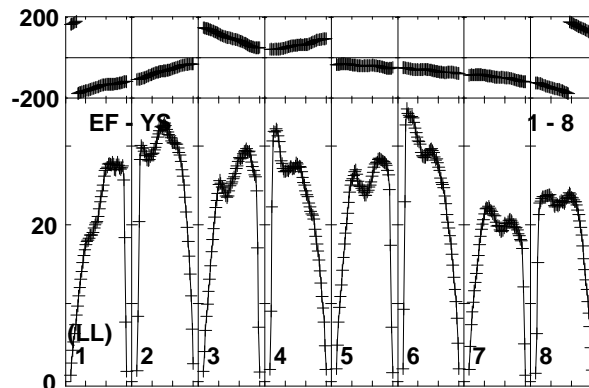
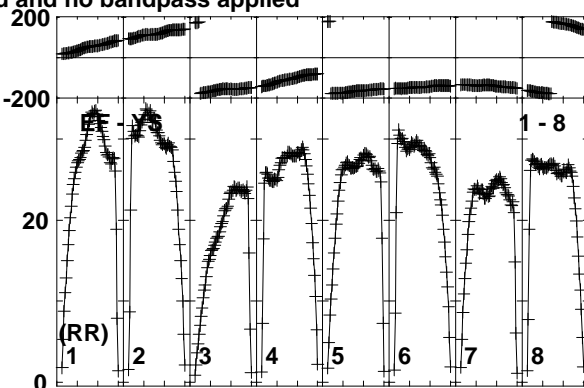
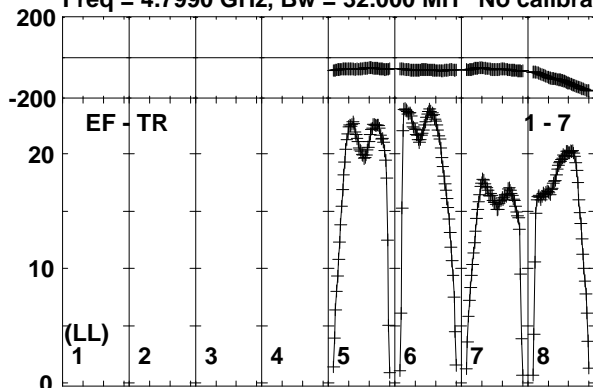

Lower frame: Milli Ampl Jy Top frame: Phas deg
Vector averaged cross-power spectrum Baseline: EF (01) - TR (07)
Timerange: 00/14:00:32 to 00/14:01:28

Plot file version 31 created 19-OCT-2017 15:35:59
 MRK841 ES081C.UVDATA.1
 Freq = 4.7990 GHz, Bw = 32.000 MH No calibration applied and no bandpass applied

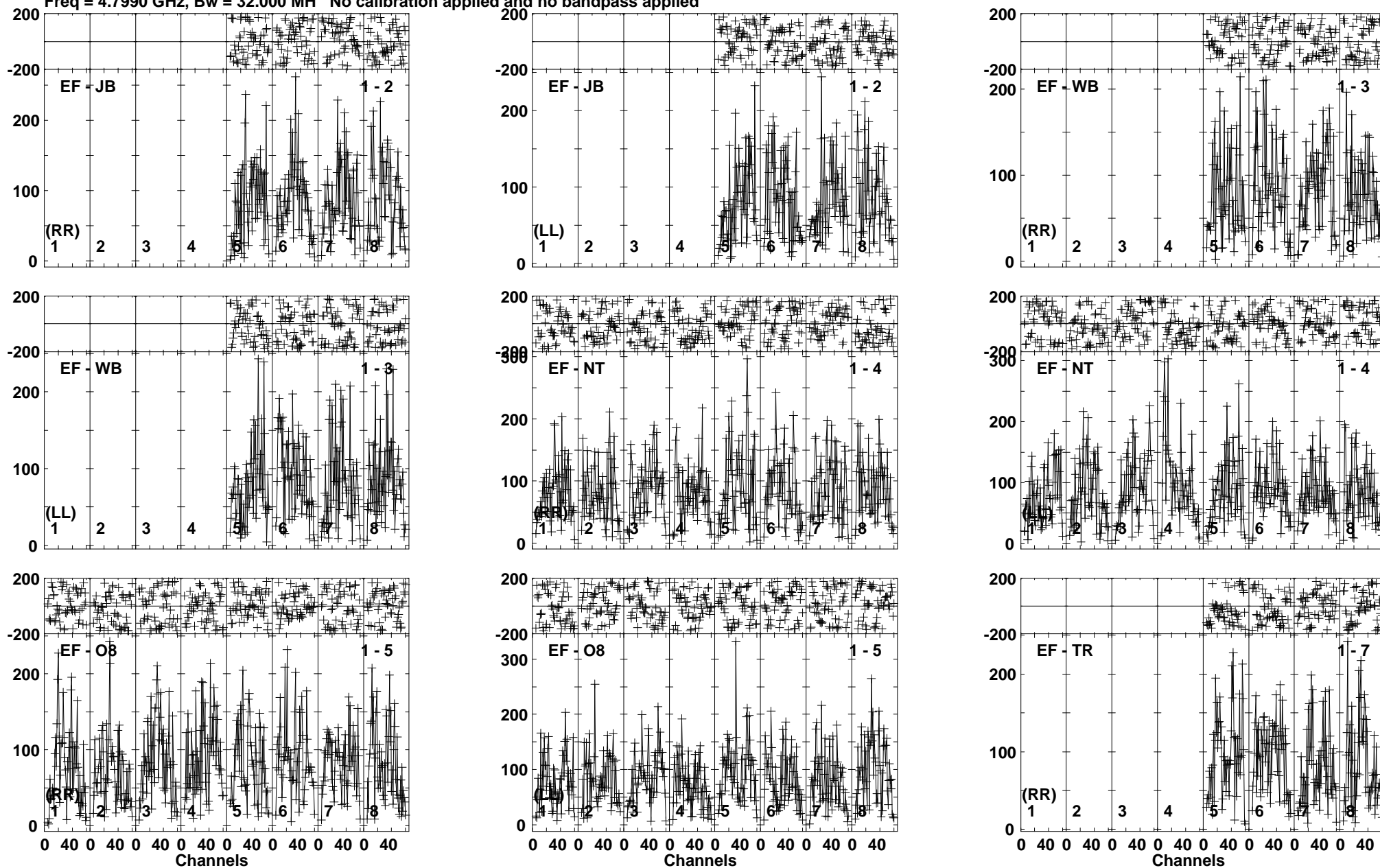

Lower frame: Micro Ampl Jy Top frame: Phas deg
 Vector averaged cross-power spectrum Baseline: EF (01) - JB (02)
 Timerange: 00/14:01:32 to 00/14:04:58

Plot file version 32 created 19-OCT-2017 15:35:59

MRK841 ES081C.UVDATA.1

Freq = 4.7990 GHz, Bw = 32.000 MH No calibration applied and no bandpass applied

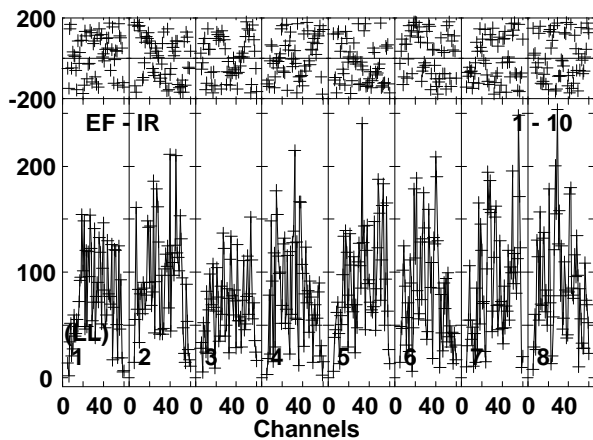
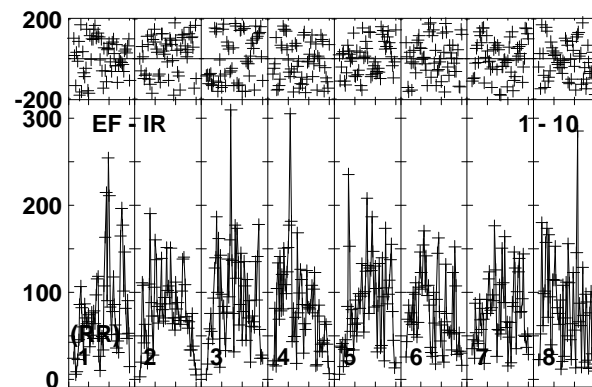
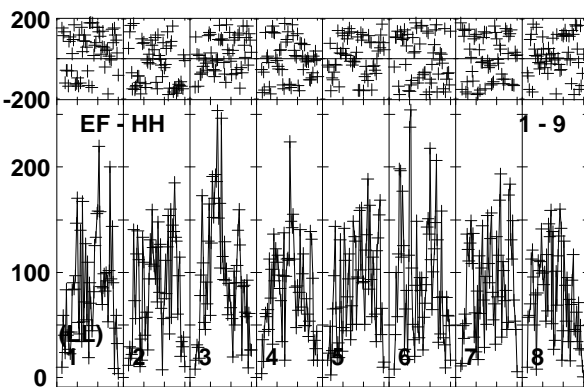
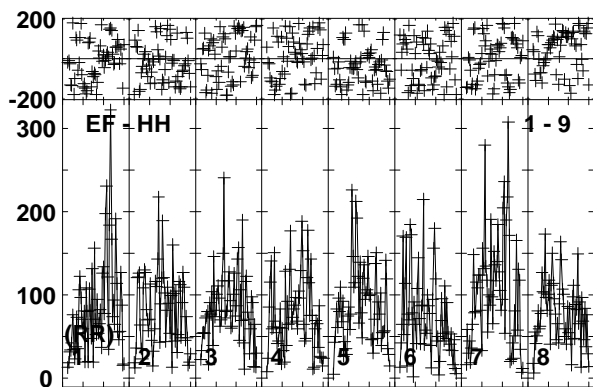
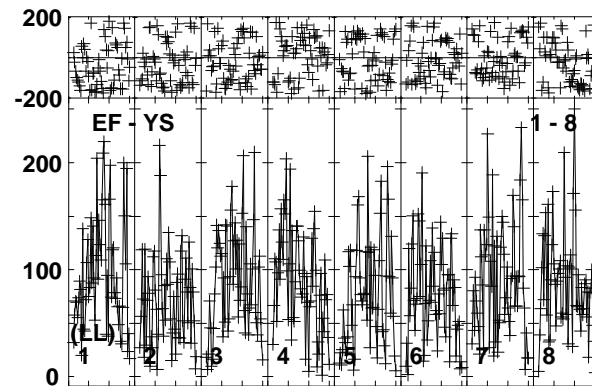
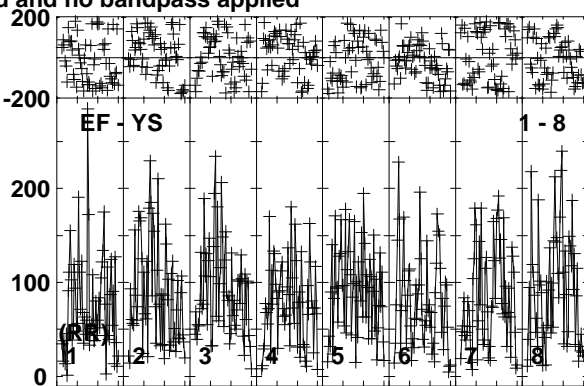
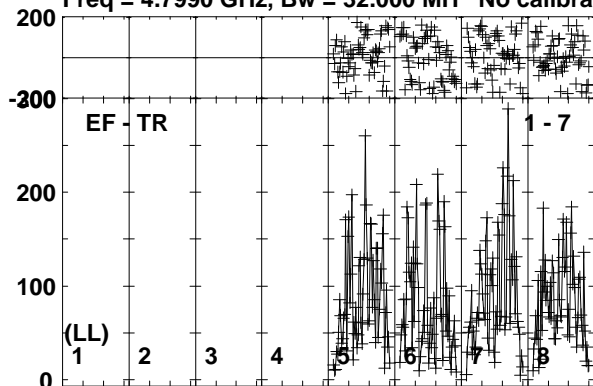

Lower frame: Micro Ampl Jy Top frame: Phas deg
Vector averaged cross-power spectrum Baseline: EF (01) - TR (07)
Timerange: 00/14:01:32 to 00/14:04:58

Plot file version 33 created 19-OCT-2017 15:35:59

J1504+1029 ES081C.UVDATA.1

Freq = 4.7990 GHz, Bw = 32.000 MH No calibration applied and no bandpass applied

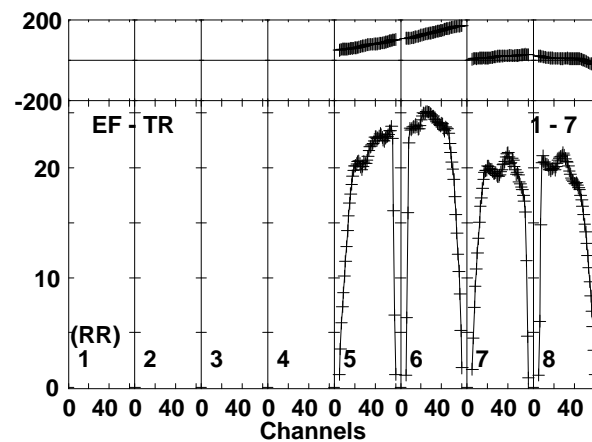
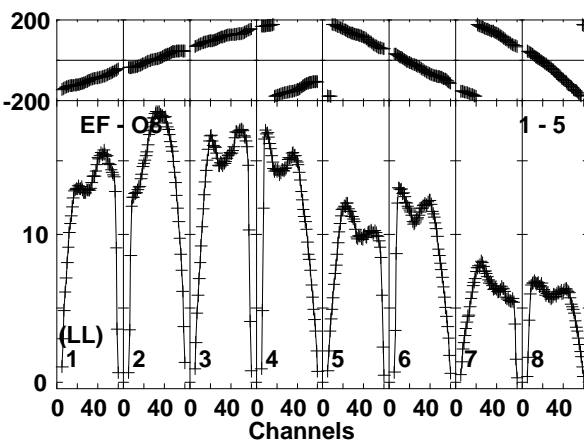
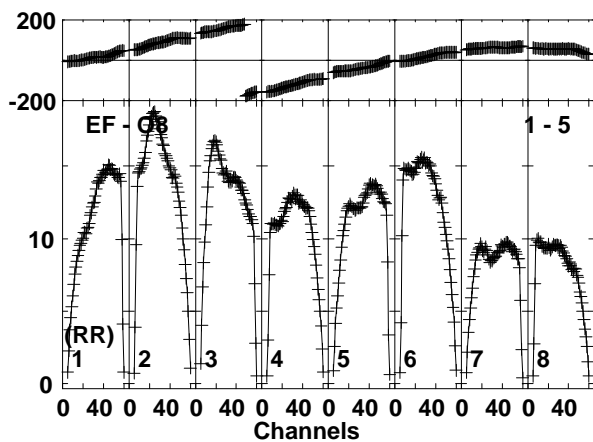
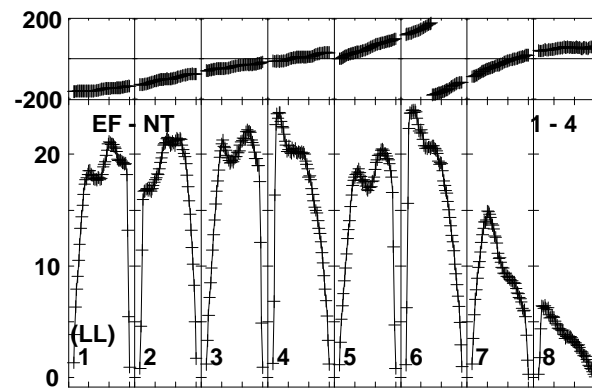
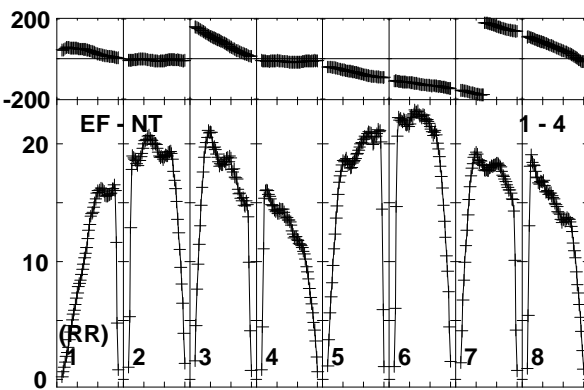
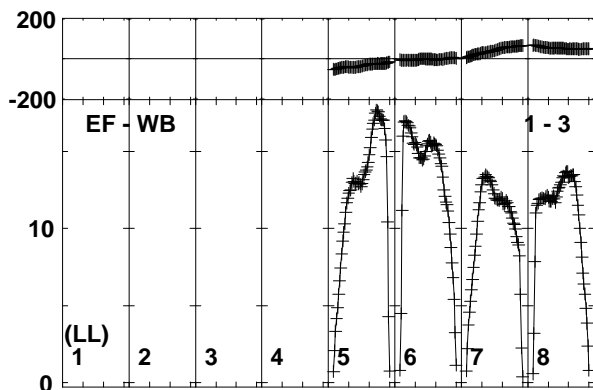
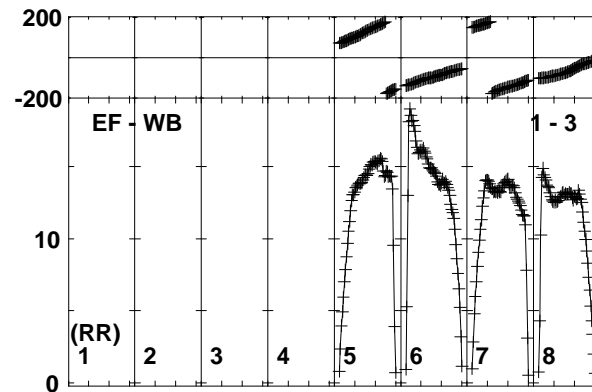
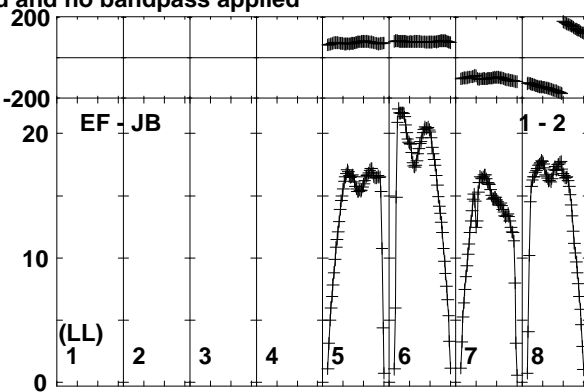
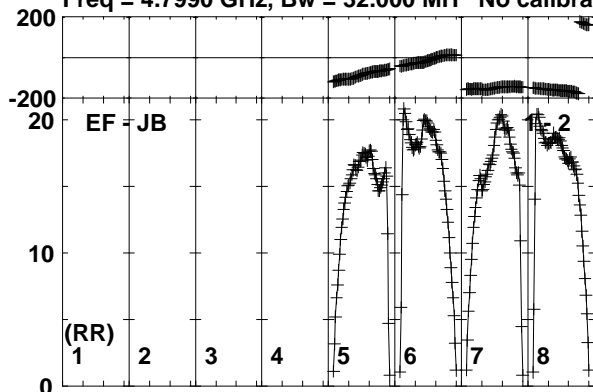

Lower frame: Milli Ampl Jy Top frame: Phas deg
Vector averaged cross-power spectrum Baseline: EF (01) - JB (02)
Timerange: 00/14:05:02 to 00/14:06:28

Plot file version 34 created 19-OCT-2017 15:35:59

J1504+1029 ES081C.UVDATA.1

Freq = 4.7990 GHz, Bw = 32.000 MH No calibration applied and no bandpass applied

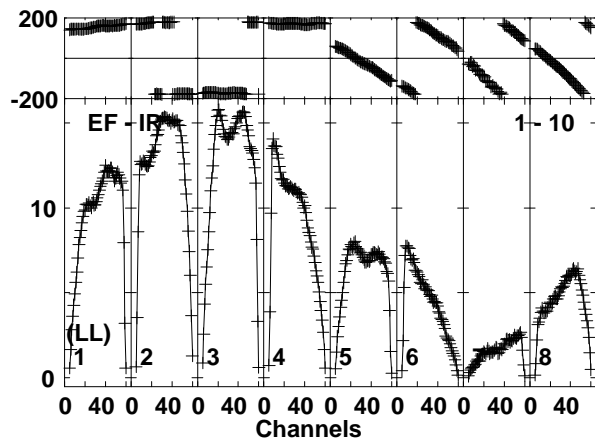
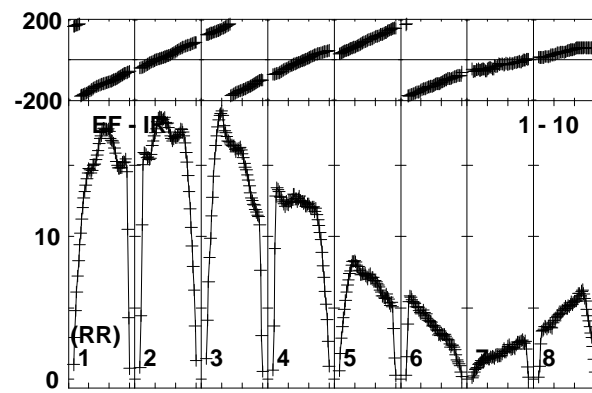
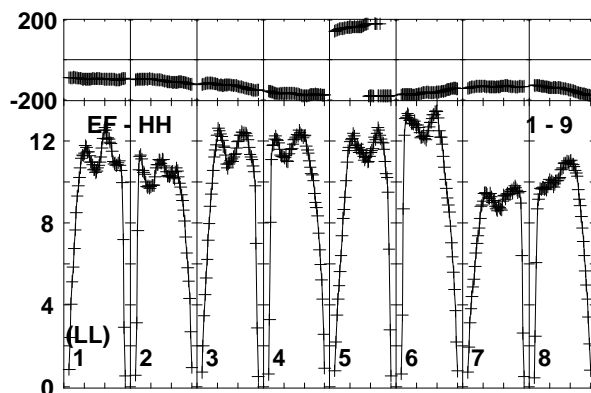
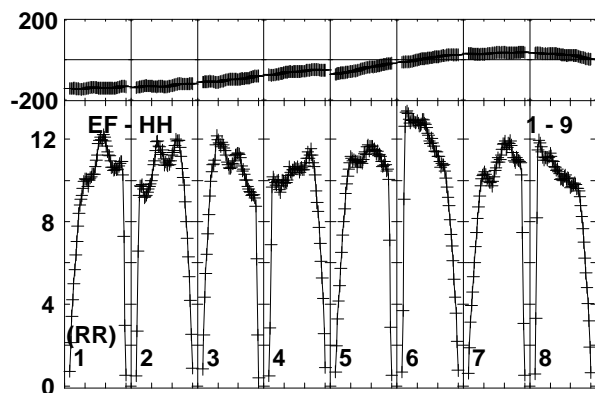
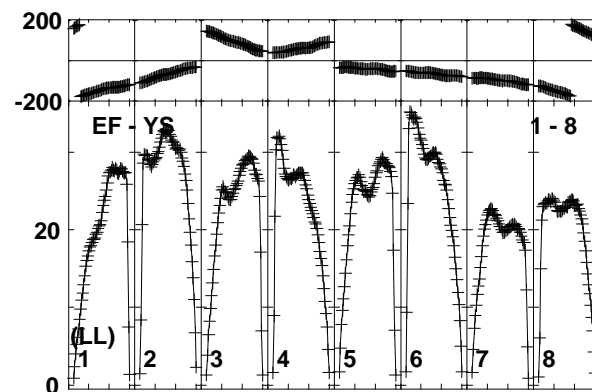
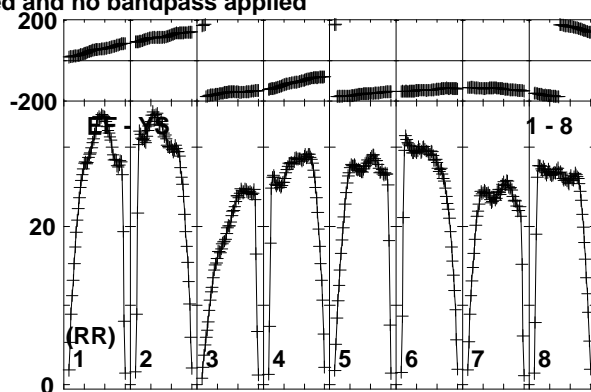
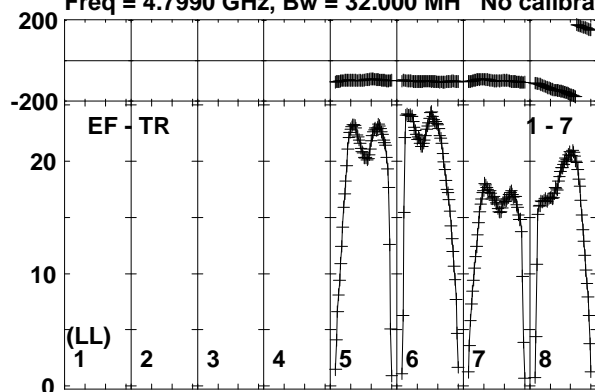

Lower frame: Milli Ampl Jy Top frame: Phas deg
Vector averaged cross-power spectrum Baseline: EF (01) - TR (07)
Timerange: 00/14:05:02 to 00/14:06:28

Plot file version 35 created 19-OCT-2017 15:35:59

MRK841 ES081C.UVDATA.1

Freq = 4.7990 GHz, Bw = 32.000 MH No calibration applied and no bandpass applied

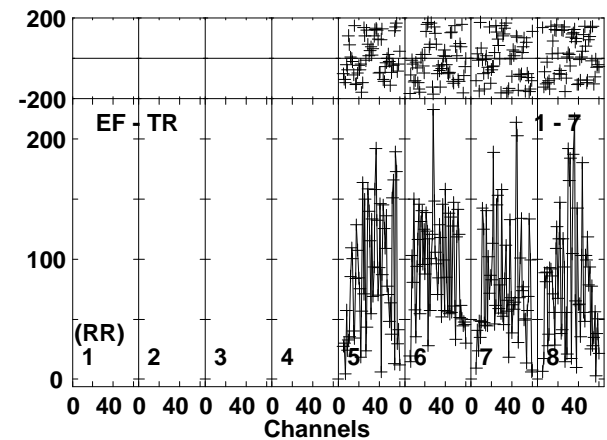
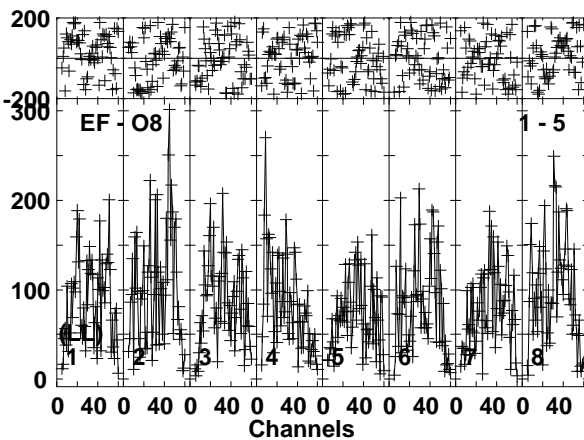
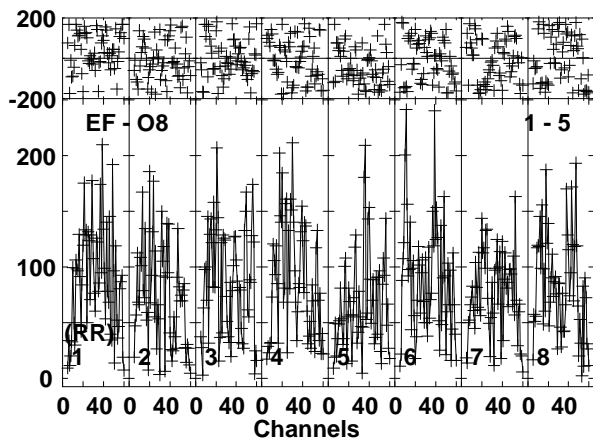
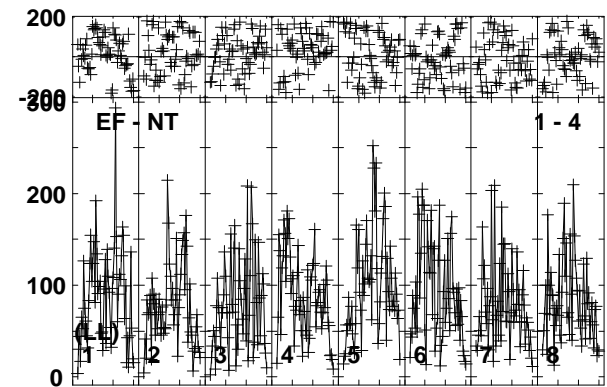
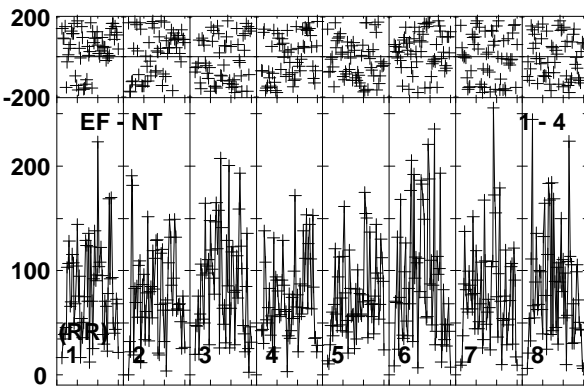
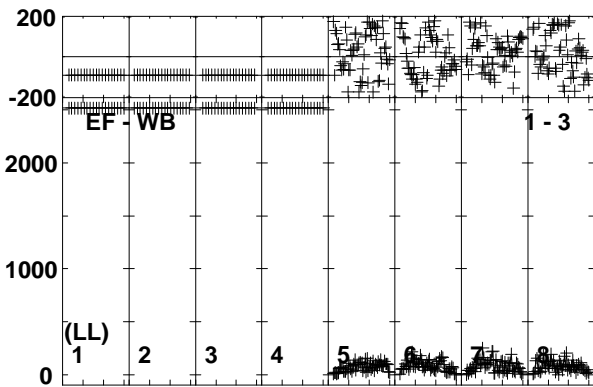
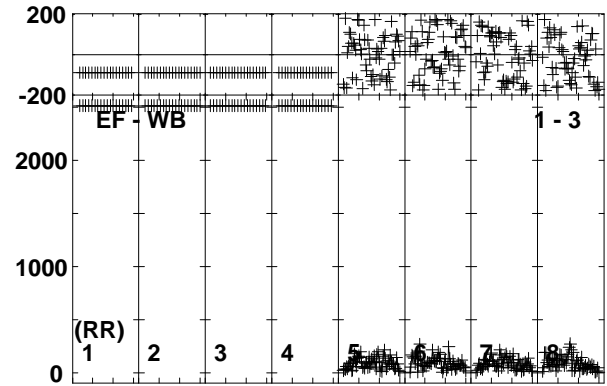
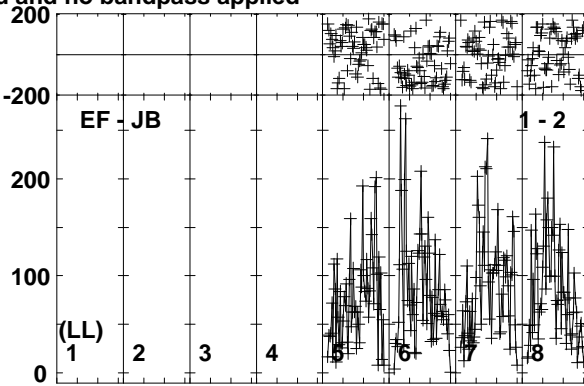
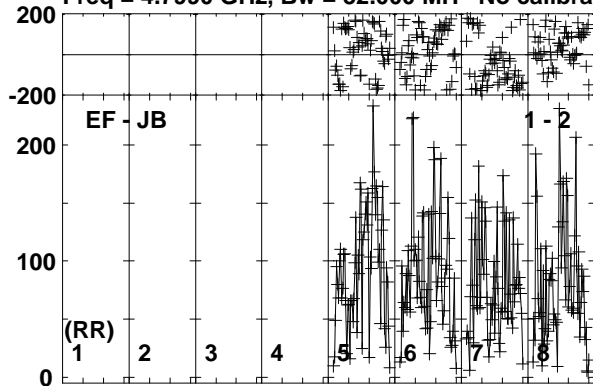

Lower frame: Micro Ampl Jy Top frame: Phas deg
Vector averaged cross-power spectrum Baseline: EF (01) - JB (02)
Timerange: 00/14:06:32 to 00/14:09:58

Plot file version 36 created 19-OCT-2017 15:35:59

MRK841 ES081C.UVDATA.1

Freq = 4.7990 GHz, Bw = 32.000 MH No calibration applied and no bandpass applied

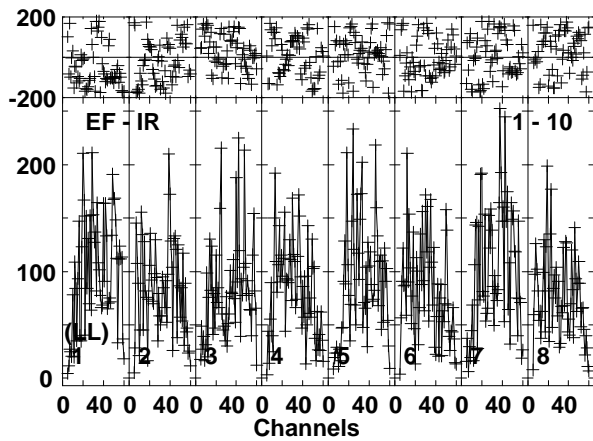
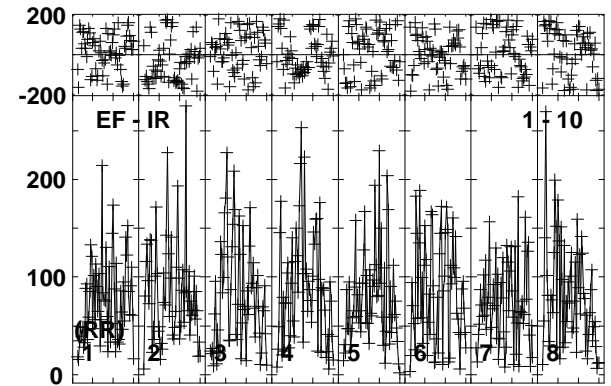
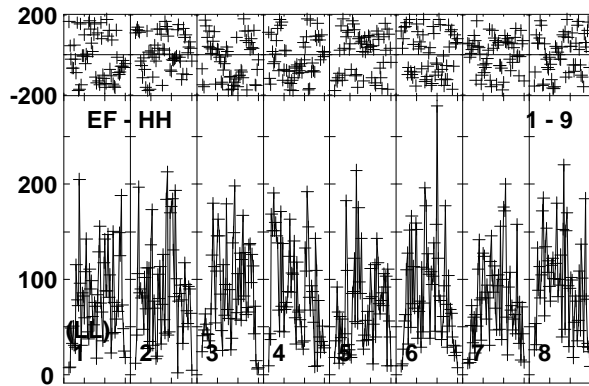
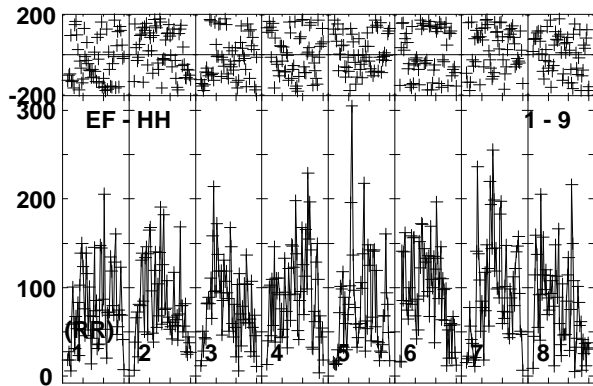
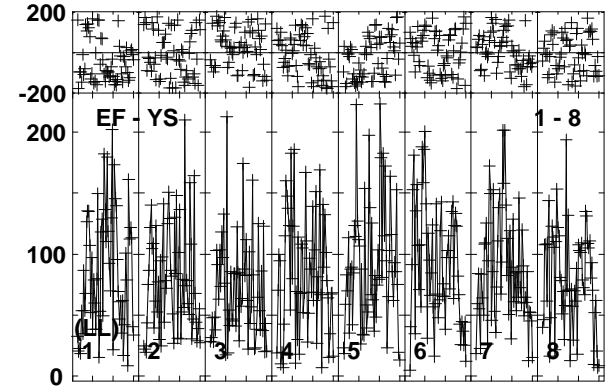
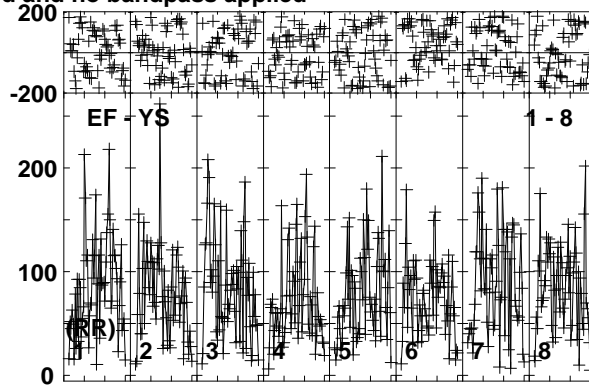
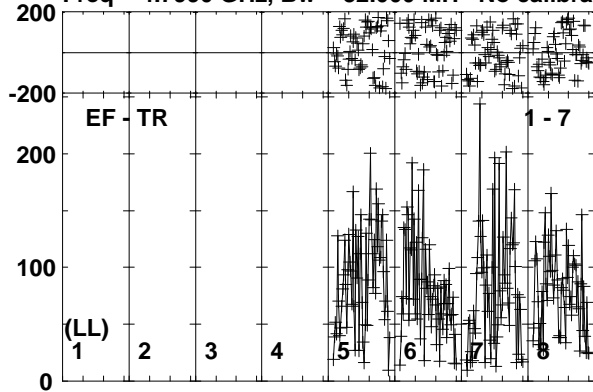

Lower frame: Micro Ampl Jy Top frame: Phas deg
Vector averaged cross-power spectrum Baseline: EF (01) - TR (07)
Timerange: 00/14:06:32 to 00/14:09:58

Plot file version 37 created 19-OCT-2017 15:36:00

J1504+1029 ES081C.UVDATA.1

Freq = 4.7990 GHz, Bw = 32.000 MH No calibration applied and no bandpass applied

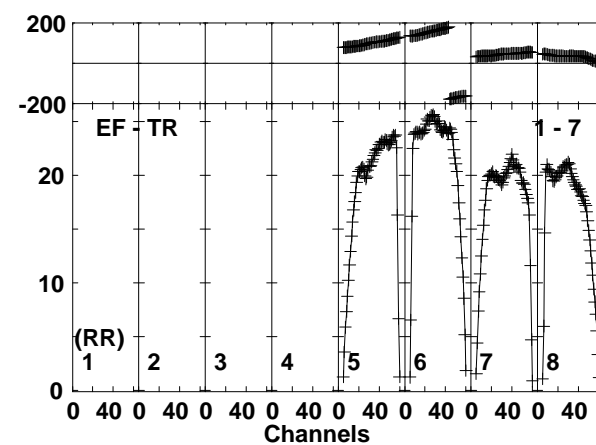
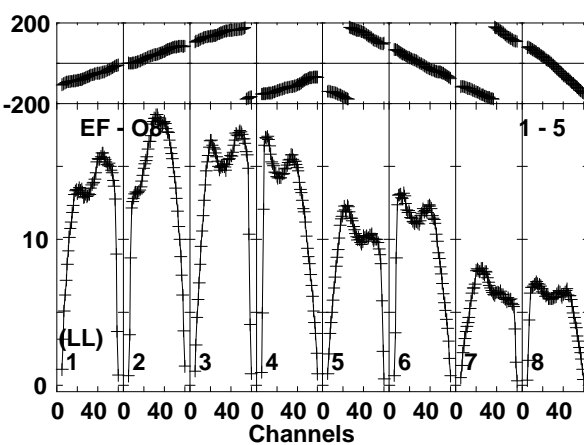
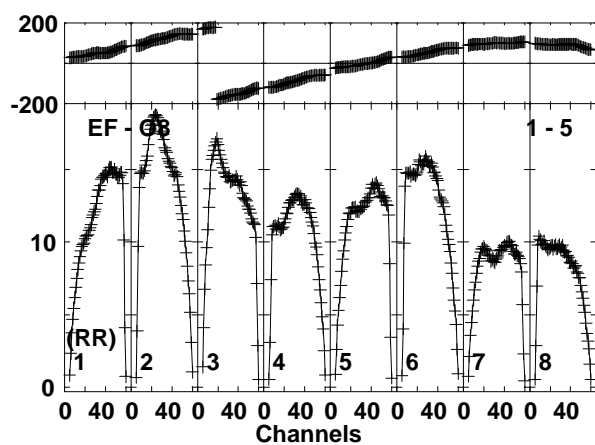
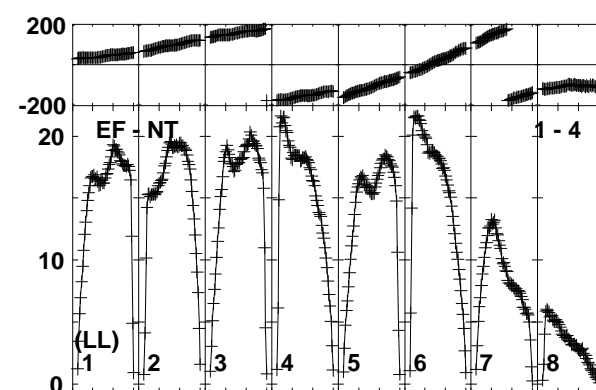
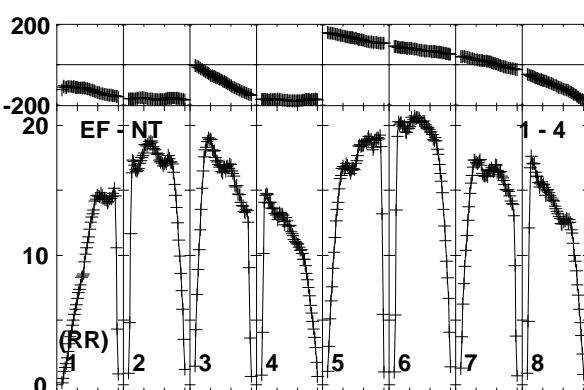
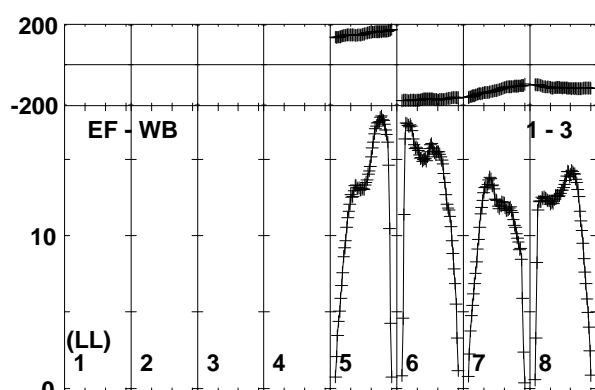
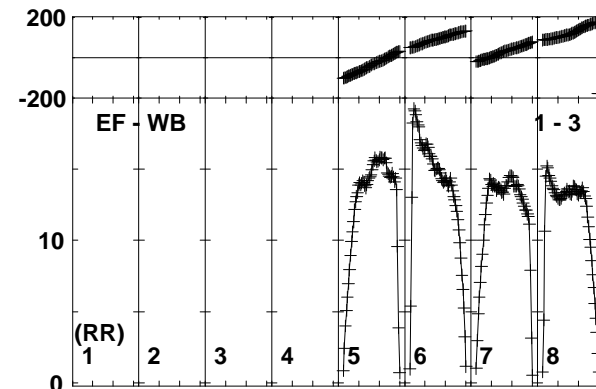
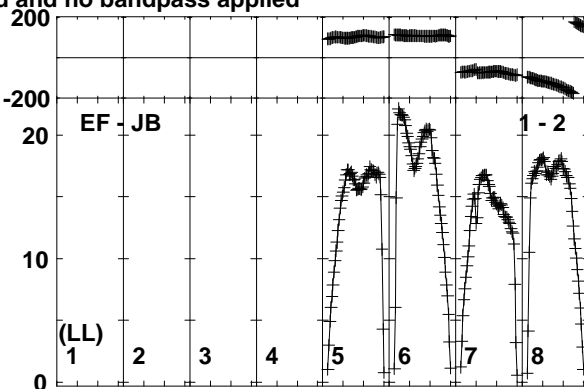
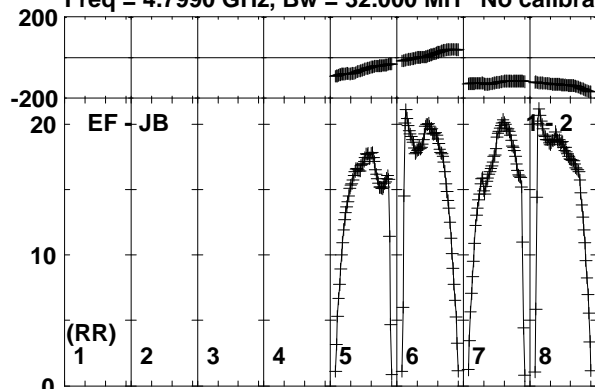

Lower frame: Milli Ampl Jy Top frame: Phas deg
Vector averaged cross-power spectrum Baseline: EF (01) - JB (02)
Timerange: 00/14:10:32 to 00/14:11:28

Plot file version 38 created 19-OCT-2017 15:36:00

J1504+1029 ES081C.UVDATA.1

Freq = 4.7990 GHz, Bw = 32.000 MH No calibration applied and no bandpass applied

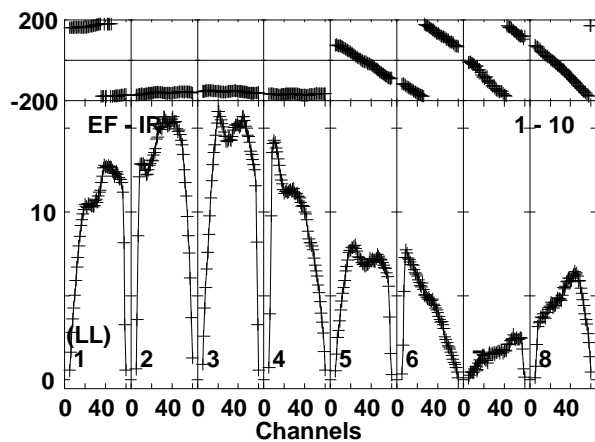
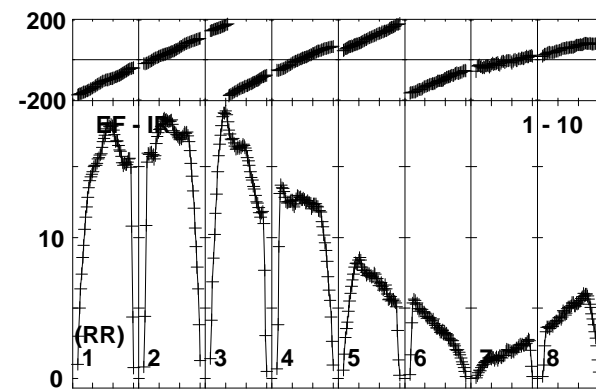
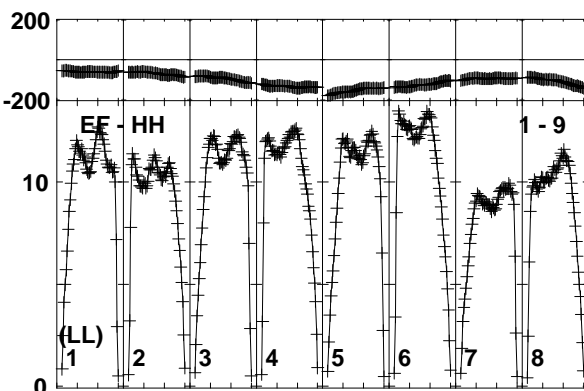
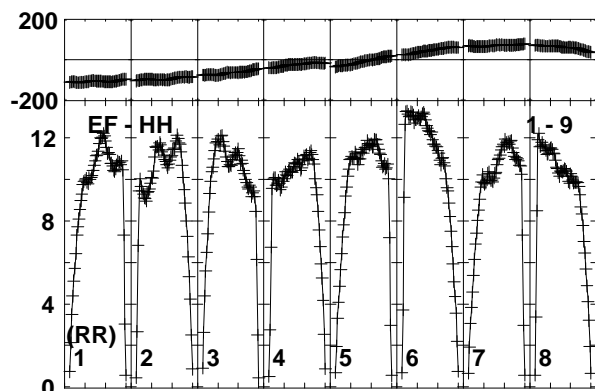
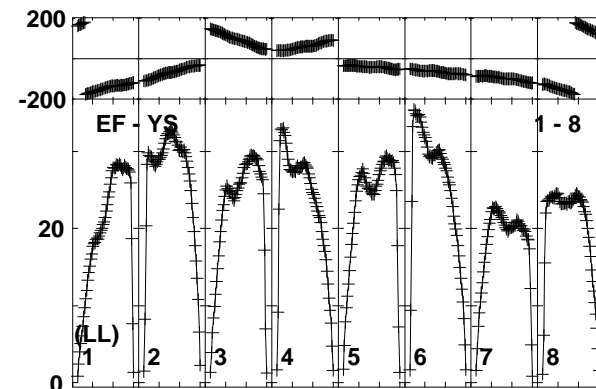
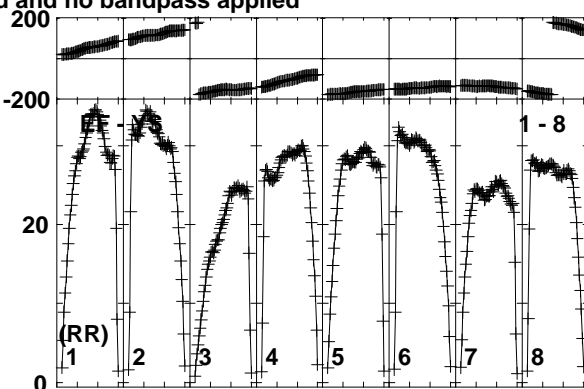
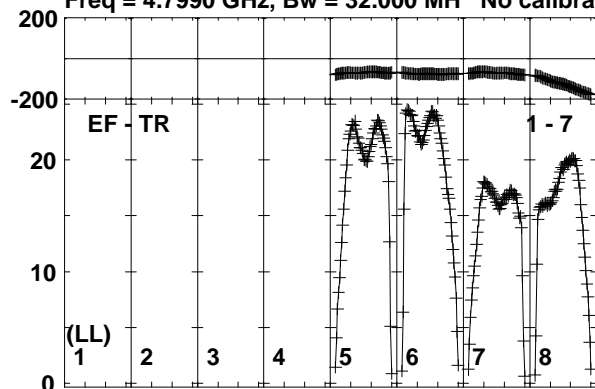

Lower frame: Milli Ampl Jy Top frame: Phas deg
Vector averaged cross-power spectrum Baseline: EF (01) - TR (07)
Timerange: 00/14:10:32 to 00/14:11:28

Plot file version 39 created 19-OCT-2017 15:36:00

MRK841 ES081C.UVDATA.1

Freq = 4.7990 GHz, Bw = 32.000 MH No calibration applied and no bandpass applied

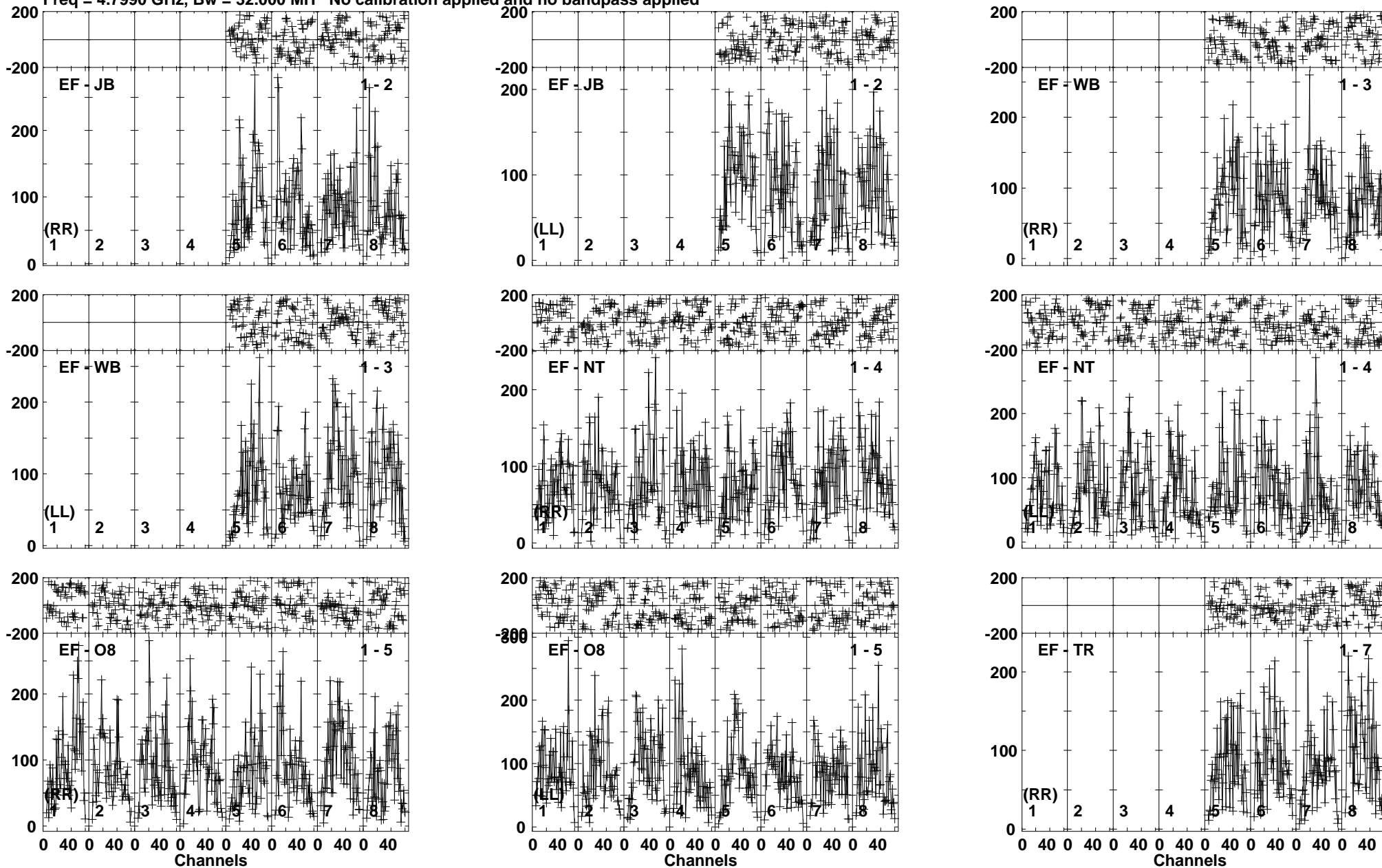

Lower frame: Micro Ampl Jy Top frame: Phas deg
Vector averaged cross-power spectrum Baseline: EF (01) - JB (02)
Timerange: 00/14:11:32 to 00/14:14:58

Plot file version 40 created 19-OCT-2017 15:36:00

MRK841 ES081C.UVDATA.1

Freq = 4.7990 GHz, Bw = 32.000 MH No calibration applied and no bandpass applied

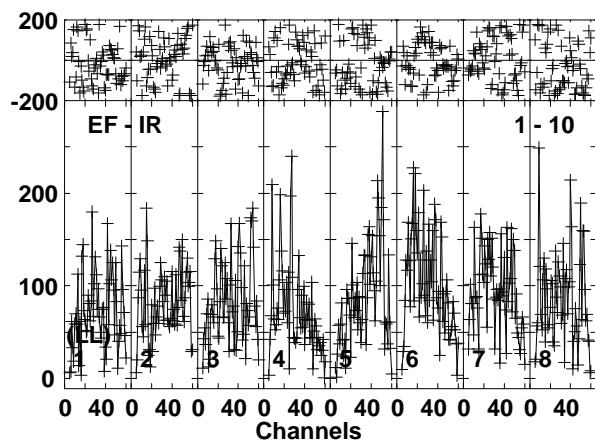
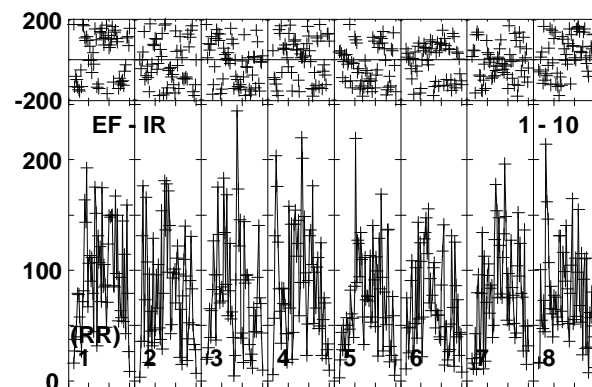
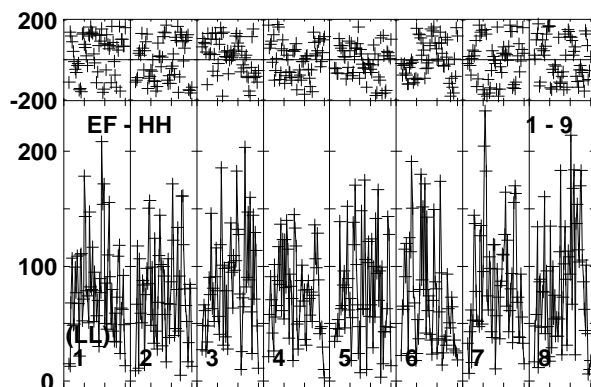
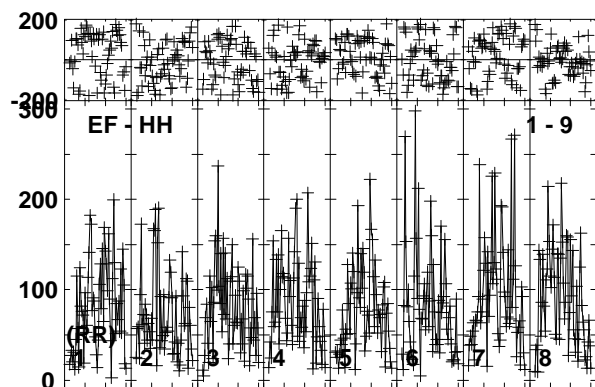
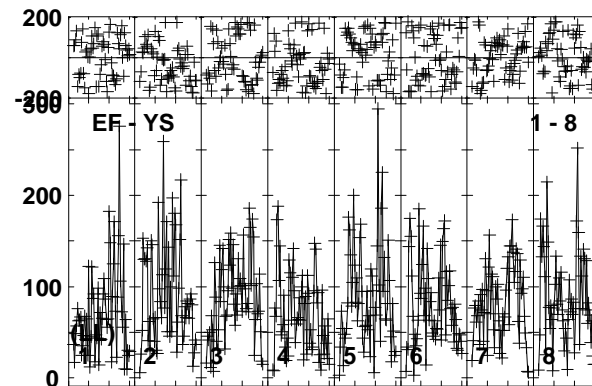
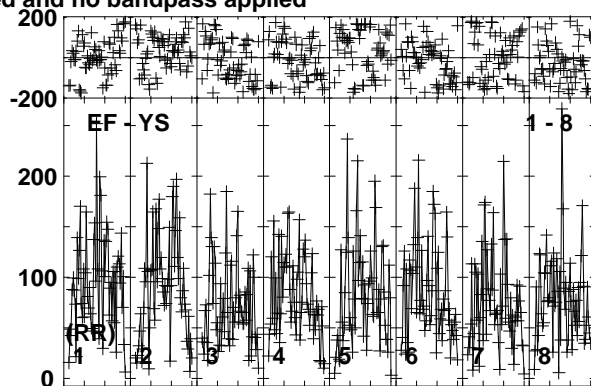
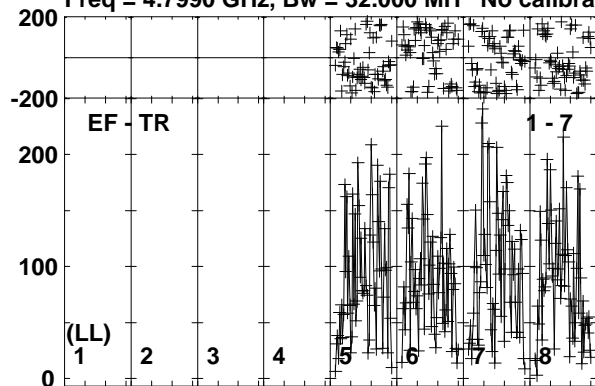

Lower frame: Micro Ampl Jy Top frame: Phas deg
Vector averaged cross-power spectrum Baseline: EF (01) - TR (07)
Timerange: 00/14:11:32 to 00/14:14:58

Plot file version 41 created 19-OCT-2017 15:36:00

J1504+1029 ES081C.UVDATA.1

Freq = 4.7990 GHz, Bw = 32.000 MH No calibration applied and no bandpass applied

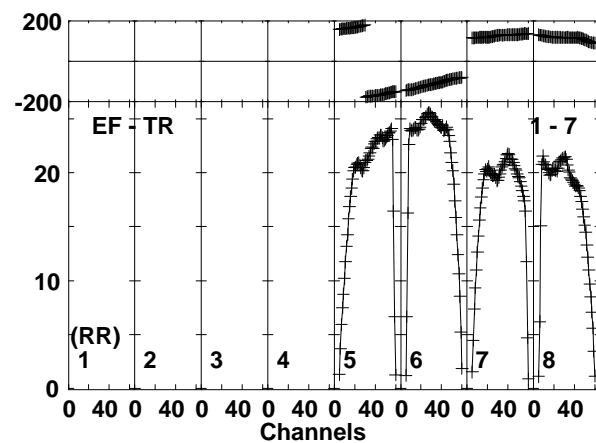
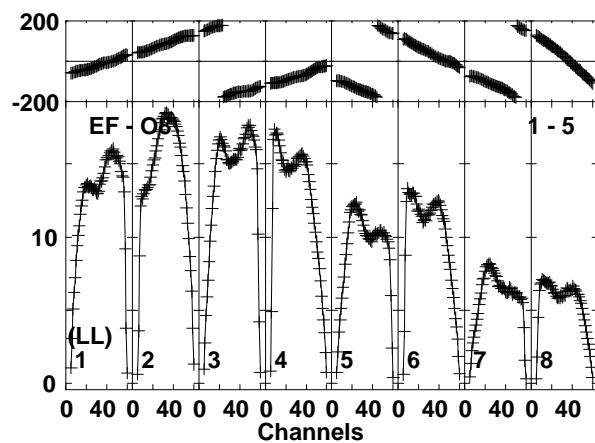
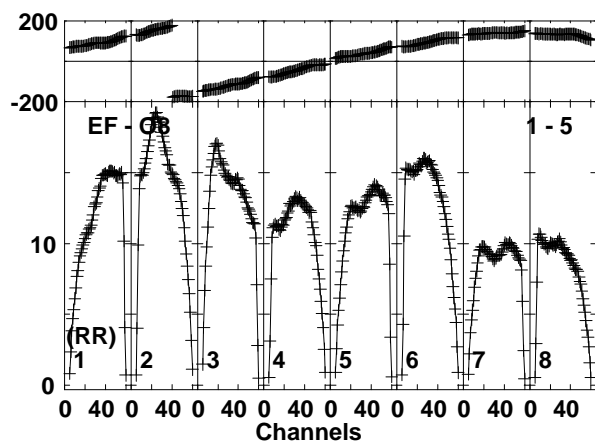
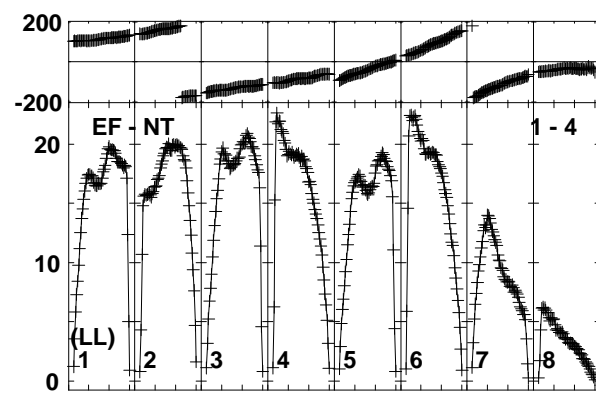
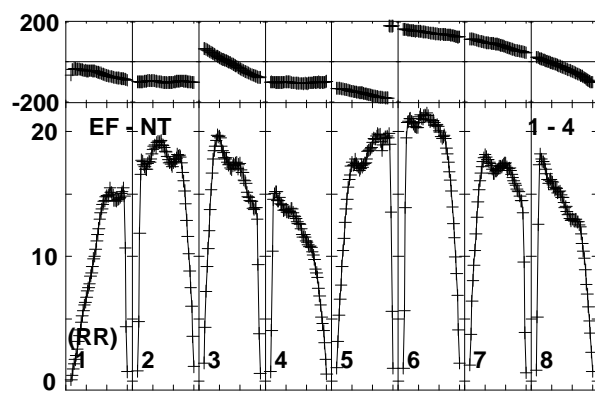
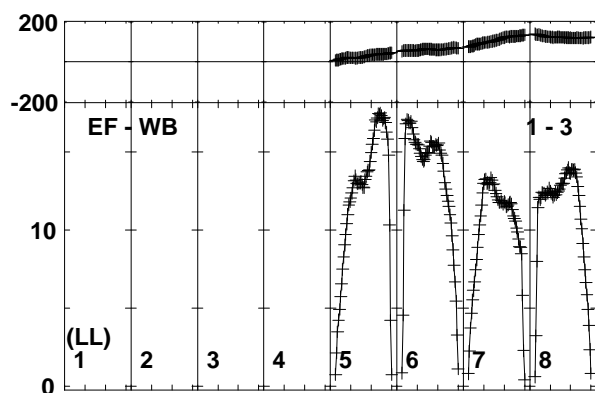
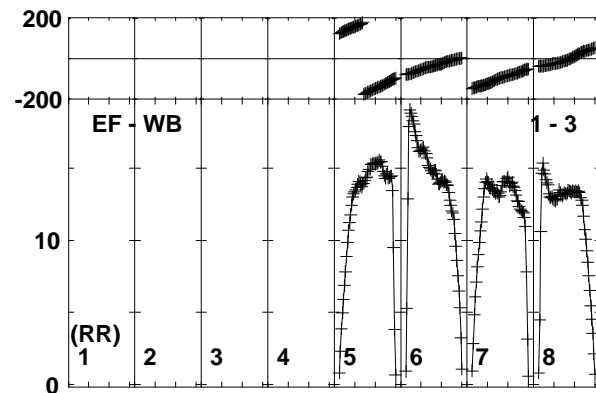
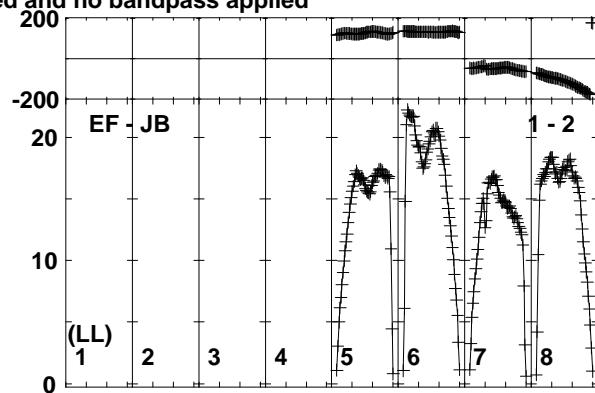
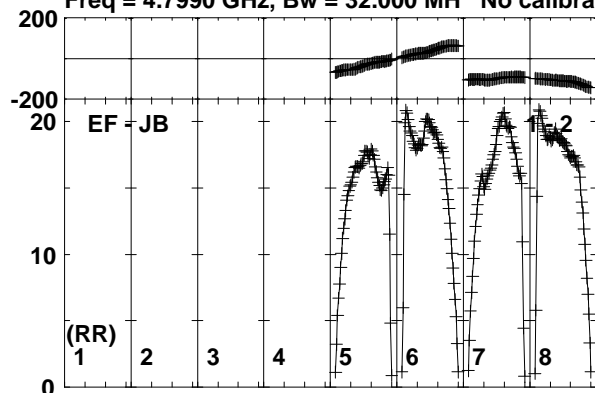

Lower frame: Milli Ampl Jy Top frame: Phas deg
Vector averaged cross-power spectrum Baseline: EF (01) - JB (02)
Timerange: 00/14:15:02 to 00/14:16:28

Plot file version 42 created 19-OCT-2017 15:36:00

J1504+1029 ES081C.UVDATA.1

Freq = 4.7990 GHz, Bw = 32.000 MH No calibration applied and no bandpass applied

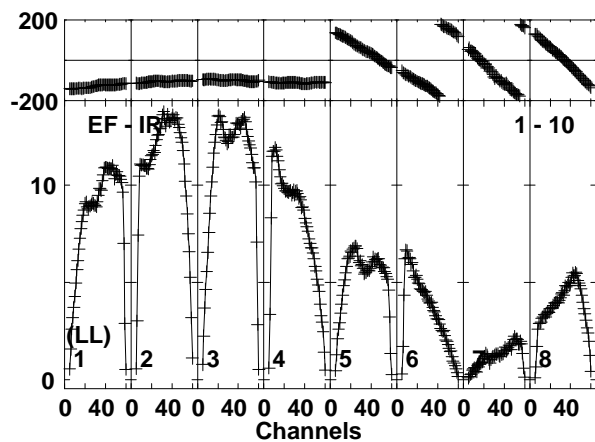
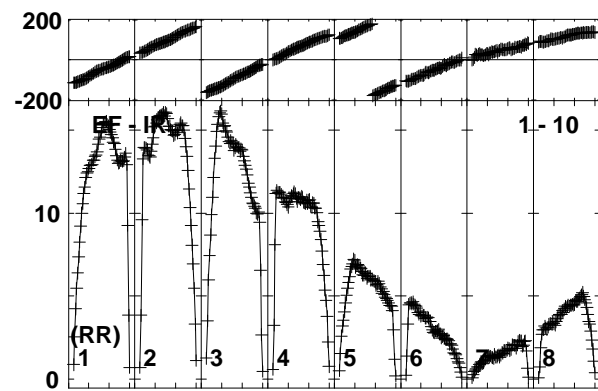
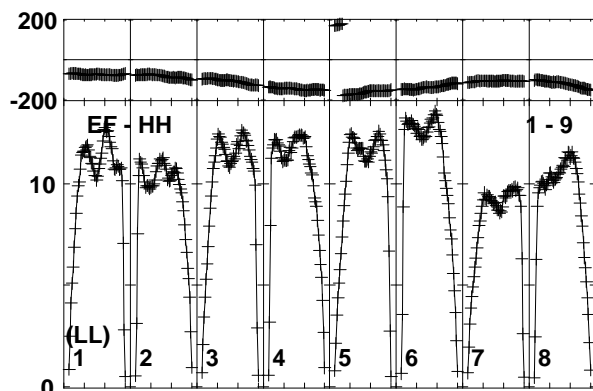
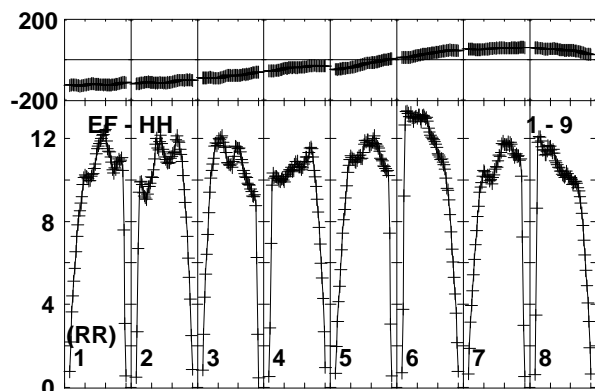
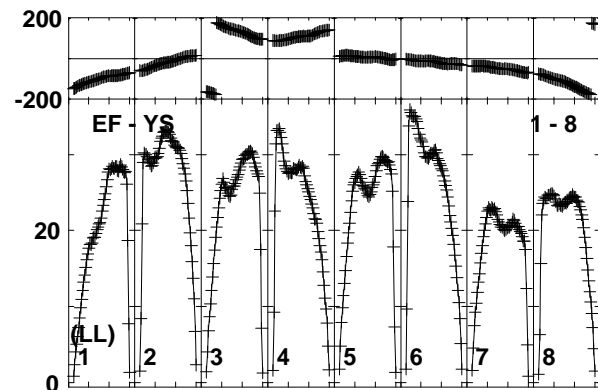
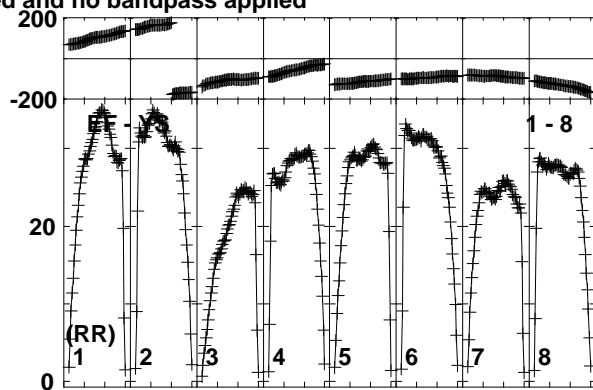
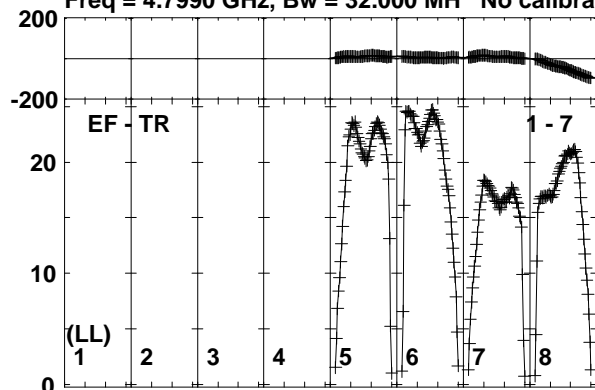

Lower frame: Milli Ampl Jy Top frame: Phas deg
Vector averaged cross-power spectrum Baseline: EF (01) - TR (07)
Timerange: 00/14:15:02 to 00/14:16:28

Plot file version 43 created 19-OCT-2017 15:36:00

MRK841 ES081C.UVDATA.1

Freq = 4.7990 GHz, Bw = 32.000 MH No calibration applied and no bandpass applied

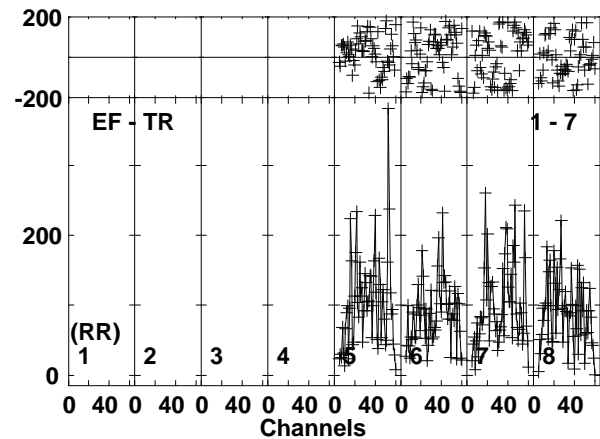
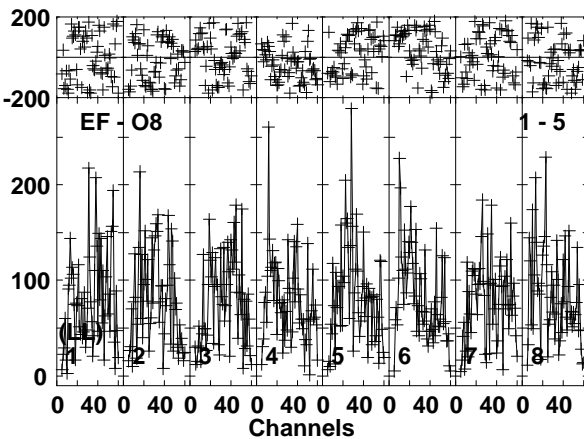
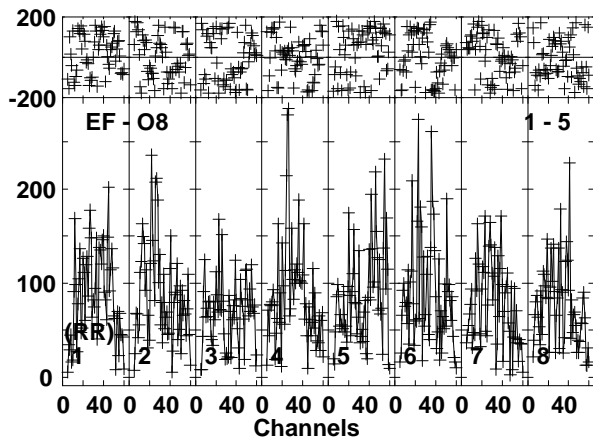
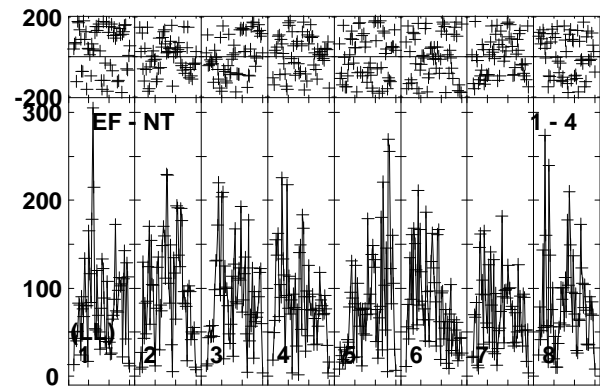
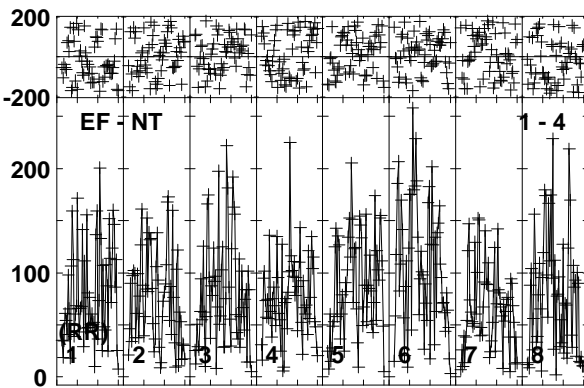
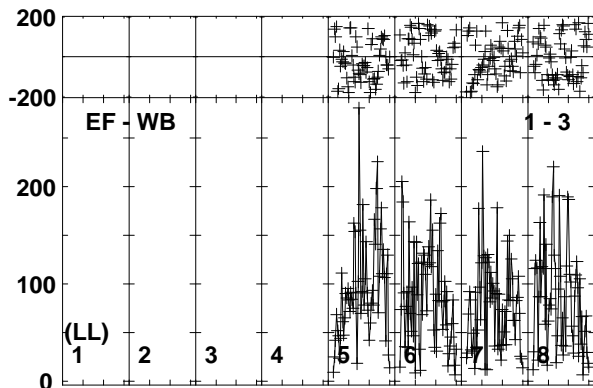
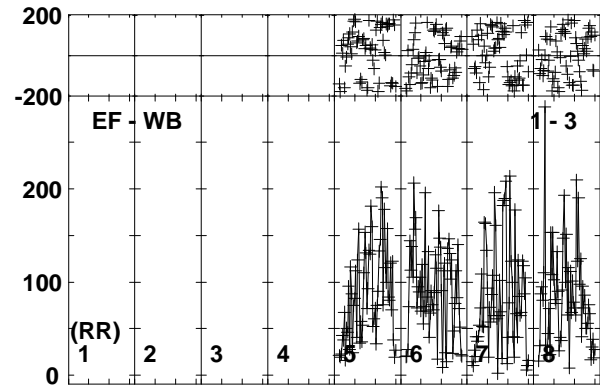
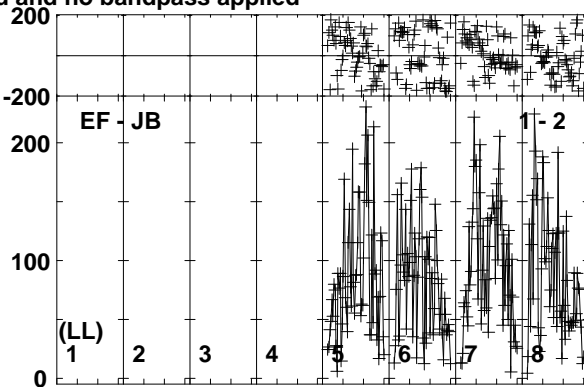
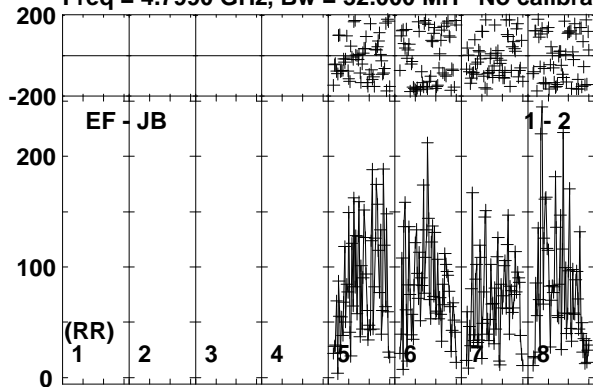

Lower frame: Micro Ampl Jy Top frame: Phas deg
Vector averaged cross-power spectrum Baseline: EF (01) - JB (02)
Timerange: 00/14:16:32 to 00/14:19:58

Plot file version 44 created 19-OCT-2017 15:36:00

MRK841 ES081C.UVDATA.1

Freq = 4.7990 GHz, Bw = 32.000 MH No calibration applied and no bandpass applied

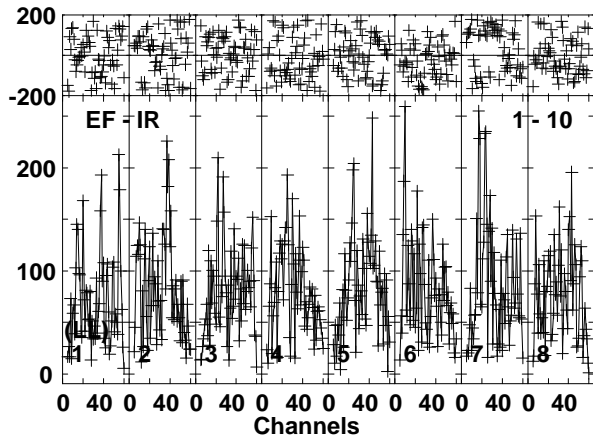
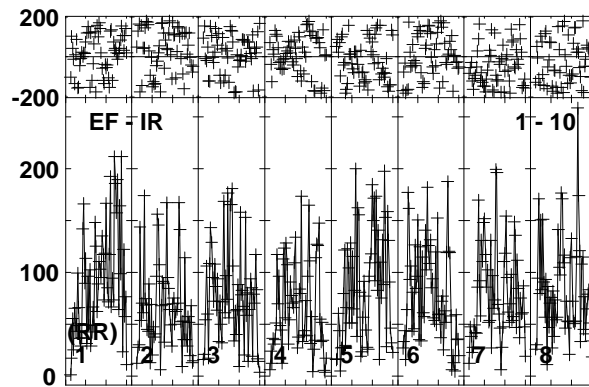
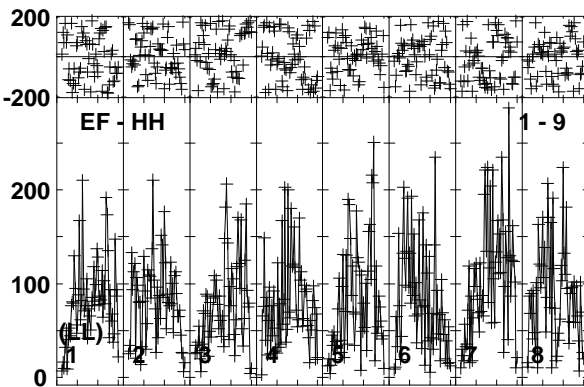
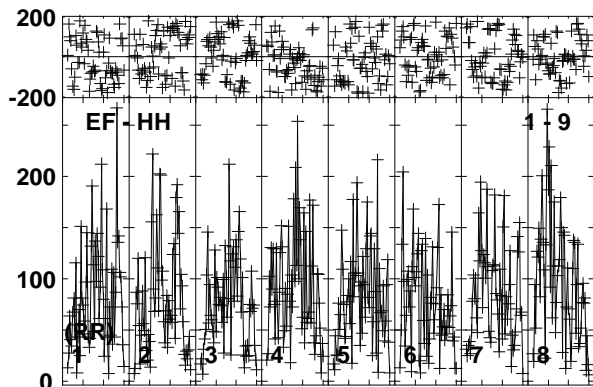
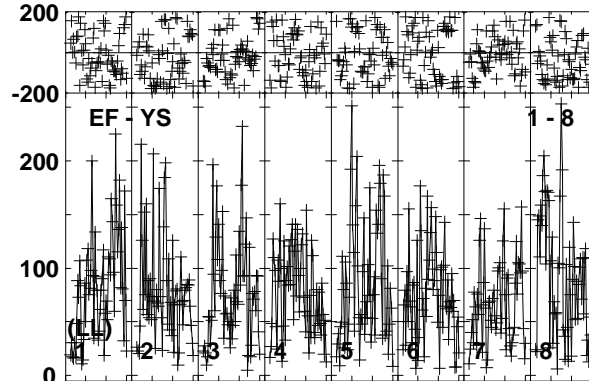
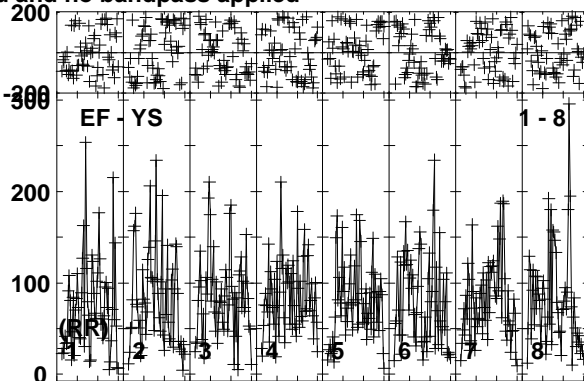
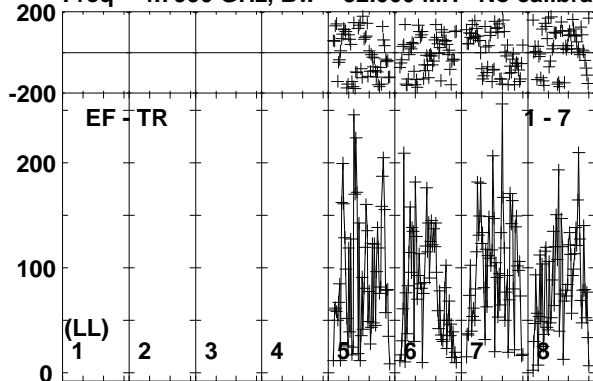

Lower frame: Micro Ampl Jy Top frame: Phas deg
Vector averaged cross-power spectrum Baseline: EF (01) - TR (07)
Timerange: 00/14:16:32 to 00/14:19:58

Plot file version 45 created 19-OCT-2017 15:36:01

J1504+1029 ES081C.UVDATA.1

Freq = 4.7990 GHz, Bw = 32.000 MH No calibration applied and no bandpass applied

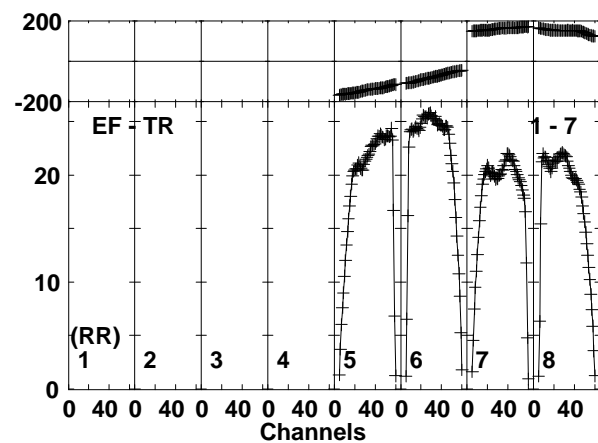
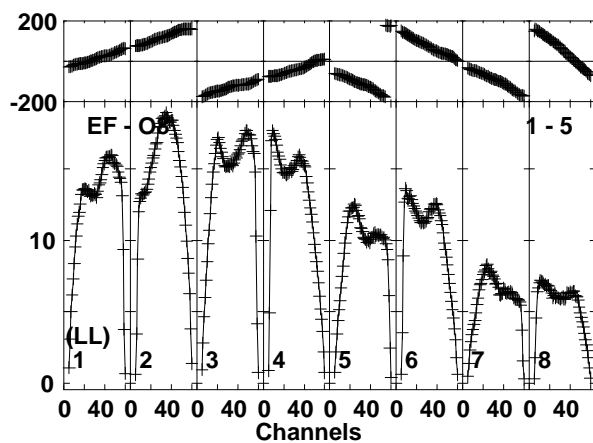
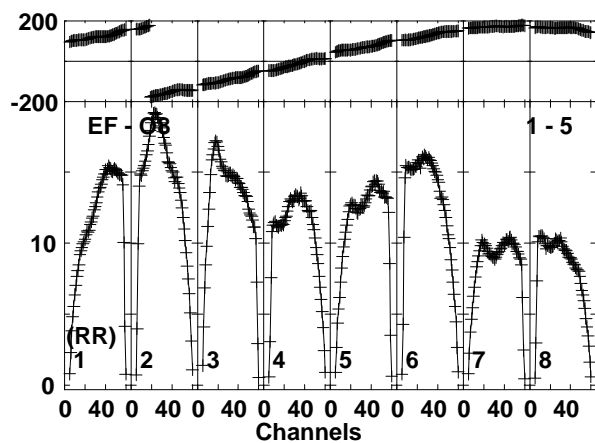
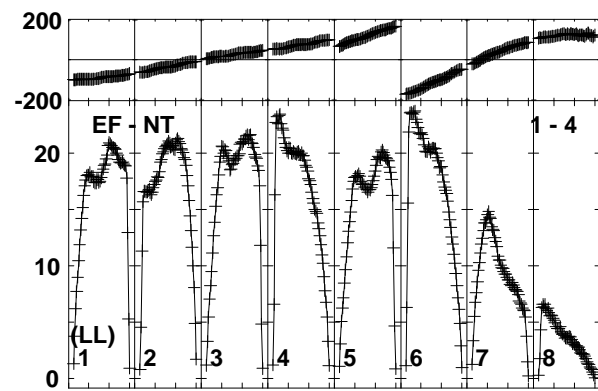
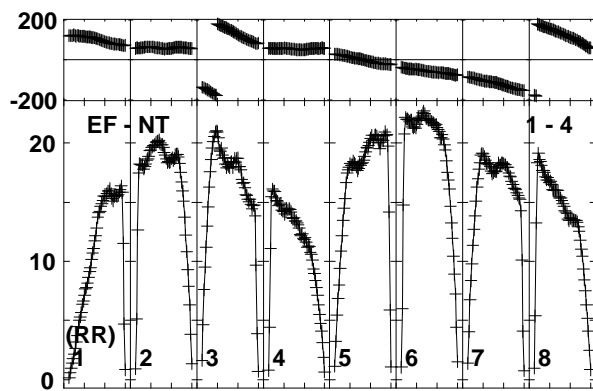
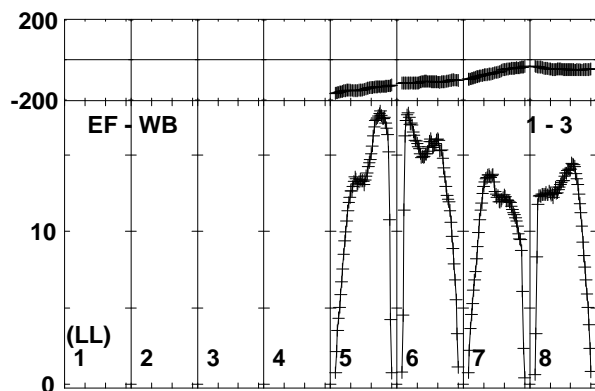
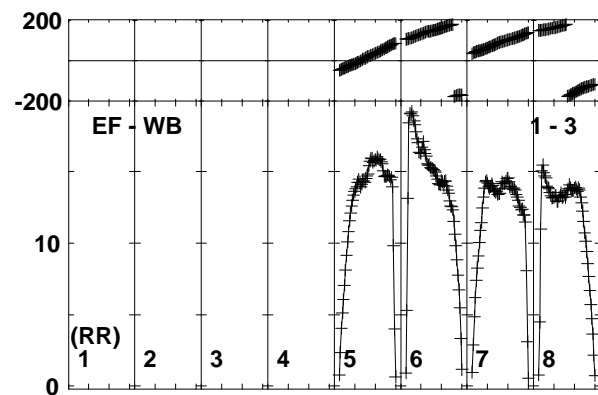
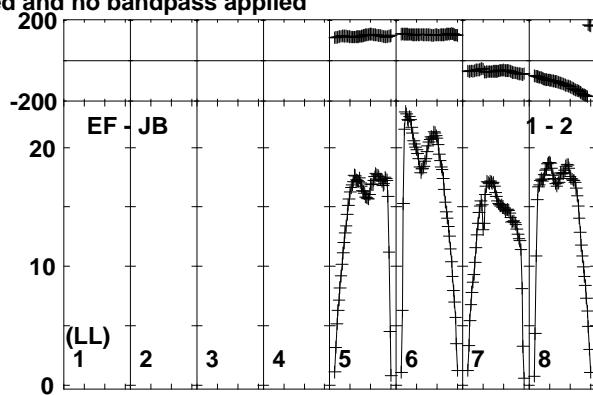
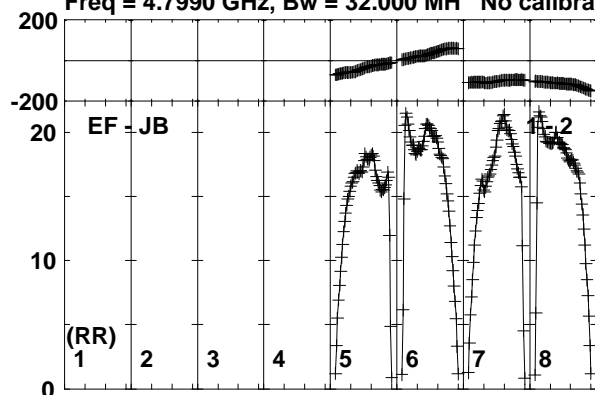

Lower frame: Milli Ampl Jy Top frame: Phas deg
Vector averaged cross-power spectrum Baseline: EF (01) - JB (02)
Timerange: 00/14:20:32 to 00/14:21:28

Plot file version 46 created 19-OCT-2017 15:36:01

J1504+1029 ES081C.UVDATA.1

Freq = 4.7990 GHz, Bw = 32.000 MH No calibration applied and no bandpass applied

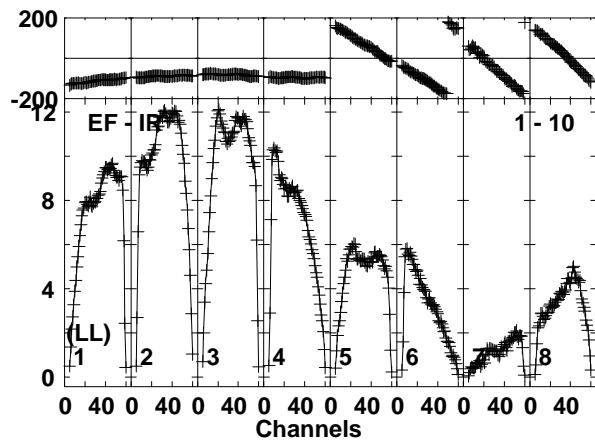
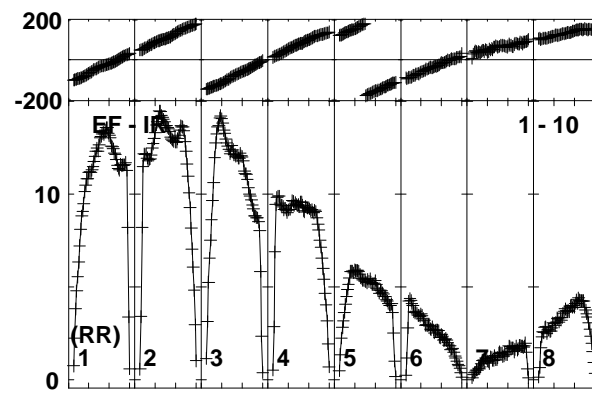
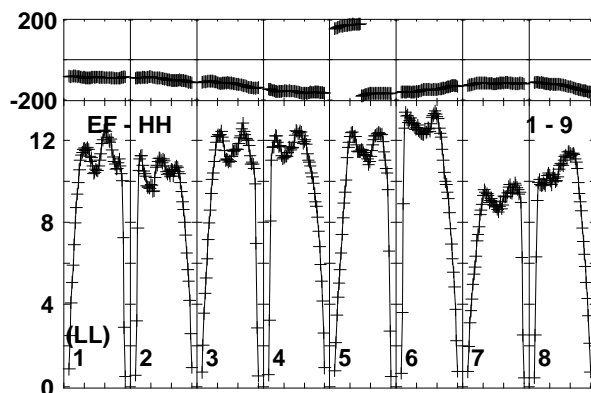
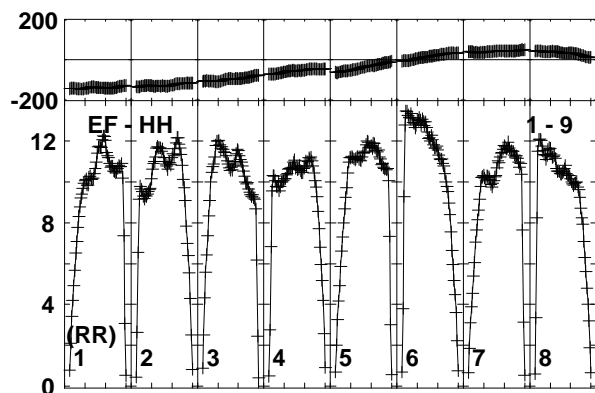
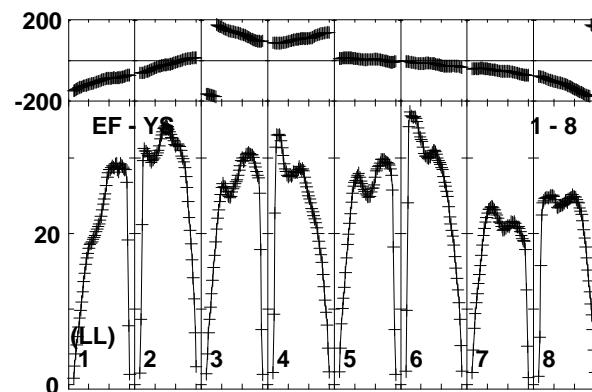
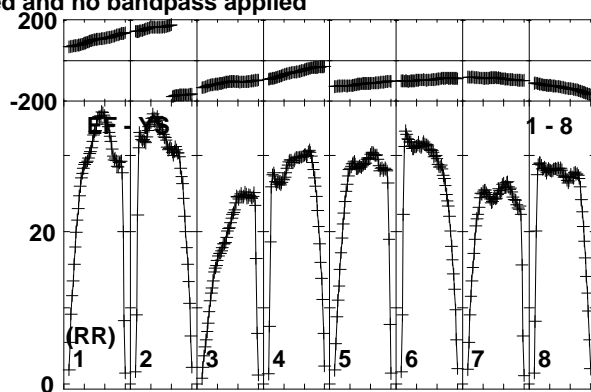
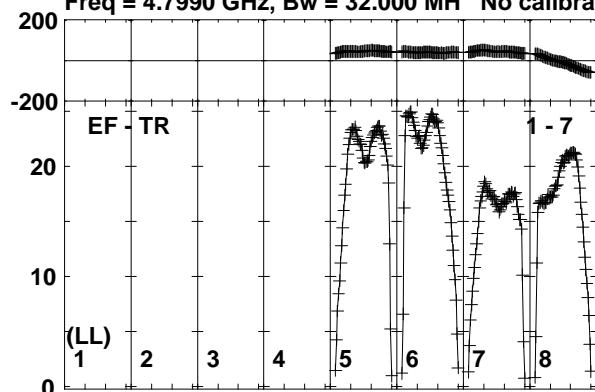

Lower frame: Milli Ampl Jy Top frame: Phas deg
Vector averaged cross-power spectrum Baseline: EF (01) - TR (07)
Timerange: 00/14:20:32 to 00/14:21:28

Plot file version 47 created 19-OCT-2017 15:36:01

MRK841 ES081C.UVDATA.1

Freq = 4.7990 GHz, Bw = 32.000 MH No calibration applied and no bandpass applied

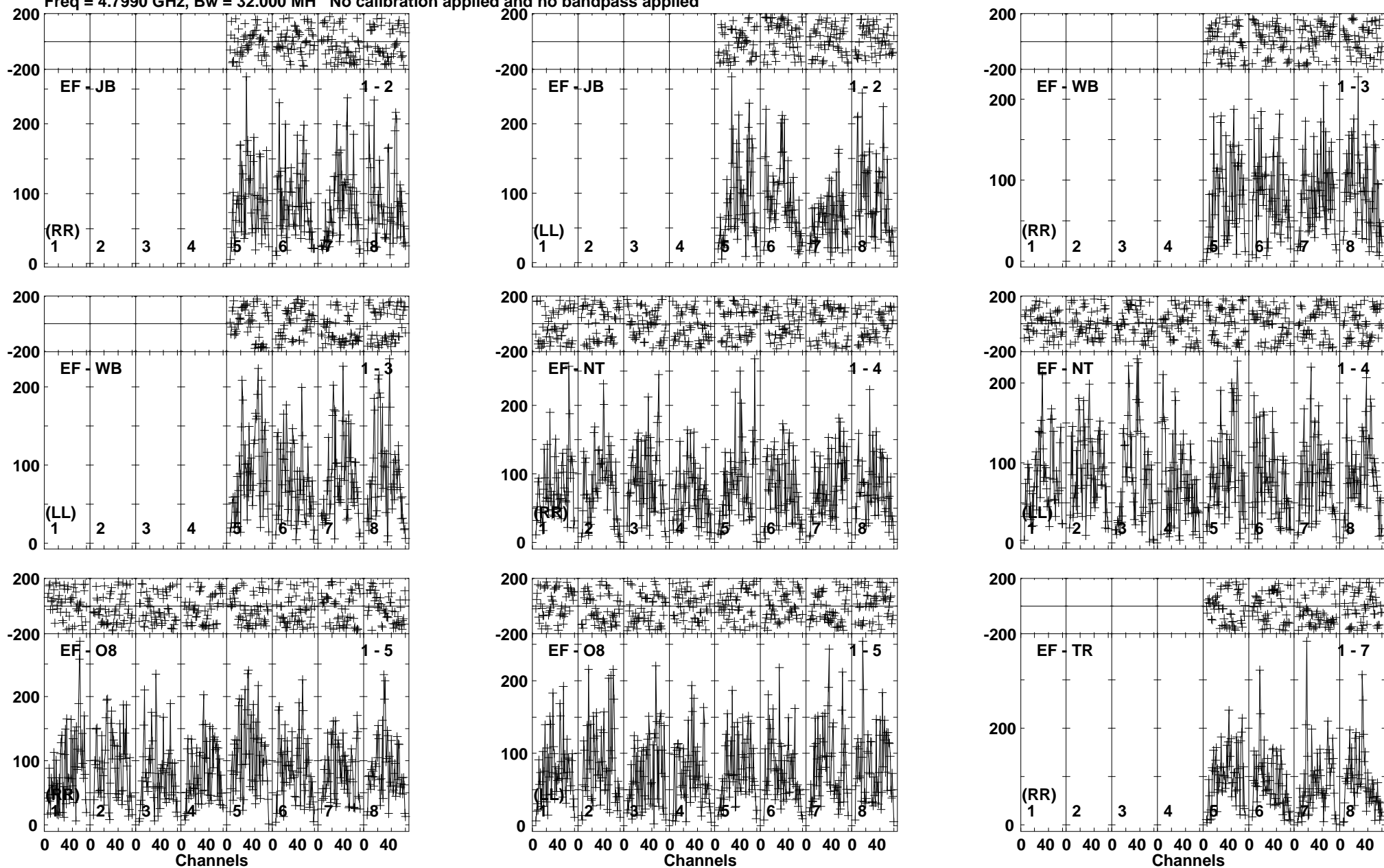

Lower frame: Micro Ampl Jy Top frame: Phas deg
Vector averaged cross-power spectrum Baseline: EF (01) - JB (02)
Timerange: 00/14:21:32 to 00/14:24:58

Plot file version 48 created 19-OCT-2017 15:36:01

MRK841 ES081C.UVDATA.1

Freq = 4.7990 GHz, Bw = 32.000 MH No calibration applied and no bandpass applied

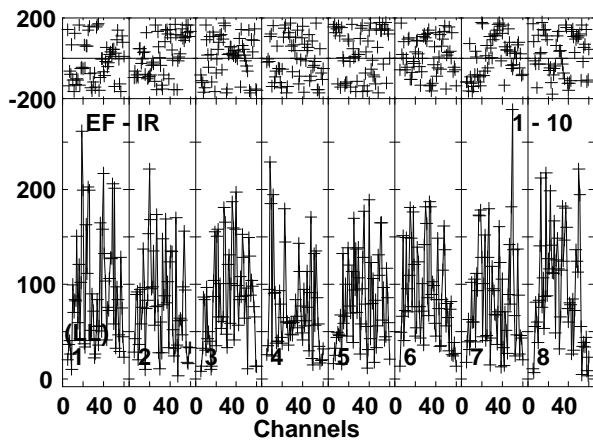
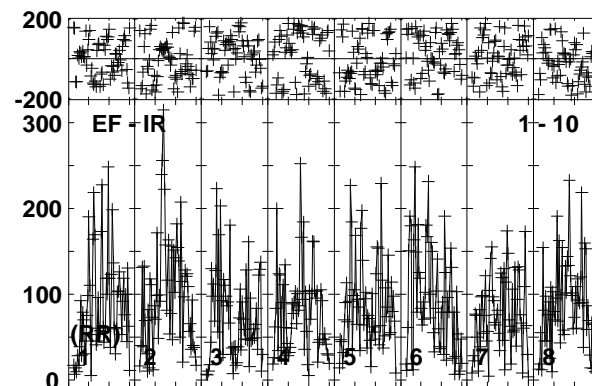
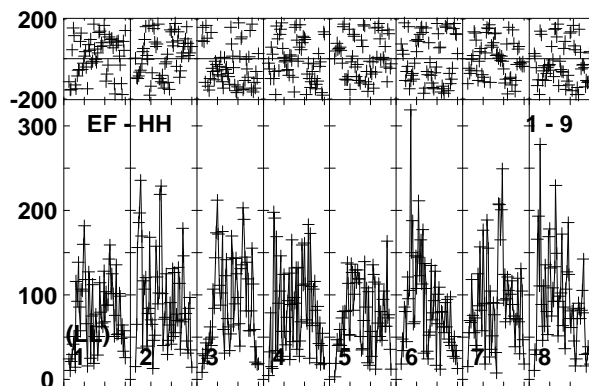
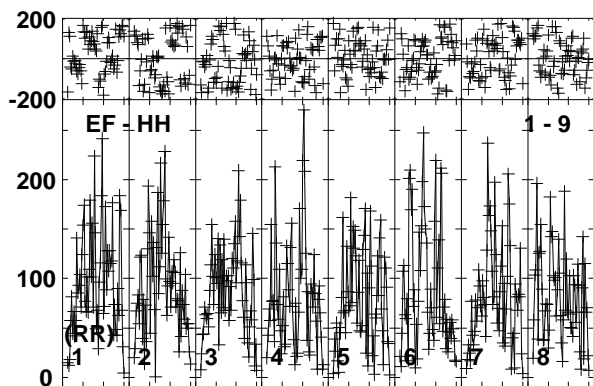
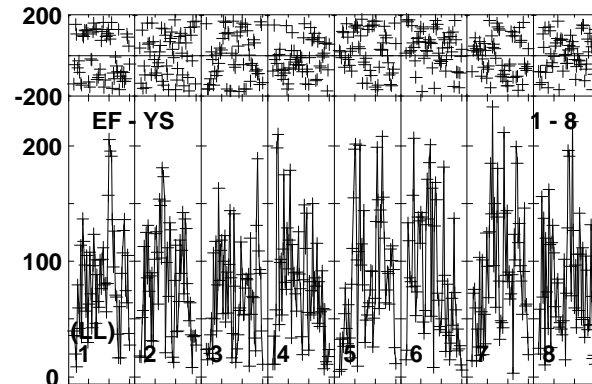
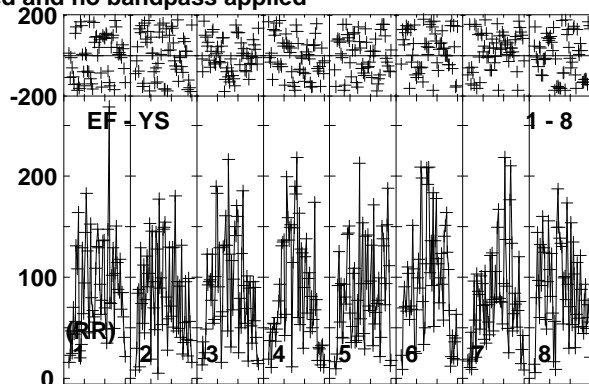
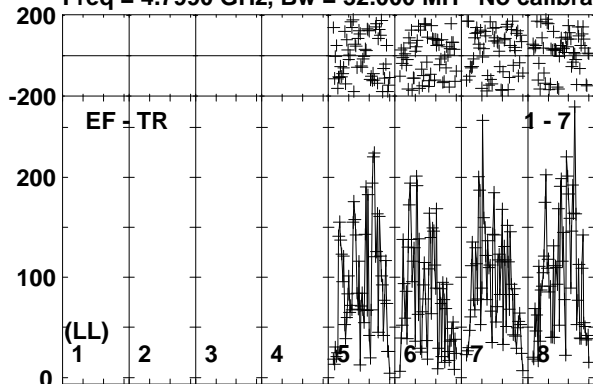

Lower frame: Micro Ampl Jy Top frame: Phas deg
Vector averaged cross-power spectrum Baseline: EF (01) - TR (07)
Timerange: 00/14:21:32 to 00/14:24:58

Plot file version 49 created 19-OCT-2017 15:36:01

J1504+1029 ES081C.UVDATA.1

Freq = 4.7990 GHz, Bw = 32.000 MH No calibration applied and no bandpass applied

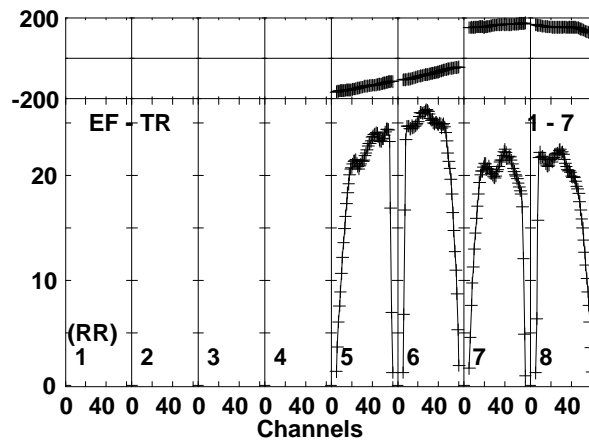
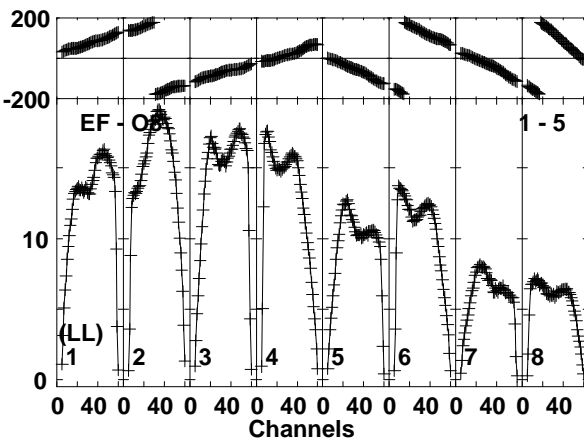
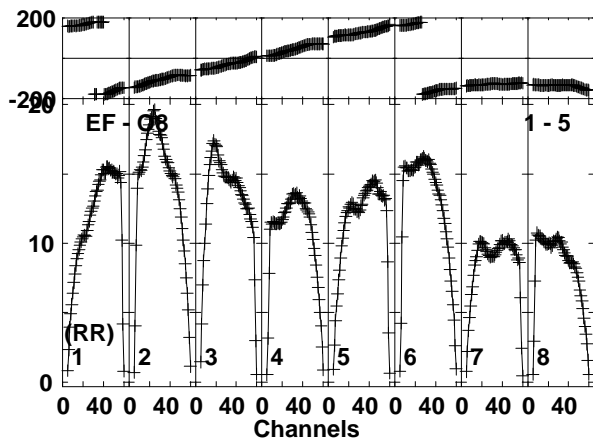
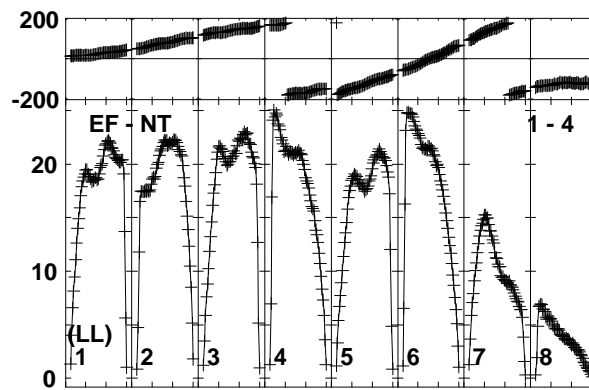
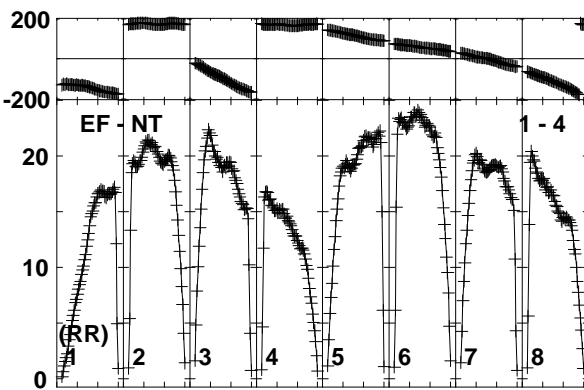
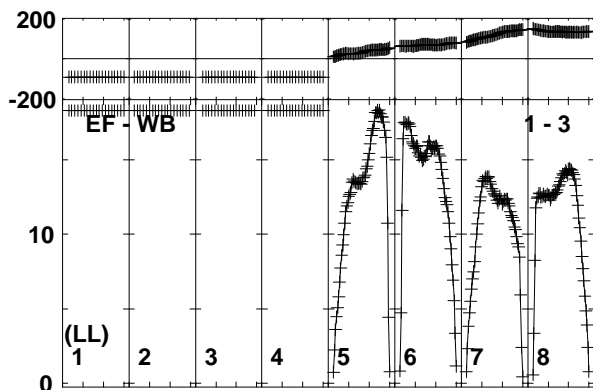
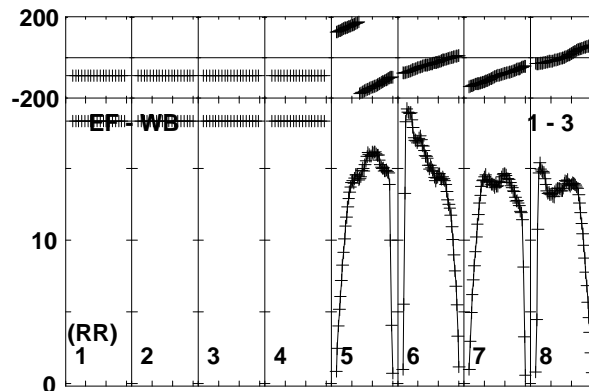
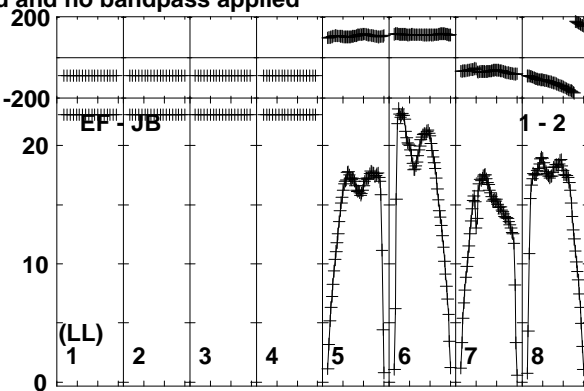
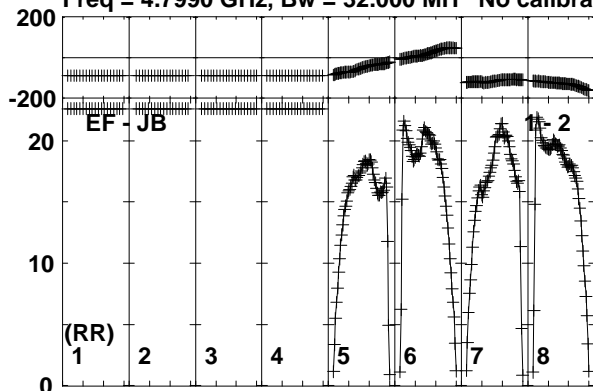

Lower frame: Milli Ampl Jy Top frame: Phas deg
Vector averaged cross-power spectrum Baseline: EF (01) - JB (02)
Timerange: 00/14:25:02 to 00/14:26:28

Plot file version 50 created 19-OCT-2017 15:36:01

J1504+1029 ES081C.UVDATA.1

Freq = 4.7990 GHz, Bw = 32.000 MH No calibration applied and no bandpass applied

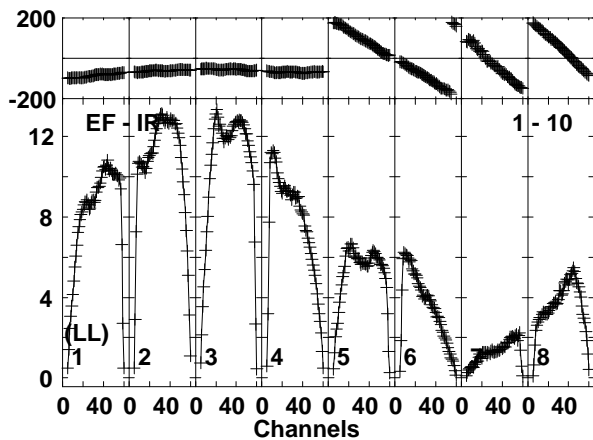
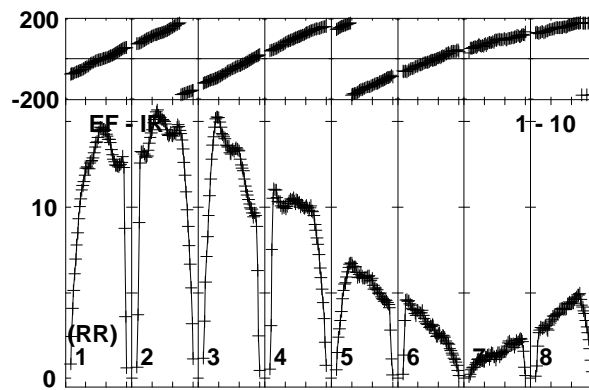
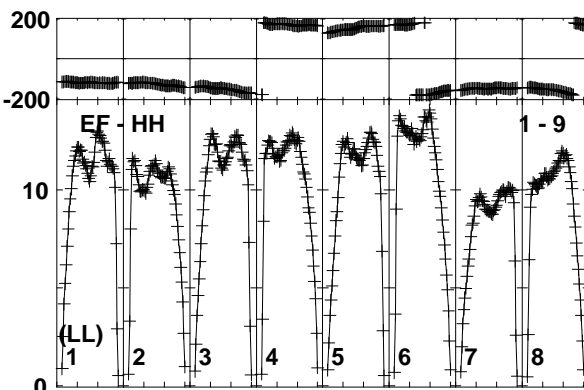
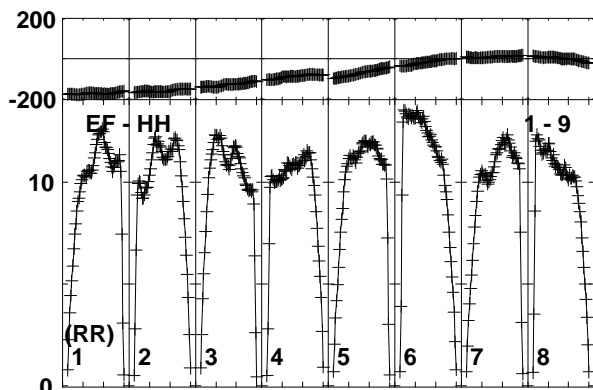
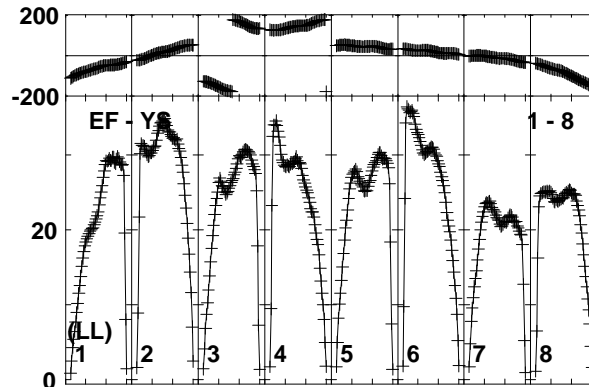
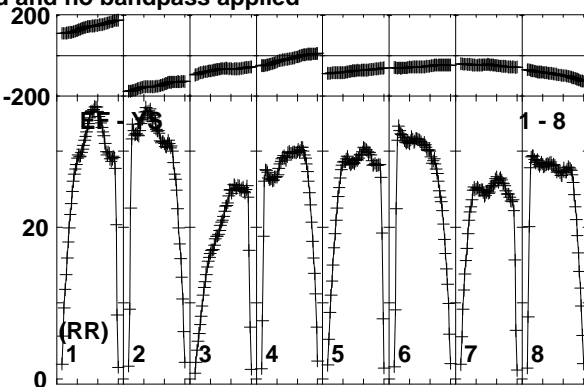
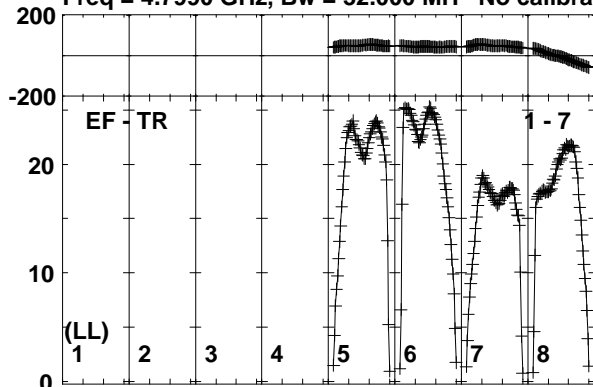

Lower frame: Milli Ampl Jy Top frame: Phas deg
Vector averaged cross-power spectrum Baseline: EF (01) - TR (07)
Timerange: 00/14:25:02 to 00/14:26:28

Plot file version 51 created 19-OCT-2017 15:36:01

MRK841 ES081C.UVDATA.1

Freq = 4.7990 GHz, Bw = 32.000 MH No calibration applied and no bandpass applied

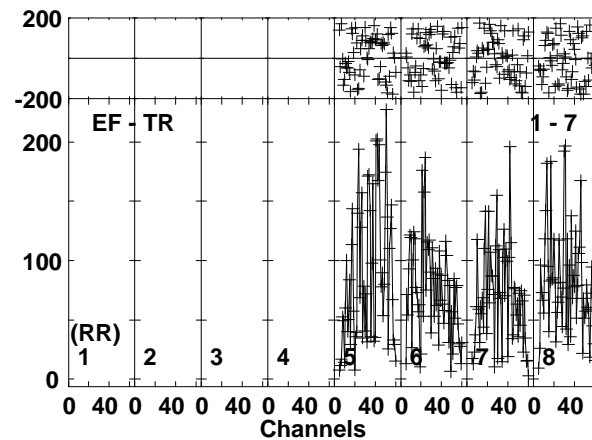
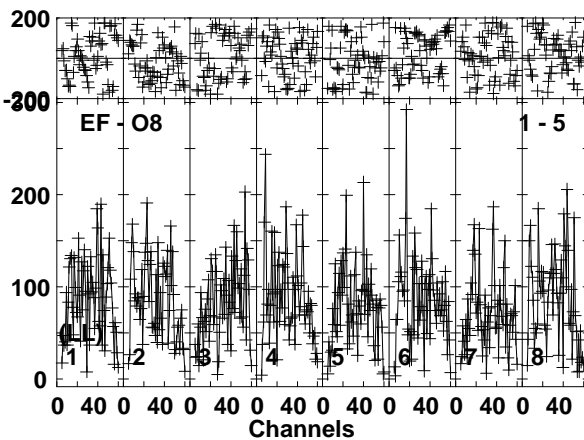
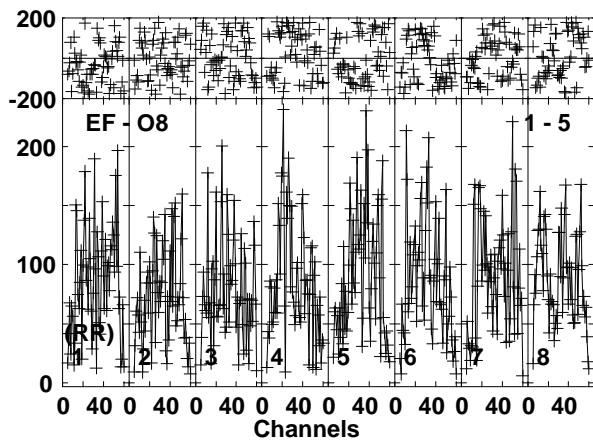
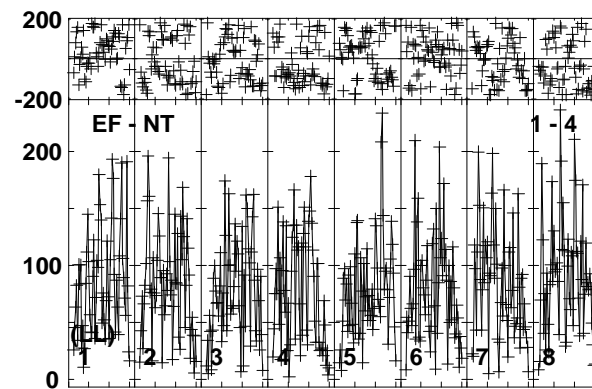
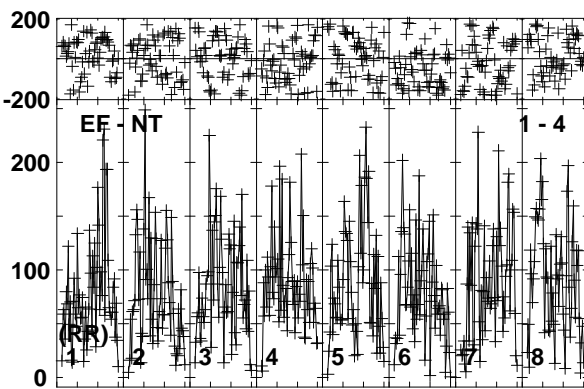
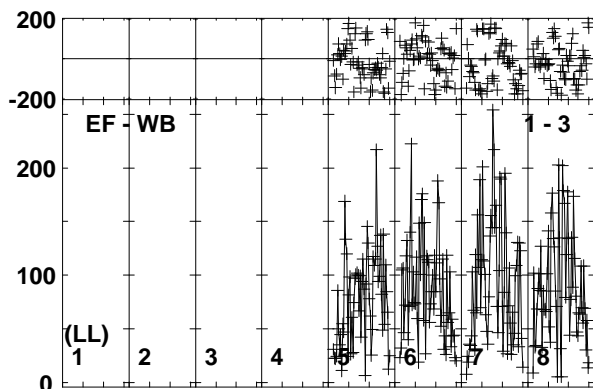
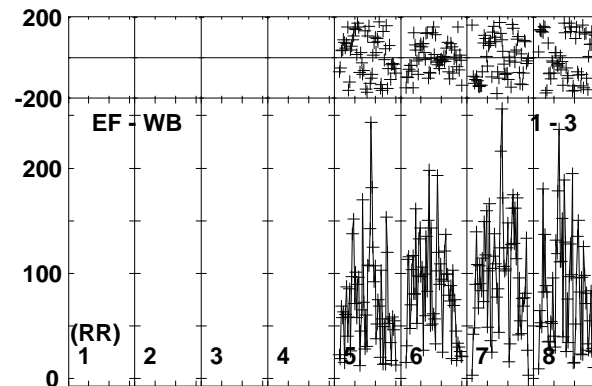
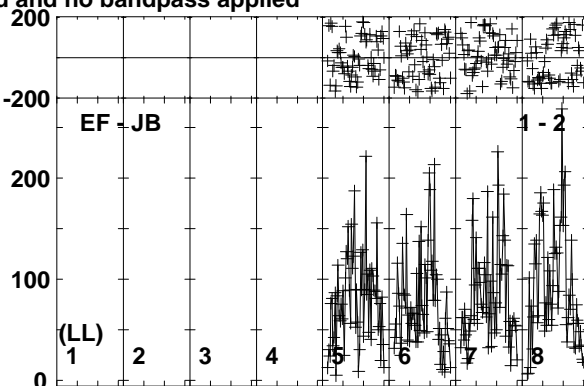
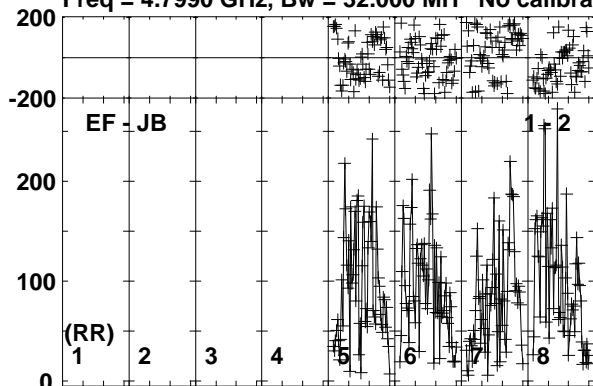

Lower frame: Micro Ampl Jy Top frame: Phas deg
Vector averaged cross-power spectrum Baseline: EF (01) - JB (02)
Timerange: 00/14:26:32 to 00/14:29:58

Plot file version 52 created 19-OCT-2017 15:36:01

MRK841 ES081C.UVDATA.1

Freq = 4.7990 GHz, Bw = 32.000 MH No calibration applied and no bandpass applied

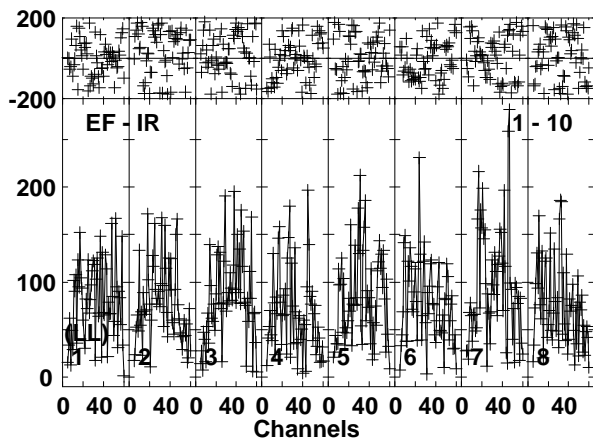
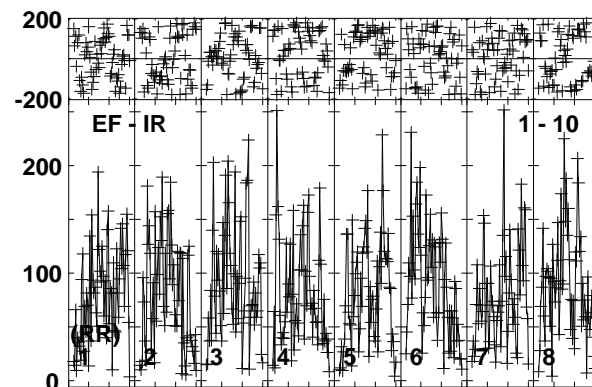
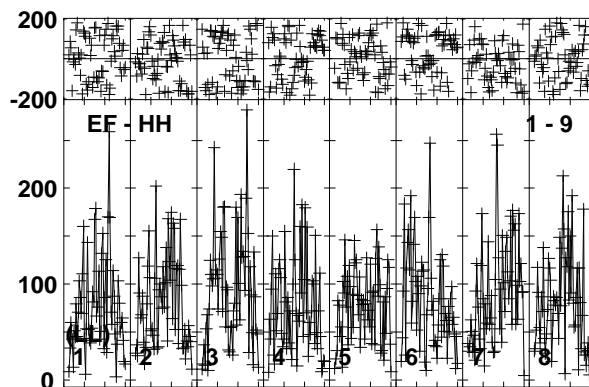
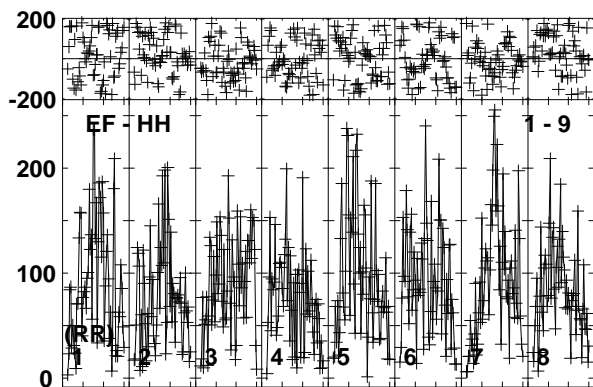
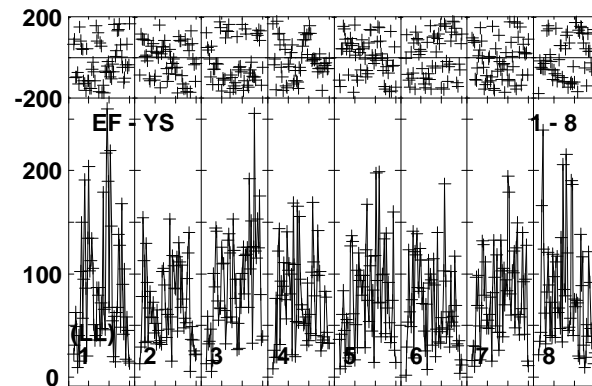
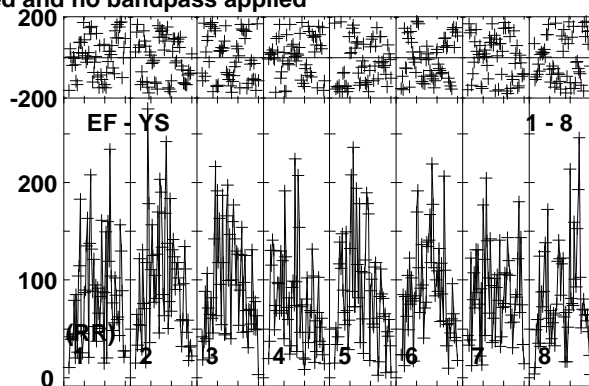
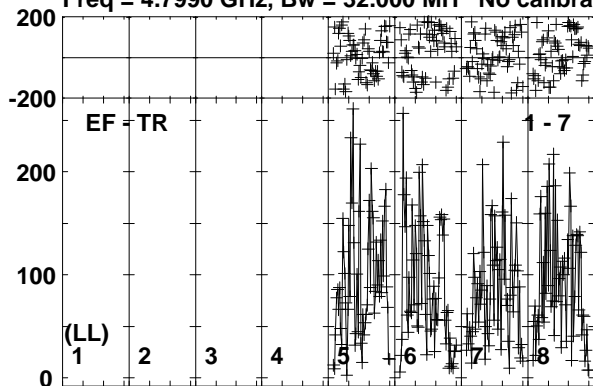

Lower frame: Micro Ampl Jy Top frame: Phas deg
Vector averaged cross-power spectrum Baseline: EF (01) - TR (07)
Timerange: 00/14:26:32 to 00/14:29:58

Plot file version 53 created 19-OCT-2017 15:36:02

J1504+1029 ES081C.UVDATA.1

Freq = 4.7990 GHz, Bw = 32.000 MH No calibration applied and no bandpass applied

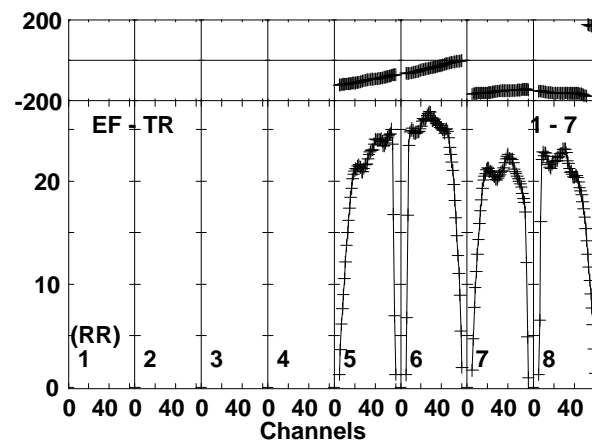
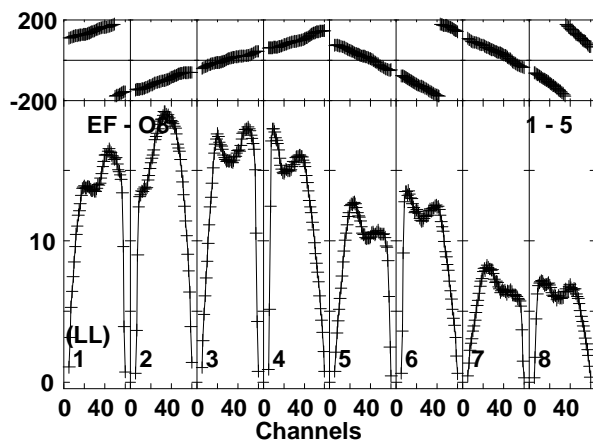
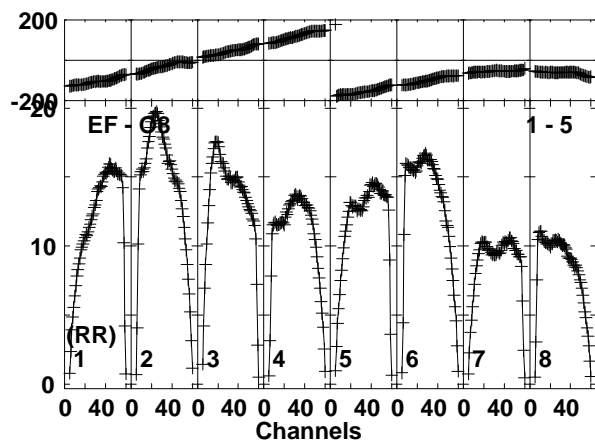
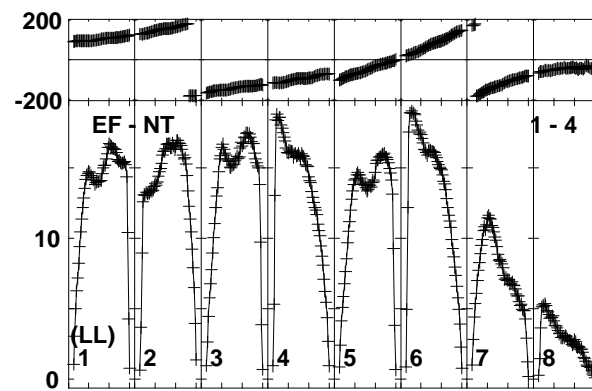
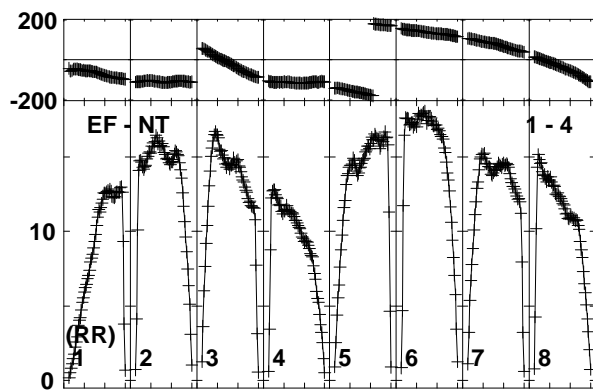
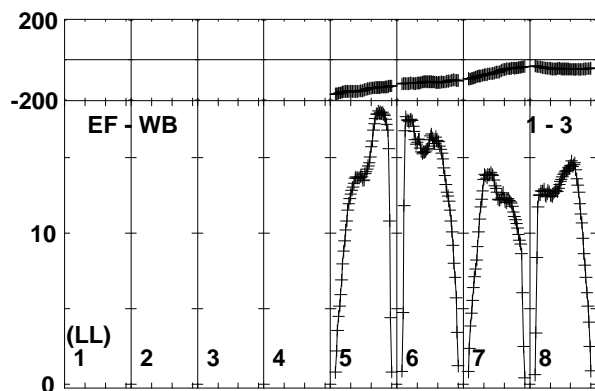
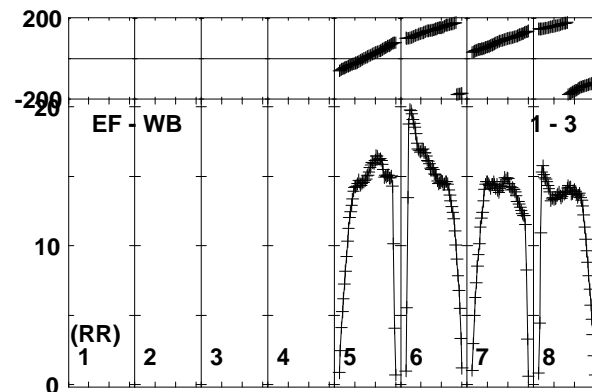
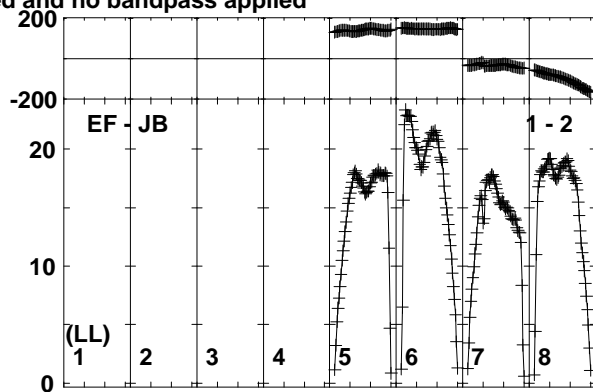
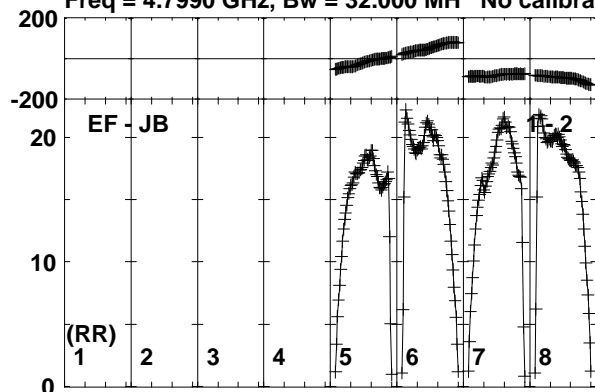

Lower frame: Milli Ampl Jy Top frame: Phas deg
Vector averaged cross-power spectrum Baseline: EF (01) - JB (02)
Timerange: 00/14:30:32 to 00/14:31:28

Plot file version 54 created 19-OCT-2017 15:36:02

J1504+1029 ES081C.UVDATA.1

Freq = 4.7990 GHz, Bw = 32.000 MH No calibration applied and no bandpass applied

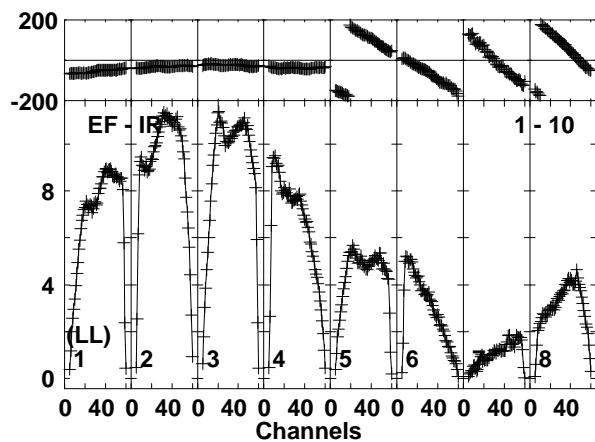
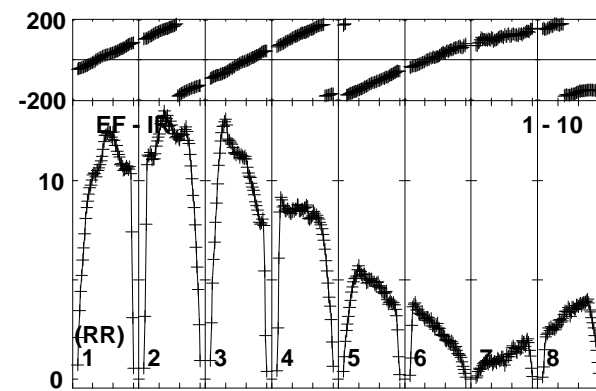
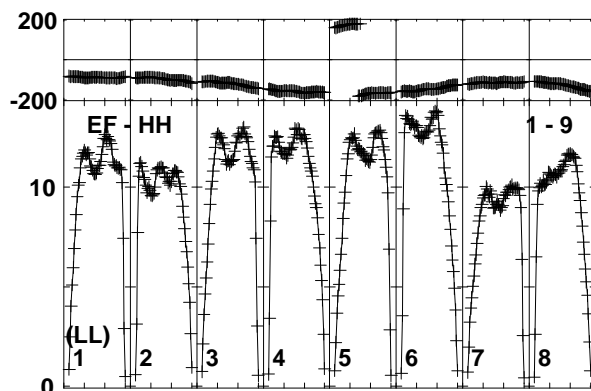
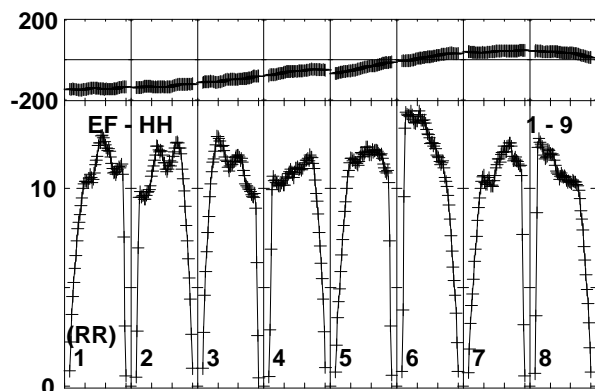
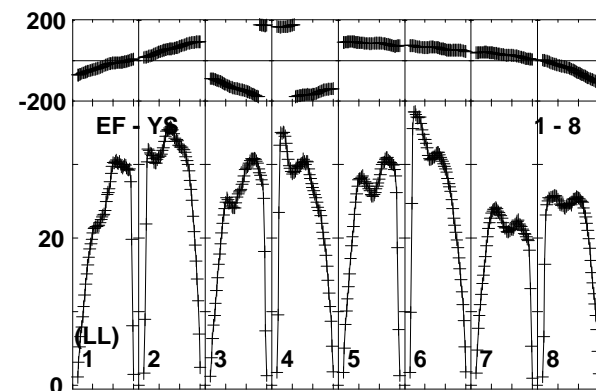
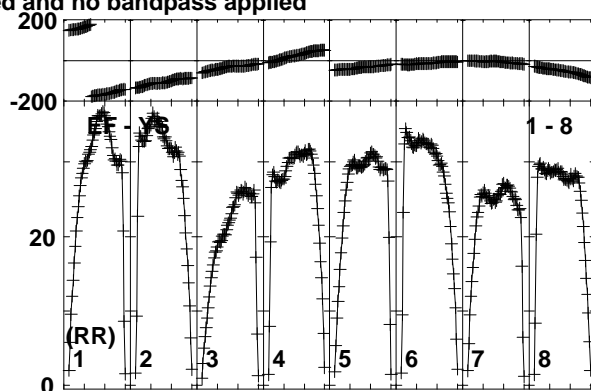
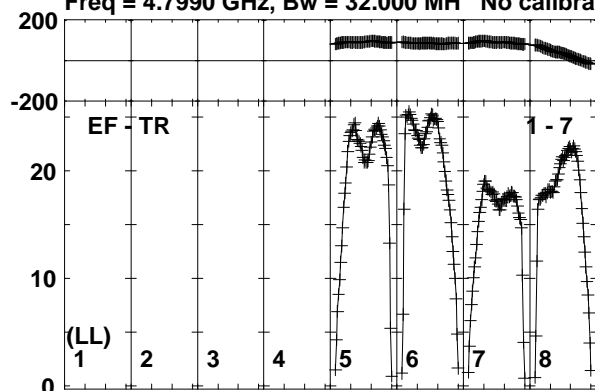

Lower frame: Milli Ampl Jy Top frame: Phas deg
Vector averaged cross-power spectrum Baseline: EF (01) - TR (07)
Timerange: 00/14:30:32 to 00/14:31:28

Plot file version 55 created 19-OCT-2017 15:36:02

MRK841 ES081C.UVDATA.1

Freq = 4.7990 GHz, Bw = 32.000 MH No calibration applied and no bandpass applied

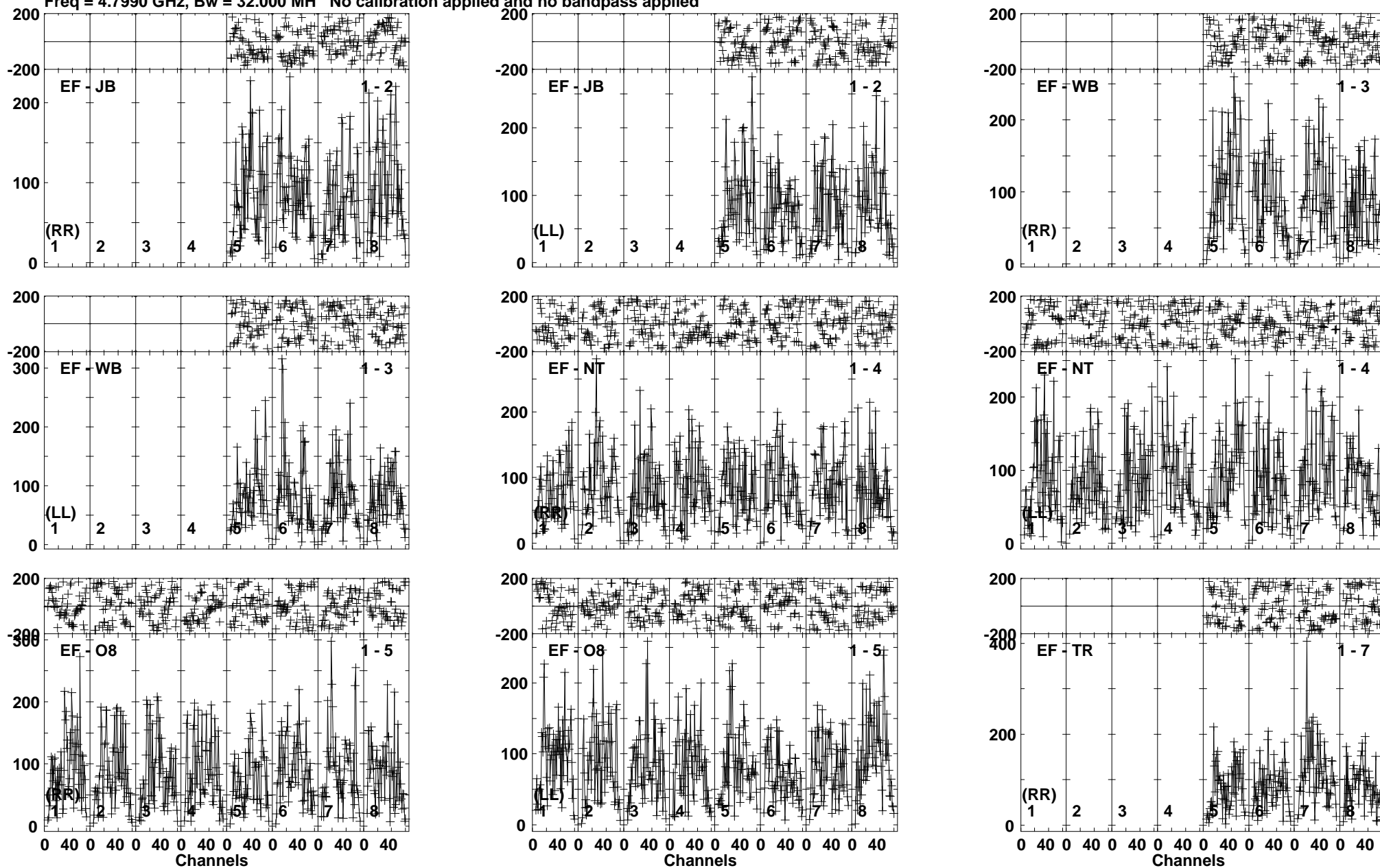

Lower frame: Micro Ampl Jy Top frame: Phas deg
Vector averaged cross-power spectrum Baseline: EF (01) - JB (02)
Timerange: 00/14:31:32 to 00/14:34:58

Plot file version 56 created 19-OCT-2017 15:36:02

MRK841 ES081C.UVDATA.1

Freq = 4.7990 GHz, Bw = 32.000 MH No calibration applied and no bandpass applied

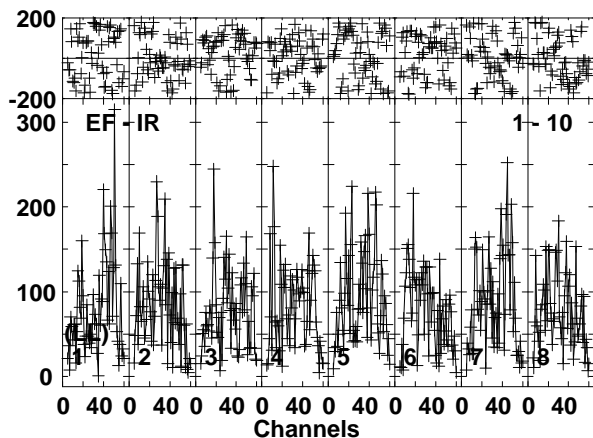
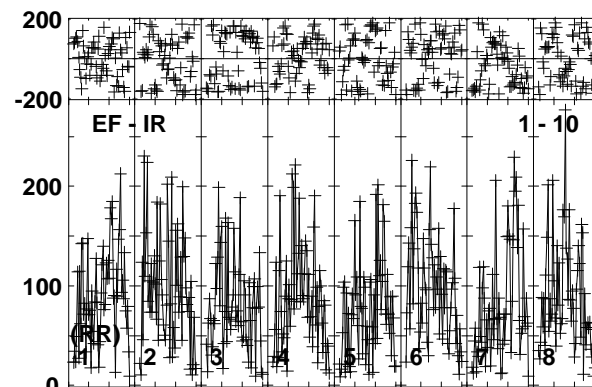
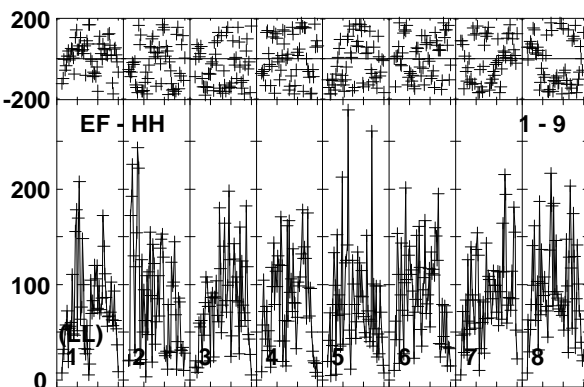
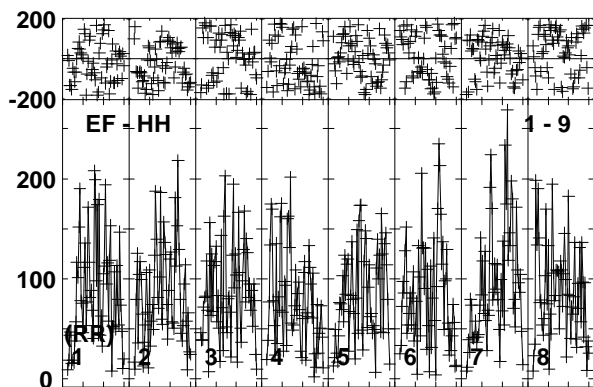
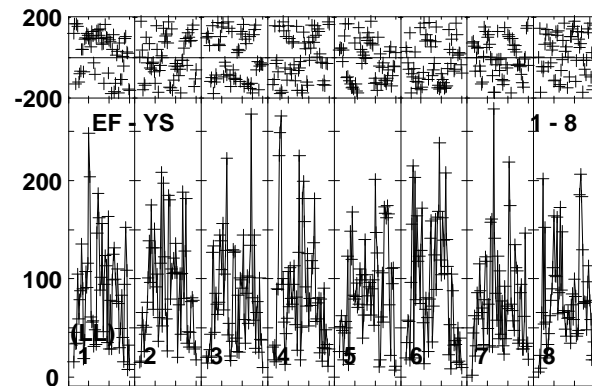
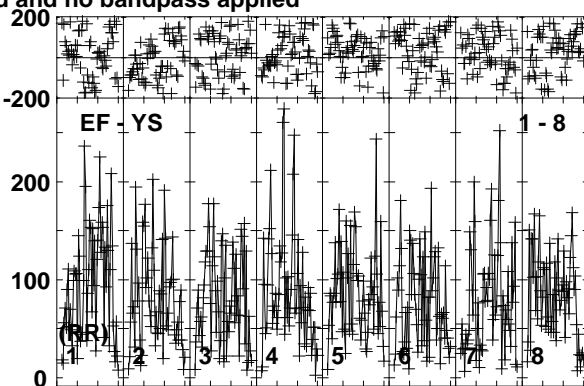
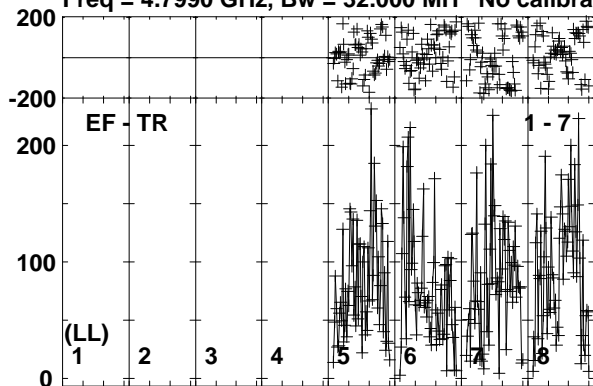

Lower frame: Micro Ampl Jy Top frame: Phas deg
Vector averaged cross-power spectrum Baseline: EF (01) - TR (07)
Timerange: 00/14:31:32 to 00/14:34:58

Plot file version 57 created 19-OCT-2017 15:36:02

J1504+1029 ES081C.UVDATA.1

Freq = 4.7990 GHz, Bw = 32.000 MH No calibration applied and no bandpass applied

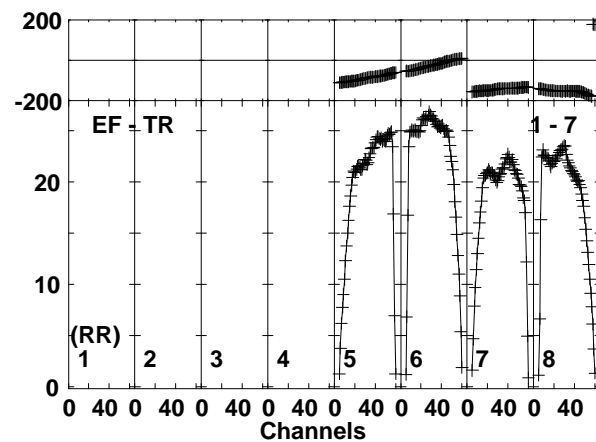
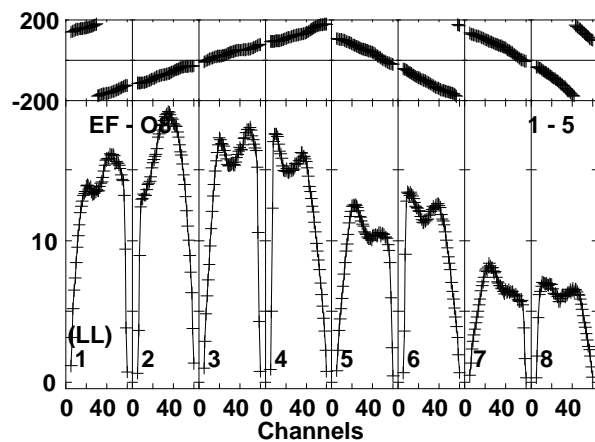
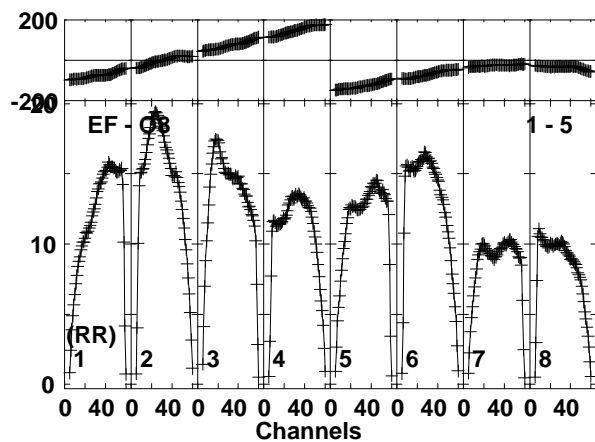
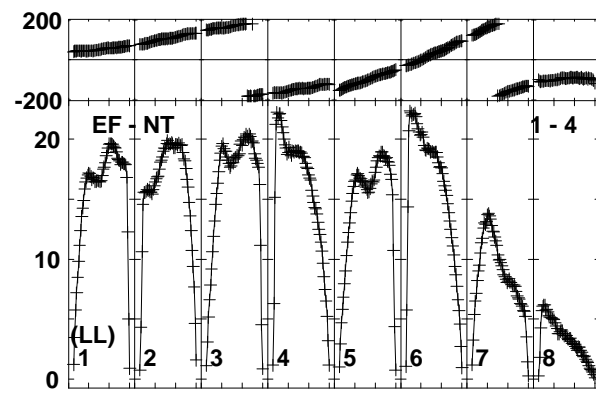
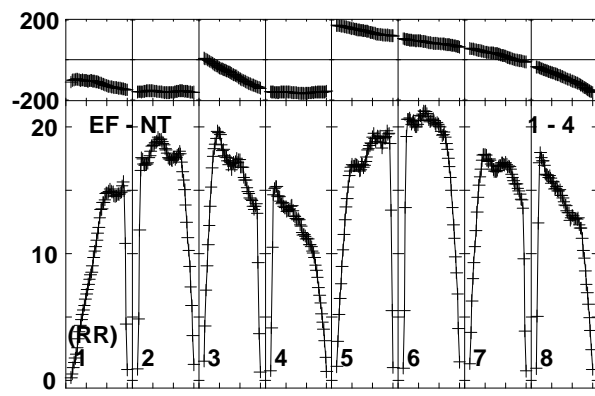
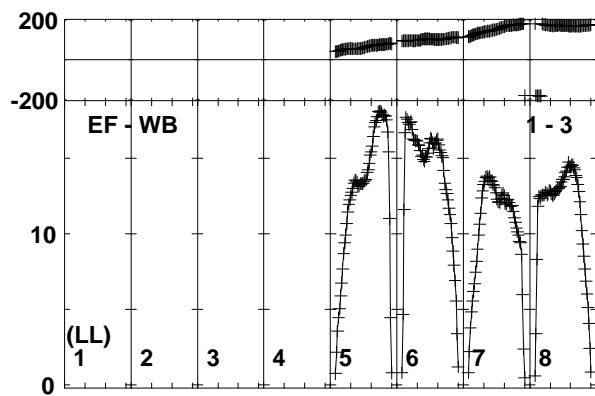
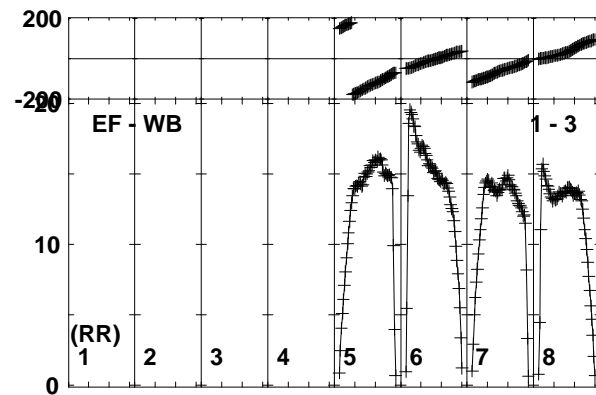
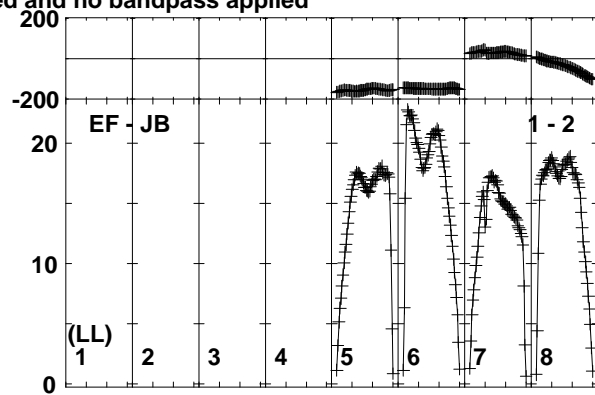
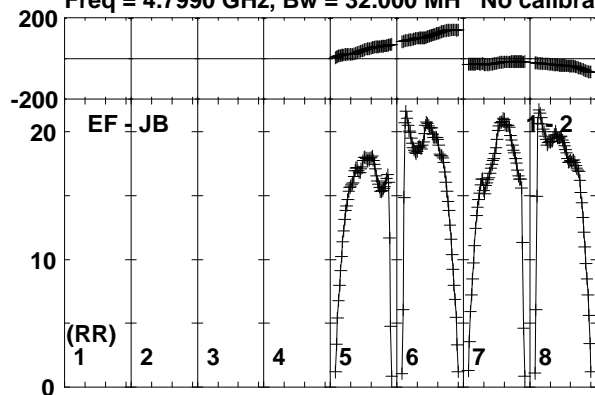

Lower frame: Milli Ampl Jy Top frame: Phas deg
Vector averaged cross-power spectrum Baseline: EF (01) - JB (02)
Timerange: 00/14:35:02 to 00/14:36:28

Plot file version 58 created 19-OCT-2017 15:36:02

J1504+1029 ES081C.UVDATA.1

Freq = 4.7990 GHz, Bw = 32.000 MH No calibration applied and no bandpass applied

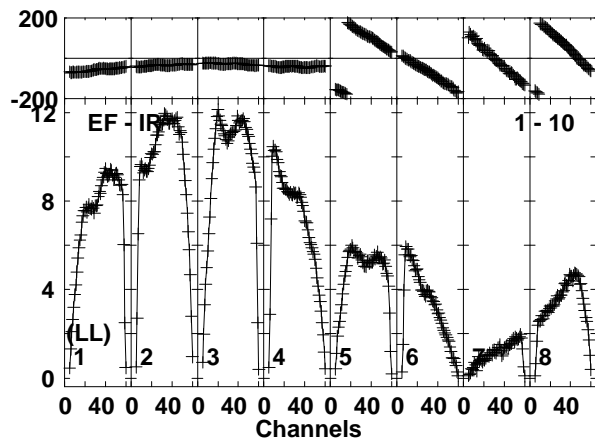
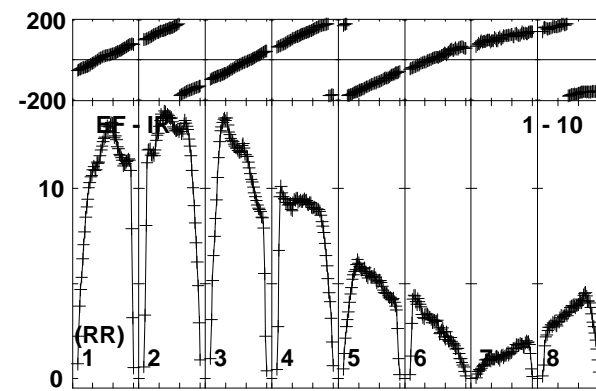
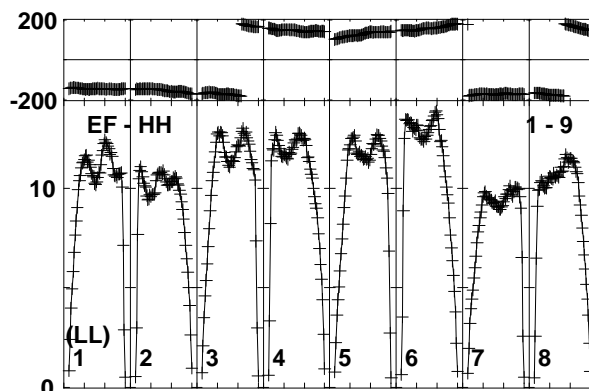
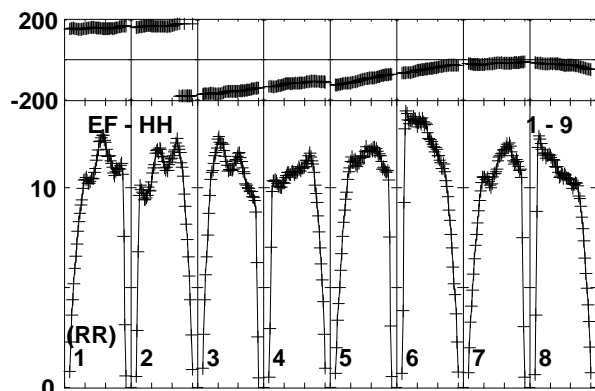
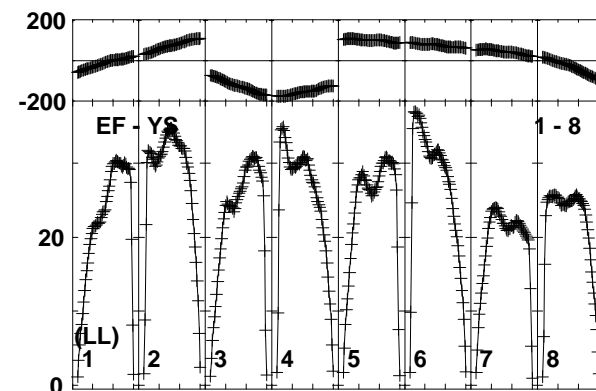
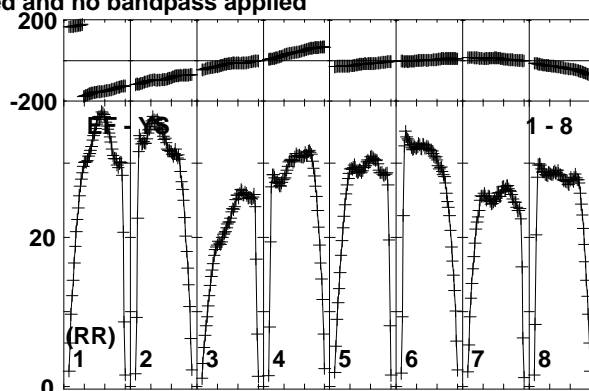
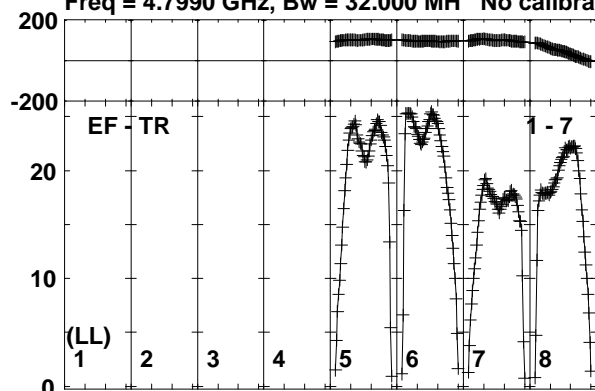

Lower frame: Milli Ampl Jy Top frame: Phas deg
Vector averaged cross-power spectrum Baseline: EF (01) - TR (07)
Timerange: 00/14:35:02 to 00/14:36:28

Plot file version 59 created 19-OCT-2017 15:36:02

MRK841 ES081C.UVDATA.1

Freq = 4.7990 GHz, Bw = 32.000 MH No calibration applied and no bandpass applied

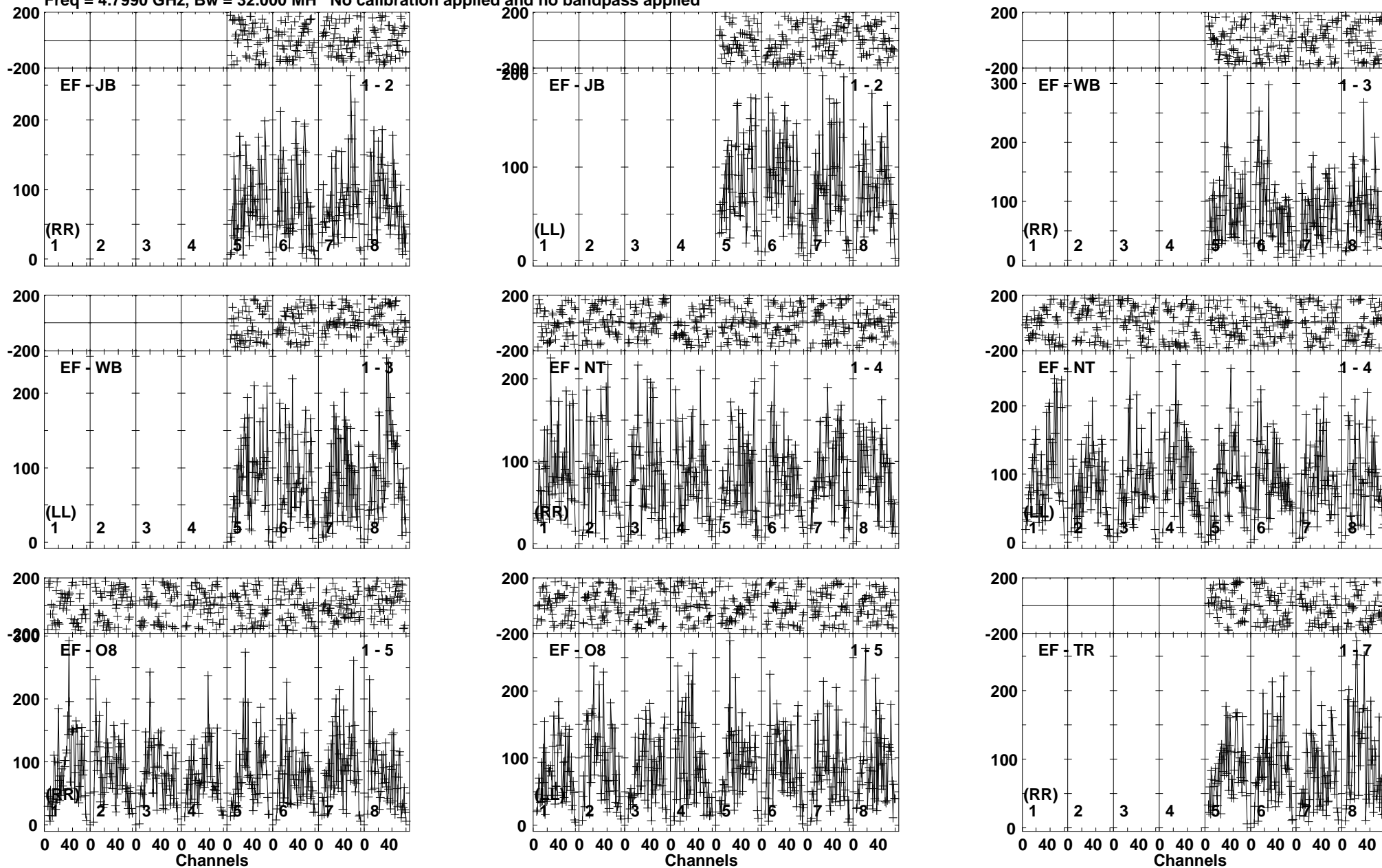

Lower frame: Micro Ampl Jy Top frame: Phas deg
Vector averaged cross-power spectrum Baseline: EF (01) - JB (02)
Timerange: 00/14:36:32 to 00/14:39:58

Plot file version 60 created 19-OCT-2017 15:36:02

MRK841 ES081C.UVDATA.1

Freq = 4.7990 GHz, Bw = 32.000 MH No calibration applied and no bandpass applied

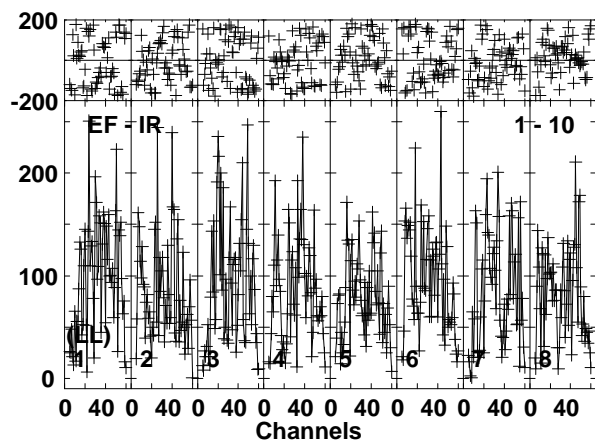
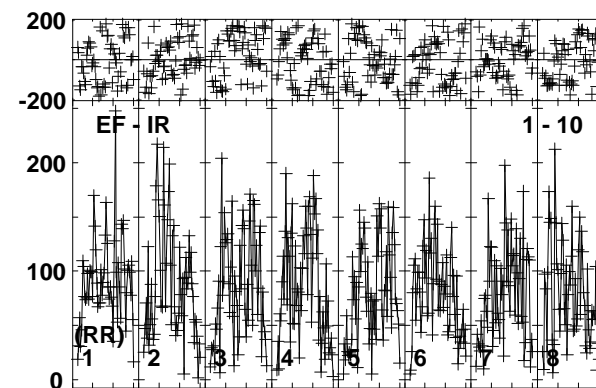
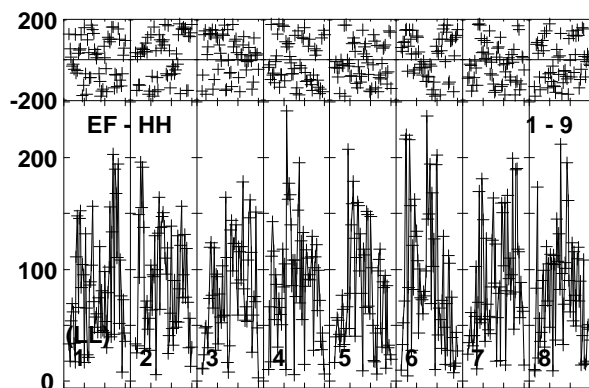
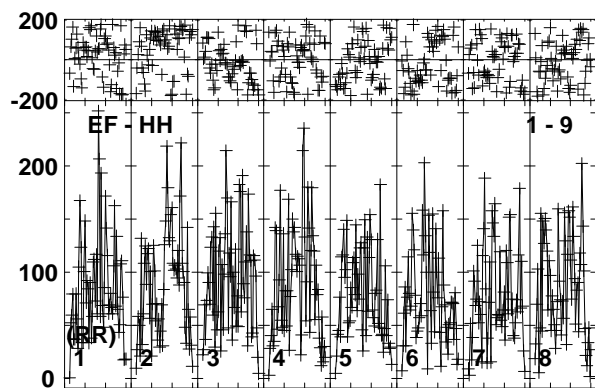
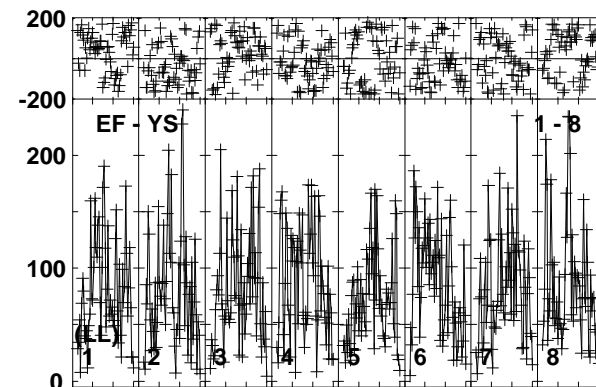
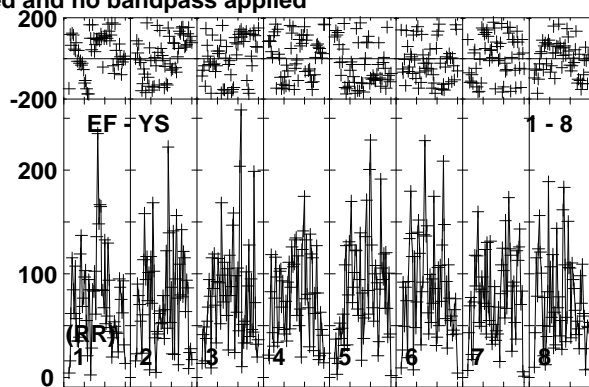
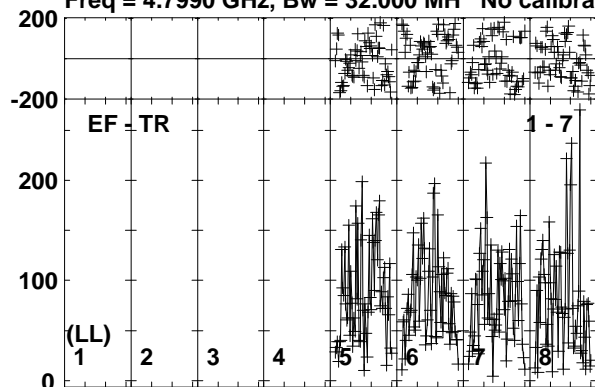

Lower frame: Micro Ampl Jy Top frame: Phas deg
Vector averaged cross-power spectrum Baseline: EF (01) - TR (07)
Timerange: 00/14:36:32 to 00/14:39:58

Plot file version 61 created 19-OCT-2017 15:36:03

J1504+1029 ES081C.UVDATA.1

Freq = 4.7990 GHz, Bw = 32.000 MH No calibration applied and no bandpass applied

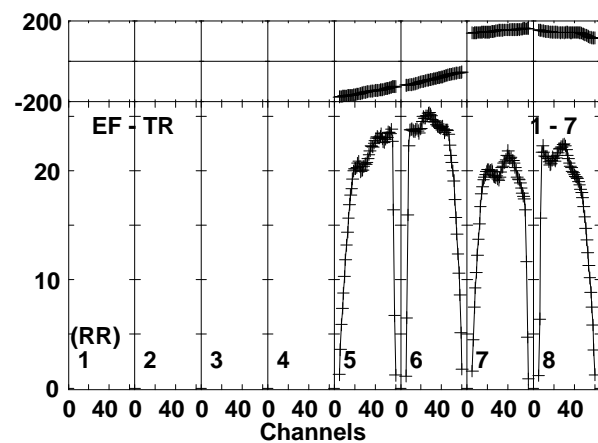
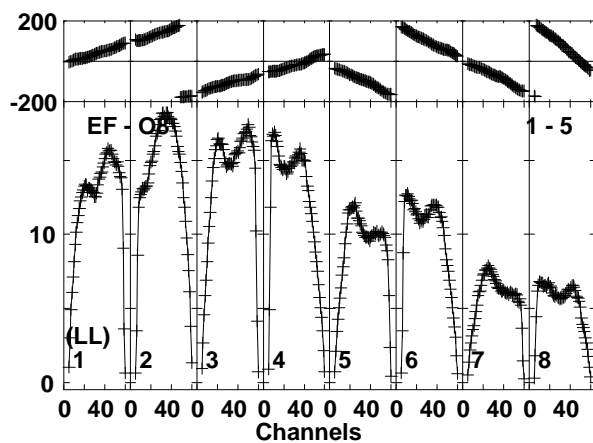
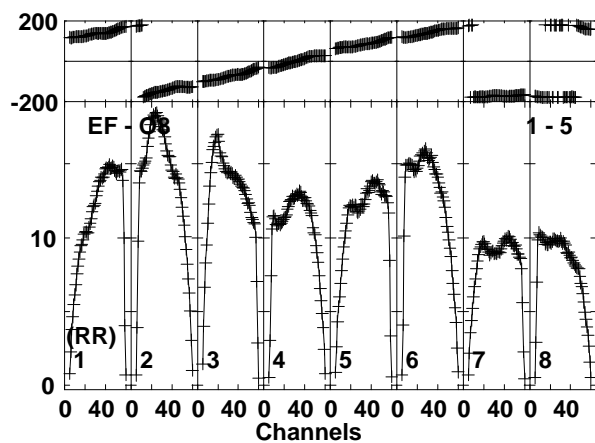
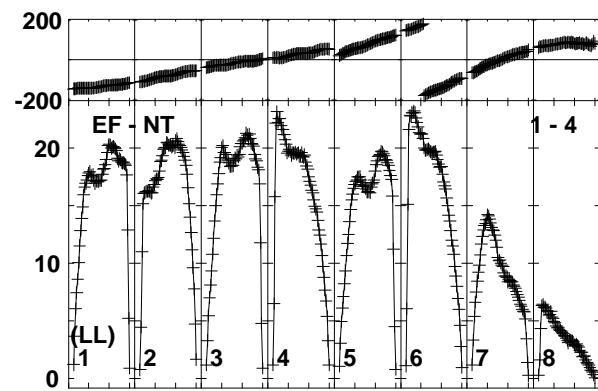
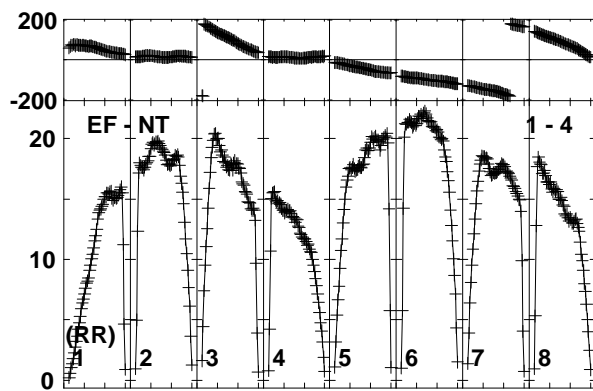
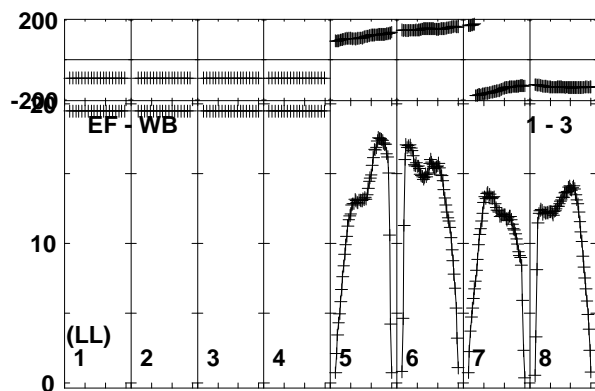
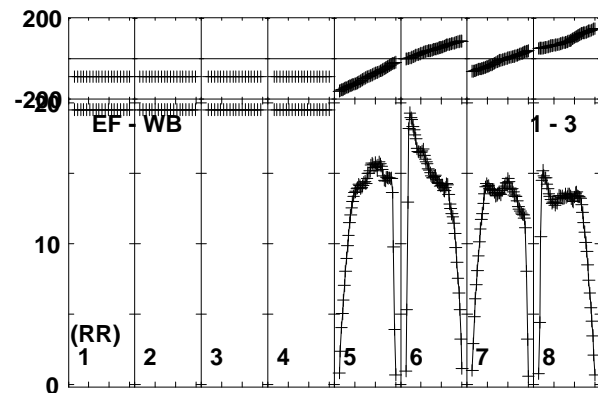
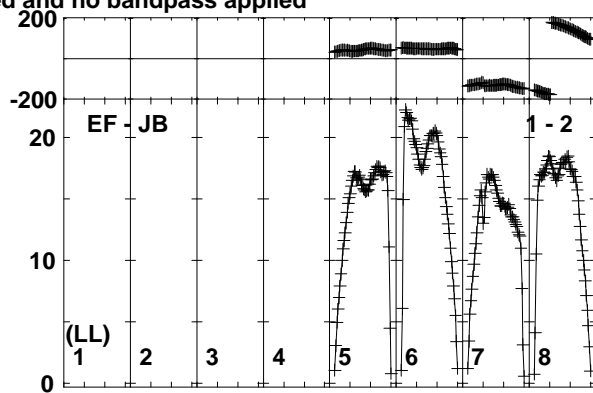
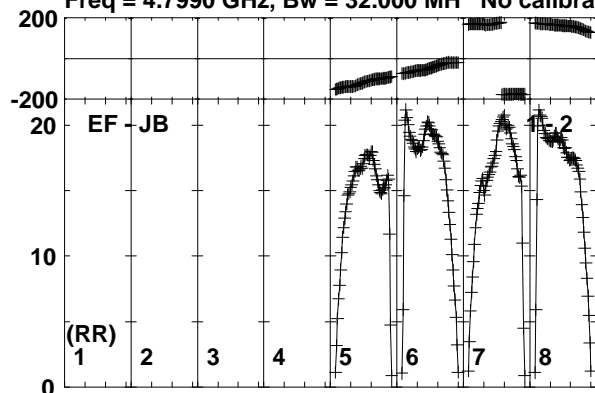

Lower frame: Milli Ampl Jy Top frame: Phas deg
Vector averaged cross-power spectrum Baseline: EF (01) - JB (02)
Timerange: 00/14:40:32 to 00/14:41:28

Plot file version 62 created 19-OCT-2017 15:36:03

J1504+1029 ES081C.UVDATA.1

Freq = 4.7990 GHz, Bw = 32.000 MH No calibration applied and no bandpass applied

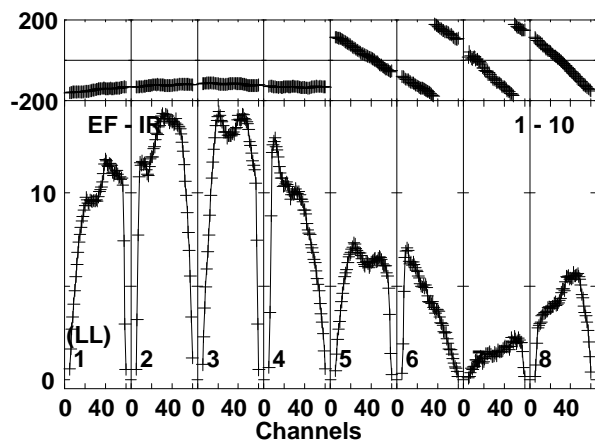
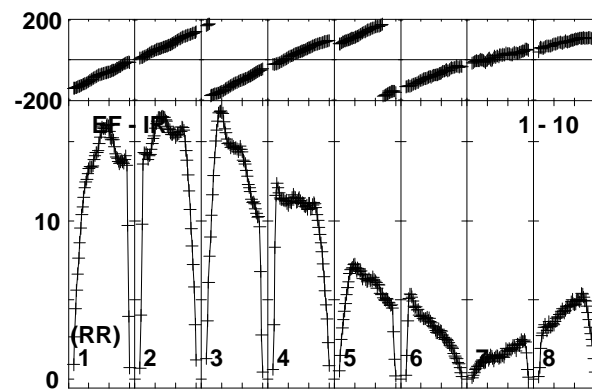
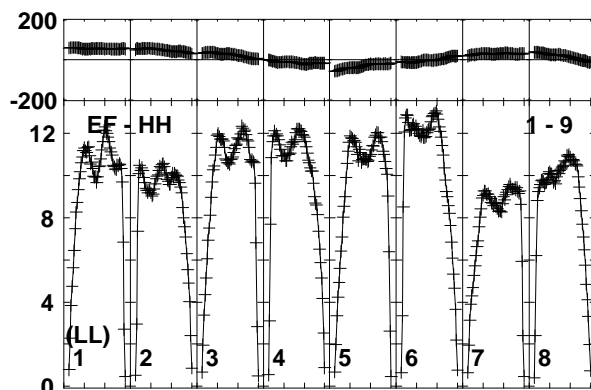
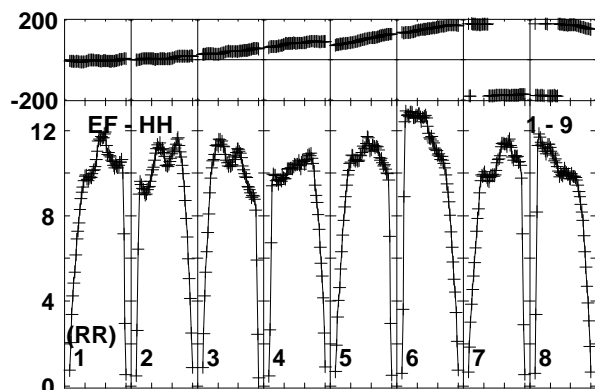
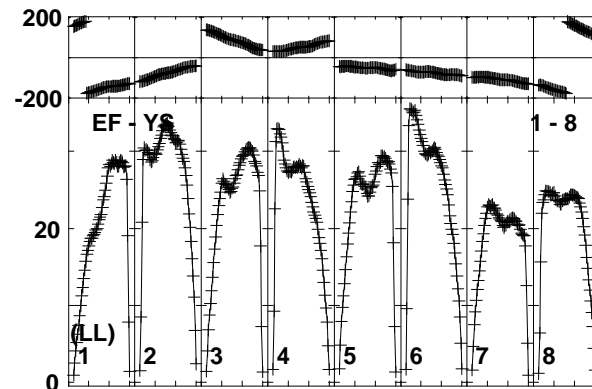
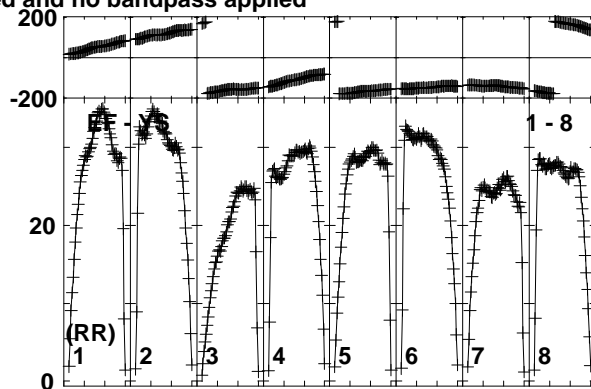
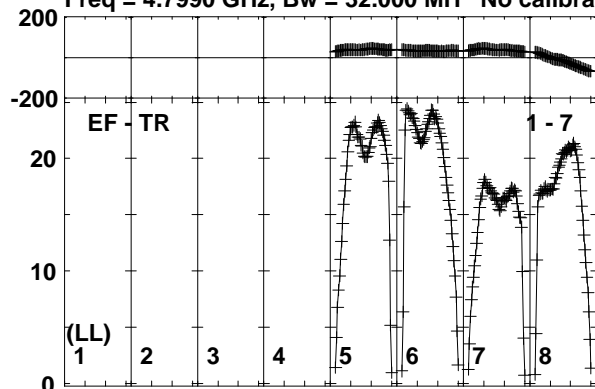

Lower frame: Milli Ampl Jy Top frame: Phas deg
Vector averaged cross-power spectrum Baseline: EF (01) - TR (07)
Timerange: 00/14:40:32 to 00/14:41:28

Plot file version 63 created 19-OCT-2017 15:36:03

MRK841 ES081C.UVDATA.1

Freq = 4.7990 GHz, Bw = 32.000 MH No calibration applied and no bandpass applied

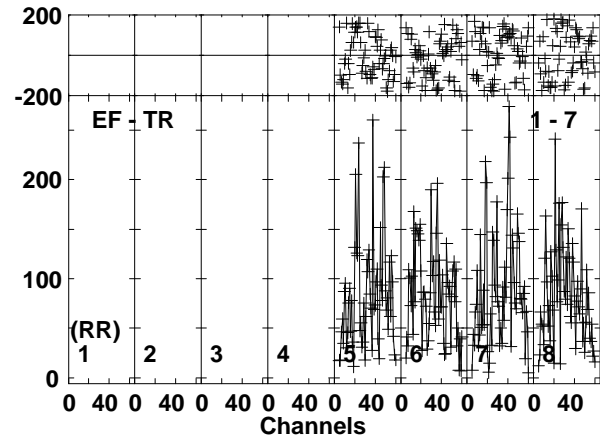
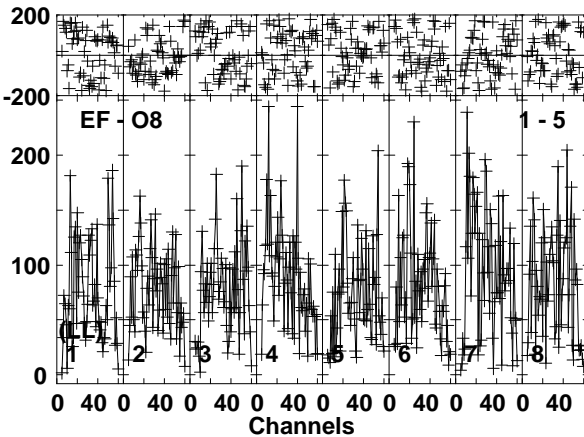
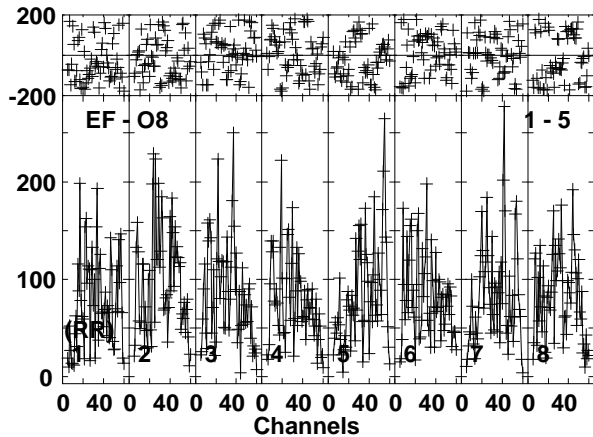
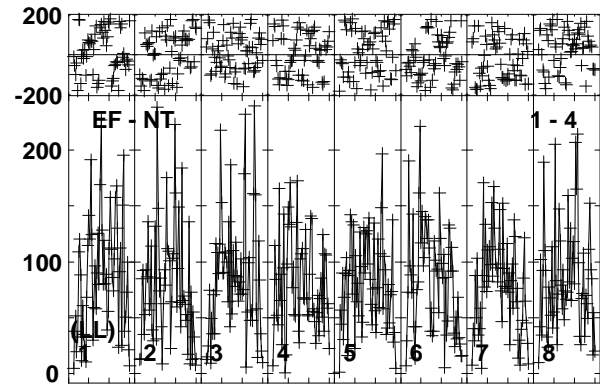
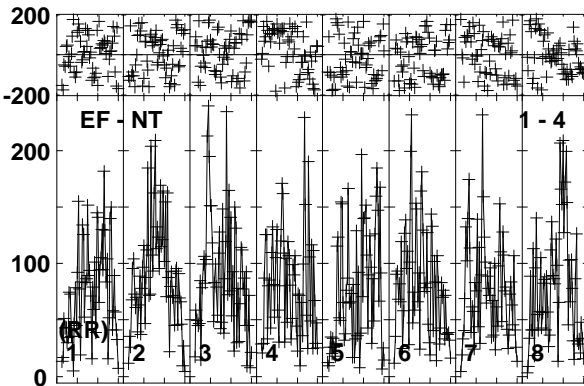
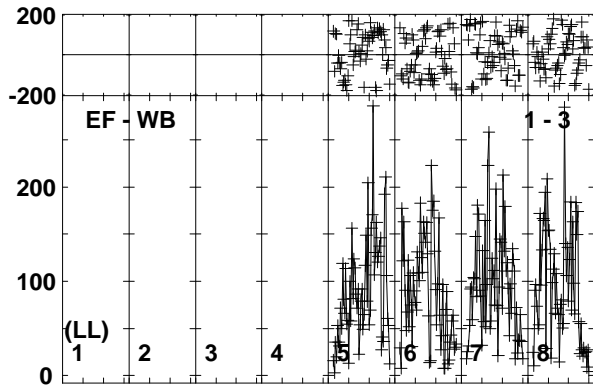
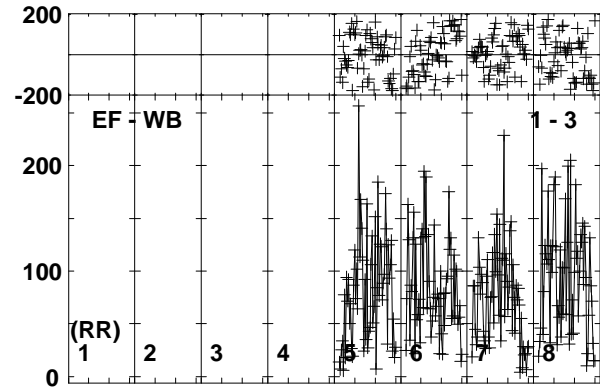
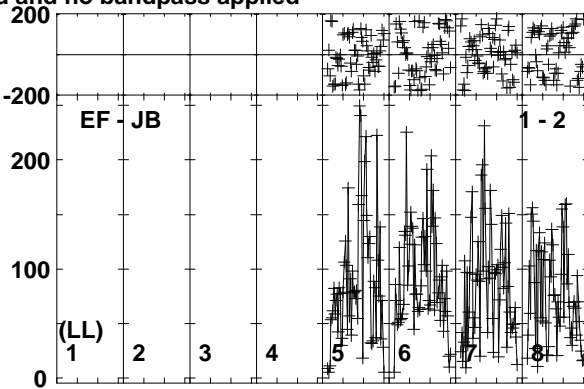
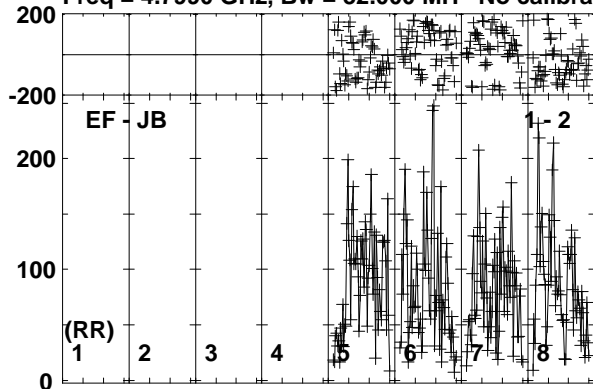

Lower frame: Micro Ampl Jy Top frame: Phas deg
Vector averaged cross-power spectrum Baseline: EF (01) - JB (02)
Timerange: 00/14:41:32 to 00/14:44:58

Plot file version 64 created 19-OCT-2017 15:36:03

MRK841 ES081C.UVDATA.1

Freq = 4.7990 GHz, Bw = 32.000 MH No calibration applied and no bandpass applied

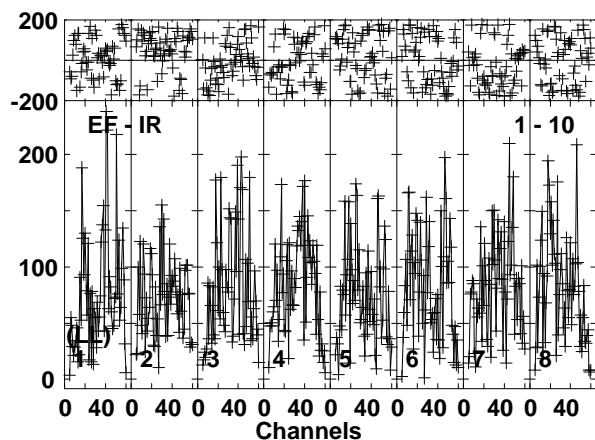
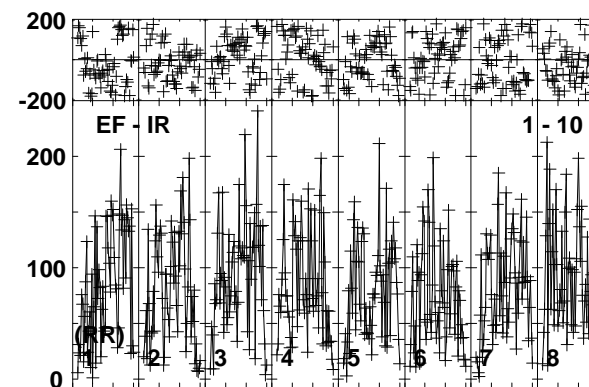
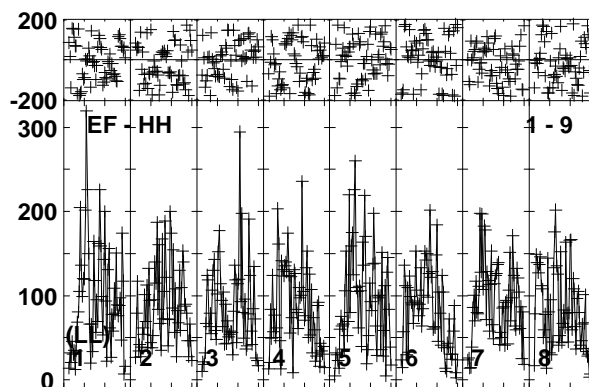
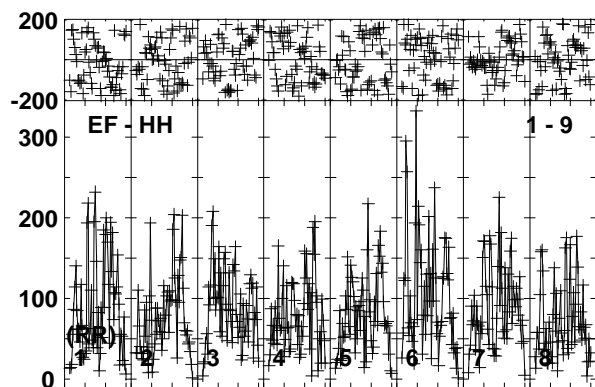
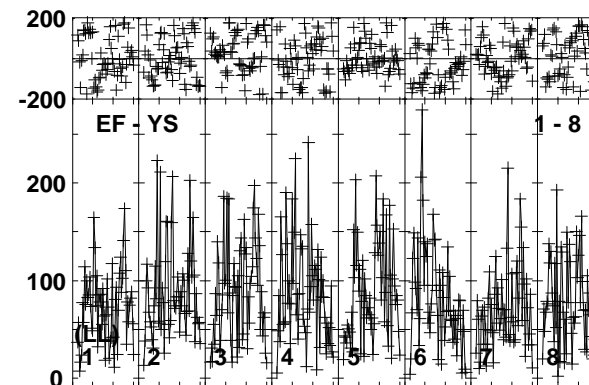
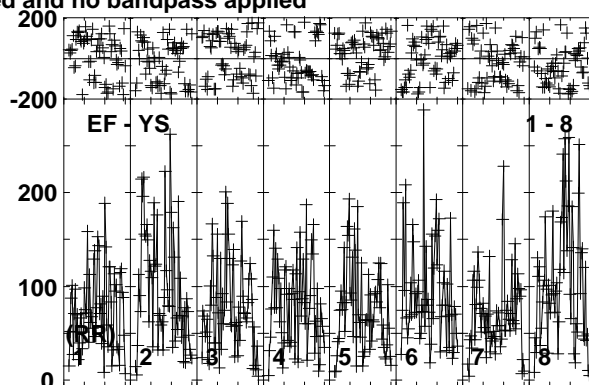
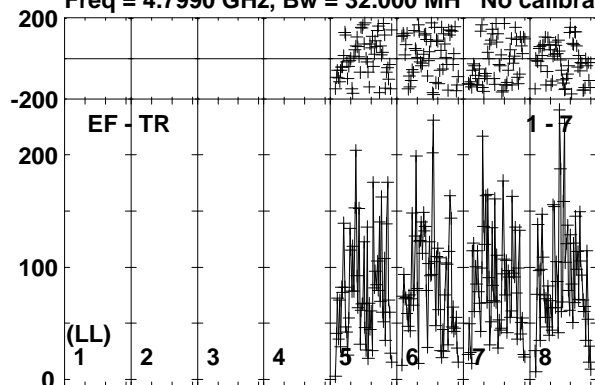

Lower frame: Micro Ampl Jy Top frame: Phas deg
Vector averaged cross-power spectrum Baseline: EF (01) - TR (07)
Timerange: 00/14:41:32 to 00/14:44:58

Plot file version 65 created 19-OCT-2017 15:36:03

J1504+1029 ES081C.UVDATA.1

Freq = 4.7990 GHz, Bw = 32.000 MH No calibration applied and no bandpass applied

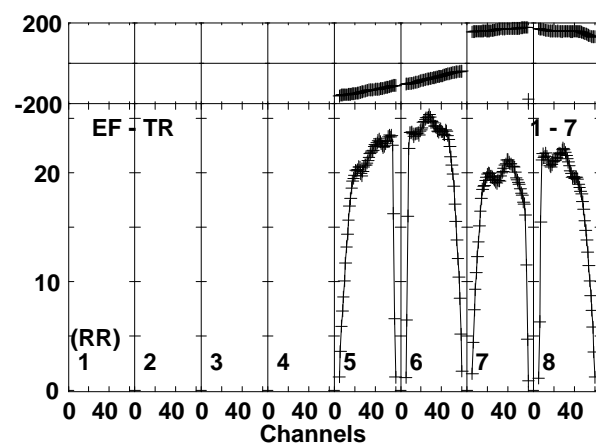
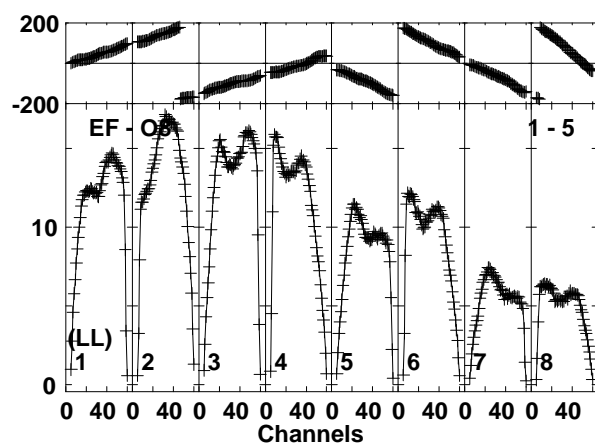
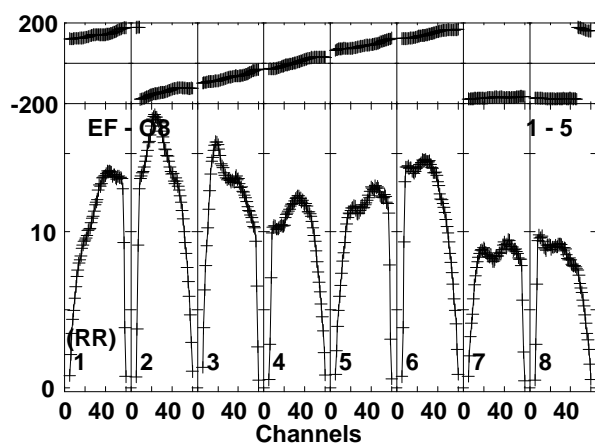
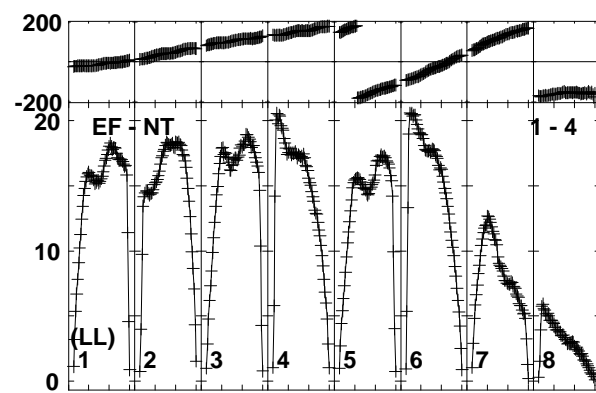
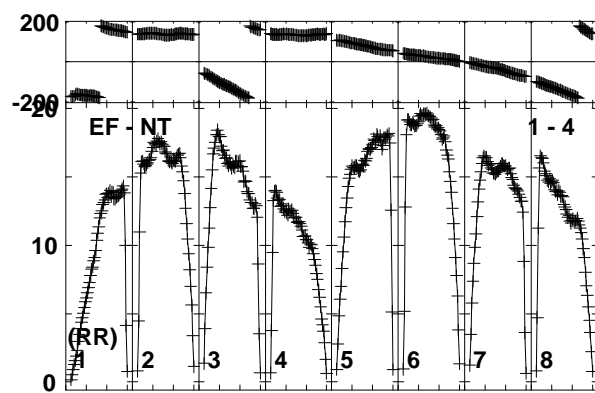
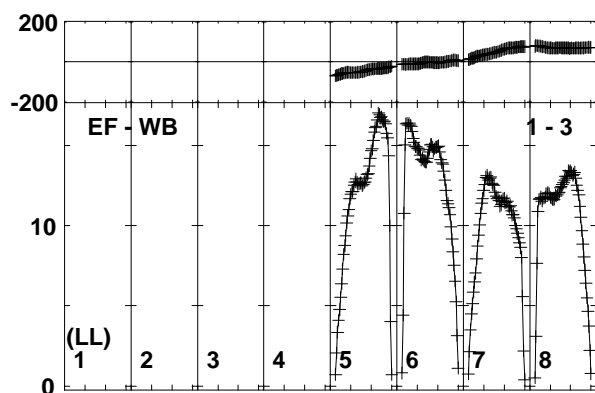
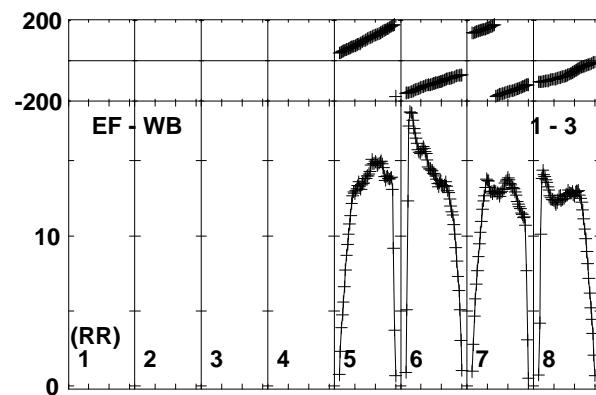
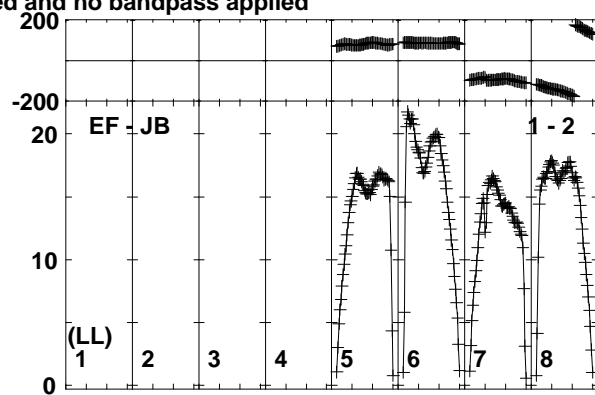
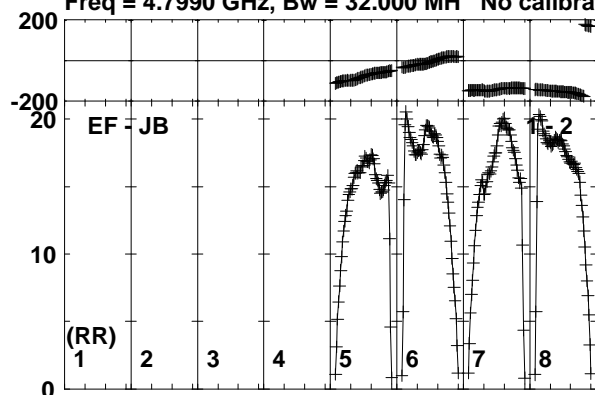

Lower frame: Milli Ampl Jy Top frame: Phas deg
Vector averaged cross-power spectrum Baseline: EF (01) - JB (02)
Timerange: 00/14:45:02 to 00/14:46:28

Plot file version 66 created 19-OCT-2017 15:36:03

J1504+1029 ES081C.UVDATA.1

Freq = 4.7990 GHz, Bw = 32.000 MH No calibration applied and no bandpass applied

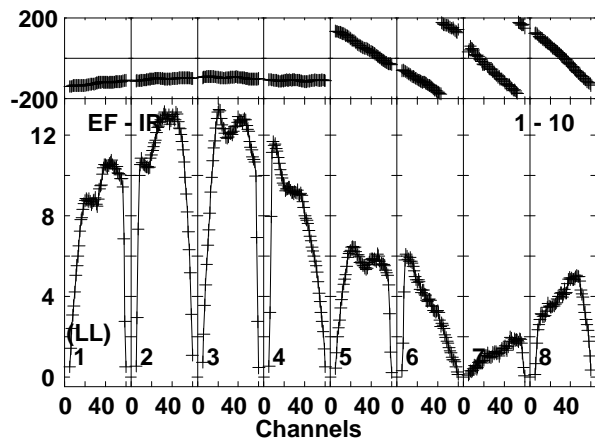
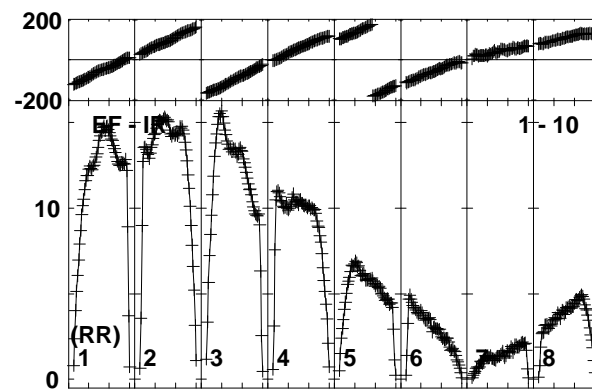
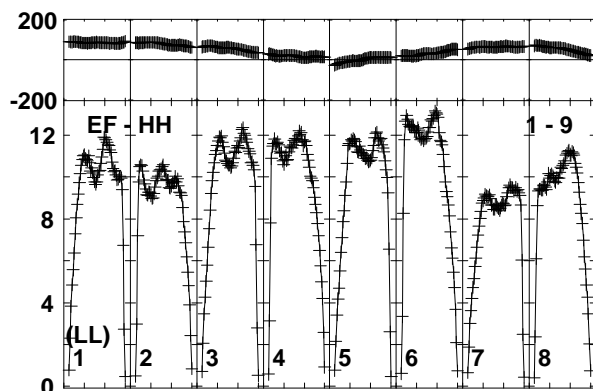
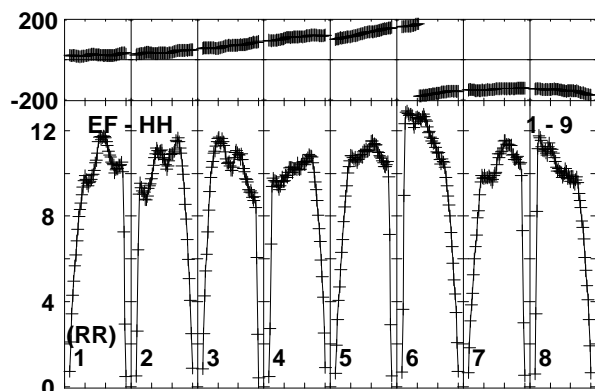
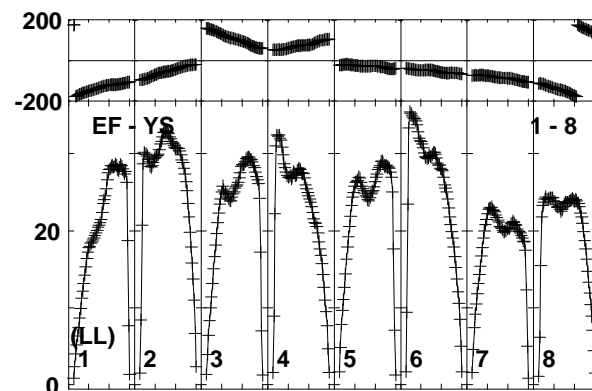
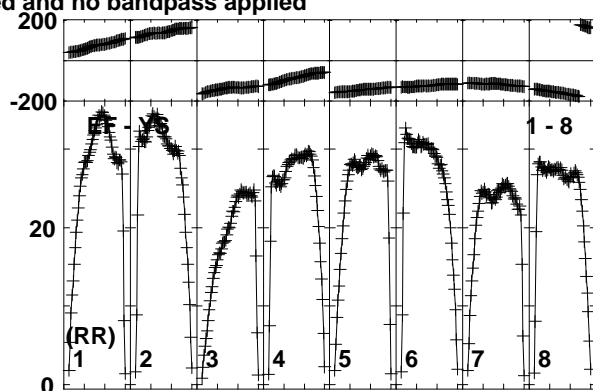
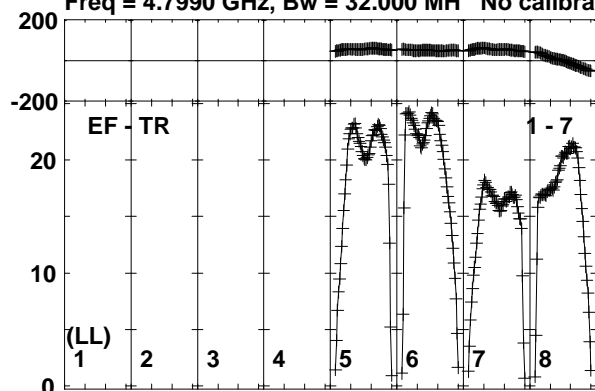

Lower frame: Milli Ampl Jy Top frame: Phas deg
Vector averaged cross-power spectrum Baseline: EF (01) - TR (07)
Timerange: 00/14:45:02 to 00/14:46:28

Plot file version 67 created 19-OCT-2017 15:36:03
 MRK841 ES081C.UVDATA.1
 Freq = 4.7990 GHz, Bw = 32.000 MH No calibration applied and no bandpass applied

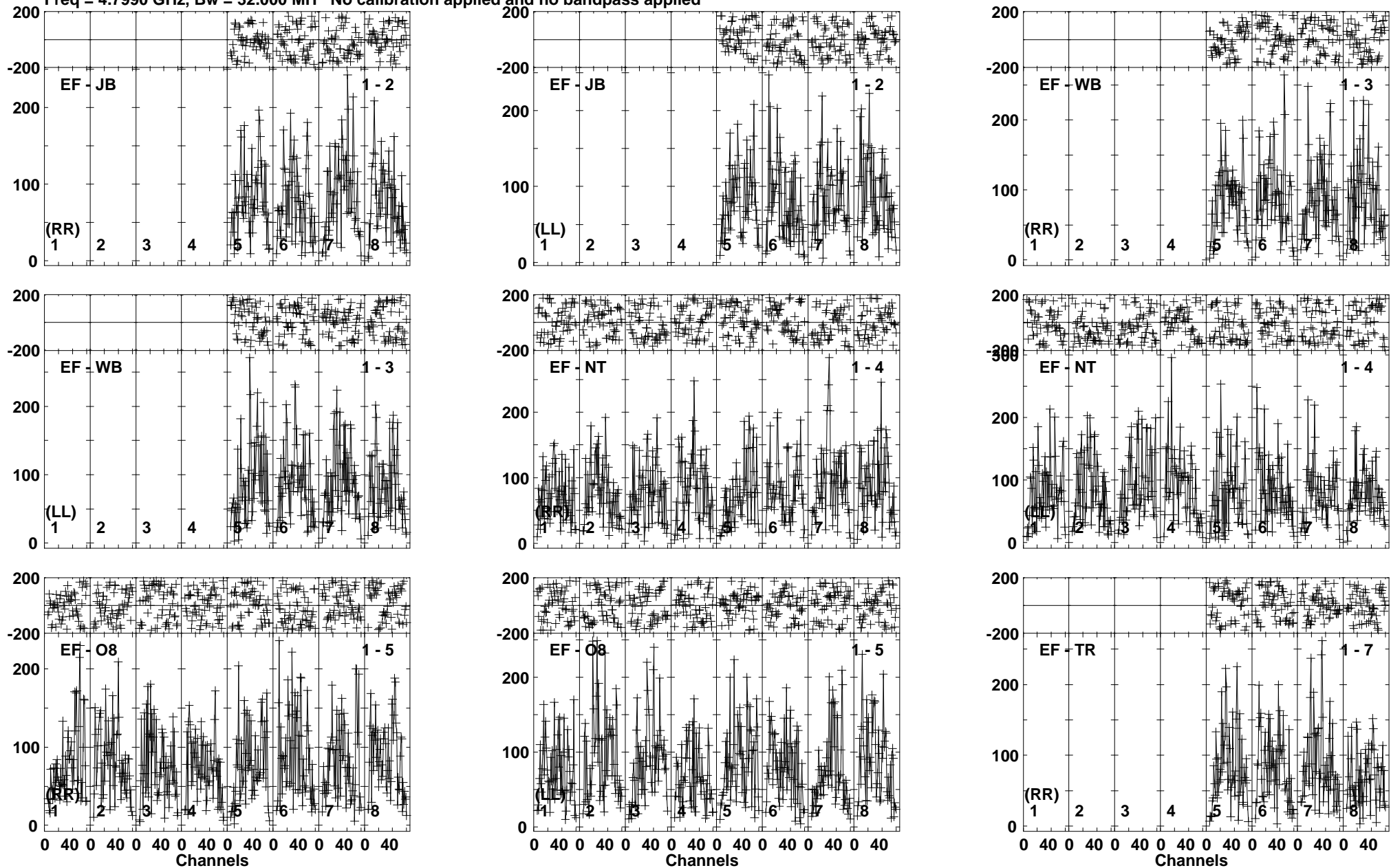

Lower frame: Micro Ampl Jy Top frame: Phas deg
 Vector averaged cross-power spectrum Baseline: EF (01) - JB (02)
 Timerange: 00/14:46:32 to 00/14:49:58

Plot file version 68 created 19-OCT-2017 15:36:03

MRK841 ES081C.UVDATA.1

Freq = 4.7990 GHz, Bw = 32.000 MH No calibration applied and no bandpass applied

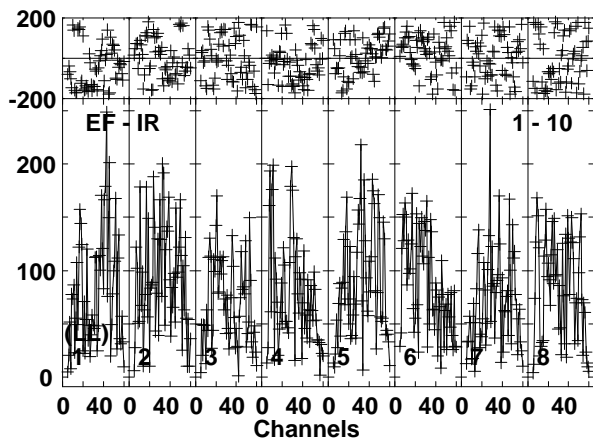
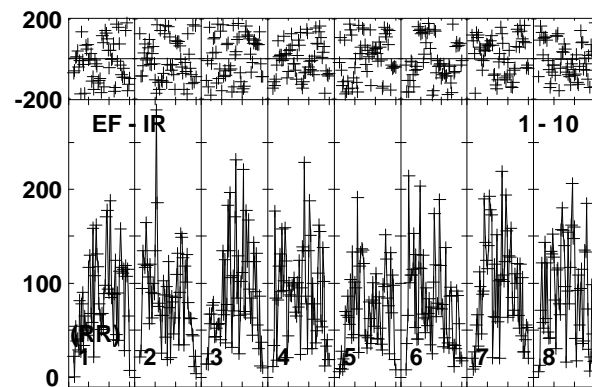
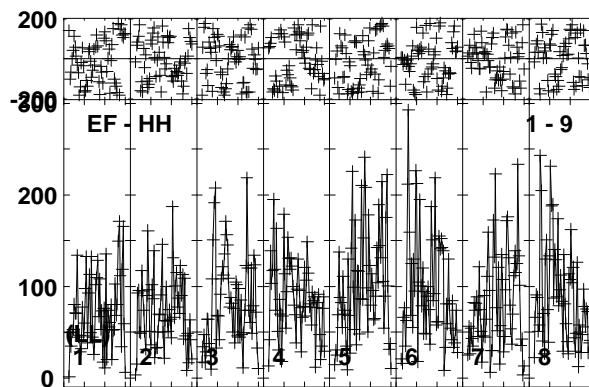
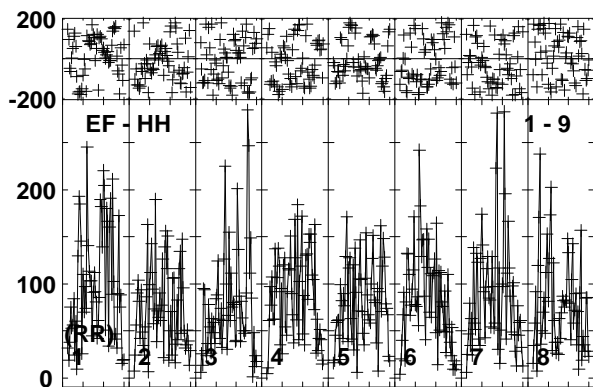
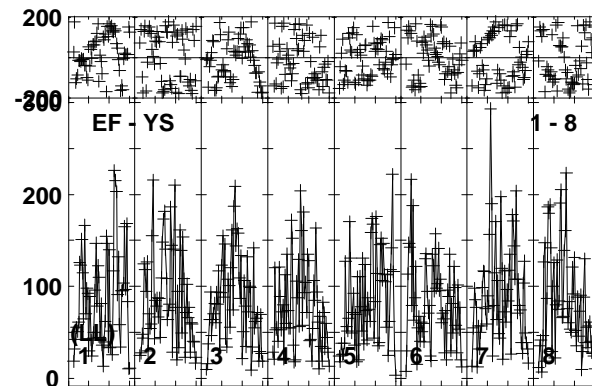
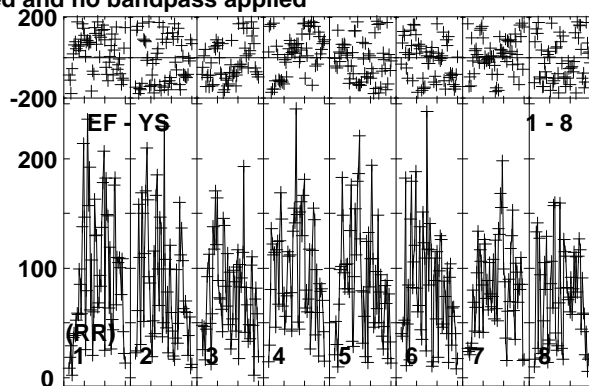
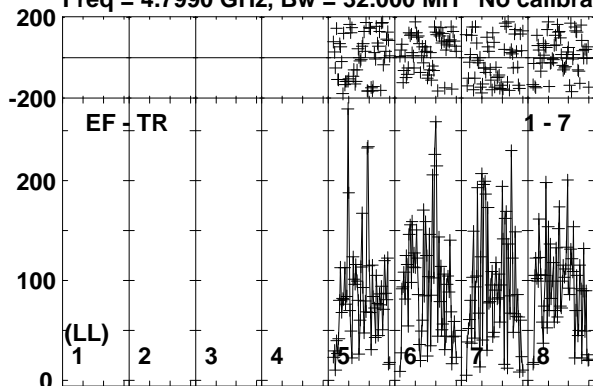

Lower frame: Micro Ampl Jy Top frame: Phas deg
Vector averaged cross-power spectrum Baseline: EF (01) - TR (07)
Timerange: 00/14:46:32 to 00/14:49:58

Plot file version 69 created 19-OCT-2017 15:36:04

J1504+1029 ES081C.UVDATA.1

Freq = 4.7990 GHz, Bw = 32.000 MH No calibration applied and no bandpass applied

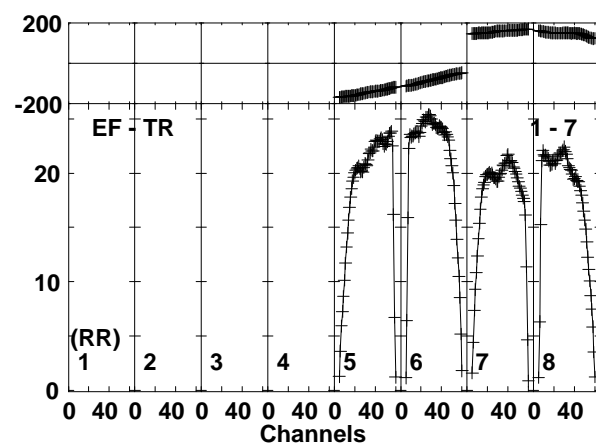
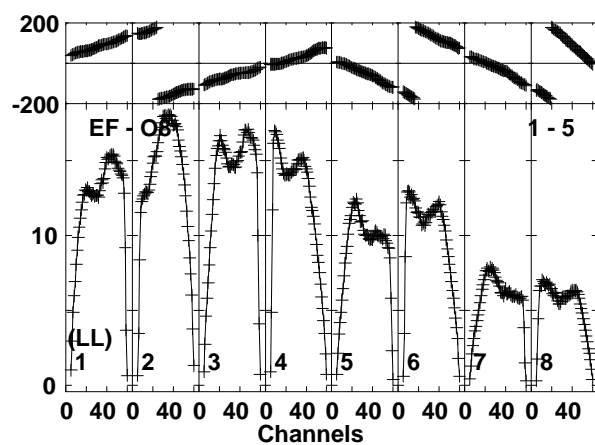
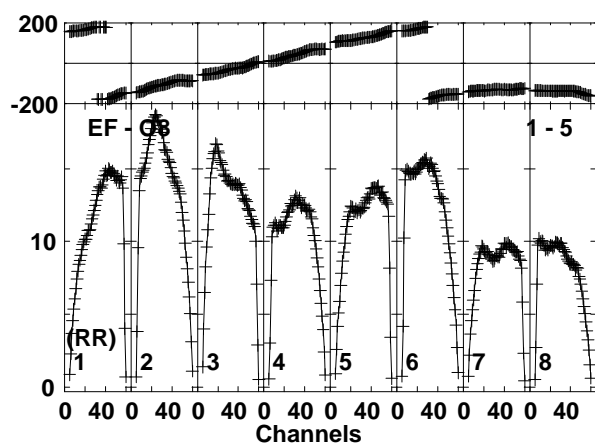
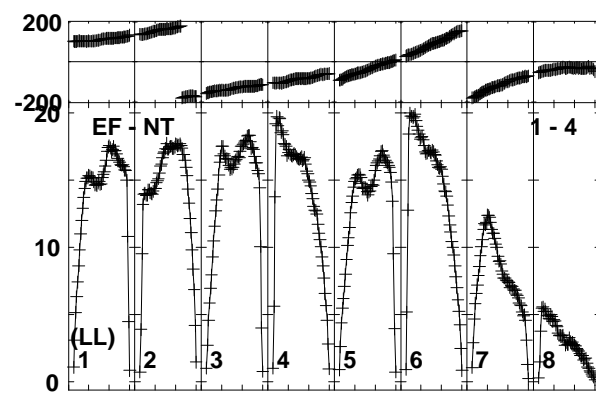
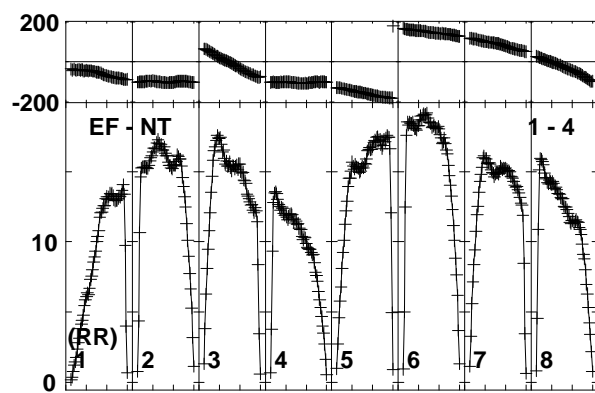
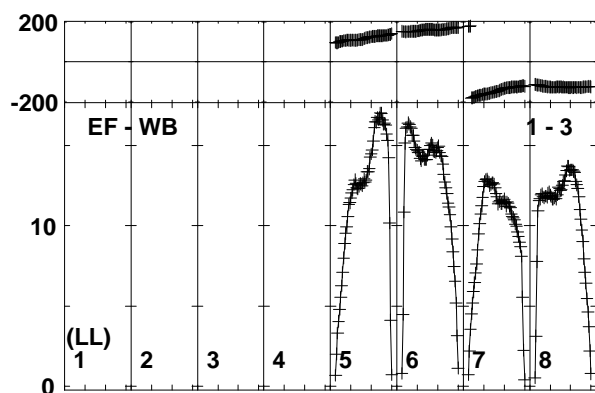
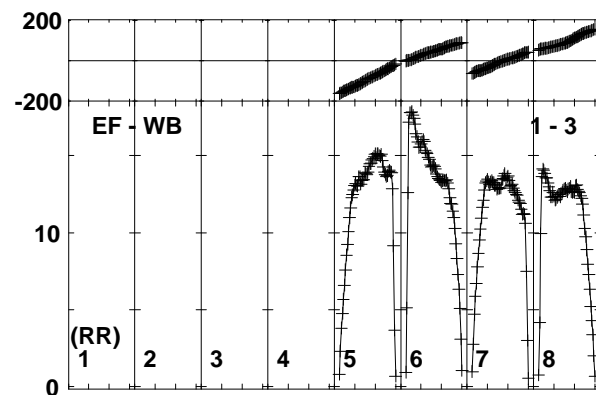
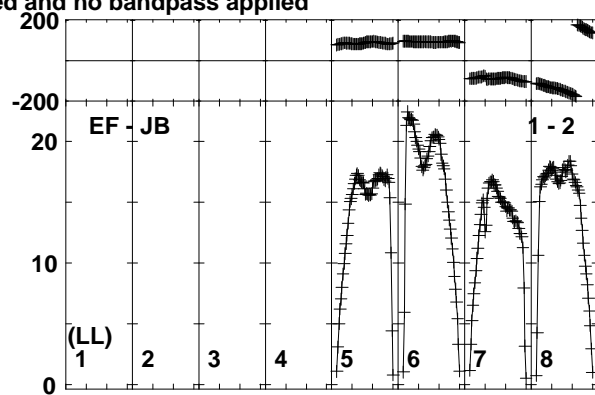
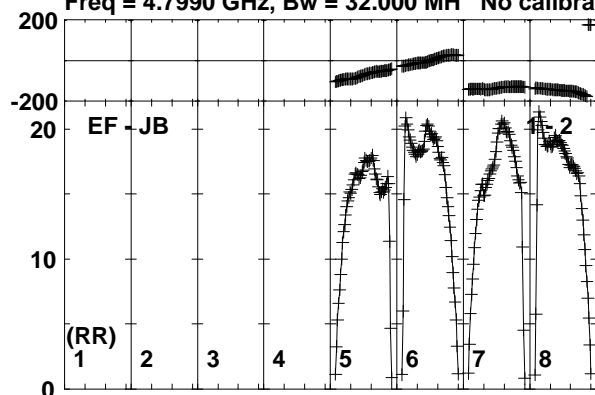

Lower frame: Milli Ampl Jy Top frame: Phas deg
Vector averaged cross-power spectrum Baseline: EF (01) - JB (02)
Timerange: 00/14:50:32 to 00/14:51:28

Plot file version 70 created 19-OCT-2017 15:36:04

J1504+1029 ES081C.UVDATA.1

Freq = 4.7990 GHz, Bw = 32.000 MH No calibration applied and no bandpass applied

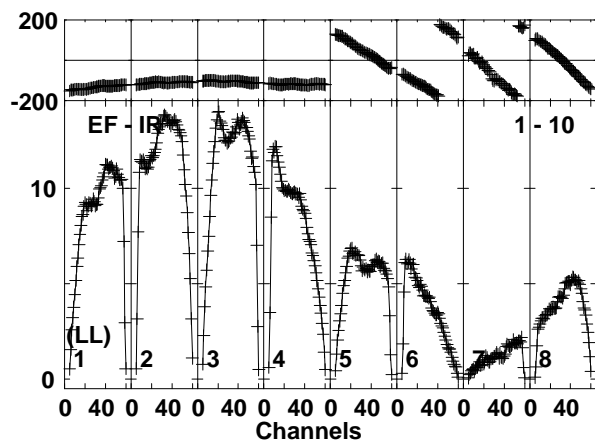
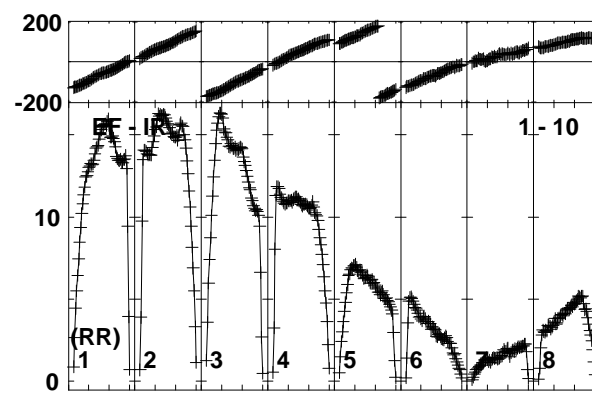
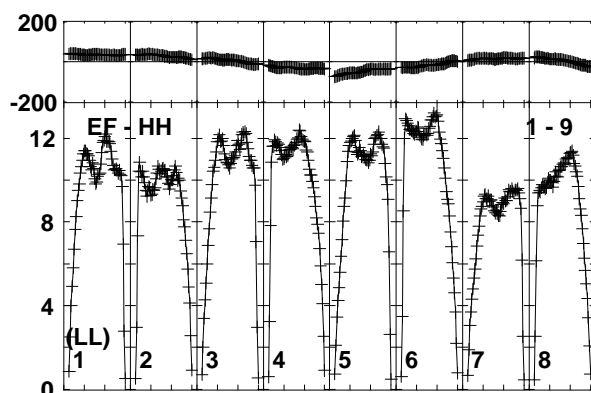
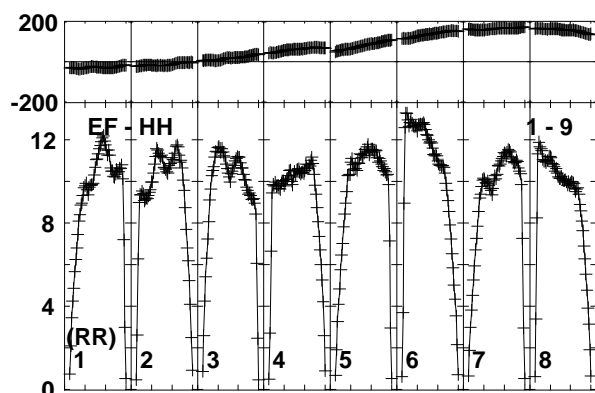
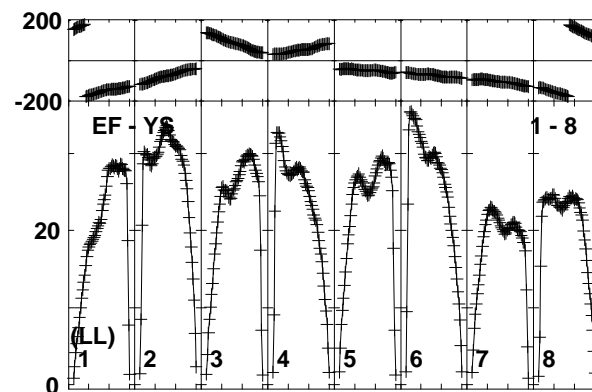
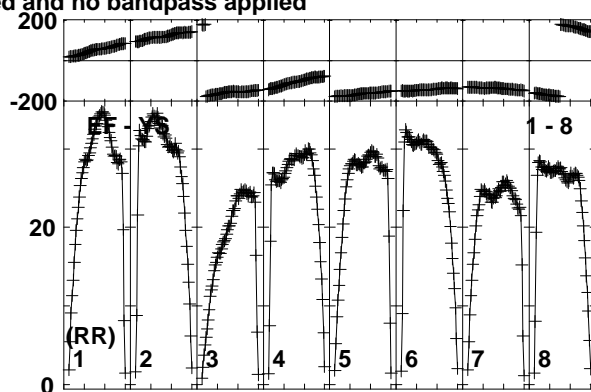
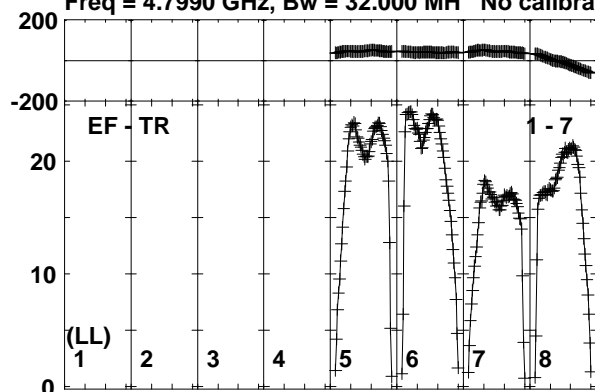

Lower frame: Milli Ampl Jy Top frame: Phas deg
Vector averaged cross-power spectrum Baseline: EF (01) - TR (07)
Timerange: 00/14:50:32 to 00/14:51:28

Plot file version 71 created 19-OCT-2017 15:36:04

MRK841 ES081C.UVDATA.1

Freq = 4.7990 GHz, Bw = 32.000 MH No calibration applied and no bandpass applied

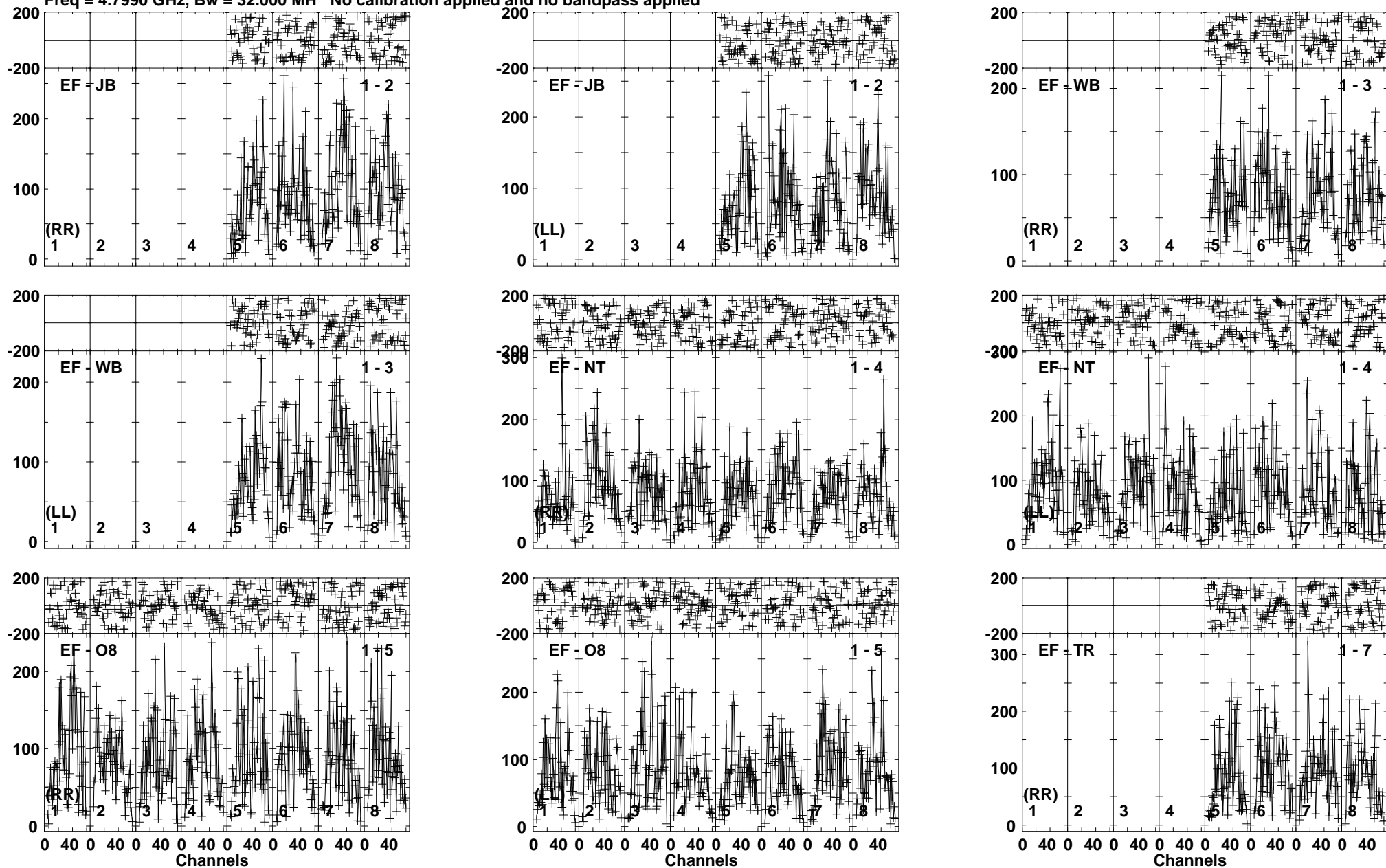

Lower frame: Micro Ampl Jy Top frame: Phas deg
Vector averaged cross-power spectrum Baseline: EF (01) - JB (02)
Timerange: 00/14:51:32 to 00/14:54:58

Plot file version 72 created 19-OCT-2017 15:36:04

MRK841 ES081C.UVDATA.1

Freq = 4.7990 GHz, Bw = 32.000 MH No calibration applied and no bandpass applied

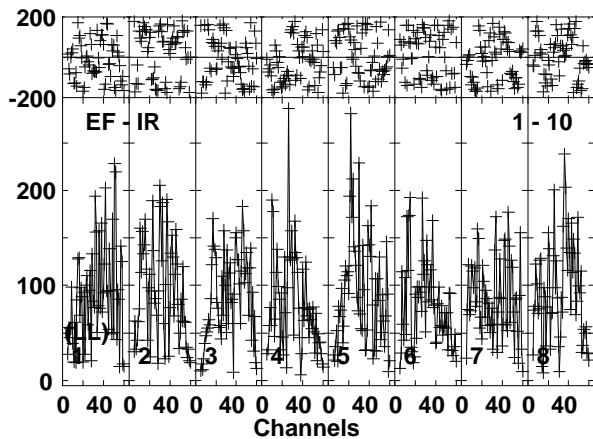
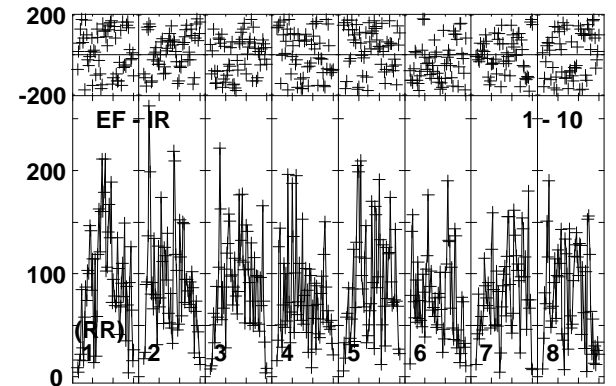
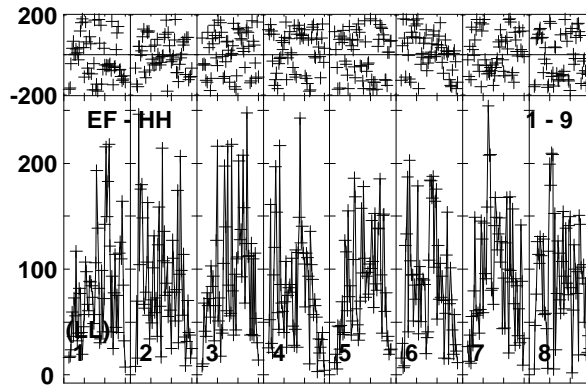
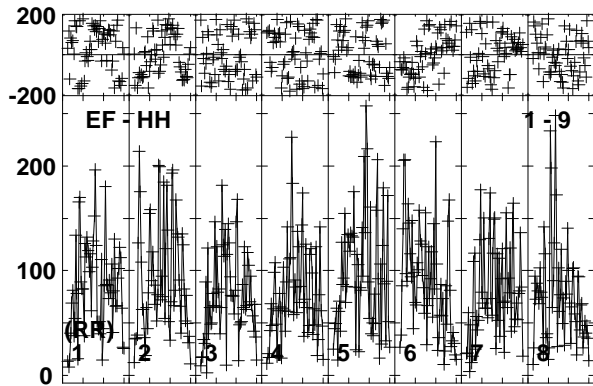
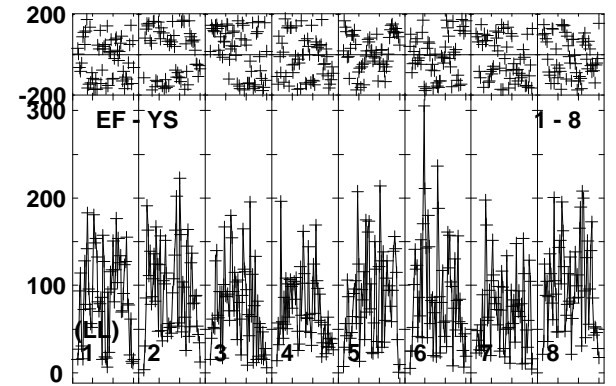
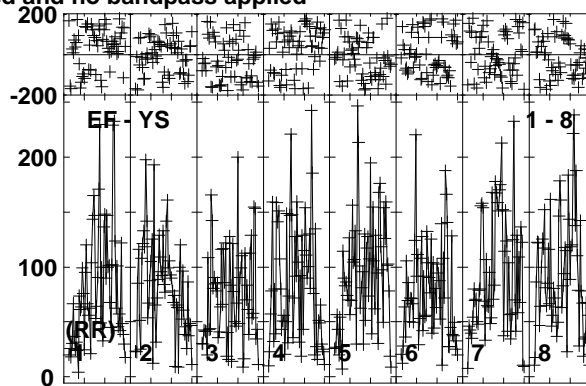
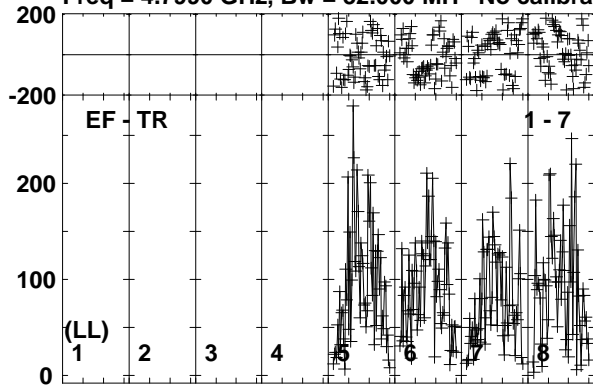

Lower frame: Micro Ampl Jy Top frame: Phas deg
Vector averaged cross-power spectrum Baseline: EF (01) - TR (07)
Timerange: 00/14:51:32 to 00/14:54:58

Plot file version 73 created 19-OCT-2017 15:36:04

J1504+1029 ES081C.UVDATA.1

Freq = 4.7990 GHz, Bw = 32.000 MH No calibration applied and no bandpass applied

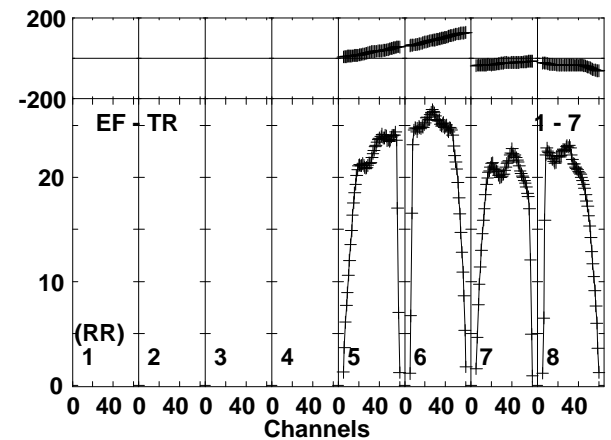
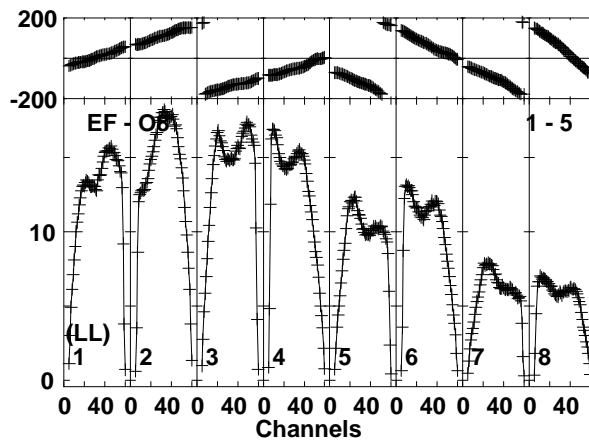
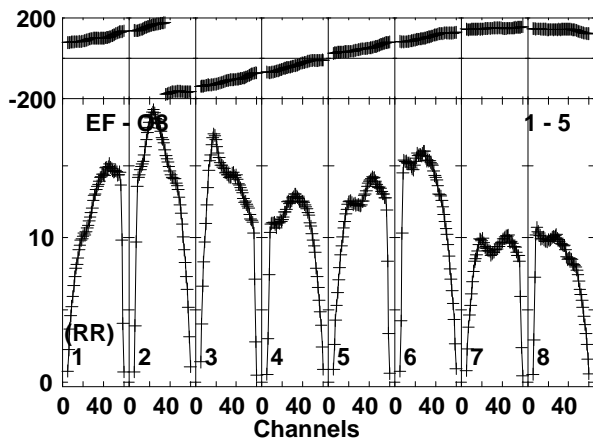
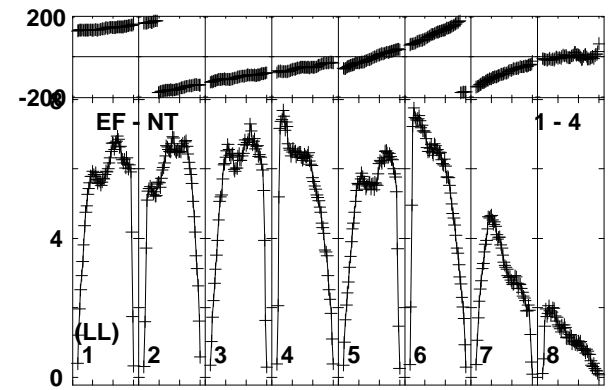
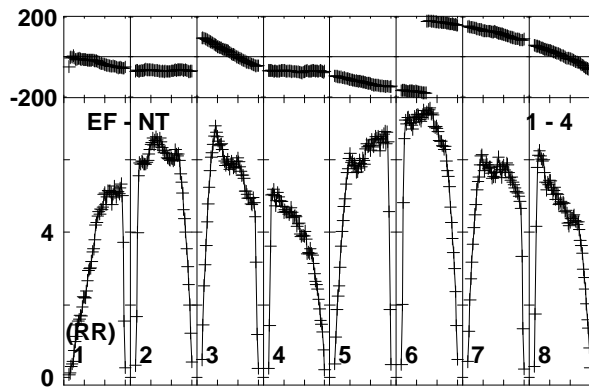
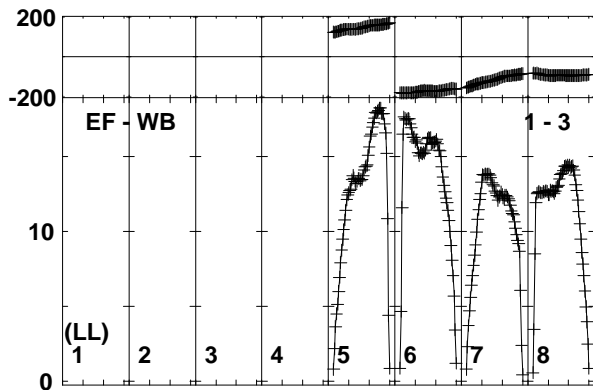
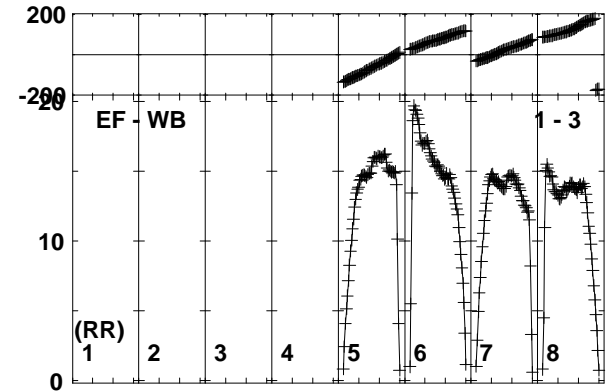
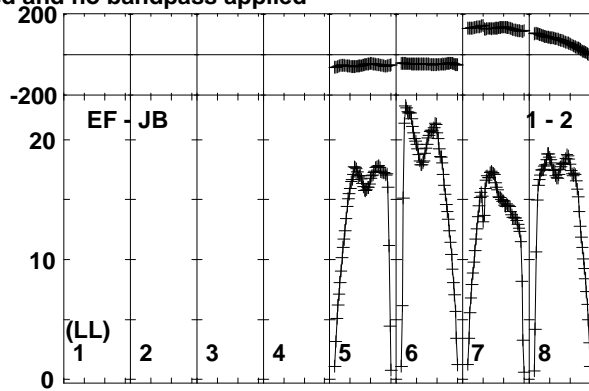
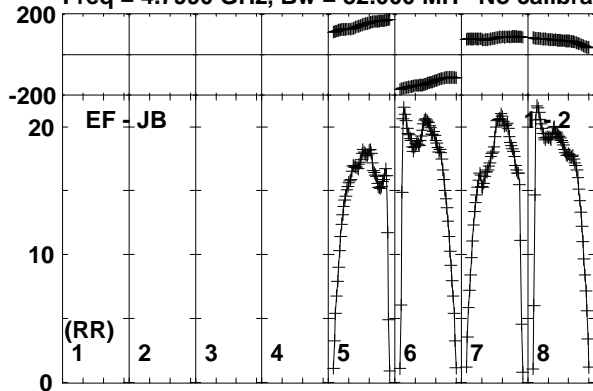

Lower frame: Milli Ampl Jy Top frame: Phas deg
Vector averaged cross-power spectrum Baseline: EF (01) - JB (02)
Timerange: 00/14:55:02 to 00/14:56:28

Plot file version 74 created 19-OCT-2017 15:36:04

J1504+1029 ES081C.UVDATA.1

Freq = 4.7990 GHz, Bw = 32.000 MH No calibration applied and no bandpass applied

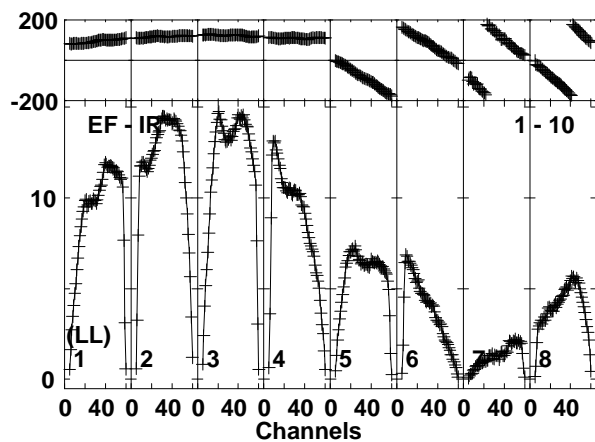
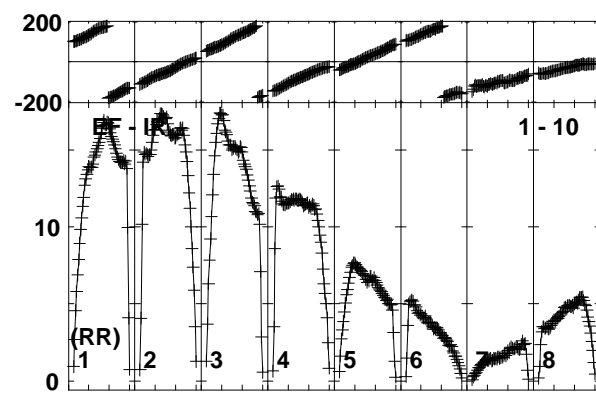
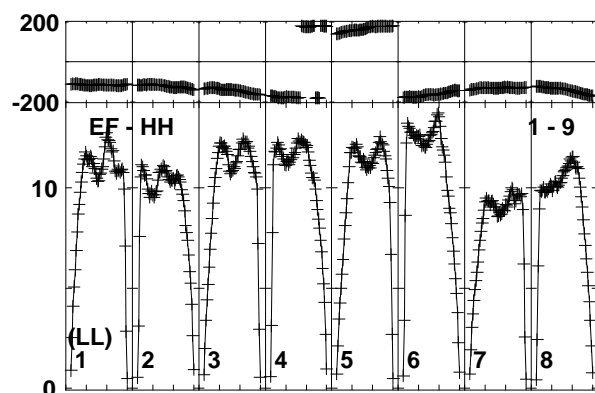
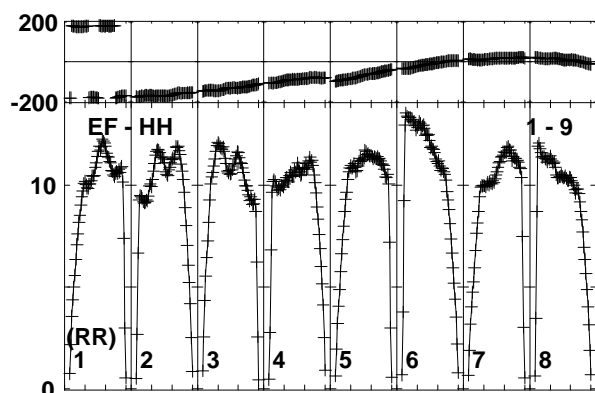
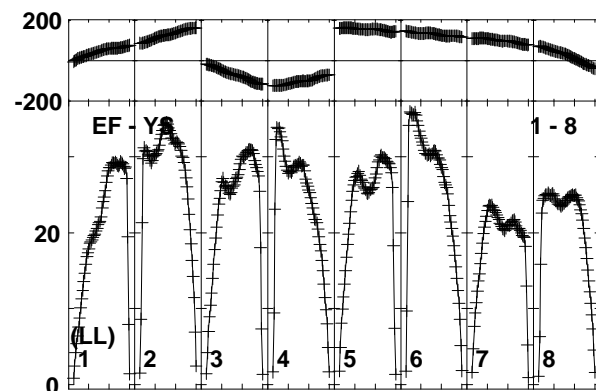
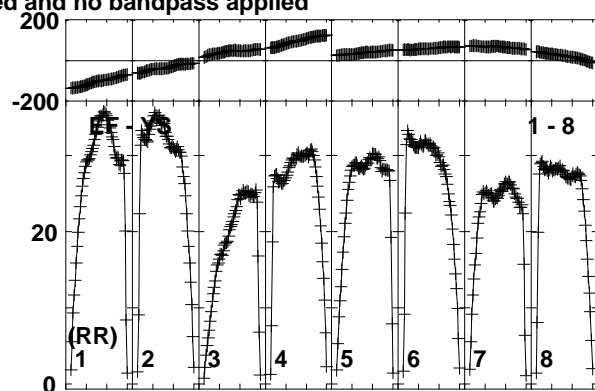
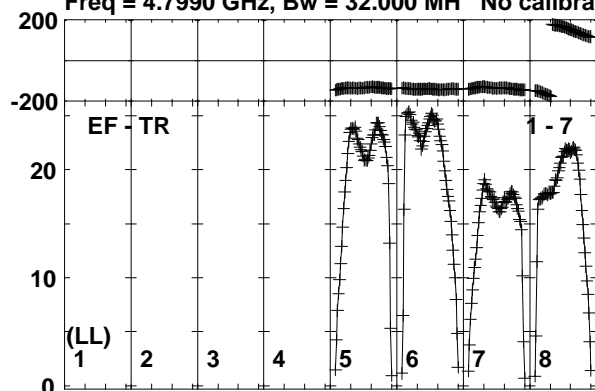

Lower frame: Milli Ampl Jy Top frame: Phas deg
Vector averaged cross-power spectrum Baseline: EF (01) - TR (07)
Timerange: 00/14:55:02 to 00/14:56:28

Plot file version 75 created 19-OCT-2017 15:36:04

MRK841 ES081C.UVDATA.1

Freq = 4.7990 GHz, Bw = 32.000 MH No calibration applied and no bandpass applied

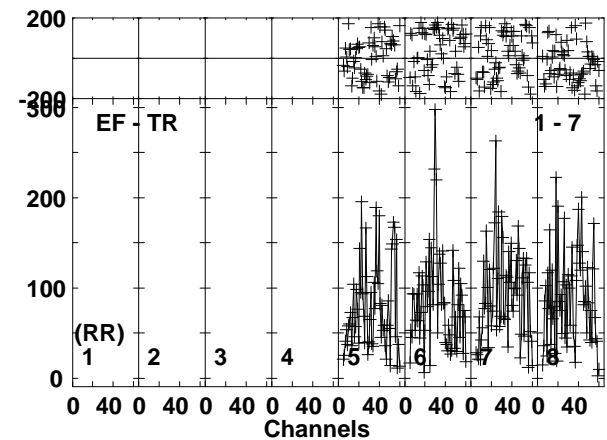
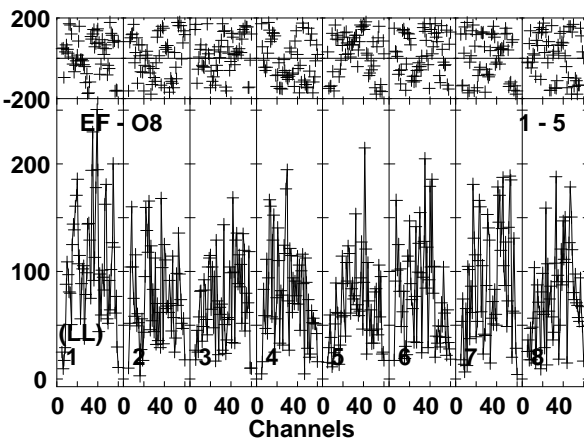
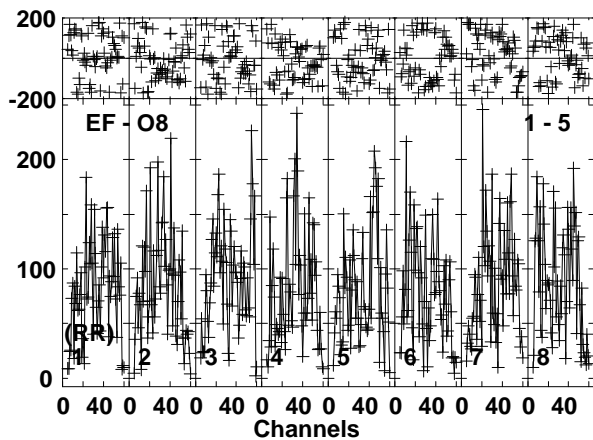
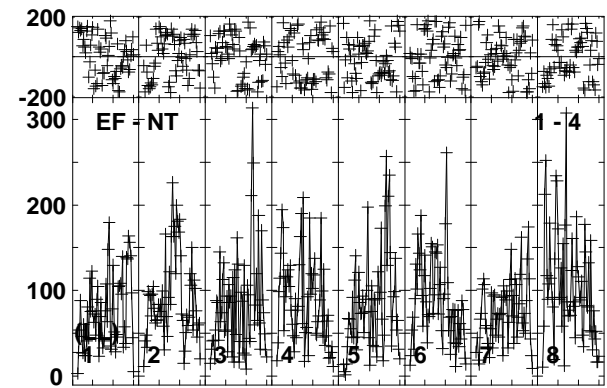
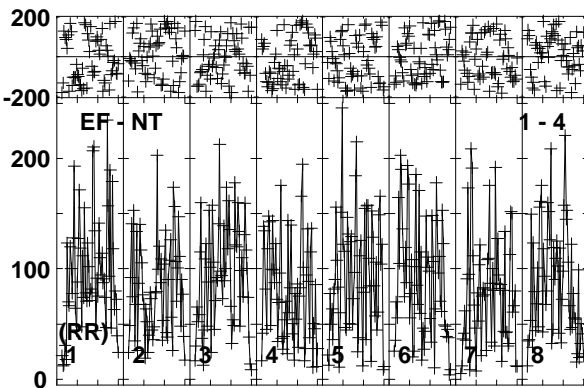
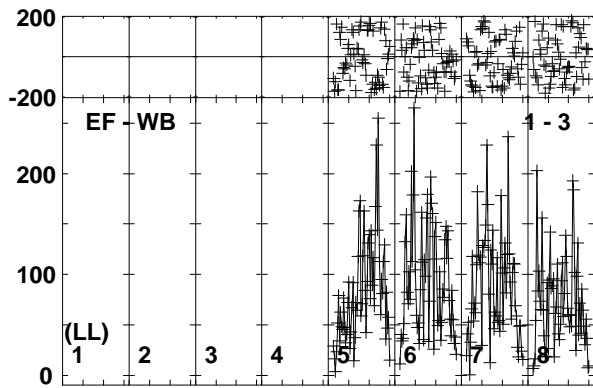
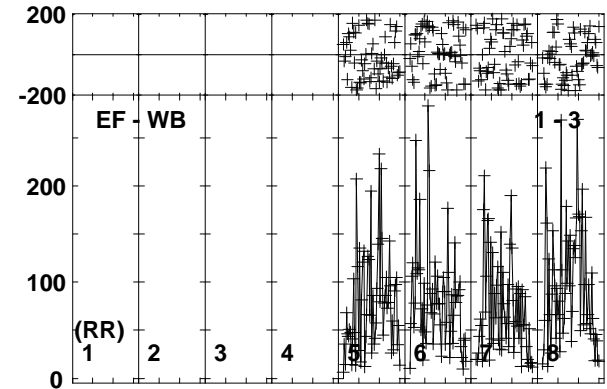
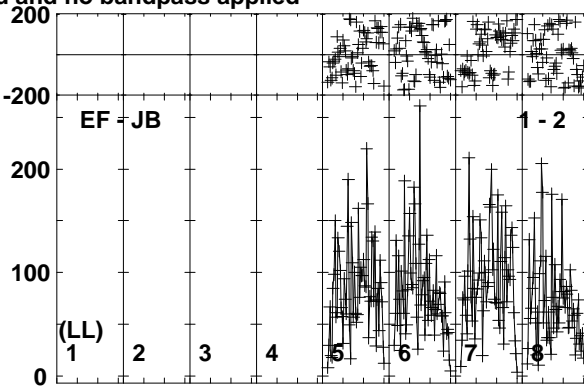
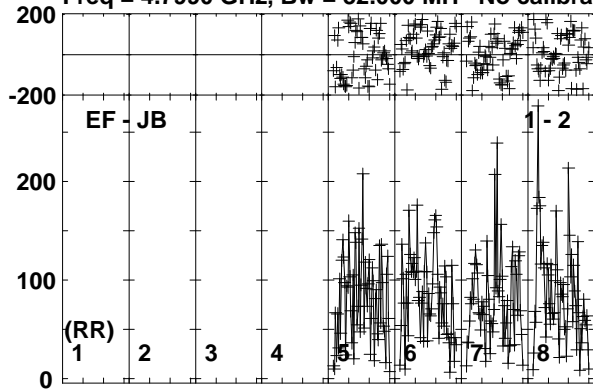

Lower frame: Micro Ampl Jy Top frame: Phas deg
Vector averaged cross-power spectrum Baseline: EF (01) - JB (02)
Timerange: 00/14:56:32 to 00/14:59:58

Plot file version 76 created 19-OCT-2017 15:36:04

MRK841 ES081C.UVDATA.1

Freq = 4.7990 GHz, Bw = 32.000 MH No calibration applied and no bandpass applied

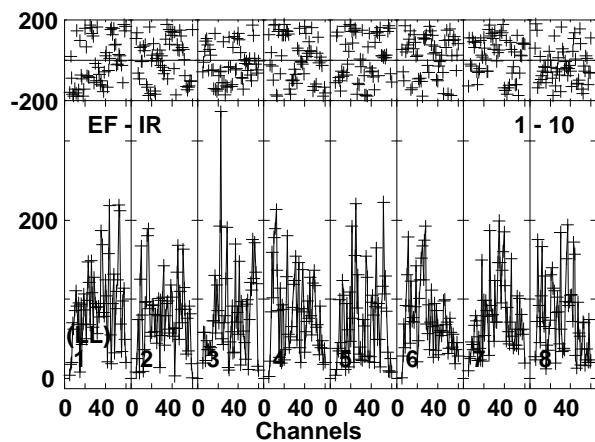
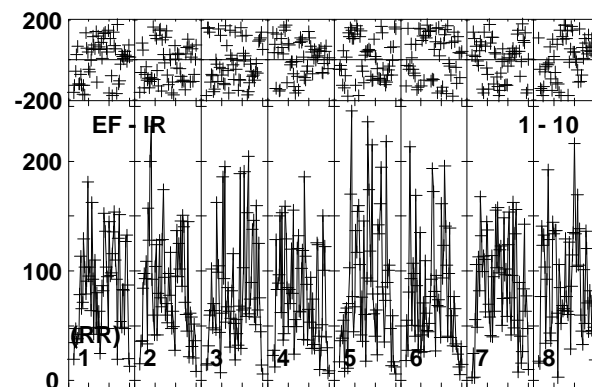
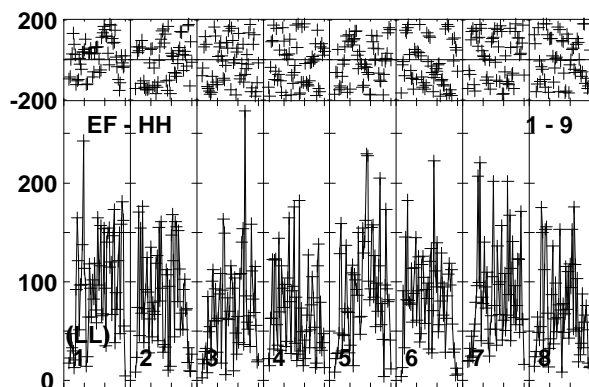
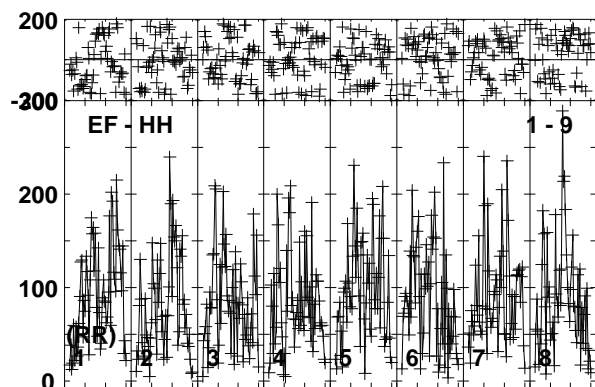
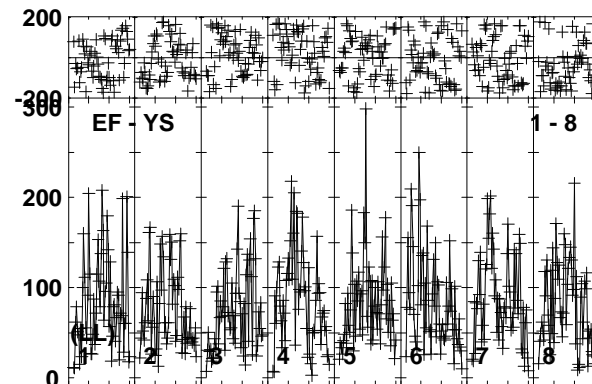
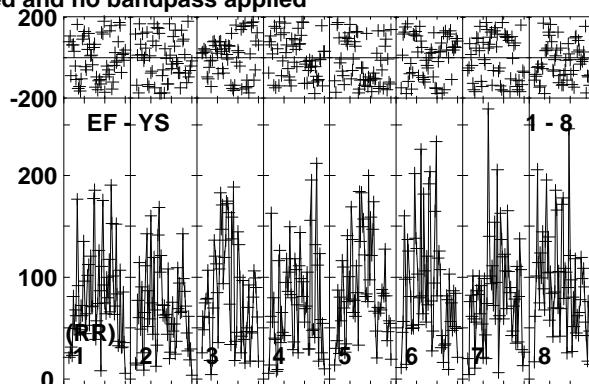
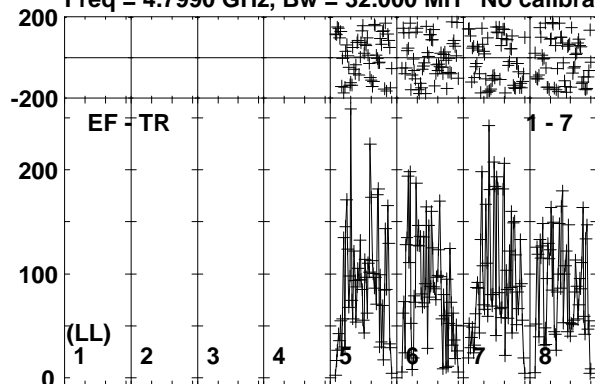

Lower frame: Micro Ampl Jy Top frame: Phas deg
Vector averaged cross-power spectrum Baseline: EF (01) - TR (07)
Timerange: 00/14:56:32 to 00/14:59:58

Plot file version 77 created 19-OCT-2017 15:36:04

J1504+1029 ES081C.UVDATA.1

Freq = 4.7990 GHz, Bw = 32.000 MH No calibration applied and no bandpass applied

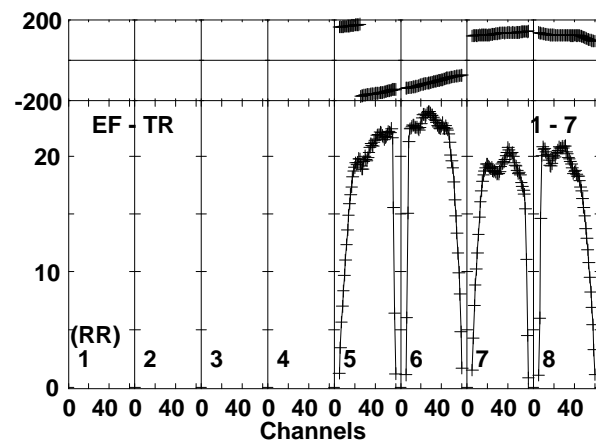
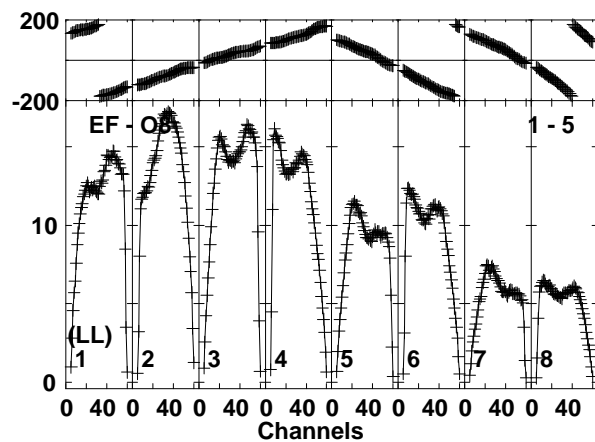
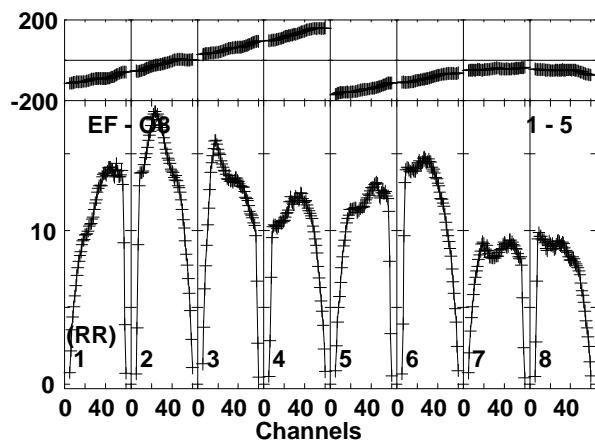
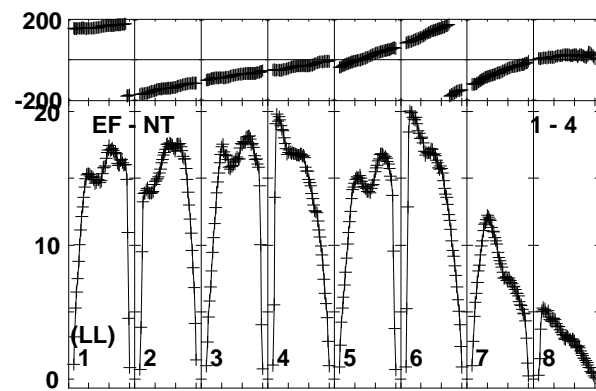
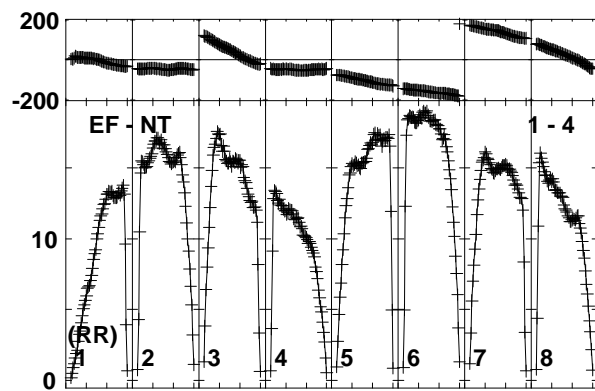
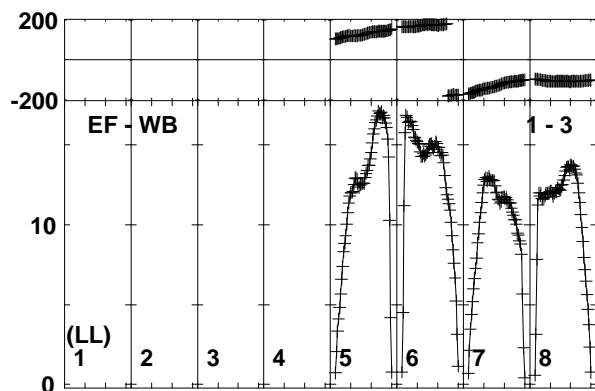
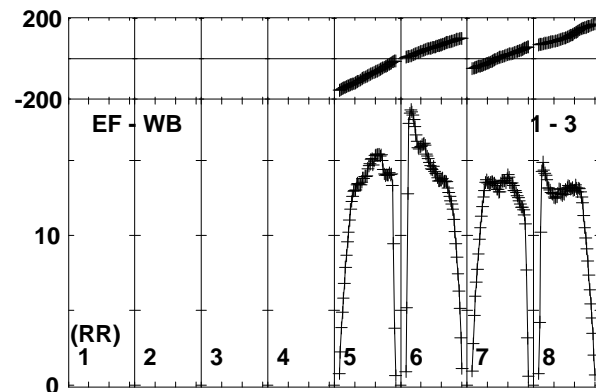
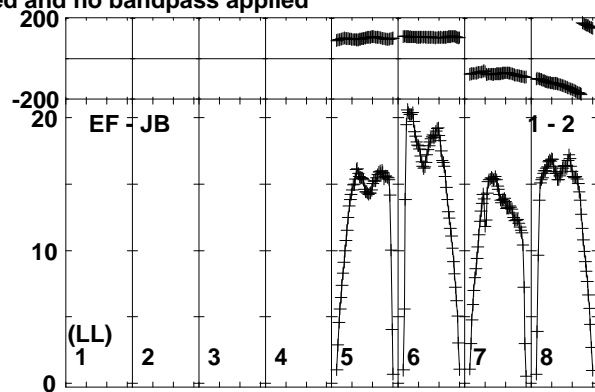
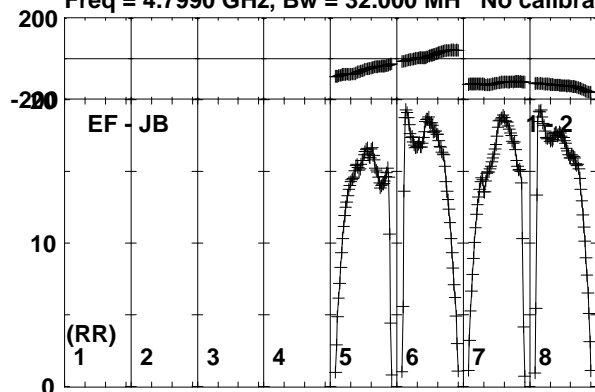

Lower frame: Milli Ampl Jy Top frame: Phas deg
Vector averaged cross-power spectrum Baseline: EF (01) - JB (02)
Timerange: 00/15:00:32 to 00/15:01:28

Plot file version 78 created 19-OCT-2017 15:36:05

J1504+1029 ES081C.UVDATA.1

Freq = 4.7990 GHz, Bw = 32.000 MH No calibration applied and no bandpass applied

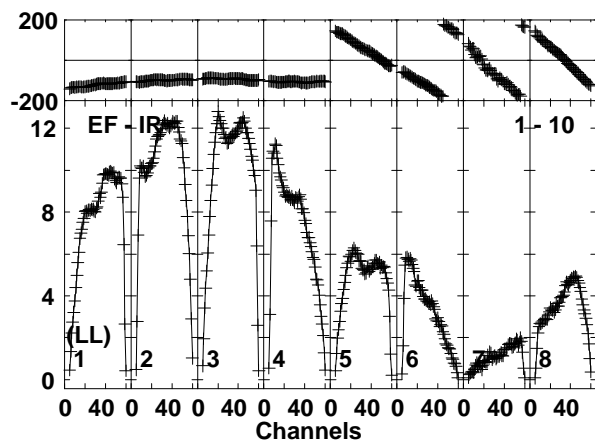
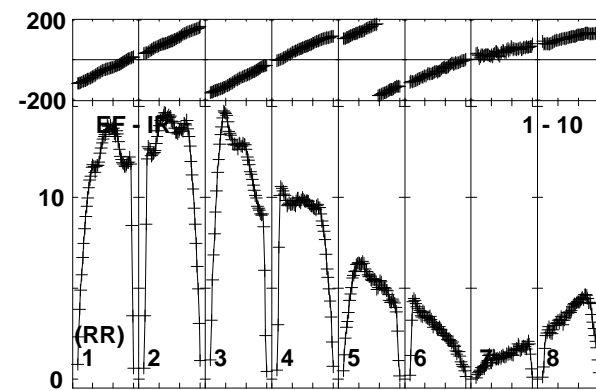
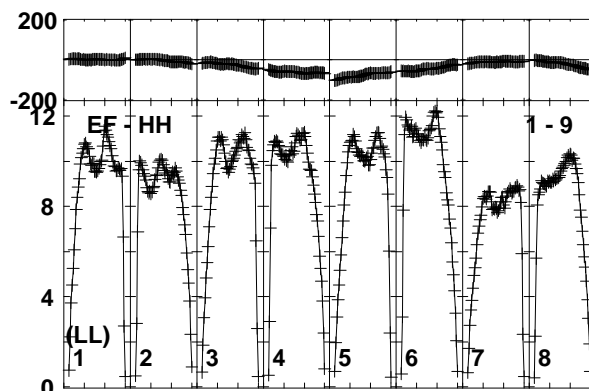
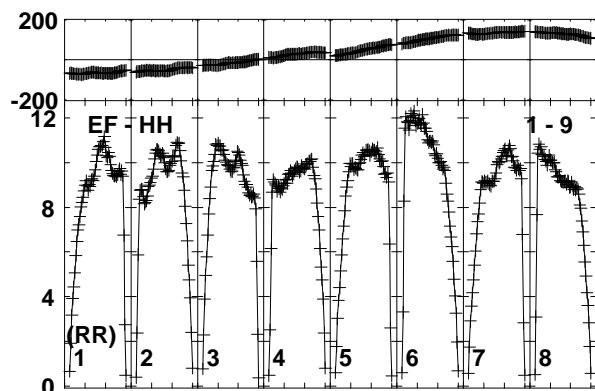
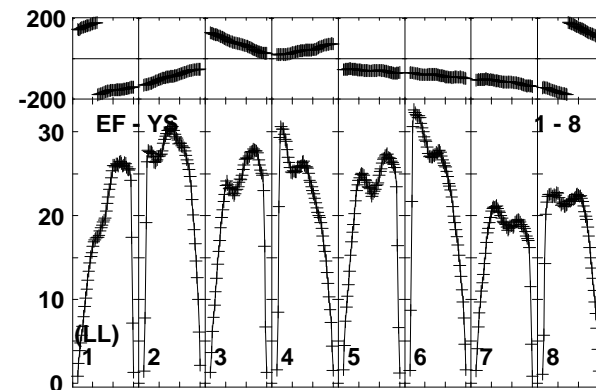
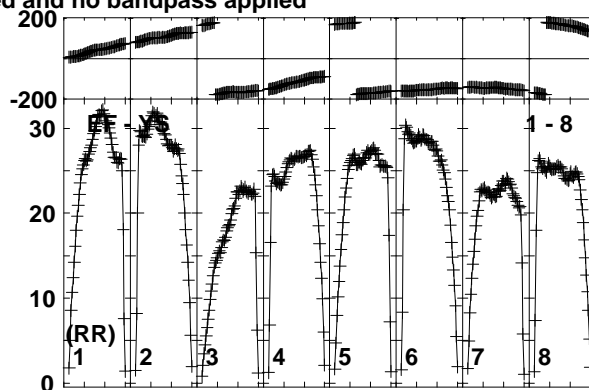
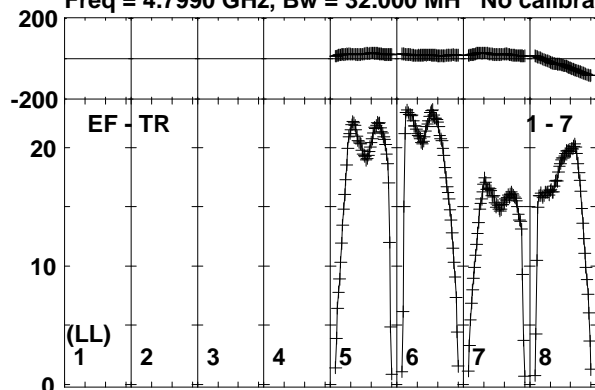

Lower frame: Milli Ampl Jy Top frame: Phas deg
Vector averaged cross-power spectrum Baseline: EF (01) - TR (07)
Timerange: 00/15:00:32 to 00/15:01:28

Plot file version 79 created 19-OCT-2017 15:36:05

MRK841 ES081C.UVDATA.1

Freq = 4.7990 GHz, Bw = 32.000 MH No calibration applied and no bandpass applied

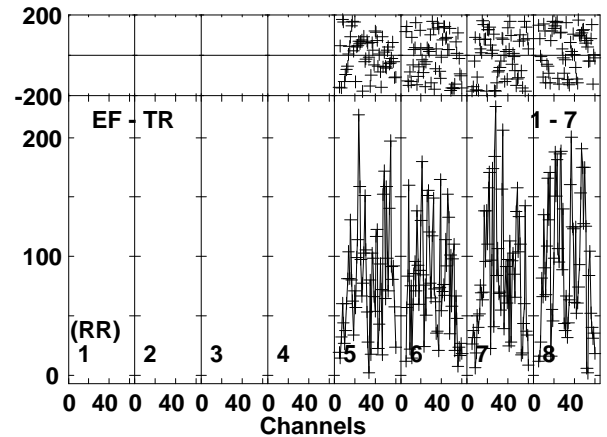
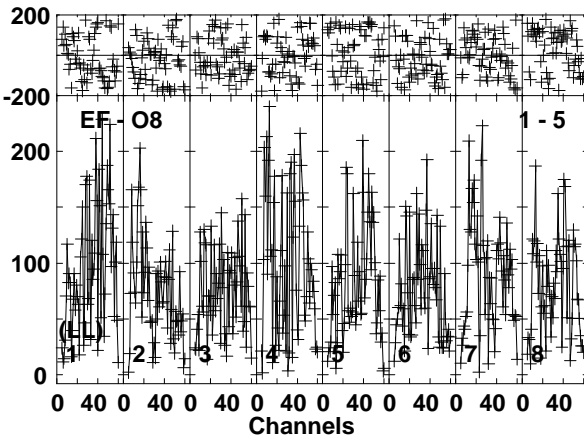
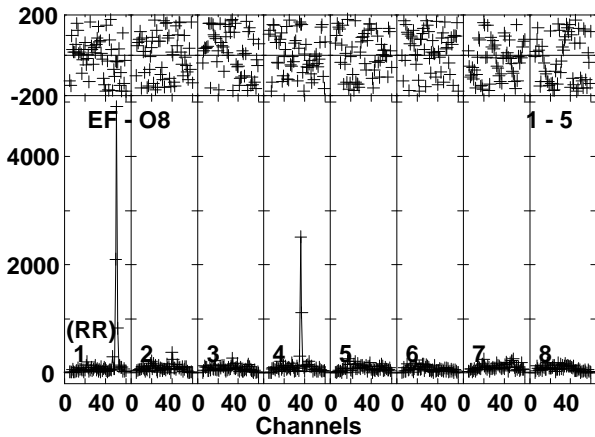
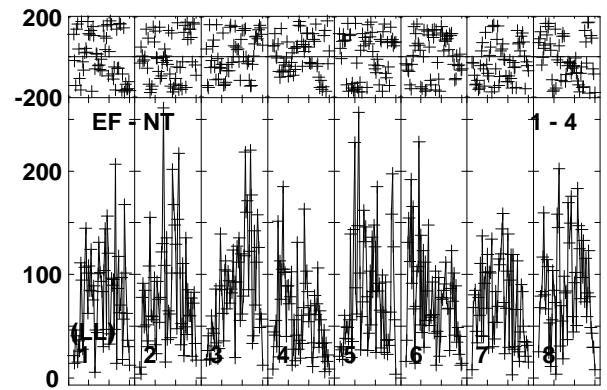
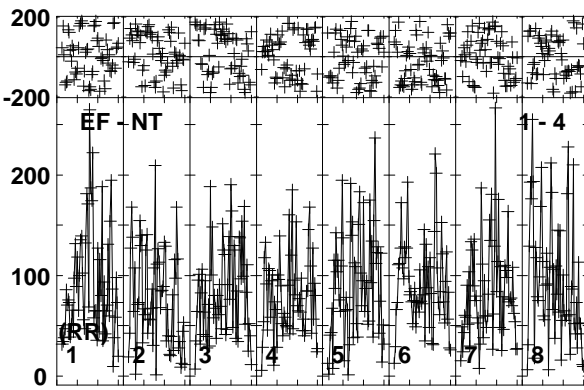
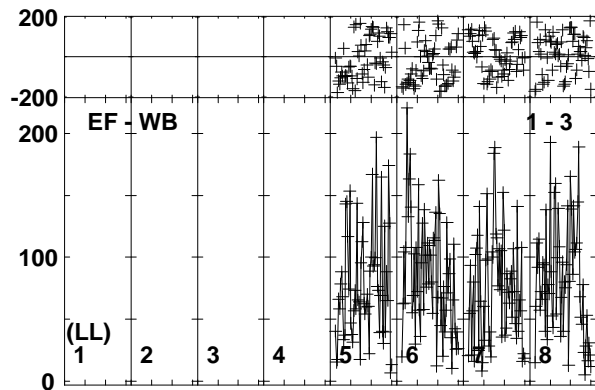
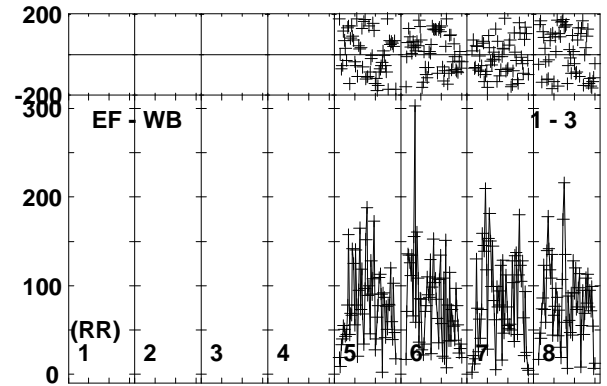
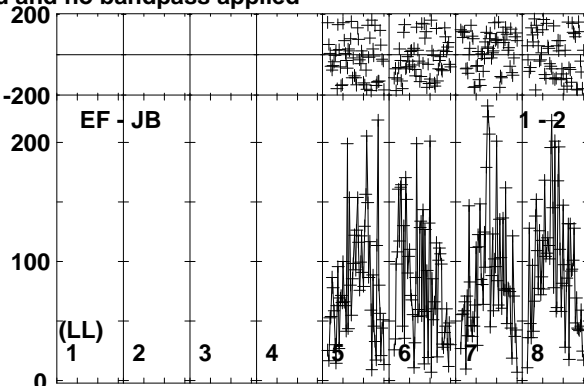
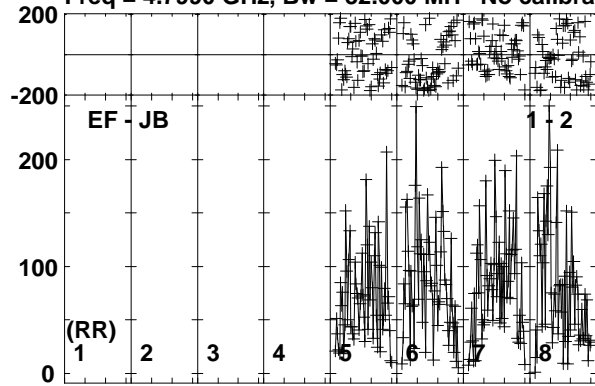

Lower frame: Micro Ampl Jy Top frame: Phas deg
Vector averaged cross-power spectrum Baseline: EF (01) - JB (02)
Timerange: 00/15:01:32 to 00/15:04:58

Plot file version 80 created 19-OCT-2017 15:36:05

MRK841 ES081C.UVDATA.1

Freq = 4.7990 GHz, Bw = 32.000 MH No calibration applied and no bandpass applied

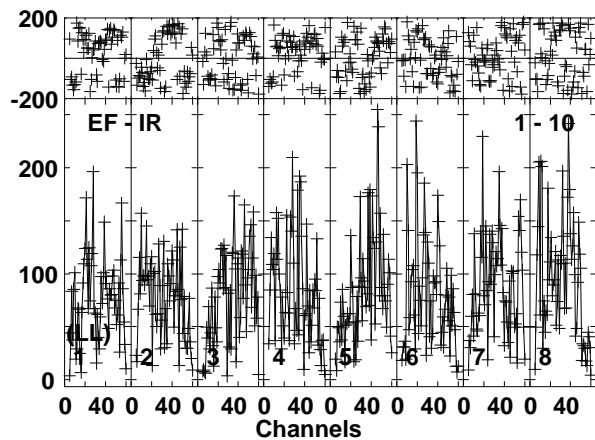
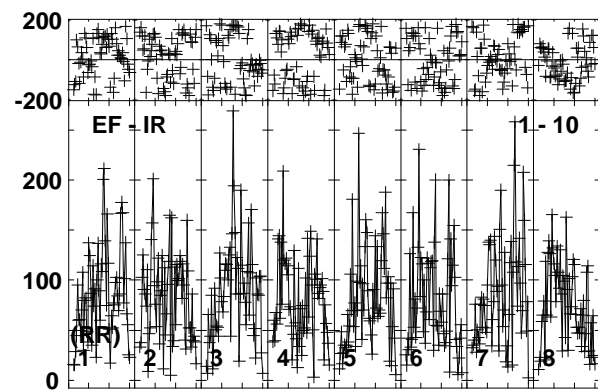
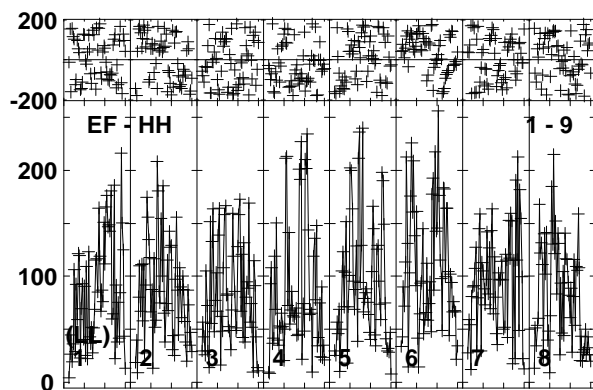
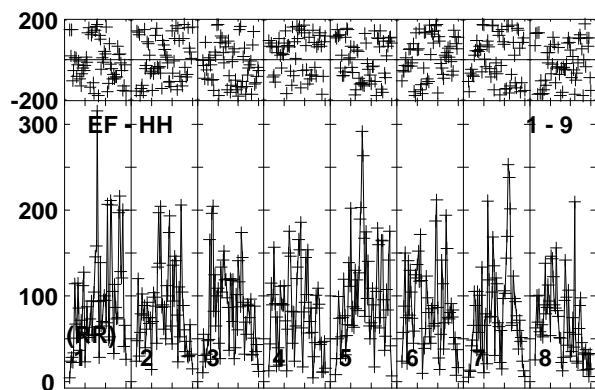
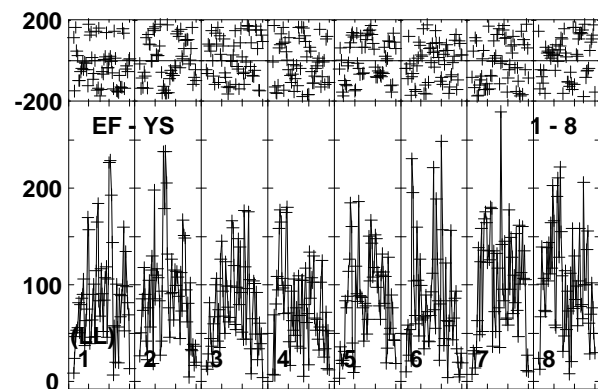
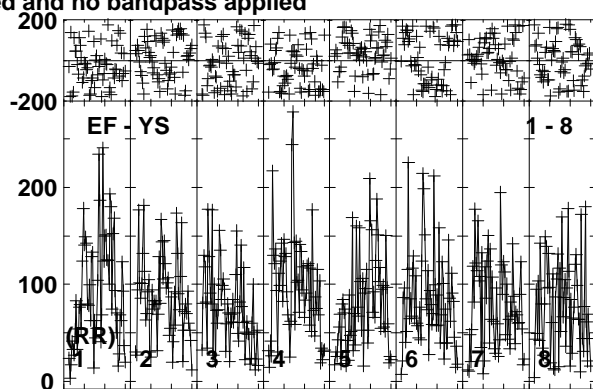
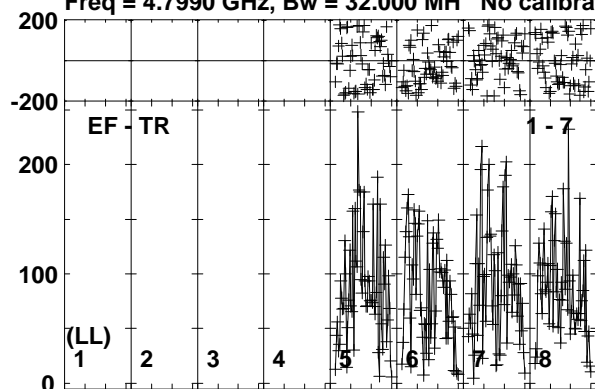

Lower frame: Micro Ampl Jy Top frame: Phas deg
Vector averaged cross-power spectrum Baseline: EF (01) - TR (07)
Timerange: 00/15:01:32 to 00/15:04:58

Plot file version 81 created 19-OCT-2017 15:36:05

J1504+1029 ES081C.UVDATA.1

Freq = 4.7990 GHz, Bw = 32.000 MH No calibration applied and no bandpass applied

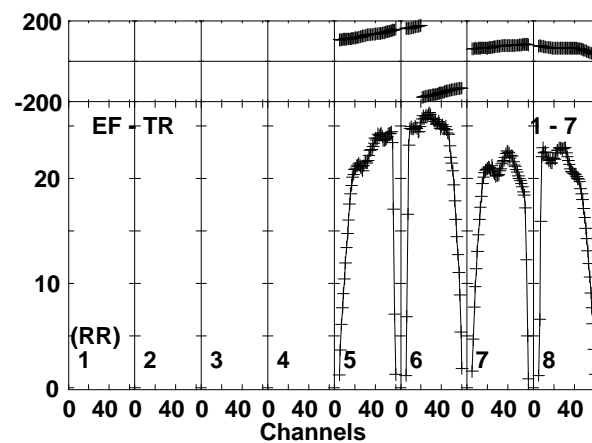
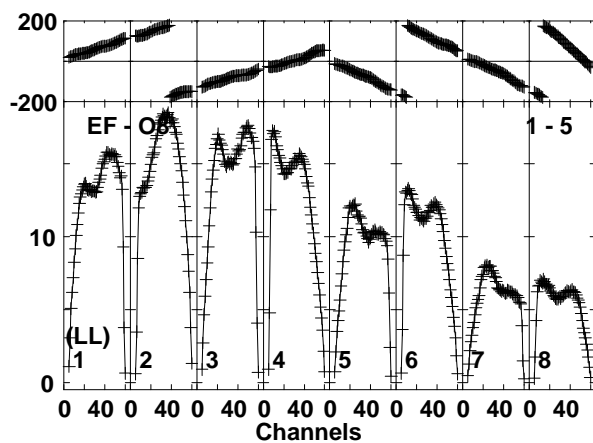
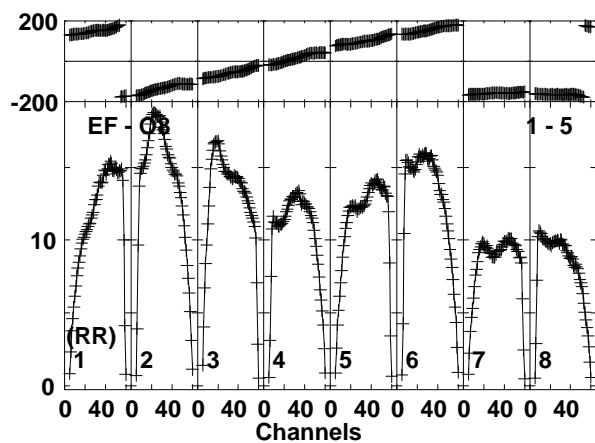
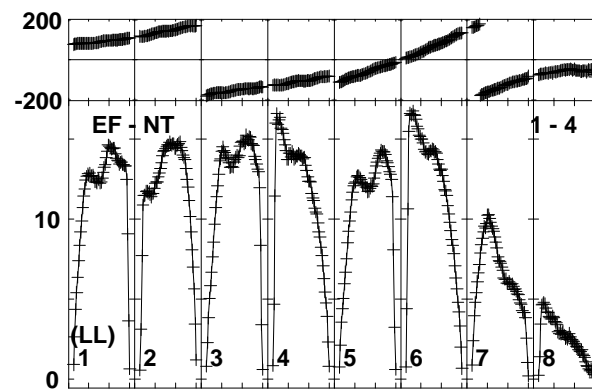
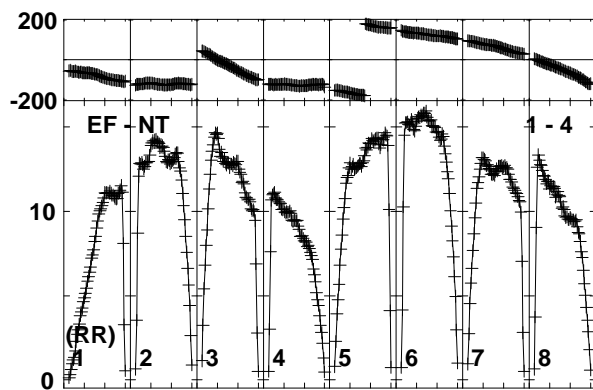
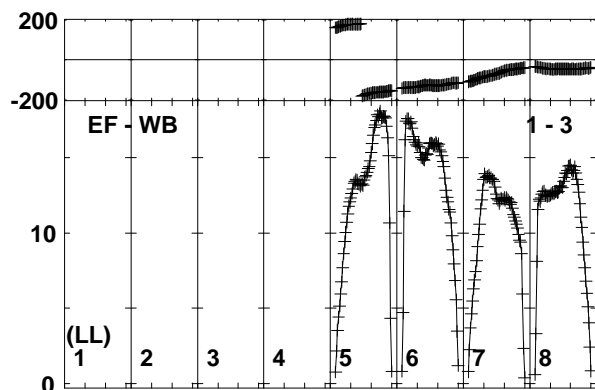
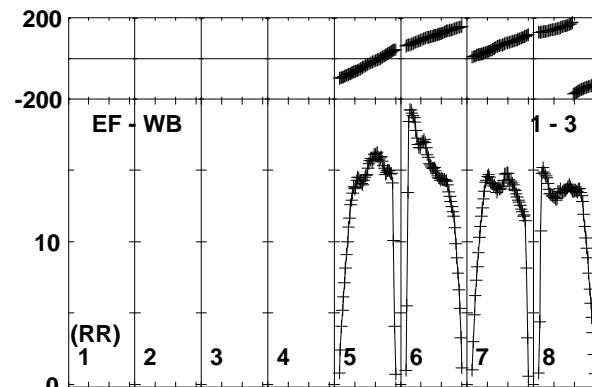
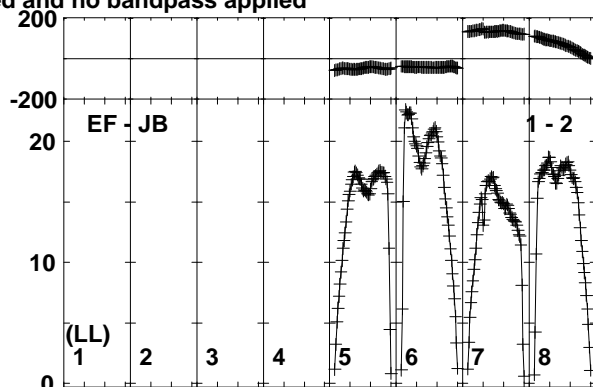
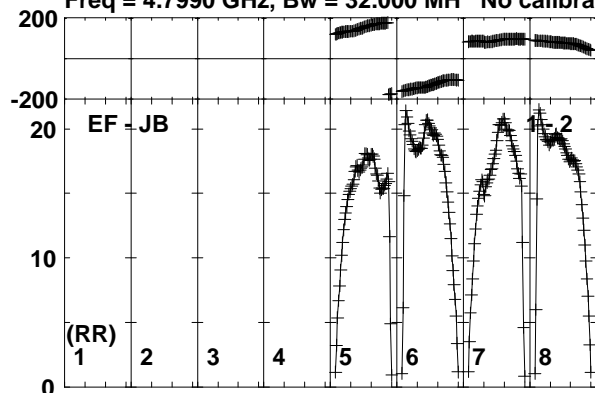

Lower frame: Milli Ampl Jy Top frame: Phas deg
Vector averaged cross-power spectrum Baseline: EF (01) - JB (02)
Timerange: 00/15:05:02 to 00/15:06:28

Plot file version 82 created 19-OCT-2017 15:36:05

J1504+1029 ES081C.UVDATA.1

Freq = 4.7990 GHz, Bw = 32.000 MH No calibration applied and no bandpass applied

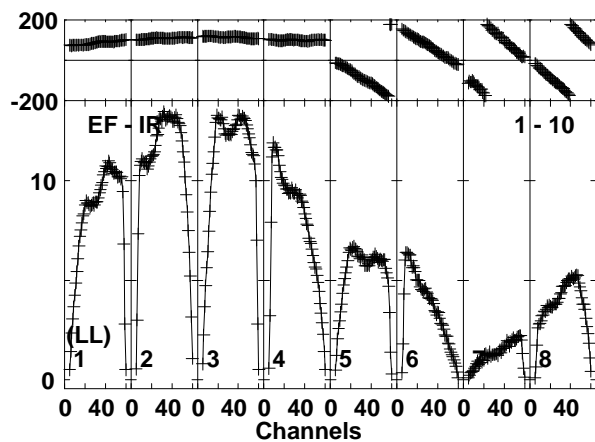
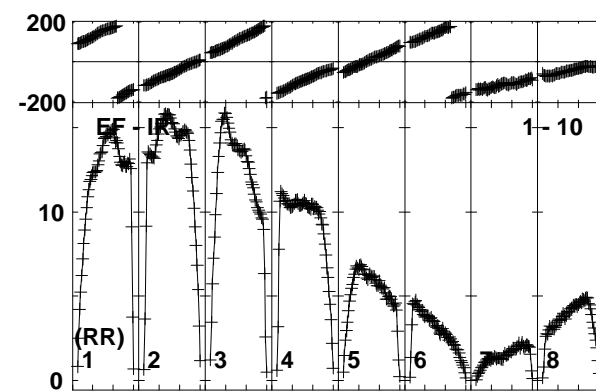
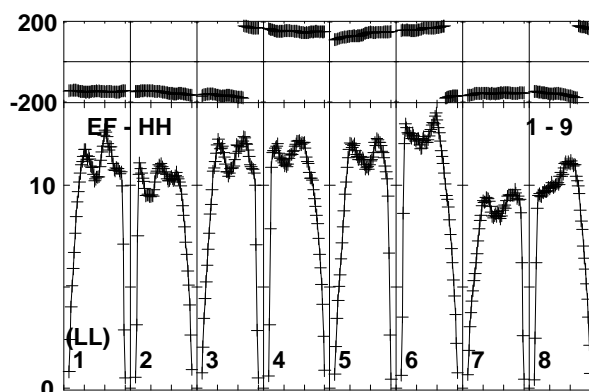
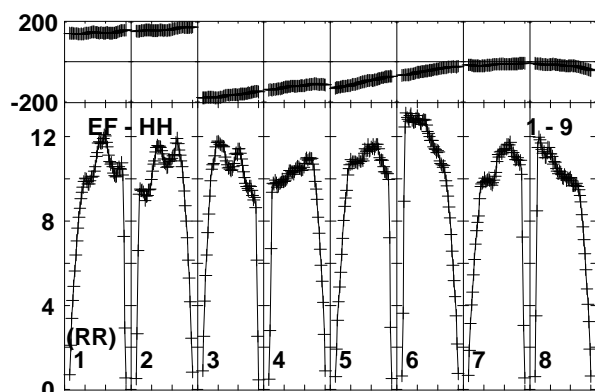
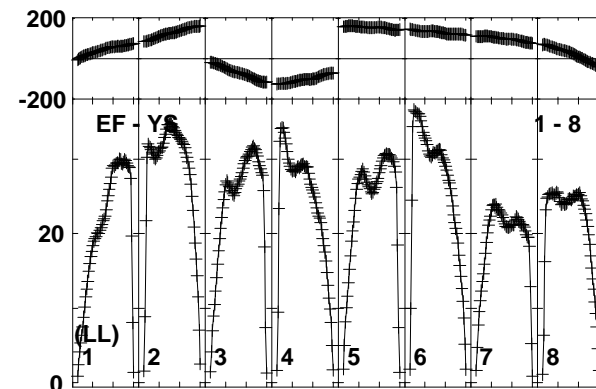
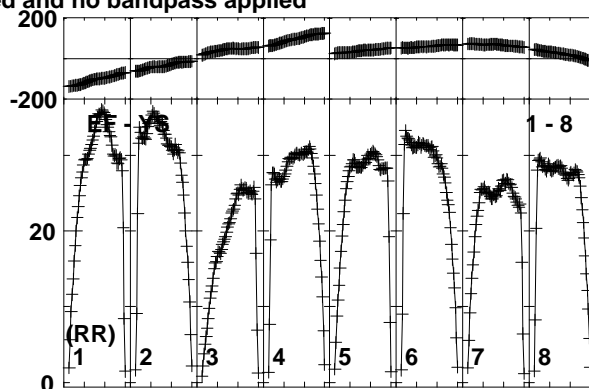
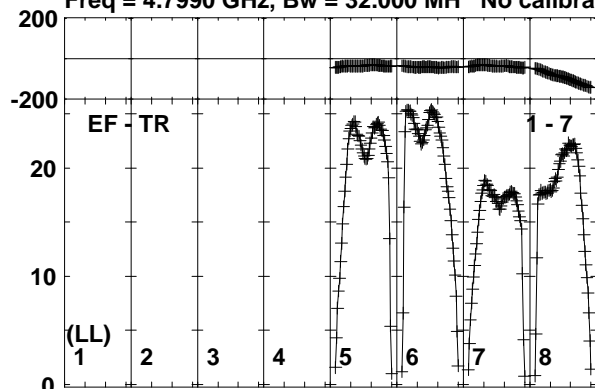

Lower frame: Milli Ampl Jy Top frame: Phas deg
Vector averaged cross-power spectrum Baseline: EF (01) - TR (07)
Timerange: 00/15:05:02 to 00/15:06:28

Plot file version 83 created 19-OCT-2017 15:36:05
 MRK841 ES081C.UVDATA.1
 Freq = 4.7990 GHz, Bw = 32.000 MH No calibration applied and no bandpass applied

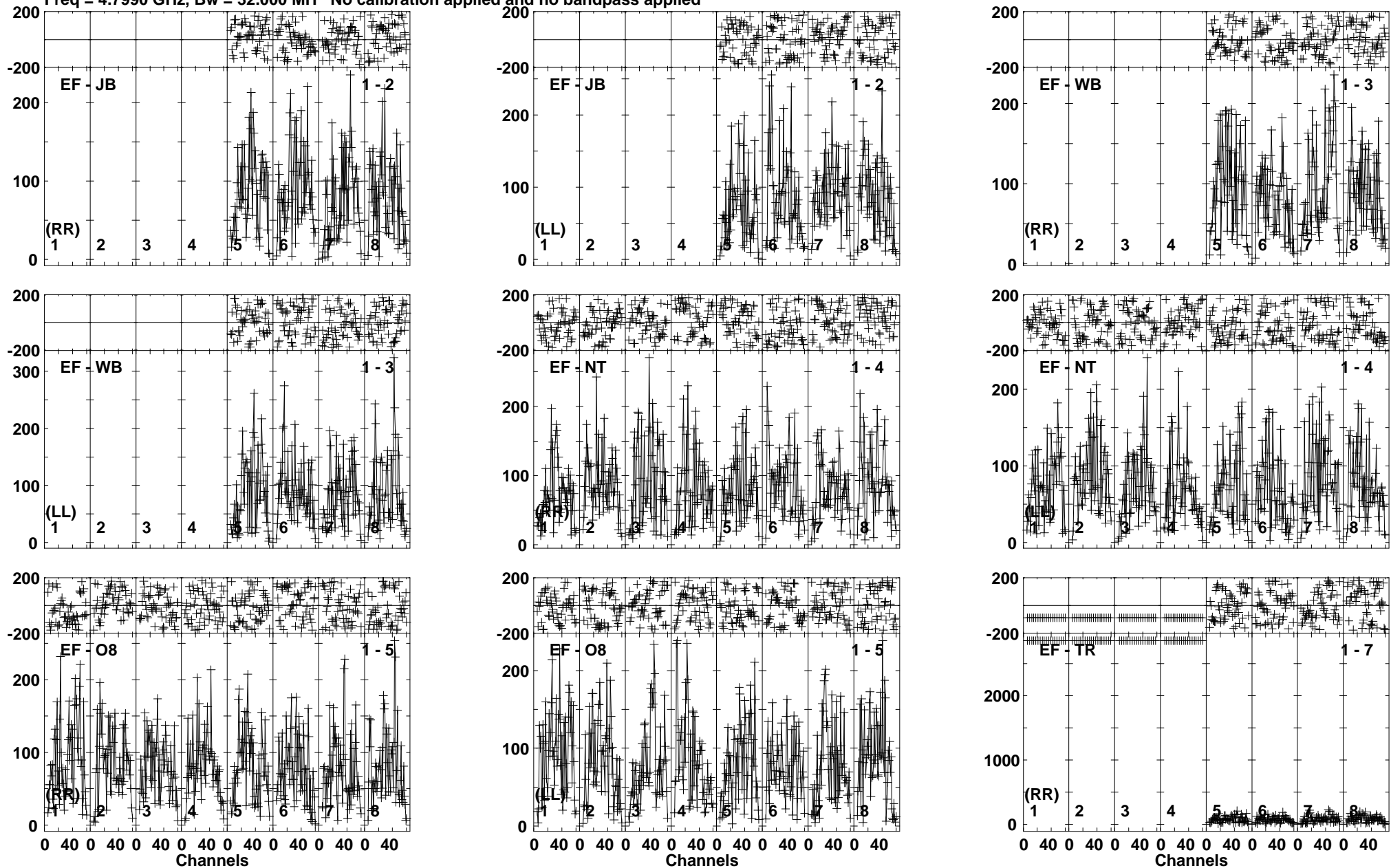

Lower frame: Micro Ampl Jy Top frame: Phas deg
 Vector averaged cross-power spectrum Baseline: EF (01) - JB (02)
 Timerange: 00/15:06:32 to 00/15:09:58

Plot file version 84 created 19-OCT-2017 15:36:05

MRK841 ES081C.UVDATA.1

Freq = 4.7990 GHz, Bw = 32.000 MH No calibration applied and no bandpass applied

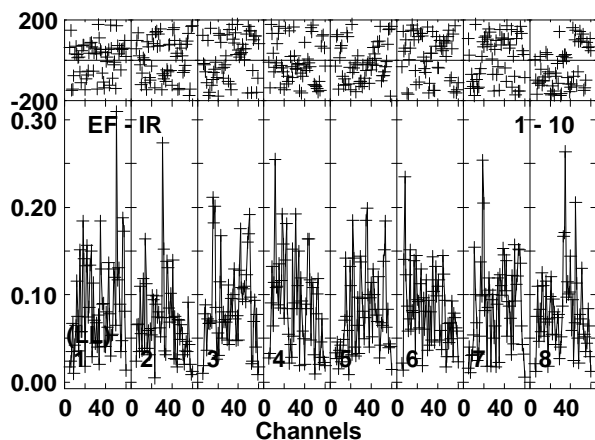
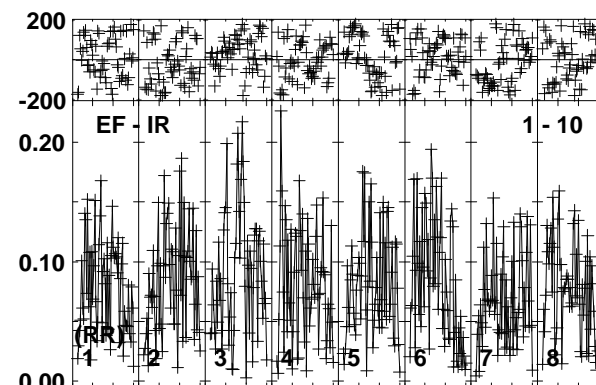
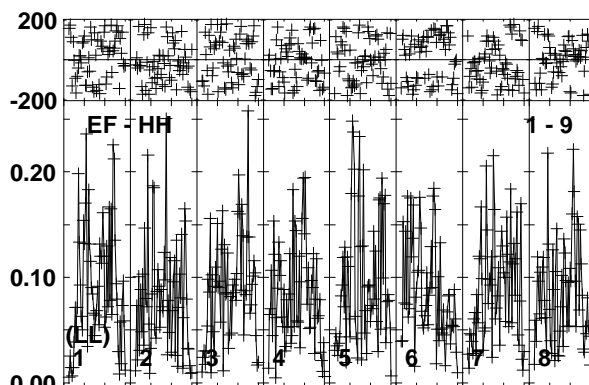
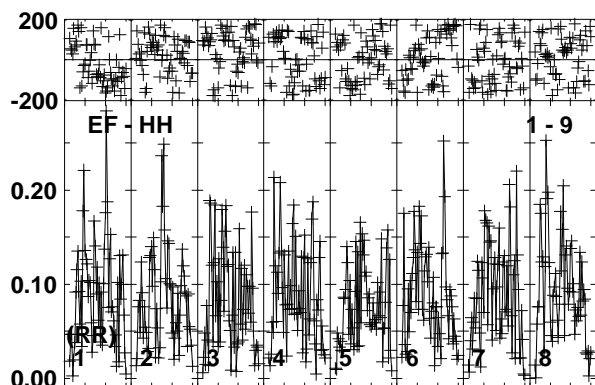
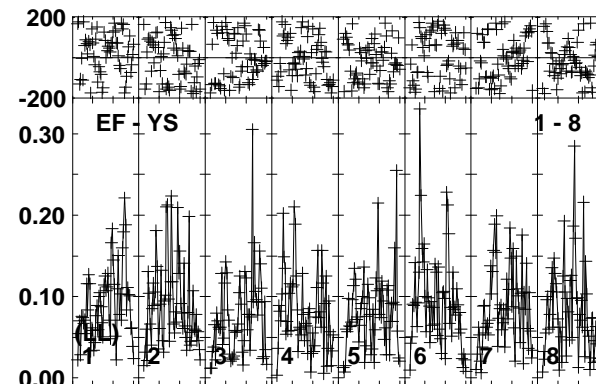
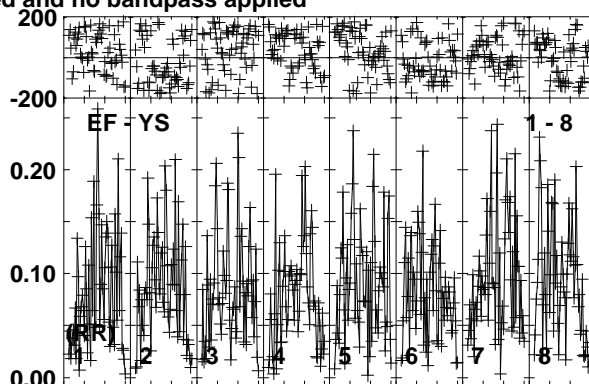
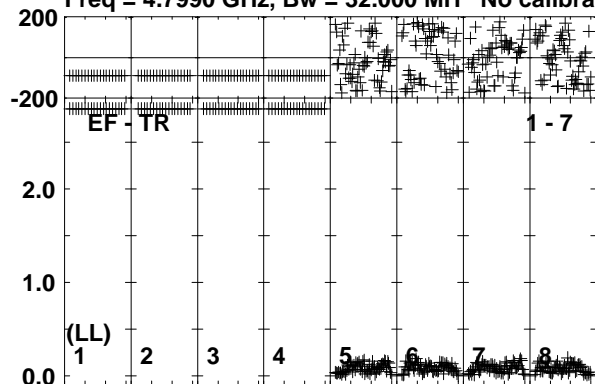

Lower frame: Milli Ampl Jy Top frame: Phas deg
Vector averaged cross-power spectrum Baseline: EF (01) - TR (07)
Timerange: 00/15:06:32 to 00/15:09:58

Plot file version 85 created 19-OCT-2017 15:36:05

J1504+1029 ES081C.UVDATA.1

Freq = 4.7990 GHz, Bw = 32.000 MH No calibration applied and no bandpass applied

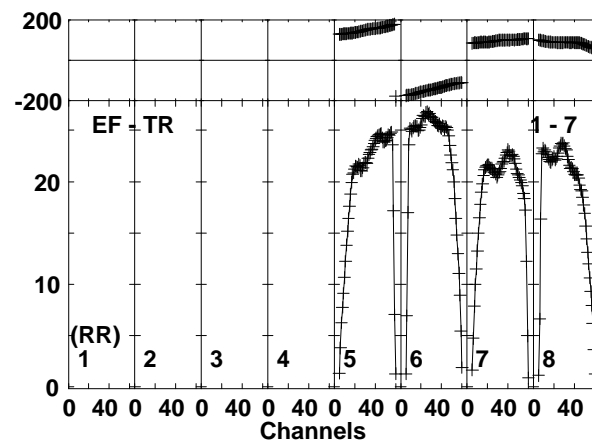
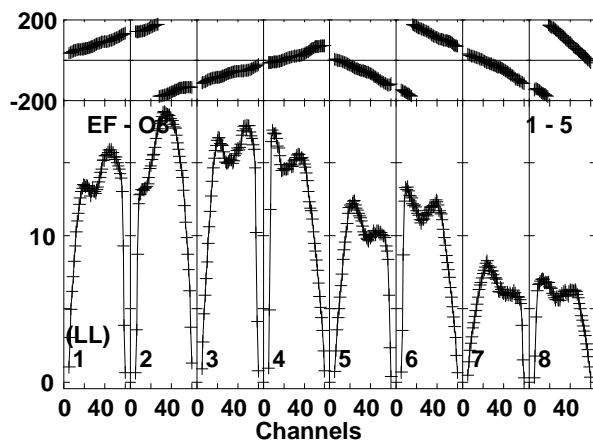
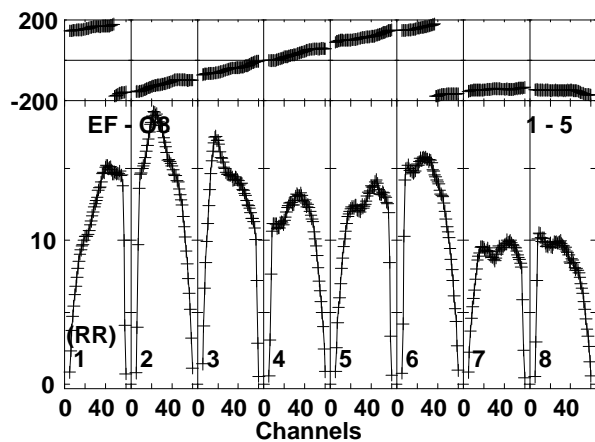
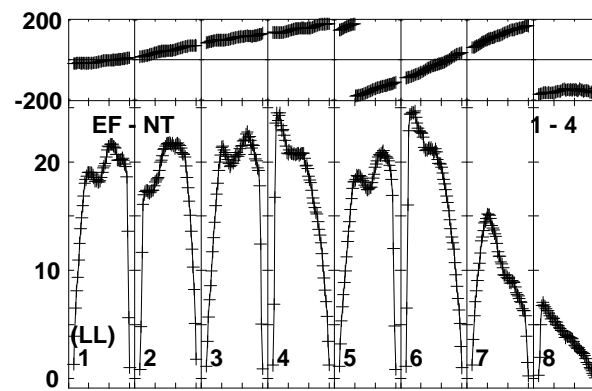
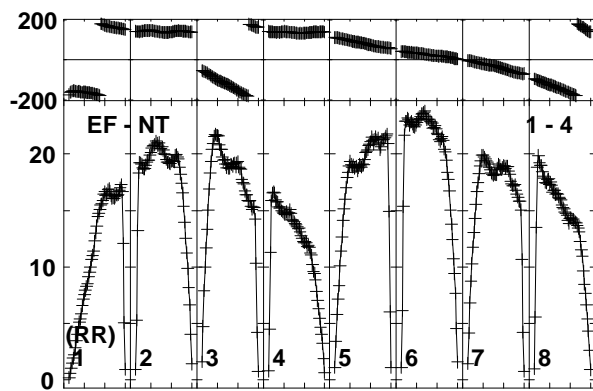
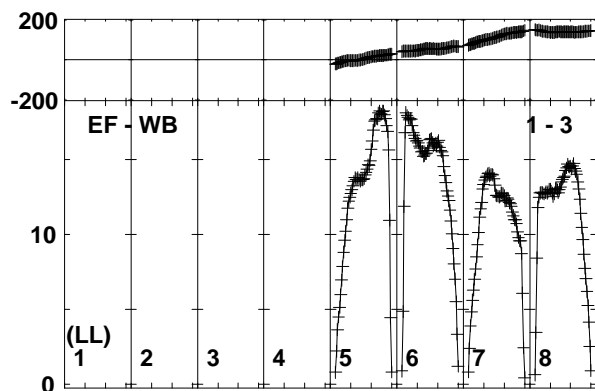
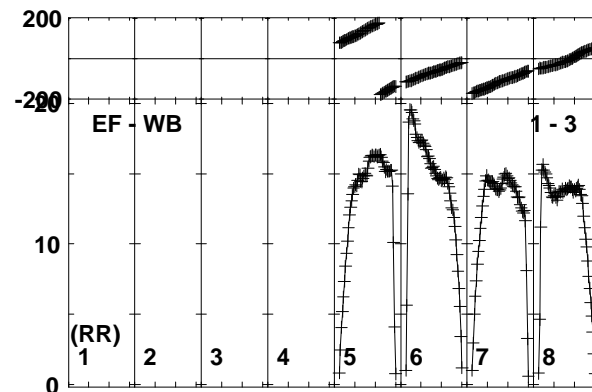
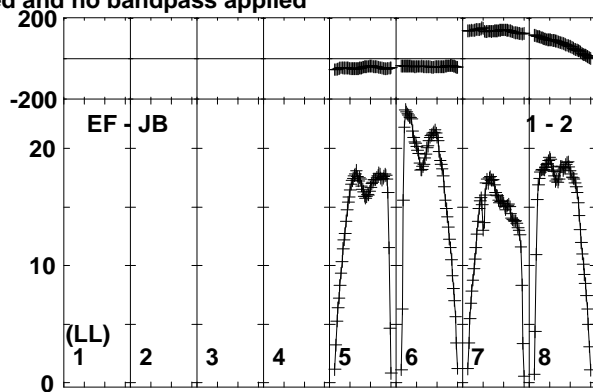
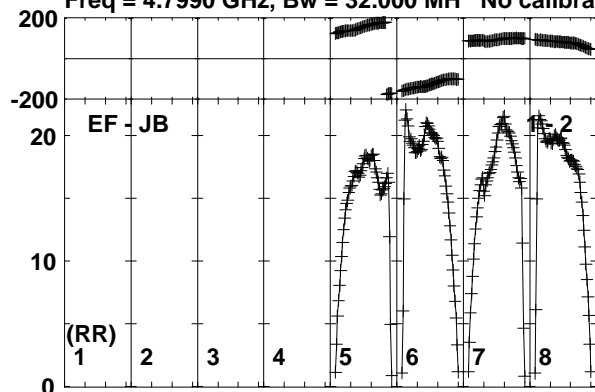

Lower frame: Milli Ampl Jy Top frame: Phas deg
Vector averaged cross-power spectrum Baseline: EF (01) - JB (02)
Timerange: 00/15:10:32 to 00/15:11:28

Plot file version 86 created 19-OCT-2017 15:36:06

J1504+1029 ES081C.UVDATA.1

Freq = 4.7990 GHz, Bw = 32.000 MH No calibration applied and no bandpass applied

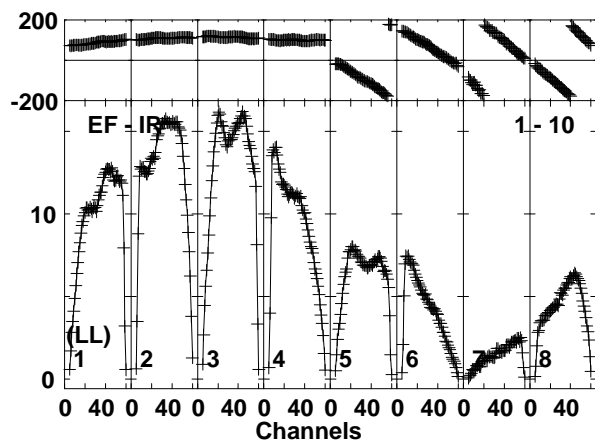
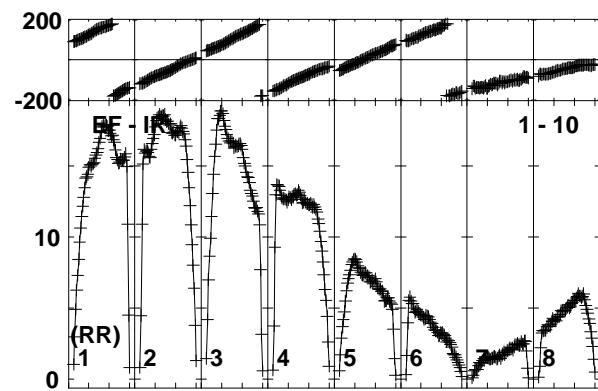
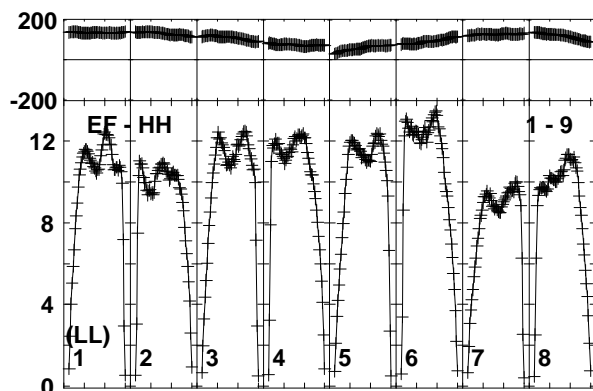
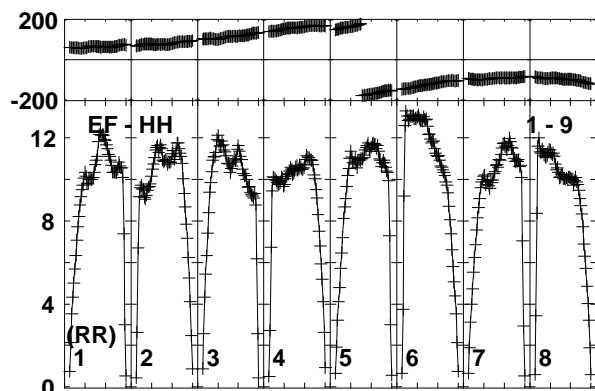
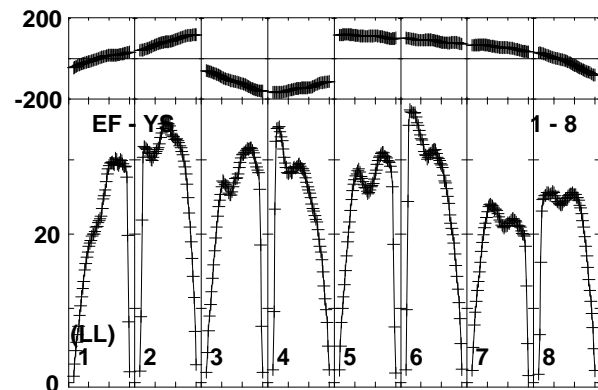
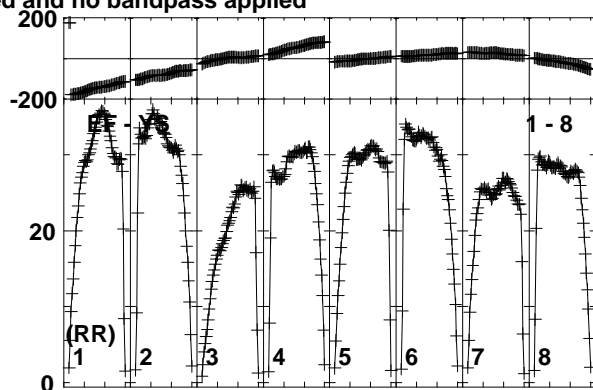
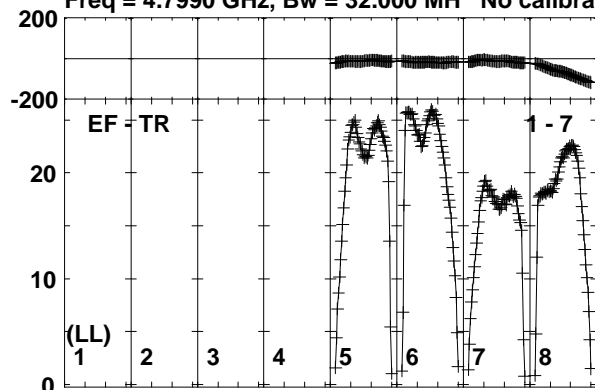

Lower frame: Milli Ampl Jy Top frame: Phas deg
Vector averaged cross-power spectrum Baseline: EF (01) - TR (07)
Timerange: 00/15:10:32 to 00/15:11:28

Plot file version 87 created 19-OCT-2017 15:36:06

MRK841 ES081C.UVDATA.1

Freq = 4.7990 GHz, Bw = 32.000 MH No calibration applied and no bandpass applied

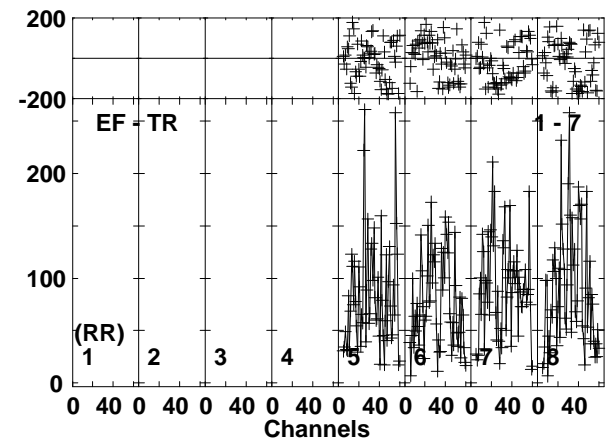
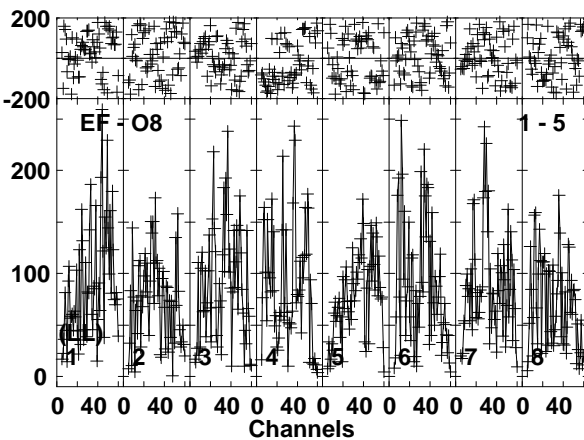
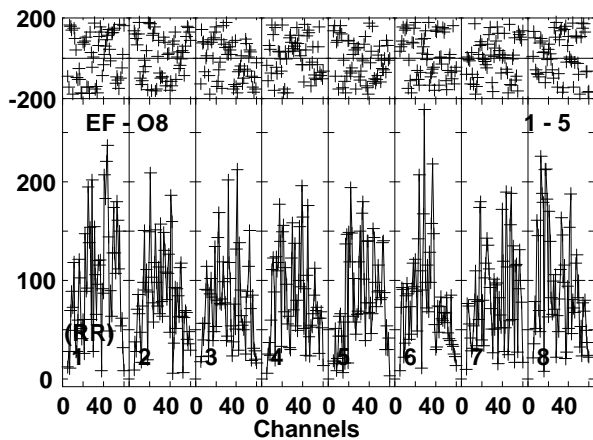
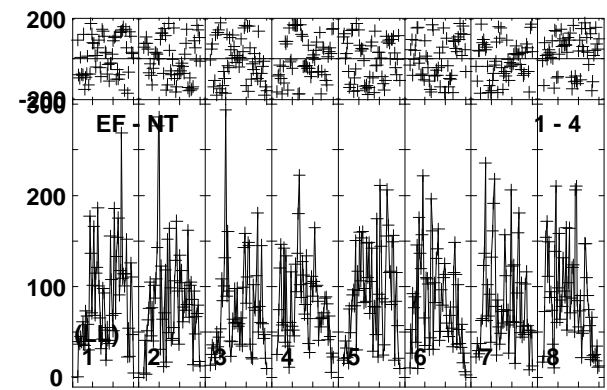
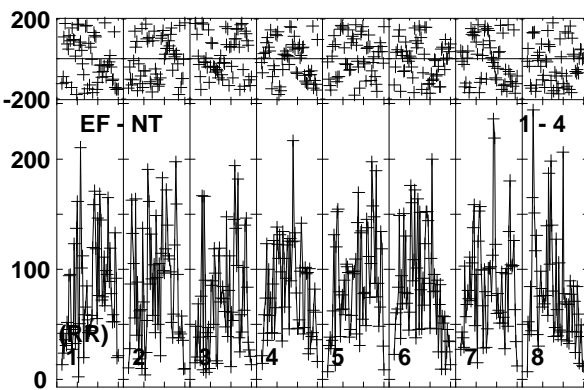
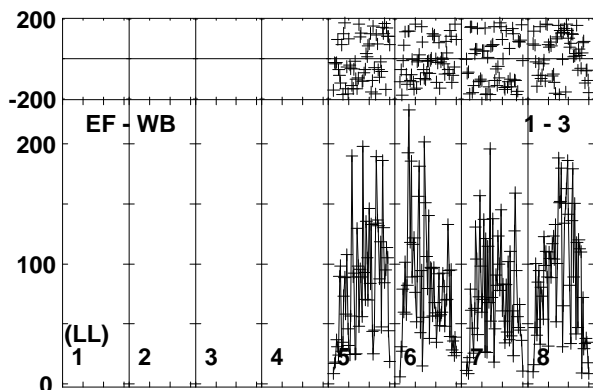
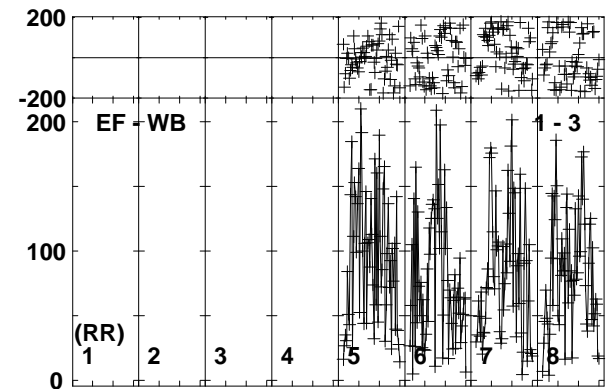
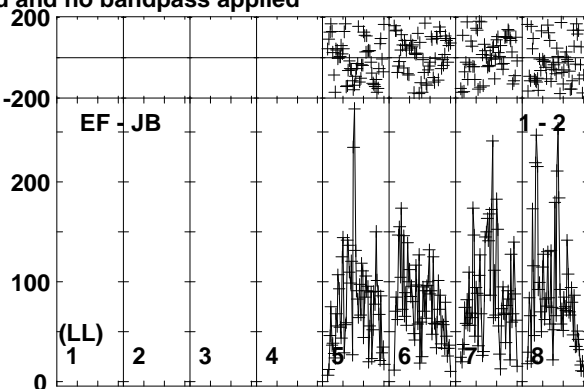
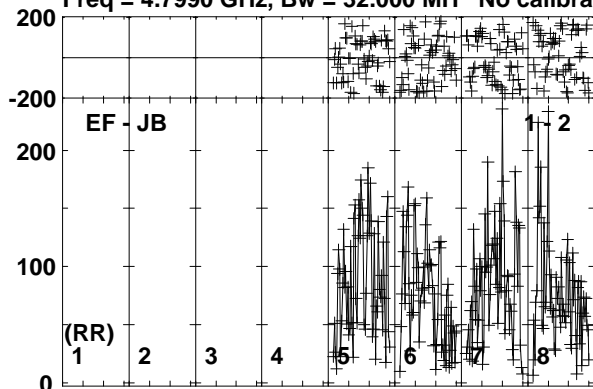

Lower frame: Micro Ampl Jy Top frame: Phas deg
Vector averaged cross-power spectrum Baseline: EF (01) - JB (02)
Timerange: 00/15:11:32 to 00/15:14:58

Plot file version 88 created 19-OCT-2017 15:36:06

MRK841 ES081C.UVDATA.1

Freq = 4.7990 GHz, Bw = 32.000 MH No calibration applied and no bandpass applied

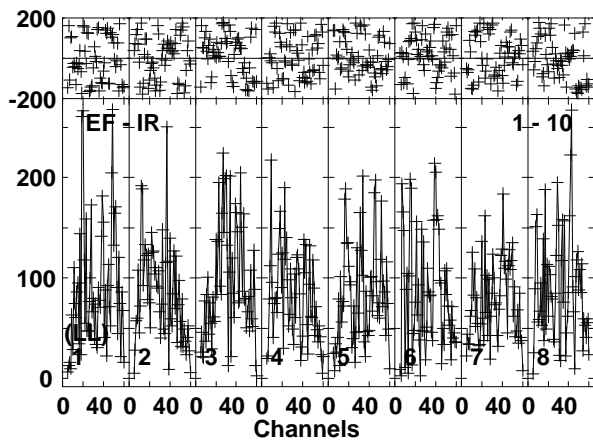
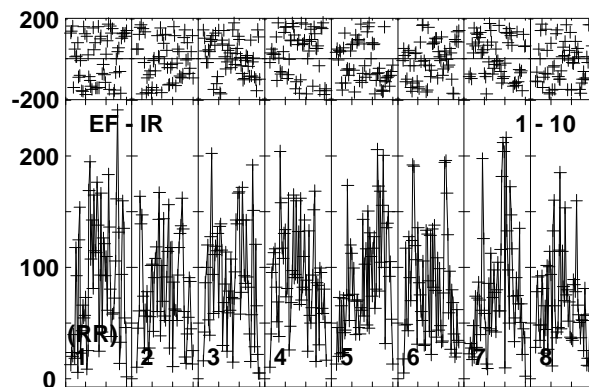
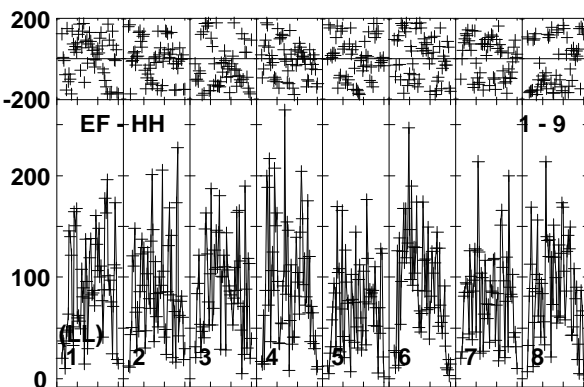
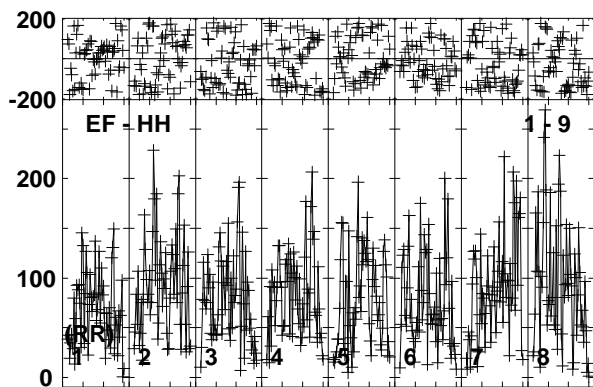
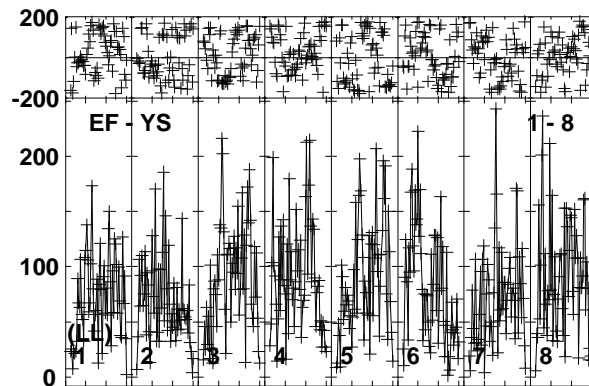
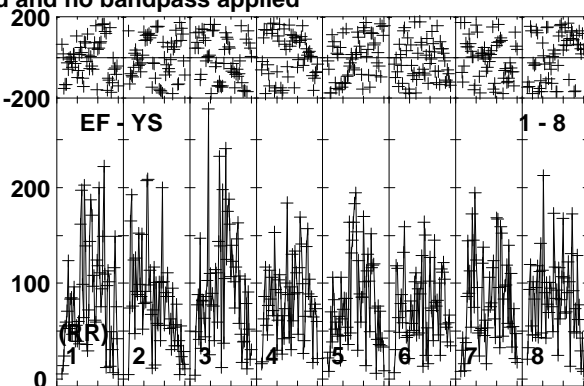
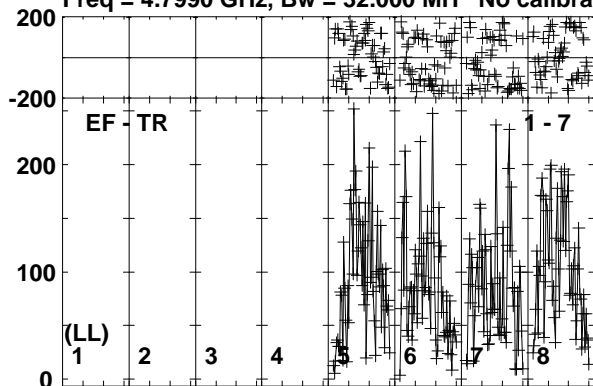

Lower frame: Micro Ampl Jy Top frame: Phas deg
Vector averaged cross-power spectrum Baseline: EF (01) - TR (07)
Timerange: 00/15:11:32 to 00/15:14:58

Plot file version 89 created 19-OCT-2017 15:36:06

J1504+1029 ES081C.UVDATA.1

Freq = 4.7990 GHz, Bw = 32.000 MH No calibration applied and no bandpass applied

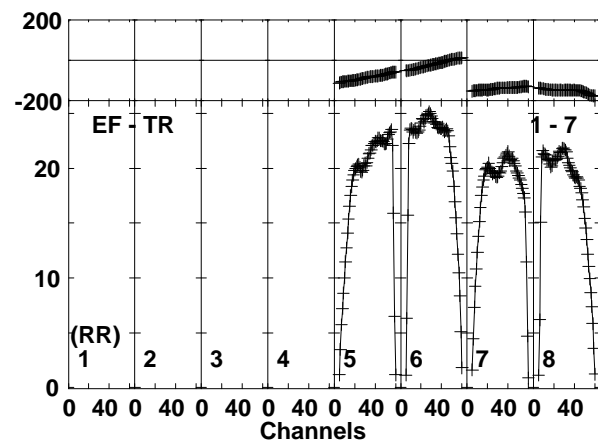
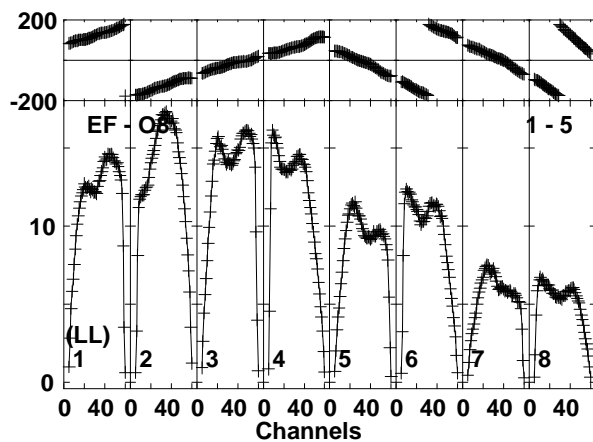
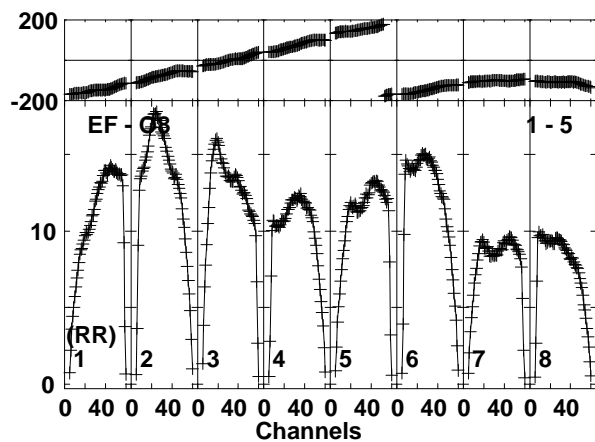
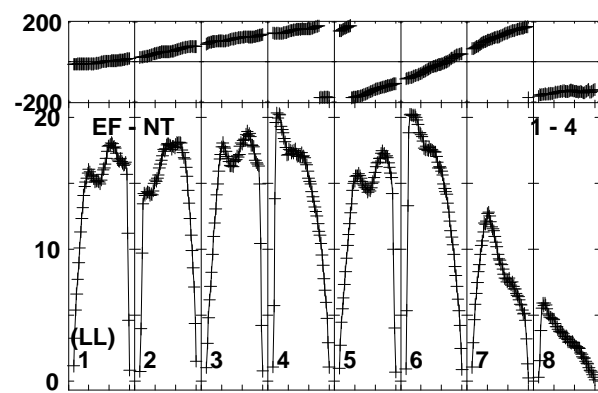
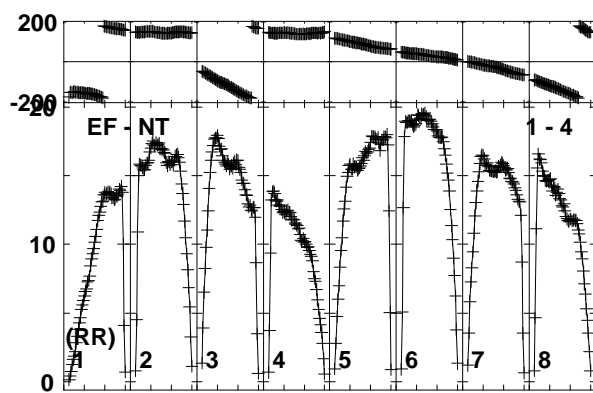
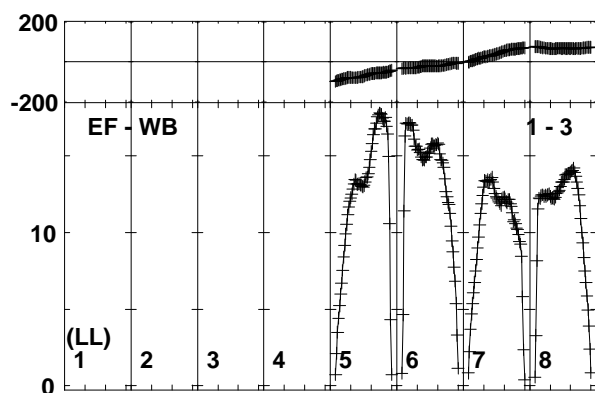
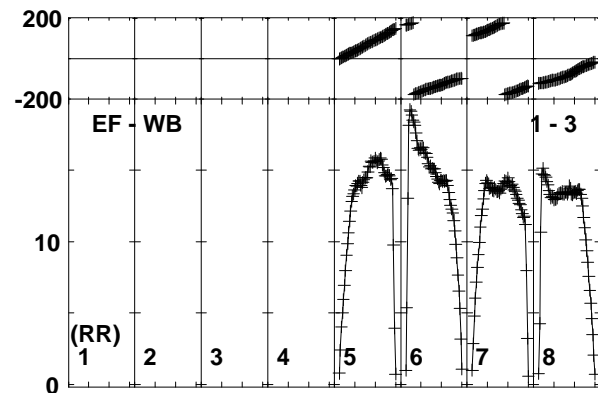
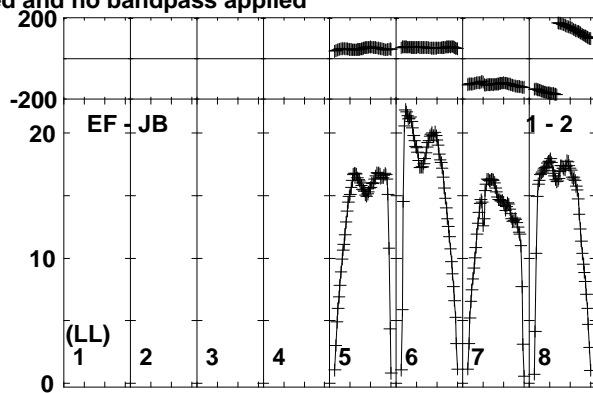
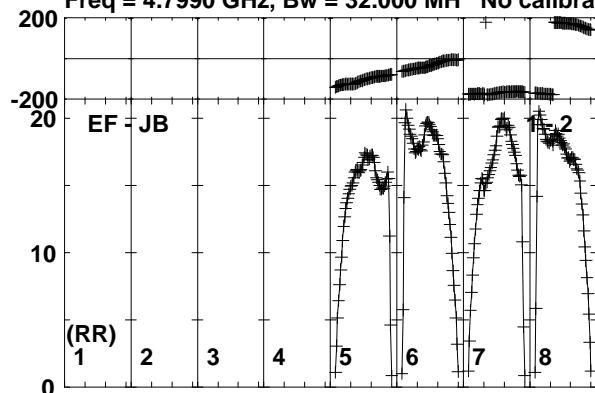

Lower frame: Milli Ampl Jy Top frame: Phas deg
Vector averaged cross-power spectrum Baseline: EF (01) - JB (02)
Timerange: 00:15:15:02 to 00:15:16:28

Plot file version 90 created 19-OCT-2017 15:36:06

J1504+1029 ES081C.UVDATA.1

Freq = 4.7990 GHz, Bw = 32.000 MH No calibration applied and no bandpass applied

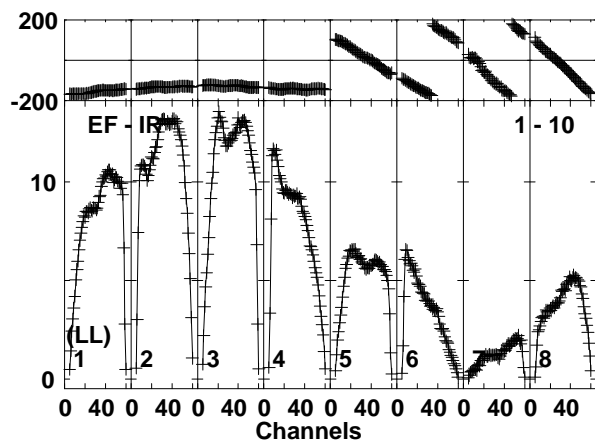
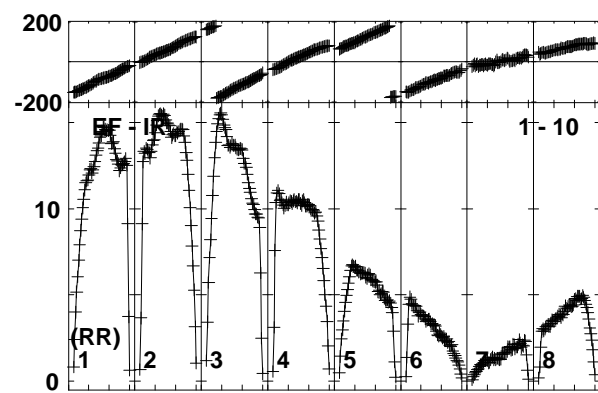
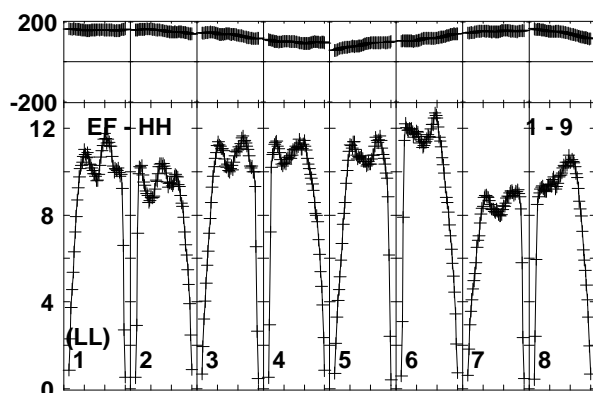
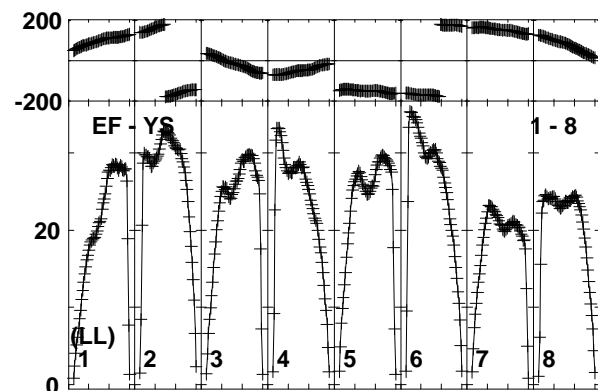
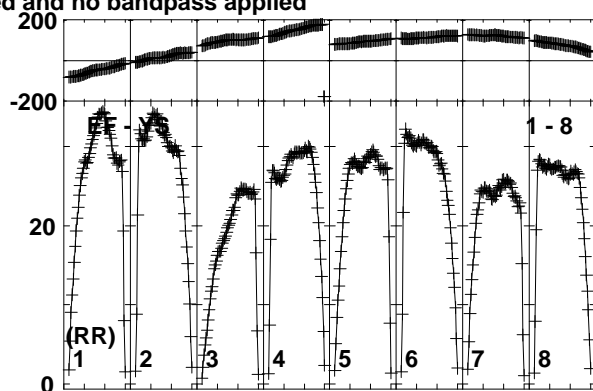
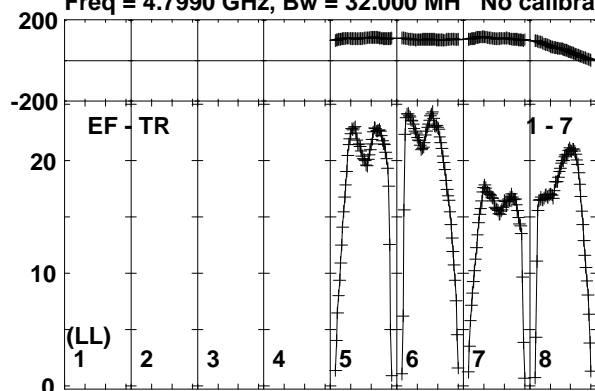

Lower frame: Milli Ampl Jy Top frame: Phas deg
Vector averaged cross-power spectrum Baseline: EF (01) - TR (07)
Timerange: 00/15:15:02 to 00/15:16:28

Plot file version 91 created 19-OCT-2017 15:36:06
 MRK841 ES081C.UVDATA.1
 Freq = 4.7990 GHz, Bw = 32.000 MH No calibration applied and no bandpass applied

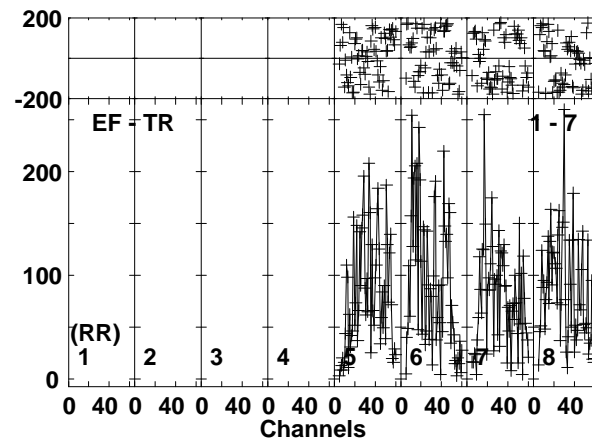
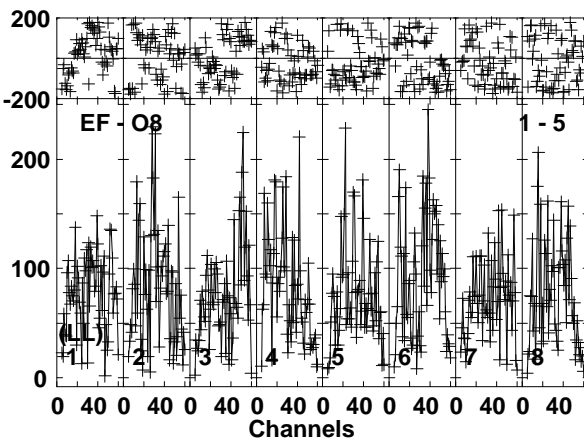
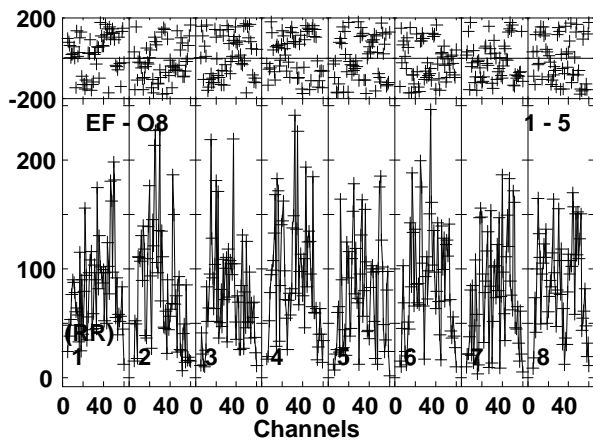
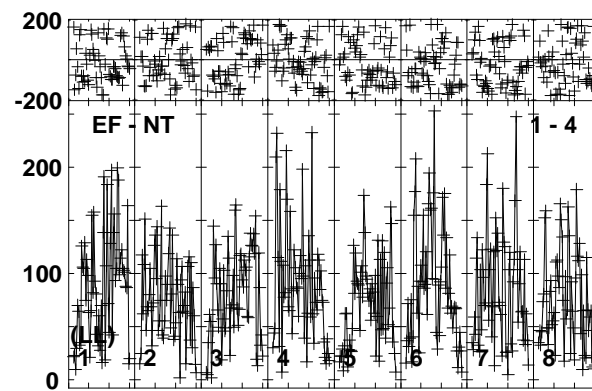
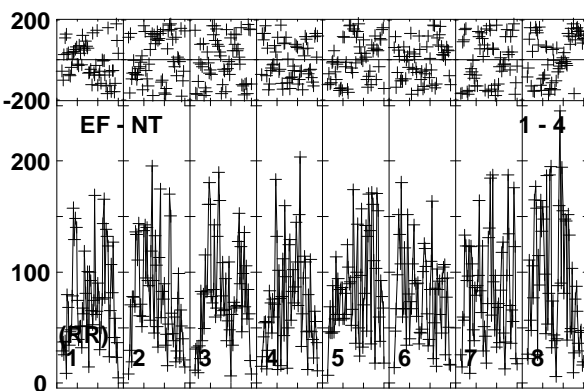
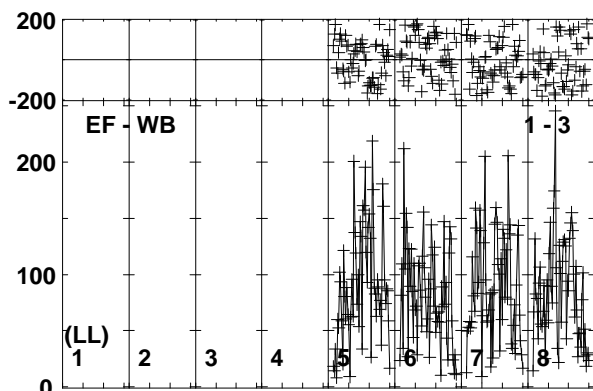
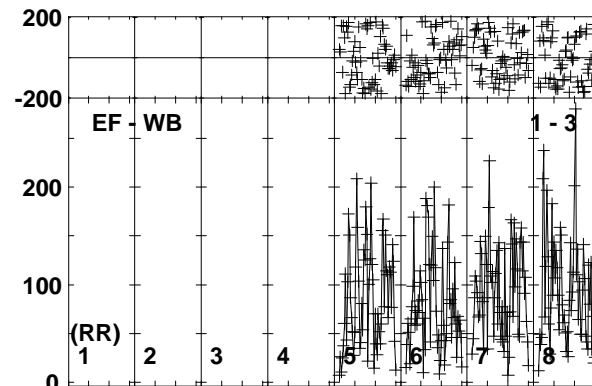
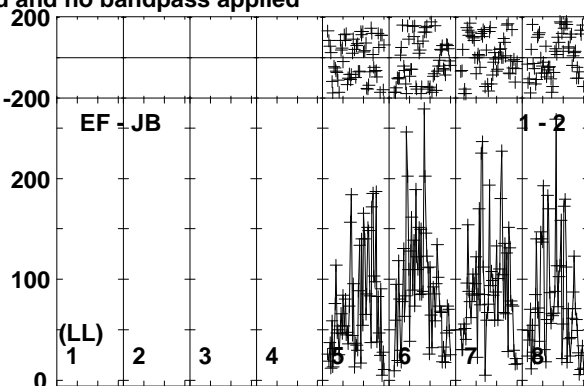
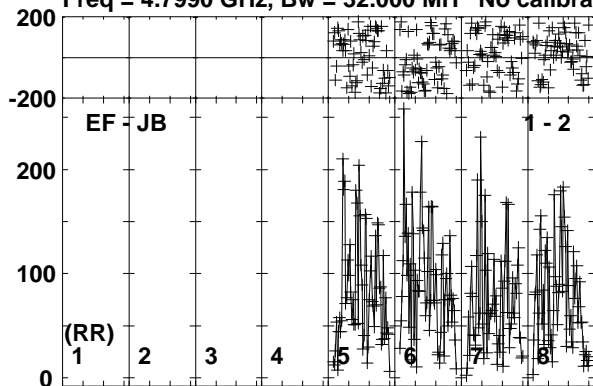

Lower frame: Micro Ampl Jy Top frame: Phas deg
 Vector averaged cross-power spectrum Baseline: EF (01) - JB (02)
 Timerange: 00/15:16:32 to 00/15:19:58

Plot file version 92 created 19-OCT-2017 15:36:06

MRK841 ES081C.UVDATA.1

Freq = 4.7990 GHz, Bw = 32.000 MH No calibration applied and no bandpass applied

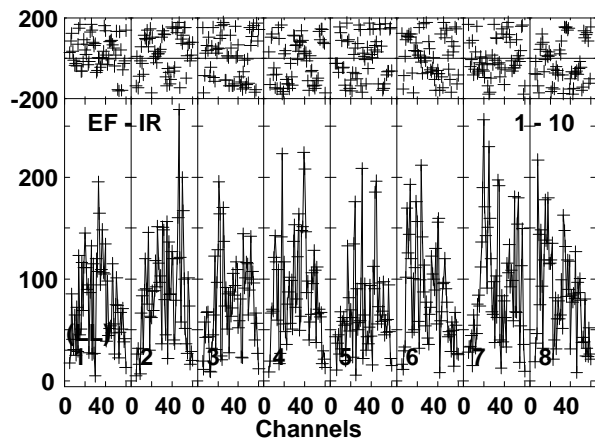
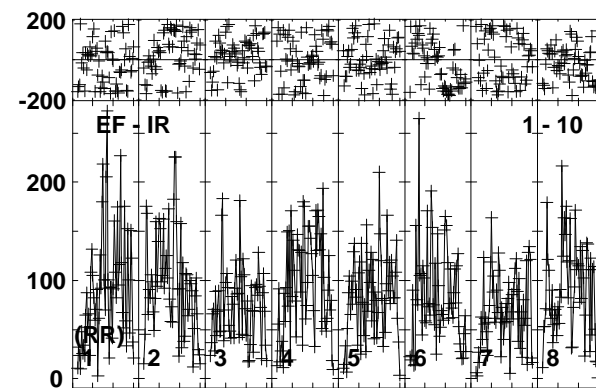
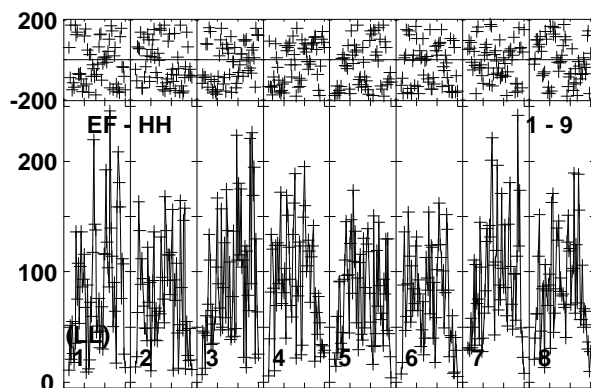
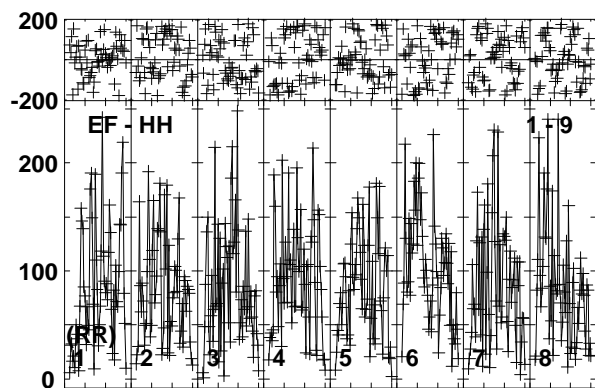
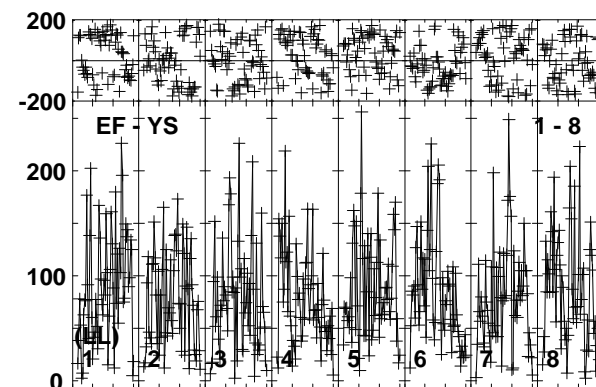
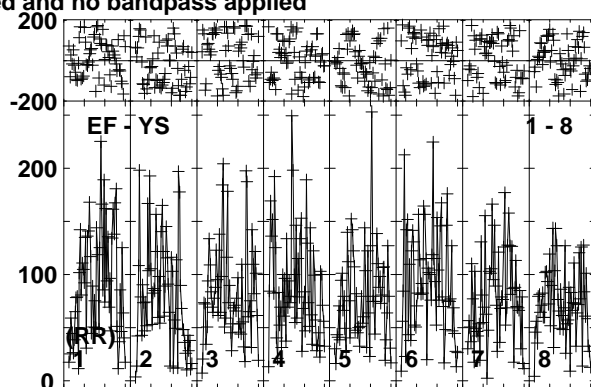
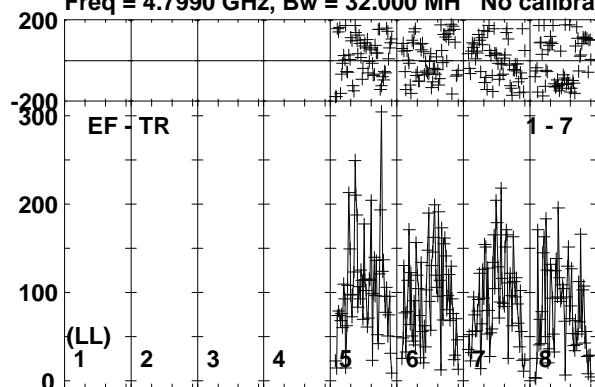

Lower frame: Micro Ampl Jy Top frame: Phas deg
Vector averaged cross-power spectrum Baseline: EF (01) - TR (07)
Timerange: 00/15:16:32 to 00/15:19:58

Plot file version 93 created 19-OCT-2017 15:36:06

J1504+1029 ES081C.UVDATA.1

Freq = 4.7990 GHz, Bw = 32.000 MH No calibration applied and no bandpass applied

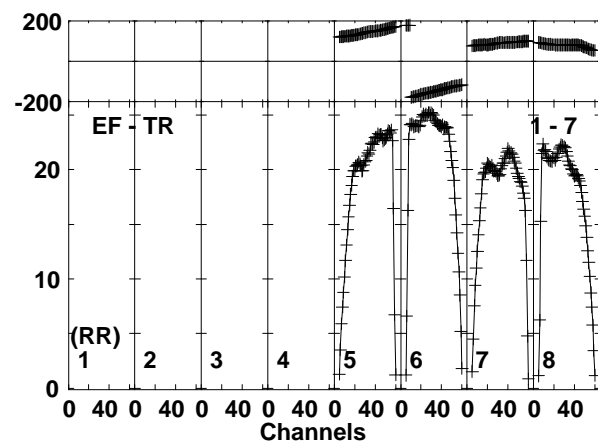
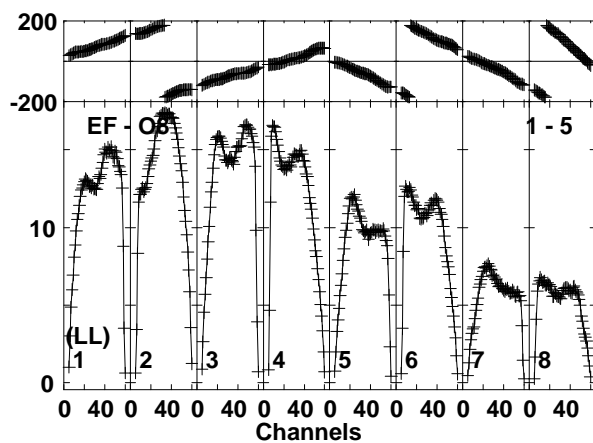
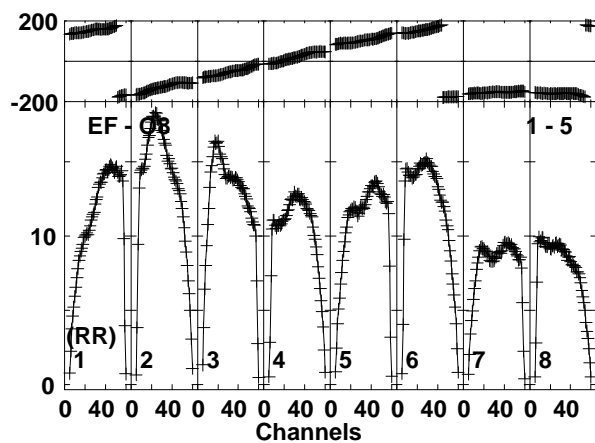
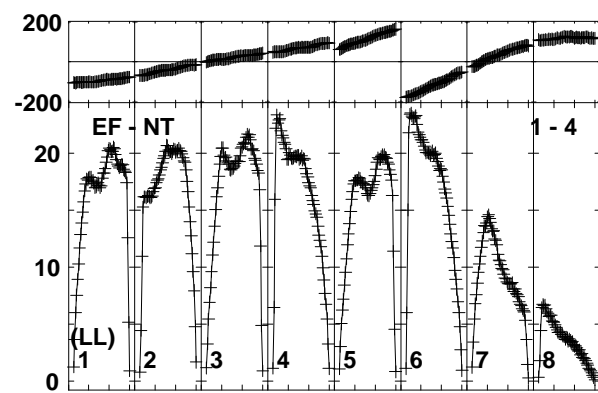
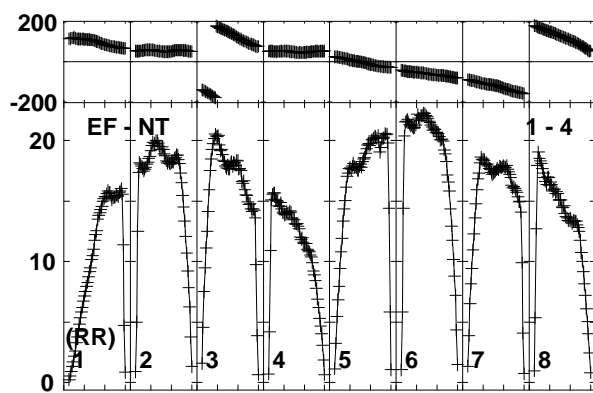
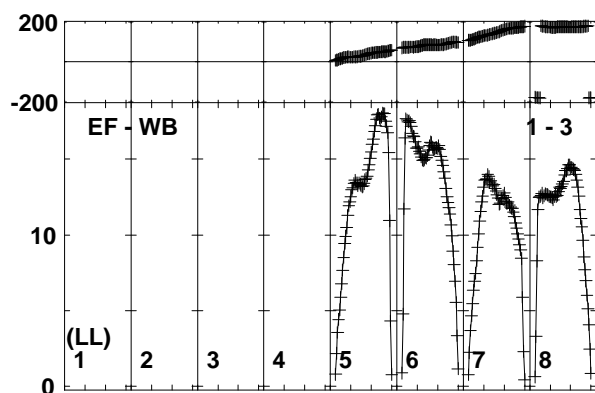
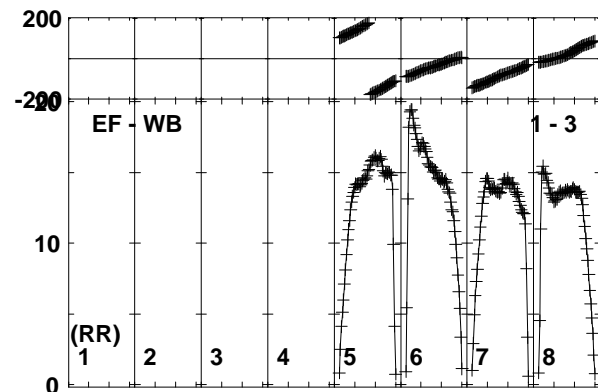
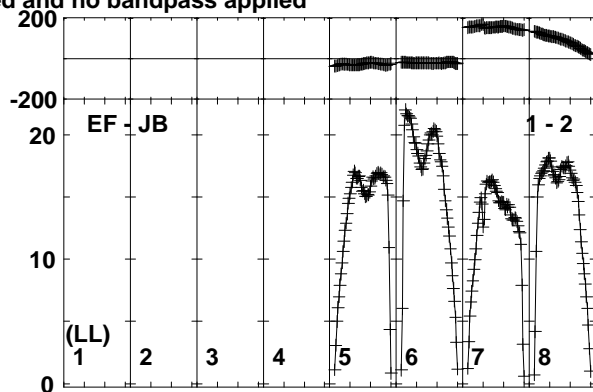
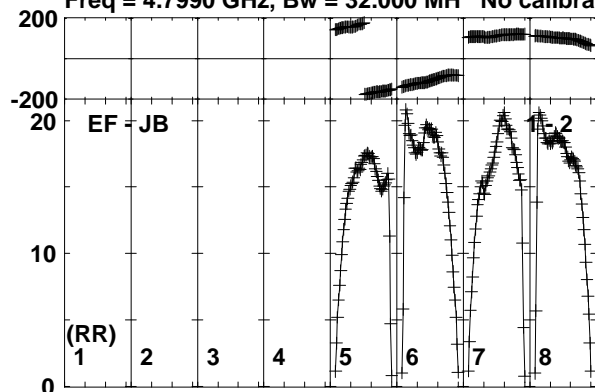

Lower frame: Milli Ampl Jy Top frame: Phas deg
Vector averaged cross-power spectrum Baseline: EF (01) - JB (02)
Timerange: 00/15:20:32 to 00/15:21:28

Plot file version 94 created 19-OCT-2017 15:36:06

J1504+1029 ES081C.UVDATA.1

Freq = 4.7990 GHz, Bw = 32.000 MH No calibration applied and no bandpass applied

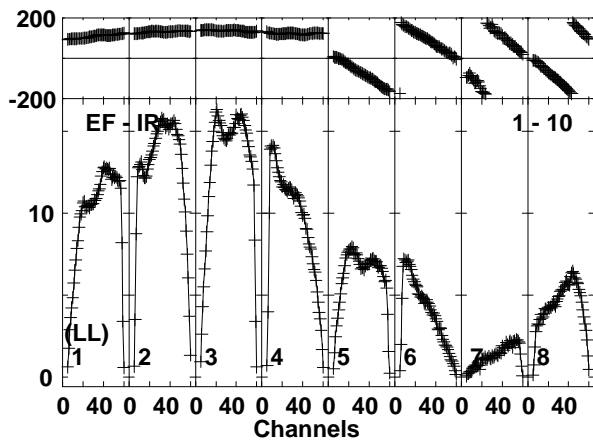
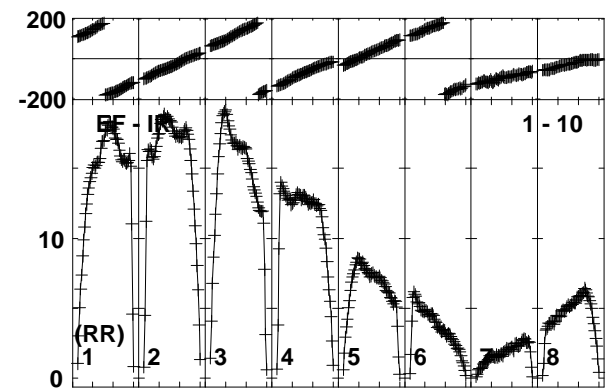
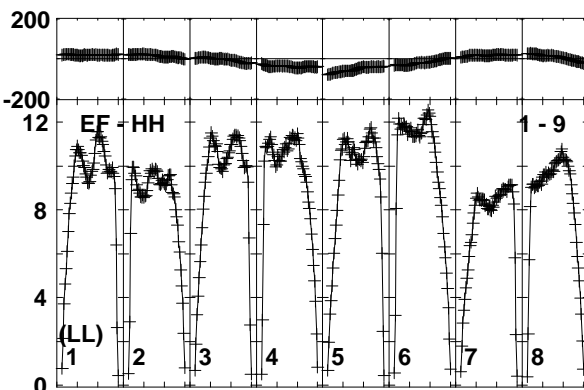
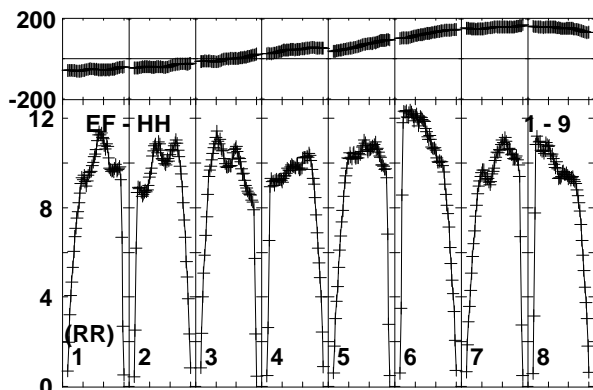
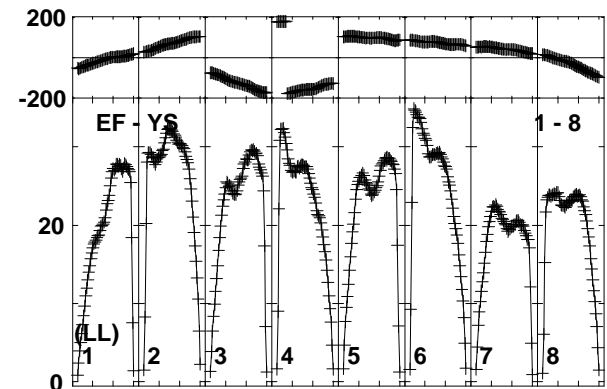
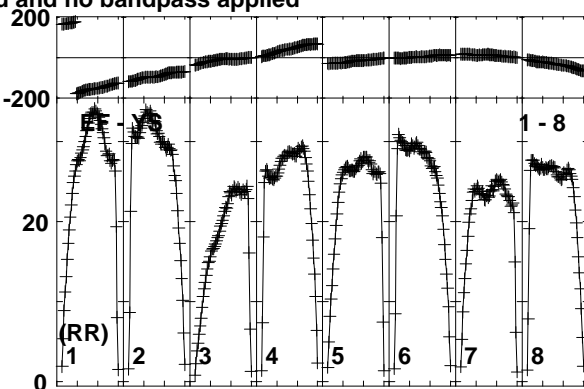
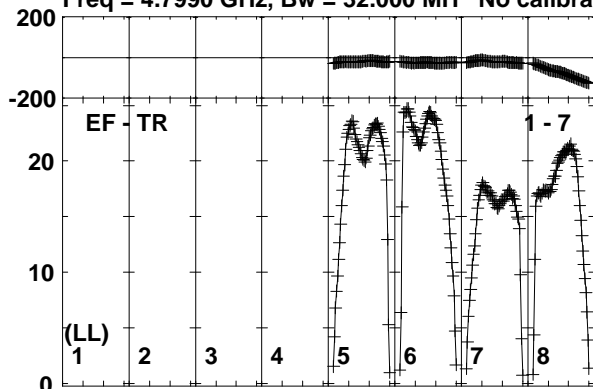

Lower frame: Milli Ampl Jy Top frame: Phas deg
Vector averaged cross-power spectrum Baseline: EF (01) - TR (07)
Timerange: 00/15:20:32 to 00/15:21:28

Plot file version 95 created 19-OCT-2017 15:36:07

MRK841 ES081C.UVDATA.1

Freq = 4.7990 GHz, Bw = 32.000 MH No calibration applied and no bandpass applied

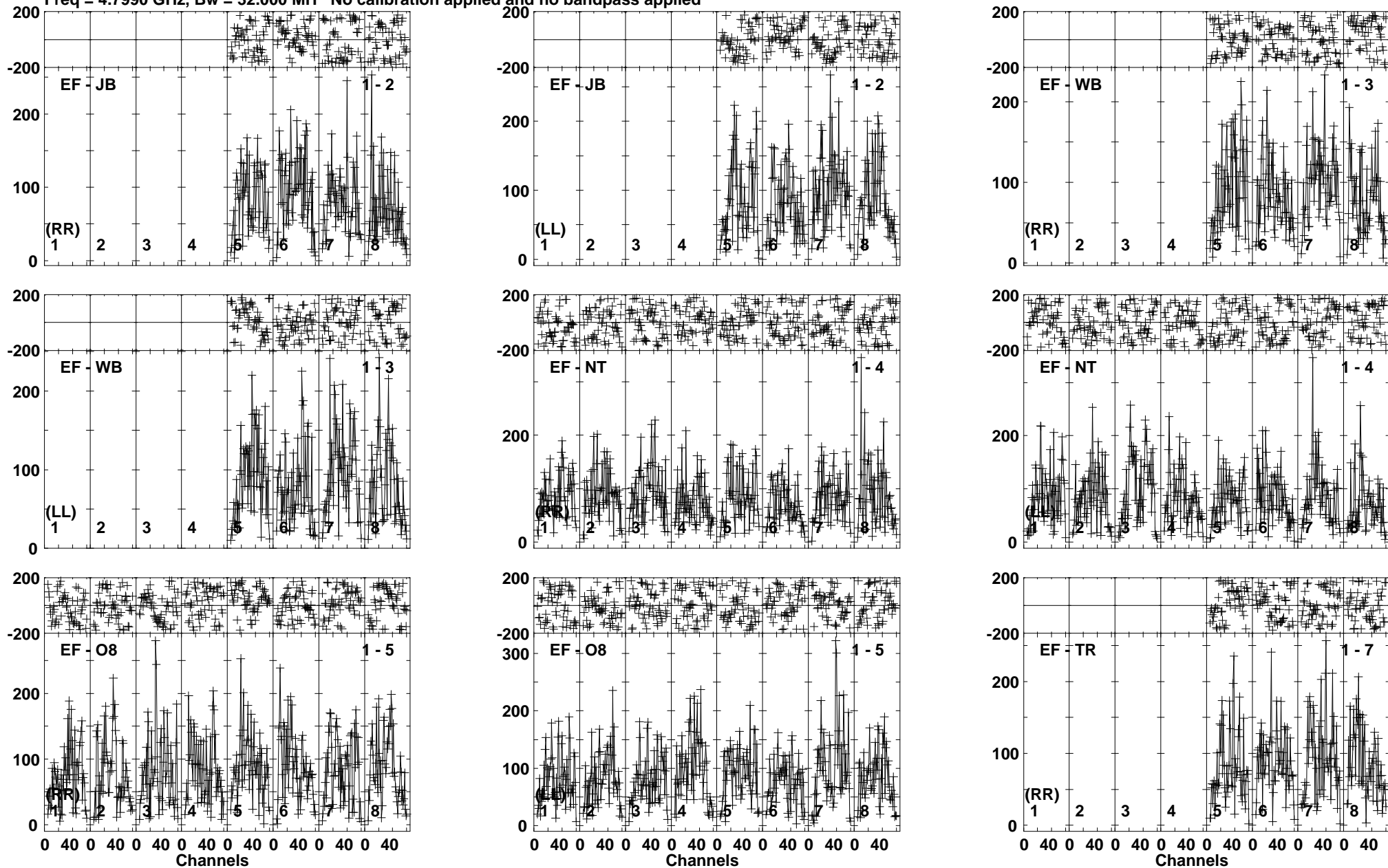

Lower frame: Micro Ampl Jy Top frame: Phas deg
Vector averaged cross-power spectrum Baseline: EF (01) - JB (02)
Timerange: 00/15:21:32 to 00/15:24:58

Plot file version 96 created 19-OCT-2017 15:36:07

MRK841 ES081C.UVDATA.1

Freq = 4.7990 GHz, Bw = 32.000 MH No calibration applied and no bandpass applied

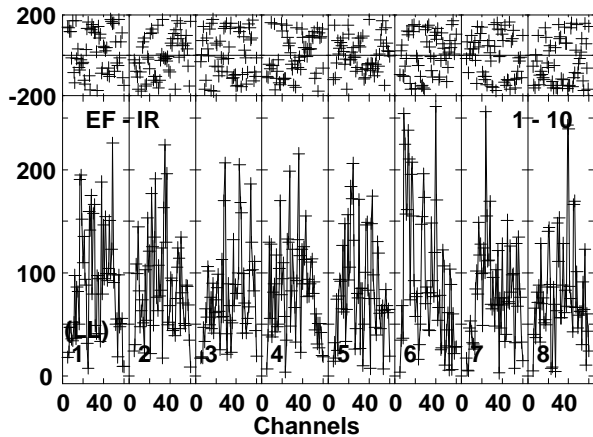
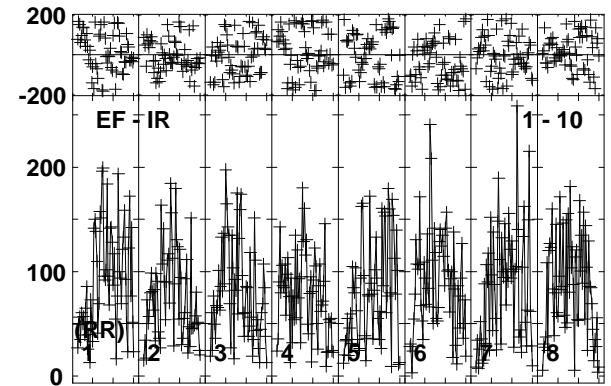
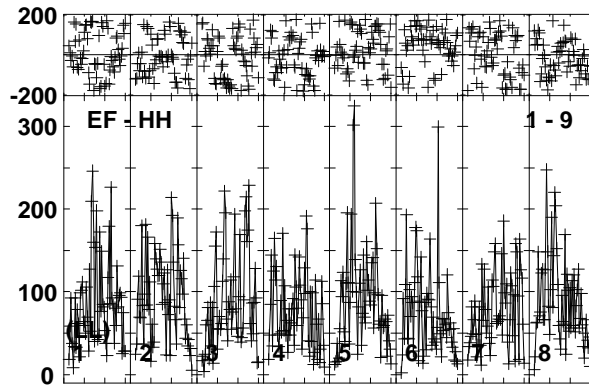
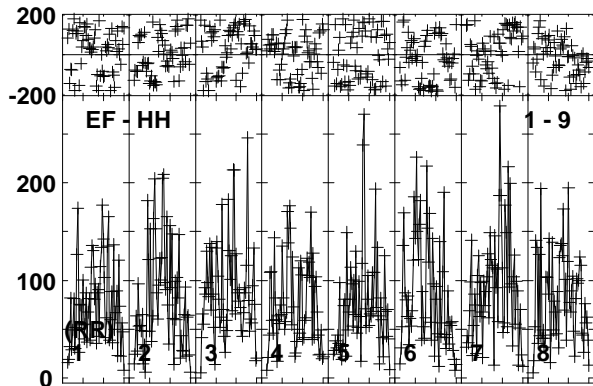
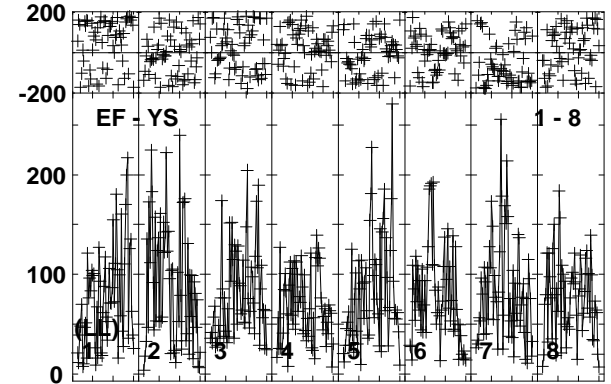
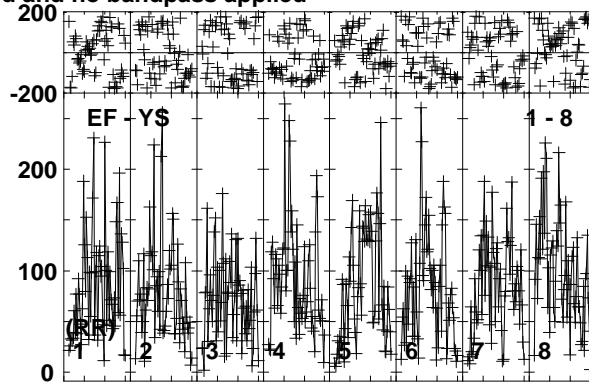
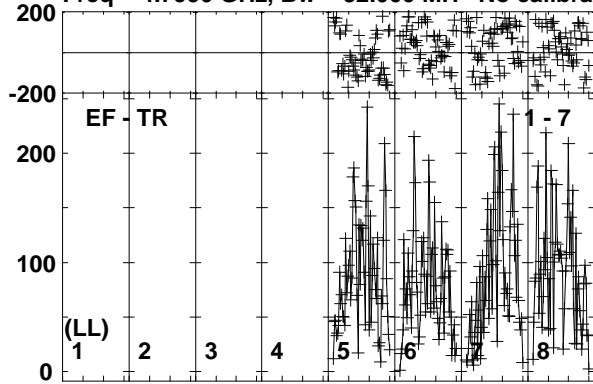

Lower frame: Micro Ampl Jy Top frame: Phas deg
Vector averaged cross-power spectrum Baseline: EF (01) - TR (07)
Timerange: 00/15:21:32 to 00/15:24:58

Plot file version 97 created 19-OCT-2017 15:36:07

J1504+1029 ES081C.UVDATA.1

Freq = 4.7990 GHz, Bw = 32.000 MH No calibration applied and no bandpass applied

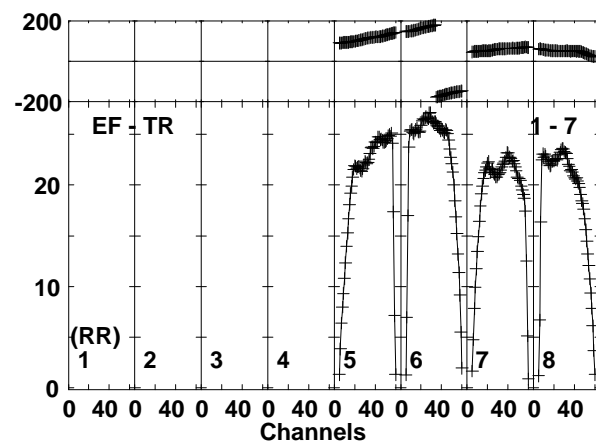
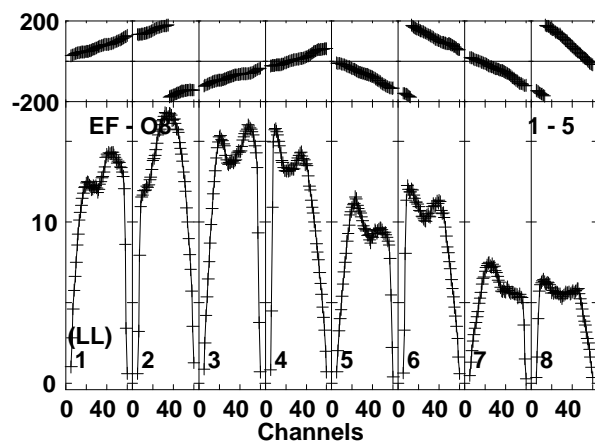
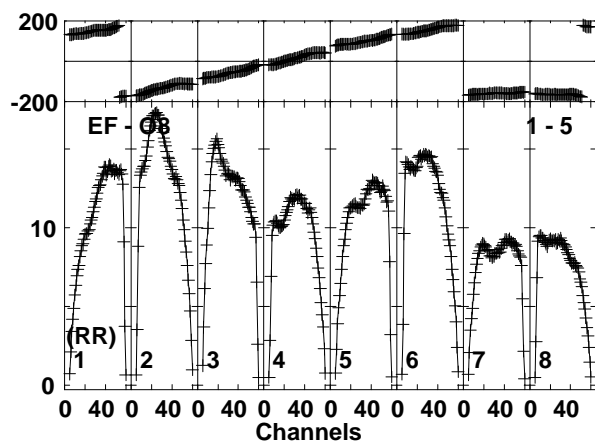
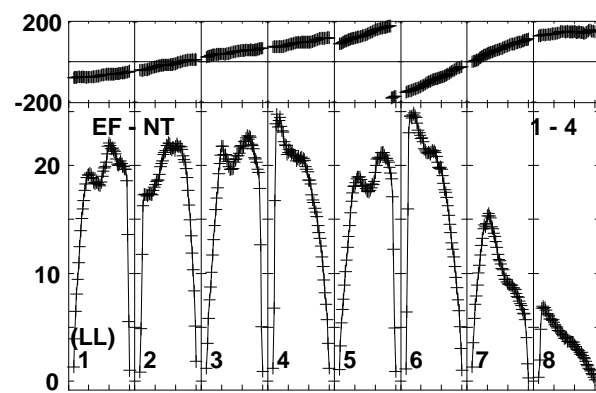
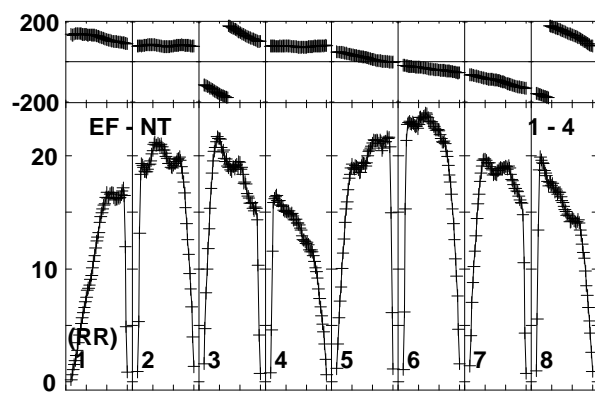
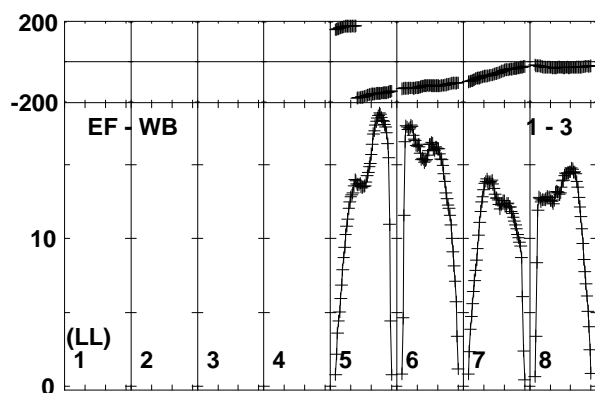
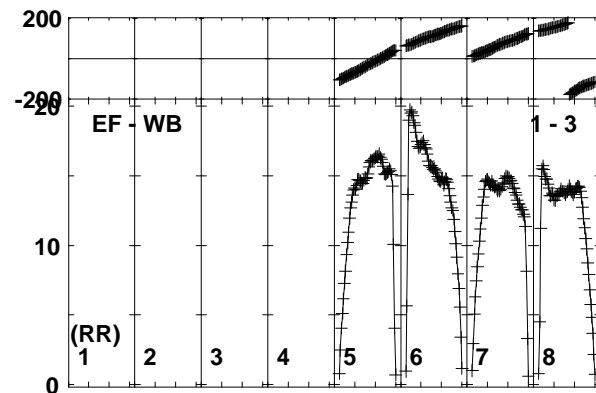
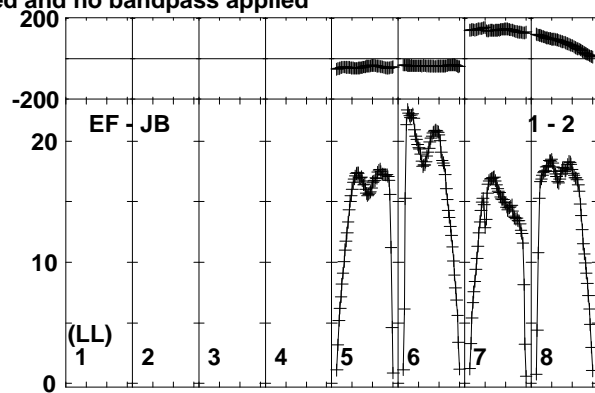
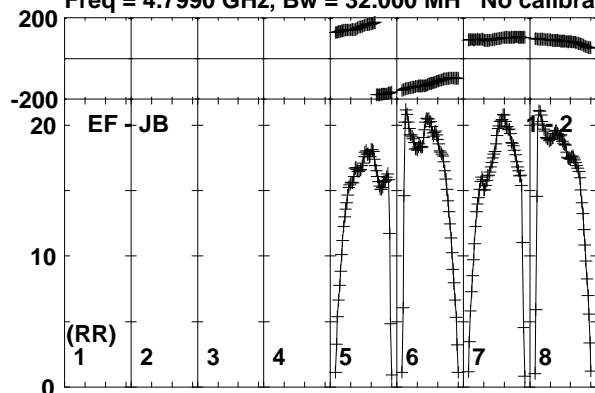

Lower frame: Milli Ampl Jy Top frame: Phas deg
Vector averaged cross-power spectrum Baseline: EF (01) - JB (02)
Timerange: 00/15:25:02 to 00/15:26:28

Plot file version 98 created 19-OCT-2017 15:36:07

J1504+1029 ES081C.UVDATA.1

Freq = 4.7990 GHz, Bw = 32.000 MH No calibration applied and no bandpass applied

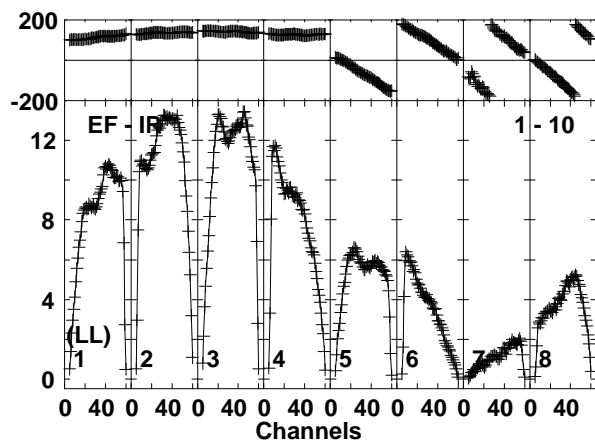
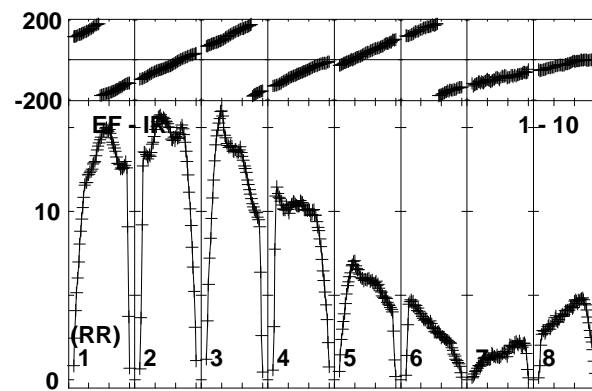
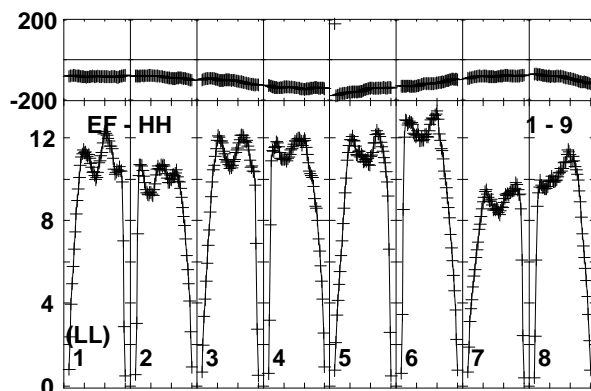
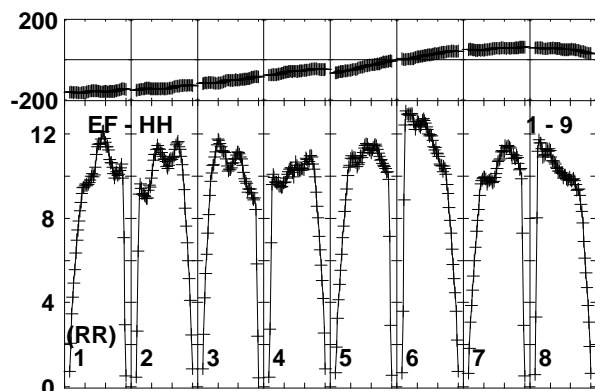
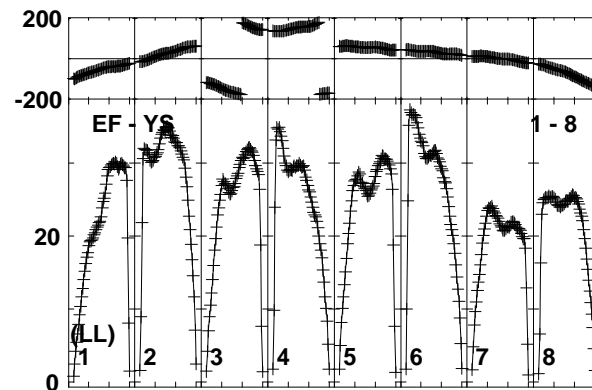
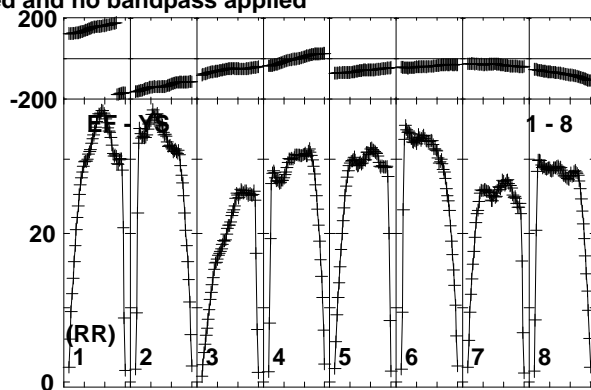
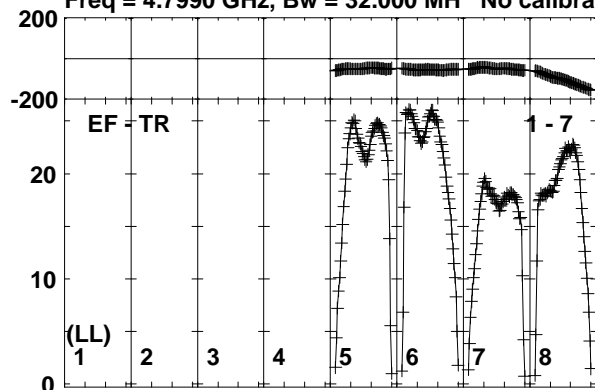

Lower frame: Milli Ampl Jy Top frame: Phas deg
Vector averaged cross-power spectrum Baseline: EF (01) - TR (07)
Timerange: 00/15:25:02 to 00/15:26:28

Plot file version 99 created 19-OCT-2017 15:36:07

MRK841 ES081C.UVDATA.1

Freq = 4.7990 GHz, Bw = 32.000 MH No calibration applied and no bandpass applied

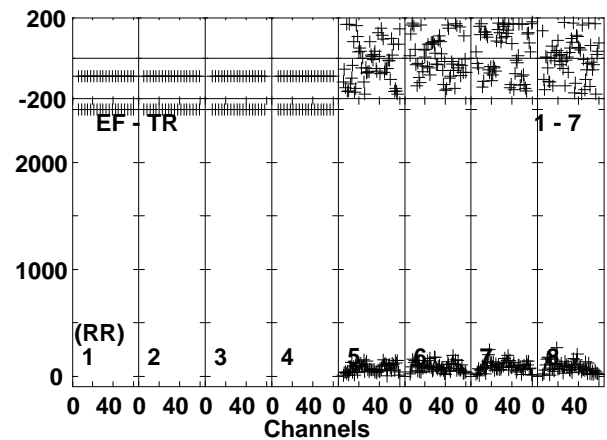
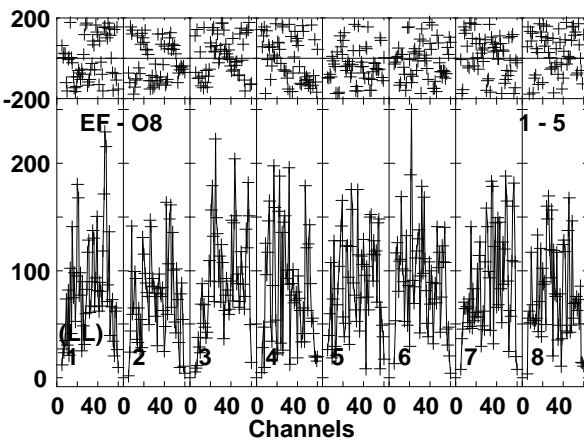
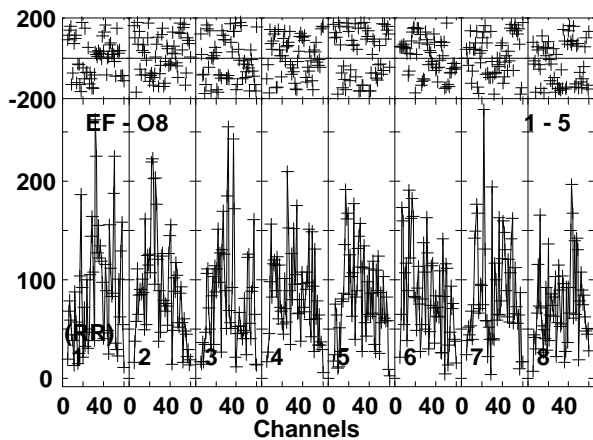
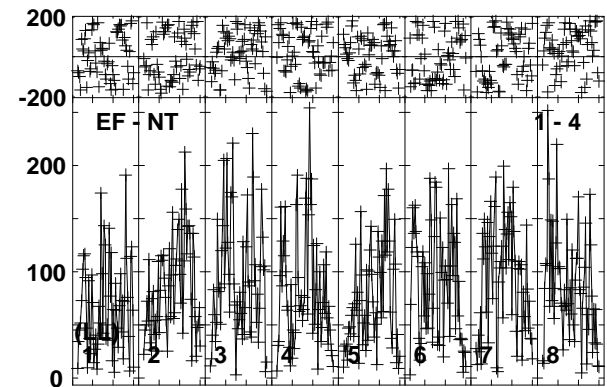
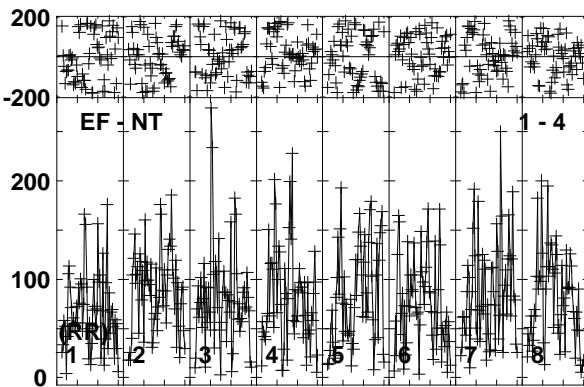
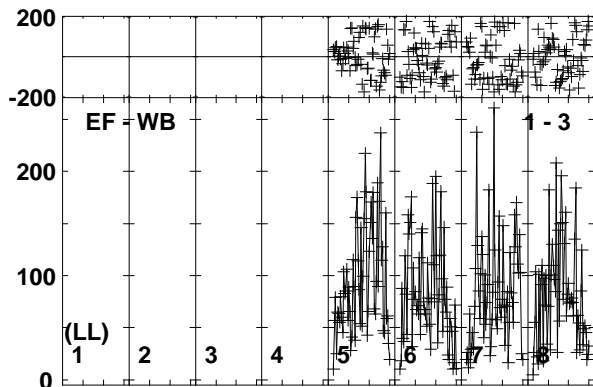
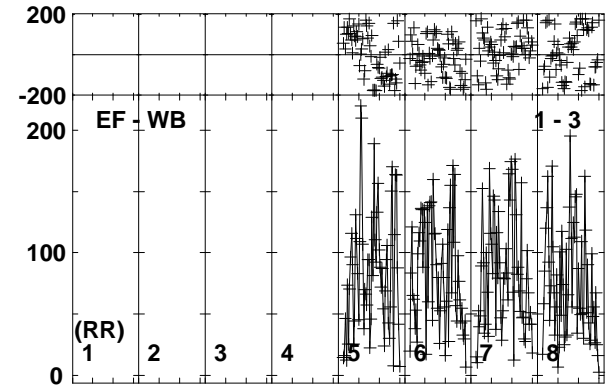
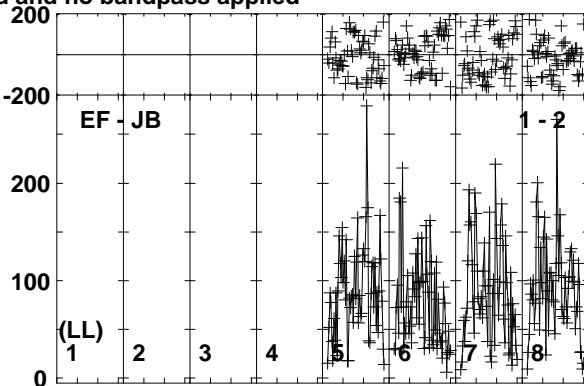
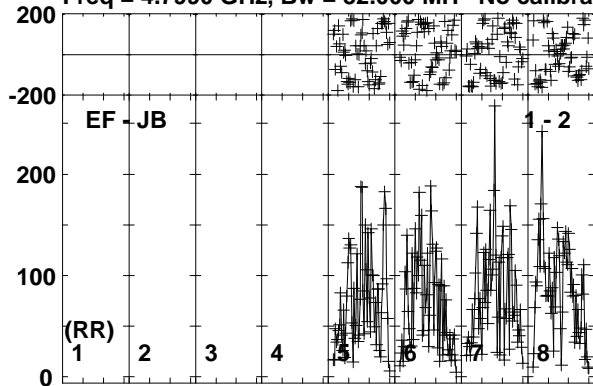

Lower frame: Micro Ampl Jy Top frame: Phas deg
Vector averaged cross-power spectrum Baseline: EF (01) - JB (02)
Timerange: 00/15:26:32 to 00/15:29:58

Plot file version 100 created 19-OCT-2017 15:36:07

MRK841 ES081C.UVDATA.1

Freq = 4.7990 GHz, Bw = 32.000 MH No calibration applied and no bandpass applied

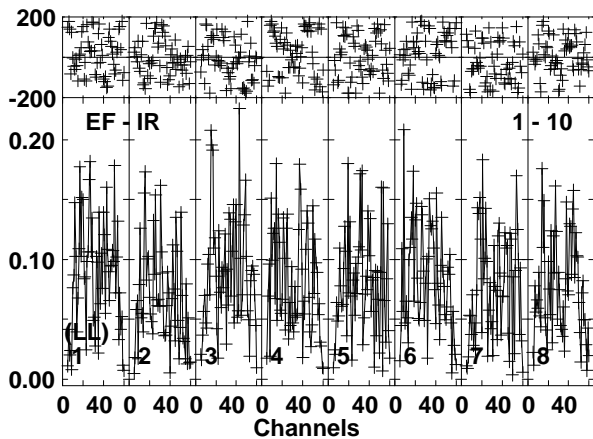
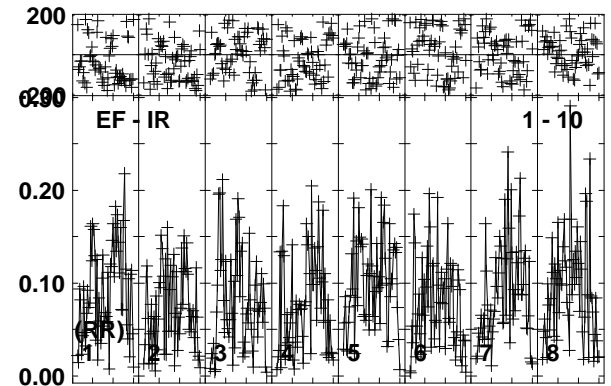
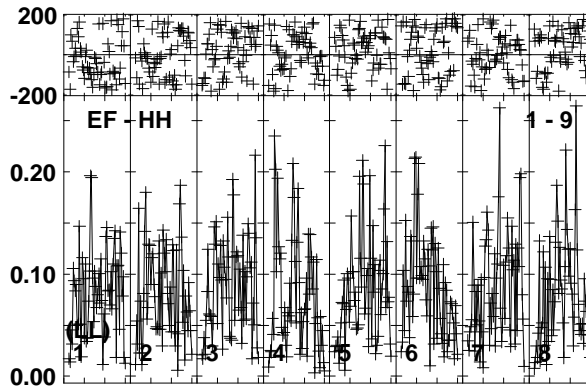
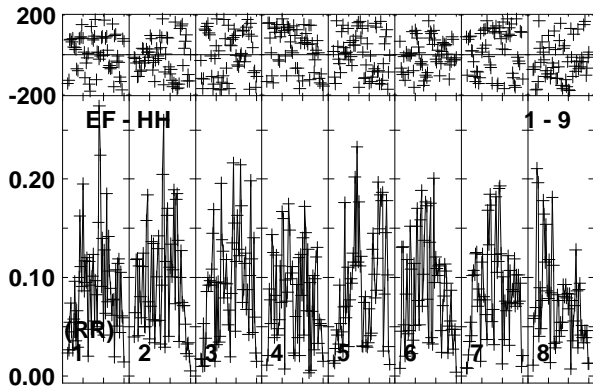
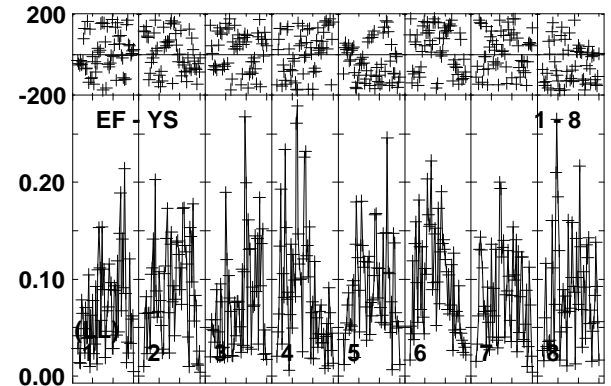
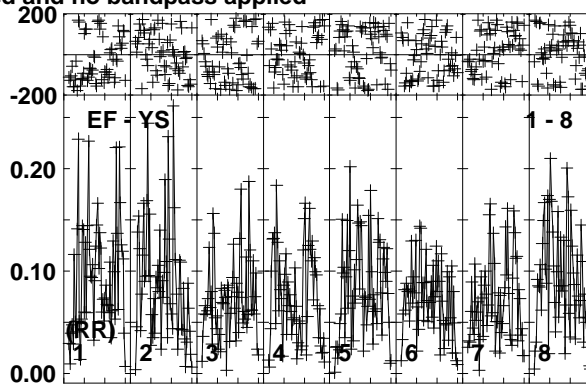
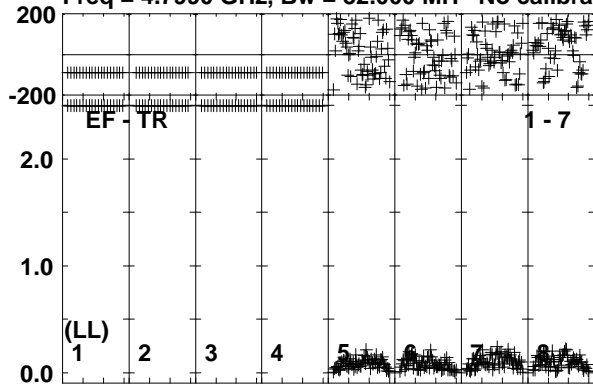

Lower frame: Milli Ampl Jy Top frame: Phas deg
Vector averaged cross-power spectrum Baseline: EF (01) - TR (07)
Timerange: 00/15:26:32 to 00/15:29:58

Plot file version 101 created 19-OCT-2017 15:36:07

J1504+1029 ES081C.UVDATA.1

Freq = 4.7990 GHz, Bw = 32.000 MH No calibration applied and no bandpass applied

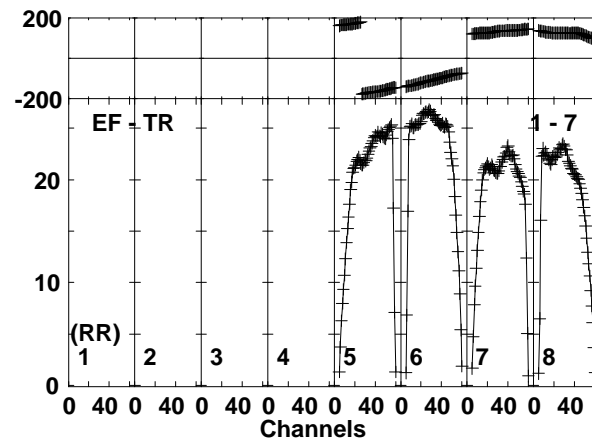
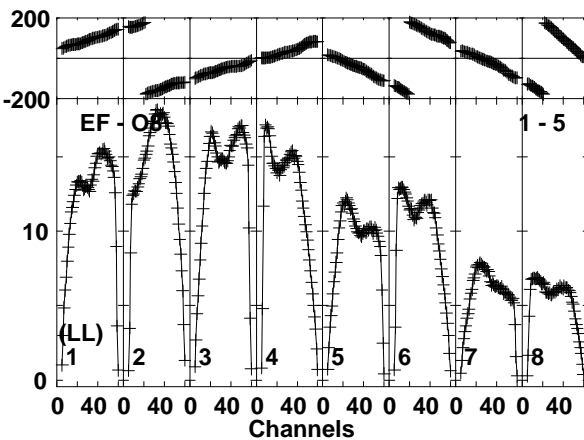
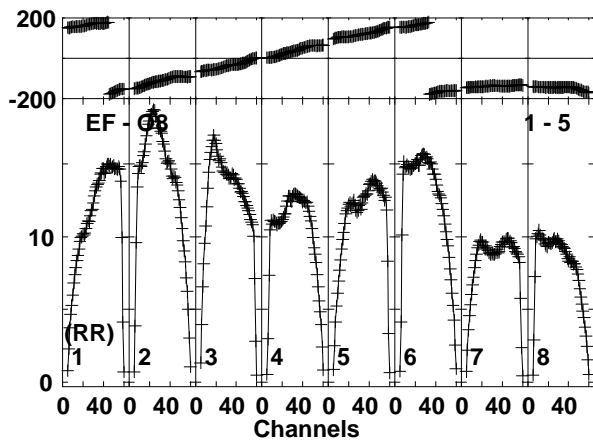
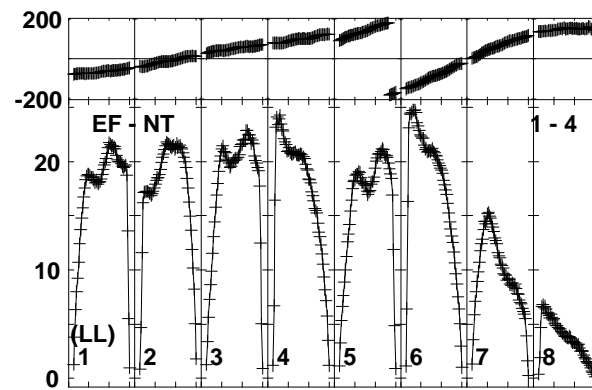
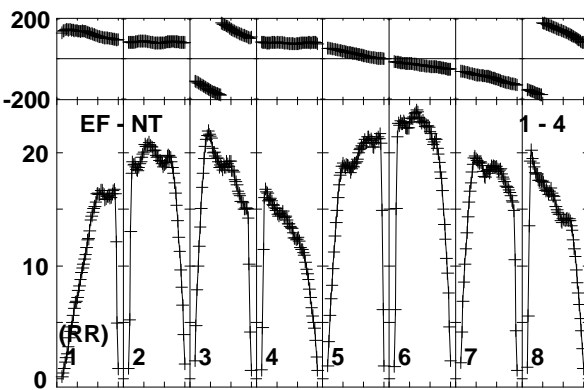
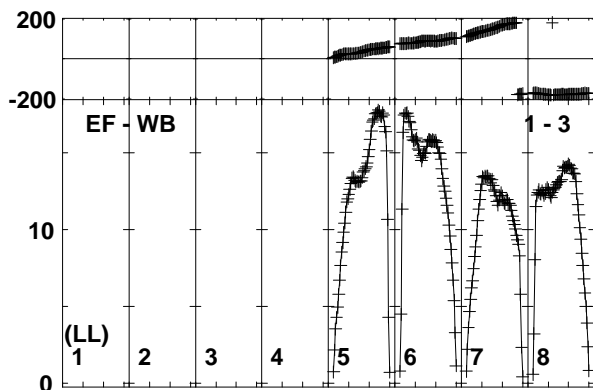
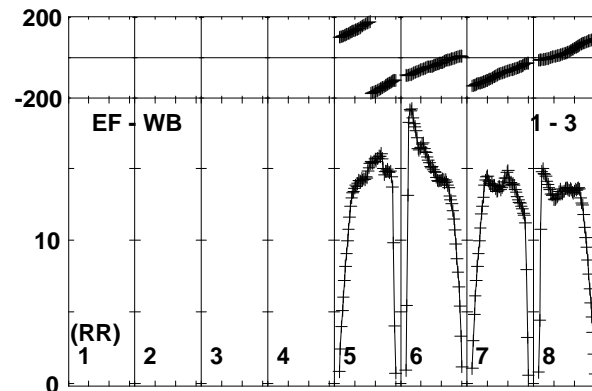
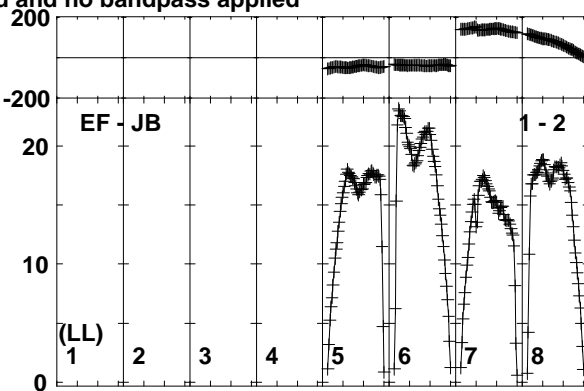
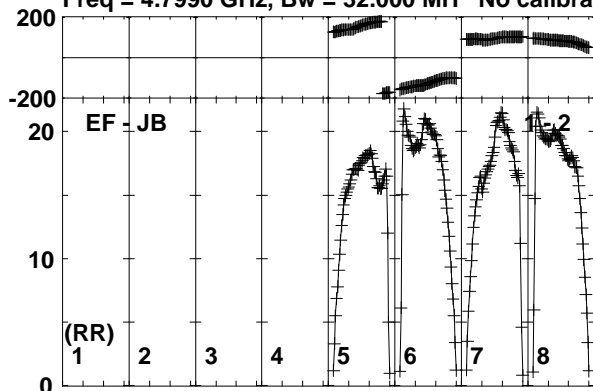

Lower frame: Milli Ampl Jy Top frame: Phas deg
Vector averaged cross-power spectrum Baseline: EF (01) - JB (02)
Timerange: 00/15:30:32 to 00/15:31:28

Plot file version 102 created 19-OCT-2017 15:36:07

J1504+1029 ES081C.UVDATA.1

Freq = 4.7990 GHz, Bw = 32.000 MH No calibration applied and no bandpass applied

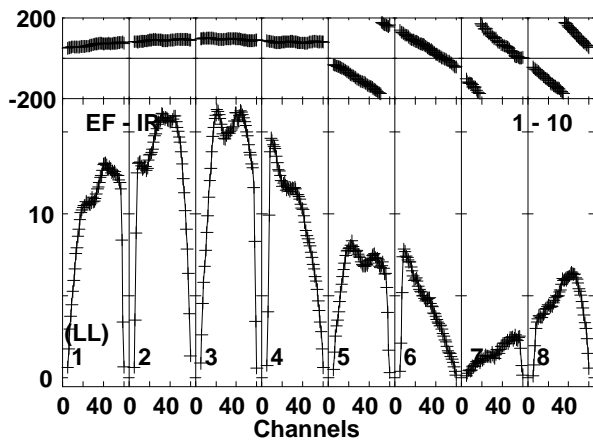
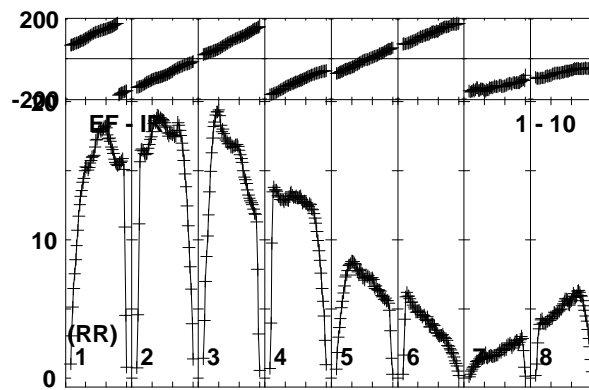
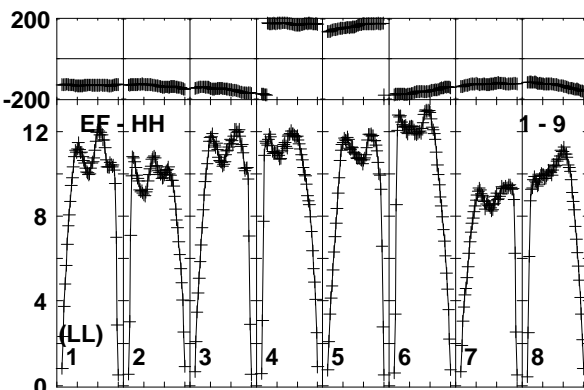
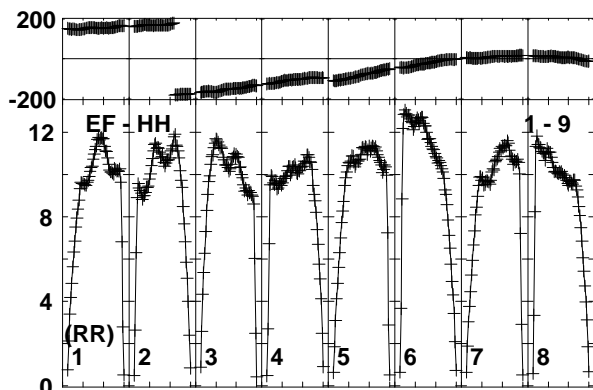
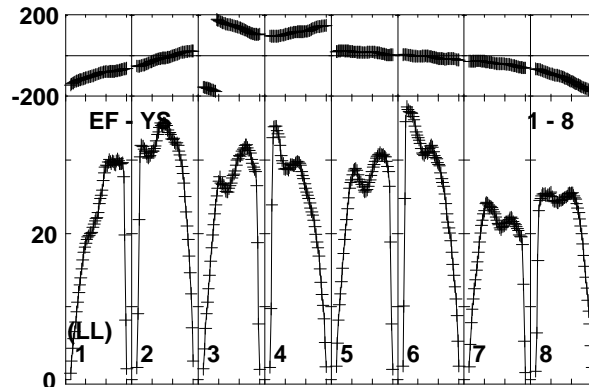
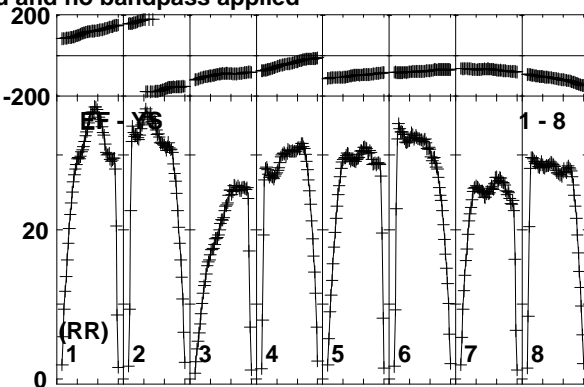
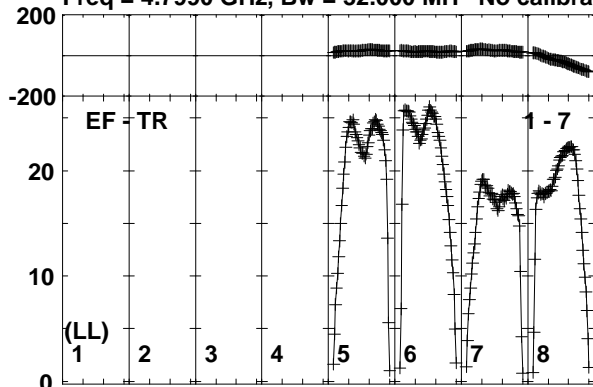

Lower frame: Milli Ampl Jy Top frame: Phas deg
Vector averaged cross-power spectrum Baseline: EF (01) - TR (07)
Timerange: 00/15:30:32 to 00/15:31:28

Plot file version 103 created 19-OCT-2017 15:36:07

MRK841 ES081C.UVDATA.1

Freq = 4.7990 GHz, Bw = 32.000 MH No calibration applied and no bandpass applied

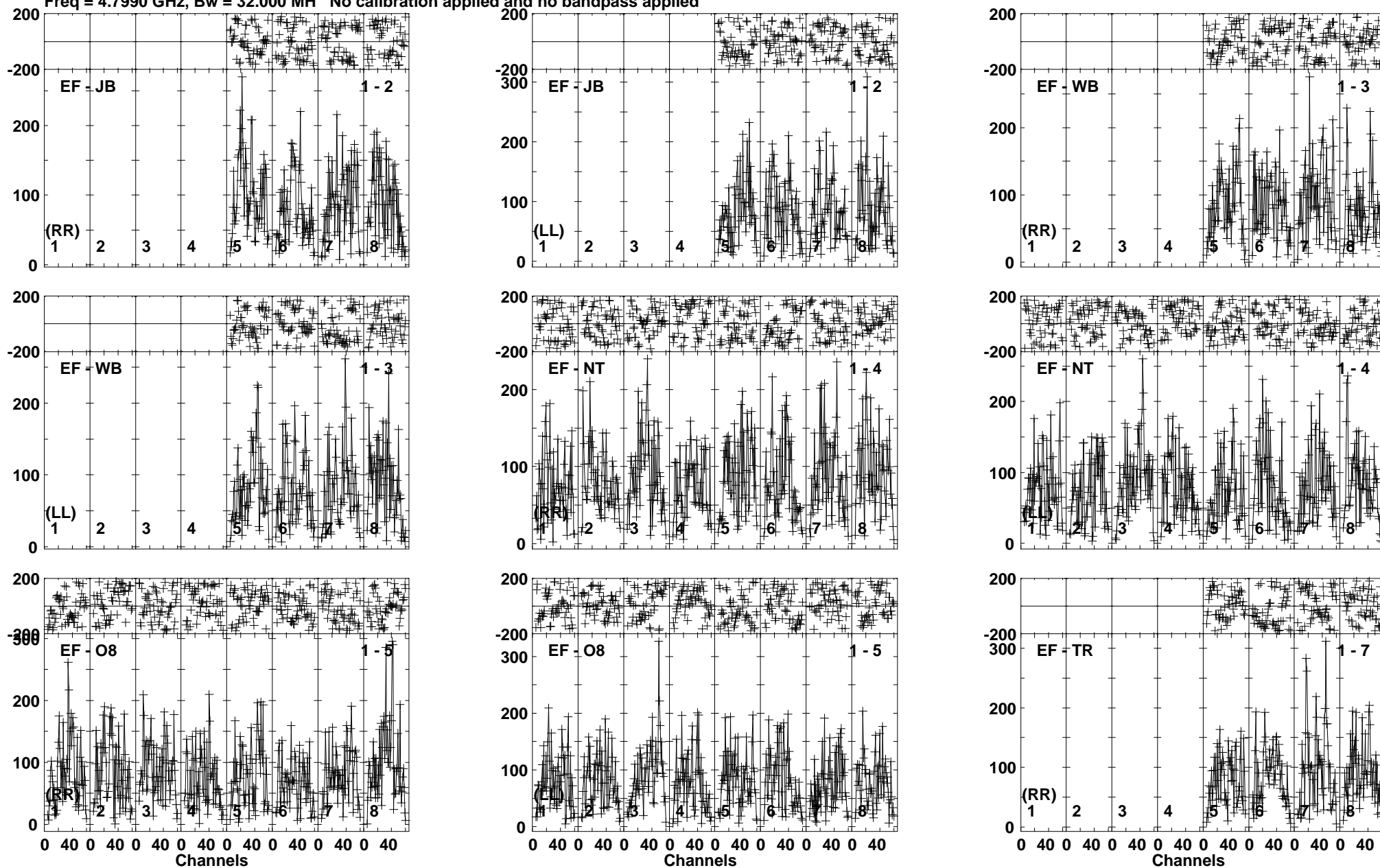

Lower frame: Micro Ampl Jy Top frame: Phas deg
Vector averaged cross-power spectrum Baseline: EF (01) - JB (02)
Timerange: 00/15:31:32 to 00/15:34:58

Plot file version 104 created 19-OCT-2017 15:36:08

MRK841 ES081C.UVDATA.1

Freq = 4.7990 GHz, Bw = 32.000 MH No calibration applied and no bandpass applied

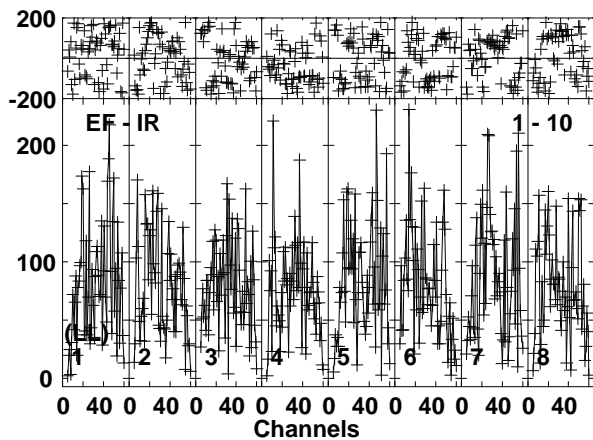
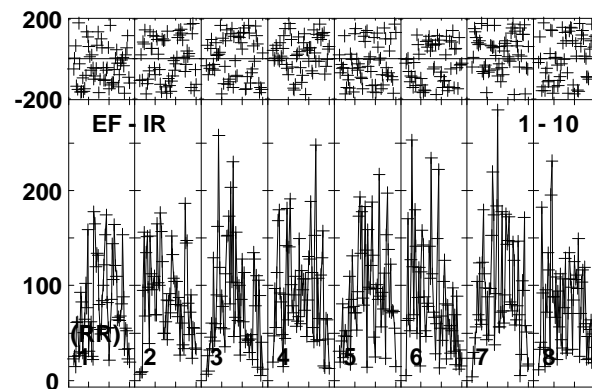
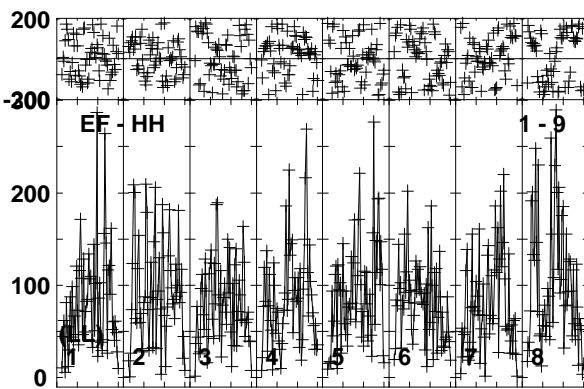
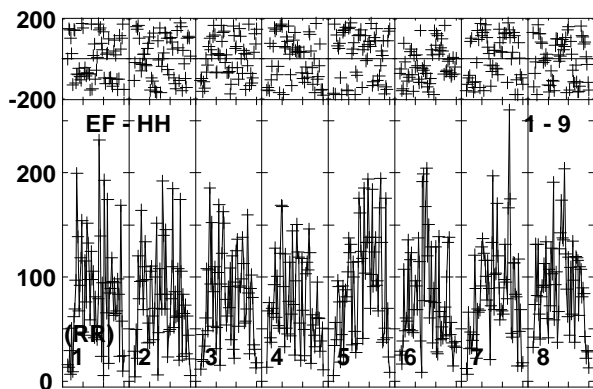
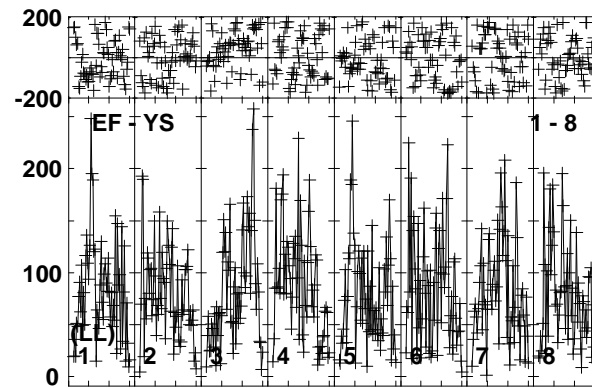
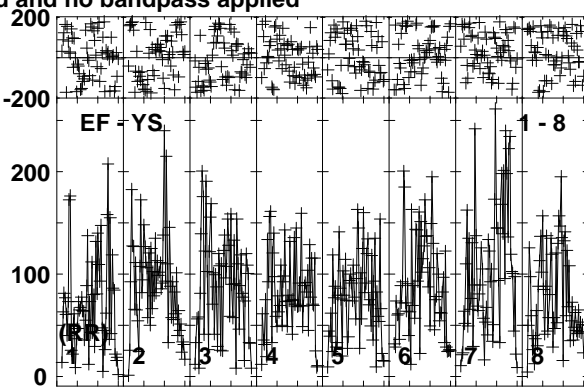
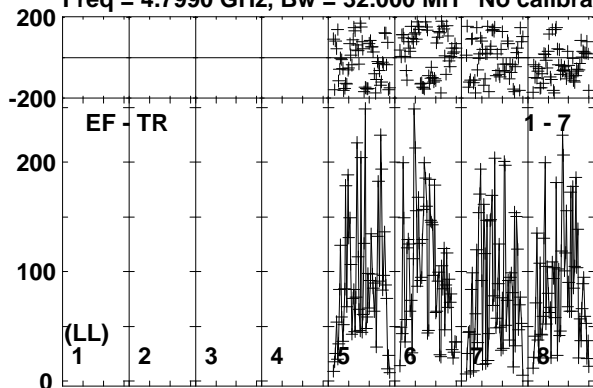

Lower frame: Micro Ampl Jy Top frame: Phas deg
Vector averaged cross-power spectrum Baseline: EF (01) - TR (07)
Timerange: 00/15:31:32 to 00/15:34:58

Plot file version 105 created 19-OCT-2017 15:36:08

J1504+1029 ES081C.UVDATA.1

Freq = 4.7990 GHz, Bw = 32.000 MH No calibration applied and no bandpass applied

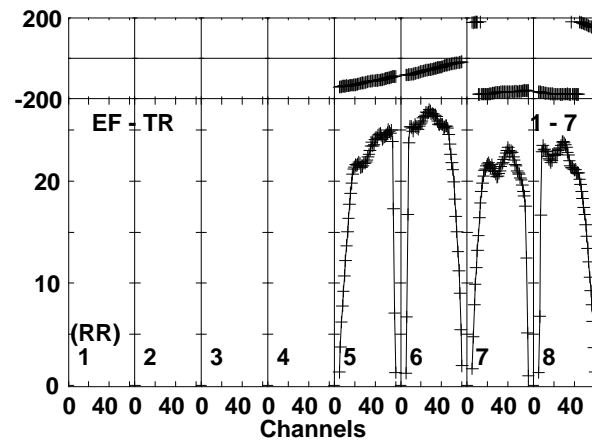
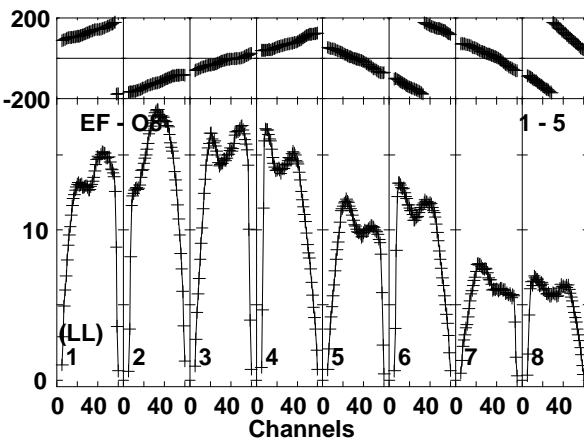
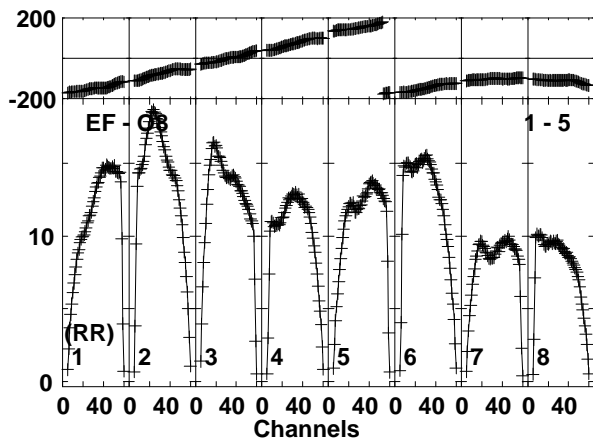
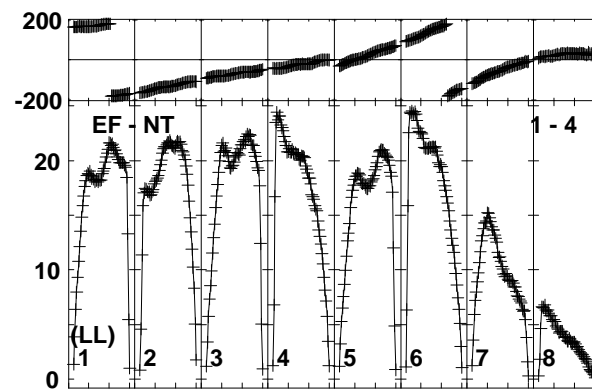
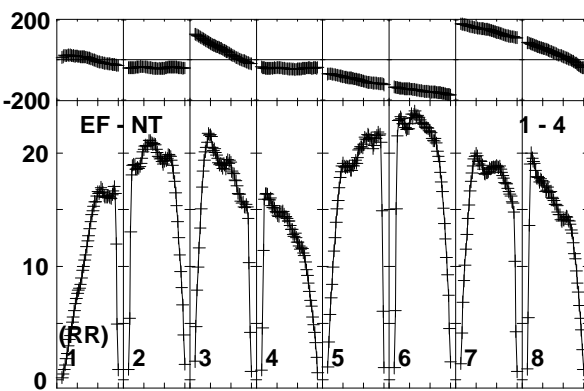
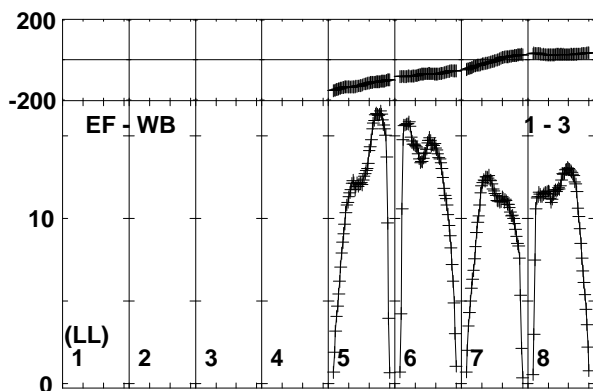
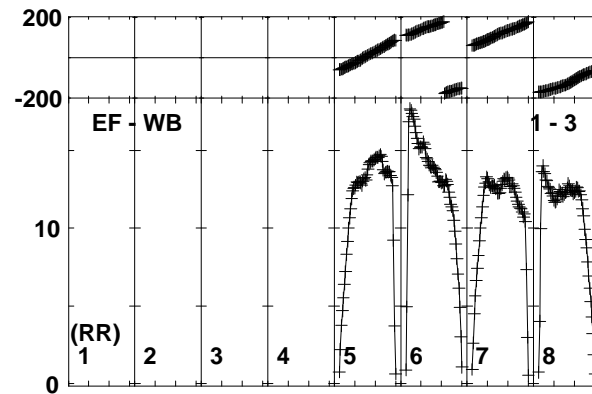
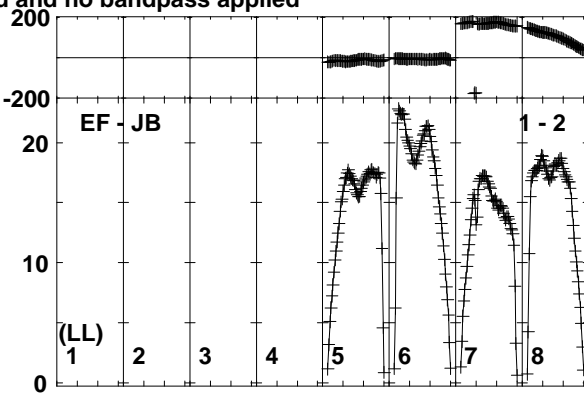
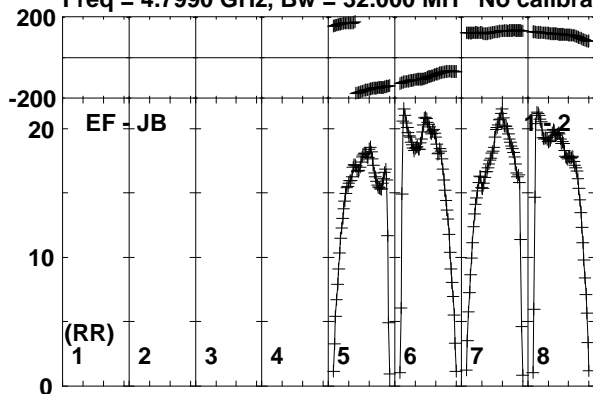

Lower frame: Milli Ampl Jy Top frame: Phas deg
Vector averaged cross-power spectrum Baseline: EF (01) - JB (02)
Timerange: 00/15:35:02 to 00/15:36:28

Plot file version 106 created 19-OCT-2017 15:36:08

J1504+1029 ES081C.UVDATA.1

Freq = 4.7990 GHz, Bw = 32.000 MH No calibration applied and no bandpass applied

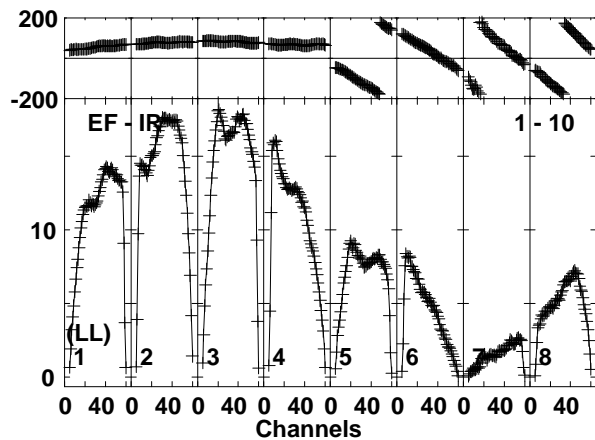
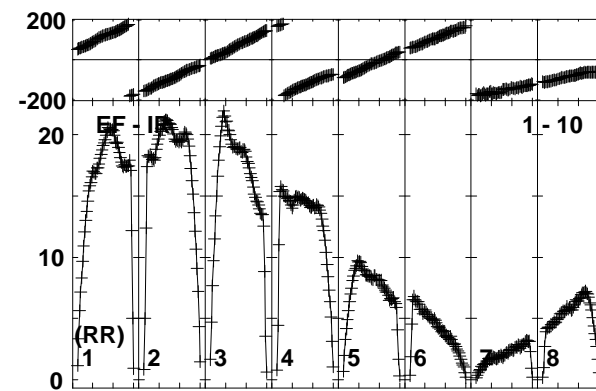
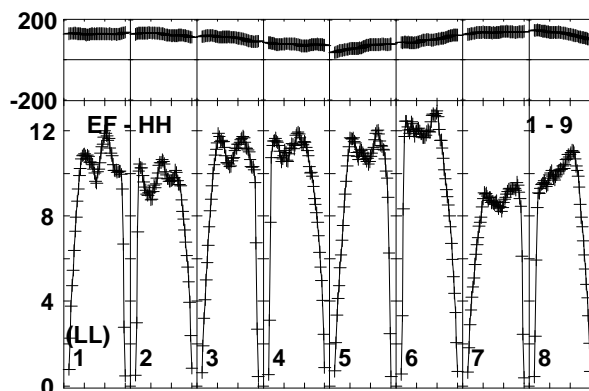
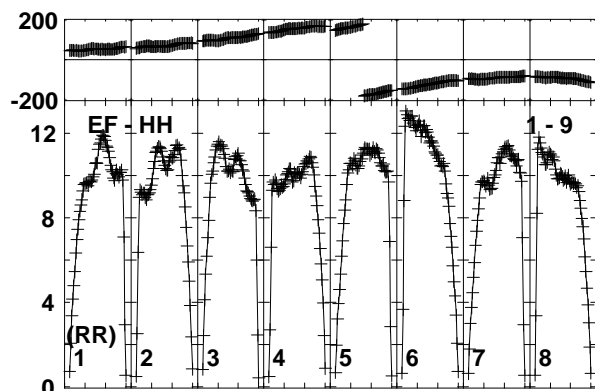
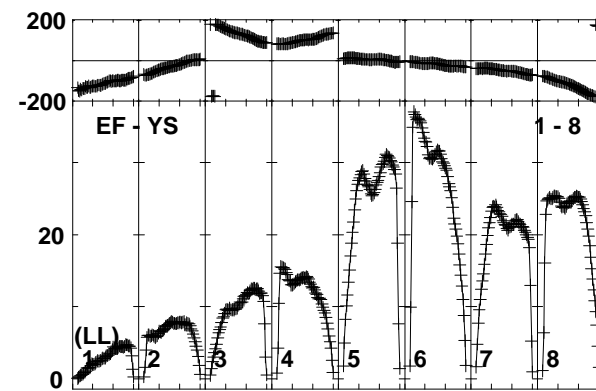
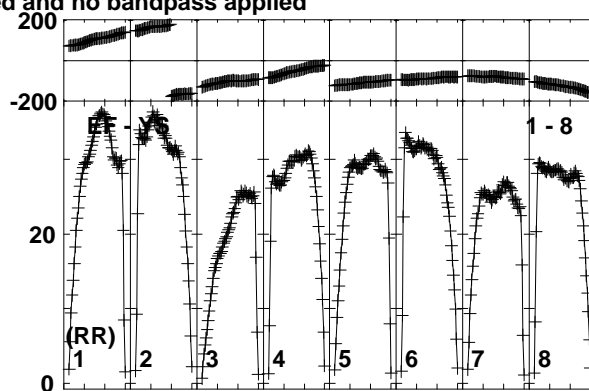
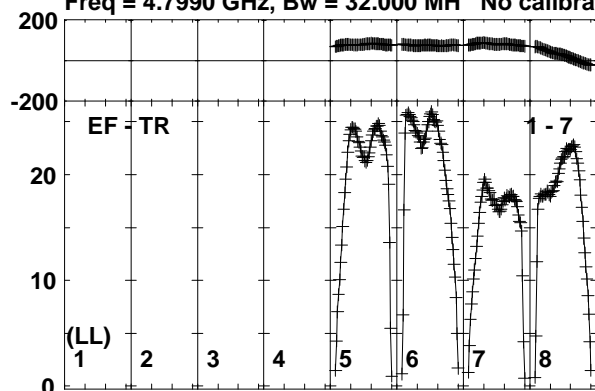

Lower frame: Milli Ampl Jy Top frame: Phas deg
Vector averaged cross-power spectrum Baseline: EF (01) - TR (07)
Timerange: 00/15:35:02 to 00/15:36:28

Plot file version 107 created 19-OCT-2017 15:36:08

MRK841 ES081C.UVDATA.1

Freq = 4.7990 GHz, Bw = 32.000 MH No calibration applied and no bandpass applied

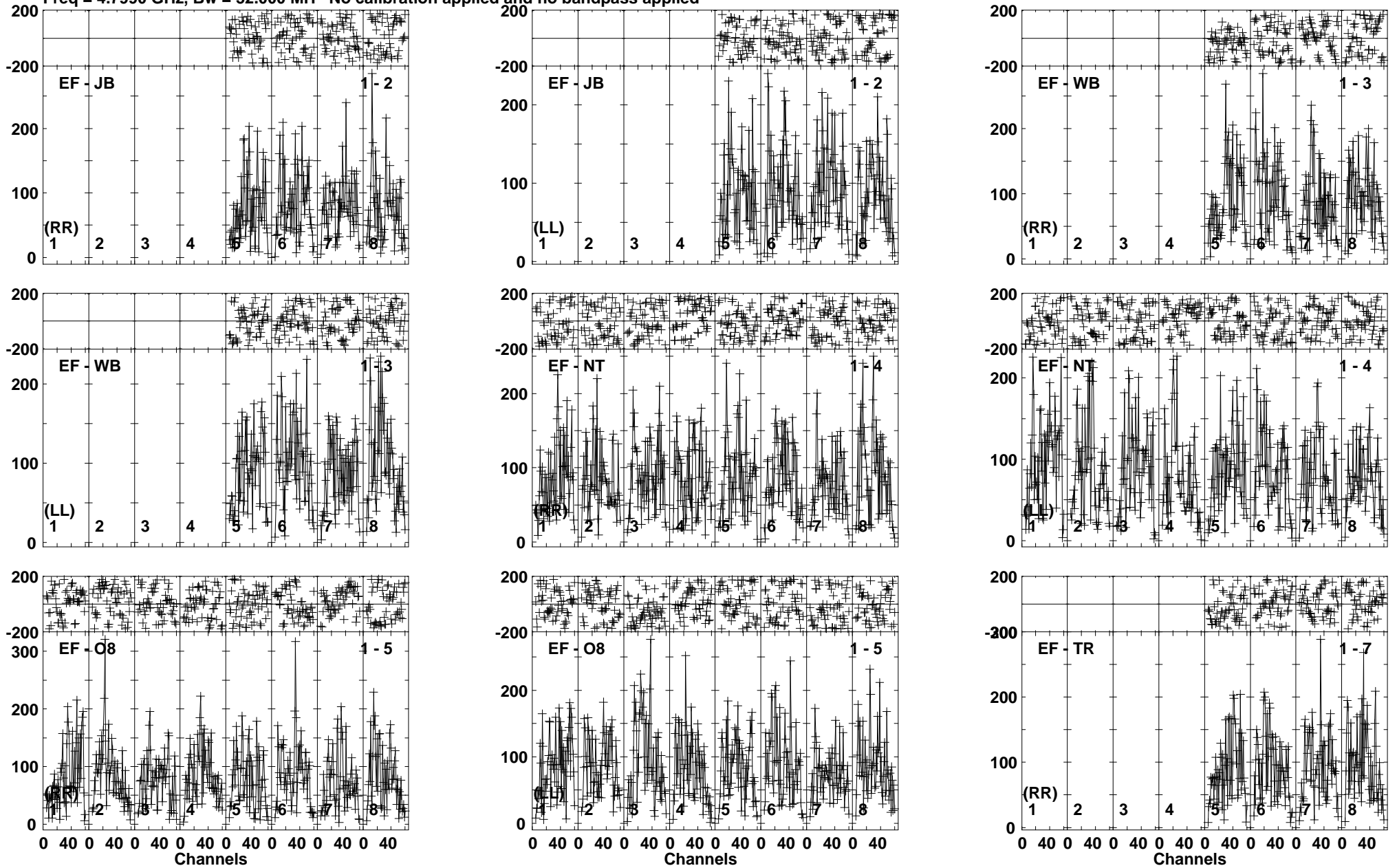

Lower frame: Micro Ampl Jy Top frame: Phas deg
Vector averaged cross-power spectrum Baseline: EF (01) - JB (02)
Timerange: 00/15:36:32 to 00/15:39:58

Plot file version 108 created 19-OCT-2017 15:36:08

MRK841 ES081C.UVDATA.1

Freq = 4.7990 GHz, Bw = 32.000 MH No calibration applied and no bandpass applied

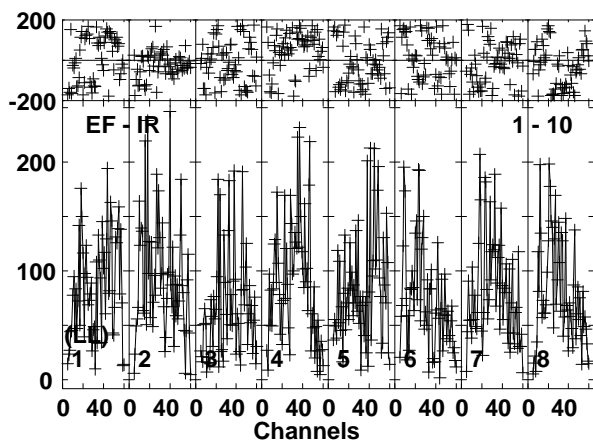
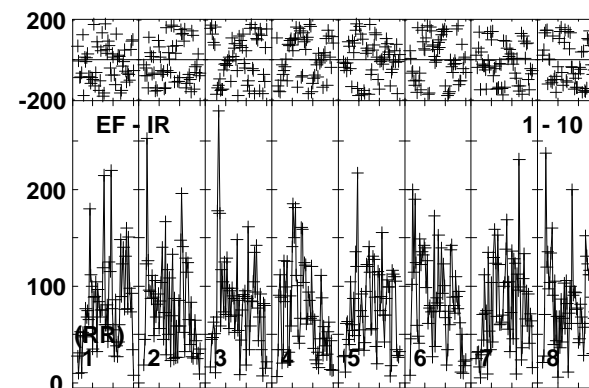
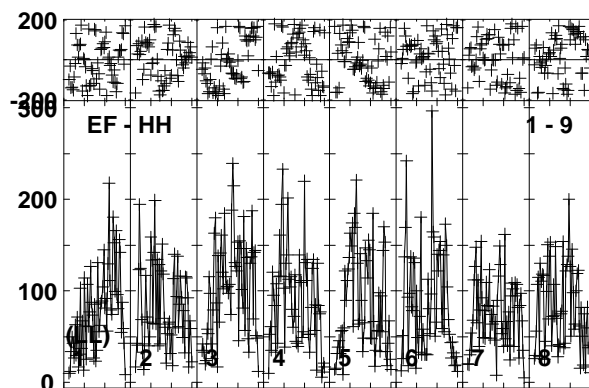
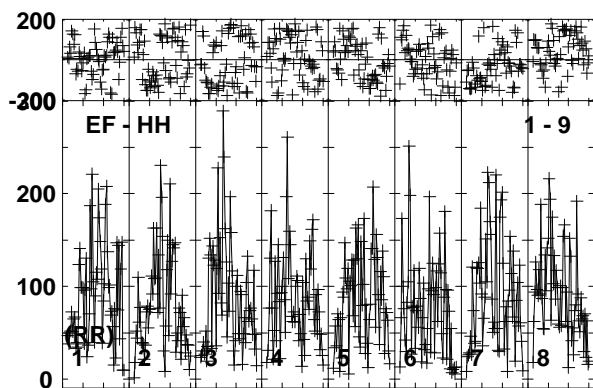
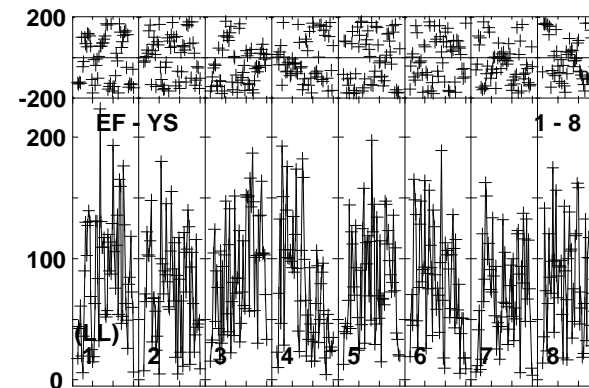
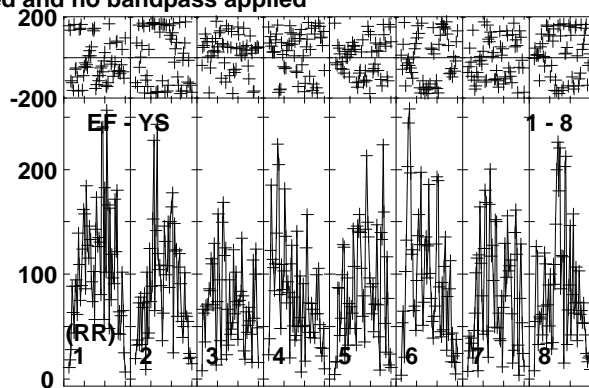
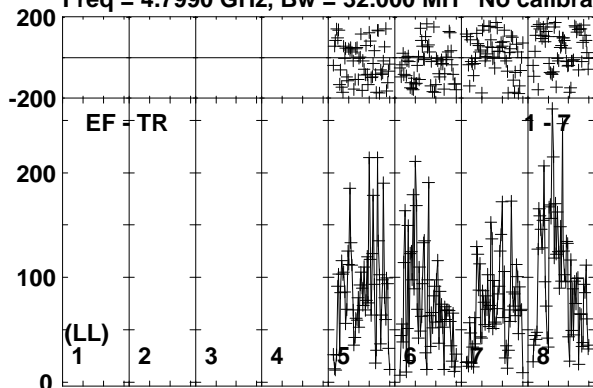

Lower frame: Micro Ampl Jy Top frame: Phas deg
Vector averaged cross-power spectrum Baseline: EF (01) - TR (07)
Timerange: 00/15:36:32 to 00/15:39:58

Plot file version 109 created 19-OCT-2017 15:36:08

J1504+1029 ES081C.UVDATA.1

Freq = 4.7990 GHz, Bw = 32.000 MH No calibration applied and no bandpass applied

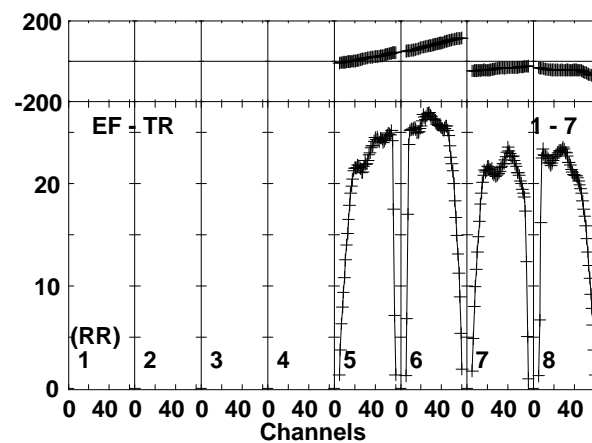
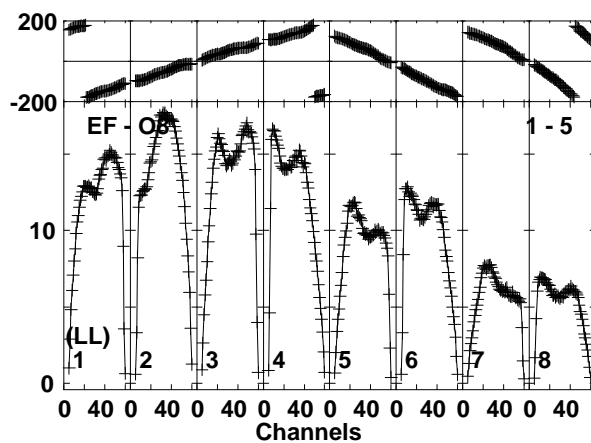
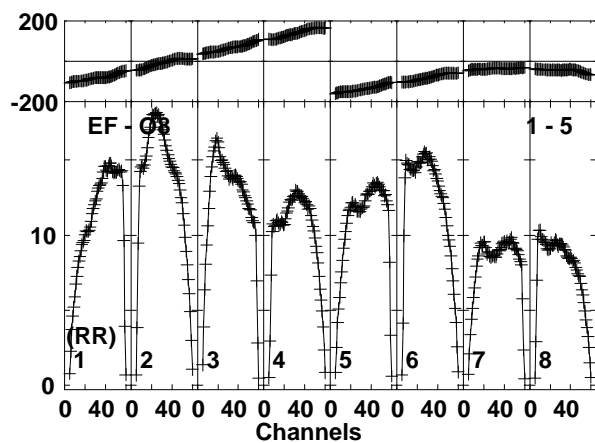
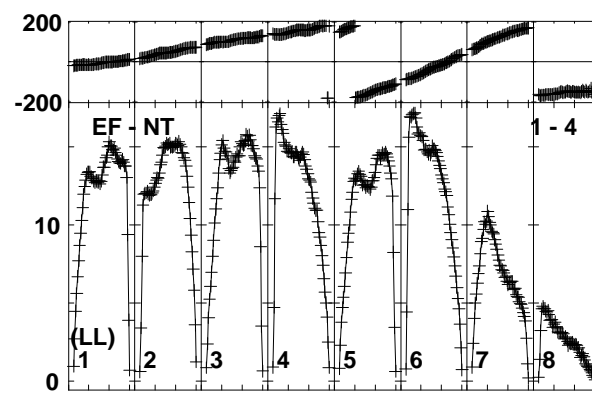
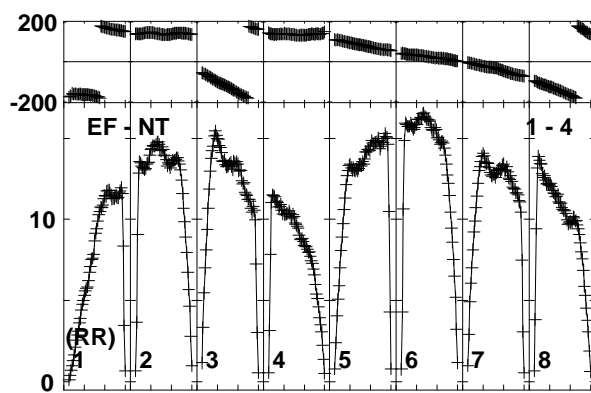
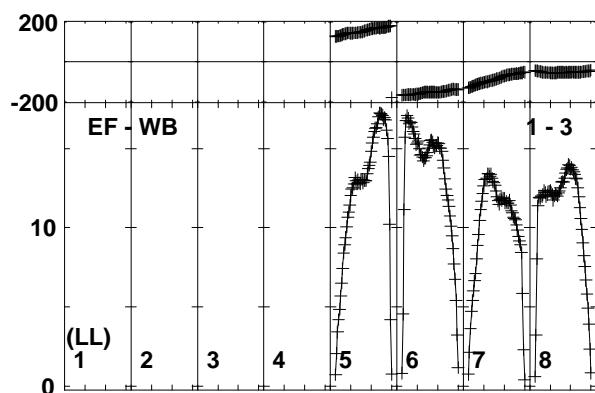
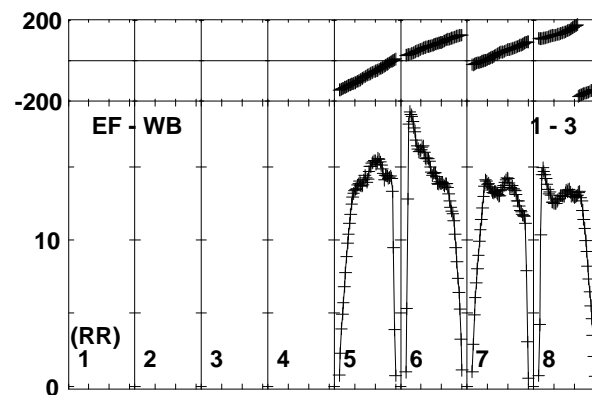
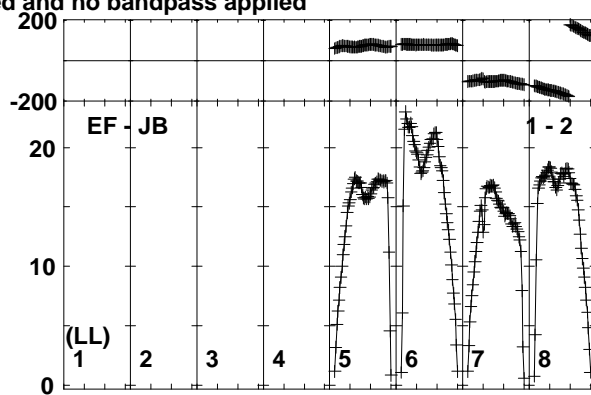
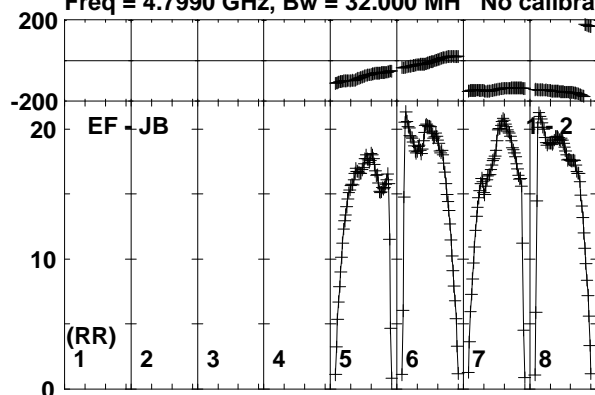

Lower frame: Milli Ampl Jy Top frame: Phas deg
Vector averaged cross-power spectrum Baseline: EF (01) - JB (02)
Timerange: 00/15:40:32 to 00/15:41:28

Plot file version 110 created 19-OCT-2017 15:36:08

J1504+1029 ES081C.UVDATA.1

Freq = 4.7990 GHz, Bw = 32.000 MH No calibration applied and no bandpass applied

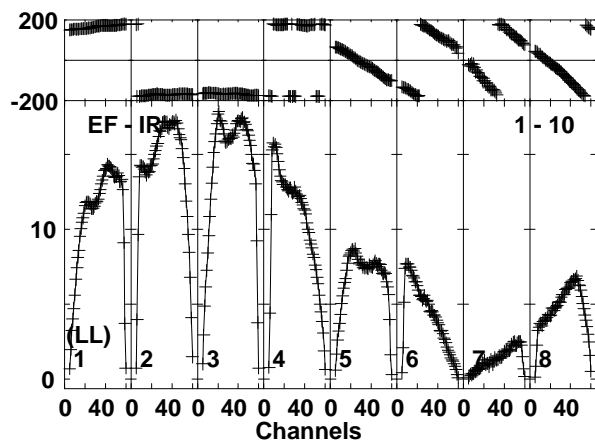
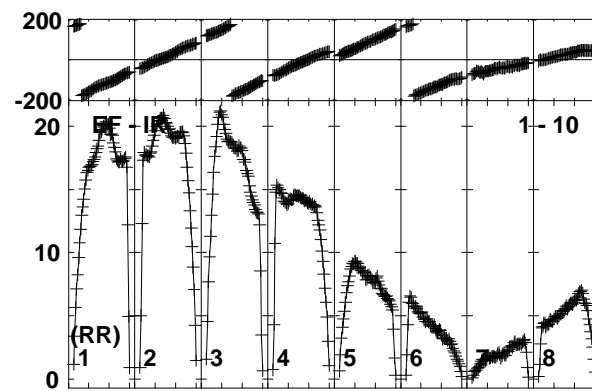
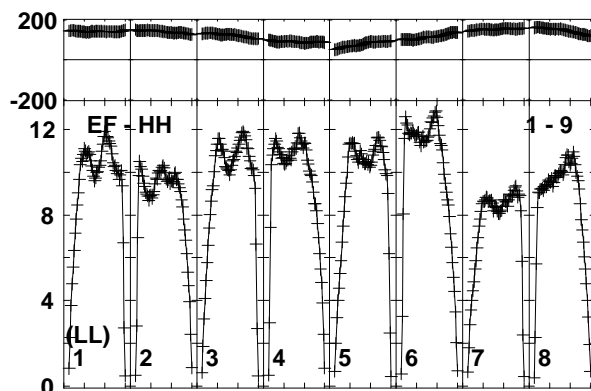
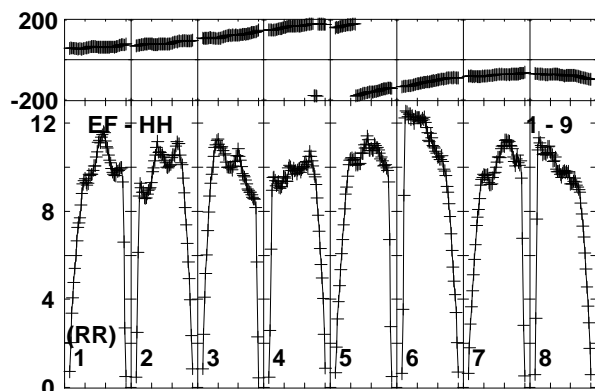
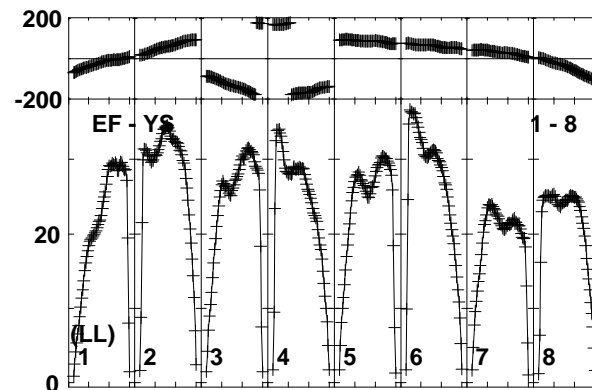
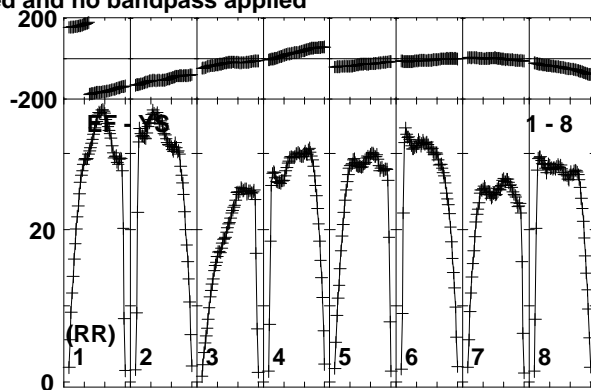
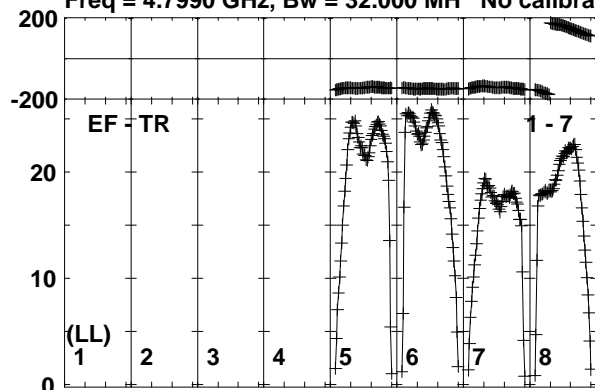

Lower frame: Milli Ampl Jy Top frame: Phas deg
Vector averaged cross-power spectrum Baseline: EF (01) - TR (07)
Timerange: 00/15:40:32 to 00/15:41:28

Plot file version 111 created 19-OCT-2017 15:36:08

J2242+2955 ES081C.UVDATA.1

Freq = 4.7990 GHz, Bw = 32.000 MH No calibration applied and no bandpass applied

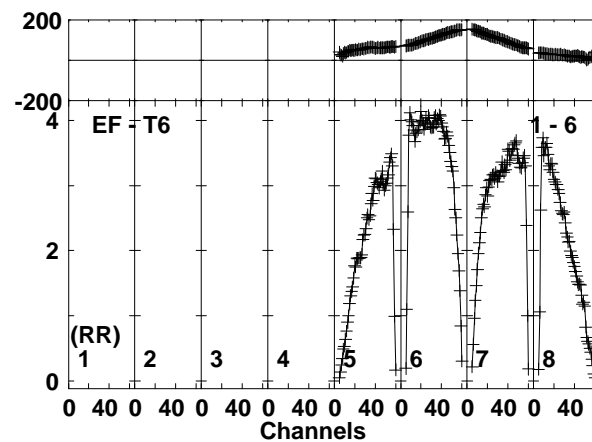
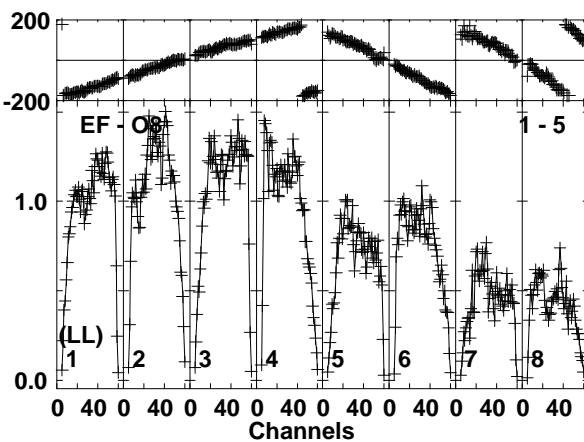
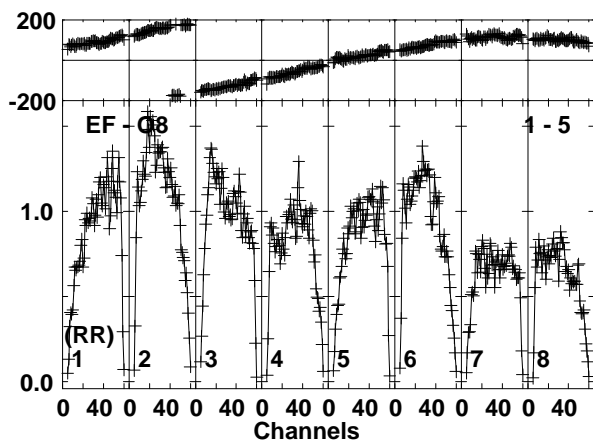
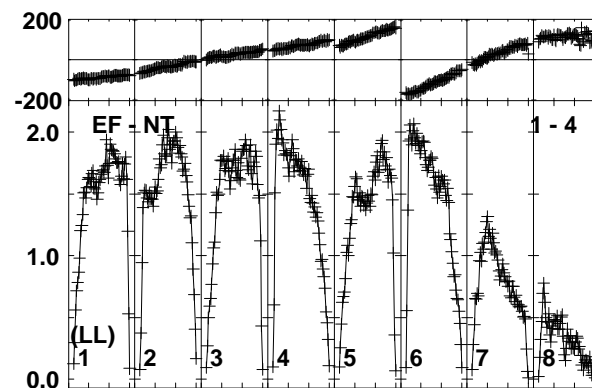
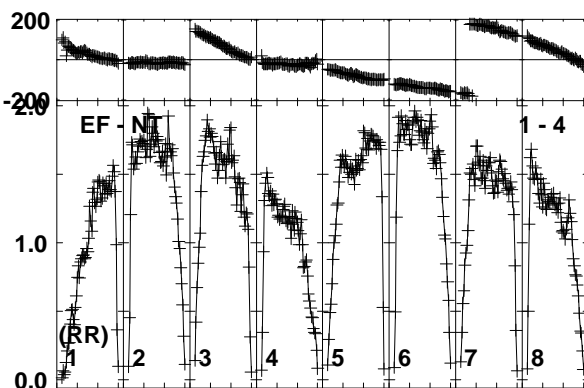
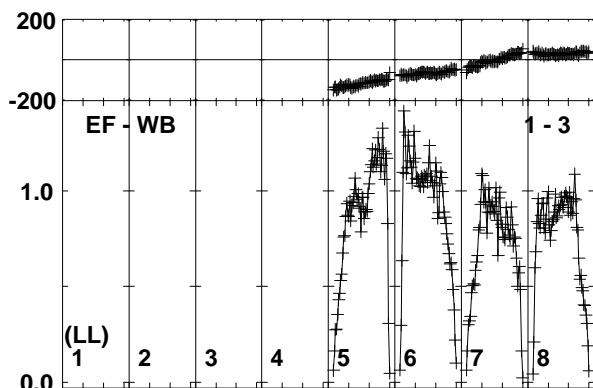
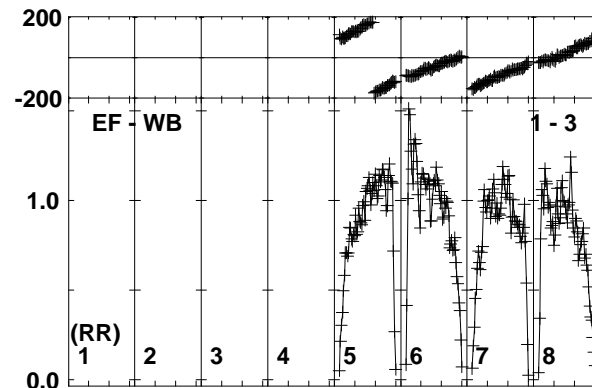
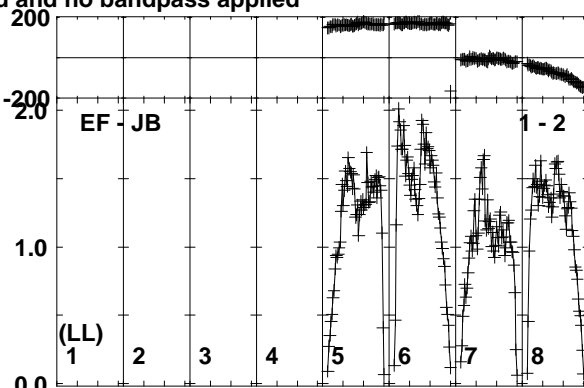
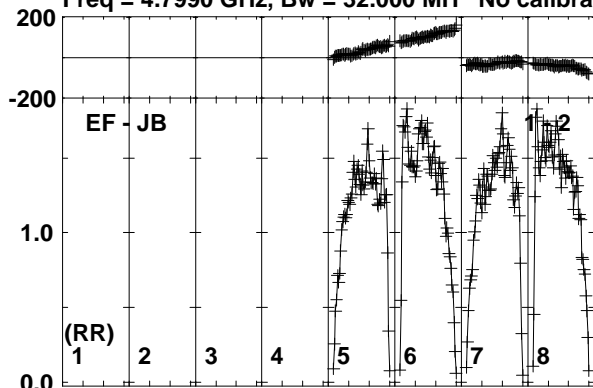

Lower frame: Milli Ampl Jy Top frame: Phas deg
Vector averaged cross-power spectrum Baseline: EF (01) - JB (02)
Timerange: 00/15:48:37 to 00/15:50:59

Plot file version 112 created 19-OCT-2017 15:36:09

J2242+2955 ES081C.UVDATA.1

Freq = 4.7990 GHz, Bw = 32.000 MH No calibration applied and no bandpass applied

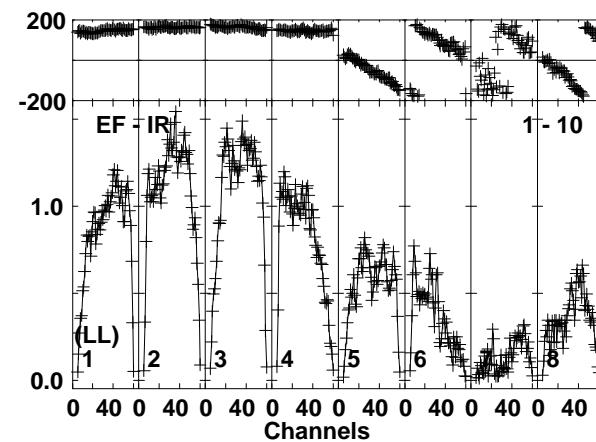
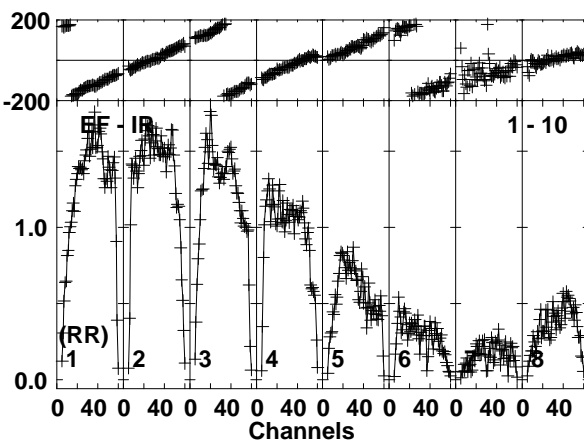
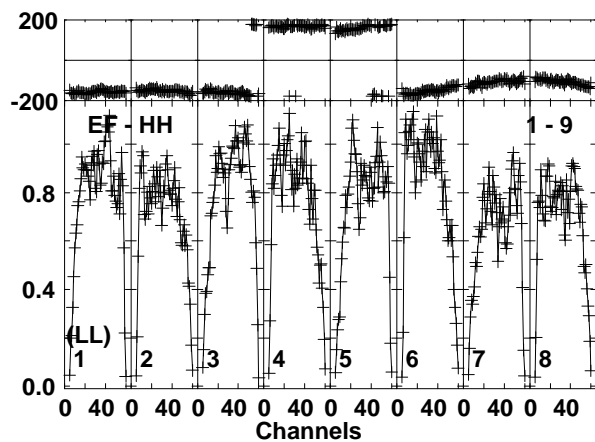
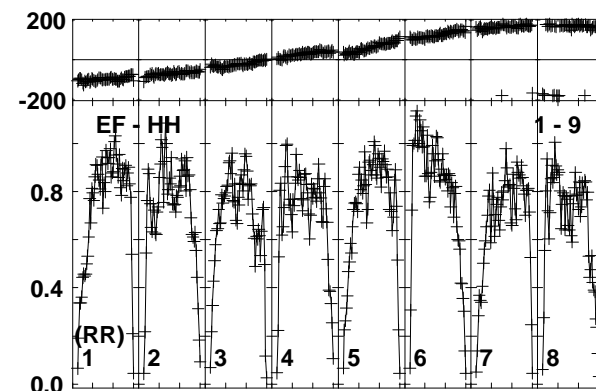
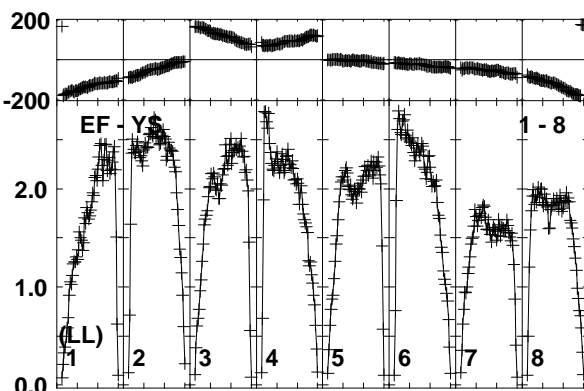
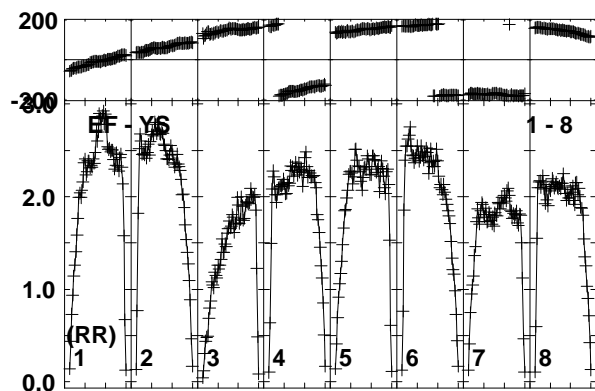
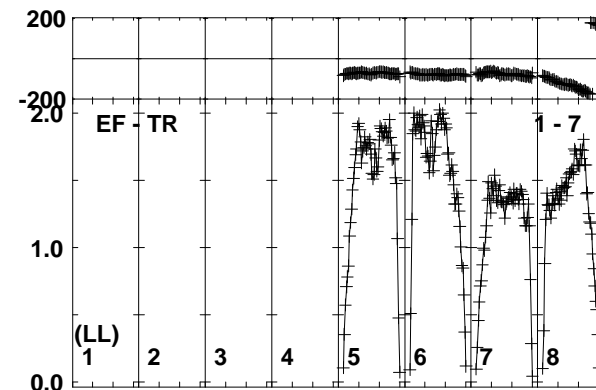
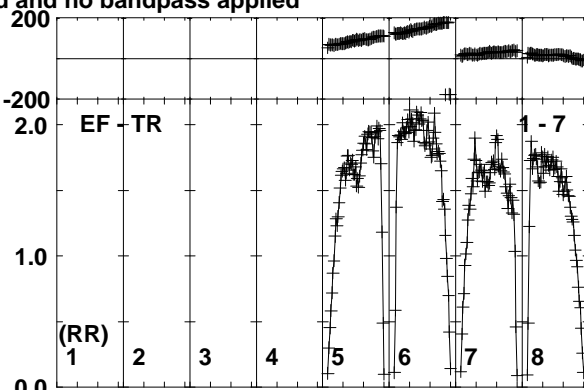
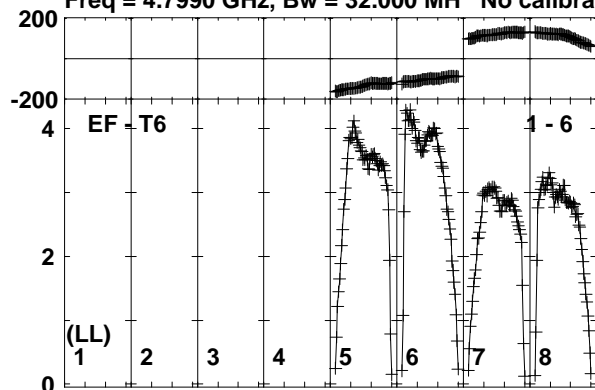

Lower frame: Milli Ampl Jy Top frame: Phas deg
Vector averaged cross-power spectrum Baseline: EF (01) - T6 (06)
Timerange: 00/15:48:37 to 00/15:50:59

Plot file version 113 created 19-OCT-2017 15:36:09
 ARK564 ES081C.UVDATA.1
 Freq = 4.7990 GHz, Bw = 32.000 MH No calibration applied and no bandpass applied

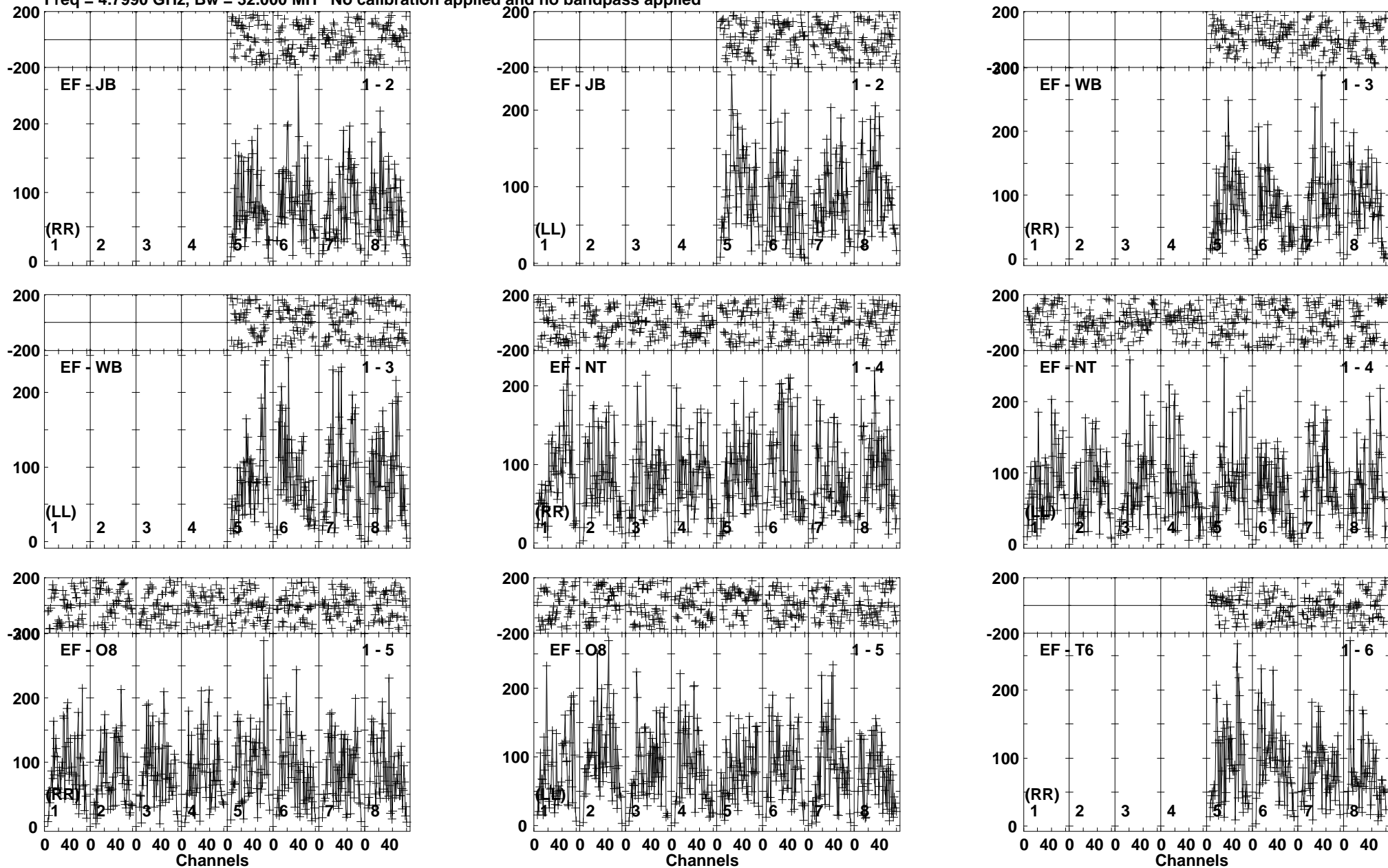

Lower frame: Micro Ampl Jy Top frame: Phas deg
 Vector averaged cross-power spectrum Baseline: EF (01) - JB (02)
 Timerange: 00/15:51:01 to 00/15:54:29

Plot file version 114 created 19-OCT-2017 15:36:09

ARK564 ES081C.UVDATA.1

Freq = 4.7990 GHz, Bw = 32.000 MH No calibration applied and no bandpass applied

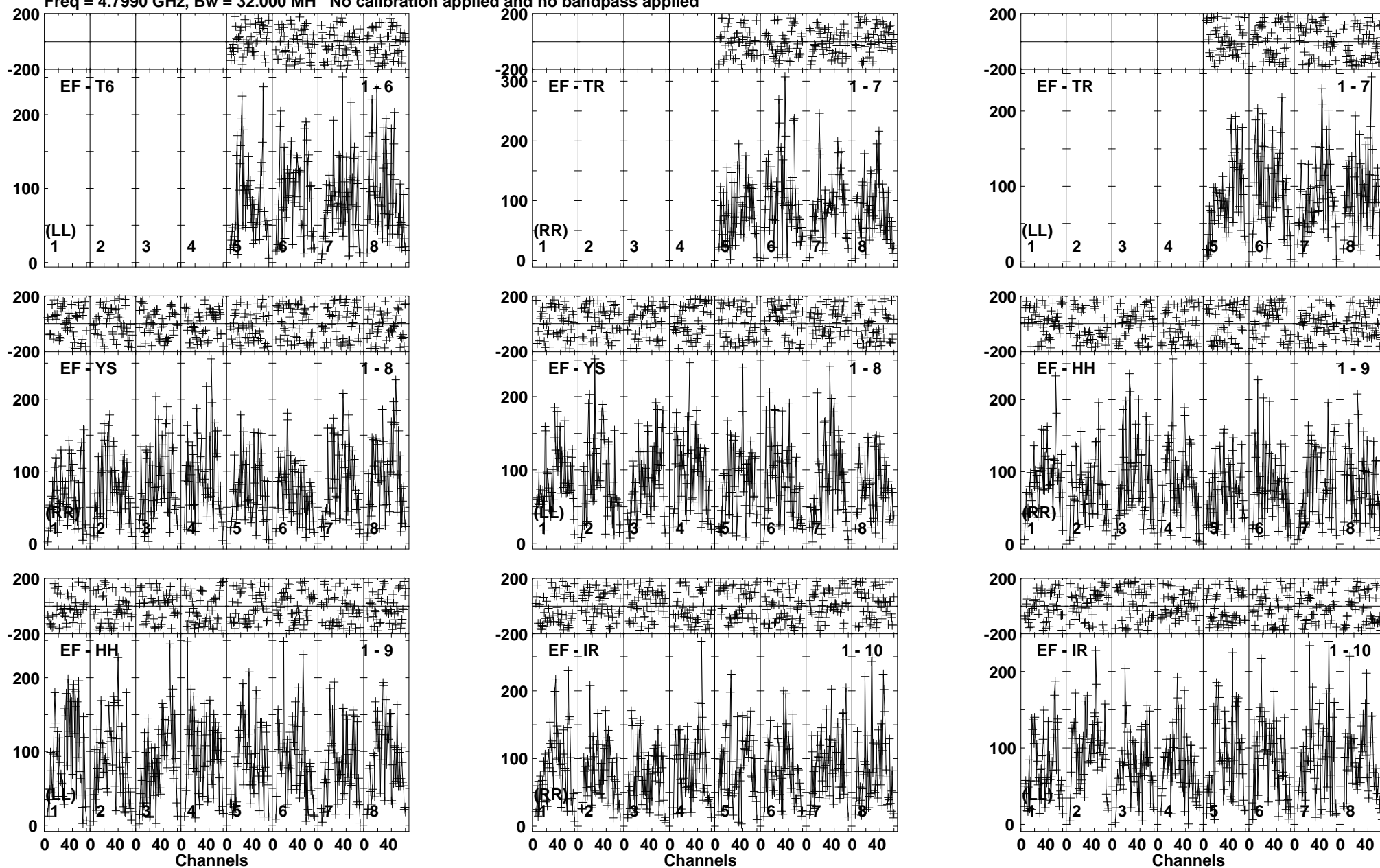

Lower frame: Micro Ampl Jy Top frame: Phas deg
Vector averaged cross-power spectrum Baseline: EF (01) - T6 (06)
Timerange: 00/15:51:01 to 00/15:54:29

Plot file version 115 created 19-OCT-2017 15:36:09

J2242+2955 ES081C.UVDATA.1

Freq = 4.7990 GHz, Bw = 32.000 MH No calibration applied and no bandpass applied

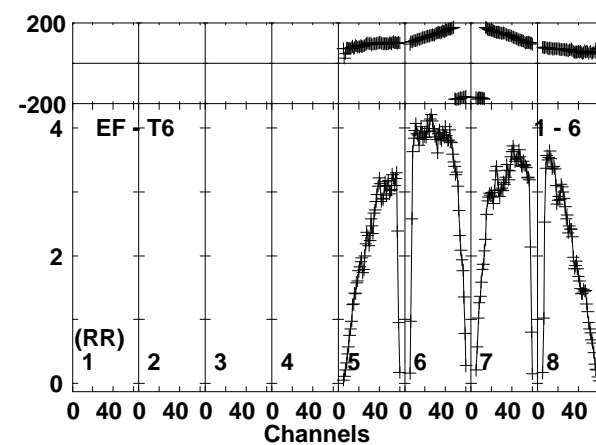
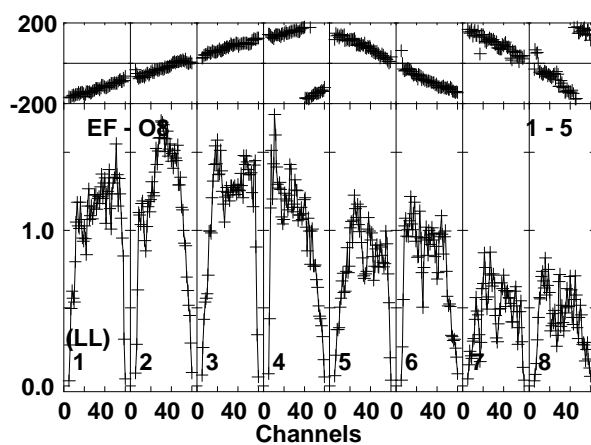
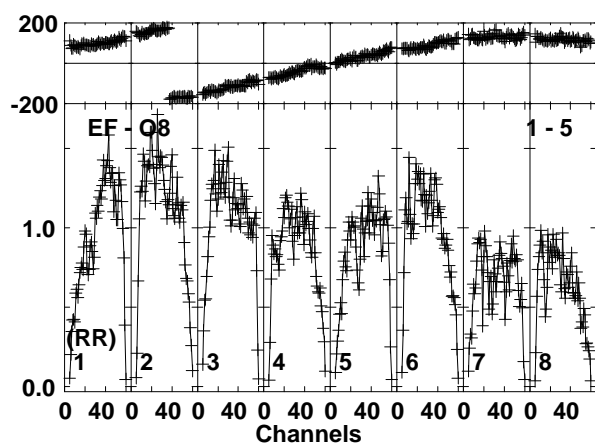
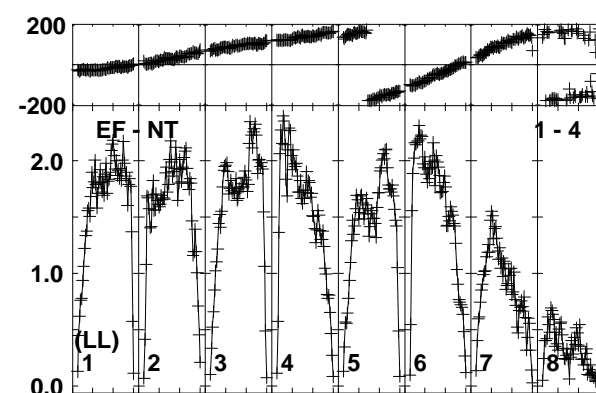
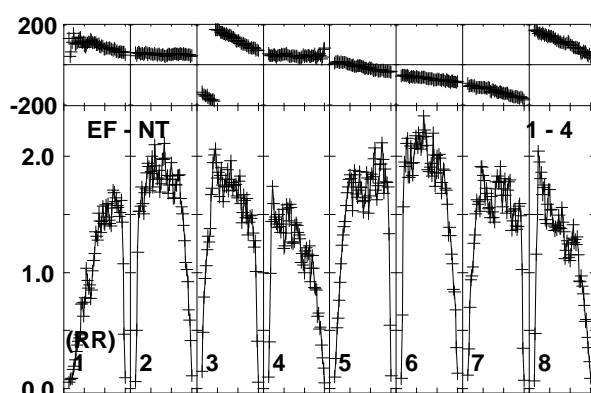
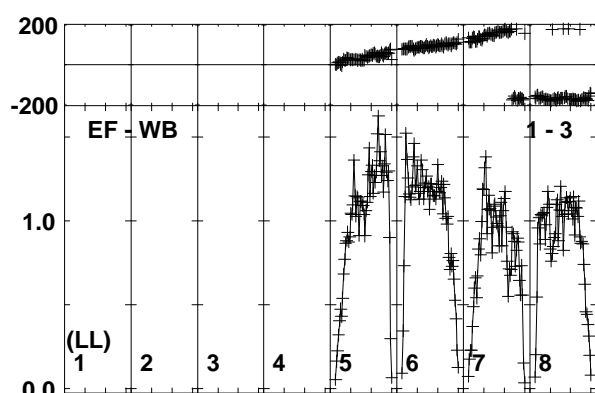
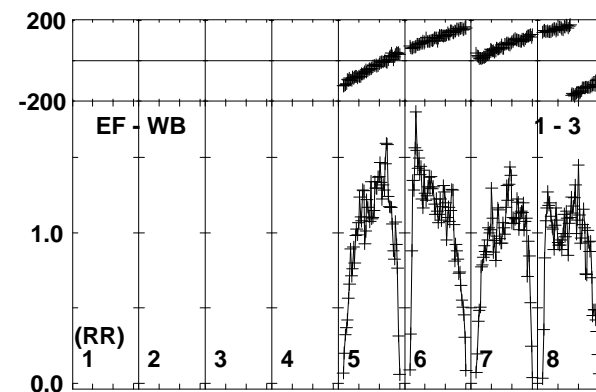
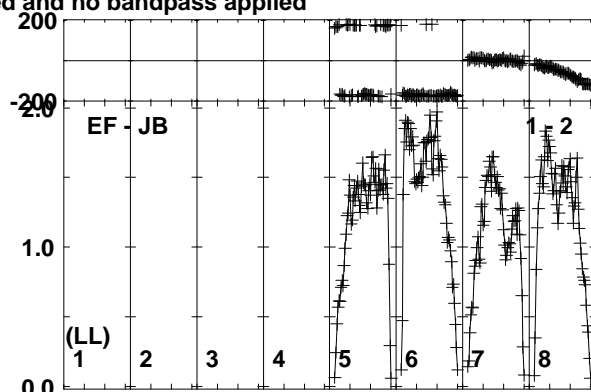
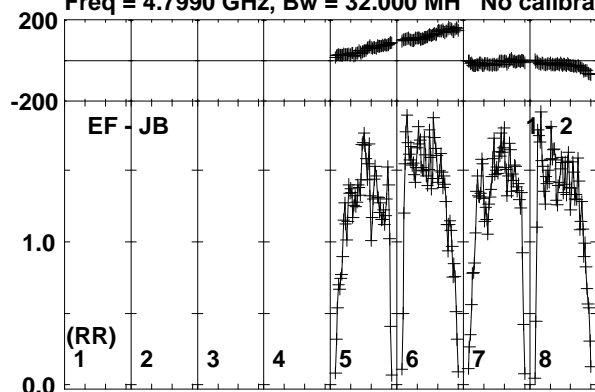

Lower frame: Milli Ampl Jy Top frame: Phas deg
Vector averaged cross-power spectrum Baseline: EF (01) - JB (02)
Timerange: 00/15:54:31 to 00/15:55:59

Plot file version 116 created 19-OCT-2017 15:36:09

J2242+2955 ES081C.UVDATA.1

Freq = 4.7990 GHz, Bw = 32.000 MH No calibration applied and no bandpass applied

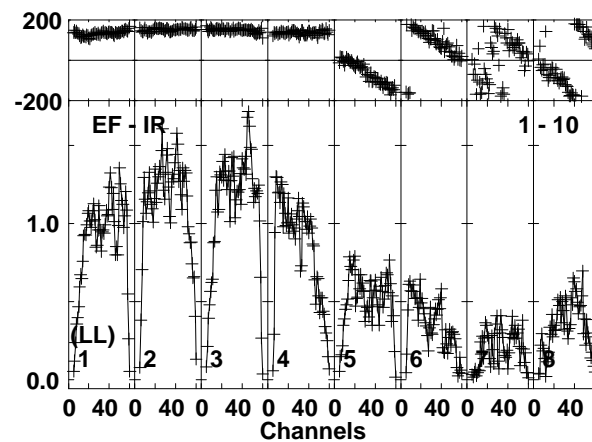
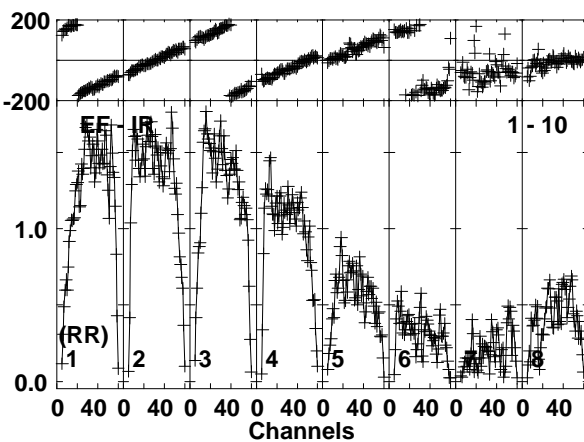
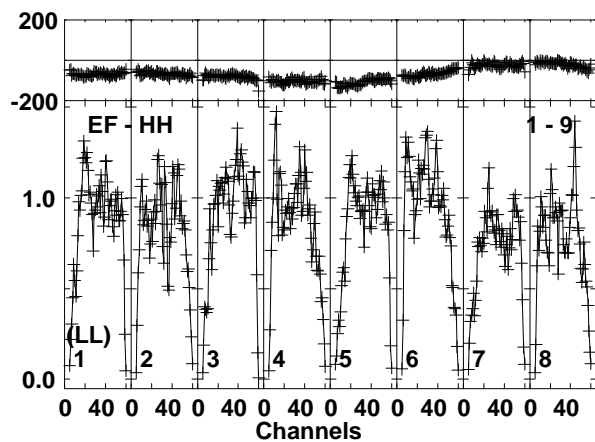
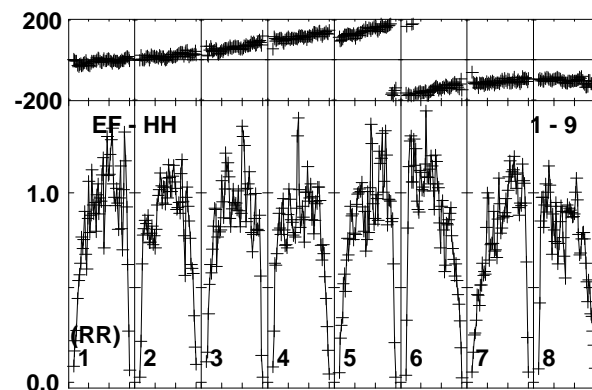
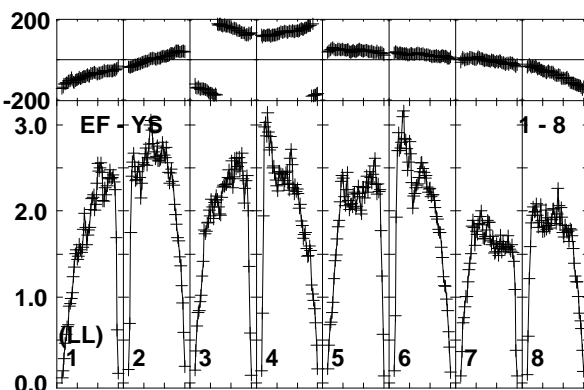
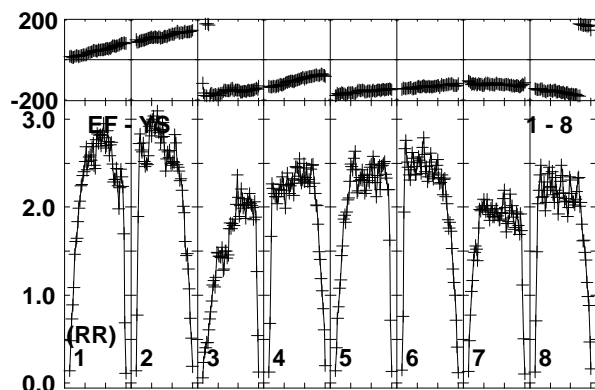
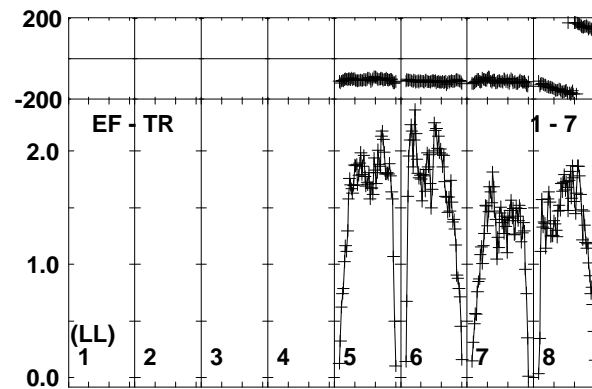
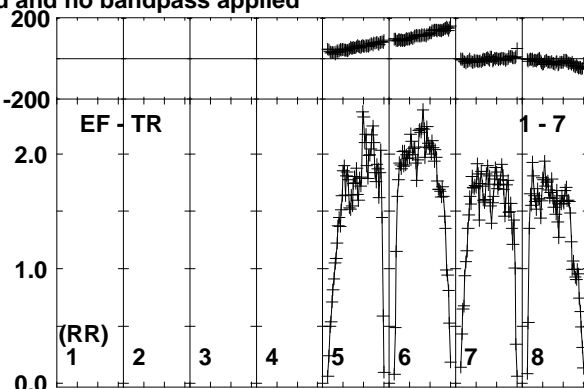
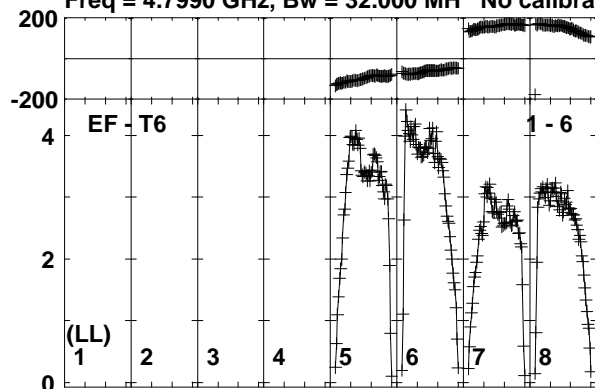

Lower frame: Milli Ampl Jy Top frame: Phas deg
Vector averaged cross-power spectrum Baseline: EF (01) - T6 (06)
Timerange: 00:15:54:31 to 00:15:55:59

Plot file version 117 created 19-OCT-2017 15:36:09

ARK564 ES081C.UVDATA.1

Freq = 4.7990 GHz, Bw = 32.000 MH No calibration applied and no bandpass applied

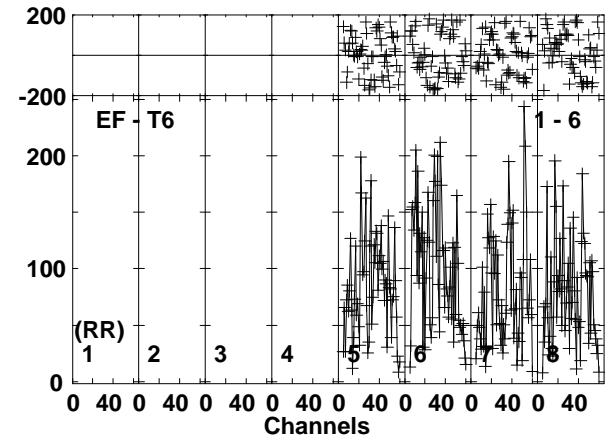
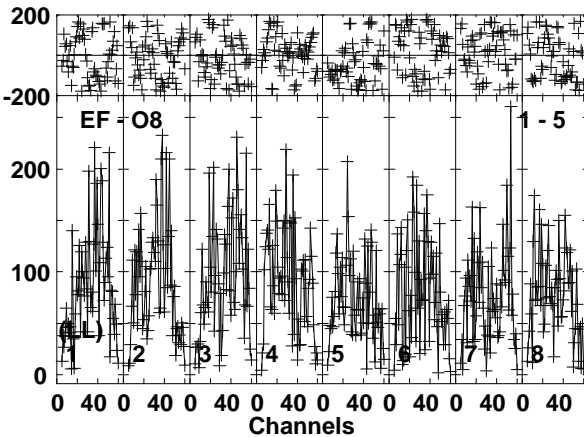
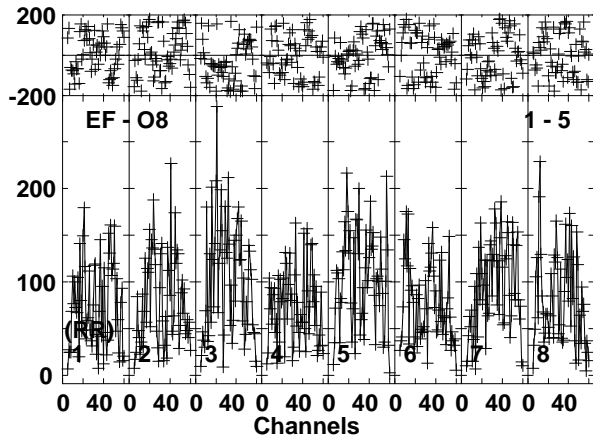
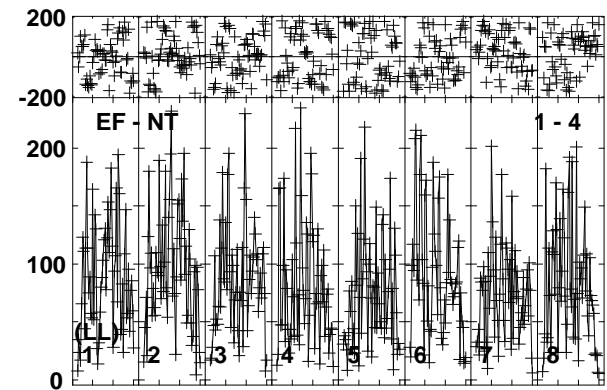
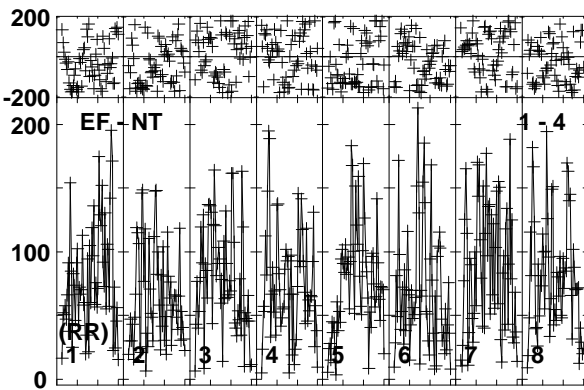
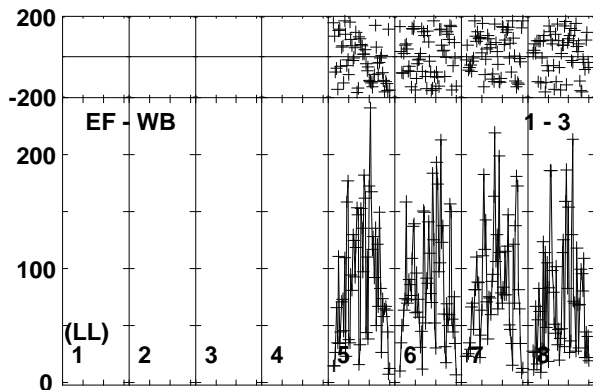
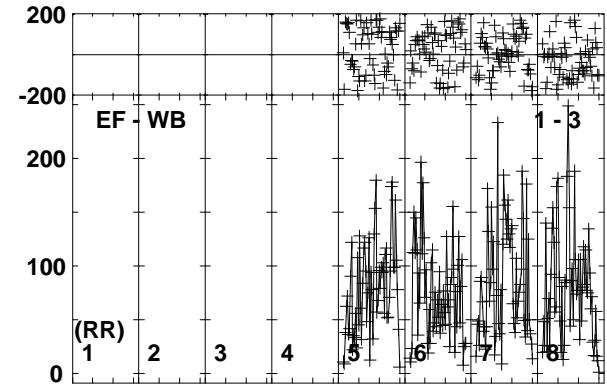
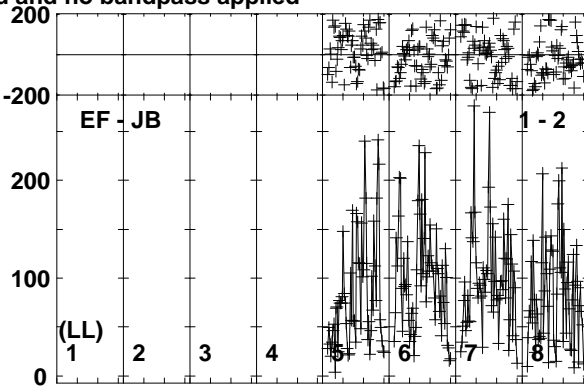
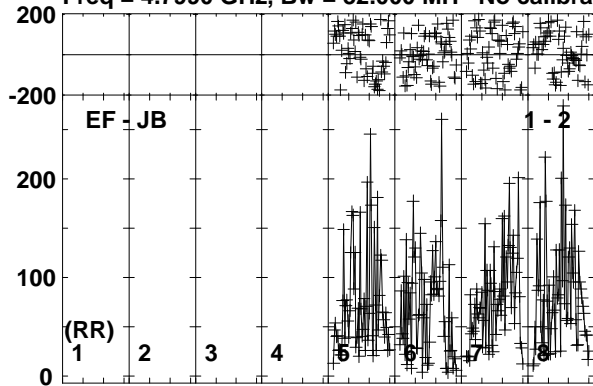

Lower frame: Micro Ampl Jy Top frame: Phas deg
Vector averaged cross-power spectrum Baseline: EF (01) - JB (02)
Timerange: 00/15:56:01 to 00/15:59:29

Plot file version 118 created 19-OCT-2017 15:36:09

ARK564 ES081C.UVDATA.1

Freq = 4.7990 GHz, Bw = 32.000 MH No calibration applied and no bandpass applied

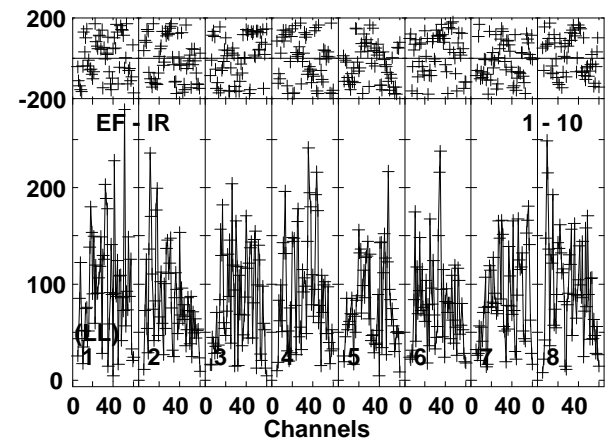
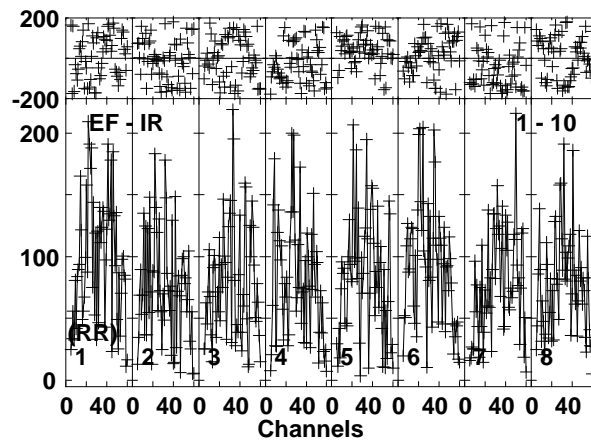
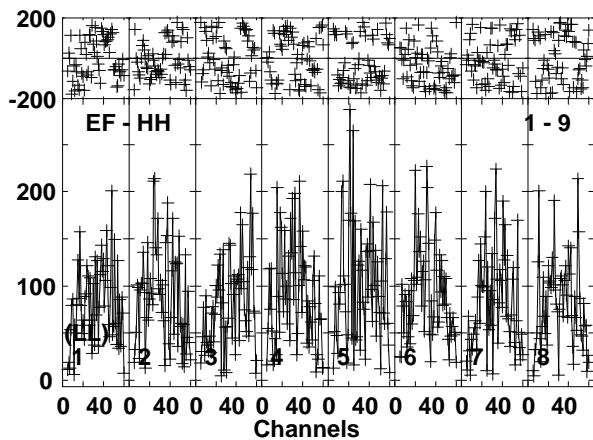
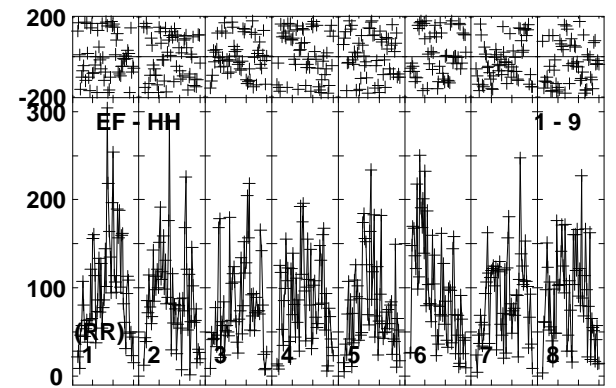
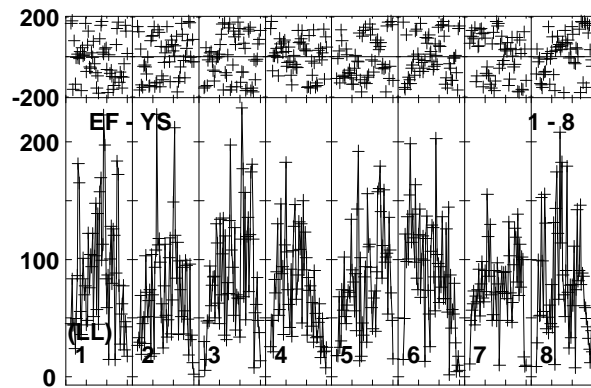
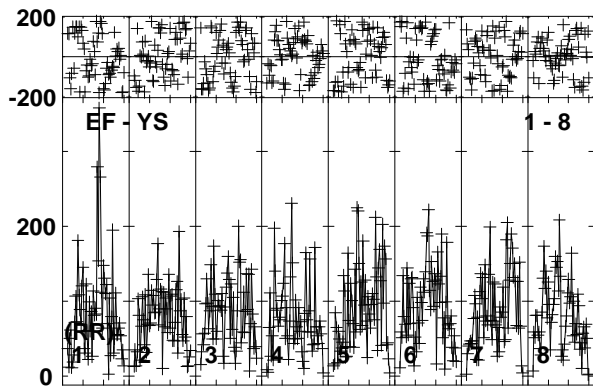
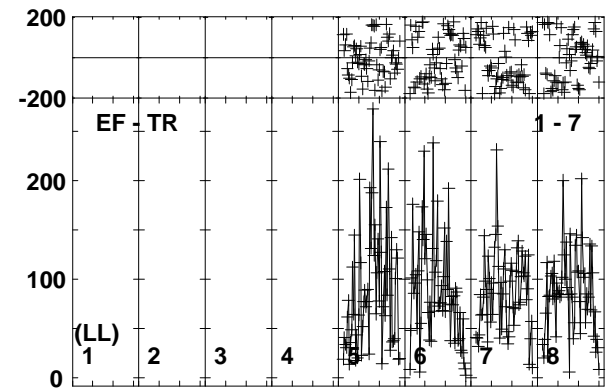
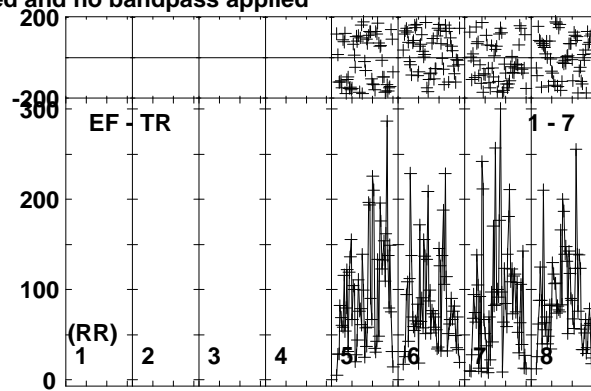
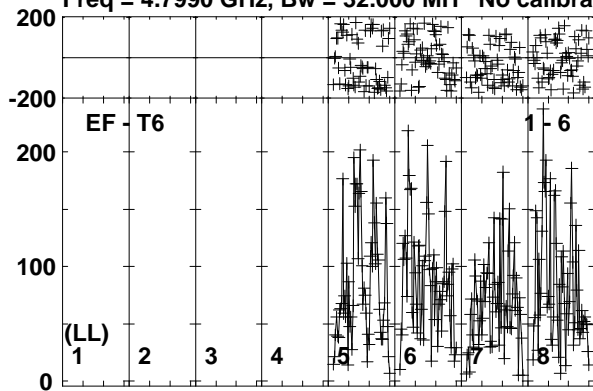

Lower frame: Micro Ampl Jy Top frame: Phas deg
Vector averaged cross-power spectrum Baseline: EF (01) - T6 (06)
Timerange: 00/15:56:01 to 00/15:59:29

Plot file version 119 created 19-OCT-2017 15:36:10

J2242+2955 ES081C.UVDATA.1

Freq = 4.7990 GHz, Bw = 32.000 MH No calibration applied and no bandpass applied

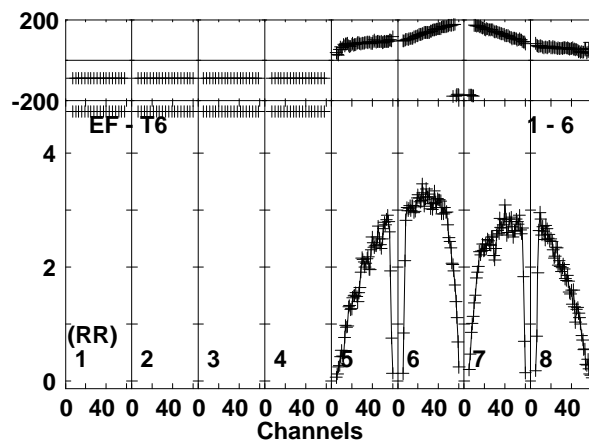
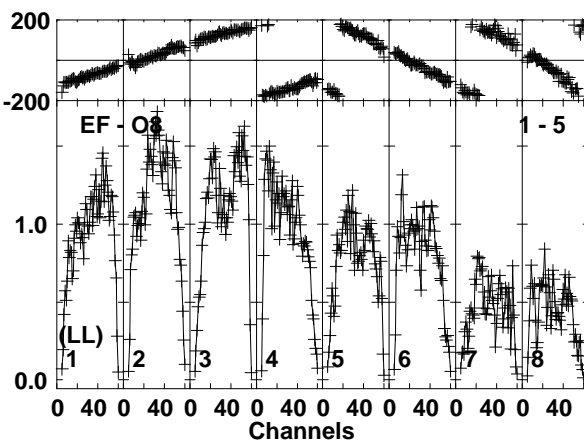
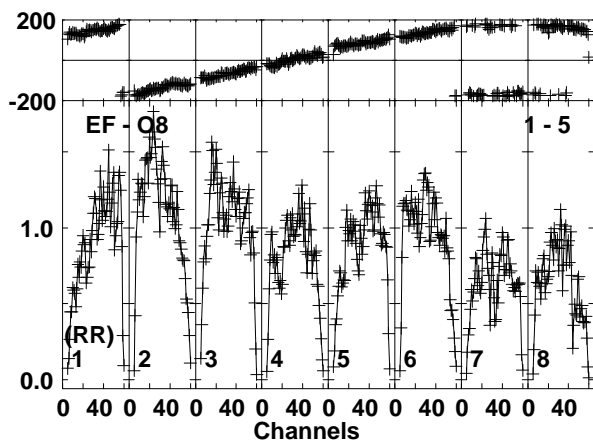
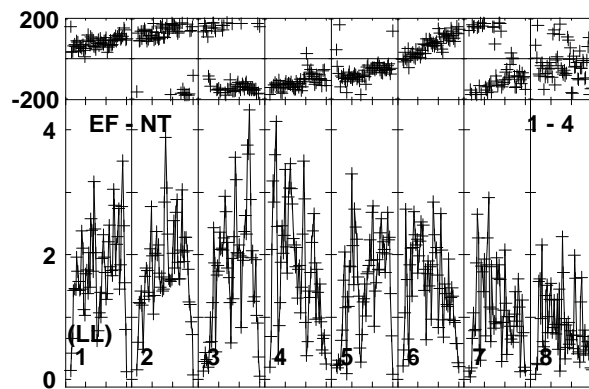
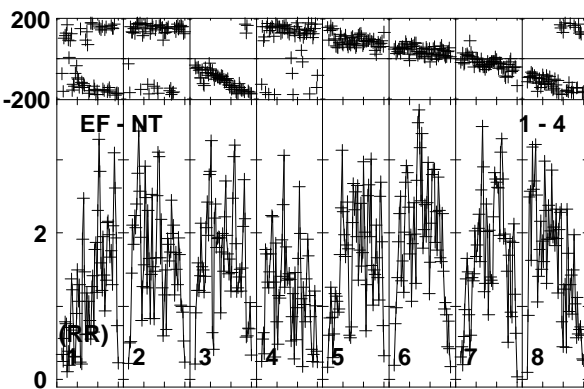
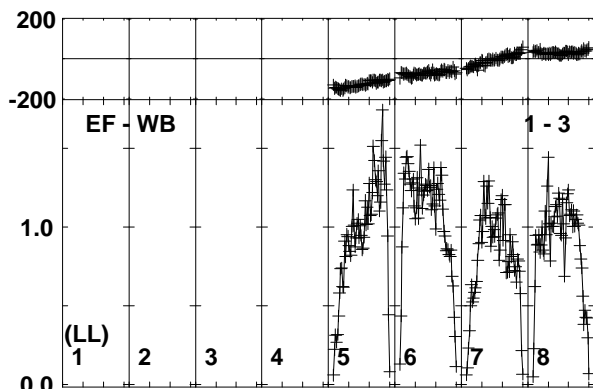
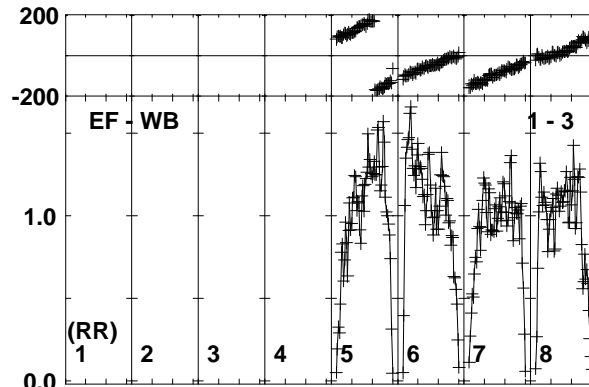
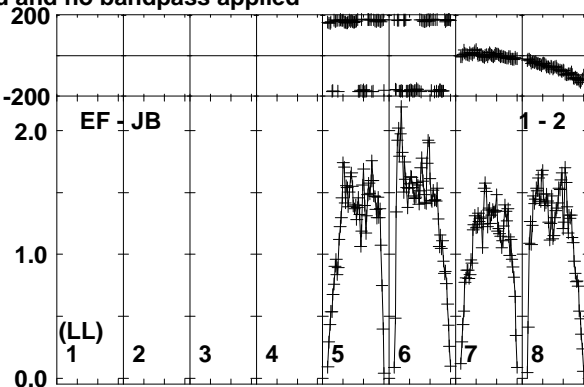
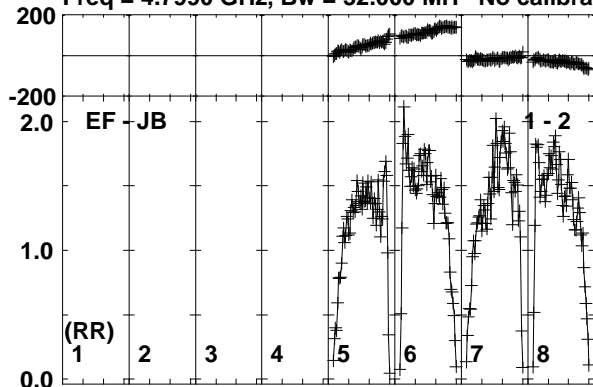

Lower frame: Milli Ampl Jy Top frame: Phas deg
Vector averaged cross-power spectrum Baseline: EF (01) - JB (02)
Timerange: 00/16:00:01 to 00/16:00:59

Plot file version 120 created 19-OCT-2017 15:36:10

J2242+2955 ES081C.UVDATA.1

Freq = 4.7990 GHz, Bw = 32.000 MH No calibration applied and no bandpass applied

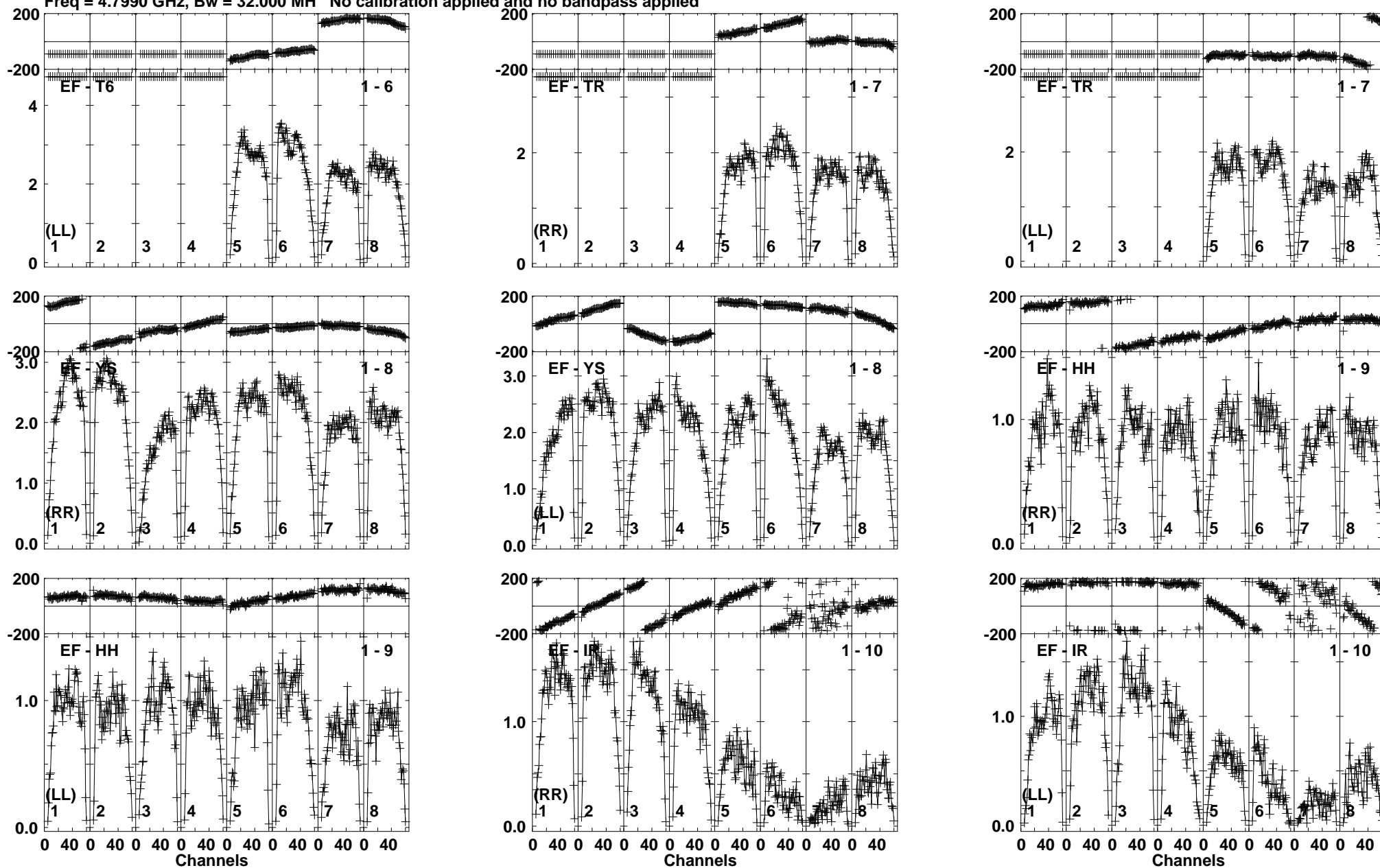

Lower frame: Milli Ampl Jy Top frame: Phas deg
Vector averaged cross-power spectrum Baseline: EF (01) - T6 (06)
Timerange: 00/16:00:01 to 00/16:00:59

Plot file version 121 created 19-OCT-2017 15:36:10

ARK564 ES081C.UVDATA.1

Freq = 4.7990 GHz, Bw = 32.000 MH No calibration applied and no bandpass applied

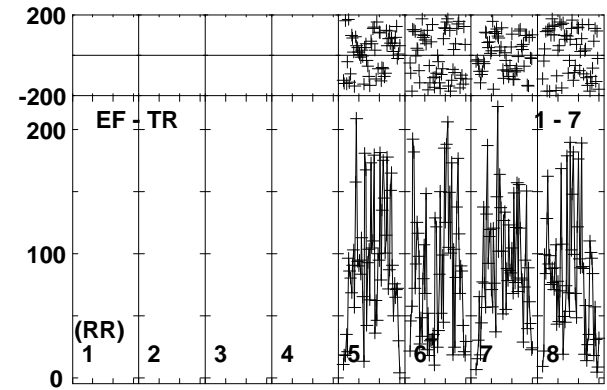
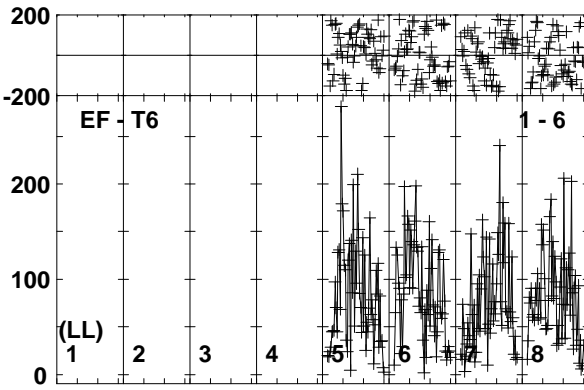
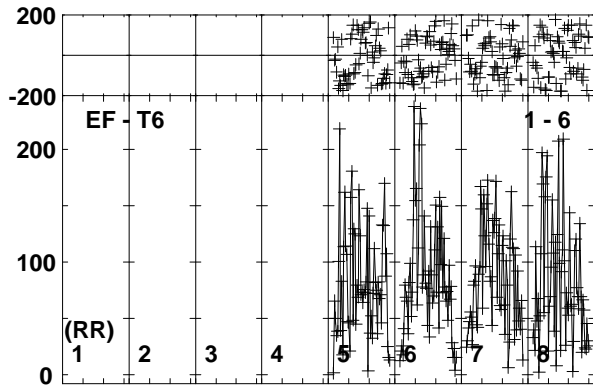
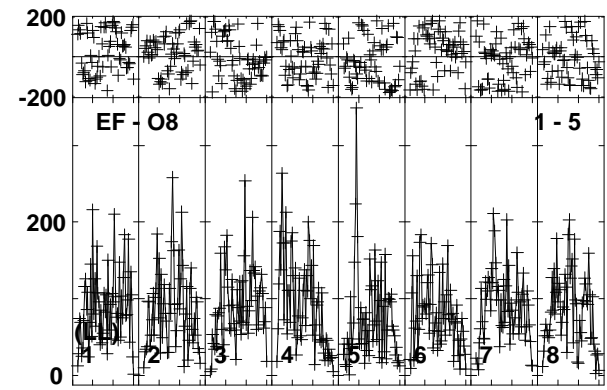
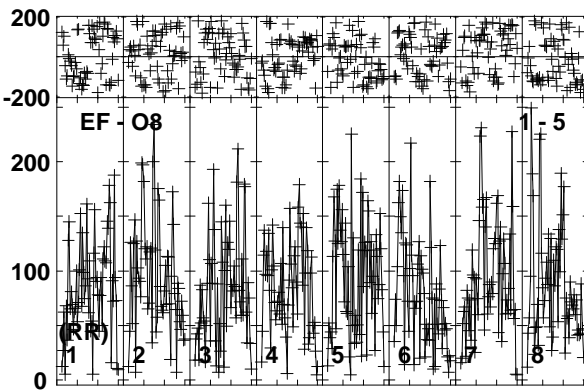
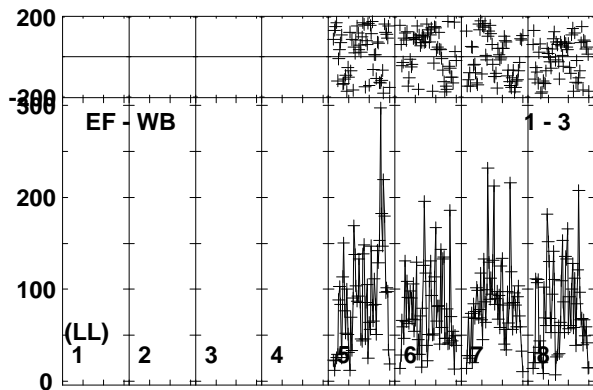
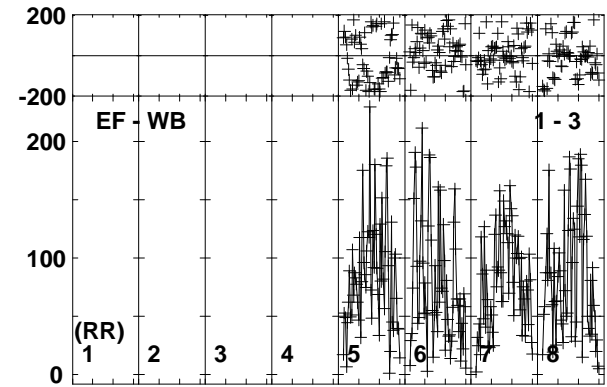
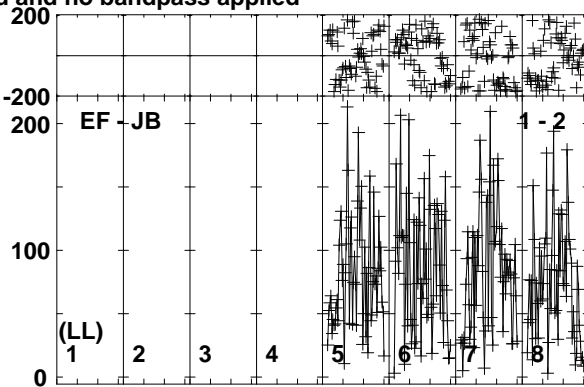
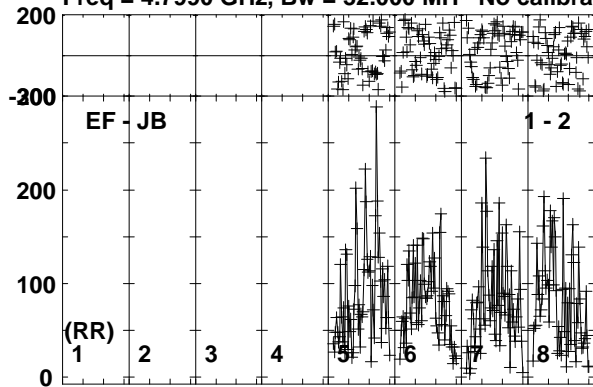

Lower frame: Micro Ampl Jy Top frame: Phas deg
Vector averaged cross-power spectrum Baseline: EF (01) - JB (02)
Timerange: 00/16:01:01 to 00/16:04:29

Plot file version 122 created 19-OCT-2017 15:36:10

ARK564 ES081C.UVDATA.1

Freq = 4.7990 GHz, Bw = 32.000 MH No calibration applied and no bandpass applied

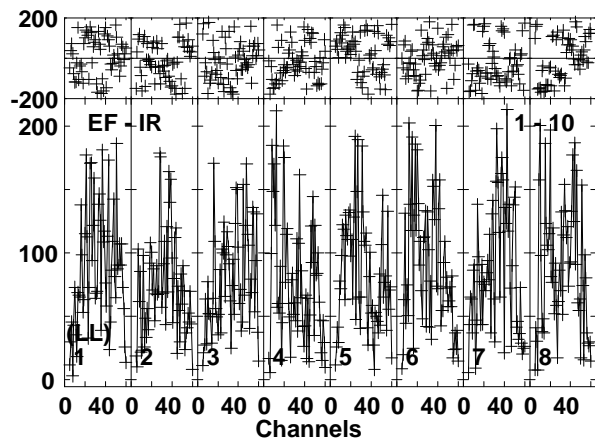
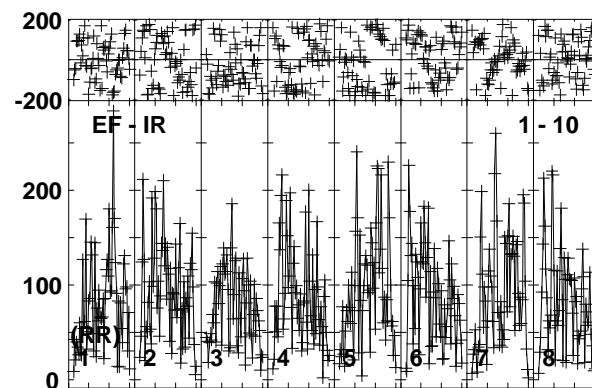
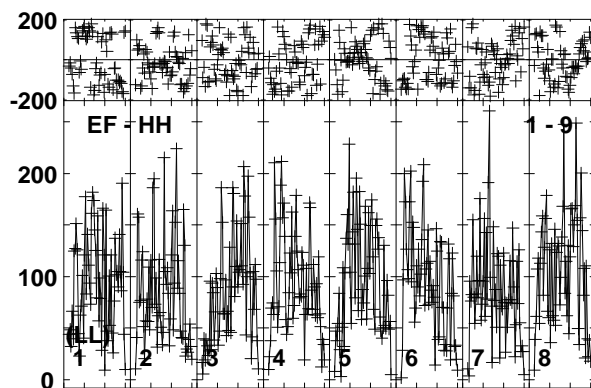
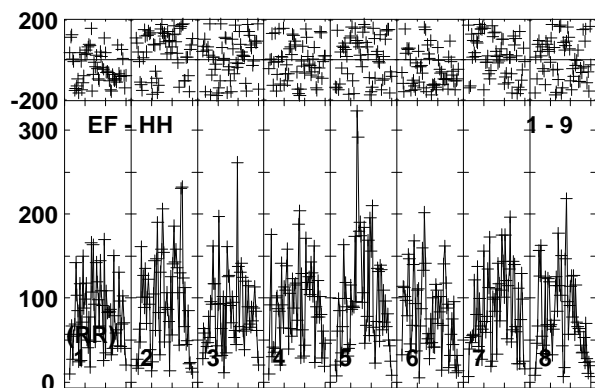
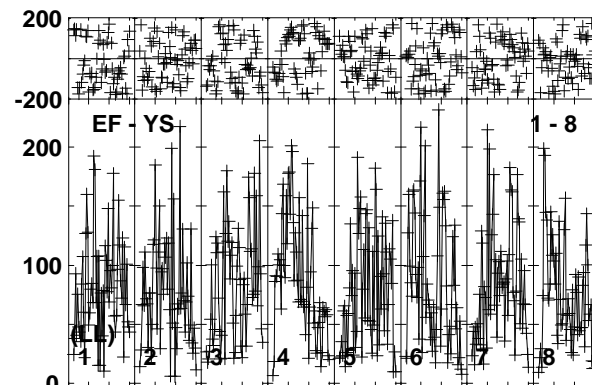
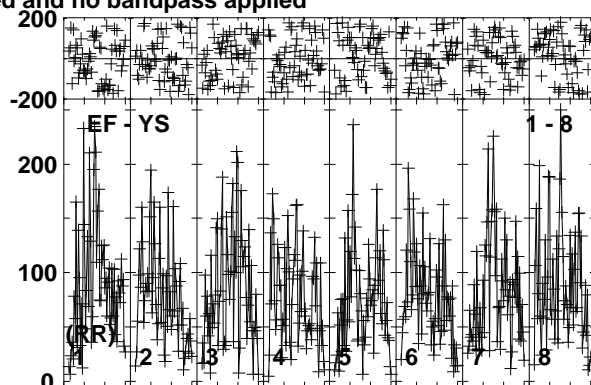
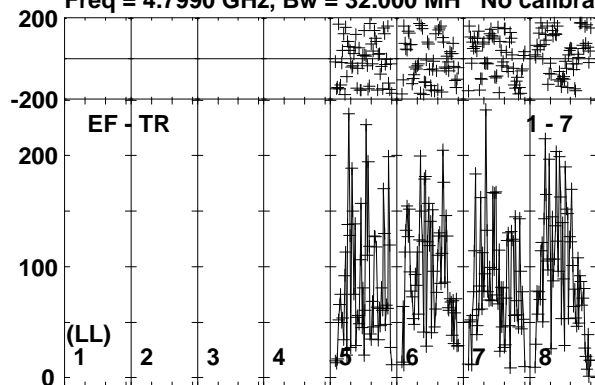

Lower frame: Micro Ampl Jy Top frame: Phas deg
Vector averaged cross-power spectrum Baseline: EF (01) - TR (07)
Timerange: 00/16:01:01 to 00/16:04:29

Plot file version 123 created 19-OCT-2017 15:36:10

J2242+2955 ES081C.UVDATA.1

Freq = 4.7990 GHz, Bw = 32.000 MH No calibration applied and no bandpass applied

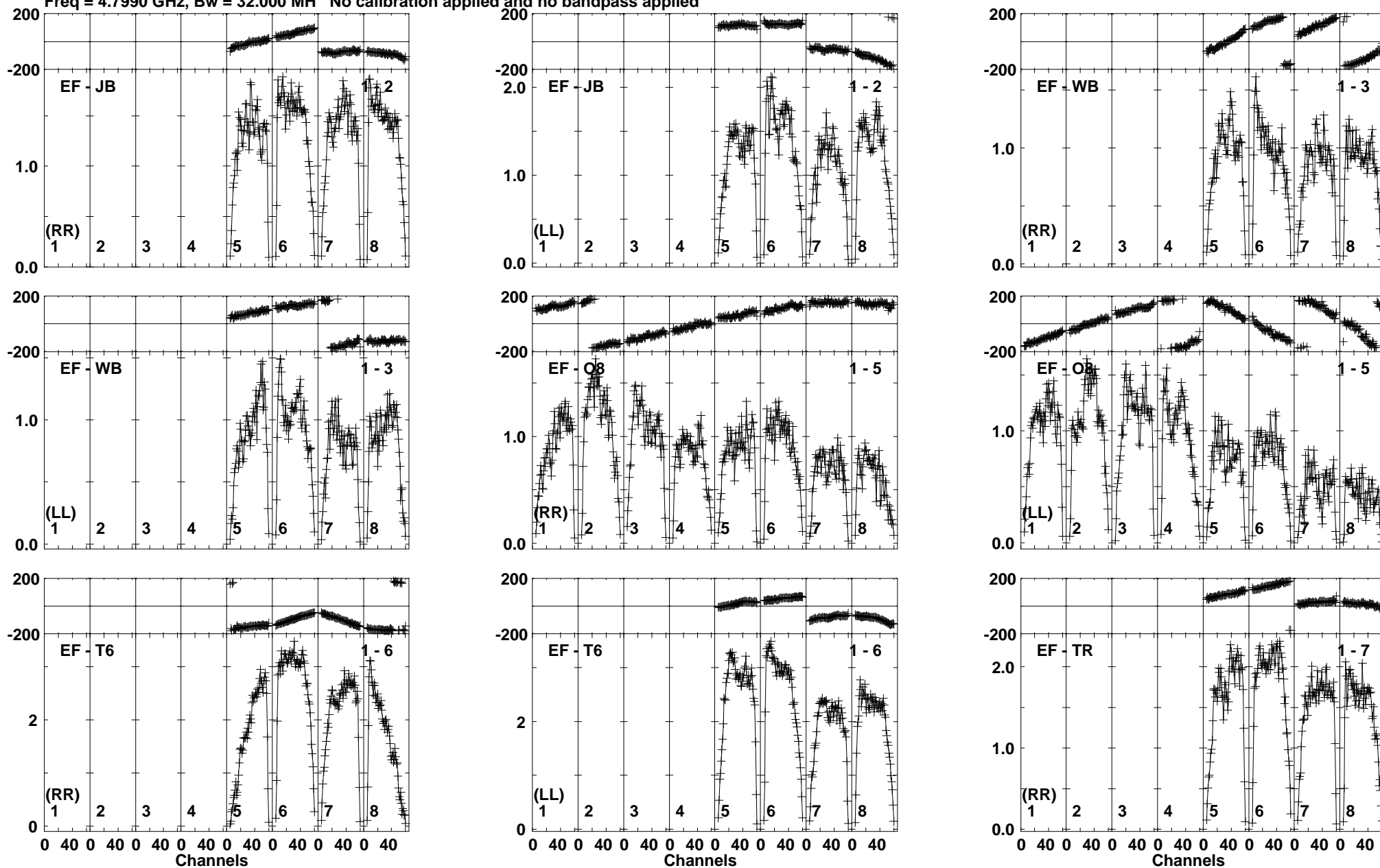

Lower frame: Milli Ampl Jy Top frame: Phas deg
Vector averaged cross-power spectrum Baseline: EF (01) - JB (02)
Timerange: 00/16:04:31 to 00/16:05:59

Plot file version 124 created 19-OCT-2017 15:36:10

J2242+2955 ES081C.UVDATA.1

Freq = 4.7990 GHz, Bw = 32.000 MH No calibration applied and no bandpass applied

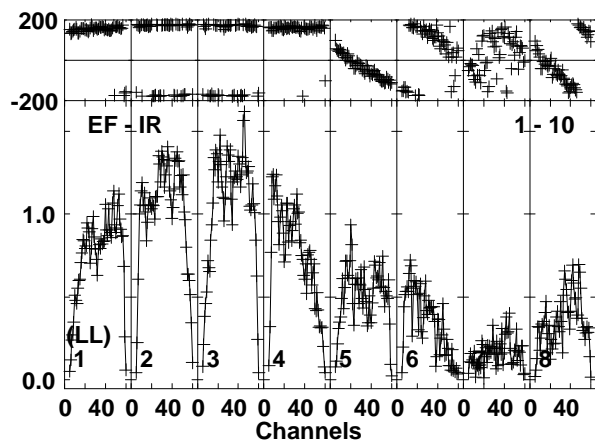
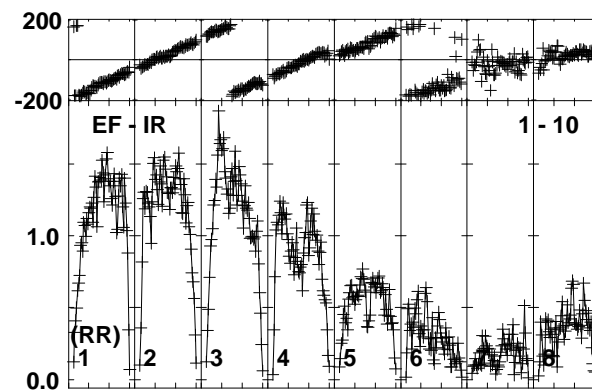
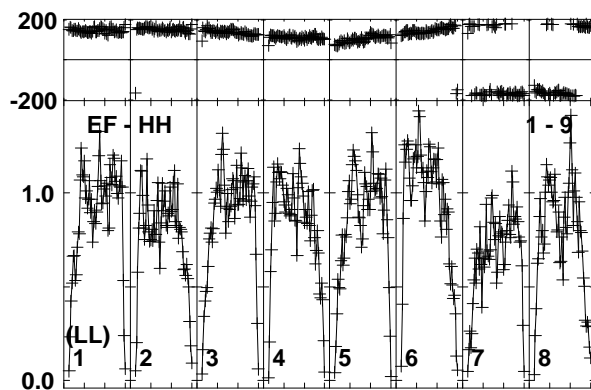
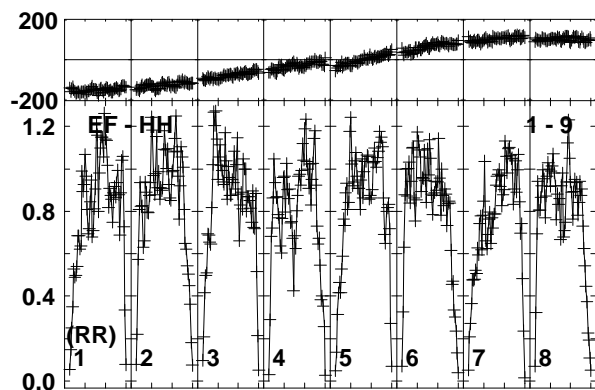
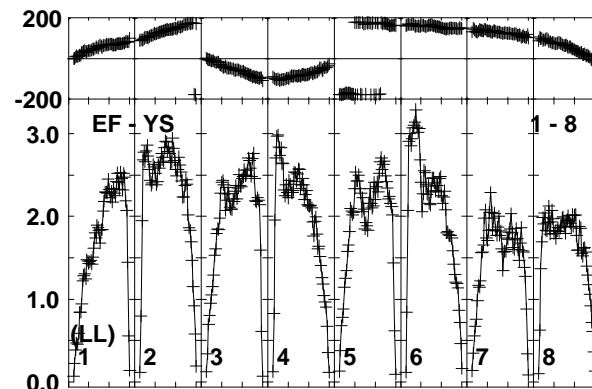
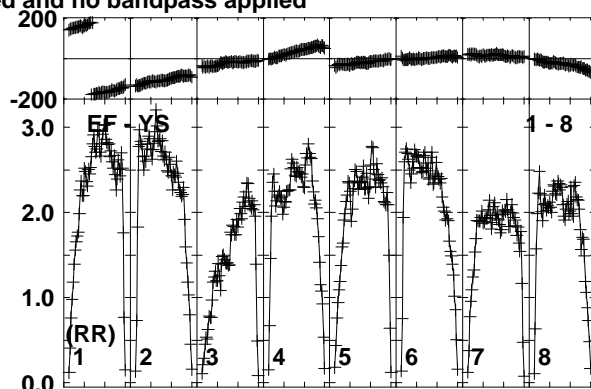
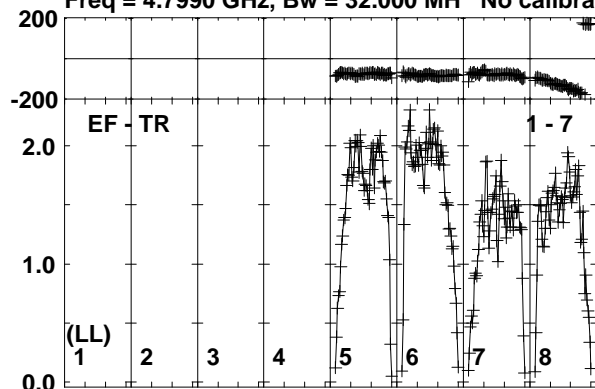

Lower frame: Milli Ampl Jy Top frame: Phas deg
Vector averaged cross-power spectrum Baseline: EF (01) - TR (07)
Timerange: 00/16:04:31 to 00/16:05:59

Plot file version 125 created 19-OCT-2017 15:36:10

ARK564 ES081C.UVDATA.1

Freq = 4.7990 GHz, Bw = 32.000 MH No calibration applied and no bandpass applied

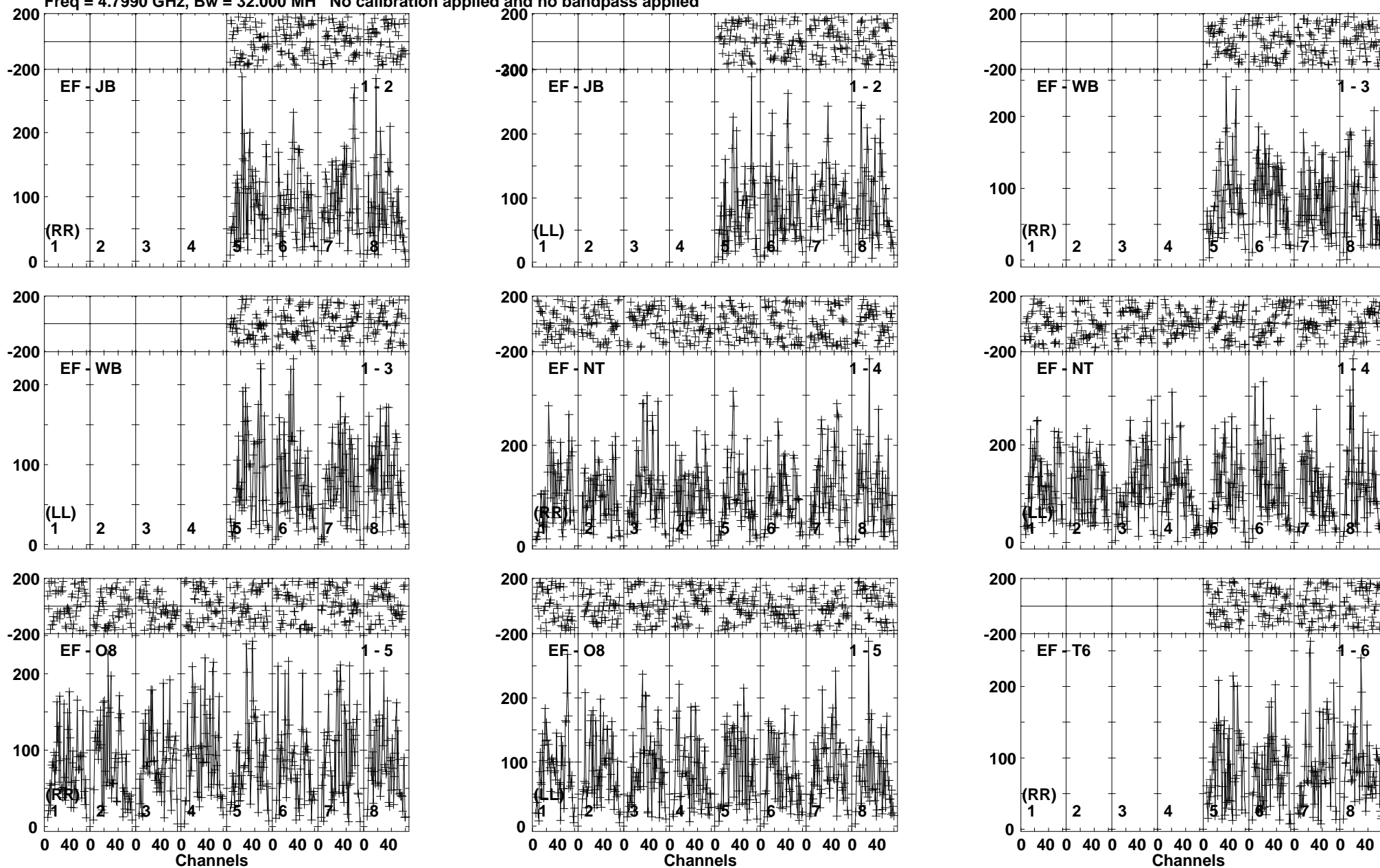

Lower frame: Micro Ampl Jy Top frame: Phas deg
Vector averaged cross-power spectrum Baseline: EF (01) - JB (02)
Timerange: 00/16:06:01 to 00/16:09:29

Plot file version 126 created 19-OCT-2017 15:36:11

ARK564 ES081C.UVDATA.1

Freq = 4.7990 GHz, Bw = 32.000 MH No calibration applied and no bandpass applied

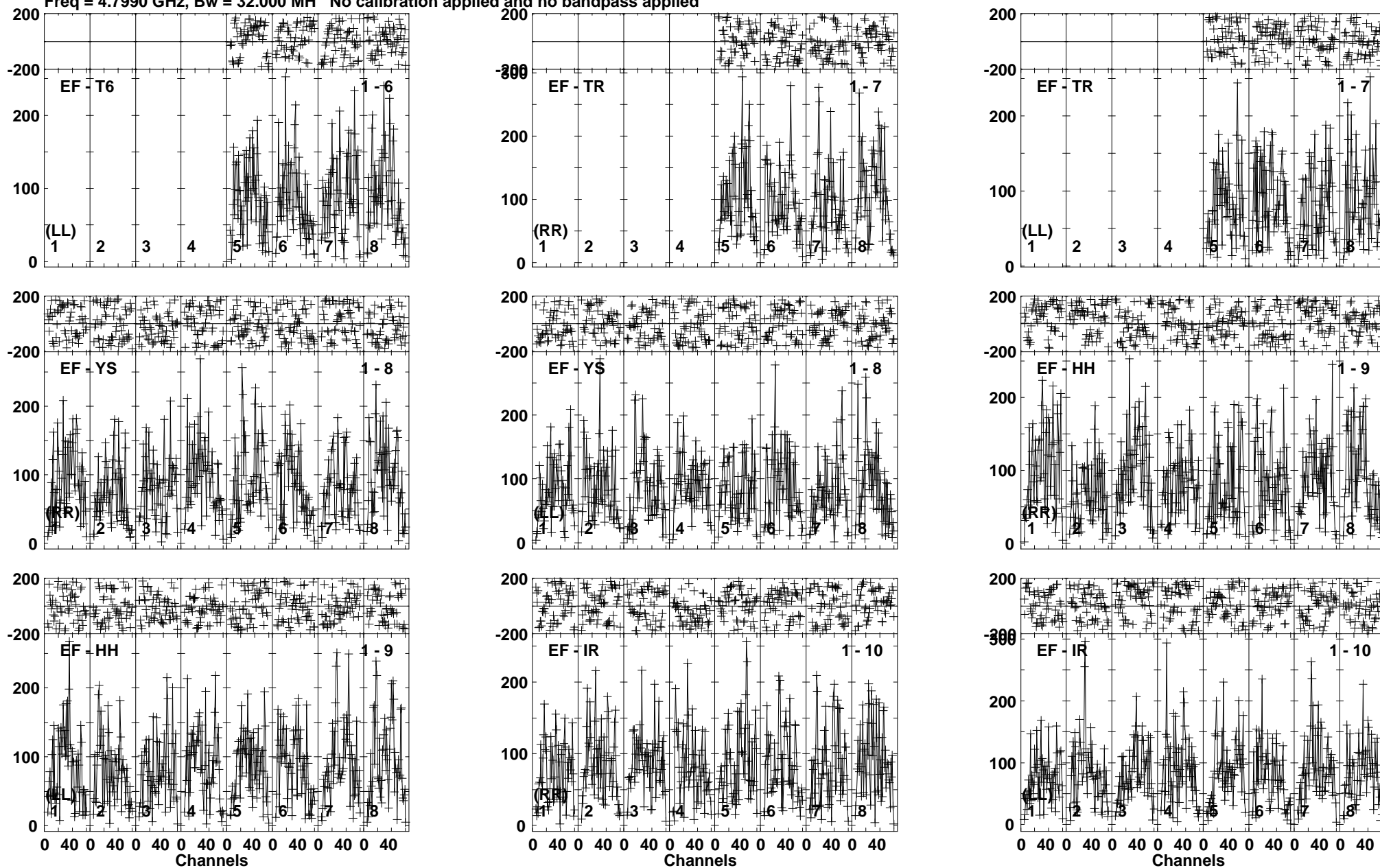

Lower frame: Micro Ampl Jy Top frame: Phas deg
Vector averaged cross-power spectrum Baseline: EF (01) - T6 (06)
Timerange: 00/16:06:01 to 00/16:09:29

Plot file version 127 created 19-OCT-2017 15:36:11

J2242+2955 ES081C.UVDATA.1

Freq = 4.7990 GHz, Bw = 32.000 MH No calibration applied and no bandpass applied

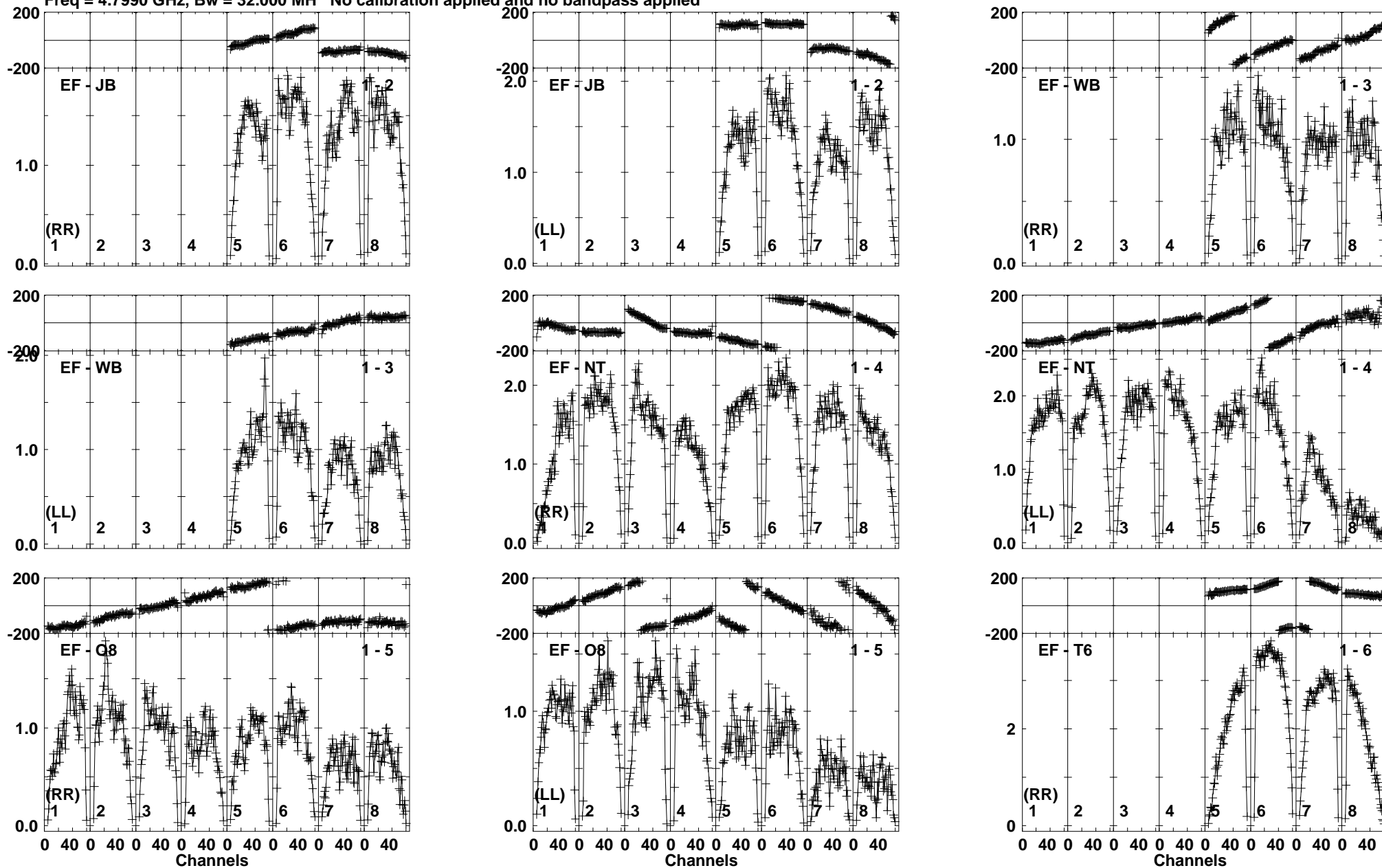

Lower frame: Milli Ampl Jy Top frame: Phas deg
Vector averaged cross-power spectrum Baseline: EF (01) - JB (02)
Timerange: 00:16:10:01 to 00:16:10:59

Plot file version 128 created 19-OCT-2017 15:36:11

J2242+2955 ES081C.UVDATA.1

Freq = 4.7990 GHz, Bw = 32.000 MH No calibration applied and no bandpass applied

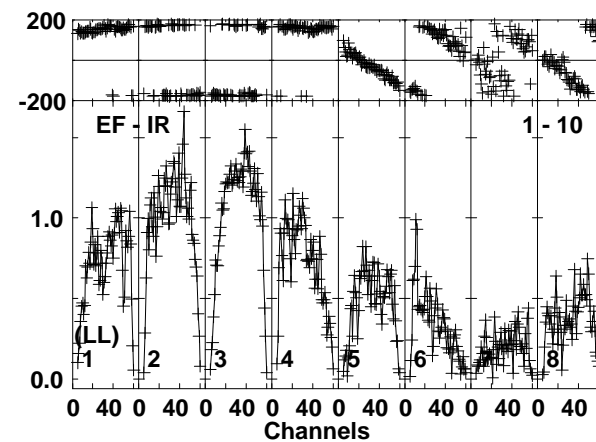
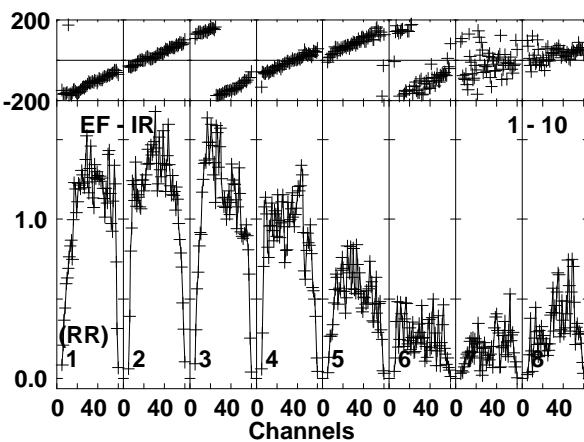
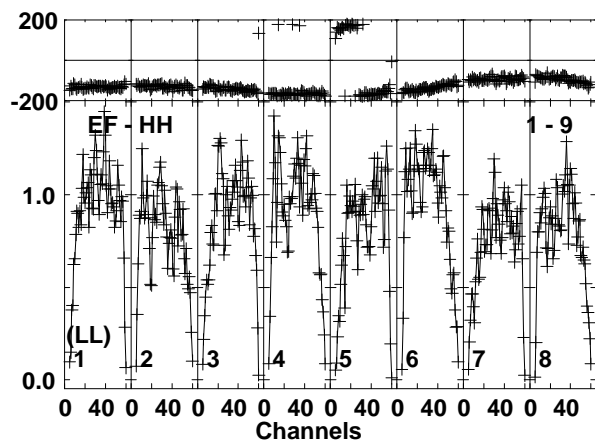
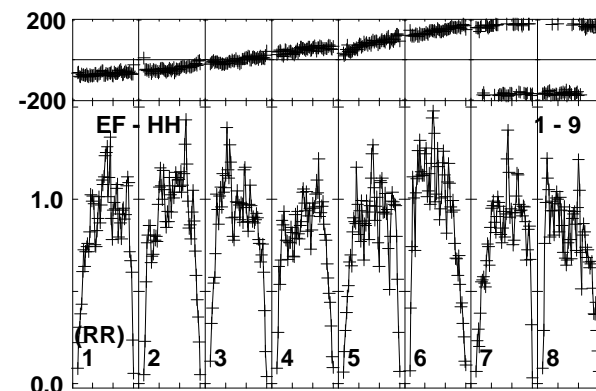
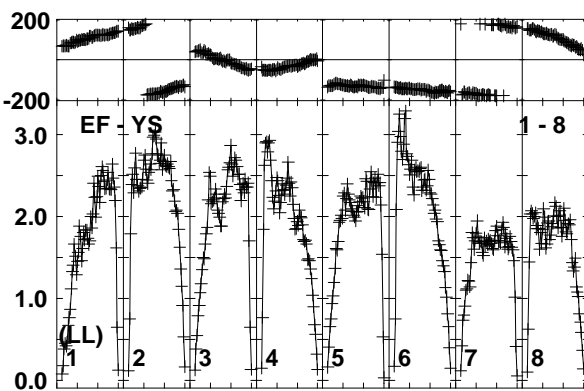
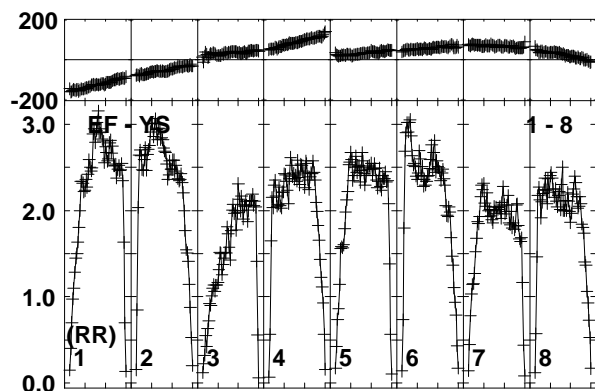
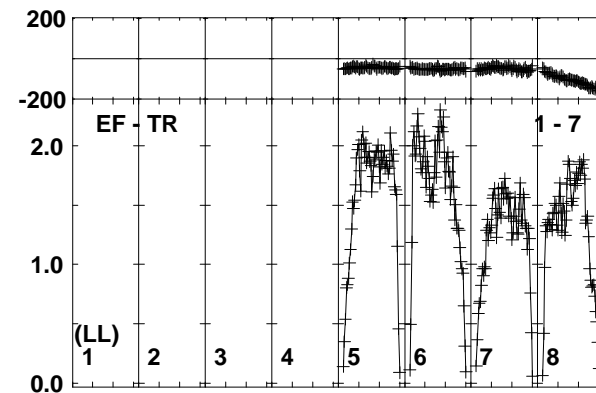
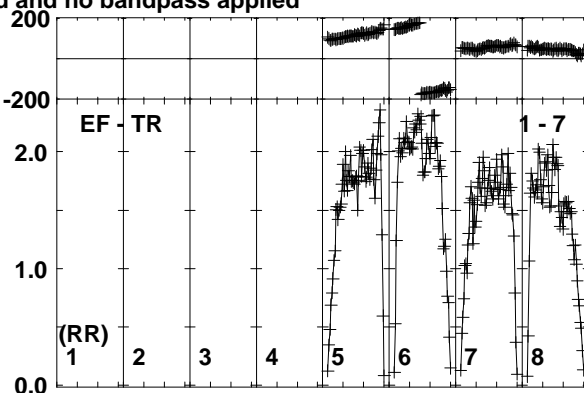
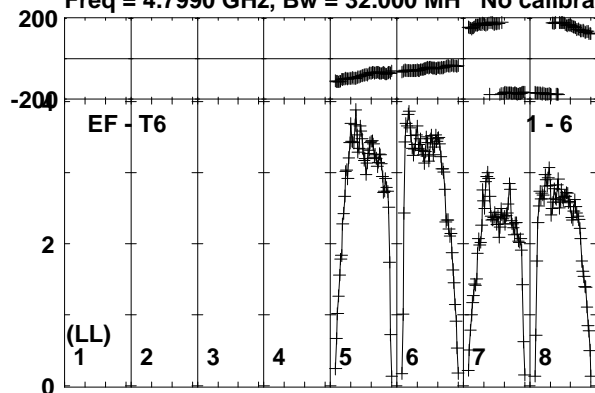

Lower frame: Milli Ampl Jy Top frame: Phas deg
Vector averaged cross-power spectrum Baseline: EF (01) - T6 (06)
Timerange: 00/16:10:01 to 00/16:10:59

Plot file version 129 created 19-OCT-2017 15:36:11

ARK564 ES081C.UVDATA.1

Freq = 4.7990 GHz, Bw = 32.000 MH No calibration applied and no bandpass applied

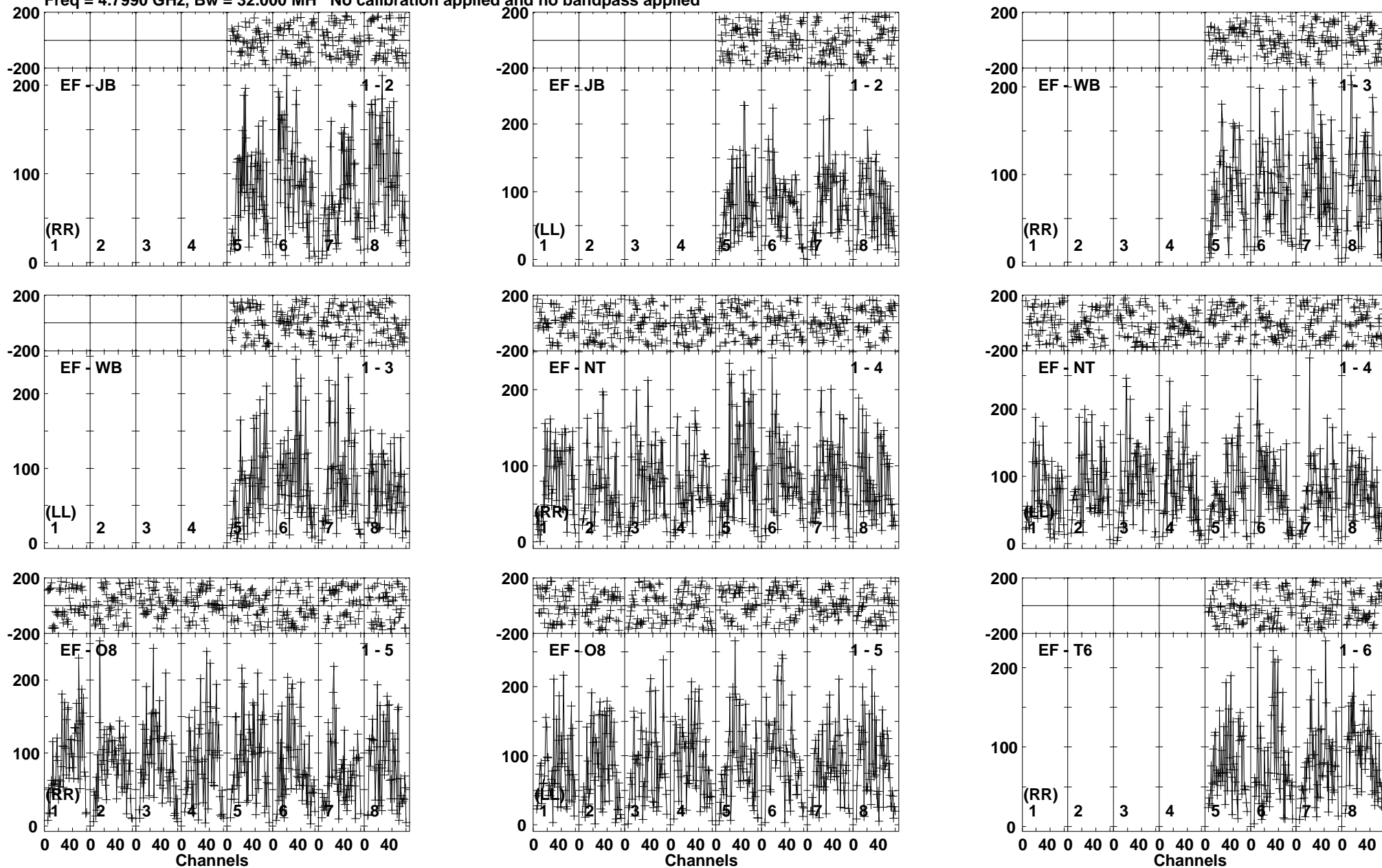

Lower frame: Micro Ampl Jy Top frame: Phas deg
Vector averaged cross-power spectrum Baseline: EF (01) - JB (02)
Timerange: 00/16:11:01 to 00/16:14:29

Plot file version 130 created 19-OCT-2017 15:36:11

ARK564 ES081C.UVDATA.1

Freq = 4.7990 GHz, Bw = 32.000 MH No calibration applied and no bandpass applied

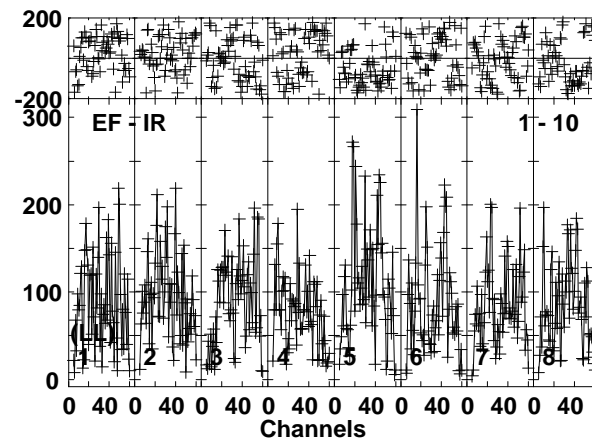
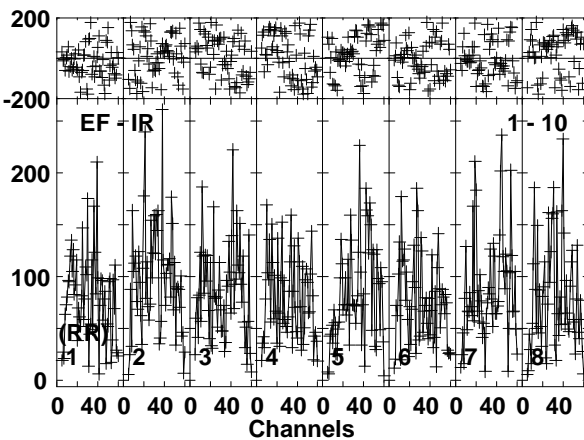
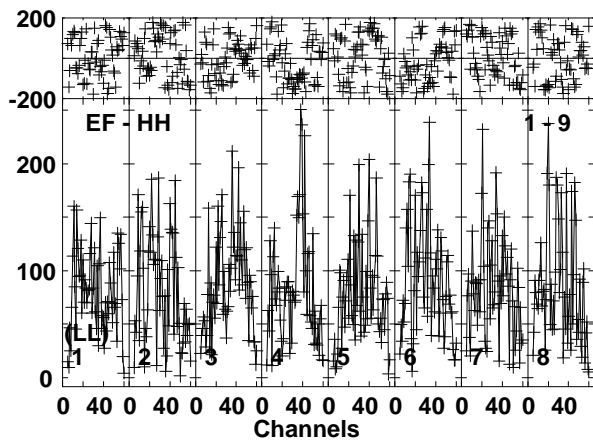
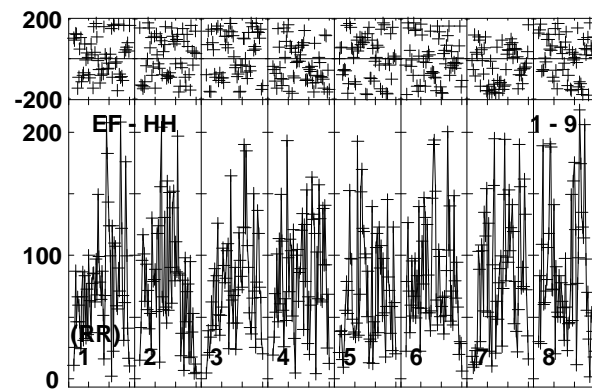
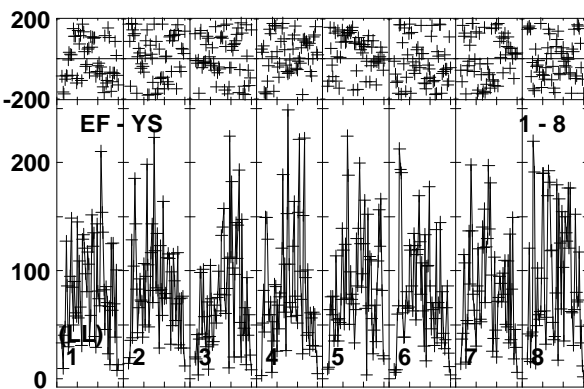
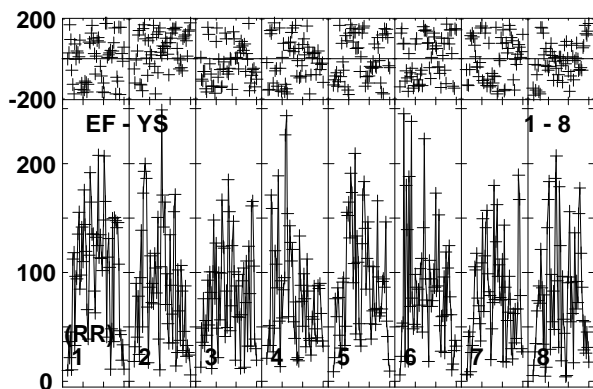
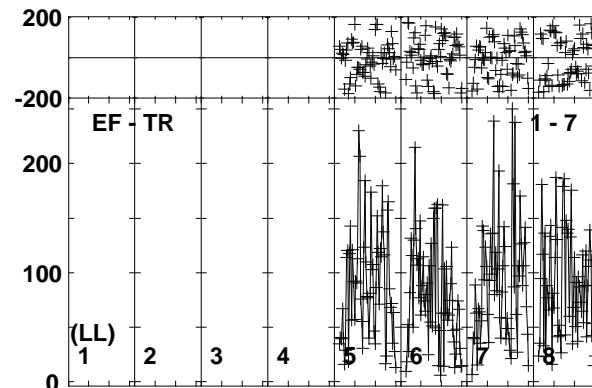
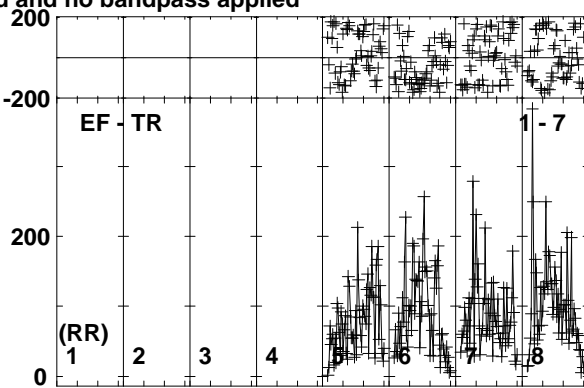
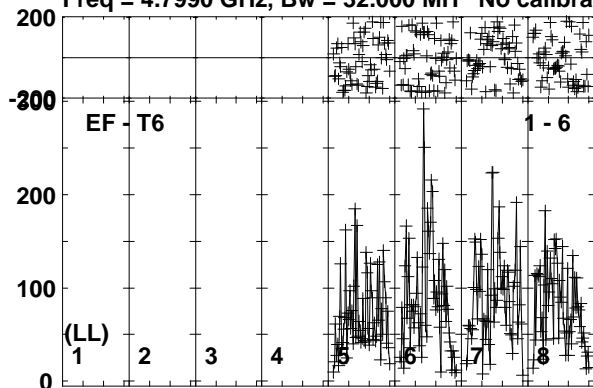

Lower frame: Micro Ampl Jy Top frame: Phas deg
Vector averaged cross-power spectrum Baseline: EF (01) - T6 (06)
Timerange: 00/16:11:01 to 00/16:14:29

Plot file version 131 created 19-OCT-2017 15:36:11

J2242+2955 ES081C.UVDATA.1

Freq = 4.7990 GHz, Bw = 32.000 MH No calibration applied and no bandpass applied

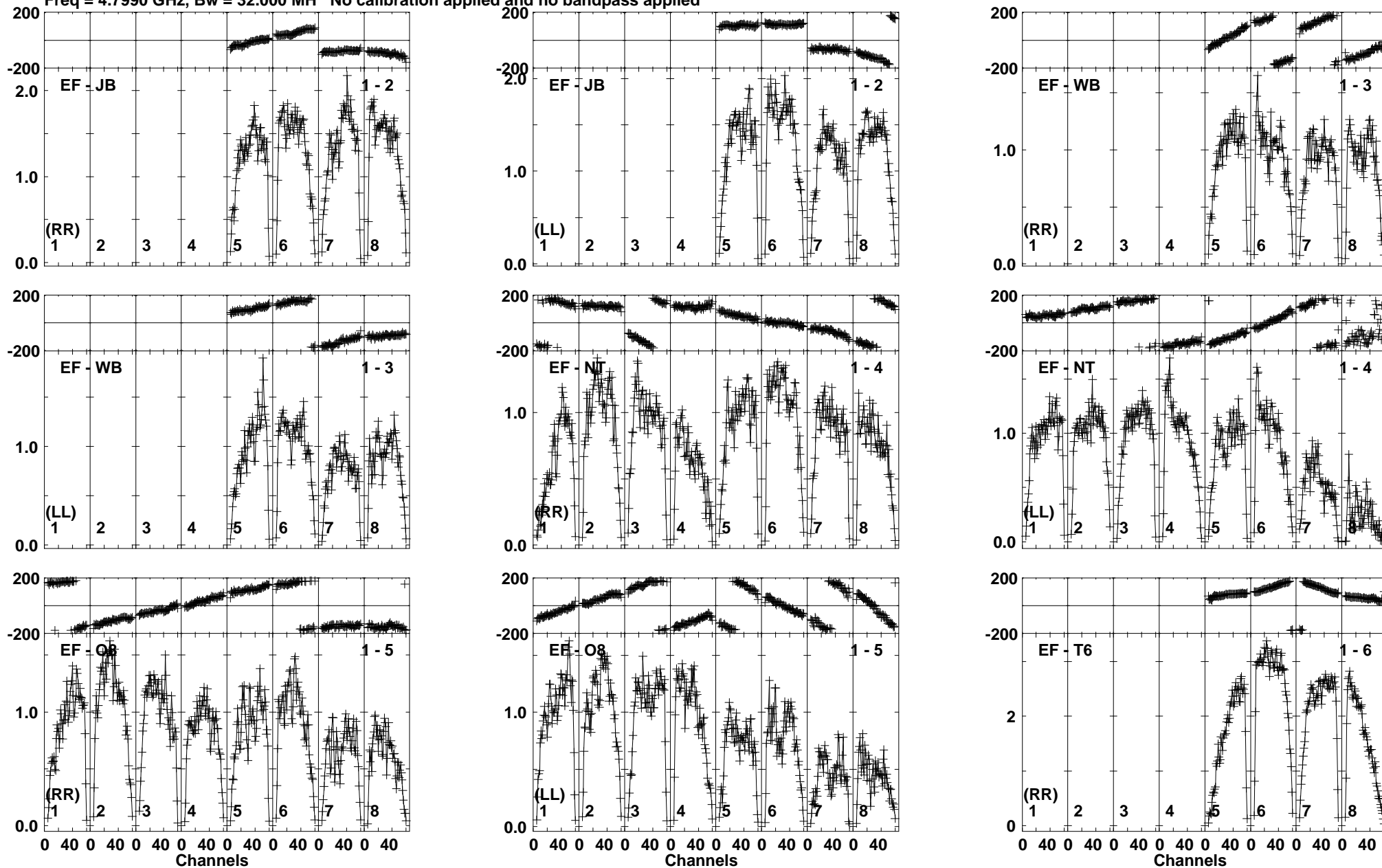

Lower frame: Milli Ampl Jy Top frame: Phas deg
Vector averaged cross-power spectrum Baseline: EF (01) - JB (02)
Timerange: 00/16:14:31 to 00/16:15:59

Plot file version 132 created 19-OCT-2017 15:36:11

J2242+2955 ES081C.UVDATA.1

Freq = 4.7990 GHz, Bw = 32.000 MH No calibration applied and no bandpass applied

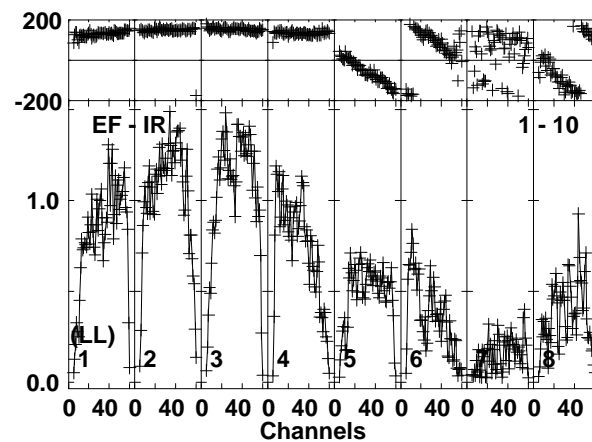
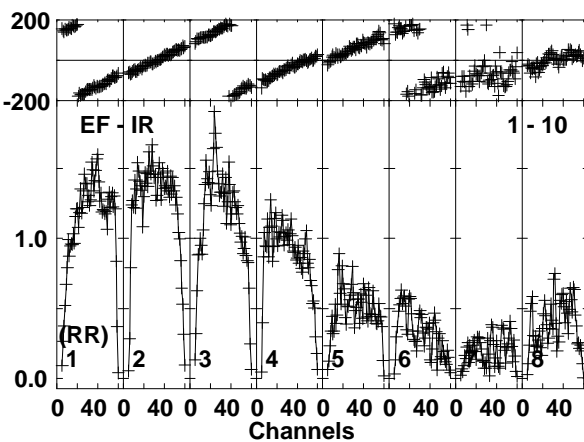
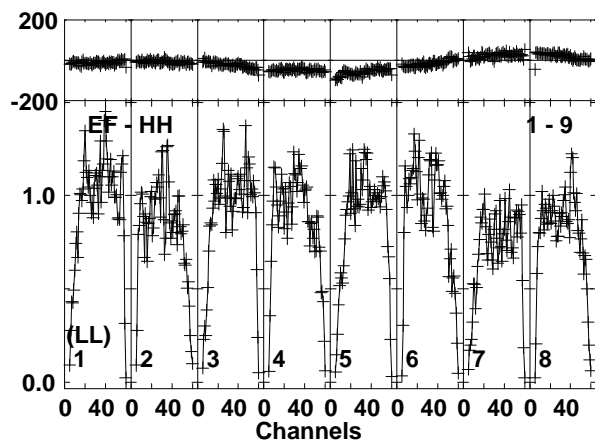
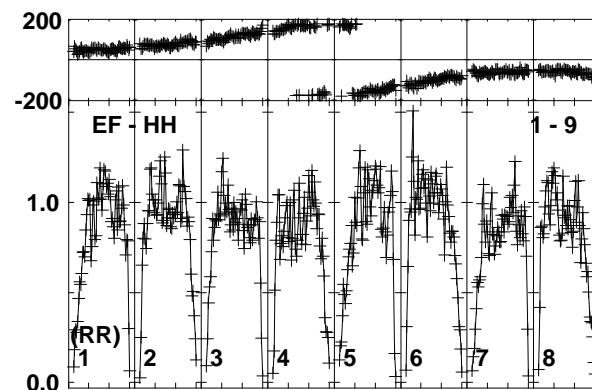
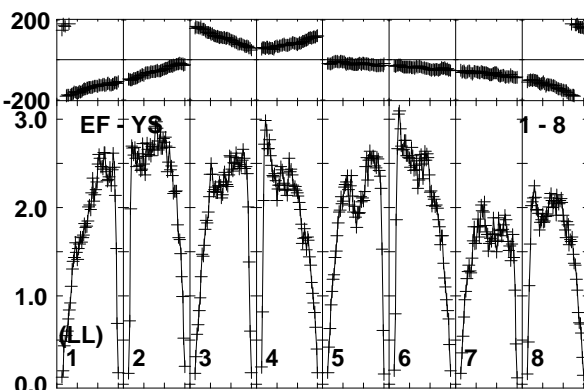
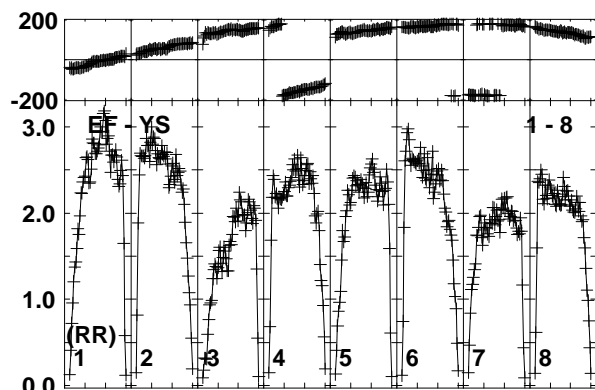
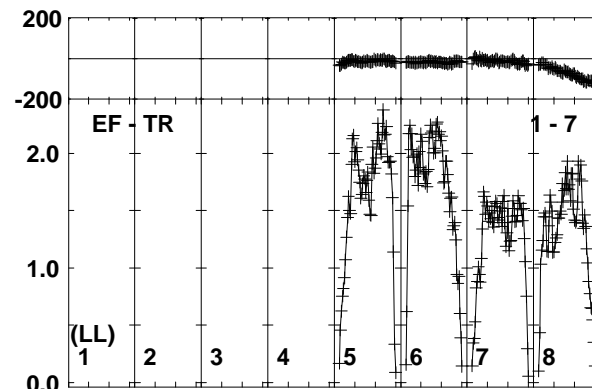
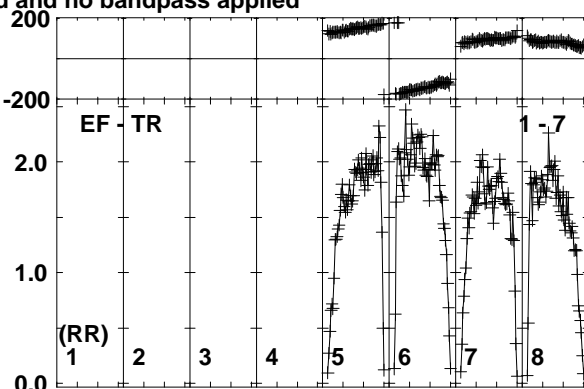
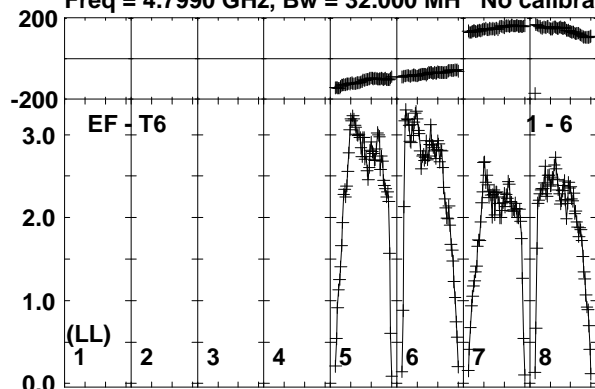

Lower frame: Milli Ampl Jy Top frame: Phas deg
Vector averaged cross-power spectrum Baseline: EF (01) - T6 (06)
Timerange: 00/16:14:31 to 00/16:15:59

Plot file version 133 created 19-OCT-2017 15:36:12

ARK564 ES081C.UVDATA.1

Freq = 4.7990 GHz, Bw = 32.000 MH No calibration applied and no bandpass applied

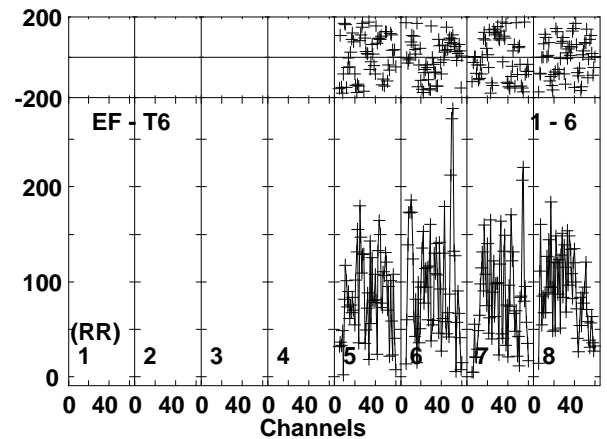
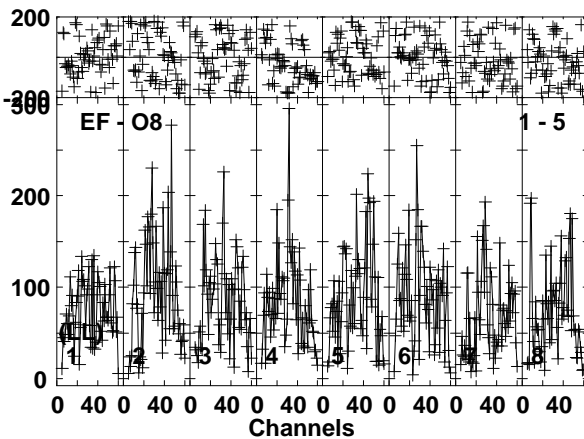
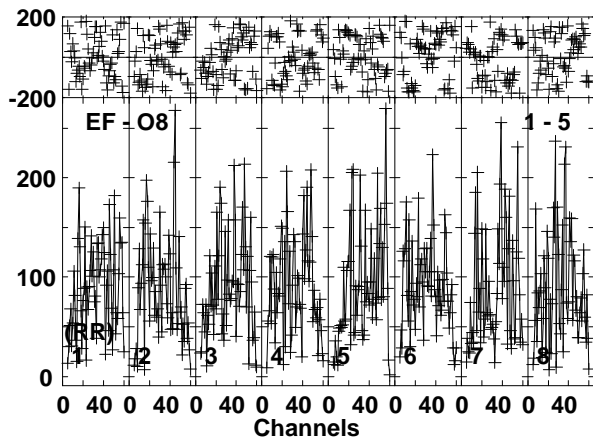
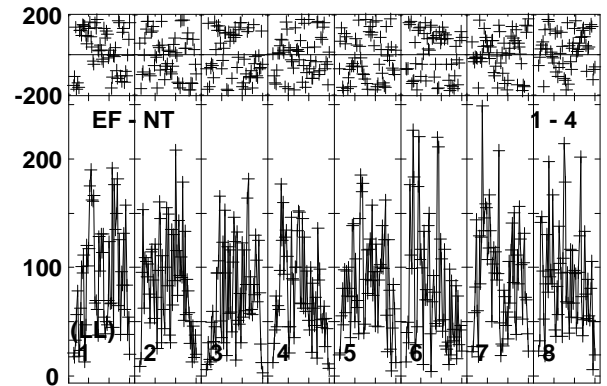
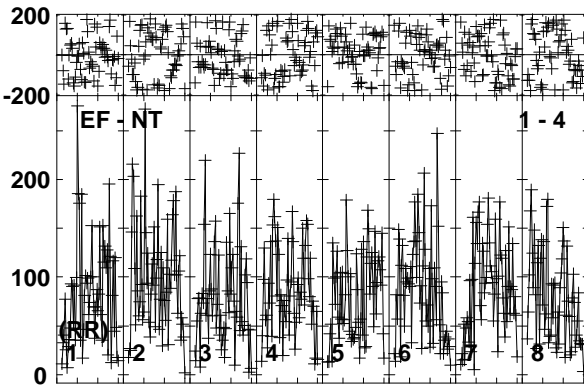
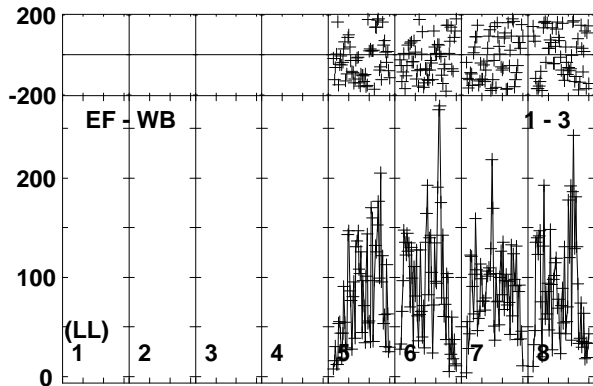
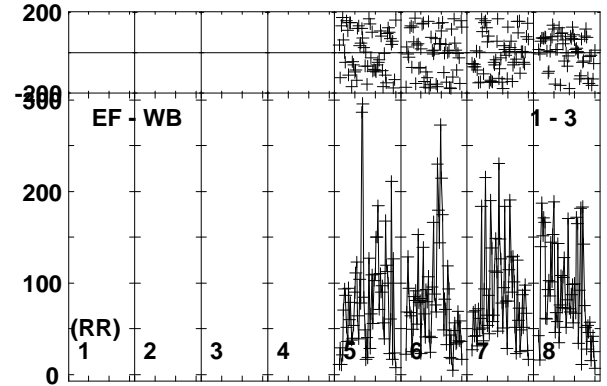
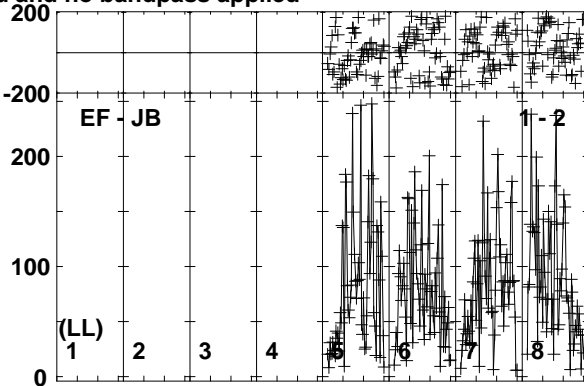
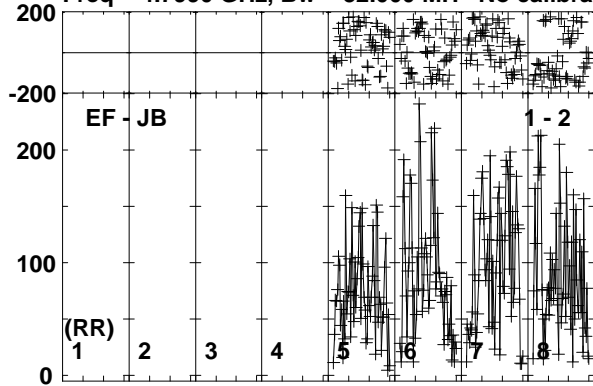

Lower frame: Micro Ampl Jy Top frame: Phas deg
Vector averaged cross-power spectrum Baseline: EF (01) - JB (02)
Timerange: 00/16:16:01 to 00/16:19:29

Plot file version 134 created 19-OCT-2017 15:36:12
 ARK564 ES081C.UVDATA.1
 Freq = 4.7990 GHz, Bw = 32.000 MH No calibration applied and no bandpass applied

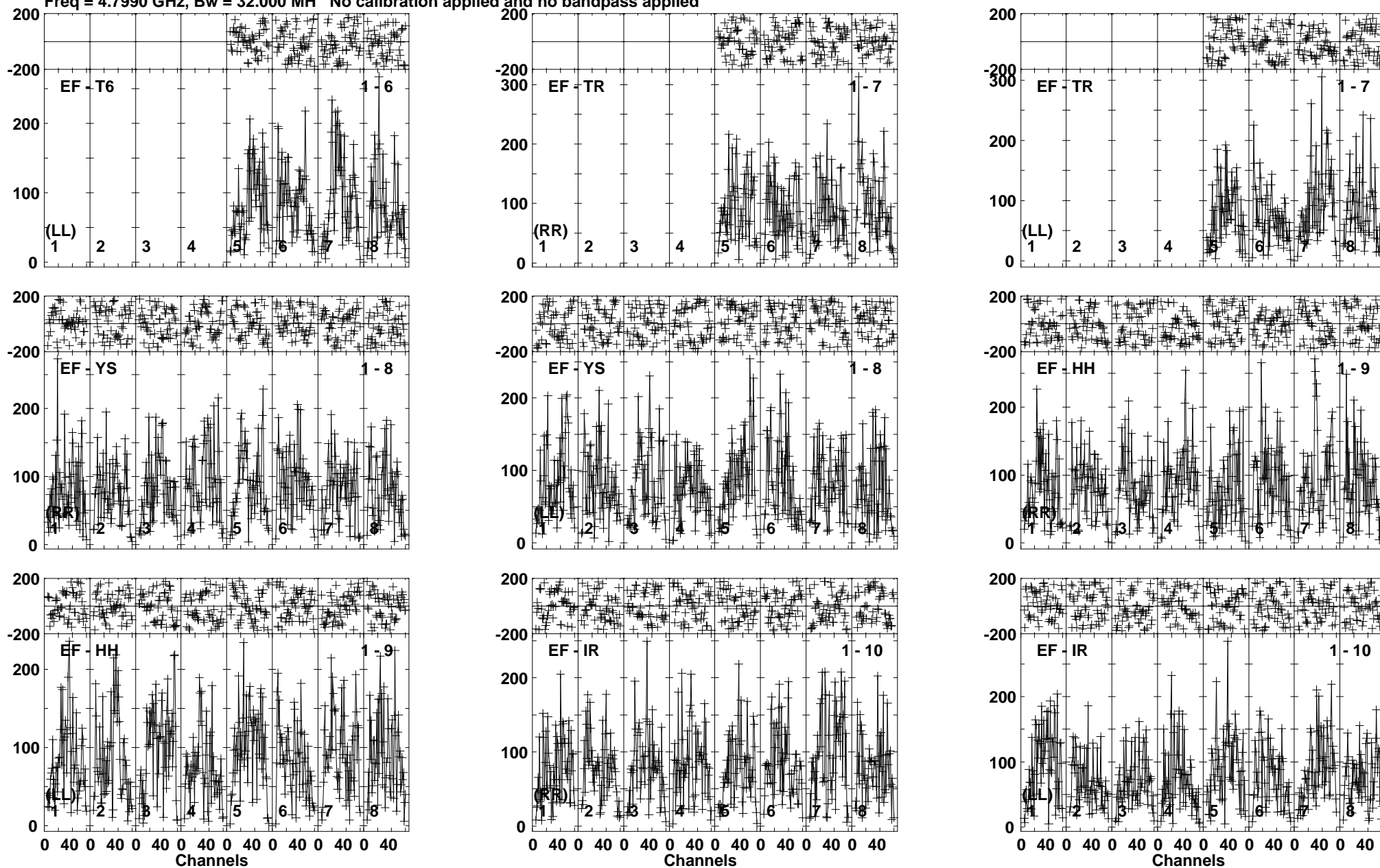

Lower frame: Micro Ampl Jy Top frame: Phas deg
 Vector averaged cross-power spectrum Baseline: EF (01) - T6 (06)
 Timerange: 00/16:16:01 to 00/16:19:29

Plot file version 135 created 19-OCT-2017 15:36:12

J2242+2955 ES081C.UVDATA.1

Freq = 4.7990 GHz, Bw = 32.000 MH No calibration applied and no bandpass applied

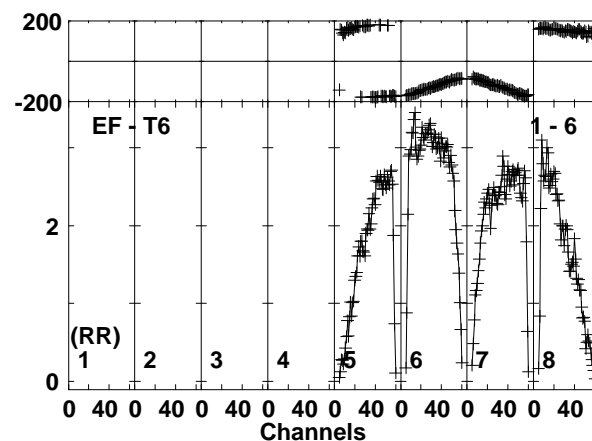
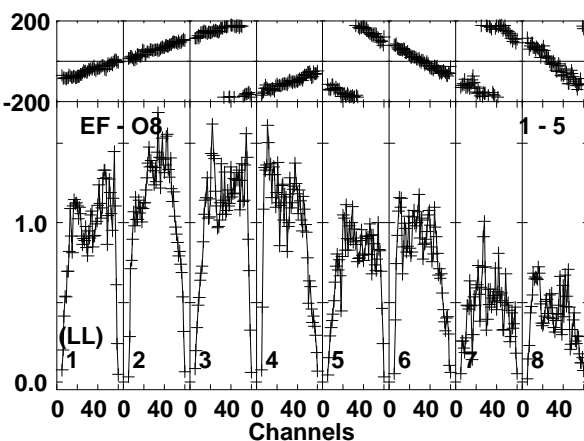
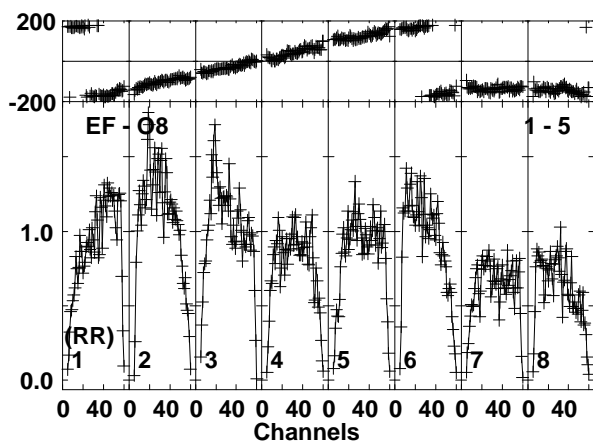
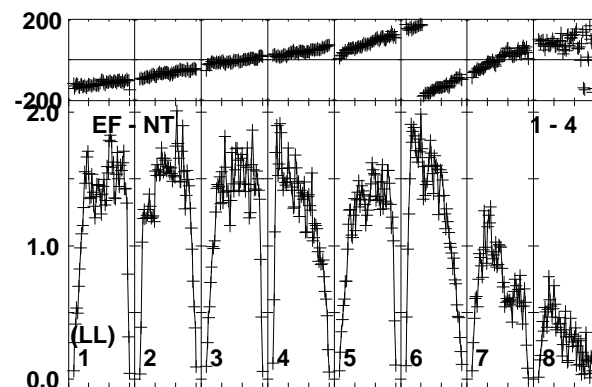
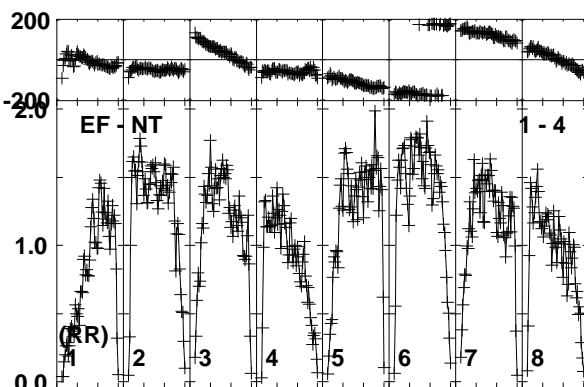
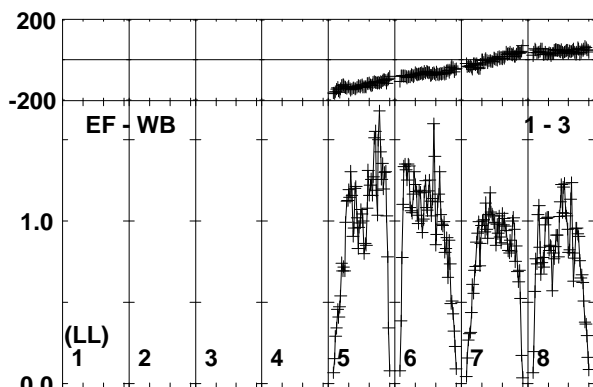
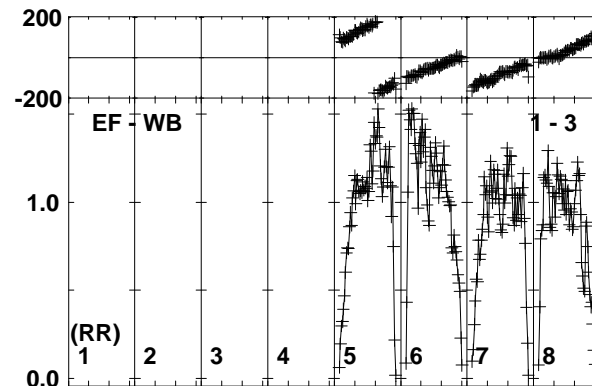
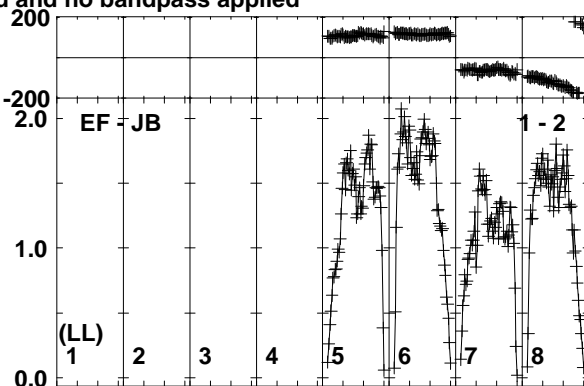
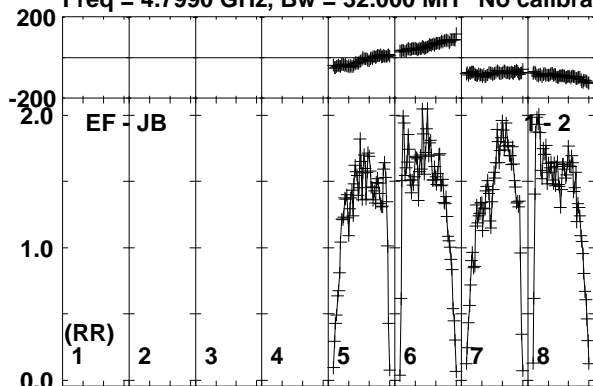

Lower frame: Milli Ampl Jy Top frame: Phas deg
Vector averaged cross-power spectrum Baseline: EF (01) - JB (02)
Timerange: 00/16:20:01 to 00/16:20:59

Plot file version 136 created 19-OCT-2017 15:36:12

J2242+2955 ES081C.UVDATA.1

Freq = 4.7990 GHz, Bw = 32.000 MH No calibration applied and no bandpass applied

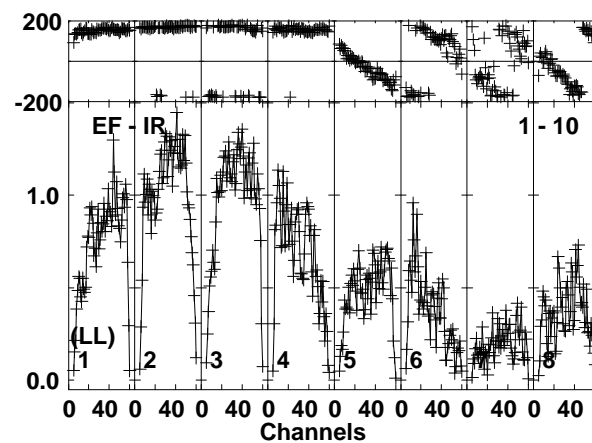
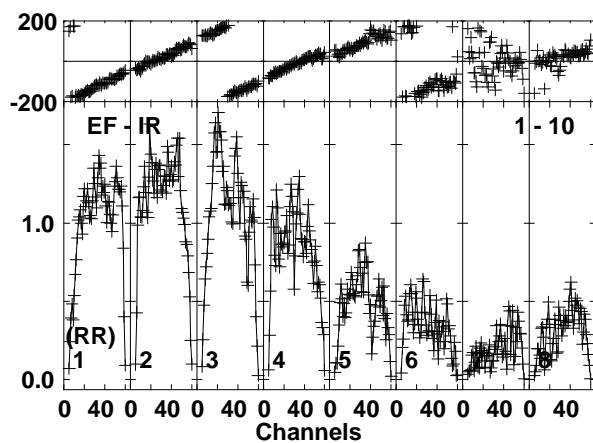
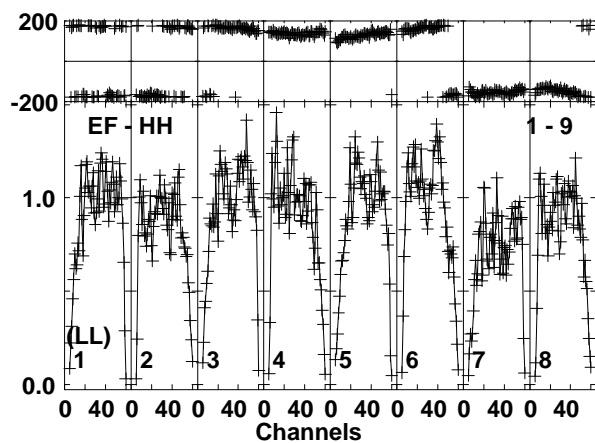
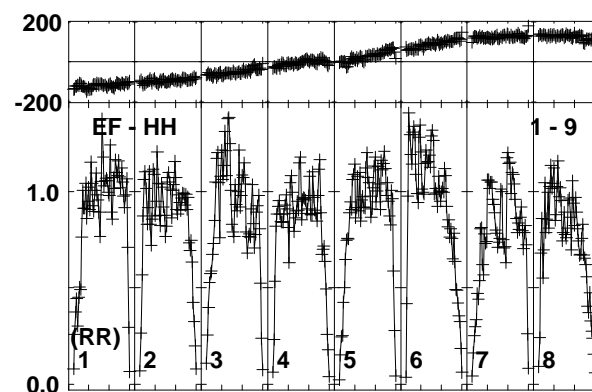
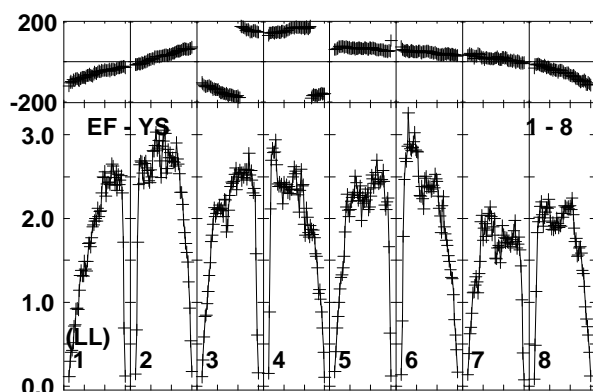
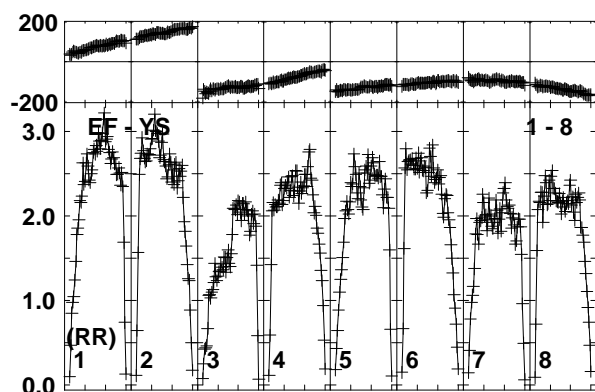
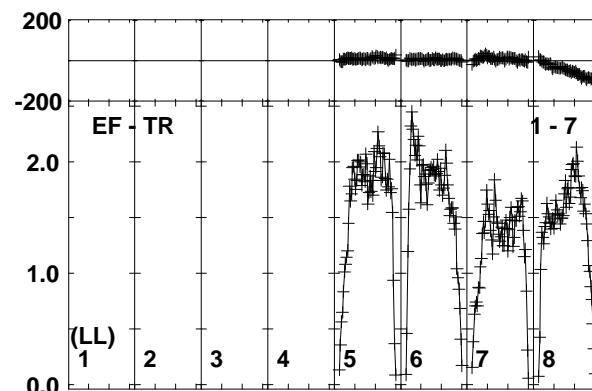
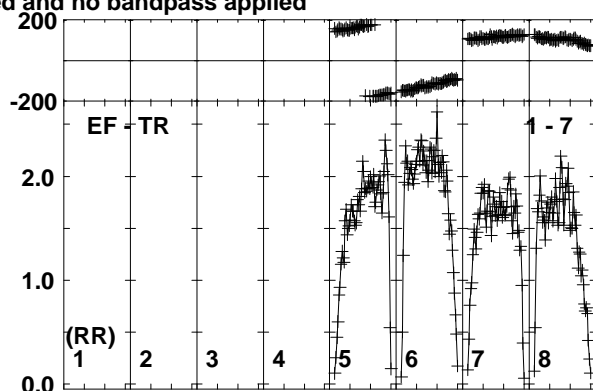
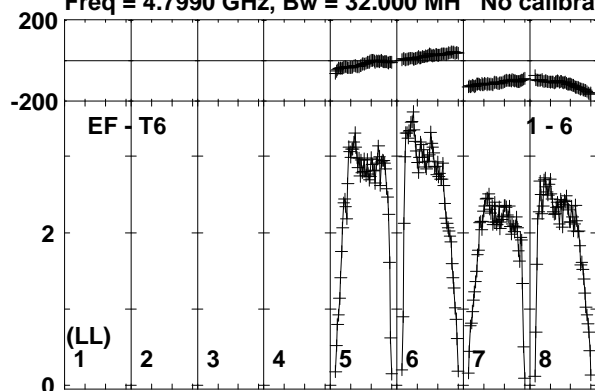

Lower frame: Milli Ampl Jy Top frame: Phas deg
Vector averaged cross-power spectrum Baseline: EF (01) - T6 (06)
Timerange: 00/16:20:01 to 00/16:20:59

Plot file version 137 created 19-OCT-2017 15:36:12

ARK564 ES081C.UVDATA.1

Freq = 4.7990 GHz, Bw = 32.000 MH No calibration applied and no bandpass applied

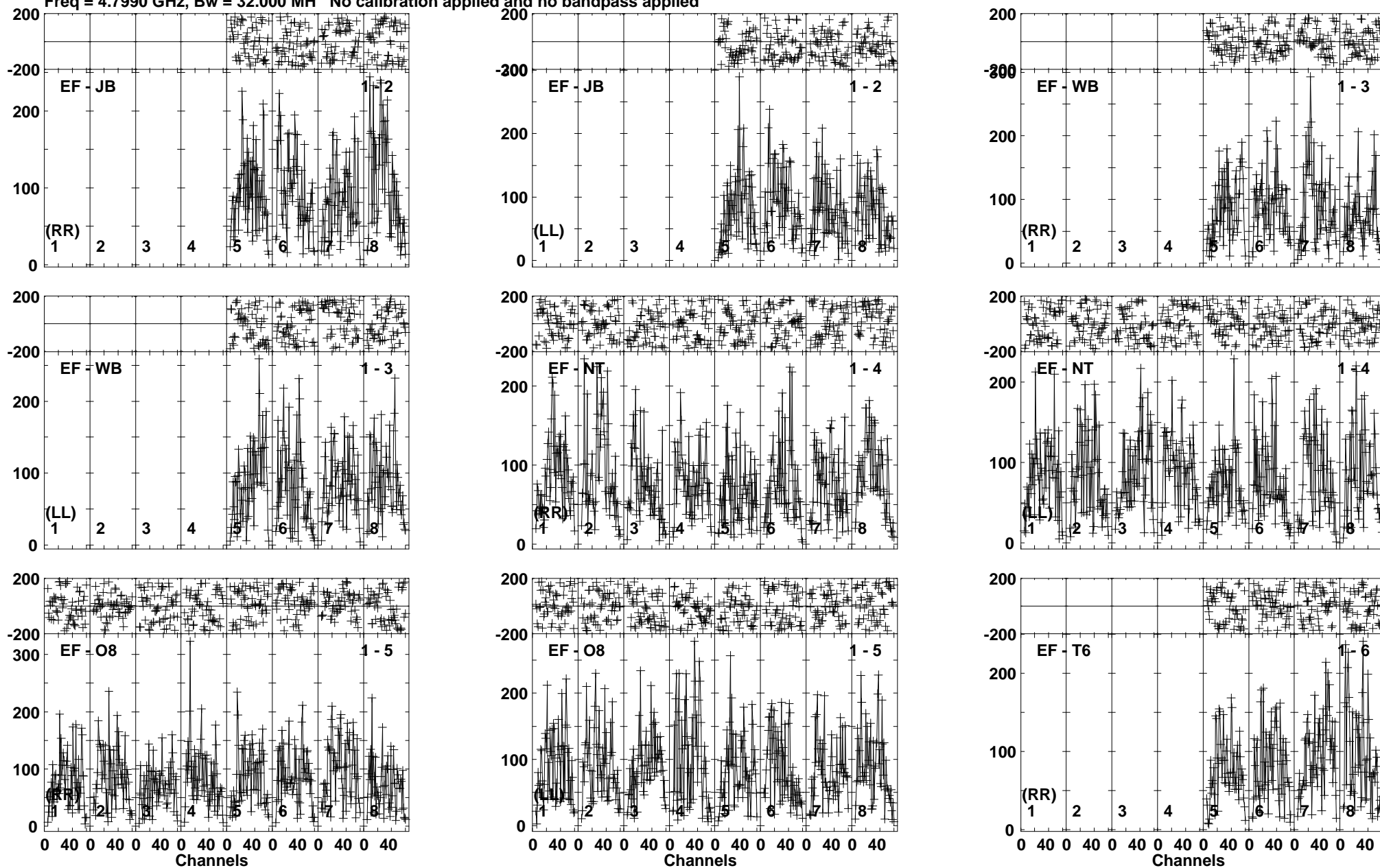

Lower frame: Micro Ampl Jy Top frame: Phas deg
Vector averaged cross-power spectrum Baseline: EF (01) - JB (02)
Timerange: 00/16:21:01 to 00/16:24:29

Plot file version 138 created 19-OCT-2017 15:36:12

ARK564 ES081C.UVDATA.1

Freq = 4.7990 GHz, Bw = 32.000 MH No calibration applied and no bandpass applied

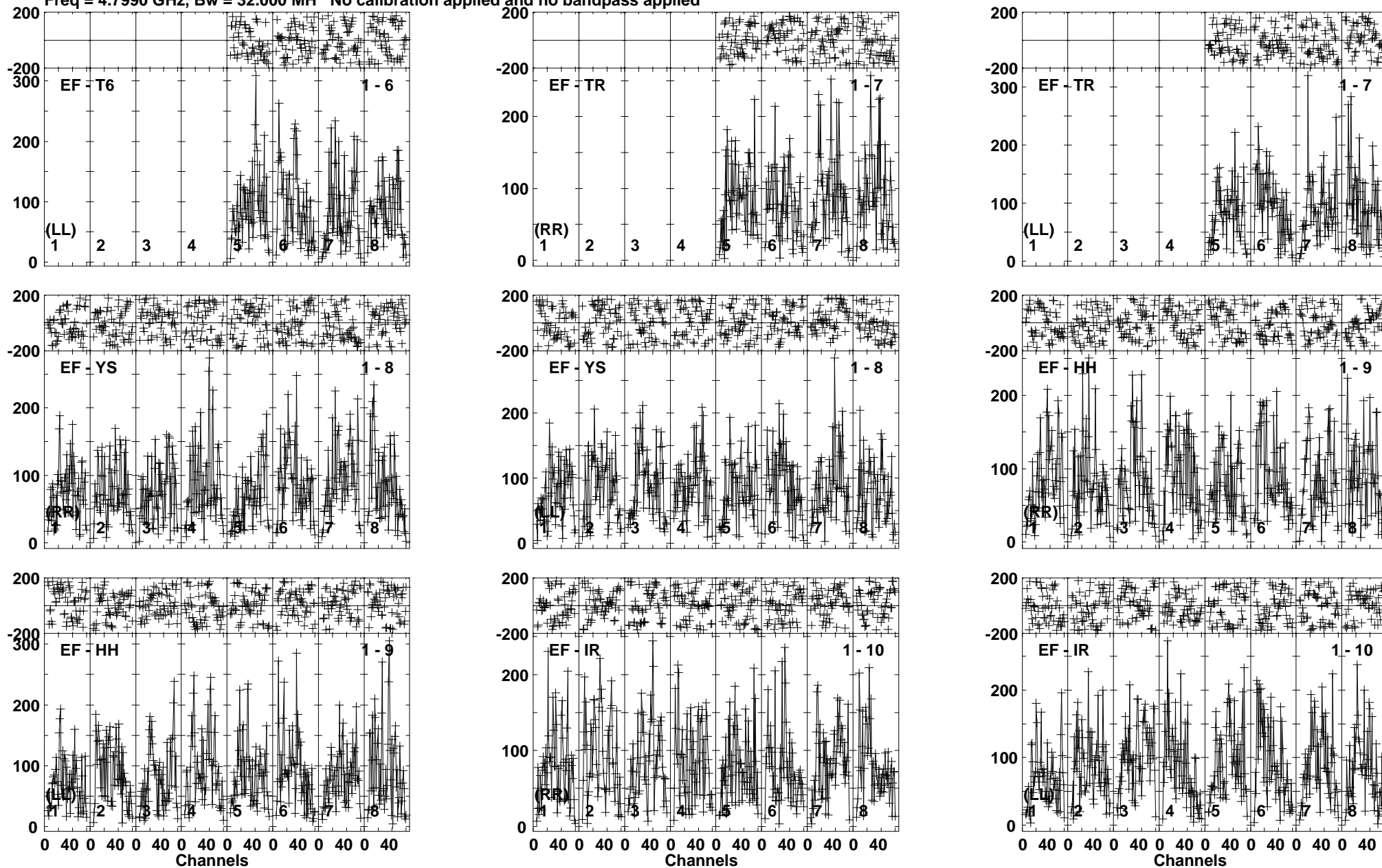

Lower frame: Micro Ampl Jy Top frame: Phas deg
Vector averaged cross-power spectrum Baseline: EF (01) - T6 (06)
Timerange: 00/16:21:01 to 00/16:24:29

Plot file version 139 created 19-OCT-2017 15:36:12

J2242+2955 ES081C.UVDATA.1

Freq = 4.7990 GHz, Bw = 32.000 MH No calibration applied and no bandpass applied

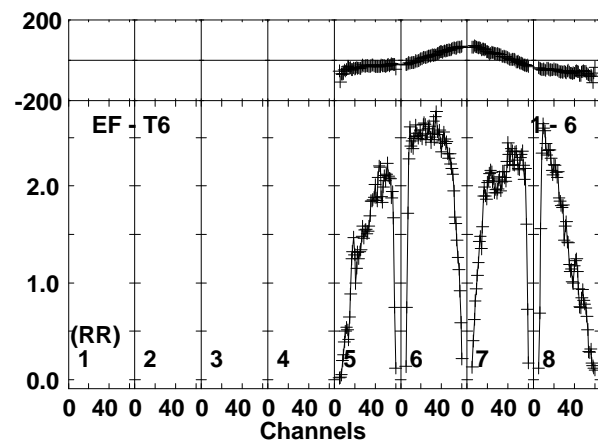
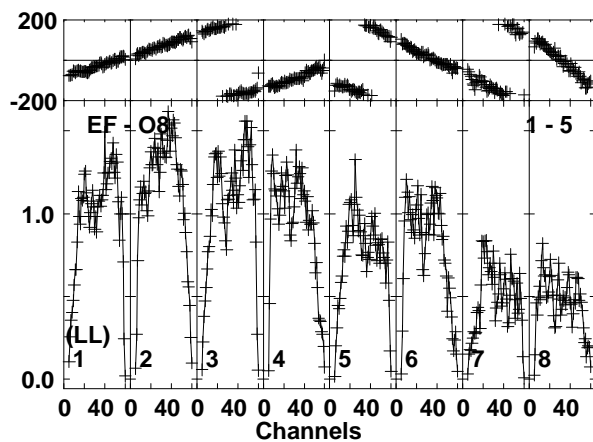
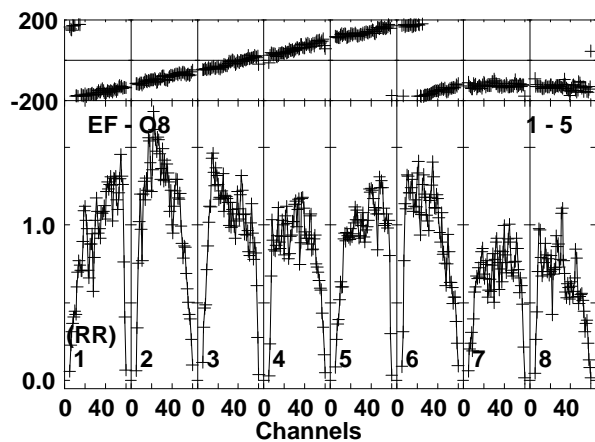
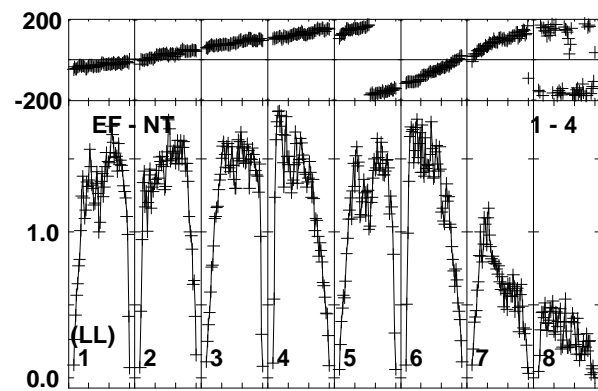
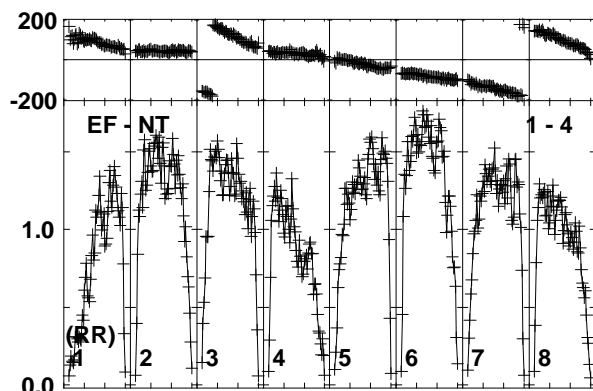
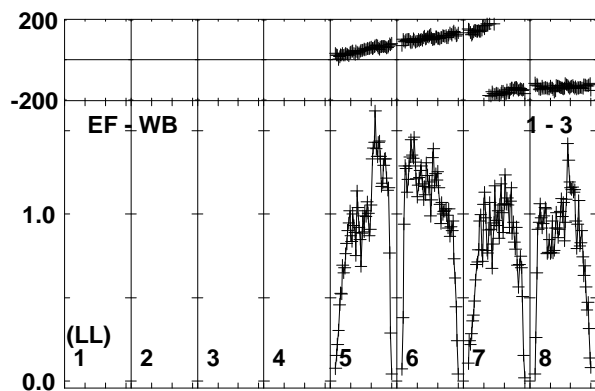
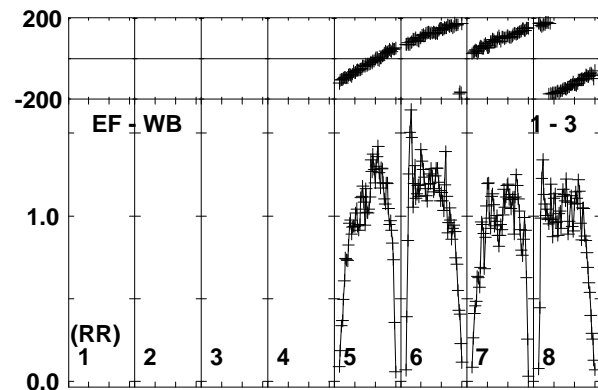
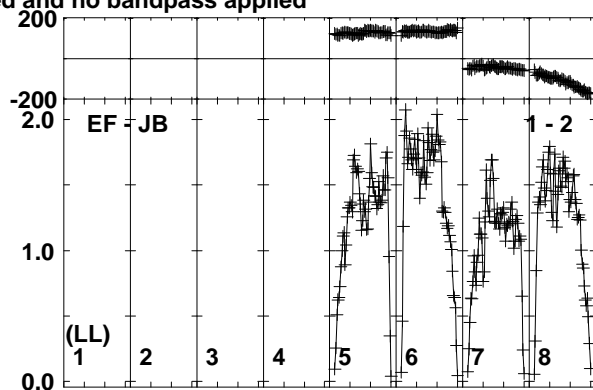
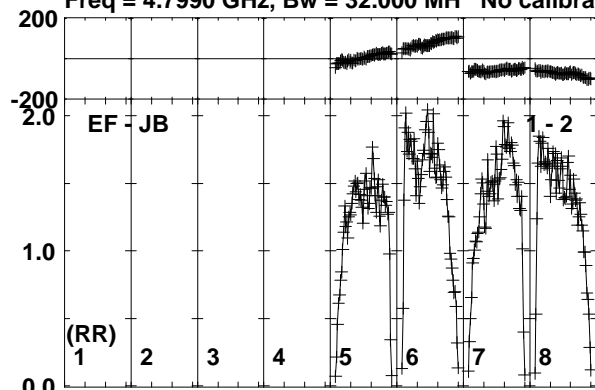

Lower frame: Milli Ampl Jy Top frame: Phas deg
Vector averaged cross-power spectrum Baseline: EF (01) - JB (02)
Timerange: 00/16:24:31 to 00/16:25:59

Plot file version 140 created 19-OCT-2017 15:36:13

J2242+2955 ES081C.UVDATA.1

Freq = 4.7990 GHz, Bw = 32.000 MH No calibration applied and no bandpass applied

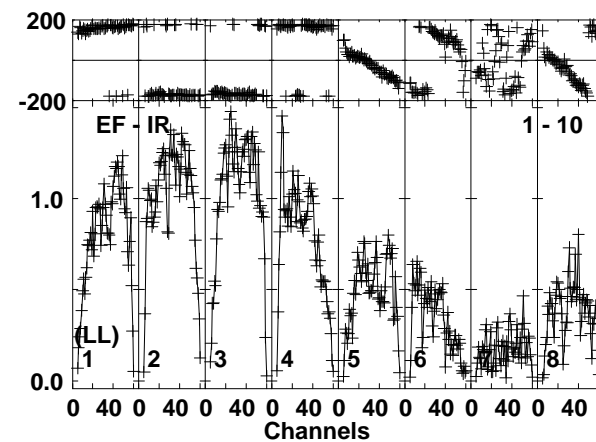
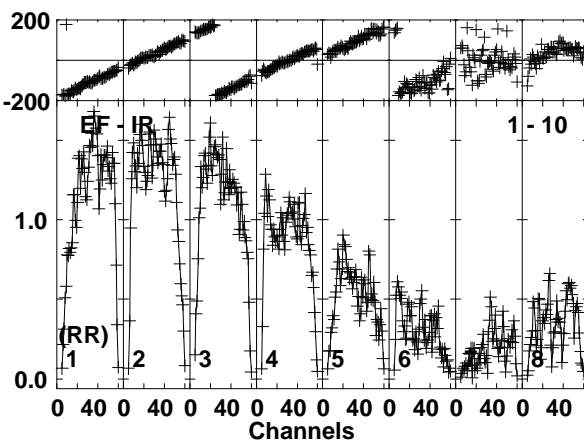
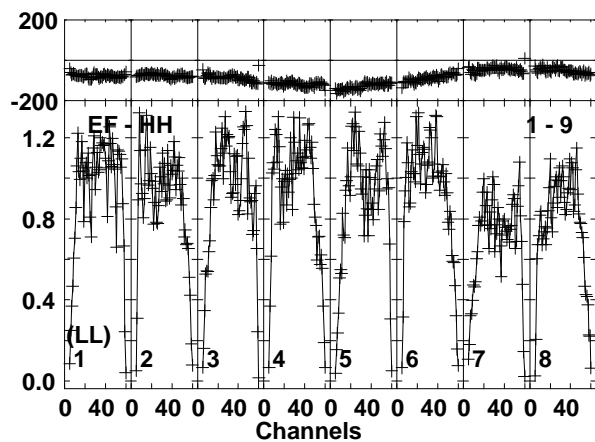
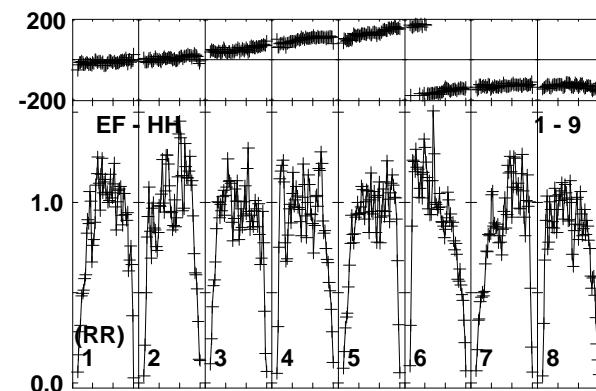
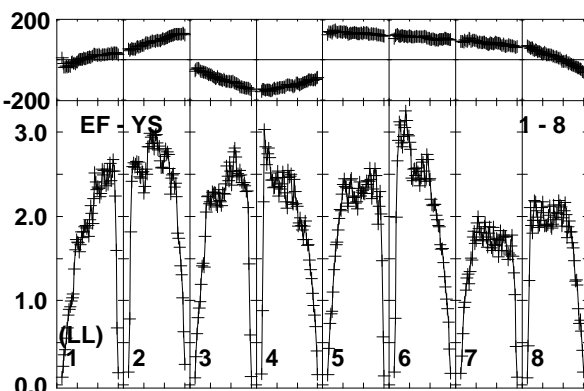
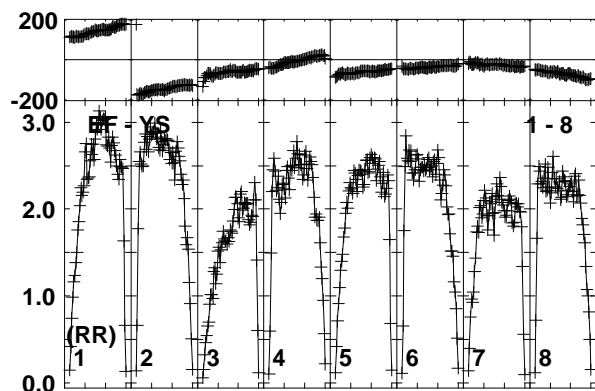
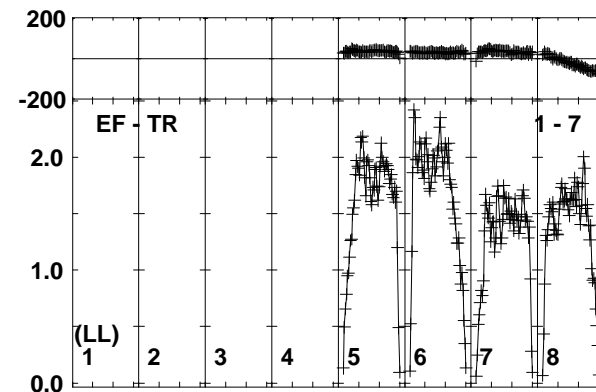
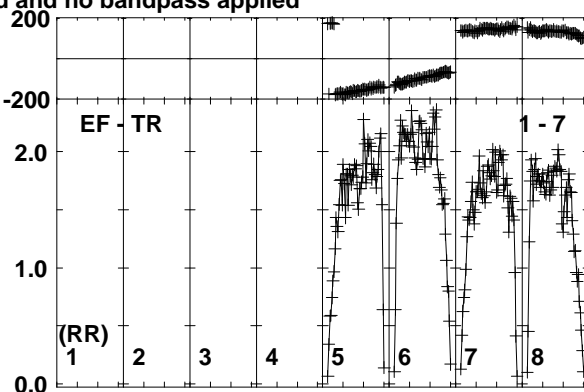
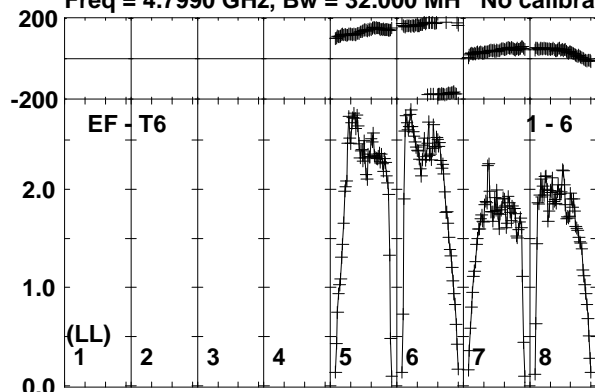

Lower frame: Milli Ampl Jy Top frame: Phas deg
Vector averaged cross-power spectrum Baseline: EF (01) - T6 (06)
Timerange: 00/16:24:31 to 00/16:25:59

Plot file version 141 created 19-OCT-2017 15:36:13

ARK564 ES081C.UVDATA.1

Freq = 4.7990 GHz, Bw = 32.000 MH No calibration applied and no bandpass applied

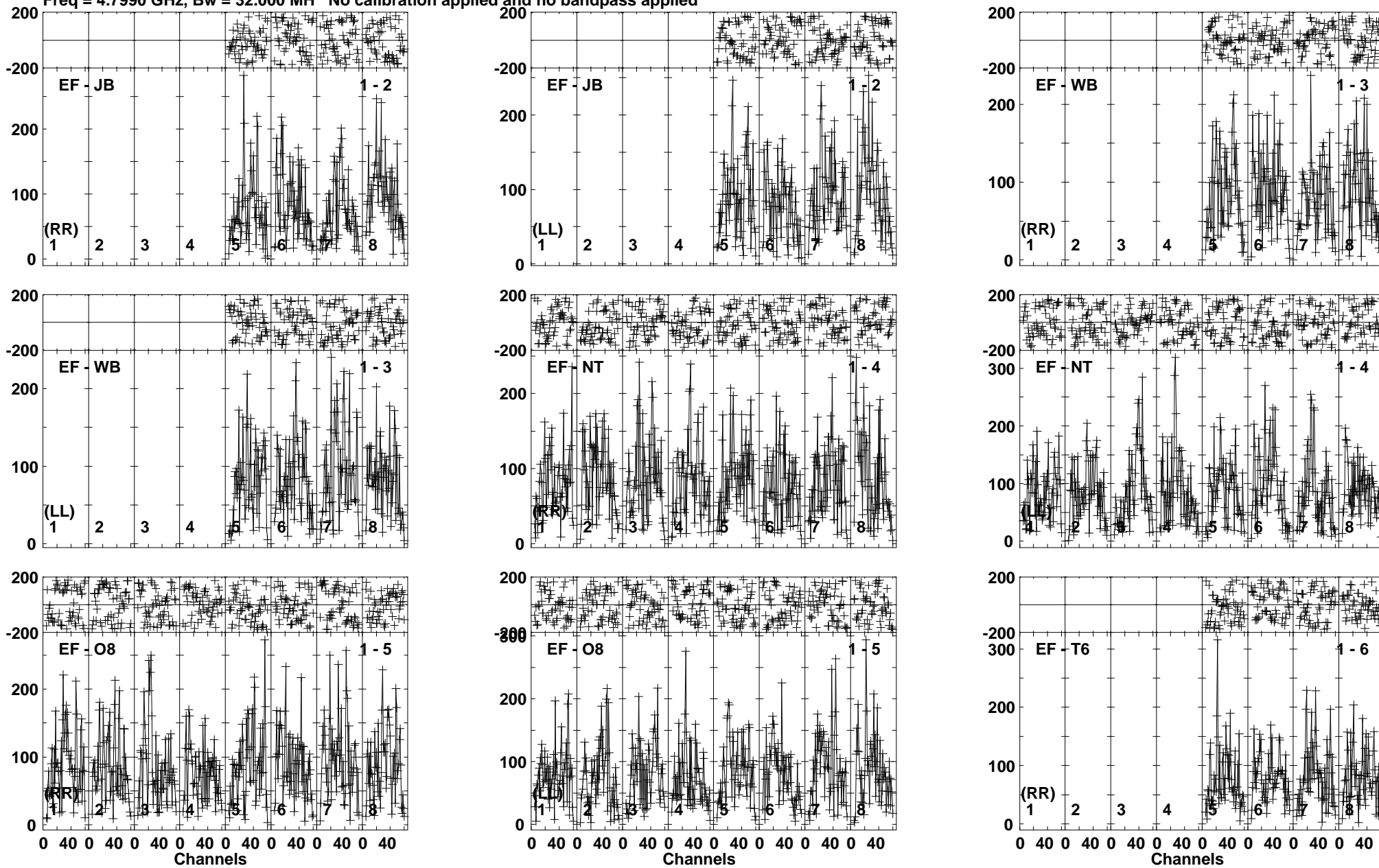

Lower frame: Micro Ampl Jy Top frame: Phas deg
Vector averaged cross-power spectrum Baseline: EF (01) - JB (02)
Timerange: 00/16:26:01 to 00/16:29:29

Plot file version 142 created 19-OCT-2017 15:36:13

ARK564 ES081C.UVDATA.1

Freq = 4.7990 GHz, Bw = 32.000 MH No calibration applied and no bandpass applied

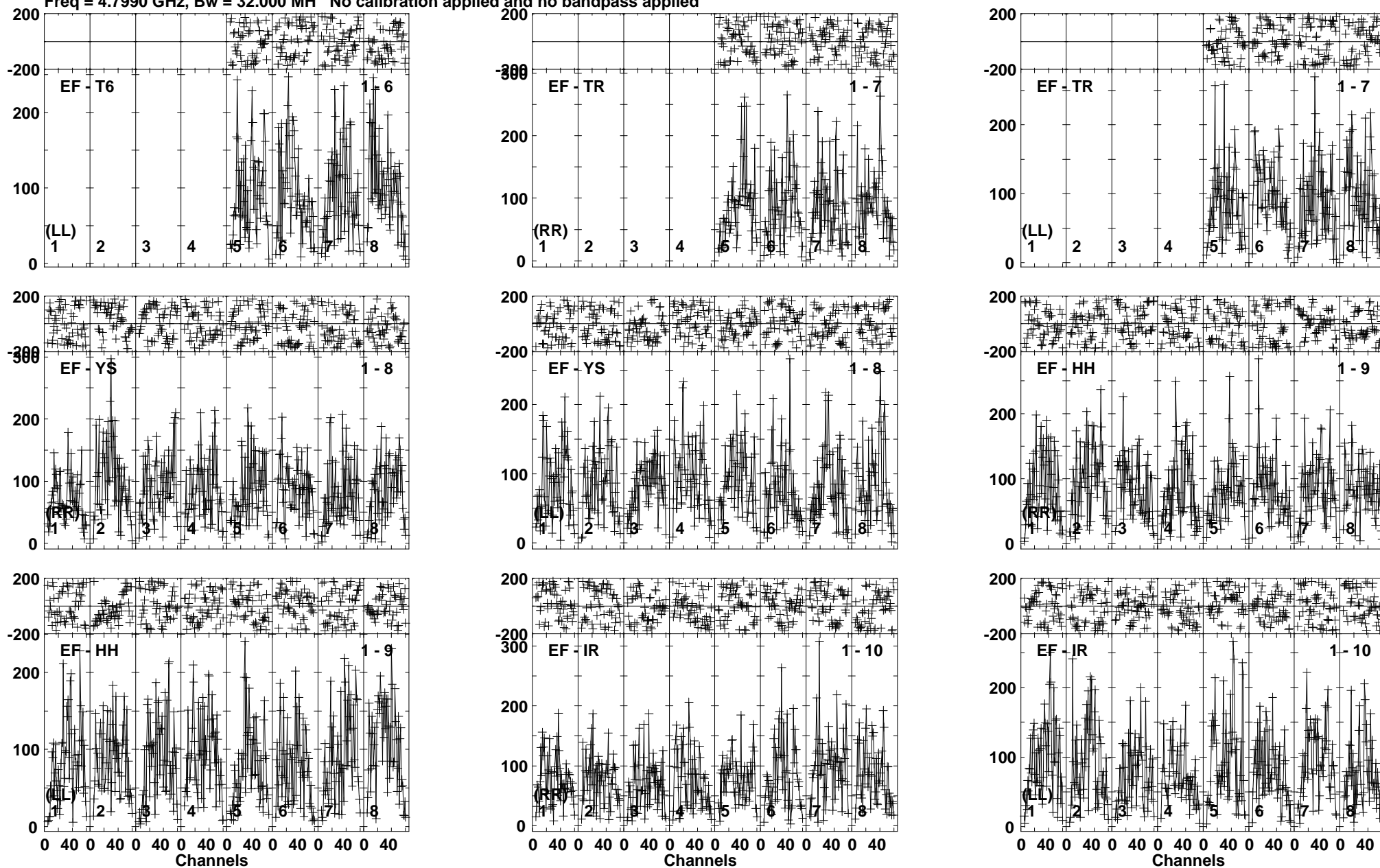

Lower frame: Micro Ampl Jy Top frame: Phas deg
Vector averaged cross-power spectrum Baseline: EF (01) - T6 (06)
Timerange: 00/16:26:01 to 00/16:29:29

Plot file version 143 created 19-OCT-2017 15:36:13

J2242+2955 ES081C.UVDATA.1

Freq = 4.7990 GHz, Bw = 32.000 MH No calibration applied and no bandpass applied

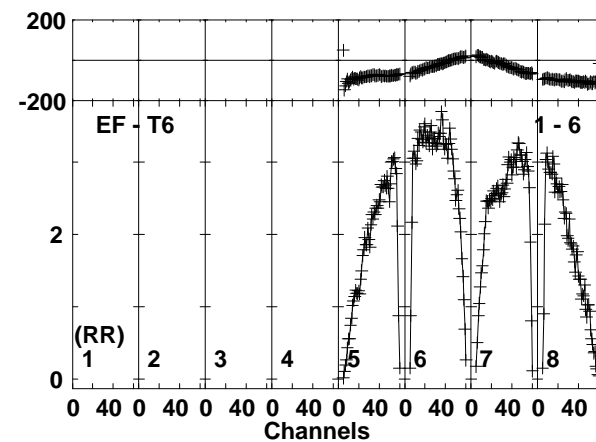
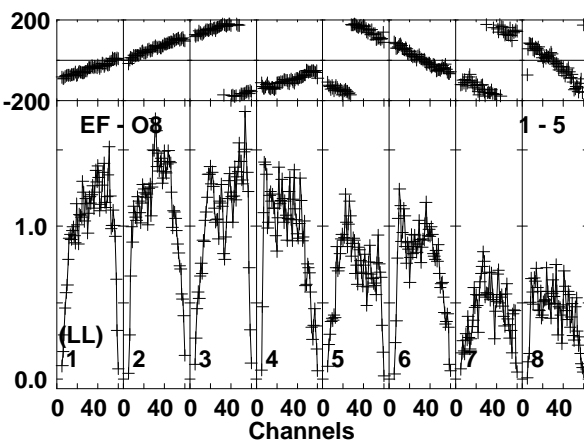
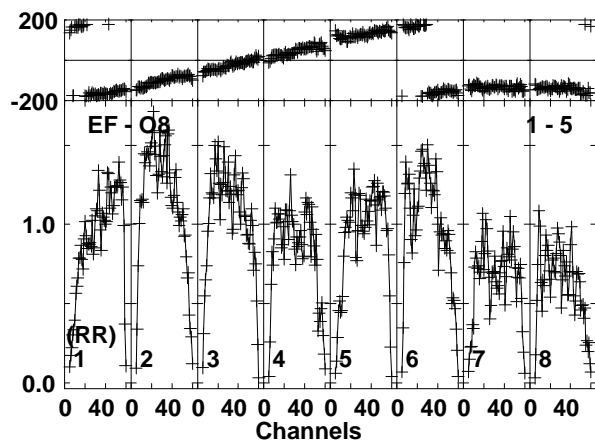
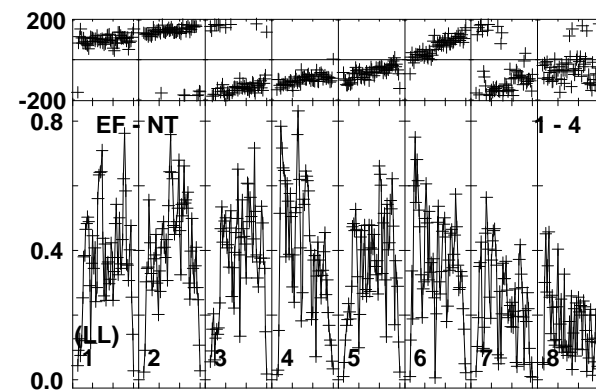
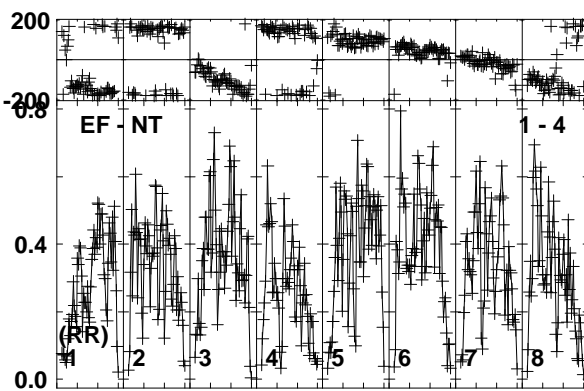
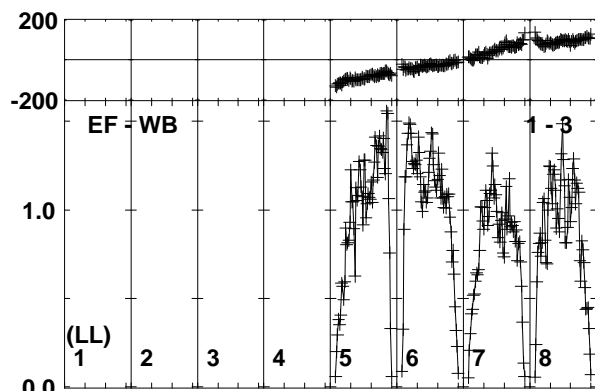
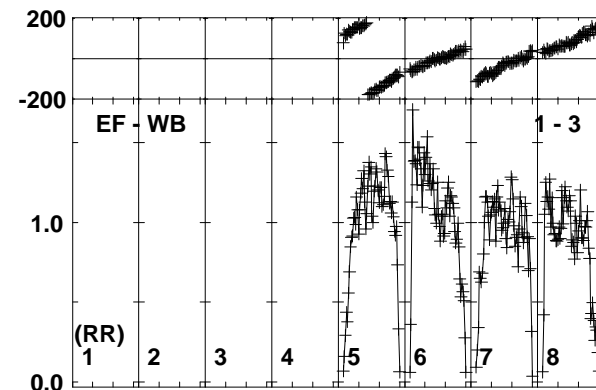
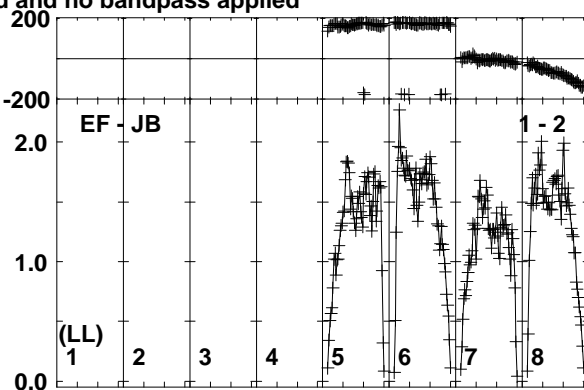
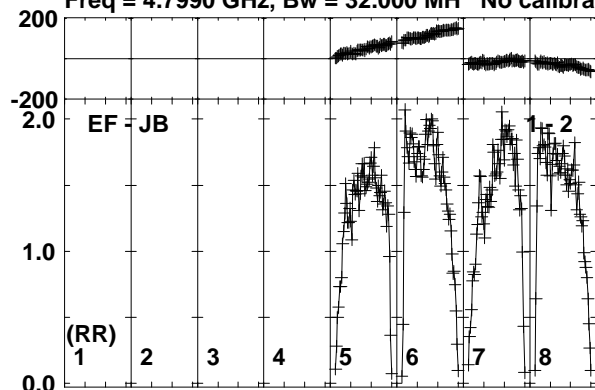

Lower frame: Milli Ampl Jy Top frame: Phas deg
Vector averaged cross-power spectrum Baseline: EF (01) - JB (02)
Timerange: 00/16:30:01 to 00/16:30:59

Plot file version 144 created 19-OCT-2017 15:36:13

J2242+2955 ES081C.UVDATA.1

Freq = 4.7990 GHz, Bw = 32.000 MH No calibration applied and no bandpass applied

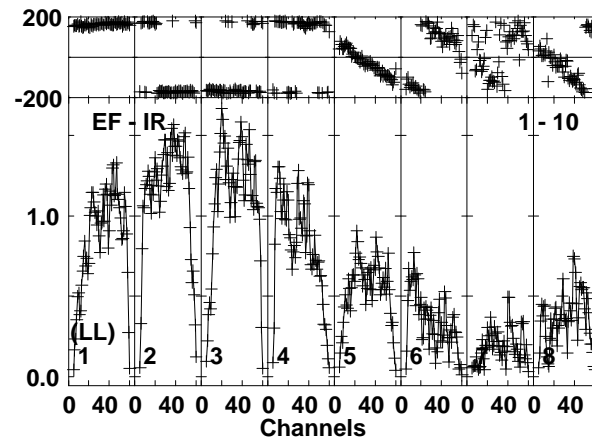
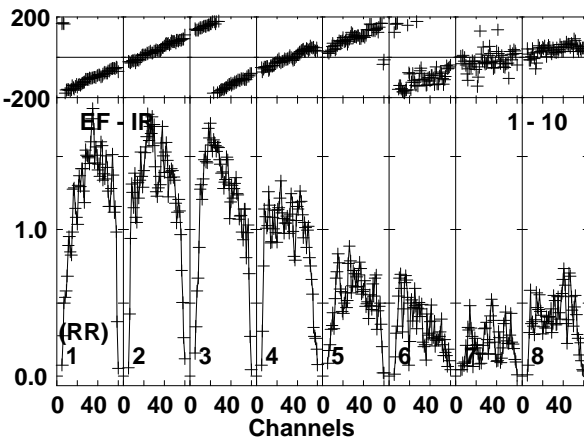
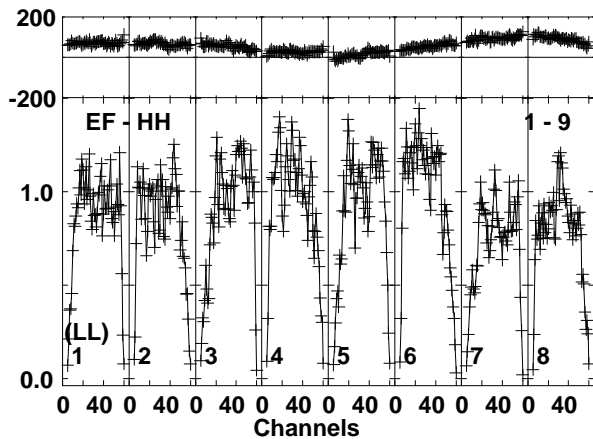
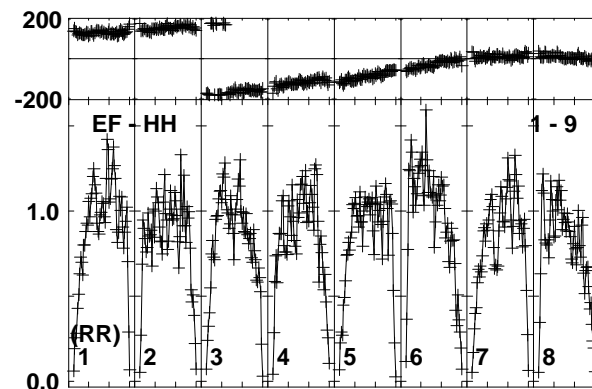
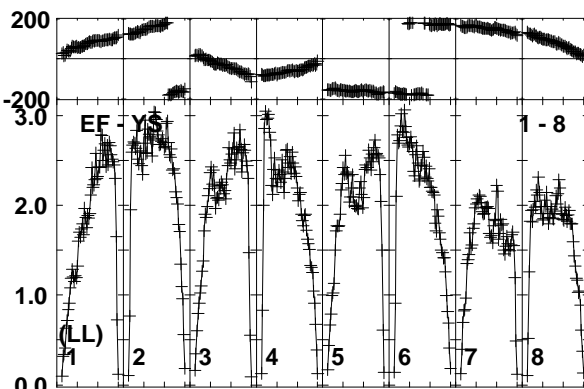
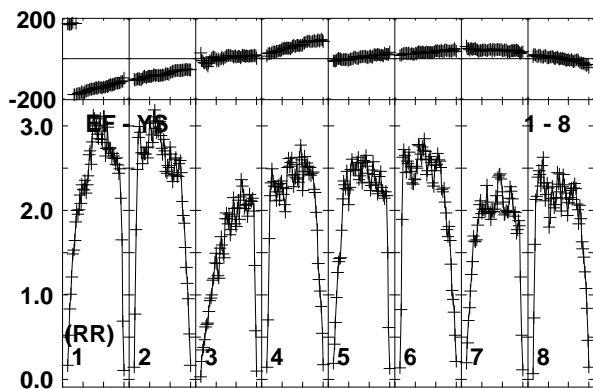
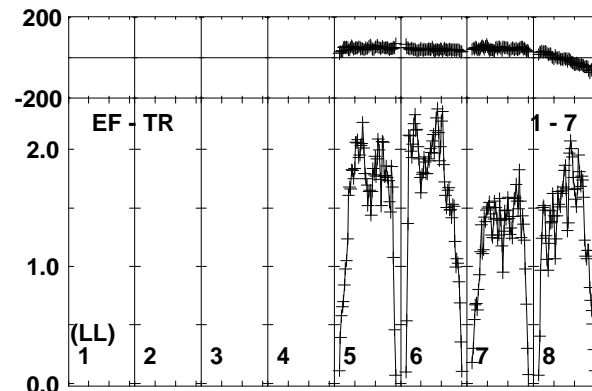
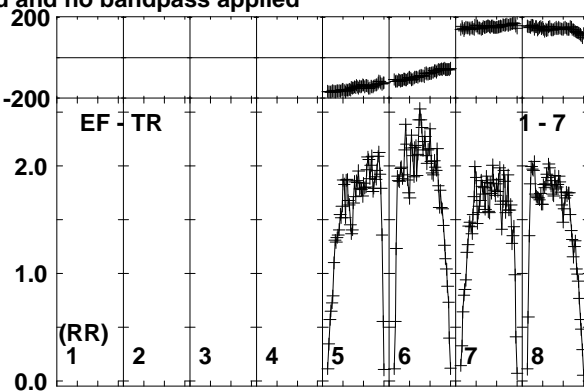
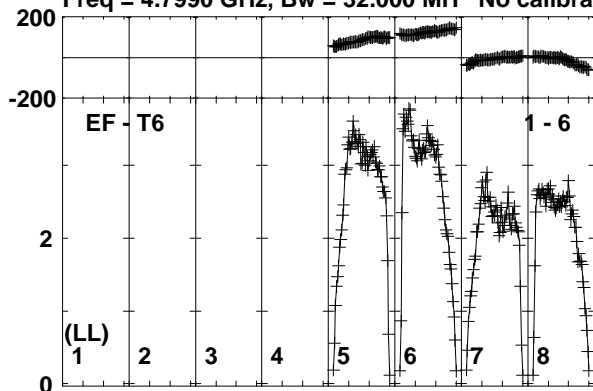

Lower frame: Milli Ampl Jy Top frame: Phas deg
Vector averaged cross-power spectrum Baseline: EF (01) - T6 (06)
Timerange: 00/16:30:01 to 00/16:30:59

Plot file version 145 created 19-OCT-2017 15:36:13

ARK564 ES081C.UVDATA.1

Freq = 4.7990 GHz, Bw = 32.000 MH No calibration applied and no bandpass applied

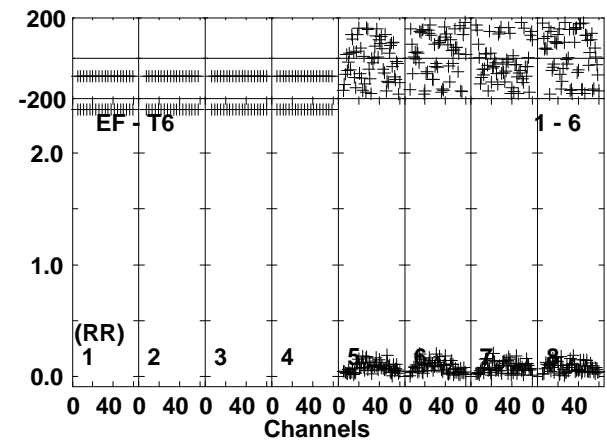
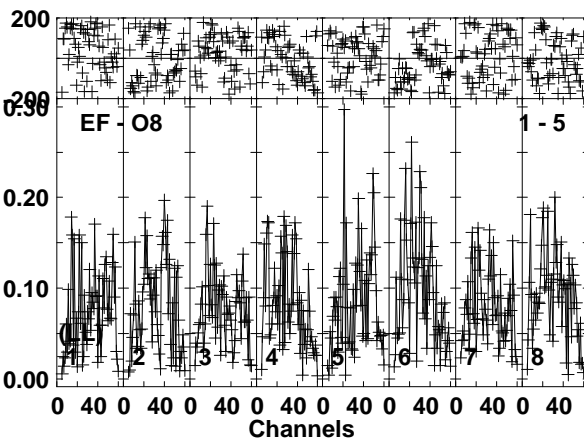
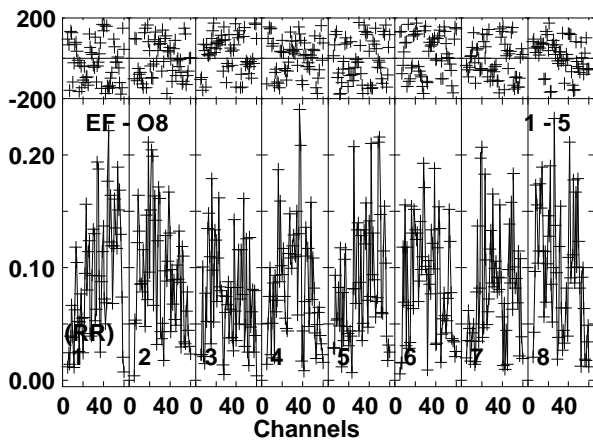
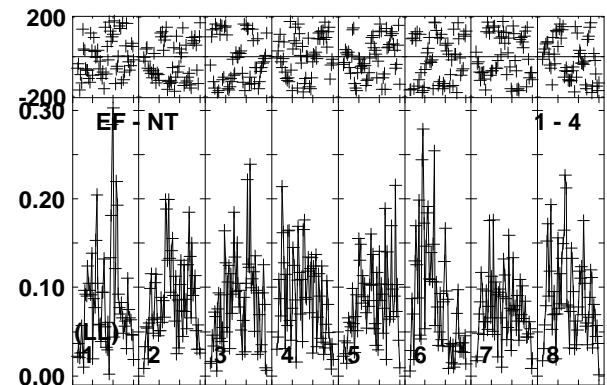
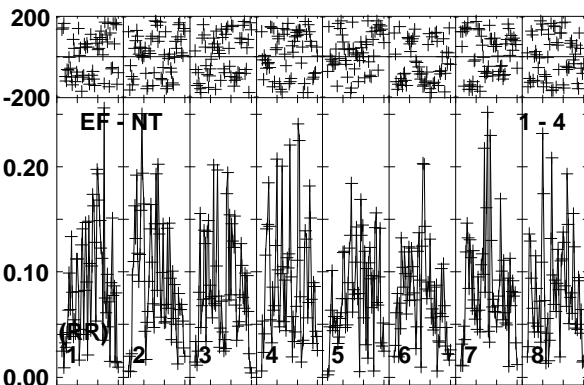
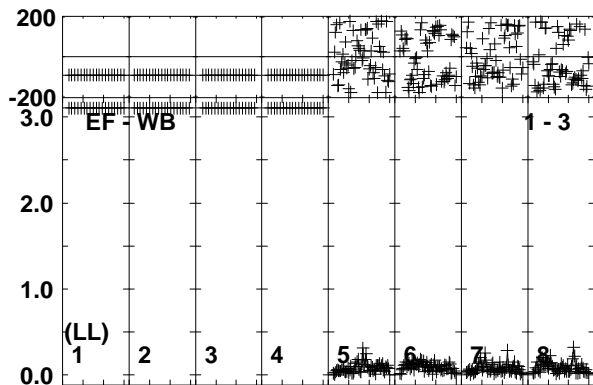
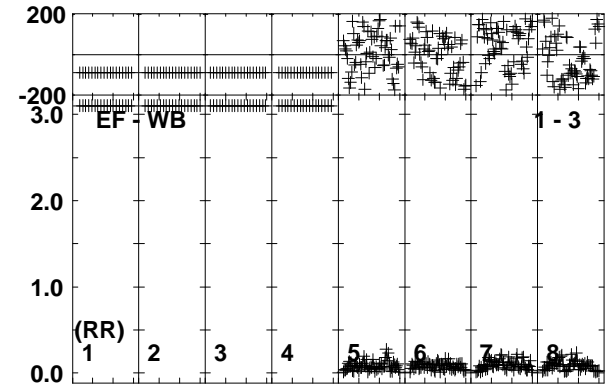
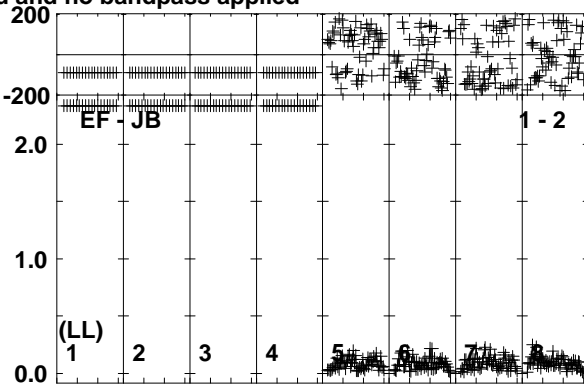
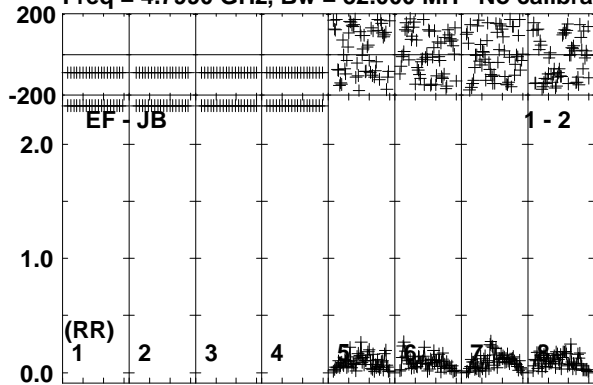

Lower frame: Milli Ampl Jy Top frame: Phas deg
Vector averaged cross-power spectrum Baseline: EF (01) - JB (02)
Timerange: 00/16:31:01 to 00/16:34:29

Plot file version 146 created 19-OCT-2017 15:36:13

ARK564 ES081C.UVDATA.1

Freq = 4.7990 GHz, Bw = 32.000 MH No calibration applied and no bandpass applied

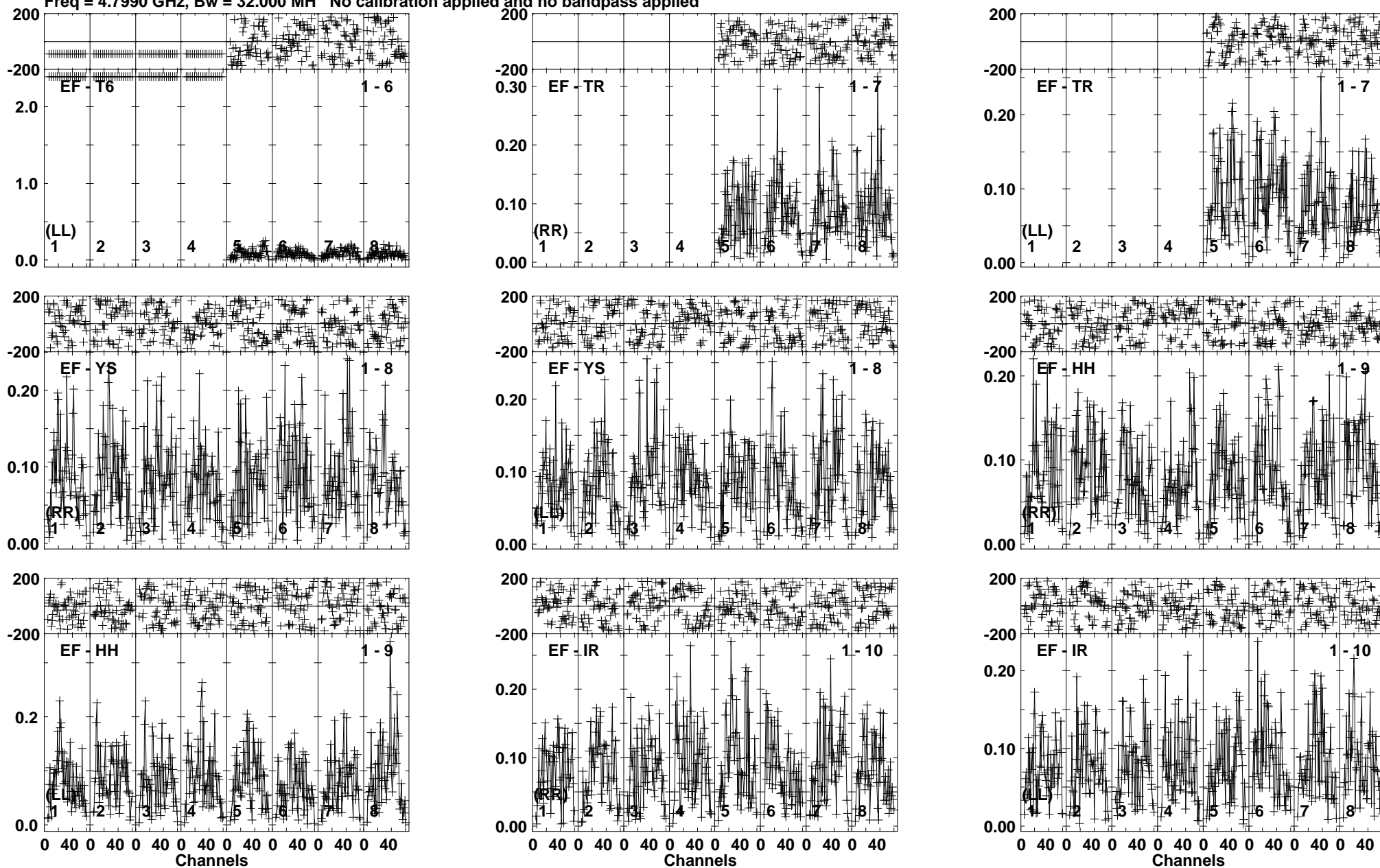

Lower frame: Milli Ampl Jy Top frame: Phas deg
Vector averaged cross-power spectrum Baseline: EF (01) - T6 (06)
Timerange: 00/16:31:01 to 00/16:34:29

Plot file version 147 created 19-OCT-2017 15:36:14

J2242+2955 ES081C.UVDATA.1

Freq = 4.7990 GHz, Bw = 32.000 MH No calibration applied and no bandpass applied

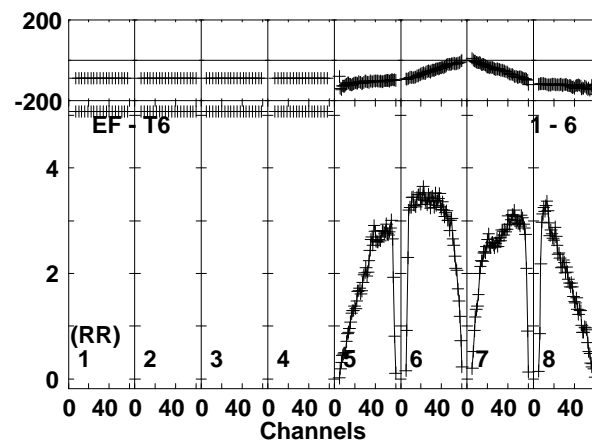
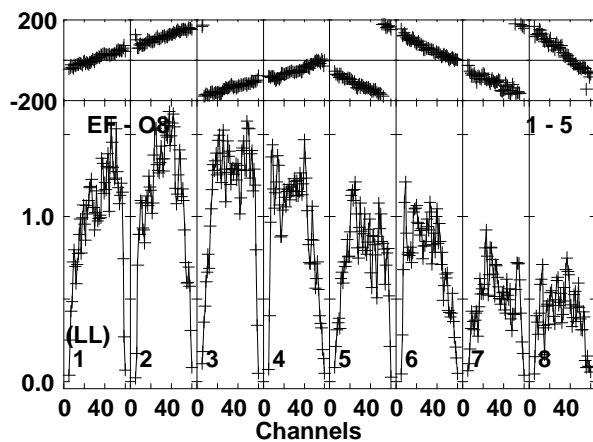
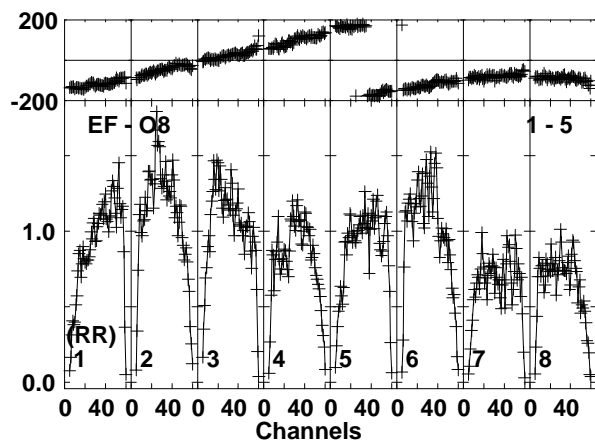
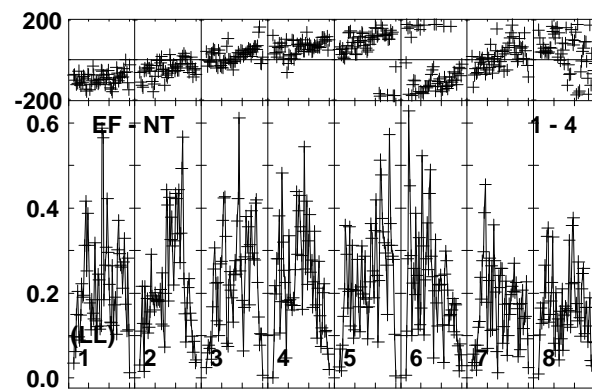
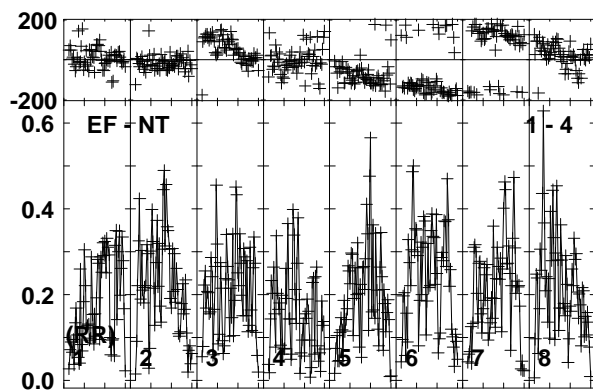
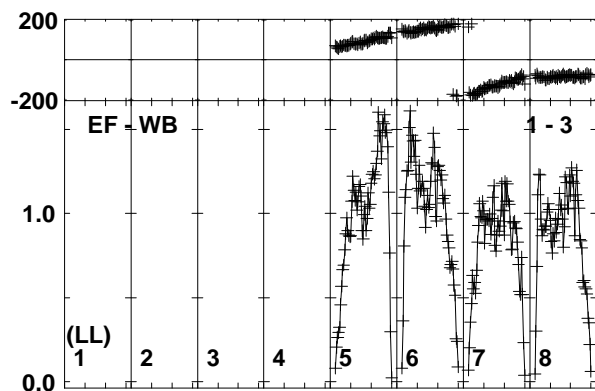
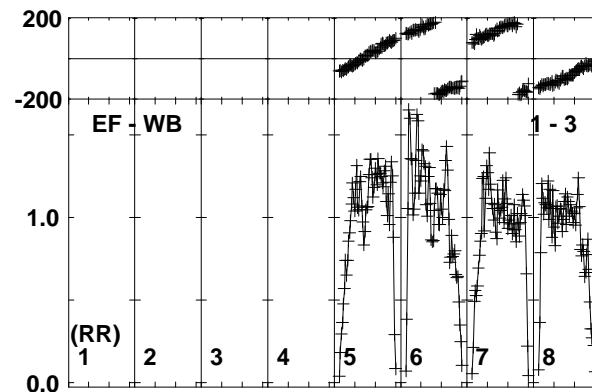
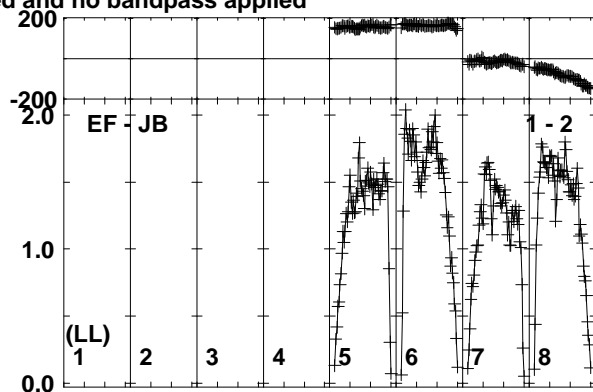
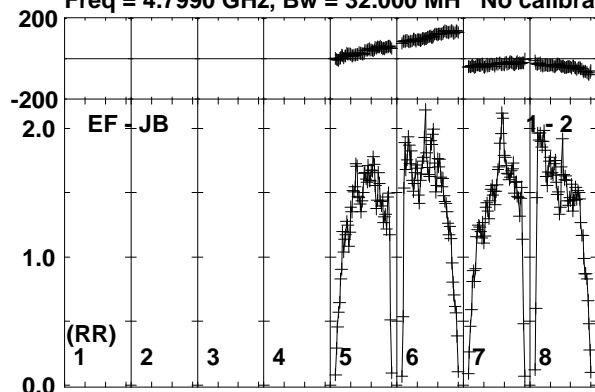

Lower frame: Milli Ampl Jy Top frame: Phas deg
Vector averaged cross-power spectrum Baseline: EF (01) - JB (02)
Timerange: 00/16:34:31 to 00/16:35:59

Plot file version 148 created 19-OCT-2017 15:36:14

J2242+2955 ES081C.UVDATA.1

Freq = 4.7990 GHz, Bw = 32.000 MH No calibration applied and no bandpass applied

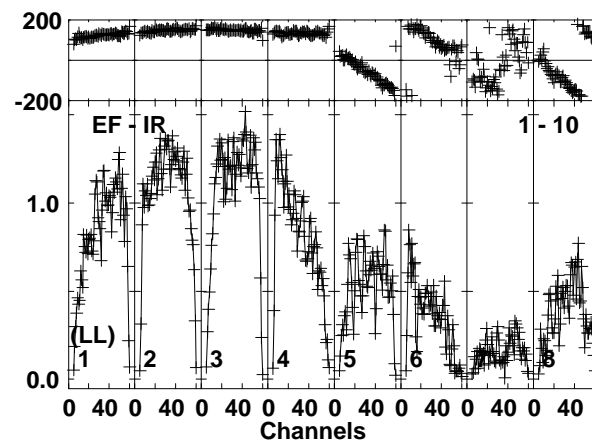
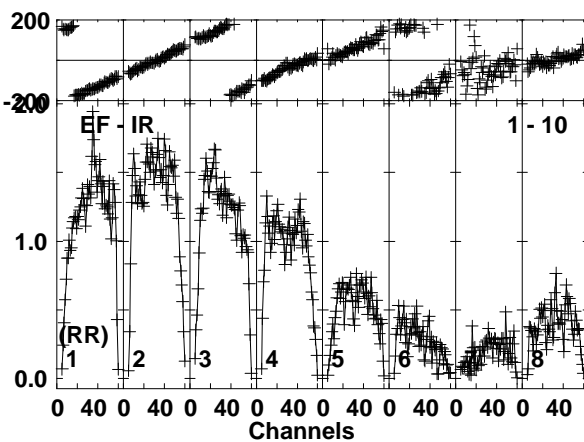
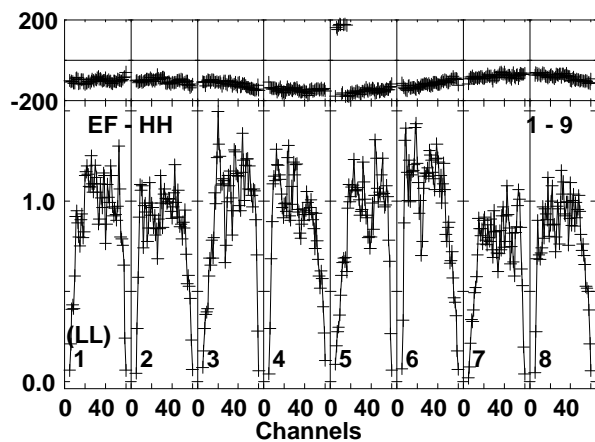
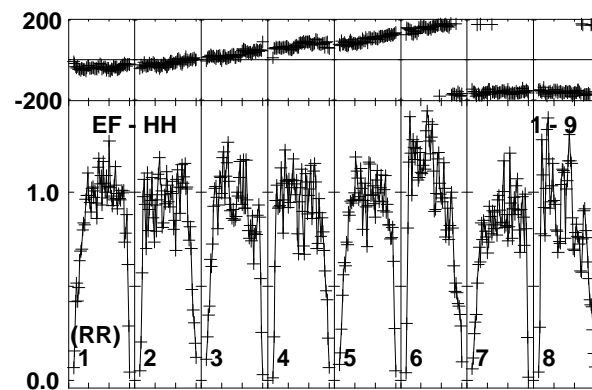
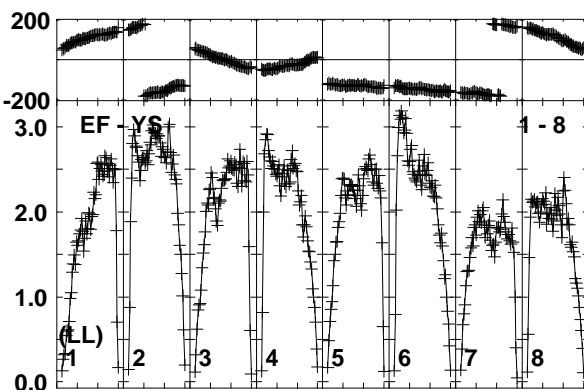
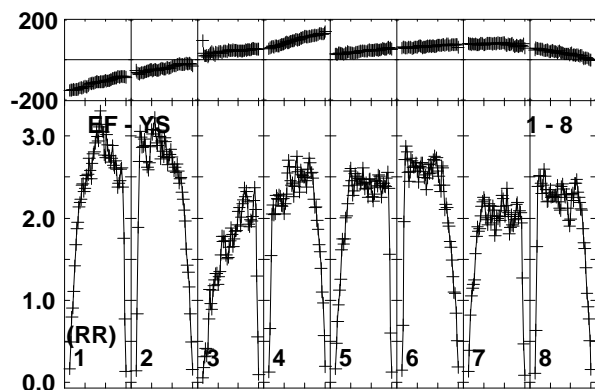
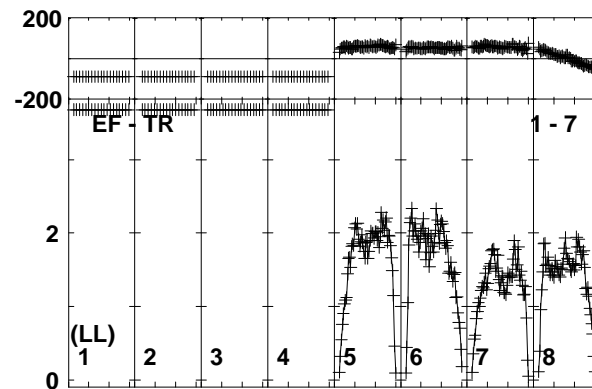
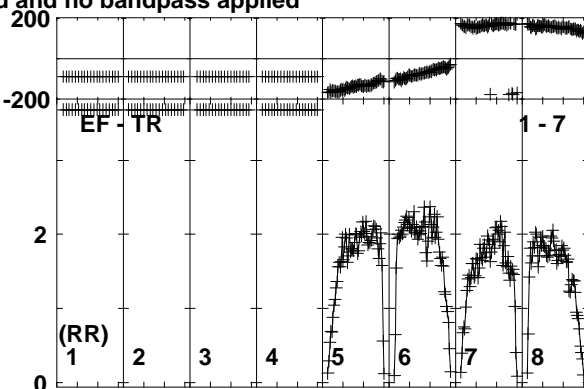
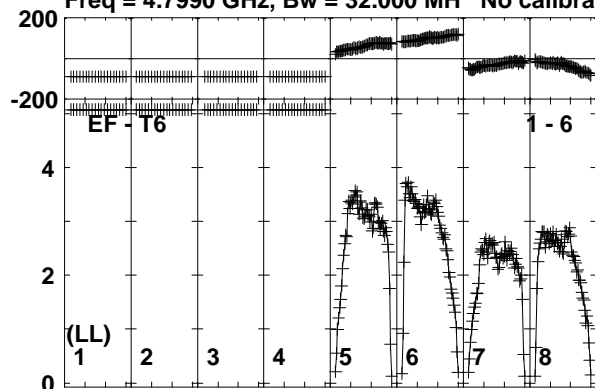

Lower frame: Milli Ampl Jy Top frame: Phas deg
Vector averaged cross-power spectrum Baseline: EF (01) - T6 (06)
Timerange: 00/16:34:31 to 00/16:35:59

Plot file version 149 created 19-OCT-2017 15:36:14

ARK564 ES081C.UVDATA.1

Freq = 4.7990 GHz, Bw = 32.000 MH No calibration applied and no bandpass applied

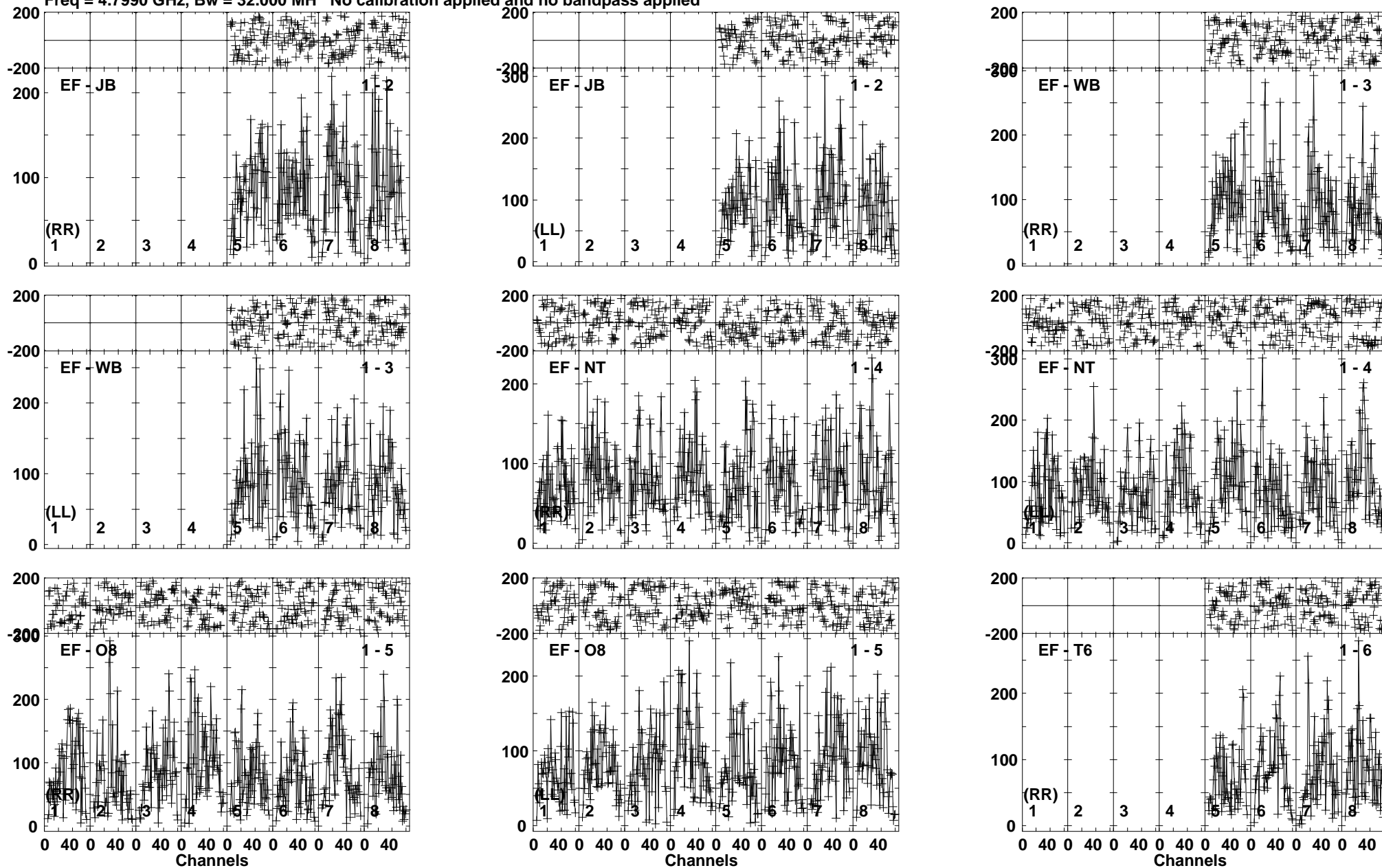

Lower frame: Micro Ampl Jy Top frame: Phas deg
Vector averaged cross-power spectrum Baseline: EF (01) - JB (02)
Timerange: 00/16:36:01 to 00/16:39:29

Plot file version 150 created 19-OCT-2017 15:36:14

ARK564 ES081C.UVDATA.1

Freq = 4.7990 GHz, Bw = 32.000 MH No calibration applied and no bandpass applied

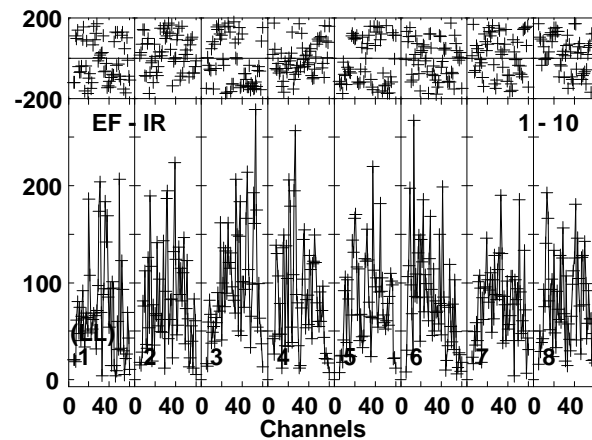
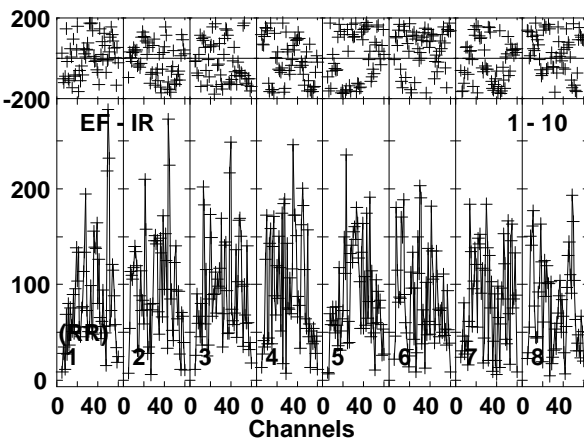
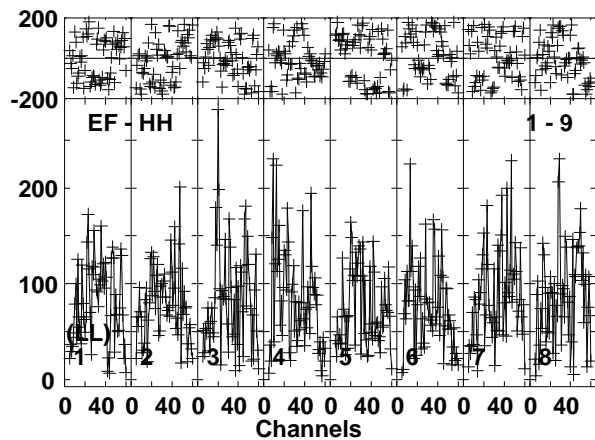
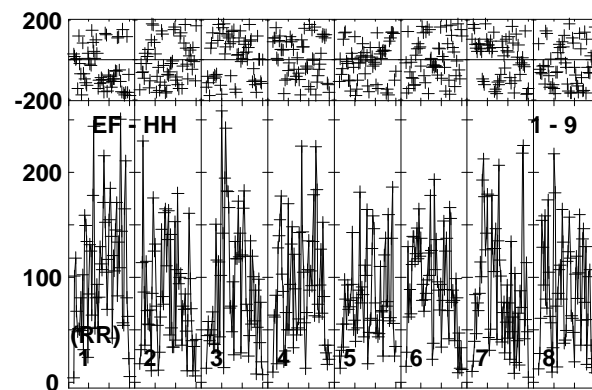
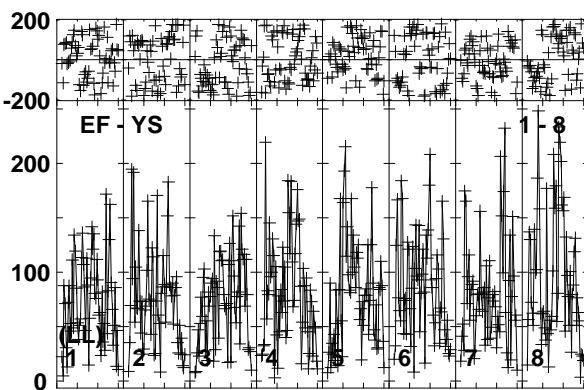
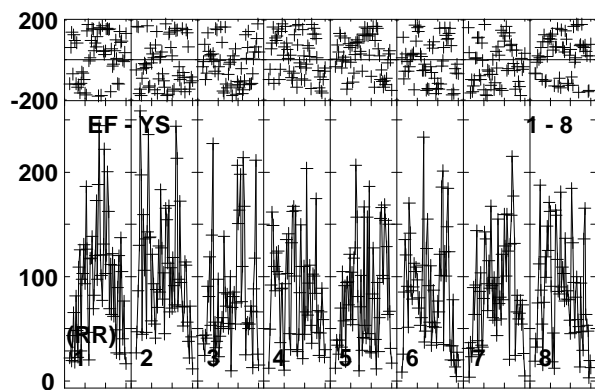
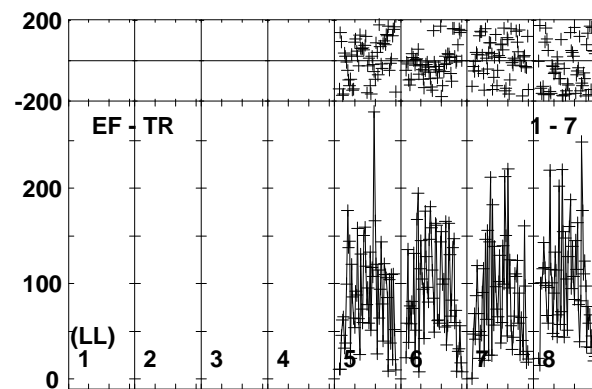
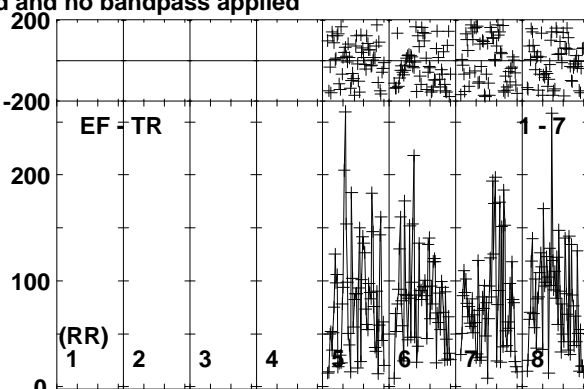
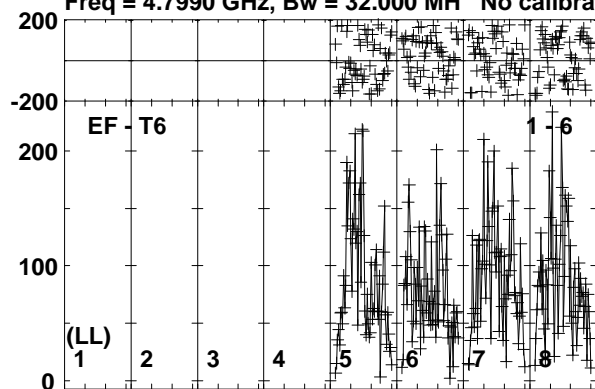

Lower frame: Micro Ampl Jy Top frame: Phas deg
Vector averaged cross-power spectrum Baseline: EF (01) - T6 (06)
Timerange: 00/16:36:01 to 00/16:39:29

Plot file version 151 created 19-OCT-2017 15:36:14

J2242+2955 ES081C.UVDATA.1

Freq = 4.7990 GHz, Bw = 32.000 MH No calibration applied and no bandpass applied

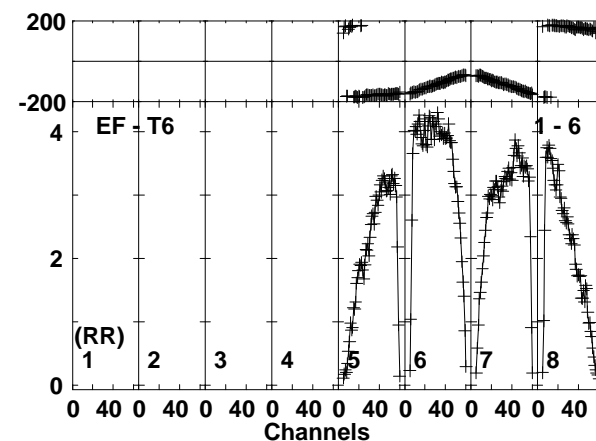
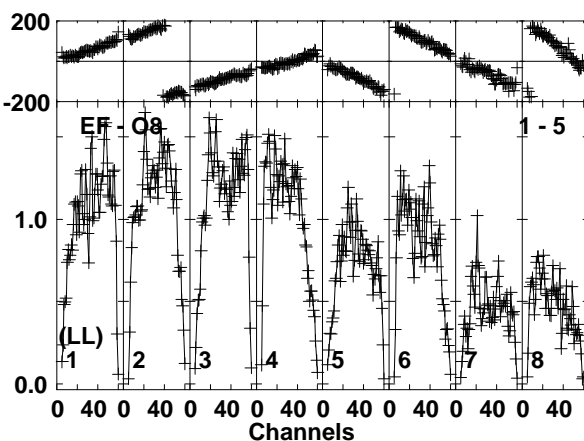
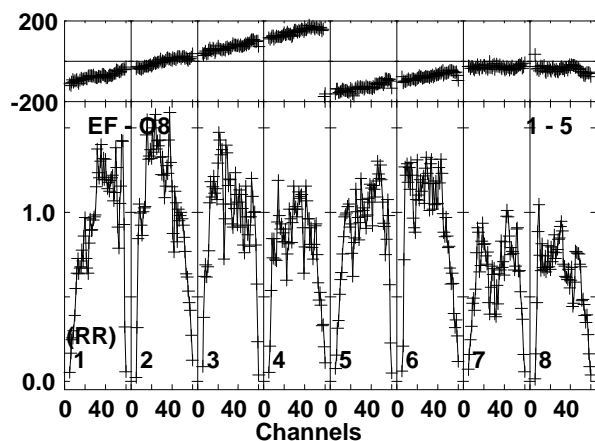
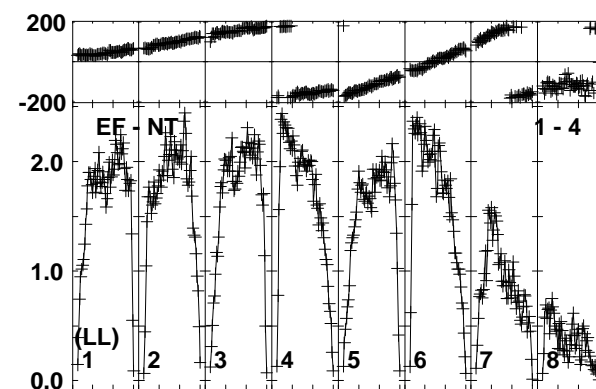
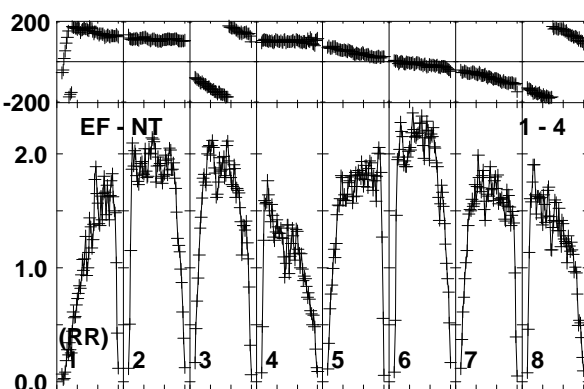
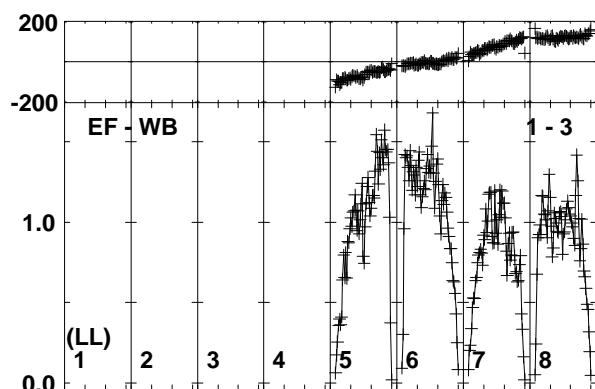
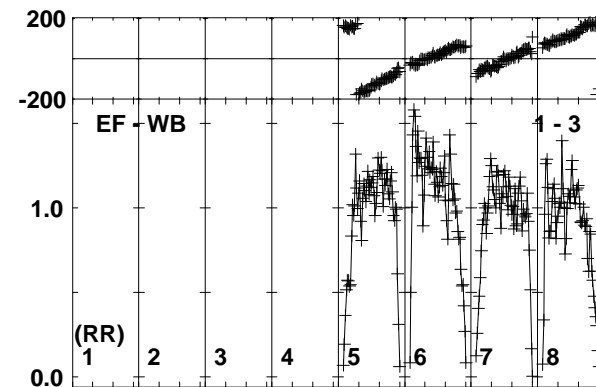
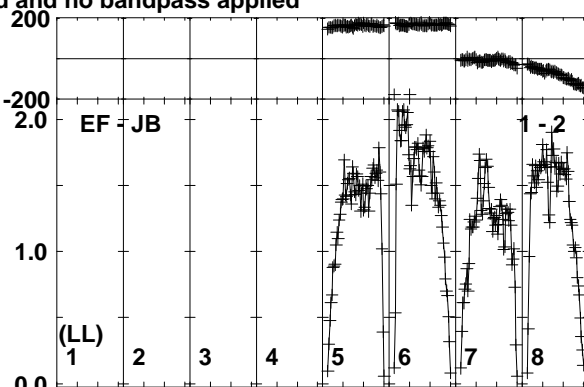
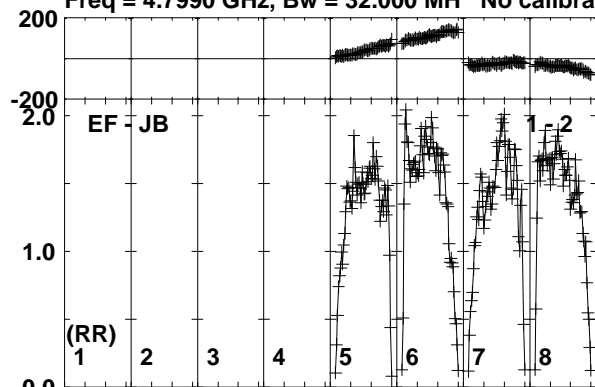

Lower frame: Milli Ampl Jy Top frame: Phas deg
Vector averaged cross-power spectrum Baseline: EF (01) - JB (02)
Timerange: 00:16:40:01 to 00:16:40:59

Plot file version 152 created 19-OCT-2017 15:36:14

J2242+2955 ES081C.UVDATA.1

Freq = 4.7990 GHz, Bw = 32.000 MH No calibration applied and no bandpass applied

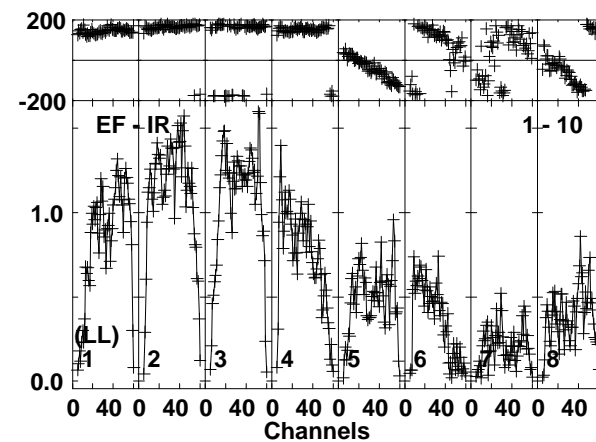
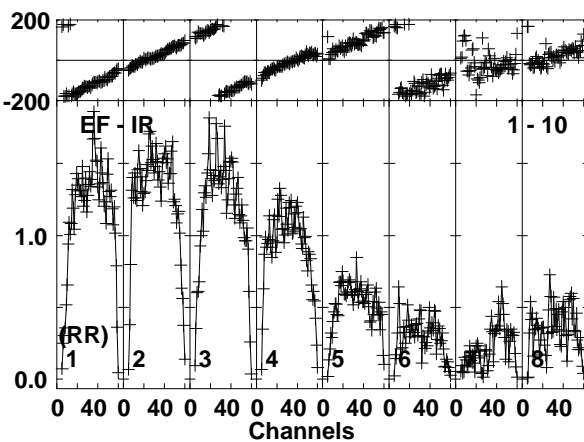
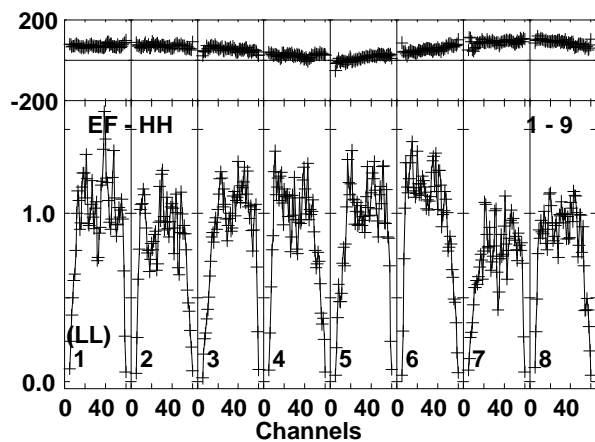
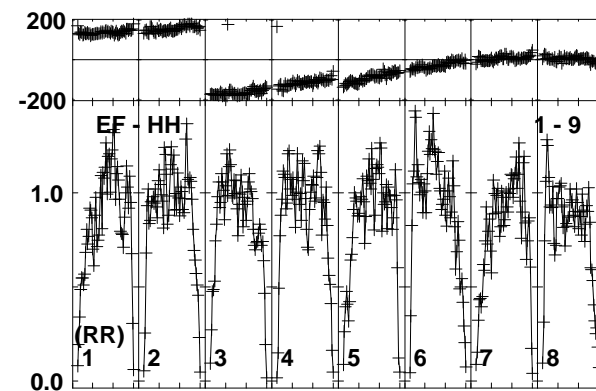
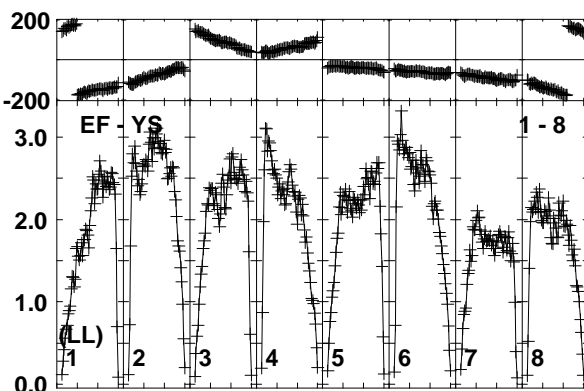
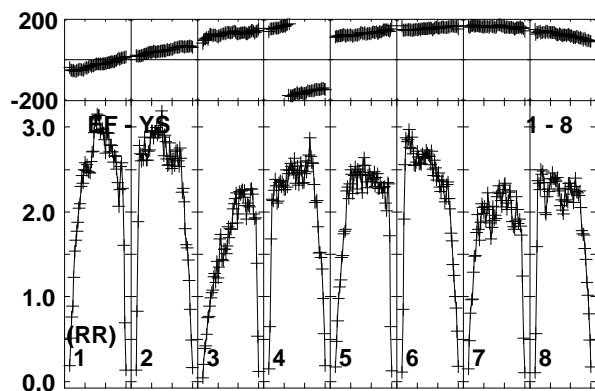
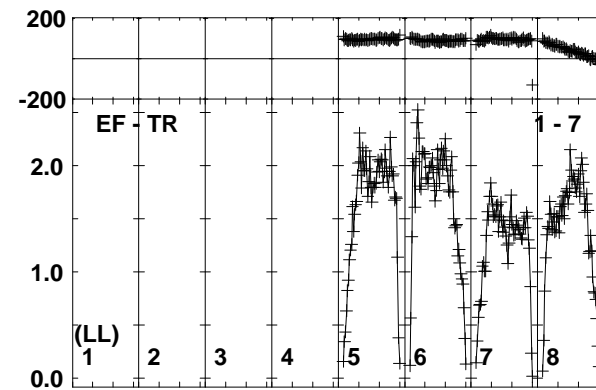
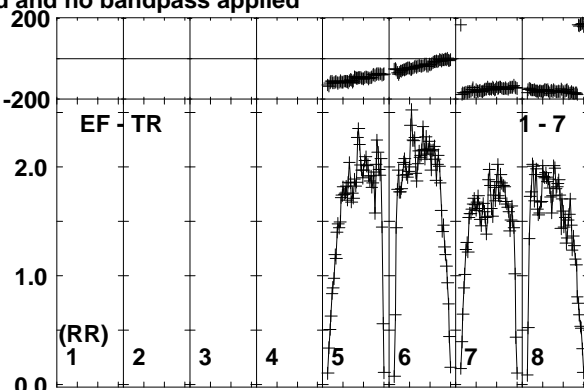
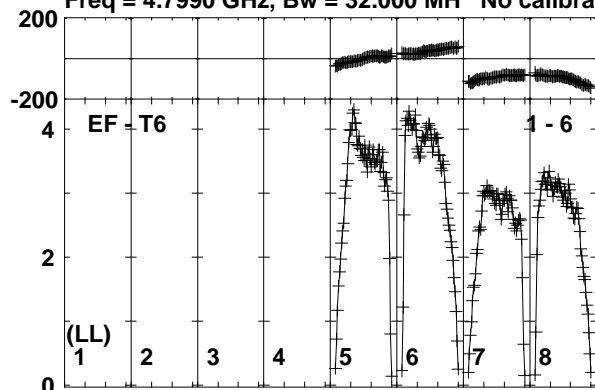

Lower frame: Milli Ampl Jy Top frame: Phas deg
Vector averaged cross-power spectrum Baseline: EF (01) - T6 (06)
Timerange: 00/16:40:01 to 00/16:40:59

Plot file version 153 created 19-OCT-2017 15:36:14

ARK564 ES081C.UVDATA.1

Freq = 4.7990 GHz, Bw = 32.000 MH No calibration applied and no bandpass applied

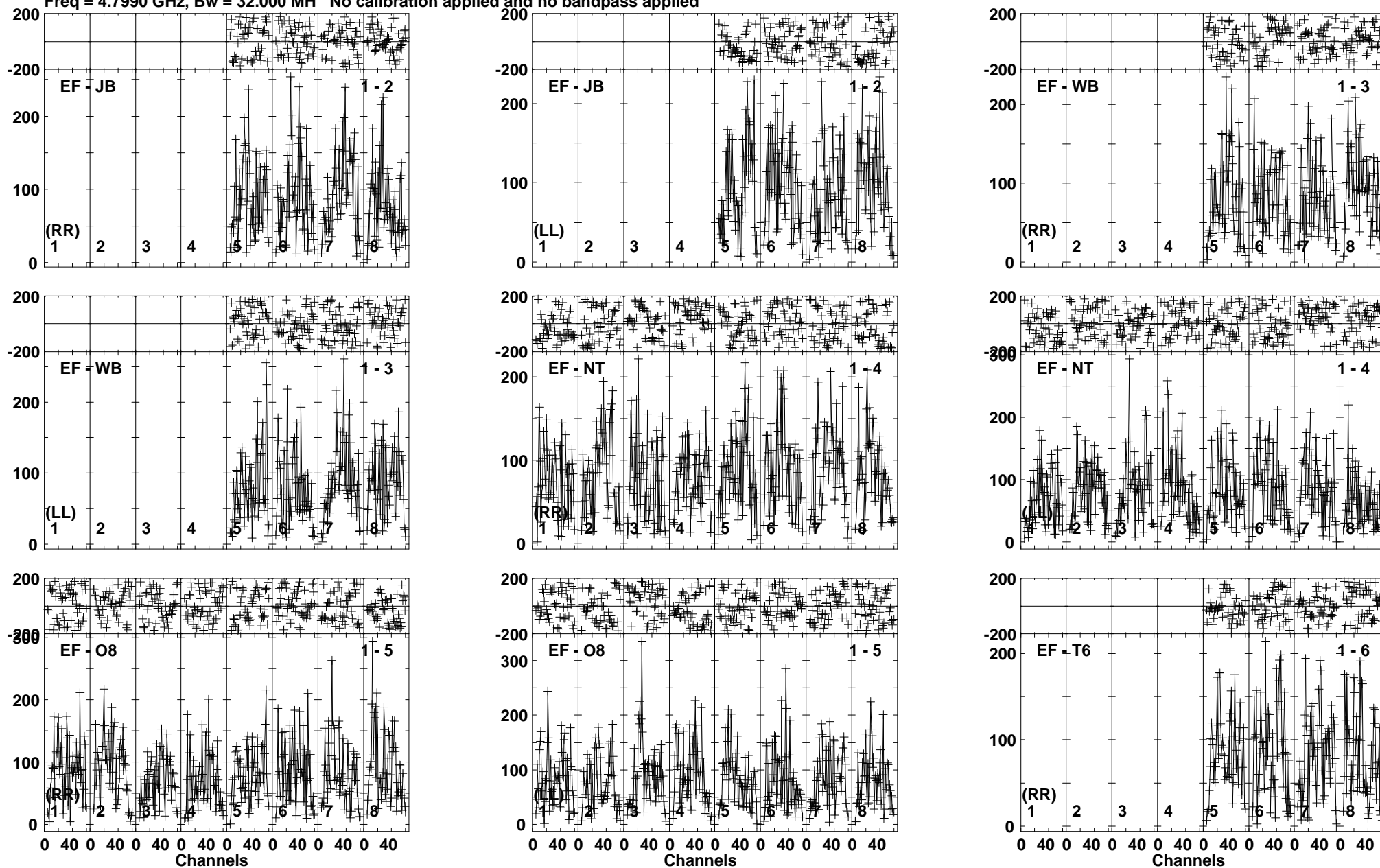

Lower frame: Micro Ampl Jy Top frame: Phas deg
Vector averaged cross-power spectrum Baseline: EF (01) - JB (02)
Timerange: 00/16:41:01 to 00/16:44:29

Plot file version 154 created 19-OCT-2017 15:36:15
 ARK564 ES081C.UVDATA.1
 Freq = 4.7990 GHz, Bw = 32.000 MH No calibration applied and no bandpass applied

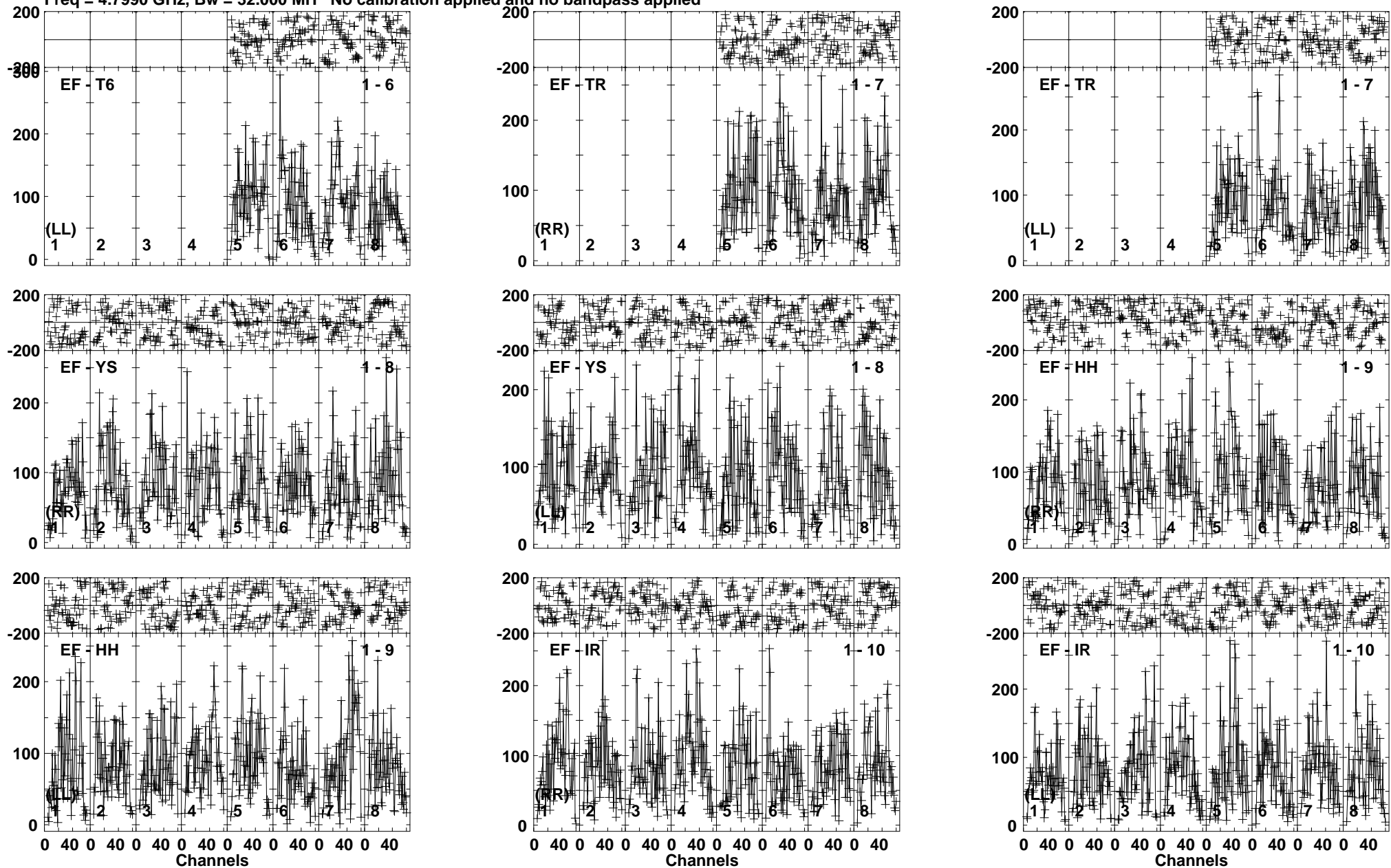

Lower frame: Micro Ampl Jy Top frame: Phas deg
 Vector averaged cross-power spectrum Baseline: EF (01) - T6 (06)
 Timerange: 00/16:41:01 to 00/16:44:29

Plot file version 155 created 19-OCT-2017 15:36:15

J2242+2955 ES081C.UVDATA.1

Freq = 4.7990 GHz, Bw = 32.000 MH No calibration applied and no bandpass applied

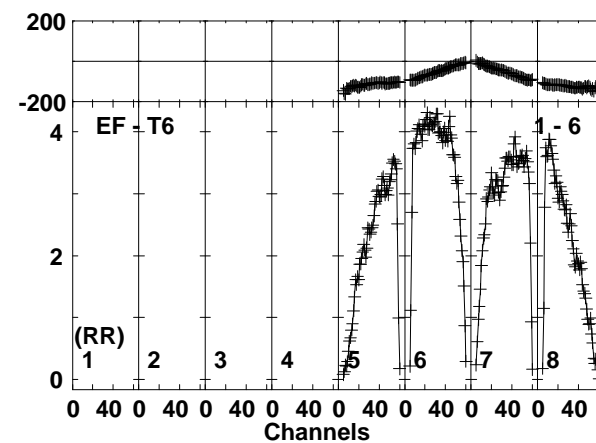
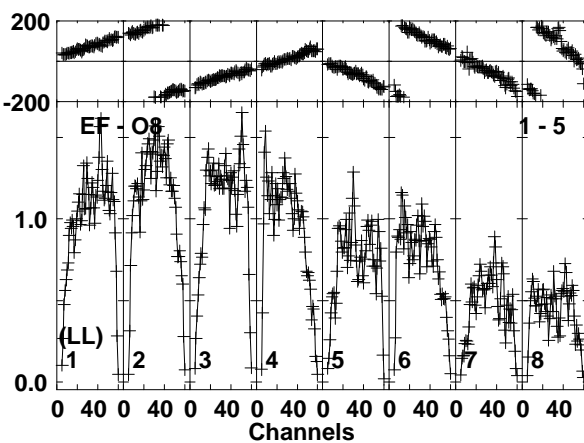
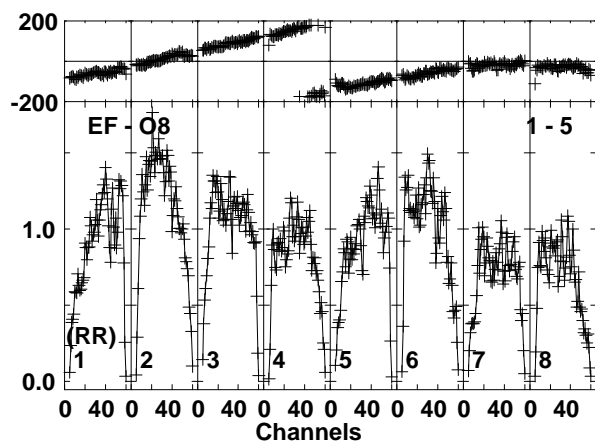
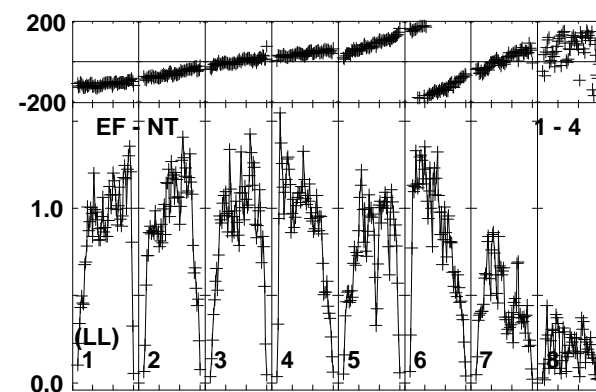
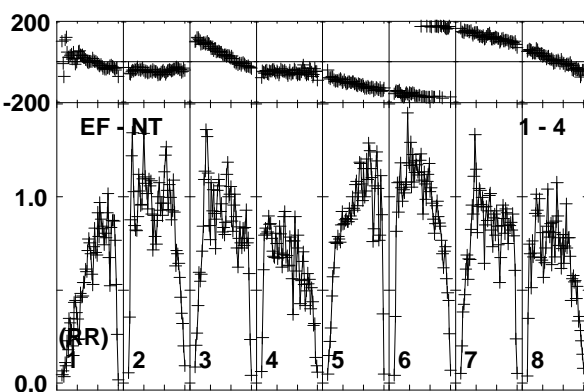
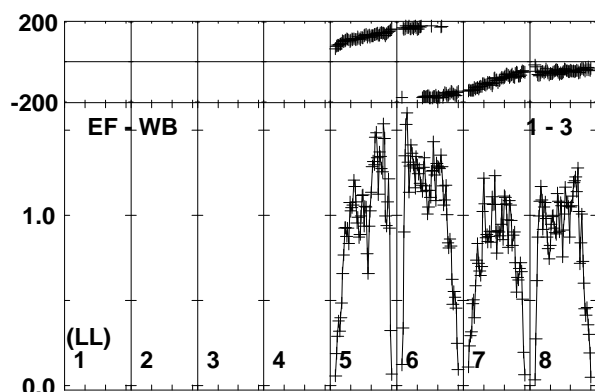
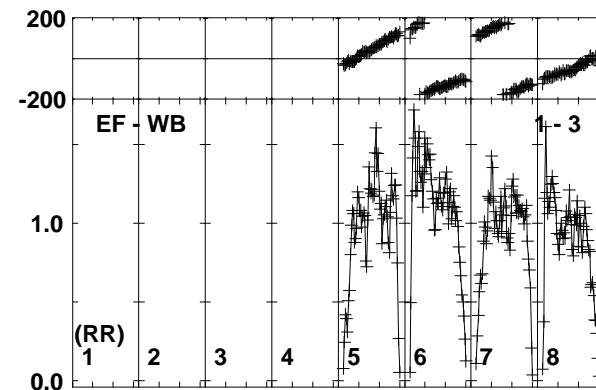
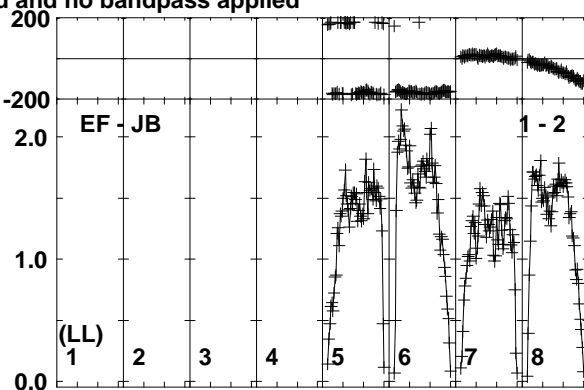
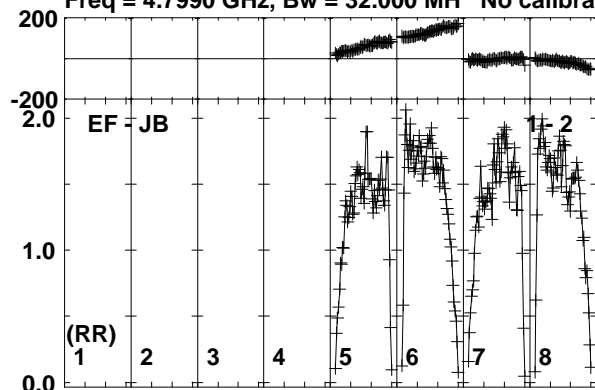

Lower frame: Milli Ampl Jy Top frame: Phas deg
Vector averaged cross-power spectrum Baseline: EF (01) - JB (02)
Timerange: 00/16:44:31 to 00/16:45:59

Plot file version 156 created 19-OCT-2017 15:36:15

J2242+2955 ES081C.UVDATA.1

Freq = 4.7990 GHz, Bw = 32.000 MH No calibration applied and no bandpass applied

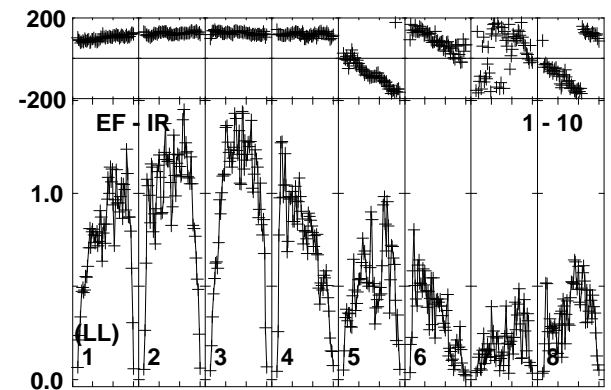
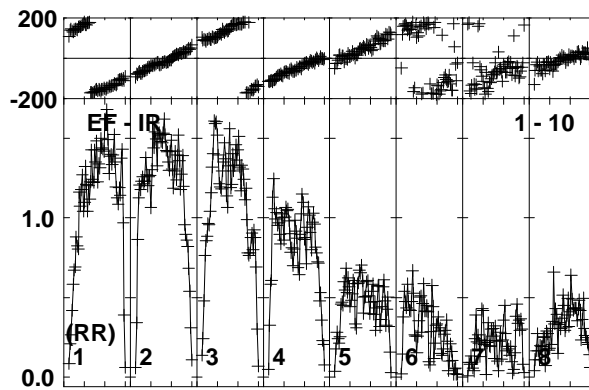
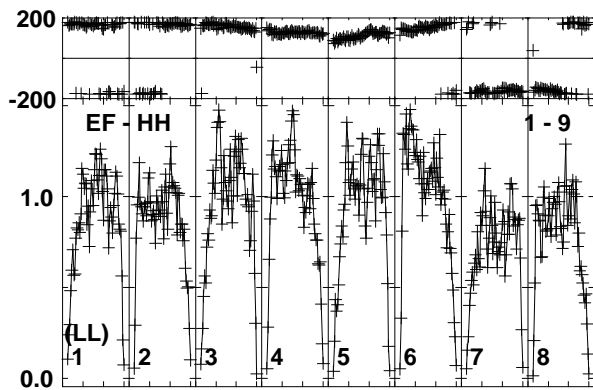
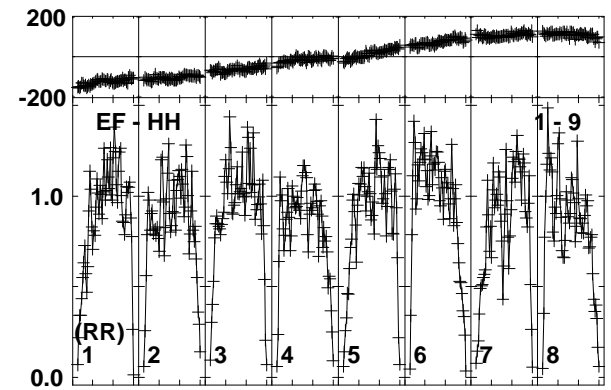
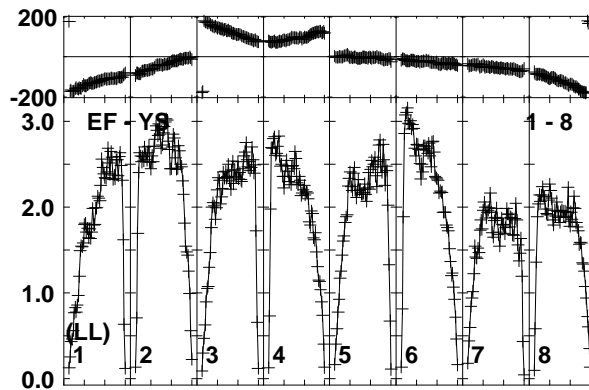
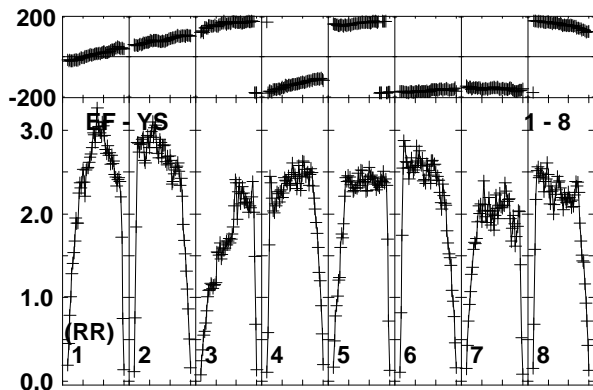
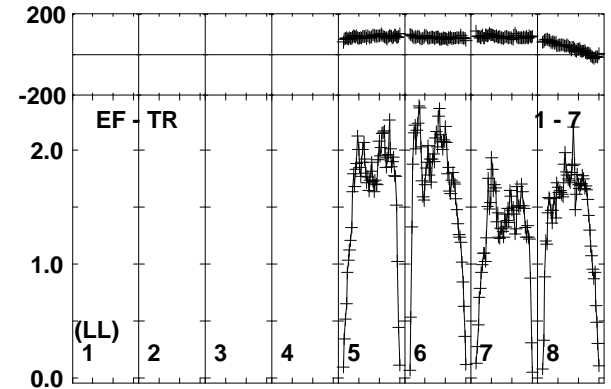
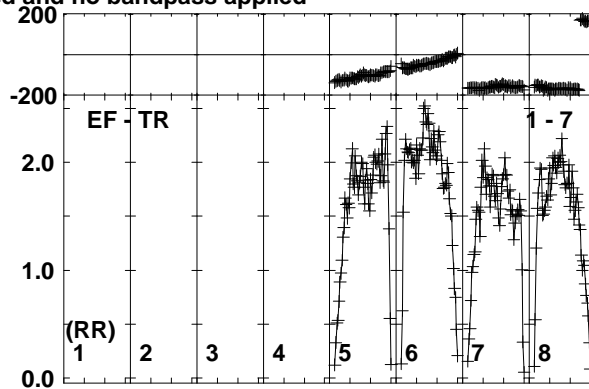
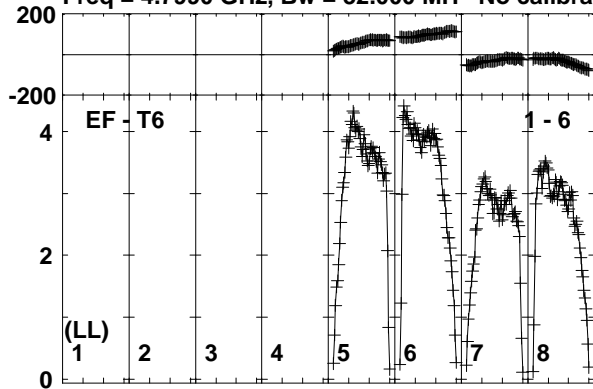

Lower frame: Milli Ampl Jy Top frame: Phas deg
Vector averaged cross-power spectrum Baseline: EF (01) - T6 (06)
Timerange: 00:16:44:31 to 00:16:45:59

Plot file version 157 created 19-OCT-2017 15:36:15
 ARK564 ES081C.UVDATA.1
 Freq = 4.7990 GHz, Bw = 32.000 MH No calibration applied and no bandpass applied

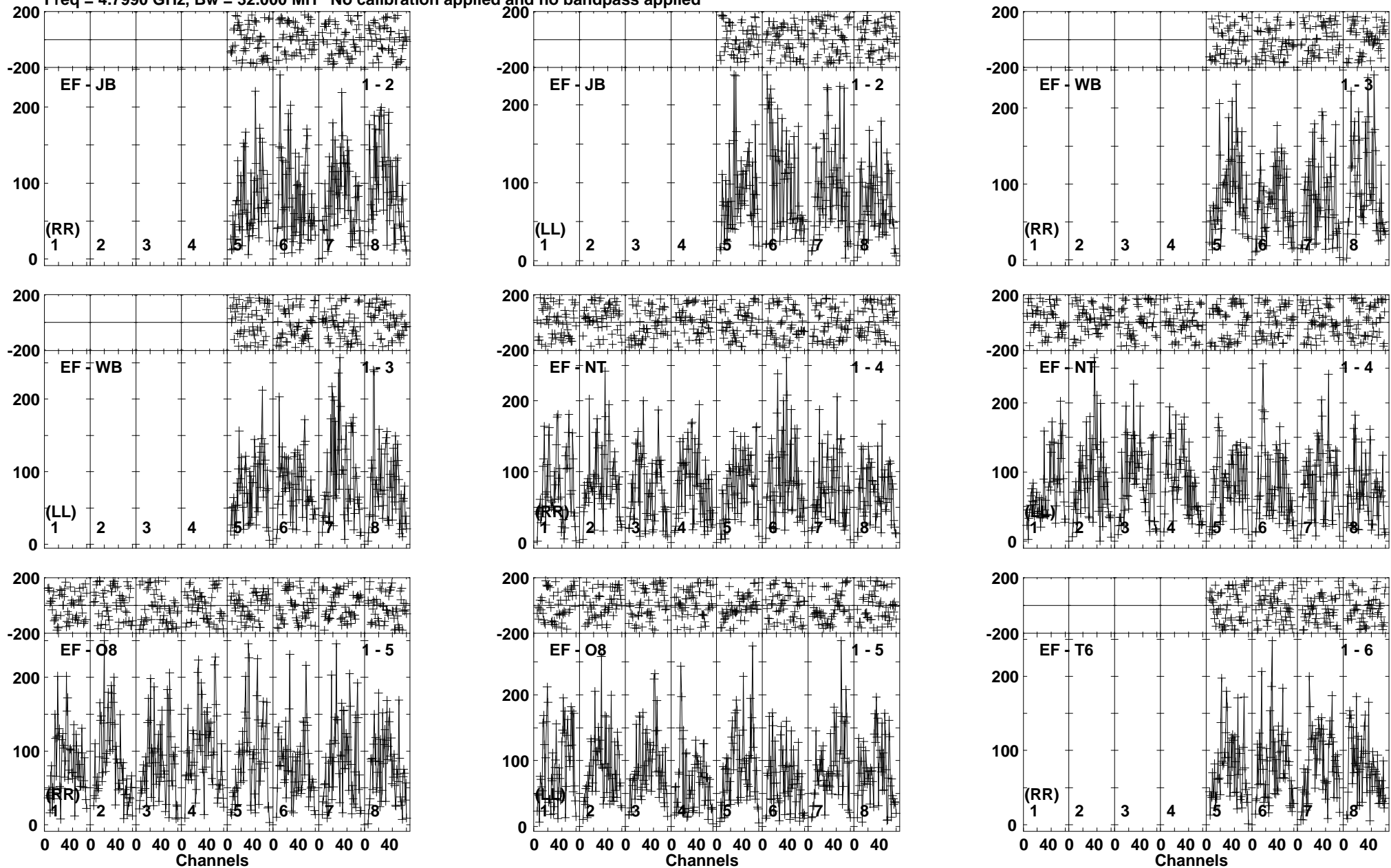

Lower frame: Micro Ampl Jy Top frame: Phas deg
 Vector averaged cross-power spectrum Baseline: EF (01) - JB (02)
 Timerange: 00/16:46:01 to 00/16:49:29

Plot file version 158 created 19-OCT-2017 15:36:15

ARK564 ES081C.UVDATA.1

Freq = 4.7990 GHz, Bw = 32.000 MH No calibration applied and no bandpass applied

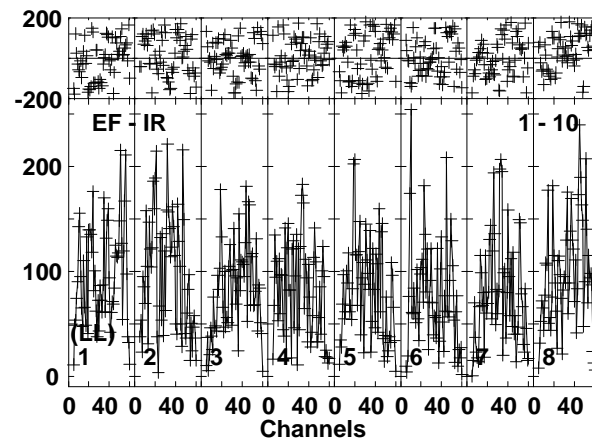
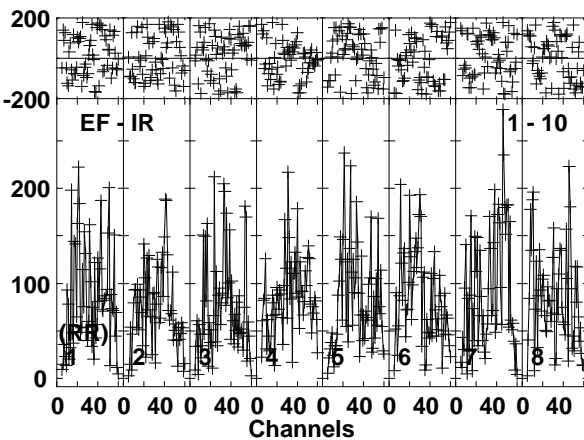
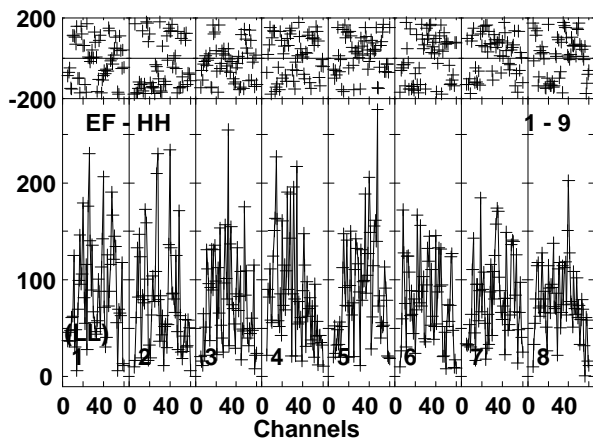
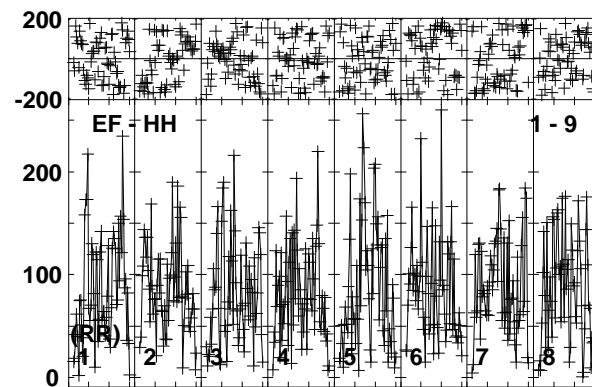
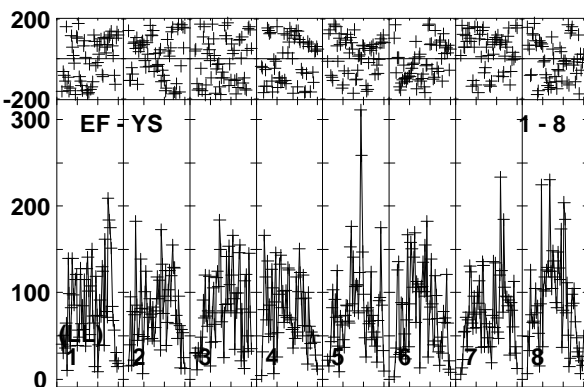
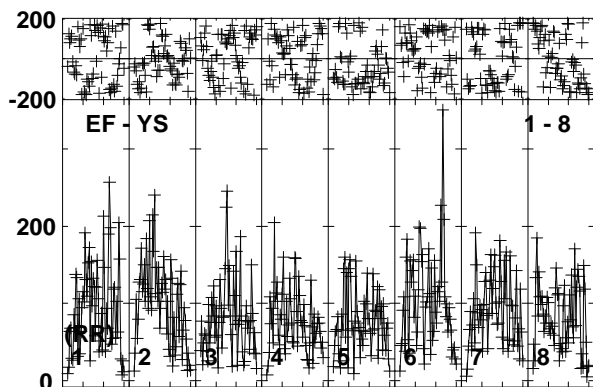
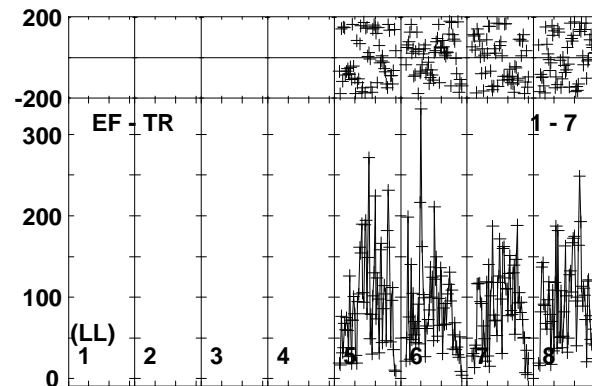
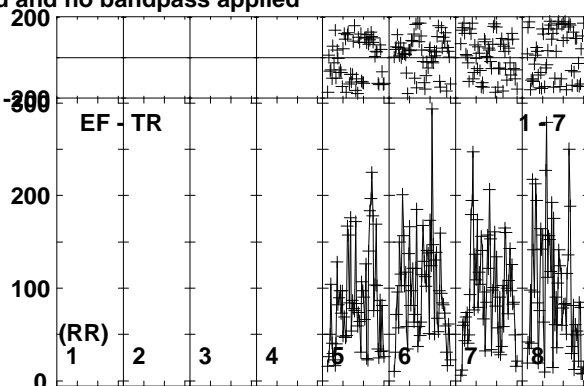
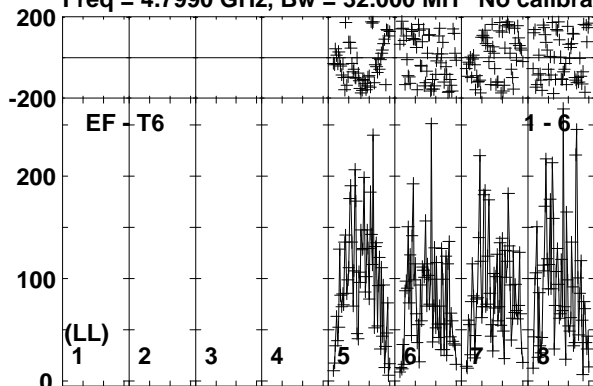

Lower frame: Micro Ampl Jy Top frame: Phas deg
Vector averaged cross-power spectrum Baseline: EF (01) - T6 (06)
Timerange: 00/16:46:01 to 00/16:49:29

Plot file version 159 created 19-OCT-2017 15:36:15

J2242+2955 ES081C.UVDATA.1

Freq = 4.7990 GHz, Bw = 32.000 MH No calibration applied and no bandpass applied

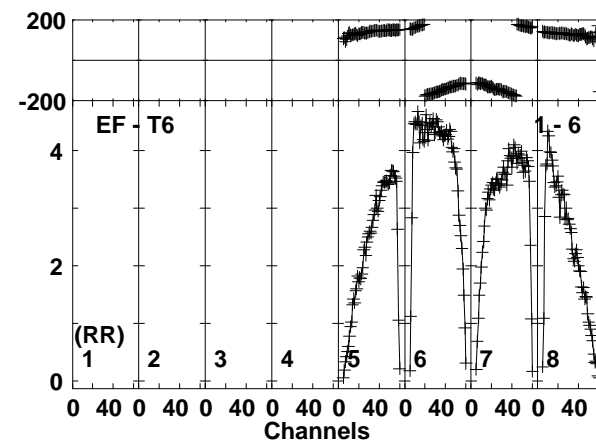
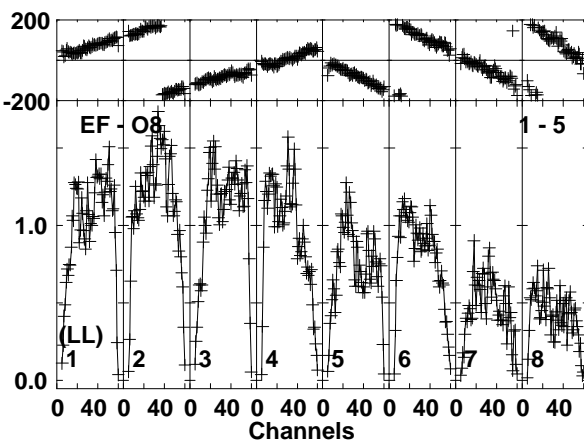
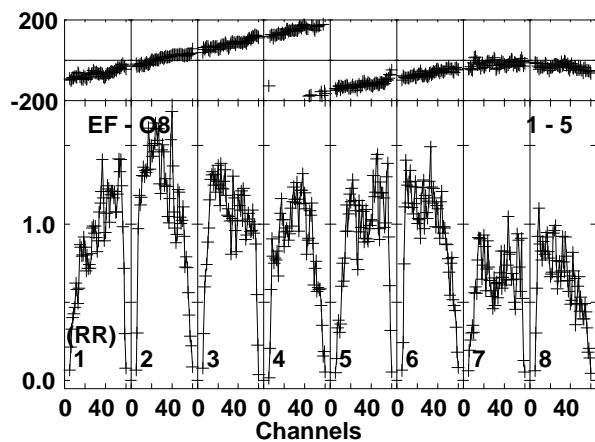
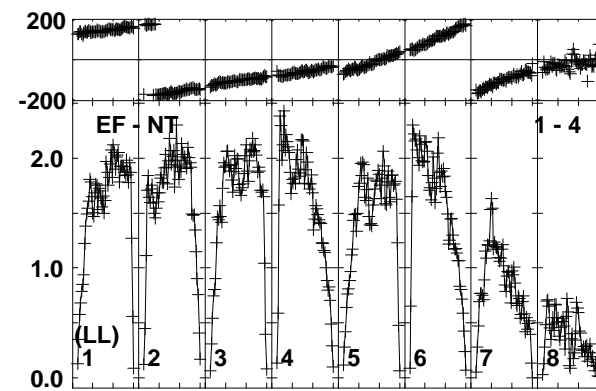
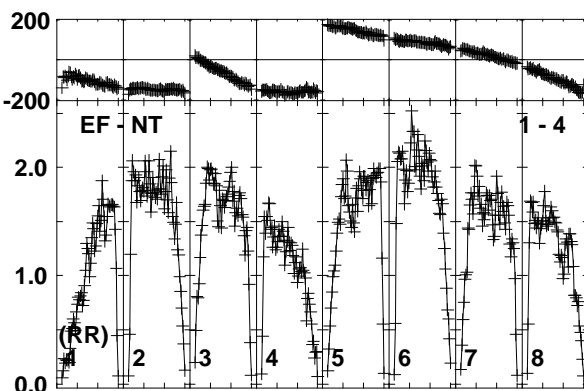
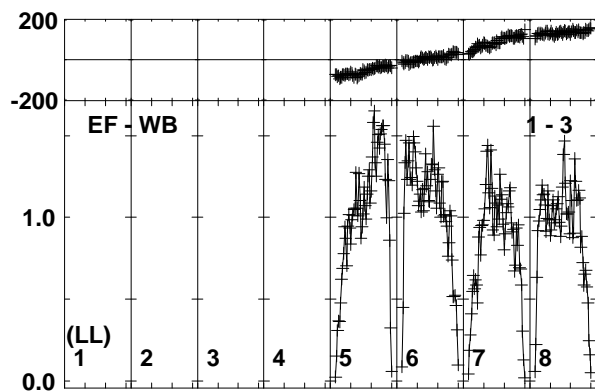
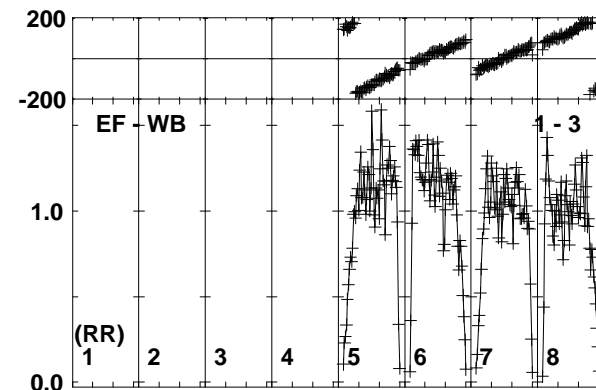
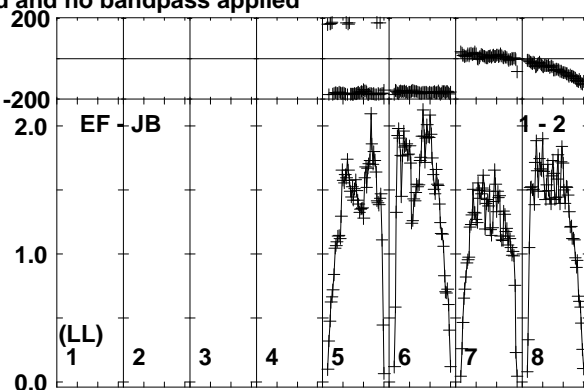
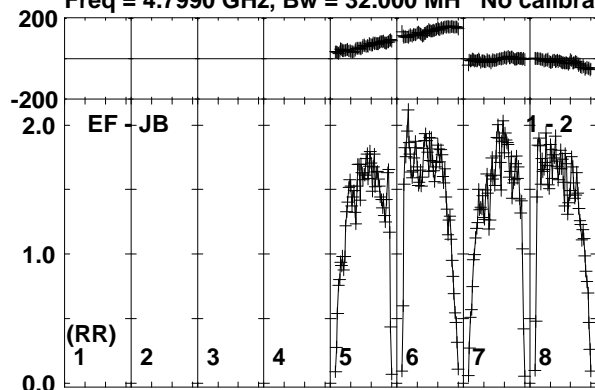

Lower frame: Milli Ampl Jy Top frame: Phas deg
Vector averaged cross-power spectrum Baseline: EF (01) - JB (02)
Timerange: 00/16:50:01 to 00/16:50:59

Plot file version 160 created 19-OCT-2017 15:36:15

J2242+2955 ES081C.UVDATA.1

Freq = 4.7990 GHz, Bw = 32.000 MH No calibration applied and no bandpass applied

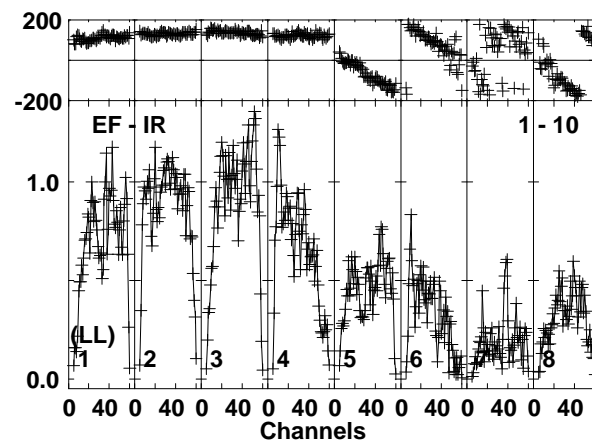
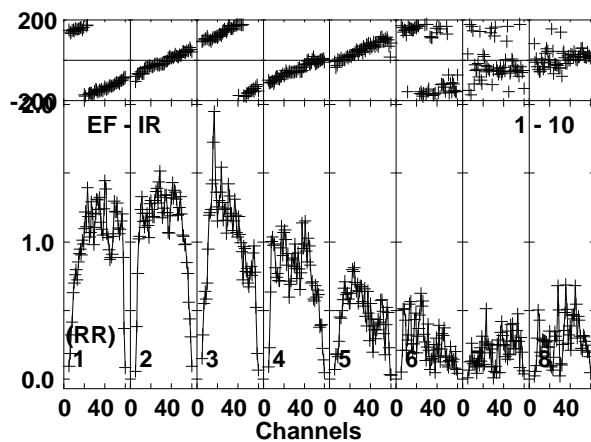
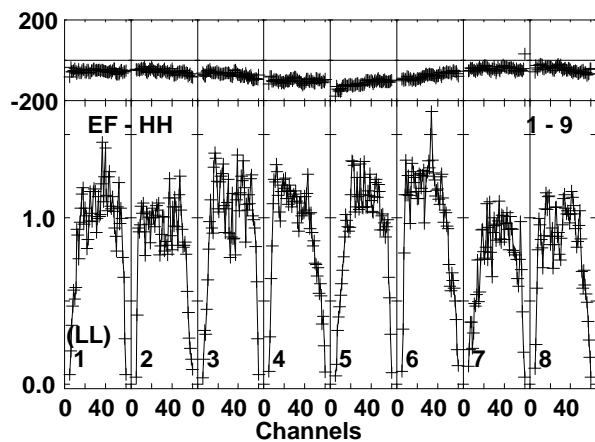
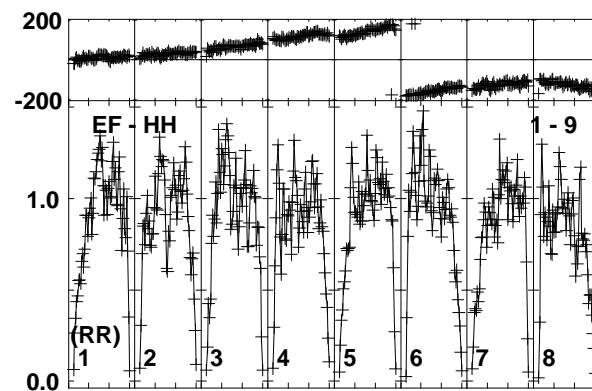
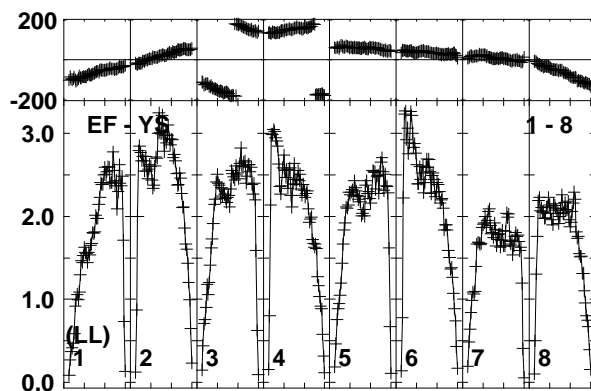
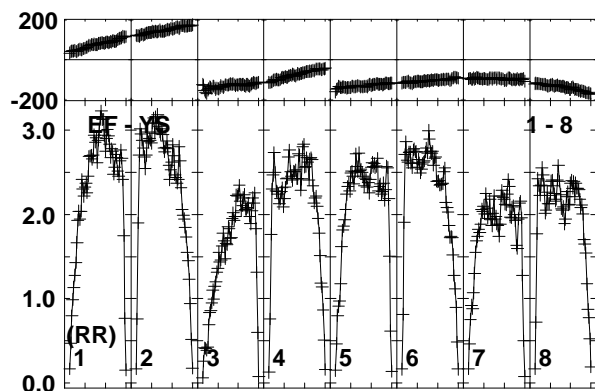
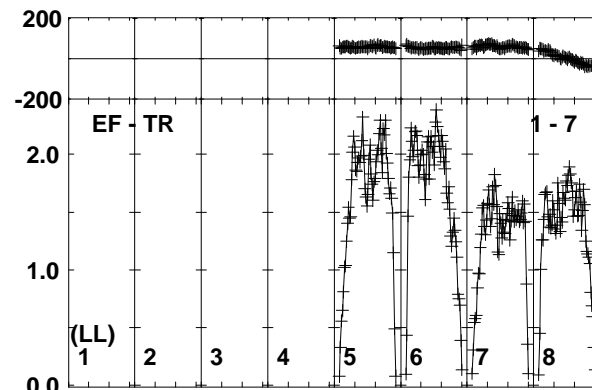
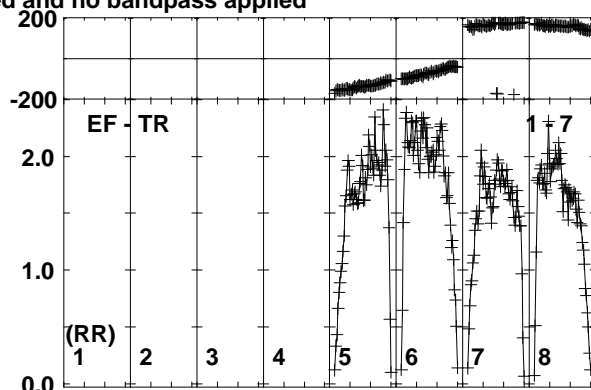
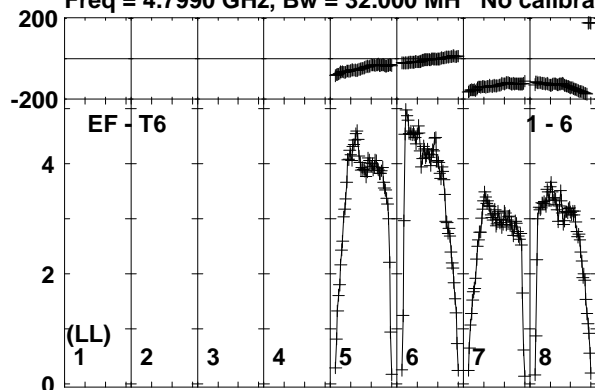

Lower frame: Milli Ampl Jy Top frame: Phas deg
Vector averaged cross-power spectrum Baseline: EF (01) - T6 (06)
Timerange: 00/16:50:01 to 00/16:50:59

Plot file version 161 created 19-OCT-2017 15:36:16
 ARK564 ES081C.UVDATA.1
 Freq = 4.7990 GHz, Bw = 32.000 MH No calibration applied and no bandpass applied

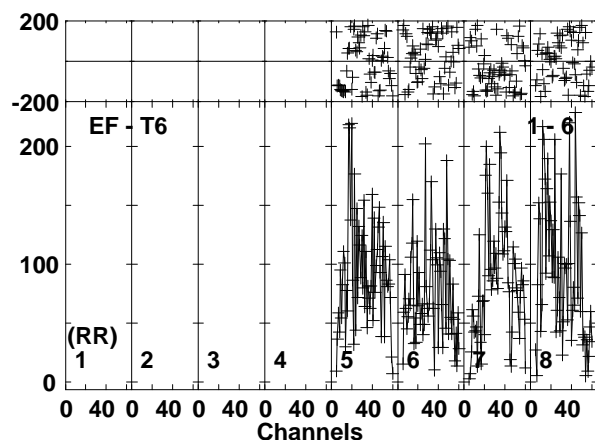
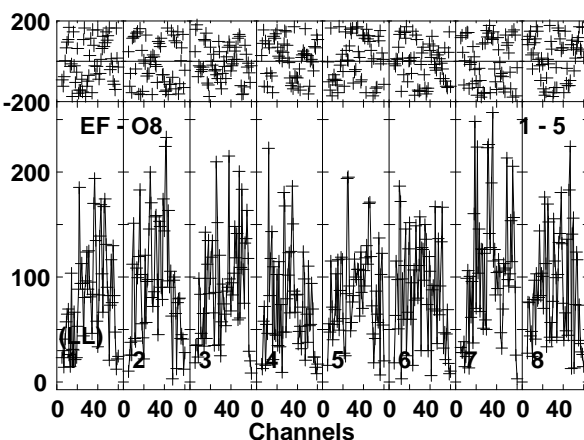
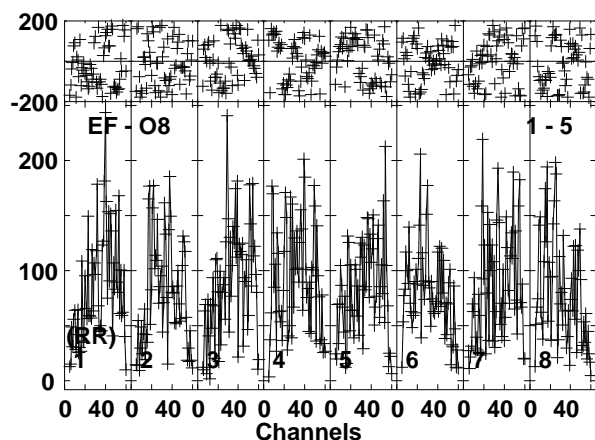
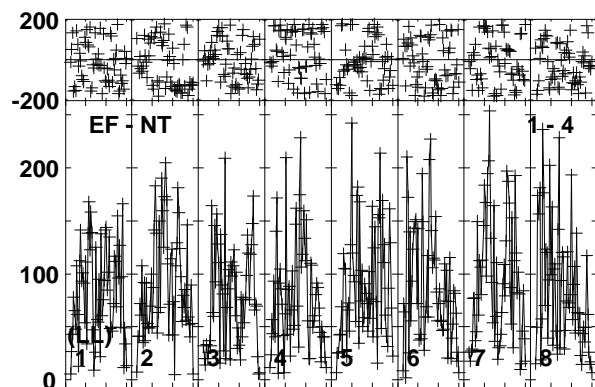
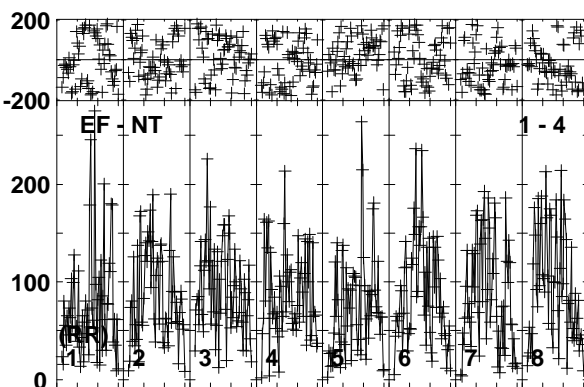
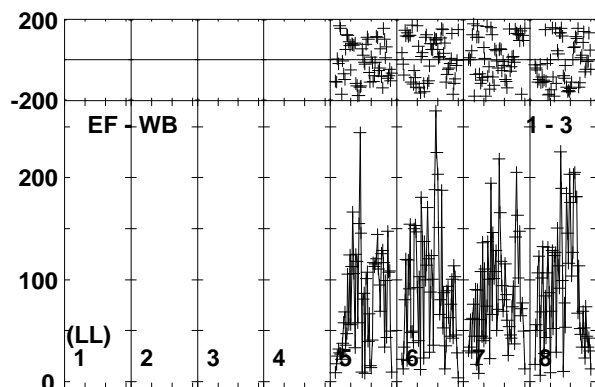
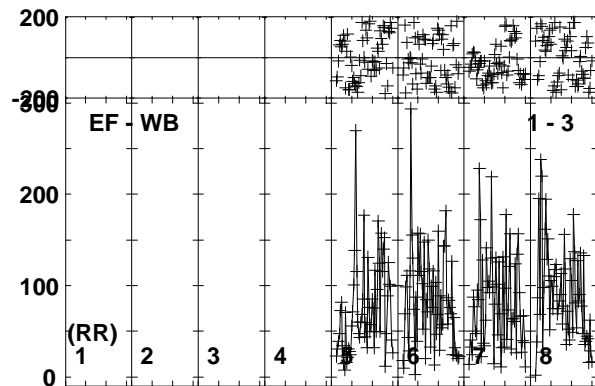
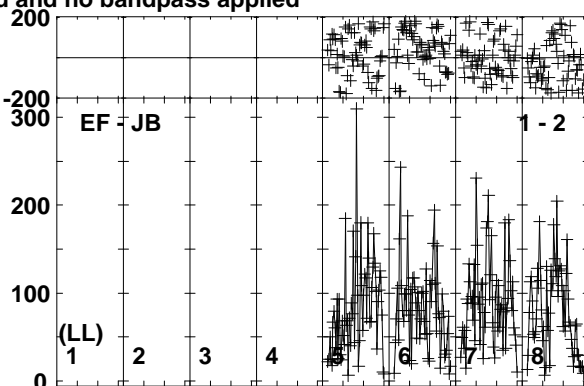
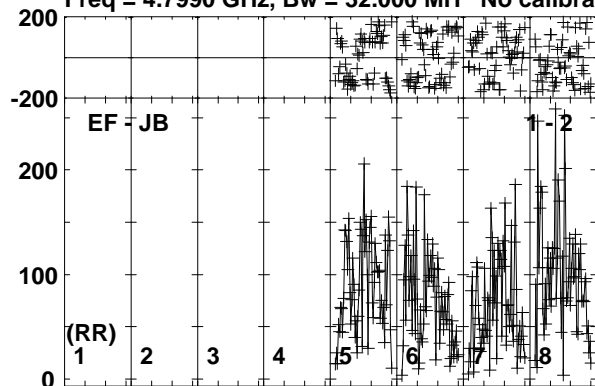

Lower frame: Micro Ampl Jy Top frame: Phas deg
 Vector averaged cross-power spectrum Baseline: EF (01) - JB (02)
 Timerange: 00/16:51:01 to 00/16:54:29

Plot file version 162 created 19-OCT-2017 15:36:16

ARK564 ES081C.UVDATA.1

Freq = 4.7990 GHz, Bw = 32.000 MH No calibration applied and no bandpass applied

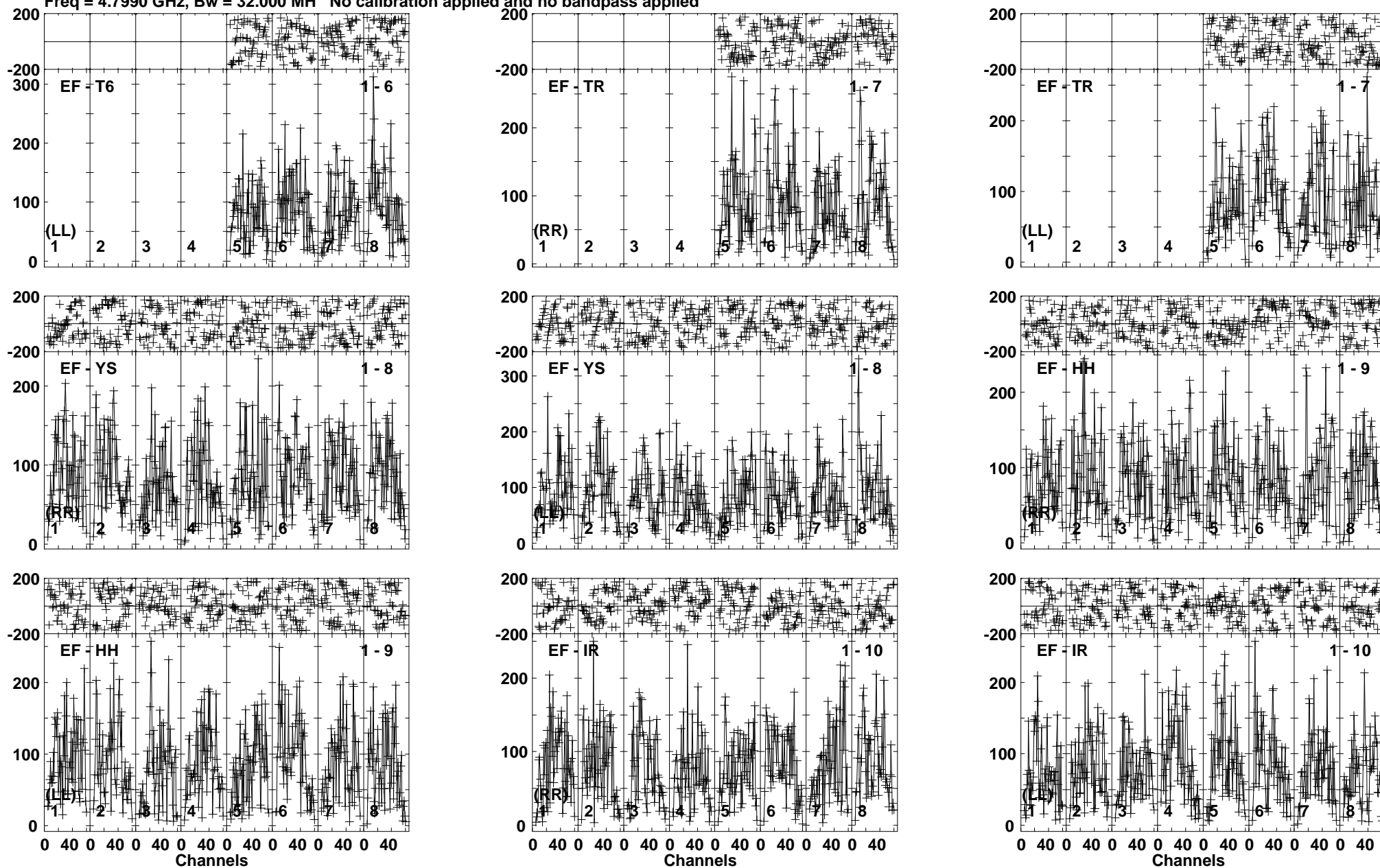

Lower frame: Micro Ampl Jy Top frame: Phas deg
Vector averaged cross-power spectrum Baseline: EF (01) - T6 (06)
Timerange: 00/16:51:01 to 00/16:54:29

Plot file version 163 created 19-OCT-2017 15:36:16

J2242+2955 ES081C.UVDATA.1

Freq = 4.7990 GHz, Bw = 32.000 MH No calibration applied and no bandpass applied

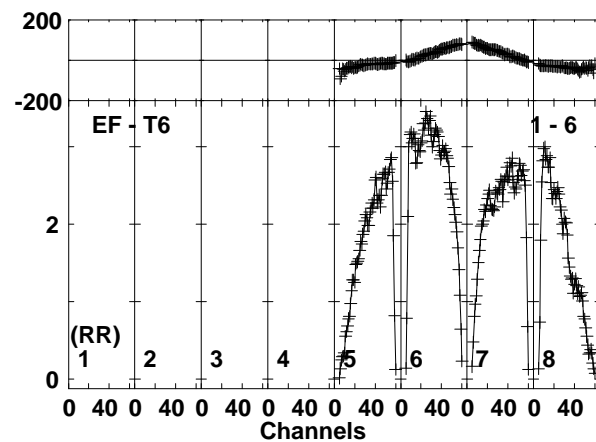
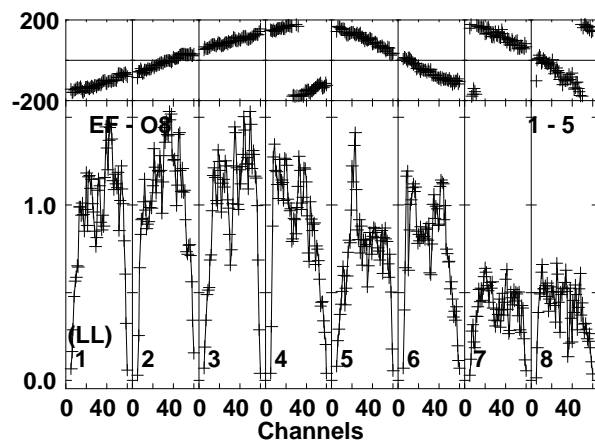
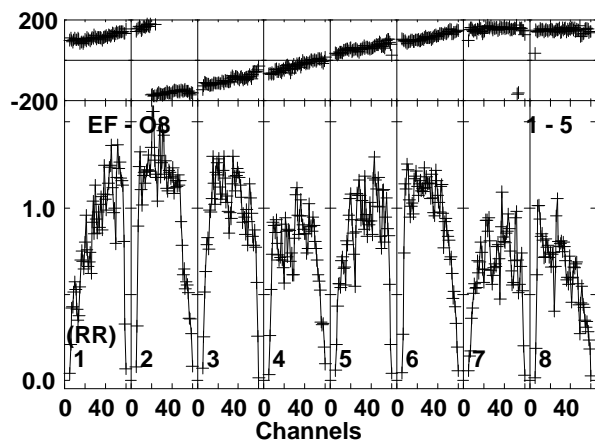
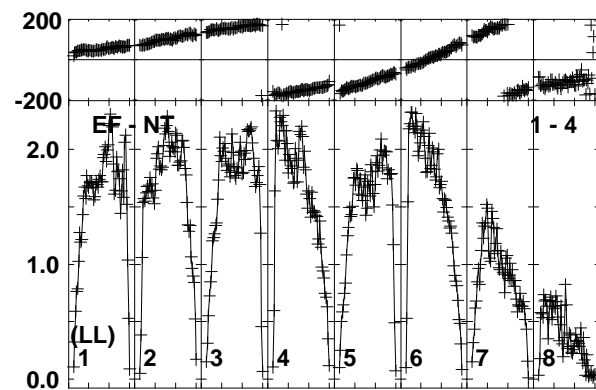
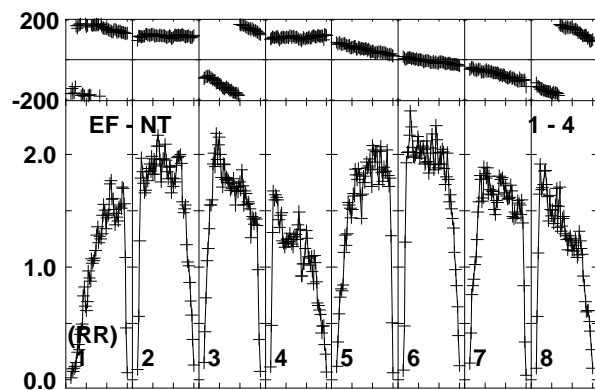
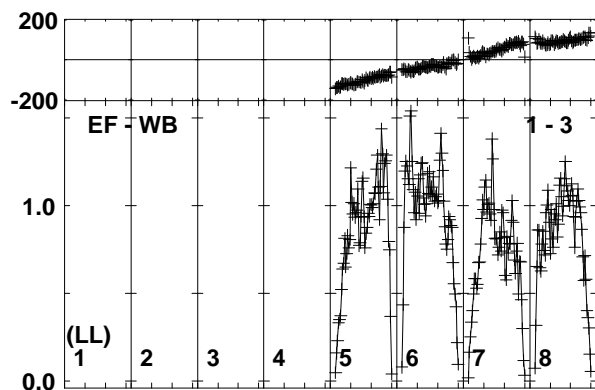
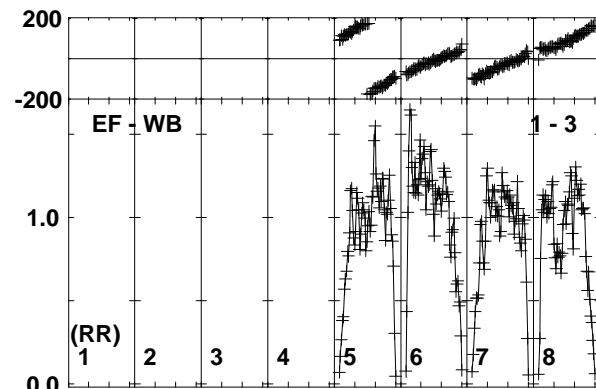
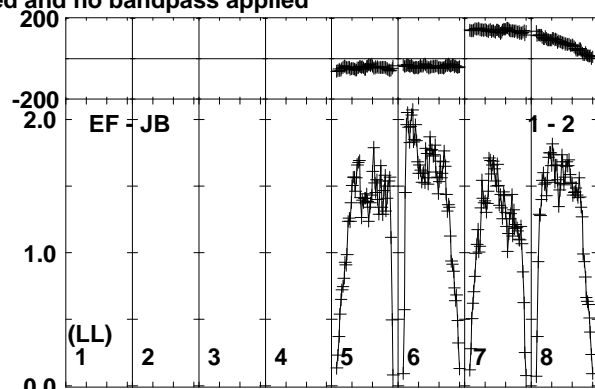
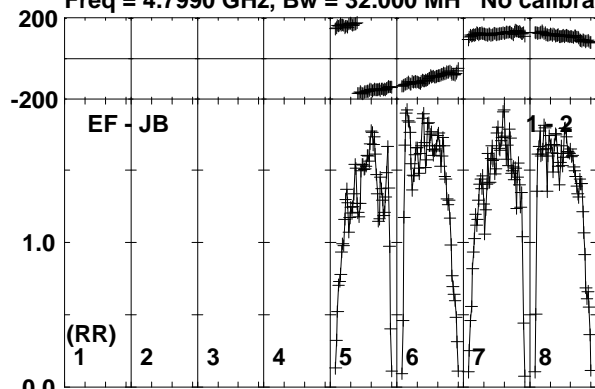

Lower frame: Milli Ampl Jy Top frame: Phas deg
Vector averaged cross-power spectrum Baseline: EF (01) - JB (02)
Timerange: 00/16:54:31 to 00/16:55:59

Plot file version 164 created 19-OCT-2017 15:36:16

J2242+2955 ES081C.UVDATA.1

Freq = 4.7990 GHz, Bw = 32.000 MH No calibration applied and no bandpass applied

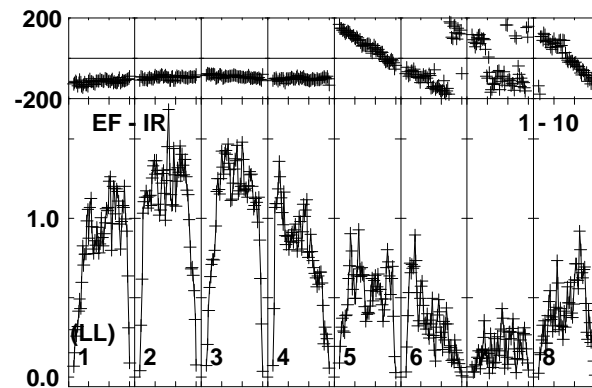
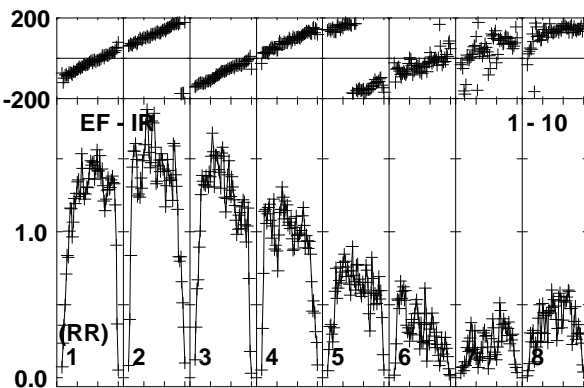
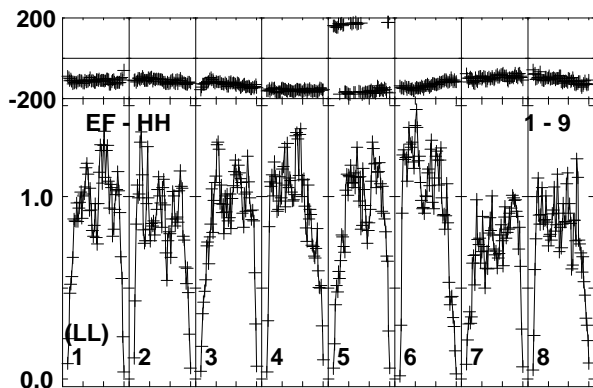
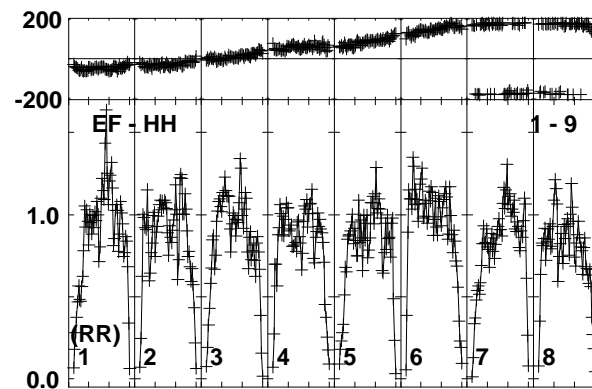
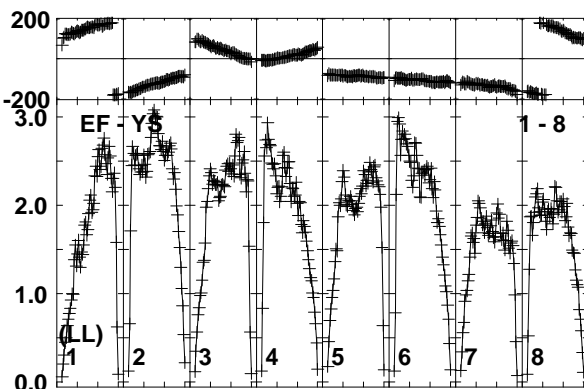
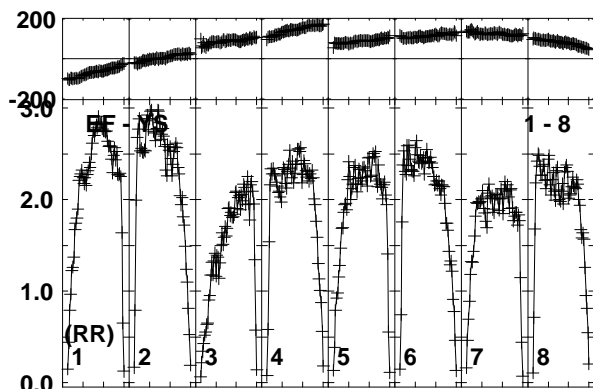
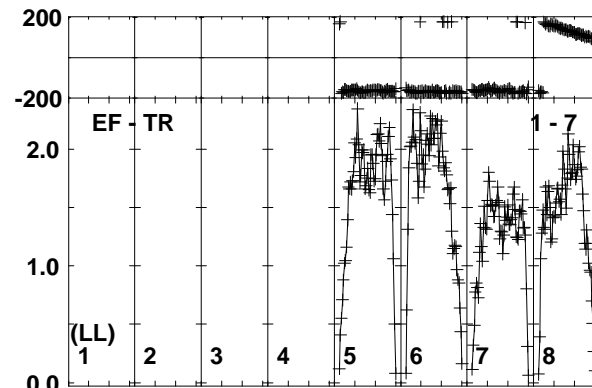
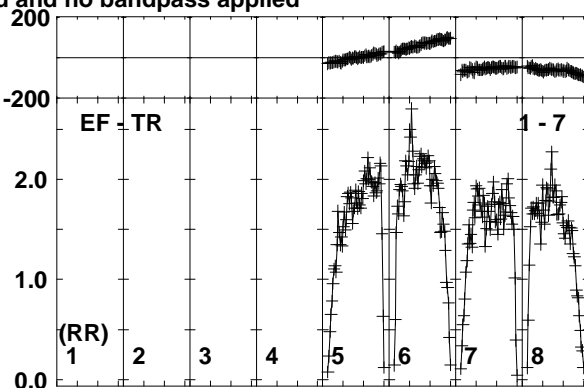
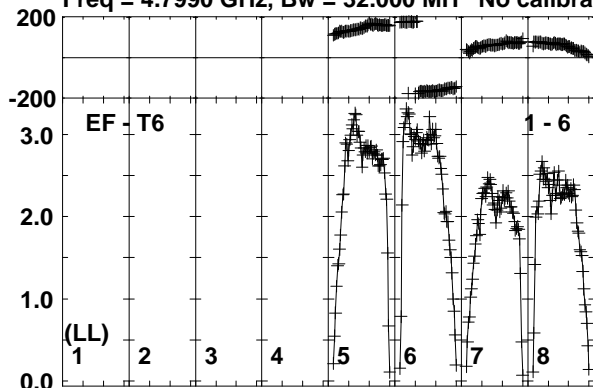

Lower frame: Milli Ampl Jy Top frame: Phas deg
Vector averaged cross-power spectrum Baseline: EF (01) - T6 (06)
Timerange: 00/16:54:31 to 00/16:55:59

Plot file version 165 created 19-OCT-2017 15:36:16
 ARK564 ES081C.UVDATA.1
 Freq = 4.7990 GHz, Bw = 32.000 MH No calibration applied and no bandpass applied

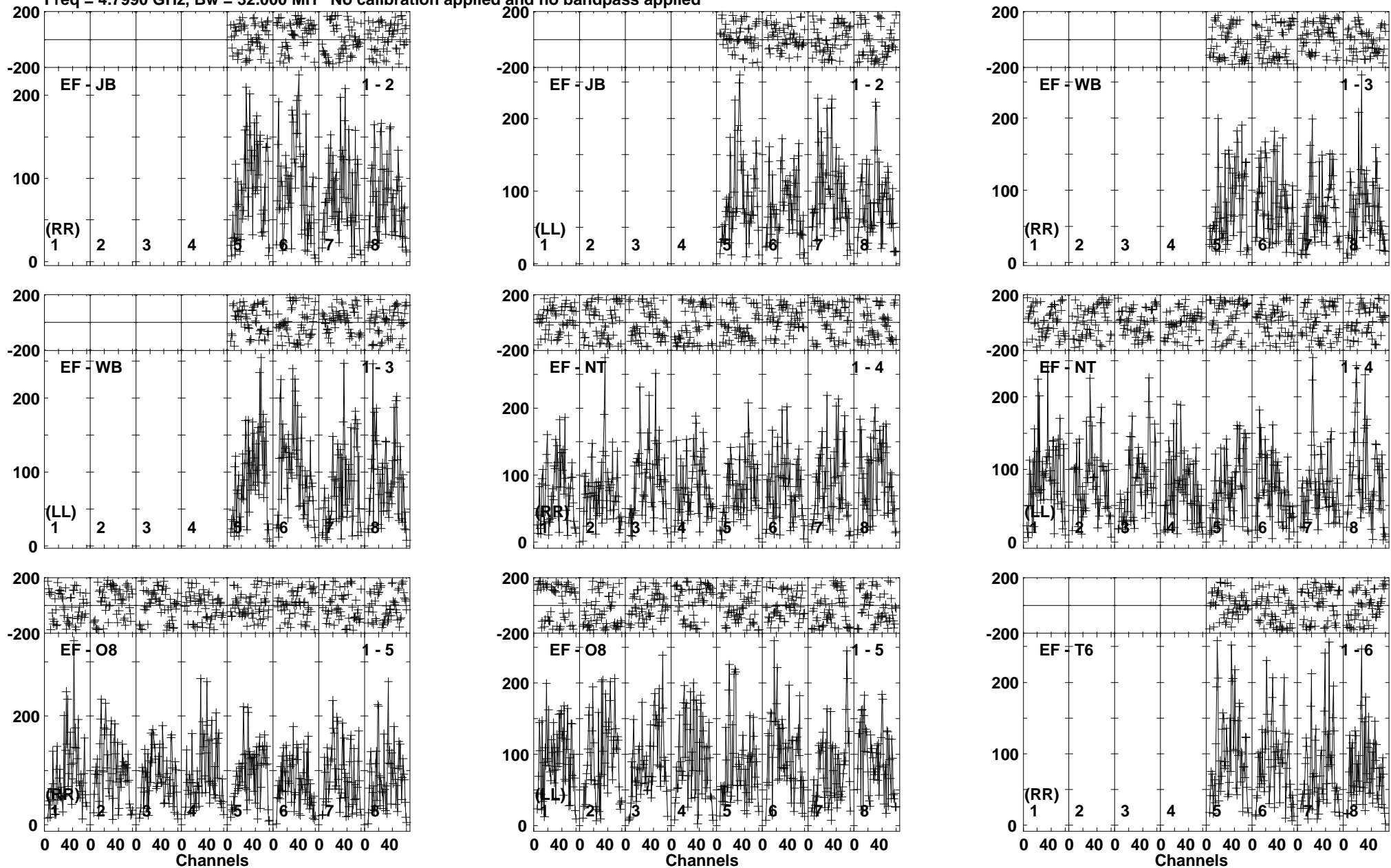

Lower frame: Micro Ampl Jy Top frame: Phas deg
 Vector averaged cross-power spectrum Baseline: EF (01) - JB (02)
 Timerange: 00/16:56:01 to 00/16:59:29

Plot file version 166 created 19-OCT-2017 15:36:16

ARK564 ES081C.UVDATA.1

Freq = 4.7990 GHz, Bw = 32.000 MH No calibration applied and no bandpass applied

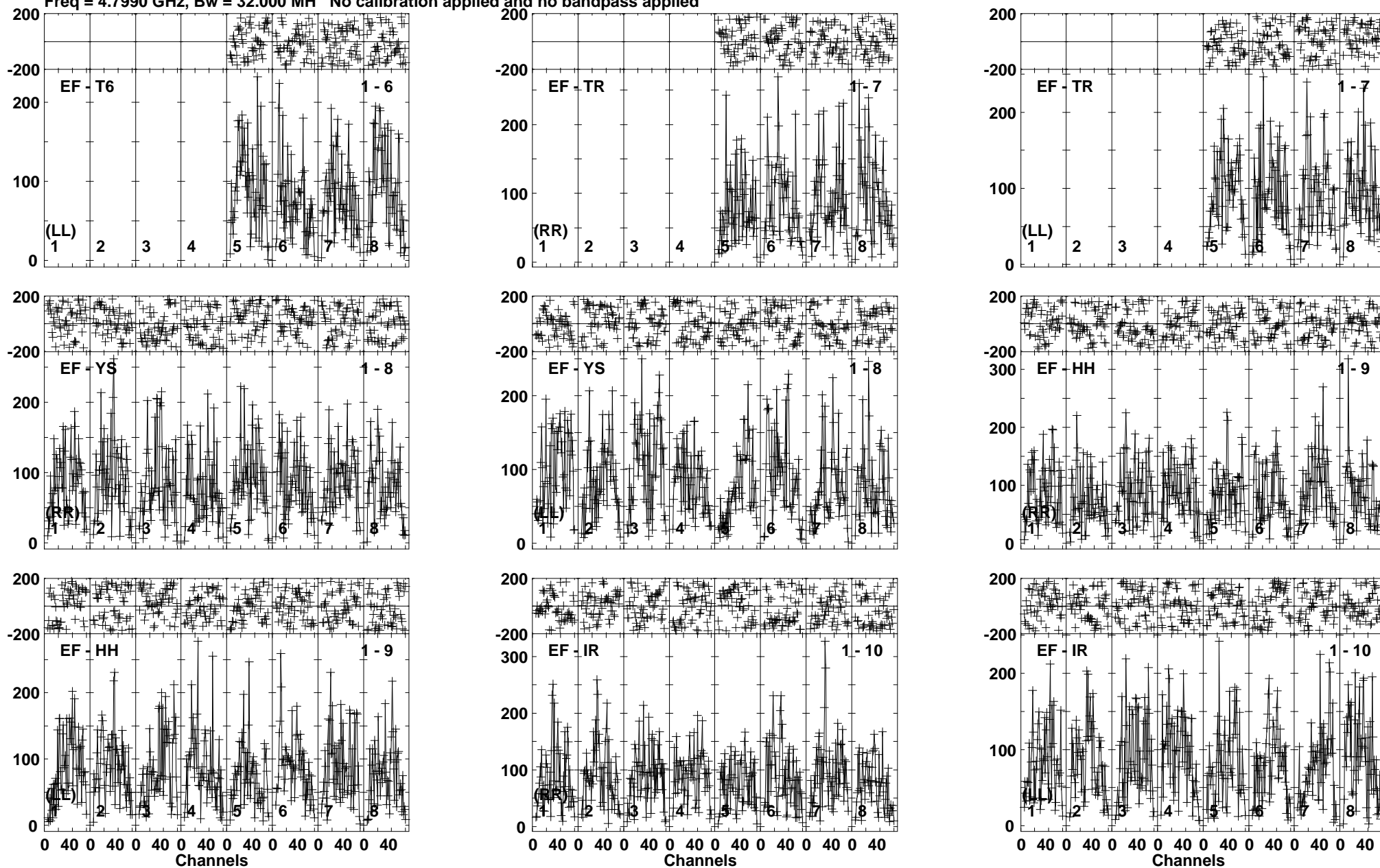

Lower frame: Micro Ampl Jy Top frame: Phas deg
Vector averaged cross-power spectrum Baseline: EF (01) - T6 (06)
Timerange: 00/16:56:01 to 00/16:59:29

Plot file version 167 created 19-OCT-2017 15:36:17

J2242+2955 ES081C.UVDATA.1

Freq = 4.7990 GHz, Bw = 32.000 MH No calibration applied and no bandpass applied

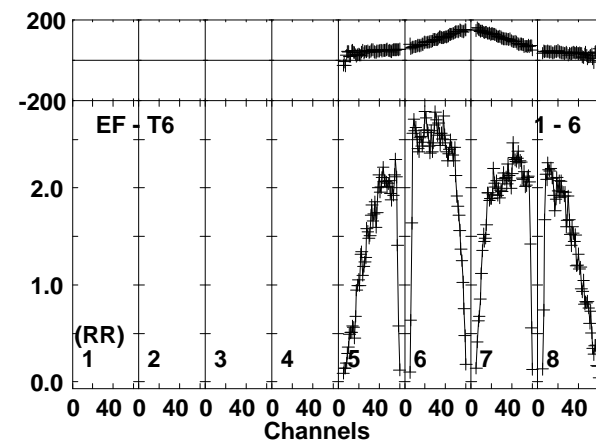
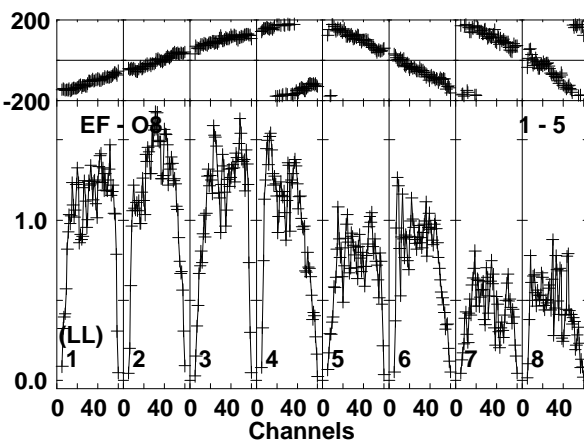
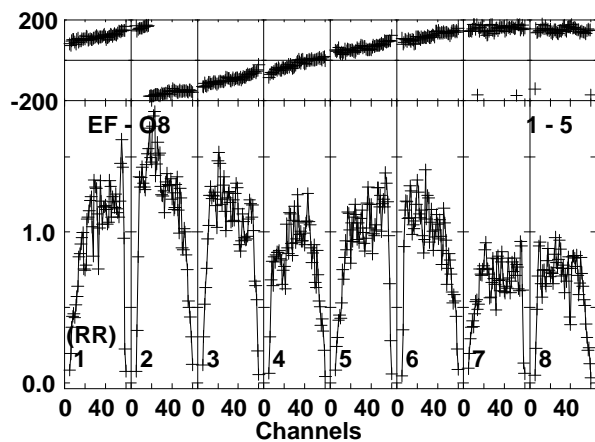
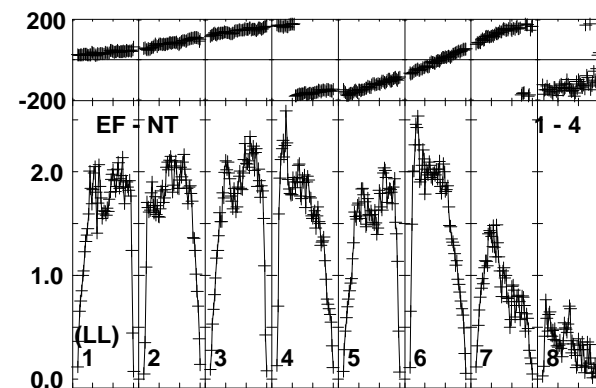
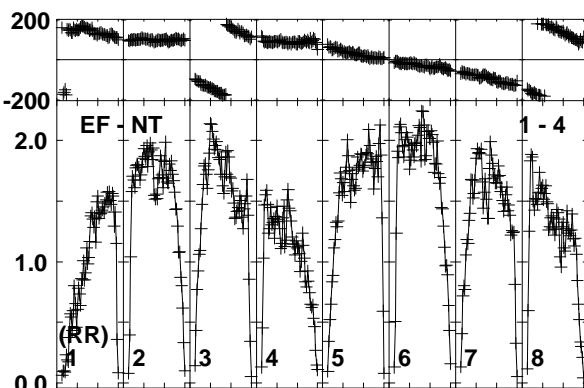
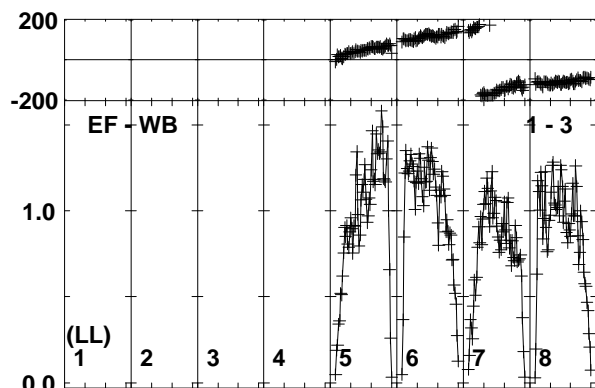
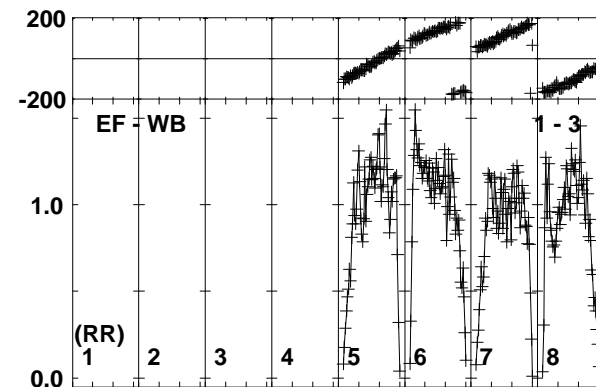
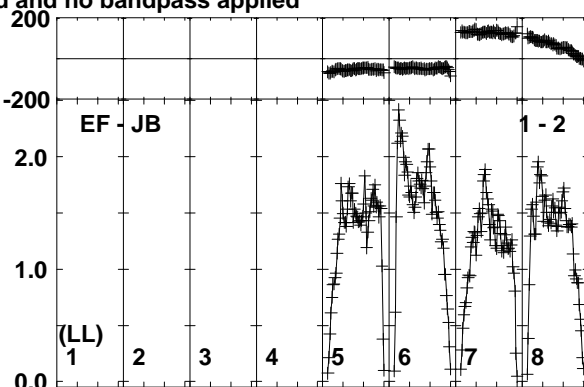
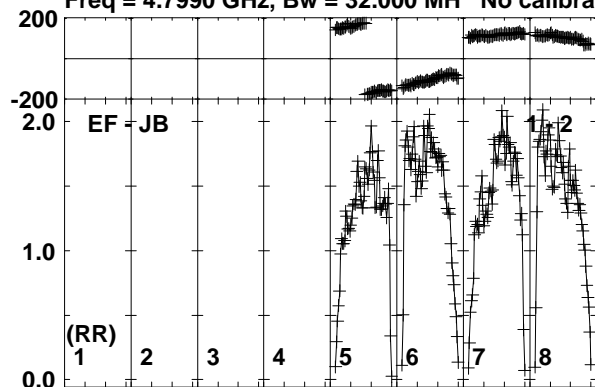

Lower frame: Milli Ampl Jy Top frame: Phas deg
Vector averaged cross-power spectrum Baseline: EF (01) - JB (02)
Timerange: 00:17:00:01 to 00:17:00:59

Plot file version 168 created 19-OCT-2017 15:36:17

J2242+2955 ES081C.UVDATA.1

Freq = 4.7990 GHz, Bw = 32.000 MH No calibration applied and no bandpass applied

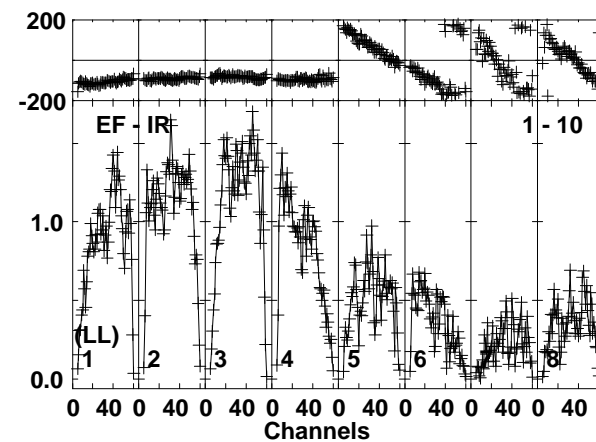
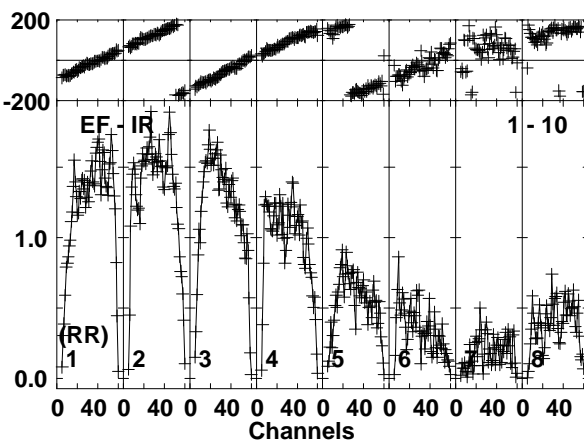
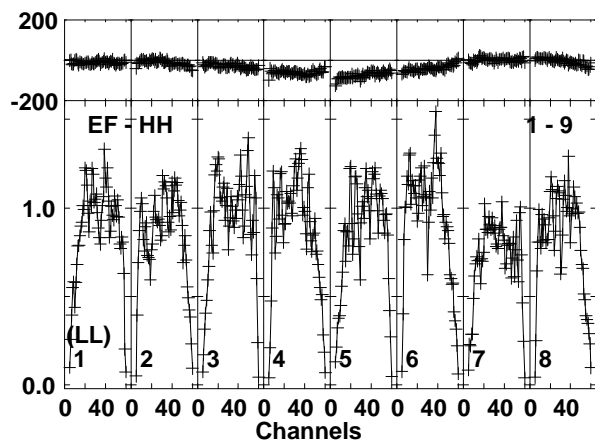
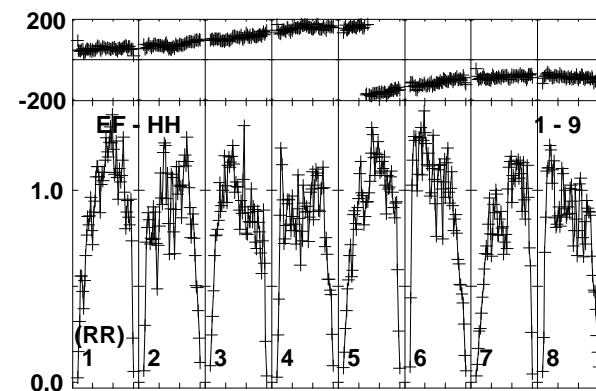
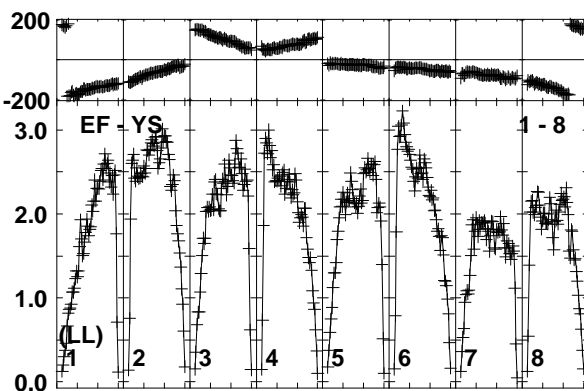
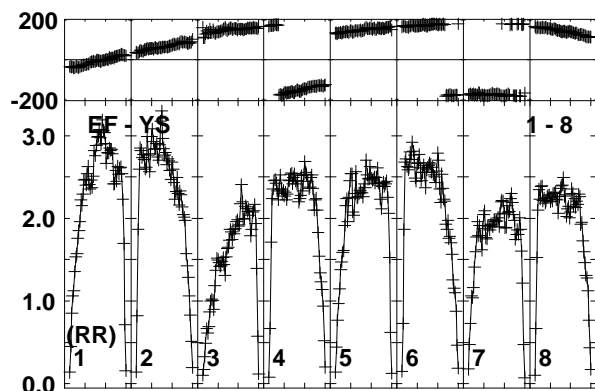
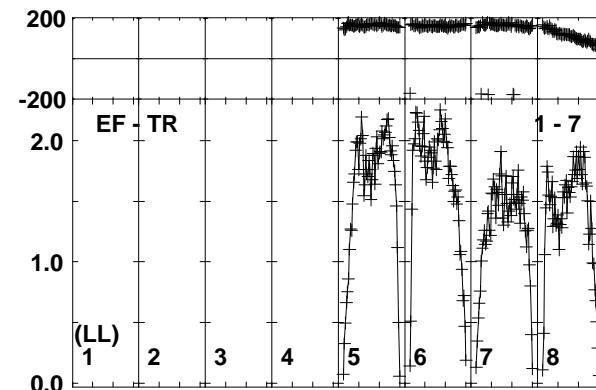
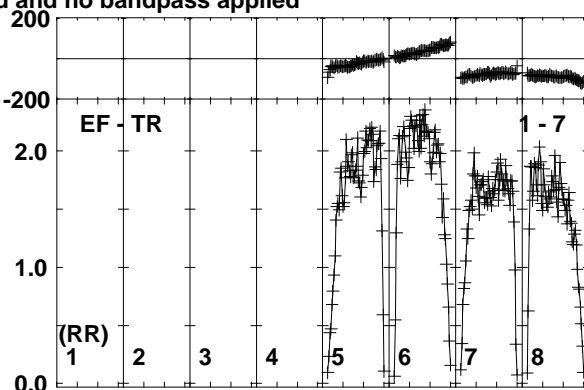
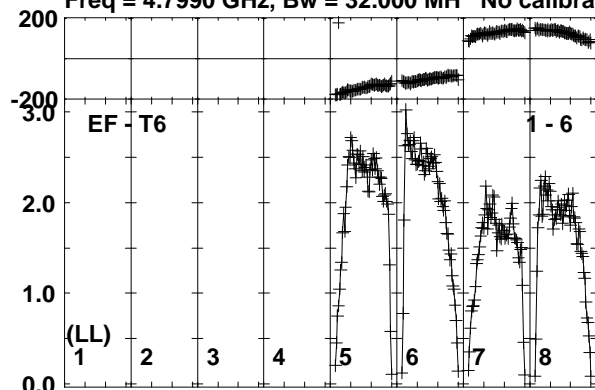

Lower frame: Milli Ampl Jy Top frame: Phas deg
Vector averaged cross-power spectrum Baseline: EF (01) - T6 (06)
Timerange: 00/17:00:01 to 00/17:00:59

Plot file version 169 created 19-OCT-2017 15:36:17

ARK564 ES081C.UVDATA.1

Freq = 4.7990 GHz, Bw = 32.000 MH No calibration applied and no bandpass applied

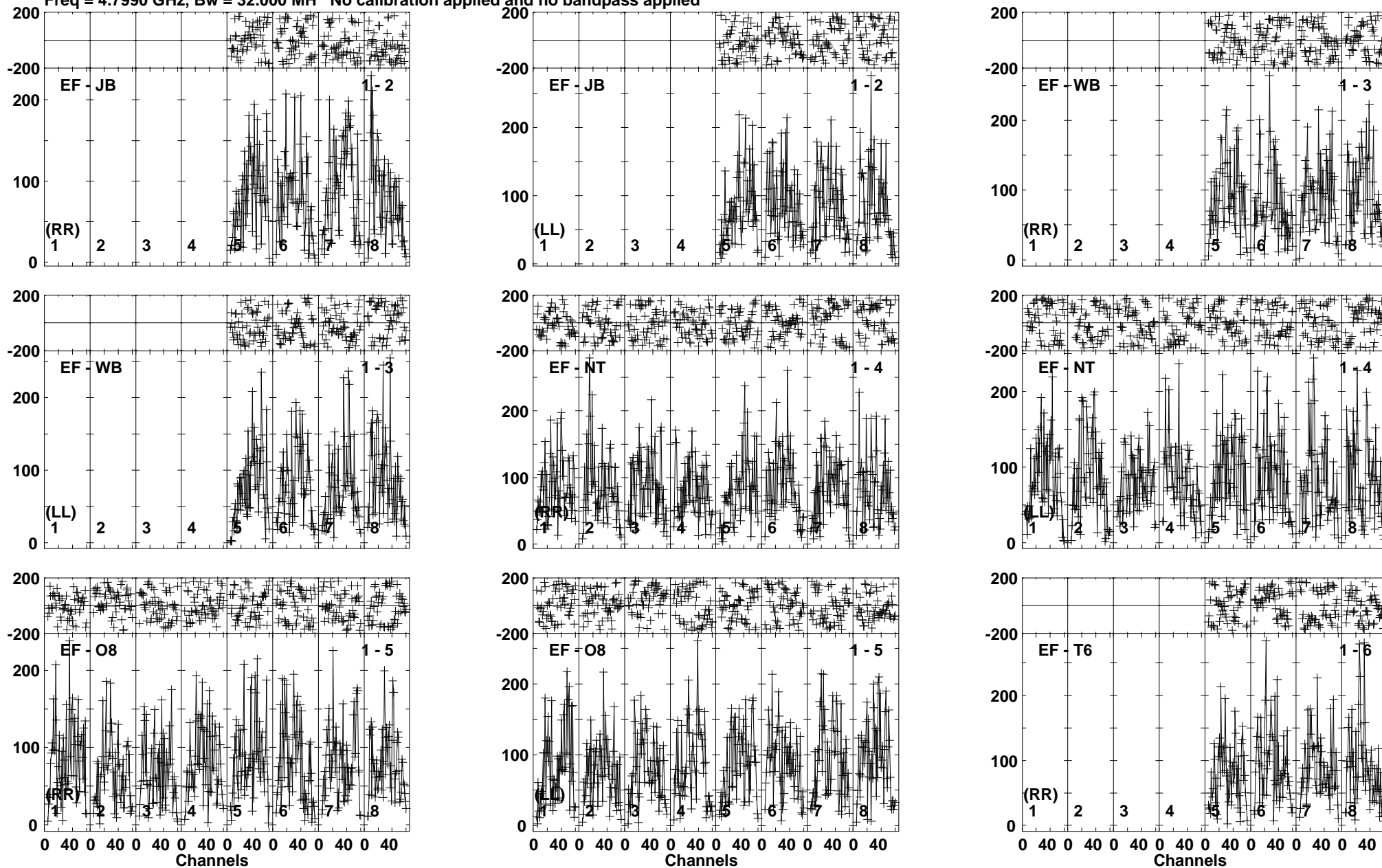

Lower frame: Micro Ampl Jy Top frame: Phas deg
Vector averaged cross-power spectrum Baseline: EF (01) - JB (02)
Timerange: 00:17:01:01 to 00:17:04:29

Plot file version 170 created 19-OCT-2017 15:36:17

ARK564 ES081C.UVDATA.1

Freq = 4.7990 GHz, Bw = 32.000 MH No calibration applied and no bandpass applied

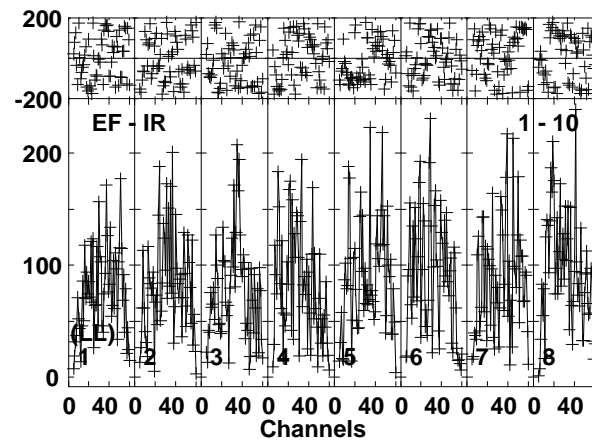
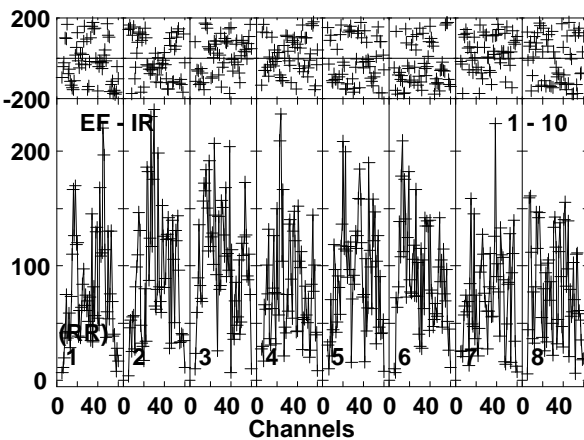
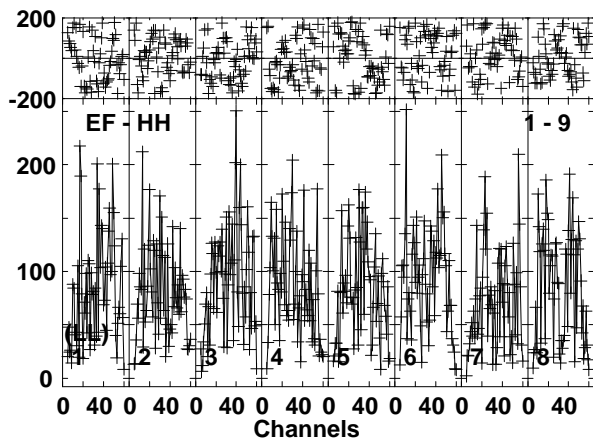
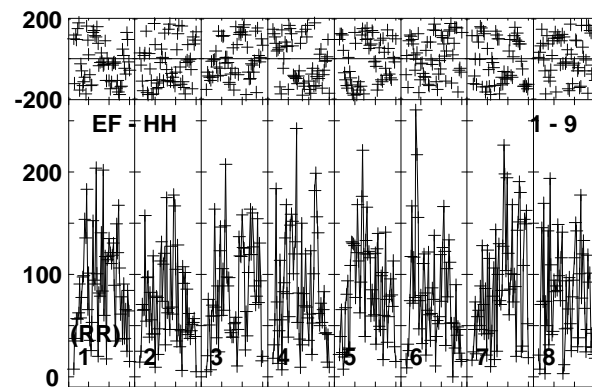
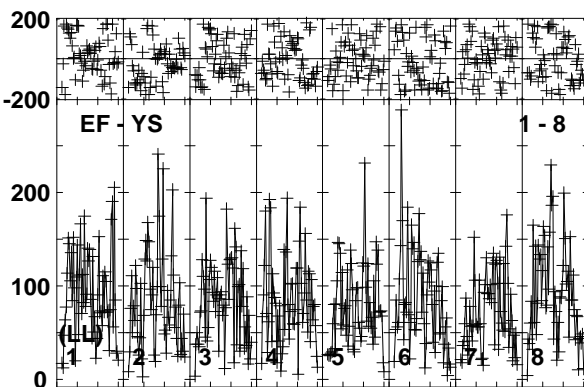
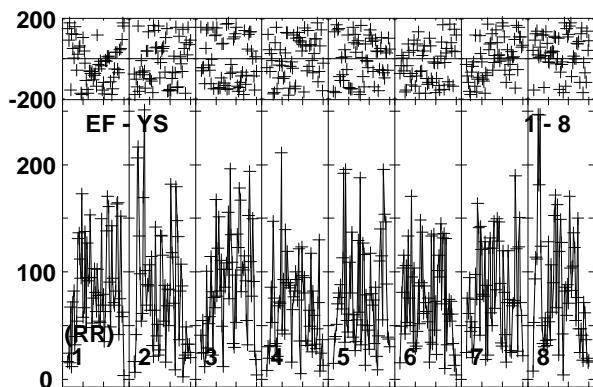
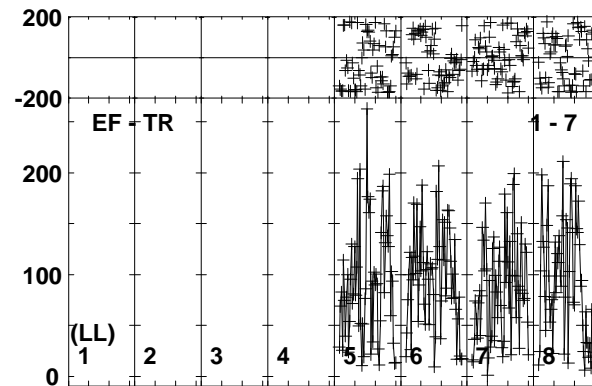
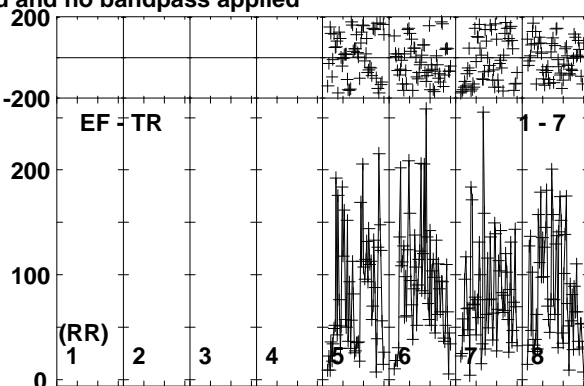
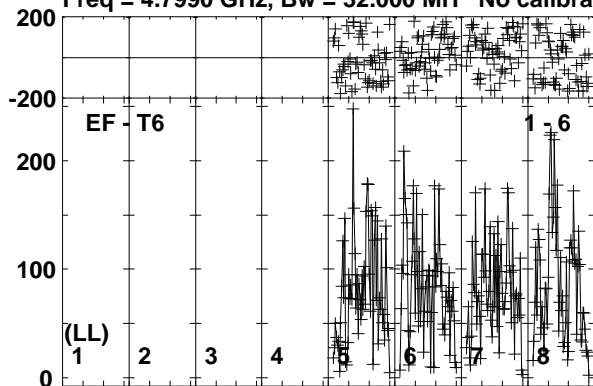

Lower frame: Micro Ampl Jy Top frame: Phas deg
Vector averaged cross-power spectrum Baseline: EF (01) - T6 (06)
Timerange: 00/17:01:01 to 00/17:04:29

Plot file version 171 created 19-OCT-2017 15:36:17

J2242+2955 ES081C.UVDATA.1

Freq = 4.7990 GHz, Bw = 32.000 MH No calibration applied and no bandpass applied

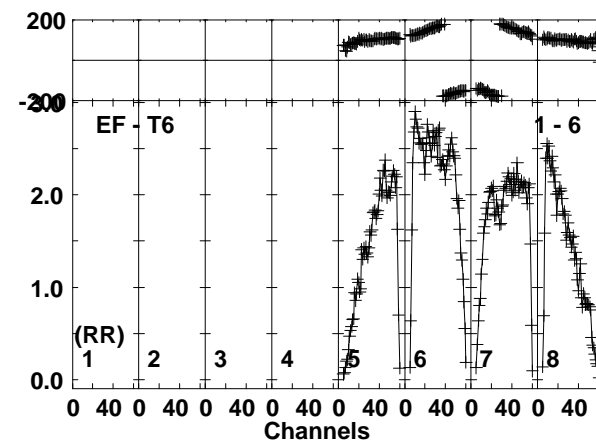
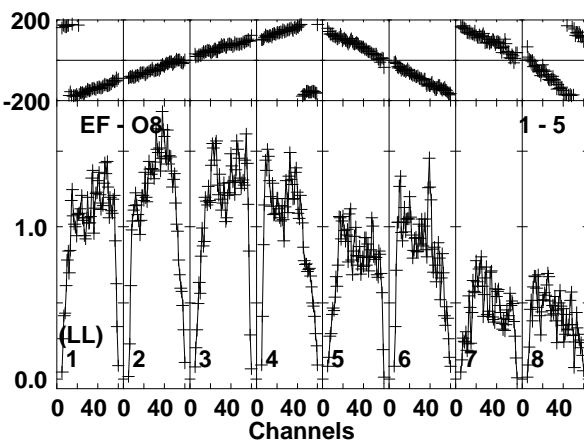
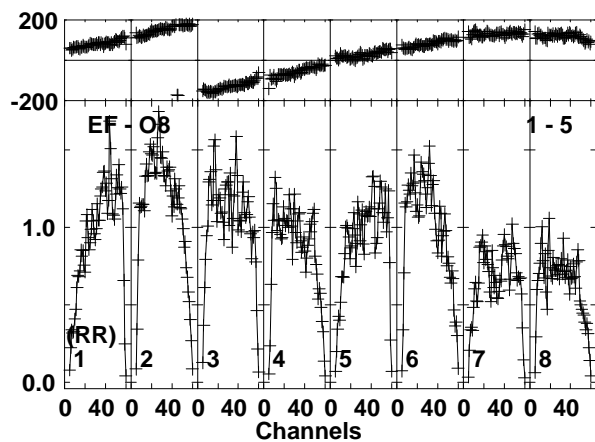
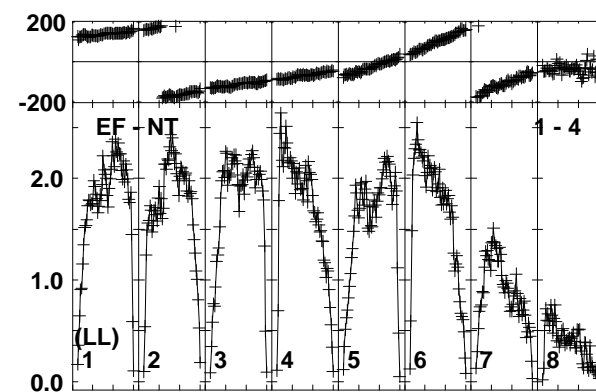
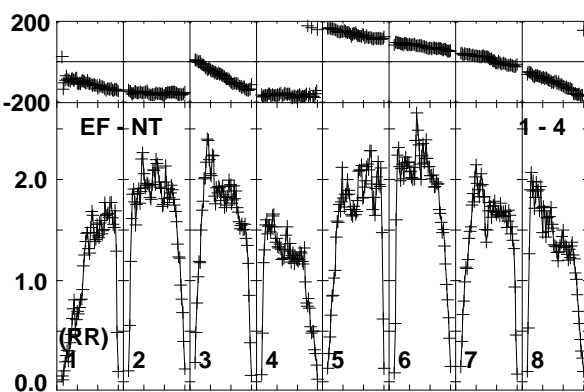
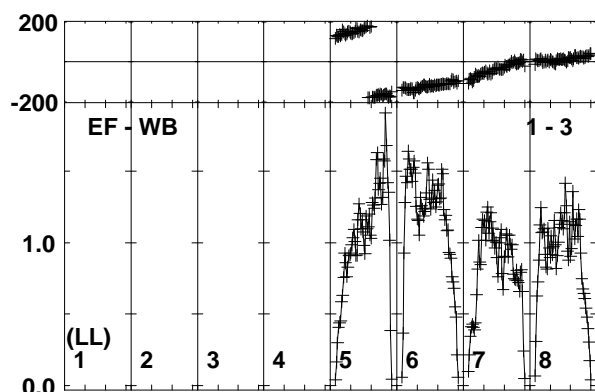
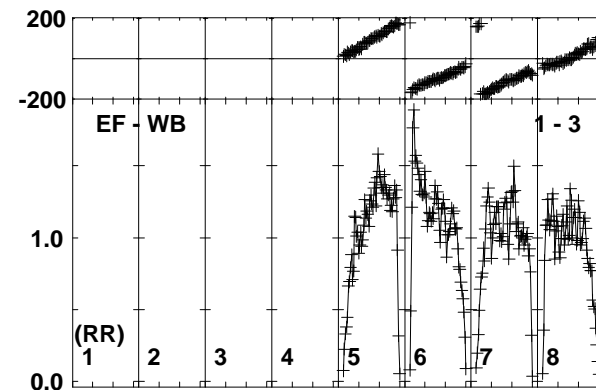
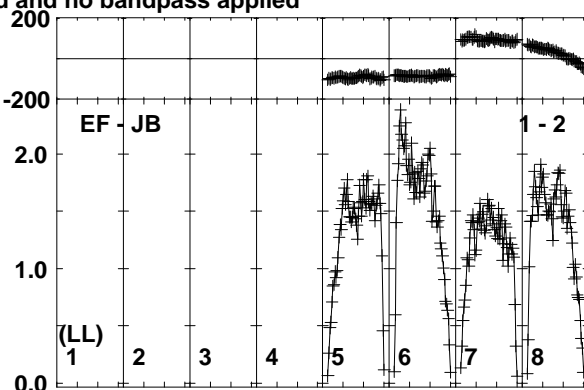
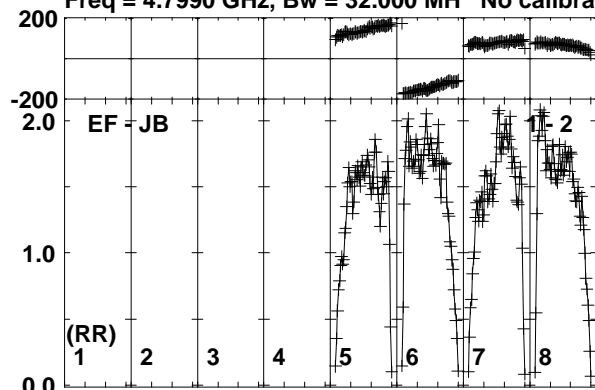

Lower frame: Milli Ampl Jy Top frame: Phas deg
Vector averaged cross-power spectrum Baseline: EF (01) - JB (02)
Timerange: 00:17:04:31 to 00:17:05:59

Plot file version 172 created 19-OCT-2017 15:36:17

J2242+2955 ES081C.UVDATA.1

Freq = 4.7990 GHz, Bw = 32.000 MH No calibration applied and no bandpass applied

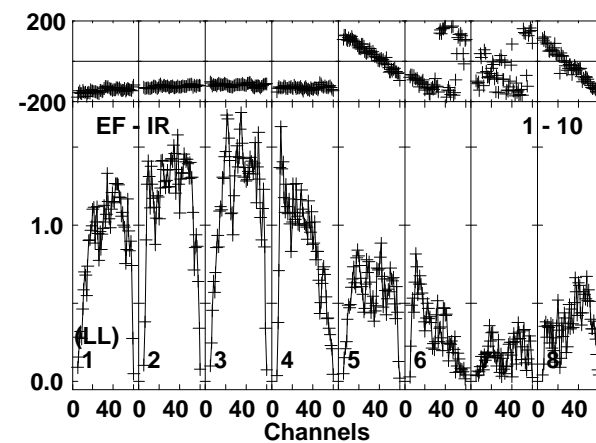
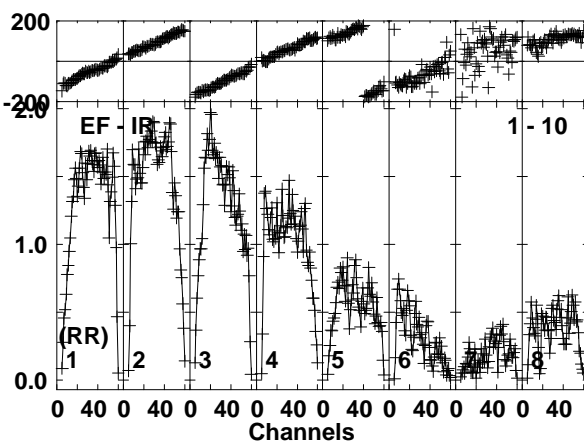
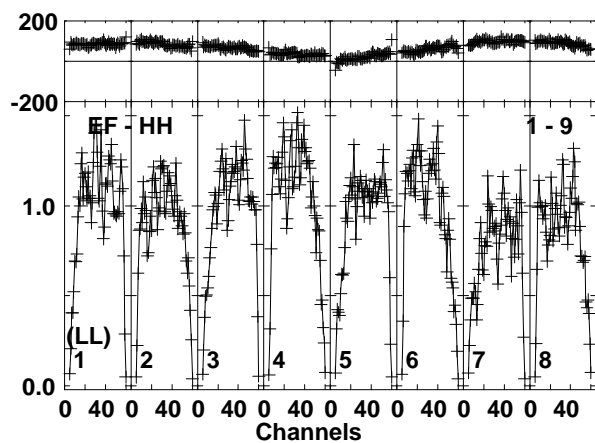
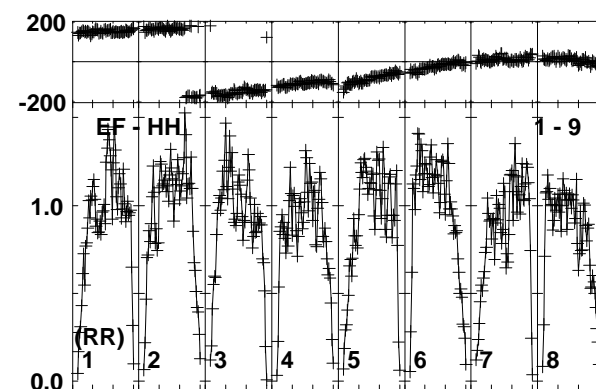
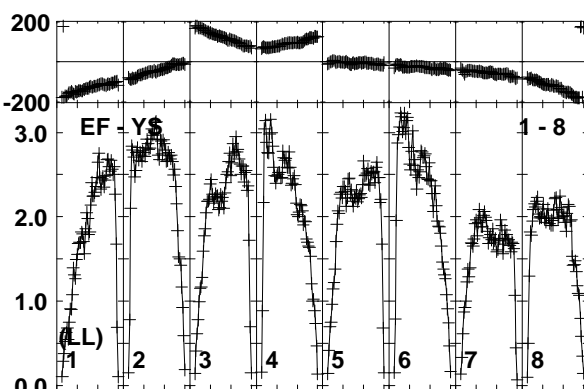
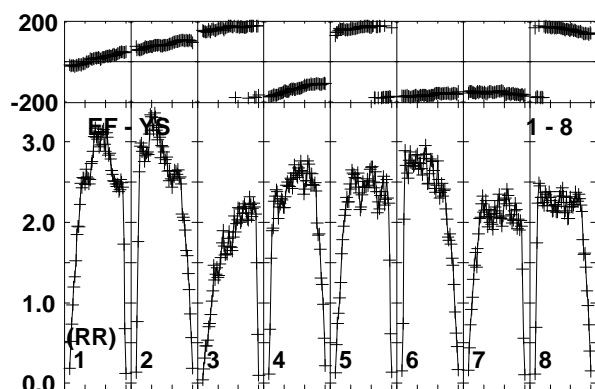
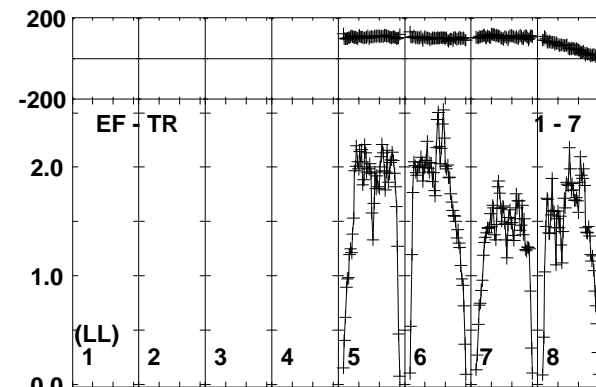
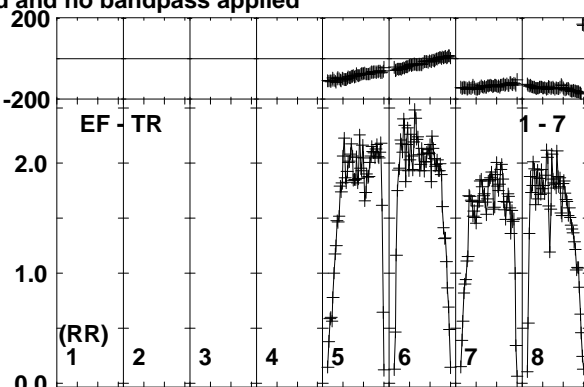
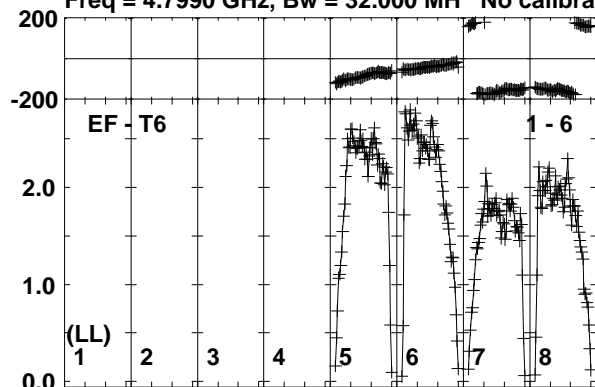

Lower frame: Milli Ampl Jy Top frame: Phas deg
Vector averaged cross-power spectrum Baseline: EF (01) - T6 (06)
Timerange: 00/17:04:31 to 00/17:05:59

Plot file version 173 created 19-OCT-2017 15:36:17

ARK564 ES081C.UVDATA.1

Freq = 4.7990 GHz, Bw = 32.000 MH No calibration applied and no bandpass applied

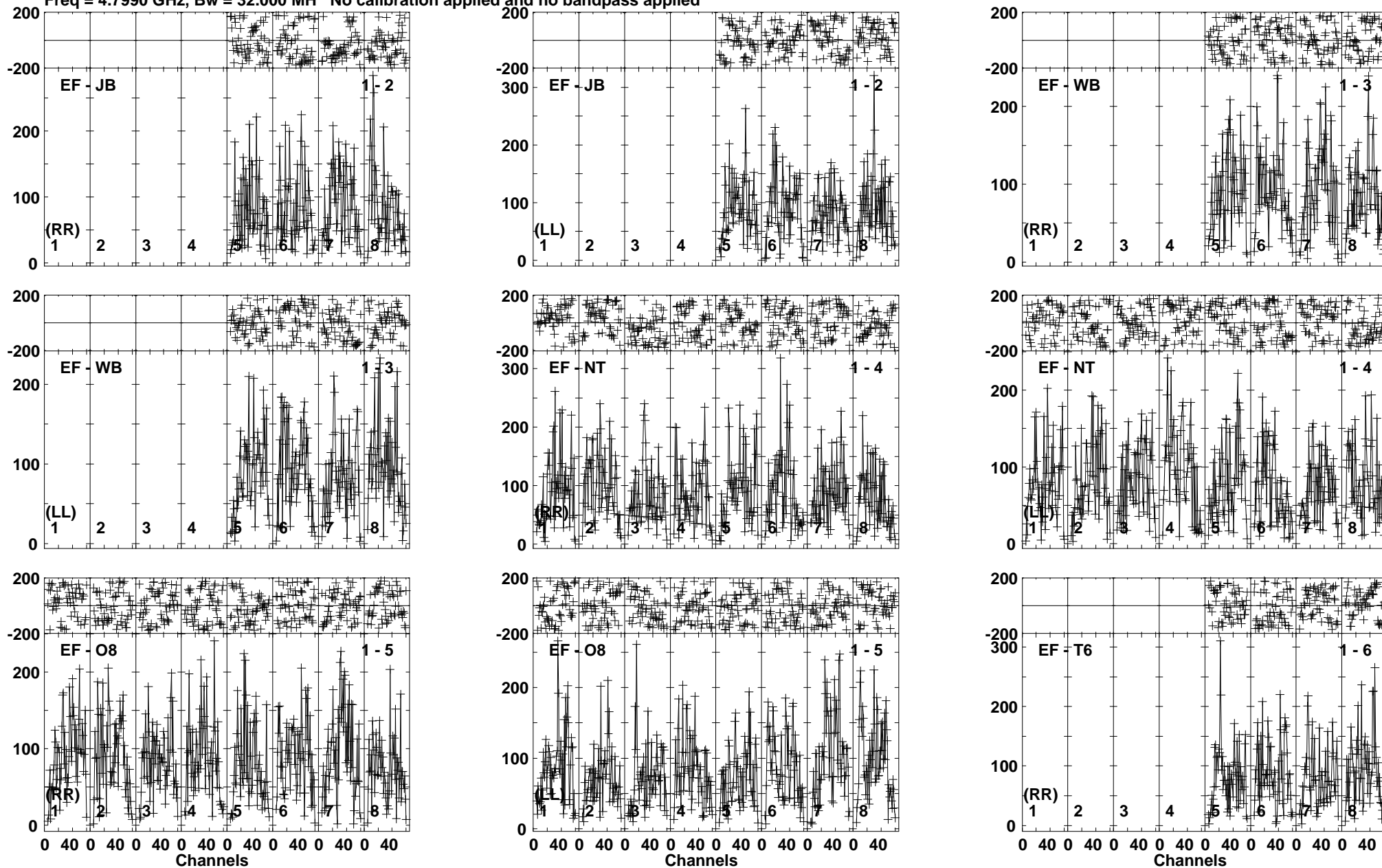

Lower frame: Micro Ampl Jy Top frame: Phas deg
Vector averaged cross-power spectrum Baseline: EF (01) - JB (02)
Timerange: 00/17:06:01 to 00/17:09:29

Plot file version 174 created 19-OCT-2017 15:36:18

ARK564 ES081C.UVDATA.1

Freq = 4.7990 GHz, Bw = 32.000 MH No calibration applied and no bandpass applied

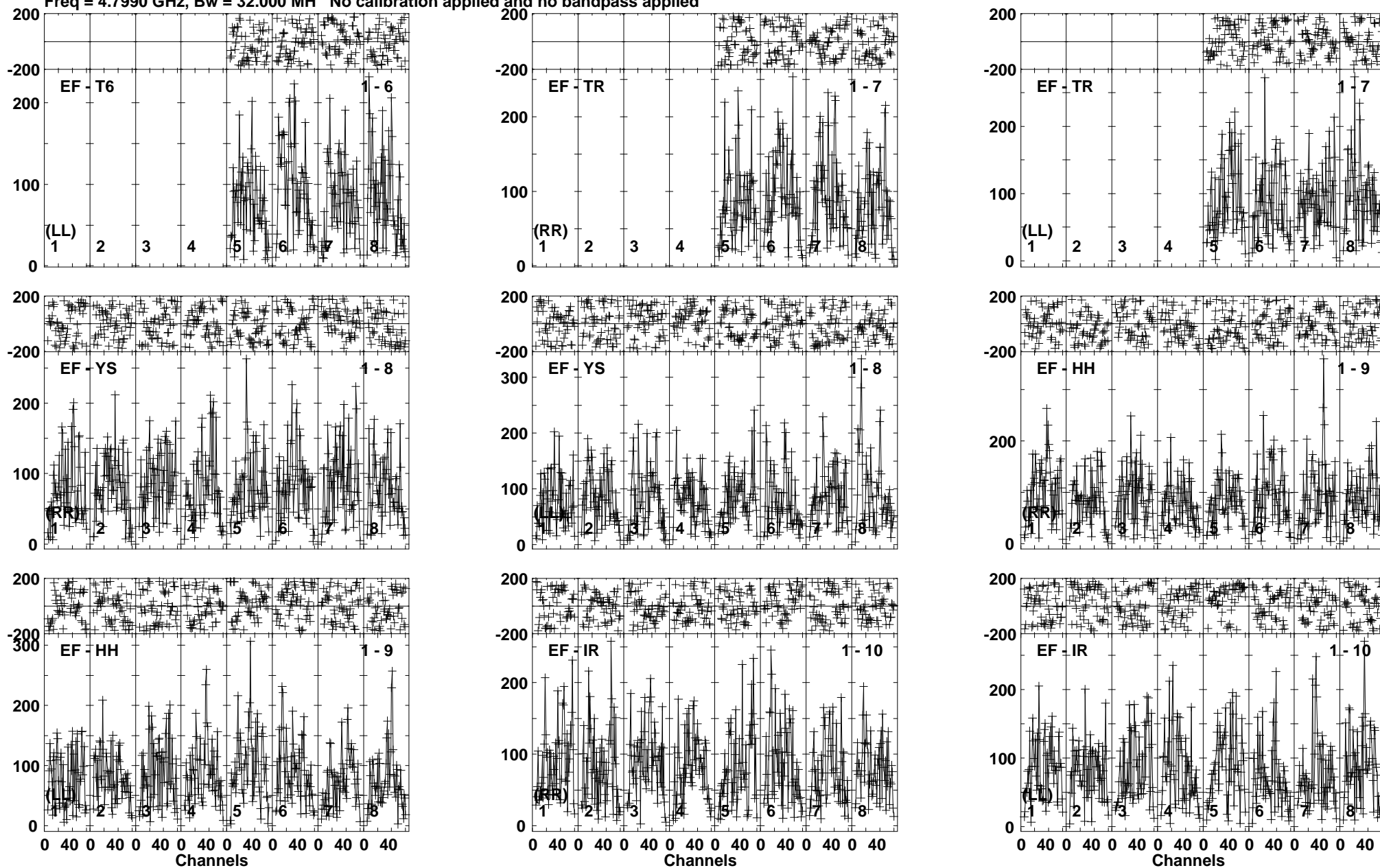

Lower frame: Micro Ampl Jy Top frame: Phas deg
Vector averaged cross-power spectrum Baseline: EF (01) - T6 (06)
Timerange: 00/17:06:01 to 00/17:09:29

Plot file version 175 created 19-OCT-2017 15:36:18

J2242+2955 ES081C.UVDATA.1

Freq = 4.7990 GHz, Bw = 32.000 MH No calibration applied and no bandpass applied

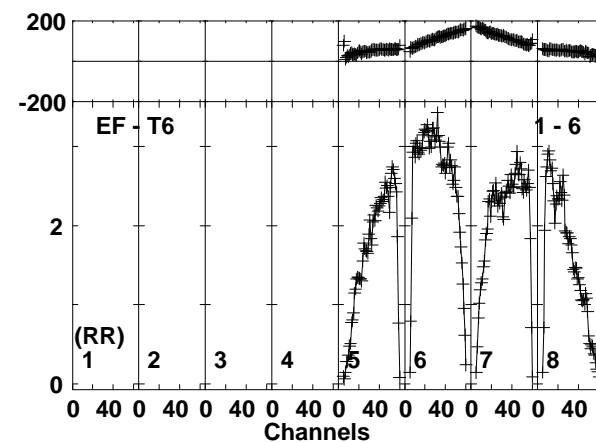
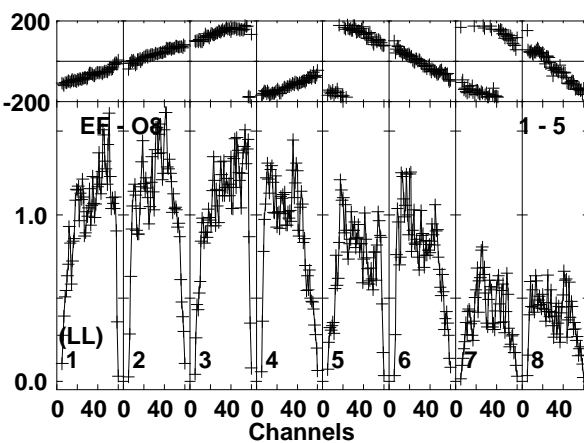
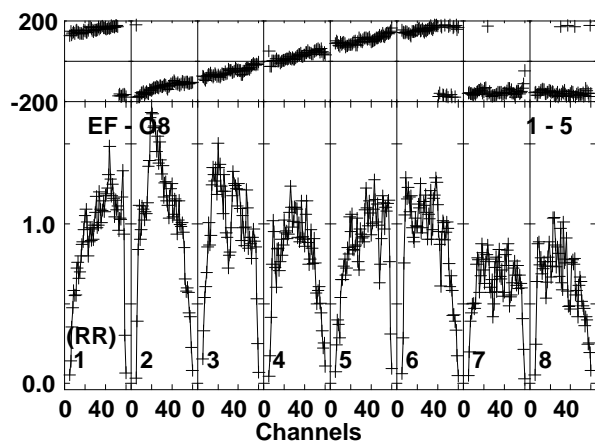
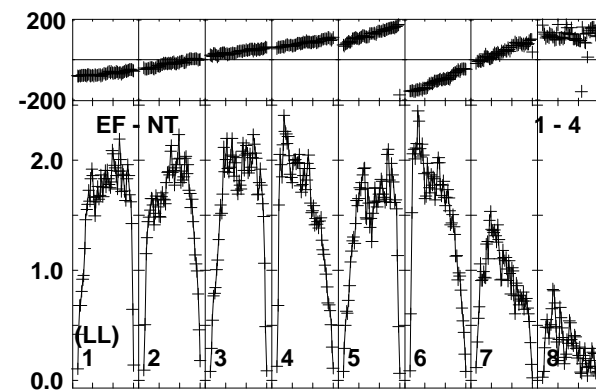
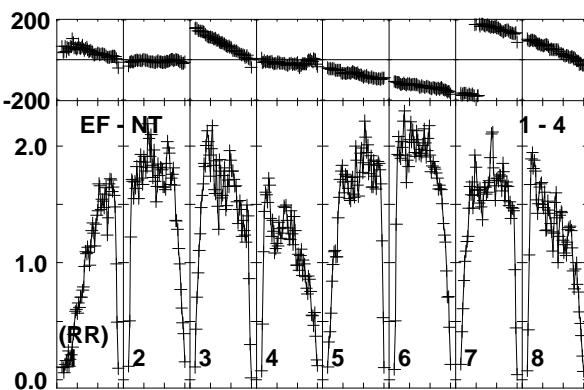
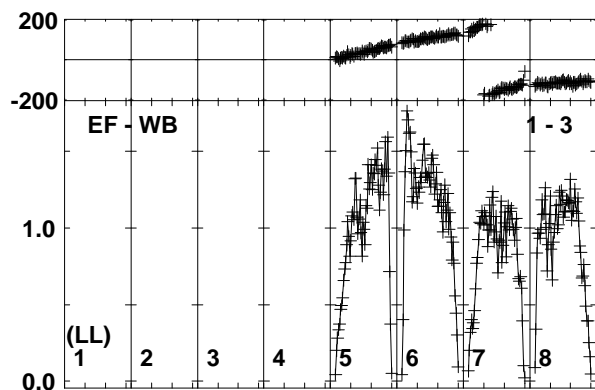
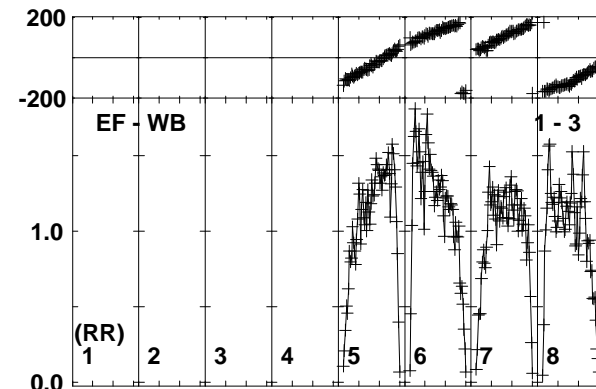
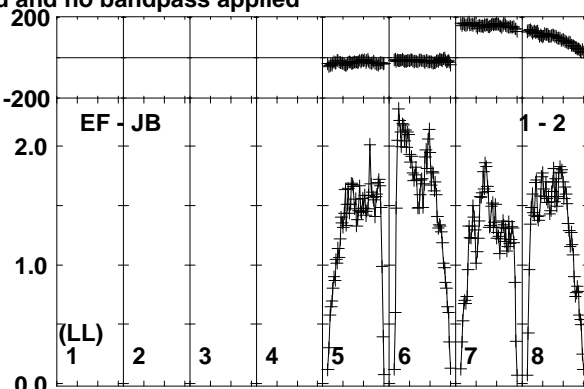
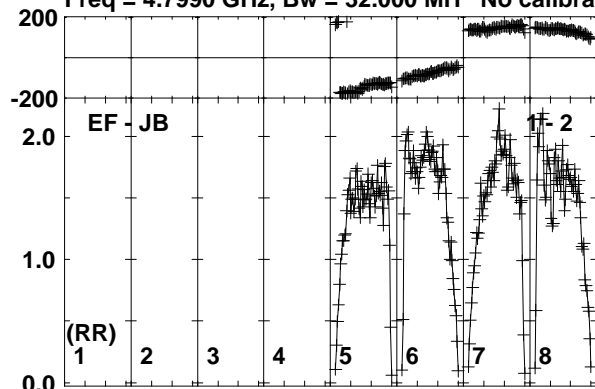

Lower frame: Milli Ampl Jy Top frame: Phas deg
Vector averaged cross-power spectrum Baseline: EF (01) - JB (02)
Timerange: 00/17:10:01 to 00/17:10:59

Plot file version 176 created 19-OCT-2017 15:36:18

J2242+2955 ES081C.UVDATA.1

Freq = 4.7990 GHz, Bw = 32.000 MH No calibration applied and no bandpass applied

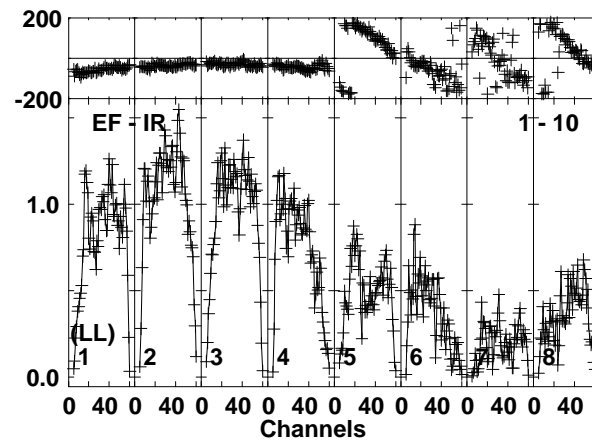
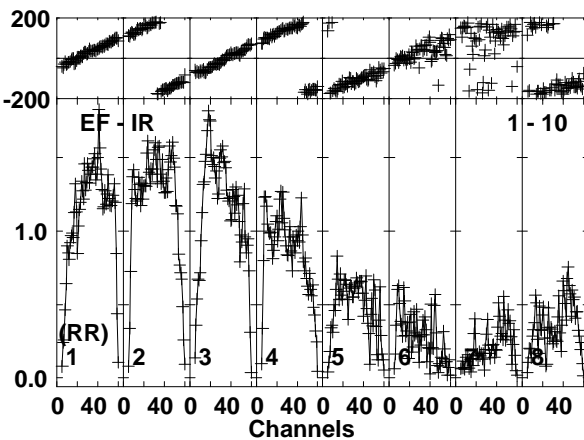
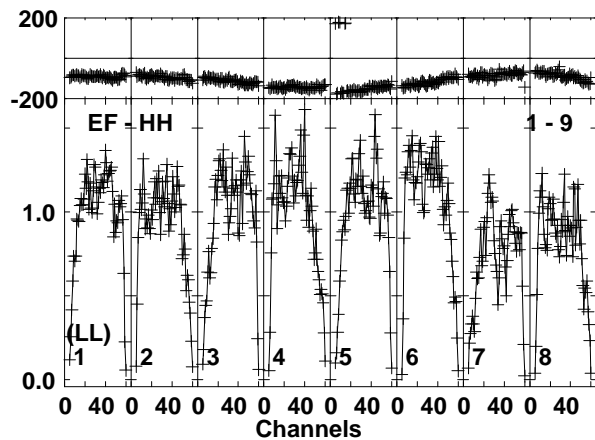
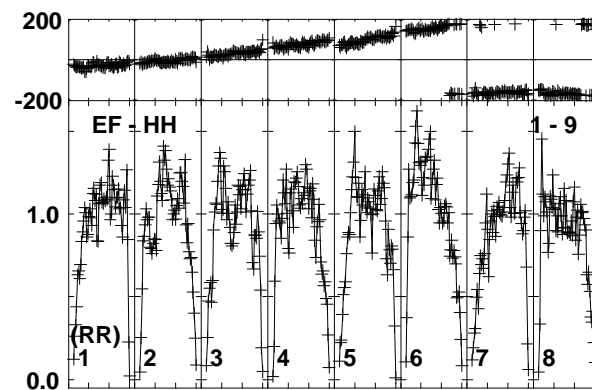
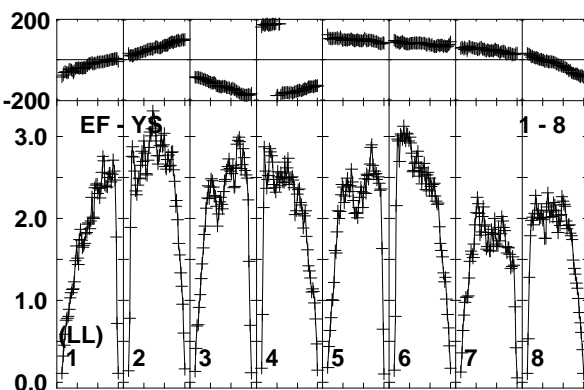
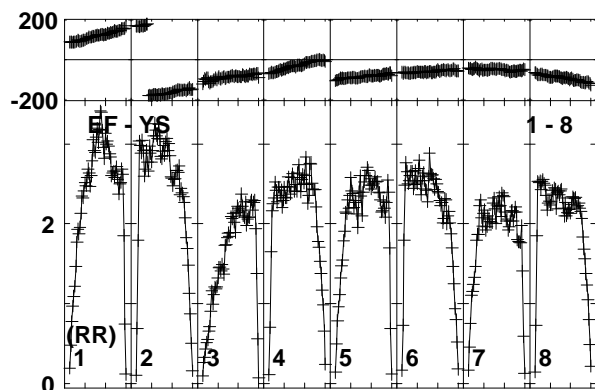
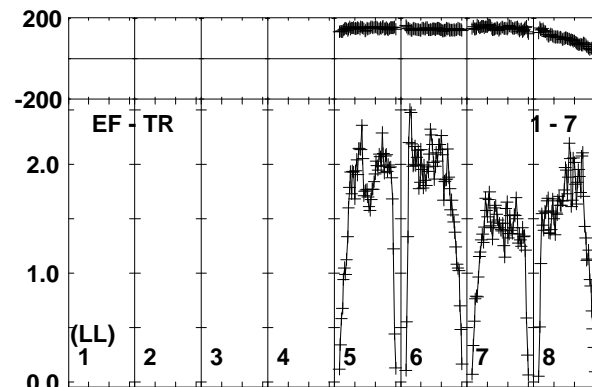
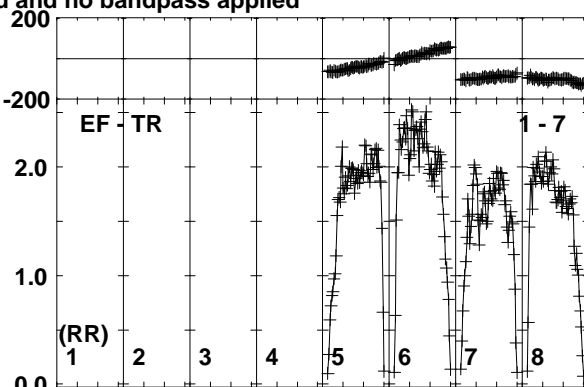
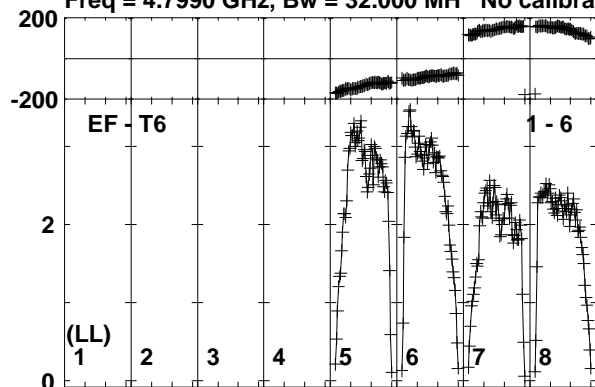

Lower frame: Milli Ampl Jy Top frame: Phas deg
Vector averaged cross-power spectrum Baseline: EF (01) - T6 (06)
Timerange: 00/17:10:01 to 00/17:10:59

Plot file version 177 created 19-OCT-2017 15:36:18

ARK564 ES081C.UVDATA.1

Freq = 4.7990 GHz, Bw = 32.000 MH No calibration applied and no bandpass applied

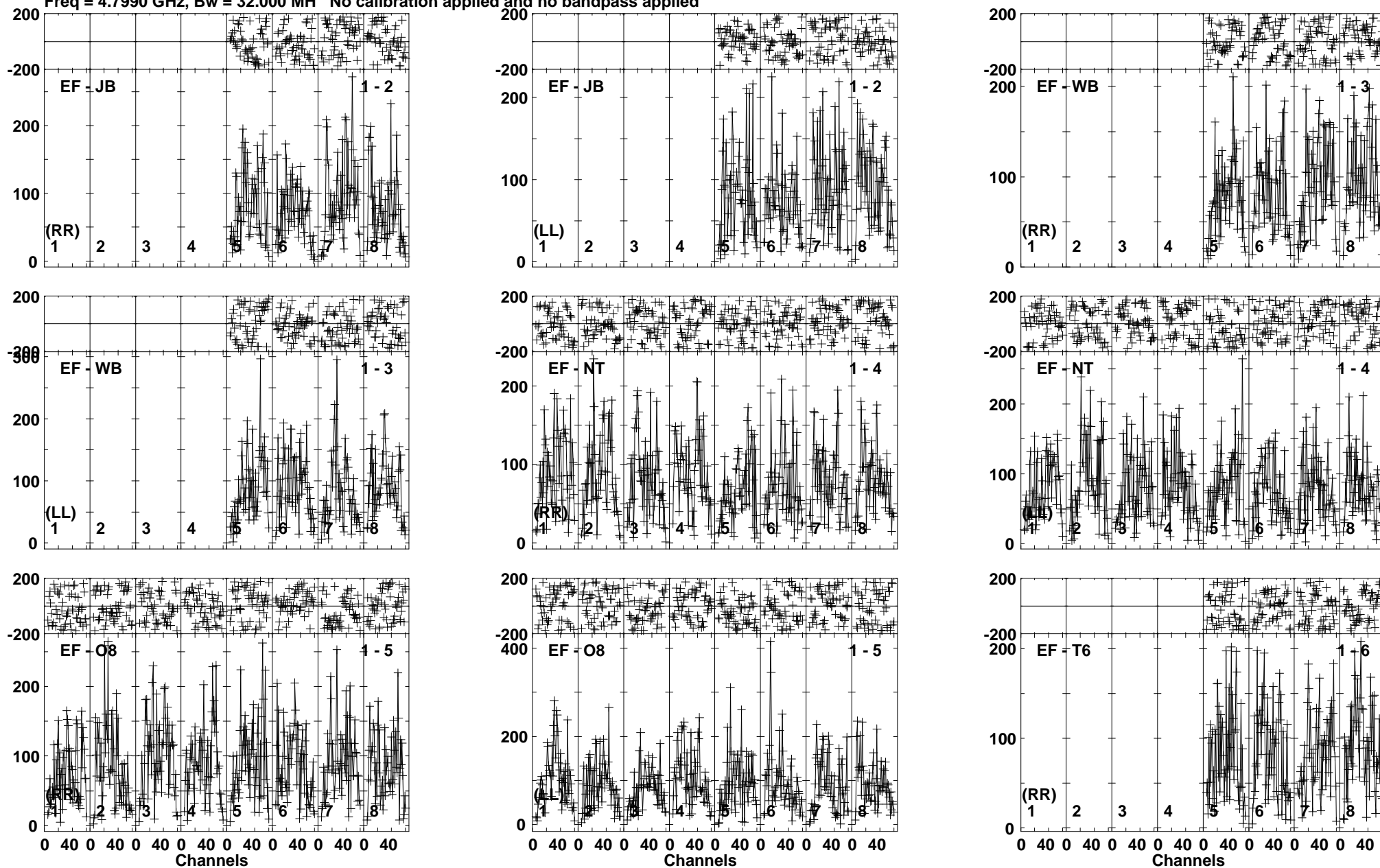

Lower frame: Micro Ampl Jy Top frame: Phas deg
Vector averaged cross-power spectrum Baseline: EF (01) - JB (02)
Timerange: 00/17:11:01 to 00/17:14:29

Plot file version 178 created 19-OCT-2017 15:36:18

ARK564 ES081C.UVDATA.1

Freq = 4.7990 GHz, Bw = 32.000 MH No calibration applied and no bandpass applied

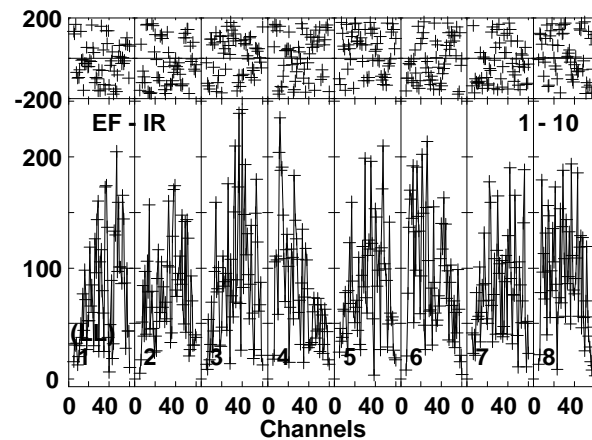
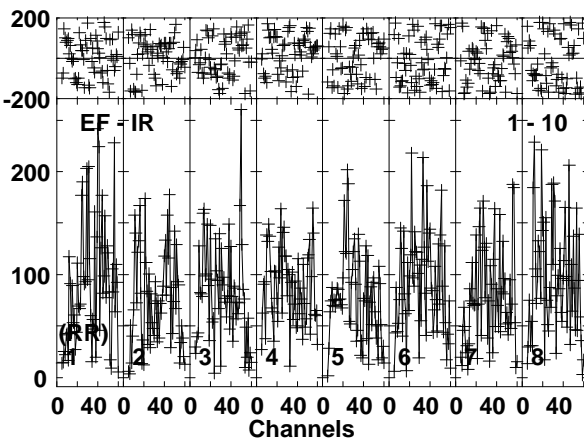
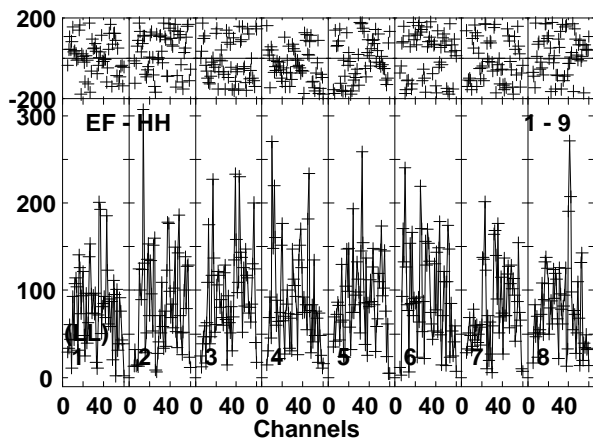
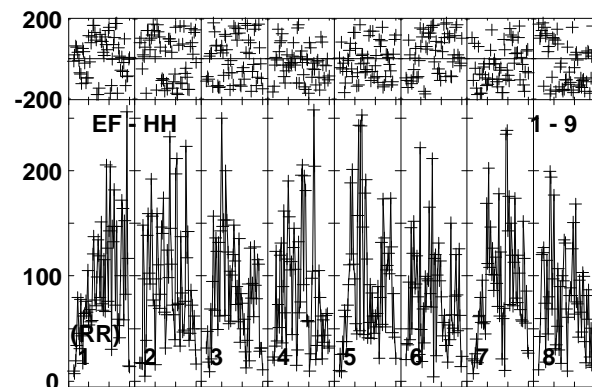
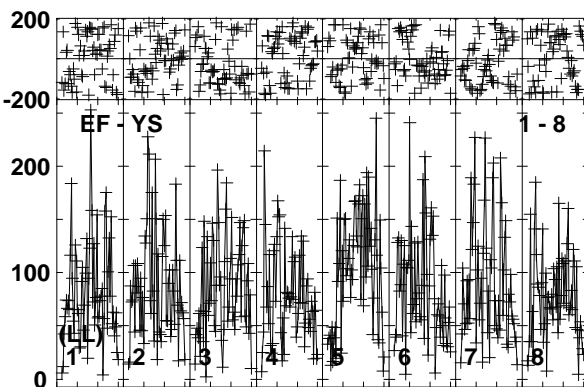
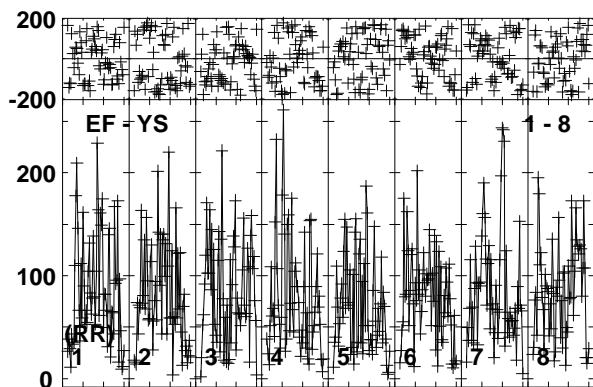
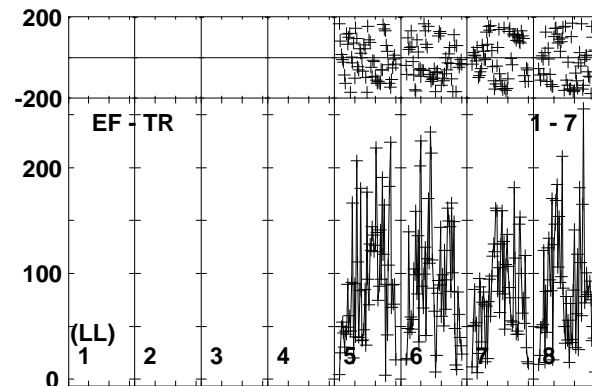
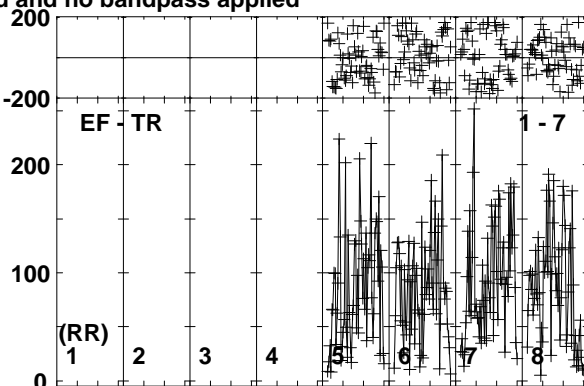
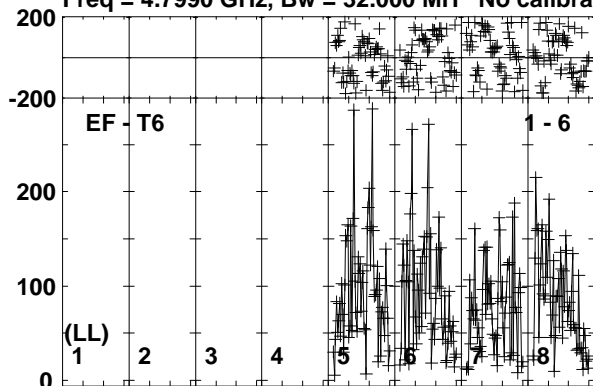

Lower frame: Micro Ampl Jy Top frame: Phas deg
Vector averaged cross-power spectrum Baseline: EF (01) - T6 (06)
Timerange: 00/17:11:01 to 00/17:14:29

Plot file version 179 created 19-OCT-2017 15:36:18

J2242+2955 ES081C.UVDATA.1

Freq = 4.7990 GHz, Bw = 32.000 MH No calibration applied and no bandpass applied

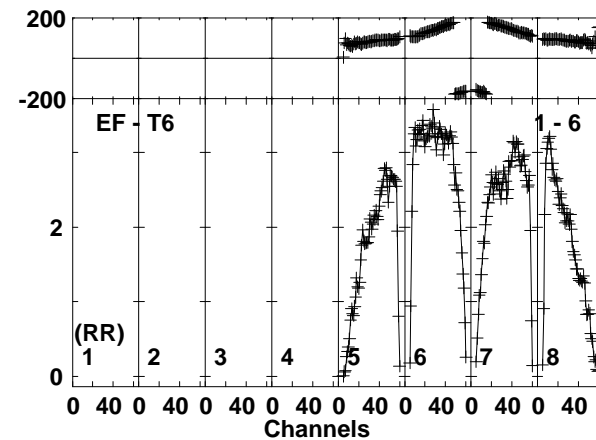
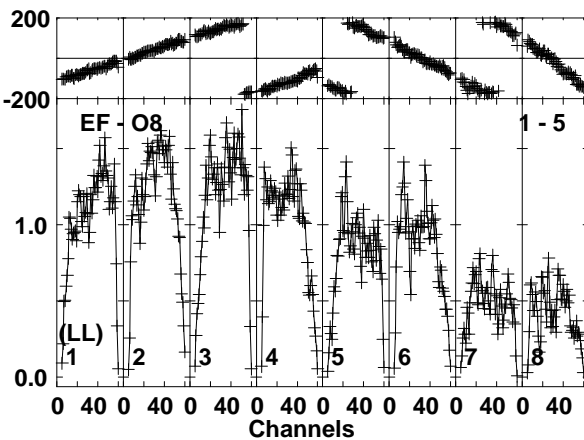
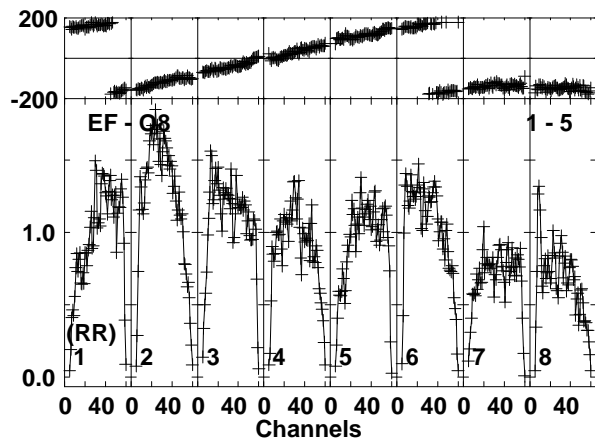
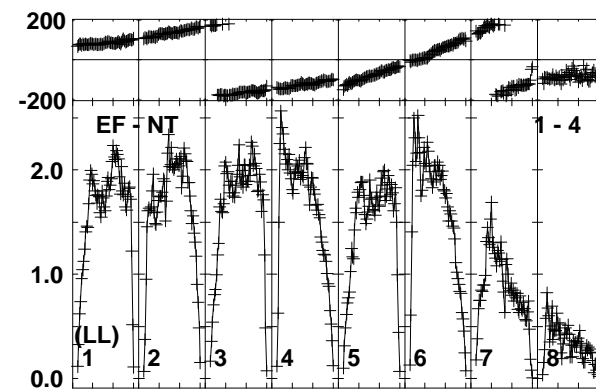
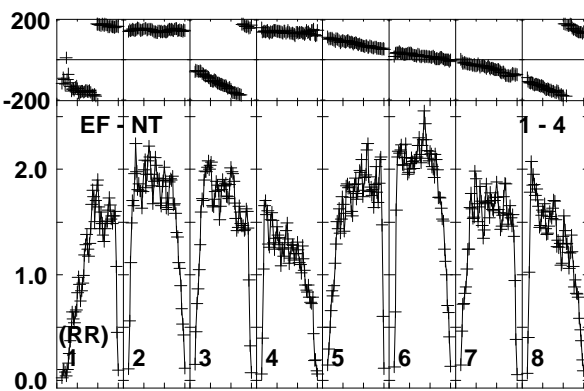
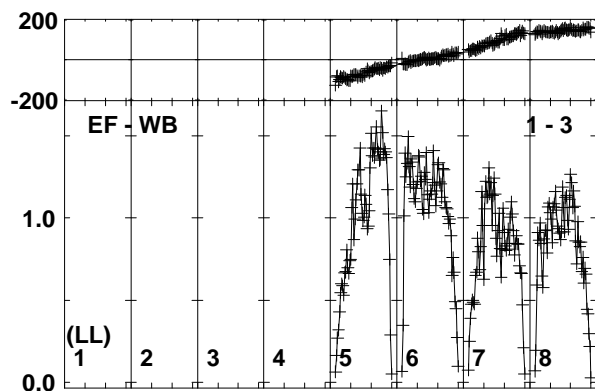
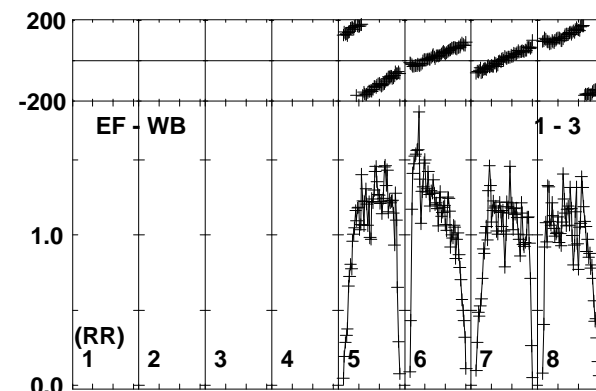
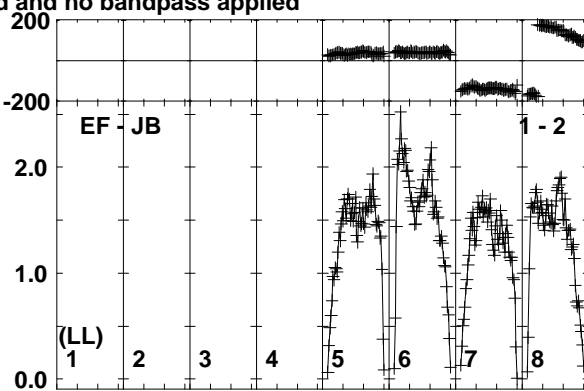
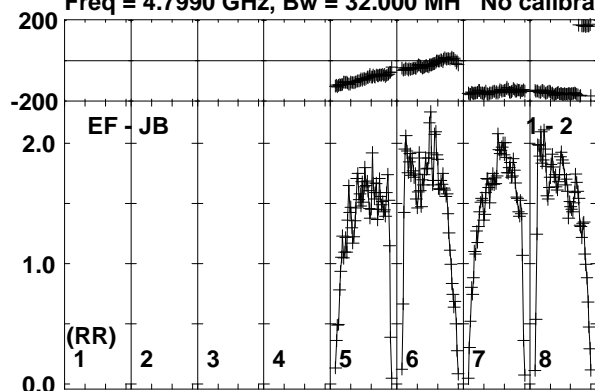

Lower frame: Milli Ampl Jy Top frame: Phas deg
Vector averaged cross-power spectrum Baseline: EF (01) - JB (02)
Timerange: 00/17:14:31 to 00/17:15:59

Plot file version 180 created 19-OCT-2017 15:36:19

J2242+2955 ES081C.UVDATA.1

Freq = 4.7990 GHz, Bw = 32.000 MH No calibration applied and no bandpass applied

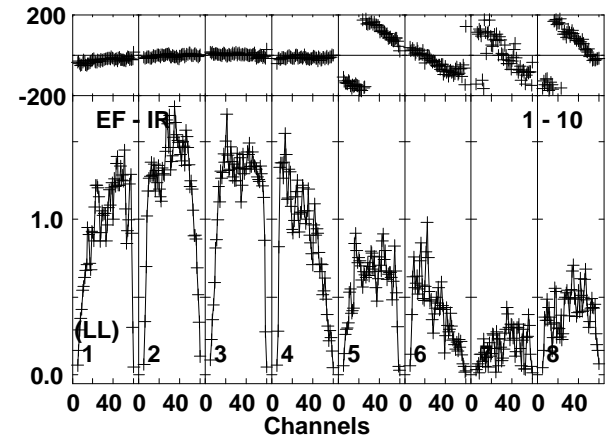
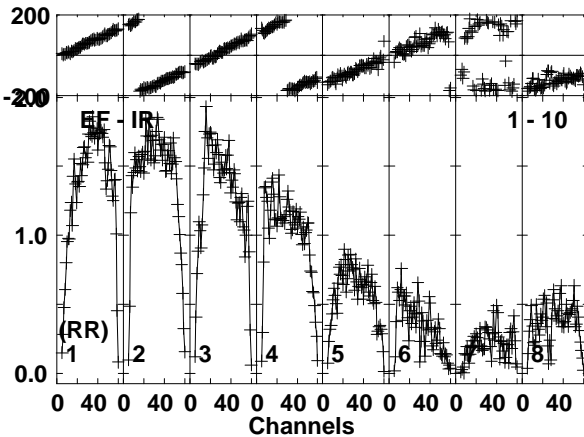
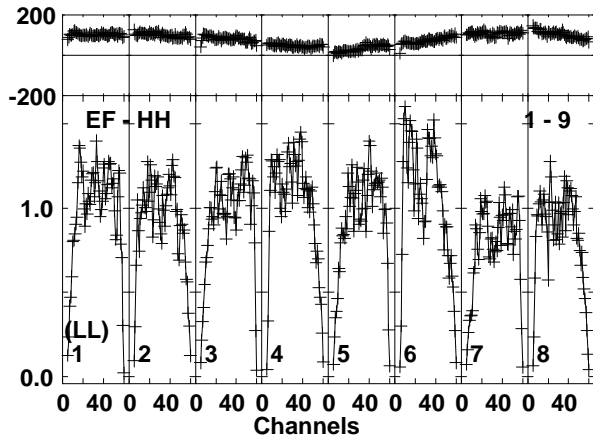
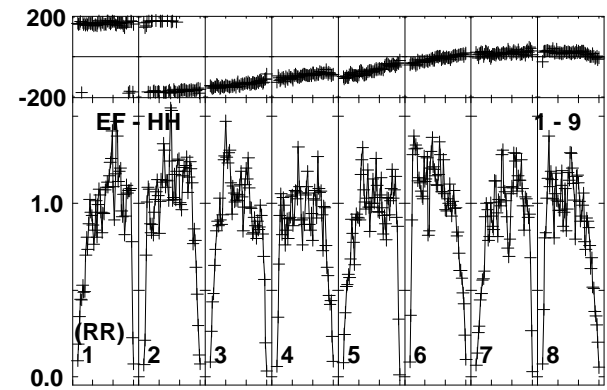
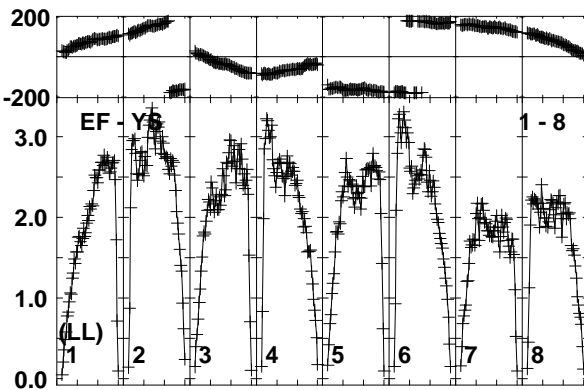
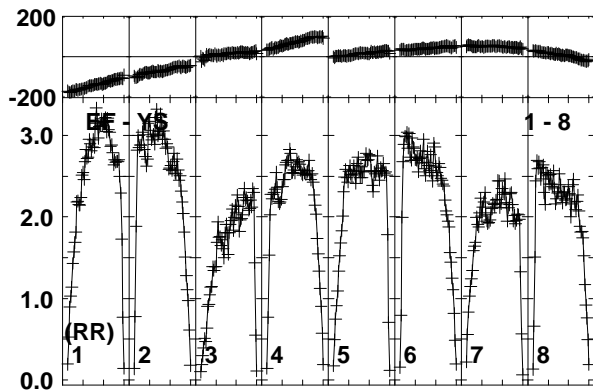
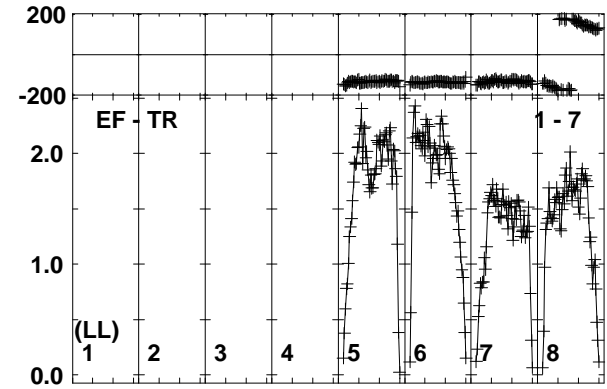
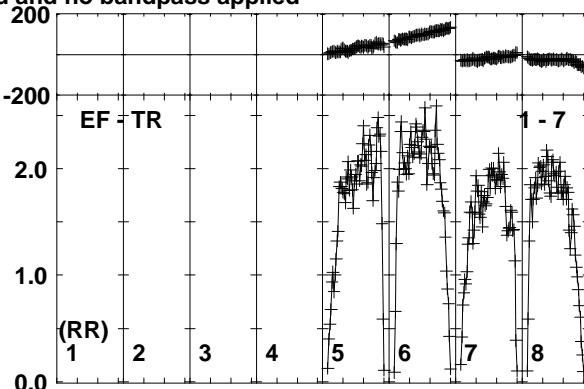
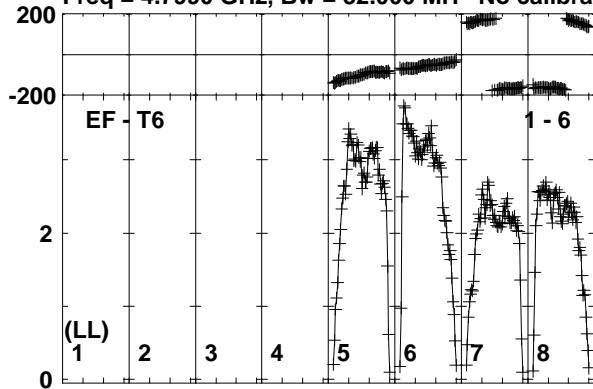

Lower frame: Milli Ampl Jy Top frame: Phas deg
Vector averaged cross-power spectrum Baseline: EF (01) - T6 (06)
Timerange: 00:17:14:31 to 00:17:15:59

Plot file version 181 created 19-OCT-2017 15:36:19

ARK564 ES081C.UVDATA.1

Freq = 4.7990 GHz, Bw = 32.000 MH No calibration applied and no bandpass applied

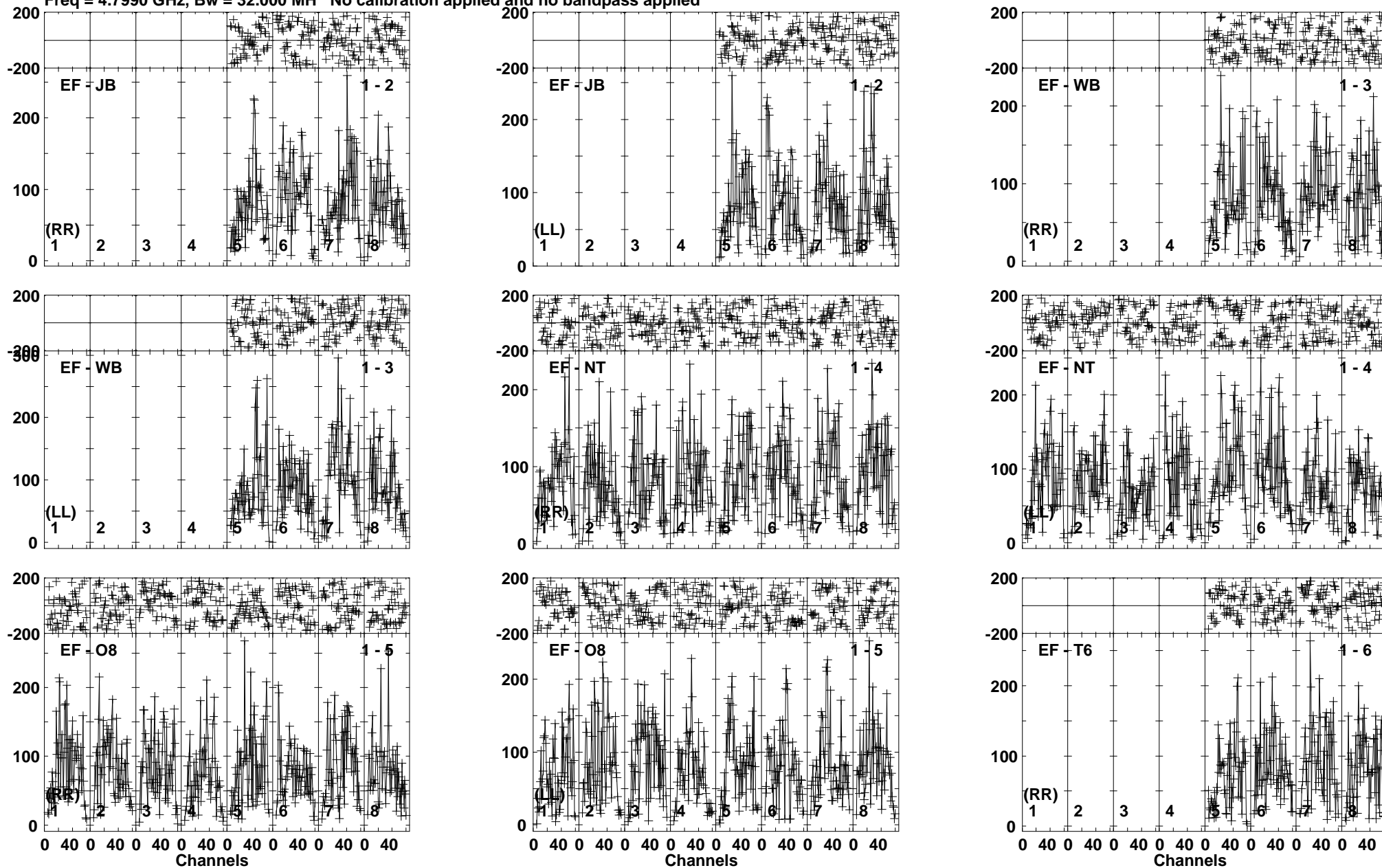

Lower frame: Micro Ampl Jy Top frame: Phas deg
Vector averaged cross-power spectrum Baseline: EF (01) - JB (02)
Timerange: 00/17:16:01 to 00/17:19:29

Plot file version 182 created 19-OCT-2017 15:36:19
ARK564 ES081C.UVDATA.1

Freq = 4.7990 GHz, Bw = 32.000 MH No calibration applied and no bandpass applied

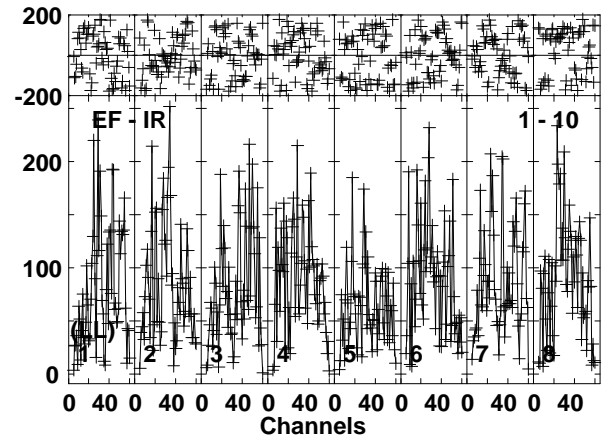
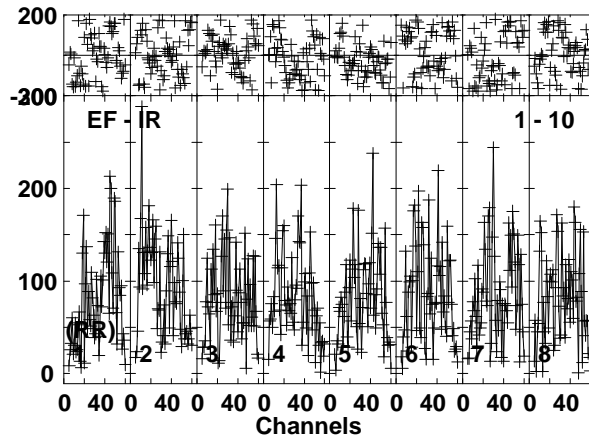
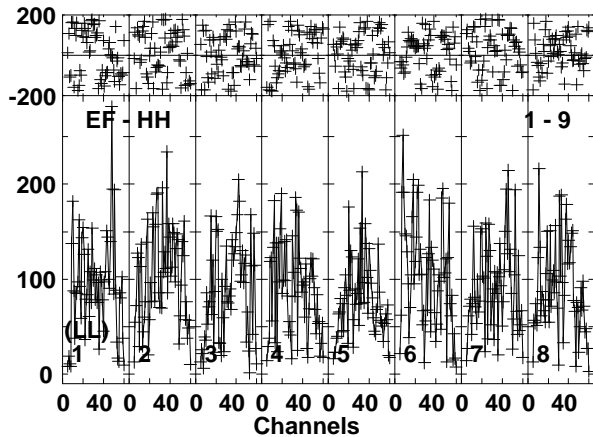
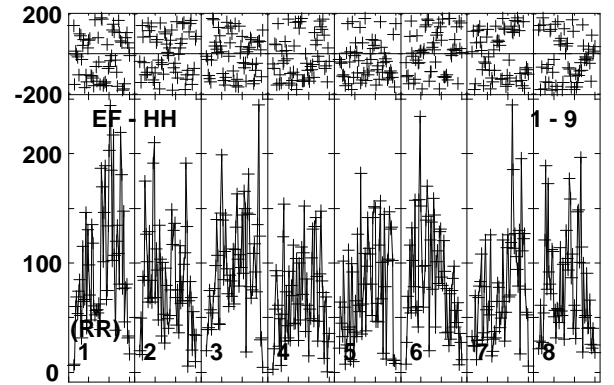
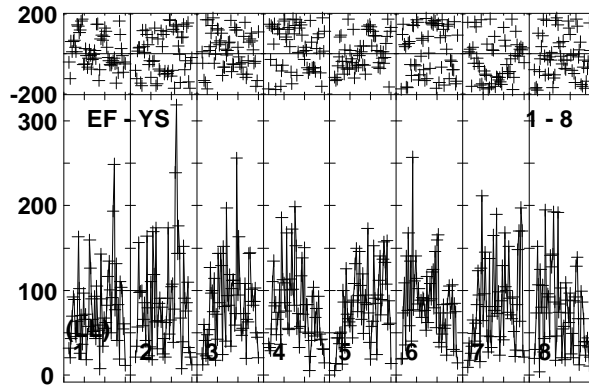
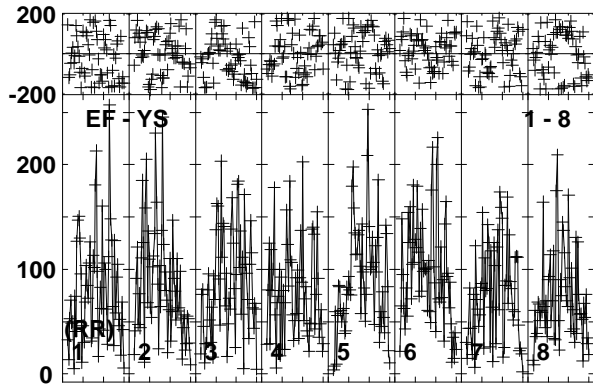
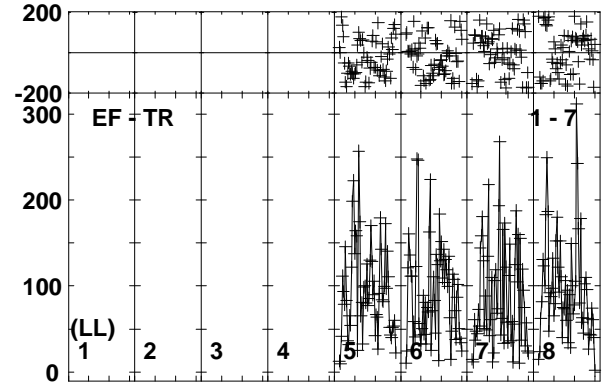
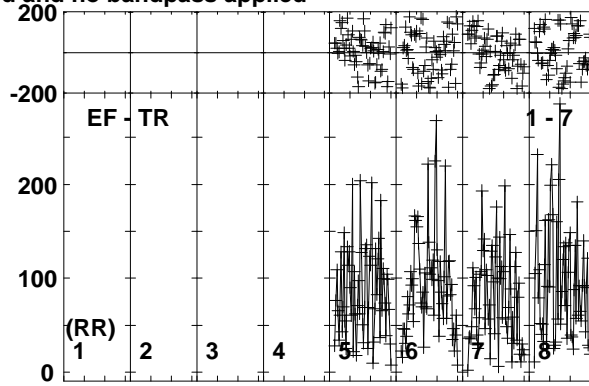
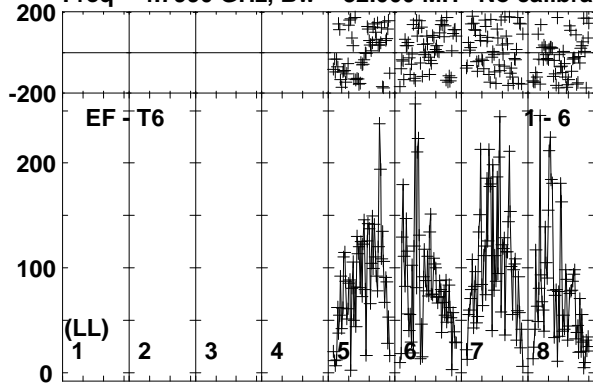

Lower frame: Micro Ampl Jy Top frame: Phas deg
Vector averaged cross-power spectrum Baseline: EF (01) - T6 (06)
Timerange: 00/17:16:01 to 00/17:19:29

Plot file version 183 created 19-OCT-2017 15:36:19

J2242+2955 ES081C.UVDATA.1

Freq = 4.7990 GHz, Bw = 32.000 MH No calibration applied and no bandpass applied

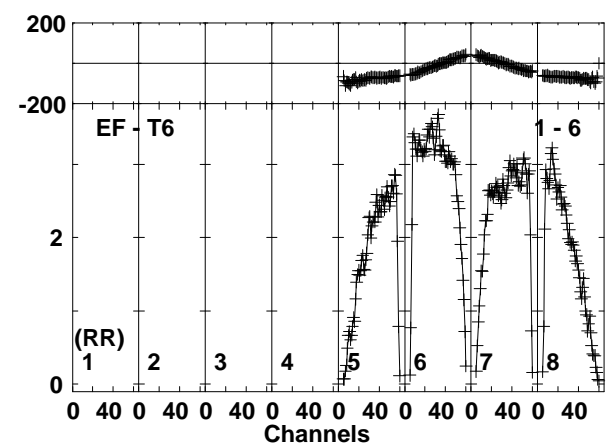
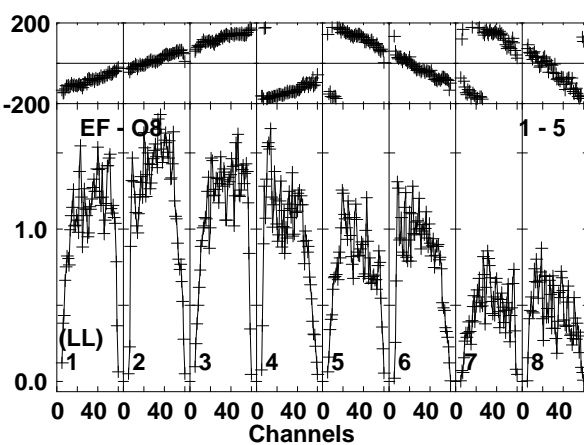
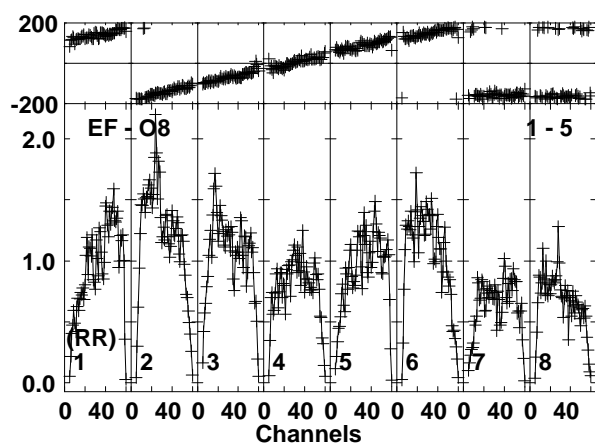
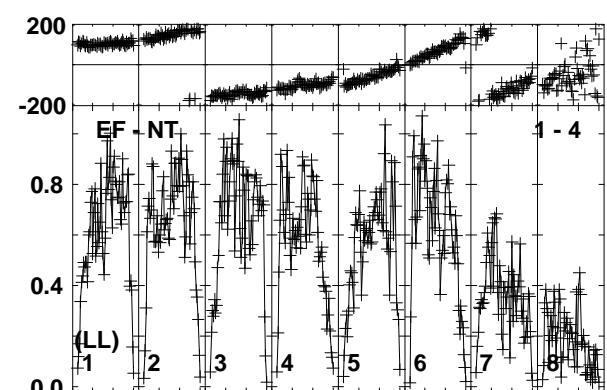
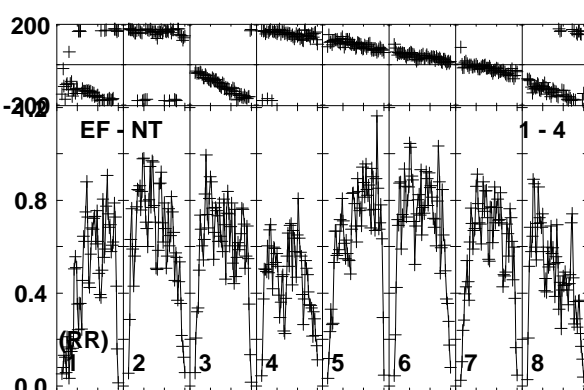
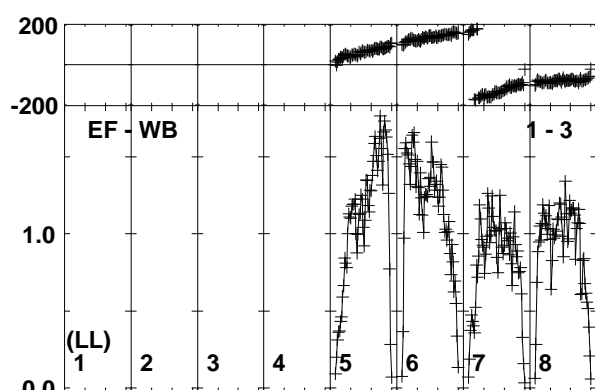
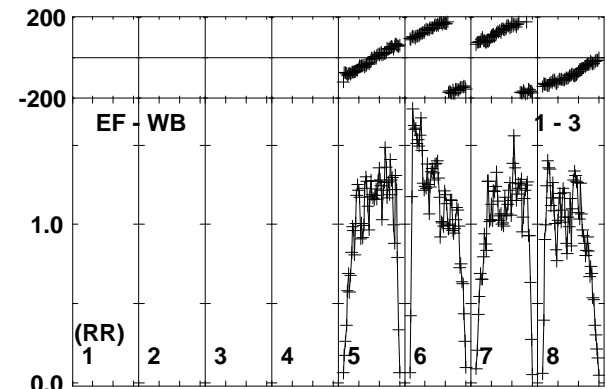
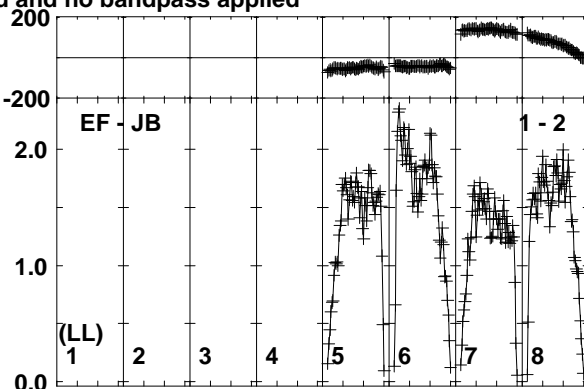
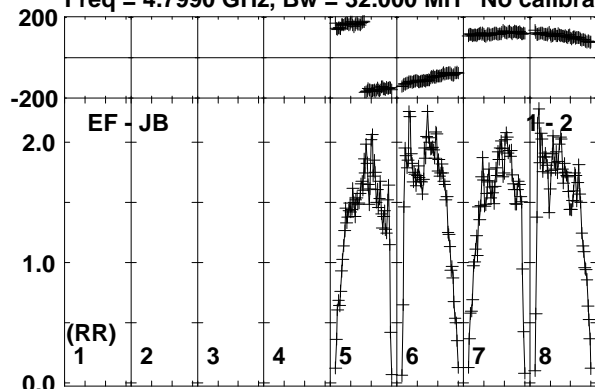

Lower frame: Milli Ampl Jy Top frame: Phas deg
Vector averaged cross-power spectrum Baseline: EF (01) - JB (02)
Timerange: 00/17:20:01 to 00/17:20:59

Plot file version 184 created 19-OCT-2017 15:36:19

J2242+2955 ES081C.UVDATA.1

Freq = 4.7990 GHz, Bw = 32.000 MH No calibration applied and no bandpass applied

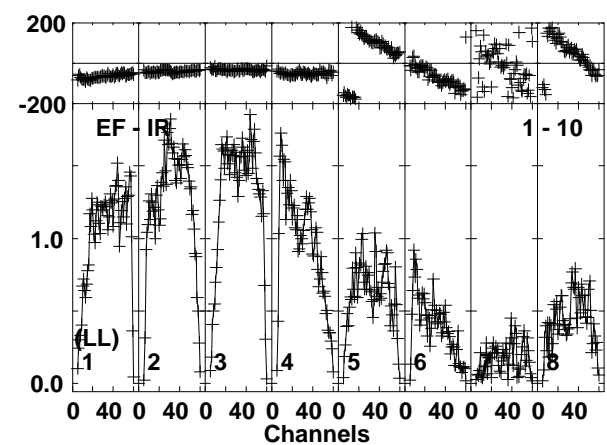
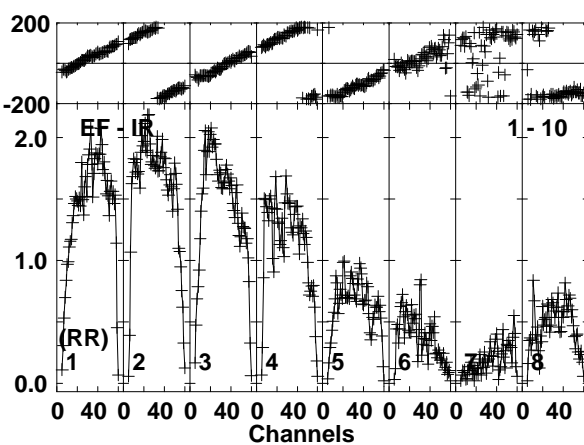
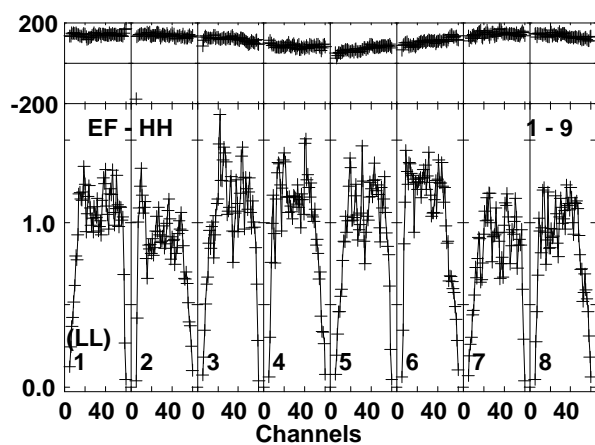
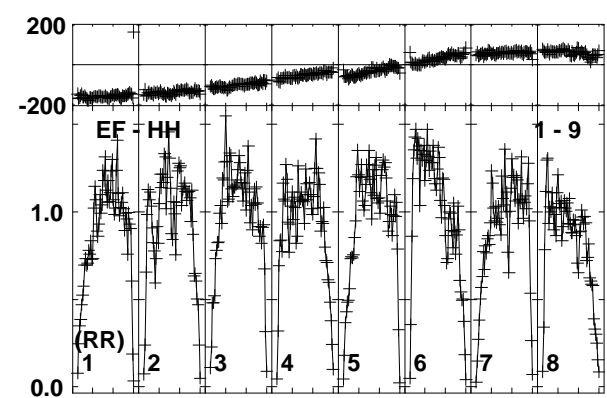
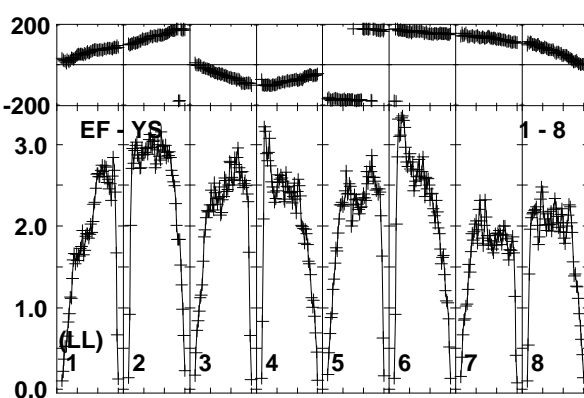
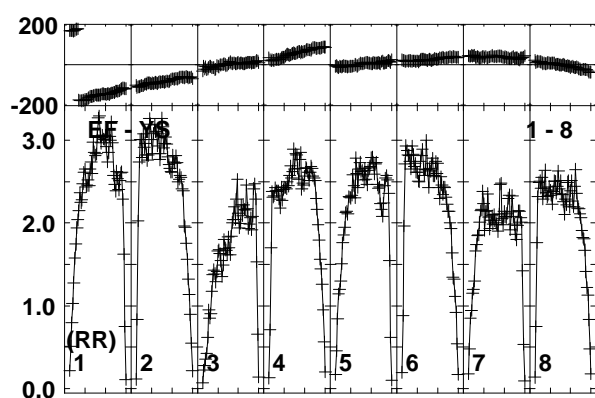
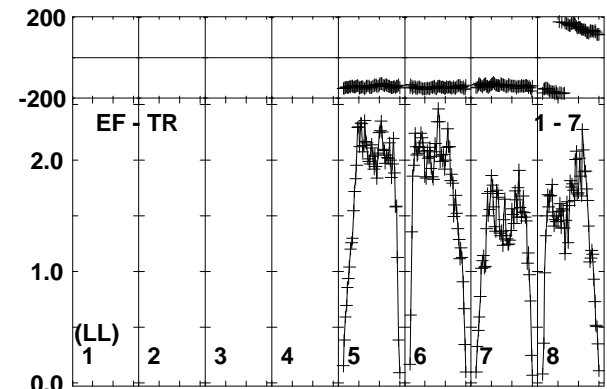
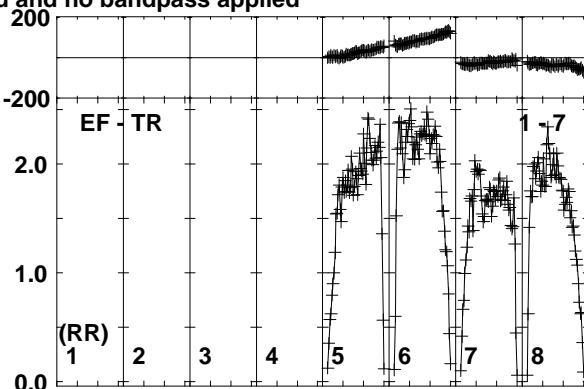
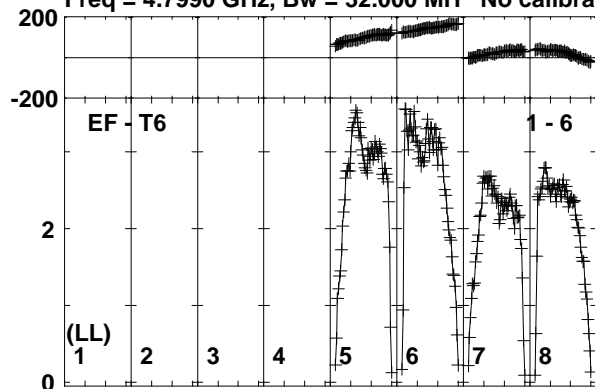

Lower frame: Milli Ampl Jy Top frame: Phas deg
Vector averaged cross-power spectrum Baseline: EF (01) - T6 (06)
Timerange: 00/17:20:01 to 00/17:20:59

Plot file version 185 created 19-OCT-2017 15:36:19

ARK564 ES081C.UVDATA.1

Freq = 4.7990 GHz, Bw = 32.000 MH No calibration applied and no bandpass applied

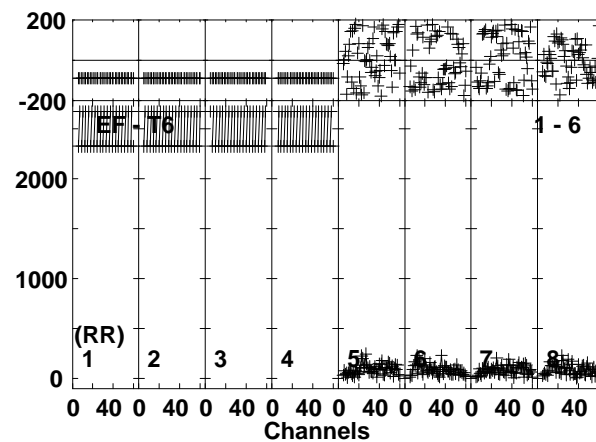
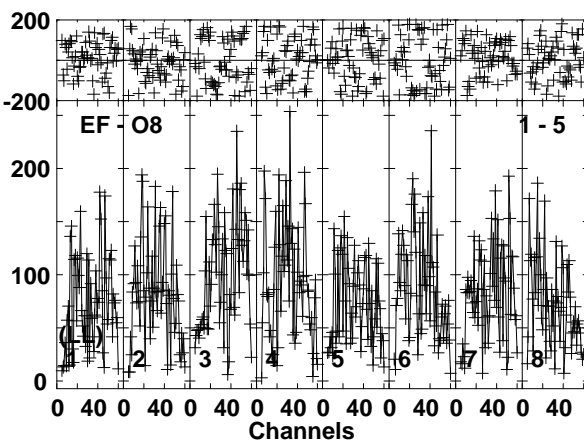
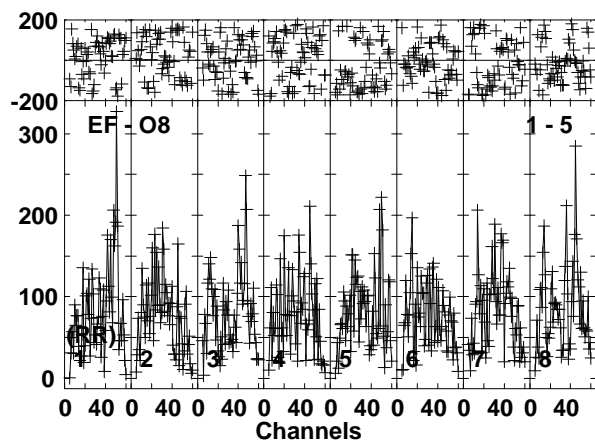
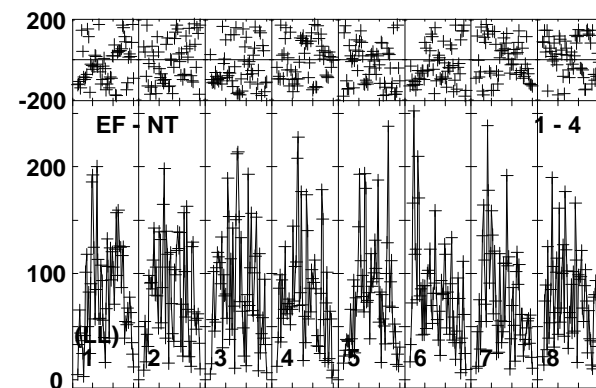
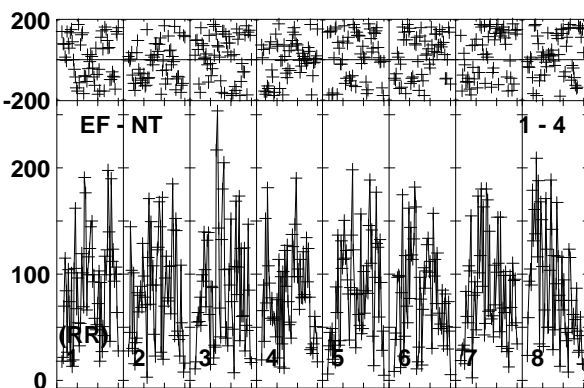
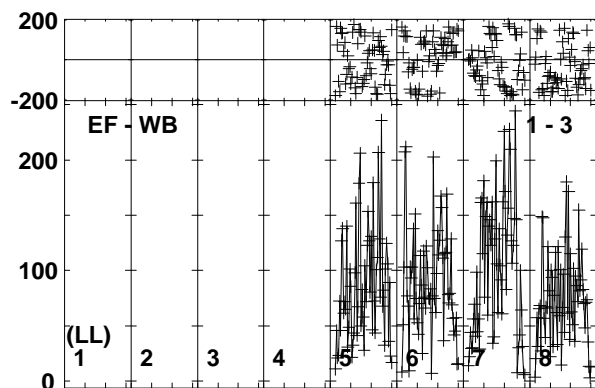
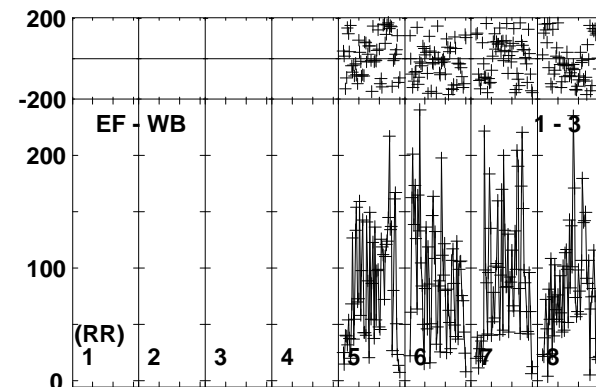
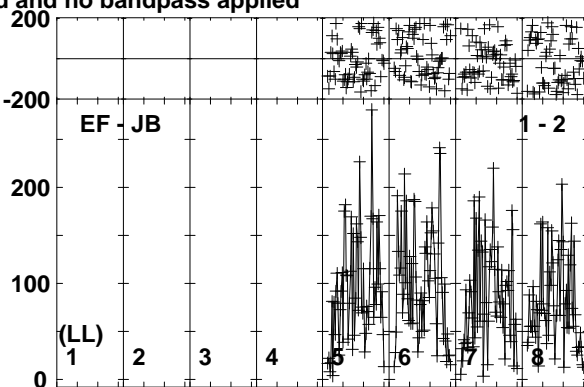
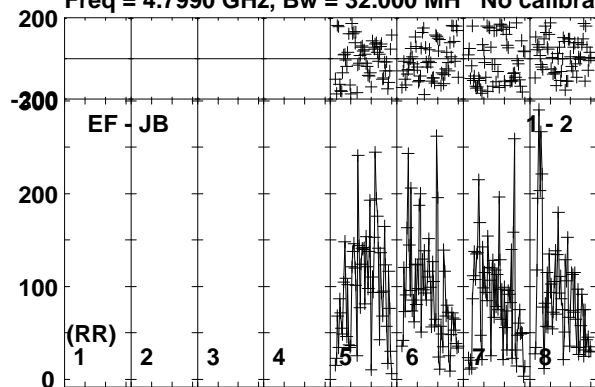

Lower frame: Micro Ampl Jy Top frame: Phas deg
Vector averaged cross-power spectrum Baseline: EF (01) - JB (02)
Timerange: 00/17:21:01 to 00/17:24:29

Plot file version 186 created 19-OCT-2017 15:36:19
 ARK564 ES081C.UVDATA.1

Freq = 4.7990 GHz, Bw = 32.000 MH No calibration applied and no bandpass applied

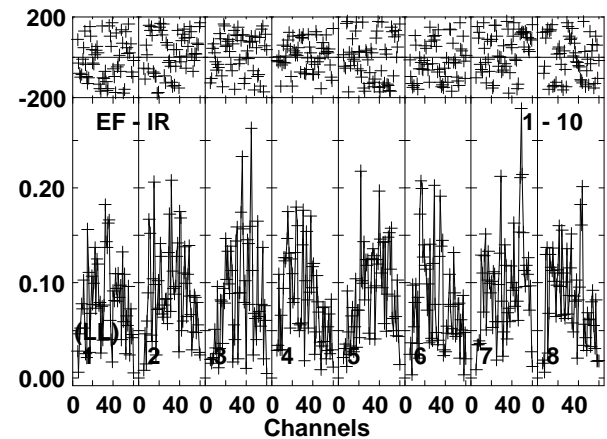
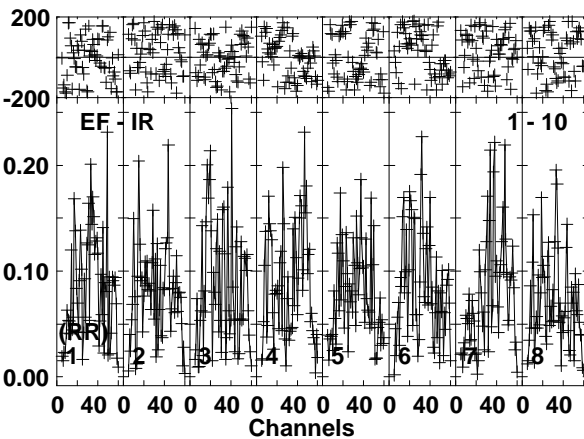
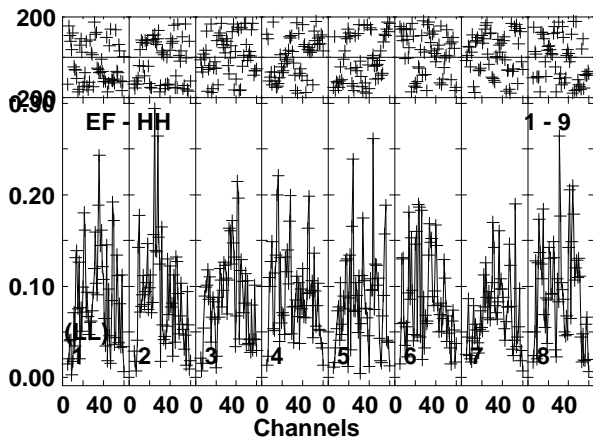
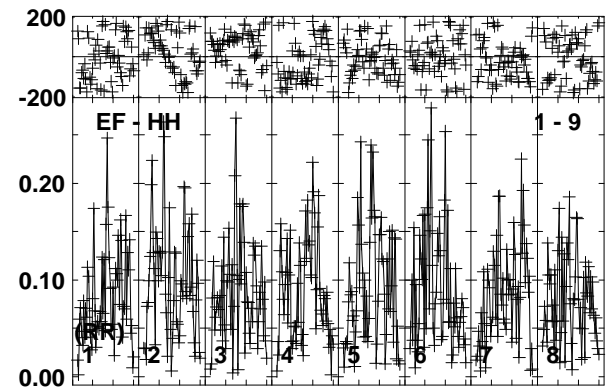
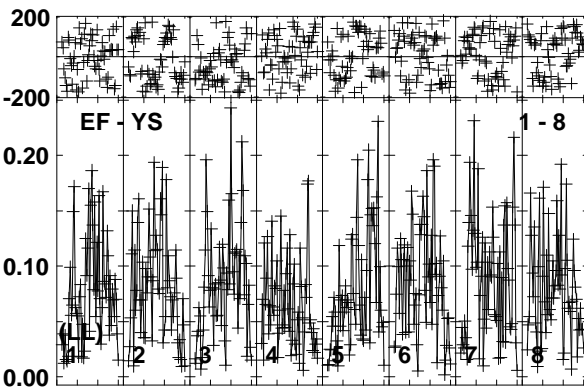
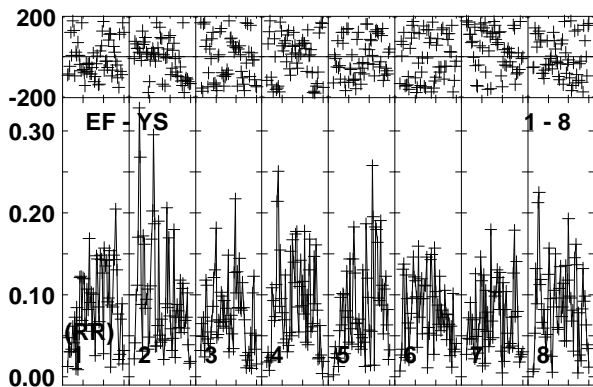
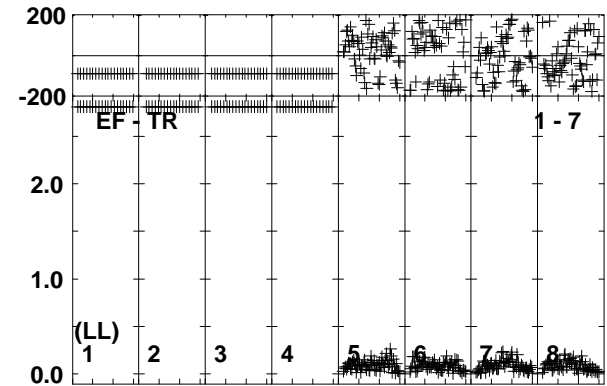
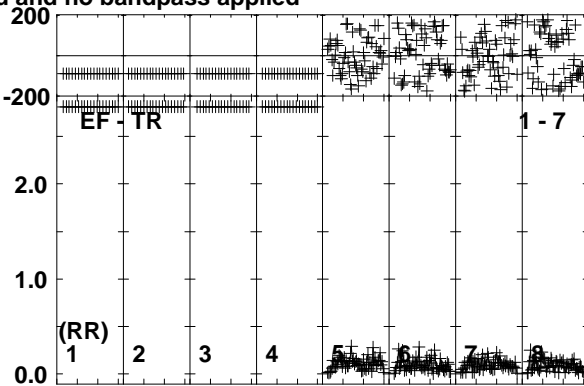
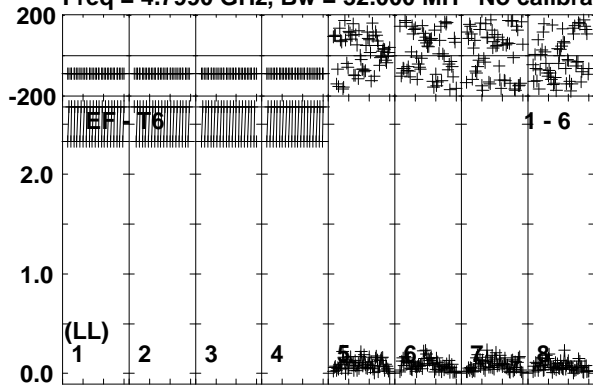

Lower frame: Milli Ampl Jy Top frame: Phas deg
 Vector averaged cross-power spectrum Baseline: EF (01) - T6 (06)
 Timerange: 00/17:21:01 to 00/17:24:29

Plot file version 187 created 19-OCT-2017 15:36:20

J2242+2955 ES081C.UVDATA.1

Freq = 4.7990 GHz, Bw = 32.000 MH No calibration applied and no bandpass applied

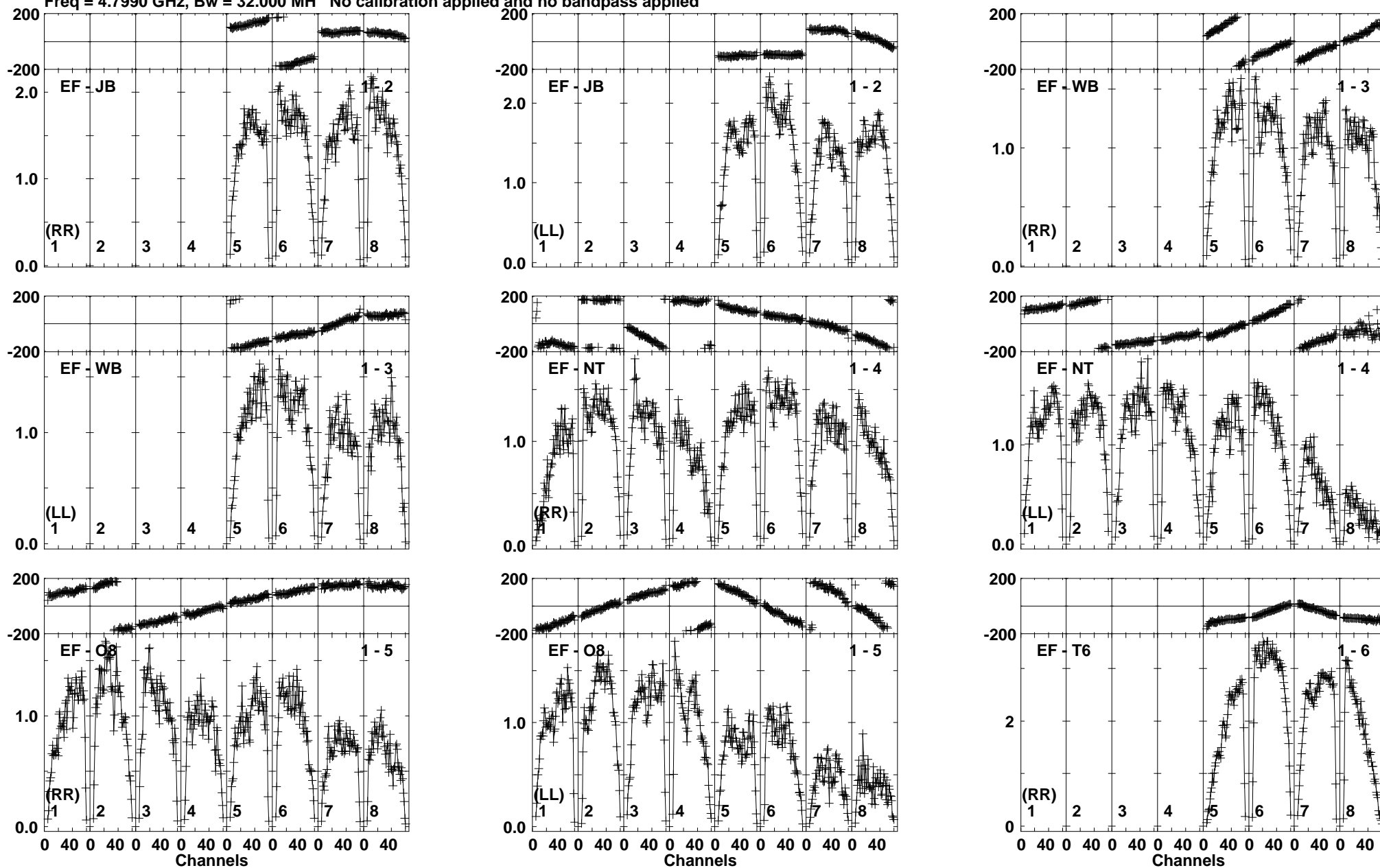

Lower frame: Milli Ampl Jy Top frame: Phas deg
Vector averaged cross-power spectrum Baseline: EF (01) - JB (02)
Timerange: 00:17:24:31 to 00:17:25:59

Plot file version 188 created 19-OCT-2017 15:36:20

J2242+2955 ES081C.UVDATA.1

Freq = 4.7990 GHz, Bw = 32.000 MH No calibration applied and no bandpass applied

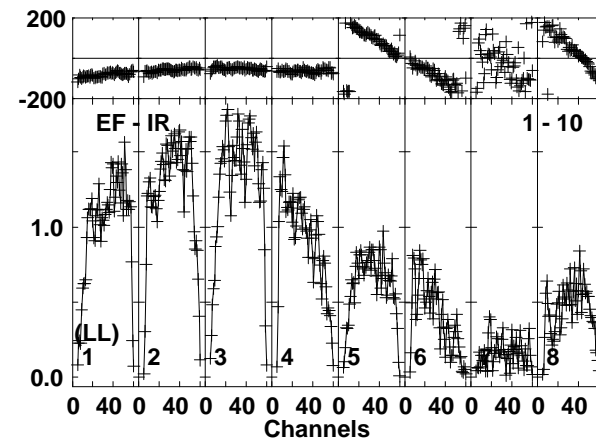
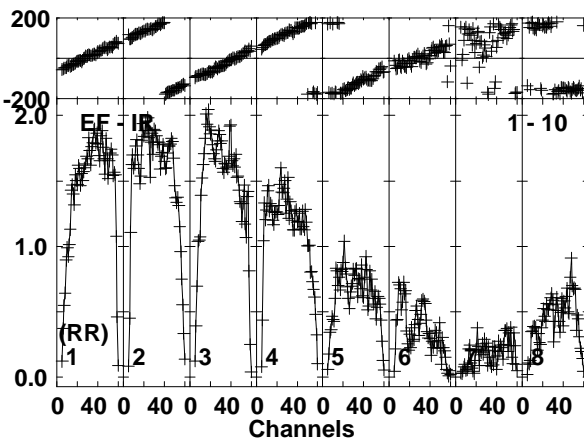
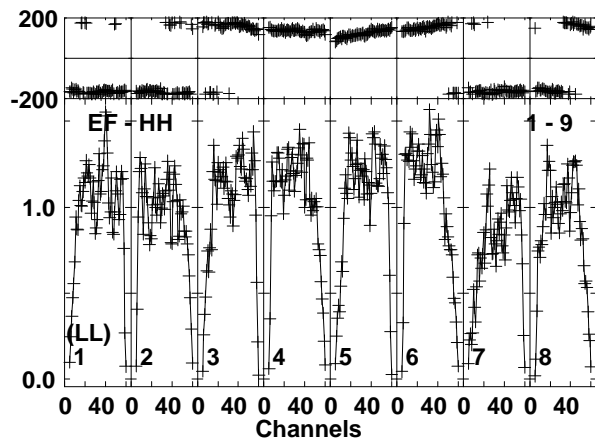
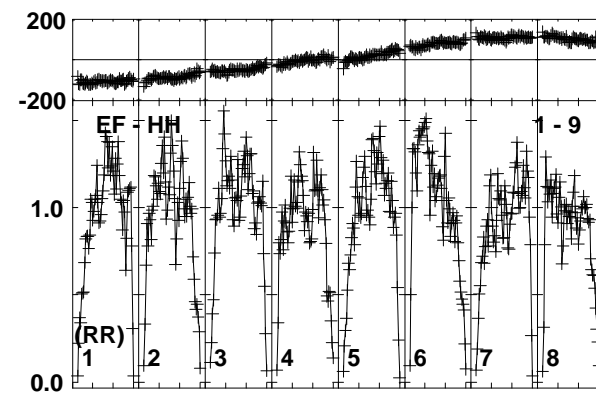
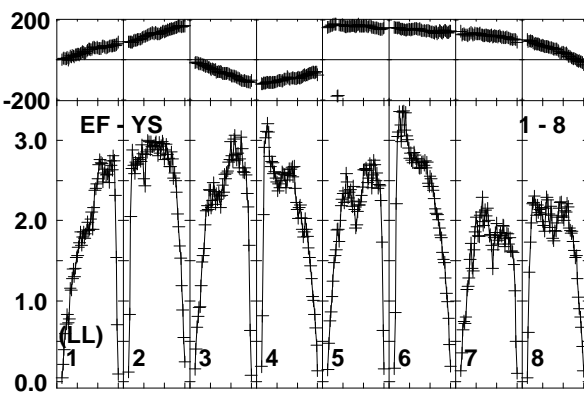
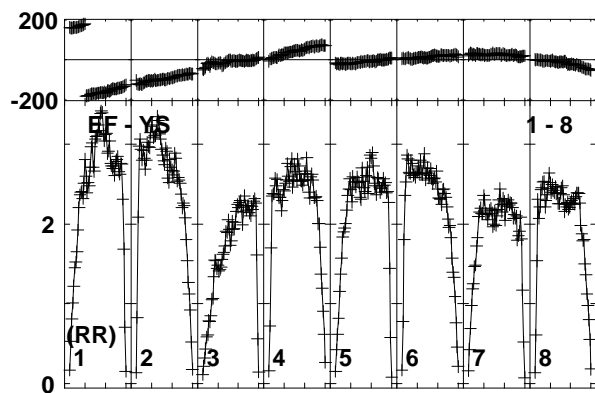
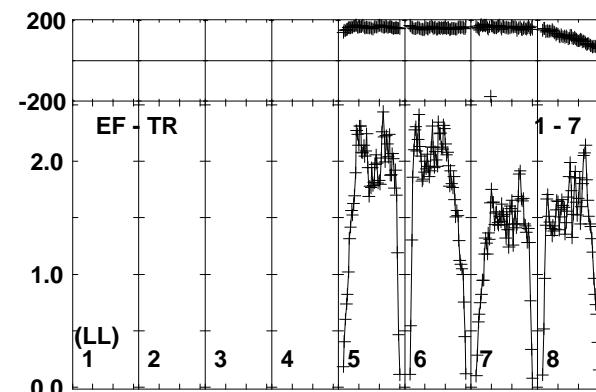
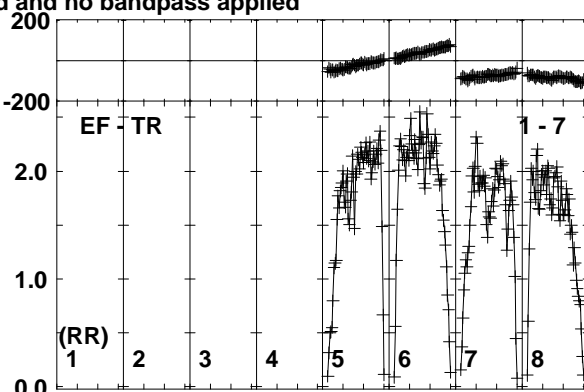
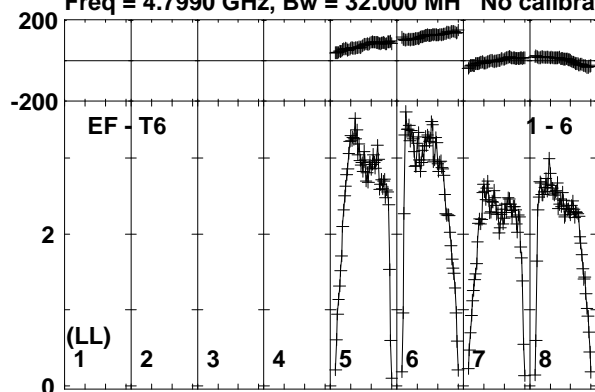

Lower frame: Milli Ampl Jy Top frame: Phas deg
Vector averaged cross-power spectrum Baseline: EF (01) - T6 (06)
Timerange: 00/17:24:31 to 00/17:25:59

Plot file version 189 created 19-OCT-2017 15:36:20

ARK564 ES081C.UVDATA.1

Freq = 4.7990 GHz, Bw = 32.000 MH No calibration applied and no bandpass applied

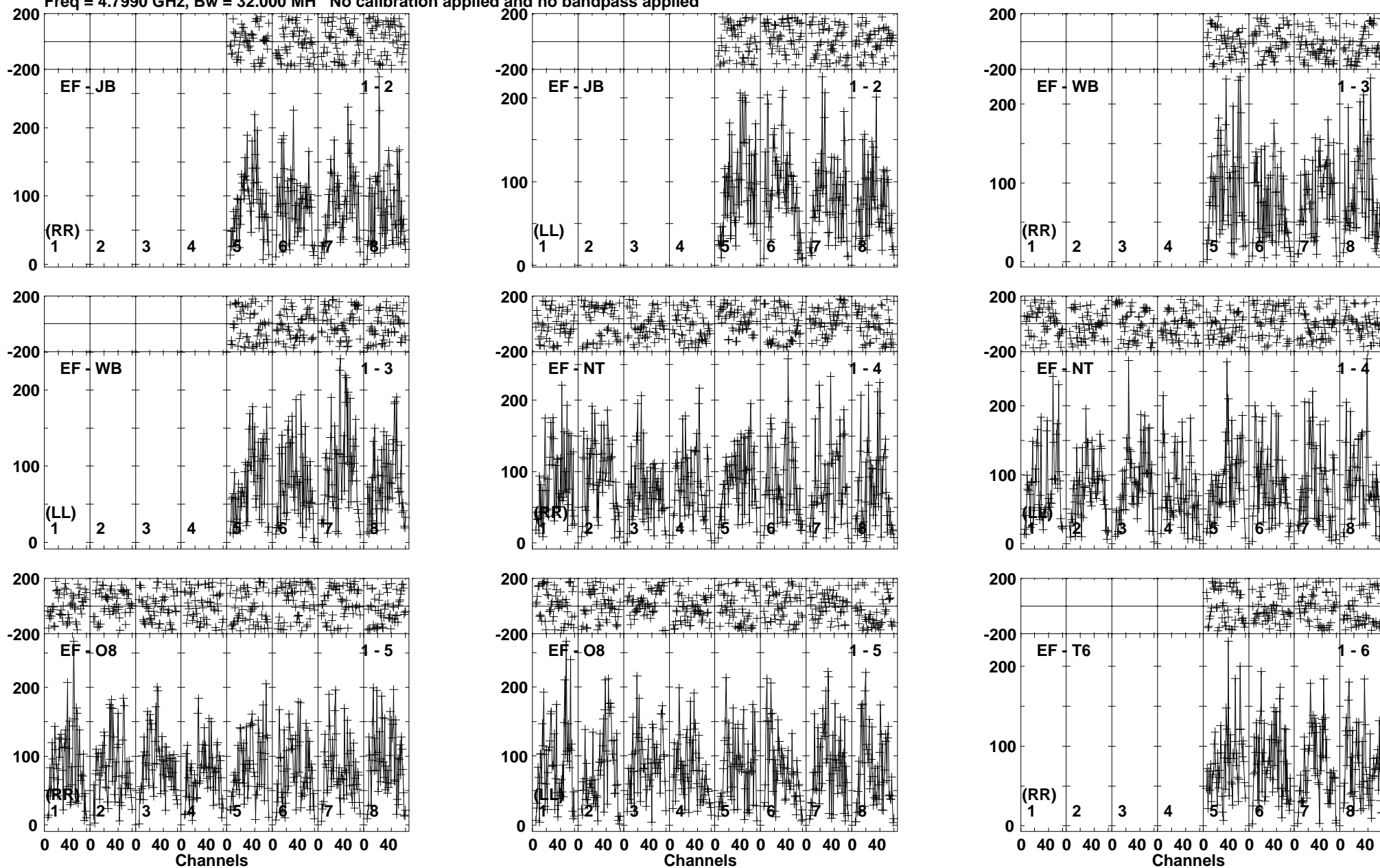

Lower frame: Micro Ampl Jy Top frame: Phas deg
Vector averaged cross-power spectrum Baseline: EF (01) - JB (02)
Timerange: 00/17:26:01 to 00/17:29:29

Plot file version 190 created 19-OCT-2017 15:36:20
 ARK564 ES081C.UVDATA.1
 Freq = 4.7990 GHz, Bw = 32.000 MH No calibration applied and no bandpass applied

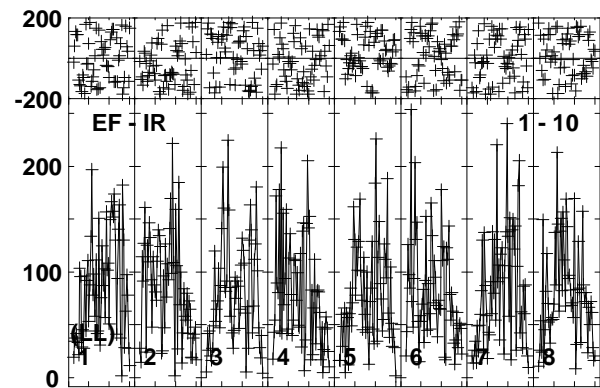
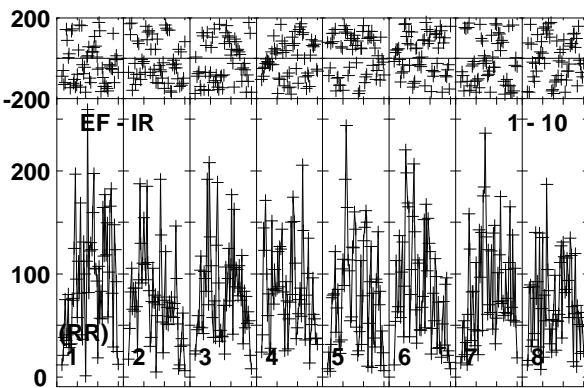
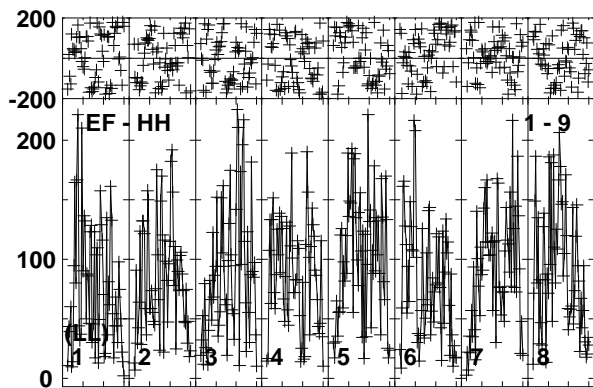
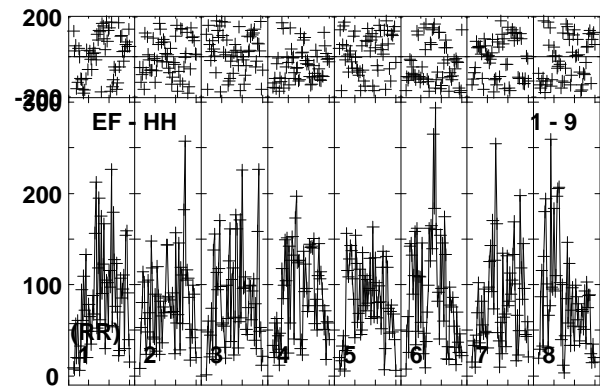
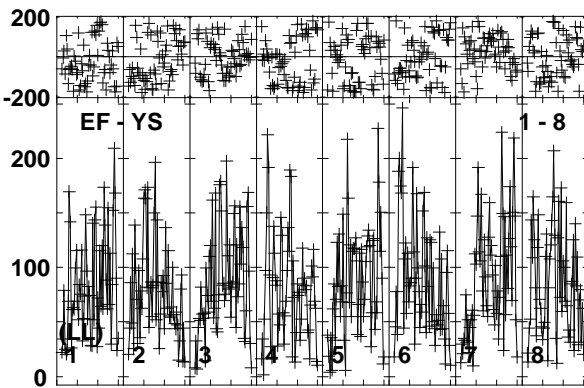
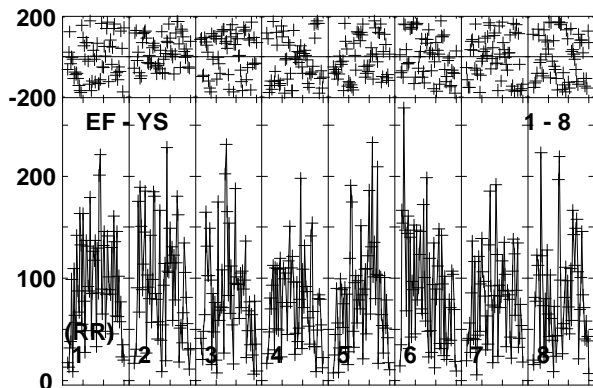
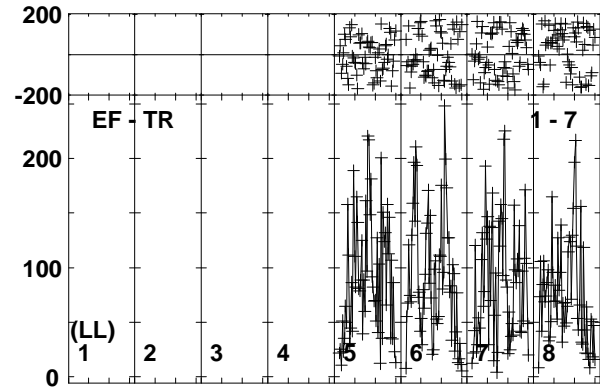
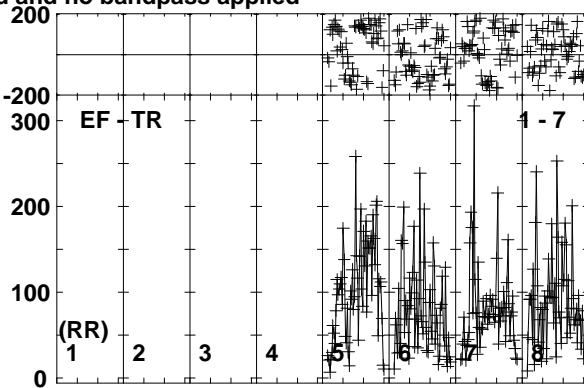
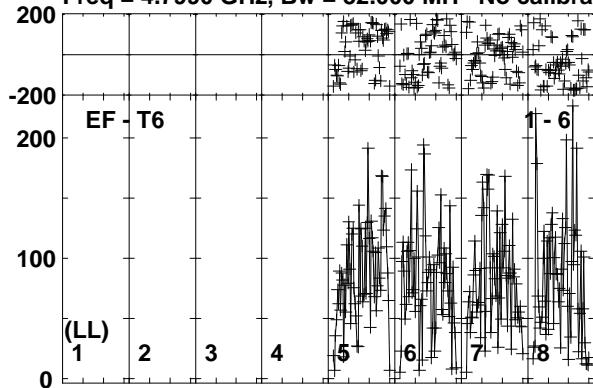

Lower frame: Micro Ampl Jy Top frame: Phas deg
 Vector averaged cross-power spectrum Baseline: EF (01) - T6 (06)
 Timerange: 00/17:26:01 to 00/17:29:29

Plot file version 191 created 19-OCT-2017 15:36:20

J2242+2955 ES081C.UVDATA.1

Freq = 4.7990 GHz, Bw = 32.000 MH No calibration applied and no bandpass applied

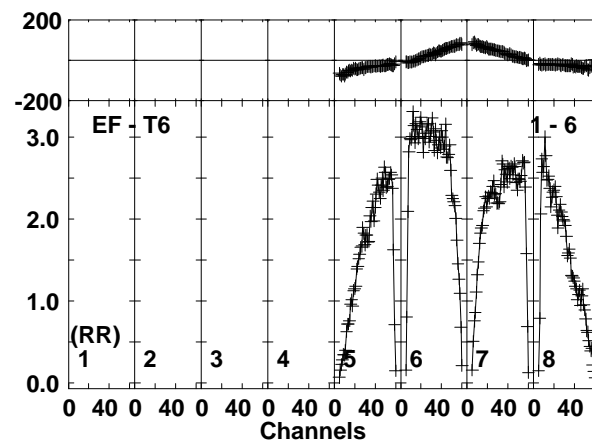
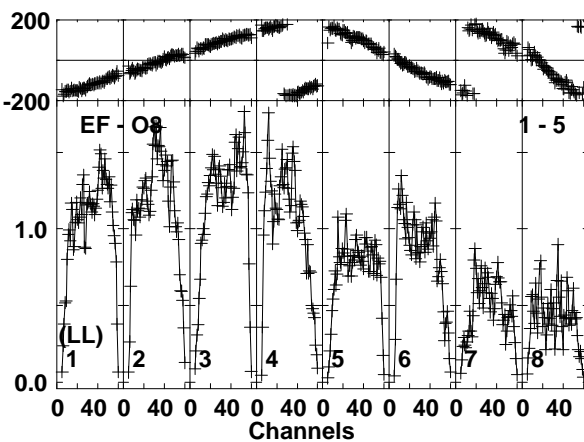
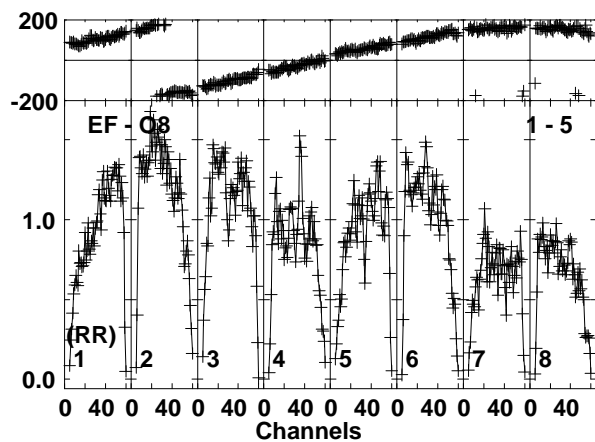
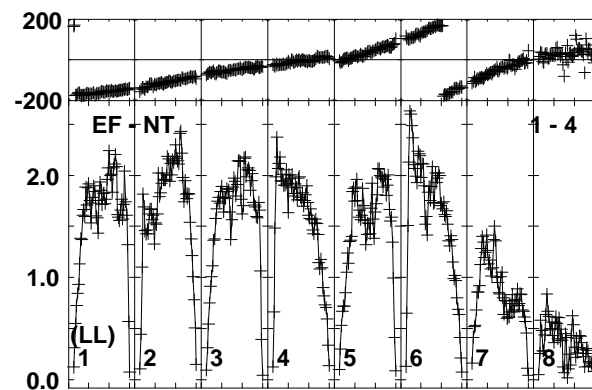
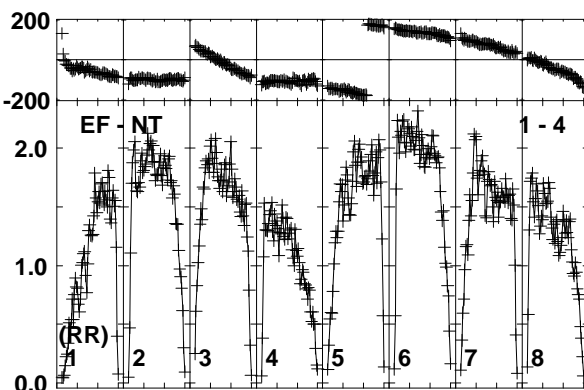
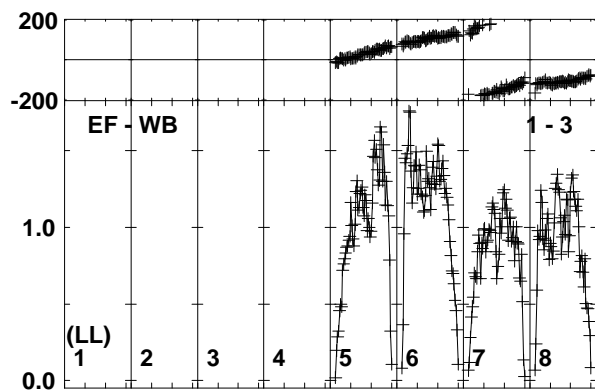
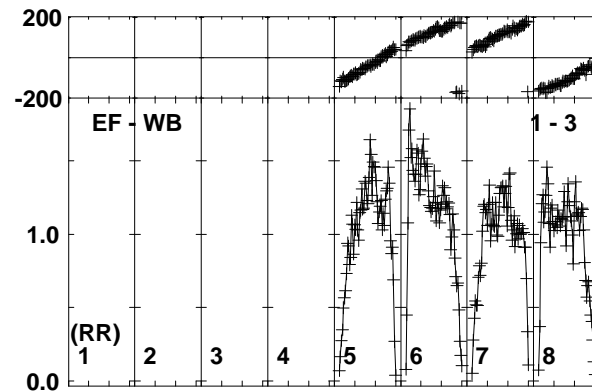
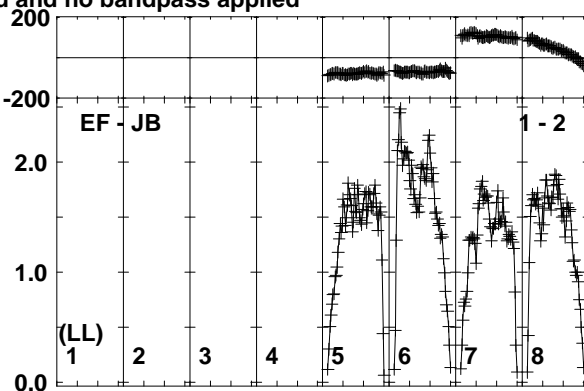
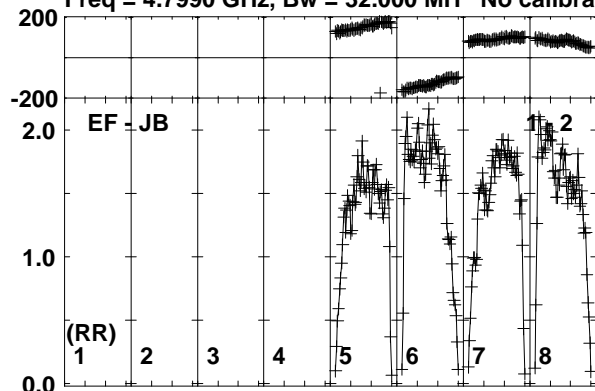

Lower frame: Milli Ampl Jy Top frame: Phas deg
Vector averaged cross-power spectrum Baseline: EF (01) - JB (02)
Timerange: 00:17:30:01 to 00:17:30:59

Plot file version 192 created 19-OCT-2017 15:36:20

J2242+2955 ES081C.UVDATA.1

Freq = 4.7990 GHz, Bw = 32.000 MH No calibration applied and no bandpass applied

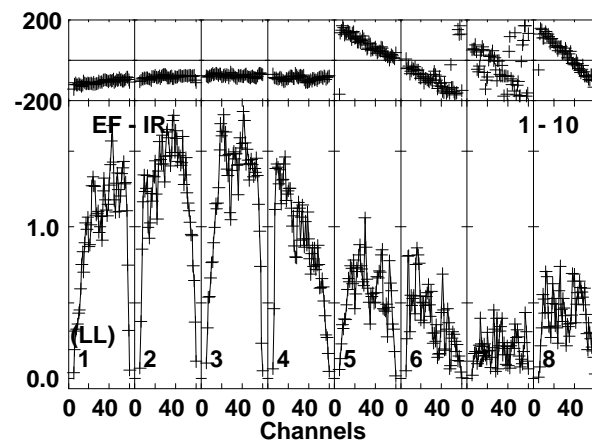
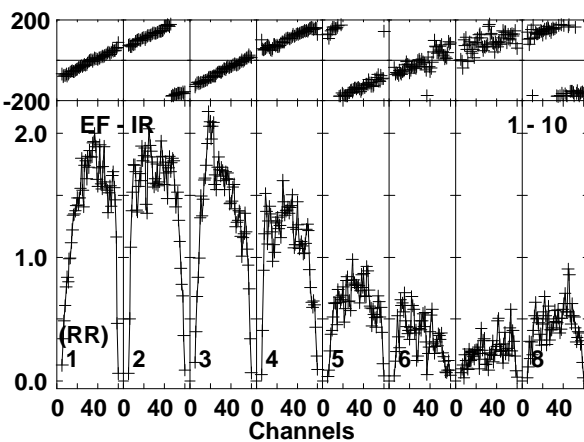
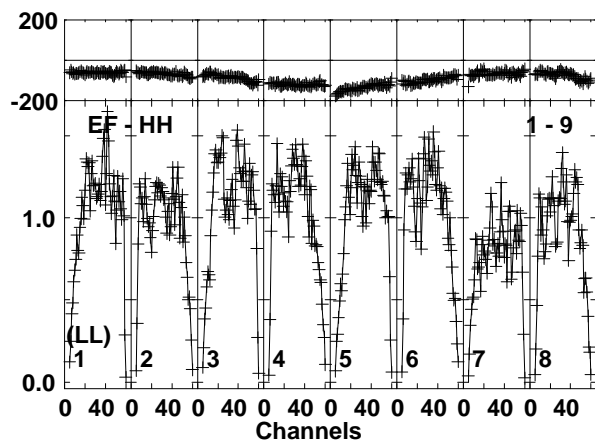
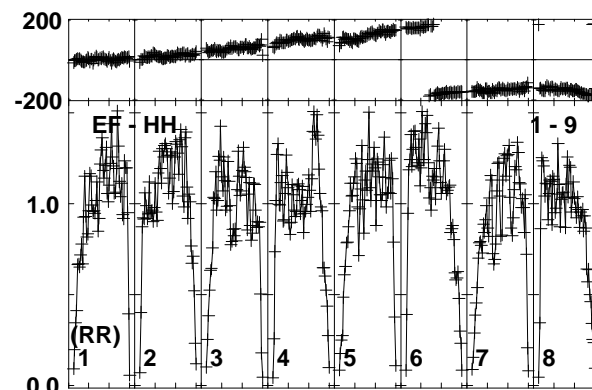
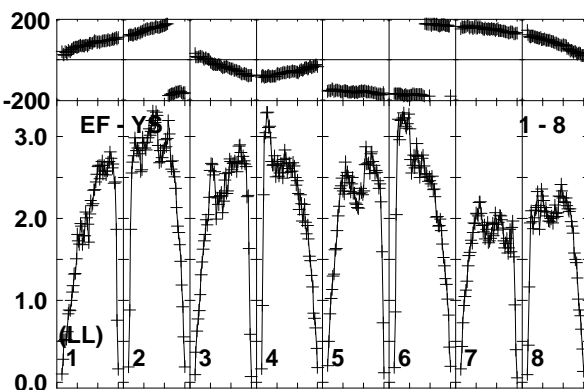
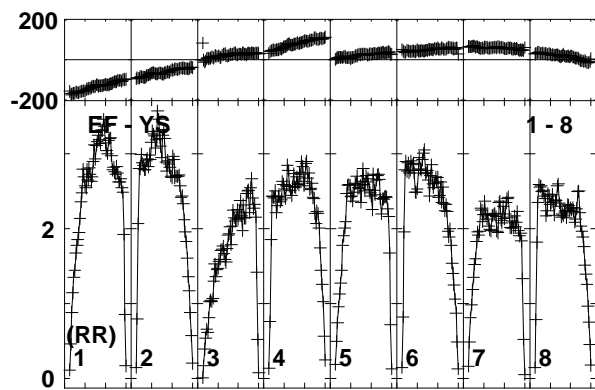
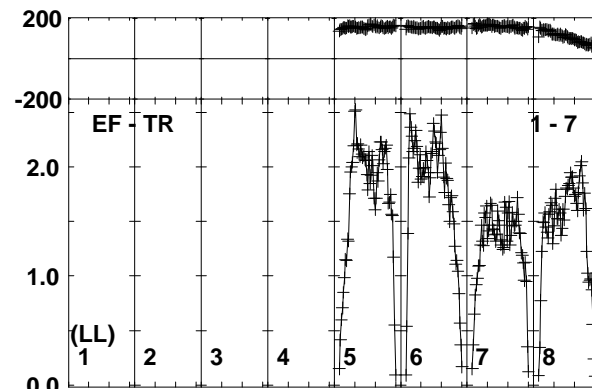
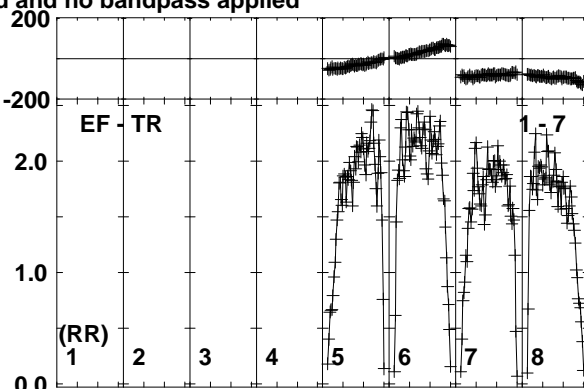
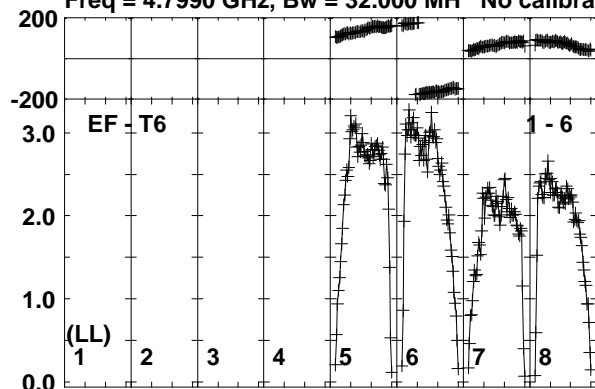

Lower frame: Milli Ampl Jy Top frame: Phas deg
Vector averaged cross-power spectrum Baseline: EF (01) - T6 (06)
Timerange: 00:17:30:01 to 00:17:30:59

Plot file version 193 created 19-OCT-2017 15:36:21

ARK564 ES081C.UVDATA.1

Freq = 4.7990 GHz, Bw = 32.000 MH No calibration applied and no bandpass applied

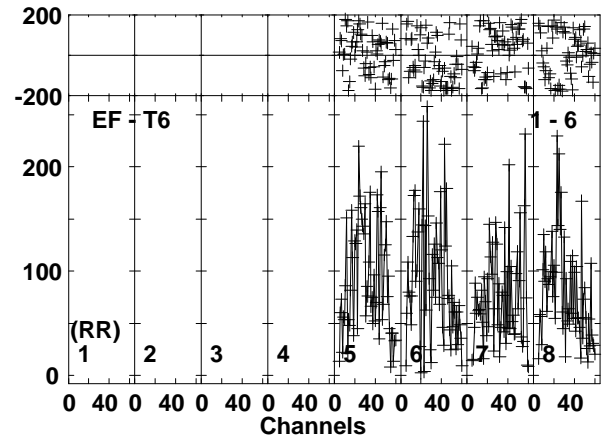
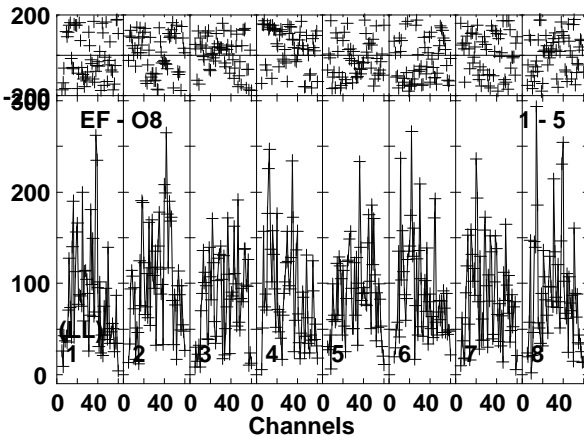
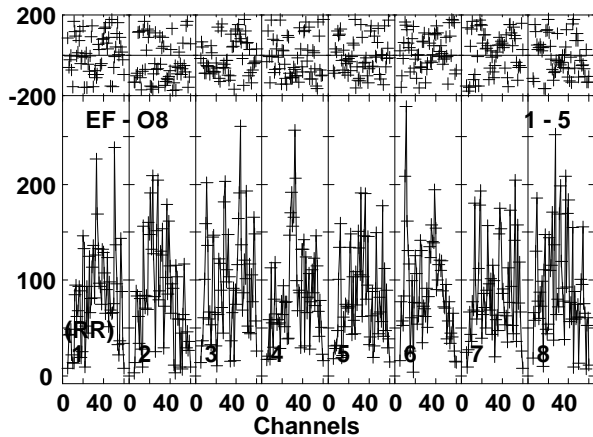
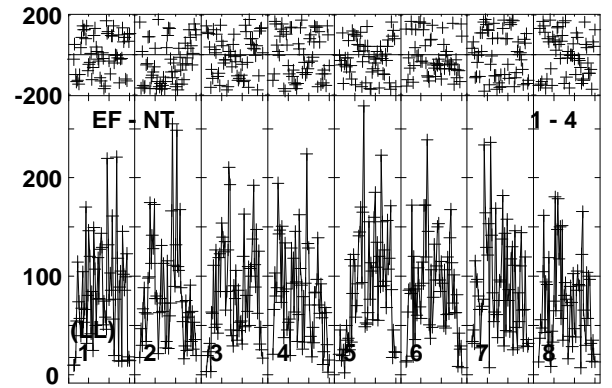
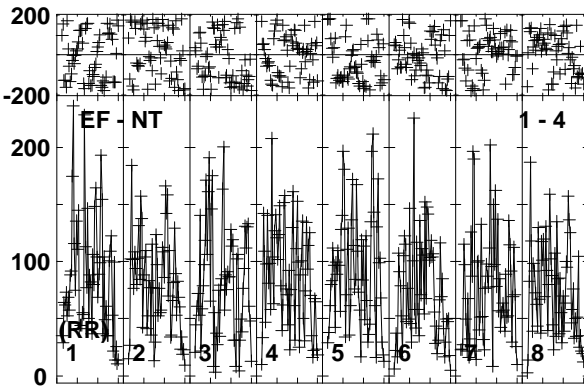
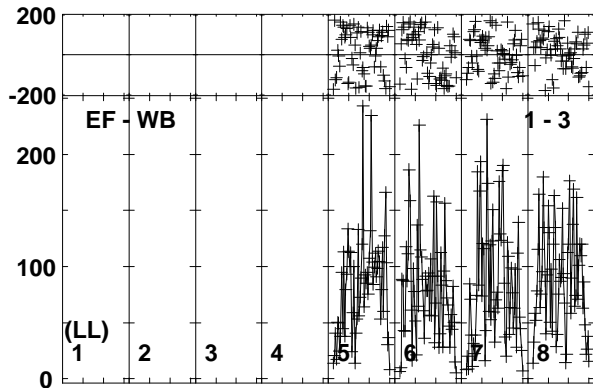
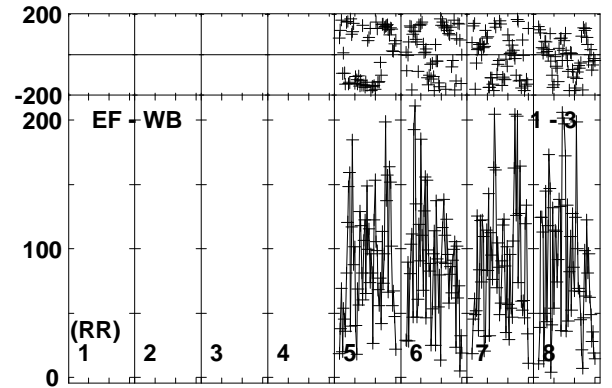
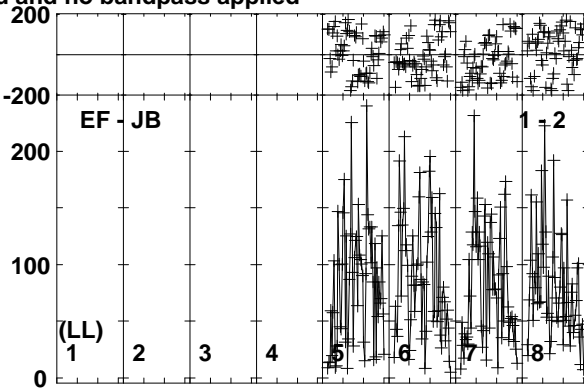
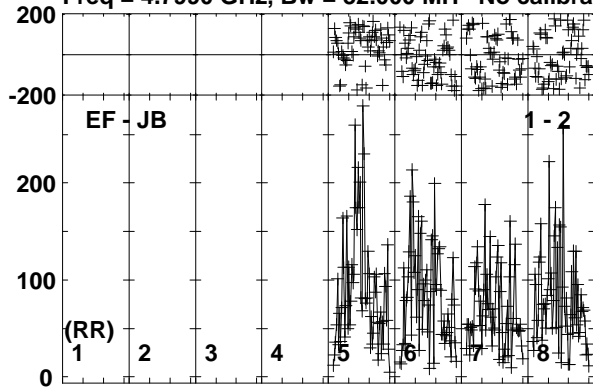

Lower frame: Micro Ampl Jy Top frame: Phas deg
Vector averaged cross-power spectrum Baseline: EF (01) - JB (02)
Timerange: 00/17:31:01 to 00/17:34:29

Plot file version 194 created 19-OCT-2017 15:36:21

ARK564 ES081C.UVDATA.1

Freq = 4.7990 GHz, Bw = 32.000 MH No calibration applied and no bandpass applied

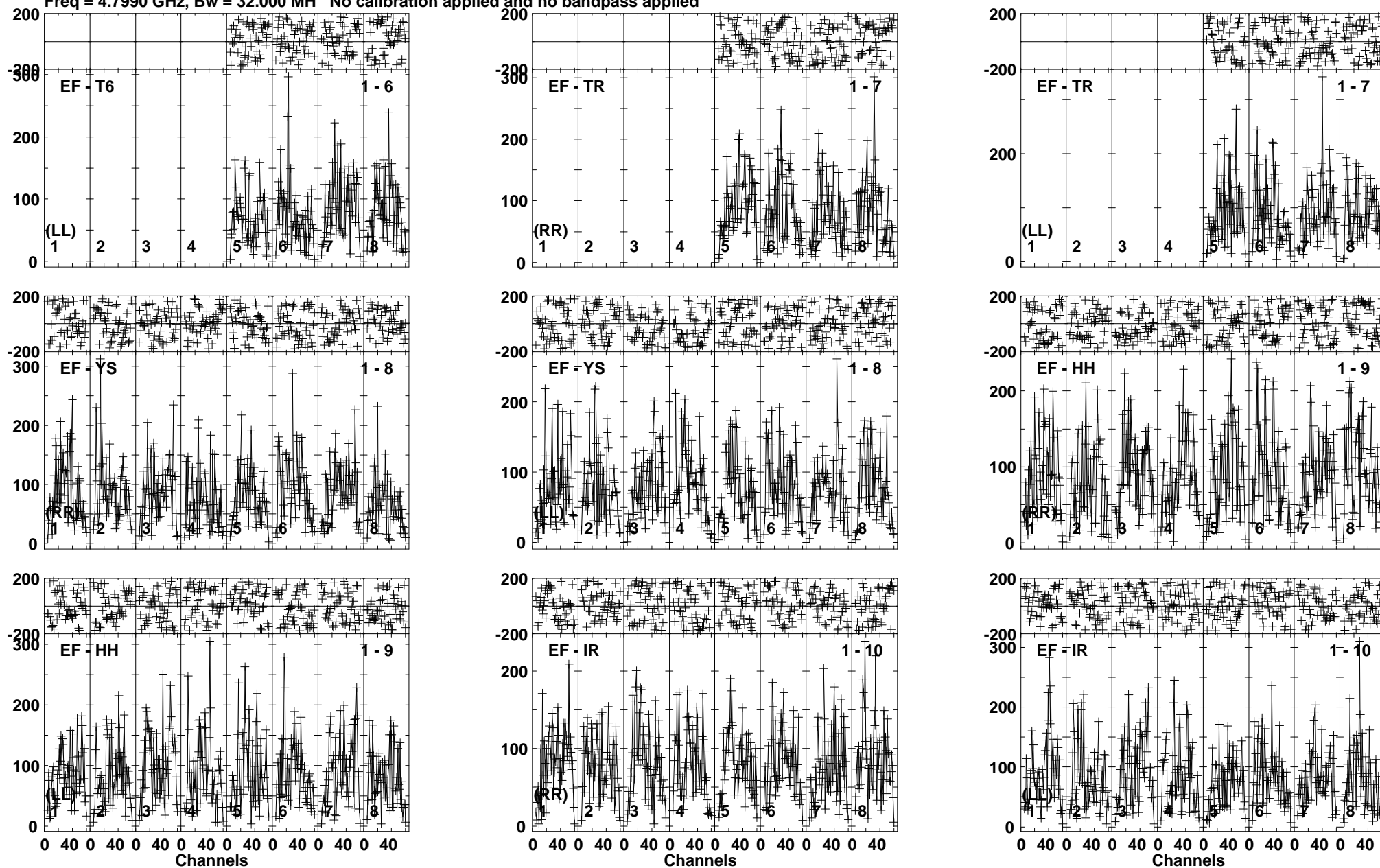

Lower frame: Micro Ampl Jy Top frame: Phas deg
Vector averaged cross-power spectrum Baseline: EF (01) - T6 (06)
Timerange: 00/17:31:01 to 00/17:34:29

Plot file version 195 created 19-OCT-2017 15:36:21

J2242+2955 ES081C.UVDATA.1

Freq = 4.7990 GHz, Bw = 32.000 MH No calibration applied and no bandpass applied

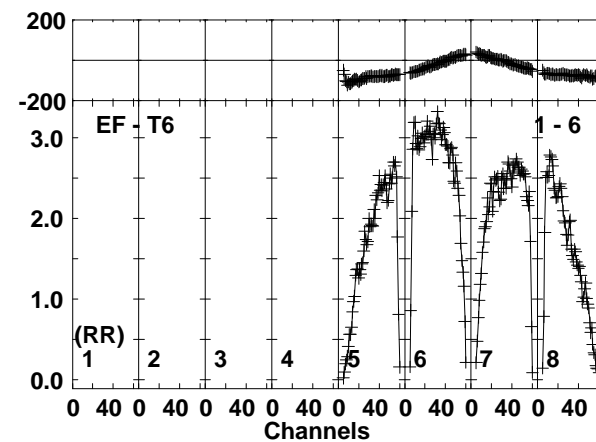
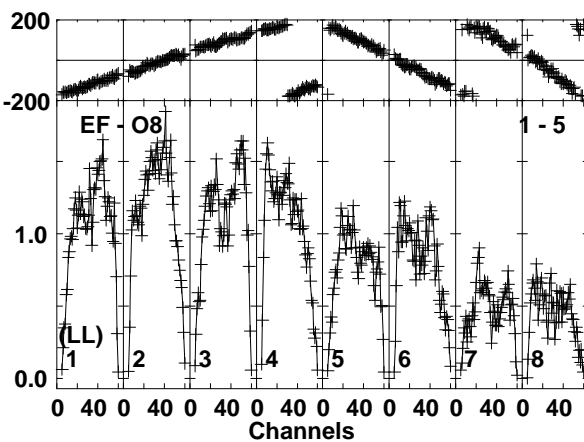
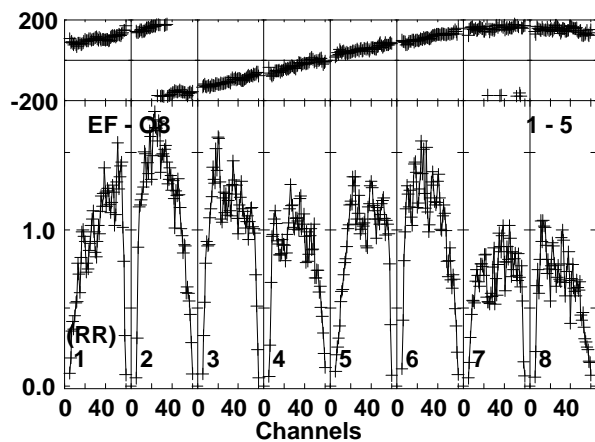
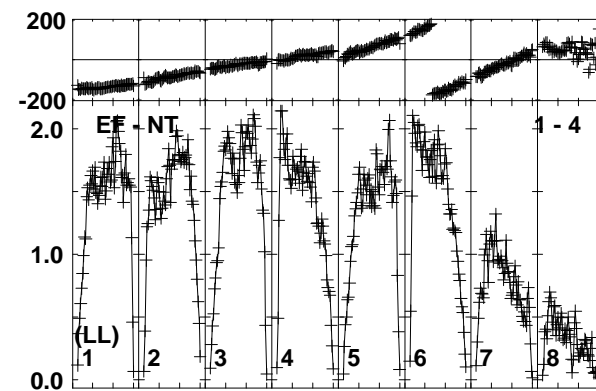
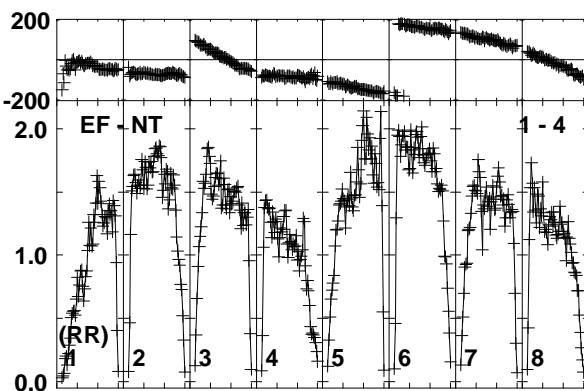
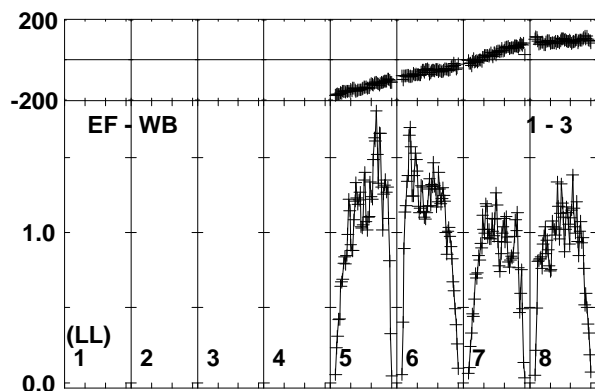
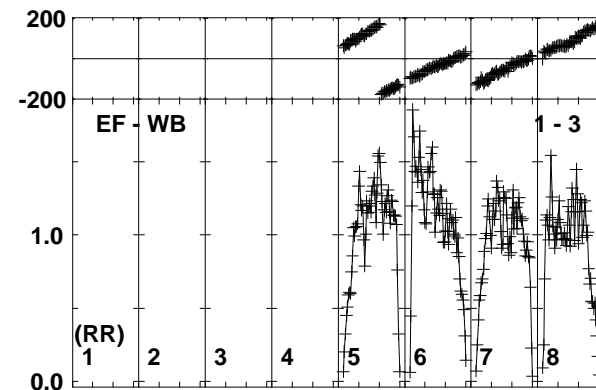
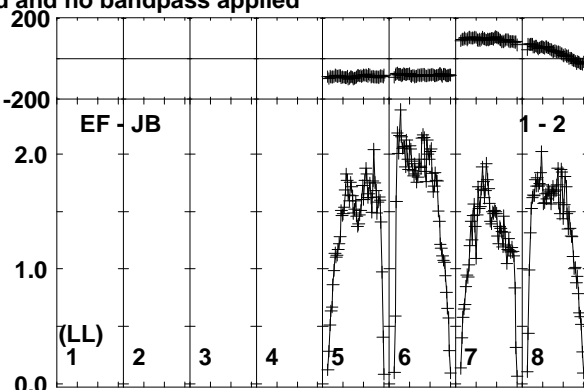
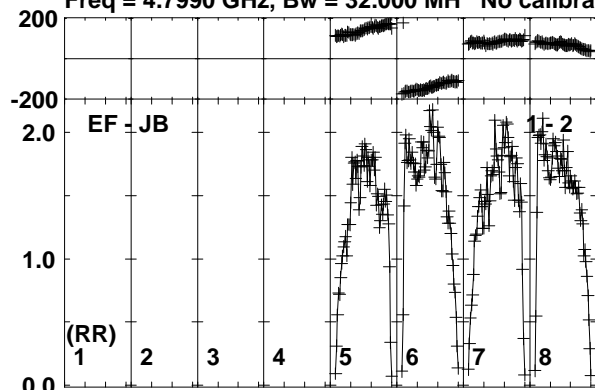

Lower frame: Milli Ampl Jy Top frame: Phas deg
Vector averaged cross-power spectrum Baseline: EF (01) - JB (02)
Timerange: 00/17:34:31 to 00/17:35:59

Plot file version 196 created 19-OCT-2017 15:36:21

J2242+2955 ES081C.UVDATA.1

Freq = 4.7990 GHz, Bw = 32.000 MH No calibration applied and no bandpass applied

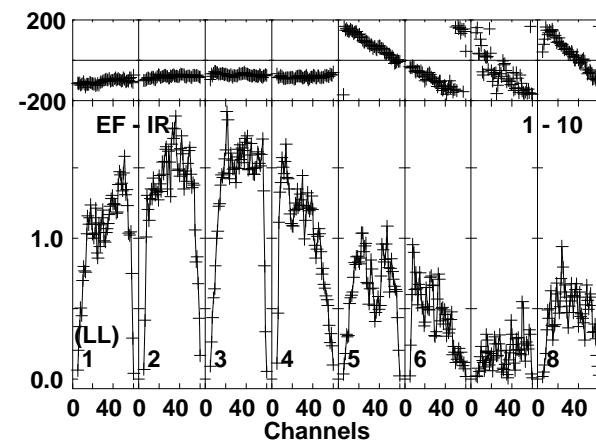
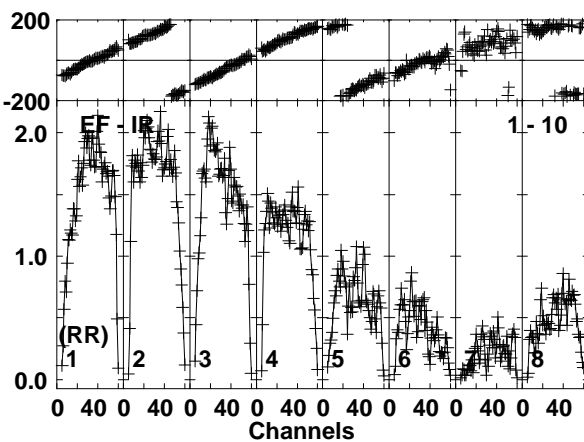
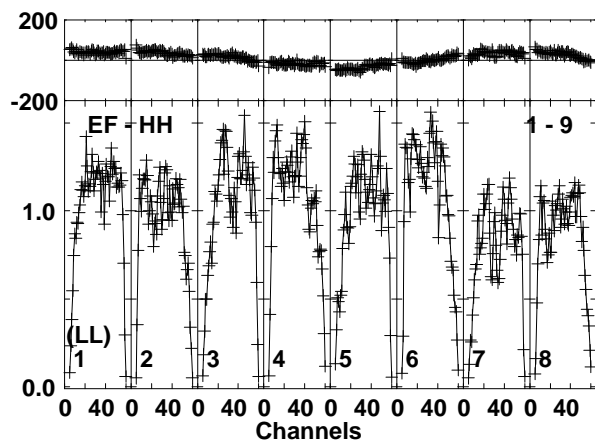
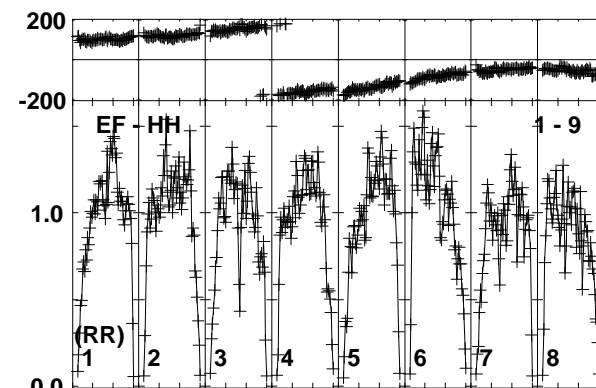
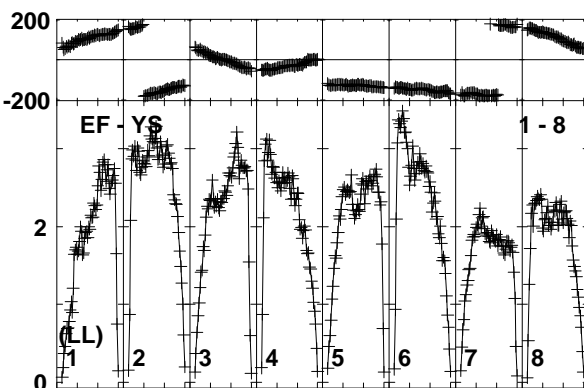
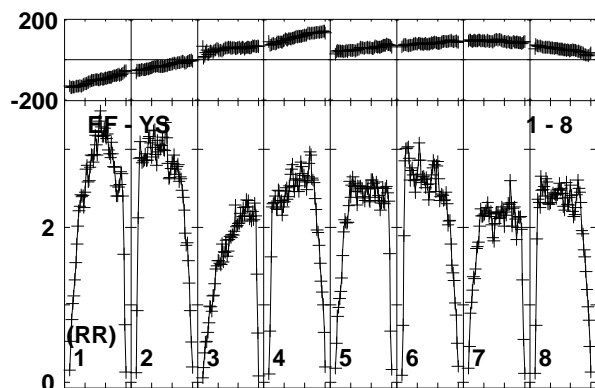
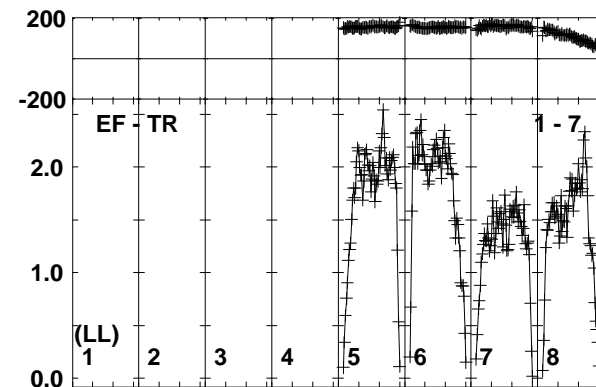
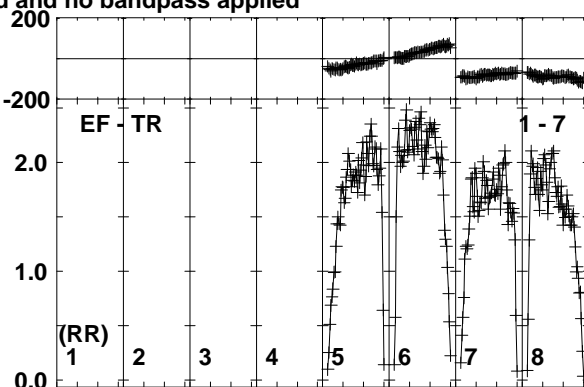
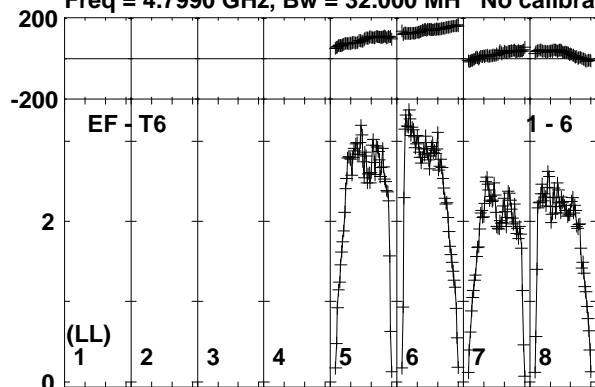

Lower frame: Milli Ampl Jy Top frame: Phas deg
Vector averaged cross-power spectrum Baseline: EF (01) - T6 (06)
Timerange: 00:17:34:31 to 00:17:35:59

Plot file version 197 created 19-OCT-2017 15:36:21
 ARK564 ES081C.UVDATA.1
 Freq = 4.7990 GHz, Bw = 32.000 MH No calibration applied and no bandpass applied

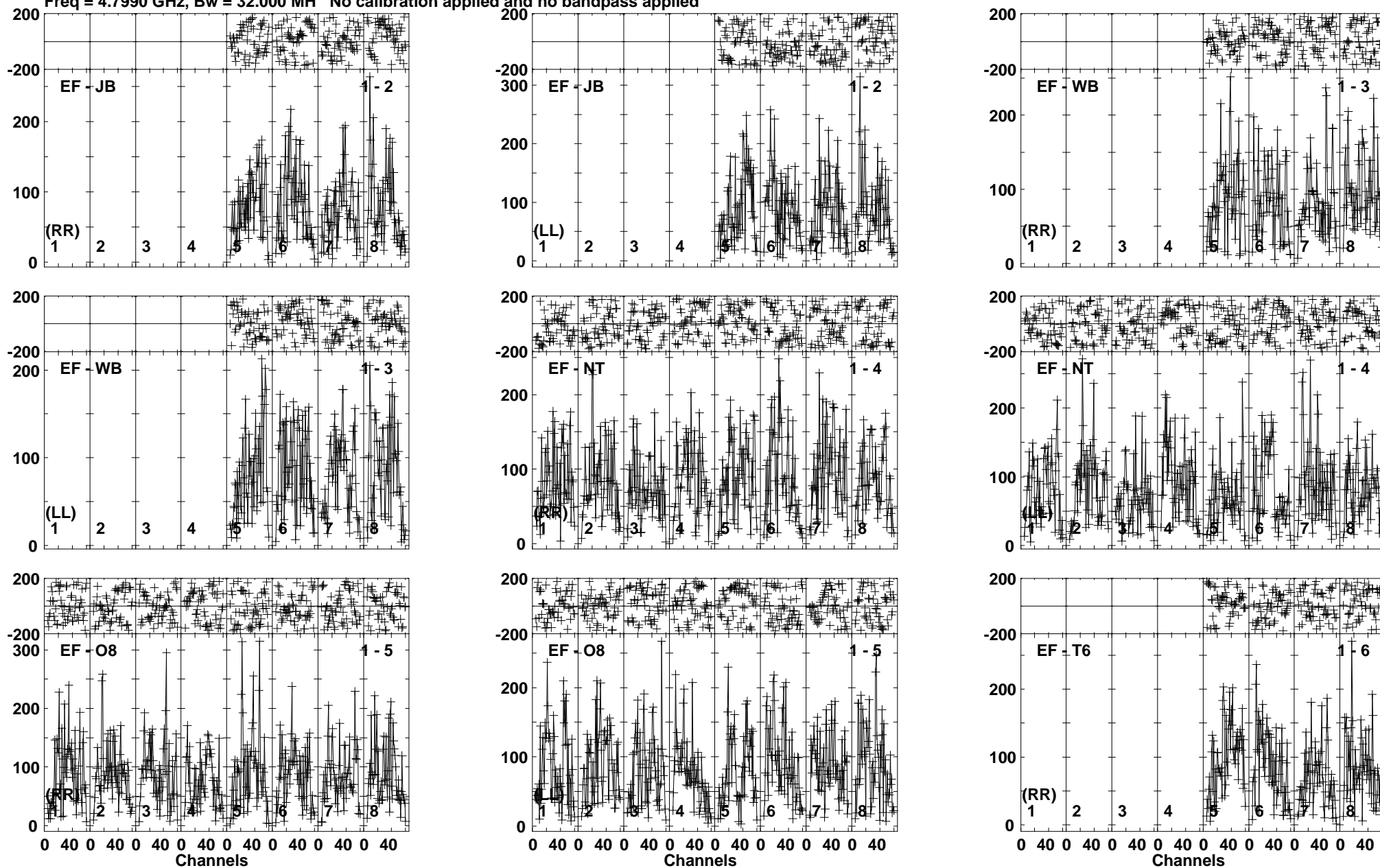

Lower frame: Micro Ampl Jy Top frame: Phas deg
 Vector averaged cross-power spectrum Baseline: EF (01) - JB (02)
 Timerange: 00/17:36:01 to 00/17:39:29

Plot file version 198 created 19-OCT-2017 15:36:21

ARK564 ES081C.UVDATA.1

Freq = 4.7990 GHz, Bw = 32.000 MH No calibration applied and no bandpass applied

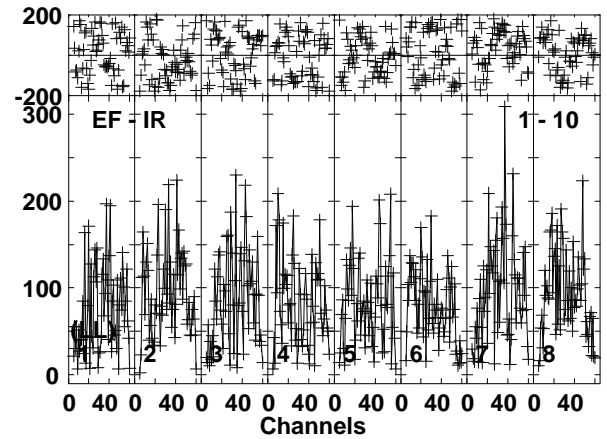
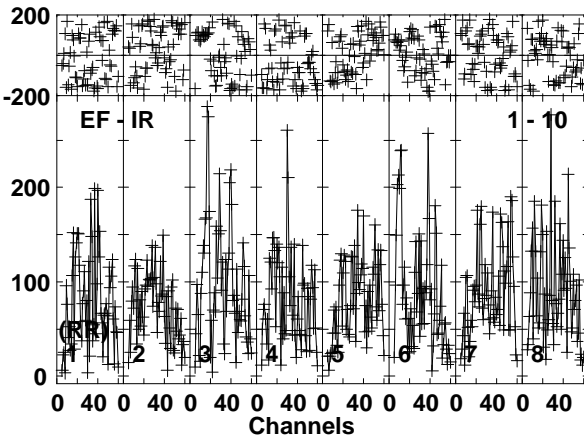
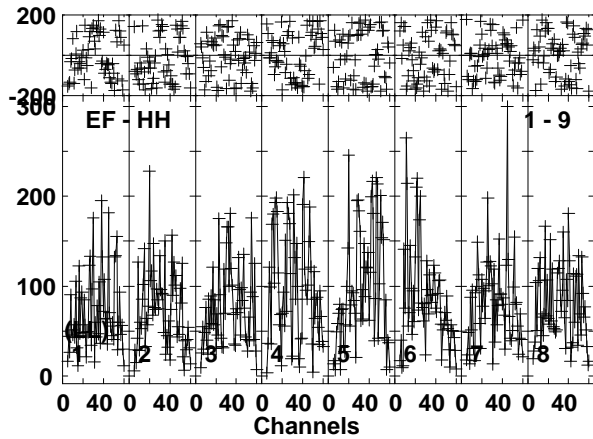
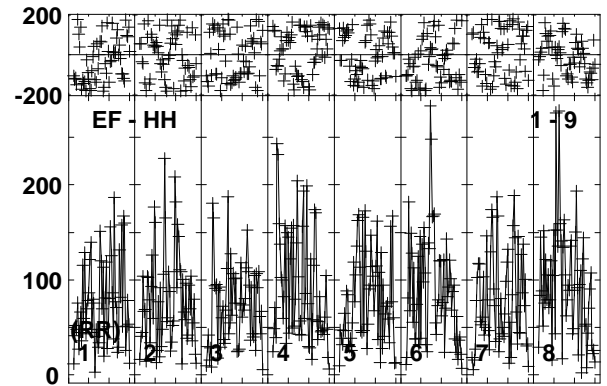
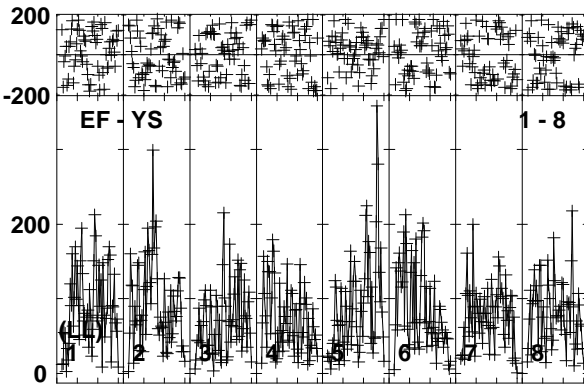
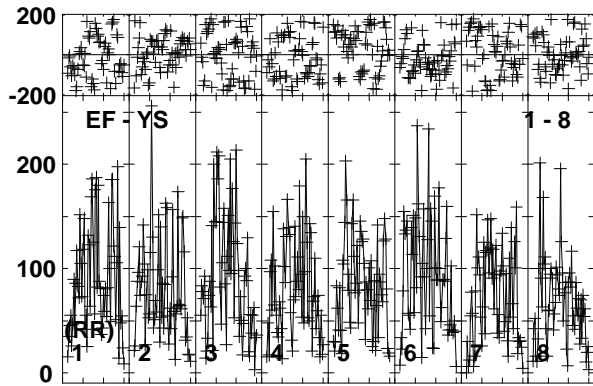
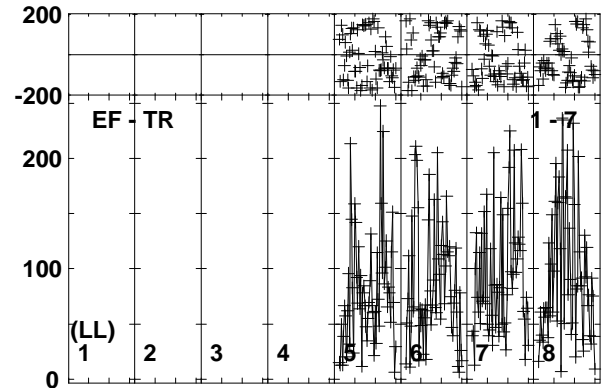
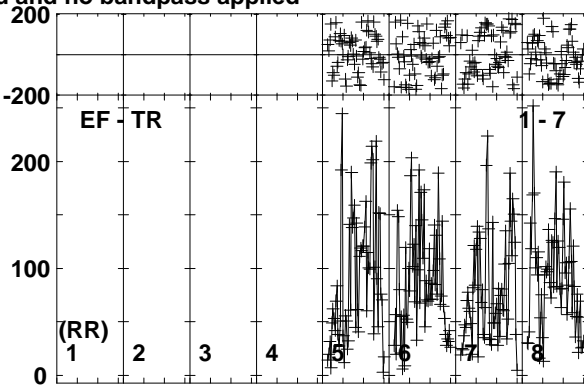
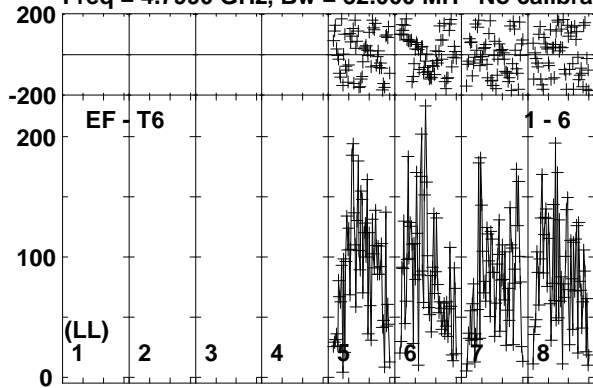

Lower frame: Micro Ampl Jy Top frame: Phas deg
Vector averaged cross-power spectrum Baseline: EF (01) - T6 (06)
Timerange: 00/17:36:01 to 00/17:39:29

Plot file version 199 created 19-OCT-2017 15:36:21

J2242+2955 ES081C.UVDATA.1

Freq = 4.7990 GHz, Bw = 32.000 MH No calibration applied and no bandpass applied

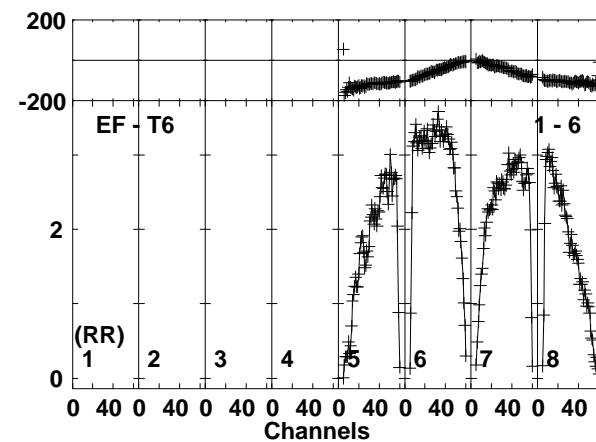
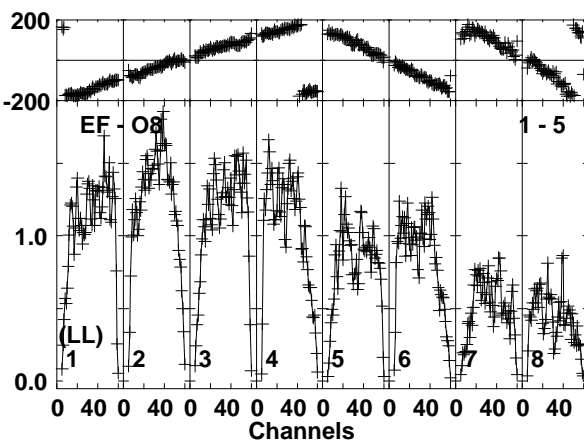
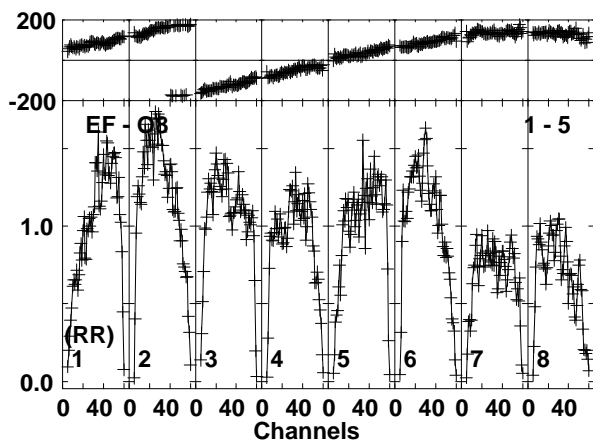
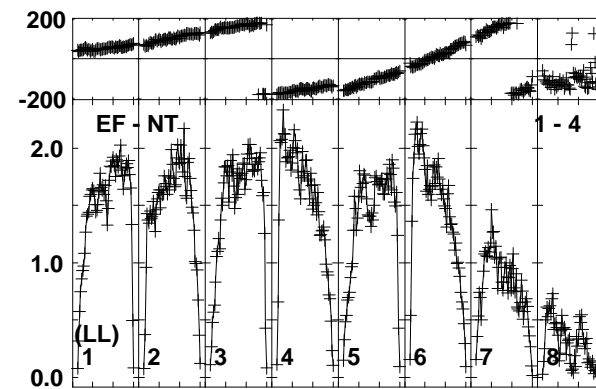
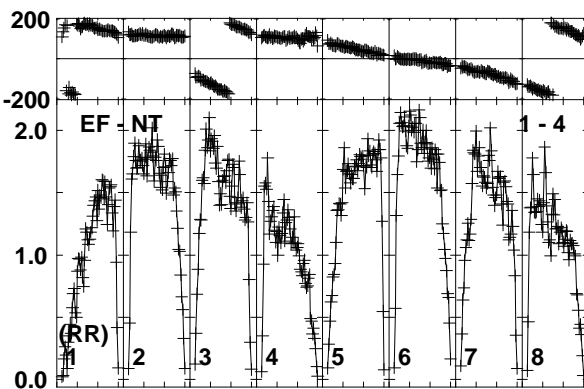
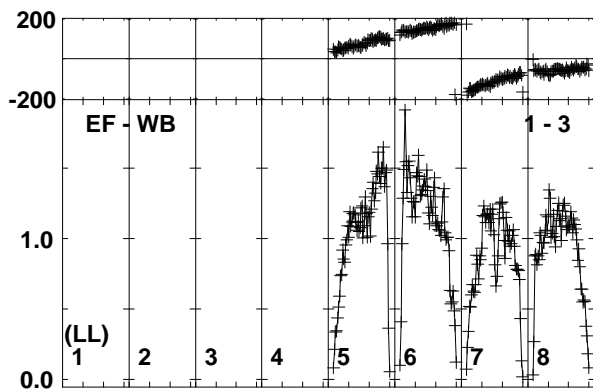
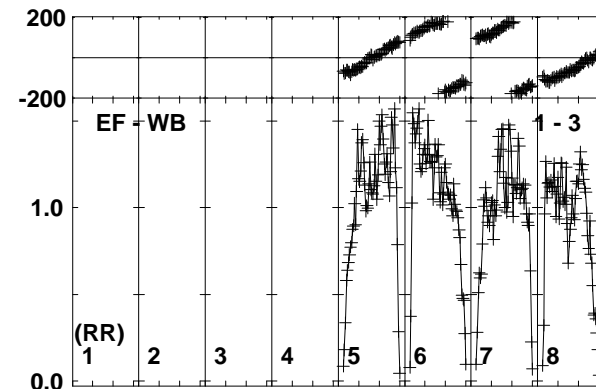
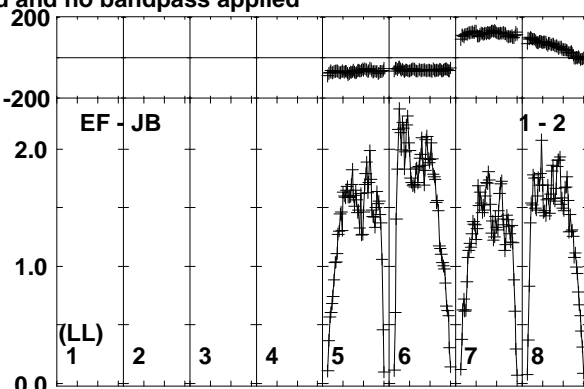
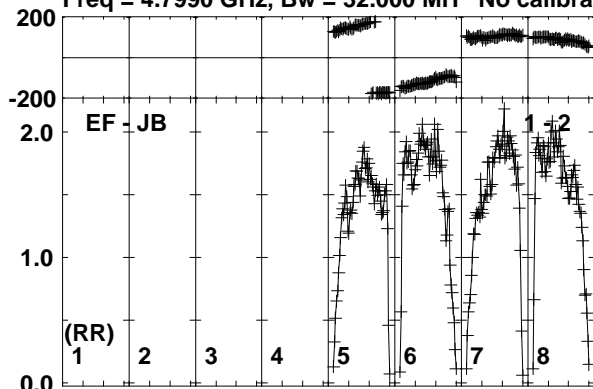

Lower frame: Milli Ampl Jy Top frame: Phas deg
Vector averaged cross-power spectrum Baseline: EF (01) - JB (02)
Timerange: 00:17:40:01 to 00:17:40:59

Plot file version 200 created 19-OCT-2017 15:36:22

J2242+2955 ES081C.UVDATA.1

Freq = 4.7990 GHz, Bw = 32.000 MH No calibration applied and no bandpass applied

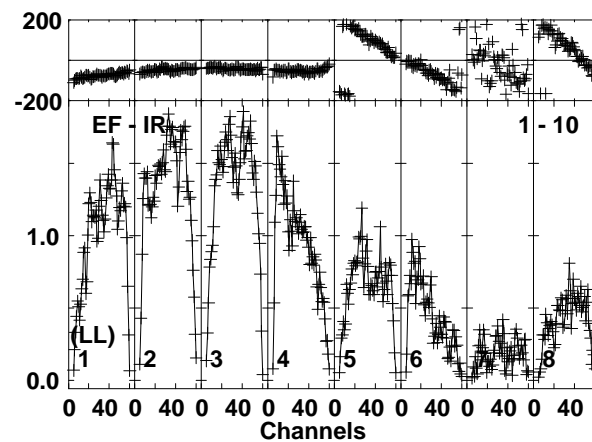
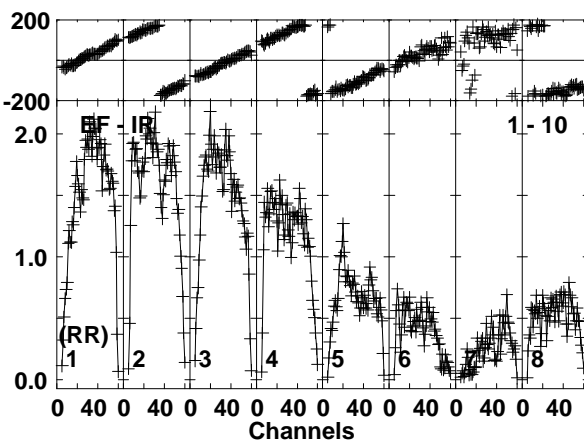
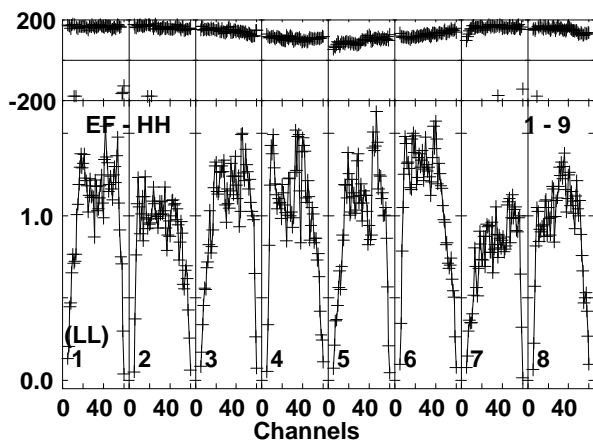
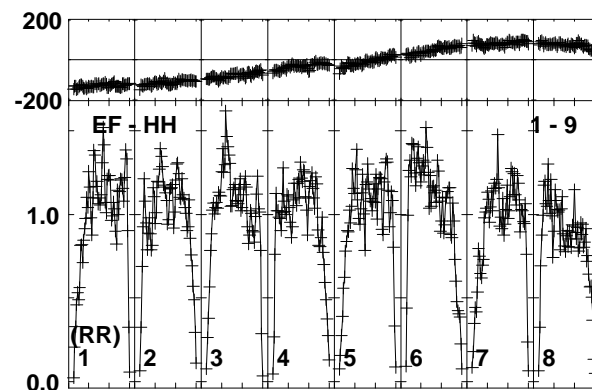
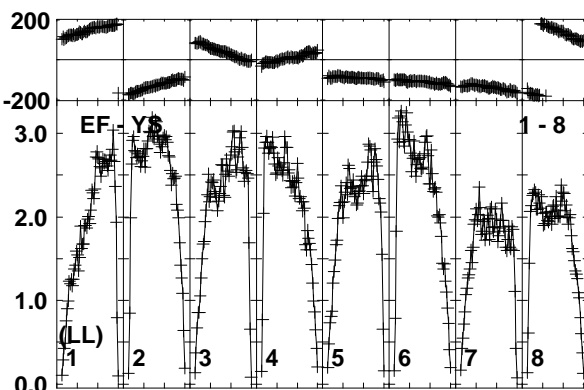
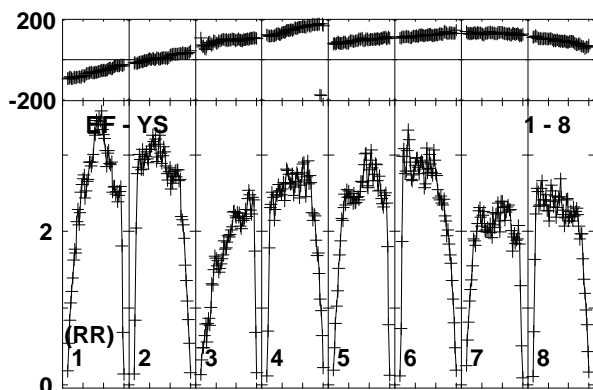
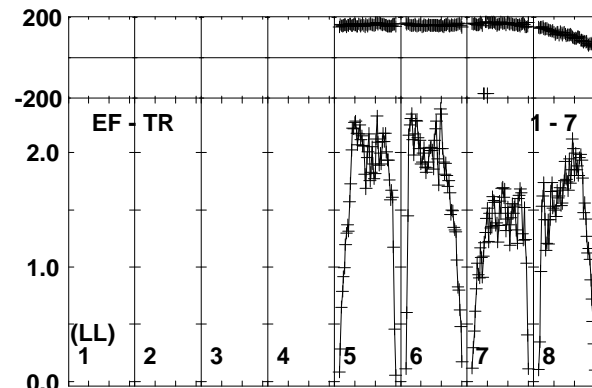
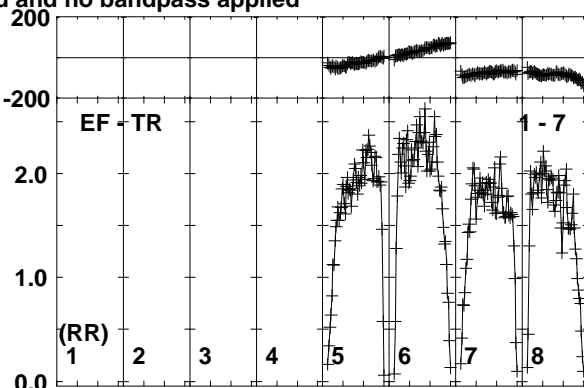
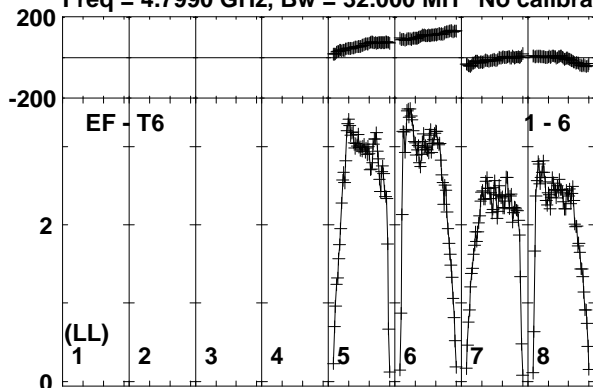

Lower frame: Milli Ampl Jy Top frame: Phas deg
Vector averaged cross-power spectrum Baseline: EF (01) - T6 (06)
Timerange: 00:17:40:01 to 00:17:40:59

Plot file version 201 created 19-OCT-2017 15:36:22

ARK564 ES081C.UVDATA.1

Freq = 4.7990 GHz, Bw = 32.000 MH No calibration applied and no bandpass applied

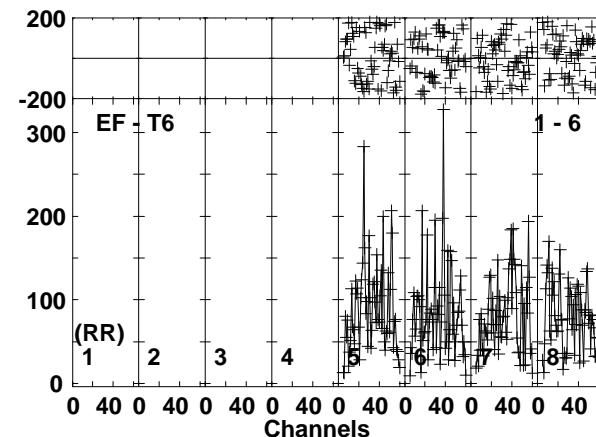
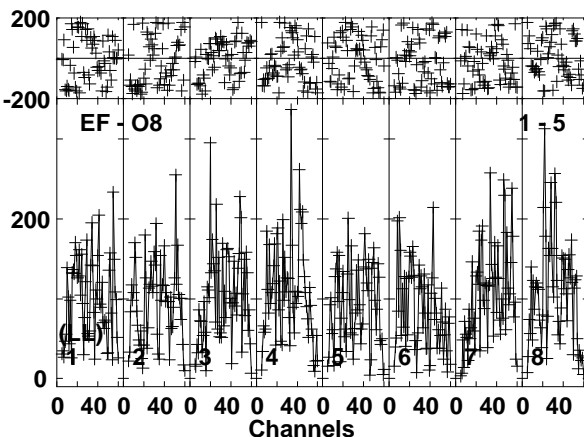
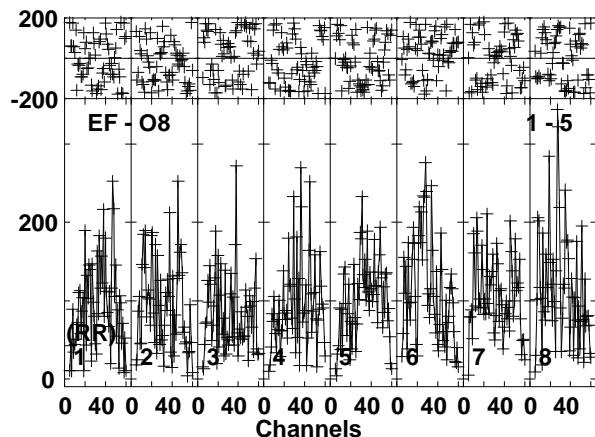
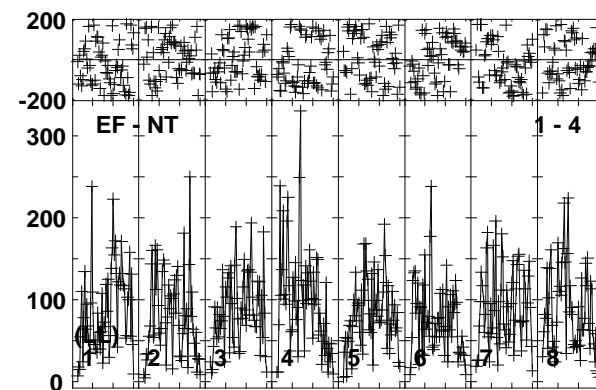
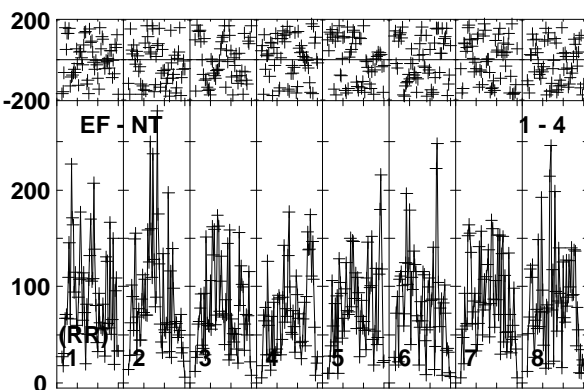
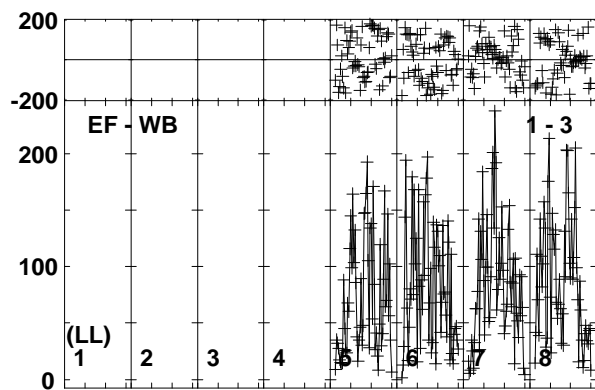
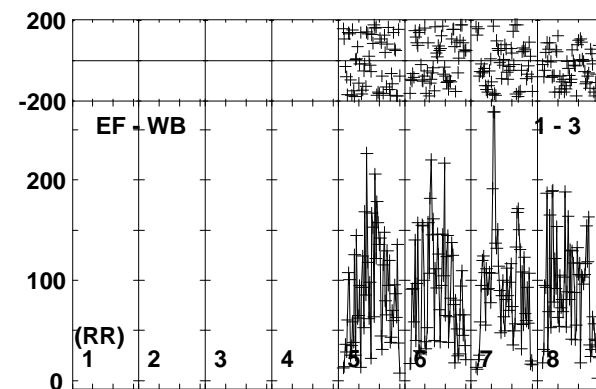
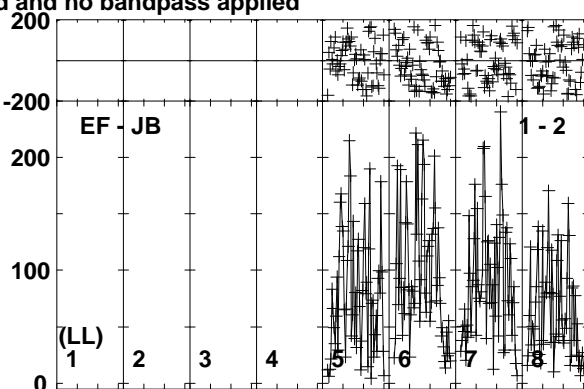
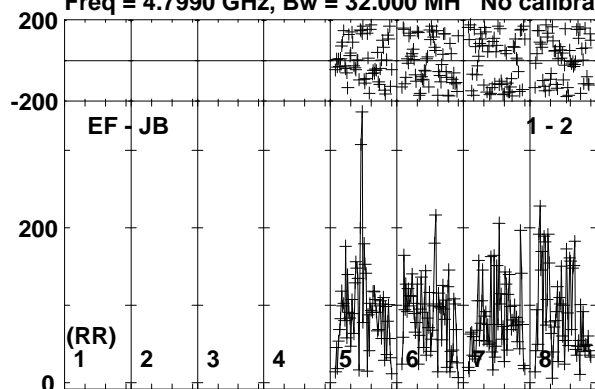

Lower frame: Micro Ampl Jy Top frame: Phas deg
Vector averaged cross-power spectrum Baseline: EF (01) - JB (02)
Timerange: 00/17:41:01 to 00/17:44:29

Plot file version 202 created 19-OCT-2017 15:36:22

ARK564 ES081C.UVDATA.1

Freq = 4.7990 GHz, Bw = 32.000 MH No calibration applied and no bandpass applied

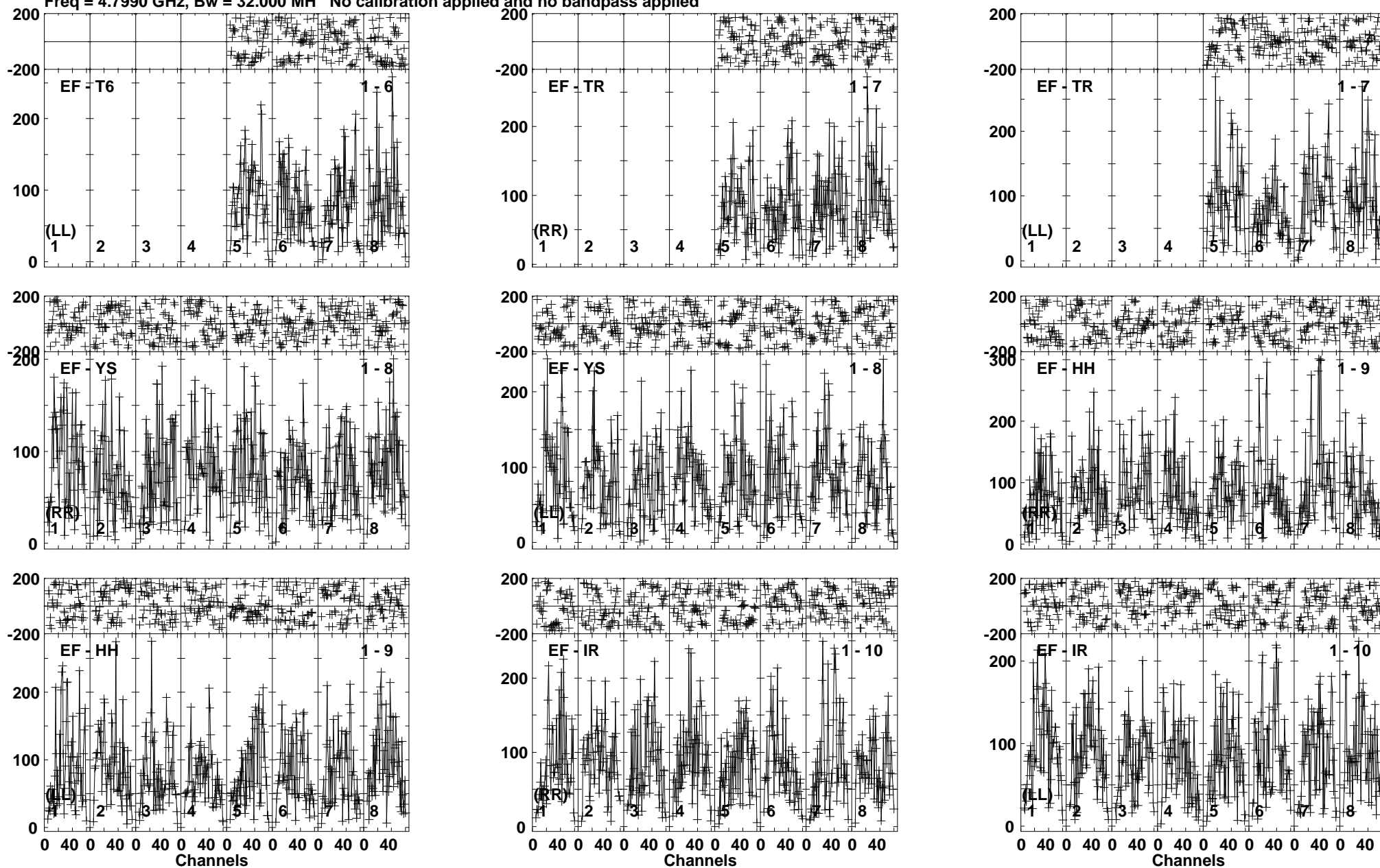

Lower frame: Micro Ampl Jy Top frame: Phas deg
Vector averaged cross-power spectrum Baseline: EF (01) - T6 (06)
Timerange: 00/17:41:01 to 00/17:44:29

Plot file version 203 created 19-OCT-2017 15:36:22

J2242+2955 ES081C.UVDATA.1

Freq = 4.7990 GHz, Bw = 32.000 MH No calibration applied and no bandpass applied

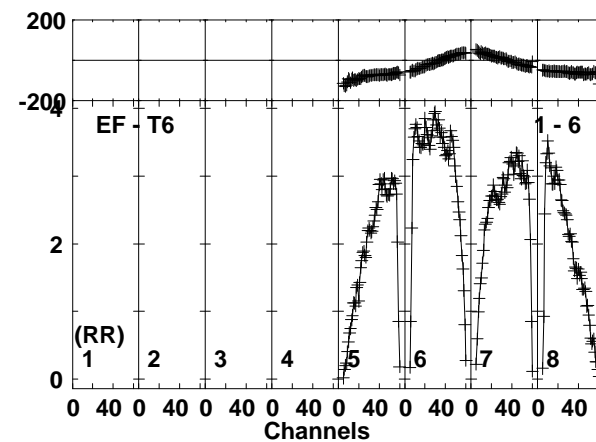
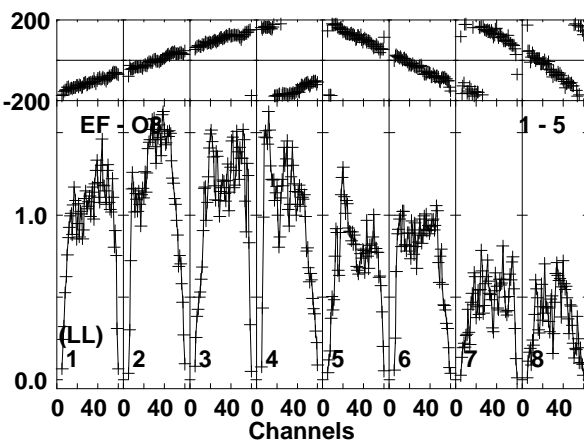
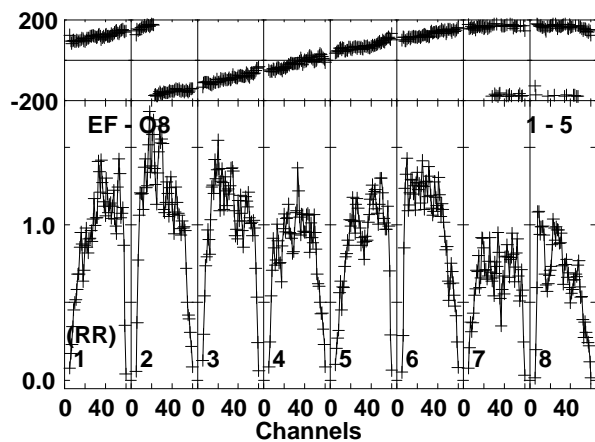
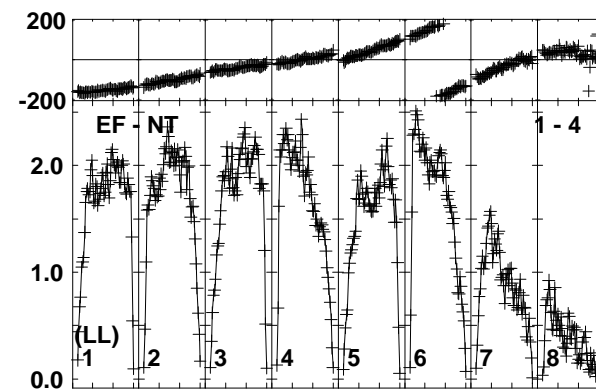
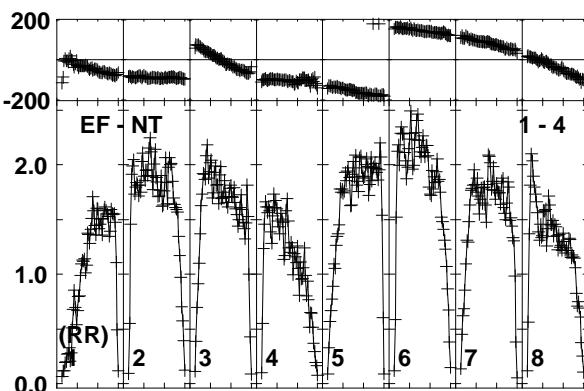
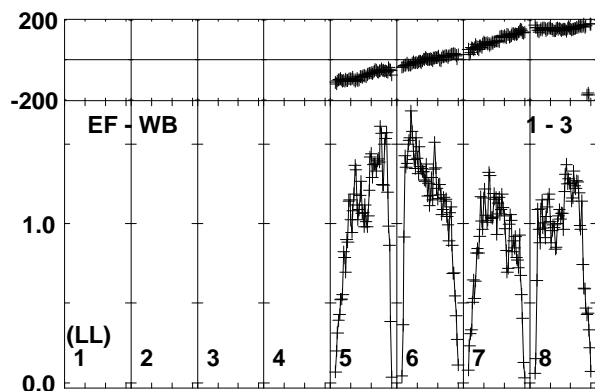
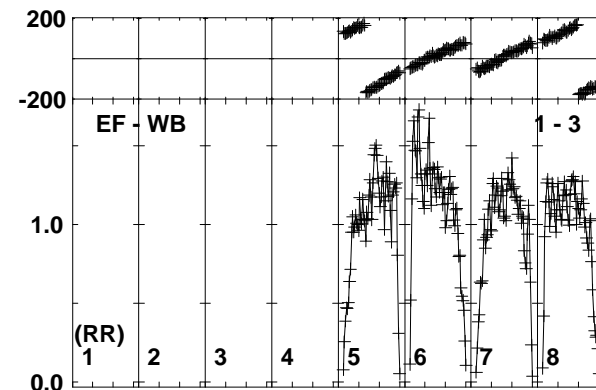
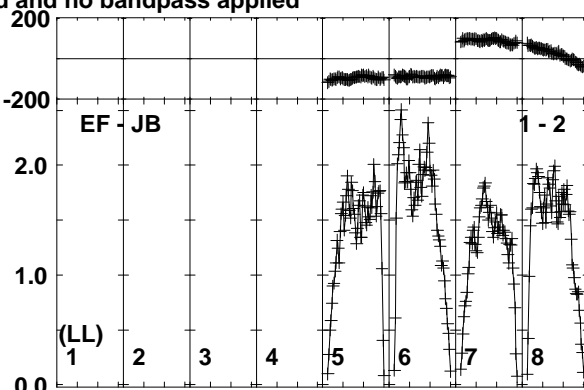
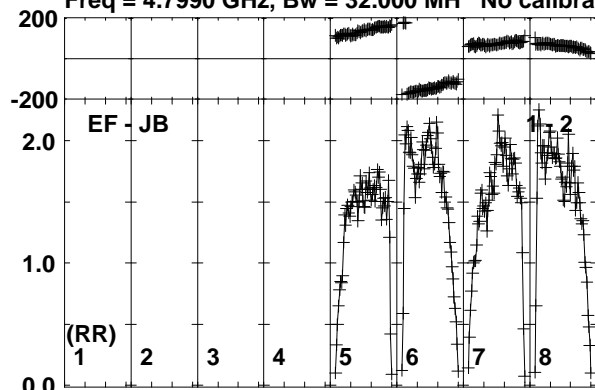

Lower frame: Milli Ampl Jy Top frame: Phas deg
Vector averaged cross-power spectrum Baseline: EF (01) - JB (02)
Timerange: 00:17:44:31 to 00:17:45:59

Plot file version 204 created 19-OCT-2017 15:36:22

J2242+2955 ES081C.UVDATA.1

Freq = 4.7990 GHz, Bw = 32.000 MH No calibration applied and no bandpass applied

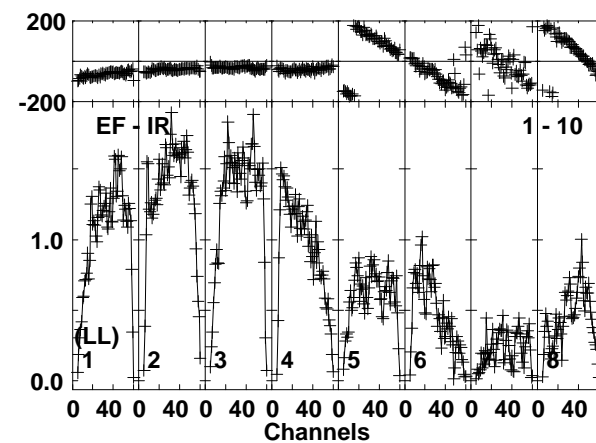
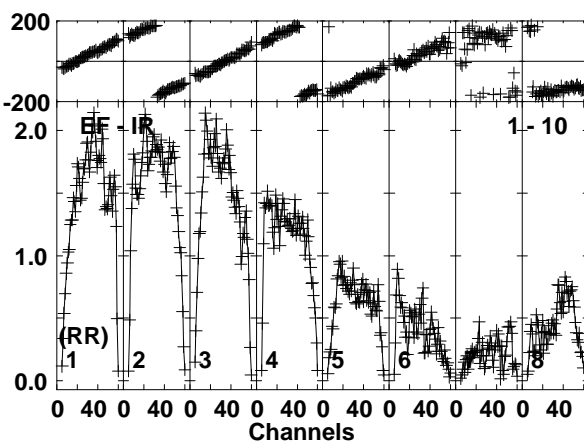
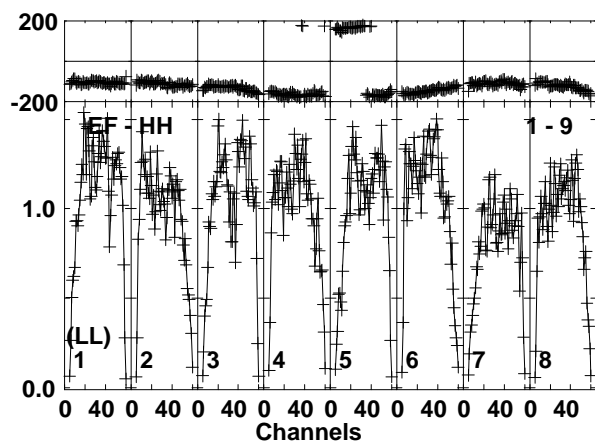
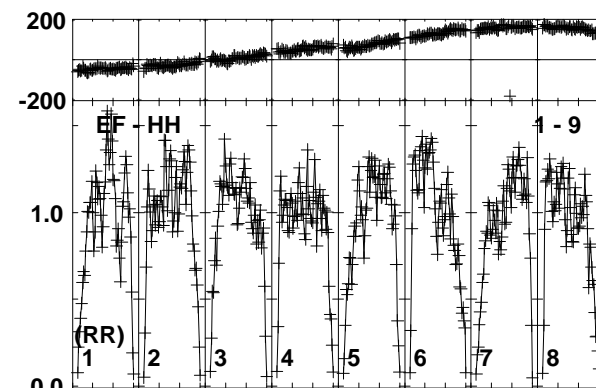
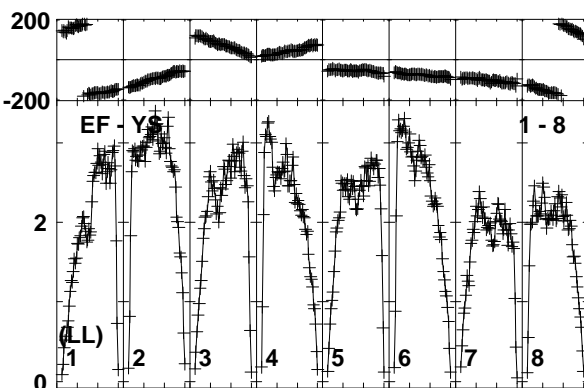
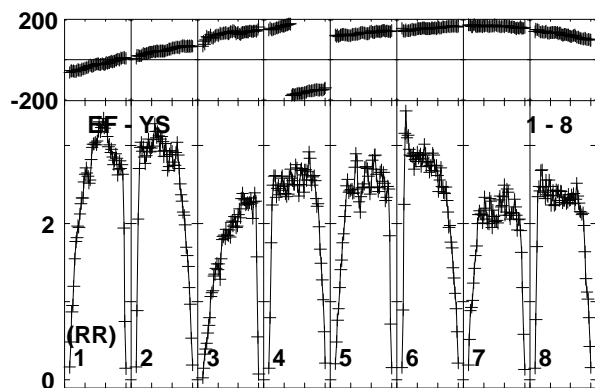
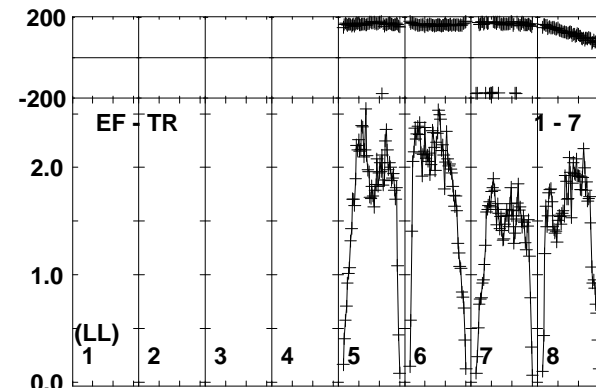
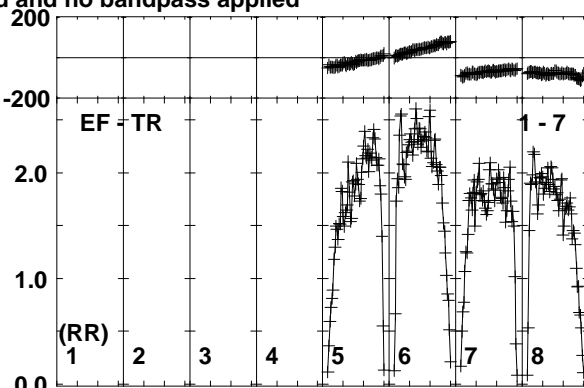
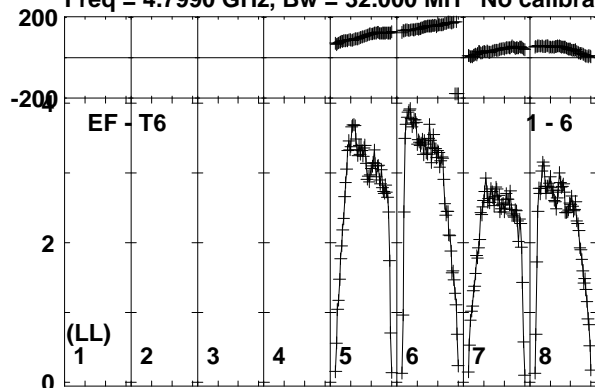

Lower frame: Milli Ampl Jy Top frame: Phas deg
Vector averaged cross-power spectrum Baseline: EF (01) - T6 (06)
Timerange: 00:17:44:31 to 00:17:45:59

Plot file version 205 created 19-OCT-2017 15:36:22

ARK564 ES081C.UVDATA.1

Freq = 4.7990 GHz, Bw = 32.000 MH No calibration applied and no bandpass applied

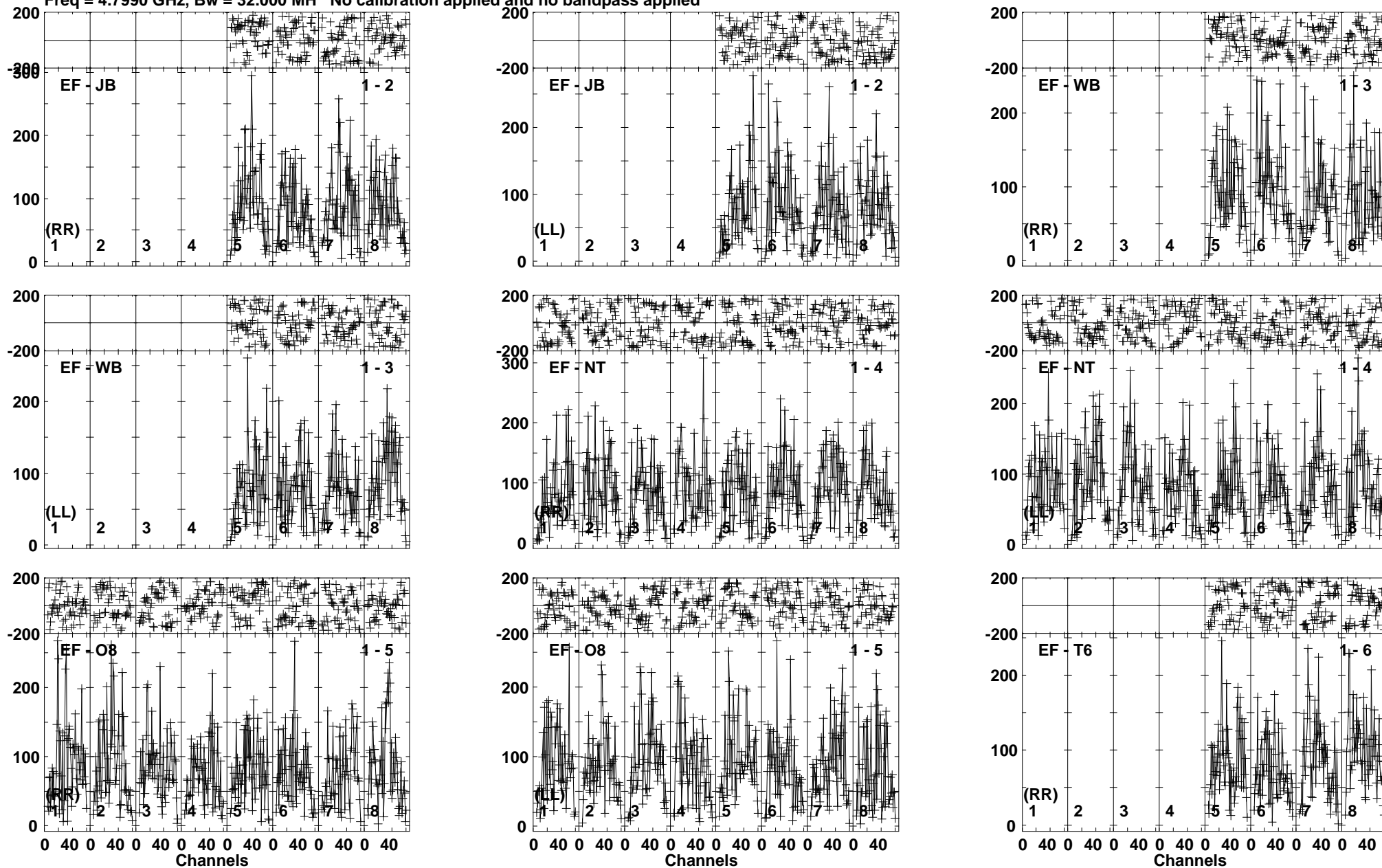

Lower frame: Micro Ampl Jy Top frame: Phas deg
Vector averaged cross-power spectrum Baseline: EF (01) - JB (02)
Timerange: 00/17:46:01 to 00/17:49:29

Plot file version 206 created 19-OCT-2017 15:36:22

ARK564 ES081C.UVDATA.1

Freq = 4.7990 GHz, Bw = 32.000 MH No calibration applied and no bandpass applied

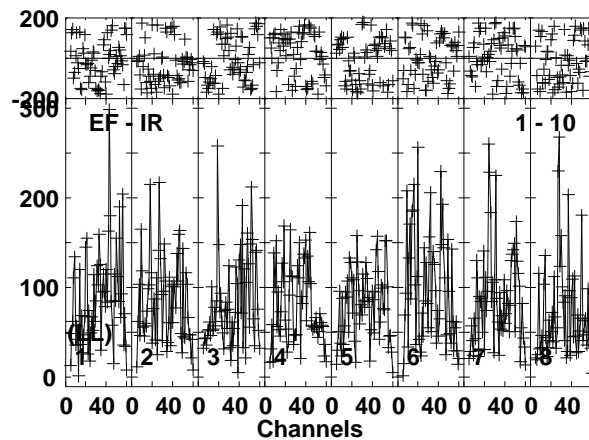
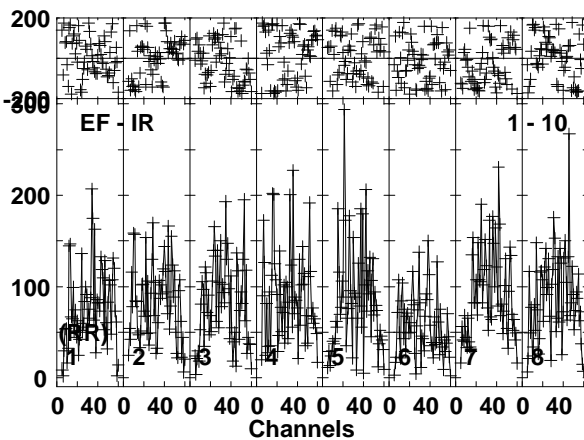
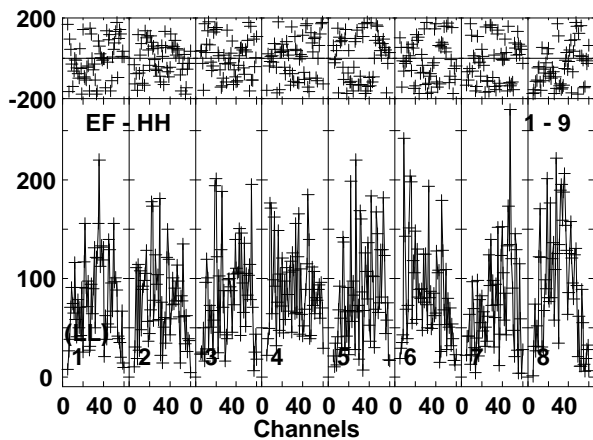
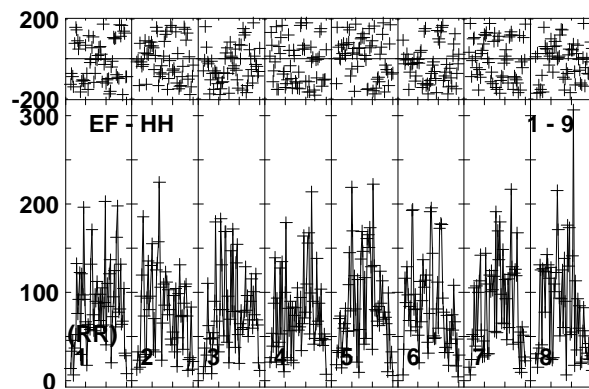
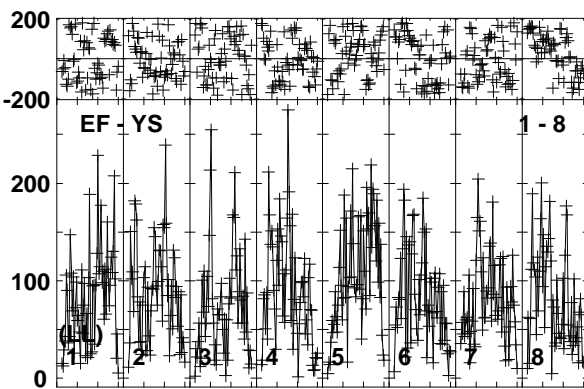
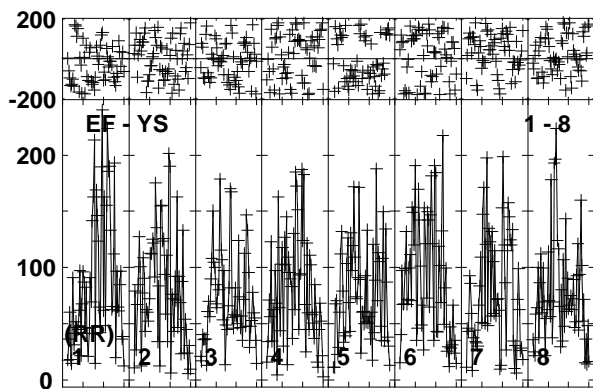
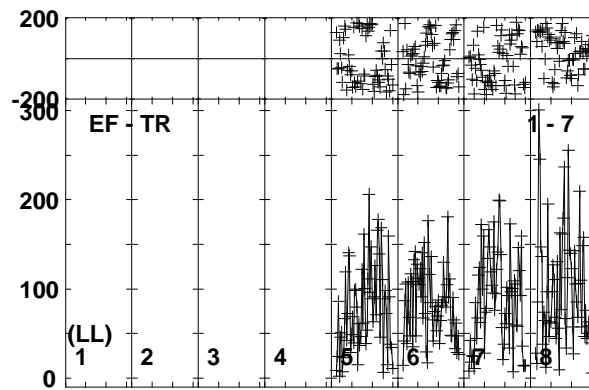
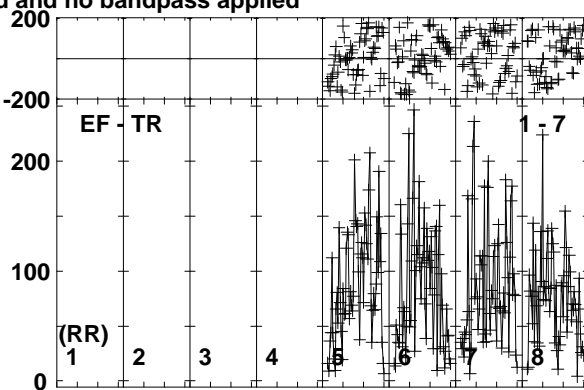
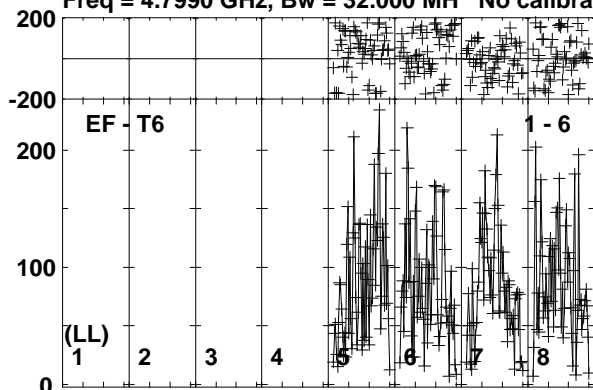

Lower frame: Micro Ampl Jy Top frame: Phas deg
Vector averaged cross-power spectrum Baseline: EF (01) - T6 (06)
Timerange: 00/17:46:01 to 00/17:49:29

Plot file version 207 created 19-OCT-2017 15:36:23

J2242+2955 ES081C.UVDATA.1

Freq = 4.7990 GHz, Bw = 32.000 MH No calibration applied and no bandpass applied

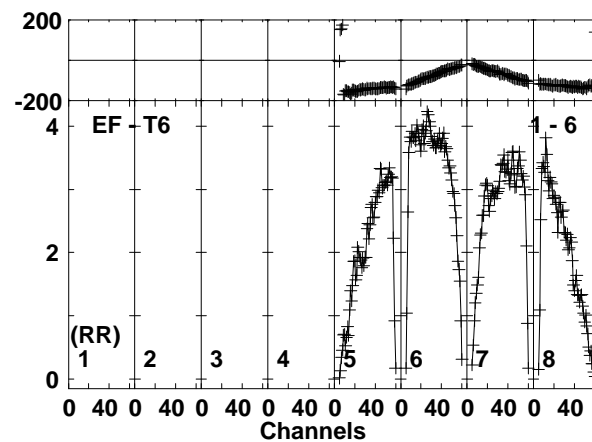
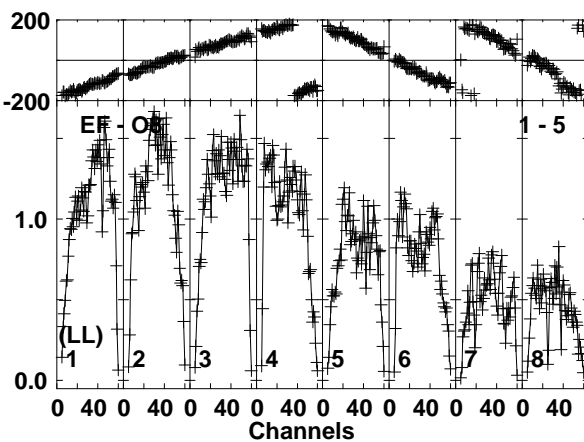
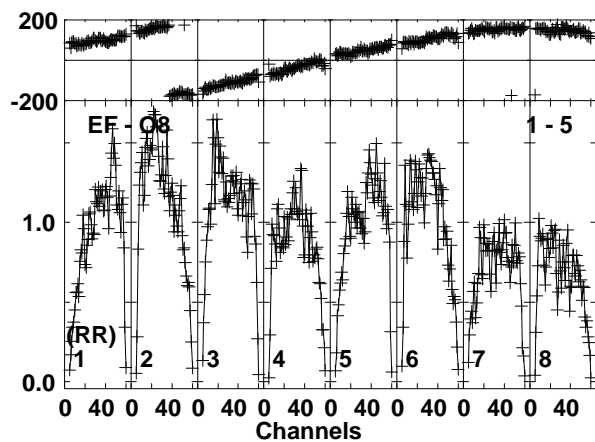
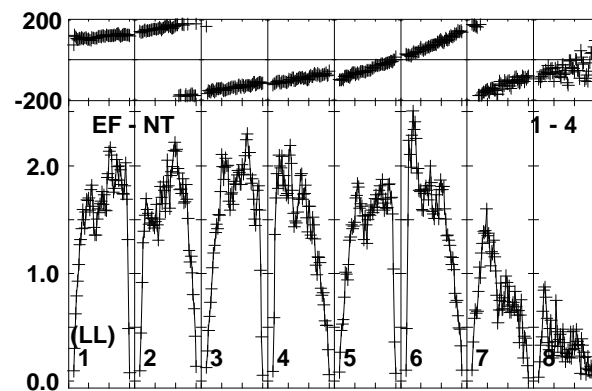
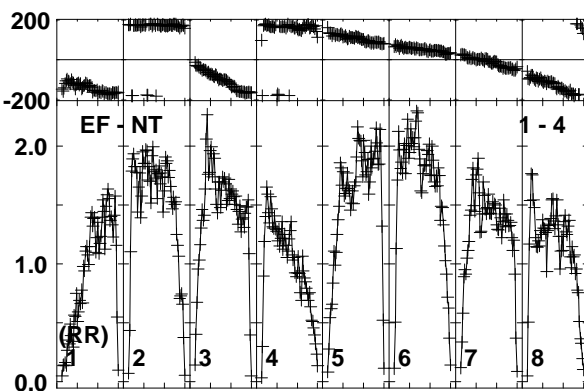
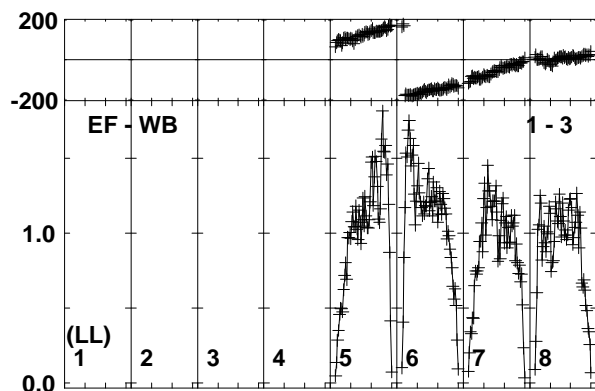
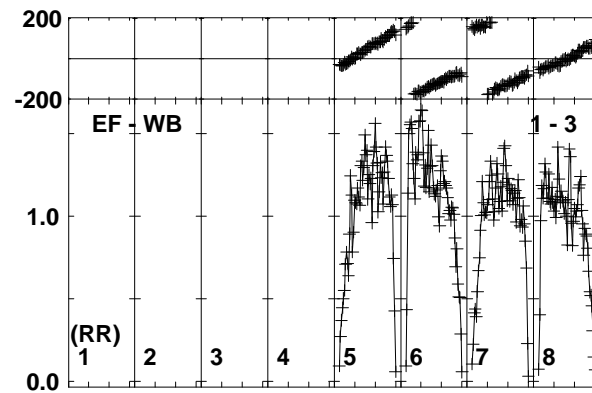
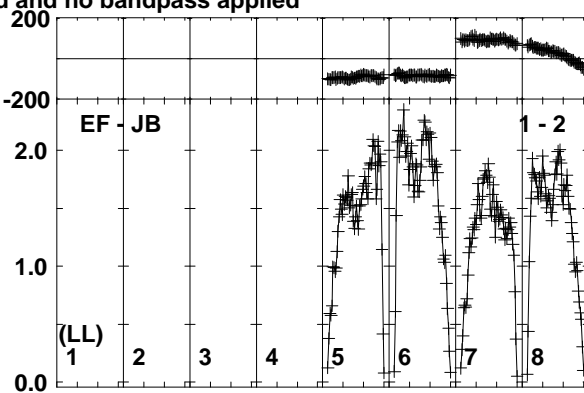
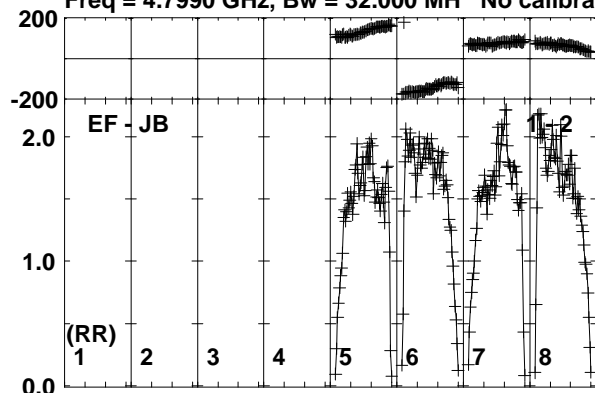

Lower frame: Milli Ampl Jy Top frame: Phas deg
Vector averaged cross-power spectrum Baseline: EF (01) - JB (02)
Timerange: 00/17:50:01 to 00/17:50:59

Plot file version 208 created 19-OCT-2017 15:36:23

J2242+2955 ES081C.UVDATA.1

Freq = 4.7990 GHz, Bw = 32.000 MH No calibration applied and no bandpass applied

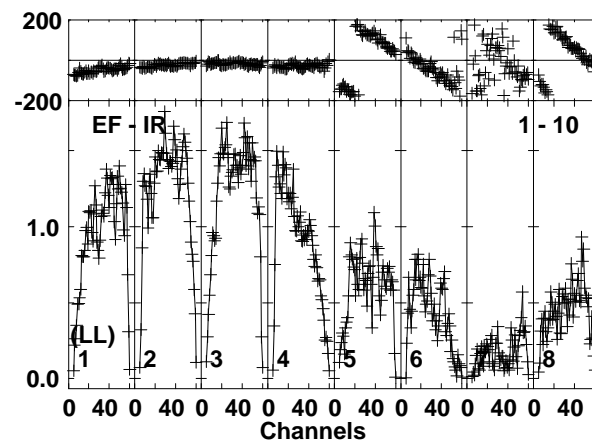
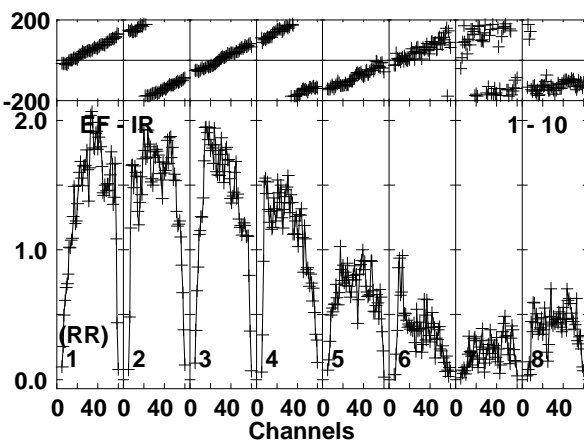
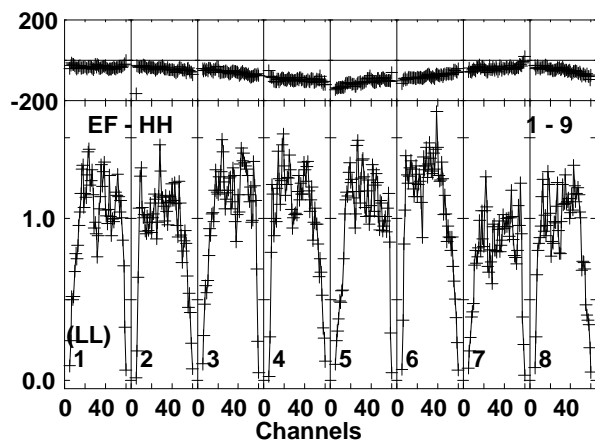
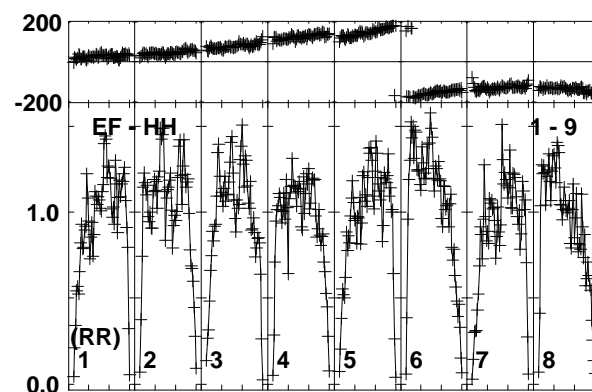
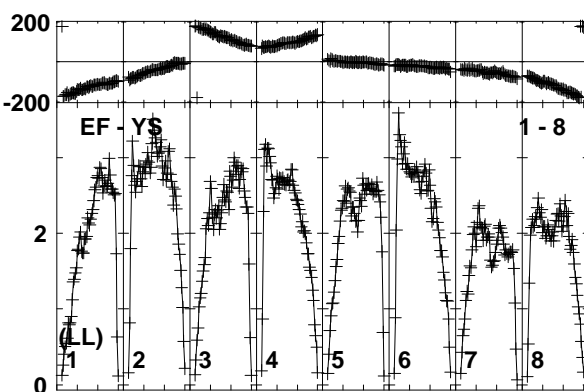
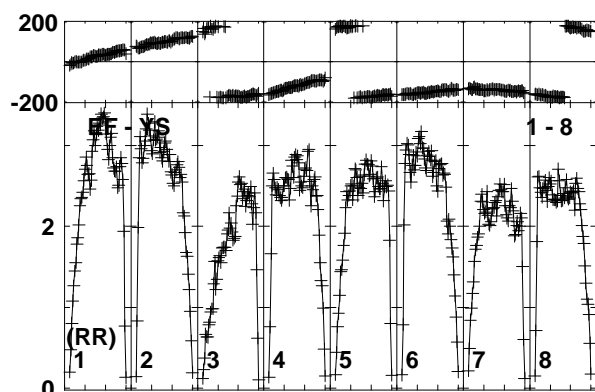
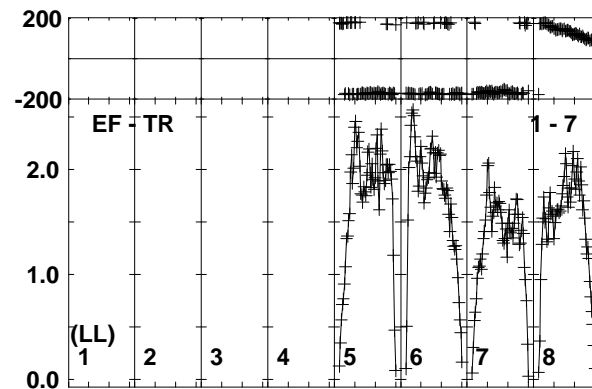
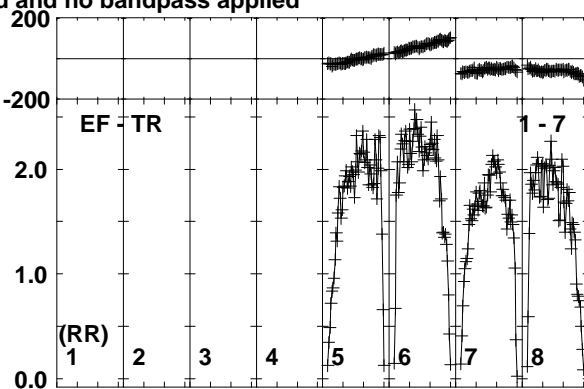
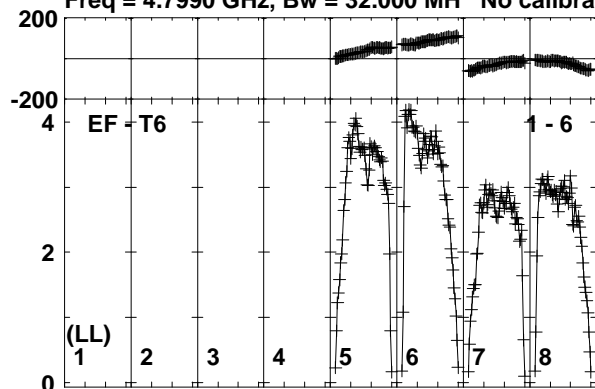

Lower frame: Milli Ampl Jy Top frame: Phas deg
Vector averaged cross-power spectrum Baseline: EF (01) - T6 (06)
Timerange: 00/17:50:01 to 00/17:50:59

Plot file version 209 created 19-OCT-2017 15:36:23

ARK564 ES081C.UVDATA.1

Freq = 4.7990 GHz, Bw = 32.000 MH No calibration applied and no bandpass applied

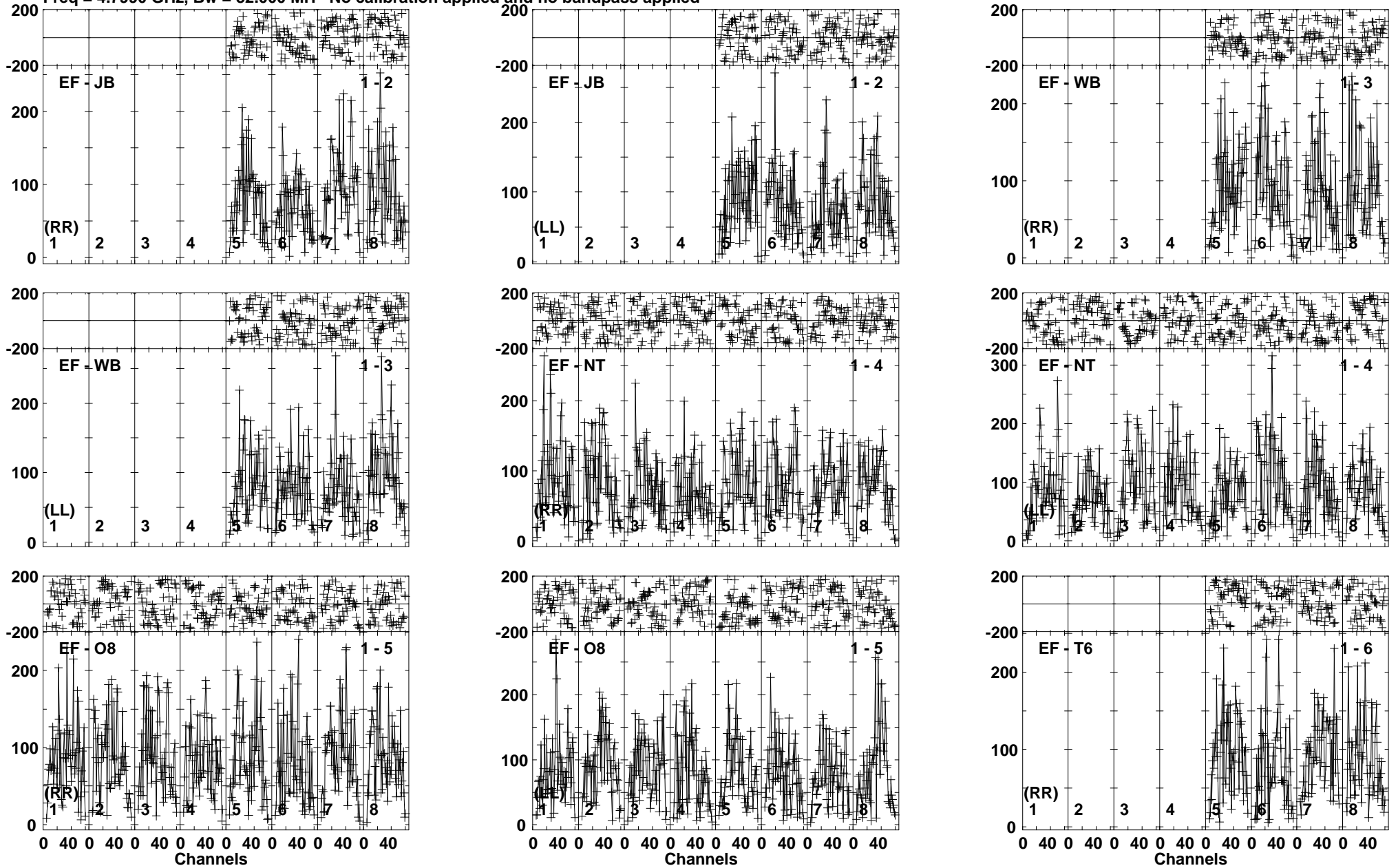

Plot file version 210 created 19-OCT-2017 15:36:23

ARK564 ES081C.UVDATA.1

Freq = 4.7990 GHz, Bw = 32.000 MH No calibration applied and no bandpass applied

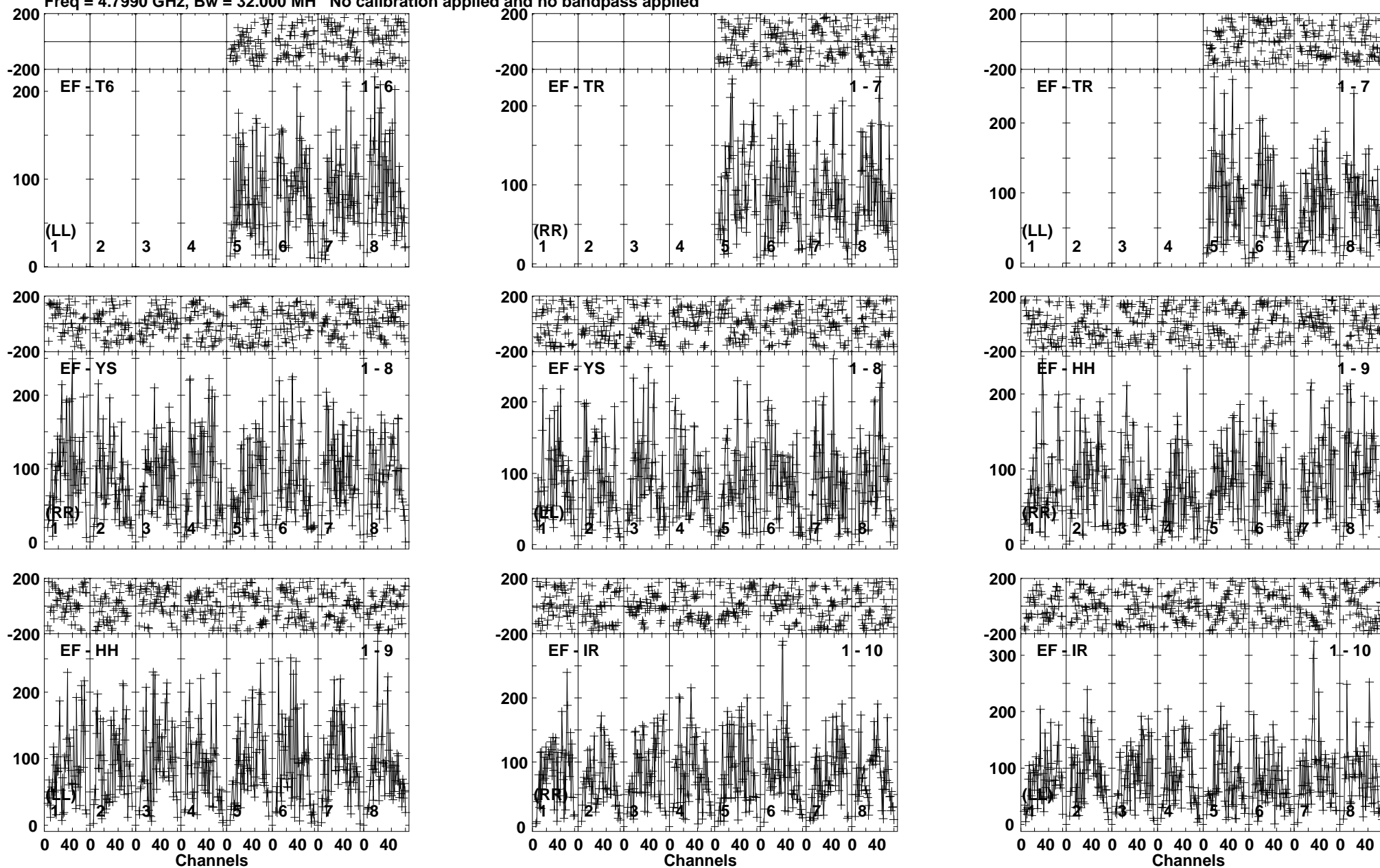

Lower frame: Micro Ampl Jy Top frame: Phas deg
Vector averaged cross-power spectrum Baseline: EF (01) - T6 (06)
Timerange: 00/17:51:01 to 00/17:54:29

Plot file version 211 created 19-OCT-2017 15:36:23

J2242+2955 ES081C.UVDATA.1

Freq = 4.7990 GHz, Bw = 32.000 MH No calibration applied and no bandpass applied

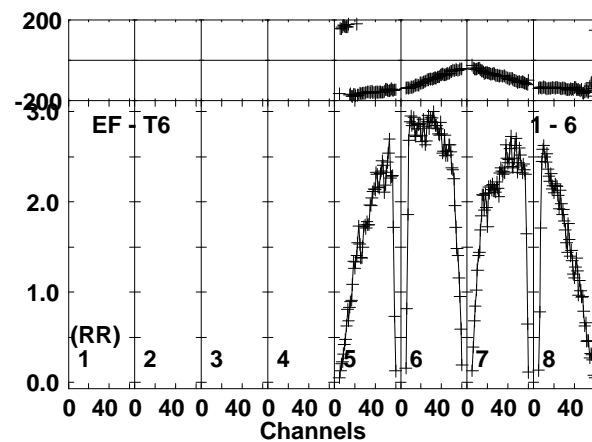
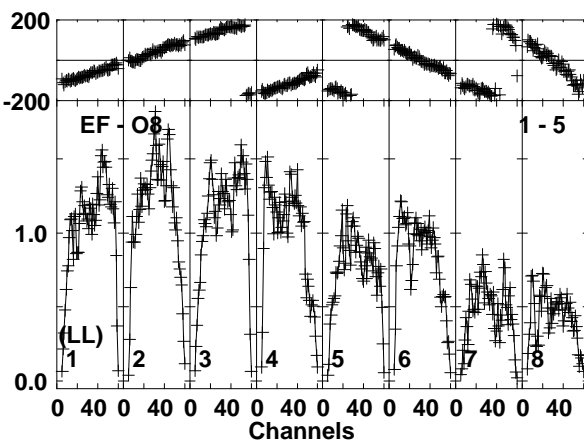
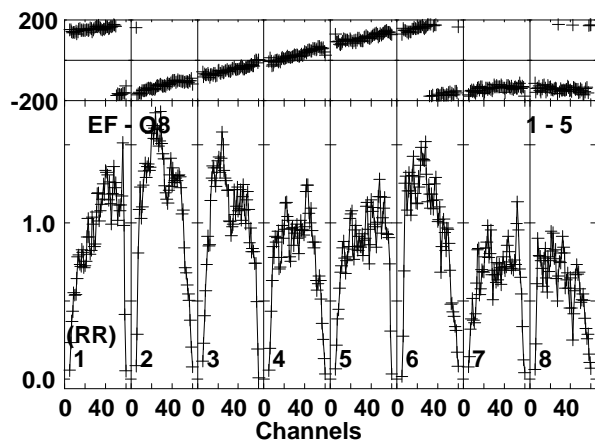
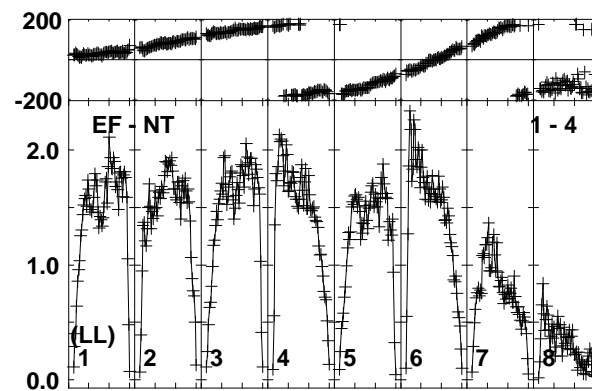
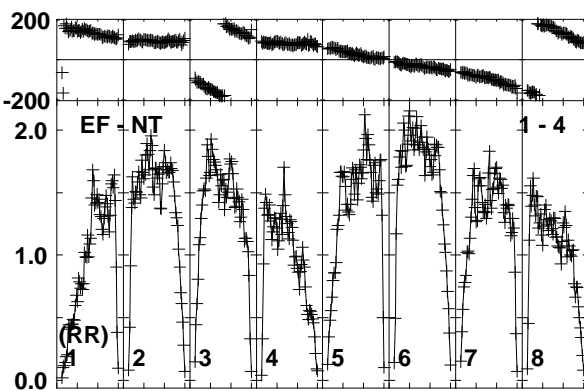
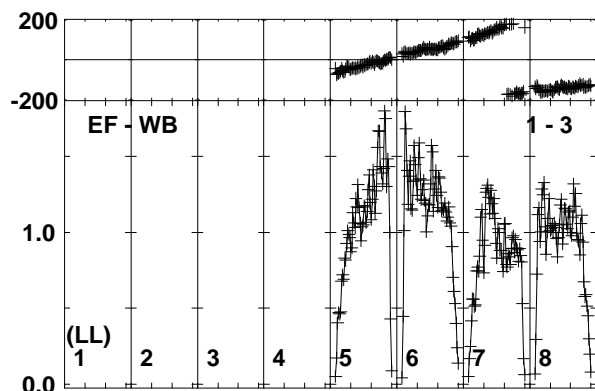
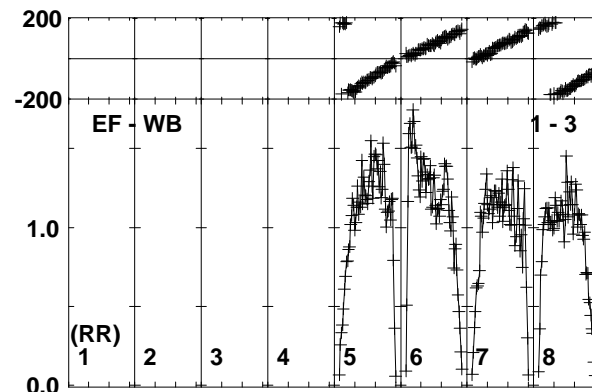
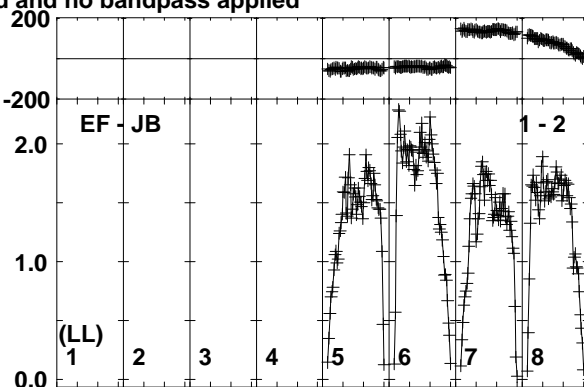
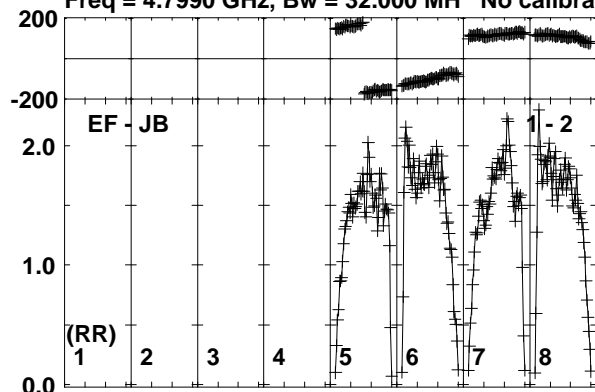

Lower frame: Milli Ampl Jy Top frame: Phas deg
Vector averaged cross-power spectrum Baseline: EF (01) - JB (02)
Timerange: 00/17:54:31 to 00/17:55:59

Plot file version 212 created 19-OCT-2017 15:36:23

J2242+2955 ES081C.UVDATA.1

Freq = 4.7990 GHz, Bw = 32.000 MH No calibration applied and no bandpass applied

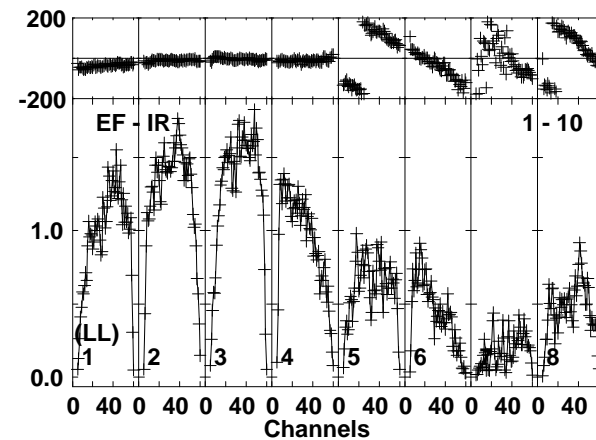
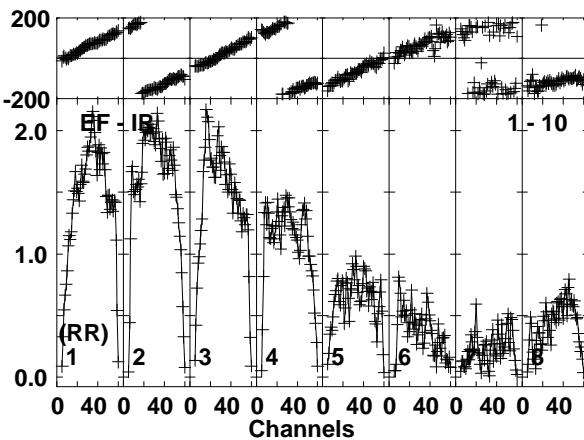
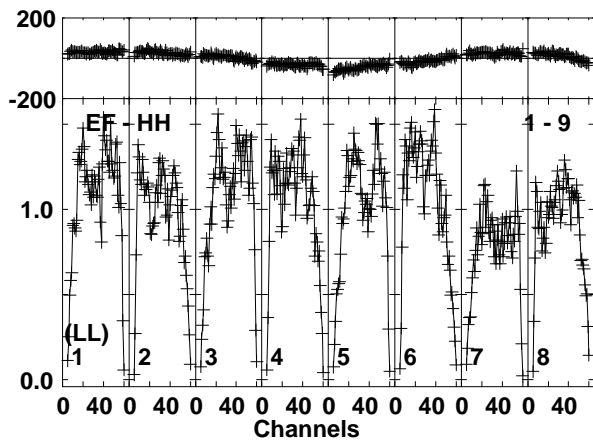
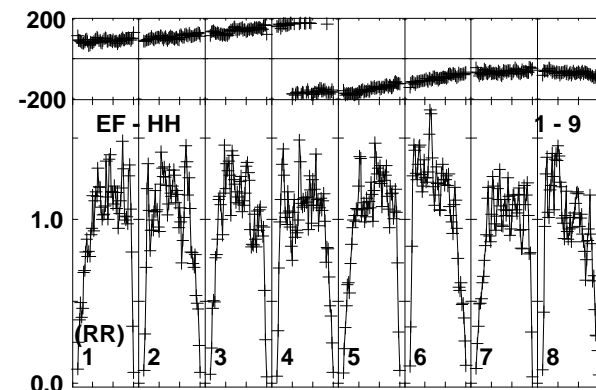
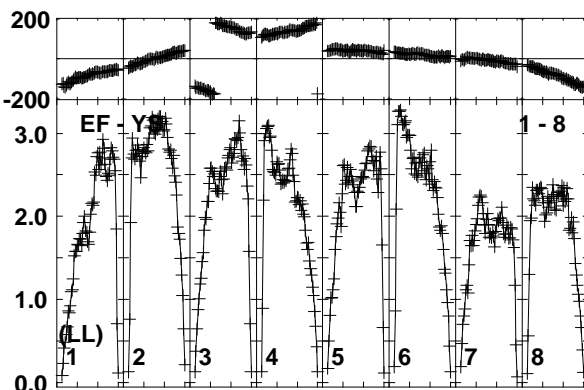
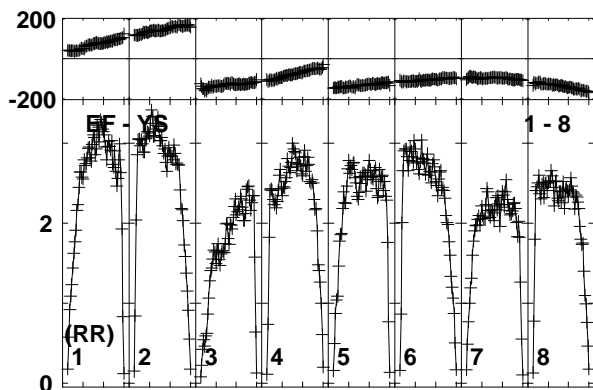
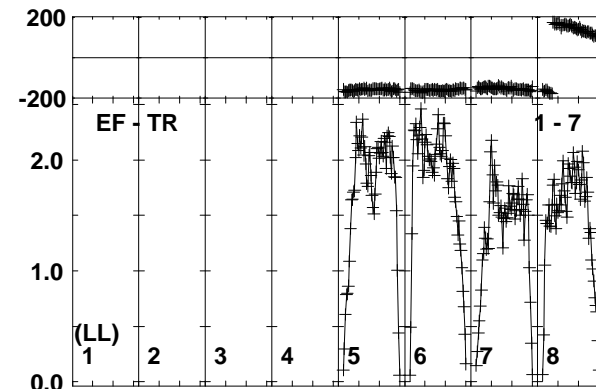
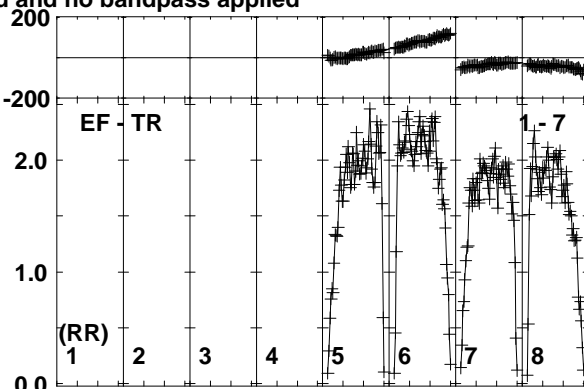
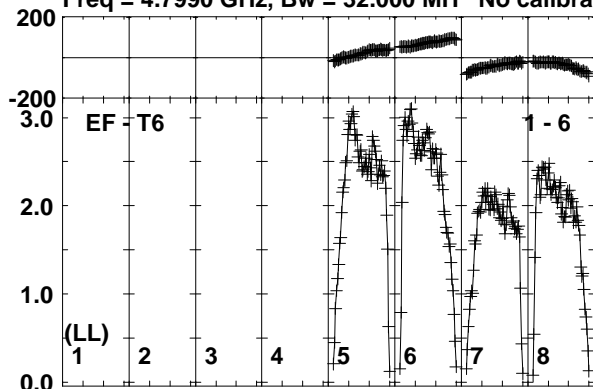

Lower frame: Milli Ampl Jy Top frame: Phas deg
Vector averaged cross-power spectrum Baseline: EF (01) - T6 (06)
Timerange: 00:17:54:31 to 00:17:55:59

Plot file version 213 created 19-OCT-2017 15:36:23

ARK564 ES081C.UVDATA.1

Freq = 4.7990 GHz, Bw = 32.000 MH No calibration applied and no bandpass applied

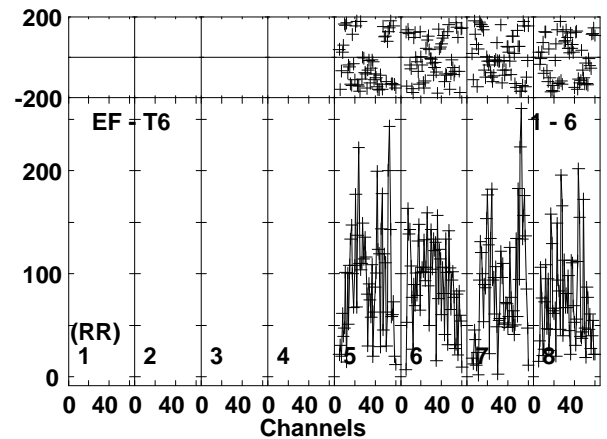
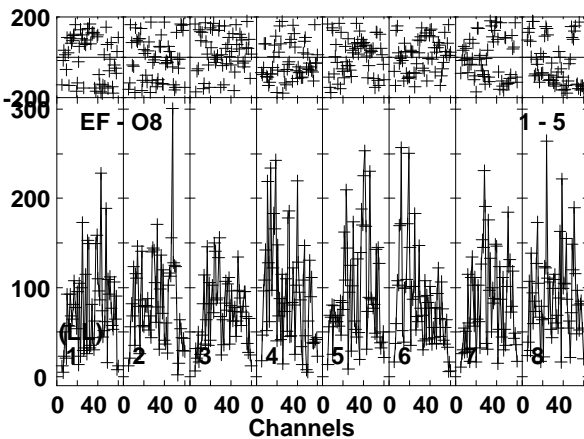
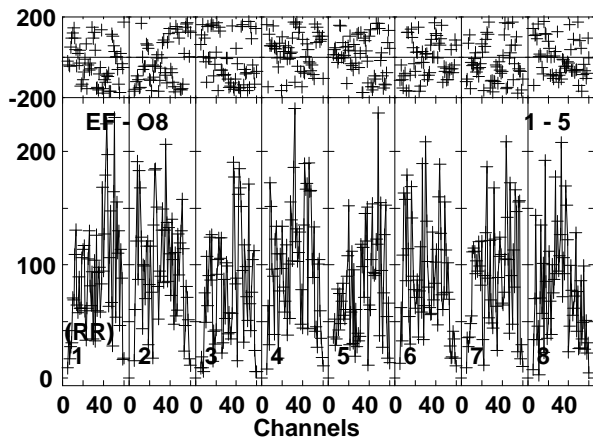
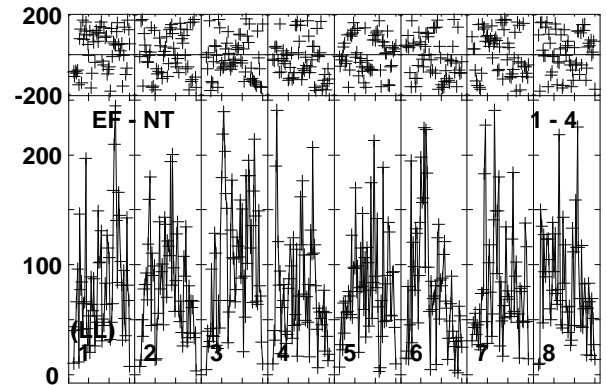
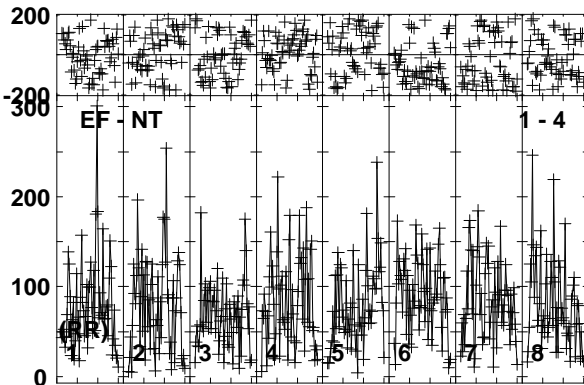
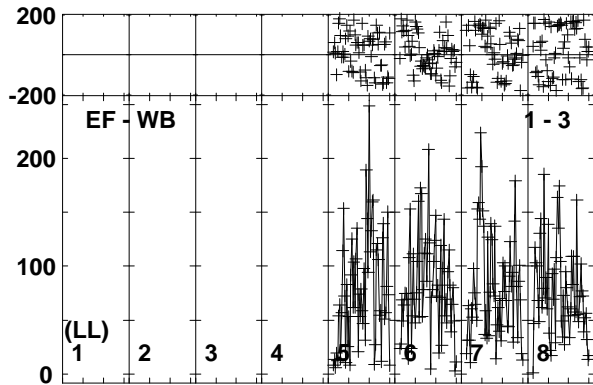
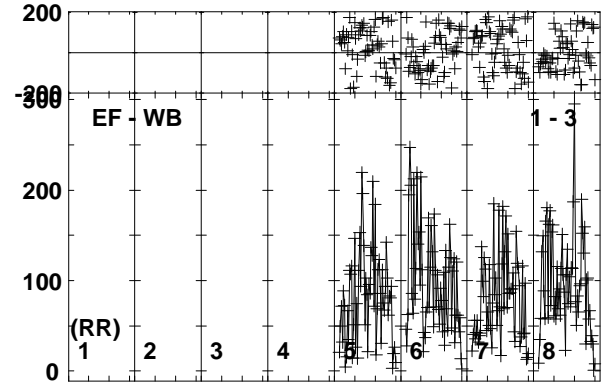
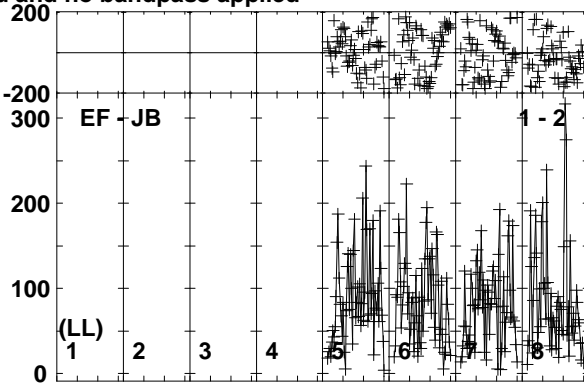
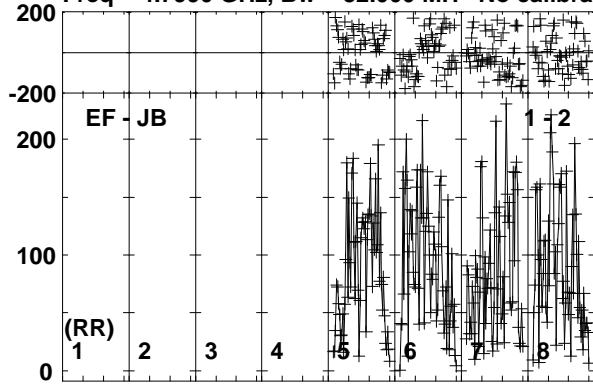

Lower frame: Micro Ampl Jy Top frame: Phas deg
Vector averaged cross-power spectrum Baseline: EF (01) - JB (02)
Timerange: 00/17:56:01 to 00/17:59:29

Plot file version 214 created 19-OCT-2017 15:36:24

ARK564 ES081C.UVDATA.1

Freq = 4.7990 GHz, Bw = 32.000 MH No calibration applied and no bandpass applied

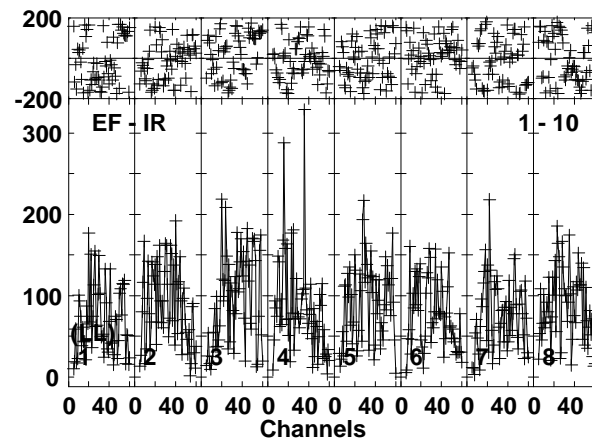
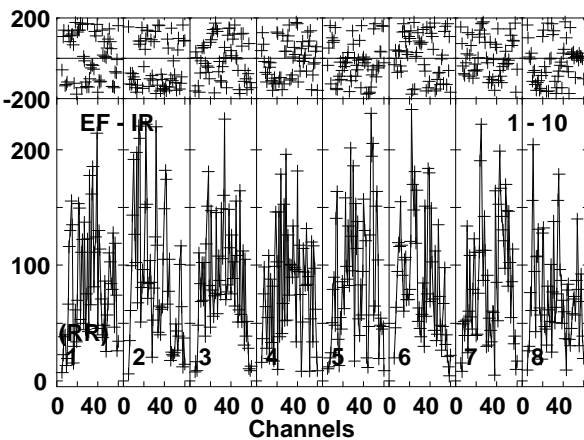
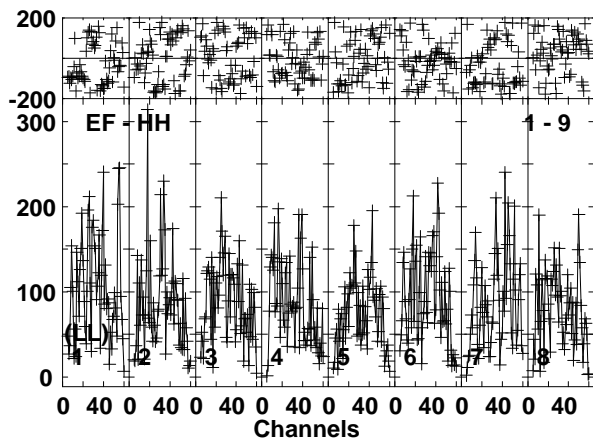
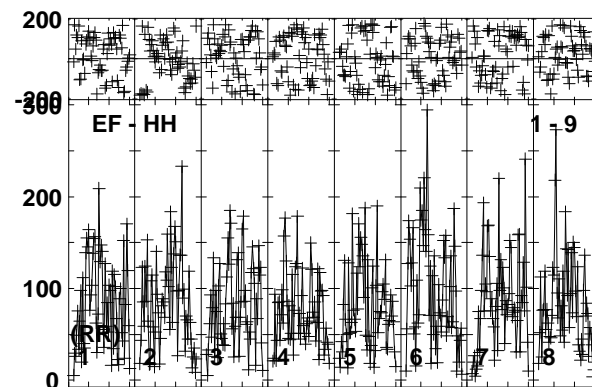
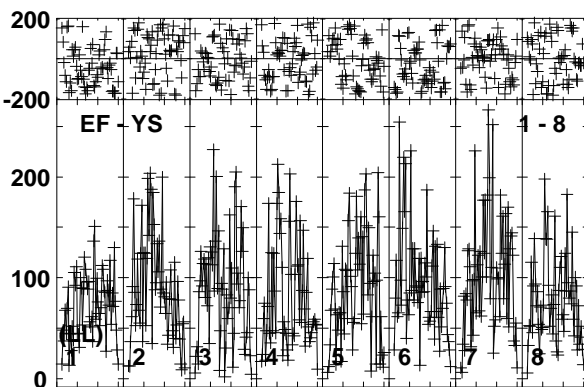
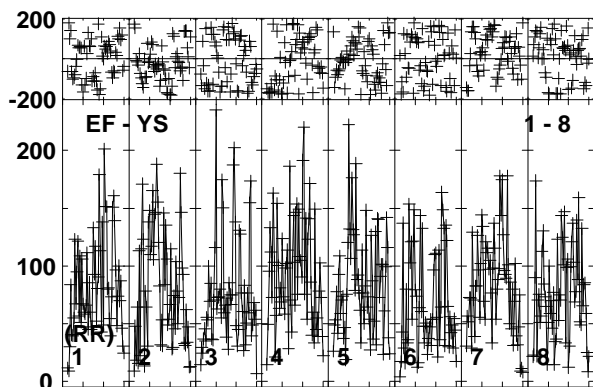
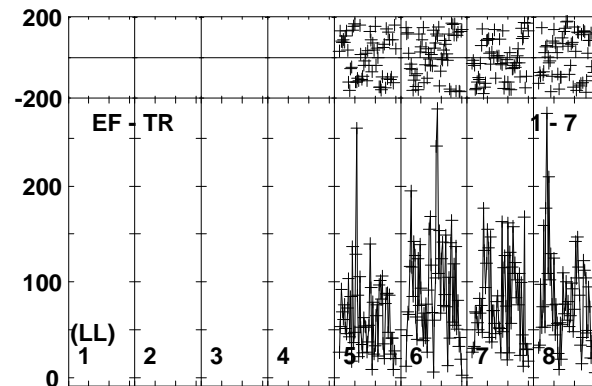
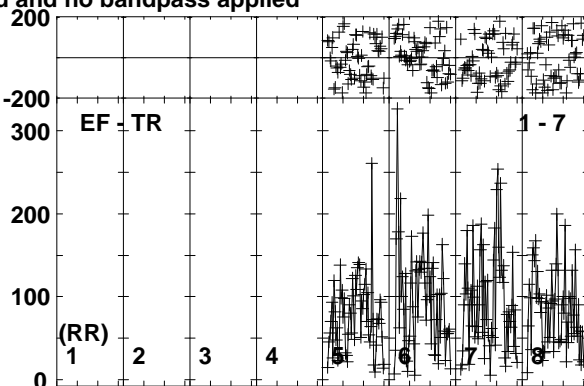
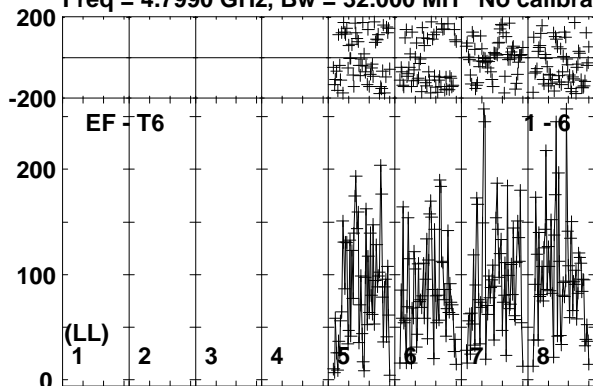

Lower frame: Micro Ampl Jy Top frame: Phas deg
Vector averaged cross-power spectrum Baseline: EF (01) - T6 (06)
Timerange: 00/17:56:01 to 00/17:59:29

Plot file version 215 created 19-OCT-2017 15:36:24

J2242+2955 ES081C.UVDATA.1

Freq = 4.7990 GHz, Bw = 32.000 MH No calibration applied and no bandpass applied

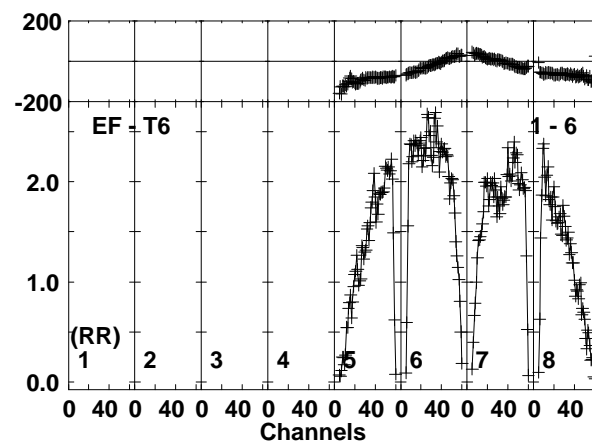
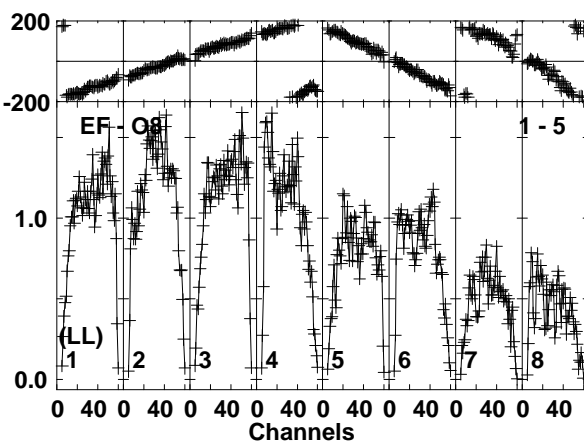
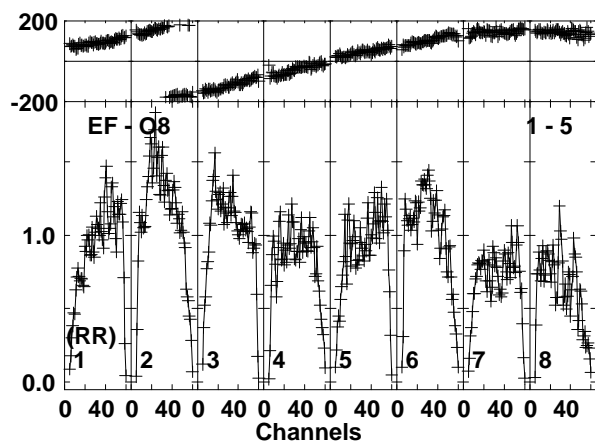
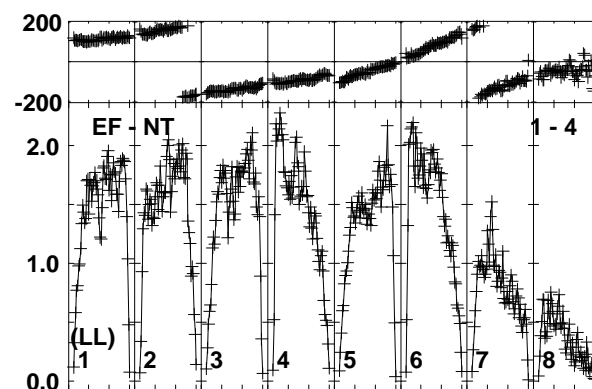
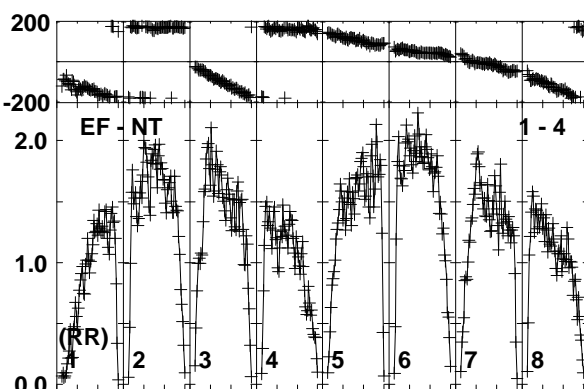
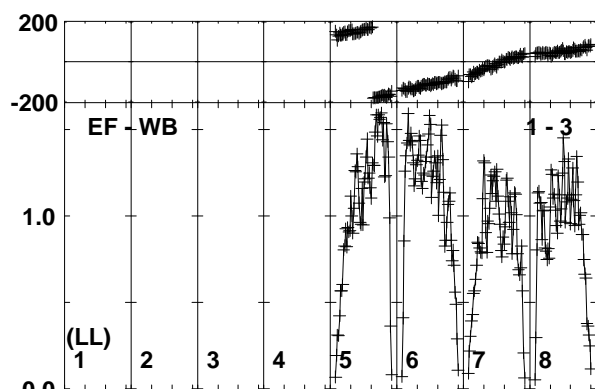
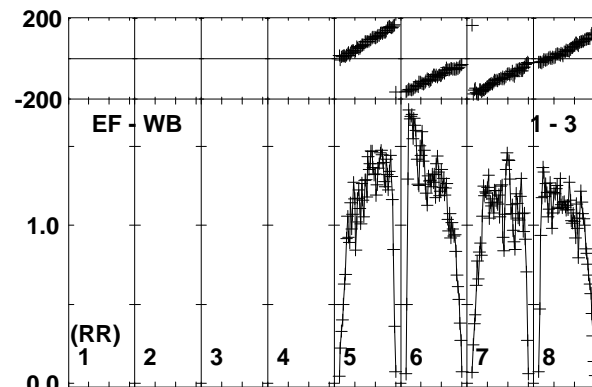
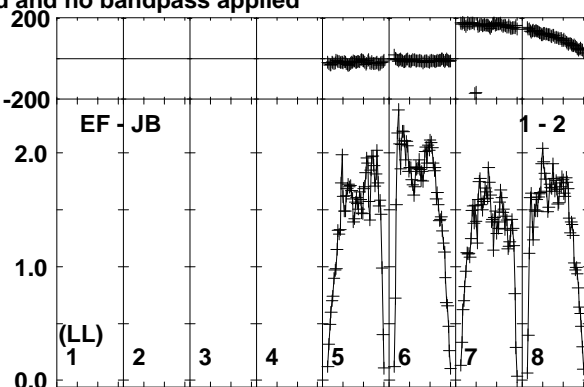
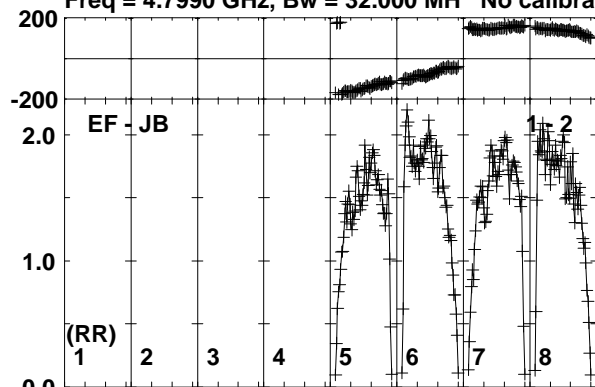

Lower frame: Milli Ampl Jy Top frame: Phas deg
Vector averaged cross-power spectrum Baseline: EF (01) - JB (02)
Timerange: 00:18:00:01 to 00:18:00:59

Plot file version 216 created 19-OCT-2017 15:36:24

J2242+2955 ES081C.UVDATA.1

Freq = 4.7990 GHz, Bw = 32.000 MH No calibration applied and no bandpass applied

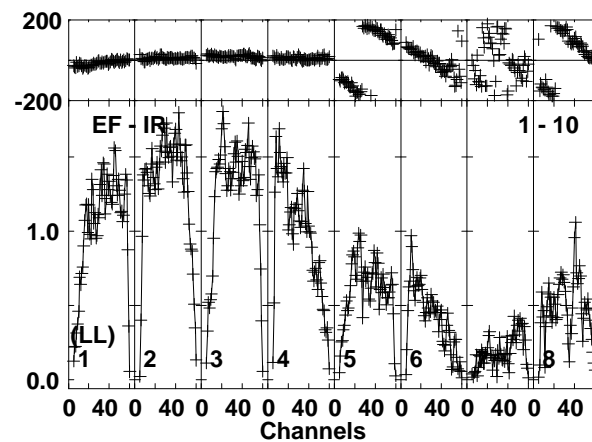
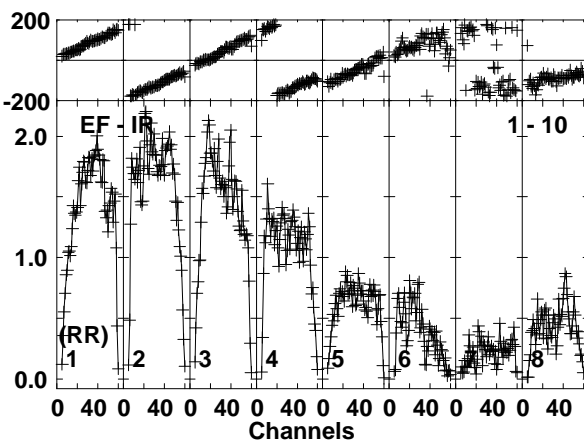
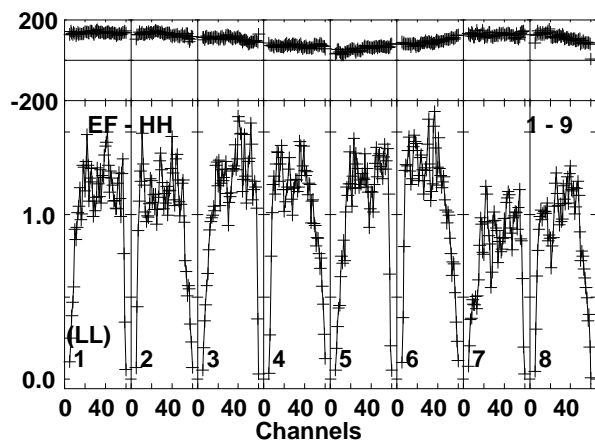
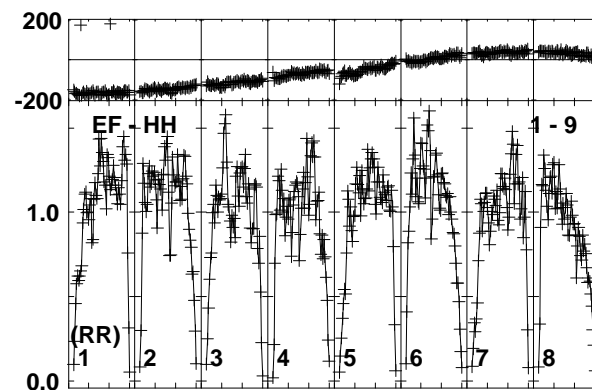
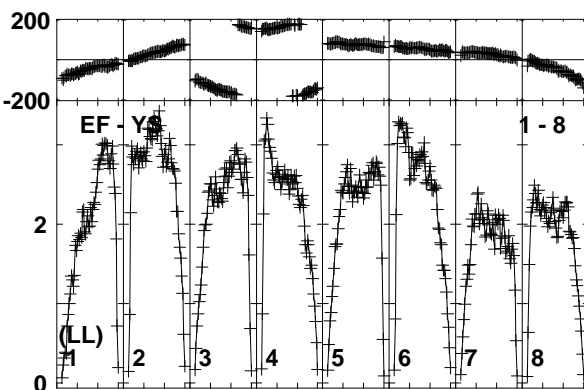
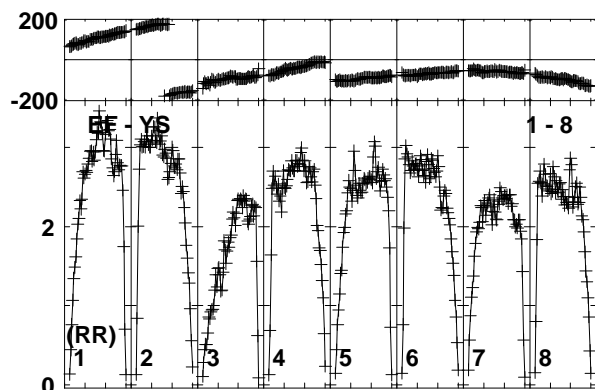
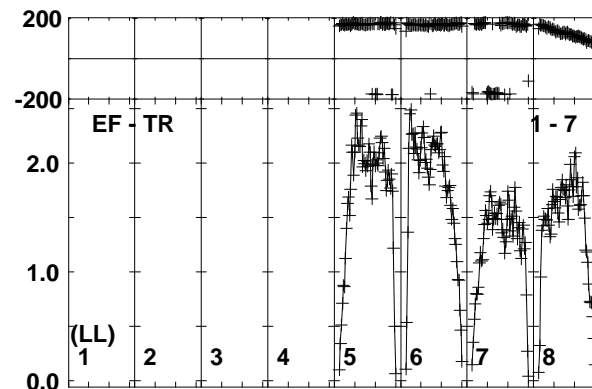
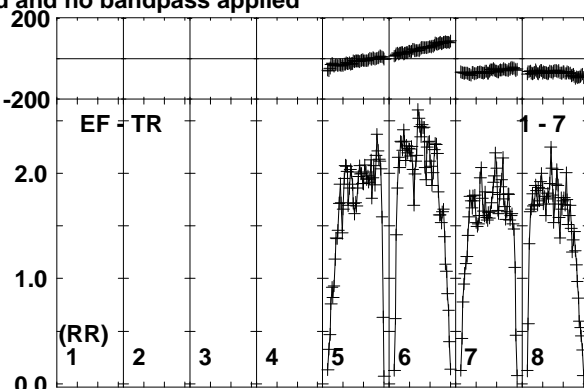
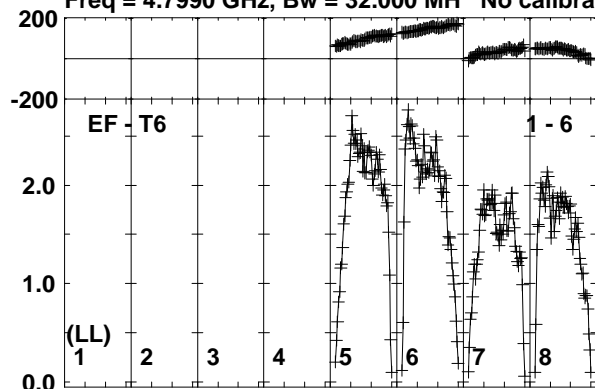

Lower frame: Milli Ampl Jy Top frame: Phas deg
Vector averaged cross-power spectrum Baseline: EF (01) - T6 (06)
Timerange: 00:18:00:01 to 00:18:00:59

Plot file version 217 created 19-OCT-2017 15:36:24

J0004+2019 ES081C.UVDATA.1

Freq = 4.7990 GHz, Bw = 32.000 MH No calibration applied and no bandpass applied

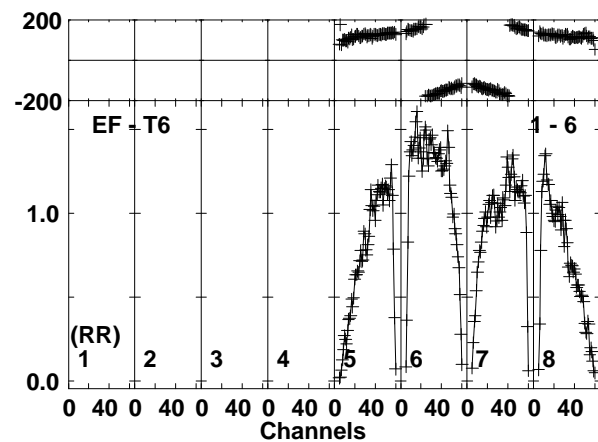
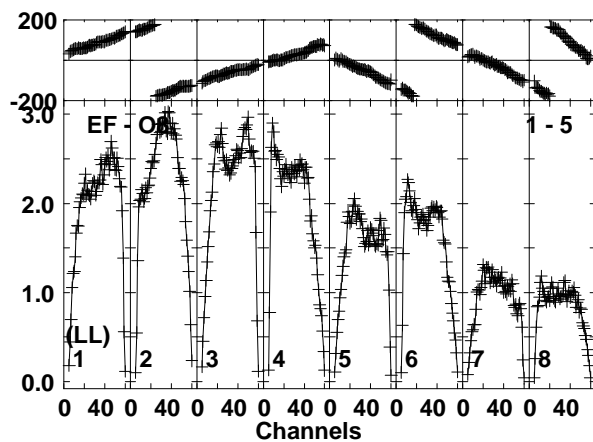
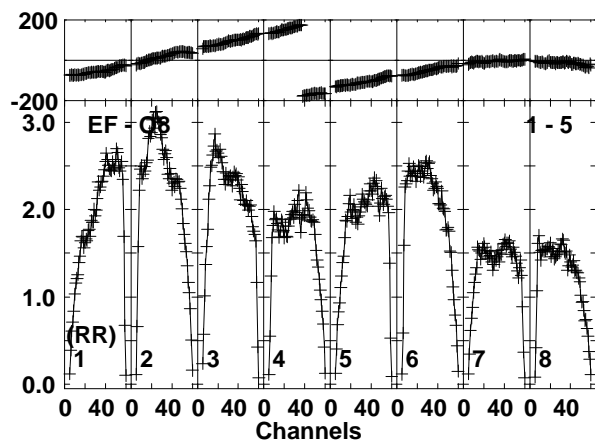
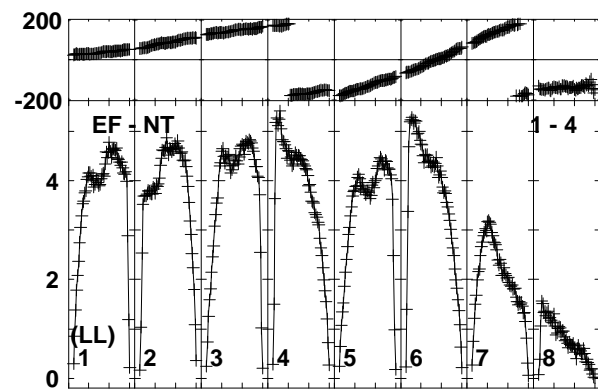
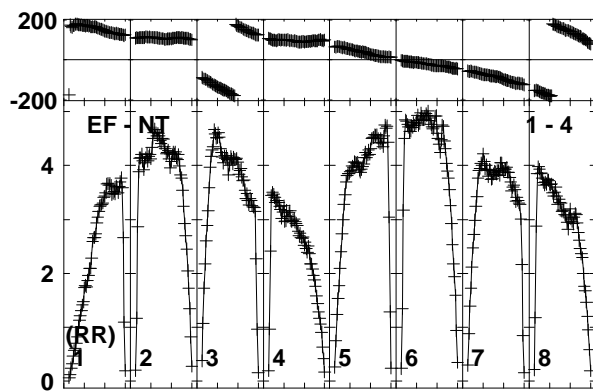
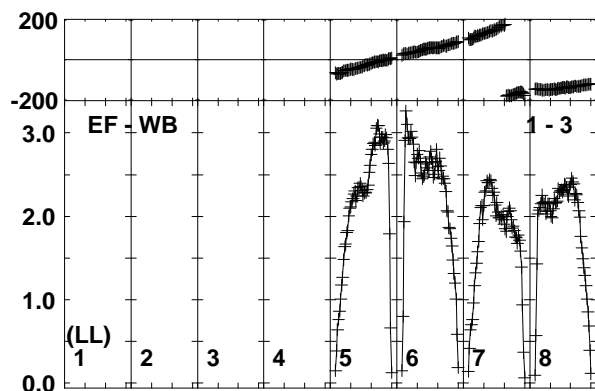
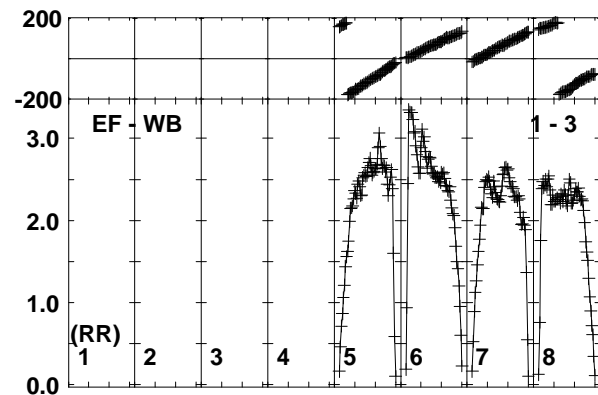
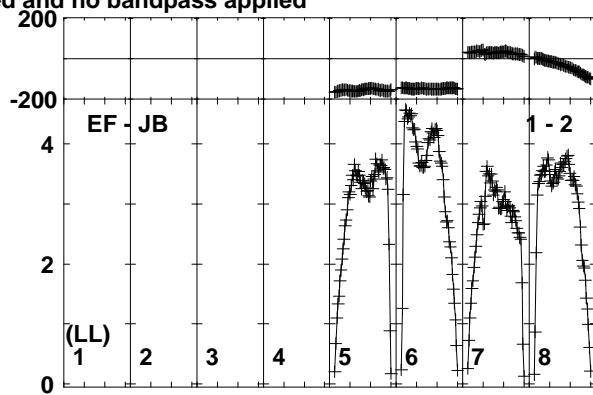
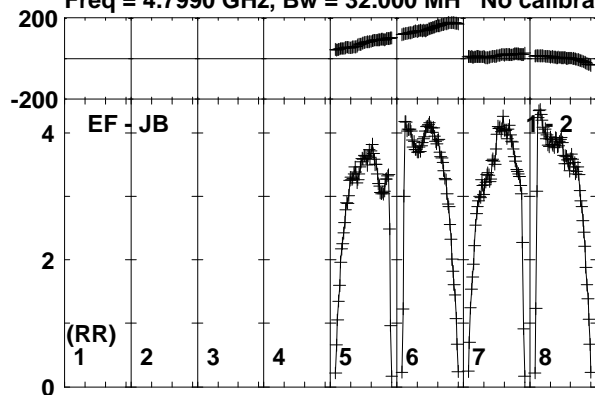

Lower frame: Milli Ampl Jy Top frame: Phas deg
Vector averaged cross-power spectrum Baseline: EF (01) - JB (02)
Timerange: 00/18:03:01 to 00/18:05:29

Plot file version 218 created 19-OCT-2017 15:36:24

J0004+2019 ES081C.UVDATA.1

Freq = 4.7990 GHz, Bw = 32.000 MH No calibration applied and no bandpass applied

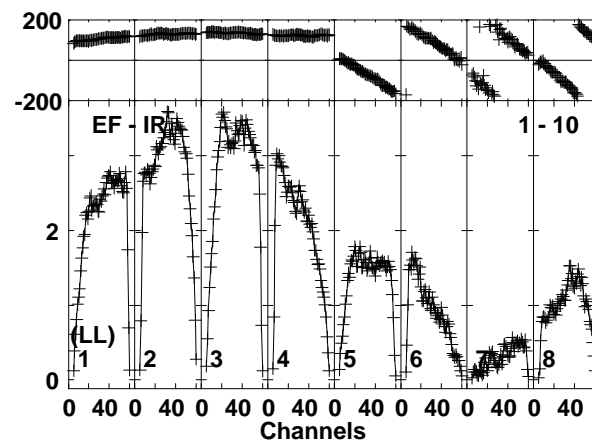
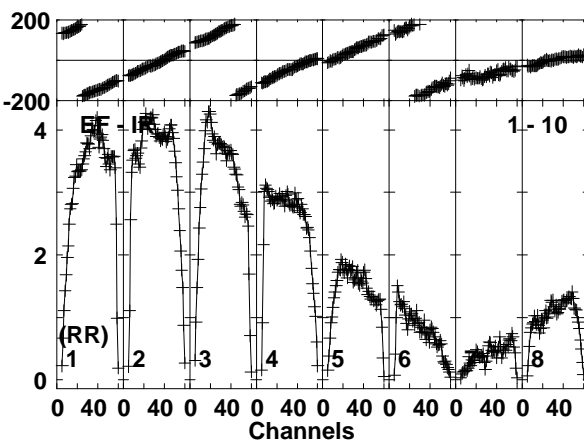
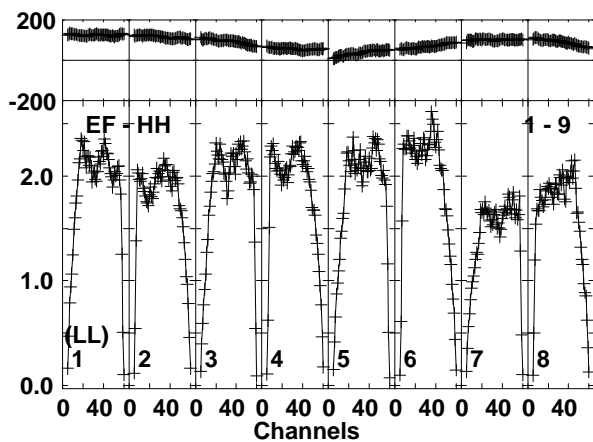
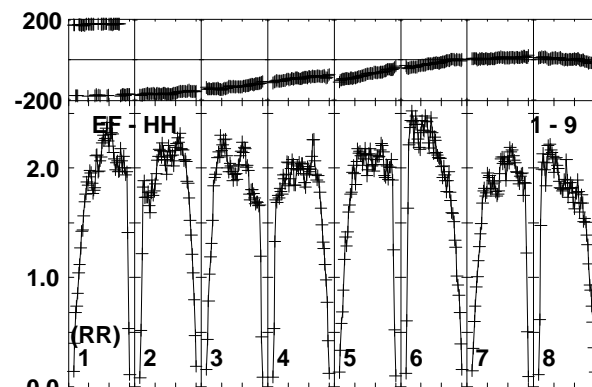
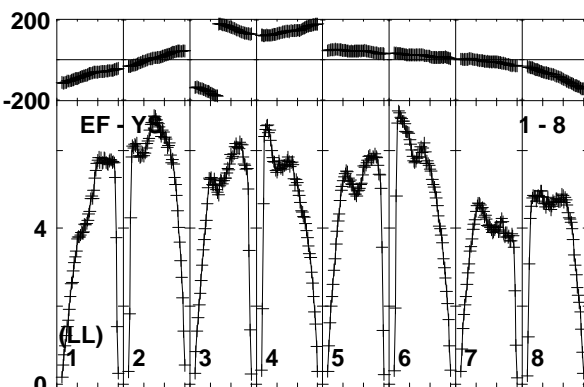
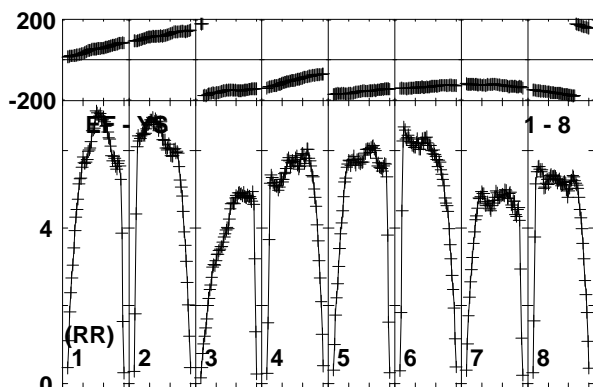
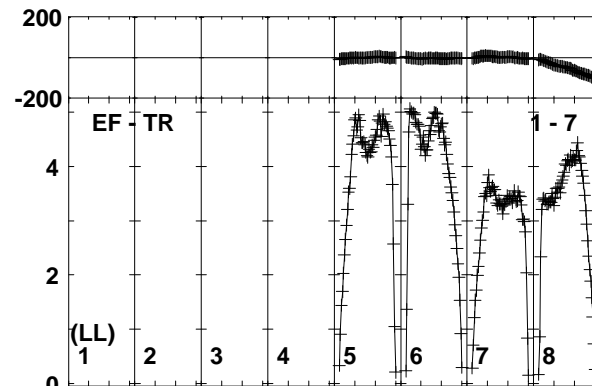
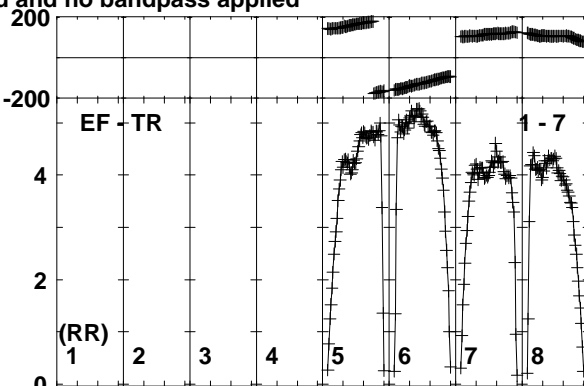
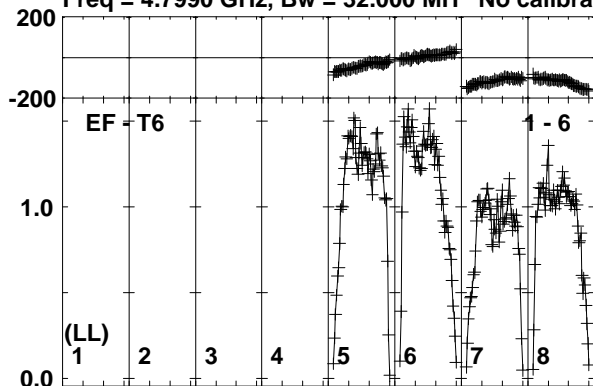

Lower frame: Milli Ampl Jy Top frame: Phas deg
Vector averaged cross-power spectrum Baseline: EF (01) - T6 (06)
Timerange: 00:18:03:01 to 00:18:05:29

Plot file version 219 created 19-OCT-2017 15:36:24

MRK335 ES081C.UVDATA.1

Freq = 4.7990 GHz, Bw = 32.000 MH No calibration applied and no bandpass applied

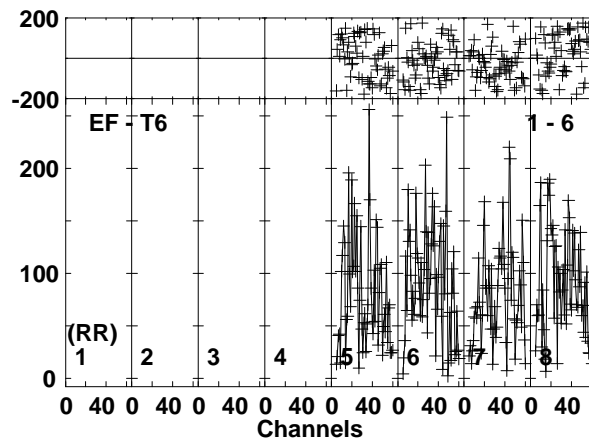
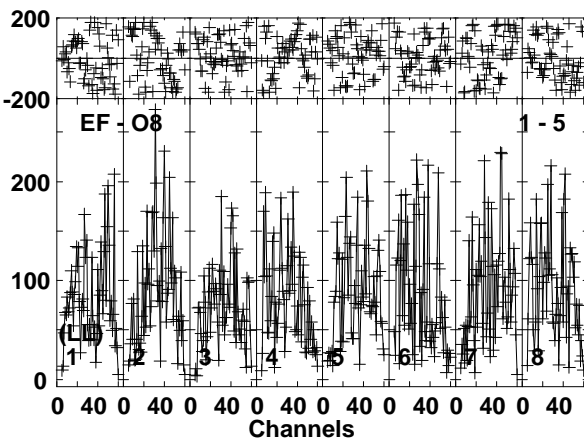
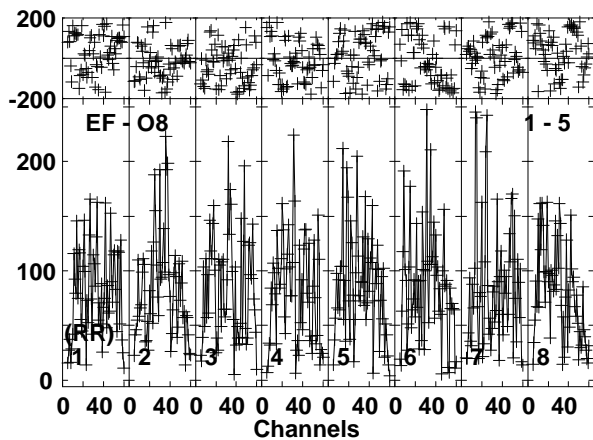
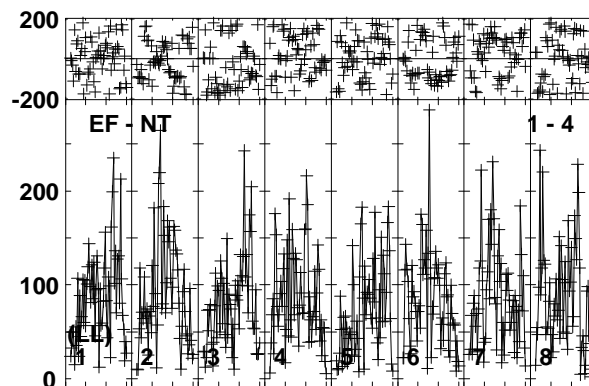
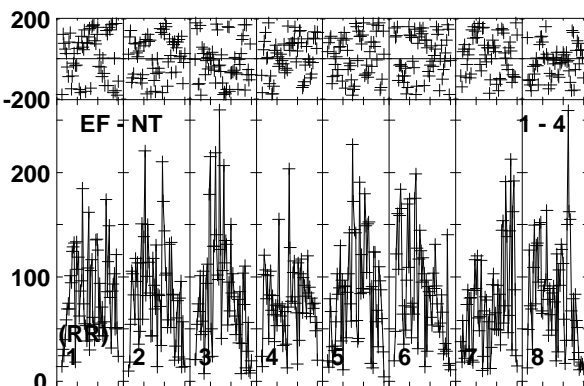
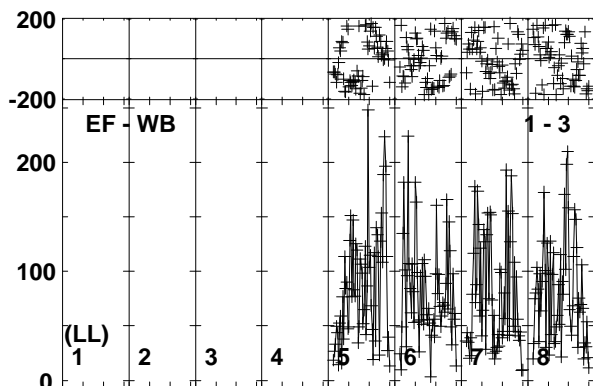
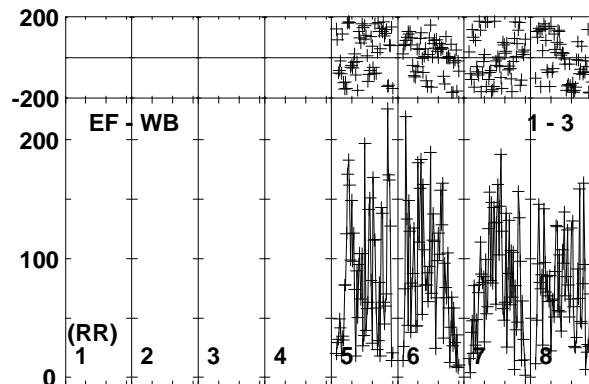
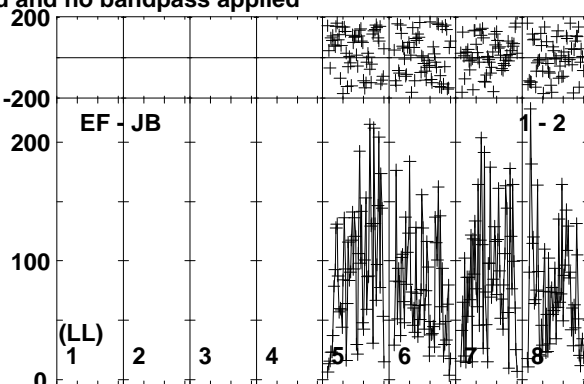
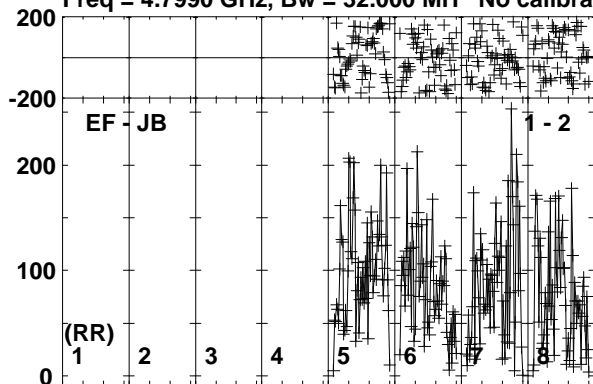

Lower frame: Micro Ampl Jy Top frame: Phas deg
Vector averaged cross-power spectrum Baseline: EF (01) - JB (02)
Timerange: 00/18:05:31 to 00/18:08:59

Plot file version 220 created 19-OCT-2017 15:36:25

MRK335 ES081C.UVDATA.1

Freq = 4.7990 GHz, Bw = 32.000 MH No calibration applied and no bandpass applied

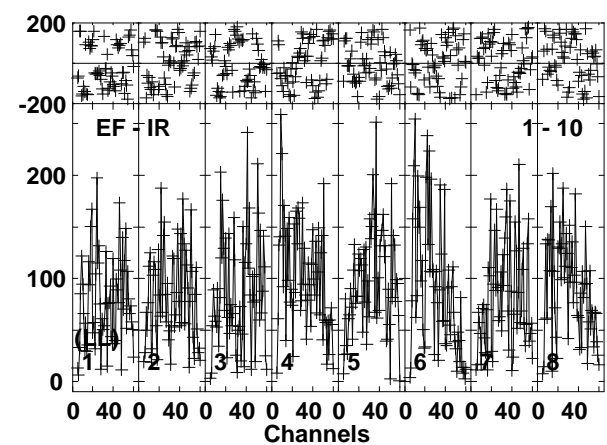
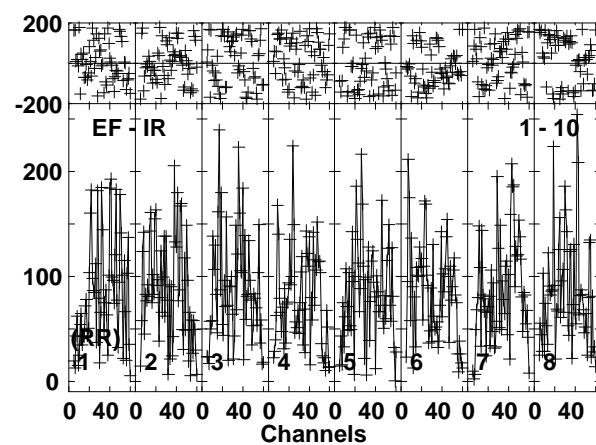
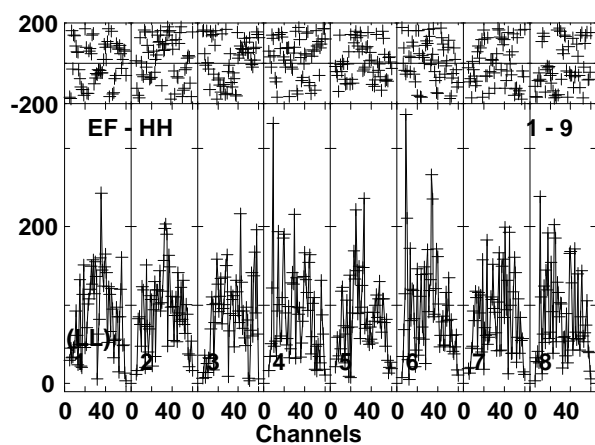
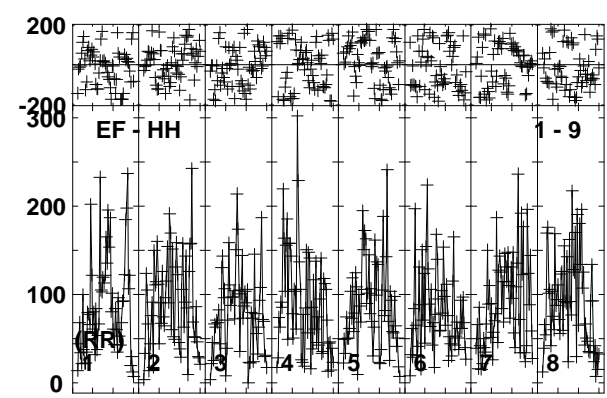
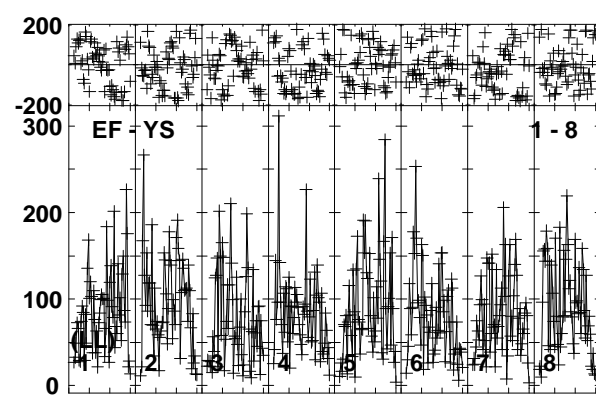
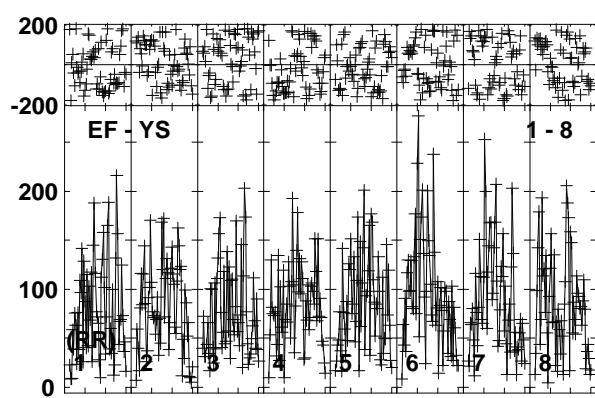
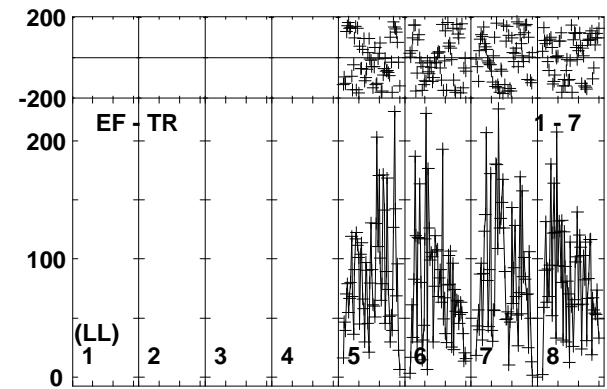
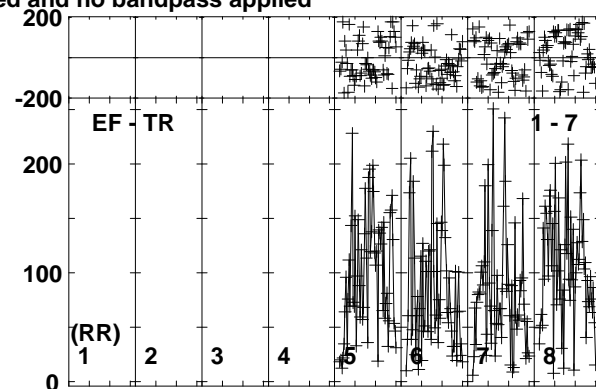
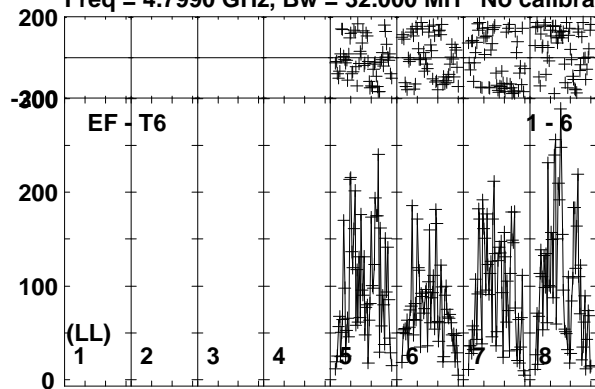

Lower frame: Micro Ampl Jy Top frame: Phas deg
Vector averaged cross-power spectrum Baseline: EF (01) - T6 (06)
Timerange: 00:18:05:31 to 00:18:08:59

Plot file version 221 created 19-OCT-2017 15:36:25

J0004+2019 ES081C.UVDATA.1

Freq = 4.7990 GHz, Bw = 32.000 MH No calibration applied and no bandpass applied

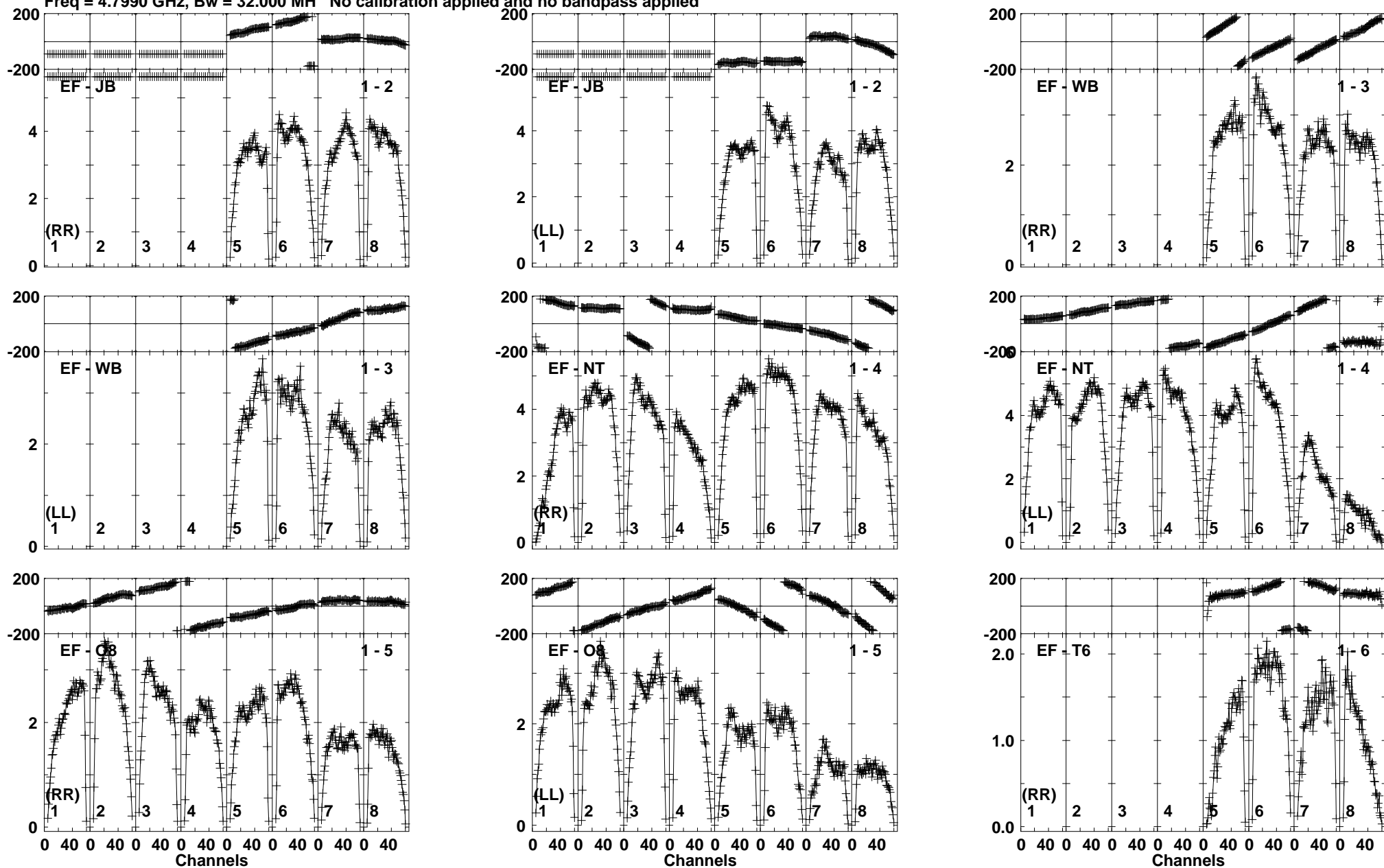

Plot file version 222 created 19-OCT-2017 15:36:25

J0004+2019 ES081C.UVDATA.1

Freq = 4.7990 GHz, Bw = 32.000 MH No calibration applied and no bandpass applied

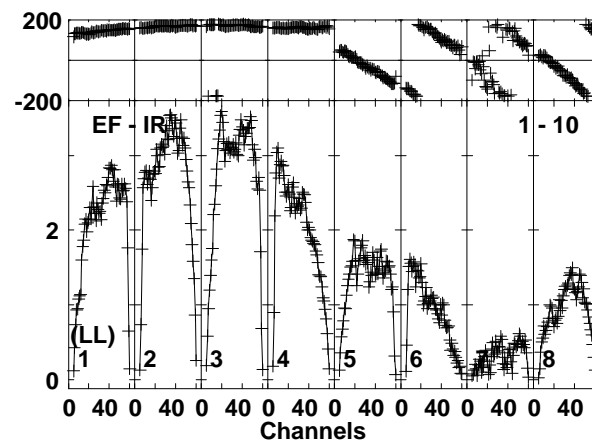
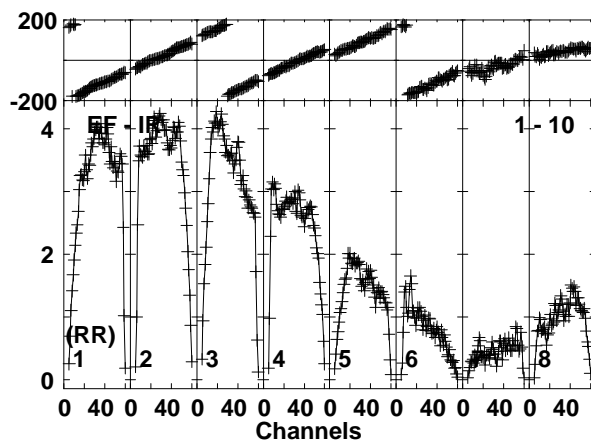
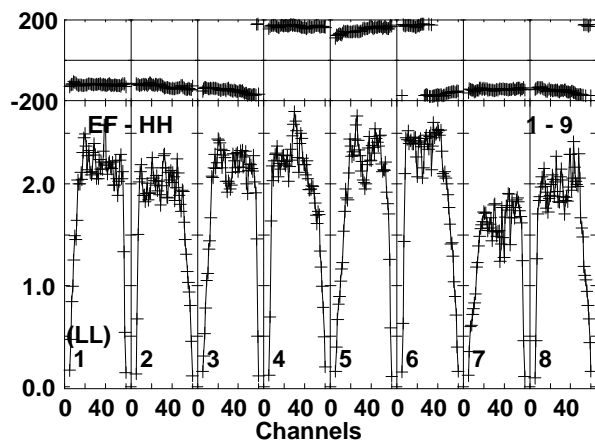
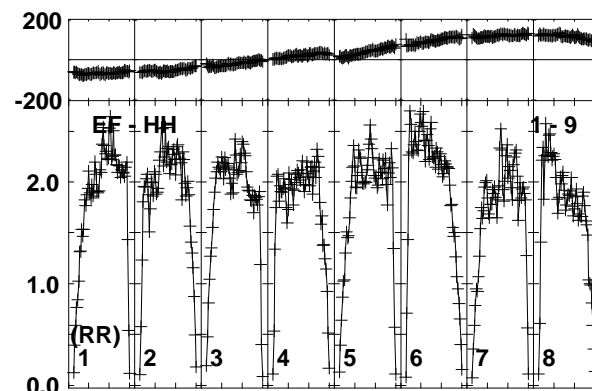
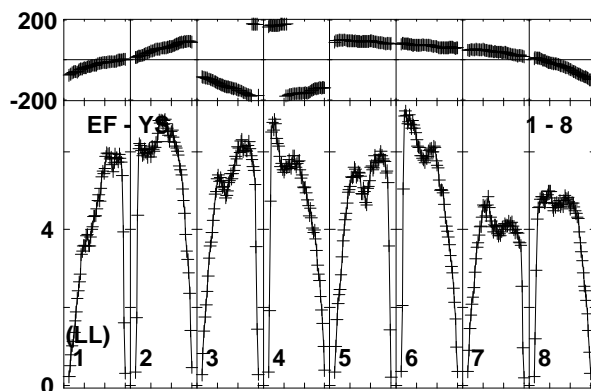
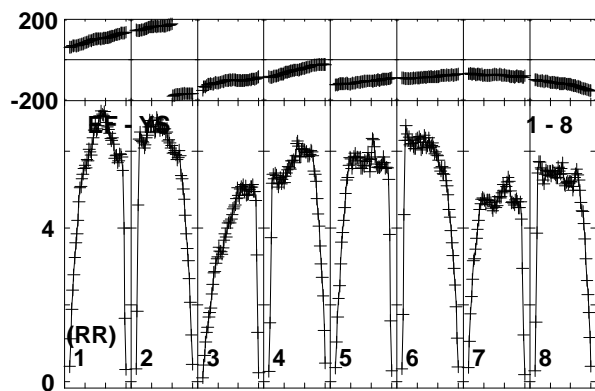
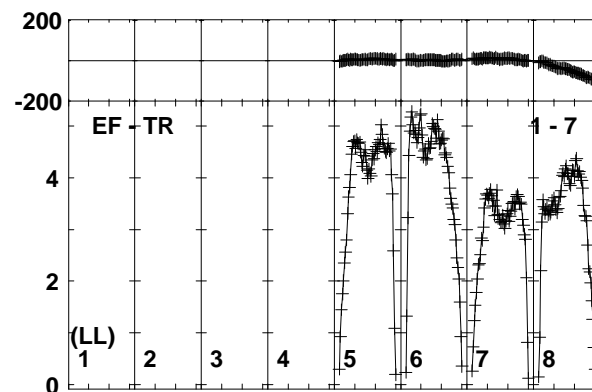
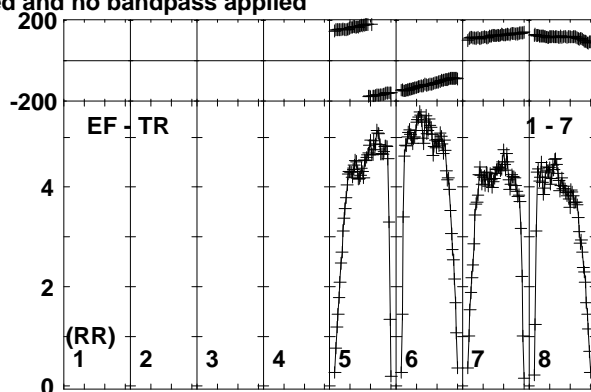
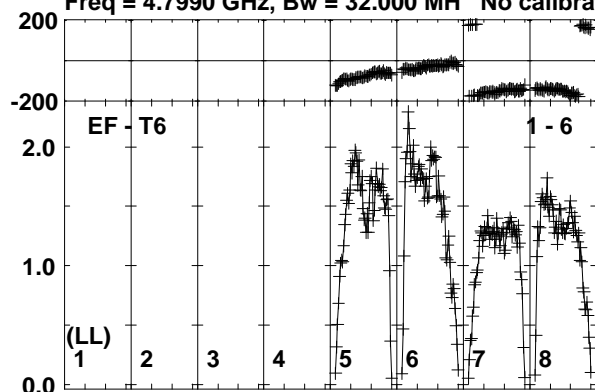

Lower frame: Milli Ampl Jy Top frame: Phas deg
Vector averaged cross-power spectrum Baseline: EF (01) - T6 (06)
Timerange: 00:18:09:01 to 00:18:10:29

Plot file version 223 created 19-OCT-2017 15:36:25
 MRK335 ES081C.UVDATA.1
 Freq = 4.7990 GHz, Bw = 32.000 MH No calibration applied and no bandpass applied

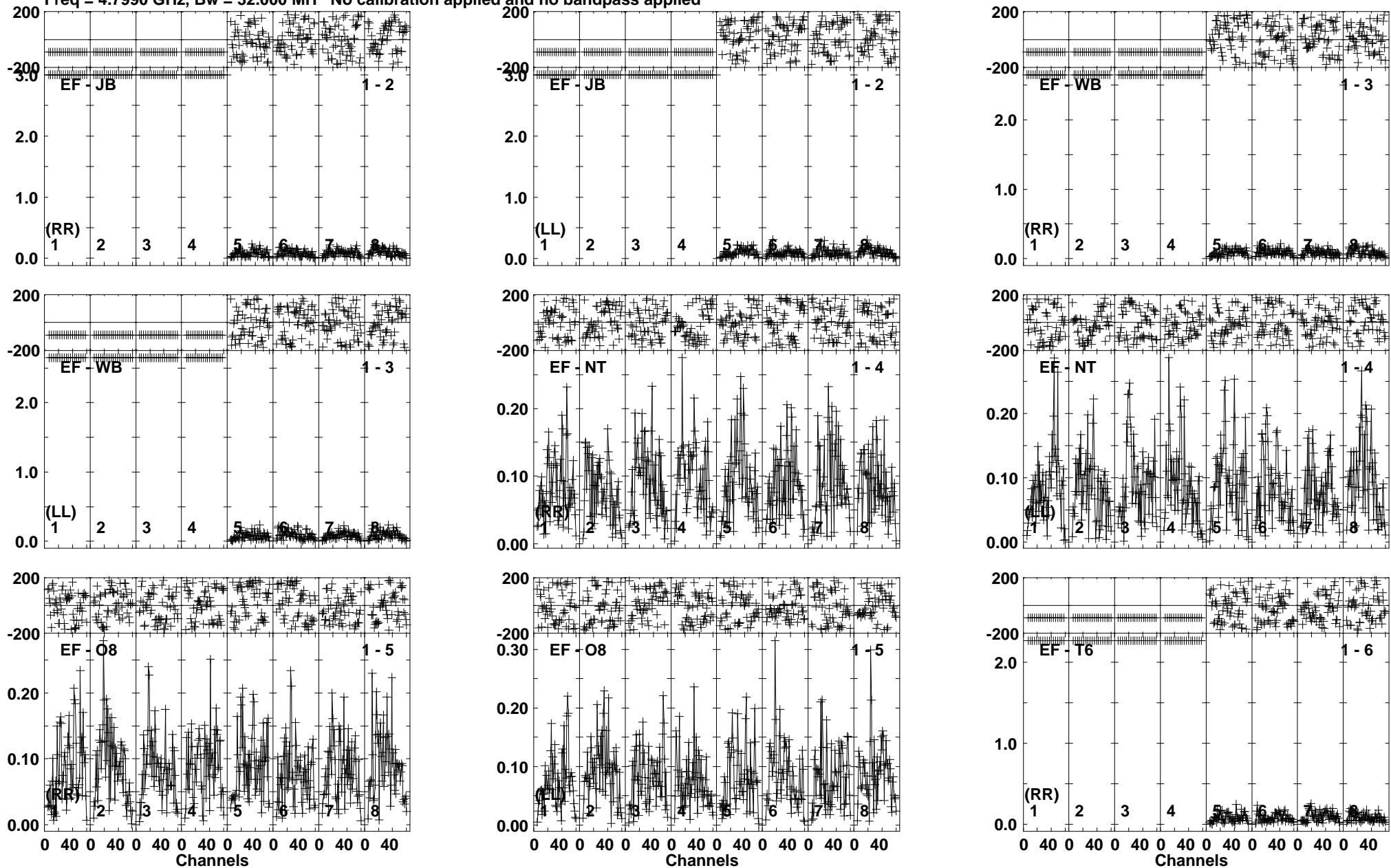

Lower frame: Milli Ampl Jy Top frame: Phas deg
 Vector averaged cross-power spectrum Baseline: EF (01) - JB (02)
 Timerange: 00/18:10:31 to 00/18:13:59

Plot file version 224 created 19-OCT-2017 15:36:25

MRK335 ES081C.UVDATA.1

Freq = 4.7990 GHz, Bw = 32.000 MH No calibration applied and no bandpass applied

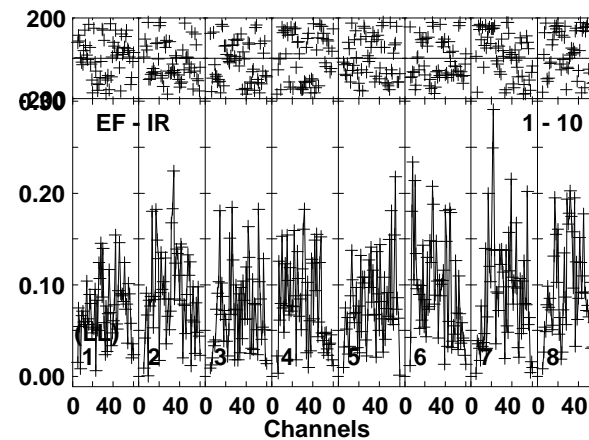
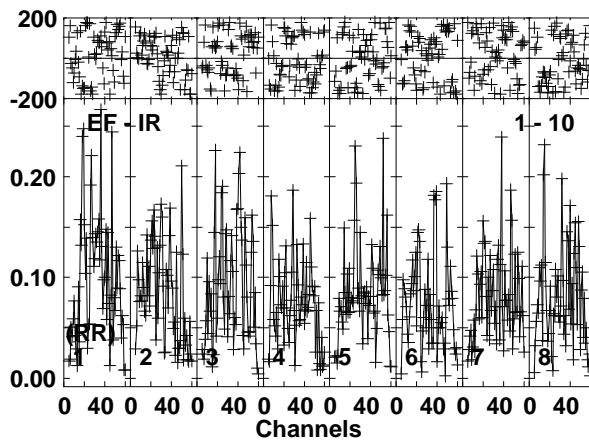
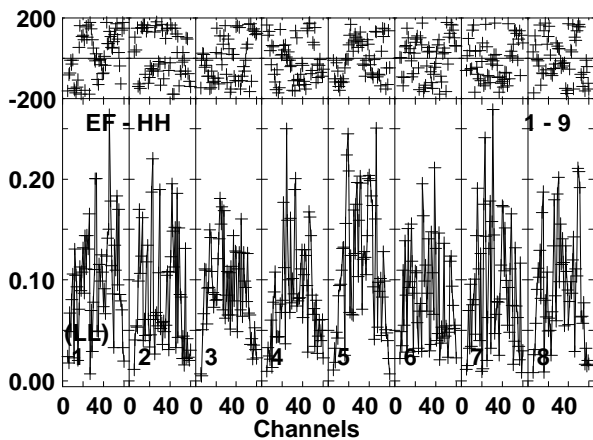
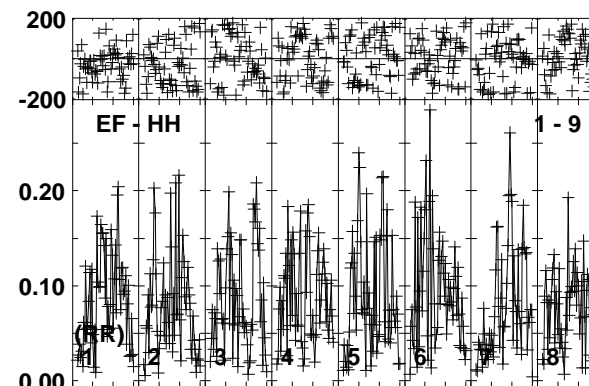
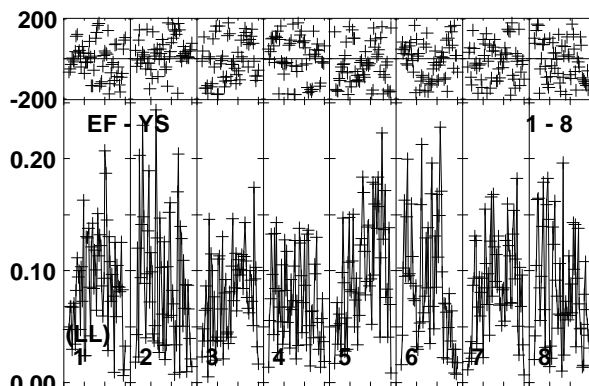
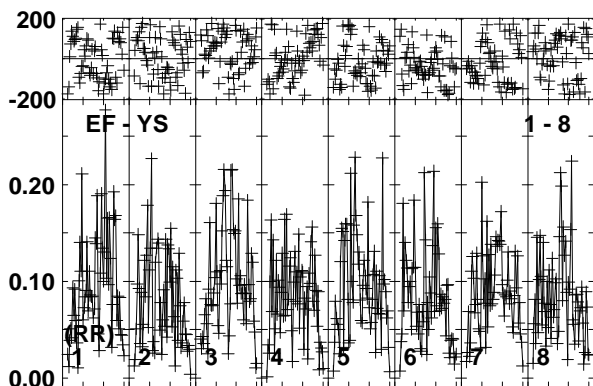
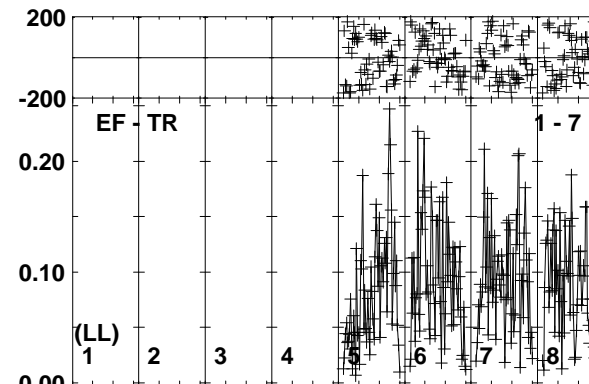
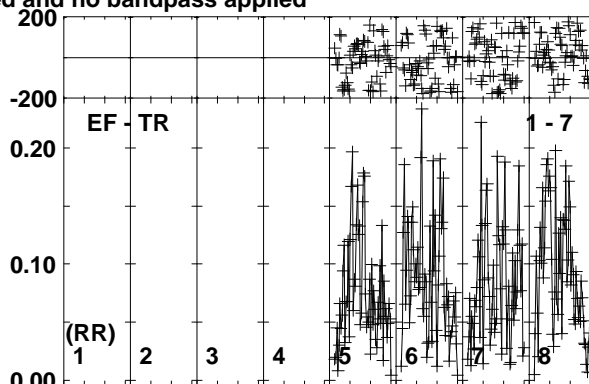
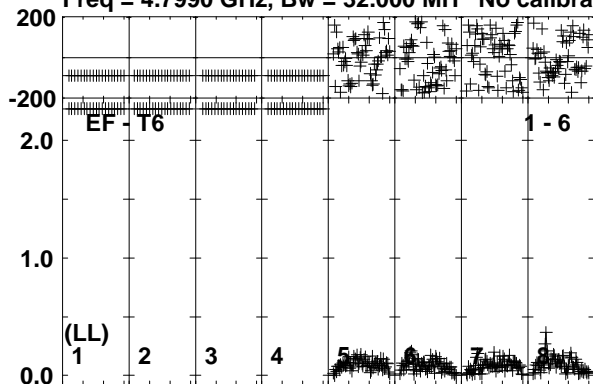

Lower frame: Milli Ampl Jy Top frame: Phas deg
Vector averaged cross-power spectrum Baseline: EF (01) - T6 (06)
Timerange: 00/18:10:31 to 00/18:13:59

Plot file version 225 created 19-OCT-2017 15:36:25

J0004+2019 ES081C.UVDATA.1

Freq = 4.7990 GHz, Bw = 32.000 MH No calibration applied and no bandpass applied

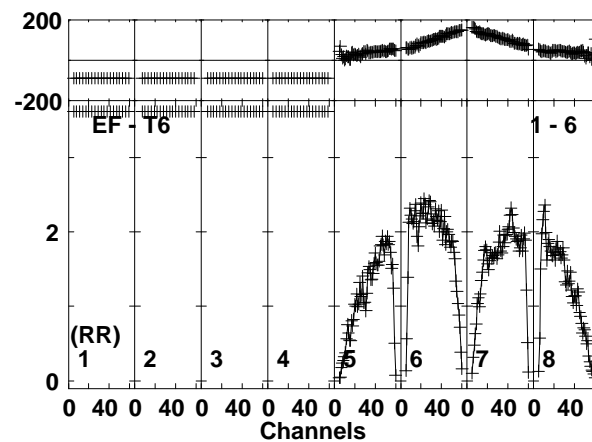
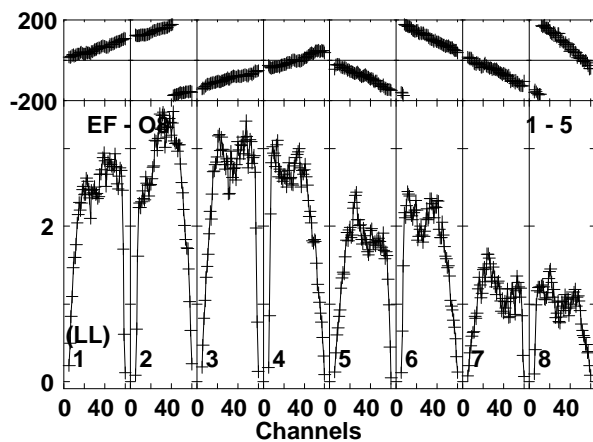
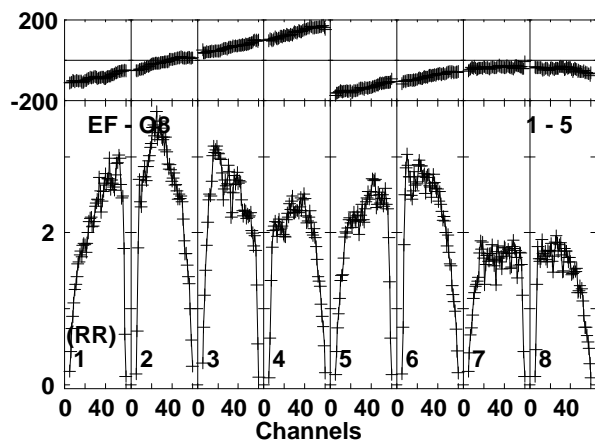
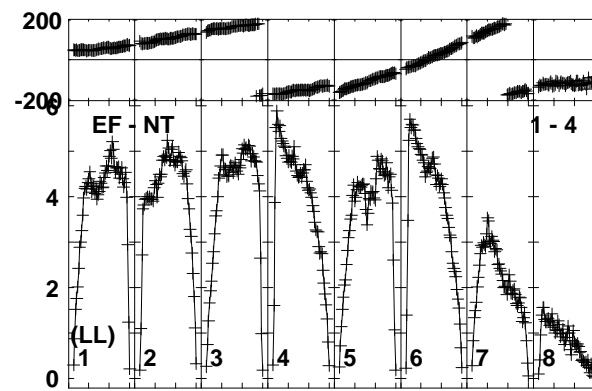
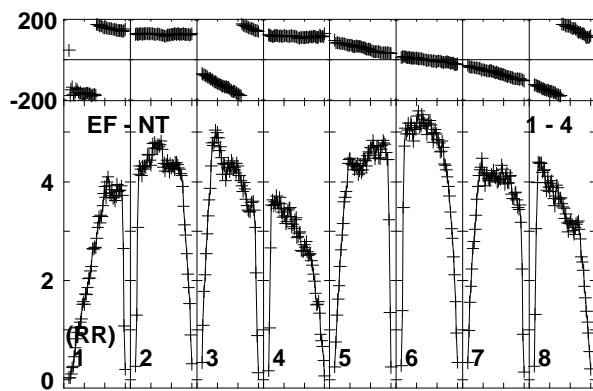
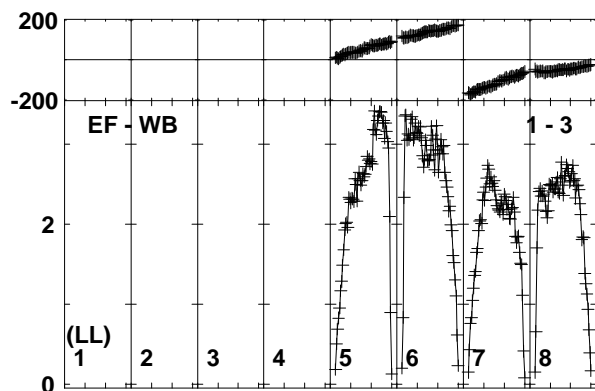
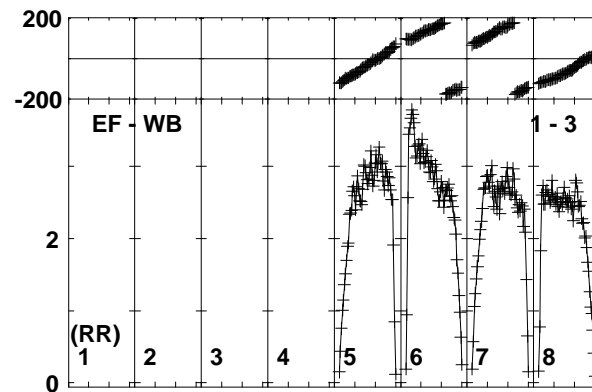
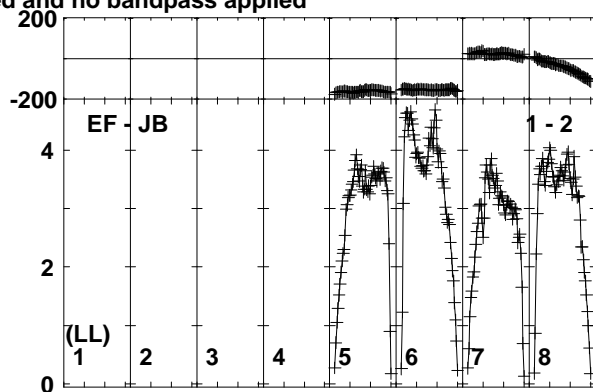
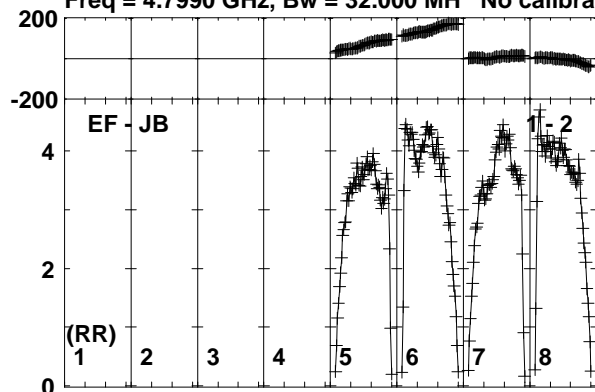

Lower frame: Milli Ampl Jy Top frame: Phas deg
Vector averaged cross-power spectrum Baseline: EF (01) - JB (02)
Timerange: 00/18:14:31 to 00/18:15:29

Plot file version 226 created 19-OCT-2017 15:36:25

J0004+2019 ES081C.UVDATA.1

Freq = 4.7990 GHz, Bw = 32.000 MH No calibration applied and no bandpass applied

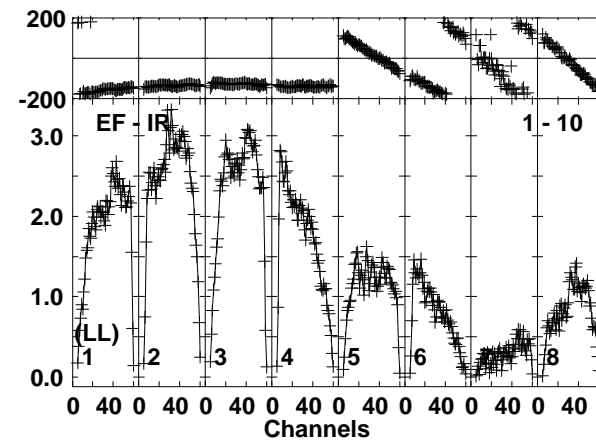
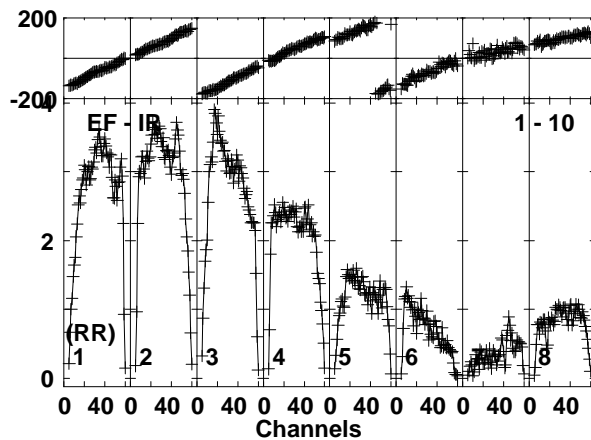
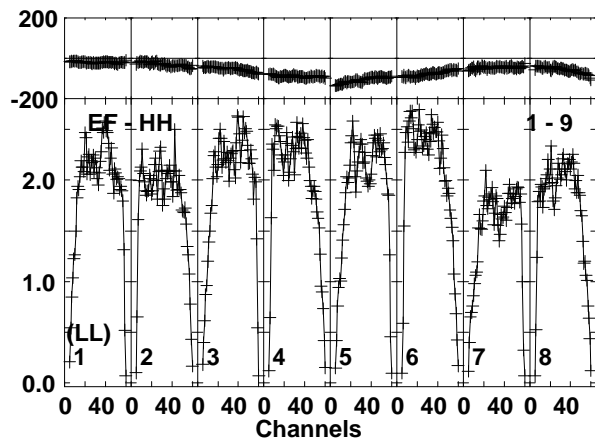
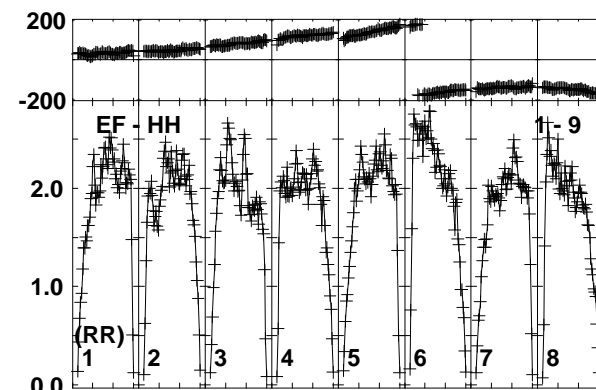
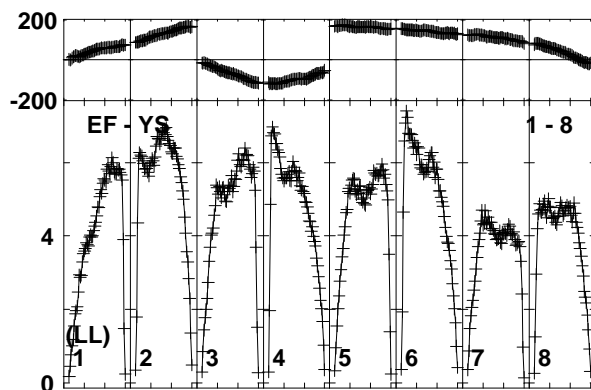
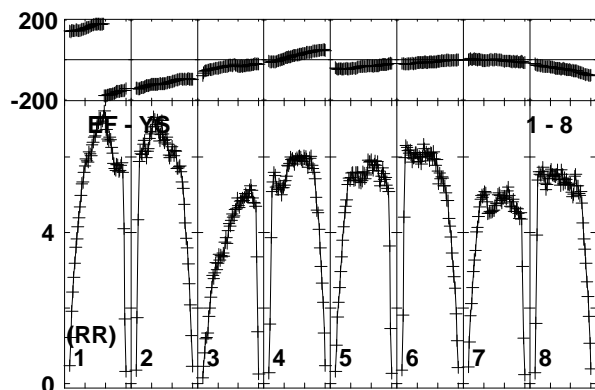
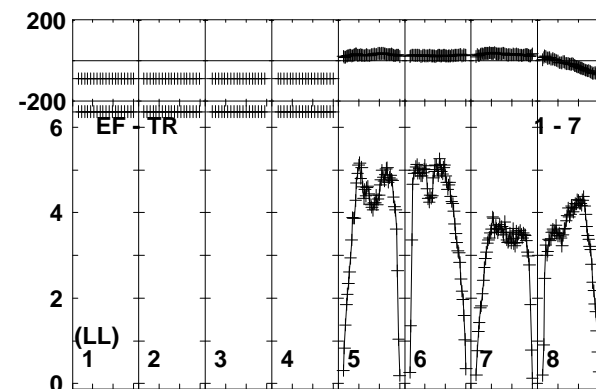
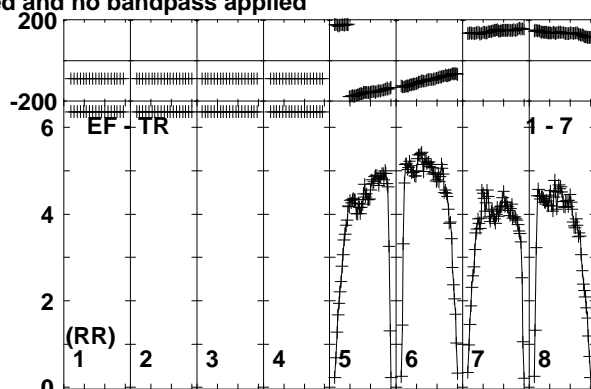
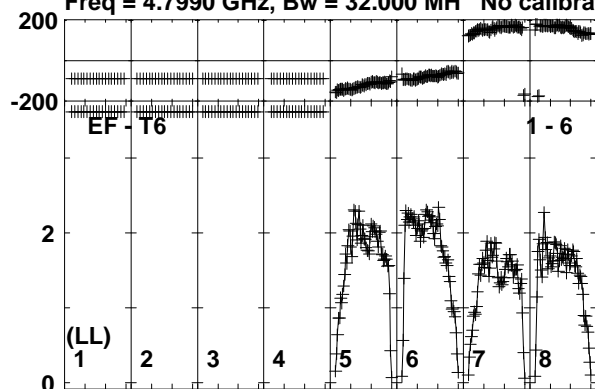

Lower frame: Milli Ampl Jy Top frame: Phas deg
Vector averaged cross-power spectrum Baseline: EF (01) - T6 (06)
Timerange: 00:18:14:31 to 00:18:15:29

Plot file version 227 created 19-OCT-2017 15:36:26

MRK335 ES081C.UVDATA.1

Freq = 4.7990 GHz, Bw = 32.000 MH No calibration applied and no bandpass applied

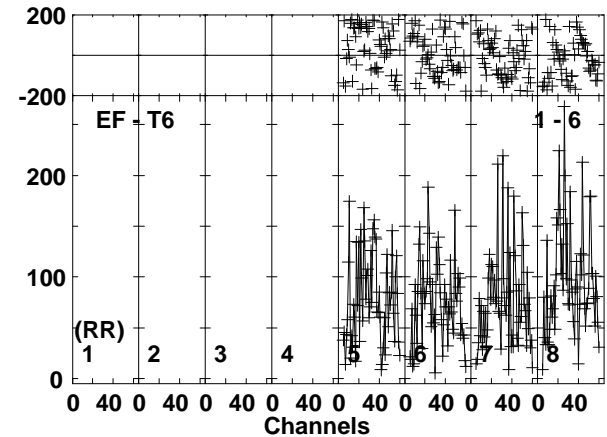
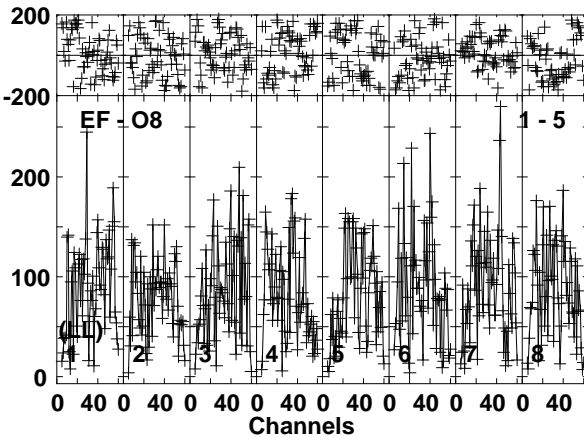
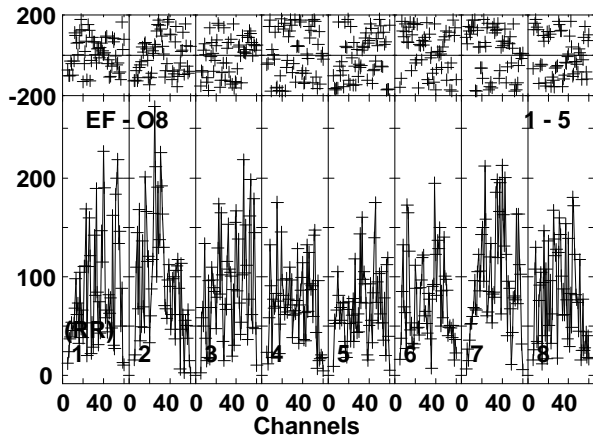
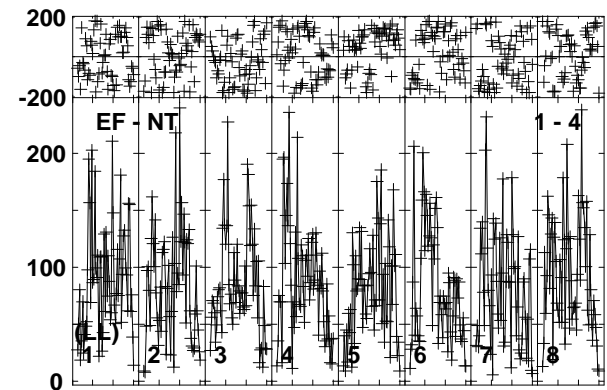
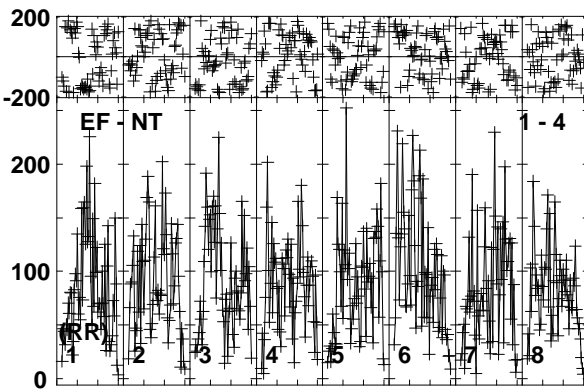
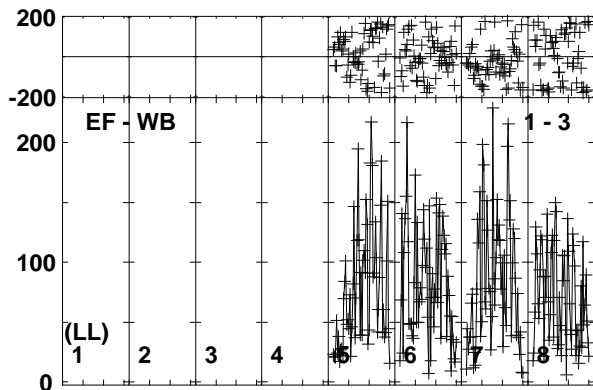
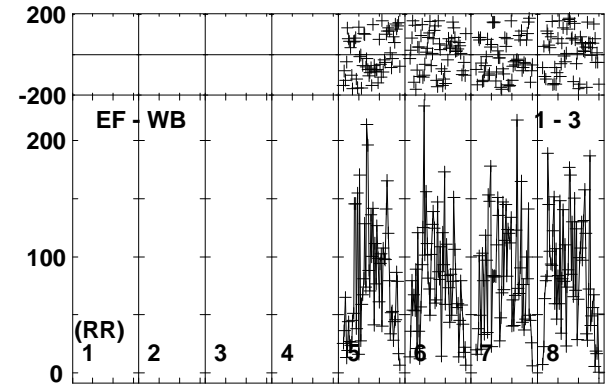
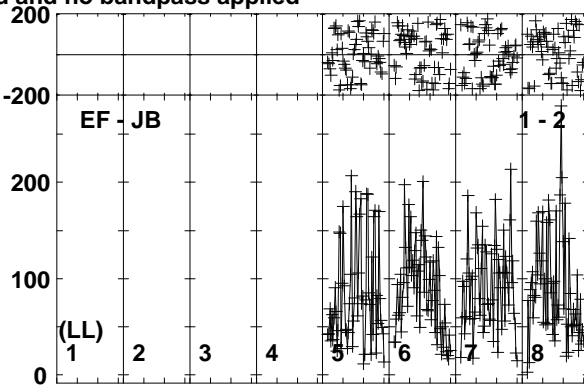
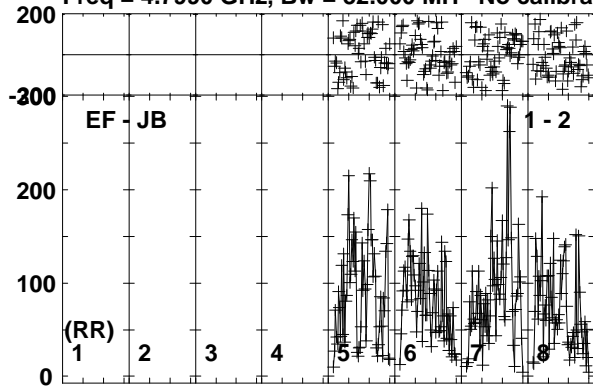

Lower frame: Micro Ampl Jy Top frame: Phas deg
Vector averaged cross-power spectrum Baseline: EF (01) - JB (02)
Timerange: 00/18:15:31 to 00/18:18:59

Plot file version 228 created 19-OCT-2017 15:36:26

MRK335 ES081C.UVDATA.1

Freq = 4.7990 GHz, Bw = 32.000 MH No calibration applied and no bandpass applied

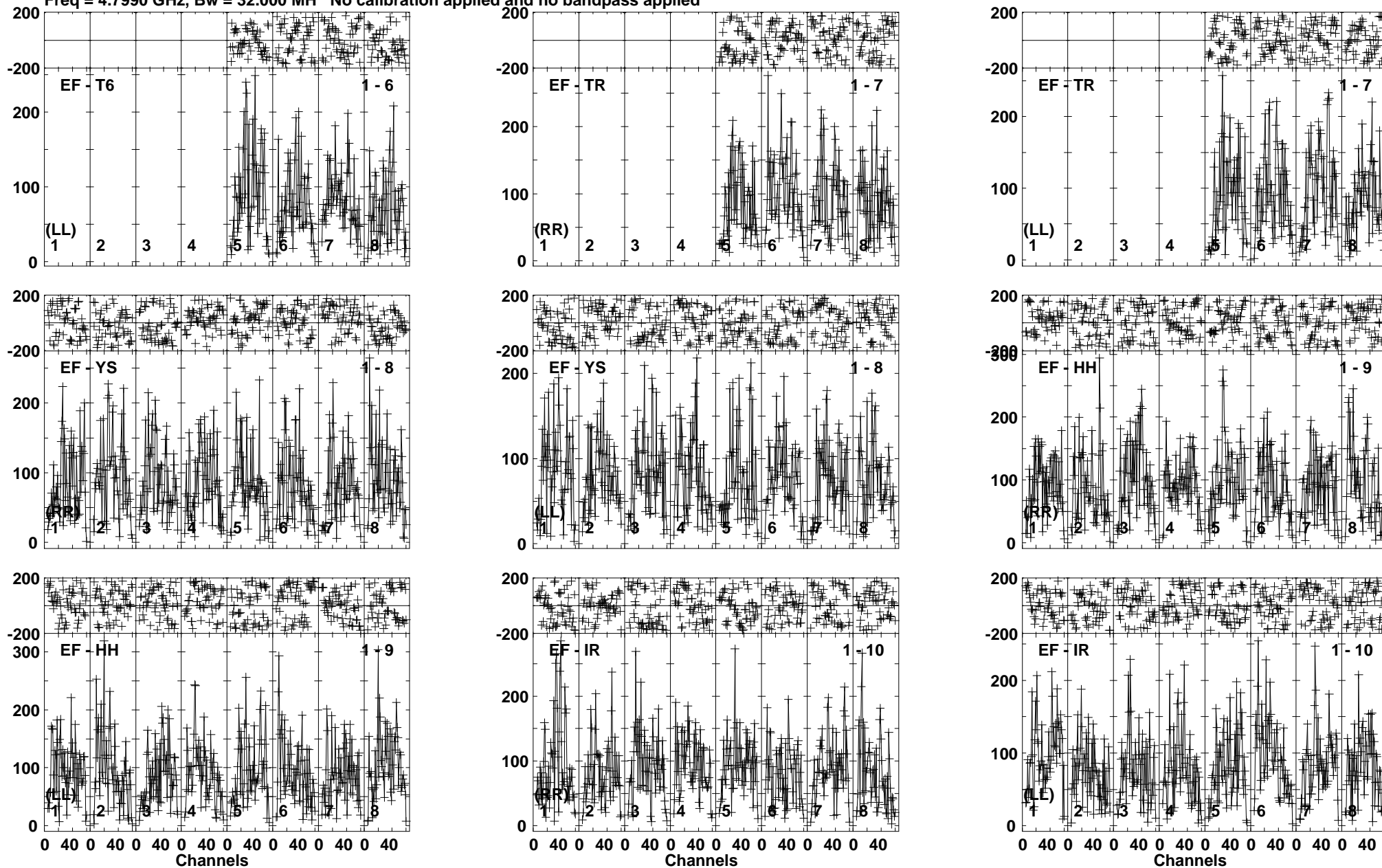

Lower frame: Micro Ampl Jy Top frame: Phas deg
Vector averaged cross-power spectrum Baseline: EF (01) - T6 (06)
Timerange: 00/18:15:31 to 00/18:18:59

Plot file version 229 created 19-OCT-2017 15:36:26

J0004+2019 ES081C.UVDATA.1

Freq = 4.7990 GHz, Bw = 32.000 MH No calibration applied and no bandpass applied

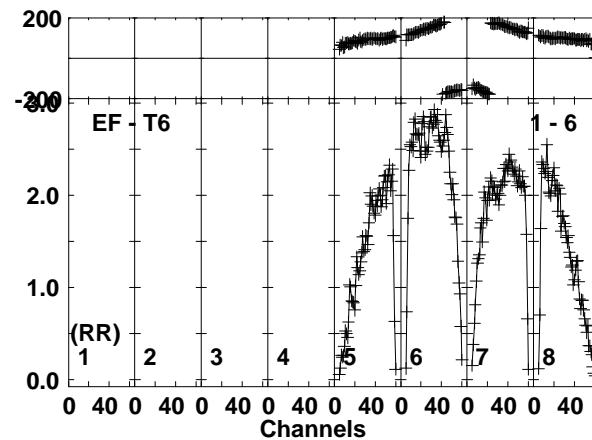
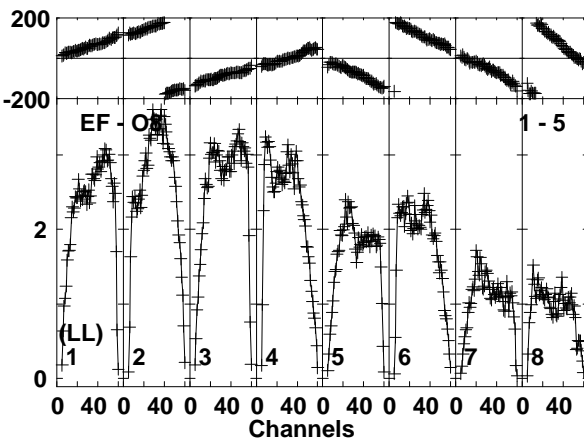
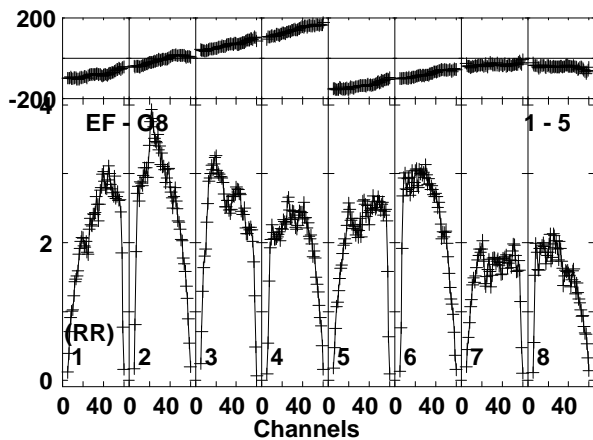
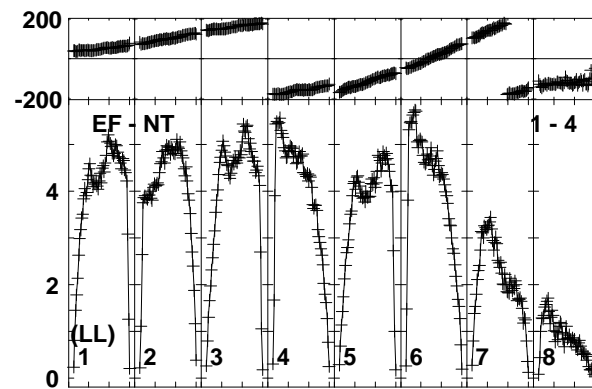
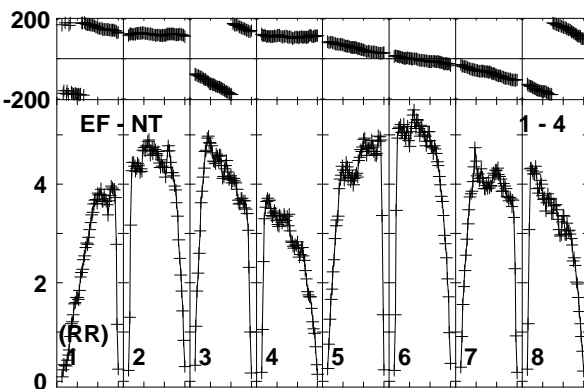
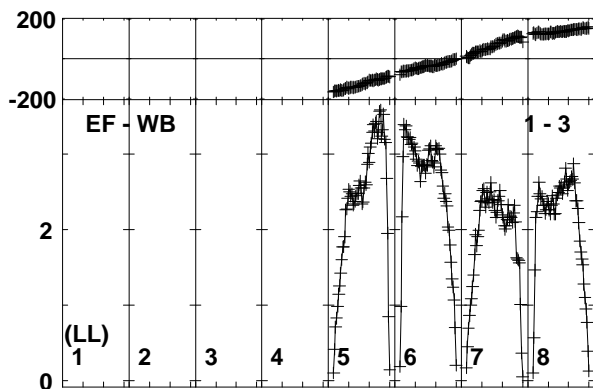
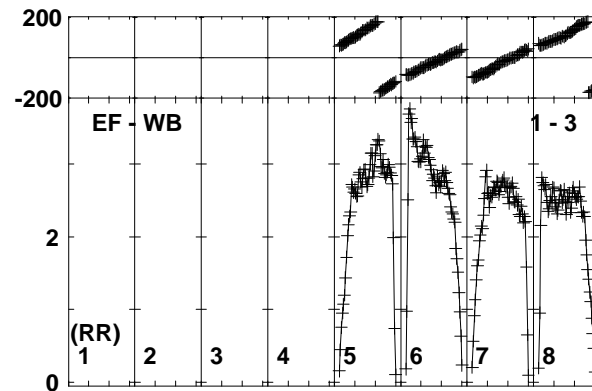
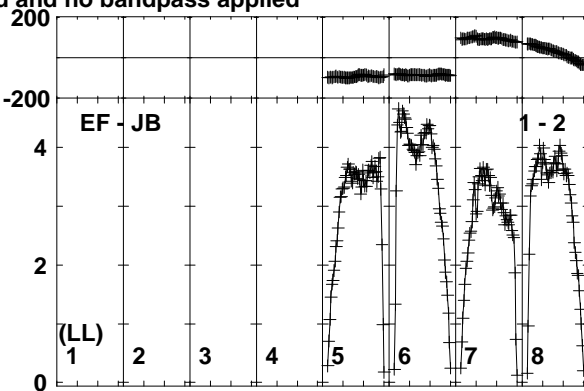
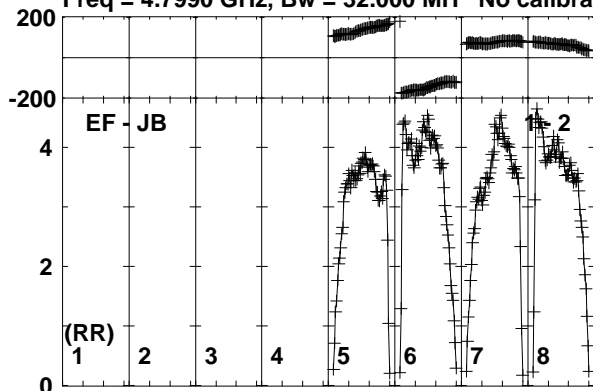

Lower frame: Milli Ampl Jy Top frame: Phas deg
Vector averaged cross-power spectrum Baseline: EF (01) - JB (02)
Timerange: 00/18:19:01 to 00/18:20:29

Plot file version 230 created 19-OCT-2017 15:36:26

J0004+2019 ES081C.UVDATA.1

Freq = 4.7990 GHz, Bw = 32.000 MH No calibration applied and no bandpass applied

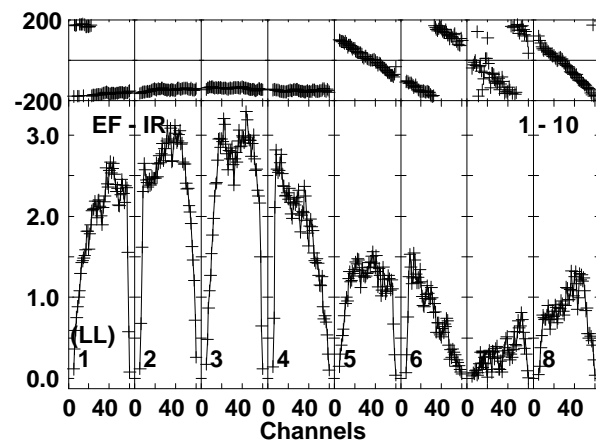
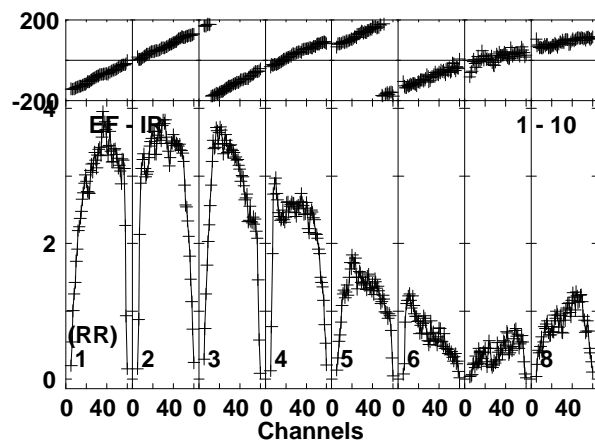
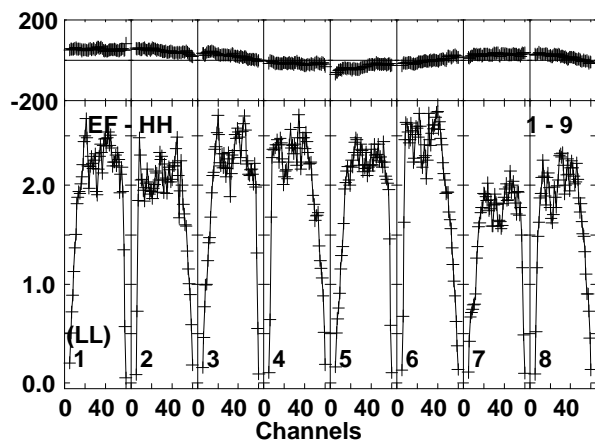
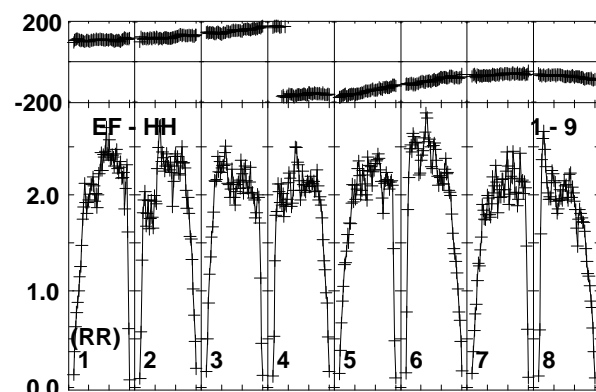
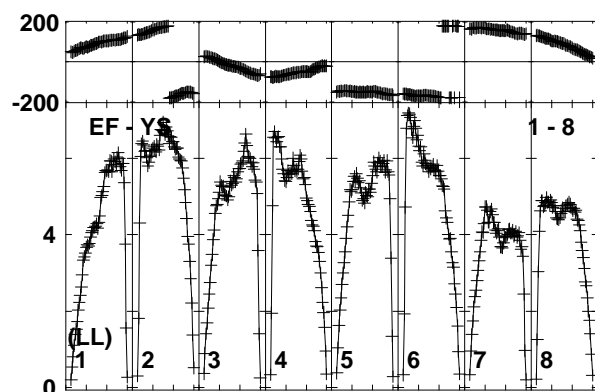
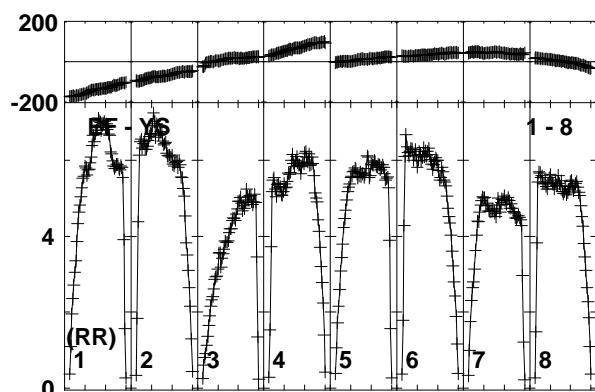
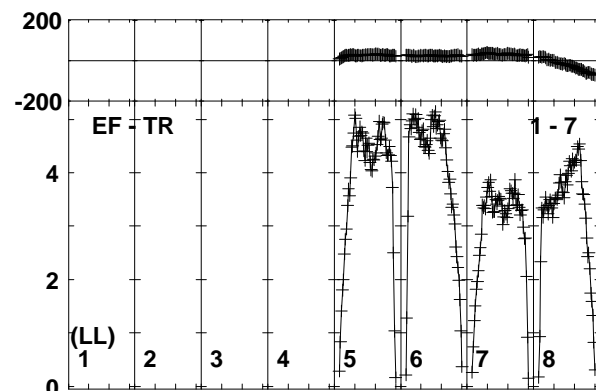
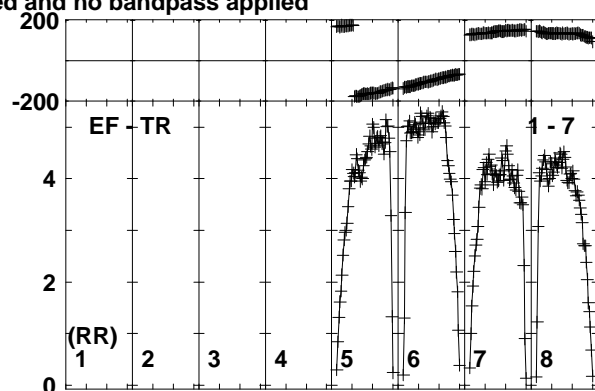
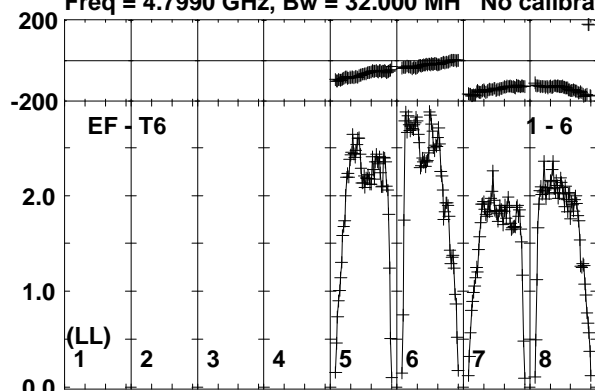

Lower frame: Milli Ampl Jy Top frame: Phas deg
Vector averaged cross-power spectrum Baseline: EF (01) - T6 (06)
Timerange: 00/18:19:01 to 00/18:20:29

Plot file version 231 created 19-OCT-2017 15:36:26

MRK335 ES081C.UVDATA.1

Freq = 4.7990 GHz, Bw = 32.000 MH No calibration applied and no bandpass applied

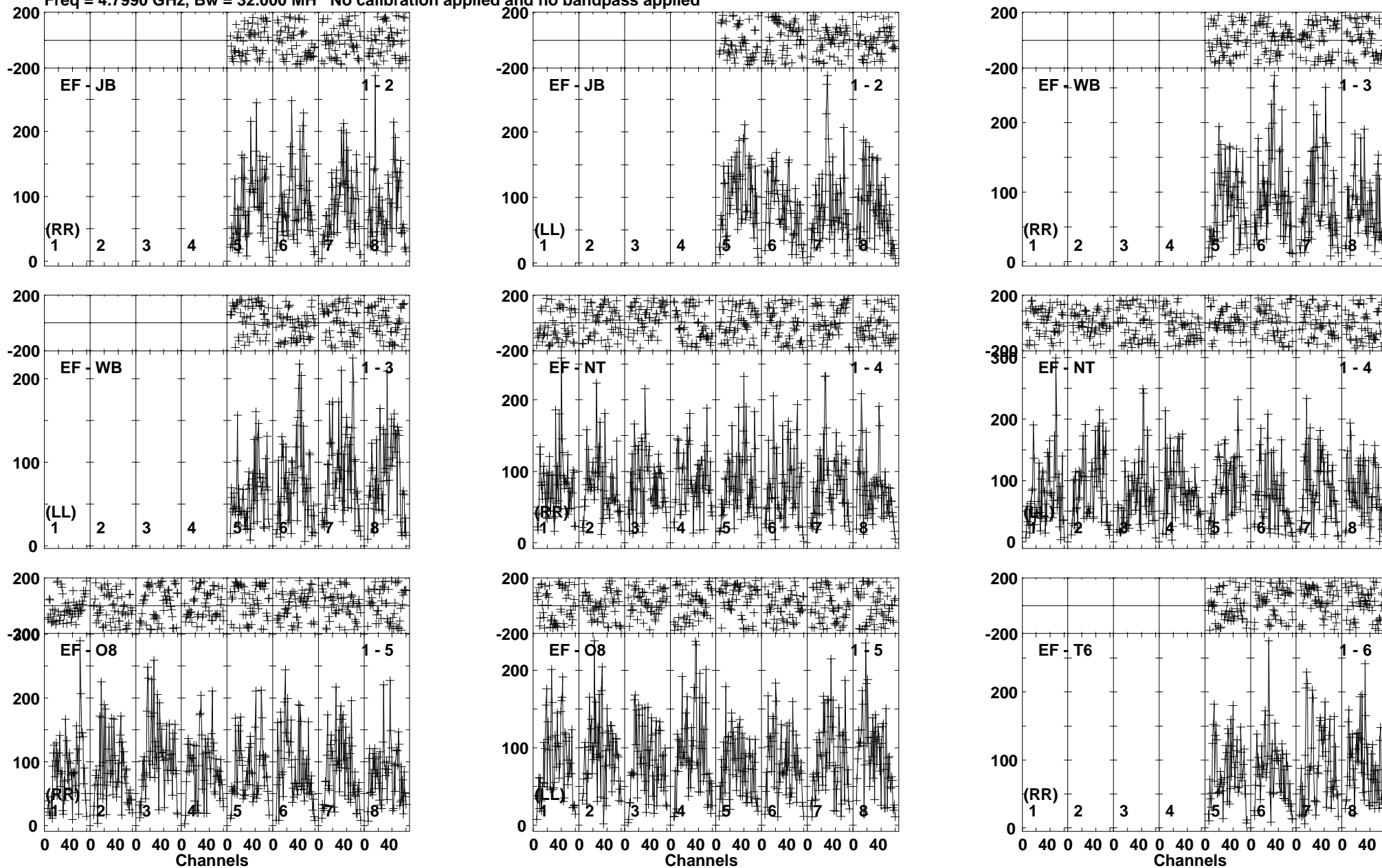

Lower frame: Micro Ampl Jy Top frame: Phas deg
Vector averaged cross-power spectrum Baseline: EF (01) - JB (02)
Timerange: 00/18:20:31 to 00/18:23:59

Plot file version 232 created 19-OCT-2017 15:36:26

MRK335 ES081C.UVDATA.1

Freq = 4.7990 GHz, Bw = 32.000 MH No calibration applied and no bandpass applied

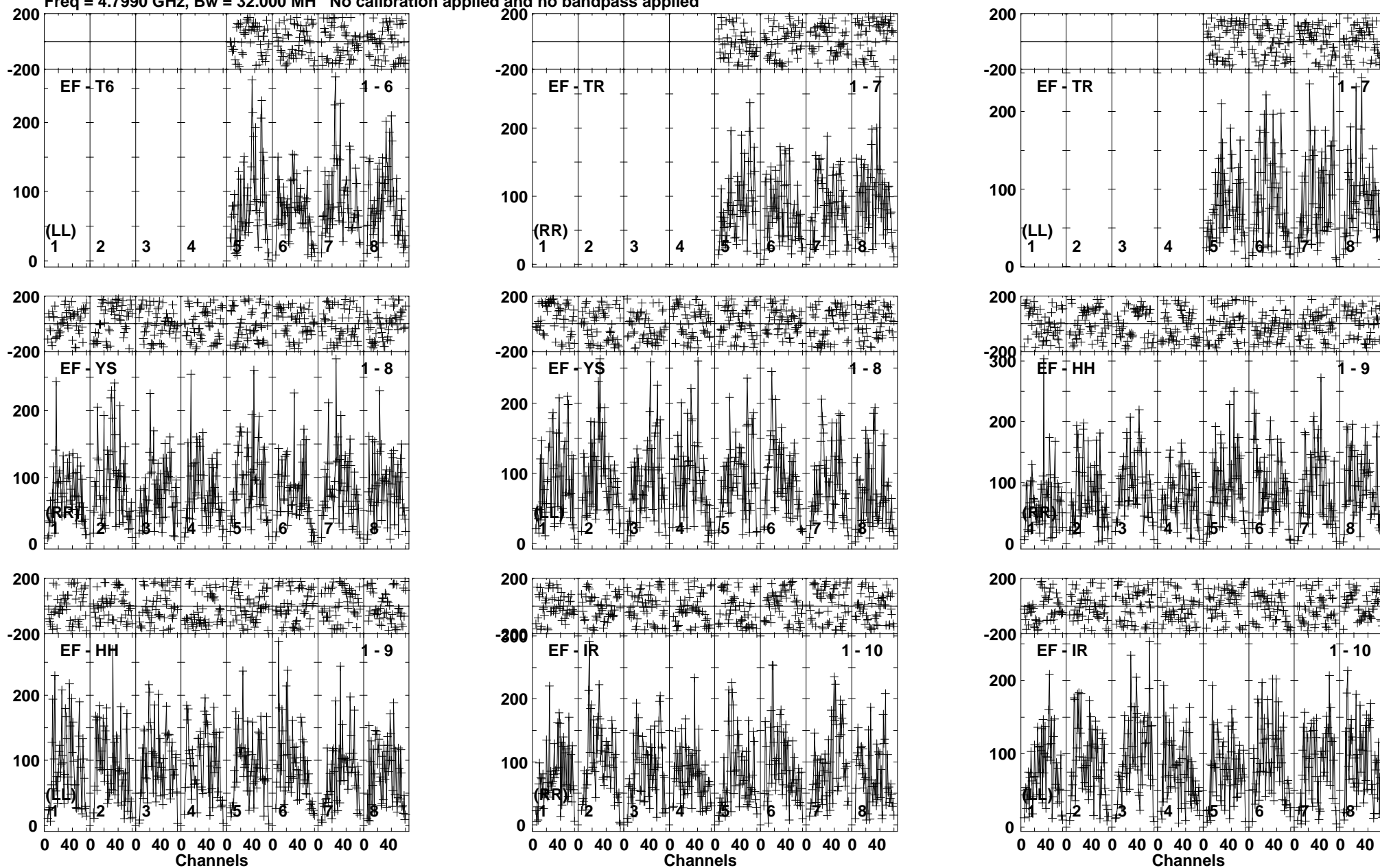

Lower frame: Micro Ampl Jy Top frame: Phas deg
Vector averaged cross-power spectrum Baseline: EF (01) - T6 (06)
Timerange: 00/18:20:31 to 00/18:23:59

Plot file version 233 created 19-OCT-2017 15:36:27

J0004+2019 ES081C.UVDATA.1

Freq = 4.7990 GHz, Bw = 32.000 MH No calibration applied and no bandpass applied

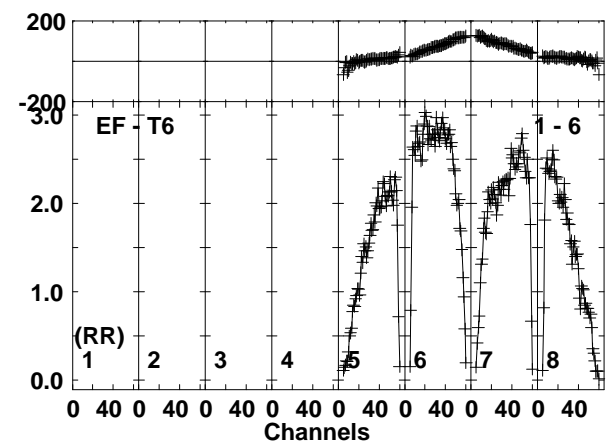
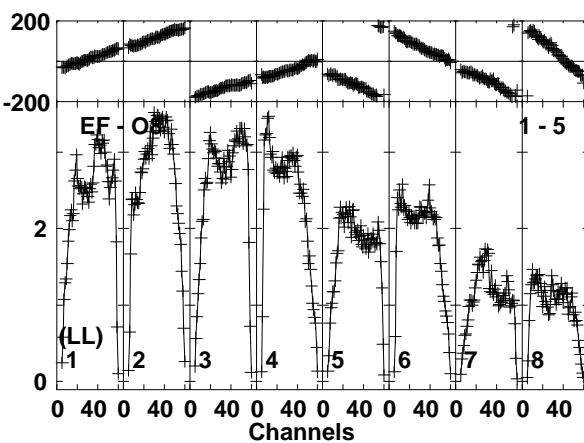
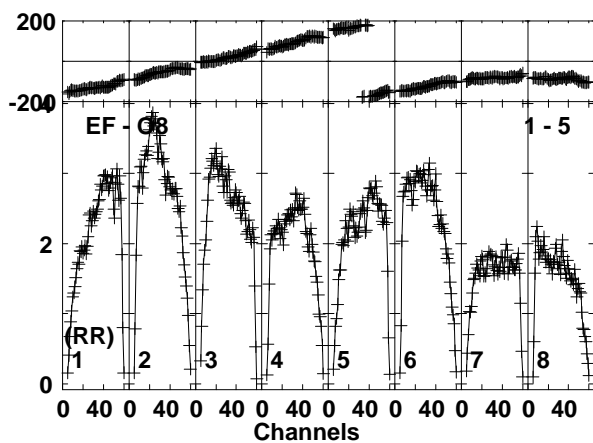
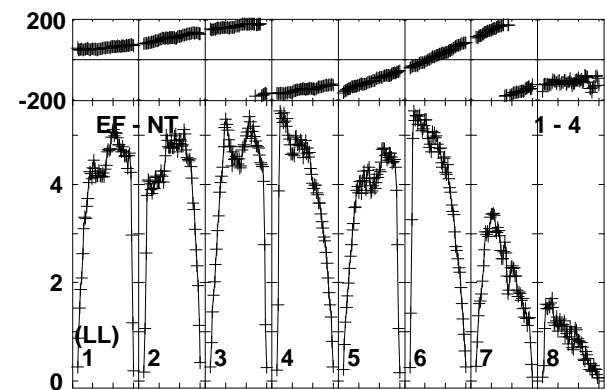
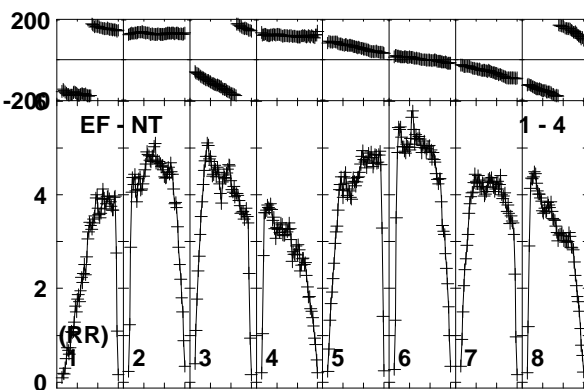
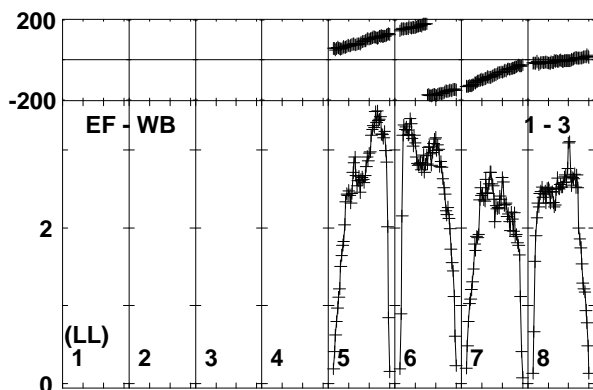
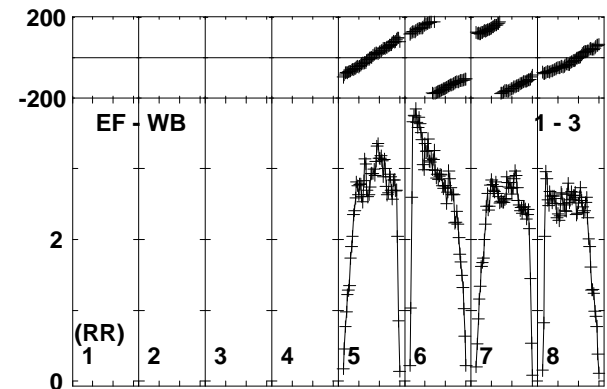
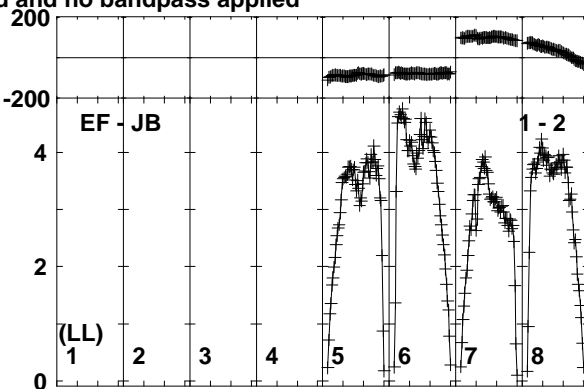
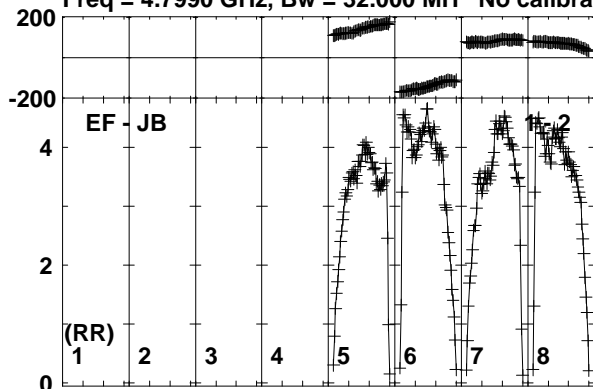

Lower frame: Milli Ampl Jy Top frame: Phas deg
Vector averaged cross-power spectrum Baseline: EF (01) - JB (02)
Timerange: 00/18:24:31 to 00/18:25:29

Plot file version 234 created 19-OCT-2017 15:36:27

J0004+2019 ES081C.UVDATA.1

Freq = 4.7990 GHz, Bw = 32.000 MH No calibration applied and no bandpass applied

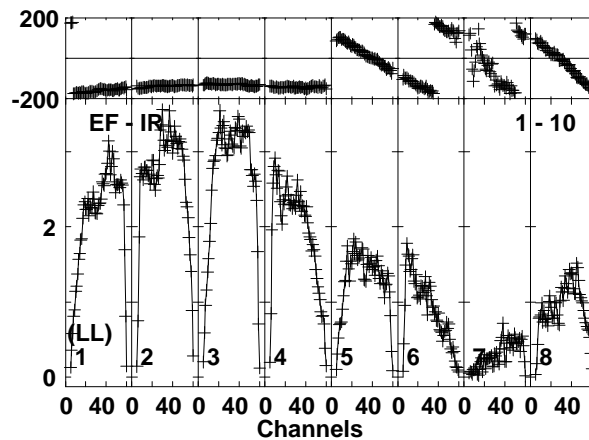
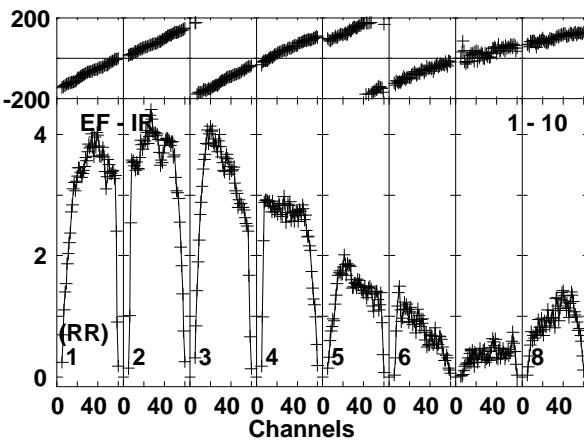
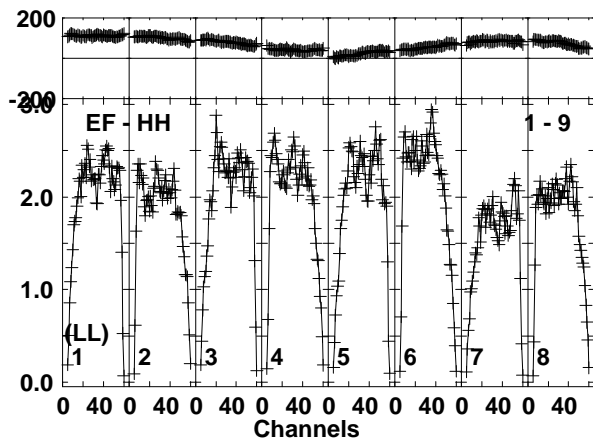
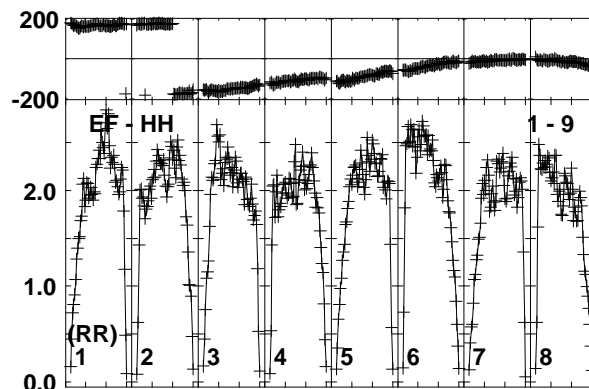
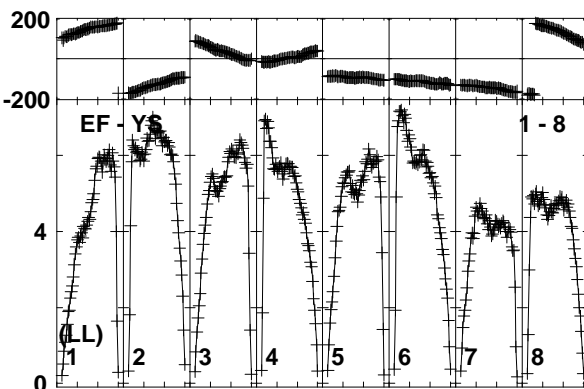
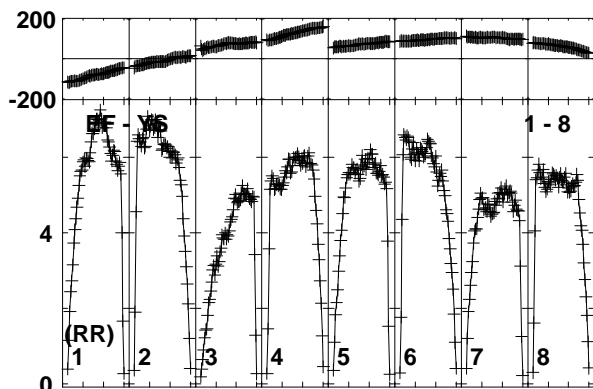
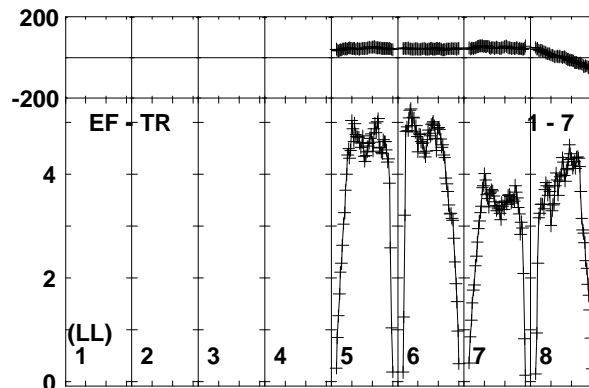
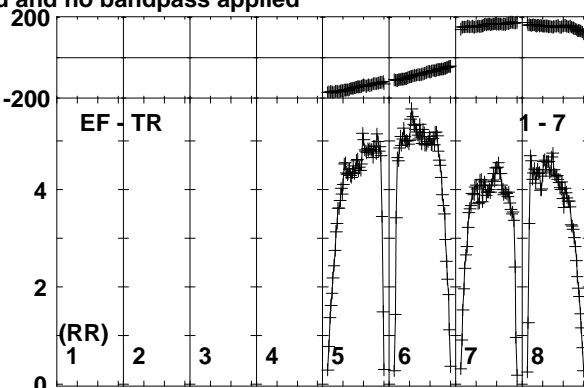
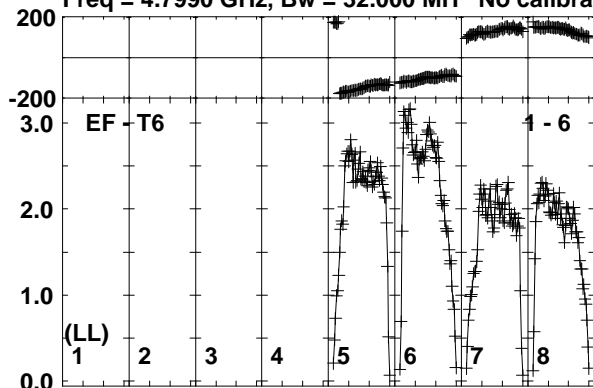

Lower frame: Milli Ampl Jy Top frame: Phas deg
Vector averaged cross-power spectrum Baseline: EF (01) - T6 (06)
Timerange: 00:18:24:31 to 00:18:25:29

Plot file version 235 created 19-OCT-2017 15:36:27

MRK335 ES081C.UVDATA.1

Freq = 4.7990 GHz, Bw = 32.000 MH No calibration applied and no bandpass applied

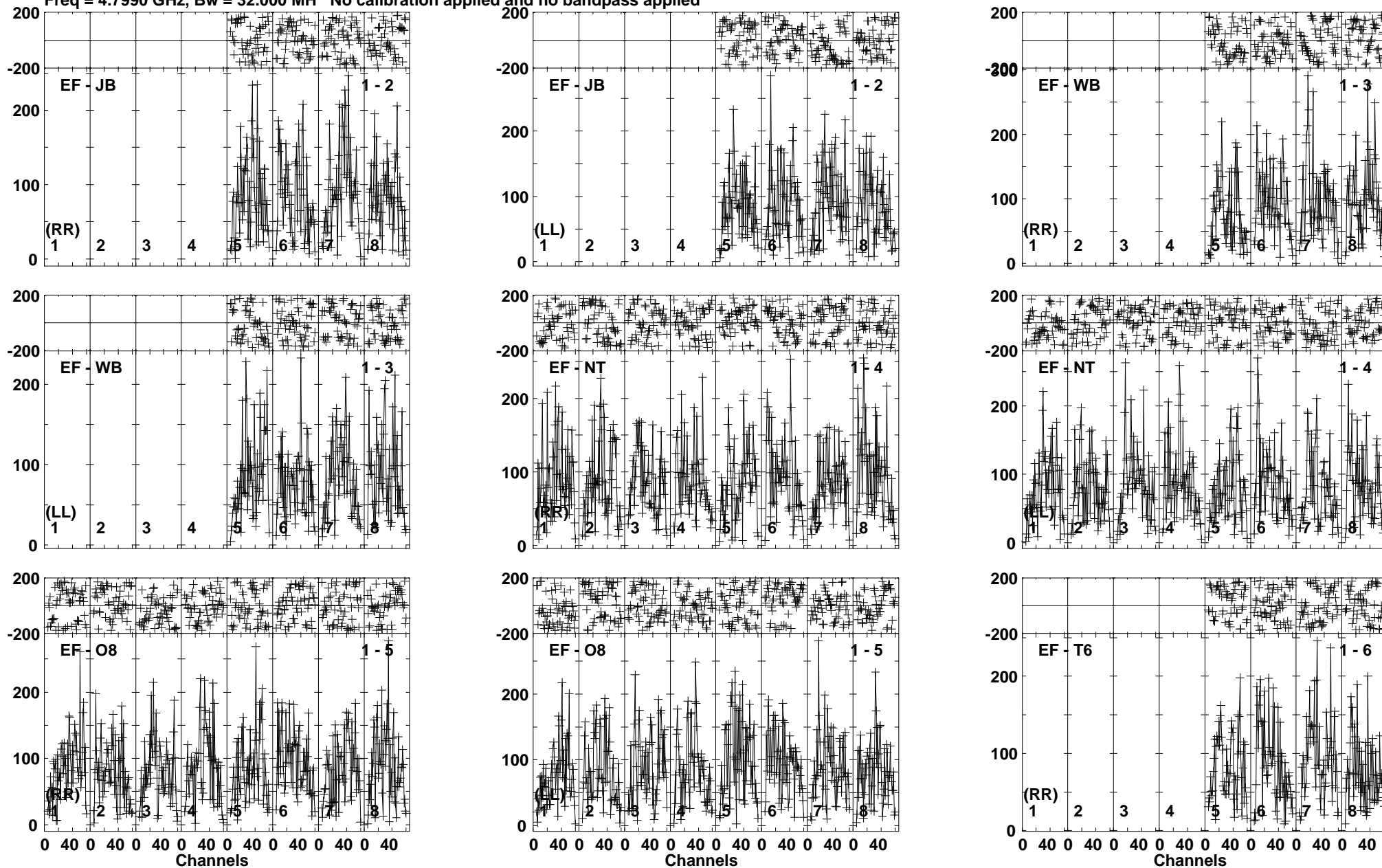

Lower frame: Micro Ampl Jy Top frame: Phas deg
Vector averaged cross-power spectrum Baseline: EF (01) - JB (02)
Timerange: 00/18:25:31 to 00/18:28:59

Plot file version 236 created 19-OCT-2017 15:36:27
 MRK335 ES081C.UVDATA.1
 Freq = 4.7990 GHz, Bw = 32.000 MH No calibration applied and no bandpass applied

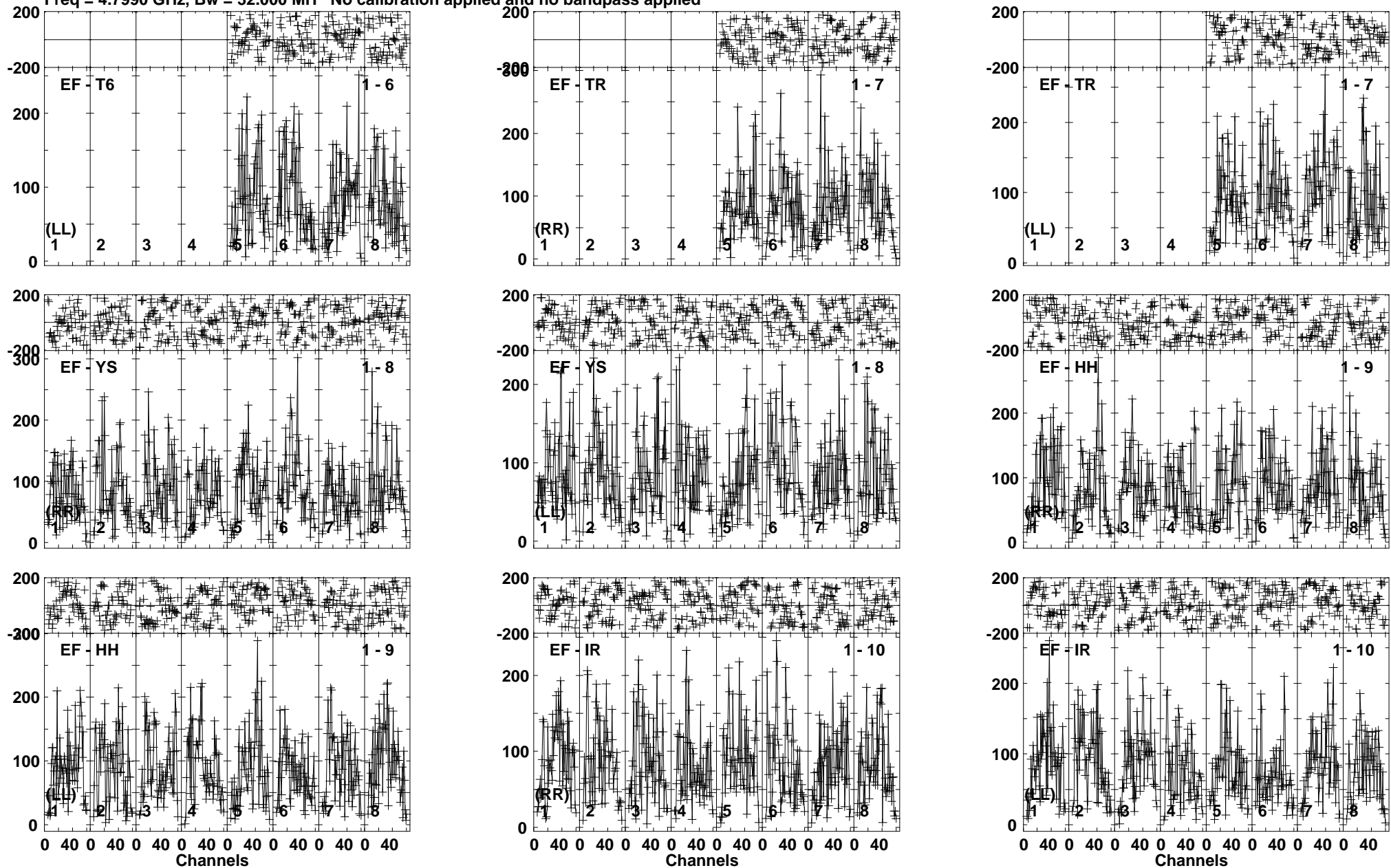

Lower frame: Micro Ampl Jy Top frame: Phas deg
 Vector averaged cross-power spectrum Baseline: EF (01) - T6 (06)
 Timerange: 00/18:25:31 to 00/18:28:59

Plot file version 237 created 19-OCT-2017 15:36:27

J0004+2019 ES081C.UVDATA.1

Freq = 4.7990 GHz, Bw = 32.000 MH No calibration applied and no bandpass applied

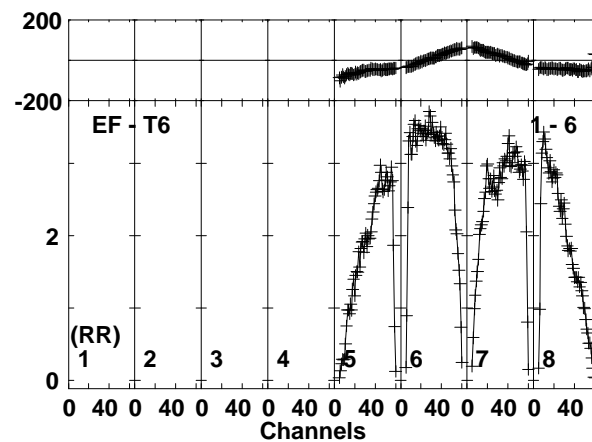
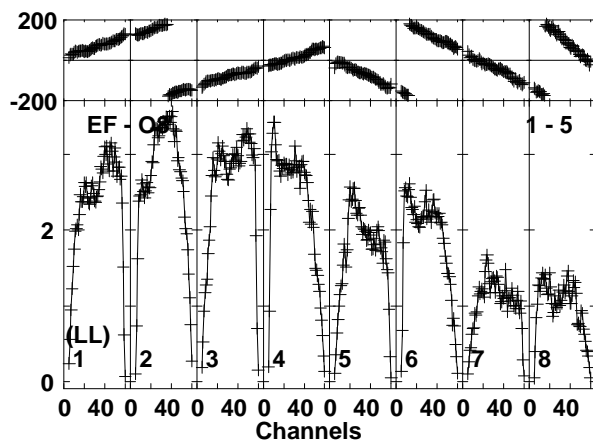
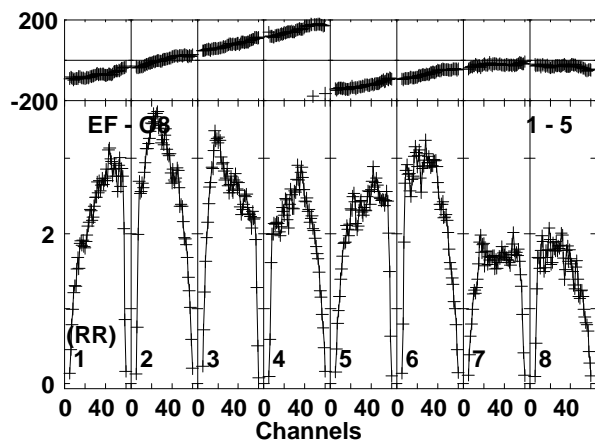
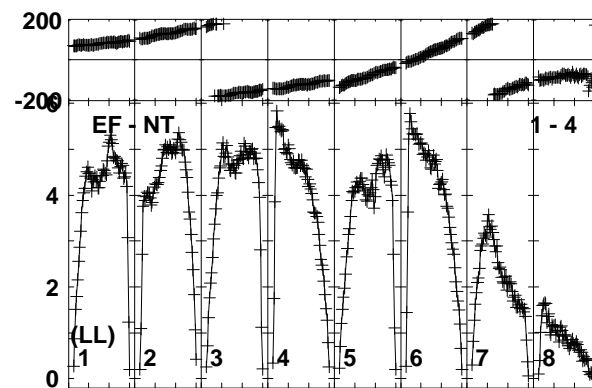
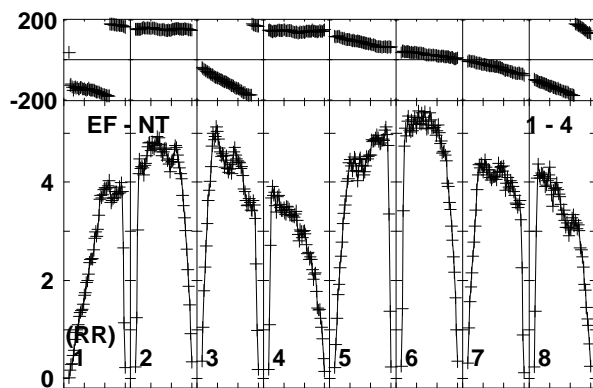
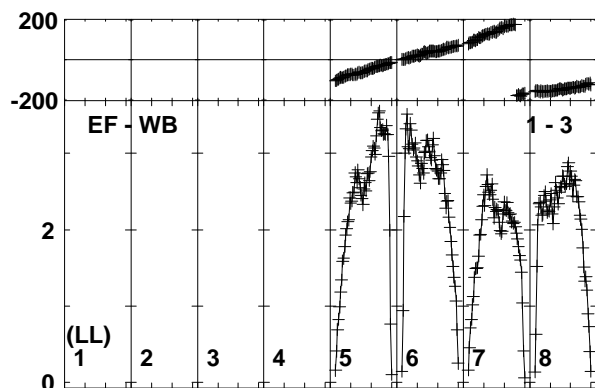
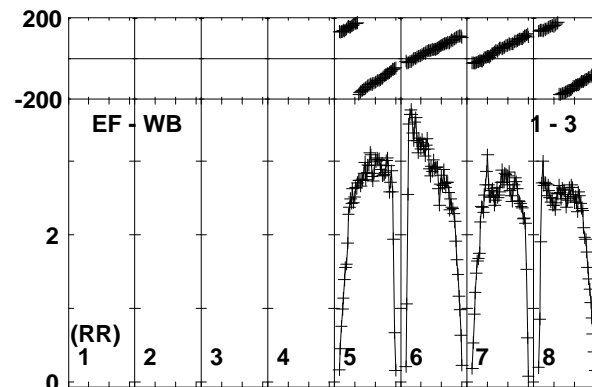
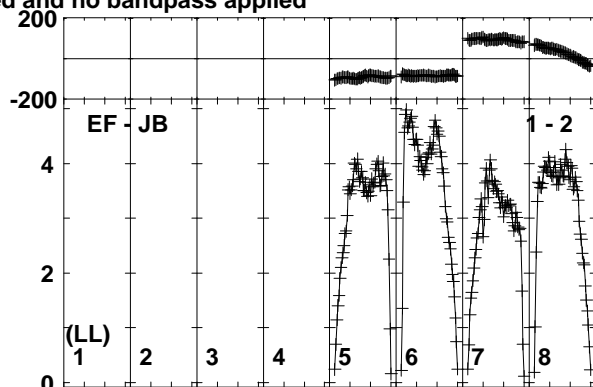
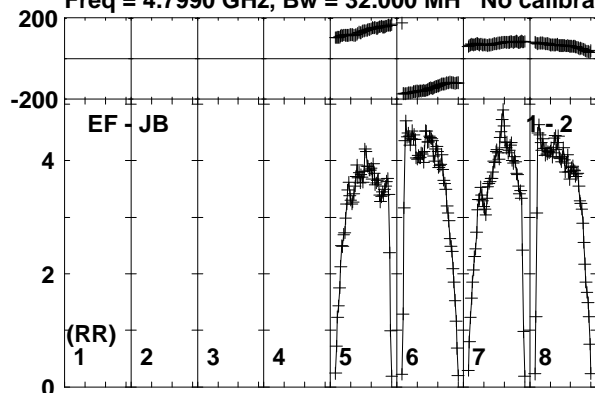

Lower frame: Milli Ampl Jy Top frame: Phas deg
Vector averaged cross-power spectrum Baseline: EF (01) - JB (02)
Timerange: 00:18:29:01 to 00:18:30:29

Plot file version 238 created 19-OCT-2017 15:36:27

J0004+2019 ES081C.UVDATA.1

Freq = 4.7990 GHz, Bw = 32.000 MH No calibration applied and no bandpass applied

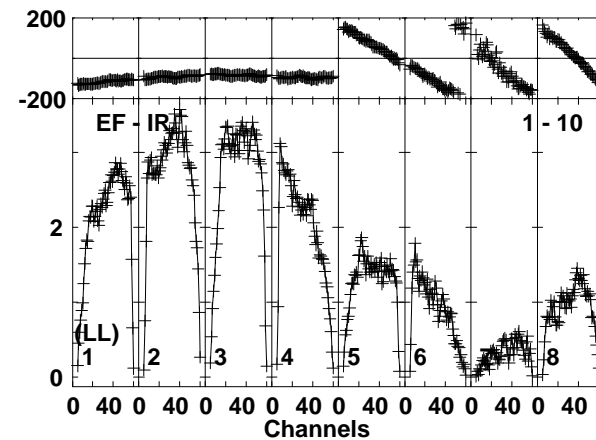
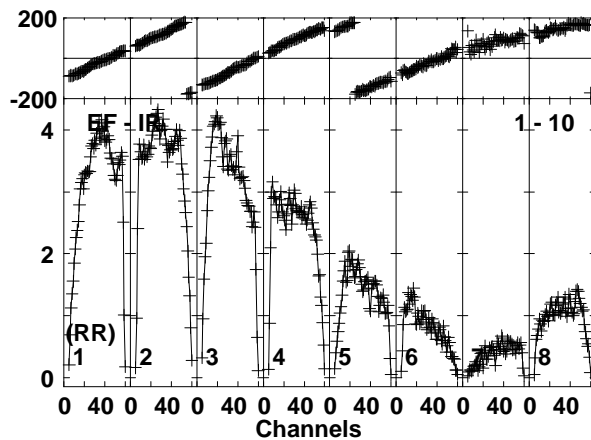
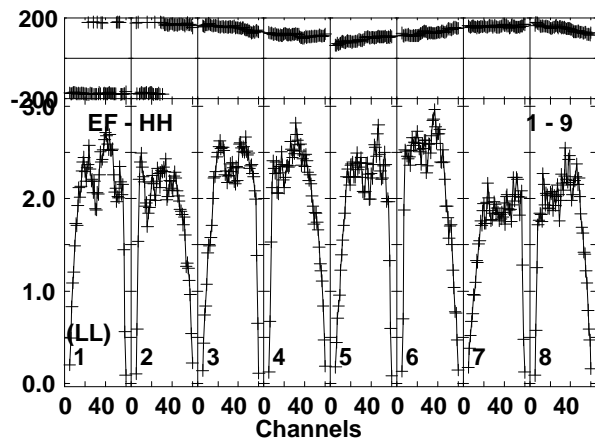
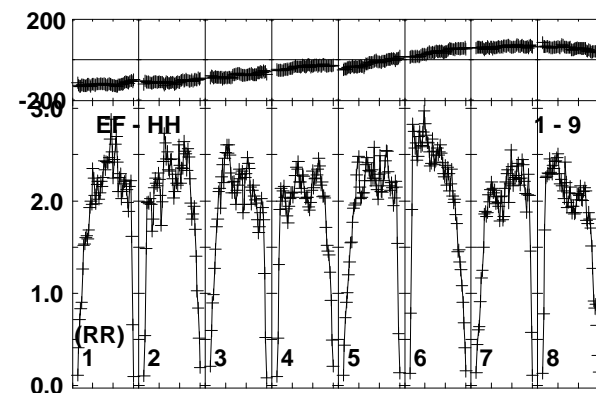
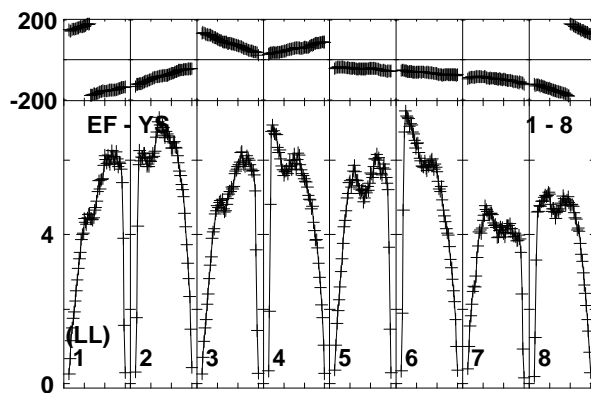
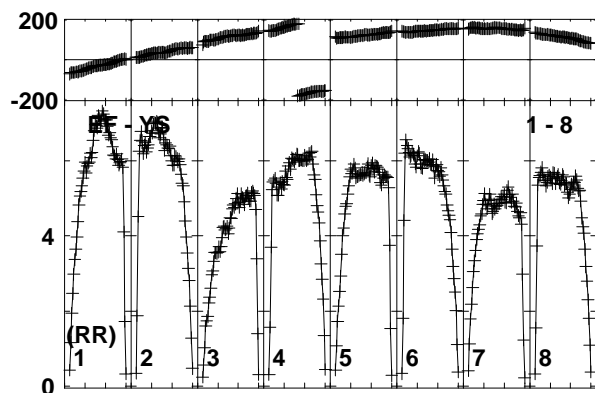
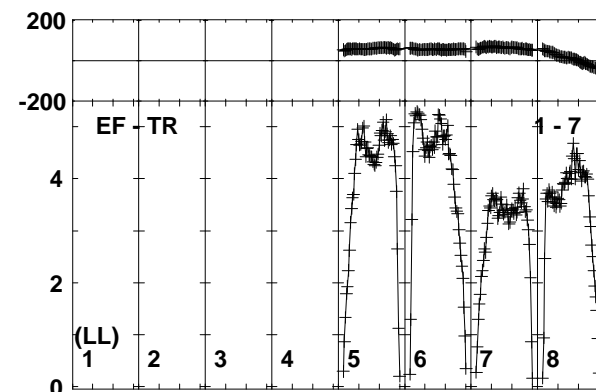
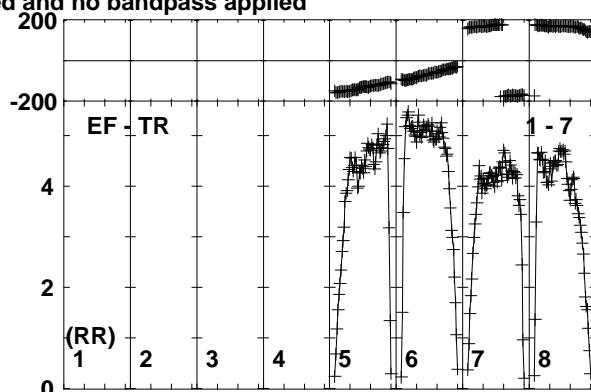
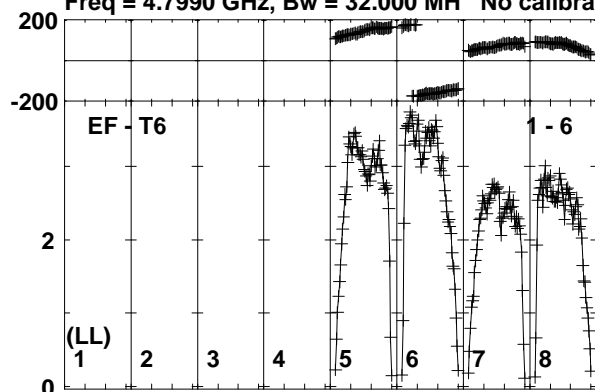

Lower frame: Milli Ampl Jy Top frame: Phas deg
Vector averaged cross-power spectrum Baseline: EF (01) - T6 (06)
Timerange: 00:18:29:01 to 00:18:30:29

Plot file version 239 created 19-OCT-2017 15:36:27
 MRK335 ES081C.UVDATA.1
 Freq = 4.7990 GHz, Bw = 32.000 MH No calibration applied and no bandpass applied

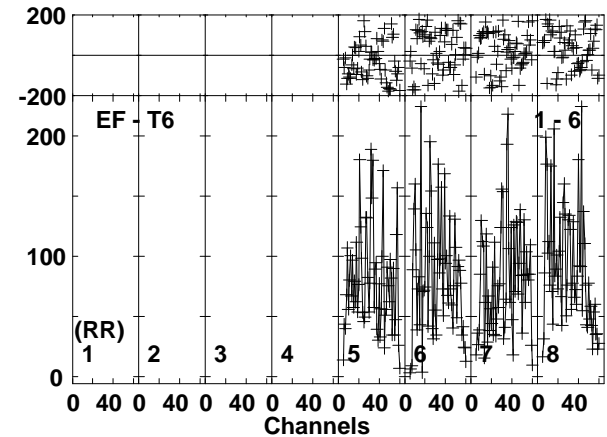
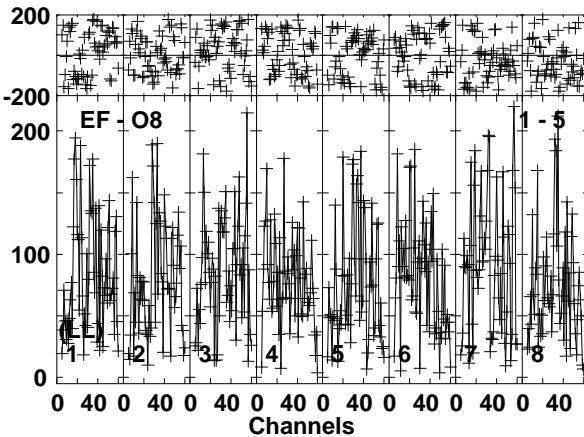
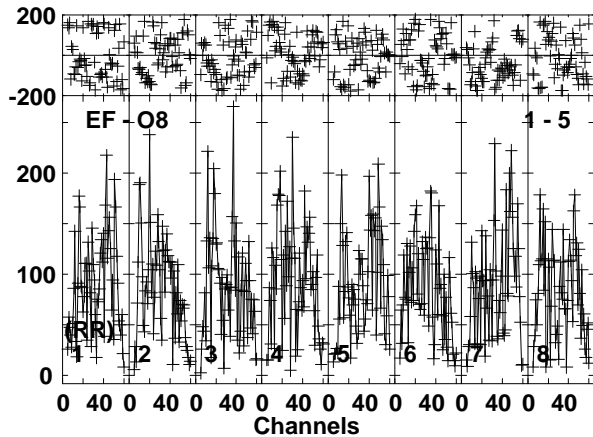
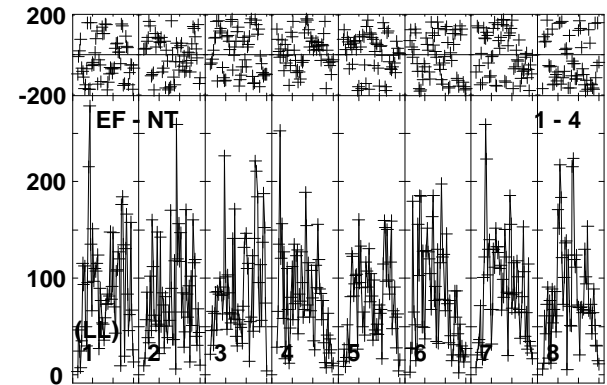
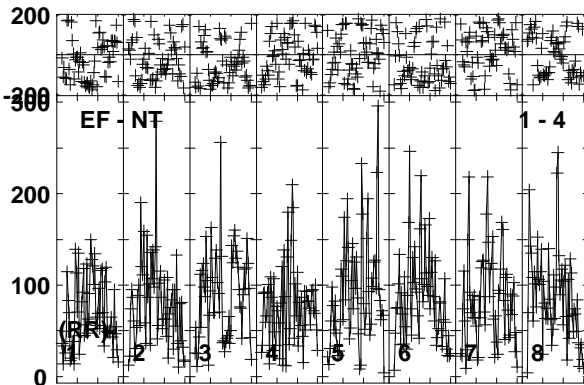
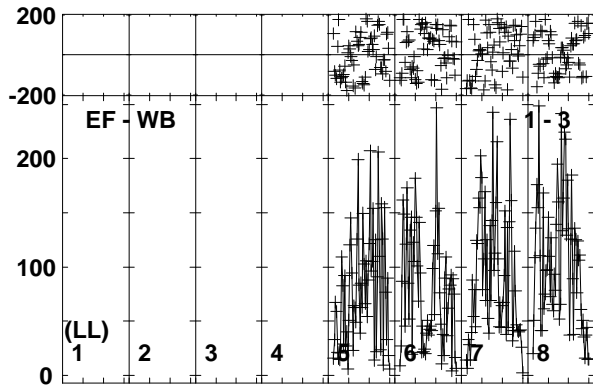
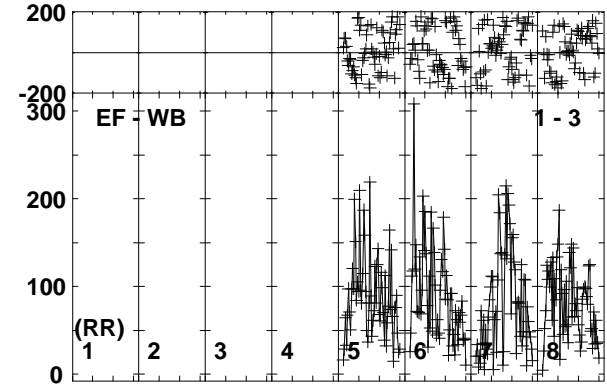
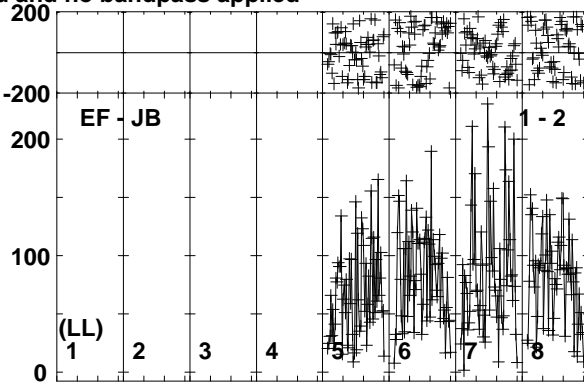
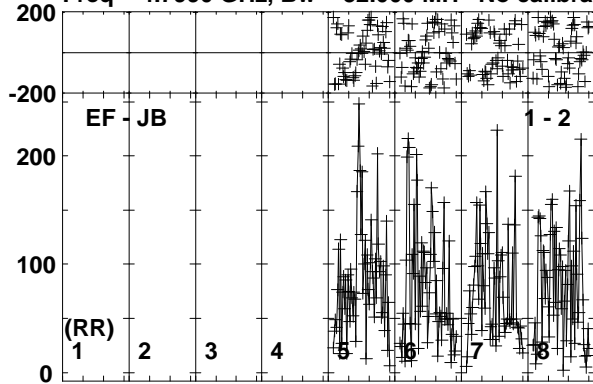

Lower frame: Micro Ampl Jy Top frame: Phas deg
 Vector averaged cross-power spectrum Baseline: EF (01) - JB (02)
 Timerange: 00/18:30:31 to 00/18:33:59

Plot file version 240 created 19-OCT-2017 15:36:28

MRK335 ES081C.UVDATA.1

Freq = 4.7990 GHz, Bw = 32.000 MH No calibration applied and no bandpass applied

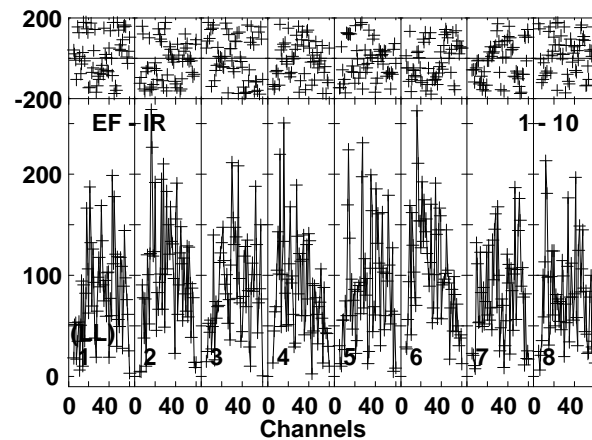
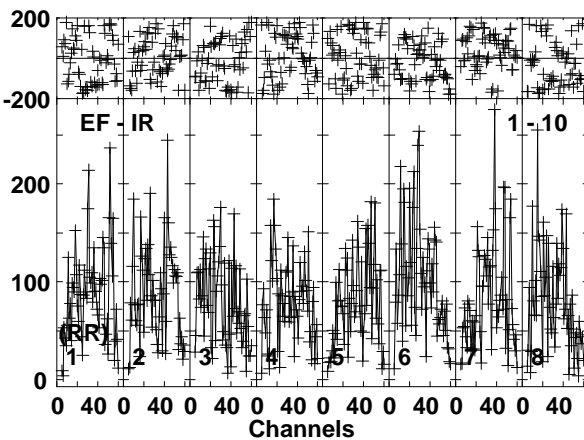
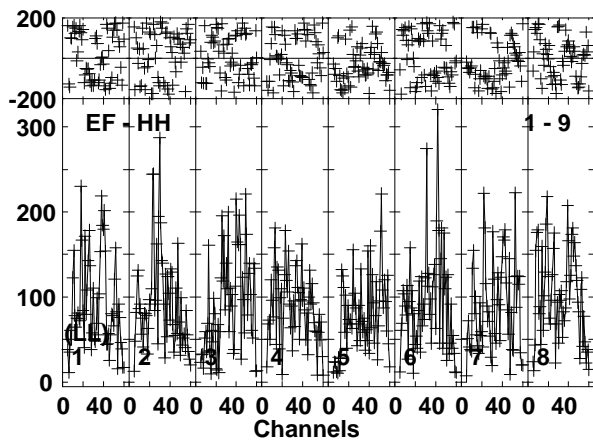
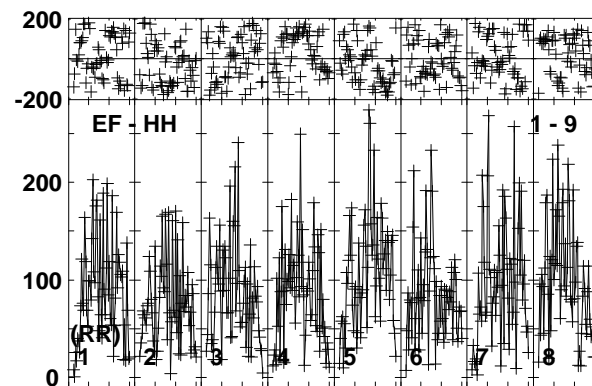
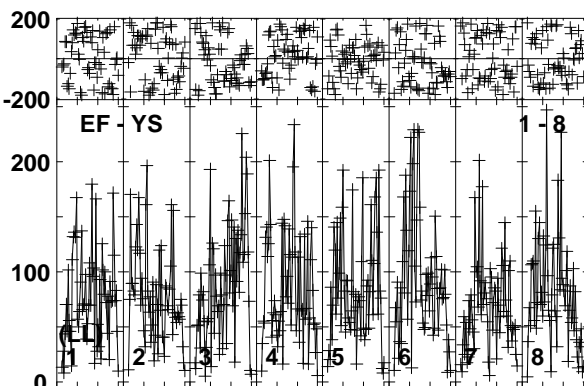
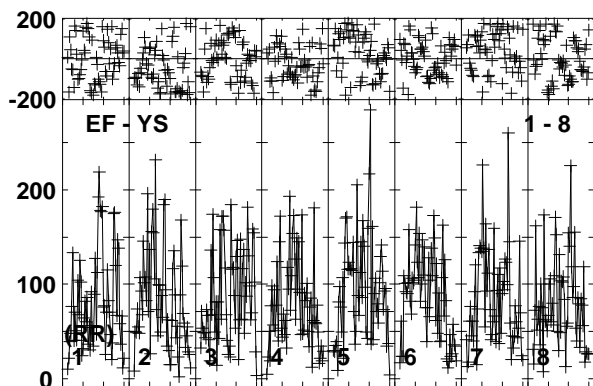
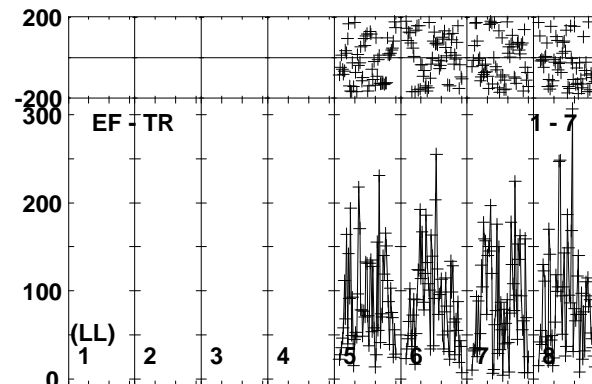
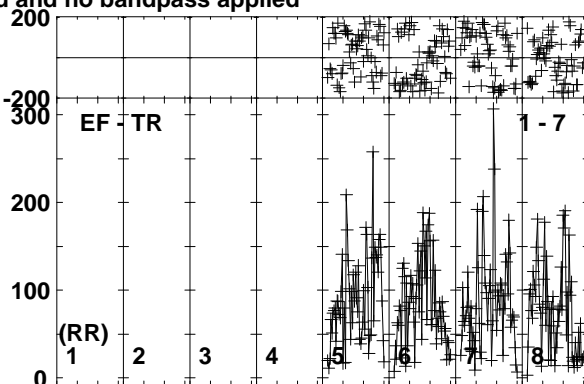
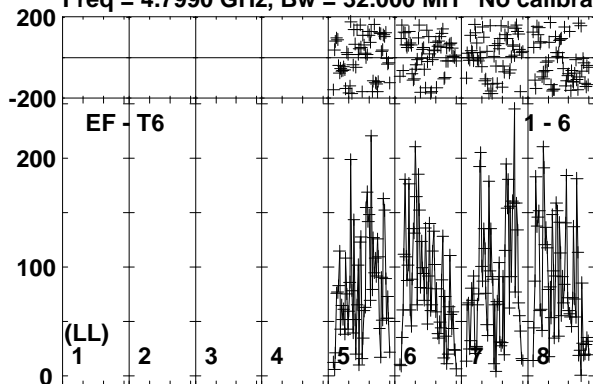

Lower frame: Micro Ampl Jy Top frame: Phas deg
Vector averaged cross-power spectrum Baseline: EF (01) - T6 (06)
Timerange: 00/18:30:31 to 00/18:33:59

Plot file version 241 created 19-OCT-2017 15:36:28

J0004+2019 ES081C.UVDATA.1

Freq = 4.7990 GHz, Bw = 32.000 MH No calibration applied and no bandpass applied

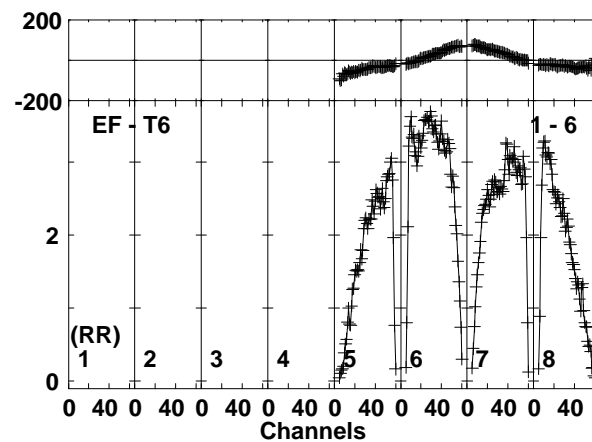
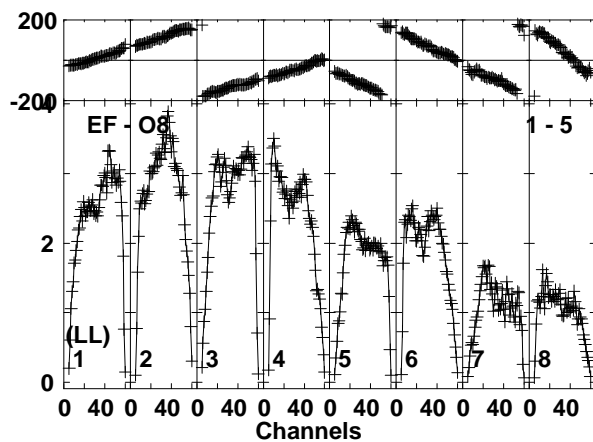
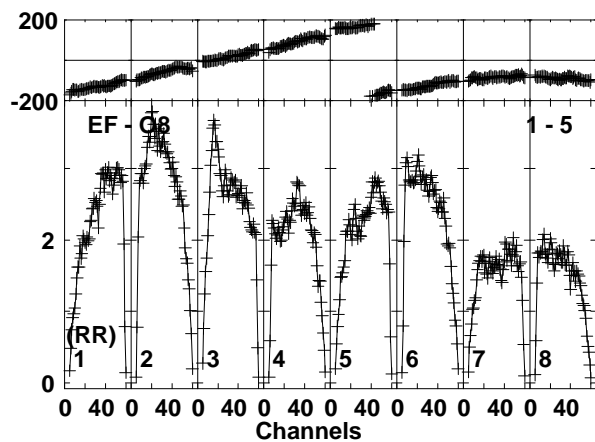
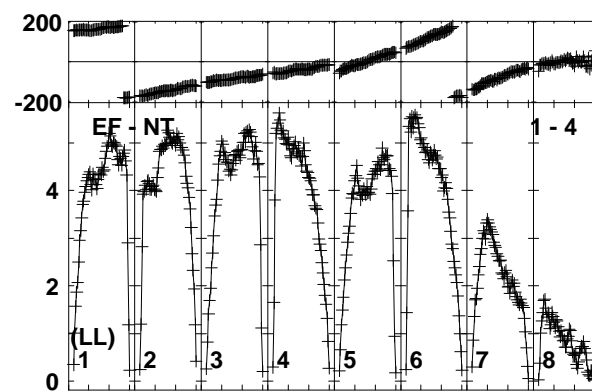
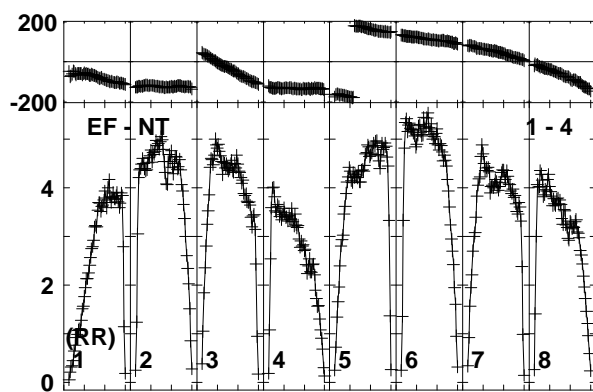
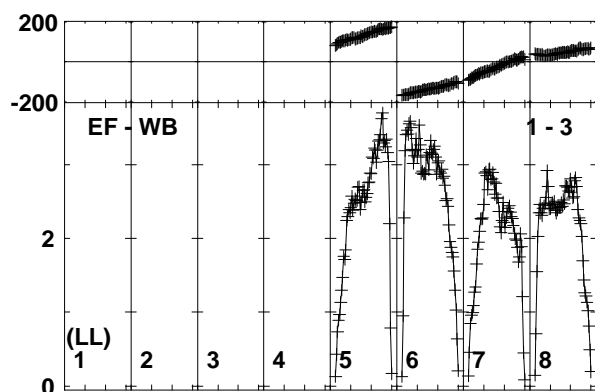
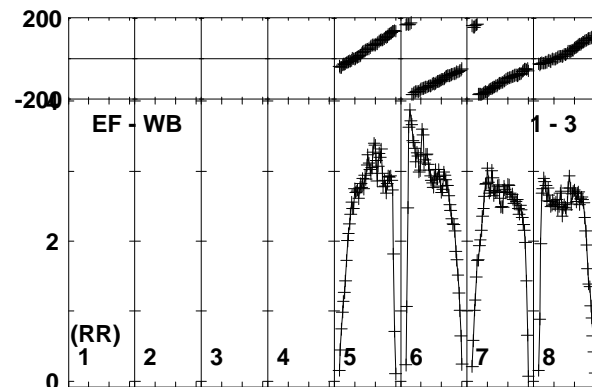
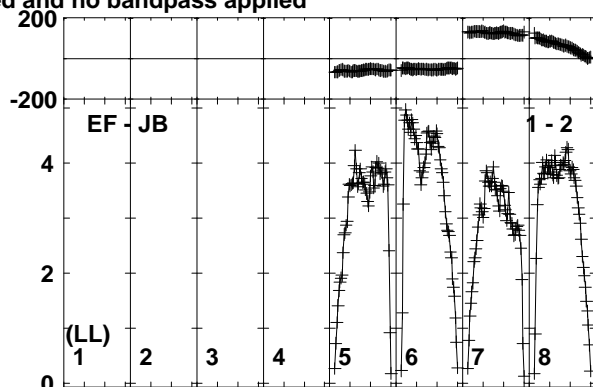
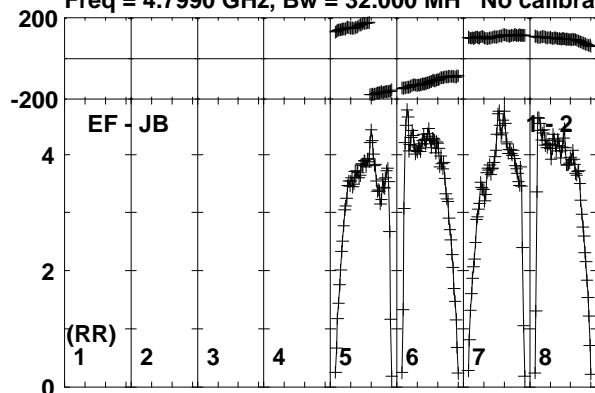

Lower frame: Milli Ampl Jy Top frame: Phas deg
Vector averaged cross-power spectrum Baseline: EF (01) - JB (02)
Timerange: 00:18:34:31 to 00:18:35:29

Plot file version 242 created 19-OCT-2017 15:36:28

J0004+2019 ES081C.UVDATA.1

Freq = 4.7990 GHz, Bw = 32.000 MH No calibration applied and no bandpass applied

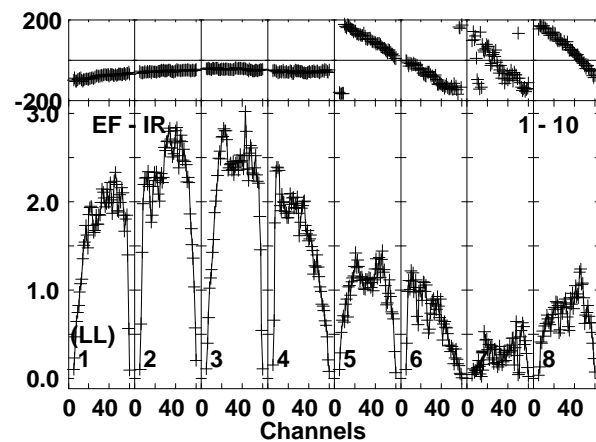
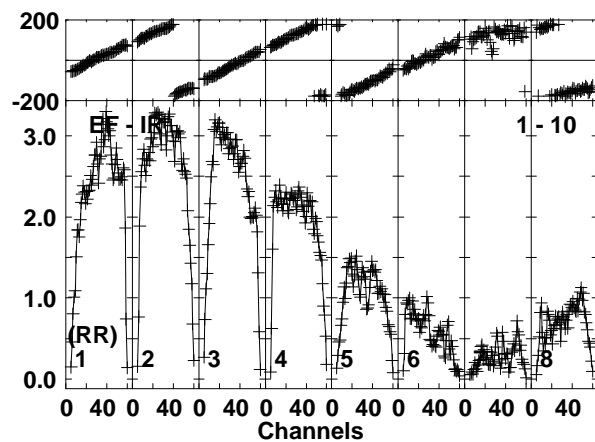
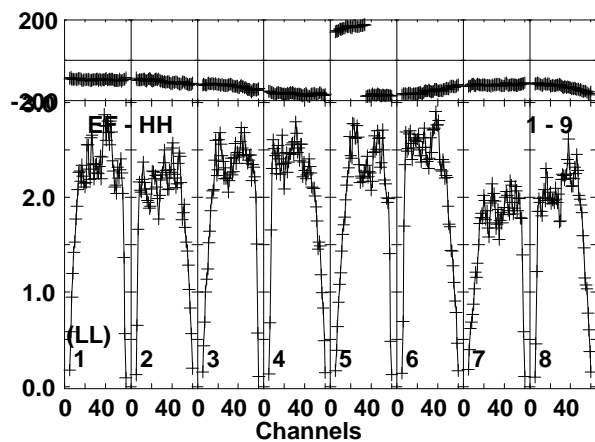
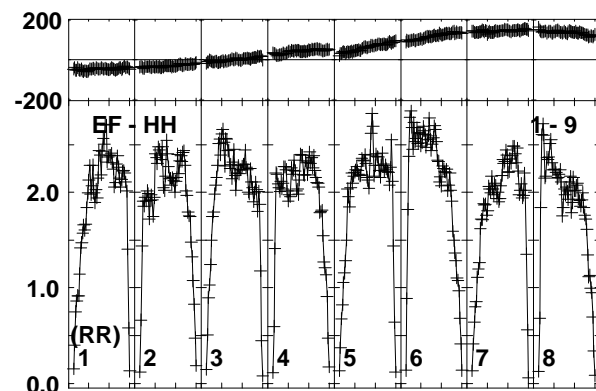
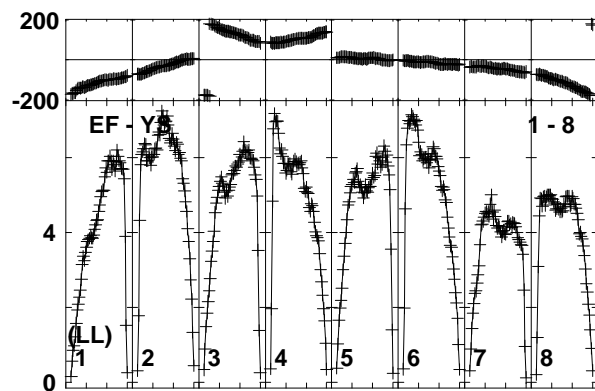
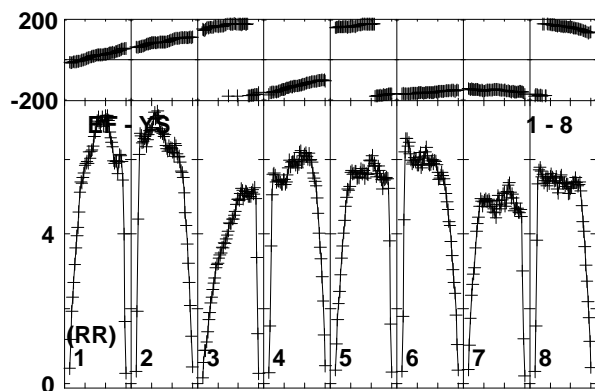
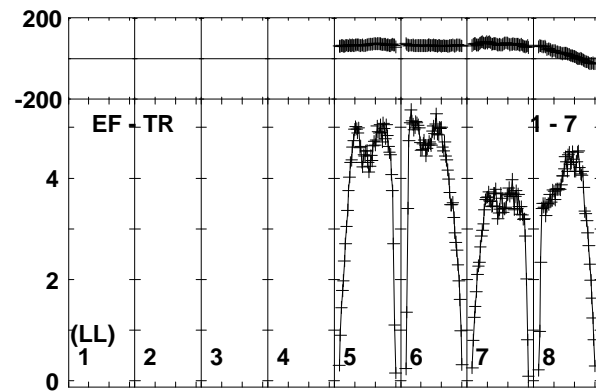
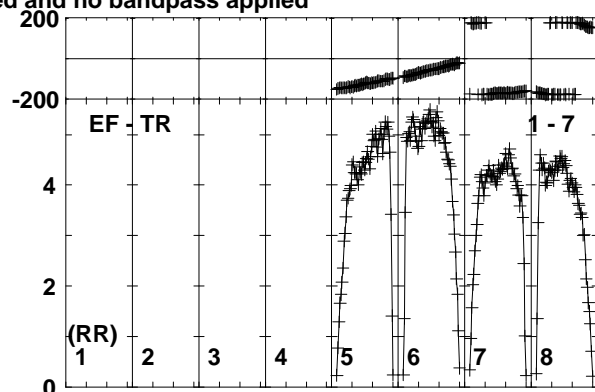
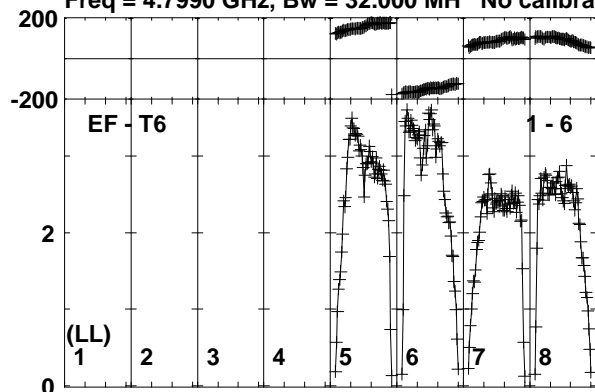

Lower frame: Milli Ampl Jy Top frame: Phas deg
Vector averaged cross-power spectrum Baseline: EF (01) - T6 (06)
Timerange: 00:18:34:31 to 00:18:35:29

Plot file version 243 created 19-OCT-2017 15:36:28

MRK335 ES081C.UVDATA.1

Freq = 4.7990 GHz, Bw = 32.000 MH No calibration applied and no bandpass applied

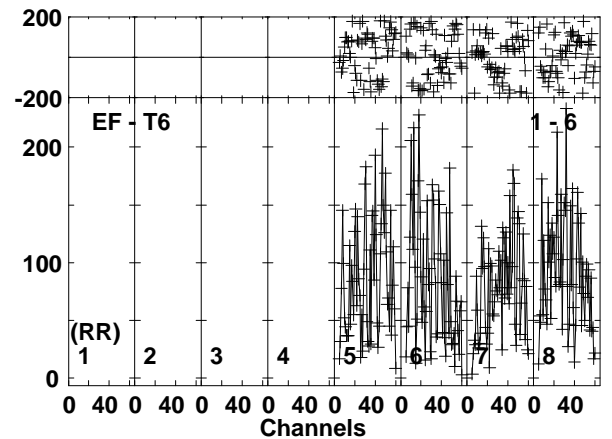
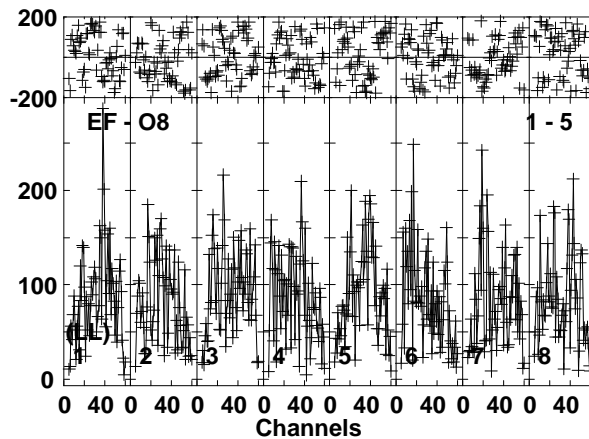
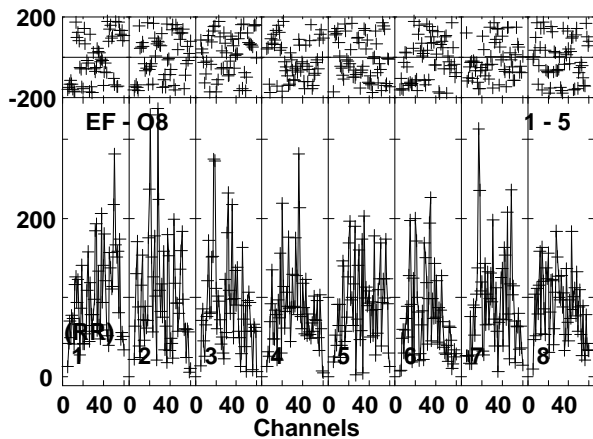
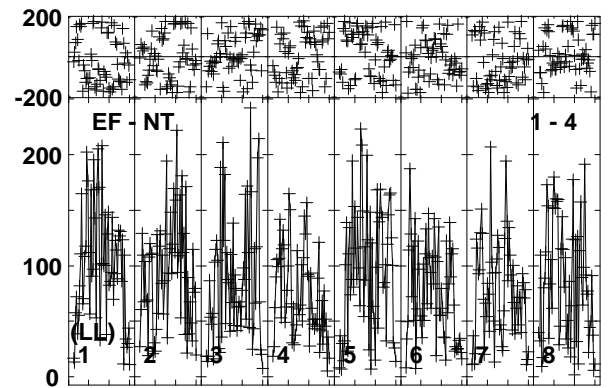
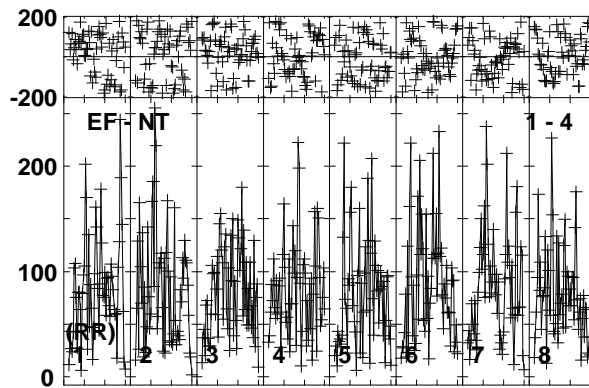
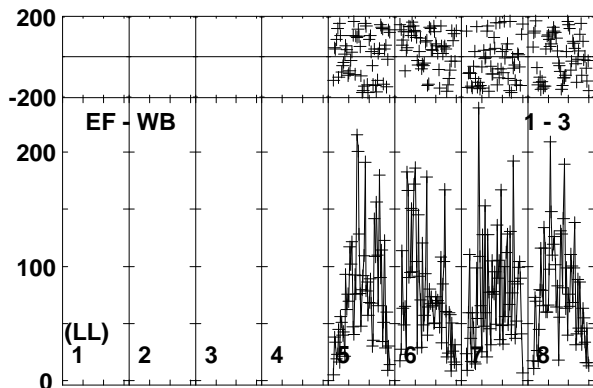
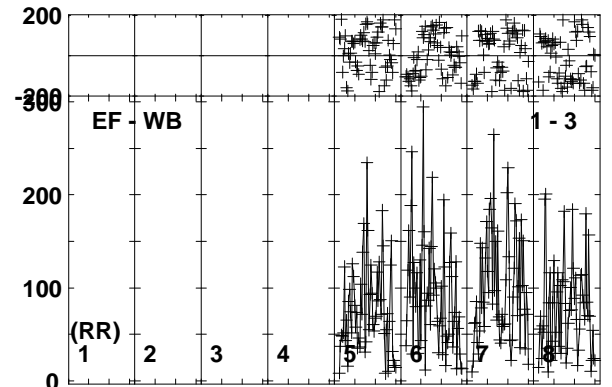
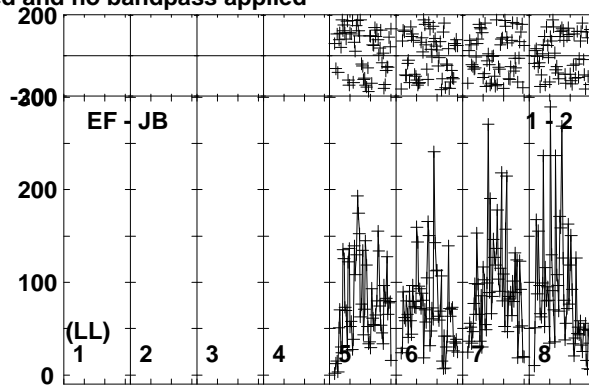
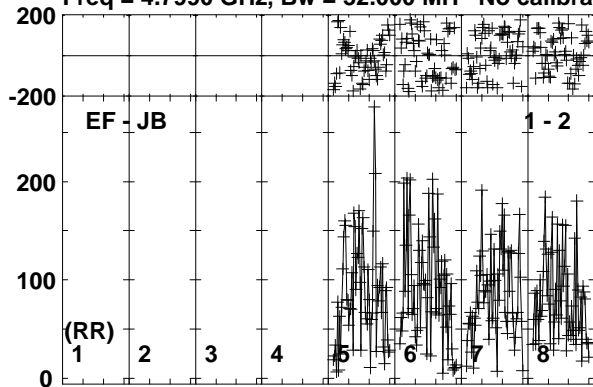

Lower frame: Micro Ampl Jy Top frame: Phas deg
Vector averaged cross-power spectrum Baseline: EF (01) - JB (02)
Timerange: 00/18:35:31 to 00/18:38:59

Plot file version 244 created 19-OCT-2017 15:36:28

MRK335 ES081C.UVDATA.1

Freq = 4.7990 GHz, Bw = 32.000 MH No calibration applied and no bandpass applied

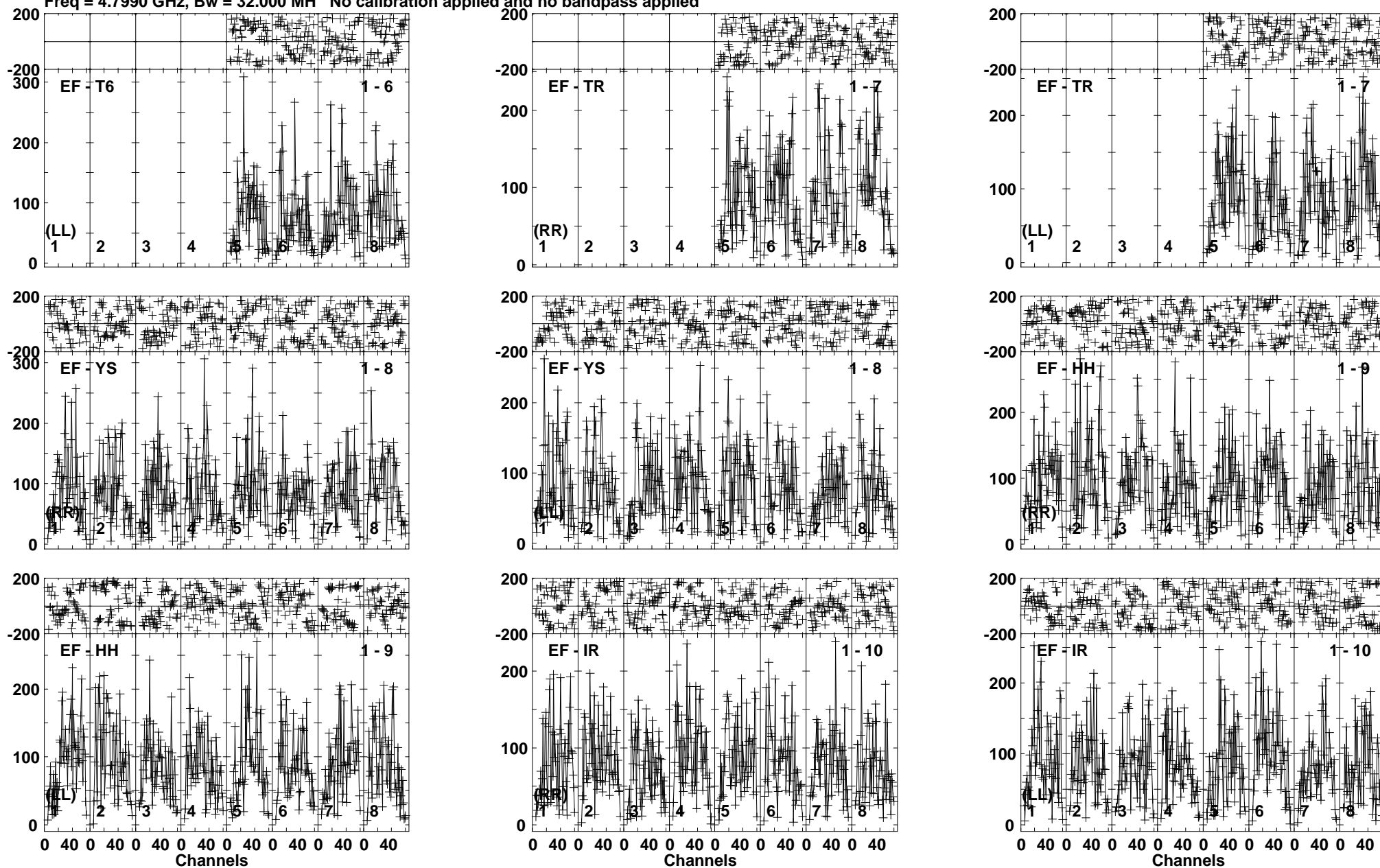

Lower frame: Micro Ampl Jy Top frame: Phas deg
Vector averaged cross-power spectrum Baseline: EF (01) - T6 (06)
Timerange: 00:18:35:31 to 00:18:38:59

Plot file version 245 created 19-OCT-2017 15:36:28

J0004+2019 ES081C.UVDATA.1

Freq = 4.7990 GHz, Bw = 32.000 MH No calibration applied and no bandpass applied

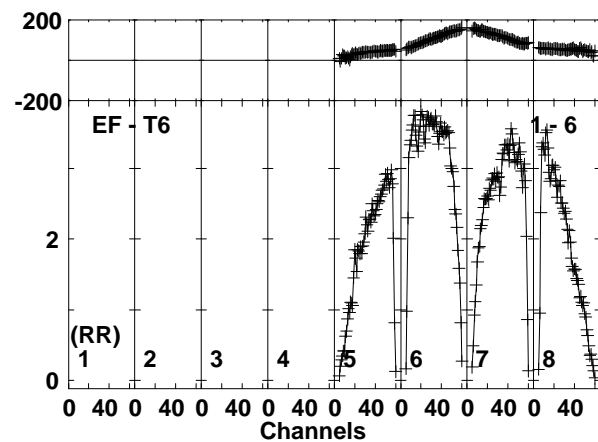
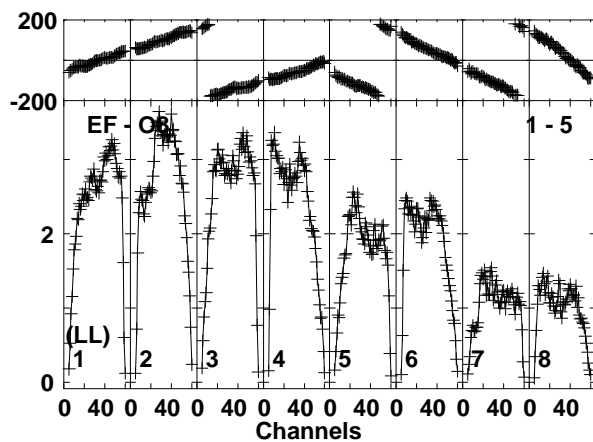
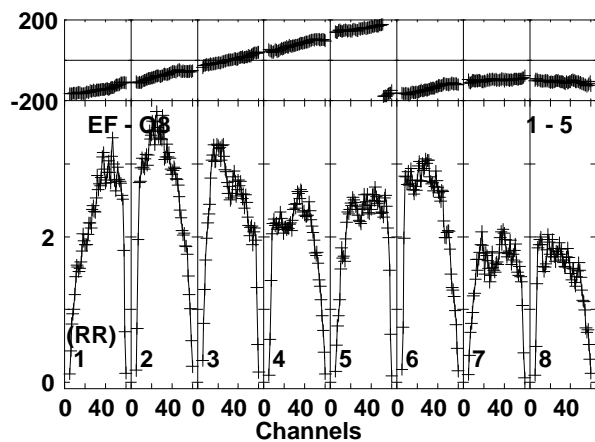
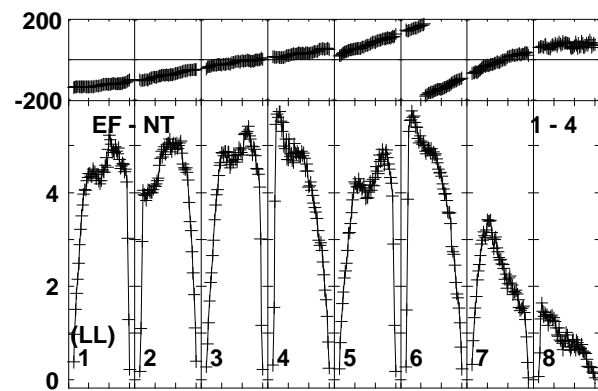
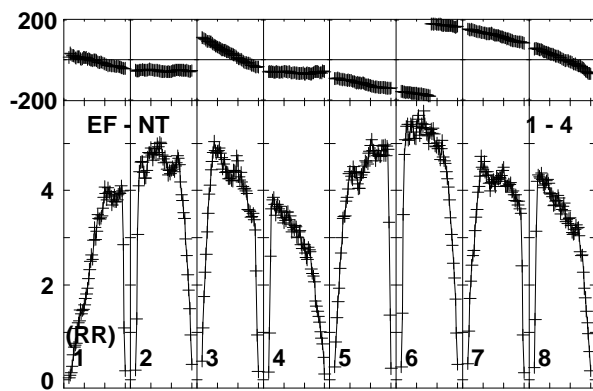
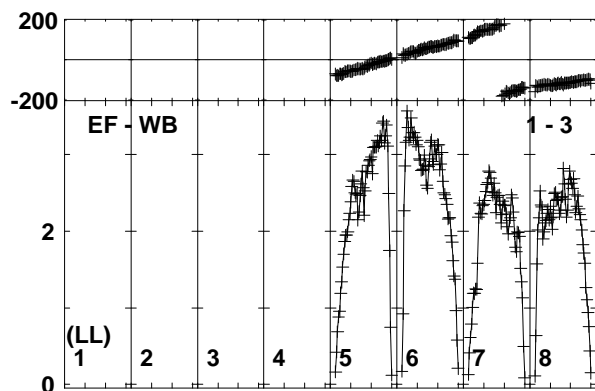
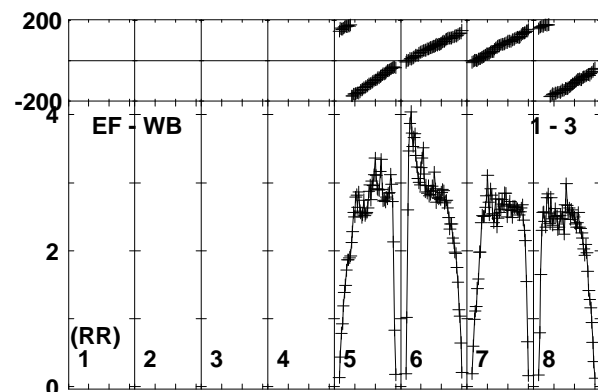
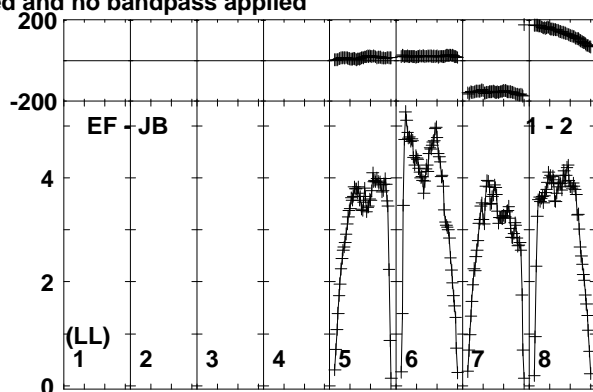
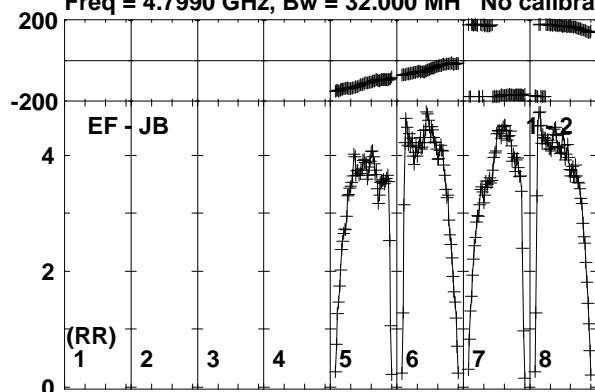

Lower frame: Milli Ampl Jy Top frame: Phas deg
Vector averaged cross-power spectrum Baseline: EF (01) - JB (02)
Timerange: 00:18:39:01 to 00:18:40:29

Plot file version 246 created 19-OCT-2017 15:36:28

J0004+2019 ES081C.UVDATA.1

Freq = 4.7990 GHz, Bw = 32.000 MH No calibration applied and no bandpass applied

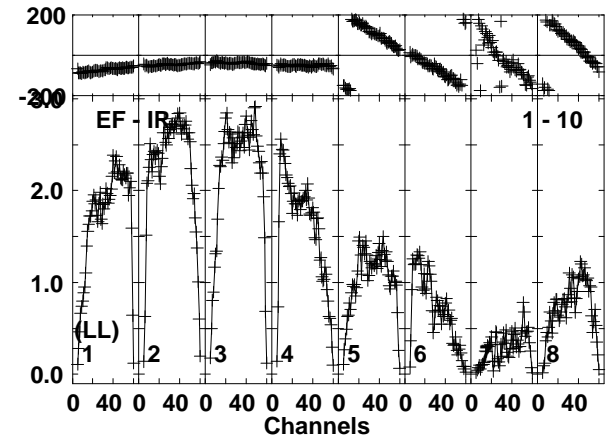
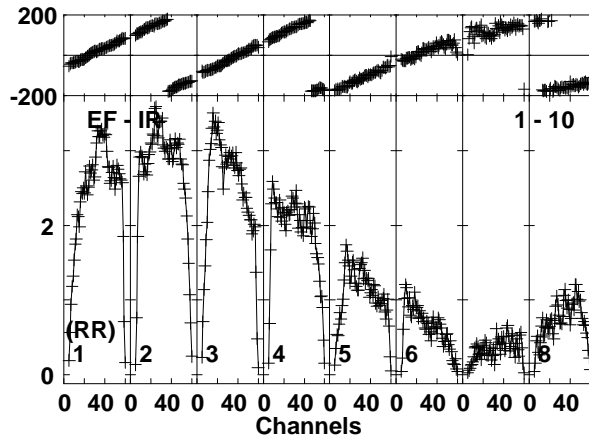
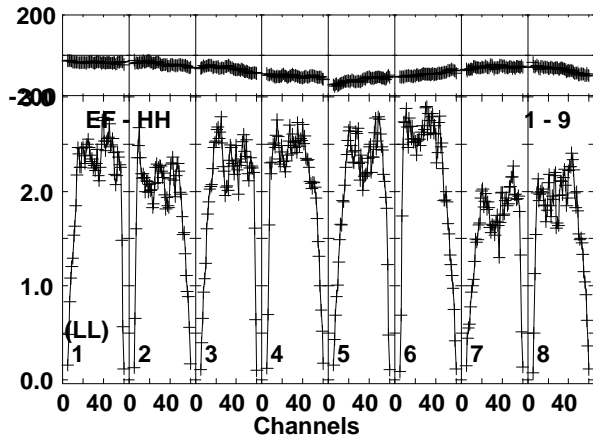
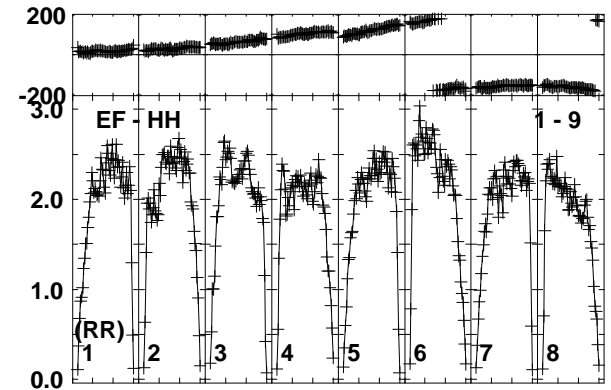
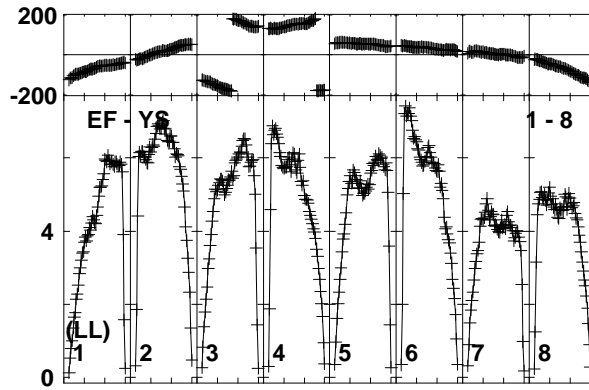
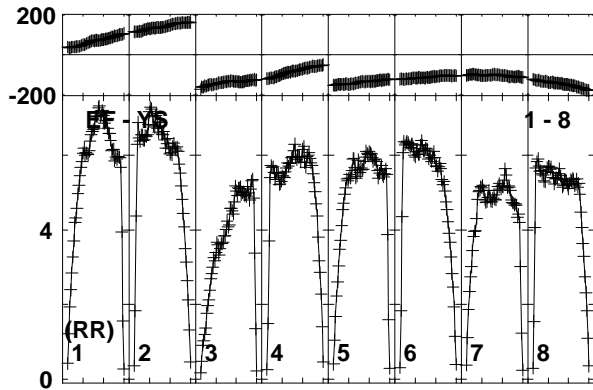
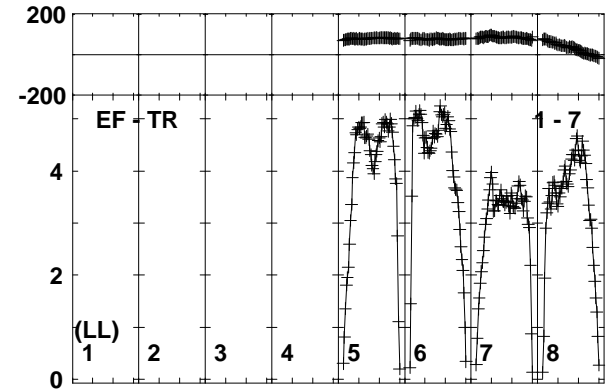
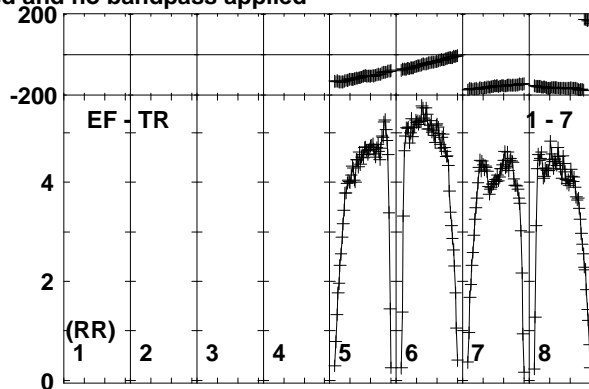
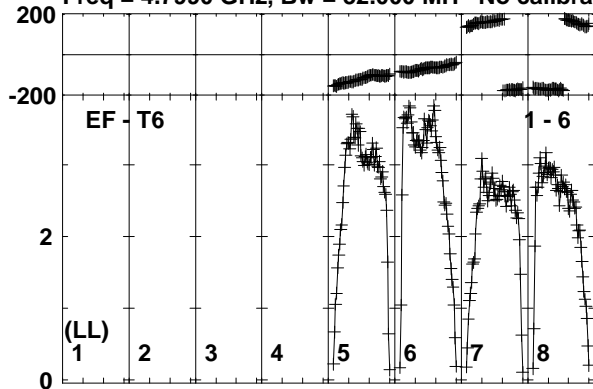

Lower frame: Milli Ampl Jy Top frame: Phas deg
Vector averaged cross-power spectrum Baseline: EF (01) - T6 (06)
Timerange: 00:18:39:01 to 00:18:40:29

Plot file version 247 created 19-OCT-2017 15:36:29

MRK335 ES081C.UVDATA.1

Freq = 4.7990 GHz, Bw = 32.000 MH No calibration applied and no bandpass applied

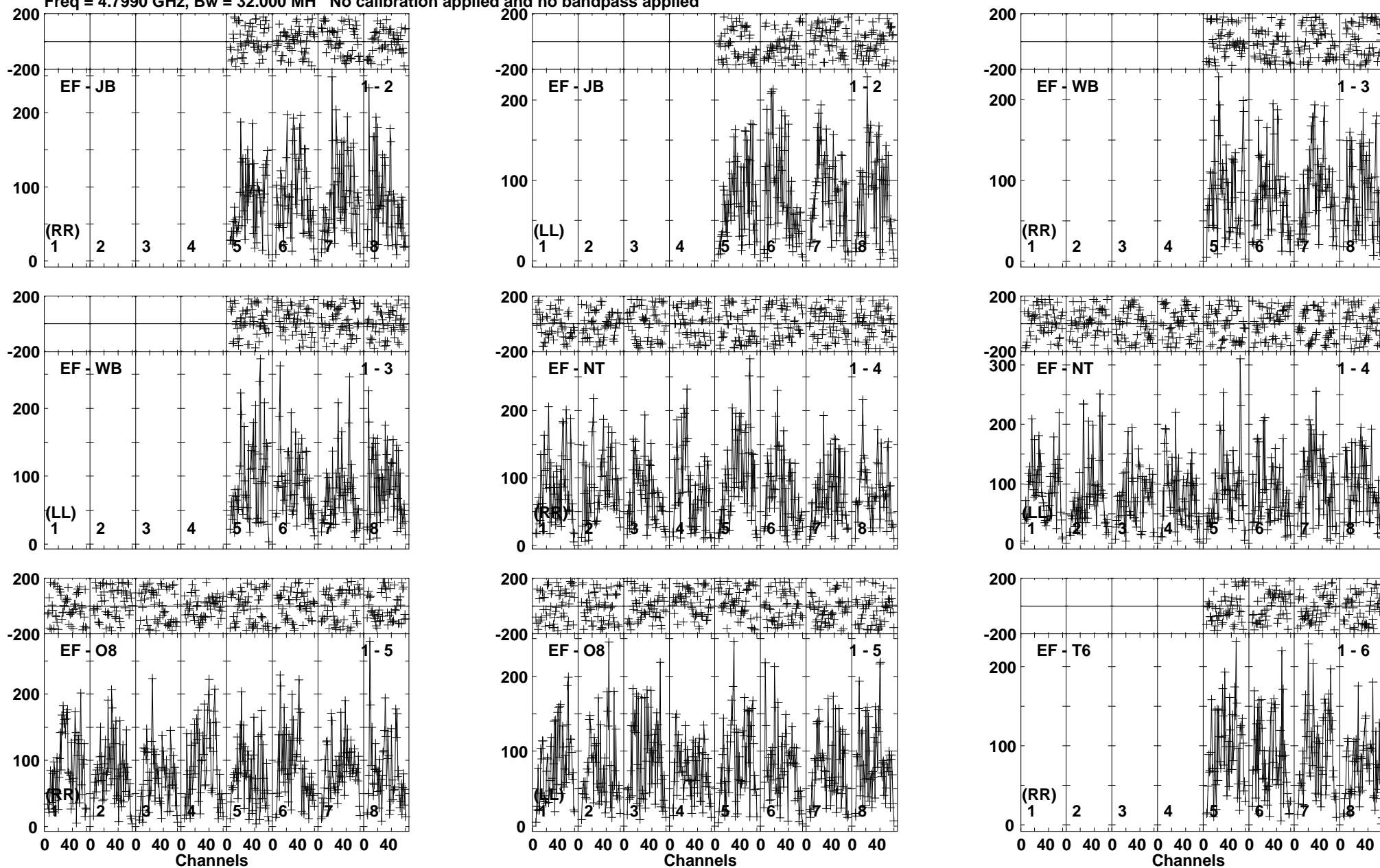

Lower frame: Micro Ampl Jy Top frame: Phas deg
Vector averaged cross-power spectrum Baseline: EF (01) - JB (02)
Timerange: 00/18:40:31 to 00/18:43:59

Plot file version 248 created 19-OCT-2017 15:36:29

MRK335 ES081C.UVDATA.1

Freq = 4.7990 GHz, Bw = 32.000 MH No calibration applied and no bandpass applied

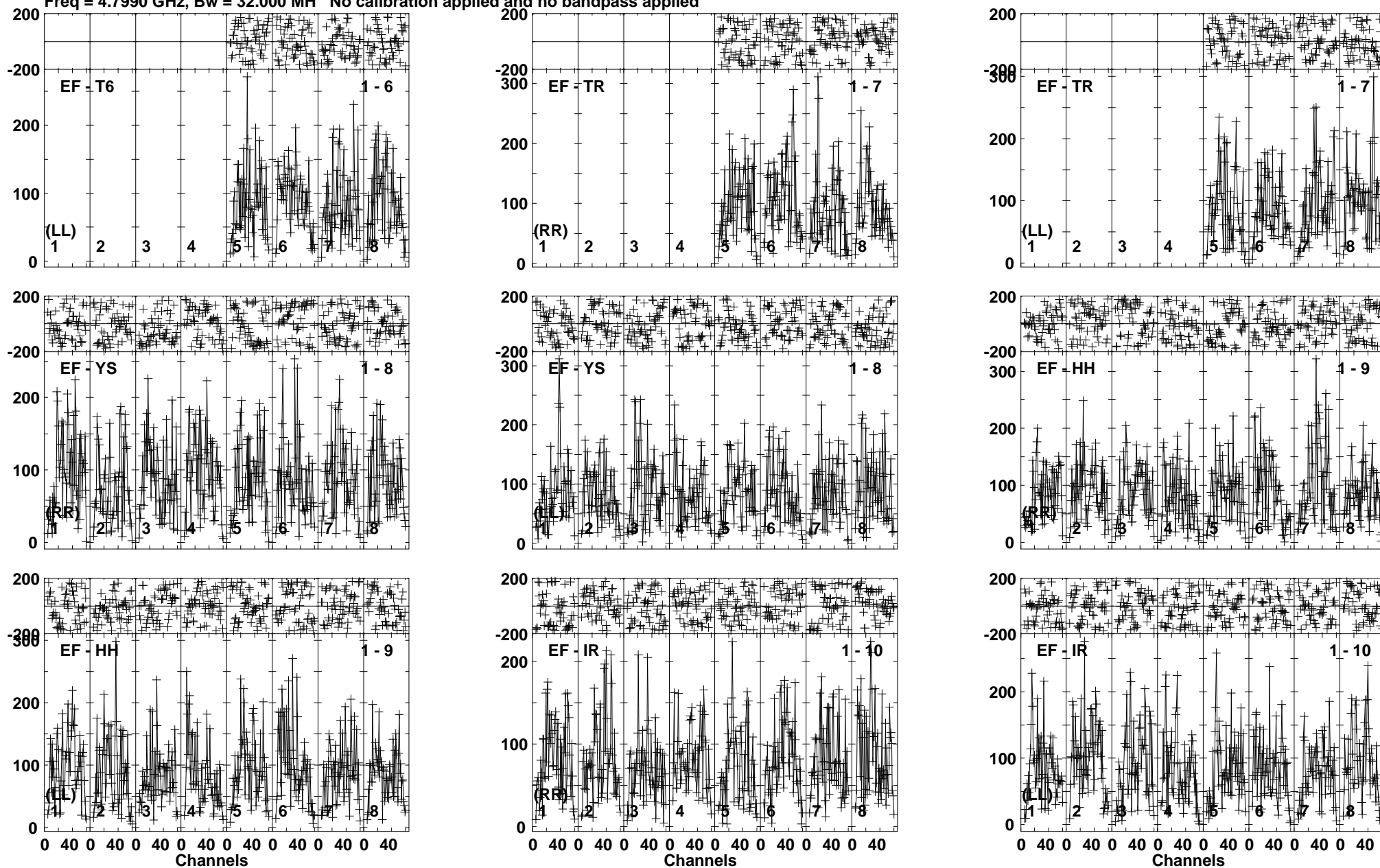

Lower frame: Micro Ampl Jy Top frame: Phas deg
Vector averaged cross-power spectrum Baseline: EF (01) - T6 (06)
Timerange: 00:18:40:31 to 00:18:43:59

Plot file version 249 created 19-OCT-2017 15:36:29
 J0004+2019 ES081C.UVDATA.1
 Freq = 4.7990 GHz, Bw = 32.000 MH No calibration applied and no bandpass applied

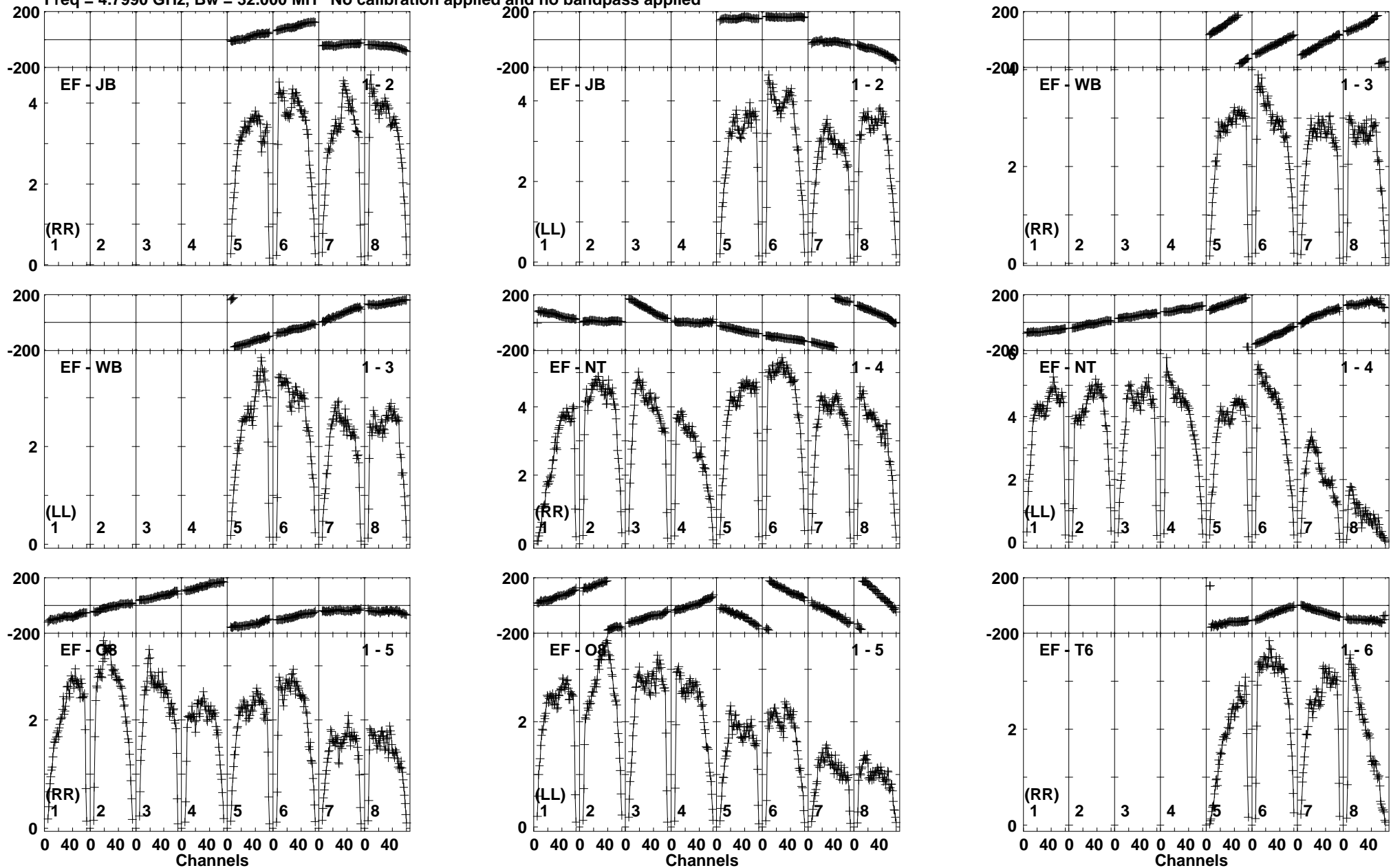

Lower frame: Milli Ampl Jy Top frame: Phas deg
 Vector averaged cross-power spectrum Baseline: EF (01) - JB (02)
 Timerange: 00:18:44:31 to 00:18:45:29

Plot file version 250 created 19-OCT-2017 15:36:29

J0004+2019 ES081C.UVDATA.1

Freq = 4.7990 GHz, Bw = 32.000 MH No calibration applied and no bandpass applied

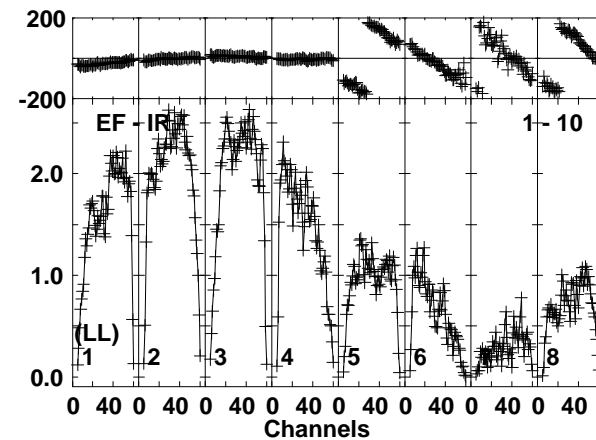
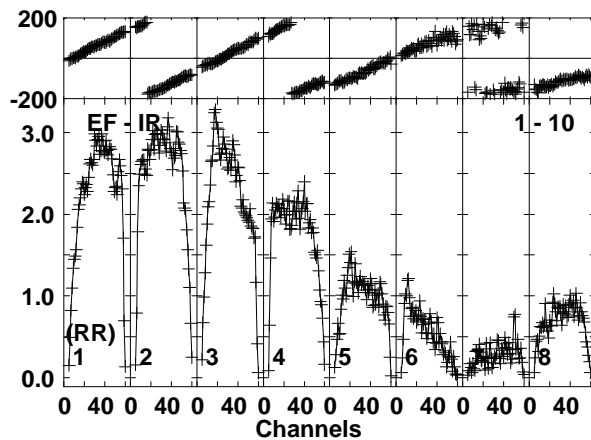
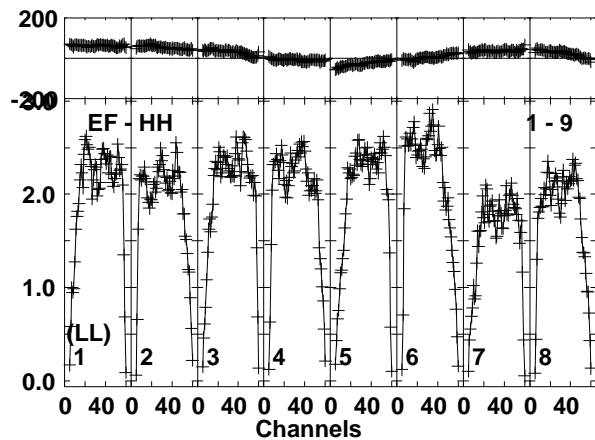
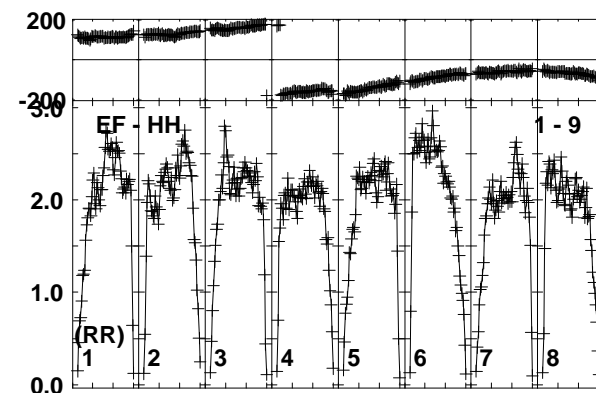
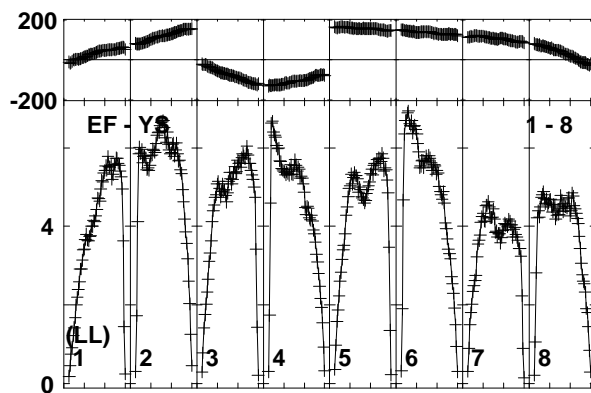
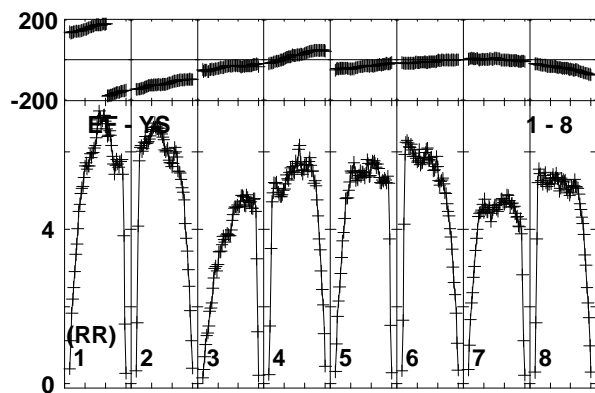
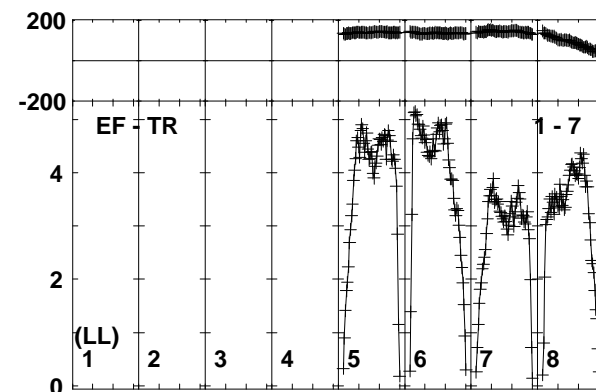
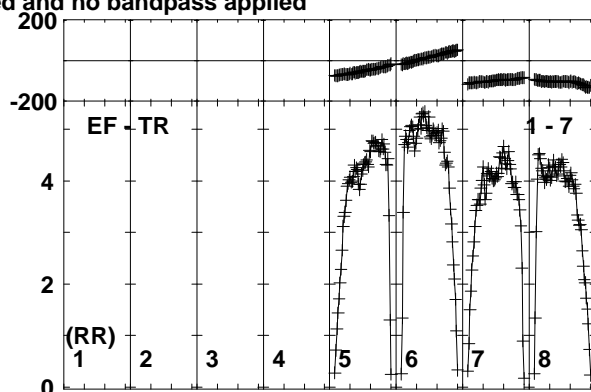
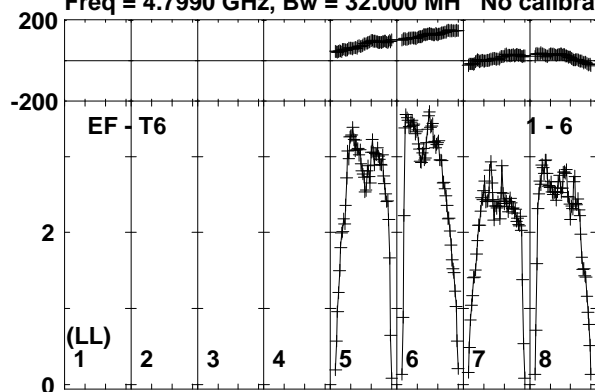

Lower frame: Milli Ampl Jy Top frame: Phas deg
Vector averaged cross-power spectrum Baseline: EF (01) - T6 (06)
Timerange: 00:18:44:31 to 00:18:45:29

Plot file version 251 created 19-OCT-2017 15:36:29

MRK335 ES081C.UVDATA.1

Freq = 4.7990 GHz, Bw = 32.000 MH No calibration applied and no bandpass applied

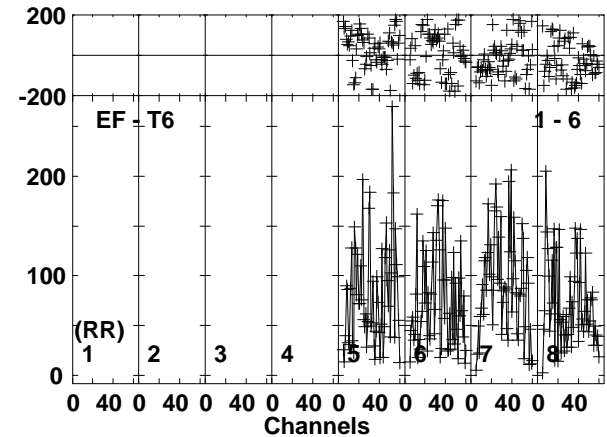
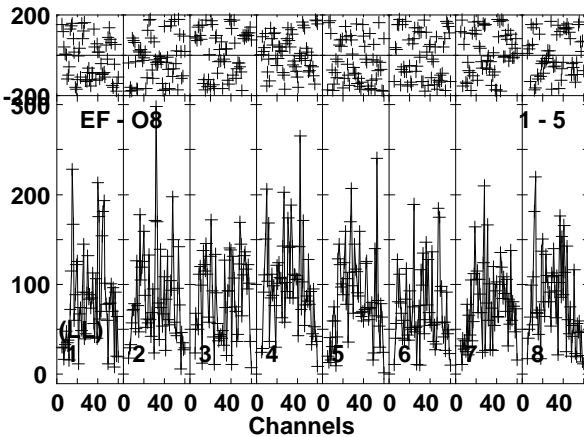
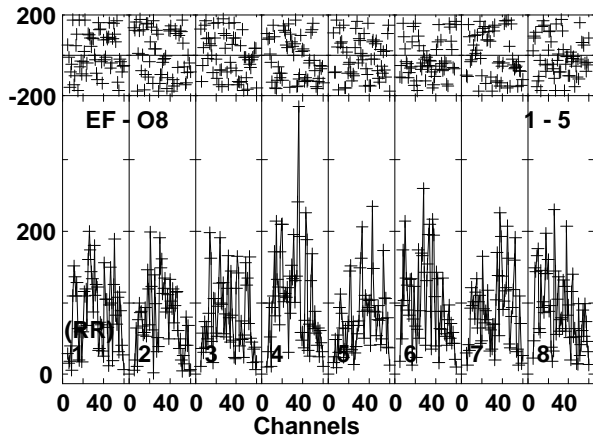
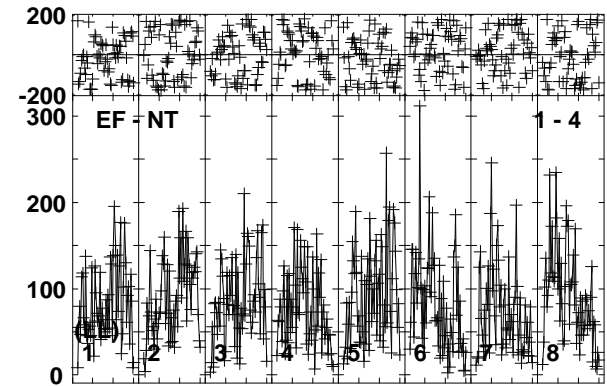
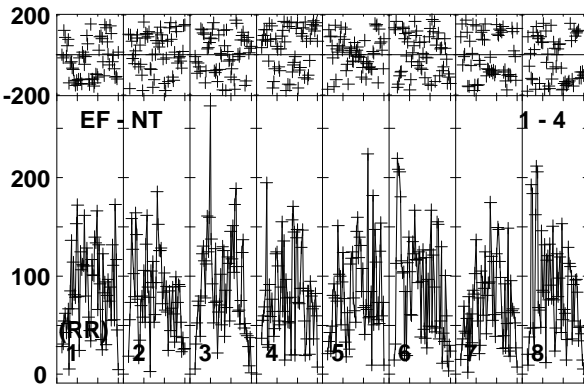
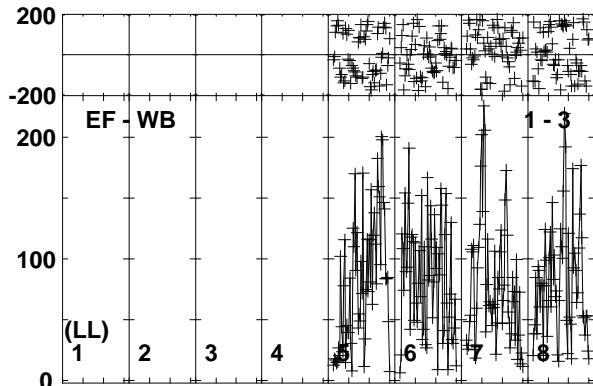
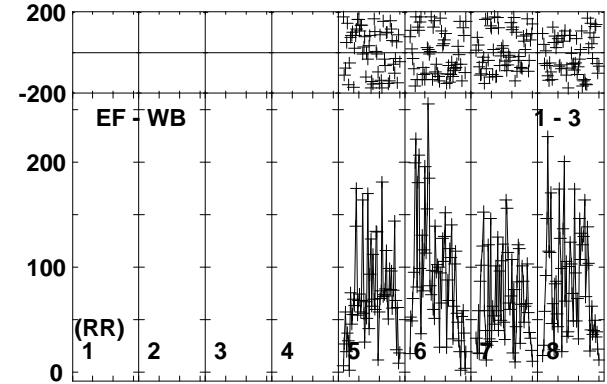
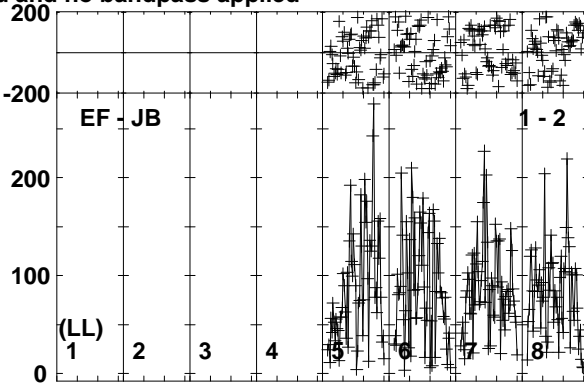
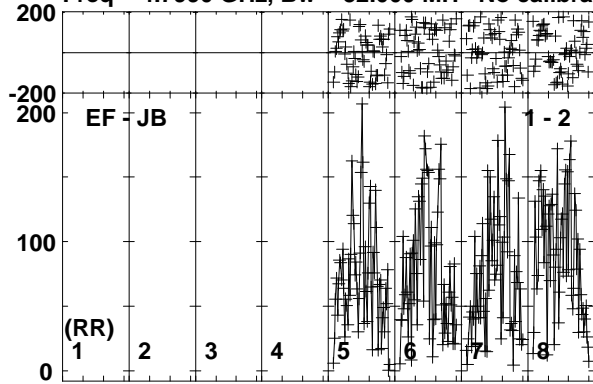

Lower frame: Micro Ampl Jy Top frame: Phas deg
Vector averaged cross-power spectrum Baseline: EF (01) - JB (02)
Timerange: 00/18:45:31 to 00/18:48:59

Plot file version 252 created 19-OCT-2017 15:36:29

MRK335 ES081C.UVDATA.1

Freq = 4.7990 GHz, Bw = 32.000 MH No calibration applied and no bandpass applied

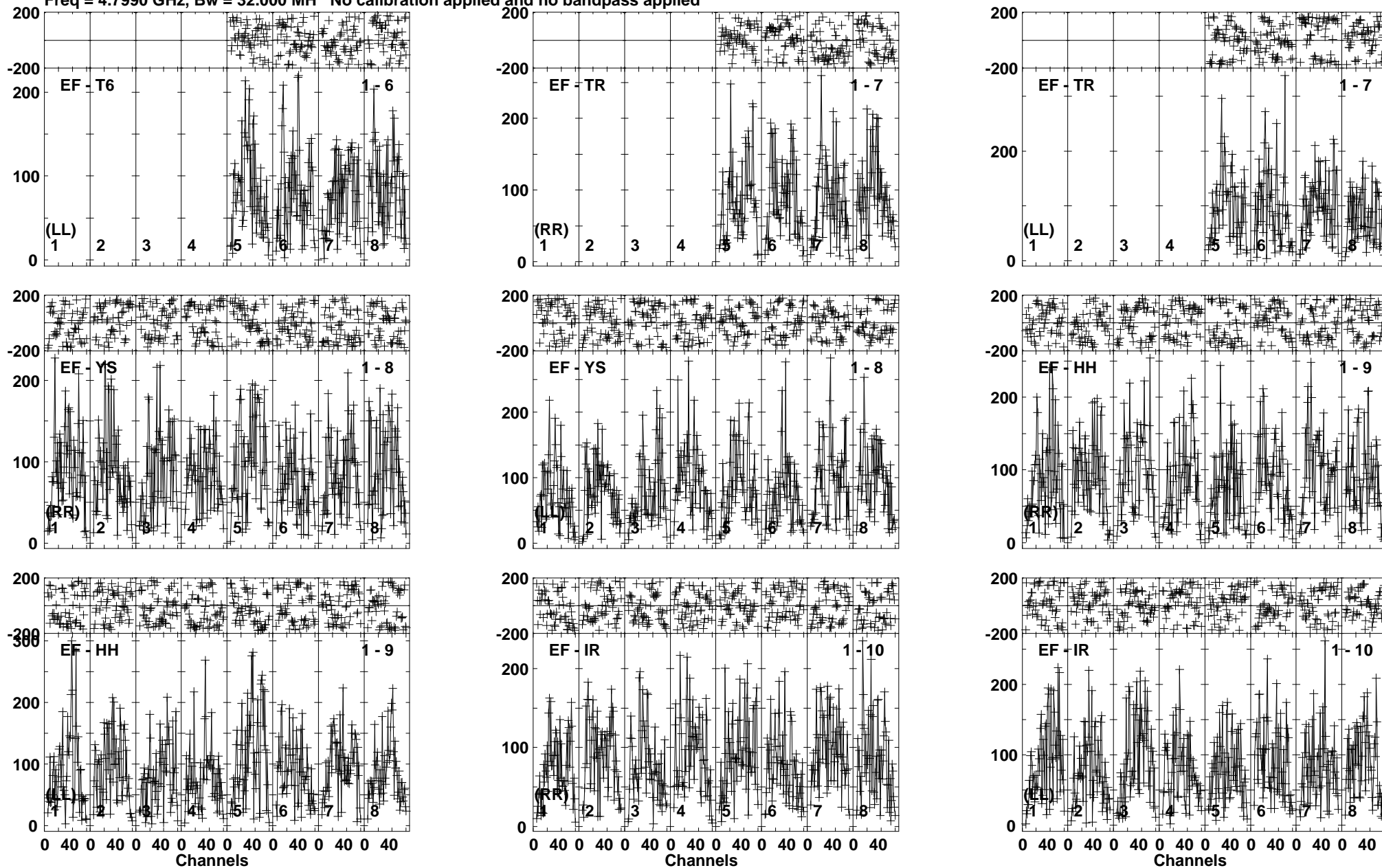

Lower frame: Micro Ampl Jy Top frame: Phas deg
Vector averaged cross-power spectrum Baseline: EF (01) - T6 (06)
Timerange: 00/18:45:31 to 00/18:48:59

Plot file version 253 created 19-OCT-2017 15:36:30

J0004+2019 ES081C.UVDATA.1

Freq = 4.7990 GHz, Bw = 32.000 MH No calibration applied and no bandpass applied

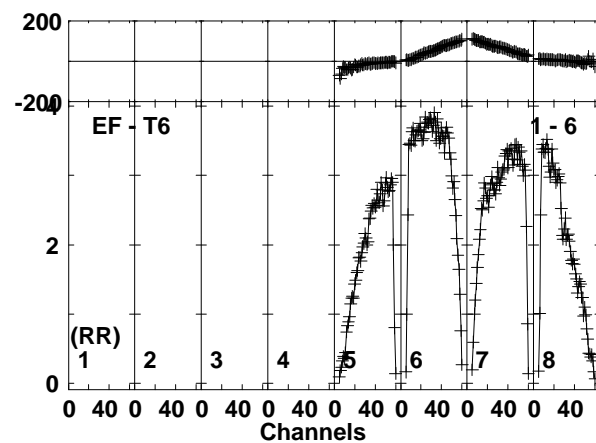
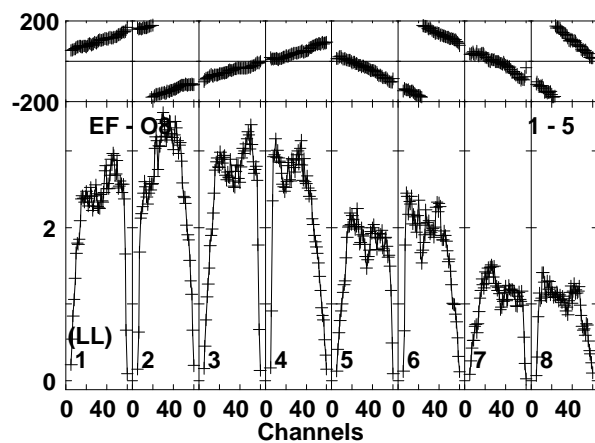
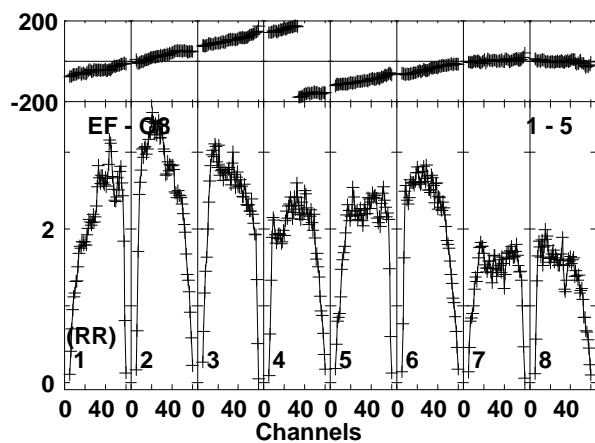
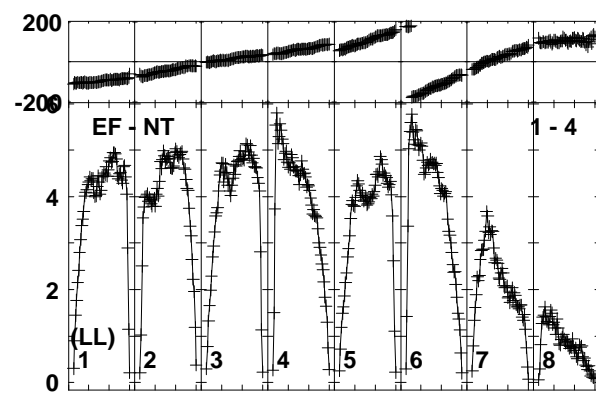
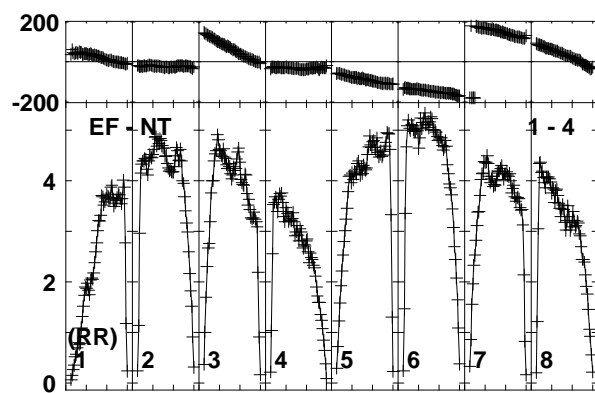
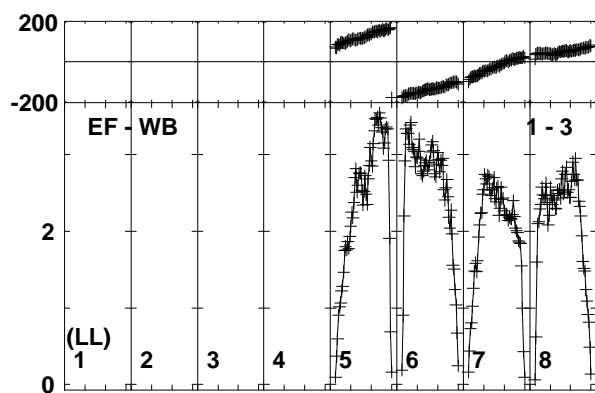
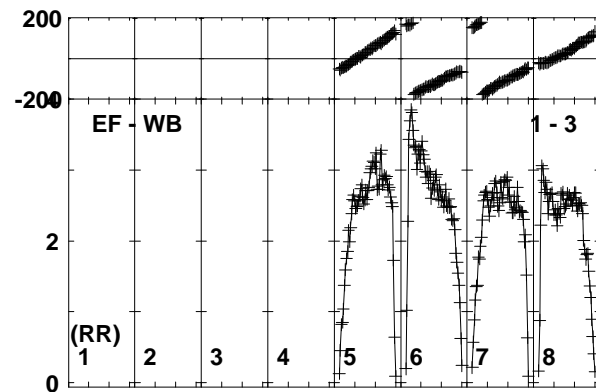
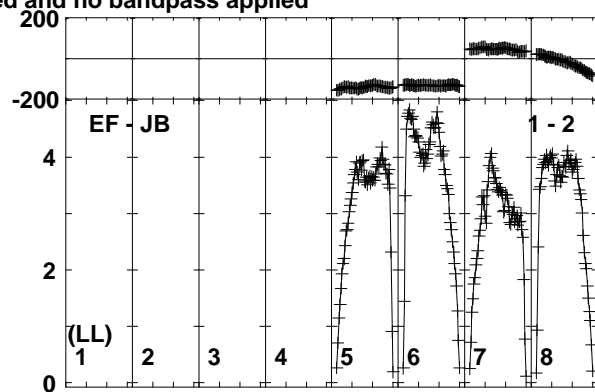
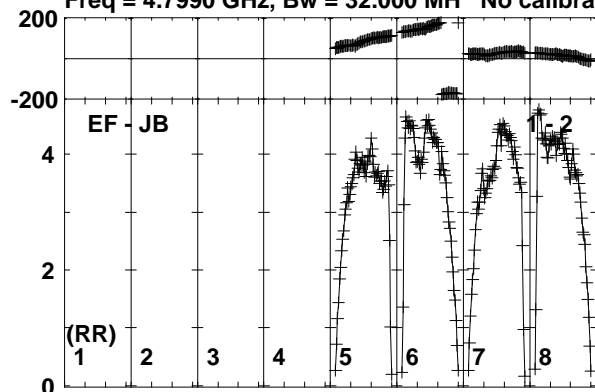

Lower frame: Milli Ampl Jy Top frame: Phas deg
Vector averaged cross-power spectrum Baseline: EF (01) - JB (02)
Timerange: 00:18:49:01 to 00:18:50:29

Plot file version 254 created 19-OCT-2017 15:36:30

J0004+2019 ES081C.UVDATA.1

Freq = 4.7990 GHz, Bw = 32.000 MH No calibration applied and no bandpass applied

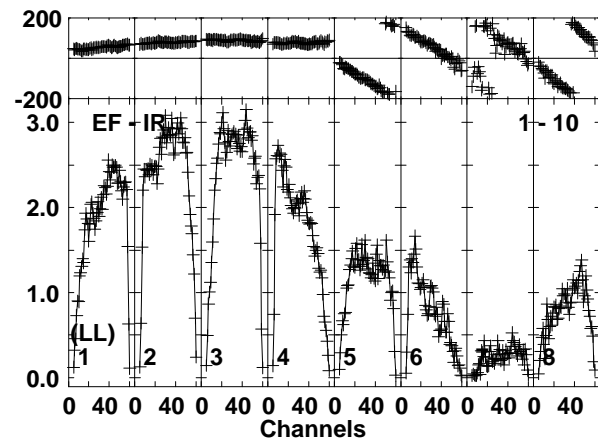
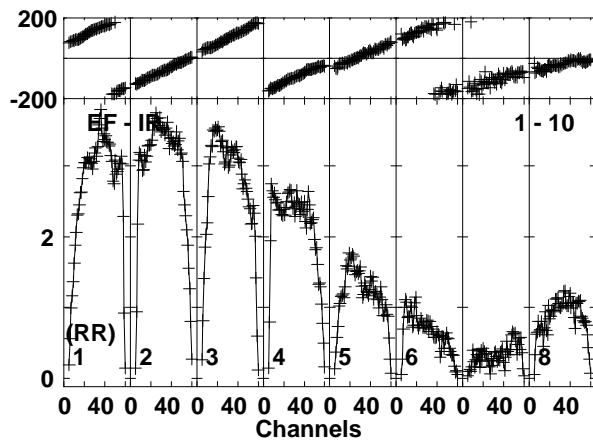
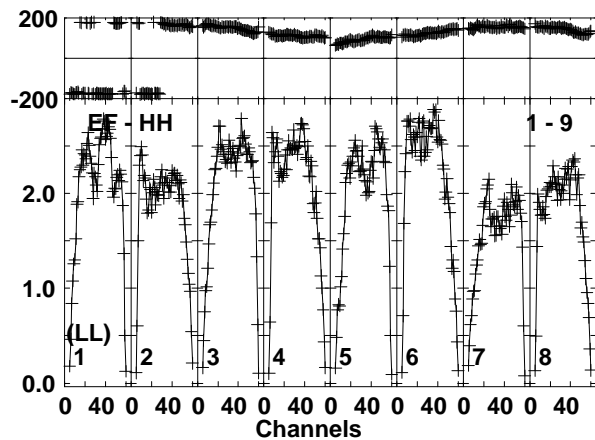
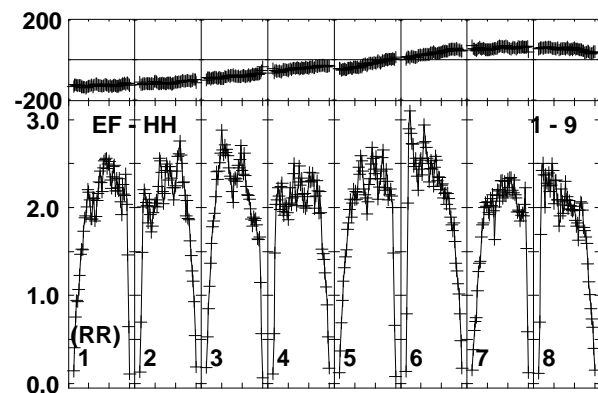
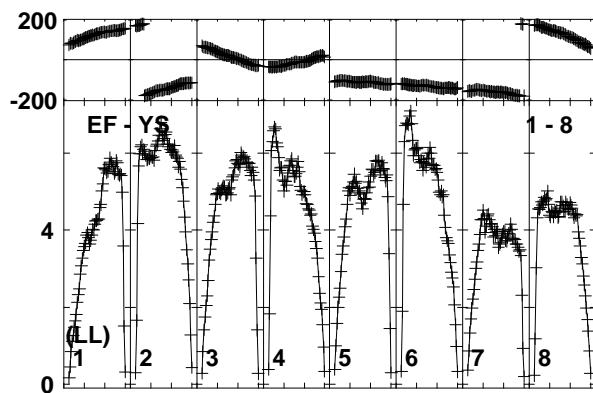
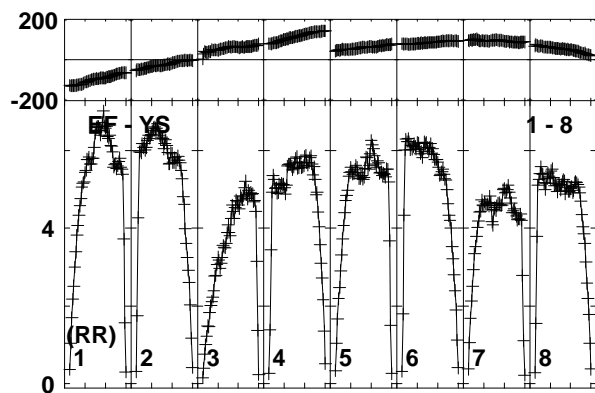
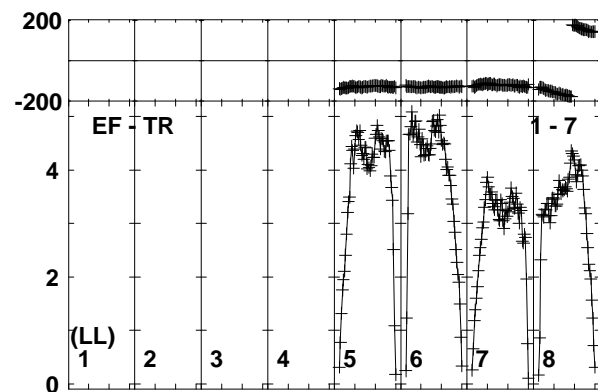
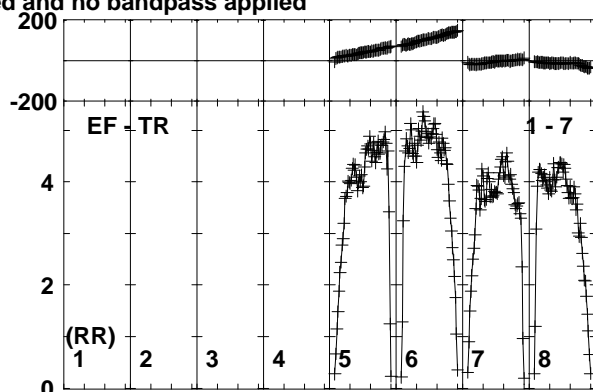
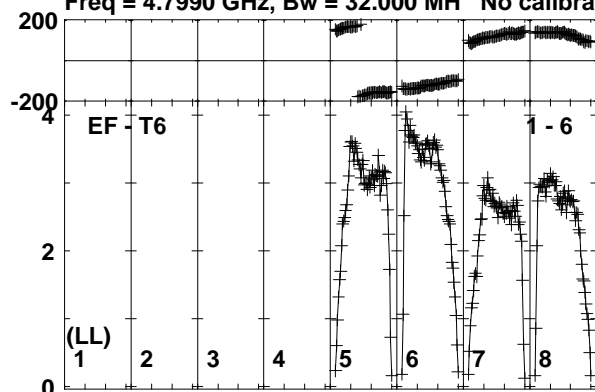

Lower frame: Milli Ampl Jy Top frame: Phas deg
Vector averaged cross-power spectrum Baseline: EF (01) - T6 (06)
Timerange: 00/18:49:01 to 00/18:50:29

Plot file version 255 created 19-OCT-2017 15:36:30
 MRK335 ES081C.UVDATA.1
 Freq = 4.7990 GHz, Bw = 32.000 MH No calibration applied and no bandpass applied

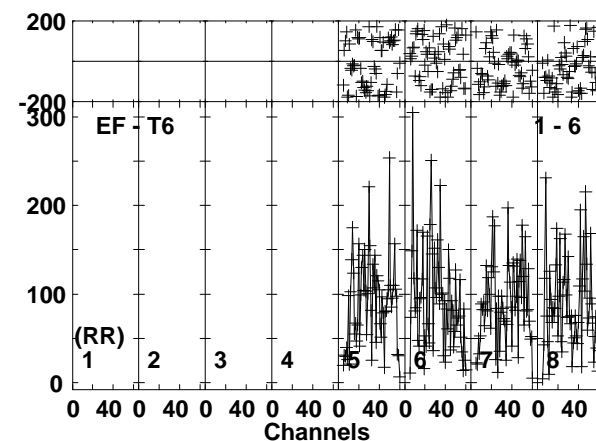
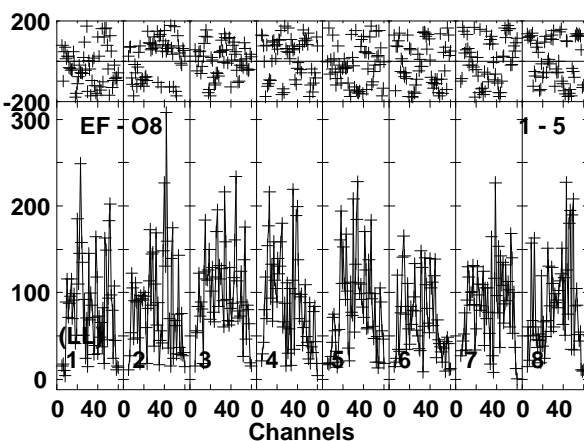
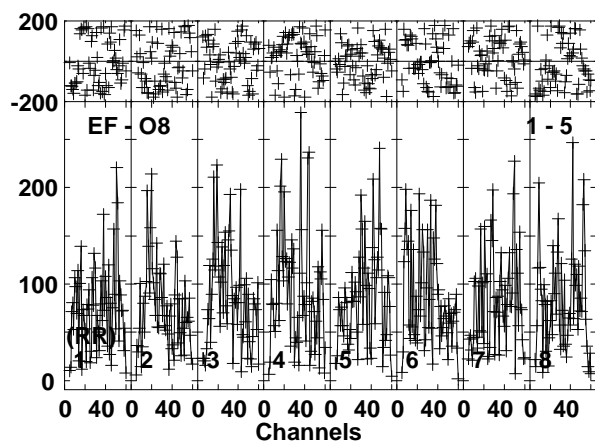
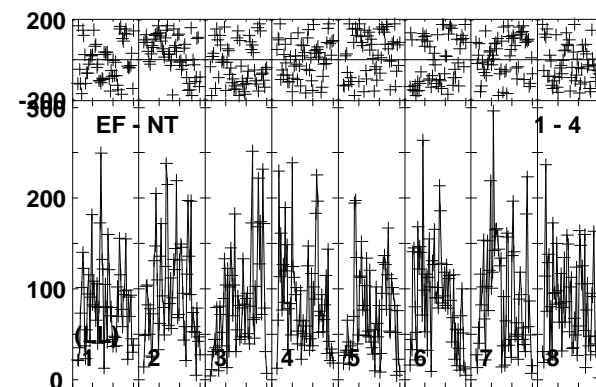
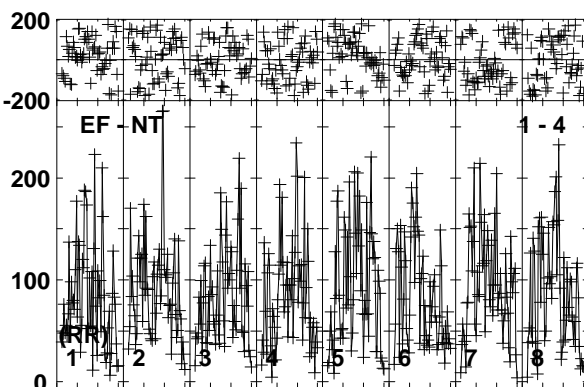
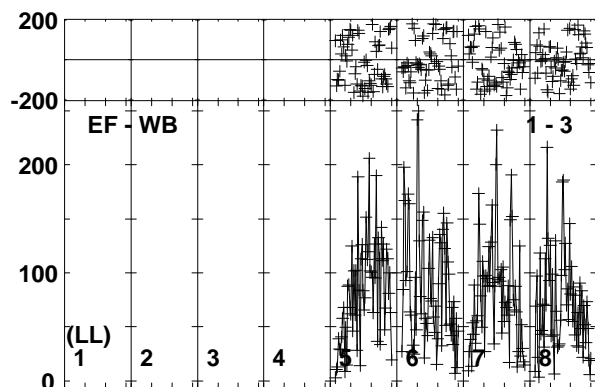
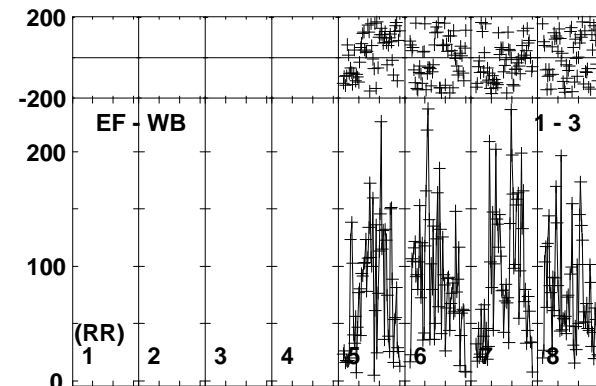
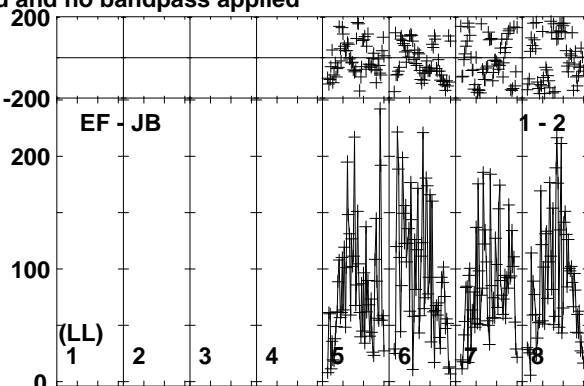
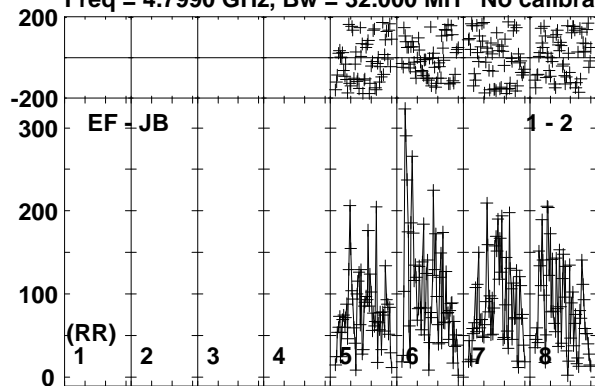

Lower frame: Micro Ampl Jy Top frame: Phas deg
 Vector averaged cross-power spectrum Baseline: EF (01) - JB (02)
 Timerange: 00/18:50:31 to 00/18:53:59

Plot file version 256 created 19-OCT-2017 15:36:30

MRK335 ES081C.UVDATA.1

Freq = 4.7990 GHz, Bw = 32.000 MH No calibration applied and no bandpass applied

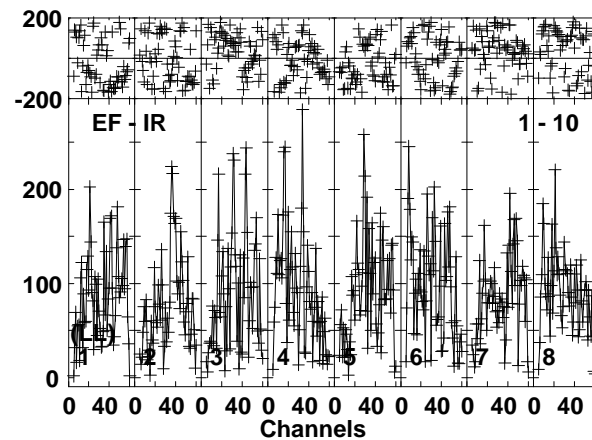
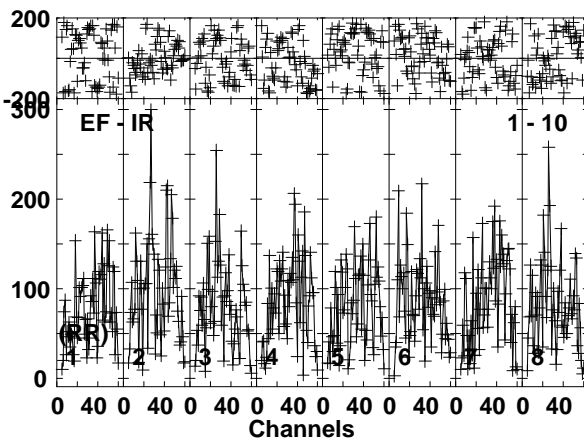
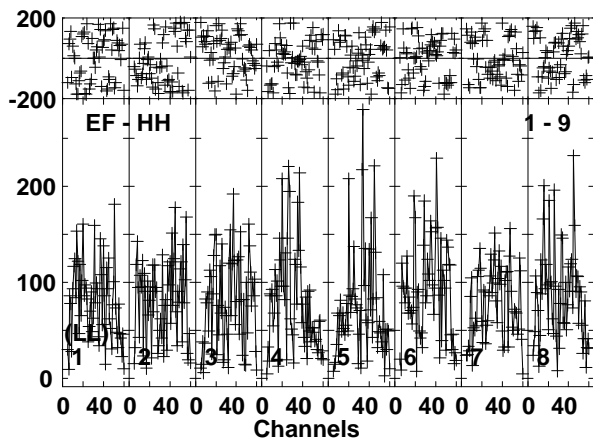
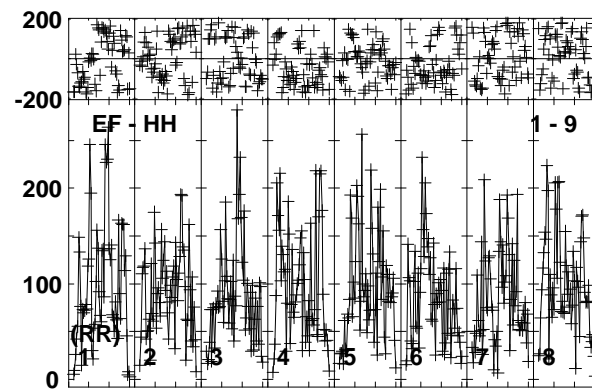
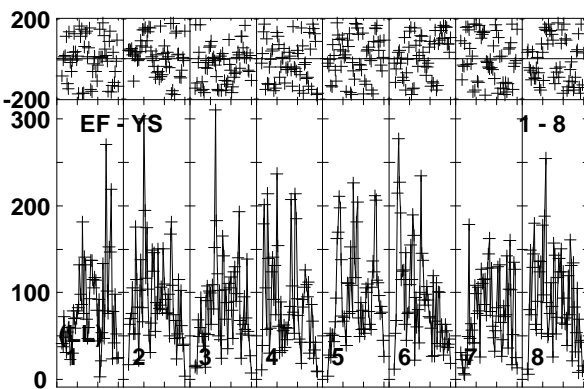
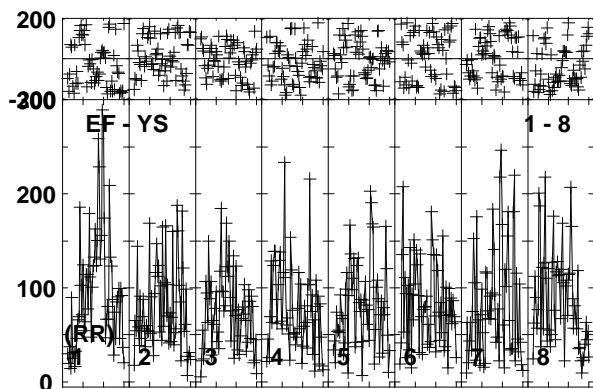
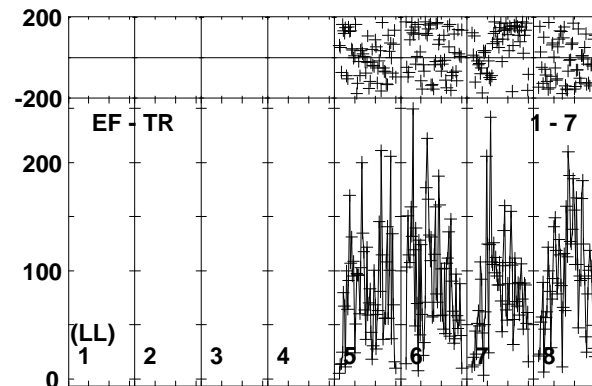
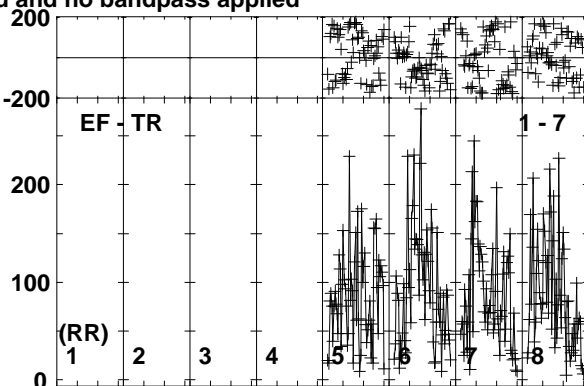
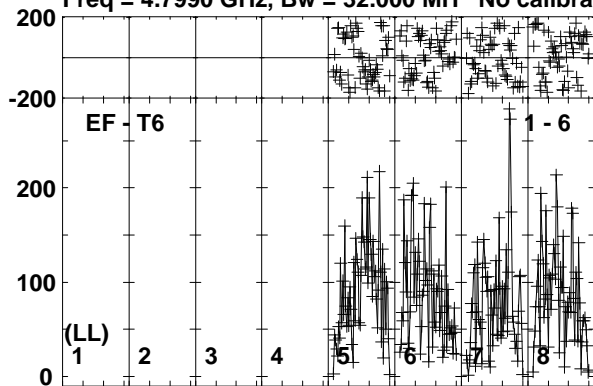

Lower frame: Micro Ampl Jy Top frame: Phas deg
Vector averaged cross-power spectrum Baseline: EF (01) - T6 (06)
Timerange: 00:18:50:31 to 00:18:53:59

Plot file version 257 created 19-OCT-2017 15:36:30

J0004+2019 ES081C.UVDATA.1

Freq = 4.7990 GHz, Bw = 32.000 MH No calibration applied and no bandpass applied

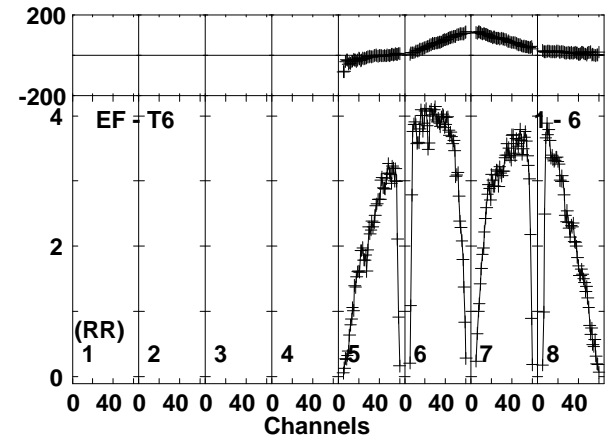
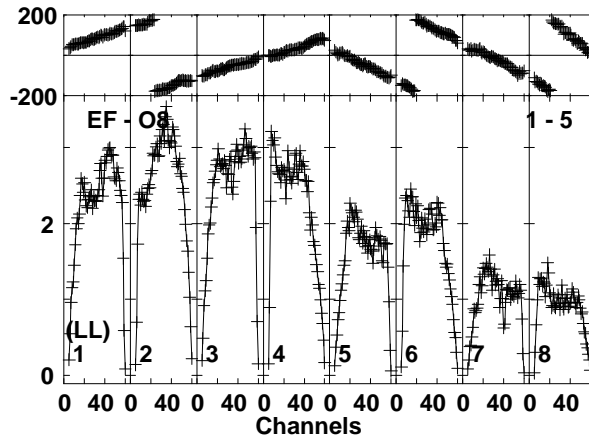
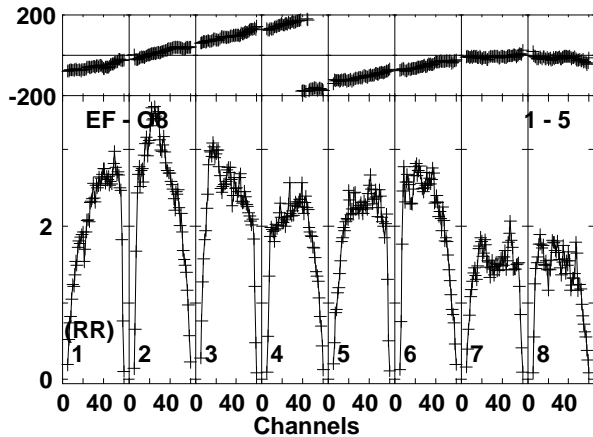
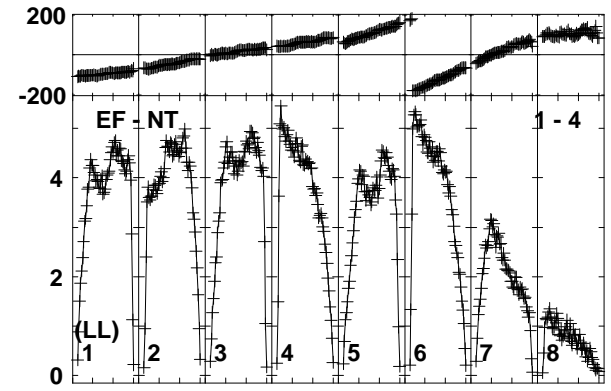
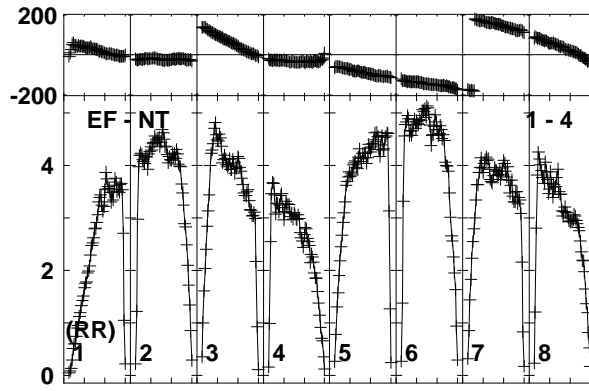
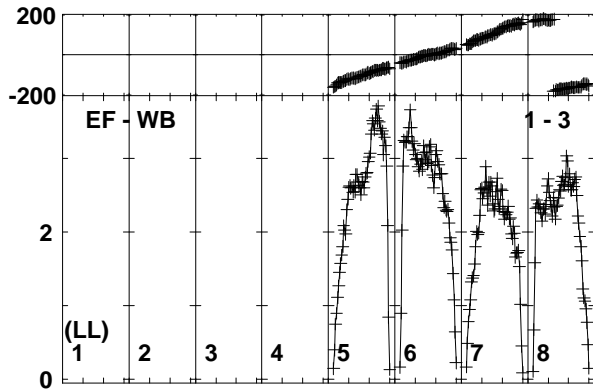
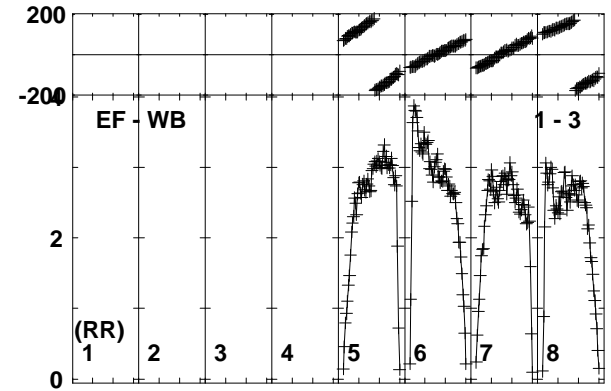
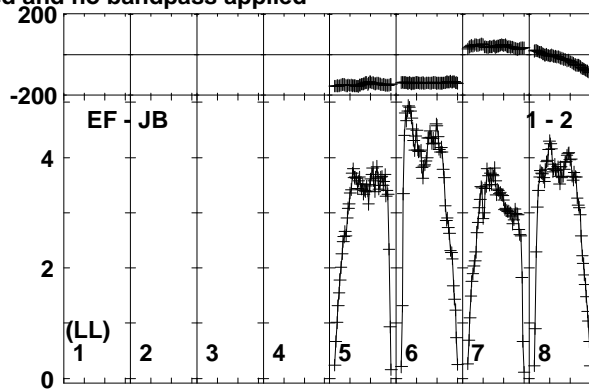
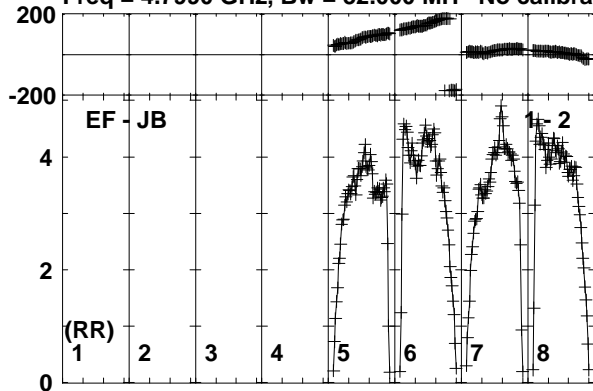

Lower frame: Milli Ampl Jy Top frame: Phas deg
Vector averaged cross-power spectrum Baseline: EF (01) - JB (02)
Timerange: 00/18:54:31 to 00/18:55:29

Plot file version 258 created 19-OCT-2017 15:36:30

J0004+2019 ES081C.UVDATA.1

Freq = 4.7990 GHz, Bw = 32.000 MH No calibration applied and no bandpass applied

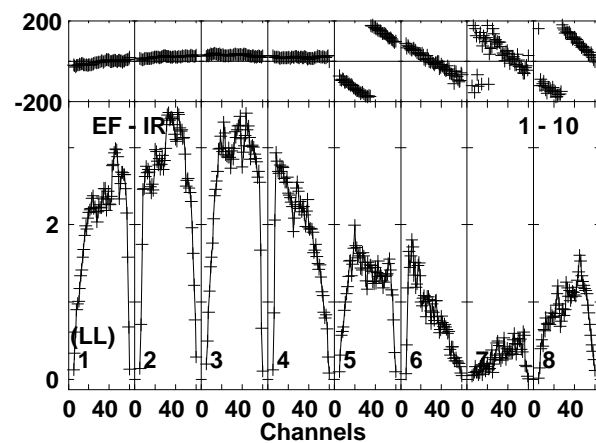
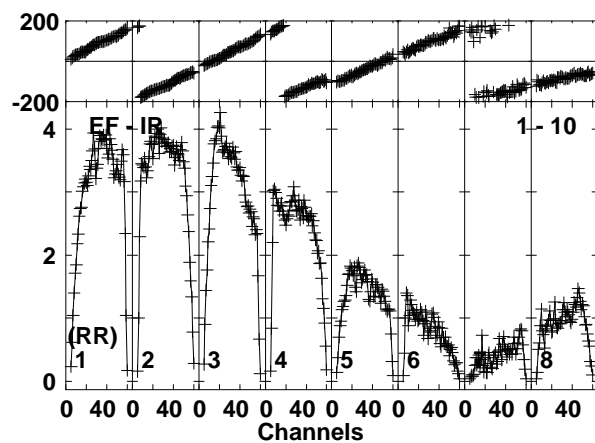
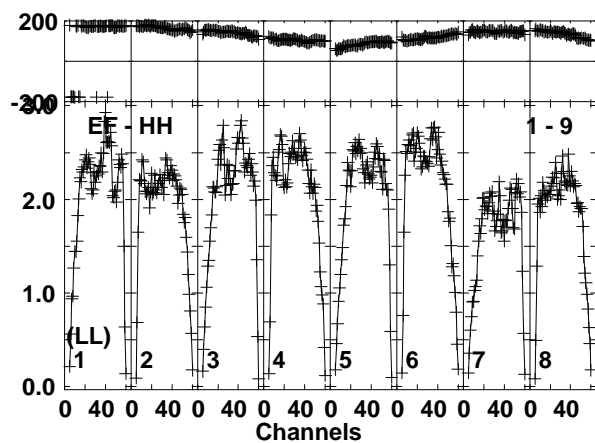
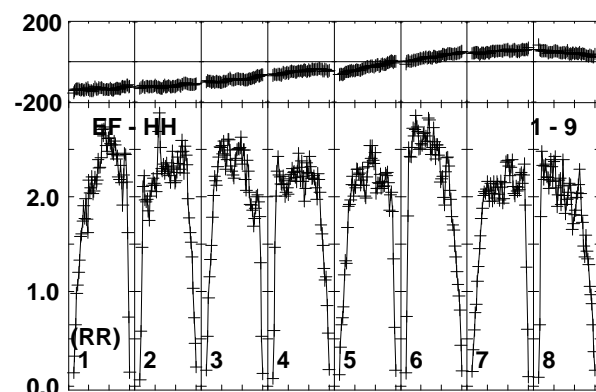
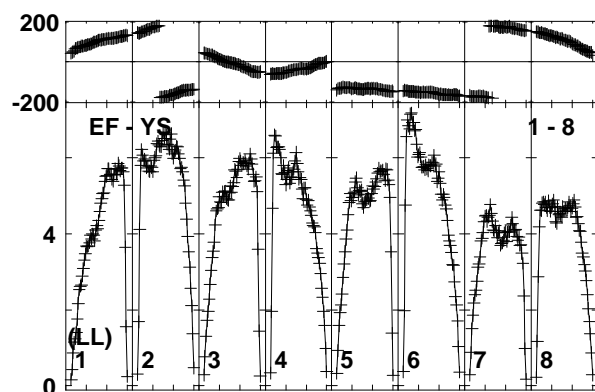
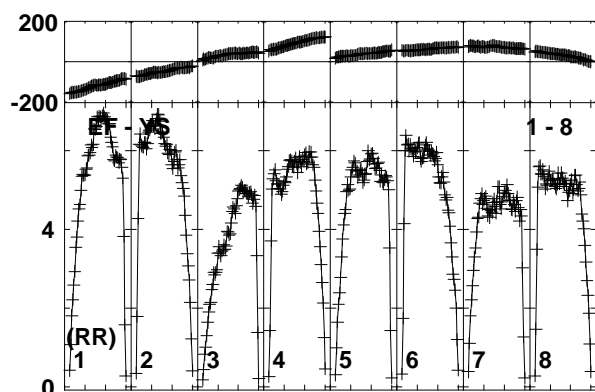
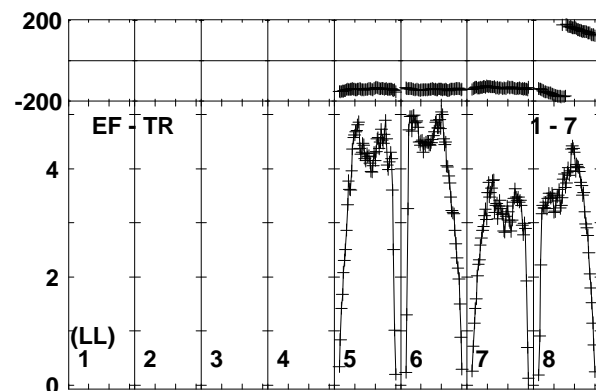
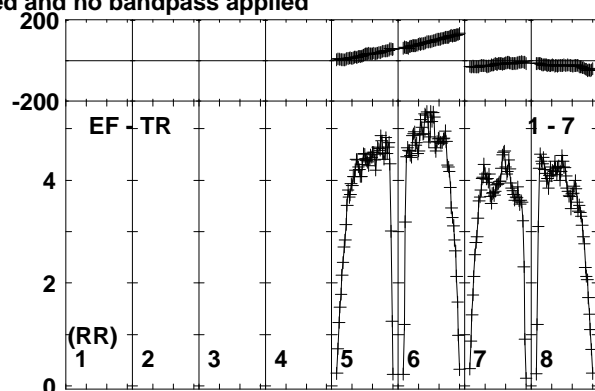
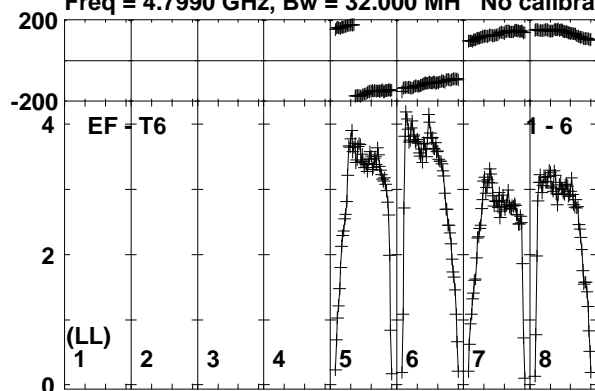

Lower frame: Milli Ampl Jy Top frame: Phas deg
Vector averaged cross-power spectrum Baseline: EF (01) - T6 (06)
Timerange: 00:18:54:31 to 00:18:55:29

Plot file version 259 created 19-OCT-2017 15:36:30

MRK335 ES081C.UVDATA.1

Freq = 4.7990 GHz, Bw = 32.000 MH No calibration applied and no bandpass applied

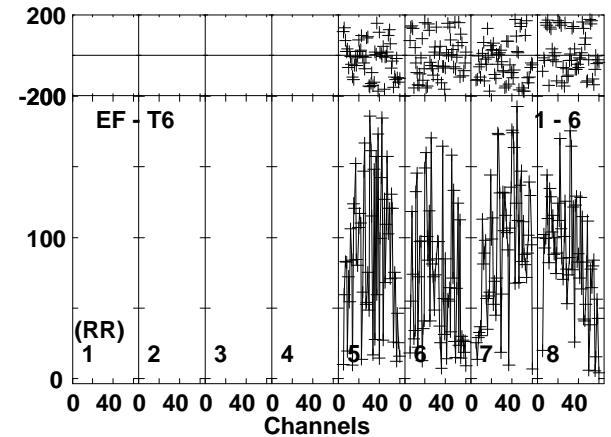
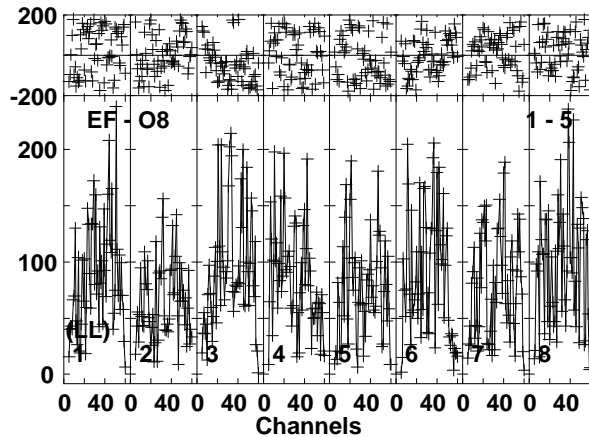
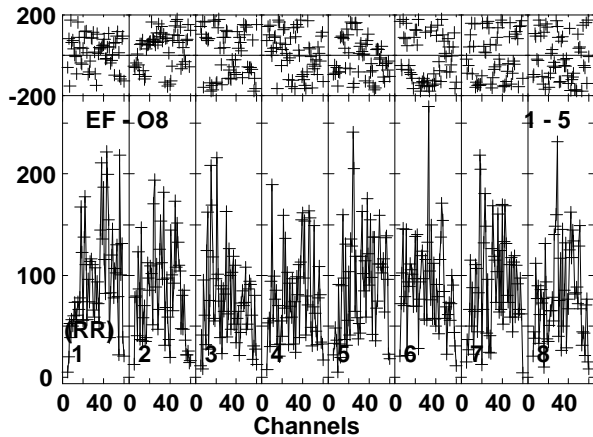
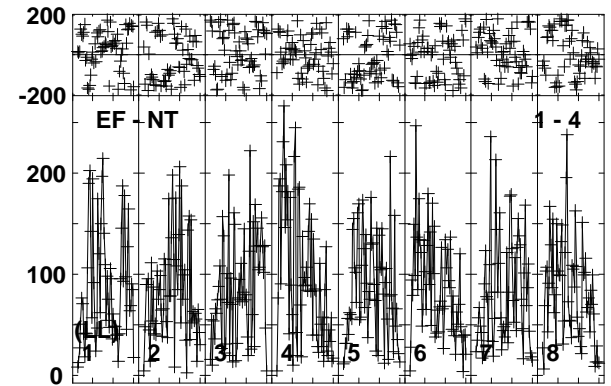
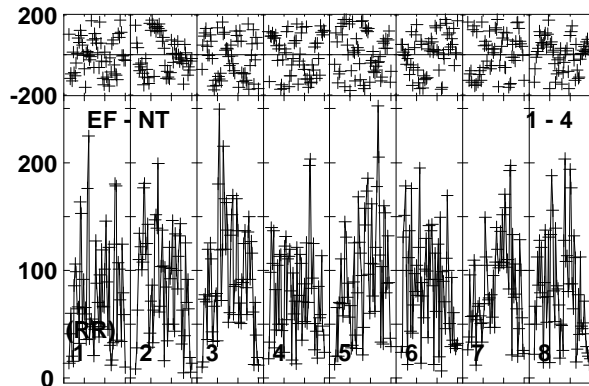
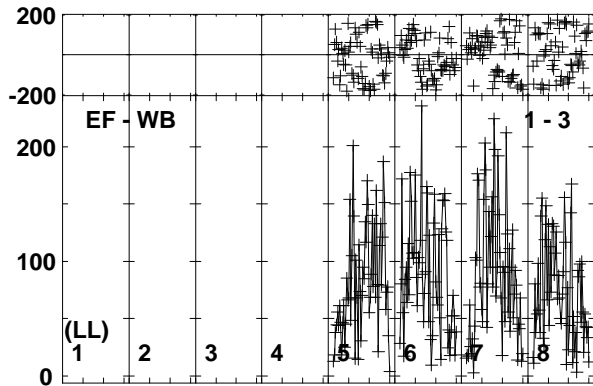
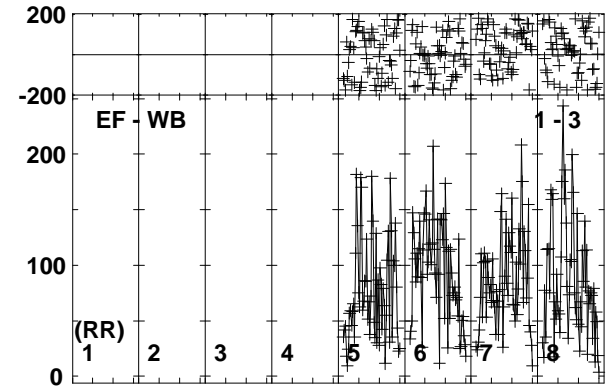
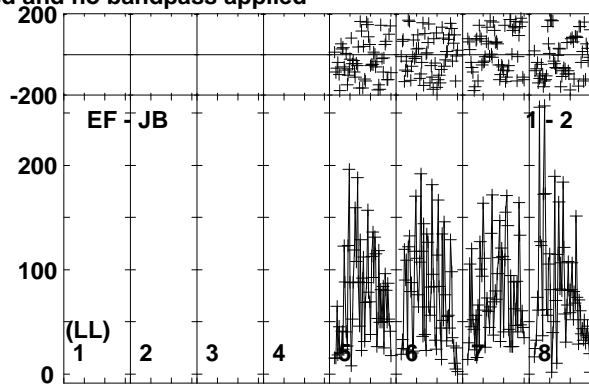
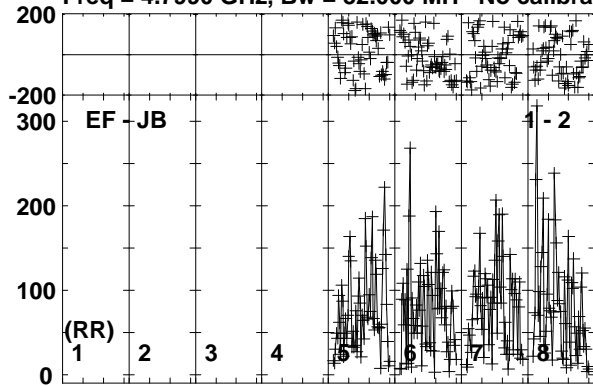

Lower frame: Micro Ampl Jy Top frame: Phas deg
Vector averaged cross-power spectrum Baseline: EF (01) - JB (02)
Timerange: 00/18:55:31 to 00/18:58:59

Plot file version 260 created 19-OCT-2017 15:36:31

MRK335 ES081C.UVDATA.1

Freq = 4.7990 GHz, Bw = 32.000 MH No calibration applied and no bandpass applied

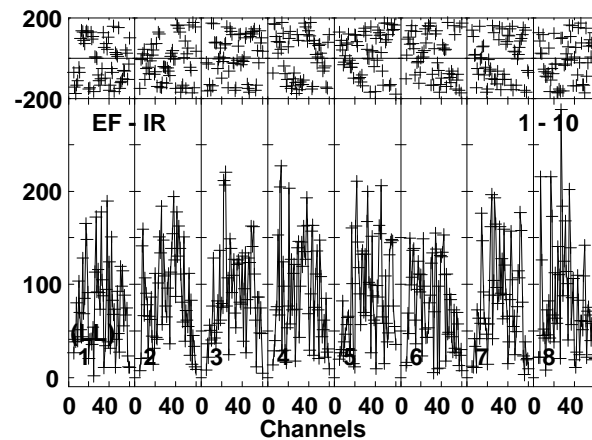
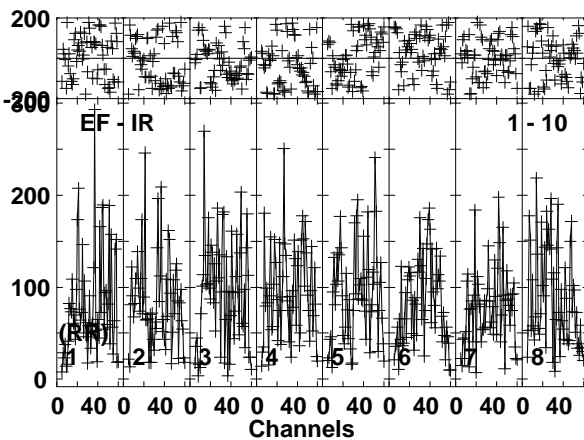
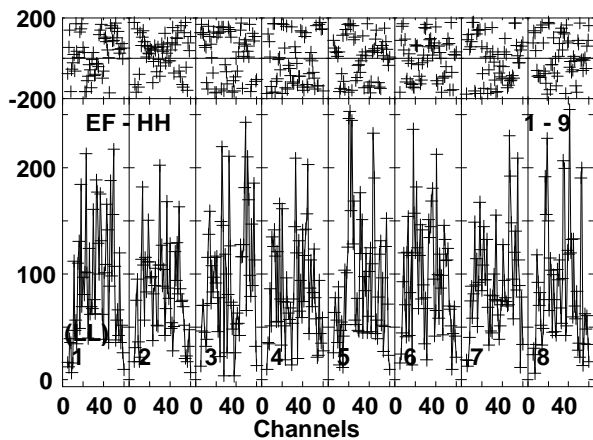
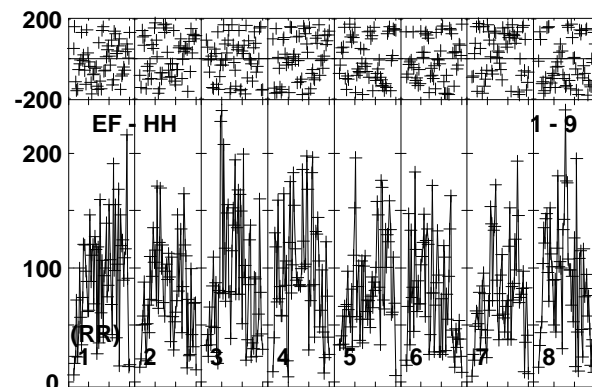
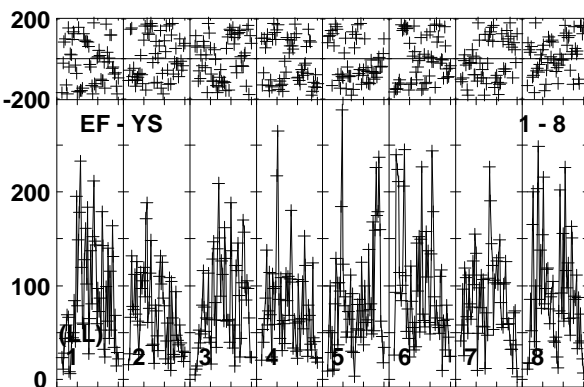
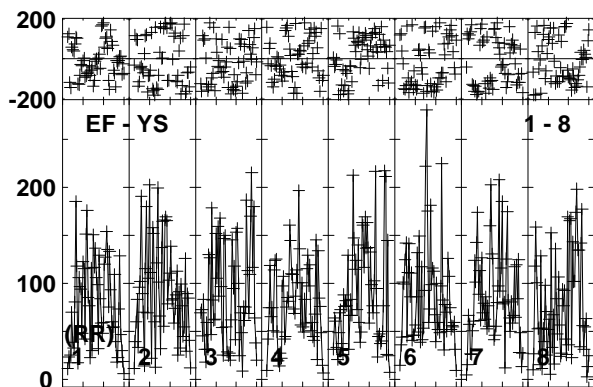
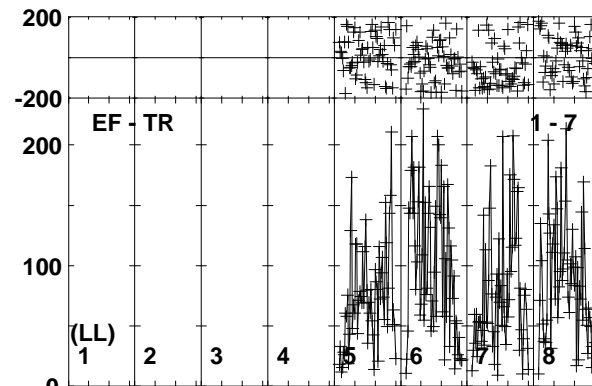
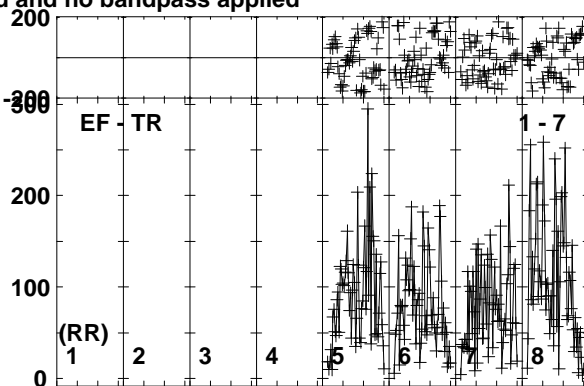
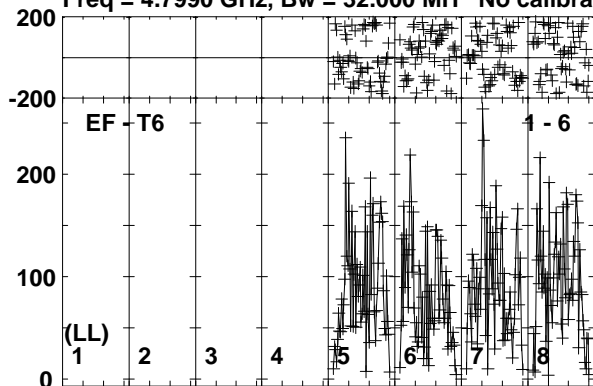

Lower frame: Micro Ampl Jy Top frame: Phas deg
Vector averaged cross-power spectrum Baseline: EF (01) - T6 (06)
Timerange: 00:18:55:31 to 00:18:58:59

Plot file version 261 created 19-OCT-2017 15:36:31

J0004+2019 ES081C.UVDATA.1

Freq = 4.7990 GHz, Bw = 32.000 MH No calibration applied and no bandpass applied

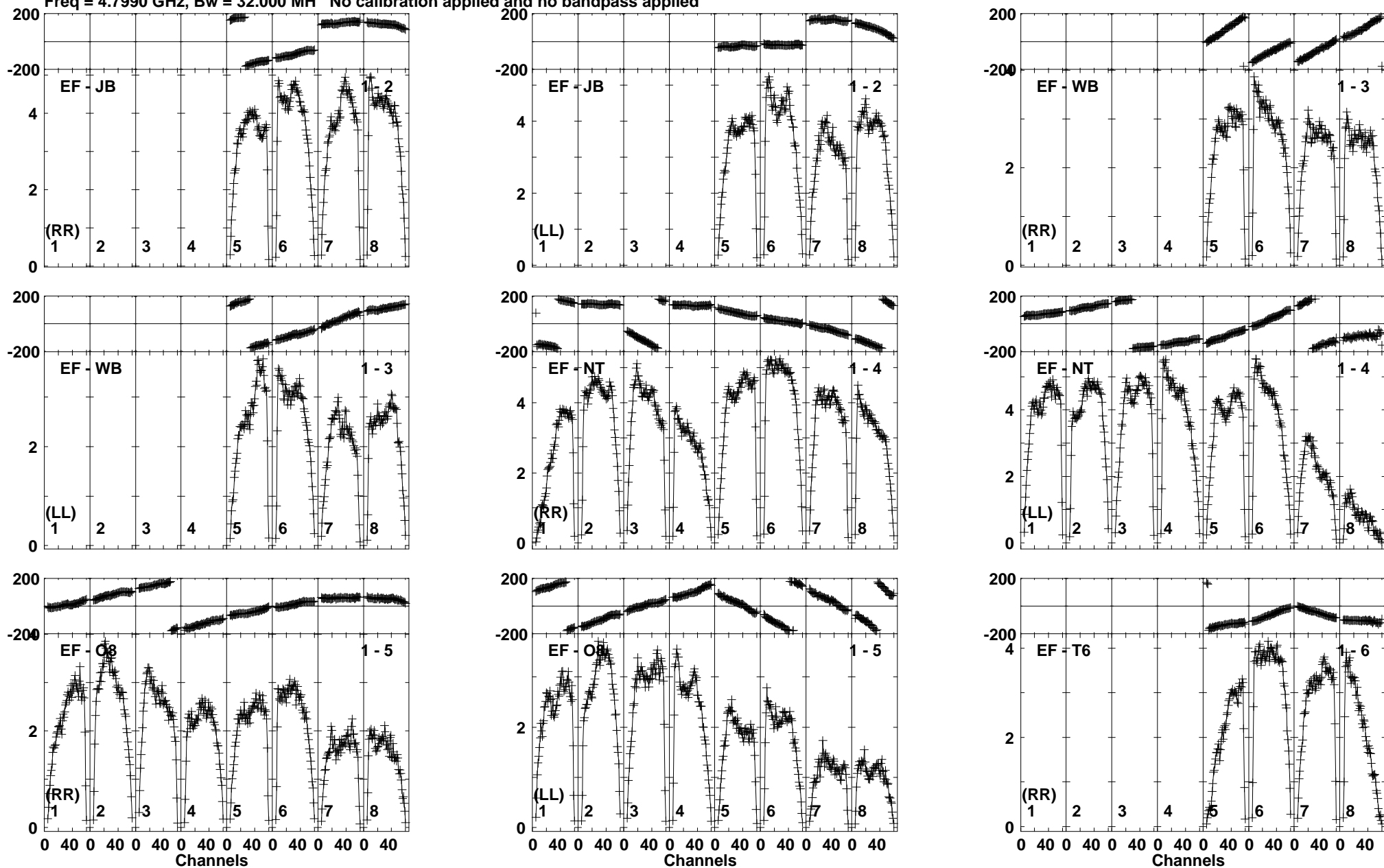

Lower frame: Milli Ampl Jy Top frame: Phas deg
Vector averaged cross-power spectrum Baseline: EF (01) - JB (02)
Timerange: 00:18:59:01 to 00:19:00:29

Plot file version 262 created 19-OCT-2017 15:36:31

J0004+2019 ES081C.UVDATA.1

Freq = 4.7990 GHz, Bw = 32.000 MH No calibration applied and no bandpass applied

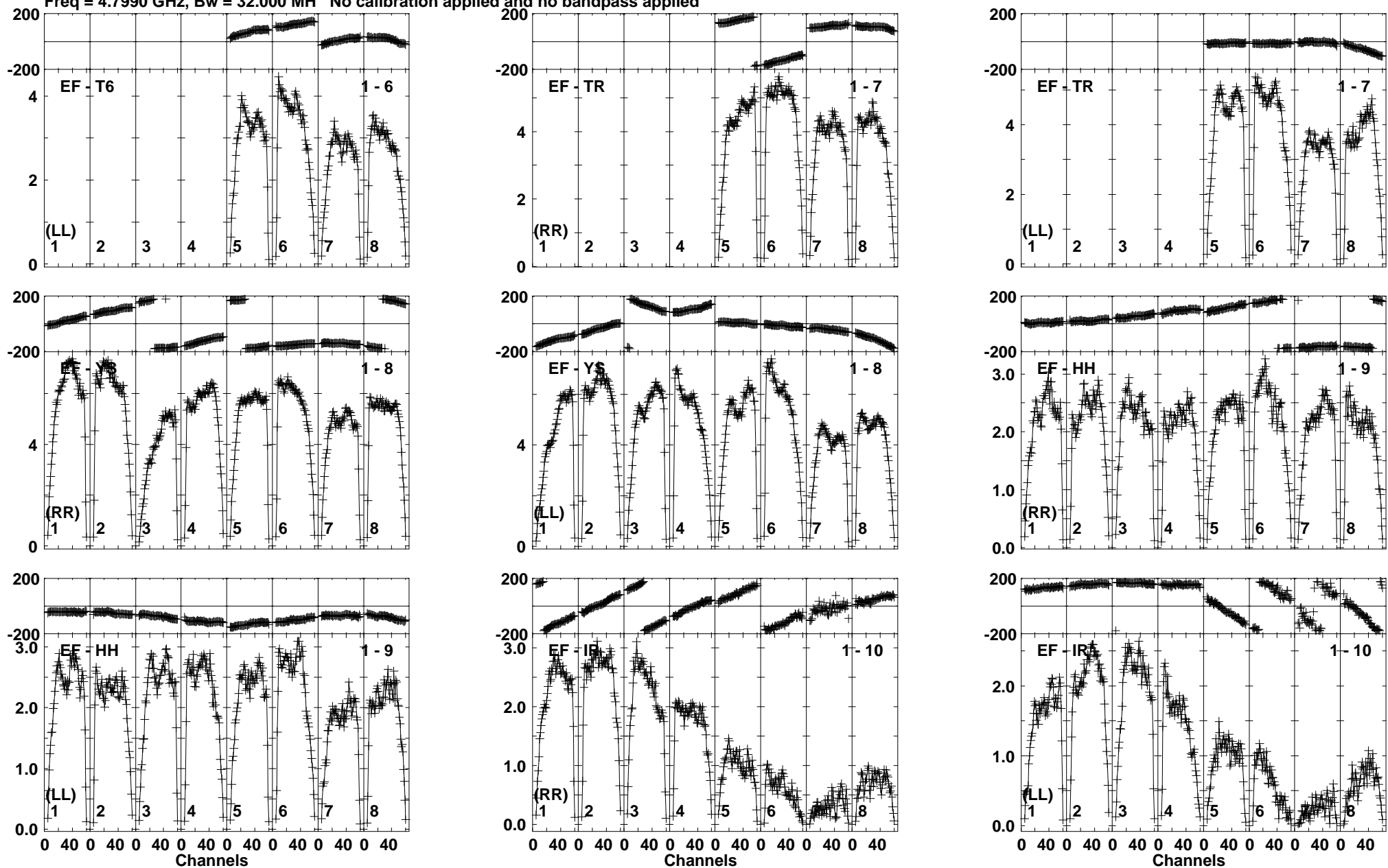

Lower frame: Milli Ampl Jy Top frame: Phas deg
Vector averaged cross-power spectrum Baseline: EF (01) - T6 (06)
Timerange: 00:18:59:01 to 00:19:00:29

Plot file version 263 created 19-OCT-2017 15:36:31

MRK335 ES081C.UVDATA.1

Freq = 4.7990 GHz, Bw = 32.000 MH No calibration applied and no bandpass applied

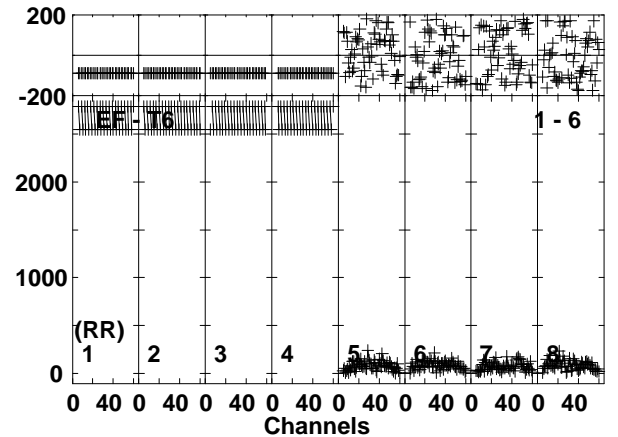
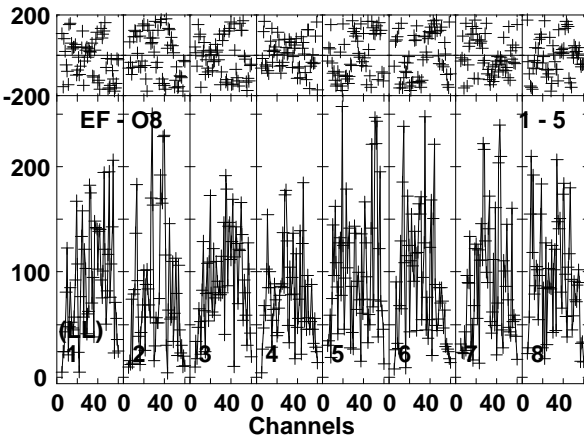
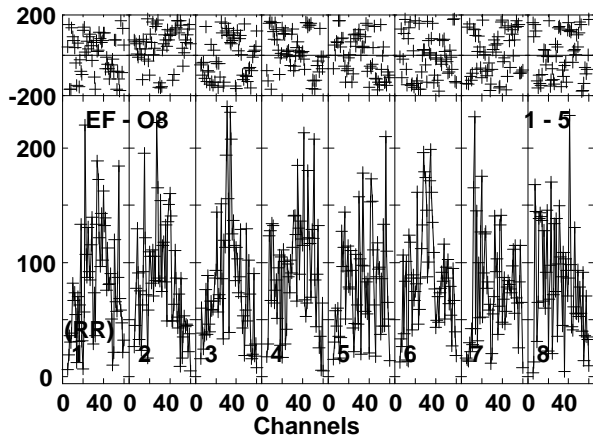
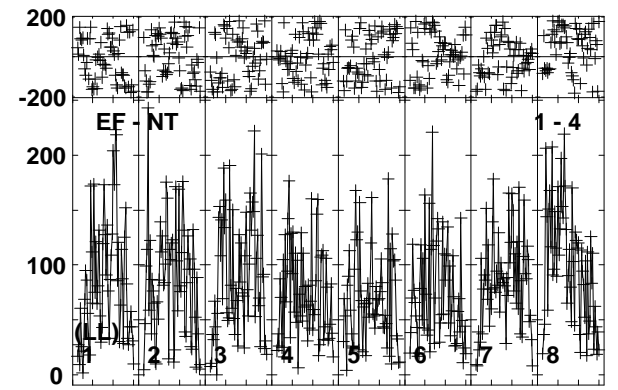
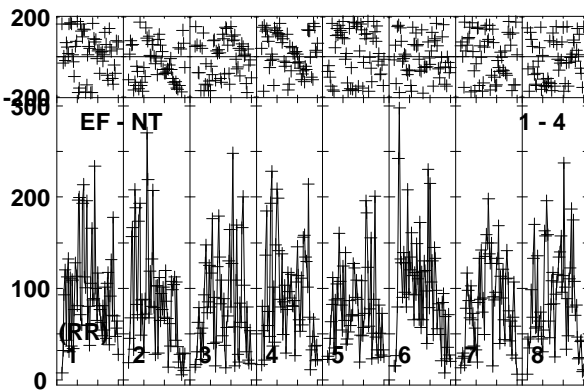
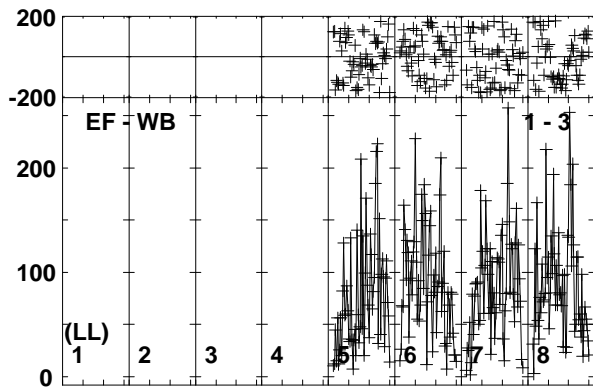
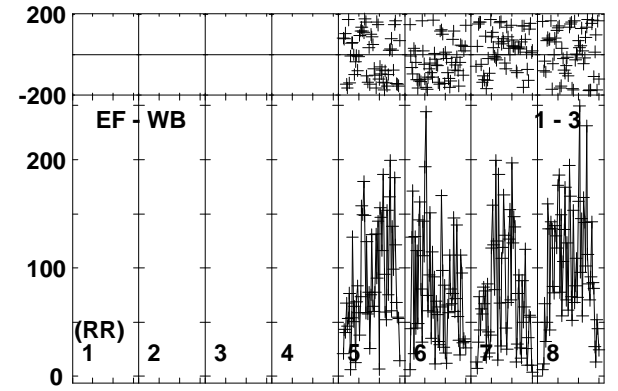
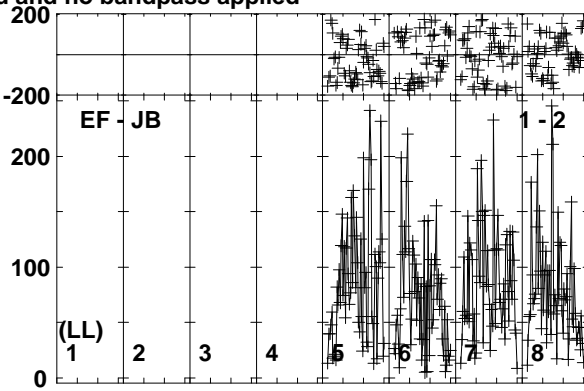
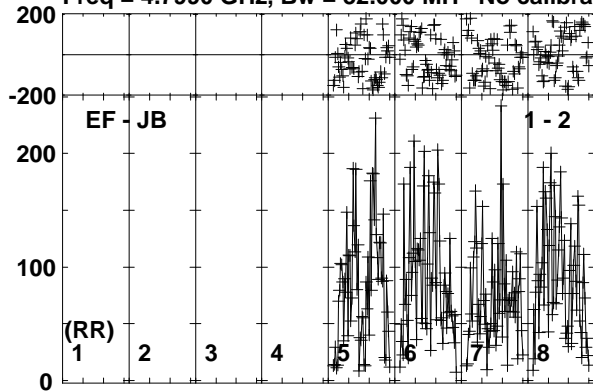

Lower frame: Micro Ampl Jy Top frame: Phas deg
Vector averaged cross-power spectrum Baseline: EF (01) - JB (02)
Timerange: 00/19:00:31 to 00/19:03:59

Plot file version 264 created 19-OCT-2017 15:36:31

MRK335 ES081C.UVDATA.1

Freq = 4.7990 GHz, Bw = 32.000 MH No calibration applied and no bandpass applied

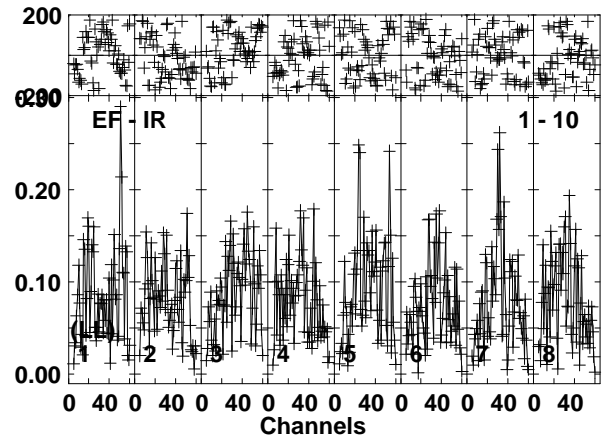
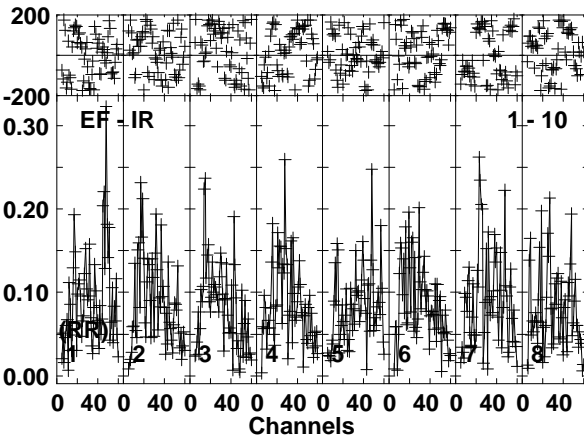
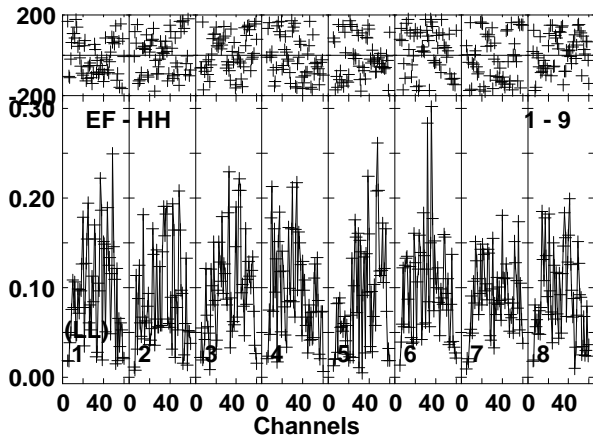
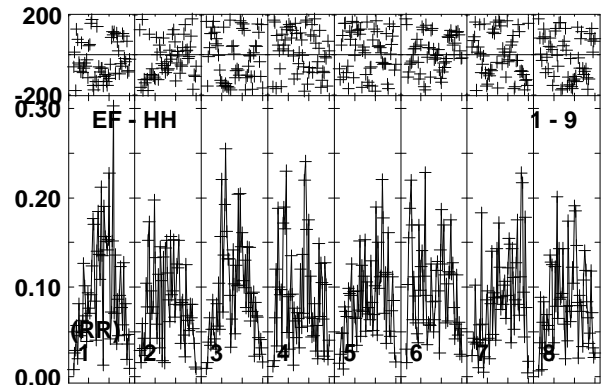
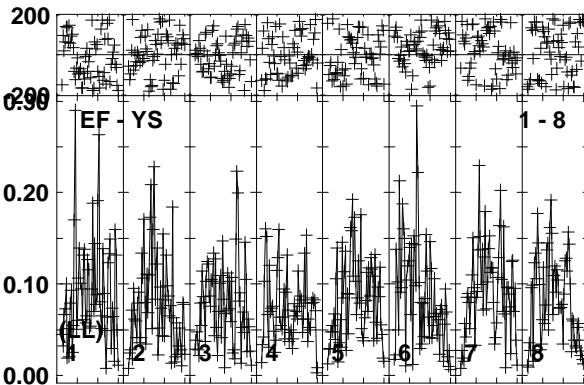
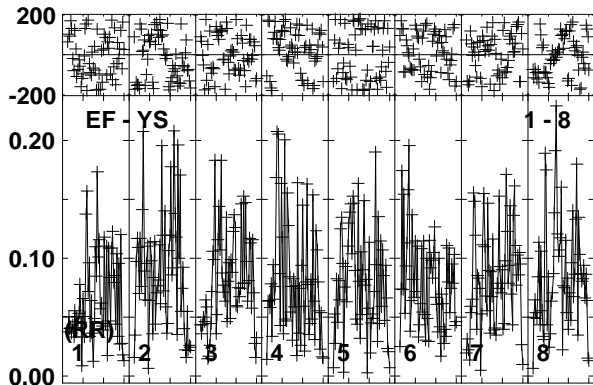
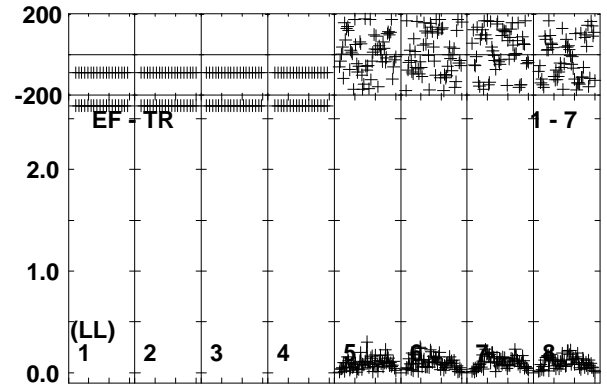
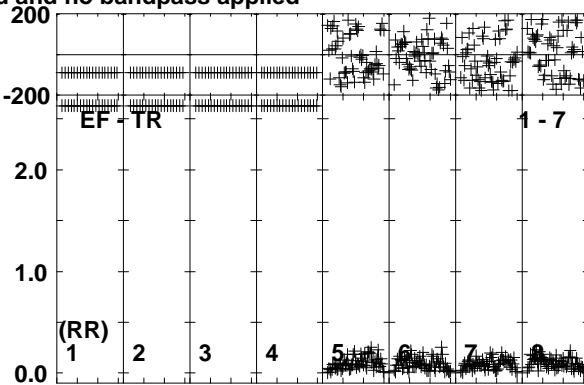
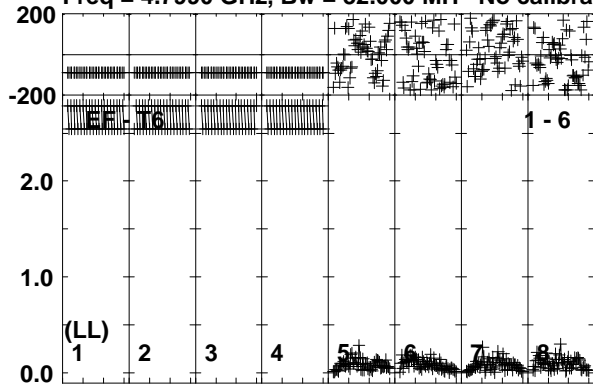

Lower frame: Milli Ampl Jy Top frame: Phas deg
Vector averaged cross-power spectrum Baseline: EF (01) - T6 (06)
Timerange: 00/19:00:31 to 00/19:03:59

Plot file version 265 created 19-OCT-2017 15:36:31

J0004+2019 ES081C.UVDATA.1

Freq = 4.7990 GHz, Bw = 32.000 MH No calibration applied and no bandpass applied

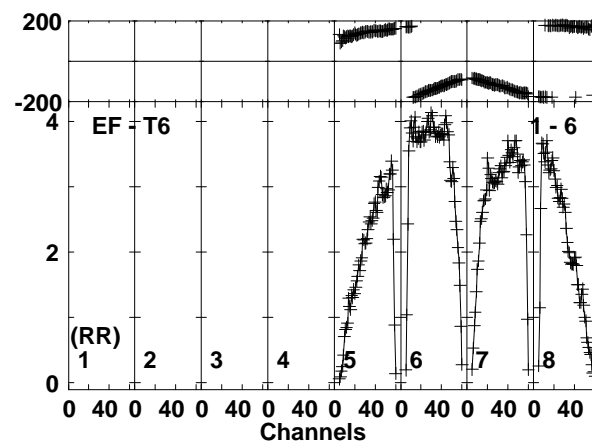
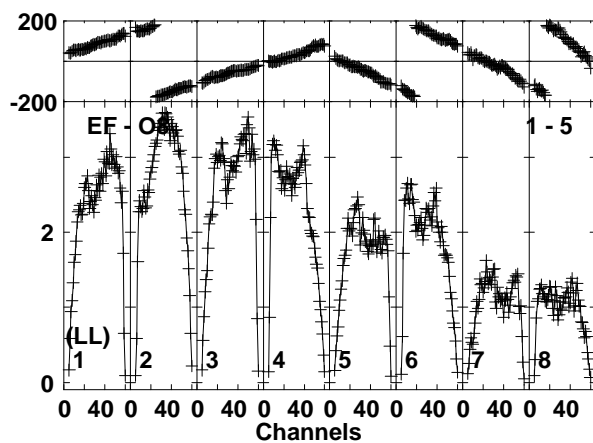
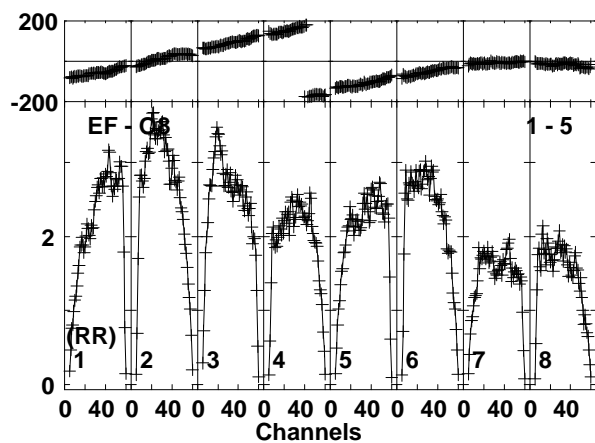
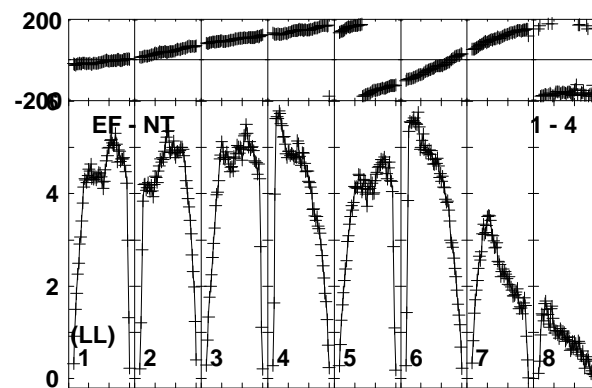
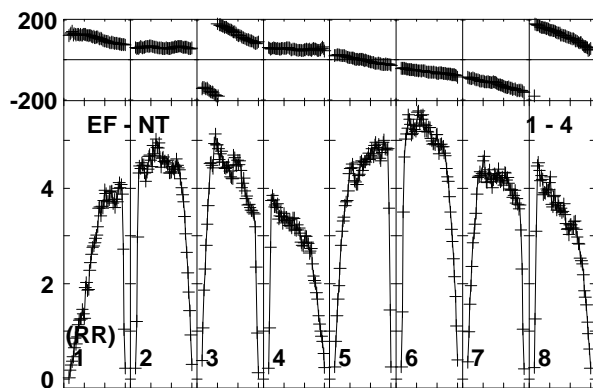
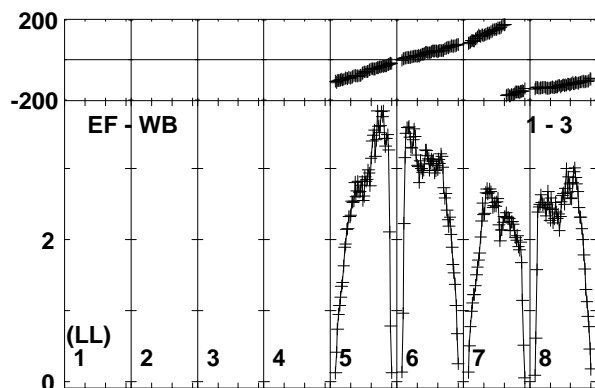
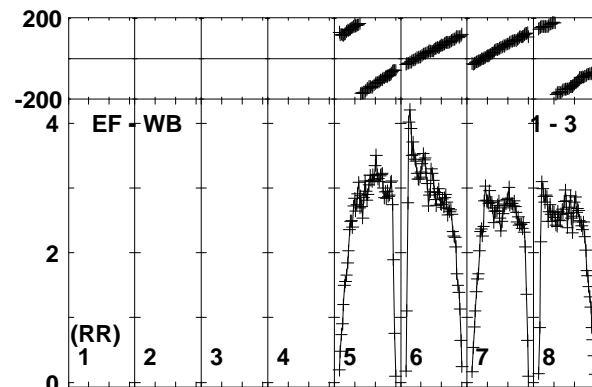
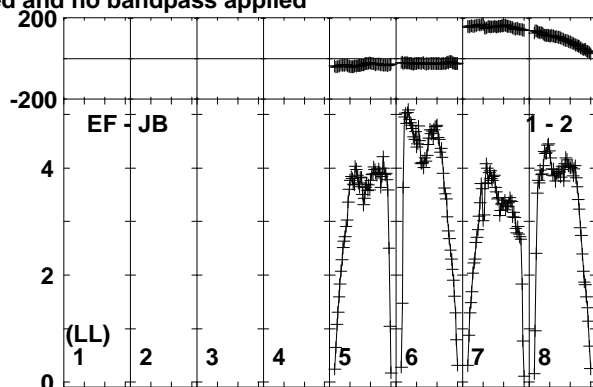
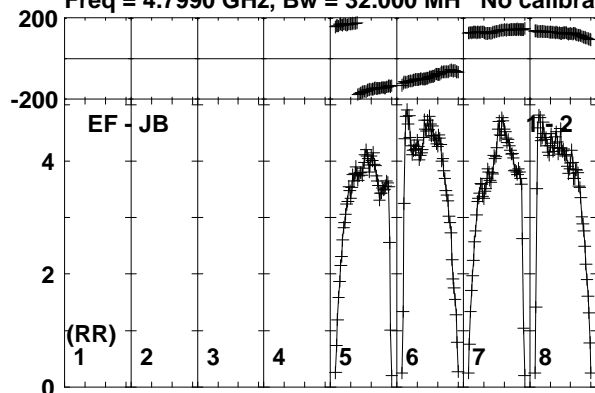

Lower frame: Milli Ampl Jy Top frame: Phas deg
Vector averaged cross-power spectrum Baseline: EF (01) - JB (02)
Timerange: 00:19:04:31 to 00:19:05:29

Plot file version 266 created 19-OCT-2017 15:36:31

J0004+2019 ES081C.UVDATA.1

Freq = 4.7990 GHz, Bw = 32.000 MH No calibration applied and no bandpass applied

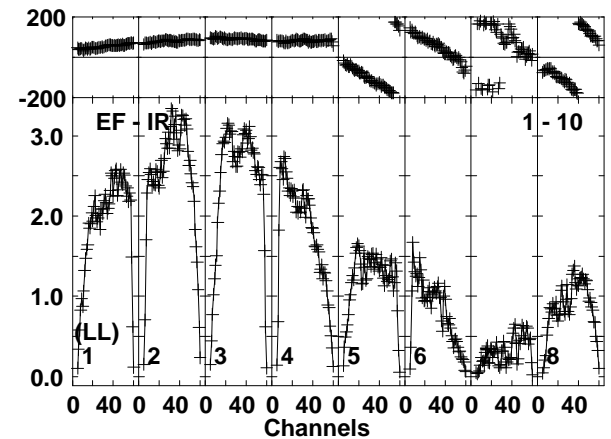
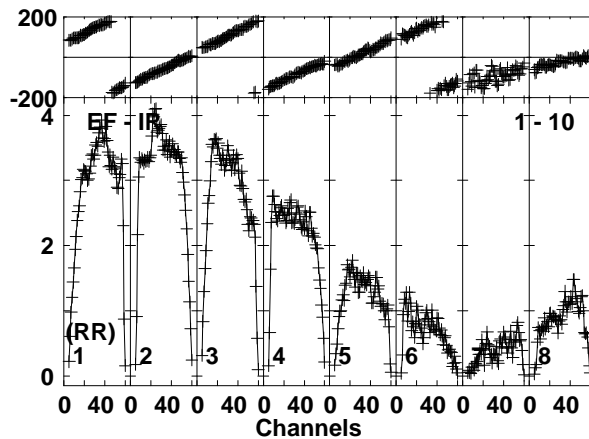
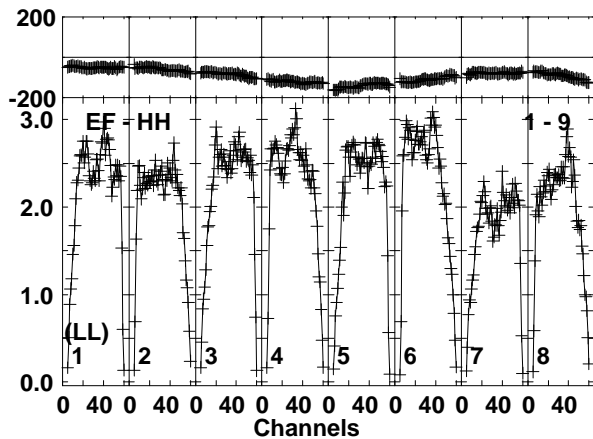
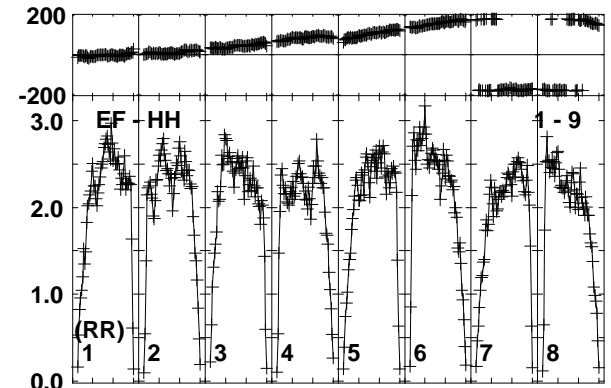
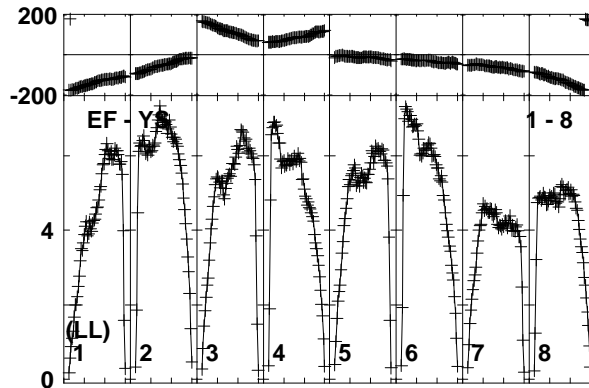
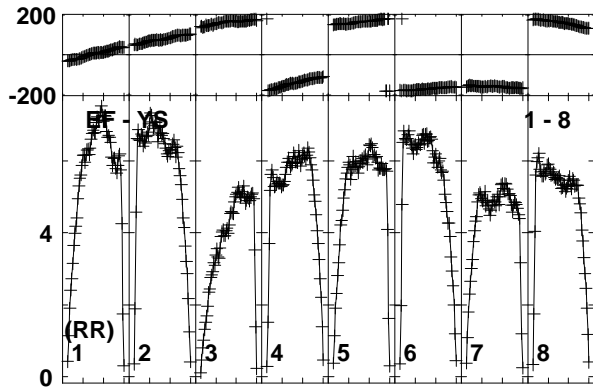
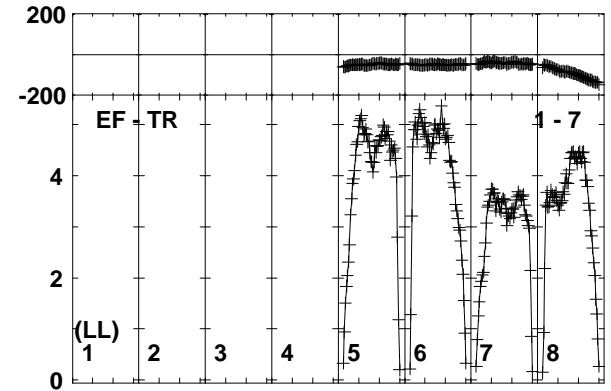
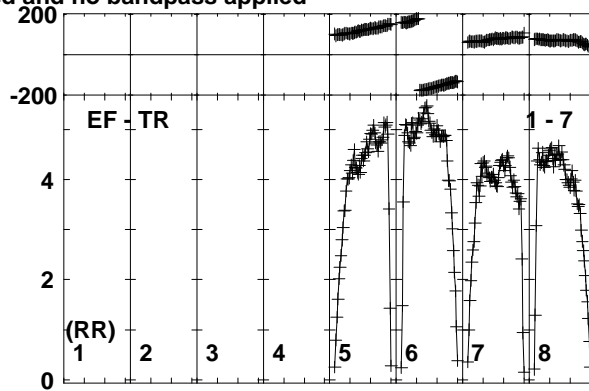
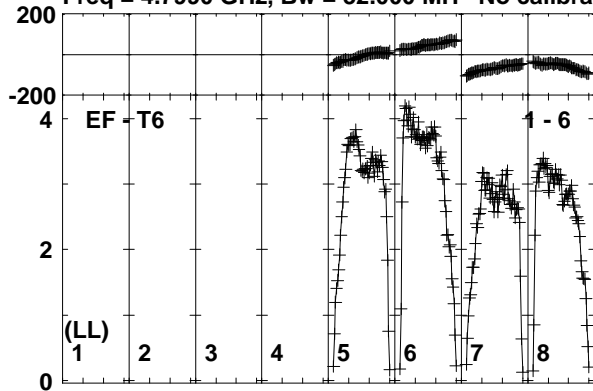

Lower frame: Milli Ampl Jy Top frame: Phas deg
Vector averaged cross-power spectrum Baseline: EF (01) - T6 (06)
Timerange: 00/19:04:31 to 00/19:05:29

Plot file version 267 created 19-OCT-2017 15:36:32
 MRK335 ES081C.UVDATA.1
 Freq = 4.7990 GHz, Bw = 32.000 MH No calibration applied and no bandpass applied

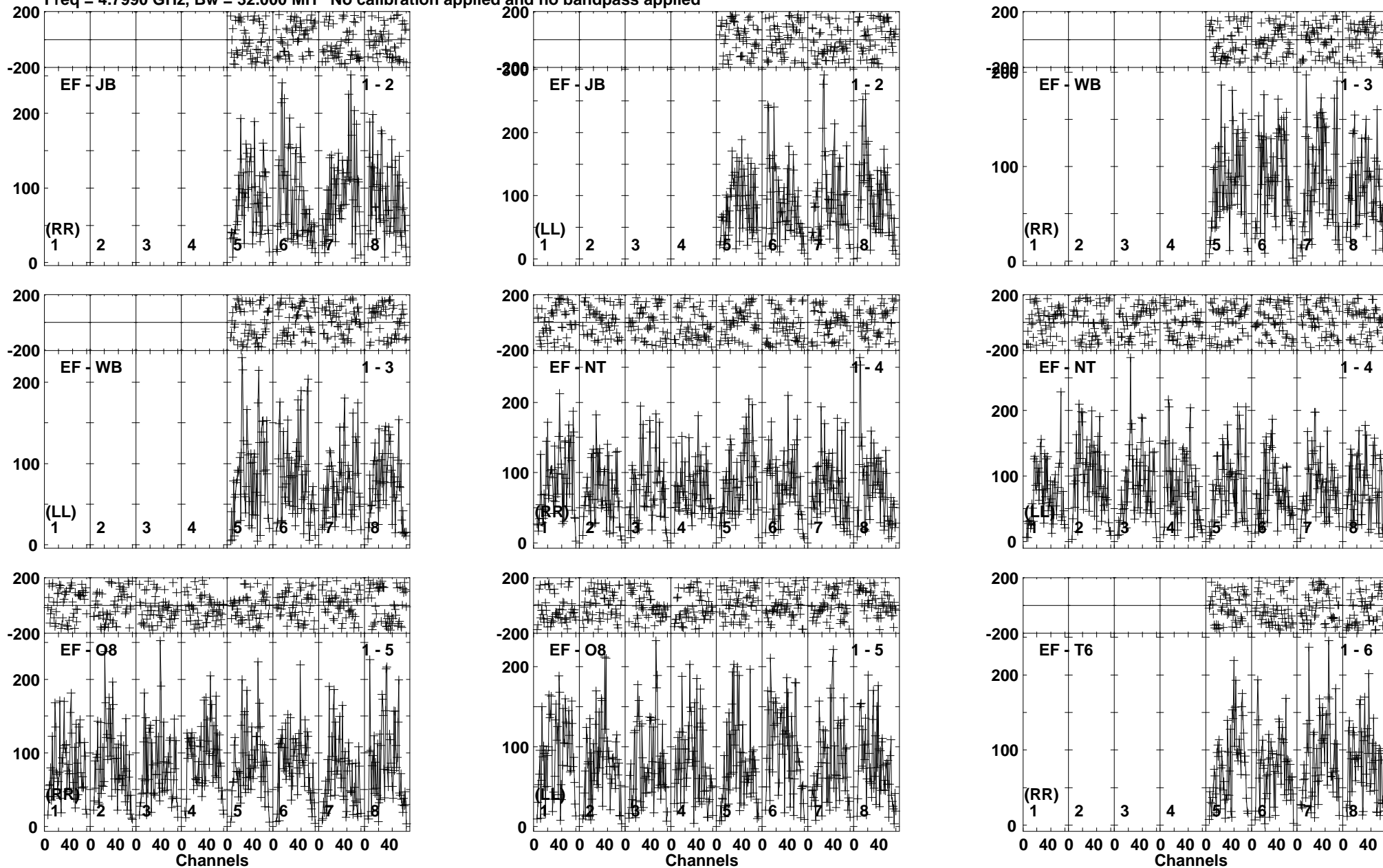

Lower frame: Micro Ampl Jy Top frame: Phas deg
 Vector averaged cross-power spectrum Baseline: EF (01) - JB (02)
 Timerange: 00/19:05:31 to 00/19:08:59

Plot file version 268 created 19-OCT-2017 15:36:32

MRK335 ES081C.UVDATA.1

Freq = 4.7990 GHz, Bw = 32.000 MH No calibration applied and no bandpass applied

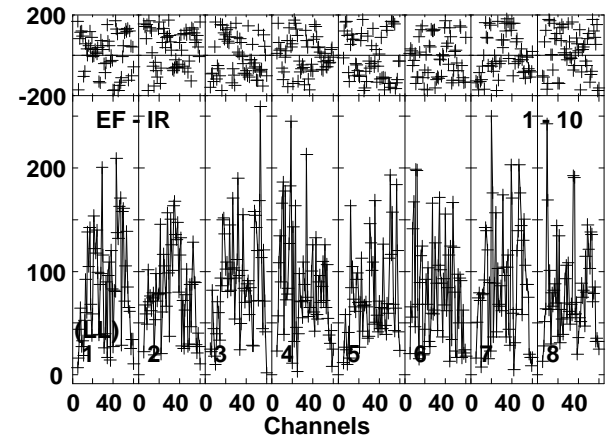
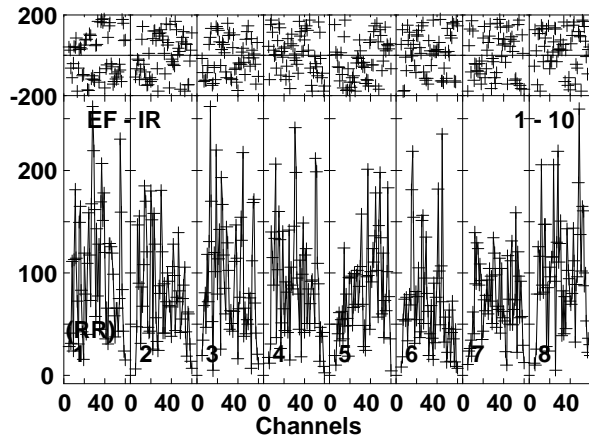
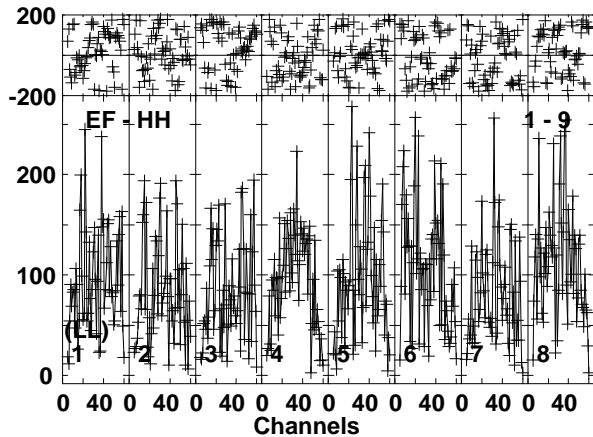
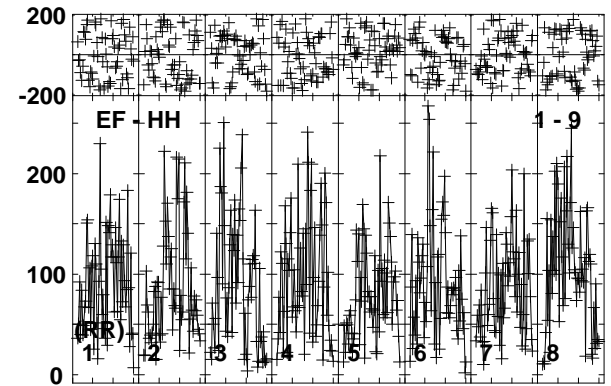
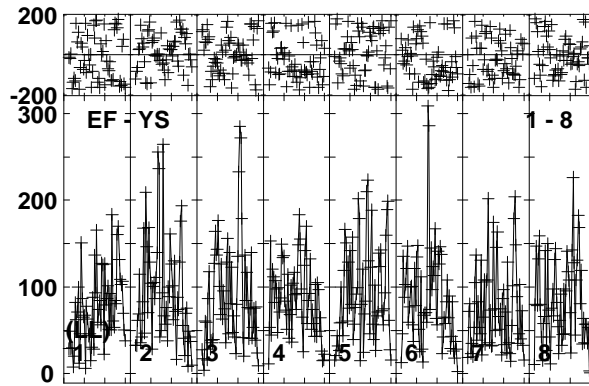
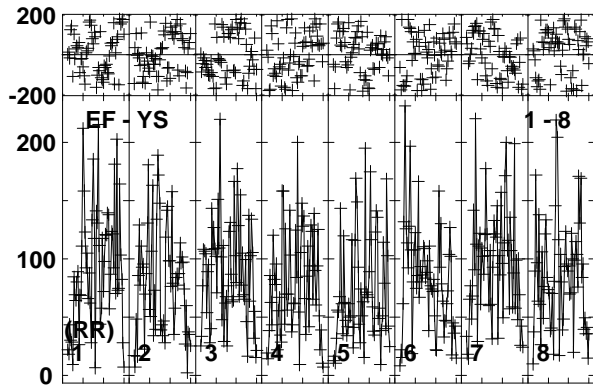
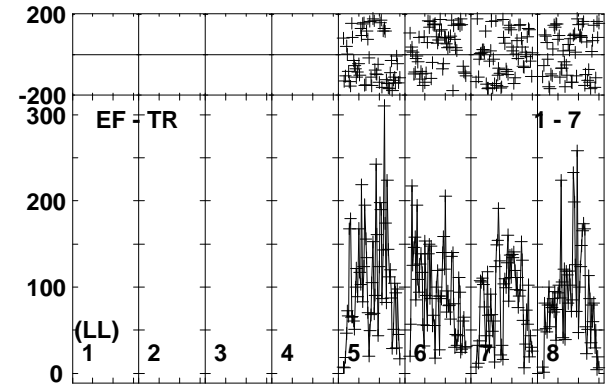
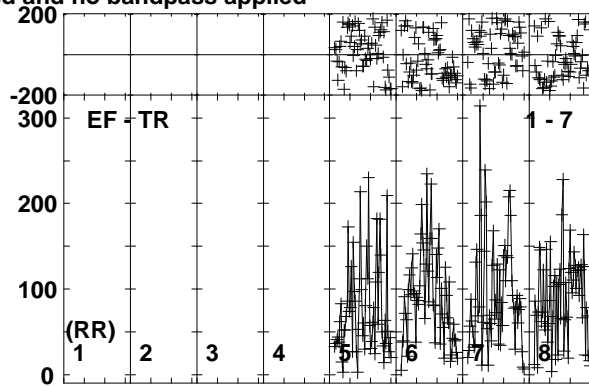
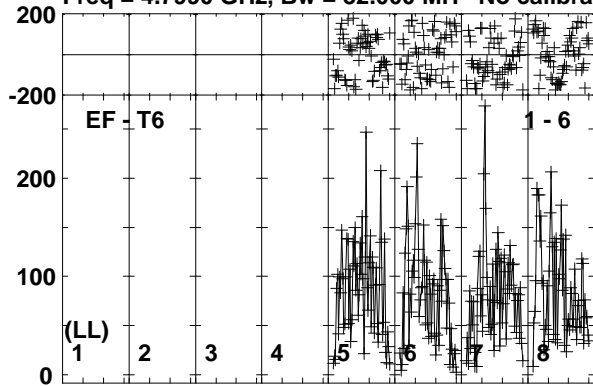

Lower frame: Micro Ampl Jy Top frame: Phas deg
Vector averaged cross-power spectrum Baseline: EF (01) - T6 (06)
Timerange: 00/19:05:31 to 00/19:08:59

Plot file version 269 created 19-OCT-2017 15:36:32

J0004+2019 ES081C.UVDATA.1

Freq = 4.7990 GHz, Bw = 32.000 MH No calibration applied and no bandpass applied

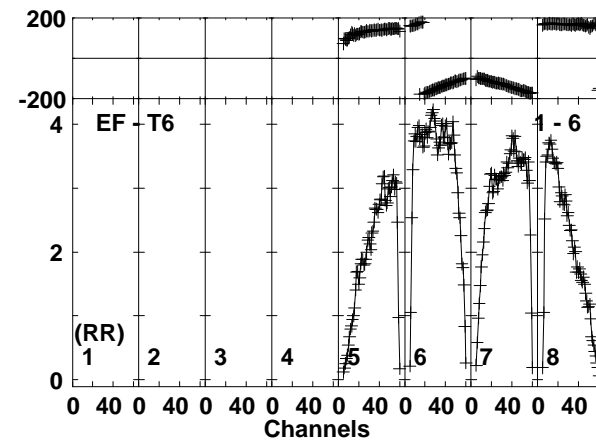
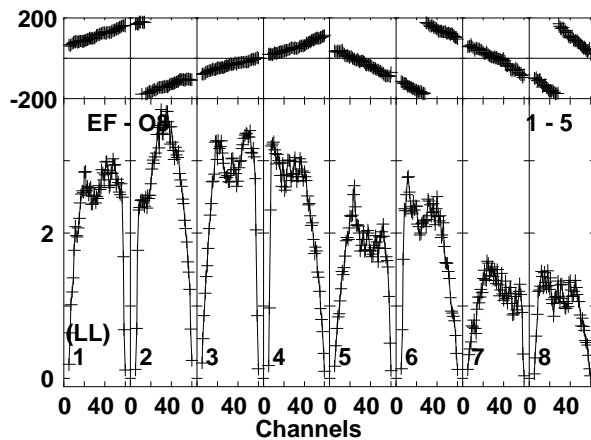
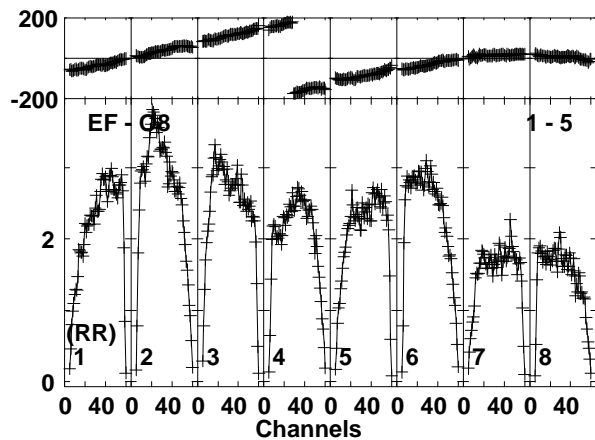
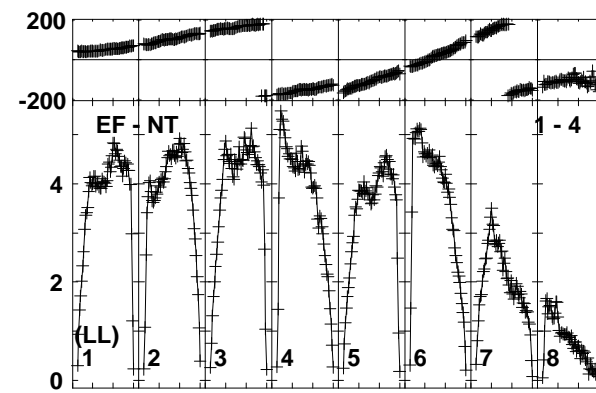
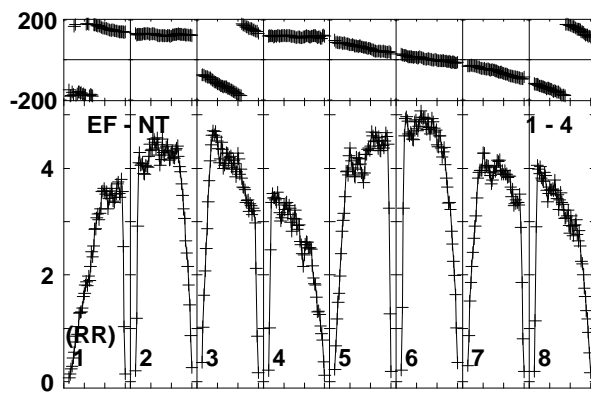
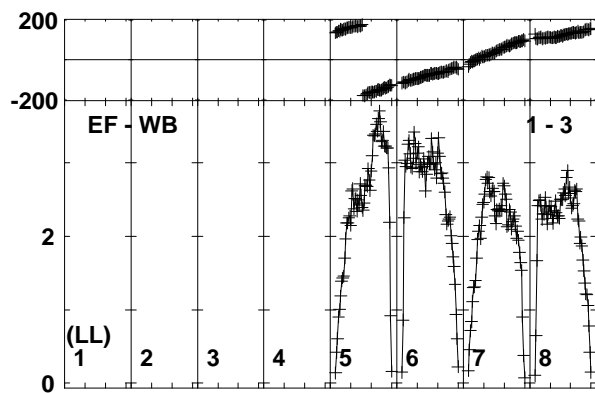
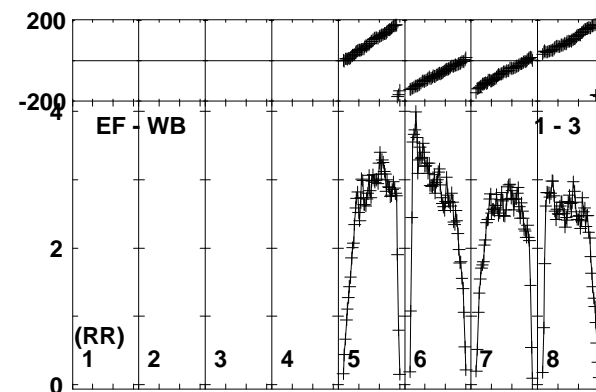
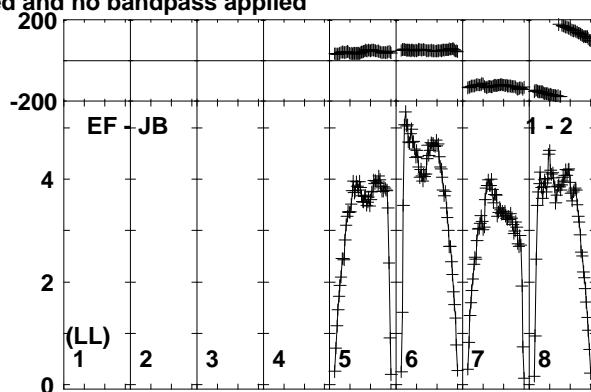
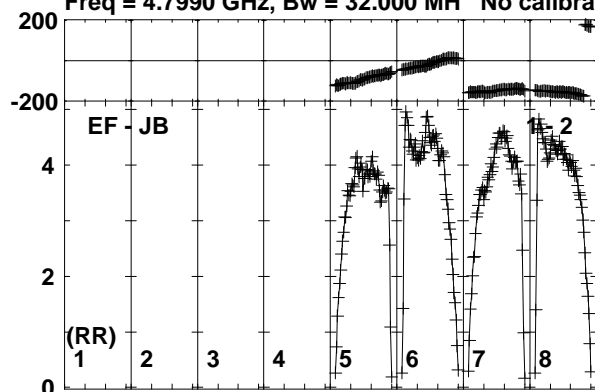

Lower frame: Milli Ampl Jy Top frame: Phas deg
Vector averaged cross-power spectrum Baseline: EF (01) - JB (02)
Timerange: 00/19:09:01 to 00/19:10:29

Plot file version 270 created 19-OCT-2017 15:36:32

J0004+2019 ES081C.UVDATA.1

Freq = 4.7990 GHz, Bw = 32.000 MH No calibration applied and no bandpass applied

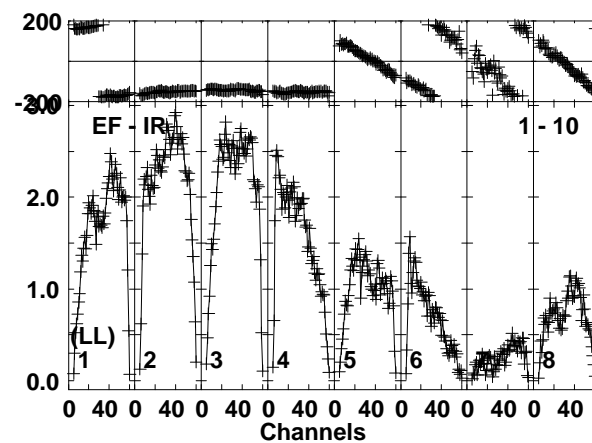
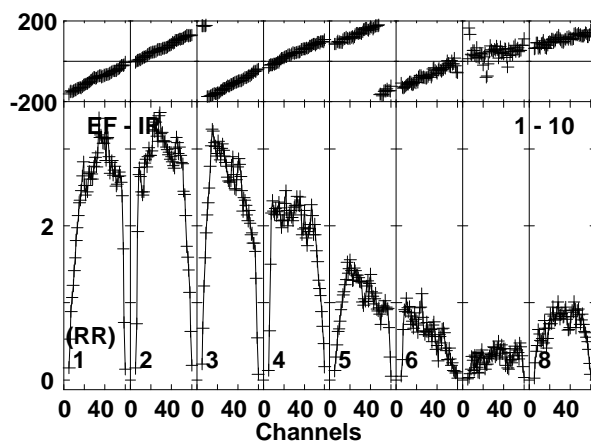
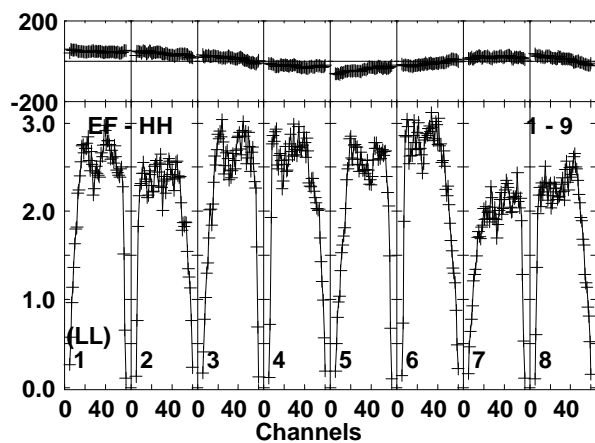
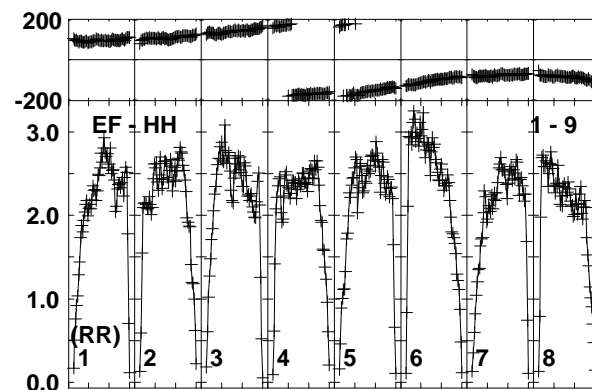
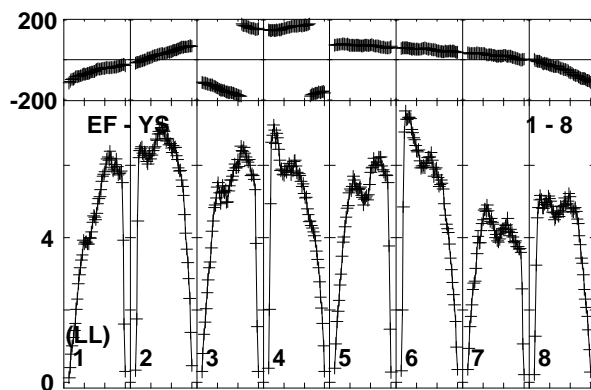
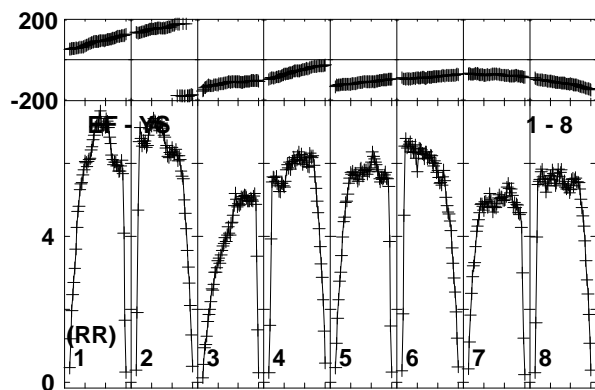
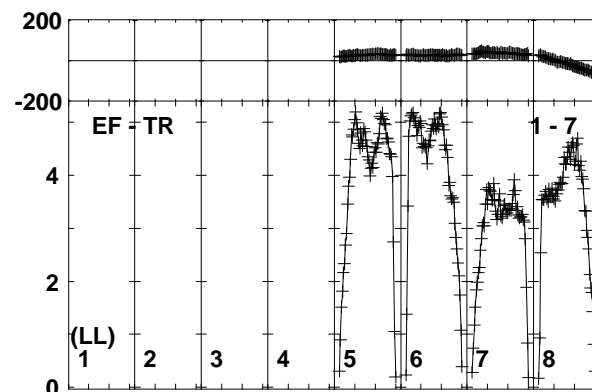
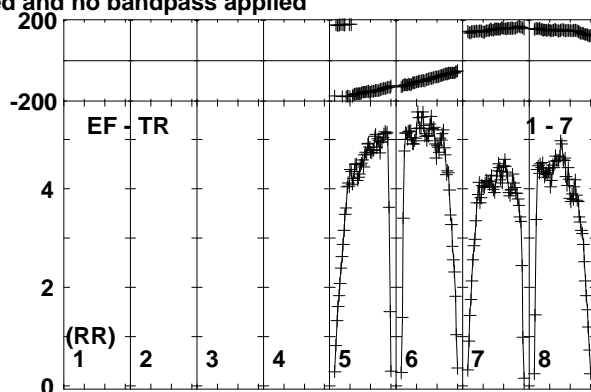
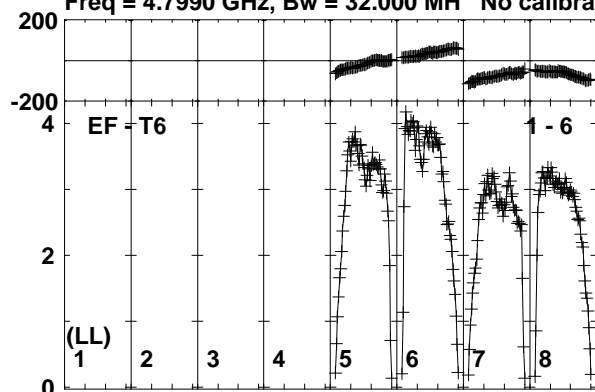

Lower frame: Milli Ampl Jy Top frame: Phas deg
Vector averaged cross-power spectrum Baseline: EF (01) - T6 (06)
Timerange: 00:19:09:01 to 00:19:10:29

Plot file version 271 created 19-OCT-2017 15:36:32

MRK335 ES081C.UVDATA.1

Freq = 4.7990 GHz, Bw = 32.000 MH No calibration applied and no bandpass applied

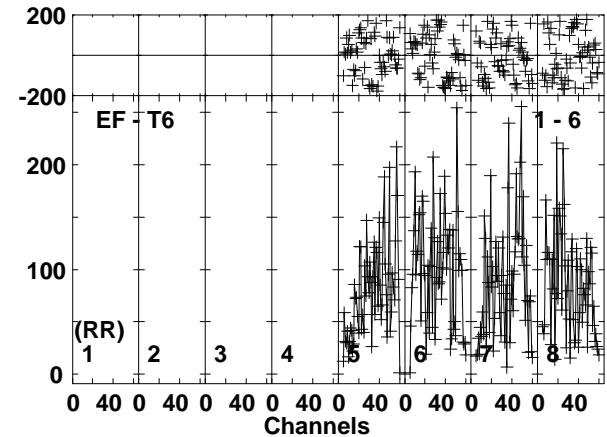
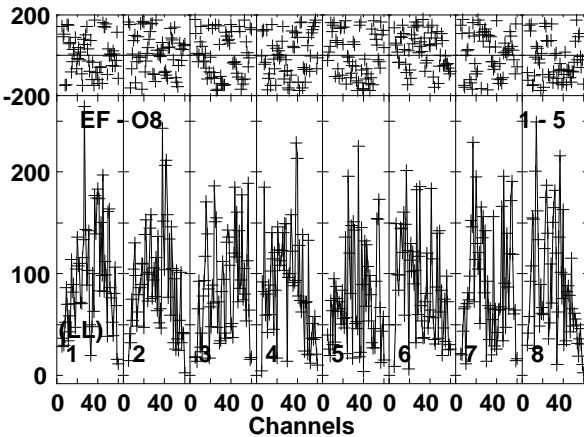
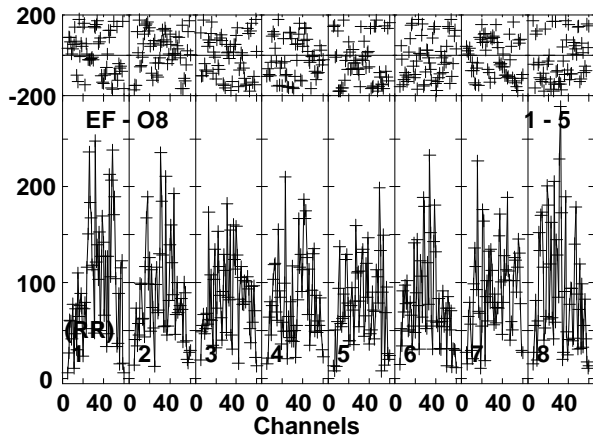
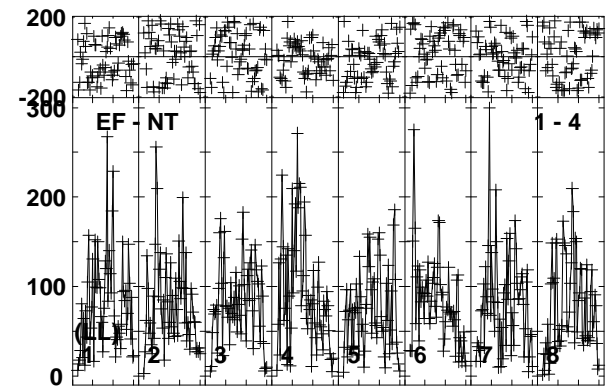
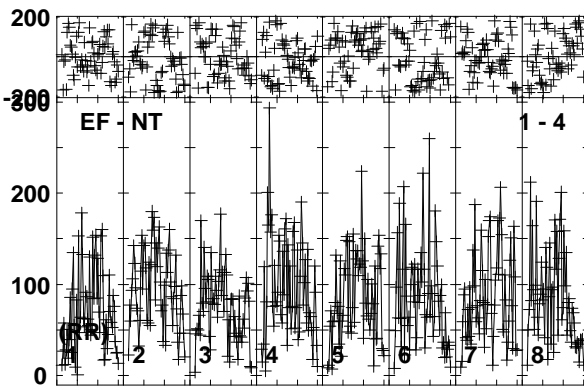
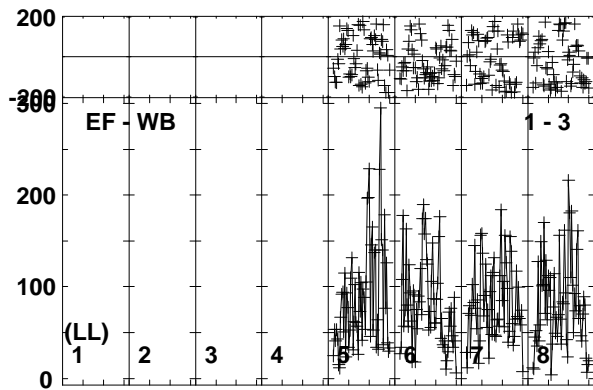
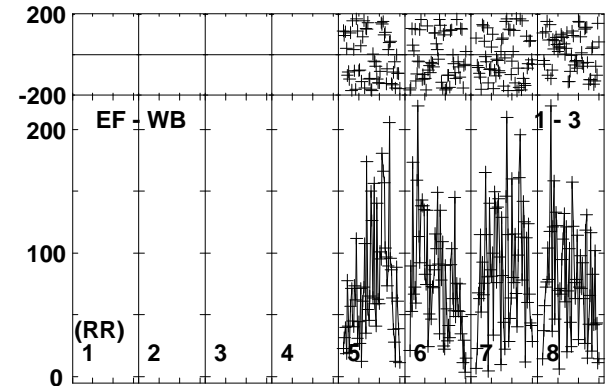
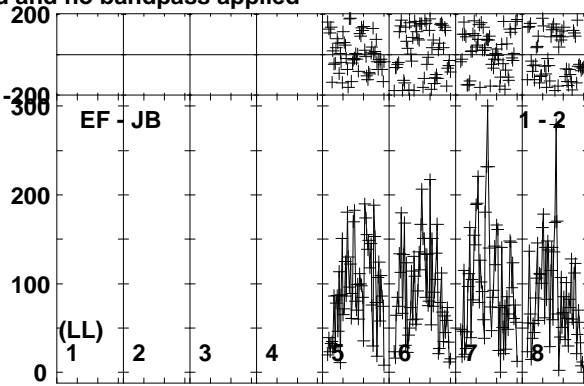
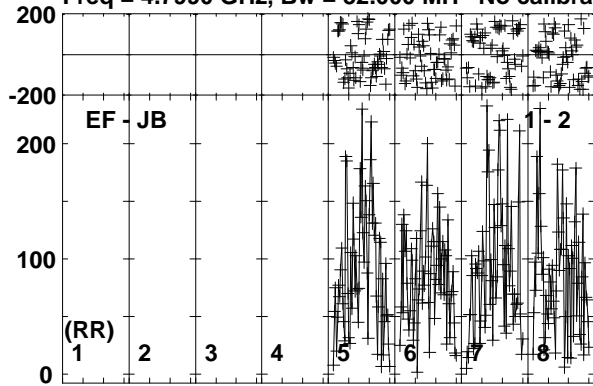

Lower frame: Micro Ampl Jy Top frame: Phas deg
Vector averaged cross-power spectrum Baseline: EF (01) - JB (02)
Timerange: 00/19:10:31 to 00/19:13:59

Plot file version 272 created 19-OCT-2017 15:36:32

MRK335 ES081C.UVDATA.1

Freq = 4.7990 GHz, Bw = 32.000 MH No calibration applied and no bandpass applied

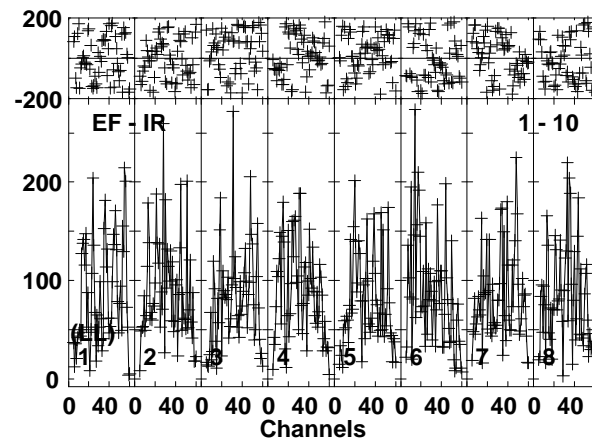
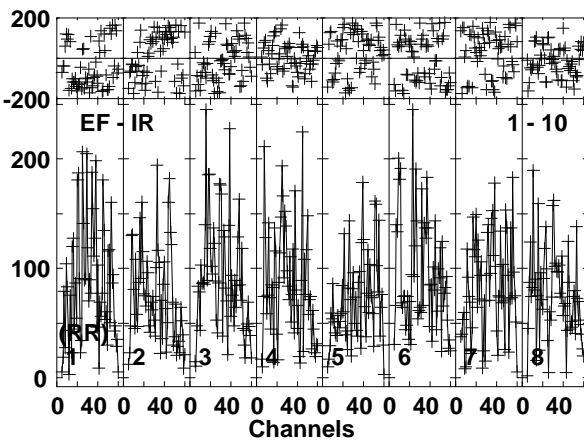
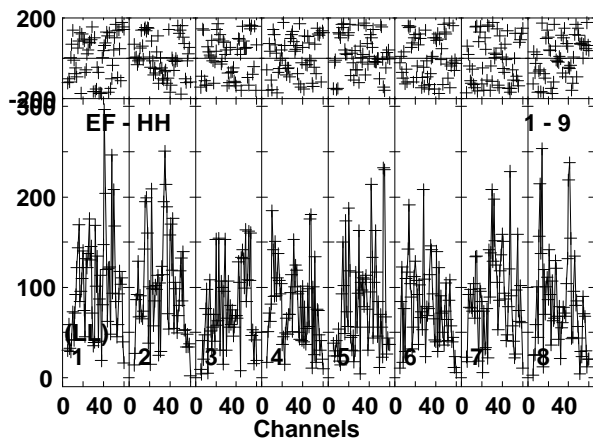
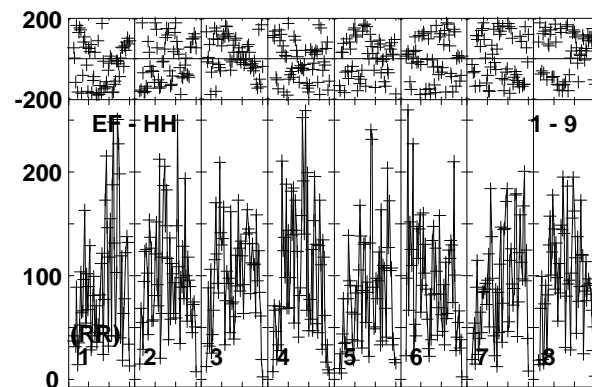
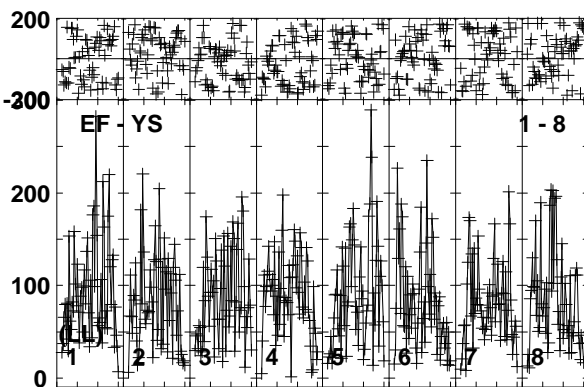
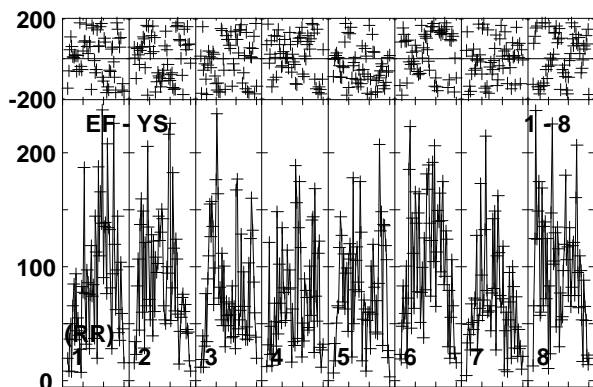
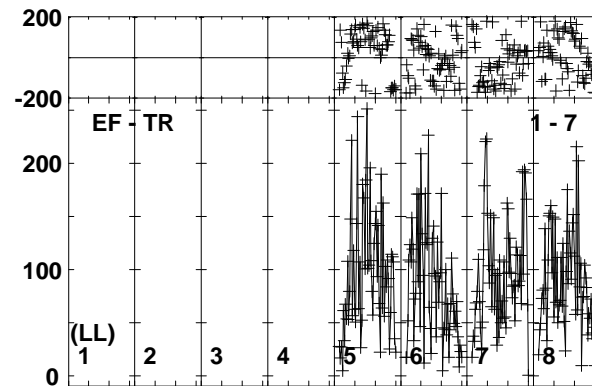
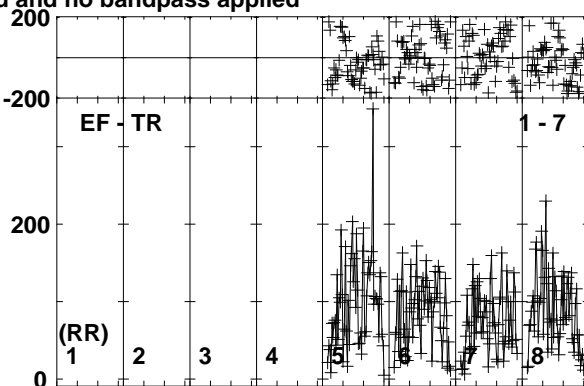
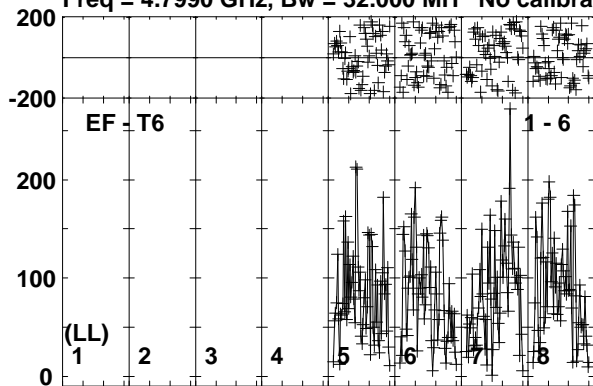

Lower frame: Micro Ampl Jy Top frame: Phas deg
Vector averaged cross-power spectrum Baseline: EF (01) - T6 (06)
Timerange: 00/19:10:31 to 00/19:13:59

Plot file version 273 created 19-OCT-2017 15:36:32

J0004+2019 ES081C.UVDATA.1

Freq = 4.7990 GHz, Bw = 32.000 MH No calibration applied and no bandpass applied

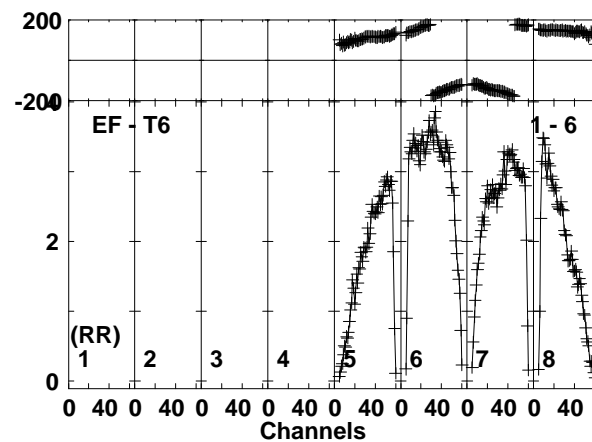
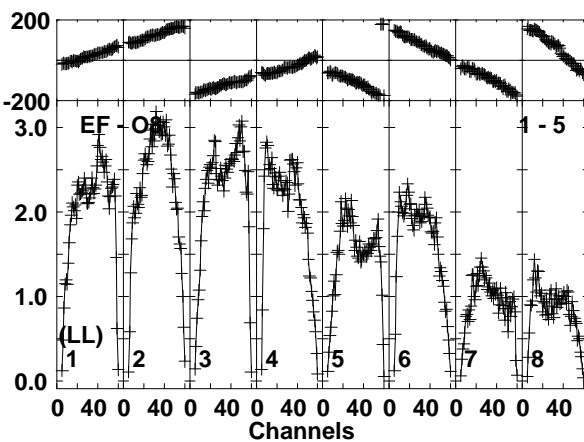
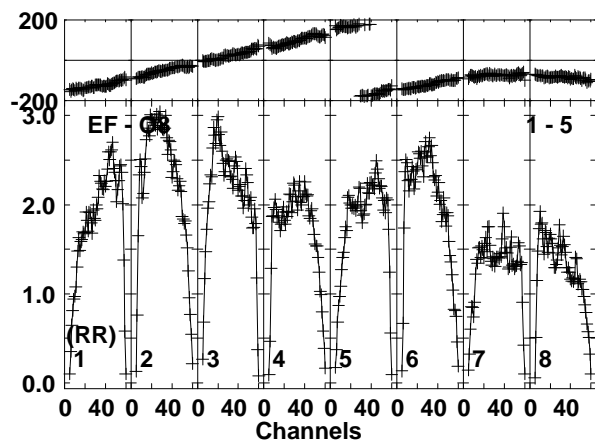
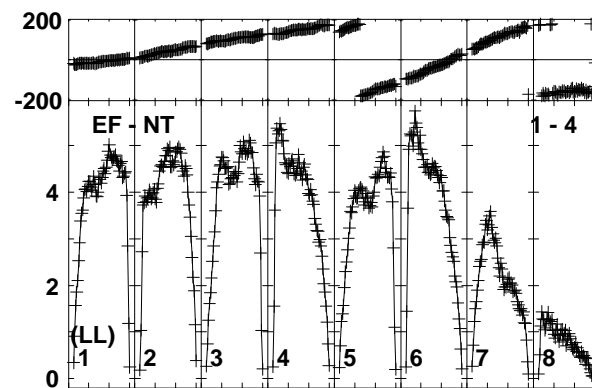
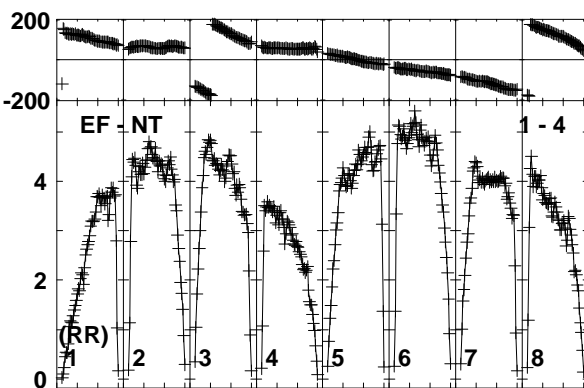
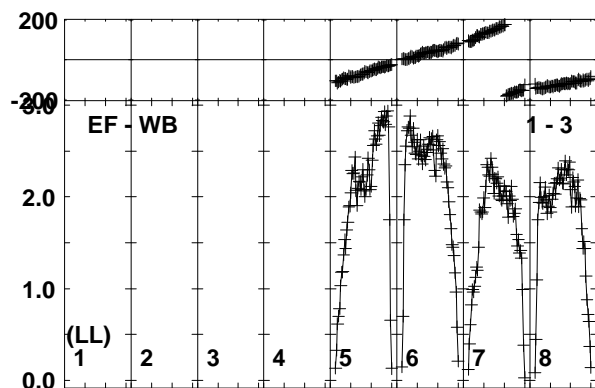
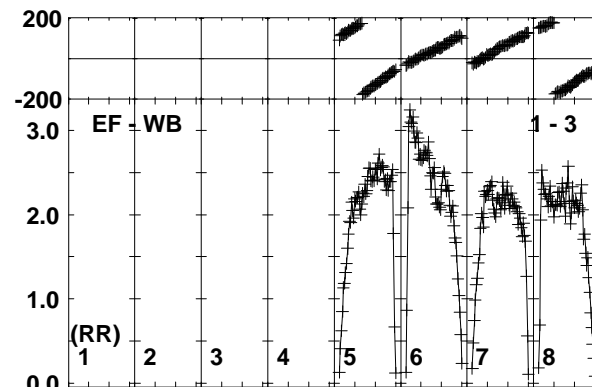
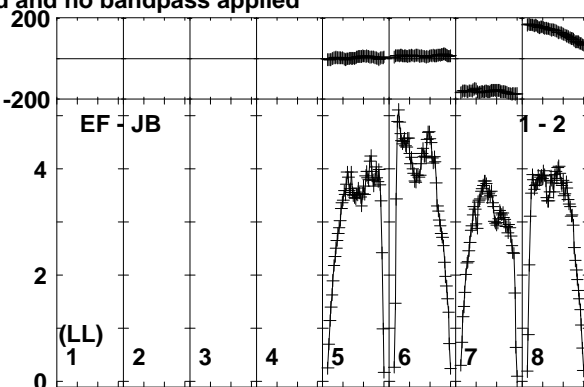
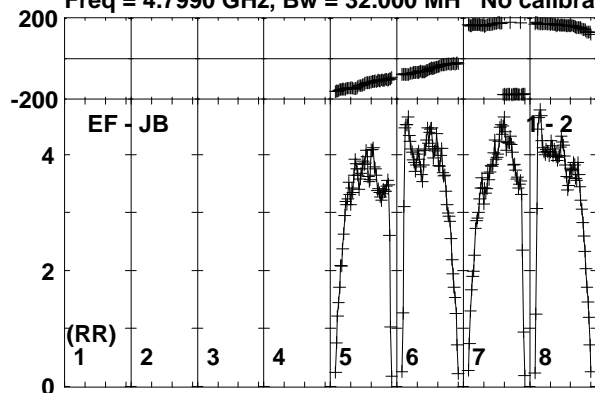

Lower frame: Milli Ampl Jy Top frame: Phas deg
Vector averaged cross-power spectrum Baseline: EF (01) - JB (02)
Timerange: 00/19:14:31 to 00/19:15:29

Plot file version 274 created 19-OCT-2017 15:36:33

J0004+2019 ES081C.UVDATA.1

Freq = 4.7990 GHz, Bw = 32.000 MH No calibration applied and no bandpass applied

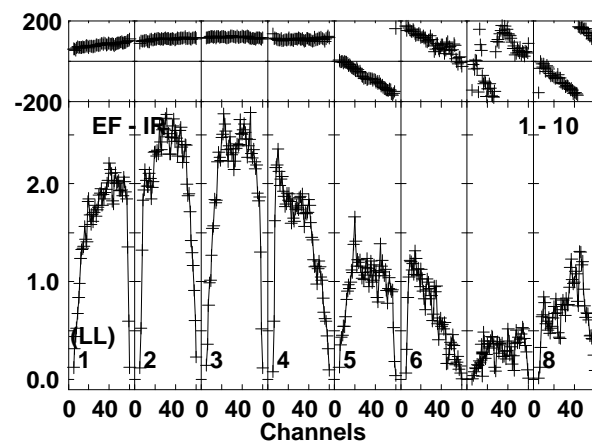
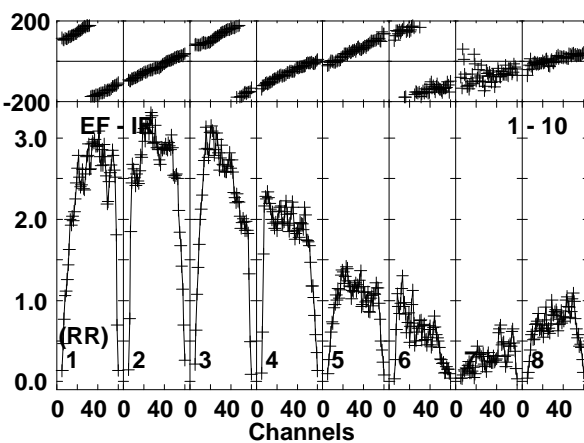
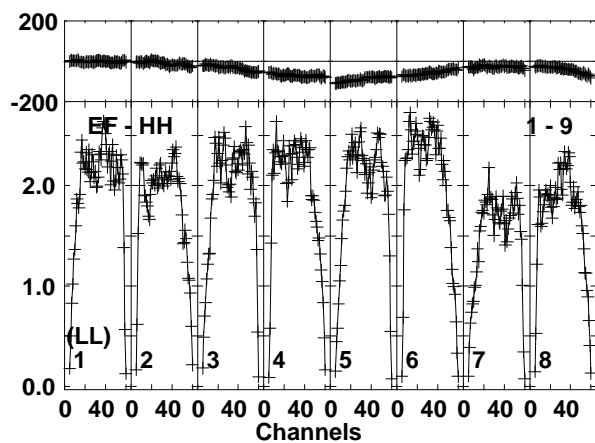
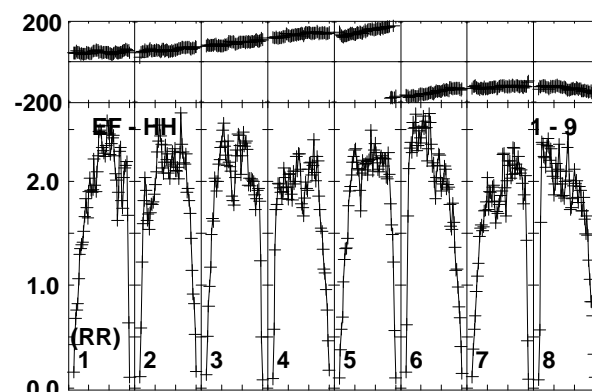
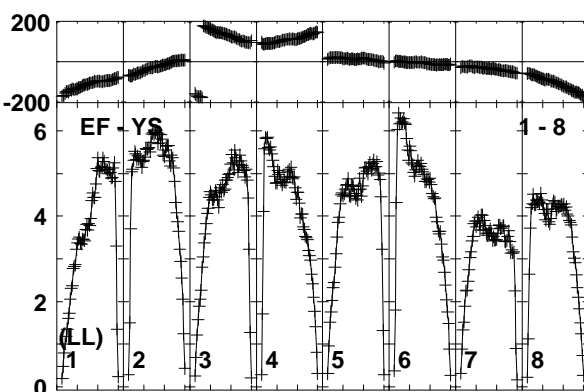
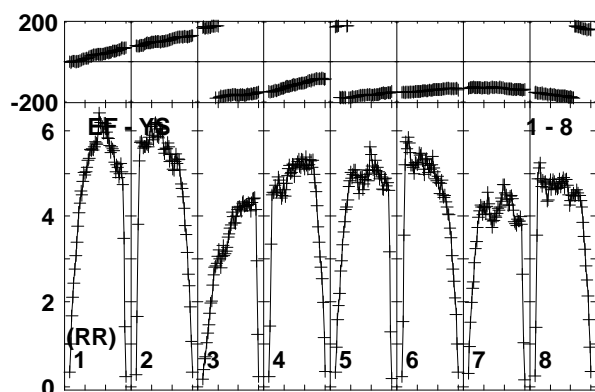
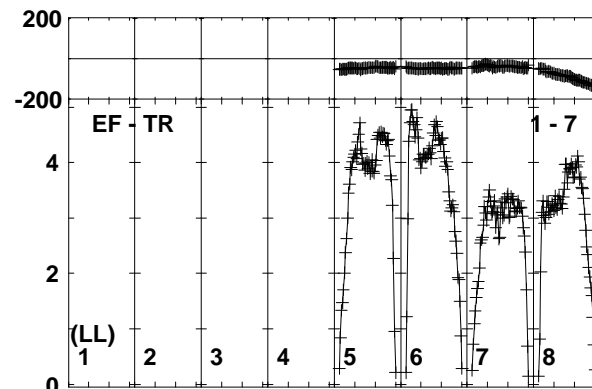
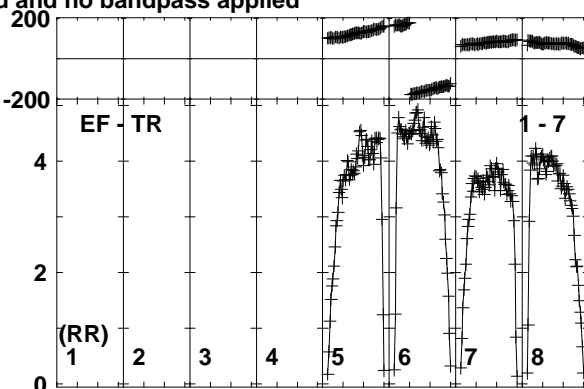
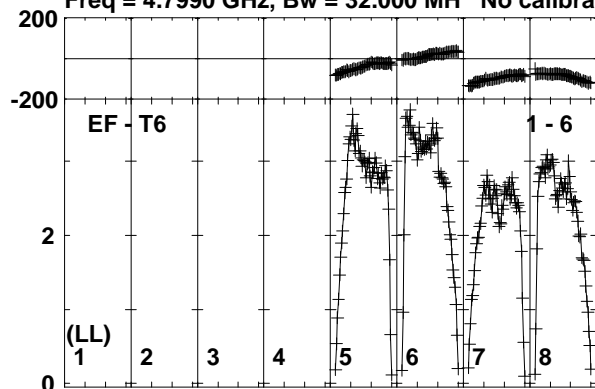

Lower frame: Milli Ampl Jy Top frame: Phas deg
Vector averaged cross-power spectrum Baseline: EF (01) - T6 (06)
Timerange: 00/19:14:31 to 00/19:15:29

Plot file version 275 created 19-OCT-2017 15:36:33

MRK335 ES081C.UVDATA.1

Freq = 4.7990 GHz, Bw = 32.000 MH No calibration applied and no bandpass applied

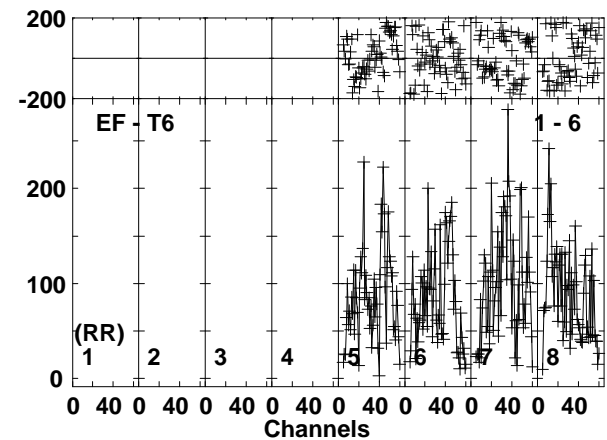
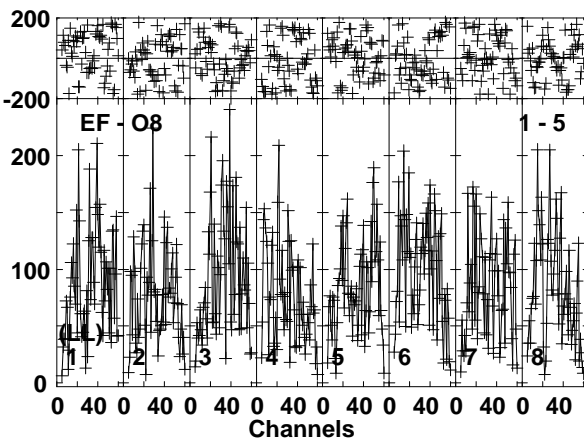
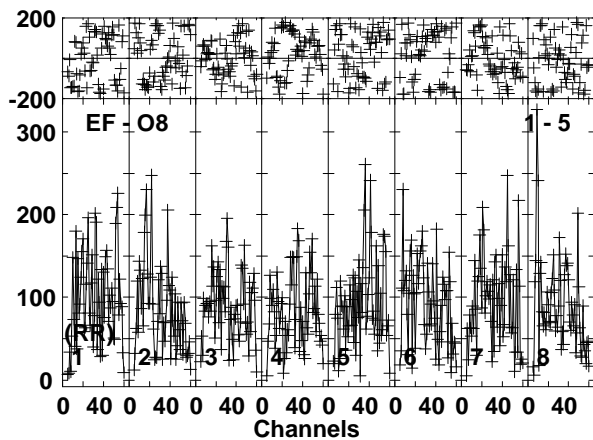
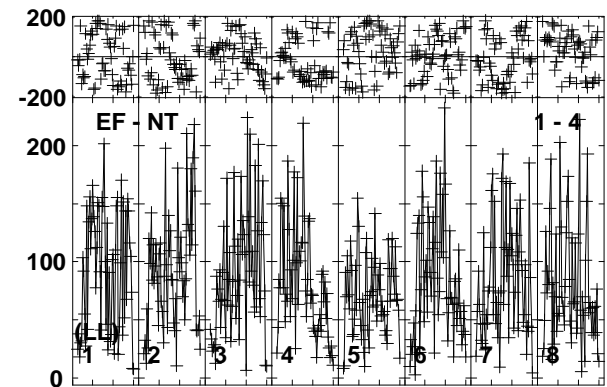
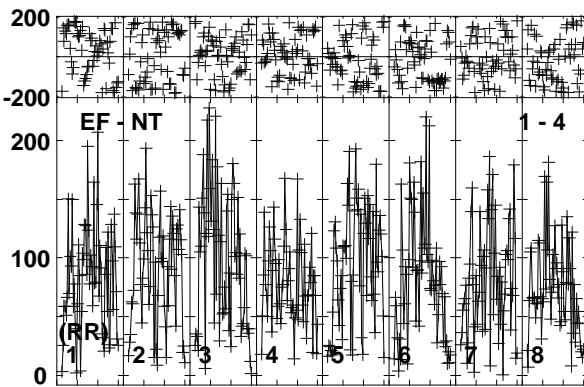
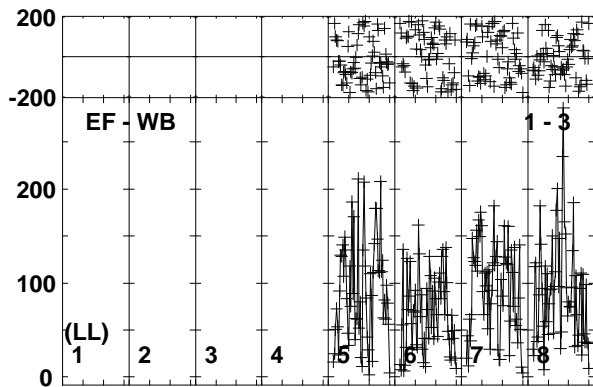
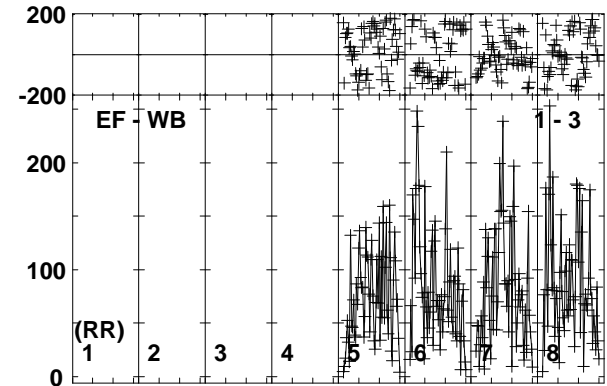
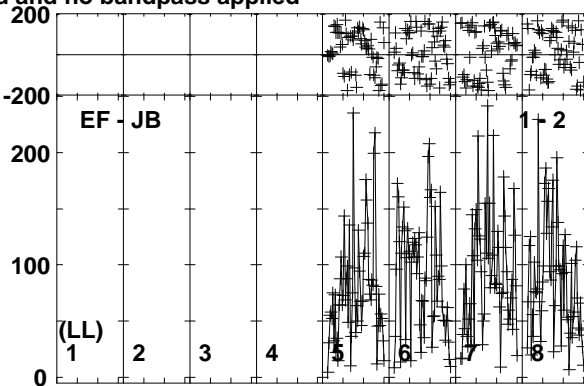
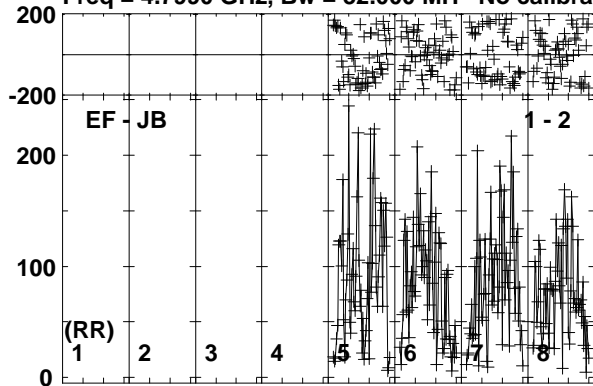

Lower frame: Micro Ampl Jy Top frame: Phas deg
Vector averaged cross-power spectrum Baseline: EF (01) - JB (02)
Timerange: 00/19:15:31 to 00/19:18:59

Plot file version 276 created 19-OCT-2017 15:36:33

MRK335 ES081C.UVDATA.1

Freq = 4.7990 GHz, Bw = 32.000 MH No calibration applied and no bandpass applied

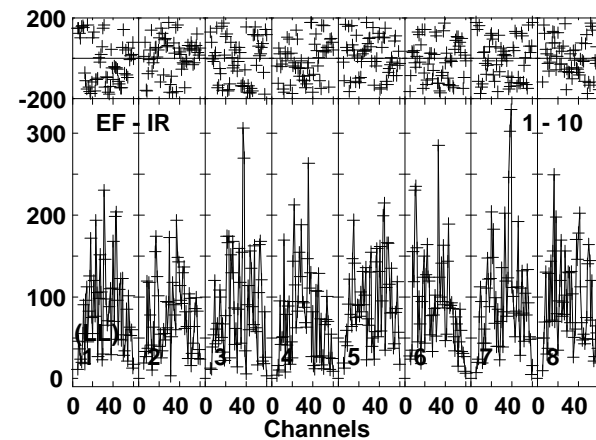
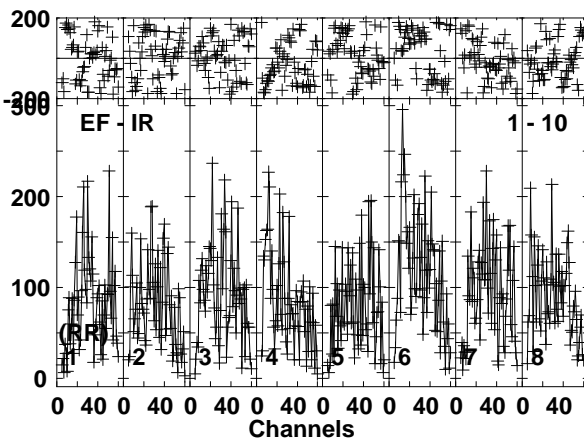
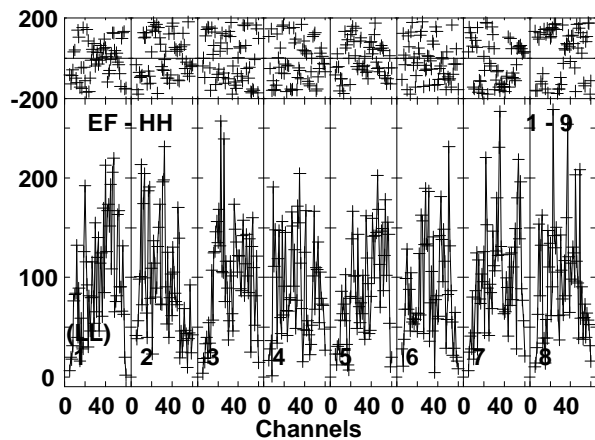
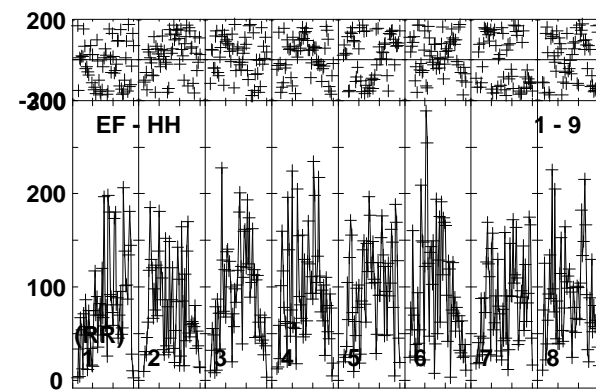
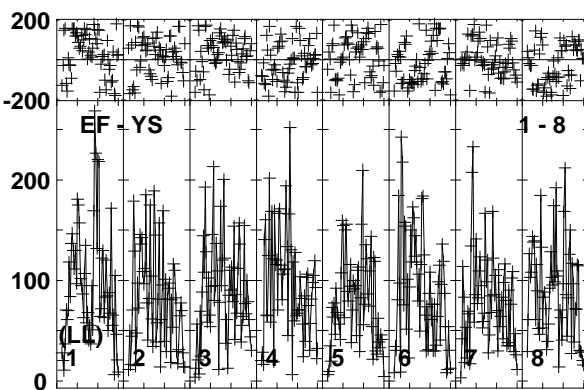
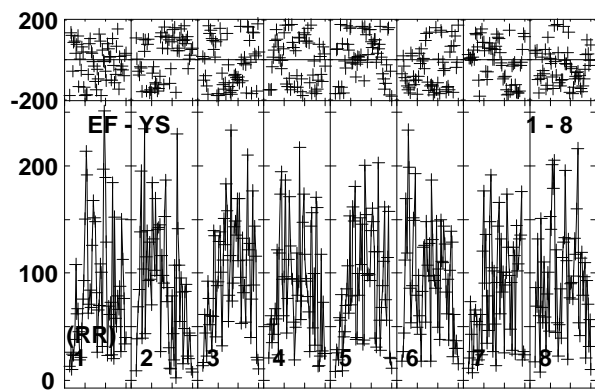
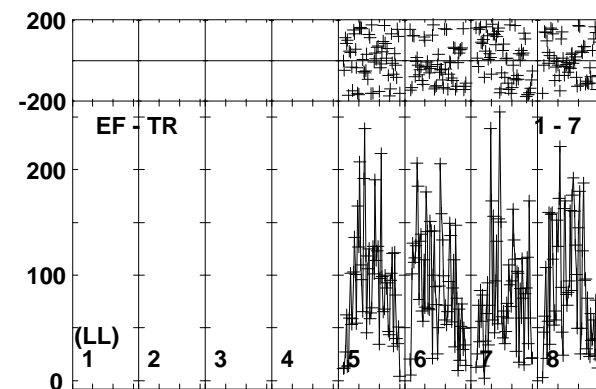
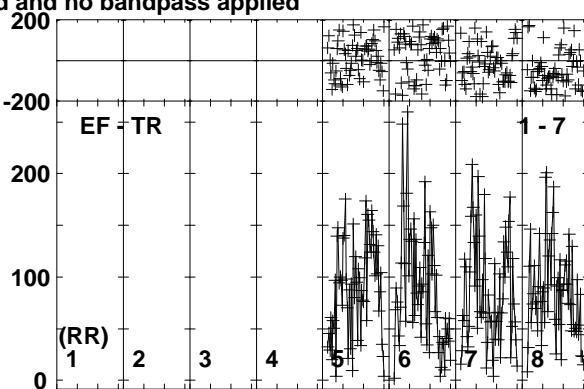
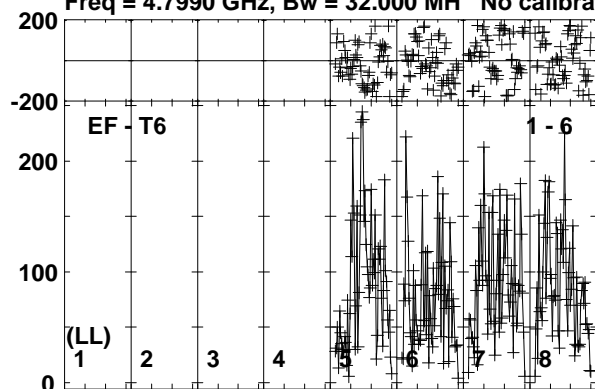

Lower frame: Micro Ampl Jy Top frame: Phas deg
Vector averaged cross-power spectrum Baseline: EF (01) - T6 (06)
Timerange: 00/19:15:31 to 00/19:18:59

Plot file version 277 created 19-OCT-2017 15:36:33

J0004+2019 ES081C.UVDATA.1

Freq = 4.7990 GHz, Bw = 32.000 MH No calibration applied and no bandpass applied

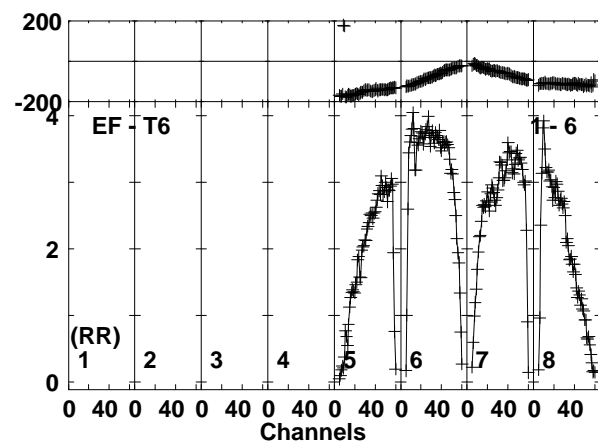
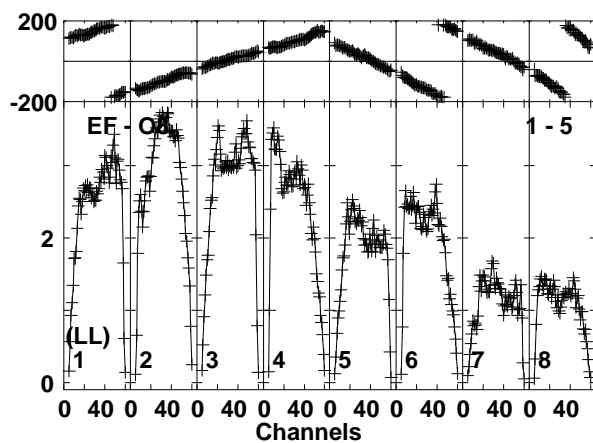
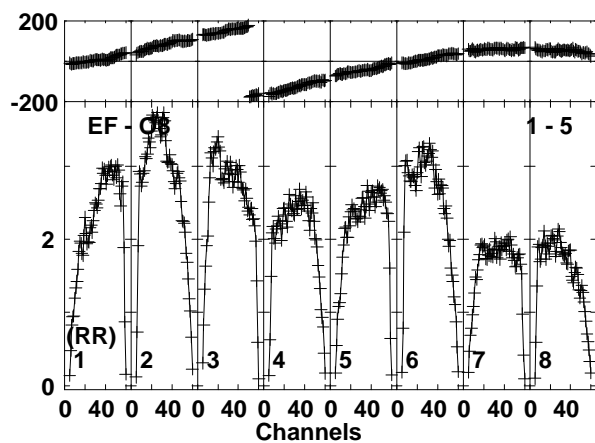
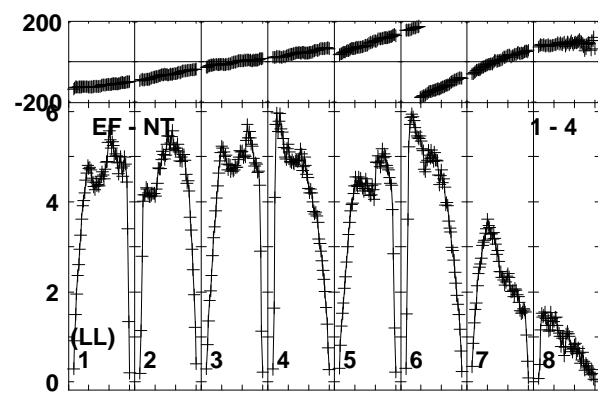
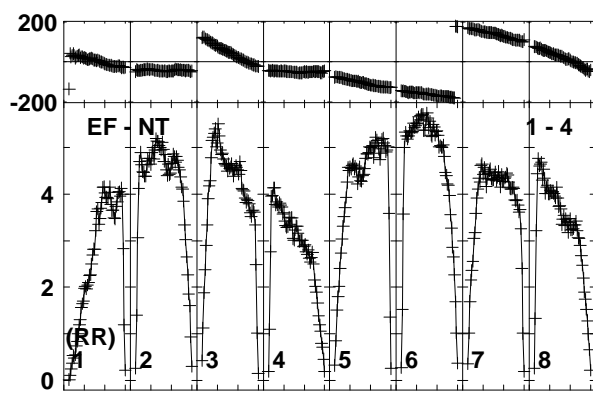
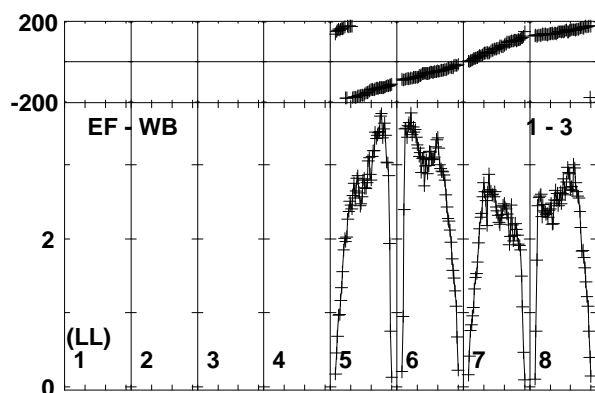
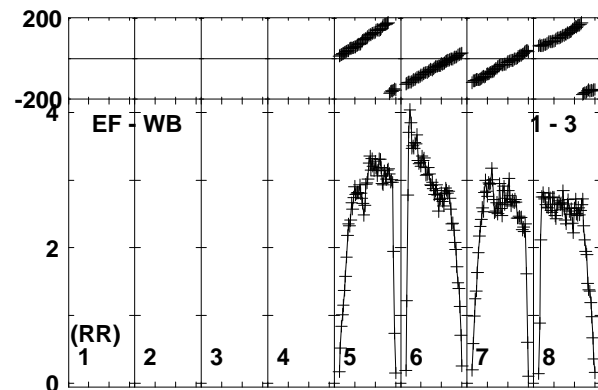
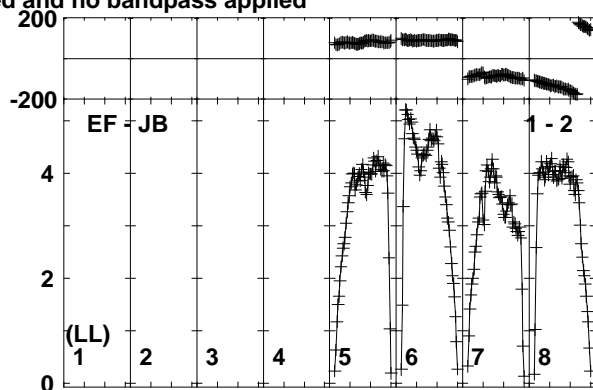
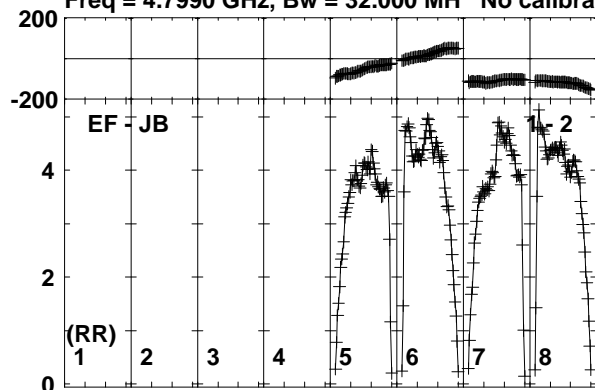

Lower frame: Milli Ampl Jy Top frame: Phas deg
Vector averaged cross-power spectrum Baseline: EF (01) - JB (02)
Timerange: 00/19:19:01 to 00/19:20:29

Plot file version 278 created 19-OCT-2017 15:36:33

J0004+2019 ES081C.UVDATA.1

Freq = 4.7990 GHz, Bw = 32.000 MH No calibration applied and no bandpass applied

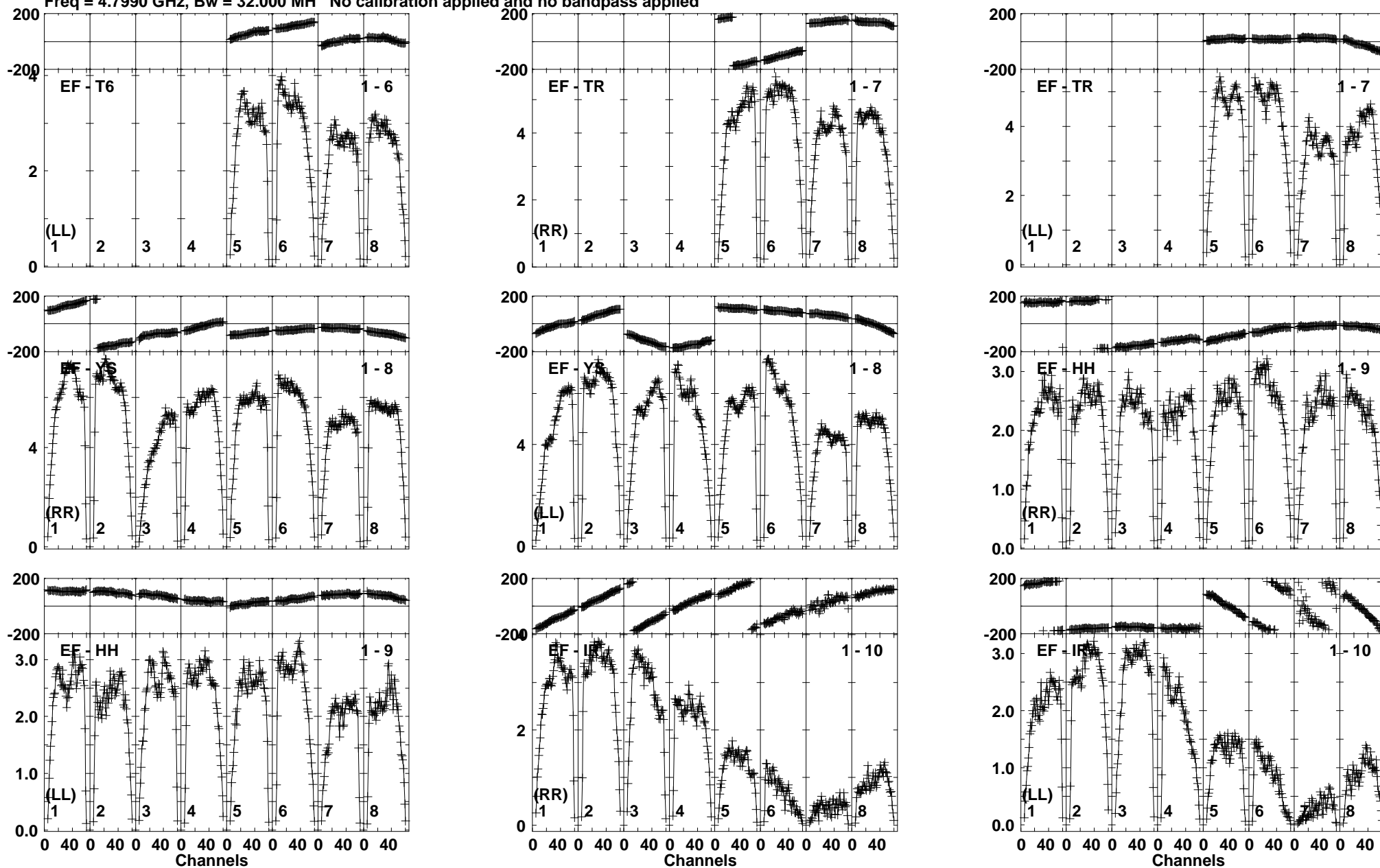

Lower frame: Milli Ampl Jy Top frame: Phas deg
Vector averaged cross-power spectrum Baseline: EF (01) - T6 (06)
Timerange: 00/19:19:01 to 00/19:20:29

Plot file version 279 created 19-OCT-2017 15:36:33
 MRK335 ES081C.UVDATA.1
 Freq = 4.7990 GHz, Bw = 32.000 MH No calibration applied and no bandpass applied

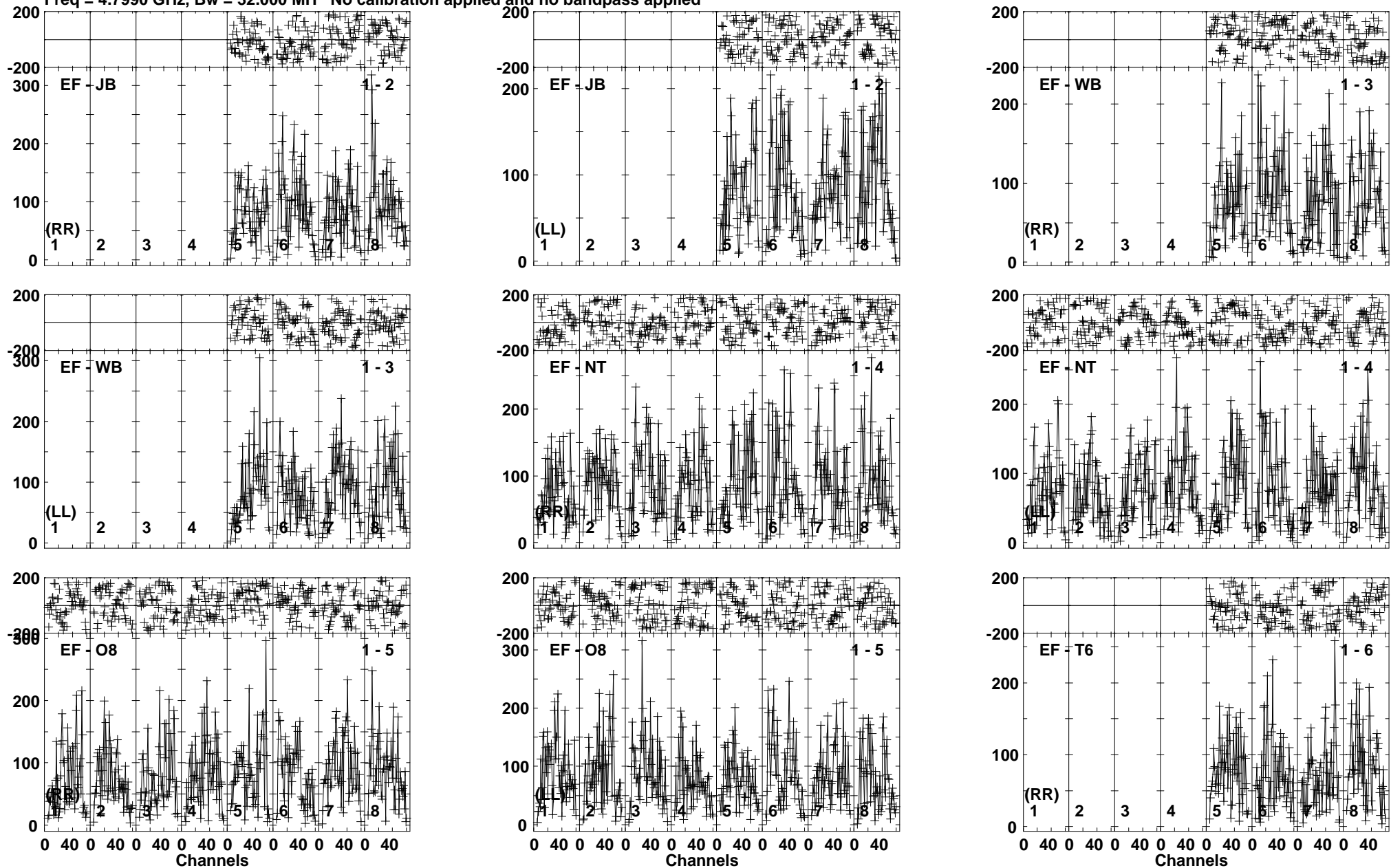

Lower frame: Micro Ampl Jy Top frame: Phas deg
 Vector averaged cross-power spectrum Baseline: EF (01) - JB (02)
 Timerange: 00/19:20:31 to 00/19:23:59

Plot file version 280 created 19-OCT-2017 15:36:33

MRK335 ES081C.UVDATA.1

Freq = 4.7990 GHz, Bw = 32.000 MH No calibration applied and no bandpass applied

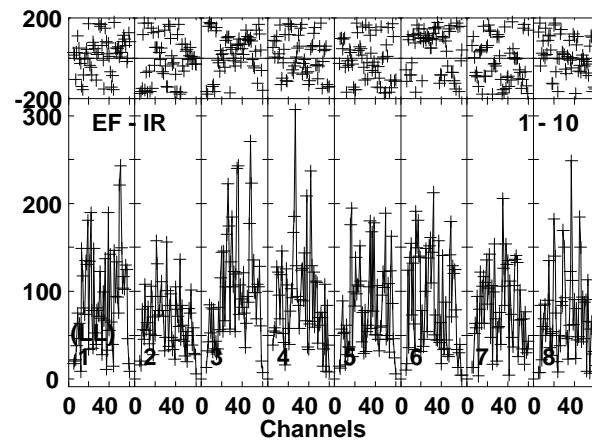
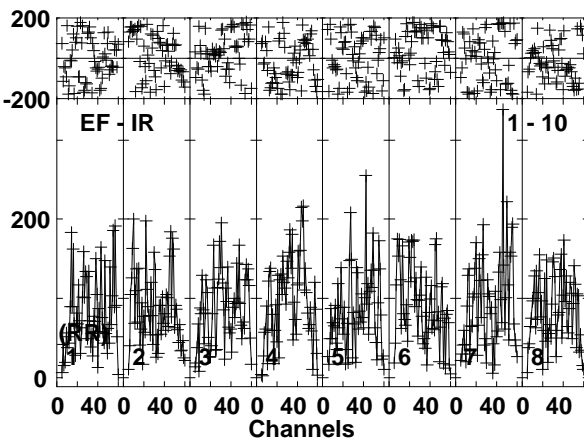
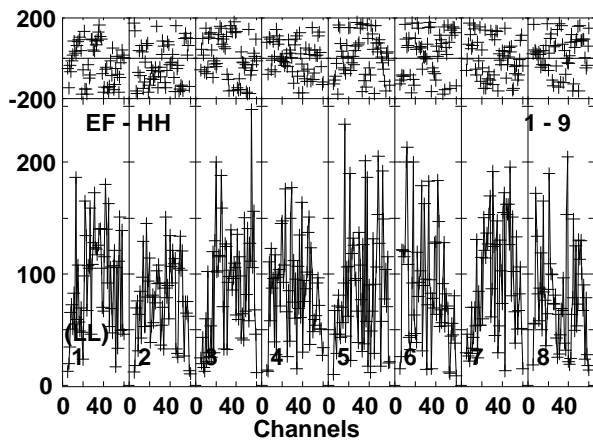
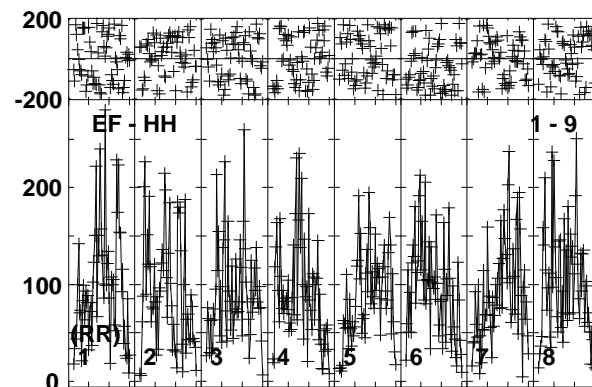
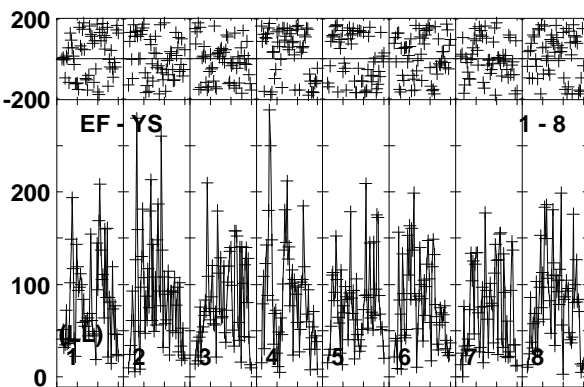
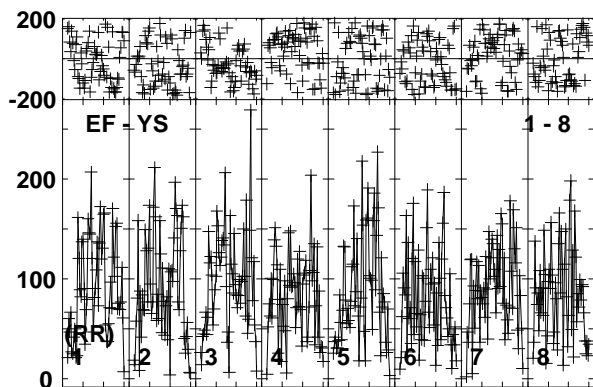
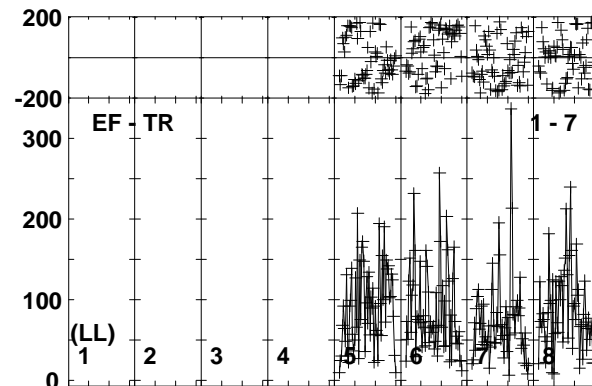
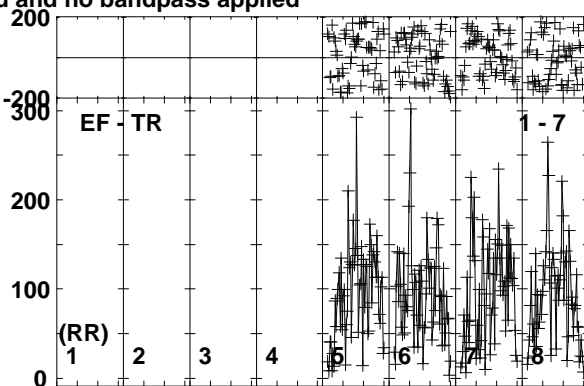
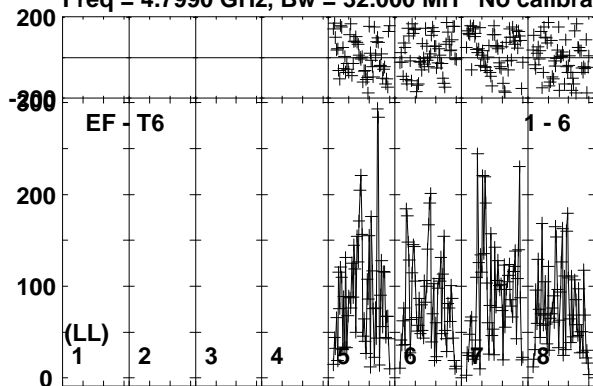

Lower frame: Micro Ampl Jy Top frame: Phas deg
Vector averaged cross-power spectrum Baseline: EF (01) - T6 (06)
Timerange: 00/19:20:31 to 00/19:23:59

Plot file version 281 created 19-OCT-2017 15:36:34

J0004+2019 ES081C.UVDATA.1

Freq = 4.7990 GHz, Bw = 32.000 MH No calibration applied and no bandpass applied

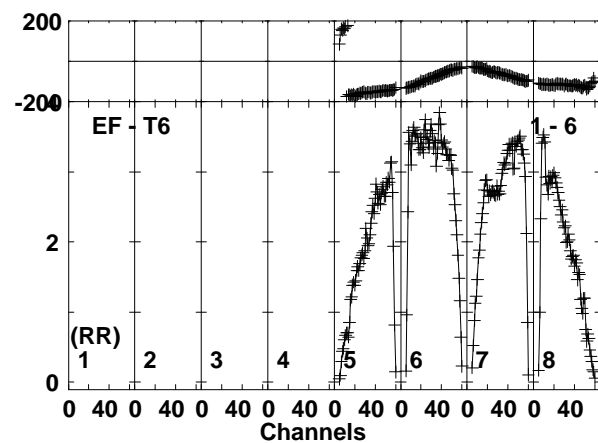
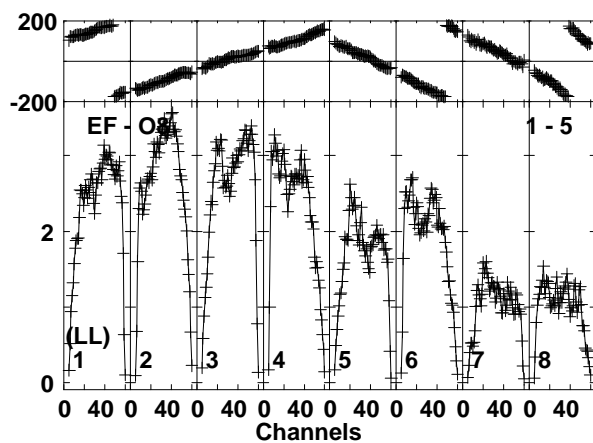
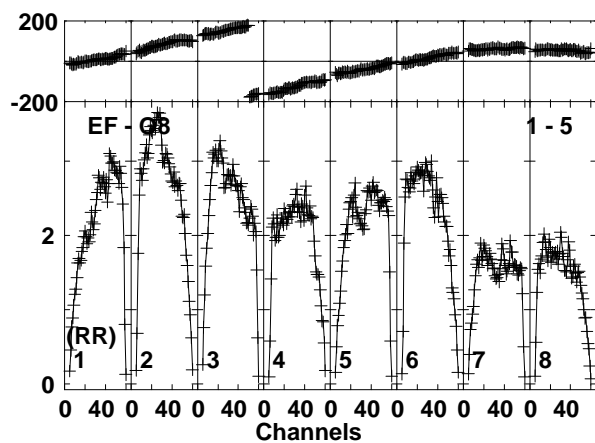
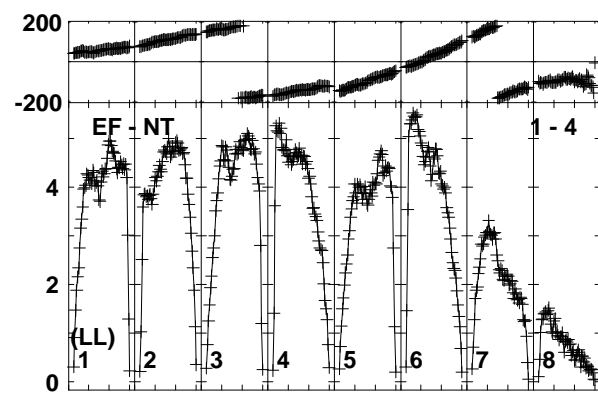
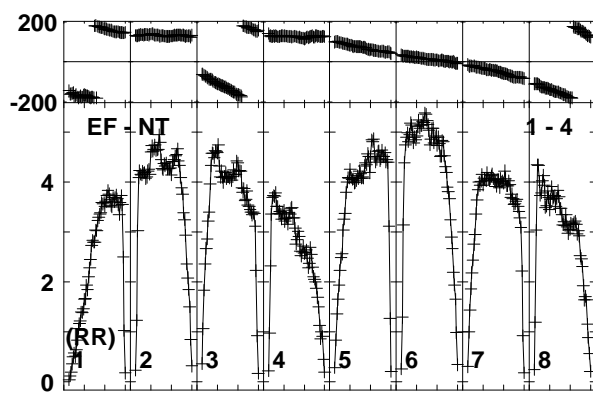
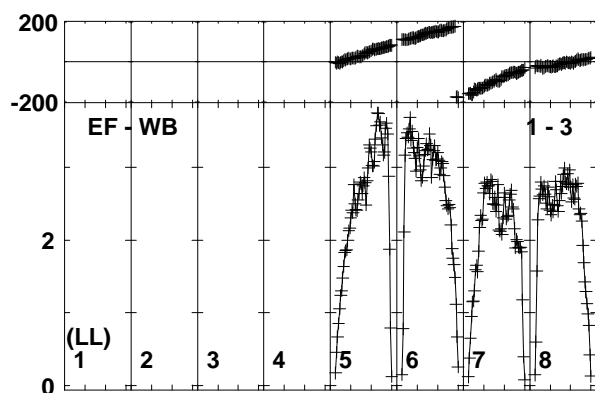
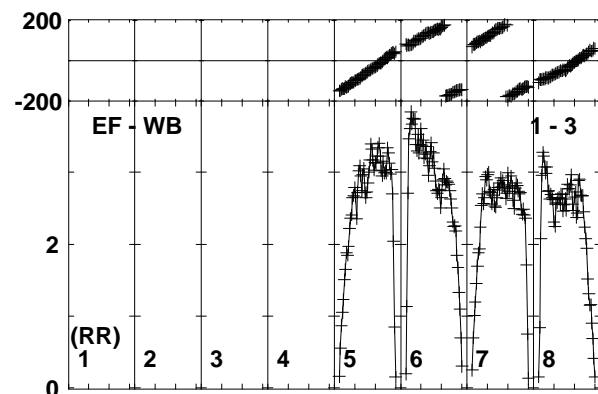
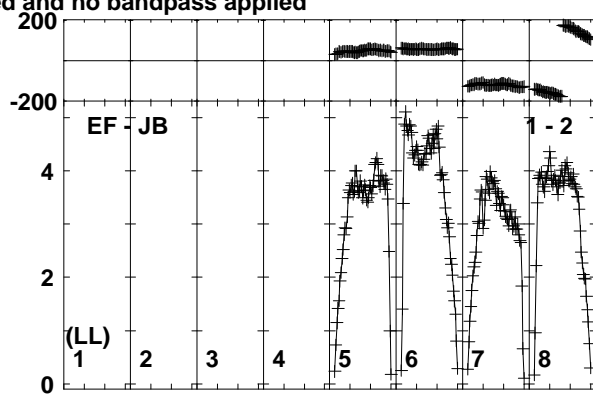
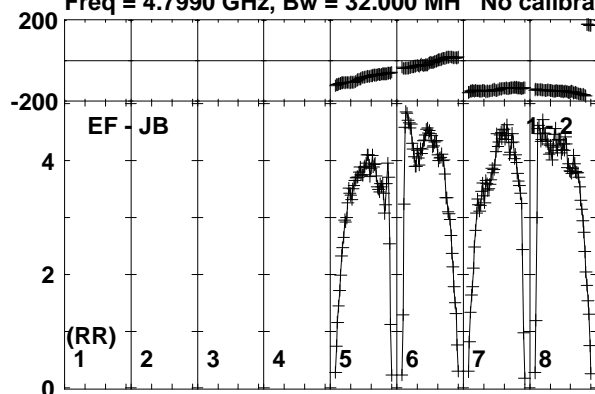

Lower frame: Milli Ampl Jy Top frame: Phas deg
Vector averaged cross-power spectrum Baseline: EF (01) - JB (02)
Timerange: 00/19:24:31 to 00/19:25:29

Plot file version 282 created 19-OCT-2017 15:36:34

J0004+2019 ES081C.UVDATA.1

Freq = 4.7990 GHz, Bw = 32.000 MH No calibration applied and no bandpass applied

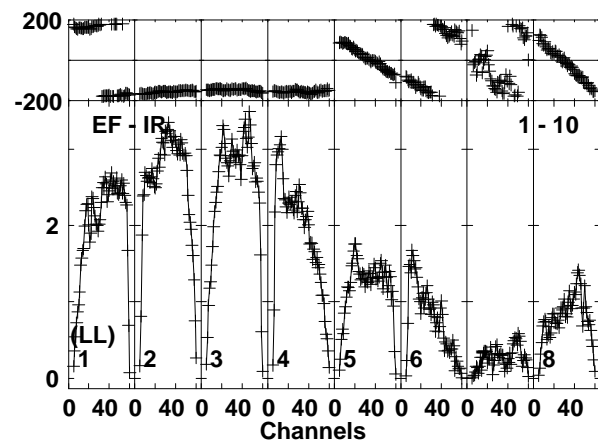
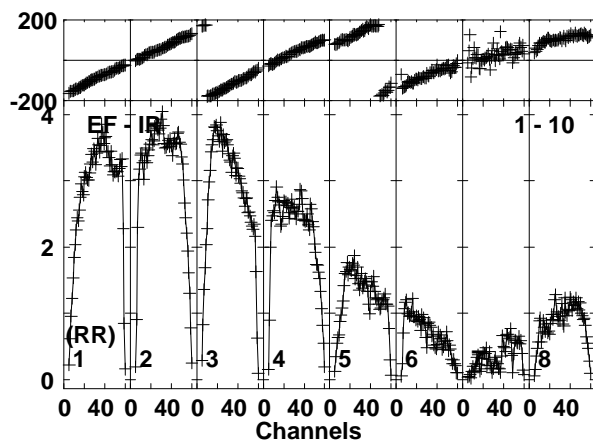
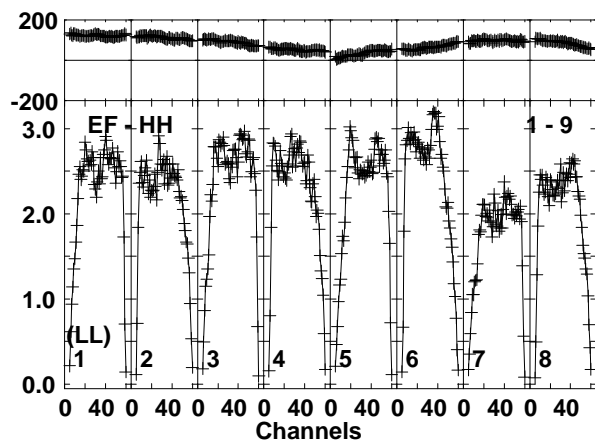
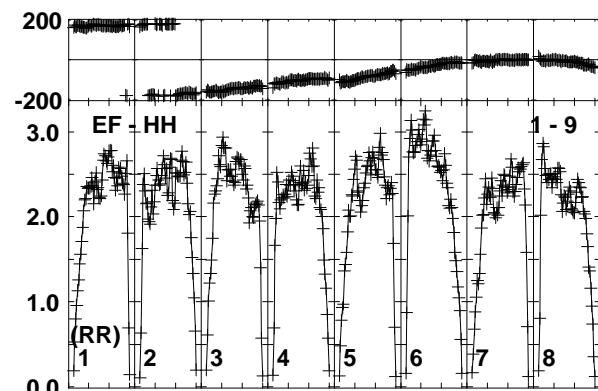
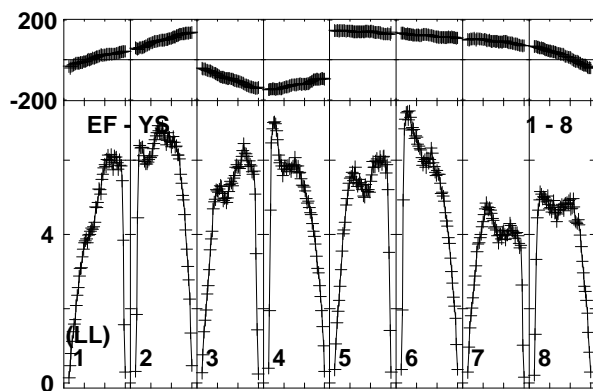
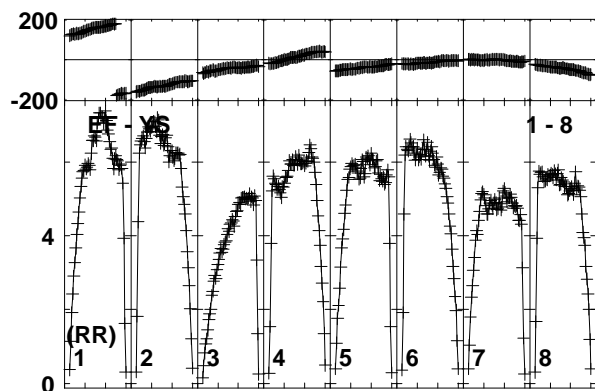
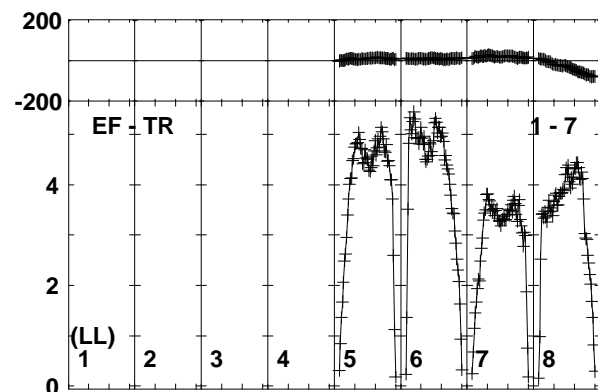
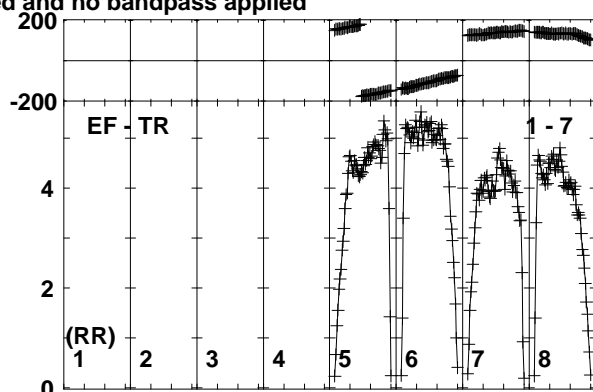
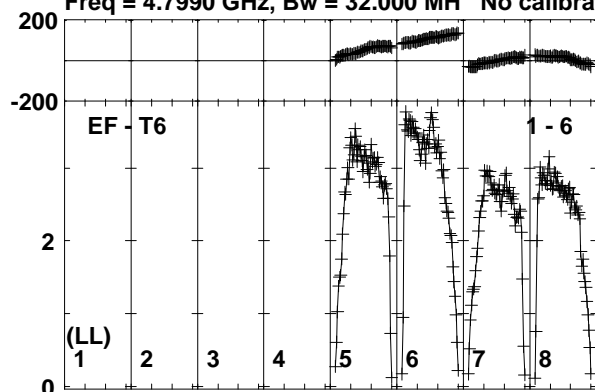

Lower frame: Milli Ampl Jy Top frame: Phas deg
Vector averaged cross-power spectrum Baseline: EF (01) - T6 (06)
Timerange: 00:19:24:31 to 00:19:25:29

Plot file version 283 created 19-OCT-2017 15:36:34

MRK335 ES081C.UVDATA.1

Freq = 4.7990 GHz, Bw = 32.000 MH No calibration applied and no bandpass applied

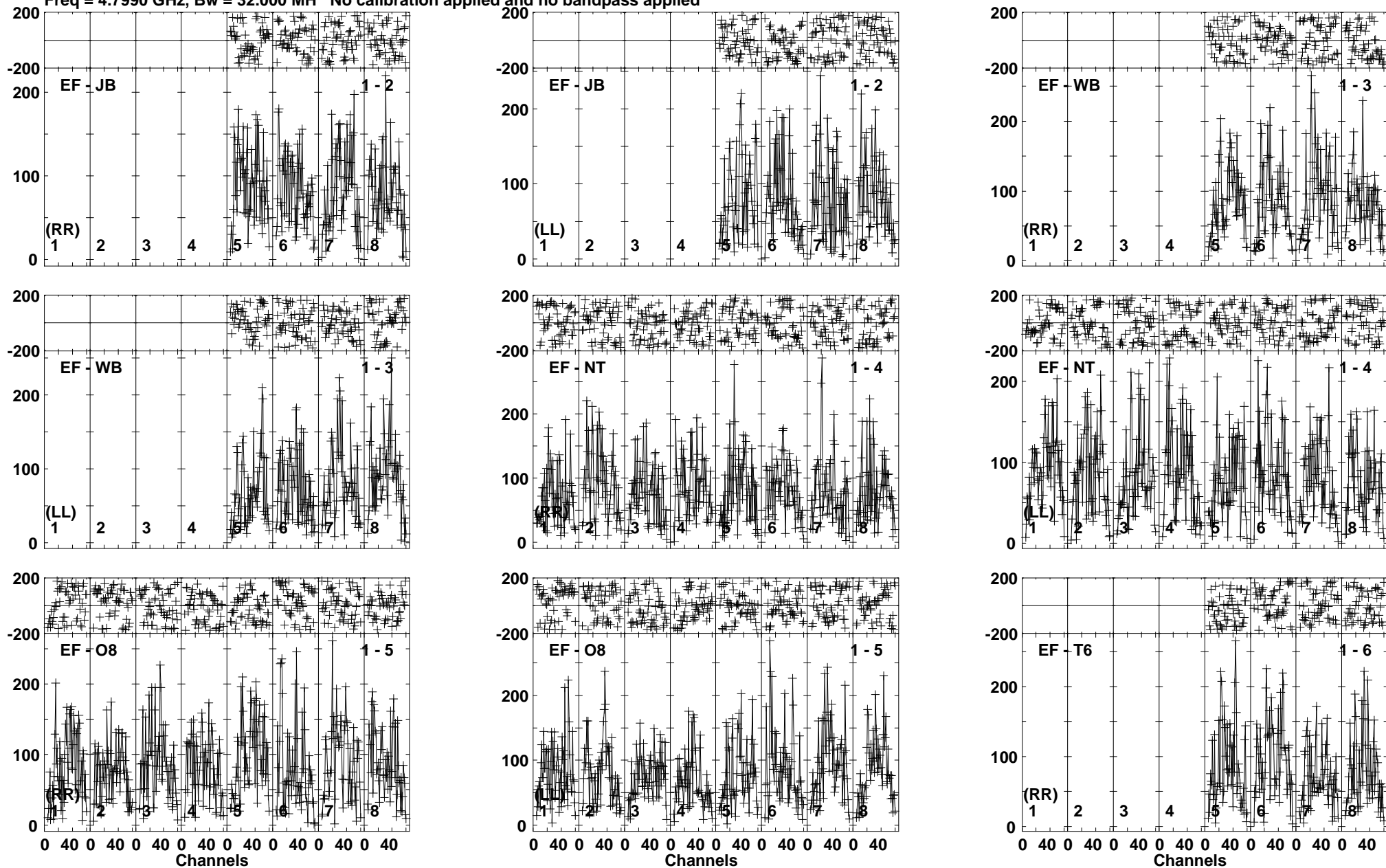

Lower frame: Micro Ampl Jy Top frame: Phas deg
Vector averaged cross-power spectrum Baseline: EF (01) - JB (02)
Timerange: 00/19:25:31 to 00/19:28:59

Plot file version 284 created 19-OCT-2017 15:36:34

MRK335 ES081C.UVDATA.1

Freq = 4.7990 GHz, Bw = 32.000 MH No calibration applied and no bandpass applied

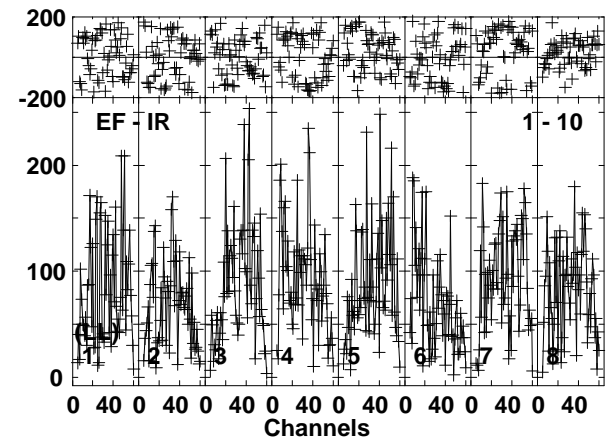
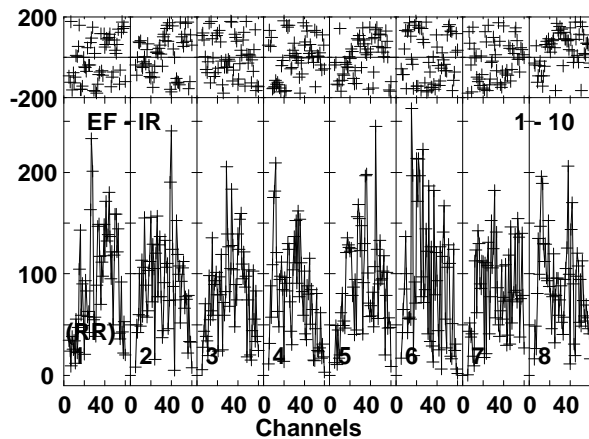
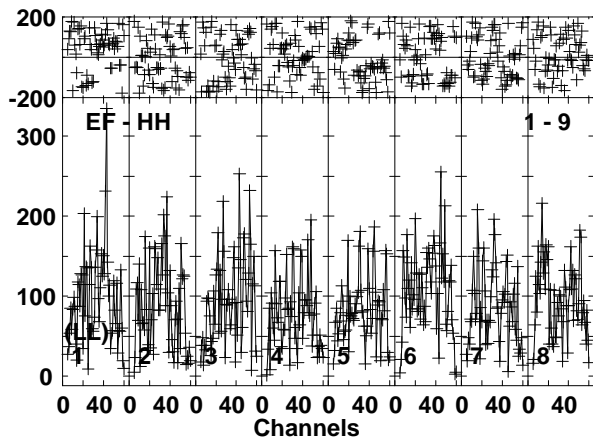
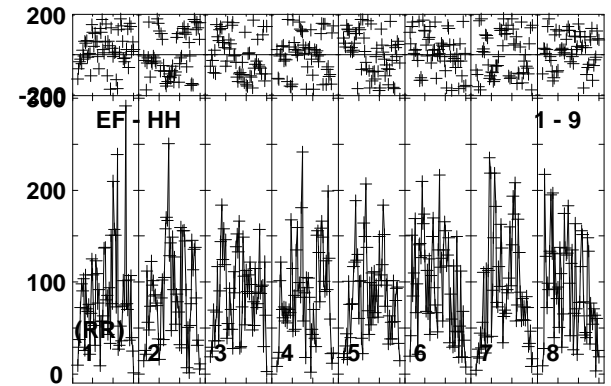
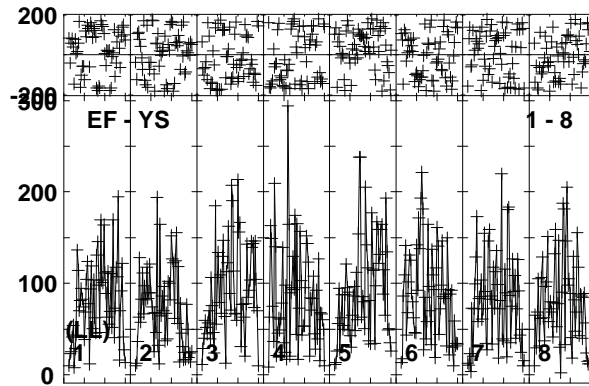
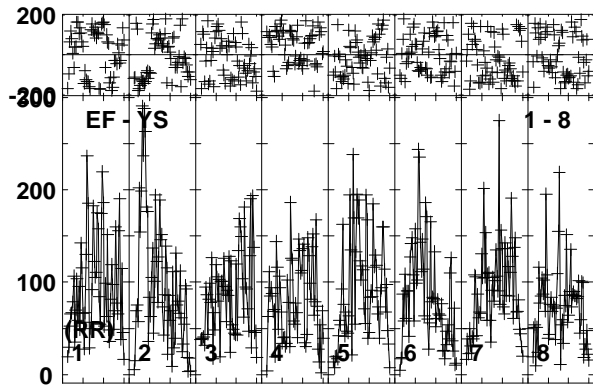
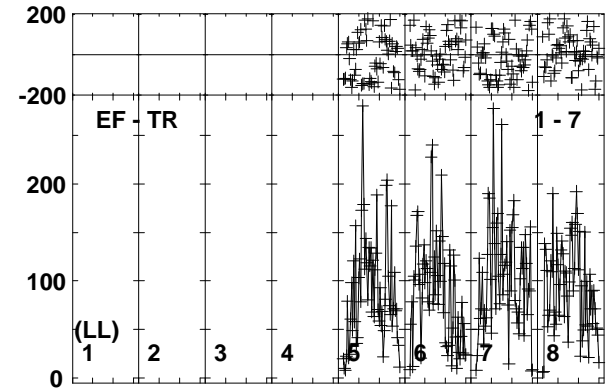
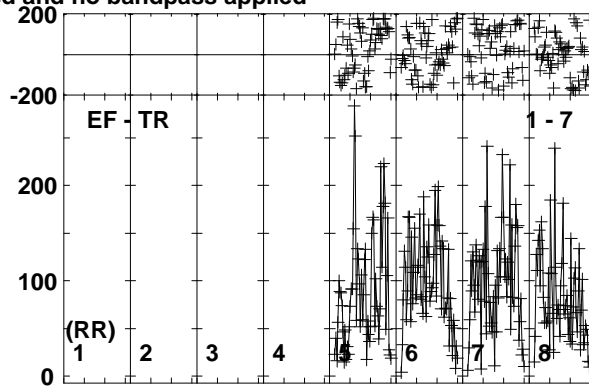
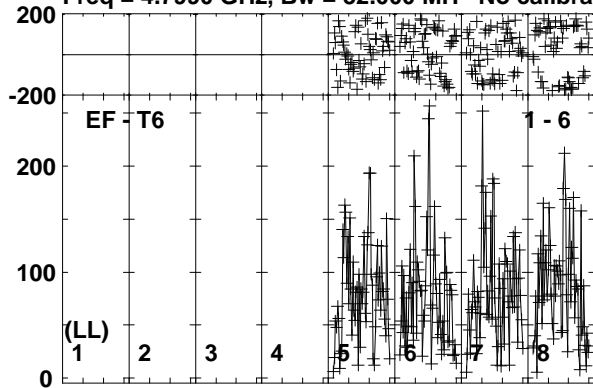

Lower frame: Micro Ampl Jy Top frame: Phas deg
Vector averaged cross-power spectrum Baseline: EF (01) - T6 (06)
Timerange: 00/19:25:31 to 00/19:28:59

Plot file version 285 created 19-OCT-2017 15:36:34

J0004+2019 ES081C.UVDATA.1

Freq = 4.7990 GHz, Bw = 32.000 MH No calibration applied and no bandpass applied

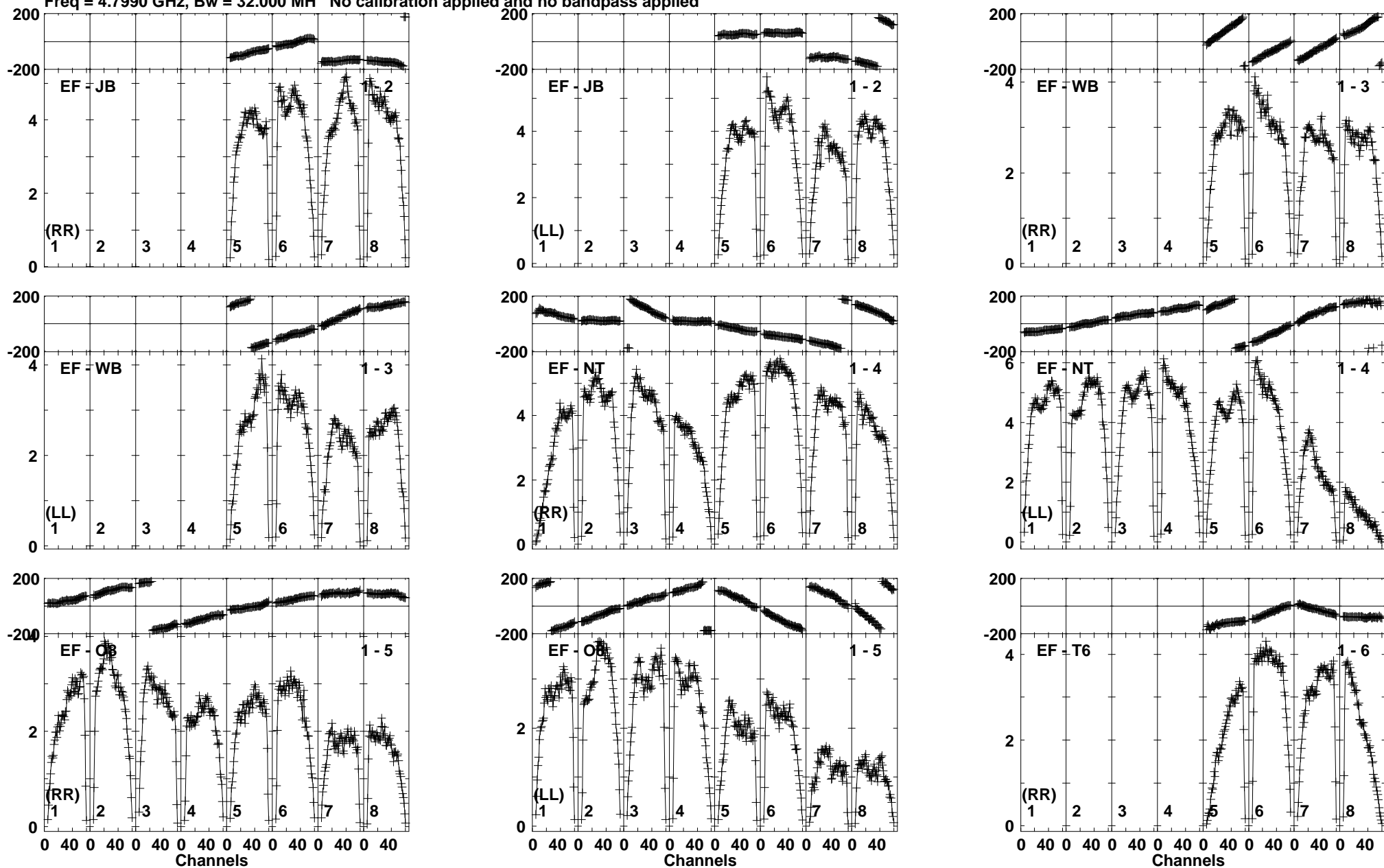

Lower frame: Milli Ampl Jy Top frame: Phas deg
Vector averaged cross-power spectrum Baseline: EF (01) - JB (02)
Timerange: 00/19:29:01 to 00/19:30:29

Plot file version 286 created 19-OCT-2017 15:36:34

J0004+2019 ES081C.UVDATA.1

Freq = 4.7990 GHz, Bw = 32.000 MH No calibration applied and no bandpass applied

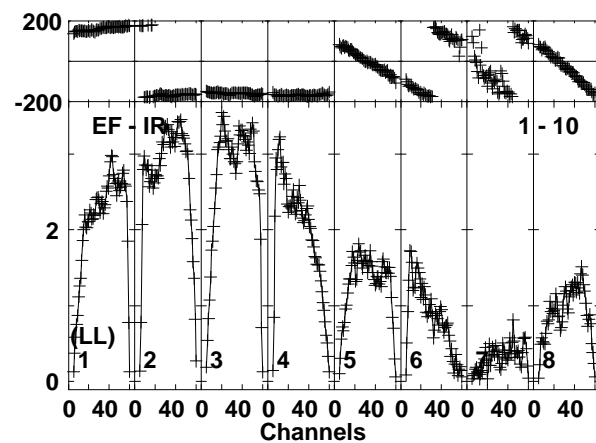
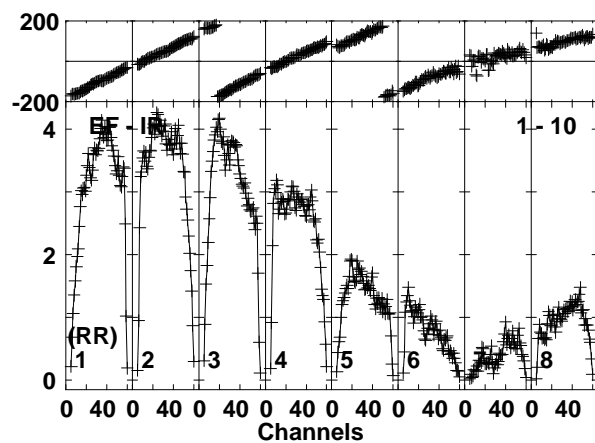
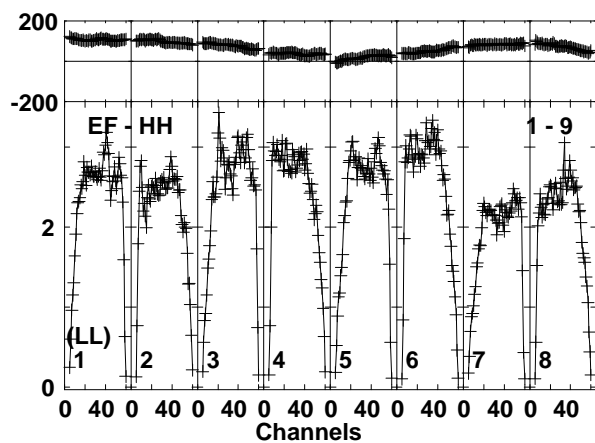
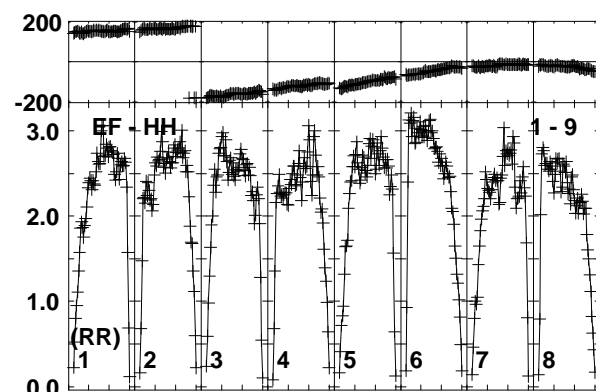
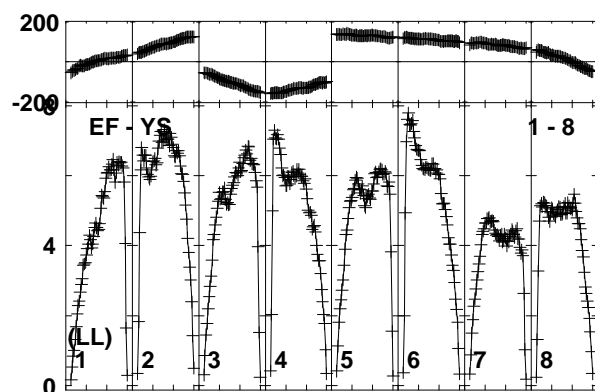
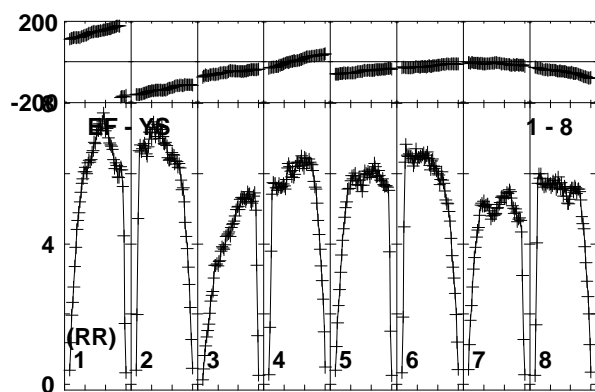
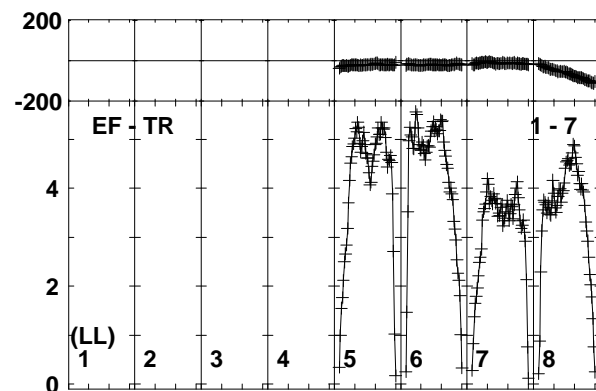
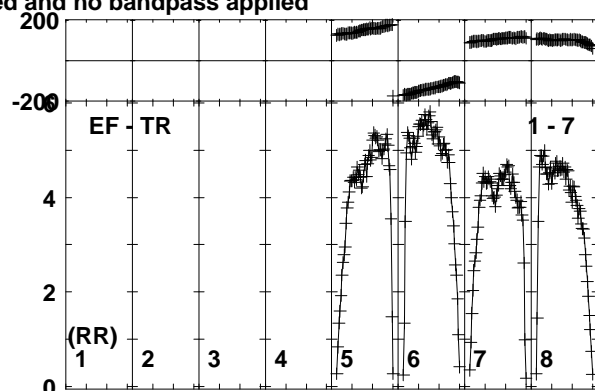
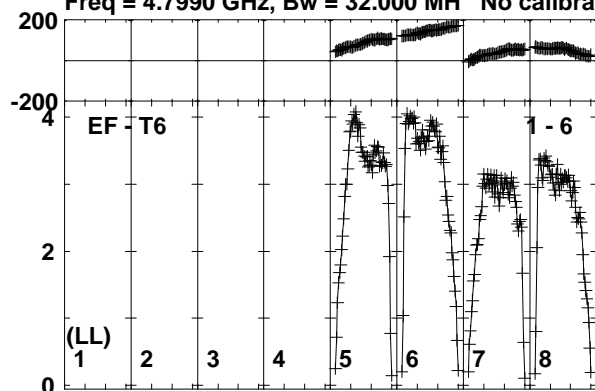

Lower frame: Milli Ampl Jy Top frame: Phas deg
Vector averaged cross-power spectrum Baseline: EF (01) - T6 (06)
Timerange: 00:19:29:01 to 00:19:30:29

Plot file version 287 created 19-OCT-2017 15:36:35

MRK335 ES081C.UVDATA.1

Freq = 4.7990 GHz, Bw = 32.000 MH No calibration applied and no bandpass applied

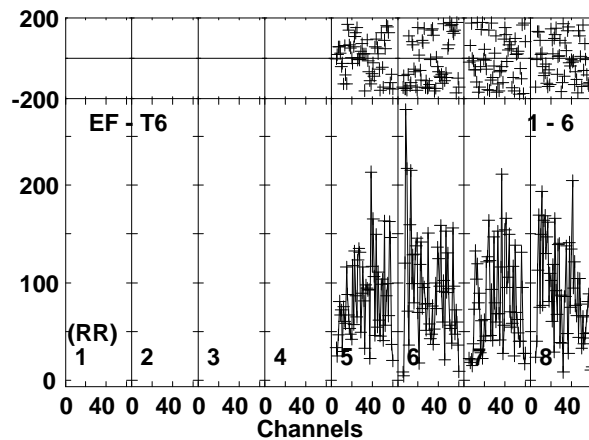
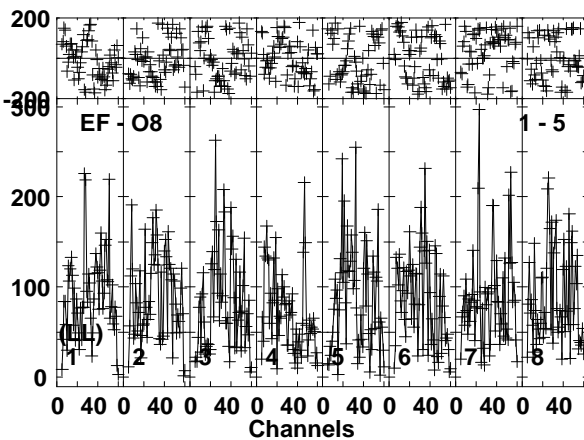
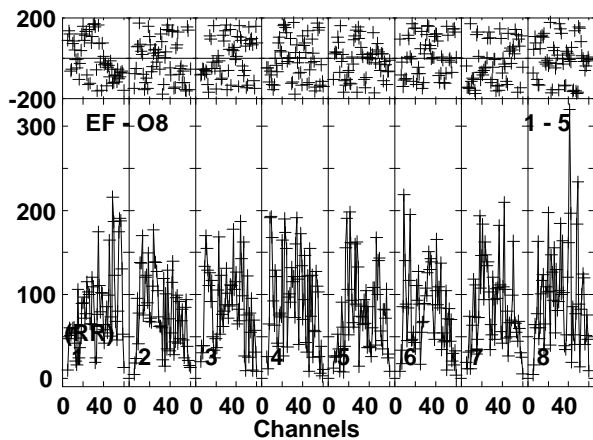
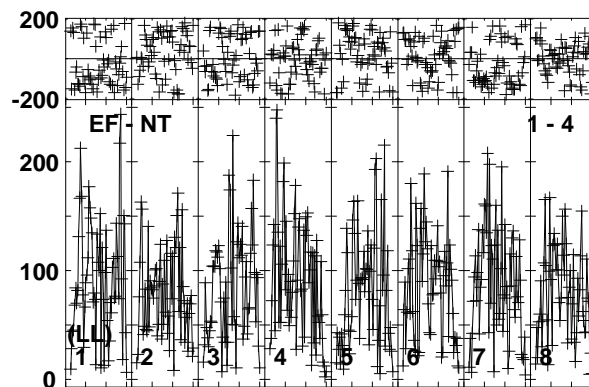
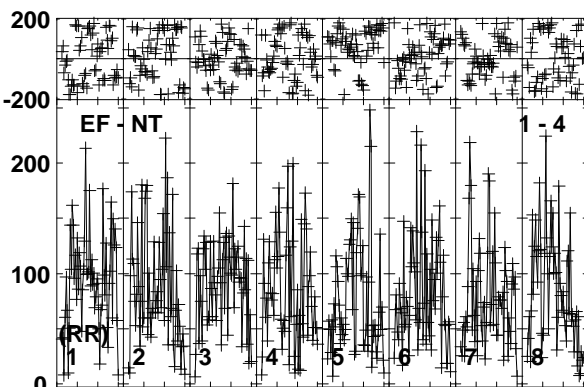
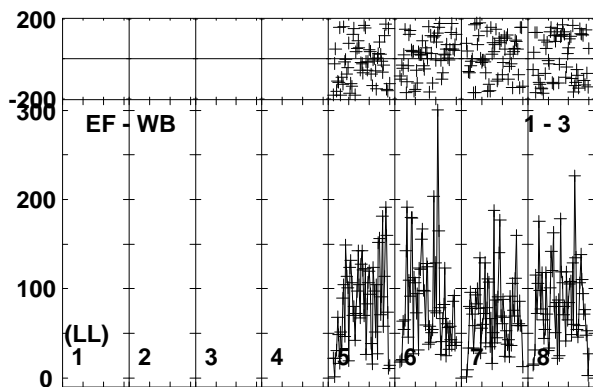
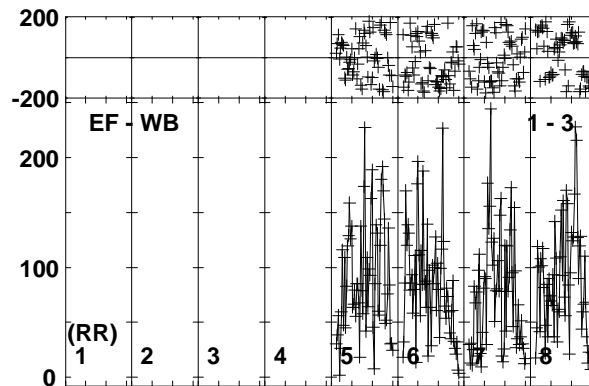
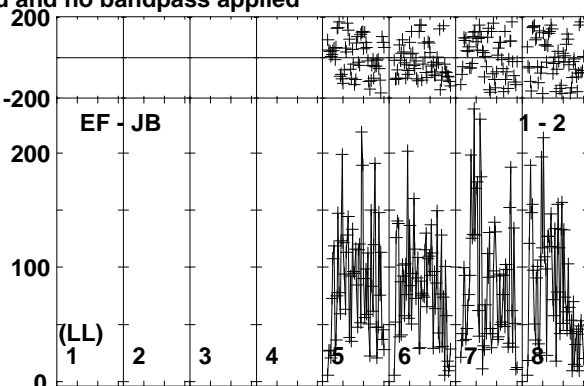
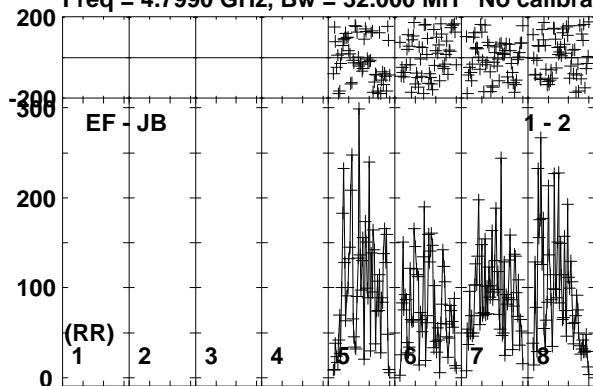

Lower frame: Micro Ampl Jy Top frame: Phas deg
Vector averaged cross-power spectrum Baseline: EF (01) - JB (02)
Timerange: 00/19:30:31 to 00/19:33:59

Plot file version 288 created 19-OCT-2017 15:36:35

MRK335 ES081C.UVDATA.1

Freq = 4.7990 GHz, Bw = 32.000 MH No calibration applied and no bandpass applied

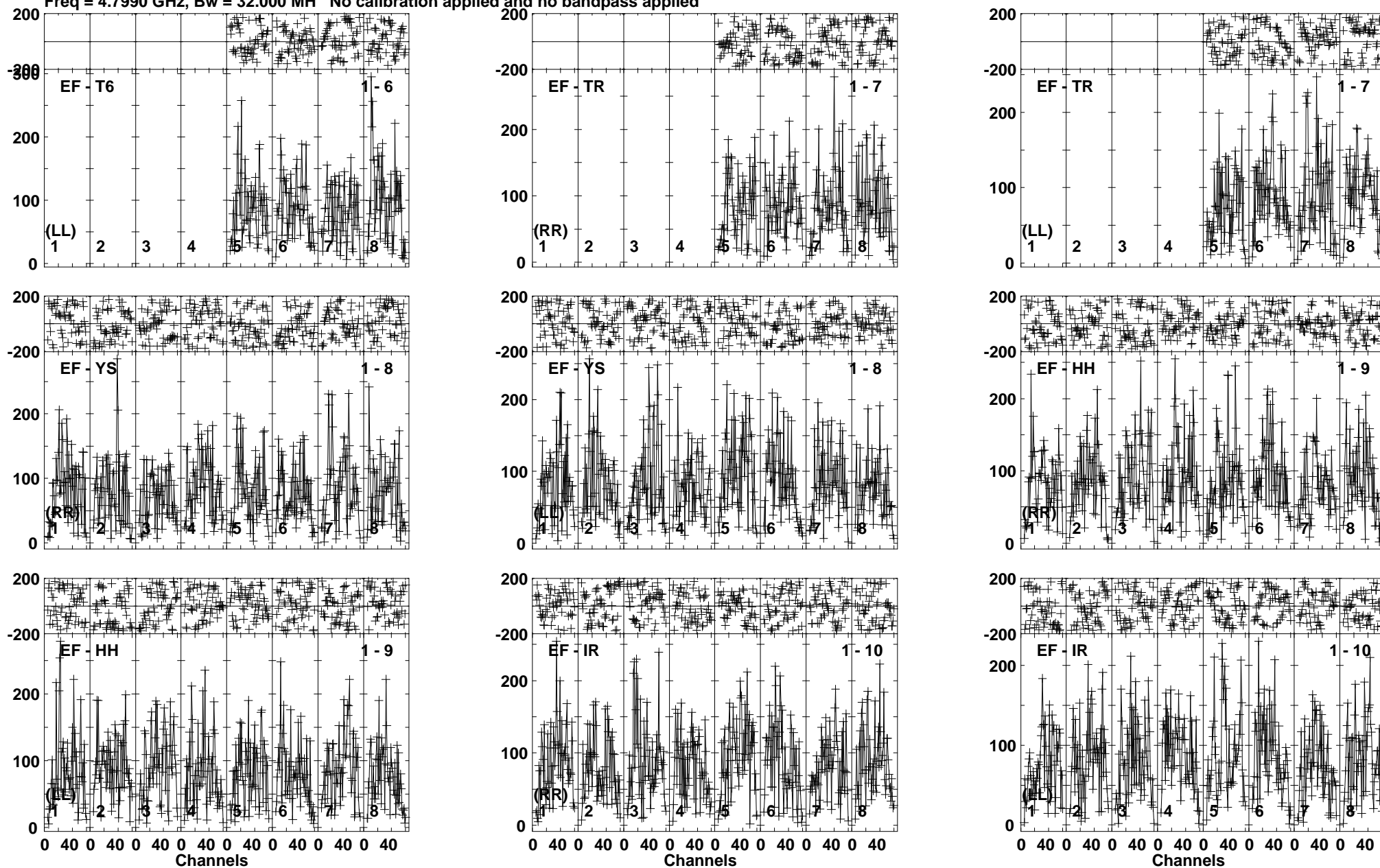

Lower frame: Micro Ampl Jy Top frame: Phas deg
Vector averaged cross-power spectrum Baseline: EF (01) - T6 (06)
Timerange: 00/19:30:31 to 00/19:33:59

Plot file version 289 created 19-OCT-2017 15:36:35

J0004+2019 ES081C.UVDATA.1

Freq = 4.7990 GHz, Bw = 32.000 MH No calibration applied and no bandpass applied

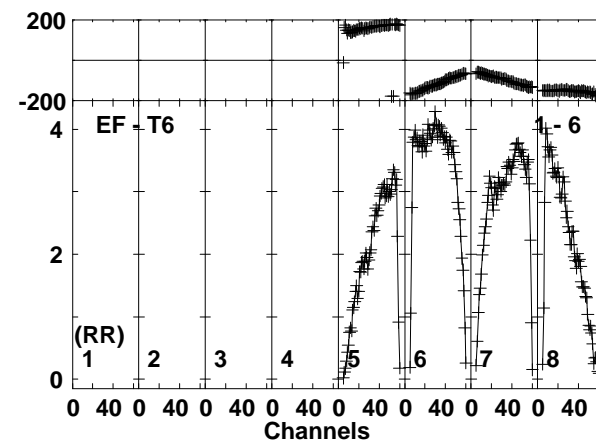
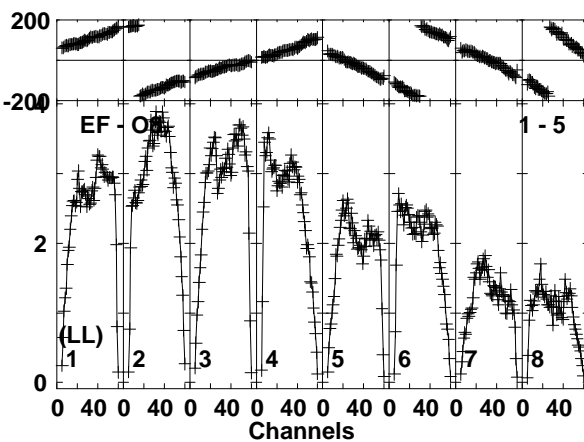
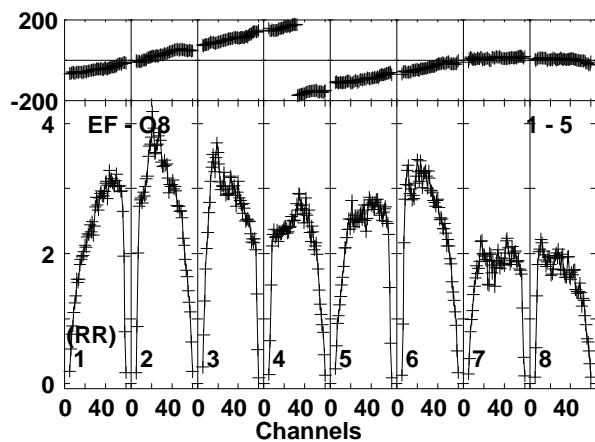
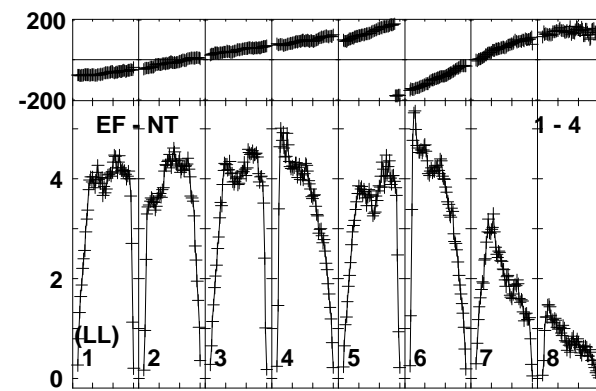
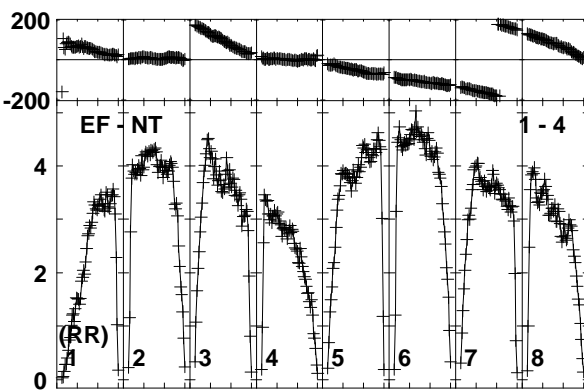
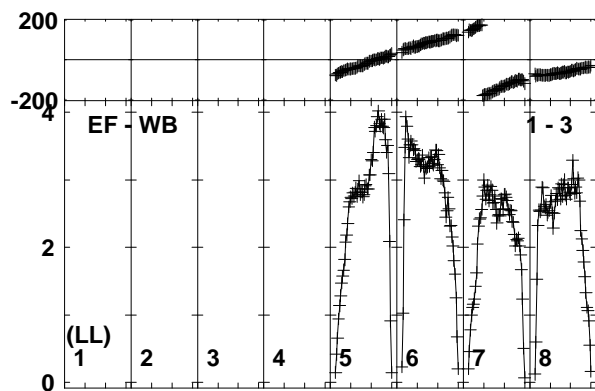
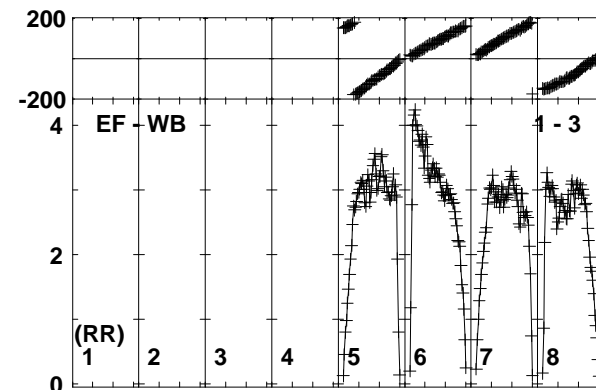
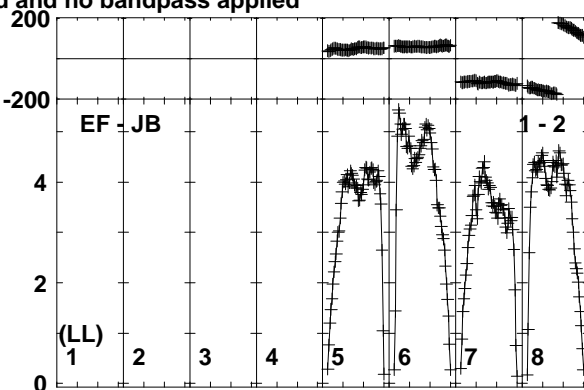
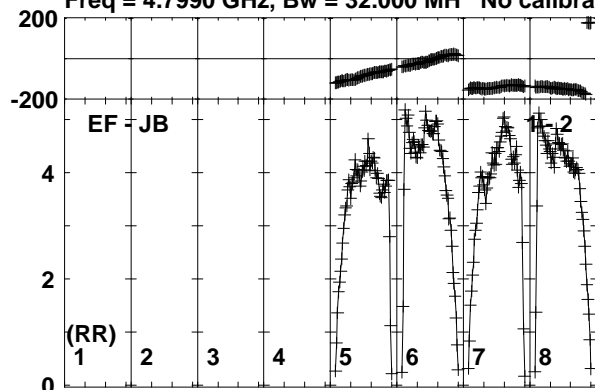

Lower frame: Milli Ampl Jy Top frame: Phas deg
Vector averaged cross-power spectrum Baseline: EF (01) - JB (02)
Timerange: 00/19:34:31 to 00/19:35:29

Plot file version 290 created 19-OCT-2017 15:36:35

J0004+2019 ES081C.UVDATA.1

Freq = 4.7990 GHz, Bw = 32.000 MH No calibration applied and no bandpass applied

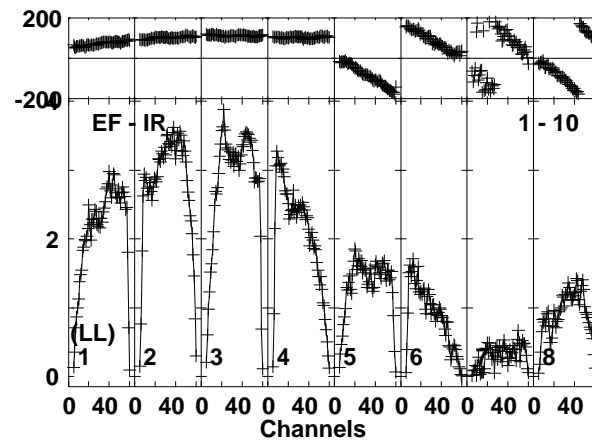
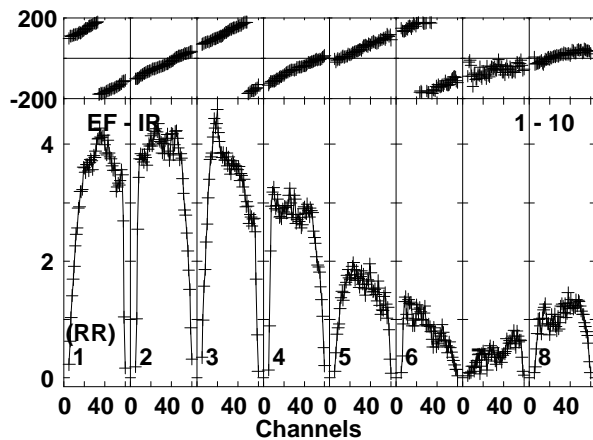
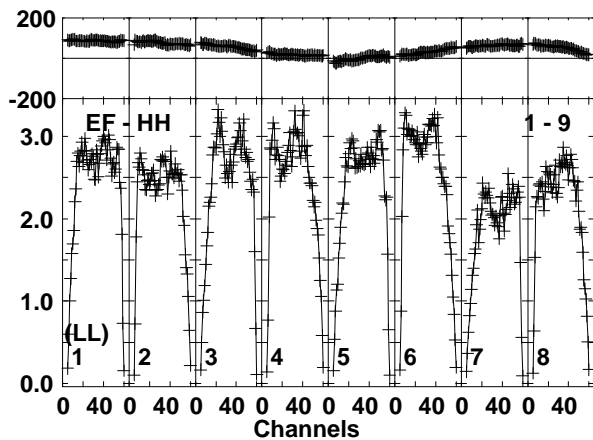
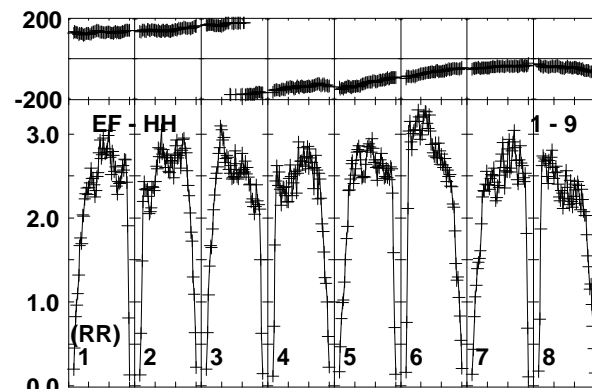
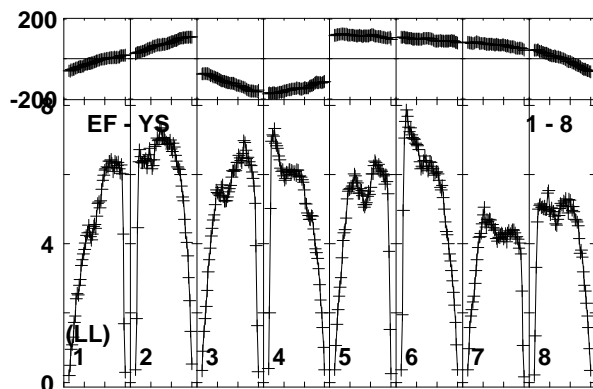
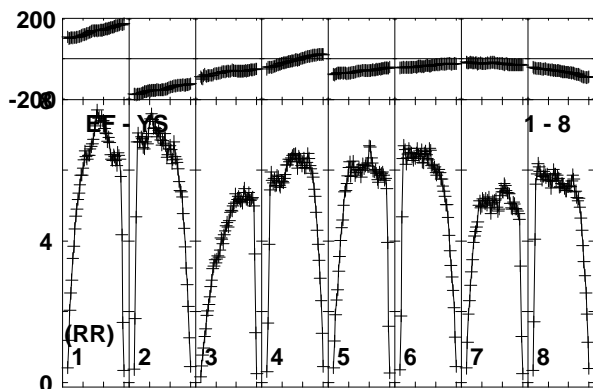
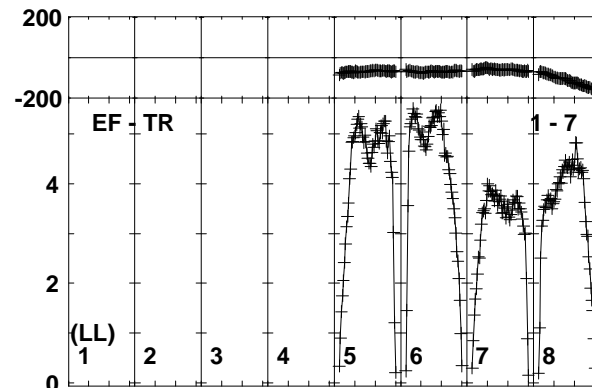
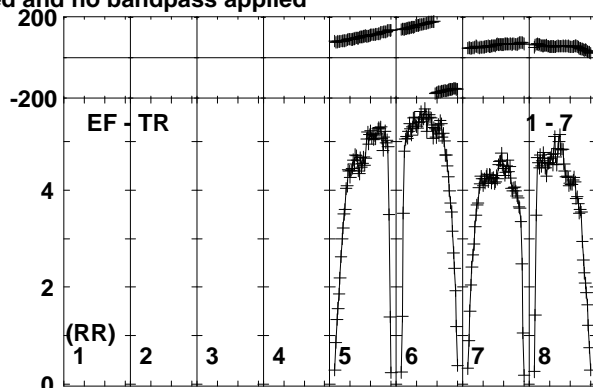
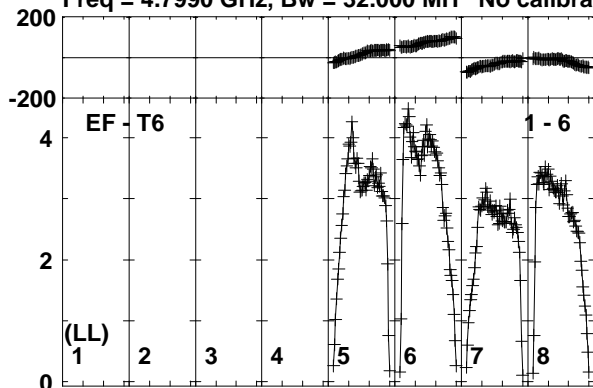

Lower frame: Milli Ampl Jy Top frame: Phas deg
Vector averaged cross-power spectrum Baseline: EF (01) - T6 (06)
Timerange: 00/19:34:31 to 00/19:35:29

Plot file version 291 created 19-OCT-2017 15:36:35

MRK335 ES081C.UVDATA.1

Freq = 4.7990 GHz, Bw = 32.000 MH No calibration applied and no bandpass applied

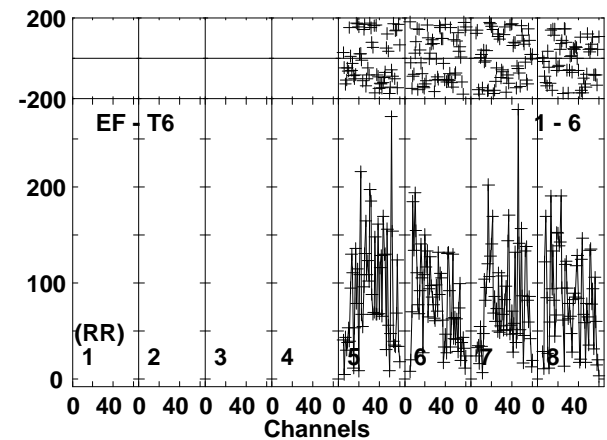
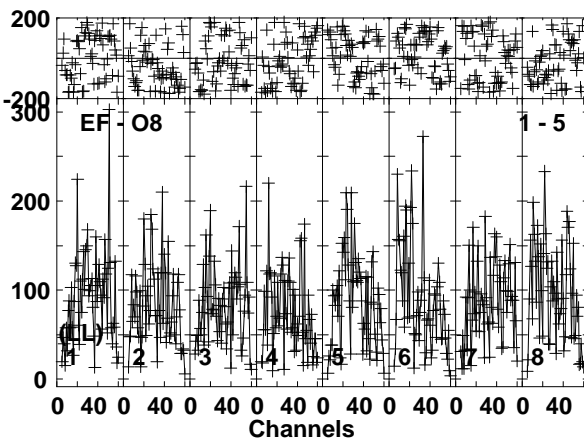
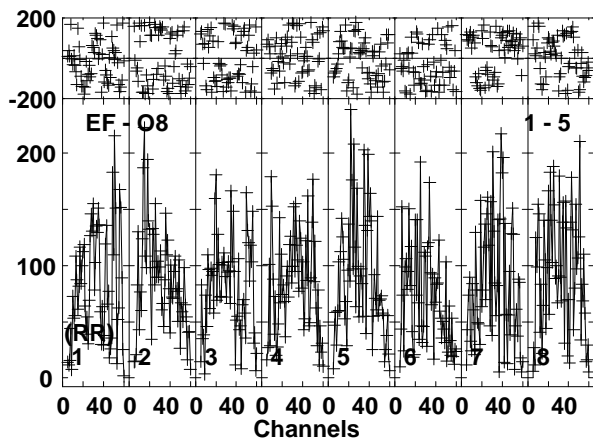
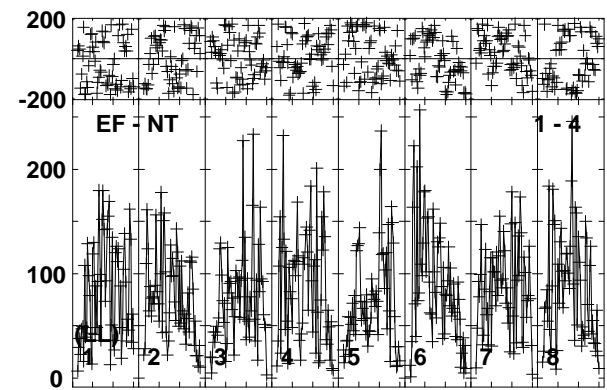
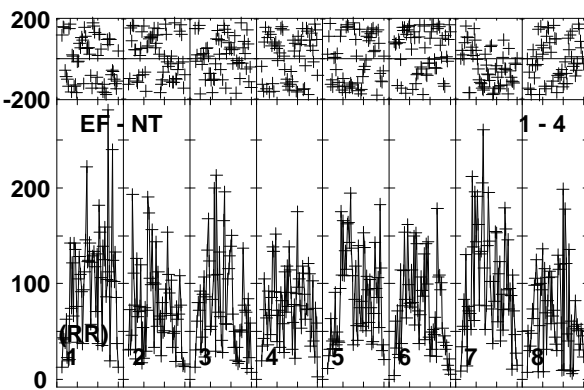
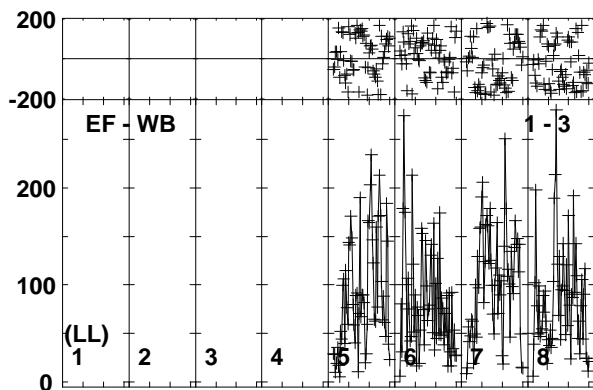
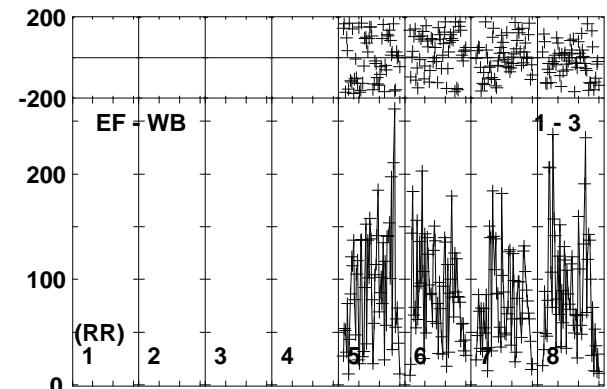
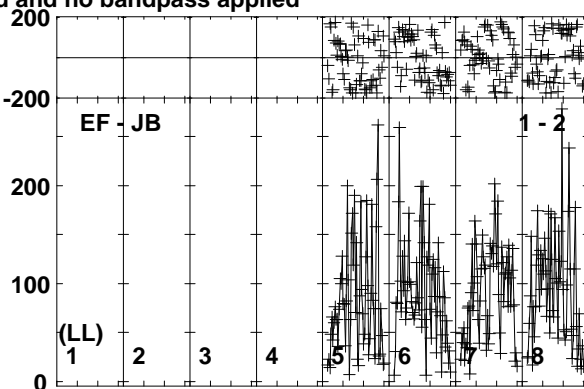
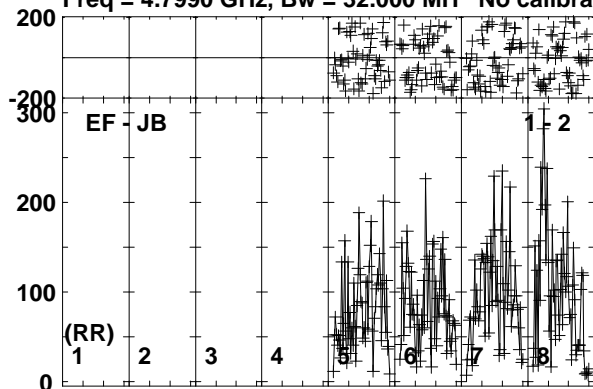

Lower frame: Micro Ampl Jy Top frame: Phas deg
Vector averaged cross-power spectrum Baseline: EF (01) - JB (02)
Timerange: 00/19:35:31 to 00/19:38:59

Plot file version 292 created 19-OCT-2017 15:36:35

MRK335 ES081C.UVDATA.1

Freq = 4.7990 GHz, Bw = 32.000 MH No calibration applied and no bandpass applied

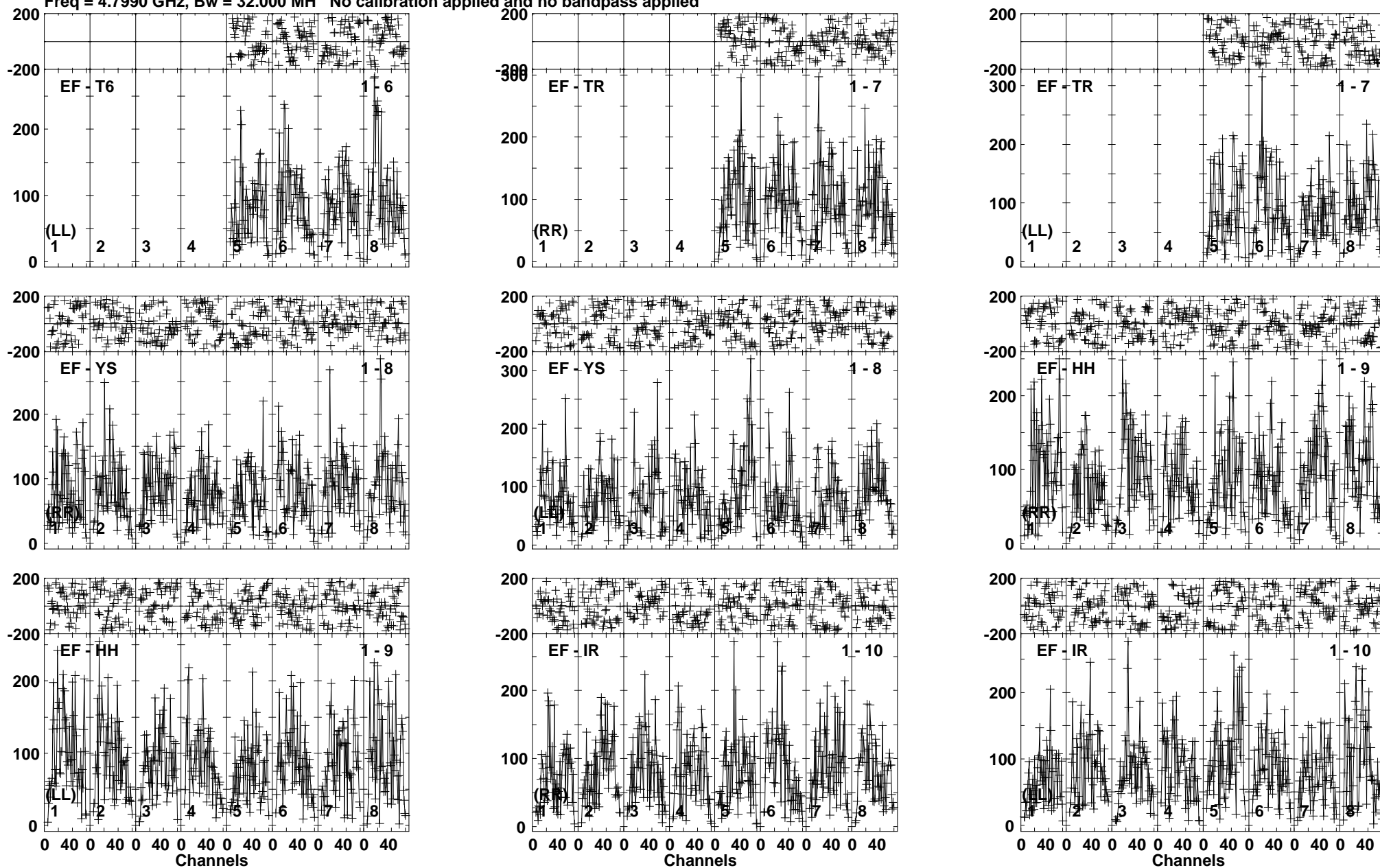

Lower frame: Micro Ampl Jy Top frame: Phas deg
Vector averaged cross-power spectrum Baseline: EF (01) - T6 (06)
Timerange: 00/19:35:31 to 00/19:38:59

Plot file version 293 created 19-OCT-2017 15:36:35

J0004+2019 ES081C.UVDATA.1

Freq = 4.7990 GHz, Bw = 32.000 MH No calibration applied and no bandpass applied

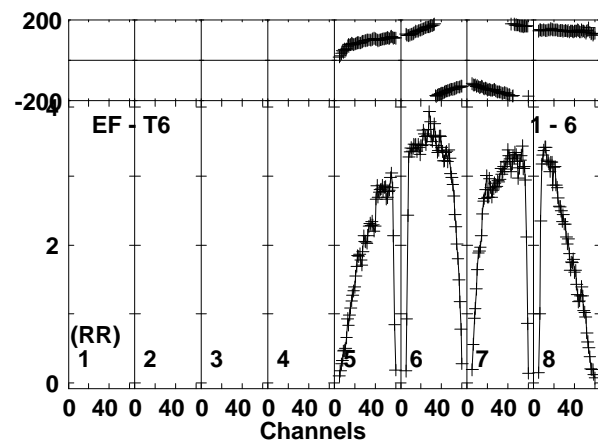
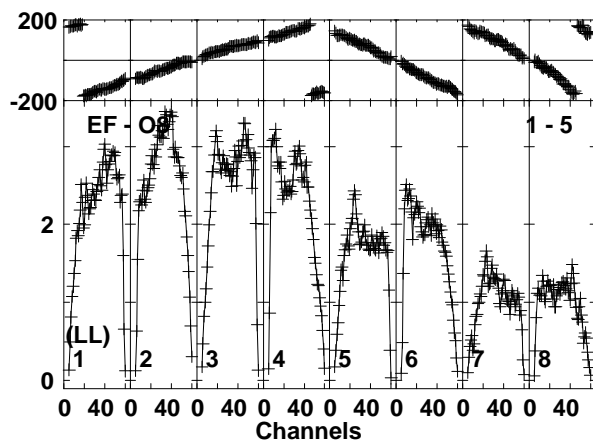
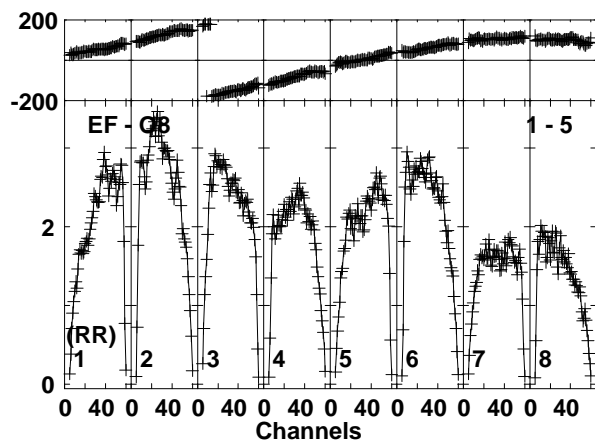
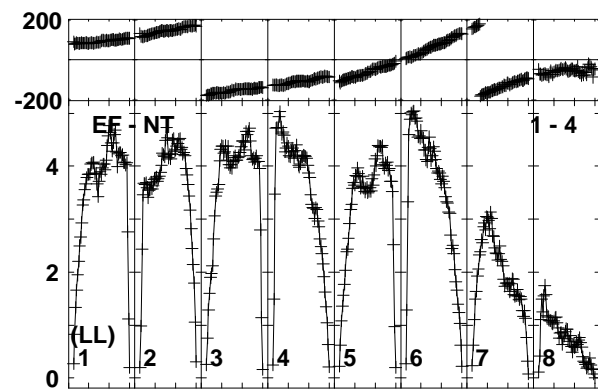
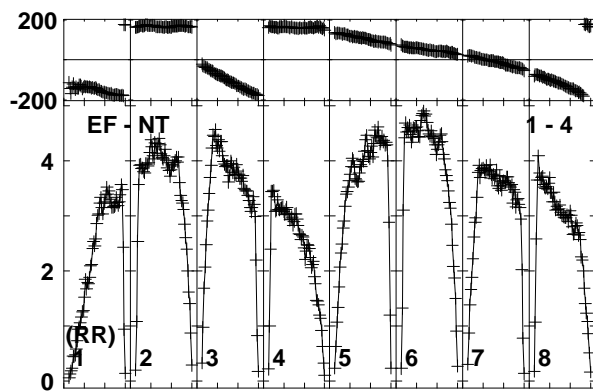
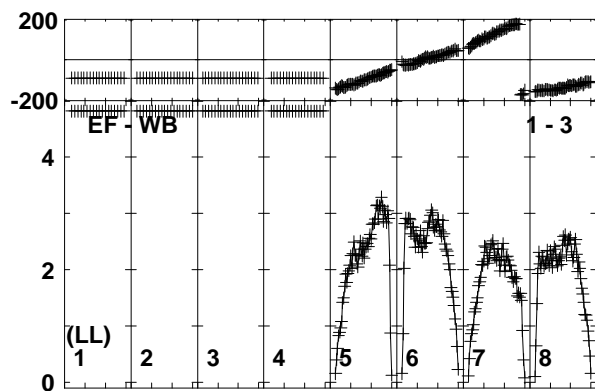
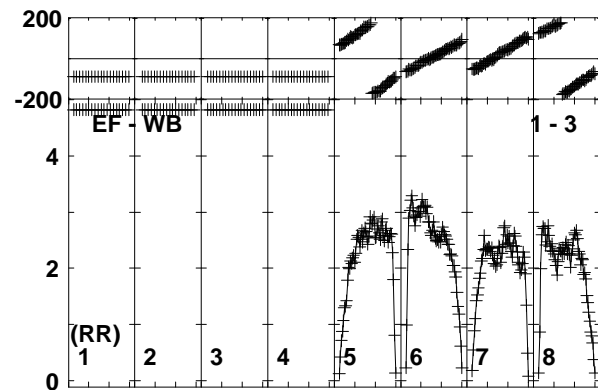
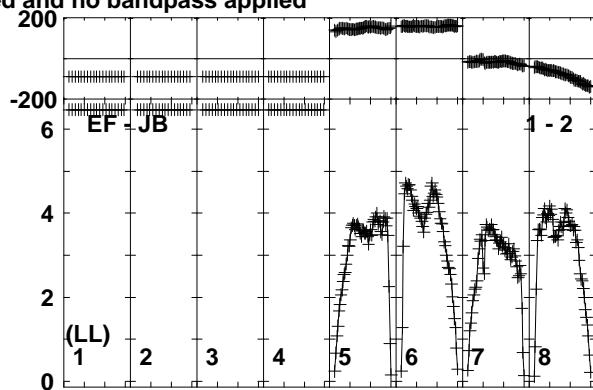
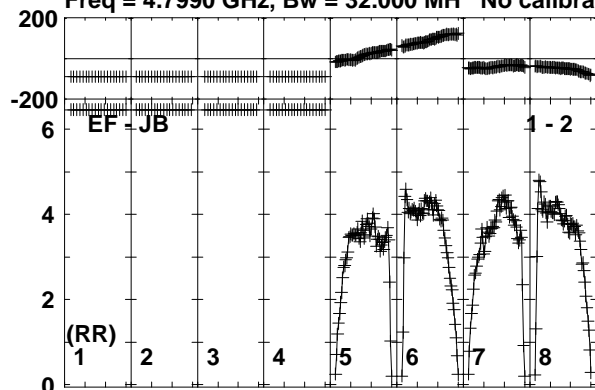

Lower frame: Milli Ampl Jy Top frame: Phas deg
Vector averaged cross-power spectrum Baseline: EF (01) - JB (02)
Timerange: 00/19:39:01 to 00/19:40:29

Plot file version 294 created 19-OCT-2017 15:36:36

J0004+2019 ES081C.UVDATA.1

Freq = 4.7990 GHz, Bw = 32.000 MH No calibration applied and no bandpass applied

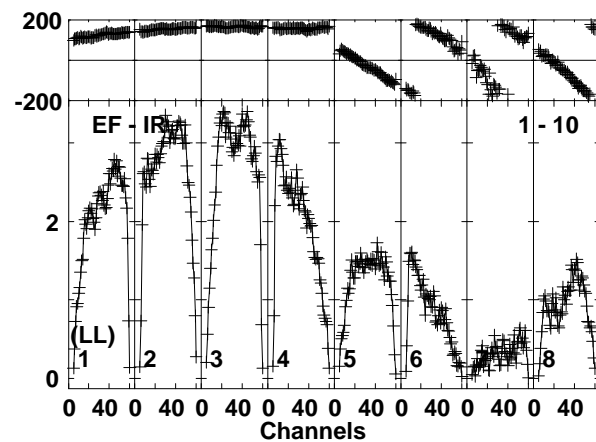
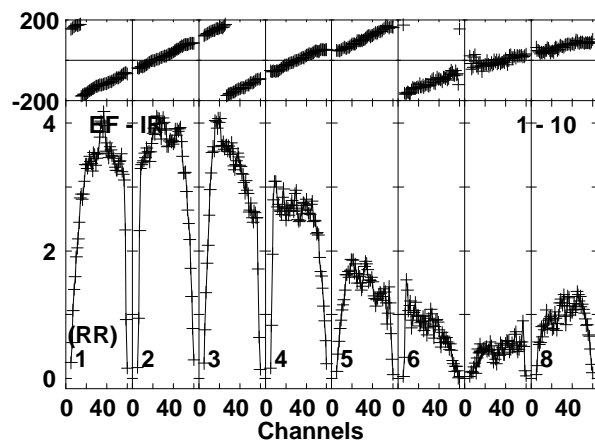
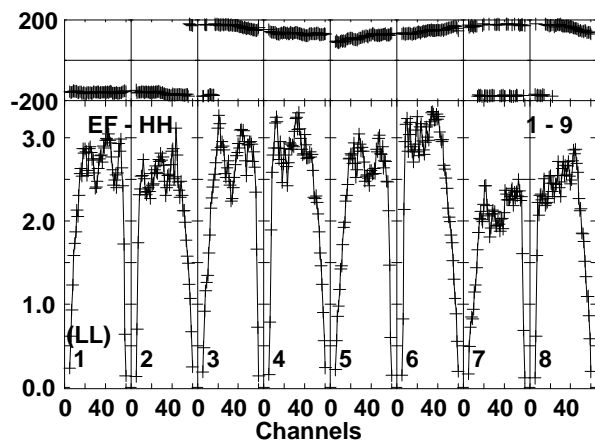
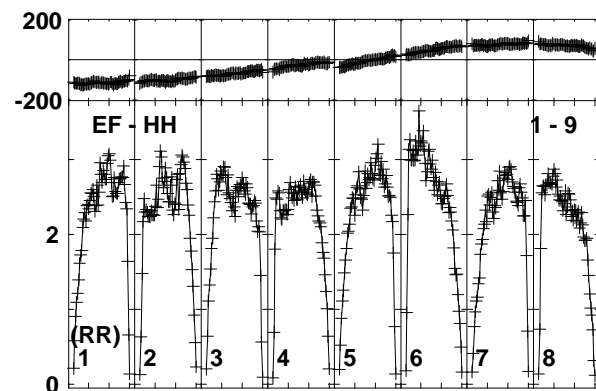
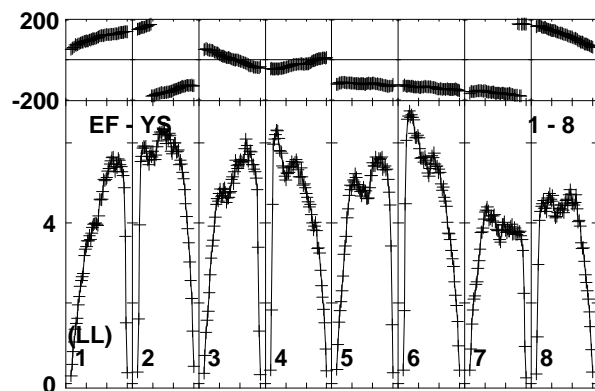
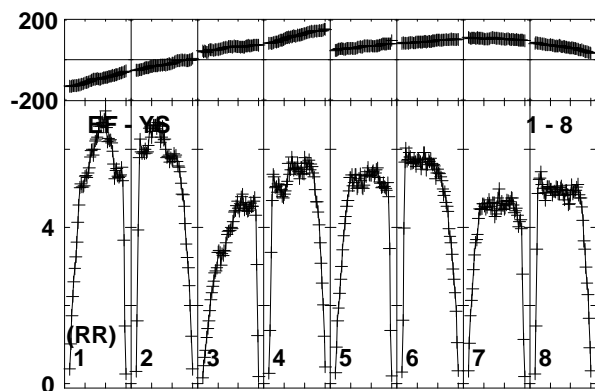
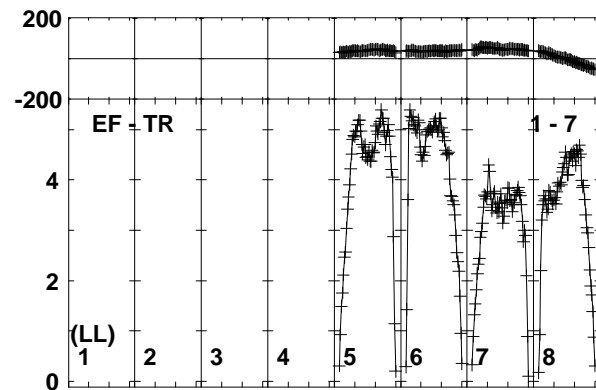
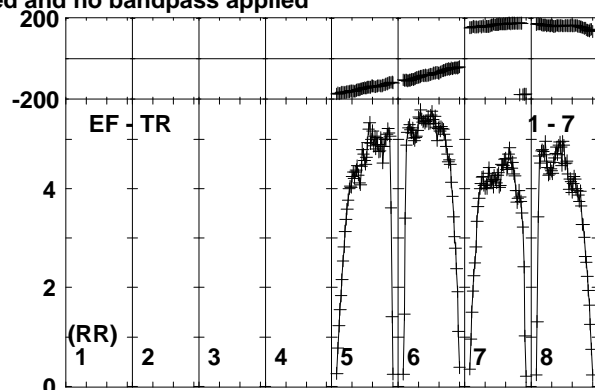
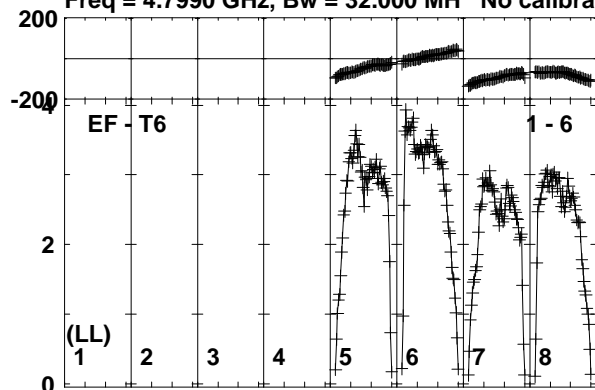

Lower frame: Milli Ampl Jy Top frame: Phas deg
Vector averaged cross-power spectrum Baseline: EF (01) - T6 (06)
Timerange: 00:19:39:01 to 00:19:40:29

Plot file version 295 created 19-OCT-2017 15:36:36

MRK335 ES081C.UVDATA.1

Freq = 4.7990 GHz, Bw = 32.000 MH No calibration applied and no bandpass applied

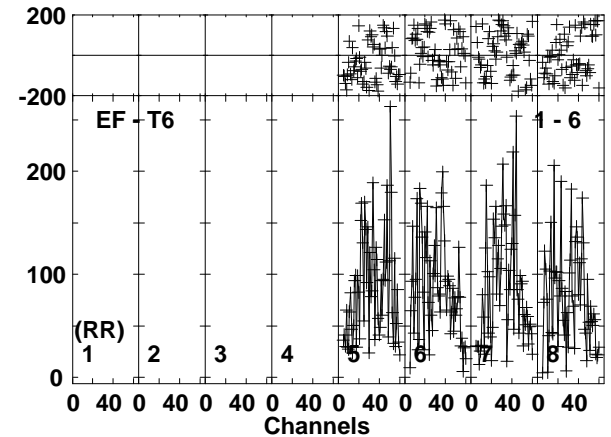
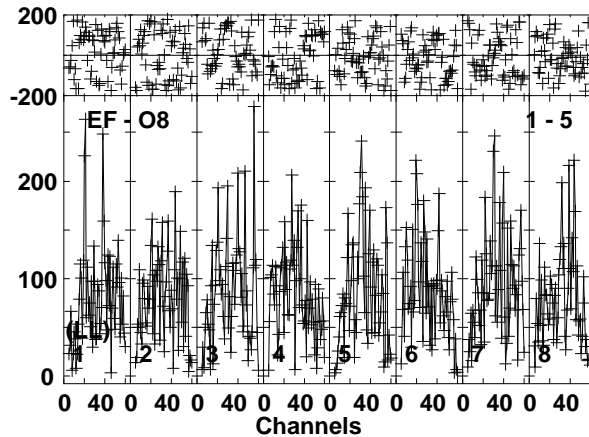
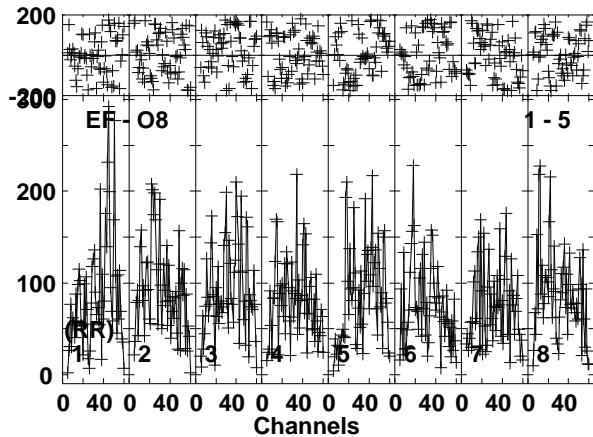
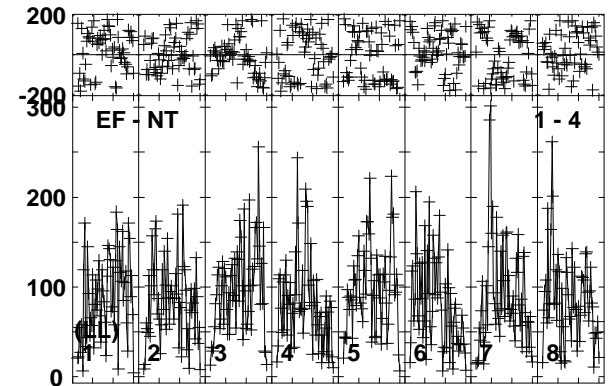
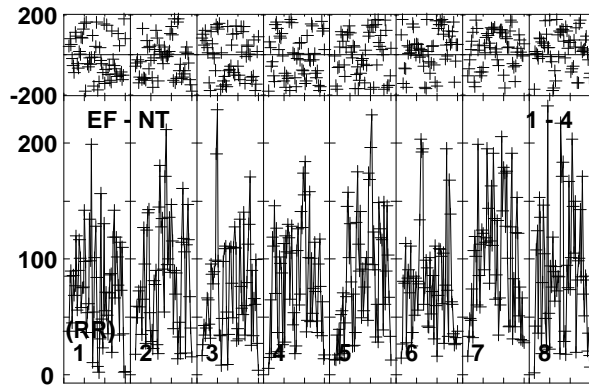
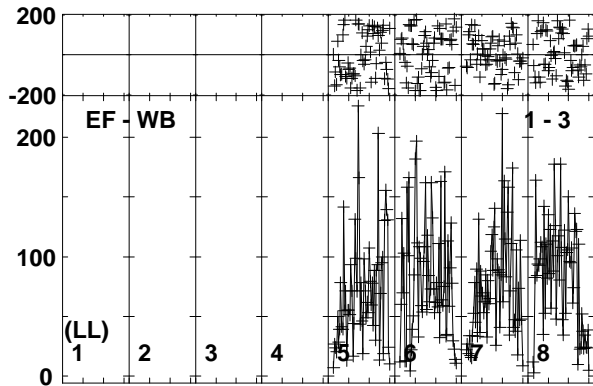
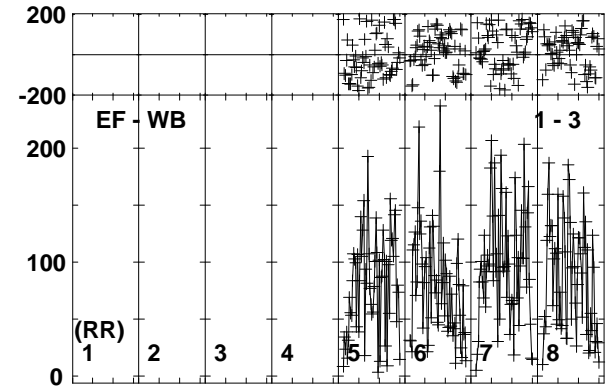
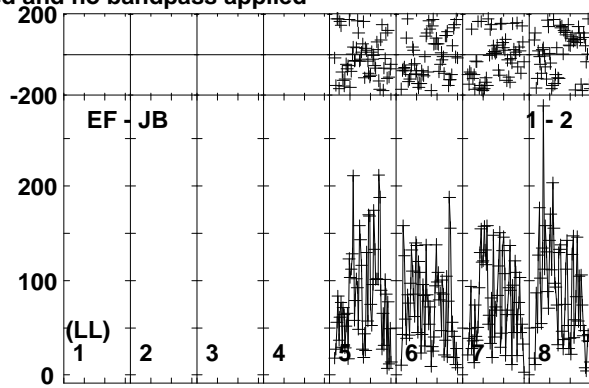
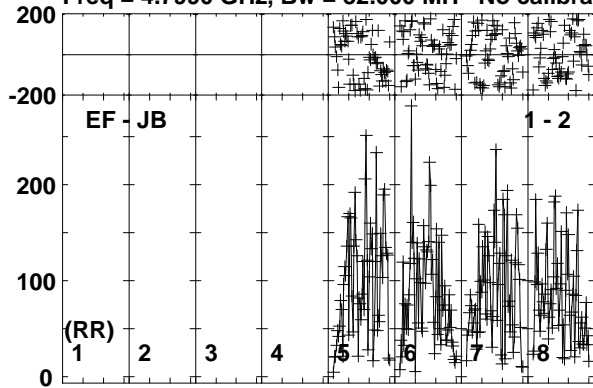

Lower frame: Micro Ampl Jy Top frame: Phas deg
Vector averaged cross-power spectrum Baseline: EF (01) - JB (02)
Timerange: 00/19:40:31 to 00/19:43:59

Plot file version 296 created 19-OCT-2017 15:36:36

MRK335 ES081C.UVDATA.1

Freq = 4.7990 GHz, Bw = 32.000 MH No calibration applied and no bandpass applied

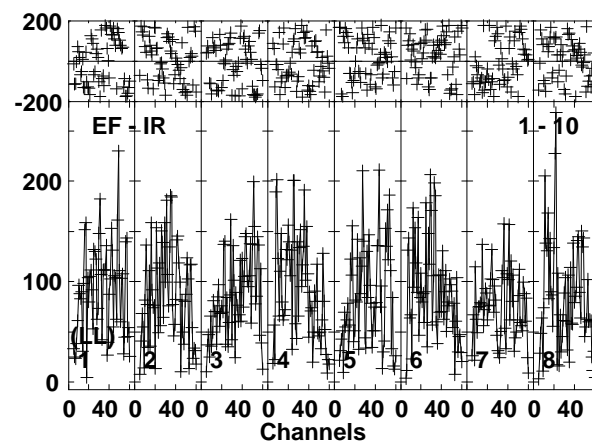
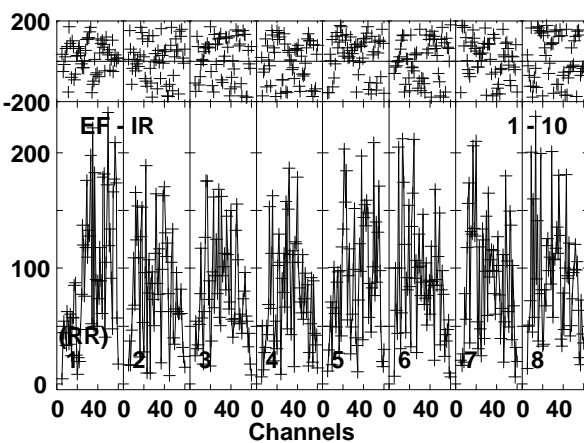
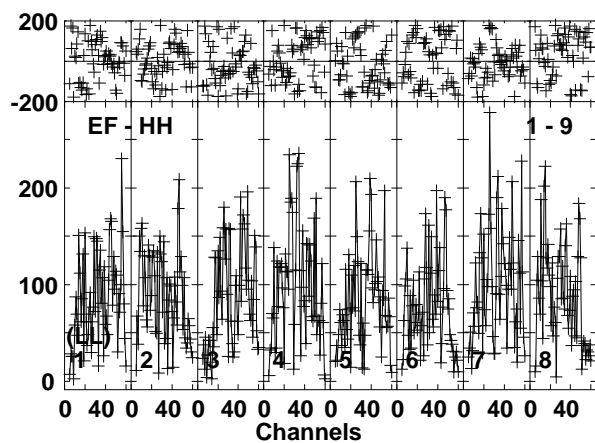
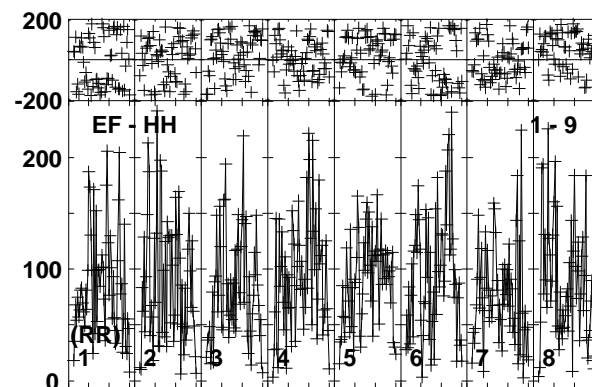
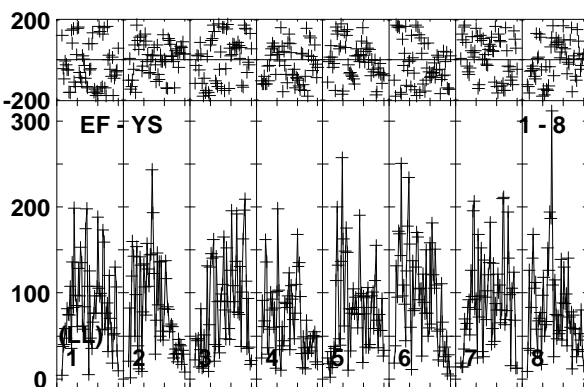
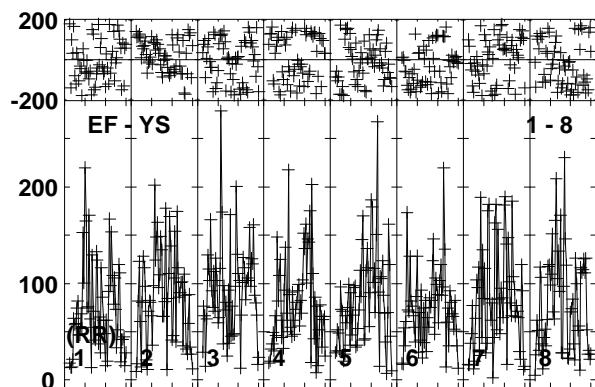
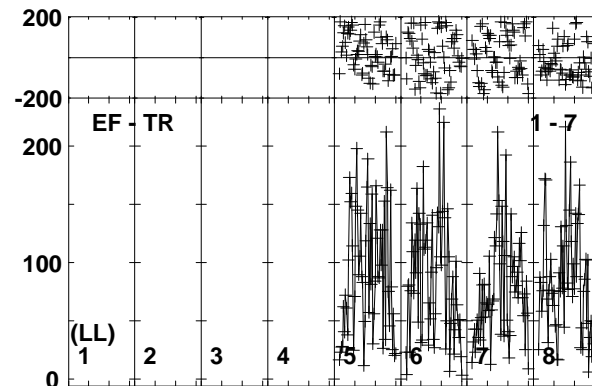
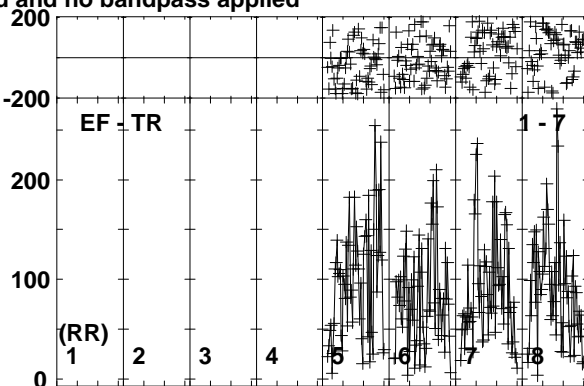
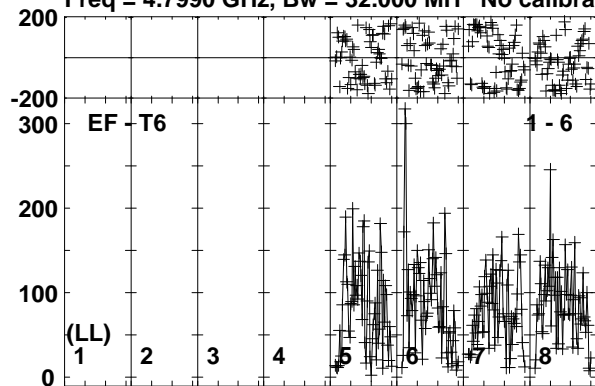

Lower frame: Micro Ampl Jy Top frame: Phas deg
Vector averaged cross-power spectrum Baseline: EF (01) - T6 (06)
Timerange: 00/19:40:31 to 00/19:43:59

Plot file version 297 created 19-OCT-2017 15:36:36

J0004+2019 ES081C.UVDATA.1

Freq = 4.7990 GHz, Bw = 32.000 MH No calibration applied and no bandpass applied

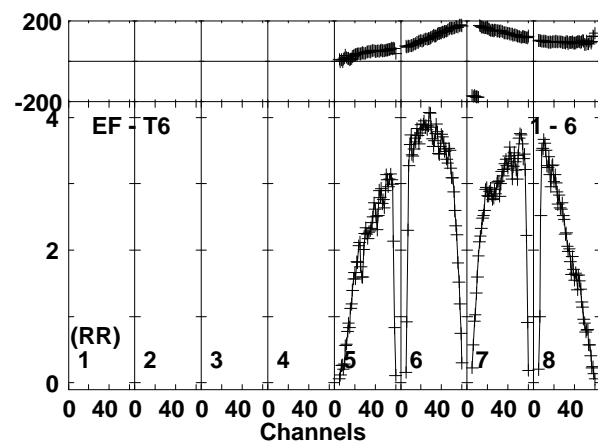
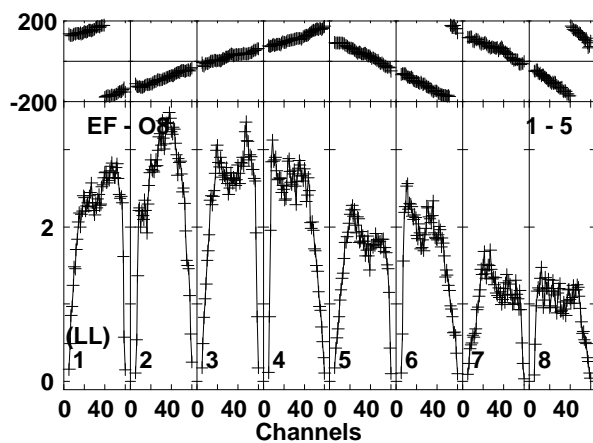
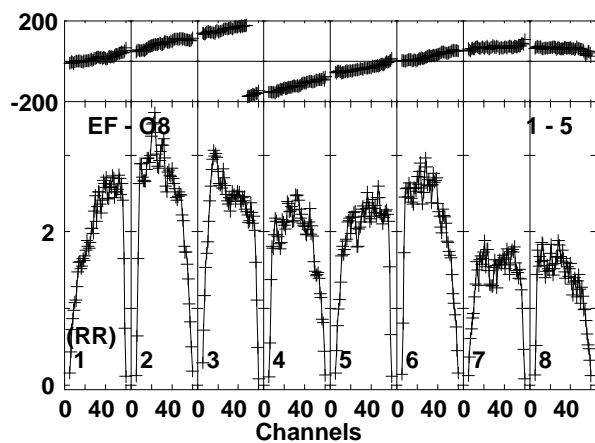
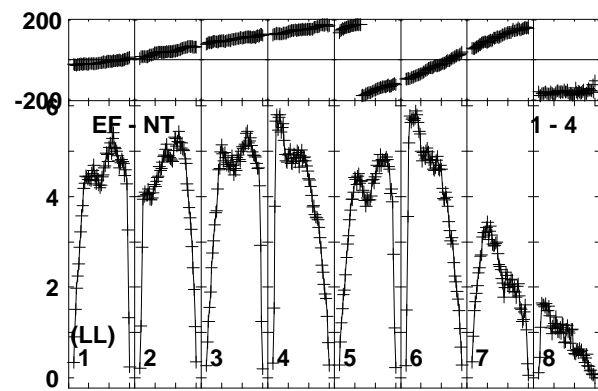
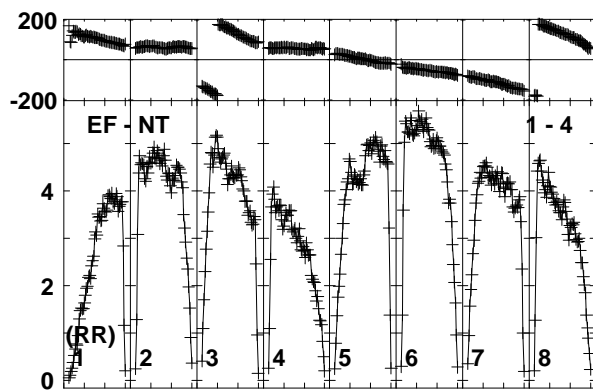
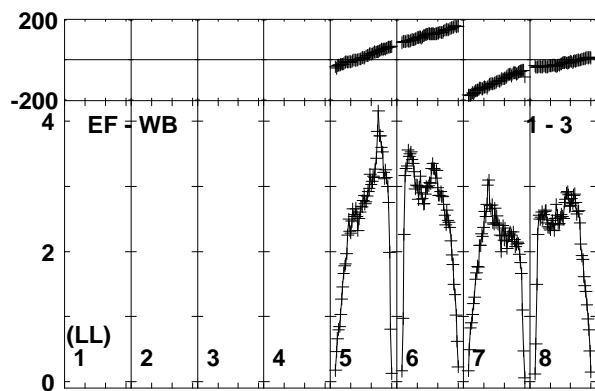
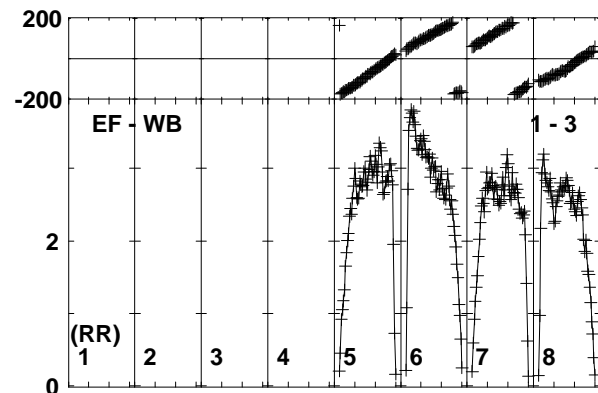
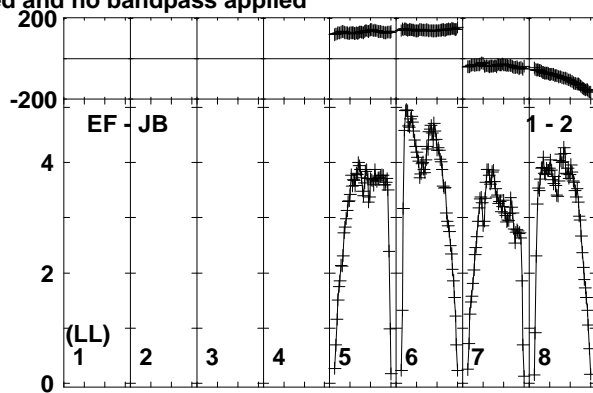
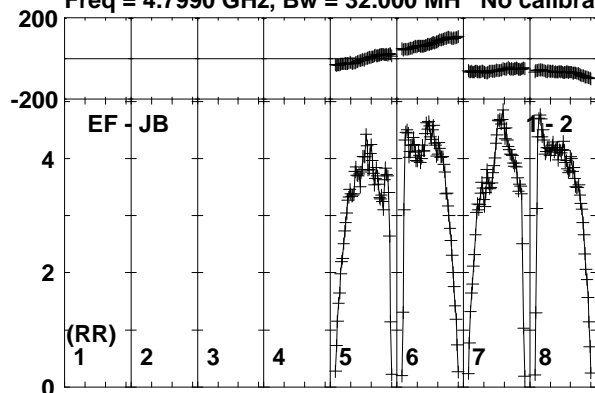

Lower frame: Milli Ampl Jy Top frame: Phas deg
Vector averaged cross-power spectrum Baseline: EF (01) - JB (02)
Timerange: 00:19:44:31 to 00:19:45:29

Plot file version 298 created 19-OCT-2017 15:36:36

J0004+2019 ES081C.UVDATA.1

Freq = 4.7990 GHz, Bw = 32.000 MH No calibration applied and no bandpass applied

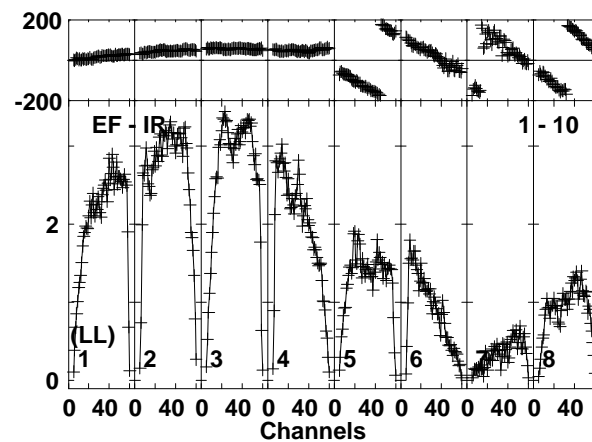
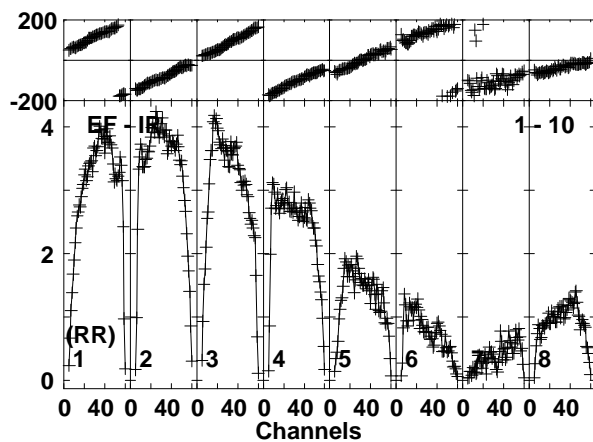
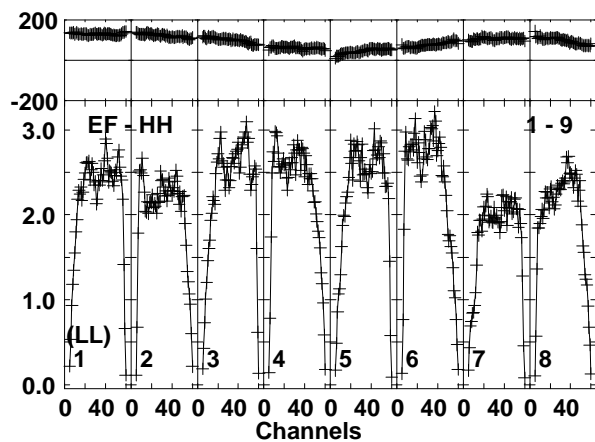
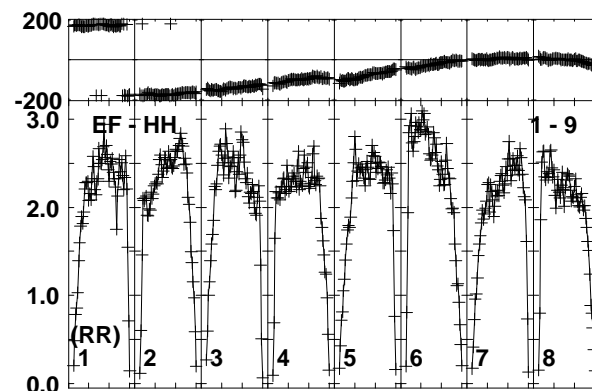
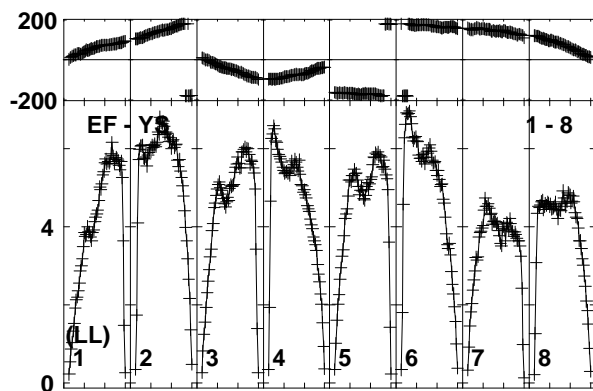
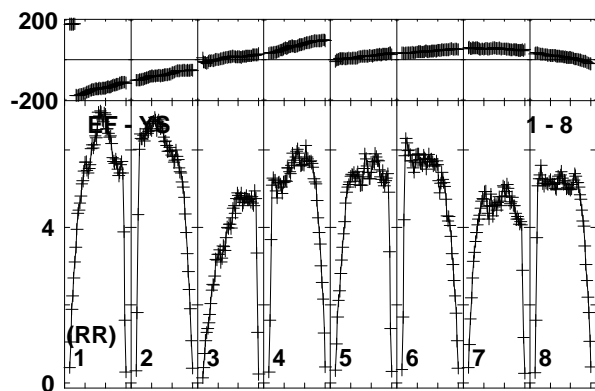
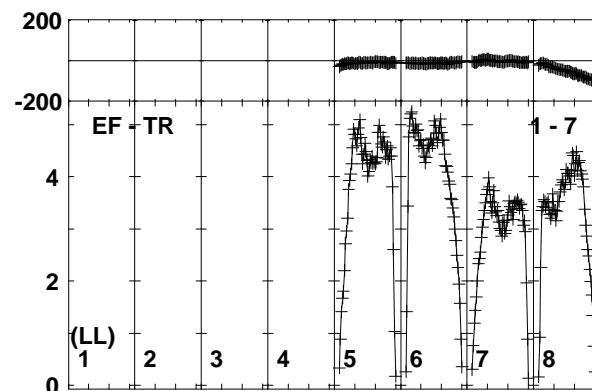
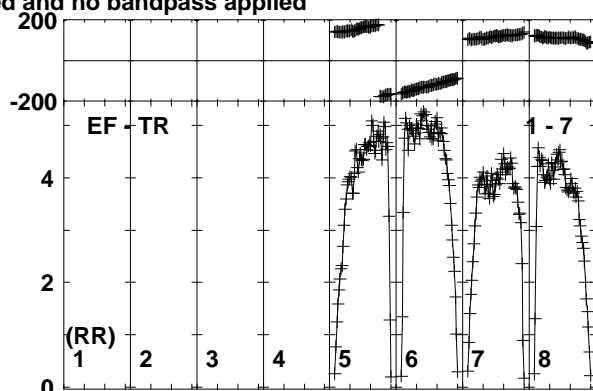
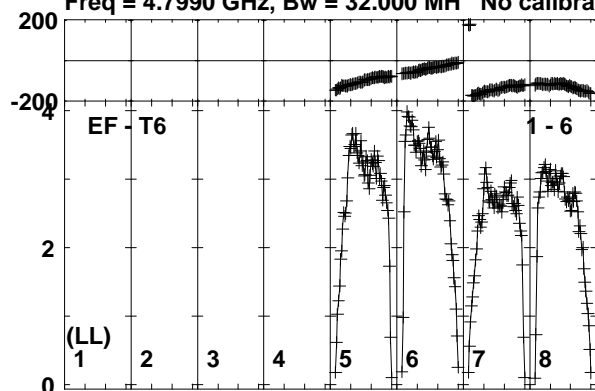

Lower frame: Milli Ampl Jy Top frame: Phas deg
Vector averaged cross-power spectrum Baseline: EF (01) - T6 (06)
Timerange: 00/19:44:31 to 00/19:45:29

Plot file version 299 created 19-OCT-2017 15:36:36

MRK335 ES081C.UVDATA.1

Freq = 4.7990 GHz, Bw = 32.000 MH No calibration applied and no bandpass applied

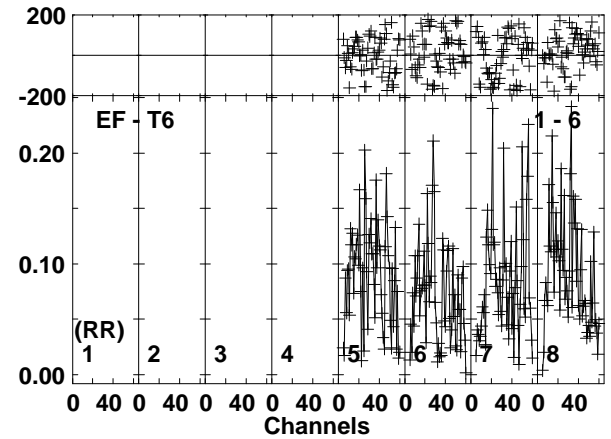
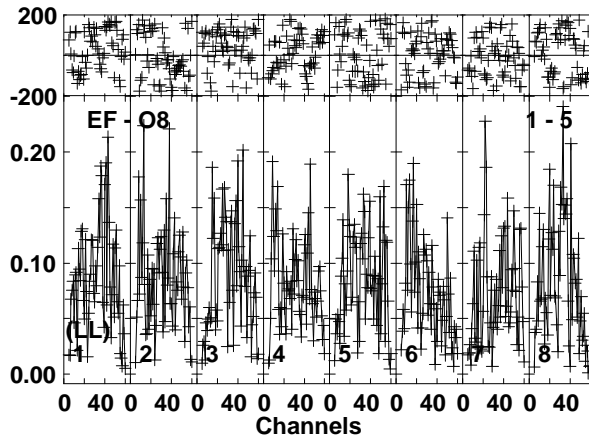
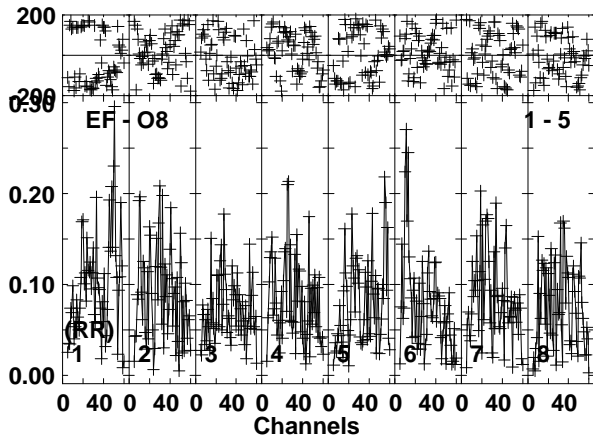
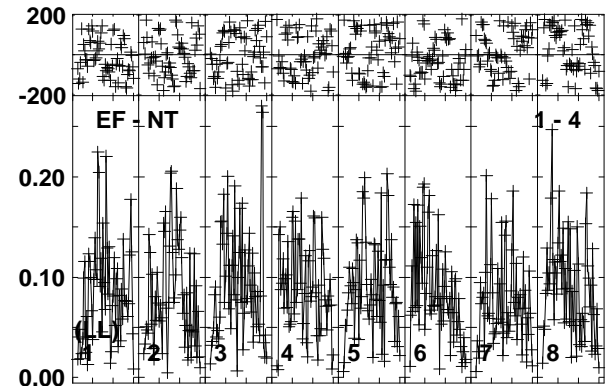
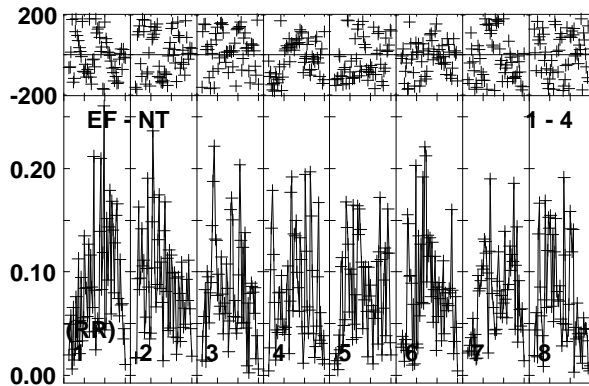
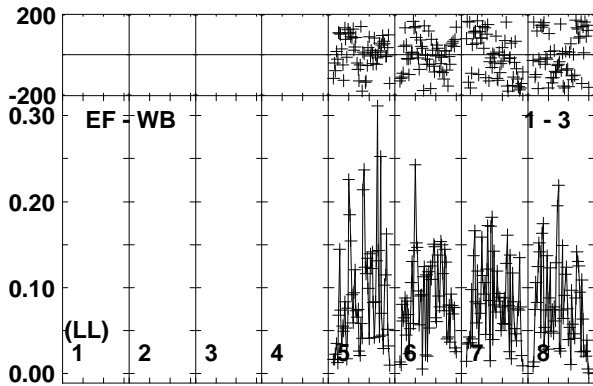
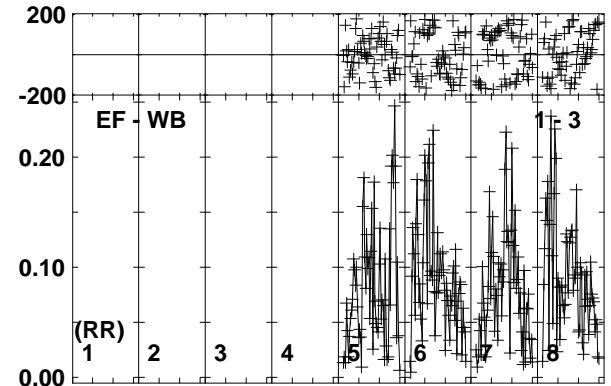
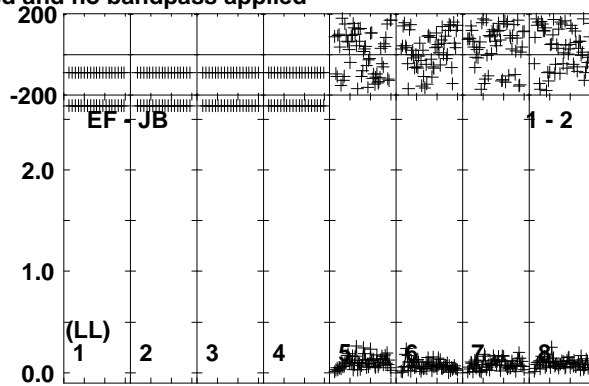
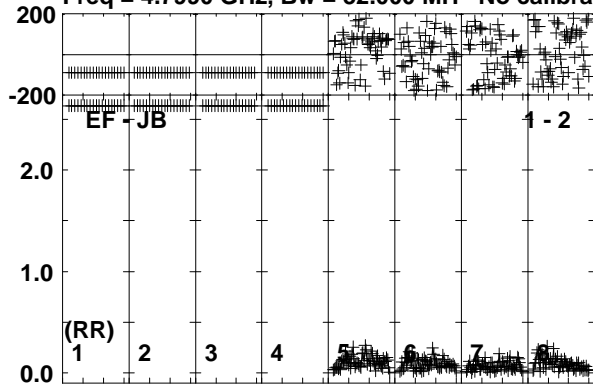

Lower frame: Milli Ampl Jy Top frame: Phas deg
Vector averaged cross-power spectrum Baseline: EF (01) - JB (02)
Timerange: 00/19:45:31 to 00/19:48:59

Plot file version 300 created 19-OCT-2017 15:36:36

MRK335 ES081C.UVDATA.1

Freq = 4.7990 GHz, Bw = 32.000 MH No calibration applied and no bandpass applied

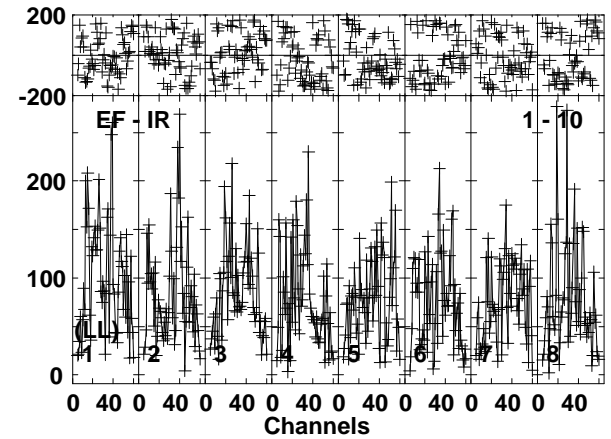
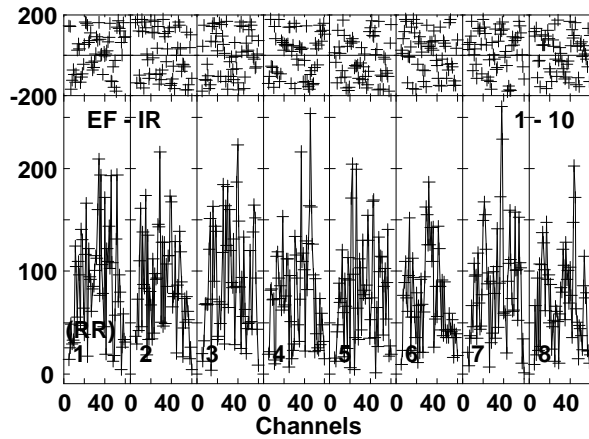
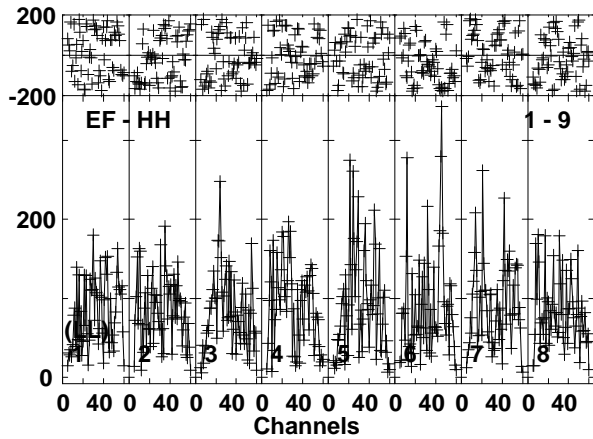
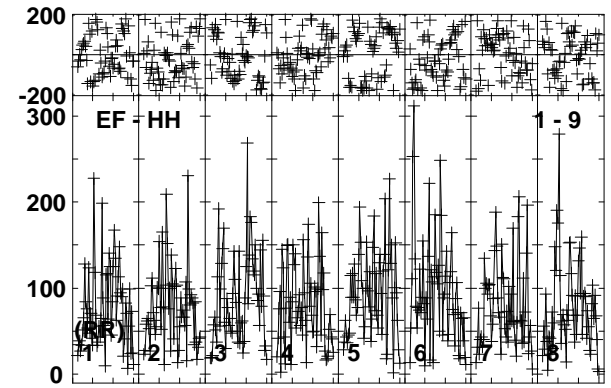
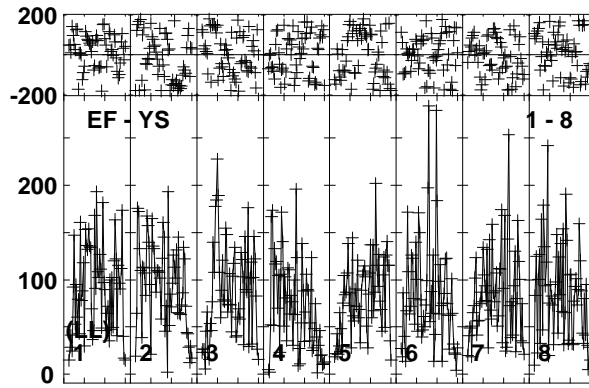
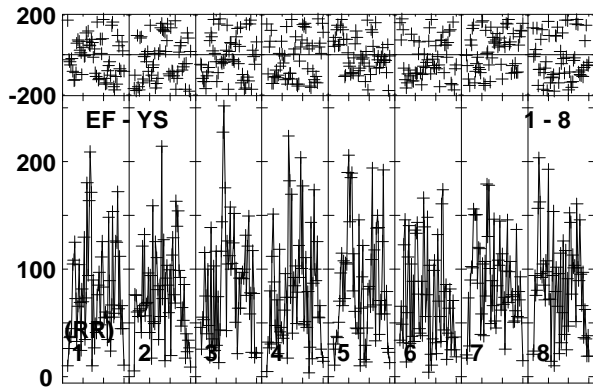
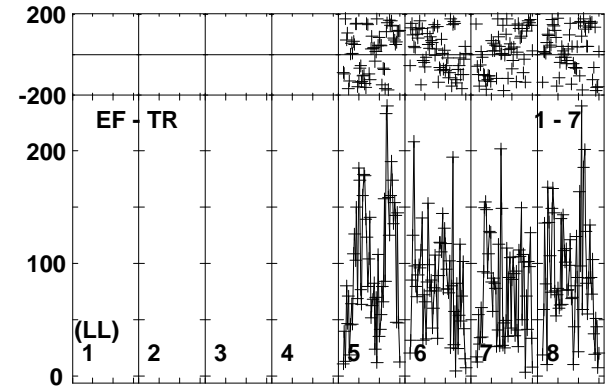
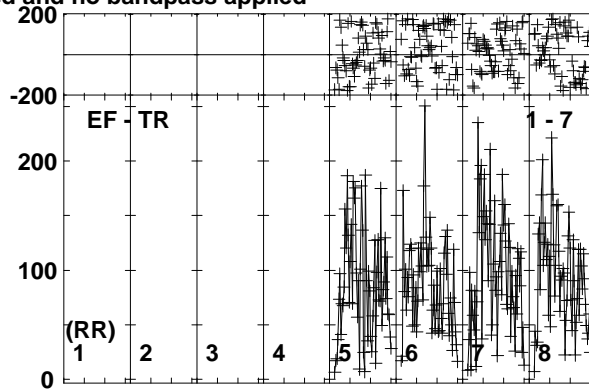
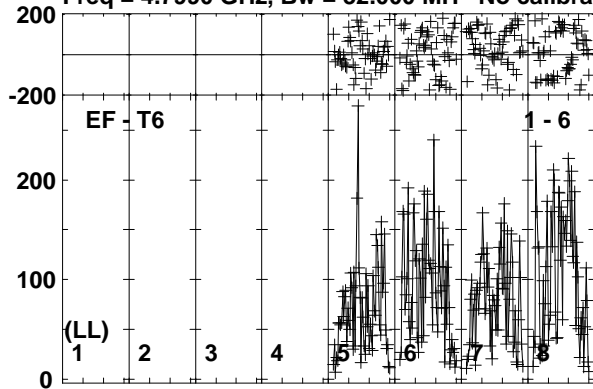

Lower frame: Micro Ampl Jy Top frame: Phas deg
Vector averaged cross-power spectrum Baseline: EF (01) - T6 (06)
Timerange: 00:19:45:31 to 00:19:48:59

Plot file version 301 created 19-OCT-2017 15:36:37

J0004+2019 ES081C.UVDATA.1

Freq = 4.7990 GHz, Bw = 32.000 MH No calibration applied and no bandpass applied

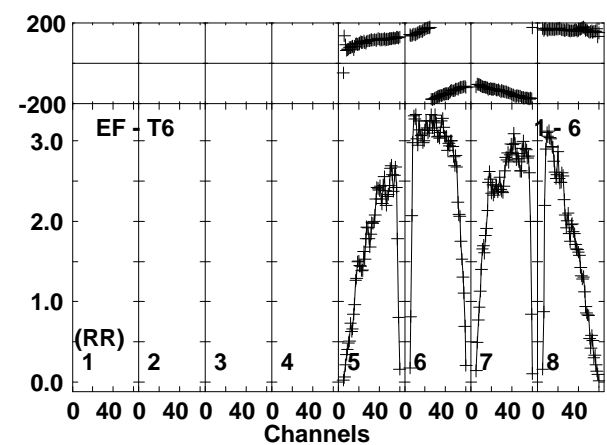
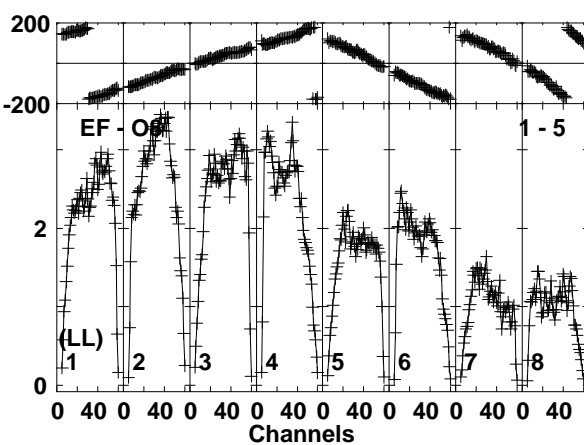
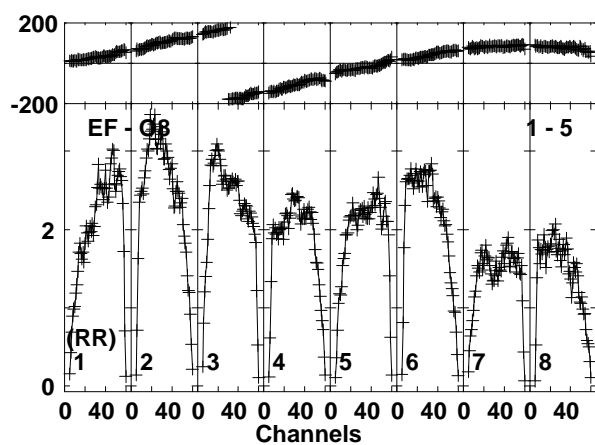
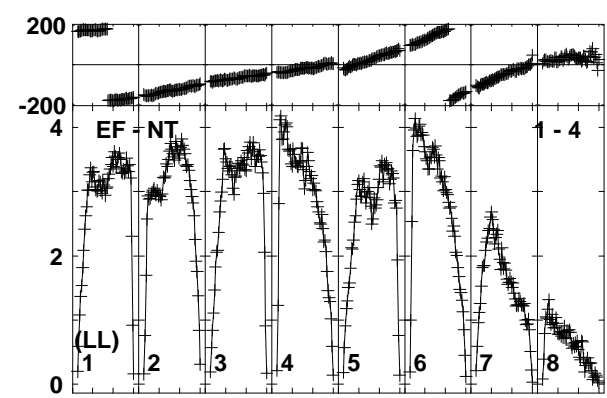
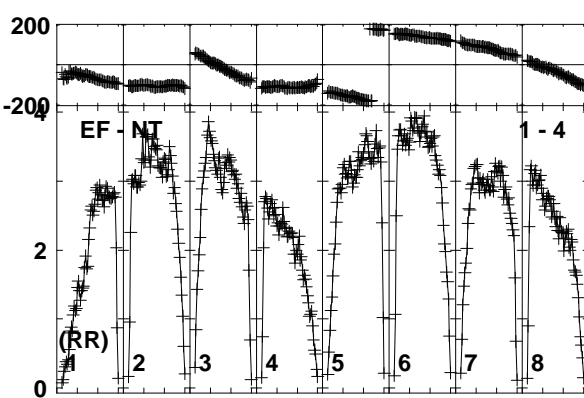
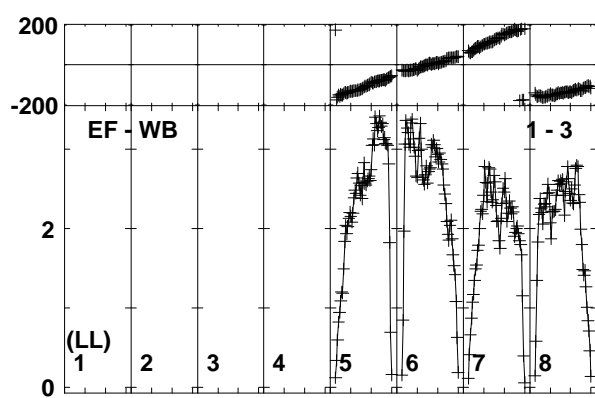
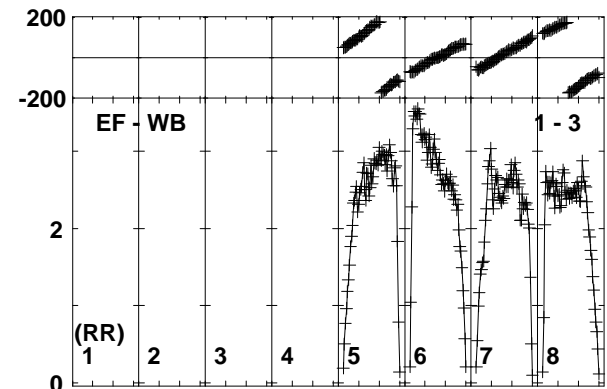
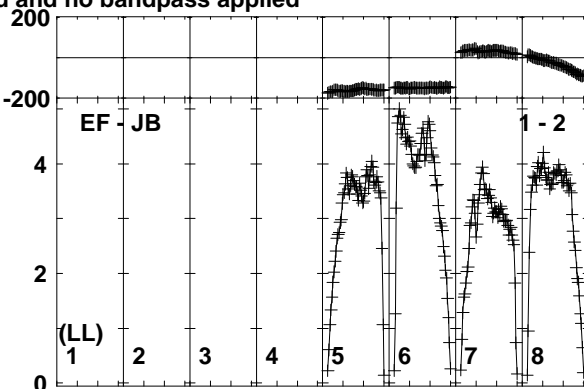
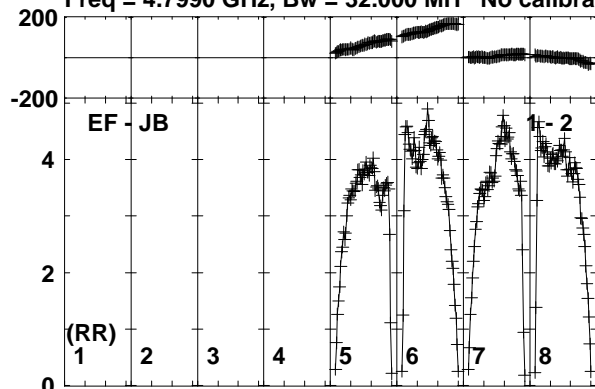

Lower frame: Milli Ampl Jy Top frame: Phas deg
Vector averaged cross-power spectrum Baseline: EF (01) - JB (02)
Timerange: 00:19:49:01 to 00:19:50:29

Plot file version 302 created 19-OCT-2017 15:36:37

J0004+2019 ES081C.UVDATA.1

Freq = 4.7990 GHz, Bw = 32.000 MH No calibration applied and no bandpass applied

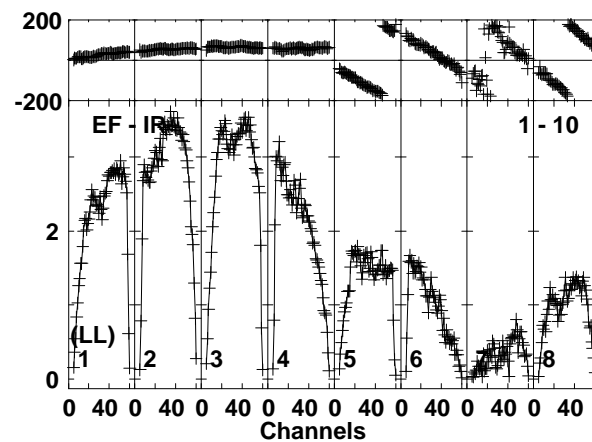
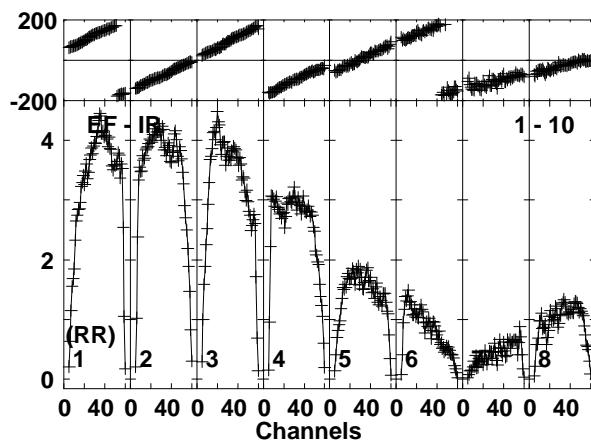
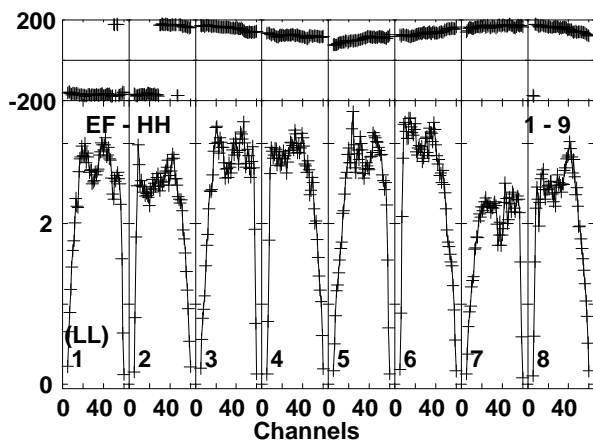
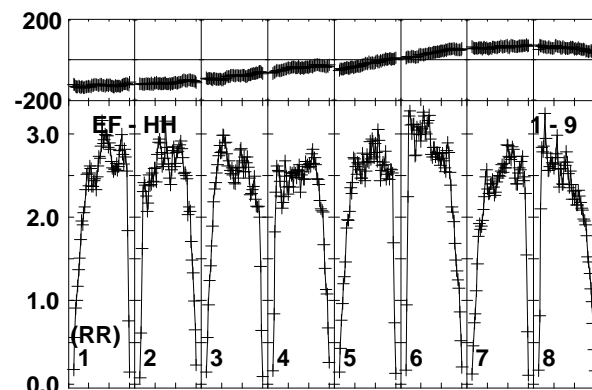
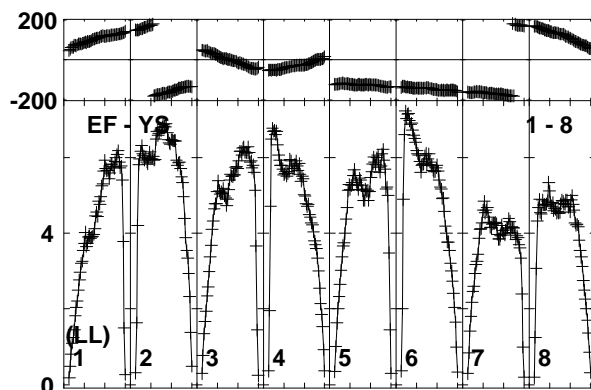
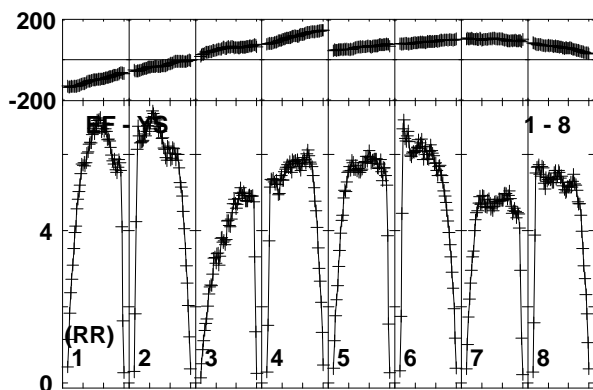
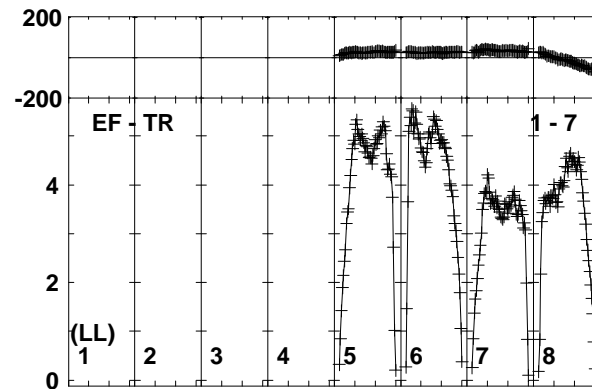
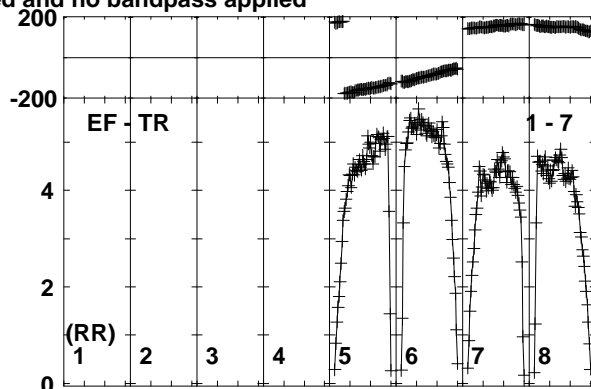
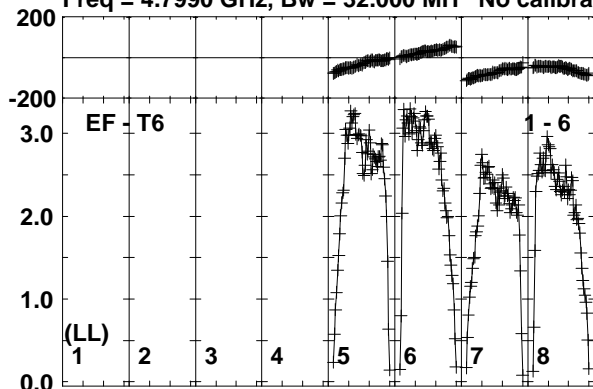

Lower frame: Milli Ampl Jy Top frame: Phas deg
Vector averaged cross-power spectrum Baseline: EF (01) - T6 (06)
Timerange: 00:19:49:01 to 00:19:50:29

Plot file version 303 created 19-OCT-2017 15:36:37

MRK335 ES081C.UVDATA.1

Freq = 4.7990 GHz, Bw = 32.000 MH No calibration applied and no bandpass applied

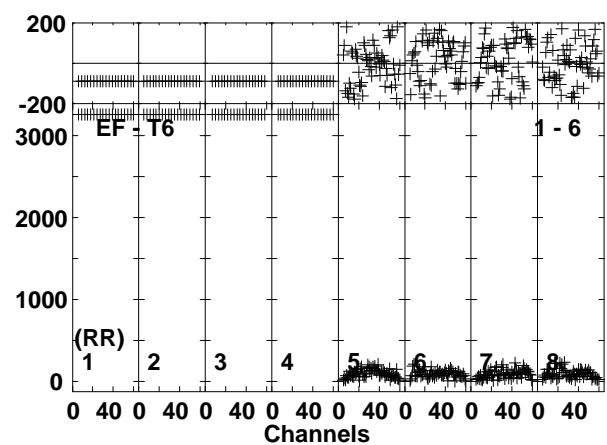
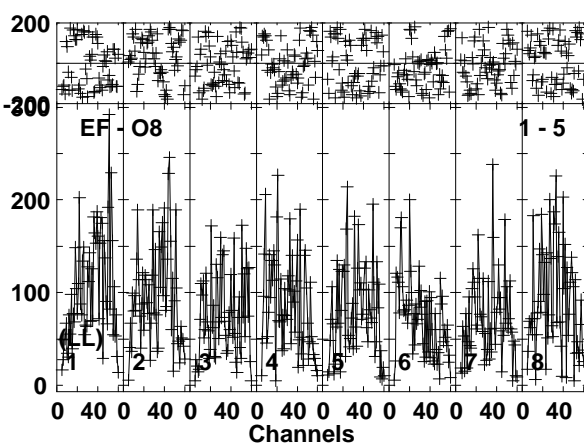
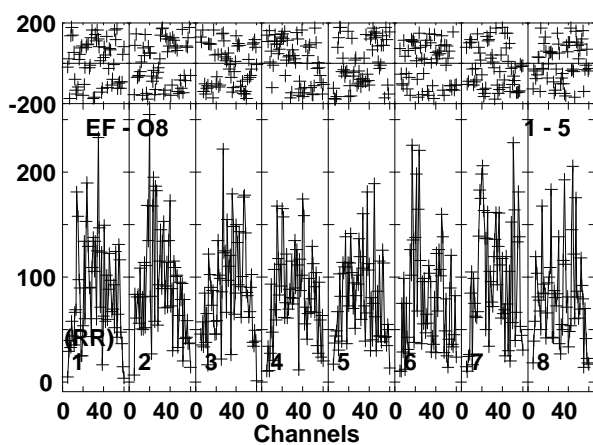
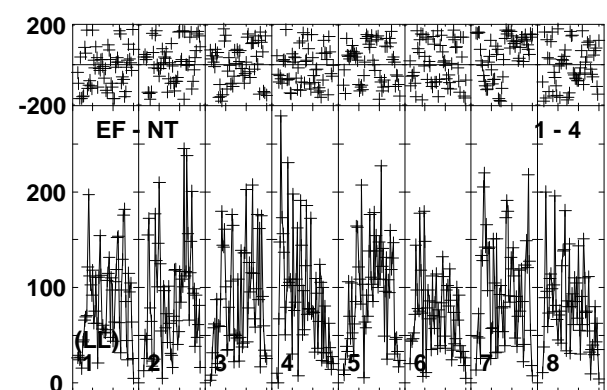
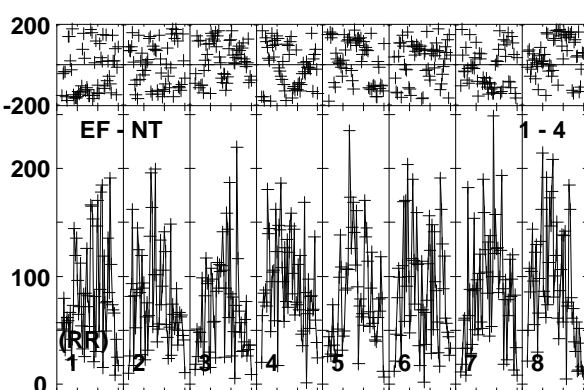
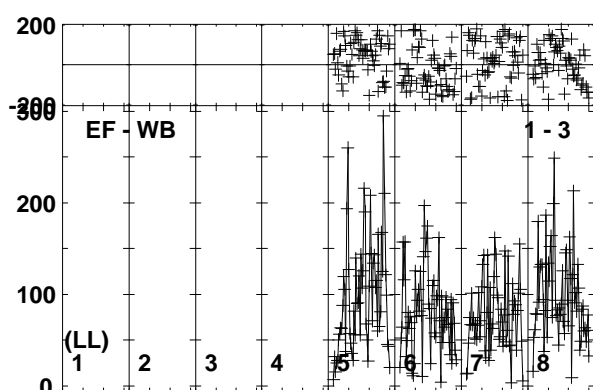
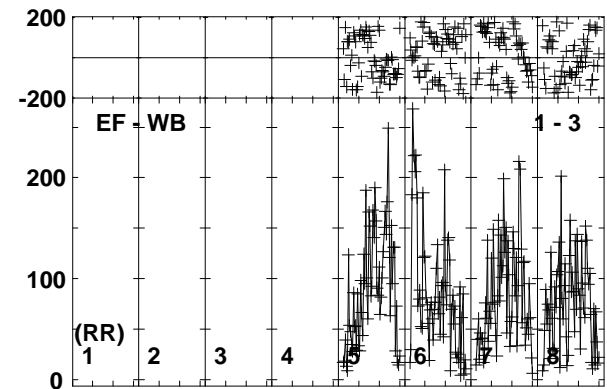
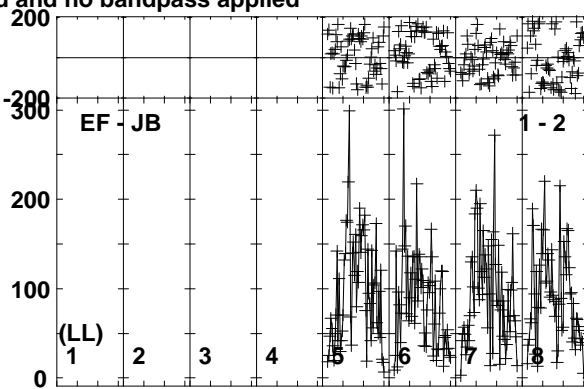
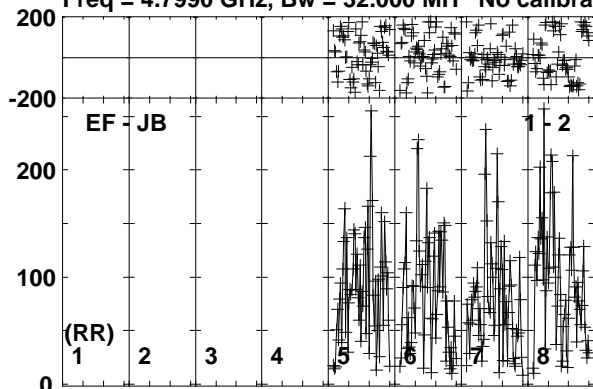

Lower frame: Micro Ampl Jy Top frame: Phas deg
Vector averaged cross-power spectrum Baseline: EF (01) - JB (02)
Timerange: 00/19:50:31 to 00/19:53:59

Plot file version 304 created 19-OCT-2017 15:36:37

MRK335 ES081C.UVDATA.1

Freq = 4.7990 GHz, Bw = 32.000 MH No calibration applied and no bandpass applied

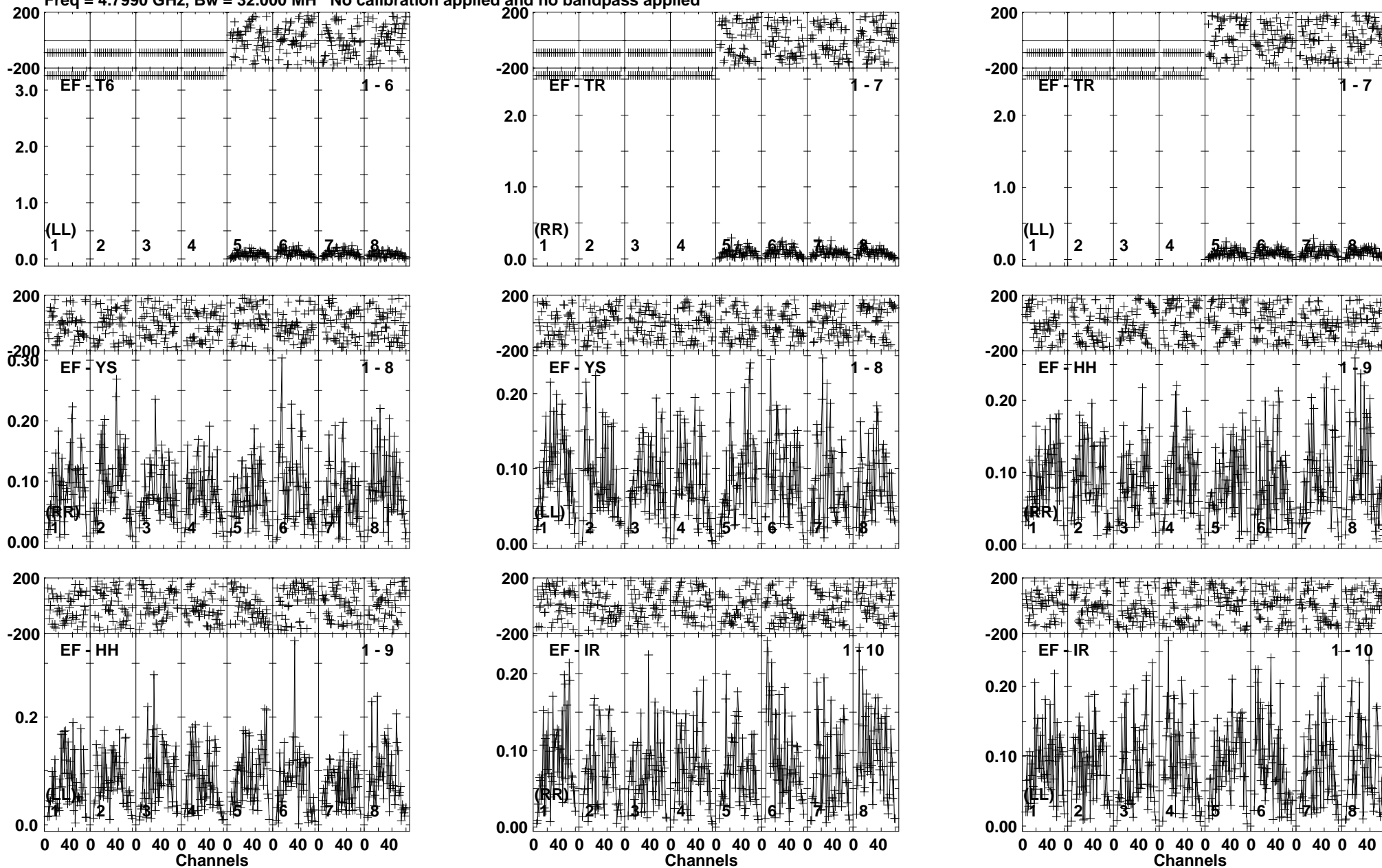

Lower frame: Milli Ampl Jy Top frame: Phas deg
Vector averaged cross-power spectrum Baseline: EF (01) - T6 (06)
Timerange: 00/19:50:31 to 00/19:53:59

Plot file version 305 created 19-OCT-2017 15:36:37

J0004+2019 ES081C.UVDATA.1

Freq = 4.7990 GHz, Bw = 32.000 MH No calibration applied and no bandpass applied

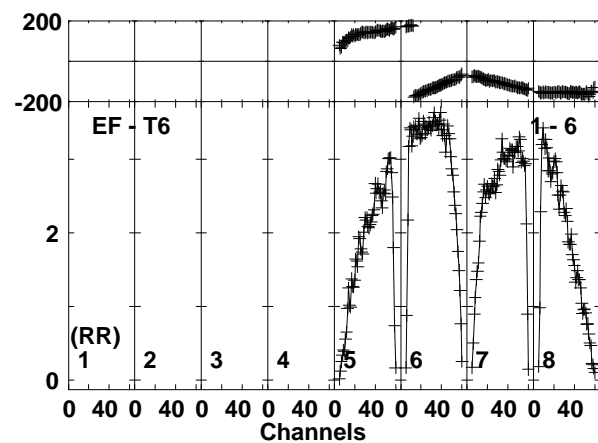
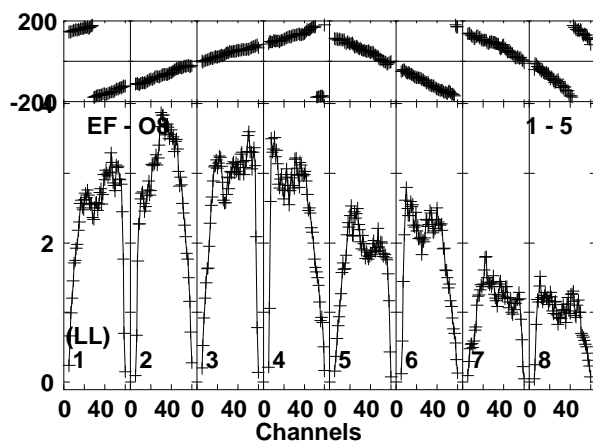
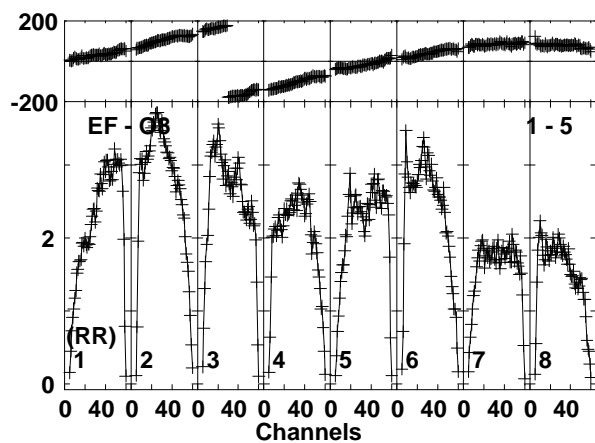
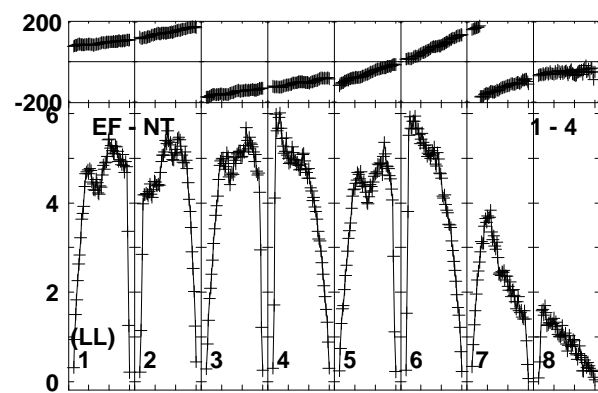
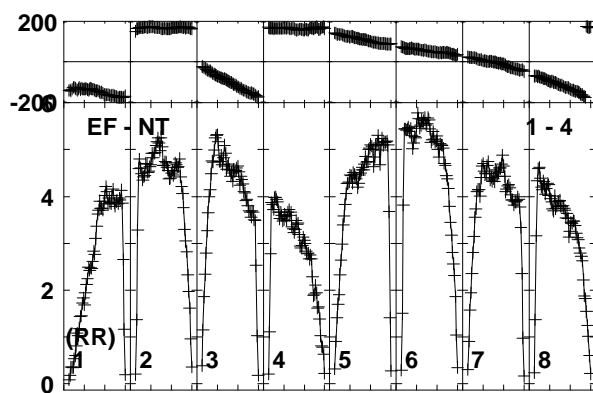
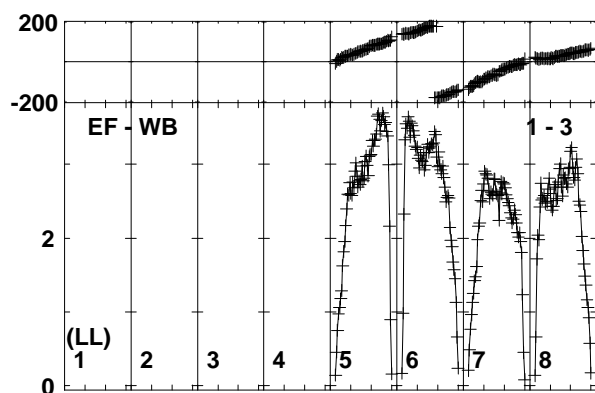
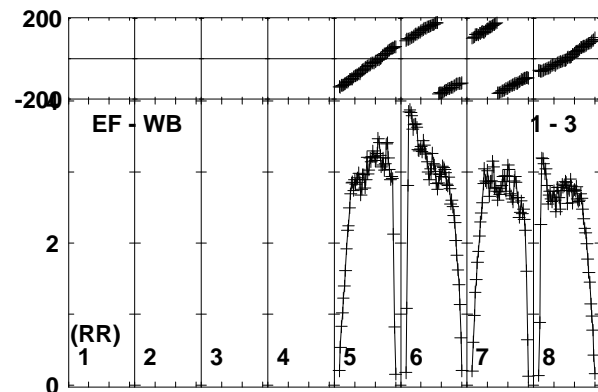
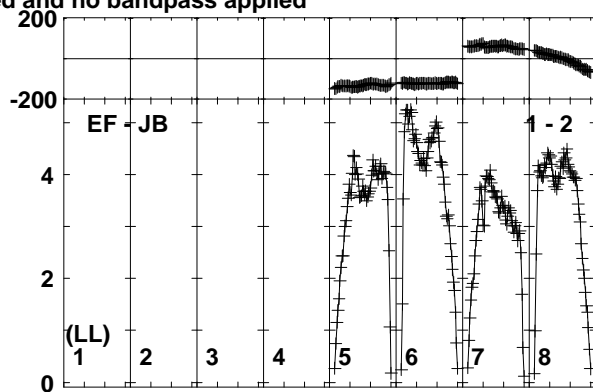
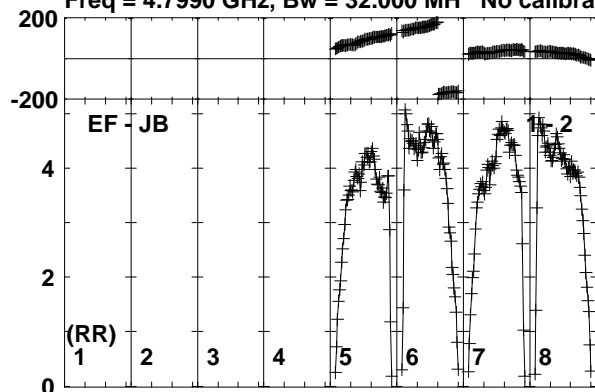

Lower frame: Milli Ampl Jy Top frame: Phas deg
Vector averaged cross-power spectrum Baseline: EF (01) - JB (02)
Timerange: 00:19:54:31 to 00:19:55:29

Plot file version 306 created 19-OCT-2017 15:36:37

J0004+2019 ES081C.UVDATA.1

Freq = 4.7990 GHz, Bw = 32.000 MH No calibration applied and no bandpass applied

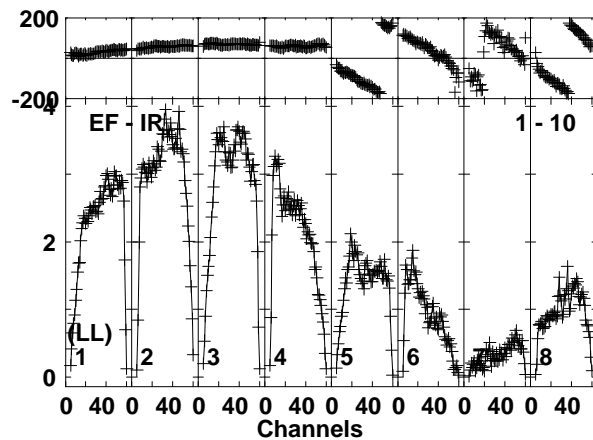
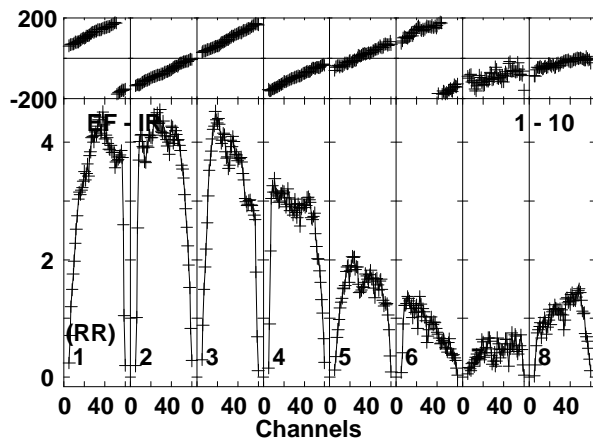
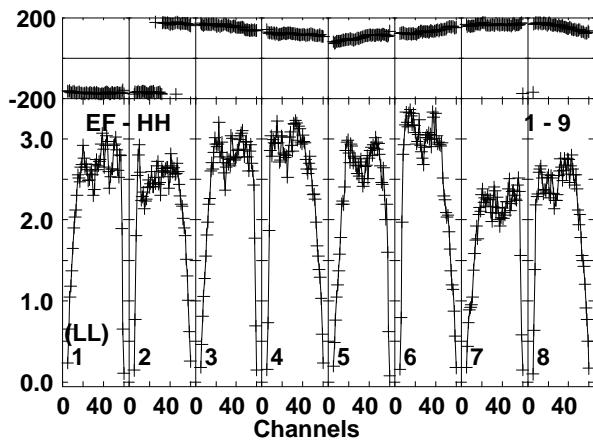
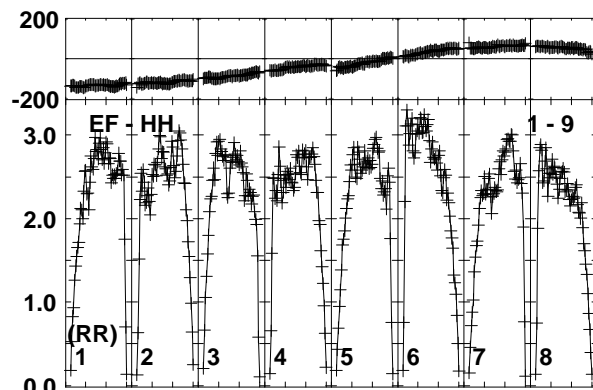
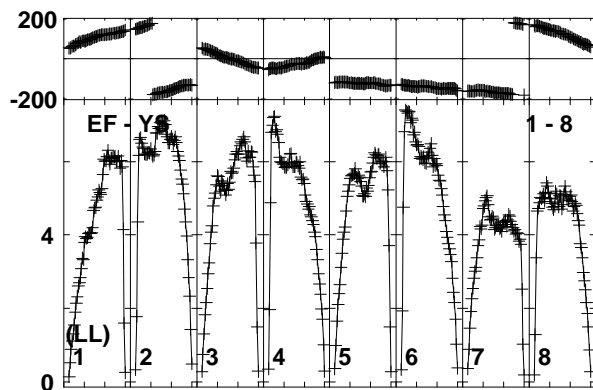
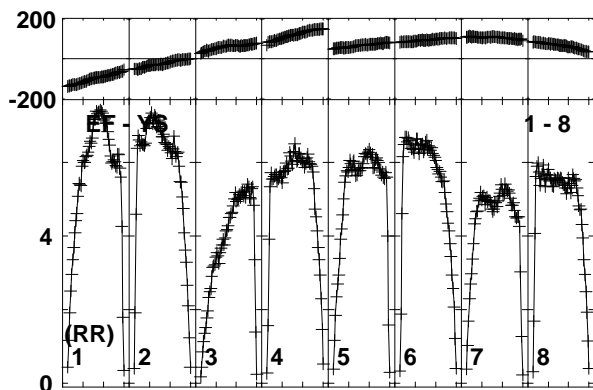
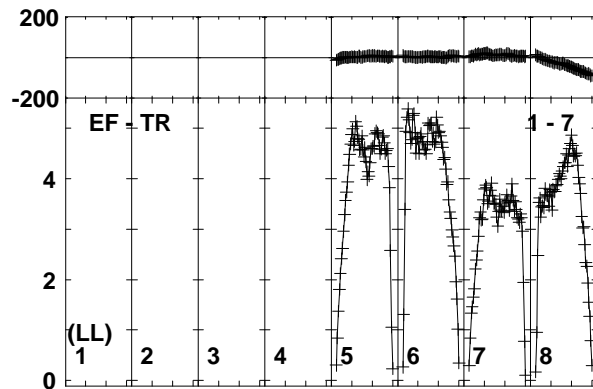
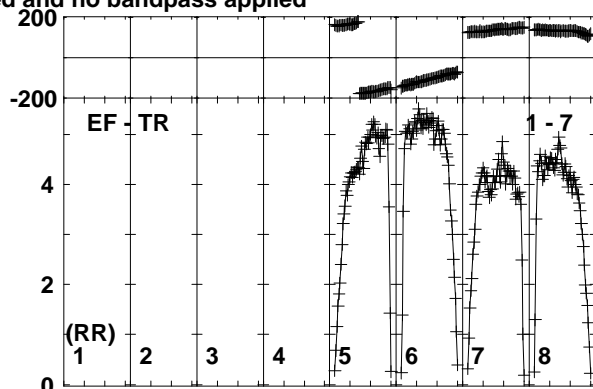
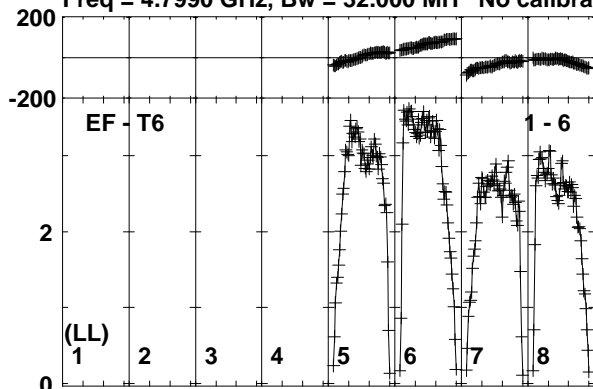

Lower frame: Milli Ampl Jy Top frame: Phas deg
Vector averaged cross-power spectrum Baseline: EF (01) - T6 (06)
Timerange: 00/19:54:31 to 00/19:55:29

Plot file version 307 created 19-OCT-2017 15:36:37

MRK335 ES081C.UVDATA.1

Freq = 4.7990 GHz, Bw = 32.000 MH No calibration applied and no bandpass applied

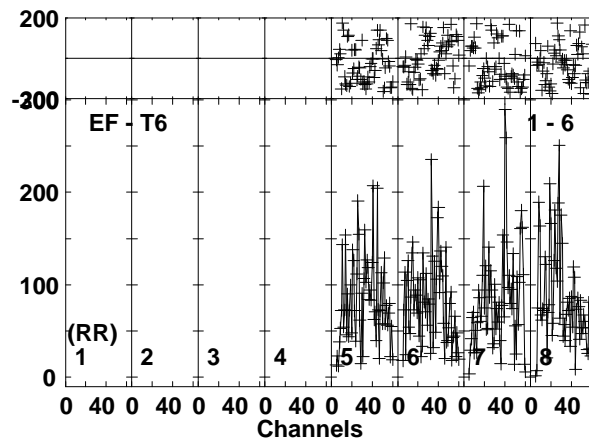
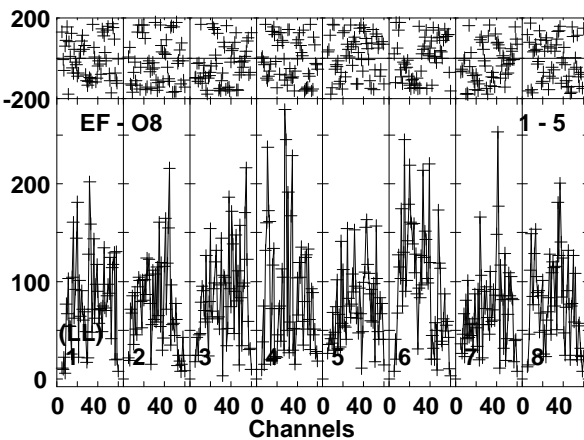
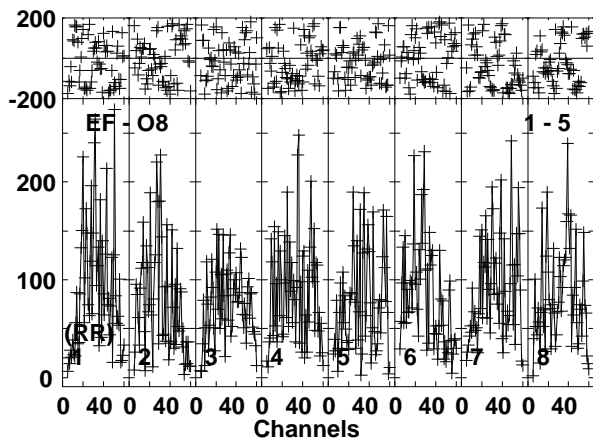
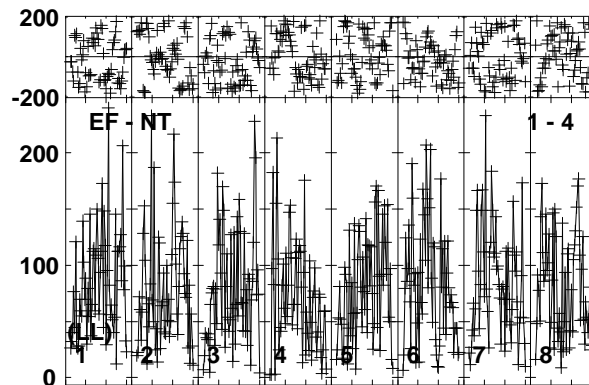
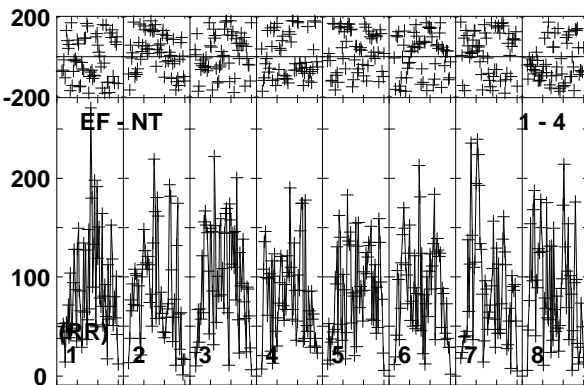
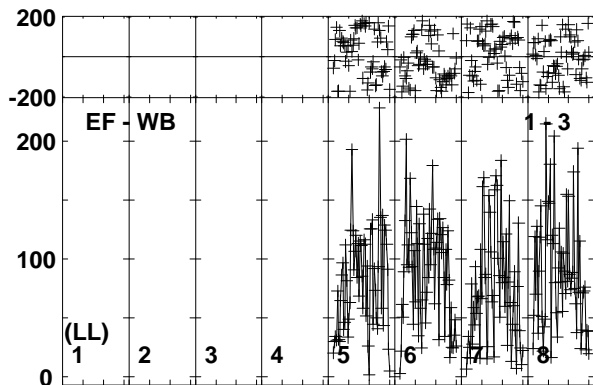
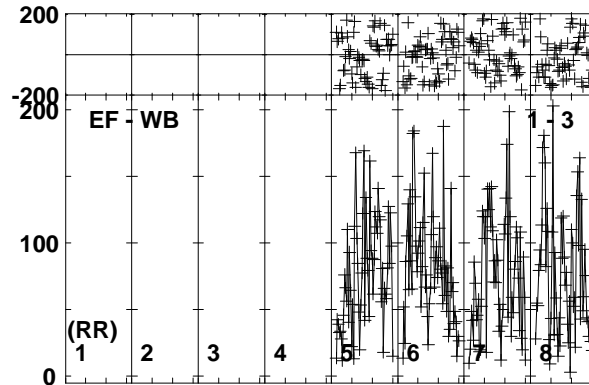
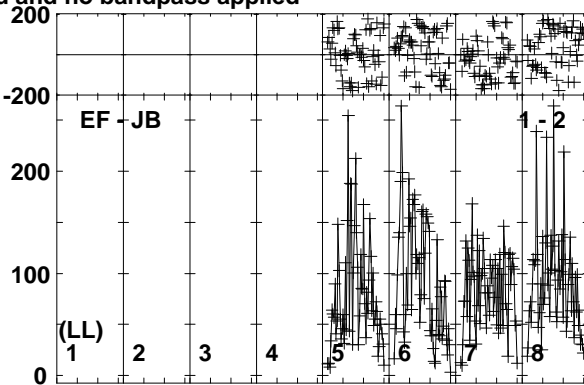
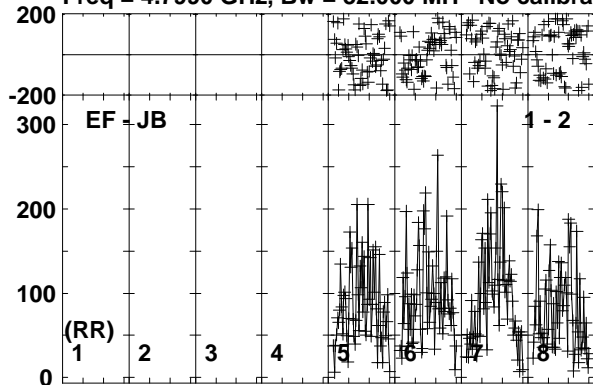

Lower frame: Micro Ampl Jy Top frame: Phas deg
Vector averaged cross-power spectrum Baseline: EF (01) - JB (02)
Timerange: 00/19:55:31 to 00/19:58:59

Plot file version 308 created 19-OCT-2017 15:36:38

MRK335 ES081C.UVDATA.1

Freq = 4.7990 GHz, Bw = 32.000 MH No calibration applied and no bandpass applied

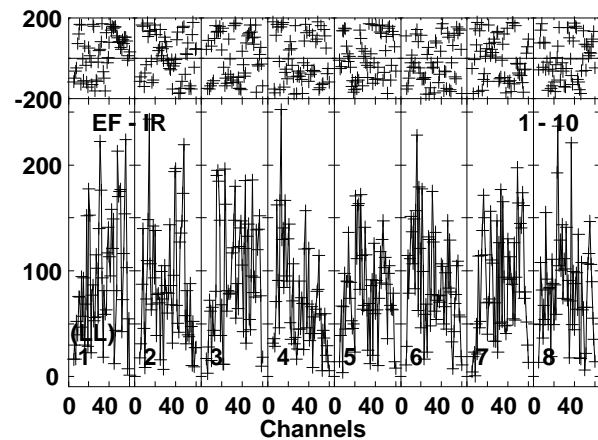
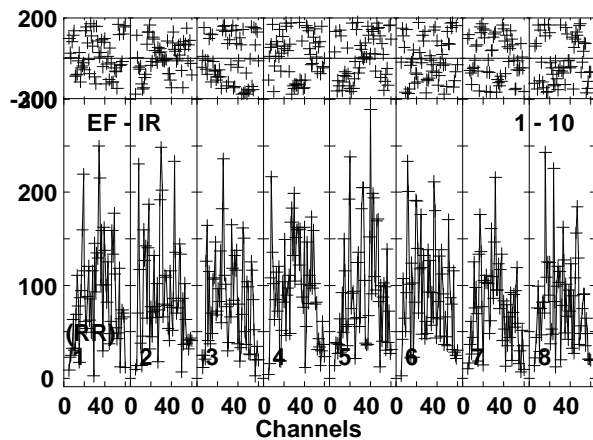
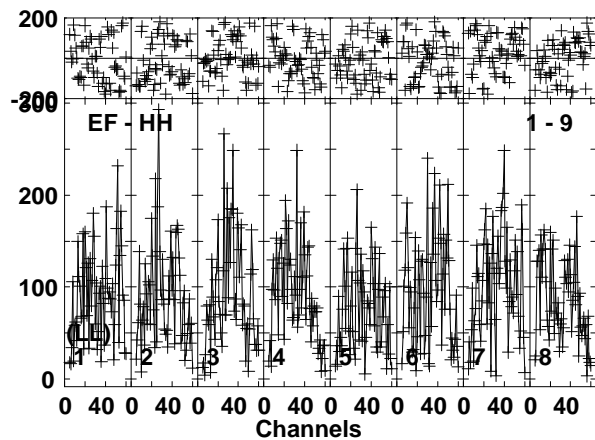
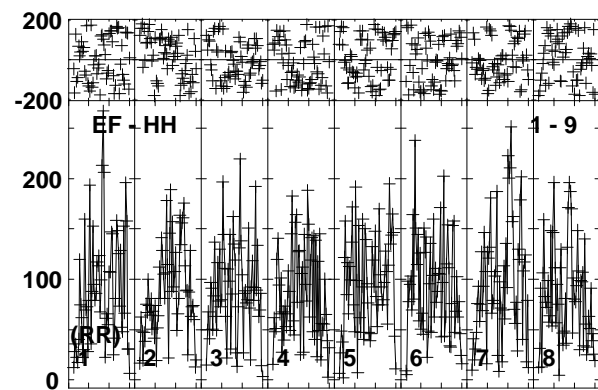
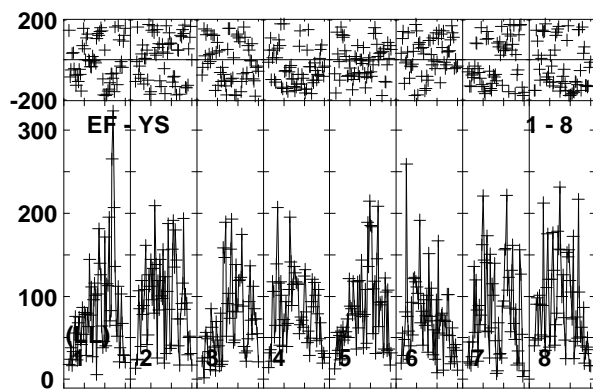
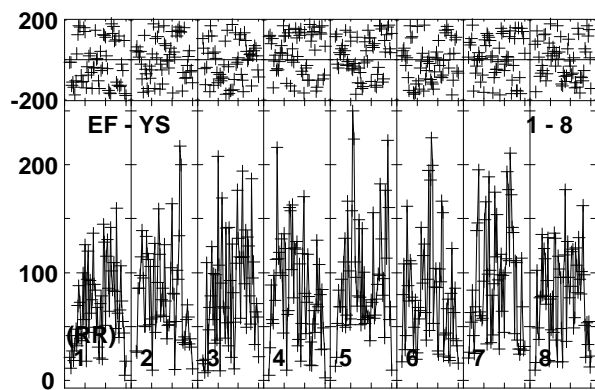
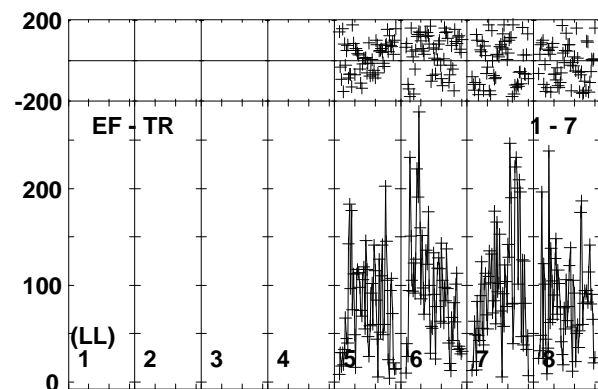
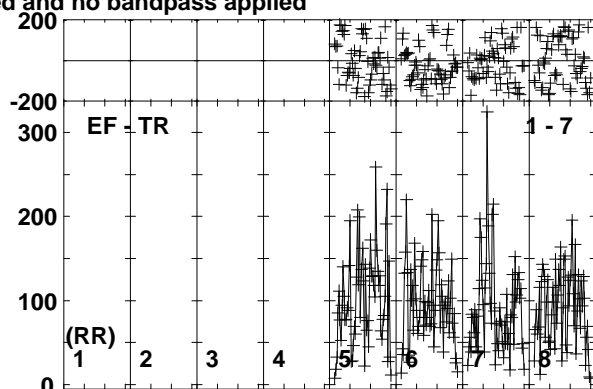
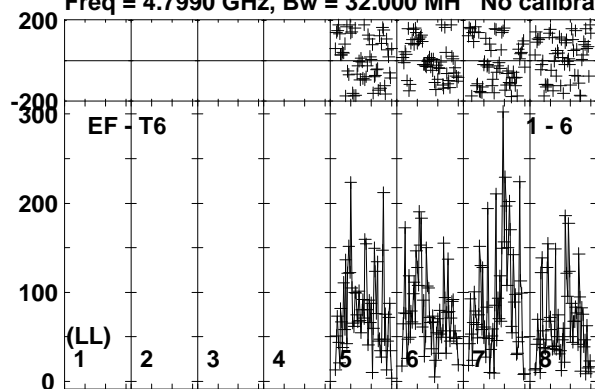

Lower frame: Micro Ampl Jy Top frame: Phas deg
Vector averaged cross-power spectrum Baseline: EF (01) - T6 (06)
Timerange: 00:19:55:31 to 00:19:58:59

Plot file version 309 created 19-OCT-2017 15:36:38

J0004+2019 ES081C.UVDATA.1

Freq = 4.7990 GHz, Bw = 32.000 MH No calibration applied and no bandpass applied

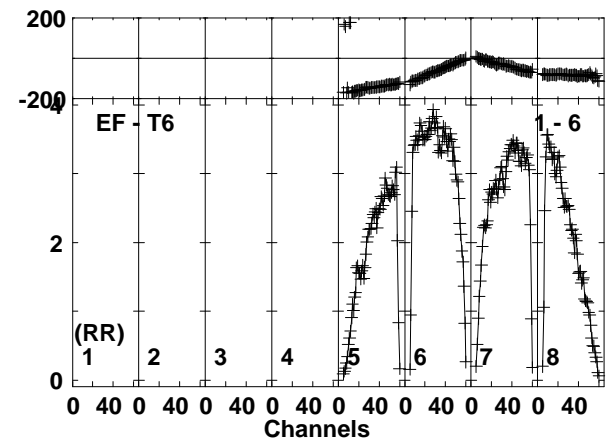
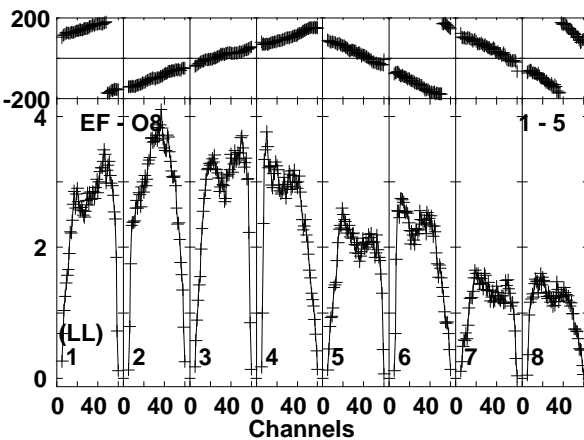
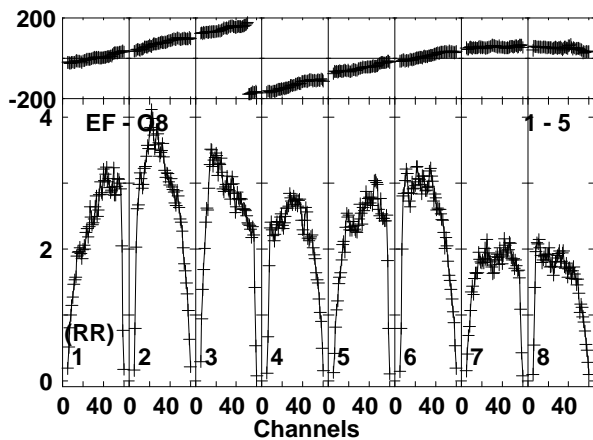
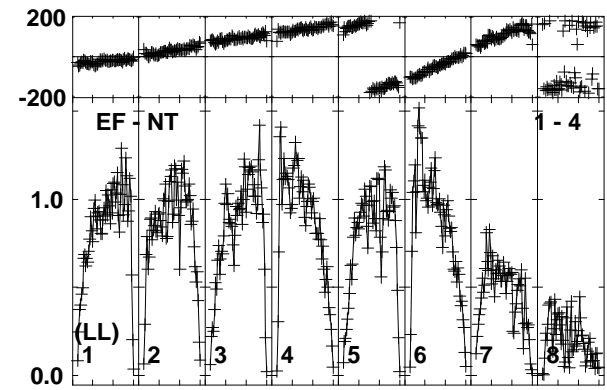
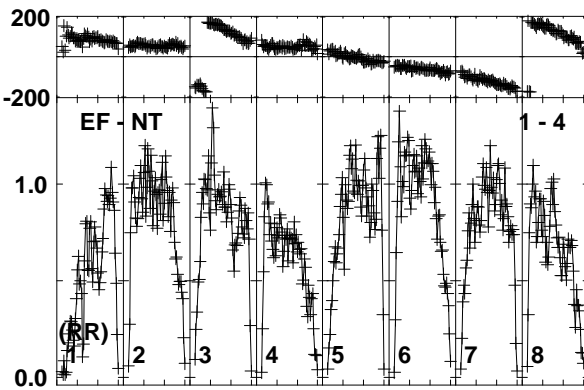
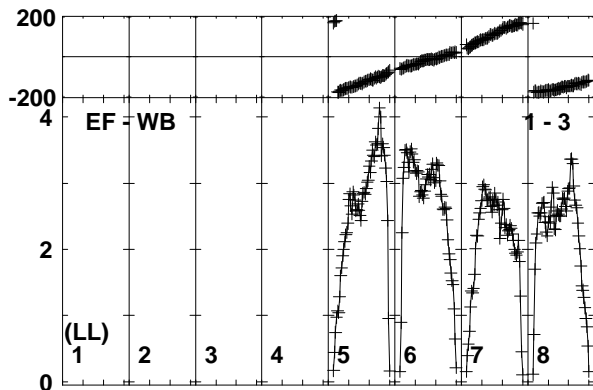
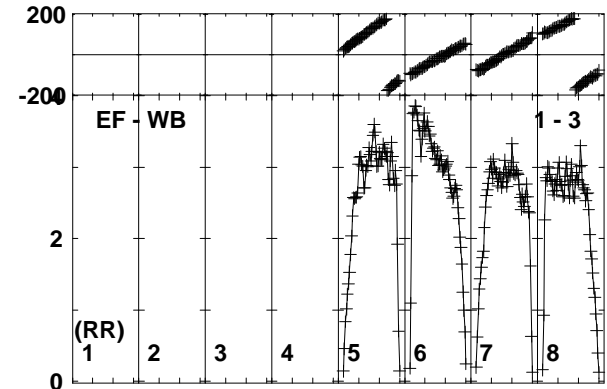
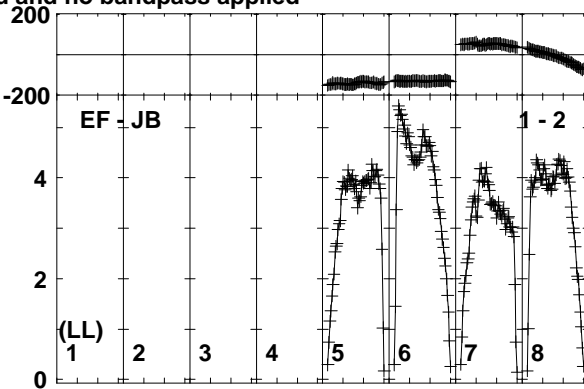
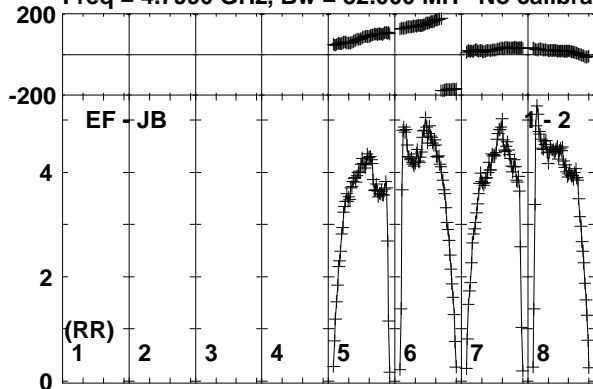

Lower frame: Milli Ampl Jy Top frame: Phas deg
Vector averaged cross-power spectrum Baseline: EF (01) - JB (02)
Timerange: 00/19:59:01 to 00/20:00:29

Plot file version 310 created 19-OCT-2017 15:36:38

J0004+2019 ES081C.UVDATA.1

Freq = 4.7990 GHz, Bw = 32.000 MH No calibration applied and no bandpass applied

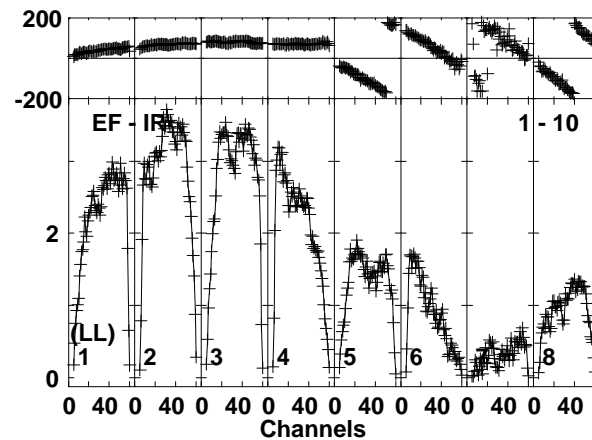
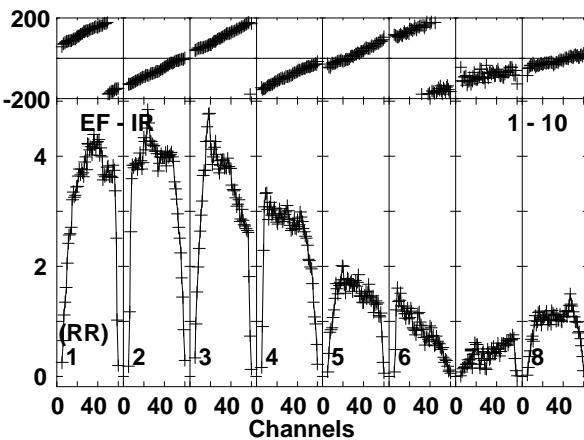
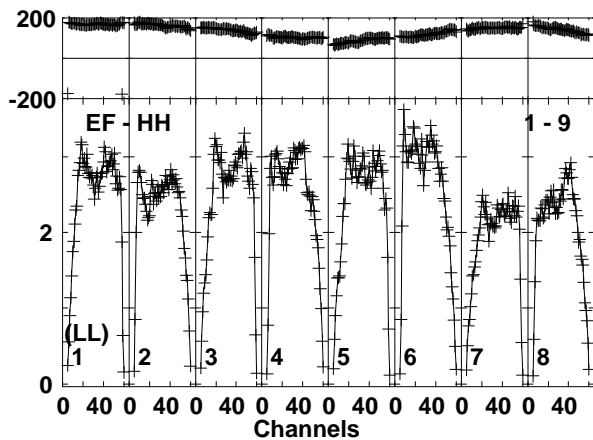
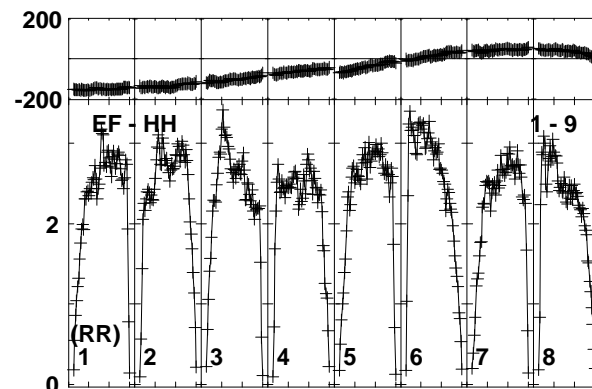
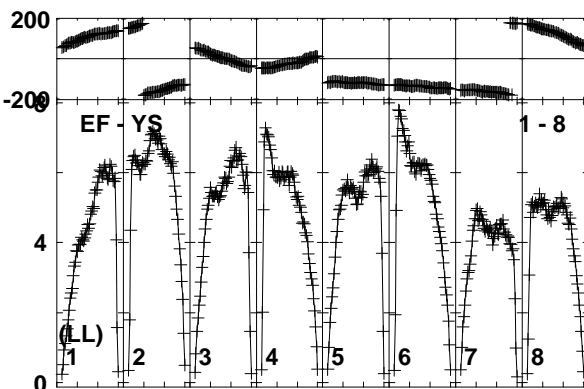
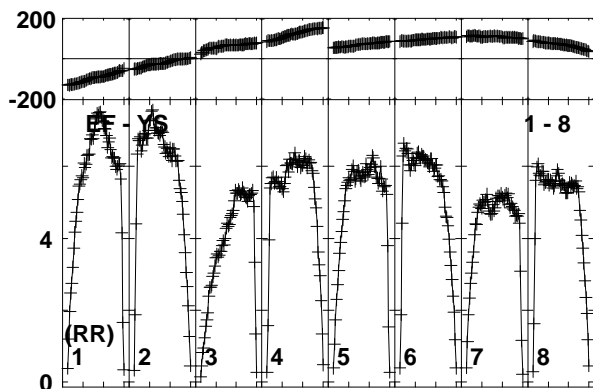
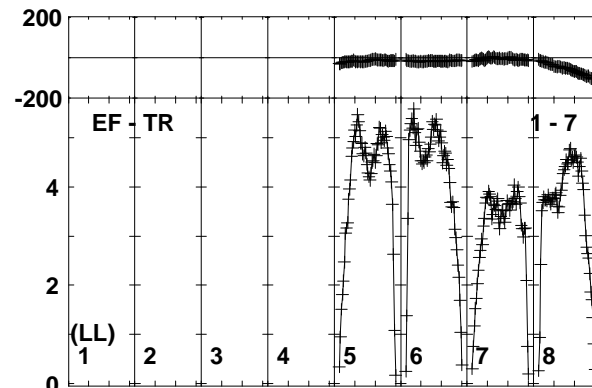
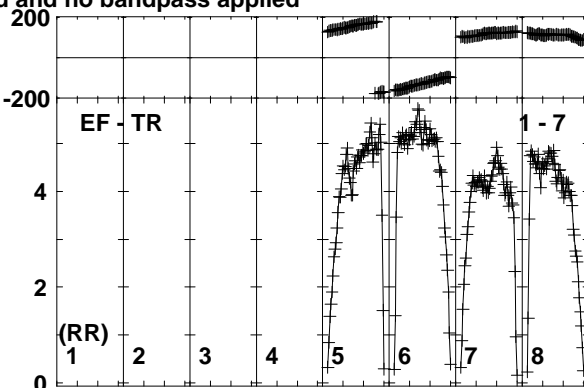
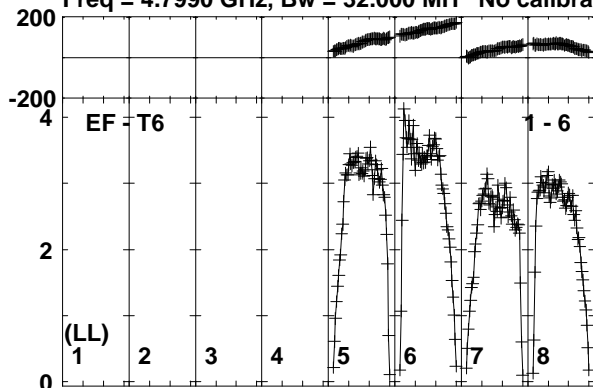

Lower frame: Milli Ampl Jy Top frame: Phas deg
Vector averaged cross-power spectrum Baseline: EF (01) - T6 (06)
Timerange: 00/19:59:01 to 00/20:00:29

Plot file version 311 created 19-OCT-2017 15:36:38

MRK335 ES081C.UVDATA.1

Freq = 4.7990 GHz, Bw = 32.000 MH No calibration applied and no bandpass applied

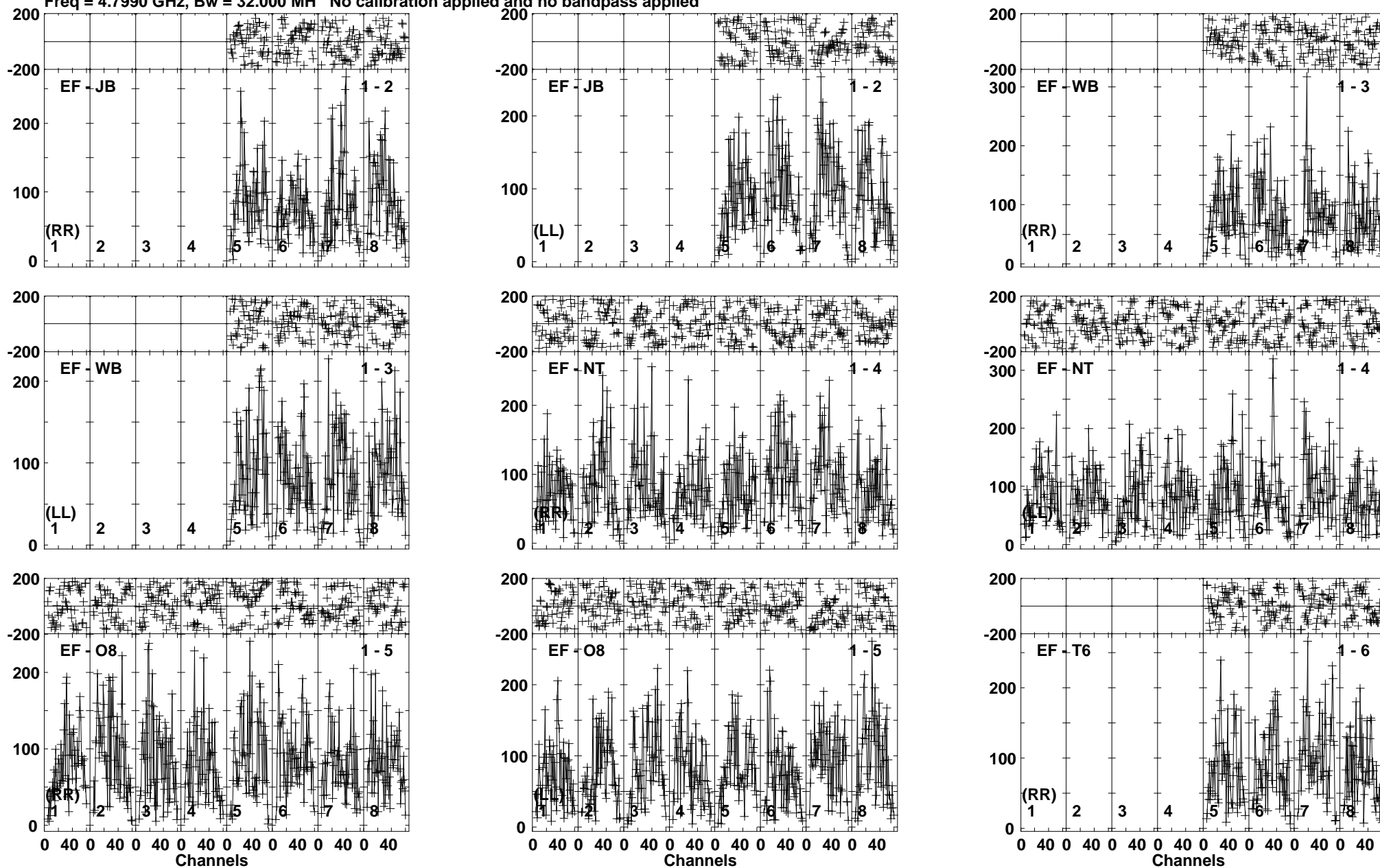

Lower frame: Micro Ampl Jy Top frame: Phas deg
Vector averaged cross-power spectrum Baseline: EF (01) - JB (02)
Timerange: 00/20:00:31 to 00/20:03:59

Plot file version 312 created 19-OCT-2017 15:36:38

MRK335 ES081C.UVDATA.1

Freq = 4.7990 GHz, Bw = 32.000 MH No calibration applied and no bandpass applied

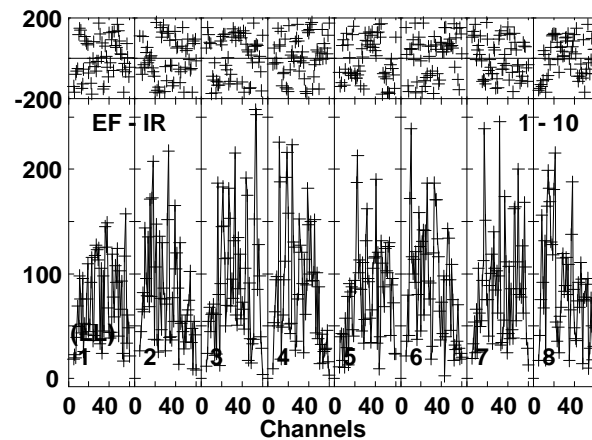
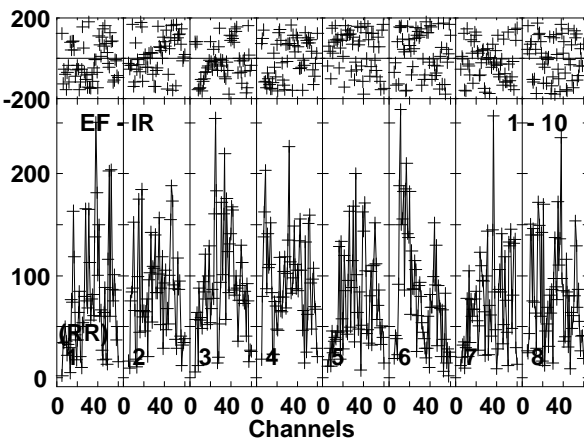
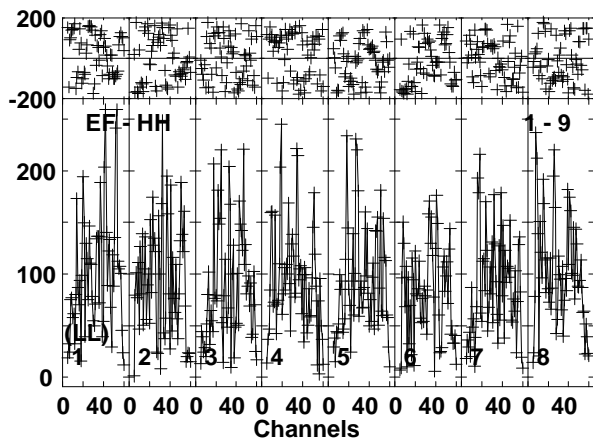
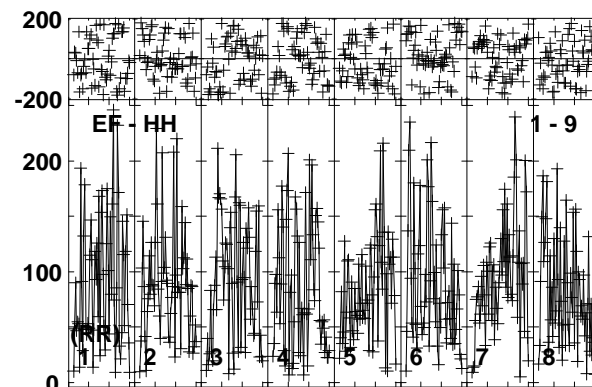
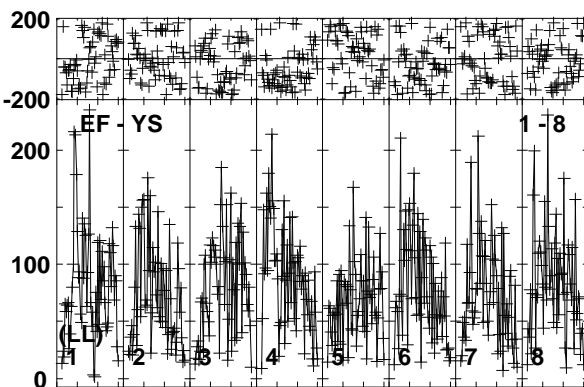
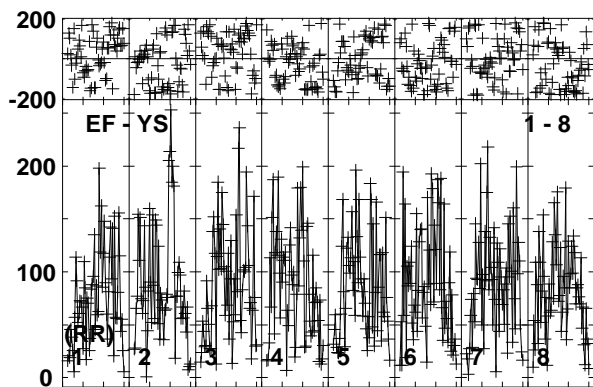
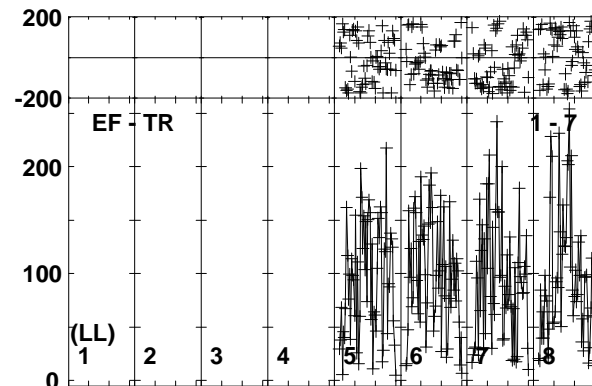
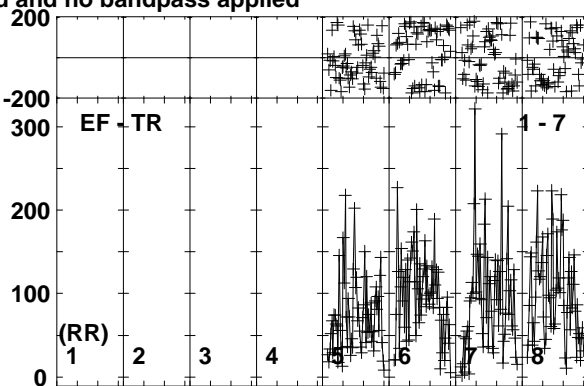
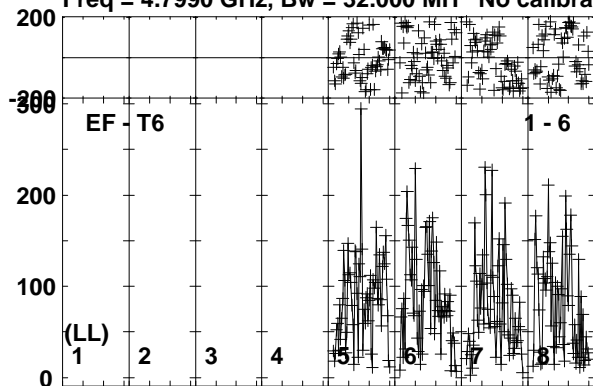

Lower frame: Micro Ampl Jy Top frame: Phas deg
Vector averaged cross-power spectrum Baseline: EF (01) - T6 (06)
Timerange: 00/20:00:31 to 00/20:03:59

Plot file version 313 created 19-OCT-2017 15:36:38

J0004+2019 ES081C.UVDATA.1

Freq = 4.7990 GHz, Bw = 32.000 MH No calibration applied and no bandpass applied

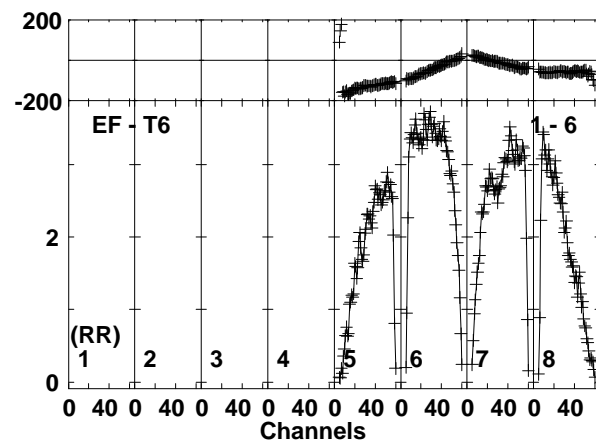
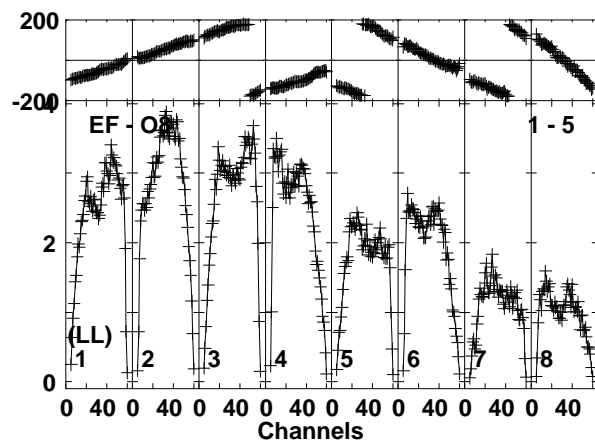
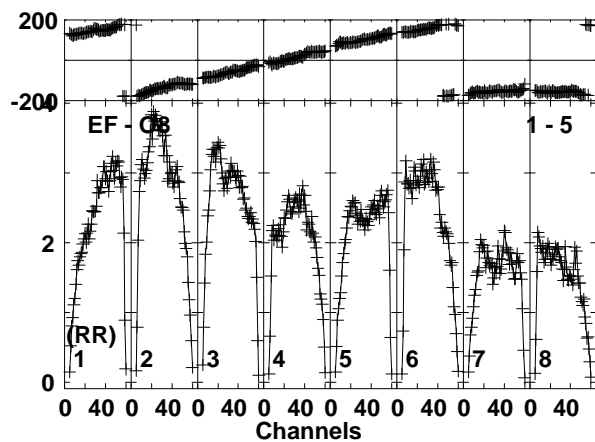
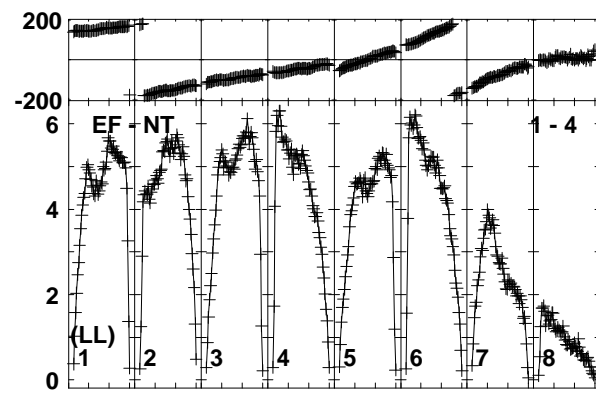
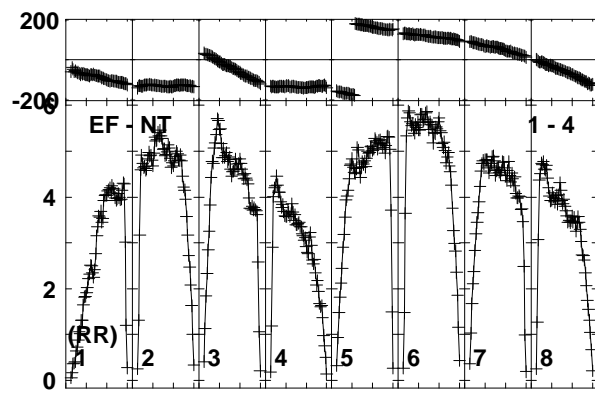
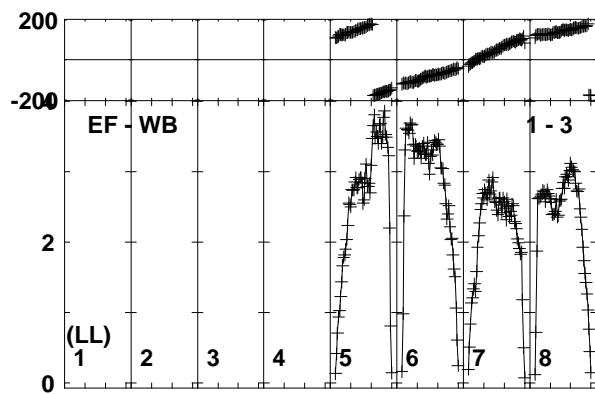
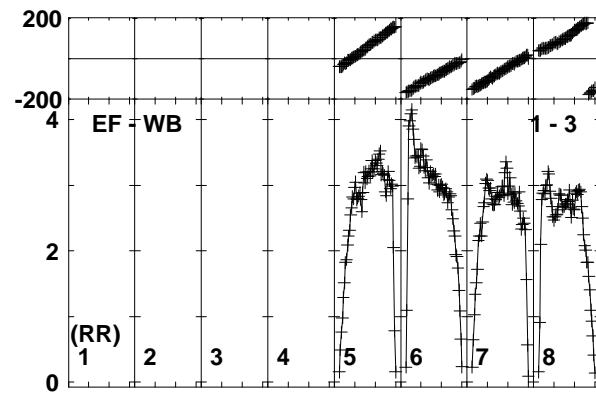
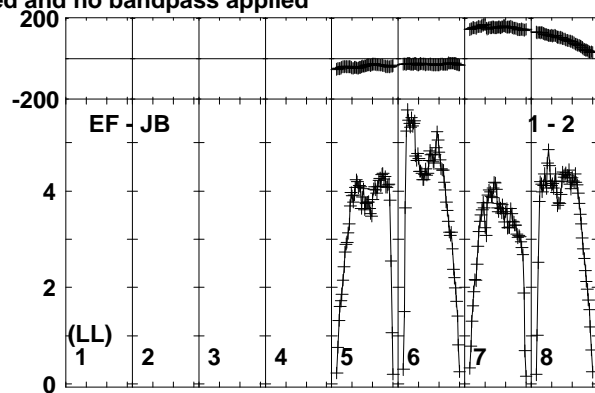
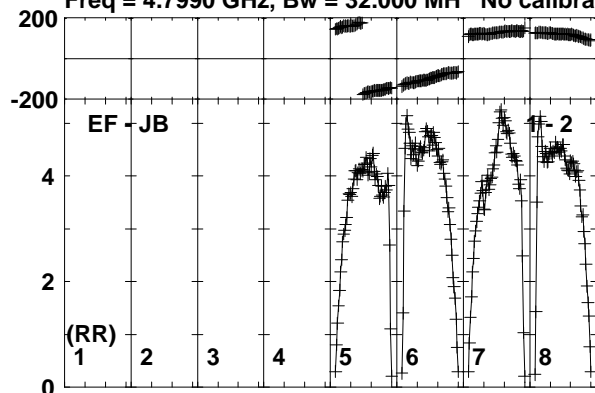

Lower frame: Milli Ampl Jy Top frame: Phas deg
Vector averaged cross-power spectrum Baseline: EF (01) - JB (02)
Timerange: 00/20:04:31 to 00/20:05:29

Plot file version 314 created 19-OCT-2017 15:36:39

J0004+2019 ES081C.UVDATA.1

Freq = 4.7990 GHz, Bw = 32.000 MH No calibration applied and no bandpass applied

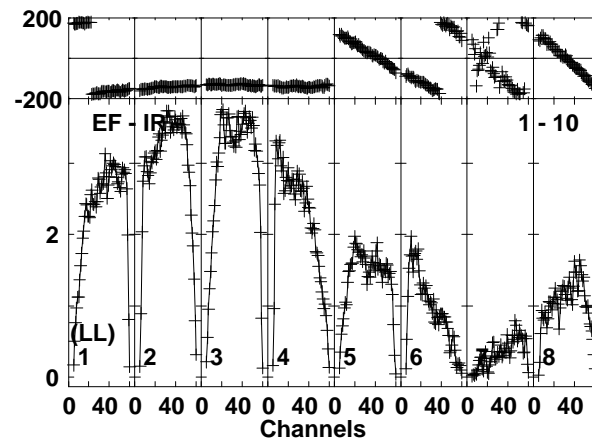
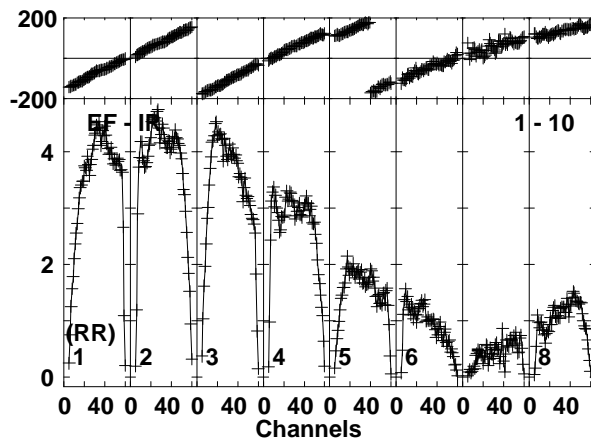
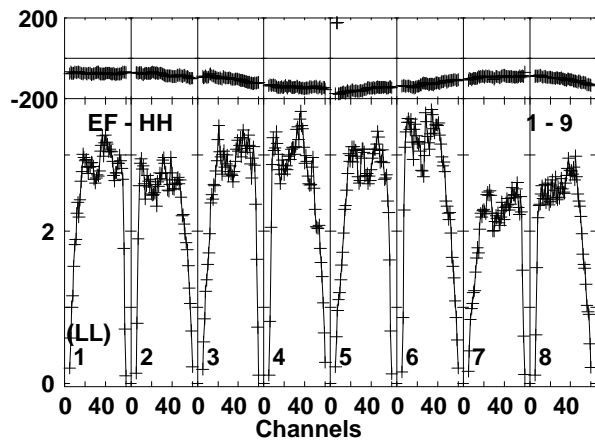
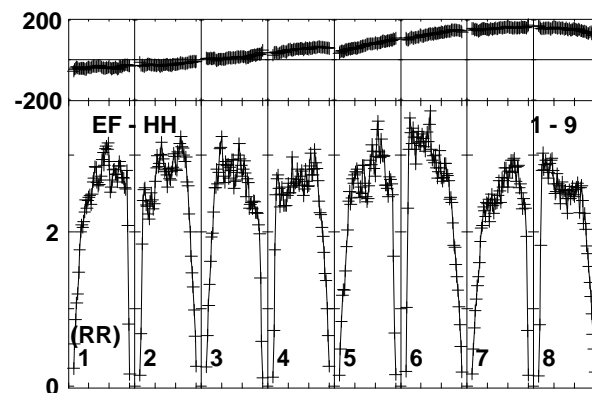
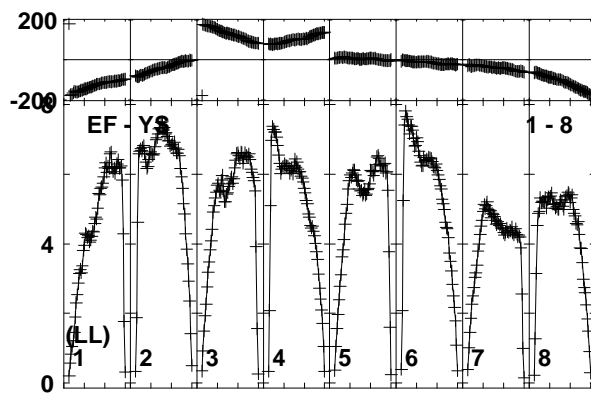
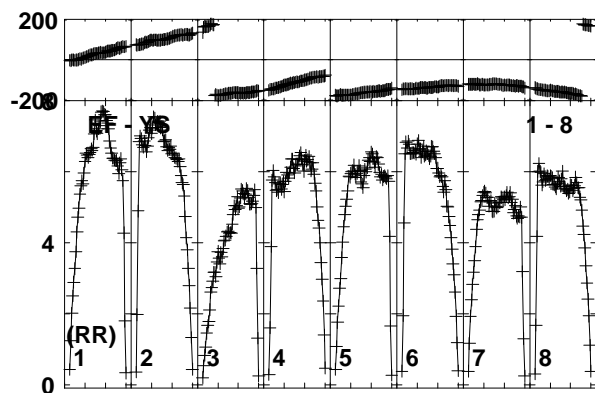
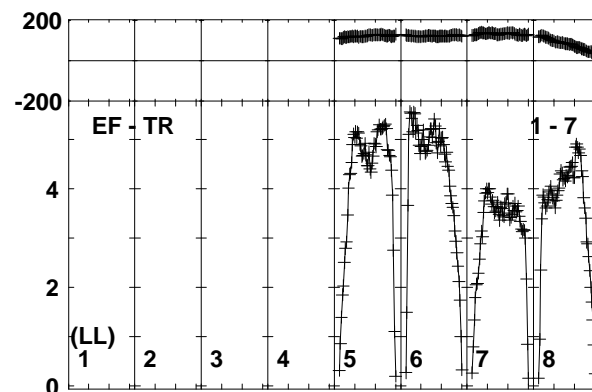
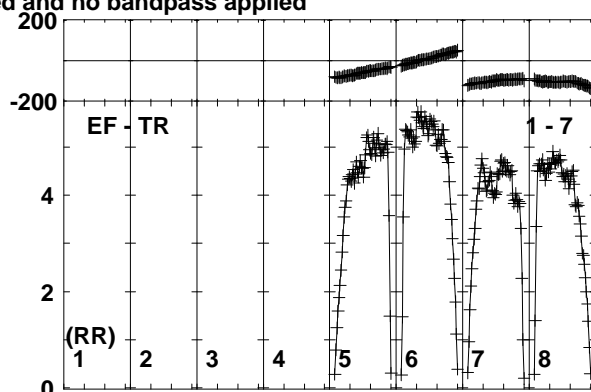
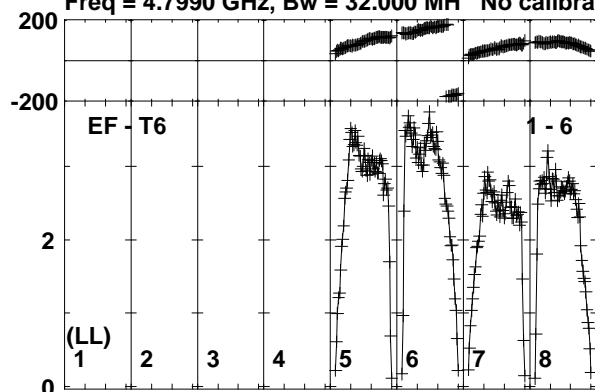

Lower frame: Milli Ampl Jy Top frame: Phas deg
Vector averaged cross-power spectrum Baseline: EF (01) - T6 (06)
Timerange: 00/20:04:31 to 00/20:05:29

Plot file version 315 created 19-OCT-2017 15:36:39

MRK335 ES081C.UVDATA.1

Freq = 4.7990 GHz, Bw = 32.000 MH No calibration applied and no bandpass applied

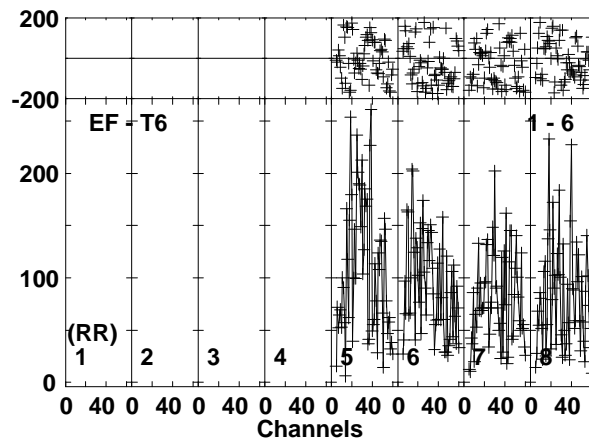
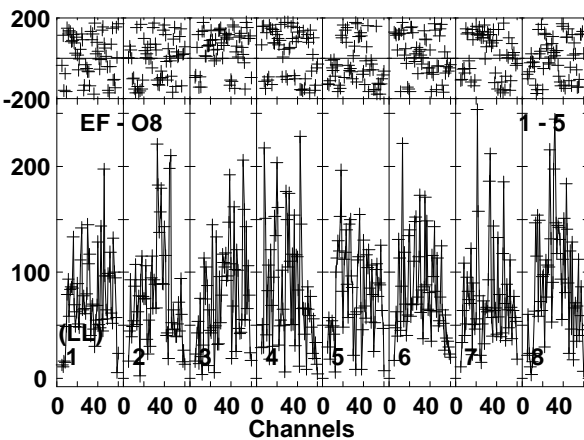
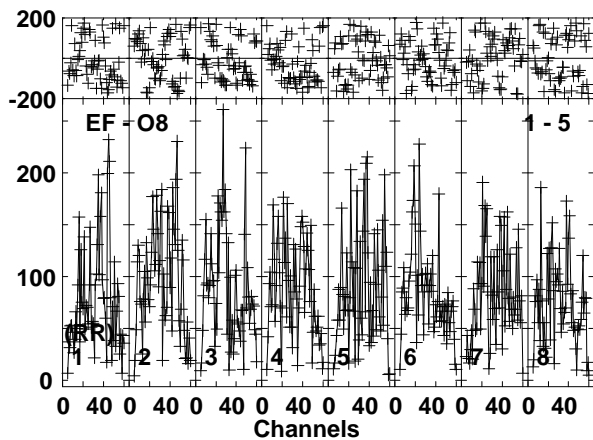
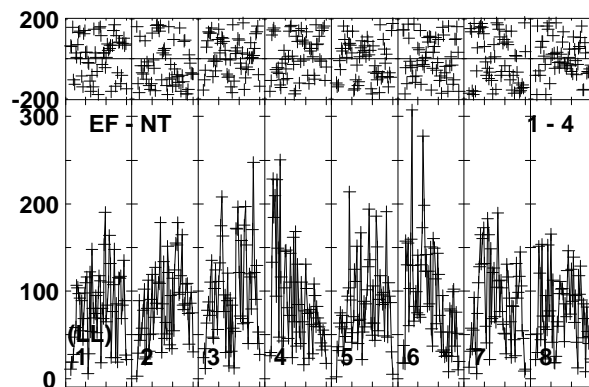
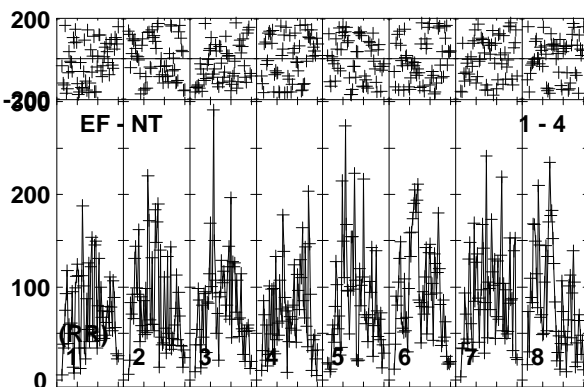
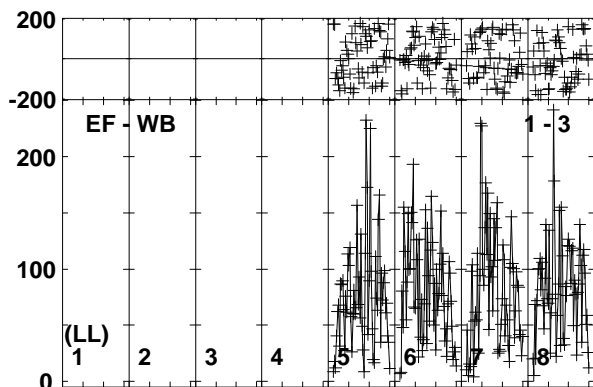
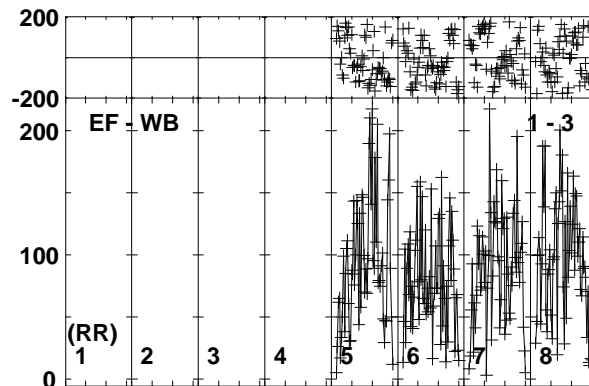
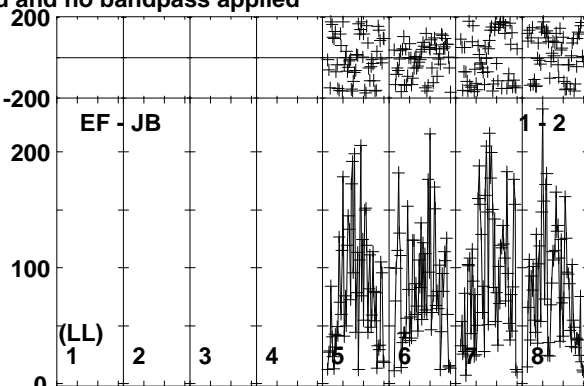
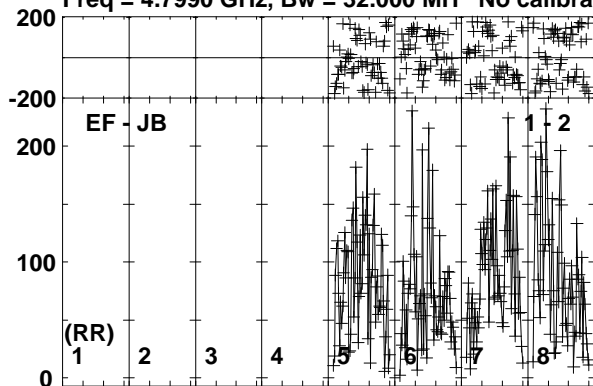

Lower frame: Micro Ampl Jy Top frame: Phas deg
Vector averaged cross-power spectrum Baseline: EF (01) - JB (02)
Timerange: 00/20:05:31 to 00/20:08:59

Plot file version 316 created 19-OCT-2017 15:36:39

MRK335 ES081C.UVDATA.1

Freq = 4.7990 GHz, Bw = 32.000 MH No calibration applied and no bandpass applied

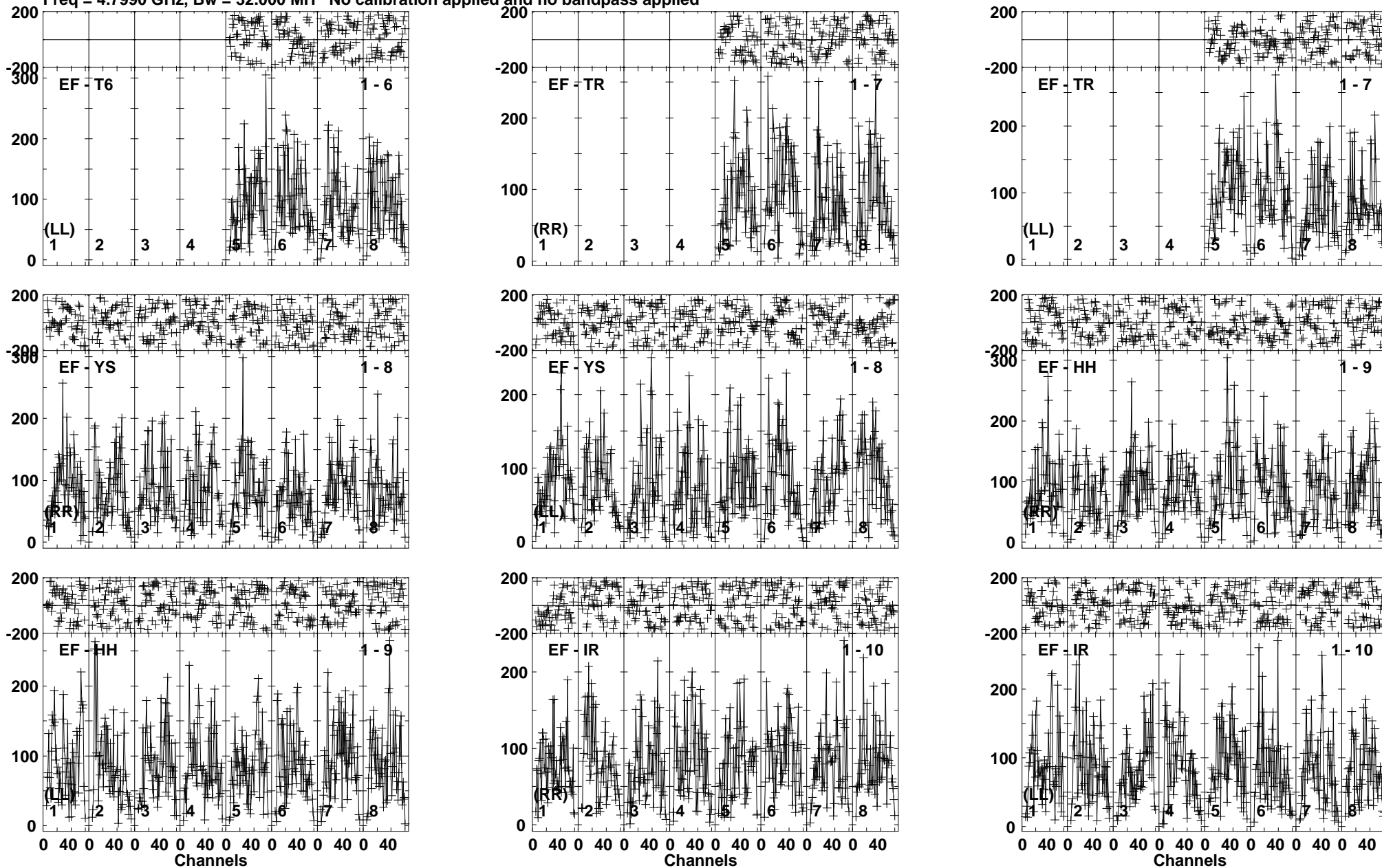

Lower frame: Micro Ampl Jy Top frame: Phas deg
Vector averaged cross-power spectrum Baseline: EF (01) - T6 (06)
Timerange: 00/20:05:31 to 00/20:08:59

Plot file version 317 created 19-OCT-2017 15:36:39

J0004+2019 ES081C.UVDATA.1

Freq = 4.7990 GHz, Bw = 32.000 MH No calibration applied and no bandpass applied

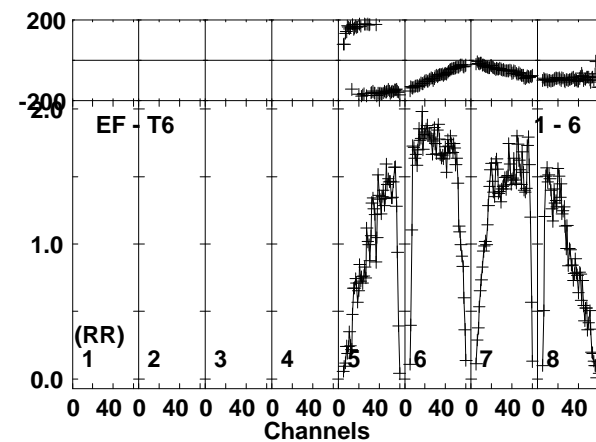
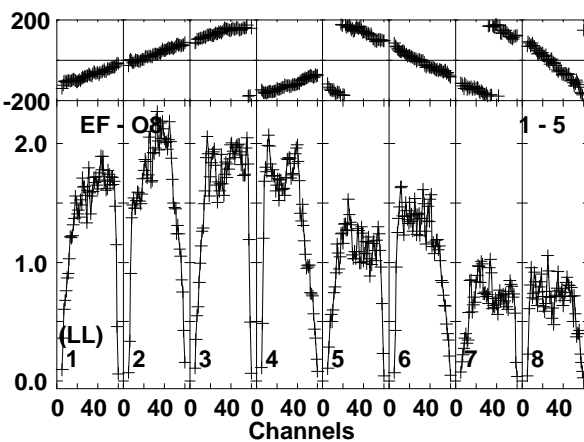
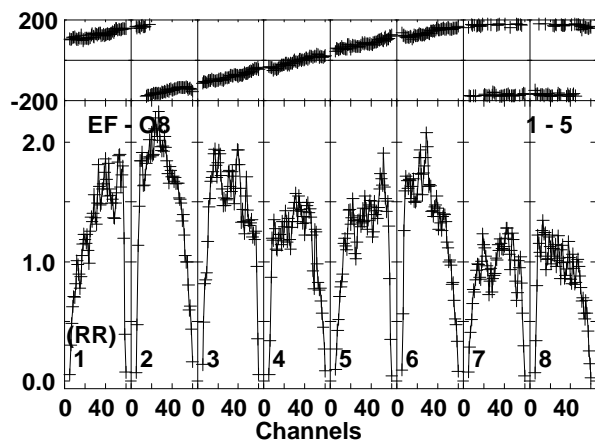
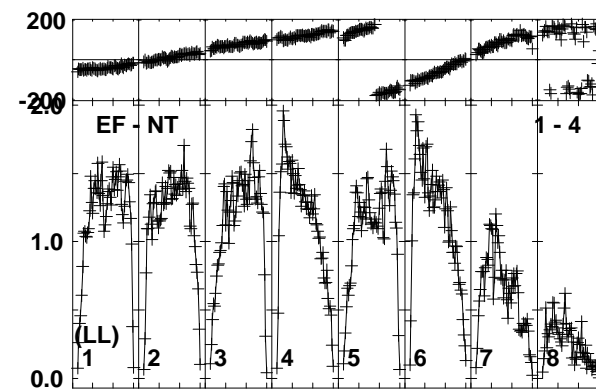
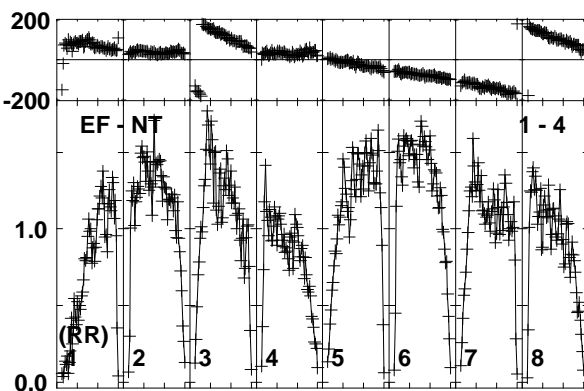
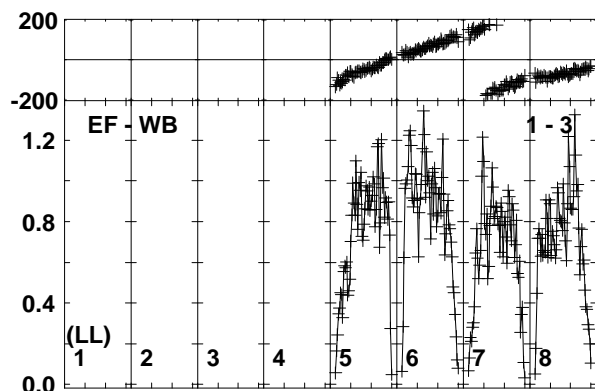
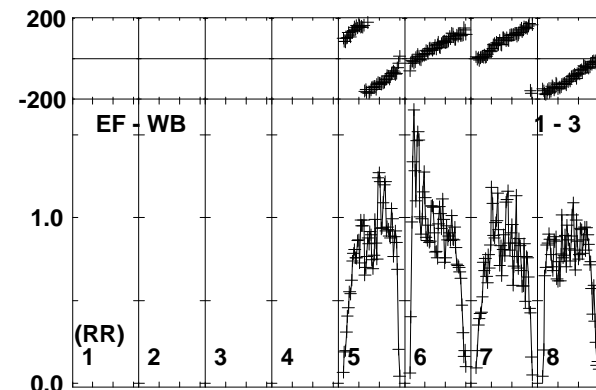
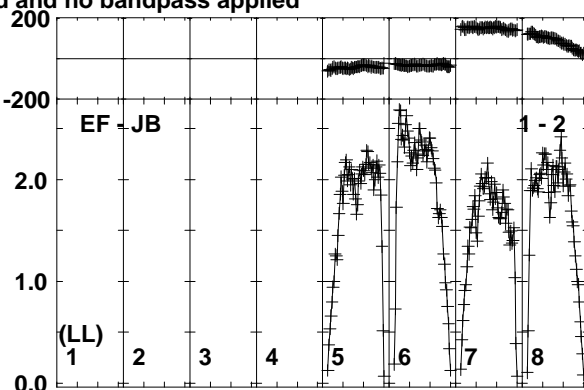
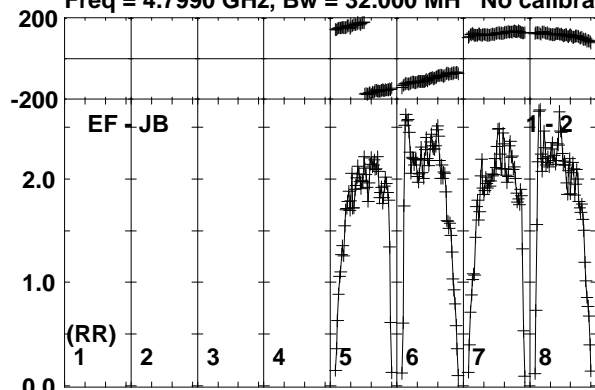

Lower frame: Milli Ampl Jy Top frame: Phas deg
Vector averaged cross-power spectrum Baseline: EF (01) - JB (02)
Timerange: 00/20:09:01 to 00/20:10:29

Plot file version 318 created 19-OCT-2017 15:36:39

J0004+2019 ES081C.UVDATA.1

Freq = 4.7990 GHz, Bw = 32.000 MH No calibration applied and no bandpass applied

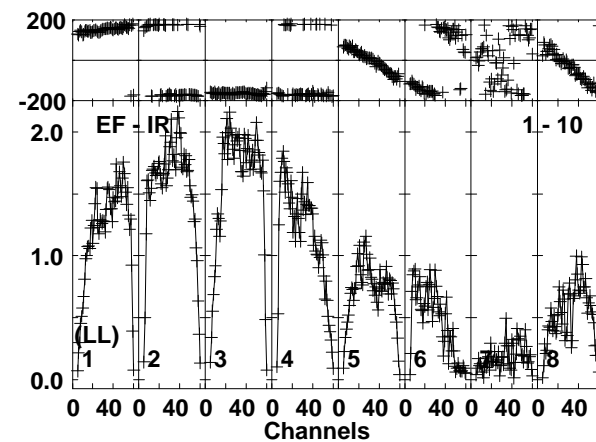
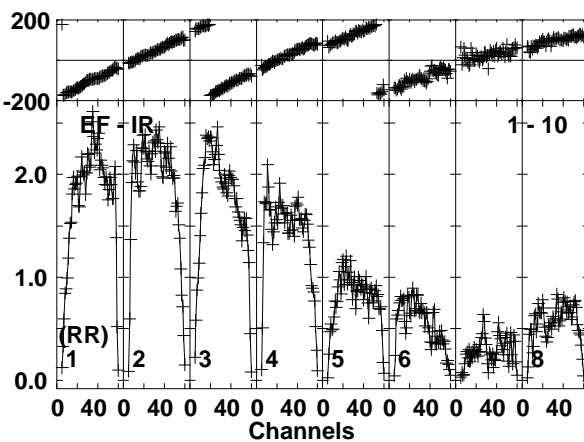
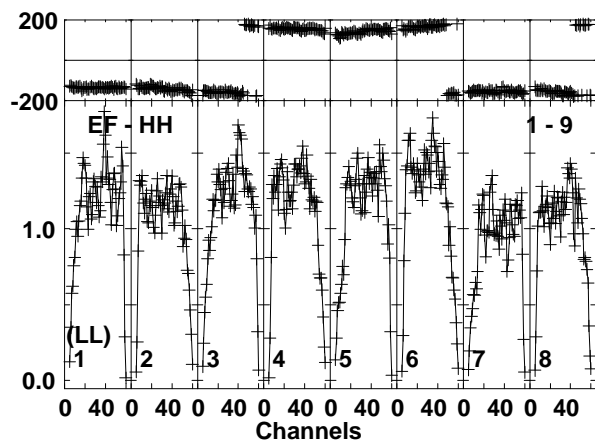
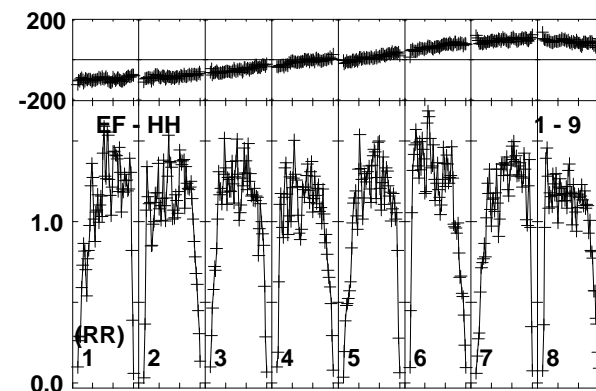
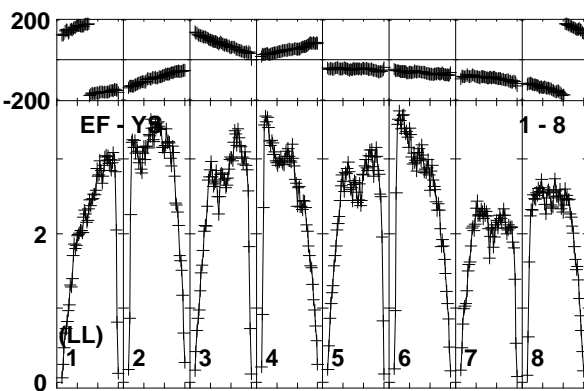
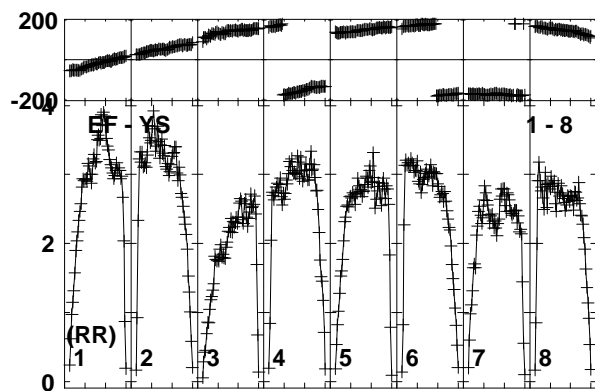
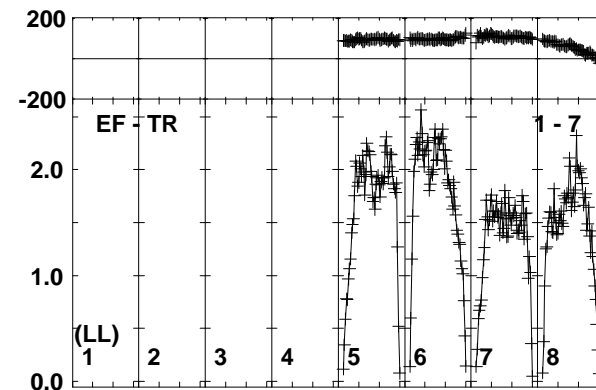
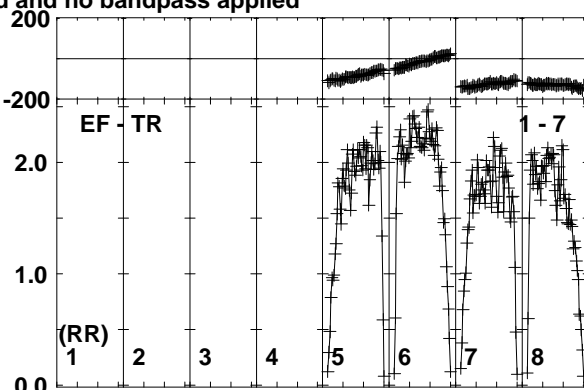
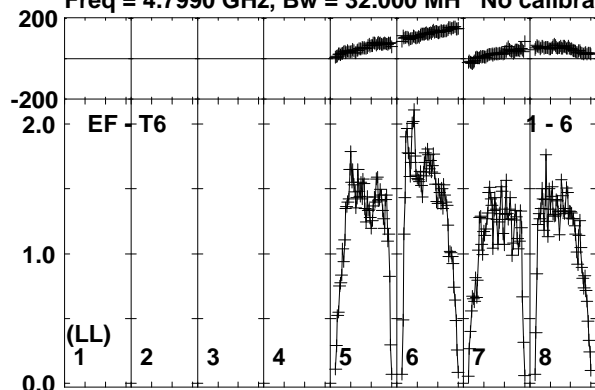

Lower frame: Milli Ampl Jy Top frame: Phas deg
Vector averaged cross-power spectrum Baseline: EF (01) - T6 (06)
Timerange: 00/20:09:01 to 00/20:10:29

Plot file version 319 created 19-OCT-2017 15:36:39

MRK335 ES081C.UVDATA.1

Freq = 4.7990 GHz, Bw = 32.000 MH No calibration applied and no bandpass applied

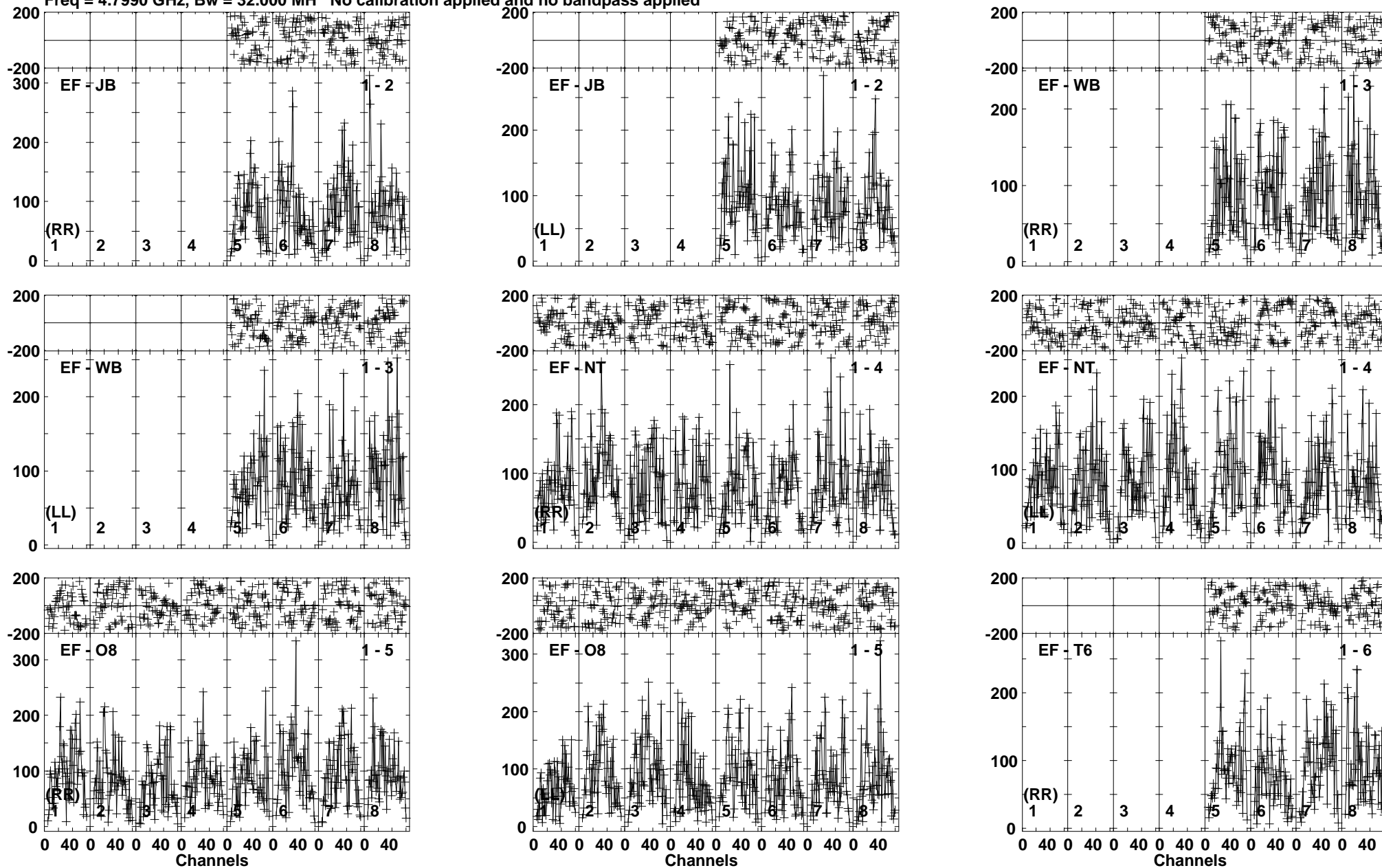

Lower frame: Micro Ampl Jy Top frame: Phas deg
Vector averaged cross-power spectrum Baseline: EF (01) - JB (02)
Timerange: 00/20:10:31 to 00/20:13:59

Plot file version 320 created 19-OCT-2017 15:36:39

MRK335 ES081C.UVDATA.1

Freq = 4.7990 GHz, Bw = 32.000 MH No calibration applied and no bandpass applied

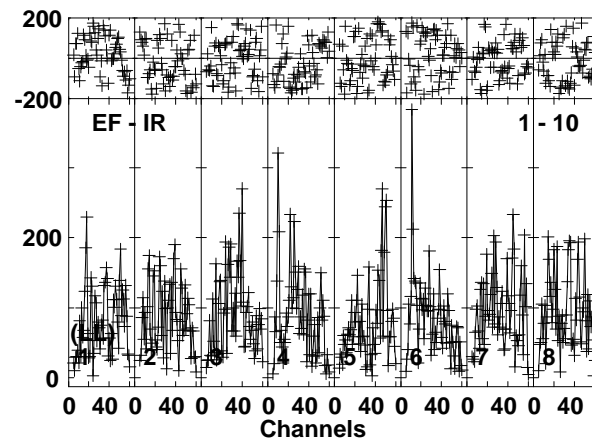
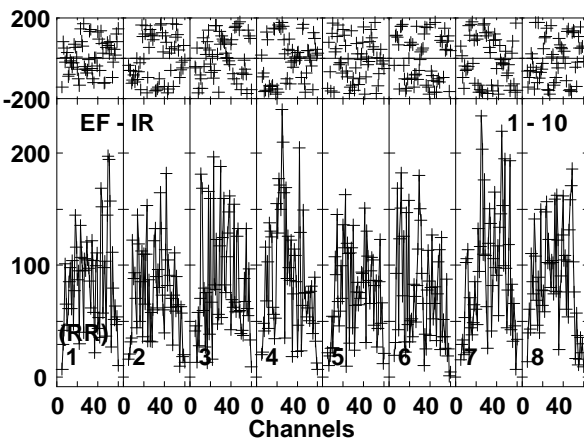
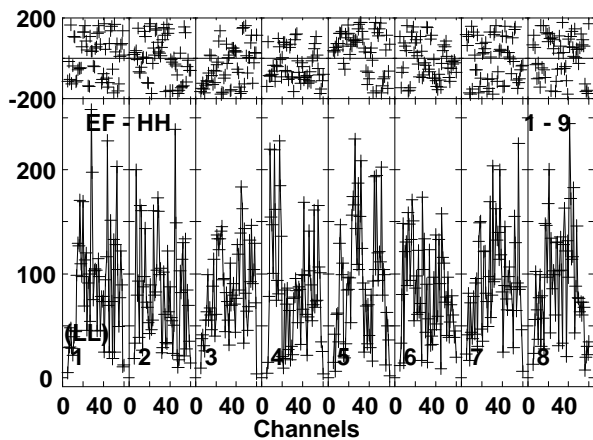
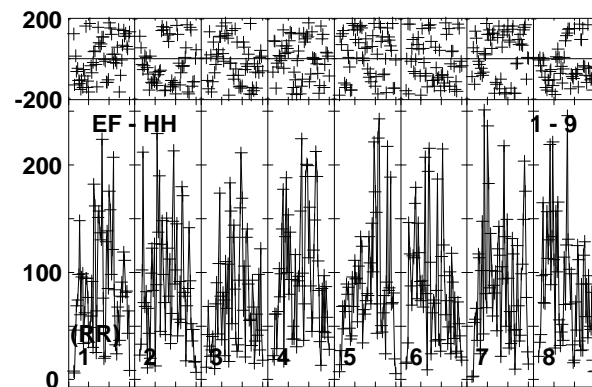
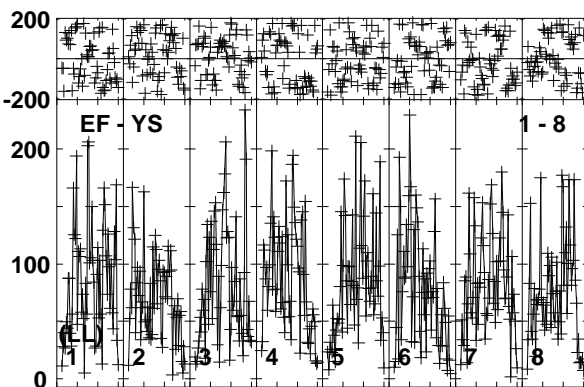
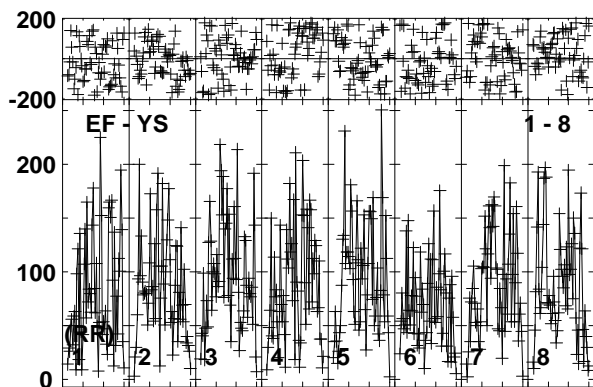
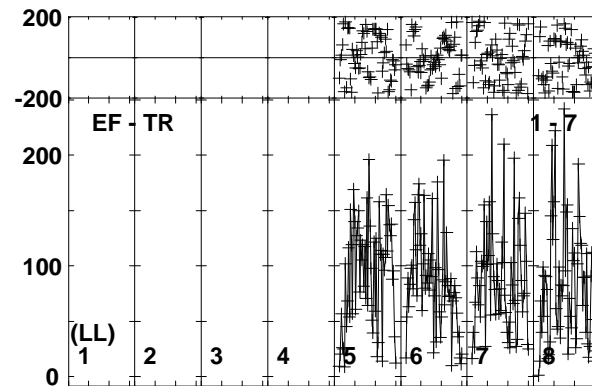
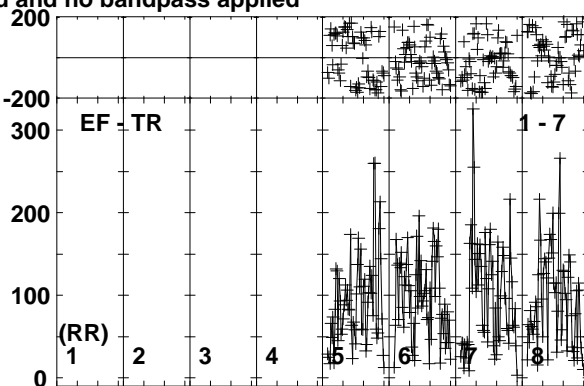
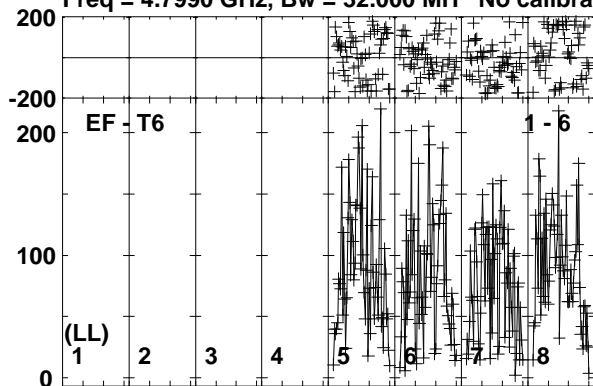

Lower frame: Micro Ampl Jy Top frame: Phas deg
 Vector averaged cross-power spectrum Baseline: EF (01) - T6 (06)
 Timerange: 00/20:10:31 to 00/20:13:59

Plot file version 321 created 19-OCT-2017 15:36:40

J0004+2019 ES081C.UVDATA.1

Freq = 4.7990 GHz, Bw = 32.000 MH No calibration applied and no bandpass applied

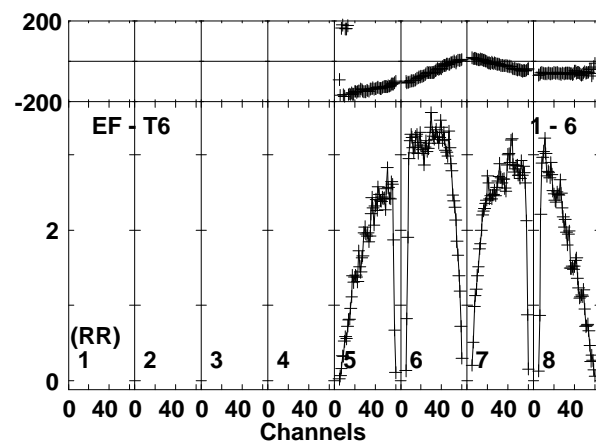
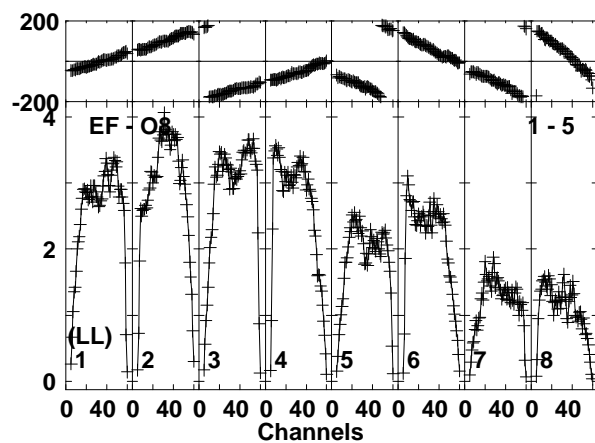
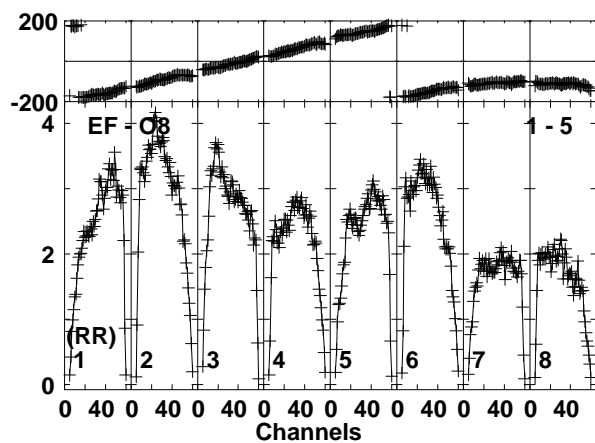
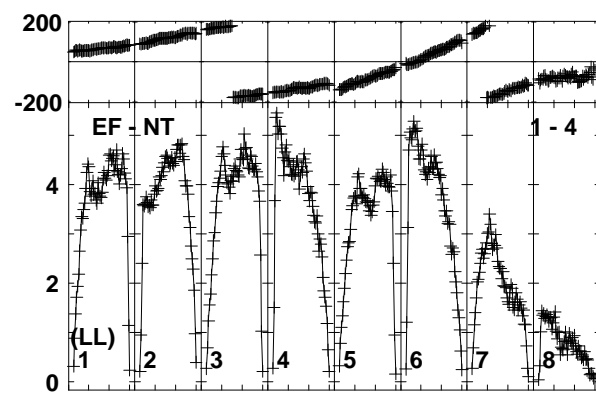
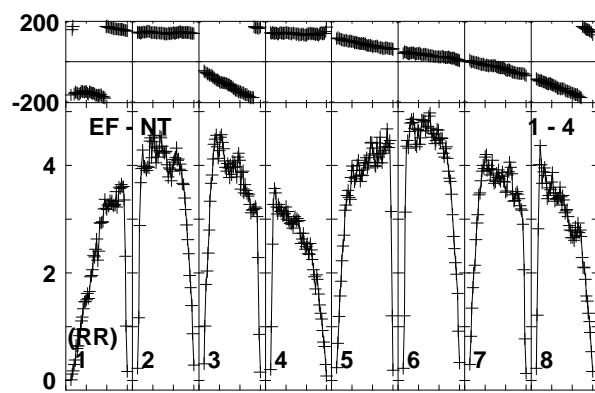
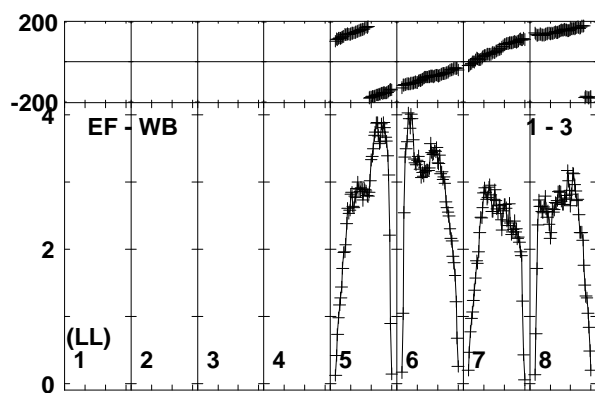
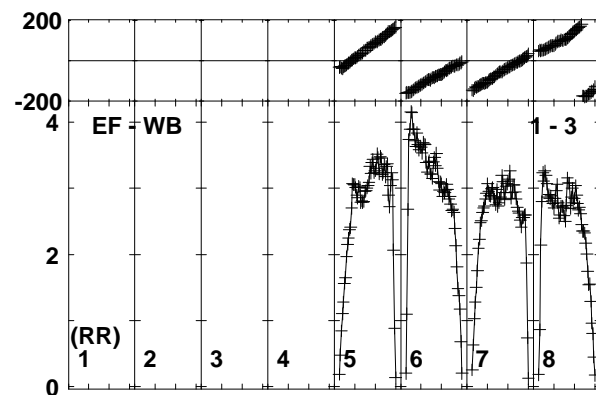
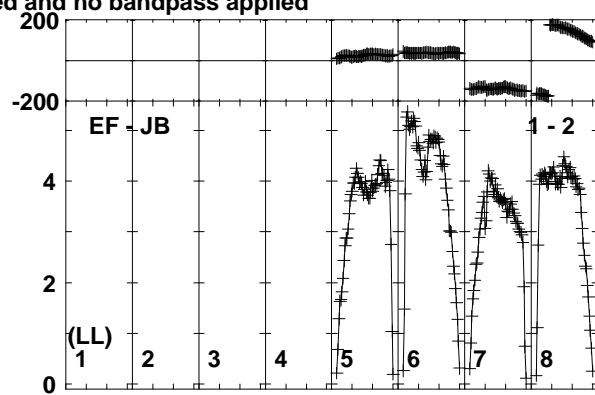
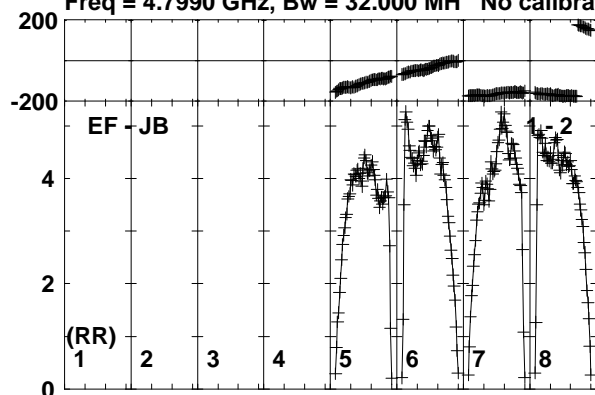

Lower frame: Milli Ampl Jy Top frame: Phas deg
Vector averaged cross-power spectrum Baseline: EF (01) - JB (02)
Timerange: 00/20:14:31 to 00/20:15:29

Plot file version 322 created 19-OCT-2017 15:36:40

J0004+2019 ES081C.UVDATA.1

Freq = 4.7990 GHz, Bw = 32.000 MH No calibration applied and no bandpass applied

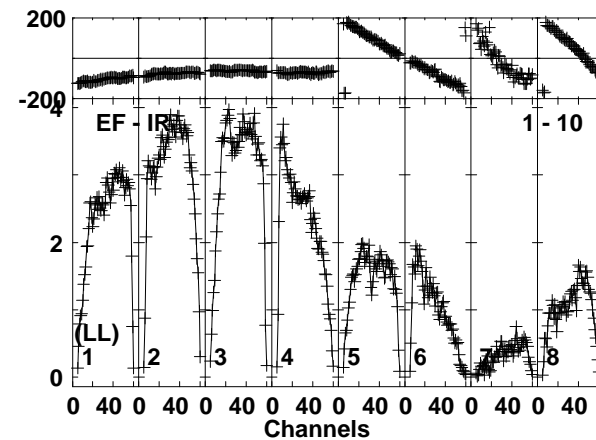
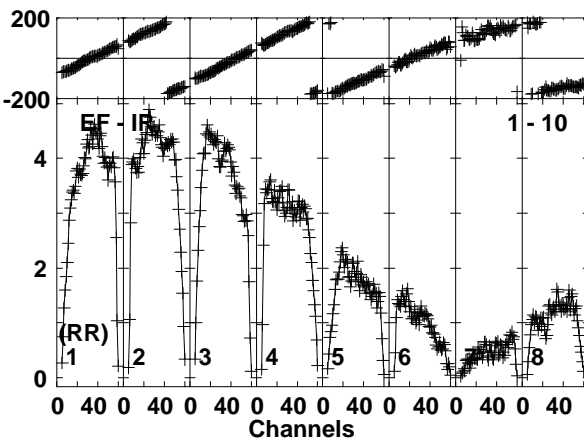
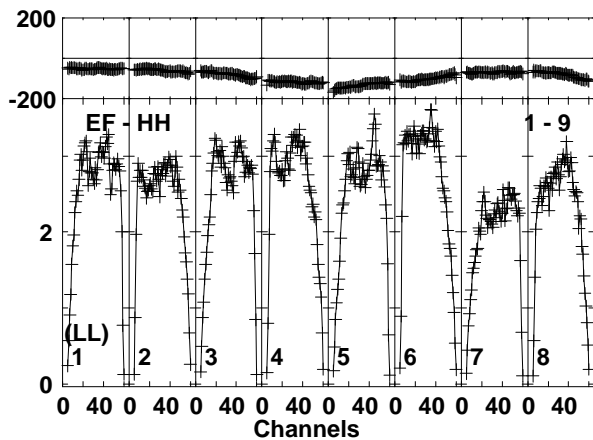
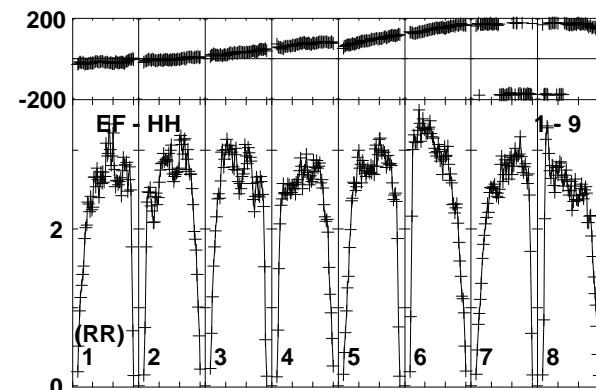
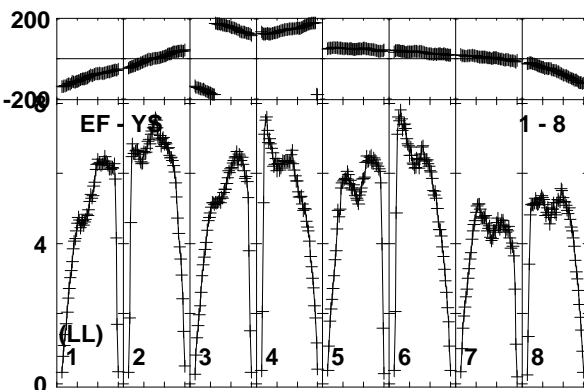
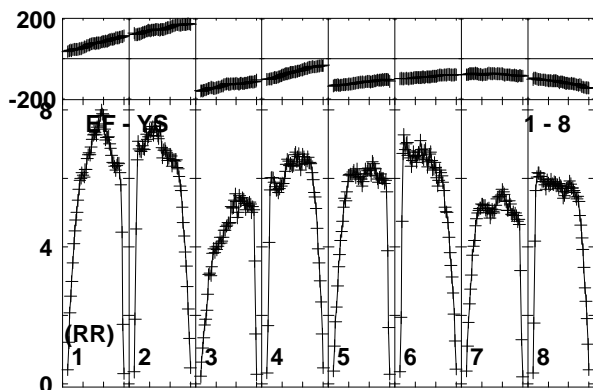
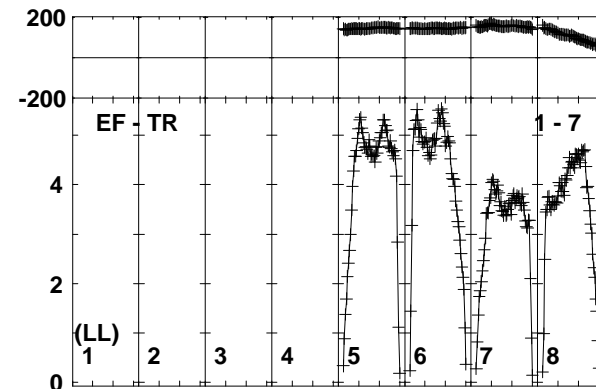
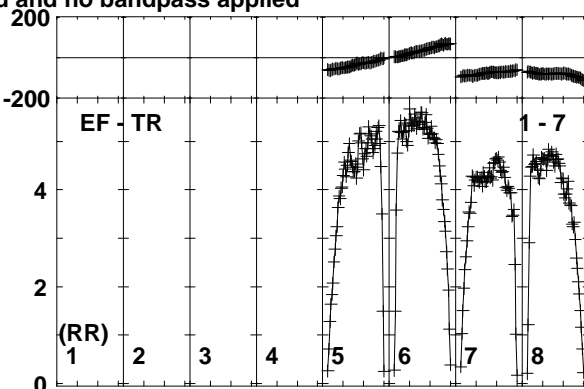
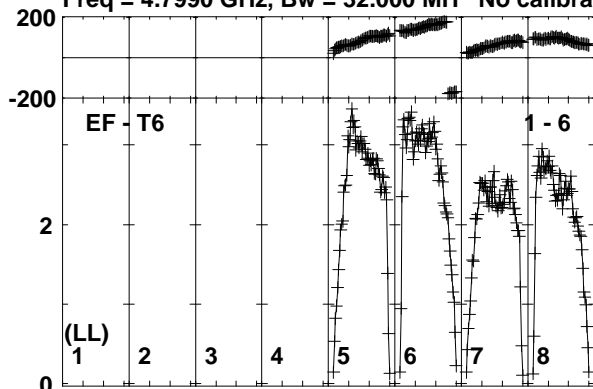

Lower frame: Milli Ampl Jy Top frame: Phas deg
Vector averaged cross-power spectrum Baseline: EF (01) - T6 (06)
Timerange: 00/20:14:31 to 00/20:15:29

Plot file version 323 created 19-OCT-2017 15:36:40

J0126+2559 ES081C.UVDATA.1

Freq = 4.7990 GHz, Bw = 32.000 MH No calibration applied and no bandpass applied

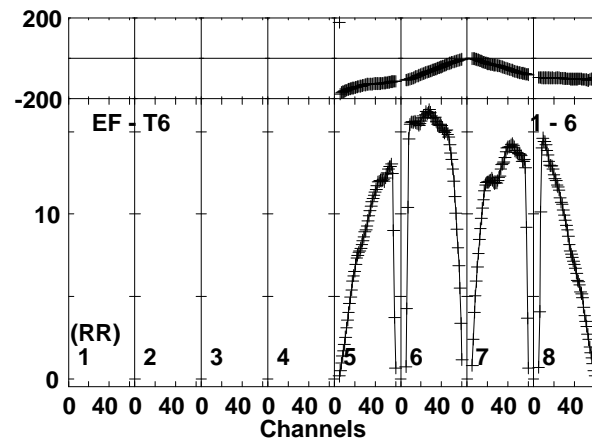
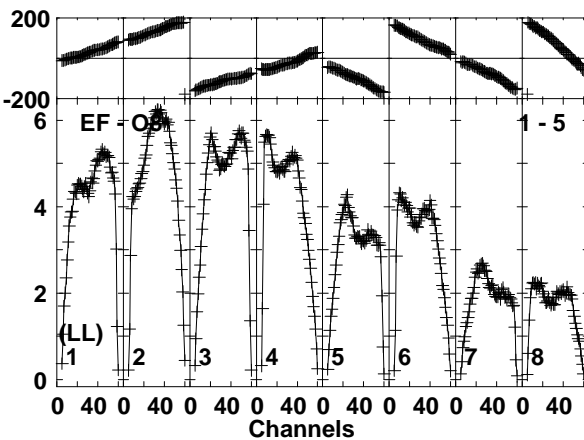
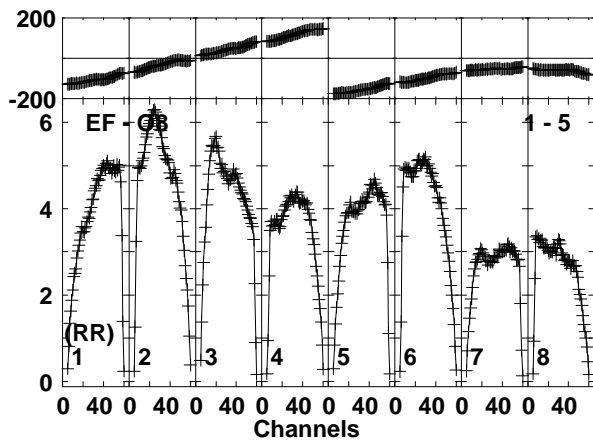
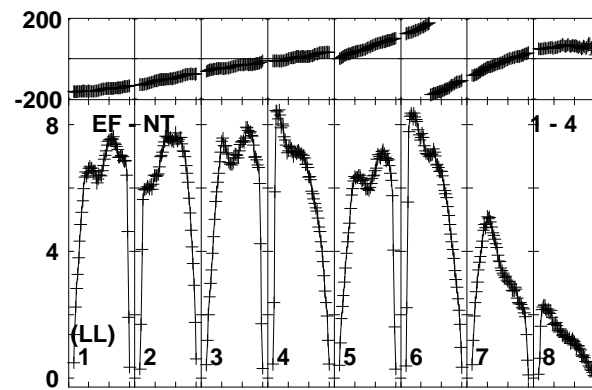
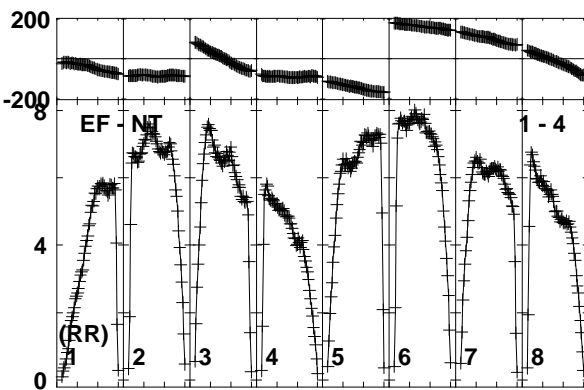
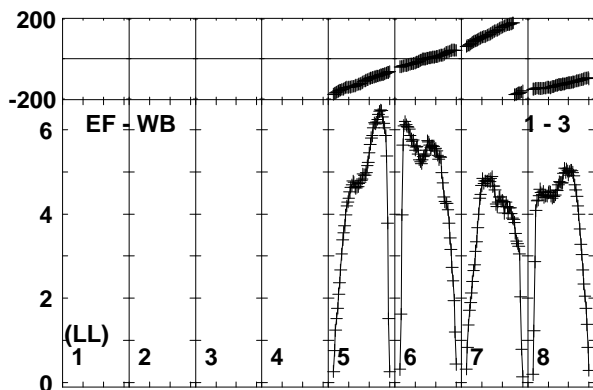
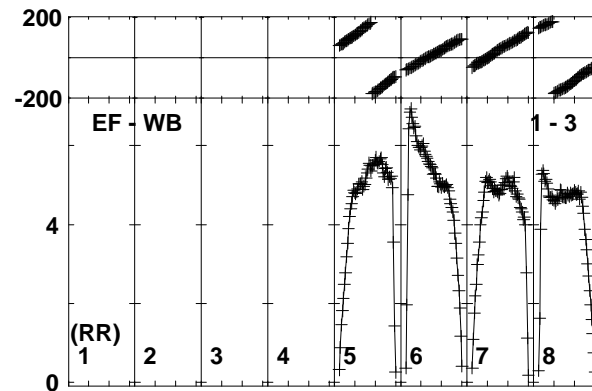
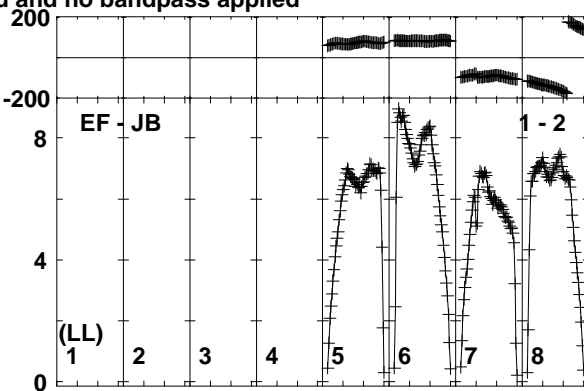
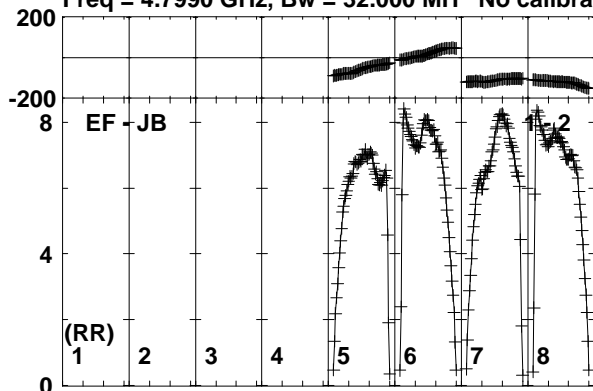

Lower frame: Milli Ampl Jy Top frame: Phas deg
Vector averaged cross-power spectrum Baseline: EF (01) - JB (02)
Timerange: 00/20:17:21 to 00/20:20:19

Plot file version 324 created 19-OCT-2017 15:36:40

J0126+2559 ES081C.UVDATA.1

Freq = 4.7990 GHz, Bw = 32.000 MH No calibration applied and no bandpass applied

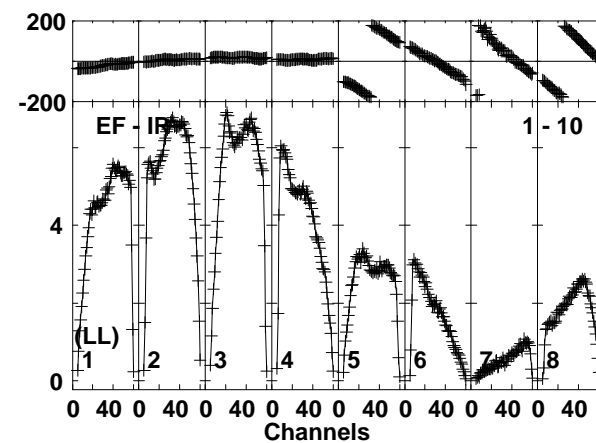
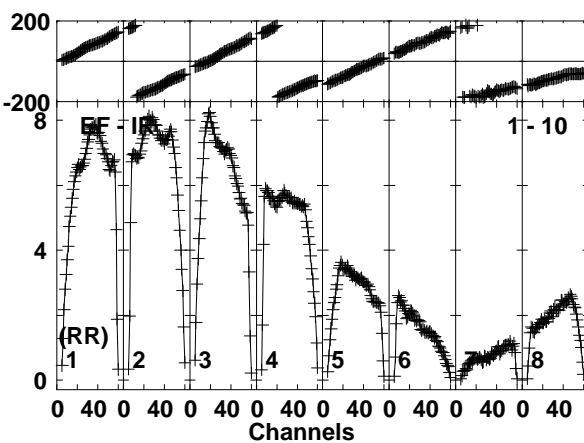
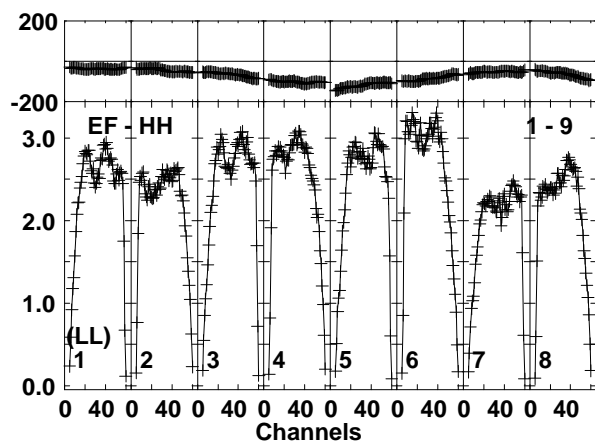
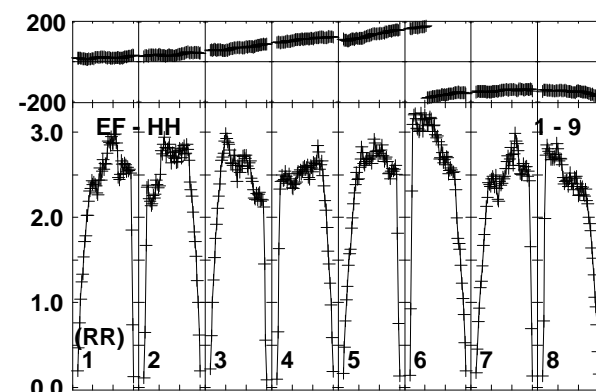
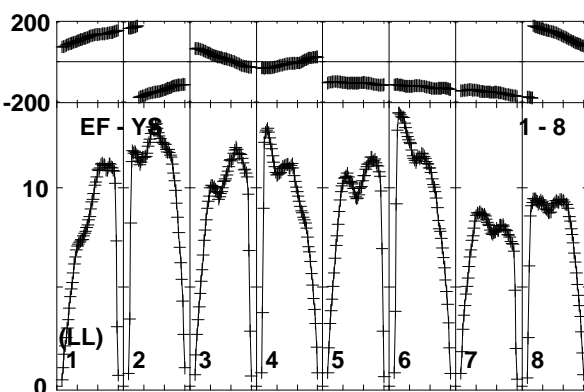
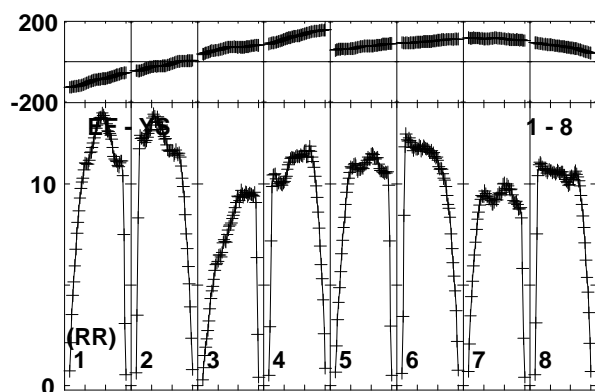
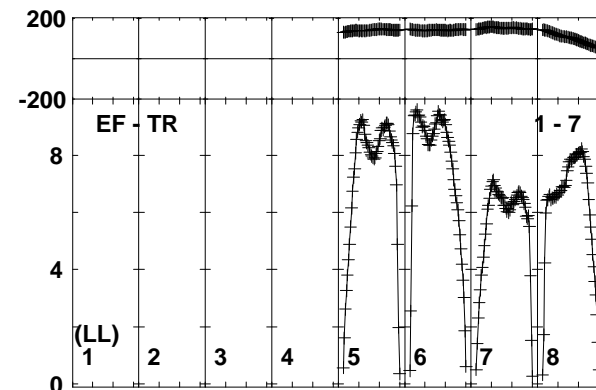
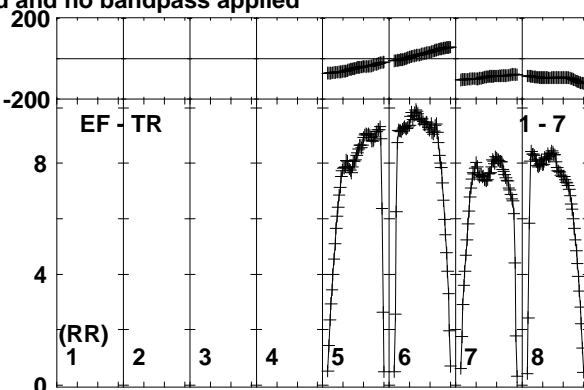
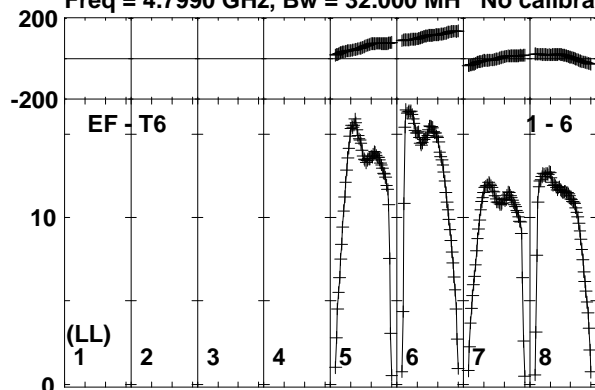

Lower frame: Milli Ampl Jy Top frame: Phas deg
Vector averaged cross-power spectrum Baseline: EF (01) - T6 (06)
Timerange: 00/20:17:21 to 00/20:20:19

Plot file version 325 created 19-OCT-2017 15:36:40

J0139+1753 ES081C.UVDATA.1

Freq = 4.7990 GHz, Bw = 32.000 MH No calibration applied and no bandpass applied

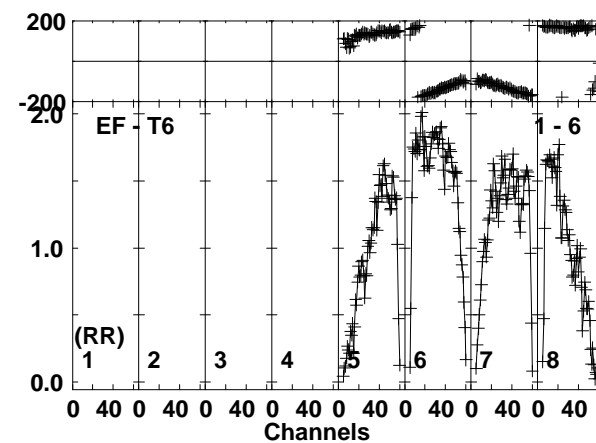
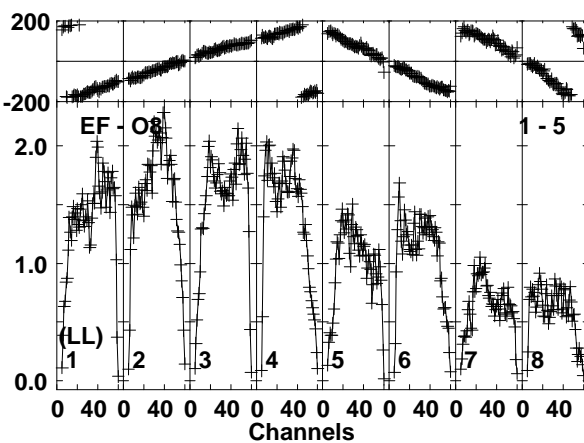
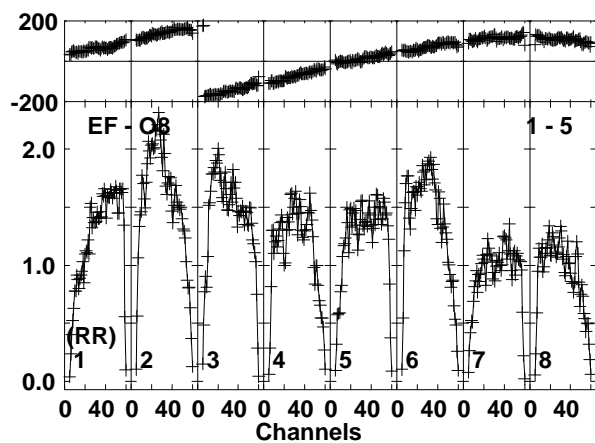
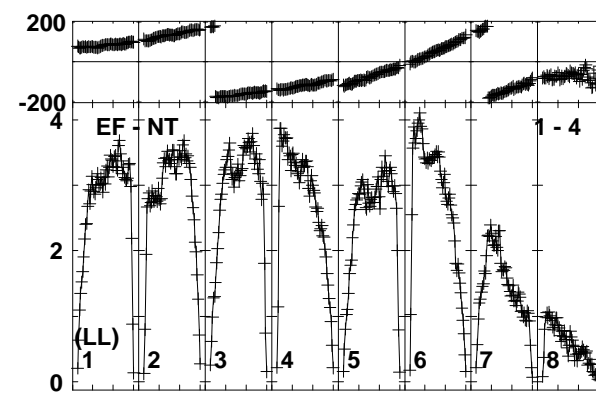
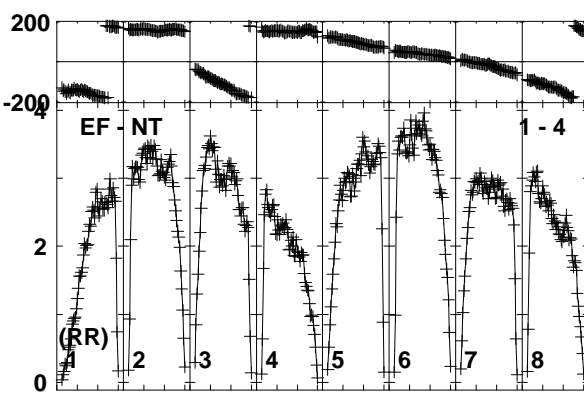
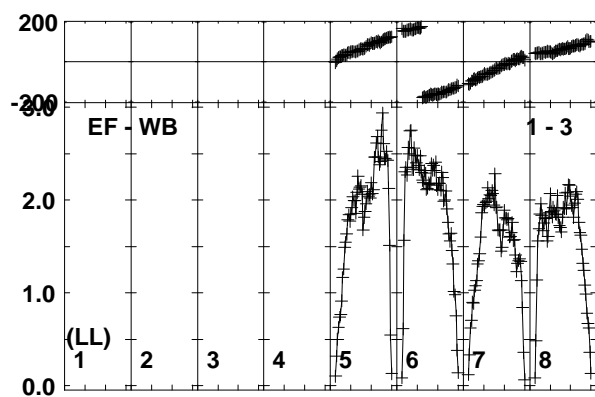
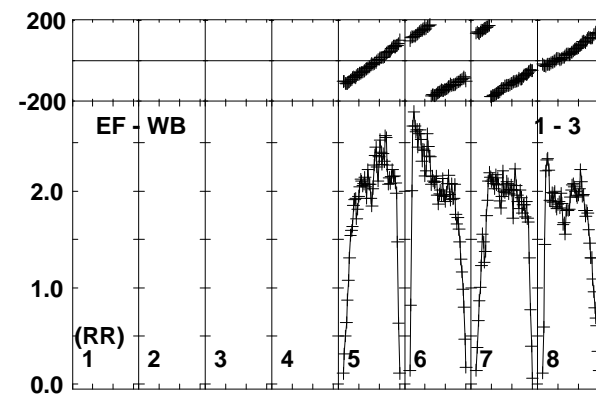
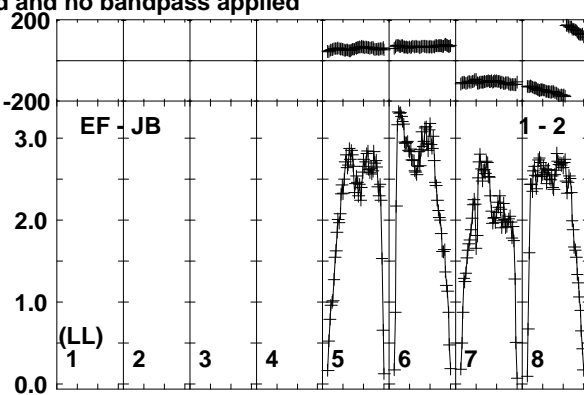
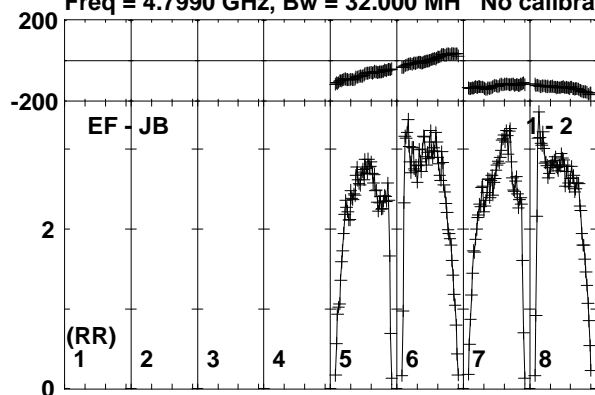

Lower frame: Milli Ampl Jy Top frame: Phas deg
Vector averaged cross-power spectrum Baseline: EF (01) - JB (02)
Timerange: 00/20:21:21 to 00/20:22:49

Plot file version 326 created 19-OCT-2017 15:36:40

J0139+1753 ES081C.UVDATA.1

Freq = 4.7990 GHz, Bw = 32.000 MH No calibration applied and no bandpass applied

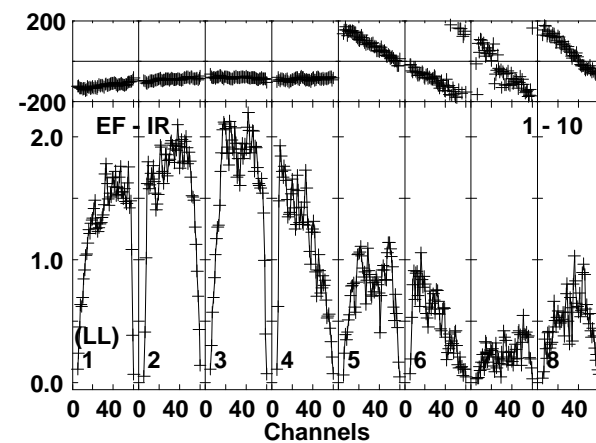
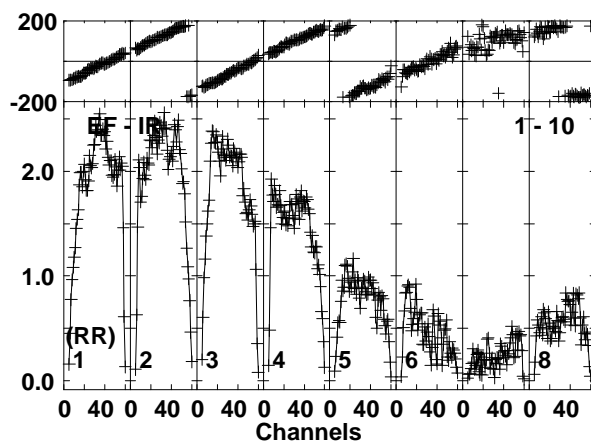
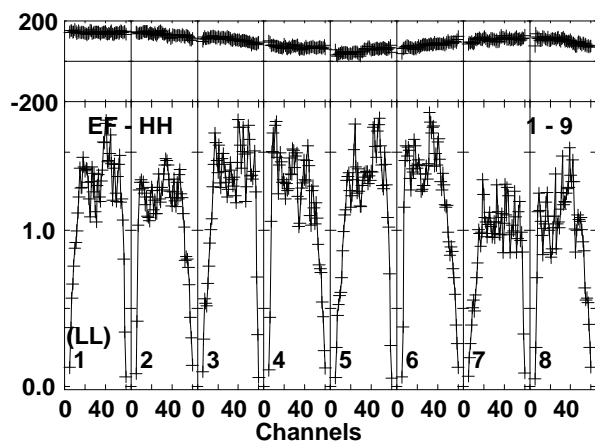
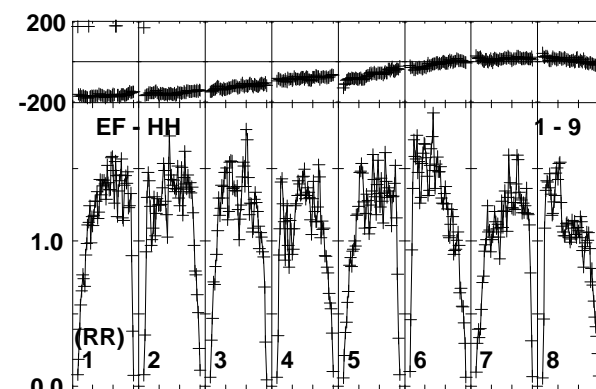
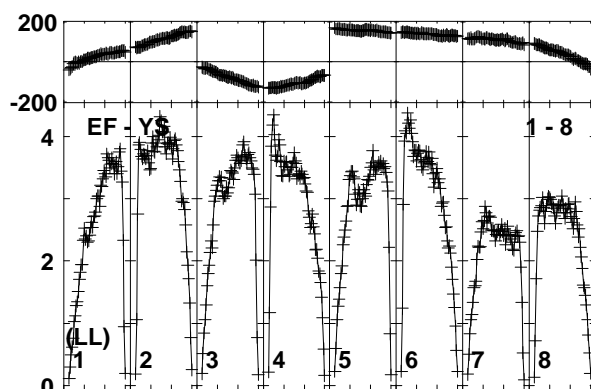
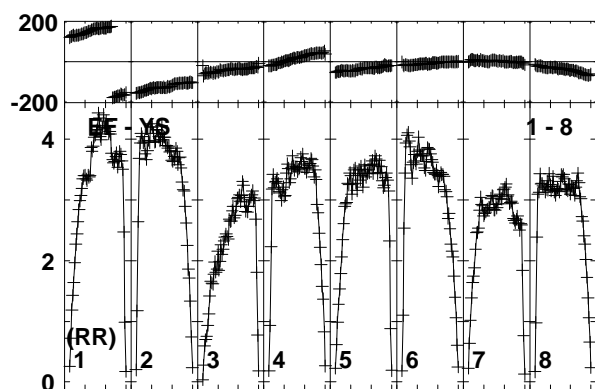
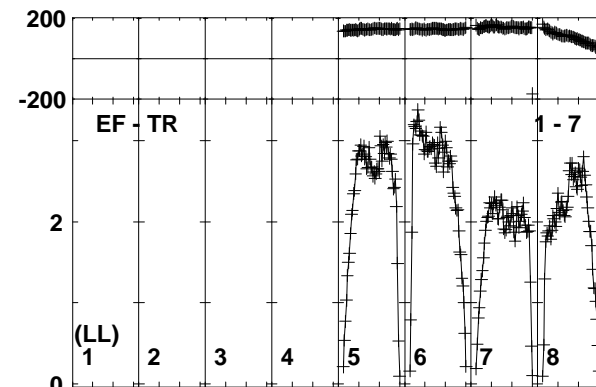
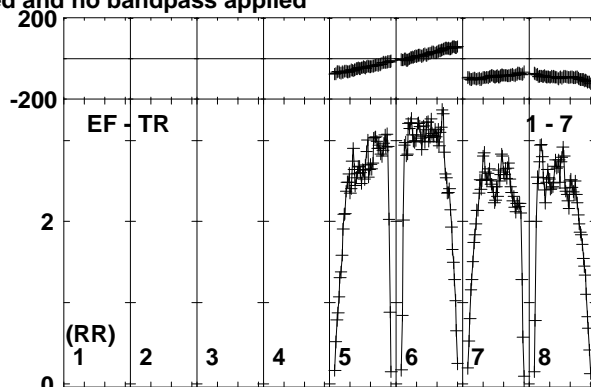
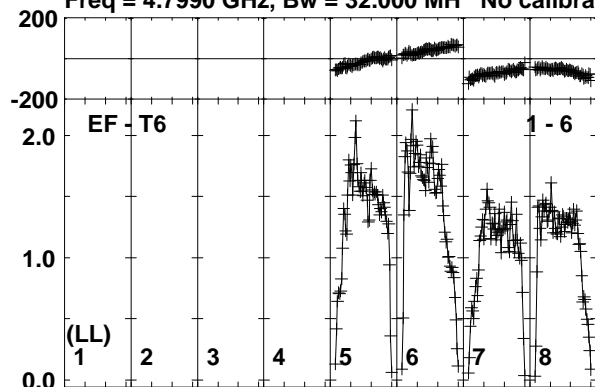

Lower frame: Milli Ampl Jy Top frame: Phas deg
Vector averaged cross-power spectrum Baseline: EF (01) - T6 (06)
Timerange: 00/20:21:21 to 00/20:22:49

Plot file version 327 created 19-OCT-2017 15:36:40
 MRK359 ES081C.UVDATA.1
 Freq = 4.7990 GHz, Bw = 32.000 MH No calibration applied and no bandpass applied

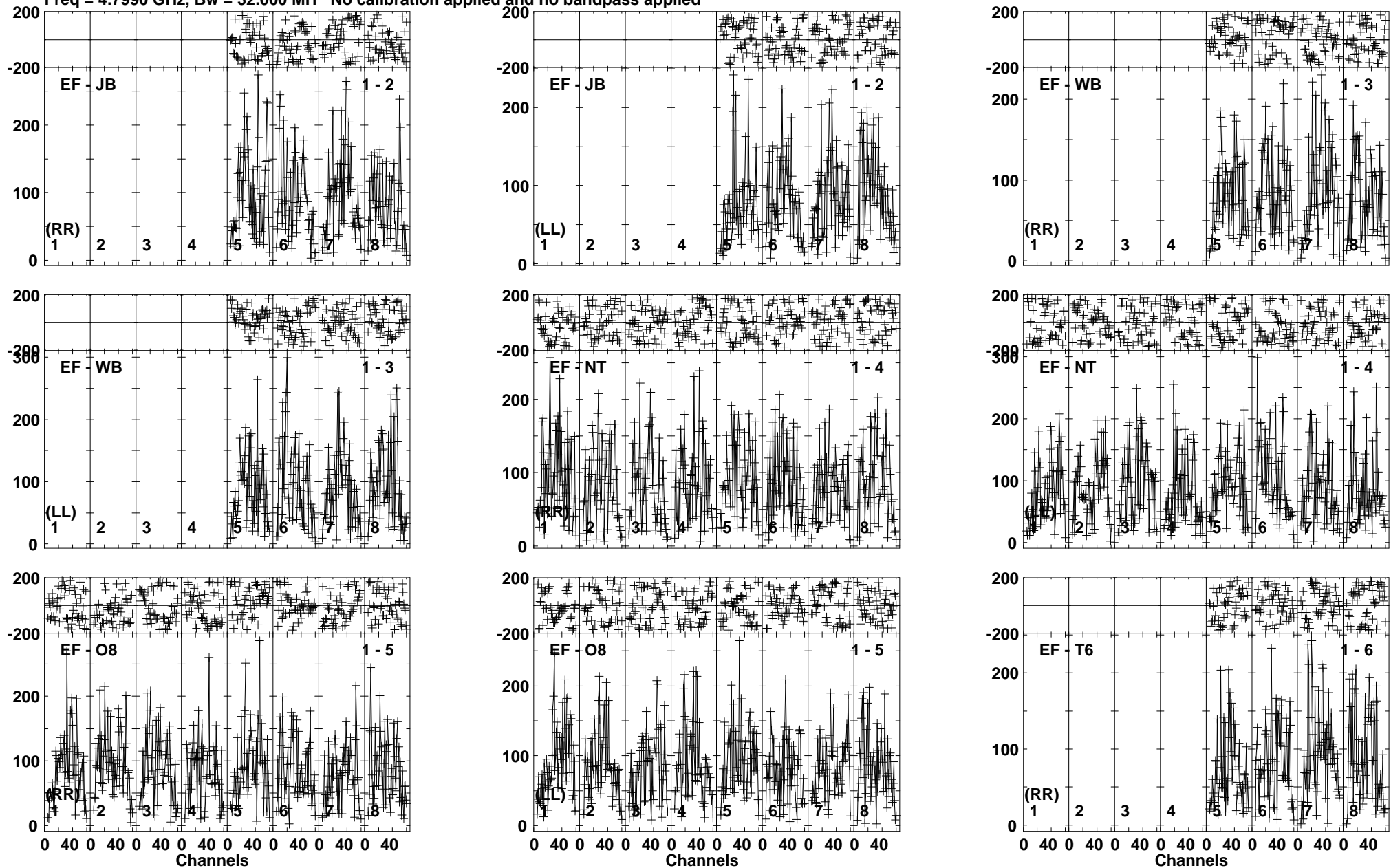

Lower frame: Micro Ampl Jy Top frame: Phas deg
 Vector averaged cross-power spectrum Baseline: EF (01) - JB (02)
 Timerange: 00/20:22:51 to 00/20:26:19

Plot file version 328 created 19-OCT-2017 15:36:41
 MRK359 ES081C.UVDATA.1
 Freq = 4.7990 GHz, Bw = 32.000 MH No calibration applied and no bandpass applied

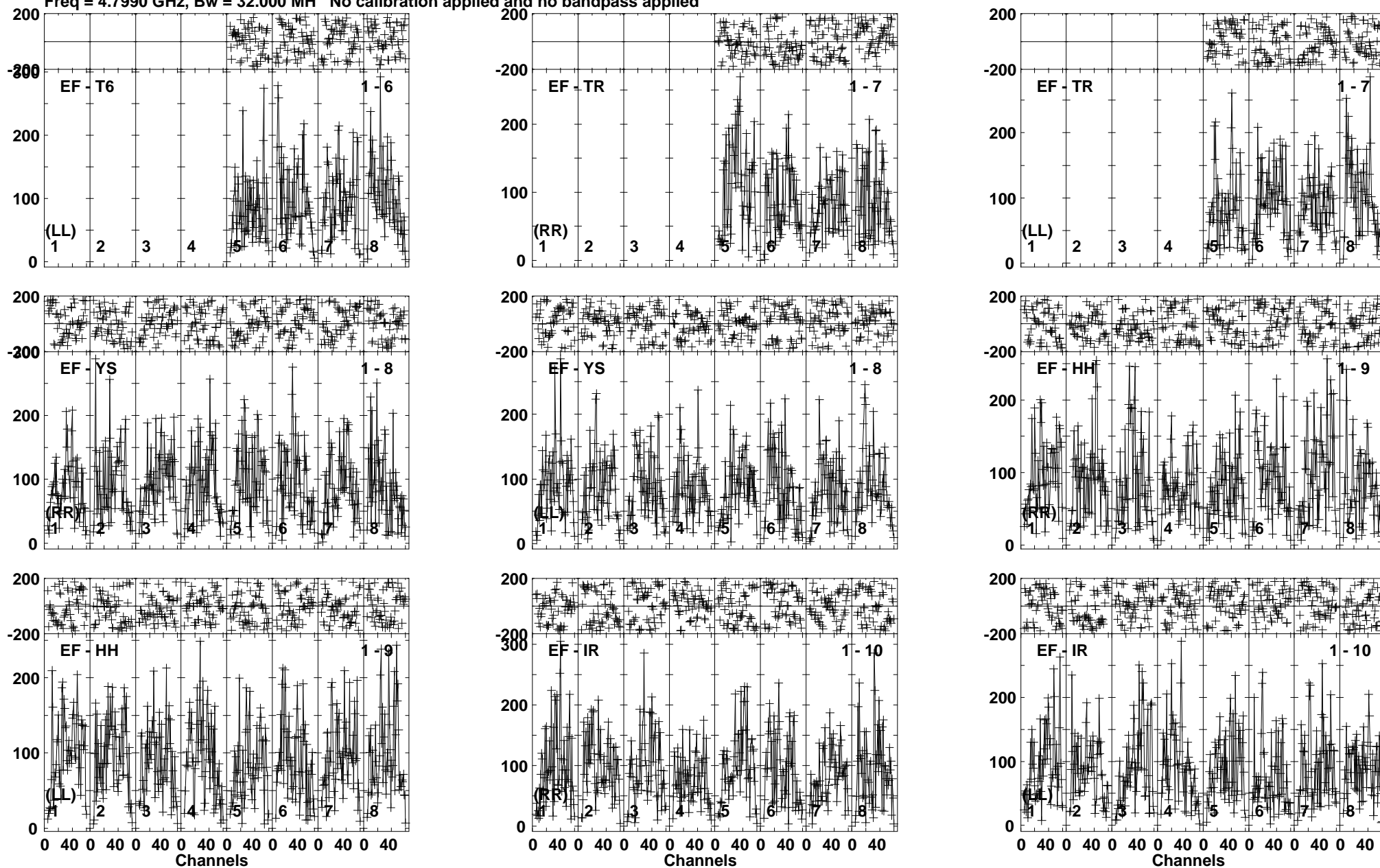

Lower frame: Micro Ampl Jy Top frame: Phas deg
 Vector averaged cross-power spectrum Baseline: EF (01) - T6 (06)
 Timerange: 00/20:22:51 to 00/20:26:19

Plot file version 329 created 19-OCT-2017 15:36:41

J0139+1753 ES081C.UVDATA.1

Freq = 4.7990 GHz, Bw = 32.000 MH No calibration applied and no bandpass applied

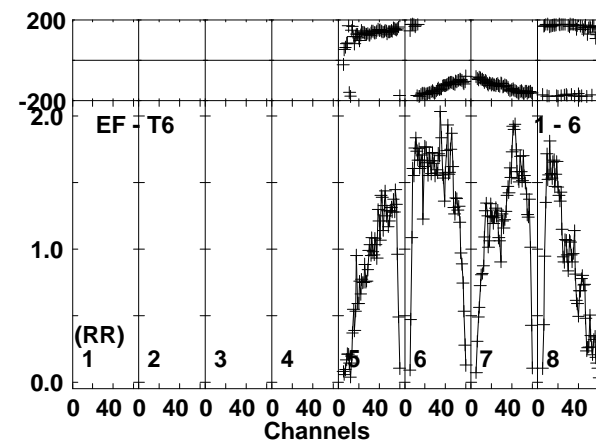
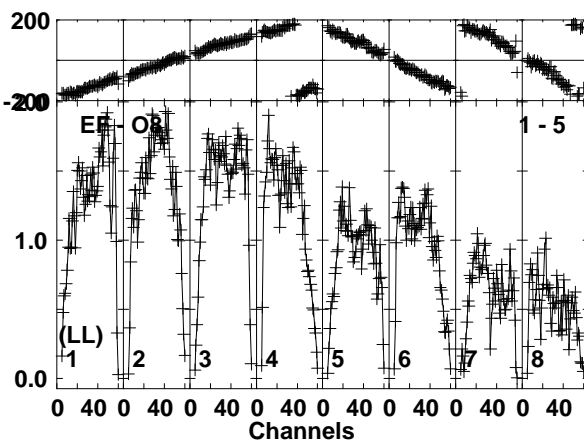
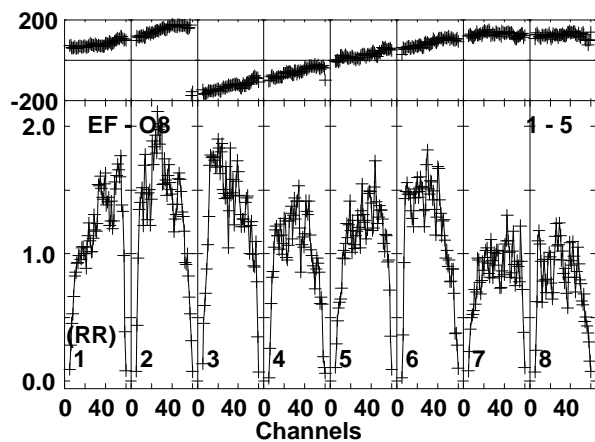
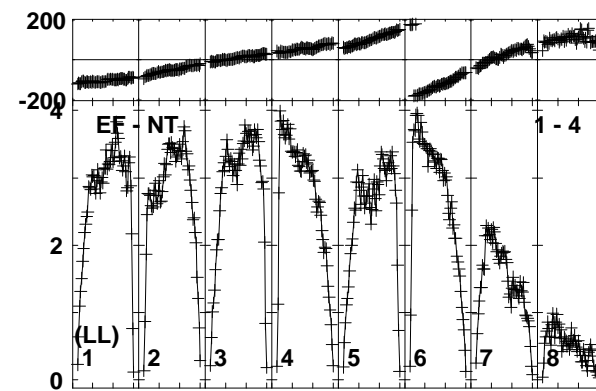
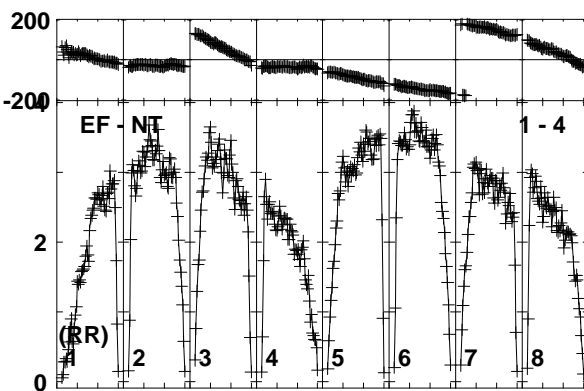
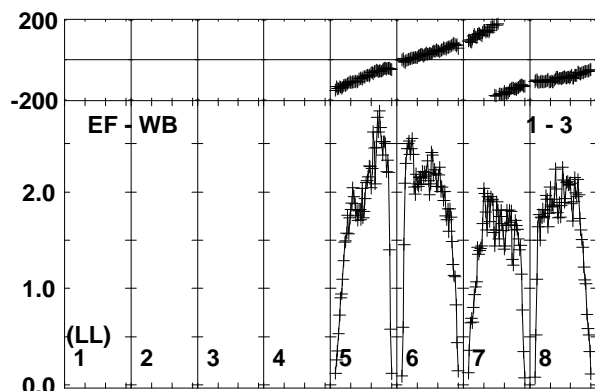
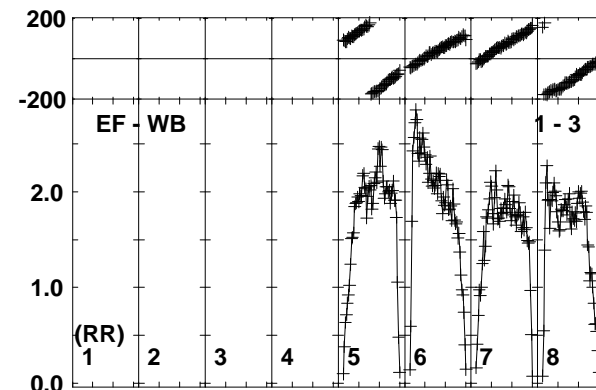
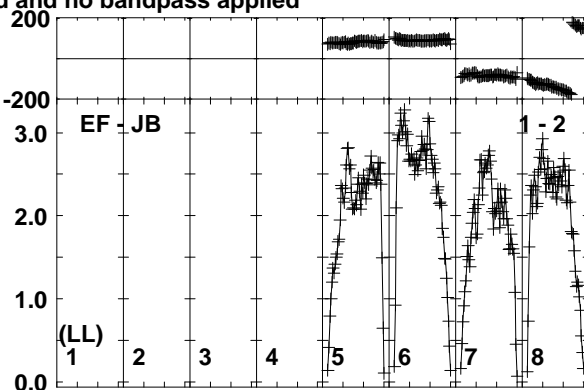
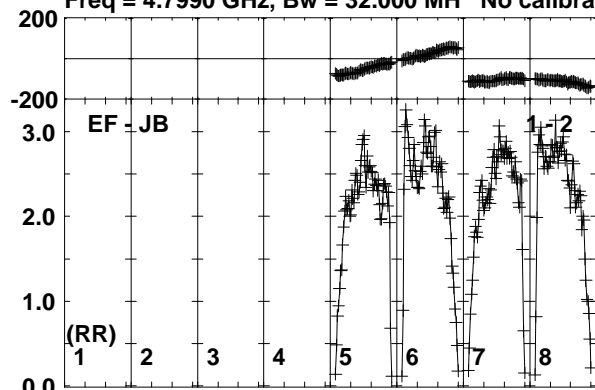

Lower frame: Milli Ampl Jy Top frame: Phas deg
Vector averaged cross-power spectrum Baseline: EF (01) - JB (02)
Timerange: 00/20:26:21 to 00/20:27:49

Plot file version 330 created 19-OCT-2017 15:36:41

J0139+1753 ES081C.UVDATA.1

Freq = 4.7990 GHz, Bw = 32.000 MH No calibration applied and no bandpass applied

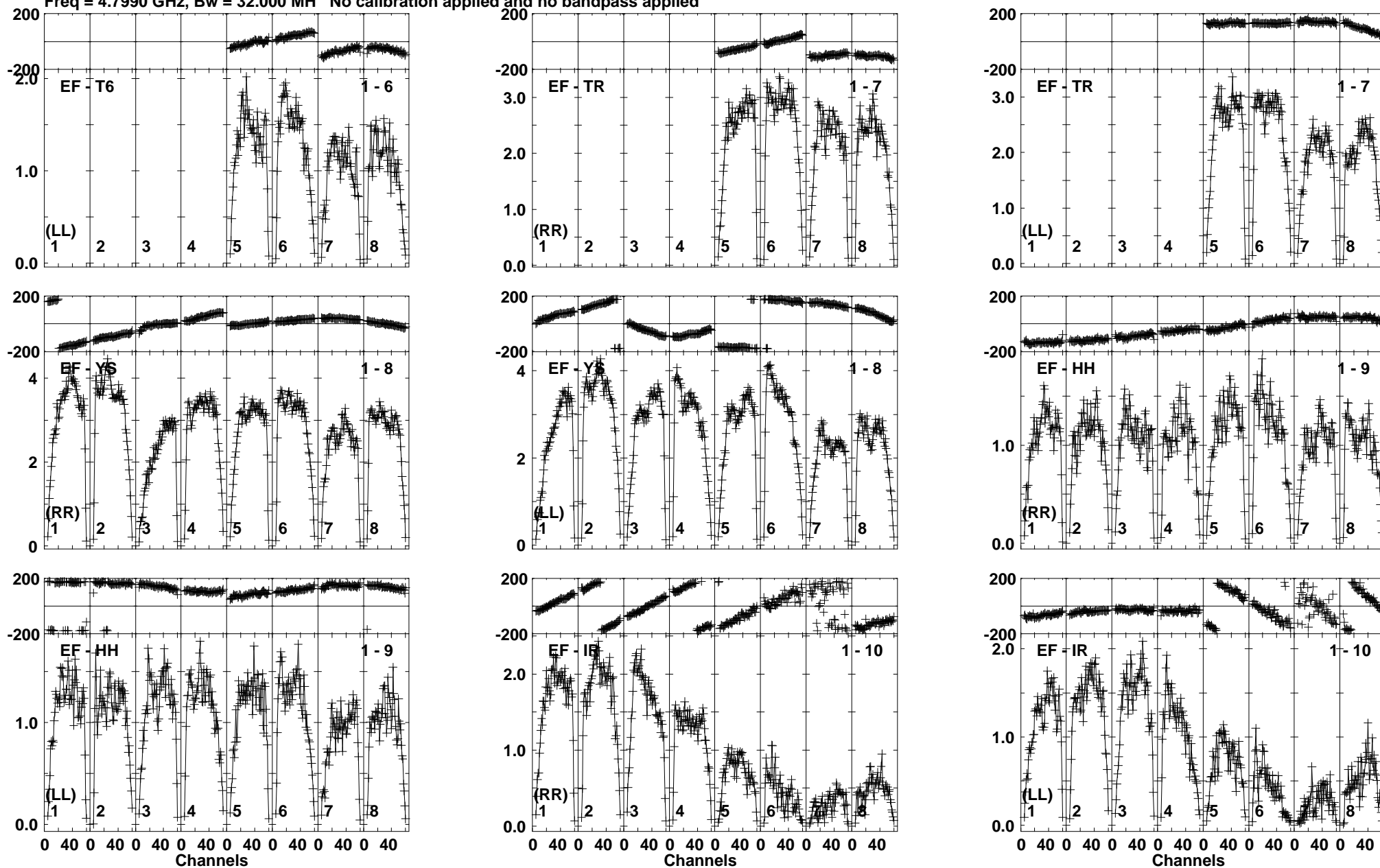

Lower frame: Milli Ampl Jy Top frame: Phas deg
Vector averaged cross-power spectrum Baseline: EF (01) - T6 (06)
Timerange: 00/20:26:21 to 00/20:27:49

Plot file version 331 created 19-OCT-2017 15:36:41
 MRK359 ES081C.UVDATA.1
 Freq = 4.7990 GHz, Bw = 32.000 MH No calibration applied and no bandpass applied

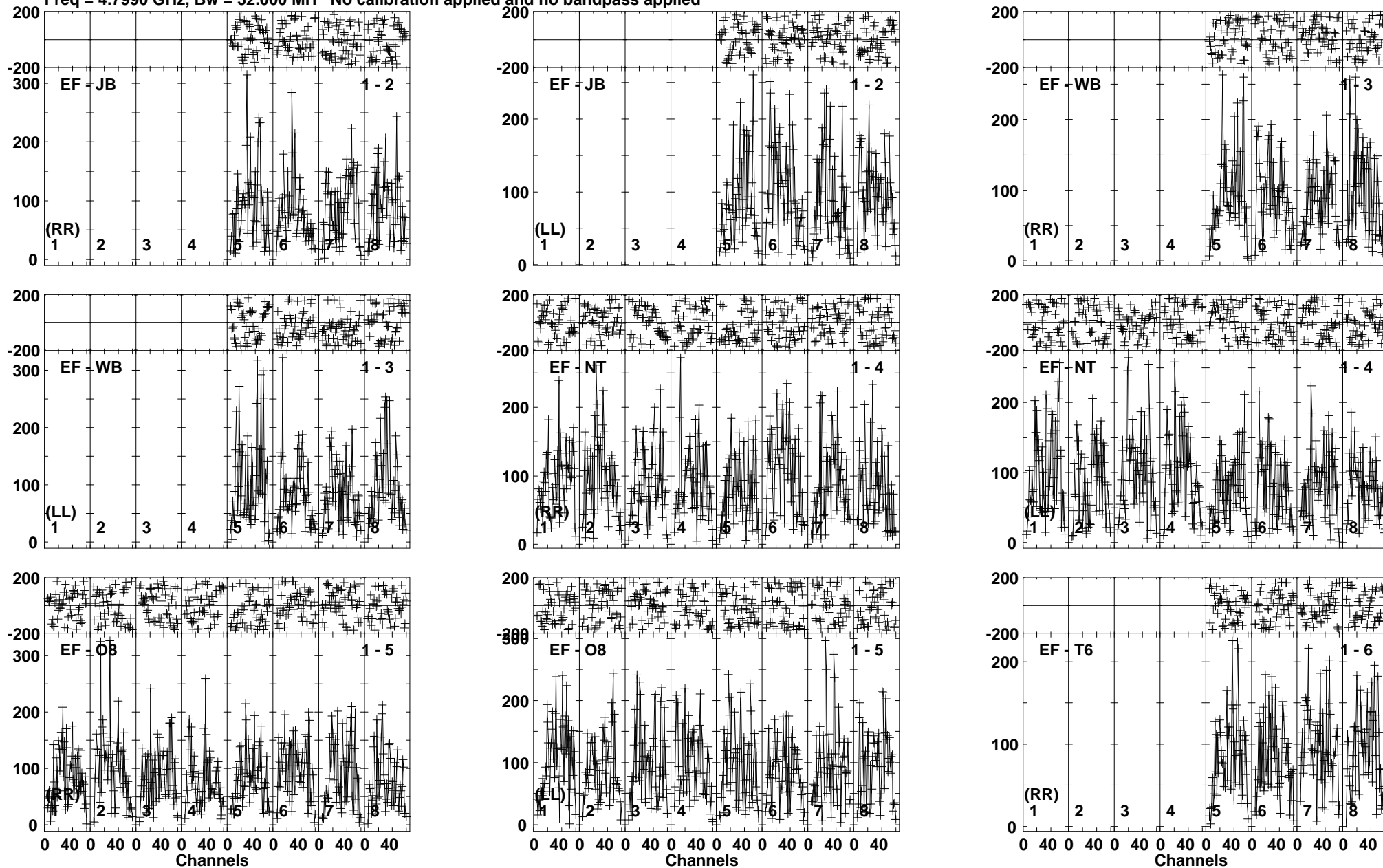

Lower frame: Micro Ampl Jy Top frame: Phas deg
 Vector averaged cross-power spectrum Baseline: EF (01) - JB (02)
 Timerange: 00/20:27:51 to 00/20:31:19

Plot file version 332 created 19-OCT-2017 15:36:41

MRK359 ES081C.UVDATA.1

Freq = 4.7990 GHz, Bw = 32.000 MH No calibration applied and no bandpass applied

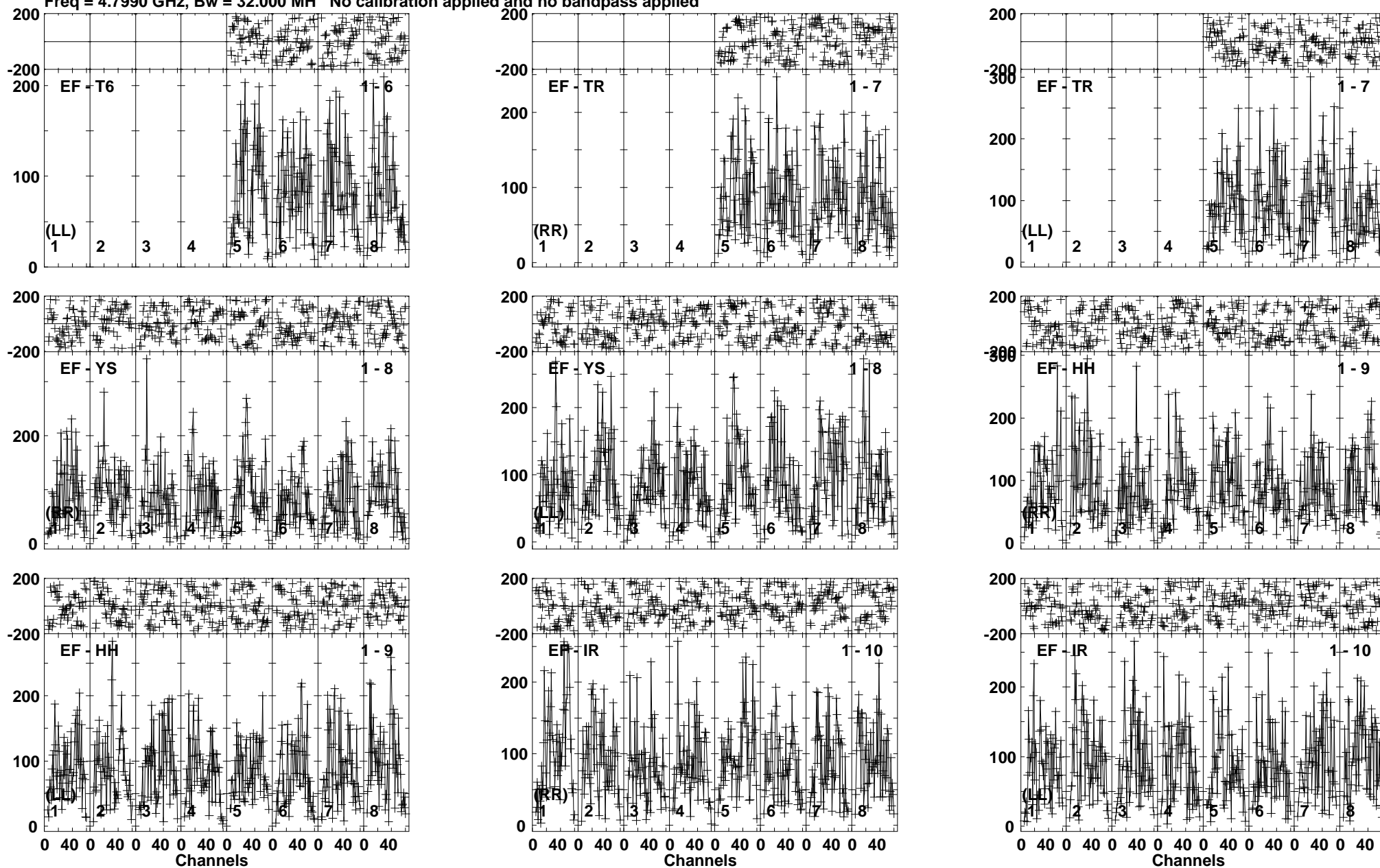

Lower frame: Micro Ampl Jy Top frame: Phas deg
Vector averaged cross-power spectrum Baseline: EF (01) - T6 (06)
Timerange: 00/20:27:51 to 00/20:31:19

Plot file version 333 created 19-OCT-2017 15:36:41

J0139+1753 ES081C.UVDATA.1

Freq = 4.7990 GHz, Bw = 32.000 MH No calibration applied and no bandpass applied

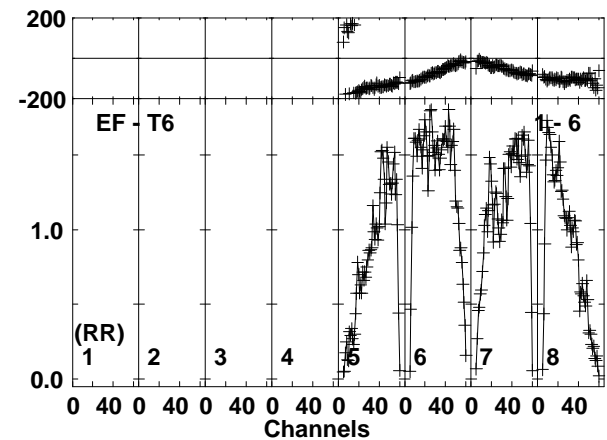
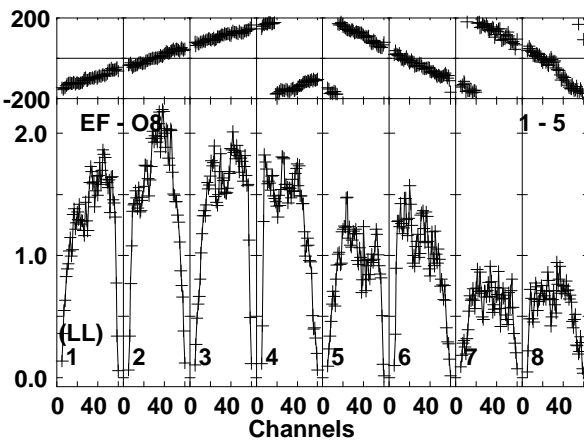
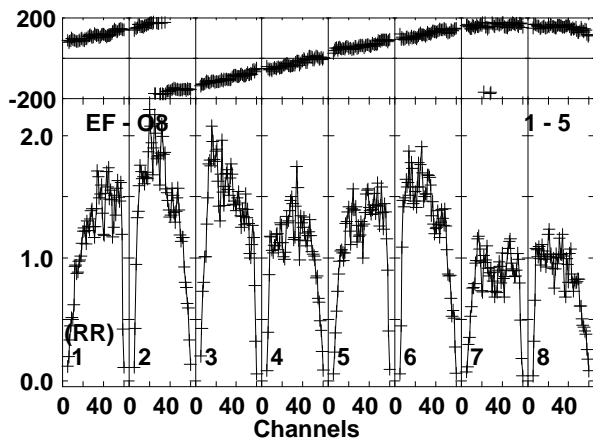
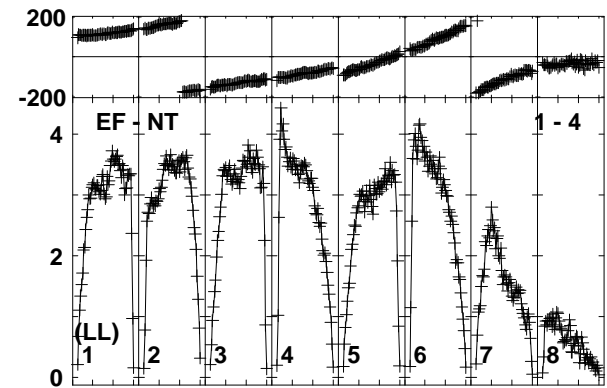
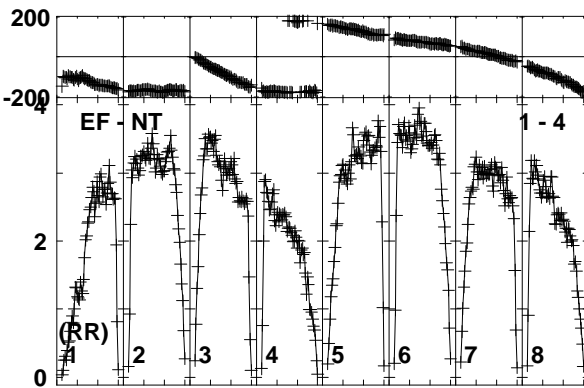
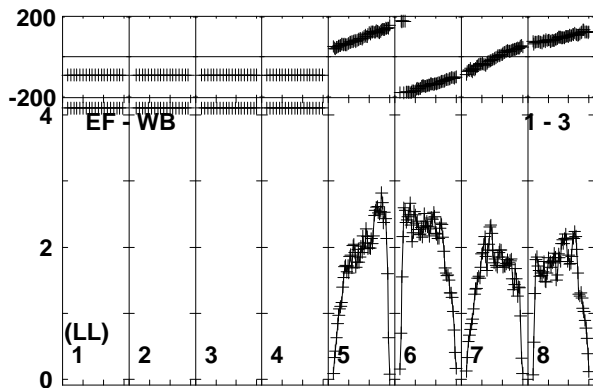
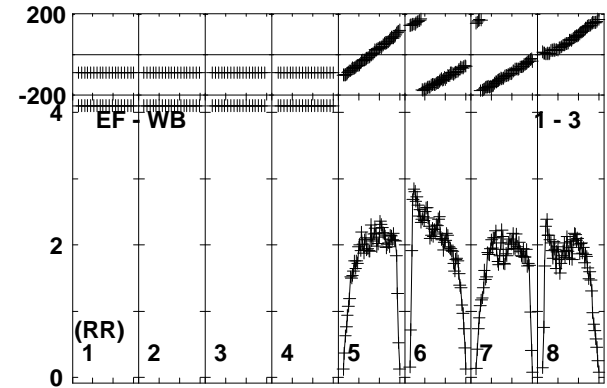
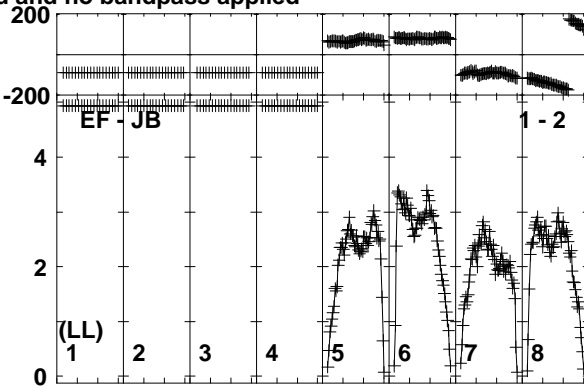
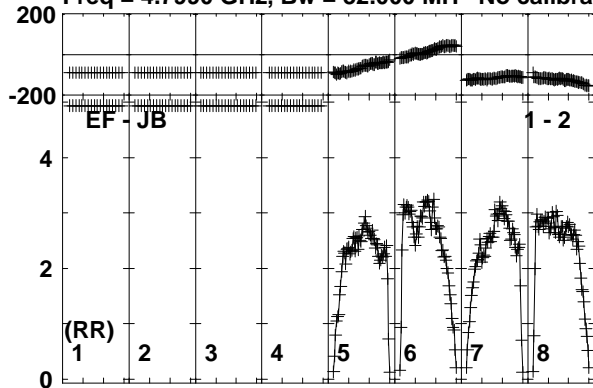

Lower frame: Milli Ampl Jy Top frame: Phas deg
Vector averaged cross-power spectrum Baseline: EF (01) - JB (02)
Timerange: 00/20:32:01 to 00/20:32:59

Plot file version 334 created 19-OCT-2017 15:36:41

J0139+1753 ES081C.UVDATA.1

Freq = 4.7990 GHz, Bw = 32.000 MH No calibration applied and no bandpass applied

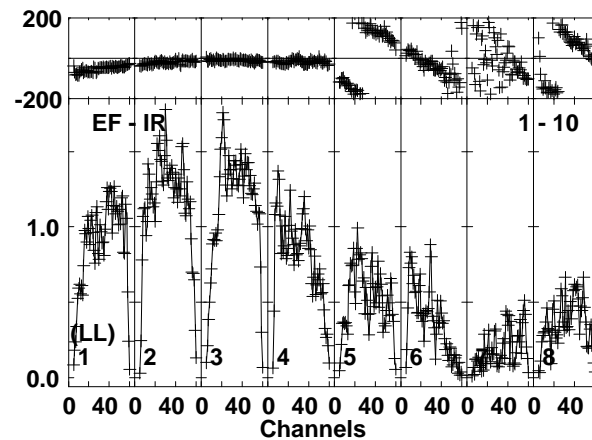
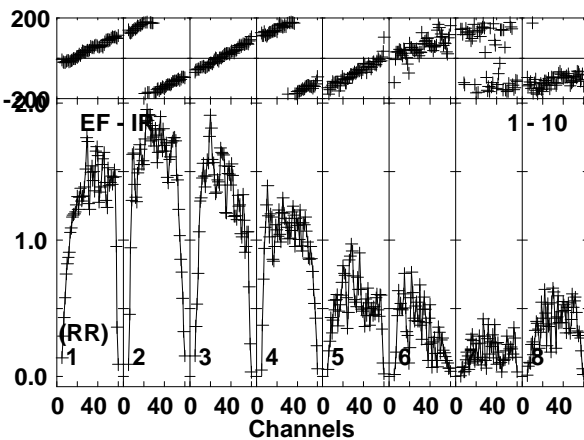
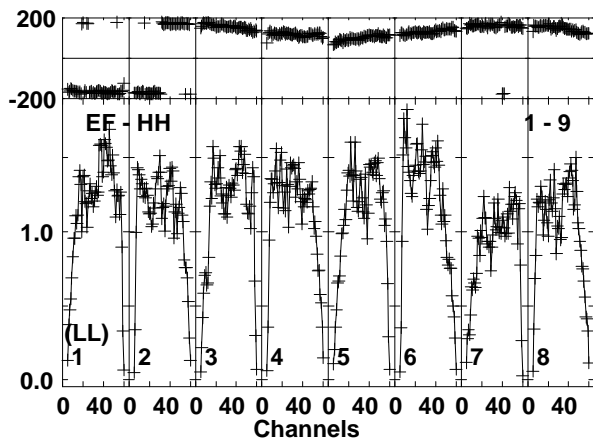
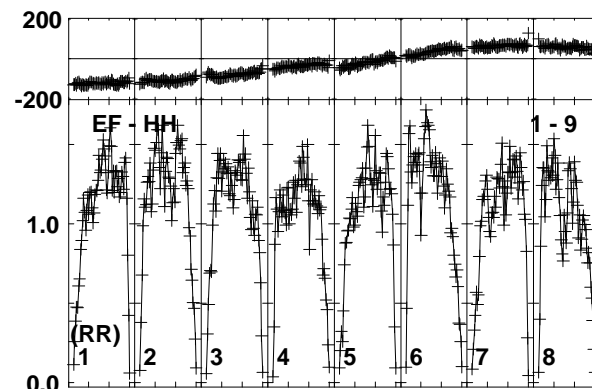
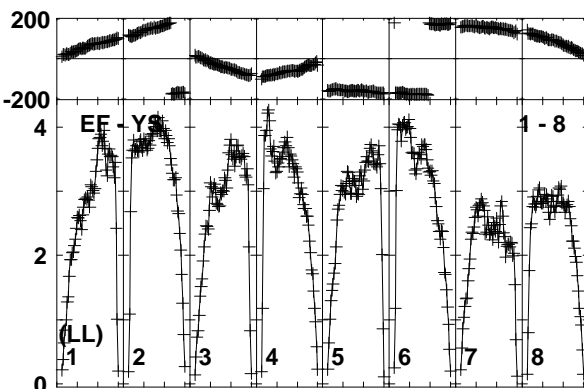
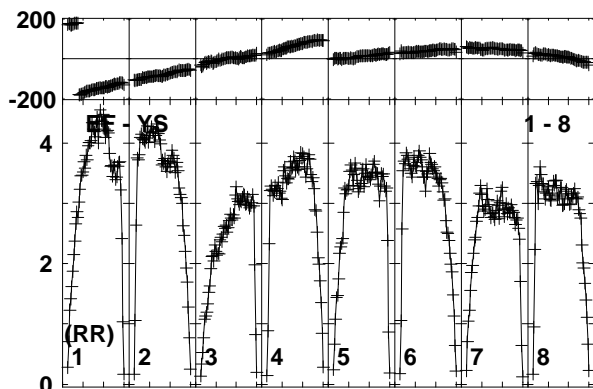
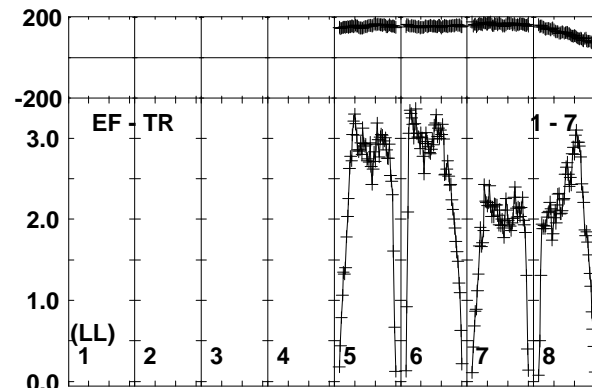
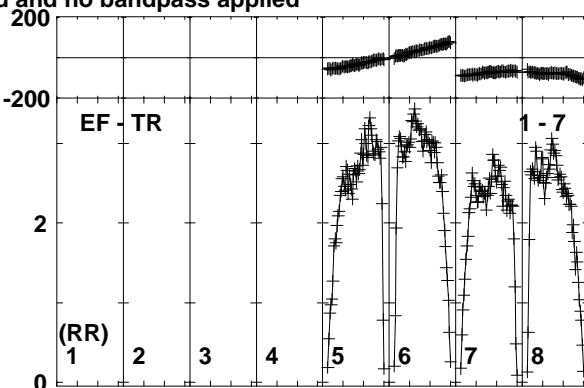
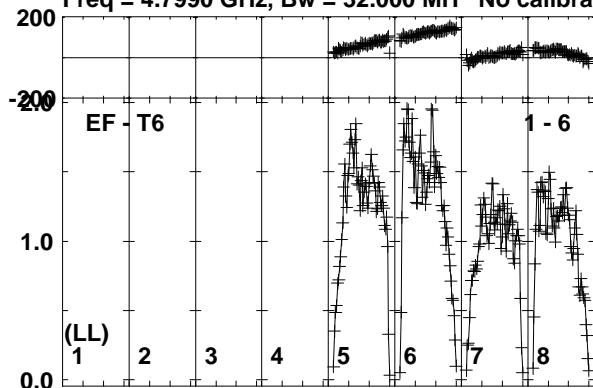

Lower frame: Milli Ampl Jy Top frame: Phas deg
Vector averaged cross-power spectrum Baseline: EF (01) - T6 (06)
Timerange: 00/20:32:01 to 00/20:32:59

Plot file version 335 created 19-OCT-2017 15:36:42

MRK359 ES081C.UVDATA.1

Freq = 4.7990 GHz, Bw = 32.000 MH No calibration applied and no bandpass applied

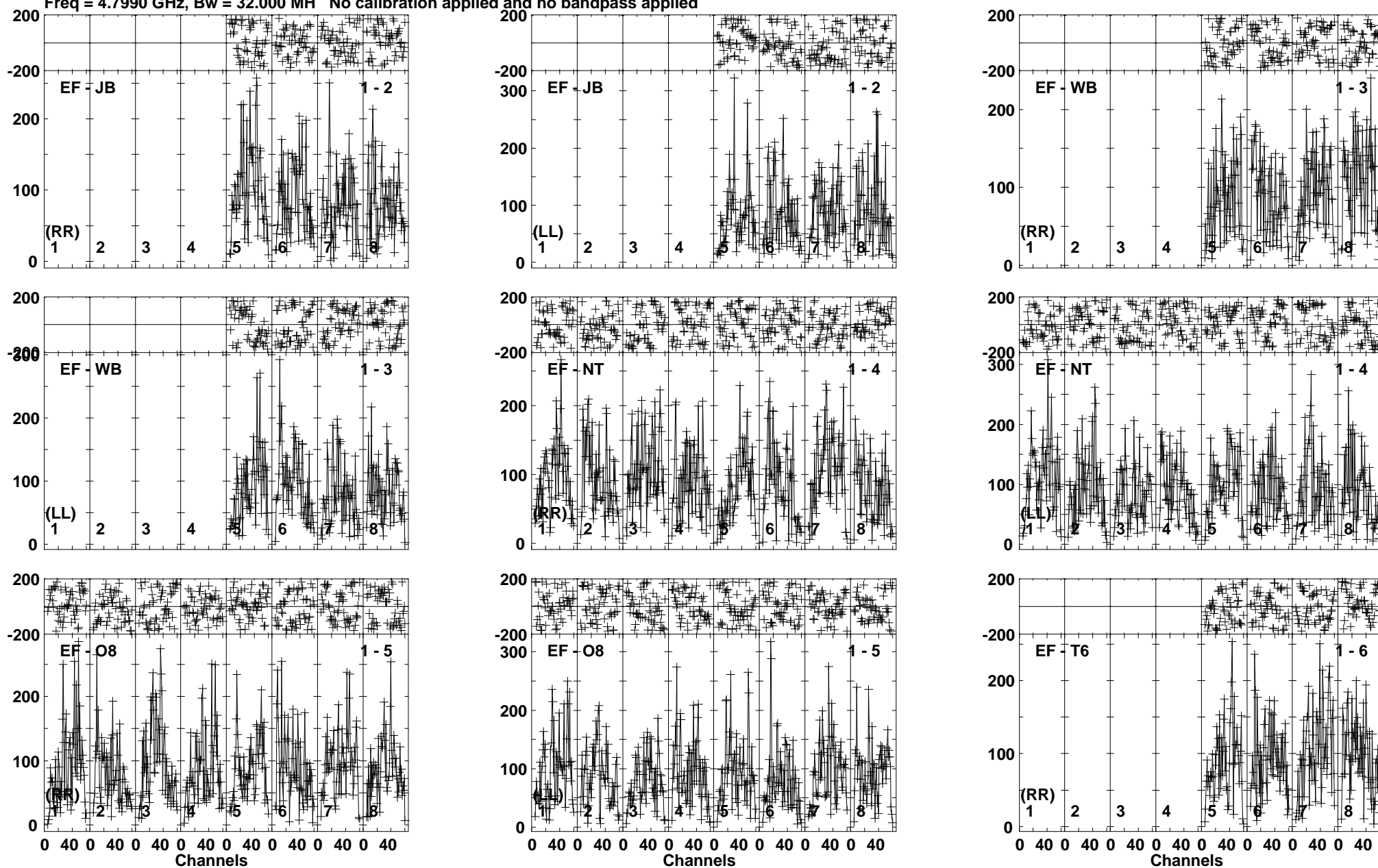

Lower frame: Micro Ampl Jy Top frame: Phas deg
Vector averaged cross-power spectrum Baseline: EF (01) - JB (02)
Timerange: 00/20:33:01 to 00/20:36:29

Plot file version 336 created 19-OCT-2017 15:36:42

MRK359 ES081C.UVDATA.1

Freq = 4.7990 GHz, Bw = 32.000 MH No calibration applied and no bandpass applied

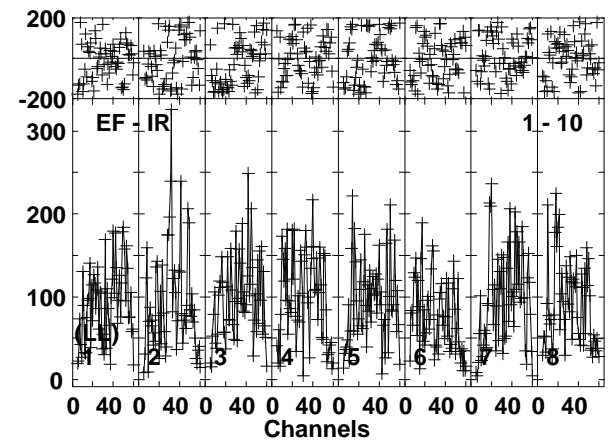
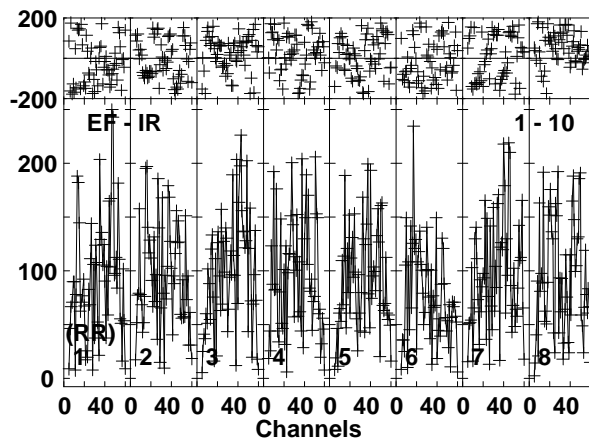
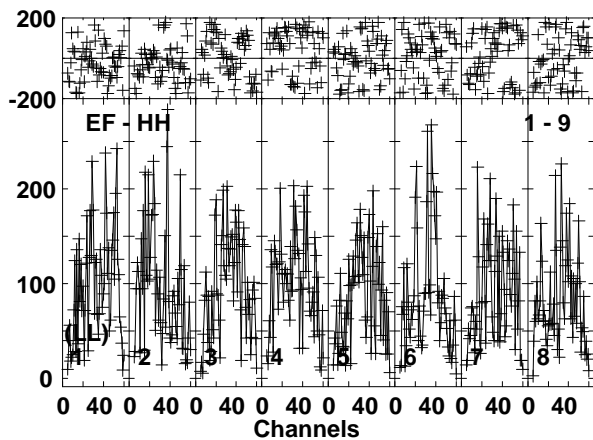
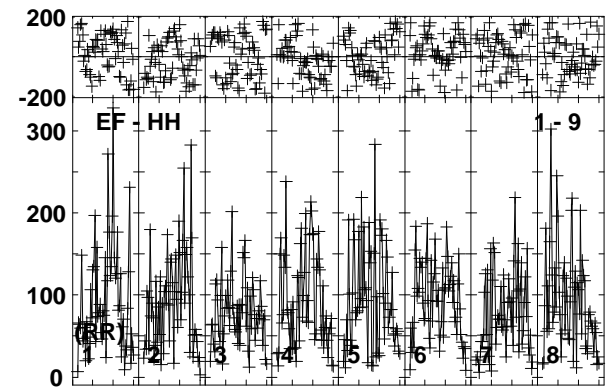
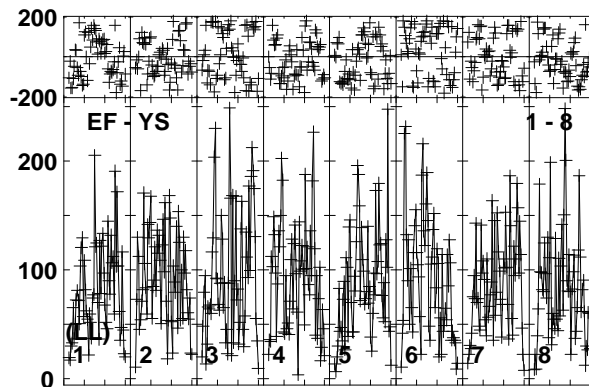
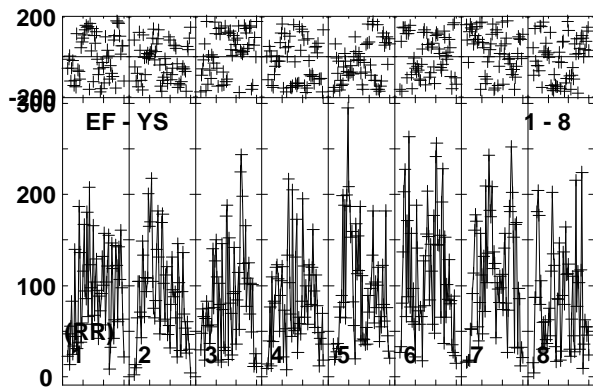
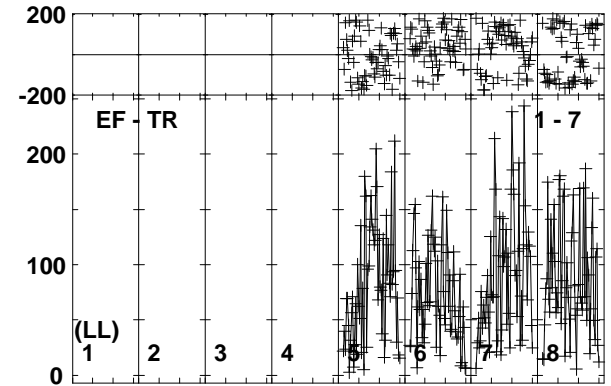
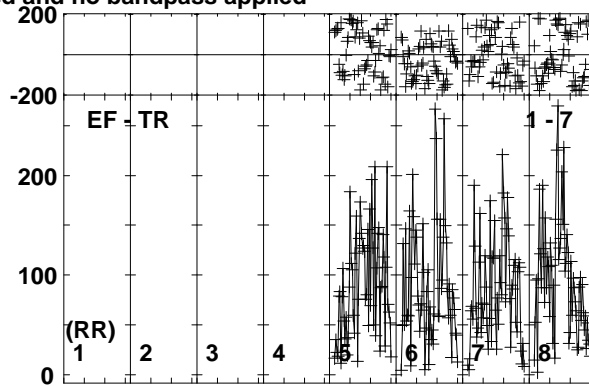
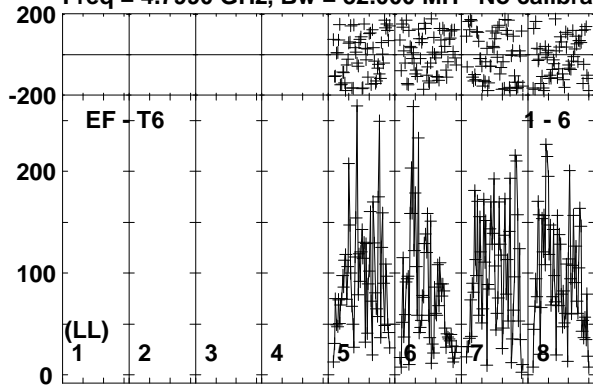

Lower frame: Micro Ampl Jy Top frame: Phas deg
Vector averaged cross-power spectrum Baseline: EF (01) - T6 (06)
Timerange: 00/20:33:01 to 00/20:36:29

Plot file version 337 created 19-OCT-2017 15:36:42
 J0139+1753 ES081C.UVDATA.1
 Freq = 4.7990 GHz, Bw = 32.000 MH No calibration applied and no bandpass applied

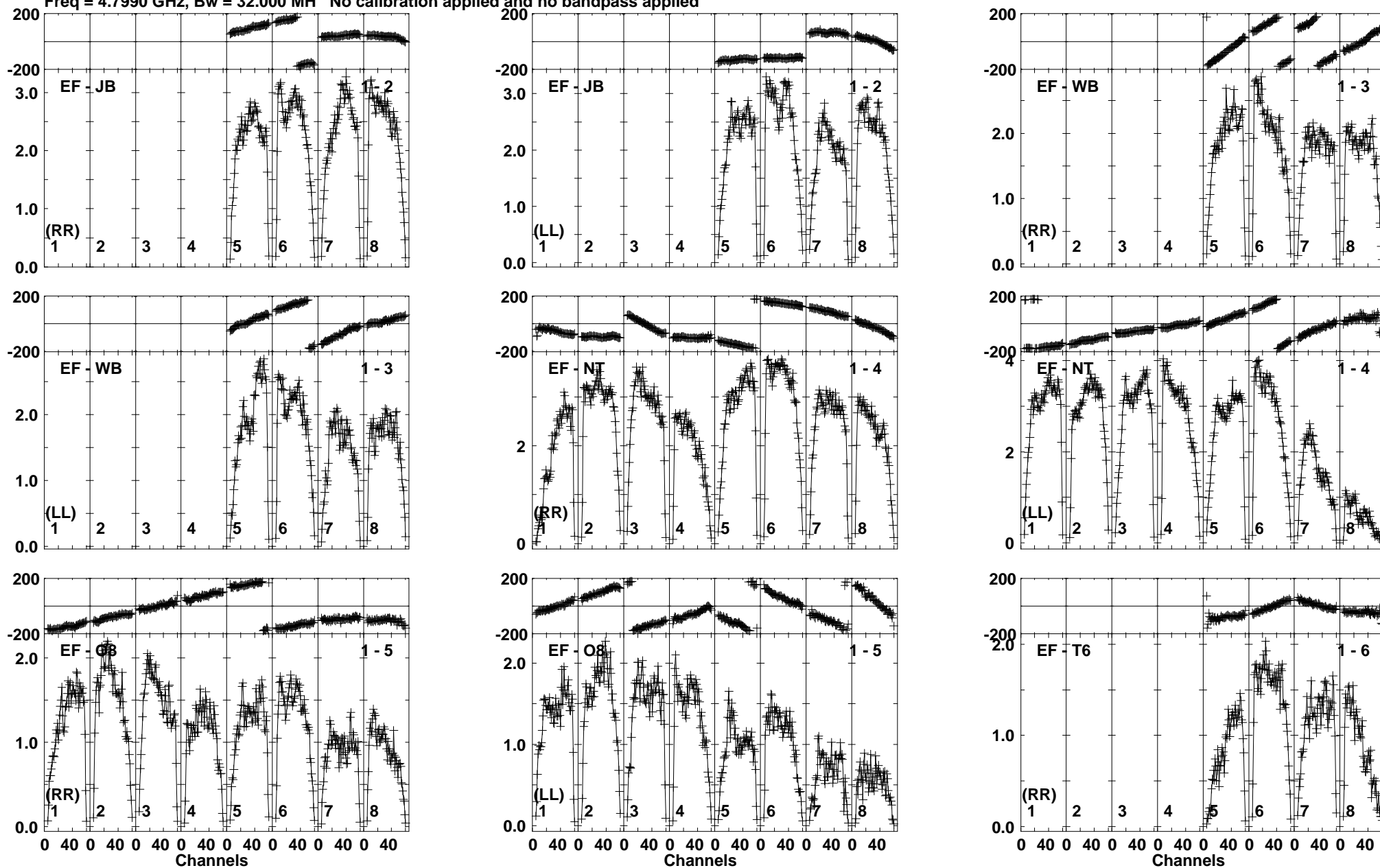

Lower frame: Milli Ampl Jy Top frame: Phas deg
 Vector averaged cross-power spectrum Baseline: EF (01) - JB (02)
 Timerange: 00/20:36:31 to 00/20:37:59

Plot file version 338 created 19-OCT-2017 15:36:42

J0139+1753 ES081C.UVDATA.1

Freq = 4.7990 GHz, Bw = 32.000 MH No calibration applied and no bandpass applied

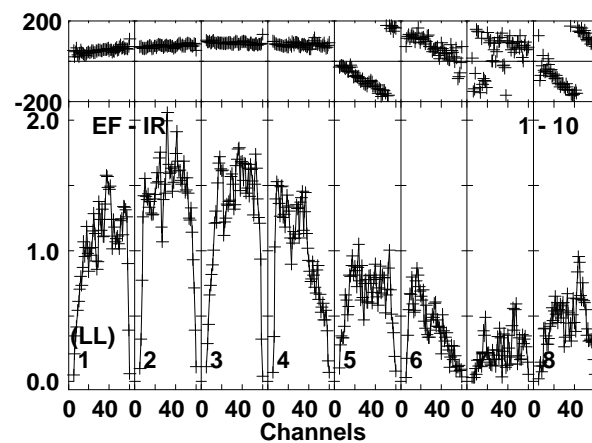
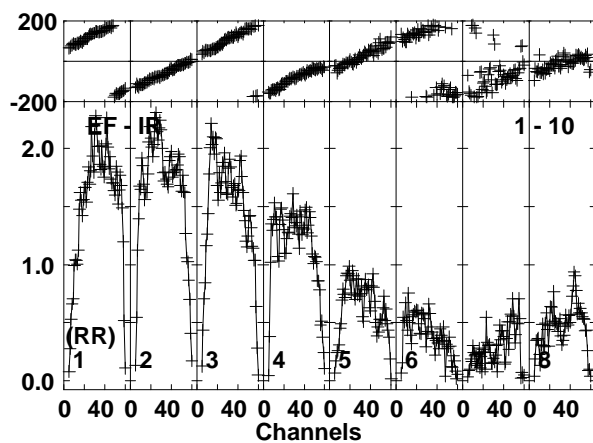
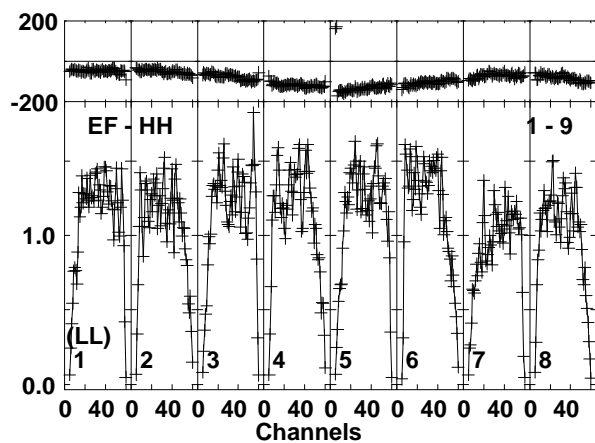
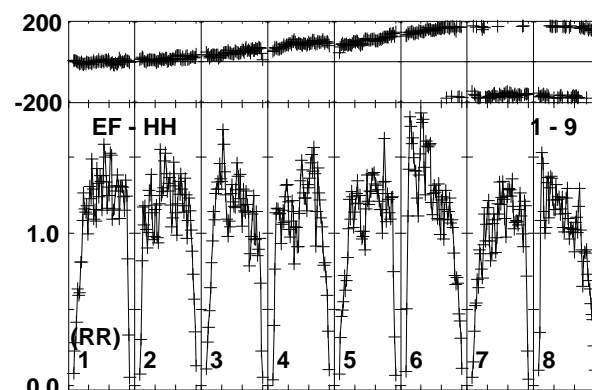
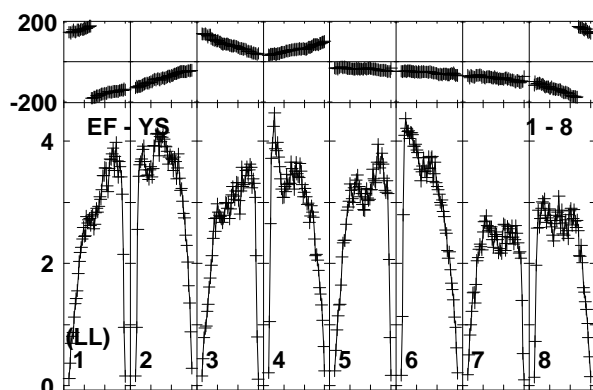
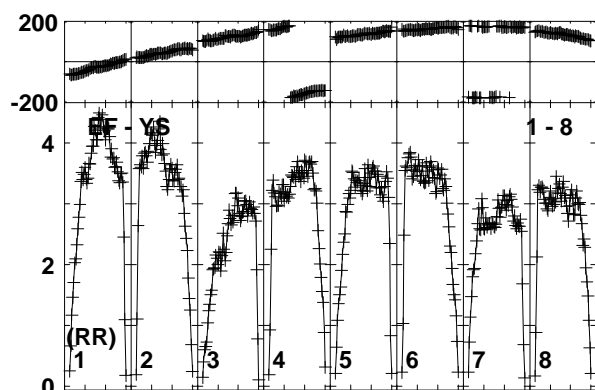
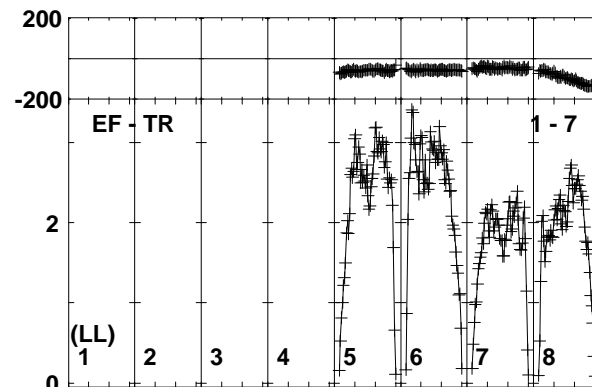
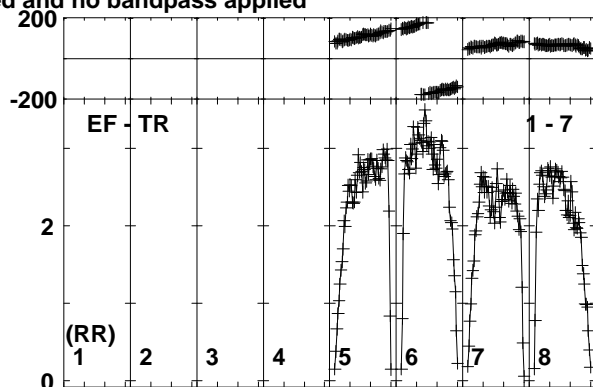
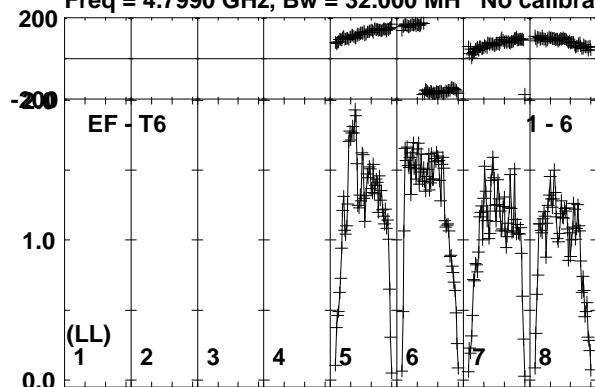

Lower frame: Milli Ampl Jy Top frame: Phas deg
Vector averaged cross-power spectrum Baseline: EF (01) - T6 (06)
Timerange: 00/20:36:31 to 00/20:37:59

Plot file version 339 created 19-OCT-2017 15:36:42

MRK359 ES081C.UVDATA.1

Freq = 4.7990 GHz, Bw = 32.000 MH No calibration applied and no bandpass applied

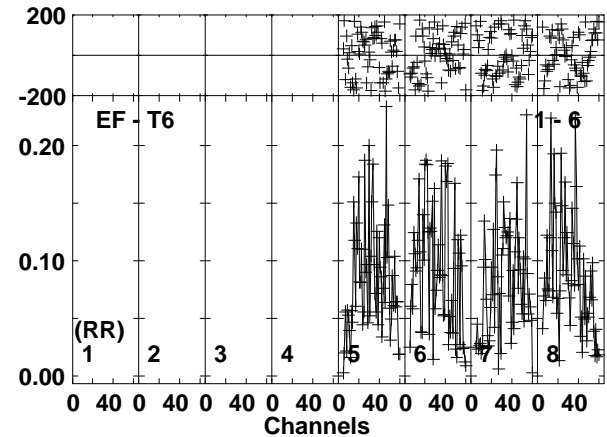
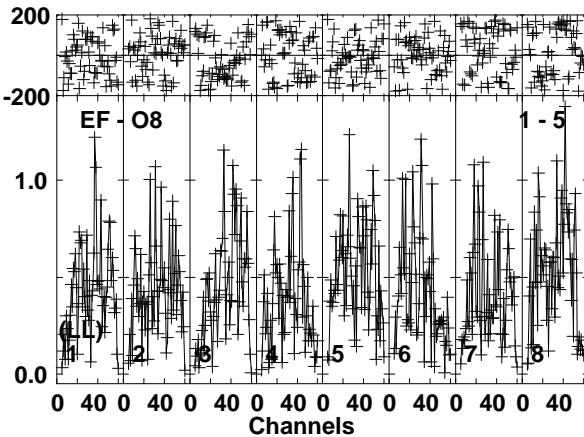
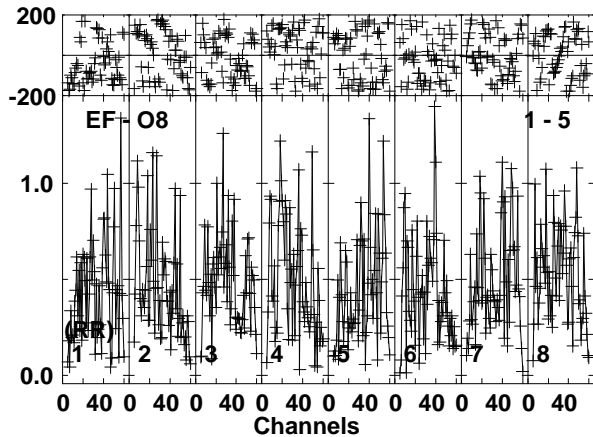
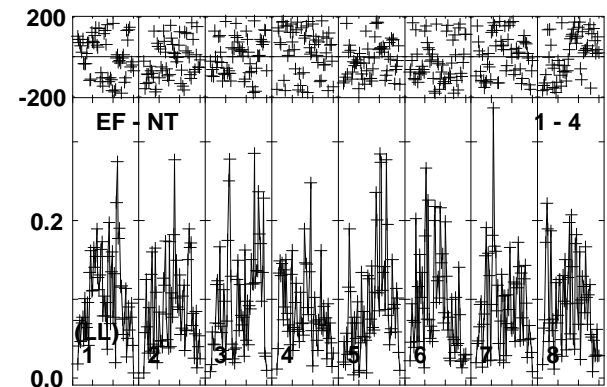
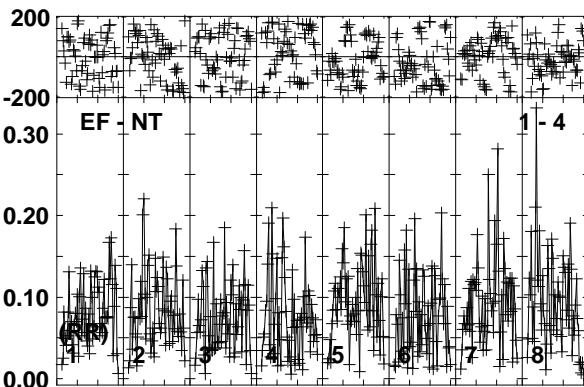
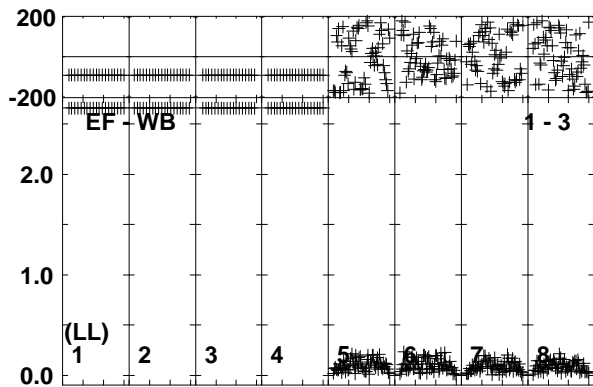
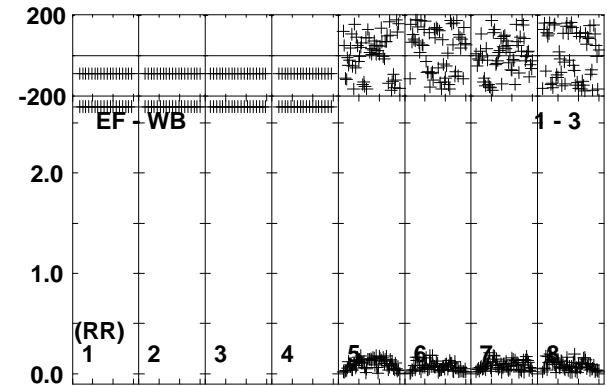
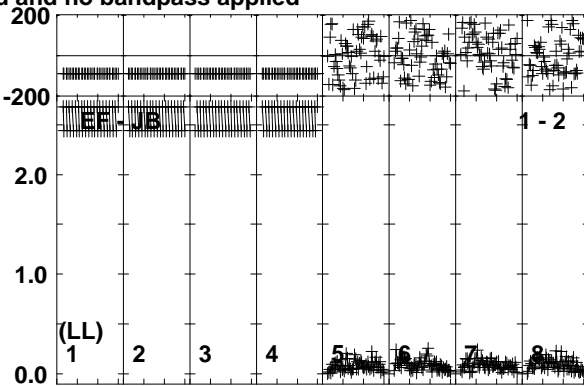
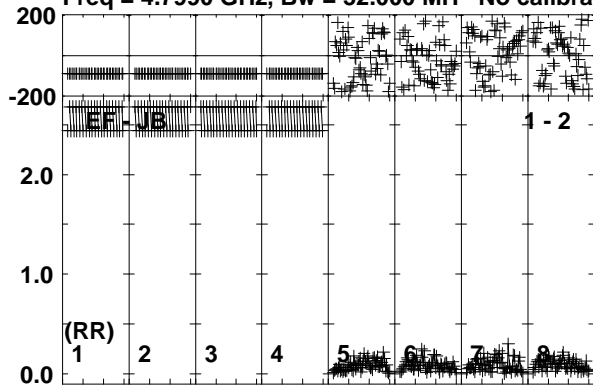

Lower frame: Milli Ampl Jy Top frame: Phas deg
Vector averaged cross-power spectrum Baseline: EF (01) - JB (02)
Timerange: 00/20:38:01 to 00/20:41:29

Plot file version 340 created 19-OCT-2017 15:36:42

MRK359 ES081C.UVDATA.1

Freq = 4.7990 GHz, Bw = 32.000 MH No calibration applied and no bandpass applied

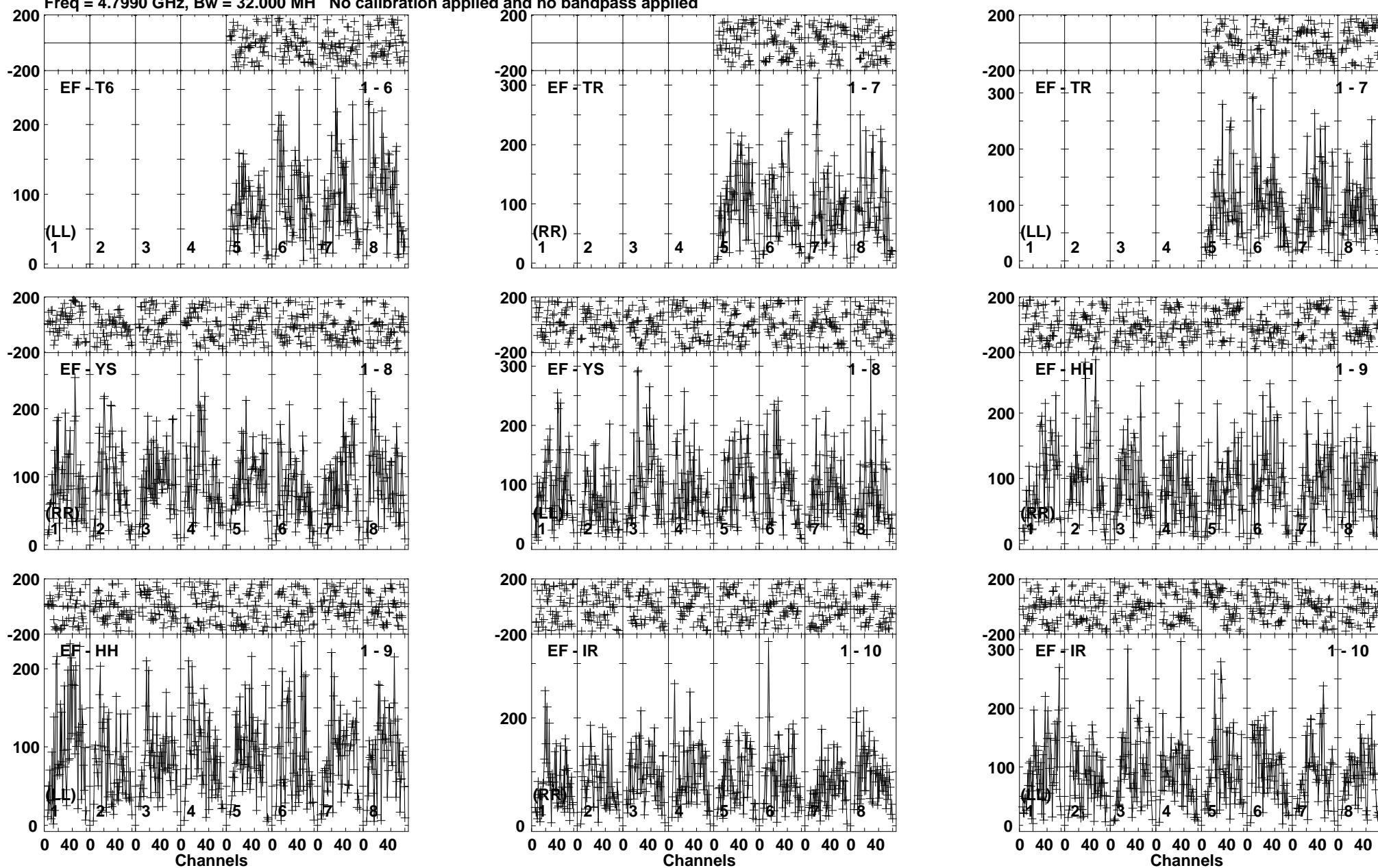

Lower frame: Micro Ampl Jy Top frame: Phas deg
Vector averaged cross-power spectrum Baseline: EF (01) - T6 (06)
Timerange: 00/20:38:01 to 00/20:41:29

Plot file version 341 created 19-OCT-2017 15:36:42

J0139+1753 ES081C.UVDATA.1

Freq = 4.7990 GHz, Bw = 32.000 MH No calibration applied and no bandpass applied

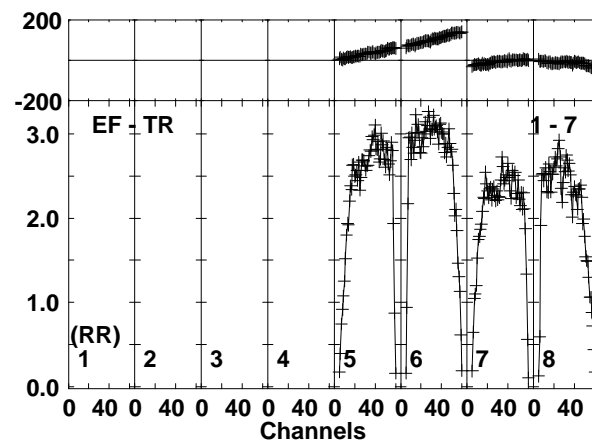
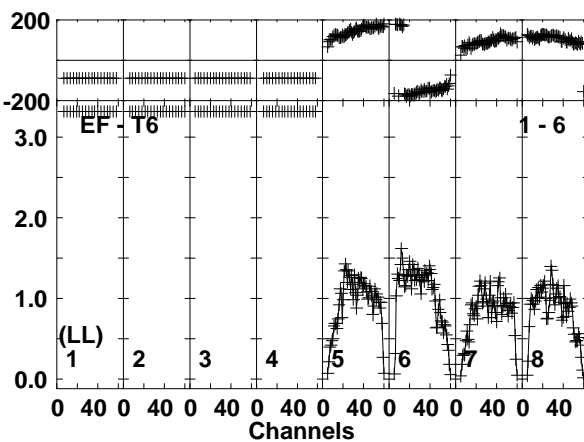
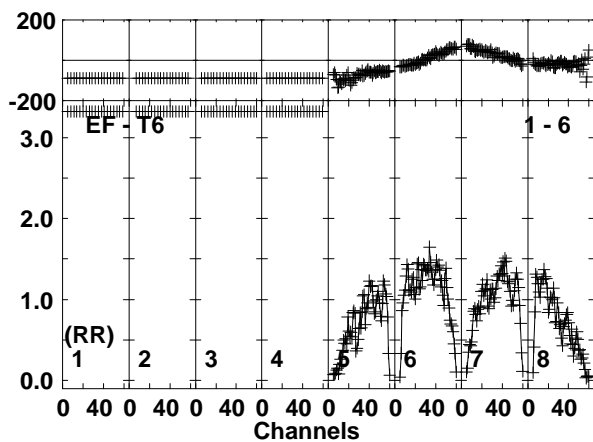
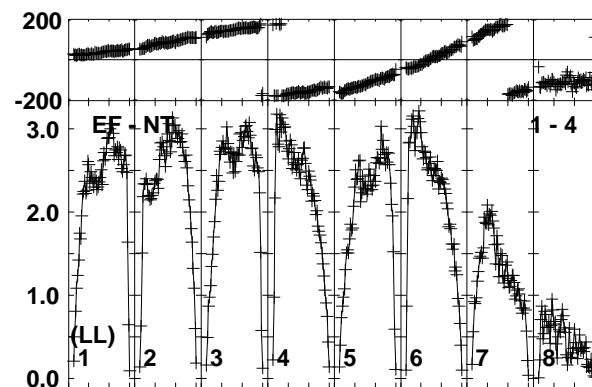
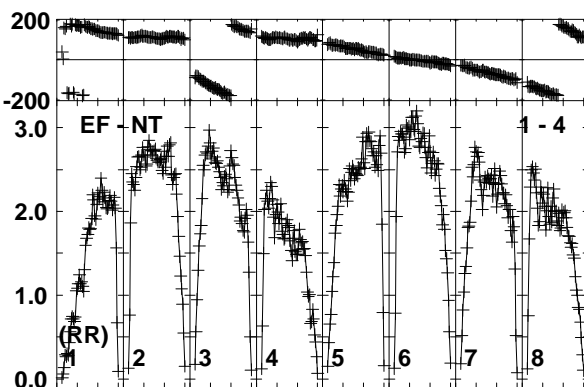
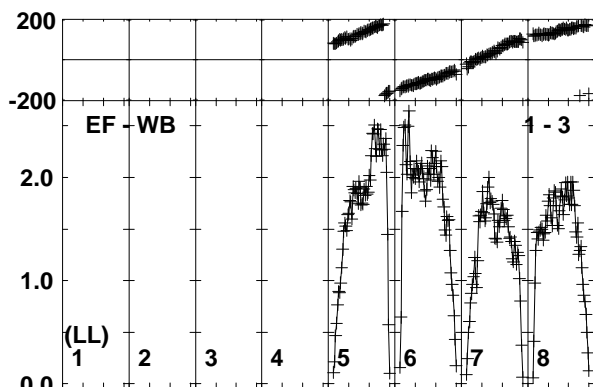
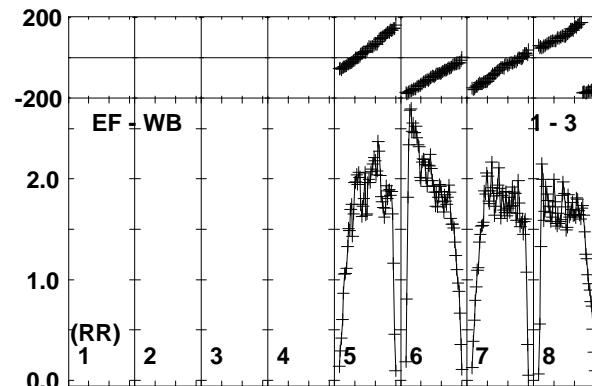
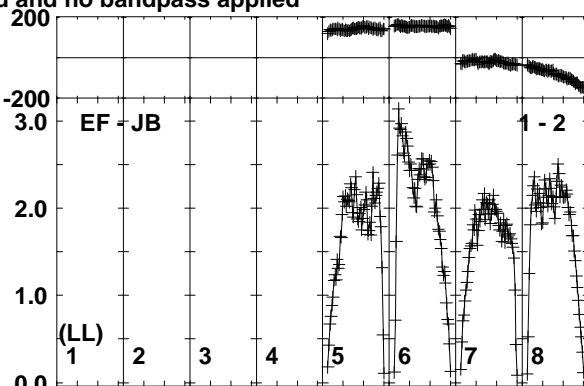
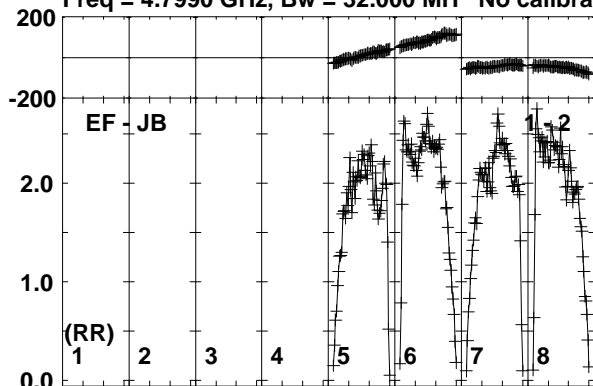

Lower frame: Milli Ampl Jy Top frame: Phas deg
Vector averaged cross-power spectrum Baseline: EF (01) - JB (02)
Timerange: 00/20:42:11 to 00/20:43:09

Plot file version 342 created 19-OCT-2017 15:36:43

J0139+1753 ES081C.UVDATA.1

Freq = 4.7990 GHz, Bw = 32.000 MH No calibration applied and no bandpass applied

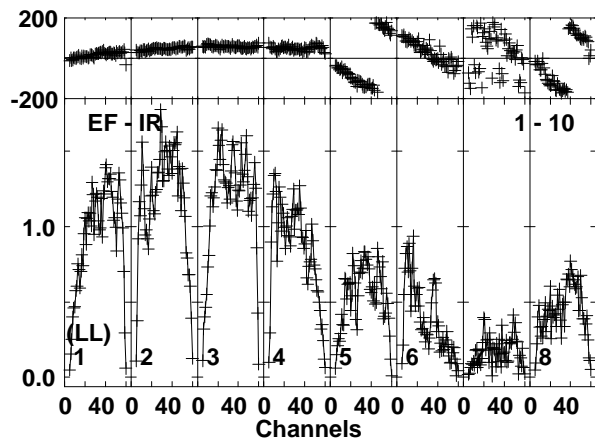
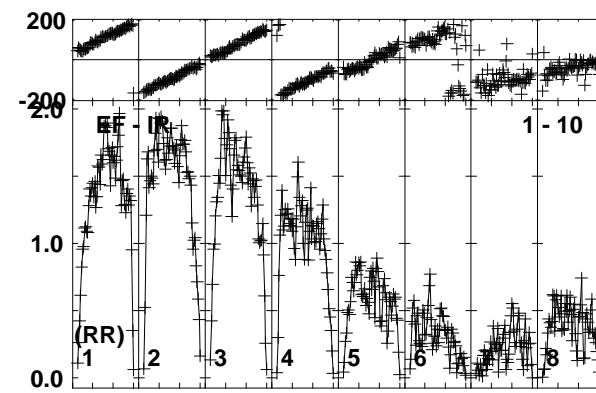
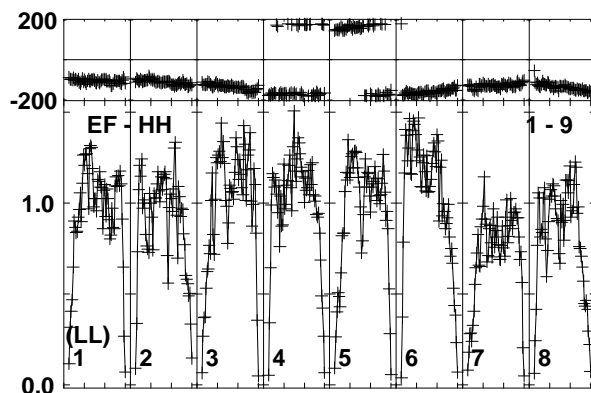
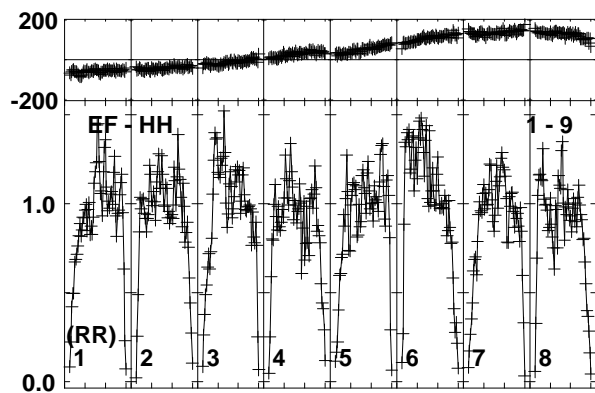
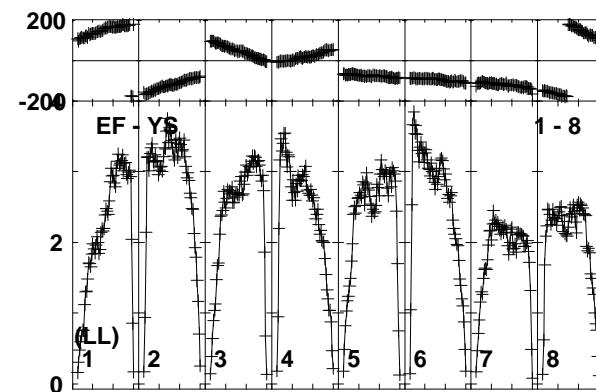
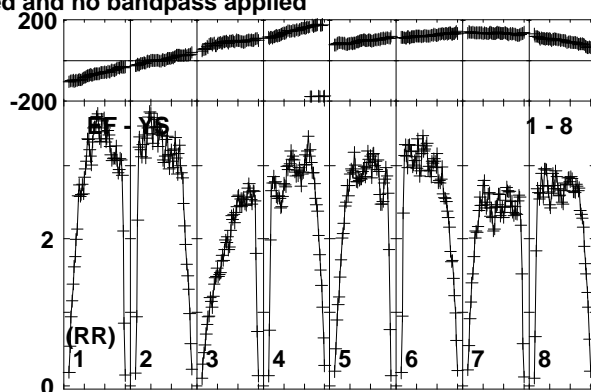
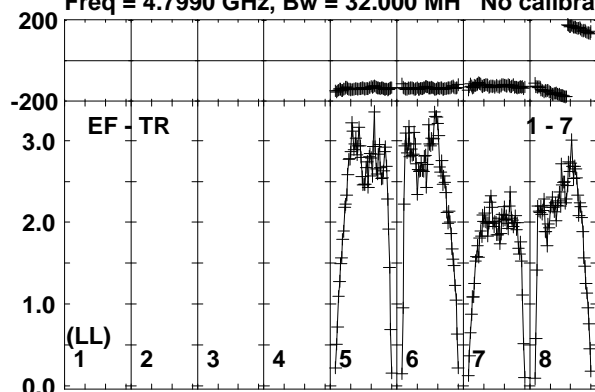

Lower frame: Milli Ampl Jy Top frame: Phas deg
Vector averaged cross-power spectrum Baseline: EF (01) - TR (07)
Timerange: 00/20:42:11 to 00/20:43:09

Plot file version 343 created 19-OCT-2017 15:36:43

MRK359 ES081C.UVDATA.1

Freq = 4.7990 GHz, Bw = 32.000 MH No calibration applied and no bandpass applied

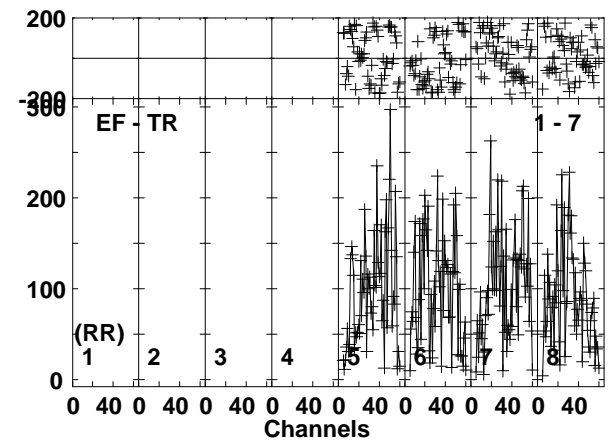
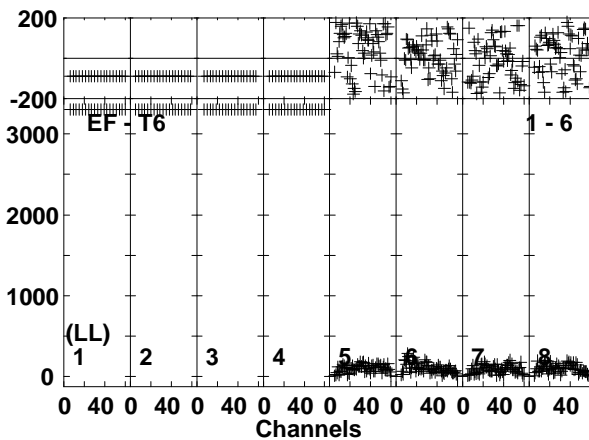
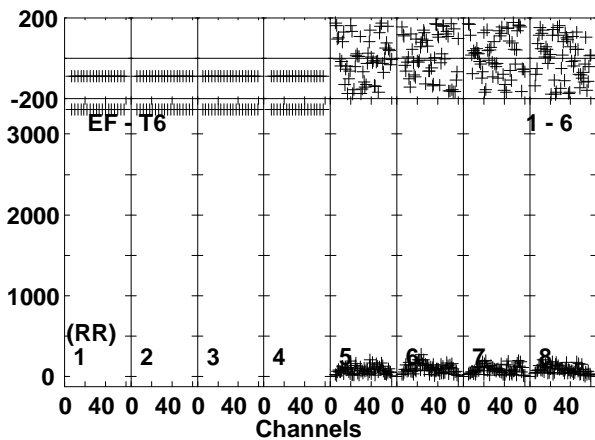
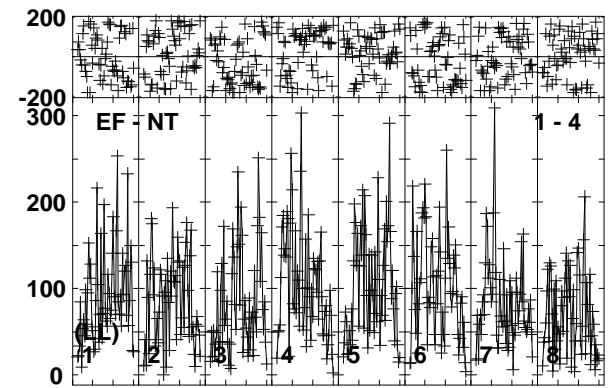
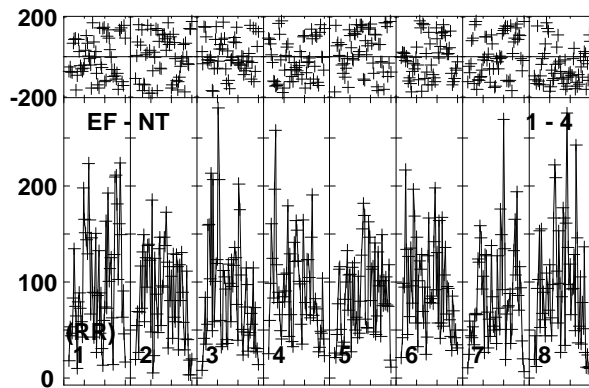
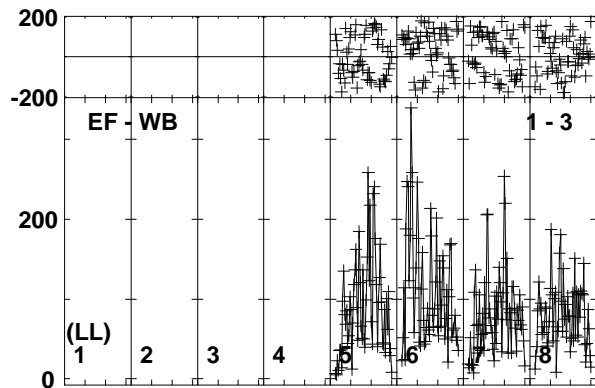
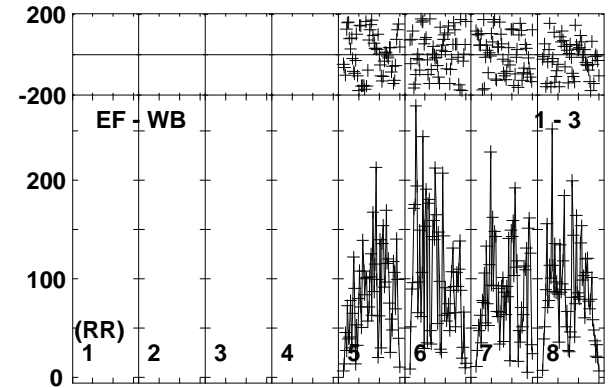
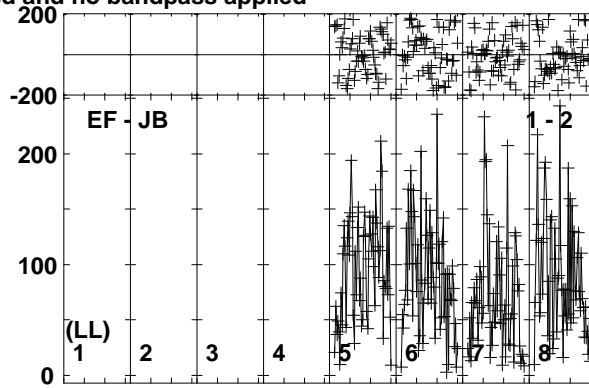
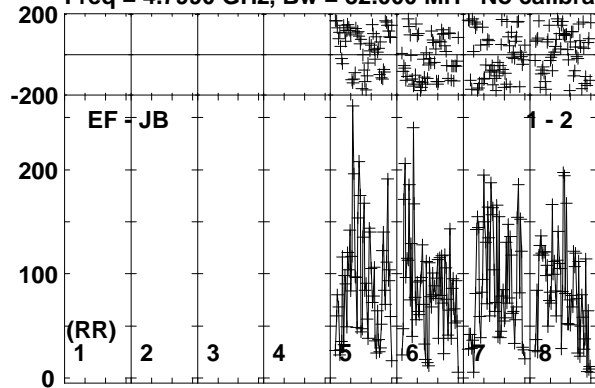

Lower frame: Micro Ampl Jy Top frame: Phas deg
Vector averaged cross-power spectrum Baseline: EF (01) - JB (02)
Timerange: 00/20:43:11 to 00/20:46:39

Plot file version 344 created 19-OCT-2017 15:36:43

MRK359 ES081C.UVDATA.1

Freq = 4.7990 GHz, Bw = 32.000 MH No calibration applied and no bandpass applied

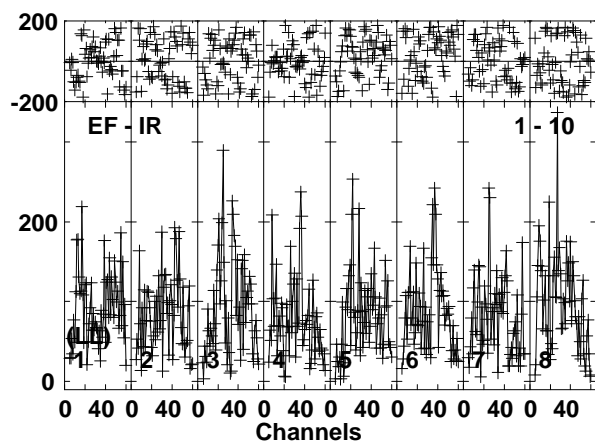
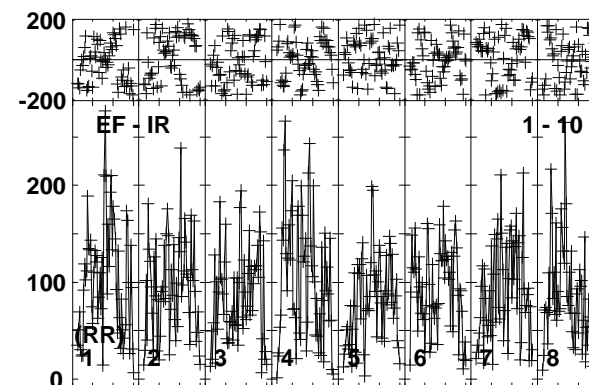
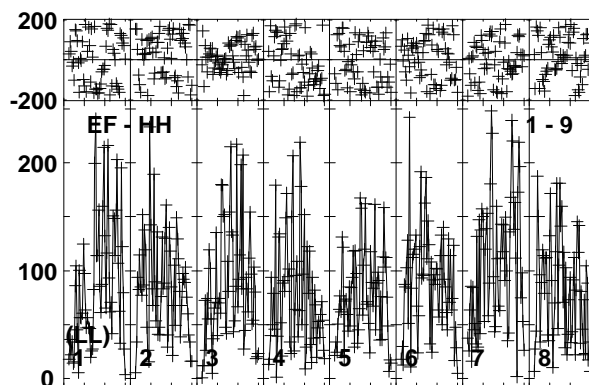
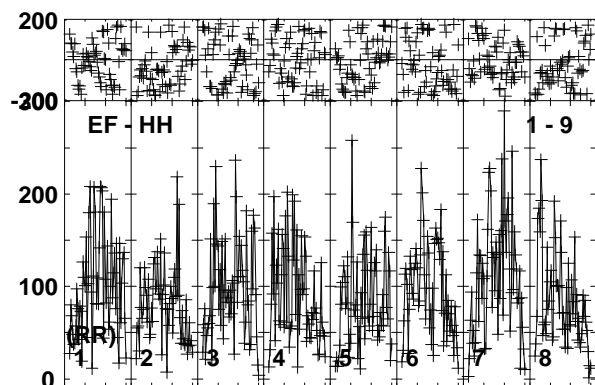
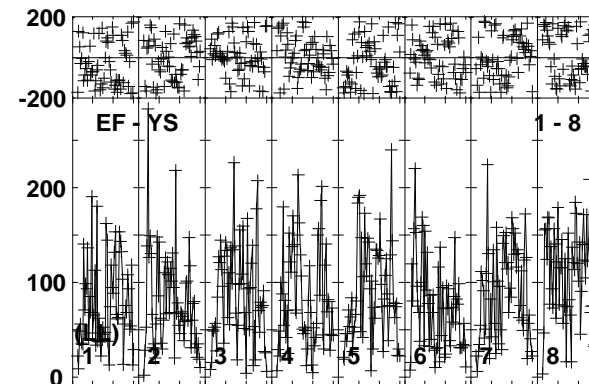
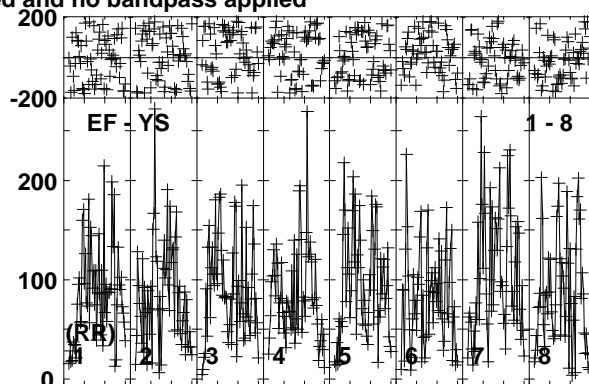
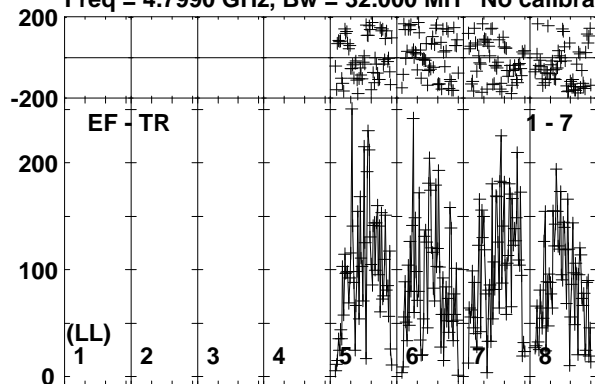

Lower frame: Micro Ampl Jy Top frame: Phas deg
Vector averaged cross-power spectrum Baseline: EF (01) - TR (07)
Timerange: 00/20:43:11 to 00/20:46:39

Plot file version 345 created 19-OCT-2017 15:36:43

J0139+1753 ES081C.UVDATA.1

Freq = 4.7990 GHz, Bw = 32.000 MH No calibration applied and no bandpass applied

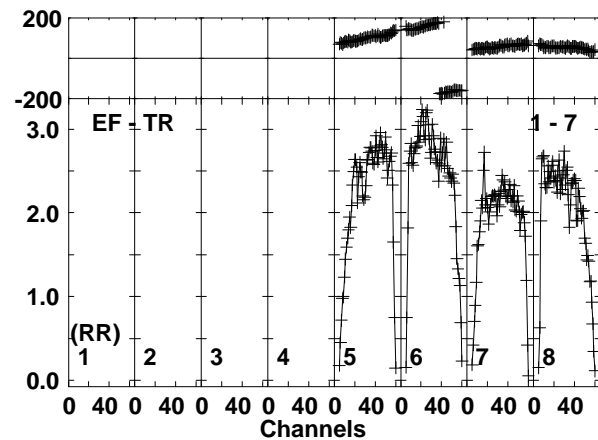
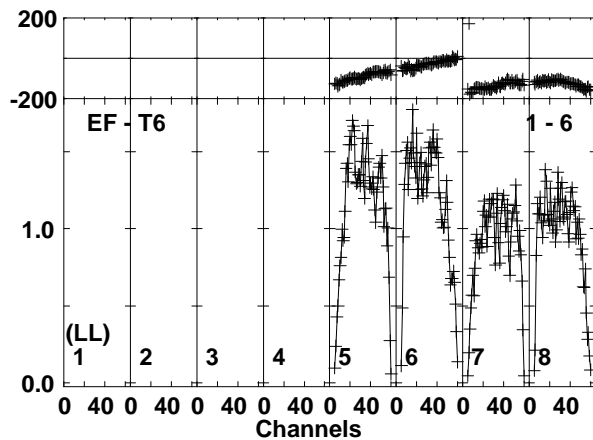
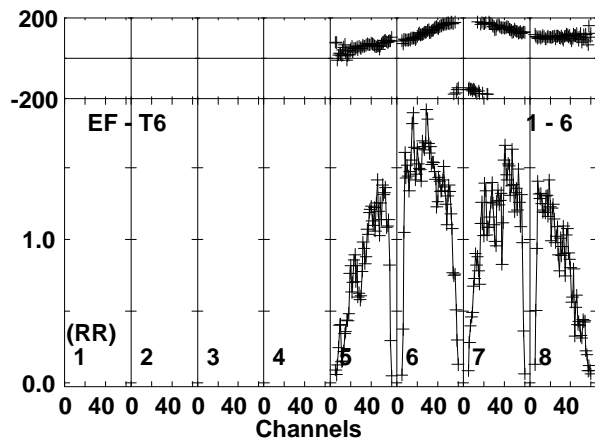
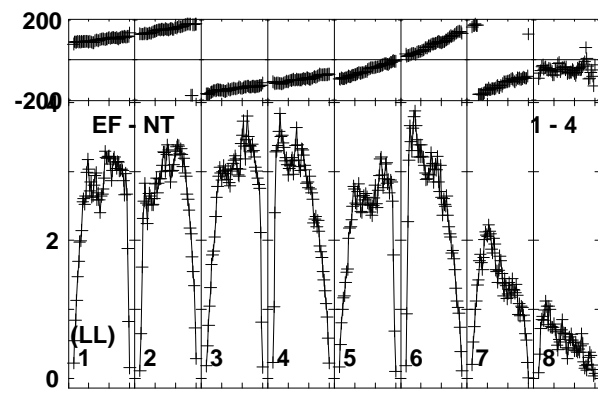
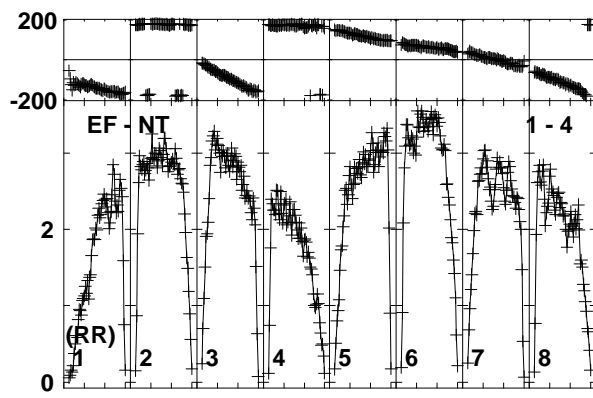
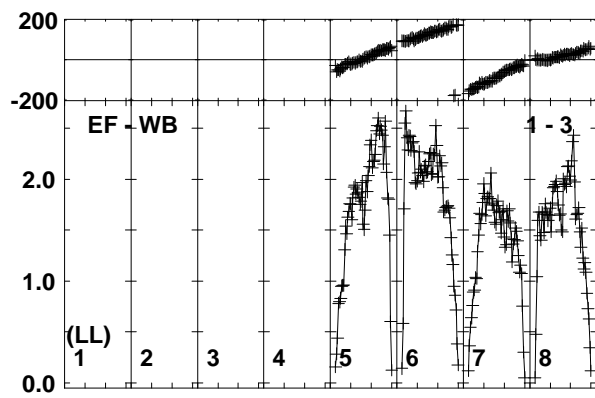
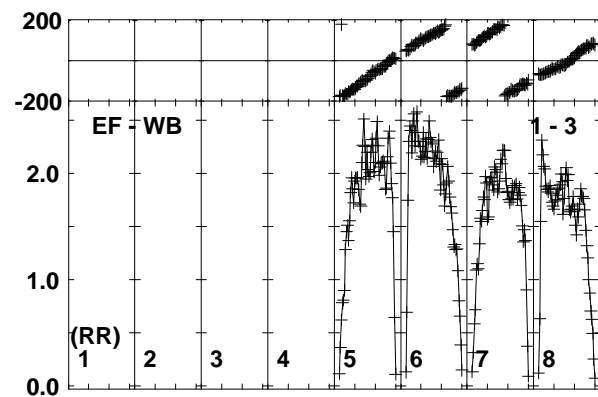
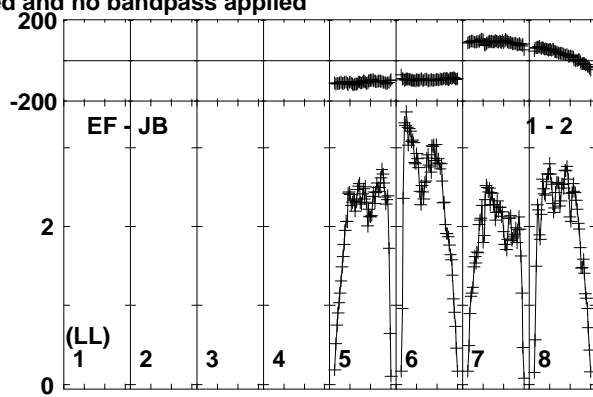
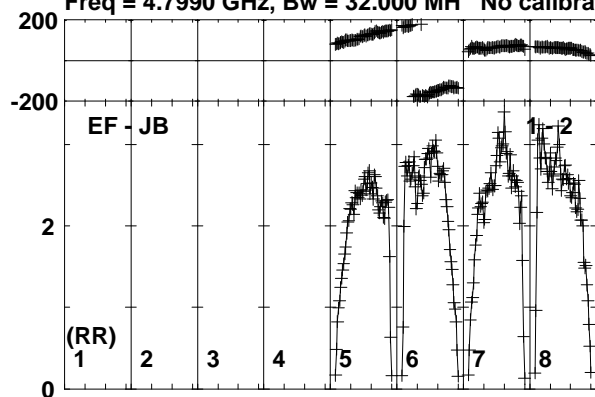

Lower frame: Milli Ampl Jy Top frame: Phas deg
Vector averaged cross-power spectrum Baseline: EF (01) - JB (02)
Timerange: 00/20:46:41 to 00/20:48:09

Plot file version 346 created 19-OCT-2017 15:36:43

J0139+1753 ES081C.UVDATA.1

Freq = 4.7990 GHz, Bw = 32.000 MH No calibration applied and no bandpass applied

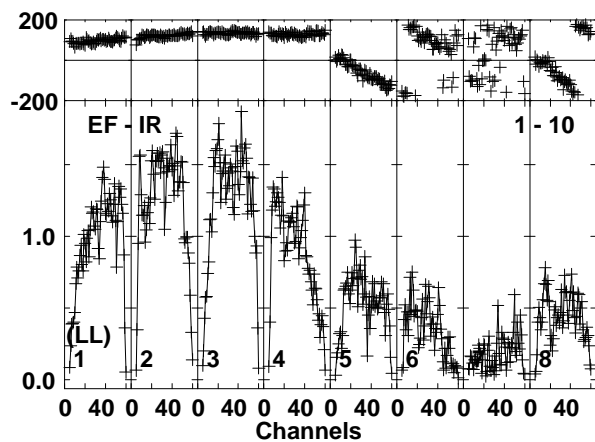
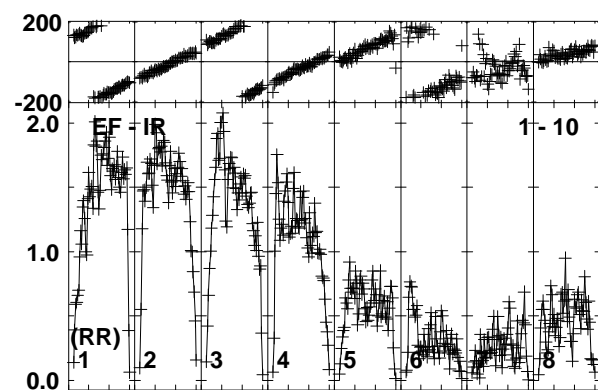
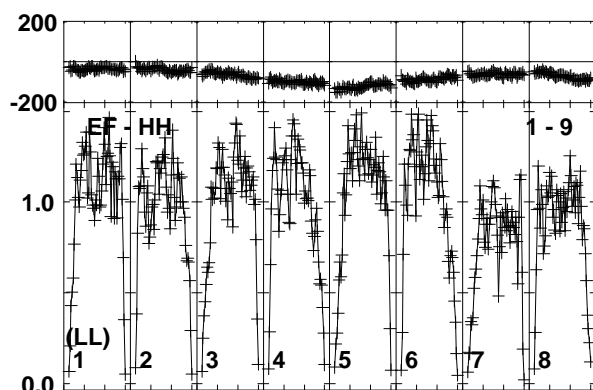
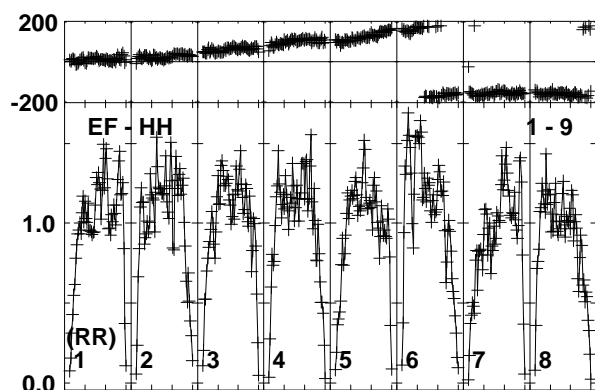
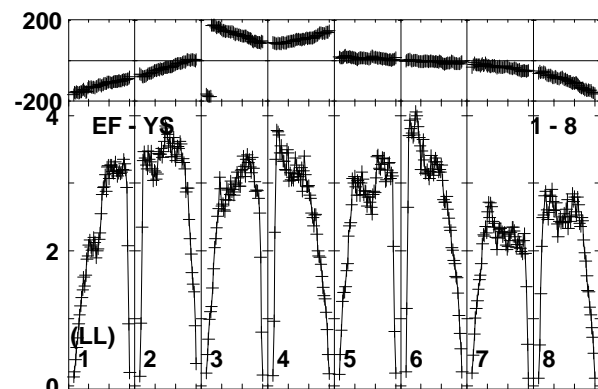
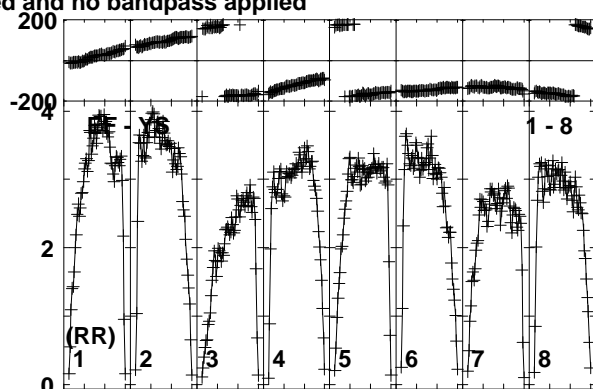
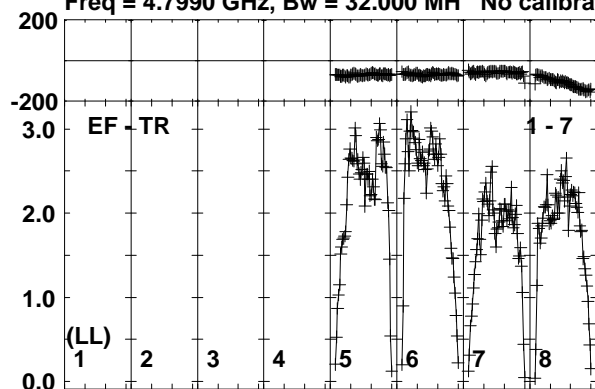

Lower frame: Milli Ampl Jy Top frame: Phas deg
Vector averaged cross-power spectrum Baseline: EF (01) - TR (07)
Timerange: 00/20:46:41 to 00/20:48:09

Plot file version 347 created 19-OCT-2017 15:36:43

MRK359 ES081C.UVDATA.1

Freq = 4.7990 GHz, Bw = 32.000 MH No calibration applied and no bandpass applied

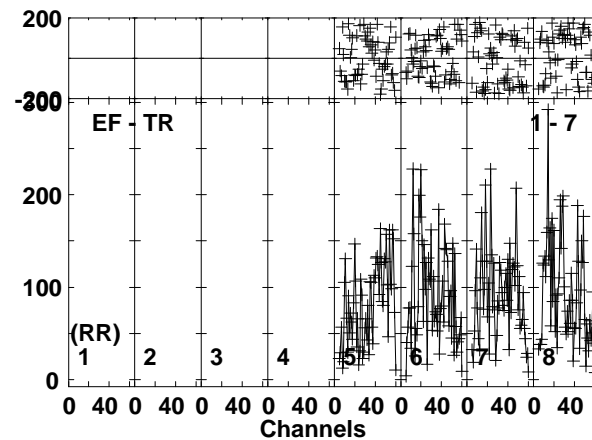
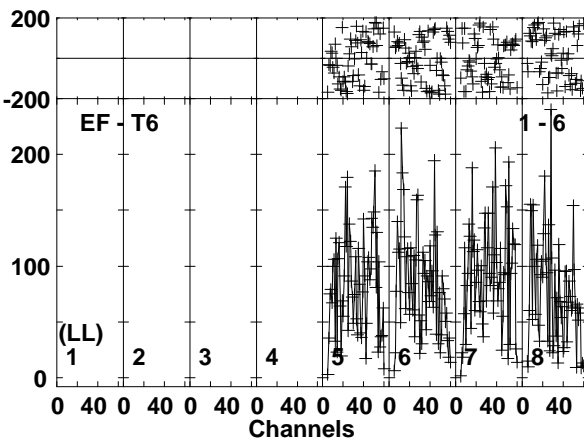
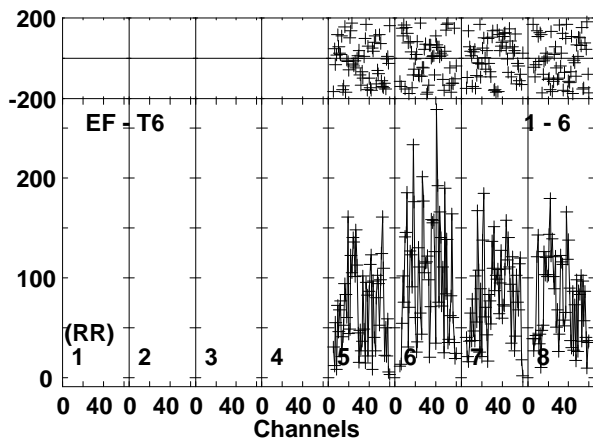
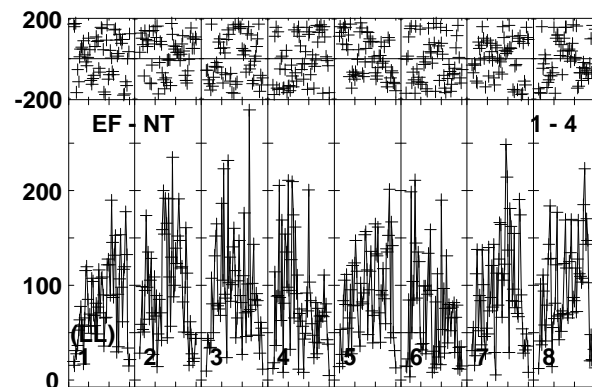
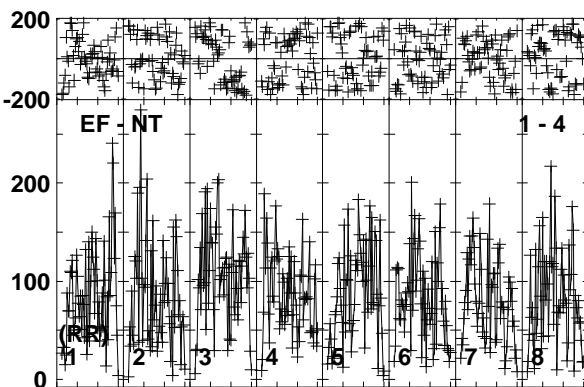
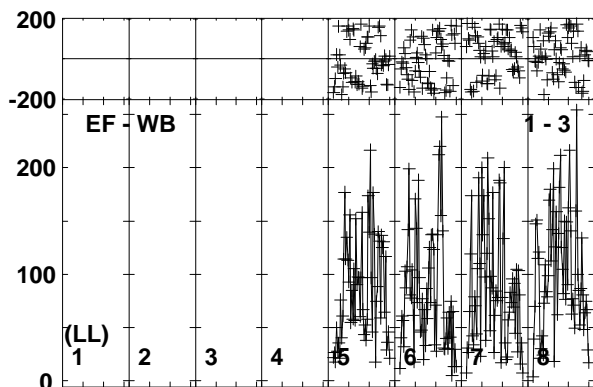
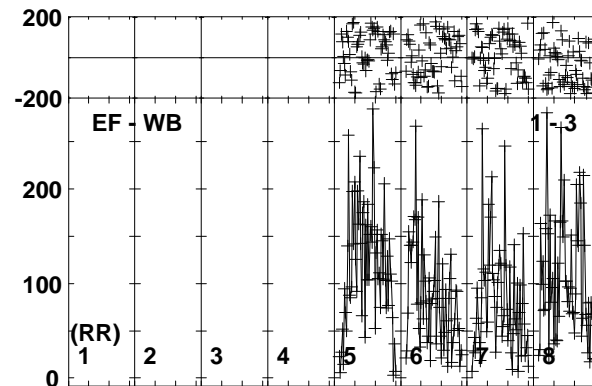
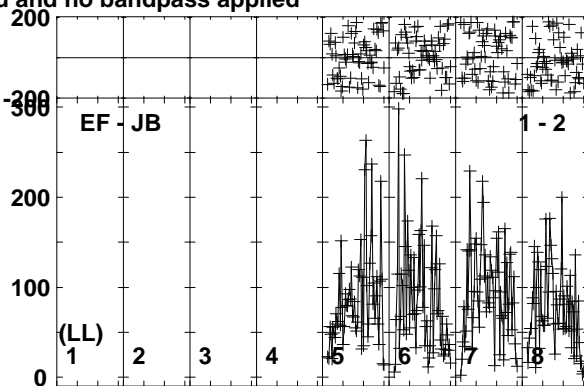
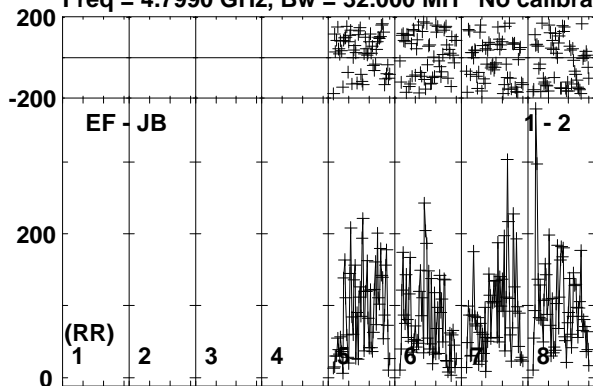

Lower frame: Micro Ampl Jy Top frame: Phas deg
Vector averaged cross-power spectrum Baseline: EF (01) - JB (02)
Timerange: 00/20:48:11 to 00/20:51:39

Plot file version 348 created 19-OCT-2017 15:36:44

MRK359 ES081C.UVDATA.1

Freq = 4.7990 GHz, Bw = 32.000 MH No calibration applied and no bandpass applied

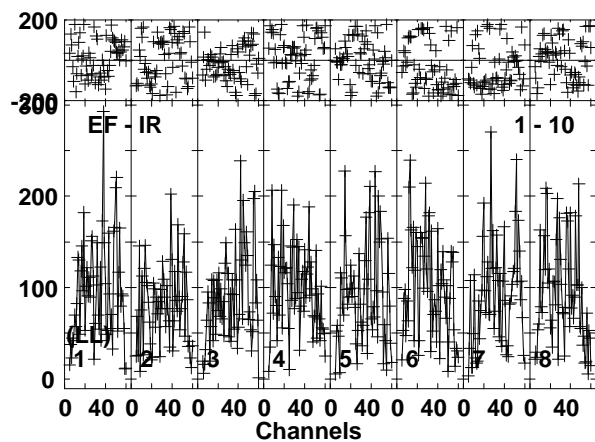
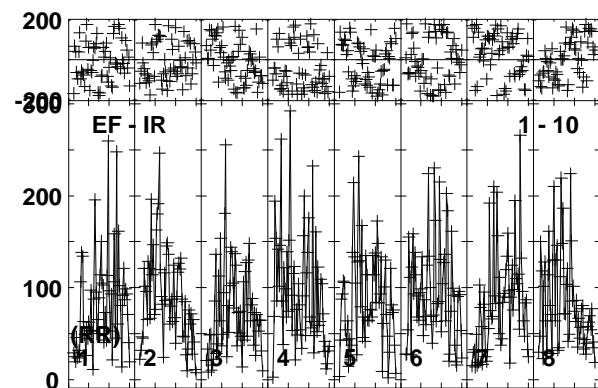
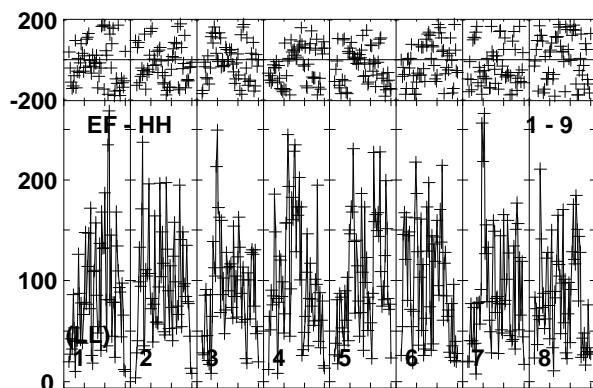
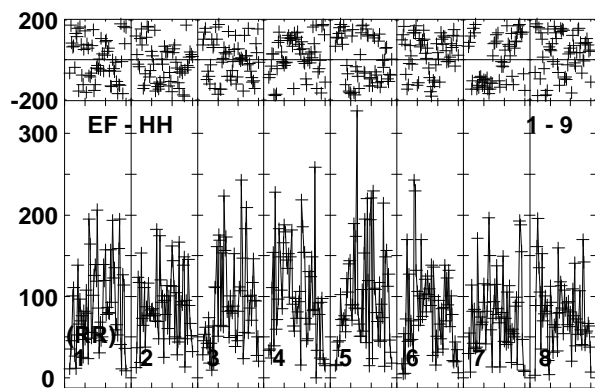
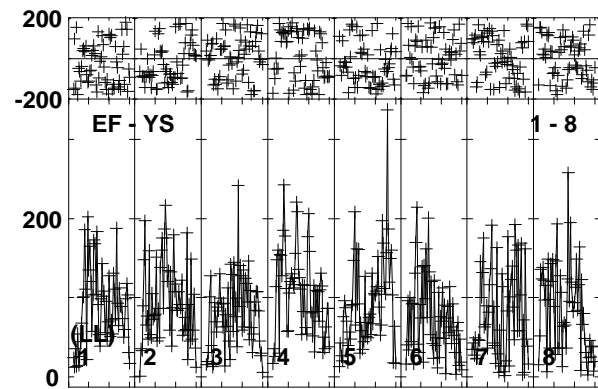
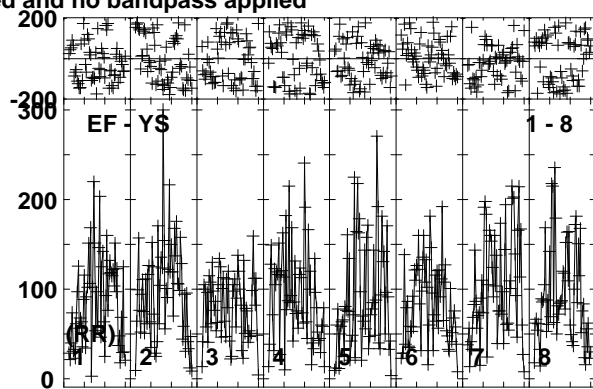
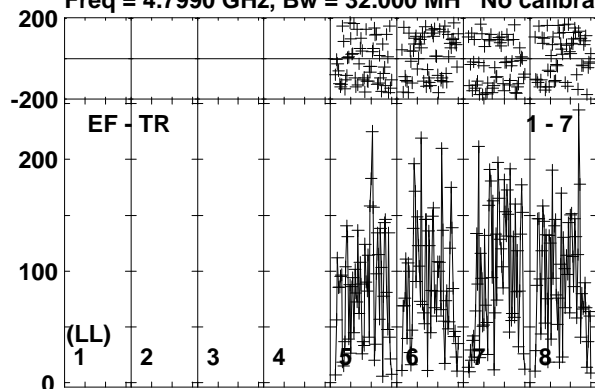

Lower frame: Micro Ampl Jy Top frame: Phas deg
Vector averaged cross-power spectrum Baseline: EF (01) - TR (07)
Timerange: 00/20:48:11 to 00/20:51:39

Plot file version 349 created 19-OCT-2017 15:36:44

J0139+1753 ES081C.UVDATA.1

Freq = 4.7990 GHz, Bw = 32.000 MH No calibration applied and no bandpass applied

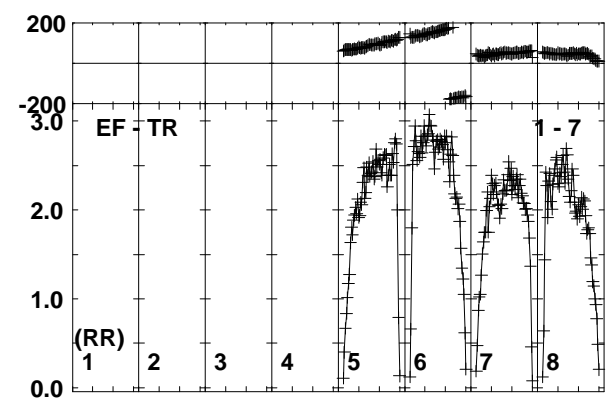
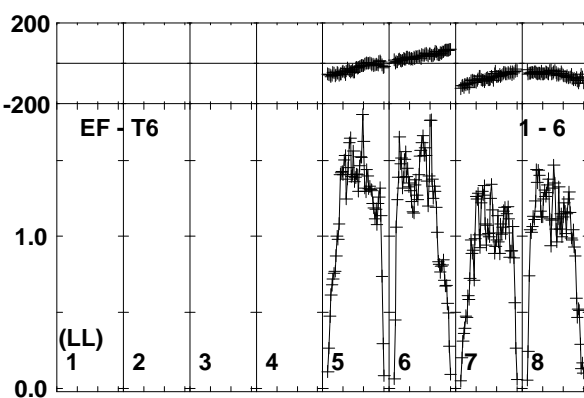
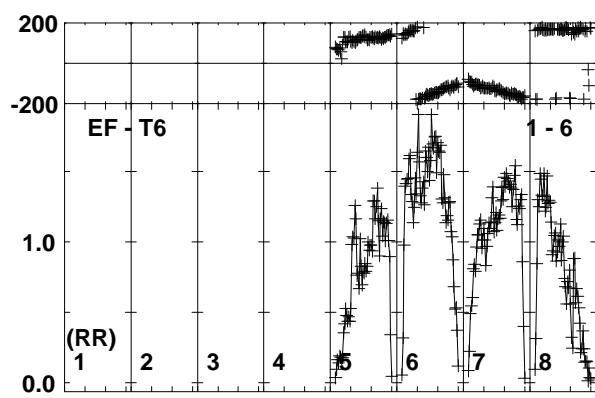
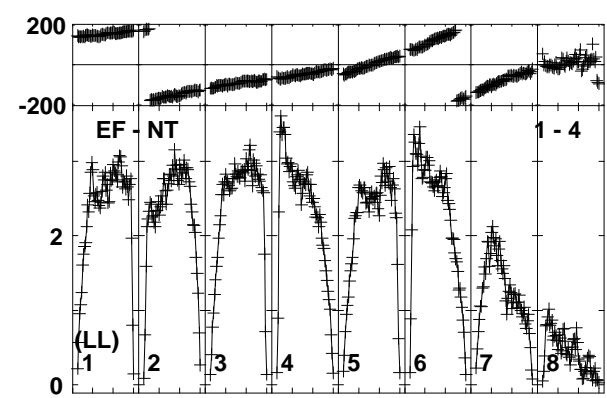
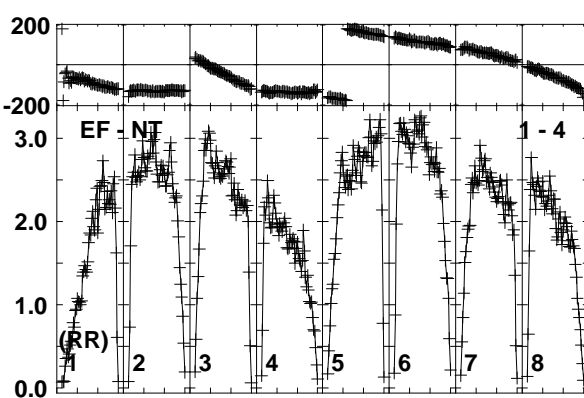
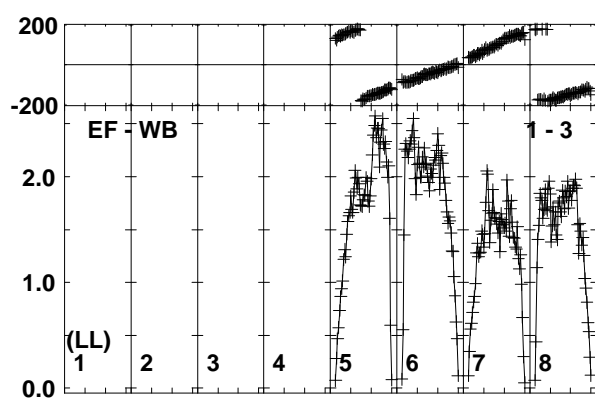
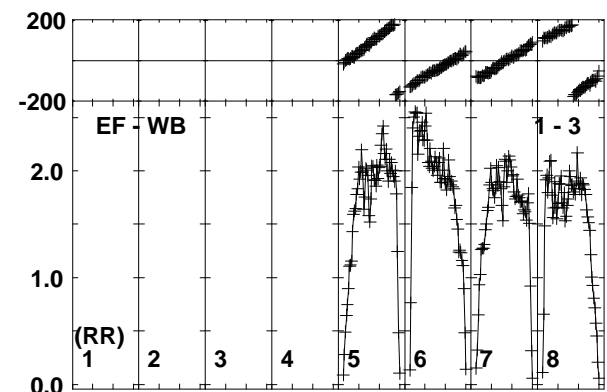
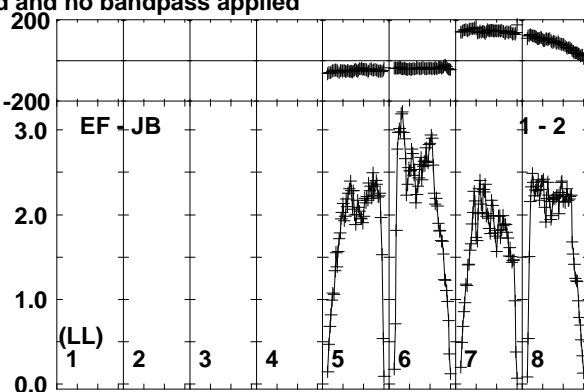
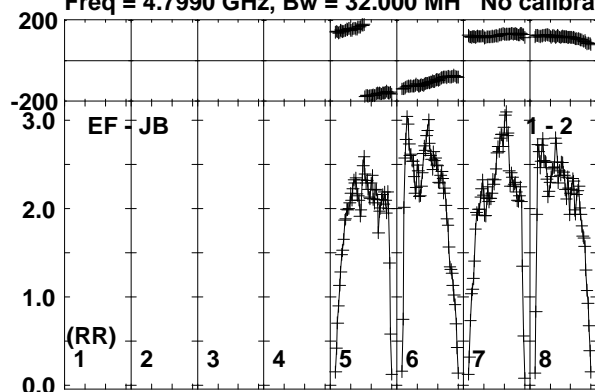

Lower frame: Milli Ampl Jy Top frame: Phas deg
Vector averaged cross-power spectrum Baseline: EF (01) - JB (02)
Timerange: 00/20:52:21 to 00/20:53:19

Plot file version 350 created 19-OCT-2017 15:36:44

J0139+1753 ES081C.UVDATA.1

Freq = 4.7990 GHz, Bw = 32.000 MH No calibration applied and no bandpass applied

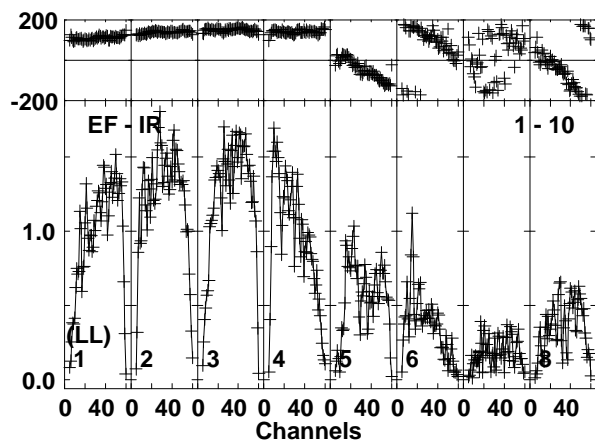
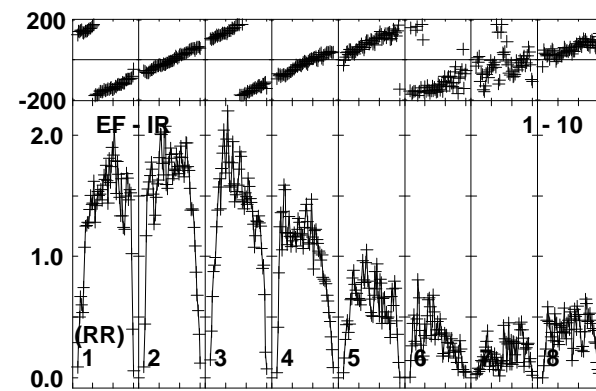
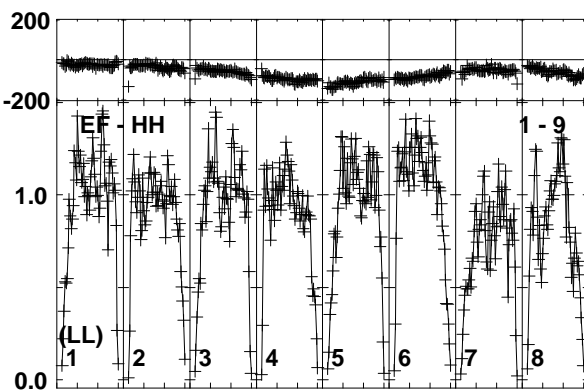
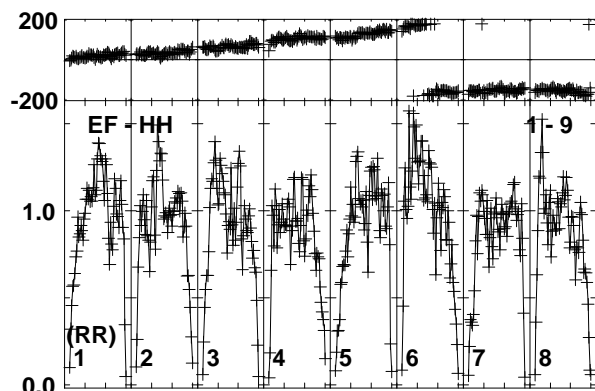
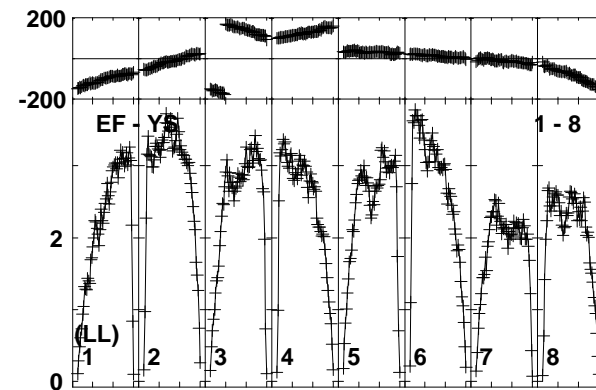
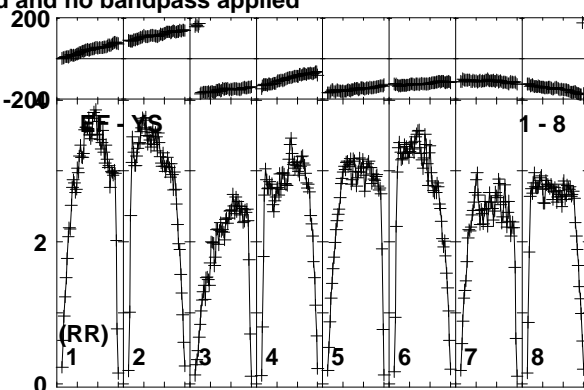
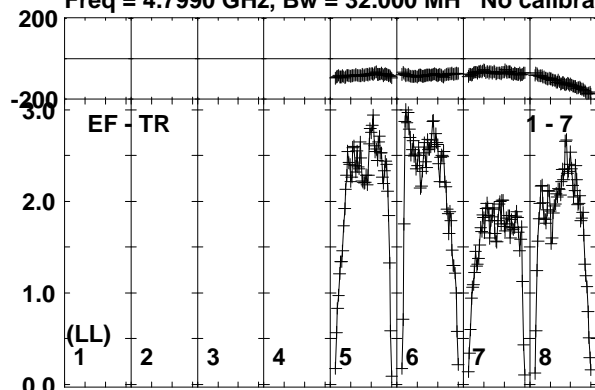

Lower frame: Milli Ampl Jy Top frame: Phas deg
Vector averaged cross-power spectrum Baseline: EF (01) - TR (07)
Timerange: 00/20:52:21 to 00/20:53:19

Plot file version 351 created 19-OCT-2017 15:36:44
 MRK359 ES081C.UVDATA.1
 Freq = 4.7990 GHz, Bw = 32.000 MH No calibration applied and no bandpass applied

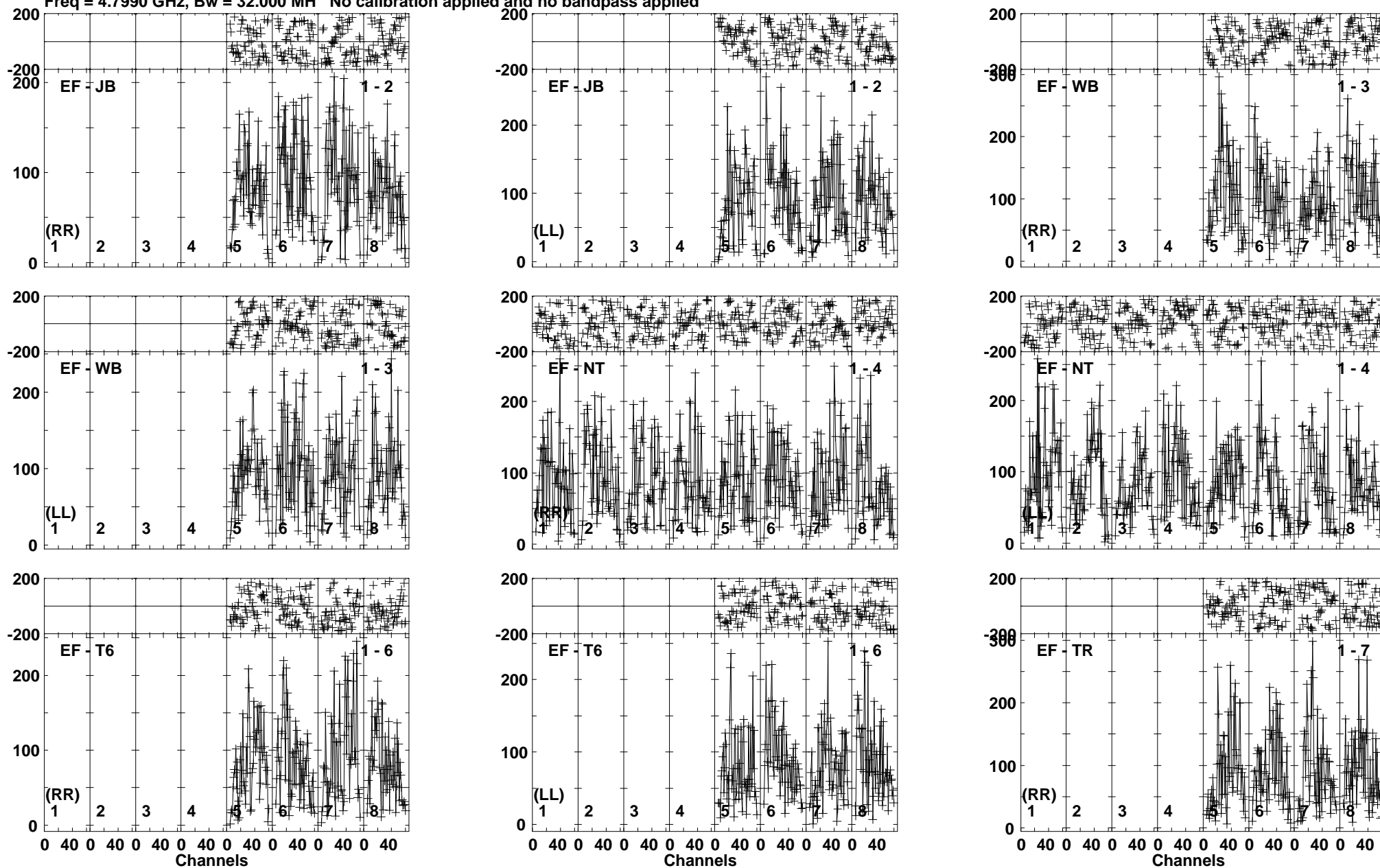

Lower frame: Micro Ampl Jy Top frame: Phas deg
 Vector averaged cross-power spectrum Baseline: EF (01) - JB (02)
 Timerange: 00/20:53:21 to 00/20:56:49

Plot file version 352 created 19-OCT-2017 15:36:44

MRK359 ES081C.UVDATA.1

Freq = 4.7990 GHz, Bw = 32.000 MH No calibration applied and no bandpass applied

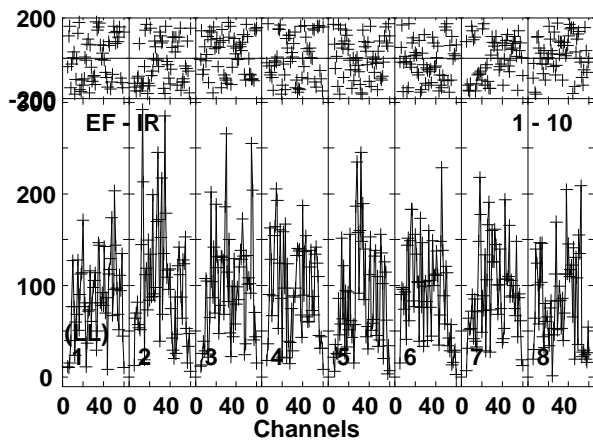
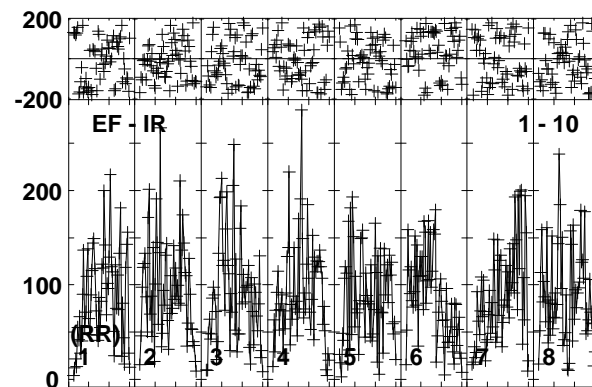
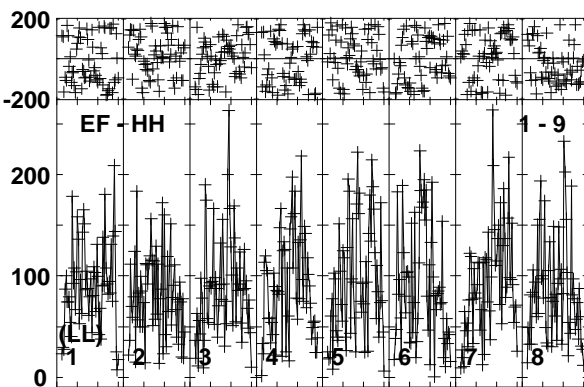
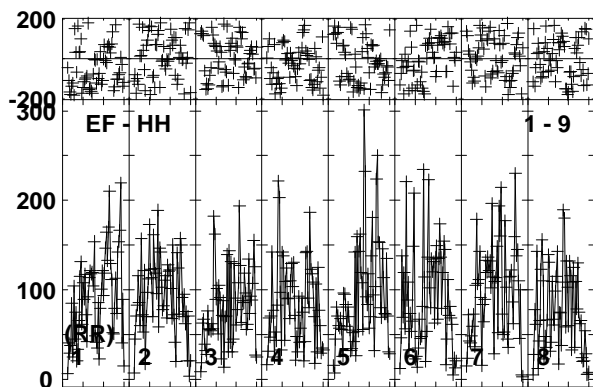
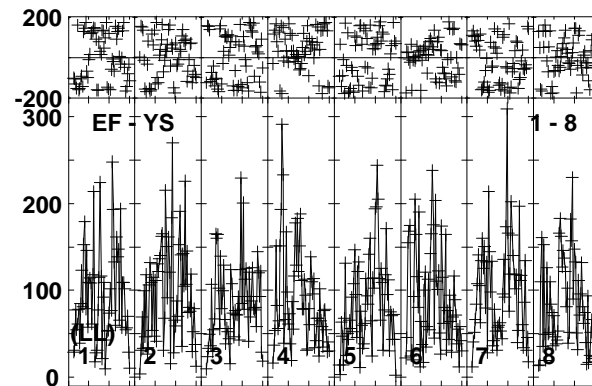
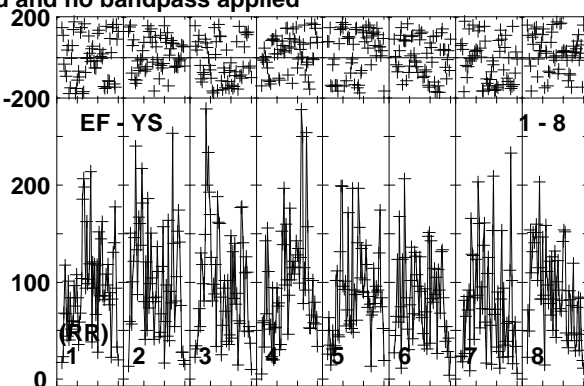
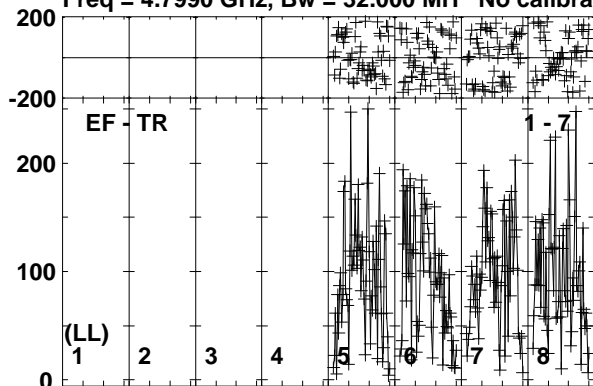

Lower frame: Micro Ampl Jy Top frame: Phas deg
Vector averaged cross-power spectrum Baseline: EF (01) - TR (07)
Timerange: 00/20:53:21 to 00/20:56:49

Plot file version 353 created 19-OCT-2017 15:36:44

J0139+1753 ES081C.UVDATA.1

Freq = 4.7990 GHz, Bw = 32.000 MH No calibration applied and no bandpass applied

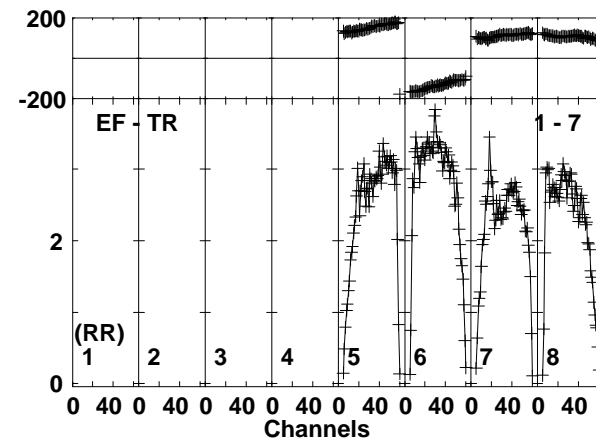
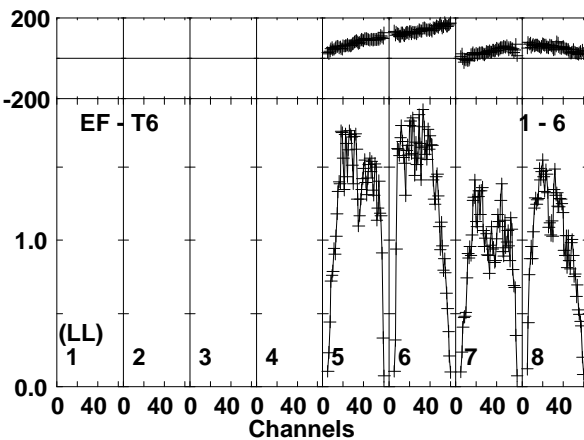
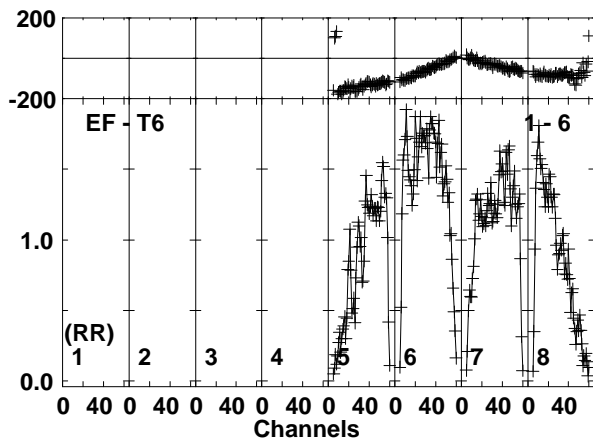
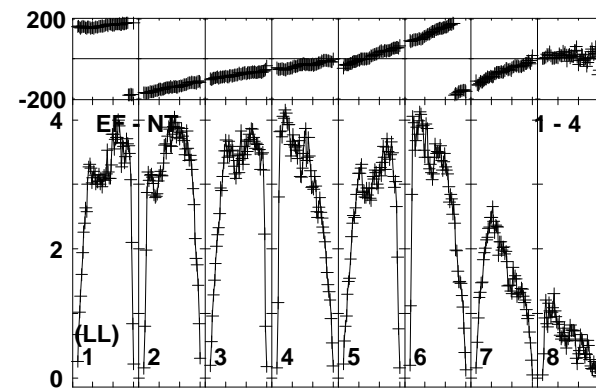
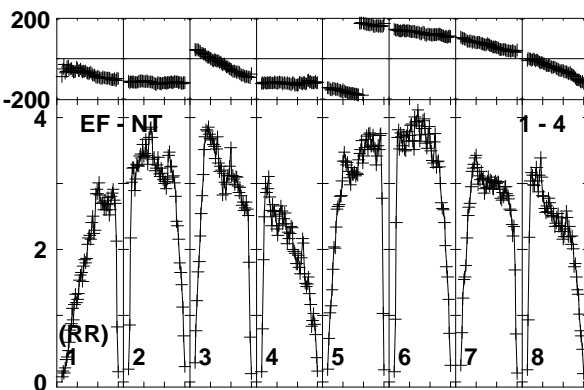
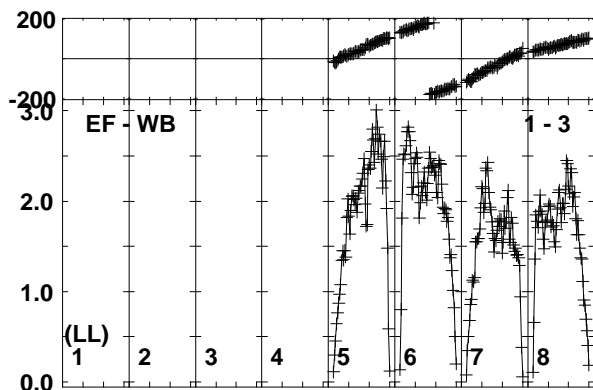
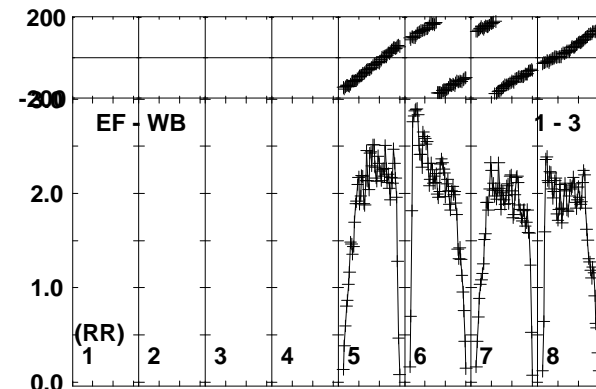
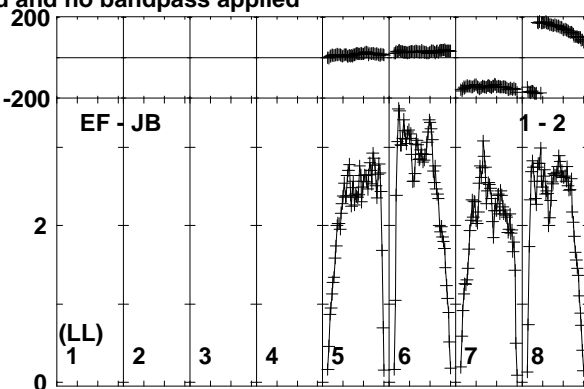
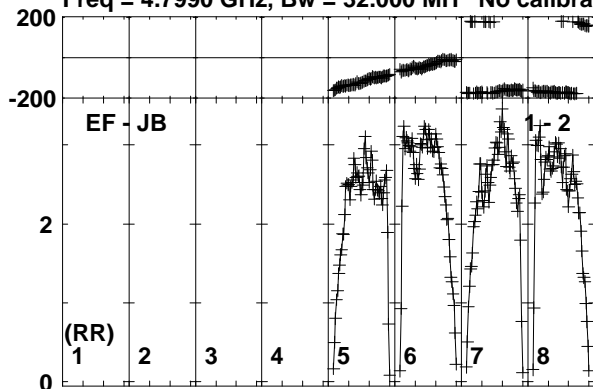

Lower frame: Milli Ampl Jy Top frame: Phas deg
Vector averaged cross-power spectrum Baseline: EF (01) - JB (02)
Timerange: 00/20:56:51 to 00/20:58:19

Plot file version 354 created 19-OCT-2017 15:36:44

J0139+1753 ES081C.UVDATA.1

Freq = 4.7990 GHz, Bw = 32.000 MH No calibration applied and no bandpass applied

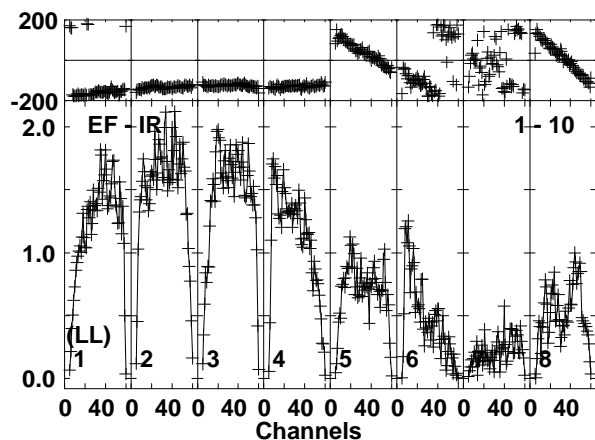
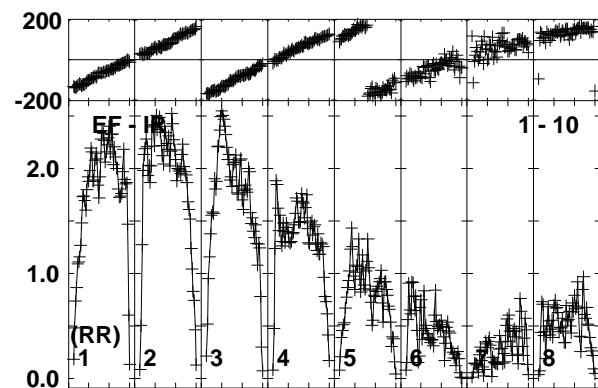
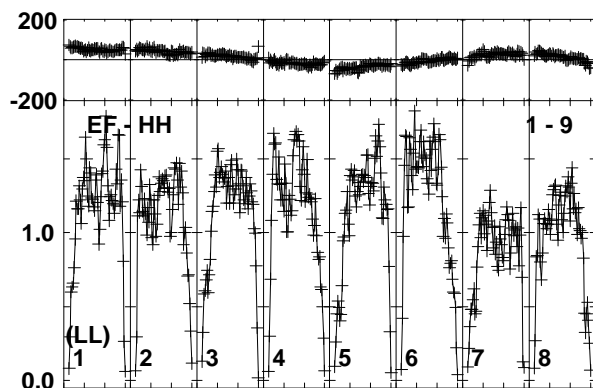
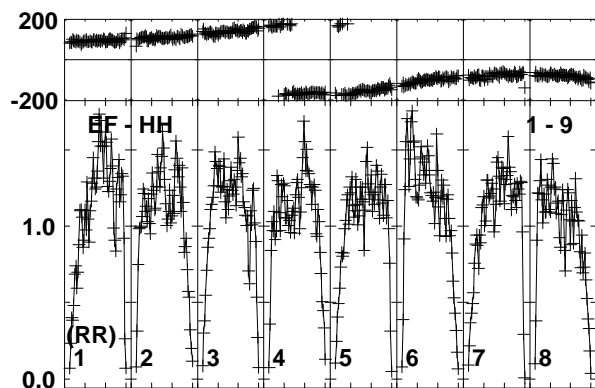
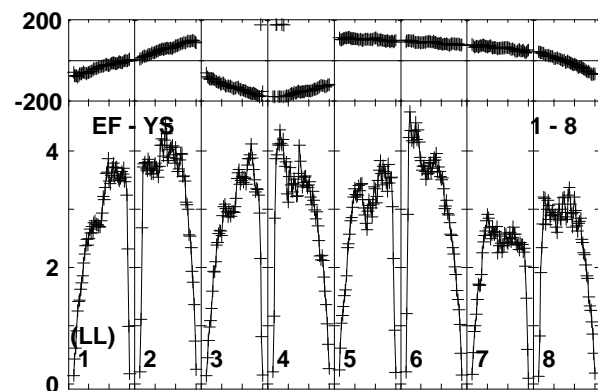
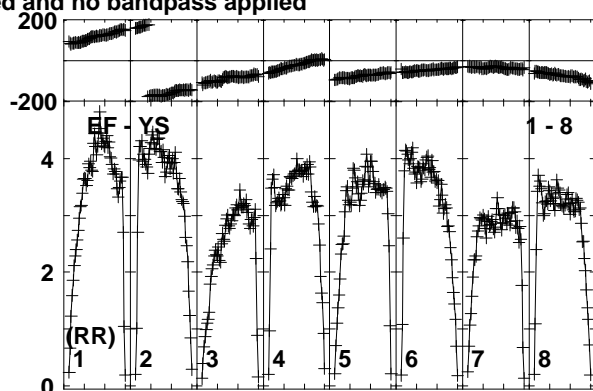
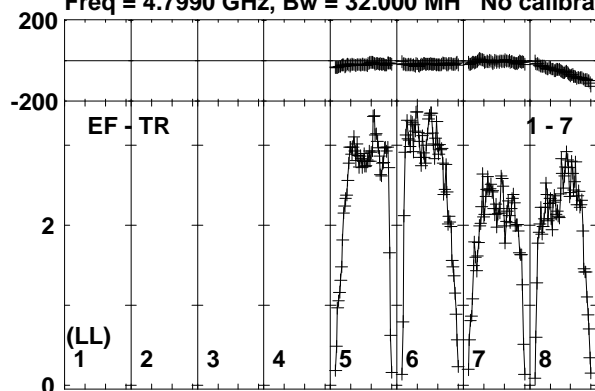

Lower frame: Milli Ampl Jy Top frame: Phas deg
Vector averaged cross-power spectrum Baseline: EF (01) - TR (07)
Timerange: 00/20:56:51 to 00/20:58:19

Plot file version 355 created 19-OCT-2017 15:36:45

MRK359 ES081C.UVDATA.1

Freq = 4.7990 GHz, Bw = 32.000 MH No calibration applied and no bandpass applied

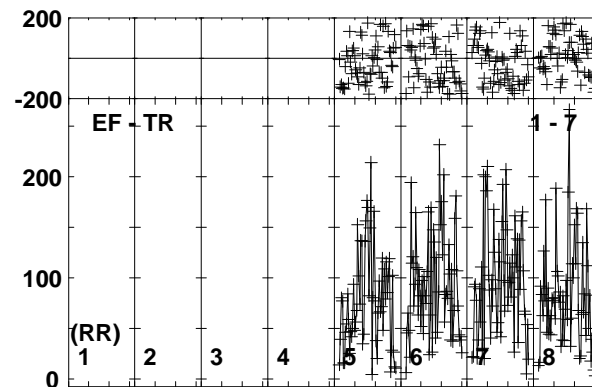
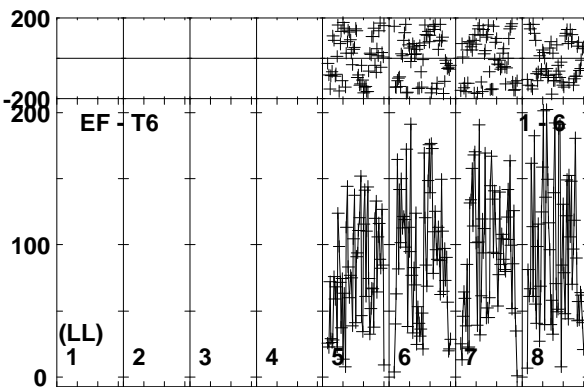
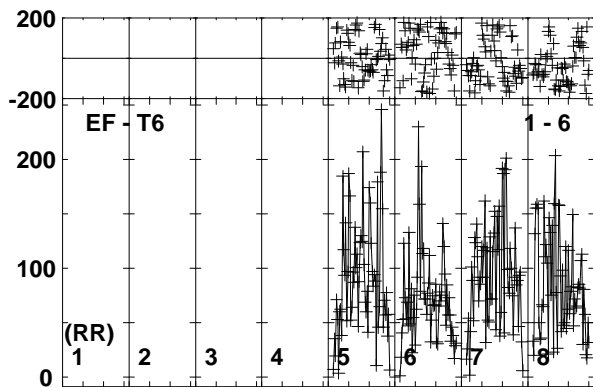
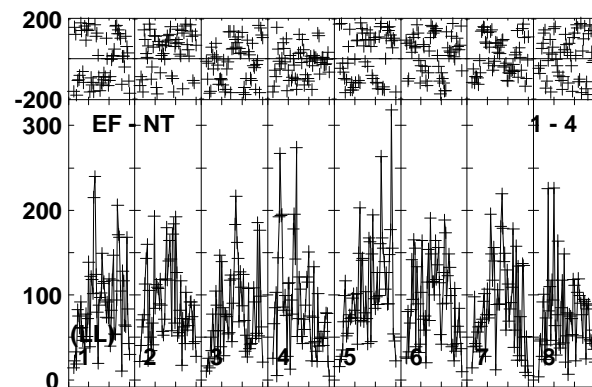
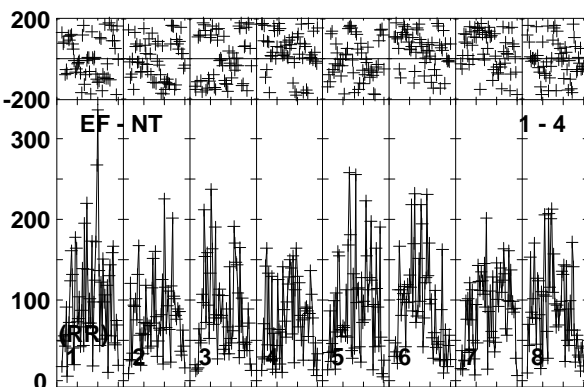
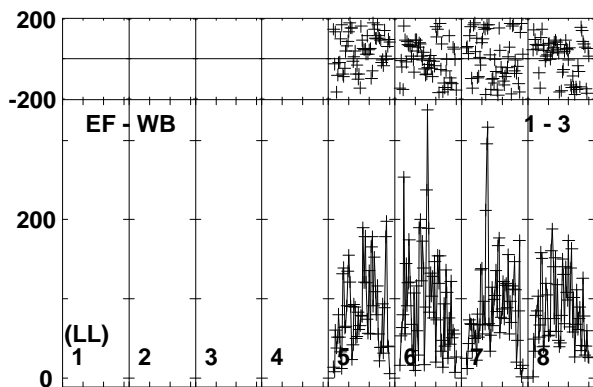
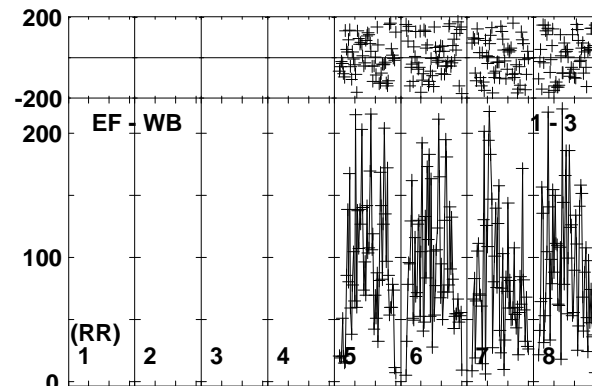
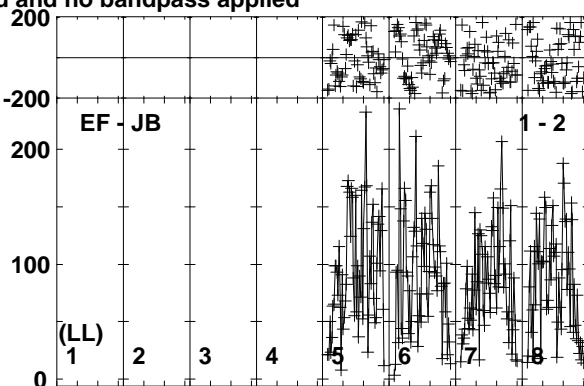
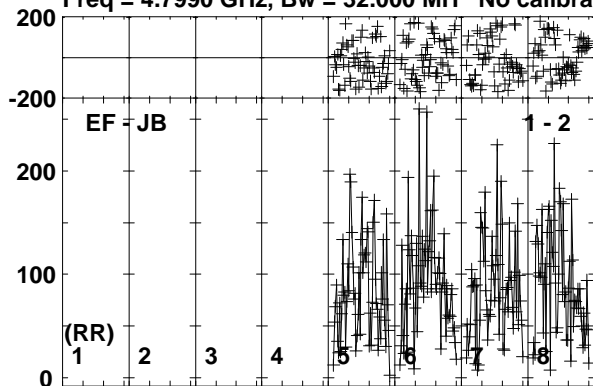

Lower frame: Micro Ampl Jy Top frame: Phas deg
Vector averaged cross-power spectrum Baseline: EF (01) - JB (02)
Timerange: 00/20:58:21 to 00/21:01:49

Plot file version 356 created 19-OCT-2017 15:36:45

MRK359 ES081C.UVDATA.1

Freq = 4.7990 GHz, Bw = 32.000 MH No calibration applied and no bandpass applied

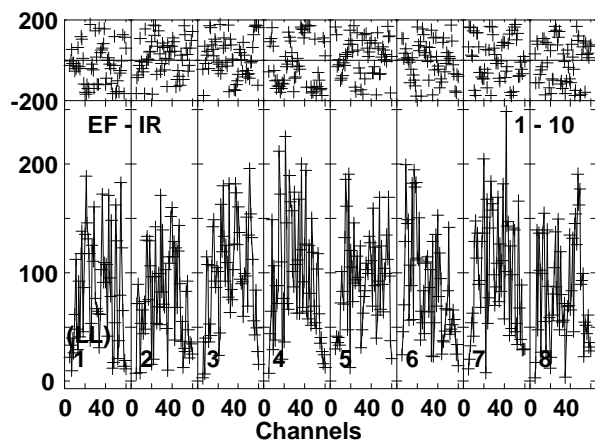
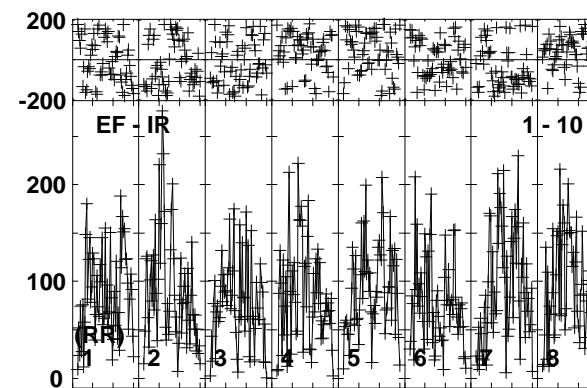
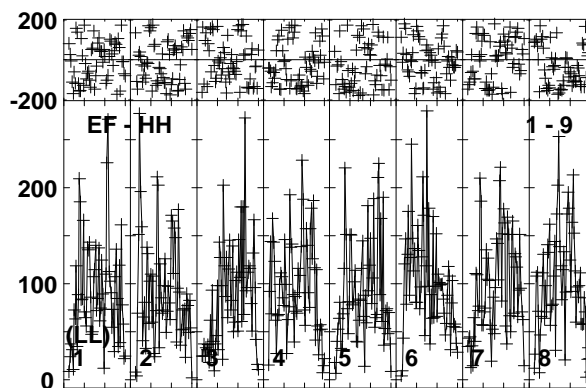
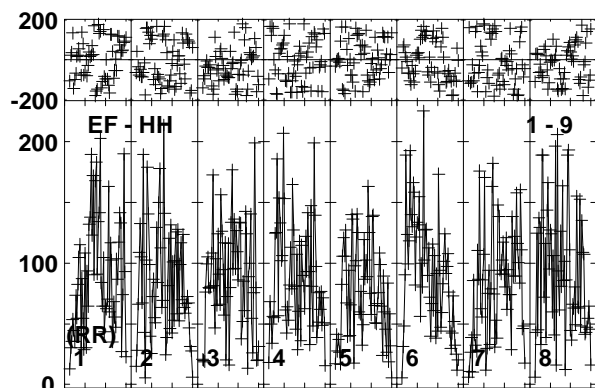
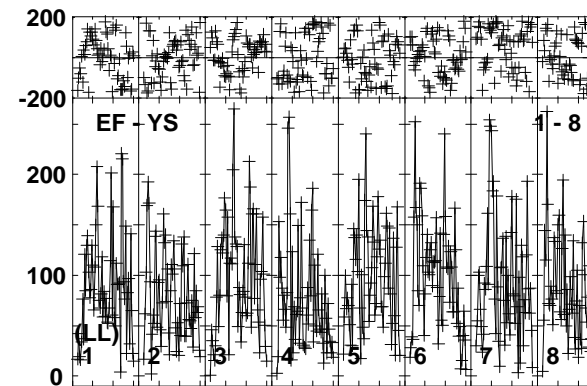
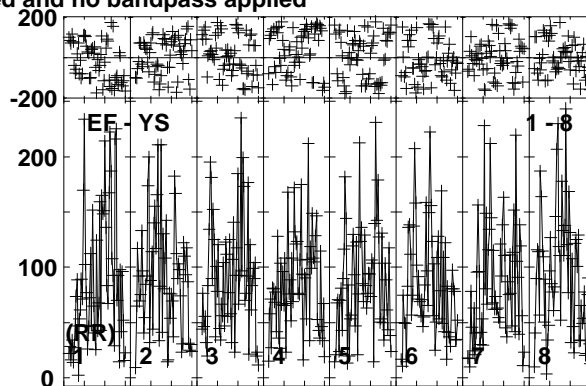
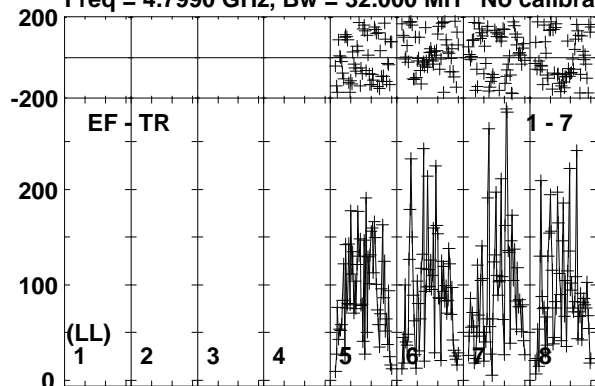

Lower frame: Micro Ampl Jy Top frame: Phas deg
Vector averaged cross-power spectrum Baseline: EF (01) - TR (07)
Timerange: 00/20:58:21 to 00/21:01:49

Plot file version 357 created 19-OCT-2017 15:36:45

J0139+1753 ES081C.UVDATA.1

Freq = 4.7990 GHz, Bw = 32.000 MH No calibration applied and no bandpass applied

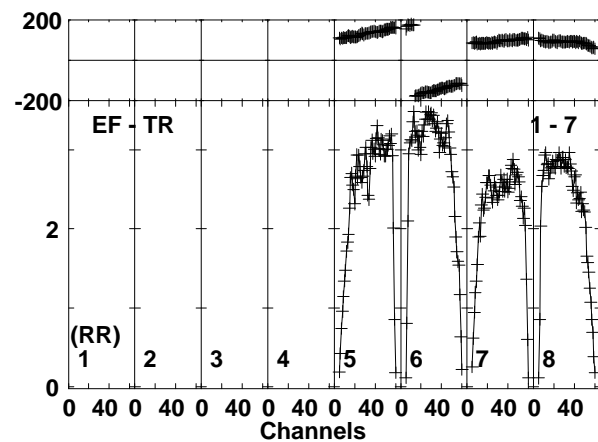
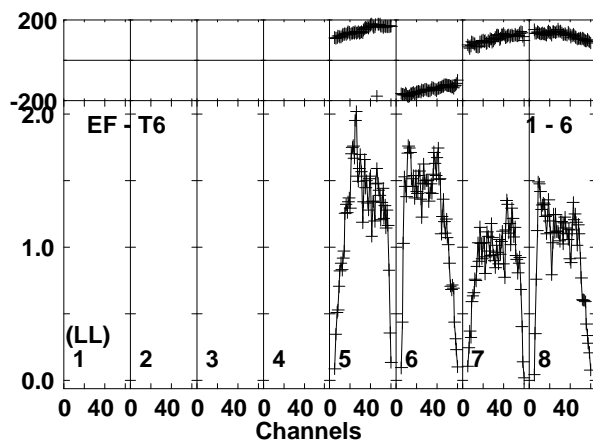
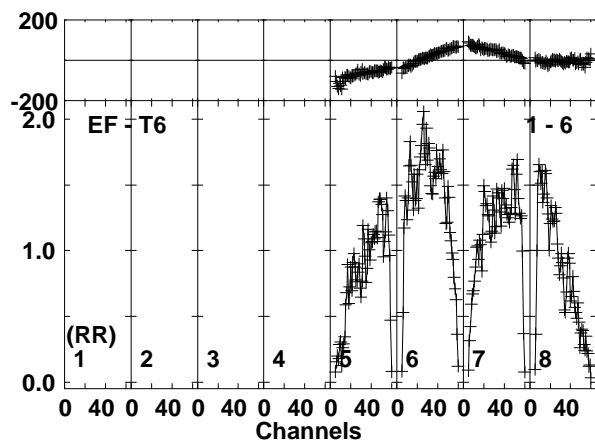
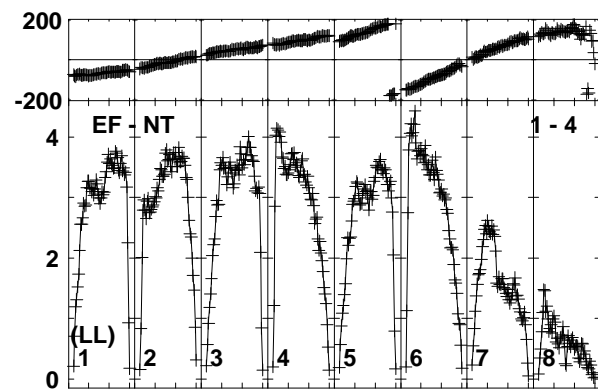
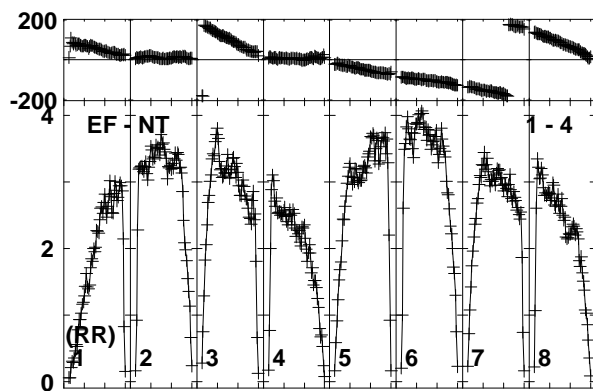
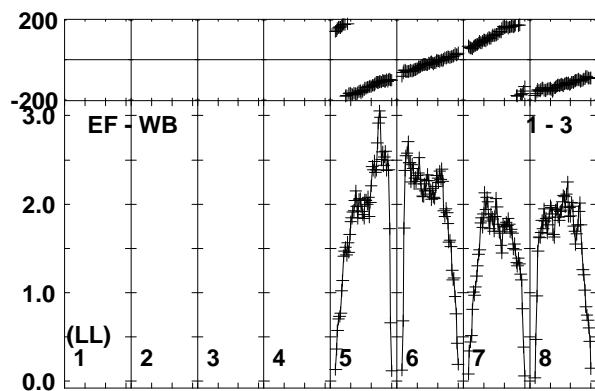
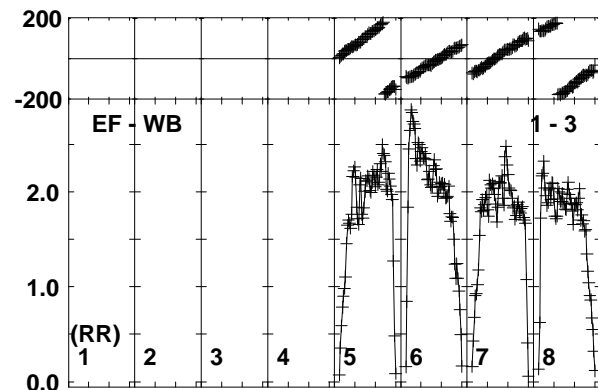
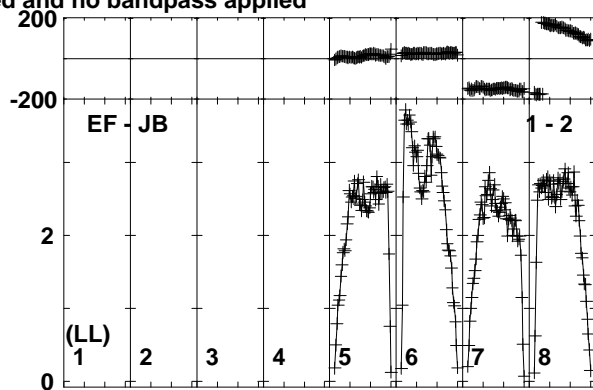
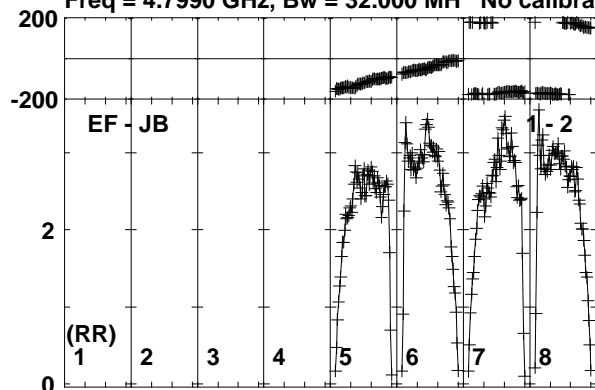

Lower frame: Milli Ampl Jy Top frame: Phas deg
Vector averaged cross-power spectrum Baseline: EF (01) - JB (02)
Timerange: 00/21:02:31 to 00/21:03:29

Plot file version 358 created 19-OCT-2017 15:36:45

J0139+1753 ES081C.UVDATA.1

Freq = 4.7990 GHz, Bw = 32.000 MH No calibration applied and no bandpass applied

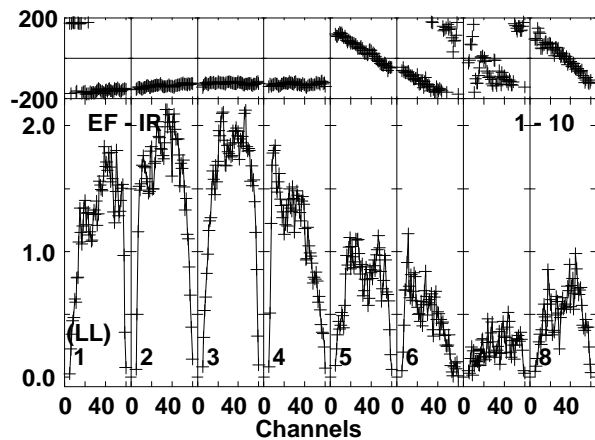
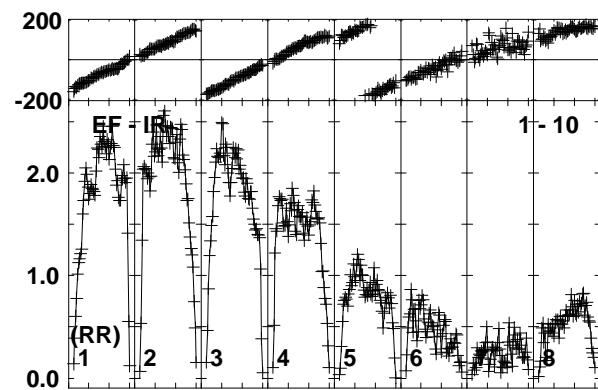
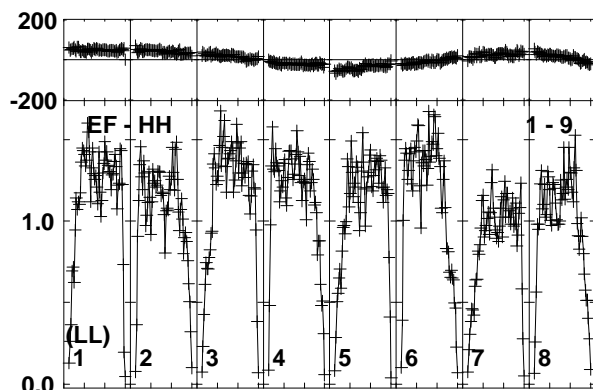
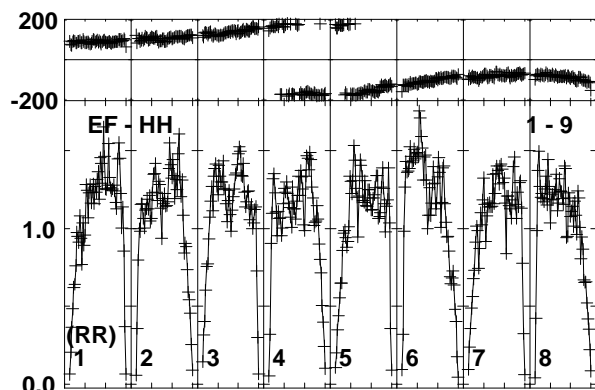
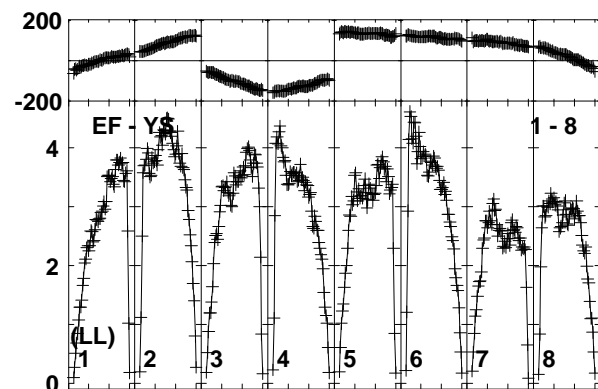
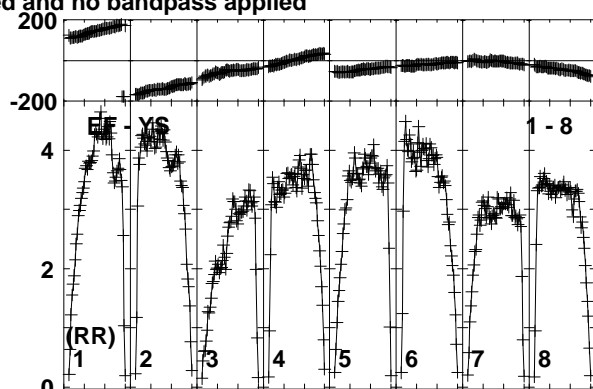
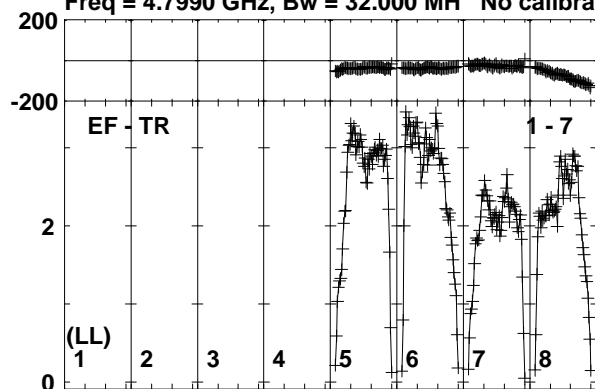

Lower frame: Milli Ampl Jy Top frame: Phas deg
Vector averaged cross-power spectrum Baseline: EF (01) - TR (07)
Timerange: 00/21:02:31 to 00/21:03:29

Plot file version 359 created 19-OCT-2017 15:36:45
MRK359 ES081C.UVDATA.1
Freq = 4.7990 GHz, Bw = 32.000 MH No calibration applied and no bandpass applied

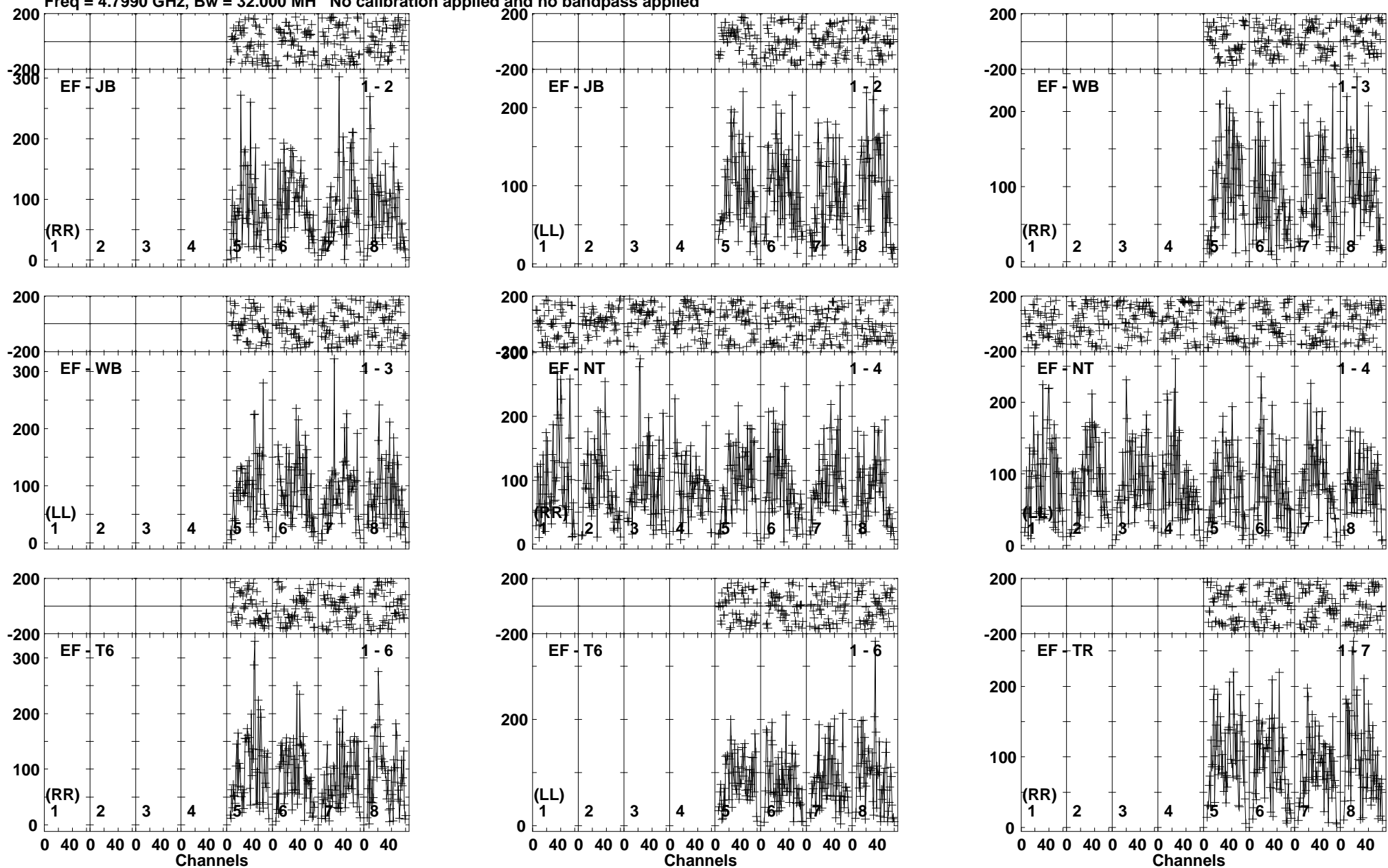

Lower frame: Micro Ampl Jy Top frame: Phas deg
Vector averaged cross-power spectrum Baseline: EF (01) - JB (02)
Timerange: 00/21:03:31 to 00/21:06:59

Plot file version 360 created 19-OCT-2017 15:36:45

MRK359 ES081C.UVDATA.1

Freq = 4.7990 GHz, Bw = 32.000 MH No calibration applied and no bandpass applied

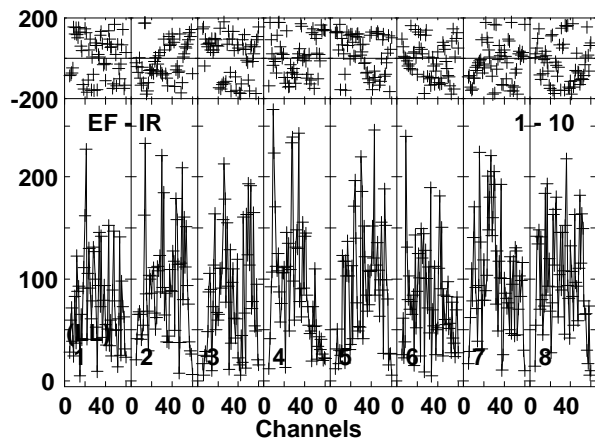
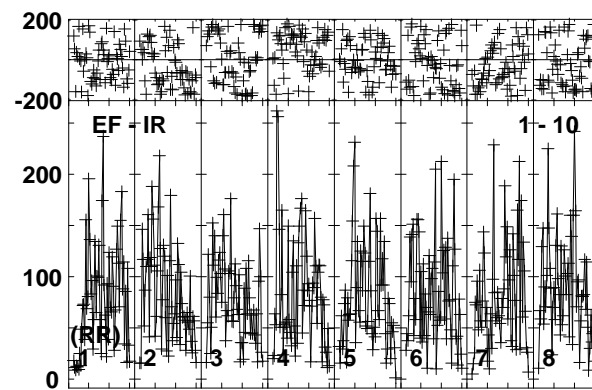
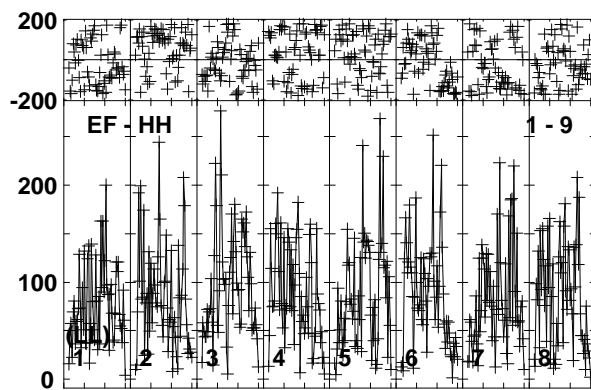
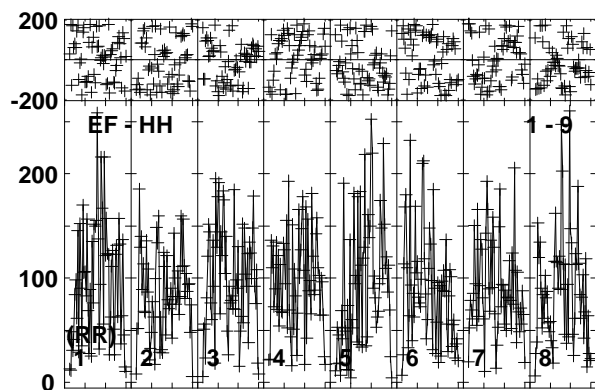
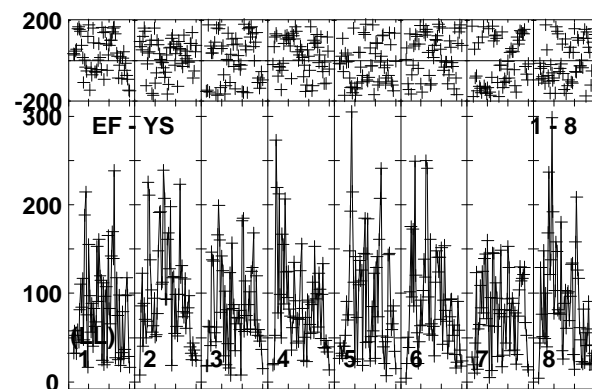
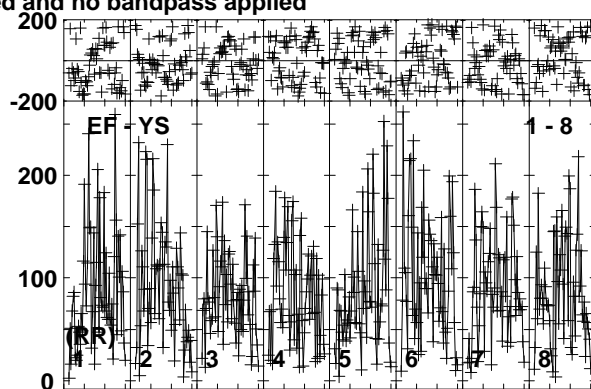
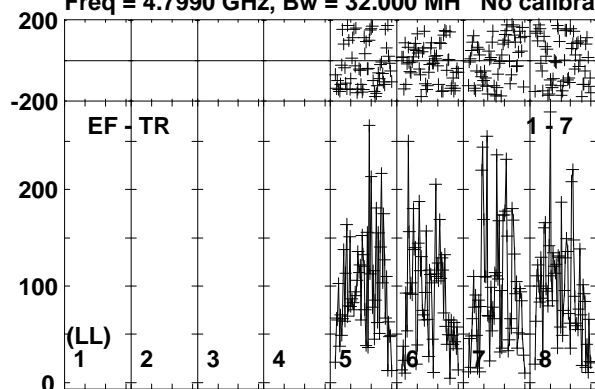

Lower frame: Micro Ampl Jy Top frame: Phas deg
Vector averaged cross-power spectrum Baseline: EF (01) - TR (07)
Timerange: 00/21:03:31 to 00/21:06:59

Plot file version 361 created 19-OCT-2017 15:36:45

J0139+1753 ES081C.UVDATA.1

Freq = 4.7990 GHz, Bw = 32.000 MH No calibration applied and no bandpass applied

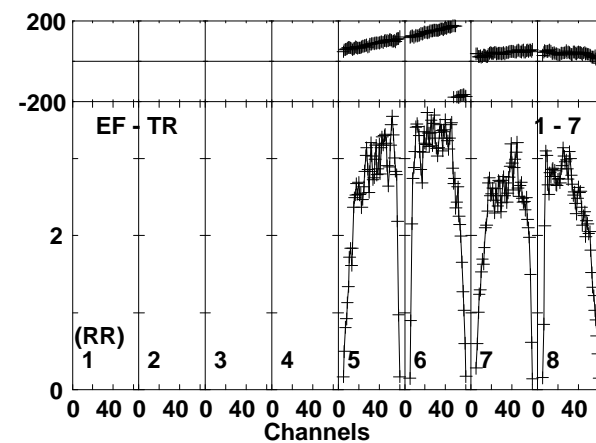
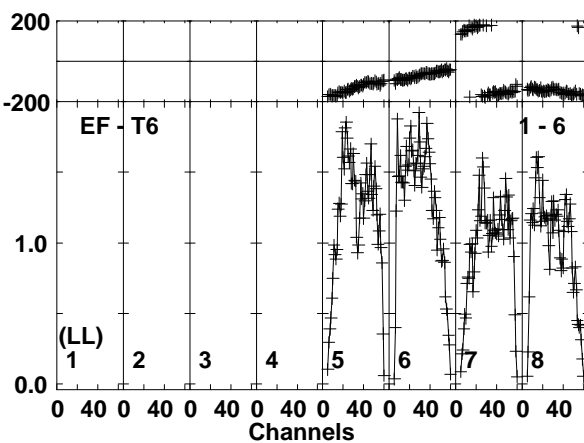
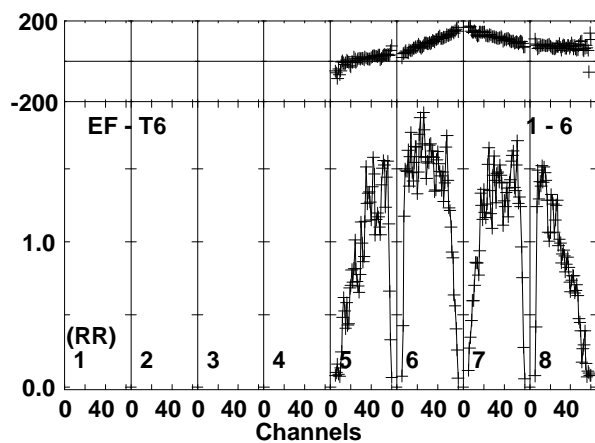
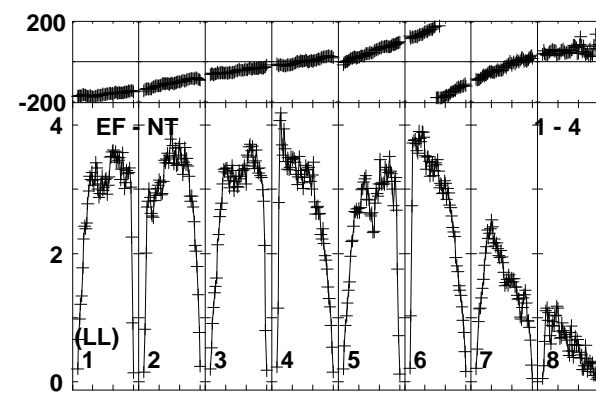
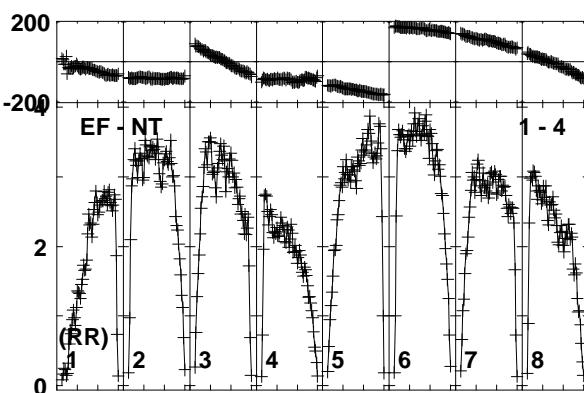
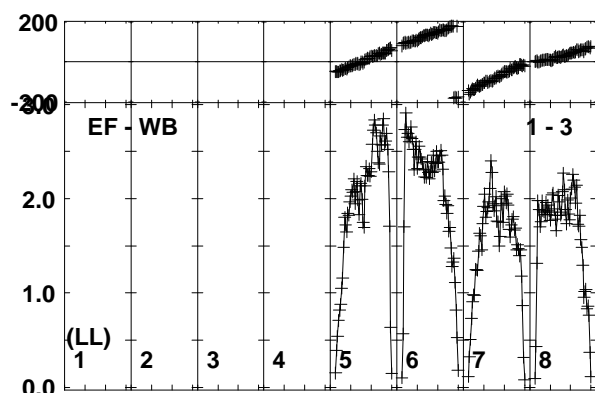
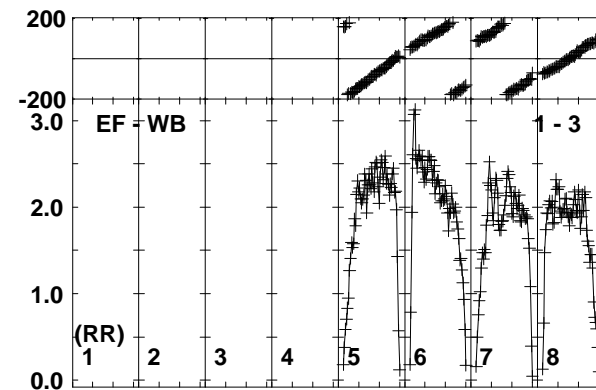
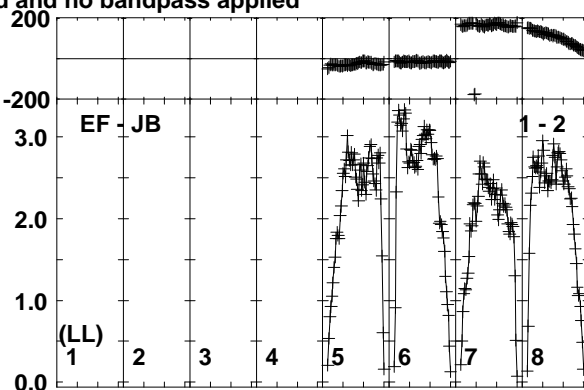
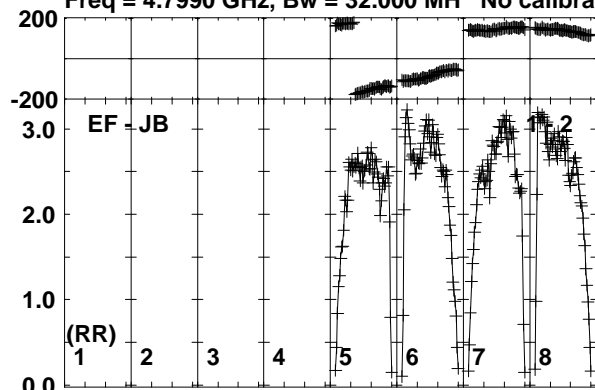

Lower frame: Milli Ampl Jy Top frame: Phas deg
Vector averaged cross-power spectrum Baseline: EF (01) - JB (02)
Timerange: 00/21:07:01 to 00/21:08:29

Plot file version 362 created 19-OCT-2017 15:36:46

J0139+1753 ES081C.UVDATA.1

Freq = 4.7990 GHz, Bw = 32.000 MH No calibration applied and no bandpass applied

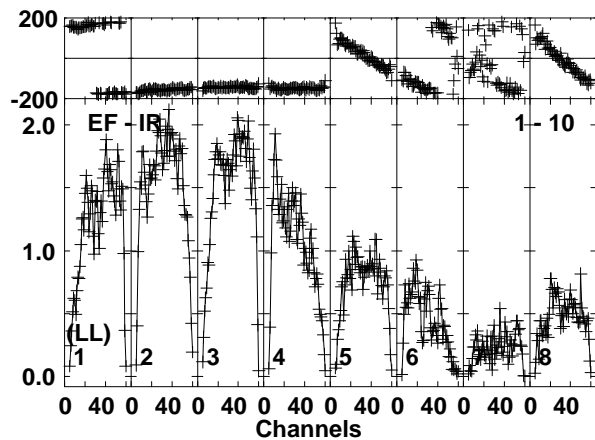
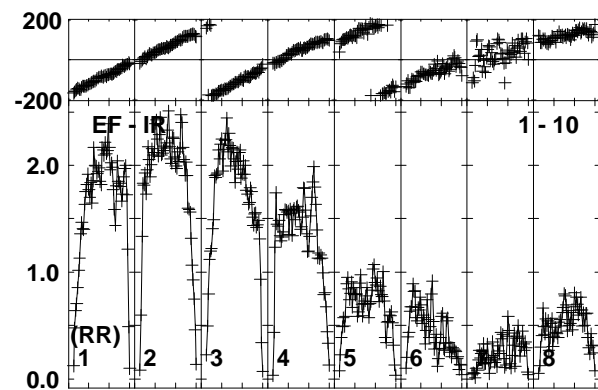
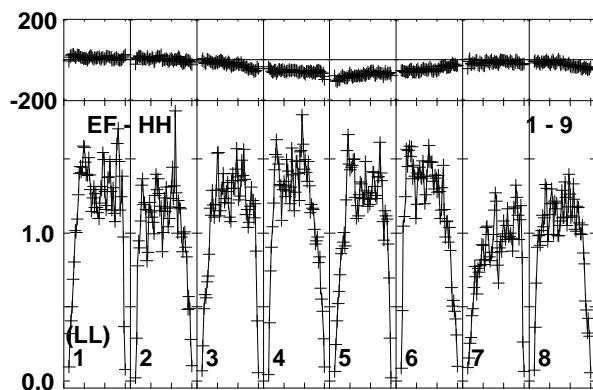
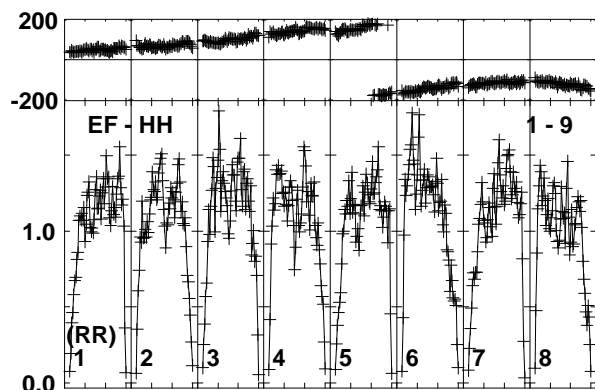
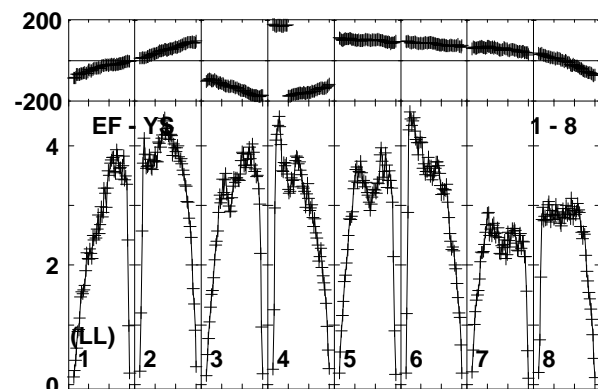
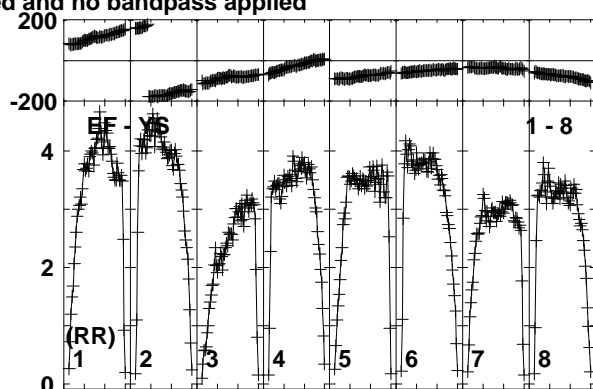
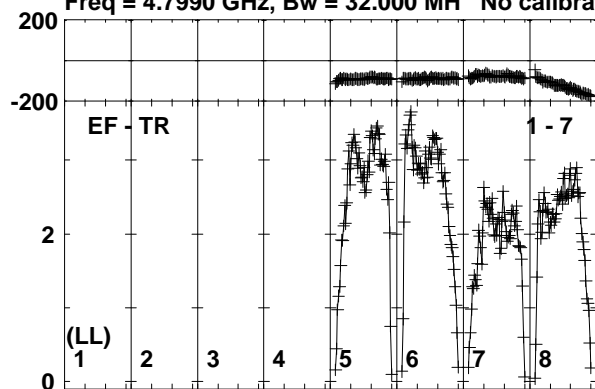

Lower frame: Milli Ampl Jy Top frame: Phas deg
Vector averaged cross-power spectrum Baseline: EF (01) - TR (07)
Timerange: 00/21:07:01 to 00/21:08:29

Plot file version 363 created 19-OCT-2017 15:36:46
 MRK359 ES081C.UVDATA.1
 Freq = 4.7990 GHz, Bw = 32.000 MH No calibration applied and no bandpass applied

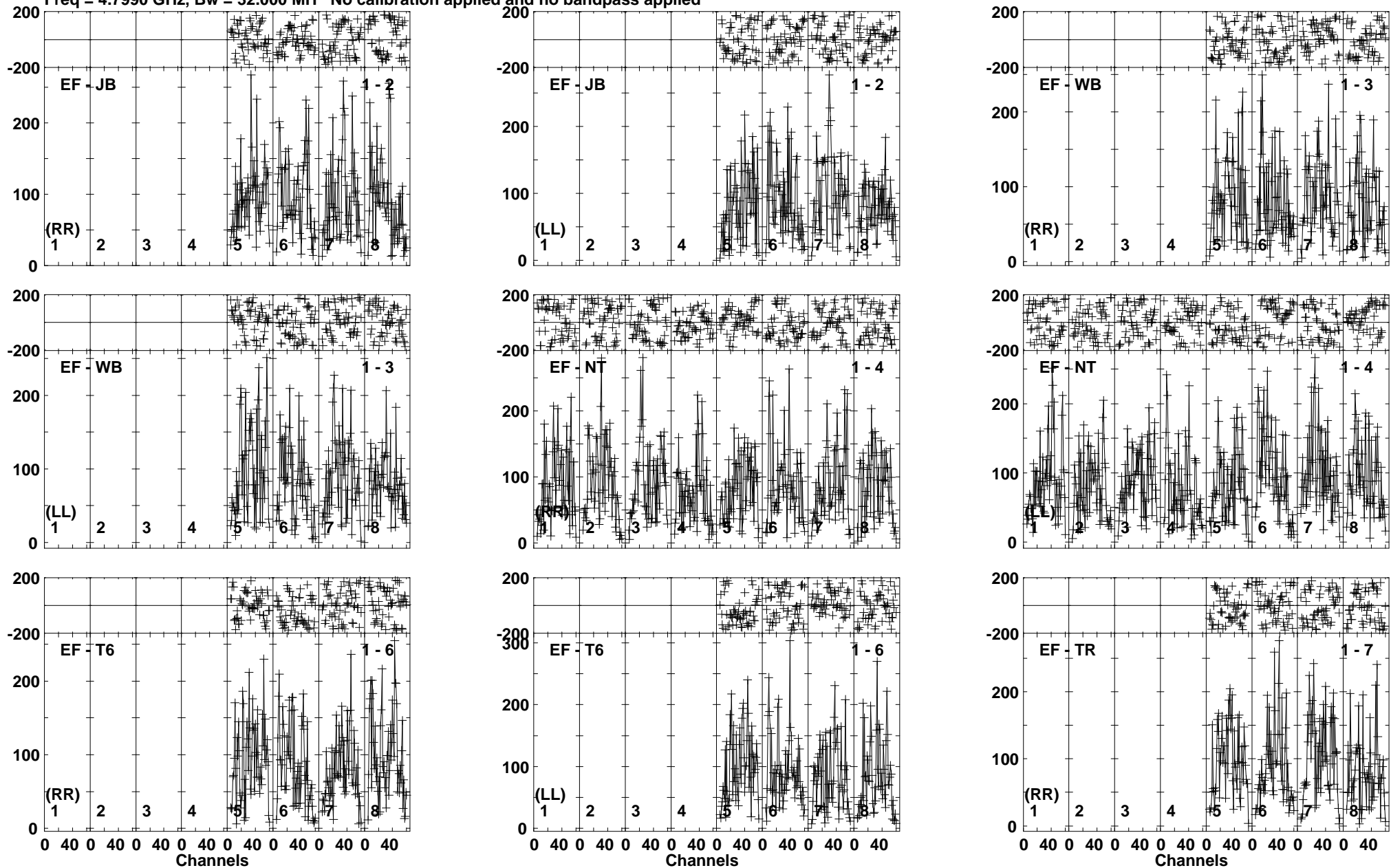

Lower frame: Micro Ampl Jy Top frame: Phas deg
 Vector averaged cross-power spectrum Baseline: EF (01) - JB (02)
 Timerange: 00/21:08:31 to 00/21:11:59

Plot file version 364 created 19-OCT-2017 15:36:46

MRK359 ES081C.UVDATA.1

Freq = 4.7990 GHz, Bw = 32.000 MH No calibration applied and no bandpass applied

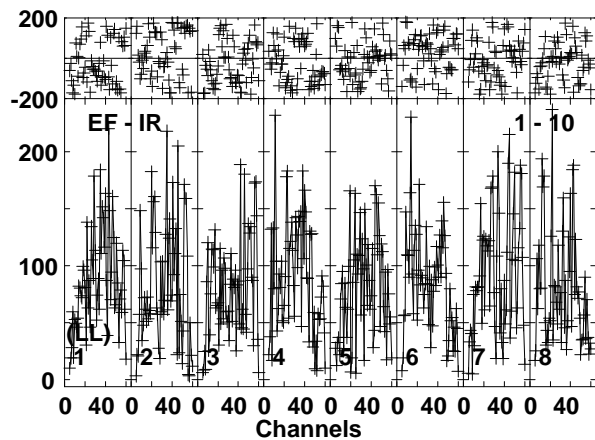
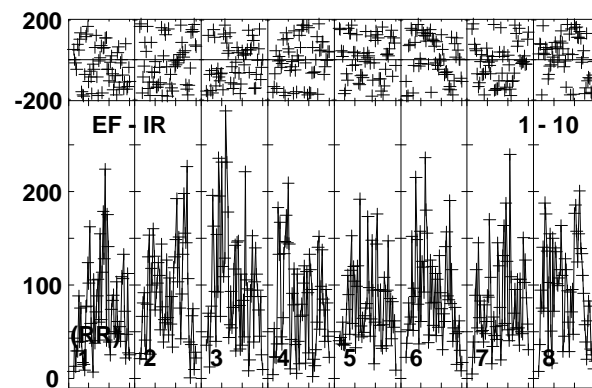
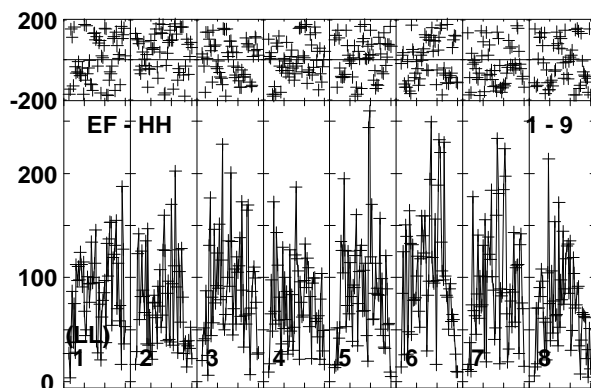
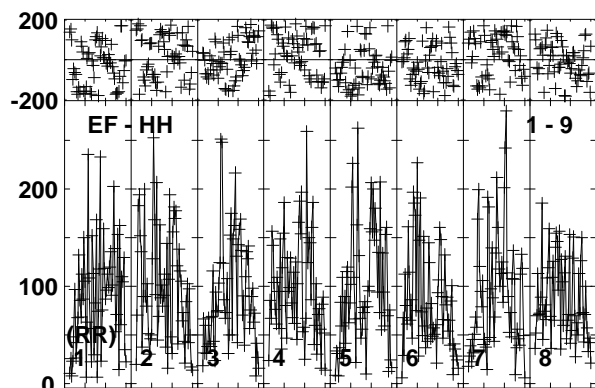
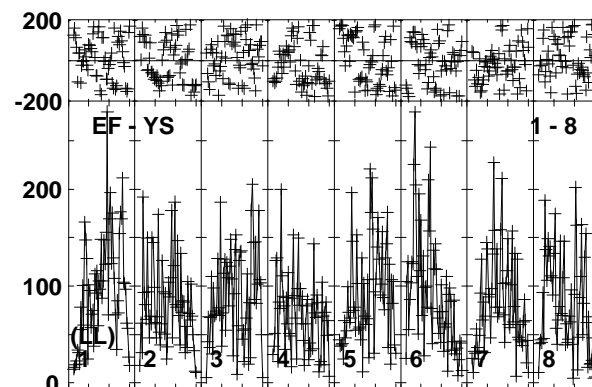
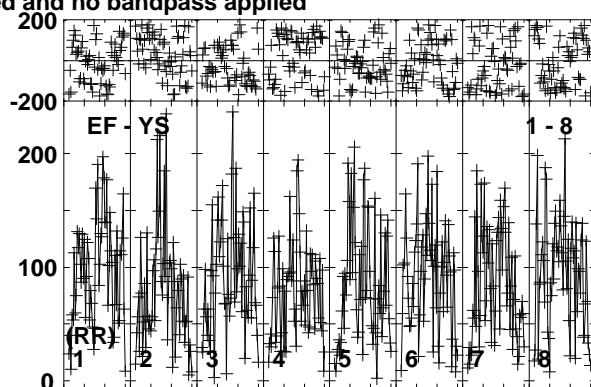
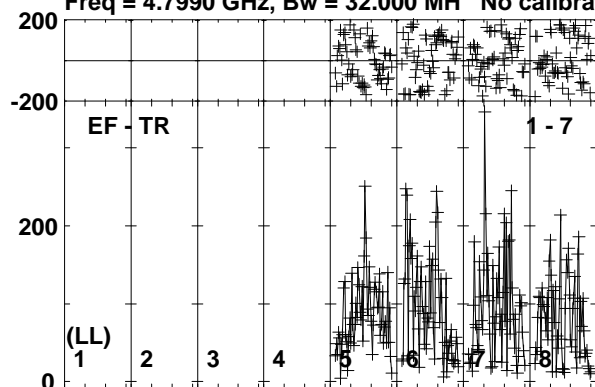

Lower frame: Micro Ampl Jy Top frame: Phas deg
Vector averaged cross-power spectrum Baseline: EF (01) - TR (07)
Timerange: 00/21:08:31 to 00/21:11:59

Plot file version 365 created 19-OCT-2017 15:36:46

J0139+1753 ES081C.UVDATA.1

Freq = 4.7990 GHz, Bw = 32.000 MH No calibration applied and no bandpass applied

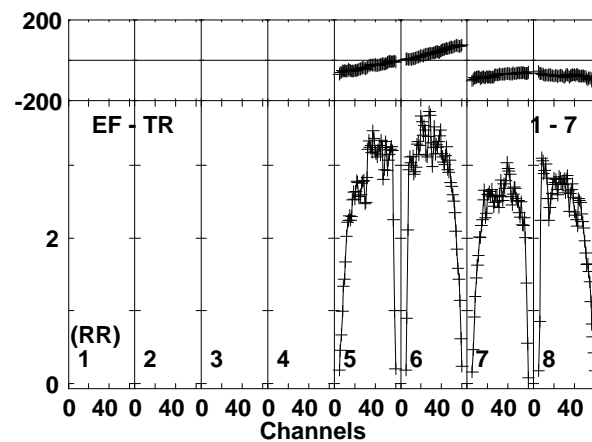
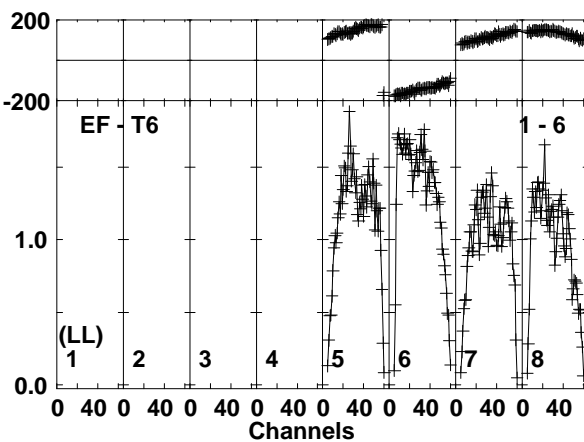
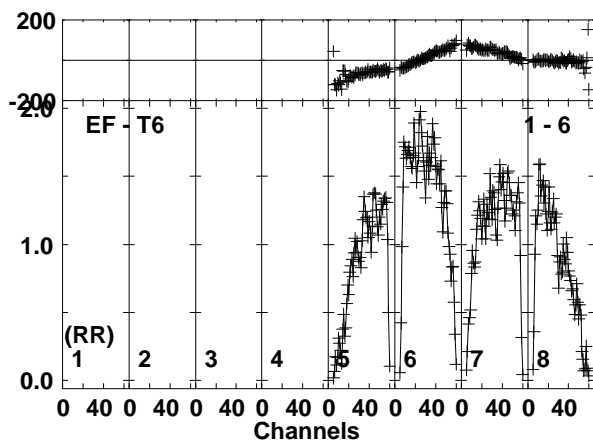
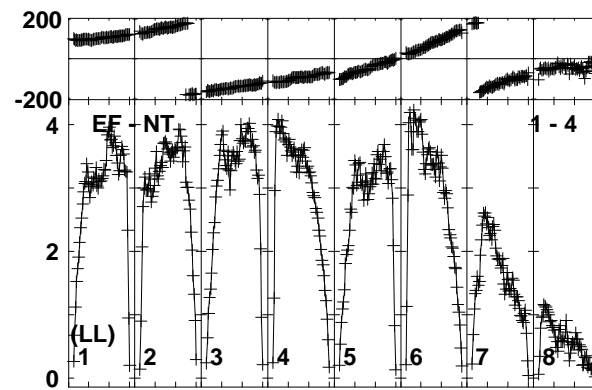
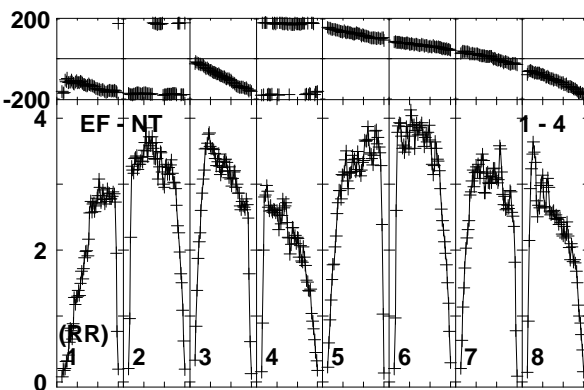
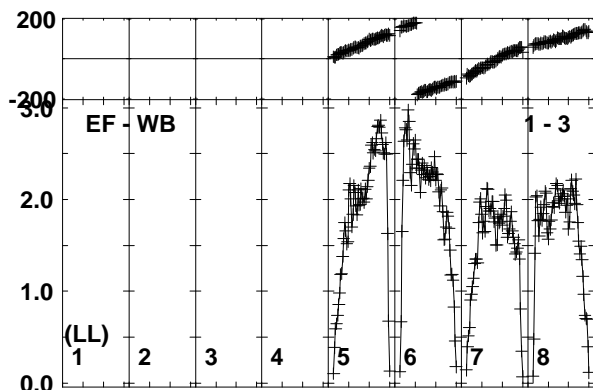
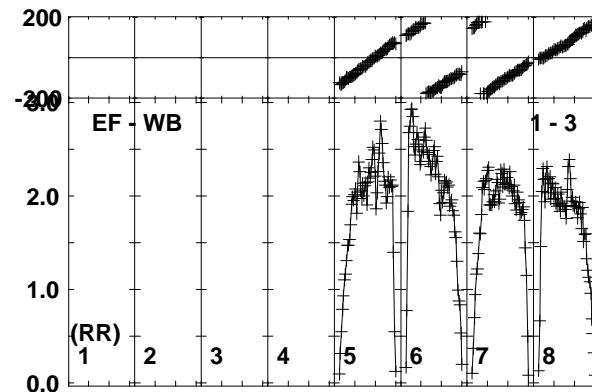
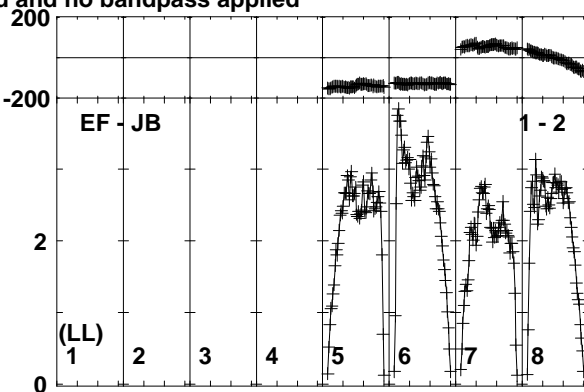
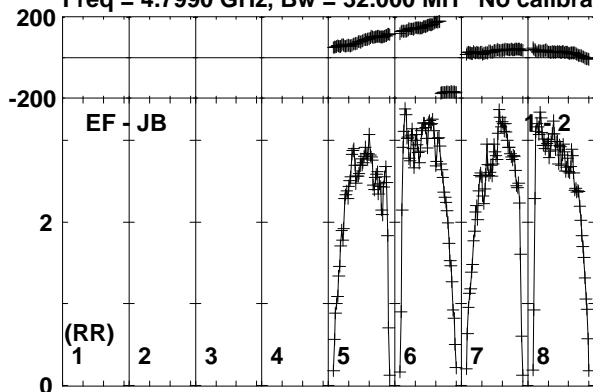

Lower frame: Milli Ampl Jy Top frame: Phas deg
Vector averaged cross-power spectrum Baseline: EF (01) - JB (02)
Timerange: 00/21:12:41 to 00/21:13:39

Plot file version 366 created 19-OCT-2017 15:36:46

J0139+1753 ES081C.UVDATA.1

Freq = 4.7990 GHz, Bw = 32.000 MH No calibration applied and no bandpass applied

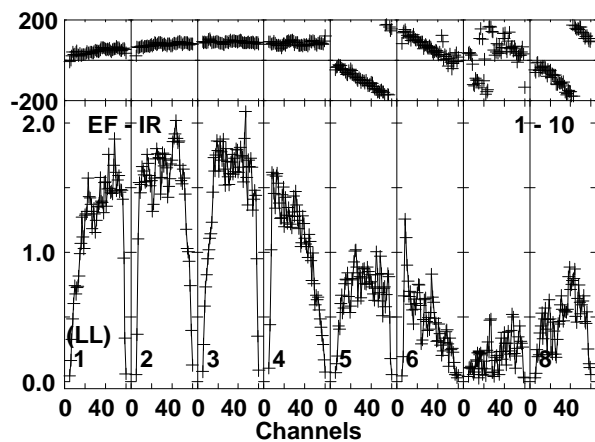
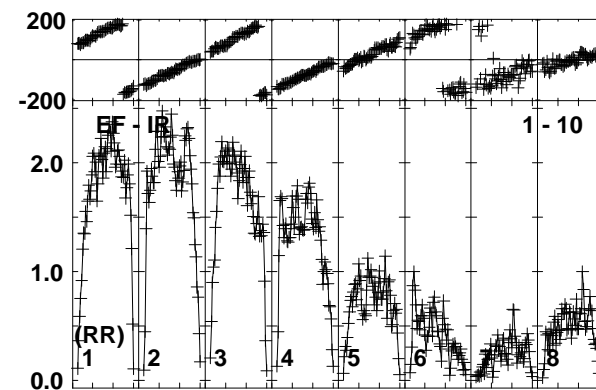
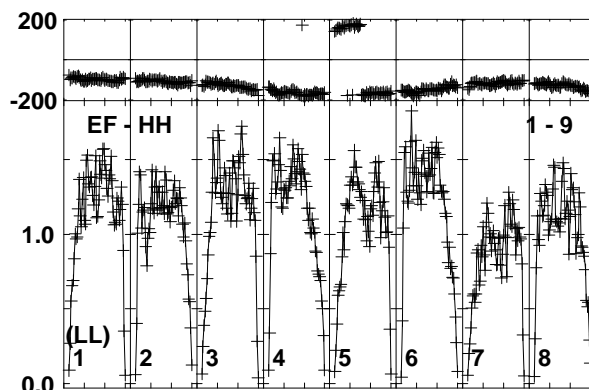
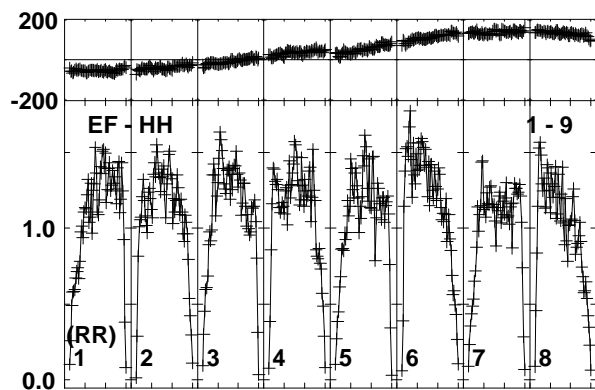
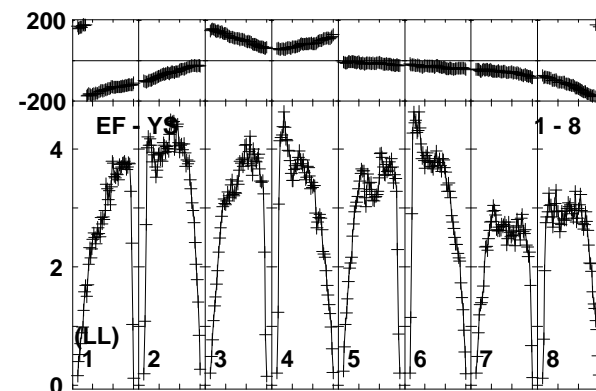
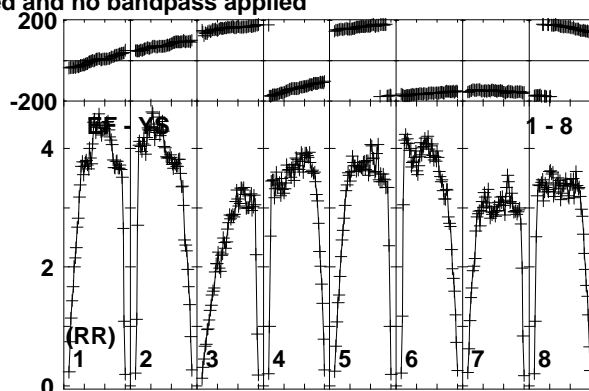
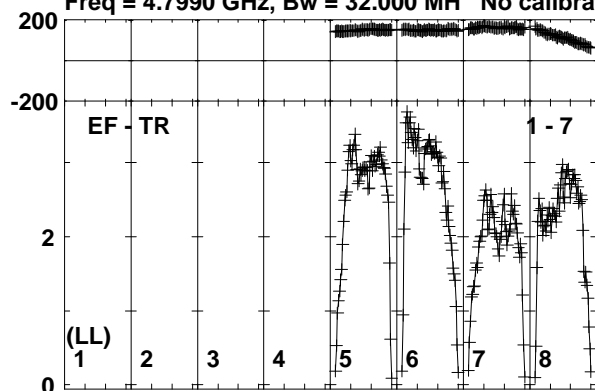

Lower frame: Milli Ampl Jy Top frame: Phas deg
Vector averaged cross-power spectrum Baseline: EF (01) - TR (07)
Timerange: 00/21:12:41 to 00/21:13:39

Plot file version 367 created 19-OCT-2017 15:36:46

MRK359 ES081C.UVDATA.1

Freq = 4.7990 GHz, Bw = 32.000 MH No calibration applied and no bandpass applied

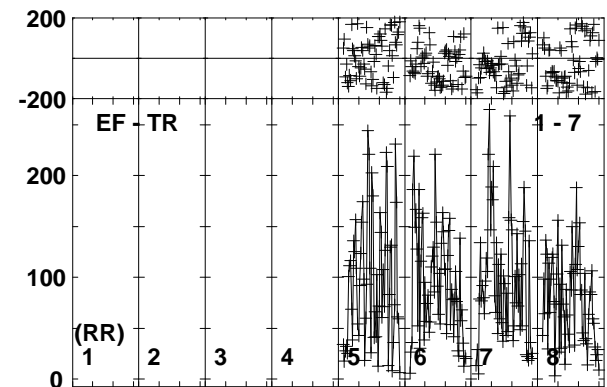
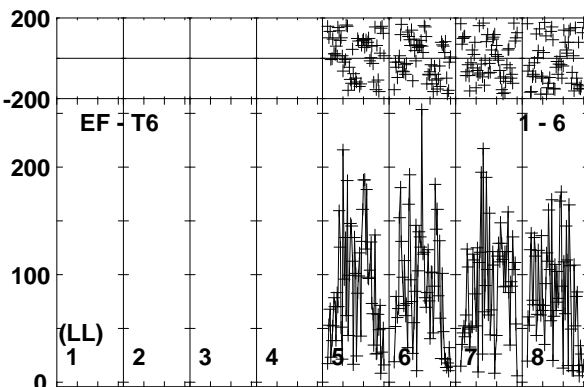
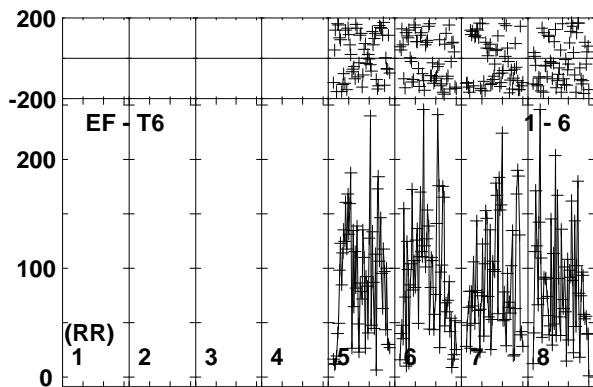
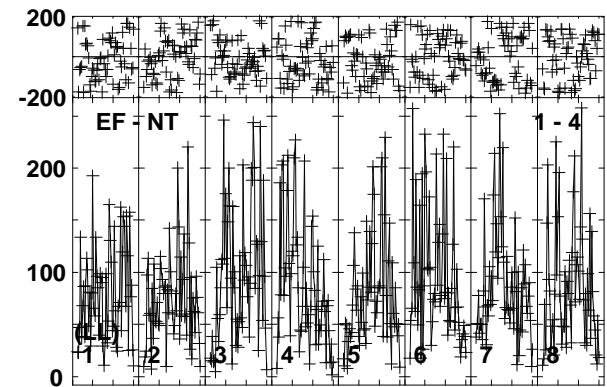
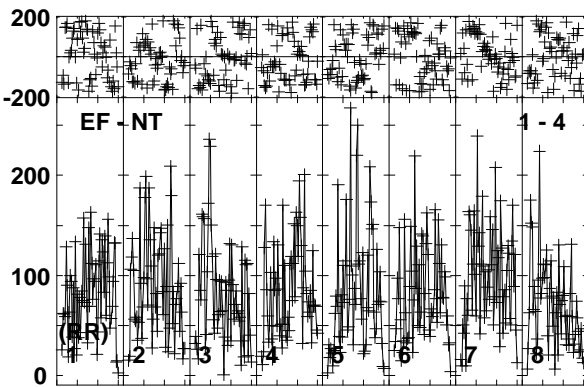
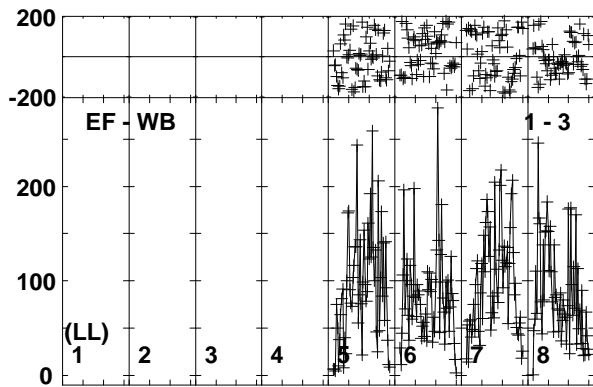
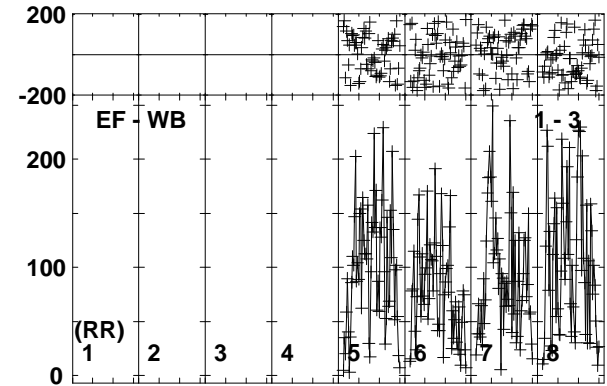
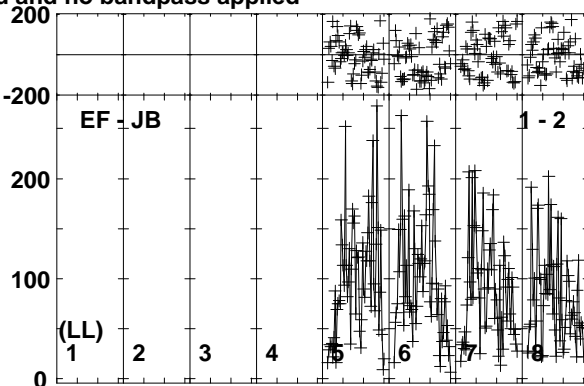
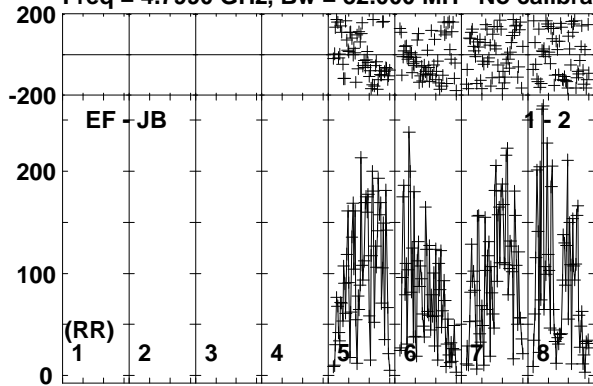

Lower frame: Micro Ampl Jy Top frame: Phas deg
Vector averaged cross-power spectrum Baseline: EF (01) - JB (02)
Timerange: 00/21:13:41 to 00/21:17:09

Plot file version 368 created 19-OCT-2017 15:36:47

MRK359 ES081C.UVDATA.1

Freq = 4.7990 GHz, Bw = 32.000 MH No calibration applied and no bandpass applied

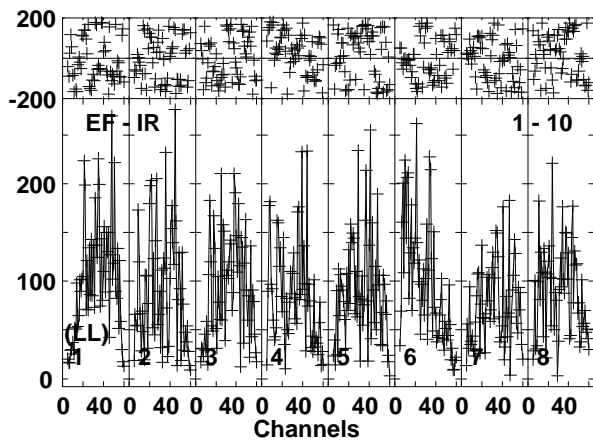
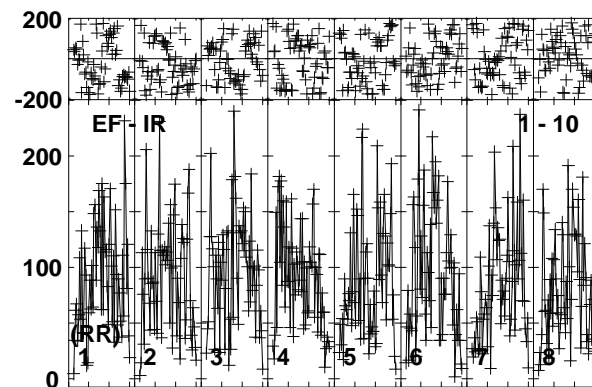
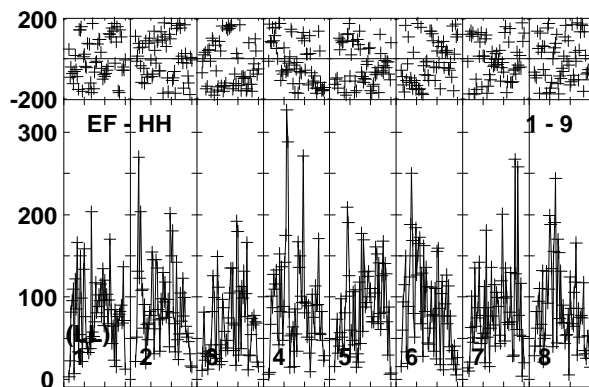
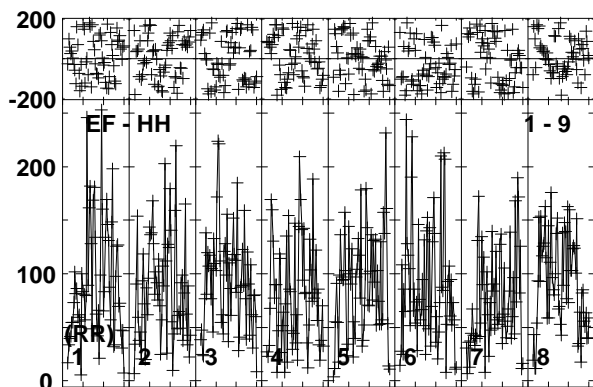
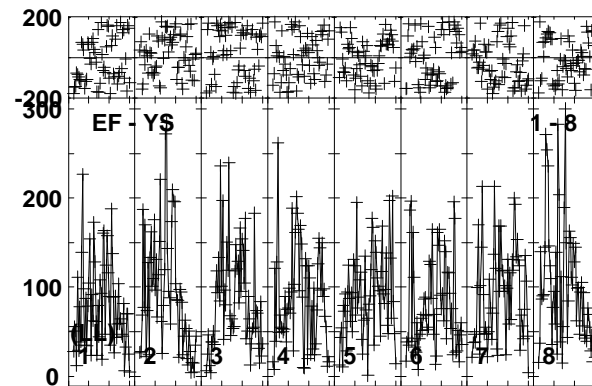
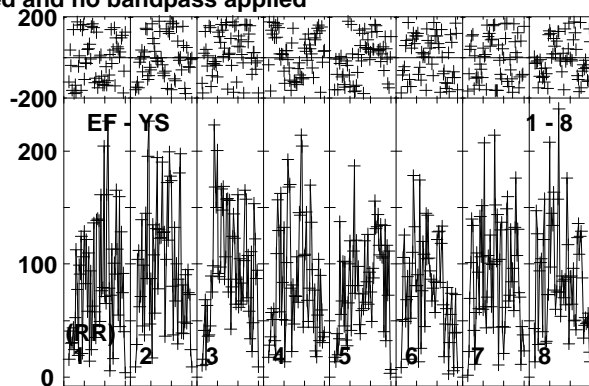
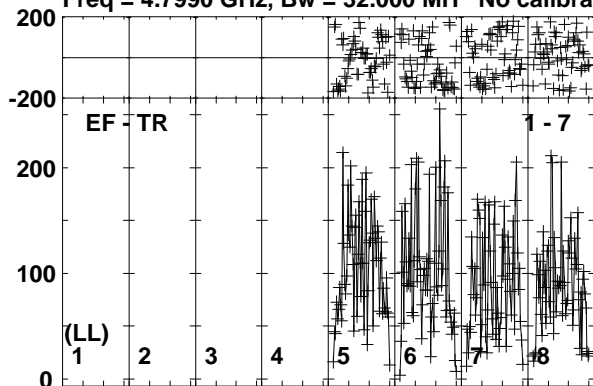

Lower frame: Micro Ampl Jy Top frame: Phas deg
Vector averaged cross-power spectrum Baseline: EF (01) - TR (07)
Timerange: 00/21:13:41 to 00/21:17:09

Plot file version 369 created 19-OCT-2017 15:36:47

J0139+1753 ES081C.UVDATA.1

Freq = 4.7990 GHz, Bw = 32.000 MH No calibration applied and no bandpass applied

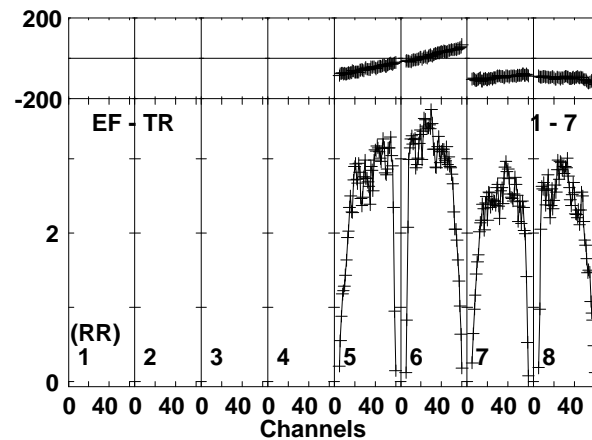
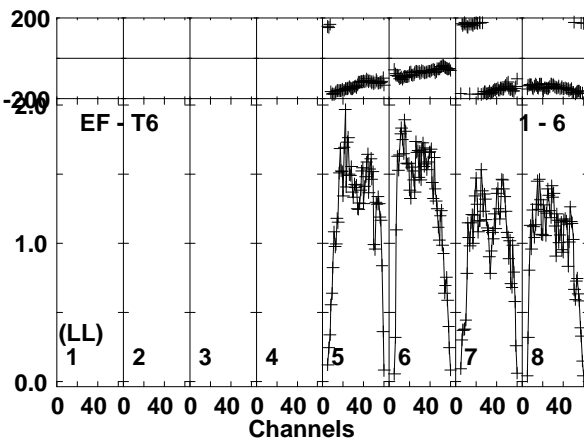
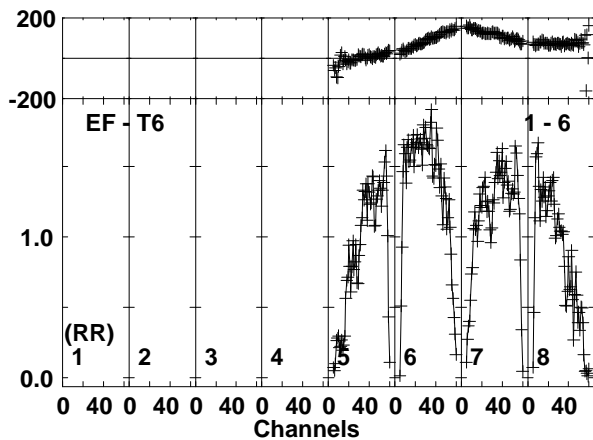
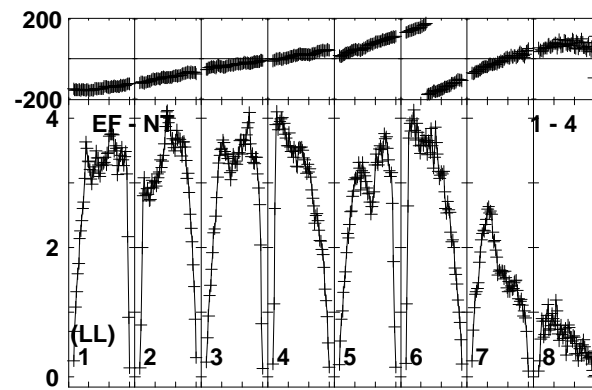
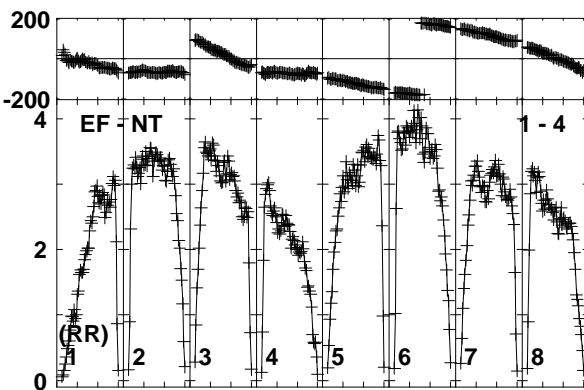
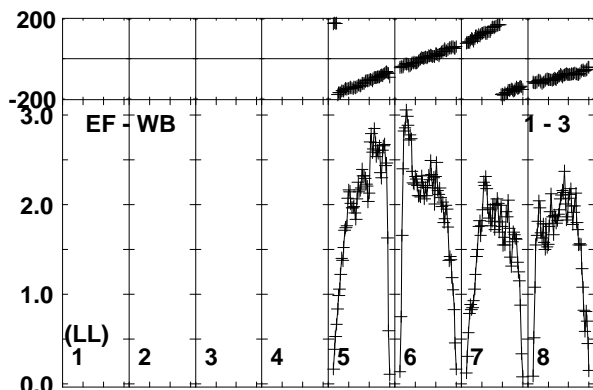
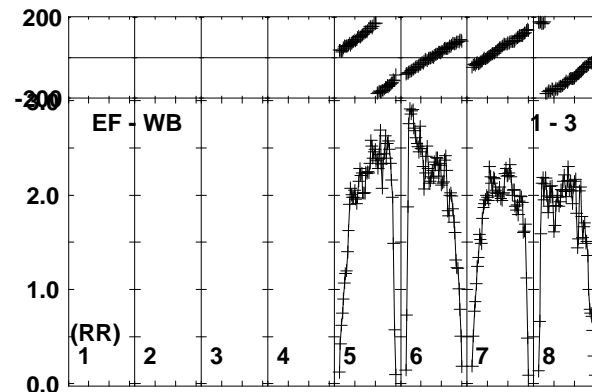
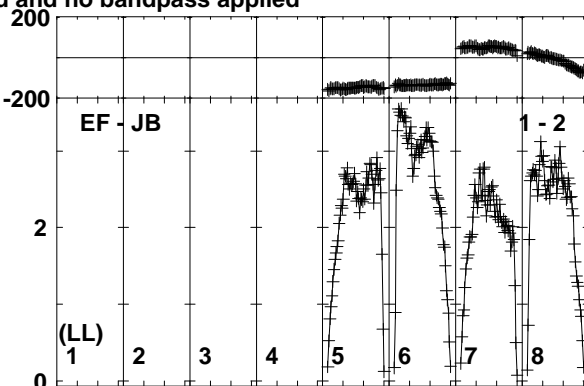
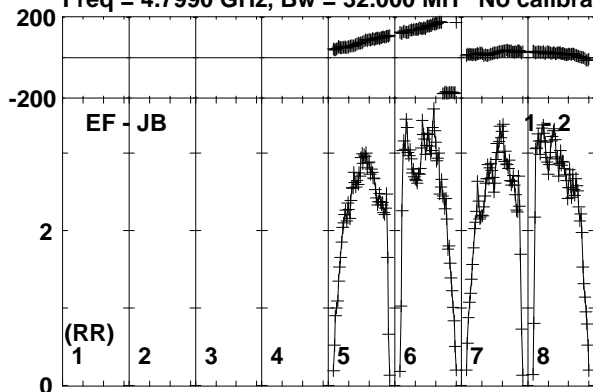

Lower frame: Milli Ampl Jy Top frame: Phas deg
Vector averaged cross-power spectrum Baseline: EF (01) - JB (02)
Timerange: 00/21:17:11 to 00/21:18:39

Plot file version 370 created 19-OCT-2017 15:36:47

J0139+1753 ES081C.UVDATA.1

Freq = 4.7990 GHz, Bw = 32.000 MH No calibration applied and no bandpass applied

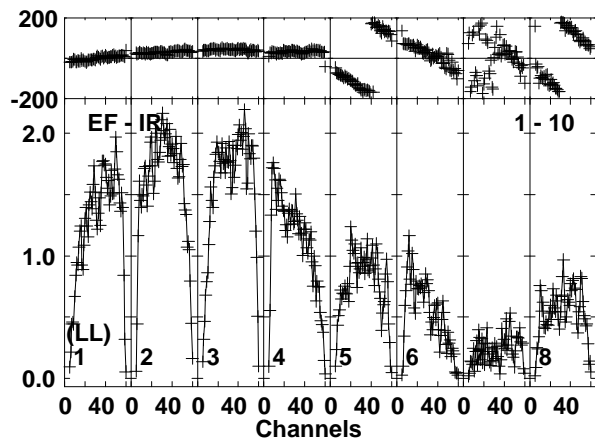
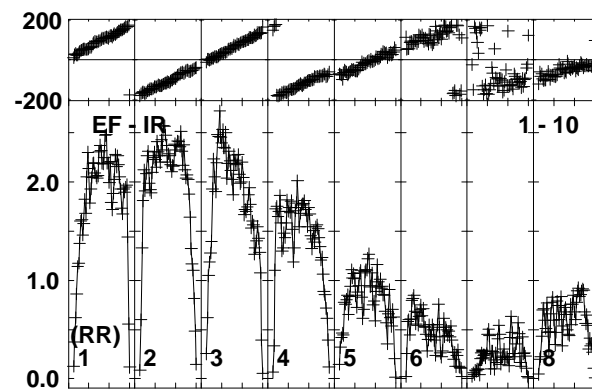
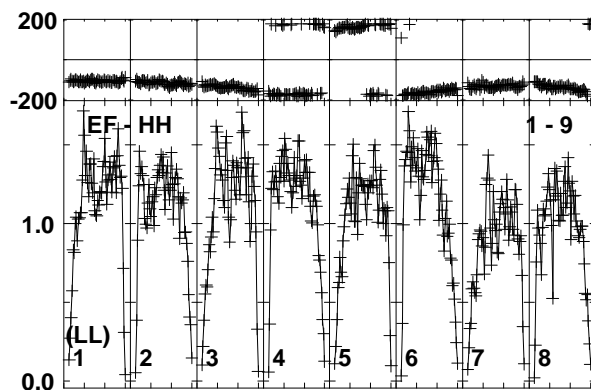
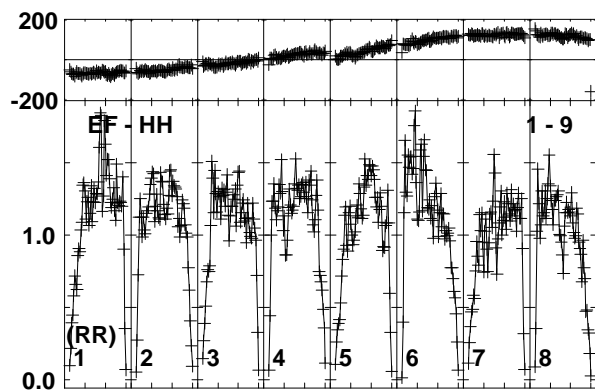
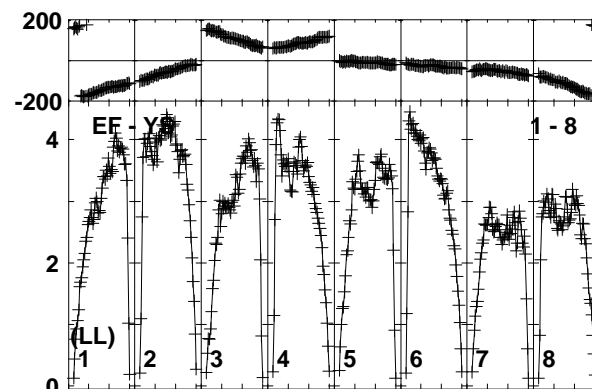
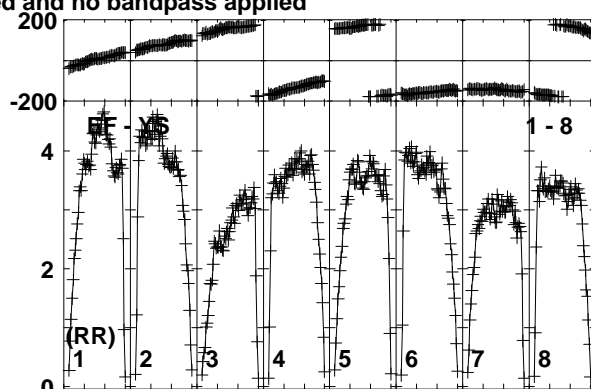
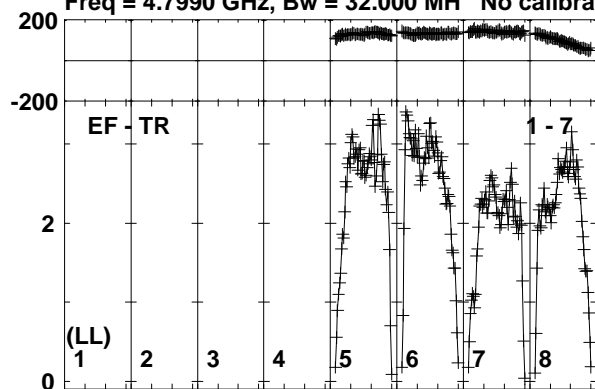

Lower frame: Milli Ampl Jy Top frame: Phas deg
Vector averaged cross-power spectrum Baseline: EF (01) - TR (07)
Timerange: 00/21:17:11 to 00/21:18:39

Plot file version 371 created 19-OCT-2017 15:36:47

MRK359 ES081C.UVDATA.1

Freq = 4.7990 GHz, Bw = 32.000 MH No calibration applied and no bandpass applied

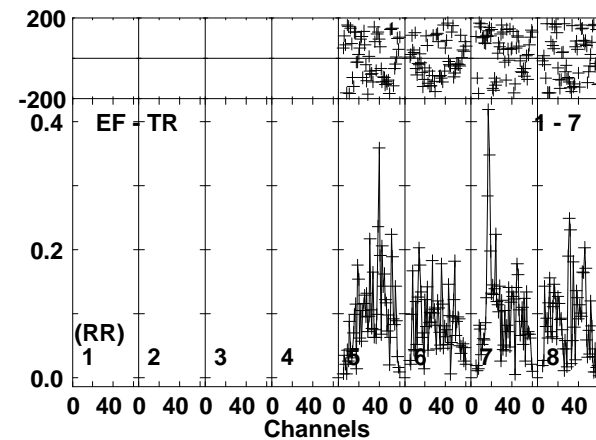
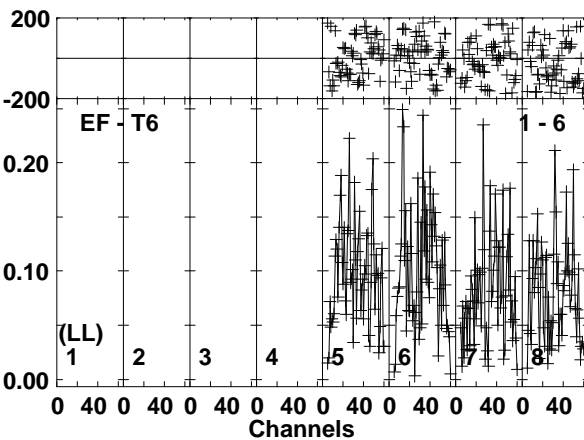
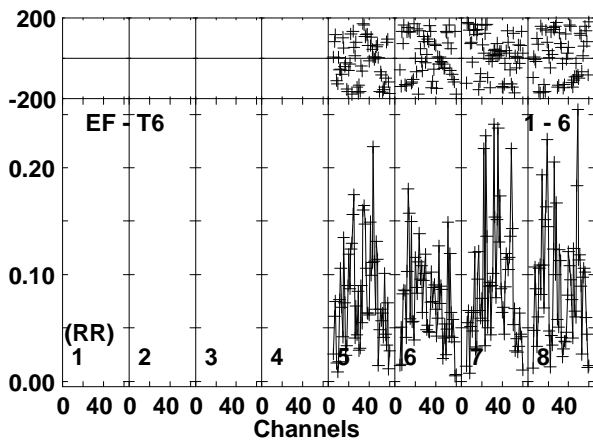
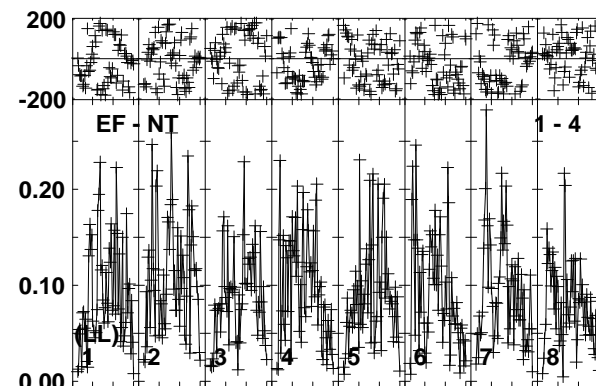
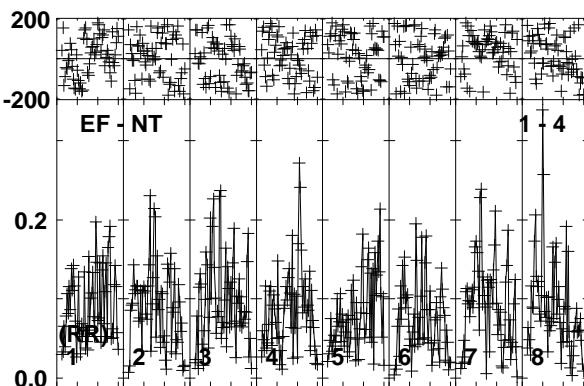
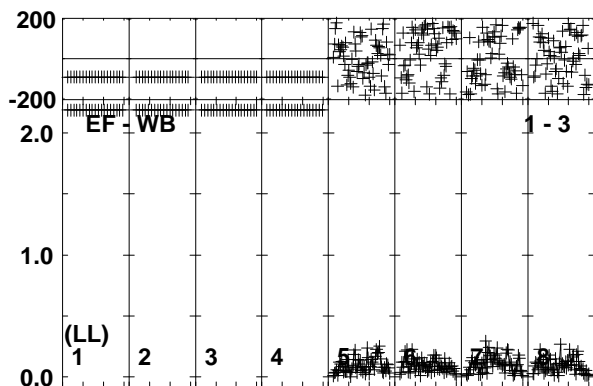
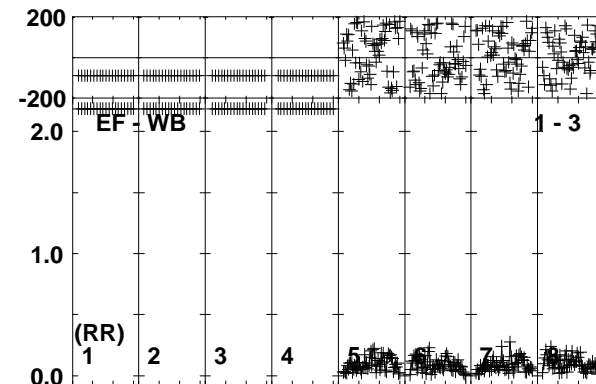
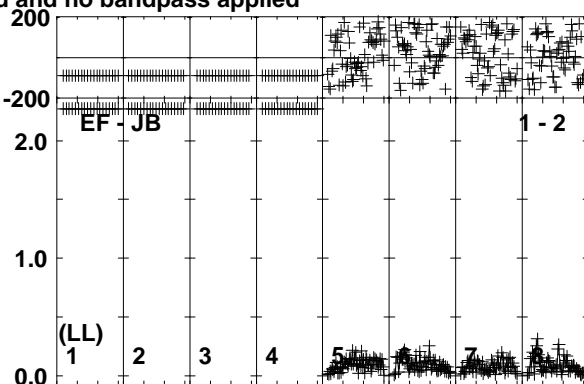
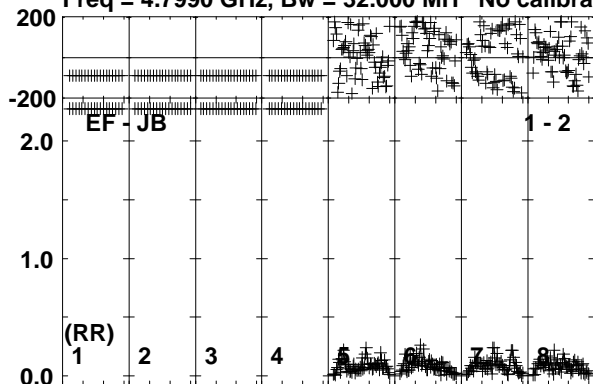

Lower frame: Milli Ampl Jy Top frame: Phas deg
Vector averaged cross-power spectrum Baseline: EF (01) - JB (02)
Timerange: 00/21:18:41 to 00/21:22:09

Plot file version 372 created 19-OCT-2017 15:36:47

MRK359 ES081C.UVDATA.1

Freq = 4.7990 GHz, Bw = 32.000 MH No calibration applied and no bandpass applied

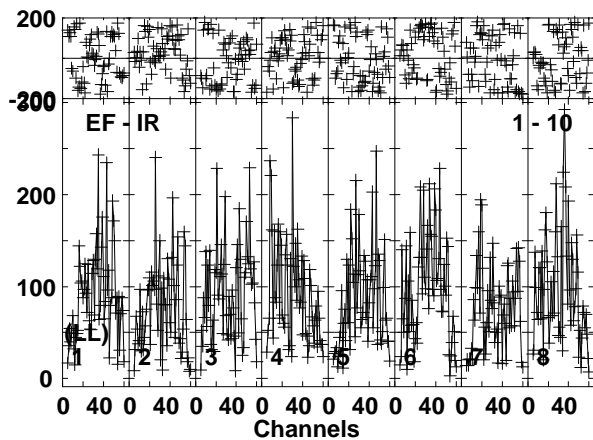
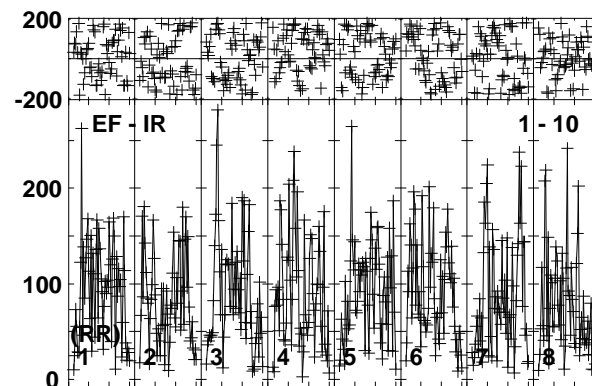
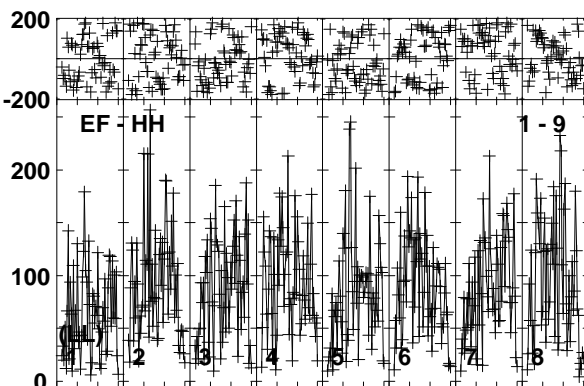
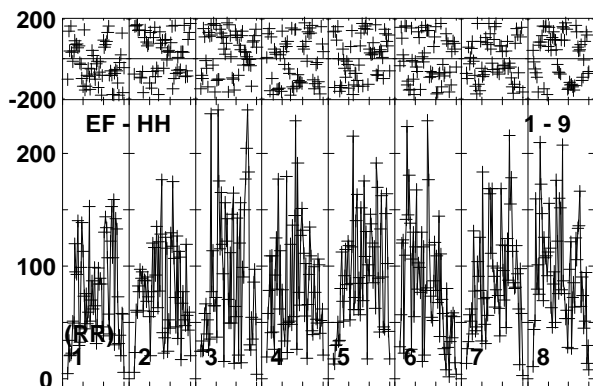
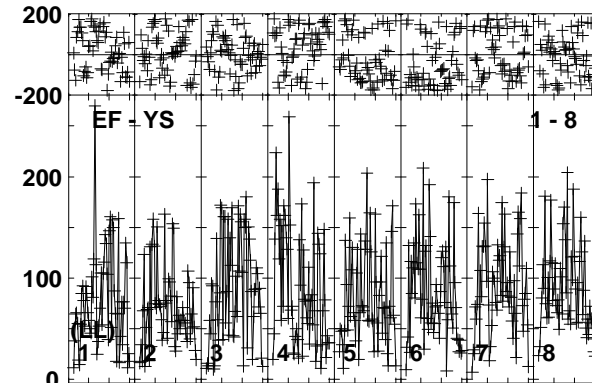
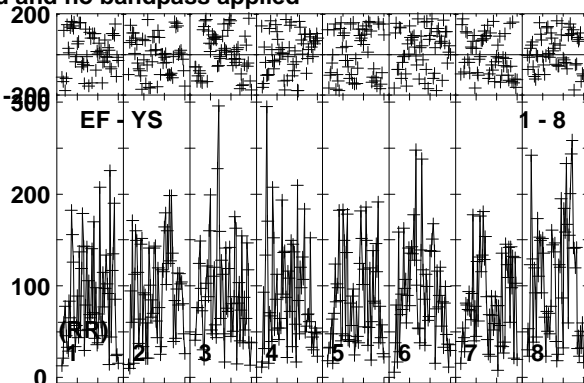
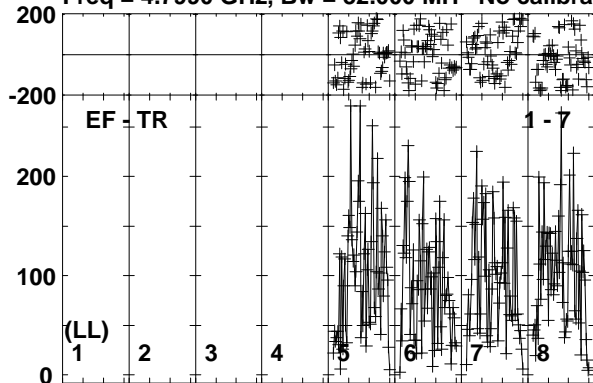

Lower frame: Micro Ampl Jy Top frame: Phas deg
Vector averaged cross-power spectrum Baseline: EF (01) - TR (07)
Timerange: 00/21:18:41 to 00/21:22:09

Plot file version 373 created 19-OCT-2017 15:36:47

J0139+1753 ES081C.UVDATA.1

Freq = 4.7990 GHz, Bw = 32.000 MH No calibration applied and no bandpass applied

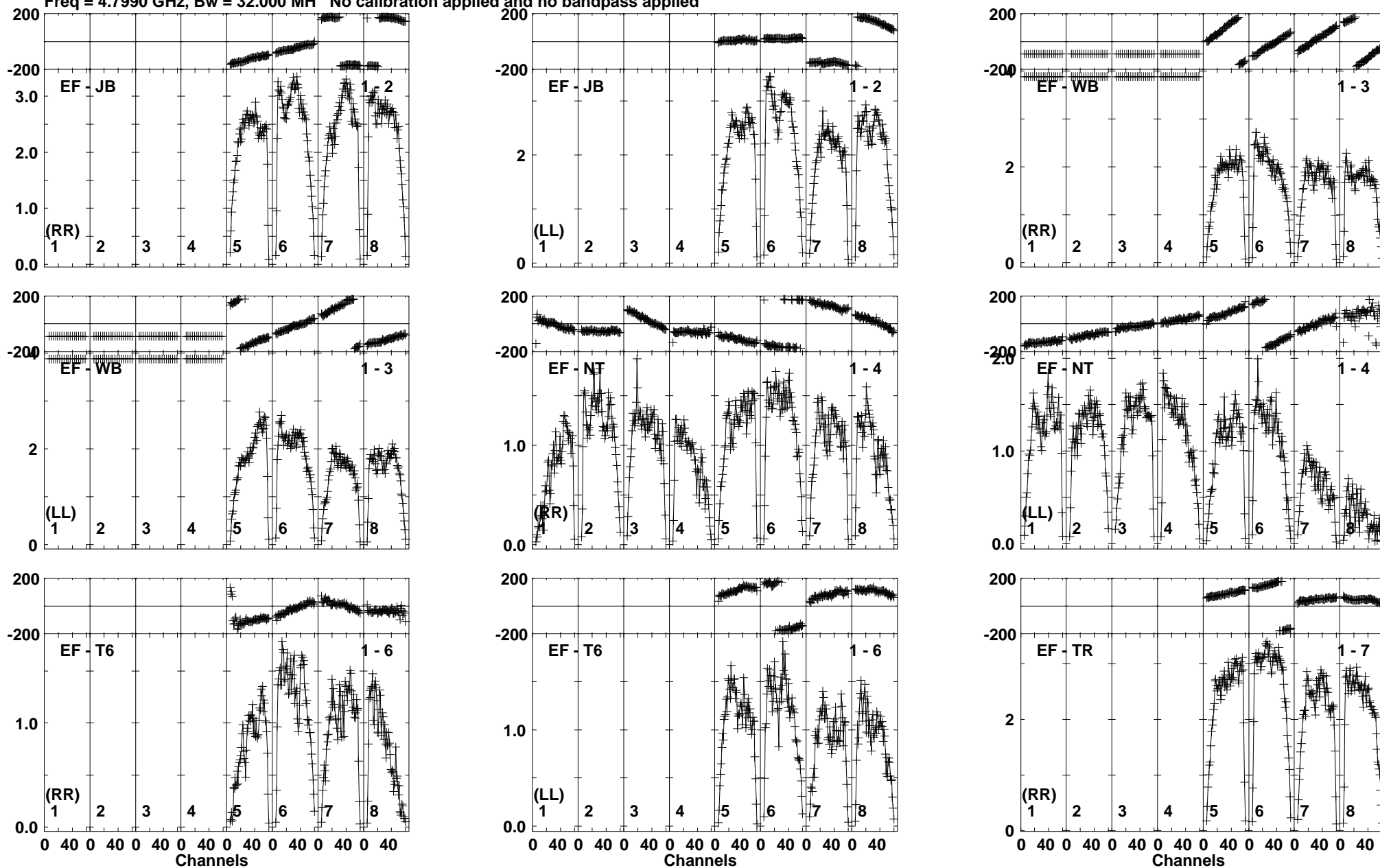

Lower frame: Milli Ampl Jy Top frame: Phas deg
Vector averaged cross-power spectrum Baseline: EF (01) - JB (02)
Timerange: 00/21:22:51 to 00/21:23:49

Plot file version 374 created 19-OCT-2017 15:36:47

J0139+1753 ES081C.UVDATA.1

Freq = 4.7990 GHz, Bw = 32.000 MH No calibration applied and no bandpass applied

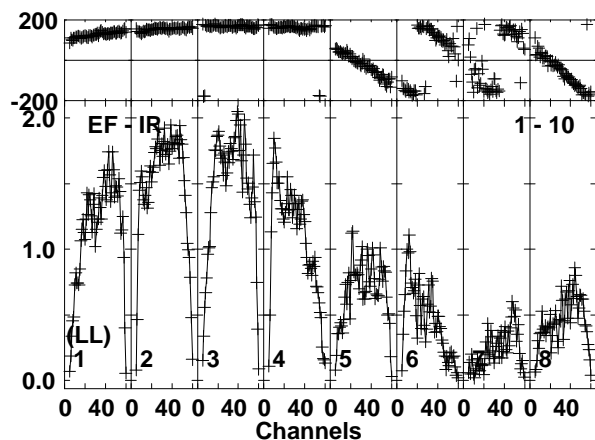
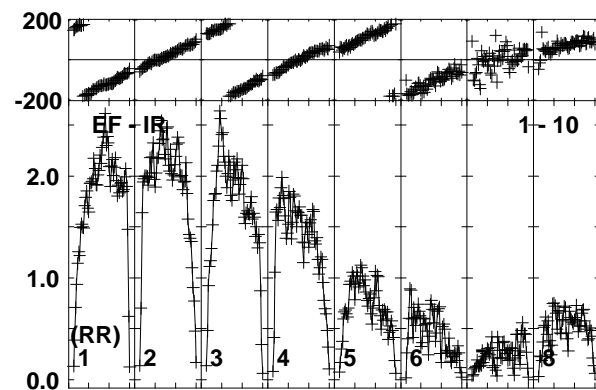
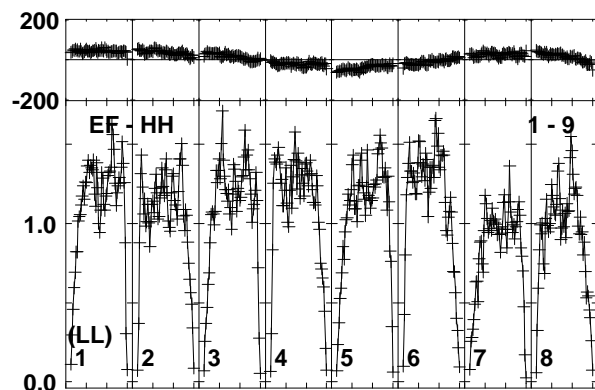
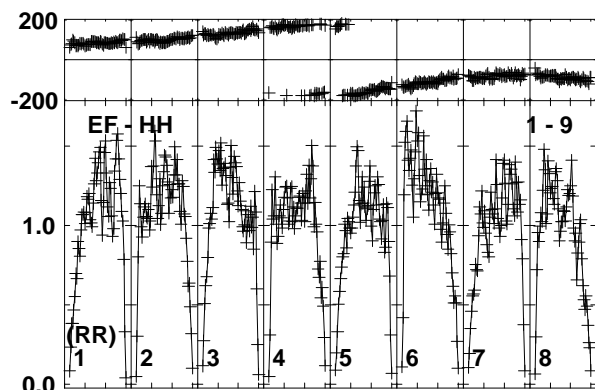
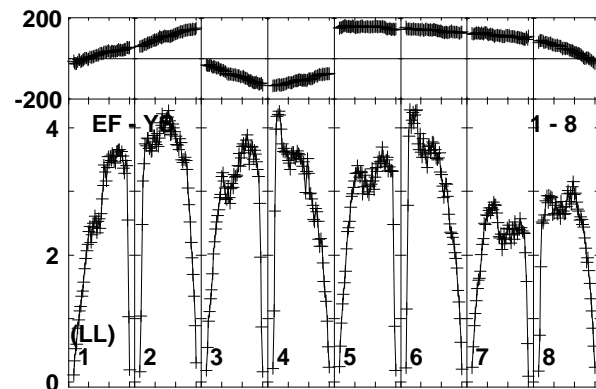
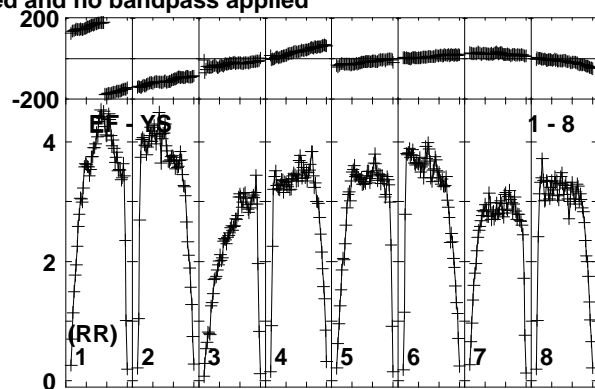
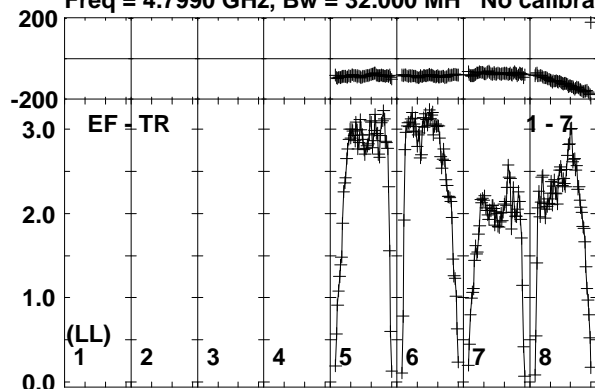

Lower frame: Milli Ampl Jy Top frame: Phas deg
Vector averaged cross-power spectrum Baseline: EF (01) - TR (07)
Timerange: 00/21:22:51 to 00/21:23:49

Plot file version 375 created 19-OCT-2017 15:36:47
 MRK359 ES081C.UVDATA.1
 Freq = 4.7990 GHz, Bw = 32.000 MH No calibration applied and no bandpass applied

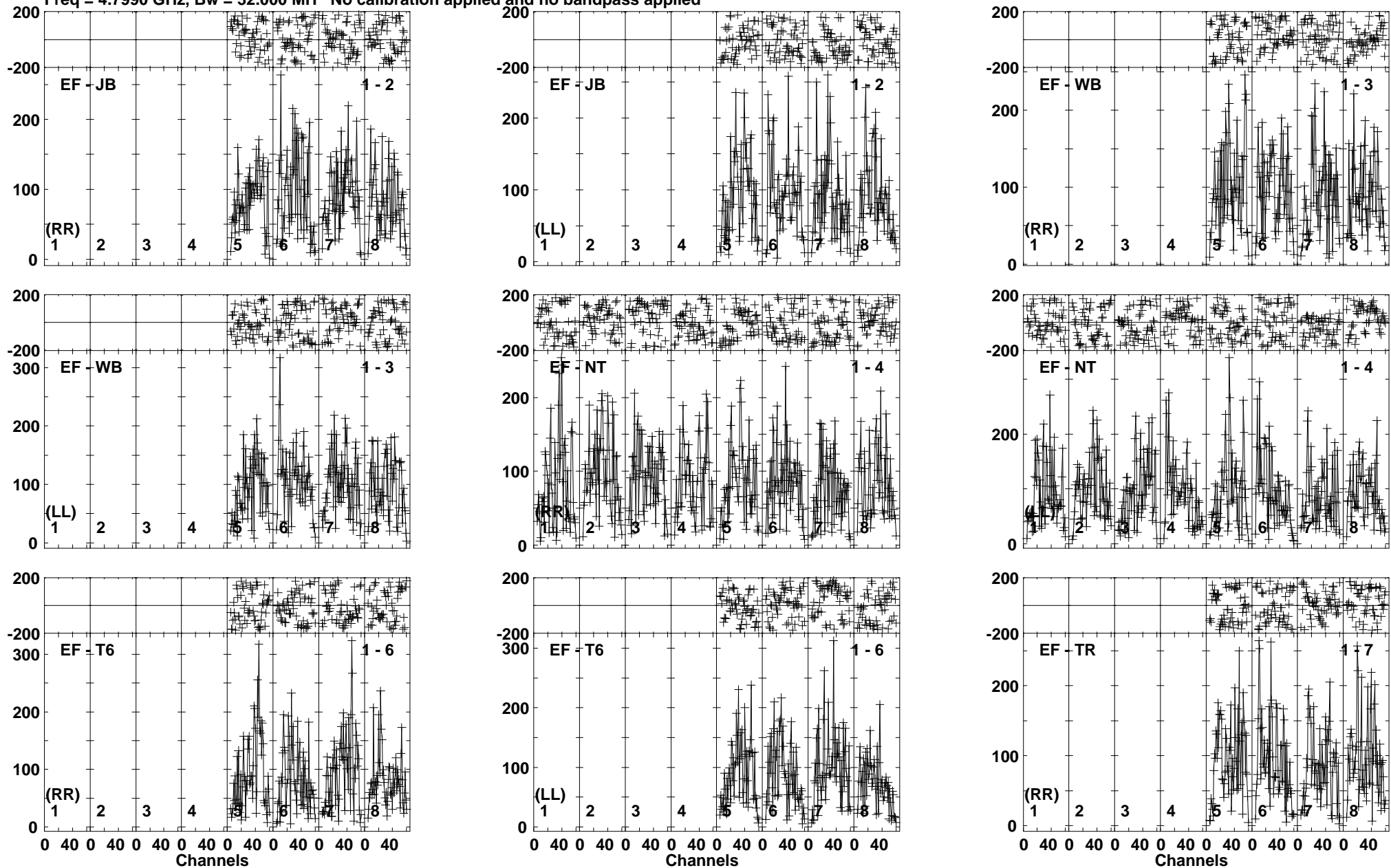

Lower frame: Micro Ampl Jy Top frame: Phas deg
 Vector averaged cross-power spectrum Baseline: EF (01) - JB (02)
 Timerange: 00/21:23:51 to 00/21:27:19

Plot file version 376 created 19-OCT-2017 15:36:48

MRK359 ES081C.UVDATA.1

Freq = 4.7990 GHz, Bw = 32.000 MH No calibration applied and no bandpass applied

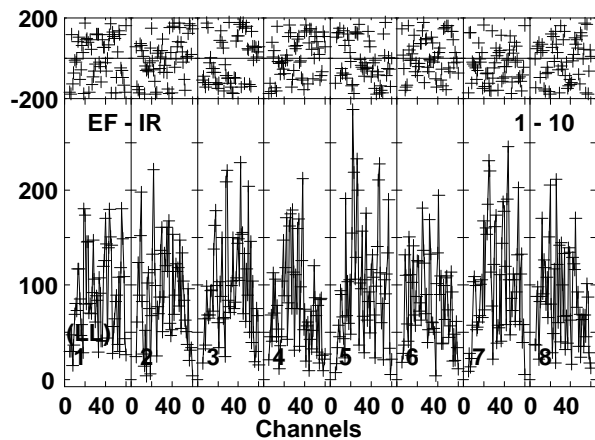
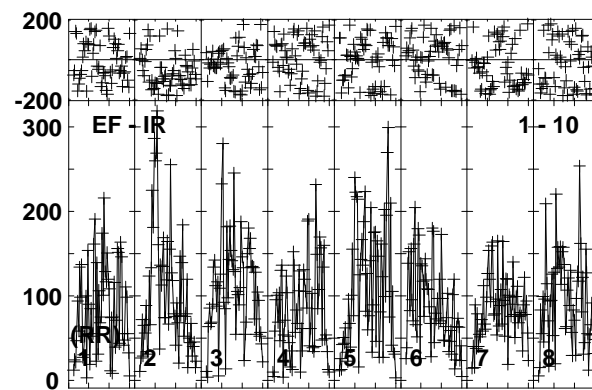
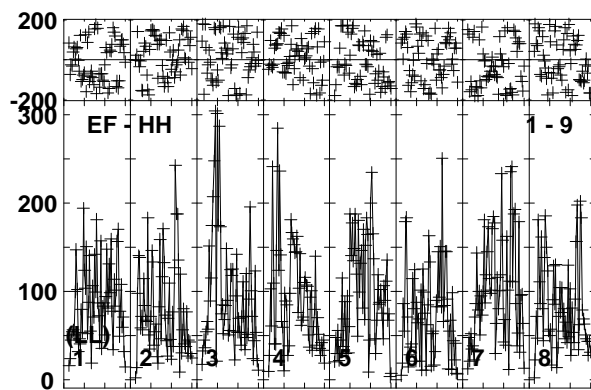
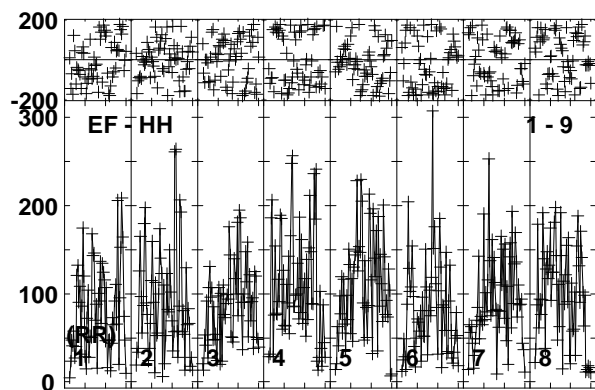
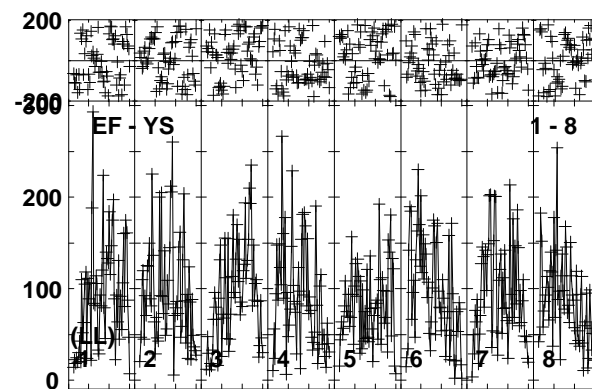
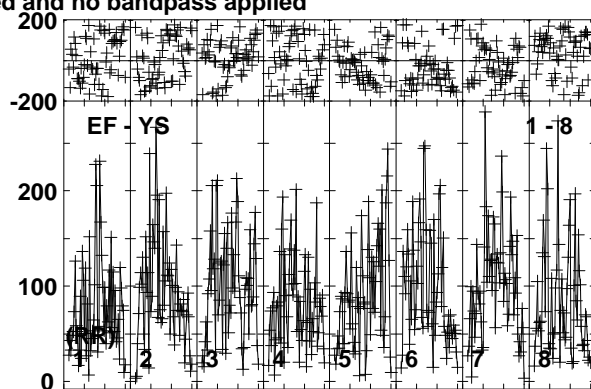
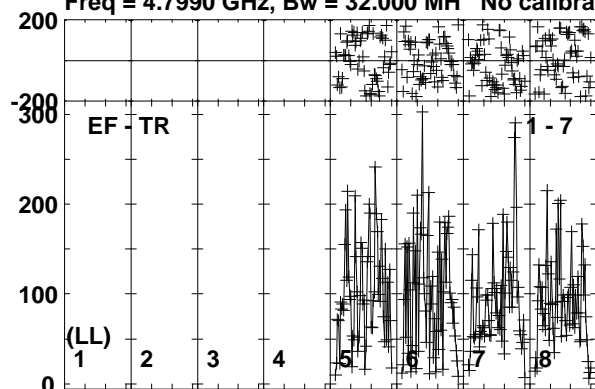

Lower frame: Micro Ampl Jy Top frame: Phas deg
Vector averaged cross-power spectrum Baseline: EF (01) - TR (07)
Timerange: 00/21:23:51 to 00/21:27:19

Plot file version 377 created 19-OCT-2017 15:36:48

J0139+1753 ES081C.UVDATA.1

Freq = 4.7990 GHz, Bw = 32.000 MH No calibration applied and no bandpass applied

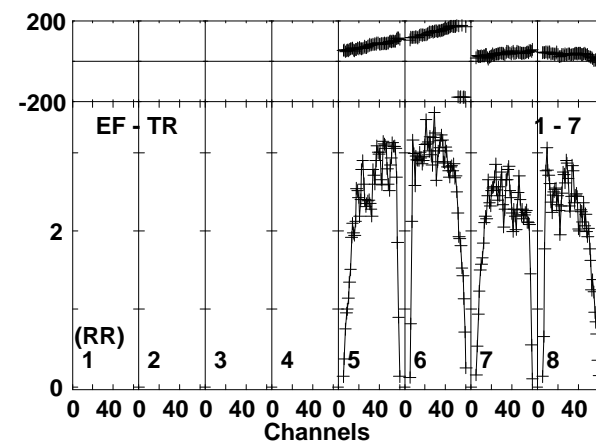
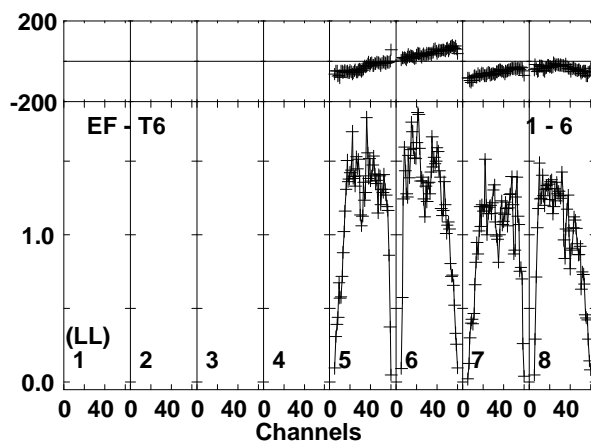
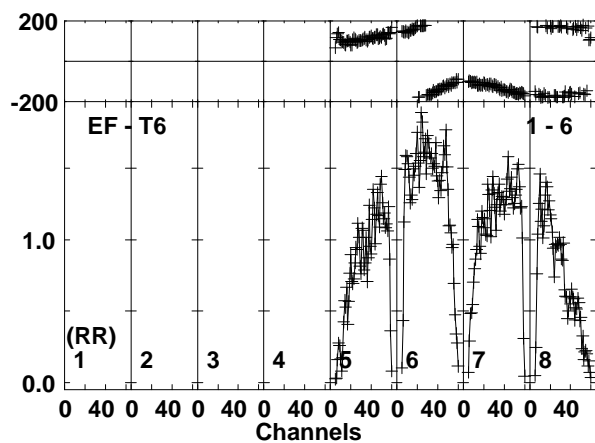
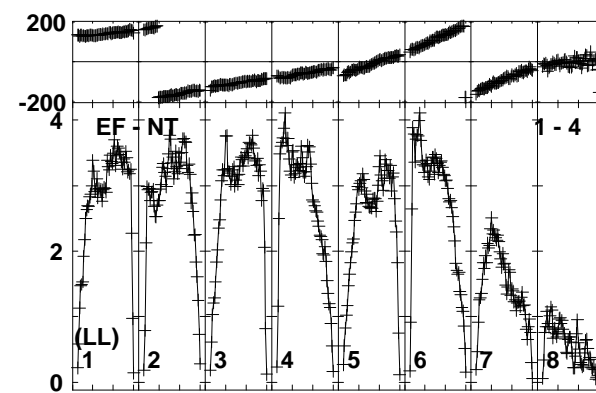
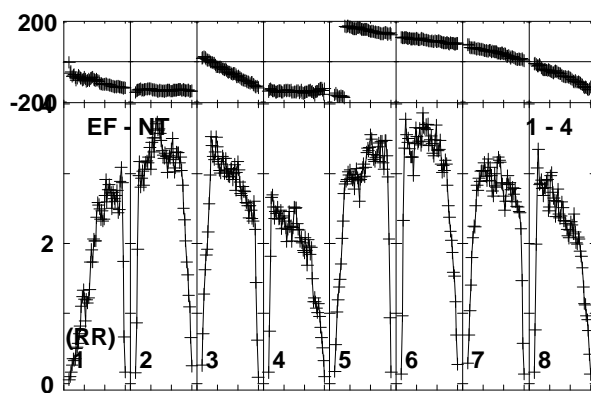
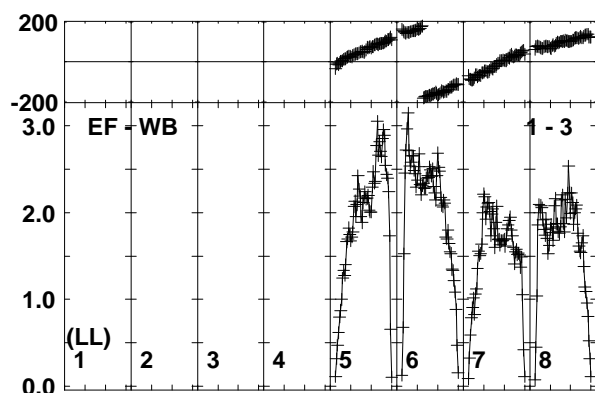
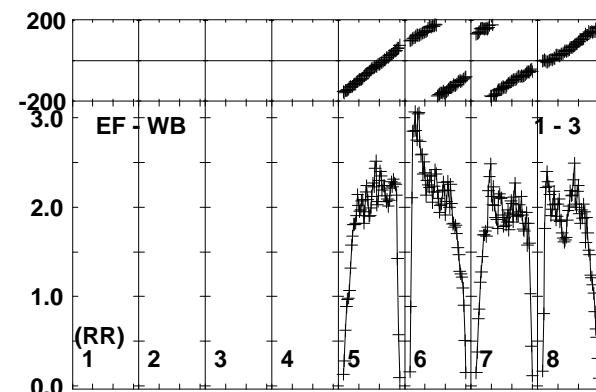
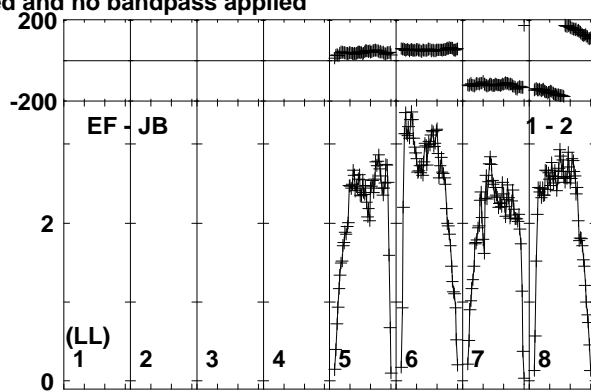
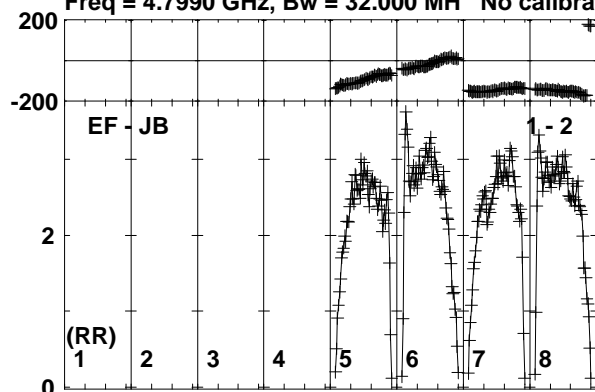

Lower frame: Milli Ampl Jy Top frame: Phas deg
Vector averaged cross-power spectrum Baseline: EF (01) - JB (02)
Timerange: 00/21:27:21 to 00/21:28:49

Plot file version 378 created 19-OCT-2017 15:36:48

J0139+1753 ES081C.UVDATA.1

Freq = 4.7990 GHz, Bw = 32.000 MH No calibration applied and no bandpass applied

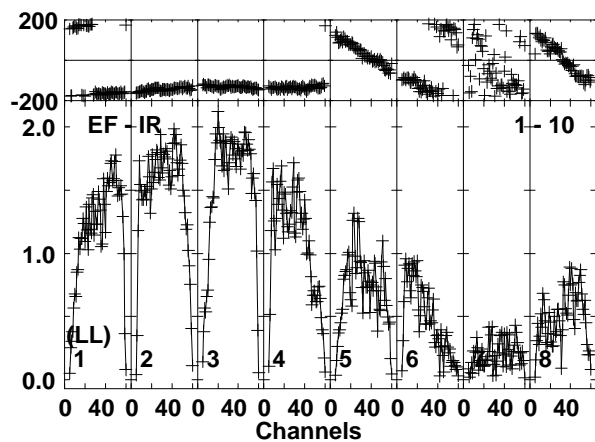
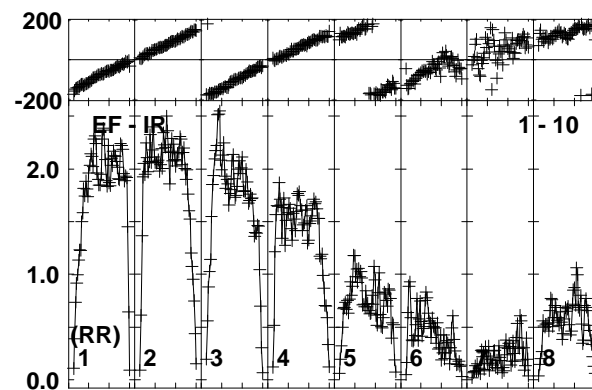
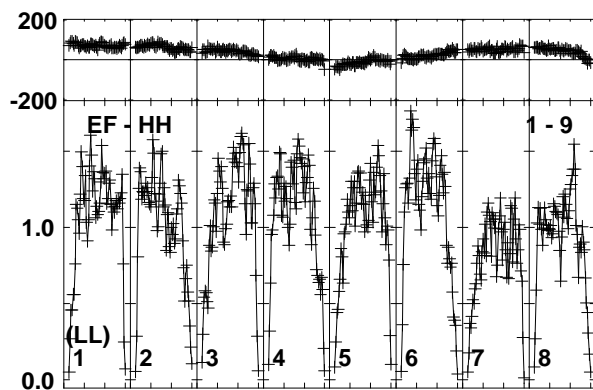
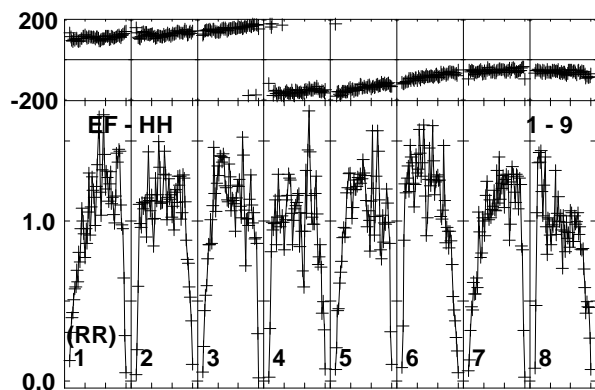
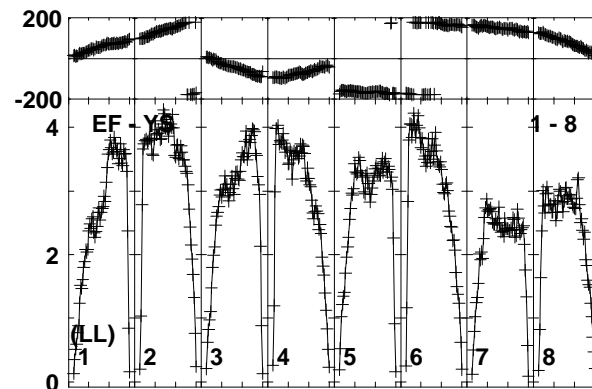
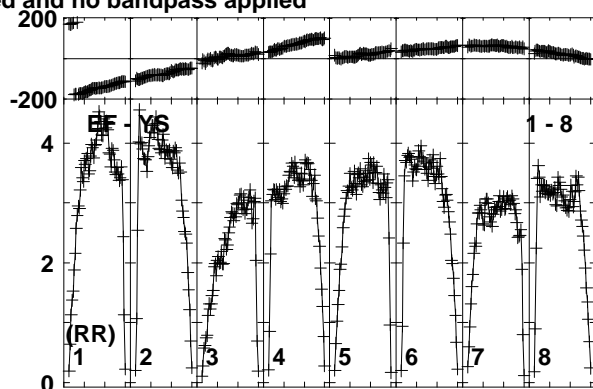
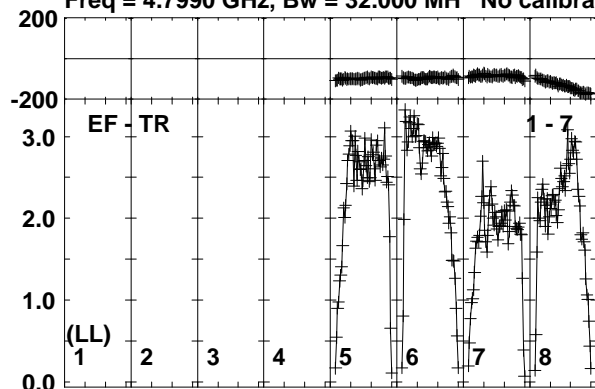

Lower frame: Milli Ampl Jy Top frame: Phas deg
Vector averaged cross-power spectrum Baseline: EF (01) - TR (07)
Timerange: 00/21:27:21 to 00/21:28:49

Plot file version 379 created 19-OCT-2017 15:36:48

MRK359 ES081C.UVDATA.1

Freq = 4.7990 GHz, Bw = 32.000 MH No calibration applied and no bandpass applied

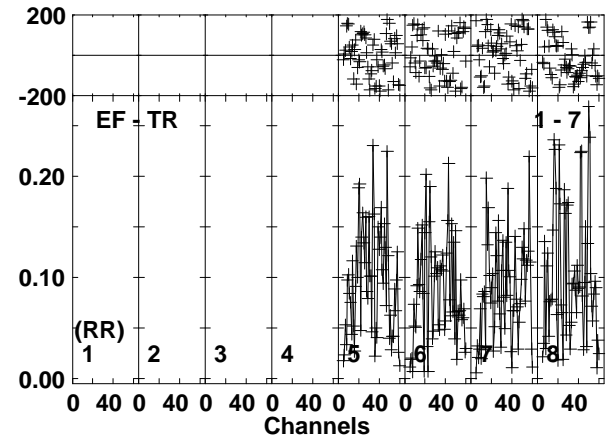
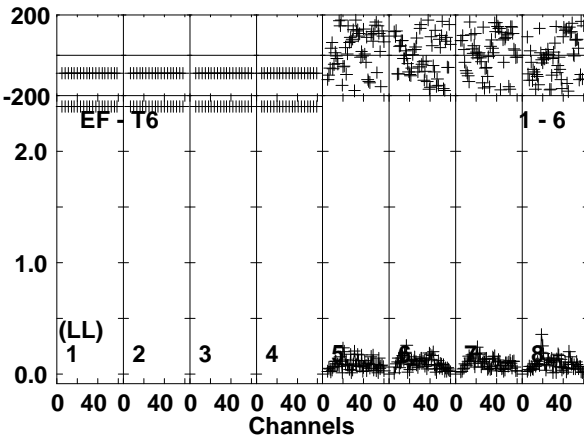
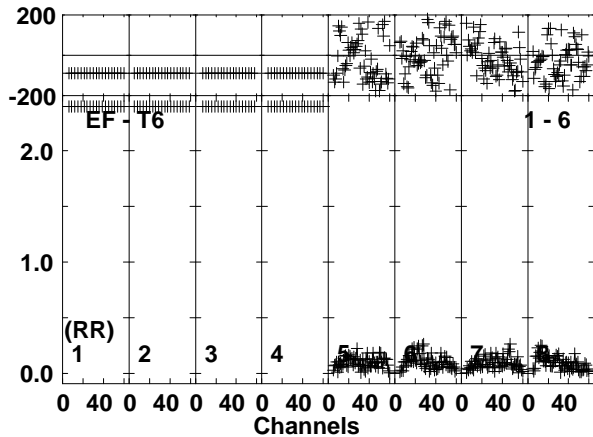
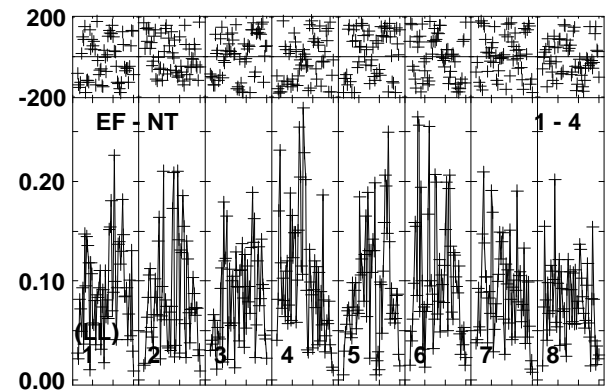
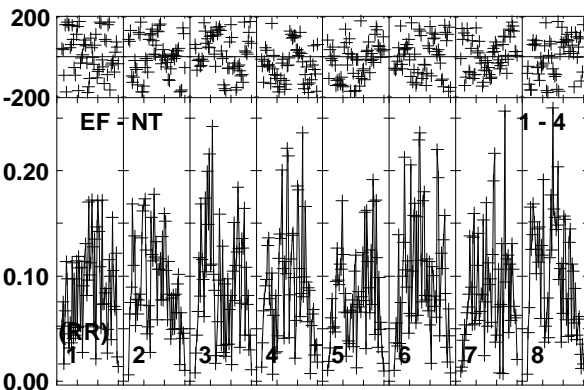
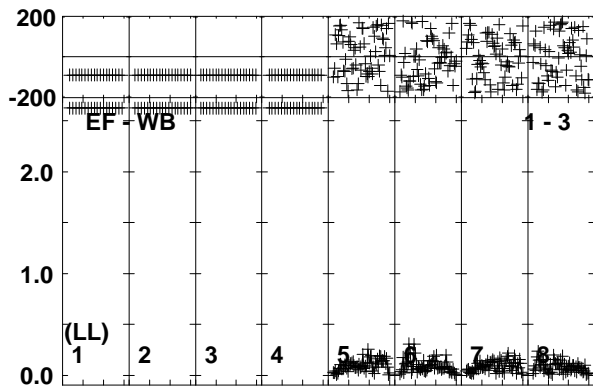
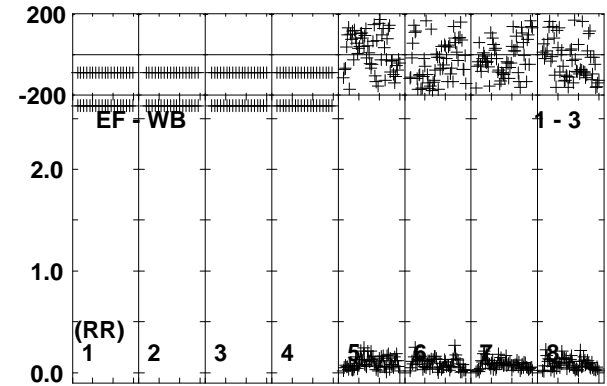
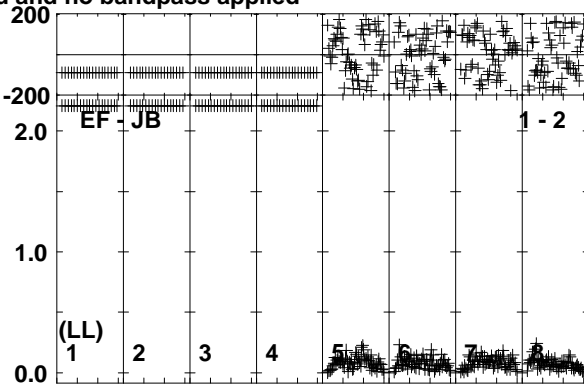
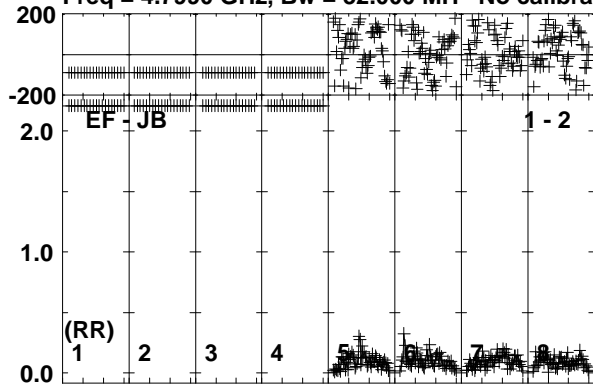

Lower frame: Milli Ampl Jy Top frame: Phas deg
Vector averaged cross-power spectrum Baseline: EF (01) - JB (02)
Timerange: 00/21:28:51 to 00/21:32:19

Plot file version 380 created 19-OCT-2017 15:36:48

MRK359 ES081C.UVDATA.1

Freq = 4.7990 GHz, Bw = 32.000 MH No calibration applied and no bandpass applied

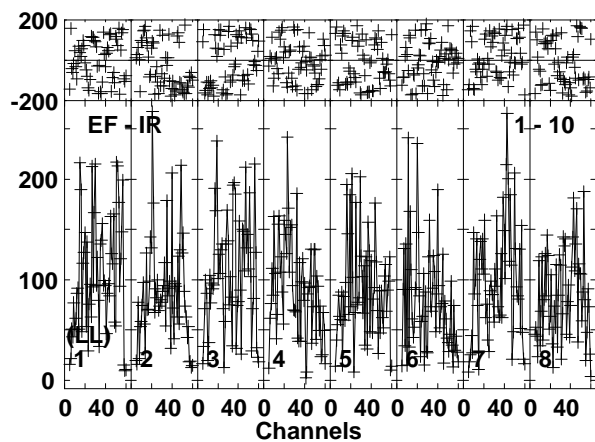
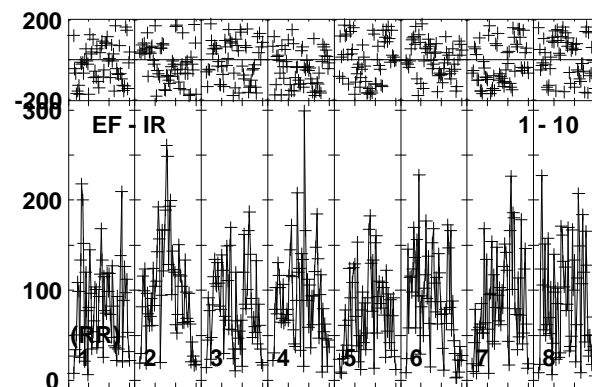
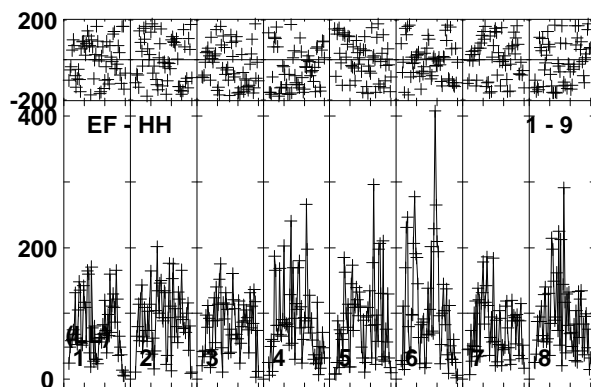
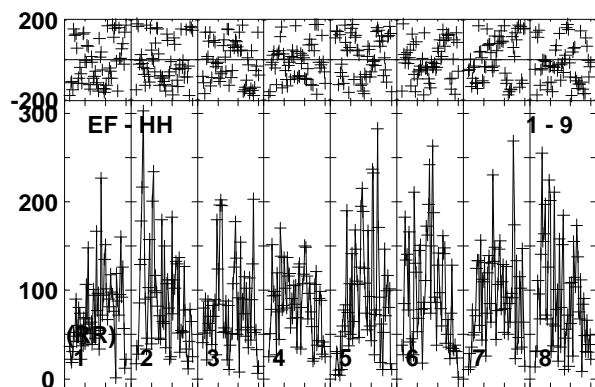
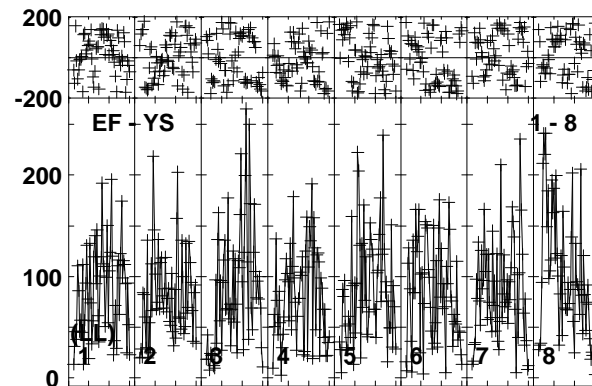
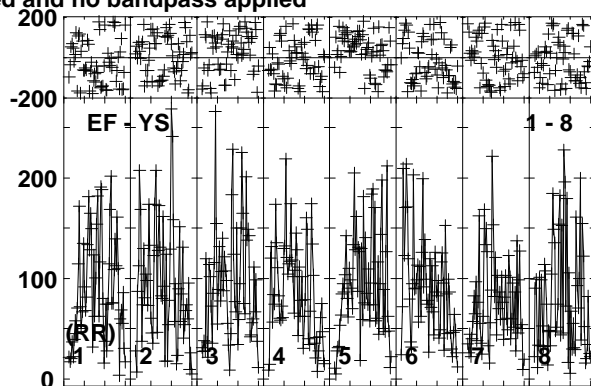
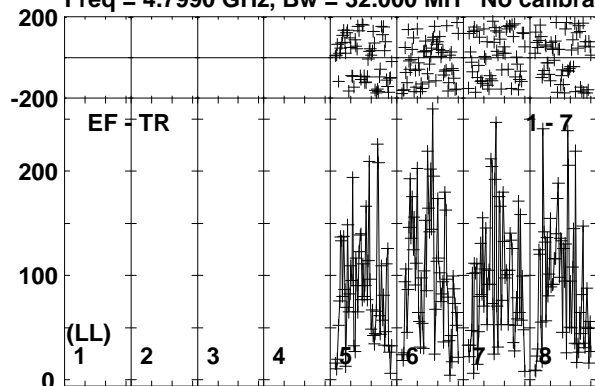

Lower frame: Micro Ampl Jy Top frame: Phas deg
Vector averaged cross-power spectrum Baseline: EF (01) - TR (07)
Timerange: 00/21:28:51 to 00/21:32:19

Plot file version 381 created 19-OCT-2017 15:36:48

J0139+1753 ES081C.UVDATA.1

Freq = 4.7990 GHz, Bw = 32.000 MH No calibration applied and no bandpass applied

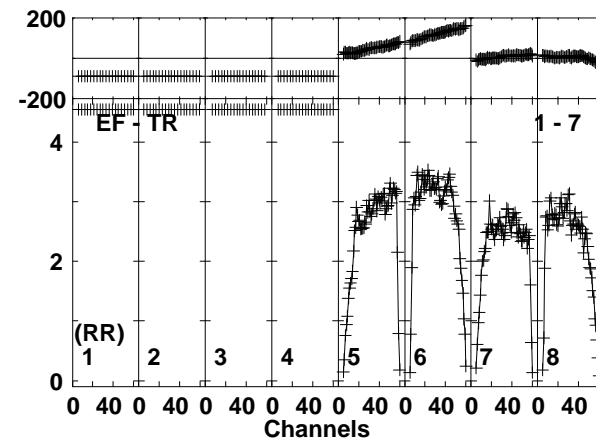
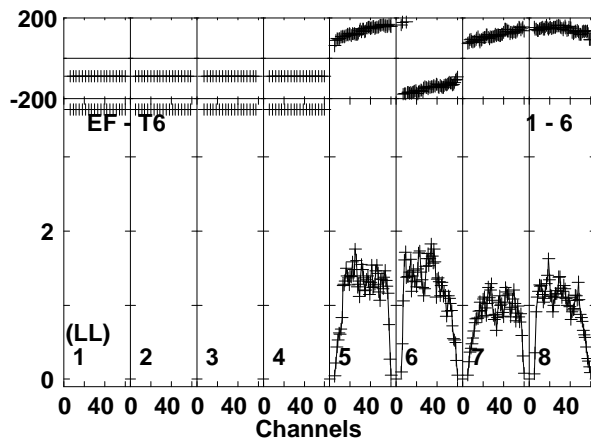
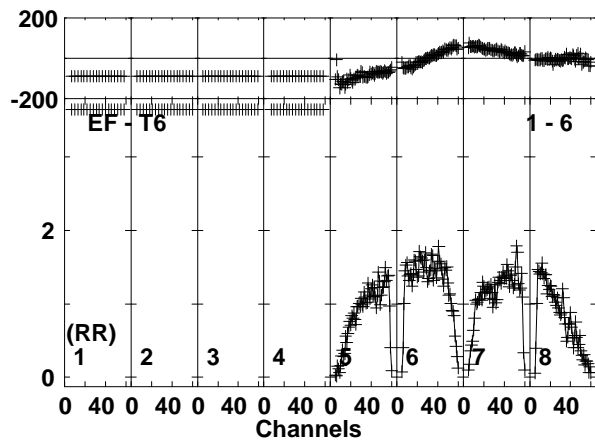
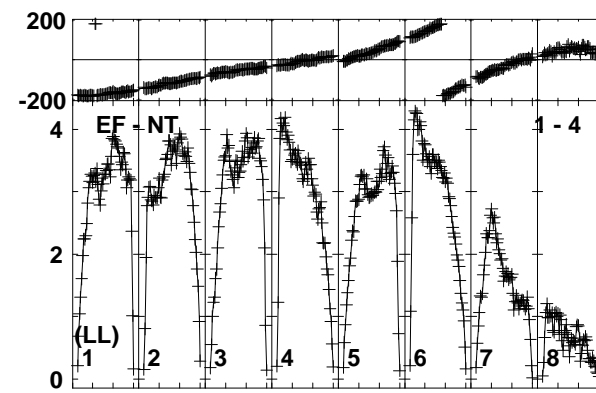
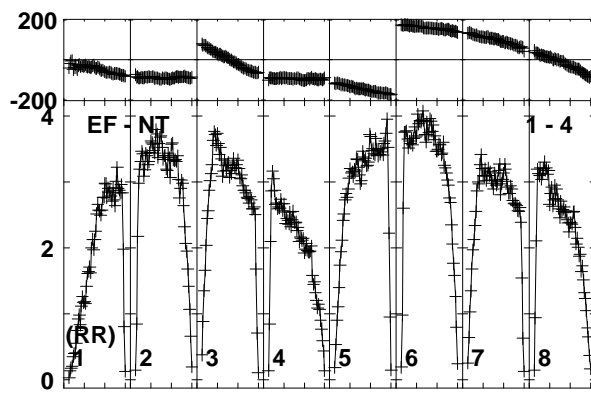
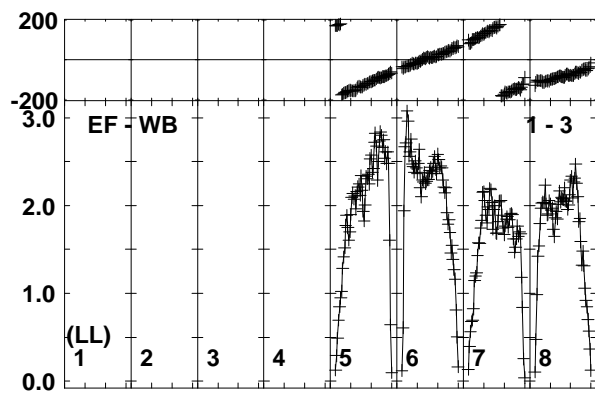
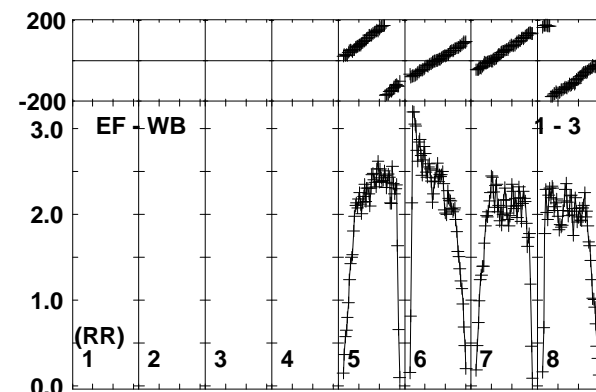
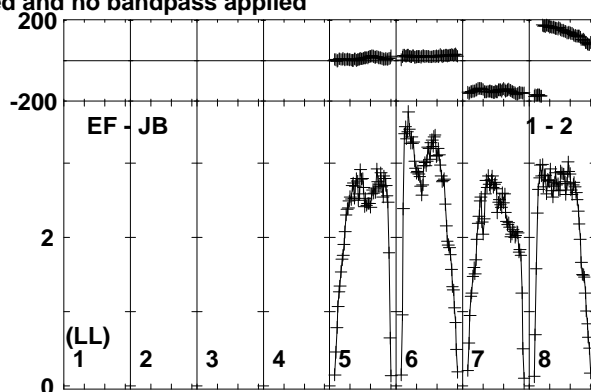
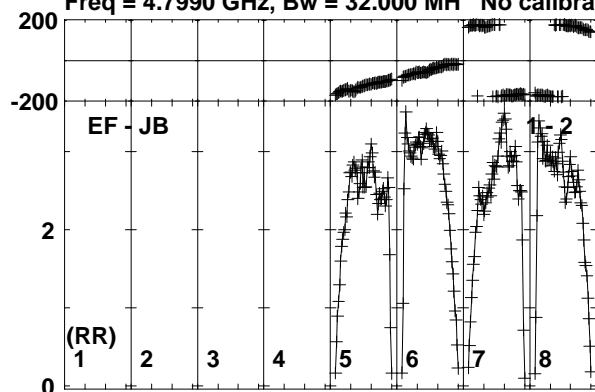

Lower frame: Milli Ampl Jy Top frame: Phas deg
Vector averaged cross-power spectrum Baseline: EF (01) - JB (02)
Timerange: 00/21:33:01 to 00/21:33:59

Plot file version 382 created 19-OCT-2017 15:36:49

J0139+1753 ES081C.UVDATA.1

Freq = 4.7990 GHz, Bw = 32.000 MH No calibration applied and no bandpass applied

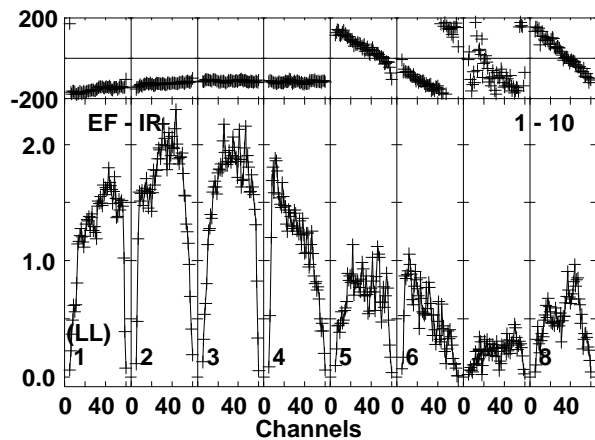
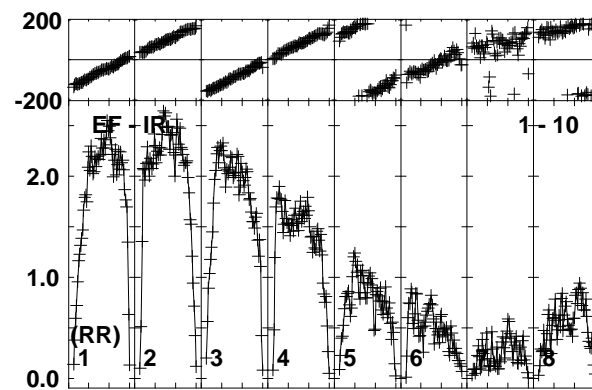
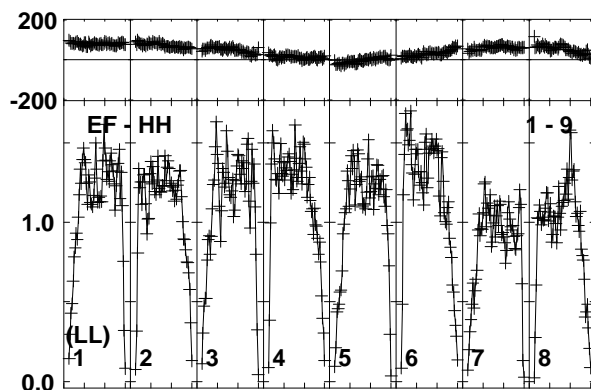
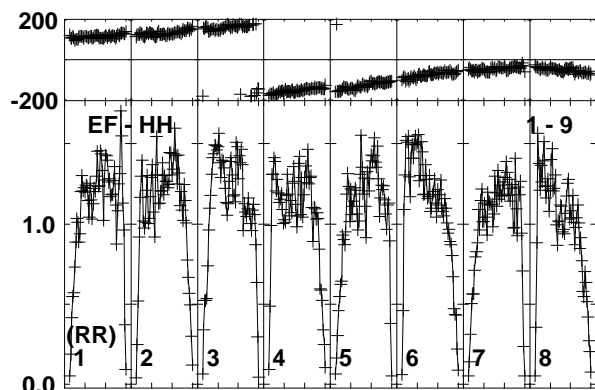
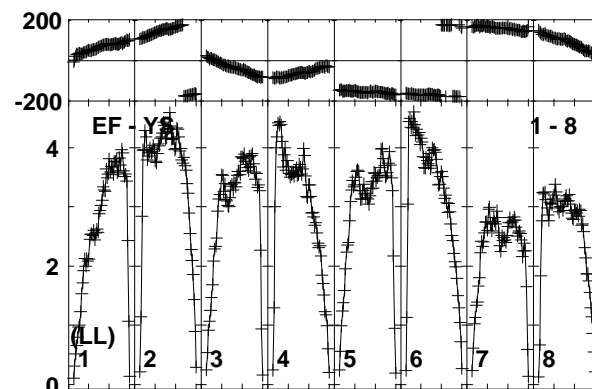
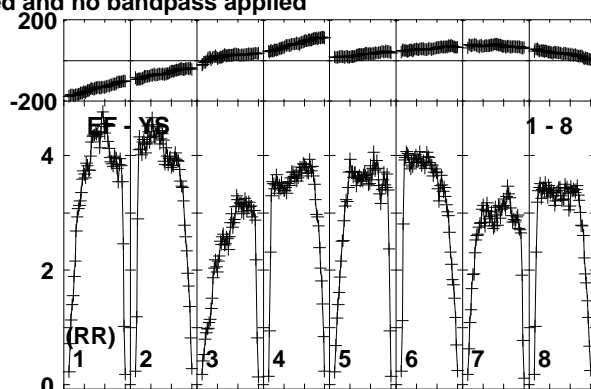
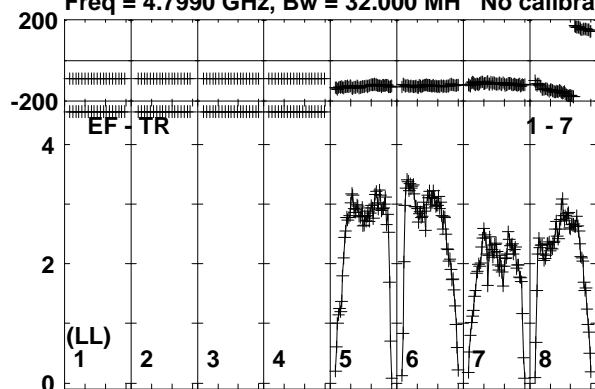

Lower frame: Milli Ampl Jy Top frame: Phas deg
Vector averaged cross-power spectrum Baseline: EF (01) - TR (07)
Timerange: 00/21:33:01 to 00/21:33:59

Plot file version 383 created 19-OCT-2017 15:36:49

MRK359 ES081C.UVDATA.1

Freq = 4.7990 GHz, Bw = 32.000 MH No calibration applied and no bandpass applied

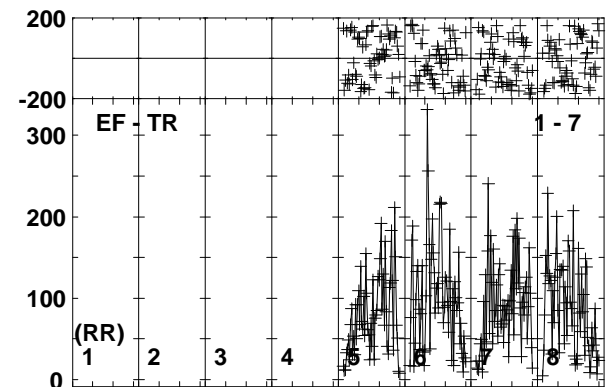
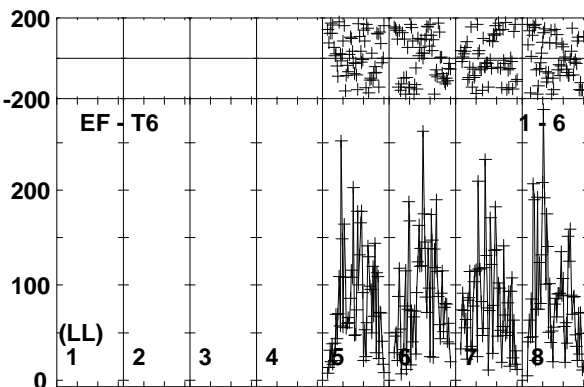
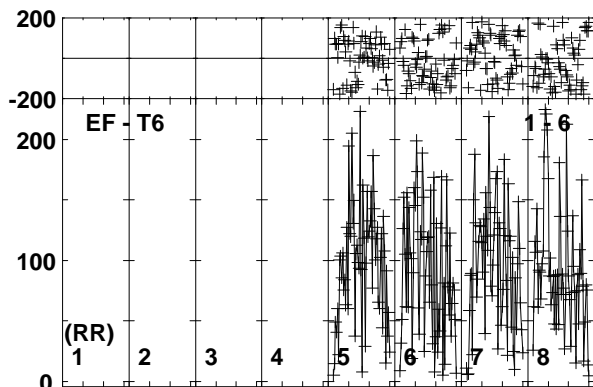
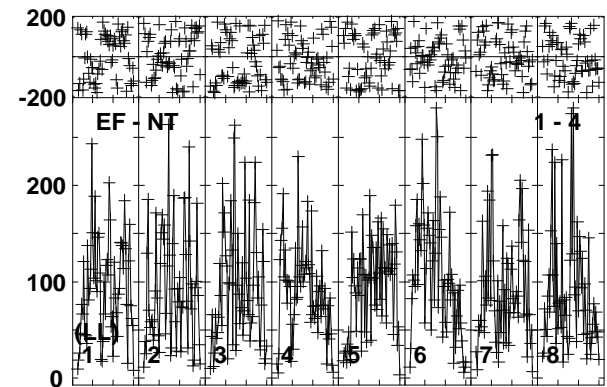
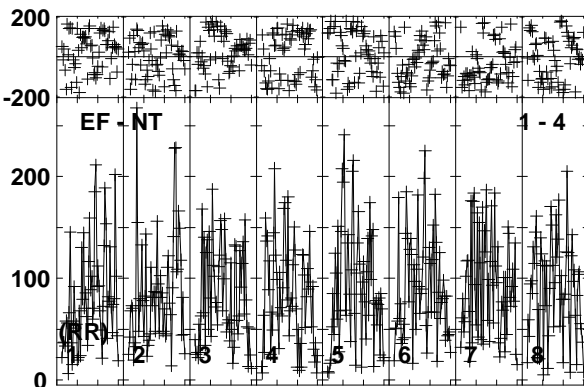
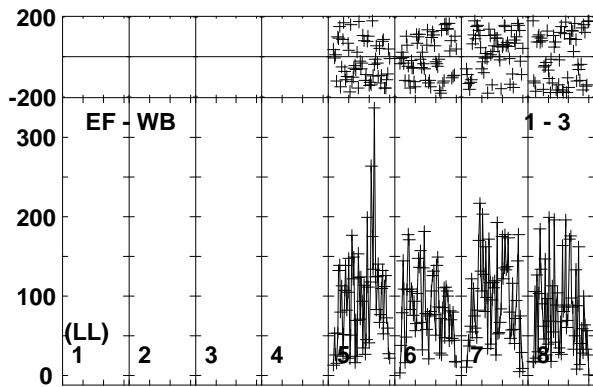
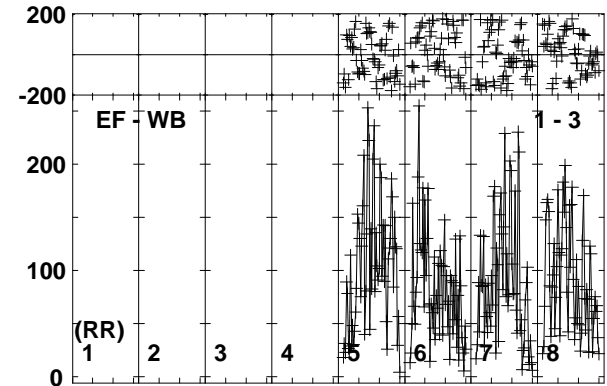
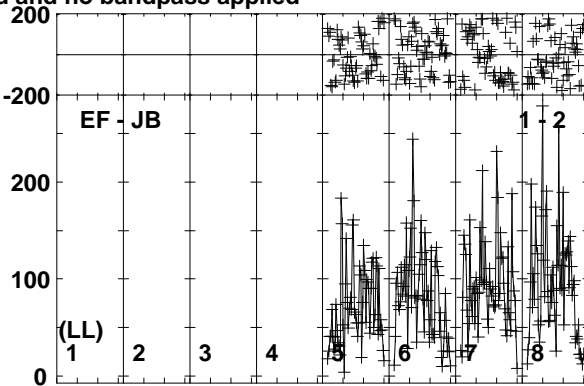
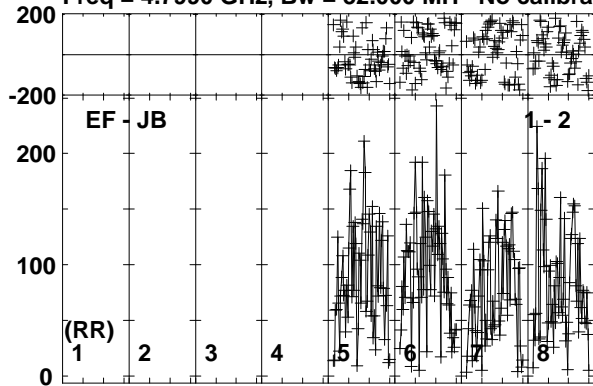

Lower frame: Micro Ampl Jy Top frame: Phas deg
Vector averaged cross-power spectrum Baseline: EF (01) - JB (02)
Timerange: 00/21:34:01 to 00/21:37:29

Plot file version 384 created 19-OCT-2017 15:36:49

MRK359 ES081C.UVDATA.1

Freq = 4.7990 GHz, Bw = 32.000 MH No calibration applied and no bandpass applied

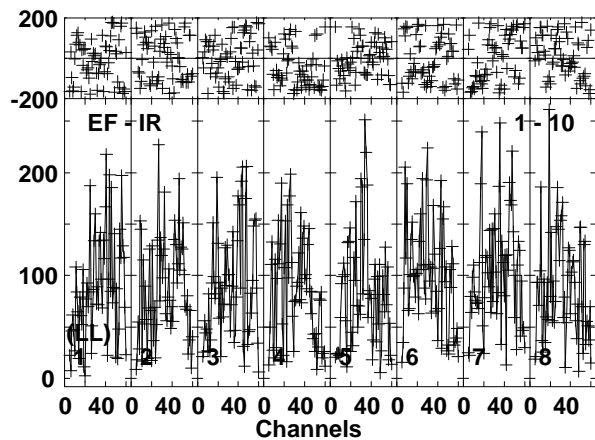
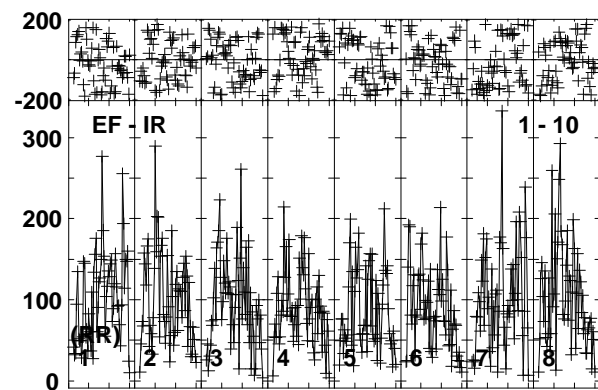
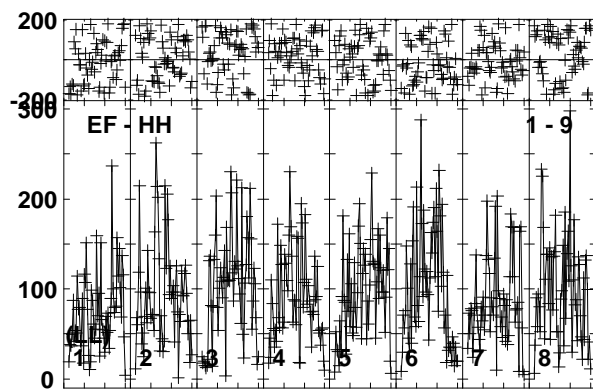
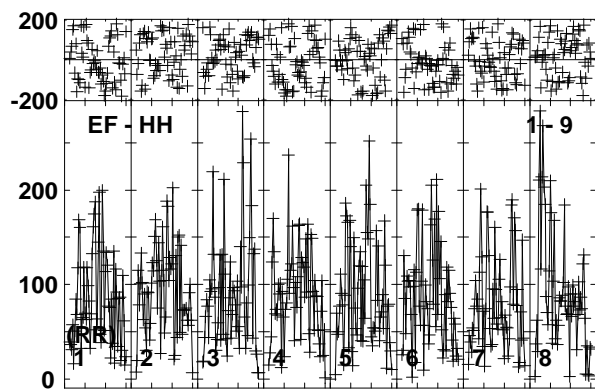
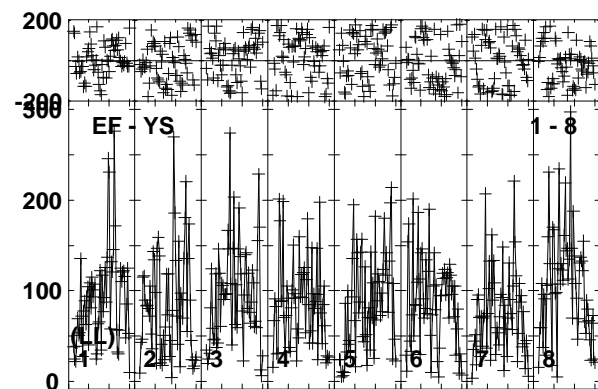
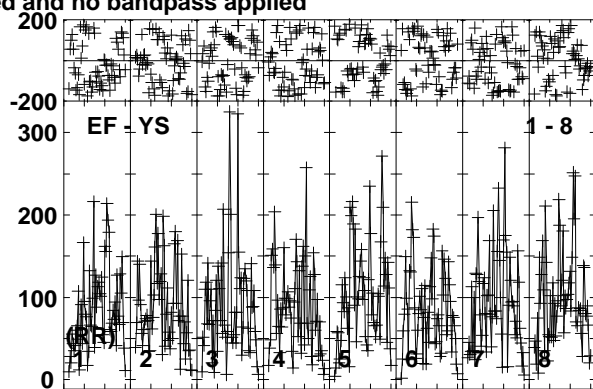
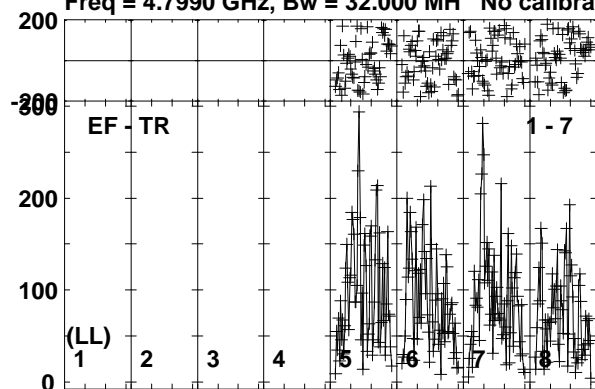

Lower frame: Micro Ampl Jy Top frame: Phas deg
Vector averaged cross-power spectrum Baseline: EF (01) - TR (07)
Timerange: 00/21:34:01 to 00/21:37:29

Plot file version 385 created 19-OCT-2017 15:36:49

J0139+1753 ES081C.UVDATA.1

Freq = 4.7990 GHz, Bw = 32.000 MH No calibration applied and no bandpass applied

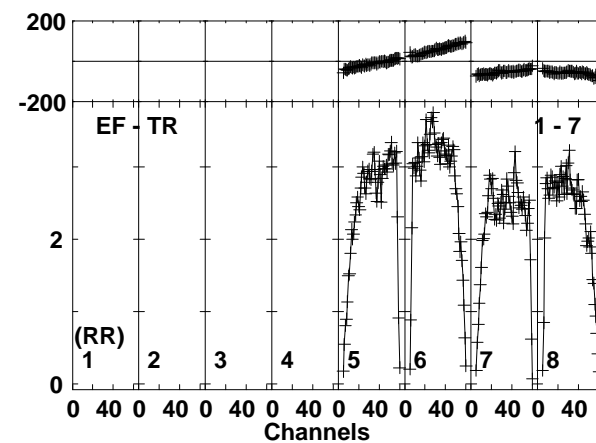
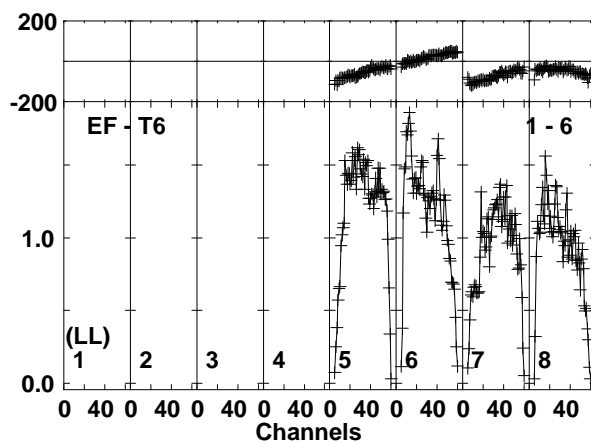
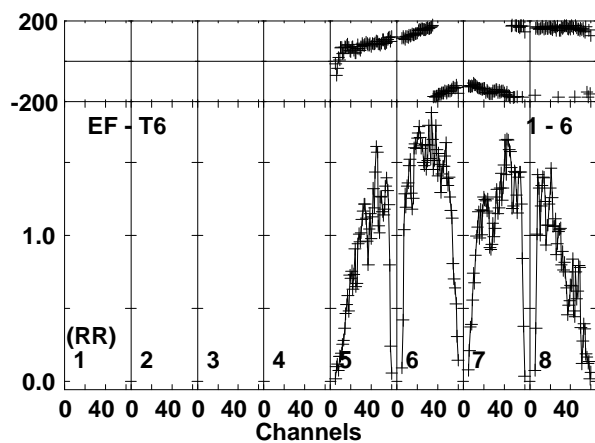
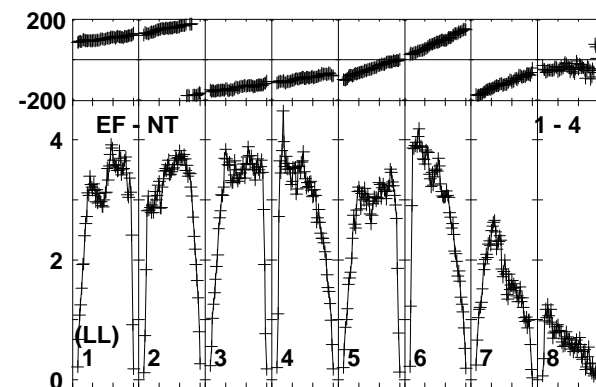
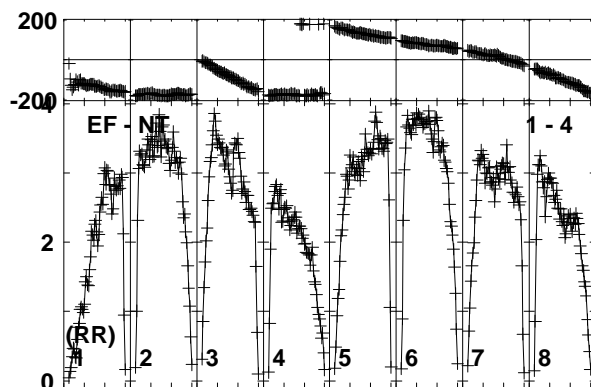
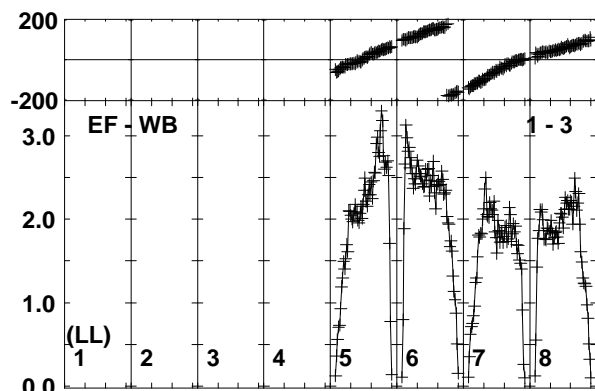
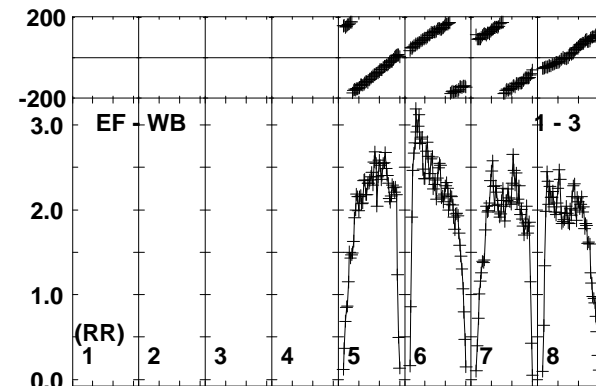
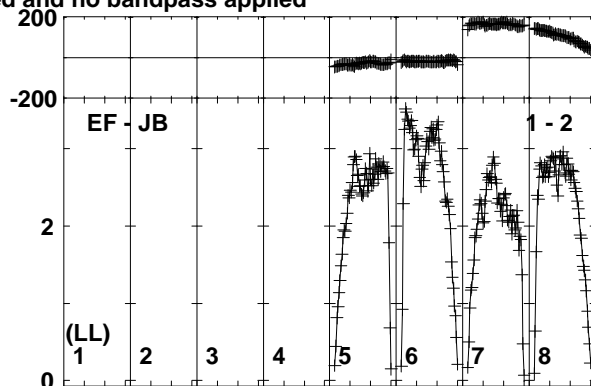
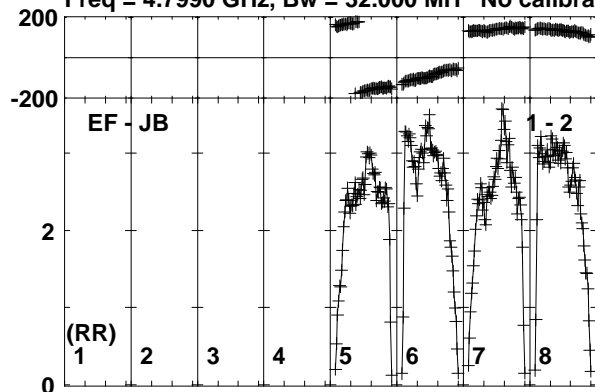

Lower frame: Milli Ampl Jy Top frame: Phas deg
Vector averaged cross-power spectrum Baseline: EF (01) - JB (02)
Timerange: 00/21:37:31 to 00/21:38:59

Plot file version 386 created 19-OCT-2017 15:36:49

J0139+1753 ES081C.UVDATA.1

Freq = 4.7990 GHz, Bw = 32.000 MH No calibration applied and no bandpass applied

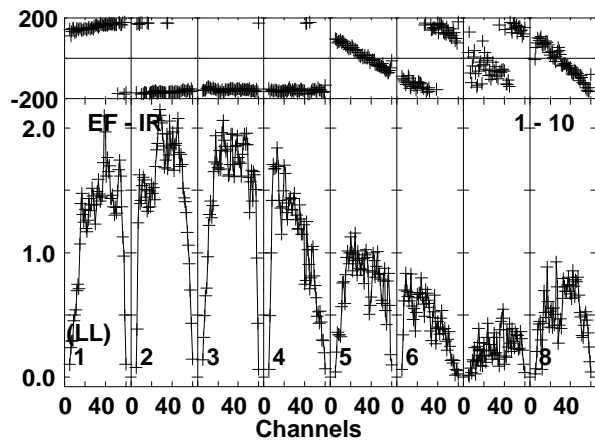
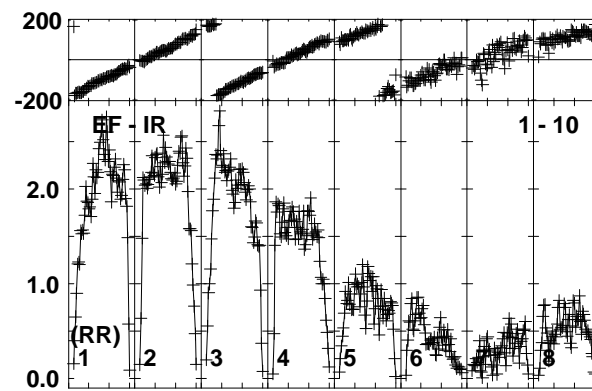
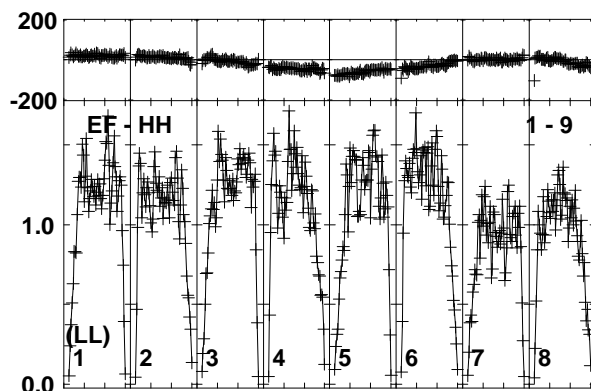
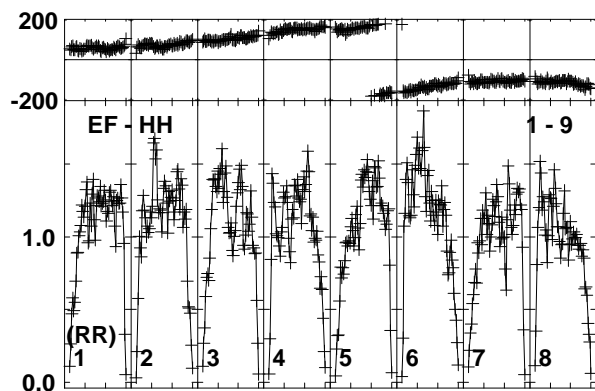
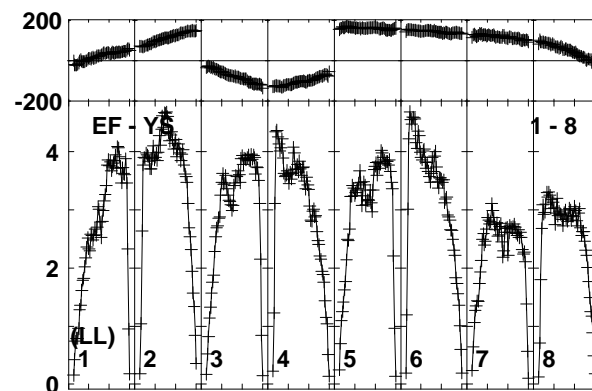
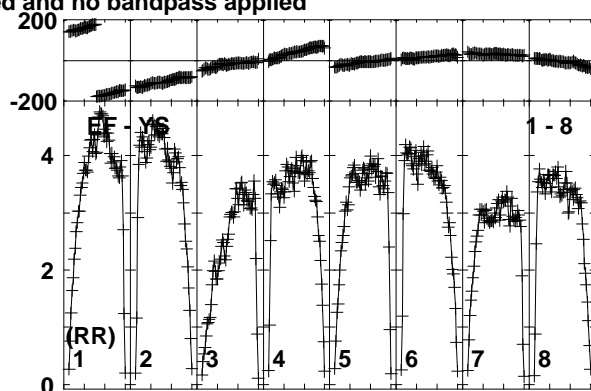
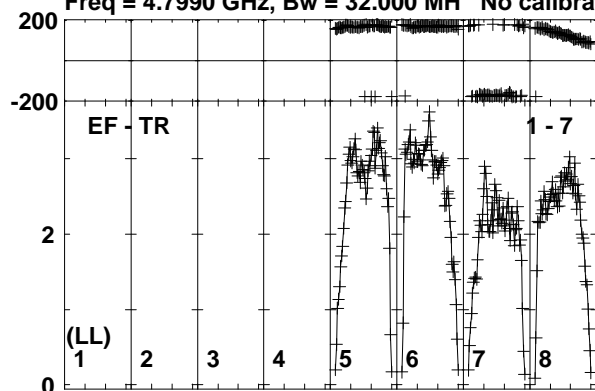

Lower frame: Milli Ampl Jy Top frame: Phas deg
Vector averaged cross-power spectrum Baseline: EF (01) - TR (07)
Timerange: 00/21:37:31 to 00/21:38:59

Plot file version 387 created 19-OCT-2017 15:36:49

MRK359 ES081C.UVDATA.1

Freq = 4.7990 GHz, Bw = 32.000 MH No calibration applied and no bandpass applied

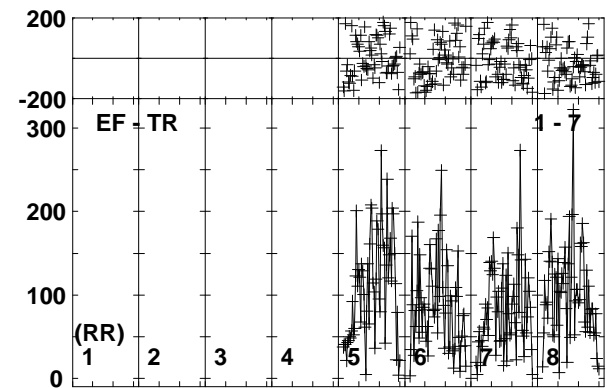
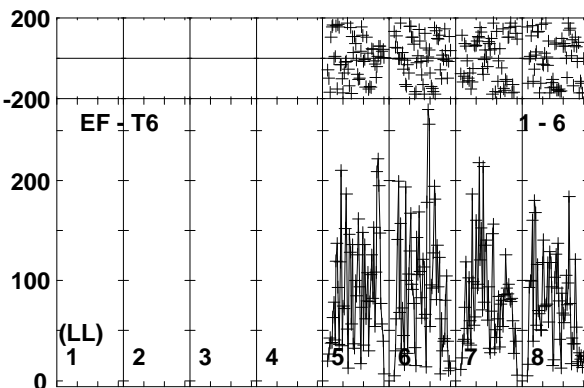
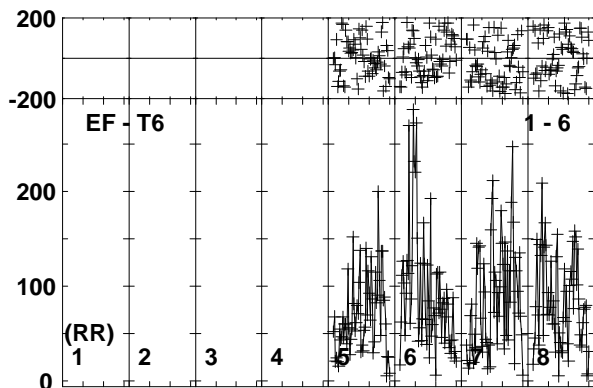
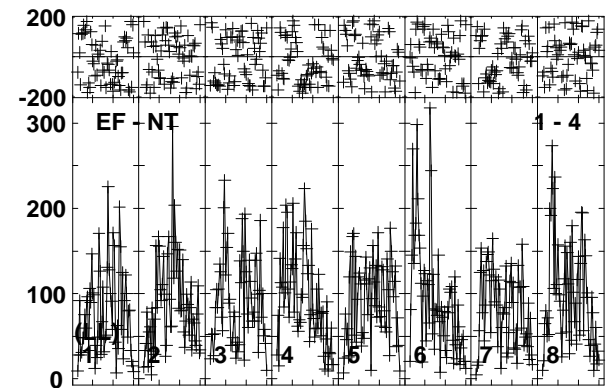
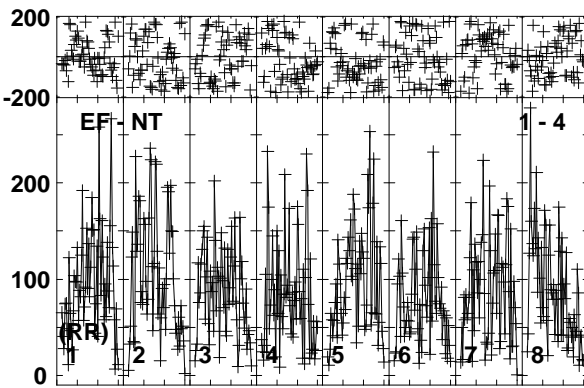
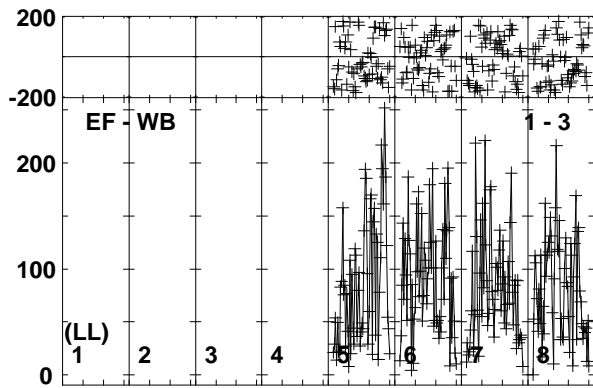
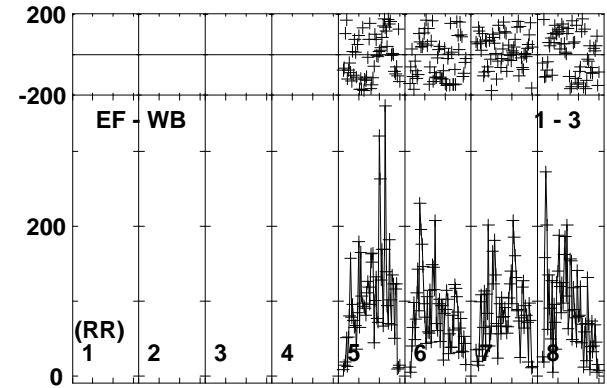
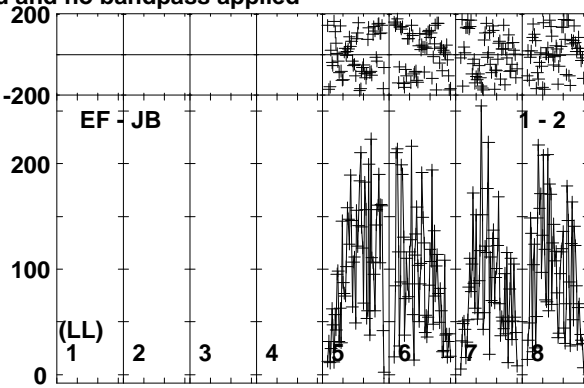
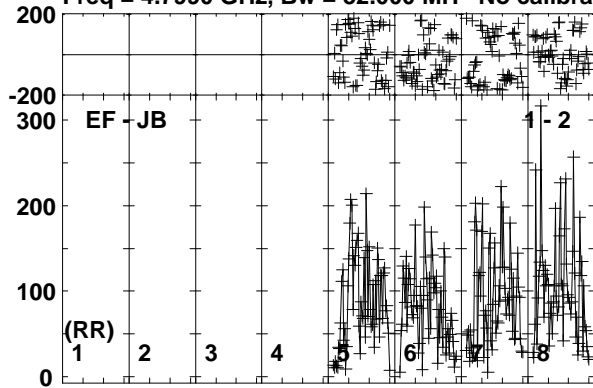

Lower frame: Micro Ampl Jy Top frame: Phas deg
Vector averaged cross-power spectrum Baseline: EF (01) - JB (02)
Timerange: 00/21:39:01 to 00/21:42:29

Plot file version 388 created 19-OCT-2017 15:36:49

MRK359 ES081C.UVDATA.1

Freq = 4.7990 GHz, Bw = 32.000 MH No calibration applied and no bandpass applied

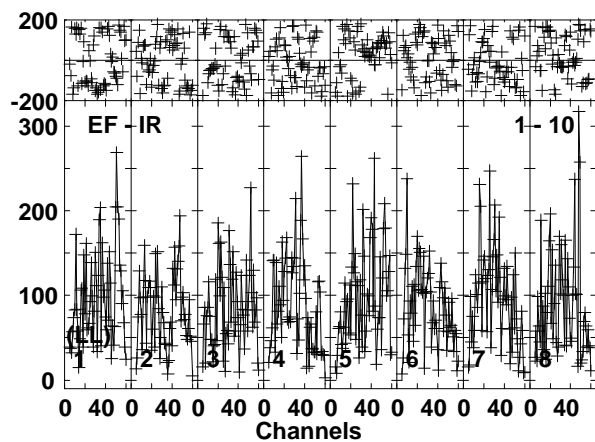
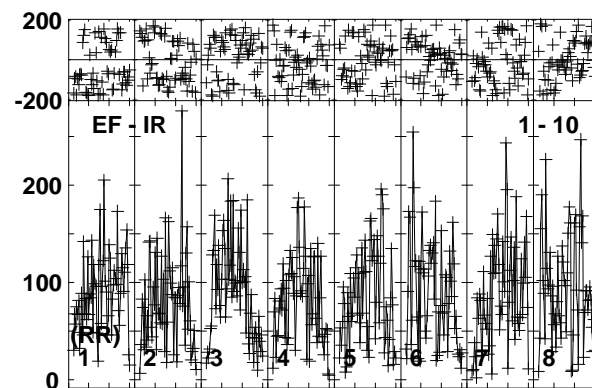
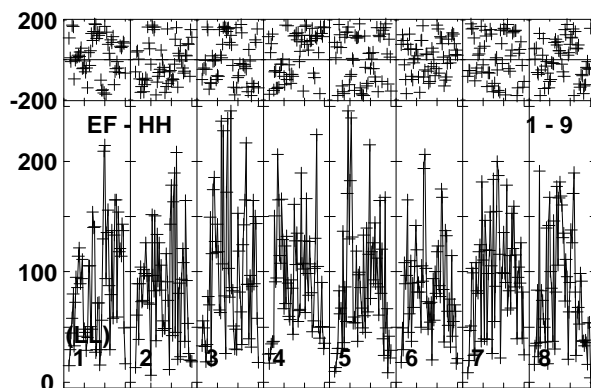
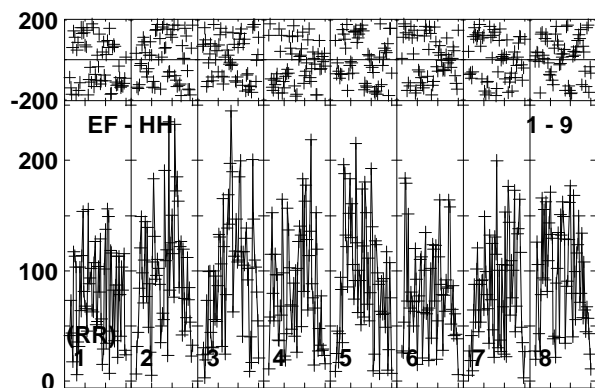
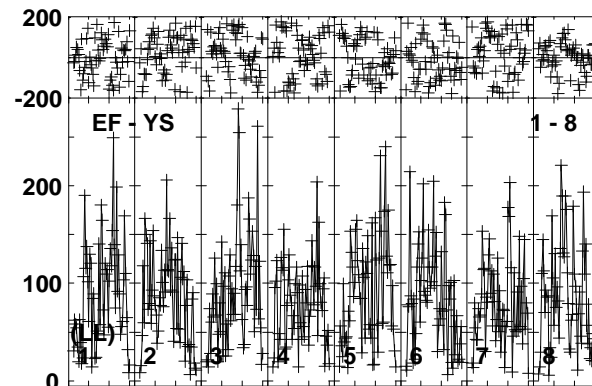
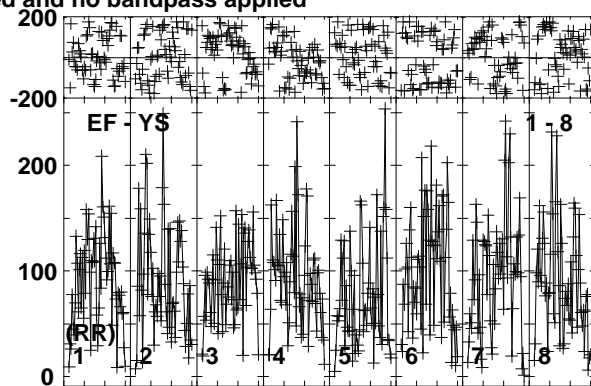
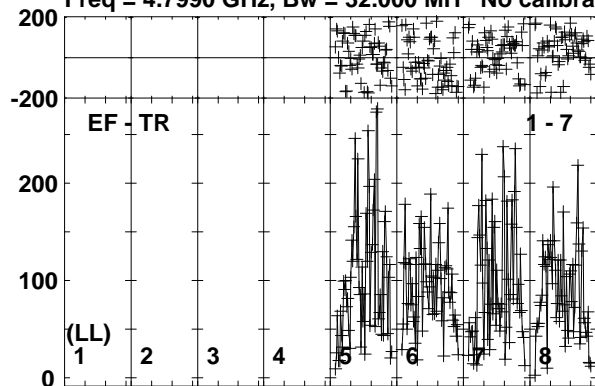

Lower frame: Micro Ampl Jy Top frame: Phas deg
Vector averaged cross-power spectrum Baseline: EF (01) - TR (07)
Timerange: 00/21:39:01 to 00/21:42:29

Plot file version 389 created 19-OCT-2017 15:36:50

J0139+1753 ES081C.UVDATA.1

Freq = 4.7990 GHz, Bw = 32.000 MH No calibration applied and no bandpass applied

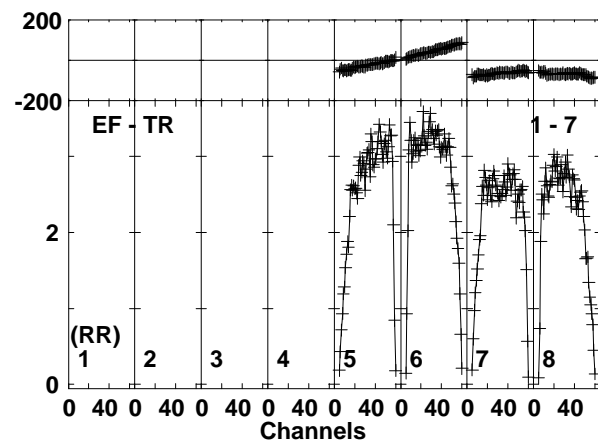
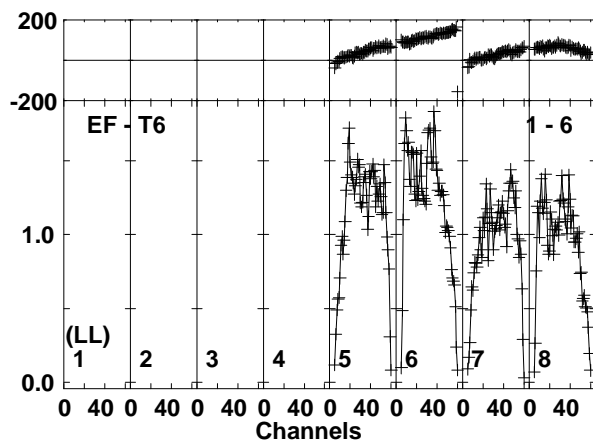
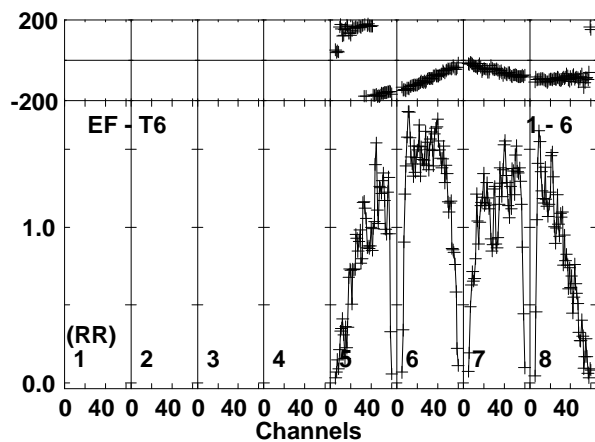
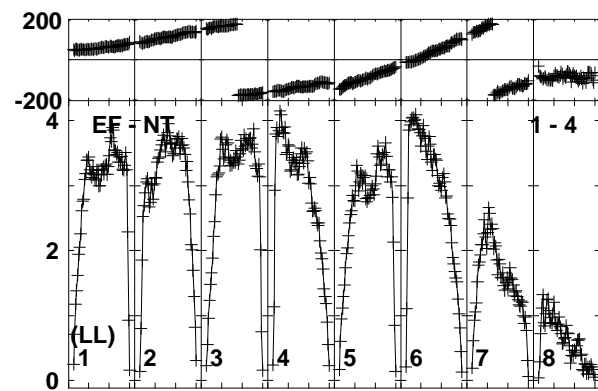
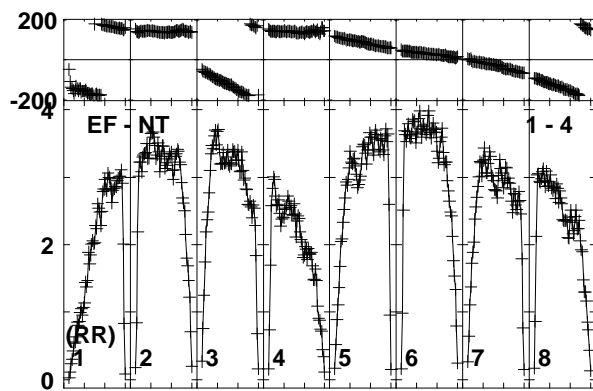
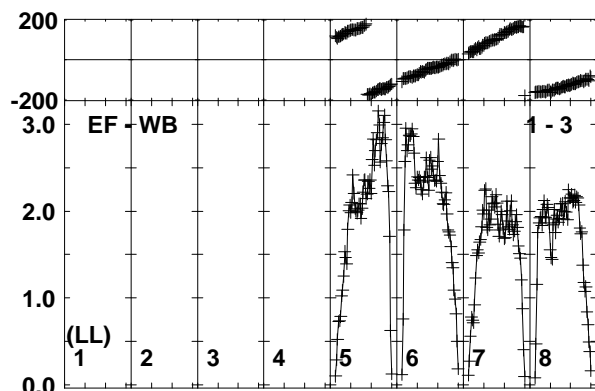
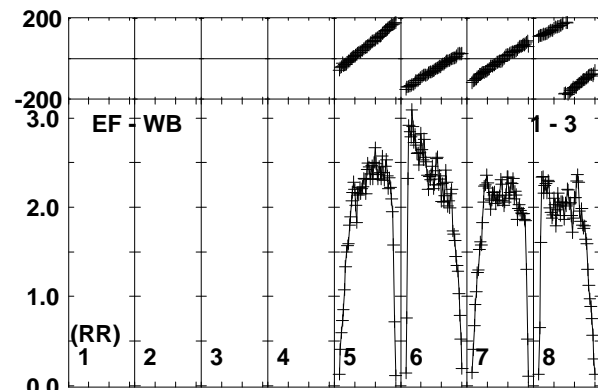
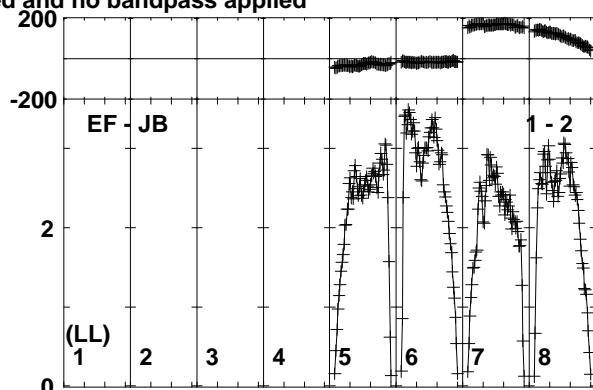
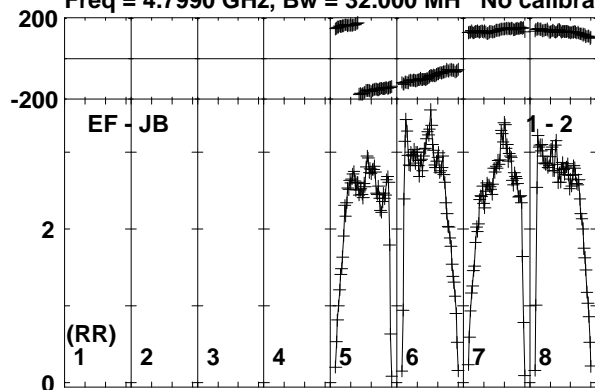

Lower frame: Milli Ampl Jy Top frame: Phas deg
Vector averaged cross-power spectrum Baseline: EF (01) - JB (02)
Timerange: 00/21:43:11 to 00/21:44:09

Plot file version 390 created 19-OCT-2017 15:36:50

J0139+1753 ES081C.UVDATA.1

Freq = 4.7990 GHz, Bw = 32.000 MH No calibration applied and no bandpass applied

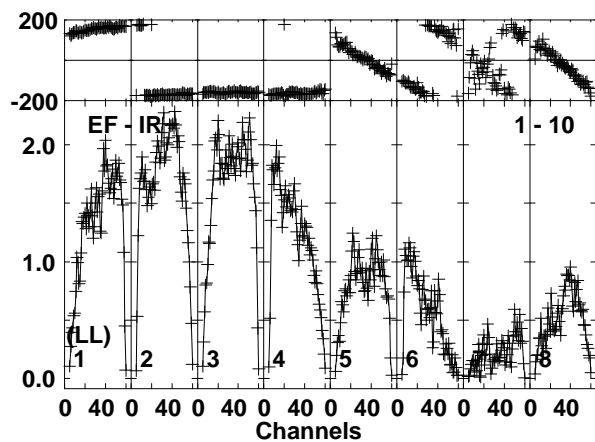
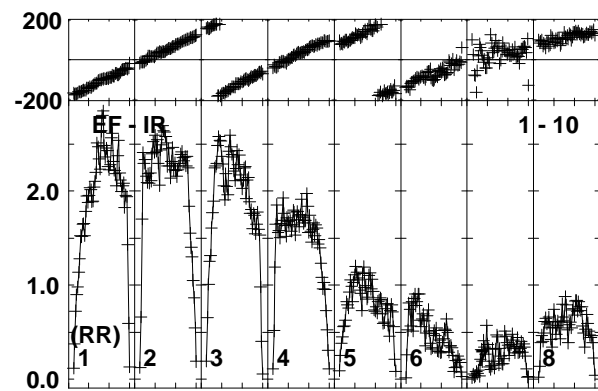
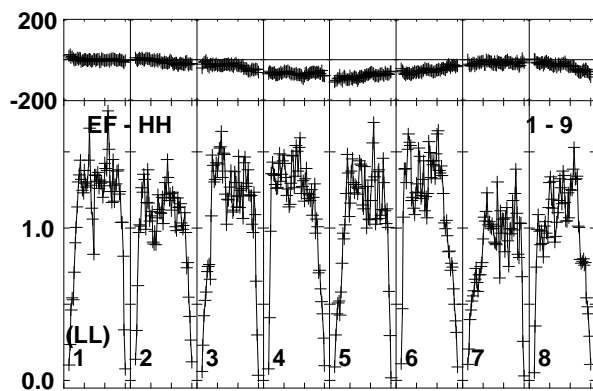
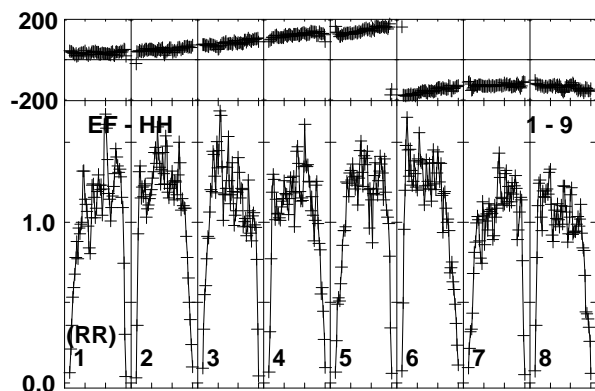
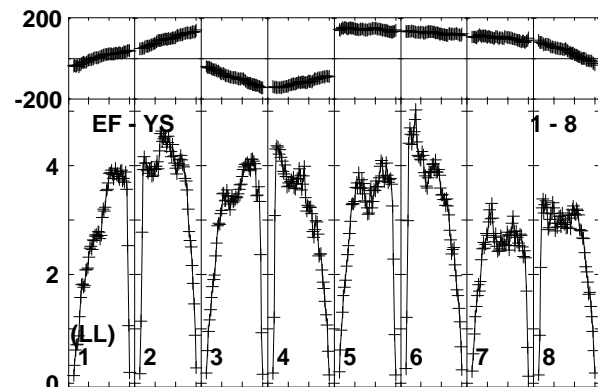
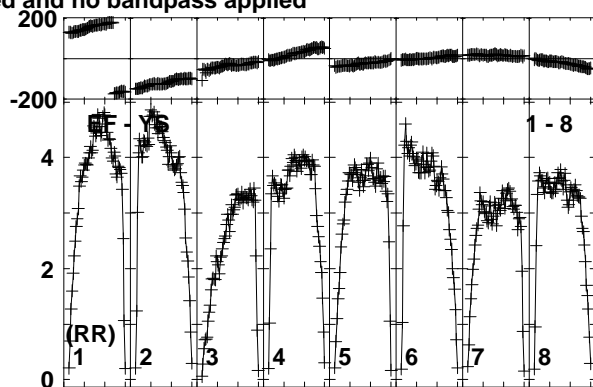
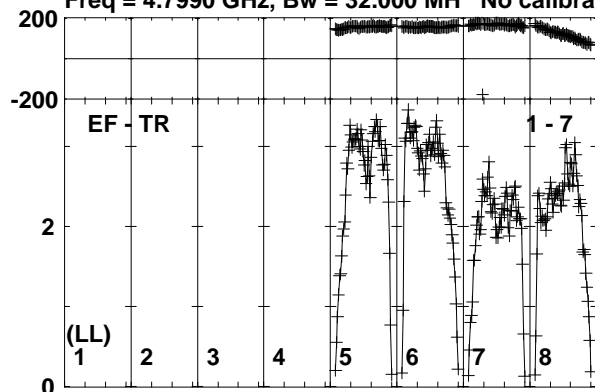

Lower frame: Milli Ampl Jy Top frame: Phas deg
Vector averaged cross-power spectrum Baseline: EF (01) - TR (07)
Timerange: 00/21:43:11 to 00/21:44:09

Plot file version 391 created 19-OCT-2017 15:36:50

MRK359 ES081C.UVDATA.1

Freq = 4.7990 GHz, Bw = 32.000 MH No calibration applied and no bandpass applied

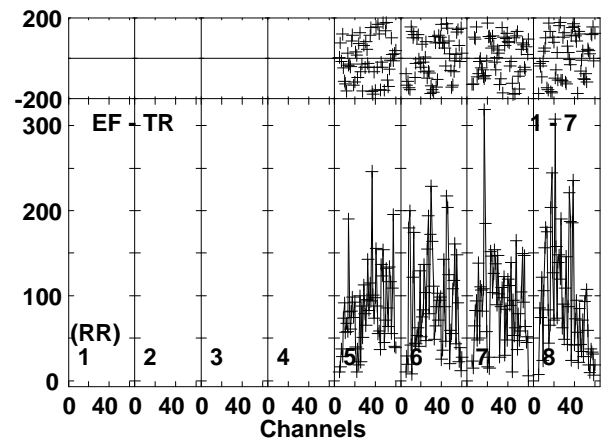
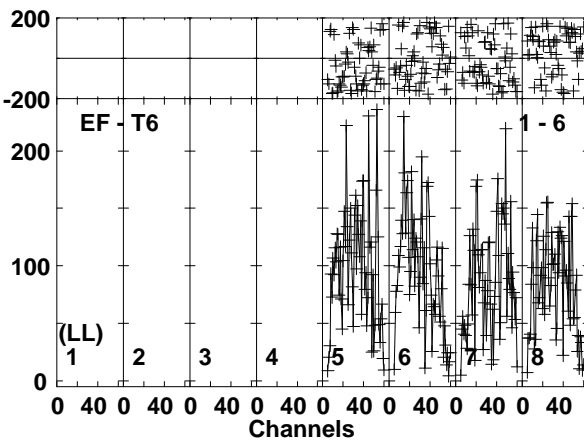
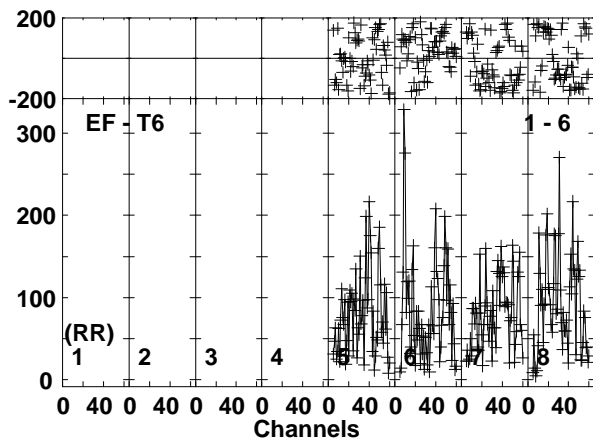
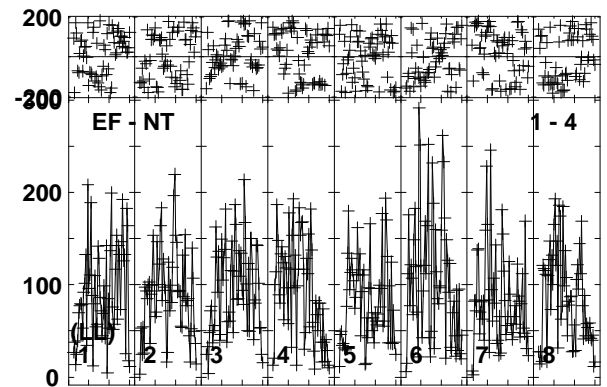
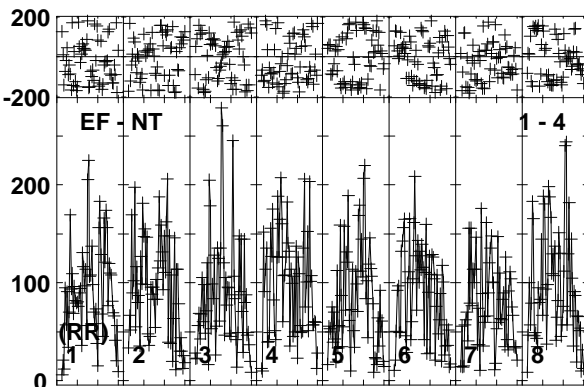
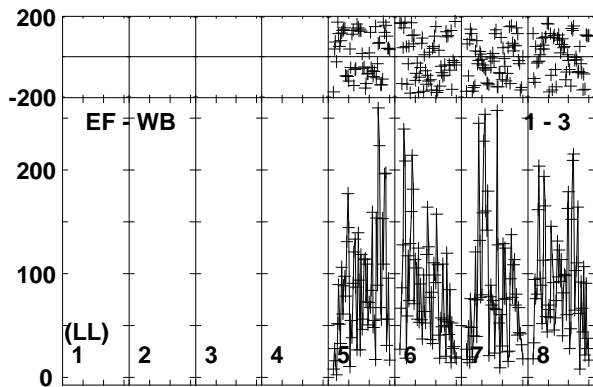
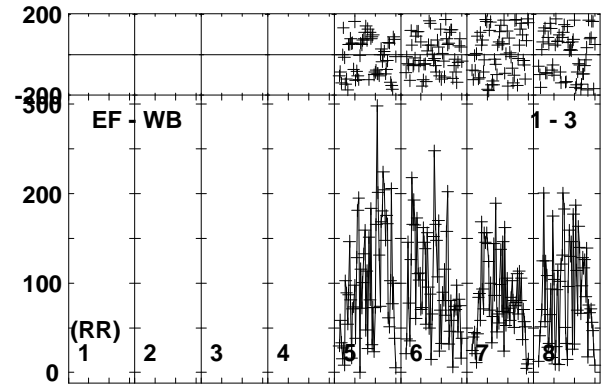
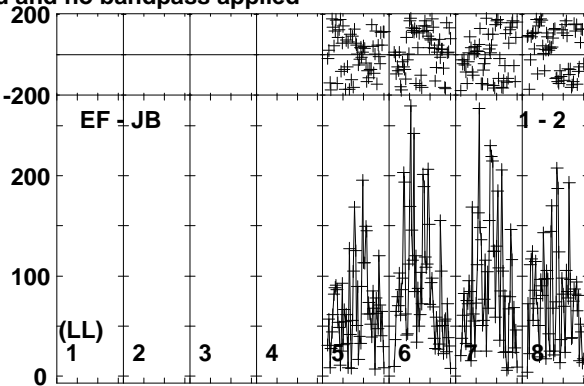
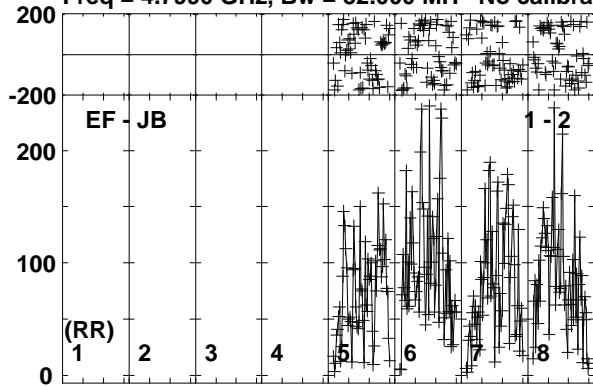

Lower frame: Micro Ampl Jy Top frame: Phas deg
Vector averaged cross-power spectrum Baseline: EF (01) - JB (02)
Timerange: 00/21:44:11 to 00/21:47:39

Plot file version 392 created 19-OCT-2017 15:36:50

MRK359 ES081C.UVDATA.1

Freq = 4.7990 GHz, Bw = 32.000 MH No calibration applied and no bandpass applied

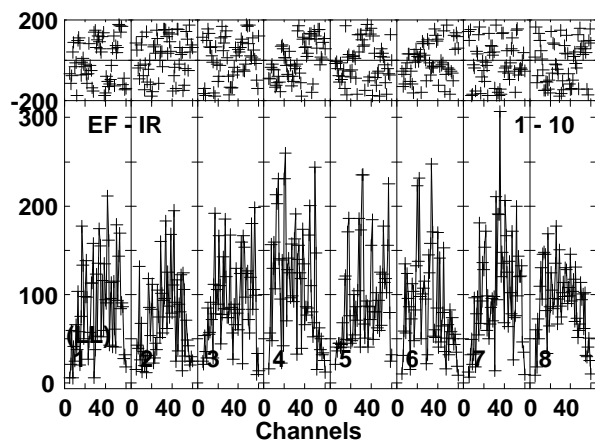
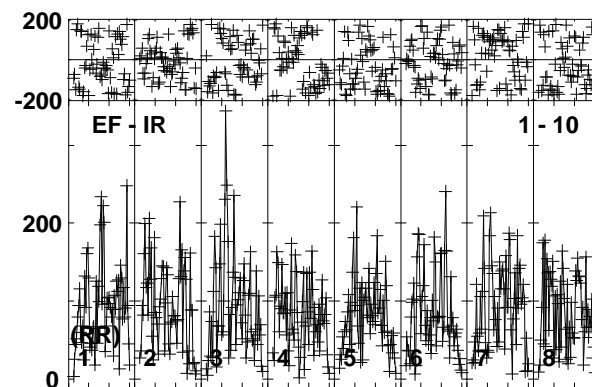
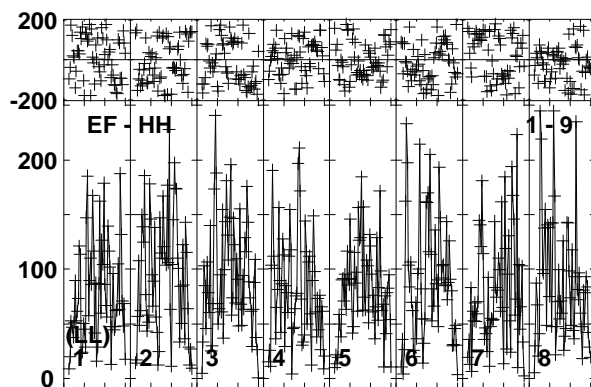
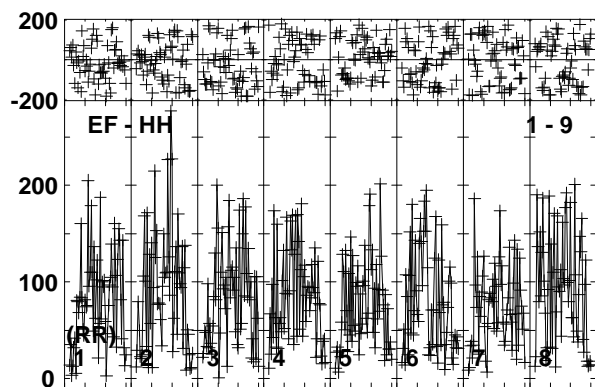
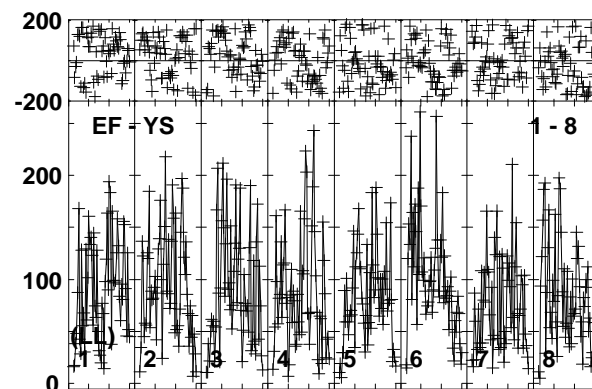
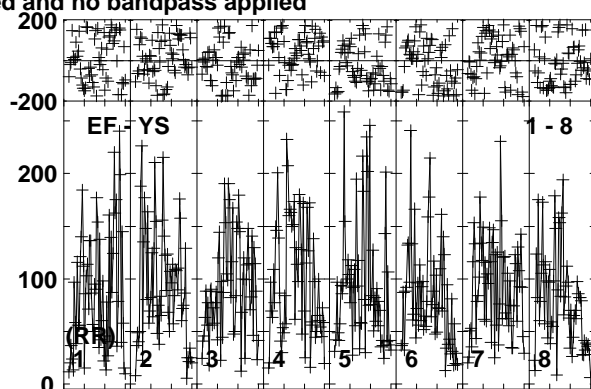
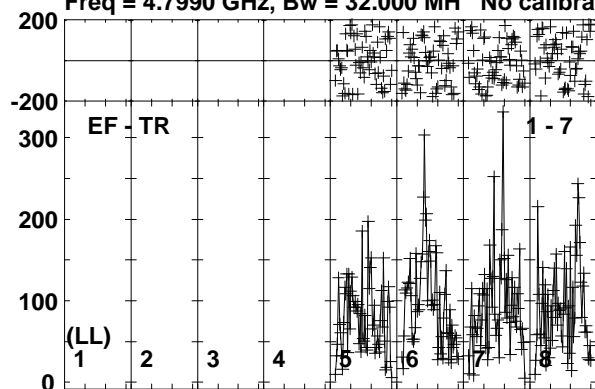

Lower frame: Micro Ampl Jy Top frame: Phas deg
Vector averaged cross-power spectrum Baseline: EF (01) - TR (07)
Timerange: 00/21:44:11 to 00/21:47:39

Plot file version 393 created 19-OCT-2017 15:36:50

J0139+1753 ES081C.UVDATA.1

Freq = 4.7990 GHz, Bw = 32.000 MH No calibration applied and no bandpass applied

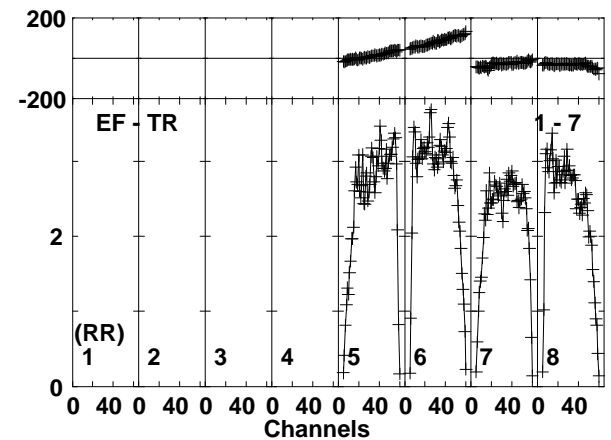
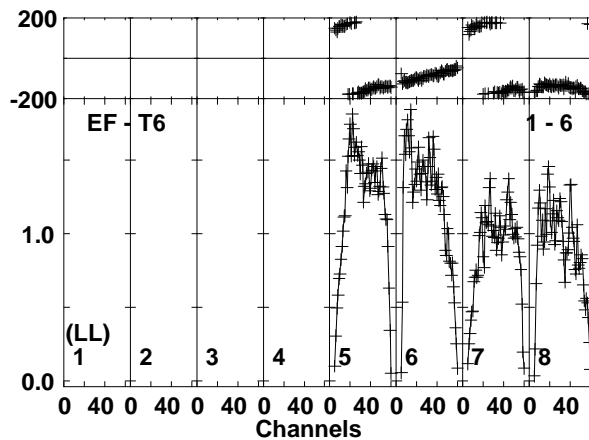
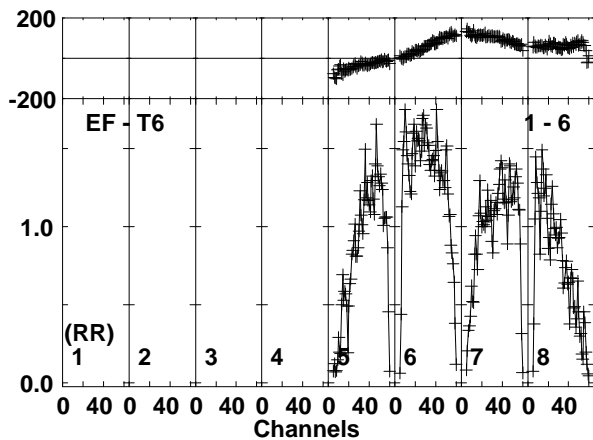
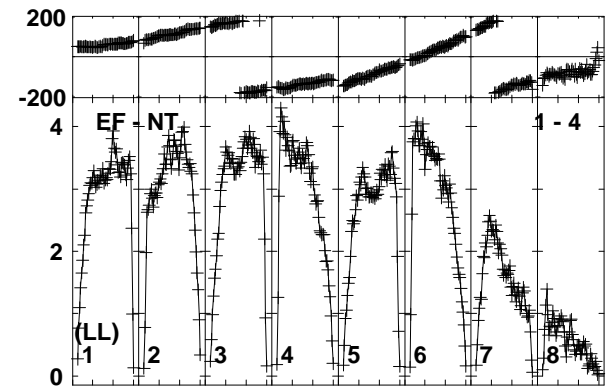
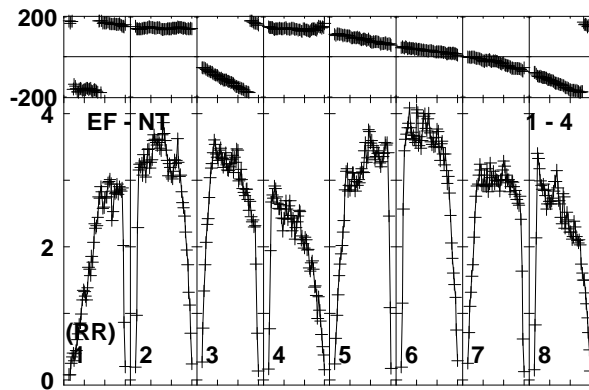
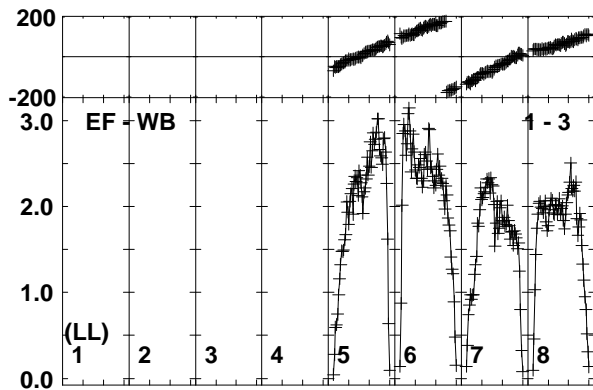
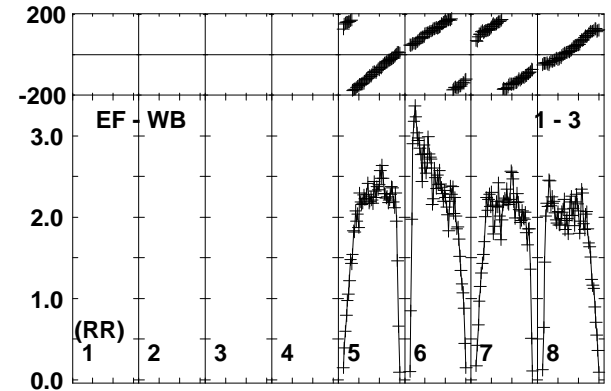
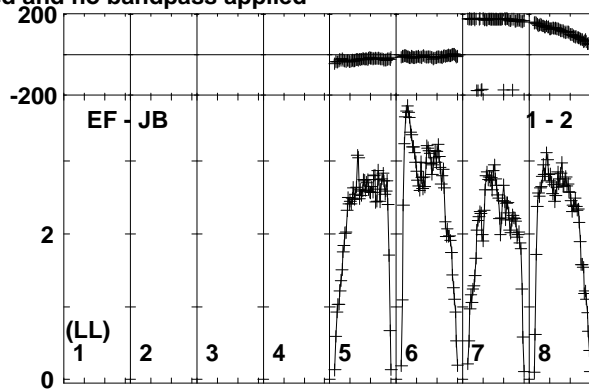
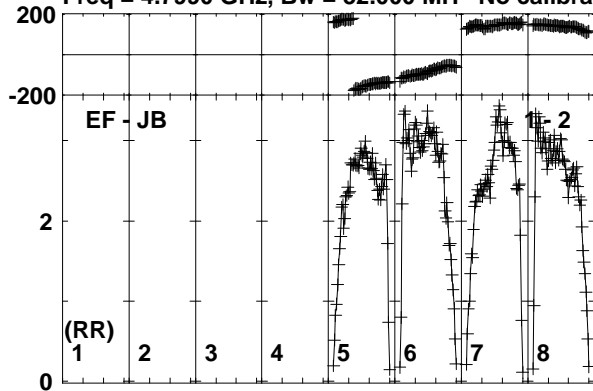

Lower frame: Milli Ampl Jy Top frame: Phas deg
Vector averaged cross-power spectrum Baseline: EF (01) - JB (02)
Timerange: 00/21:47:41 to 00/21:49:09

Plot file version 394 created 19-OCT-2017 15:36:50

J0139+1753 ES081C.UVDATA.1

Freq = 4.7990 GHz, Bw = 32.000 MH No calibration applied and no bandpass applied

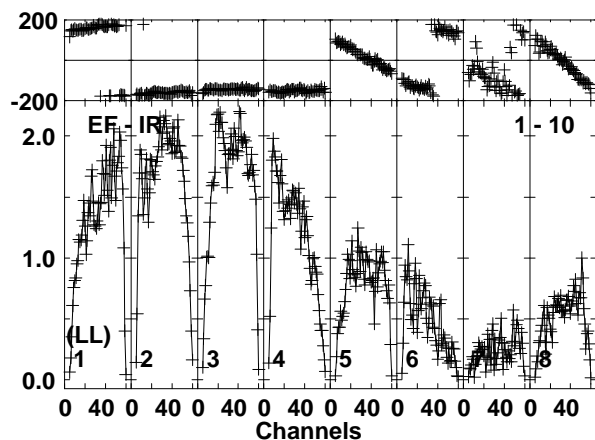
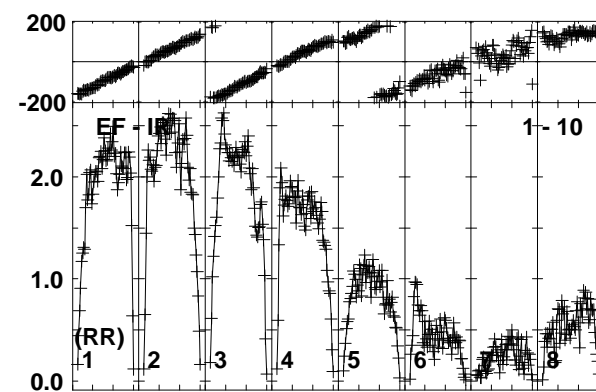
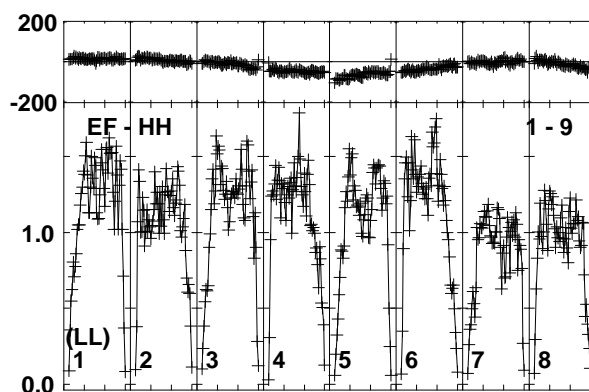
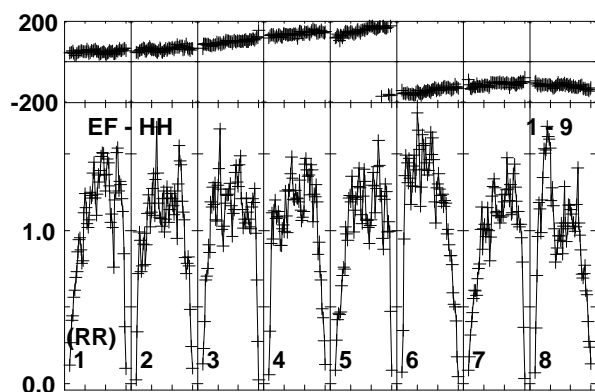
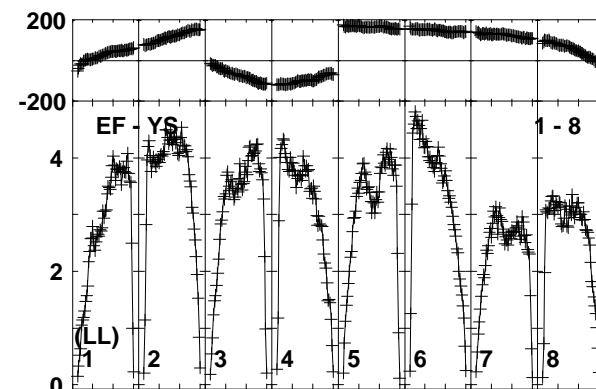
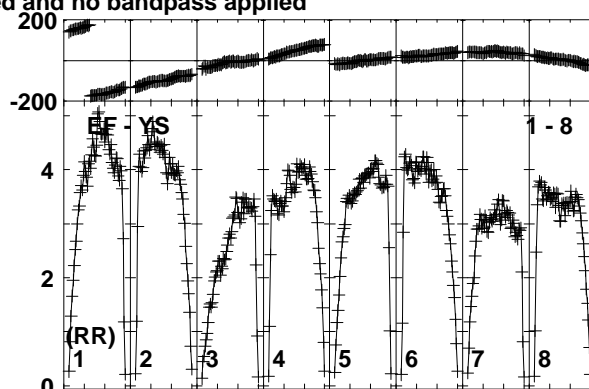
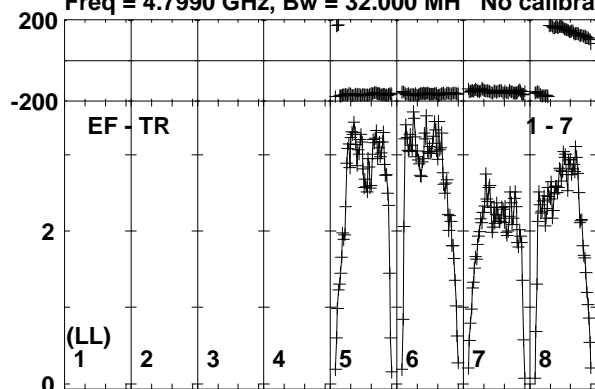

Lower frame: Milli Ampl Jy Top frame: Phas deg
Vector averaged cross-power spectrum Baseline: EF (01) - TR (07)
Timerange: 00/21:47:41 to 00/21:49:09

Plot file version 395 created 19-OCT-2017 15:36:50

MRK359 ES081C.UVDATA.1

Freq = 4.7990 GHz, Bw = 32.000 MH No calibration applied and no bandpass applied

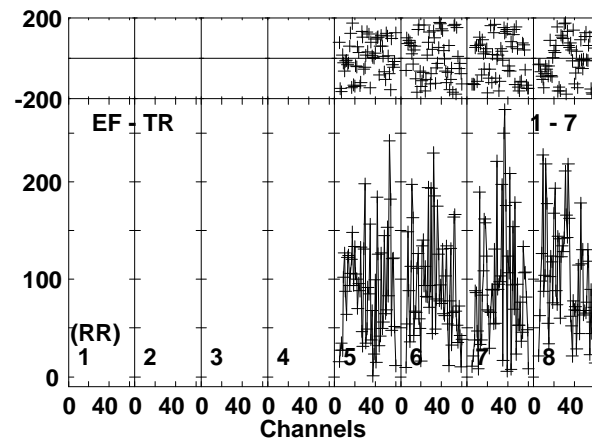
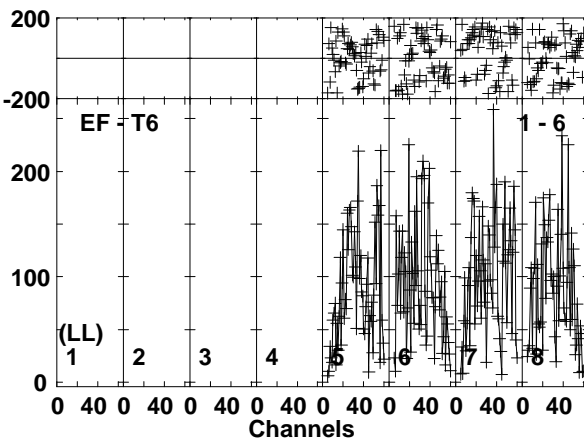
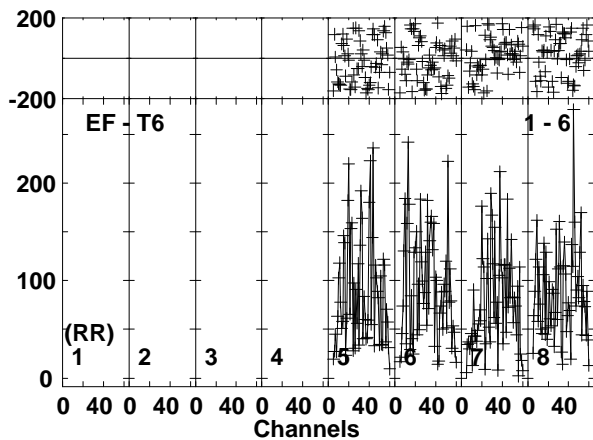
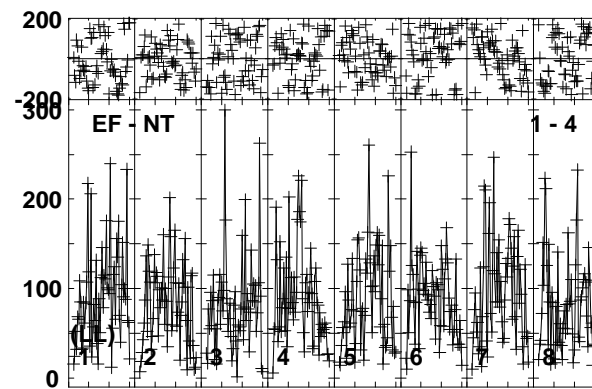
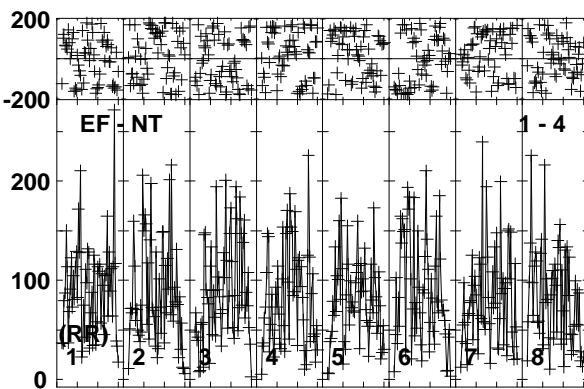
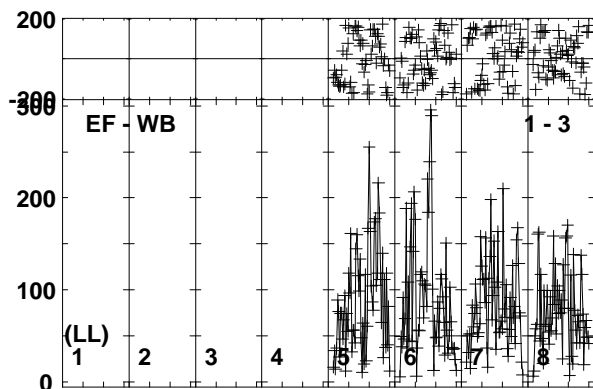
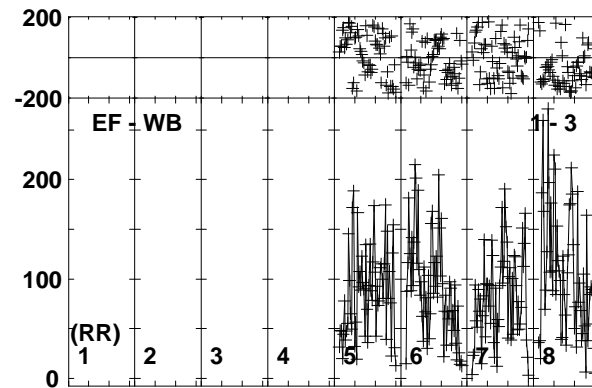
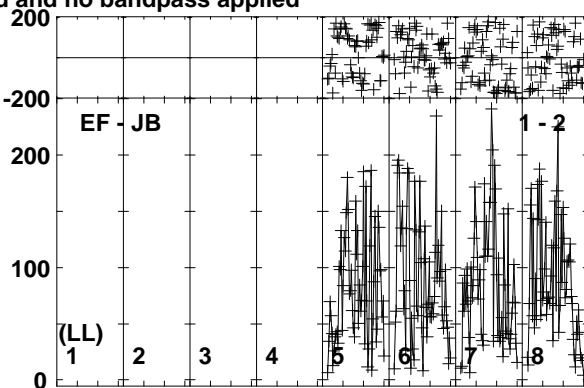
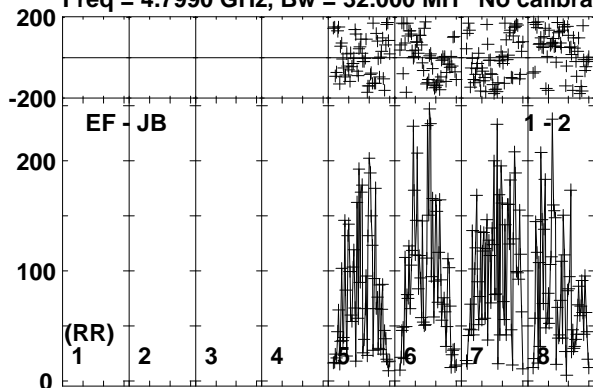

Lower frame: Micro Ampl Jy Top frame: Phas deg
Vector averaged cross-power spectrum Baseline: EF (01) - JB (02)
Timerange: 00/21:49:11 to 00/21:52:39

Plot file version 396 created 19-OCT-2017 15:36:51

MRK359 ES081C.UVDATA.1

Freq = 4.7990 GHz, Bw = 32.000 MH No calibration applied and no bandpass applied

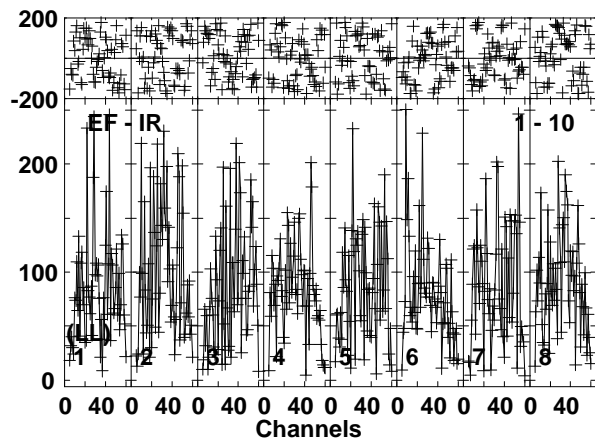
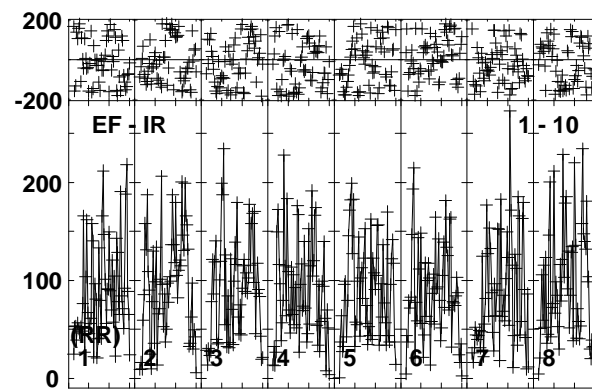
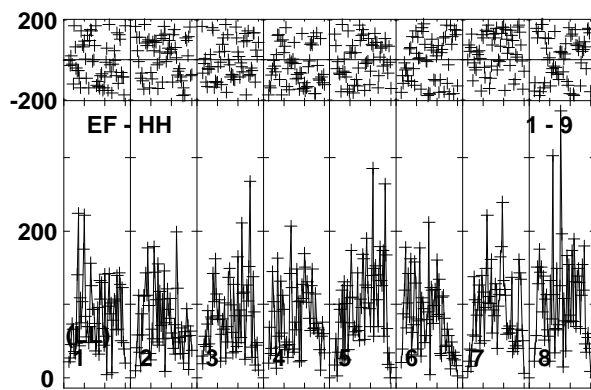
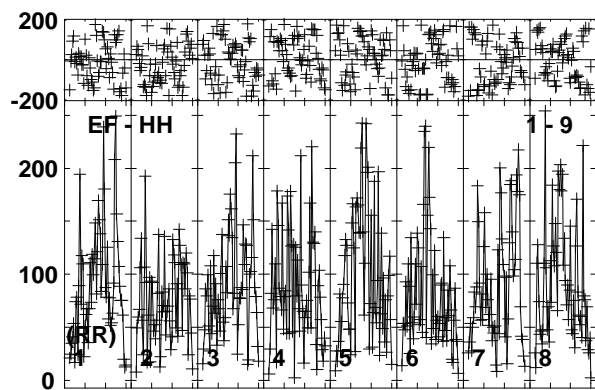
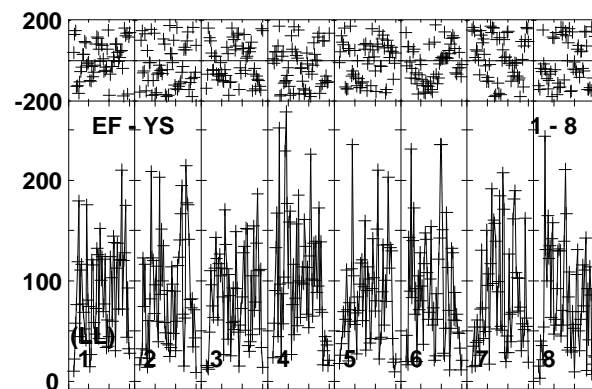
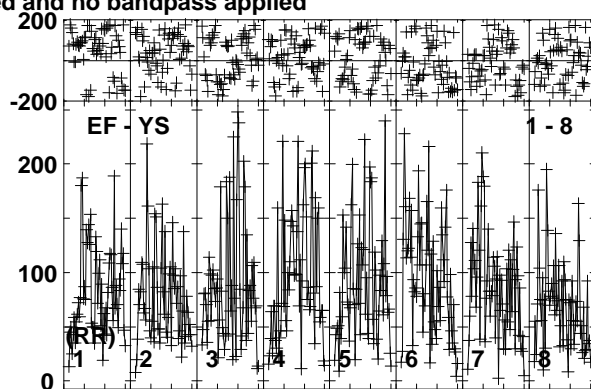
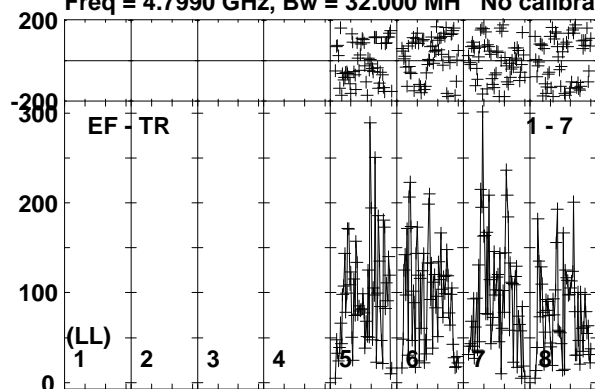

Lower frame: Micro Ampl Jy Top frame: Phas deg
Vector averaged cross-power spectrum Baseline: EF (01) - TR (07)
Timerange: 00/21:49:11 to 00/21:52:39

Plot file version 397 created 19-OCT-2017 15:36:51

J0139+1753 ES081C.UVDATA.1

Freq = 4.7990 GHz, Bw = 32.000 MH No calibration applied and no bandpass applied

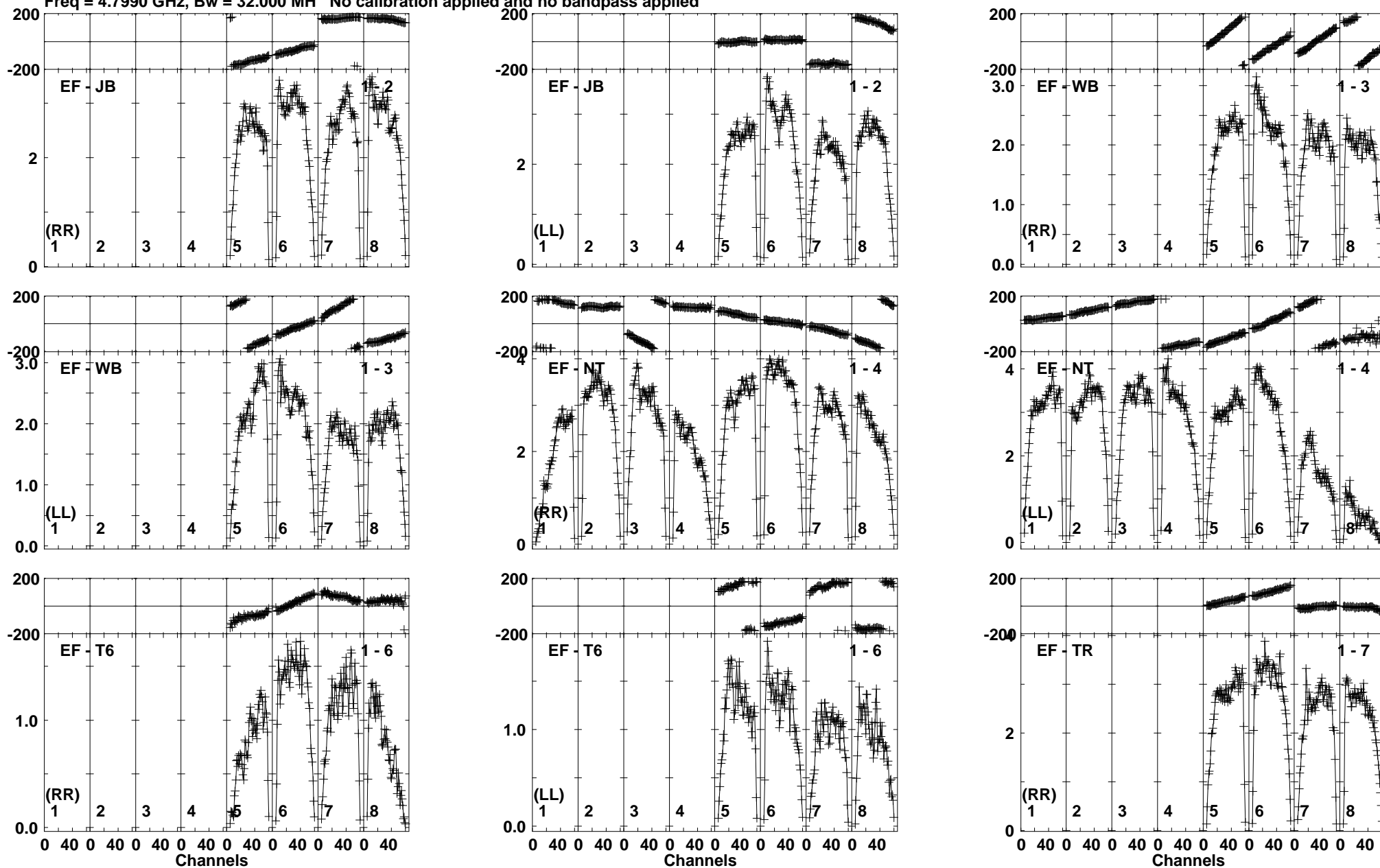

Lower frame: Milli Ampl Jy Top frame: Phas deg
Vector averaged cross-power spectrum Baseline: EF (01) - JB (02)
Timerange: 00/21:53:21 to 00/21:54:19

Plot file version 398 created 19-OCT-2017 15:36:51

J0139+1753 ES081C.UVDATA.1

Freq = 4.7990 GHz, Bw = 32.000 MH No calibration applied and no bandpass applied

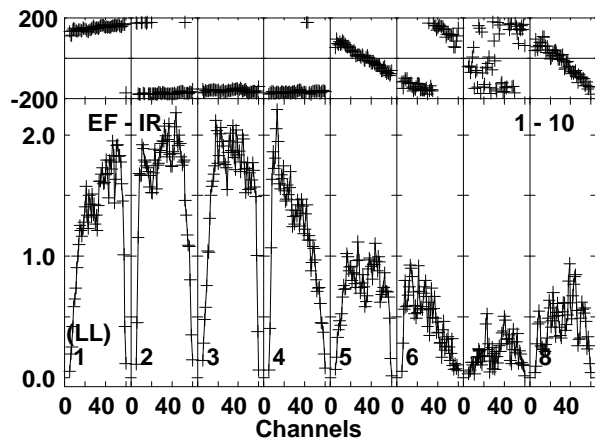
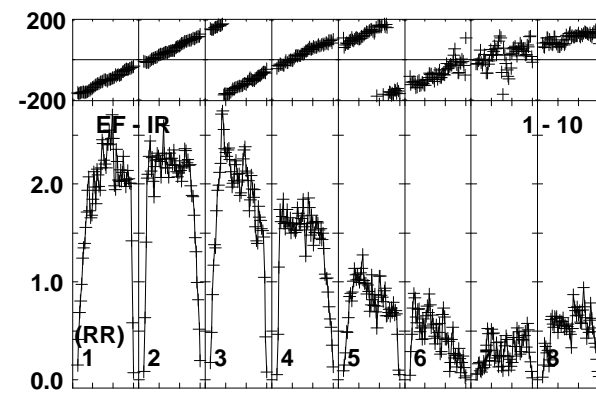
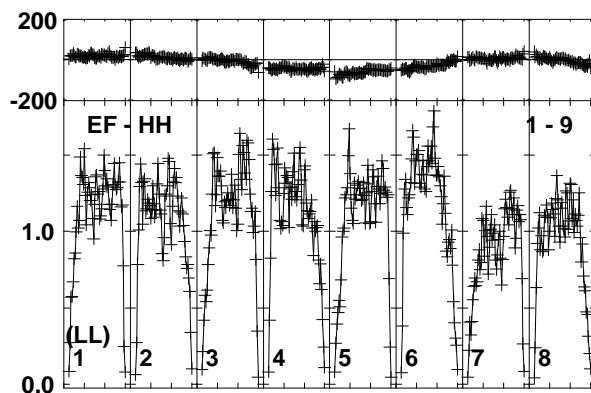
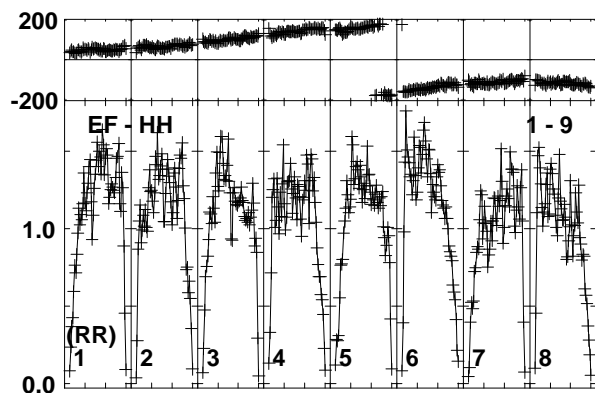
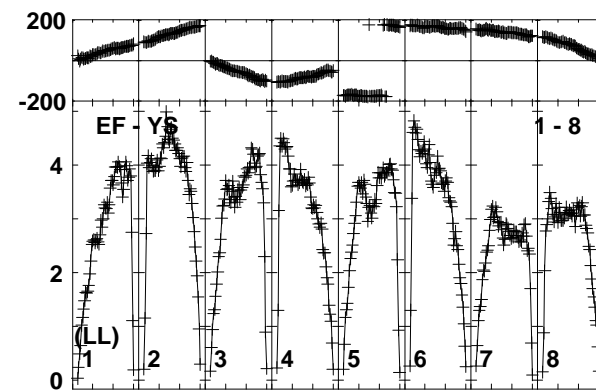
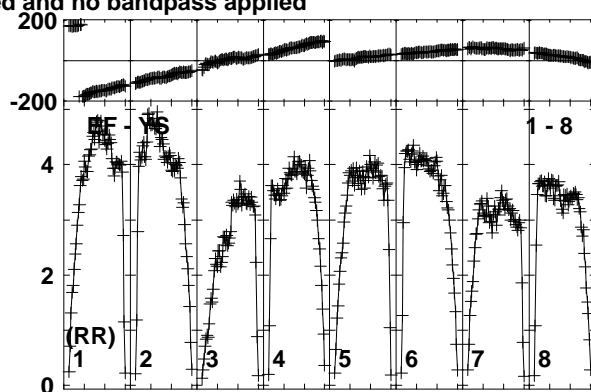
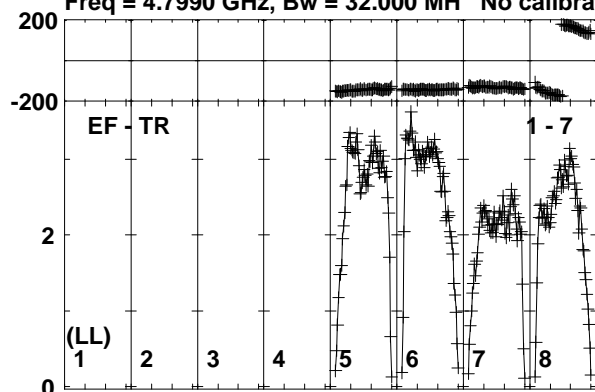

Lower frame: Milli Ampl Jy Top frame: Phas deg
Vector averaged cross-power spectrum Baseline: EF (01) - TR (07)
Timerange: 00/21:53:21 to 00/21:54:19

Plot file version 399 created 19-OCT-2017 15:36:51
 MRK359 ES081C.UVDATA.1
 Freq = 4.7990 GHz, Bw = 32.000 MH No calibration applied and no bandpass applied

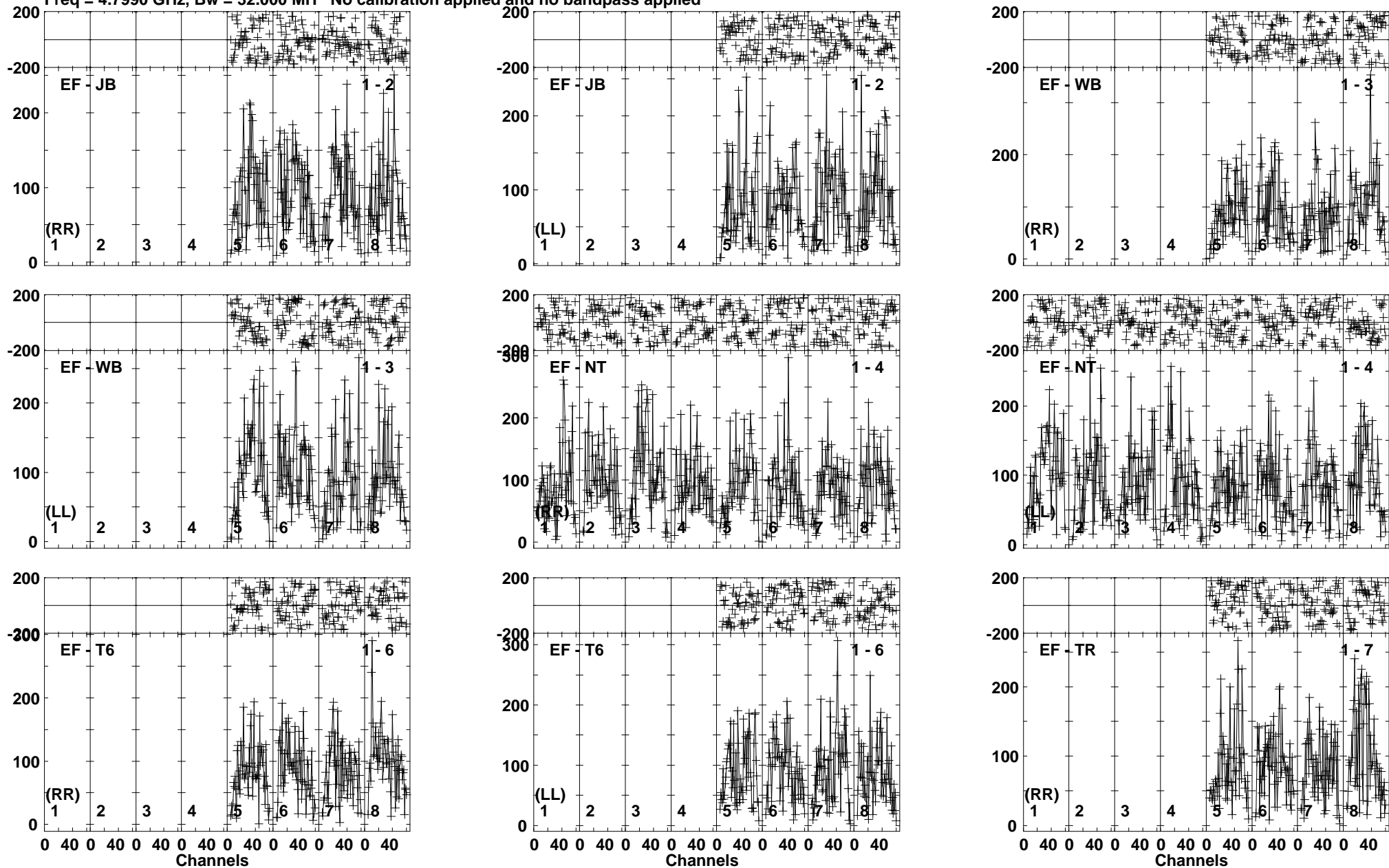

Lower frame: Micro Ampl Jy Top frame: Phas deg
 Vector averaged cross-power spectrum Baseline: EF (01) - JB (02)
 Timerange: 00/21:54:21 to 00/21:57:49

Plot file version 400 created 19-OCT-2017 15:36:51

MRK359 ES081C.UVDATA.1

Freq = 4.7990 GHz, Bw = 32.000 MH No calibration applied and no bandpass applied

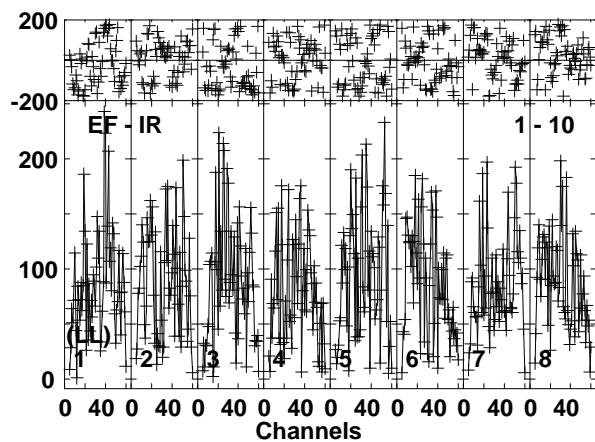
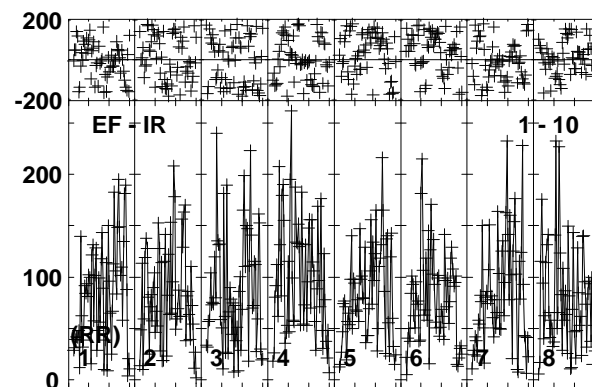
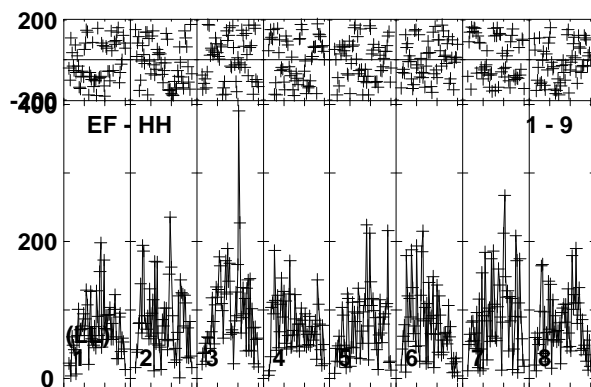
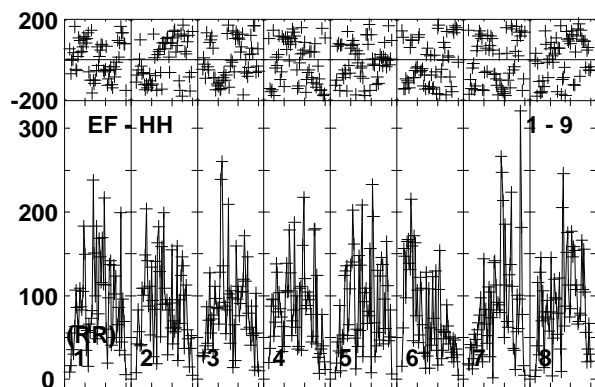
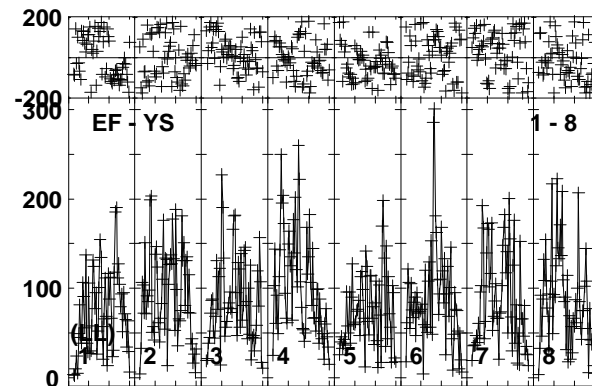
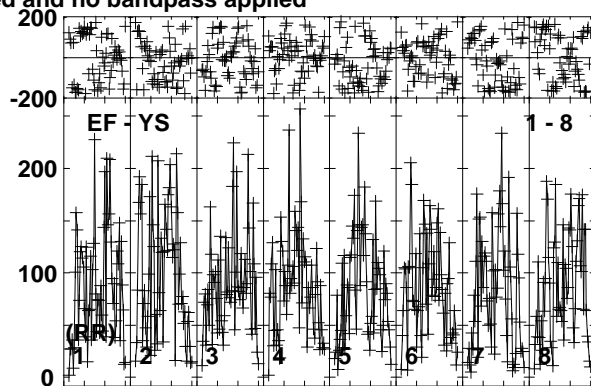
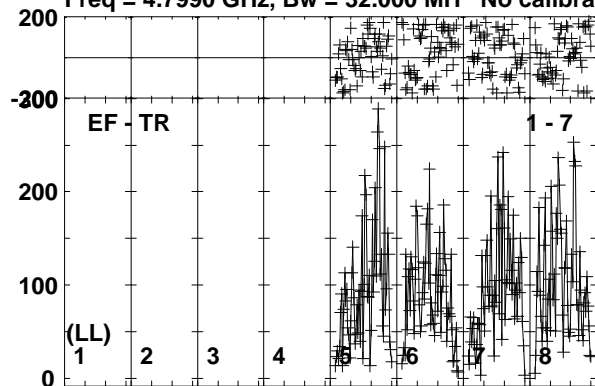

Lower frame: Micro Ampl Jy Top frame: Phas deg
Vector averaged cross-power spectrum Baseline: EF (01) - TR (07)
Timerange: 00/21:54:21 to 00/21:57:49

Plot file version 401 created 19-OCT-2017 15:36:51

J0139+1753 ES081C.UVDATA.1

Freq = 4.7990 GHz, Bw = 32.000 MH No calibration applied and no bandpass applied

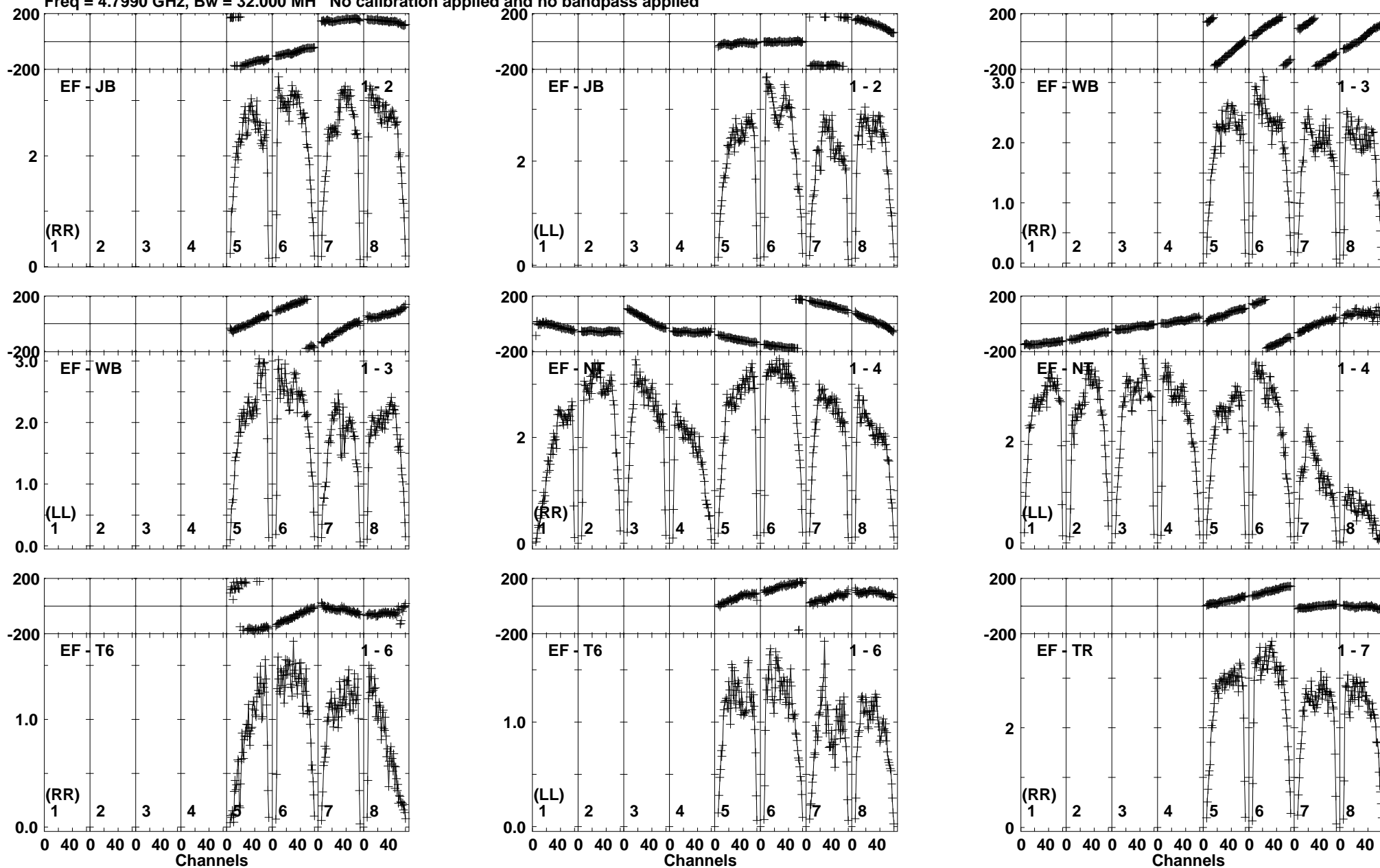

Lower frame: Milli Ampl Jy Top frame: Phas deg
Vector averaged cross-power spectrum Baseline: EF (01) - JB (02)
Timerange: 00/21:57:51 to 00/21:59:19

Plot file version 402 created 19-OCT-2017 15:36:51

J0139+1753 ES081C.UVDATA.1

Freq = 4.7990 GHz, Bw = 32.000 MH No calibration applied and no bandpass applied

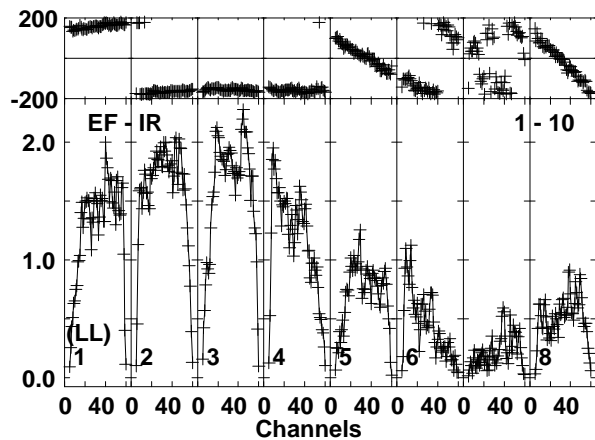
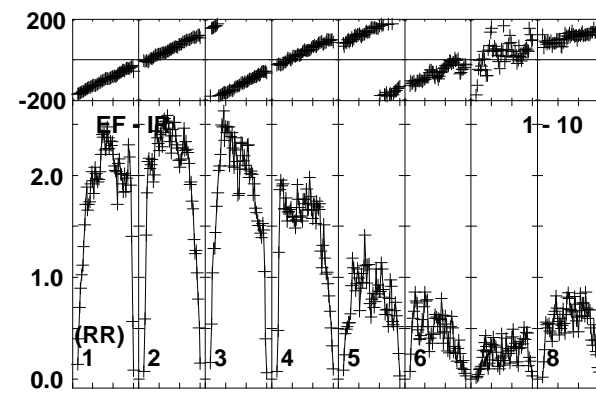
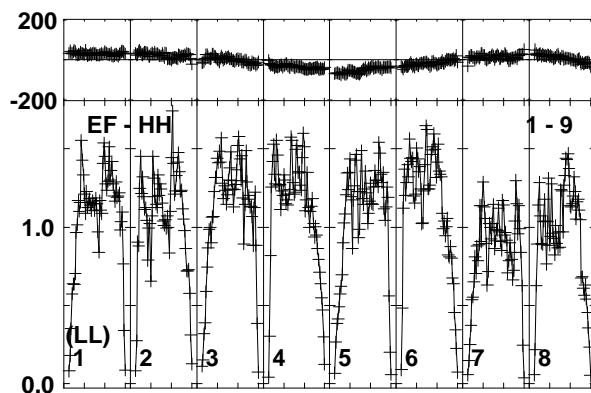
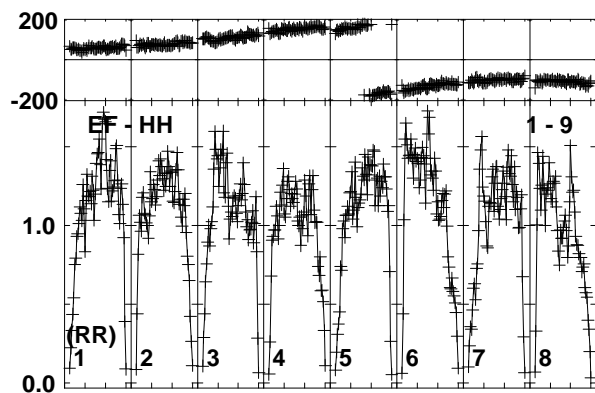
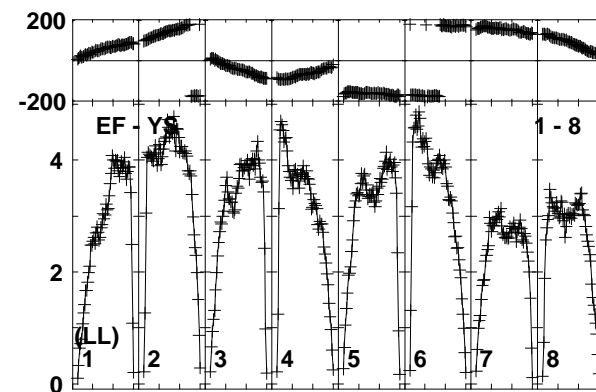
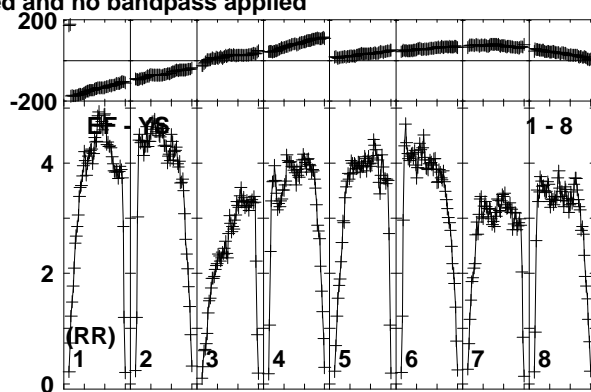
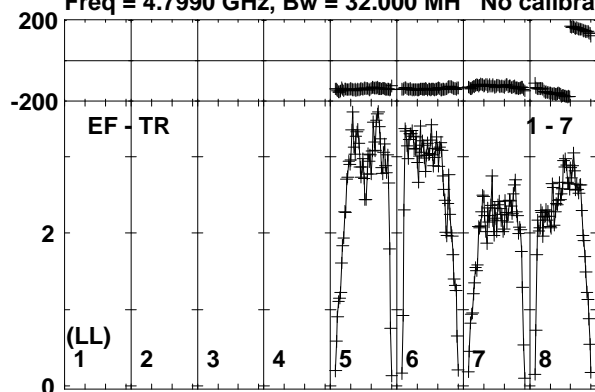

Lower frame: Milli Ampl Jy Top frame: Phas deg
Vector averaged cross-power spectrum Baseline: EF (01) - TR (07)
Timerange: 00/21:57:51 to 00/21:59:19

Plot file version 403 created 19-OCT-2017 15:36:52

MRK359 ES081C.UVDATA.1

Freq = 4.7990 GHz, Bw = 32.000 MH No calibration applied and no bandpass applied

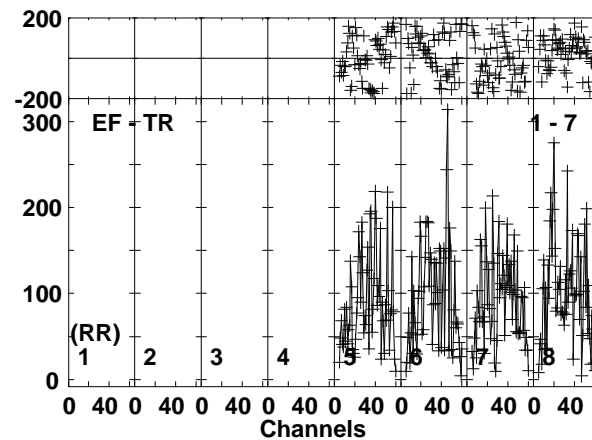
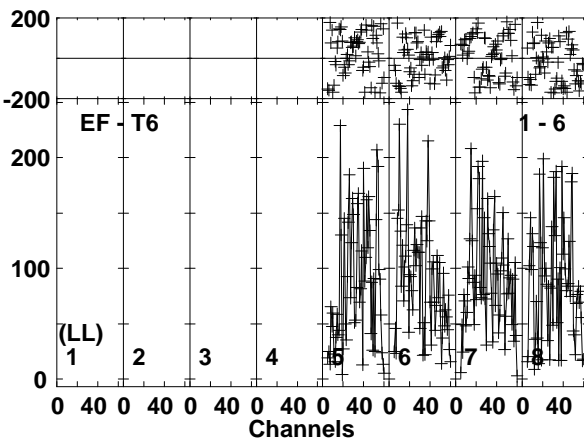
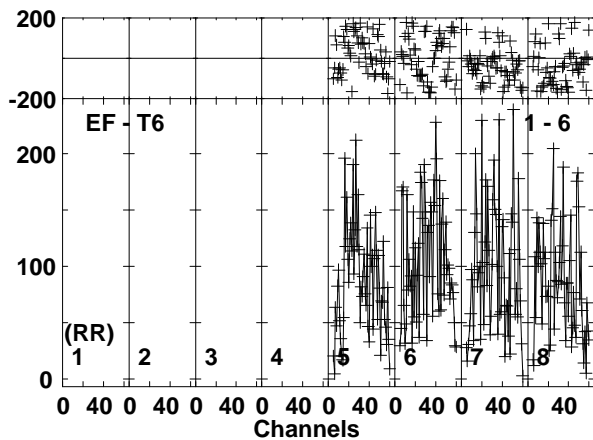
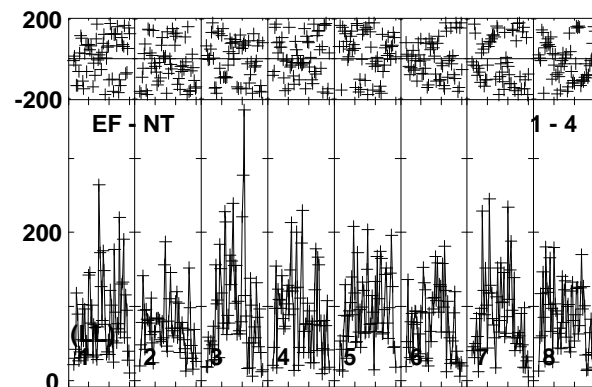
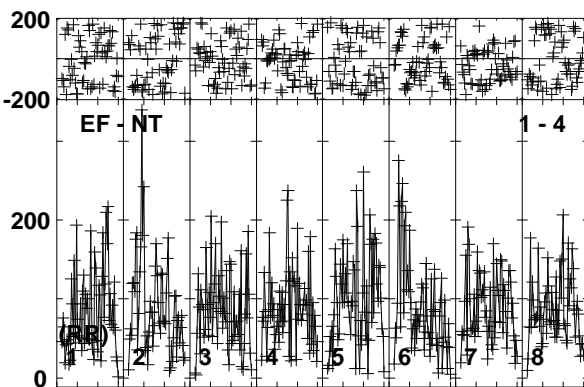
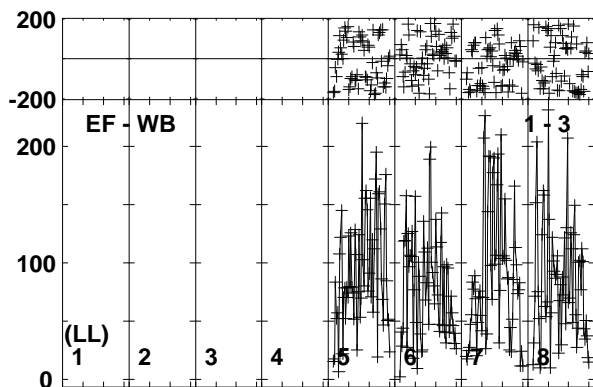
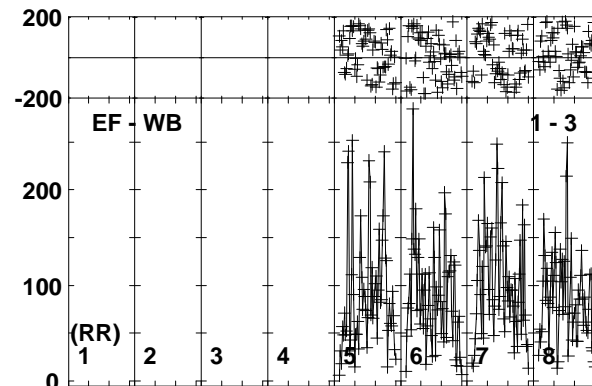
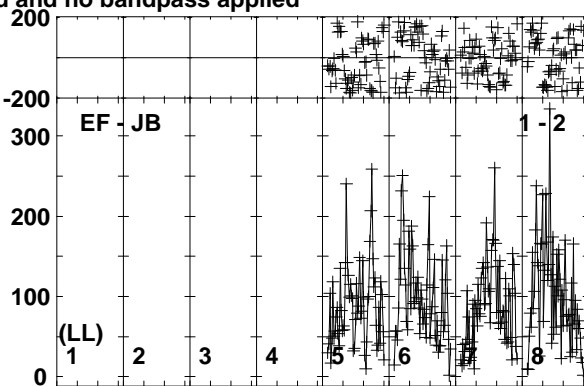
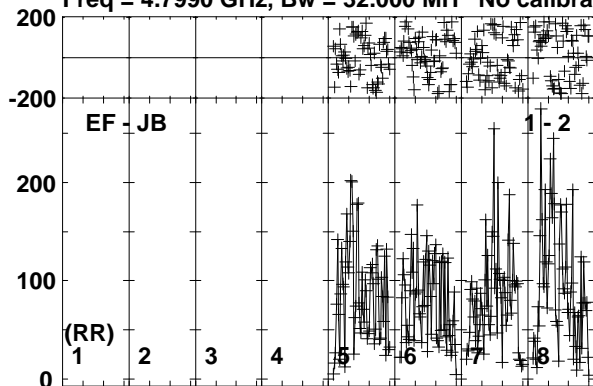

Lower frame: Micro Ampl Jy Top frame: Phas deg
Vector averaged cross-power spectrum Baseline: EF (01) - JB (02)
Timerange: 00/21:59:21 to 00/22:02:49

Plot file version 404 created 19-OCT-2017 15:36:52

MRK359 ES081C.UVDATA.1

Freq = 4.7990 GHz, Bw = 32.000 MH No calibration applied and no bandpass applied

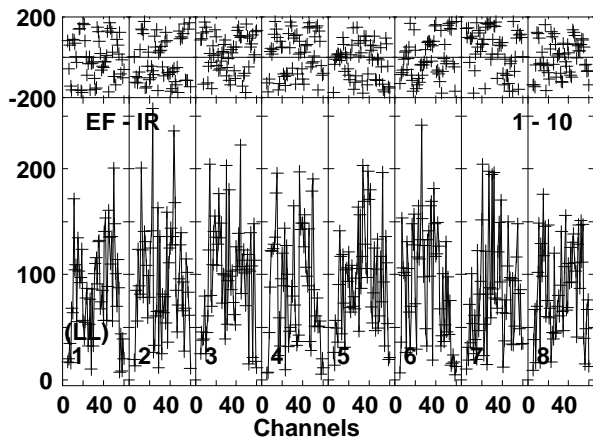
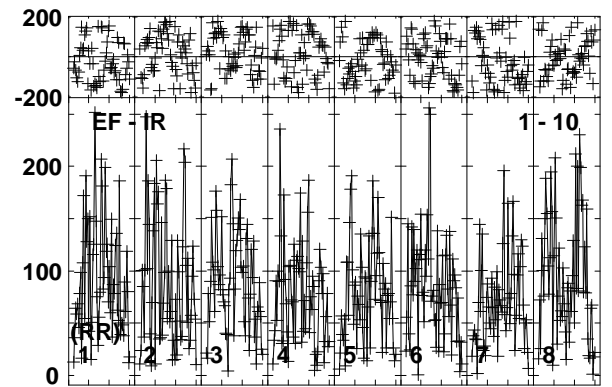
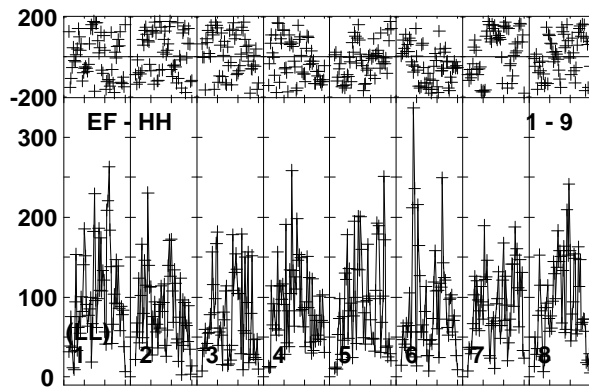
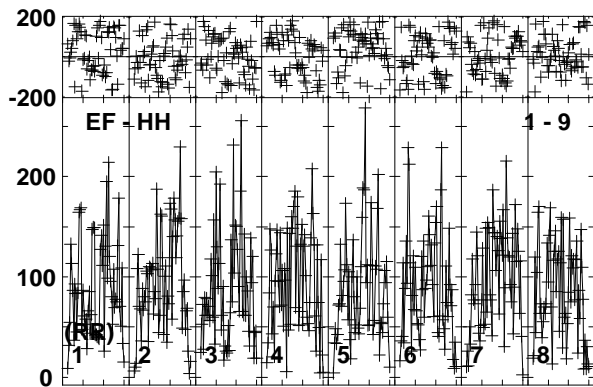
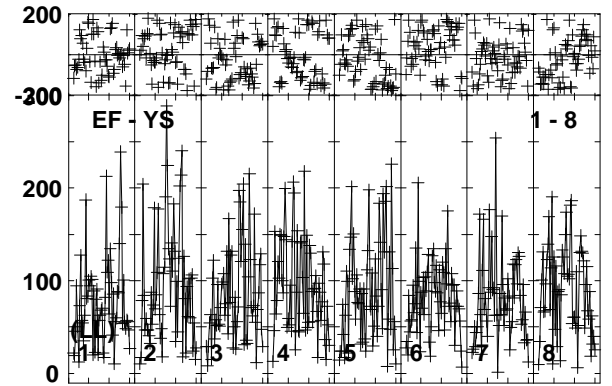
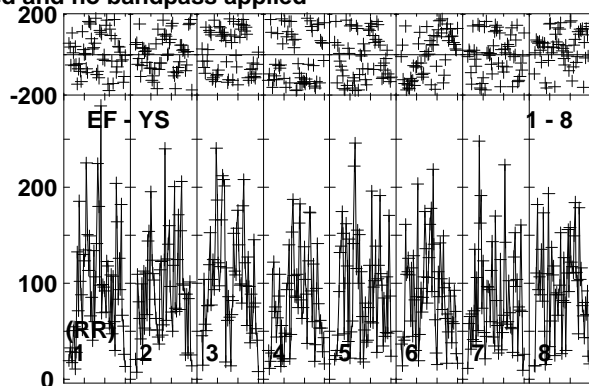
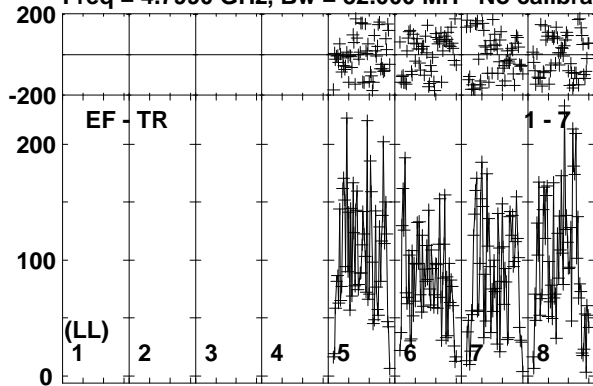

Lower frame: Micro Ampl Jy Top frame: Phas deg
Vector averaged cross-power spectrum Baseline: EF (01) - TR (07)
Timerange: 00/21:59:21 to 00/22:02:49

Plot file version 405 created 19-OCT-2017 15:36:52

J0139+1753 ES081C.UVDATA.1

Freq = 4.7990 GHz, Bw = 32.000 MH No calibration applied and no bandpass applied

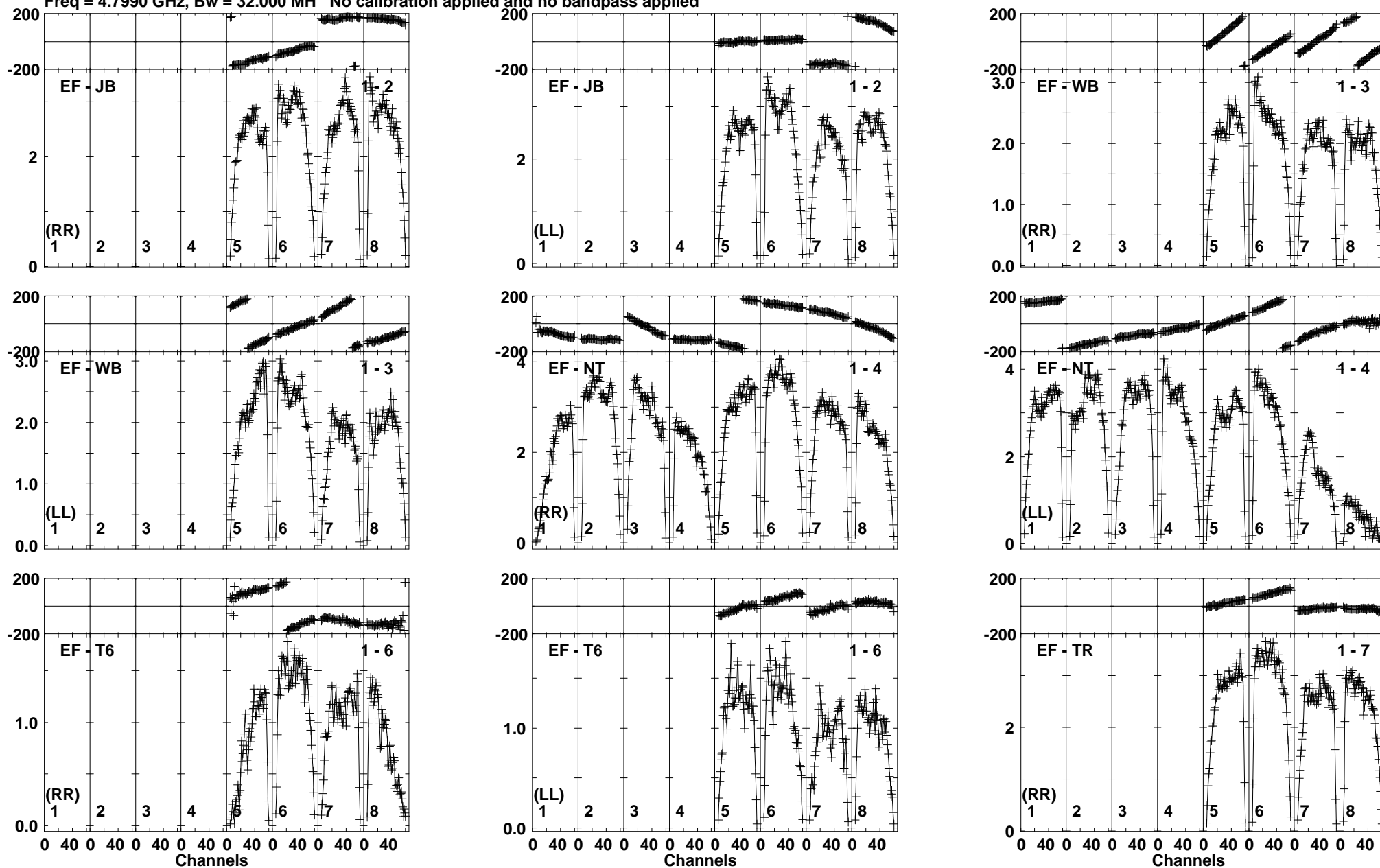

Lower frame: Milli Ampl Jy Top frame: Phas deg
Vector averaged cross-power spectrum Baseline: EF (01) - JB (02)
Timerange: 00/22:03:31 to 00/22:04:29

Plot file version 406 created 19-OCT-2017 15:36:52

J0139+1753 ES081C.UVDATA.1

Freq = 4.7990 GHz, Bw = 32.000 MH No calibration applied and no bandpass applied

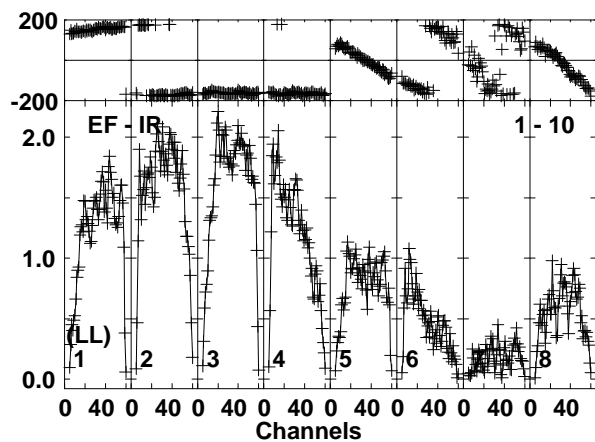
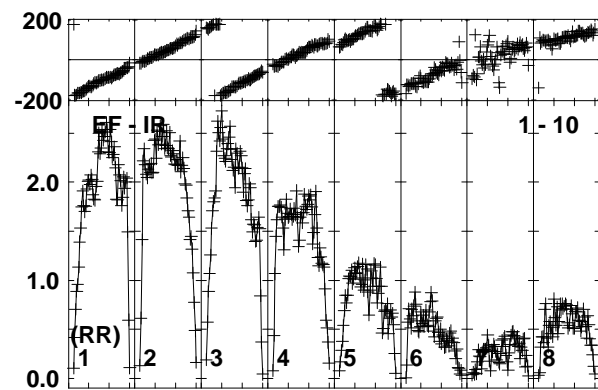
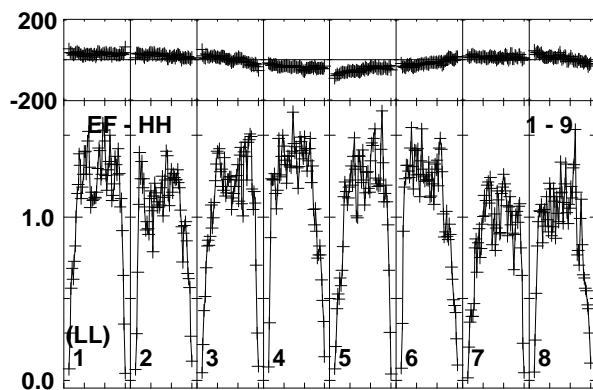
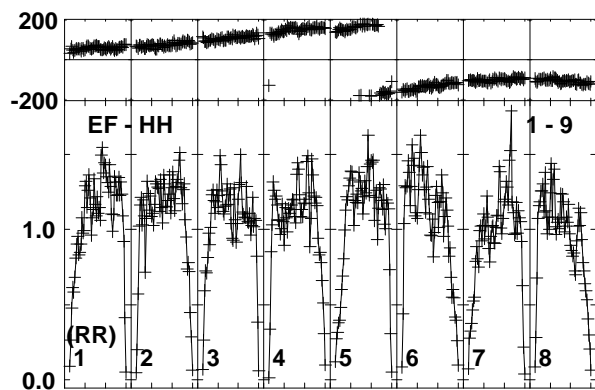
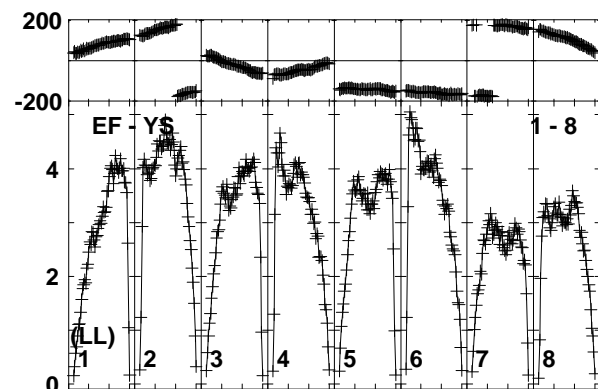
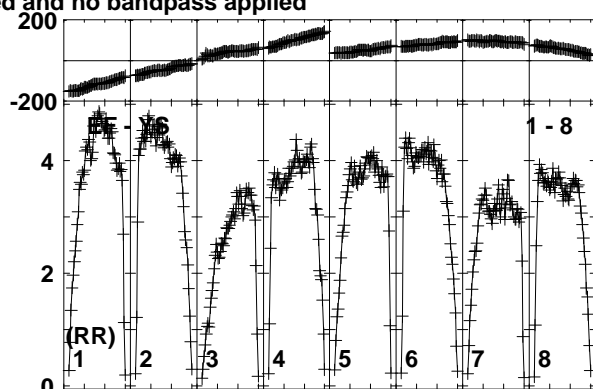
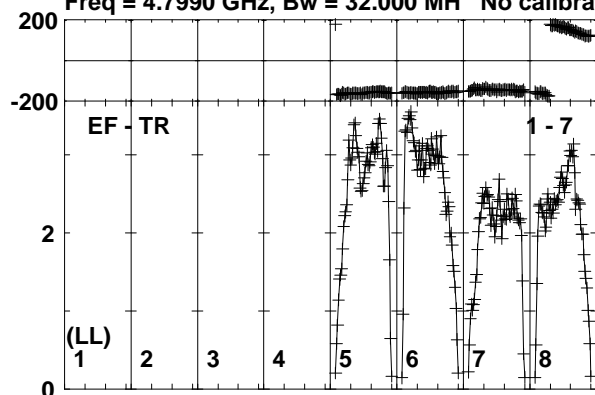

Lower frame: Milli Ampl Jy Top frame: Phas deg
Vector averaged cross-power spectrum Baseline: EF (01) - TR (07)
Timerange: 00:22:03:31 to 00:22:04:29

Plot file version 407 created 19-OCT-2017 15:36:52

MRK359 ES081C.UVDATA.1

Freq = 4.7990 GHz, Bw = 32.000 MHz No calibration applied and no bandpass applied

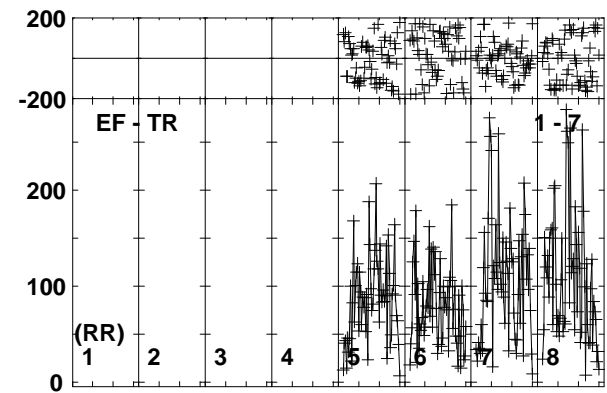
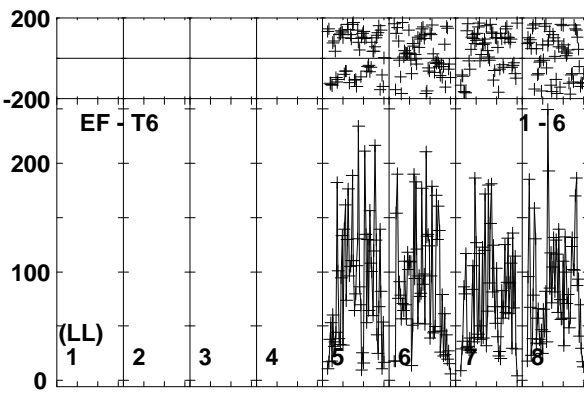
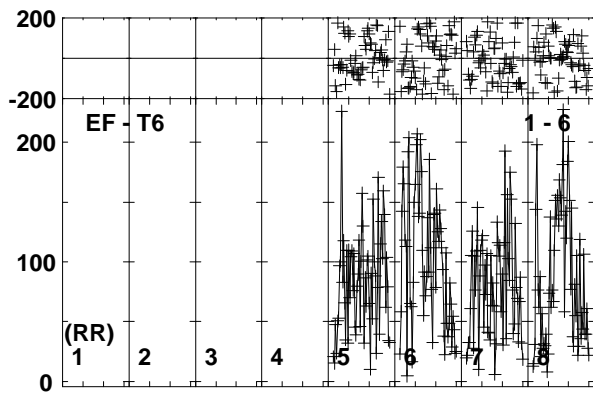
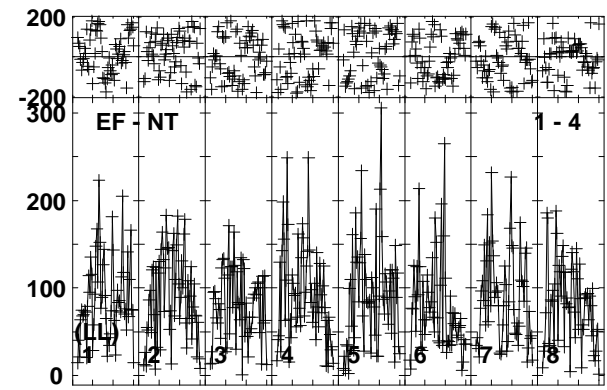
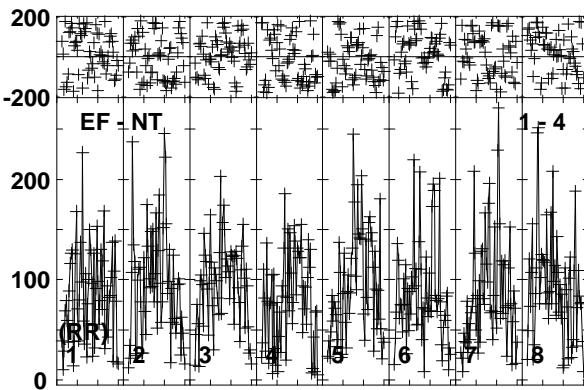
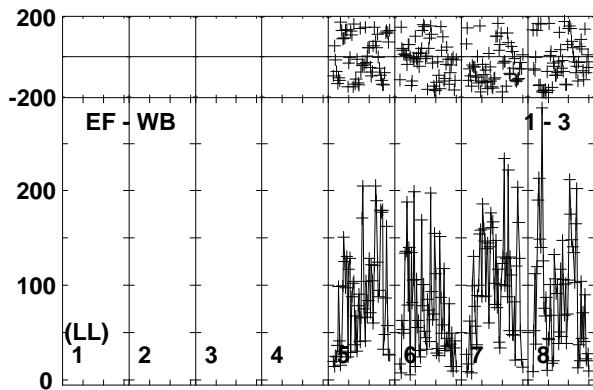
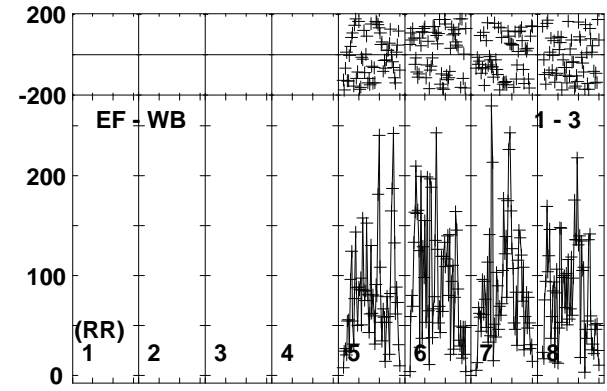
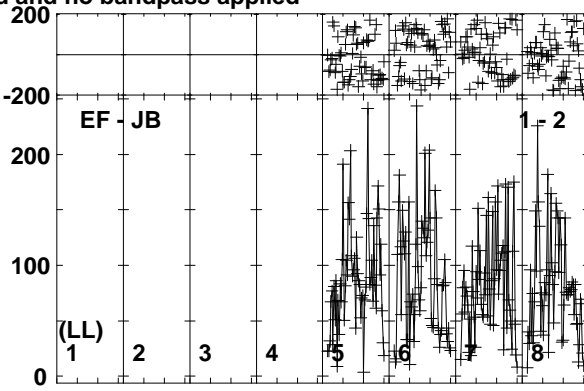
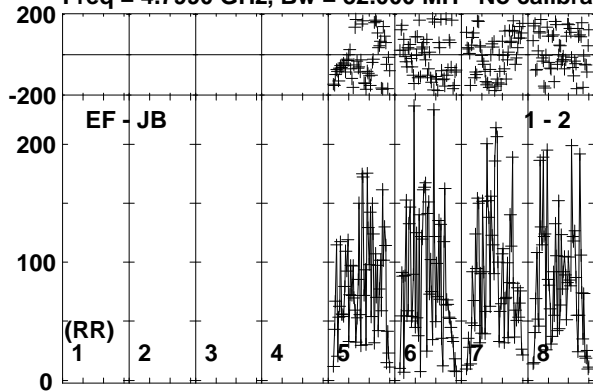

Lower frame: Micro Ampl Jy Top frame: Phas deg
Vector averaged cross-power spectrum Baseline: EF (01) - JB (02)
Timerange: 00/22:04:31 to 00/22:07:59

Plot file version 408 created 19-OCT-2017 15:36:52

MRK359 ES081C.UVDATA.1

Freq = 4.7990 GHz, Bw = 32.000 MH No calibration applied and no bandpass applied

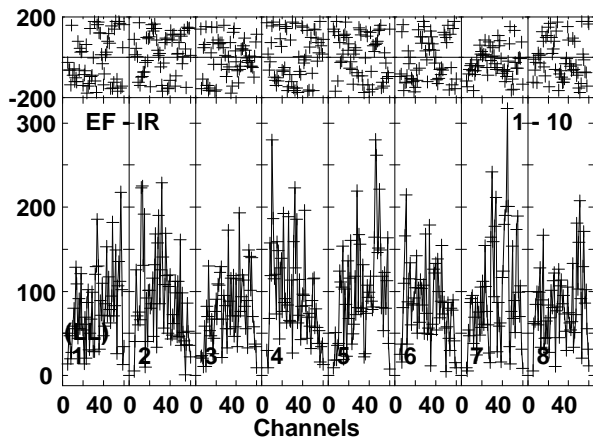
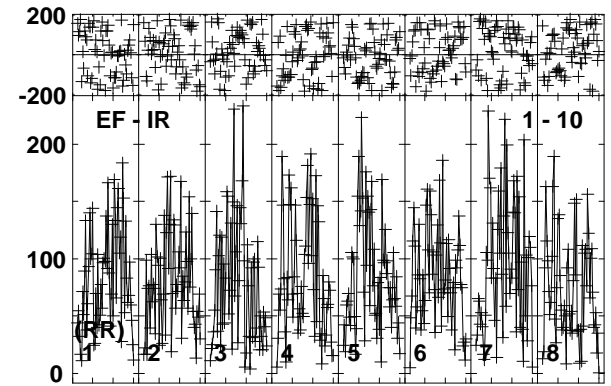
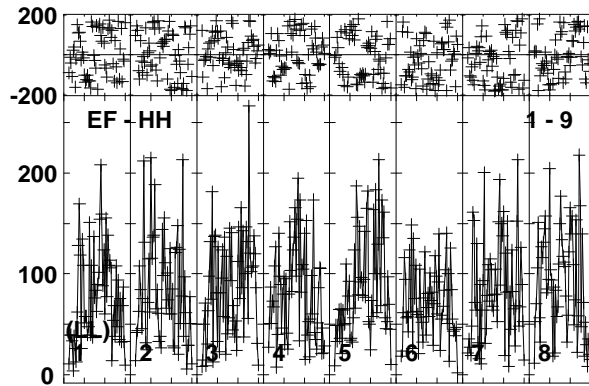
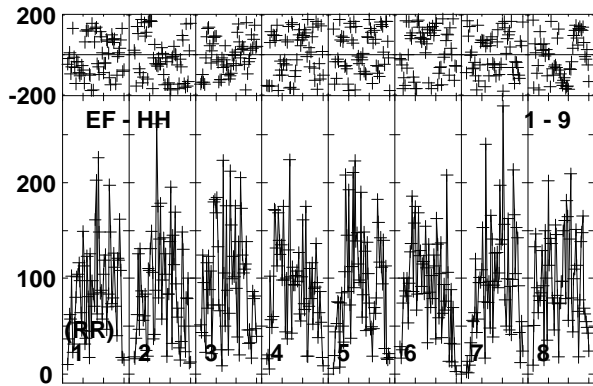
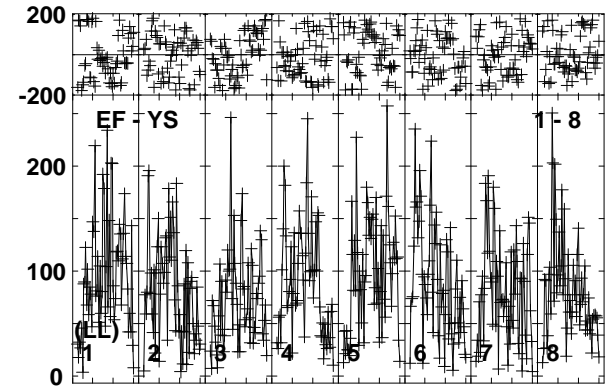
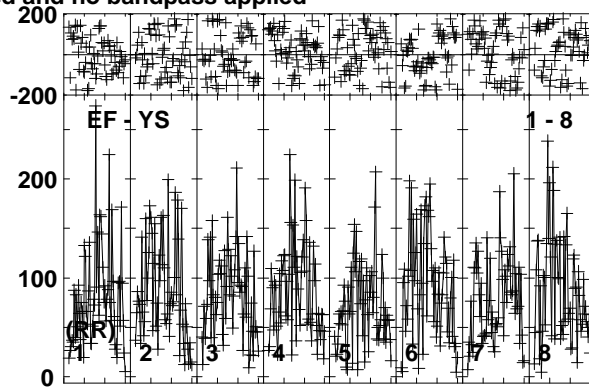
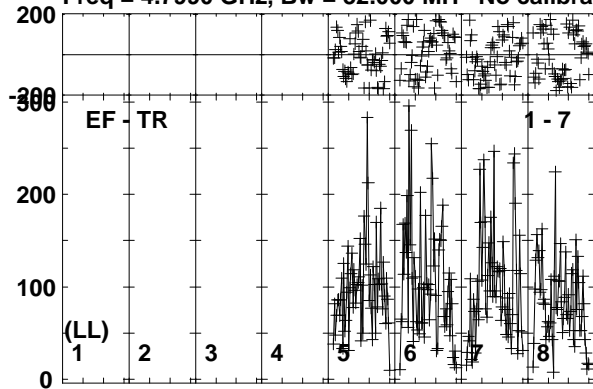

Lower frame: Micro Ampl Jy Top frame: Phas deg
Vector averaged cross-power spectrum Baseline: EF (01) - TR (07)
Timerange: 00:22:04:31 to 00:22:07:59

Plot file version 409 created 19-OCT-2017 15:36:52
 J0139+1753 ES081C.UVDATA.1
 Freq = 4.7990 GHz, Bw = 32.000 MH No calibration applied and no bandpass applied

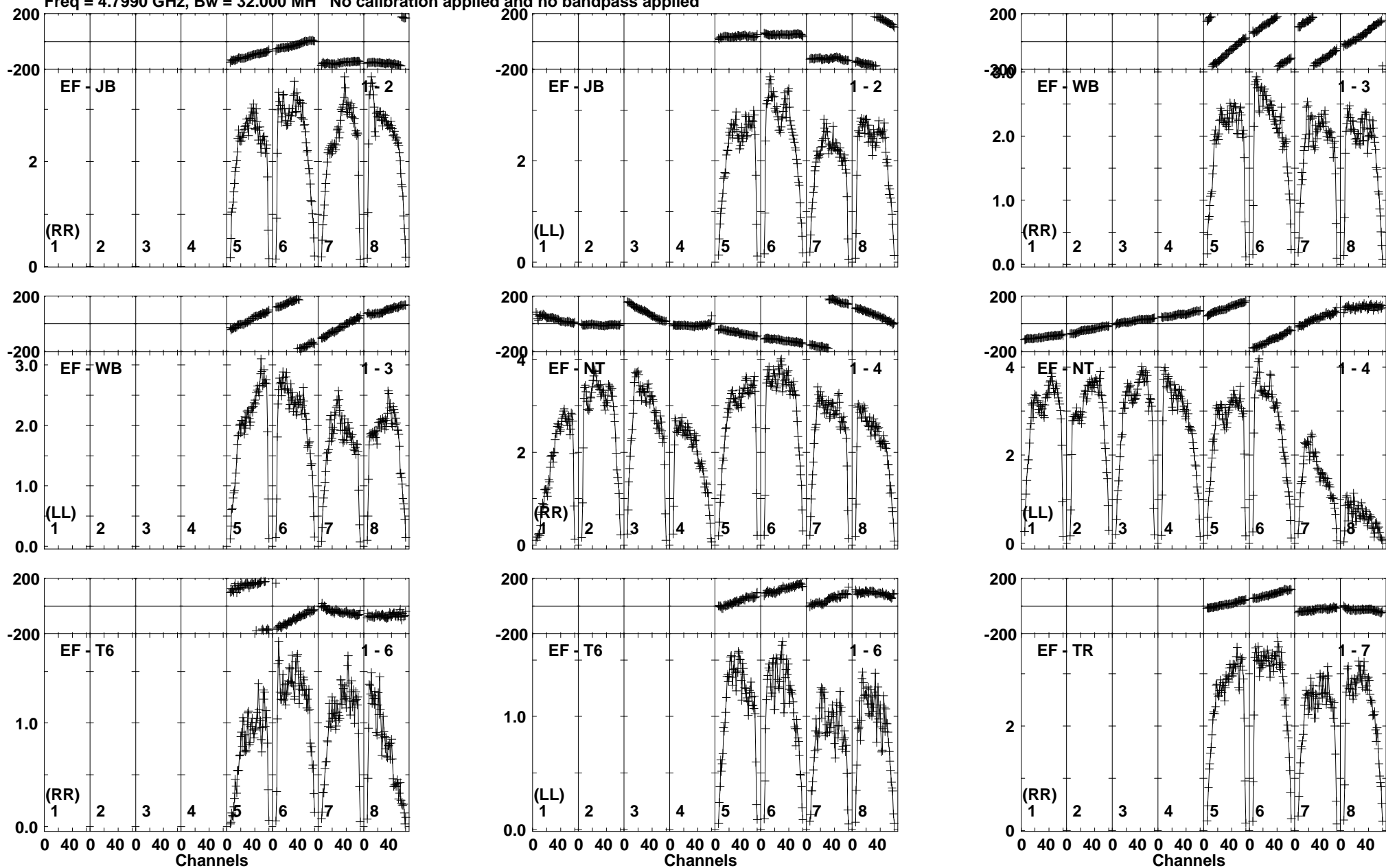

Lower frame: Milli Ampl Jy Top frame: Phas deg
 Vector averaged cross-power spectrum Baseline: EF (01) - JB (02)
 Timerange: 00/22:08:01 to 00/22:09:29

Plot file version 410 created 19-OCT-2017 15:36:53

J0139+1753 ES081C.UVDATA.1

Freq = 4.7990 GHz, Bw = 32.000 MH No calibration applied and no bandpass applied

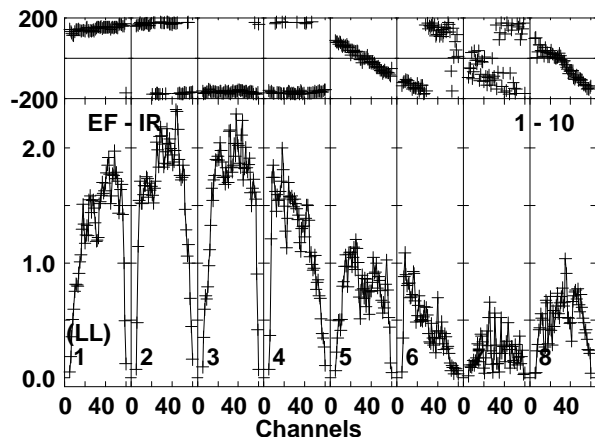
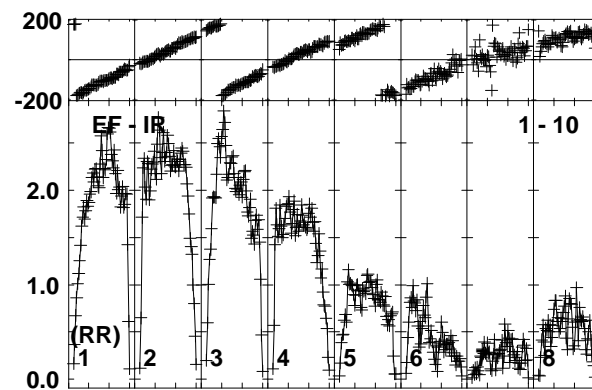
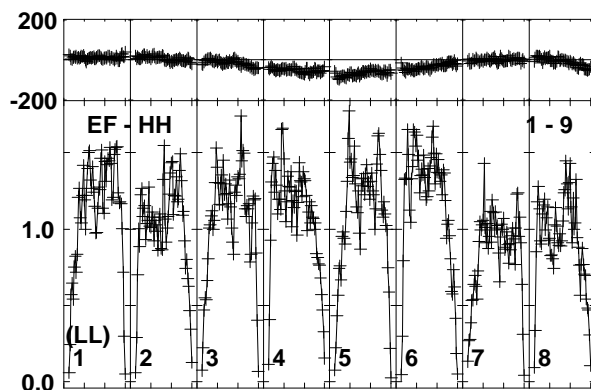
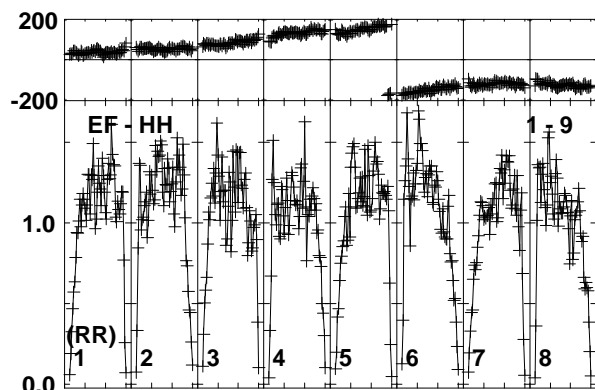
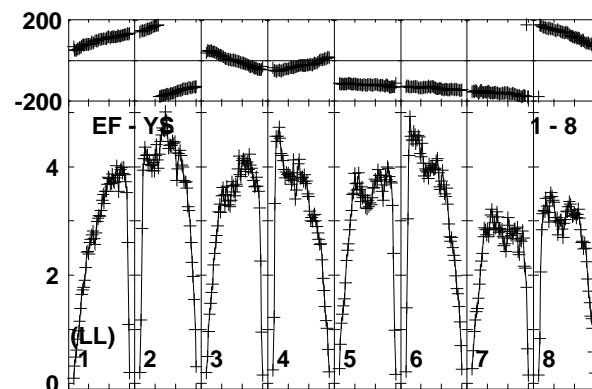
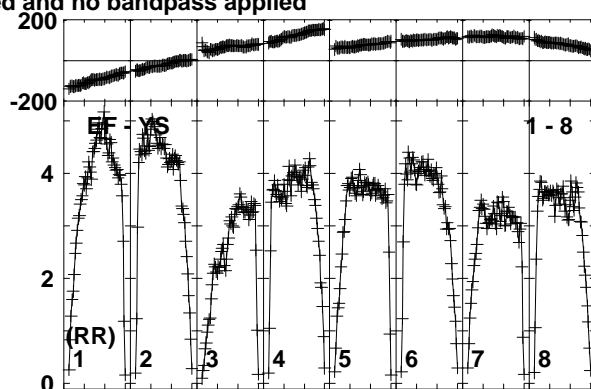
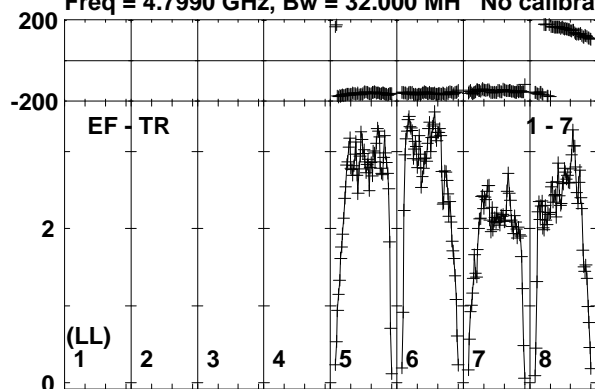

Lower frame: Milli Ampl Jy Top frame: Phas deg
Vector averaged cross-power spectrum Baseline: EF (01) - TR (07)
Timerange: 00/22:08:01 to 00/22:09:29

Plot file version 411 created 19-OCT-2017 15:36:53
 MRK359 ES081C.UVDATA.1
 Freq = 4.7990 GHz, Bw = 32.000 MH No calibration applied and no bandpass applied

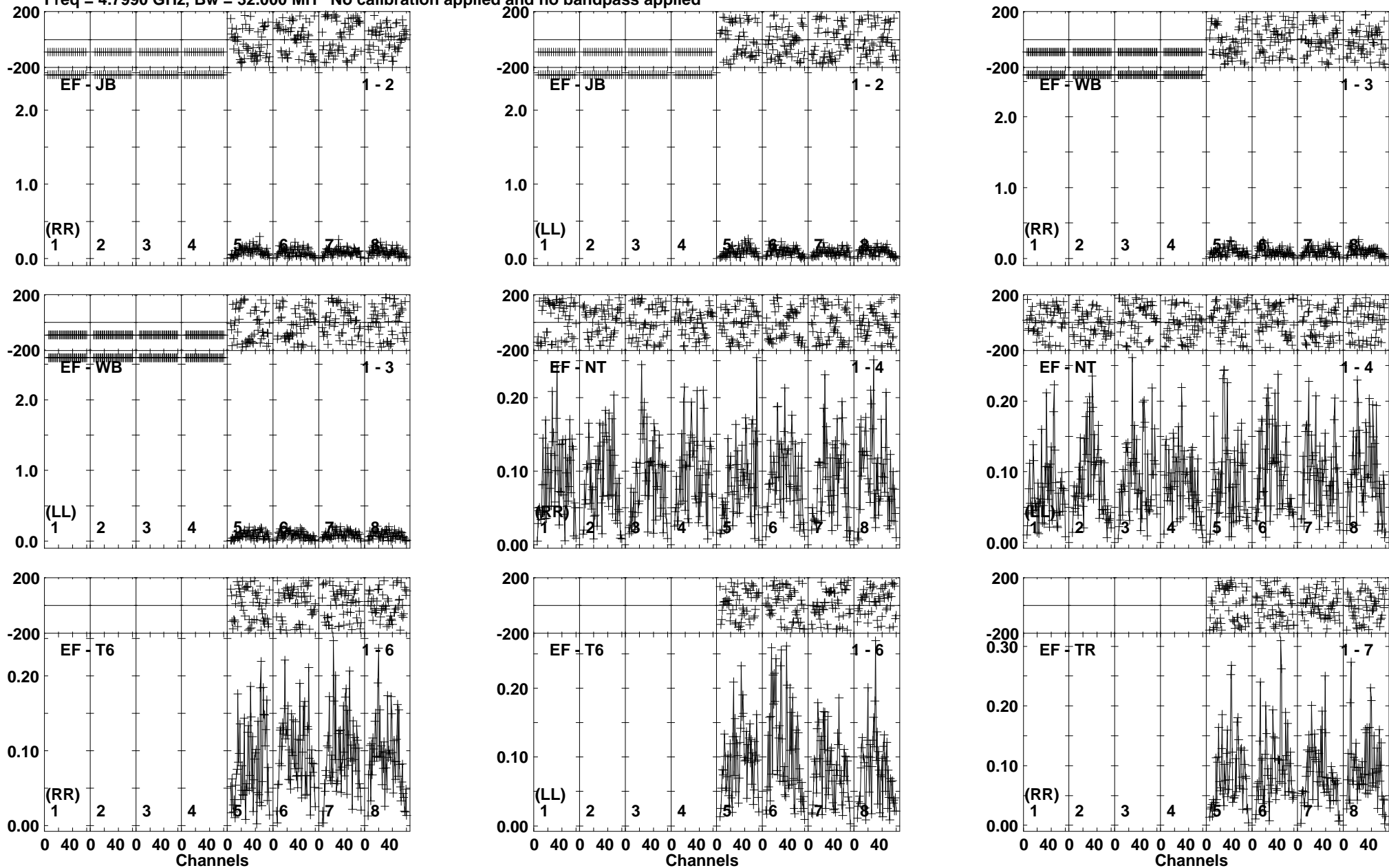

Lower frame: Milli Ampl Jy Top frame: Phas deg
 Vector averaged cross-power spectrum Baseline: EF (01) - JB (02)
 Timerange: 00/22:09:31 to 00/22:12:59

Plot file version 412 created 19-OCT-2017 15:36:53

MRK359 ES081C.UVDATA.1

Freq = 4.7990 GHz, Bw = 32.000 MH No calibration applied and no bandpass applied

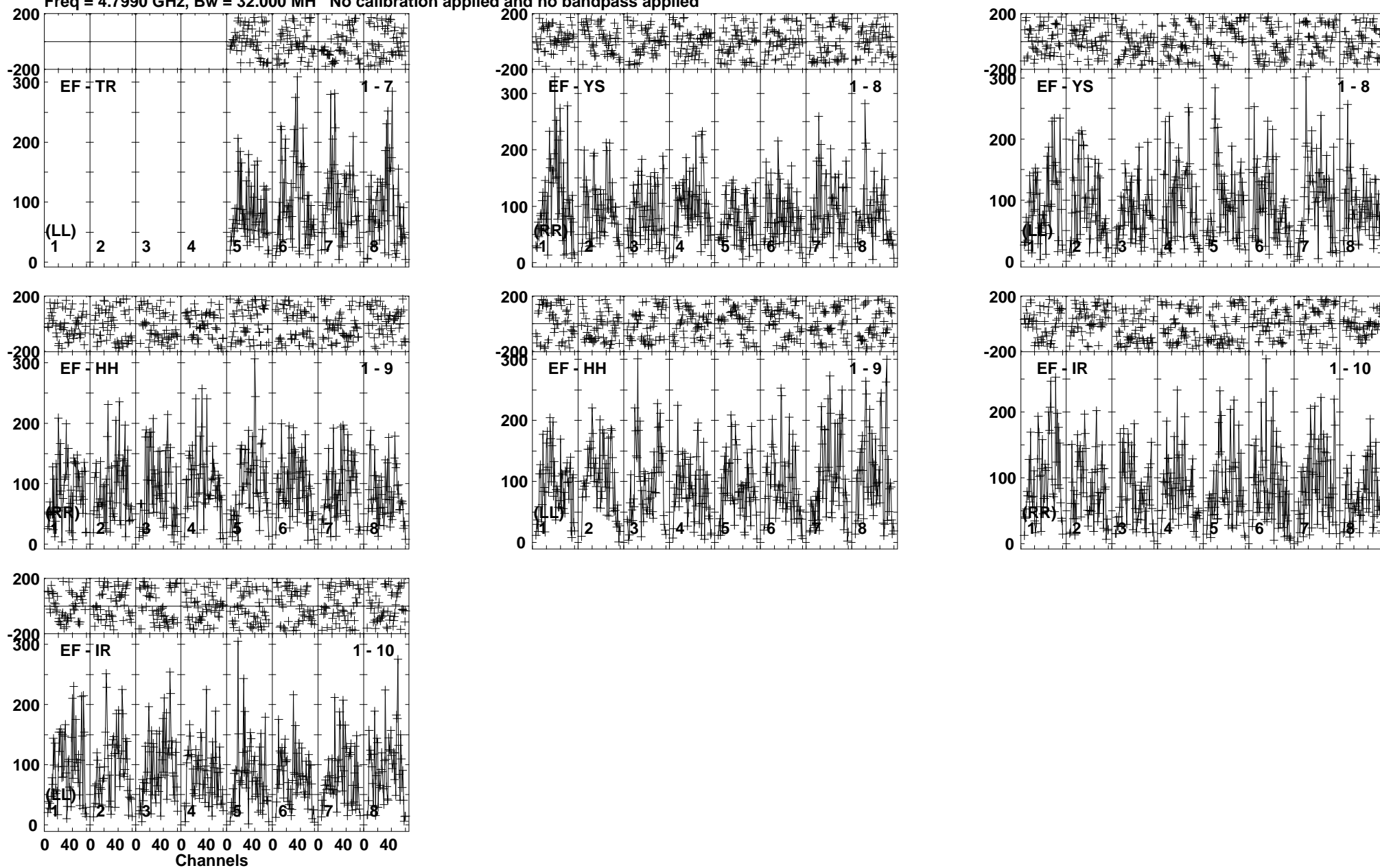

Lower frame: Micro Ampl Jy Top frame: Phas deg
Vector averaged cross-power spectrum Baseline: EF (01) - TR (07)
Timerange: 00:22:09:31 to 00:22:12:59

Plot file version 413 created 19-OCT-2017 15:36:53

J0139+1753 ES081C.UVDATA.1

Freq = 4.7990 GHz, Bw = 32.000 MH No calibration applied and no bandpass applied

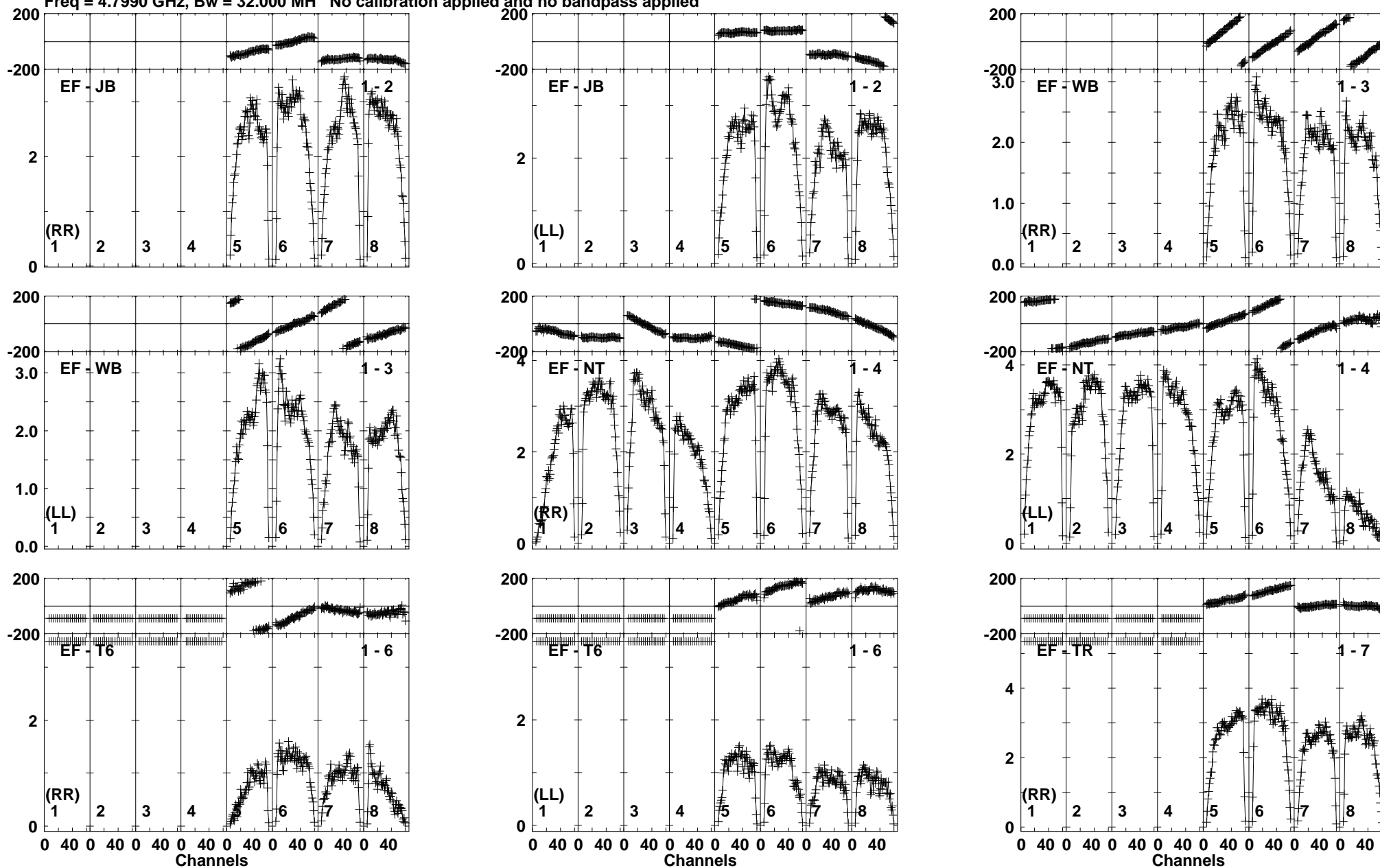

Lower frame: Milli Ampl Jy Top frame: Phas deg
Vector averaged cross-power spectrum Baseline: EF (01) - JB (02)
Timerange: 00/22:13:41 to 00/22:14:39

Plot file version 414 created 19-OCT-2017 15:36:53

J0139+1753 ES081C.UVDATA.1

Freq = 4.7990 GHz, Bw = 32.000 MH No calibration applied and no bandpass applied

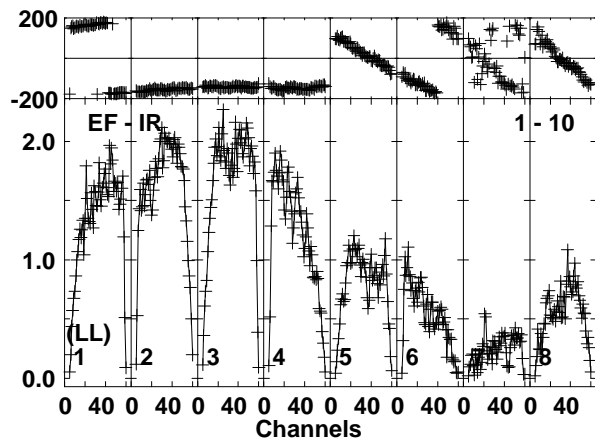
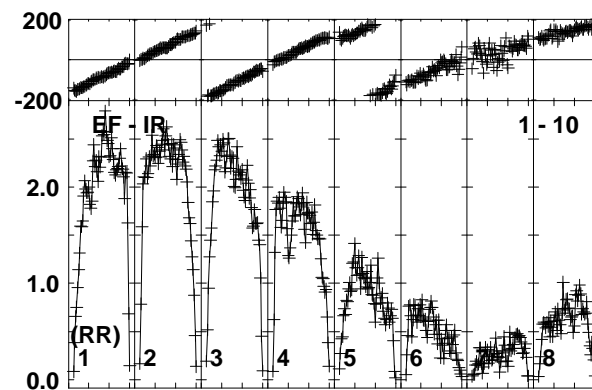
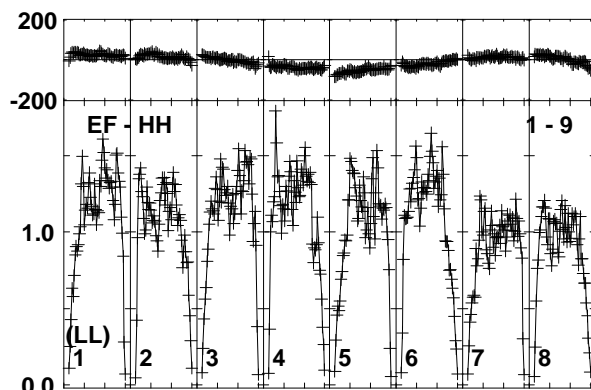
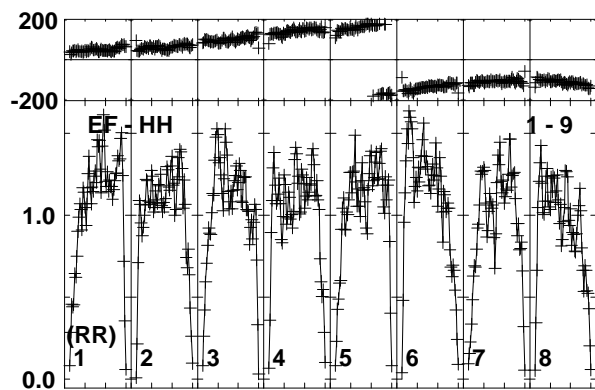
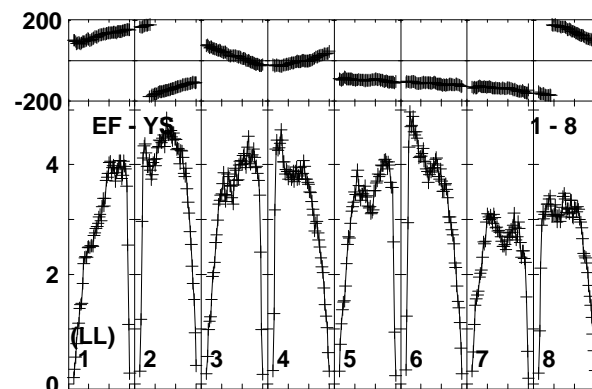
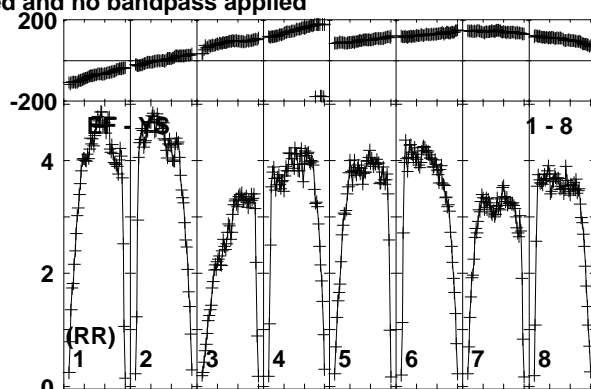
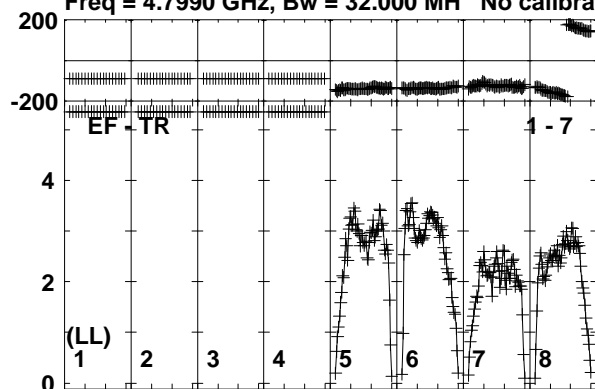

Lower frame: Milli Ampl Jy Top frame: Phas deg
Vector averaged cross-power spectrum Baseline: EF (01) - TR (07)
Timerange: 00:22:13:41 to 00:22:14:39

Plot file version 415 created 19-OCT-2017 15:36:53

MRK359 ES081C.UVDATA.1

Freq = 4.7990 GHz, Bw = 32.000 MH No calibration applied and no bandpass applied

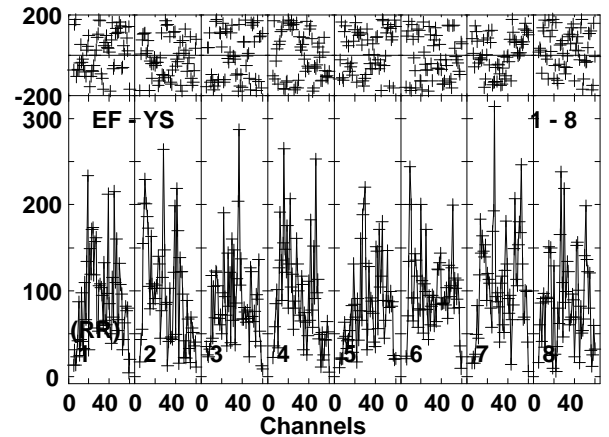
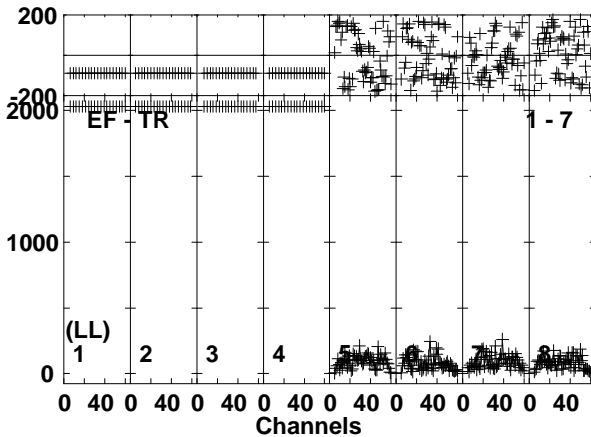
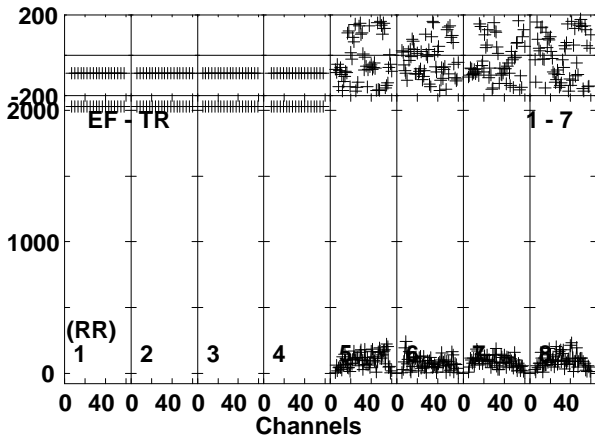
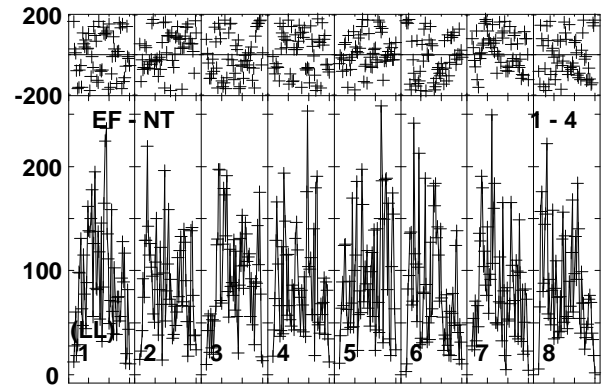
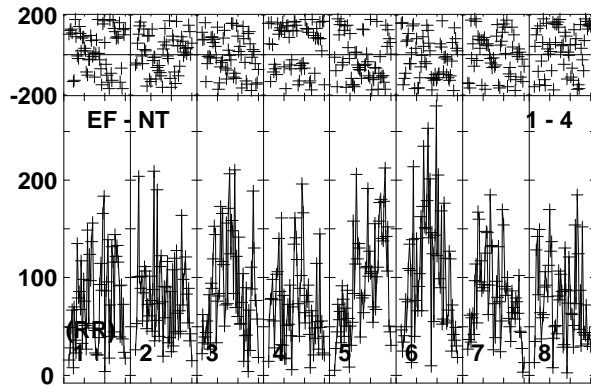
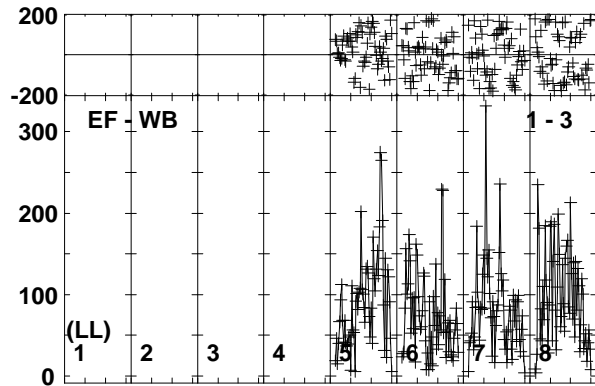
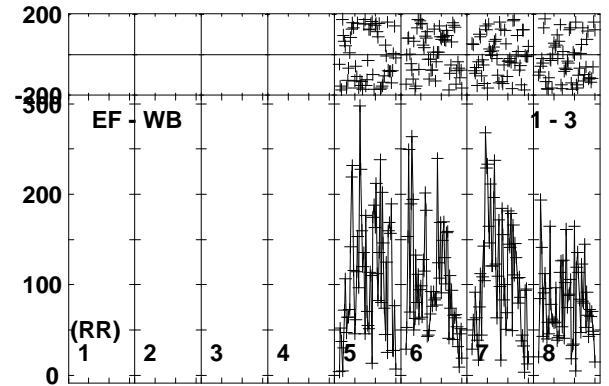
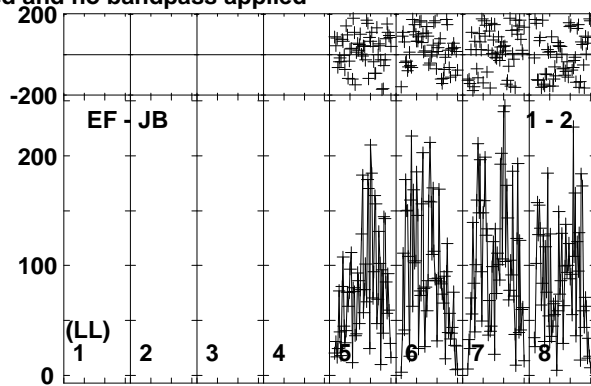
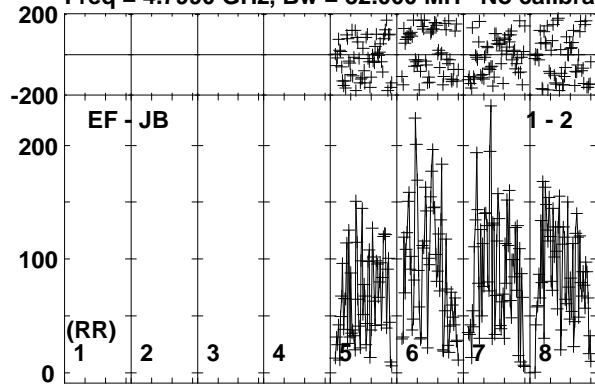

Lower frame: Micro Ampl Jy Top frame: Phas deg
Vector averaged cross-power spectrum Baseline: EF (01) - JB (02)
Timerange: 00/22:14:41 to 00/22:18:09

Plot file version 416 created 19-OCT-2017 15:36:53

MRK359 ES081C.UVDATA.1

Freq = 4.7990 GHz, Bw = 32.000 MH No calibration applied and no bandpass applied

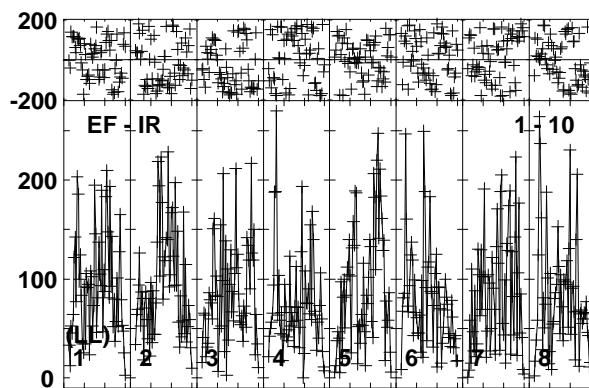
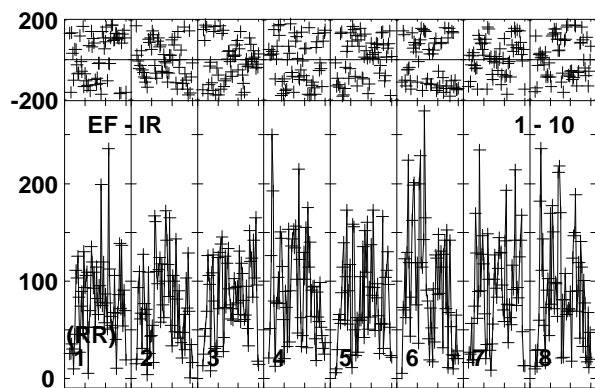
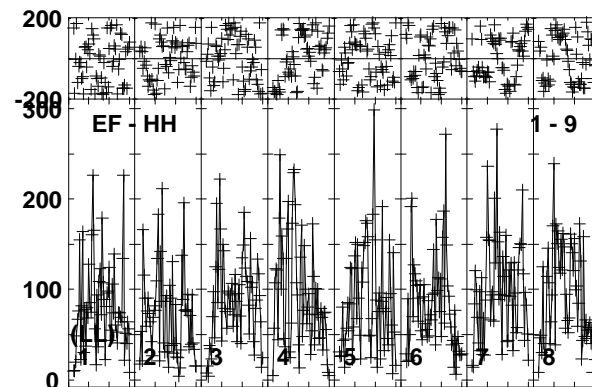
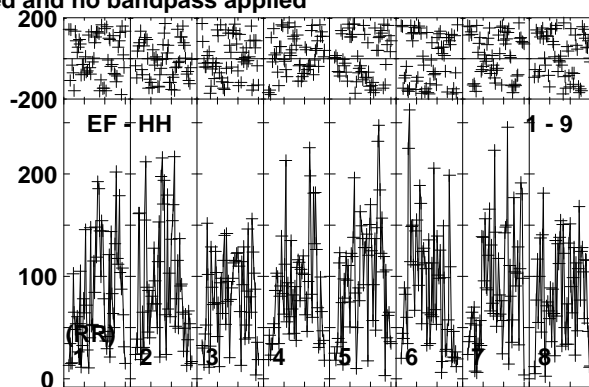
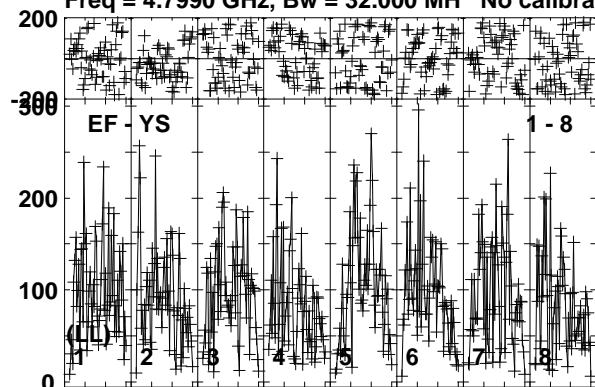

Lower frame: Micro Ampl Jy Top frame: Phas deg
Vector averaged cross-power spectrum Baseline: EF (01) - YS (08)
Timerange: 00/22:14:41 to 00/22:18:09

Plot file version 417 created 19-OCT-2017 15:36:54

J0139+1753 ES081C.UVDATA.1

Freq = 4.7990 GHz, Bw = 32.000 MH No calibration applied and no bandpass applied

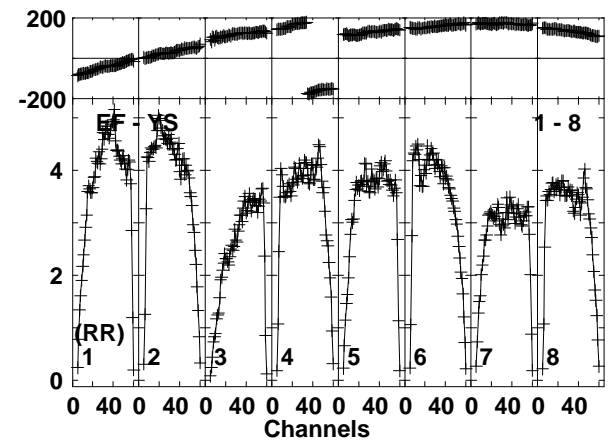
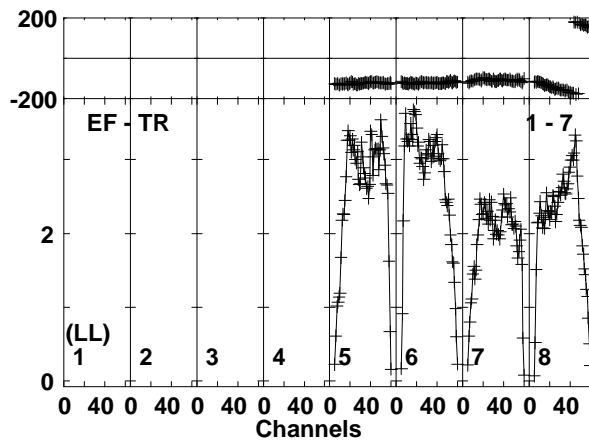
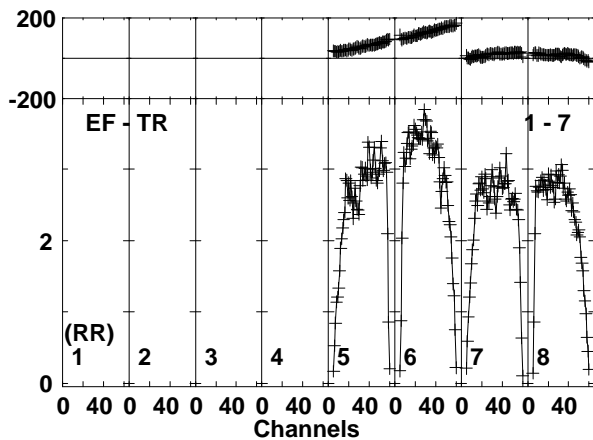
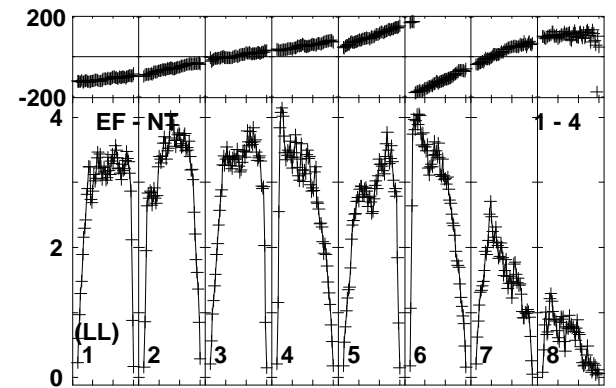
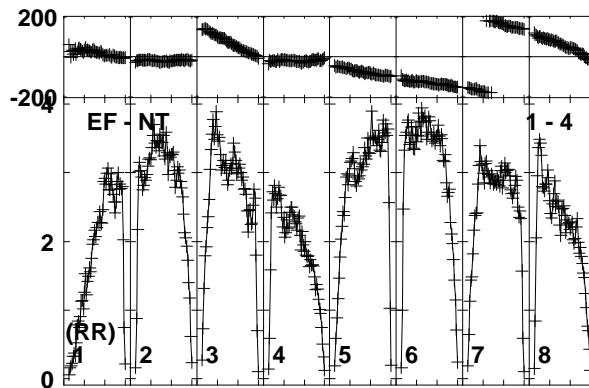
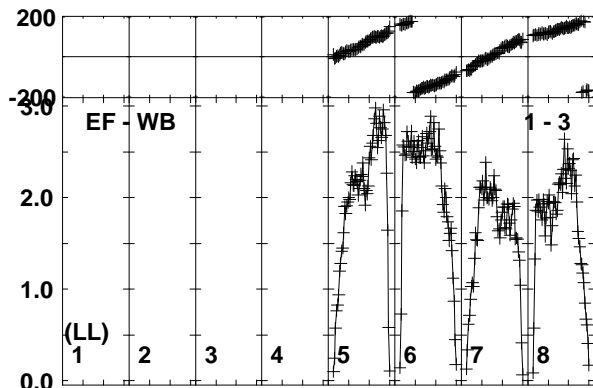
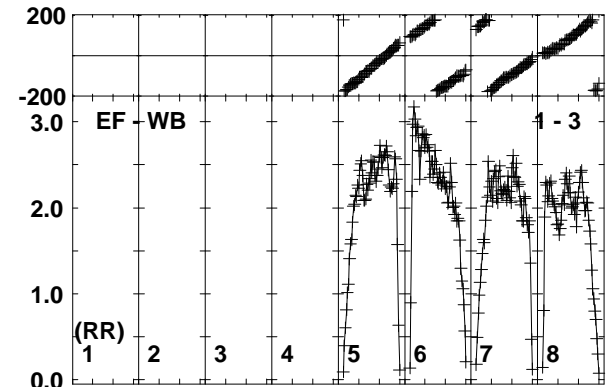
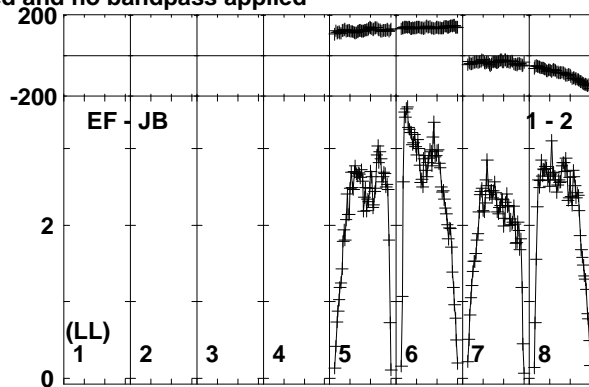
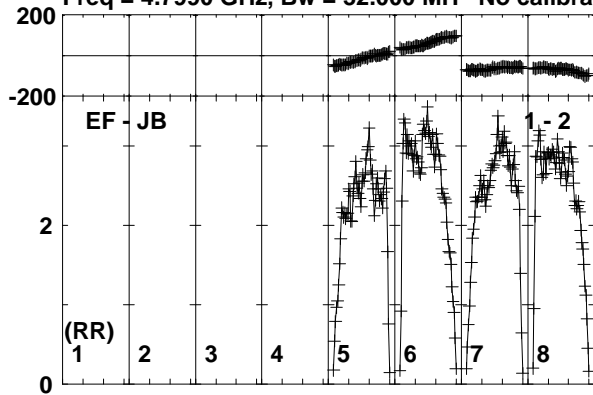

Lower frame: Milli Ampl Jy Top frame: Phas deg
Vector averaged cross-power spectrum Baseline: EF (01) - JB (02)
Timerange: 00/22:18:11 to 00/22:19:39

Plot file version 418 created 19-OCT-2017 15:36:54

J0139+1753 ES081C.UVDATA.1

Freq = 4.7990 GHz, Bw = 32.000 MH No calibration applied and no bandpass applied

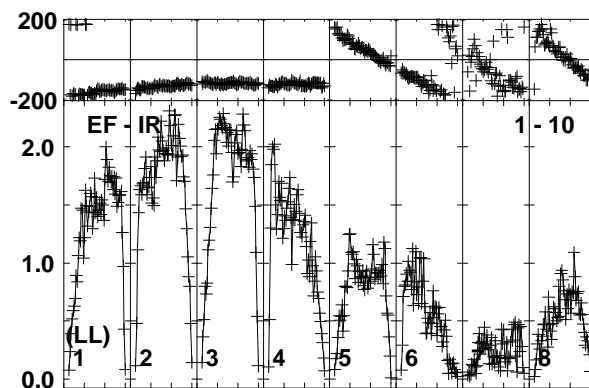
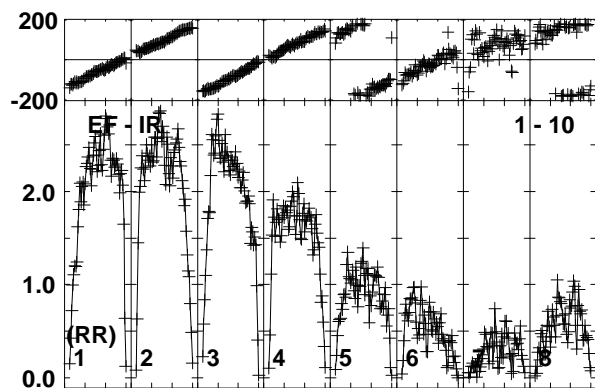
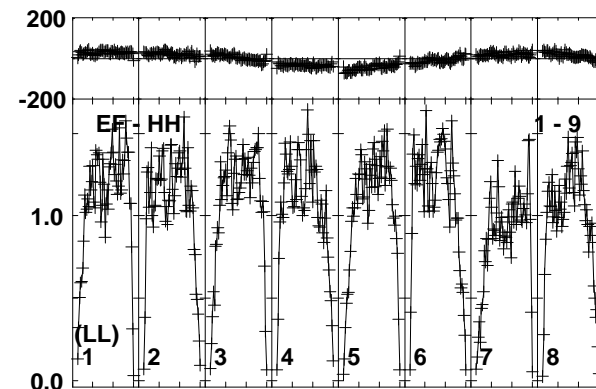
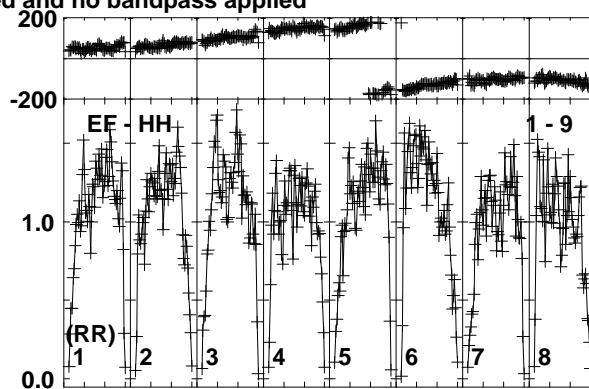
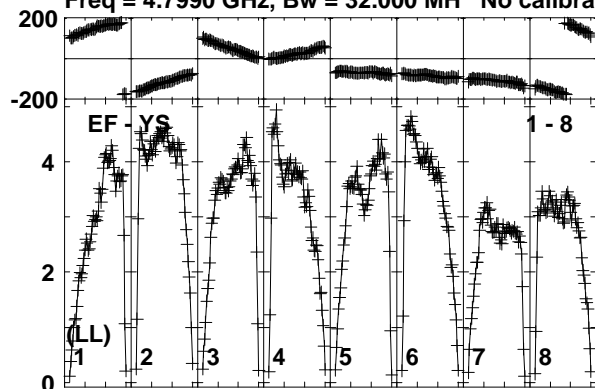

Lower frame: Milli Ampl Jy Top frame: Phas deg
Vector averaged cross-power spectrum Baseline: EF (01) - YS (08)
Timerange: 00/22:18:11 to 00/22:19:39

Plot file version 419 created 19-OCT-2017 15:36:54

MRK359 ES081C.UVDATA.1

Freq = 4.7990 GHz, Bw = 32.000 MH No calibration applied and no bandpass applied

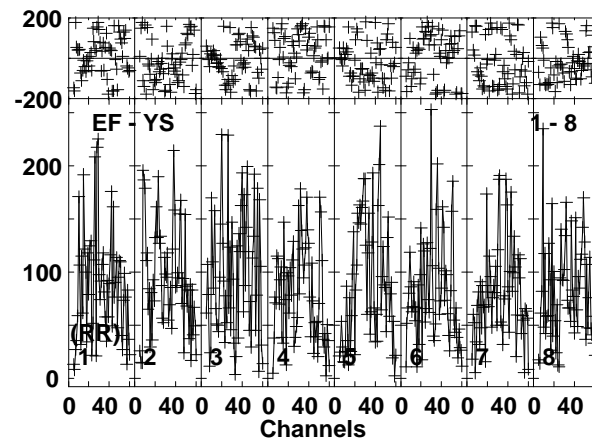
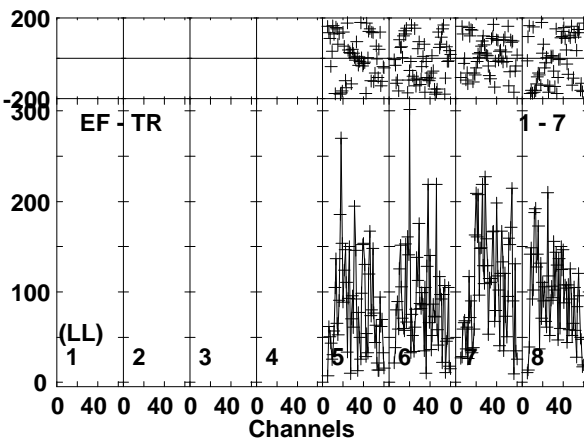
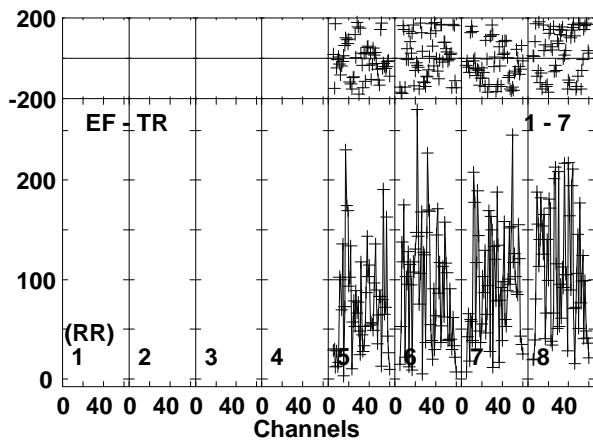
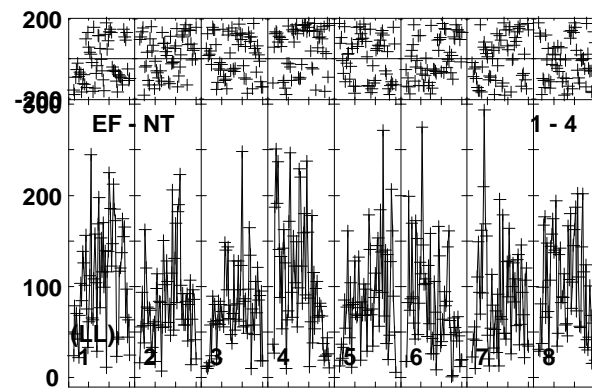
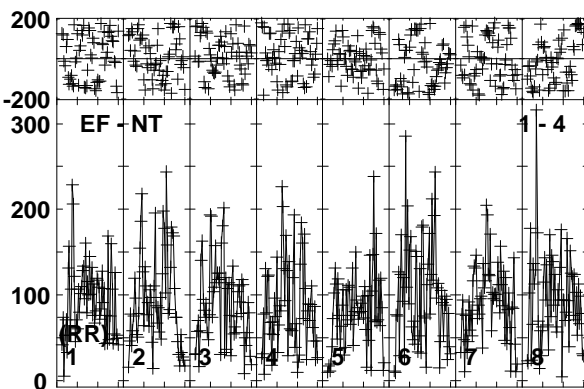
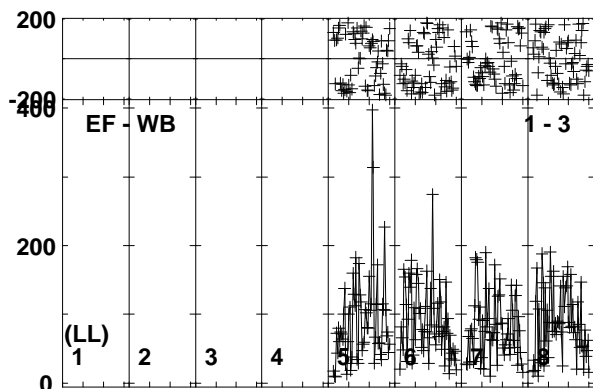
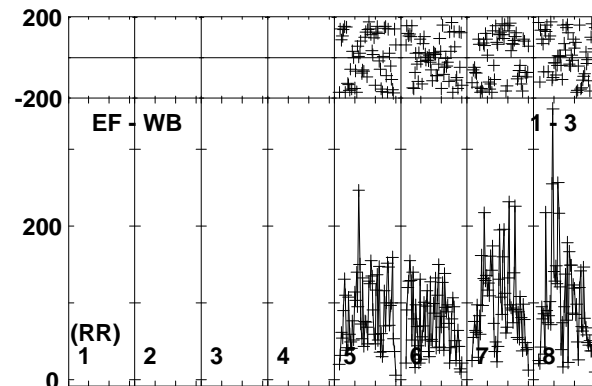
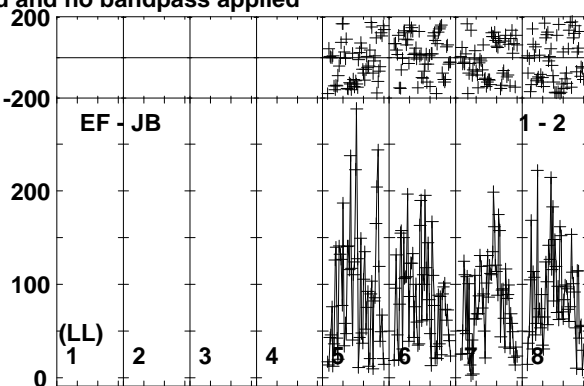
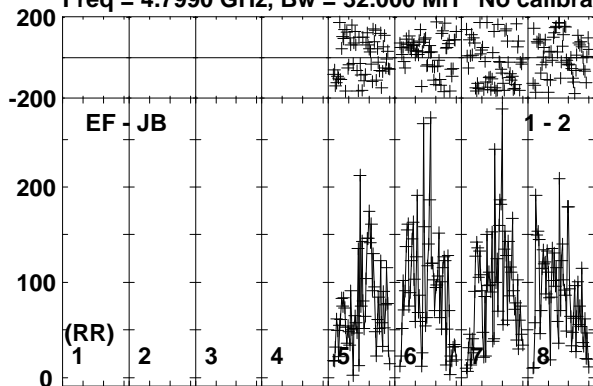

Lower frame: Micro Ampl Jy Top frame: Phas deg
Vector averaged cross-power spectrum Baseline: EF (01) - JB (02)
Timerange: 00/22:19:41 to 00/22:23:09

Plot file version 420 created 19-OCT-2017 15:36:54

MRK359 ES081C.UVDATA.1

Freq = 4.7990 GHz, Bw = 32.000 MH No calibration applied and no bandpass applied

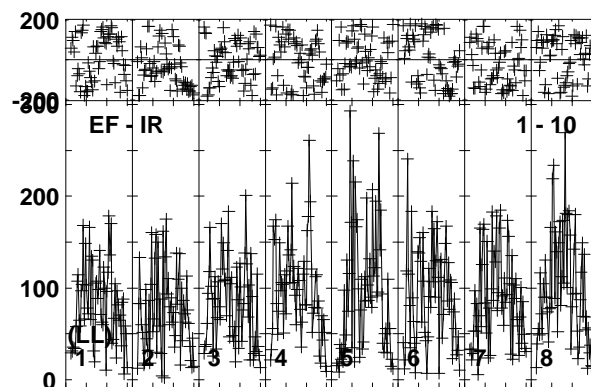
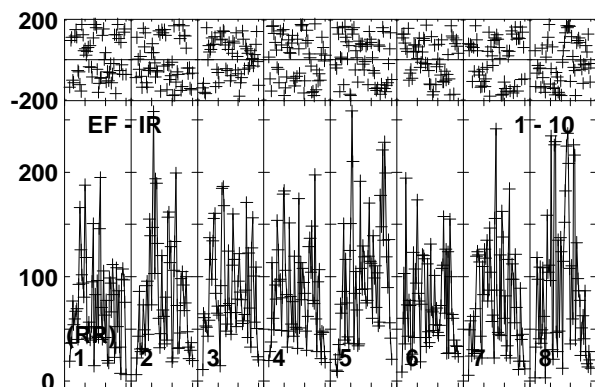
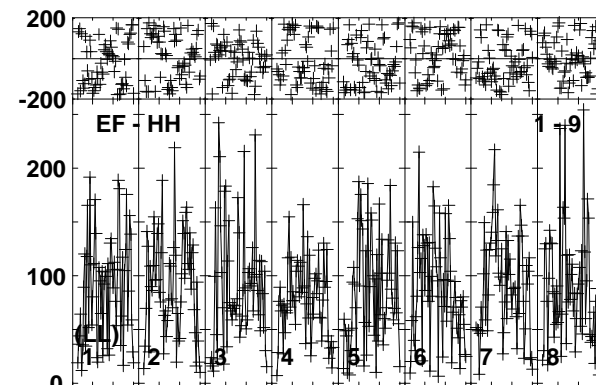
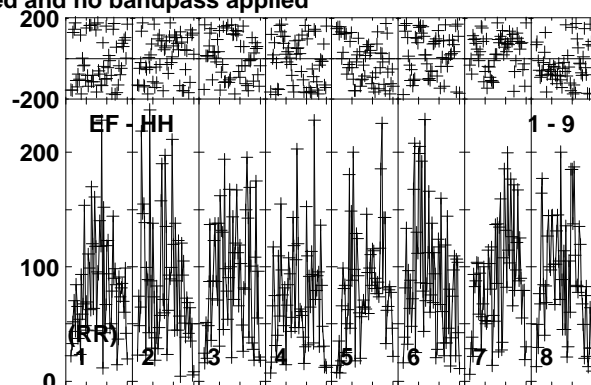
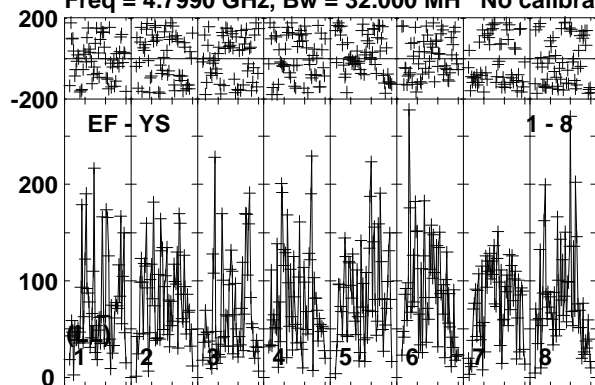

Lower frame: Micro Ampl Jy Top frame: Phas deg
Vector averaged cross-power spectrum Baseline: EF (01) - YS (08)
Timerange: 00/22:19:41 to 00/22:23:09

Plot file version 421 created 19-OCT-2017 15:36:54

J0139+1753 ES081C.UVDATA.1

Freq = 4.7990 GHz, Bw = 32.000 MH No calibration applied and no bandpass applied

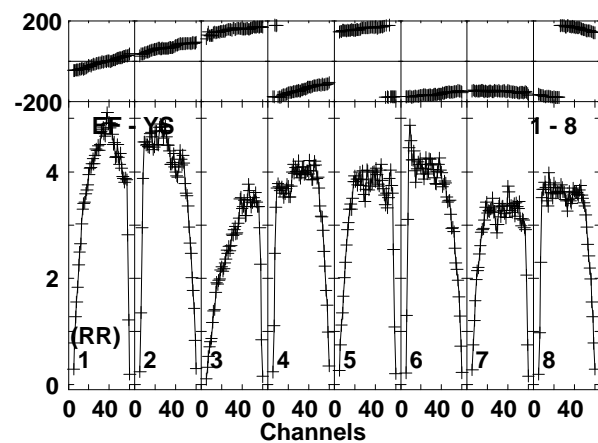
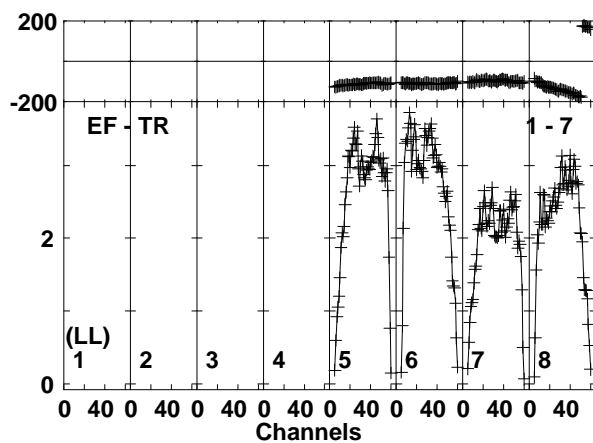
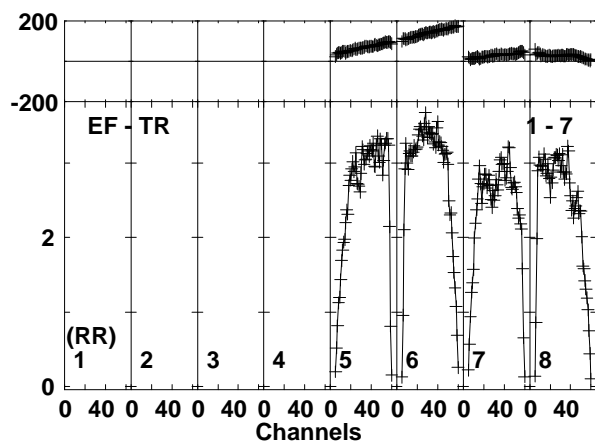
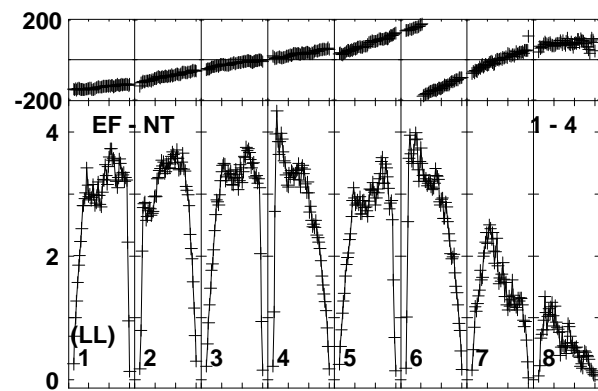
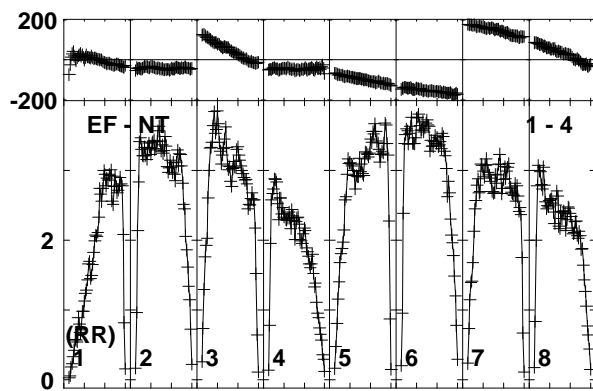
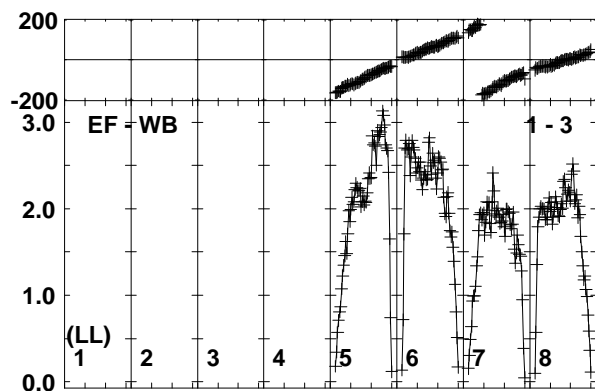
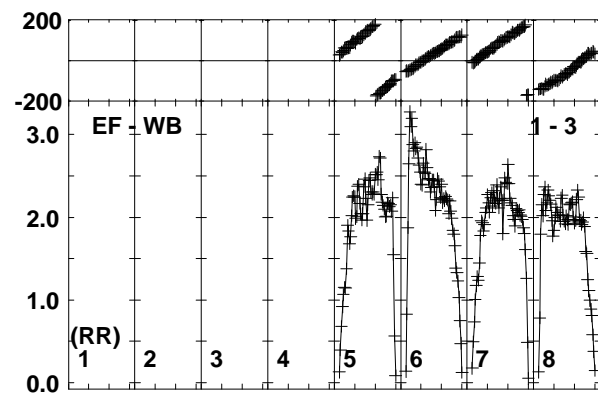
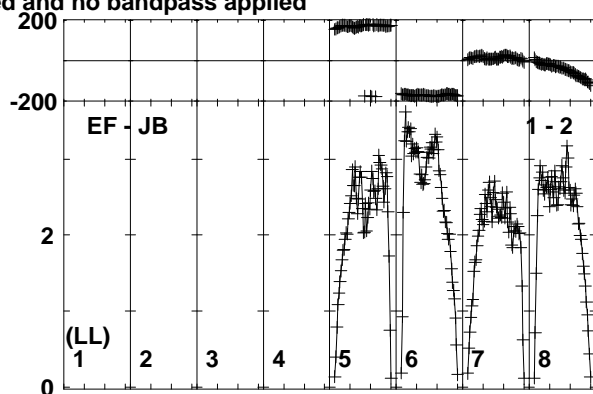
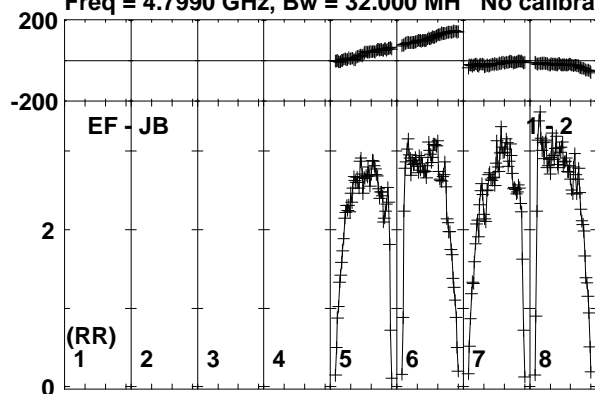

Lower frame: Milli Ampl Jy Top frame: Phas deg
Vector averaged cross-power spectrum Baseline: EF (01) - JB (02)
Timerange: 00:22:23:51 to 00:22:24:49

Plot file version 422 created 19-OCT-2017 15:36:54

J0139+1753 ES081C.UVDATA.1

Freq = 4.7990 GHz, Bw = 32.000 MH No calibration applied and no bandpass applied

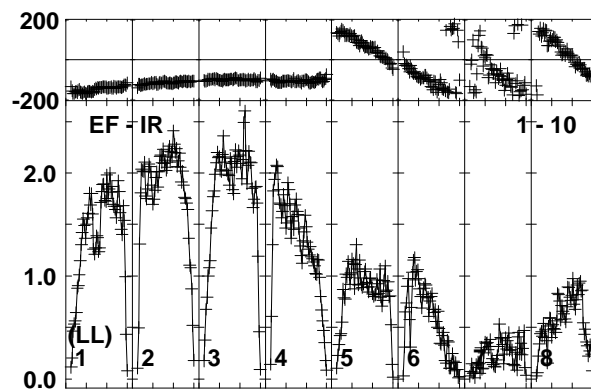
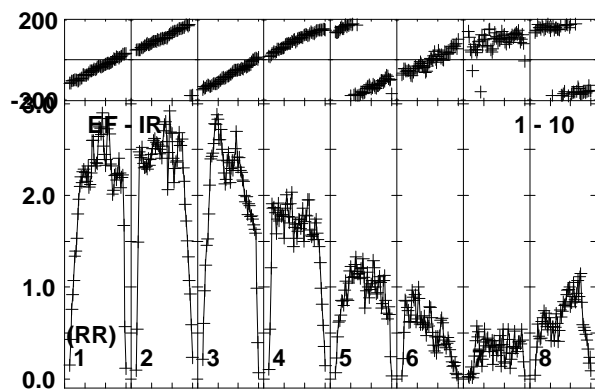
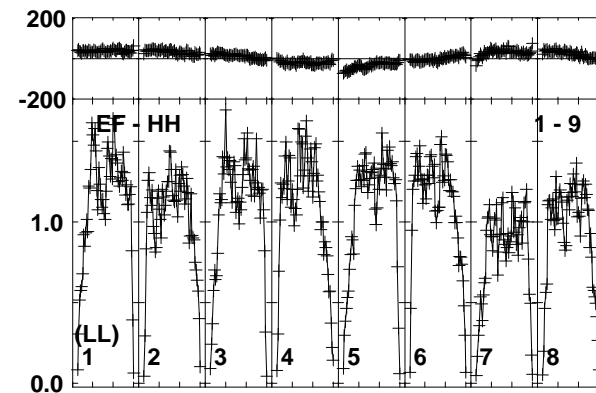
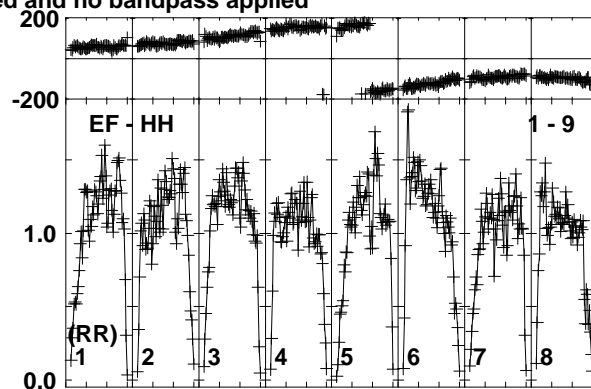
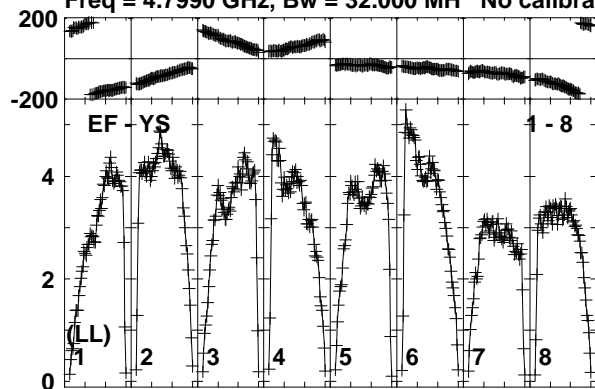

Lower frame: Milli Ampl Jy Top frame: Phas deg
Vector averaged cross-power spectrum Baseline: EF (01) - YS (08)
Timerange: 00/22:23:51 to 00/22:24:49

Plot file version 423 created 19-OCT-2017 15:36:54

MRK359 ES081C.UVDATA.1

Freq = 4.7990 GHz, Bw = 32.000 MH No calibration applied and no bandpass applied

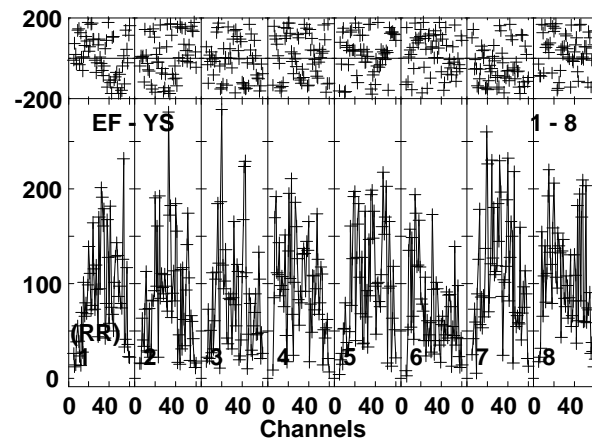
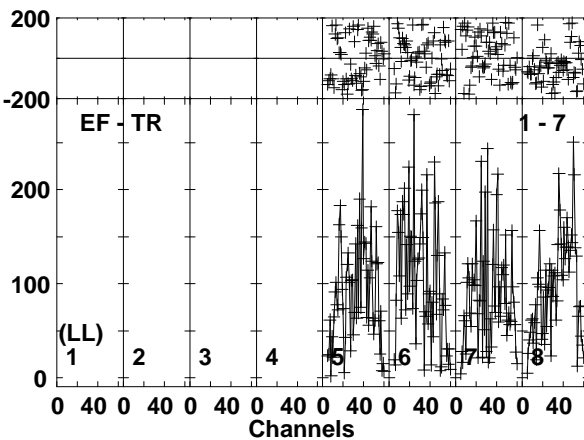
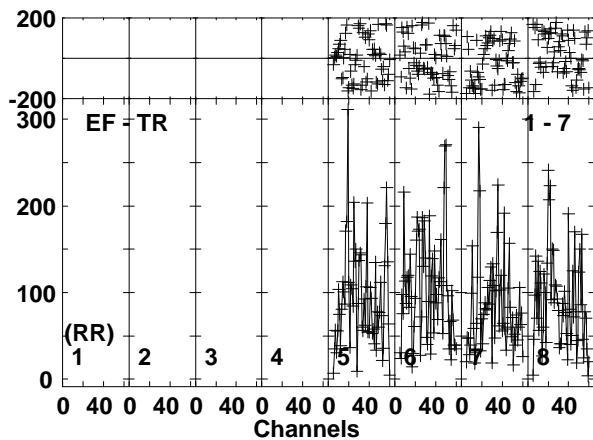
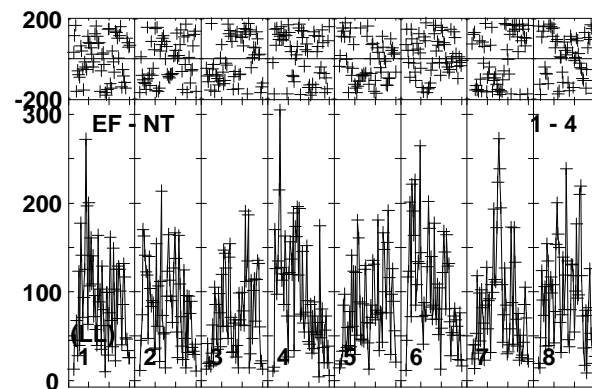
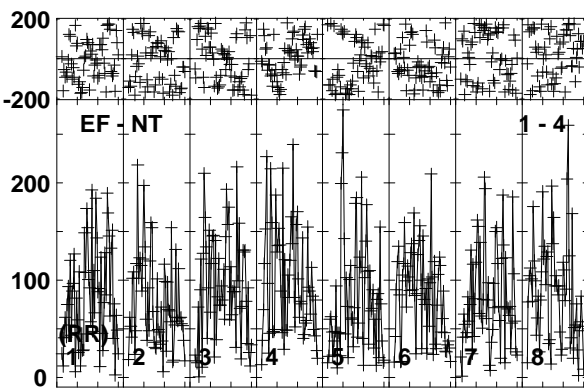
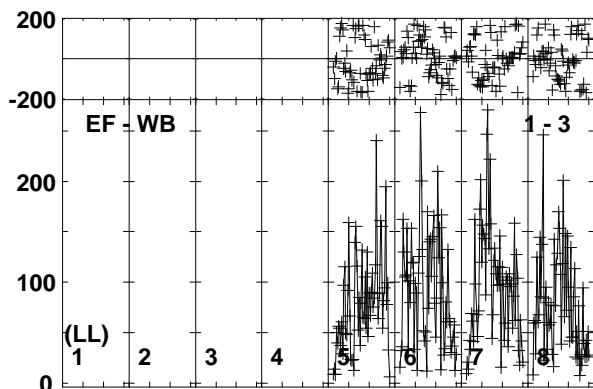
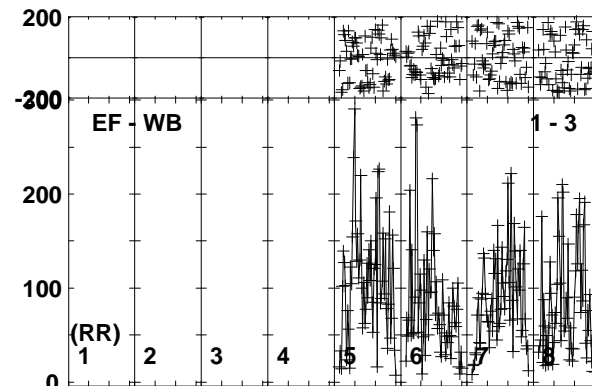
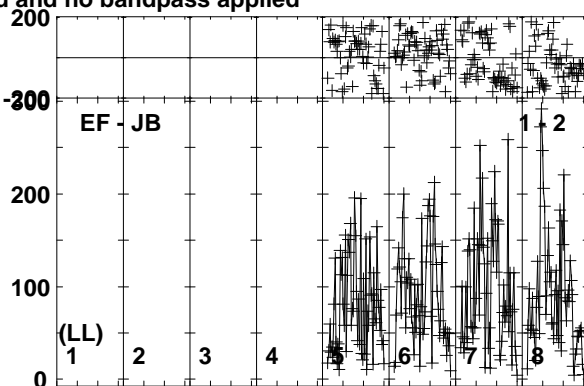
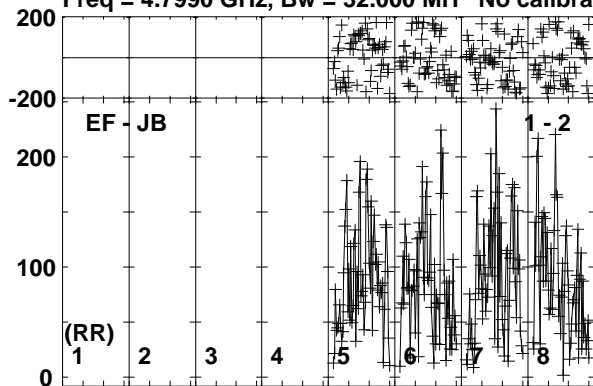

Lower frame: Micro Ampl Jy Top frame: Phas deg
Vector averaged cross-power spectrum Baseline: EF (01) - JB (02)
Timerange: 00:22:24:51 to 00:22:28:19

Plot file version 424 created 19-OCT-2017 15:36:54

MRK359 ES081C.UVDATA.1

Freq = 4.7990 GHz, Bw = 32.000 MH No calibration applied and no bandpass applied

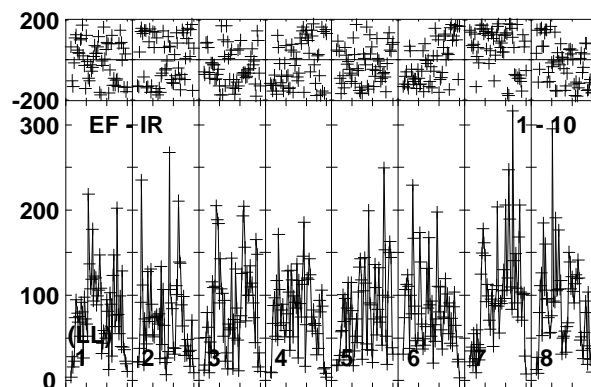
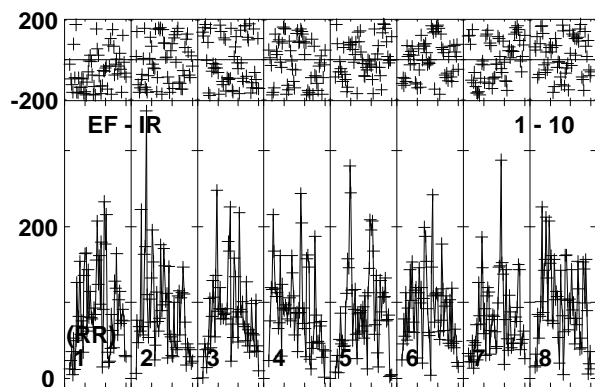
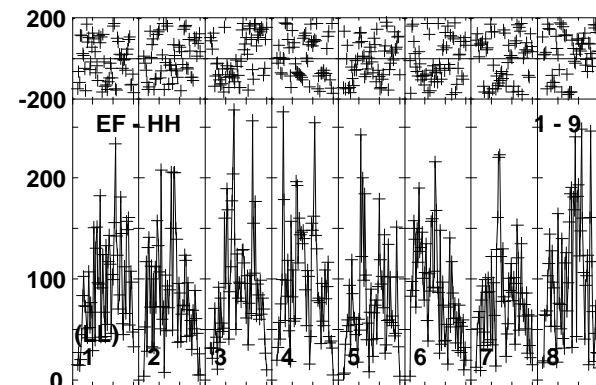
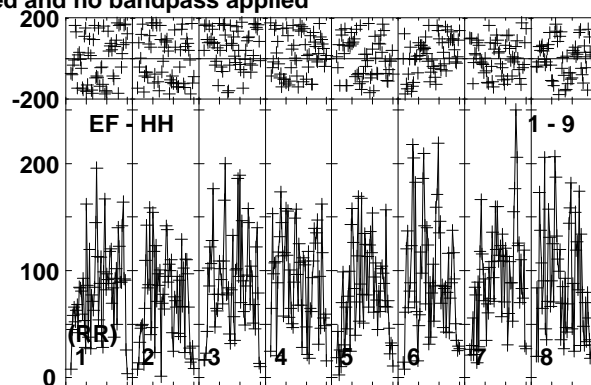
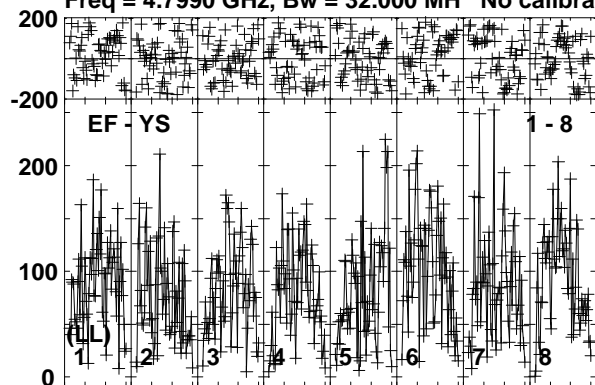

Lower frame: Micro Ampl Jy Top frame: Phas deg
Vector averaged cross-power spectrum Baseline: EF (01) - YS (08)
Timerange: 00/22:24:51 to 00/22:28:19

Plot file version 425 created 19-OCT-2017 15:36:55
 J0139+1753 ES081C.UVDATA.1
 Freq = 4.7990 GHz, Bw = 32.000 MH No calibration applied and no bandpass applied

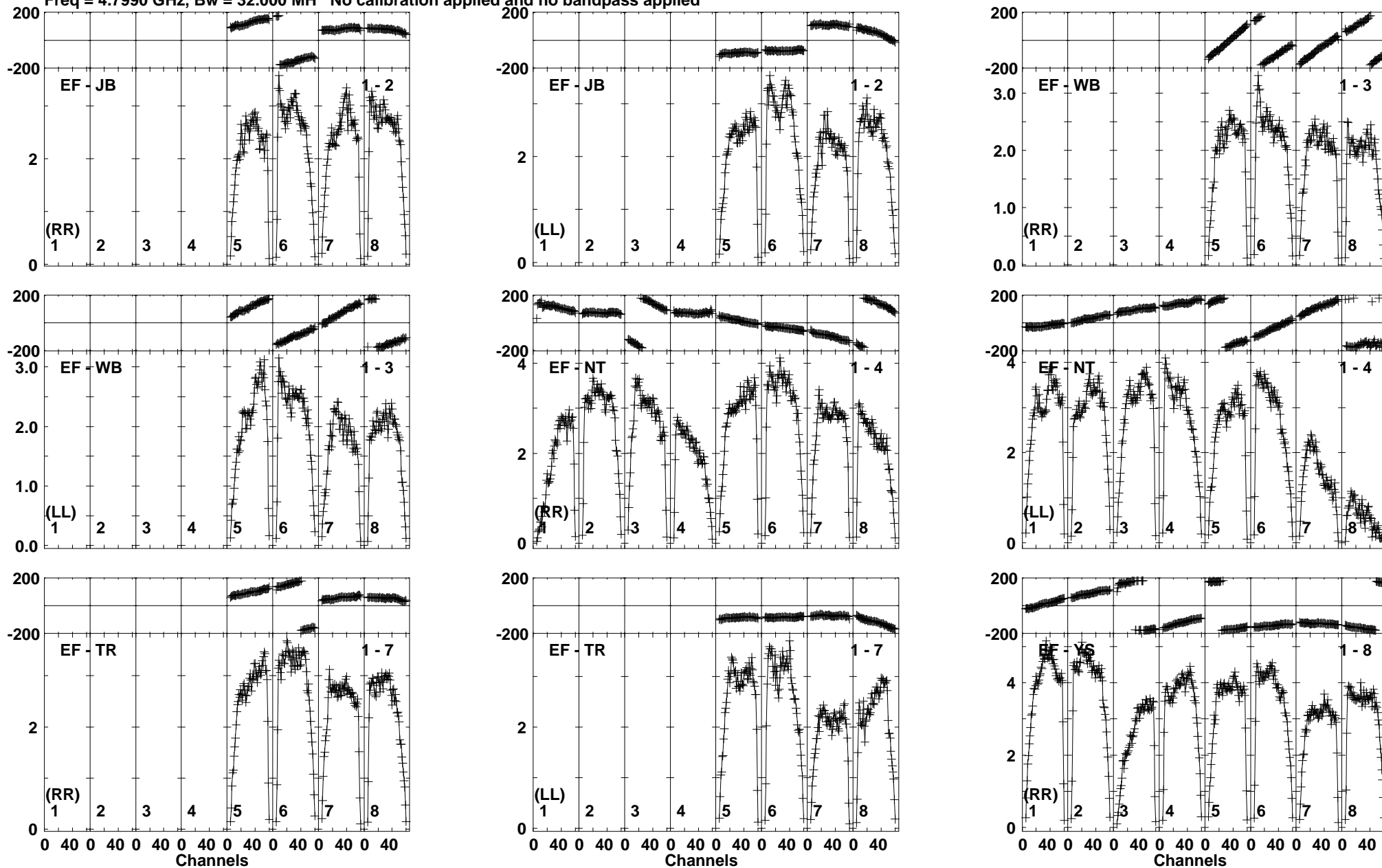

Lower frame: Milli Ampl Jy Top frame: Phas deg
 Vector averaged cross-power spectrum Baseline: EF (01) - JB (02)
 Timerange: 00:22:29:01 to 00:22:29:59

Plot file version 426 created 19-OCT-2017 15:36:55

J0139+1753 ES081C.UVDATA.1

Freq = 4.7990 GHz, Bw = 32.000 MH No calibration applied and no bandpass applied

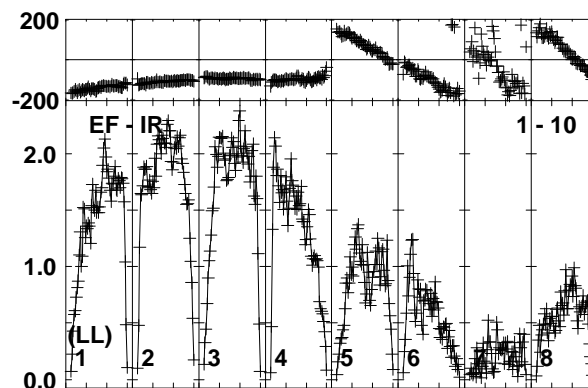
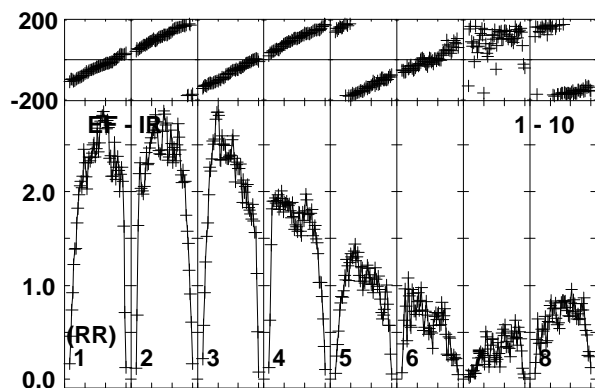
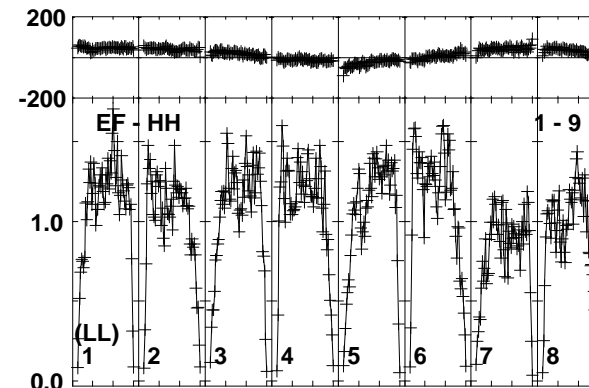
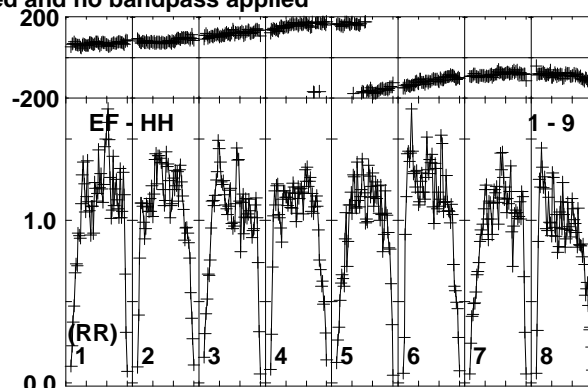
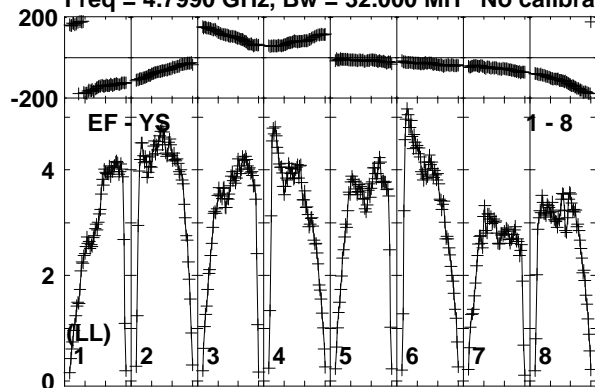

Lower frame: Milli Ampl Jy Top frame: Phas deg
Vector averaged cross-power spectrum Baseline: EF (01) - YS (08)
Timerange: 00/22:29:01 to 00/22:29:59

Plot file version 427 created 19-OCT-2017 15:36:55

J0423-0120 ES081C.UVDATA.1

Freq = 4.7990 GHz, Bw = 32.000 MH No calibration applied and no bandpass applied

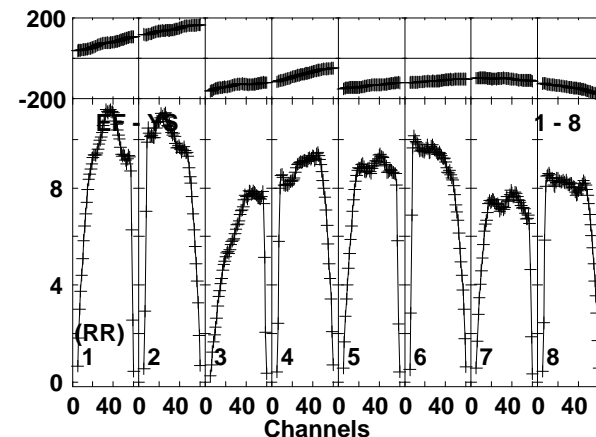
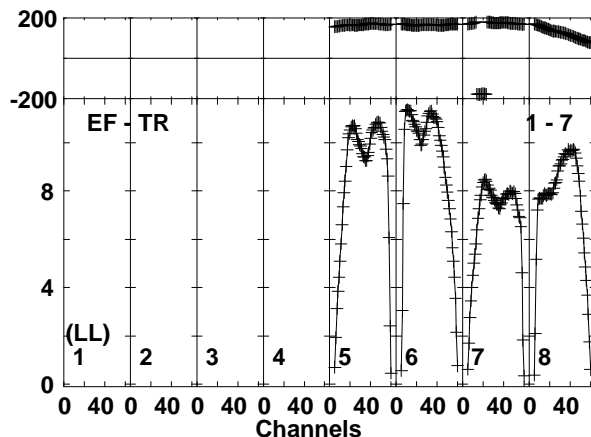
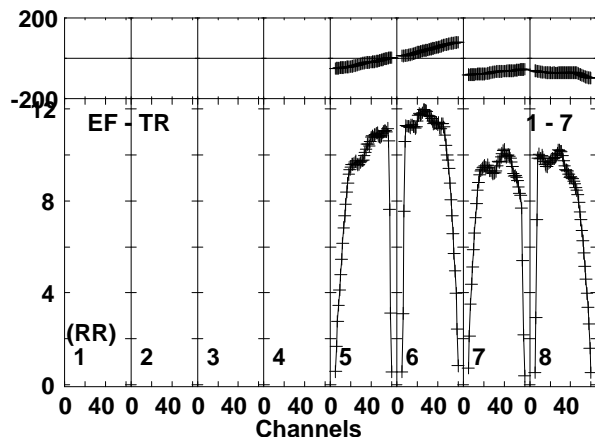
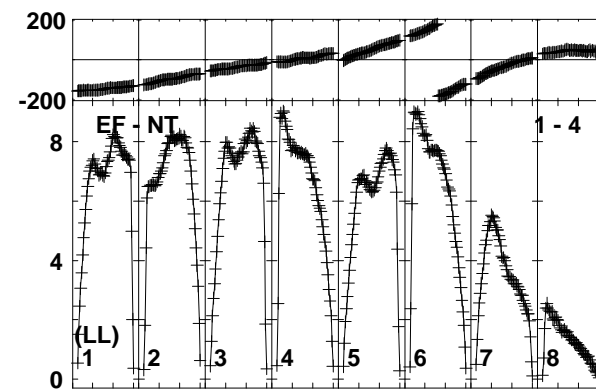
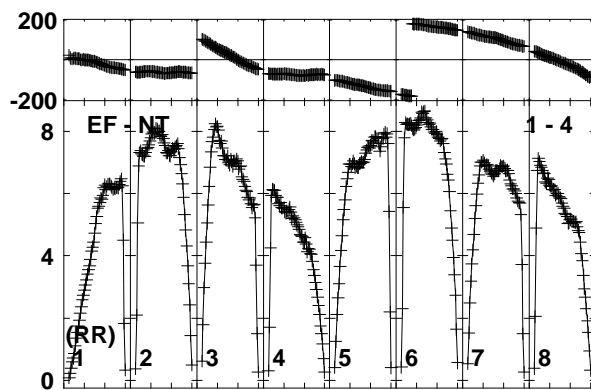
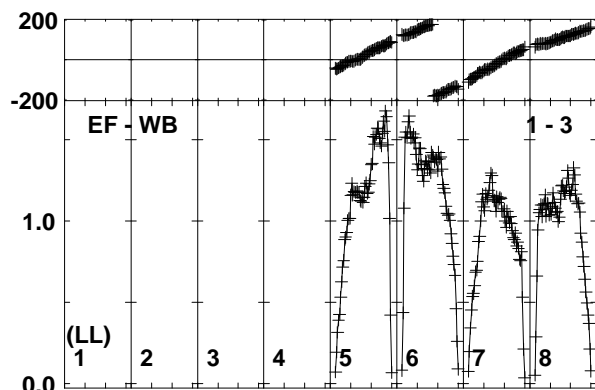
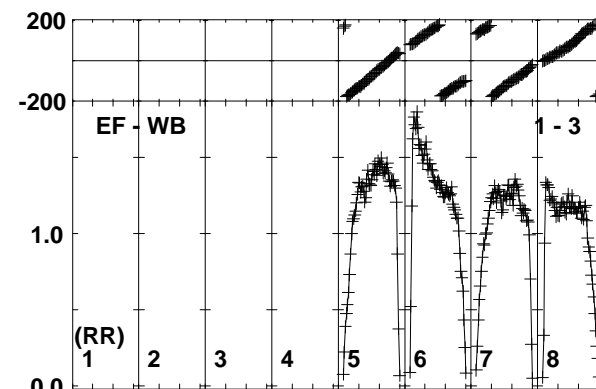
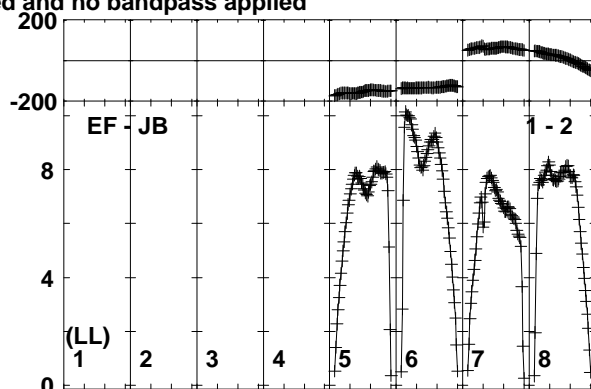
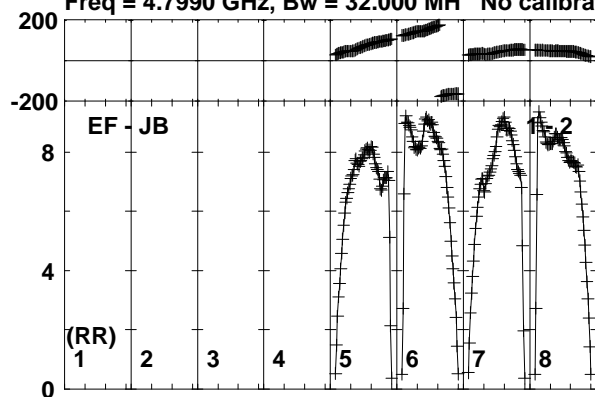

Lower frame: Milli Ampl Jy Top frame: Phas deg
Vector averaged cross-power spectrum Baseline: EF (01) - JB (02)
Timerange: 00:22:33:01 to 00:22:39:59

Plot file version 428 created 19-OCT-2017 15:36:55

J0423-0120 ES081C.UVDATA.1

Freq = 4.7990 GHz, Bw = 32.000 MH No calibration applied and no bandpass applied

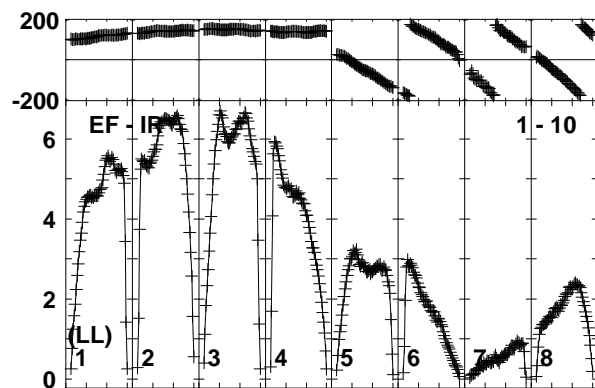
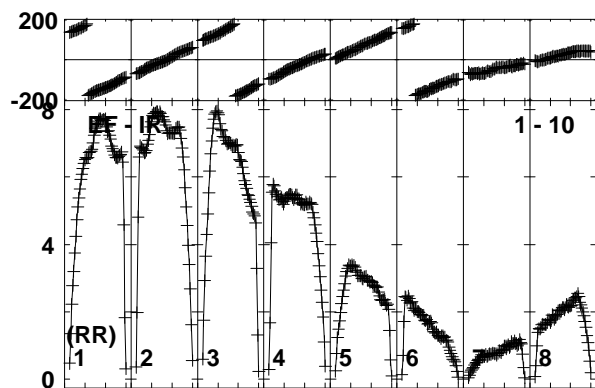
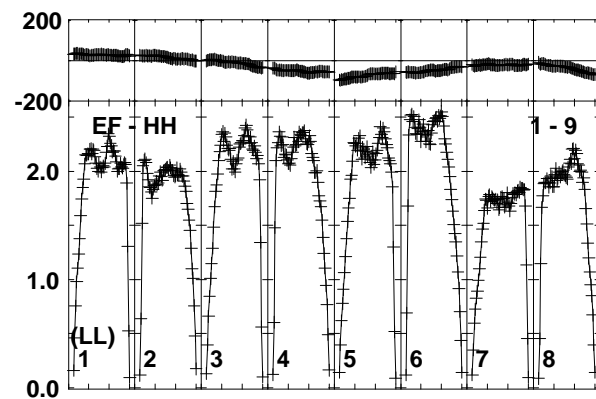
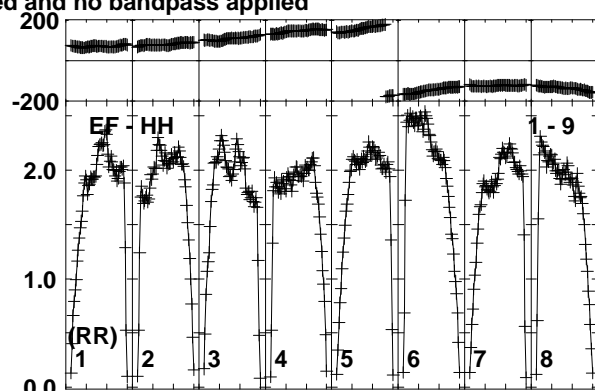
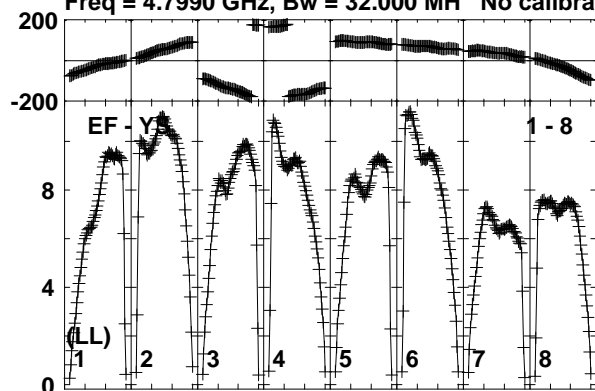

Lower frame: Milli Ampl Jy Top frame: Phas deg
Vector averaged cross-power spectrum Baseline: EF (01) - YS (08)
Timerange: 00/22:33:01 to 00/22:39:59