

Plot file version 1 created 12-JUN-2023 14:39:07

3C286 ES106B.UVDATA.1

Freq = 1.5950 GHz, Bw = 32.000 MH No calibration applied and no bandpass applied

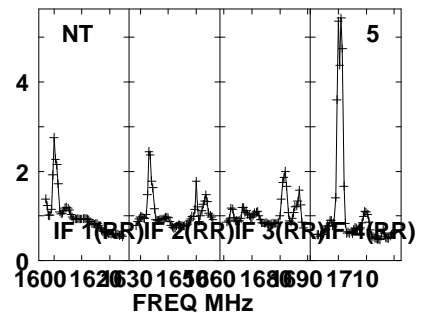
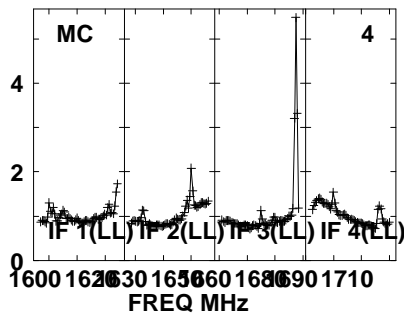
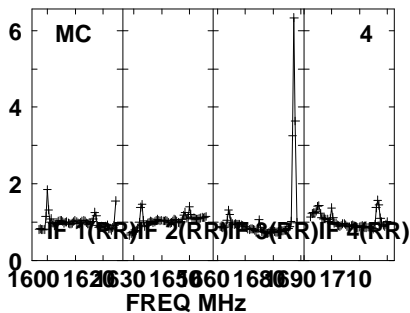
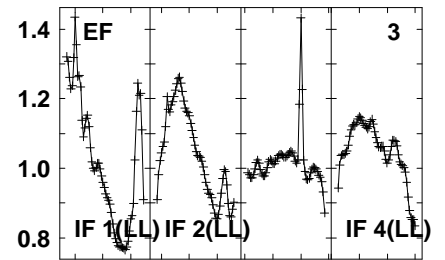
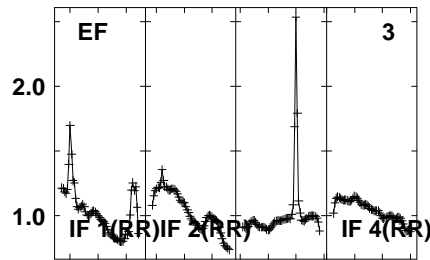
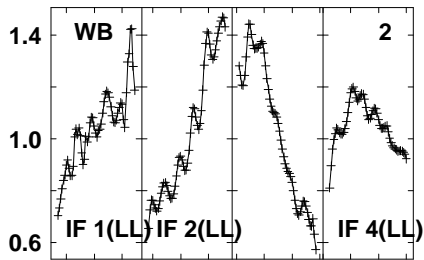
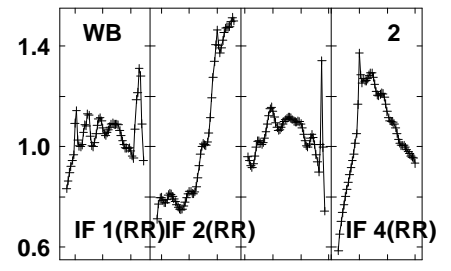
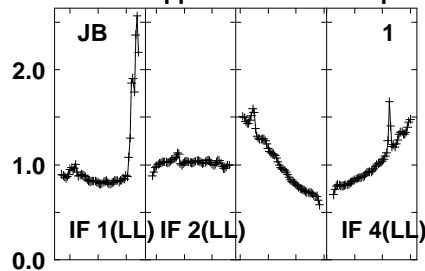
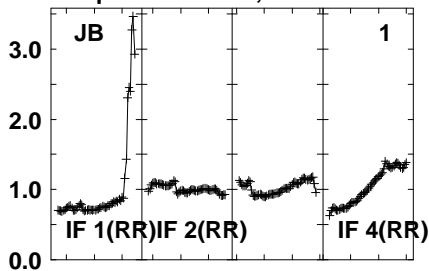

Lower frame: Real Jy

Auto-corr total-power spectrum Antenna: *

Timerange: 00/23:30:01 to 00/23:33:53

Plot file version 2 created 12-JUN-2023 14:39:07

3C286 ES106B.UVDATA.1

Freq = 1.5950 GHz, Bw = 32.000 MH No calibration applied and no bandpass applied

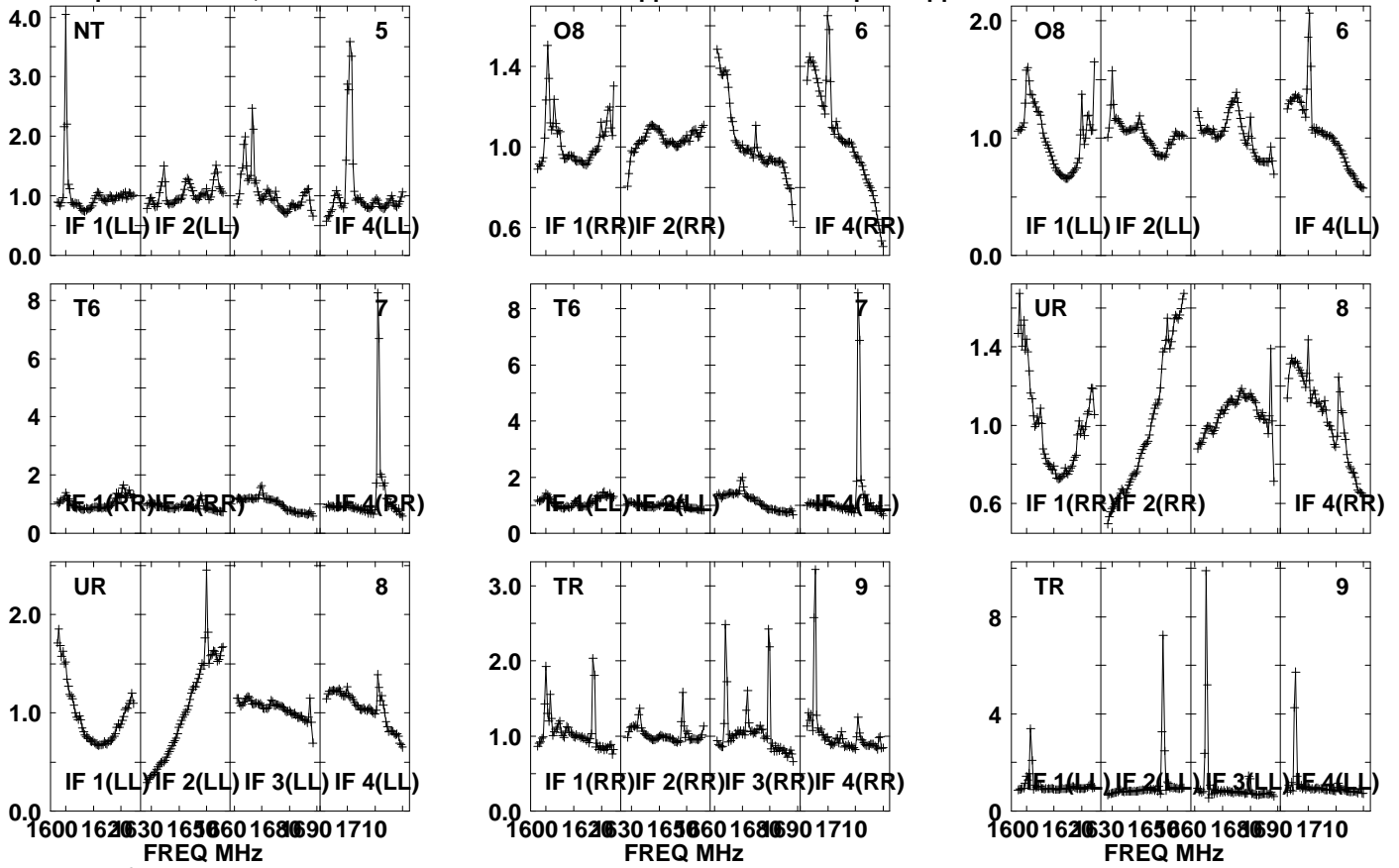

Lower frame: Real Jy
Auto-corr total-power spectrum Antenna: *
Timerange: 00/23:30:01 to 00/23:33:53

Plot file version 3 created 12-JUN-2023 14:39:07

3C286 ES106B.UVDATA.1

Freq = 1.5950 GHz, Bw = 32.000 MH No calibration applied and no bandpass applied

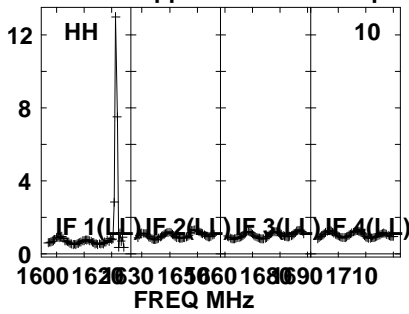
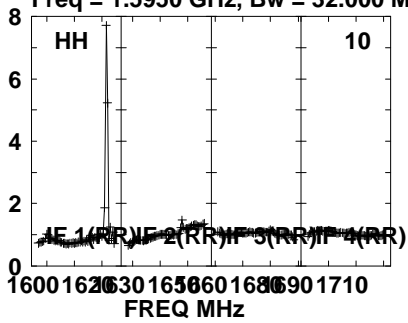

Lower frame: Real Jy
Auto-corr total-power spectrum Antenna: *
Timerange: 00/23:30:01 to 00/23:33:53

Plot file version 4 created 12-JUN-2023 14:39:07

J1547+2052 ES106B.UVDATA.1

Freq = 1.5950 GHz, Bw = 32.000 MH No calibration applied and no bandpass applied

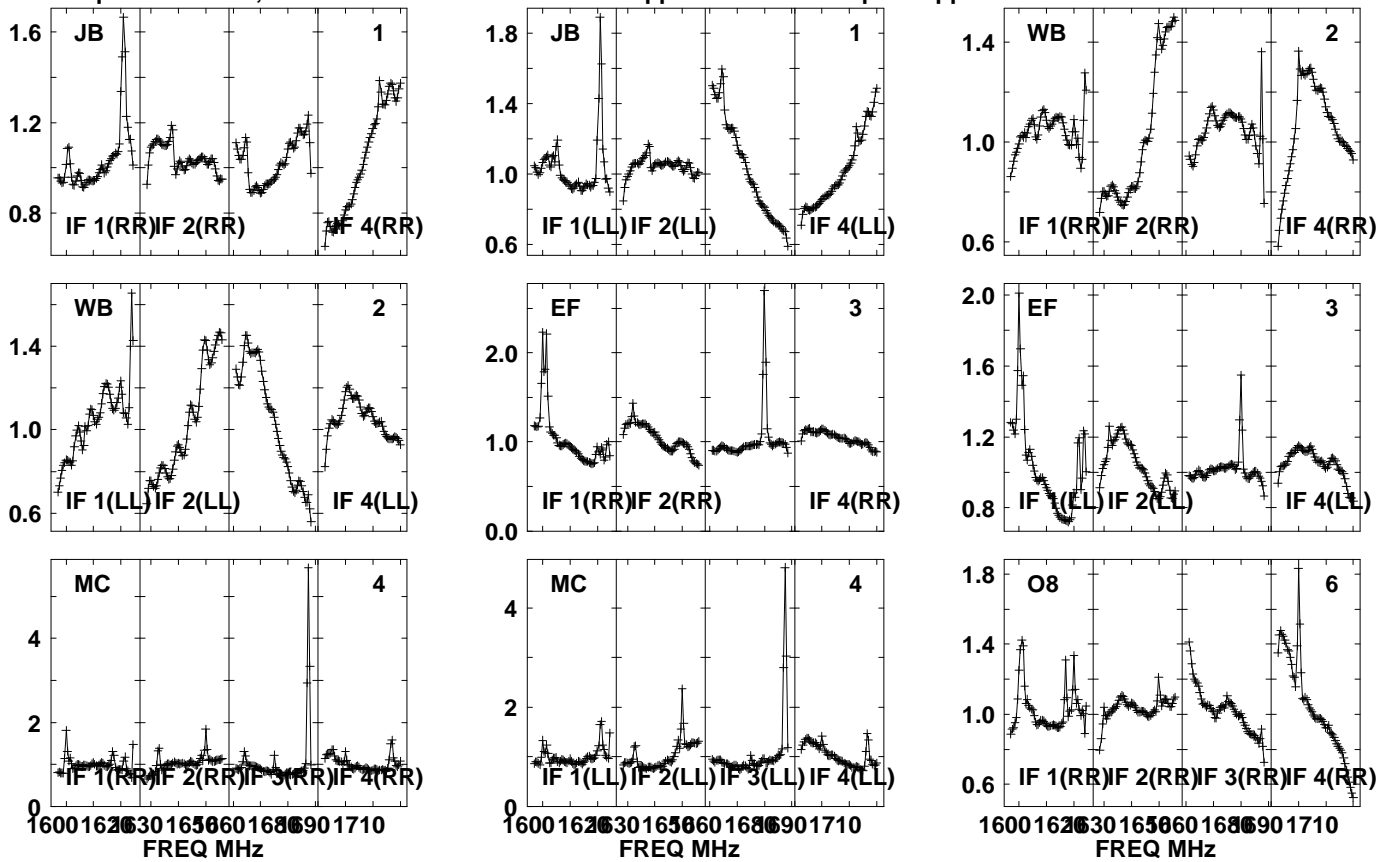

Lower frame: Real Jy
Auto-corr total-power spectrum Antenna: *
Timerange: 00/23:36:01 to 00/23:37:49

Plot file version 5 created 12-JUN-2023 14:39:07

J1547+2052 ES106B.UVDATA.1

Freq = 1.5950 GHz, Bw = 32.000 MH No calibration applied and no bandpass applied

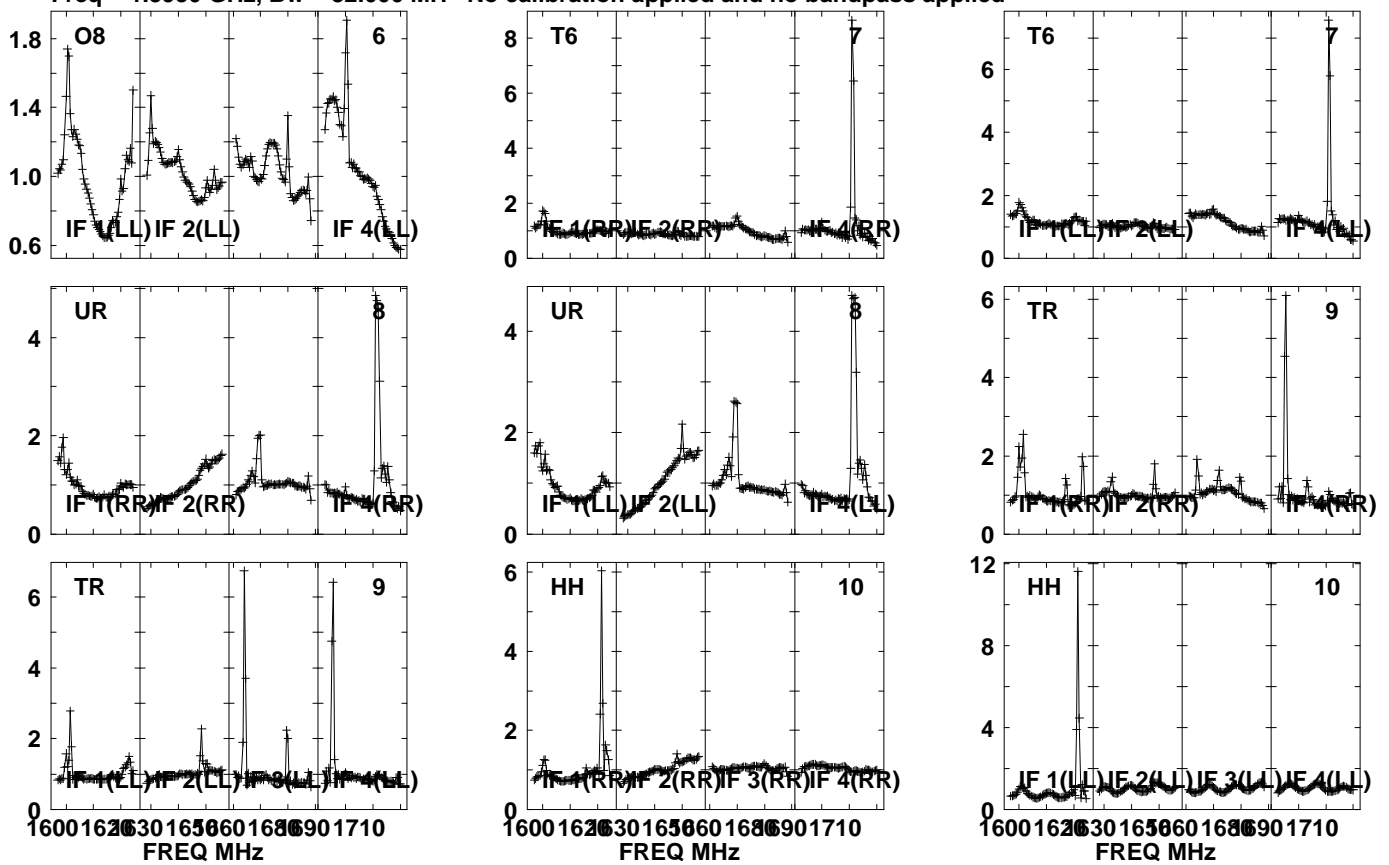

Lower frame: Real Jy
Auto-corr total-power spectrum Antenna: *
Timerange: 00/23:36:01 to 00/23:37:49

Plot file version 6 created 12-JUN-2023 14:39:07

J1548 ES106B.UVDATA.1

Freq = 1.5950 GHz, Bw = 32.000 MH No calibration applied and no bandpass applied

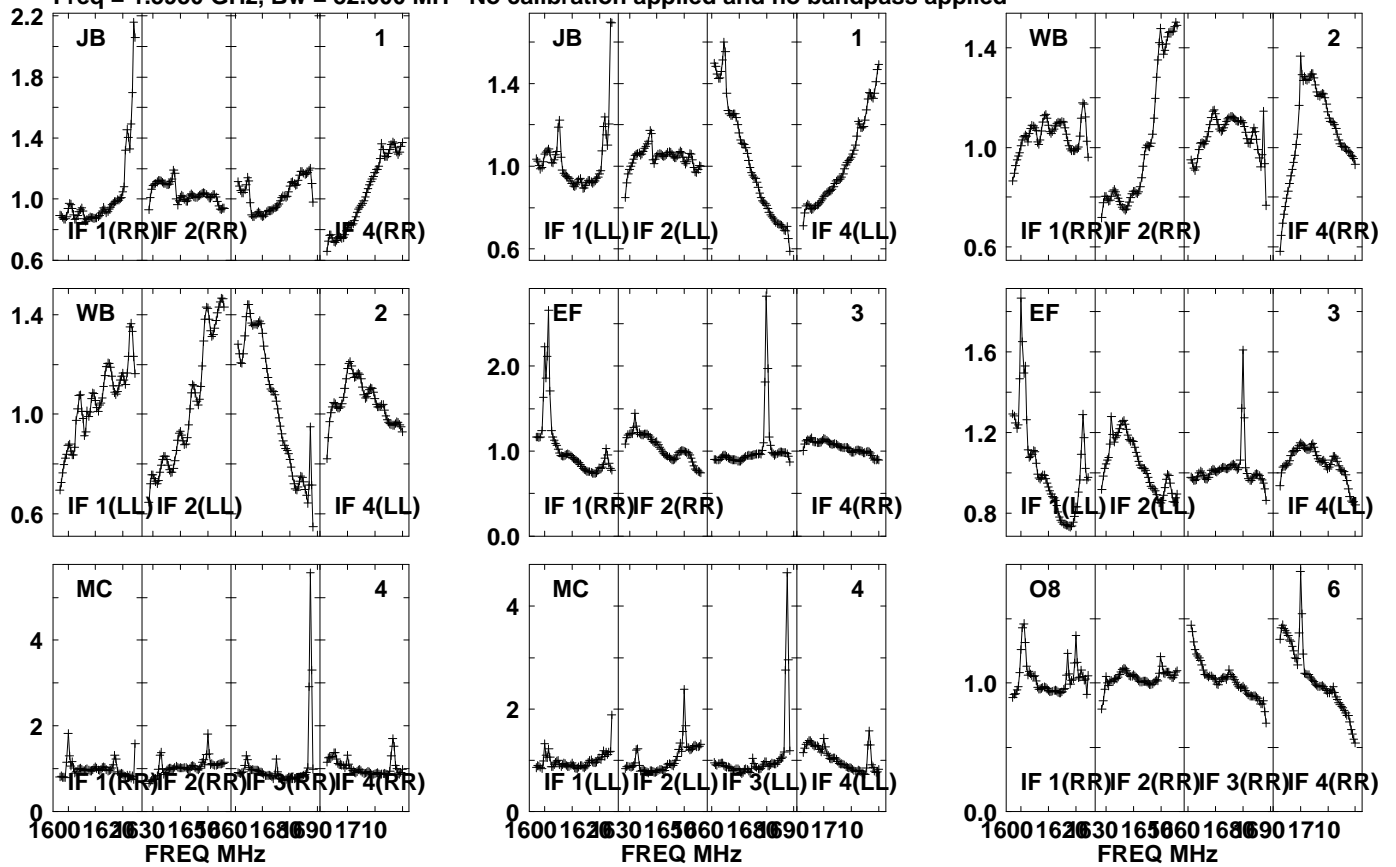

Lower frame: Real Jy
Auto-corr total-power spectrum Antenna: *
Timerange: 00/23:37:51 to 00/23:41:19

Plot file version 7 created 12-JUN-2023 14:39:07

J1548 ES106B.UVDATA.1

Freq = 1.5950 GHz, Bw = 32.000 MH No calibration applied and no bandpass applied

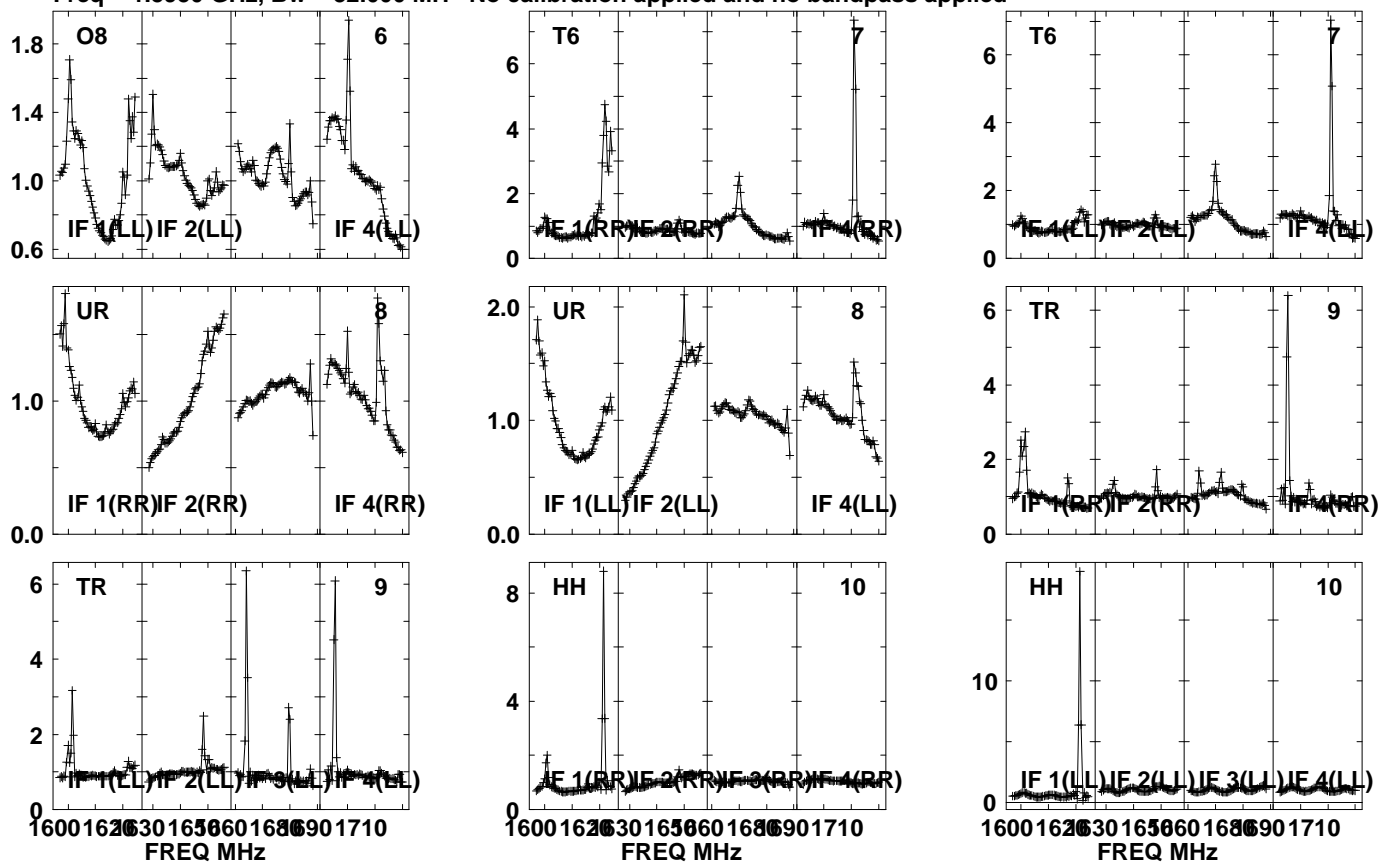

Lower frame: Real Jy
Auto-corr total-power spectrum Antenna: *
Timerange: 00/23:37:51 to 00/23:41:19

Plot file version 8 created 12-JUN-2023 14:39:07

J1547+2052 ES106B.UVDATA.1

Freq = 1.5950 GHz, Bw = 32.000 MH No calibration applied and no bandpass applied

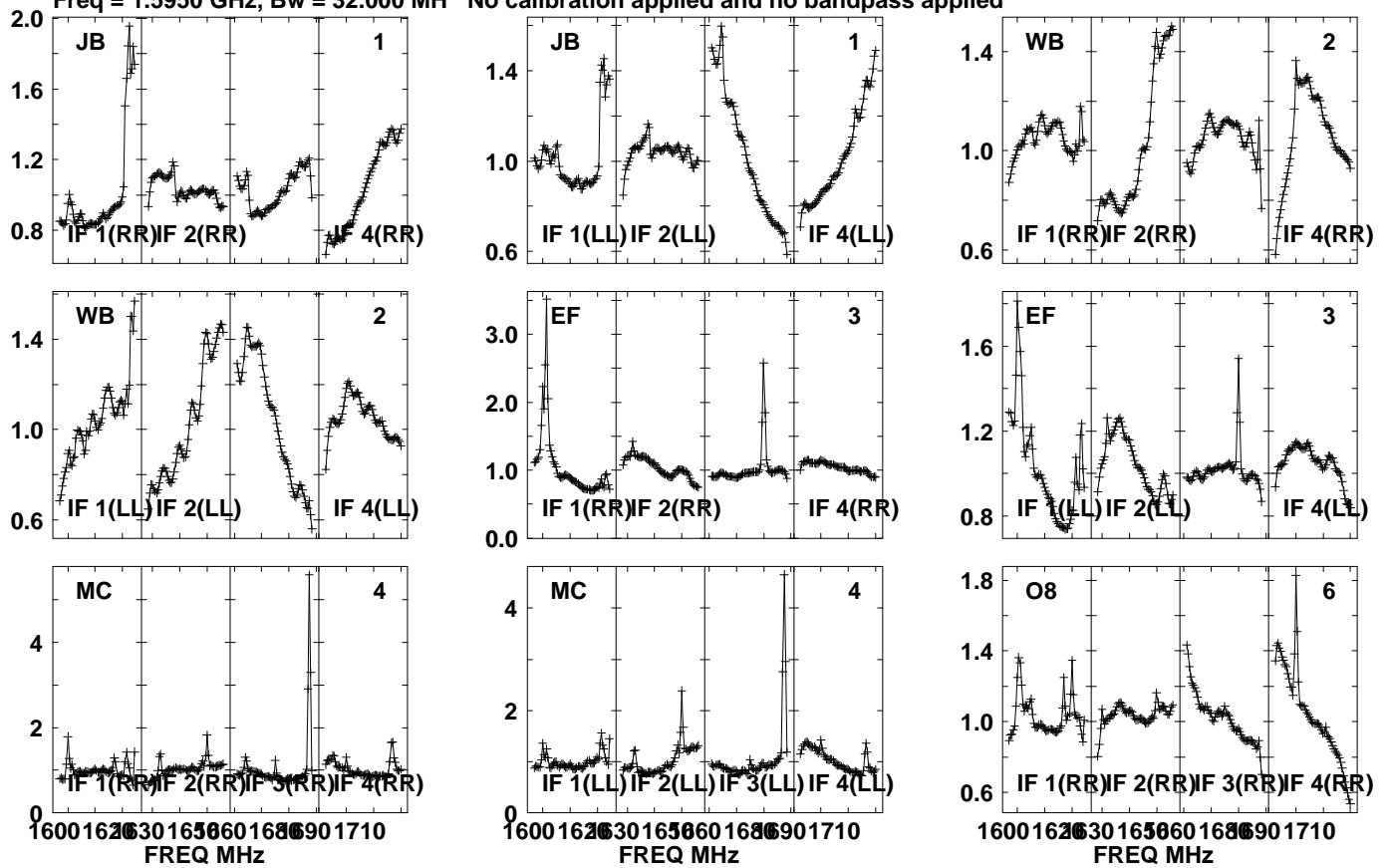

Lower frame: Real Jy
Auto-corr total-power spectrum Antenna: *
Timerange: 00/23:41:21 to 00/23:42:49

Plot file version 9 created 12-JUN-2023 14:39:07

J1547+2052 ES106B.UVDATA.1

Freq = 1.5950 GHz, Bw = 32.000 MH No calibration applied and no bandpass applied

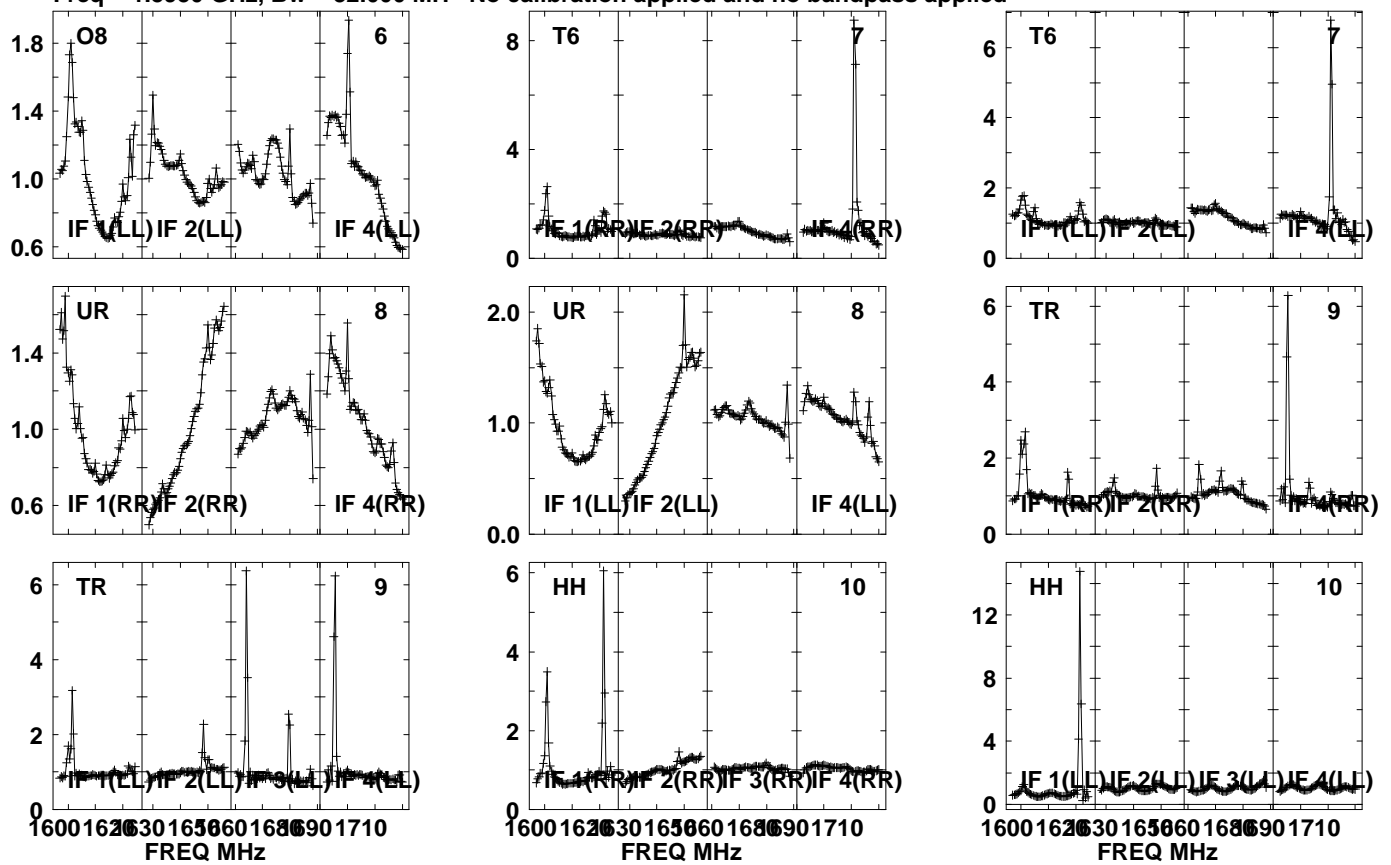

Lower frame: Real Jy
Auto-corr total-power spectrum Antenna: *
Timerange: 00/23:41:21 to 00/23:42:49

Plot file version 10 created 12-JUN-2023 14:39:08

J1545+2006 ES106B.UVDATA.1

Freq = 1.5950 GHz, Bw = 32.000 MH No calibration applied and no bandpass applied

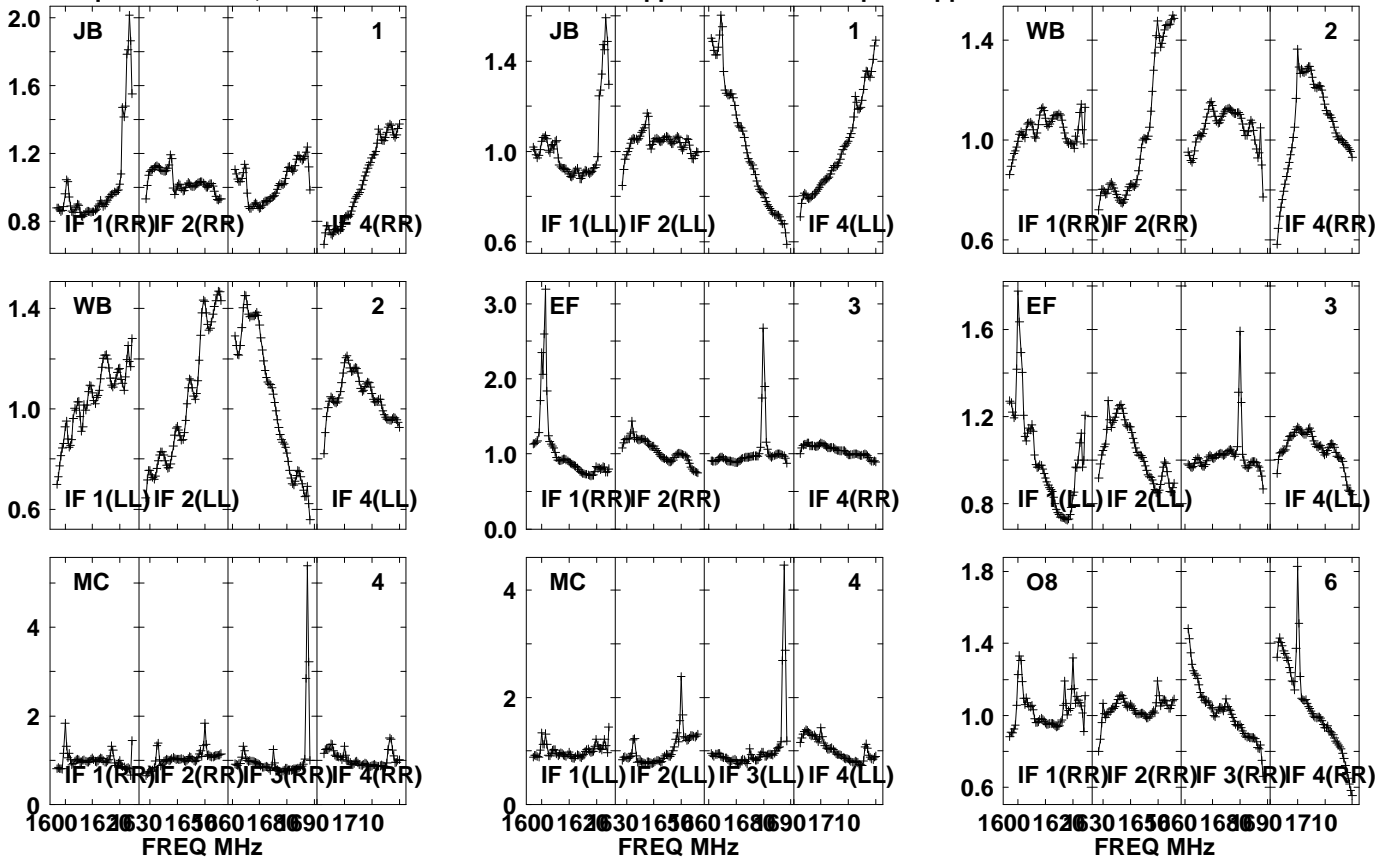

Lower frame: Real Jy
Auto-corr total-power spectrum Antenna: *
Timerange: 00/23:42:51 to 00/23:45:19

Plot file version 11 created 12-JUN-2023 14:39:08

J1545+2006 ES106B.UVDATA.1

Freq = 1.5950 GHz, Bw = 32.000 MH No calibration applied and no bandpass applied

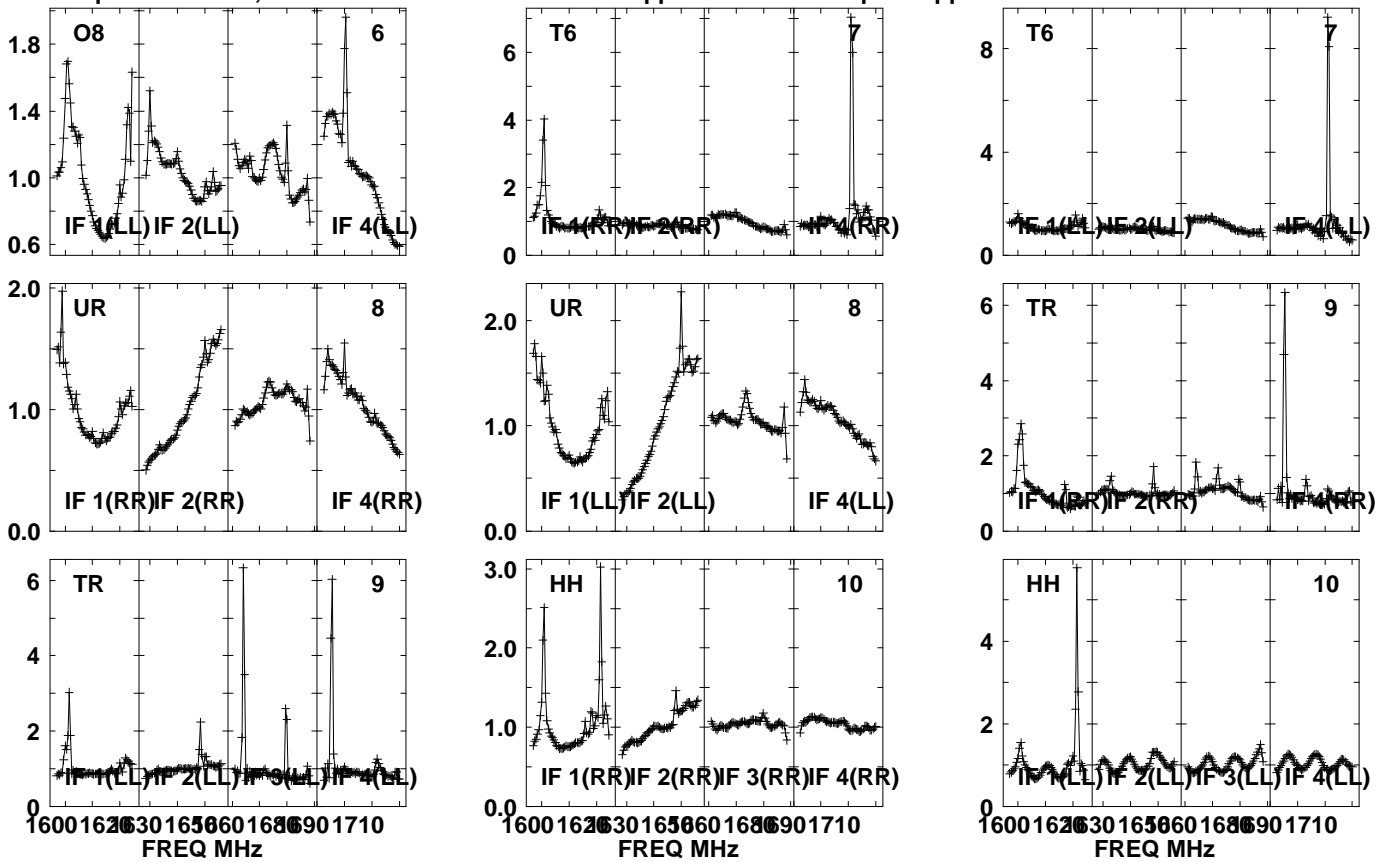

Lower frame: Real Jy
Auto-corr total-power spectrum Antenna: *
Timerange: 00/23:42:51 to 00/23:45:19

Plot file version 12 created 12-JUN-2023 14:39:08

J1547+2052 ES106B.UVDATA.1

Freq = 1.5950 GHz, Bw = 32.000 MH No calibration applied and no bandpass applied

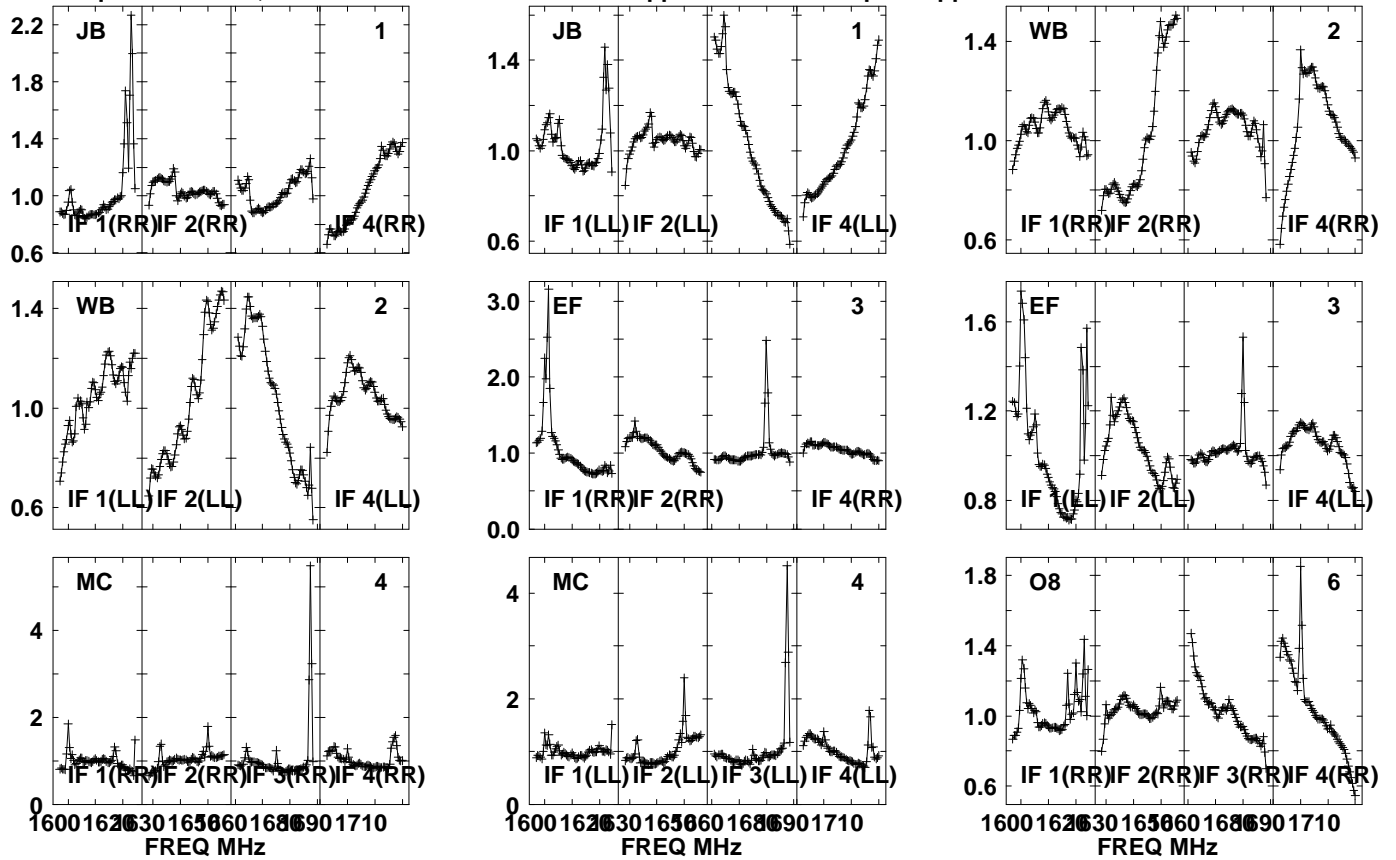

Lower frame: Real Jy
Auto-corr total-power spectrum Antenna: *
Timerange: 00/23:45:21 to 00/23:46:49

Plot file version 13 created 12-JUN-2023 14:39:08

J1547+2052 ES106B.UVDATA.1

Freq = 1.5950 GHz, Bw = 32.000 MH No calibration applied and no bandpass applied

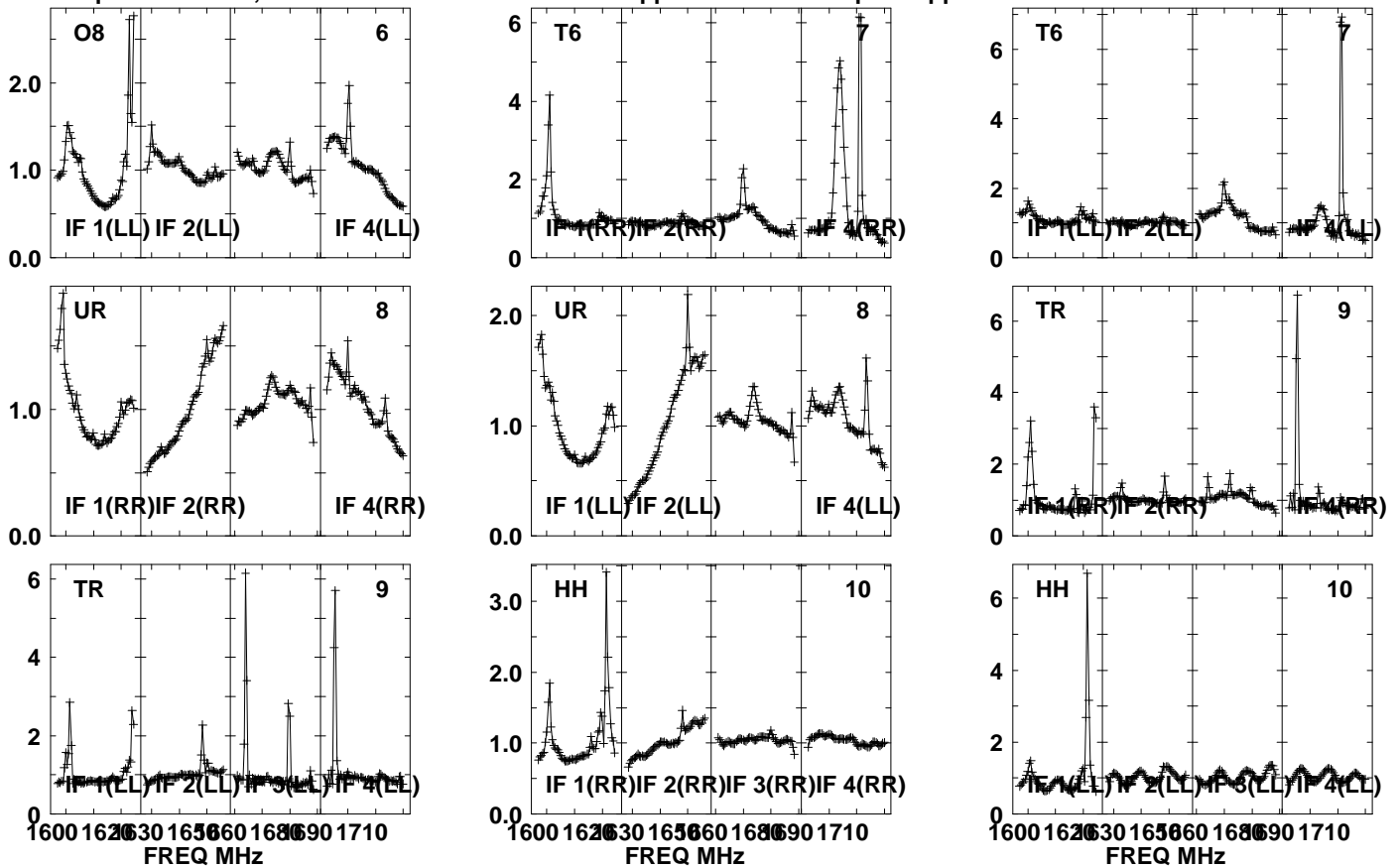

Lower frame: Real Jy

Auto-corr total-power spectrum Antenna: *

Timerange: 00/23:45:21 to 00/23:46:49

Plot file version 14 created 12-JUN-2023 14:39:08

J1548 ES106B.UVDATA.1

Freq = 1.5950 GHz, Bw = 32.000 MH No calibration applied and no bandpass applied

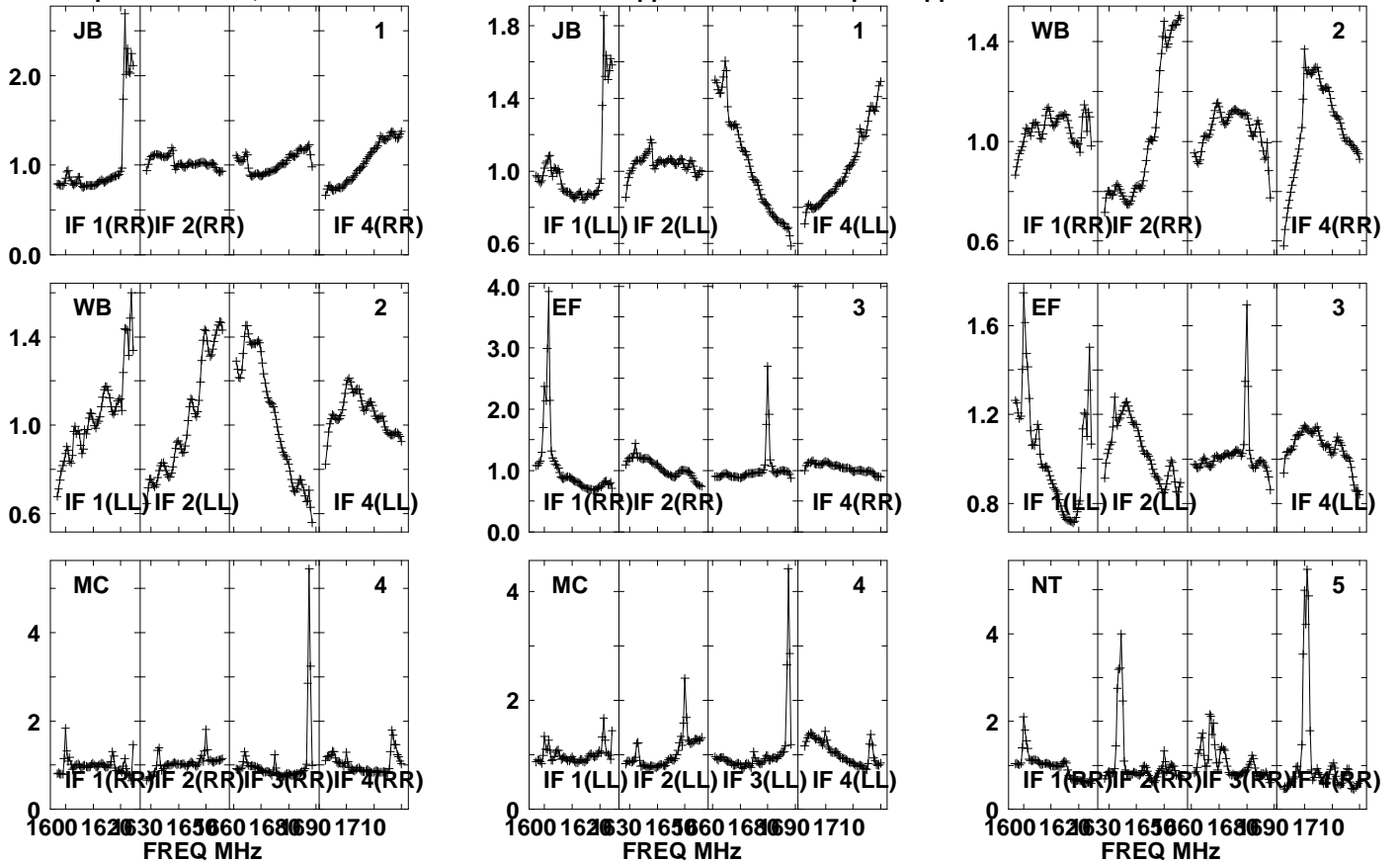

Lower frame: Real Jy

Auto-corr total-power spectrum Antenna: *

Timerange: 00/23:47:21 to 00/23:51:19

Plot file version 15 created 12-JUN-2023 14:39:08

J1548 ES106B.UVDATA.1

Freq = 1.5950 GHz, Bw = 32.000 MH No calibration applied and no bandpass applied

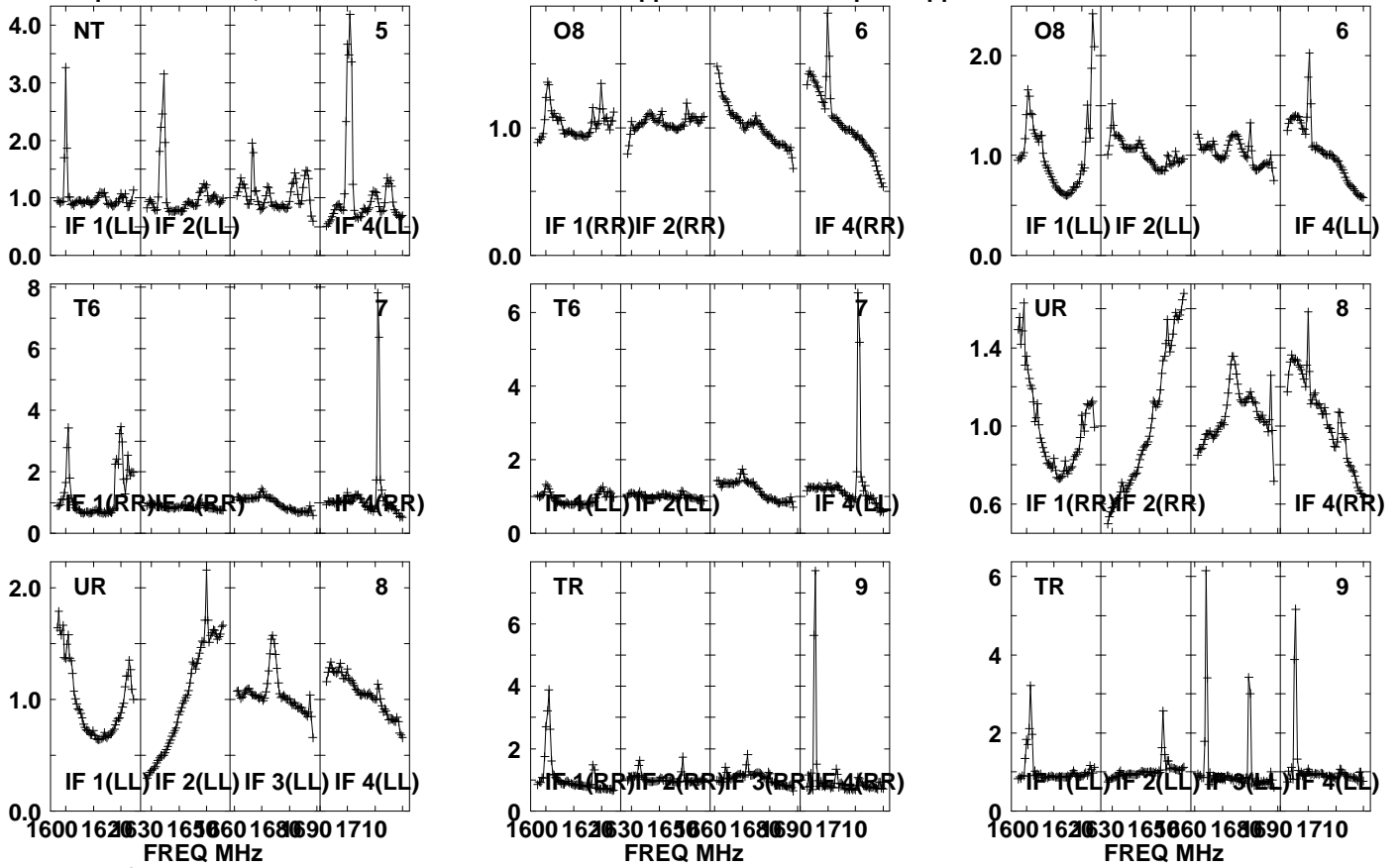

Lower frame: Real Jy
Auto-corr total-power spectrum Antenna: *
Timerange: 00/23:47:21 to 00/23:51:19

Plot file version 16 created 12-JUN-2023 14:39:08

J1548 ES106B.UVDATA.1

Freq = 1.5950 GHz, Bw = 32.000 MH No calibration applied and no bandpass applied

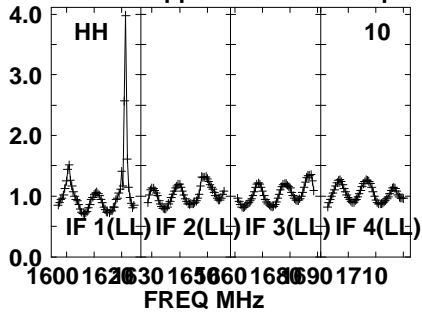
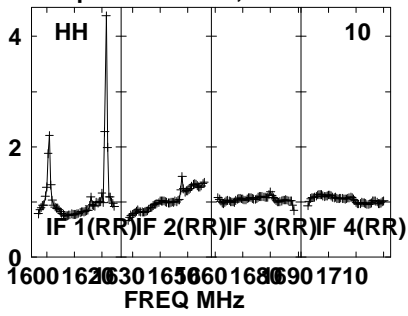

Lower frame: Real Jy
Auto-corr total-power spectrum Antenna: *
Timerange: 00/23:47:21 to 00/23:51:19

Plot file version 17 created 12-JUN-2023 14:39:08

J1547+2052 ES106B.UVDATA.1

Freq = 1.5950 GHz, Bw = 32.000 MH No calibration applied and no bandpass applied

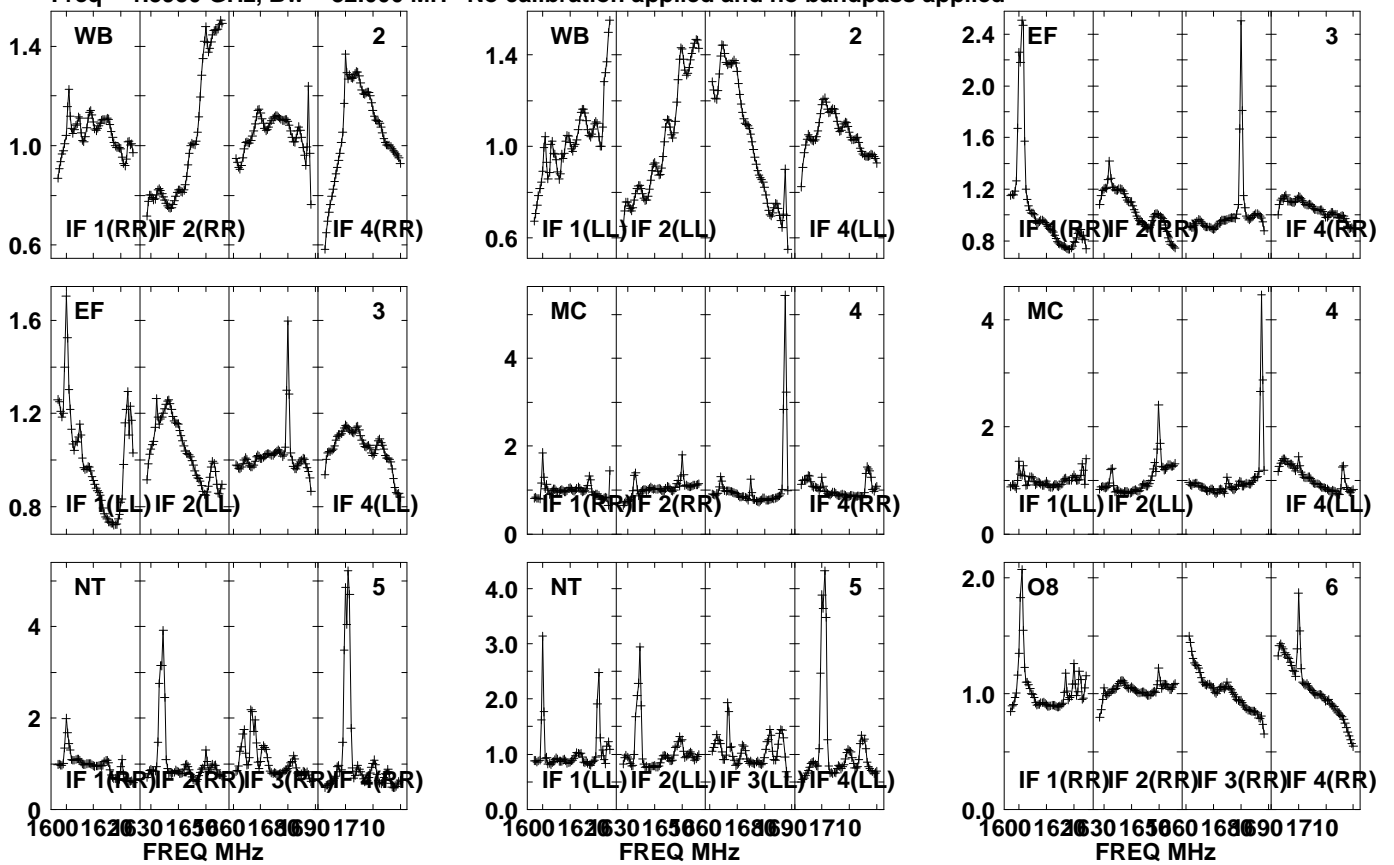

Lower frame: Real Jy

Auto-corr total-power spectrum Antenna: *

Timerange: 00/23:51:21 to 00/23:52:49

Plot file version 18 created 12-JUN-2023 14:39:08

J1547+2052 ES106B.UVDATA.1

Freq = 1.5950 GHz, Bw = 32.000 MH No calibration applied and no bandpass applied

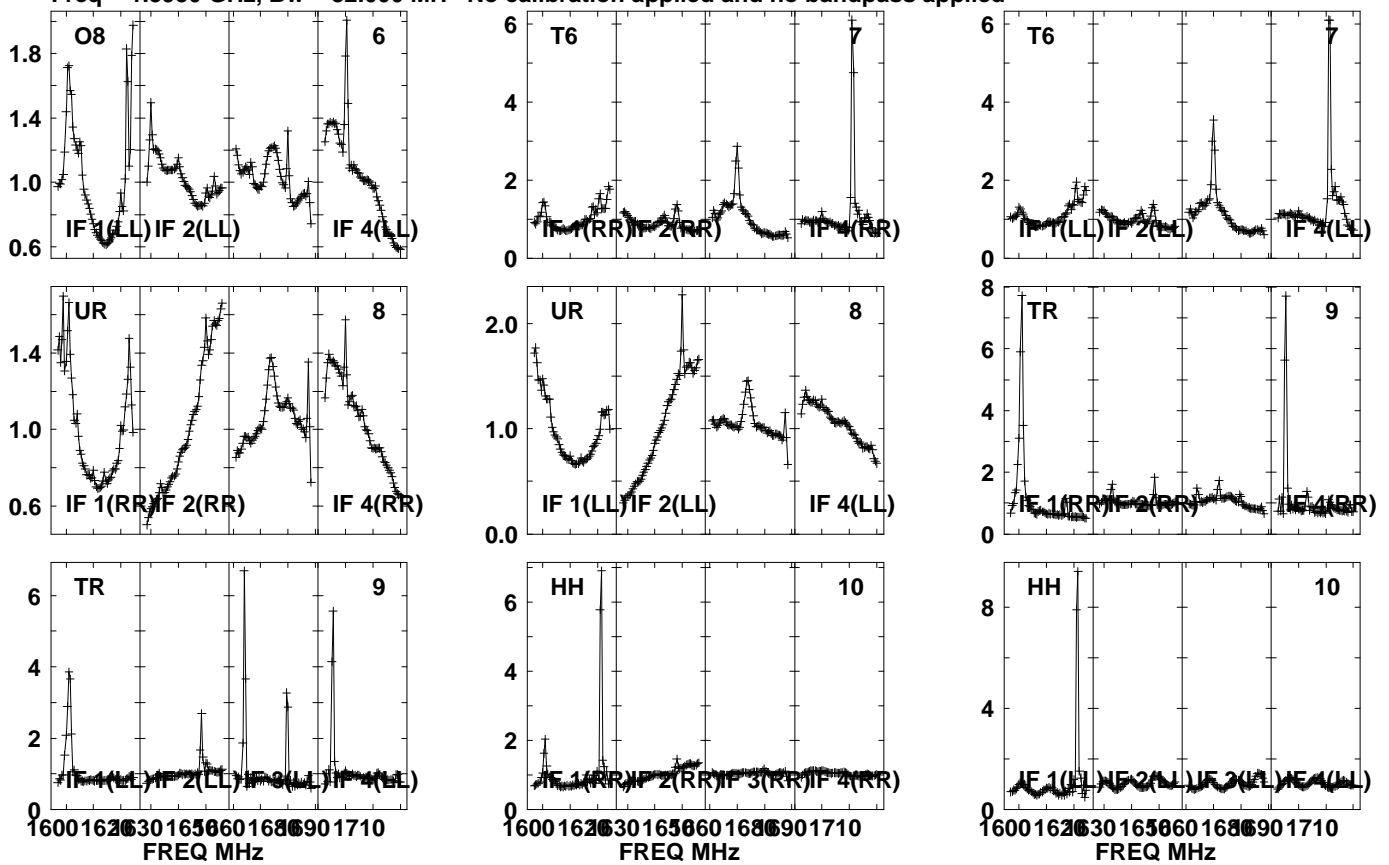

Lower frame: Real Jy
Auto-corr total-power spectrum Antenna: *
Timerange: 00/23:51:21 to 00/23:52:49

Plot file version 19 created 12-JUN-2023 14:39:08

J1548 ES106B.UVDATA.1

Freq = 1.5950 GHz, Bw = 32.000 MH No calibration applied and no bandpass applied

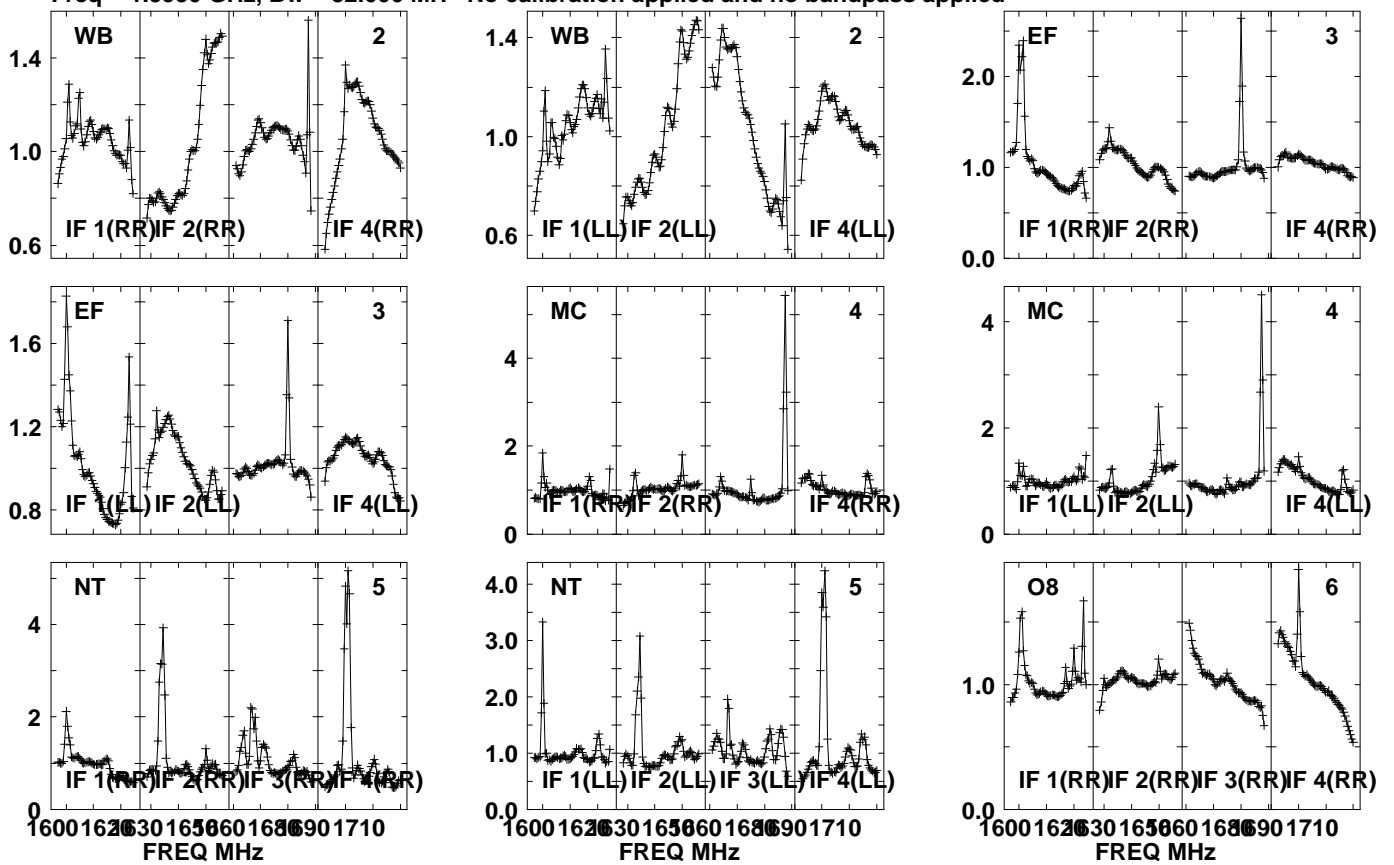

Lower frame: Real Jy
Auto-corr total-power spectrum Antenna: *
Timerange: 00/23:52:51 to 00/23:56:19

Plot file version 20 created 12-JUN-2023 14:39:08

J1548 ES106B.UVDATA.1

Freq = 1.5950 GHz, Bw = 32.000 MH No calibration applied and no bandpass applied

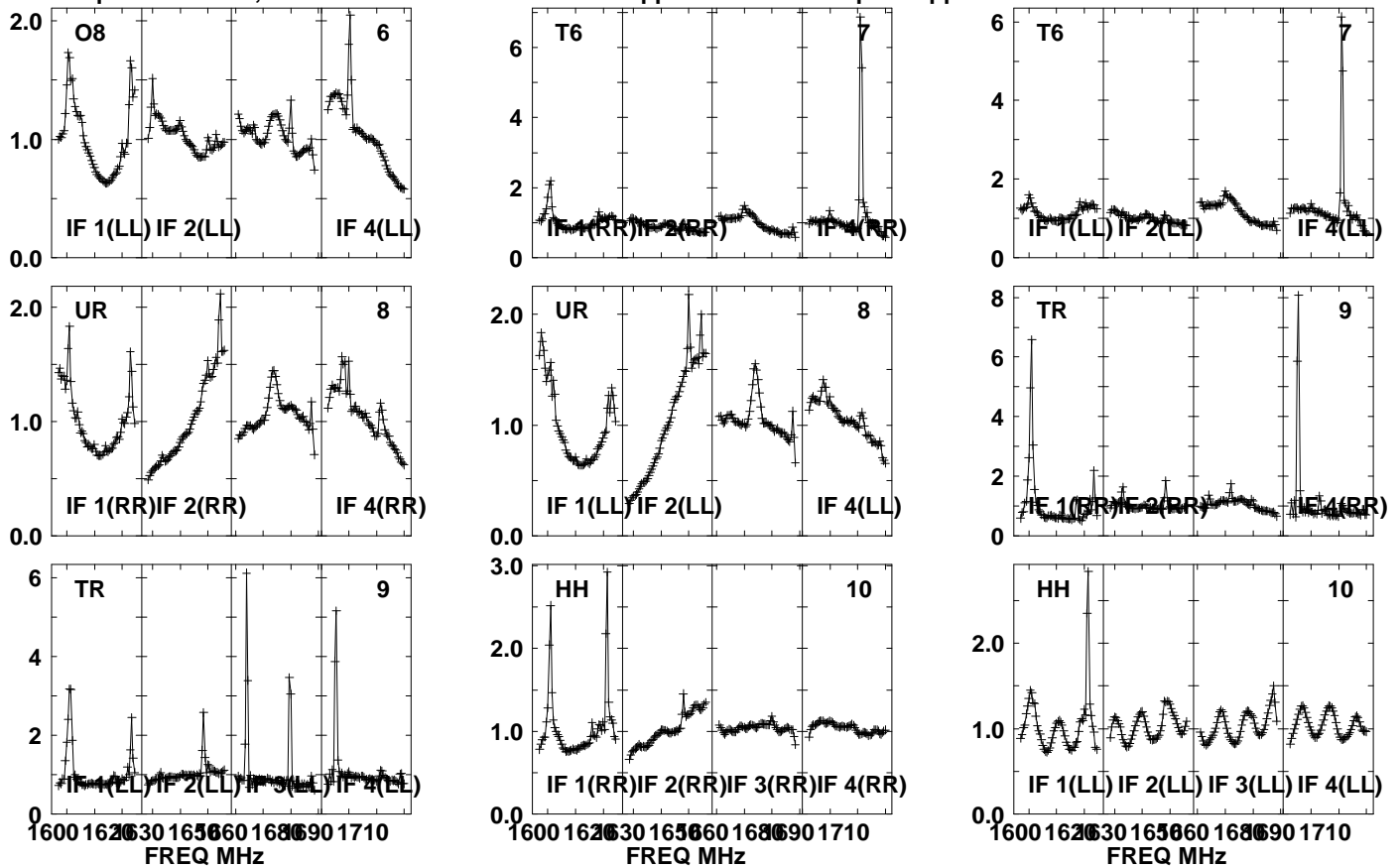

Lower frame: Real Jy

Auto-corr total-power spectrum Antenna: *

Timerange: 00/23:52:51 to 00/23:56:19

Plot file version 21 created 12-JUN-2023 14:39:08

J1547+2052 ES106B.UVDATA.1

Freq = 1.5950 GHz, Bw = 32.000 MH No calibration applied and no bandpass applied

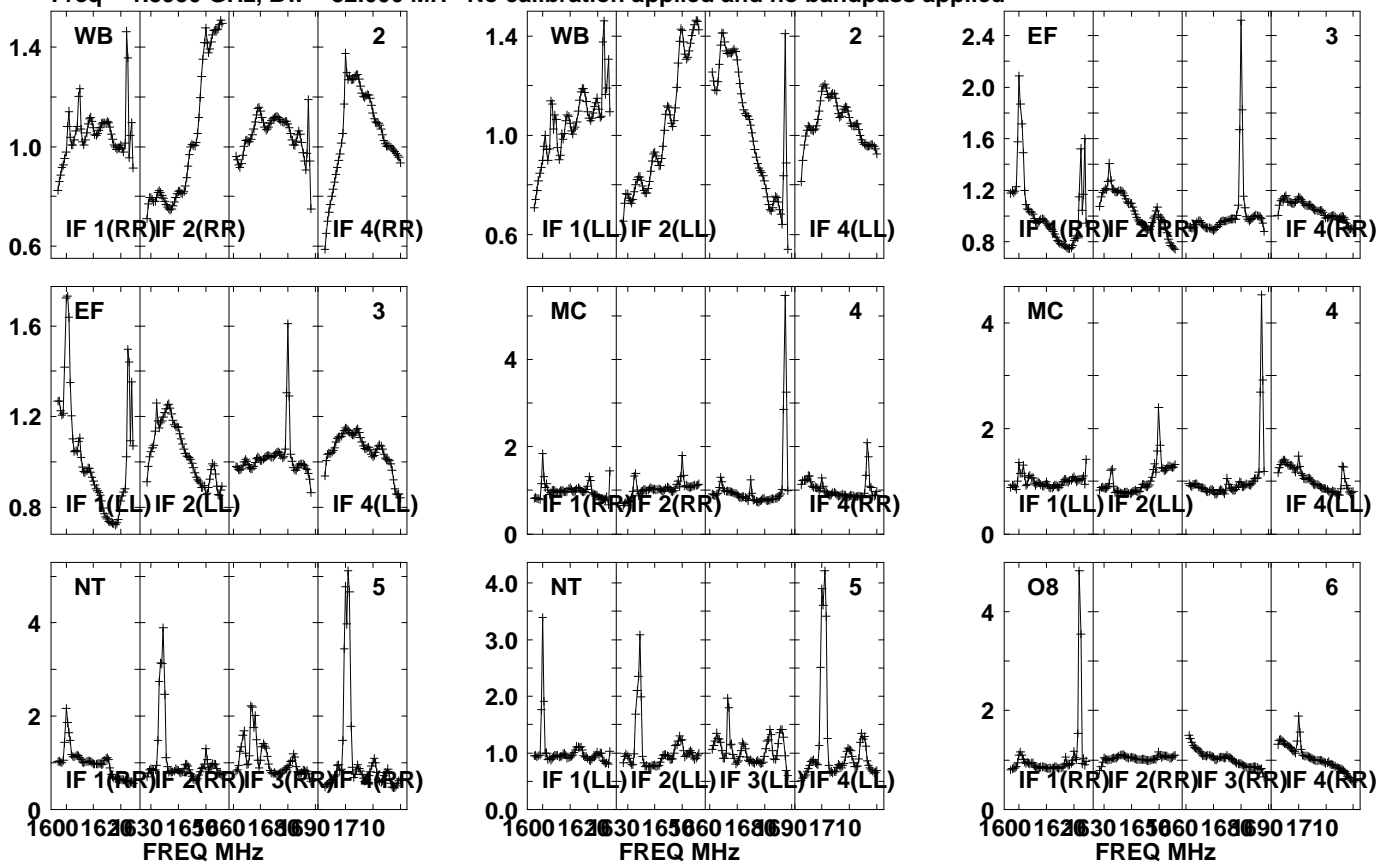

Lower frame: Real Jy
Auto-corr total-power spectrum Antenna: *
Timerange: 00/23:56:51 to 00/23:58:19

Plot file version 22 created 12-JUN-2023 14:39:08

J1547+2052 ES106B.UVDATA.1

Freq = 1.5950 GHz, Bw = 32.000 MH No calibration applied and no bandpass applied

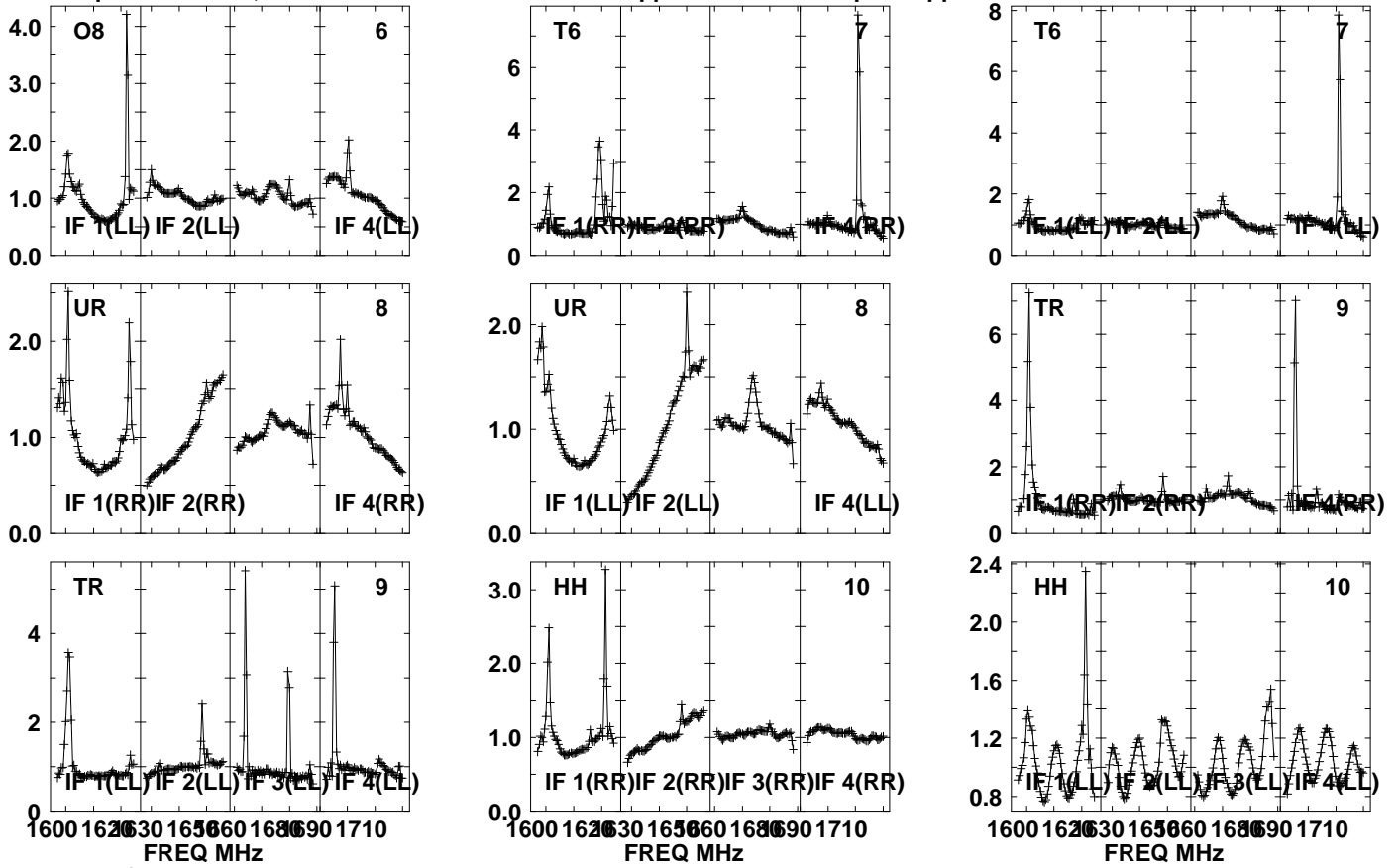

Lower frame: Real Jy

Auto-corr total-power spectrum Antenna: *

Timerange: 00/23:56:51 to 00/23:58:19

Plot file version 23 created 12-JUN-2023 14:39:08

J1548 ES106B.UVDATA.1

Freq = 1.5950 GHz, Bw = 32.000 MH No calibration applied and no bandpass applied

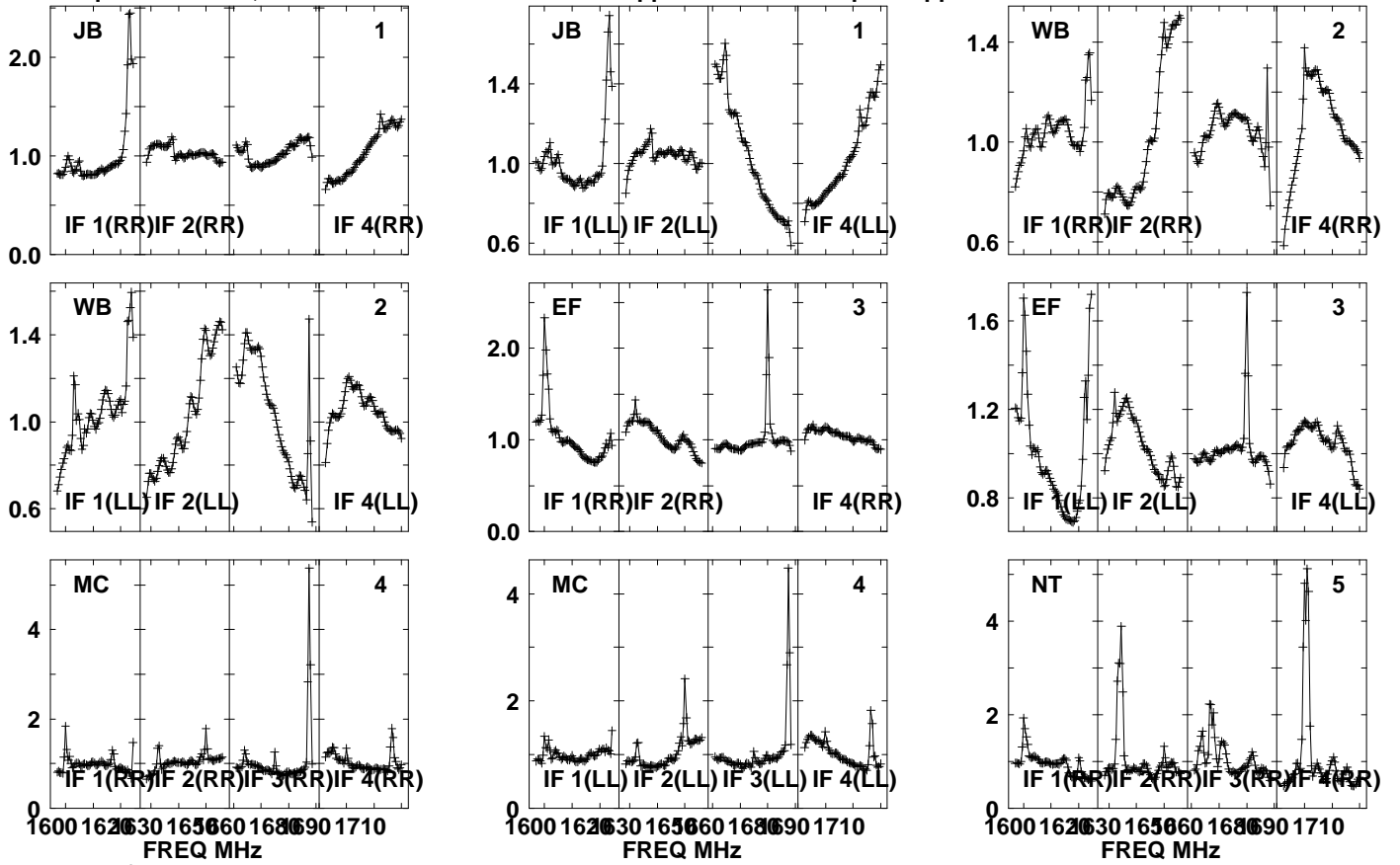

Lower frame: Real Jy
Auto-corr total-power spectrum Antenna: *
Timerange: 00/23:58:21 to 01/00:01:49

Plot file version 24 created 12-JUN-2023 14:39:09

J1548 ES106B.UVDATA.1

Freq = 1.5950 GHz, Bw = 32.000 MH No calibration applied and no bandpass applied

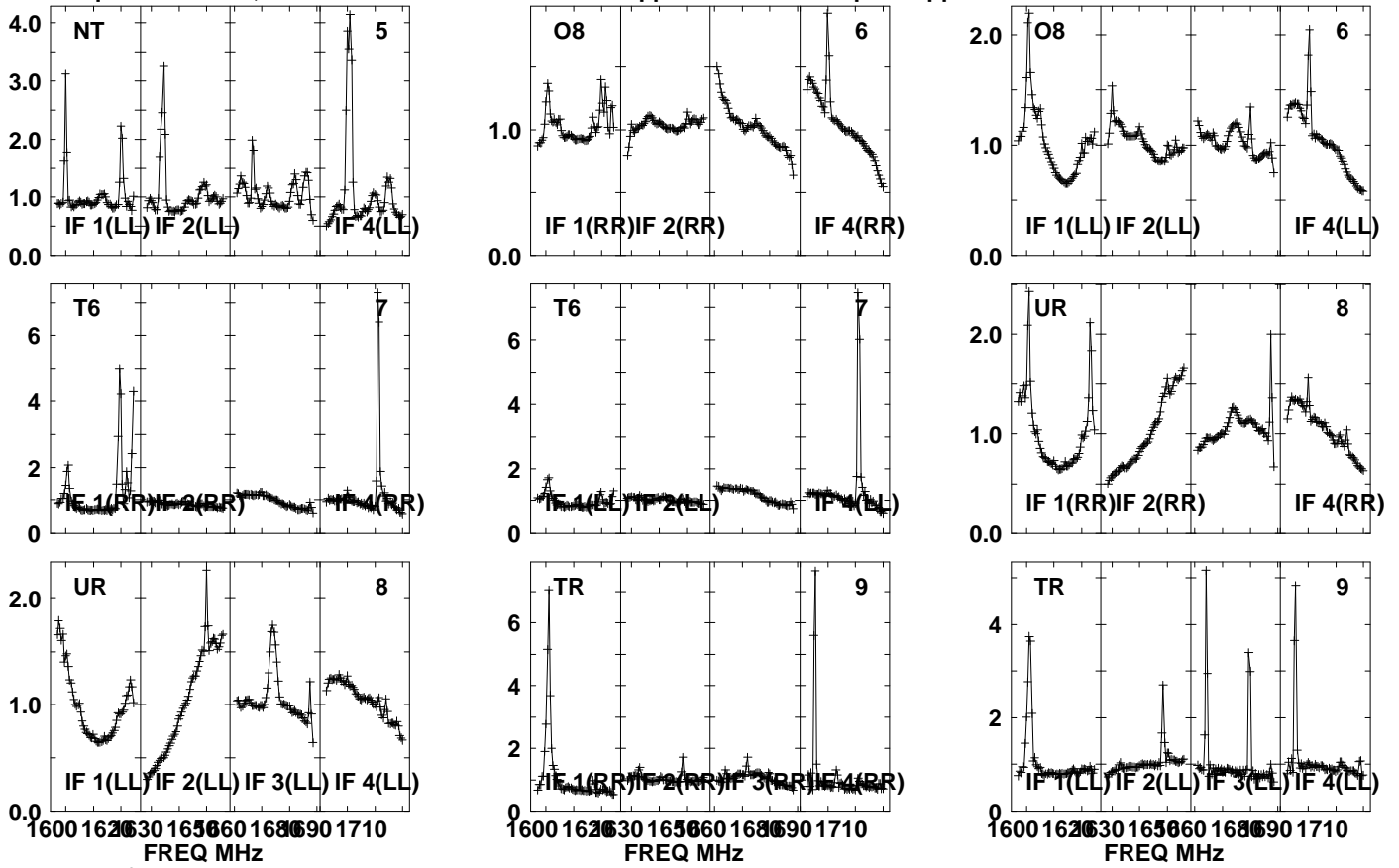

Lower frame: Real Jy
Auto-corr total-power spectrum Antenna: *
Timerange: 00/23:58:21 to 01/00:01:49

Plot file version 25 created 12-JUN-2023 14:39:09

J1548 ES106B.UVDATA.1

Freq = 1.5950 GHz, Bw = 32.000 MH No calibration applied and no bandpass applied

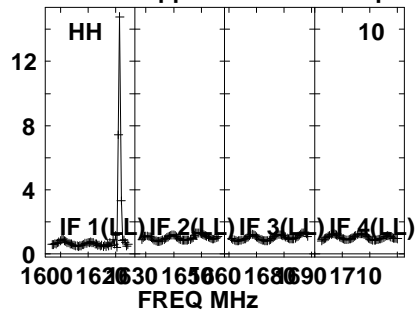
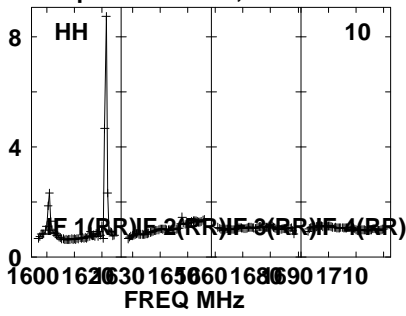

Lower frame: Real Jy
Auto-corr total-power spectrum Antenna: *
Timerange: 00/23:58:21 to 01/00:01:49

Plot file version 26 created 12-JUN-2023 14:39:09

J1547+2052 ES106B.UVDATA.1

Freq = 1.5950 GHz, Bw = 32.000 MH No calibration applied and no bandpass applied

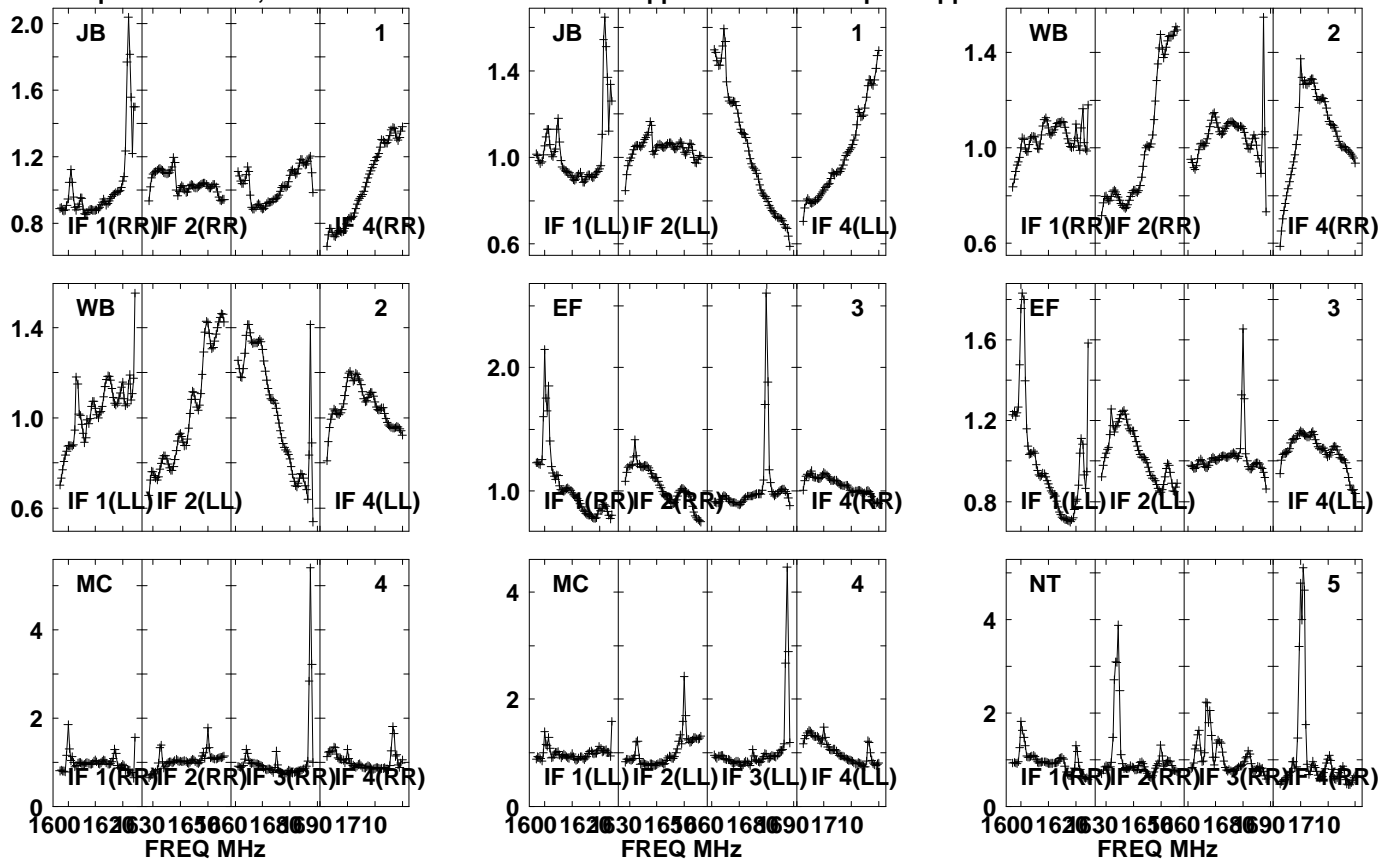

Lower frame: Real Jy
Auto-corr total-power spectrum Antenna: *
Timerange: 01/00:01:51 to 01/00:03:19

Plot file version 27 created 12-JUN-2023 14:39:09

J1547+2052 ES106B.UVDATA.1

Freq = 1.5950 GHz, Bw = 32.000 MH No calibration applied and no bandpass applied

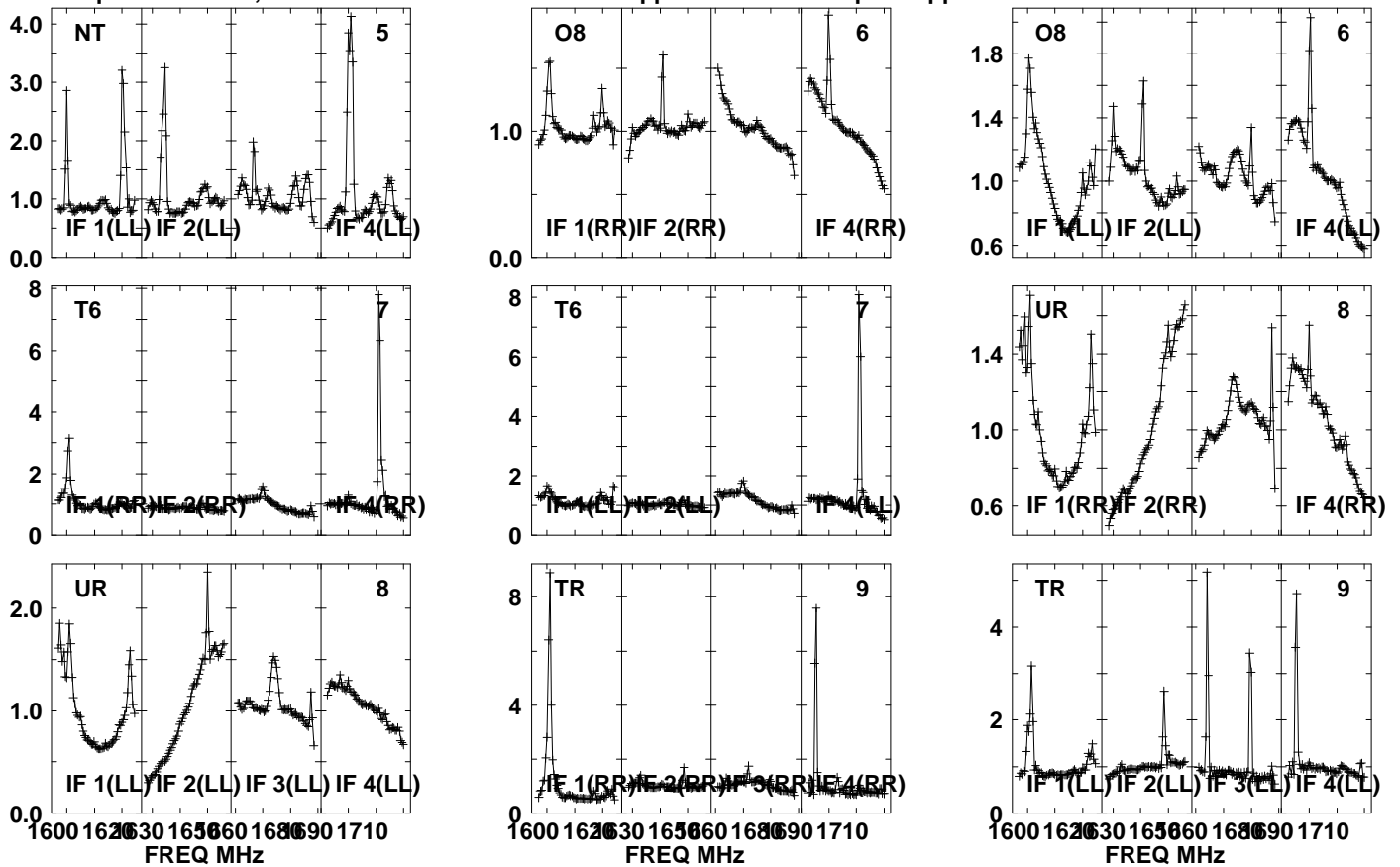

Lower frame: Real Jy

Auto-corr total-power spectrum Antenna: *

Timerange: 01/00:01:51 to 01/00:03:19

Plot file version 28 created 12-JUN-2023 14:39:09

J1547+2052 ES106B.UVDATA.1

Freq = 1.5950 GHz, Bw = 32.000 MH No calibration applied and no bandpass applied

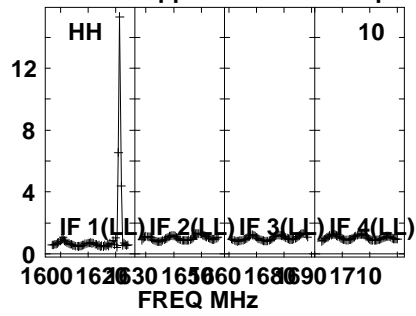
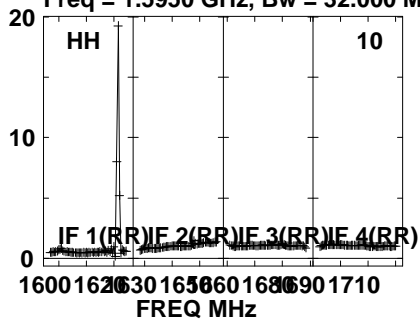

Lower frame: Real Jy
Auto-corr total-power spectrum Antenna: *
Timerange: 01/00:01:51 to 01/00:03:19

Plot file version 29 created 12-JUN-2023 14:39:09

J1545+2006 ES106B.UVDATA.1

Freq = 1.5950 GHz, Bw = 32.000 MH No calibration applied and no bandpass applied

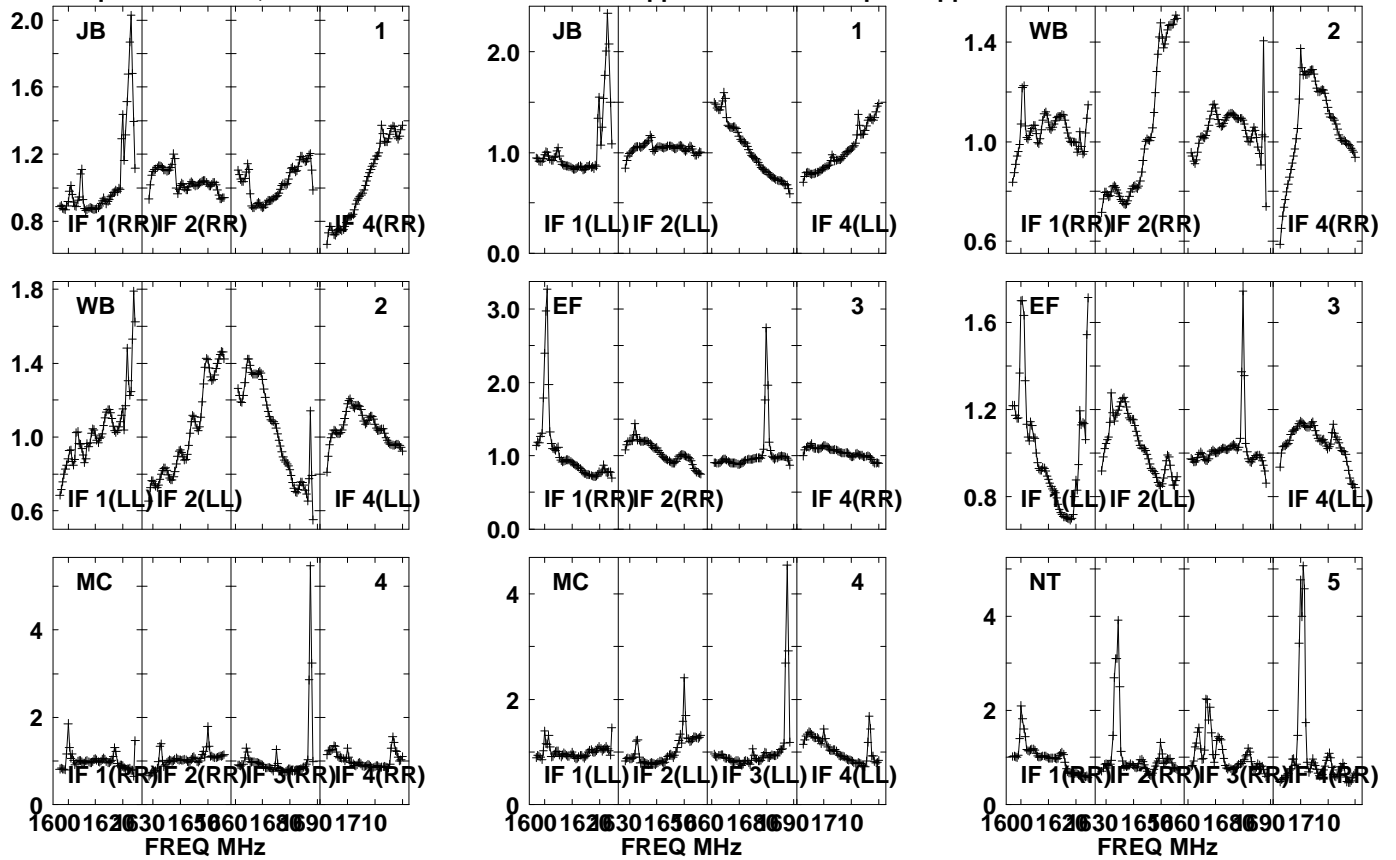

Lower frame: Real Jy
Auto-corr total-power spectrum Antenna: *
Timerange: 01/00:03:21 to 01/00:05:49

Plot file version 30 created 12-JUN-2023 14:39:09

J1545+2006 ES106B.UVDATA.1

Freq = 1.5950 GHz, Bw = 32.000 MH No calibration applied and no bandpass applied

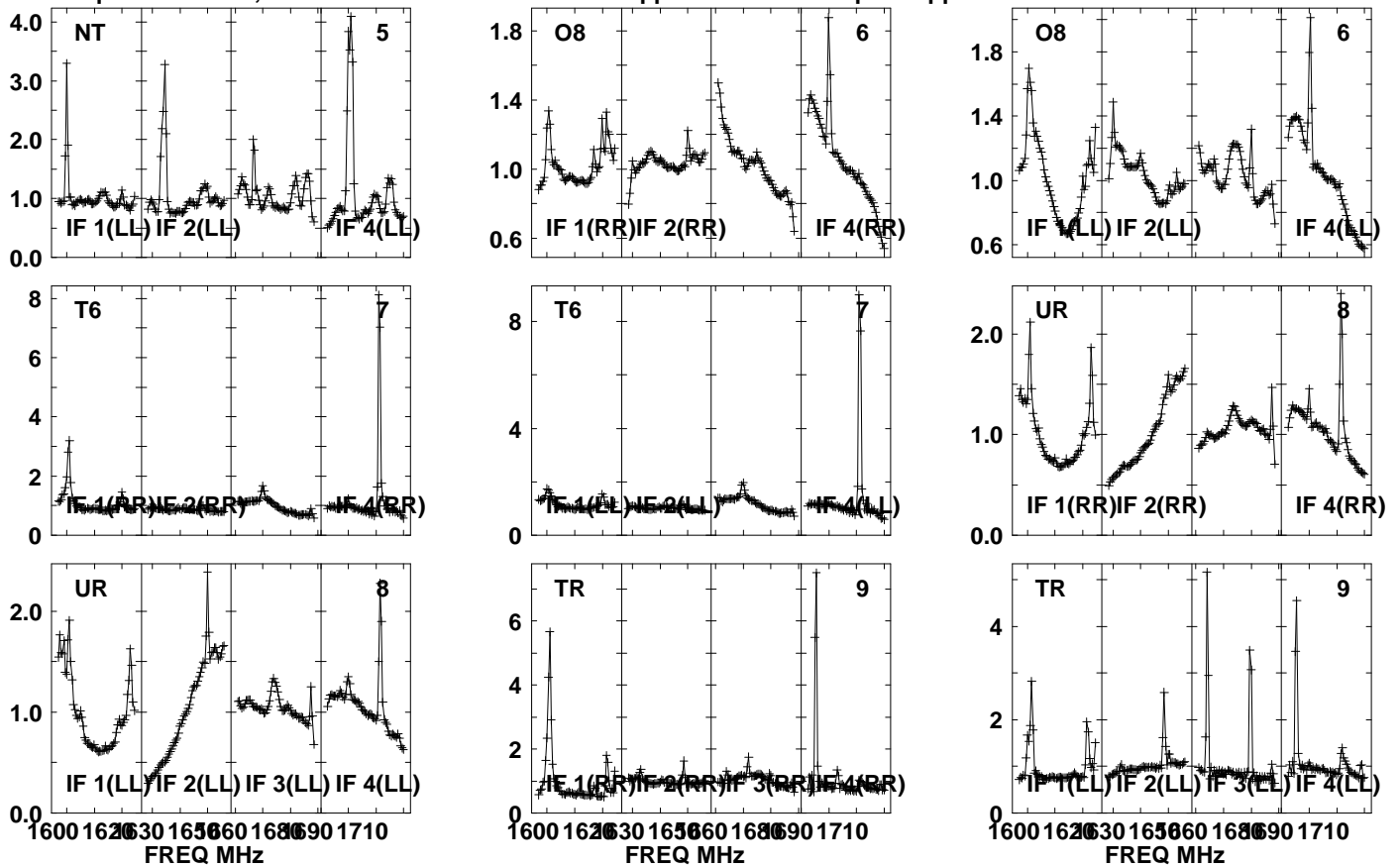

Lower frame: Real Jy

Auto-corr total-power spectrum Antenna: *

Timerange: 01/00:03:21 to 01/00:05:49

Plot file version 31 created 12-JUN-2023 14:39:09

J1545+2006 ES106B.UVDATA.1

Freq = 1.5950 GHz, Bw = 32.000 MH No calibration applied and no bandpass applied

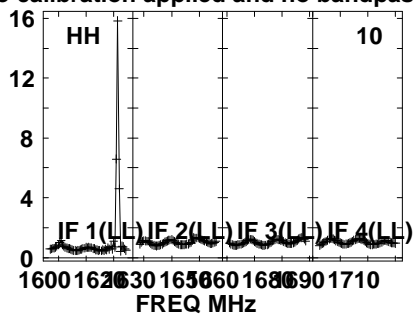
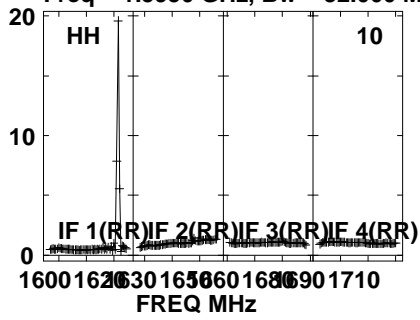

Lower frame: Real Jy
Auto-corr total-power spectrum Antenna: *
Timerange: 01/00:03:21 to 01/00:05:49

Plot file version 32 created 12-JUN-2023 14:39:09

J1547+2052 ES106B.UVDATA.1

Freq = 1.5950 GHz, Bw = 32.000 MH No calibration applied and no bandpass applied

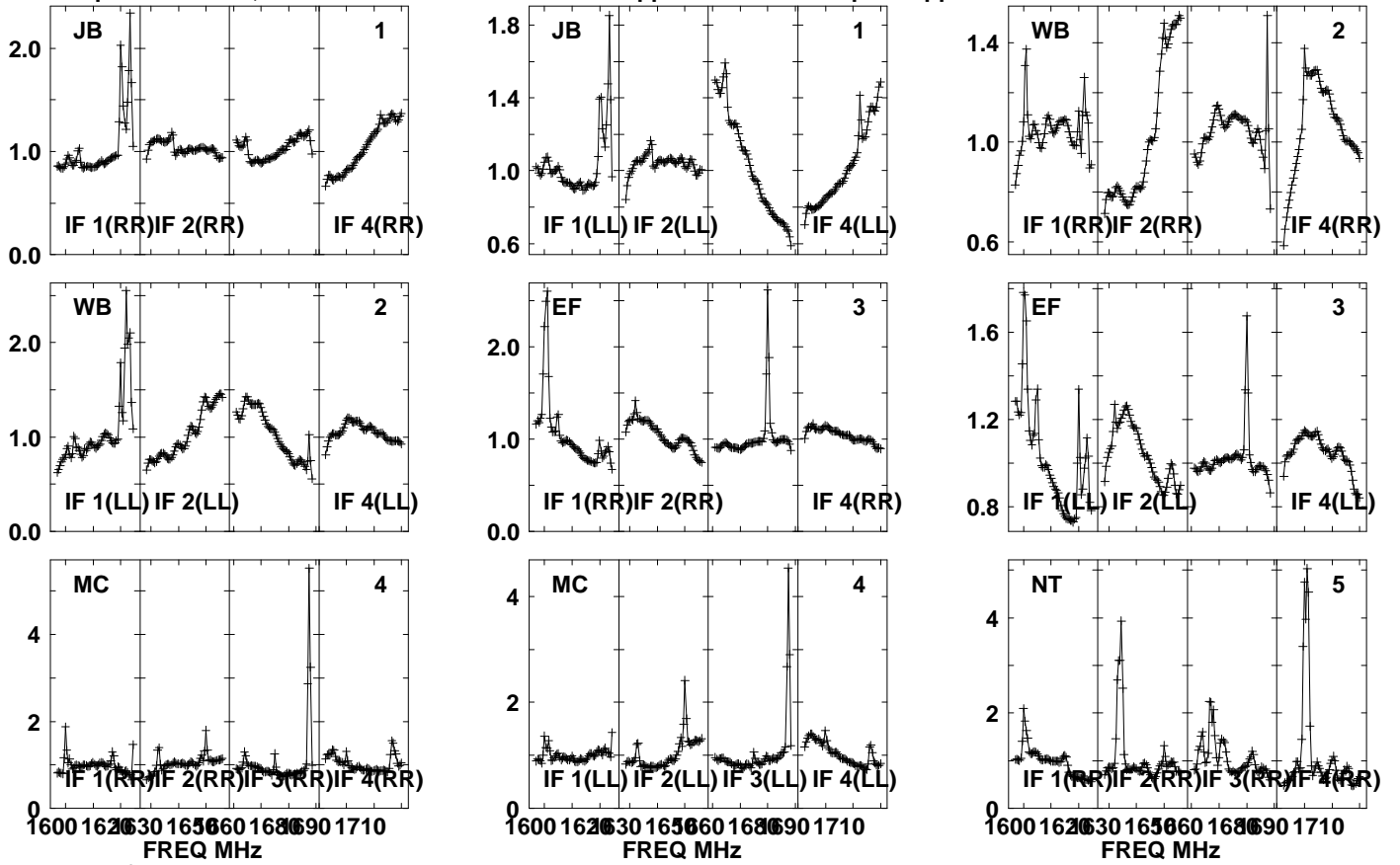

Lower frame: Real Jy

Auto-corr total-power spectrum Antenna: *

Timerange: 01/00:05:51 to 01/00:07:19

Plot file version 33 created 12-JUN-2023 14:39:09

J1547+2052 ES106B.UVDATA.1

Freq = 1.5950 GHz, Bw = 32.000 MH No calibration applied and no bandpass applied

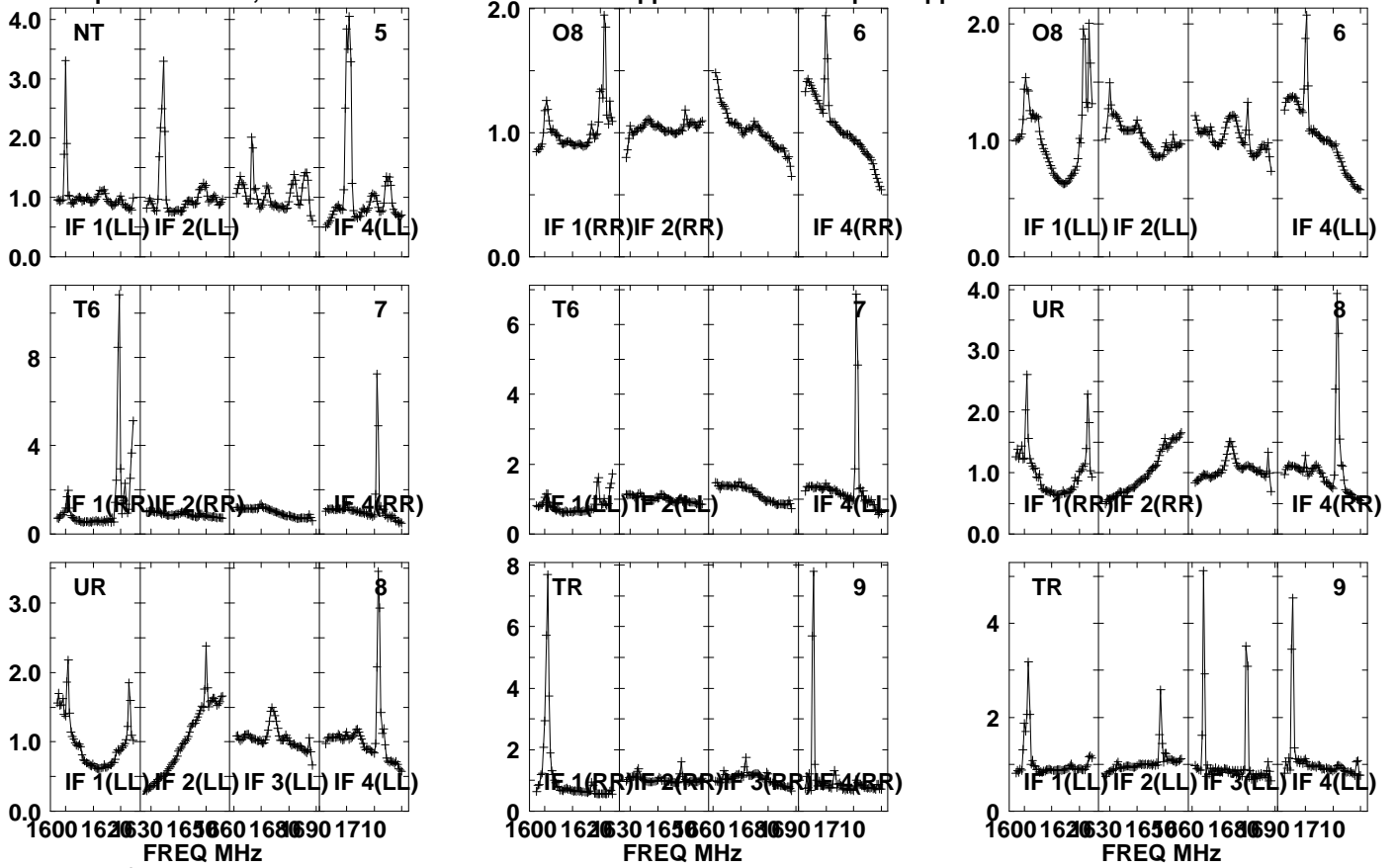

Lower frame: Real Jy
Auto-corr total-power spectrum Antenna: *
Timerange: 01/00:05:51 to 01/00:07:19

Plot file version 34 created 12-JUN-2023 14:39:09

J1547+2052 ES106B.UVDATA.1

Freq = 1.5950 GHz, Bw = 32.000 MH No calibration applied and no bandpass applied

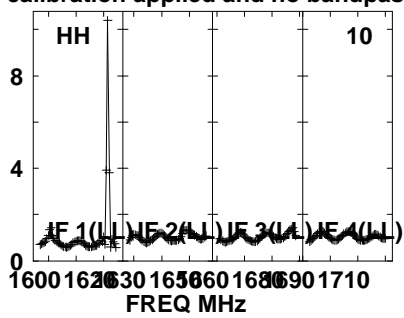
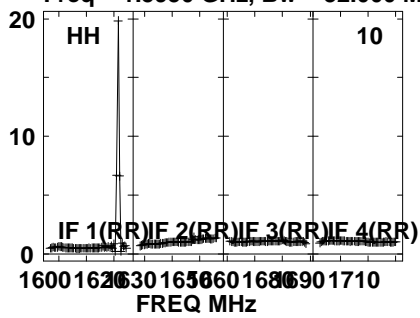

Lower frame: Real Jy
Auto-corr total-power spectrum Antenna: *
Timerange: 01/00:05:51 to 01/00:07:19

Plot file version 35 created 12-JUN-2023 14:39:09

J1548 ES106B.UVDATA.1

Freq = 1.5950 GHz, Bw = 32.000 MH No calibration applied and no bandpass applied

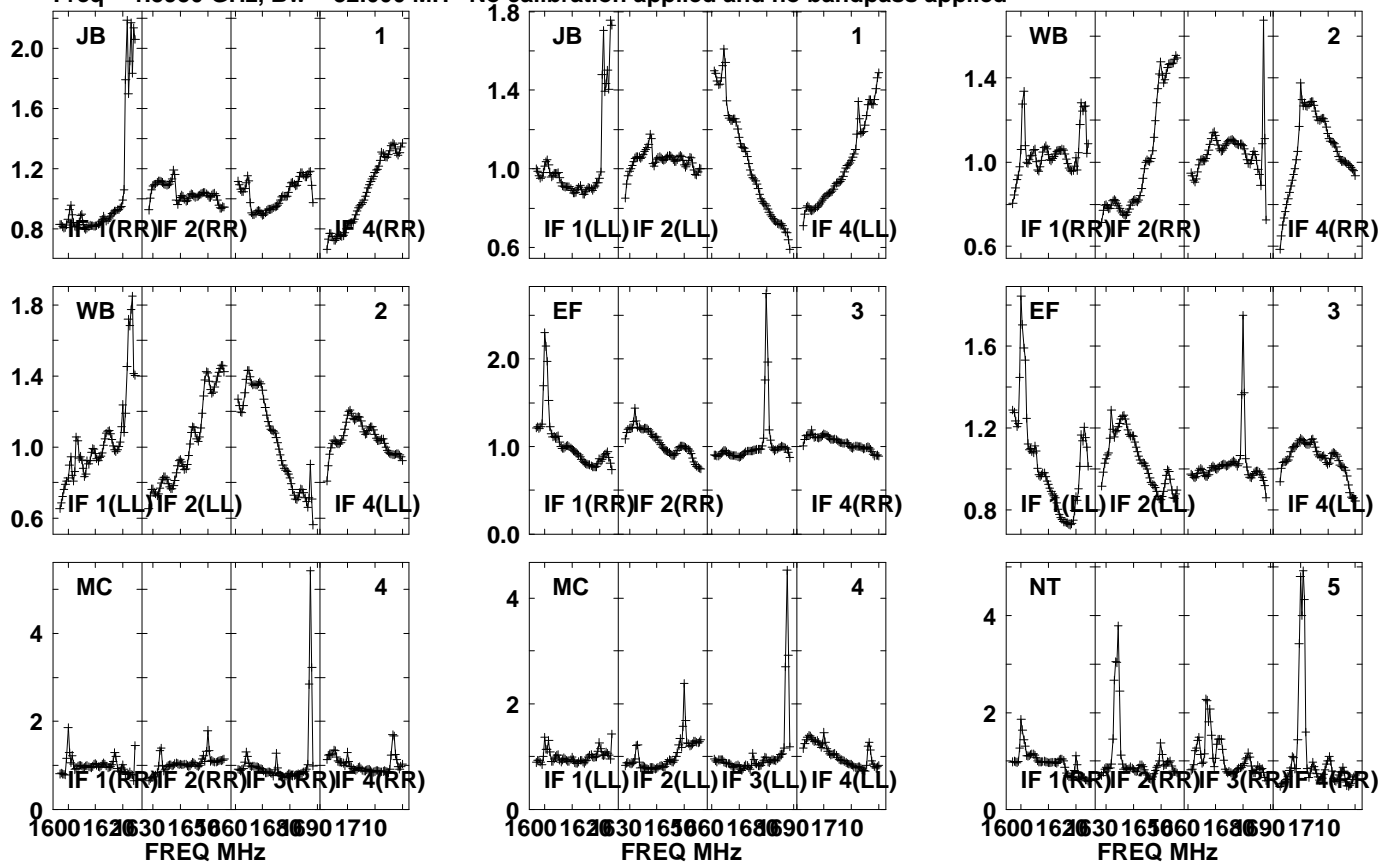

Lower frame: Real Jy
Auto-corr total-power spectrum Antenna: *
Timerange: 01/00:07:51 to 01/00:11:49

Plot file version 36 created 12-JUN-2023 14:39:09

J1548 ES106B.UVDATA.1

Freq = 1.5950 GHz, Bw = 32.000 MH No calibration applied and no bandpass applied

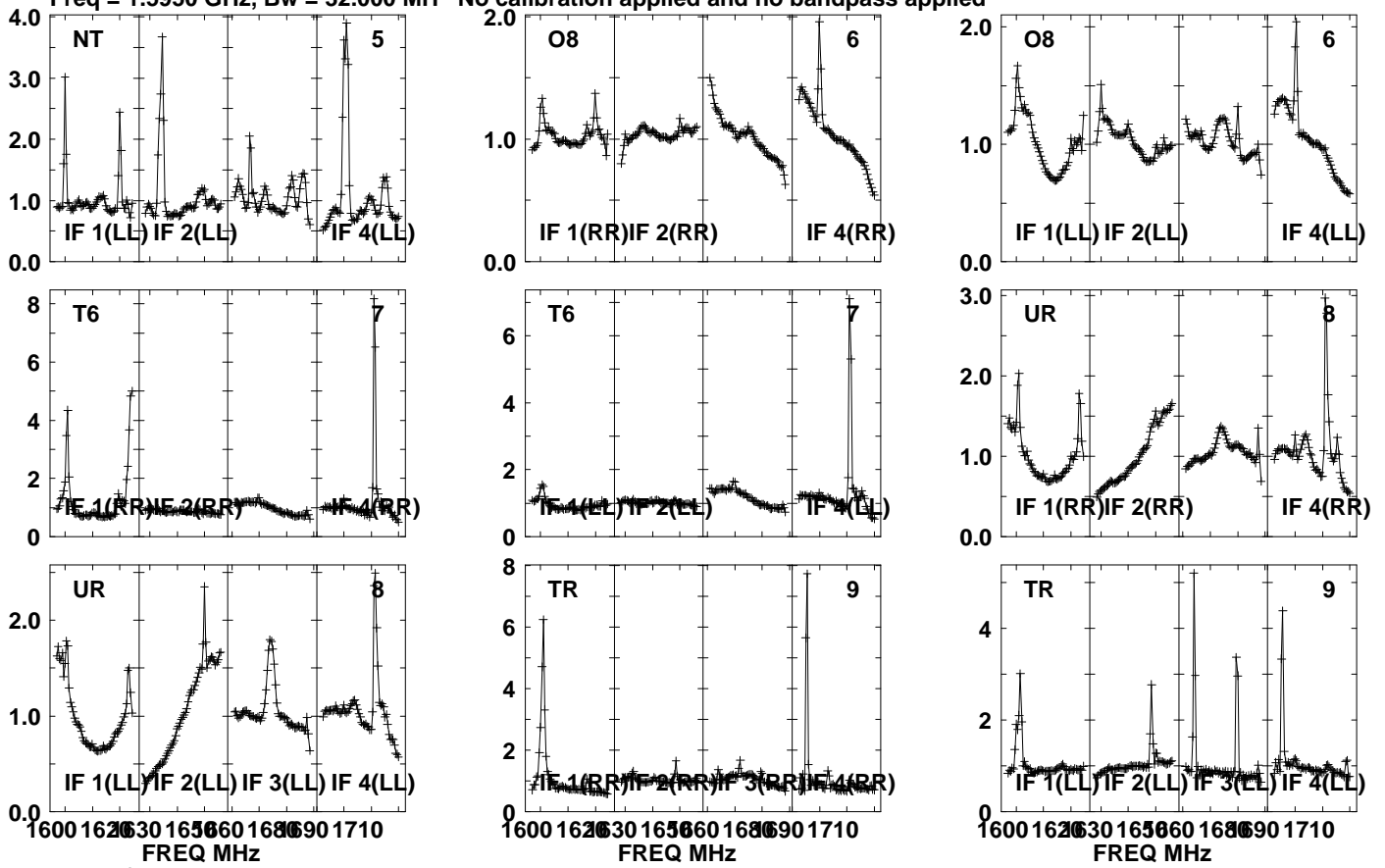

Lower frame: Real Jy
Auto-corr total-power spectrum Antenna: *
Timerange: 01/00:07:51 to 01/00:11:49

Plot file version 37 created 12-JUN-2023 14:39:09

J1548 ES106B.UVDATA.1

Freq = 1.5950 GHz, Bw = 32.000 MH No calibration applied and no bandpass applied

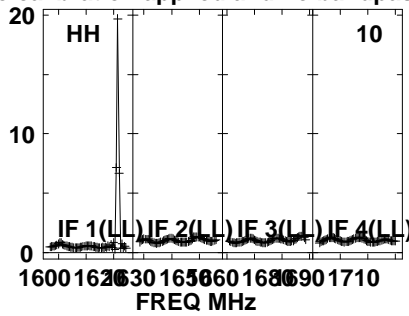
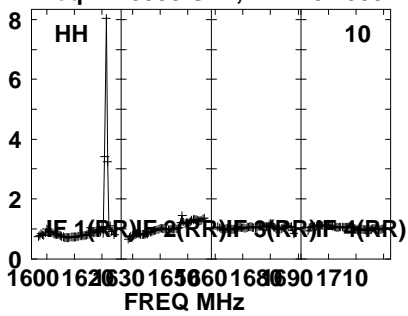

Lower frame: Real Jy
Auto-corr total-power spectrum Antenna: *
Timerange: 01/00:07:51 to 01/00:11:49

Plot file version 38 created 12-JUN-2023 14:39:09

J1547+2052 ES106B.UVDATA.1

Freq = 1.5950 GHz, Bw = 32.000 MH No calibration applied and no bandpass applied

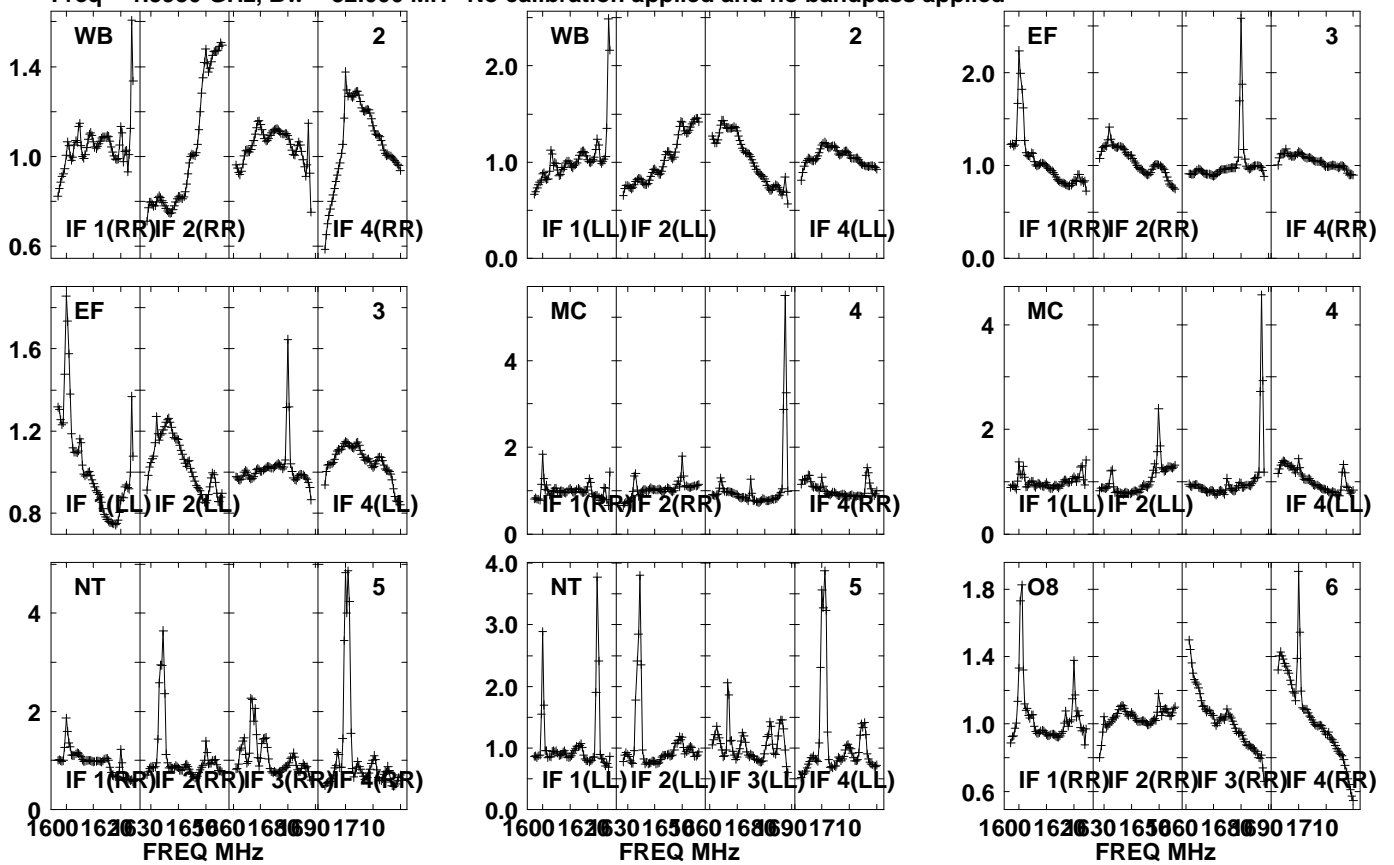

Lower frame: Real Jy
Auto-corr total-power spectrum Antenna: *
Timerange: 01/00:11:51 to 01/00:13:19

Plot file version 39 created 12-JUN-2023 14:39:09

J1547+2052 ES106B.UVDATA.1

Freq = 1.5950 GHz, Bw = 32.000 MH No calibration applied and no bandpass applied

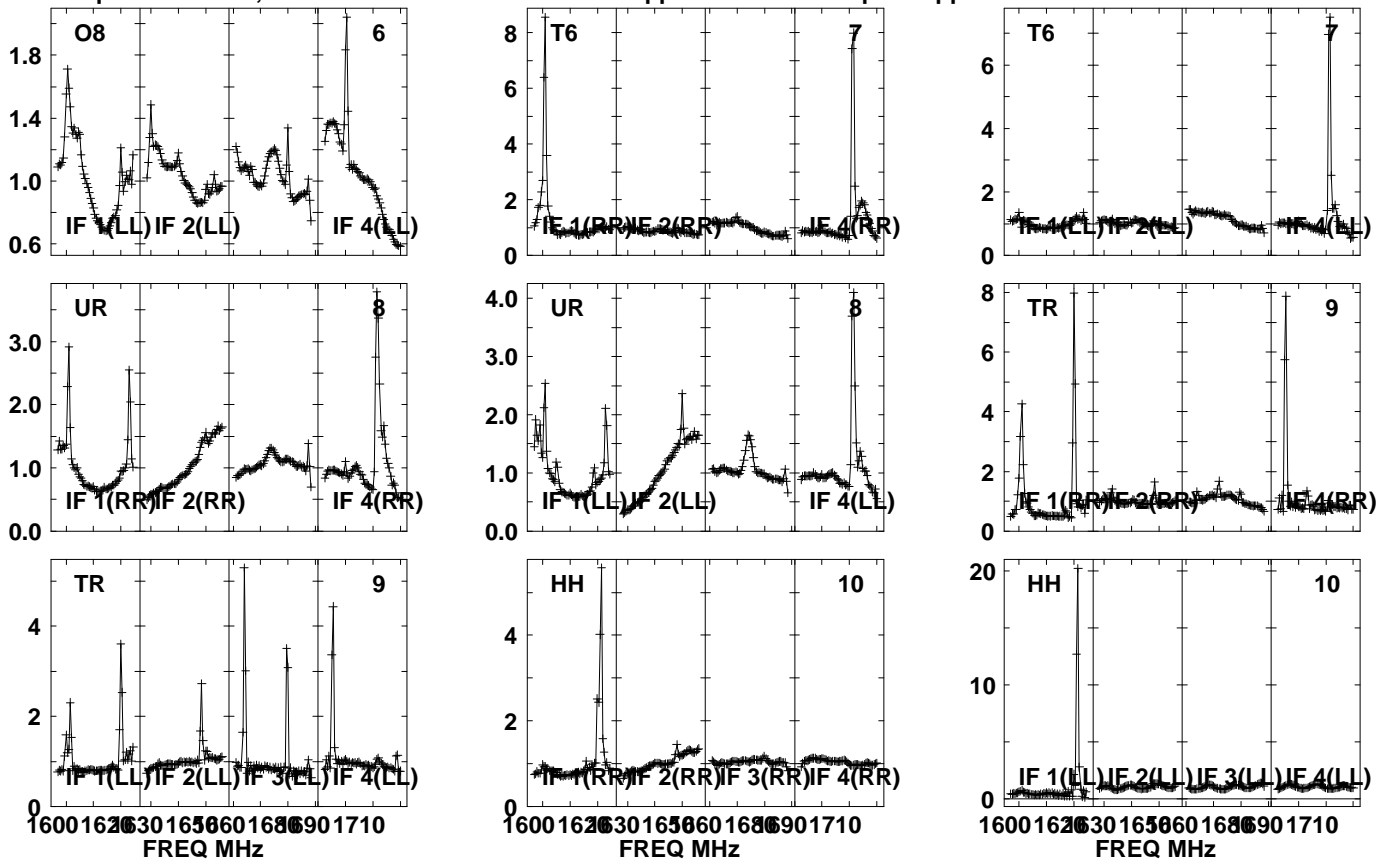

Lower frame: Real Jy
Auto-corr total-power spectrum Antenna: *
Timerange: 01/00:11:51 to 01/00:13:19

Plot file version 40 created 12-JUN-2023 14:39:09

J1548 ES106B.UVDATA.1

Freq = 1.5950 GHz, Bw = 32.000 MH No calibration applied and no bandpass applied

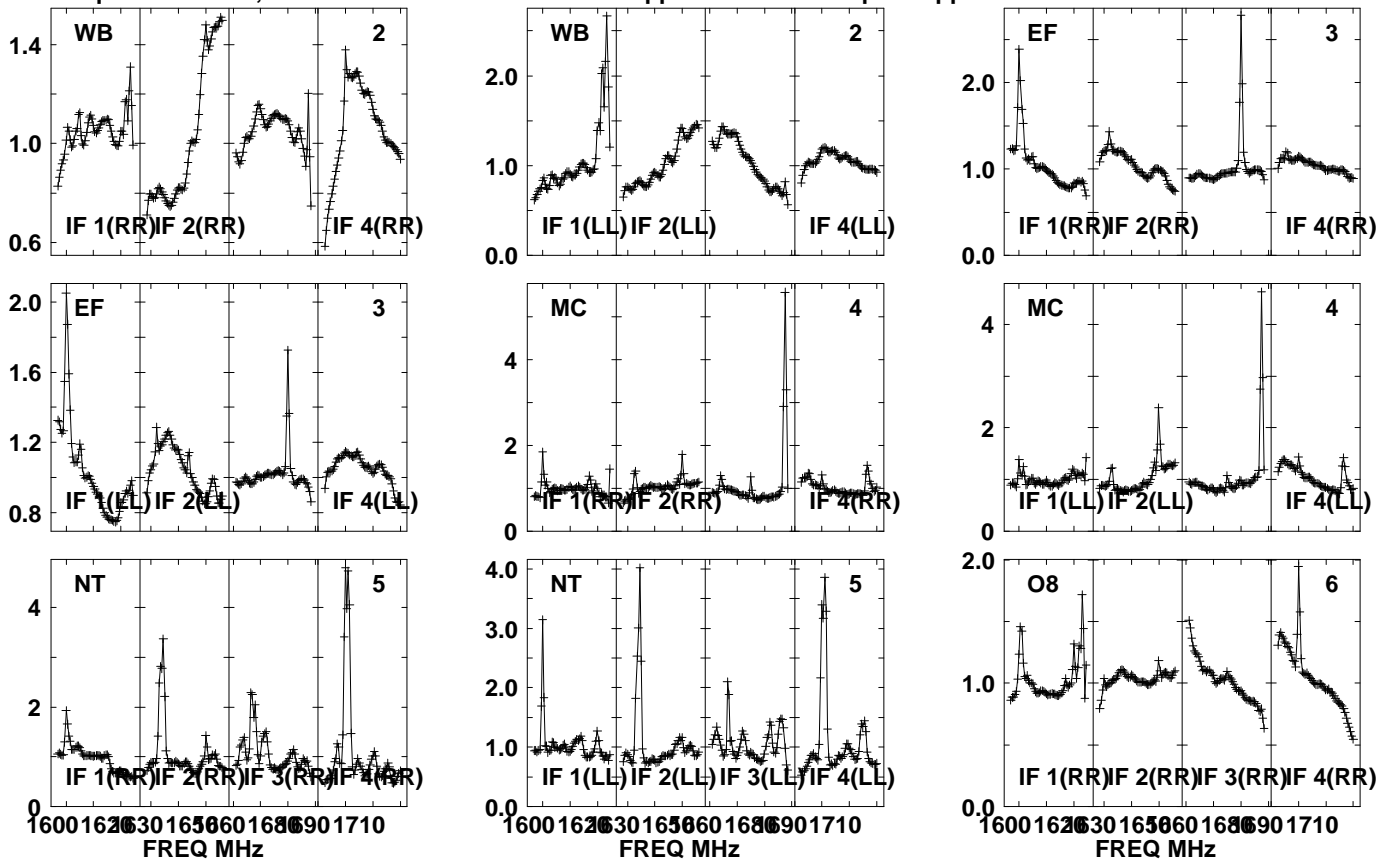

Lower frame: Real Jy
Auto-corr total-power spectrum Antenna: *
Timerange: 01/00:13:21 to 01/00:16:49

Plot file version 41 created 12-JUN-2023 14:39:09

J1548 ES106B.UVDATA.1

Freq = 1.5950 GHz, Bw = 32.000 MH No calibration applied and no bandpass applied

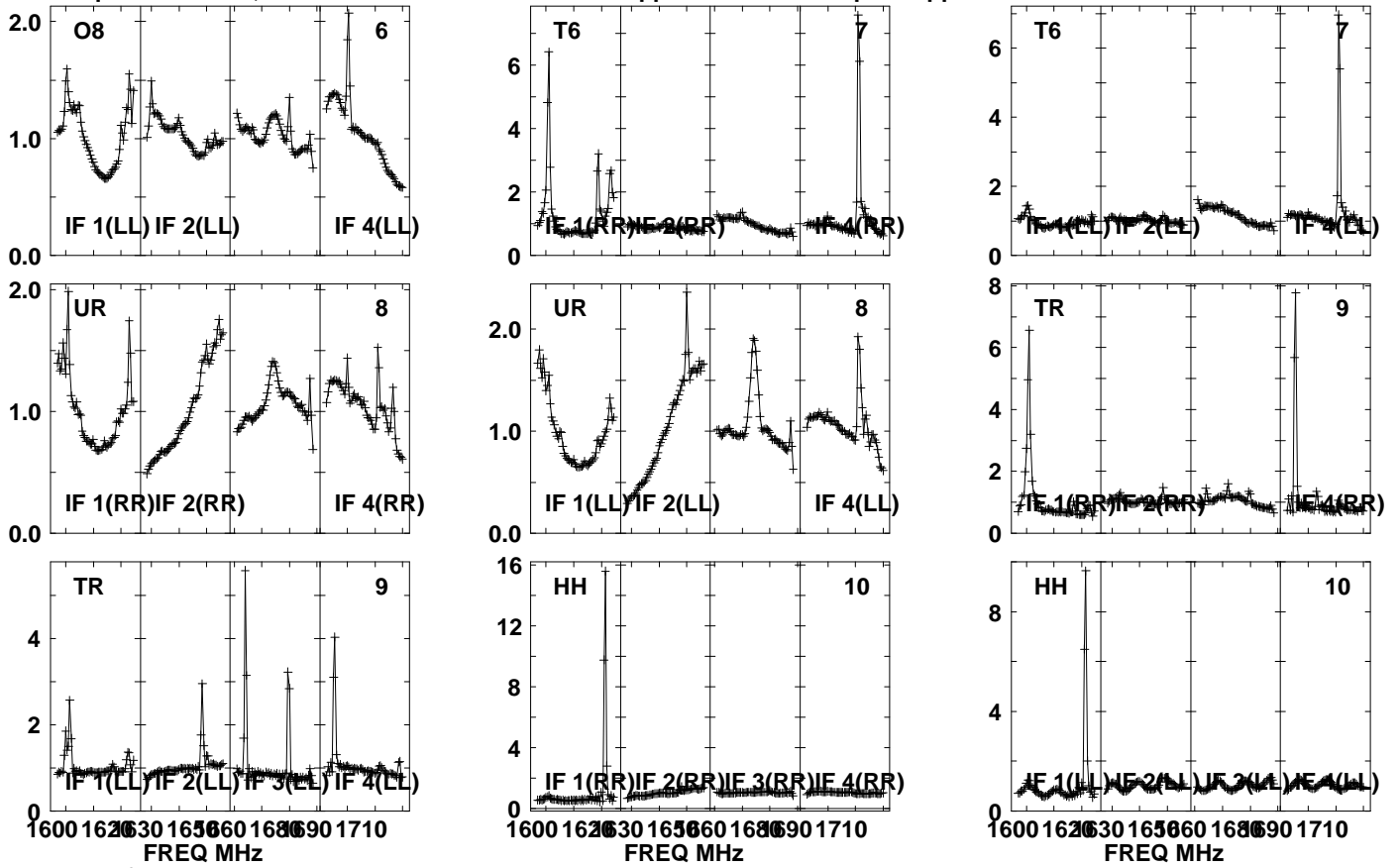

Lower frame: Real Jy

Auto-corr total-power spectrum Antenna: *

Timerange: 01/00:13:21 to 01/00:16:49

Plot file version 42 created 12-JUN-2023 14:39:10

J1547+2052 ES106B.UVDATA.1

Freq = 1.5950 GHz, Bw = 32.000 MH No calibration applied and no bandpass applied

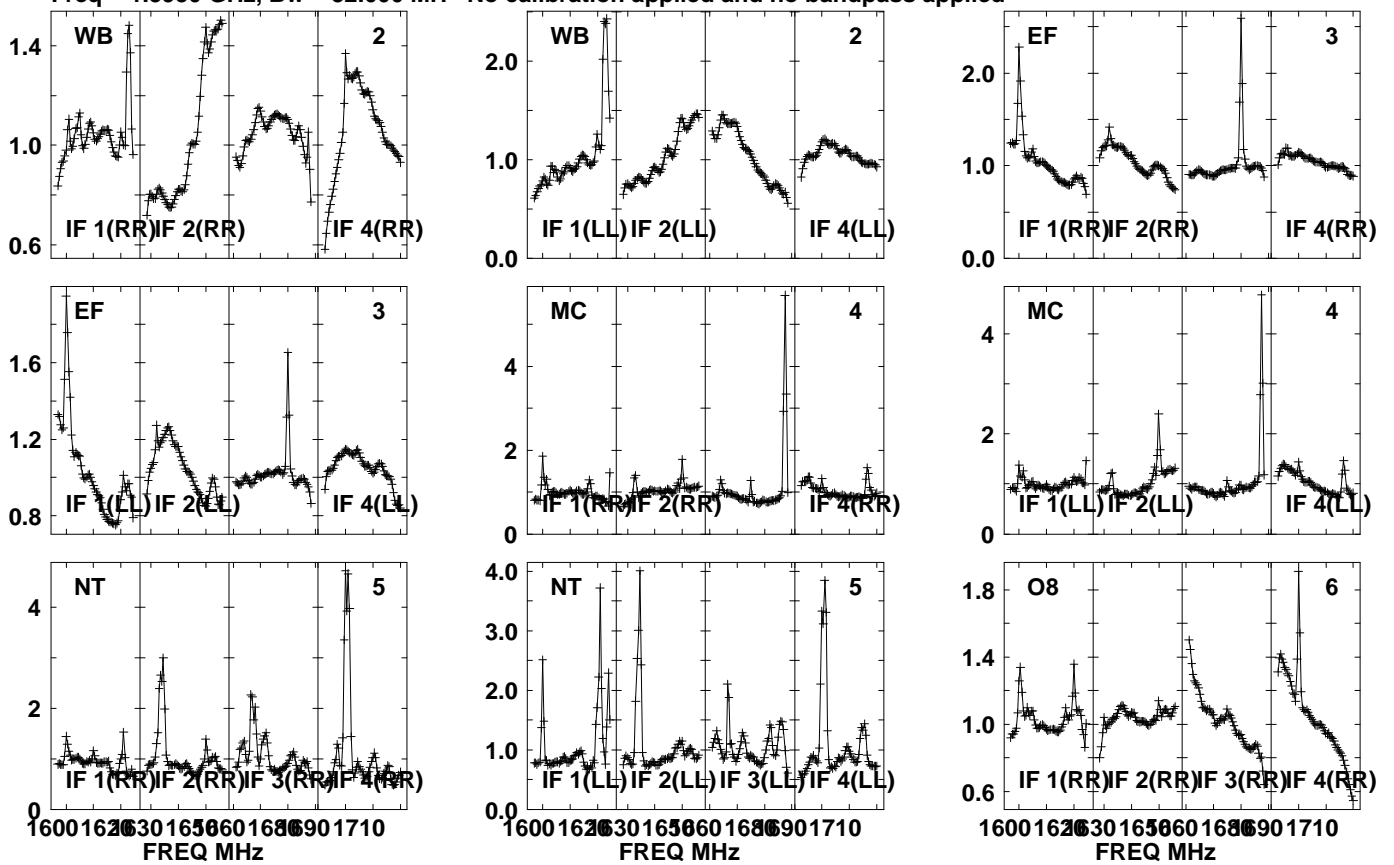

Lower frame: Real Jy
Auto-corr total-power spectrum Antenna: *
Timerange: 01/00:17:21 to 01/00:18:49

Plot file version 43 created 12-JUN-2023 14:39:10

J1547+2052 ES106B.UVDATA.1

Freq = 1.5950 GHz, Bw = 32.000 MH No calibration applied and no bandpass applied

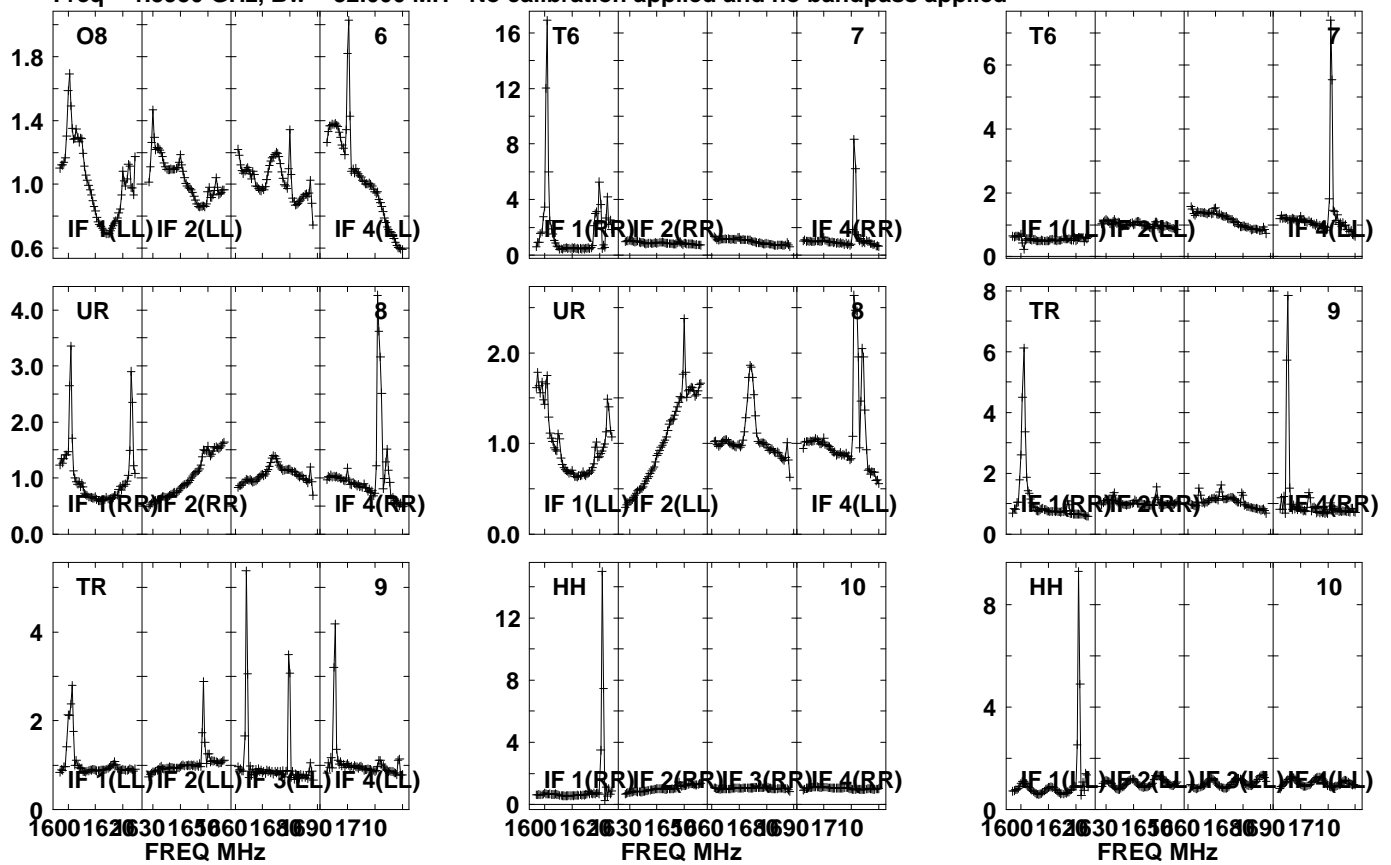

Lower frame: Real Jy

Auto-corr total-power spectrum Antenna: *

Timerange: 01/00:17:21 to 01/00:18:49

Plot file version 44 created 12-JUN-2023 14:39:10

J1548 ES106B.UVDATA.1

Freq = 1.5950 GHz, Bw = 32.000 MH No calibration applied and no bandpass applied

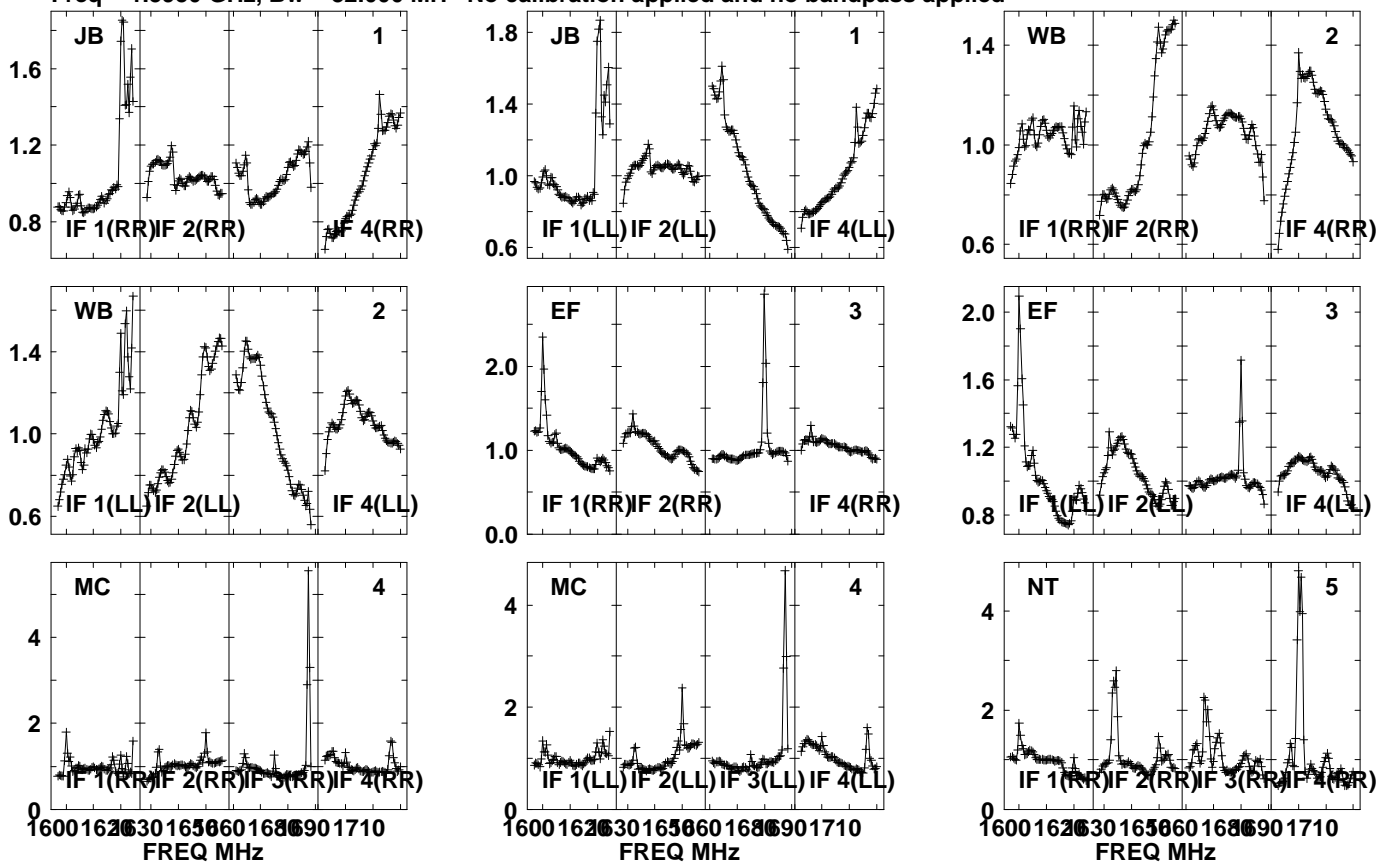

Lower frame: Real Jy
Auto-corr total-power spectrum Antenna: *
Timerange: 01/00:18:51 to 01/00:22:19

Plot file version 45 created 12-JUN-2023 14:39:10

J1548 ES106B.UVDATA.1

Freq = 1.5950 GHz, Bw = 32.000 MH No calibration applied and no bandpass applied

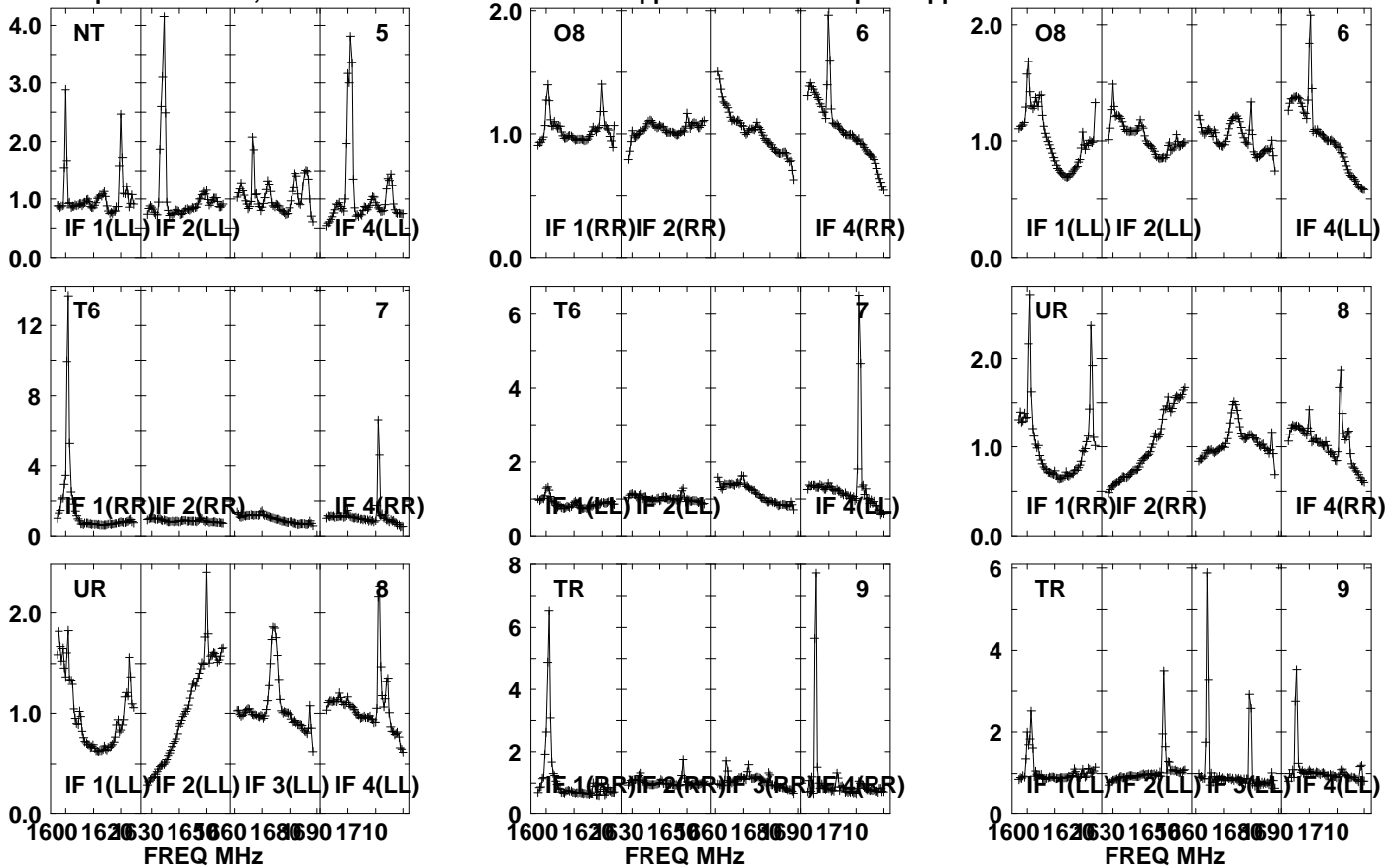

Lower frame: Real Jy
Auto-corr total-power spectrum Antenna: *
Timerange: 01/00:18:51 to 01/00:22:19

Plot file version 46 created 12-JUN-2023 14:39:10

J1548 ES106B.UVDATA.1

Freq = 1.5950 GHz, Bw = 32.000 MH No calibration applied and no bandpass applied

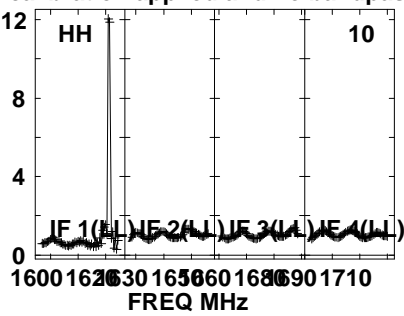
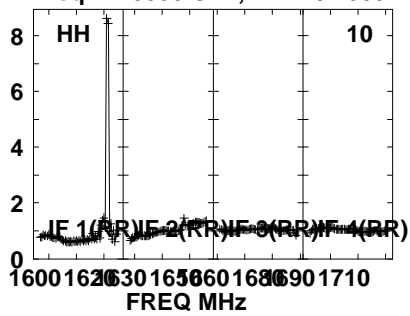

Lower frame: Real Jy
Auto-corr total-power spectrum Antenna: *
Timerange: 01/00:18:51 to 01/00:22:19

Plot file version 47 created 12-JUN-2023 14:39:10

J1547+2052 ES106B.UVDATA.1

Freq = 1.5950 GHz, Bw = 32.000 MH No calibration applied and no bandpass applied

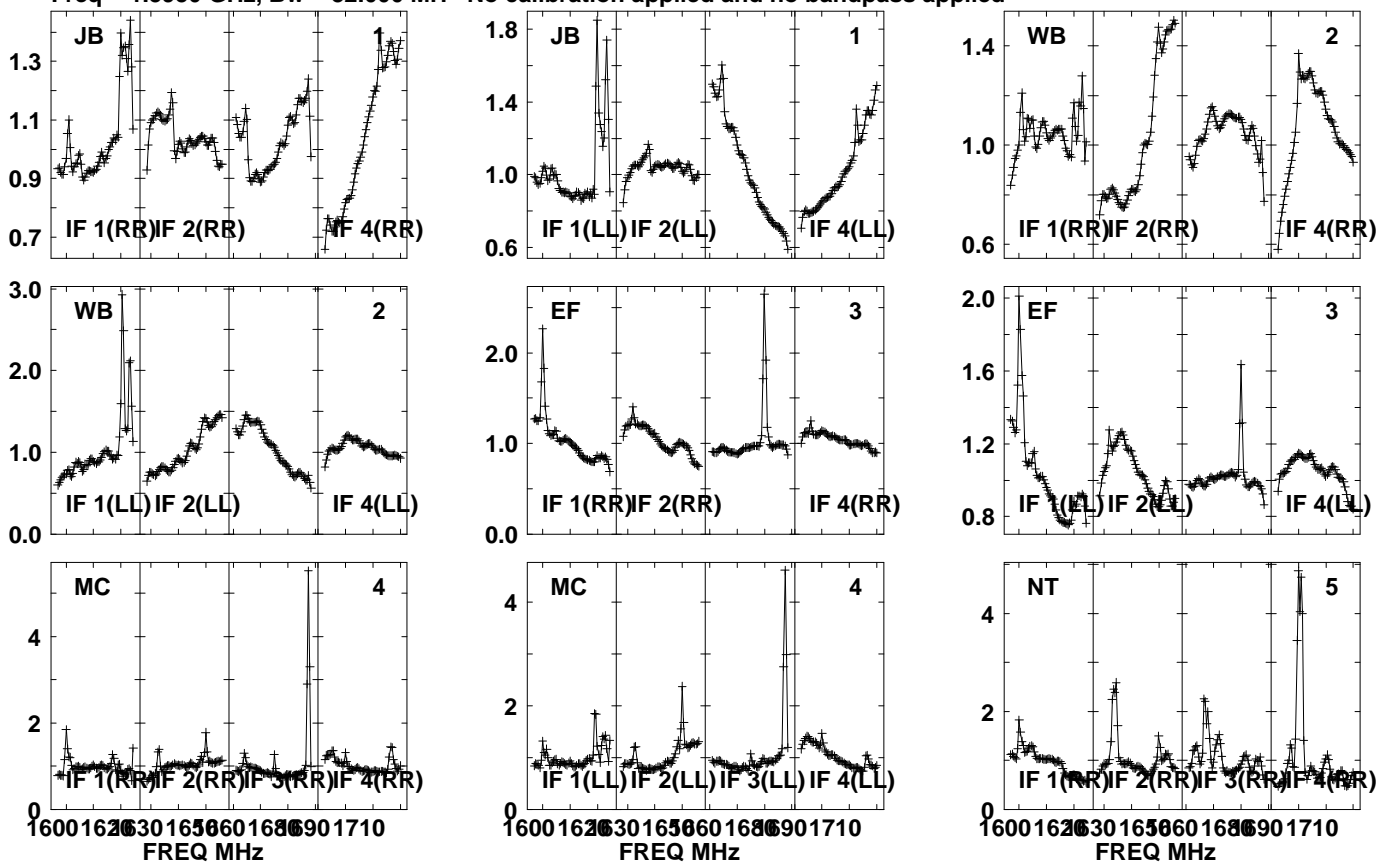

Lower frame: Real Jy
Auto-corr total-power spectrum Antenna: *
Timerange: 01/00:22:21 to 01/00:23:49

Plot file version 48 created 12-JUN-2023 14:39:10

J1547+2052 ES106B.UVDATA.1

Freq = 1.5950 GHz, Bw = 32.000 MH No calibration applied and no bandpass applied

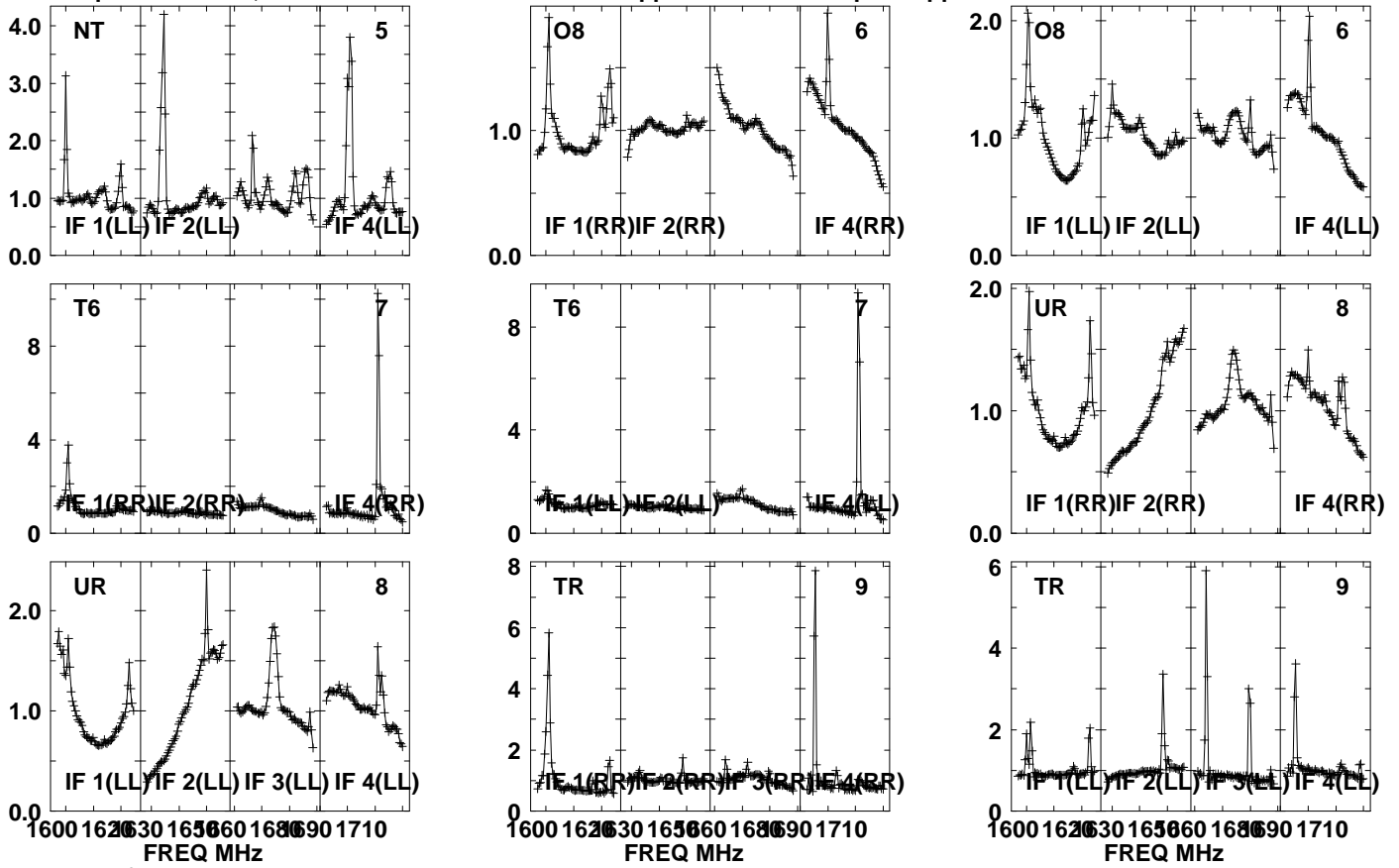

Lower frame: Real Jy

Auto-corr total-power spectrum Antenna: *

Timerange: 01/00:22:21 to 01/00:23:49

Plot file version 49 created 12-JUN-2023 14:39:10

J1547+2052 ES106B.UVDATA.1

Freq = 1.5950 GHz, Bw = 32.000 MH No calibration applied and no bandpass applied

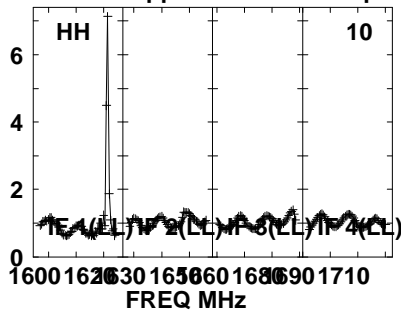
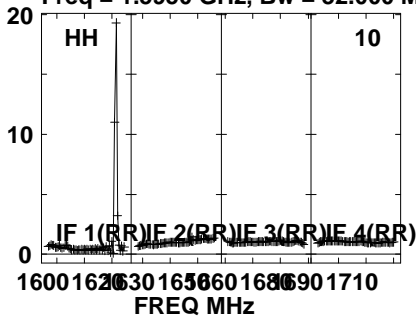

Lower frame: Real Jy
Auto-corr total-power spectrum Antenna: *
Timerange: 01/00:22:21 to 01/00:23:49

Plot file version 50 created 12-JUN-2023 14:39:10

J1545+2006 ES106B.UVDATA.1

Freq = 1.5950 GHz, Bw = 32.000 MH No calibration applied and no bandpass applied

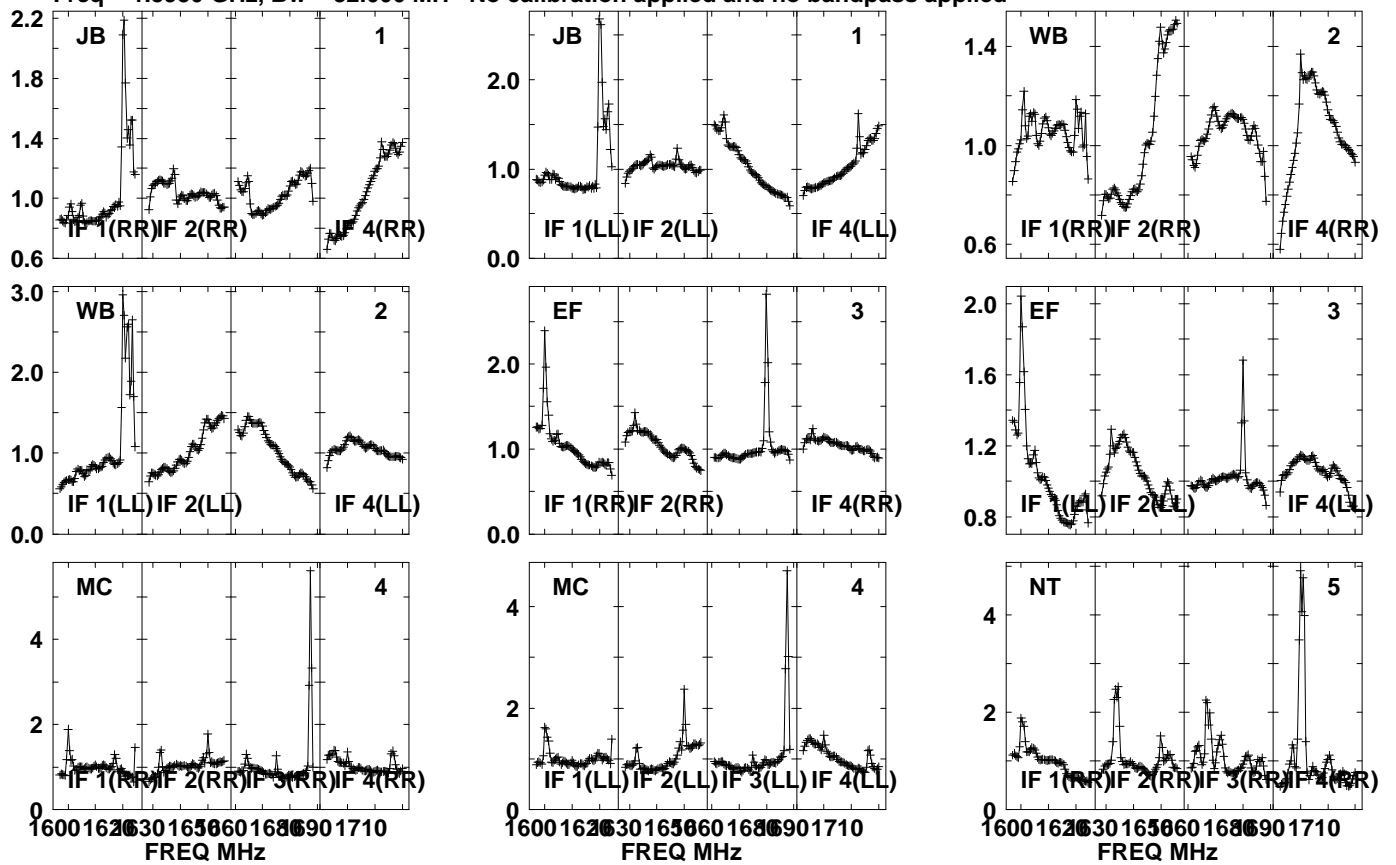

Lower frame: Real Jy
Auto-corr total-power spectrum Antenna: *
Timerange: 01/00:23:51 to 01/00:26:19

Plot file version 51 created 12-JUN-2023 14:39:10

J1545+2006 ES106B.UVDATA.1

Freq = 1.5950 GHz, Bw = 32.000 MH No calibration applied and no bandpass applied

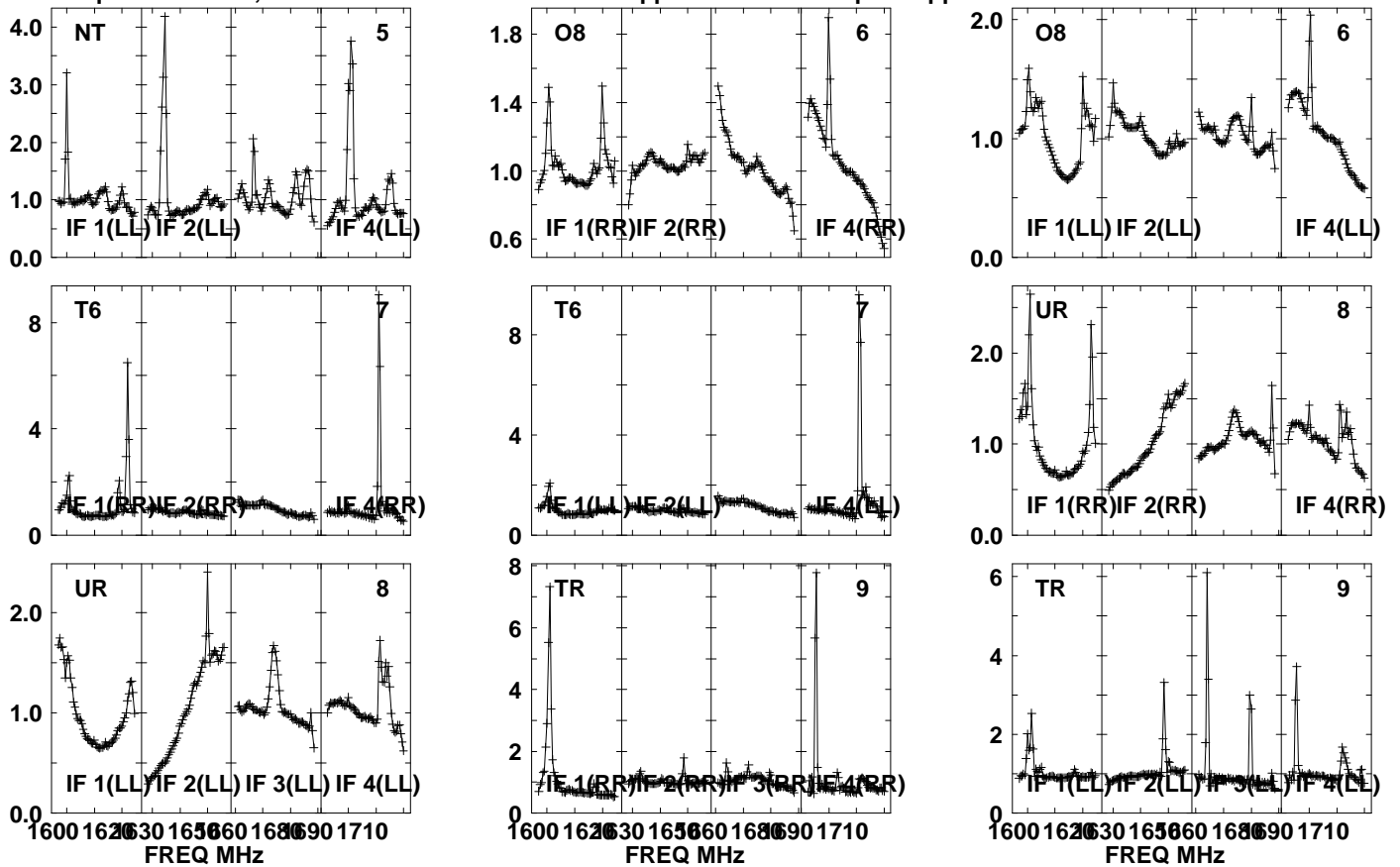

Lower frame: Real Jy

Auto-corr total-power spectrum Antenna: *

Timerange: 01/00:23:51 to 01/00:26:19

Plot file version 52 created 12-JUN-2023 14:39:10

J1545+2006 ES106B.UVDATA.1

Freq = 1.5950 GHz, Bw = 32.000 MH No calibration applied and no bandpass applied

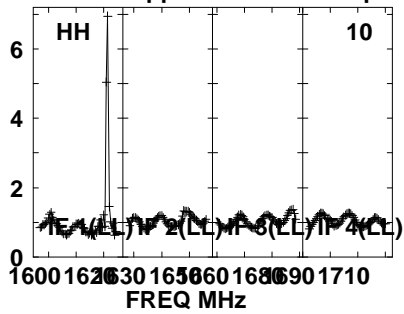
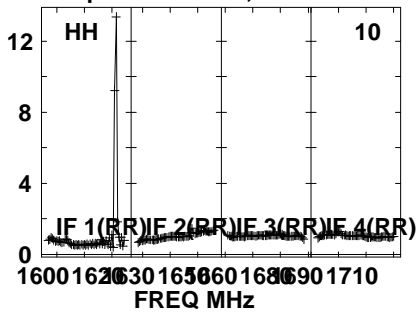

Lower frame: Real Jy
Auto-corr total-power spectrum Antenna: *
Timerange: 01/00:23:51 to 01/00:26:19

Plot file version 53 created 12-JUN-2023 14:39:10

J1547+2052 ES106B.UVDATA.1

Freq = 1.5950 GHz, Bw = 32.000 MH No calibration applied and no bandpass applied

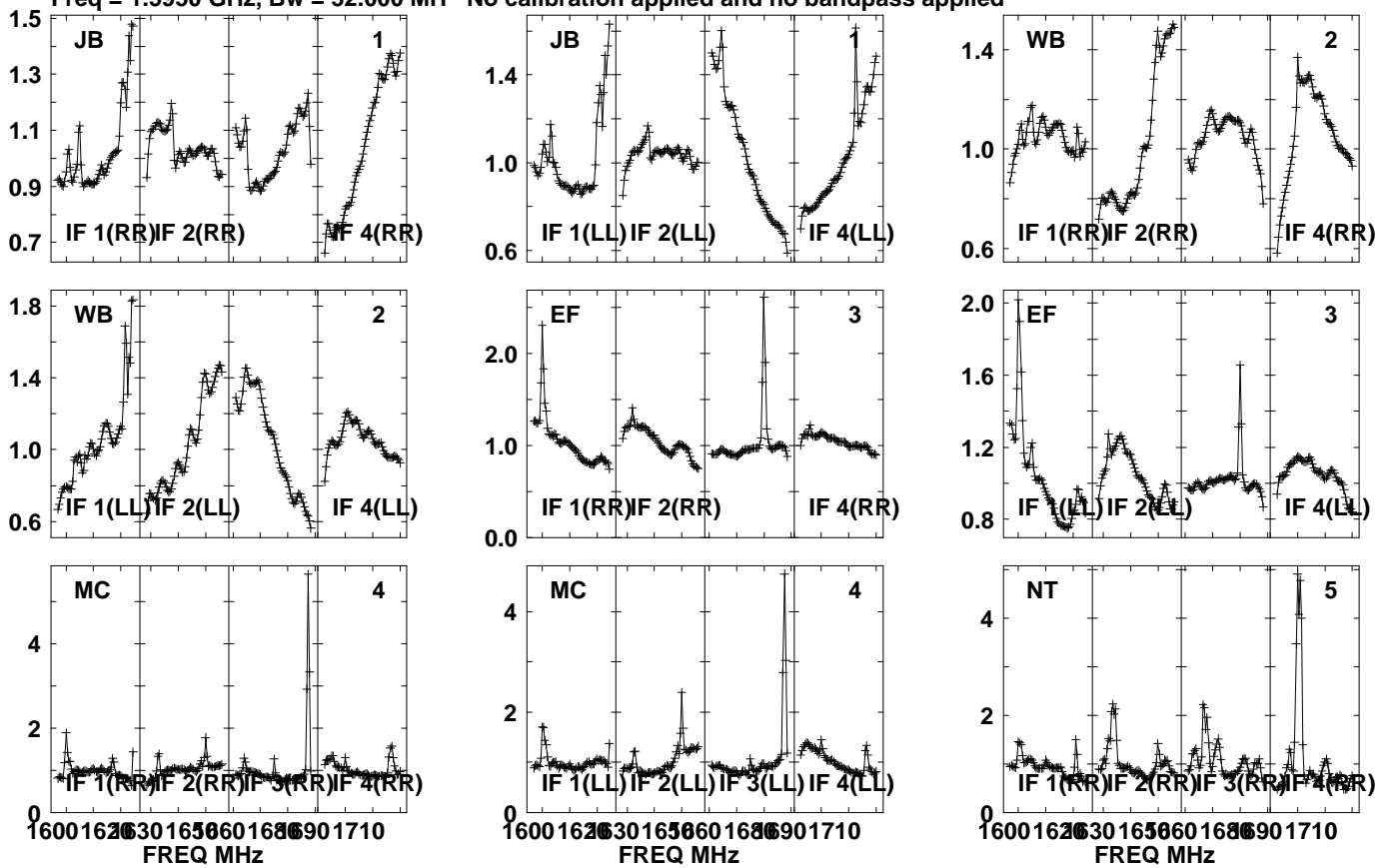

Lower frame: Real Jy
Auto-corr total-power spectrum Antenna: *
Timerange: 01/00:26:21 to 01/00:27:49

Plot file version 54 created 12-JUN-2023 14:39:10

J1547+2052 ES106B.UVDATA.1

Freq = 1.5950 GHz, Bw = 32.000 MH No calibration applied and no bandpass applied

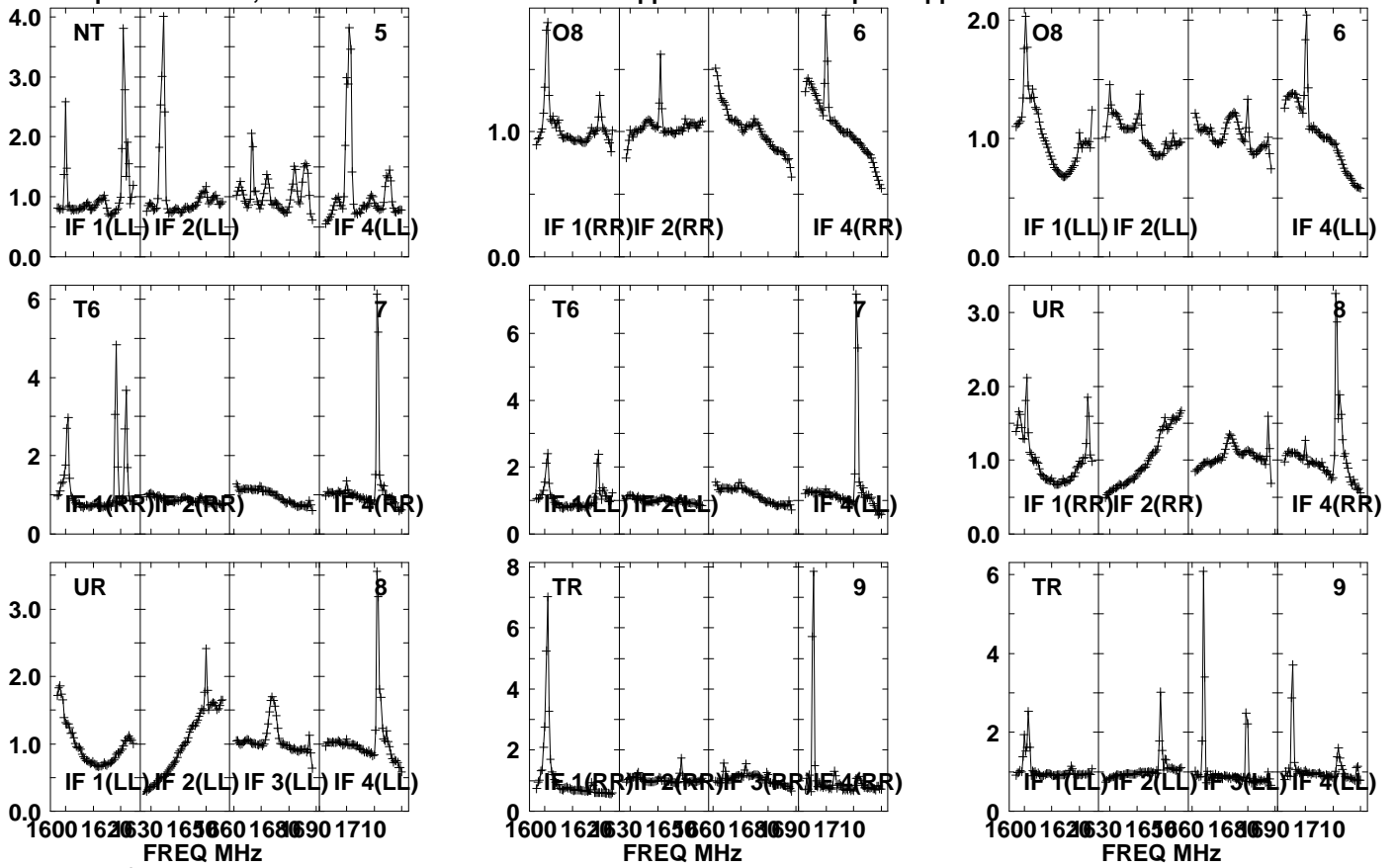

Lower frame: Real Jy
Auto-corr total-power spectrum Antenna: *
Timerange: 01/00:26:21 to 01/00:27:49

Plot file version 55 created 12-JUN-2023 14:39:10

J1547+2052 ES106B.UVDATA.1

Freq = 1.5950 GHz, Bw = 32.000 MH No calibration applied and no bandpass applied

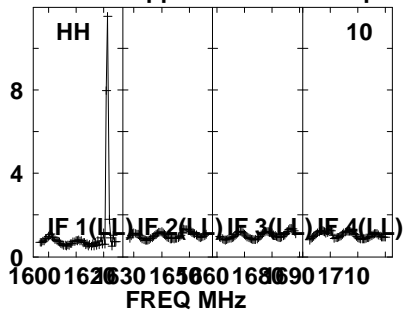
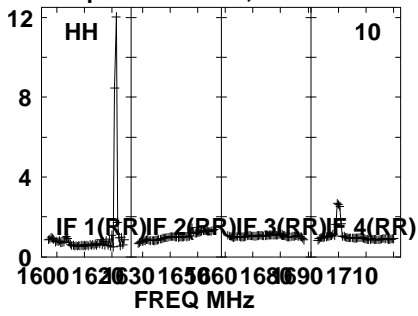

Lower frame: Real Jy
Auto-corr total-power spectrum Antenna: *
Timerange: 01/00:26:21 to 01/00:27:49

Plot file version 56 created 12-JUN-2023 14:39:10

J1548 ES106B.UVDATA.1

Freq = 1.5950 GHz, Bw = 32.000 MH No calibration applied and no bandpass applied

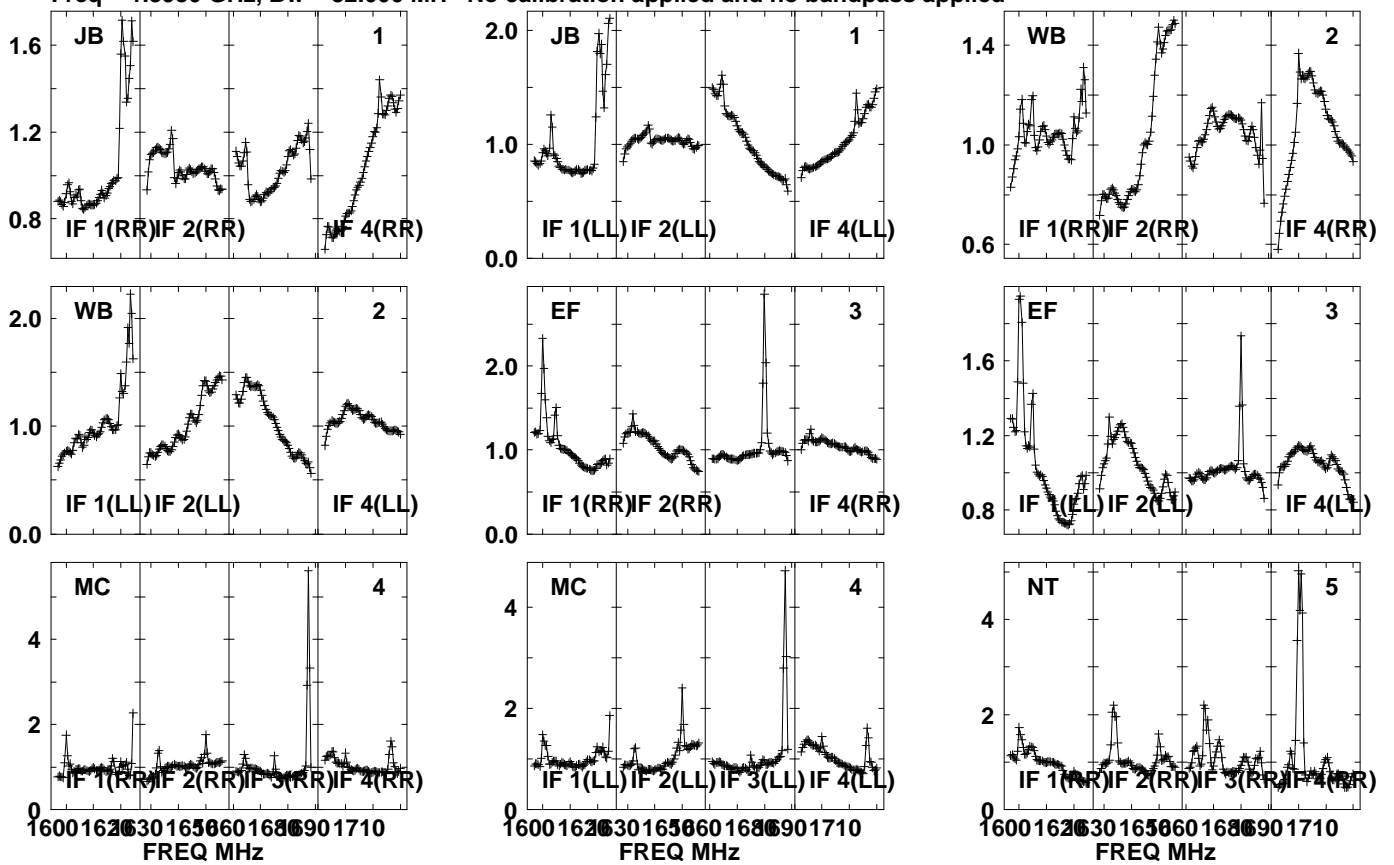

Lower frame: Real Jy
Auto-corr total-power spectrum Antenna: *
Timerange: 01/00:28:21 to 01/00:32:19

Plot file version 57 created 12-JUN-2023 14:39:10

J1548 ES106B.UVDATA.1

Freq = 1.5950 GHz, Bw = 32.000 MH No calibration applied and no bandpass applied

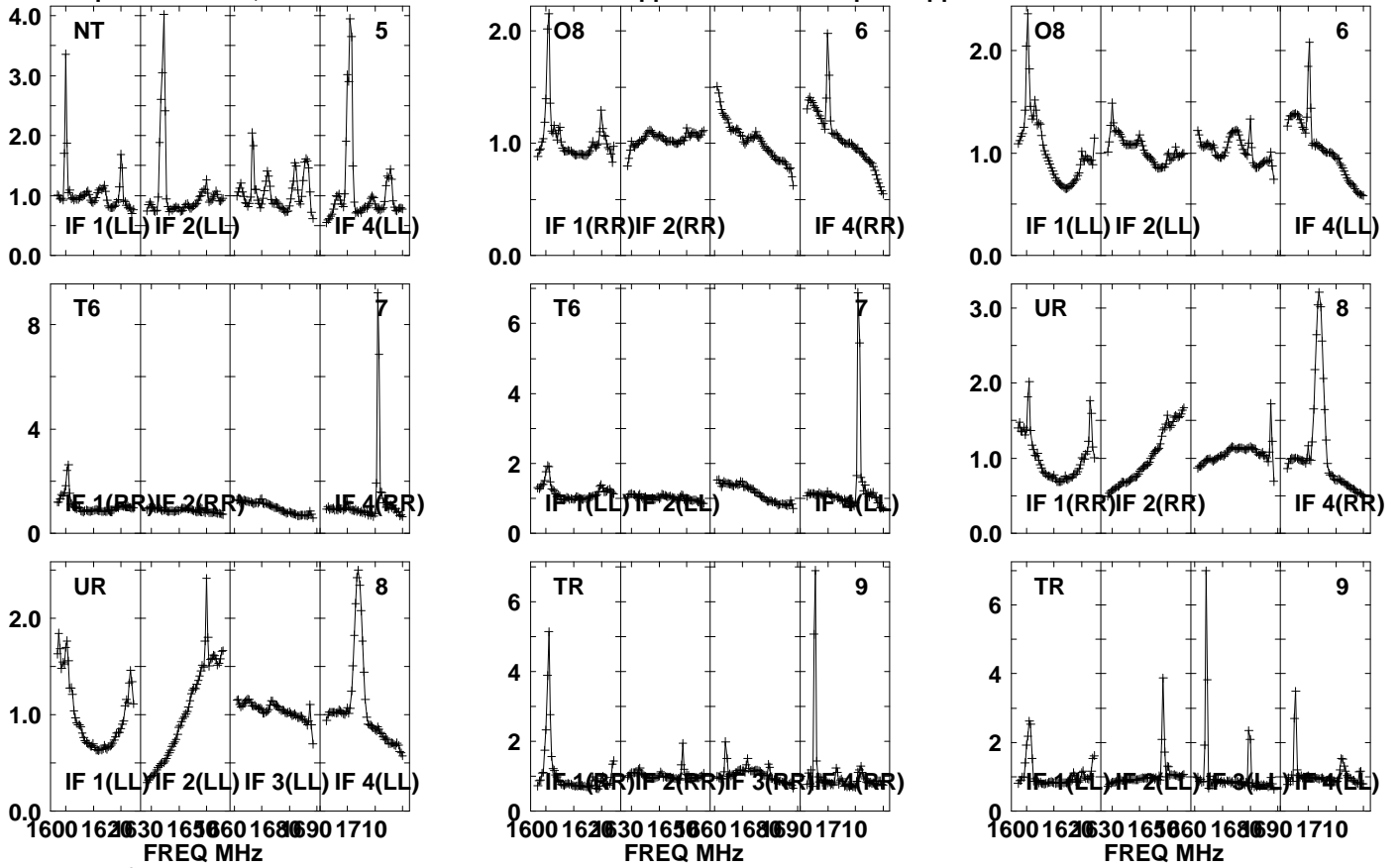

Lower frame: Real Jy

Auto-corr total-power spectrum Antenna: *

Timerange: 01/00:28:21 to 01/00:32:19

Plot file version 58 created 12-JUN-2023 14:39:10

J1548 ES106B.UVDATA.1

Freq = 1.5950 GHz, Bw = 32.000 MH No calibration applied and no bandpass applied

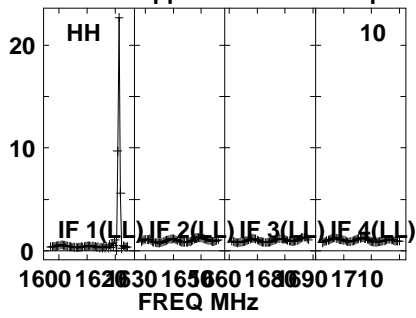
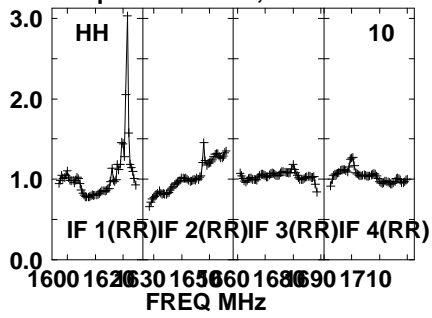

Lower frame: Real Jy

Auto-corr total-power spectrum Antenna: *

Timerange: 01/00:28:21 to 01/00:32:19

Plot file version 59 created 12-JUN-2023 14:39:11

J1547+2052 ES106B.UVDATA.1

Freq = 1.5950 GHz, Bw = 32.000 MH No calibration applied and no bandpass applied

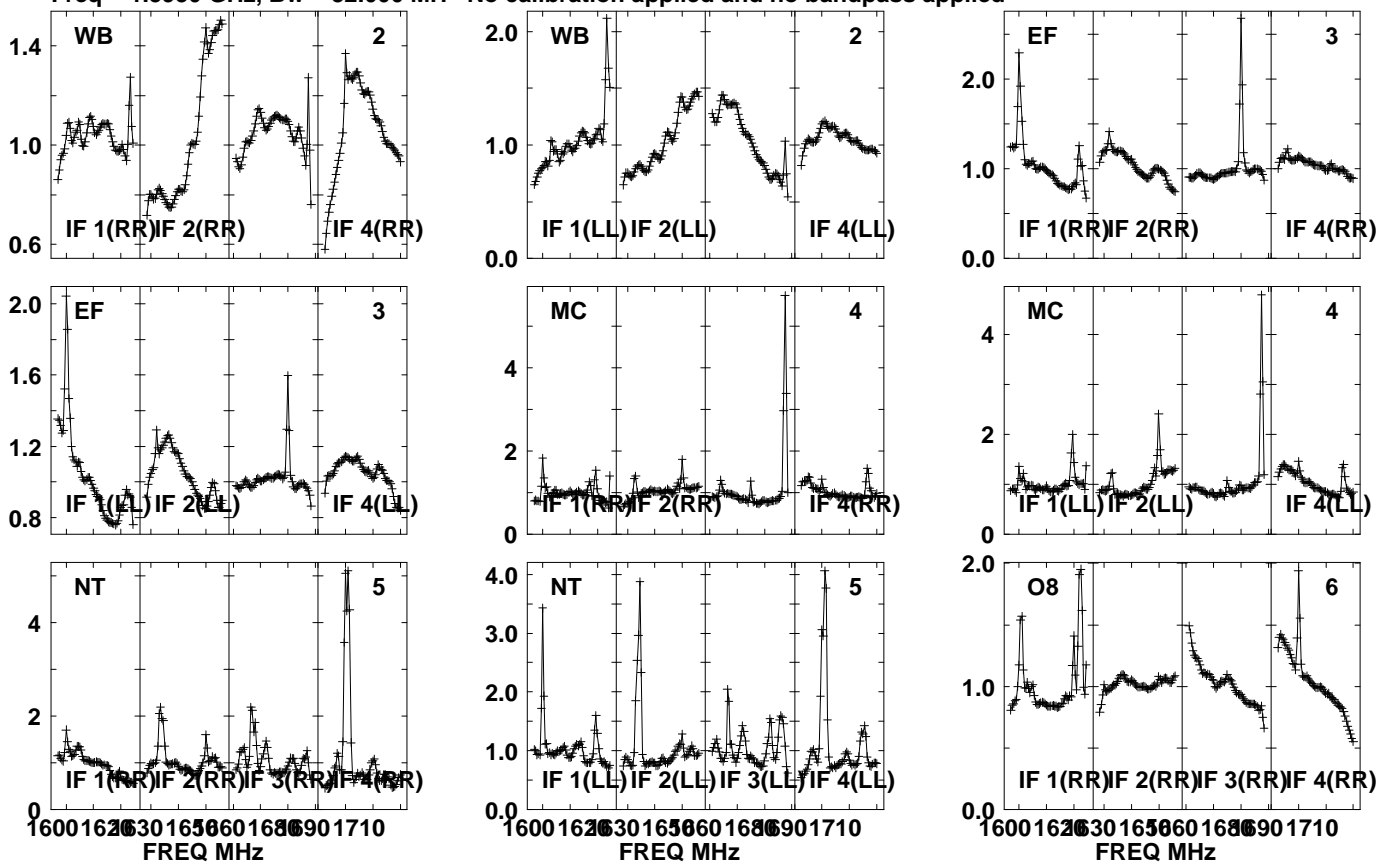

Lower frame: Real Jy
Auto-corr total-power spectrum Antenna: *
Timerange: 01/00:32:21 to 01/00:33:49

Plot file version 60 created 12-JUN-2023 14:39:11

J1547+2052 ES106B.UVDATA.1

Freq = 1.5950 GHz, Bw = 32.000 MH No calibration applied and no bandpass applied

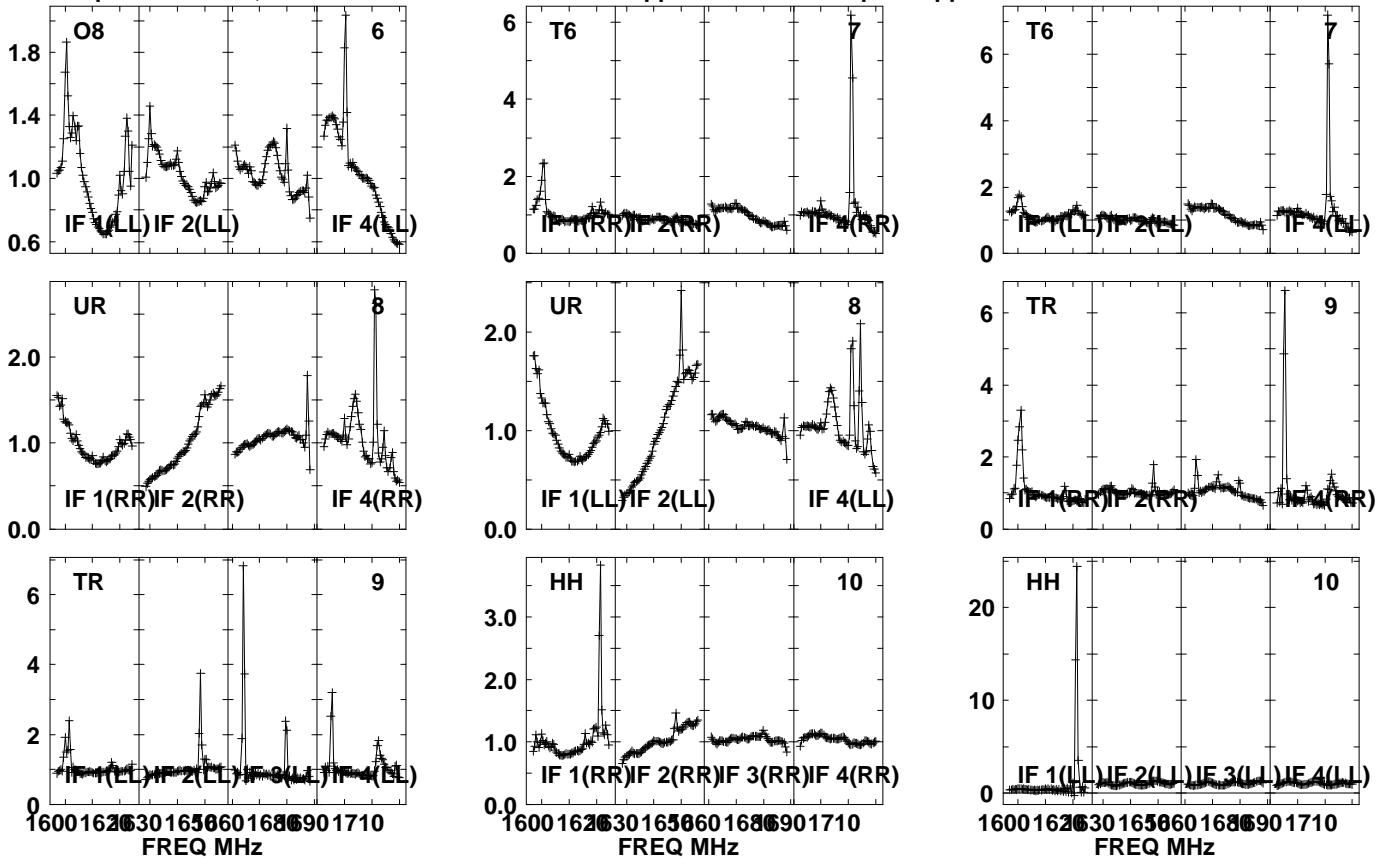

Lower frame: Real Jy
Auto-corr total-power spectrum Antenna: *
Timerange: 01/00:32:21 to 01/00:33:49

Plot file version 61 created 12-JUN-2023 14:39:11

J1548 ES106B.UVDATA.1

Freq = 1.5950 GHz, Bw = 32.000 MH No calibration applied and no bandpass applied

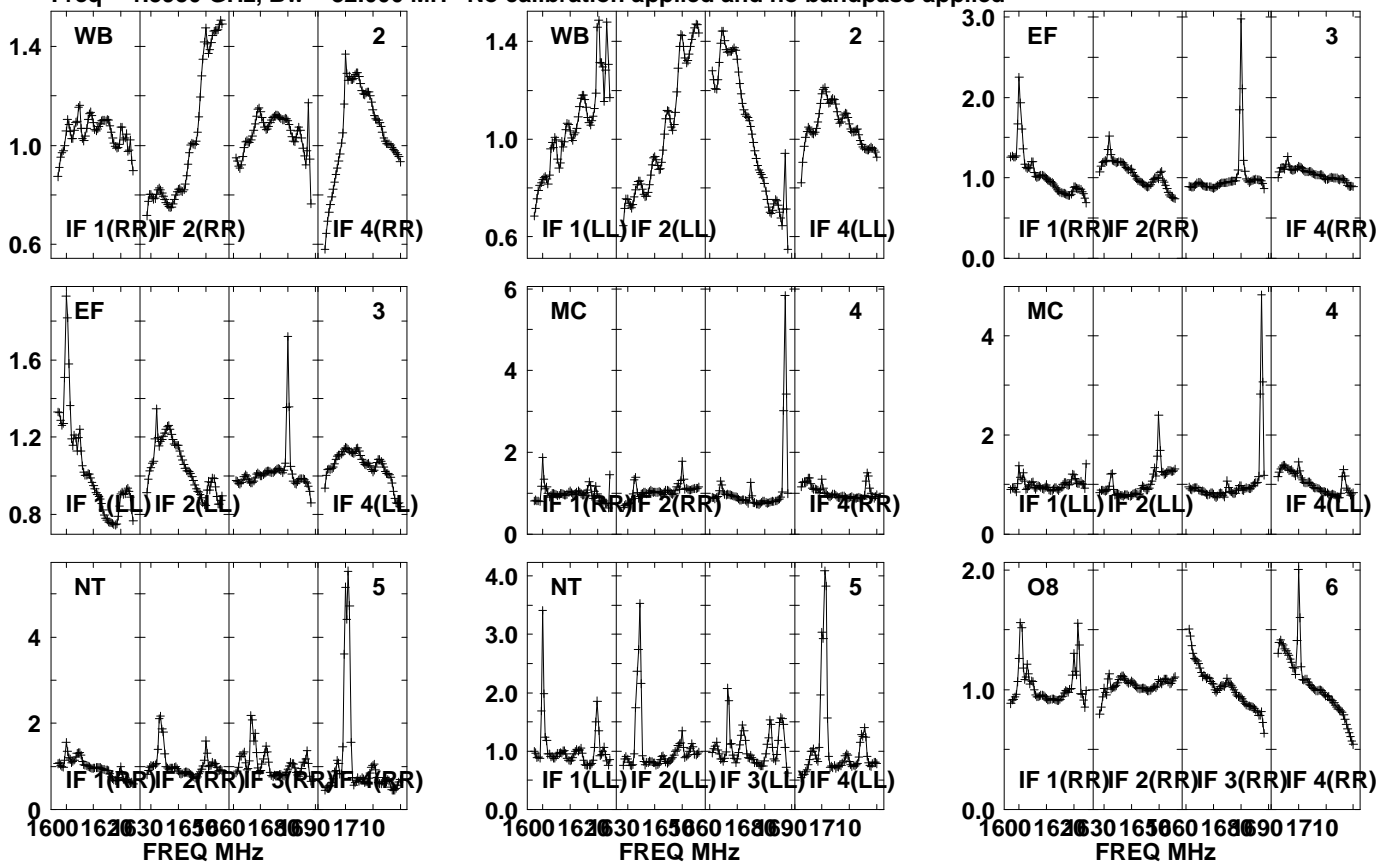

Lower frame: Real Jy

Auto-corr total-power spectrum Antenna: *

Timerange: 01/00:33:51 to 01/00:37:19

Plot file version 62 created 12-JUN-2023 14:39:11

J1548 ES106B.UVDATA.1

Freq = 1.5950 GHz, Bw = 32.000 MH No calibration applied and no bandpass applied

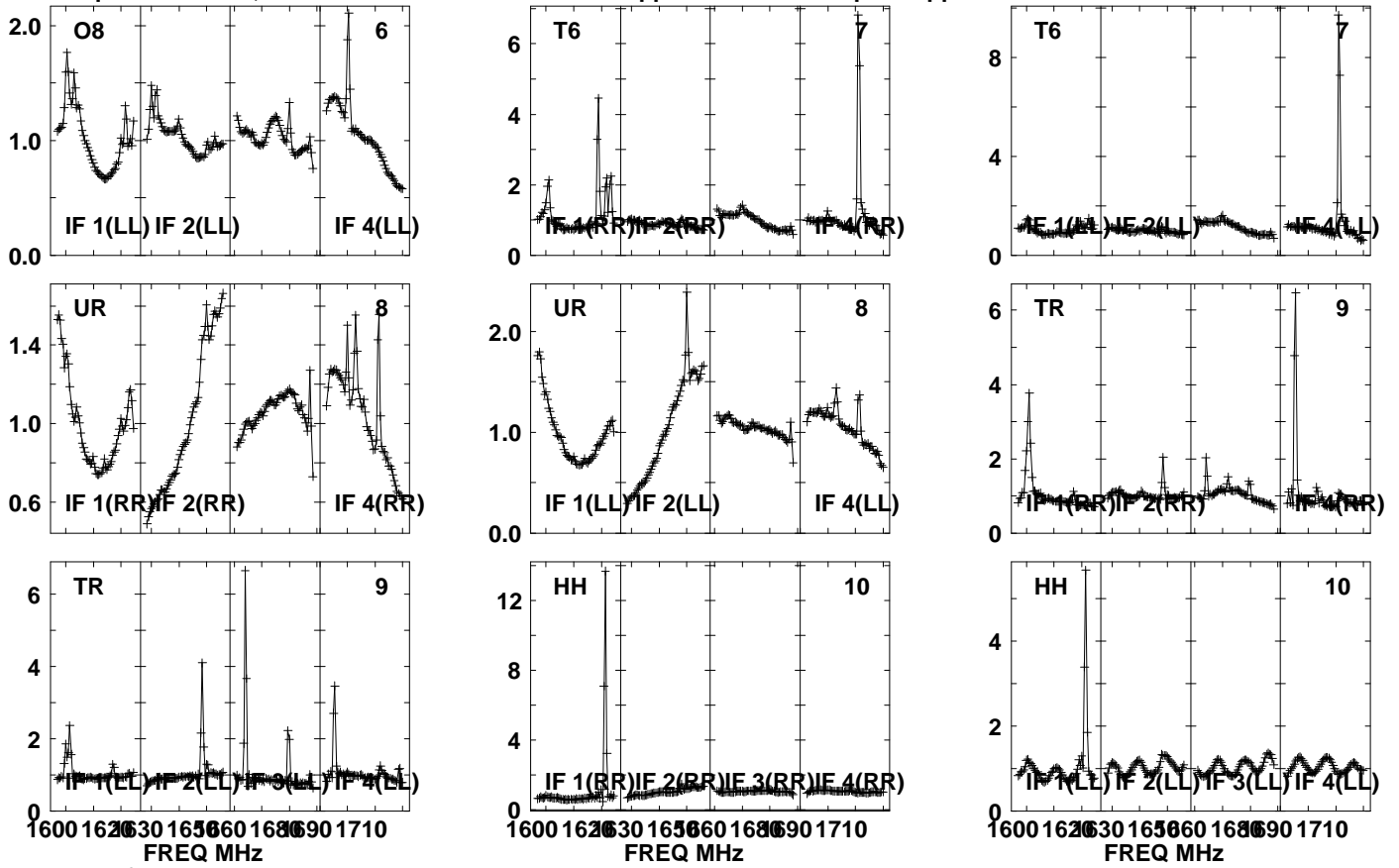

Lower frame: Real Jy

Auto-corr total-power spectrum Antenna: *

Timerange: 01/00:33:51 to 01/00:37:19

Plot file version 63 created 12-JUN-2023 14:39:11

J1547+2052 ES106B.UVDATA.1

Freq = 1.5950 GHz, Bw = 32.000 MH No calibration applied and no bandpass applied

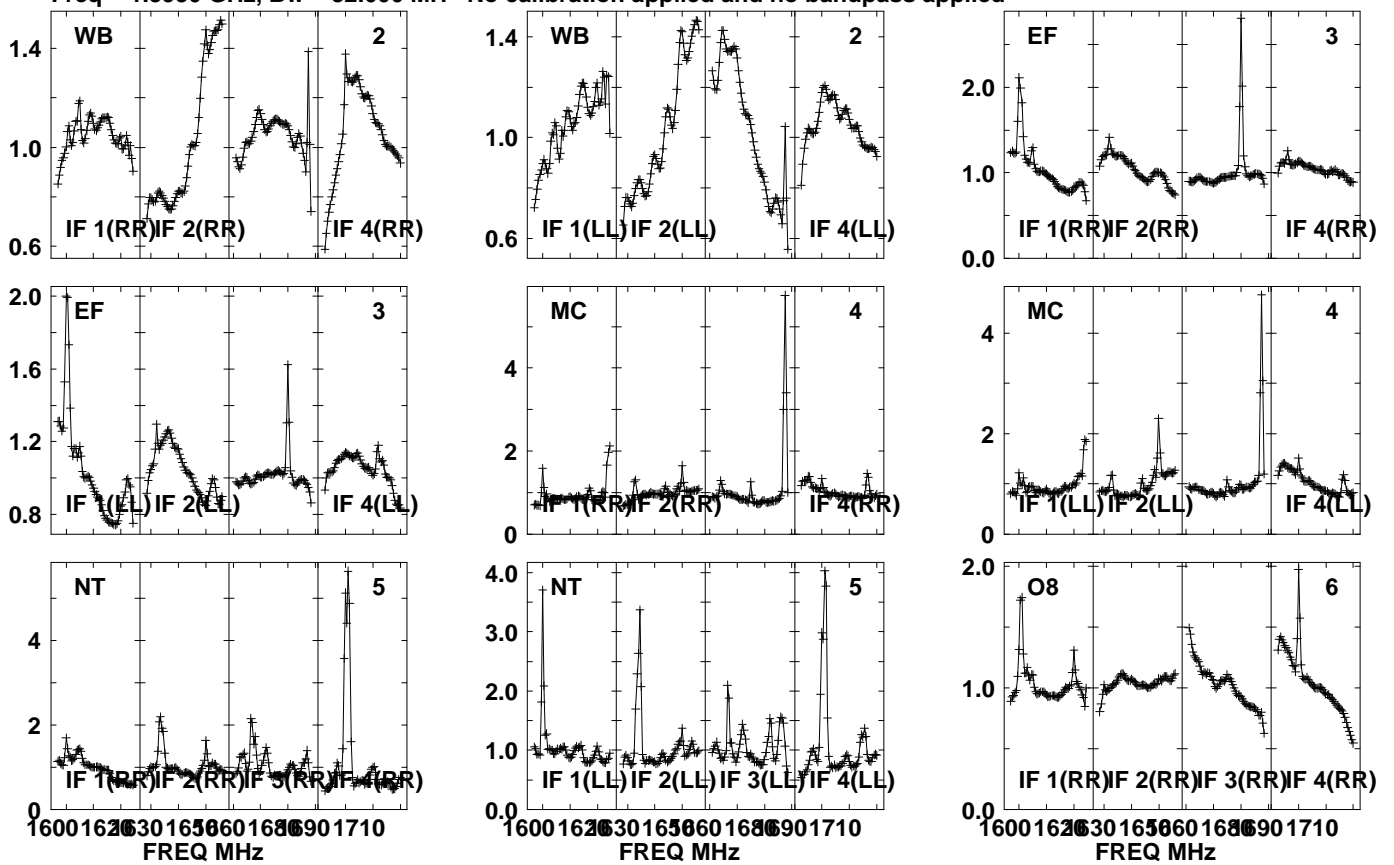

Lower frame: Real Jy
Auto-corr total-power spectrum Antenna: *
Timerange: 01/00:37:51 to 01/00:39:19

Plot file version 64 created 12-JUN-2023 14:39:11

J1547+2052 ES106B.UVDATA.1

Freq = 1.5950 GHz, Bw = 32.000 MH No calibration applied and no bandpass applied

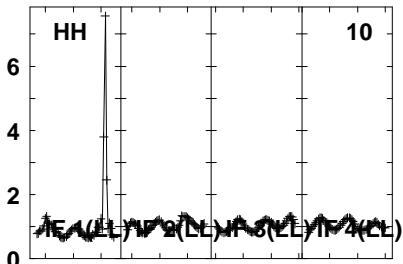
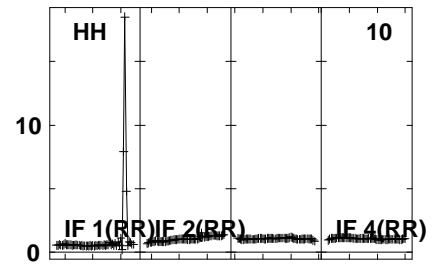
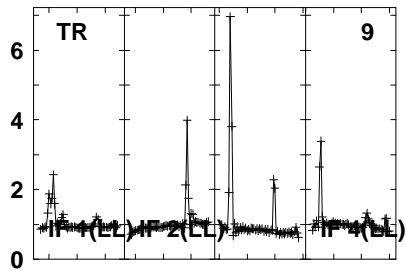
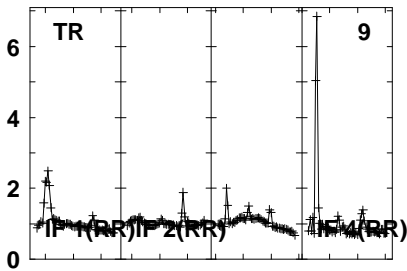
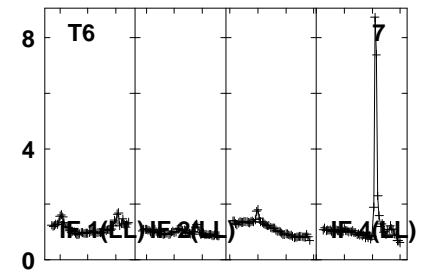
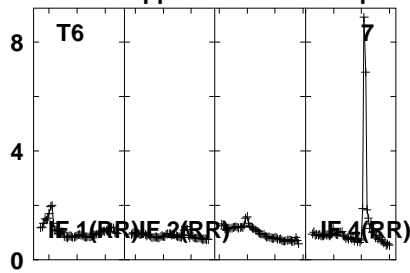
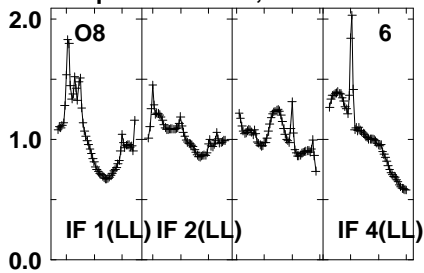

1600 1620 1630 1650 1660 1680 1690 1710

FREQ MHz

Lower frame: Real Jy

Auto-corr total-power spectrum Antenna: *

Timerange: 01/00:37:51 to 01/00:39:19

Plot file version 65 created 12-JUN-2023 14:39:11

J1548 ES106B.UVDATA.1

Freq = 1.5950 GHz, Bw = 32.000 MH No calibration applied and no bandpass applied

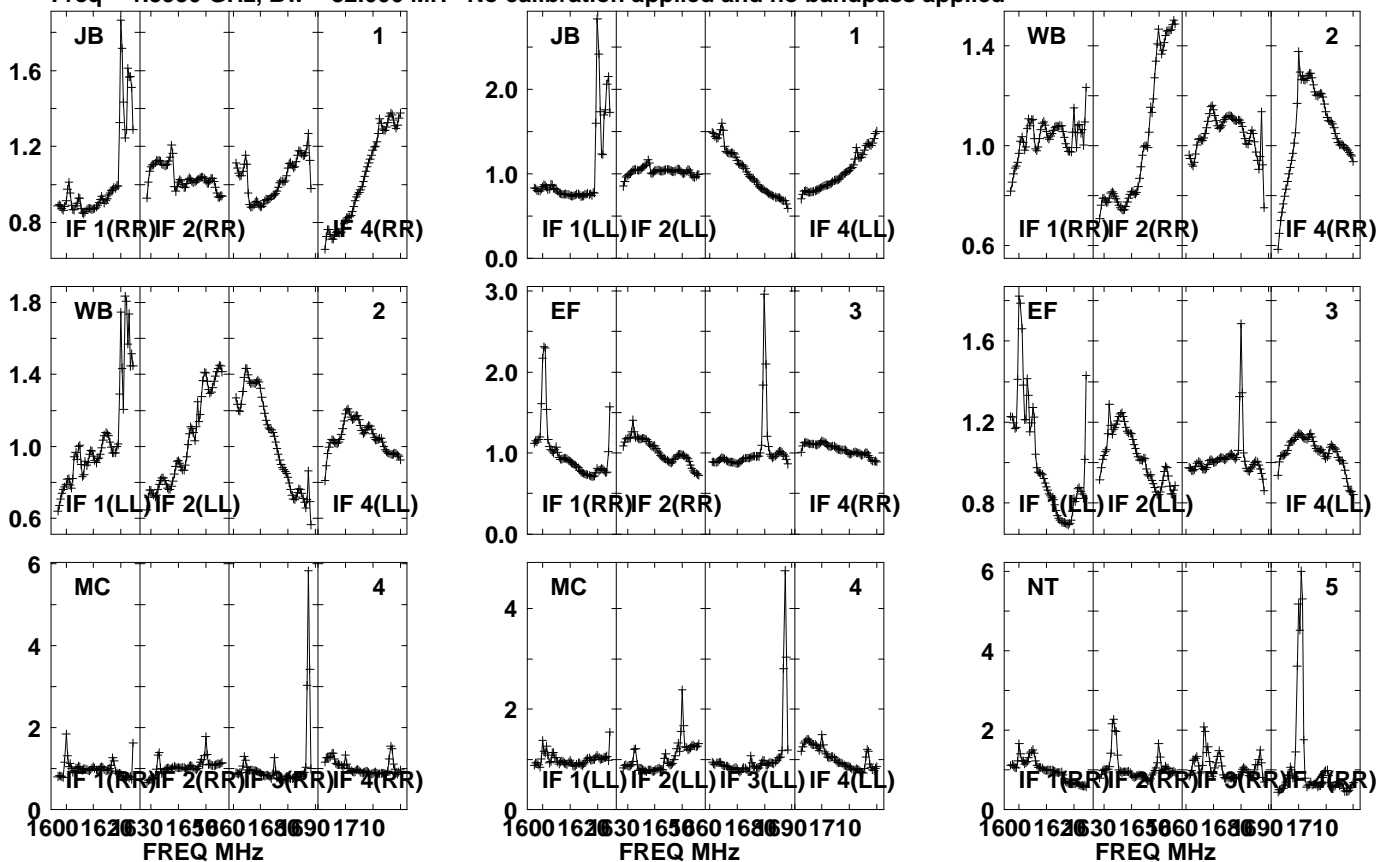

Lower frame: Real Jy
Auto-corr total-power spectrum Antenna: *
Timerange: 01/00:39:21 to 01/00:42:49

Plot file version 66 created 12-JUN-2023 14:39:11

J1548 ES106B.UVDATA.1

Freq = 1.5950 GHz, Bw = 32.000 MH No calibration applied and no bandpass applied

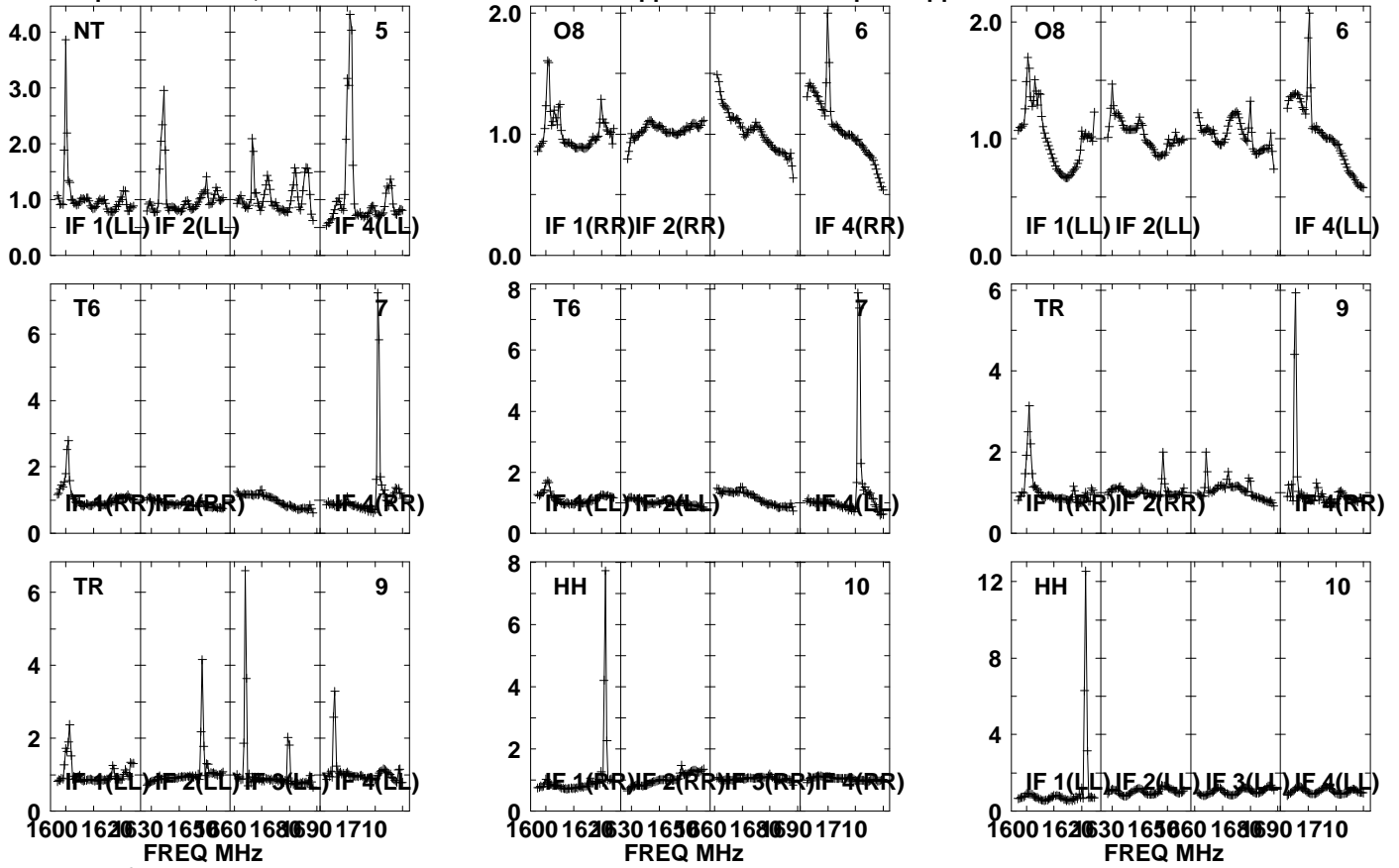

Lower frame: Real Jy
Auto-corr total-power spectrum Antenna: *
Timerange: 01/00:39:21 to 01/00:42:49

Plot file version 67 created 12-JUN-2023 14:39:11

J1547+2052 ES106B.UVDATA.1

Freq = 1.5950 GHz, Bw = 32.000 MH No calibration applied and no bandpass applied

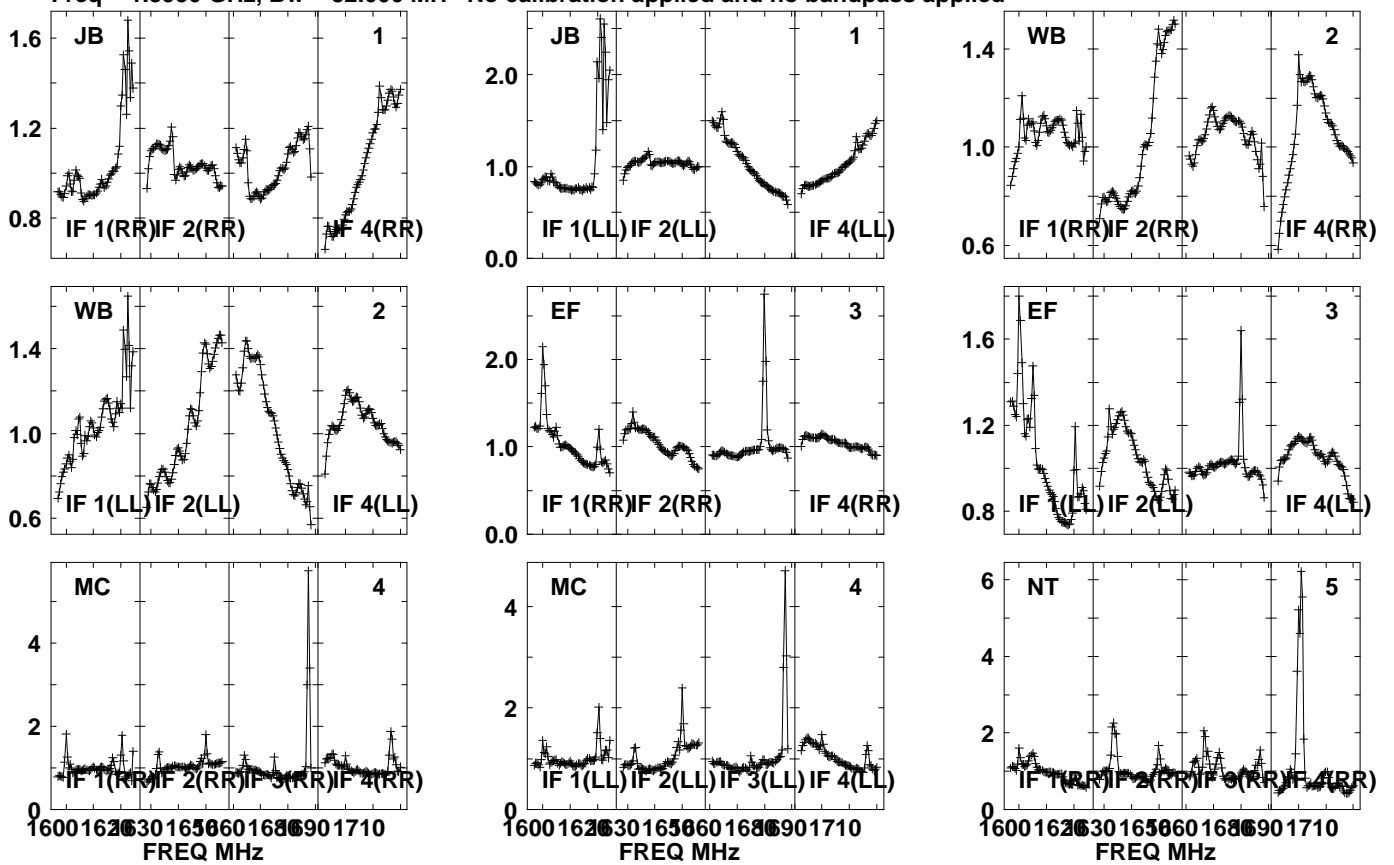

Lower frame: Real Jy
Auto-corr total-power spectrum Antenna: *
Timerange: 01/00:42:51 to 01/00:44:19

Plot file version 68 created 12-JUN-2023 14:39:11

J1547+2052 ES106B.UVDATA.1

Freq = 1.5950 GHz, Bw = 32.000 MH No calibration applied and no bandpass applied

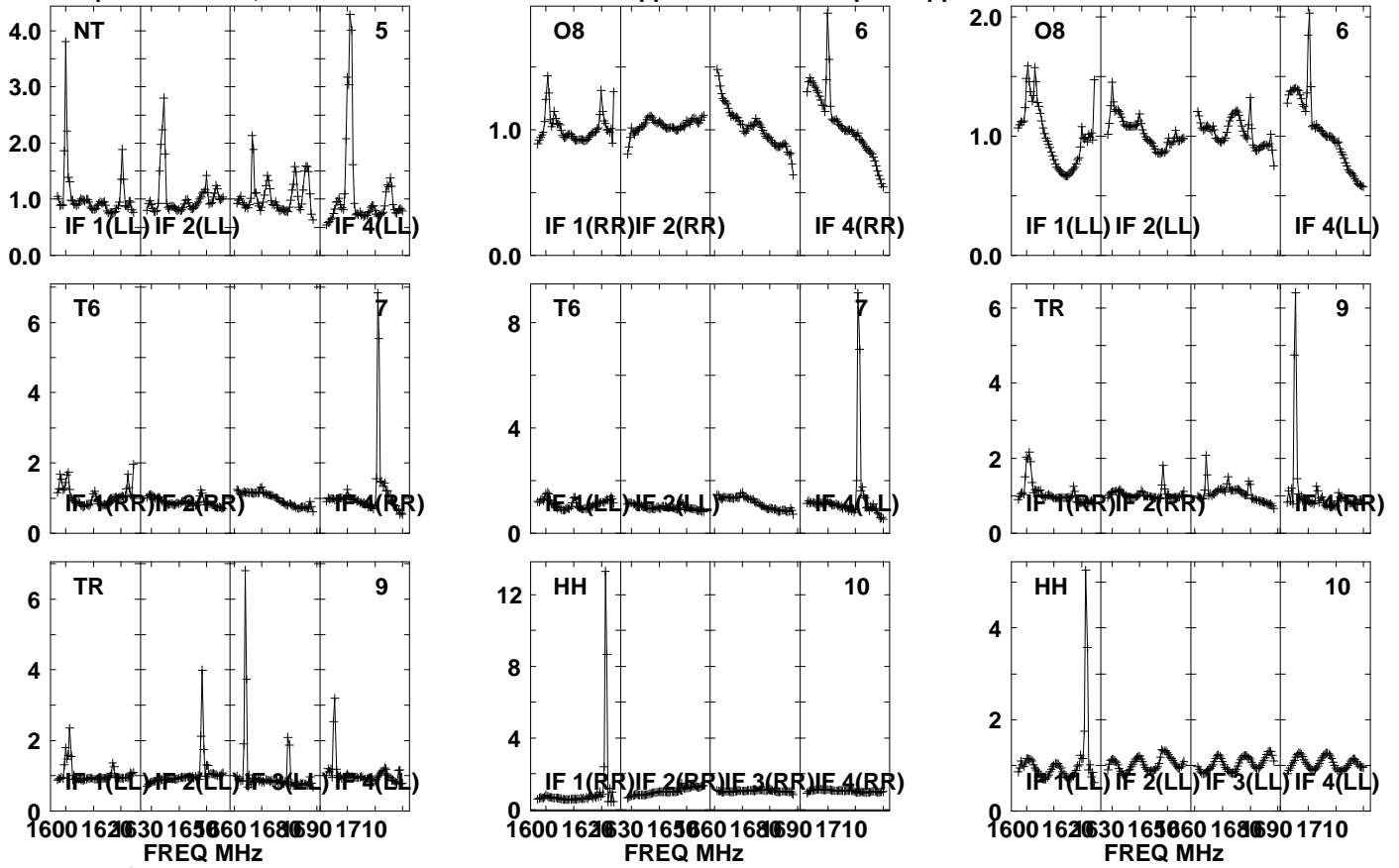

Lower frame: Real Jy

Auto-corr total-power spectrum Antenna: *

Timerange: 01/00:42:51 to 01/00:44:19

Plot file version 69 created 12-JUN-2023 14:39:11

J1545+2006 ES106B.UVDATA.1

Freq = 1.5950 GHz, Bw = 32.000 MH No calibration applied and no bandpass applied

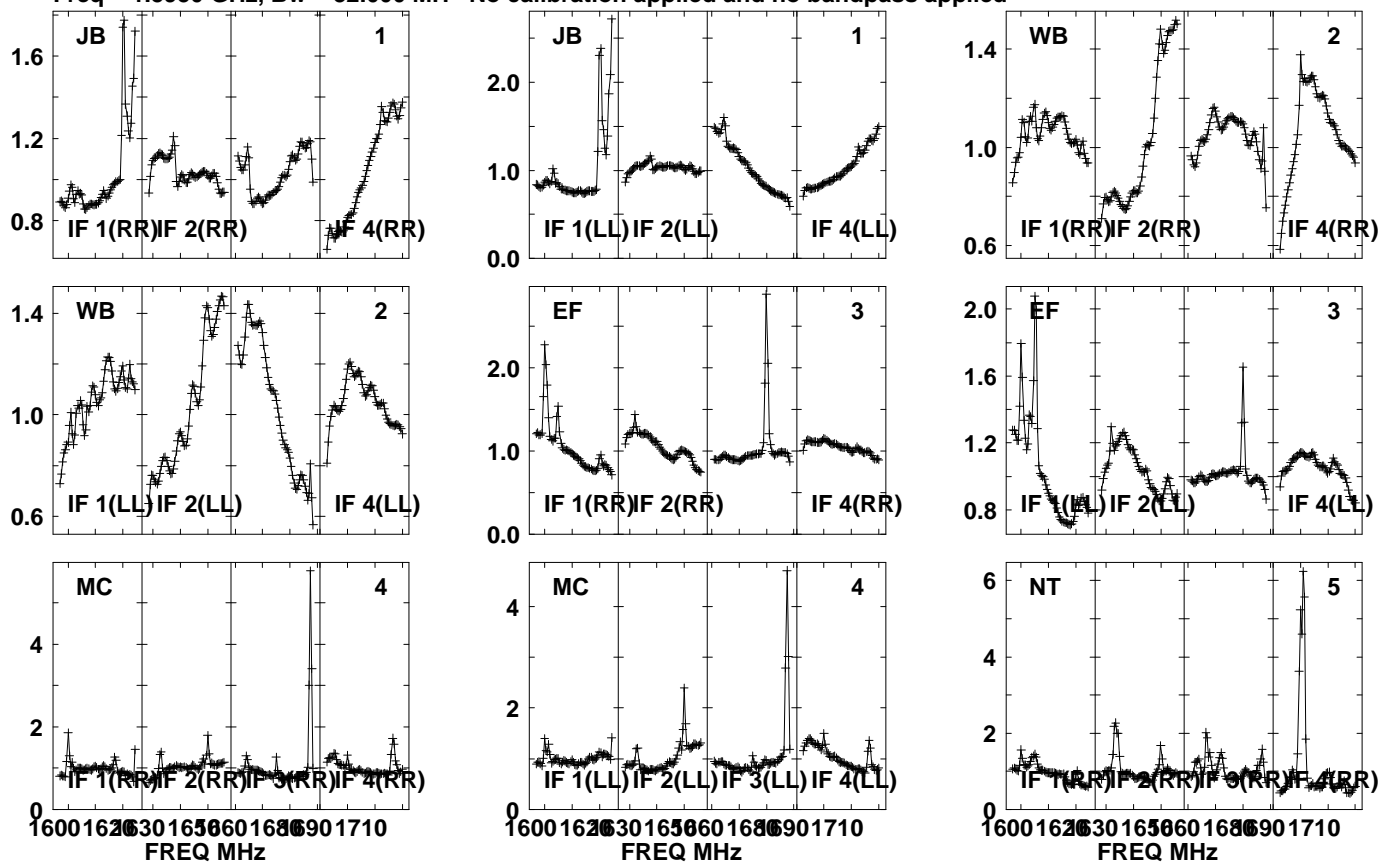

Lower frame: Real Jy

Auto-corr total-power spectrum Antenna: *

Timerange: 01/00:44:21 to 01/00:46:49

Plot file version 70 created 12-JUN-2023 14:39:11

J1545+2006 ES106B.UVDATA.1

Freq = 1.5950 GHz, Bw = 32.000 MH No calibration applied and no bandpass applied

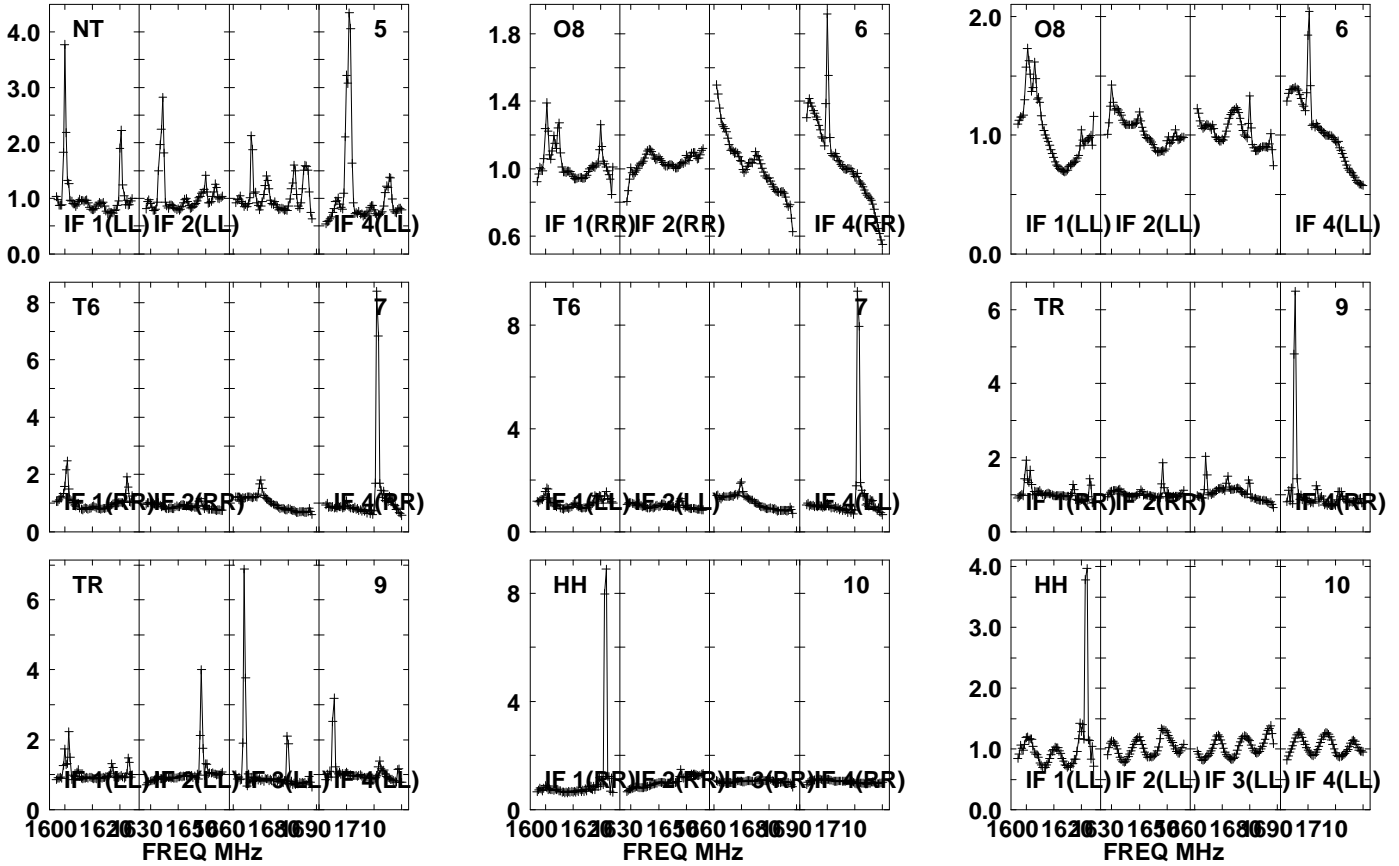

Lower frame: Real Jy

Auto-corr total-power spectrum Antenna: *

Timerange: 01/00:44:21 to 01/00:46:49

Plot file version 71 created 12-JUN-2023 14:39:11

J1547+2052 ES106B.UVDATA.1

Freq = 1.5950 GHz, Bw = 32.000 MH No calibration applied and no bandpass applied

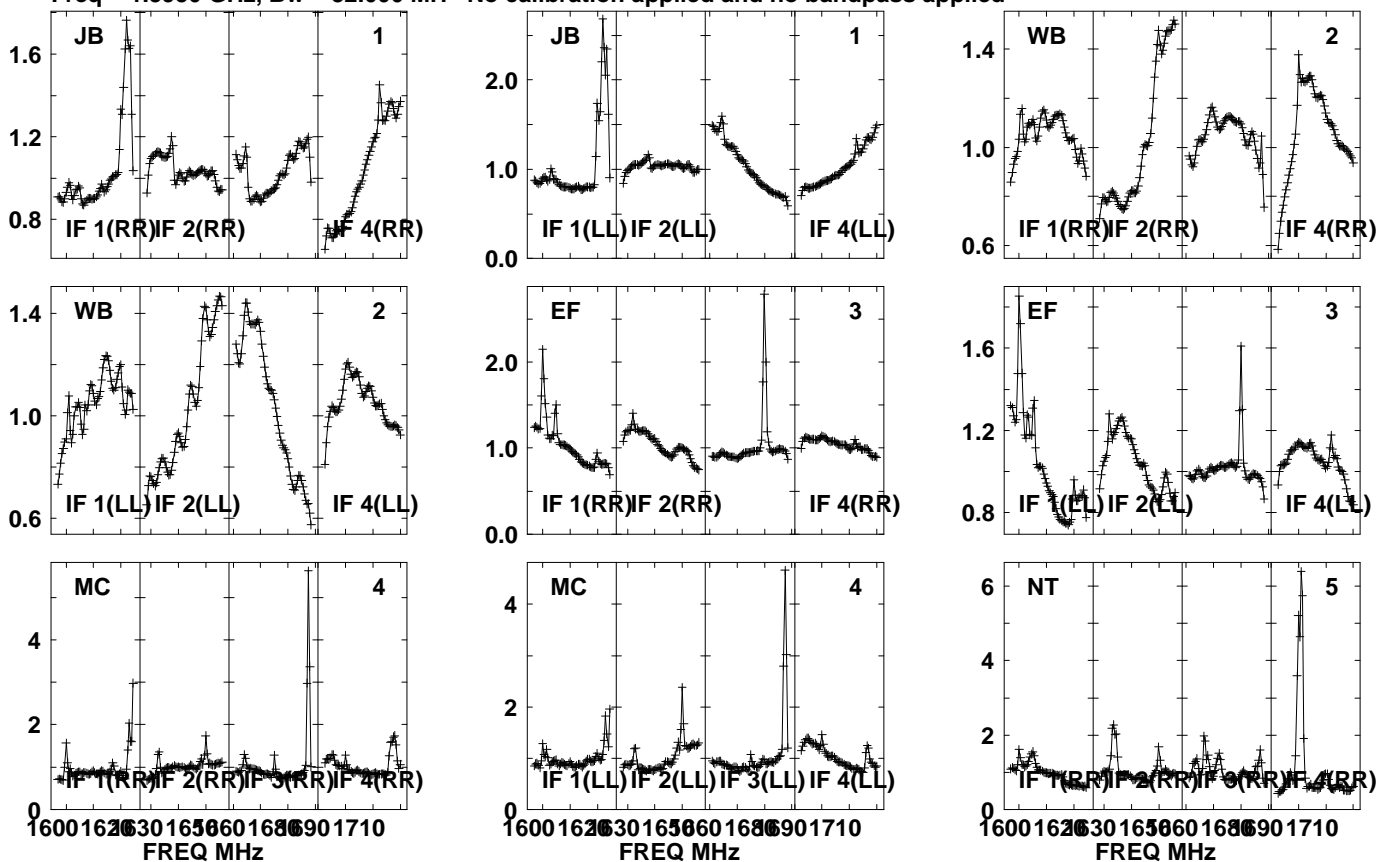

Lower frame: Real Jy
Auto-corr total-power spectrum Antenna: *
Timerange: 01/00:46:51 to 01/00:48:19

Plot file version 72 created 12-JUN-2023 14:39:11

J1547+2052 ES106B.UVDATA.1

Freq = 1.5950 GHz, Bw = 32.000 MH No calibration applied and no bandpass applied

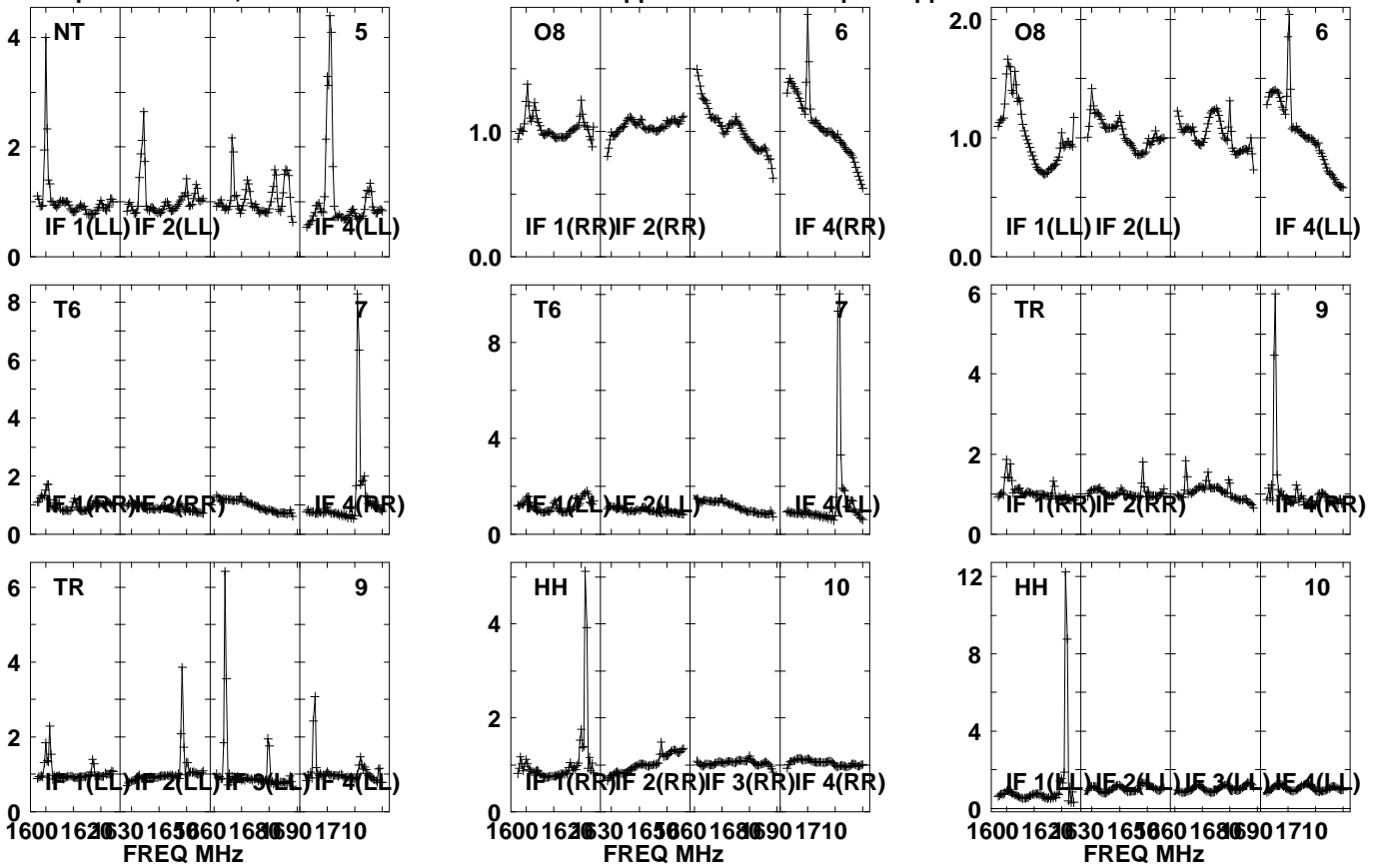

Lower frame: Real Jy

Auto-corr total-power spectrum Antenna: *

Timerange: 01/00:46:51 to 01/00:48:19

Plot file version 73 created 12-JUN-2023 14:39:11

J1548 ES106B.UVDATA.1

Freq = 1.5950 GHz, Bw = 32.000 MH No calibration applied and no bandpass applied

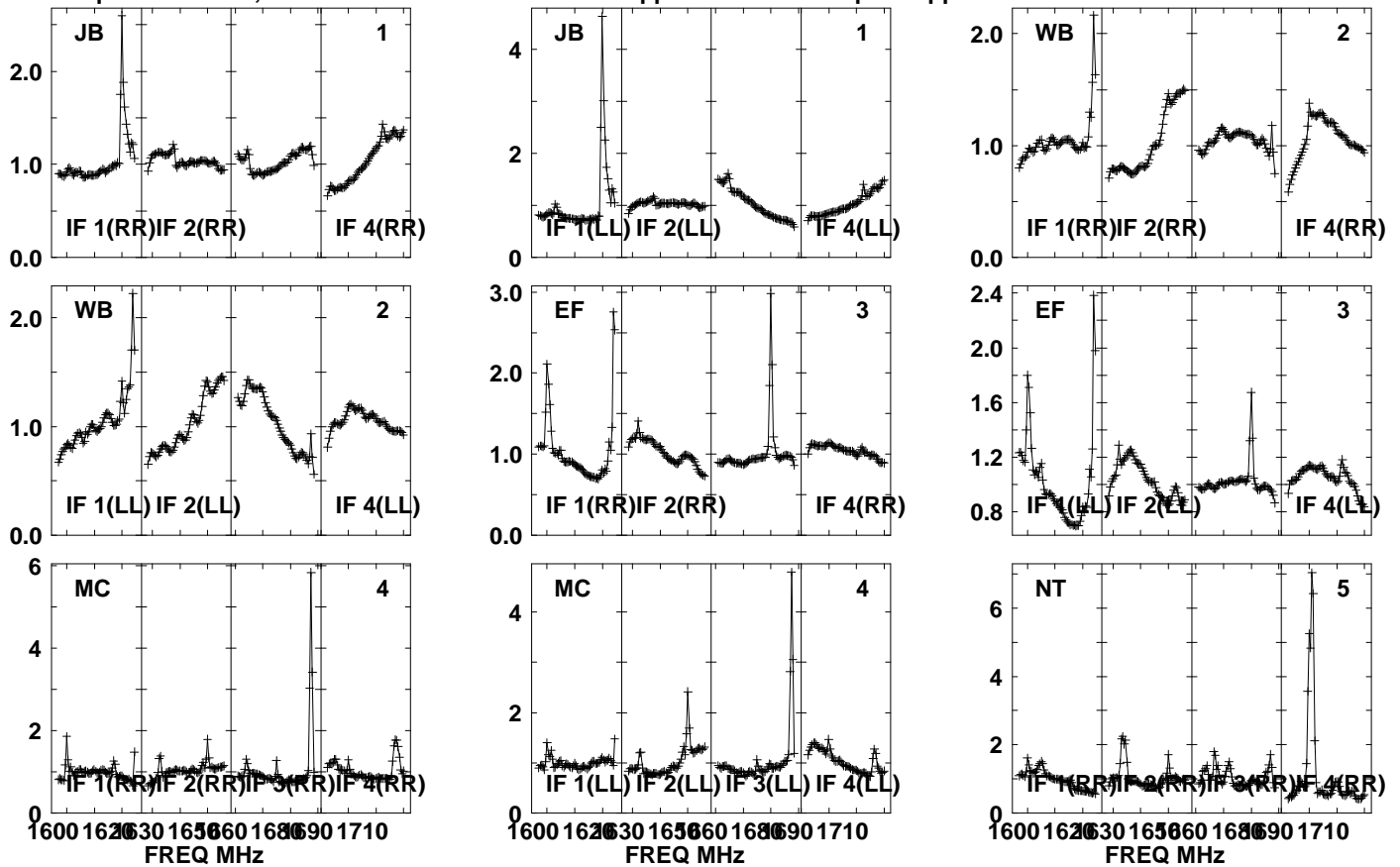

Lower frame: Real Jy

Auto-corr total-power spectrum Antenna: *

Timerange: 01/00:48:51 to 01/00:52:49

Plot file version 74 created 12-JUN-2023 14:39:12

J1548 ES106B.UVDATA.1

Freq = 1.5950 GHz, Bw = 32.000 MH No calibration applied and no bandpass applied

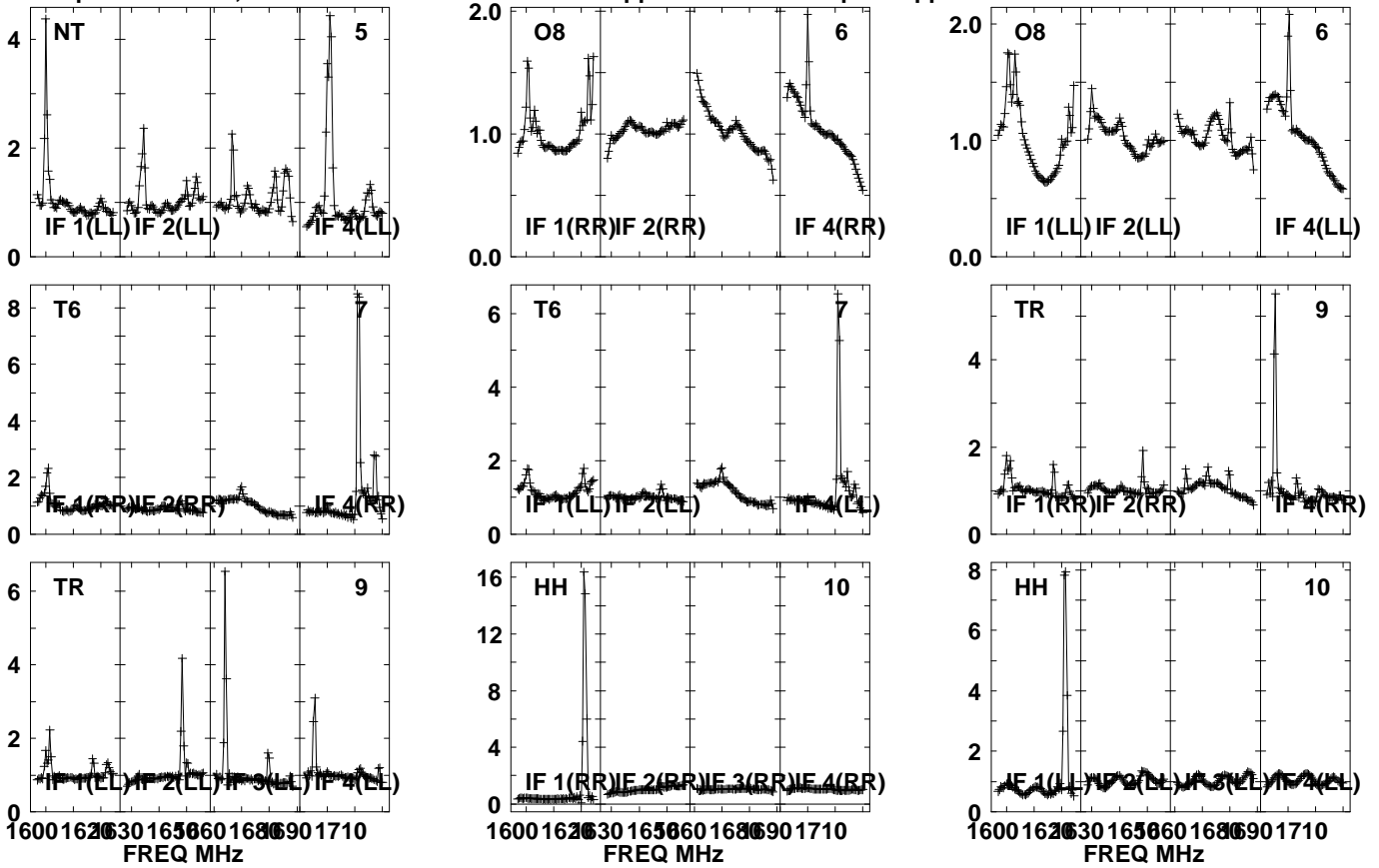

Lower frame: Real Jy
Auto-corr total-power spectrum Antenna: *
Timerange: 01/00:48:51 to 01/00:52:49

Plot file version 75 created 12-JUN-2023 14:39:12

J1547+2052 ES106B.UVDATA.1

Freq = 1.5950 GHz, Bw = 32.000 MH No calibration applied and no bandpass applied

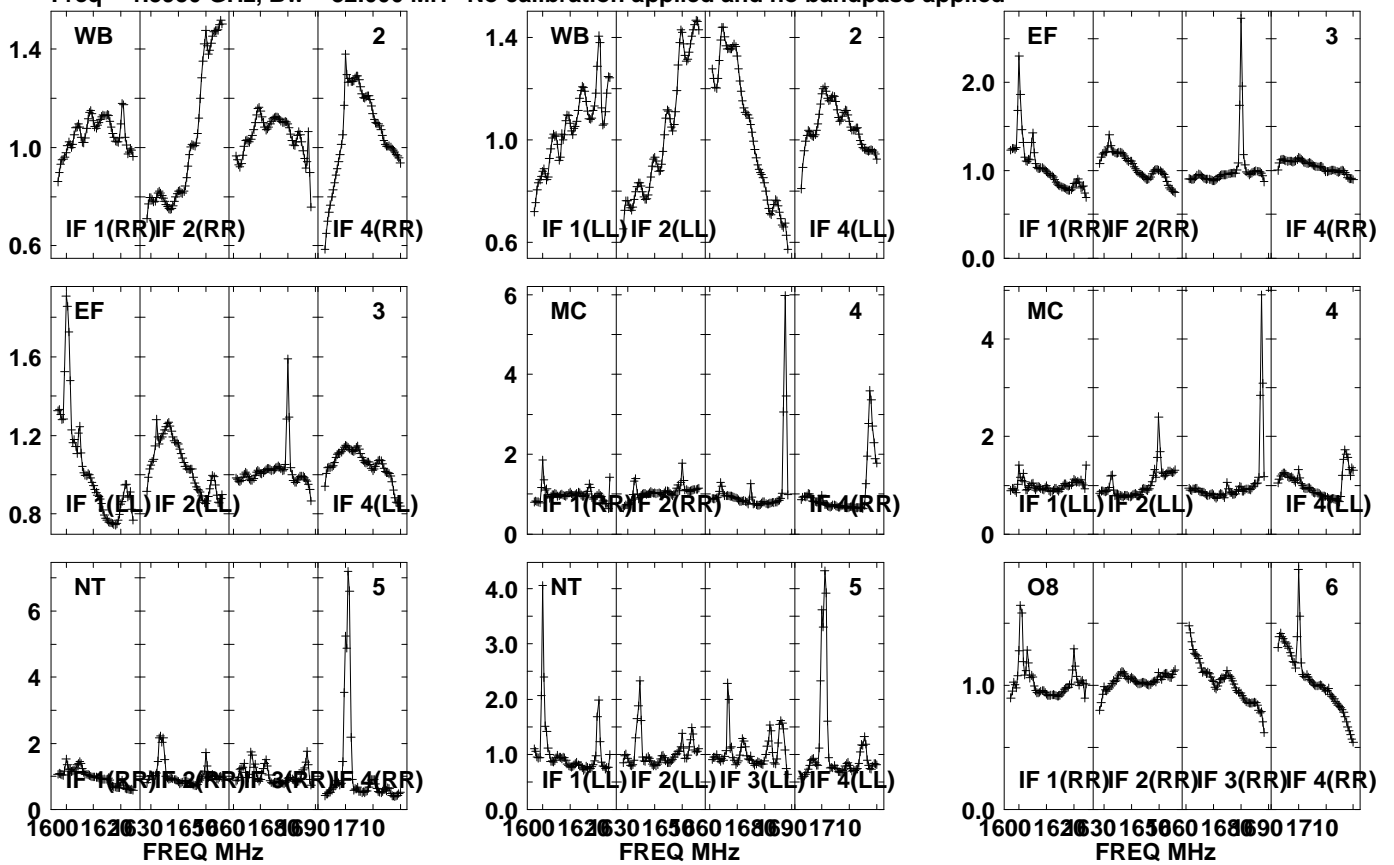

Lower frame: Real Jy
Auto-corr total-power spectrum Antenna: *
Timerange: 01/00:52:51 to 01/00:54:19

Plot file version 76 created 12-JUN-2023 14:39:12

J1547+2052 ES106B.UVDATA.1

Freq = 1.5950 GHz, Bw = 32.000 MH No calibration applied and no bandpass applied

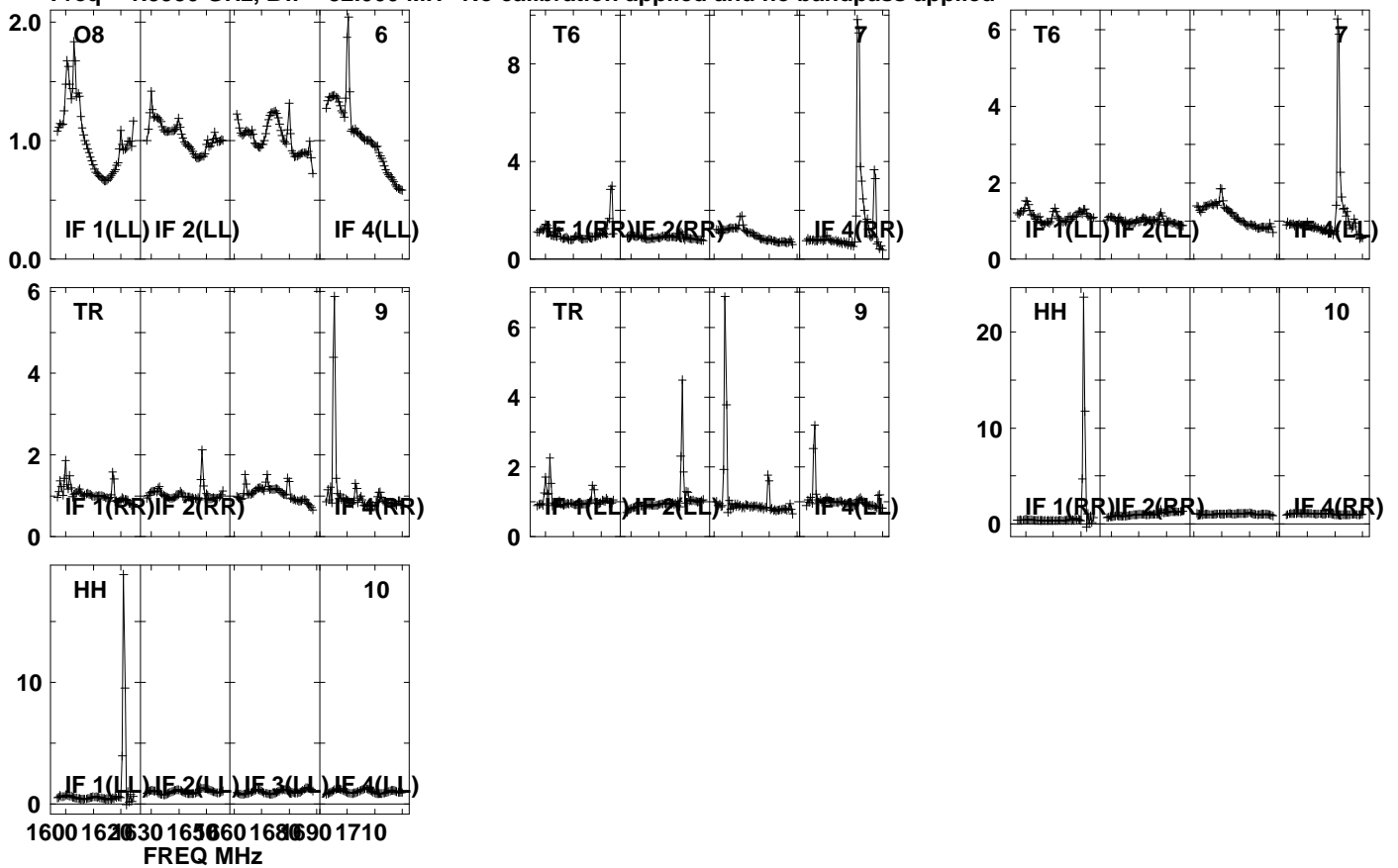

Lower frame: Real Jy

Auto-corr total-power spectrum Antenna: *

Timerange: 01/00:52:51 to 01/00:54:19

Plot file version 77 created 12-JUN-2023 14:39:12

J1548 ES106B.UVDATA.1

Freq = 1.5950 GHz, Bw = 32.000 MH No calibration applied and no bandpass applied

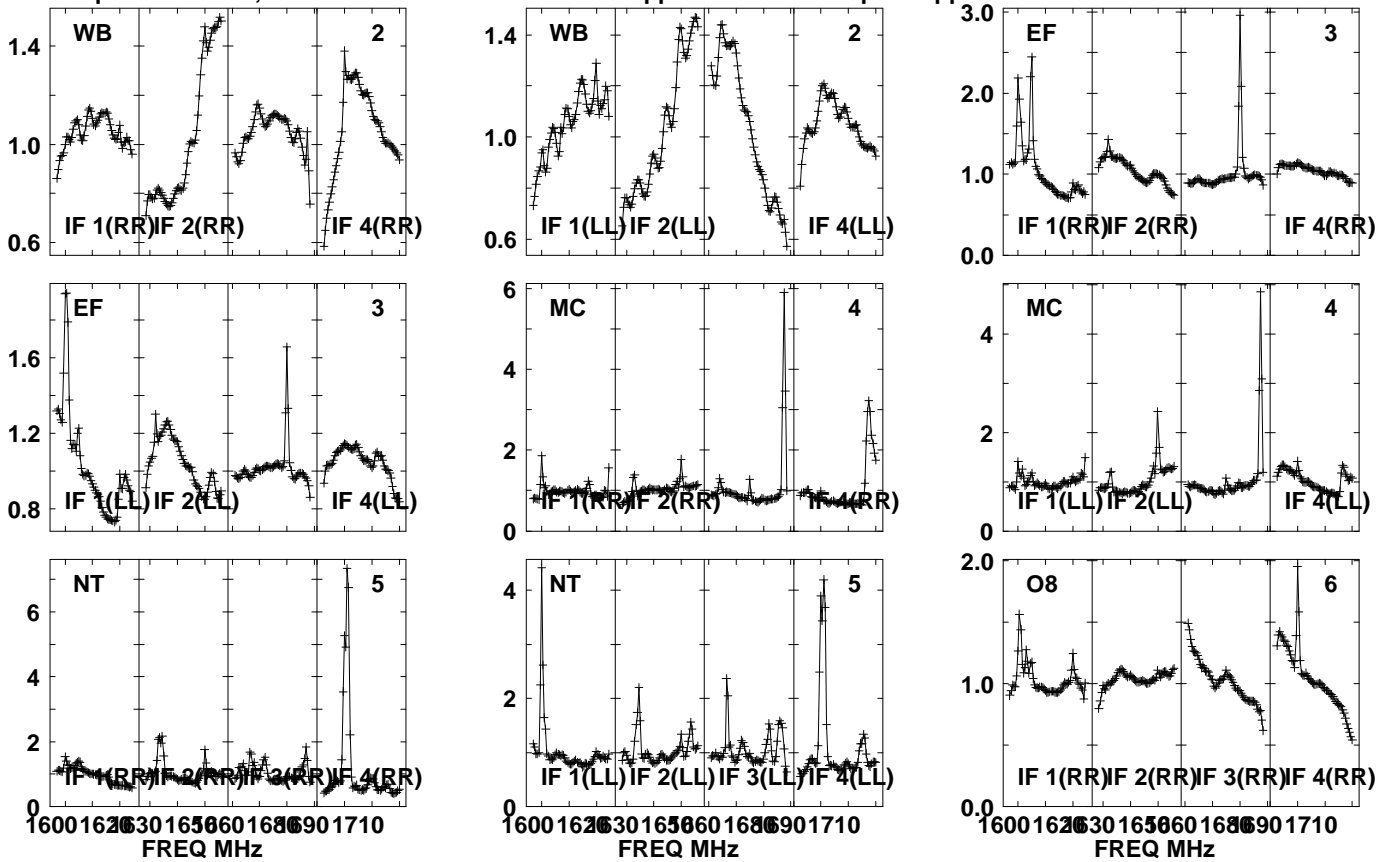

Lower frame: Real Jy
Auto-corr total-power spectrum Antenna: *
Timerange: 01/00:54:21 to 01/00:57:49

Plot file version 78 created 12-JUN-2023 14:39:12

J1548 ES106B.UVDATA.1

Freq = 1.5950 GHz, Bw = 32.000 MHz No calibration applied and no bandpass applied

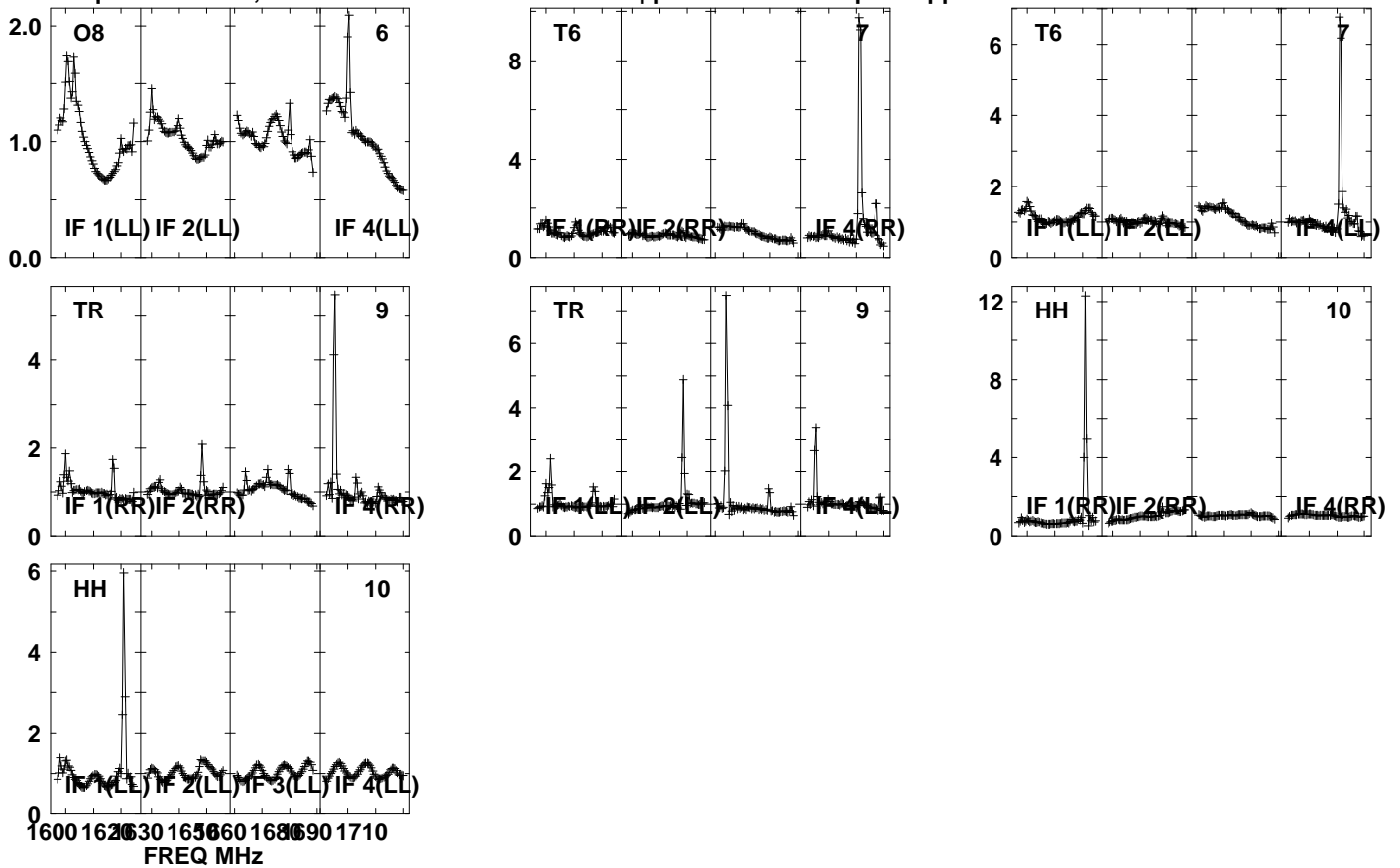

Lower frame: Real Jy

Auto-corr total-power spectrum Antenna: *

Timerange: 01/00:54:21 to 01/00:57:49

Plot file version 79 created 12-JUN-2023 14:39:12

J1547+2052 ES106B.UVDATA.1

Freq = 1.5950 GHz, Bw = 32.000 MH No calibration applied and no bandpass applied

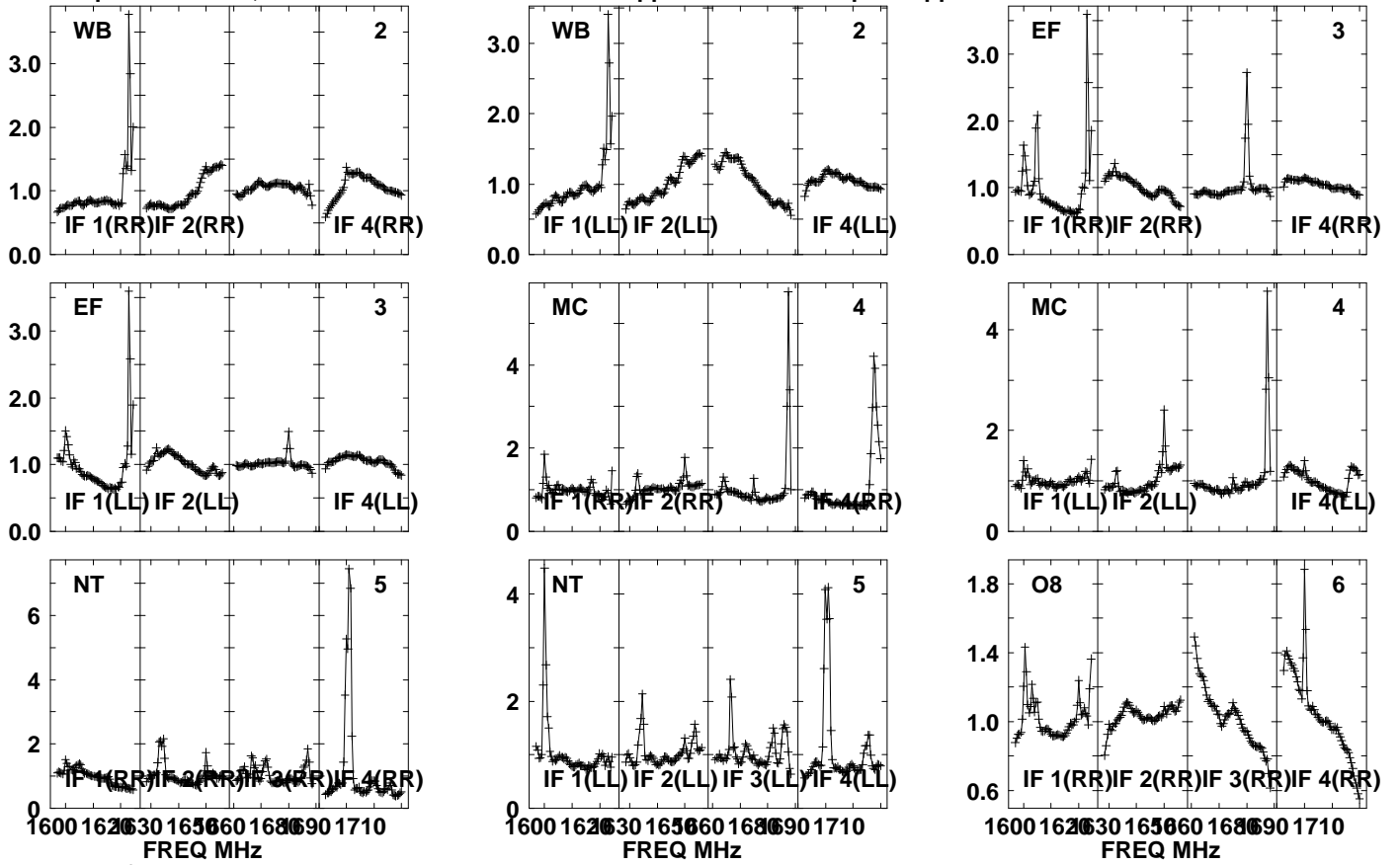

Lower frame: Real Jy
Auto-corr total-power spectrum Antenna: *
Timerange: 01/00:58:21 to 01/00:59:49

Plot file version 80 created 12-JUN-2023 14:39:12

J1547+2052 ES106B.UVDATA.1

Freq = 1.5950 GHz, Bw = 32.000 MH No calibration applied and no bandpass applied

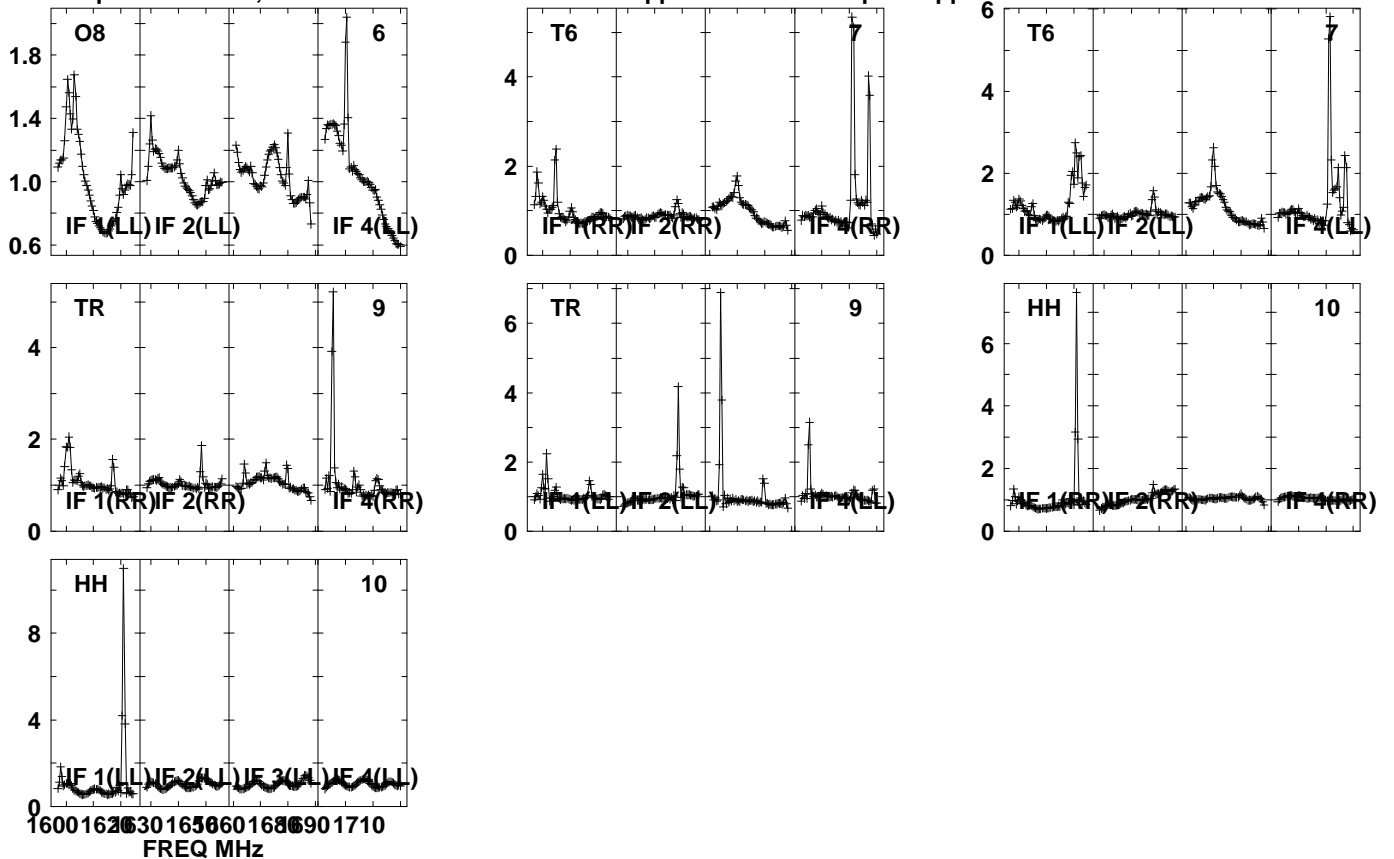

Lower frame: Real Jy
Auto-corr total-power spectrum Antenna: *
Timerange: 01/00:58:21 to 01/00:59:49

Plot file version 81 created 12-JUN-2023 14:39:12

J1548 ES106B.UVDATA.1

Freq = 1.5950 GHz, Bw = 32.000 MH No calibration applied and no bandpass applied

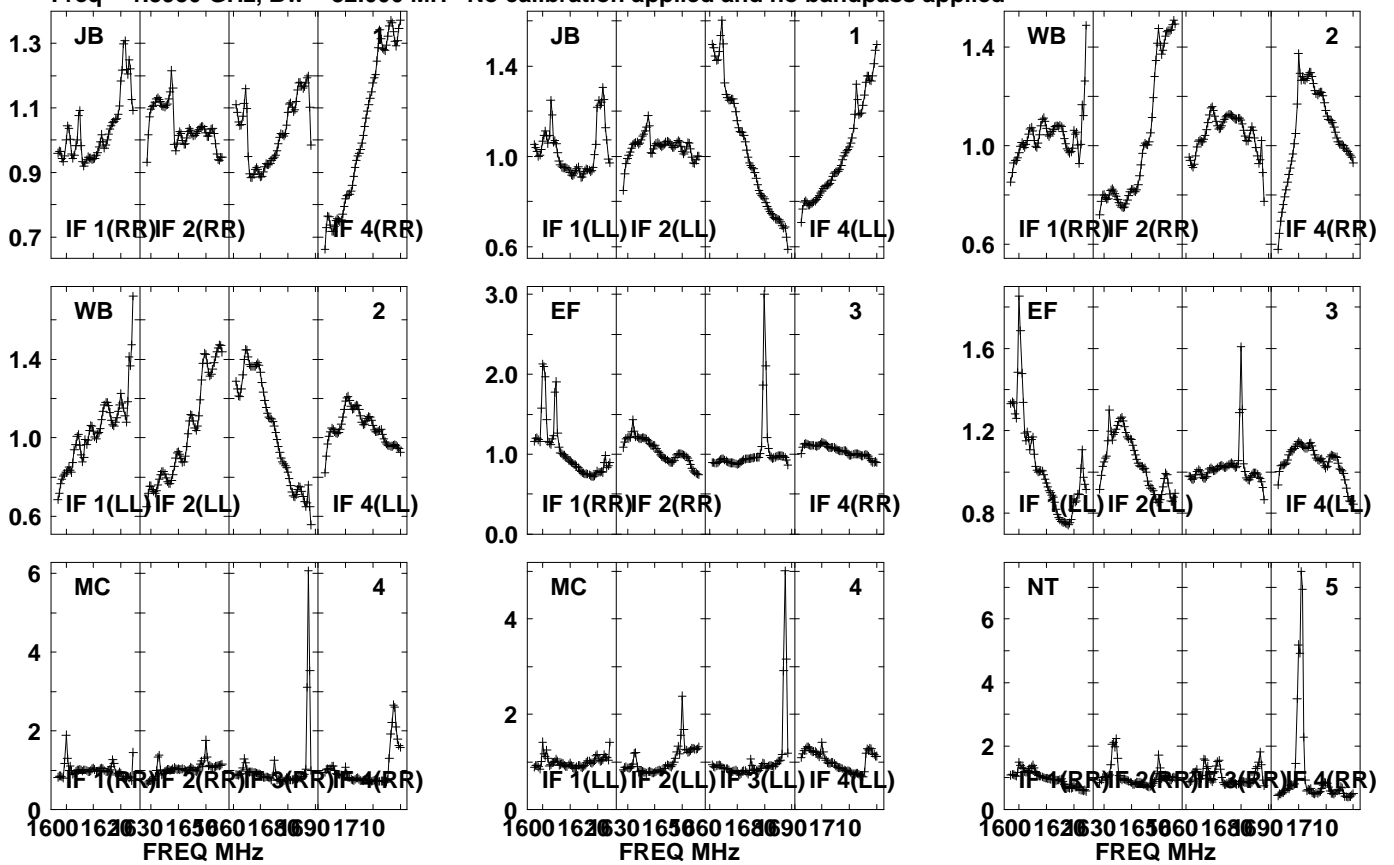

Lower frame: Real Jy
Auto-corr total-power spectrum Antenna: *
Timerange: 01/00:59:51 to 01/01:03:19

Plot file version 82 created 12-JUN-2023 14:39:12

J1548 ES106B.UVDATA.1

Freq = 1.5950 GHz, Bw = 32.000 MH No calibration applied and no bandpass applied

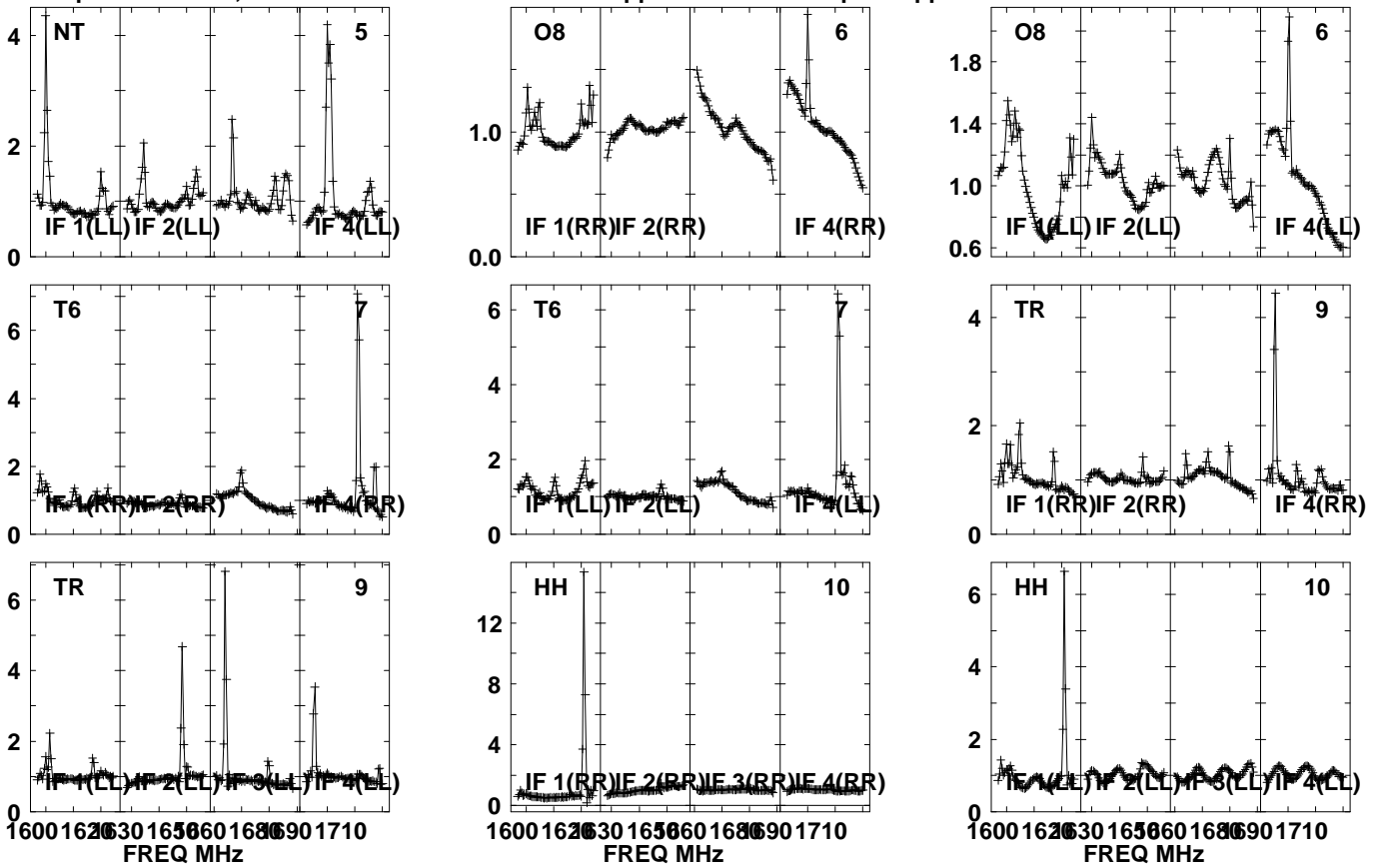

Lower frame: Real Jy

Auto-corr total-power spectrum Antenna: *

Timerange: 01/00:59:51 to 01/01:03:19

Plot file version 83 created 12-JUN-2023 14:39:12

J1547+2052 ES106B.UVDATA.1

Freq = 1.5950 GHz, Bw = 32.000 MH No calibration applied and no bandpass applied

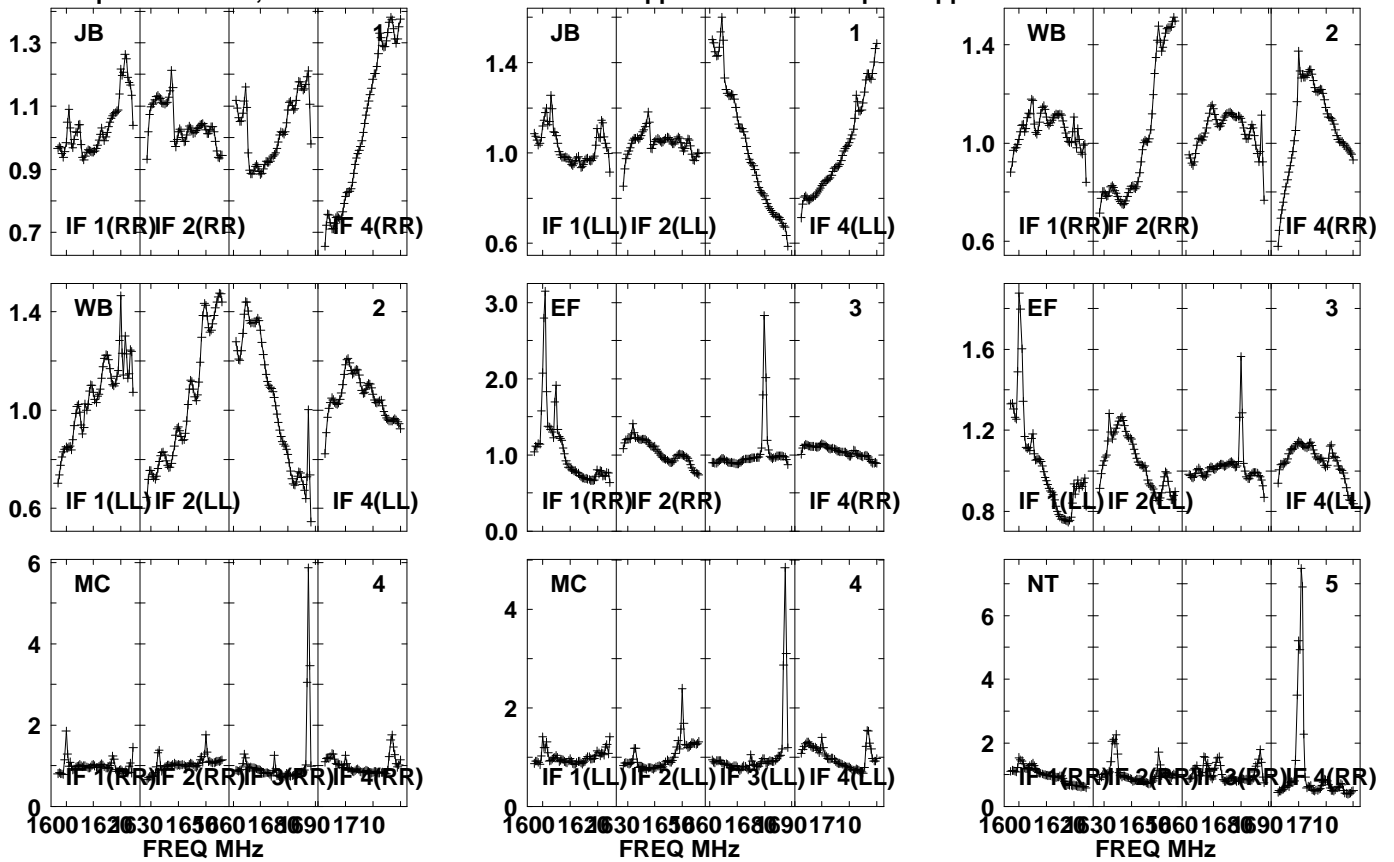

Lower frame: Real Jy
Auto-corr total-power spectrum Antenna: *
Timerange: 01/01:03:21 to 01/01:04:49

Plot file version 84 created 12-JUN-2023 14:39:12

J1547+2052 ES106B.UVDATA.1

Freq = 1.5950 GHz, Bw = 32.000 MH No calibration applied and no bandpass applied

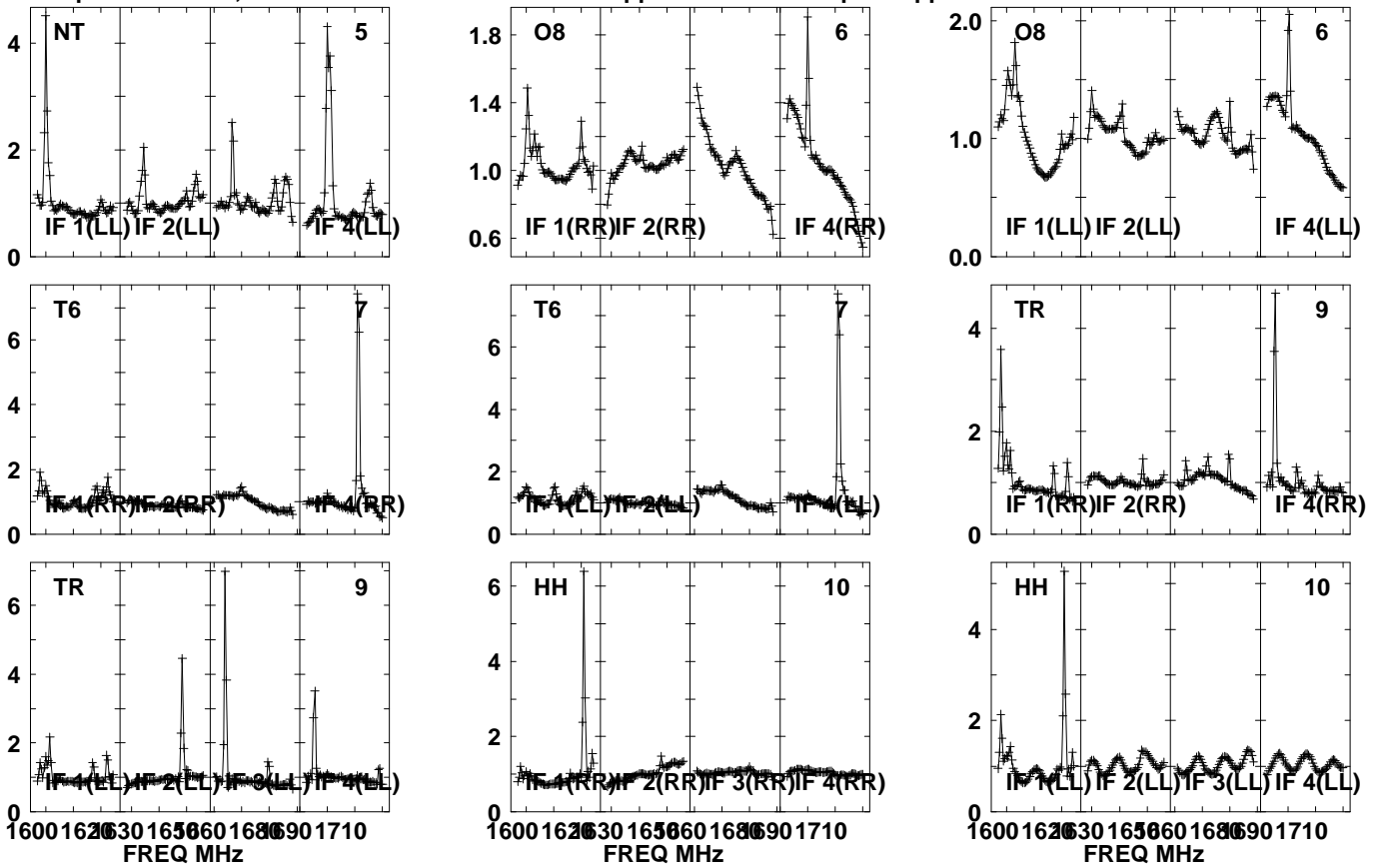

Lower frame: Real Jy

Auto-corr total-power spectrum Antenna: *

Timerange: 01/01:03:21 to 01/01:04:49

Plot file version 85 created 12-JUN-2023 14:39:12

J1545+2006 ES106B.UVDATA.1

Freq = 1.5950 GHz, Bw = 32.000 MH No calibration applied and no bandpass applied

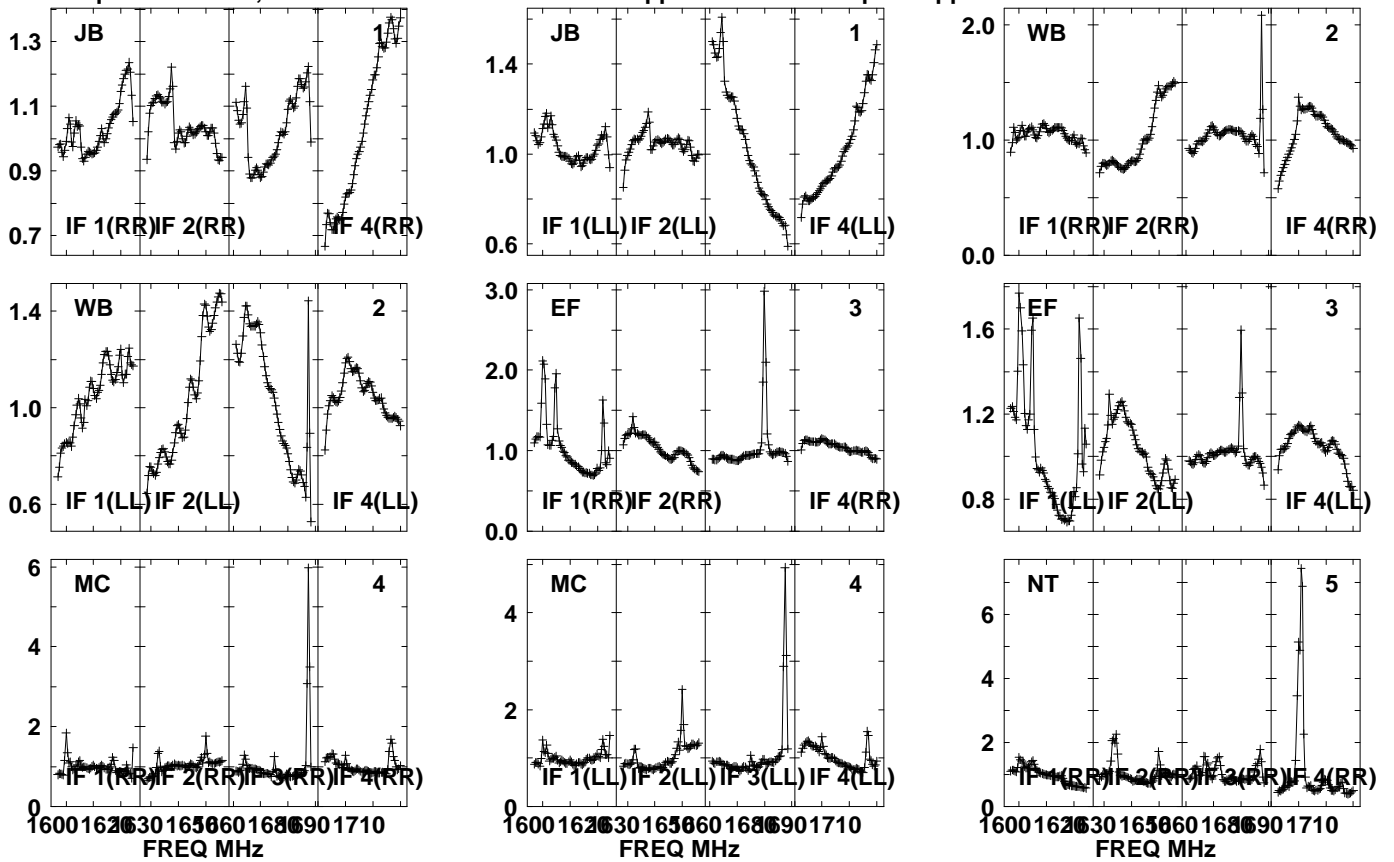

Lower frame: Real Jy

Auto-corr total-power spectrum Antenna: *

Timerange: 01/01:04:51 to 01/01:07:19

Plot file version 86 created 12-JUN-2023 14:39:12

J1545+2006 ES106B.UVDATA.1

Freq = 1.5950 GHz, Bw = 32.000 MH No calibration applied and no bandpass applied

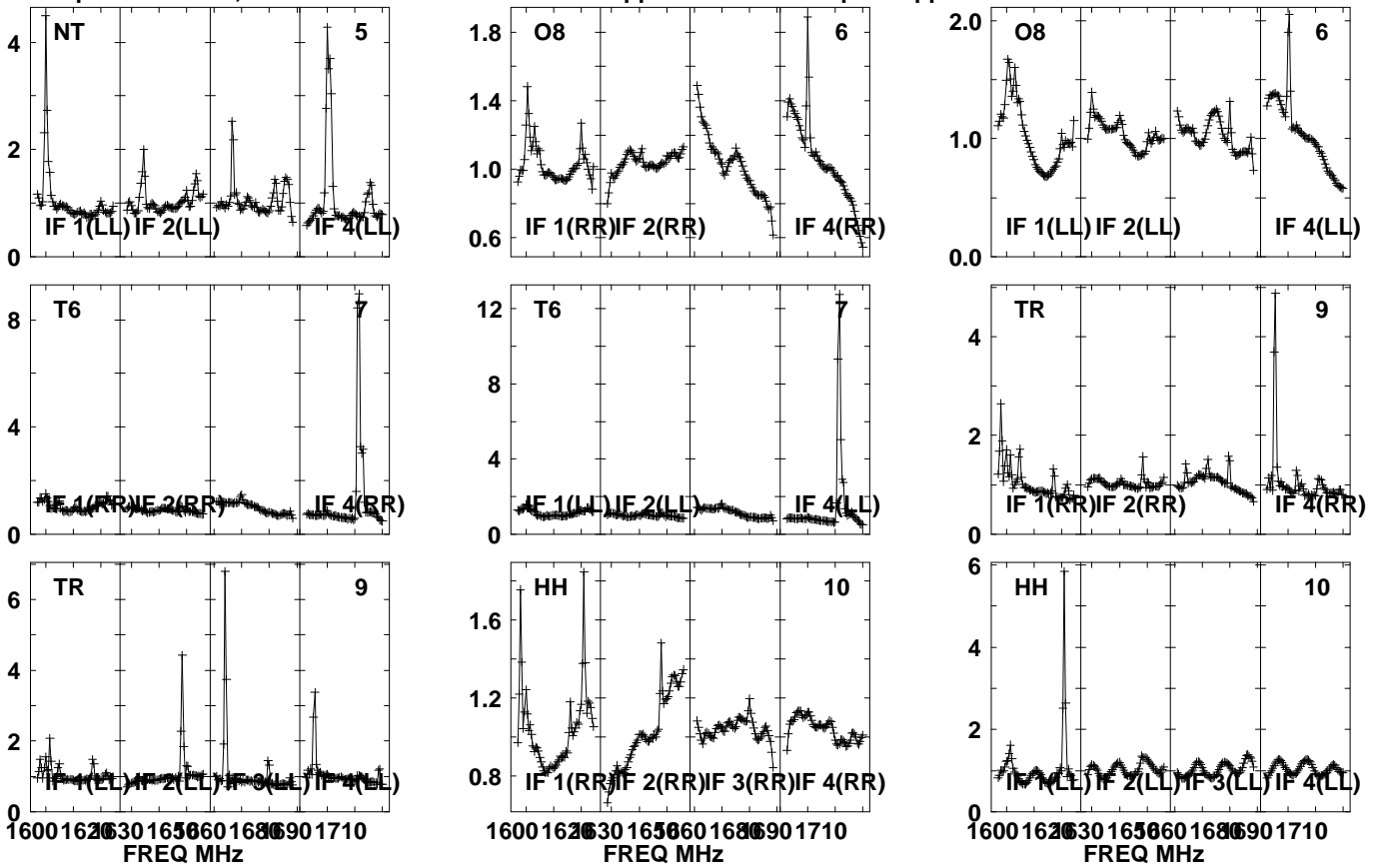

Lower frame: Real Jy

Auto-corr total-power spectrum Antenna: *

Timerange: 01/01:04:51 to 01/01:07:19

Plot file version 87 created 12-JUN-2023 14:39:12

J1547+2052 ES106B.UVDATA.1

Freq = 1.5950 GHz, Bw = 32.000 MH No calibration applied and no bandpass applied

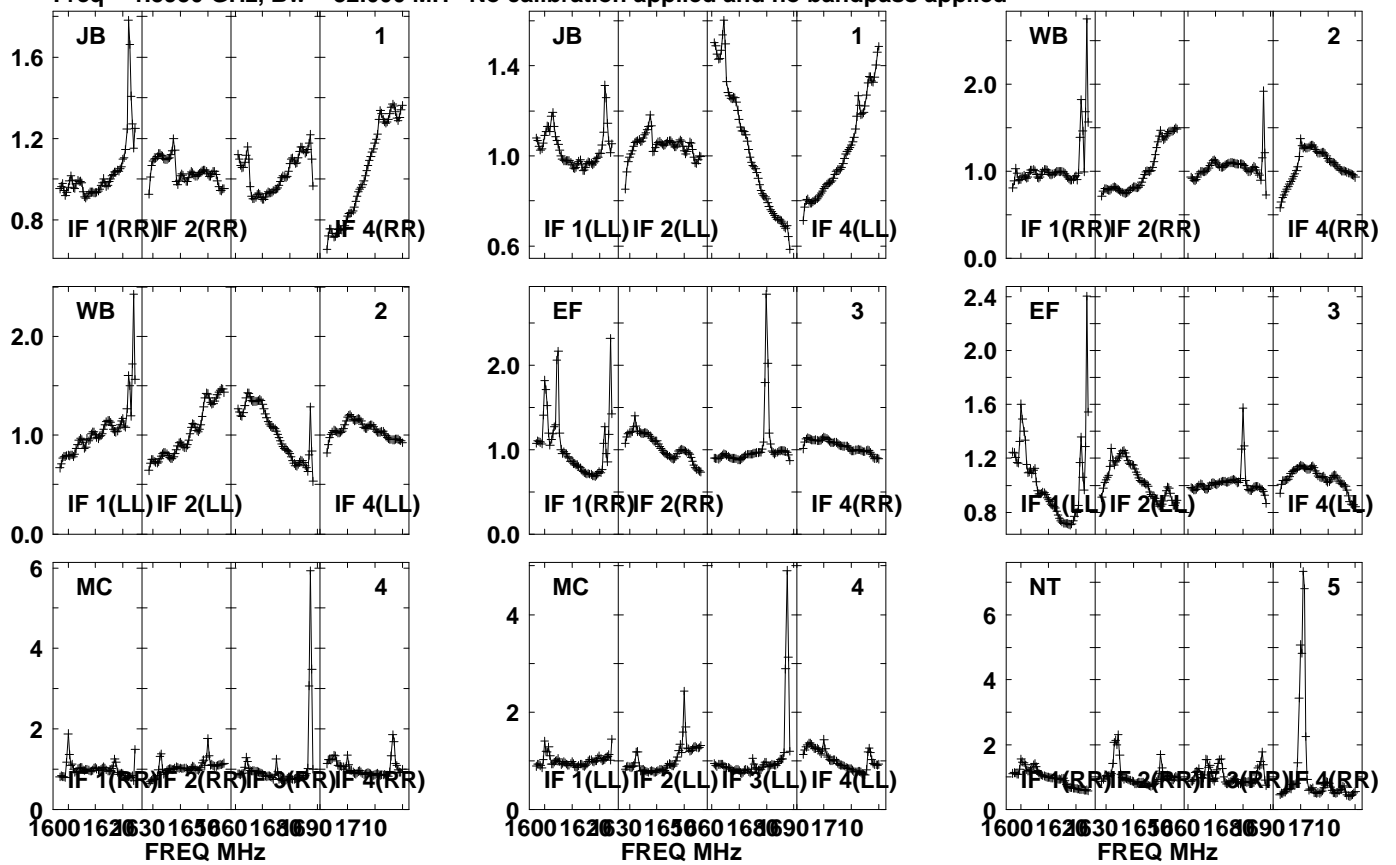

Lower frame: Real Jy
Auto-corr total-power spectrum Antenna: *
Timerange: 01/01:07:21 to 01/01:08:49

Plot file version 88 created 12-JUN-2023 14:39:12

J1547+2052 ES106B.UVDATA.1

Freq = 1.5950 GHz, Bw = 32.000 MH No calibration applied and no bandpass applied

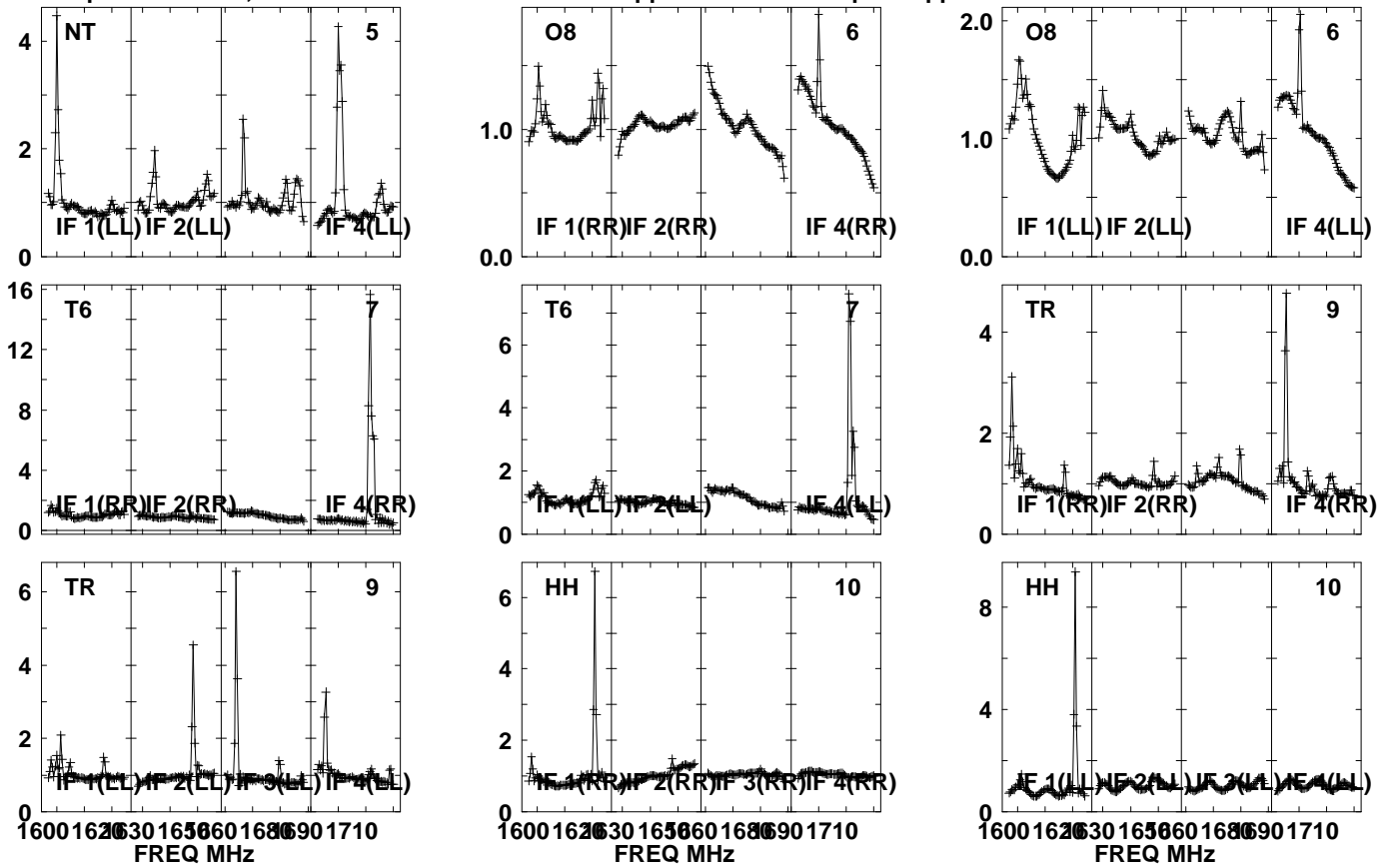

Lower frame: Real Jy
Auto-corr total-power spectrum Antenna: *
Timerange: 01/01:07:21 to 01/01:08:49

Plot file version 89 created 12-JUN-2023 14:39:13

J1548 ES106B.UVDATA.1

Freq = 1.5950 GHz, Bw = 32.000 MH No calibration applied and no bandpass applied

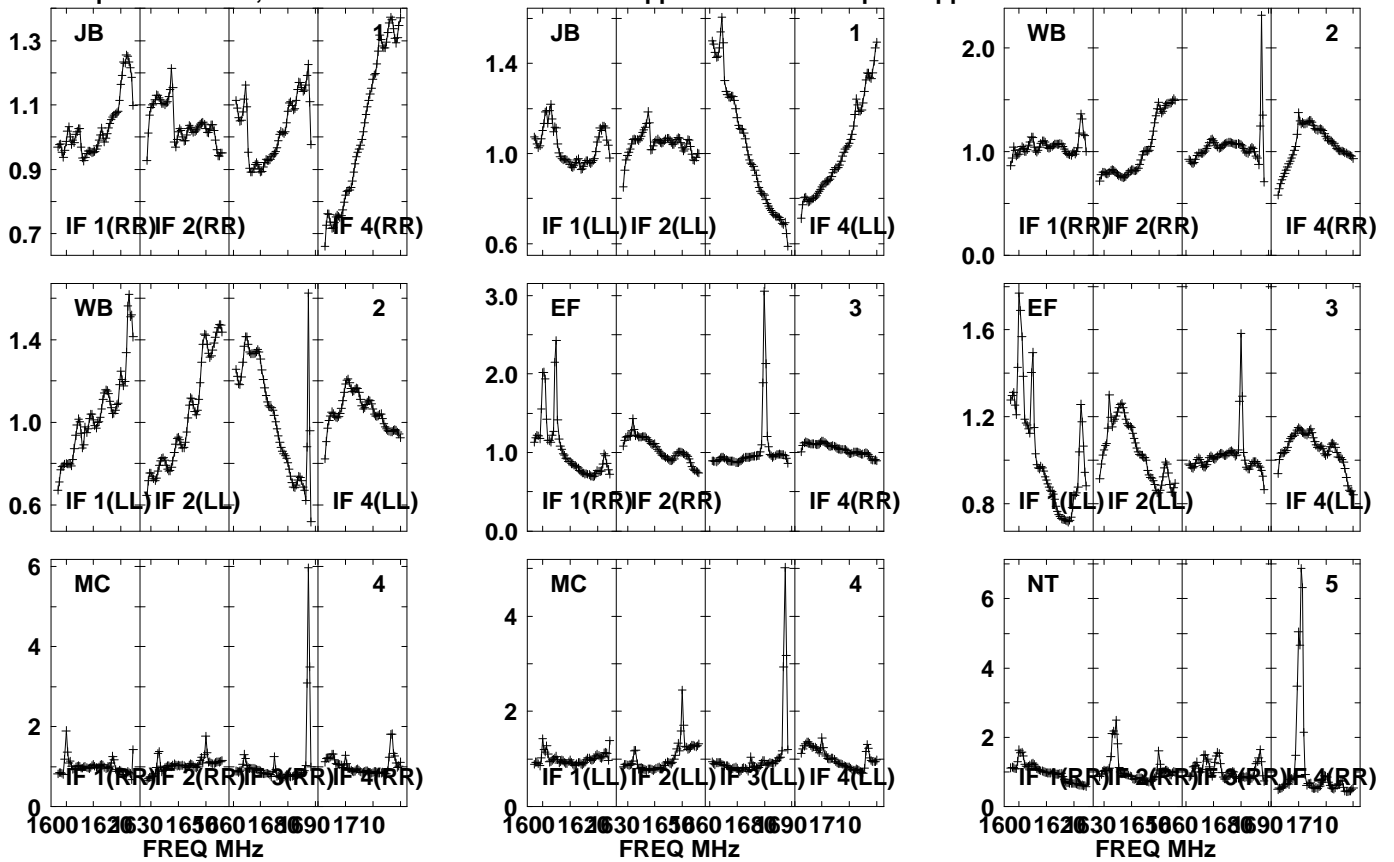

Lower frame: Real Jy
Auto-corr total-power spectrum Antenna: *
Timerange: 01/01:09:21 to 01/01:13:19

Plot file version 90 created 12-JUN-2023 14:39:13

J1548 ES106B.UVDATA.1

Freq = 1.5950 GHz, Bw = 32.000 MH No calibration applied and no bandpass applied

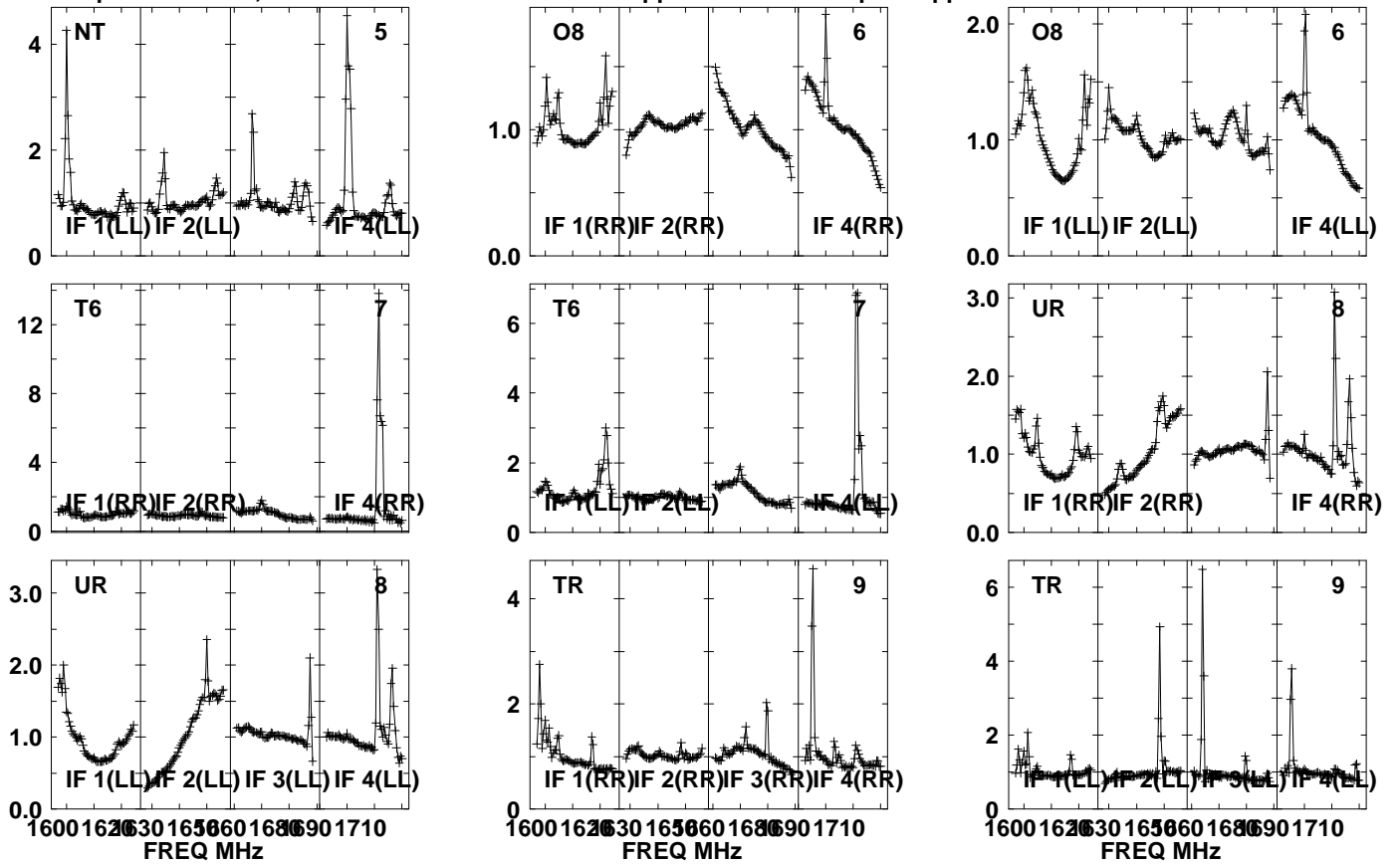

Lower frame: Real Jy

Auto-corr total-power spectrum Antenna: *

Timerange: 01/01:09:21 to 01/01:13:19

Plot file version 91 created 12-JUN-2023 14:39:13

J1548 ES106B.UVDATA.1

Freq = 1.5950 GHz, Bw = 32.000 MH No calibration applied and no bandpass applied

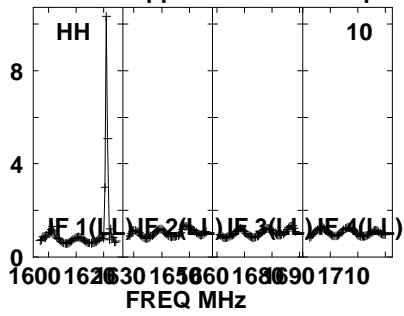
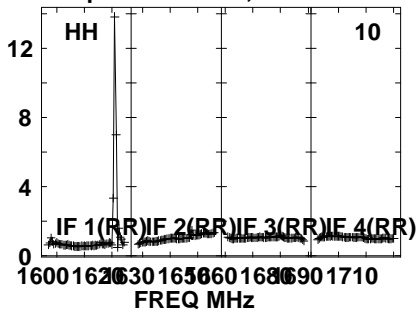

Lower frame: Real Jy
Auto-corr total-power spectrum Antenna: *
Timerange: 01/01:09:21 to 01/01:13:19

Plot file version 92 created 12-JUN-2023 14:39:13

J1547+2052 ES106B.UVDATA.1

Freq = 1.5950 GHz, Bw = 32.000 MH No calibration applied and no bandpass applied

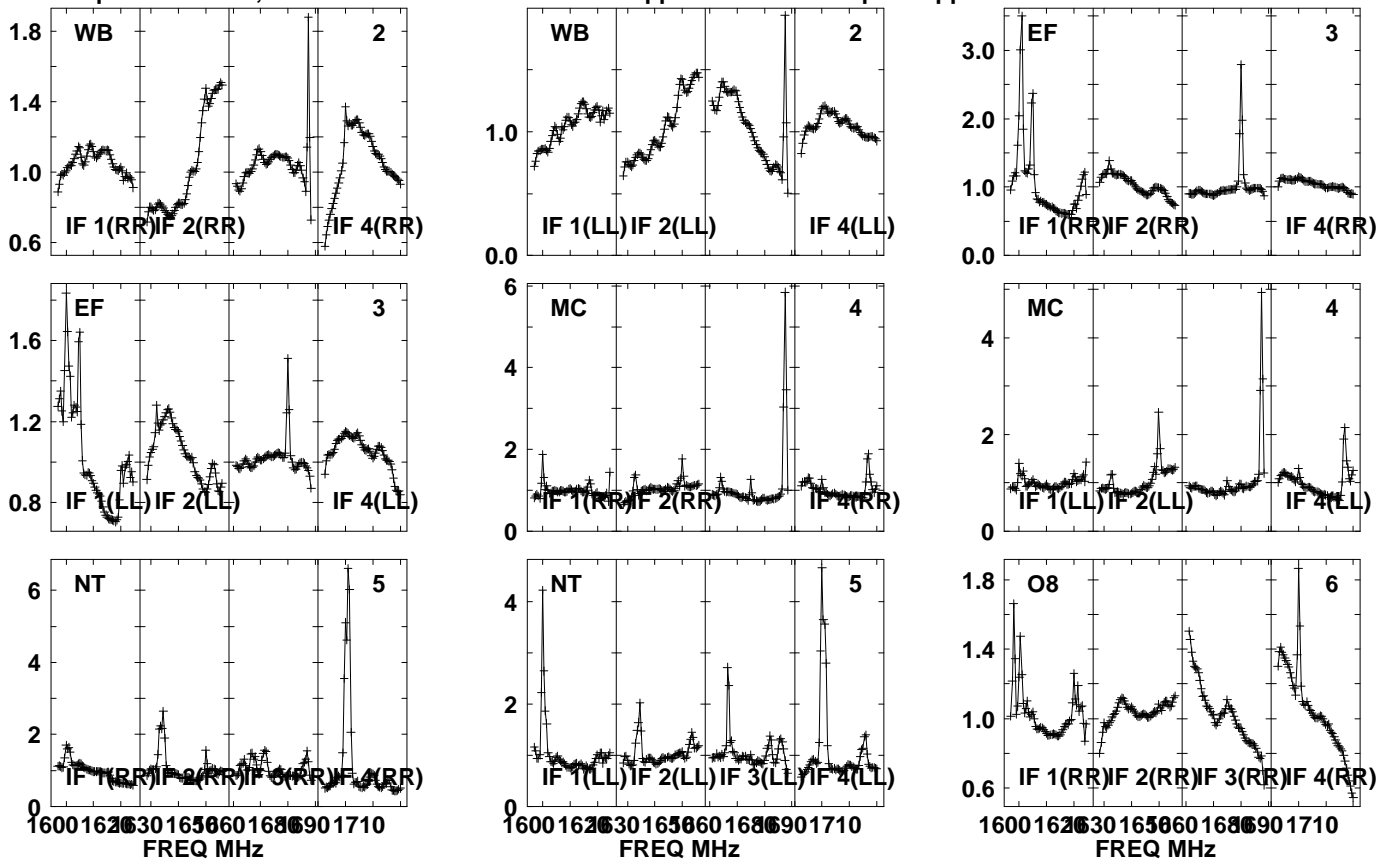

Lower frame: Real Jy
Auto-corr total-power spectrum Antenna: *
Timerange: 01/01:13:21 to 01/01:14:49

Plot file version 93 created 12-JUN-2023 14:39:13

J1547+2052 ES106B.UVDATA.1

Freq = 1.5950 GHz, Bw = 32.000 MH No calibration applied and no bandpass applied

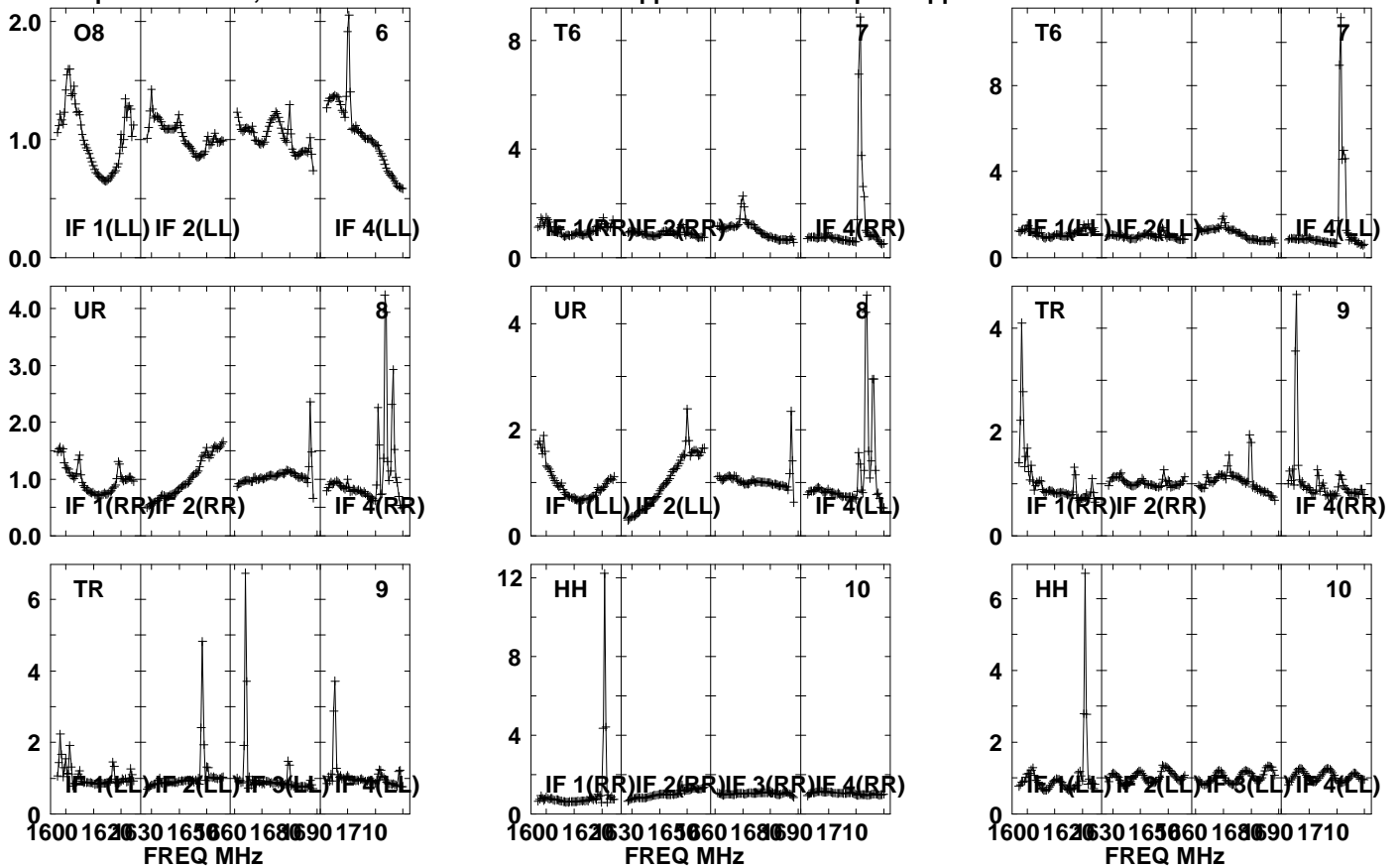

Lower frame: Real Jy

Auto-corr total-power spectrum Antenna: *

Timerange: 01/01:13:21 to 01/01:14:49

Plot file version 94 created 12-JUN-2023 14:39:13

J1548 ES106B.UVDATA.1

Freq = 1.5950 GHz, Bw = 32.000 MH No calibration applied and no bandpass applied

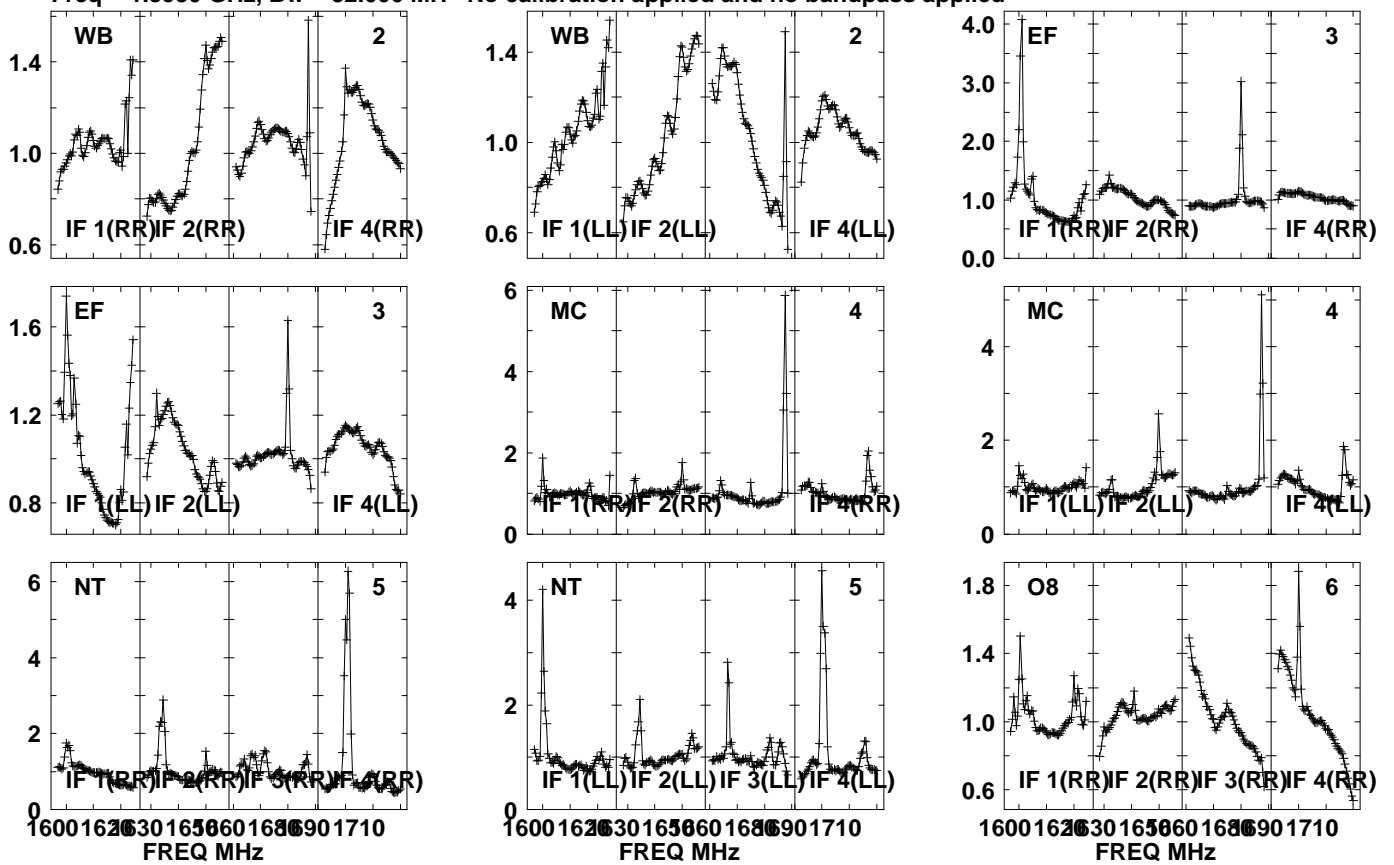

Lower frame: Real Jy
Auto-corr total-power spectrum Antenna: *
Timerange: 01/01:14:51 to 01/01:18:19

Plot file version 95 created 12-JUN-2023 14:39:13

J1548 ES106B.UVDATA.1

Freq = 1.5950 GHz, Bw = 32.000 MH No calibration applied and no bandpass applied

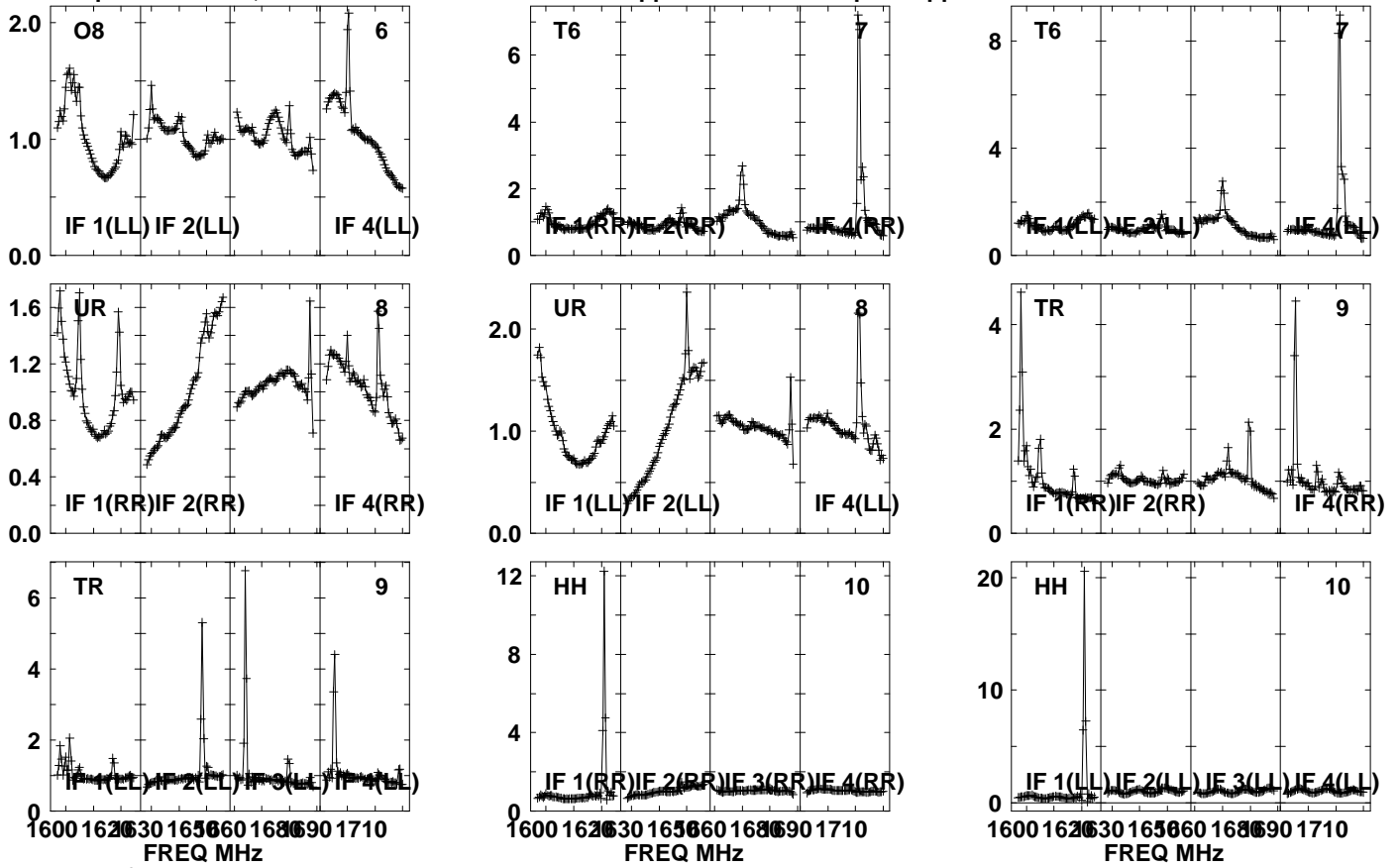

Lower frame: Real Jy
Auto-corr total-power spectrum Antenna: *
Timerange: 01/01:14:51 to 01/01:18:19

Plot file version 96 created 12-JUN-2023 14:39:13

J1547+2052 ES106B.UVDATA.1

Freq = 1.5950 GHz, Bw = 32.000 MH No calibration applied and no bandpass applied

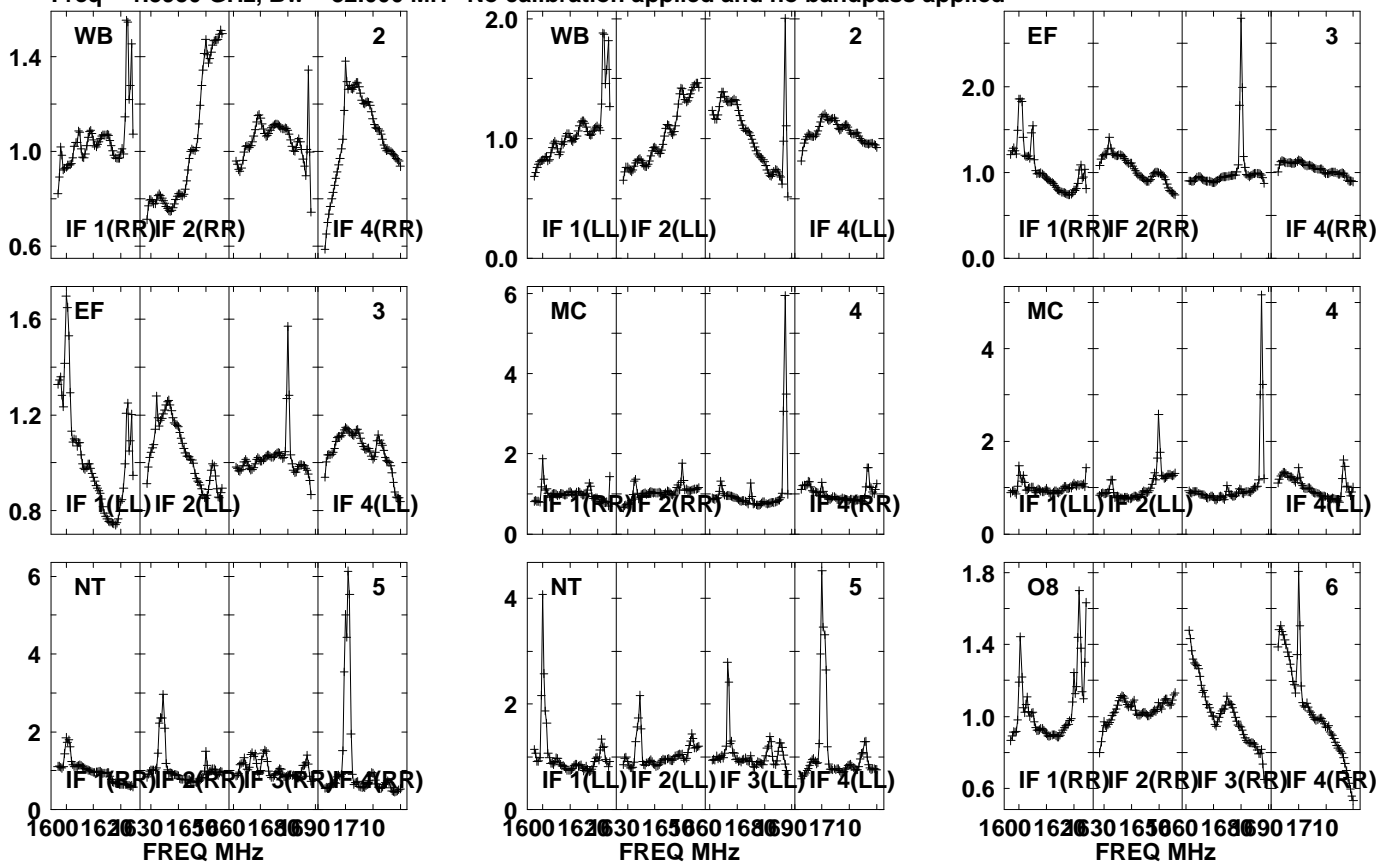

Lower frame: Real Jy
Auto-corr total-power spectrum Antenna: *
Timerange: 01/01:18:51 to 01/01:20:19

Plot file version 97 created 12-JUN-2023 14:39:13

J1547+2052 ES106B.UVDATA.1

Freq = 1.5950 GHz, Bw = 32.000 MH No calibration applied and no bandpass applied

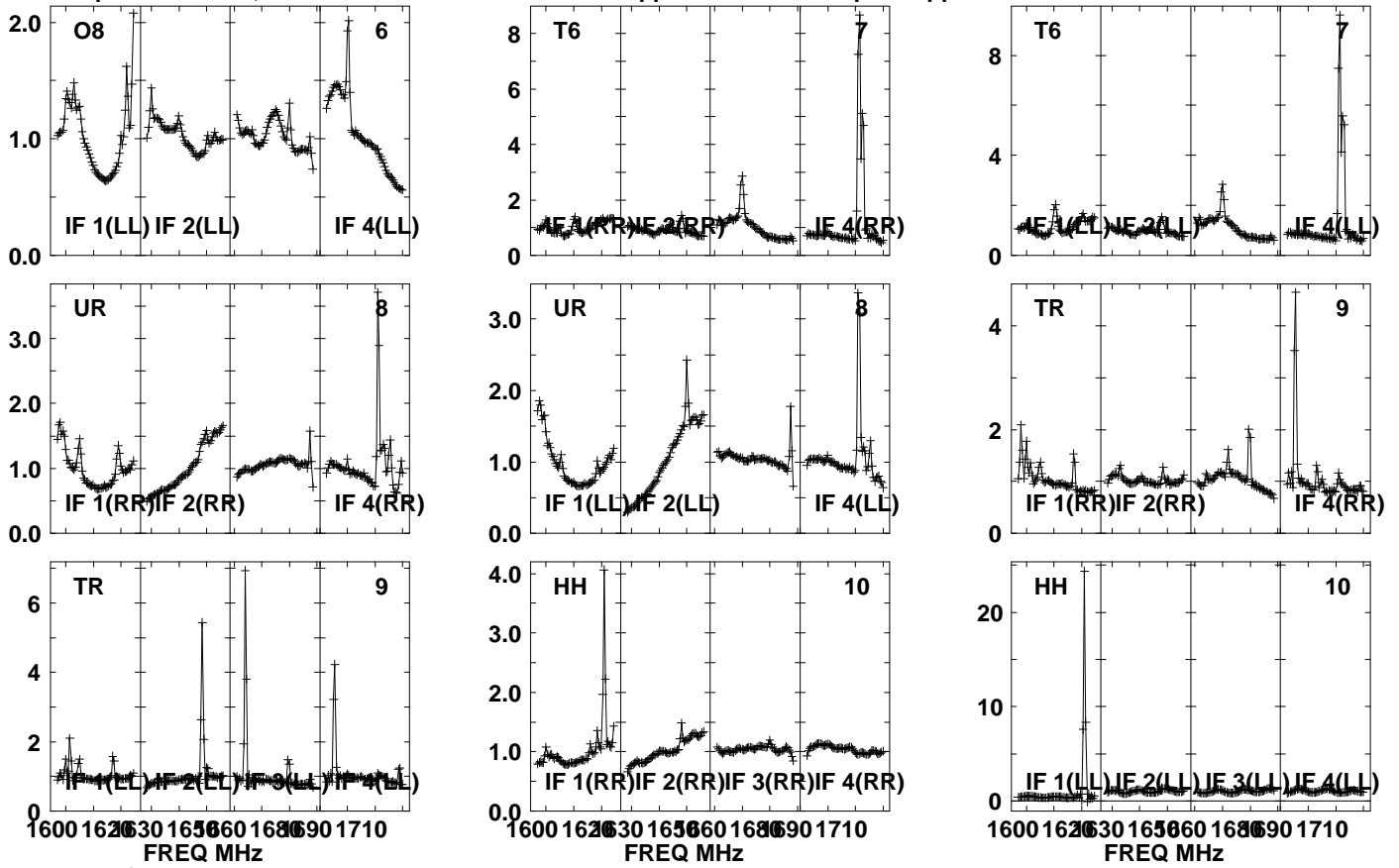

Lower frame: Real Jy

Auto-corr total-power spectrum Antenna: *

Timerange: 01/01:18:51 to 01/01:20:19

Plot file version 98 created 12-JUN-2023 14:39:13

J1548 ES106B.UVDATA.1

Freq = 1.5950 GHz, Bw = 32.000 MH No calibration applied and no bandpass applied

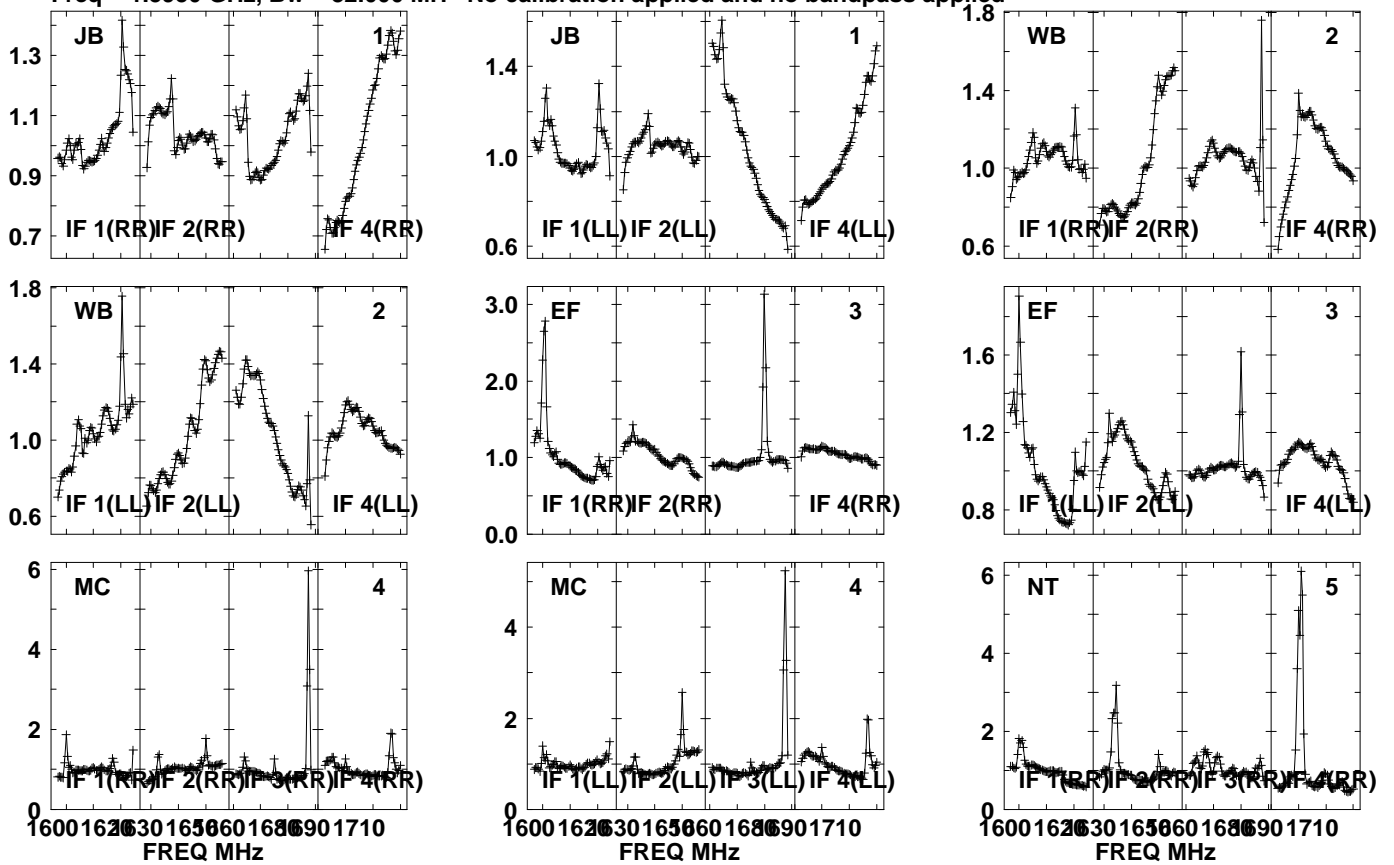

Lower frame: Real Jy
Auto-corr total-power spectrum Antenna: *
Timerange: 01/01:20:21 to 01/01:23:49

Plot file version 99 created 12-JUN-2023 14:39:13

J1548 ES106B.UVDATA.1

Freq = 1.5950 GHz, Bw = 32.000 MH No calibration applied and no bandpass applied

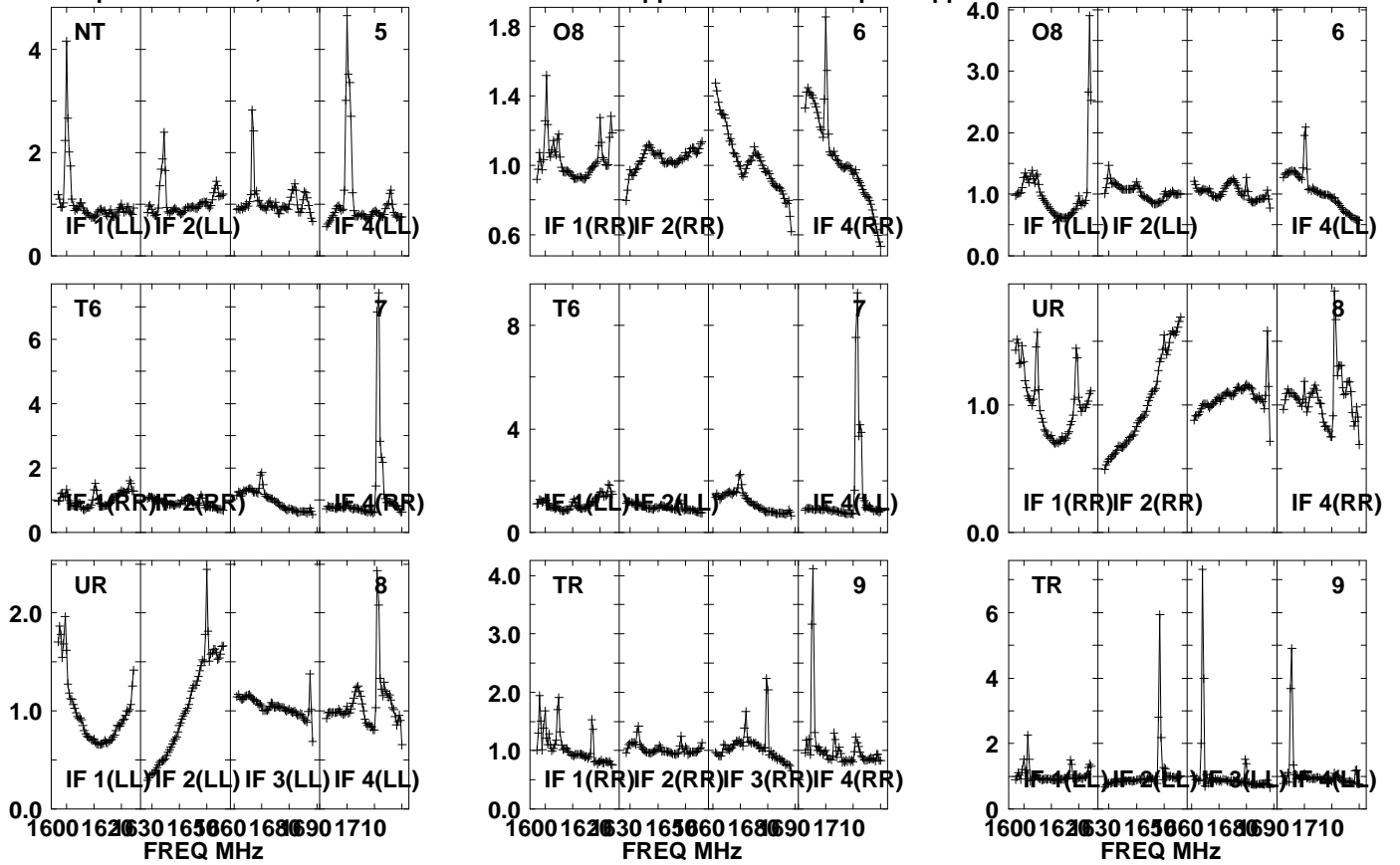

Lower frame: Real Jy
Auto-corr total-power spectrum Antenna: *
Timerange: 01/01:20:21 to 01/01:23:49

Plot file version 100 created 12-JUN-2023 14:39:13

J1548 ES106B.UVDATA.1

Freq = 1.5950 GHz, Bw = 32.000 MH No calibration applied and no bandpass applied

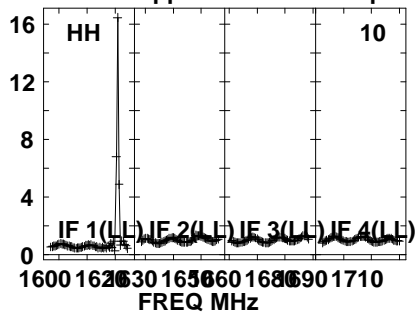
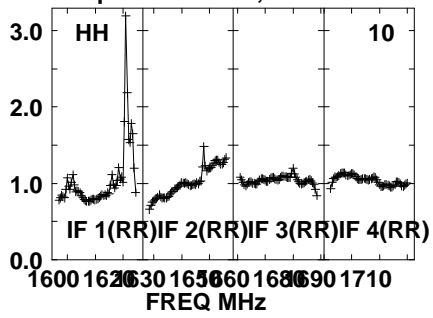

Lower frame: Real Jy

Auto-corr total-power spectrum Antenna: *

Timerange: 01/01:20:21 to 01/01:23:49

Plot file version 101 created 12-JUN-2023 14:39:13

J1547+2052 ES106B.UVDATA.1

Freq = 1.5950 GHz, Bw = 32.000 MH No calibration applied and no bandpass applied

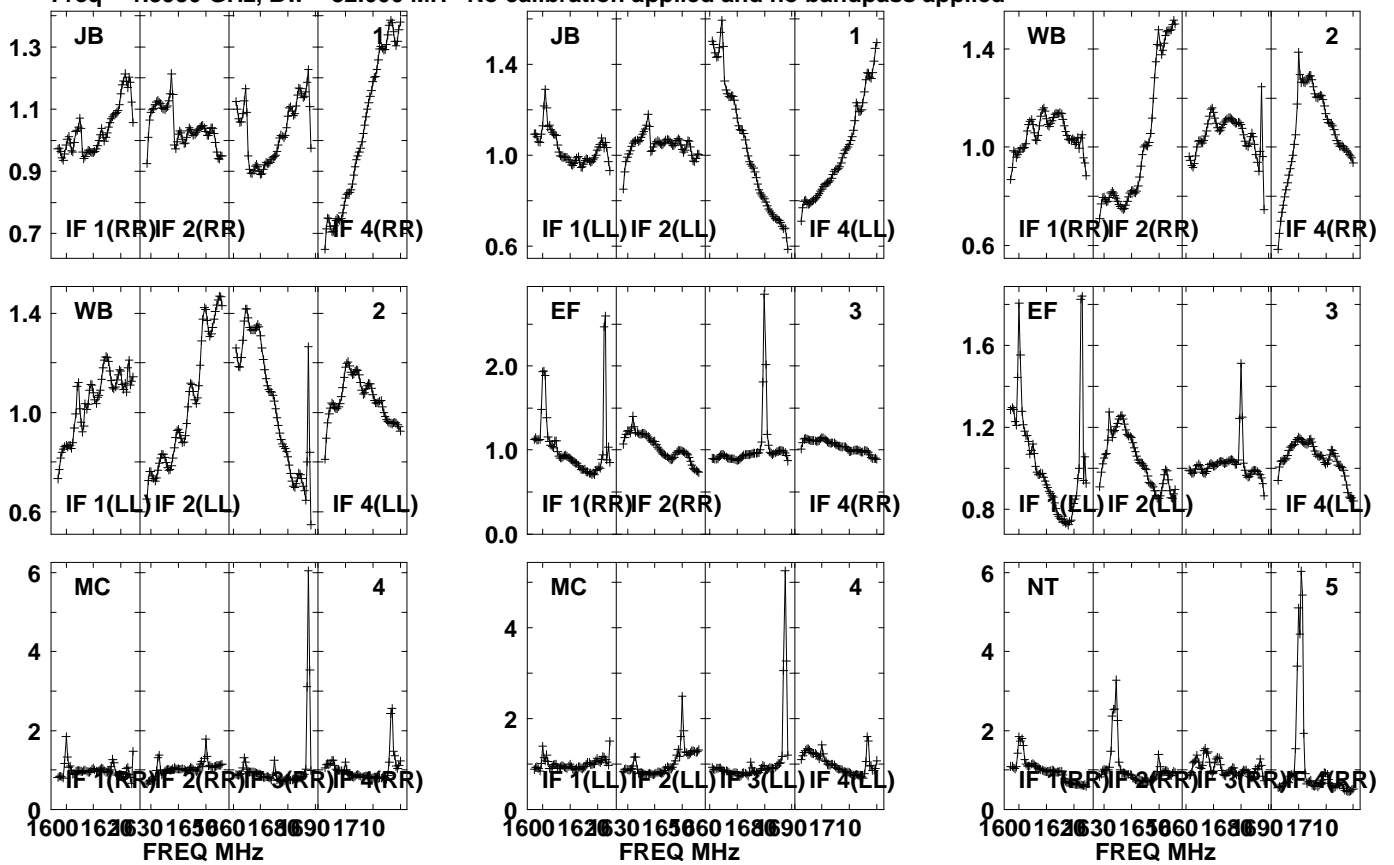

Lower frame: Real Jy
Auto-corr total-power spectrum Antenna: *
Timerange: 01/01:23:51 to 01/01:25:19

Plot file version 102 created 12-JUN-2023 14:39:13

J1547+2052 ES106B.UVDATA.1

Freq = 1.5950 GHz, Bw = 32.000 MH No calibration applied and no bandpass applied

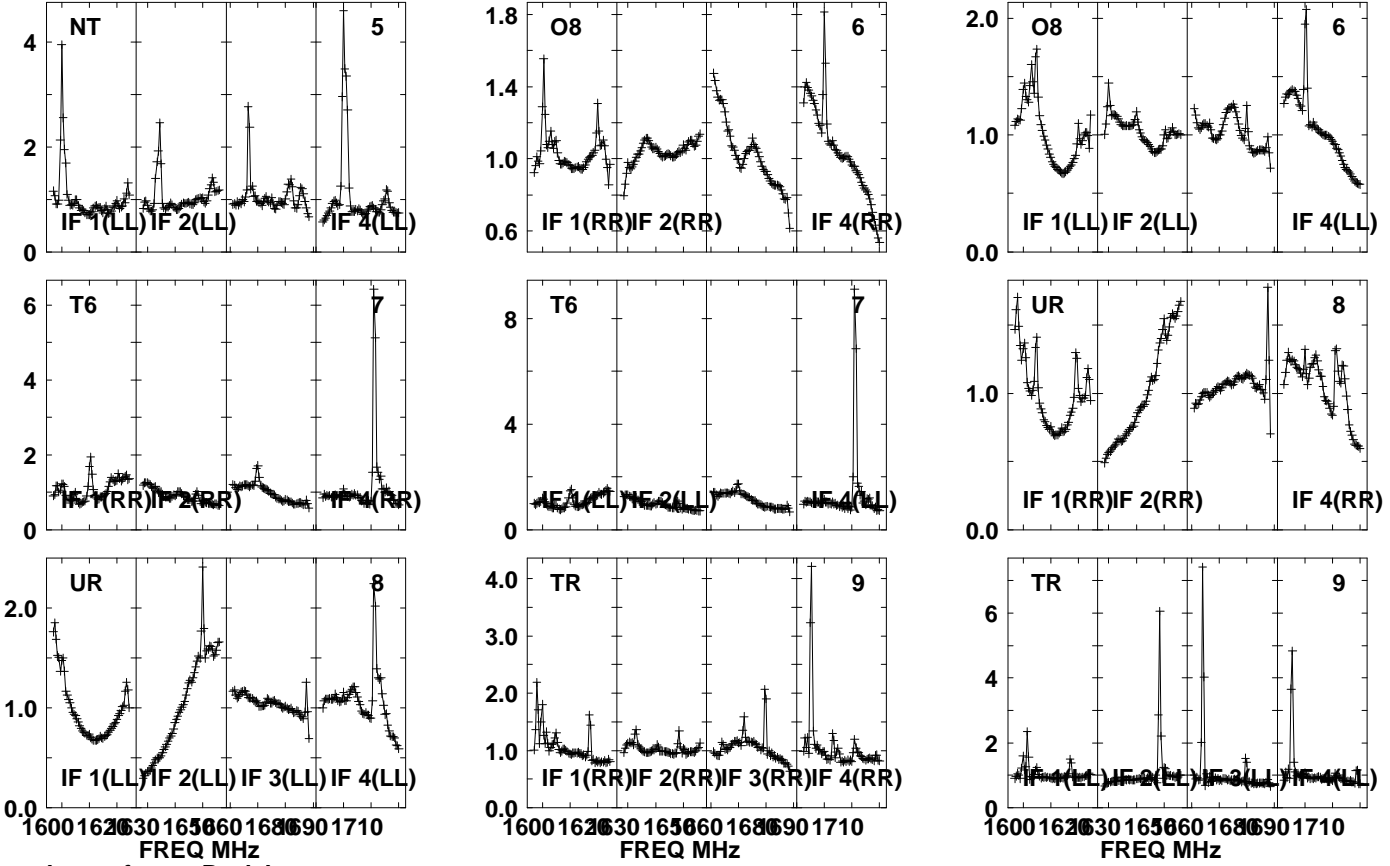

Lower frame: Real Jy
Auto-corr total-power spectrum Antenna: *
Timerange: 01/01:23:51 to 01/01:25:19

Plot file version 103 created 12-JUN-2023 14:39:13

J1547+2052 ES106B.UVDATA.1

Freq = 1.5950 GHz, Bw = 32.000 MH No calibration applied and no bandpass applied

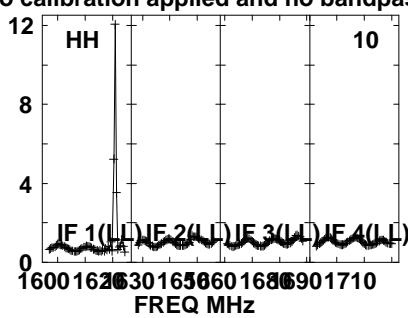
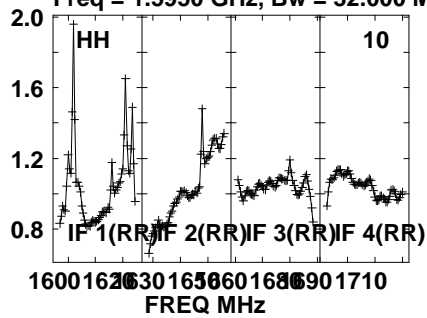

Lower frame: Real Jy
Auto-corr total-power spectrum Antenna: *
Timerange: 01/01:23:51 to 01/01:25:19

Plot file version 104 created 12-JUN-2023 14:39:13

J1545+2006 ES106B.UVDATA.1

Freq = 1.5950 GHz, Bw = 32.000 MH No calibration applied and no bandpass applied

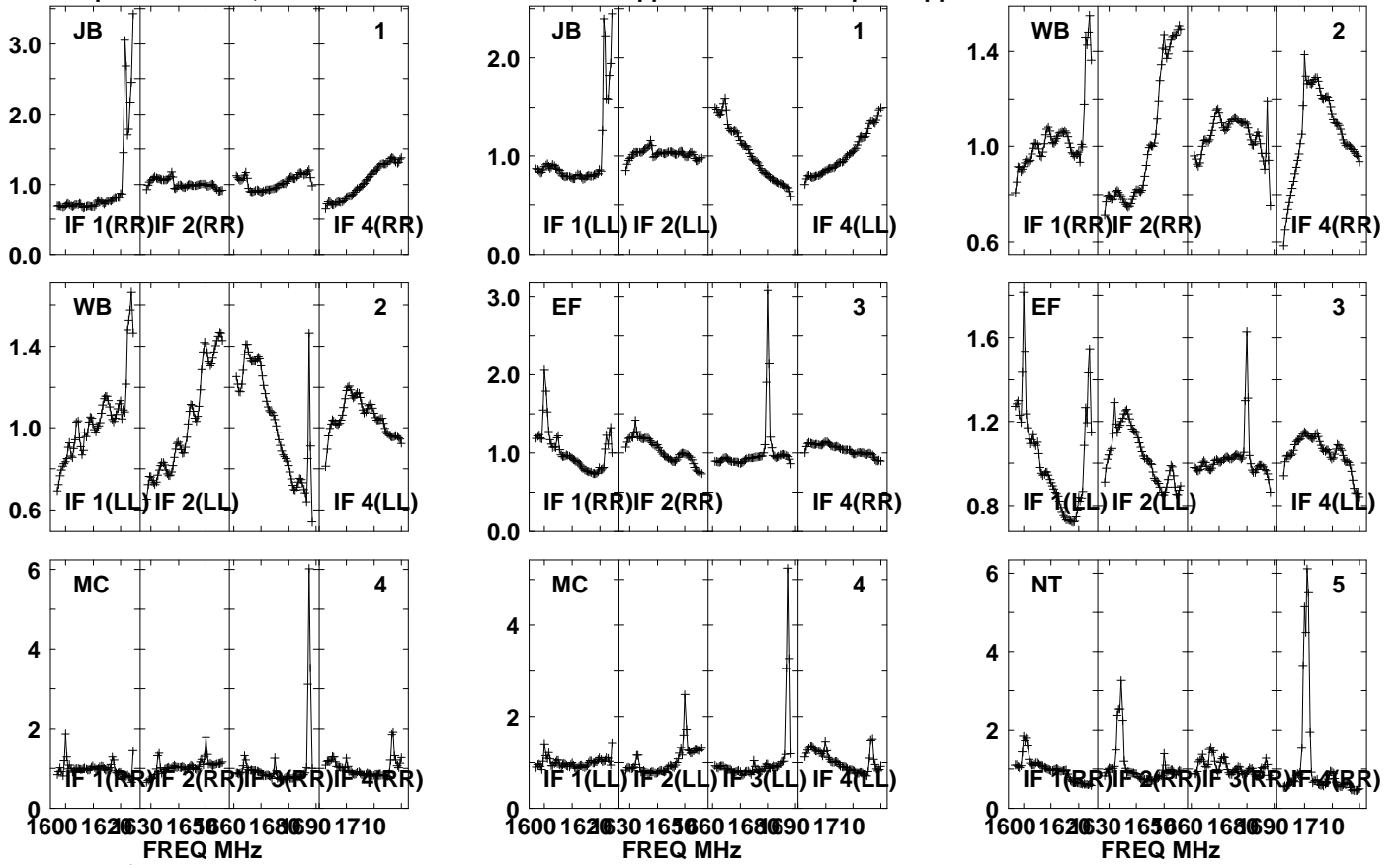

Lower frame: Real Jy
Auto-corr total-power spectrum Antenna: *
Timerange: 01/01:25:21 to 01/01:27:49

Plot file version 105 created 12-JUN-2023 14:39:14

J1545+2006 ES106B.UVDATA.1

Freq = 1.5950 GHz, Bw = 32.000 MH No calibration applied and no bandpass applied

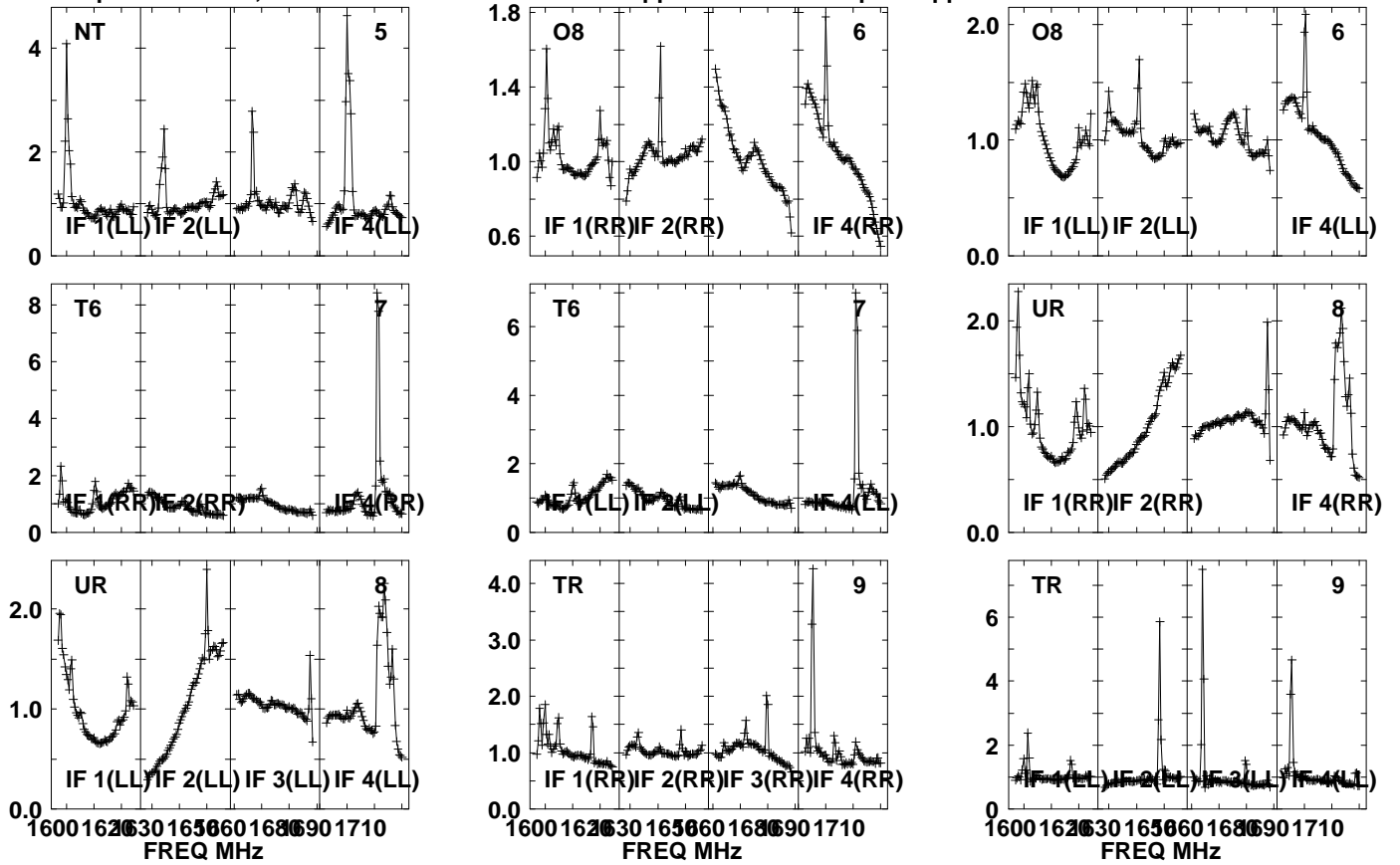

Lower frame: Real Jy
Auto-corr total-power spectrum Antenna: *
Timerange: 01/01:25:21 to 01/01:27:49

Plot file version 106 created 12-JUN-2023 14:39:14

J1545+2006 ES106B.UVDATA.1

Freq = 1.5950 GHz, Bw = 32.000 MH No calibration applied and no bandpass applied

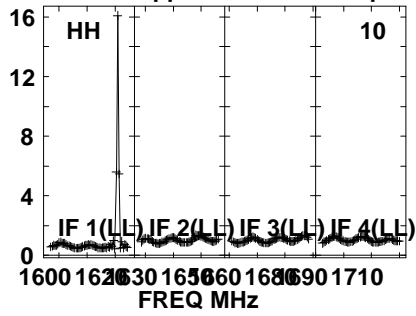
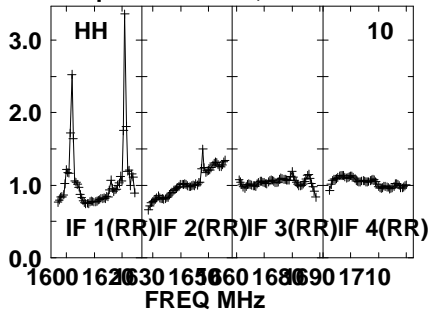

Lower frame: Real Jy

Auto-corr total-power spectrum Antenna: *

Timerange: 01/01:25:21 to 01/01:27:49

Plot file version 107 created 12-JUN-2023 14:39:14

J1547+2052 ES106B.UVDATA.1

Freq = 1.5950 GHz, Bw = 32.000 MH No calibration applied and no bandpass applied

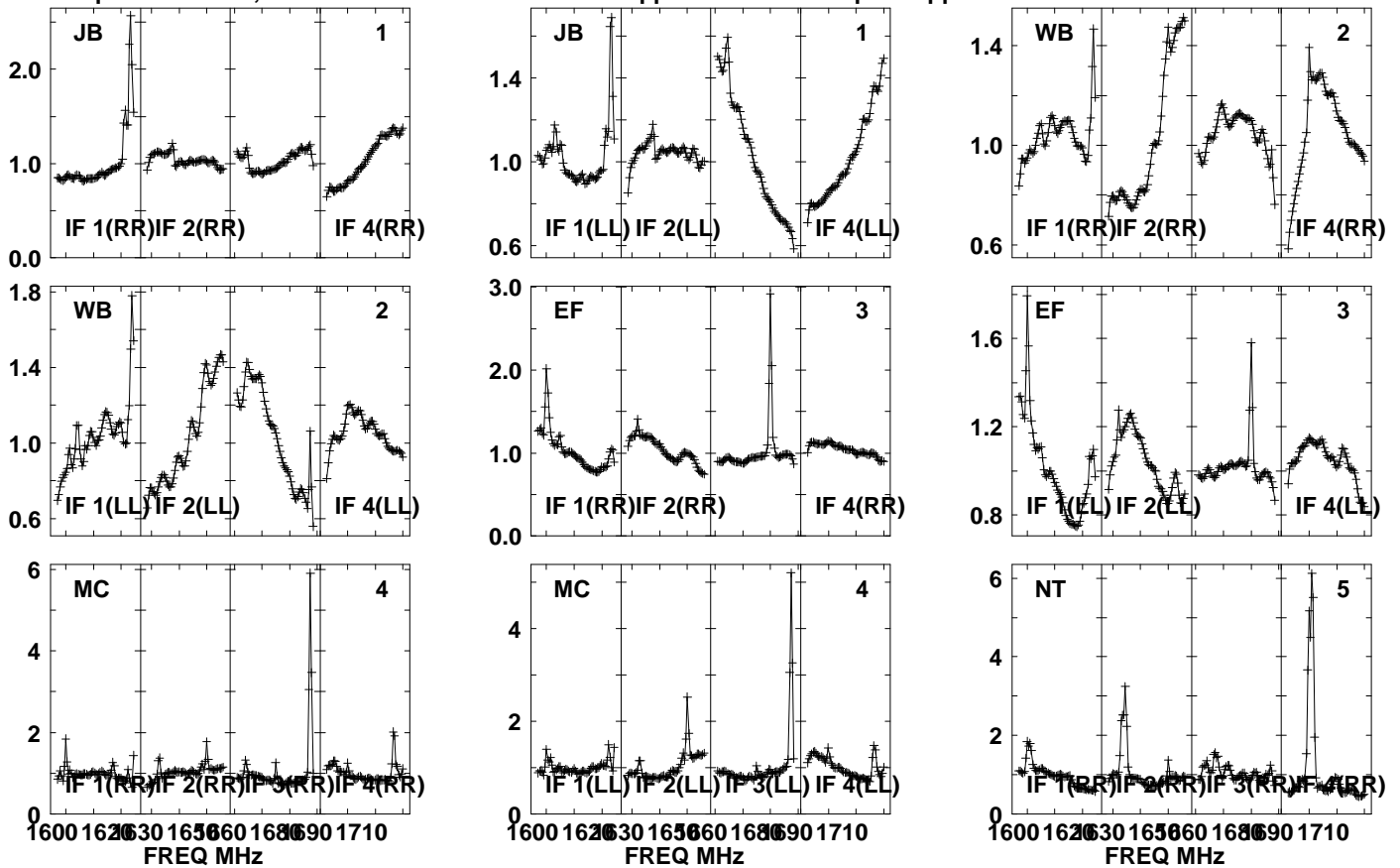

Lower frame: Real Jy

Auto-corr total-power spectrum Antenna: *

Timerange: 01/01:27:51 to 01/01:29:19

Plot file version 108 created 12-JUN-2023 14:39:14

J1547+2052 ES106B.UVDATA.1

Freq = 1.5950 GHz, Bw = 32.000 MH No calibration applied and no bandpass applied

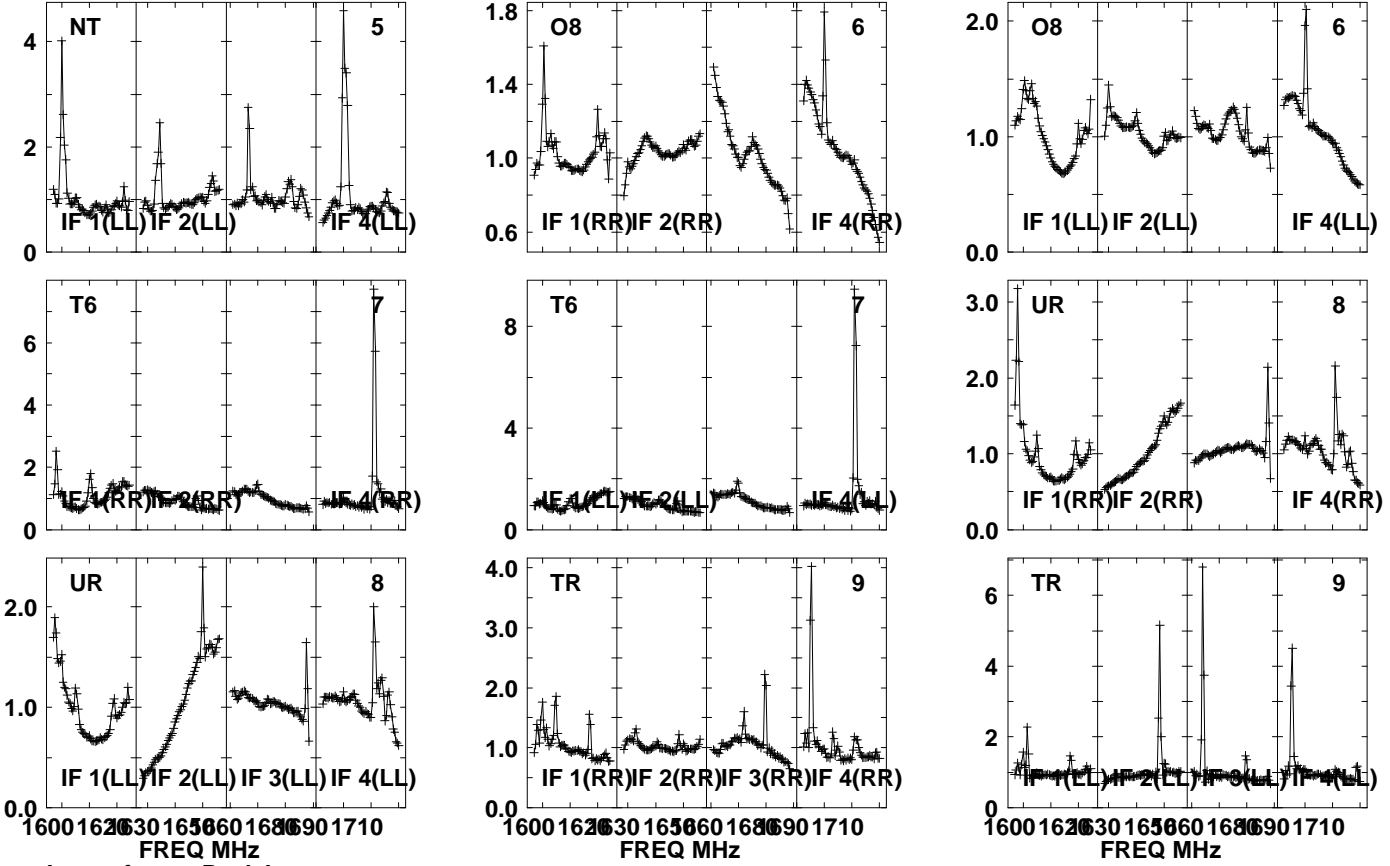

Lower frame: Real Jy
Auto-corr total-power spectrum Antenna: *
Timerange: 01/01:27:51 to 01/01:29:19

Plot file version 109 created 12-JUN-2023 14:39:14

J1547+2052 ES106B.UVDATA.1

Freq = 1.5950 GHz, Bw = 32.000 MH No calibration applied and no bandpass applied

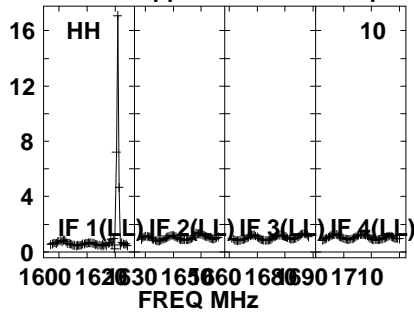
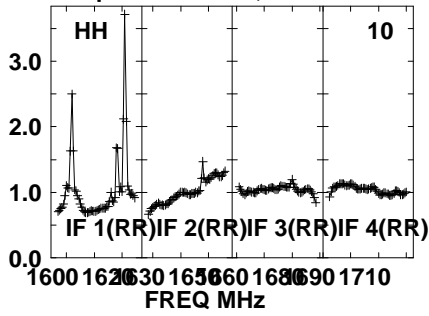

Lower frame: Real Jy

Auto-corr total-power spectrum Antenna: *

Timerange: 01/01:27:51 to 01/01:29:19

Plot file version 110 created 12-JUN-2023 14:39:14

J1548 ES106B.UVDATA.1

Freq = 1.5950 GHz, Bw = 32.000 MH No calibration applied and no bandpass applied

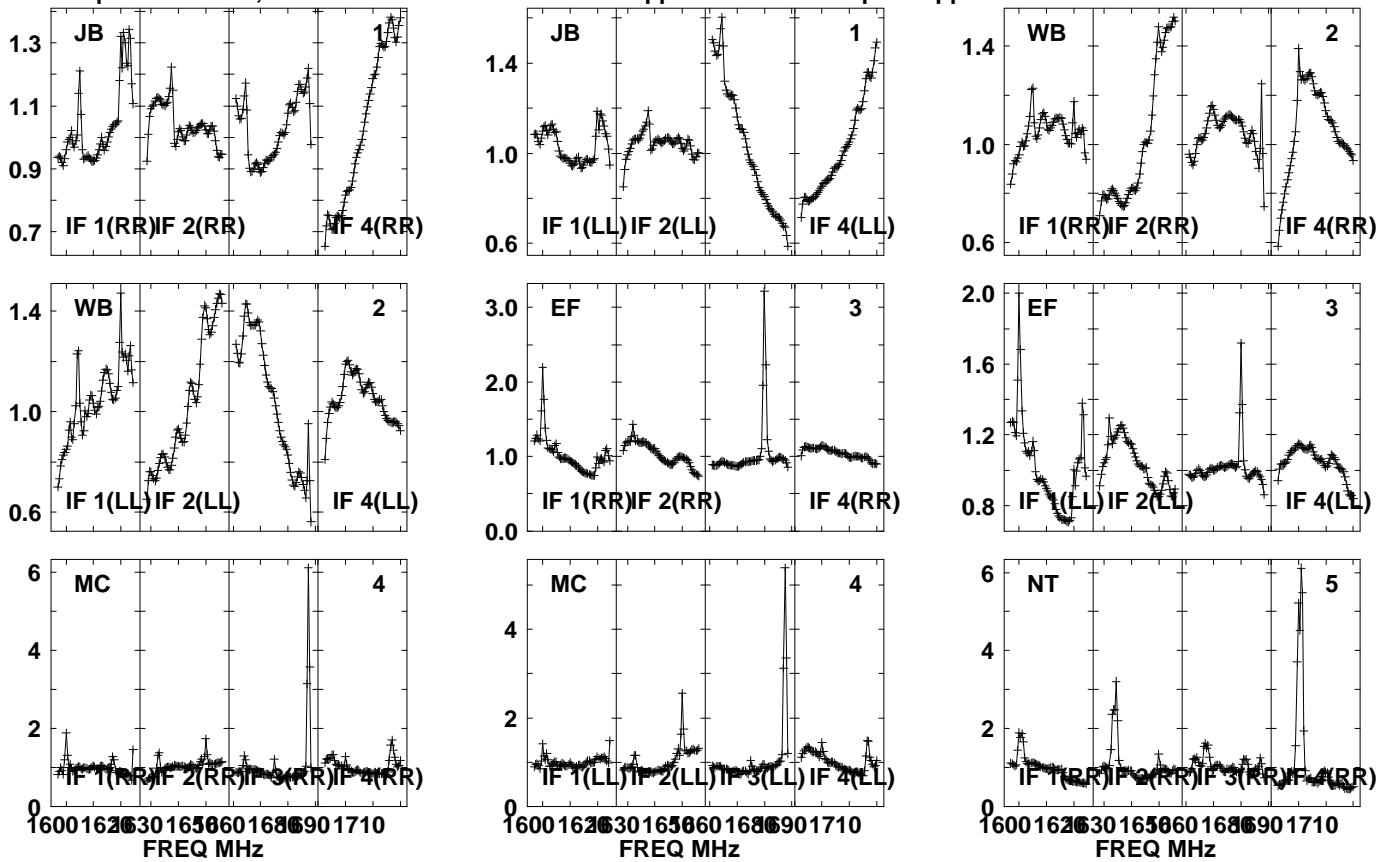

Lower frame: Real Jy
Auto-corr total-power spectrum Antenna: *
Timerange: 01/01:29:51 to 01/01:33:49

Plot file version 111 created 12-JUN-2023 14:39:14

J1548 ES106B.UVDATA.1

Freq = 1.5950 GHz, Bw = 32.000 MH No calibration applied and no bandpass applied

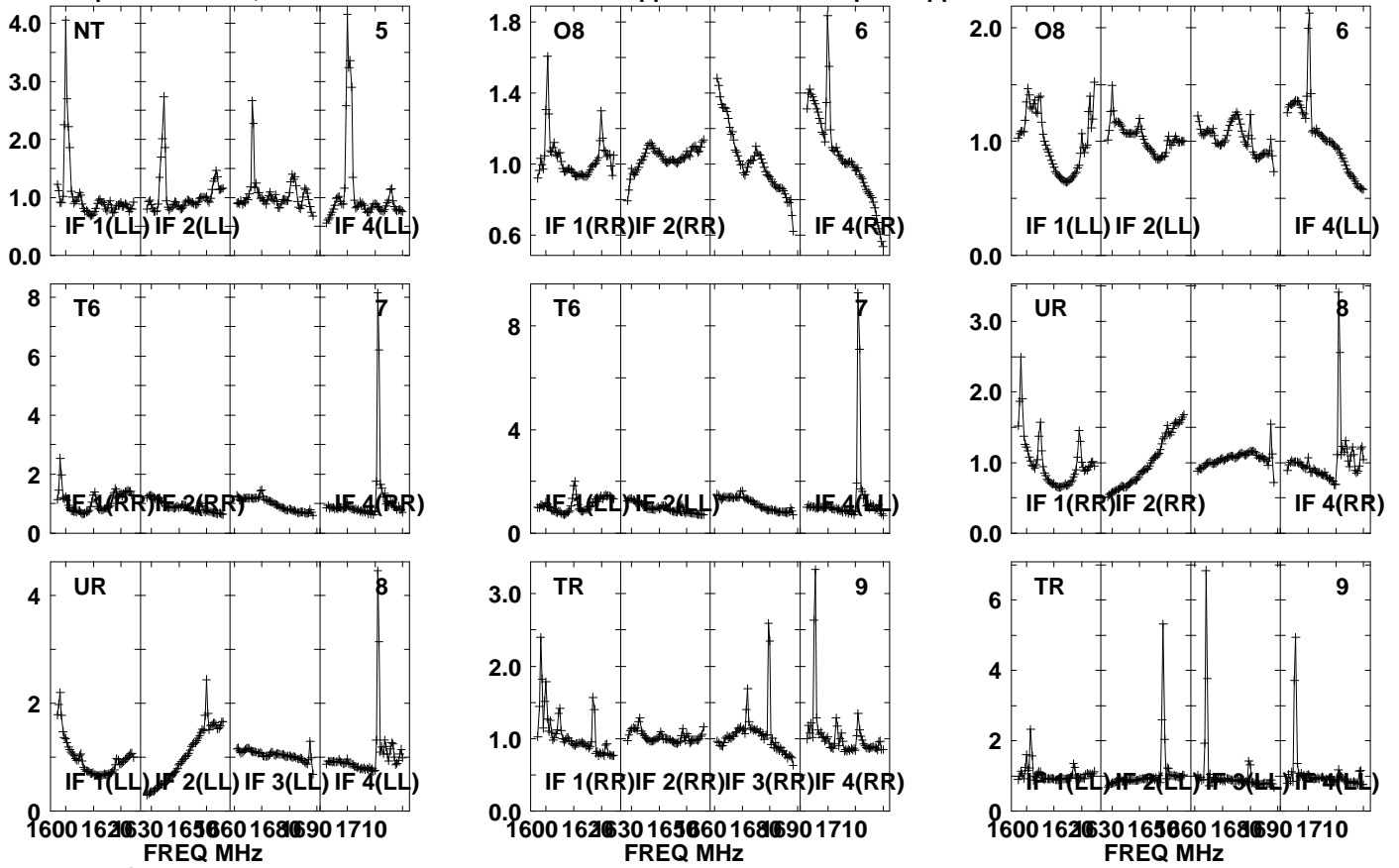

Lower frame: Real Jy

Auto-corr total-power spectrum Antenna: *

Timerange: 01/01:29:51 to 01/01:33:49

Plot file version 112 created 12-JUN-2023 14:39:14

J1548 ES106B.UVDATA.1

Freq = 1.5950 GHz, Bw = 32.000 MH No calibration applied and no bandpass applied

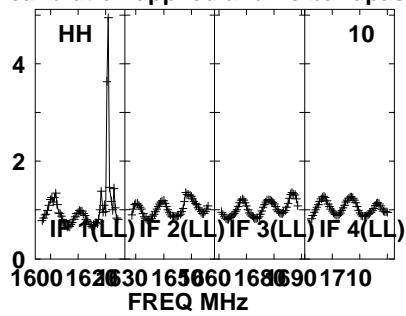
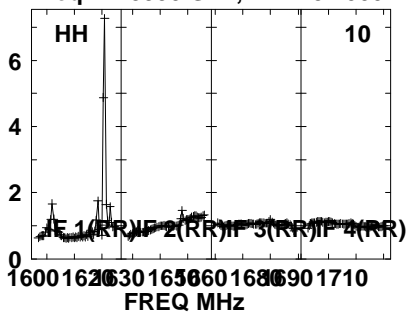

Lower frame: Real Jy

Auto-corr total-power spectrum Antenna: *

Timerange: 01/01:29:51 to 01/01:33:49

Plot file version 113 created 12-JUN-2023 14:39:14

J1547+2052 ES106B.UVDATA.1

Freq = 1.5950 GHz, Bw = 32.000 MH No calibration applied and no bandpass applied

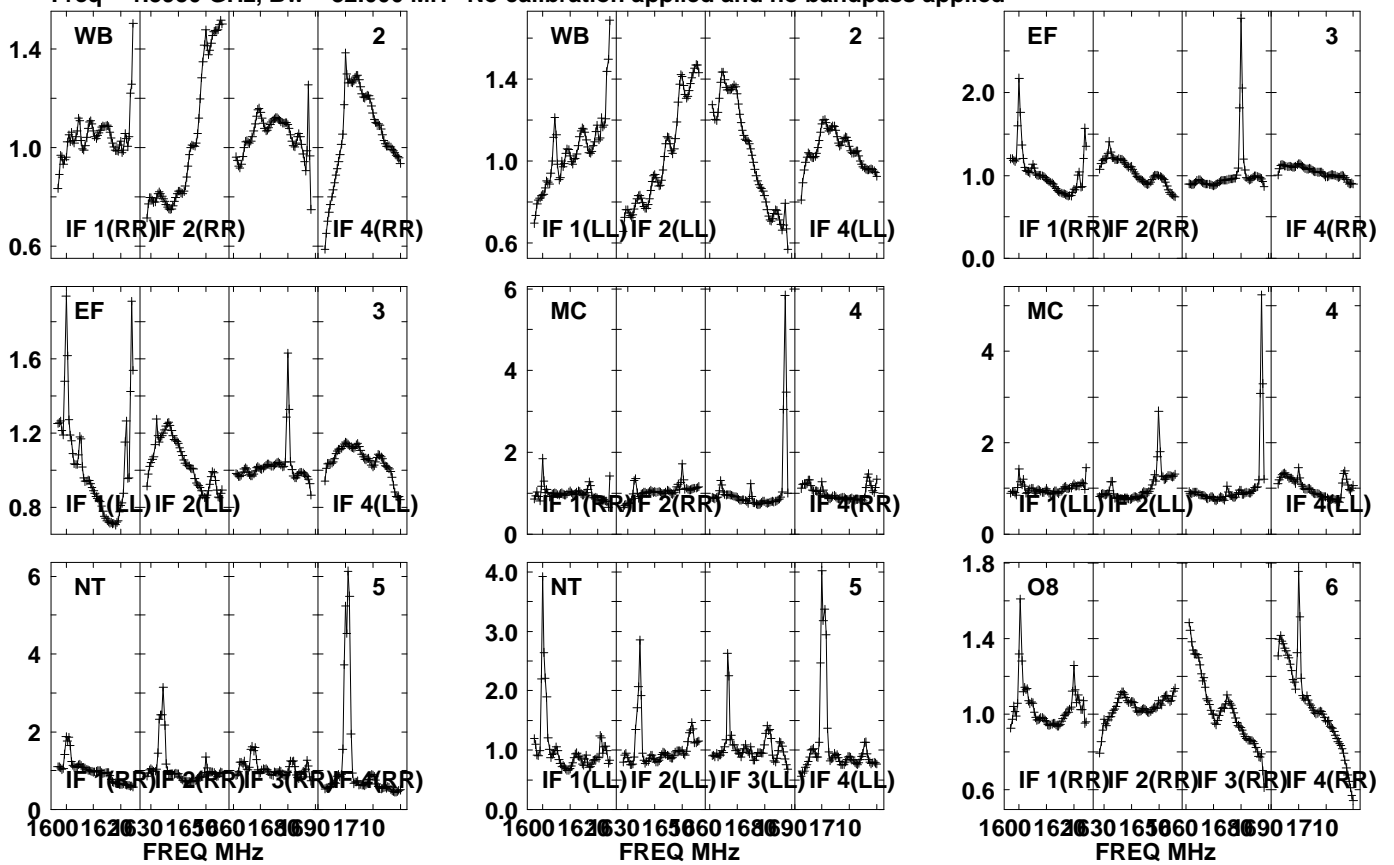

Lower frame: Real Jy
Auto-corr total-power spectrum Antenna: *
Timerange: 01/01:33:51 to 01/01:35:19

Plot file version 114 created 12-JUN-2023 14:39:14

J1547+2052 ES106B.UVDATA.1

Freq = 1.5950 GHz, Bw = 32.000 MH No calibration applied and no bandpass applied

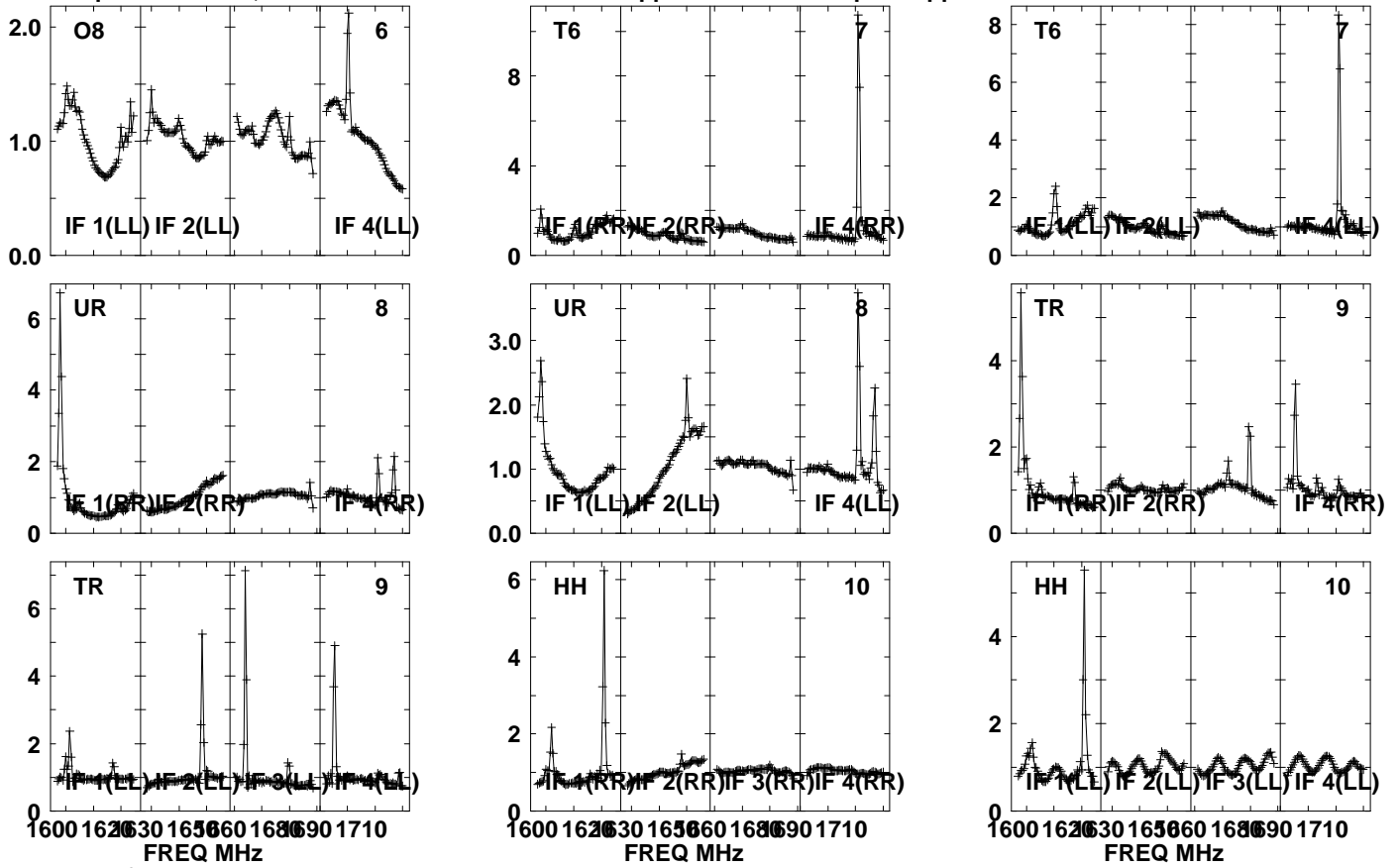

Lower frame: Real Jy

Auto-corr total-power spectrum Antenna: *

Timerange: 01/01:33:51 to 01/01:35:19

Plot file version 115 created 12-JUN-2023 14:39:14

J1548 ES106B.UVDATA.1

Freq = 1.5950 GHz, Bw = 32.000 MH No calibration applied and no bandpass applied

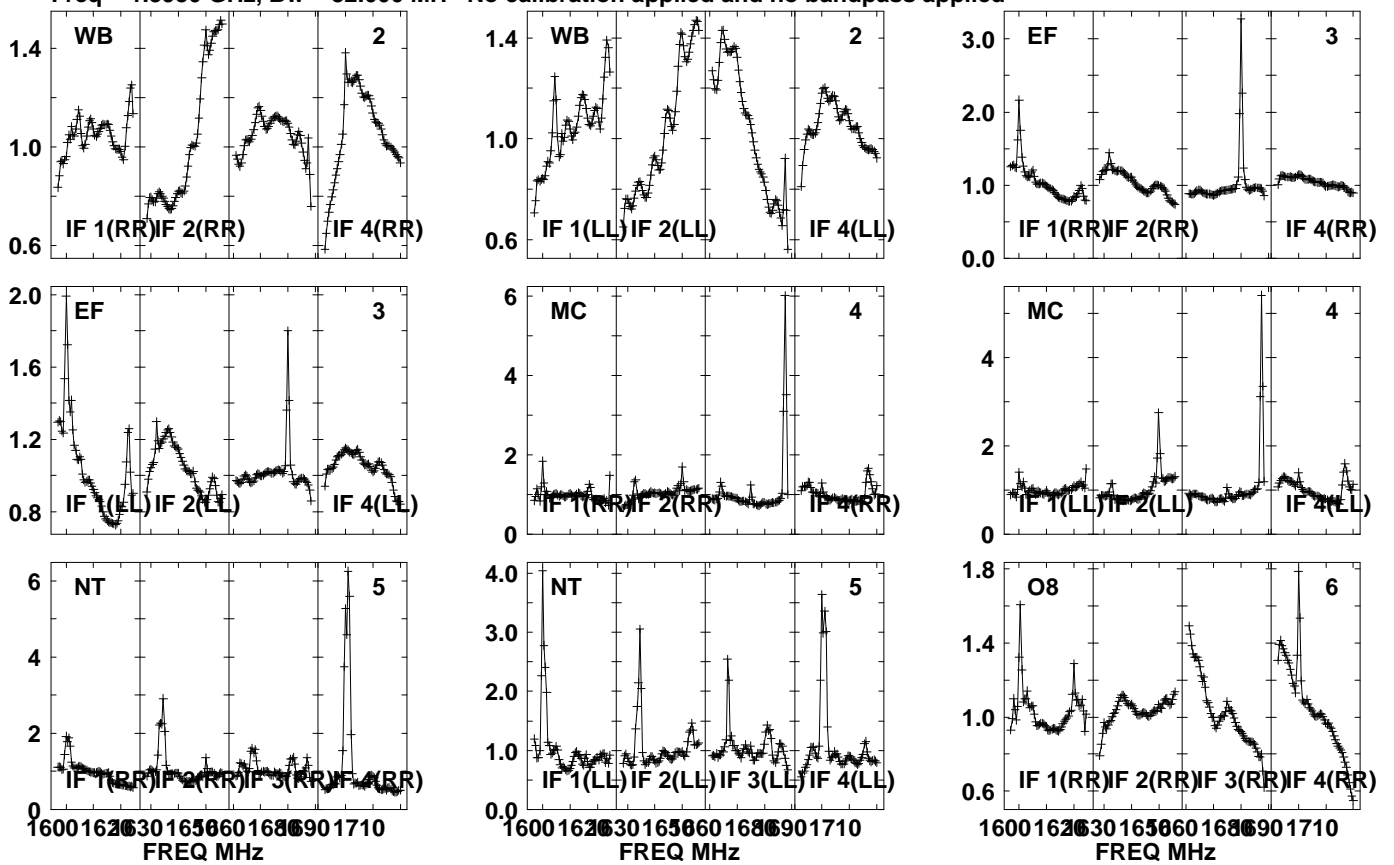

Lower frame: Real Jy
Auto-corr total-power spectrum Antenna: *
Timerange: 01/01:35:21 to 01/01:38:49

Plot file version 116 created 12-JUN-2023 14:39:14

J1548 ES106B.UVDATA.1

Freq = 1.5950 GHz, Bw = 32.000 MH No calibration applied and no bandpass applied

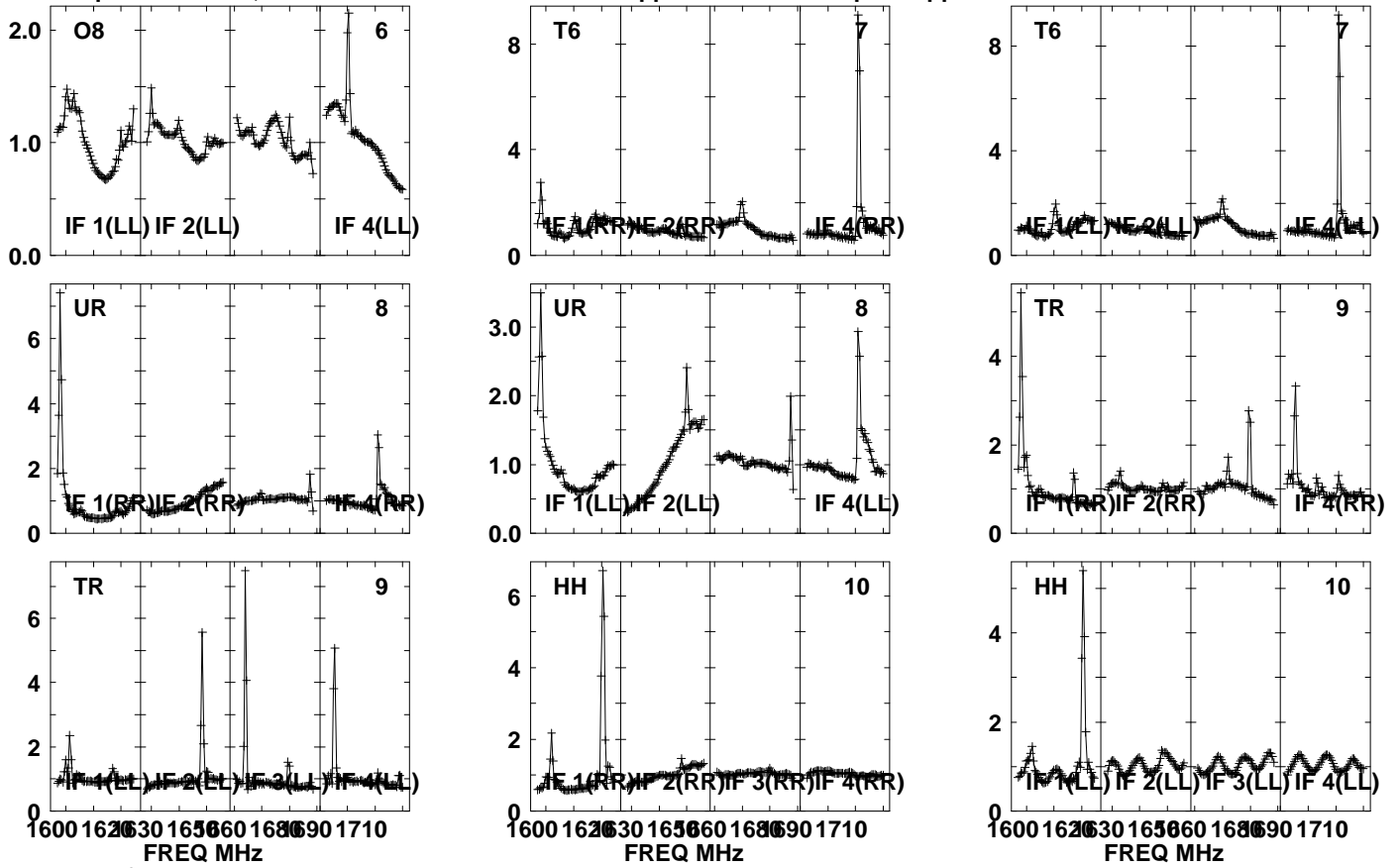

Plot file version 117 created 12-JUN-2023 14:39:14

J1547+2052 ES106B.UVDATA.1

Freq = 1.5950 GHz, Bw = 32.000 MH No calibration applied and no bandpass applied

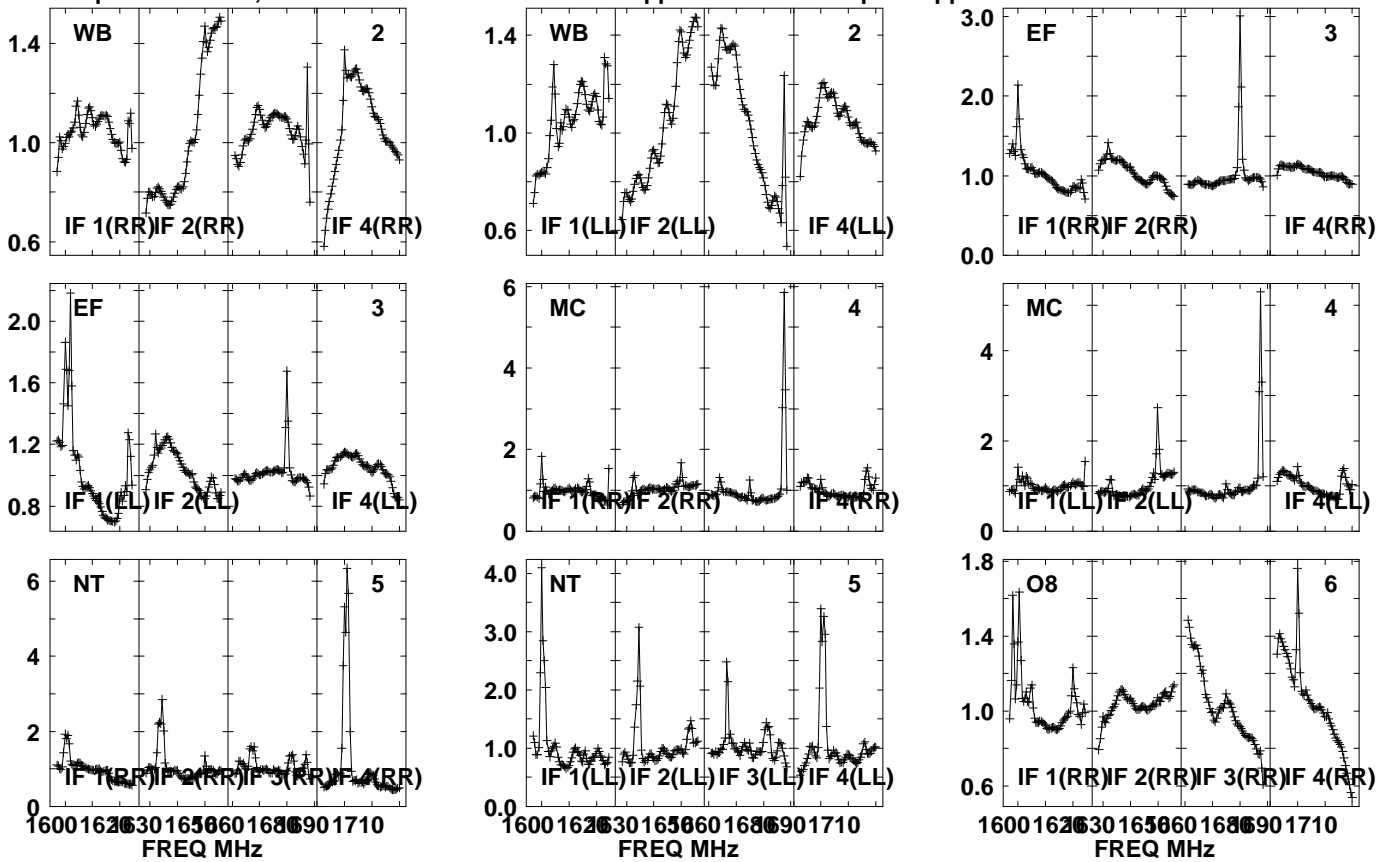

Lower frame: Real Jy
Auto-corr total-power spectrum Antenna: *
Timerange: 01/01:39:21 to 01/01:40:49

Plot file version 118 created 12-JUN-2023 14:39:14

J1547+2052 ES106B.UVDATA.1

Freq = 1.5950 GHz, Bw = 32.000 MH No calibration applied and no bandpass applied

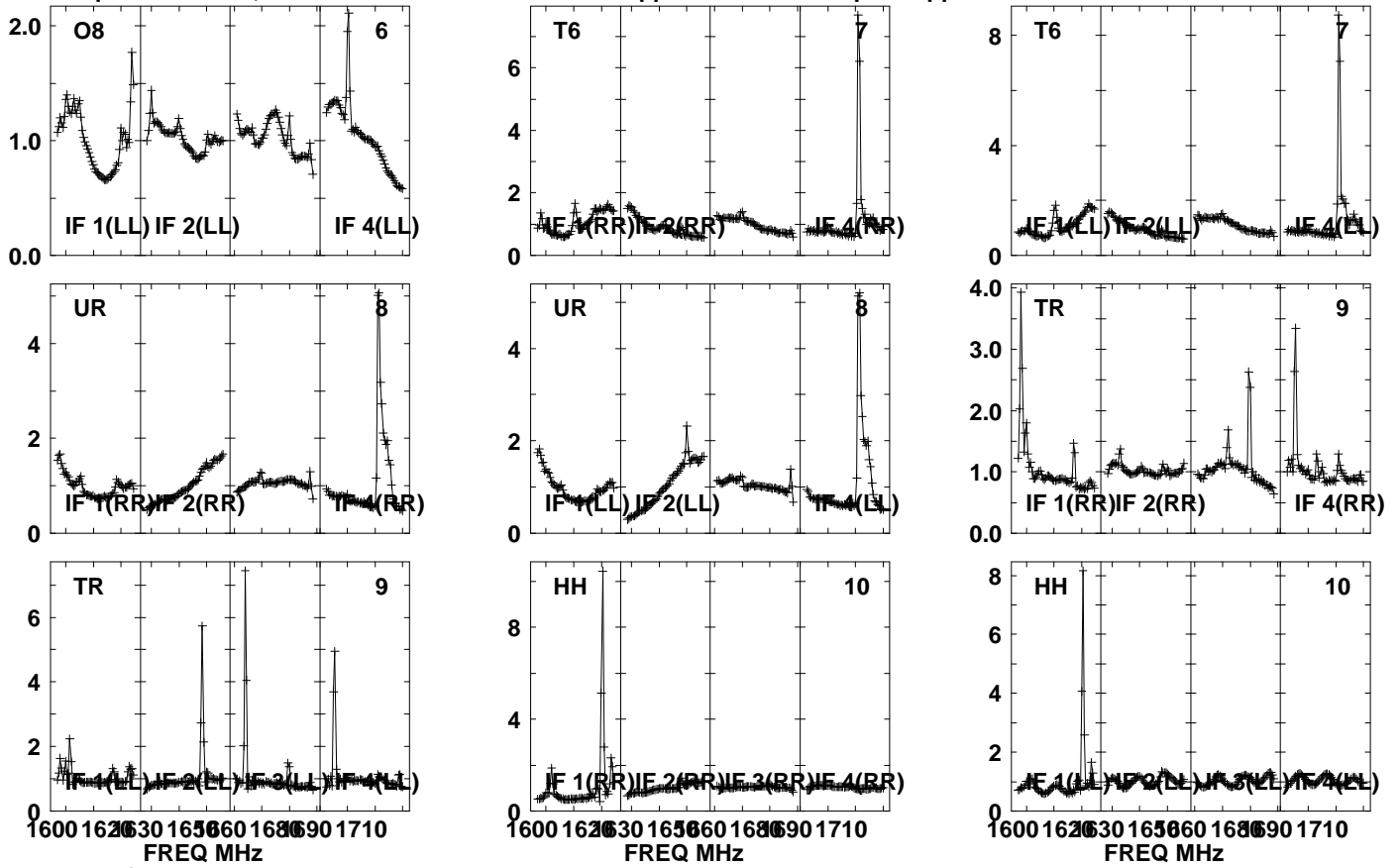

Lower frame: Real Jy

Auto-corr total-power spectrum Antenna: *

Timerange: 01/01:39:21 to 01/01:40:49

Plot file version 119 created 12-JUN-2023 14:39:14

J1548 ES106B.UVDATA.1

Freq = 1.5950 GHz, Bw = 32.000 MH No calibration applied and no bandpass applied

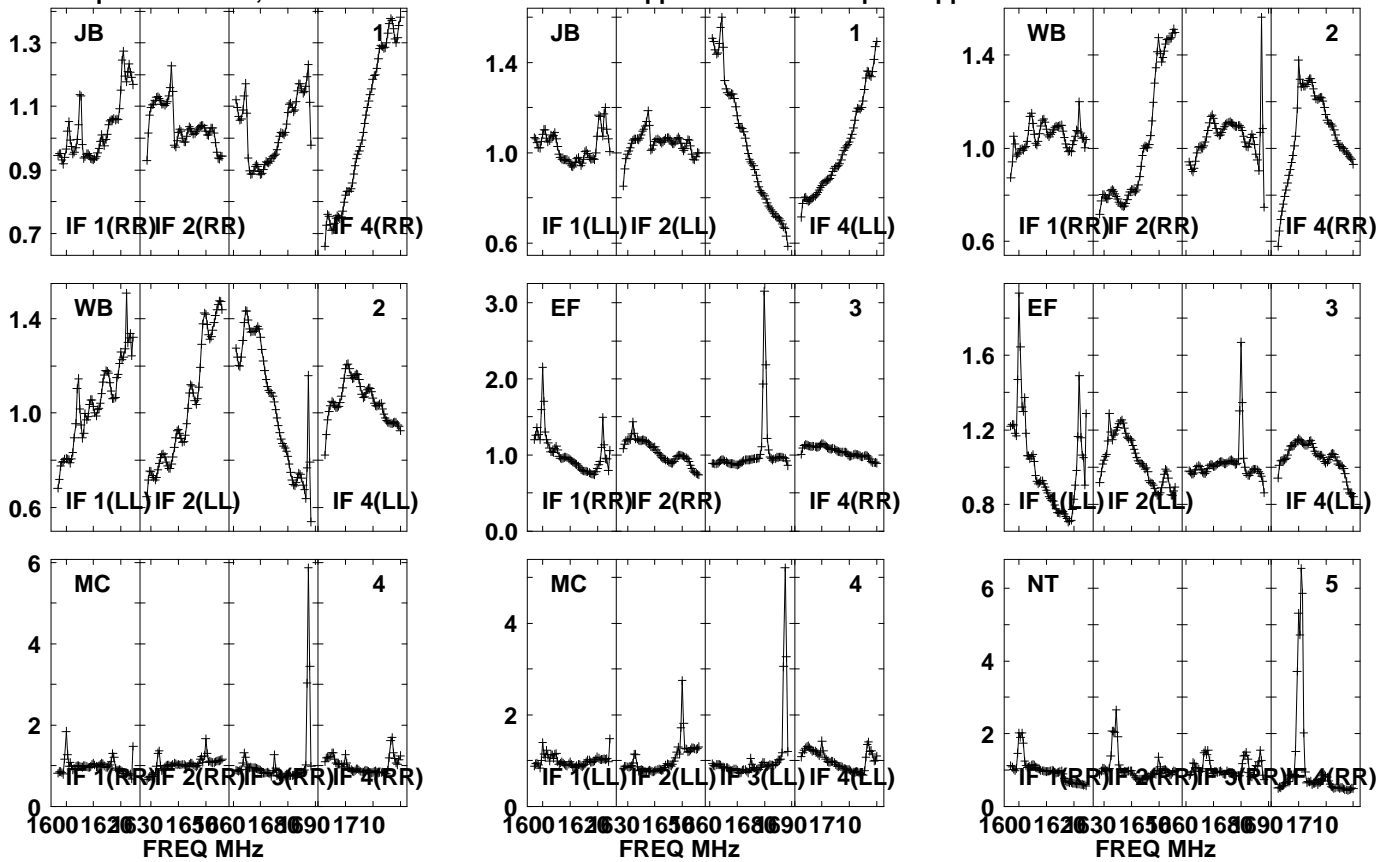

Lower frame: Real Jy
Auto-corr total-power spectrum Antenna: *
Timerange: 01/01:40:51 to 01/01:44:19

Plot file version 120 created 12-JUN-2023 14:39:15

J1548 ES106B.UVDATA.1

Freq = 1.5950 GHz, Bw = 32.000 MH No calibration applied and no bandpass applied

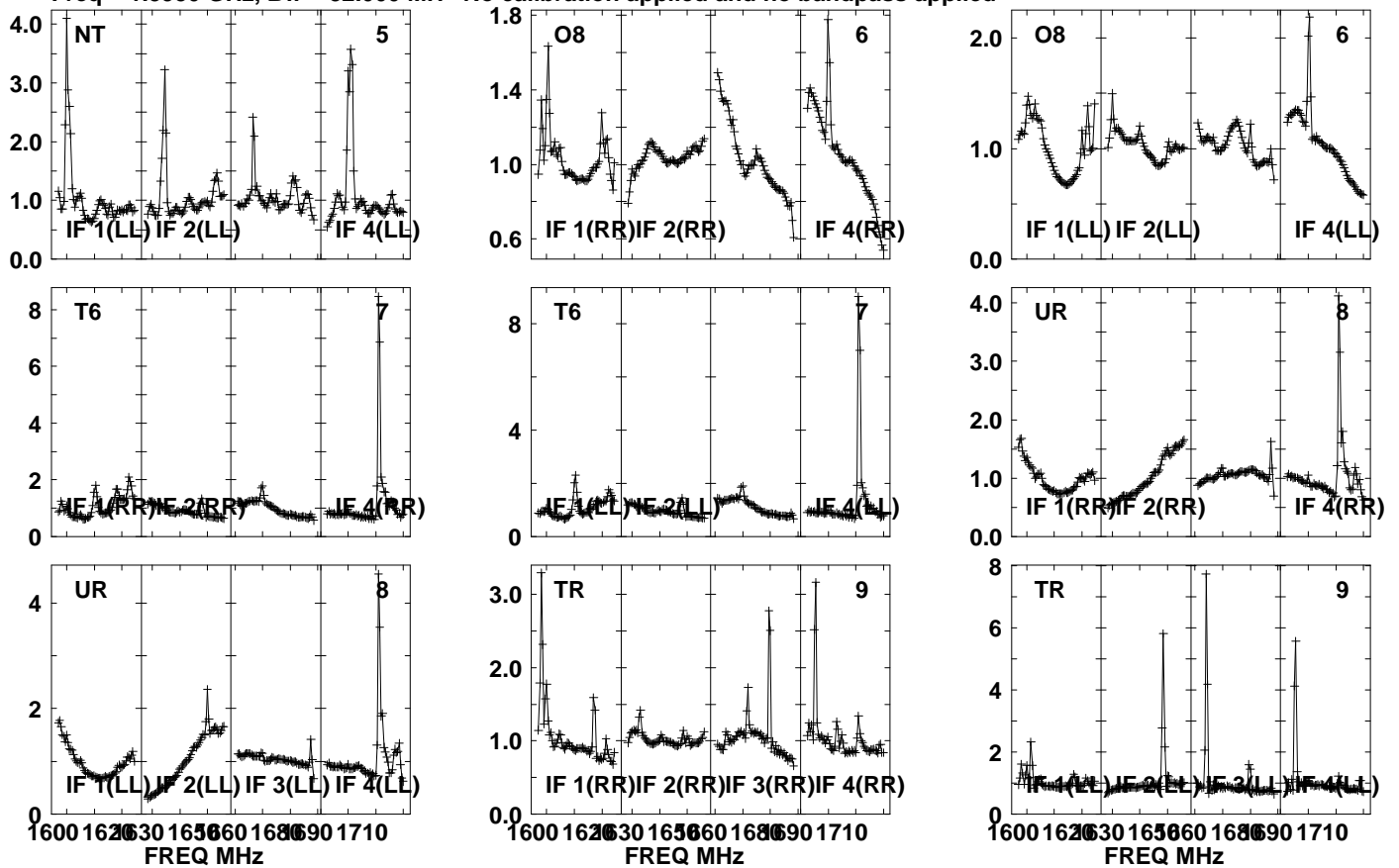

Lower frame: Real Jy

Auto-corr total-power spectrum Antenna: *

Timerange: 01/01:40:51 to 01/01:44:19

Plot file version 121 created 12-JUN-2023 14:39:15

J1548 ES106B.UVDATA.1

Freq = 1.5950 GHz, Bw = 32.000 MH No calibration applied and no bandpass applied

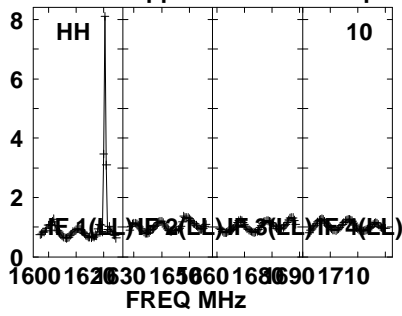
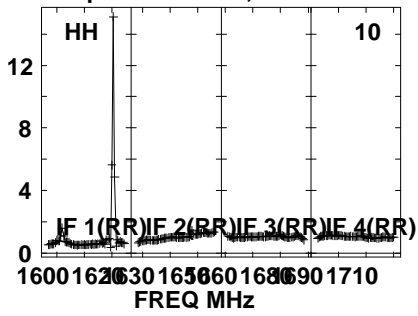

Lower frame: Real Jy
Auto-corr total-power spectrum Antenna: *
Timerange: 01/01:40:51 to 01/01:44:19

Plot file version 122 created 12-JUN-2023 14:39:15

J1547+2052 ES106B.UVDATA.1

Freq = 1.5950 GHz, Bw = 32.000 MH No calibration applied and no bandpass applied

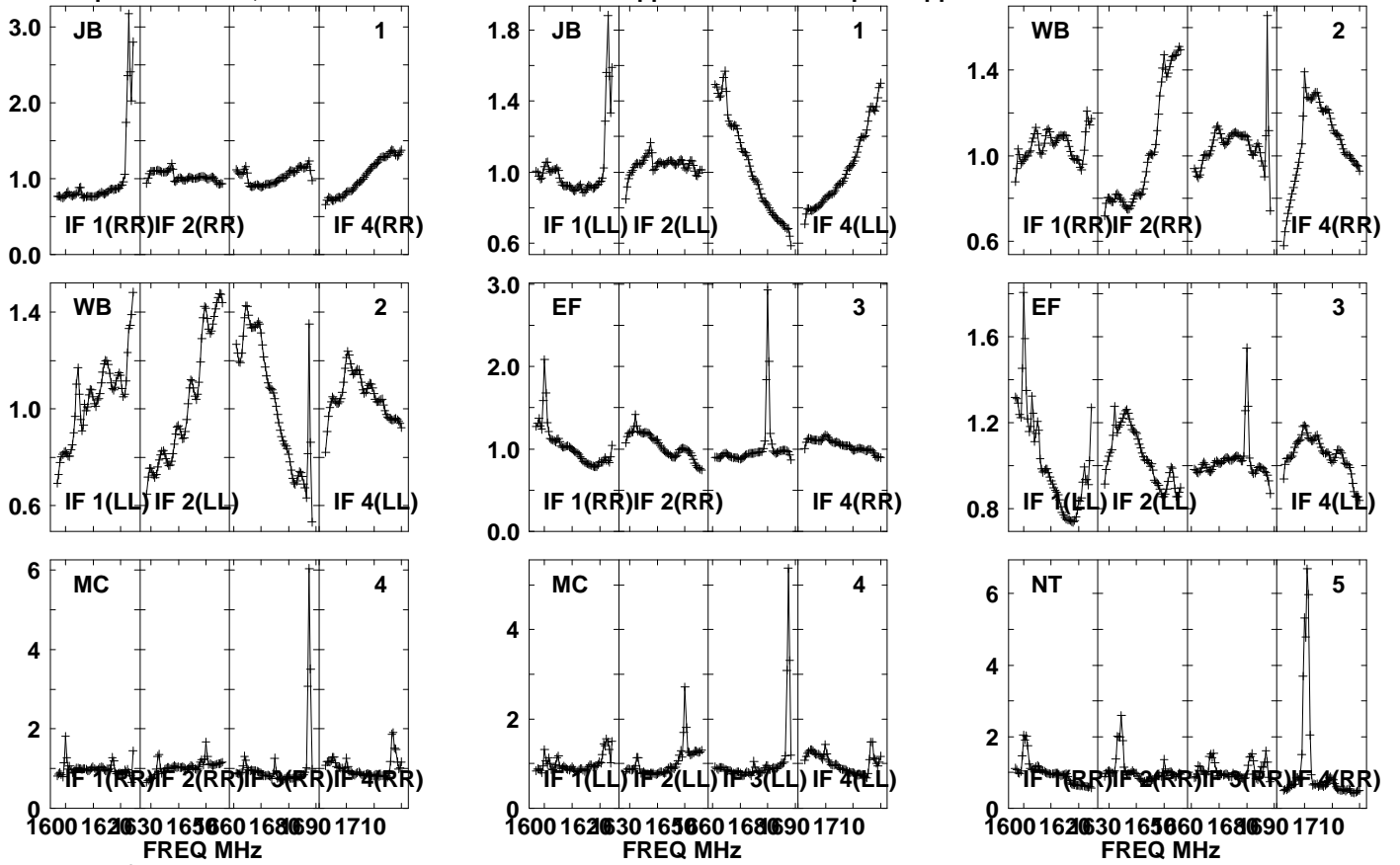

Lower frame: Real Jy

Auto-corr total-power spectrum Antenna: *

Timerange: 01/01:44:21 to 01/01:45:49

Plot file version 123 created 12-JUN-2023 14:39:15

J1547+2052 ES106B.UVDATA.1

Freq = 1.5950 GHz, Bw = 32.000 MH No calibration applied and no bandpass applied

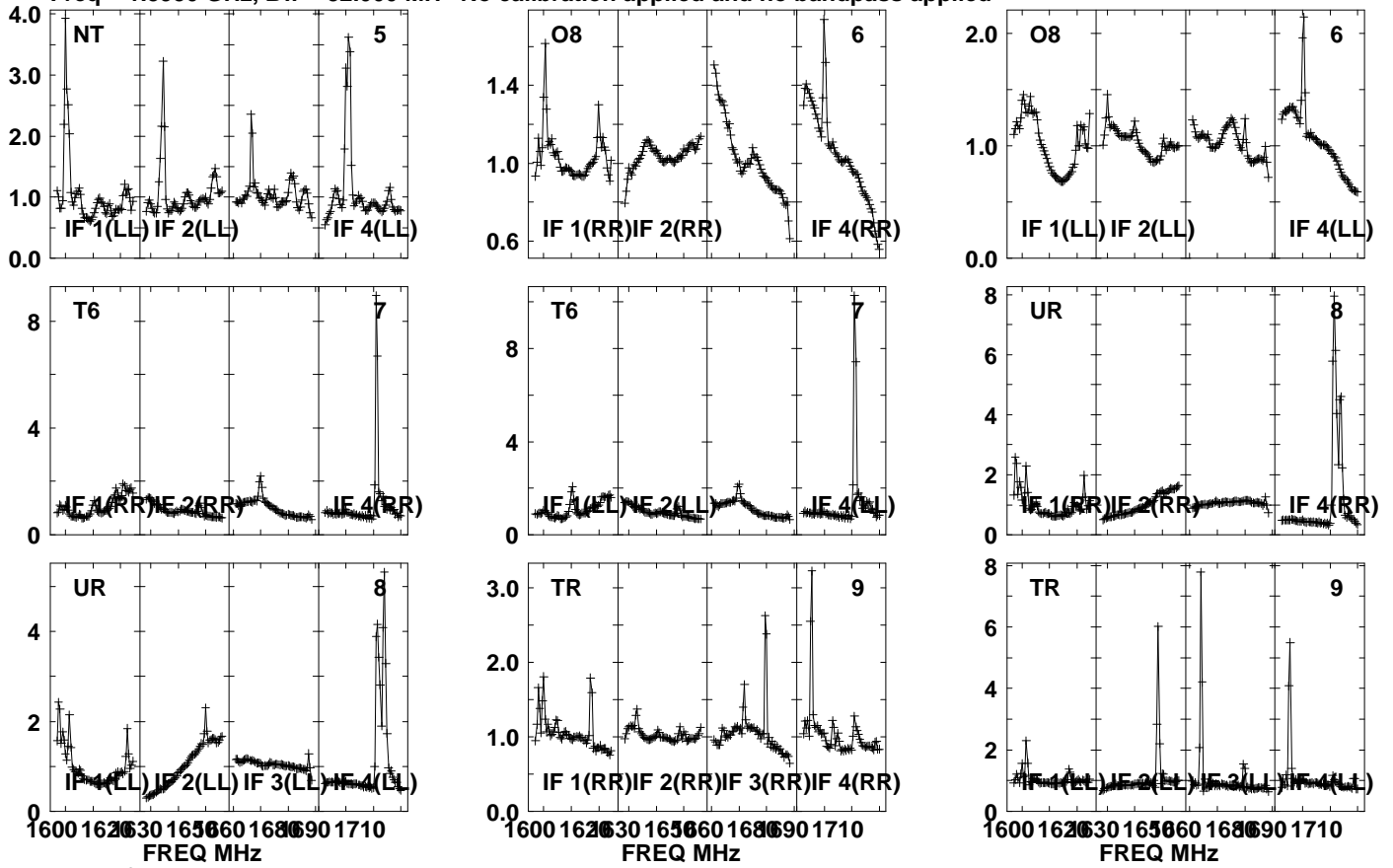

Lower frame: Real Jy

Auto-corr total-power spectrum Antenna: *

Timerange: 01/01:44:21 to 01/01:45:49

Plot file version 124 created 12-JUN-2023 14:39:15

J1547+2052 ES106B.UVDATA.1

Freq = 1.5950 GHz, Bw = 32.000 MH No calibration applied and no bandpass applied

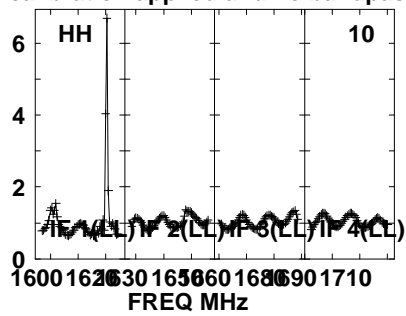
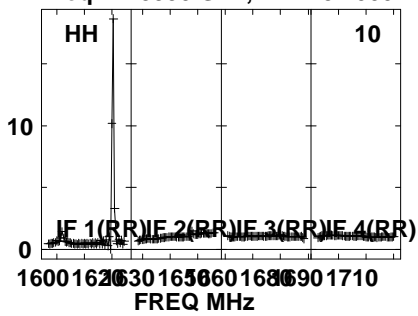

Lower frame: Real Jy
Auto-corr total-power spectrum Antenna: *
Timerange: 01/01:44:21 to 01/01:45:49

Plot file version 125 created 12-JUN-2023 14:39:15

J1545+2006 ES106B.UVDATA.1

Freq = 1.5950 GHz, Bw = 32.000 MH No calibration applied and no bandpass applied

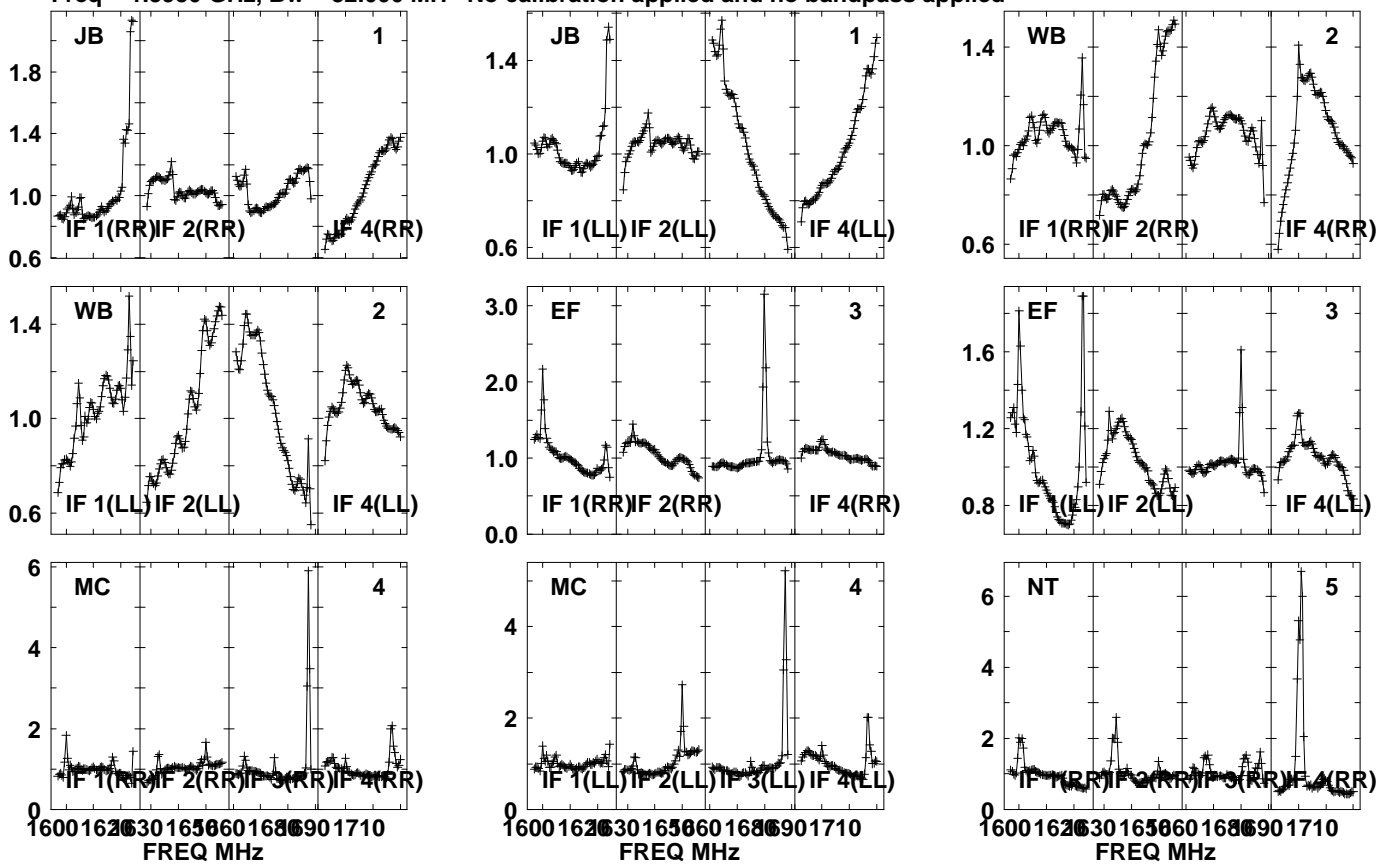

Lower frame: Real Jy
Auto-corr total-power spectrum Antenna: *
Timerange: 01/01:45:51 to 01/01:48:19

Plot file version 126 created 12-JUN-2023 14:39:15

J1545+2006 ES106B.UVDATA.1

Freq = 1.5950 GHz, Bw = 32.000 MH No calibration applied and no bandpass applied

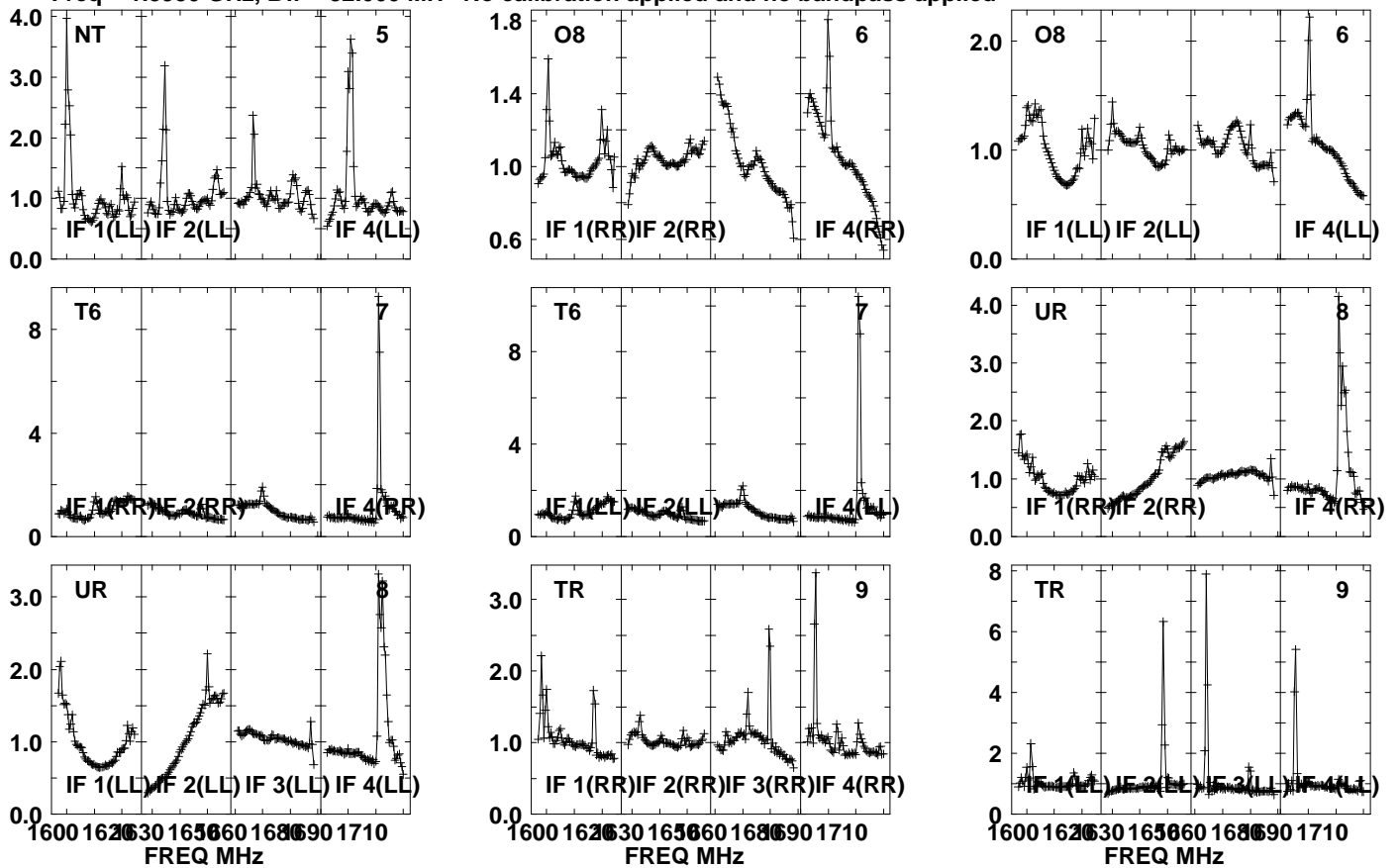

Lower frame: Real Jy

Auto-corr total-power spectrum Antenna: *

Timerange: 01/01:45:51 to 01/01:48:19

Plot file version 127 created 12-JUN-2023 14:39:15

J1545+2006 ES106B.UVDATA.1

Freq = 1.5950 GHz, Bw = 32.000 MH No calibration applied and no bandpass applied

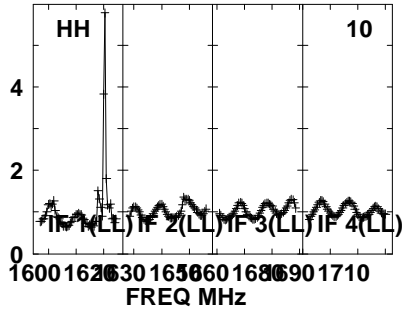
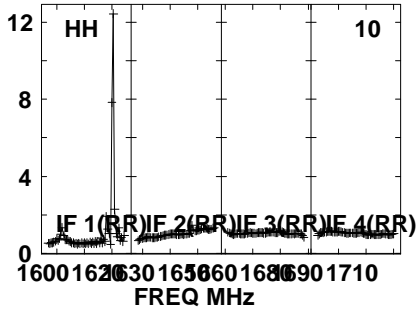

Lower frame: Real Jy
Auto-corr total-power spectrum Antenna: *
Timerange: 01/01:45:51 to 01/01:48:19

Plot file version 128 created 12-JUN-2023 14:39:15

J1547+2052 ES106B.UVDATA.1

Freq = 1.5950 GHz, Bw = 32.000 MH No calibration applied and no bandpass applied

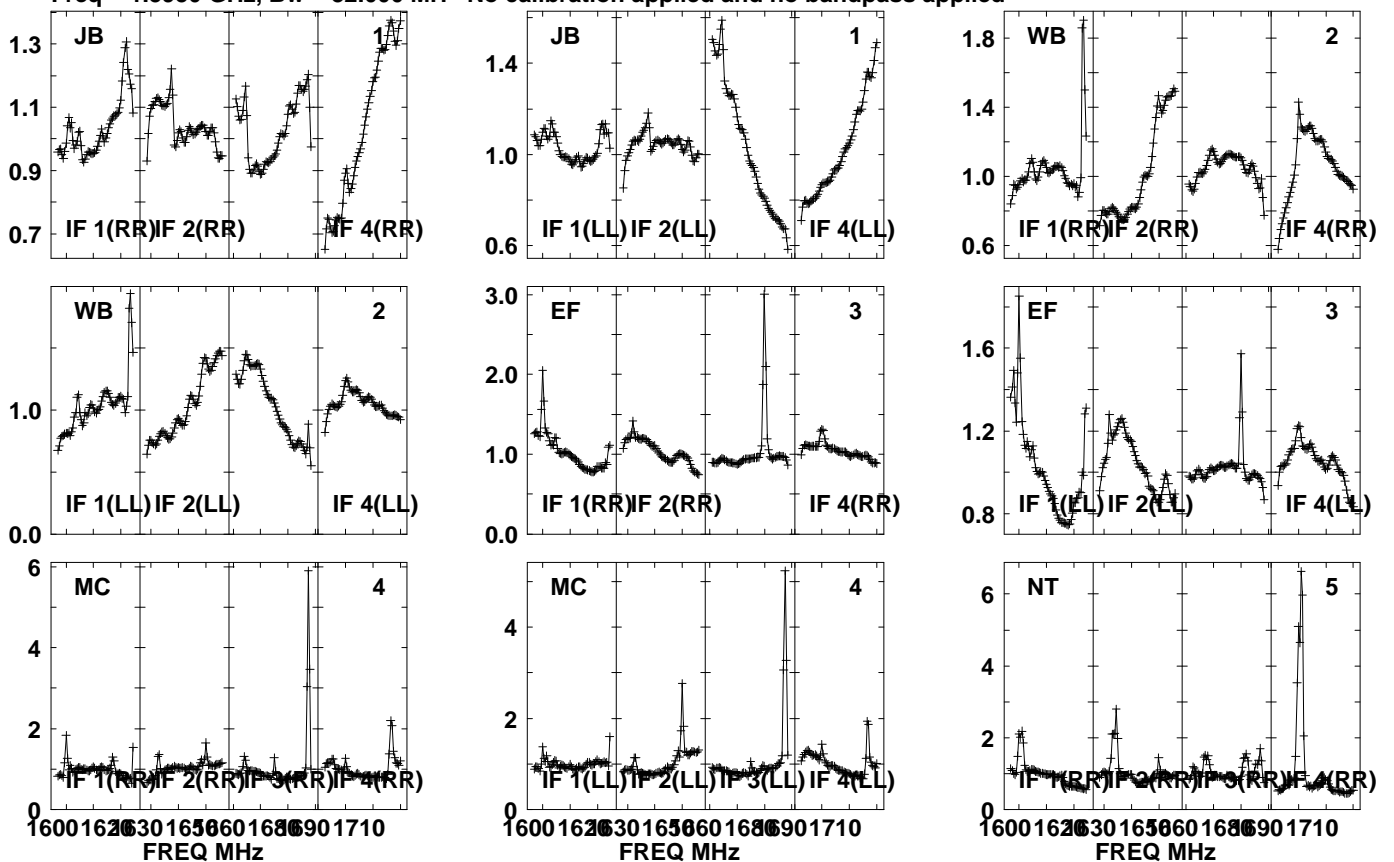

Lower frame: Real Jy
Auto-corr total-power spectrum Antenna: *
Timerange: 01/01:48:21 to 01/01:49:49

Plot file version 129 created 12-JUN-2023 14:39:15

J1547+2052 ES106B.UVDATA.1

Freq = 1.5950 GHz, Bw = 32.000 MH No calibration applied and no bandpass applied

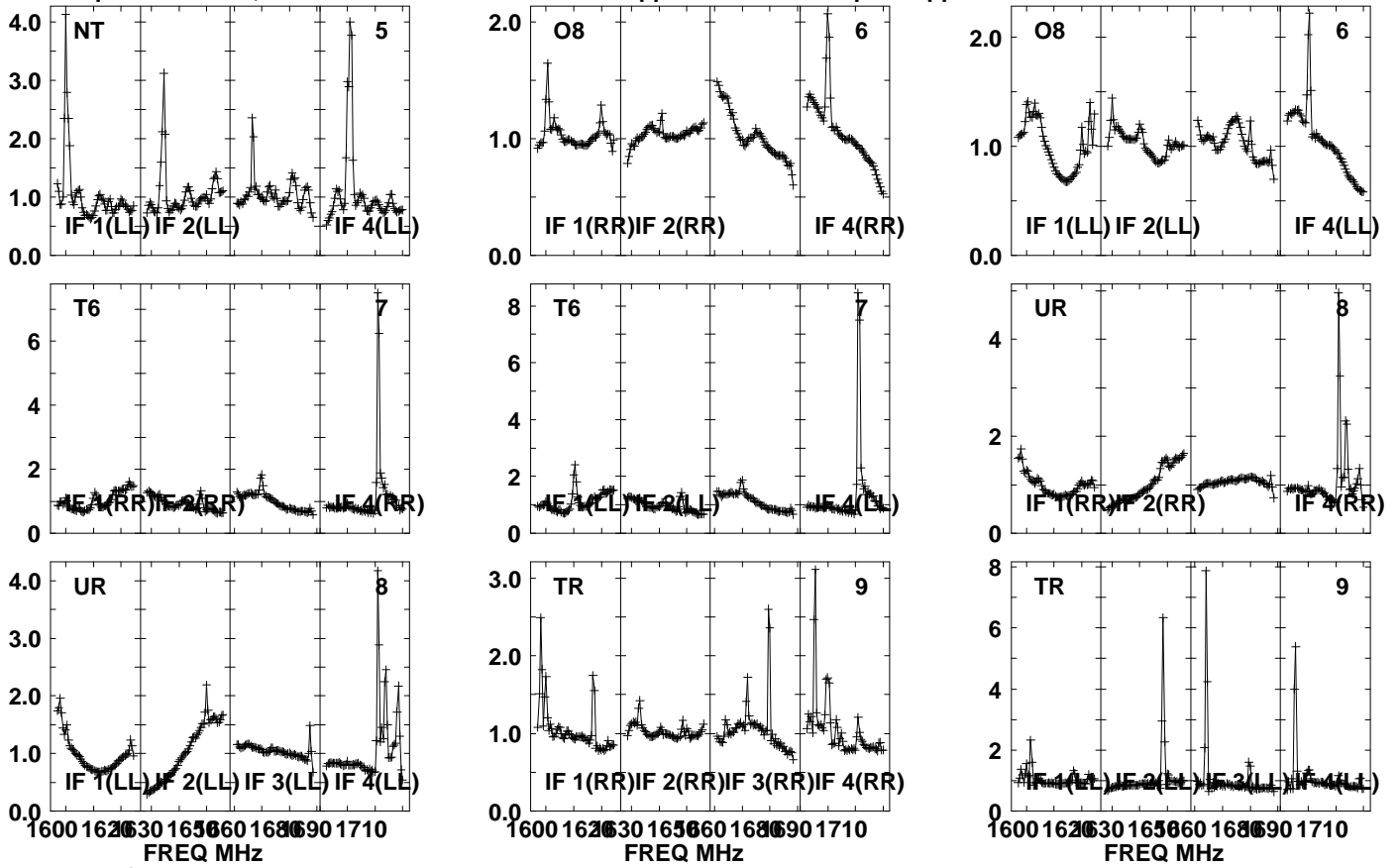

Lower frame: Real Jy
Auto-corr total-power spectrum Antenna: *
Timerange: 01/01:48:21 to 01/01:49:49

Plot file version 130 created 12-JUN-2023 14:39:15

J1547+2052 ES106B.UVDATA.1

Freq = 1.5950 GHz, Bw = 32.000 MH No calibration applied and no bandpass applied

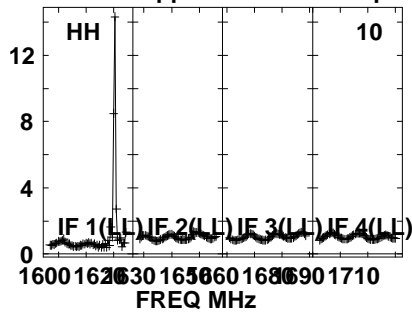
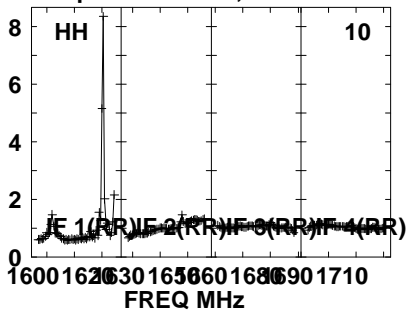

Lower frame: Real Jy
Auto-corr total-power spectrum Antenna: *
Timerange: 01/01:48:21 to 01/01:49:49

Plot file version 131 created 12-JUN-2023 14:39:15

J1548 ES106B.UVDATA.1

Freq = 1.5950 GHz, Bw = 32.000 MH No calibration applied and no bandpass applied

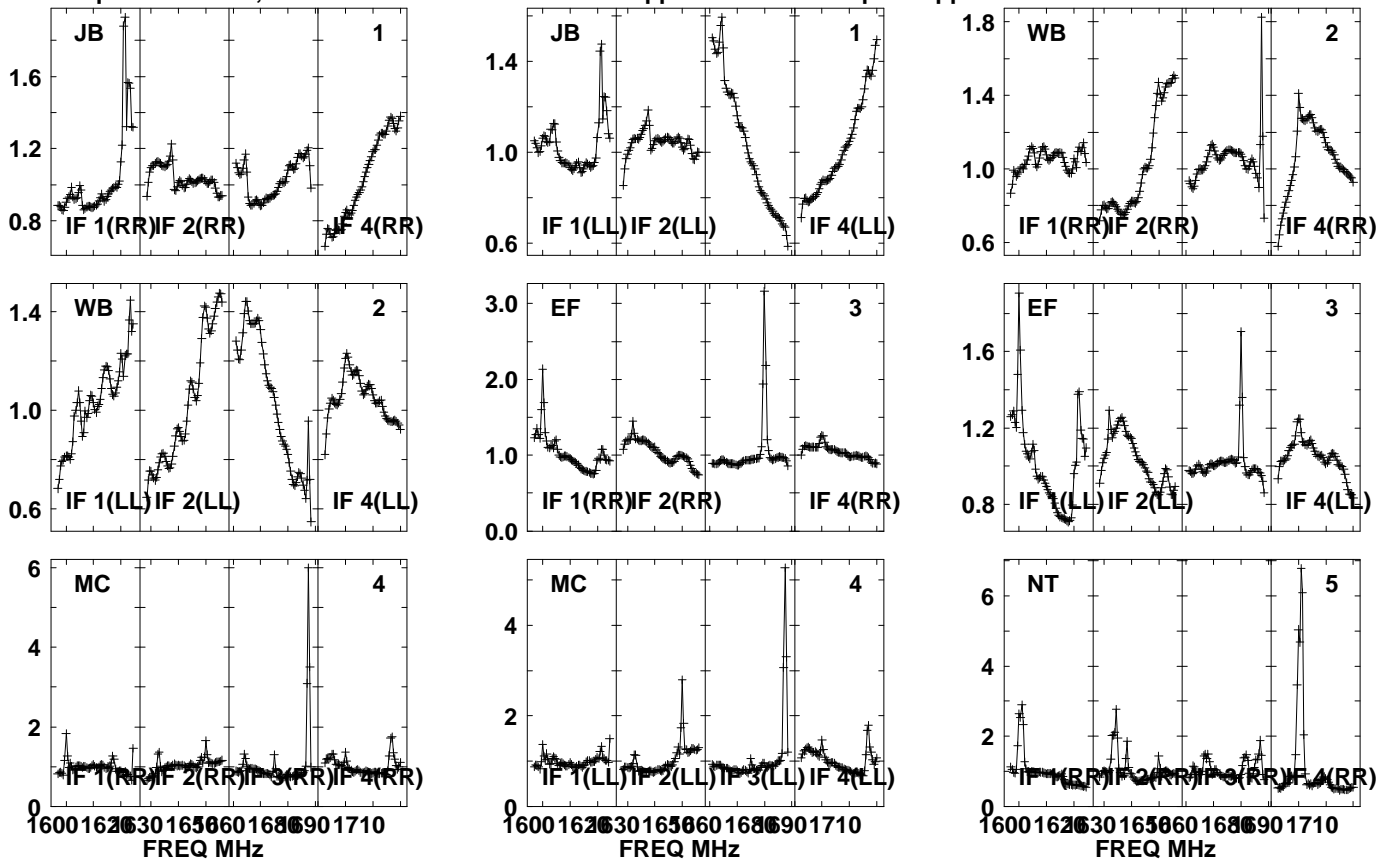

Lower frame: Real Jy
Auto-corr total-power spectrum Antenna: *
Timerange: 01/01:50:21 to 01/01:54:19

Plot file version 132 created 12-JUN-2023 14:39:15

J1548 ES106B.UVDATA.1

Freq = 1.5950 GHz, Bw = 32.000 MH No calibration applied and no bandpass applied

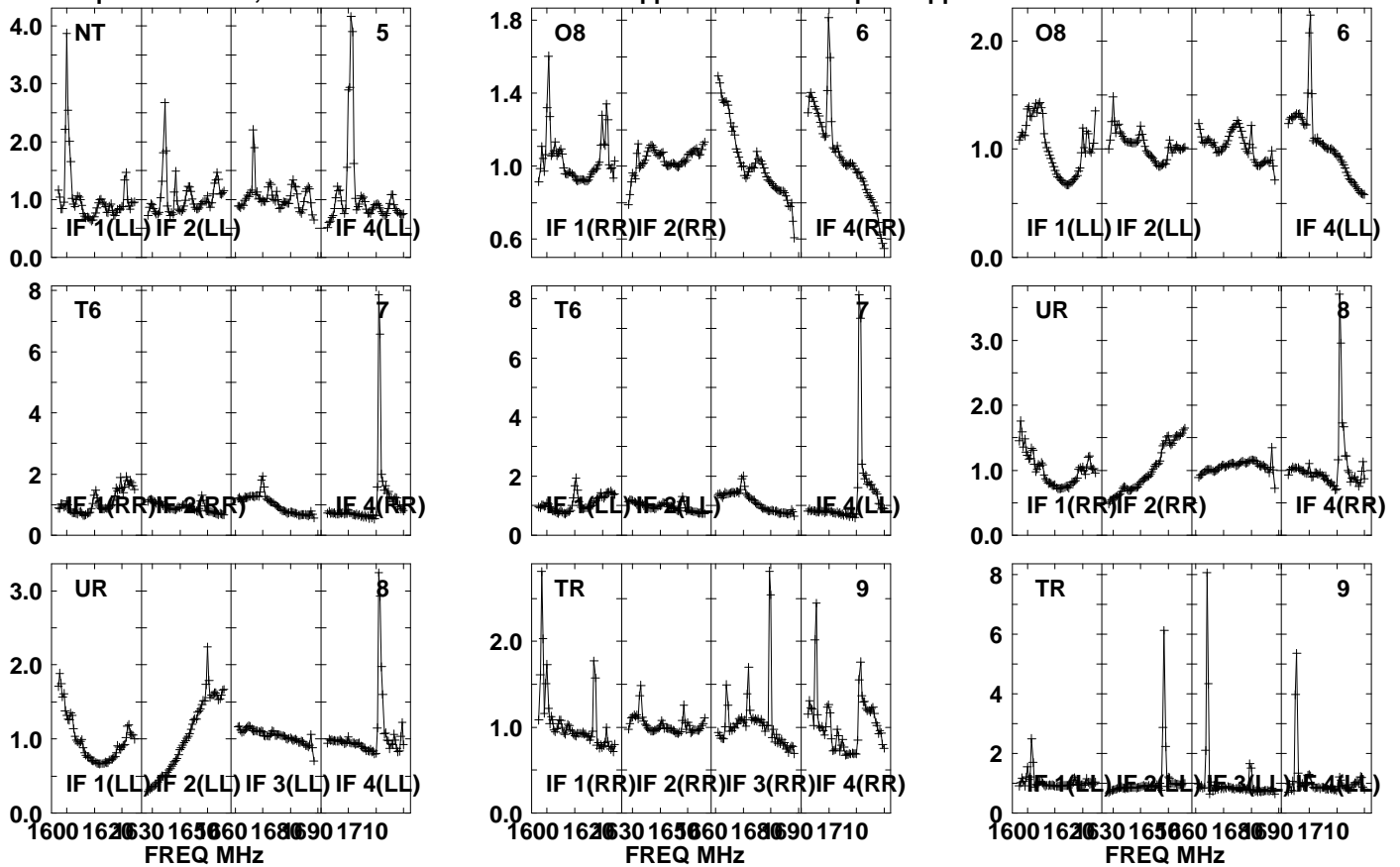

Lower frame: Real Jy

Auto-corr total-power spectrum Antenna: *

Timerange: 01/01:50:21 to 01/01:54:19

Plot file version 133 created 12-JUN-2023 14:39:15

J1548 ES106B.UVDATA.1

Freq = 1.5950 GHz, Bw = 32.000 MH No calibration applied and no bandpass applied

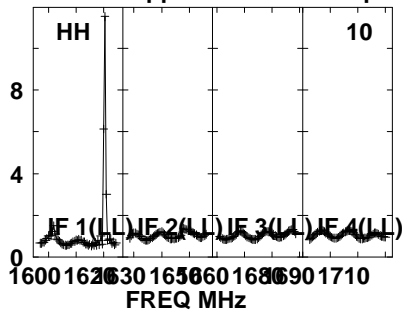
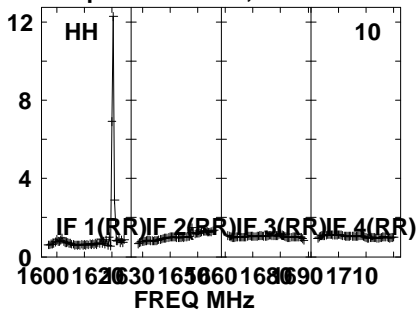

Lower frame: Real Jy
Auto-corr total-power spectrum Antenna: *
Timerange: 01/01:50:21 to 01/01:54:19

Plot file version 134 created 12-JUN-2023 14:39:15

J1547+2052 ES106B.UVDATA.1

Freq = 1.5950 GHz, Bw = 32.000 MH No calibration applied and no bandpass applied

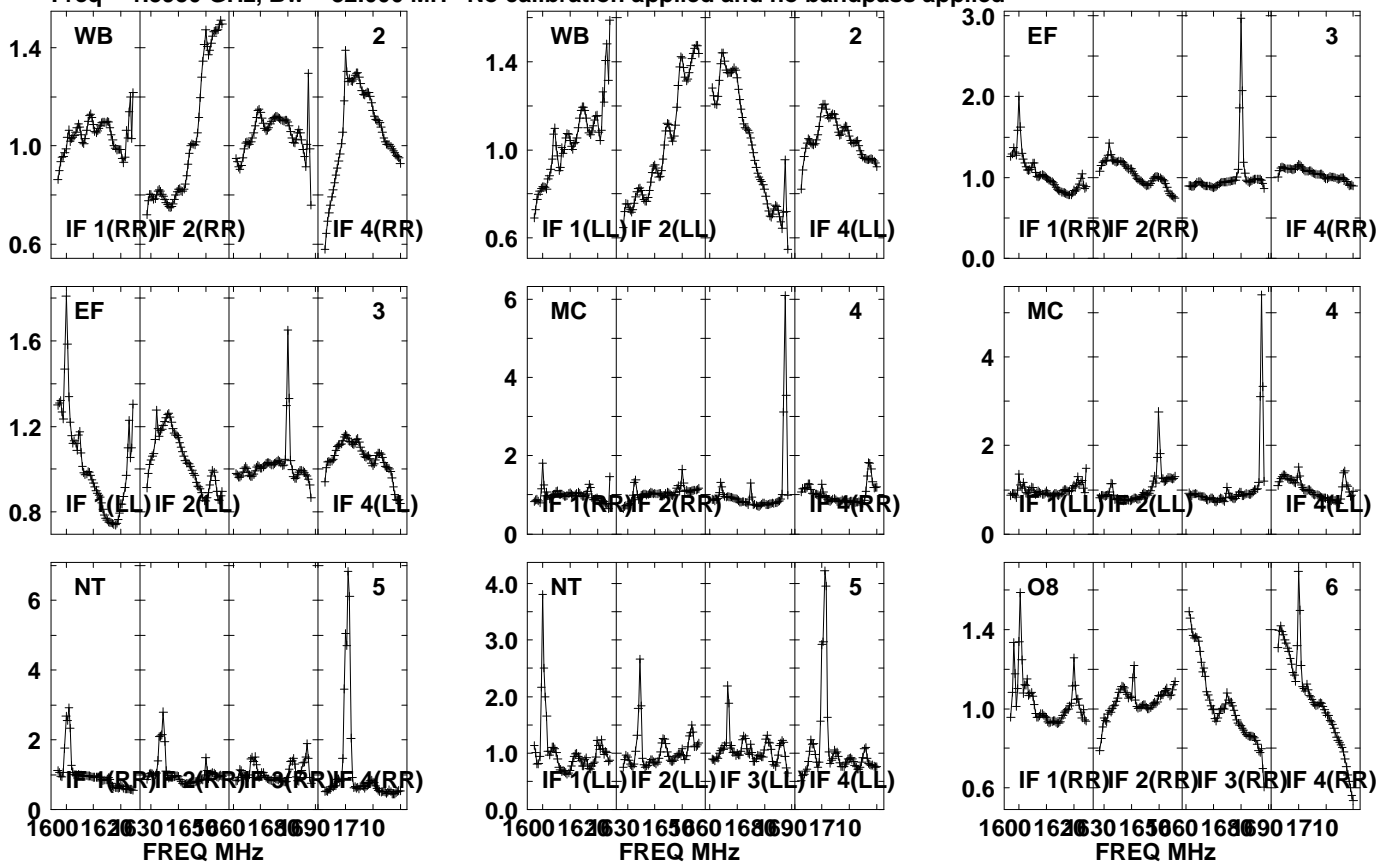

Lower frame: Real Jy
Auto-corr total-power spectrum Antenna: *
Timerange: 01/01:54:21 to 01/01:55:49

Plot file version 135 created 12-JUN-2023 14:39:15

J1547+2052 ES106B.UVDATA.1

Freq = 1.5950 GHz, Bw = 32.000 MH No calibration applied and no bandpass applied

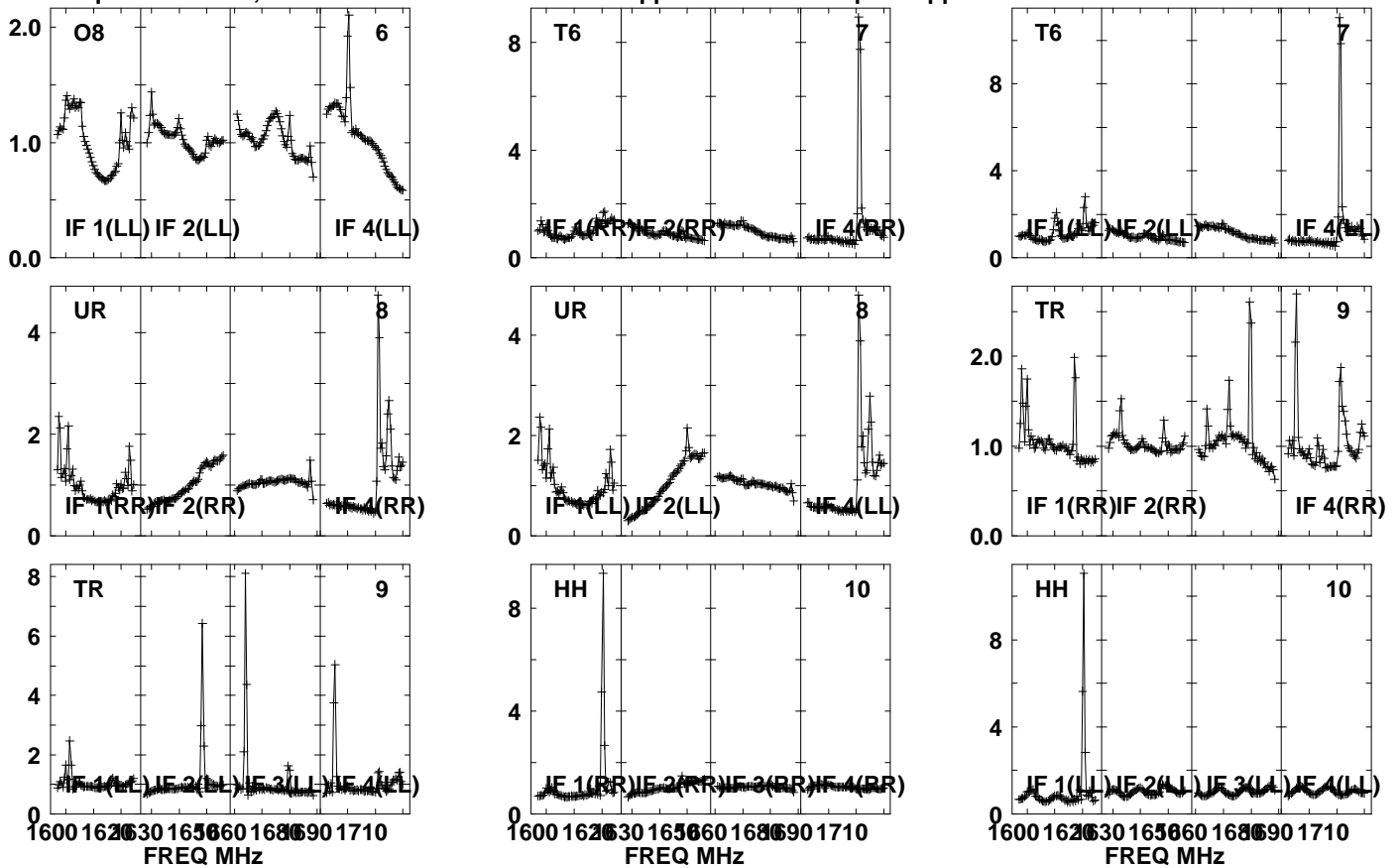

Lower frame: Real Jy

Auto-corr total-power spectrum Antenna: *

Timerange: 01/01:54:21 to 01/01:55:49

Plot file version 136 created 12-JUN-2023 14:39:15

J1548 ES106B.UVDATA.1

Freq = 1.5950 GHz, Bw = 32.000 MH No calibration applied and no bandpass applied

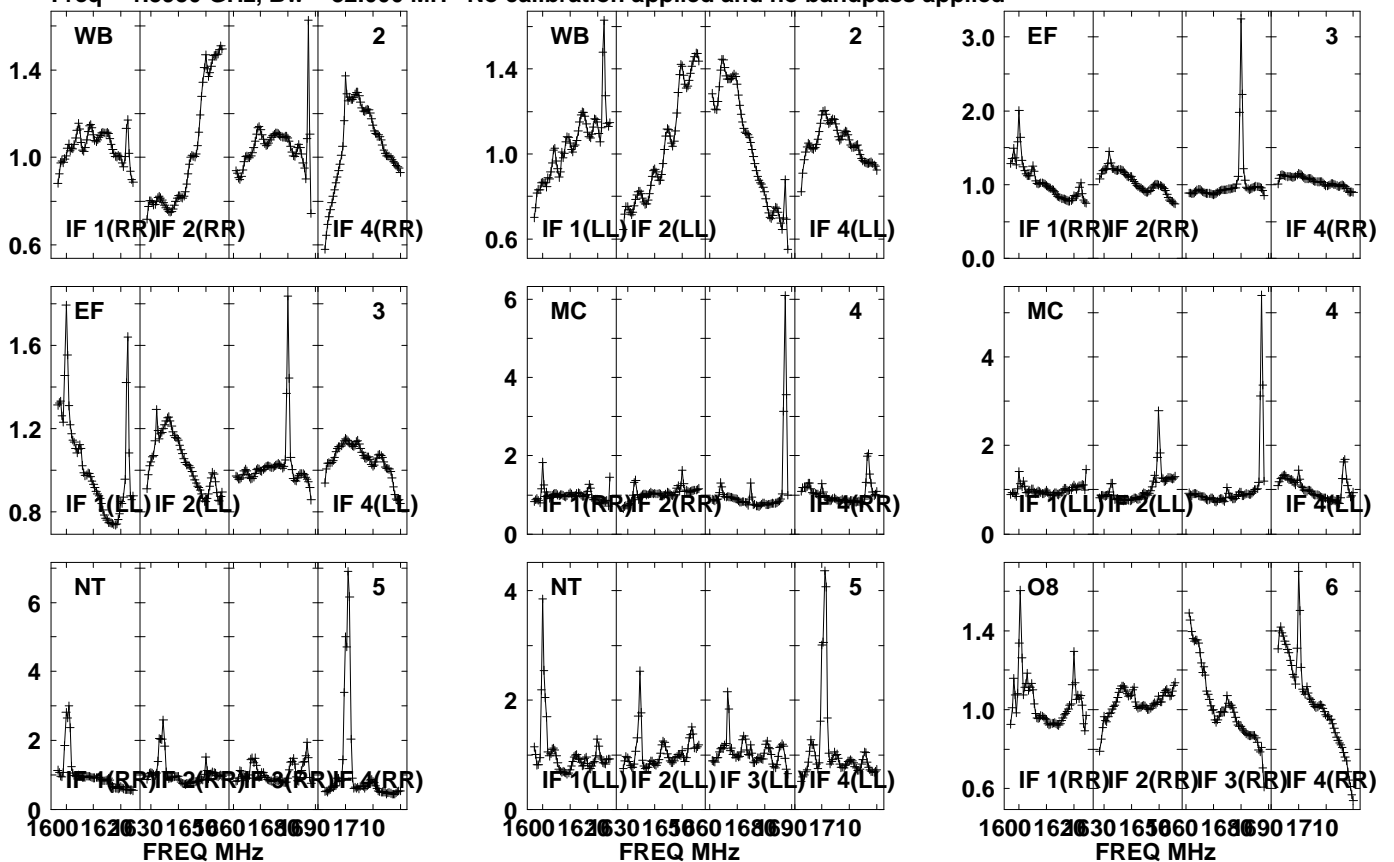

Lower frame: Real Jy
Auto-corr total-power spectrum Antenna: *
Timerange: 01/01:55:51 to 01/01:59:19

Plot file version 137 created 12-JUN-2023 14:39:16

J1548 ES106B.UVDATA.1

Freq = 1.5950 GHz, Bw = 32.000 MH No calibration applied and no bandpass applied

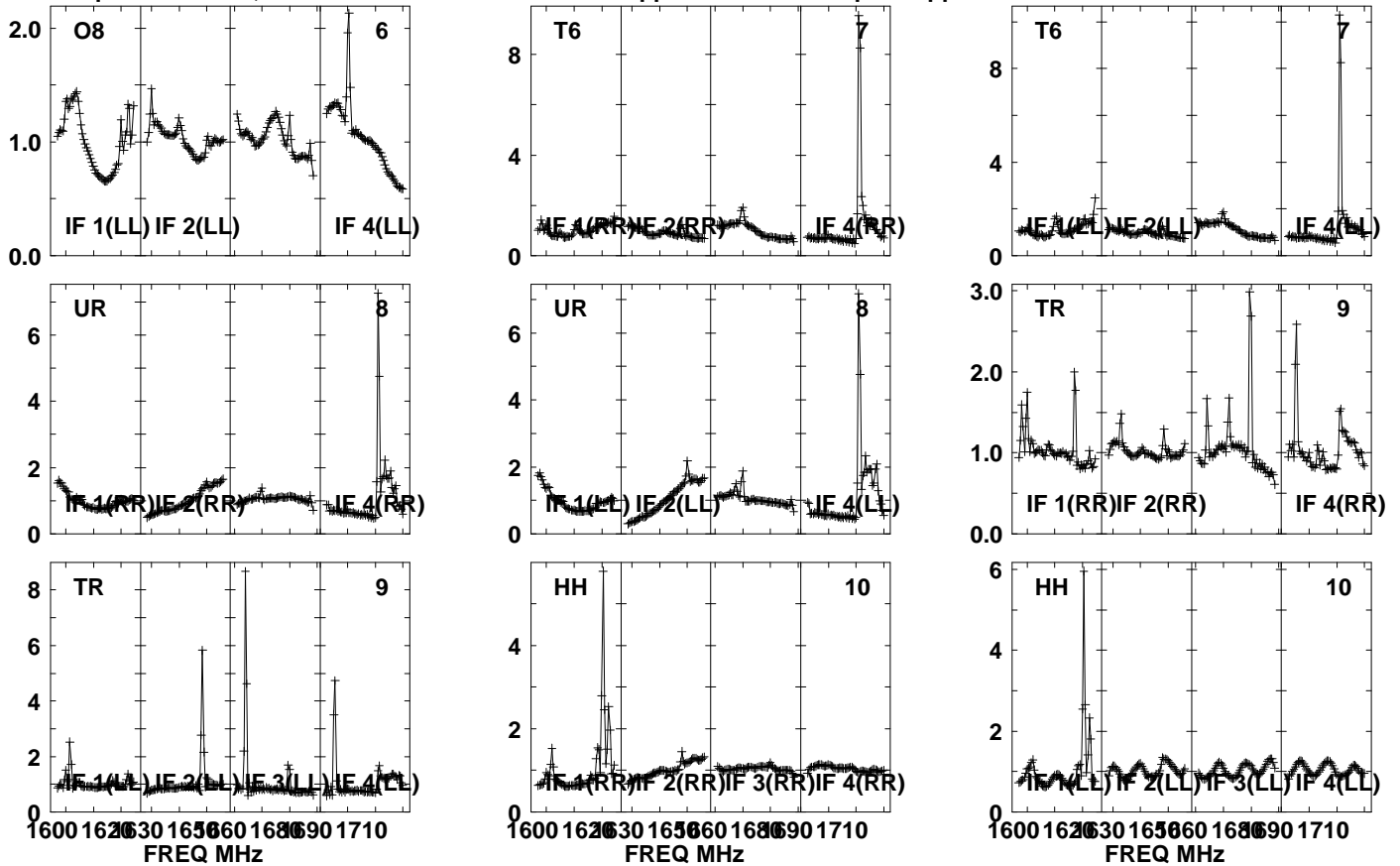

Lower frame: Real Jy

Auto-corr total-power spectrum Antenna: *

Timerange: 01/01:55:51 to 01/01:59:19

Plot file version 138 created 12-JUN-2023 14:39:16

J1547+2052 ES106B.UVDATA.1

Freq = 1.5950 GHz, Bw = 32.000 MH No calibration applied and no bandpass applied

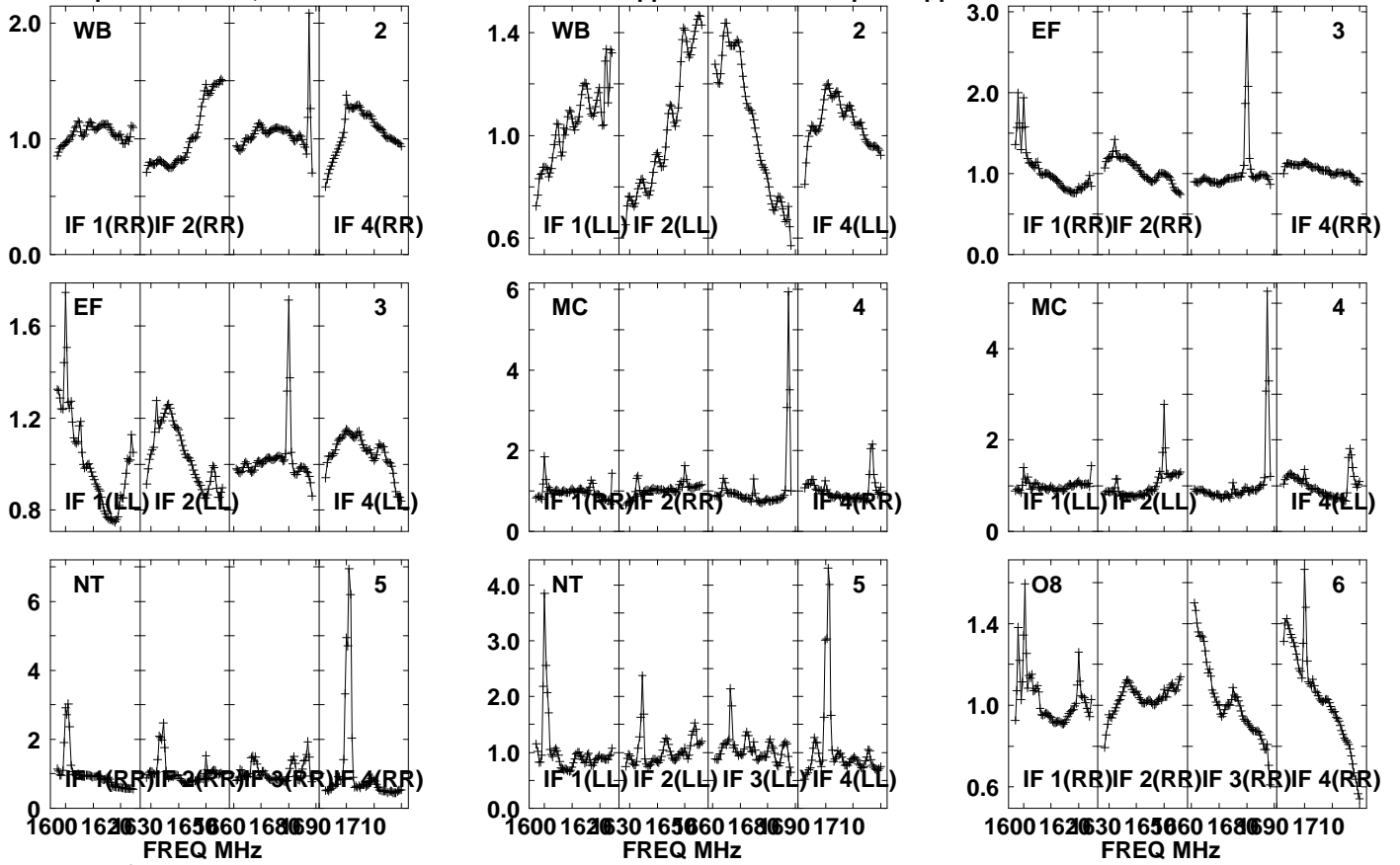

Lower frame: Real Jy
Auto-corr total-power spectrum Antenna: *
Timerange: 01/01:59:51 to 01/02:01:19

Plot file version 139 created 12-JUN-2023 14:39:16

J1547+2052 ES106B.UVDATA.1

Freq = 1.5950 GHz, Bw = 32.000 MH No calibration applied and no bandpass applied

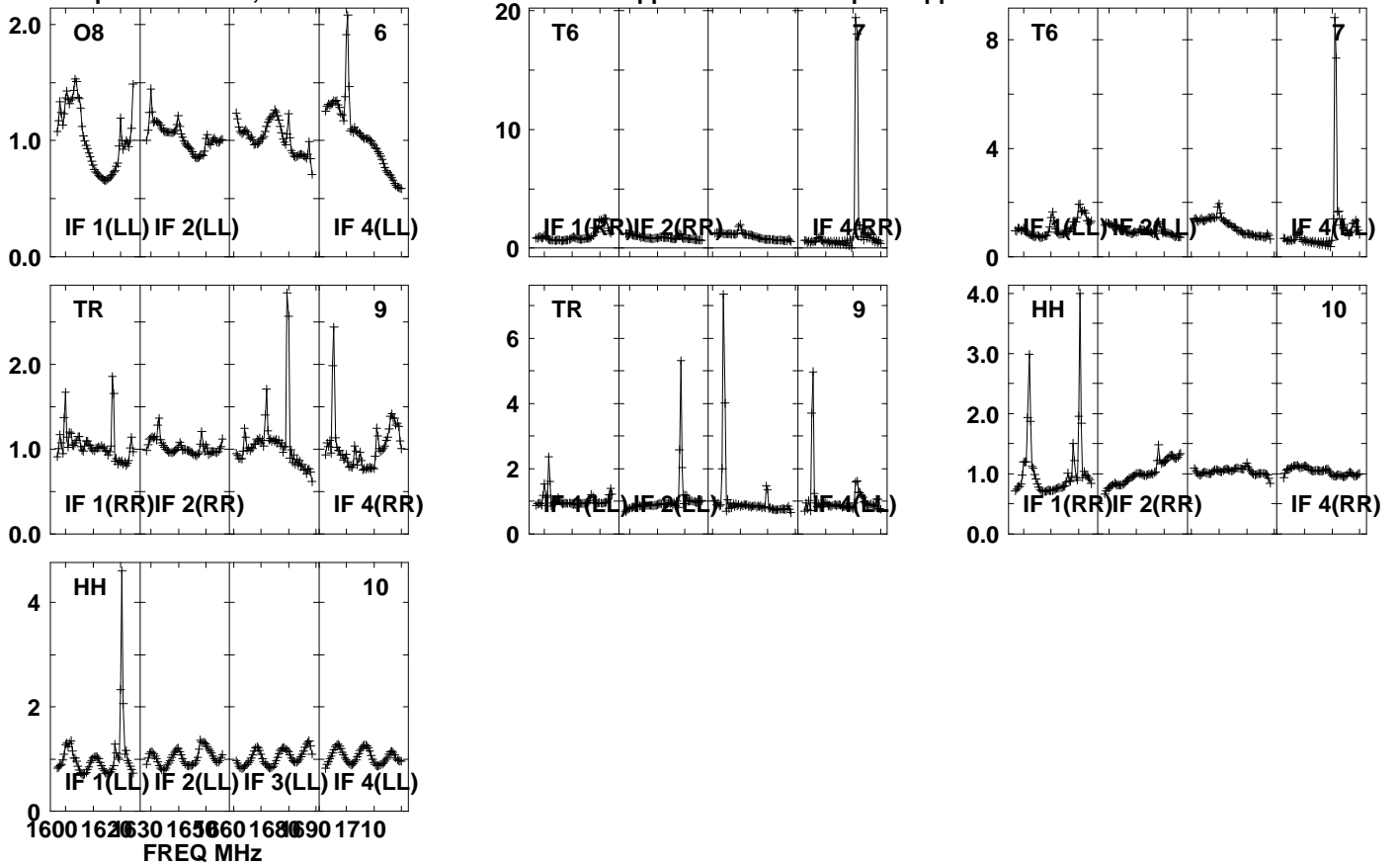

Lower frame: Real Jy

Auto-corr total-power spectrum Antenna: *

Timerange: 01/01:59:51 to 01/02:01:19

Plot file version 140 created 12-JUN-2023 14:39:16

J1548 ES106B.UVDATA.1

Freq = 1.5950 GHz, Bw = 32.000 MH No calibration applied and no bandpass applied

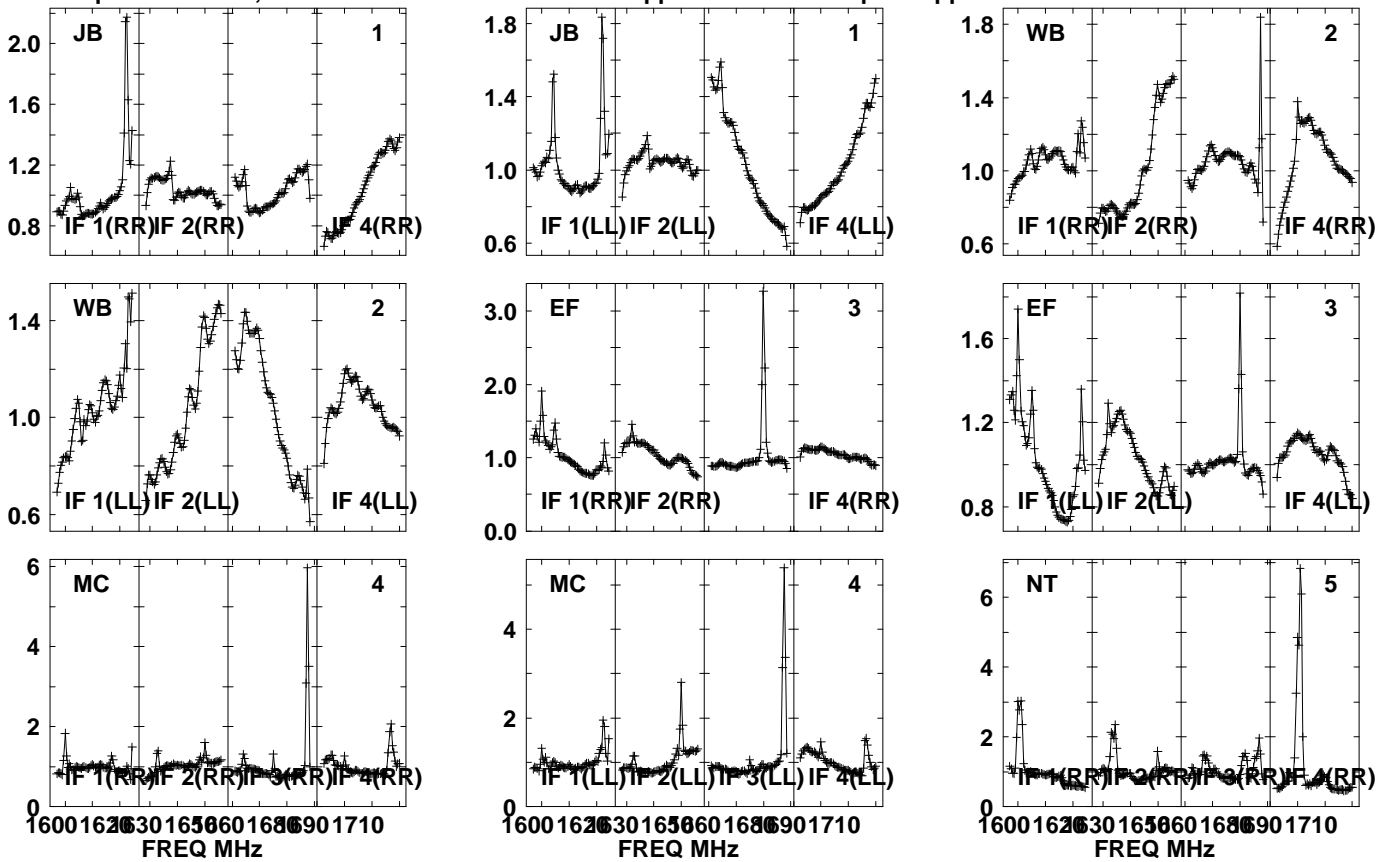

Lower frame: Real Jy

Auto-corr total-power spectrum Antenna: *

Timerange: 01/02:01:21 to 01/02:04:49

Plot file version 141 created 12-JUN-2023 14:39:16

J1548 ES106B.UVDATA.1

Freq = 1.5950 GHz, Bw = 32.000 MH No calibration applied and no bandpass applied

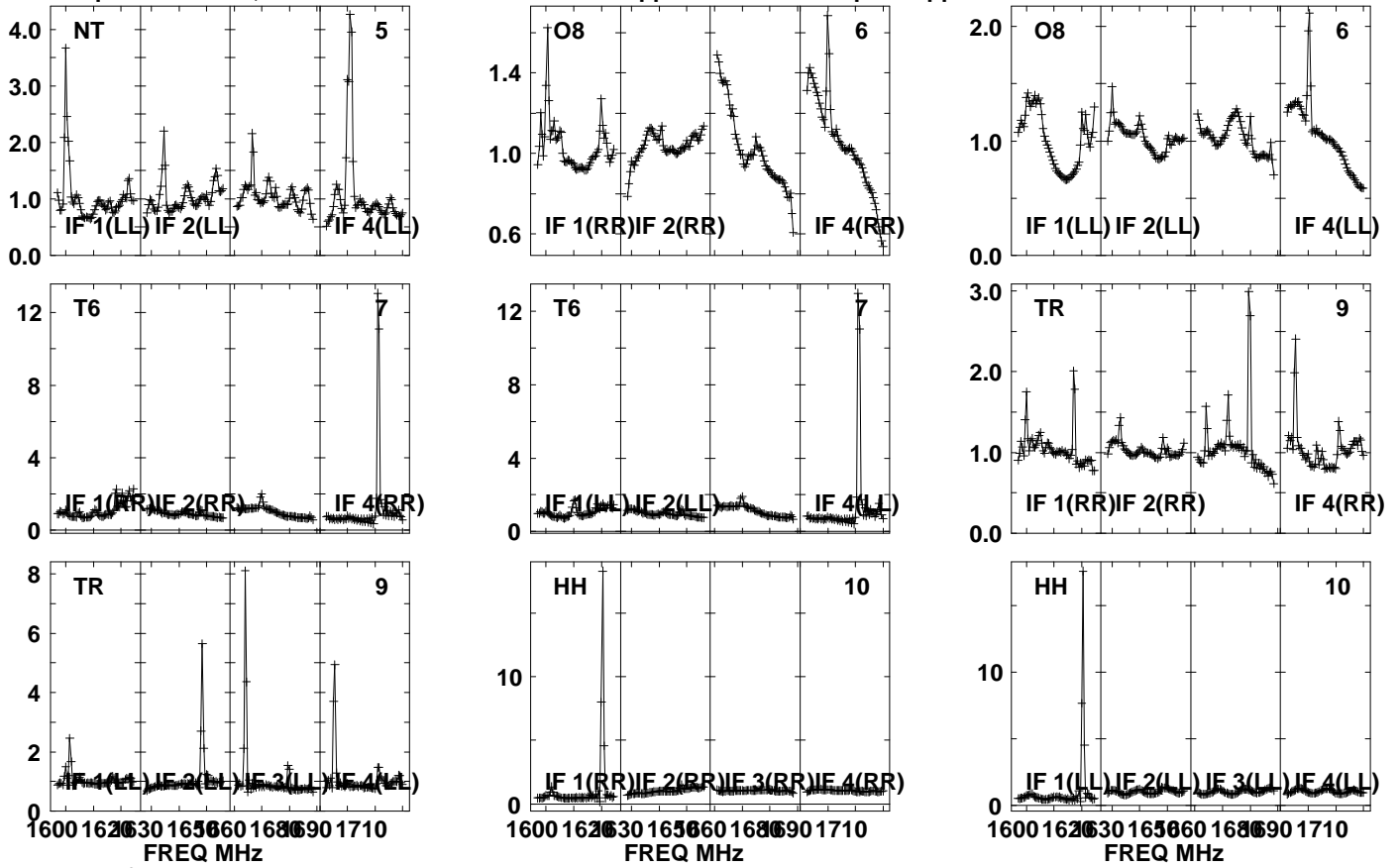

Lower frame: Real Jy

Auto-corr total-power spectrum Antenna: *

Timerange: 01/02:01:21 to 01/02:04:49

Plot file version 142 created 12-JUN-2023 14:39:16

J1547+2052 ES106B.UVDATA.1

Freq = 1.5950 GHz, Bw = 32.000 MH No calibration applied and no bandpass applied

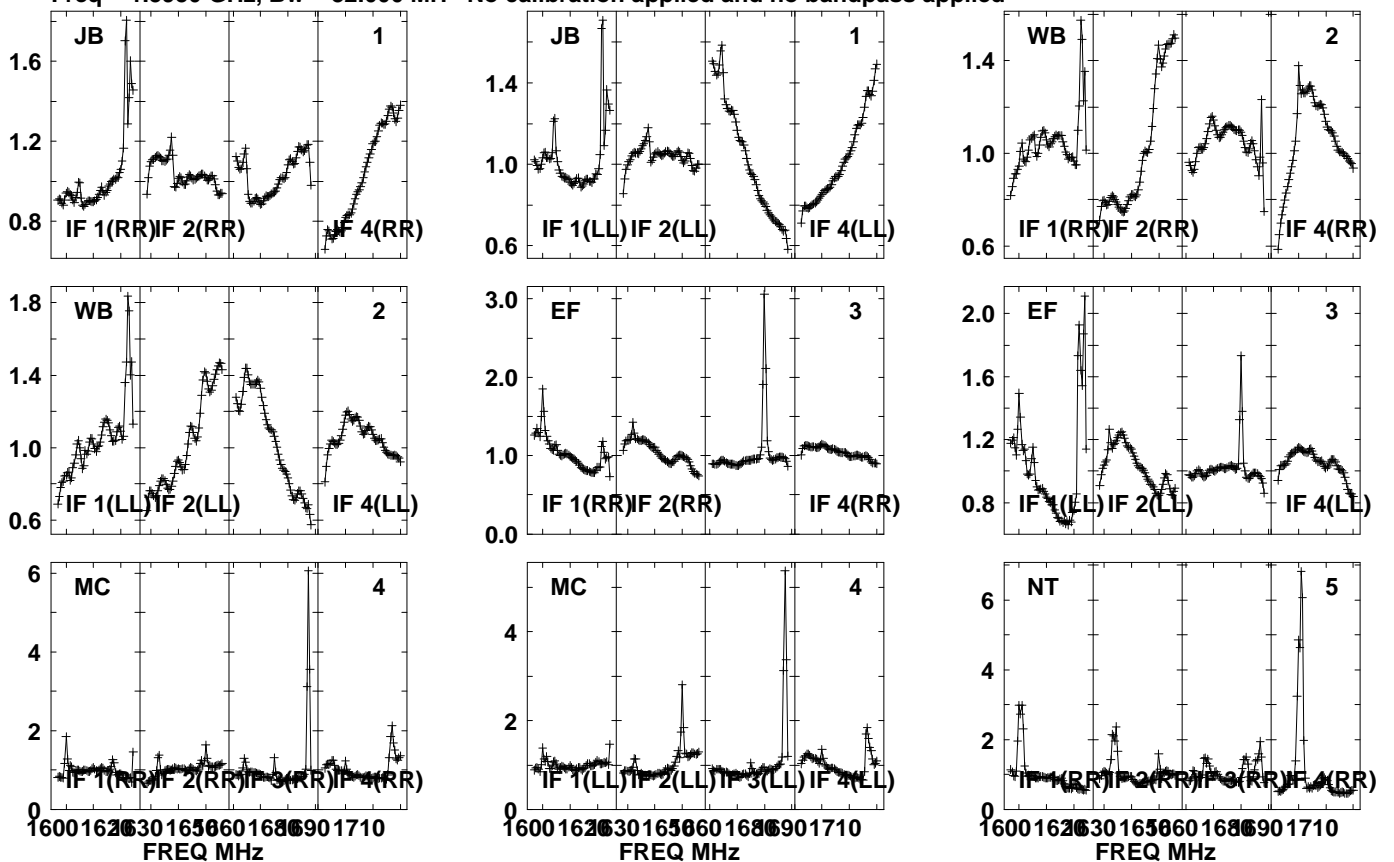

Lower frame: Real Jy
Auto-corr total-power spectrum Antenna: *
Timerange: 01/02:04:51 to 01/02:06:19

Plot file version 143 created 12-JUN-2023 14:39:16

J1547+2052 ES106B.UVDATA.1

Freq = 1.5950 GHz, Bw = 32.000 MH No calibration applied and no bandpass applied

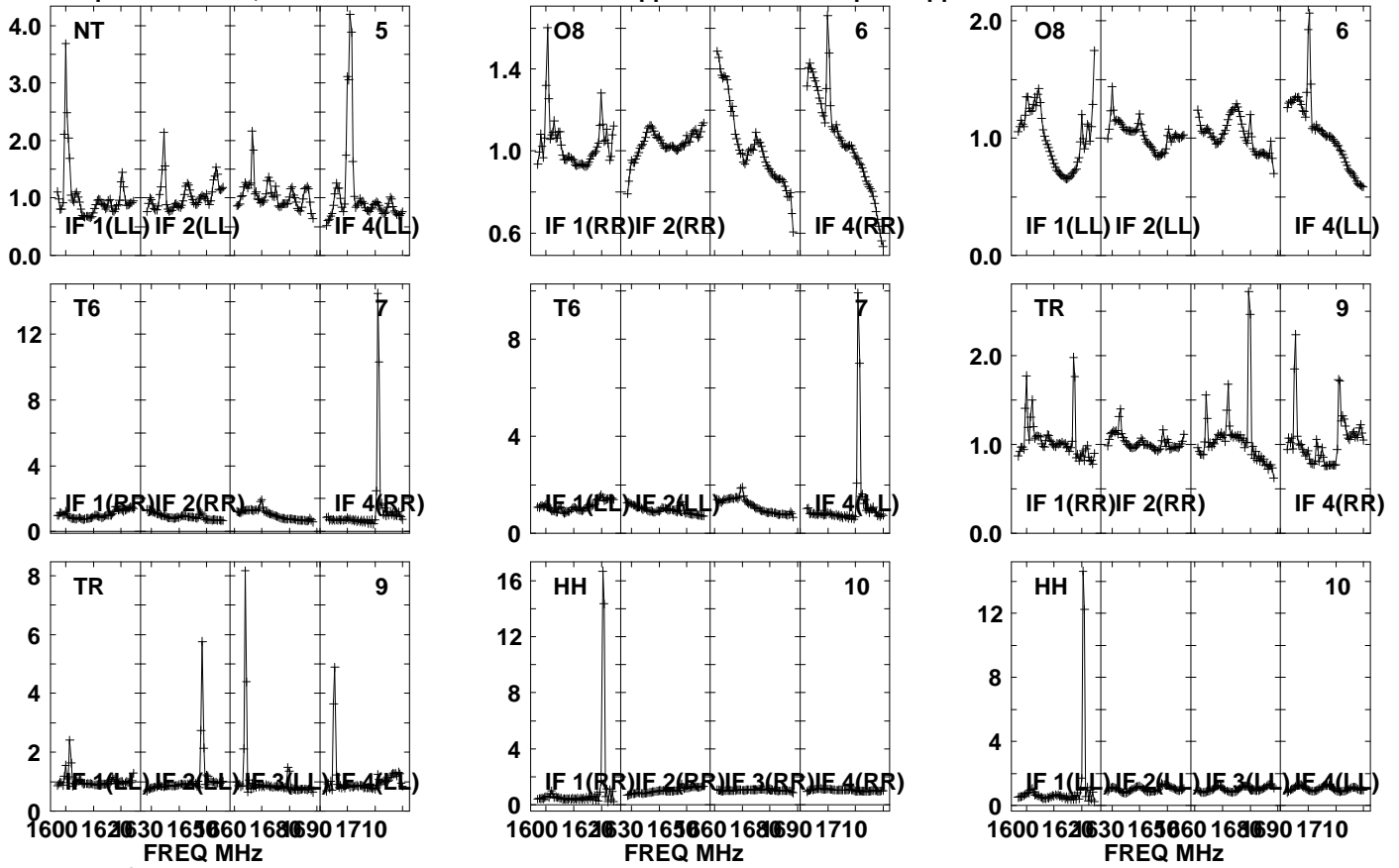

Lower frame: Real Jy
Auto-corr total-power spectrum Antenna: *
Timerange: 01/02:04:51 to 01/02:06:19

Plot file version 144 created 12-JUN-2023 14:39:16

J1545+2006 ES106B.UVDATA.1

Freq = 1.5950 GHz, Bw = 32.000 MH No calibration applied and no bandpass applied

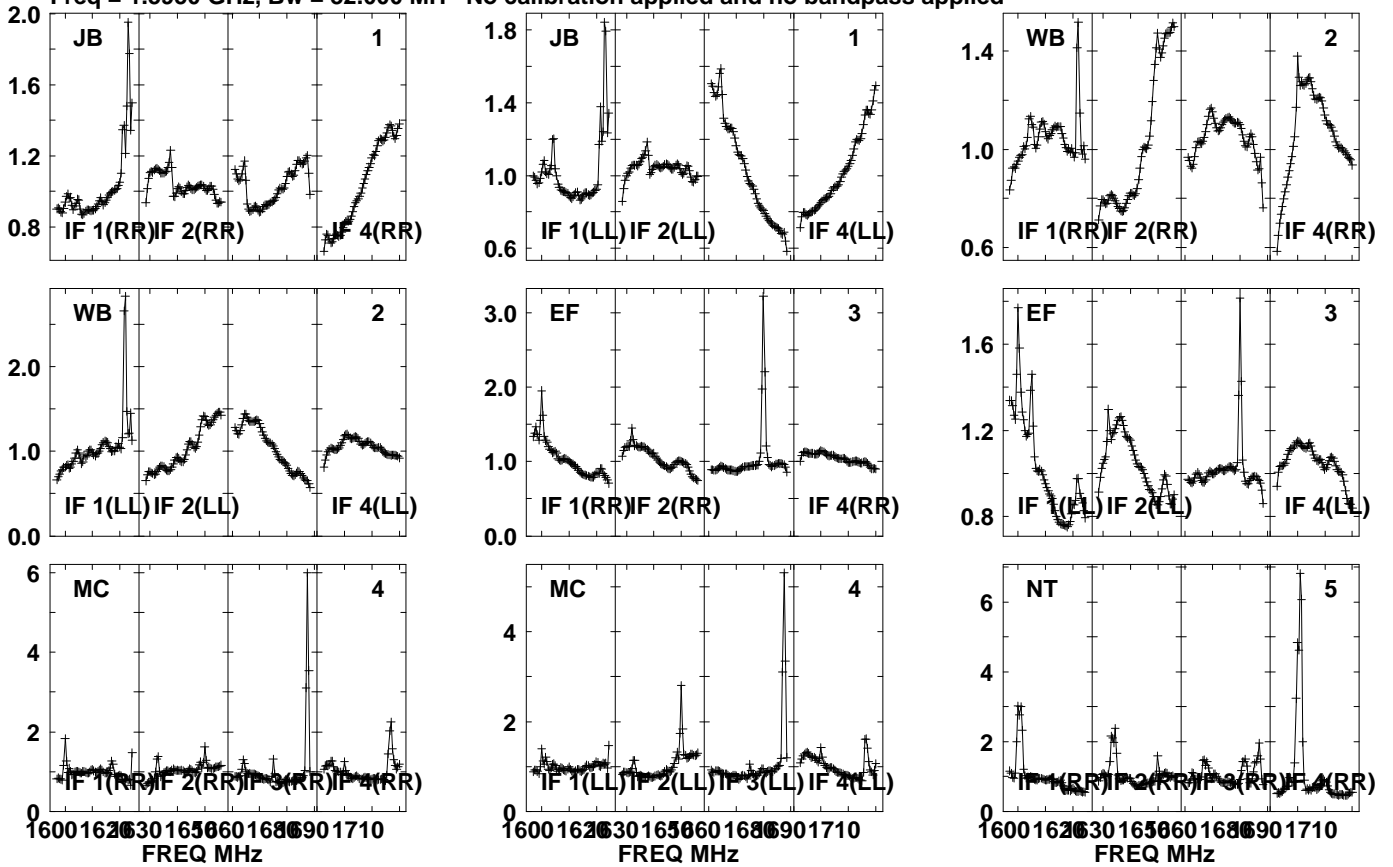

Lower frame: Real Jy
Auto-corr total-power spectrum Antenna: *
Timerange: 01/02:06:21 to 01/02:08:49

Plot file version 145 created 12-JUN-2023 14:39:16

J1545+2006 ES106B.UVDATA.1

Freq = 1.5950 GHz, Bw = 32.000 MH No calibration applied and no bandpass applied

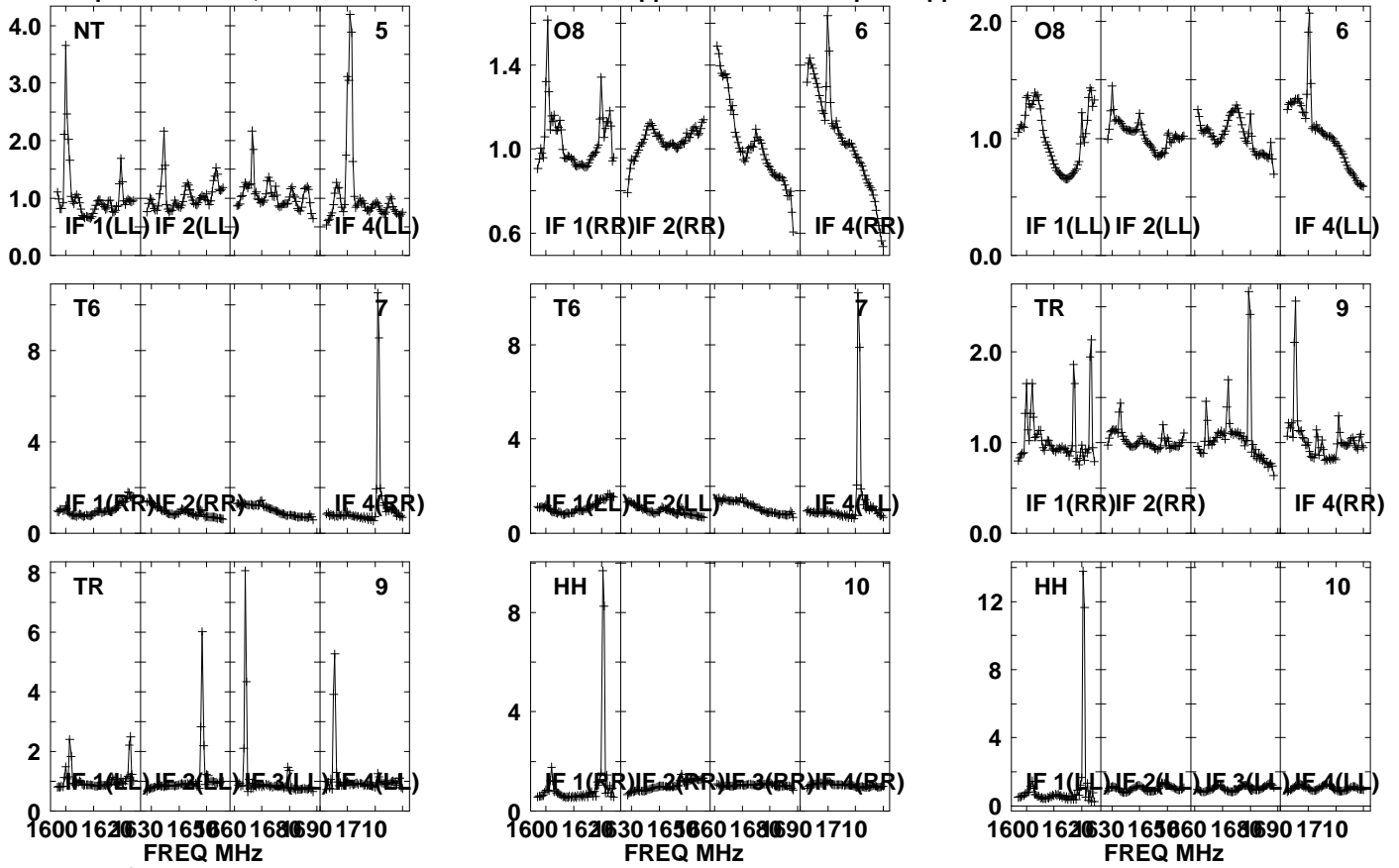

Lower frame: Real Jy

Auto-corr total-power spectrum Antenna: *

Timerange: 01/02:06:21 to 01/02:08:49

Plot file version 146 created 12-JUN-2023 14:39:16

J1547+2052 ES106B.UVDATA.1

Freq = 1.5950 GHz, Bw = 32.000 MH No calibration applied and no bandpass applied

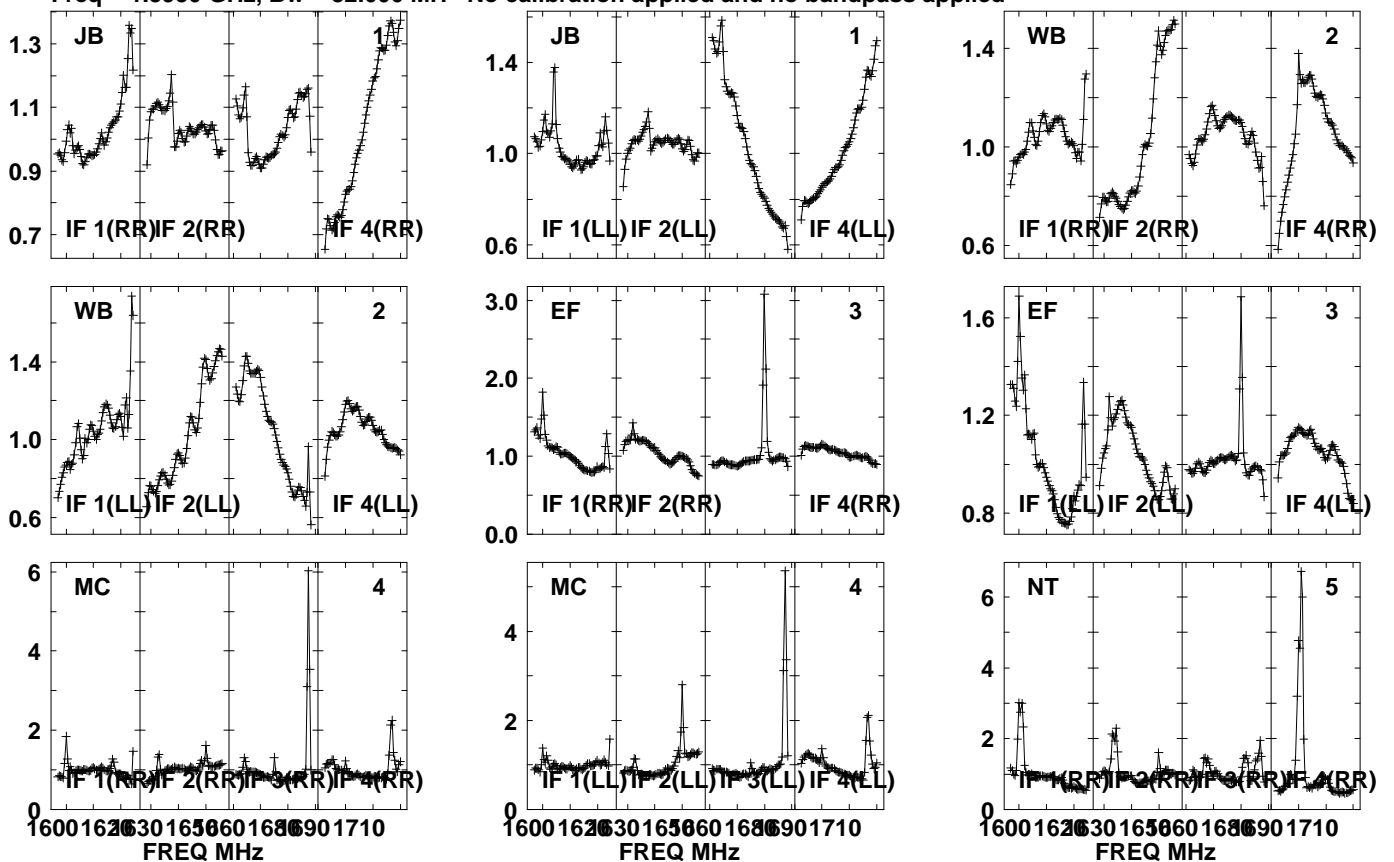

Lower frame: Real Jy
Auto-corr total-power spectrum Antenna: *
Timerange: 01/02:08:51 to 01/02:10:19

Plot file version 147 created 12-JUN-2023 14:39:16

J1547+2052 ES106B.UVDATA.1

Freq = 1.5950 GHz, Bw = 32.000 MH No calibration applied and no bandpass applied

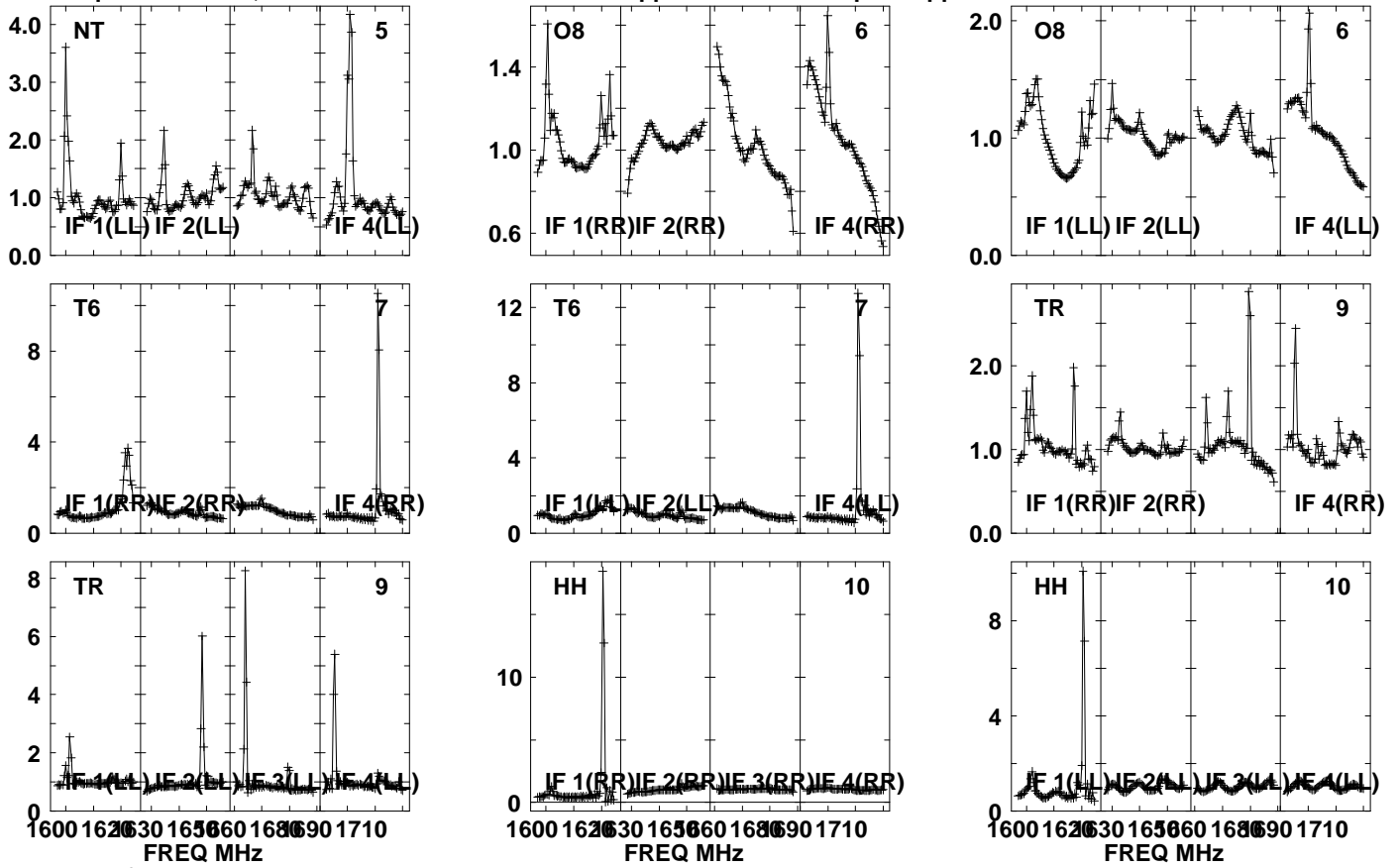

Lower frame: Real Jy

Auto-corr total-power spectrum Antenna: *

Timerange: 01/02:08:51 to 01/02:10:19

Plot file version 148 created 12-JUN-2023 14:39:16

J1548 ES106B.UVDATA.1

Freq = 1.5950 GHz, Bw = 32.000 MH No calibration applied and no bandpass applied

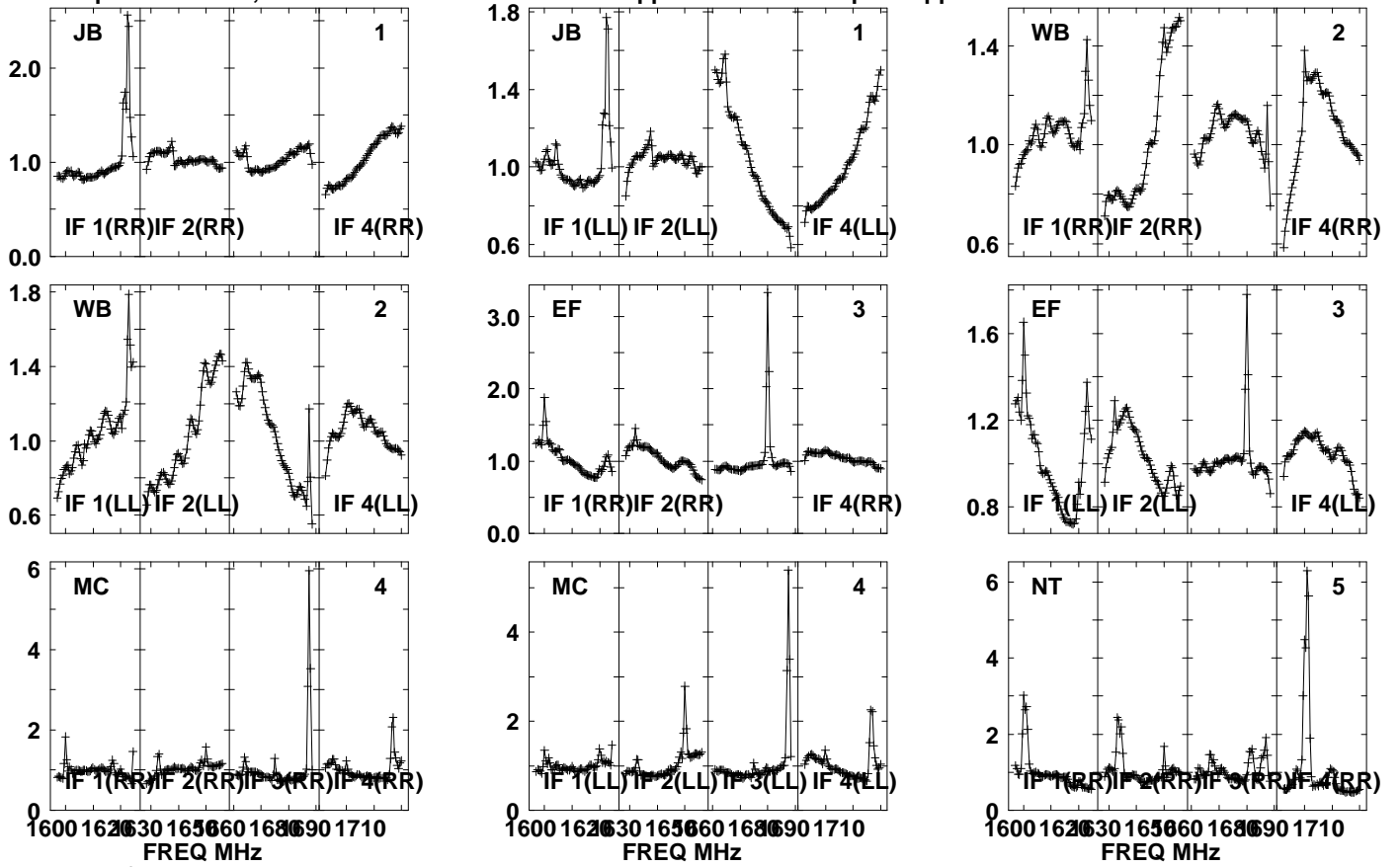

Lower frame: Real Jy
Auto-corr total-power spectrum Antenna: *
Timerange: 01/02:10:51 to 01/02:14:49

Plot file version 149 created 12-JUN-2023 14:39:16

J1548 ES106B.UVDATA.1

Freq = 1.5950 GHz, Bw = 32.000 MH No calibration applied and no bandpass applied

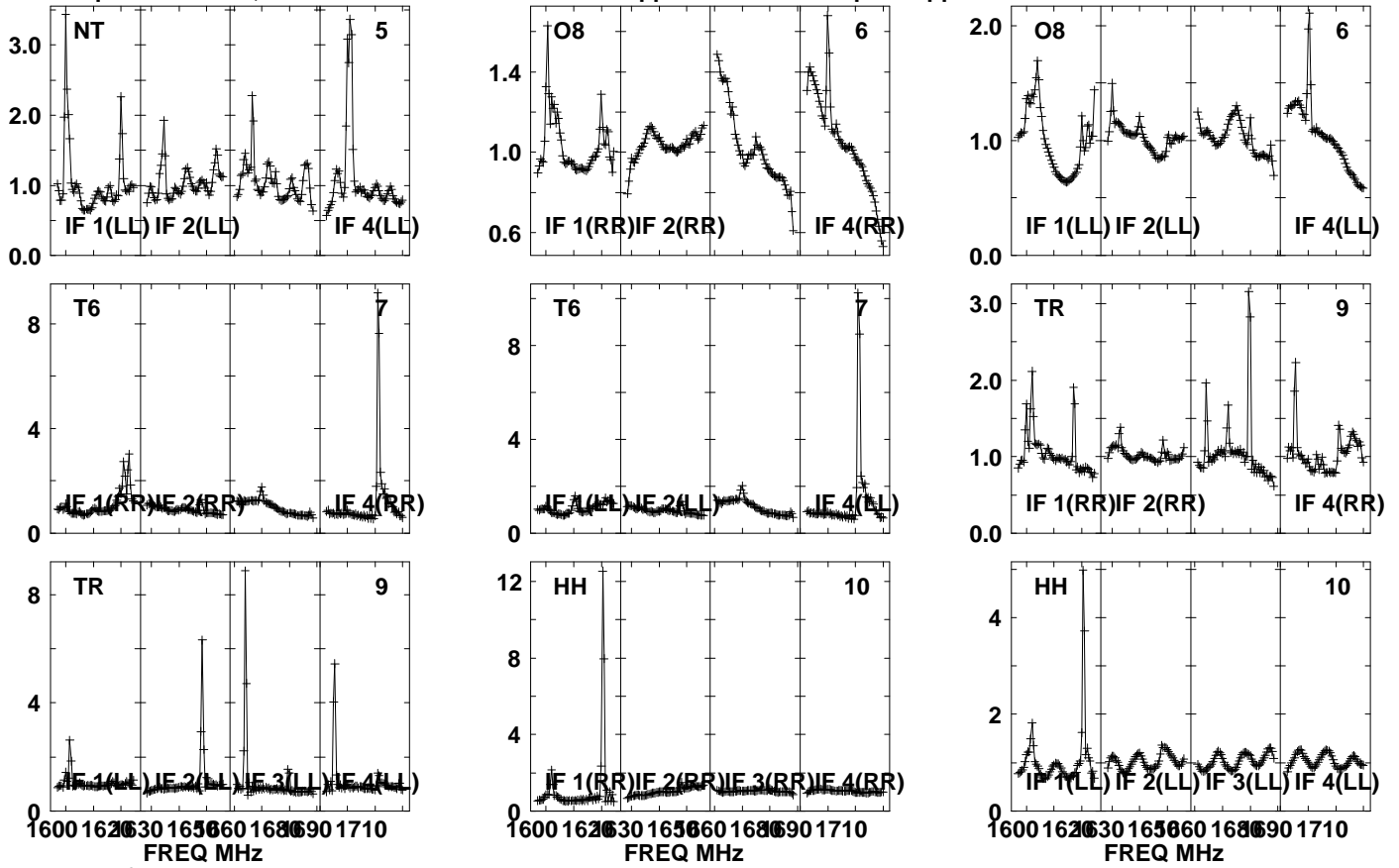

Lower frame: Real Jy

Auto-corr total-power spectrum Antenna: *

Timerange: 01/02:10:51 to 01/02:14:49

Plot file version 150 created 12-JUN-2023 14:39:16

J1547+2052 ES106B.UVDATA.1

Freq = 1.5950 GHz, Bw = 32.000 MH No calibration applied and no bandpass applied

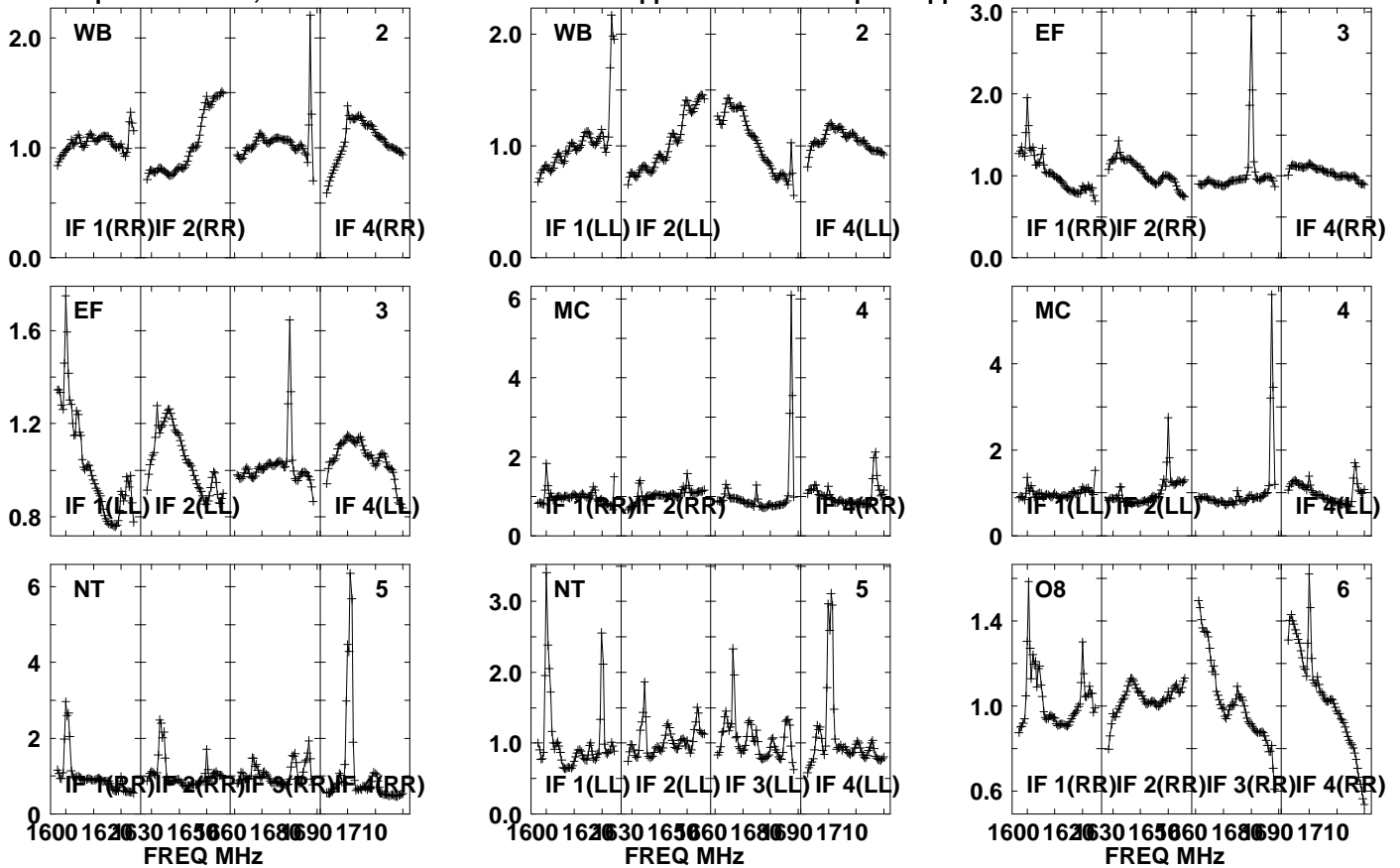

Lower frame: Real Jy

Auto-corr total-power spectrum Antenna: *

Timerange: 01/02:14:51 to 01/02:16:19

Plot file version 151 created 12-JUN-2023 14:39:16

J1547+2052 ES106B.UVDATA.1

Freq = 1.5950 GHz, Bw = 32.000 MH No calibration applied and no bandpass applied

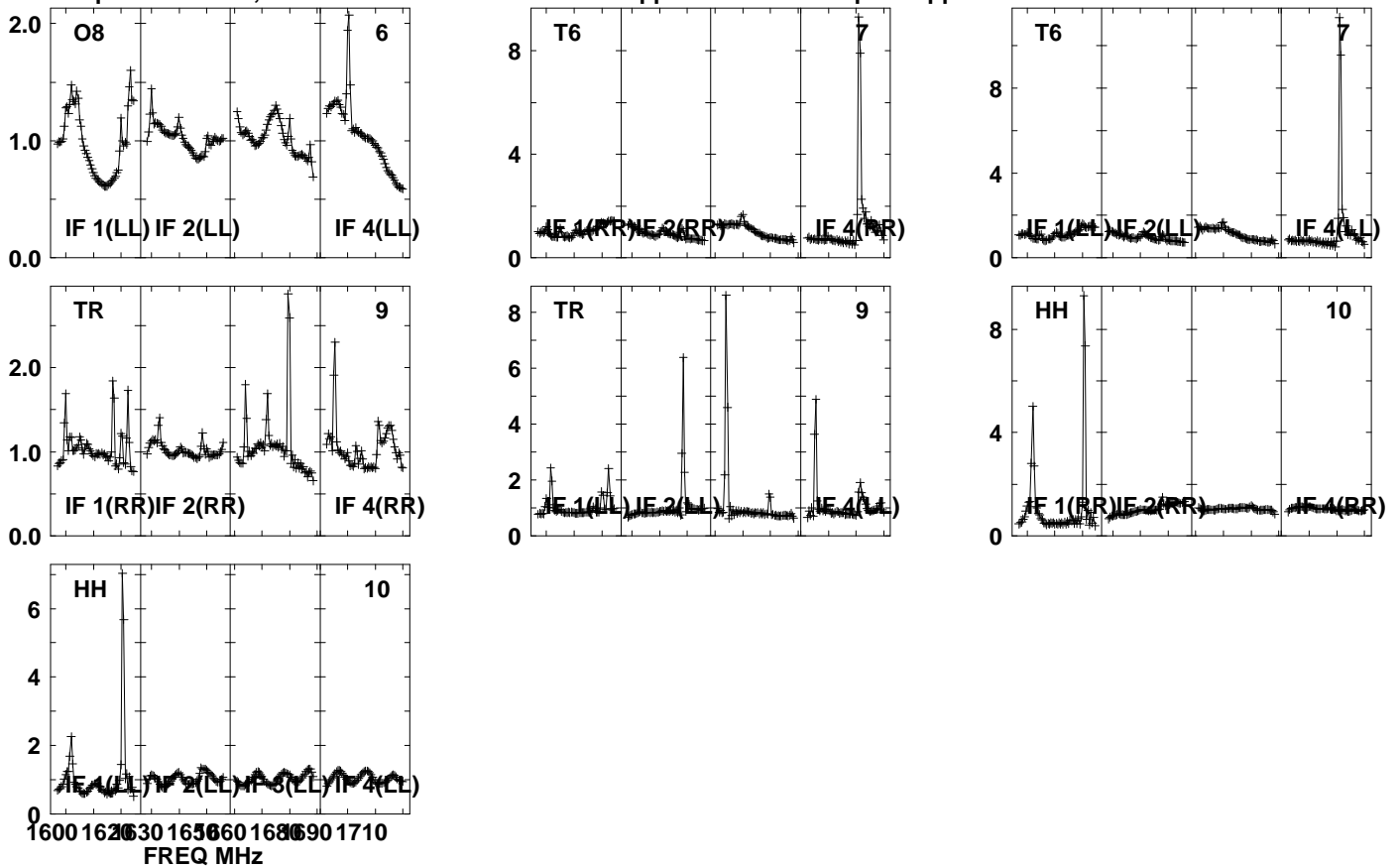

Lower frame: Real Jy

Auto-corr total-power spectrum Antenna: *

Timerange: 01/02:14:51 to 01/02:16:19

Plot file version 152 created 12-JUN-2023 14:39:17

J1548 ES106B.UVDATA.1

Freq = 1.5950 GHz, Bw = 32.000 MH No calibration applied and no bandpass applied

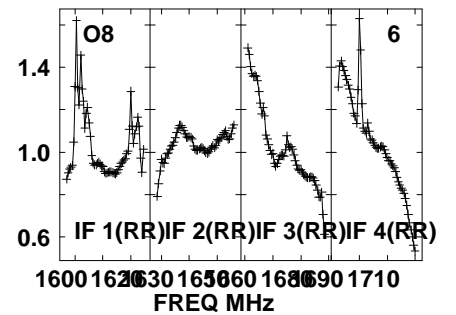
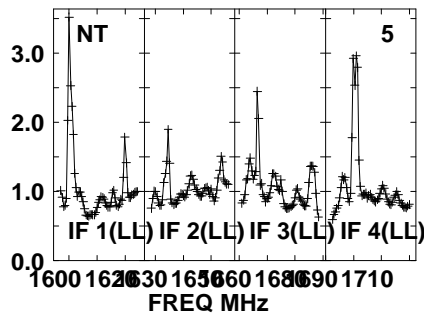
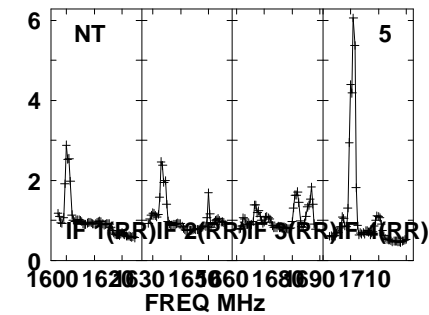
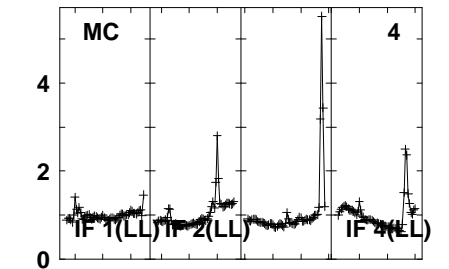
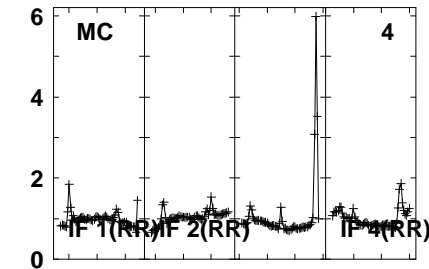
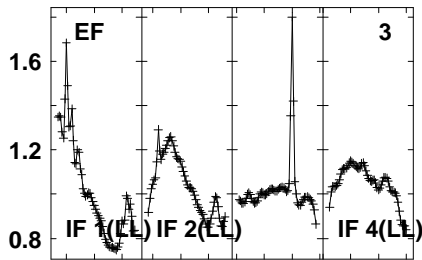
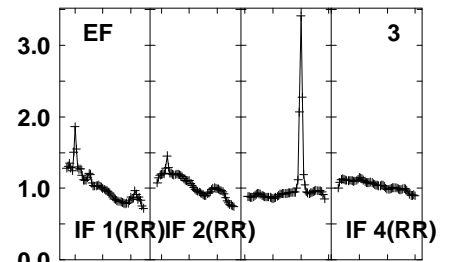
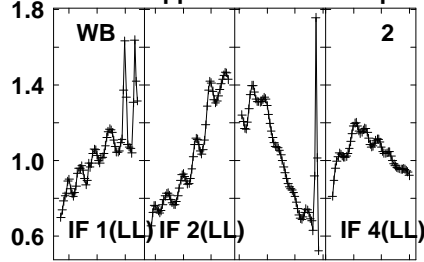
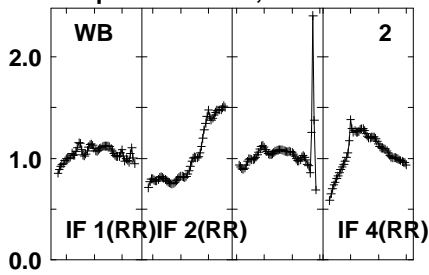

Lower frame: Real Jy

Auto-corr total-power spectrum Antenna: *

Timerange: 01/02:16:21 to 01/02:19:49

Plot file version 153 created 12-JUN-2023 14:39:17

J1548 ES106B.UVDATA.1

Freq = 1.5950 GHz, Bw = 32.000 MH No calibration applied and no bandpass applied

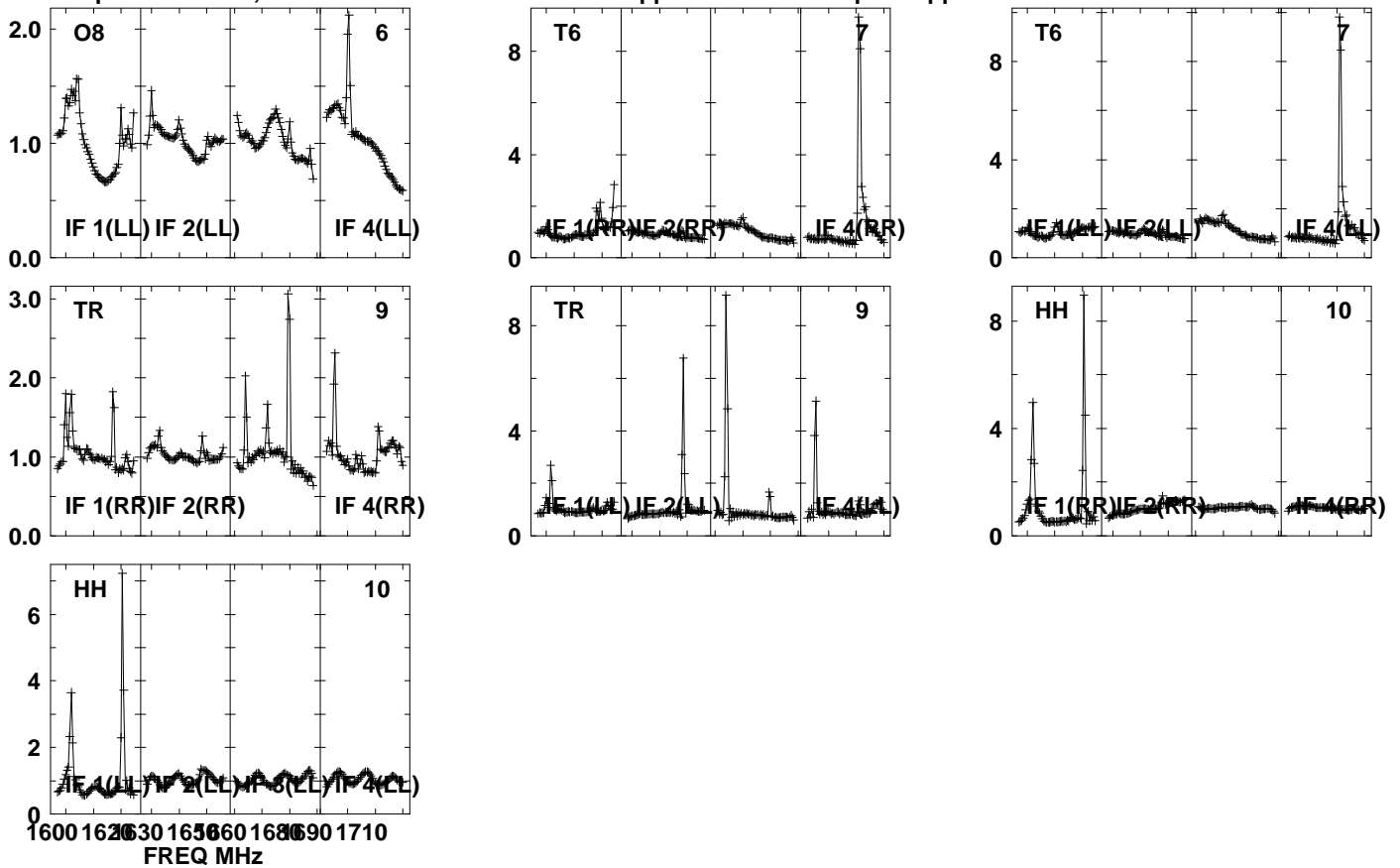

Lower frame: Real Jy

Auto-corr total-power spectrum Antenna: *

Timerange: 01/02:16:21 to 01/02:19:49

Plot file version 154 created 12-JUN-2023 14:39:17

J1547+2052 ES106B.UVDATA.1

Freq = 1.5950 GHz, Bw = 32.000 MH No calibration applied and no bandpass applied

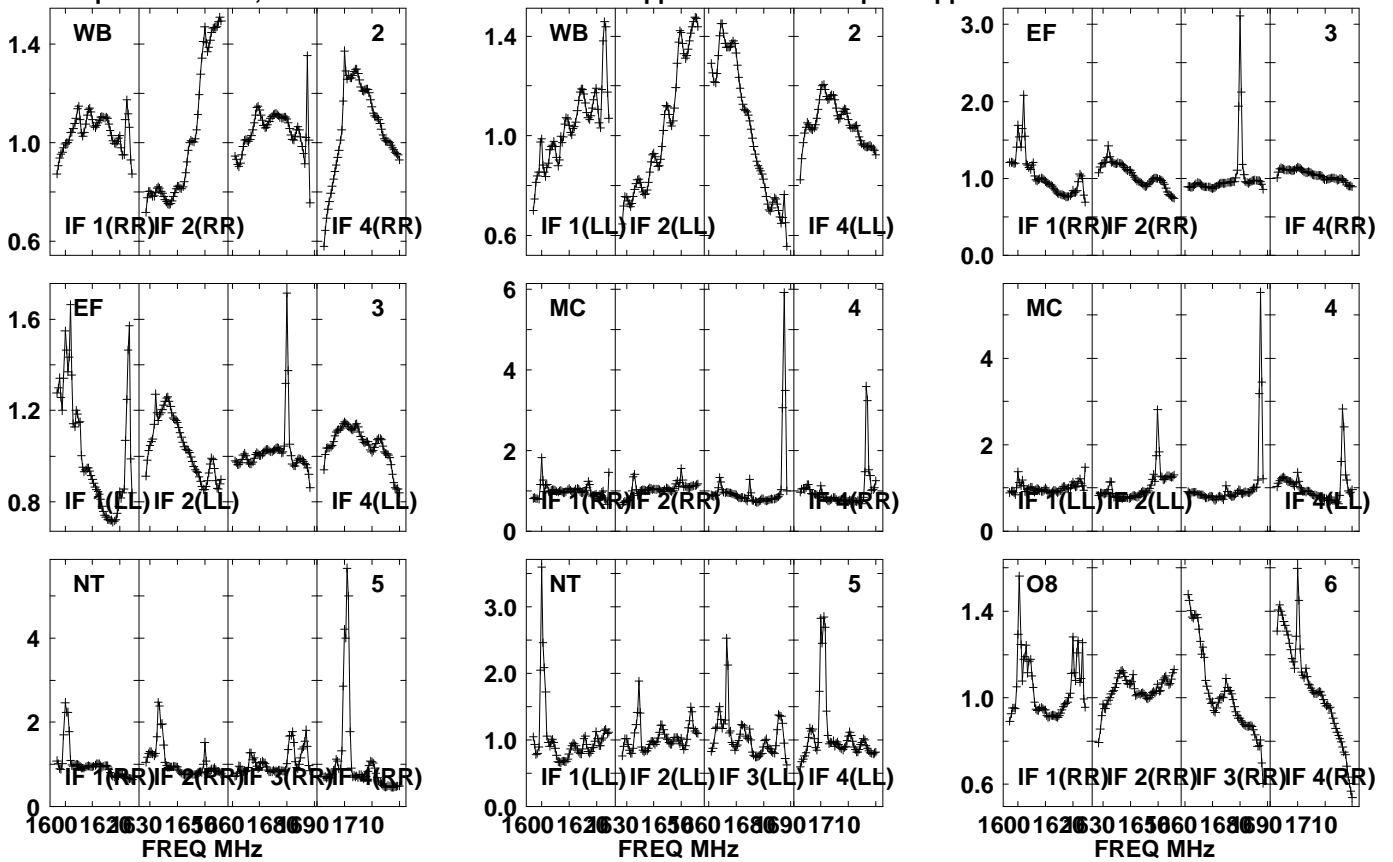

Lower frame: Real Jy
Auto-corr total-power spectrum Antenna: *
Timerange: 01/02:20:21 to 01/02:21:49

Plot file version 155 created 12-JUN-2023 14:39:17

J1547+2052 ES106B.UVDATA.1

Freq = 1.5950 GHz, Bw = 32.000 MH No calibration applied and no bandpass applied

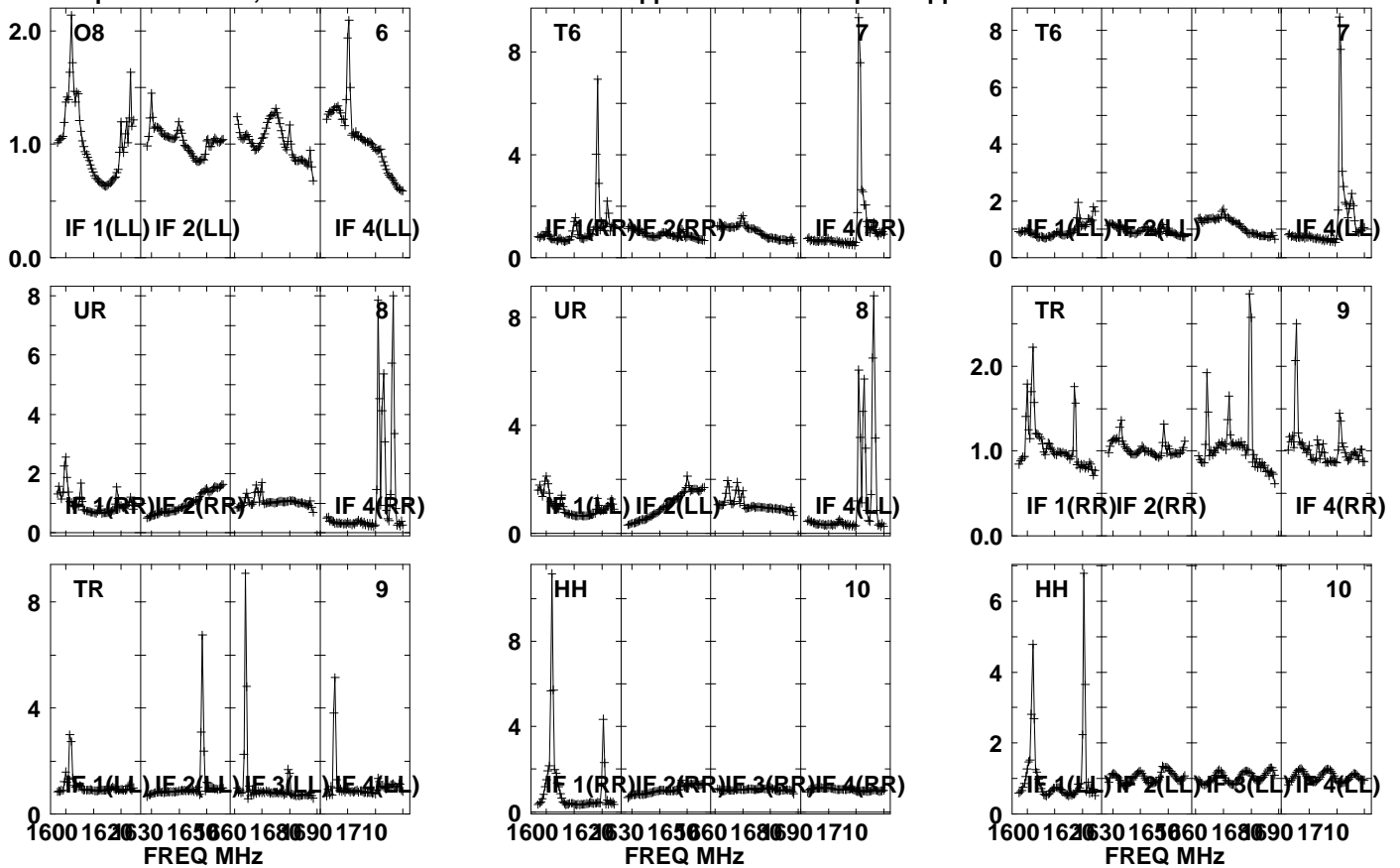

Lower frame: Real Jy

Auto-corr total-power spectrum Antenna: *

Timerange: 01/02:20:21 to 01/02:21:49

Plot file version 156 created 12-JUN-2023 14:39:17

J1548 ES106B.UVDATA.1

Freq = 1.5950 GHz, Bw = 32.000 MH No calibration applied and no bandpass applied

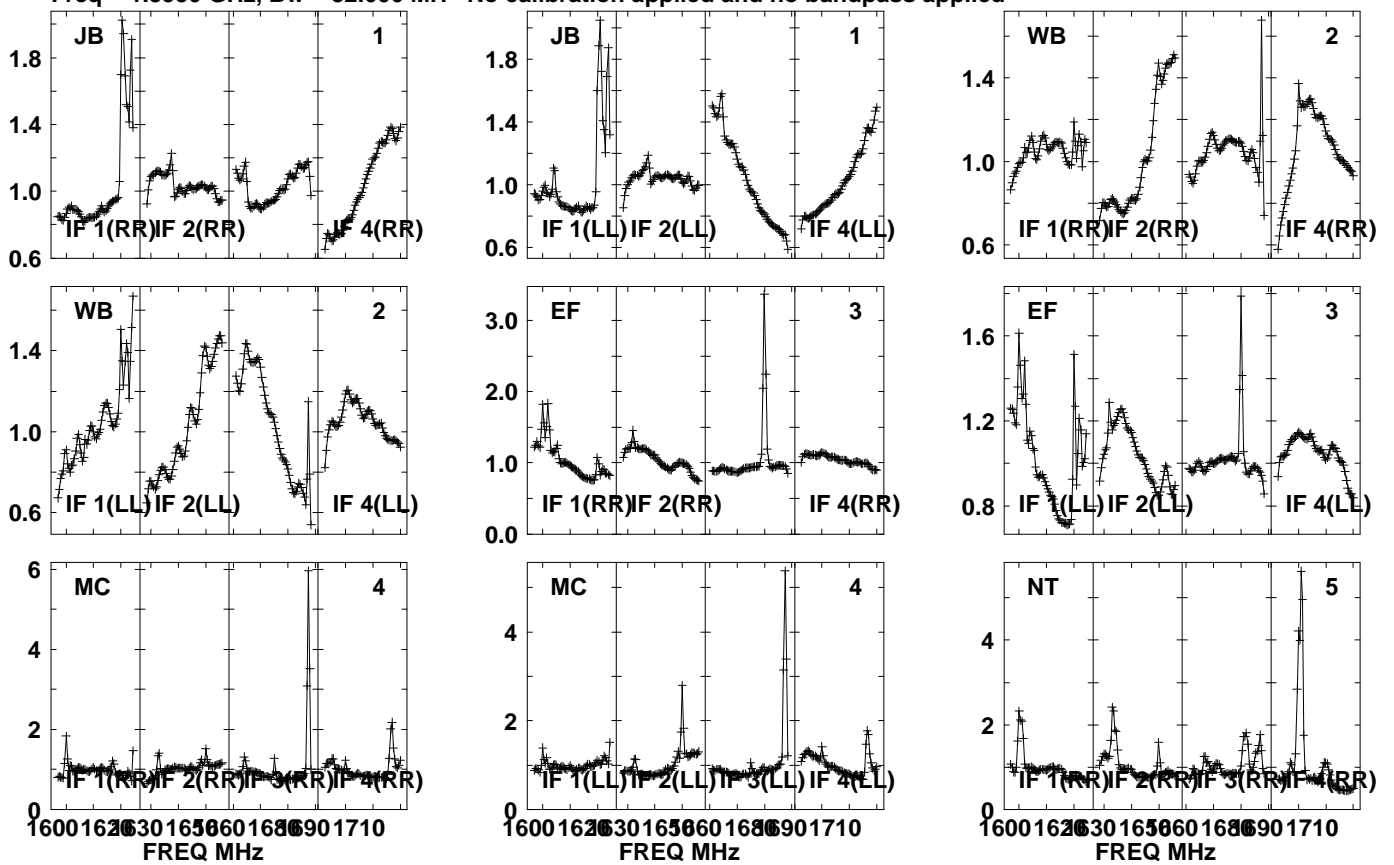

Lower frame: Real Jy
Auto-corr total-power spectrum Antenna: *
Timerange: 01/02:21:51 to 01/02:25:19

Plot file version 157 created 12-JUN-2023 14:39:17

J1548 ES106B.UVDATA.1

Freq = 1.5950 GHz, Bw = 32.000 MH No calibration applied and no bandpass applied

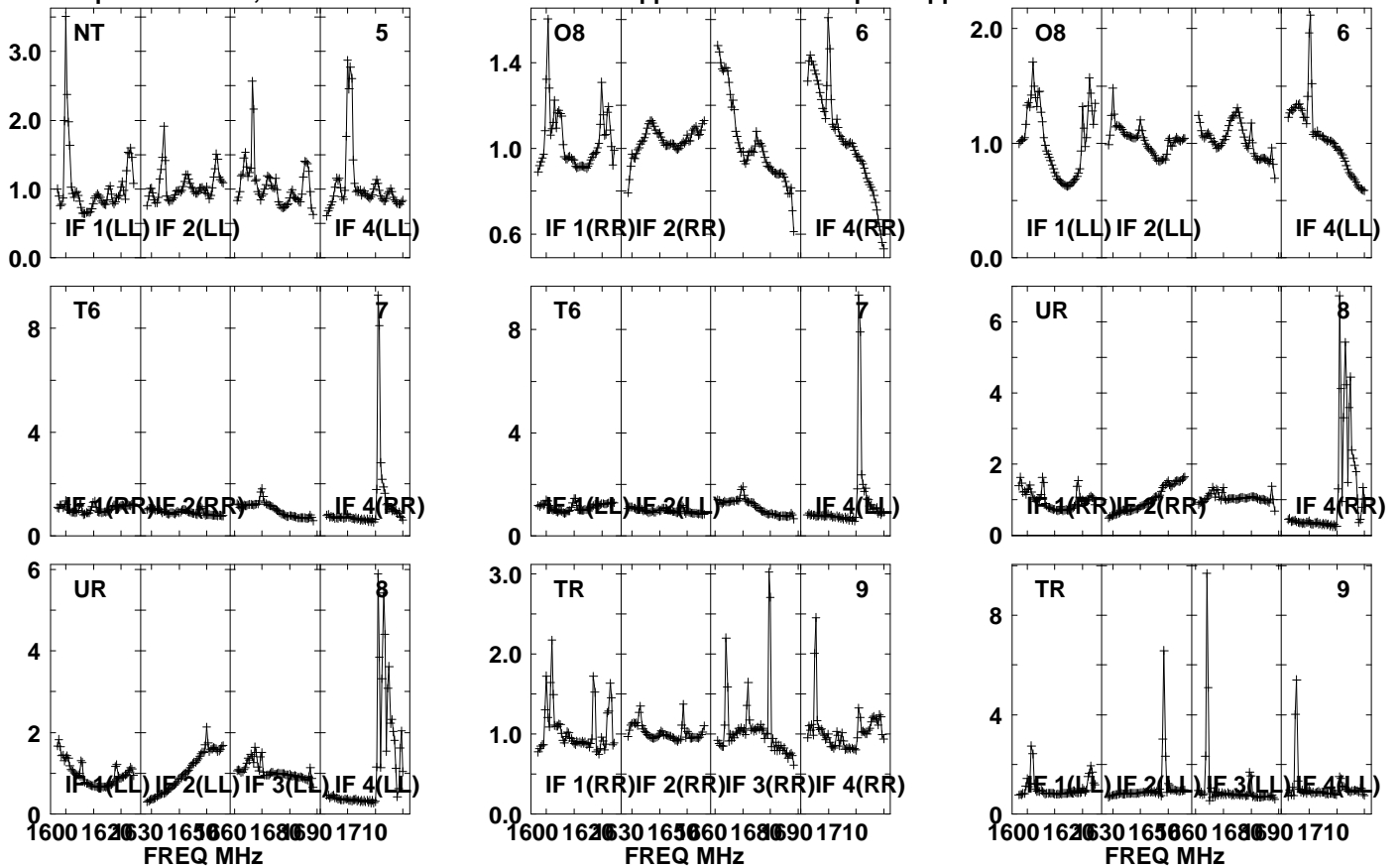

Lower frame: Real Jy

Auto-corr total-power spectrum Antenna: *

Timerange: 01/02:21:51 to 01/02:25:19

Plot file version 158 created 12-JUN-2023 14:39:17

J1548 ES106B.UVDATA.1

Freq = 1.5950 GHz, Bw = 32.000 MH No calibration applied and no bandpass applied

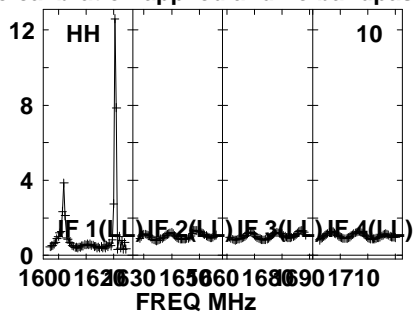
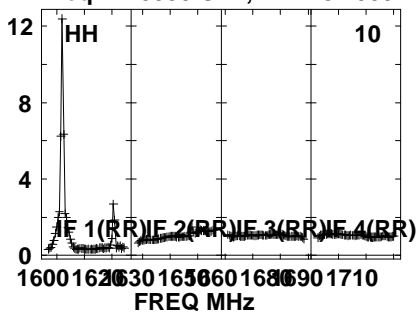

Lower frame: Real Jy
Auto-corr total-power spectrum Antenna: *
Timerange: 01/02:21:51 to 01/02:25:19

Plot file version 159 created 12-JUN-2023 14:39:17

J1547+2052 ES106B.UVDATA.1

Freq = 1.5950 GHz, Bw = 32.000 MH No calibration applied and no bandpass applied

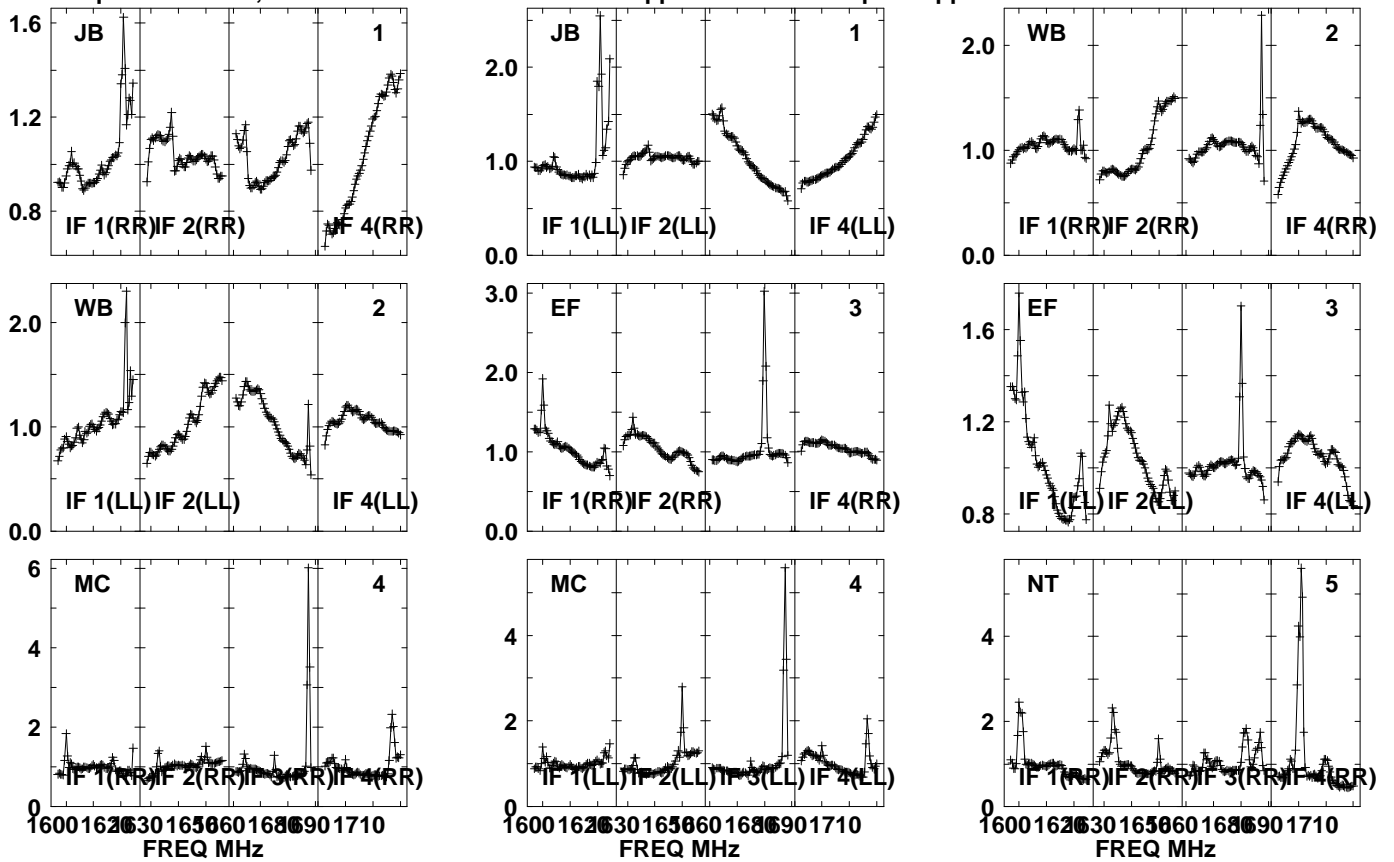

Lower frame: Real Jy
Auto-corr total-power spectrum Antenna: *
Timerange: 01/02:25:21 to 01/02:26:49

Plot file version 160 created 12-JUN-2023 14:39:17

J1547+2052 ES106B.UVDATA.1

Freq = 1.5950 GHz, Bw = 32.000 MH No calibration applied and no bandpass applied

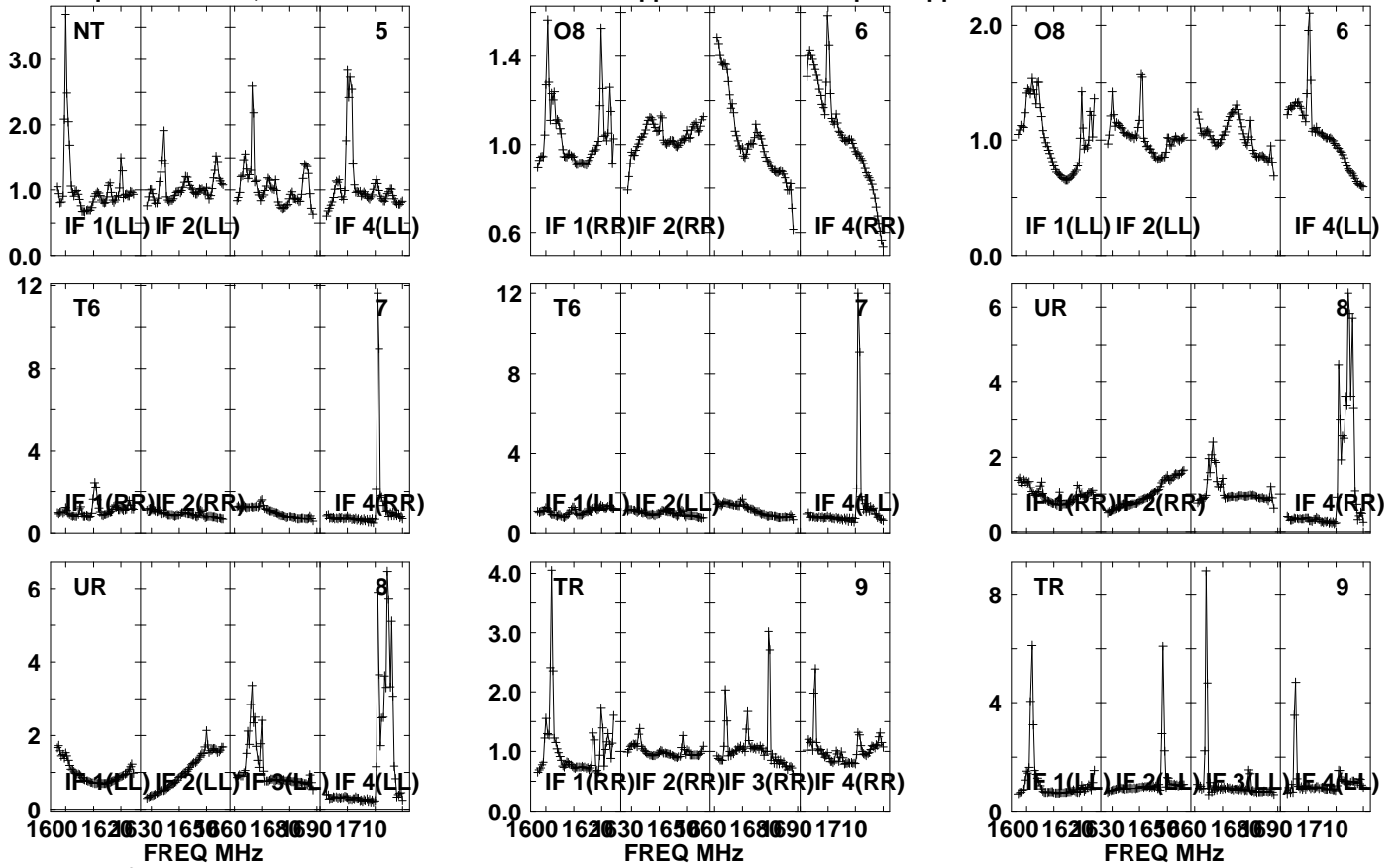

Lower frame: Real Jy
Auto-corr total-power spectrum Antenna: *
Timerange: 01/02:25:21 to 01/02:26:49

Plot file version 161 created 12-JUN-2023 14:39:17

J1547+2052 ES106B.UVDATA.1

Freq = 1.5950 GHz, Bw = 32.000 MH No calibration applied and no bandpass applied

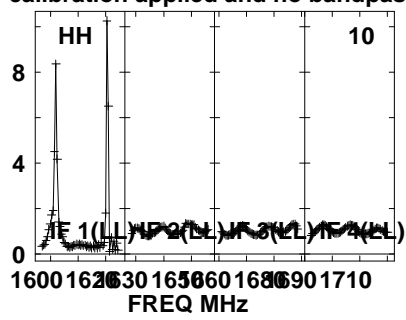
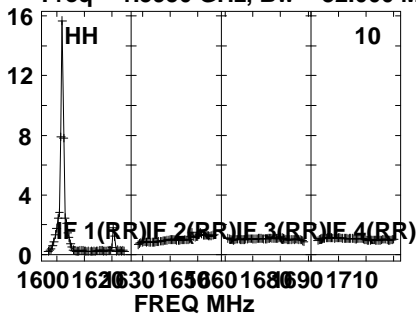

Lower frame: Real Jy
Auto-corr total-power spectrum Antenna: *
Timerange: 01/02:25:21 to 01/02:26:49

Plot file version 162 created 12-JUN-2023 14:39:17

J1545+2006 ES106B.UVDATA.1

Freq = 1.5950 GHz, Bw = 32.000 MH No calibration applied and no bandpass applied

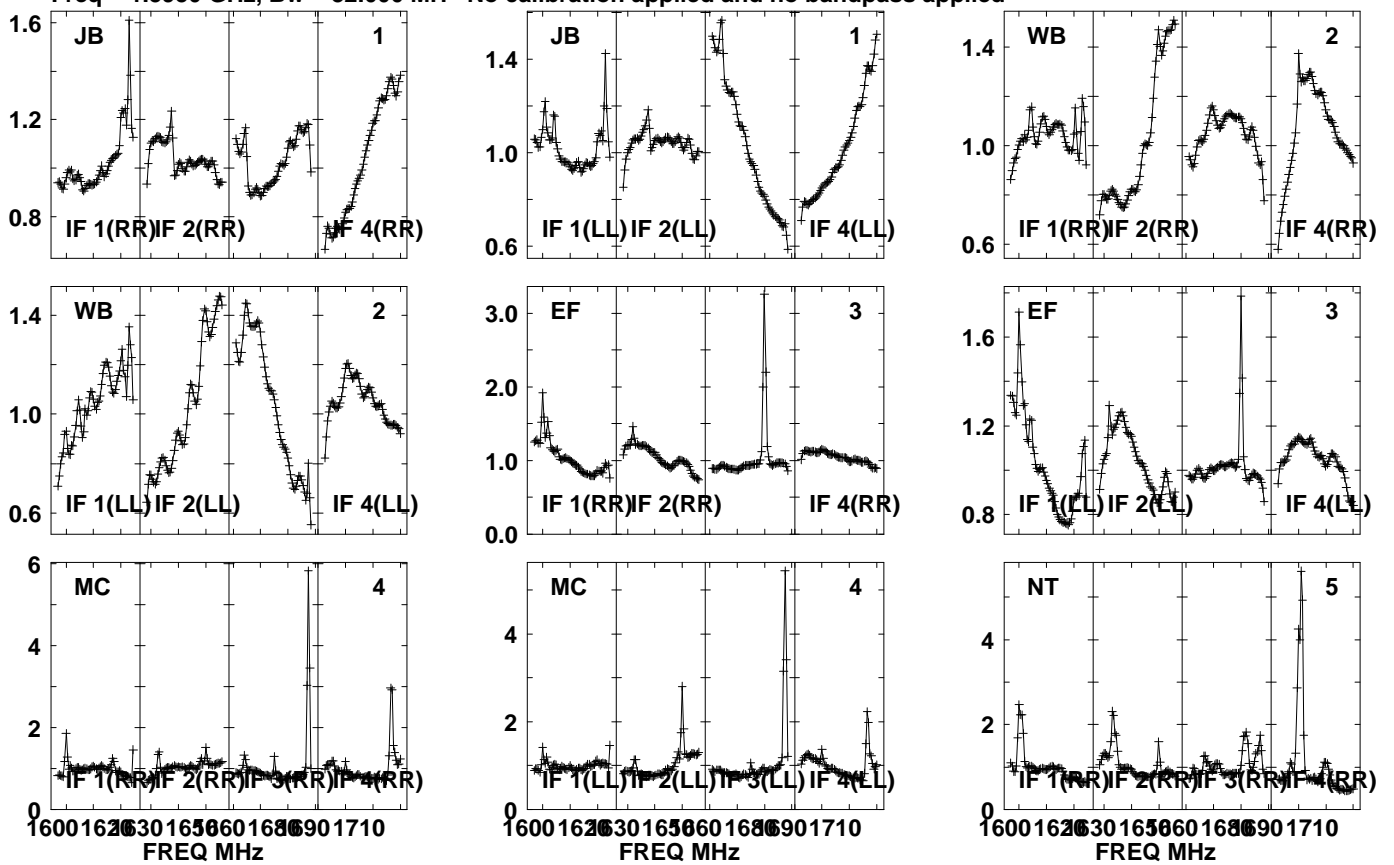

Lower frame: Real Jy
Auto-corr total-power spectrum Antenna: *
Timerange: 01/02:26:51 to 01/02:29:19

Plot file version 163 created 12-JUN-2023 14:39:17

J1545+2006 ES106B.UVDATA.1

Freq = 1.5950 GHz, Bw = 32.000 MH No calibration applied and no bandpass applied

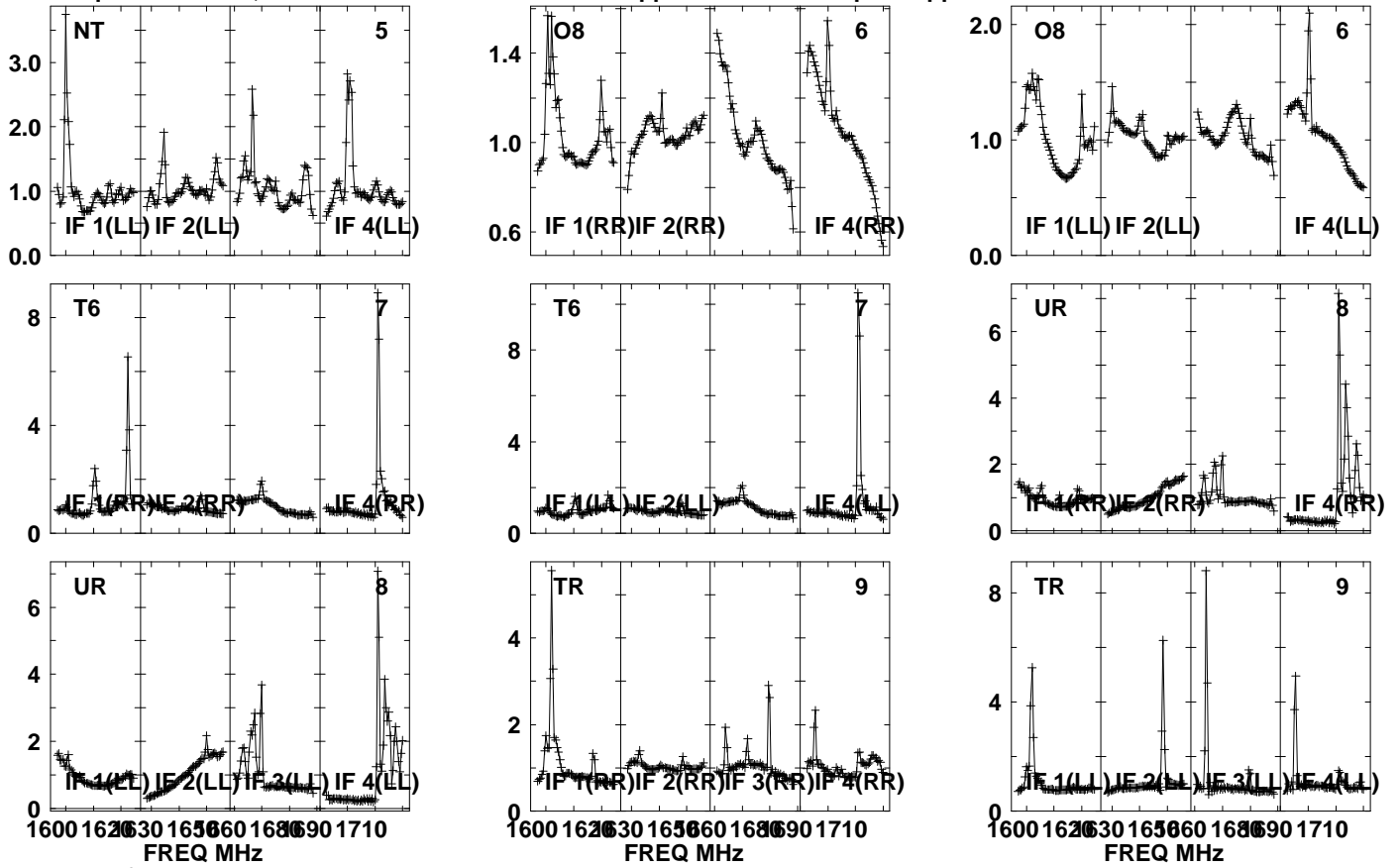

Lower frame: Real Jy

Auto-corr total-power spectrum Antenna: *

Timerange: 01/02:26:51 to 01/02:29:19

Plot file version 164 created 12-JUN-2023 14:39:17

J1545+2006 ES106B.UVDATA.1

Freq = 1.5950 GHz, Bw = 32.000 MH No calibration applied and no bandpass applied

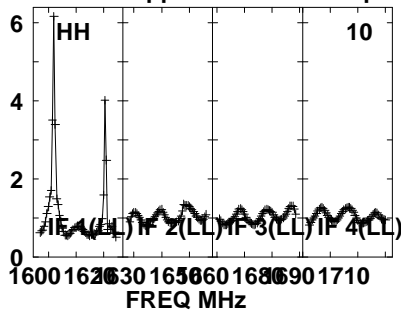
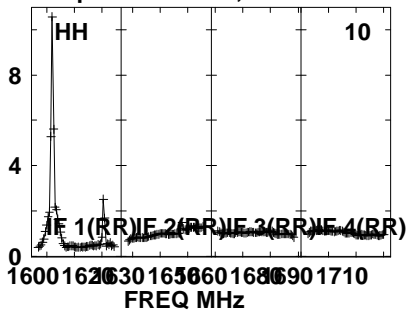

Lower frame: Real Jy
Auto-corr total-power spectrum Antenna: *
Timerange: 01/02:26:51 to 01/02:29:19

Plot file version 165 created 12-JUN-2023 14:39:17

J1547+2052 ES106B.UVDATA.1

Freq = 1.5950 GHz, Bw = 32.000 MH No calibration applied and no bandpass applied

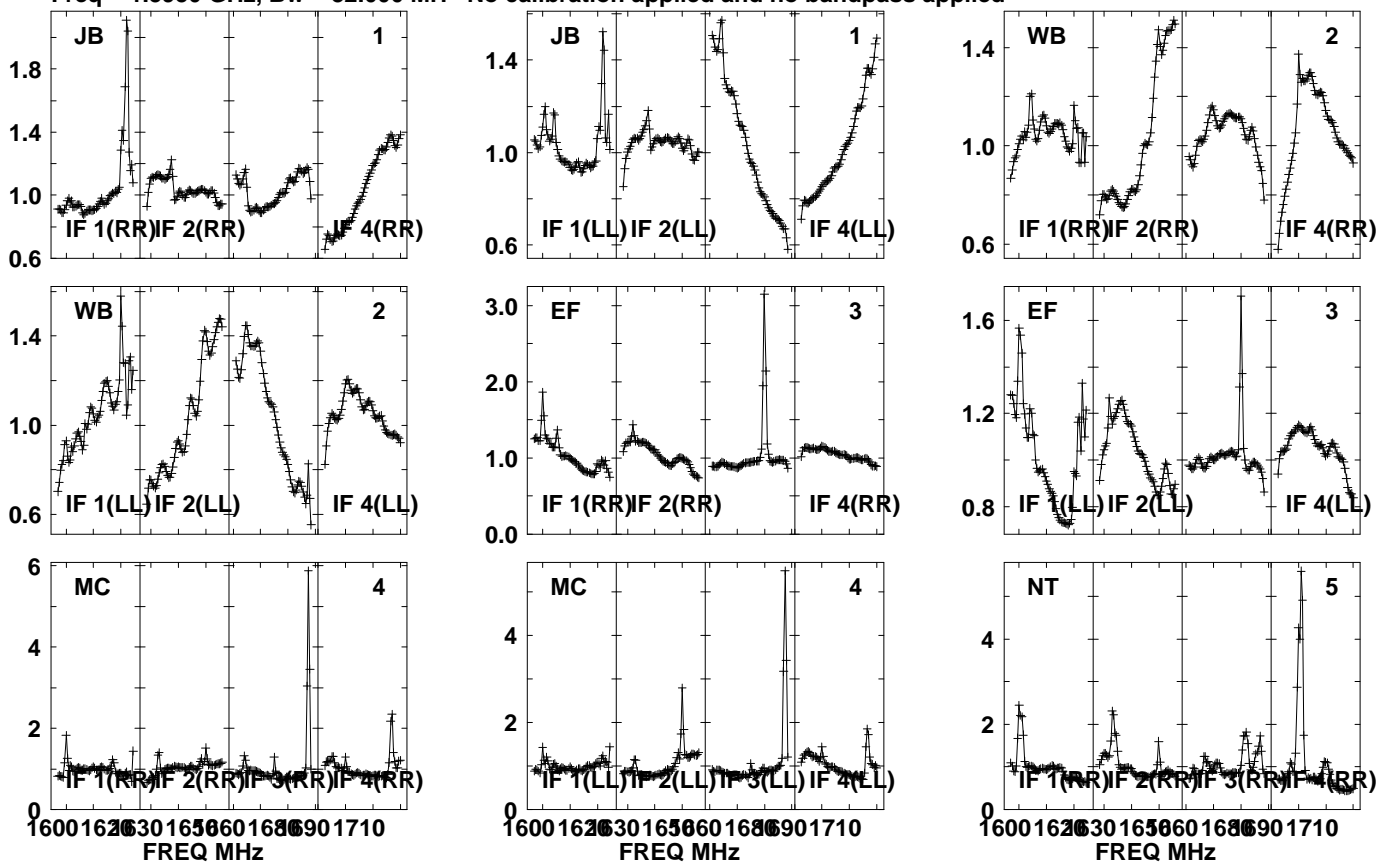

Lower frame: Real Jy
Auto-corr total-power spectrum Antenna: *
Timerange: 01/02:29:21 to 01/02:30:49

Plot file version 166 created 12-JUN-2023 14:39:17

J1547+2052 ES106B.UVDATA.1

Freq = 1.5950 GHz, Bw = 32.000 MH No calibration applied and no bandpass applied

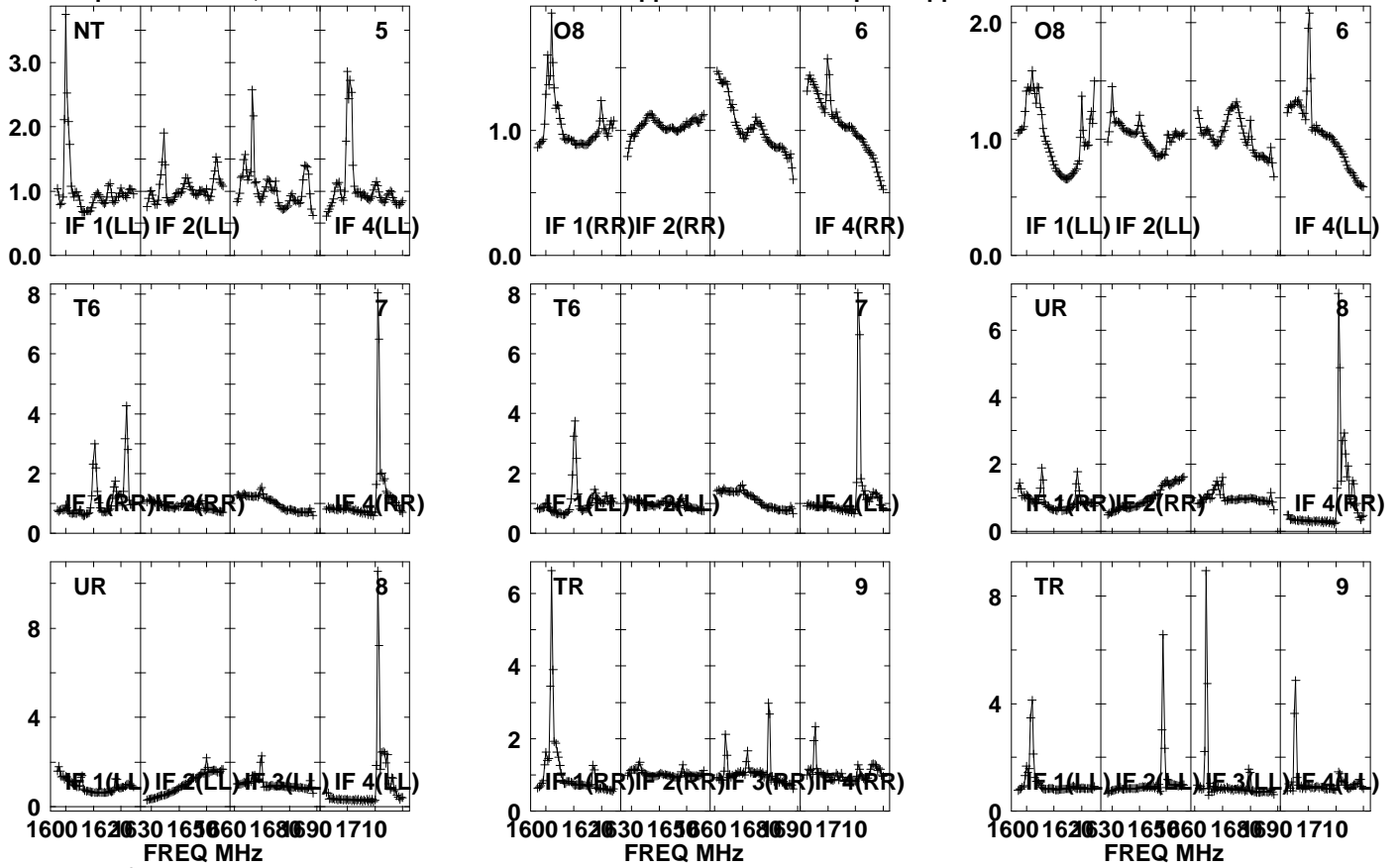

Lower frame: Real Jy
Auto-corr total-power spectrum Antenna: *
Timerange: 01/02:29:21 to 01/02:30:49

Plot file version 167 created 12-JUN-2023 14:39:17

J1547+2052 ES106B.UVDATA.1

Freq = 1.5950 GHz, Bw = 32.000 MH No calibration applied and no bandpass applied

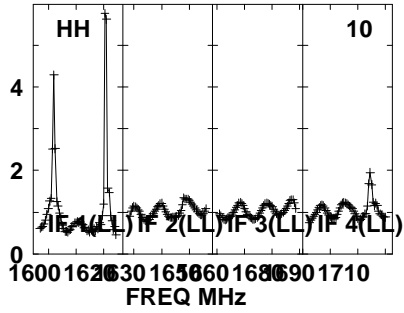
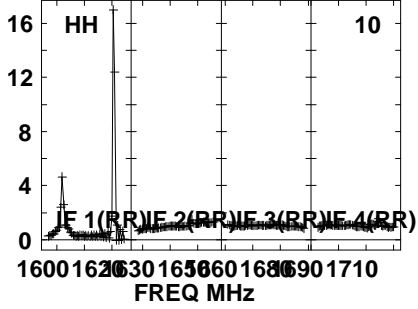

Lower frame: Real Jy
Auto-corr total-power spectrum Antenna: *
Timerange: 01/02:29:21 to 01/02:30:49

Plot file version 168 created 12-JUN-2023 14:39:17

J1548 ES106B.UVDATA.1

Freq = 1.5950 GHz, Bw = 32.000 MH No calibration applied and no bandpass applied

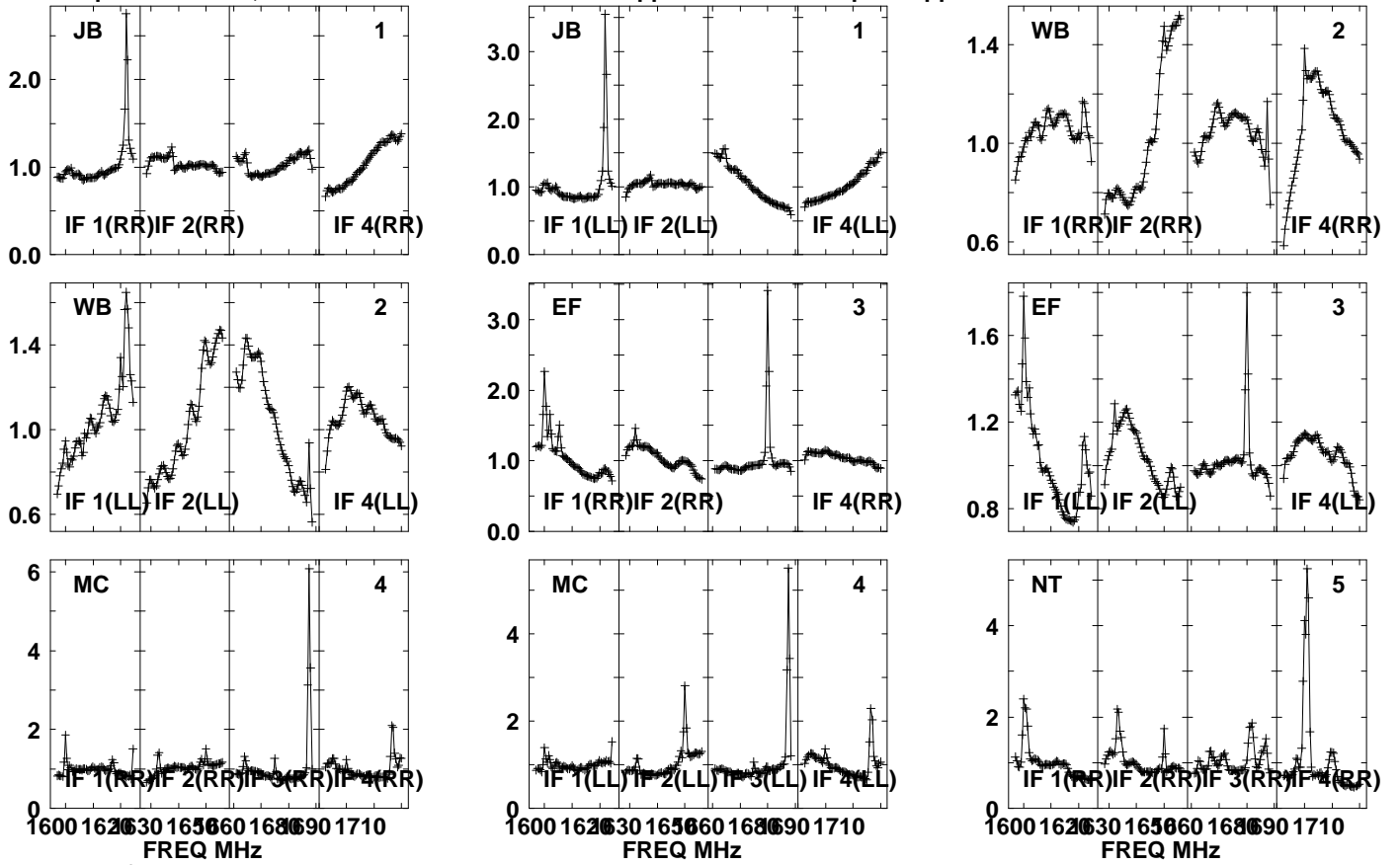

Lower frame: Real Jy

Auto-corr total-power spectrum Antenna: *

Timerange: 01/02:31:21 to 01/02:35:19

Plot file version 169 created 12-JUN-2023 14:39:17

J1548 ES106B.UVDATA.1

Freq = 1.5950 GHz, Bw = 32.000 MH No calibration applied and no bandpass applied

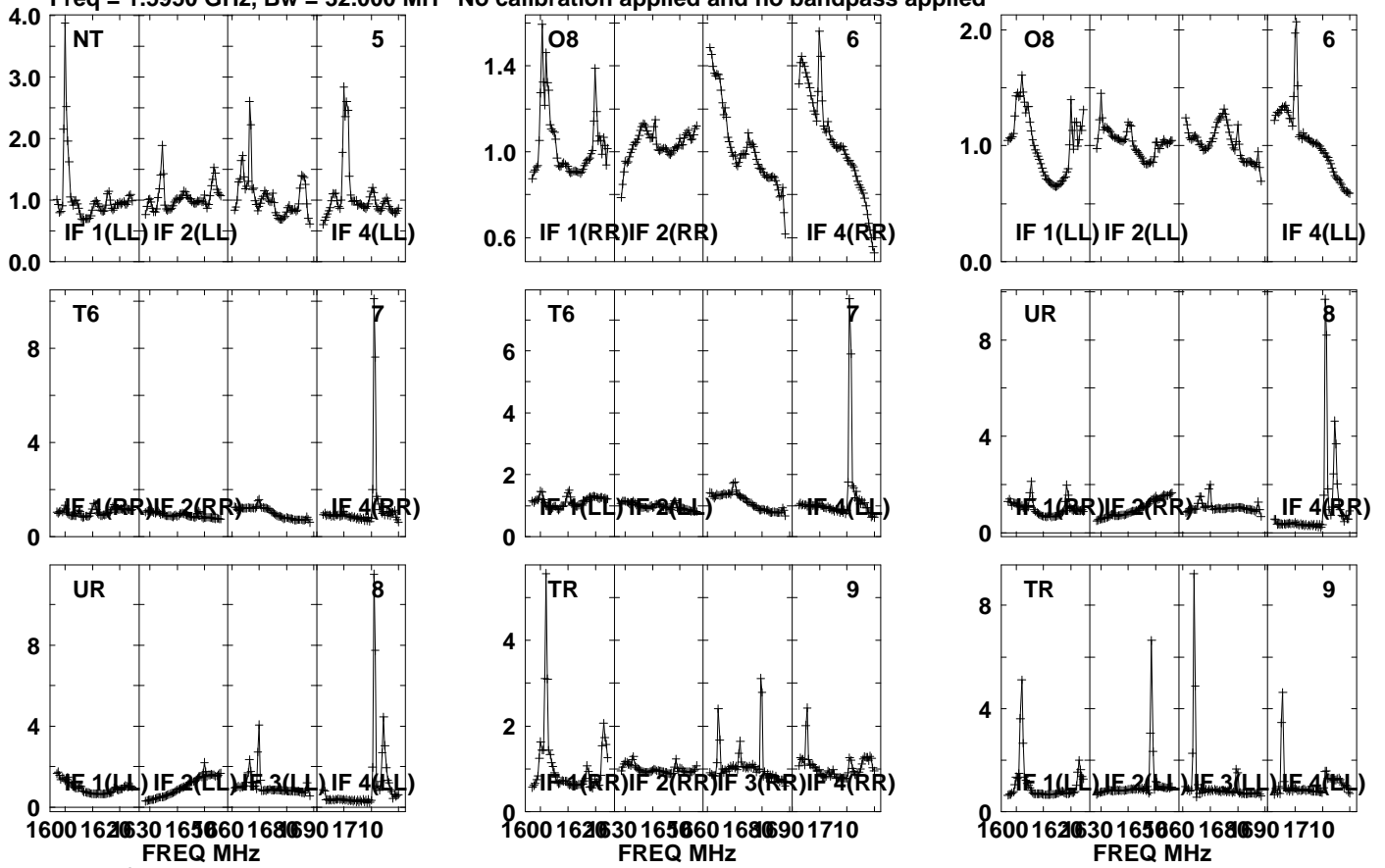

Lower frame: Real Jy

Auto-corr total-power spectrum Antenna: *

Timerange: 01/02:31:21 to 01/02:35:19

Plot file version 170 created 12-JUN-2023 14:39:18

J1548 ES106B.UVDATA.1

Freq = 1.5950 GHz, Bw = 32.000 MH No calibration applied and no bandpass applied

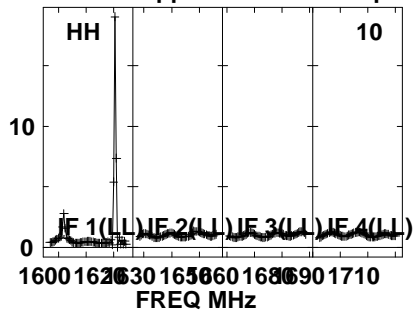
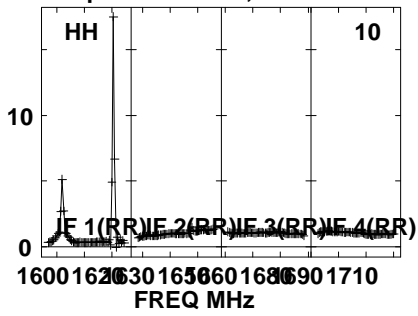

Lower frame: Real Jy
Auto-corr total-power spectrum Antenna: *
Timerange: 01/02:31:21 to 01/02:35:19

Plot file version 171 created 12-JUN-2023 14:39:18

J1547+2052 ES106B.UVDATA.1

Freq = 1.5950 GHz, Bw = 32.000 MH No calibration applied and no bandpass applied

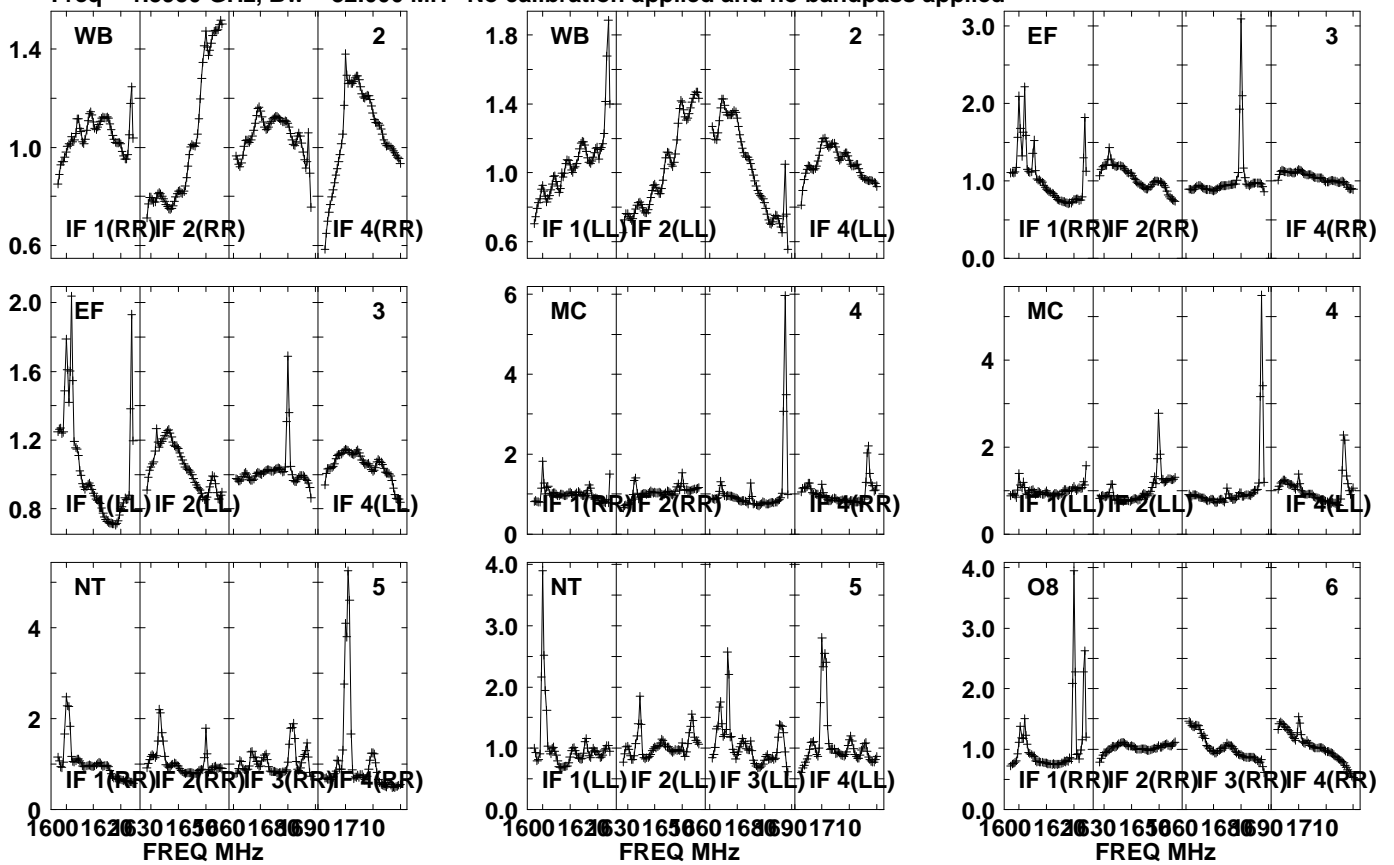

Lower frame: Real Jy

Auto-corr total-power spectrum Antenna: *

Timerange: 01/02:35:21 to 01/02:36:49

Plot file version 172 created 12-JUN-2023 14:39:18

J1547+2052 ES106B.UVDATA.1

Freq = 1.5950 GHz, Bw = 32.000 MH No calibration applied and no bandpass applied

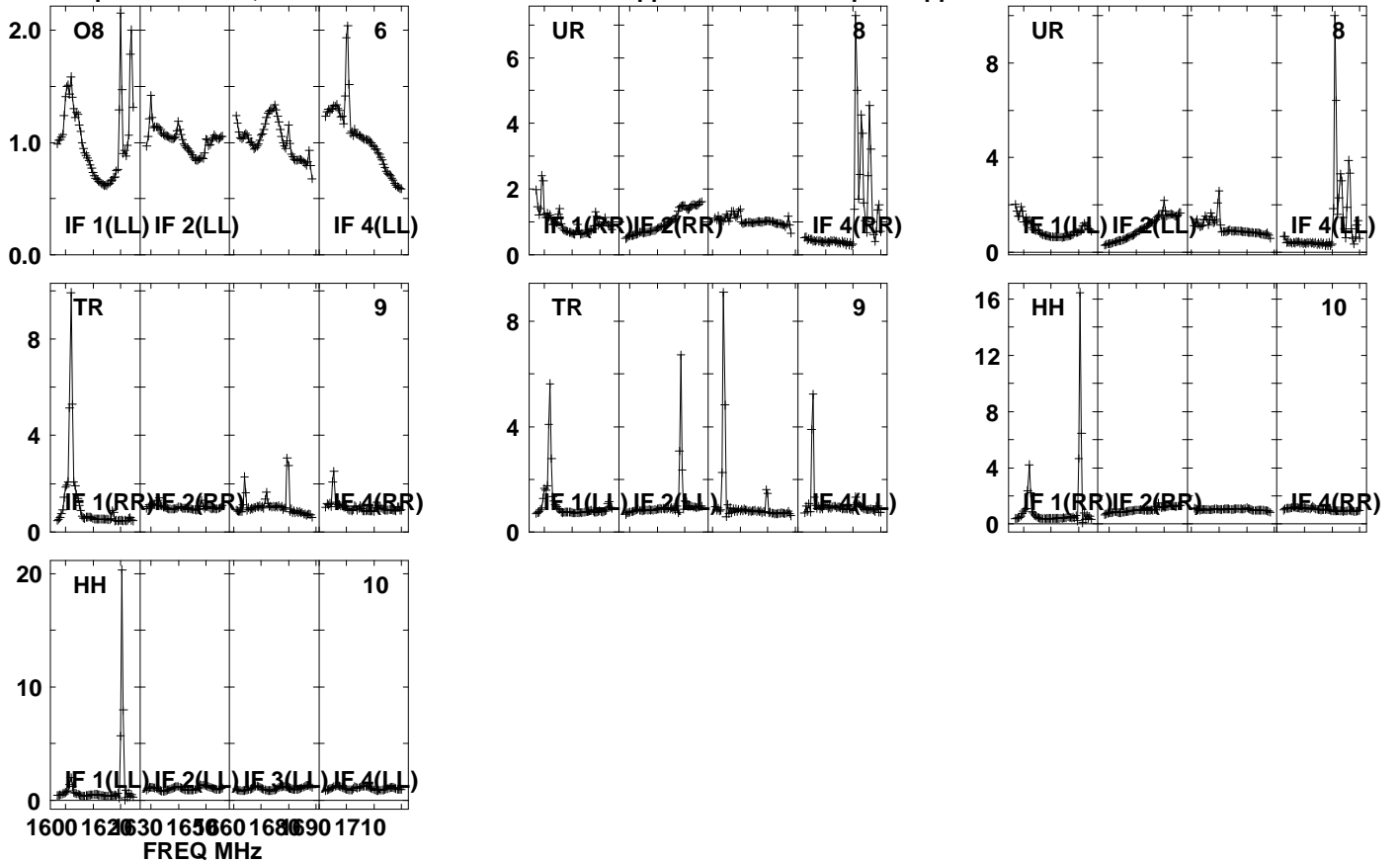

1600 1620 1630 1650 1660 1680 1690 1710
FREQ MHz

Lower frame: Real Jy

Auto-corr total-power spectrum Antenna: *

Timerange: 01/02:35:21 to 01/02:36:49

Plot file version 173 created 12-JUN-2023 14:39:18

J1548 ES106B.UVDATA.1

Freq = 1.5950 GHz, Bw = 32.000 MH No calibration applied and no bandpass applied

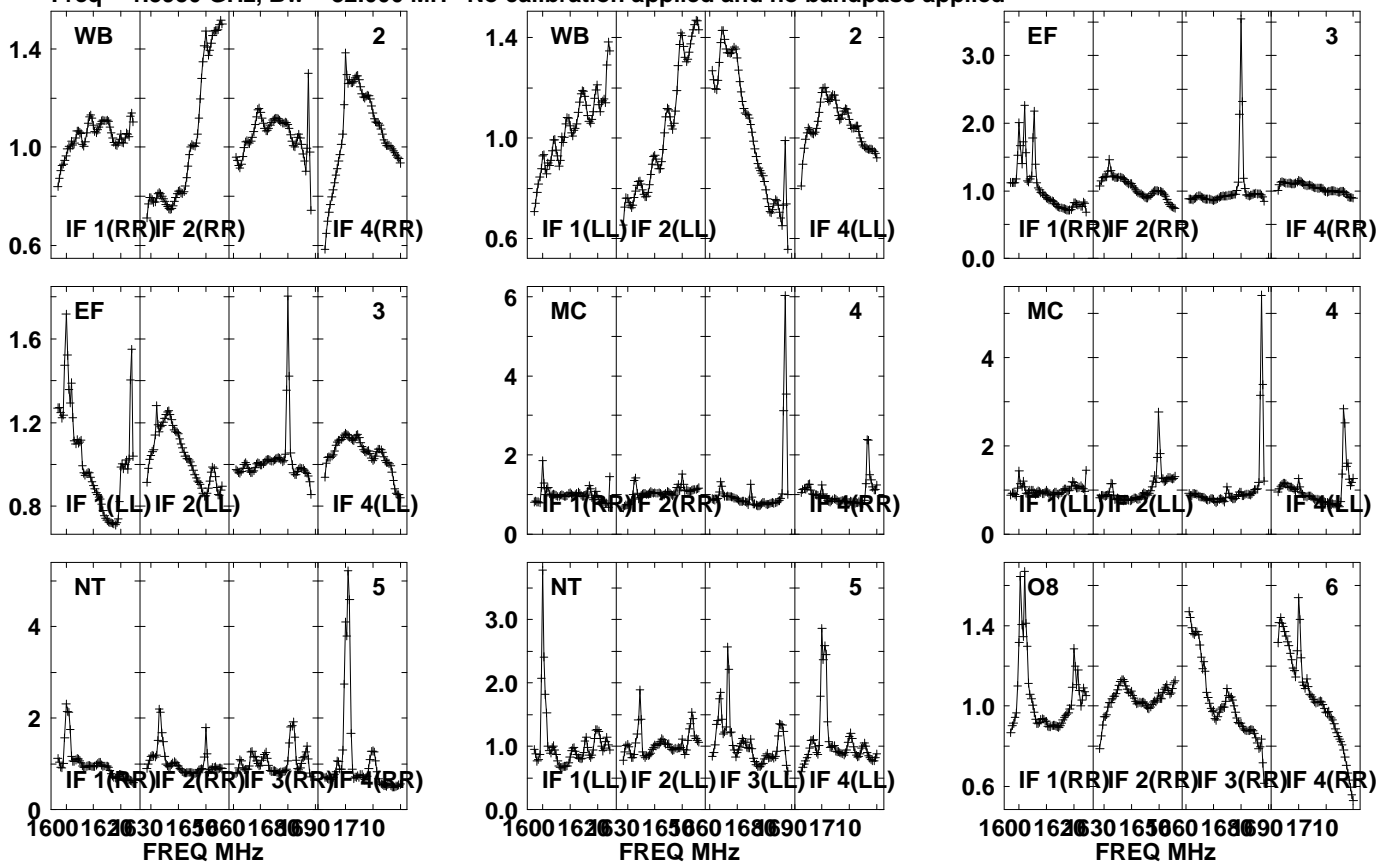

Lower frame: Real Jy
Auto-corr total-power spectrum Antenna: *
Timerange: 01/02:36:51 to 01/02:40:19

Plot file version 174 created 12-JUN-2023 14:39:18

J1548 ES106B.UVDATA.1

Freq = 1.5950 GHz, Bw = 32.000 MH No calibration applied and no bandpass applied

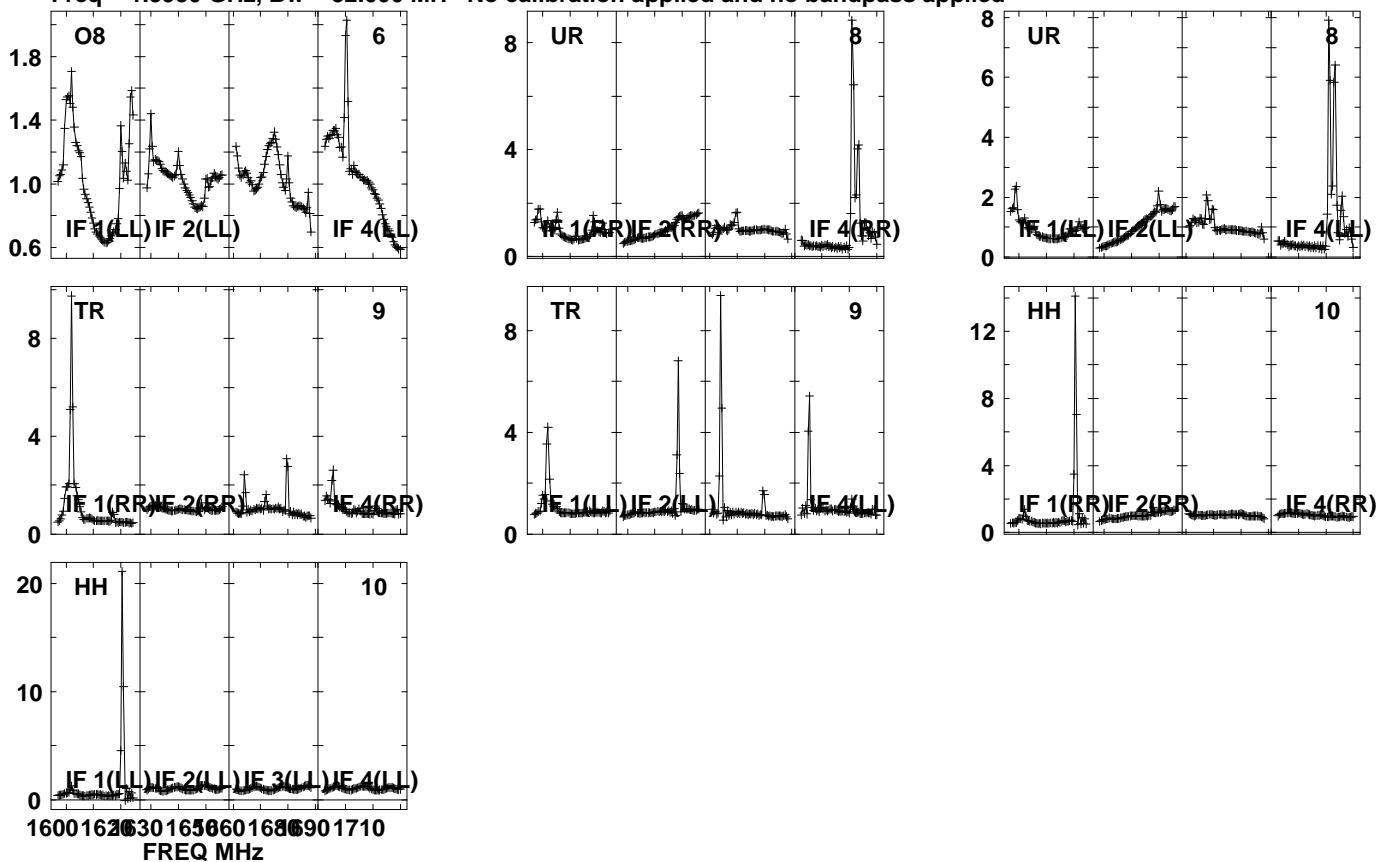

Lower frame: Real Jy

Auto-corr total-power spectrum Antenna: *

Timerange: 01/02:36:51 to 01/02:40:19

Plot file version 175 created 12-JUN-2023 14:39:18

J1547+2052 ES106B.UVDATA.1

Freq = 1.5950 GHz, Bw = 32.000 MH No calibration applied and no bandpass applied

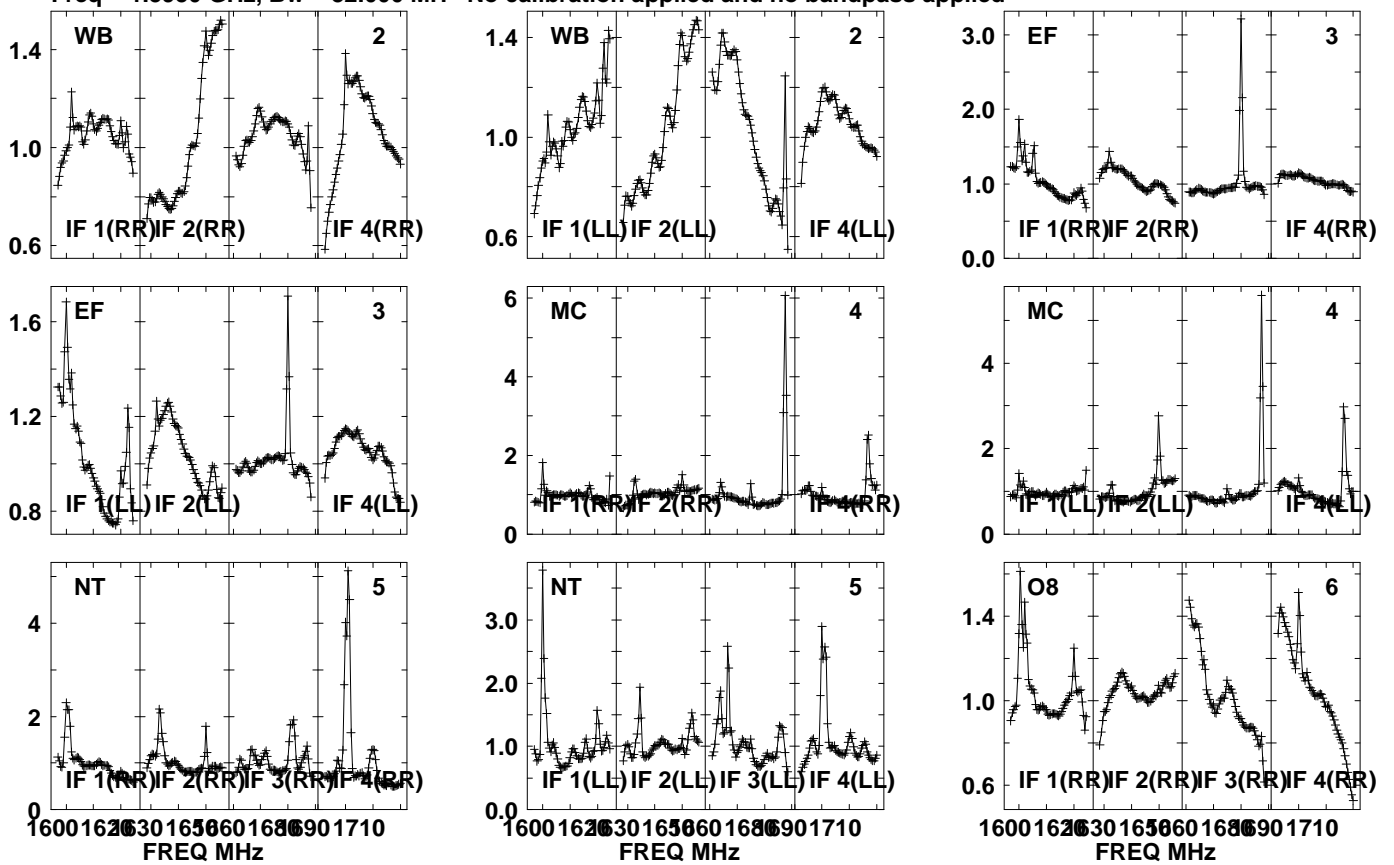

Lower frame: Real Jy

Auto-corr total-power spectrum Antenna: *

Timerange: 01/02:40:51 to 01/02:42:19

Plot file version 176 created 12-JUN-2023 14:39:18

J1547+2052 ES106B.UVDATA.1

Freq = 1.5950 GHz, Bw = 32.000 MH No calibration applied and no bandpass applied

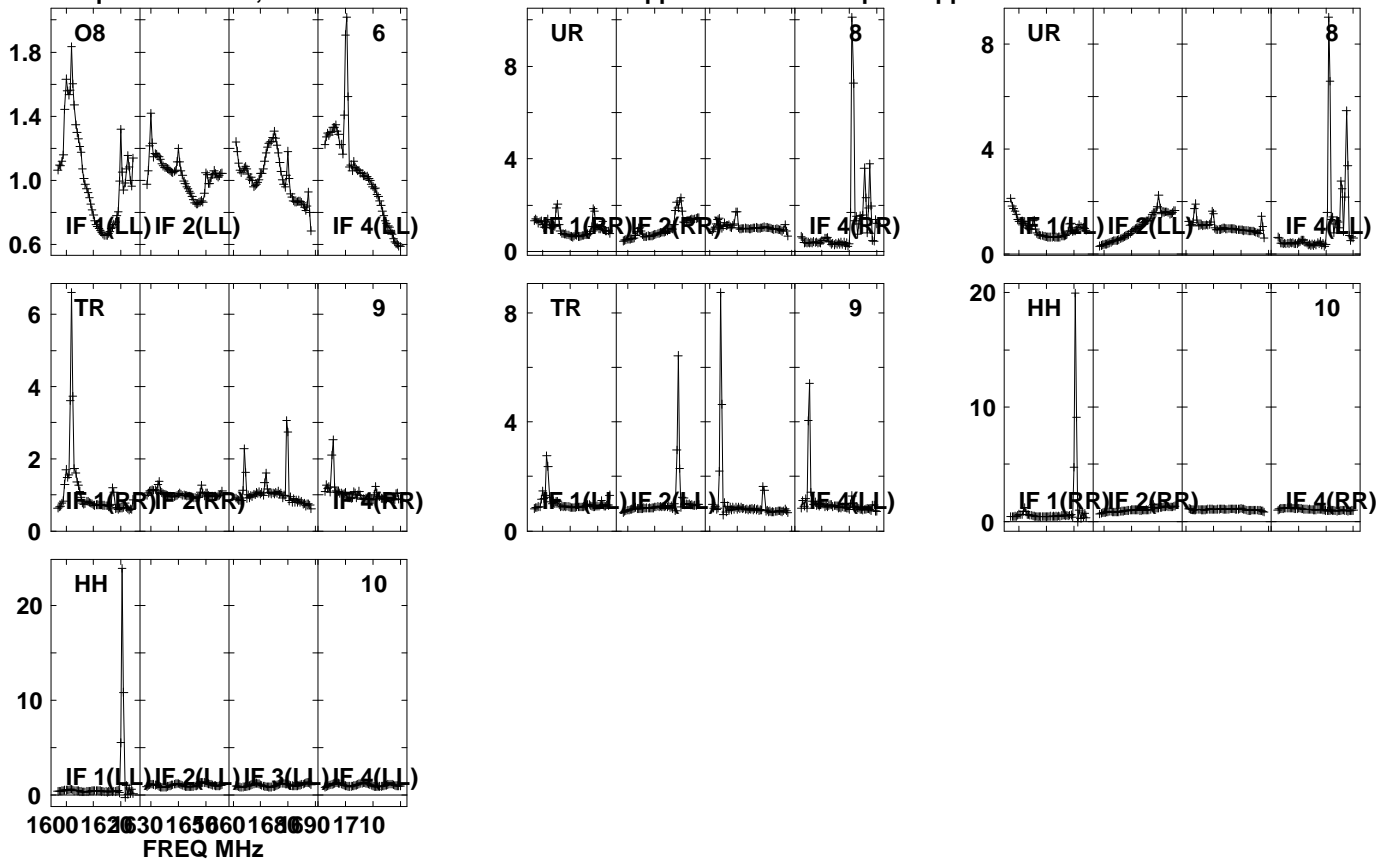

Lower frame: Real Jy
Auto-corr total-power spectrum Antenna: *
Timerange: 01/02:40:51 to 01/02:42:19

Plot file version 177 created 12-JUN-2023 14:39:18

J1548 ES106B.UVDATA.1

Freq = 1.5950 GHz, Bw = 32.000 MH No calibration applied and no bandpass applied

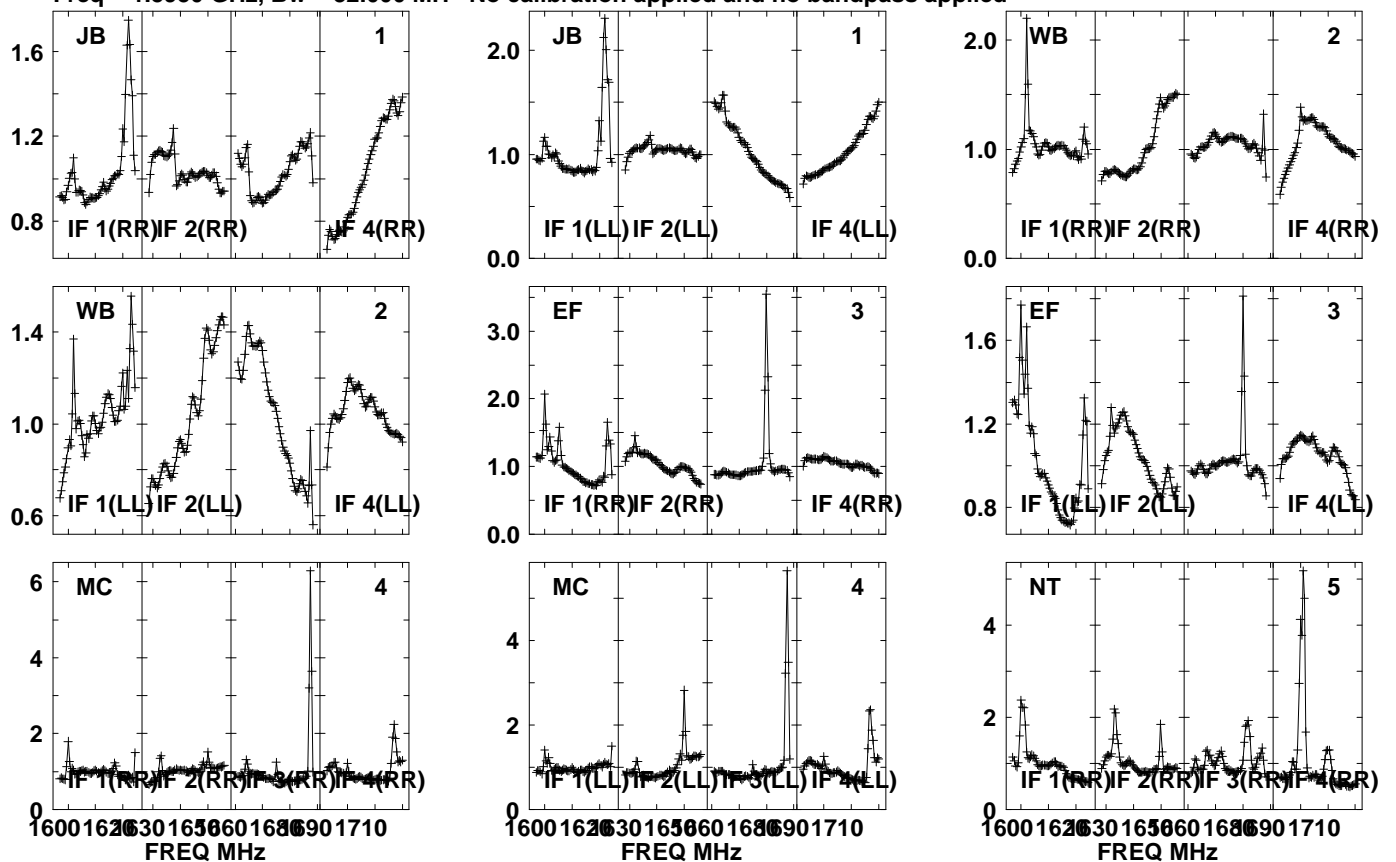

Lower frame: Real Jy
Auto-corr total-power spectrum Antenna: *
Timerange: 01/02:42:21 to 01/02:45:49

Plot file version 178 created 12-JUN-2023 14:39:18

J1548 ES106B.UVDATA.1

Freq = 1.5950 GHz, Bw = 32.000 MH No calibration applied and no bandpass applied

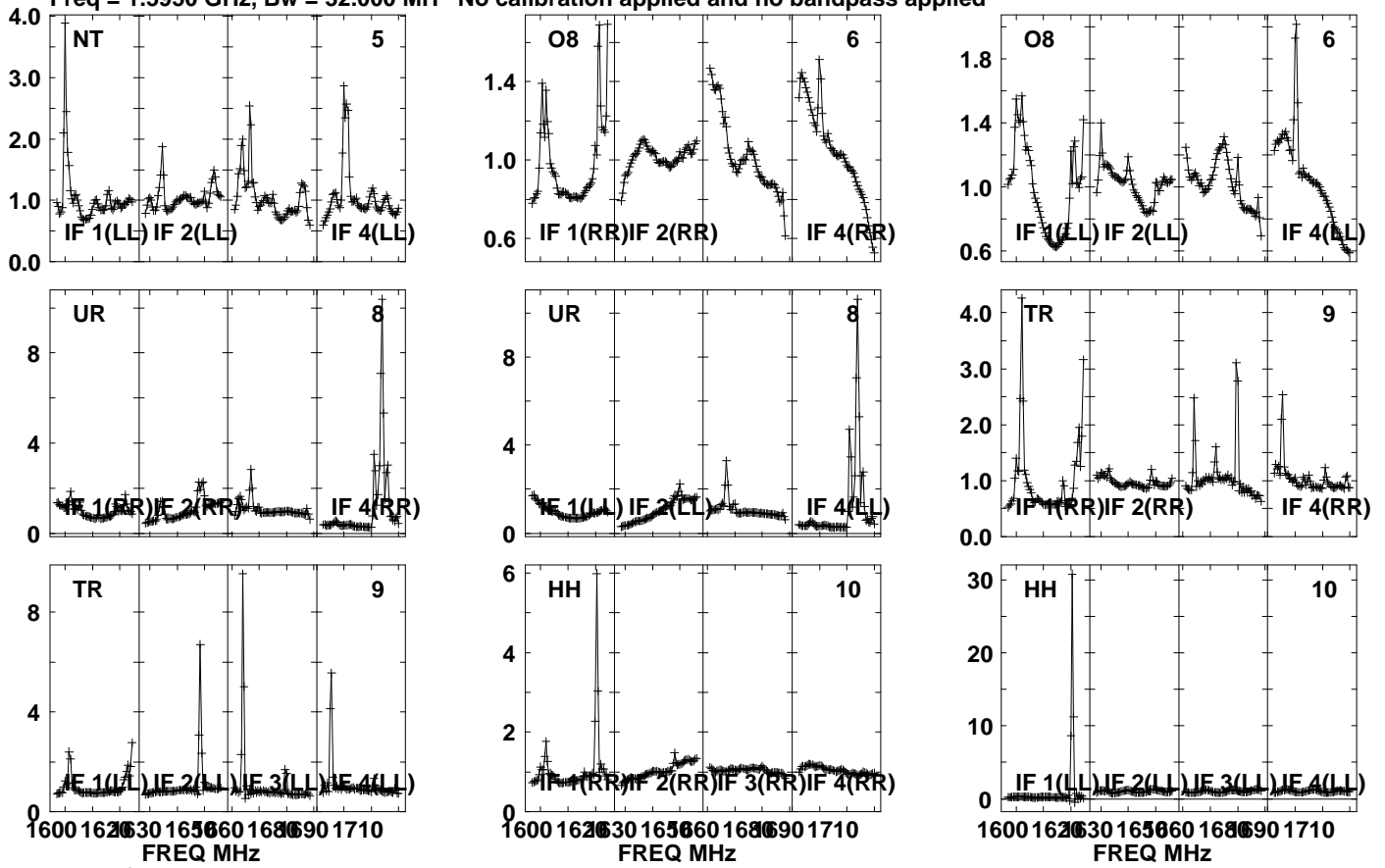

Lower frame: Real Jy

Auto-corr total-power spectrum Antenna: *

Timerange: 01/02:42:21 to 01/02:45:49

Plot file version 179 created 12-JUN-2023 14:39:18

J1547+2052 ES106B.UVDATA.1

Freq = 1.5950 GHz, Bw = 32.000 MH No calibration applied and no bandpass applied

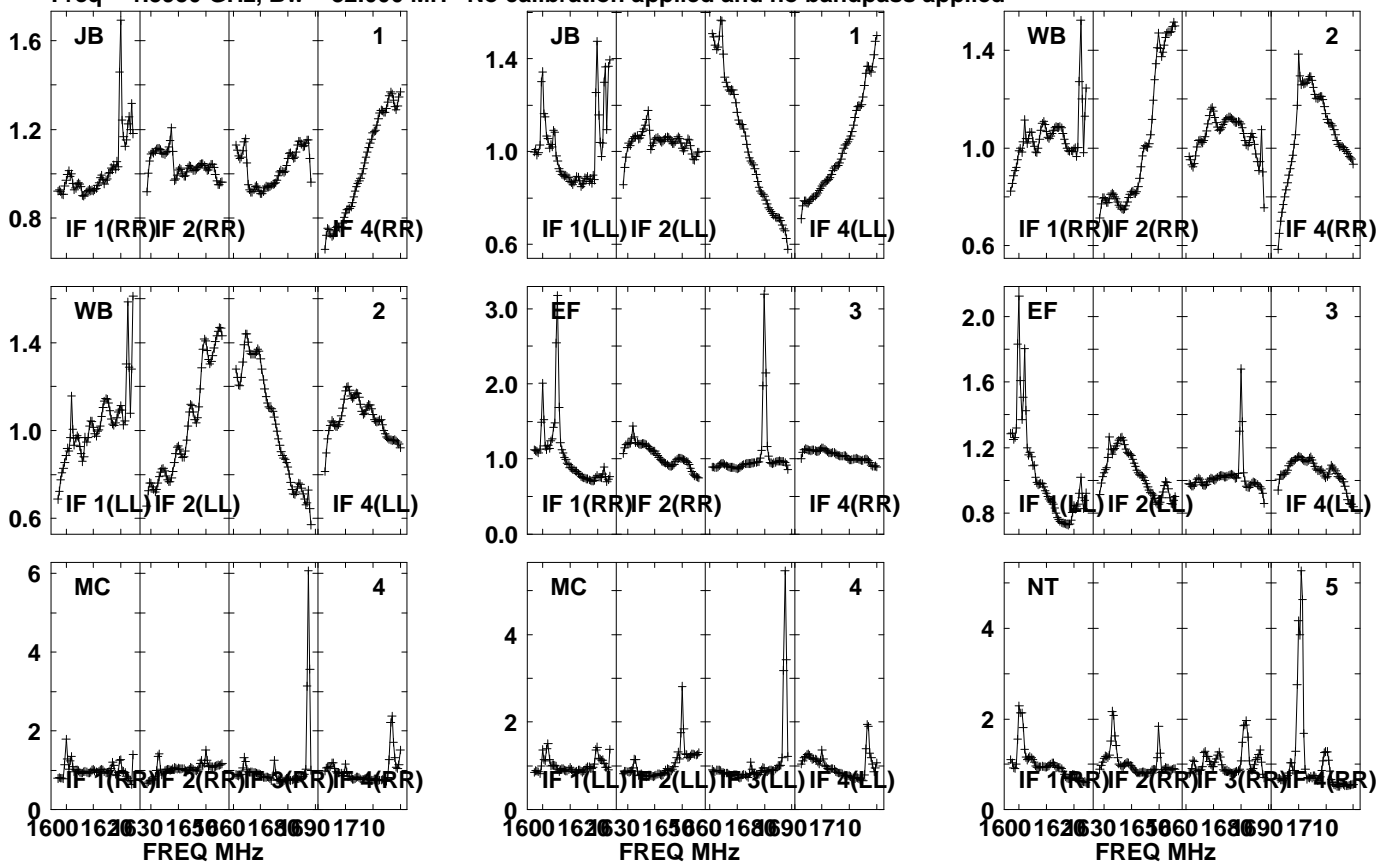

Lower frame: Real Jy
Auto-corr total-power spectrum Antenna: *
Timerange: 01/02:45:51 to 01/02:47:19

Plot file version 180 created 12-JUN-2023 14:39:18

J1547+2052 ES106B.UVDATA.1

Freq = 1.5950 GHz, Bw = 32.000 MH No calibration applied and no bandpass applied

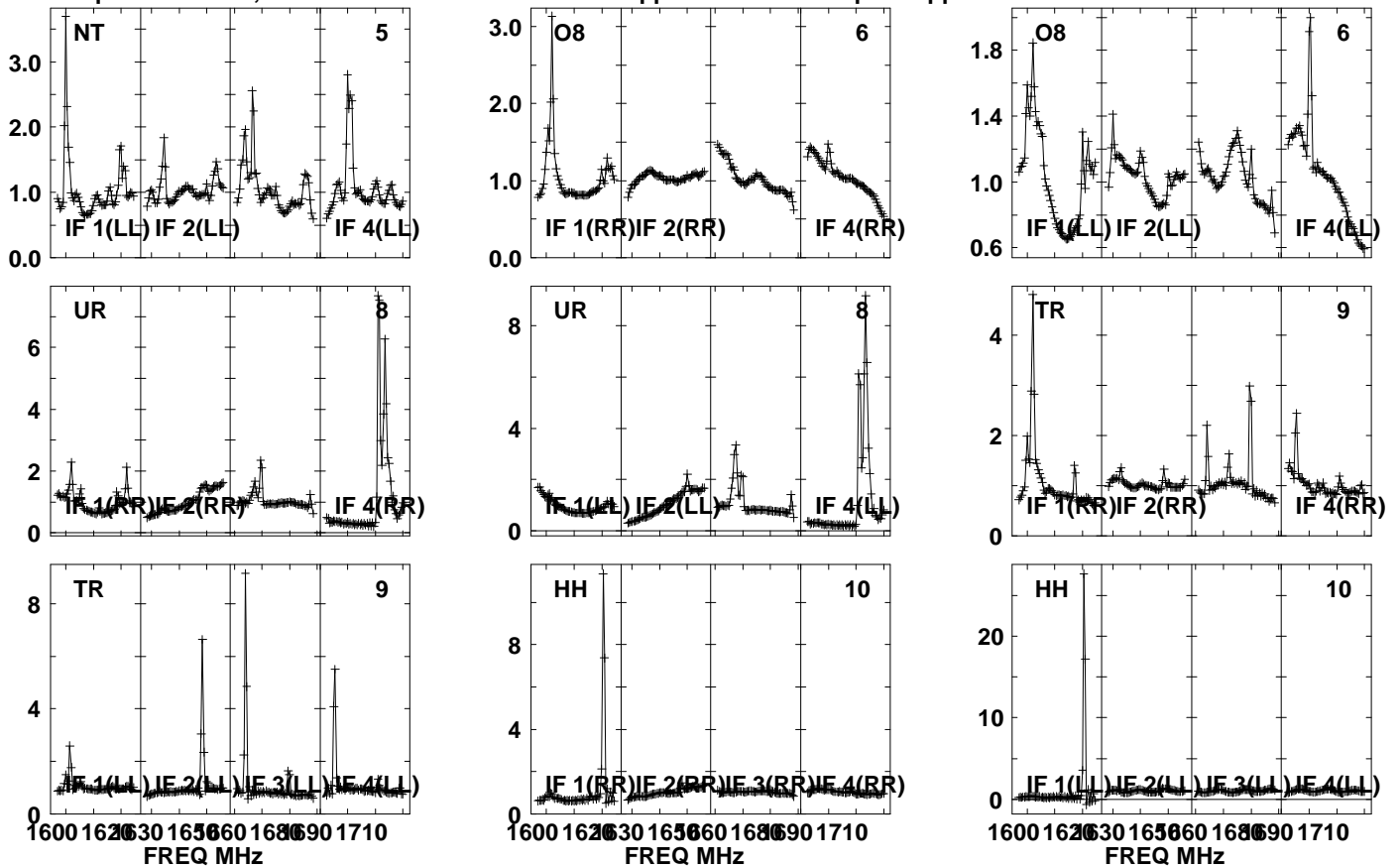

Lower frame: Real Jy

Auto-corr total-power spectrum Antenna: *

Timerange: 01/02:45:51 to 01/02:47:19

Plot file version 181 created 12-JUN-2023 14:39:18

J1545+2006 ES106B.UVDATA.1

Freq = 1.5950 GHz, Bw = 32.000 MH No calibration applied and no bandpass applied

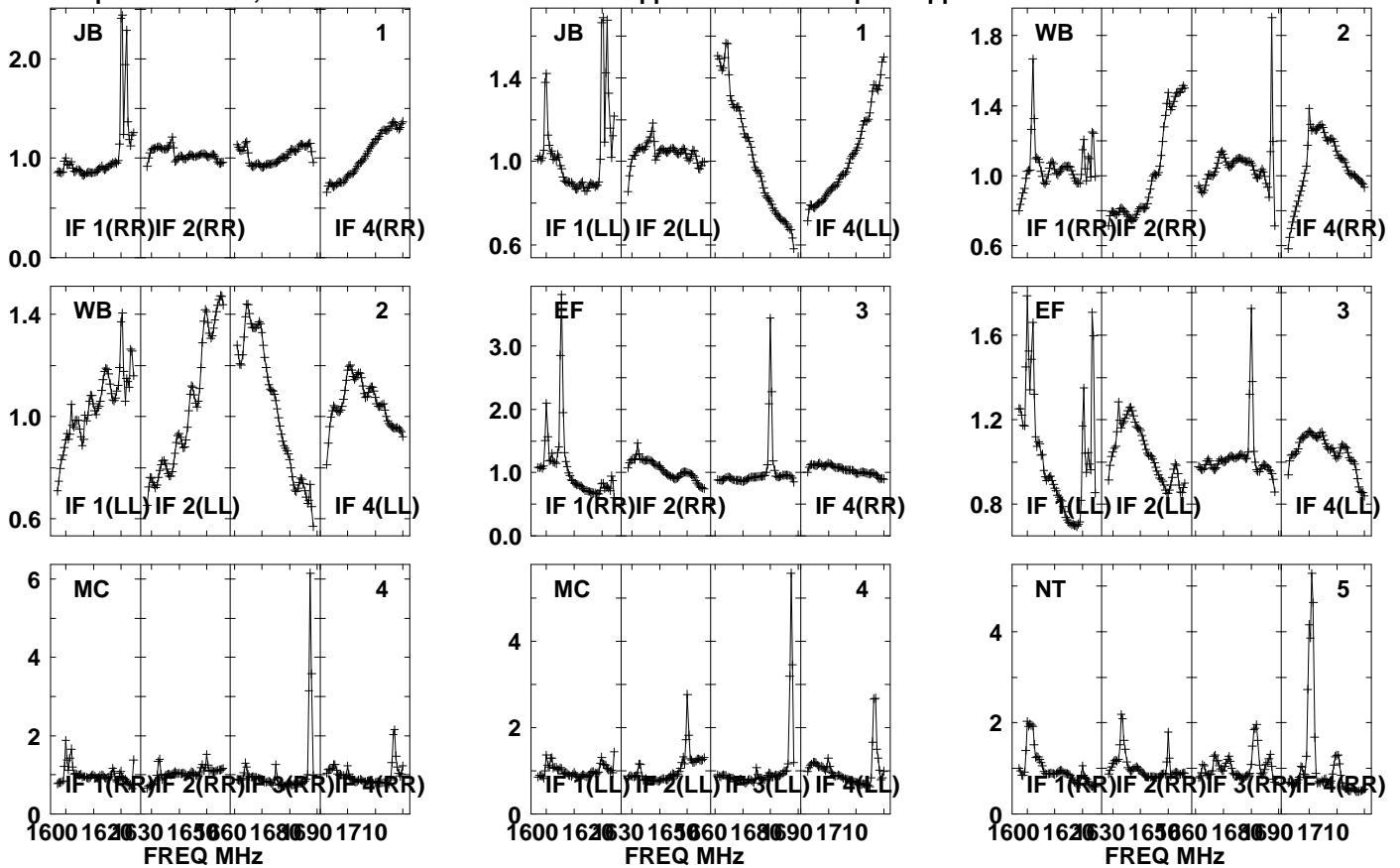

Lower frame: Real Jy

Auto-corr total-power spectrum Antenna: *

Timerange: 01/02:47:21 to 01/02:49:49

Plot file version 182 created 12-JUN-2023 14:39:18

J1545+2006 ES106B.UVDATA.1

Freq = 1.5950 GHz, Bw = 32.000 MH No calibration applied and no bandpass applied

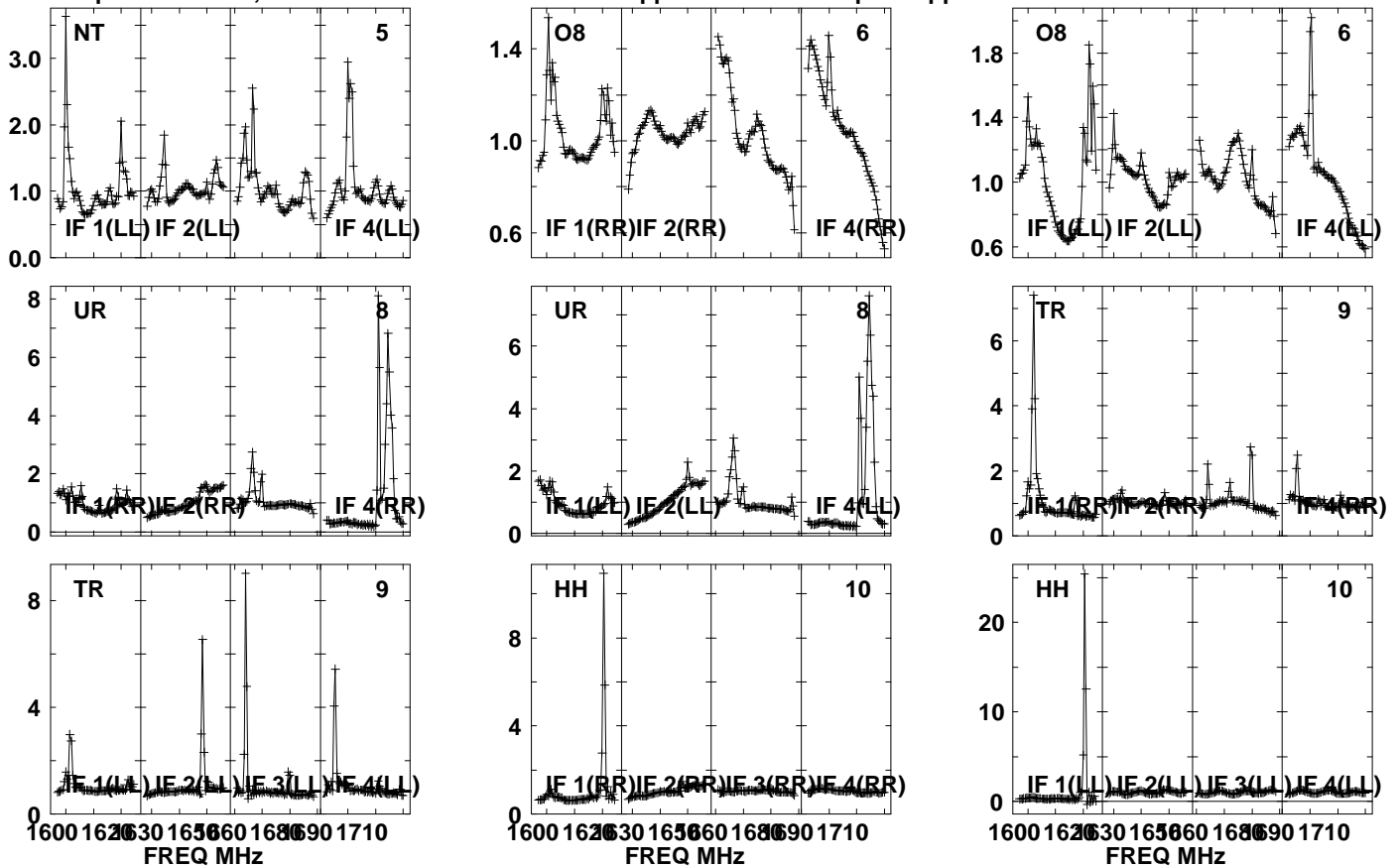

Lower frame: Real Jy

Auto-corr total-power spectrum Antenna: *

Timerange: 01/02:47:21 to 01/02:49:49

Plot file version 183 created 12-JUN-2023 14:39:18

J1547+2052 ES106B.UVDATA.1

Freq = 1.5950 GHz, Bw = 32.000 MH

No calibration applied and no bandpass applied

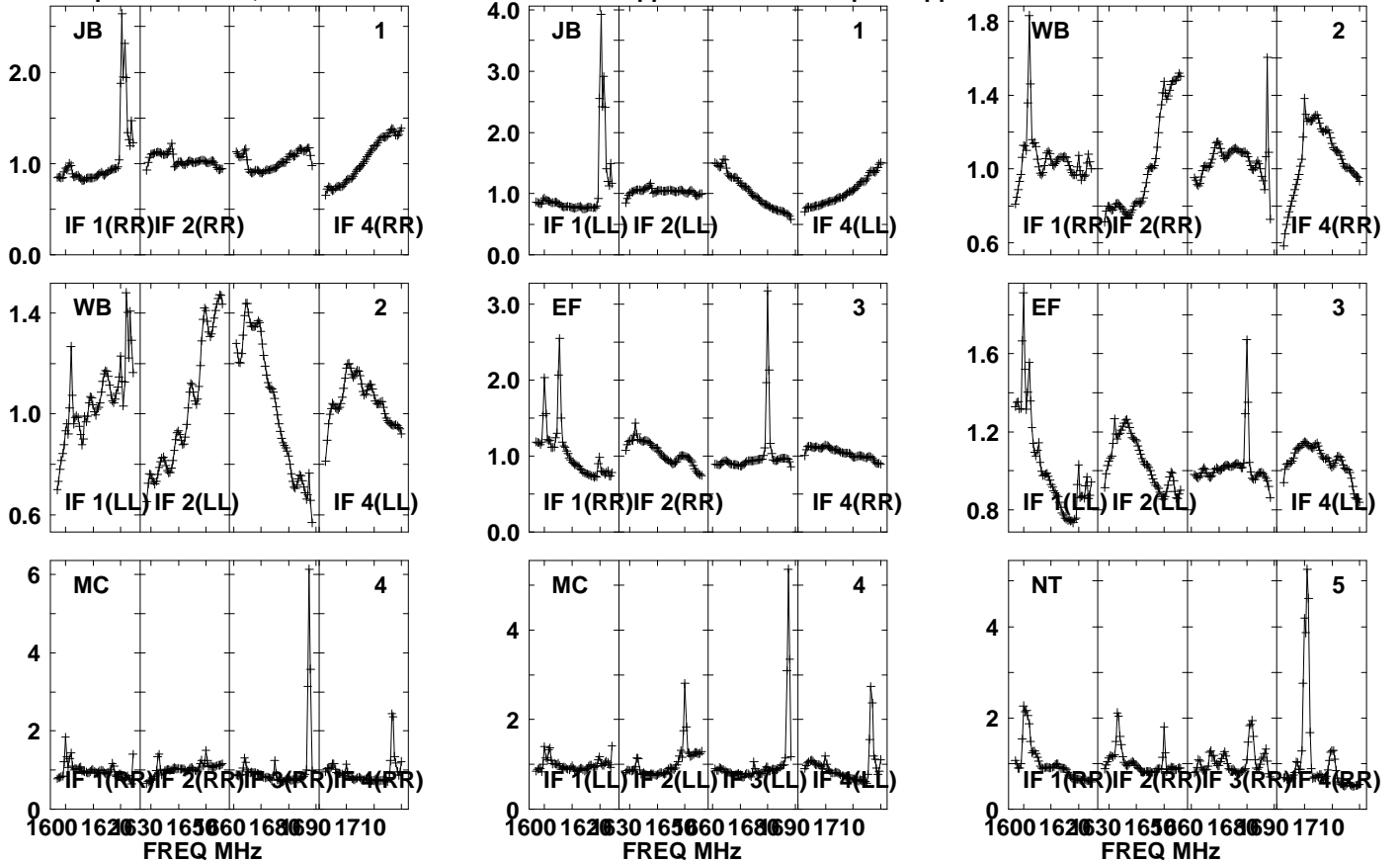

Lower frame: Real Jy

Auto-corr total-power spectrum Antenna: *

Timerange: 01/02:49:51 to 01/02:51:19

Plot file version 184 created 12-JUN-2023 14:39:18

J1547+2052 ES106B.UVDATA.1

Freq = 1.5950 GHz, Bw = 32.000 MH No calibration applied and no bandpass applied

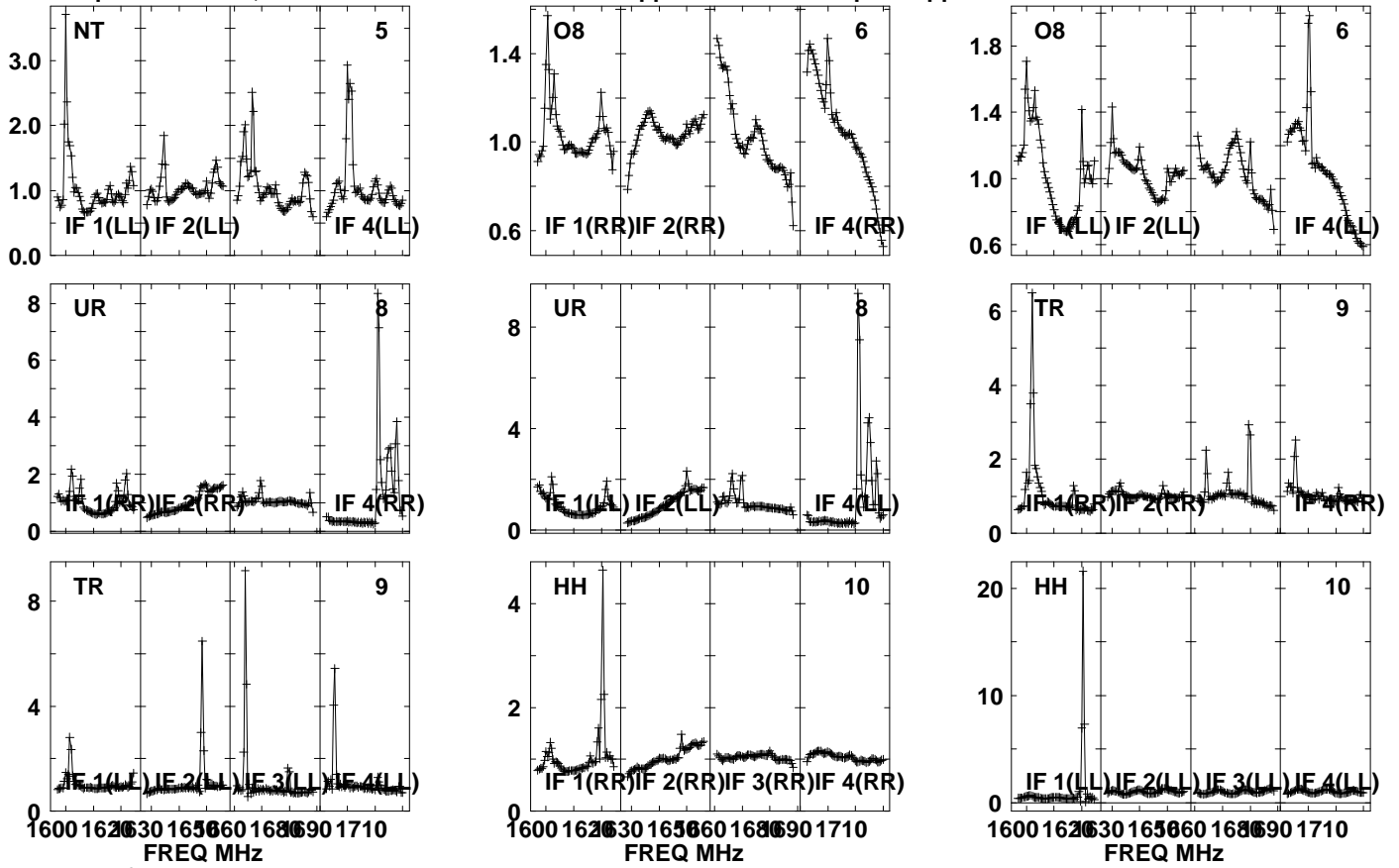

Lower frame: Real Jy

Auto-corr total-power spectrum Antenna: *

Timerange: 01/02:49:51 to 01/02:51:19

Plot file version 185 created 12-JUN-2023 14:39:18

J1548 ES106B.UVDATA.1

Freq = 1.5950 GHz, Bw = 32.000 MH No calibration applied and no bandpass applied

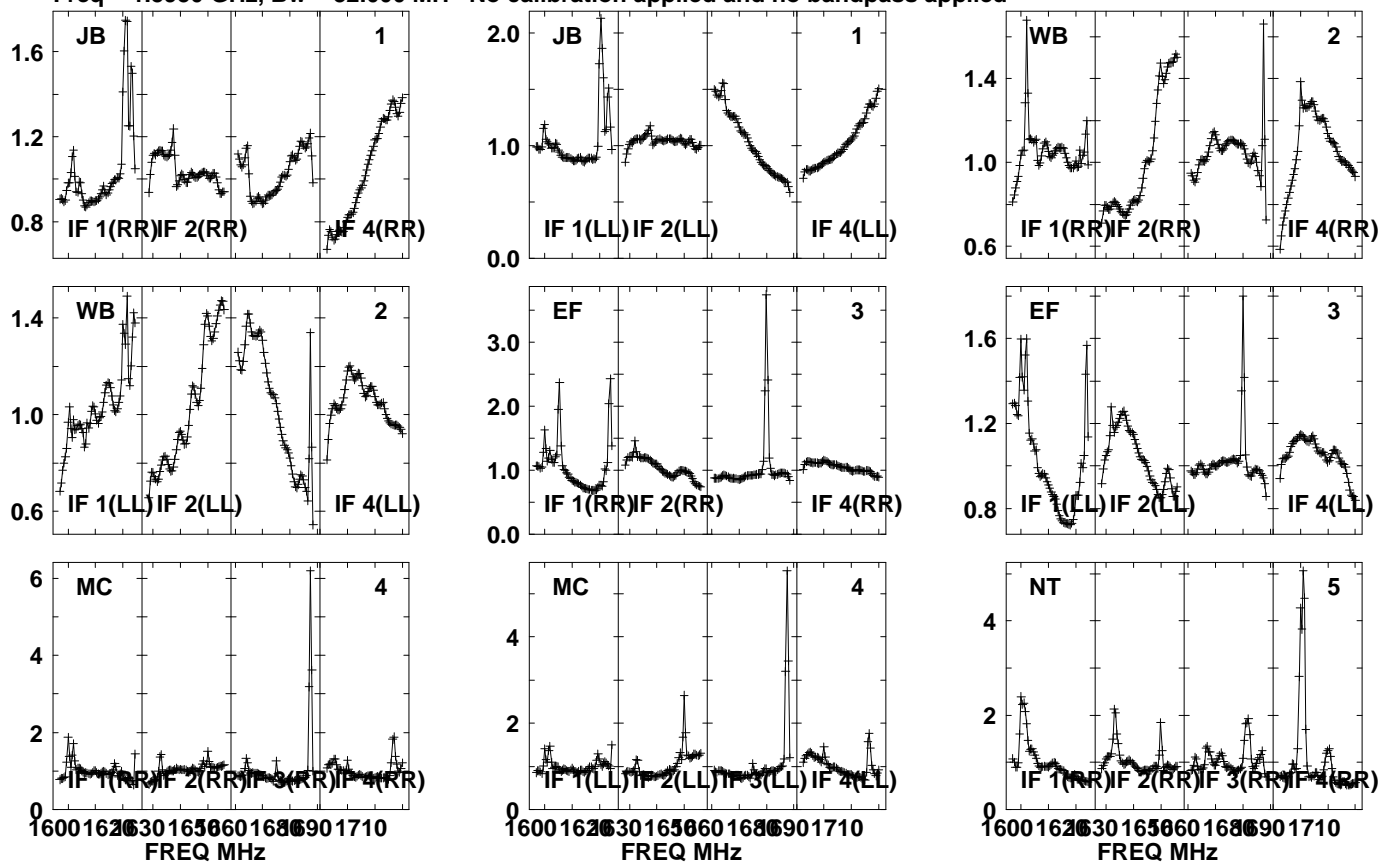

Lower frame: Real Jy
Auto-corr total-power spectrum Antenna: *
Timerange: 01/02:51:51 to 01/02:55:49

Plot file version 186 created 12-JUN-2023 14:39:19

J1548 ES106B.UVDATA.1

Freq = 1.5950 GHz, Bw = 32.000 MH No calibration applied and no bandpass applied

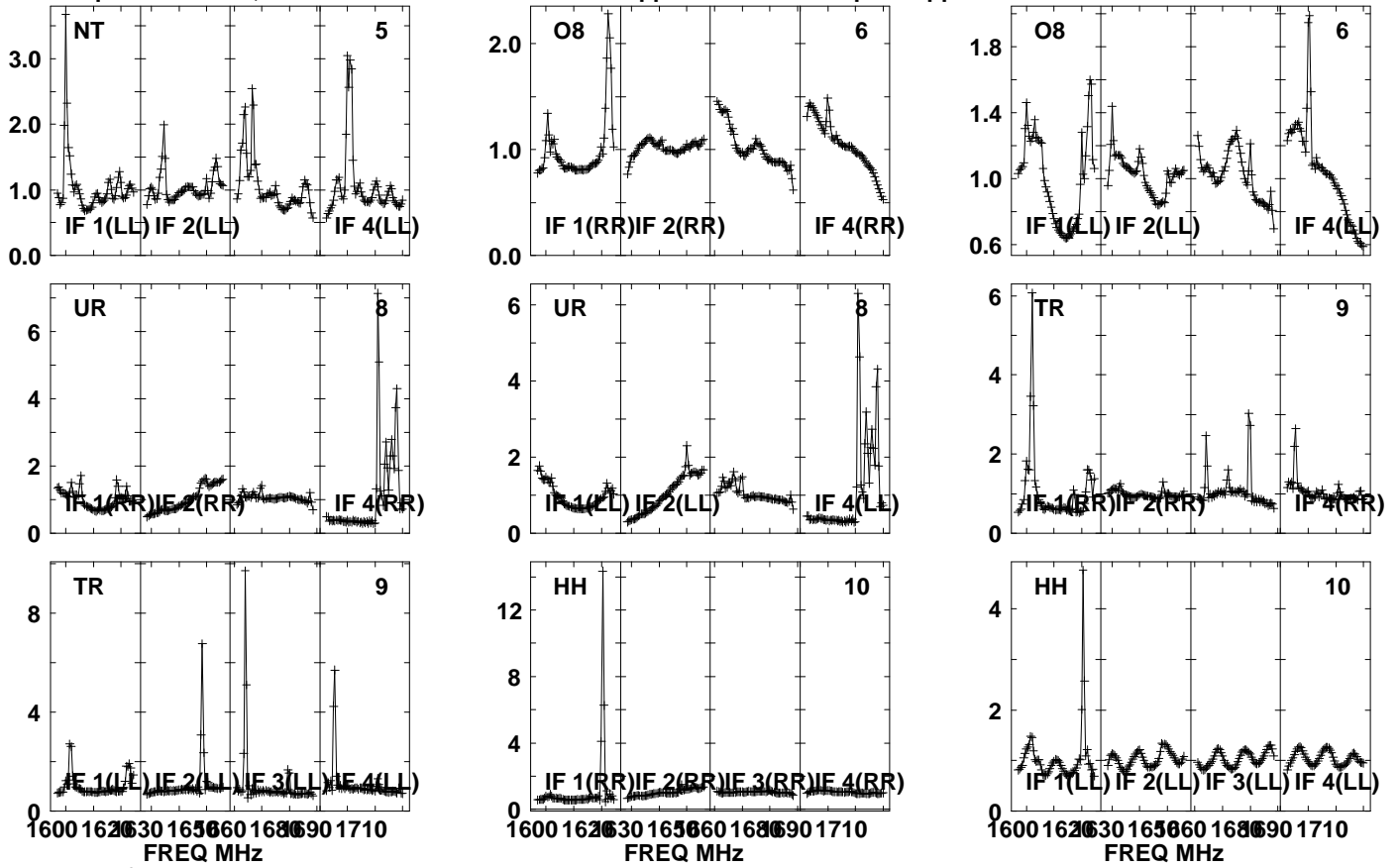

Lower frame: Real Jy

Auto-corr total-power spectrum Antenna: *

Timerange: 01/02:51:51 to 01/02:55:49

Plot file version 187 created 12-JUN-2023 14:39:19

J1547+2052 ES106B.UVDATA.1

Freq = 1.5950 GHz, Bw = 32.000 MH No calibration applied and no bandpass applied

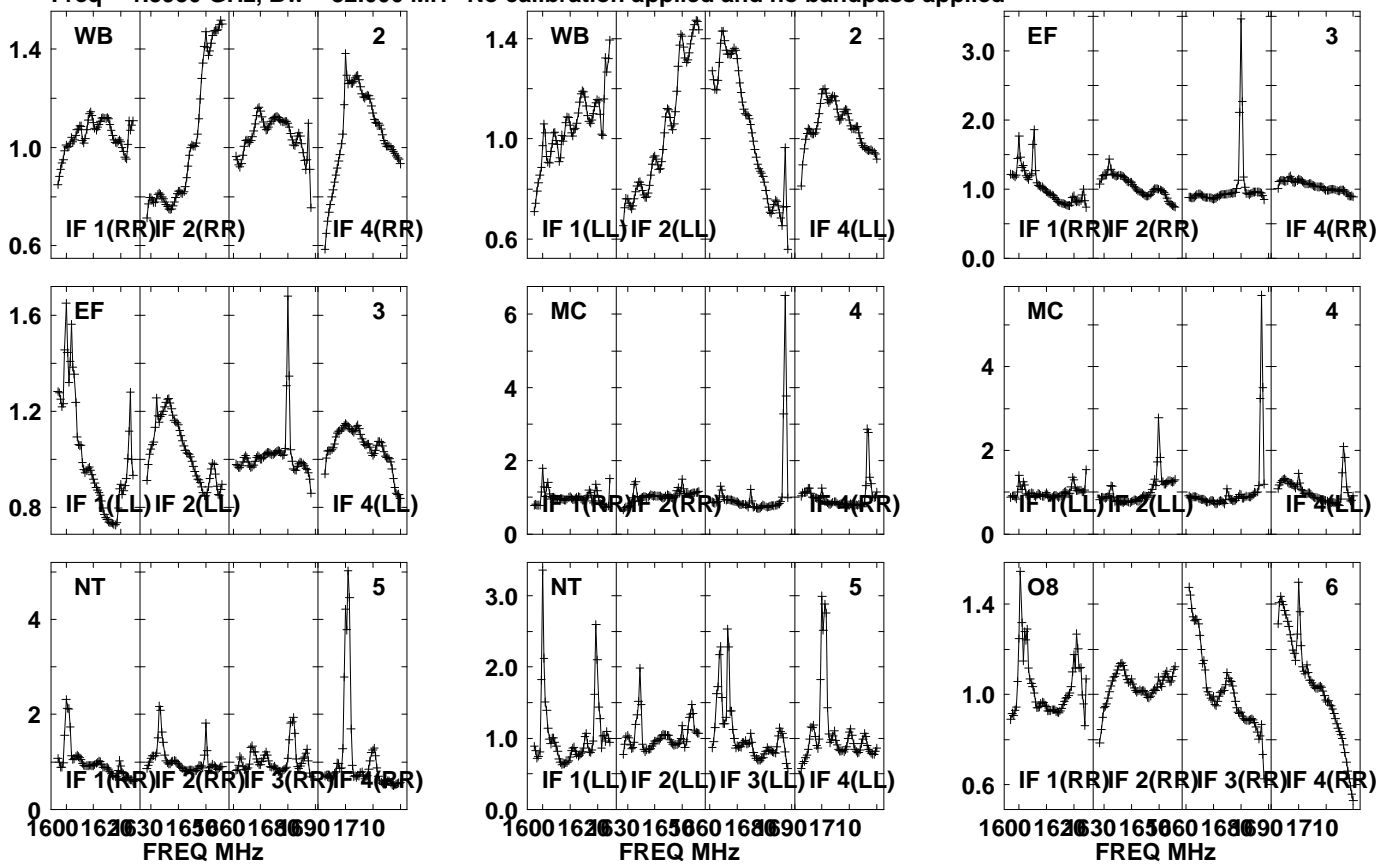

Lower frame: Real Jy
Auto-corr total-power spectrum Antenna: *
Timerange: 01/02:55:51 to 01/02:57:19

Plot file version 188 created 12-JUN-2023 14:39:19

J1547+2052 ES106B.UVDATA.1

Freq = 1.5950 GHz, Bw = 32.000 MH No calibration applied and no bandpass applied

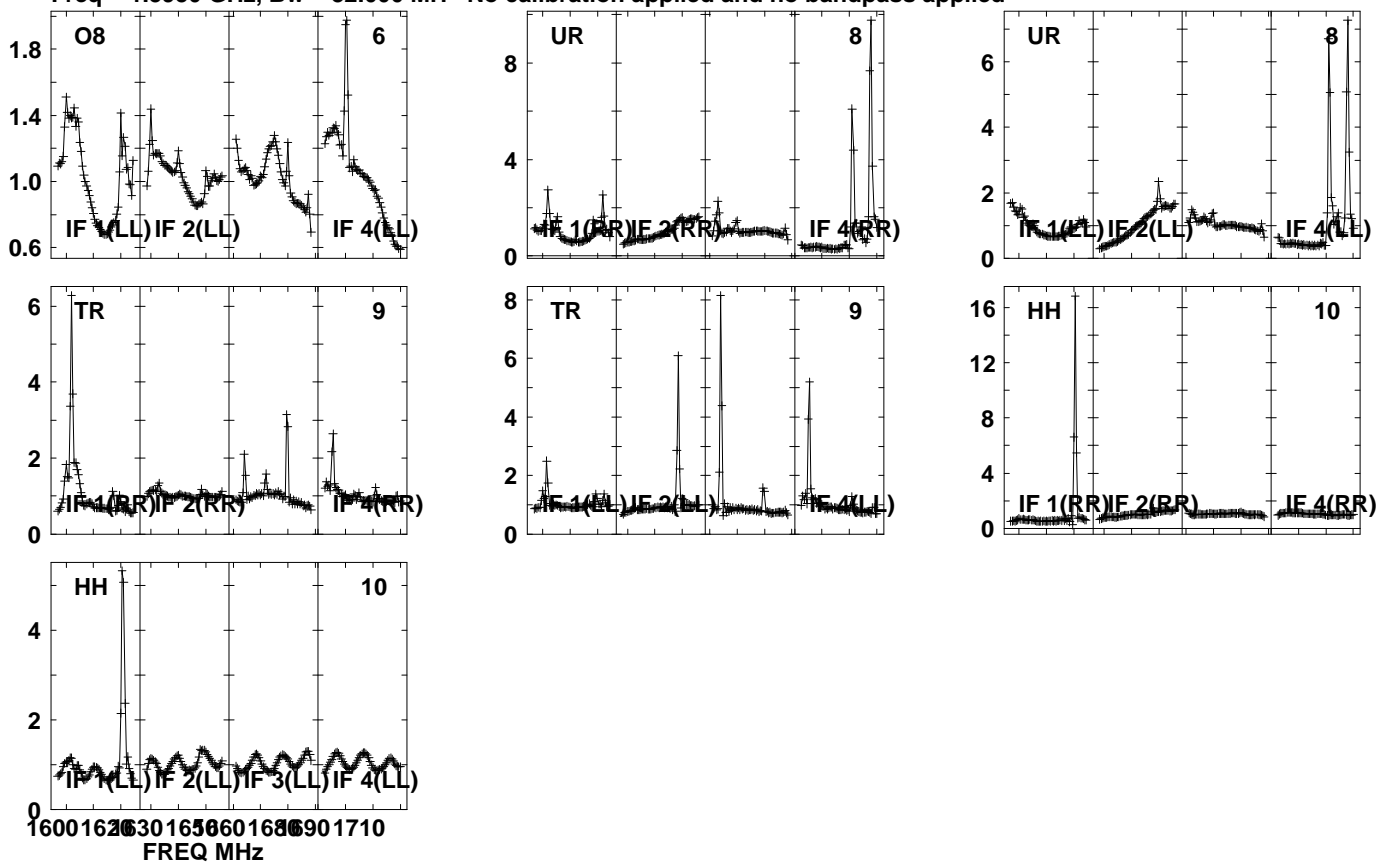

Lower frame: Real Jy

Auto-corr total-power spectrum Antenna: *

Timerange: 01/02:55:51 to 01/02:57:19

Plot file version 189 created 12-JUN-2023 14:39:19

J1548 ES106B.UVDATA.1

Freq = 1.5950 GHz, Bw = 32.000 MH No calibration applied and no bandpass applied

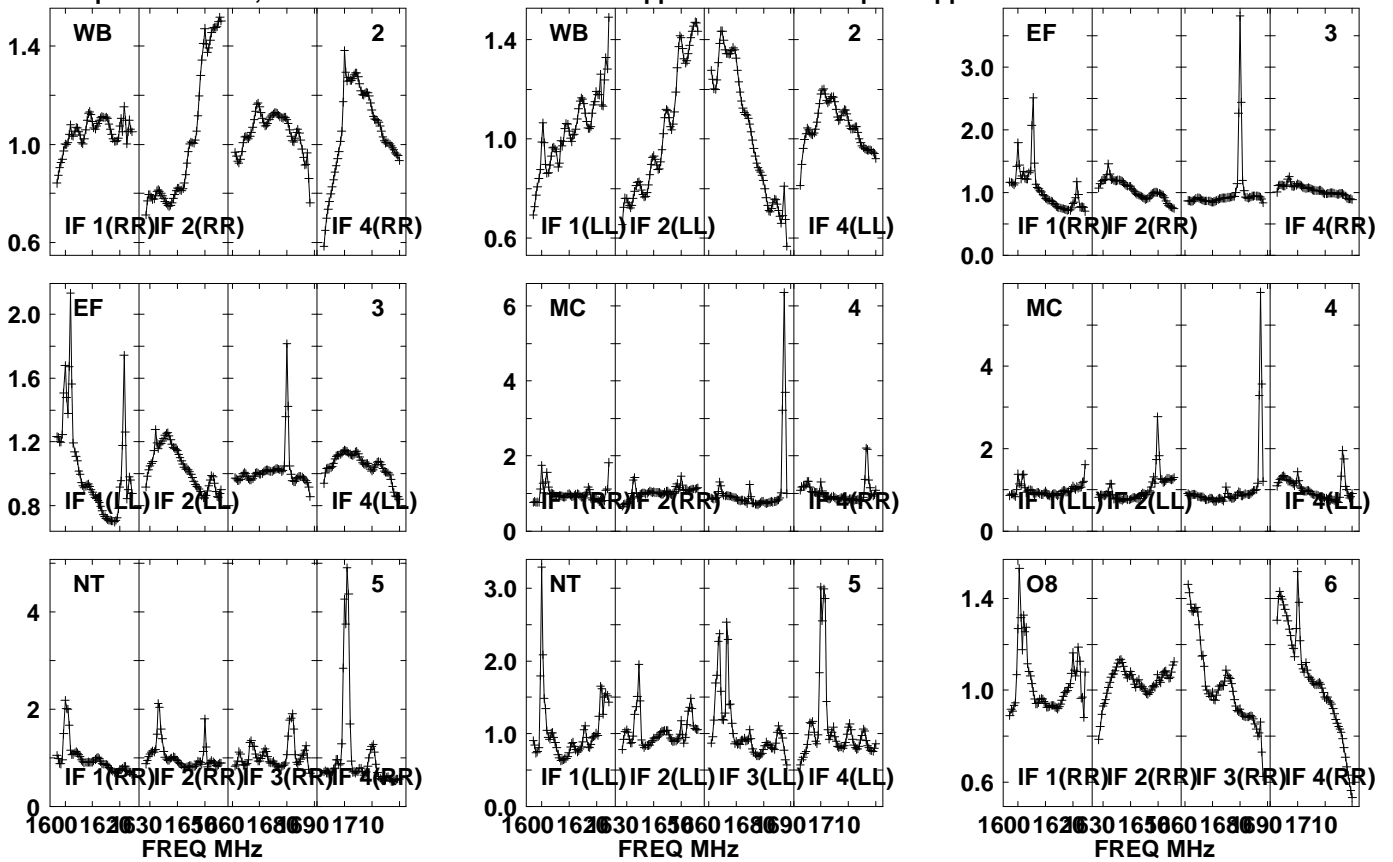

Lower frame: Real Jy
Auto-corr total-power spectrum Antenna: *
Timerange: 01/02:57:21 to 01/03:00:49

Plot file version 190 created 12-JUN-2023 14:39:19

J1548 ES106B.UVDATA.1

Freq = 1.5950 GHz, Bw = 32.000 MH No calibration applied and no bandpass applied

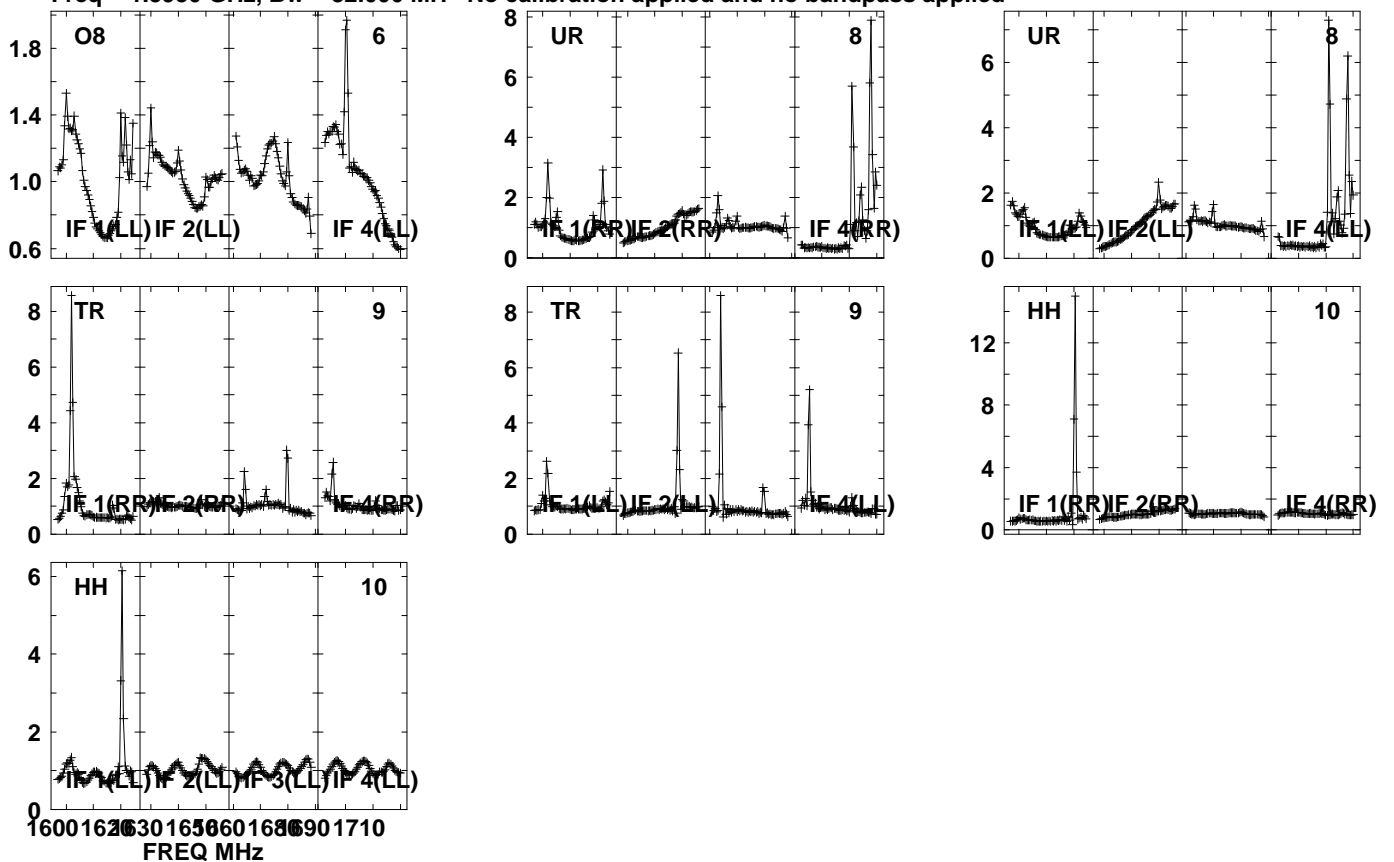

Lower frame: Real Jy

Auto-corr total-power spectrum Antenna: *

Timerange: 01/02:57:21 to 01/03:00:49

Plot file version 191 created 12-JUN-2023 14:39:19

J1547+2052 ES106B.UVDATA.1

Freq = 1.5950 GHz, Bw = 32.000 MH No calibration applied and no bandpass applied

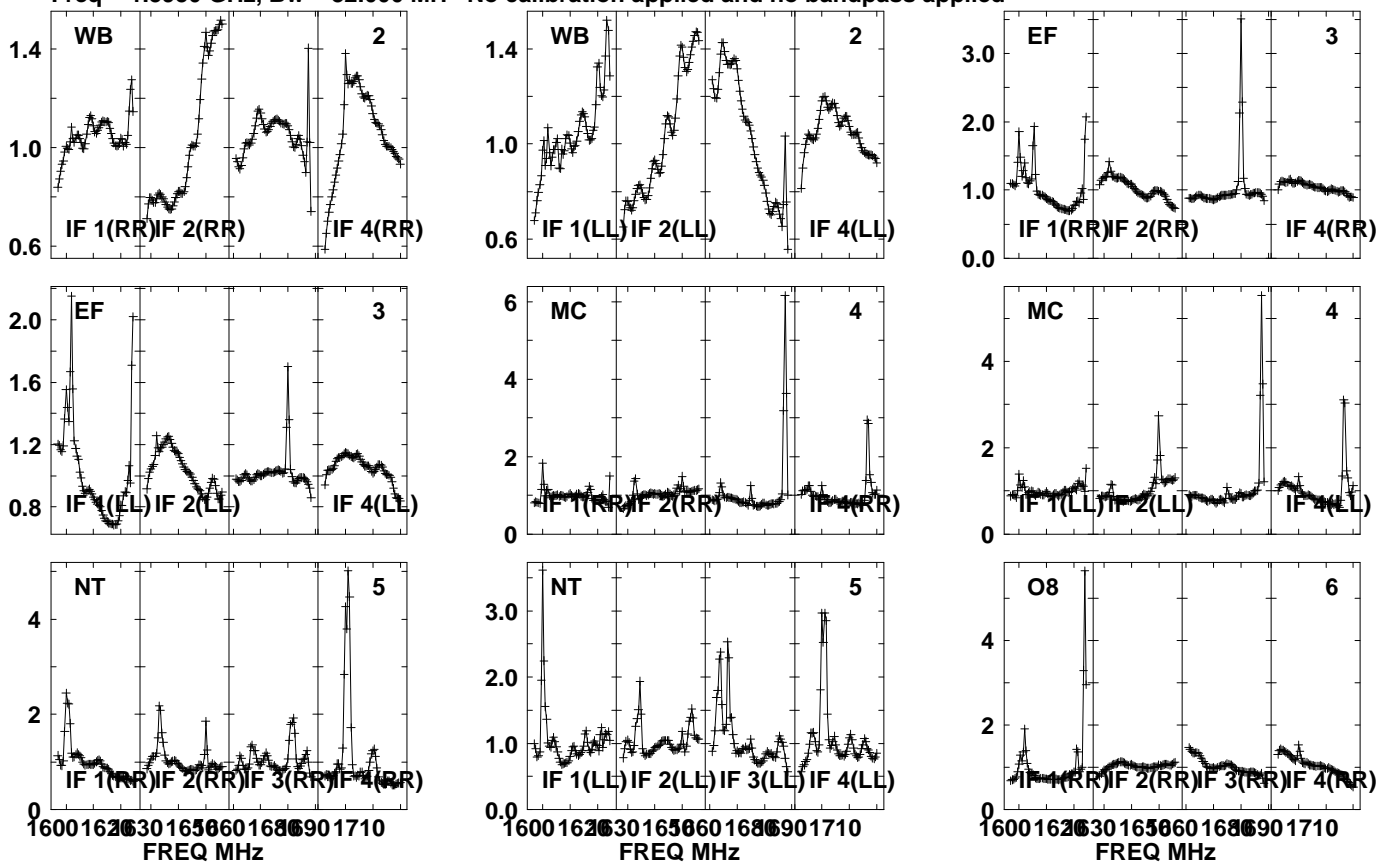

Lower frame: Real Jy
Auto-corr total-power spectrum Antenna: *
Timerange: 01/03:01:21 to 01/03:02:49

Plot file version 192 created 12-JUN-2023 14:39:19

J1547+2052 ES106B.UVDATA.1

Freq = 1.5950 GHz, Bw = 32.000 MH No calibration applied and no bandpass applied

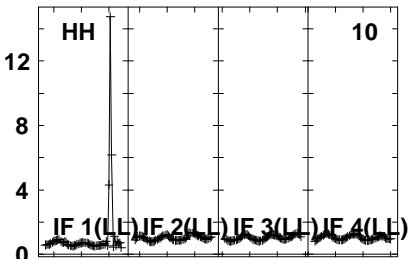
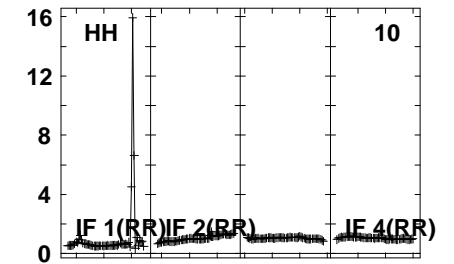
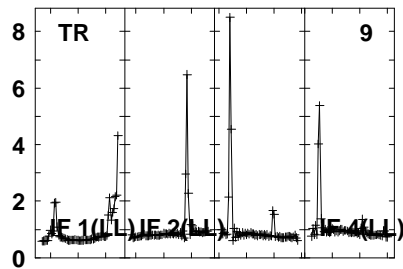
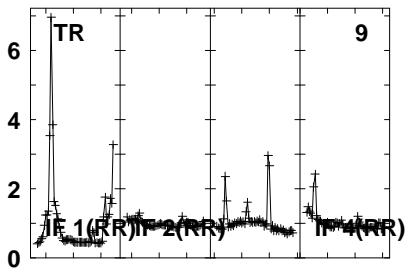
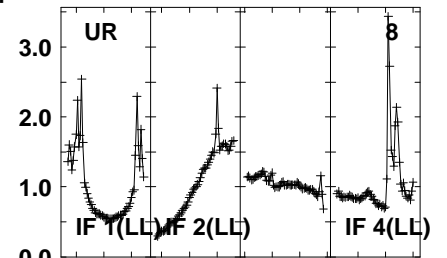
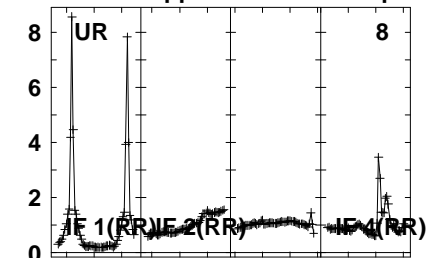
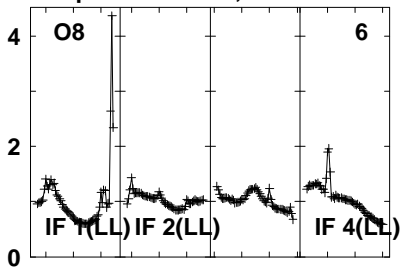

16001620163016501660168016901710
FREQ MHz

Lower frame: Real Jy

Auto-corr total-power spectrum Antenna: *

Timerange: 01/03:01:21 to 01/03:02:49

Plot file version 193 created 12-JUN-2023 14:39:19

J1548 ES106B.UVDATA.1

Freq = 1.5950 GHz, Bw = 32.000 MH No calibration applied and no bandpass applied

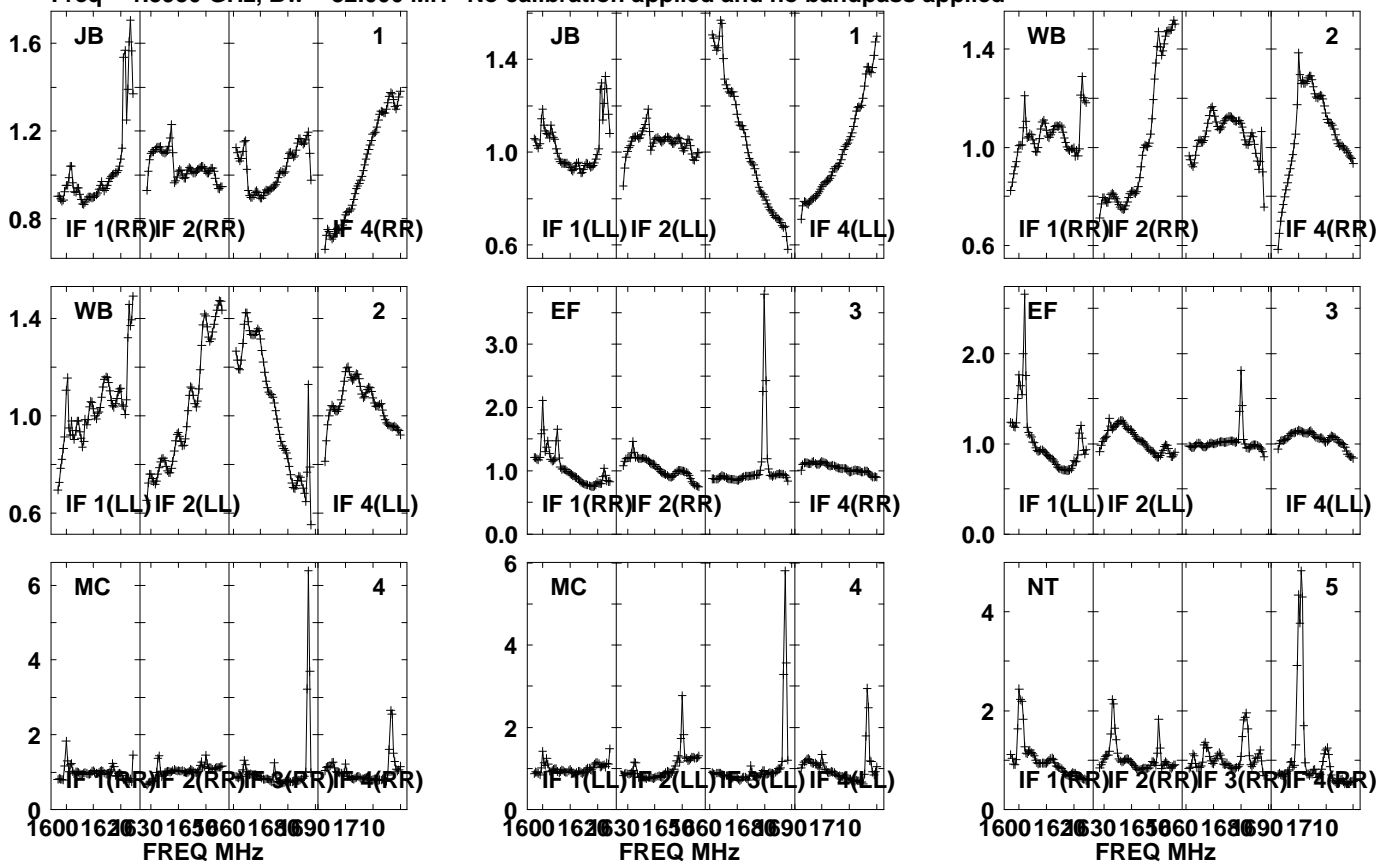

Lower frame: Real Jy
Auto-corr total-power spectrum Antenna: *
Timerange: 01/03:02:51 to 01/03:06:19

Plot file version 194 created 12-JUN-2023 14:39:19

J1548 ES106B.UVDATA.1

Freq = 1.5950 GHz, Bw = 32.000 MH No calibration applied and no bandpass applied

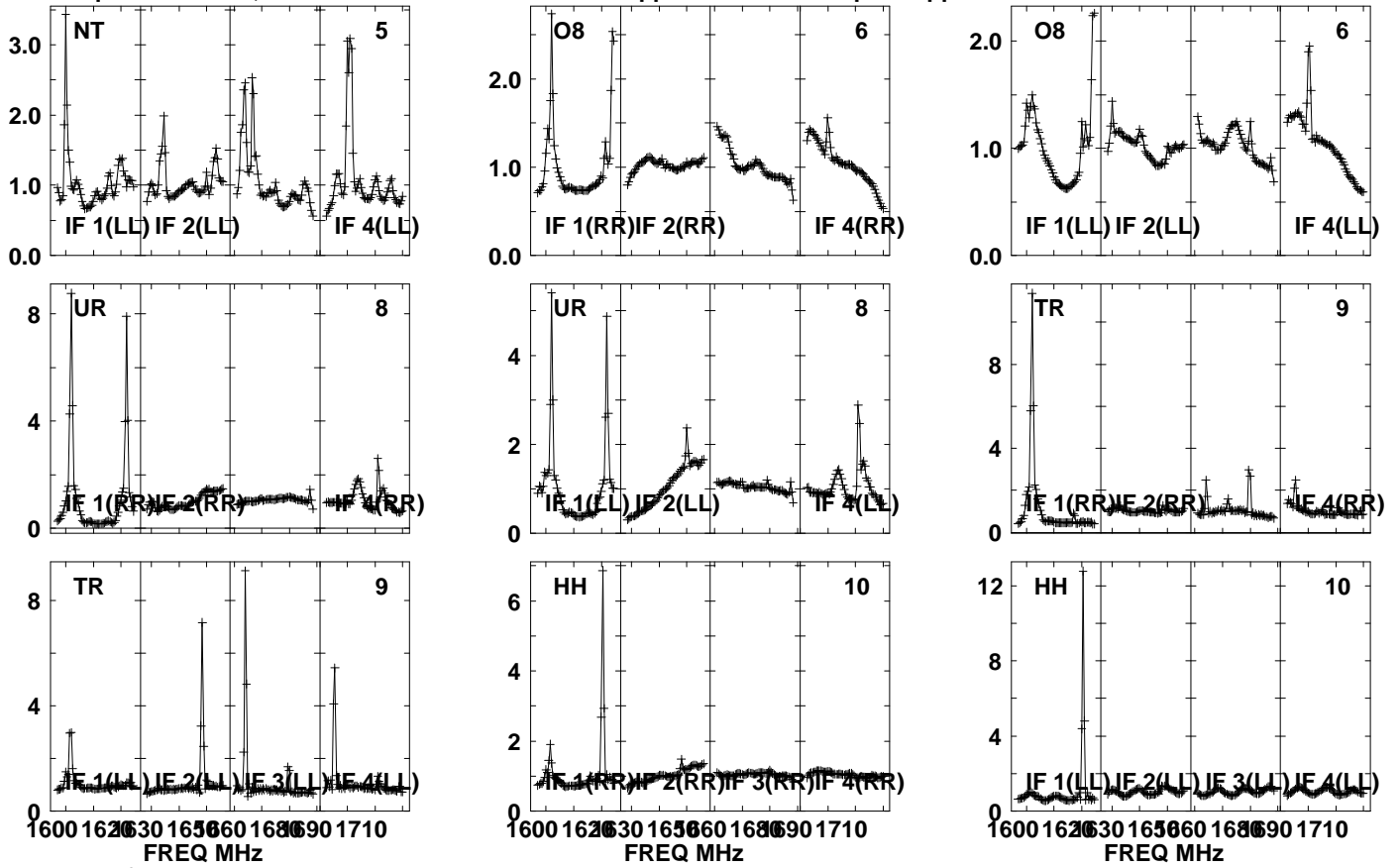

Lower frame: Real Jy

Auto-corr total-power spectrum Antenna: *

Timerange: 01/03:02:51 to 01/03:06:19

Plot file version 195 created 12-JUN-2023 14:39:19

J1547+2052 ES106B.UVDATA.1

Freq = 1.5950 GHz, Bw = 32.000 MH No calibration applied and no bandpass applied

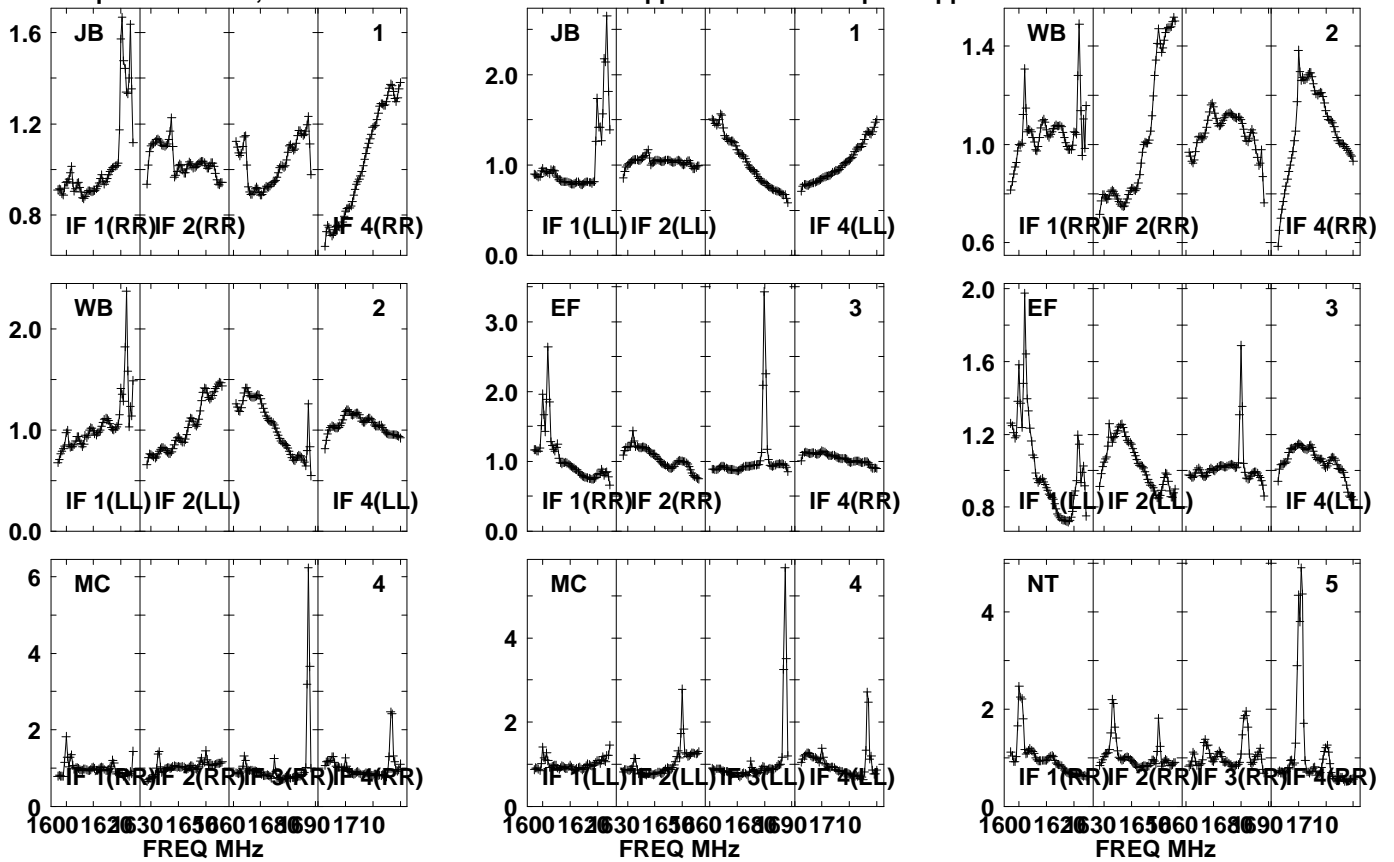

Lower frame: Real Jy
Auto-corr total-power spectrum Antenna: *
Timerange: 01/03:06:51 to 01/03:08:19

Plot file version 196 created 12-JUN-2023 14:39:19

J1547+2052 ES106B.UVDATA.1

Freq = 1.5950 GHz, Bw = 32.000 MH No calibration applied and no bandpass applied

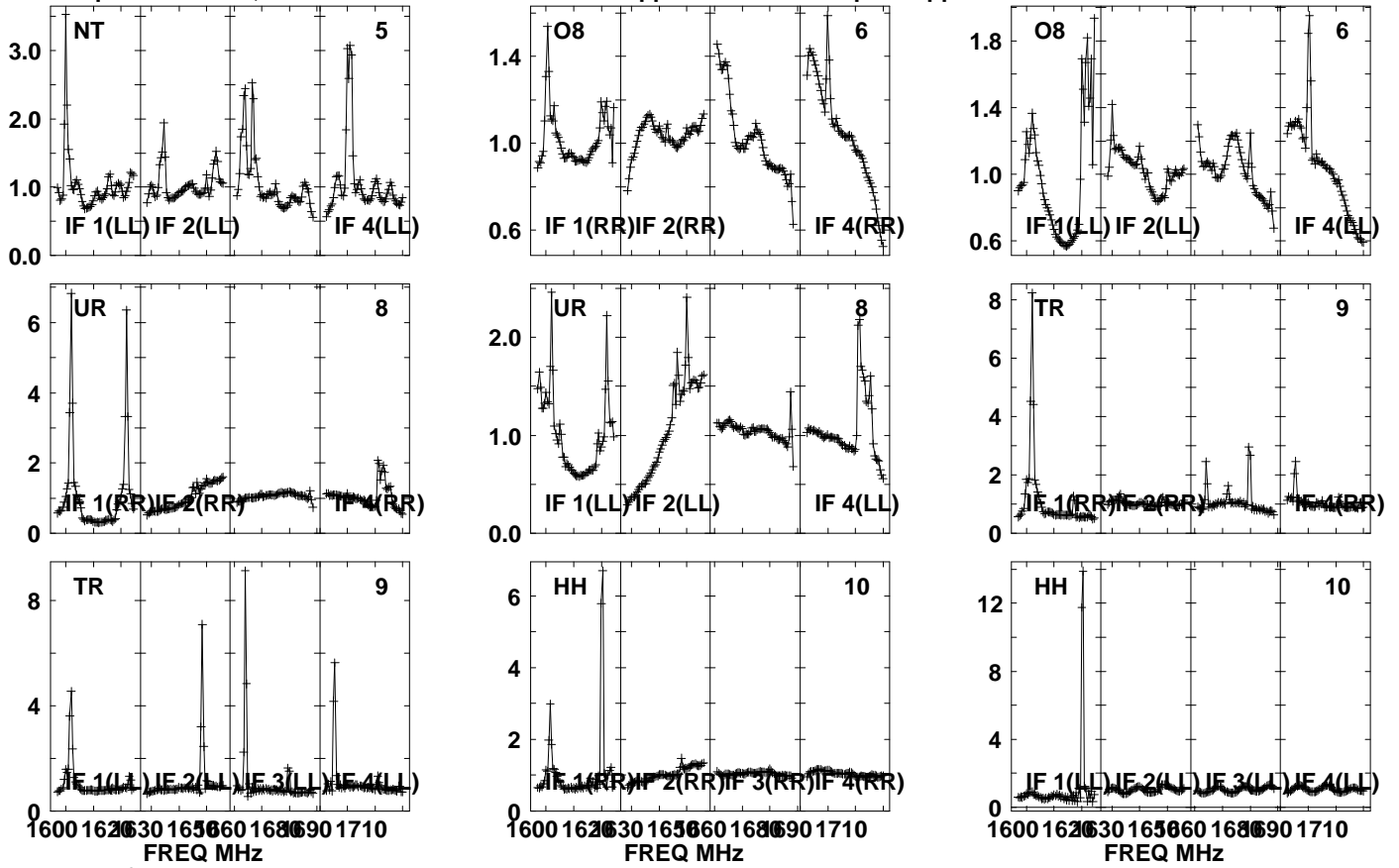

Lower frame: Real Jy

Auto-corr total-power spectrum Antenna: *

Timerange: 01/03:06:51 to 01/03:08:19

Plot file version 197 created 12-JUN-2023 14:39:19

3C345 ES106B.UVDATA.1

Freq = 1.5950 GHz, Bw = 32.000 MH No calibration applied and no bandpass applied

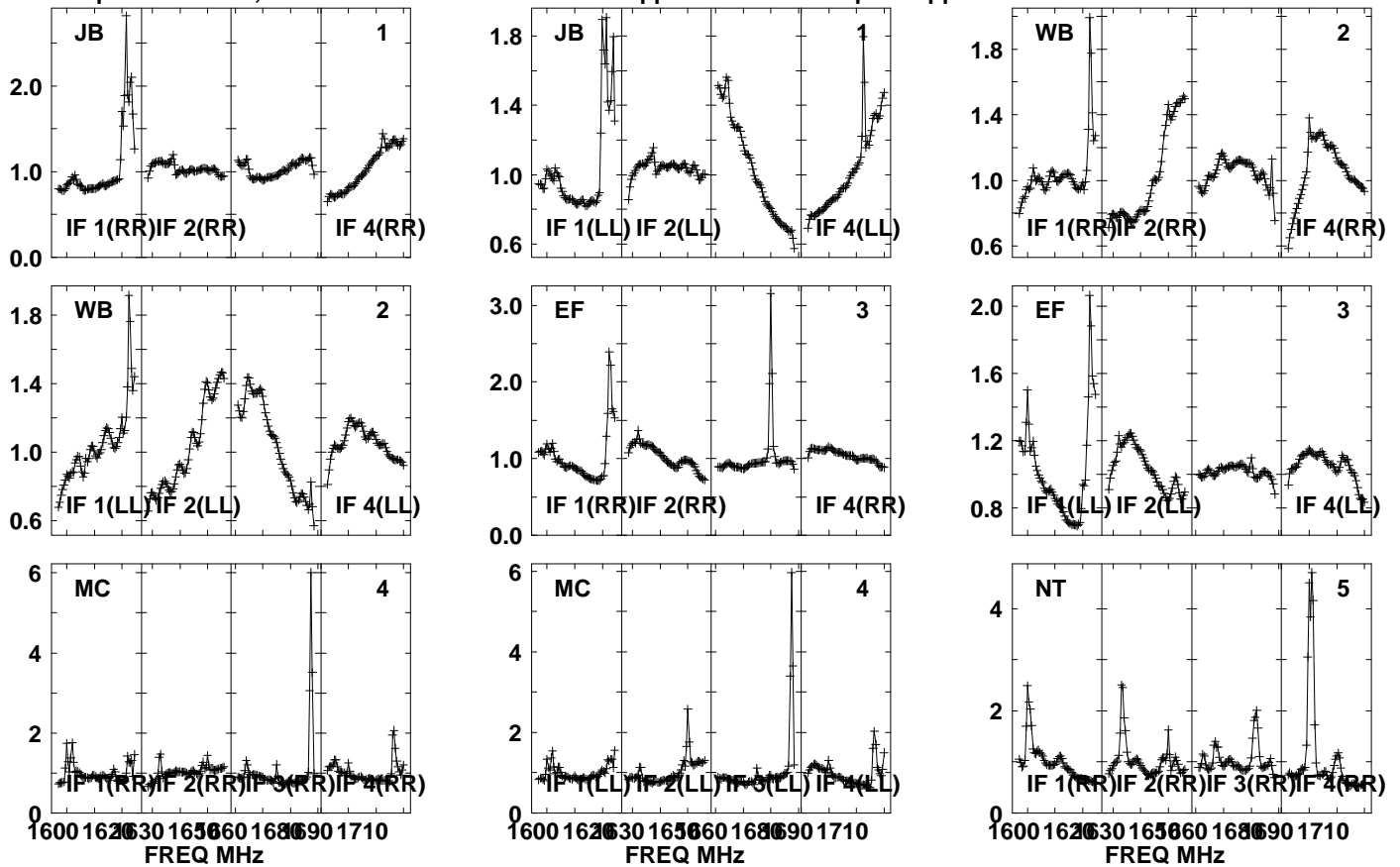

Lower frame: Real Jy

Auto-corr total-power spectrum Antenna: *

Timerange: 01/03:09:51 to 01/03:13:49

Plot file version 198 created 12-JUN-2023 14:39:19

3C345 ES106B.UVDATA.1

Freq = 1.5950 GHz, Bw = 32.000 MH No calibration applied and no bandpass applied

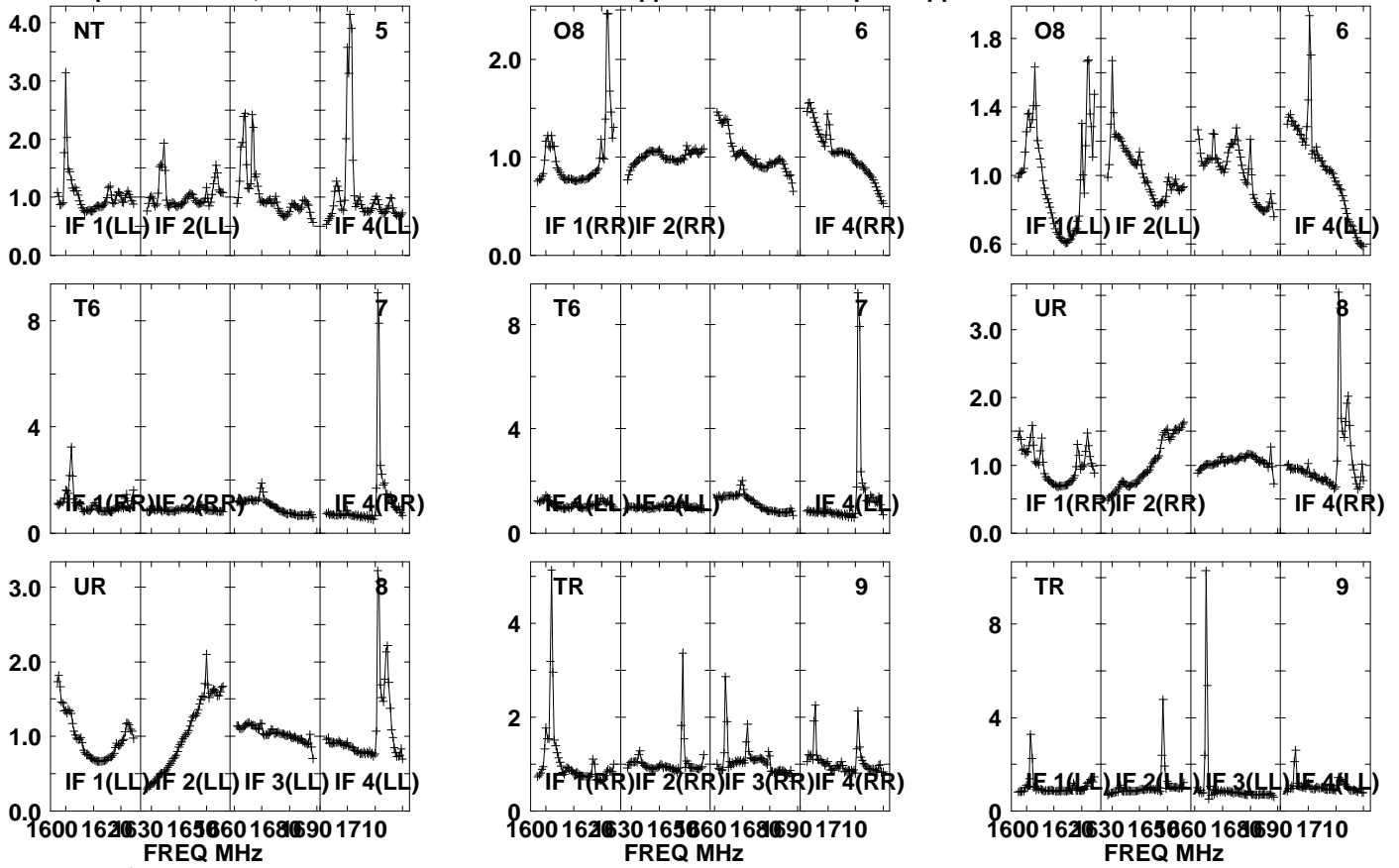

Lower frame: Real Jy
Auto-corr total-power spectrum Antenna: *
Timerange: 01/03:09:51 to 01/03:13:49

Plot file version 199 created 12-JUN-2023 14:39:19

3C345 ES106B.UVDATA.1

Freq = 1.5950 GHz, Bw = 32.000 MH No calibration applied and no bandpass applied

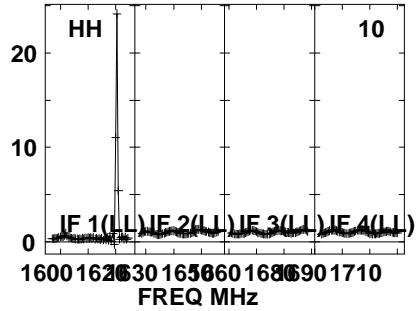
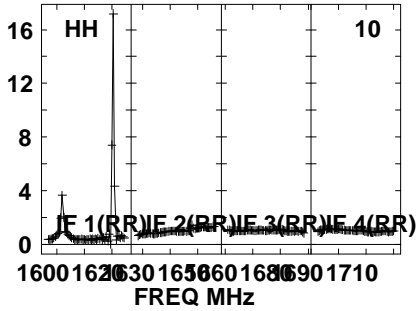

Lower frame: Real Jy
Auto-corr total-power spectrum Antenna: *
Timerange: 01/03:09:51 to 01/03:13:49

Plot file version 200 created 12-JUN-2023 14:39:19

J1547+2052 ES106B.UVDATA.1

Freq = 1.5950 GHz, Bw = 32.000 MH No calibration applied and no bandpass applied

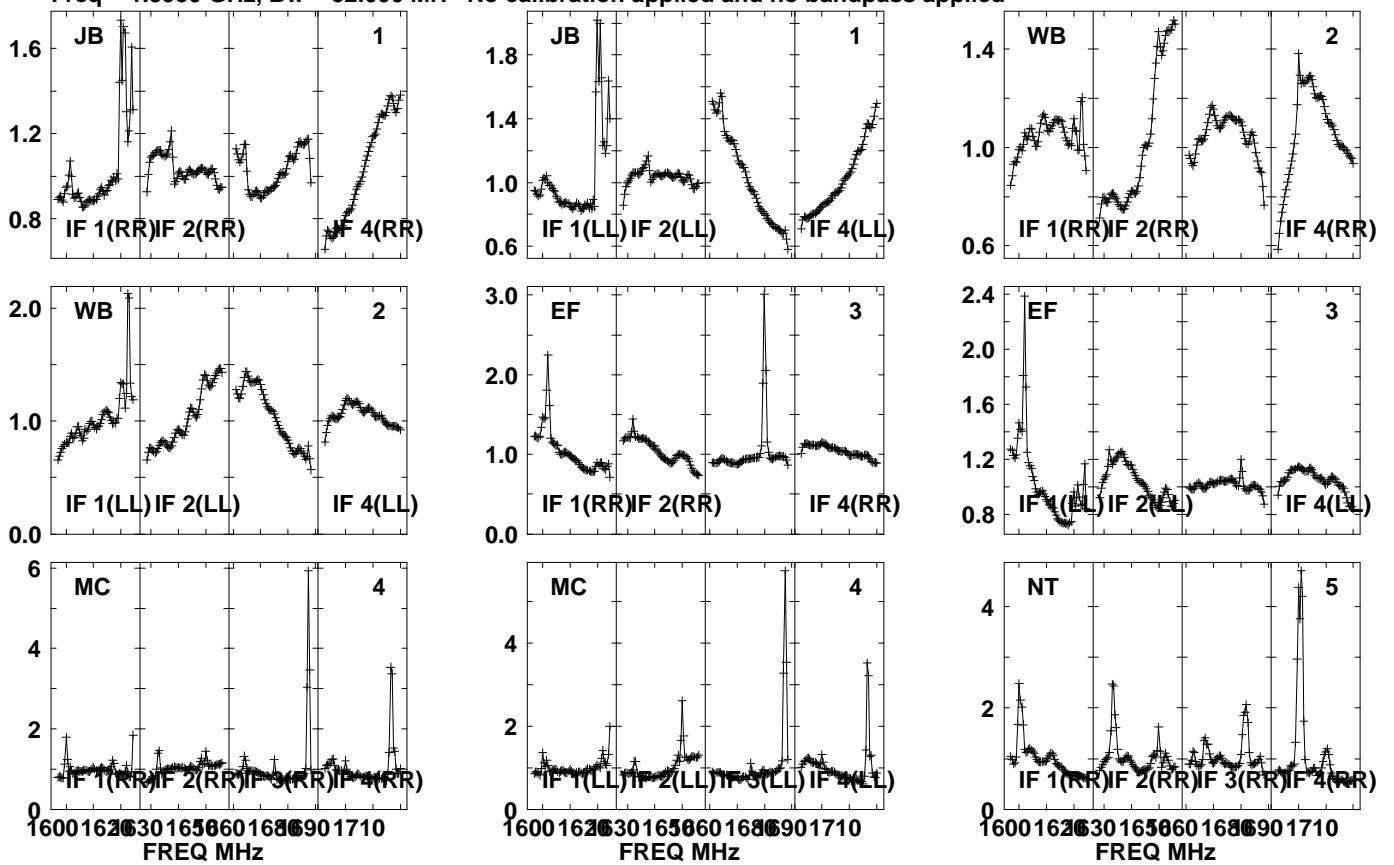

Lower frame: Real Jy
Auto-corr total-power spectrum Antenna: *
Timerange: 01/03:16:11 to 01/03:17:59

Plot file version 201 created 12-JUN-2023 14:39:20

J1547+2052 ES106B.UVDATA.1

Freq = 1.5950 GHz, Bw = 32.000 MH No calibration applied and no bandpass applied

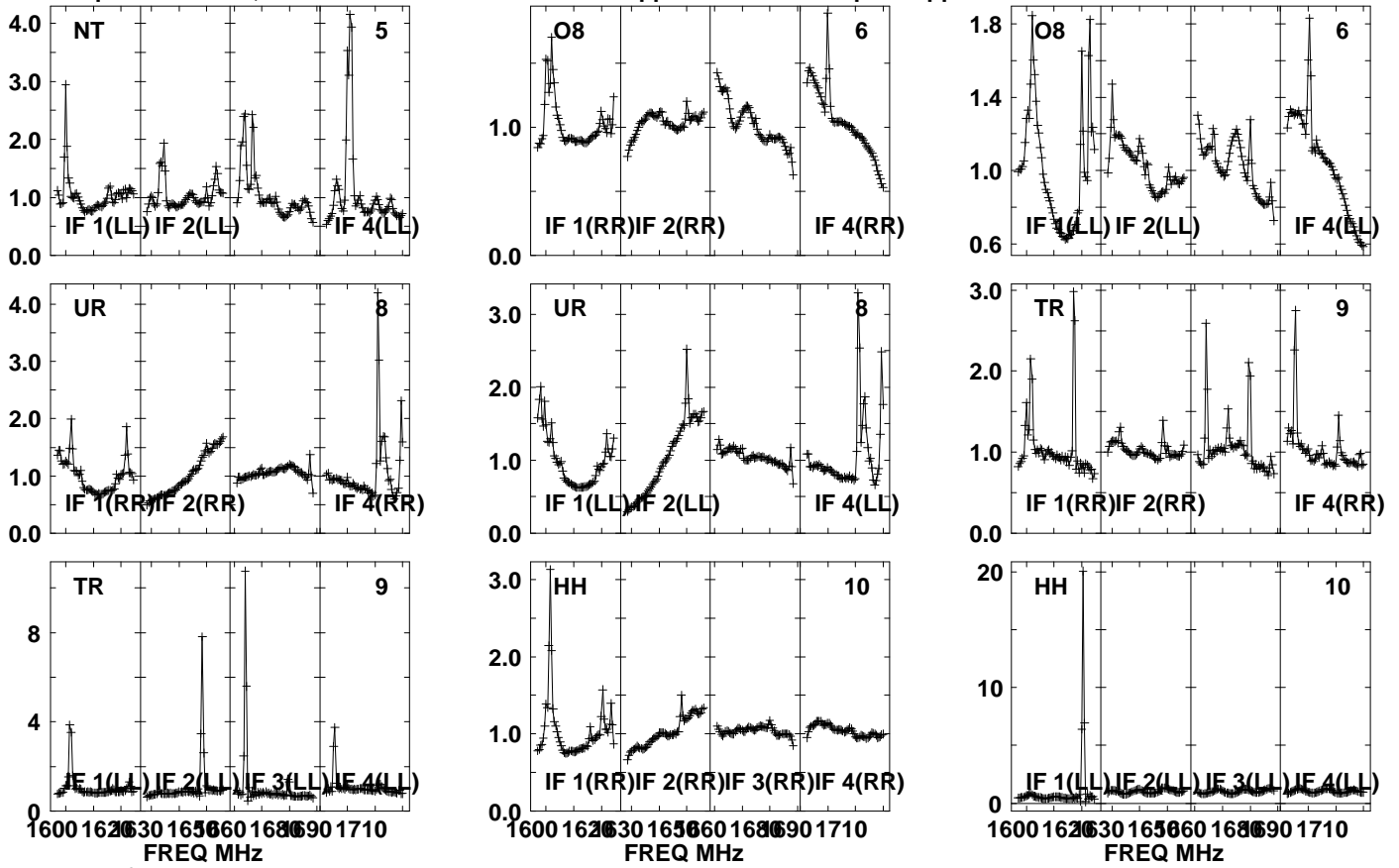

Lower frame: Real Jy

Auto-corr total-power spectrum Antenna: *

Timerange: 01/03:16:11 to 01/03:17:59

Plot file version 202 created 12-JUN-2023 14:39:20

J1548 ES106B.UVDATA.1

Freq = 1.5950 GHz, Bw = 32.000 MH No calibration applied and no bandpass applied

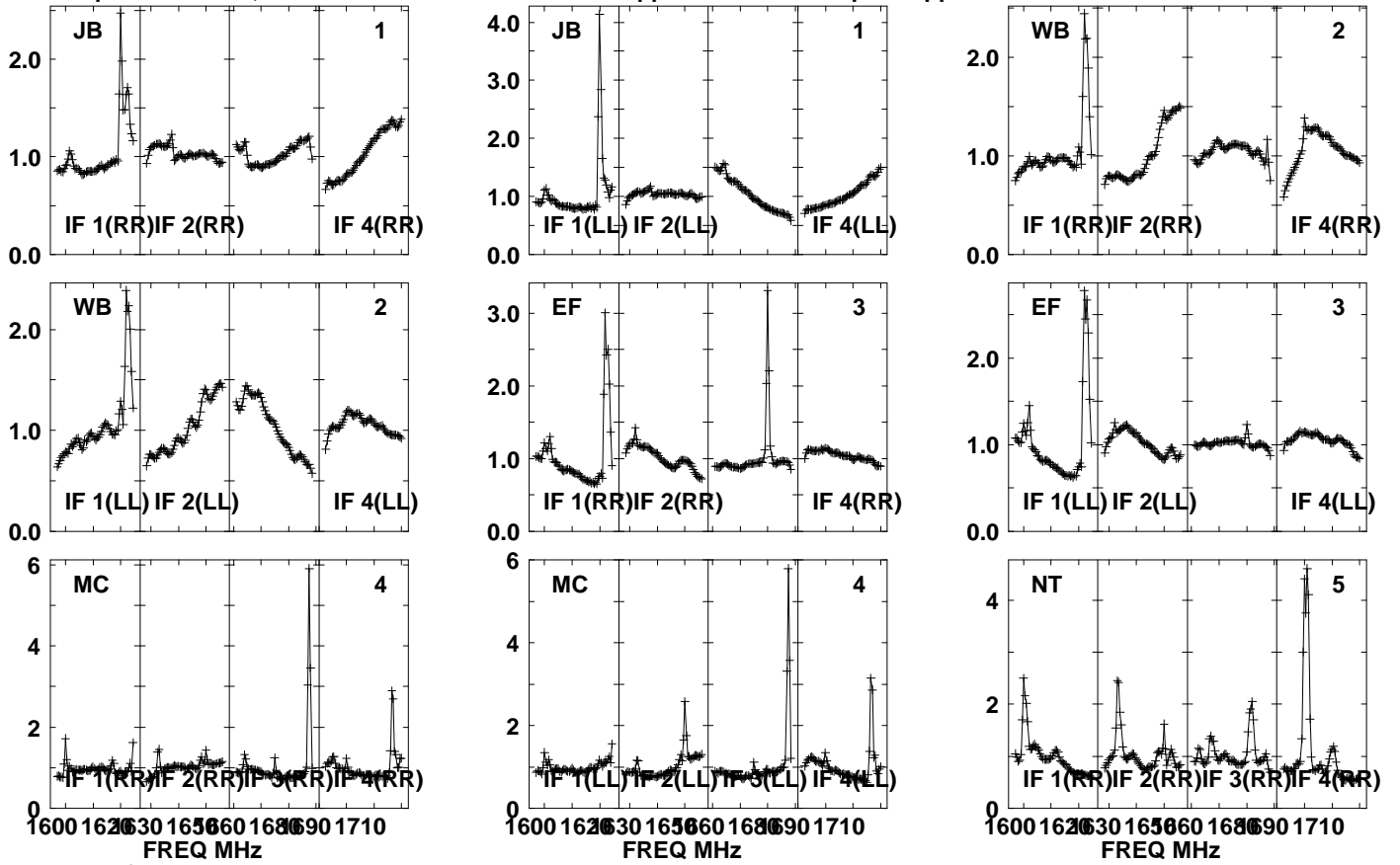

Lower frame: Real Jy

Auto-corr total-power spectrum Antenna: *

Timerange: 01/03:18:01 to 01/03:21:29

Plot file version 203 created 12-JUN-2023 14:39:20

J1548 ES106B.UVDATA.1

Freq = 1.5950 GHz, Bw = 32.000 MH No calibration applied and no bandpass applied

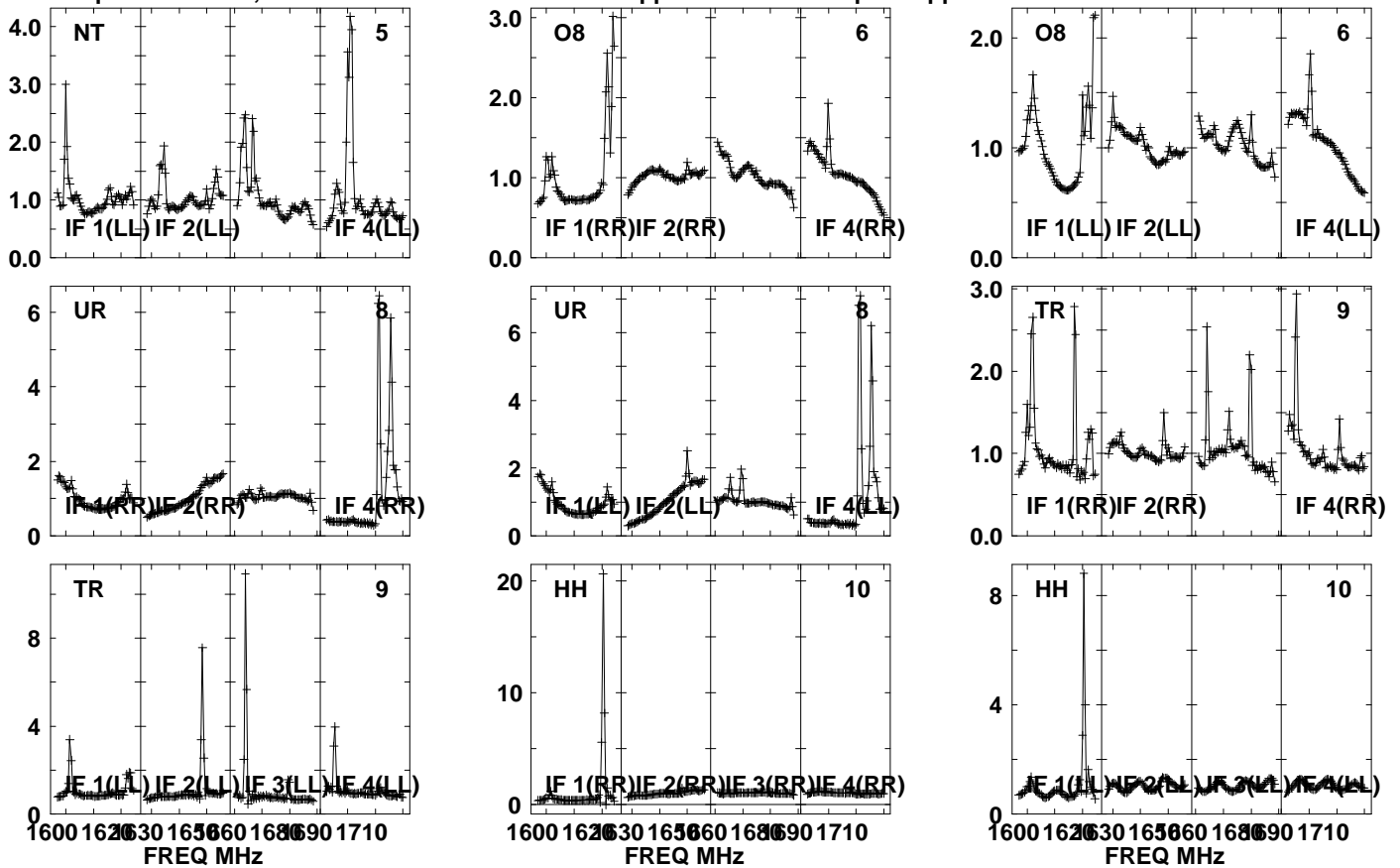

Lower frame: Real Jy

Auto-corr total-power spectrum Antenna: *

Timerange: 01/03:18:01 to 01/03:21:29

Plot file version 204 created 12-JUN-2023 14:39:20

J1547+2052 ES106B.UVDATA.1

Freq = 1.5950 GHz, Bw = 32.000 MH No calibration applied and no bandpass applied

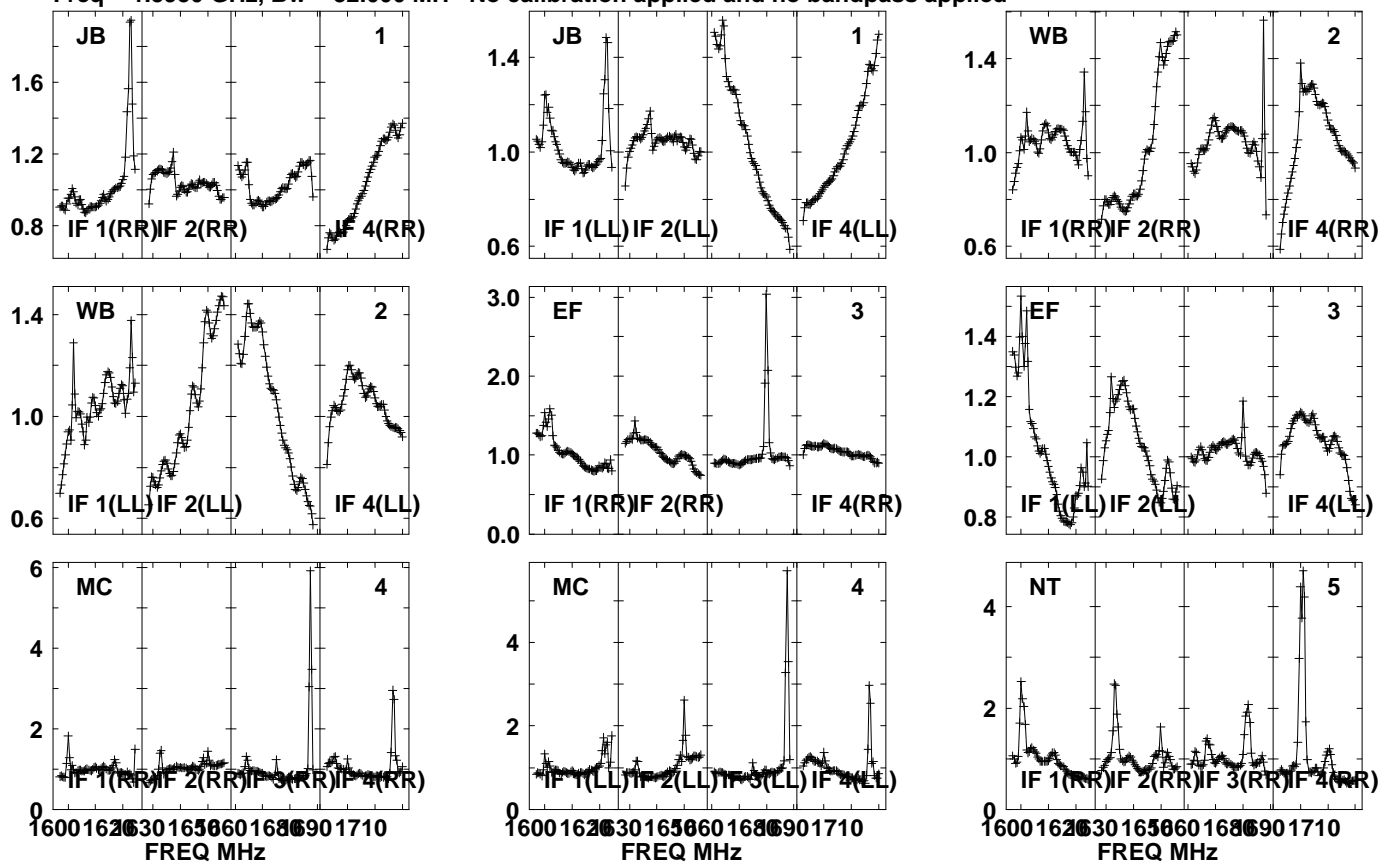

Lower frame: Real Jy
Auto-corr total-power spectrum Antenna: *
Timerange: 01/03:21:31 to 01/03:22:59

Plot file version 205 created 12-JUN-2023 14:39:20

J1547+2052 ES106B.UVDATA.1

Freq = 1.5950 GHz, Bw = 32.000 MH No calibration applied and no bandpass applied

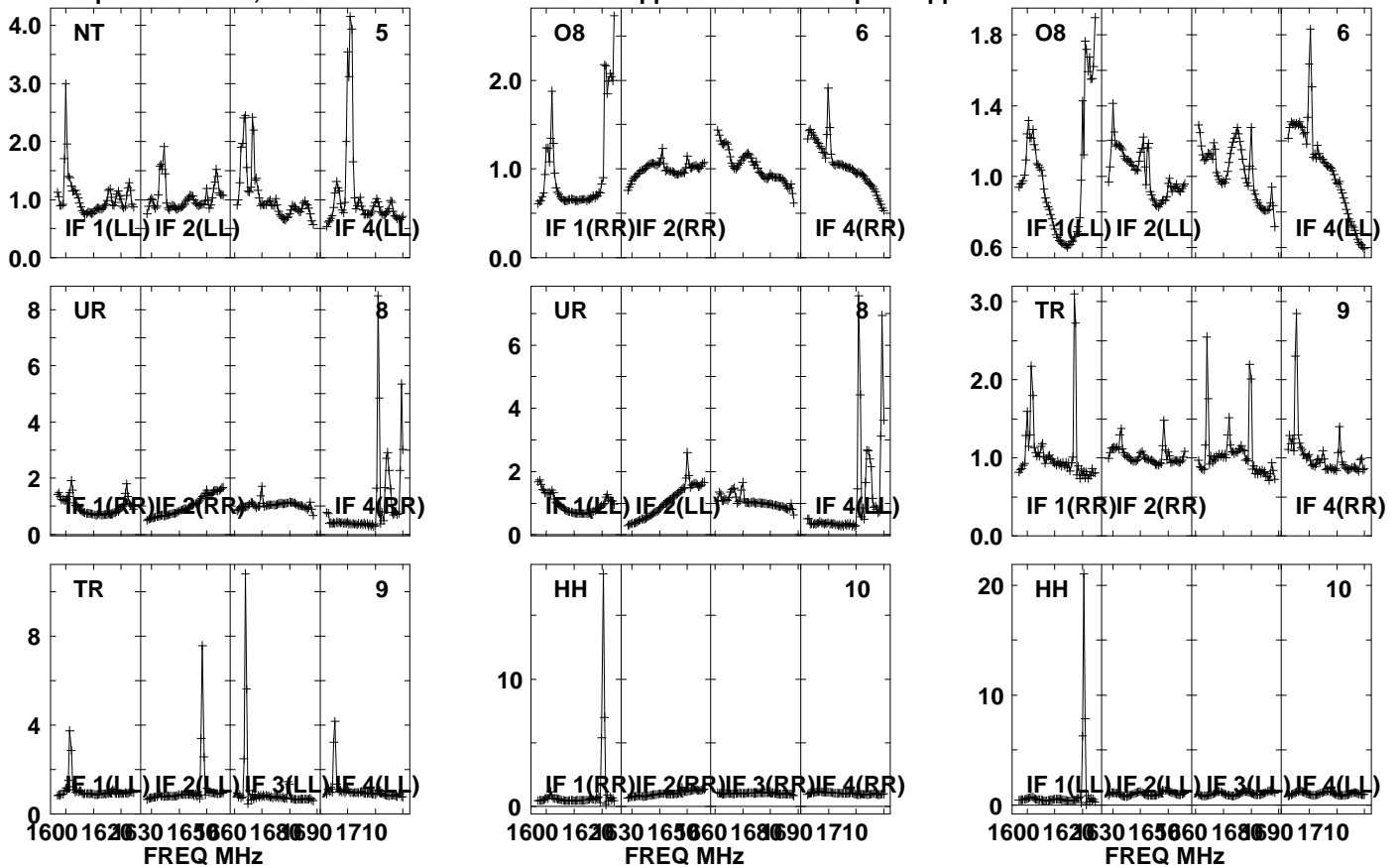

Lower frame: Real Jy

Auto-corr total-power spectrum Antenna: *

Timerange: 01/03:21:31 to 01/03:22:59

Plot file version 206 created 12-JUN-2023 14:39:20

J1545+2006 ES106B.UVDATA.1

Freq = 1.5950 GHz, Bw = 32.000 MH No calibration applied and no bandpass applied

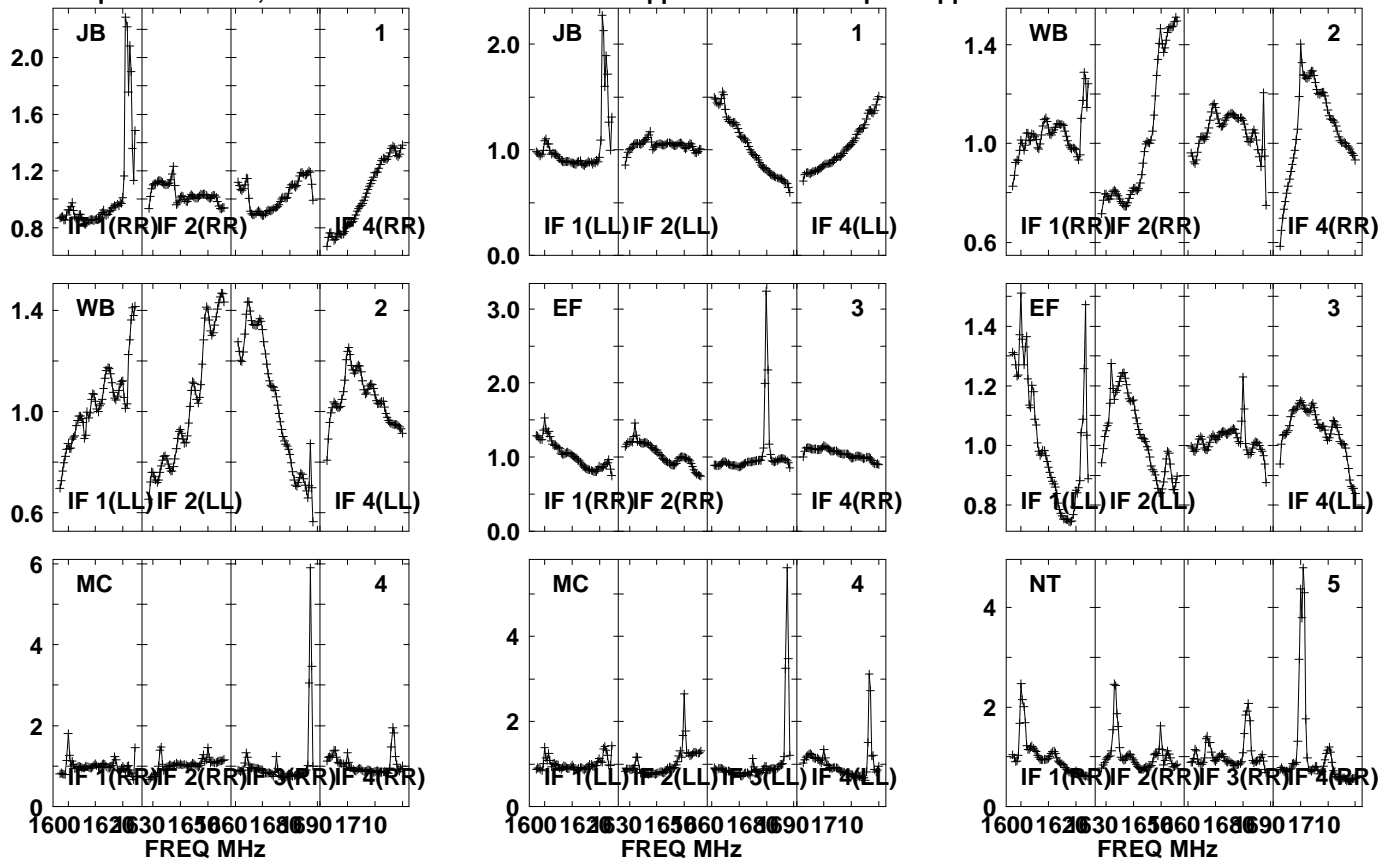

Lower frame: Real Jy
Auto-corr total-power spectrum Antenna: *
Timerange: 01/03:23:01 to 01/03:25:29

Plot file version 207 created 12-JUN-2023 14:39:20

J1545+2006 ES106B.UVDATA.1

Freq = 1.5950 GHz, Bw = 32.000 MH No calibration applied and no bandpass applied

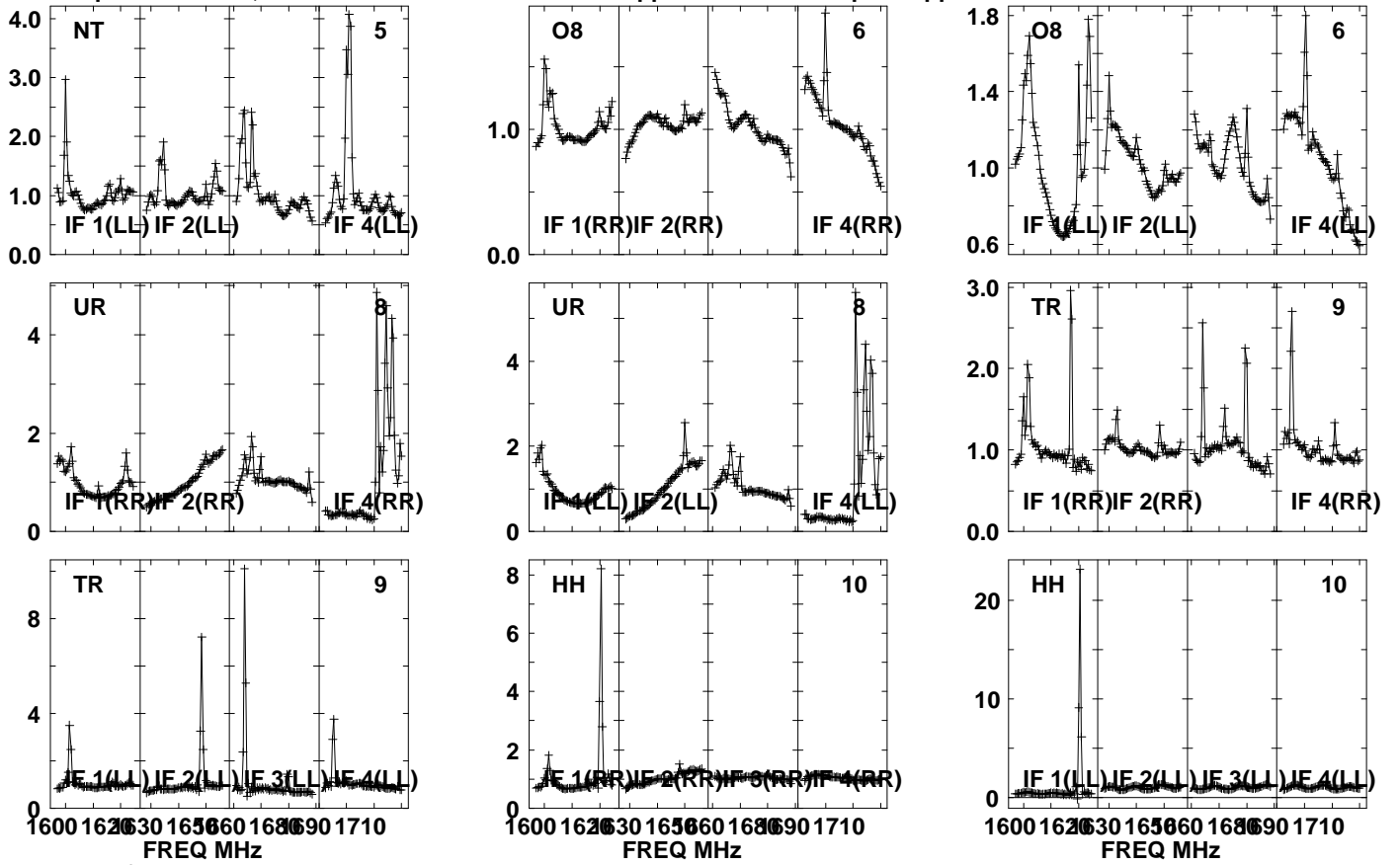

Lower frame: Real Jy

Auto-corr total-power spectrum Antenna: *

Timerange: 01/03:23:01 to 01/03:25:29

Plot file version 208 created 12-JUN-2023 14:39:20

J1547+2052 ES106B.UVDATA.1

Freq = 1.5950 GHz, Bw = 32.000 MH No calibration applied and no bandpass applied

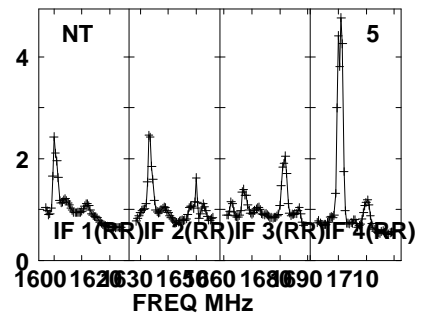
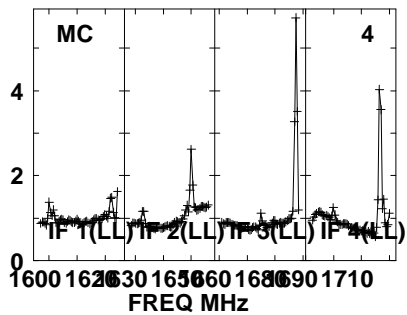
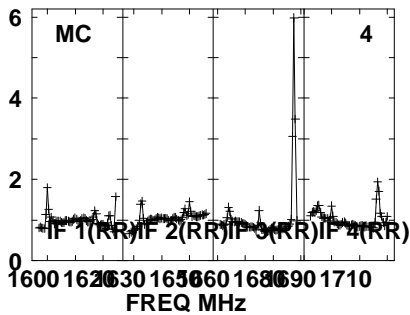
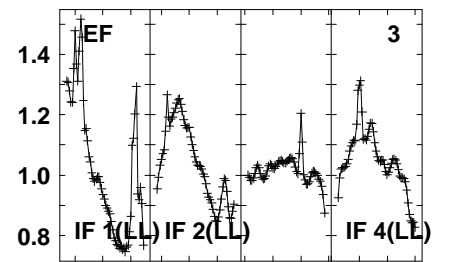
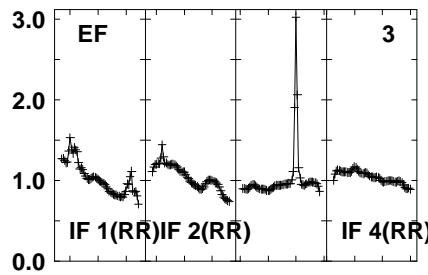
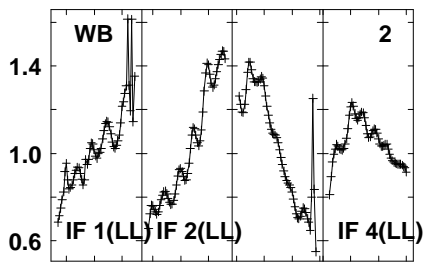
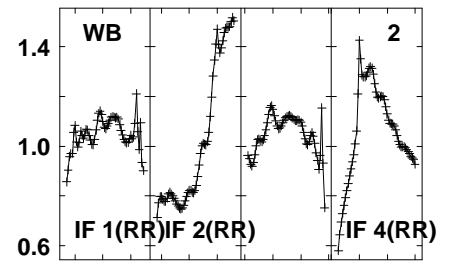
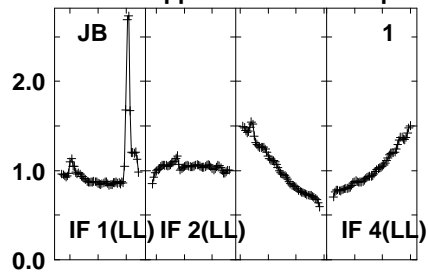
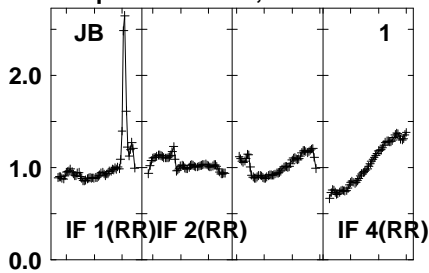

Lower frame: Real Jy

Auto-corr total-power spectrum Antenna: *

Timerange: 01/03:25:31 to 01/03:26:59

Plot file version 209 created 12-JUN-2023 14:39:20

J1547+2052 ES106B.UVDATA.1

Freq = 1.5950 GHz, Bw = 32.000 MH No calibration applied and no bandpass applied

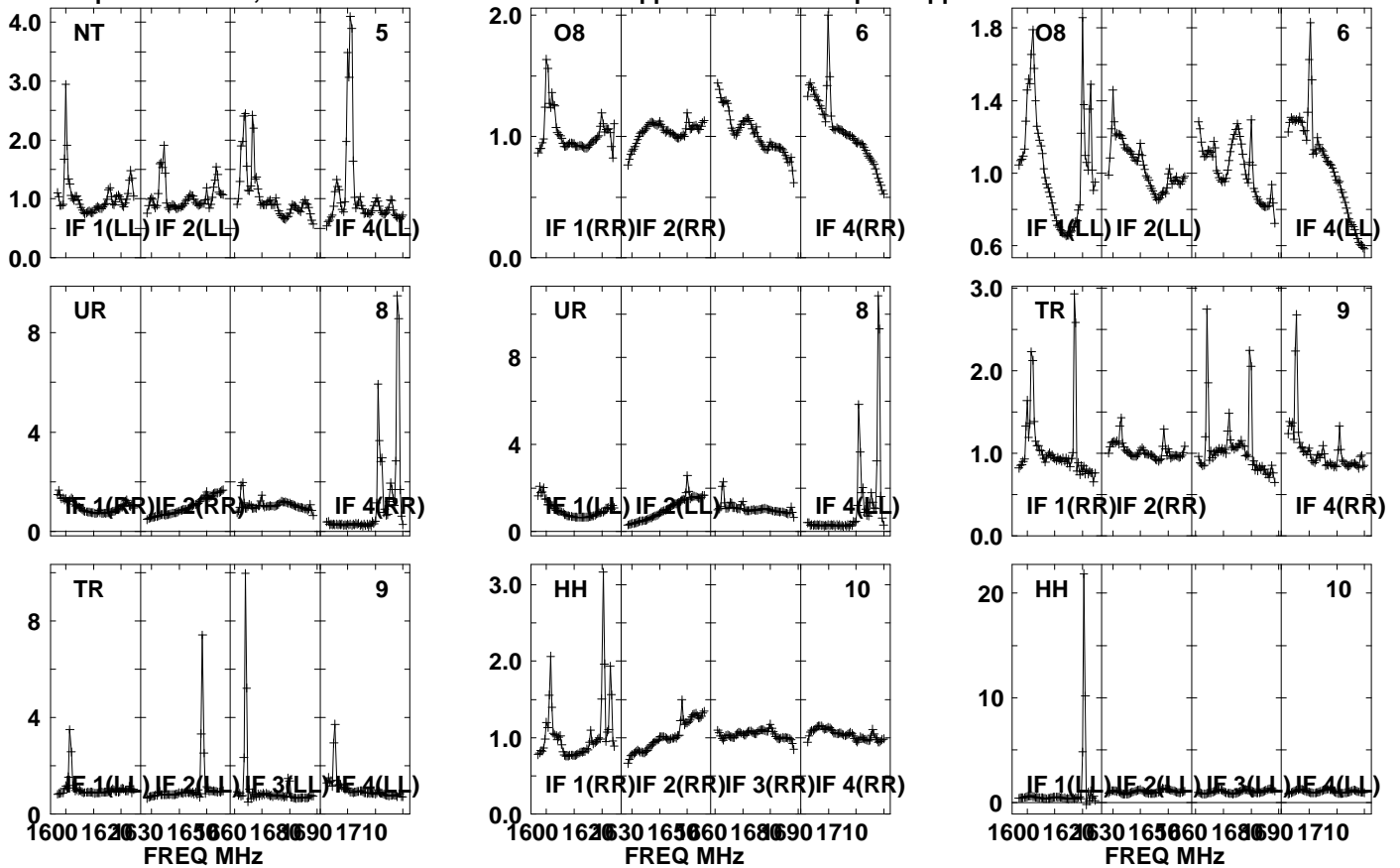

Lower frame: Real Jy

Auto-corr total-power spectrum Antenna: *

Timerange: 01/03:25:31 to 01/03:26:59

Plot file version 210 created 12-JUN-2023 14:39:20

J1548 ES106B.UVDATA.1

Freq = 1.5950 GHz, Bw = 32.000 MH No calibration applied and no bandpass applied

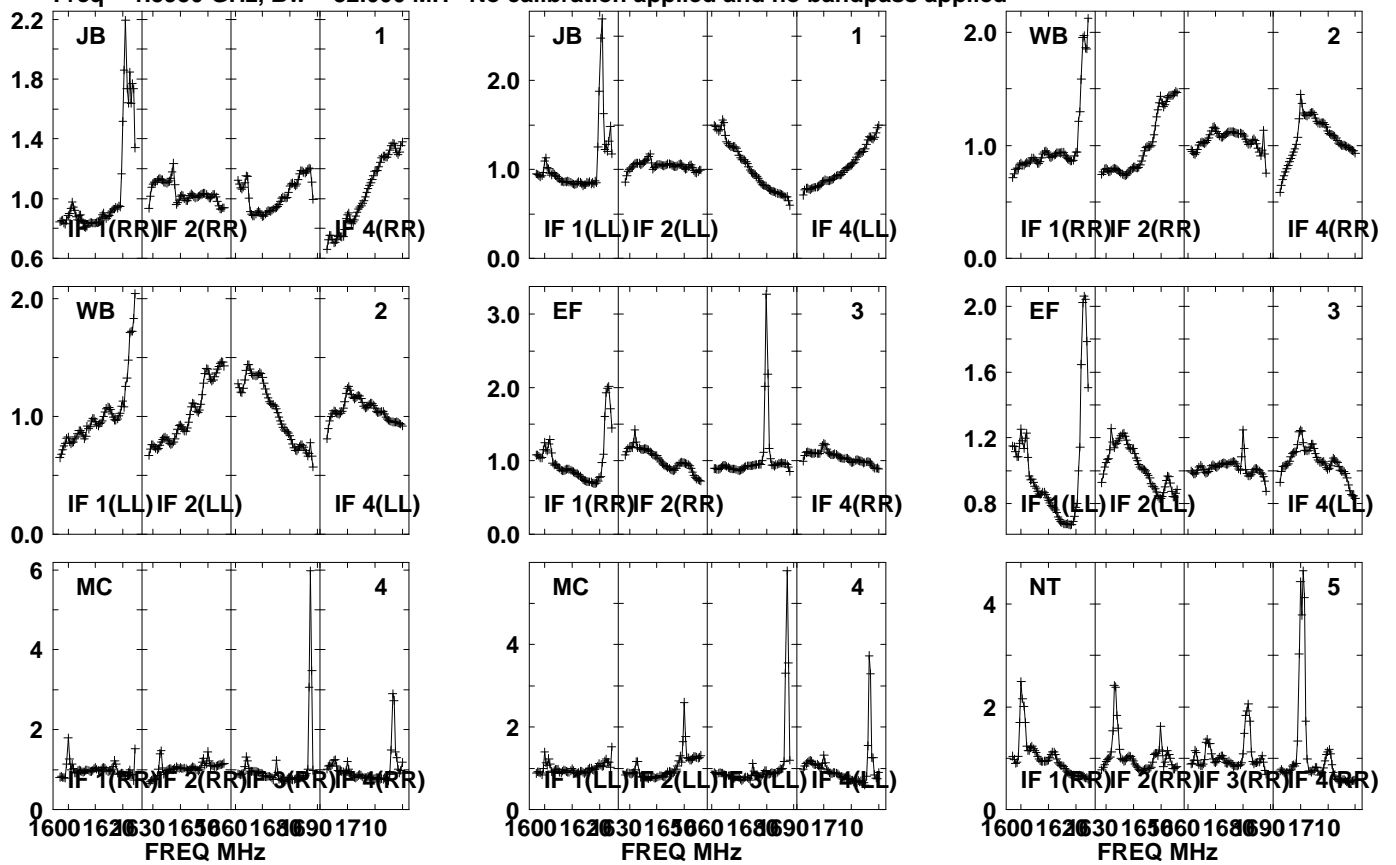

Lower frame: Real Jy
Auto-corr total-power spectrum Antenna: *
Timerange: 01/03:27:31 to 01/03:31:29

Plot file version 211 created 12-JUN-2023 14:39:20

J1548 ES106B.UVDATA.1

Freq = 1.5950 GHz, Bw = 32.000 MH No calibration applied and no bandpass applied

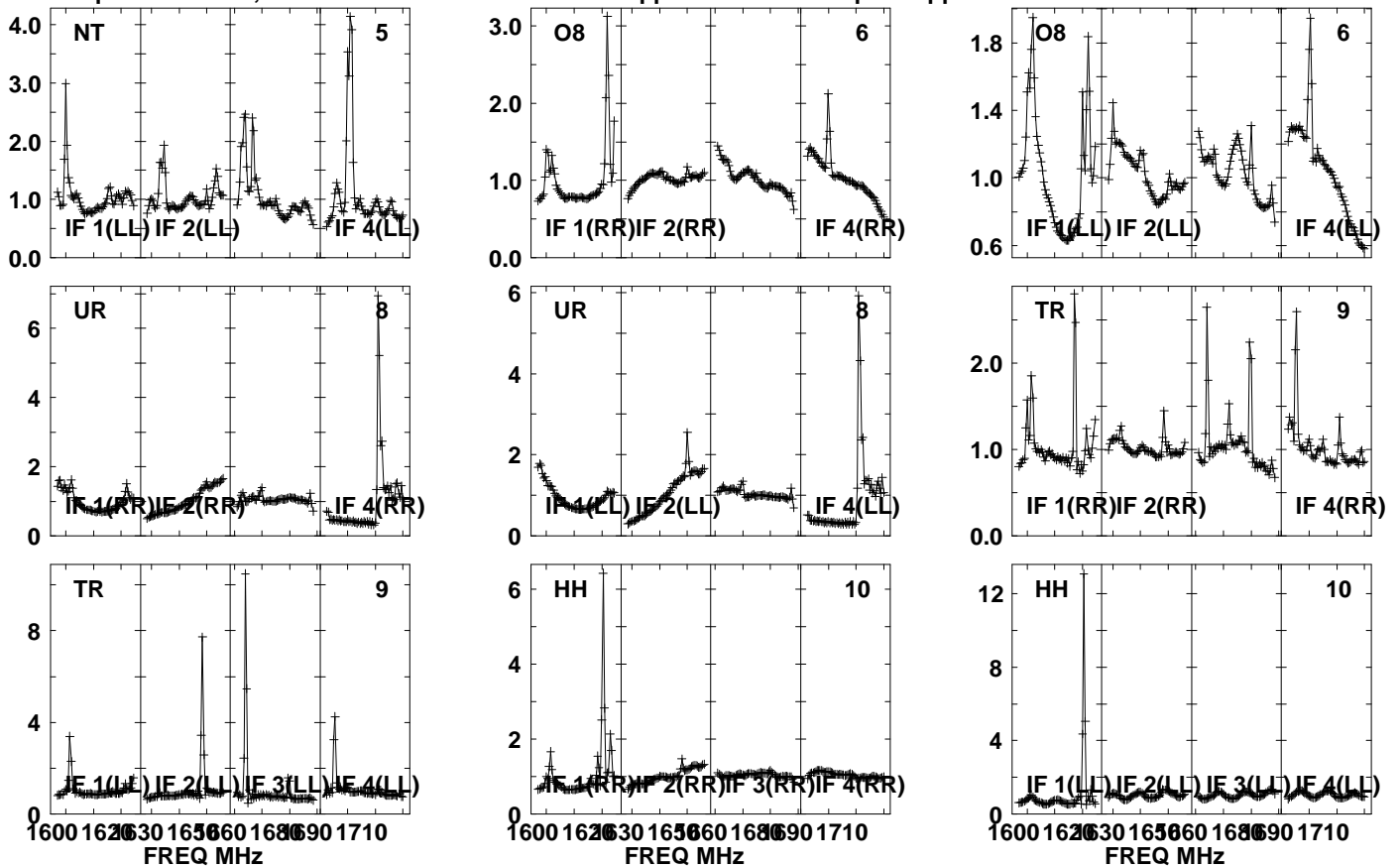

Lower frame: Real Jy

Auto-corr total-power spectrum Antenna: *

Timerange: 01/03:27:31 to 01/03:31:29

Plot file version 212 created 12-JUN-2023 14:39:20

J1547+2052 ES106B.UVDATA.1

Freq = 1.5950 GHz, Bw = 32.000 MH No calibration applied and no bandpass applied

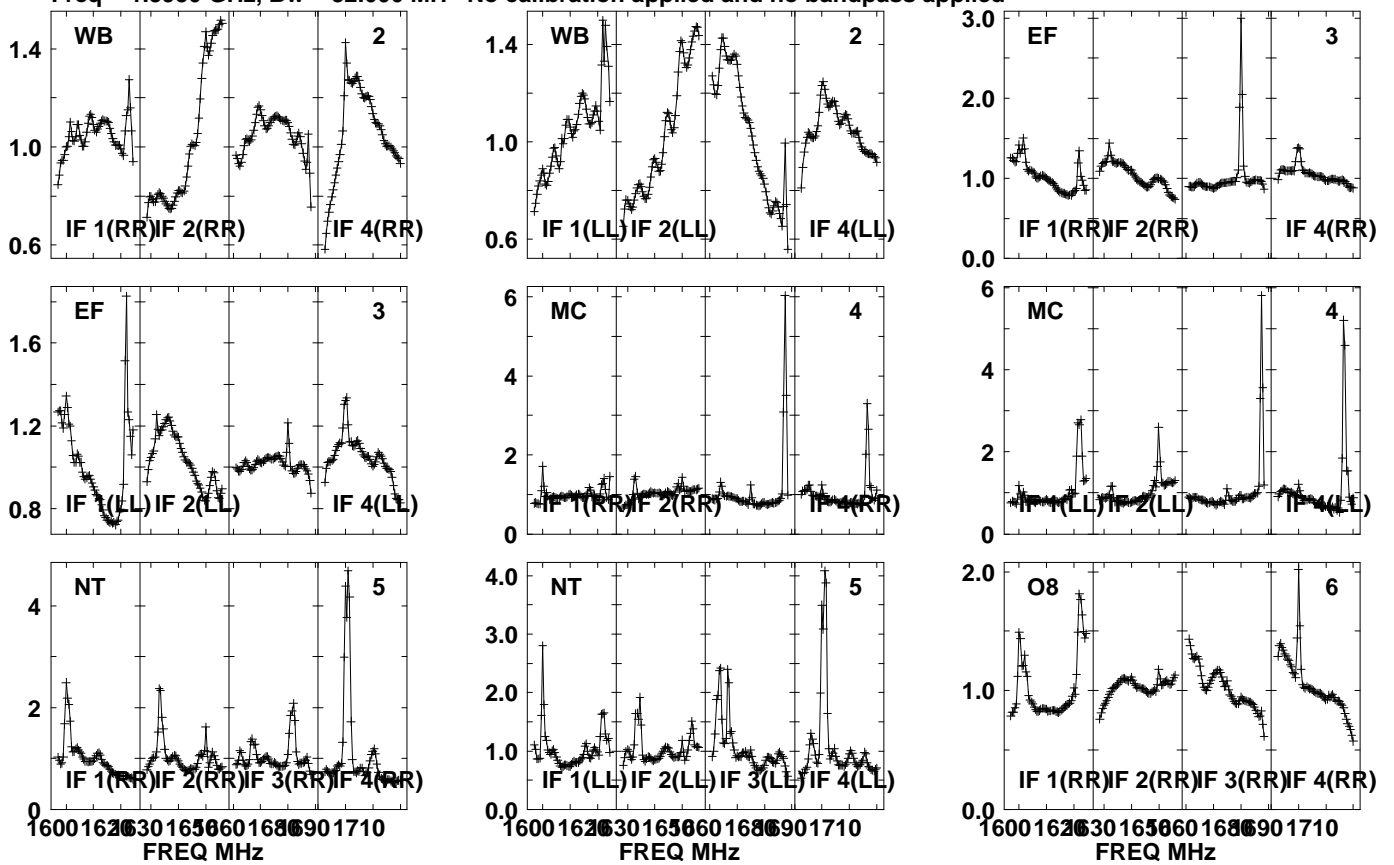

Lower frame: Real Jy
Auto-corr total-power spectrum Antenna: *
Timerange: 01/03:31:31 to 01/03:32:59

Plot file version 213 created 12-JUN-2023 14:39:20

J1547+2052 ES106B.UVDATA.1

Freq = 1.5950 GHz, Bw = 32.000 MH No calibration applied and no bandpass applied

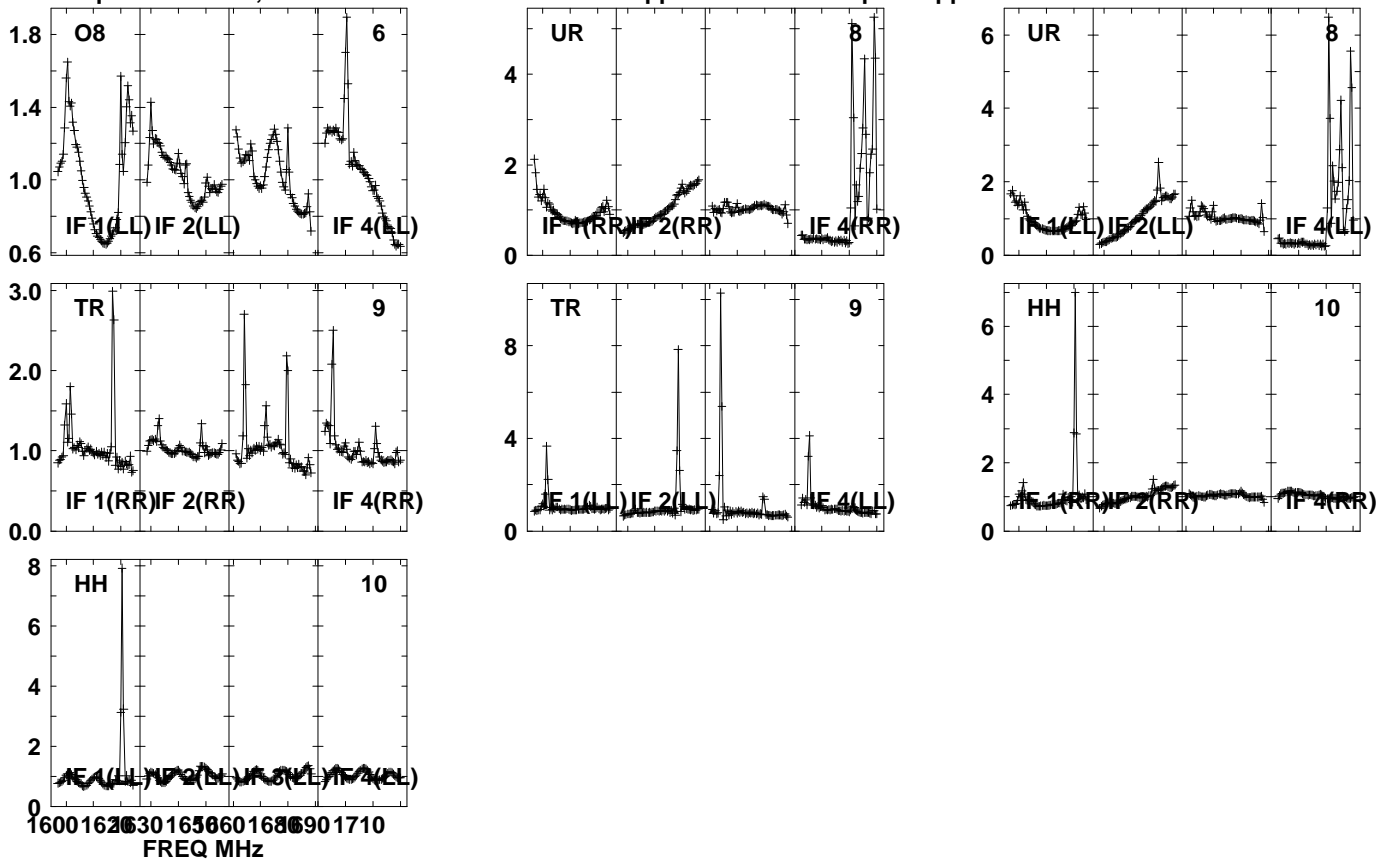

Lower frame: Real Jy

Auto-corr total-power spectrum Antenna: *

Timerange: 01/03:31:31 to 01/03:32:59

Plot file version 214 created 12-JUN-2023 14:39:20

J1548 ES106B.UVDATA.1

Freq = 1.5950 GHz, Bw = 32.000 MH No calibration applied and no bandpass applied

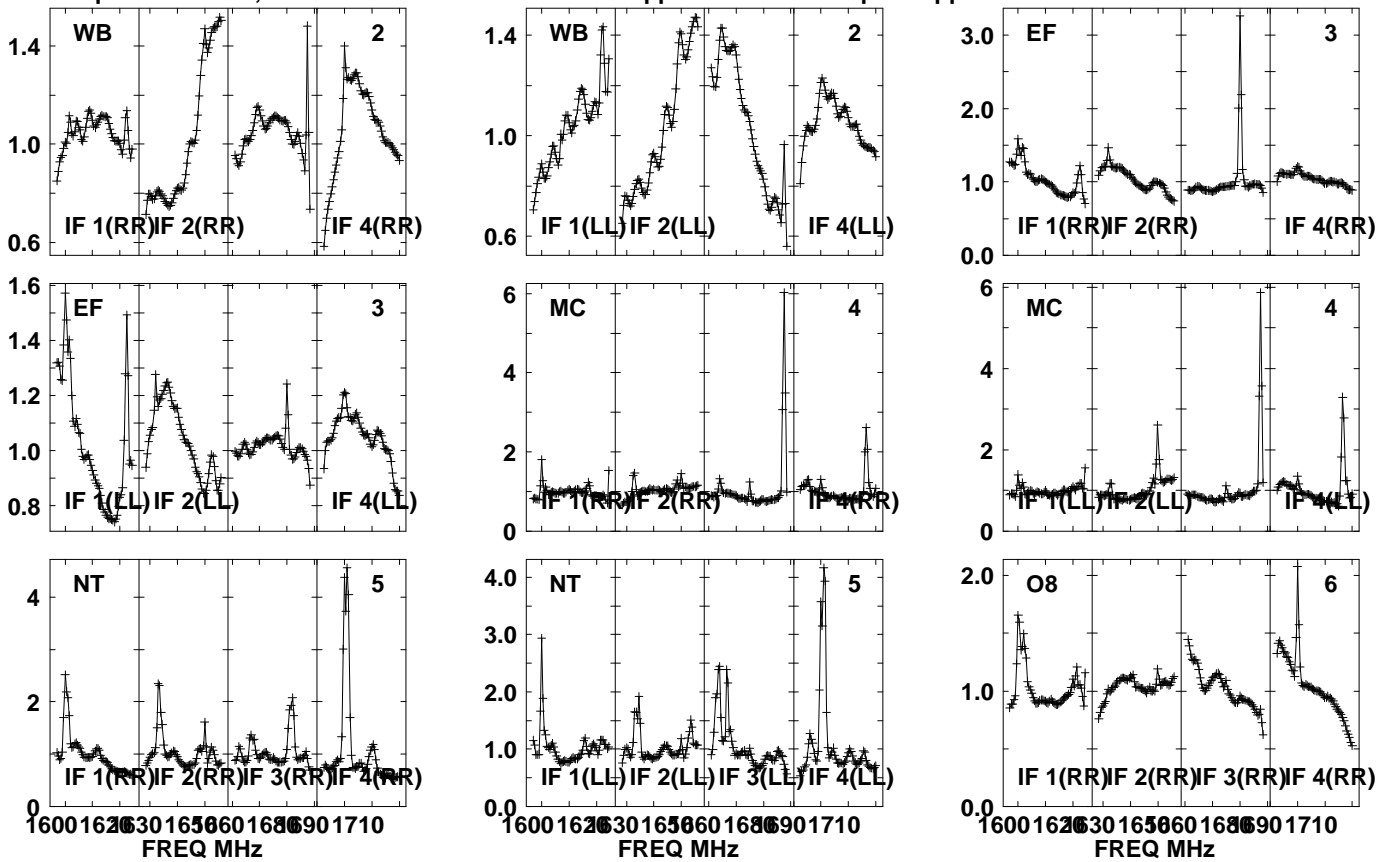

Lower frame: Real Jy
Auto-corr total-power spectrum Antenna: *
Timerange: 01/03:33:01 to 01/03:36:29

Plot file version 215 created 12-JUN-2023 14:39:21

J1548 ES106B.UVDATA.1

Freq = 1.5950 GHz, Bw = 32.000 MH No calibration applied and no bandpass applied

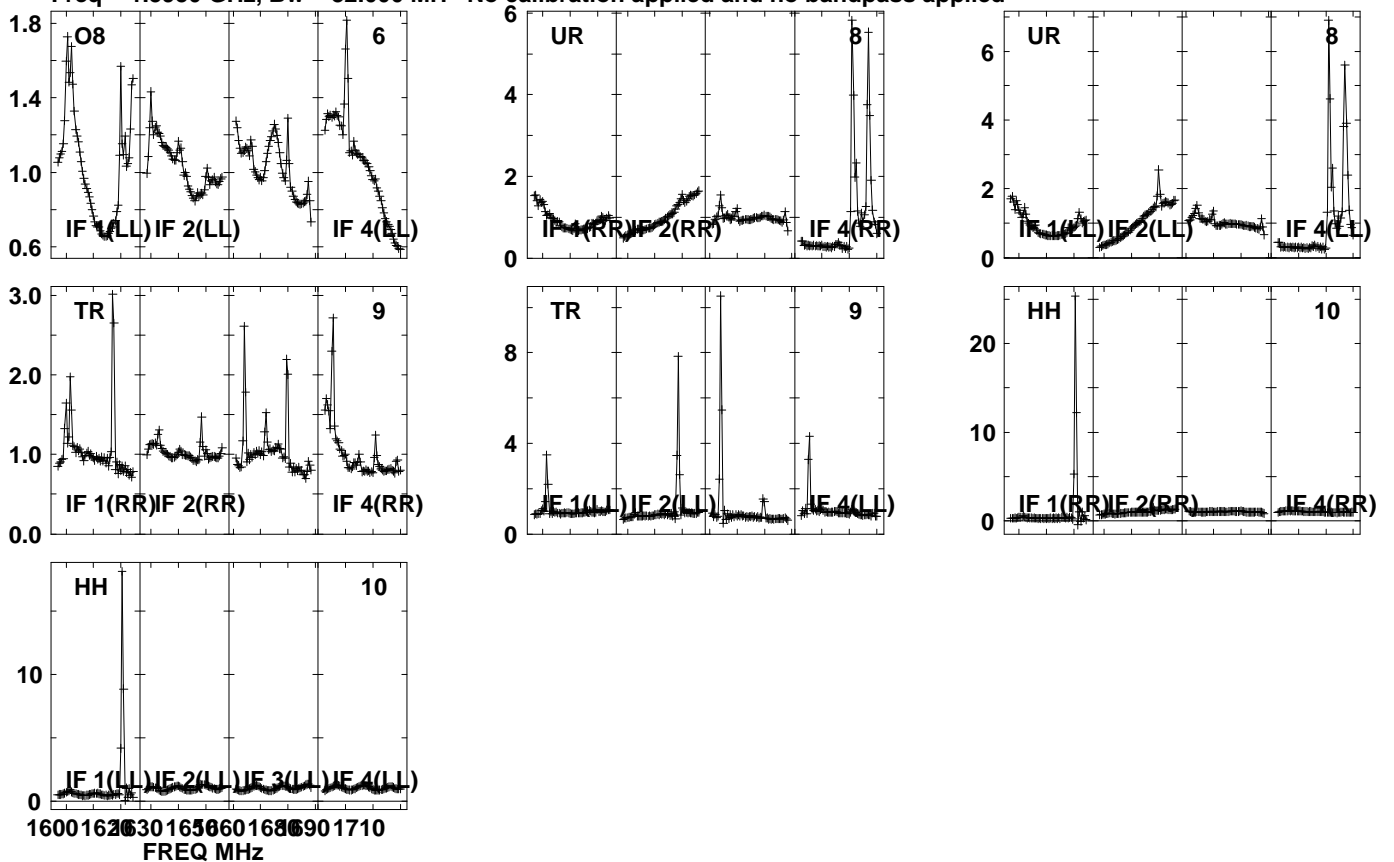

1600 1620 1630 1650 1660 1680 1690 1710

FREQ MHz

Lower frame: Real Jy

Auto-corr total-power spectrum Antenna: *

Timerange: 01/03:33:01 to 01/03:36:29

Plot file version 216 created 12-JUN-2023 14:39:21

J1547+2052 ES106B.UVDATA.1

Freq = 1.5950 GHz, Bw = 32.000 MH No calibration applied and no bandpass applied

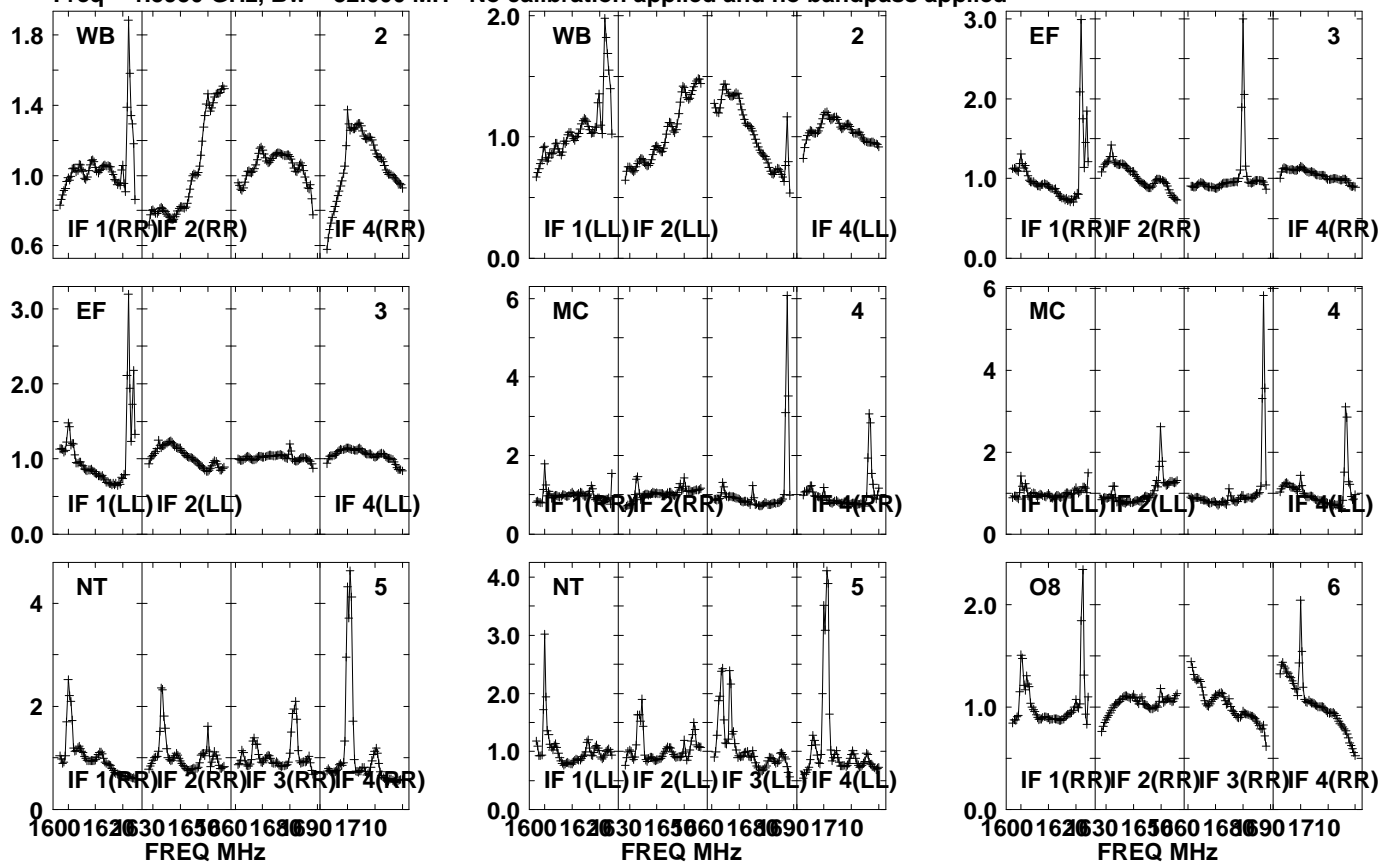

Lower frame: Real Jy
Auto-corr total-power spectrum Antenna: *
Timerange: 01/03:37:01 to 01/03:38:29

Plot file version 217 created 12-JUN-2023 14:39:21

J1547+2052 ES106B.UVDATA.1

Freq = 1.5950 GHz, Bw = 32.000 MH No calibration applied and no bandpass applied

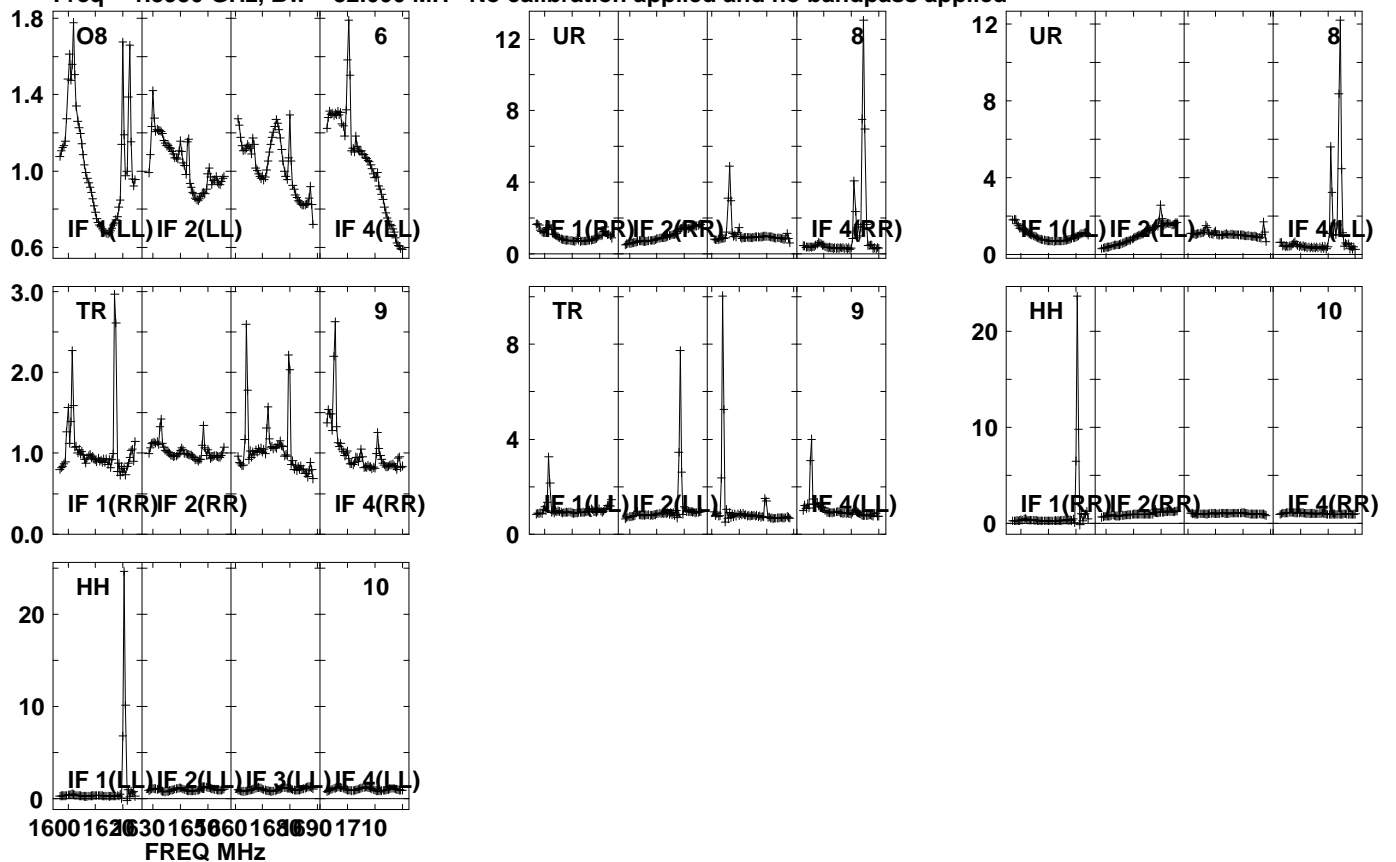

Lower frame: Real Jy

Auto-corr total-power spectrum Antenna: *

Timerange: 01/03:37:01 to 01/03:38:29

Plot file version 218 created 12-JUN-2023 14:39:21

J1548 ES106B.UVDATA.1

Freq = 1.5950 GHz, Bw = 32.000 MH No calibration applied and no bandpass applied

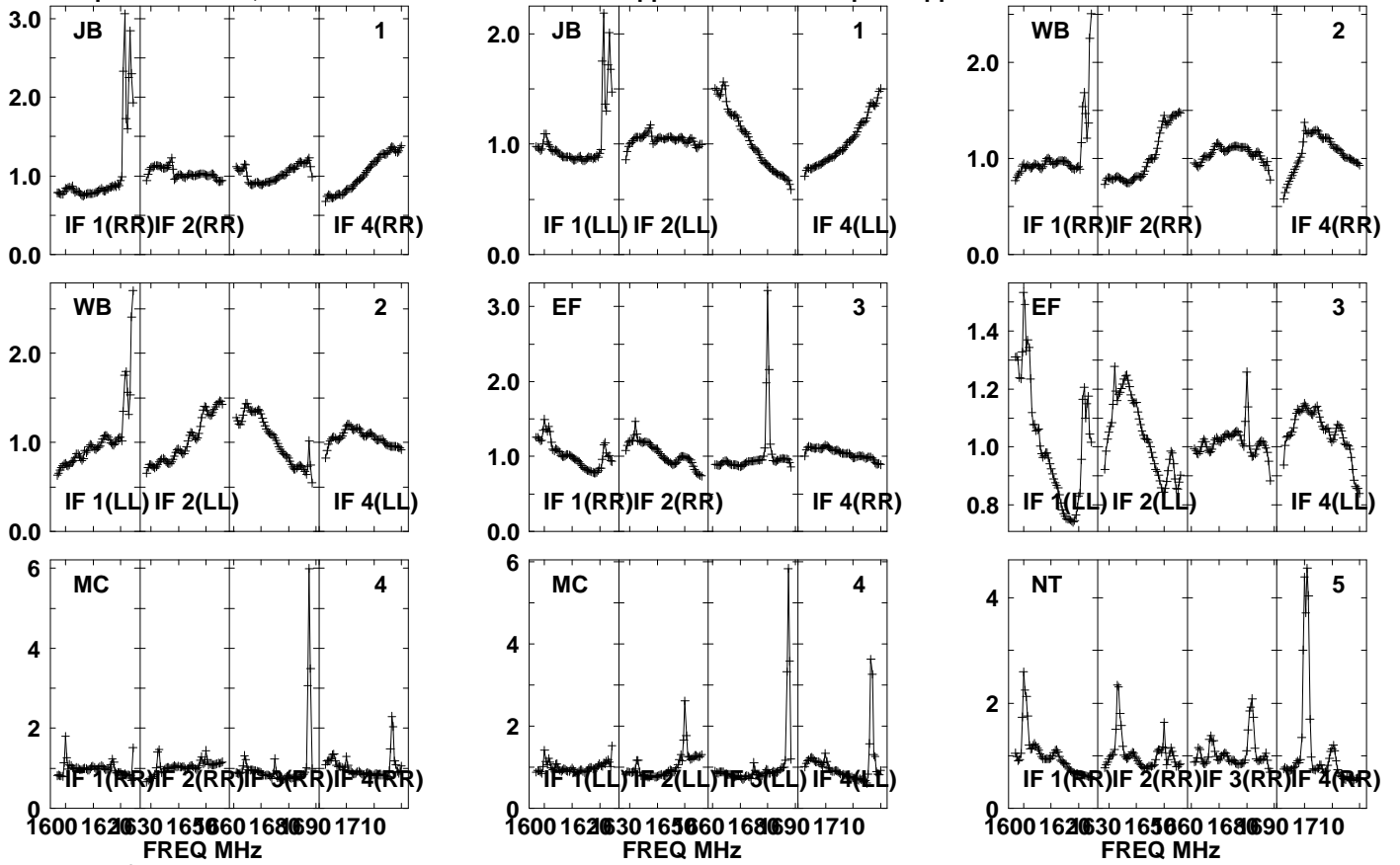

Lower frame: Real Jy

Auto-corr total-power spectrum Antenna: *

Timerange: 01/03:38:31 to 01/03:41:59

Plot file version 219 created 12-JUN-2023 14:39:21

J1548 ES106B.UVDATA.1

Freq = 1.5950 GHz, Bw = 32.000 MH No calibration applied and no bandpass applied

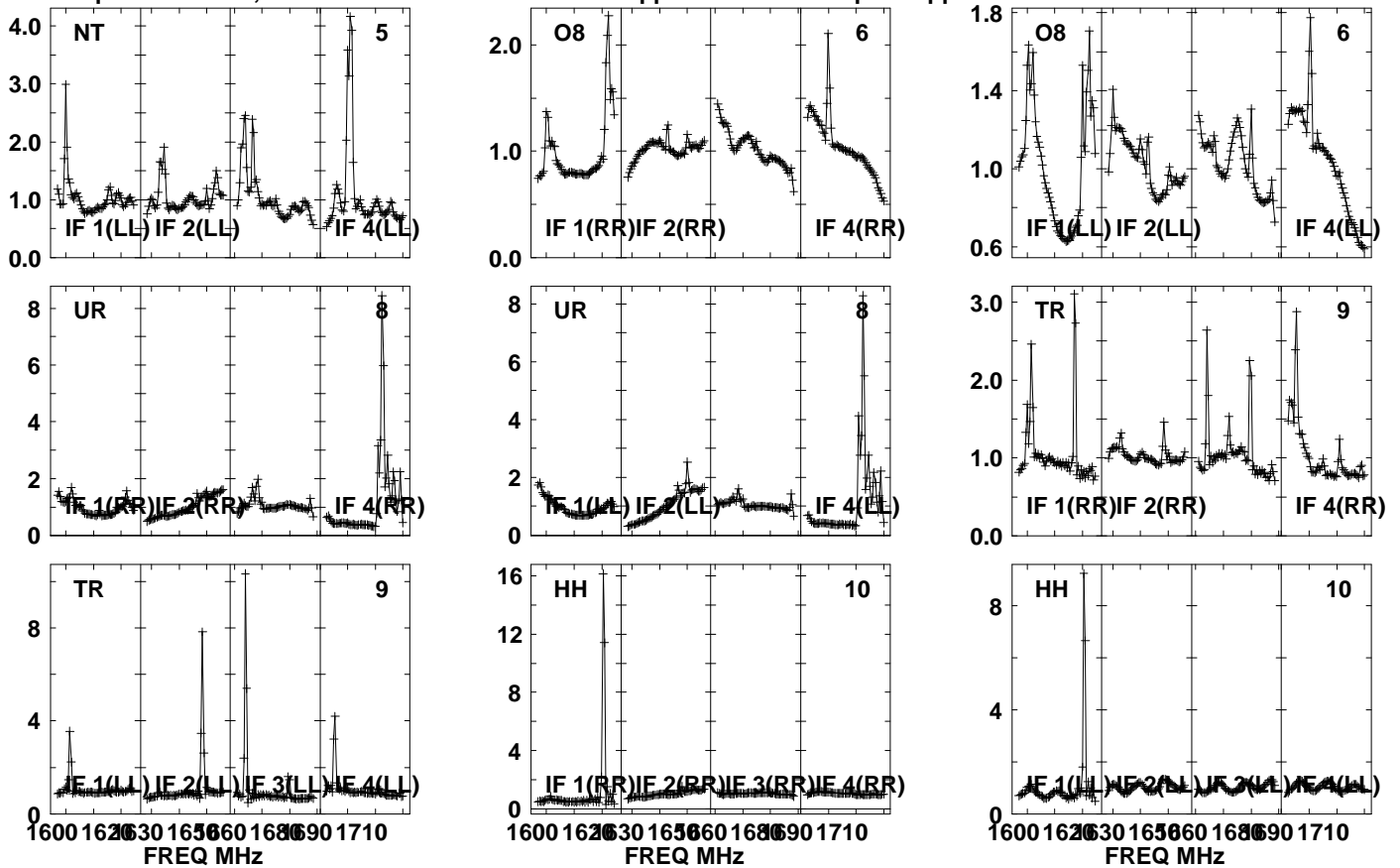

Lower frame: Real Jy

Auto-corr total-power spectrum Antenna: *

Timerange: 01/03:38:31 to 01/03:41:59

Plot file version 220 created 12-JUN-2023 14:39:21

J1547+2052 ES106B.UVDATA.1

Freq = 1.5950 GHz, Bw = 32.000 MH No calibration applied and no bandpass applied

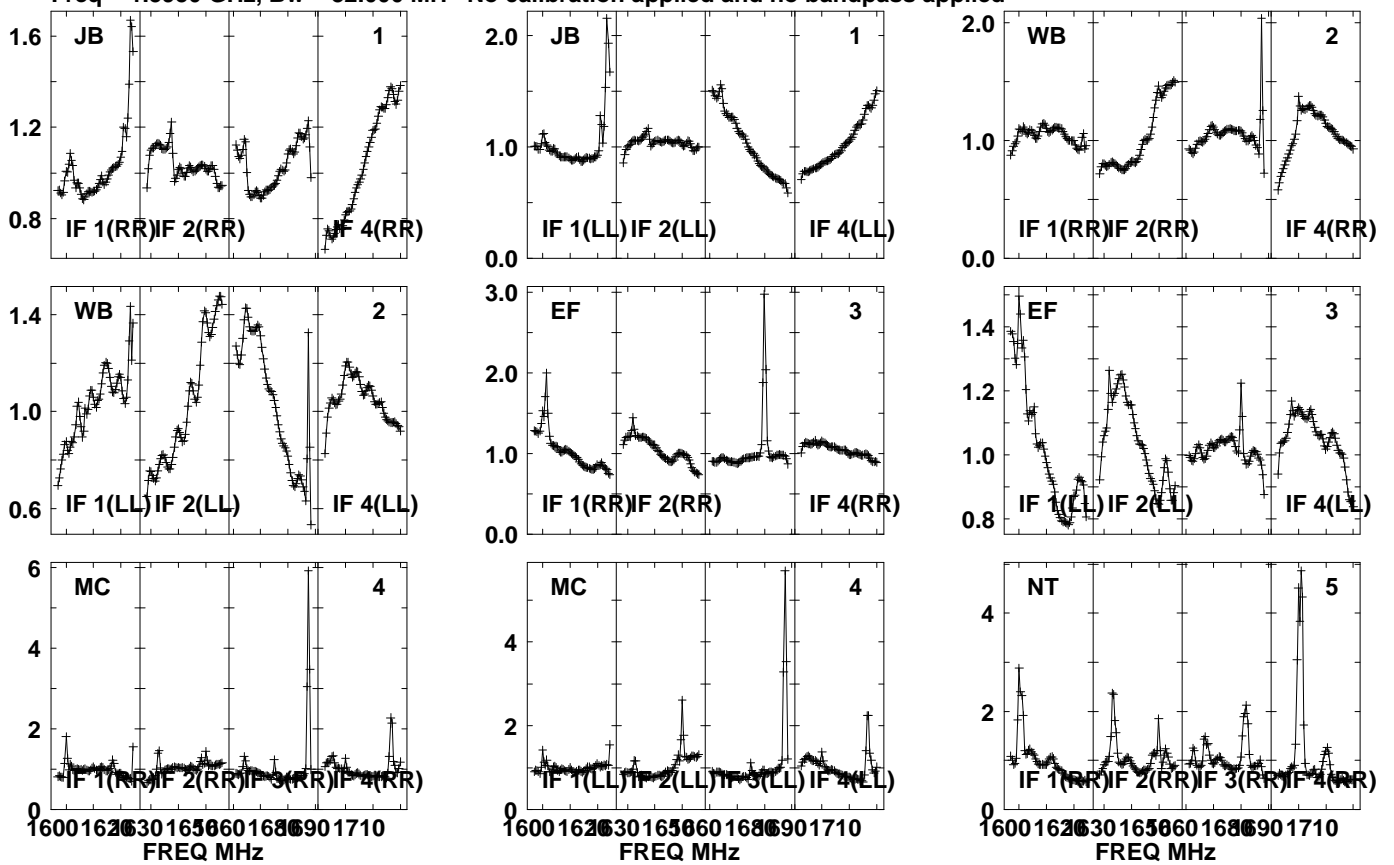

Lower frame: Real Jy
Auto-corr total-power spectrum Antenna: *
Timerange: 01/03:42:01 to 01/03:43:29

Plot file version 221 created 12-JUN-2023 14:39:21

J1547+2052 ES106B.UVDATA.1

Freq = 1.5950 GHz, Bw = 32.000 MH No calibration applied and no bandpass applied

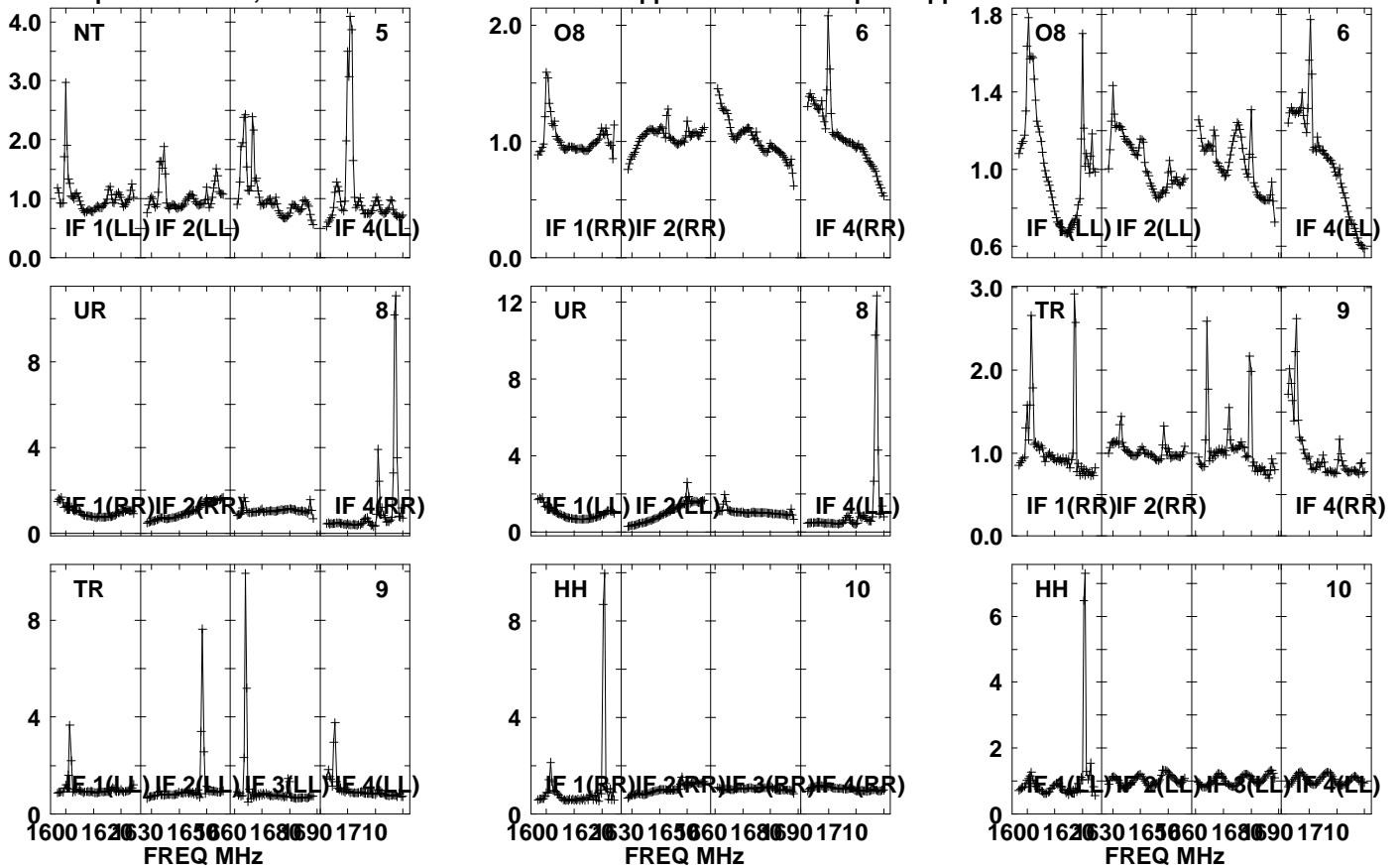

Lower frame: Real Jy

Auto-corr total-power spectrum Antenna: *

Timerange: 01/03:42:01 to 01/03:43:29

Plot file version 222 created 12-JUN-2023 14:39:21

J1545+2006 ES106B.UVDATA.1

Freq = 1.5950 GHz, Bw = 32.000 MH No calibration applied and no bandpass applied

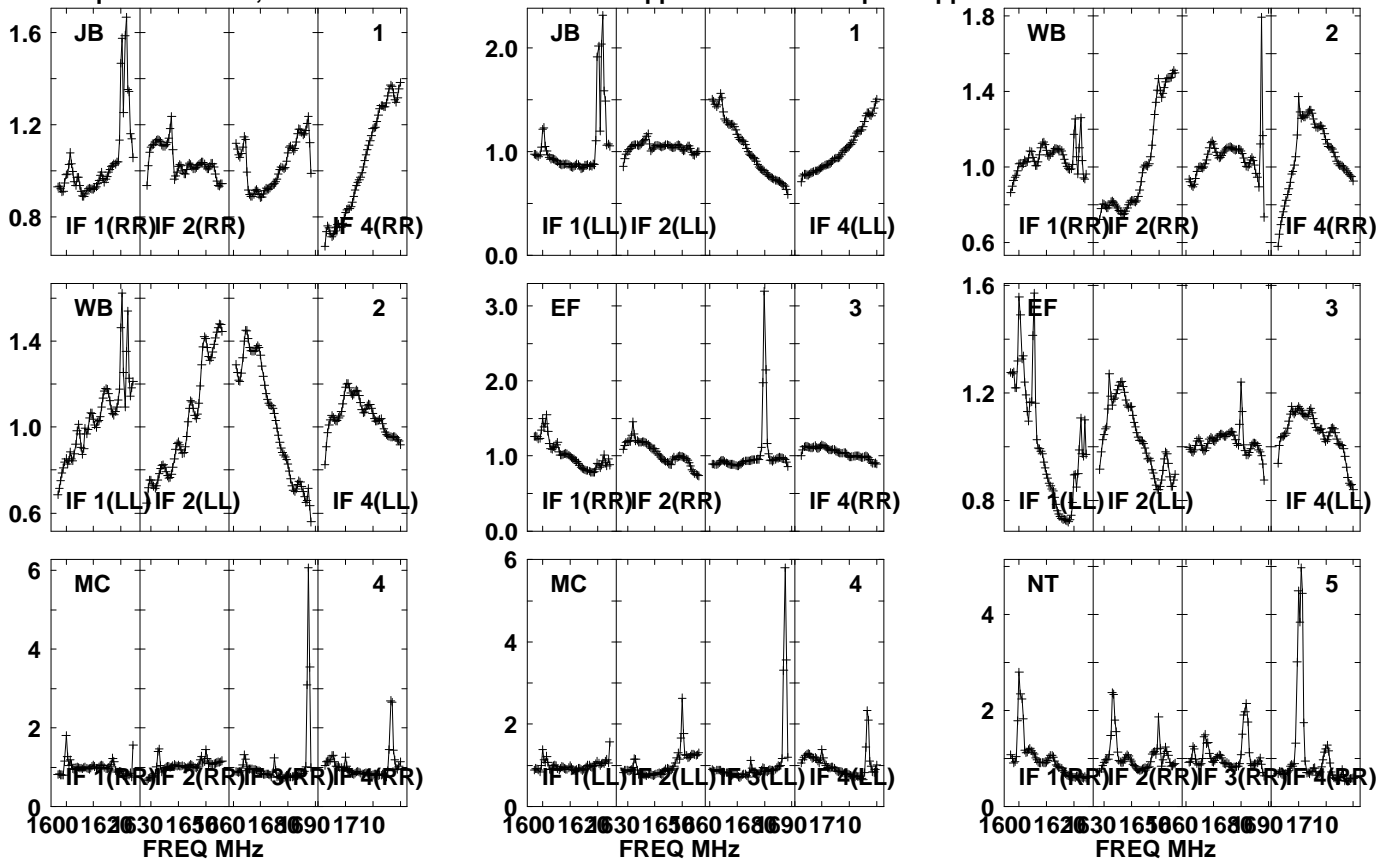

Lower frame: Real Jy
Auto-corr total-power spectrum Antenna: *
Timerange: 01/03:43:31 to 01/03:45:59

Plot file version 223 created 12-JUN-2023 14:39:21

J1545+2006 ES106B.UVDATA.1

Freq = 1.5950 GHz, Bw = 32.000 MH No calibration applied and no bandpass applied

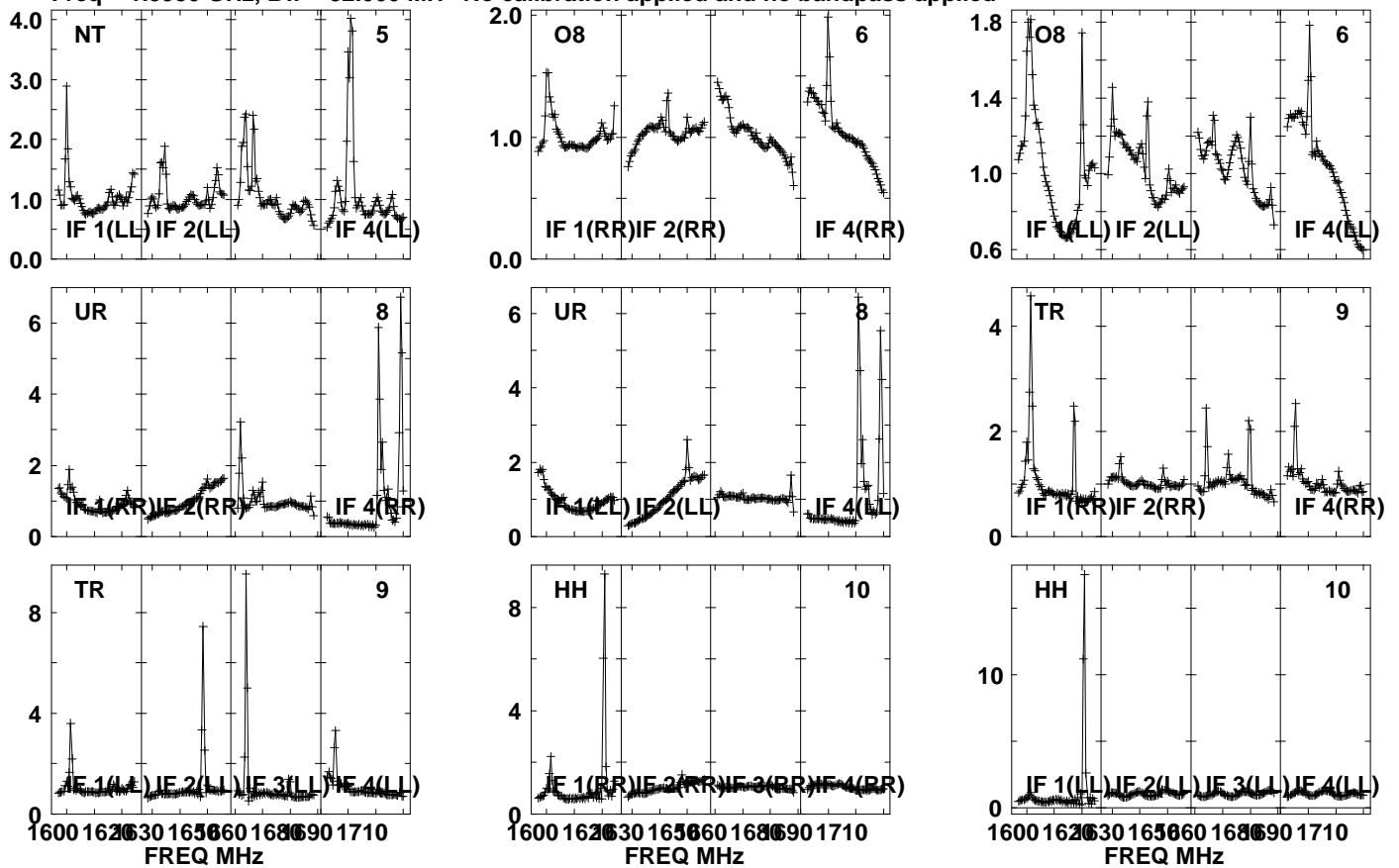

Lower frame: Real Jy

Auto-corr total-power spectrum Antenna: *

Timerange: 01/03:43:31 to 01/03:45:59

Plot file version 224 created 12-JUN-2023 14:39:21

J1547+2052 ES106B.UVDATA.1

Freq = 1.5950 GHz, Bw = 32.000 MH No calibration applied and no bandpass applied

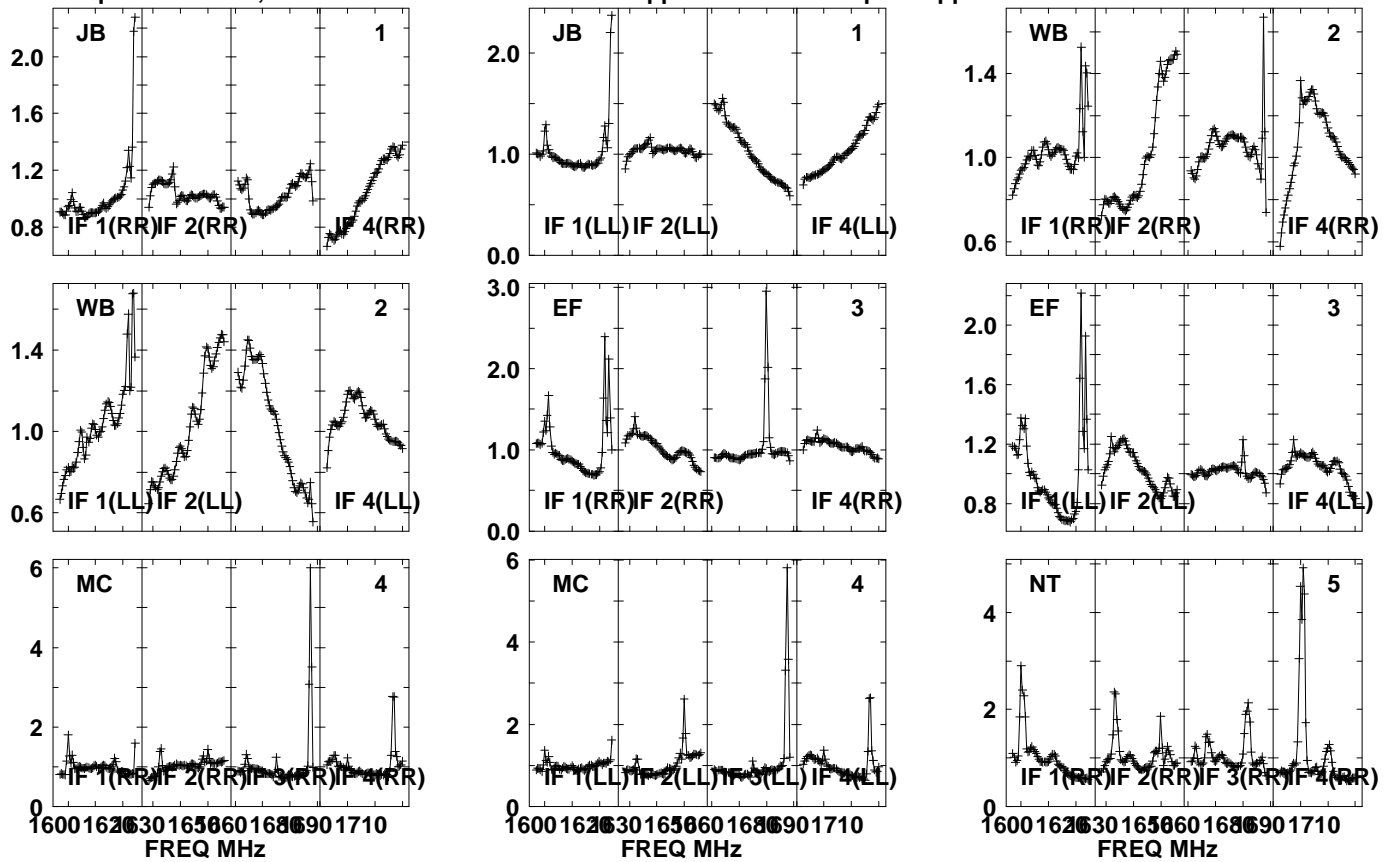

Lower frame: Real Jy
Auto-corr total-power spectrum Antenna: *
Timerange: 01/03:46:01 to 01/03:47:29

Plot file version 225 created 12-JUN-2023 14:39:21

J1547+2052 ES106B.UVDATA.1

Freq = 1.5950 GHz, Bw = 32.000 MH No calibration applied and no bandpass applied

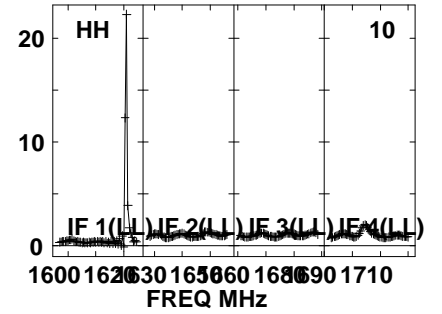
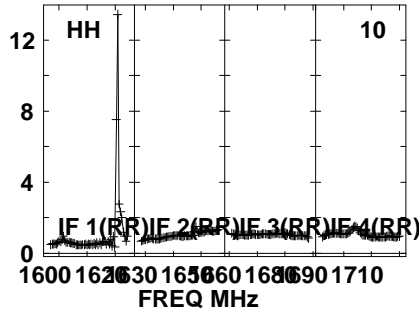
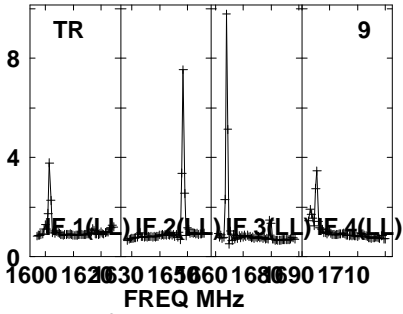
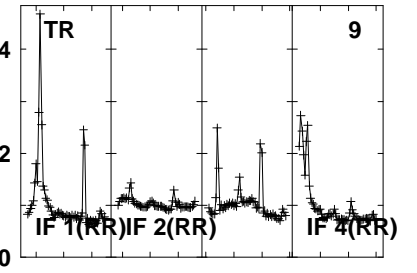
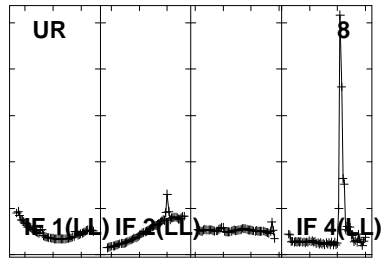
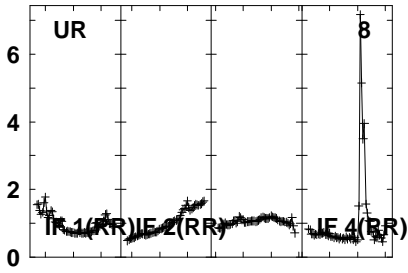
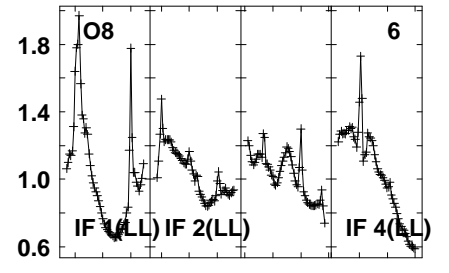
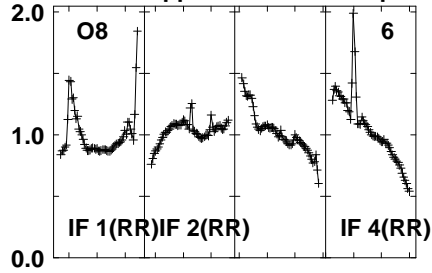
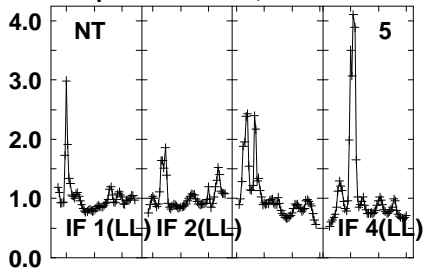

Lower frame: Real Jy

Auto-corr total-power spectrum Antenna: *

Timerange: 01/03:46:01 to 01/03:47:29

Plot file version 226 created 12-JUN-2023 14:39:21

J1548 ES106B.UVDATA.1

Freq = 1.5950 GHz, Bw = 32.000 MH No calibration applied and no bandpass applied

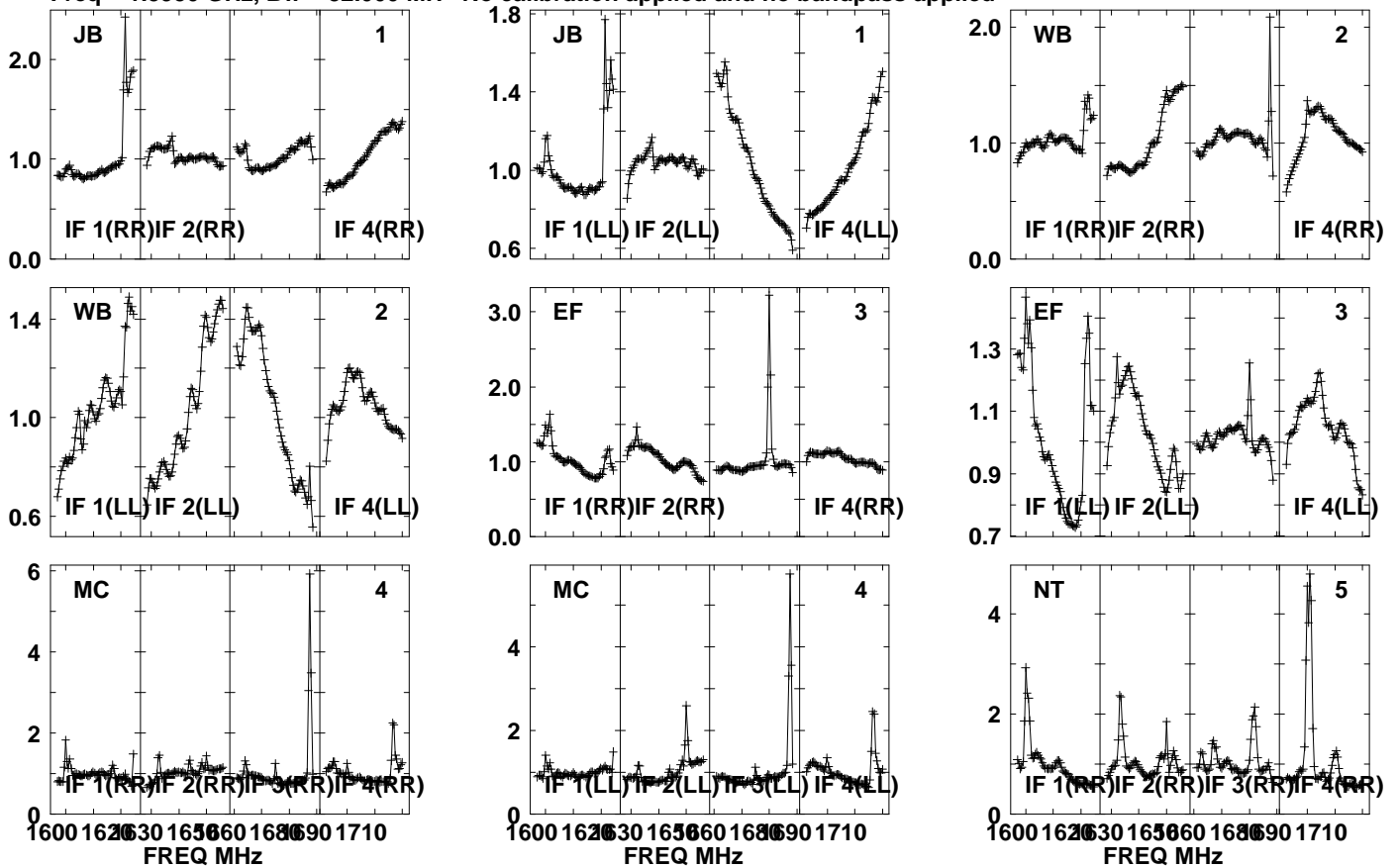

Lower frame: Real Jy

Auto-corr total-power spectrum Antenna: *

Timerange: 01/03:48:01 to 01/03:51:59

Plot file version 227 created 12-JUN-2023 14:39:21

J1548 ES106B.UVDATA.1

Freq = 1.5950 GHz, Bw = 32.000 MH No calibration applied and no bandpass applied

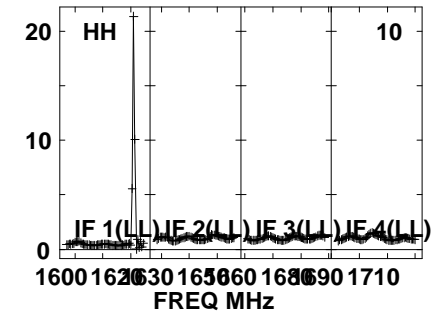
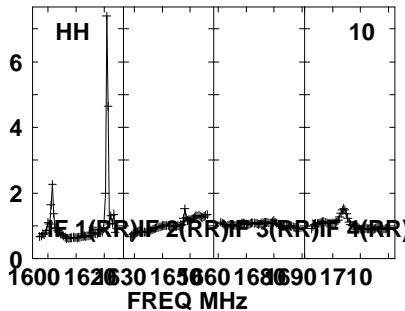
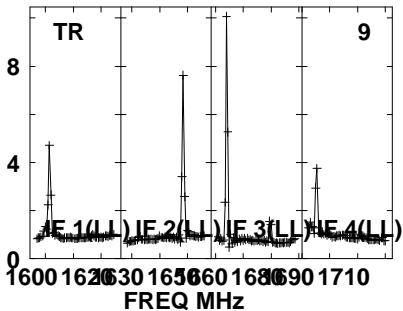
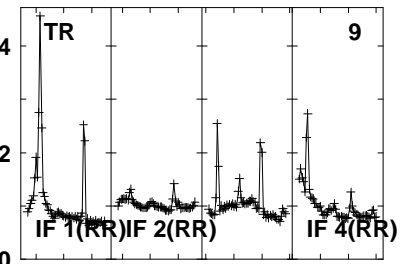
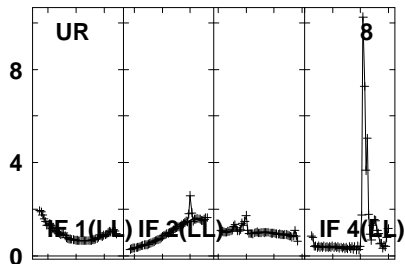
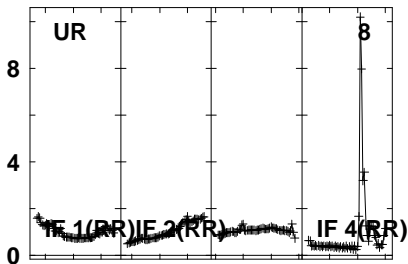
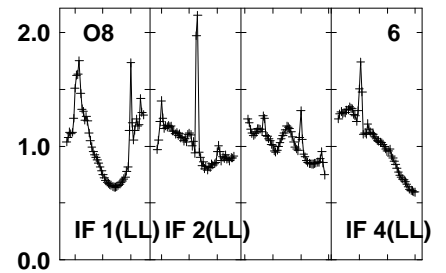
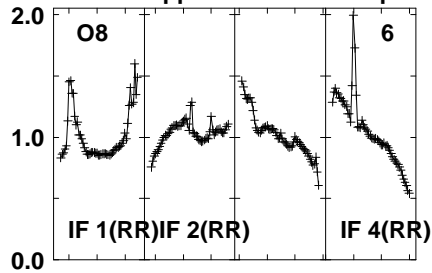
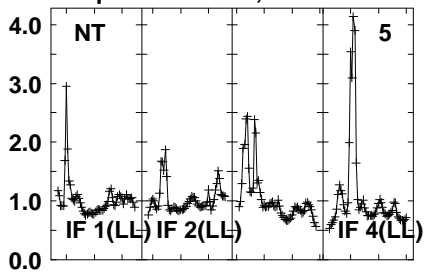

Lower frame: Real Jy

Auto-corr total-power spectrum Antenna: *

Timerange: 01/03:48:01 to 01/03:51:59

Plot file version 228 created 12-JUN-2023 14:39:21

J1547+2052 ES106B.UVDATA.1

Freq = 1.5950 GHz, Bw = 32.000 MH No calibration applied and no bandpass applied

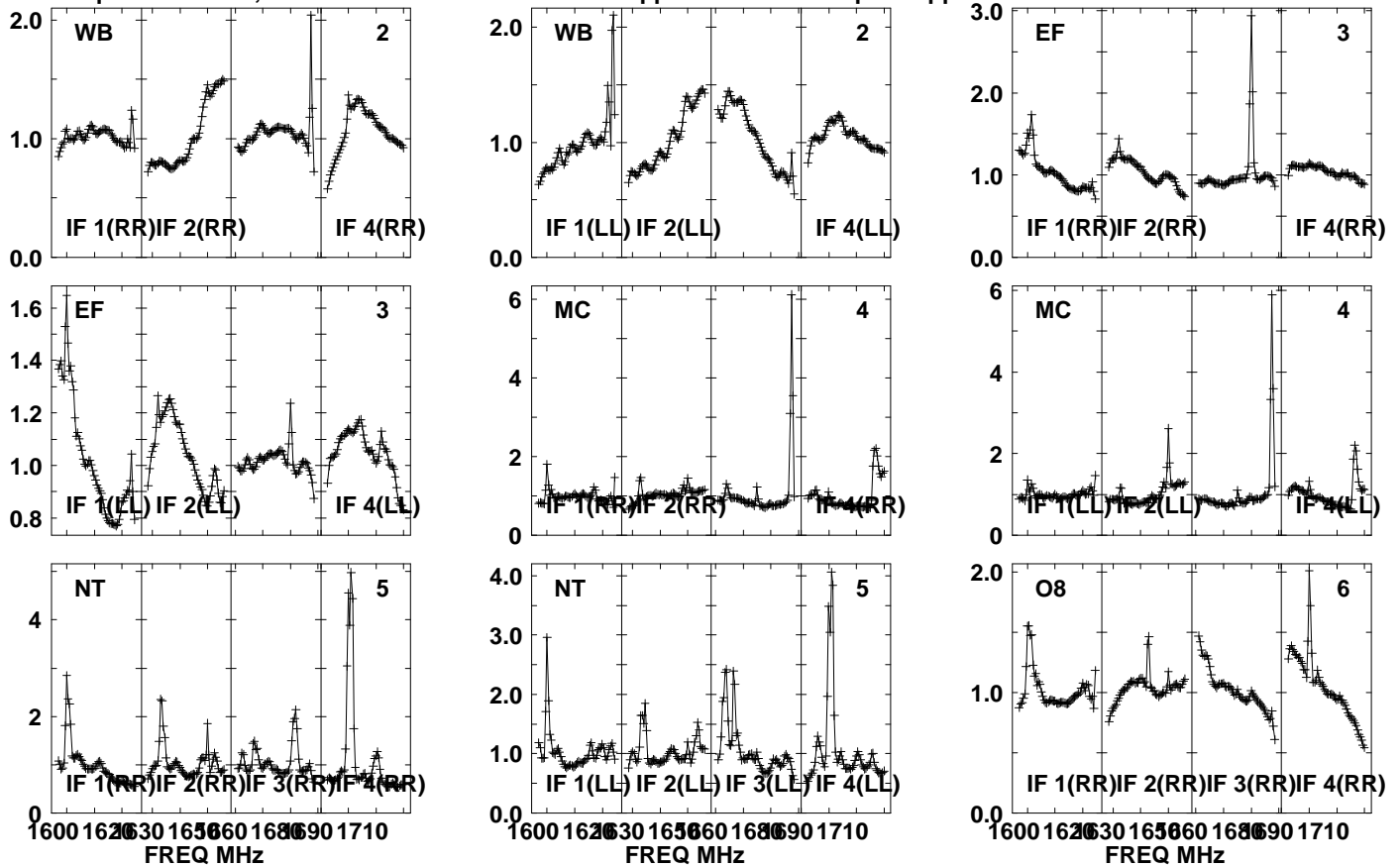

Lower frame: Real Jy

Auto-corr total-power spectrum Antenna: *

Timerange: 01/03:52:01 to 01/03:53:29

Plot file version 229 created 12-JUN-2023 14:39:21

J1547+2052 ES106B.UVDATA.1

Freq = 1.5950 GHz, Bw = 32.000 MH No calibration applied and no bandpass applied

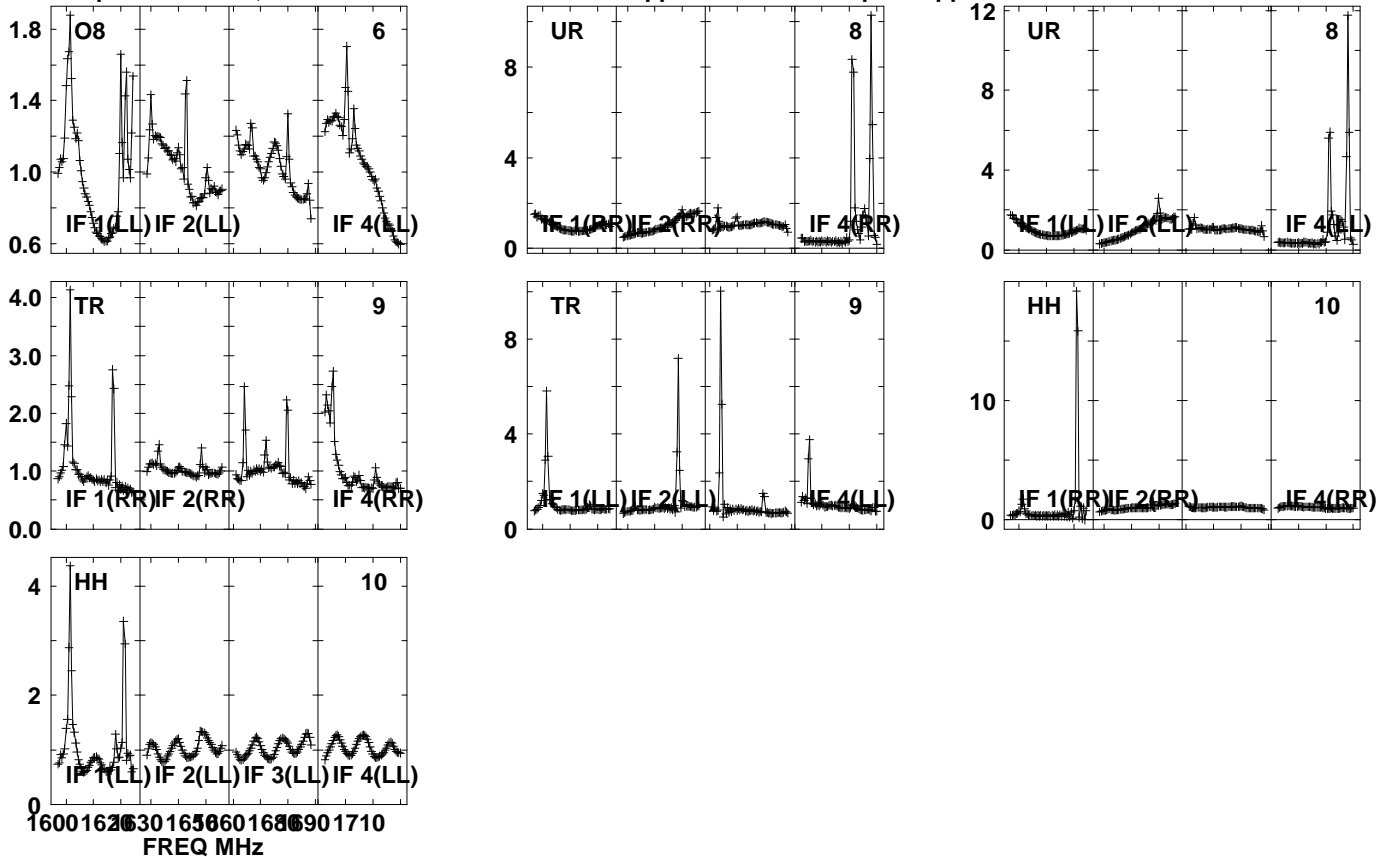

Lower frame: Real Jy
Auto-corr total-power spectrum Antenna: *
Timerange: 01/03:52:01 to 01/03:53:29

Plot file version 230 created 12-JUN-2023 14:39:21

J1548 ES106B.UVDATA.1

Freq = 1.5950 GHz, Bw = 32.000 MH No calibration applied and no bandpass applied

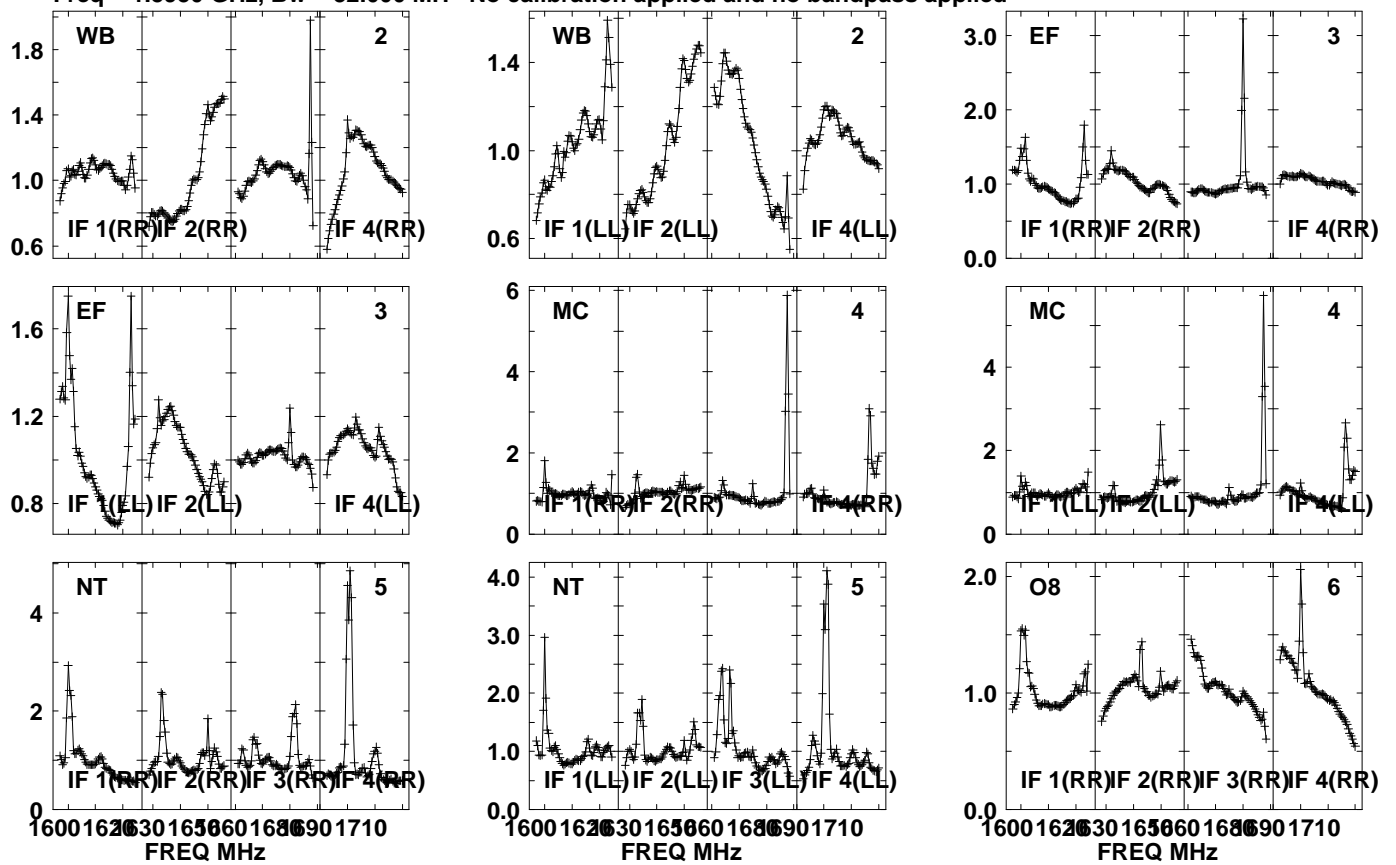

Lower frame: Real Jy
Auto-corr total-power spectrum Antenna: *
Timerange: 01/03:53:31 to 01/03:56:59

Plot file version 231 created 12-JUN-2023 14:39:22

J1548 ES106B.UVDATA.1

Freq = 1.5950 GHz, Bw = 32.000 MH No calibration applied and no bandpass applied

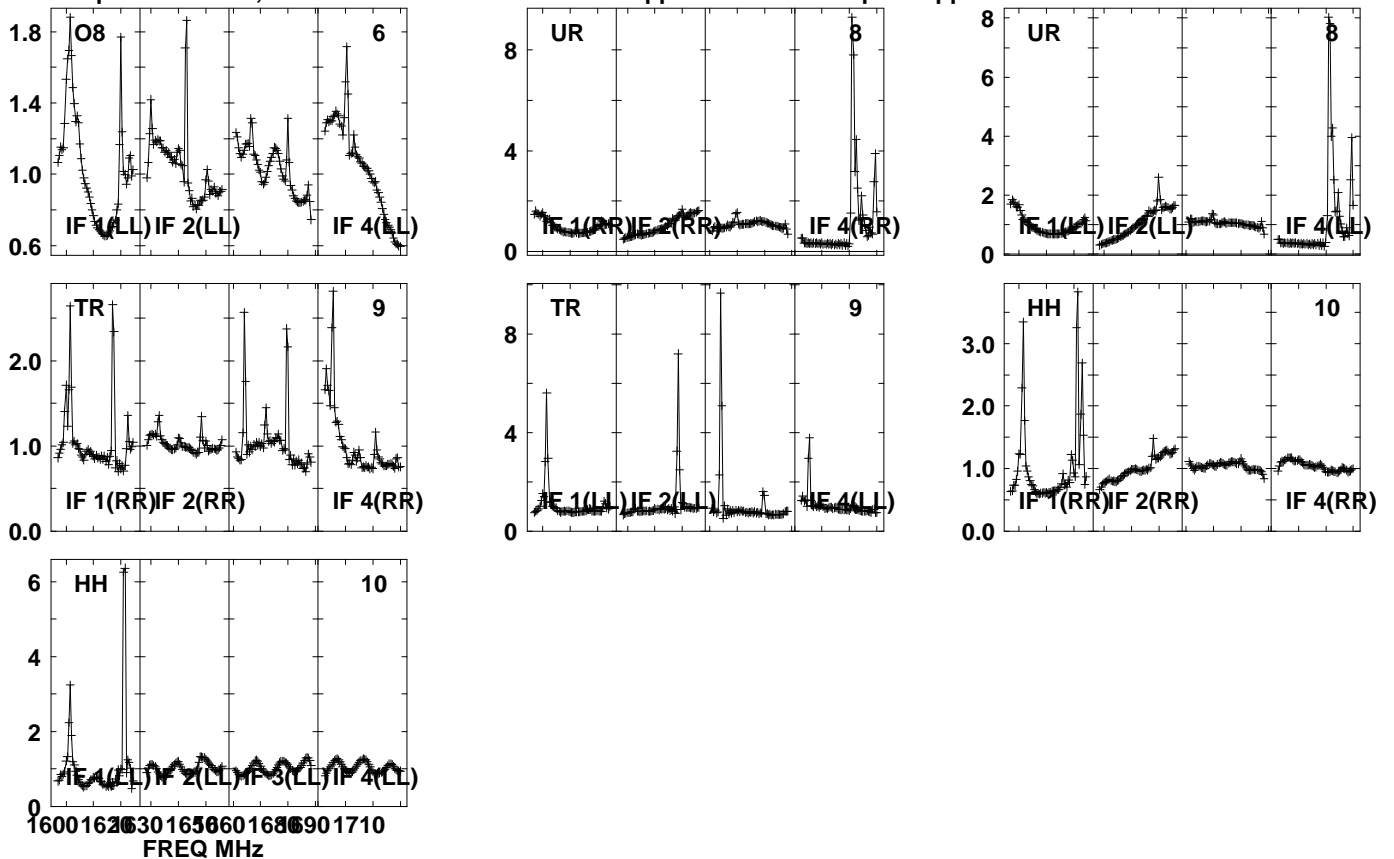

Lower frame: Real Jy

Auto-corr total-power spectrum Antenna: *

Timerange: 01/03:53:31 to 01/03:56:59

Plot file version 232 created 12-JUN-2023 14:39:22

J1547+2052 ES106B.UVDATA.1

Freq = 1.5950 GHz, Bw = 32.000 MH No calibration applied and no bandpass applied

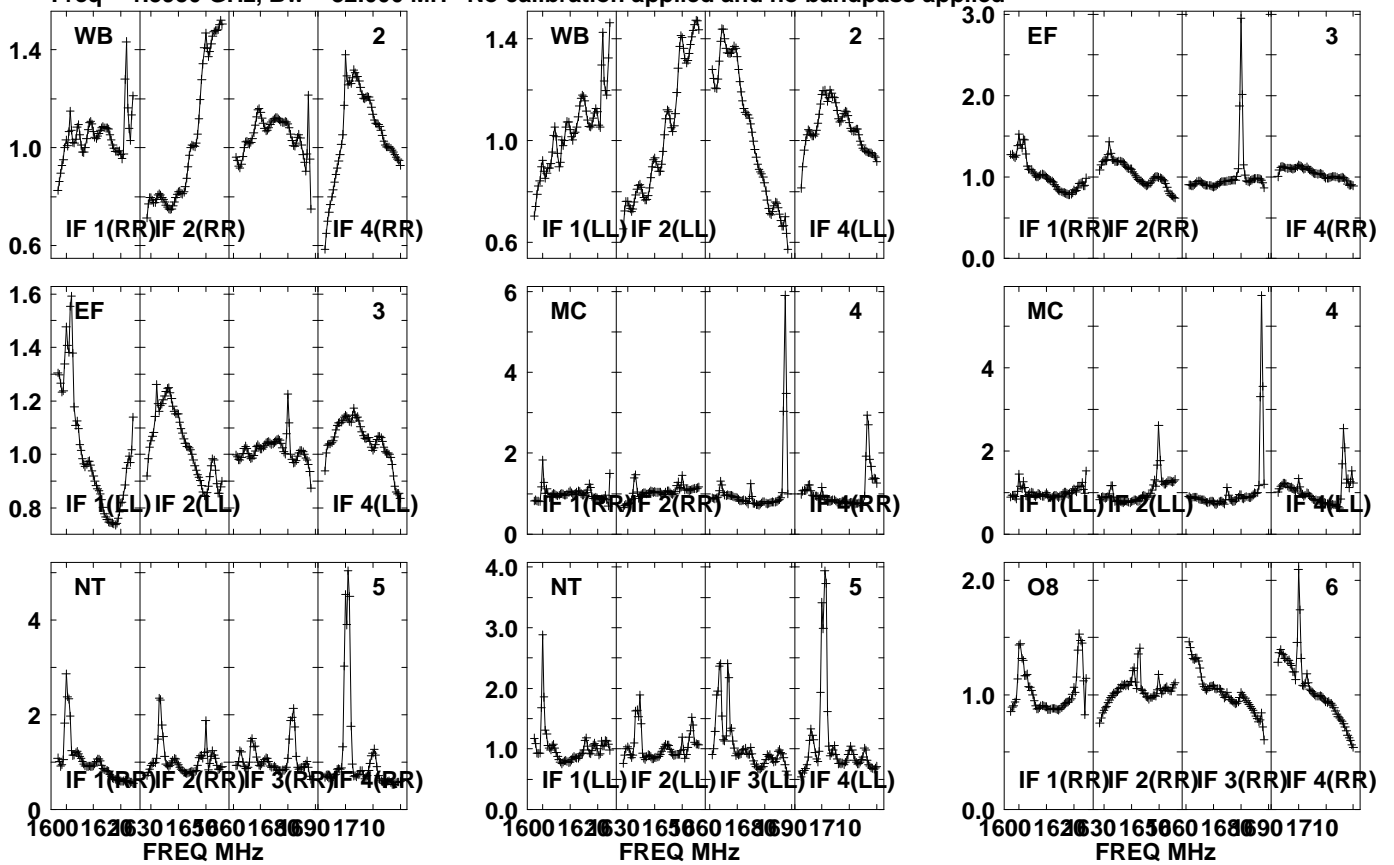

Lower frame: Real Jy
Auto-corr total-power spectrum Antenna: *
Timerange: 01/03:57:31 to 01/03:58:59

Plot file version 233 created 12-JUN-2023 14:39:22

J1547+2052 ES106B.UVDATA.1

Freq = 1.5950 GHz, Bw = 32.000 MH No calibration applied and no bandpass applied

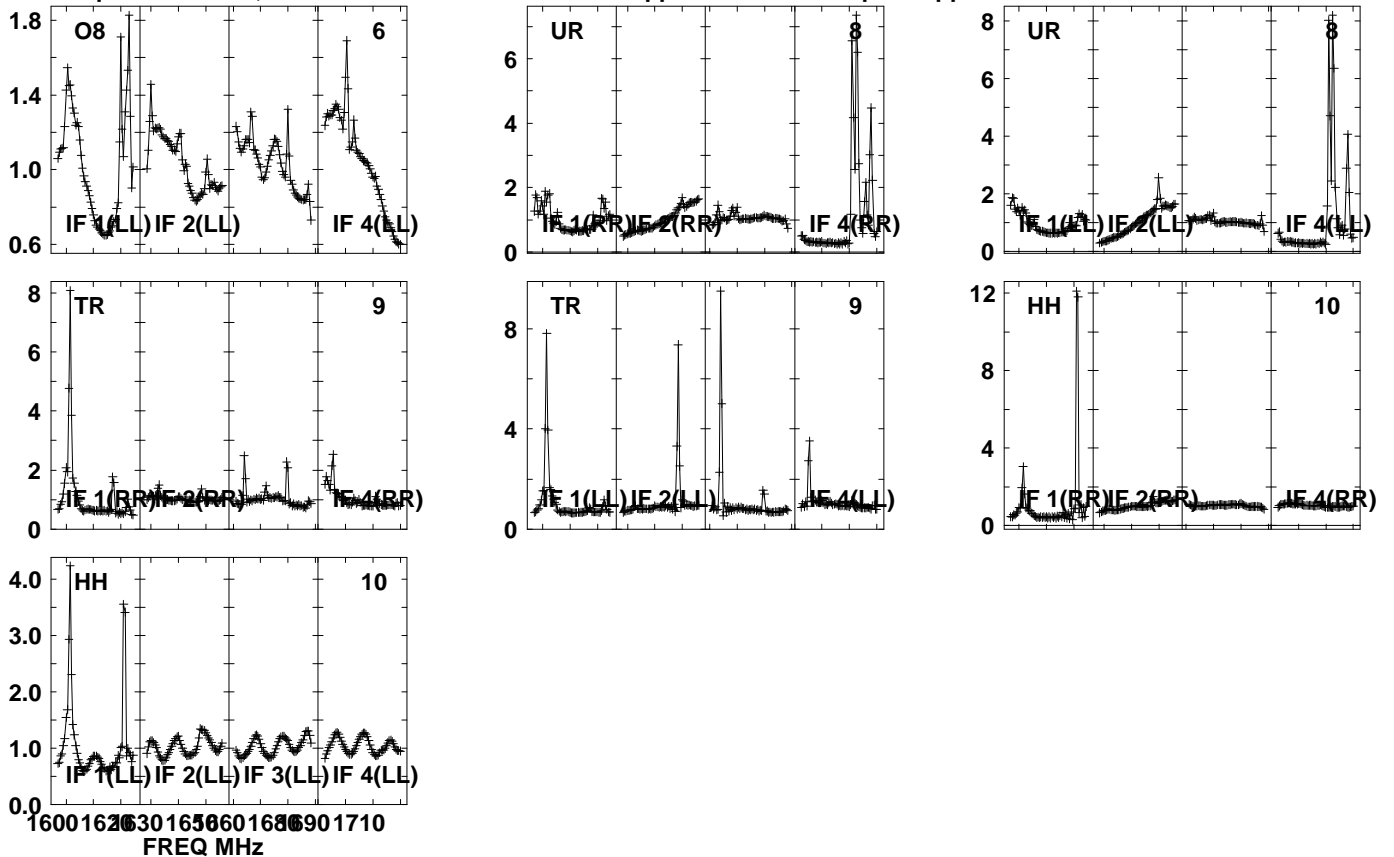

Lower frame: Real Jy

Auto-corr total-power spectrum Antenna: *

Timerange: 01/03:57:31 to 01/03:58:59

Plot file version 234 created 12-JUN-2023 14:39:22

J1548 ES106B.UVDATA.1

Freq = 1.5950 GHz, Bw = 32.000 MH No calibration applied and no bandpass applied

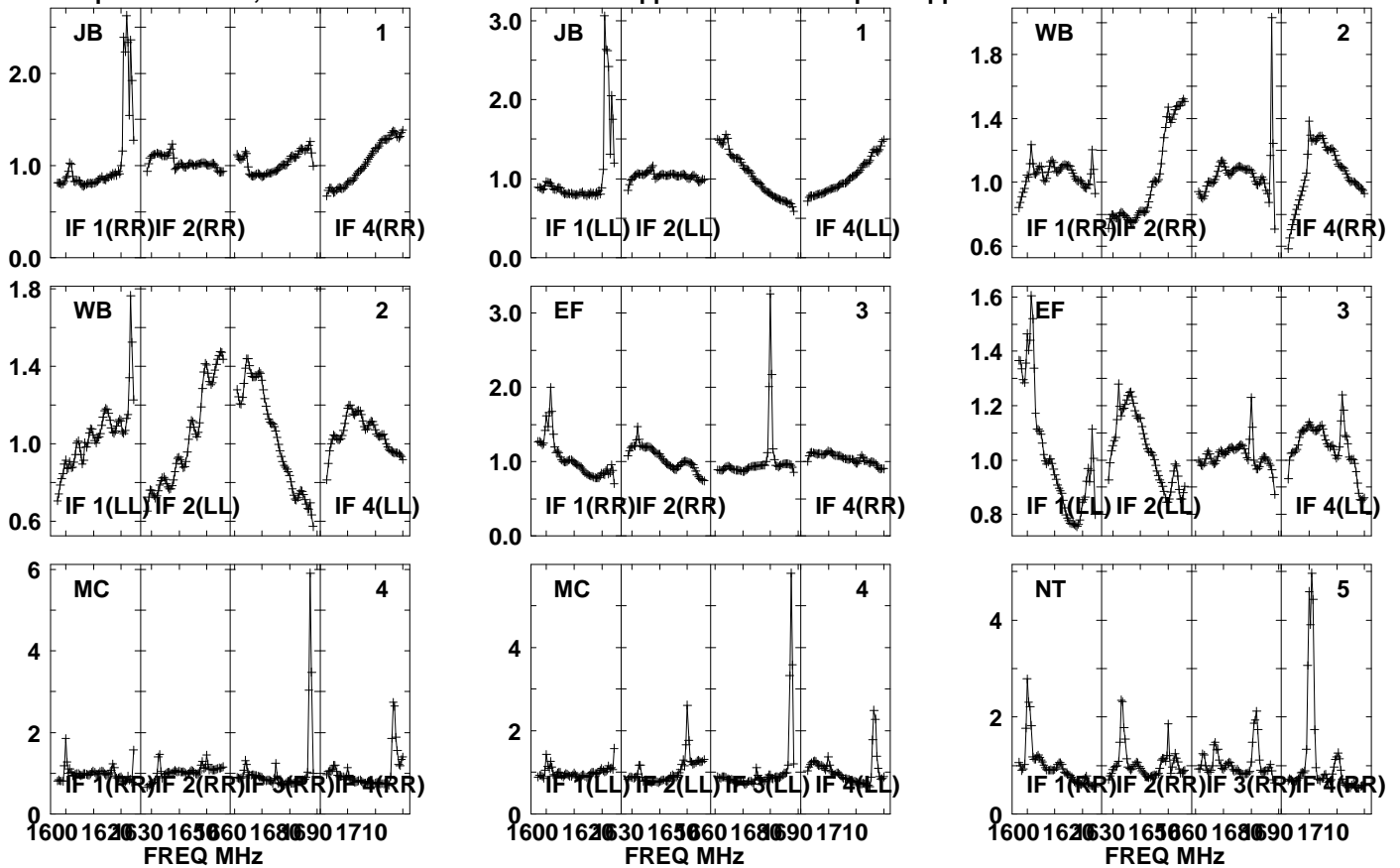

Lower frame: Real Jy

Auto-corr total-power spectrum Antenna: *

Timerange: 01/03:59:01 to 01/04:02:29

Plot file version 235 created 12-JUN-2023 14:39:22

J1548 ES106B.UVDATA.1

Freq = 1.5950 GHz, Bw = 32.000 MH No calibration applied and no bandpass applied

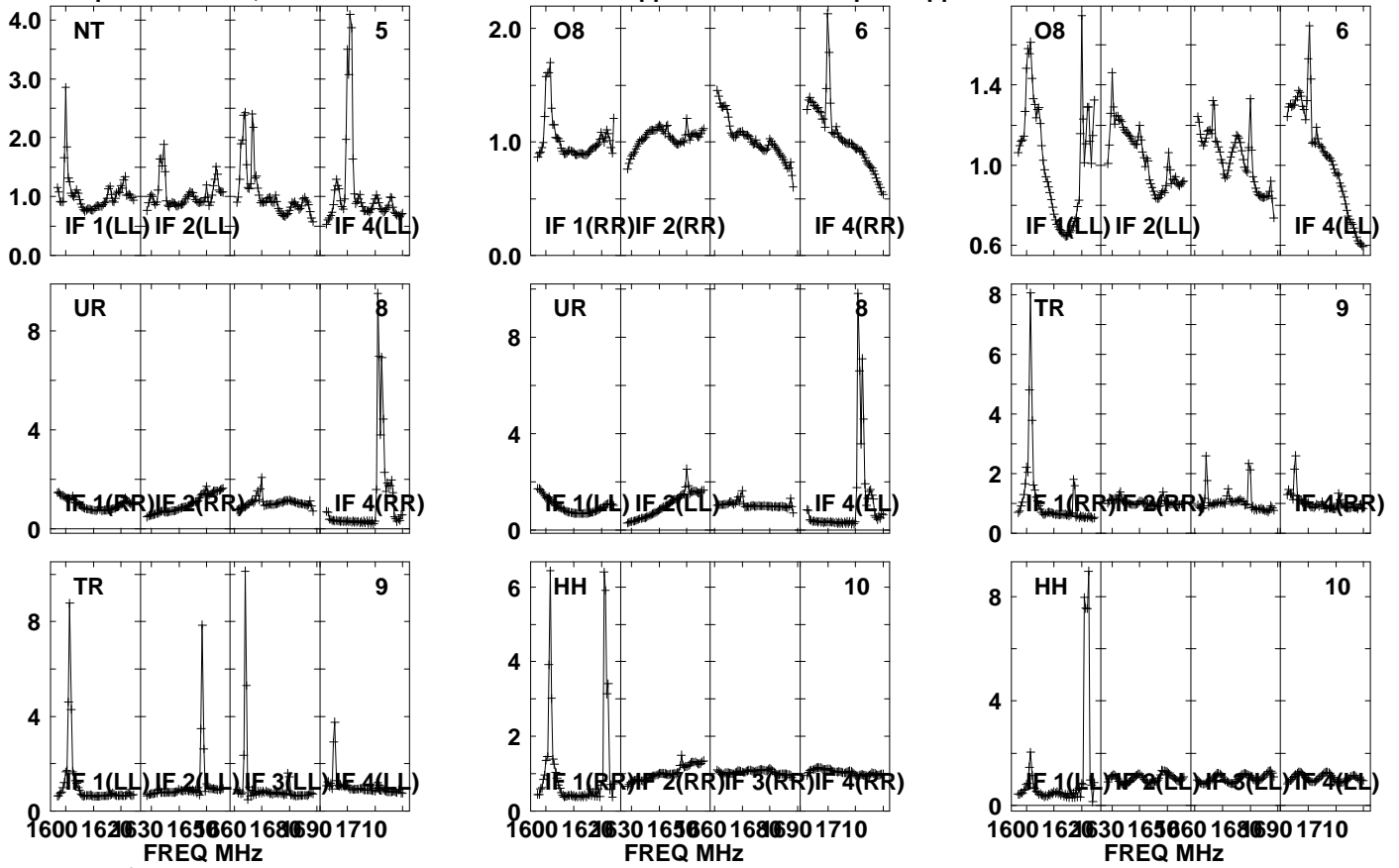

Lower frame: Real Jy

Auto-corr total-power spectrum Antenna: *

Timerange: 01/03:59:01 to 01/04:02:29

Plot file version 236 created 12-JUN-2023 14:39:22

J1547+2052 ES106B.UVDATA.1

Freq = 1.5950 GHz, Bw = 32.000 MH No calibration applied and no bandpass applied

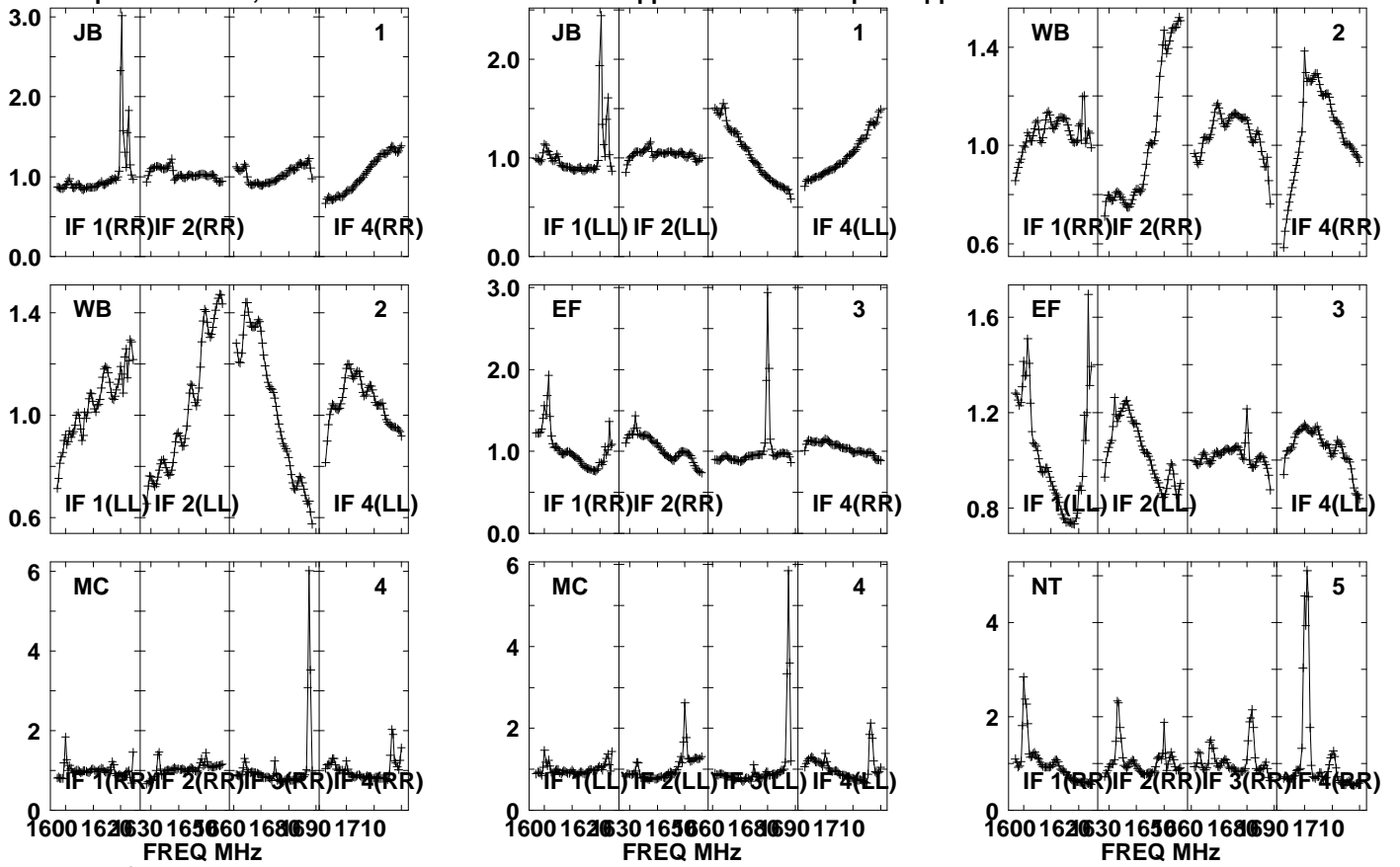

Lower frame: Real Jy

Auto-corr total-power spectrum Antenna: *

Timerange: 01/04:02:31 to 01/04:03:59

Plot file version 237 created 12-JUN-2023 14:39:22

J1547+2052 ES106B.UVDATA.1

Freq = 1.5950 GHz, Bw = 32.000 MH No calibration applied and no bandpass applied

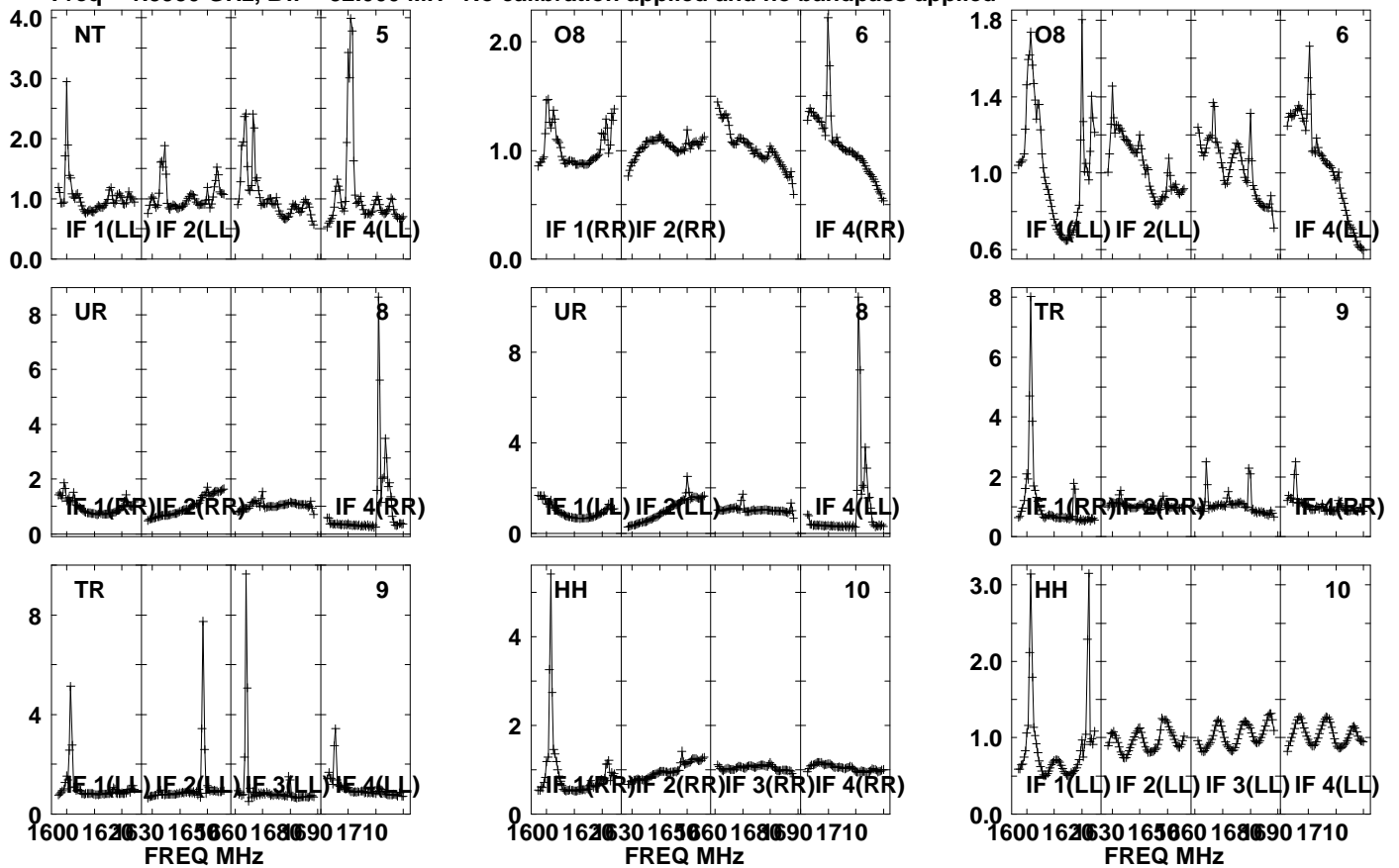

Lower frame: Real Jy

Auto-corr total-power spectrum Antenna: *

Timerange: 01/04:02:31 to 01/04:03:59

Plot file version 238 created 12-JUN-2023 14:39:22

J1545+2006 ES106B.UVDATA.1

Freq = 1.5950 GHz, Bw = 32.000 MH No calibration applied and no bandpass applied

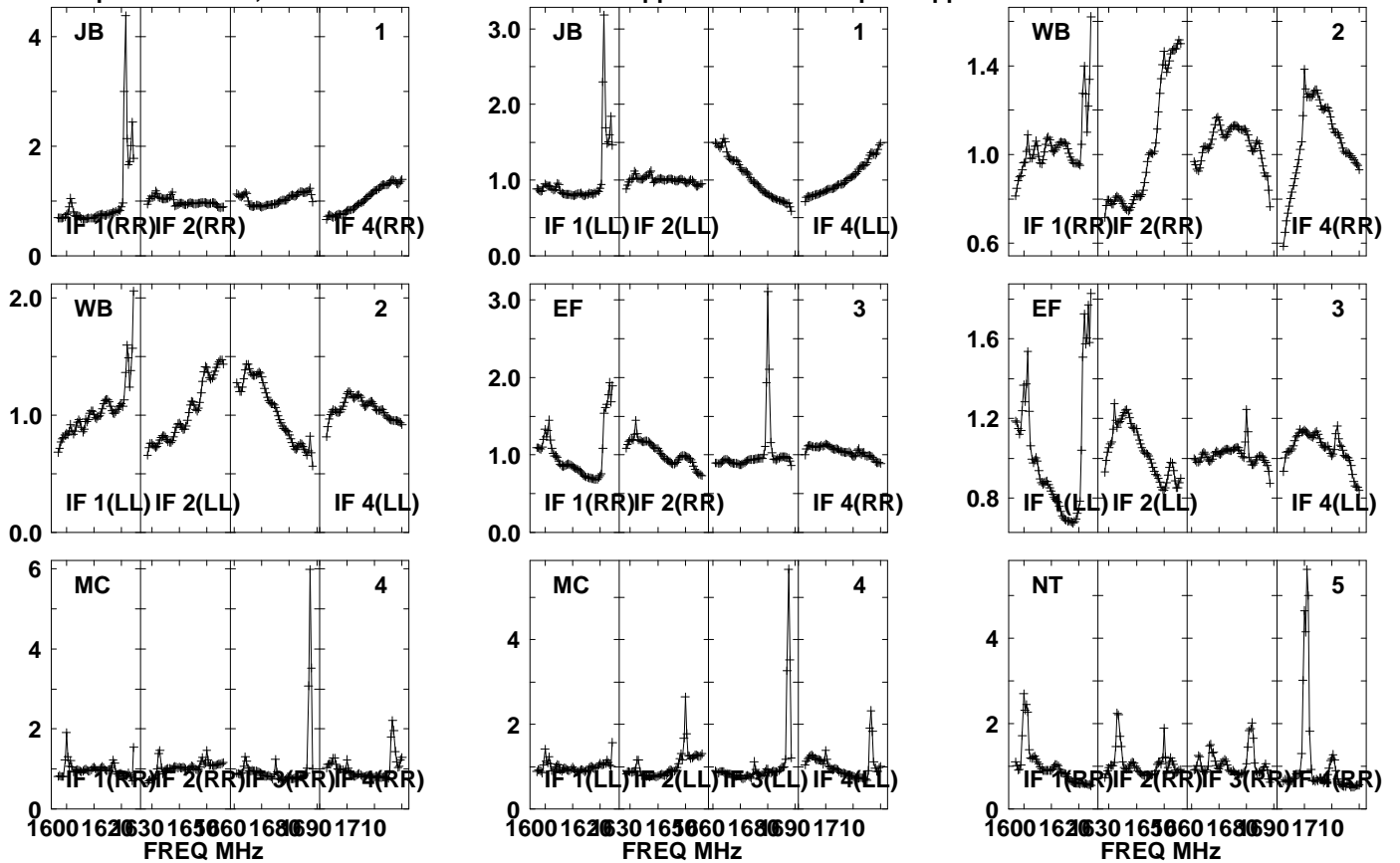

Lower frame: Real Jy

Auto-corr total-power spectrum Antenna: *

Timerange: 01/04:04:01 to 01/04:06:29

Plot file version 239 created 12-JUN-2023 14:39:22

J1545+2006 ES106B.UVDATA.1

Freq = 1.5950 GHz, Bw = 32.000 MH No calibration applied and no bandpass applied

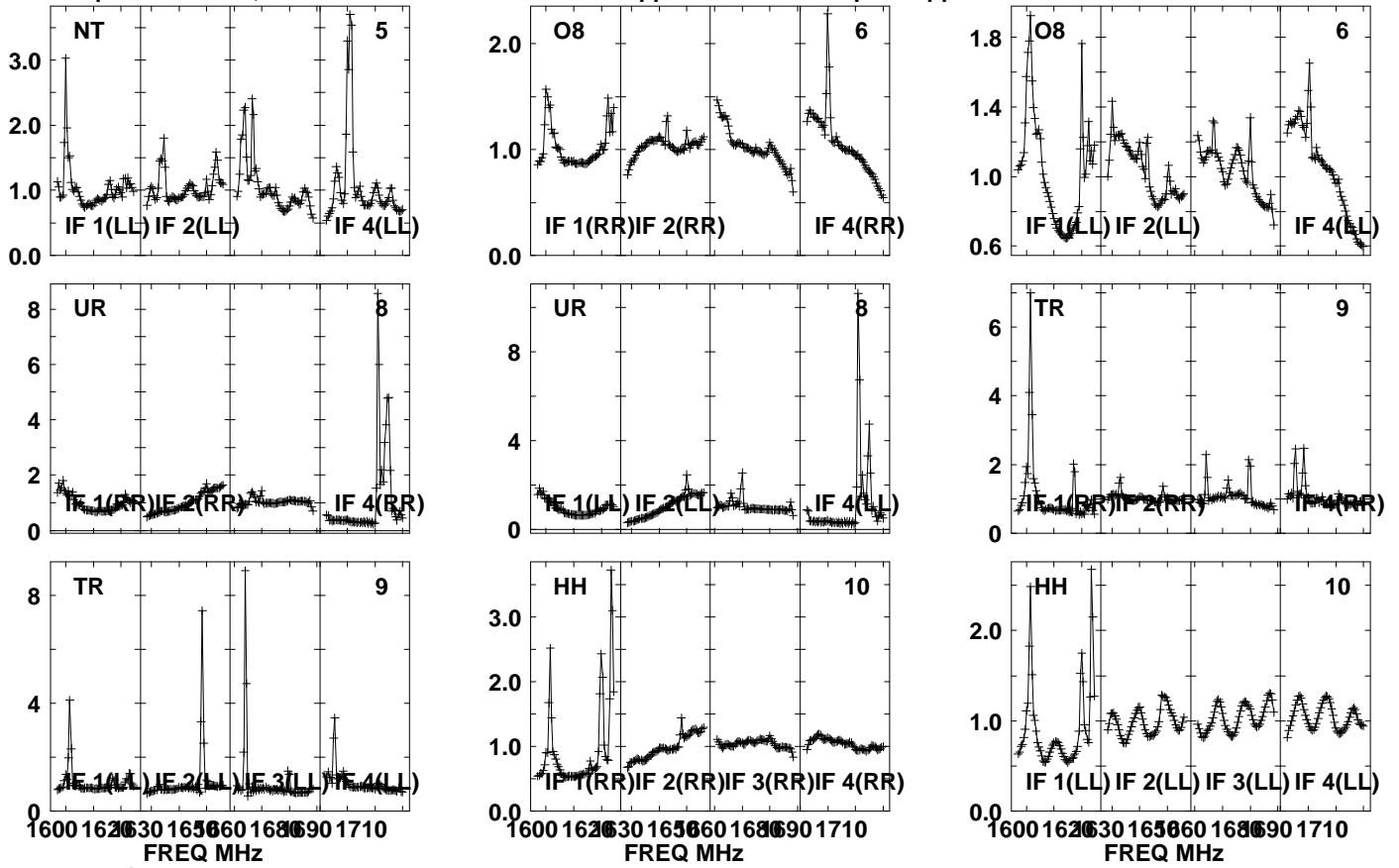

Lower frame: Real Jy

Auto-corr total-power spectrum Antenna: *

Timerange: 01/04:04:01 to 01/04:06:29

Plot file version 240 created 12-JUN-2023 14:39:22

J1547+2052 ES106B.UVDATA.1

Freq = 1.5950 GHz, Bw = 32.000 MH No calibration applied and no bandpass applied

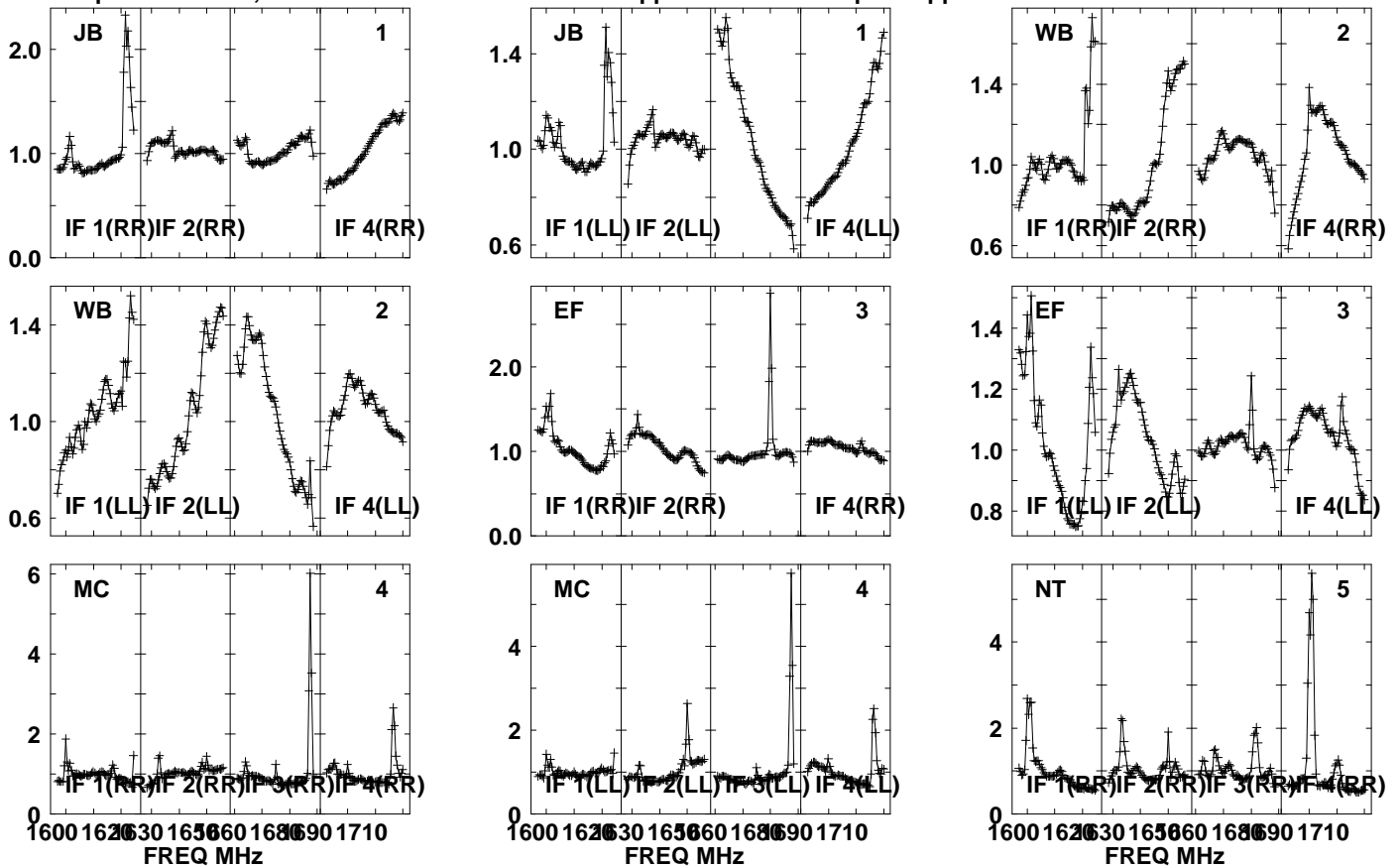

Lower frame: Real Jy

Auto-corr total-power spectrum Antenna: *

Timerange: 01/04:06:31 to 01/04:07:59

Plot file version 241 created 12-JUN-2023 14:39:22

J1547+2052 ES106B.UVDATA.1

Freq = 1.5950 GHz, Bw = 32.000 MH No calibration applied and no bandpass applied

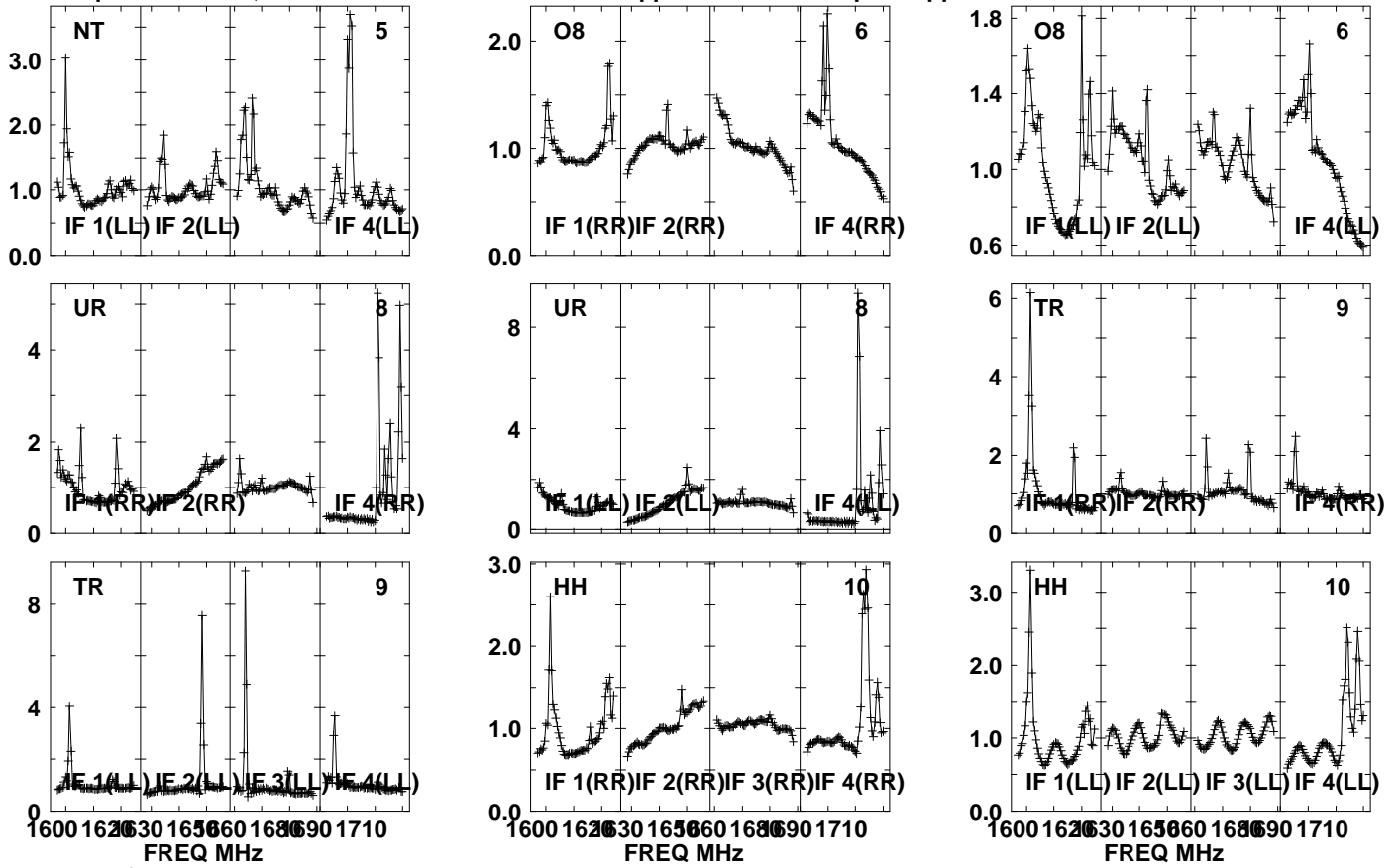

Lower frame: Real Jy

Auto-corr total-power spectrum Antenna: *

Timerange: 01/04:06:31 to 01/04:07:59

Plot file version 242 created 12-JUN-2023 14:39:22

J1548 ES106B.UVDATA.1

Freq = 1.5950 GHz, Bw = 32.000 MH No calibration applied and no bandpass applied

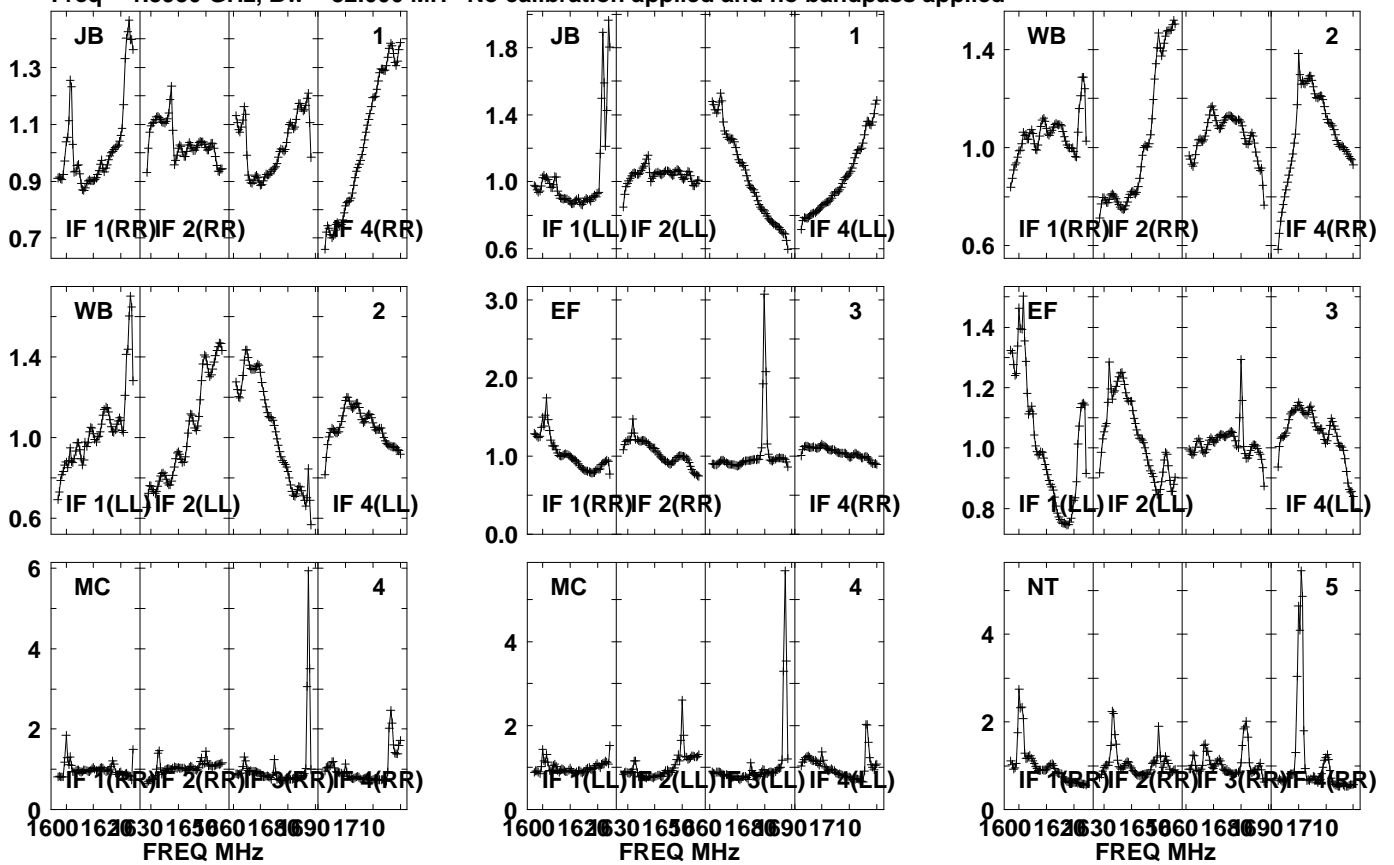

Lower frame: Real Jy
Auto-corr total-power spectrum Antenna: *
Timerange: 01/04:08:31 to 01/04:12:29

Plot file version 243 created 12-JUN-2023 14:39:22

J1548 ES106B.UVDATA.1

Freq = 1.5950 GHz, Bw = 32.000 MH No calibration applied and no bandpass applied

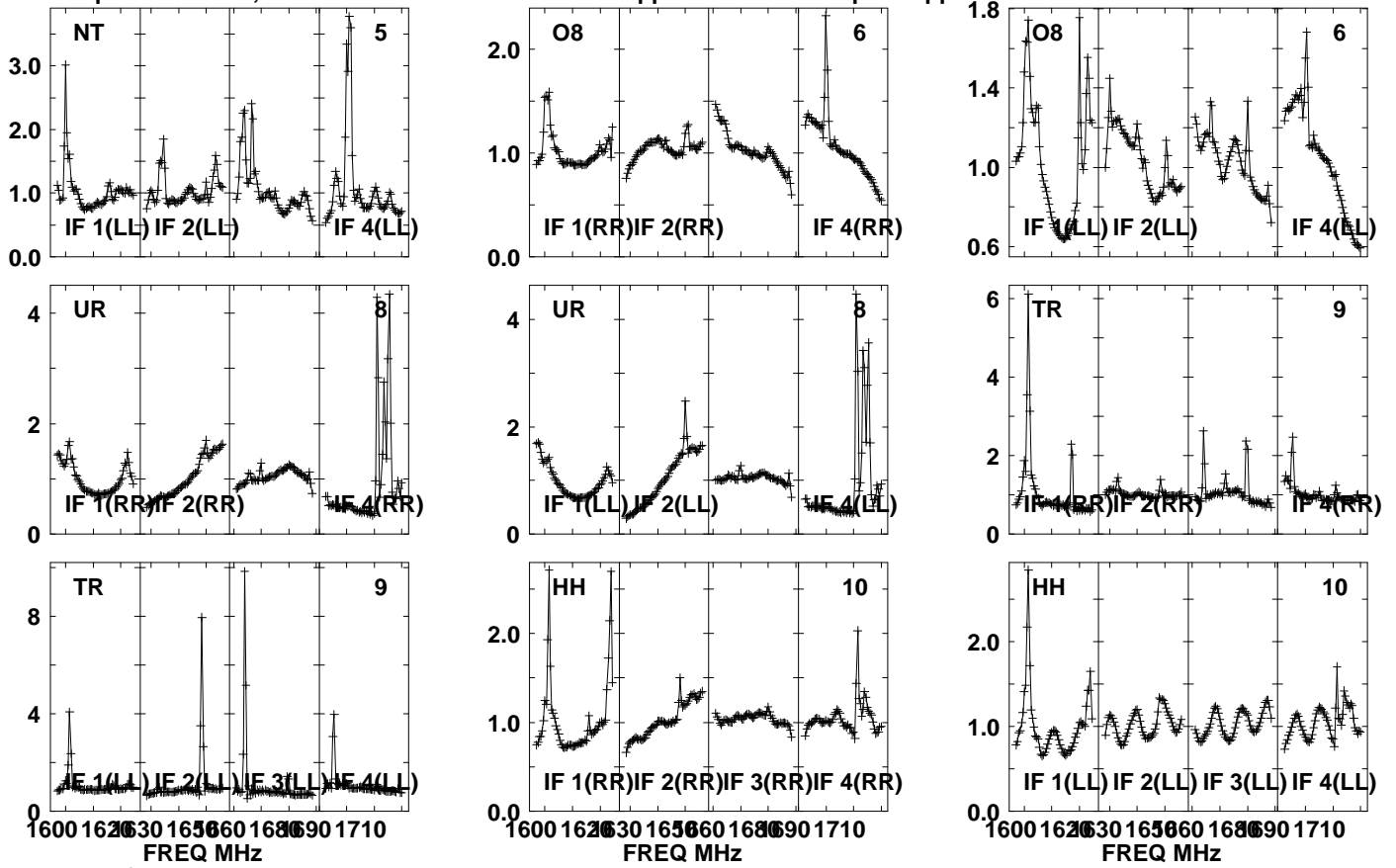

Lower frame: Real Jy

Auto-corr total-power spectrum Antenna: *

Timerange: 01/04:08:31 to 01/04:12:29

Plot file version 244 created 12-JUN-2023 14:39:22

J1547+2052 ES106B.UVDATA.1

Freq = 1.5950 GHz, Bw = 32.000 MH No calibration applied and no bandpass applied

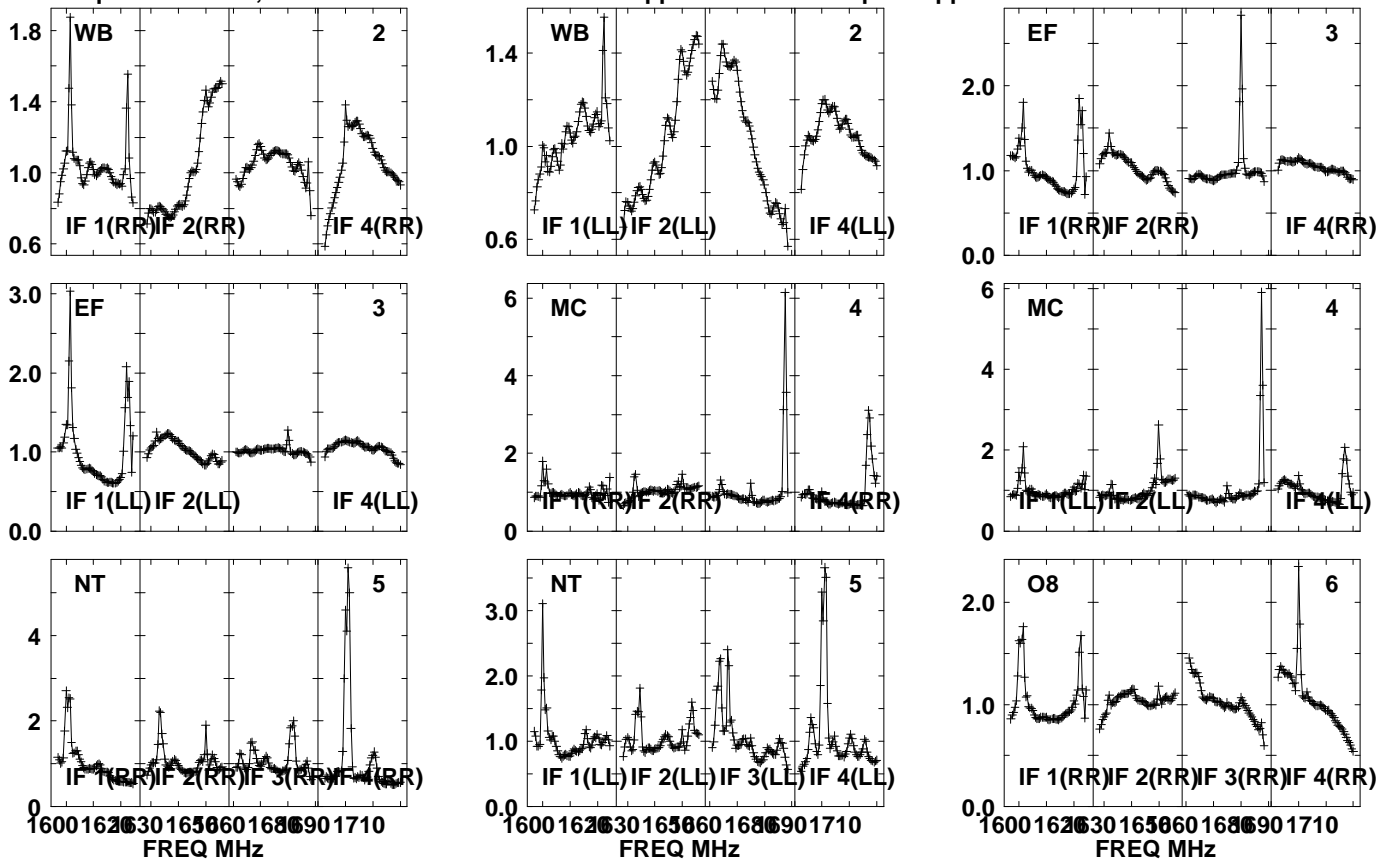

Lower frame: Real Jy
Auto-corr total-power spectrum Antenna: *
Timerange: 01/04:12:31 to 01/04:13:59

Plot file version 245 created 12-JUN-2023 14:39:22

J1547+2052 ES106B.UVDATA.1

Freq = 1.5950 GHz, Bw = 32.000 MH No calibration applied and no bandpass applied

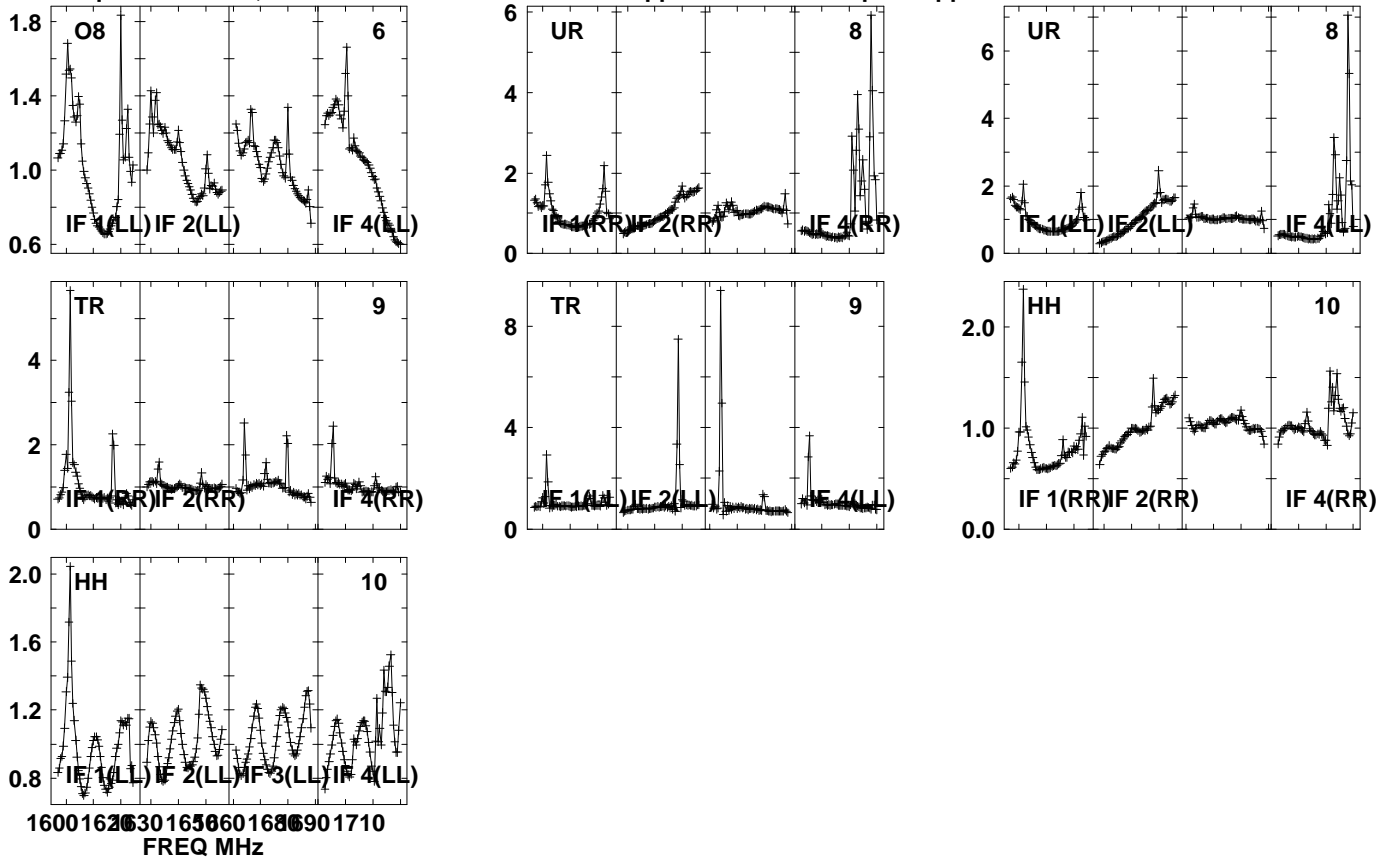

Lower frame: Real Jy

Auto-corr total-power spectrum Antenna: *

Timerange: 01/04:12:31 to 01/04:13:59

Plot file version 246 created 12-JUN-2023 14:39:22

J1548 ES106B.UVDATA.1

Freq = 1.5950 GHz, Bw = 32.000 MH No calibration applied and no bandpass applied

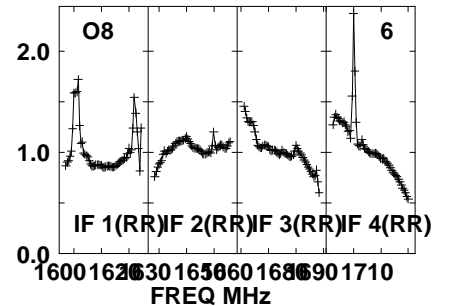
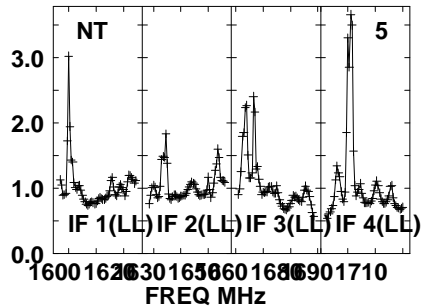
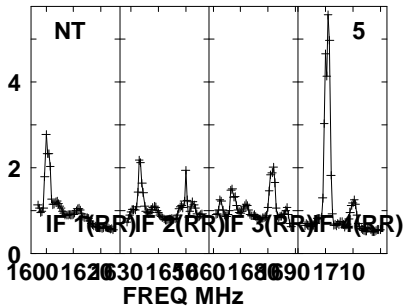
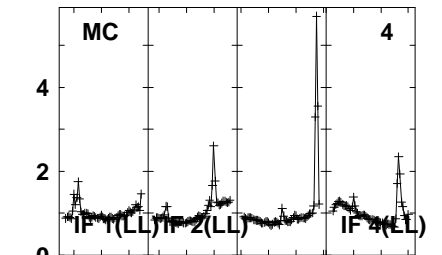
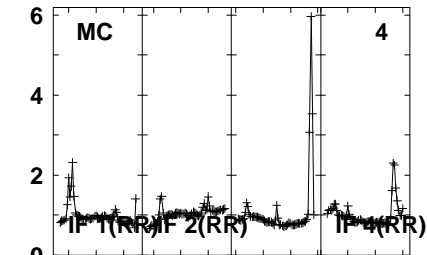
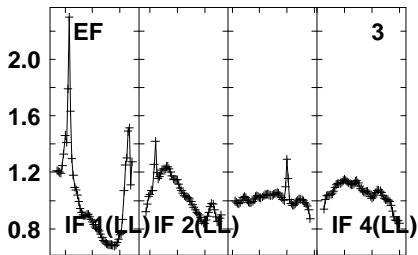
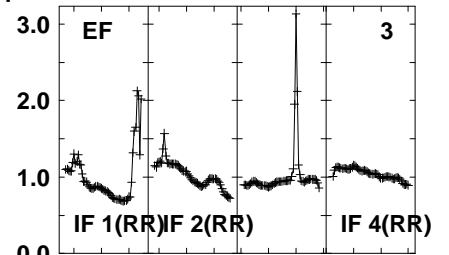
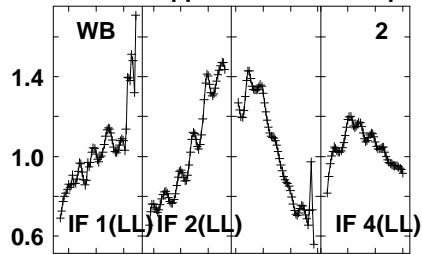
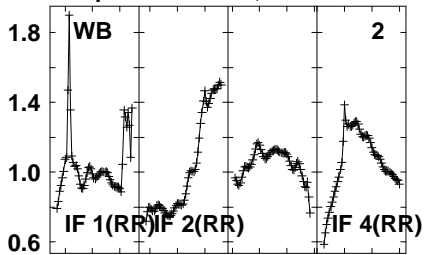

Lower frame: Real Jy
Auto-corr total-power spectrum Antenna: *
Timerange: 01/04:14:01 to 01/04:17:29

Plot file version 247 created 12-JUN-2023 14:39:23

J1548 ES106B.UVDATA.1

Freq = 1.5950 GHz, Bw = 32.000 MH No calibration applied and no bandpass applied

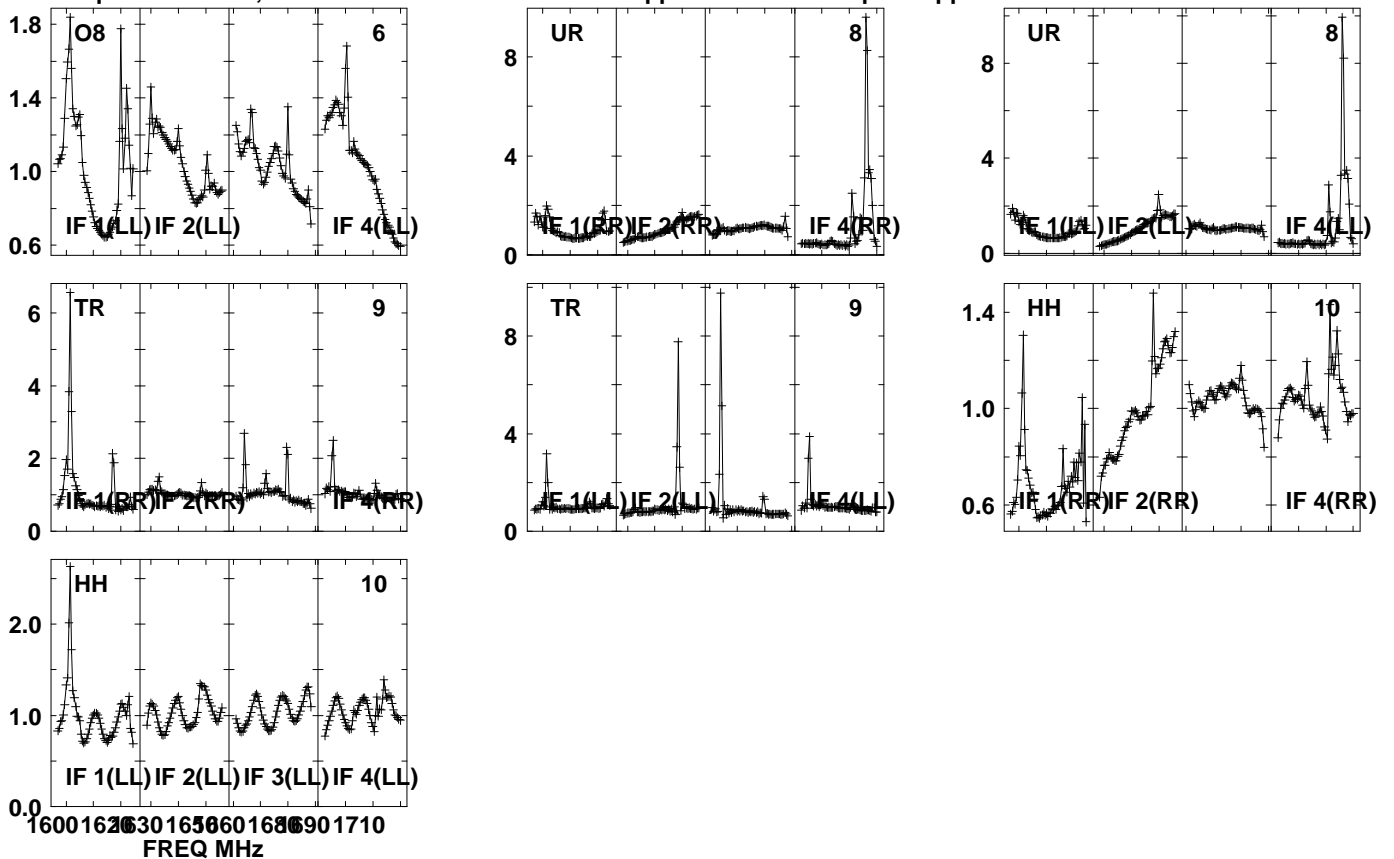

Lower frame: Real Jy
Auto-corr total-power spectrum Antenna: *
Timerange: 01/04:14:01 to 01/04:17:29

Plot file version 248 created 12-JUN-2023 14:39:23

J1547+2052 ES106B.UVDATA.1

Freq = 1.5950 GHz, Bw = 32.000 MH No calibration applied and no bandpass applied

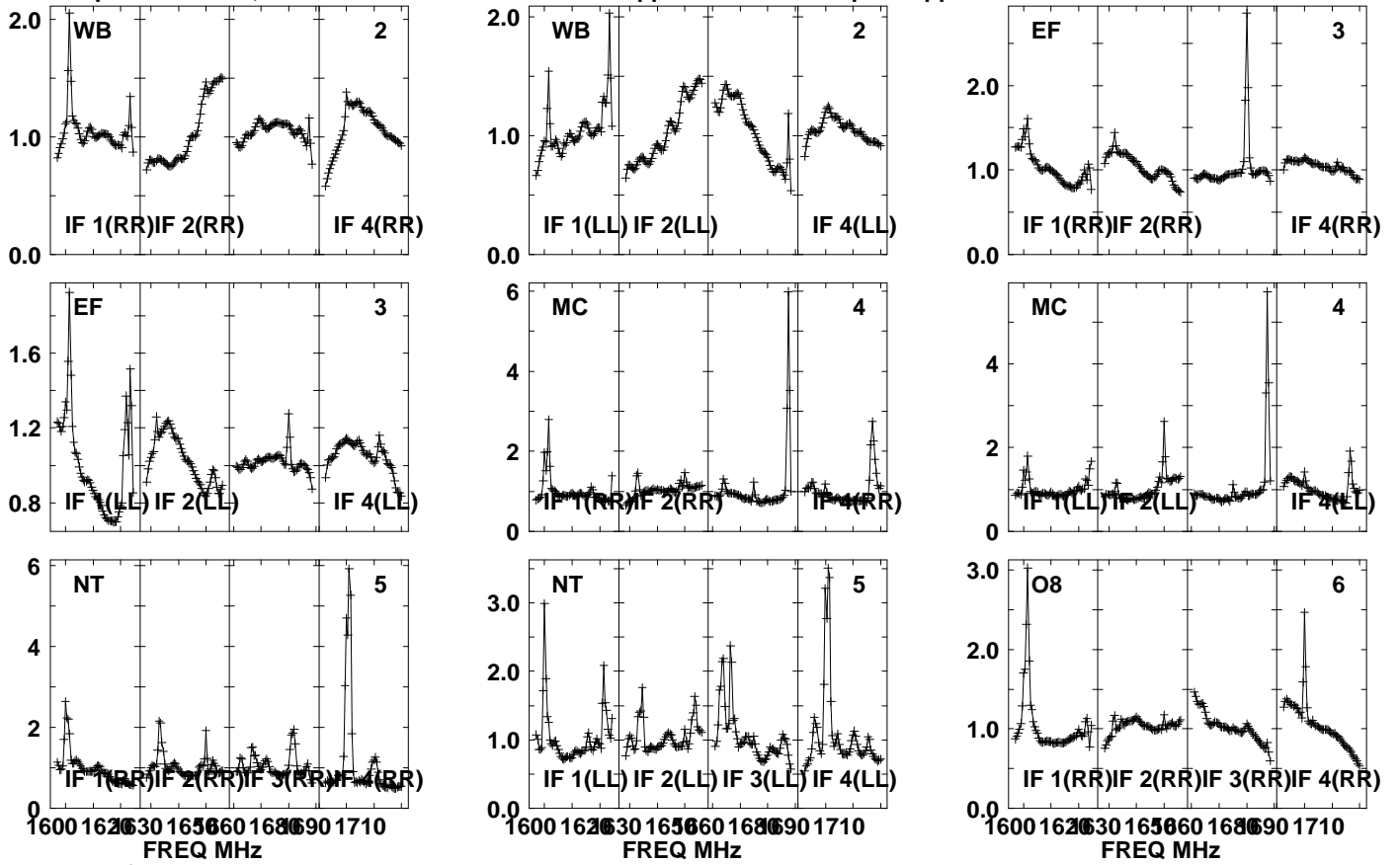

Lower frame: Real Jy

Auto-corr total-power spectrum Antenna: *

Timerange: 01/04:18:01 to 01/04:19:29

Plot file version 249 created 12-JUN-2023 14:39:23

J1547+2052 ES106B.UVDATA.1

Freq = 1.5950 GHz, Bw = 32.000 MH No calibration applied and no bandpass applied

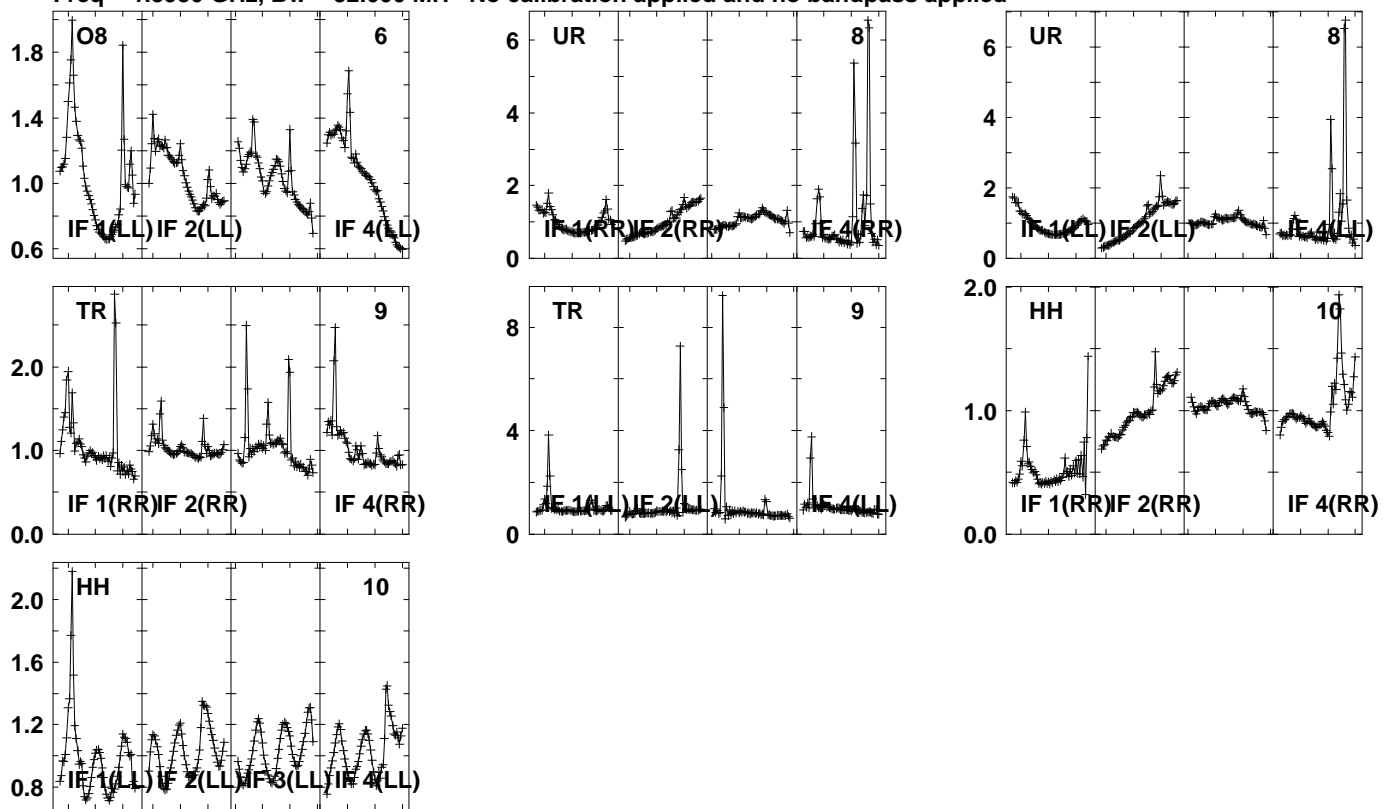

1600 1620 1630 1650 1660 1680 1690 1710

FREQ MHz

Lower frame: Real Jy

Auto-corr total-power spectrum Antenna: *

Timerange: 01/04:18:01 to 01/04:19:29

Plot file version 250 created 12-JUN-2023 14:39:23

J1548 ES106B.UVDATA.1

Freq = 1.5950 GHz, Bw = 32.000 MH No calibration applied and no bandpass applied

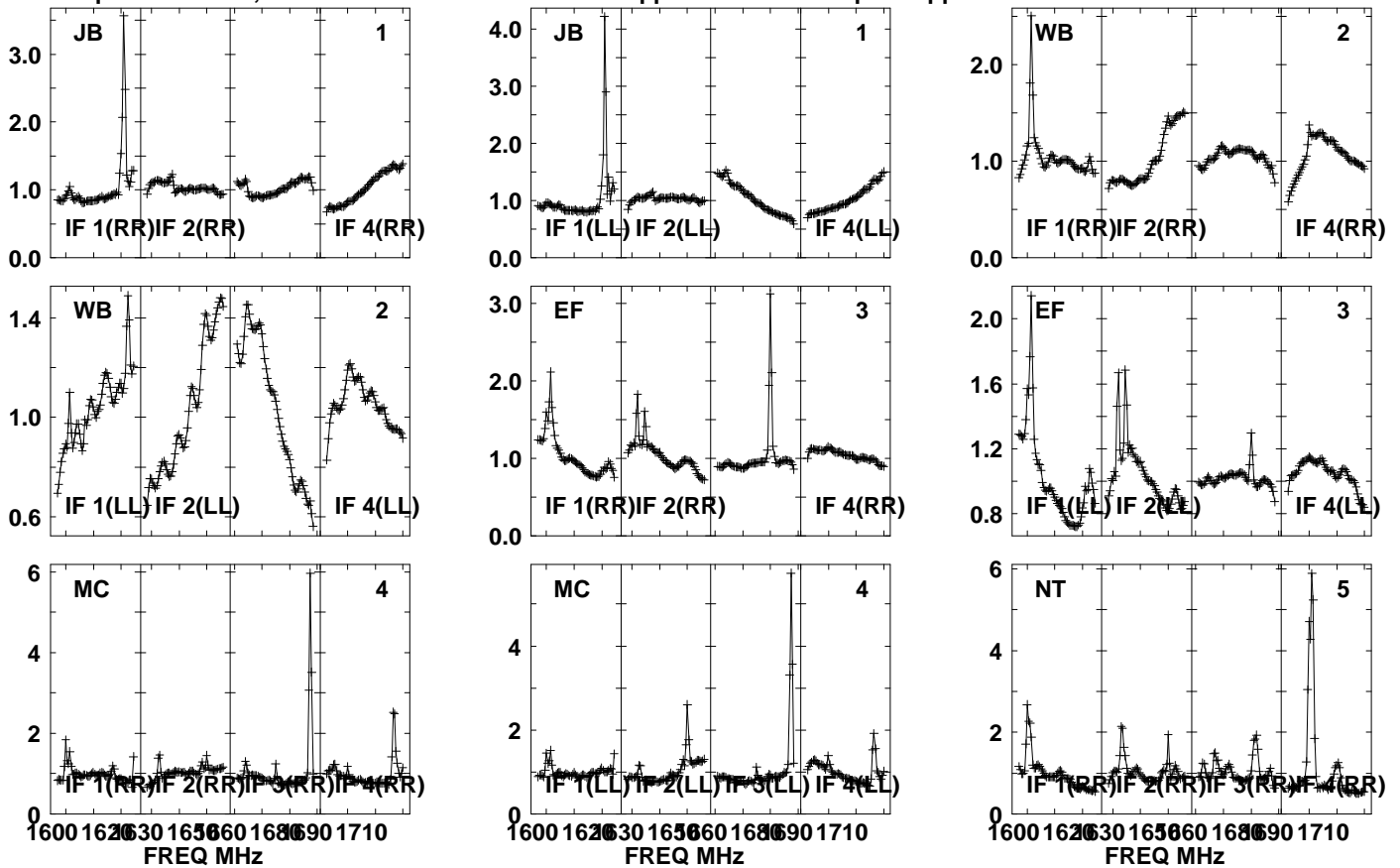

Lower frame: Real Jy

Auto-corr total-power spectrum Antenna: *

Timerange: 01/04:19:31 to 01/04:22:59

Plot file version 251 created 12-JUN-2023 14:39:23

J1548 ES106B.UVDATA.1

Freq = 1.5950 GHz, Bw = 32.000 MH No calibration applied and no bandpass applied

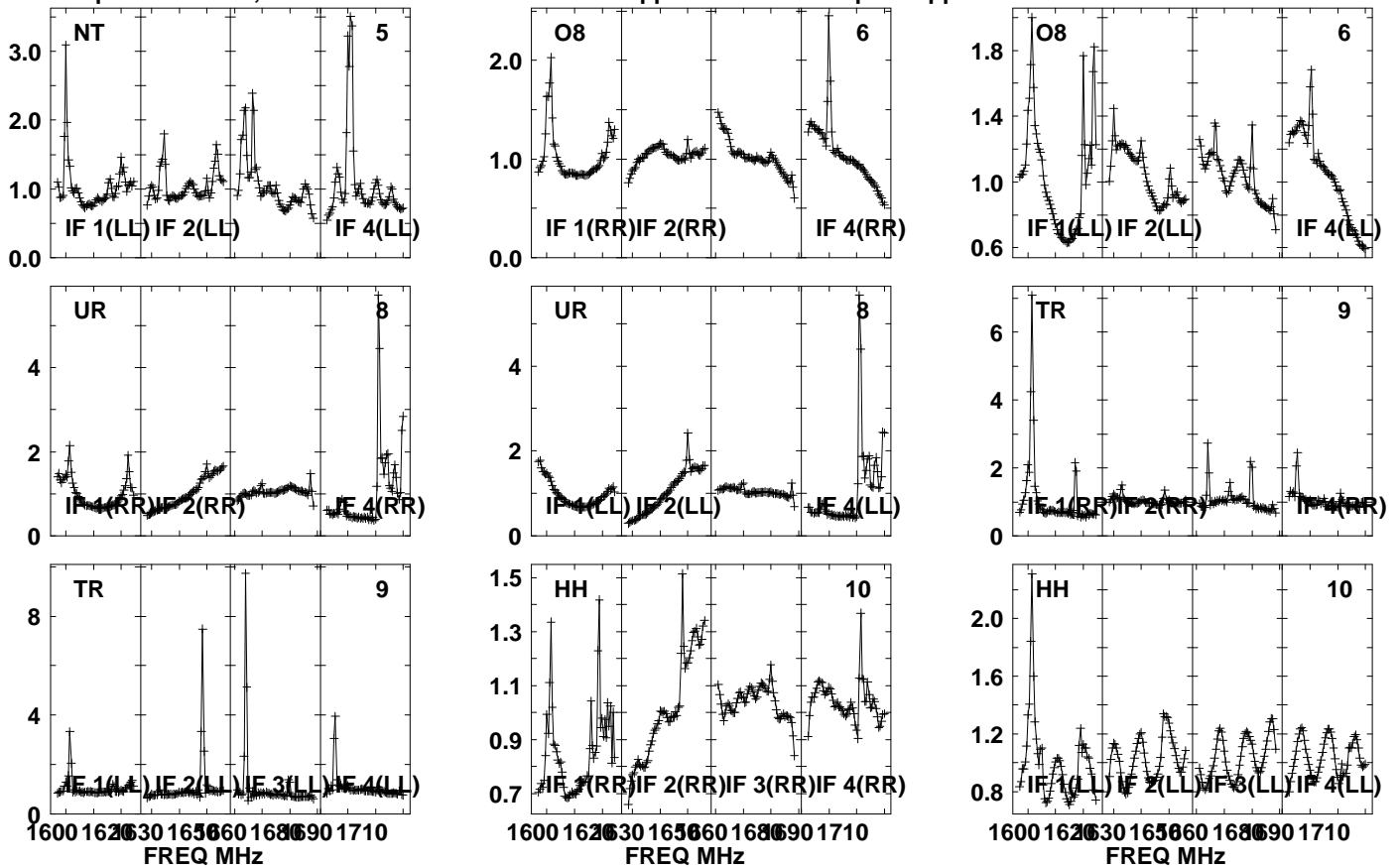

Lower frame: Real Jy

Auto-corr total-power spectrum Antenna: *

Timerange: 01/04:19:31 to 01/04:22:59

Plot file version 252 created 12-JUN-2023 14:39:23

J1547+2052 ES106B.UVDATA.1

Freq = 1.5950 GHz, Bw = 32.000 MH No calibration applied and no bandpass applied

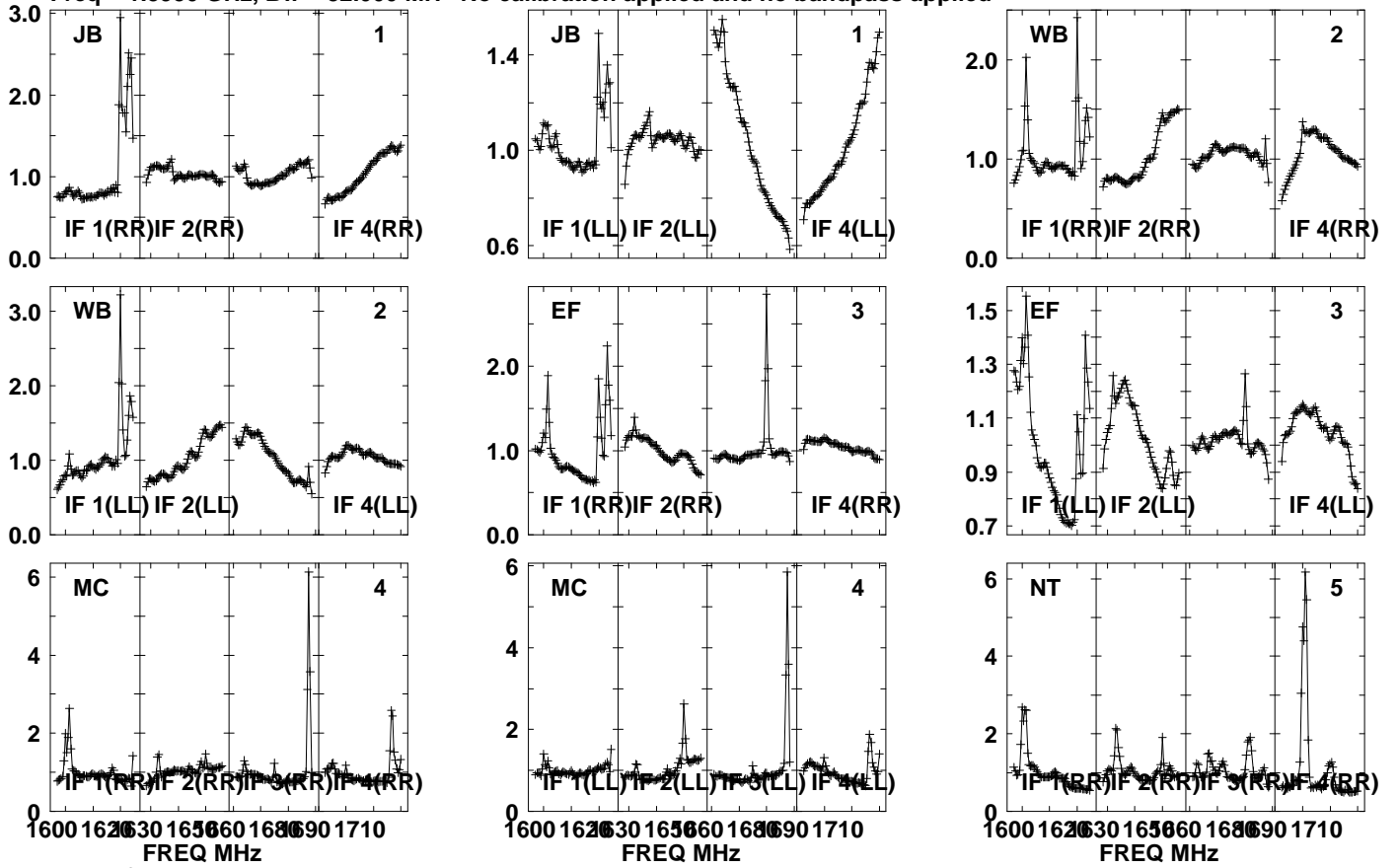

Lower frame: Real Jy

Auto-corr total-power spectrum Antenna: *

Timerange: 01/04:23:01 to 01/04:24:29

Plot file version 253 created 12-JUN-2023 14:39:23

J1547+2052 ES106B.UVDATA.1

Freq = 1.5950 GHz, Bw = 32.000 MH No calibration applied and no bandpass applied

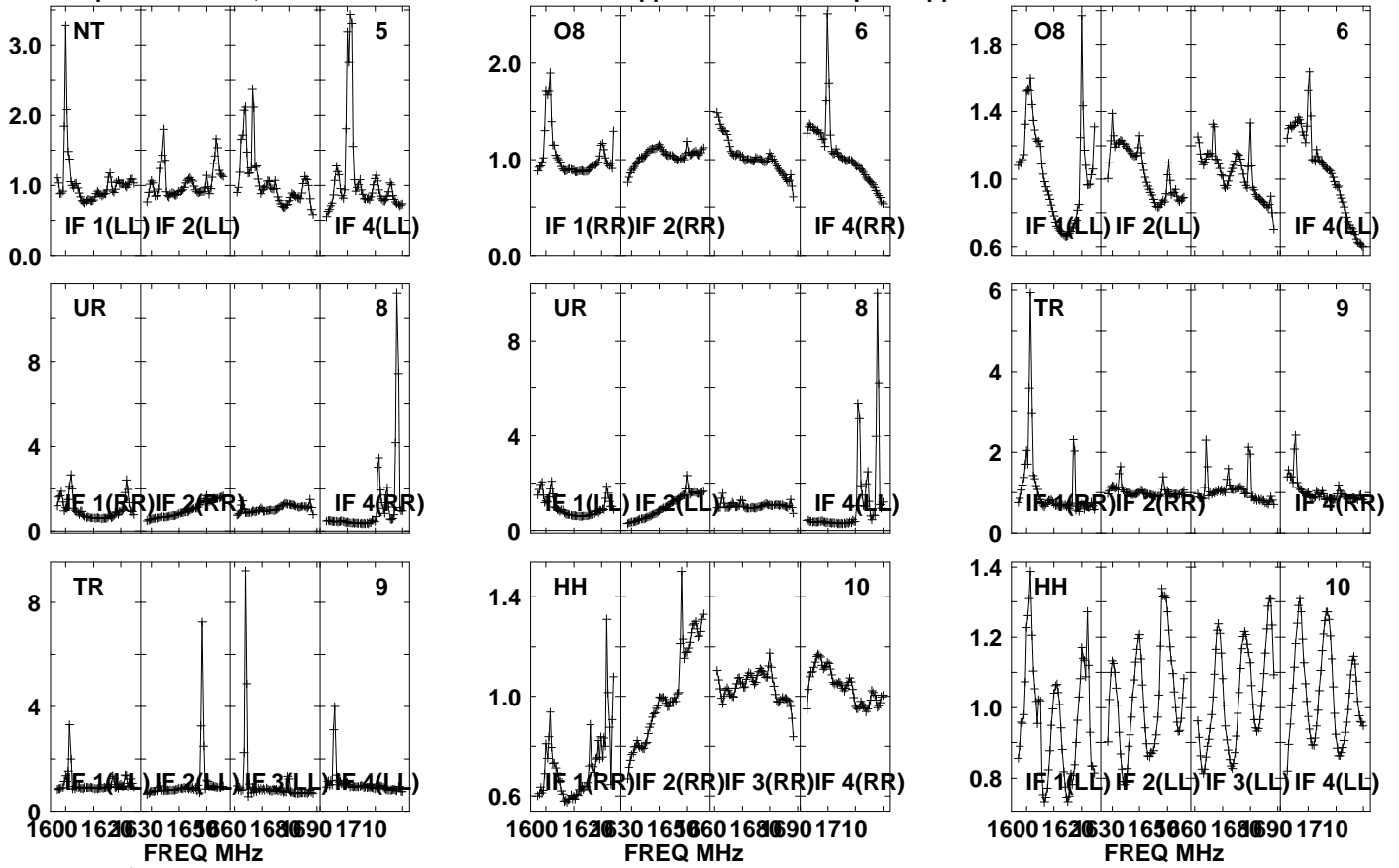

Lower frame: Real Jy
Auto-corr total-power spectrum Antenna: *
Timerange: 01/04:23:01 to 01/04:24:29

Plot file version 254 created 12-JUN-2023 14:39:23

J1545+2006 ES106B.UVDATA.1

Freq = 1.5950 GHz, Bw = 32.000 MH No calibration applied and no bandpass applied

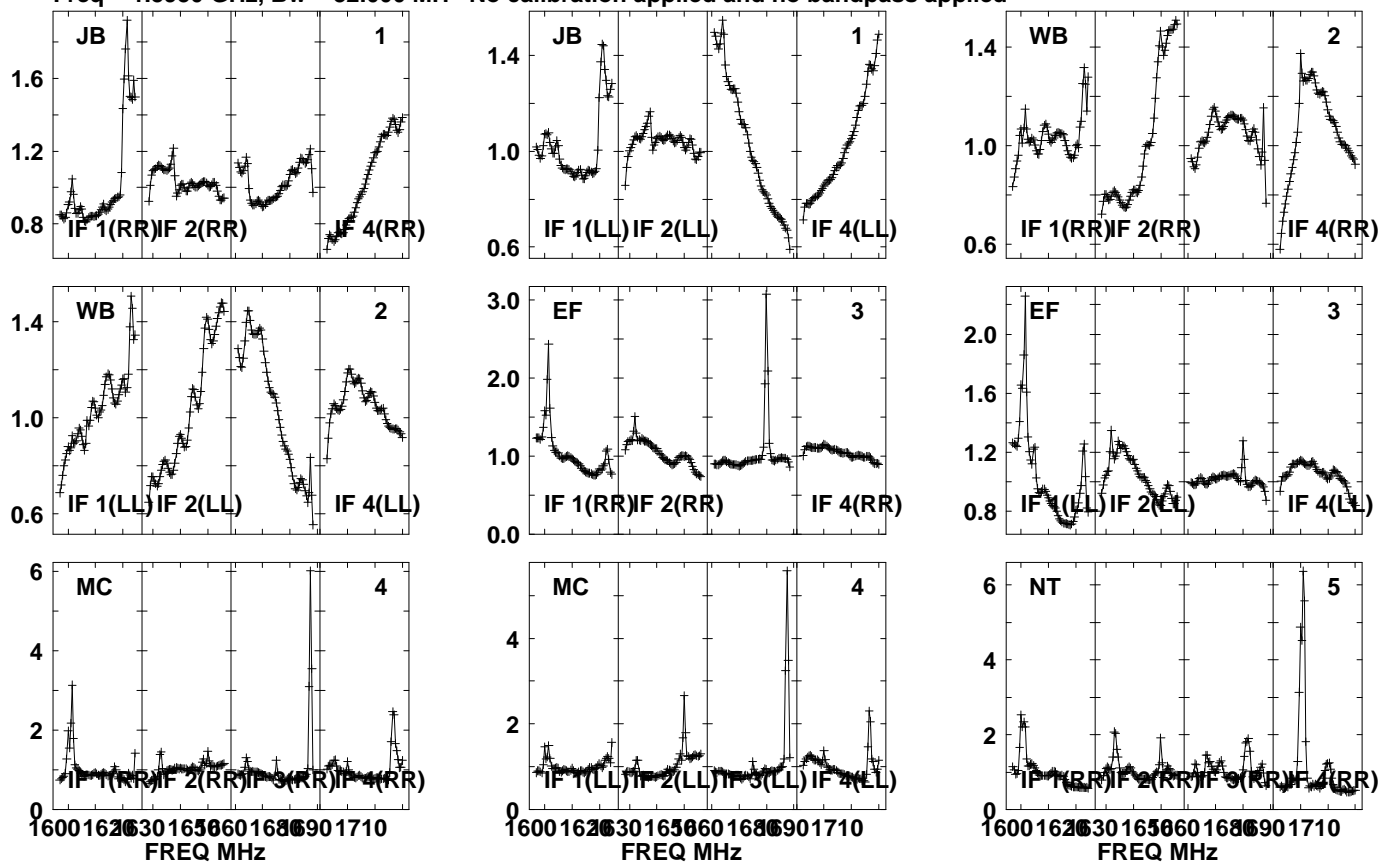

Lower frame: Real Jy
Auto-corr total-power spectrum Antenna: *
Timerange: 01/04:24:31 to 01/04:26:59

Plot file version 255 created 12-JUN-2023 14:39:23

J1545+2006 ES106B.UVDATA.1

Freq = 1.5950 GHz, Bw = 32.000 MH No calibration applied and no bandpass applied

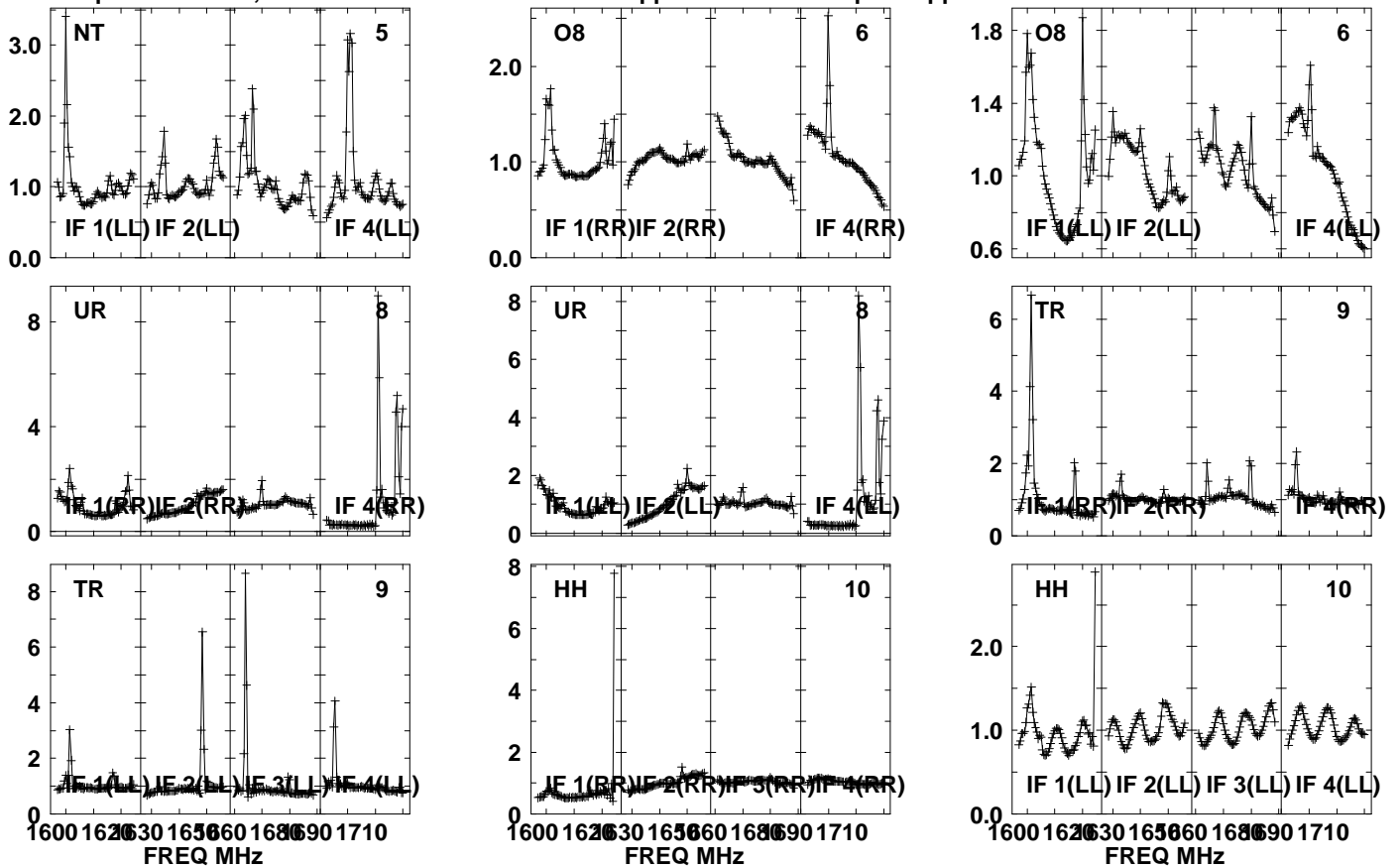

Lower frame: Real Jy

Auto-corr total-power spectrum Antenna: *

Timerange: 01/04:24:31 to 01/04:26:59

Plot file version 256 created 12-JUN-2023 14:39:23

J1547+2052 ES106B.UVDATA.1

Freq = 1.5950 GHz, Bw = 32.000 MH No calibration applied and no bandpass applied

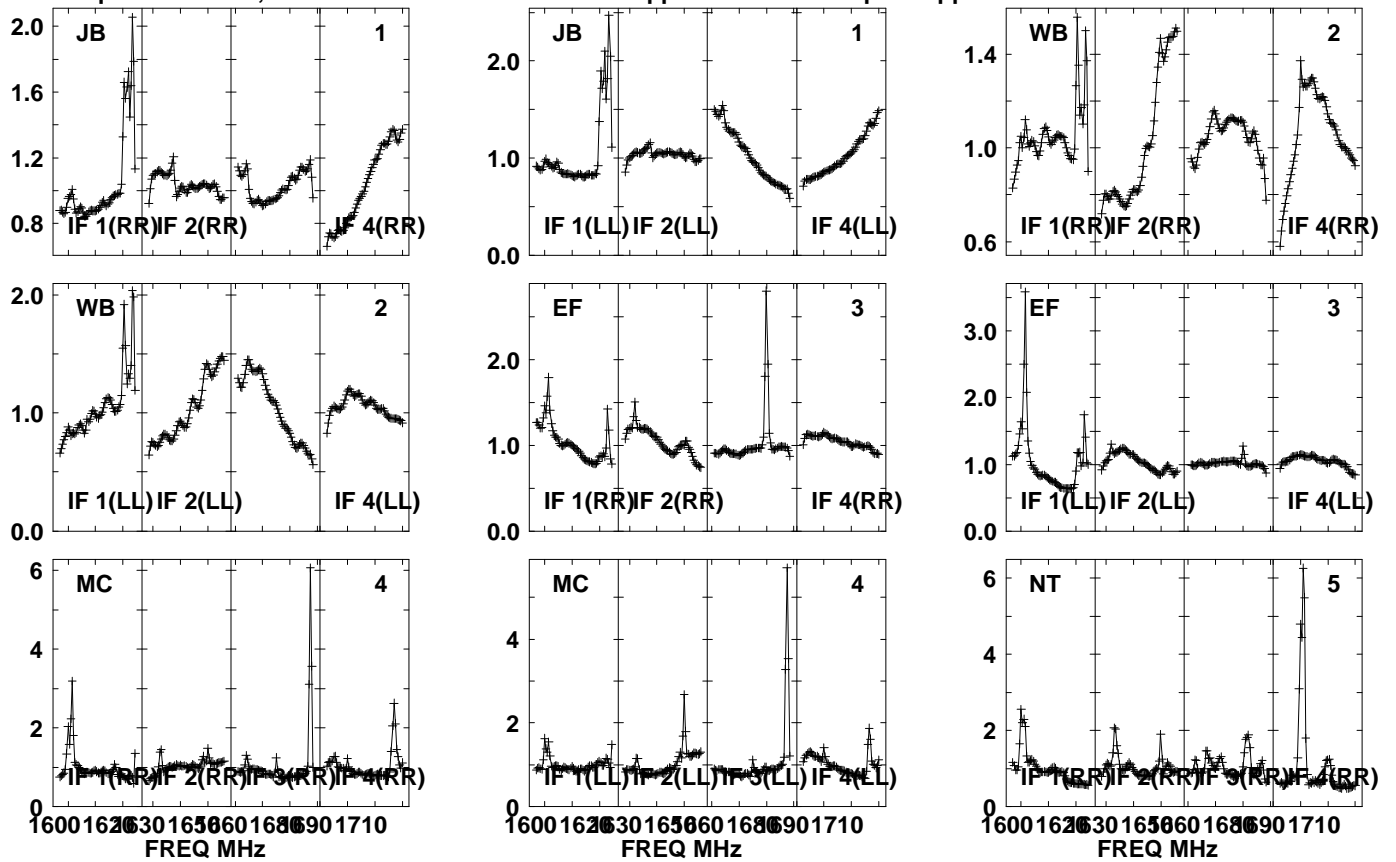

Lower frame: Real Jy
Auto-corr total-power spectrum Antenna: *
Timerange: 01/04:27:01 to 01/04:28:29

Plot file version 257 created 12-JUN-2023 14:39:23

J1547+2052 ES106B.UVDATA.1

Freq = 1.5950 GHz, Bw = 32.000 MH No calibration applied and no bandpass applied

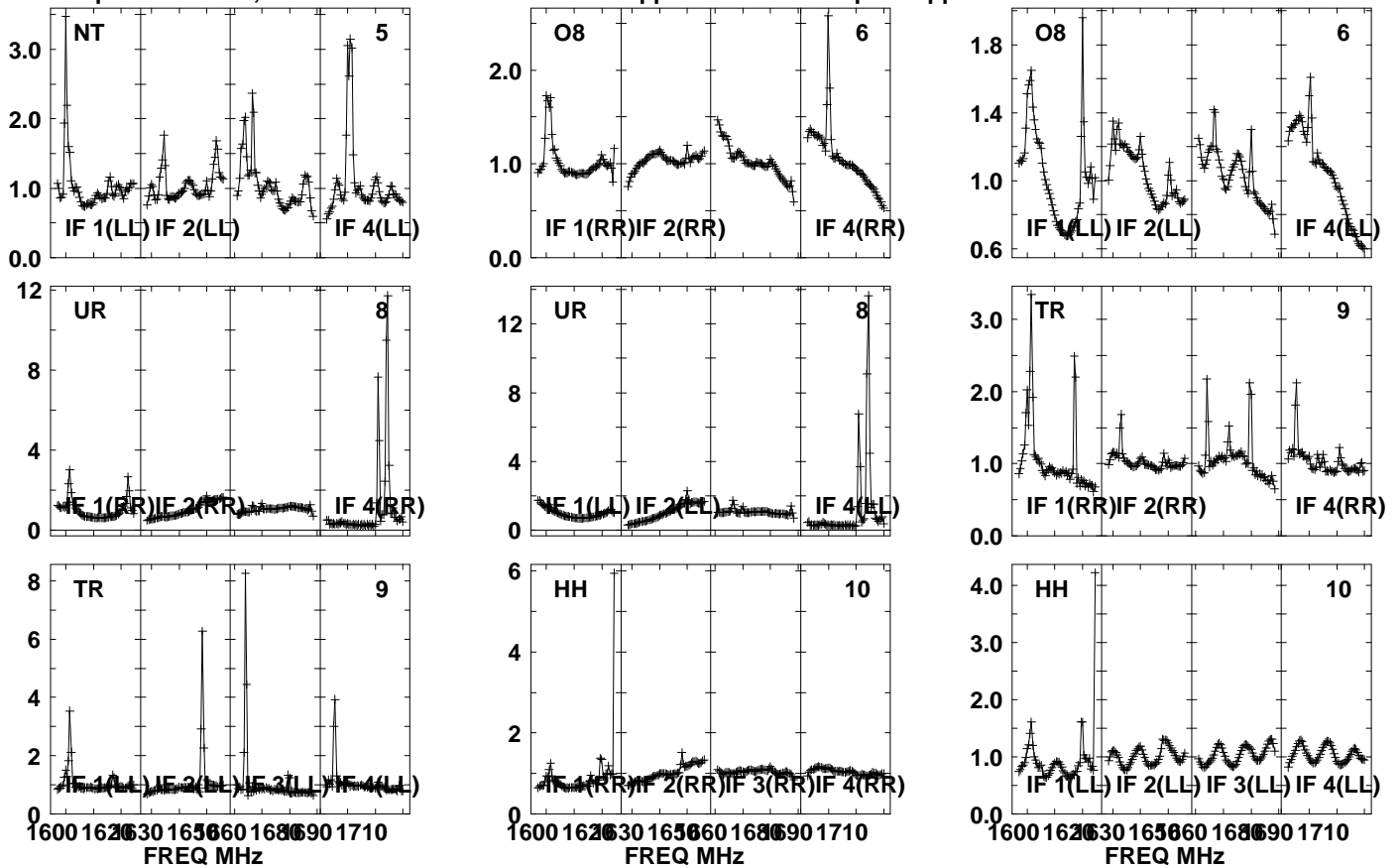

Lower frame: Real Jy

Auto-corr total-power spectrum Antenna: *

Timerange: 01/04:27:01 to 01/04:28:29

Plot file version 258 created 12-JUN-2023 14:39:23

J1548 ES106B.UVDATA.1

Freq = 1.5950 GHz, Bw = 32.000 MH No calibration applied and no bandpass applied

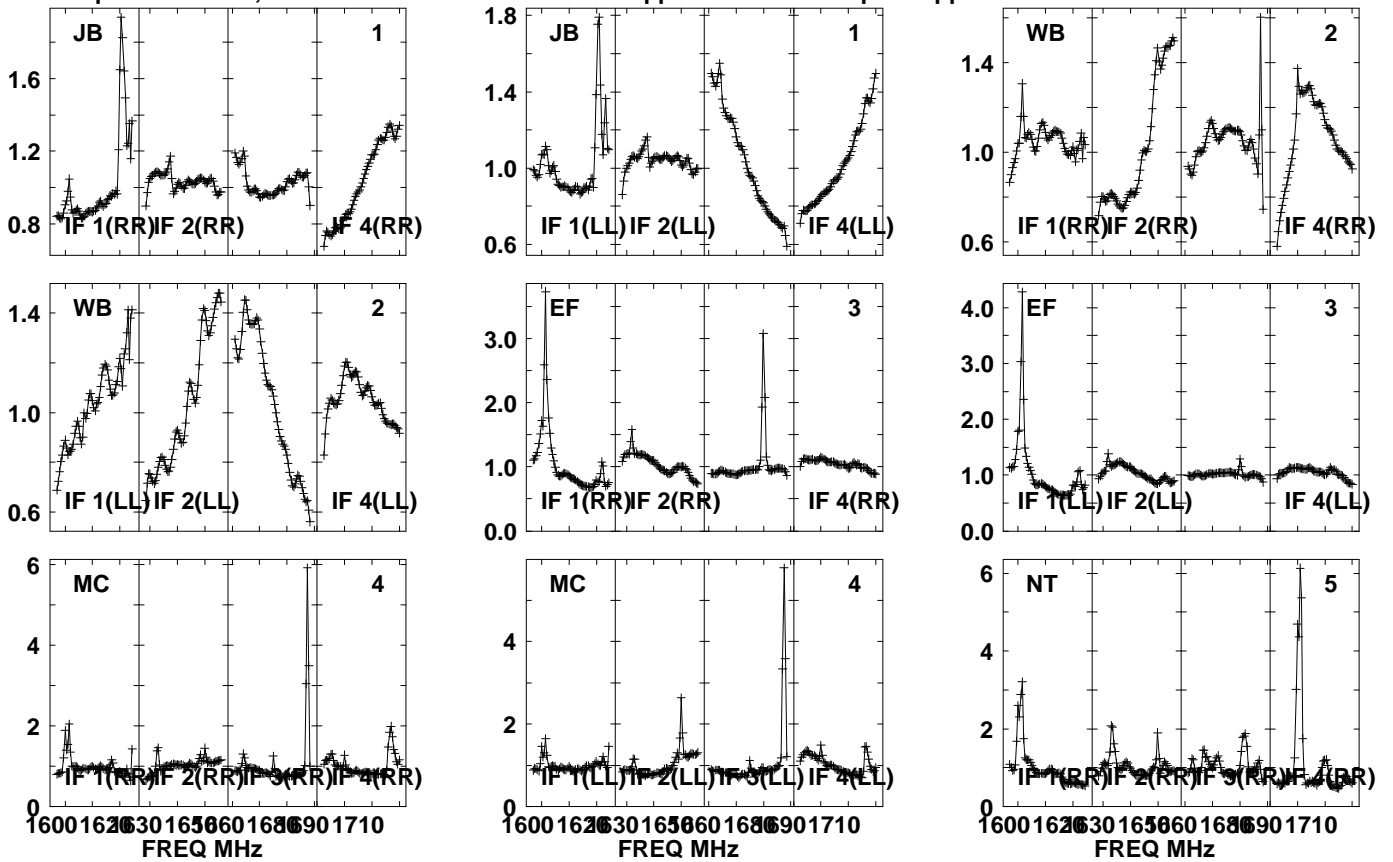

Lower frame: Real Jy
Auto-corr total-power spectrum Antenna: *
Timerange: 01/04:29:01 to 01/04:32:59

Plot file version 259 created 12-JUN-2023 14:39:23

J1548 ES106B.UVDATA.1

Freq = 1.5950 GHz, Bw = 32.000 MH No calibration applied and no bandpass applied

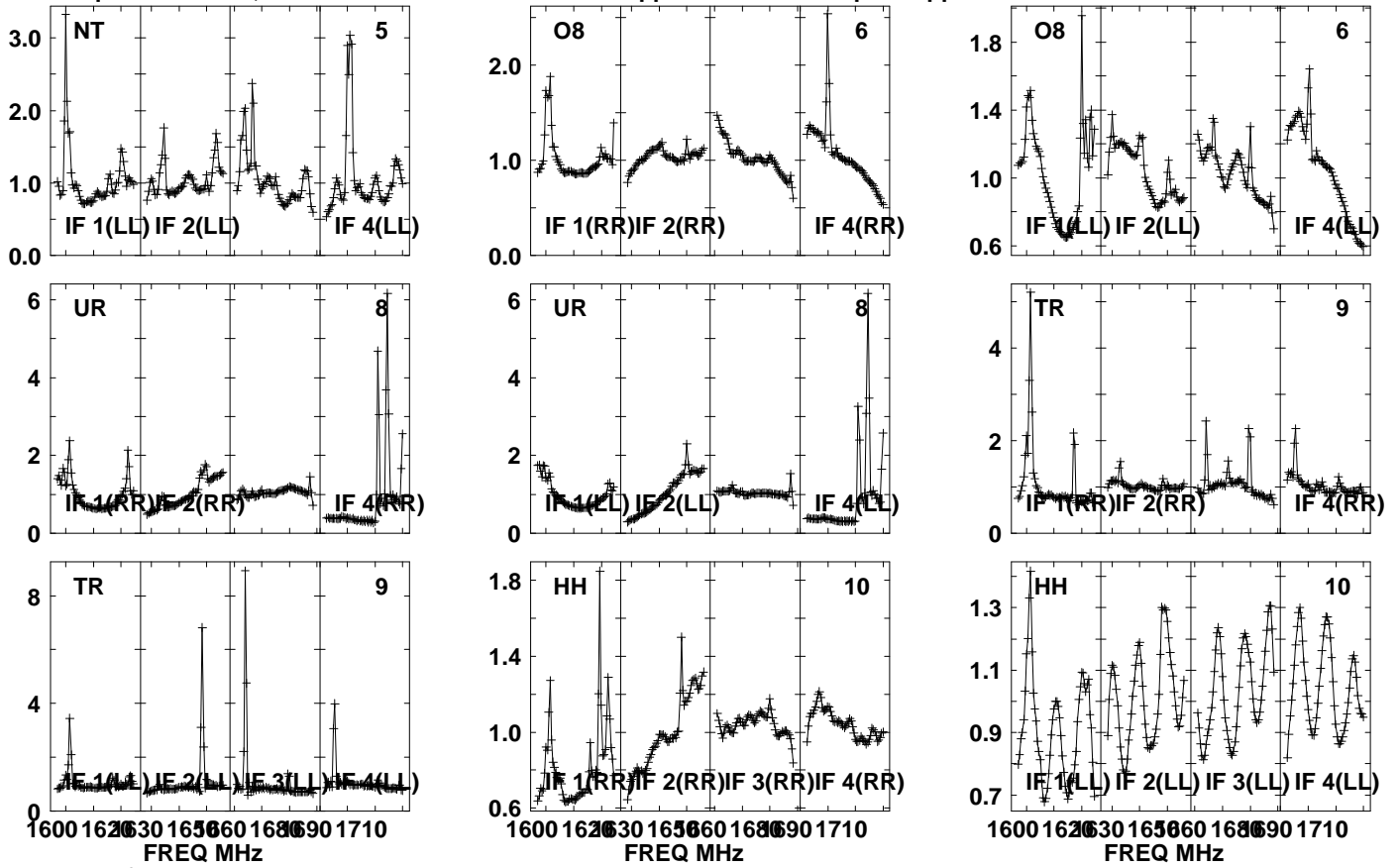

Lower frame: Real Jy

Auto-corr total-power spectrum Antenna: *

Timerange: 01/04:29:01 to 01/04:32:59

Plot file version 260 created 12-JUN-2023 14:39:23

J1547+2052 ES106B.UVDATA.1

Freq = 1.5950 GHz, Bw = 32.000 MH No calibration applied and no bandpass applied

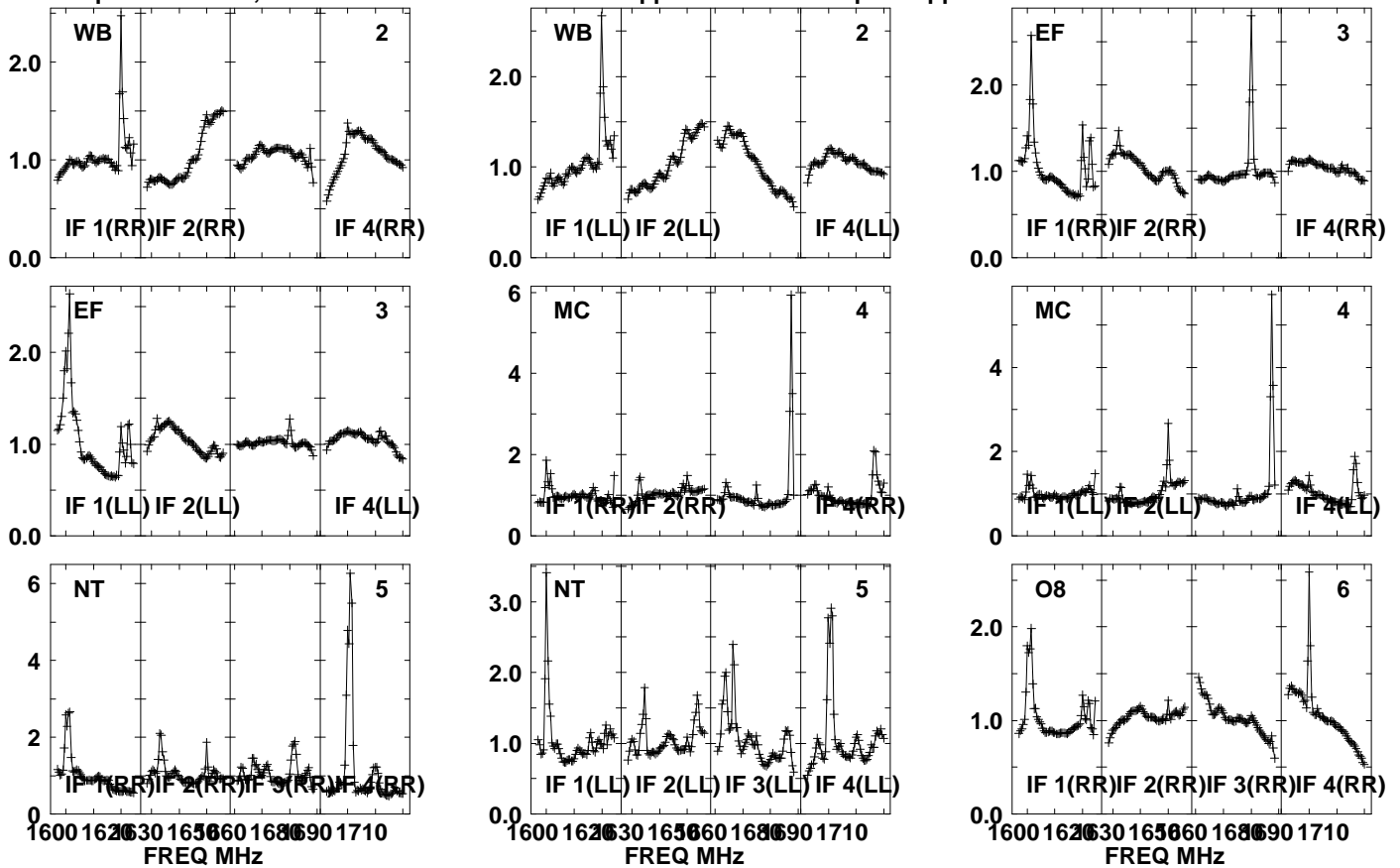

Lower frame: Real Jy

Auto-corr total-power spectrum Antenna: *

Timerange: 01/04:33:01 to 01/04:34:29

Plot file version 261 created 12-JUN-2023 14:39:23

J1547+2052 ES106B.UVDATA.1

Freq = 1.5950 GHz, Bw = 32.000 MHz No calibration applied and no bandpass applied

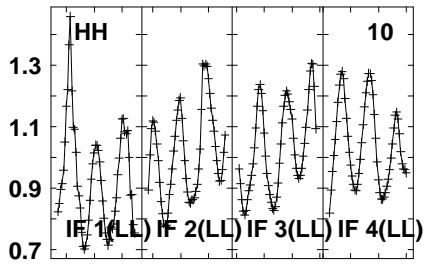
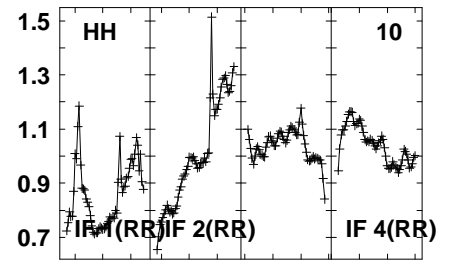
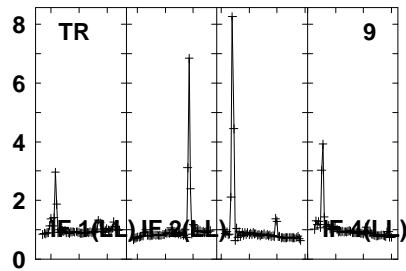
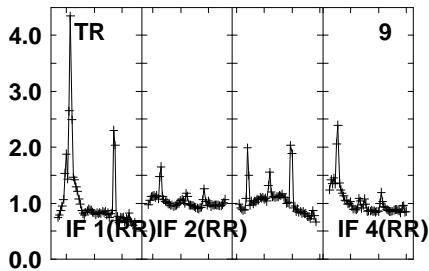
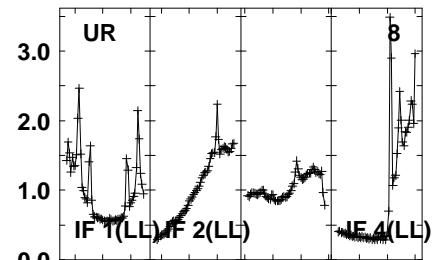
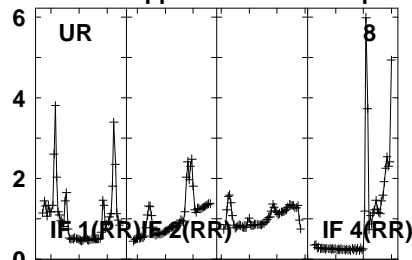
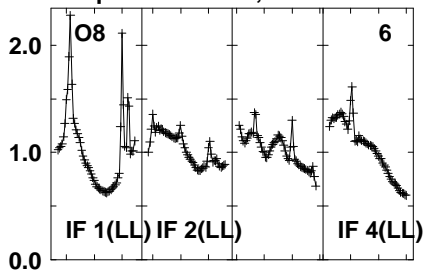

1600 1620 1630 1650 1660 1680 1690 1710

FREQ MHz

Lower frame: Real Jy

Auto-corr total-power spectrum Antenna: *

Timerange: 01/04:33:01 to 01/04:34:29

Plot file version 262 created 12-JUN-2023 14:39:23

J1548 ES106B.UVDATA.1

Freq = 1.5950 GHz, Bw = 32.000 MH No calibration applied and no bandpass applied

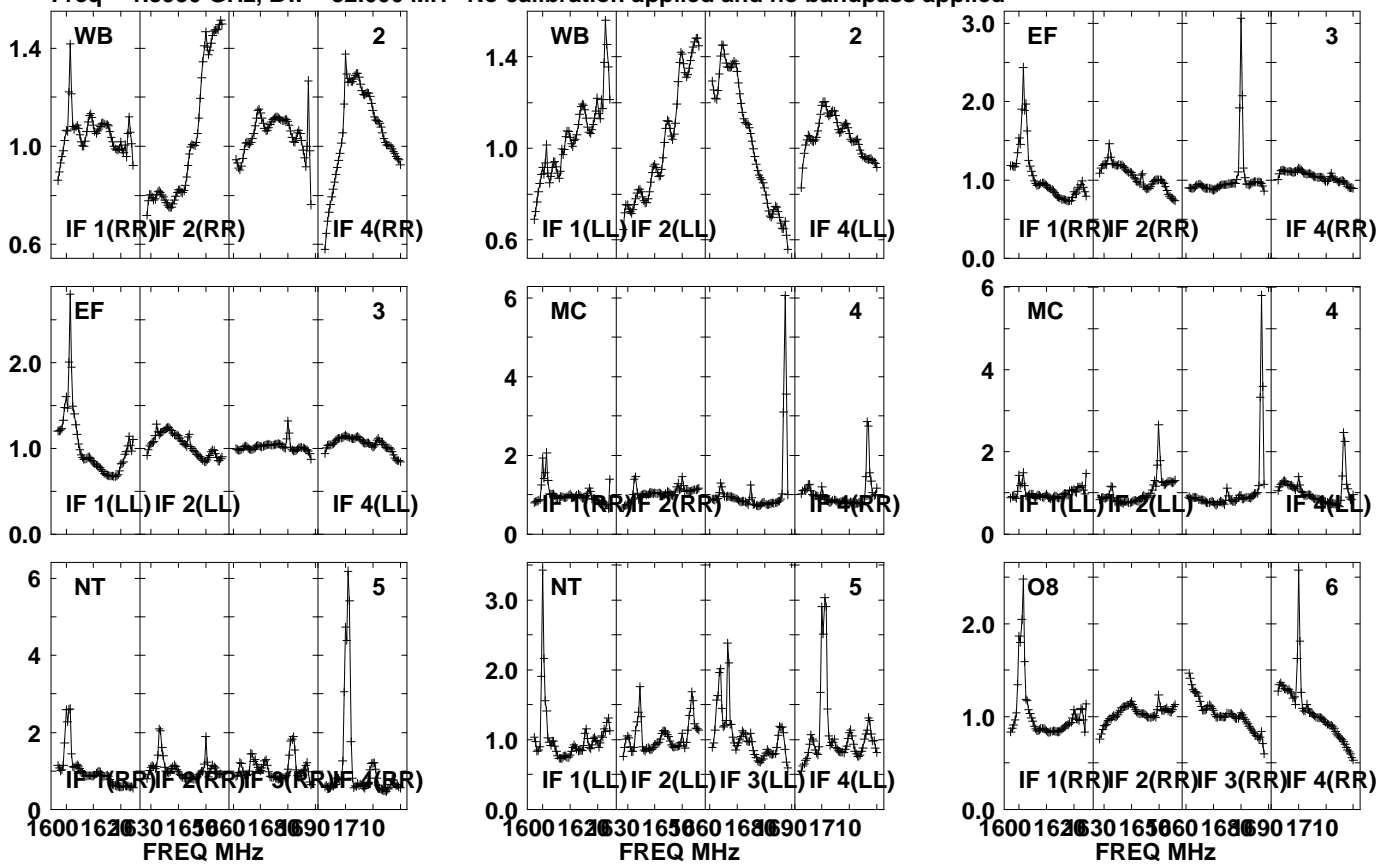

Lower frame: Real Jy
Auto-corr total-power spectrum Antenna: *
Timerange: 01/04:34:31 to 01/04:37:59

Plot file version 263 created 12-JUN-2023 14:39:24

J1548 ES106B.UVDATA.1

Freq = 1.5950 GHz, Bw = 32.000 MH No calibration applied and no bandpass applied

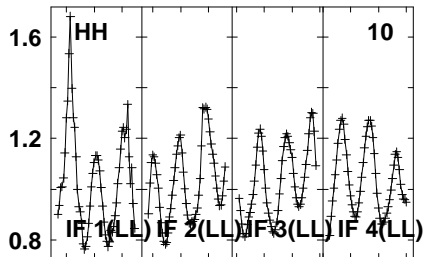
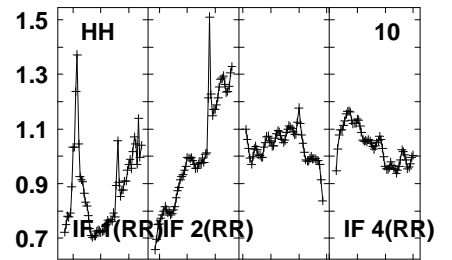
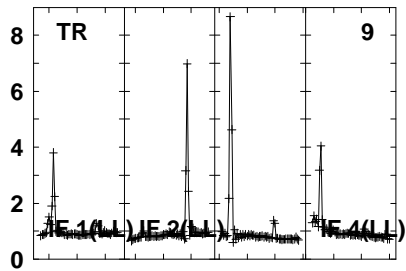
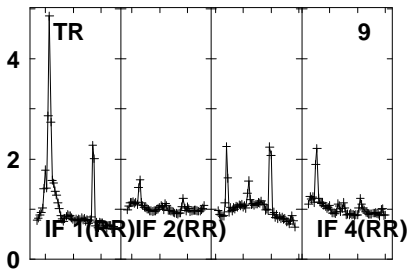
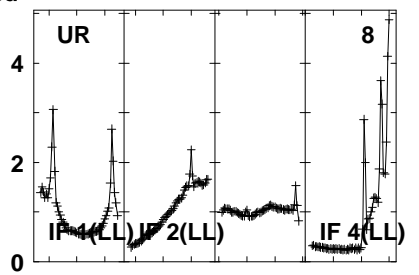
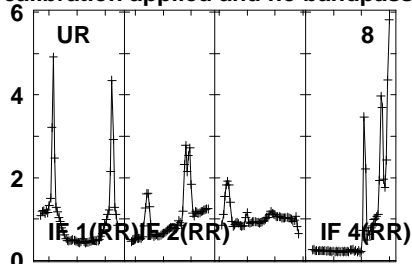
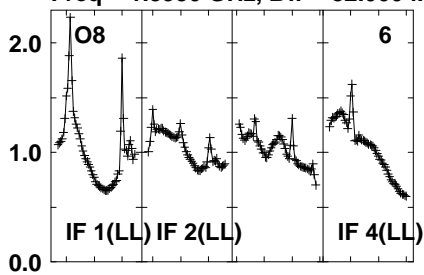

1600 1620 1640 1660 1680 1700 1710

FREQ MHz

Lower frame: Real Jy

Auto-corr total-power spectrum Antenna: *

Timerange: 01/04:34:31 to 01/04:37:59

Plot file version 264 created 12-JUN-2023 14:39:24

J1547+2052 ES106B.UVDATA.1

Freq = 1.5950 GHz, Bw = 32.000 MH No calibration applied and no bandpass applied

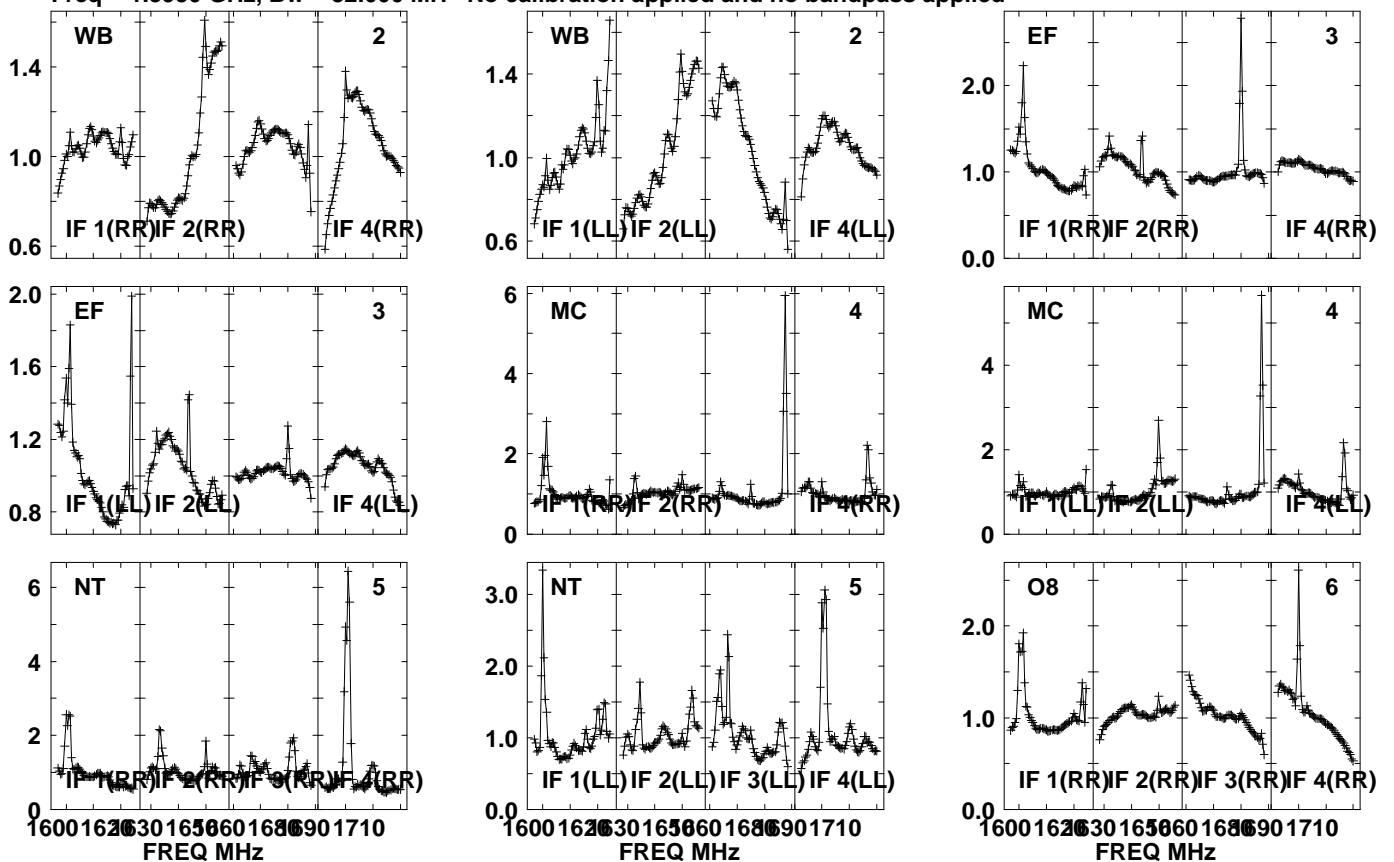

Lower frame: Real Jy
Auto-corr total-power spectrum Antenna: *
Timerange: 01/04:38:31 to 01/04:39:59

Plot file version 265 created 12-JUN-2023 14:39:24

J1547+2052 ES106B.UVDATA.1

Freq = 1.5950 GHz, Bw = 32.000 MH No calibration applied and no bandpass applied

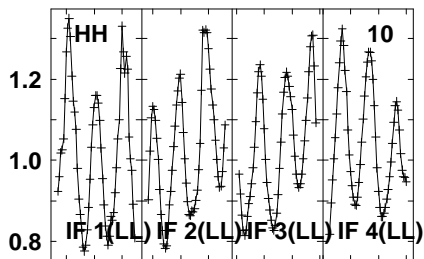
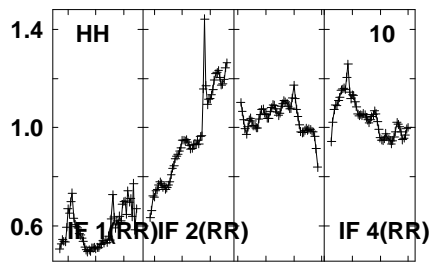
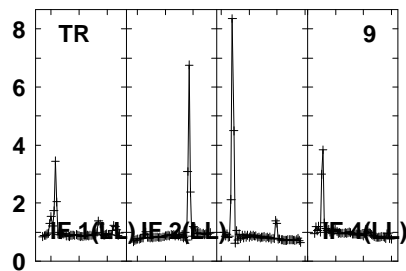
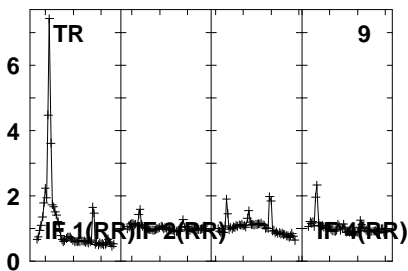
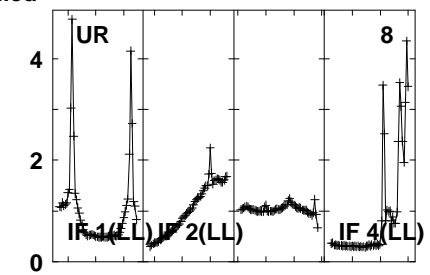
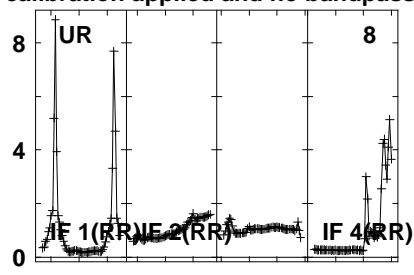
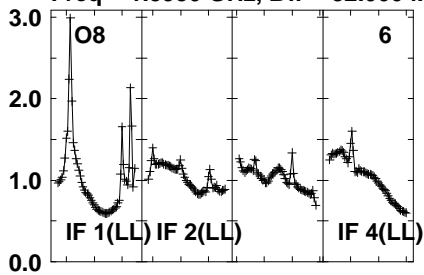

1600 1620 1630 1650 1660 1680 1690 1710
FREQ MHz

Lower frame: Real Jy

Auto-corr total-power spectrum Antenna: *

Timerange: 01/04:38:31 to 01/04:39:59

Plot file version 266 created 12-JUN-2023 14:39:24

J1548 ES106B.UVDATA.1

Freq = 1.5950 GHz, Bw = 32.000 MH No calibration applied and no bandpass applied

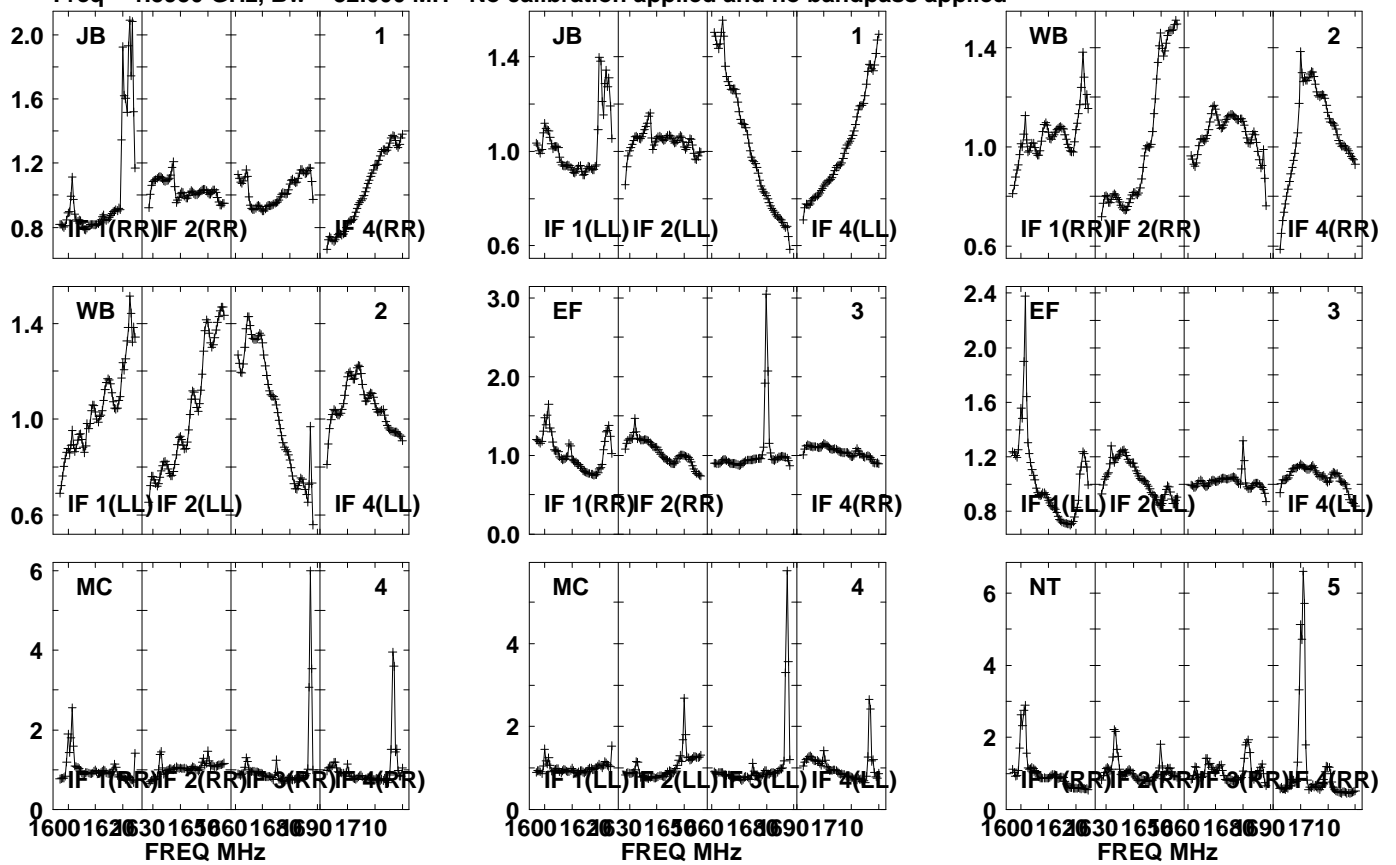

Lower frame: Real Jy
Auto-corr total-power spectrum Antenna: *
Timerange: 01/04:40:01 to 01/04:43:29

Plot file version 267 created 12-JUN-2023 14:39:24

J1548 ES106B.UVDATA.1

Freq = 1.5950 GHz, Bw = 32.000 MH No calibration applied and no bandpass applied

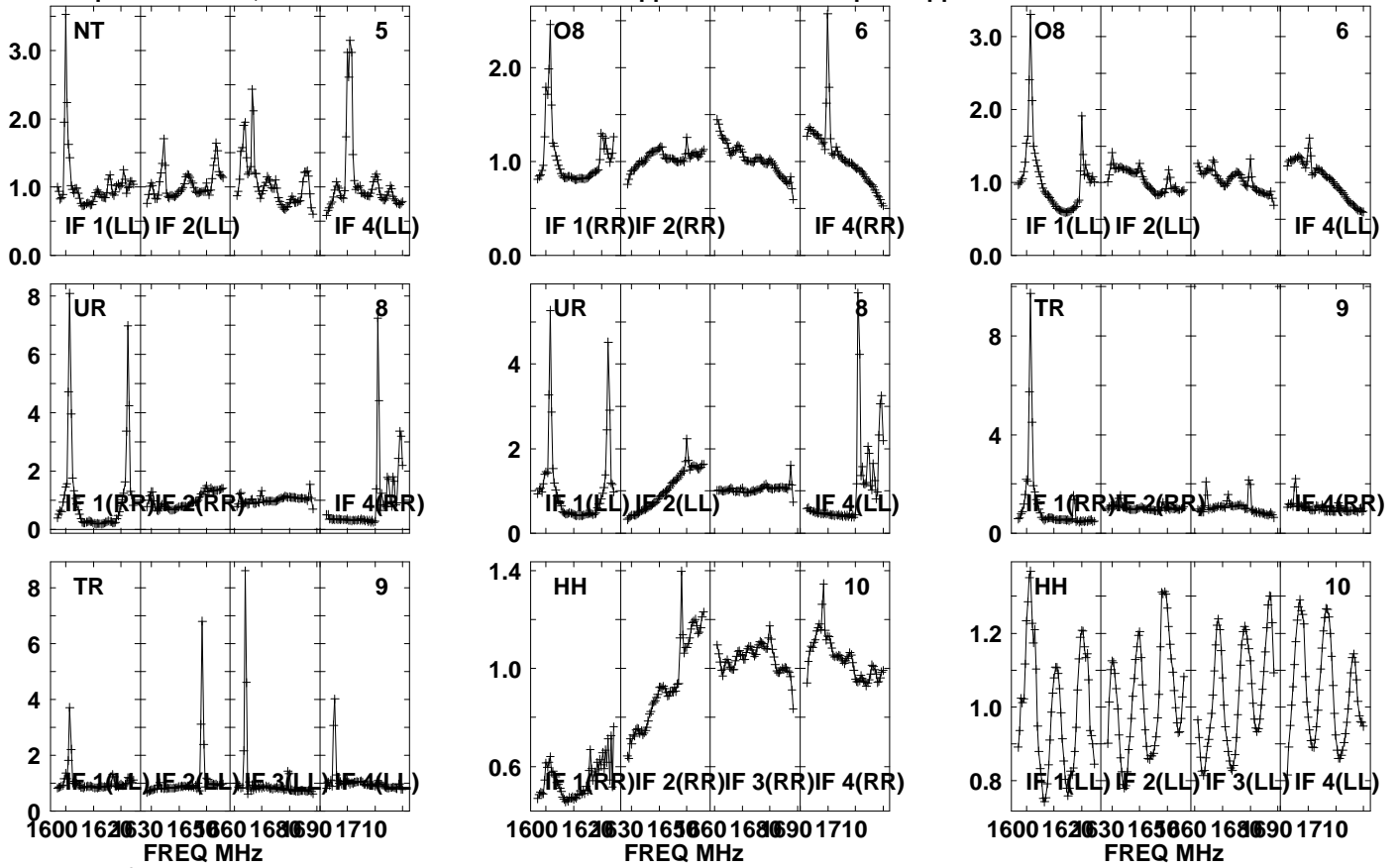

Lower frame: Real Jy

Auto-corr total-power spectrum Antenna: *

Timerange: 01/04:40:01 to 01/04:43:29

Plot file version 268 created 12-JUN-2023 14:39:24

J1547+2052 ES106B.UVDATA.1

Freq = 1.5950 GHz, Bw = 32.000 MH No calibration applied and no bandpass applied

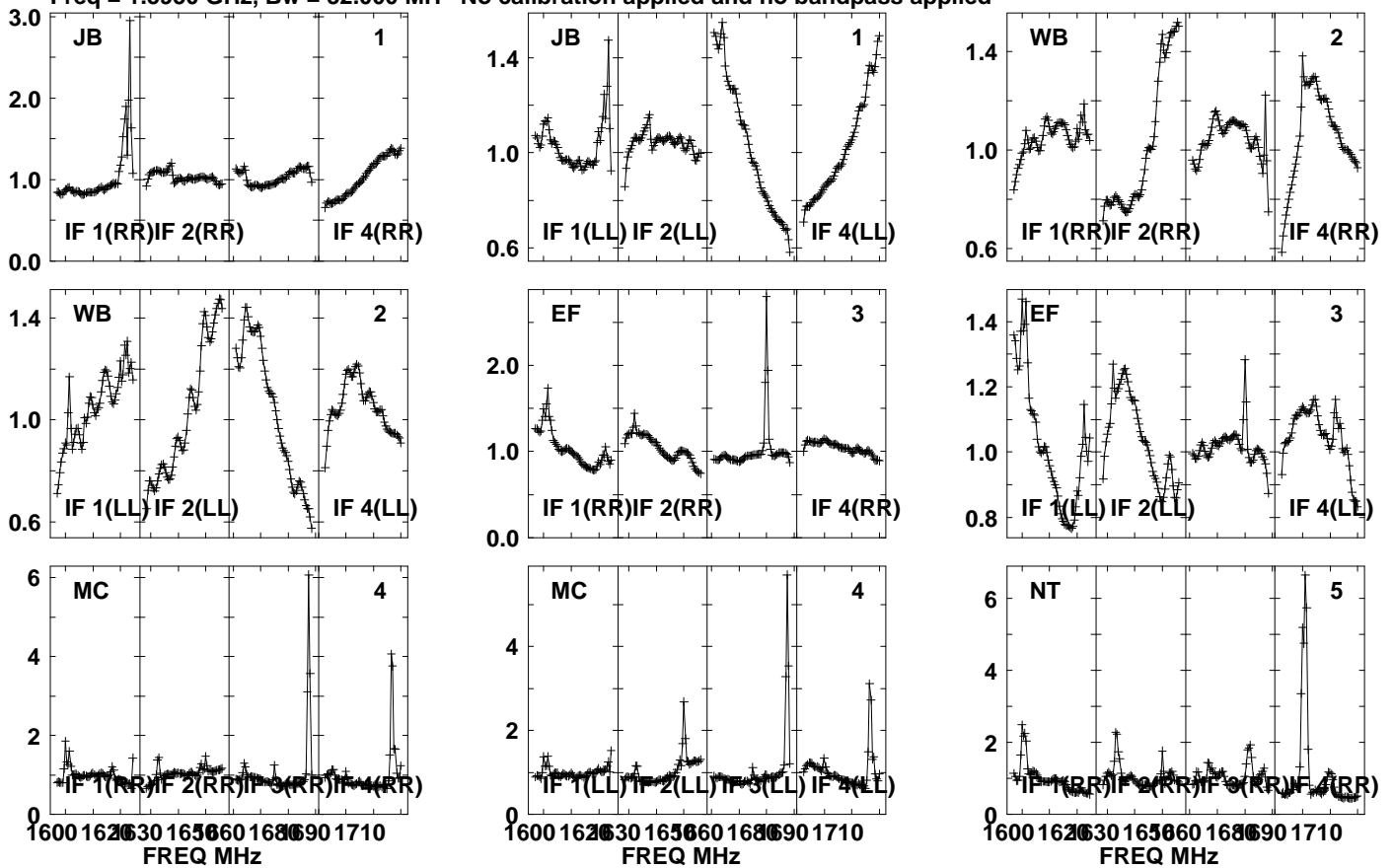

Lower frame: Real Jy

Auto-corr total-power spectrum Antenna: *

Timerange: 01/04:43:31 to 01/04:44:59

Plot file version 269 created 12-JUN-2023 14:39:24

J1547+2052 ES106B.UVDATA.1

Freq = 1.5950 GHz, Bw = 32.000 MH No calibration applied and no bandpass applied

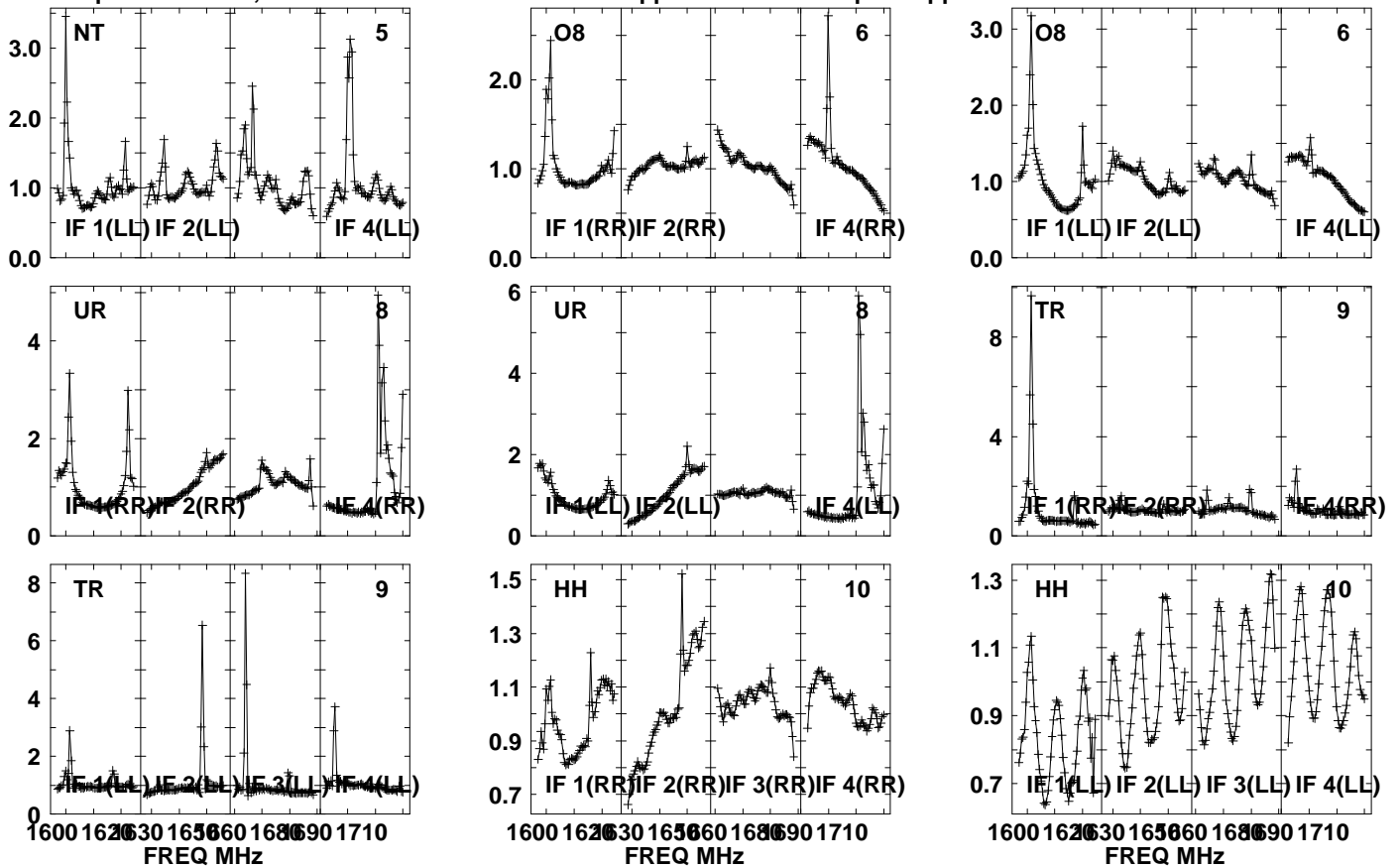

Lower frame: Real Jy

Auto-corr total-power spectrum Antenna: *

Timerange: 01/04:43:31 to 01/04:44:59

Plot file version 270 created 12-JUN-2023 14:39:24

J1545+2006 ES106B.UVDATA.1

Freq = 1.5950 GHz, Bw = 32.000 MH No calibration applied and no bandpass applied

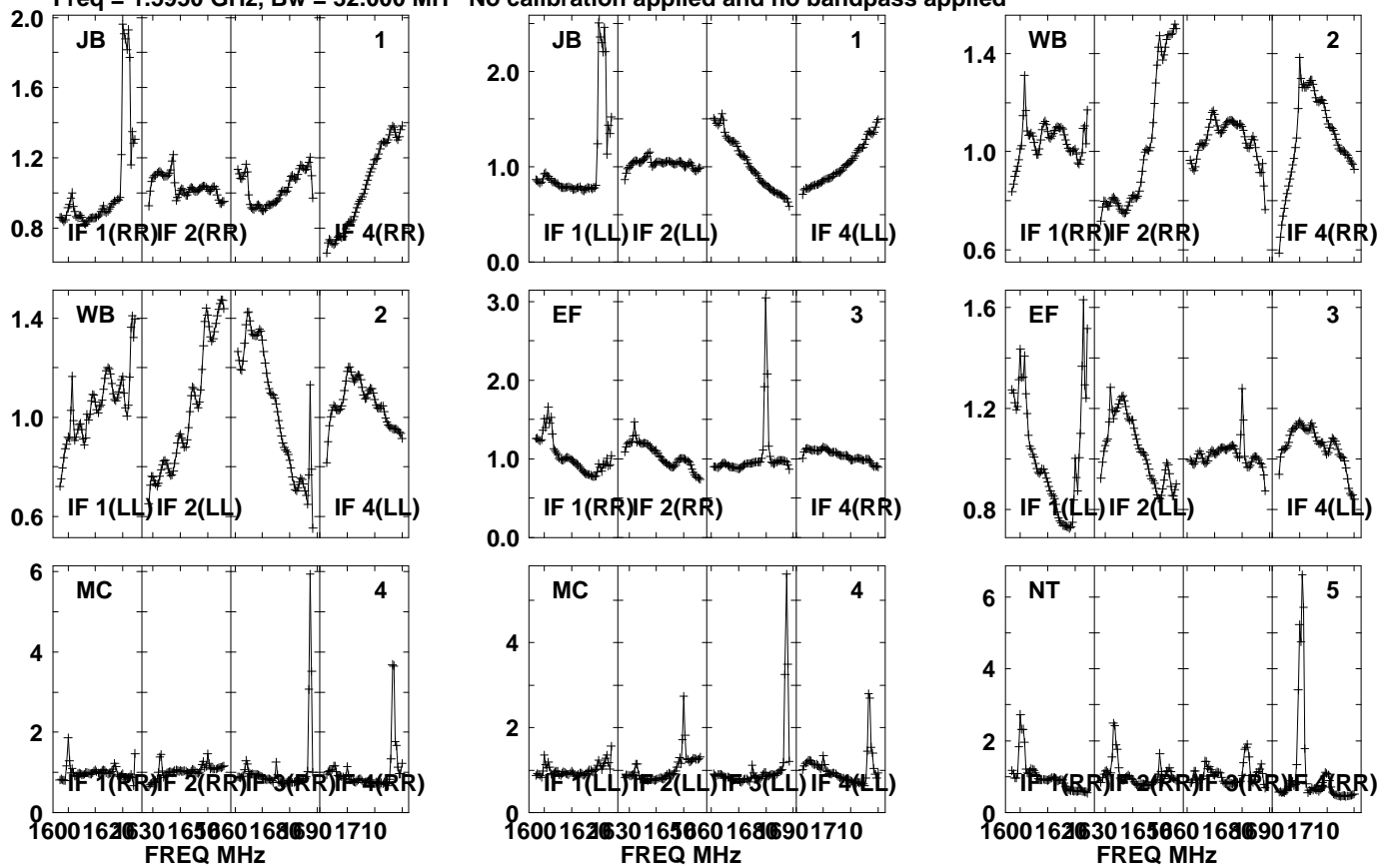

Lower frame: Real Jy
Auto-corr total-power spectrum Antenna: *
Timerange: 01/04:45:01 to 01/04:47:29

Plot file version 271 created 12-JUN-2023 14:39:24

J1545+2006 ES106B.UVDATA.1

Freq = 1.5950 GHz, Bw = 32.000 MH No calibration applied and no bandpass applied

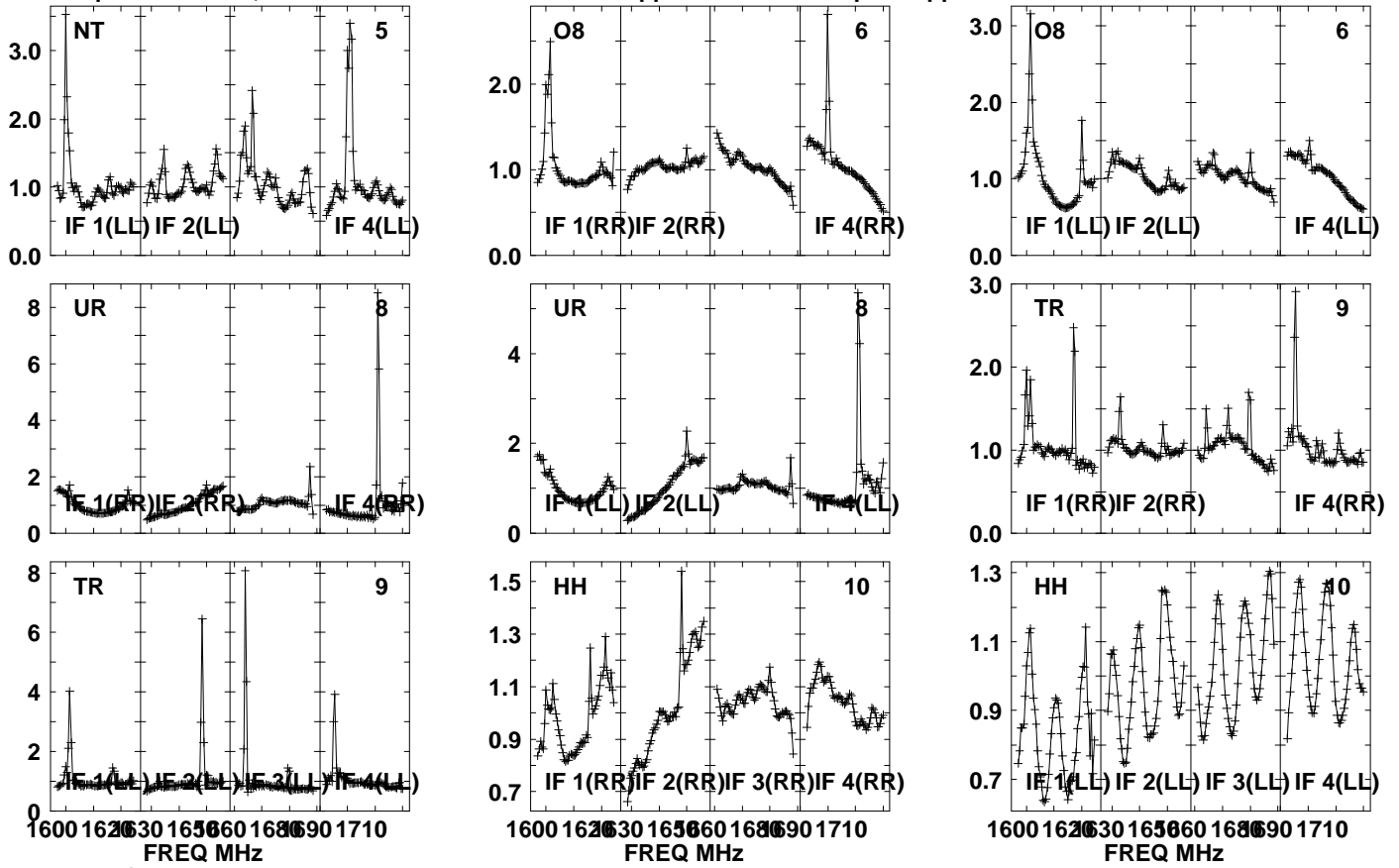

Lower frame: Real Jy
 Auto-corr total-power spectrum Antenna: *
 Timerange: 01/04:45:01 to 01/04:47:29

Plot file version 272 created 12-JUN-2023 14:39:24

J1547+2052 ES106B.UVDATA.1

Freq = 1.5950 GHz, Bw = 32.000 MH No calibration applied and no bandpass applied

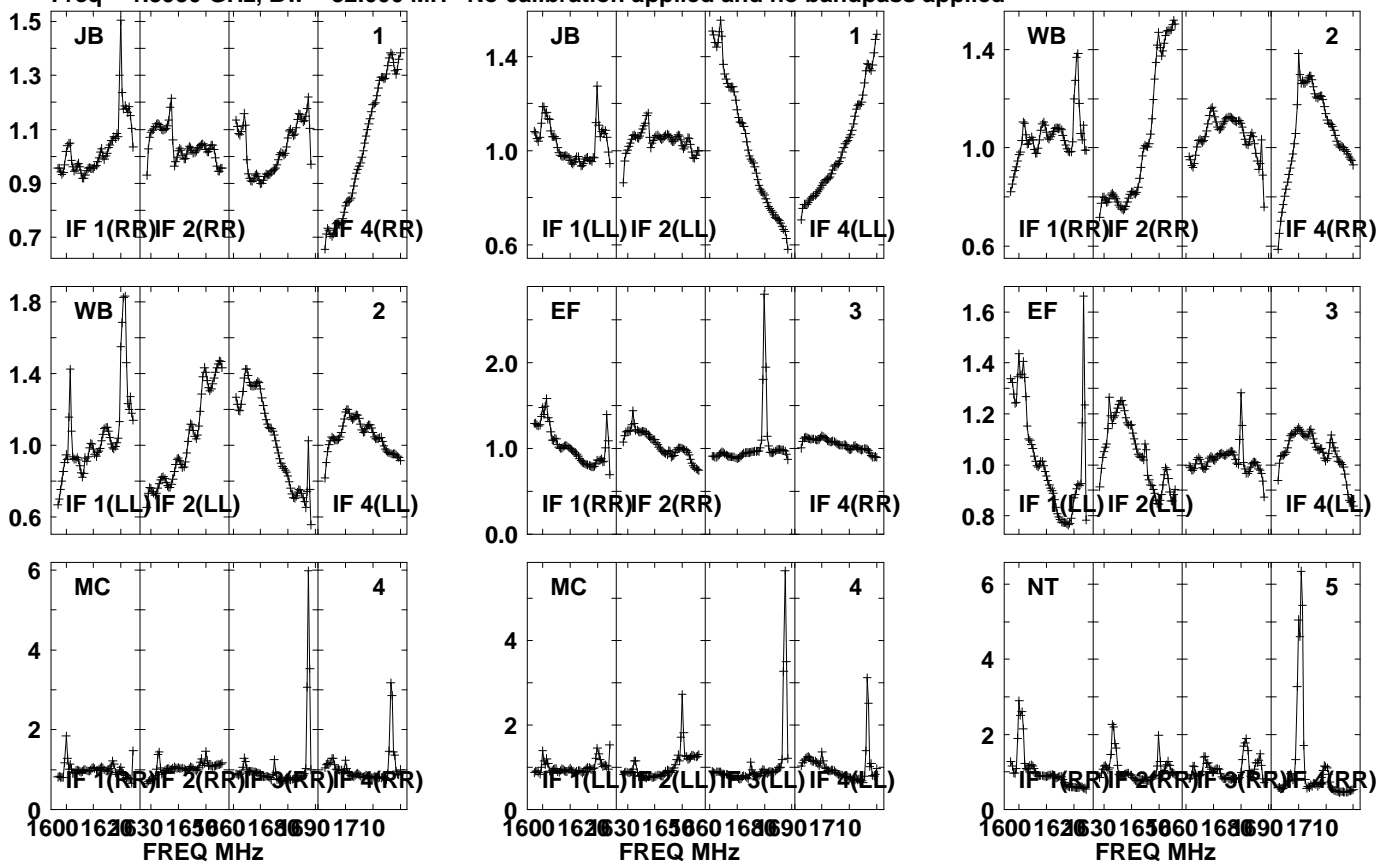

Lower frame: Real Jy
Auto-corr total-power spectrum Antenna: *
Timerange: 01/04:47:31 to 01/04:48:59

Plot file version 273 created 12-JUN-2023 14:39:24

J1547+2052 ES106B.UVDATA.1

Freq = 1.5950 GHz, Bw = 32.000 MH No calibration applied and no bandpass applied

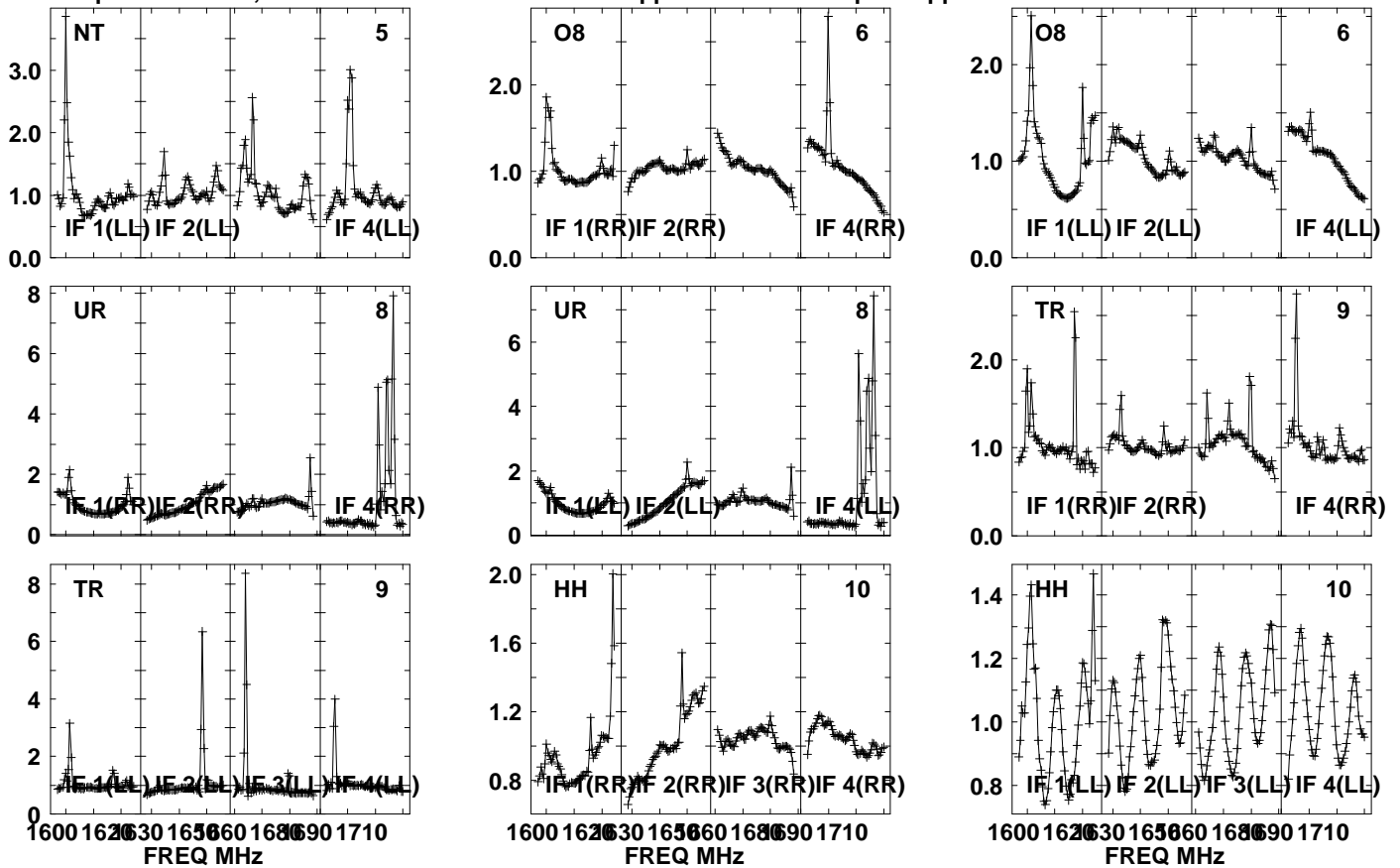

Lower frame: Real Jy

Auto-corr total-power spectrum Antenna: *

Timerange: 01/04:47:31 to 01/04:48:59

Plot file version 274 created 12-JUN-2023 14:39:24

J1548 ES106B.UVDATA.1

Freq = 1.5950 GHz, Bw = 32.000 MH No calibration applied and no bandpass applied

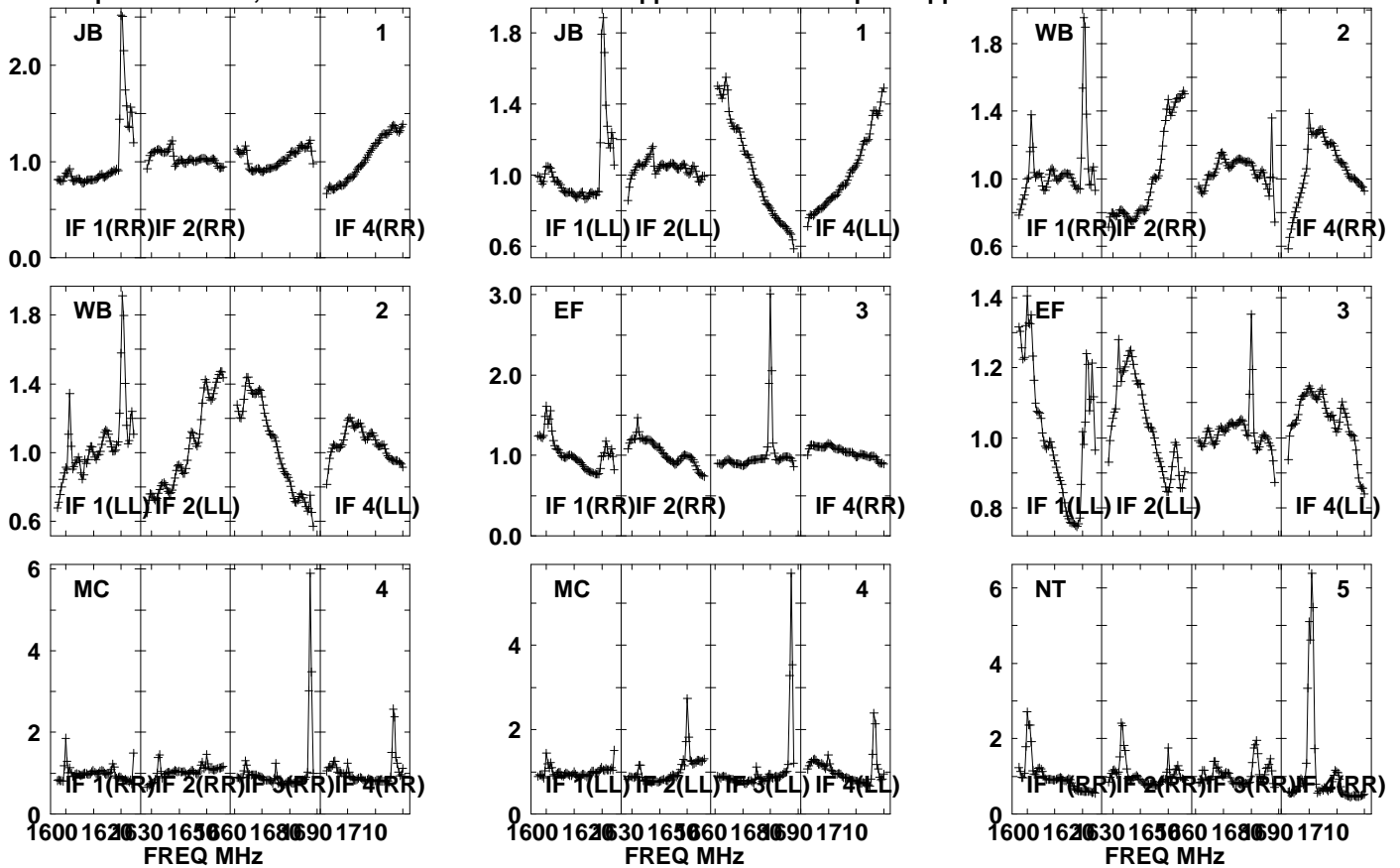

Lower frame: Real Jy

Auto-corr total-power spectrum Antenna: *

Timerange: 01/04:49:31 to 01/04:53:29

Plot file version 275 created 12-JUN-2023 14:39:24

J1548 ES106B.UVDATA.1

Freq = 1.5950 GHz, Bw = 32.000 MH No calibration applied and no bandpass applied

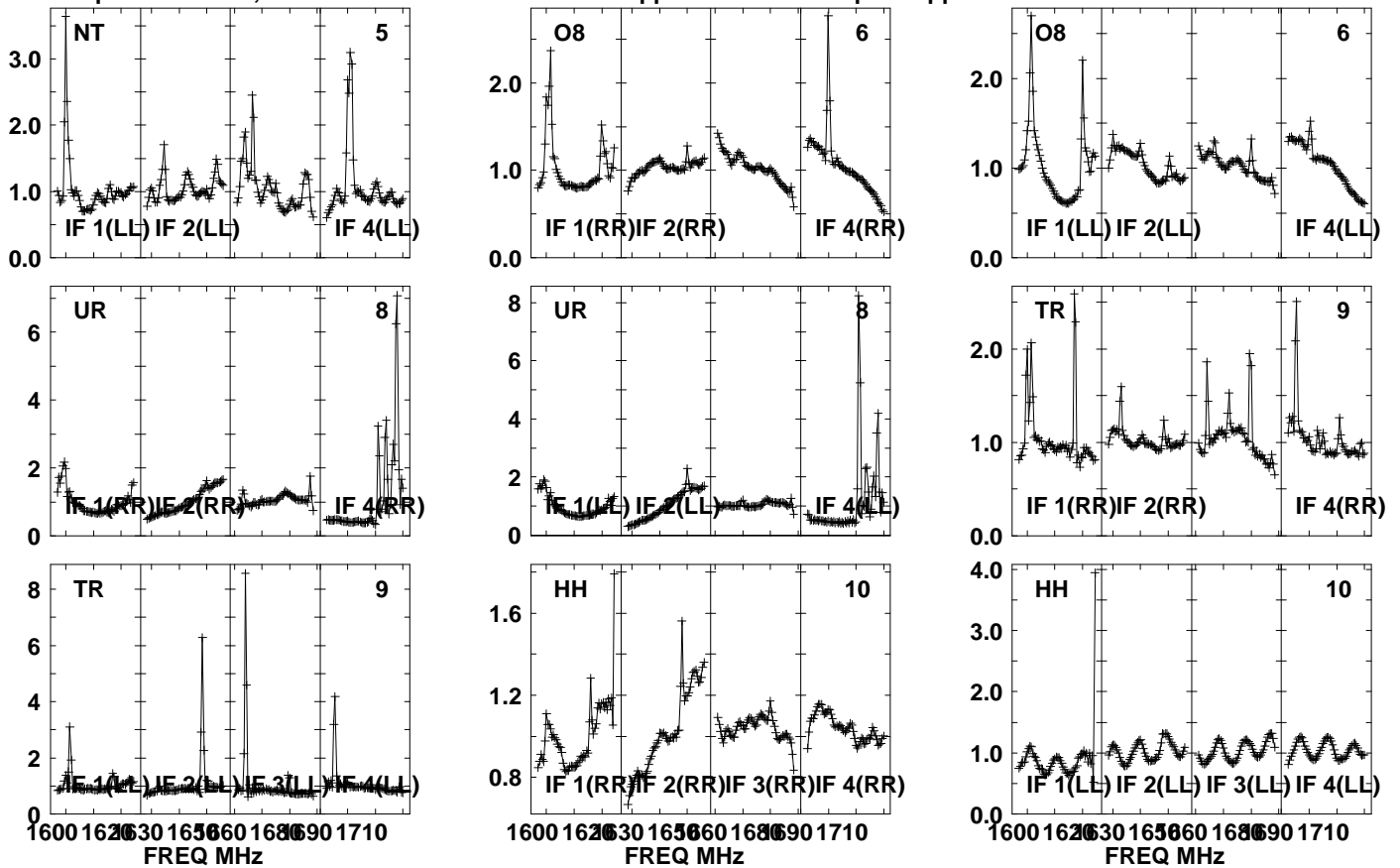

Lower frame: Real Jy

Auto-corr total-power spectrum Antenna: *

Timerange: 01/04:49:31 to 01/04:53:29

Plot file version 276 created 12-JUN-2023 14:39:24

J1547+2052 ES106B.UVDATA.1

Freq = 1.5950 GHz, Bw = 32.000 MH No calibration applied and no bandpass applied

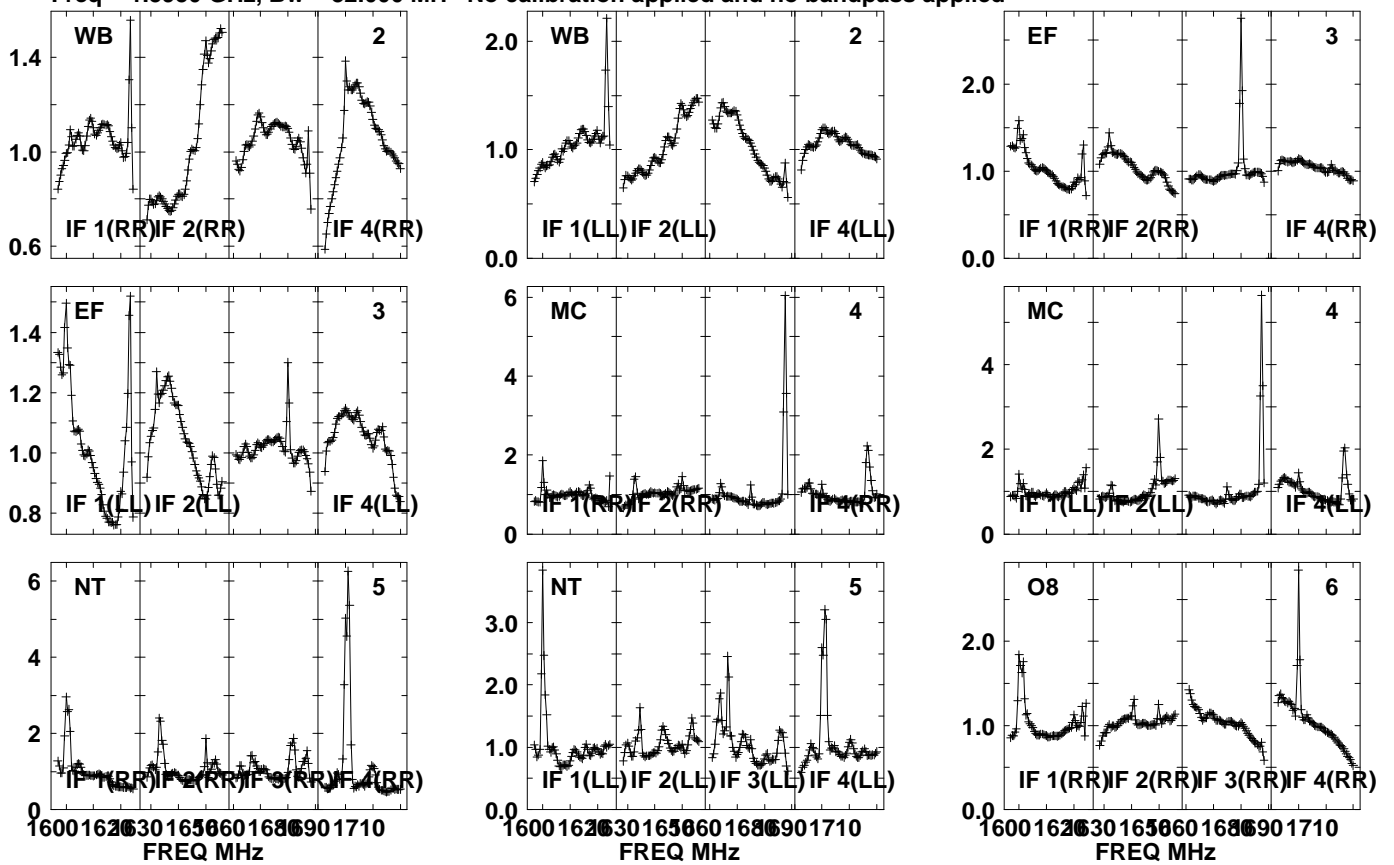

Lower frame: Real Jy

Auto-corr total-power spectrum Antenna: *

Timerange: 01/04:53:31 to 01/04:54:59

Plot file version 277 created 12-JUN-2023 14:39:24

J1547+2052 ES106B.UVDATA.1

Freq = 1.5950 GHz, Bw = 32.000 MH No calibration applied and no bandpass applied

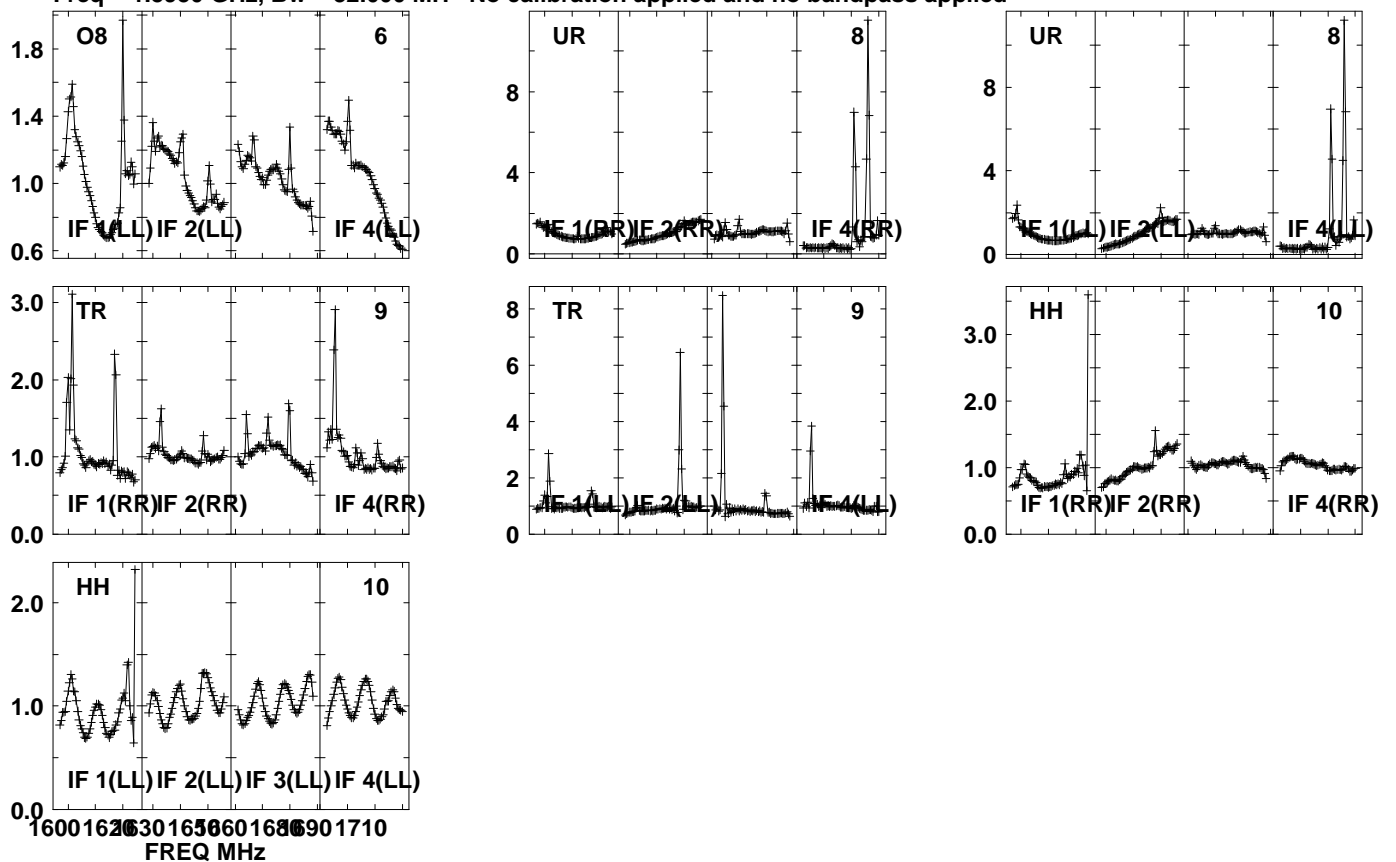

Lower frame: Real Jy
Auto-corr total-power spectrum Antenna: *
Timerange: 01/04:53:31 to 01/04:54:59

Plot file version 278 created 12-JUN-2023 14:39:24

J1548 ES106B.UVDATA.1

Freq = 1.5950 GHz, Bw = 32.000 MH No calibration applied and no bandpass applied

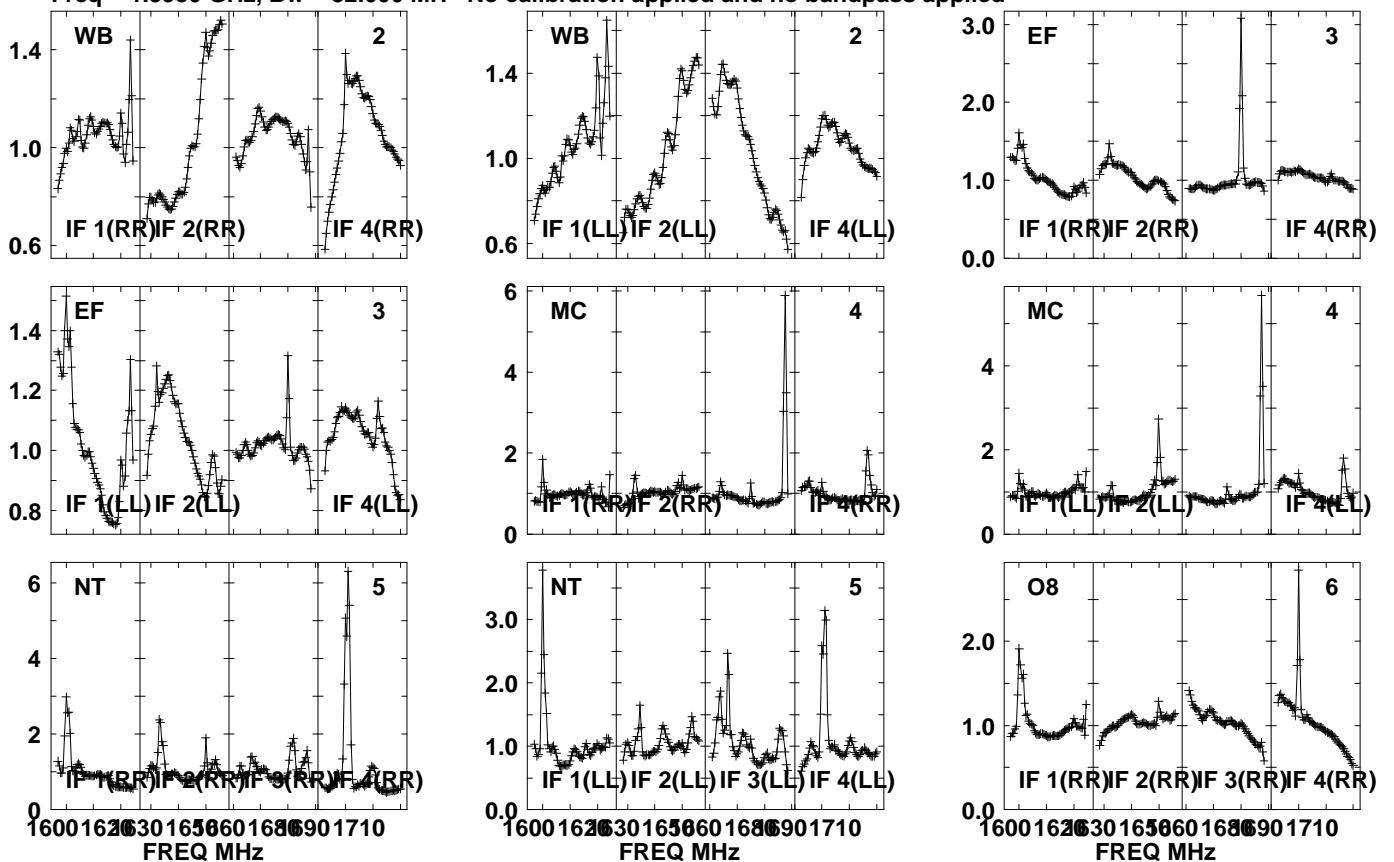

Lower frame: Real Jy
Auto-corr total-power spectrum Antenna: *
Timerange: 01/04:55:01 to 01/04:58:29

Plot file version 279 created 12-JUN-2023 14:39:25

J1548 ES106B.UVDATA.1

Freq = 1.5950 GHz, Bw = 32.000 MH No calibration applied and no bandpass applied

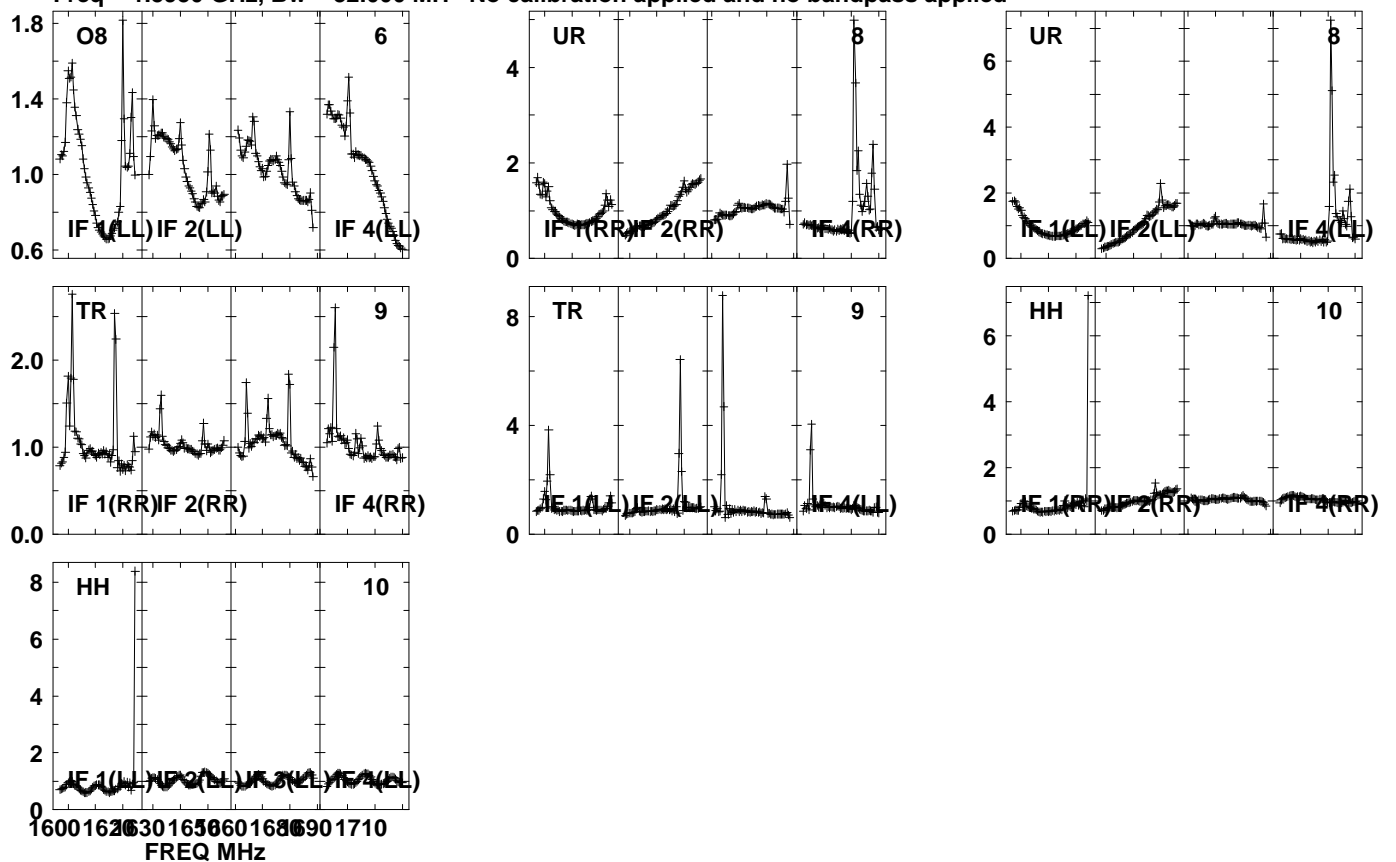

Lower frame: Real Jy
Auto-corr total-power spectrum Antenna: *
Timerange: 01/04:55:01 to 01/04:58:29

Plot file version 280 created 12-JUN-2023 14:39:25

J1547+2052 ES106B.UVDATA.1

Freq = 1.5950 GHz, Bw = 32.000 MH No calibration applied and no bandpass applied

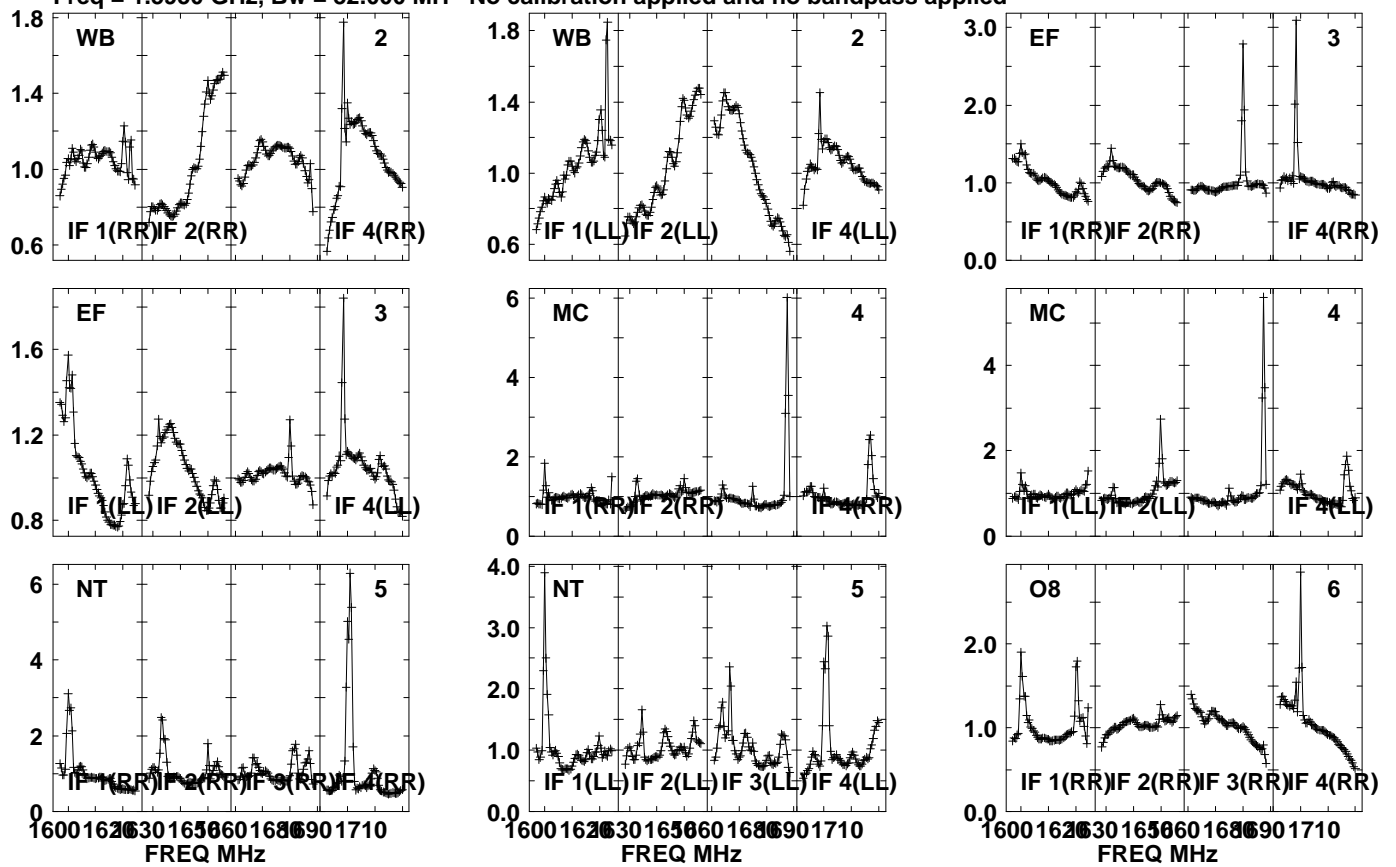

Lower frame: Real Jy
Auto-corr total-power spectrum Antenna: *
Timerange: 01/04:59:01 to 01/05:00:29

Plot file version 281 created 12-JUN-2023 14:39:25

J1547+2052 ES106B.UVDATA.1

Freq = 1.5950 GHz, Bw = 32.000 MH No calibration applied and no bandpass applied

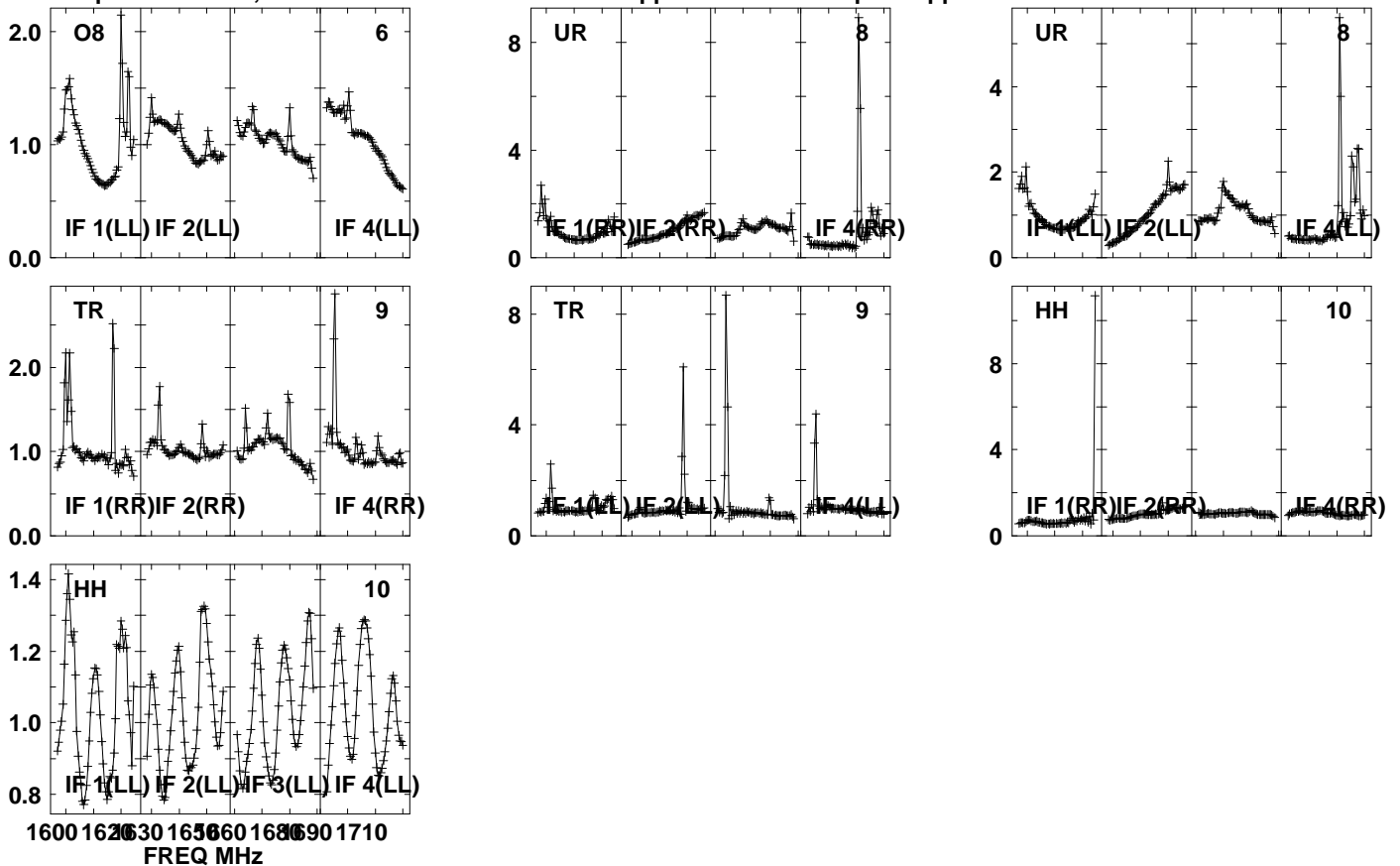

Lower frame: Real Jy

Auto-corr total-power spectrum Antenna: *

Timerange: 01/04:59:01 to 01/05:00:29

Plot file version 282 created 12-JUN-2023 14:39:25

J1548 ES106B.UVDATA.1

Freq = 1.5950 GHz, Bw = 32.000 MH No calibration applied and no bandpass applied

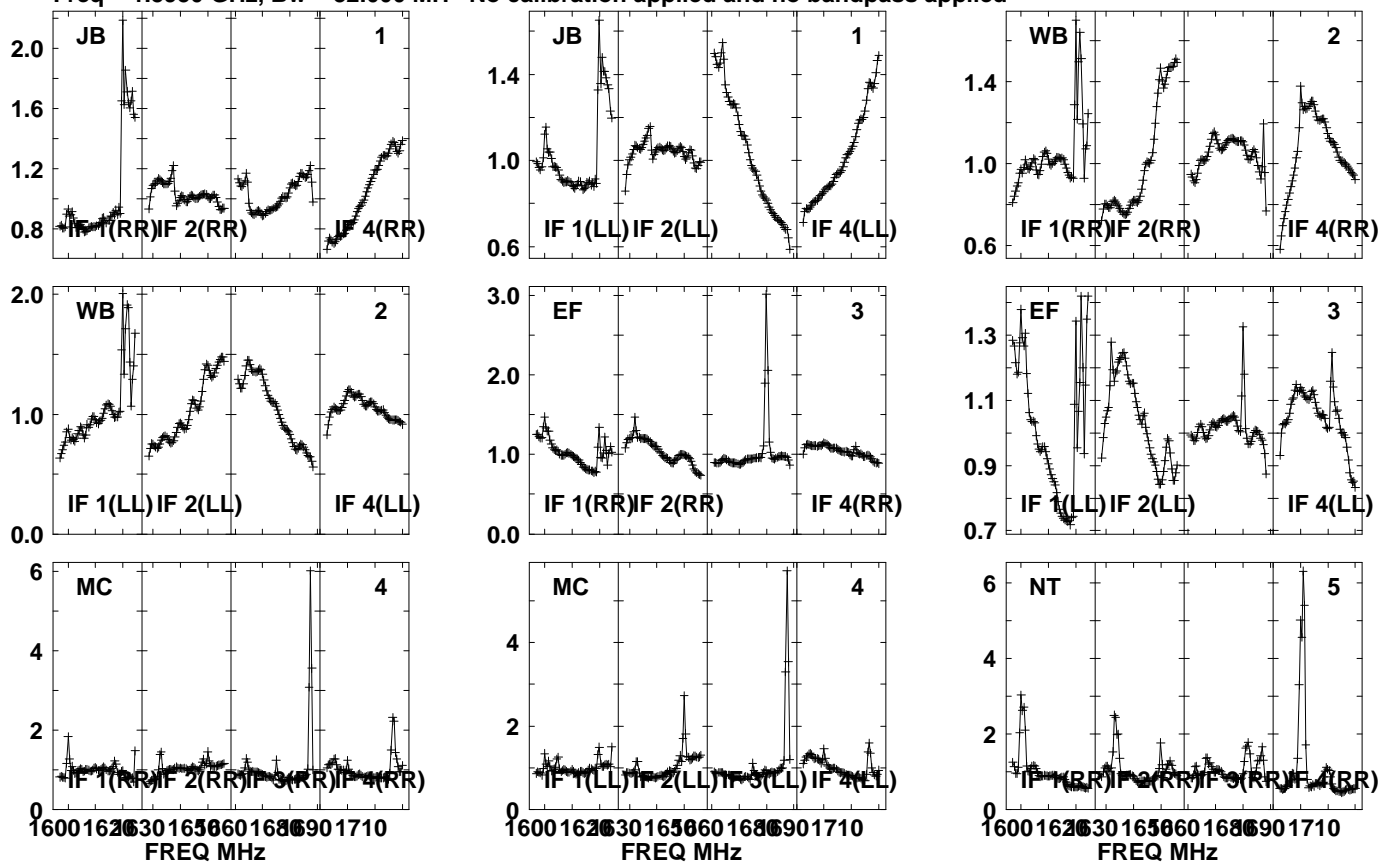

Lower frame: Real Jy
Auto-corr total-power spectrum Antenna: *
Timerange: 01/05:00:31 to 01/05:03:59

Plot file version 283 created 12-JUN-2023 14:39:25

J1548 ES106B.UVDATA.1

Freq = 1.5950 GHz, Bw = 32.000 MH No calibration applied and no bandpass applied

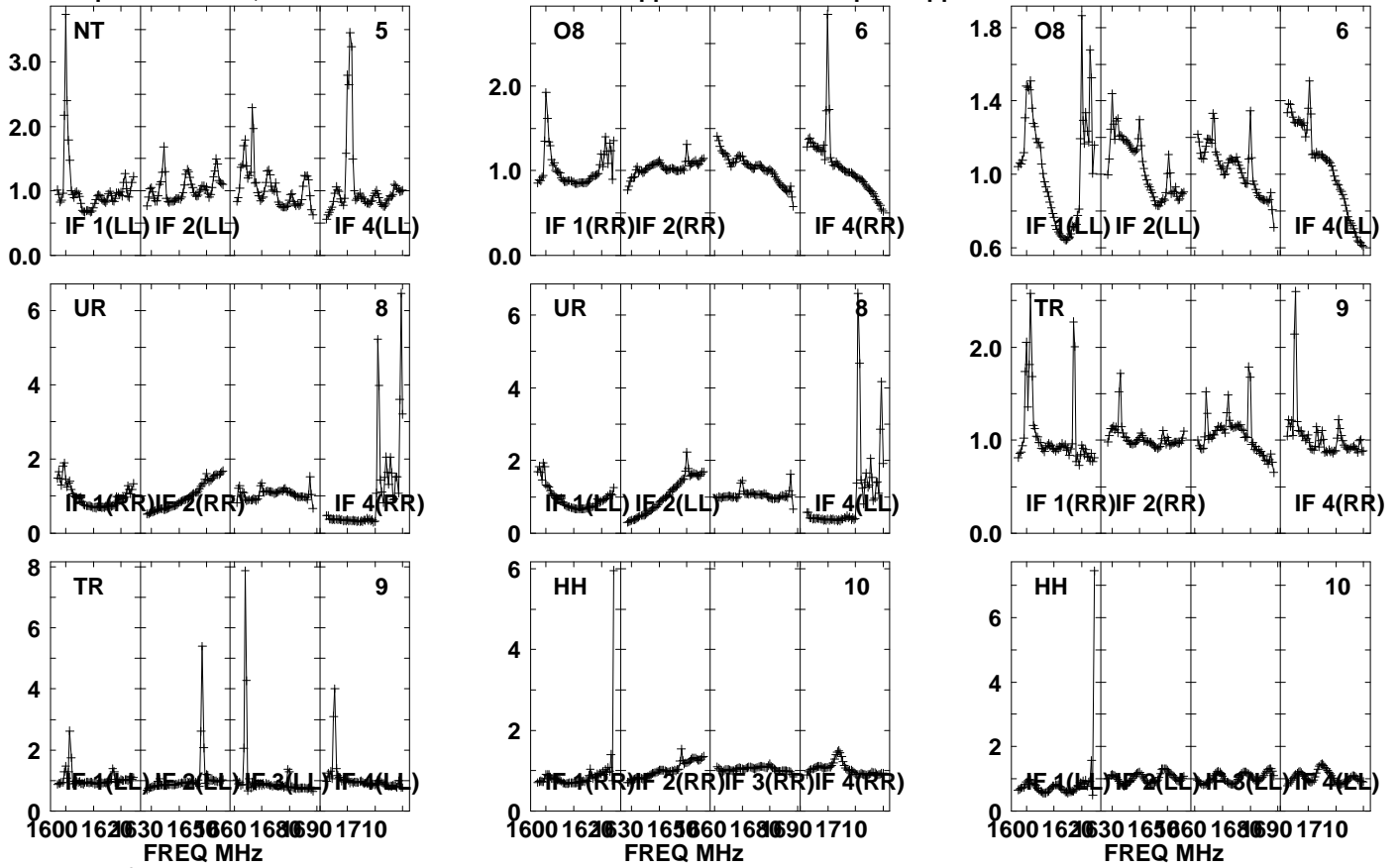

Lower frame: Real Jy

Auto-corr total-power spectrum Antenna: *

Timerange: 01/05:00:31 to 01/05:03:59

Plot file version 284 created 12-JUN-2023 14:39:25

J1547+2052 ES106B.UVDATA.1

Freq = 1.5950 GHz, Bw = 32.000 MH No calibration applied and no bandpass applied

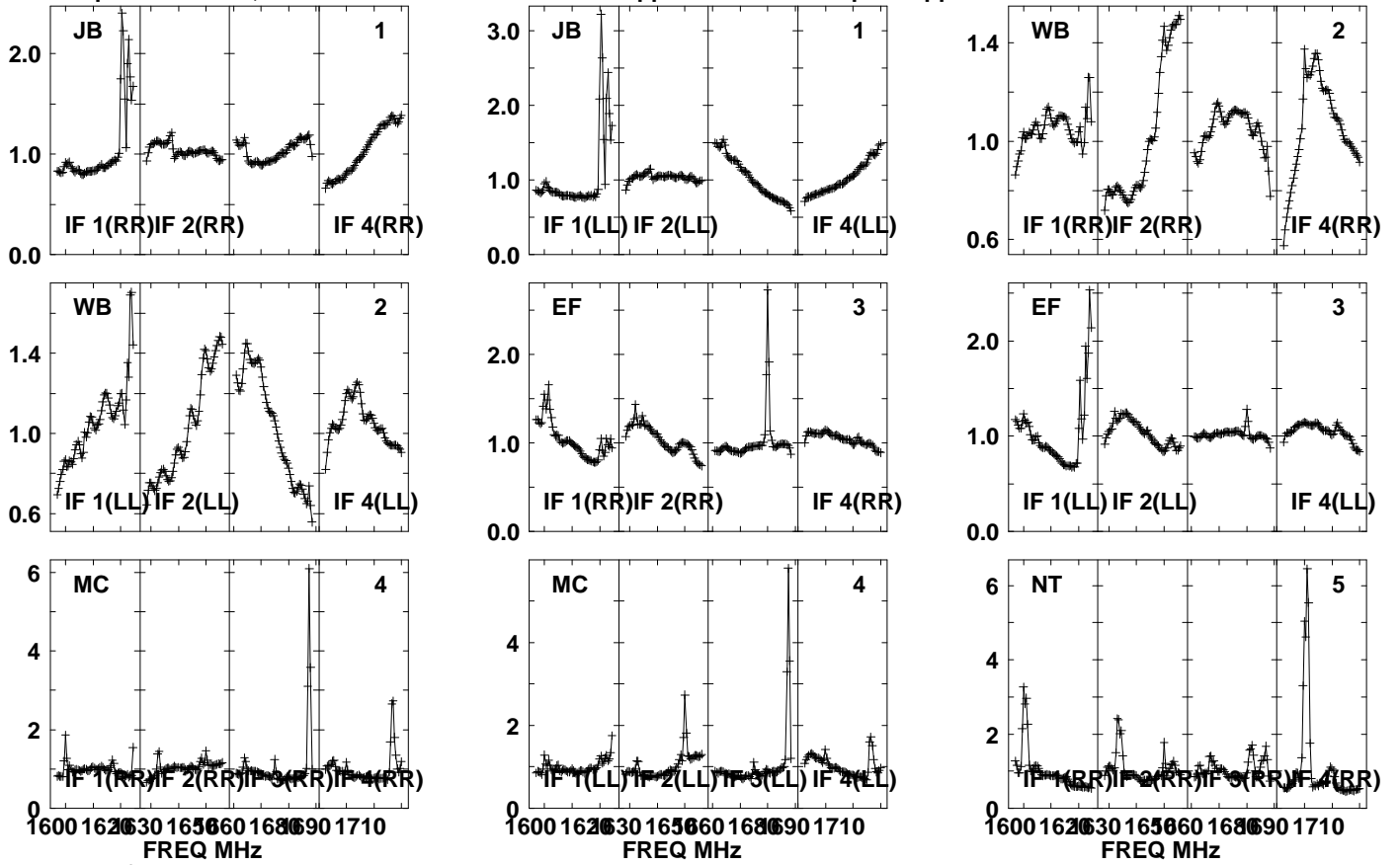

Lower frame: Real Jy

Auto-corr total-power spectrum Antenna: *

Timerange: 01/05:04:01 to 01/05:05:29

Plot file version 285 created 12-JUN-2023 14:39:25

J1547+2052 ES106B.UVDATA.1

Freq = 1.5950 GHz, Bw = 32.000 MH No calibration applied and no bandpass applied

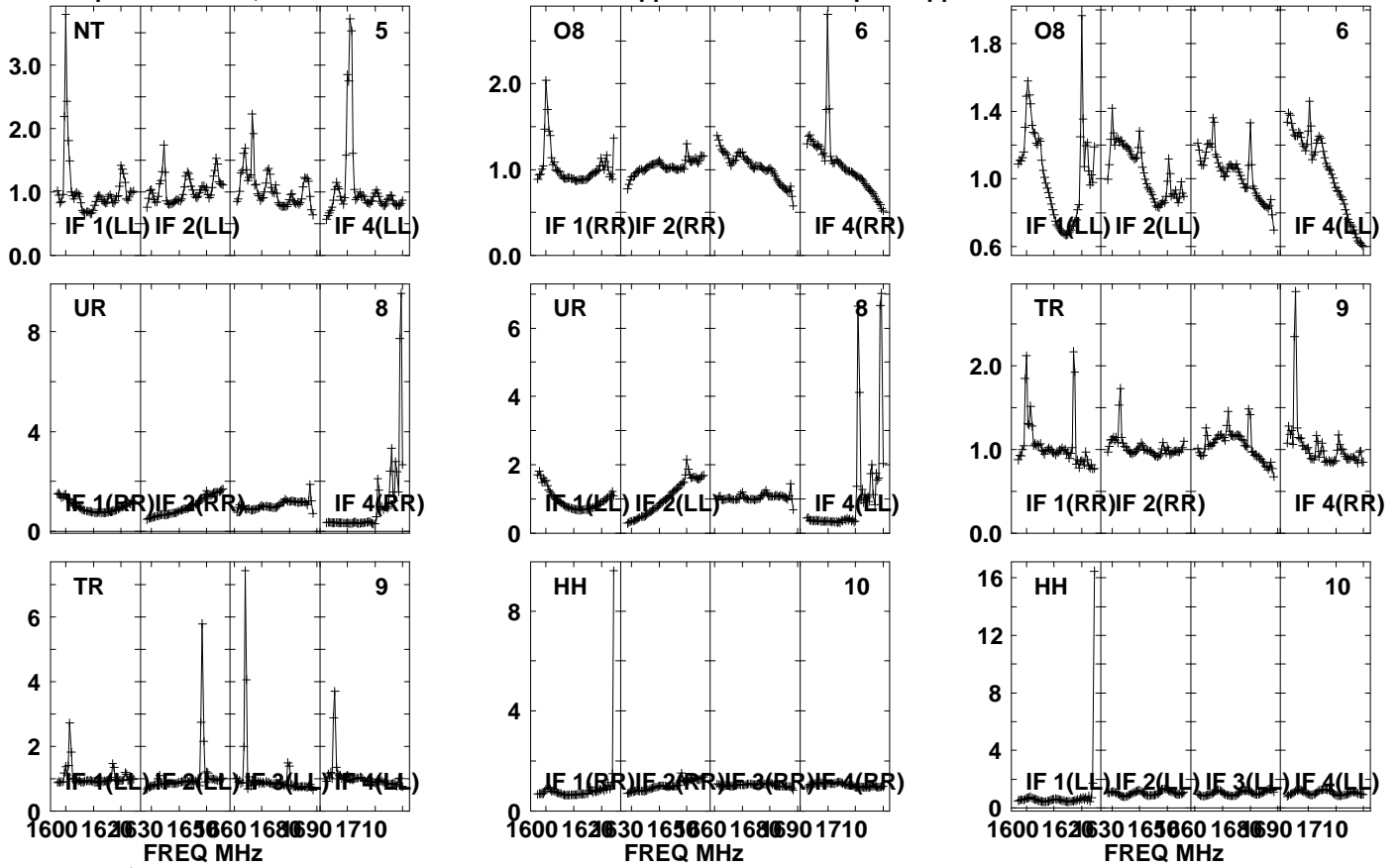

Lower frame: Real Jy
Auto-corr total-power spectrum Antenna: *
Timerange: 01/05:04:01 to 01/05:05:29

Plot file version 286 created 12-JUN-2023 14:39:25

J1545+2006 ES106B.UVDATA.1

Freq = 1.5950 GHz, Bw = 32.000 MH No calibration applied and no bandpass applied

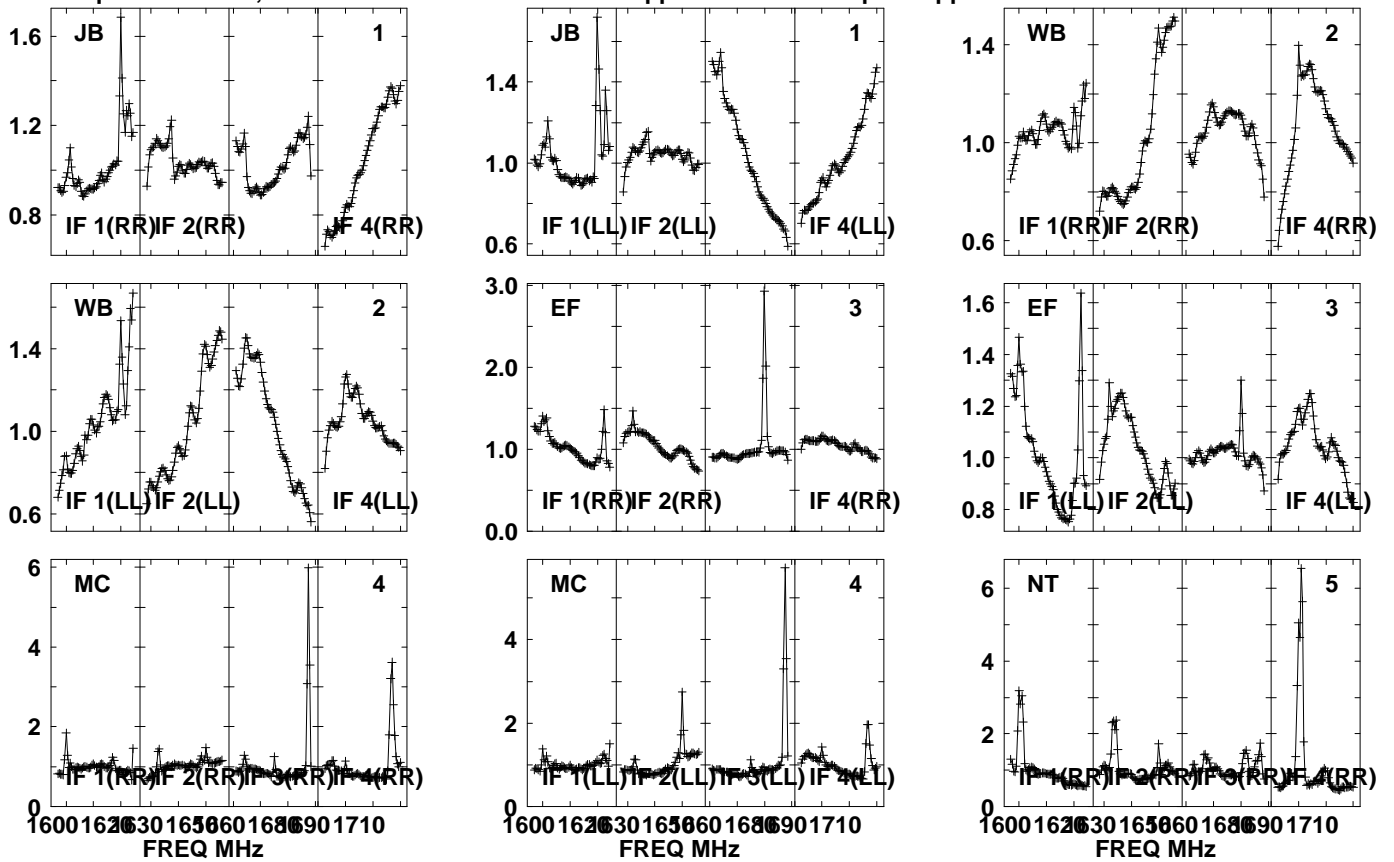

Lower frame: Real Jy
Auto-corr total-power spectrum Antenna: *
Timerange: 01/05:05:31 to 01/05:07:59

Plot file version 287 created 12-JUN-2023 14:39:25

J1545+2006 ES106B.UVDATA.1

Freq = 1.5950 GHz, Bw = 32.000 MH No calibration applied and no bandpass applied

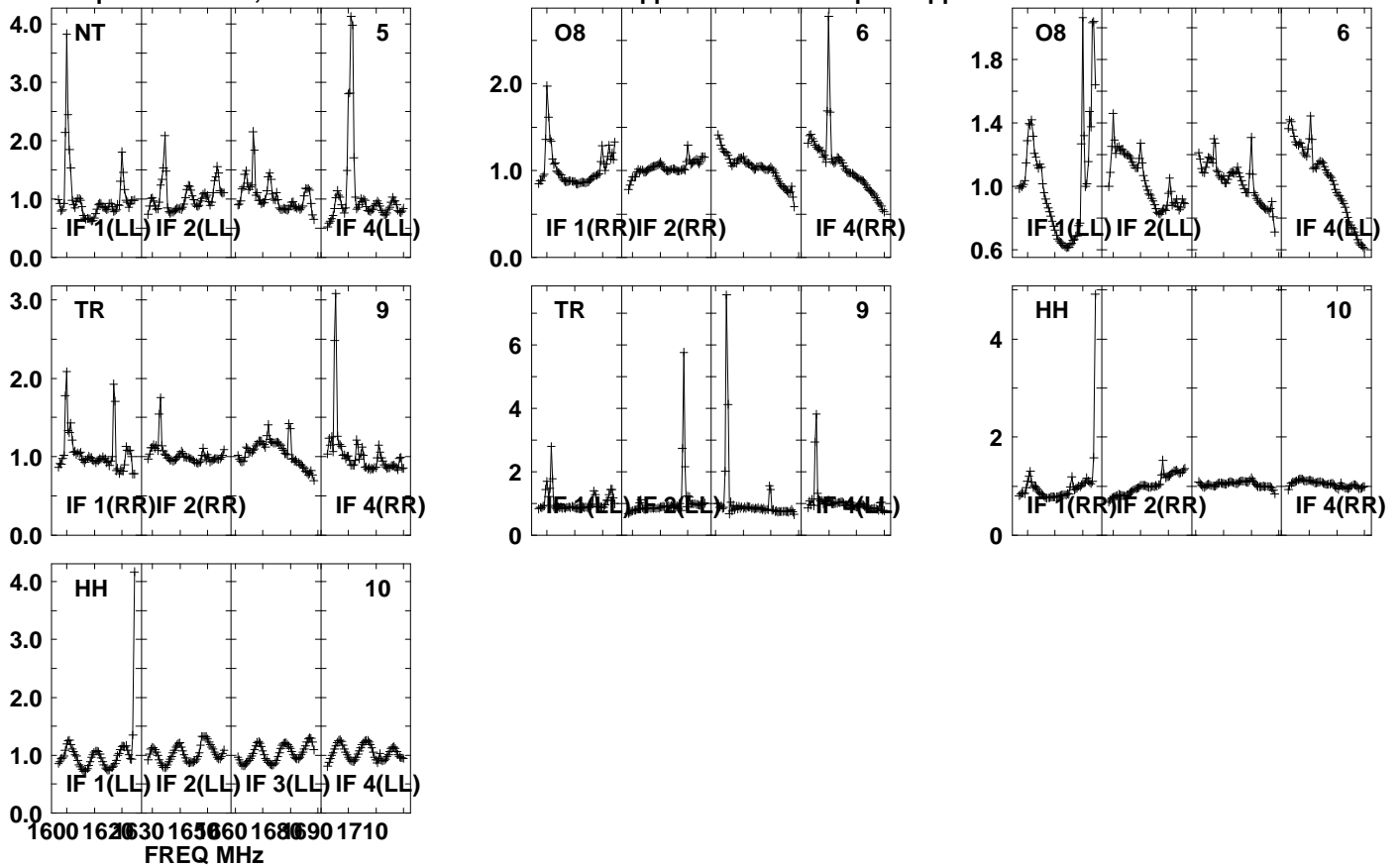

Lower frame: Real Jy

Auto-corr total-power spectrum Antenna: *

Timerange: 01/05:05:31 to 01/05:07:59

Plot file version 288 created 12-JUN-2023 14:39:25

J1547+2052 ES106B.UVDATA.1

Freq = 1.5950 GHz, Bw = 32.000 MH No calibration applied and no bandpass applied

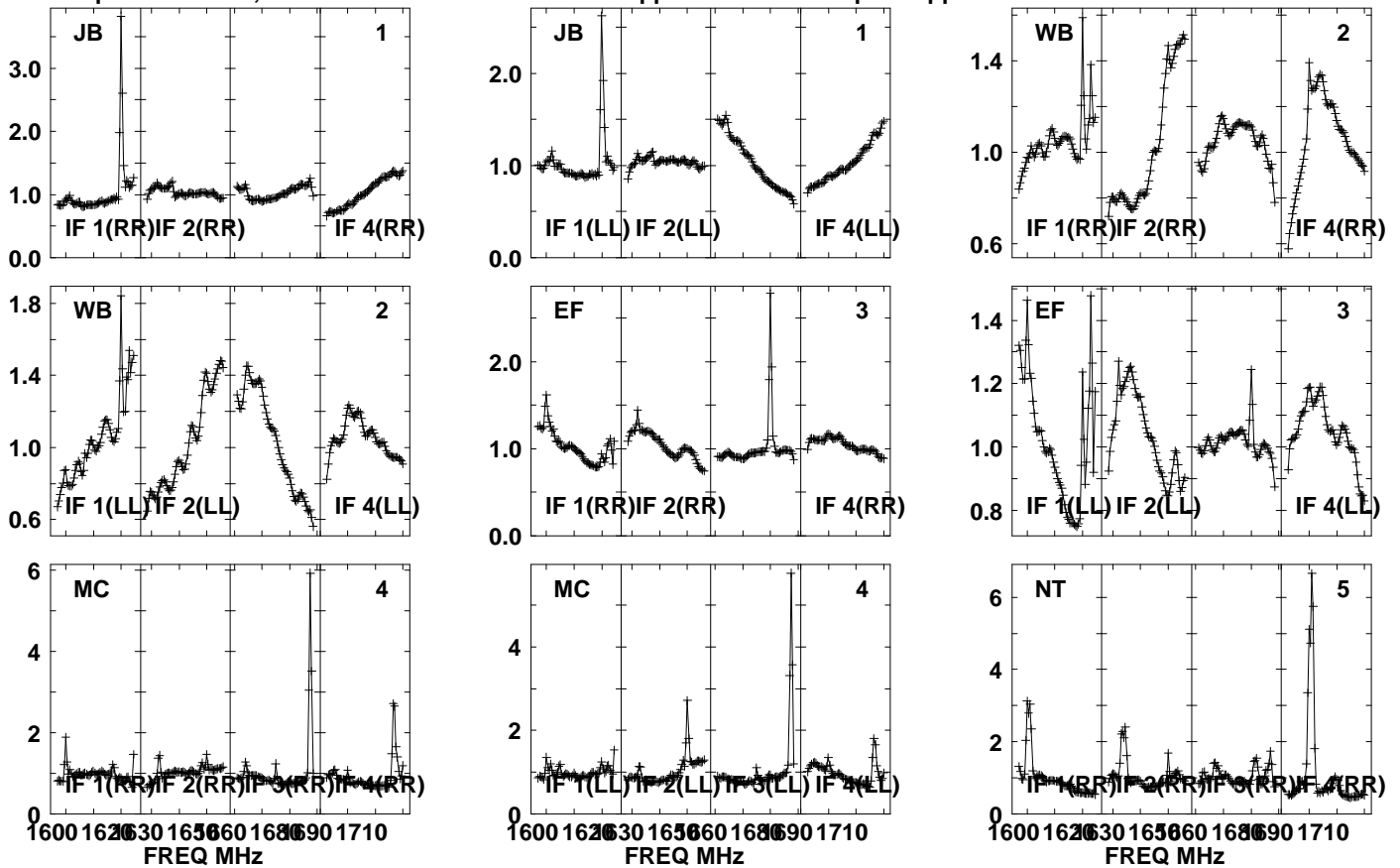

Lower frame: Real Jy

Auto-corr total-power spectrum Antenna: *

Timerange: 01/05:08:01 to 01/05:09:29

Plot file version 289 created 12-JUN-2023 14:39:25

J1547+2052 ES106B.UVDATA.1

Freq = 1.5950 GHz, Bw = 32.000 MH No calibration applied and no bandpass applied

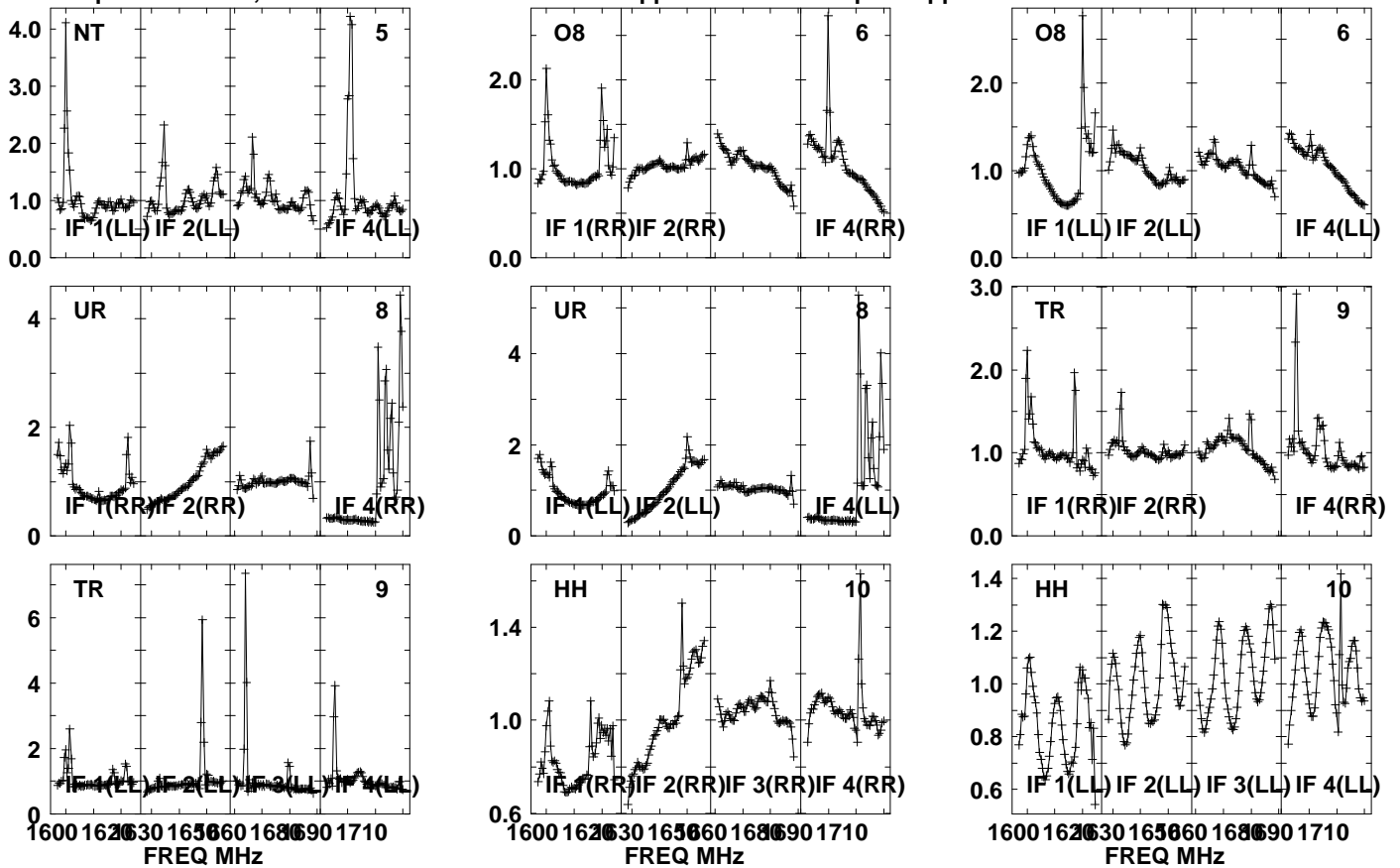

Lower frame: Real Jy

Auto-corr total-power spectrum Antenna: *

Timerange: 01/05:08:01 to 01/05:09:29

Plot file version 290 created 12-JUN-2023 14:39:25

J1548 ES106B.UVDATA.1

Freq = 1.5950 GHz, Bw = 32.000 MH No calibration applied and no bandpass applied

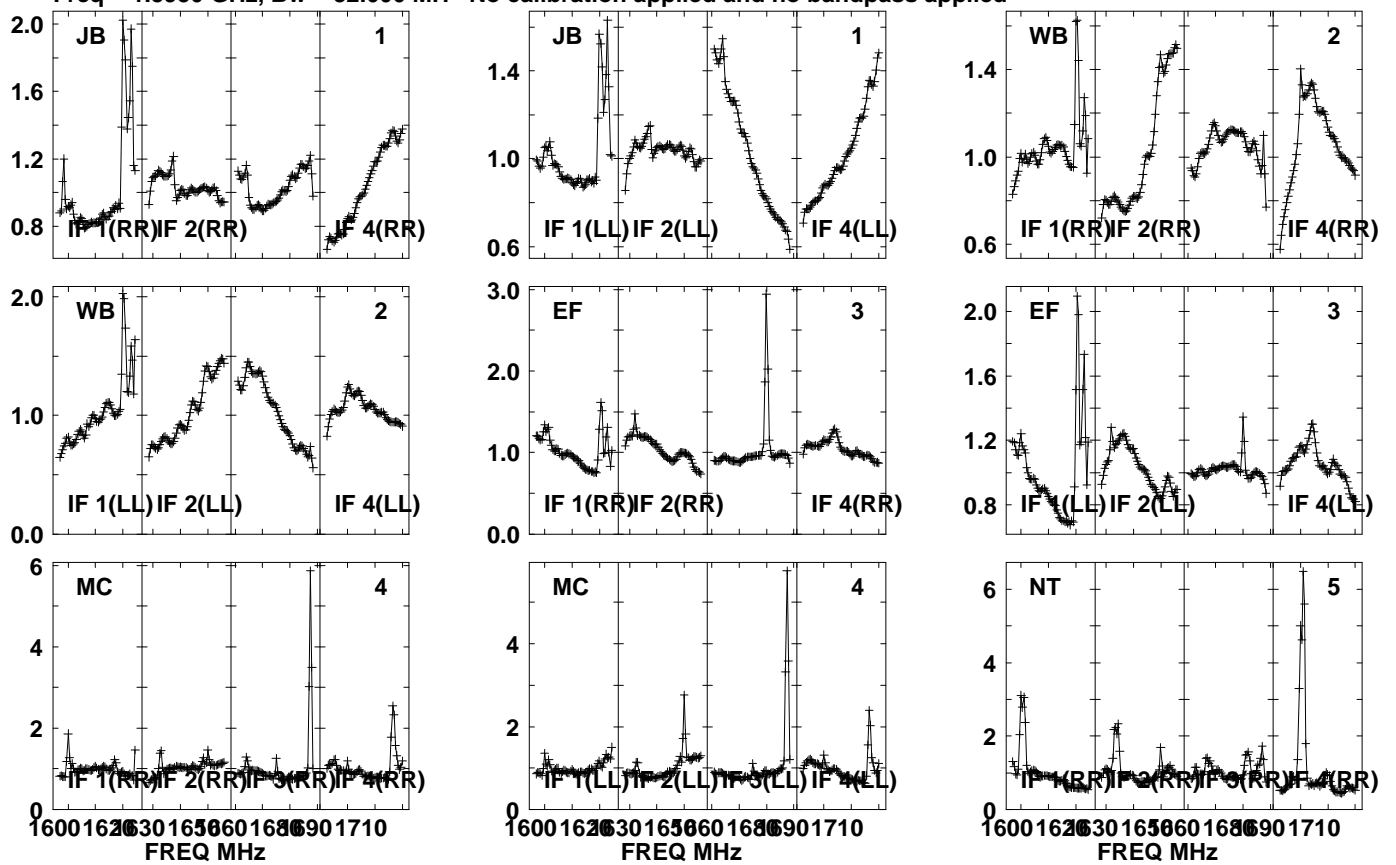

Lower frame: Real Jy
Auto-corr total-power spectrum Antenna: *
Timerange: 01/05:10:01 to 01/05:13:59

Plot file version 291 created 12-JUN-2023 14:39:25

J1548 ES106B.UVDATA.1

Freq = 1.5950 GHz, Bw = 32.000 MH No calibration applied and no bandpass applied

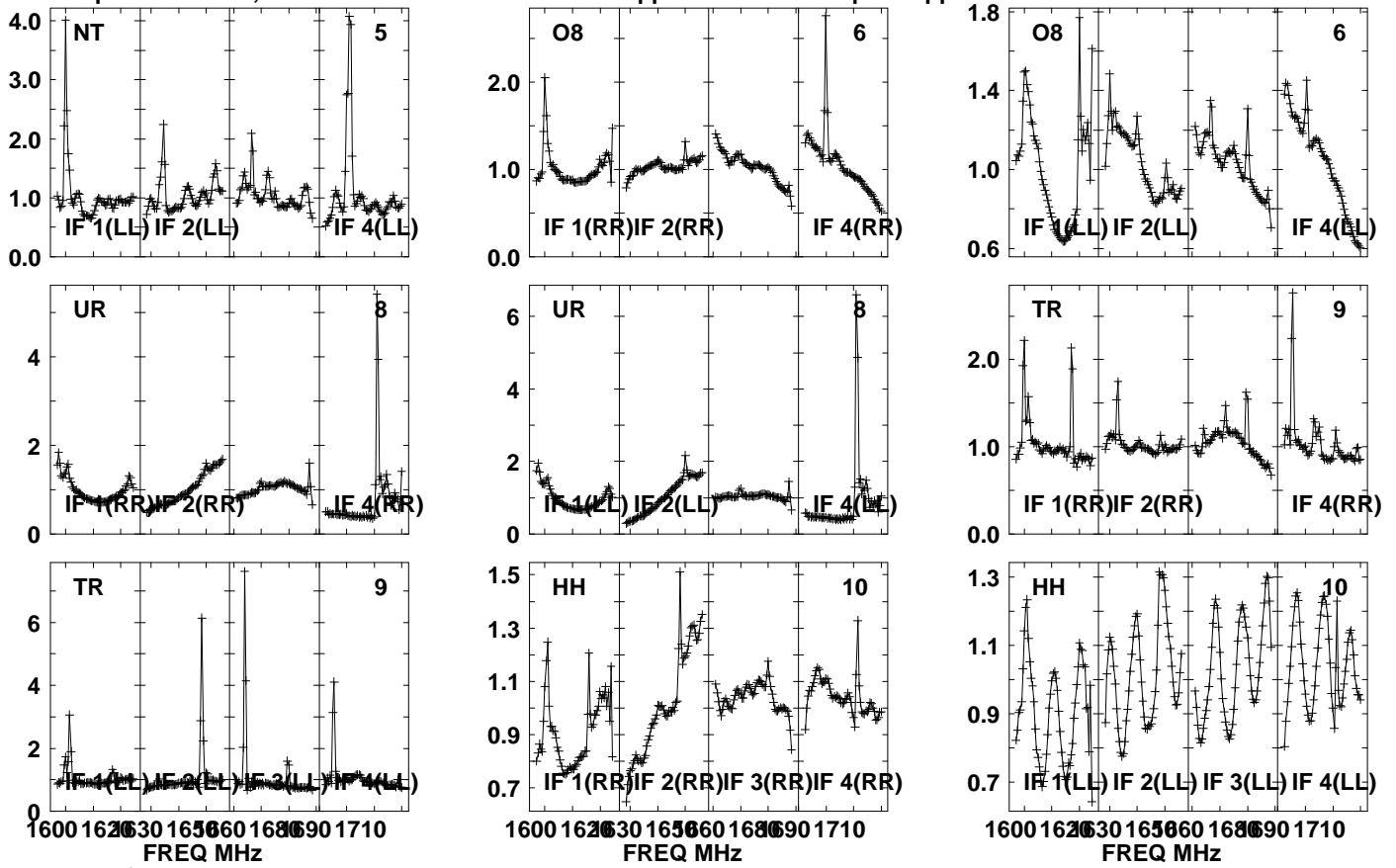

Lower frame: Real Jy

Auto-corr total-power spectrum Antenna: *

Timerange: 01/05:10:01 to 01/05:13:59

Plot file version 292 created 12-JUN-2023 14:39:25

J1547+2052 ES106B.UVDATA.1

Freq = 1.5950 GHz, Bw = 32.000 MH No calibration applied and no bandpass applied

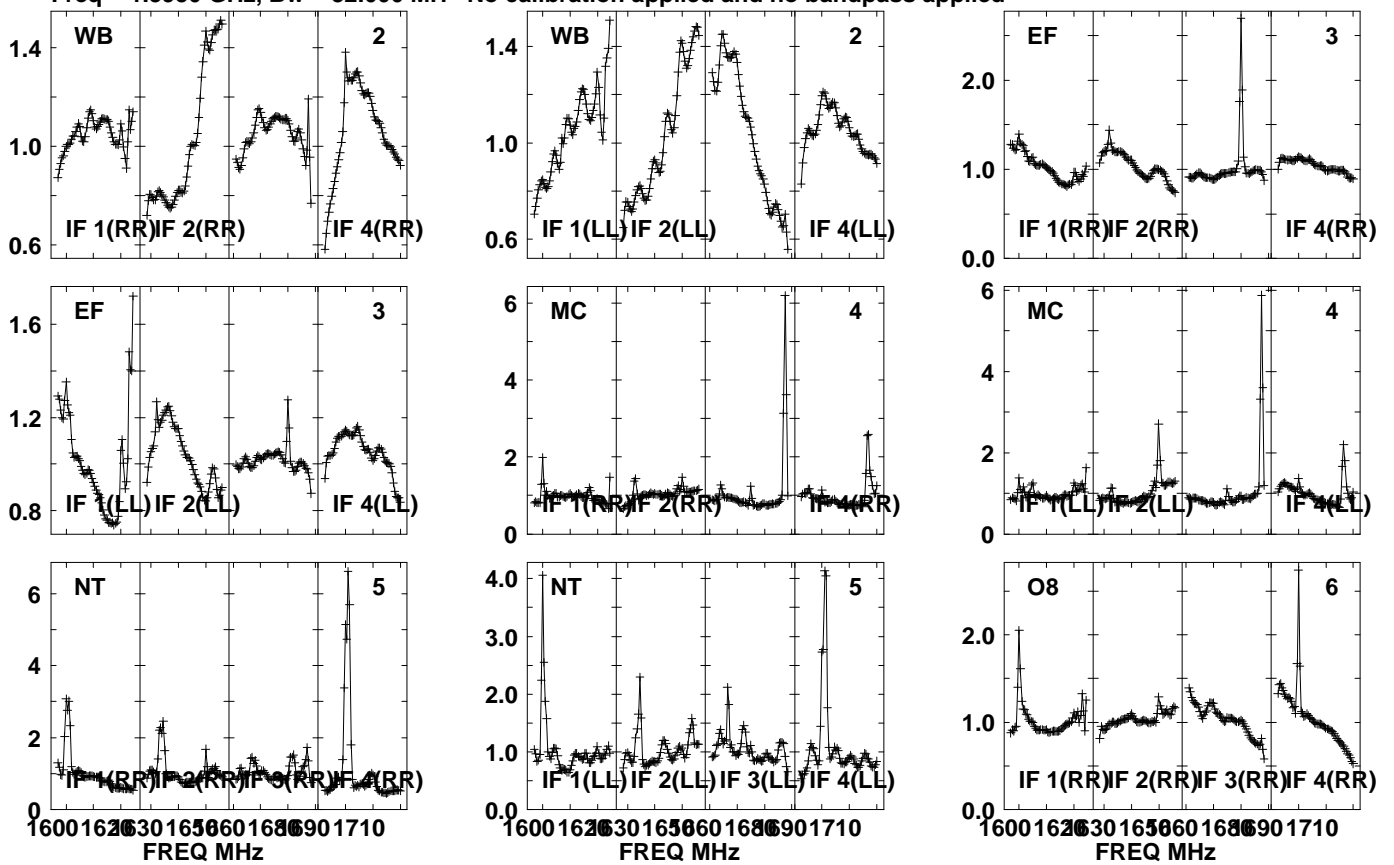

Lower frame: Real Jy

Auto-corr total-power spectrum Antenna: *

Timerange: 01/05:14:01 to 01/05:15:29

Plot file version 293 created 12-JUN-2023 14:39:25

J1547+2052 ES106B.UVDATA.1

Freq = 1.5950 GHz, Bw = 32.000 MH No calibration applied and no bandpass applied

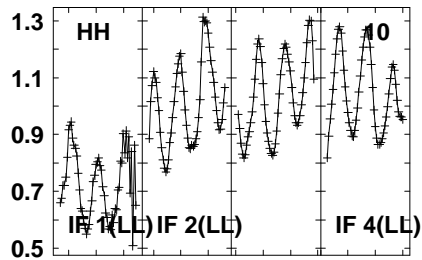
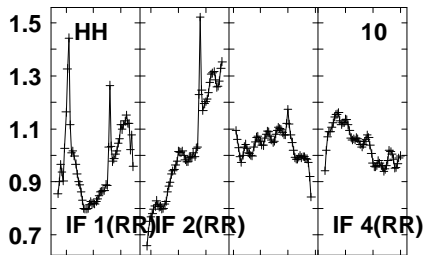
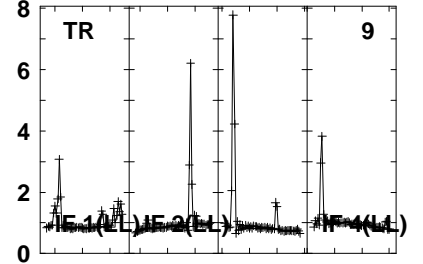
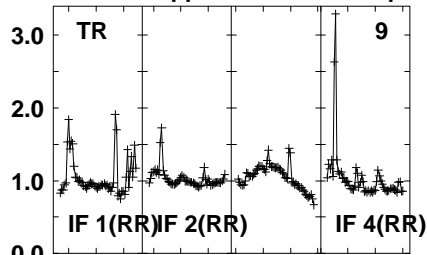
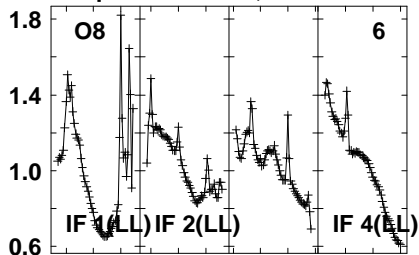

Lower frame: Real Jy
Auto-corr total-power spectrum Antenna: *
Timerange: 01/05:14:01 to 01/05:15:29

Plot file version 294 created 12-JUN-2023 14:39:26

J1548 ES106B.UVDATA.1

Freq = 1.5950 GHz, Bw = 32.000 MH No calibration applied and no bandpass applied

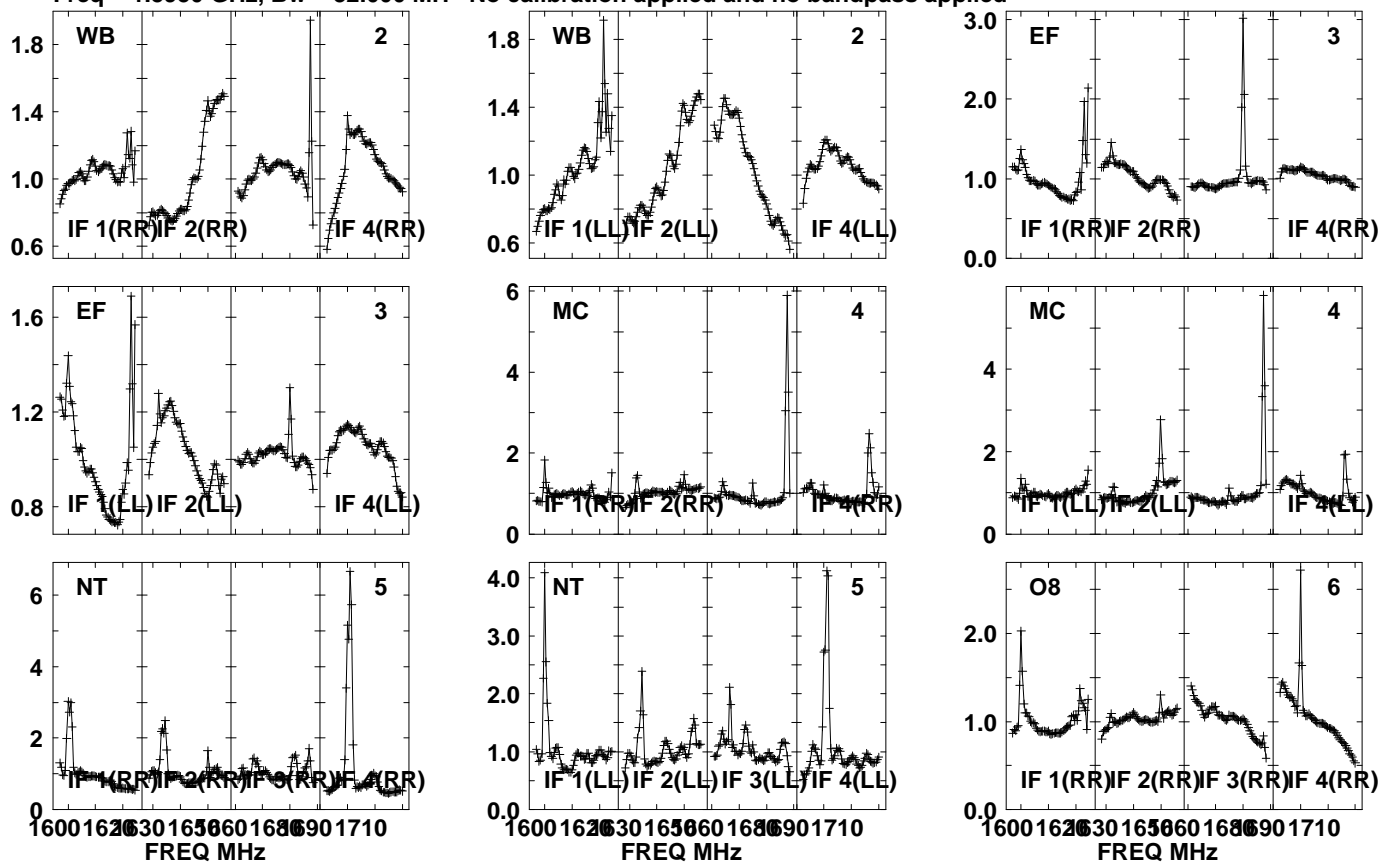

Lower frame: Real Jy
Auto-corr total-power spectrum Antenna: *
Timerange: 01/05:15:31 to 01/05:18:59

Plot file version 295 created 12-JUN-2023 14:39:26

J1548 ES106B.UVDATA.1

Freq = 1.5950 GHz, Bw = 32.000 MH No calibration applied and no bandpass applied

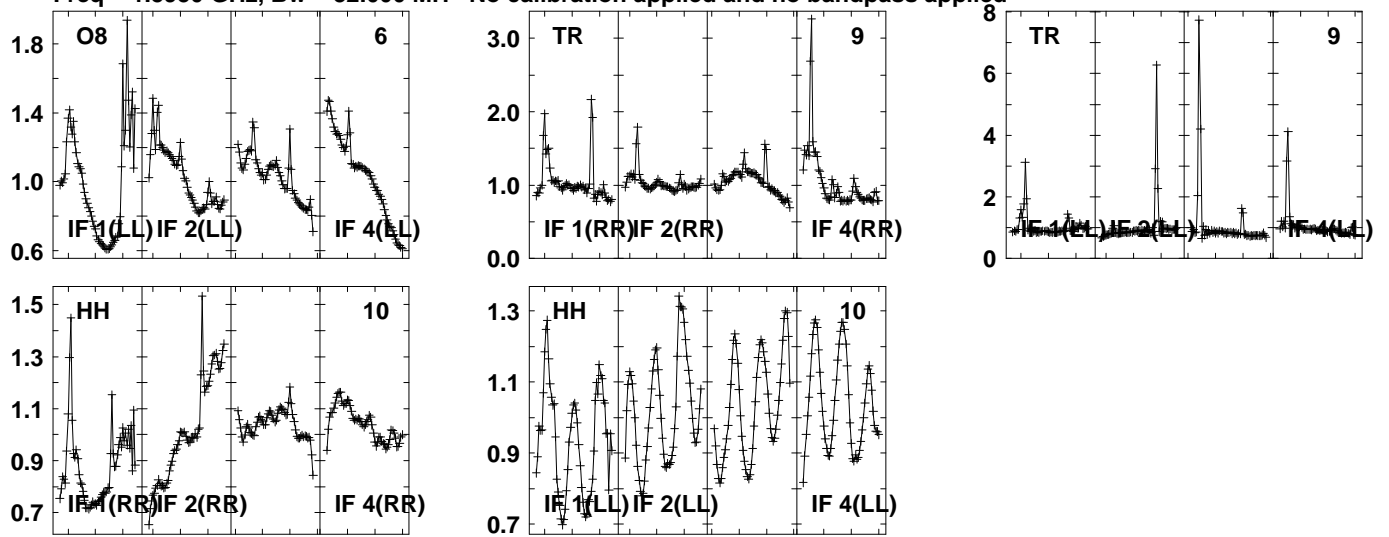

Lower frame: Real Jy
Auto-corr total-power spectrum Antenna: *
Timerange: 01/05:15:31 to 01/05:18:59

Plot file version 296 created 12-JUN-2023 14:39:26

J1547+2052 ES106B.UVDATA.1

Freq = 1.5950 GHz, Bw = 32.000 MH No calibration applied and no bandpass applied

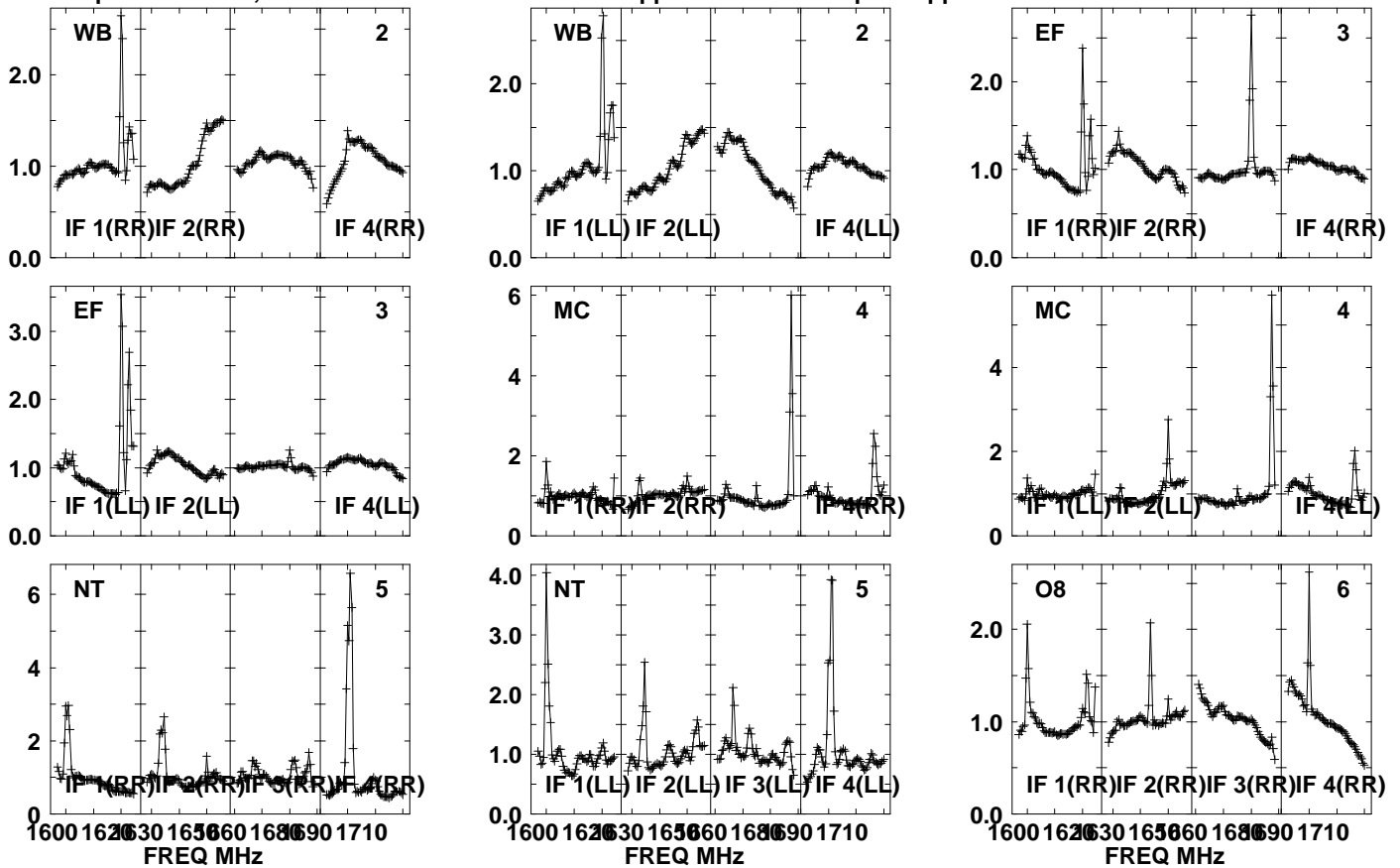

Lower frame: Real Jy

Auto-corr total-power spectrum Antenna: *

Timerange: 01/05:19:31 to 01/05:20:59

Plot file version 297 created 12-JUN-2023 14:39:26

J1547+2052 ES106B.UVDATA.1

Freq = 1.5950 GHz, Bw = 32.000 MH No calibration applied and no bandpass applied

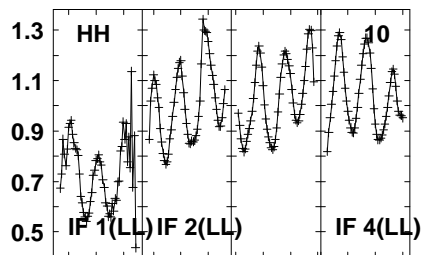
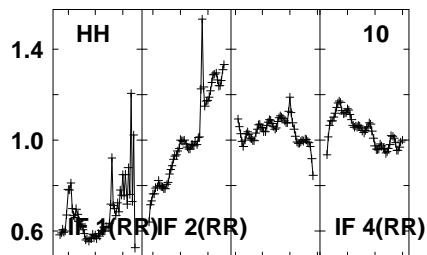
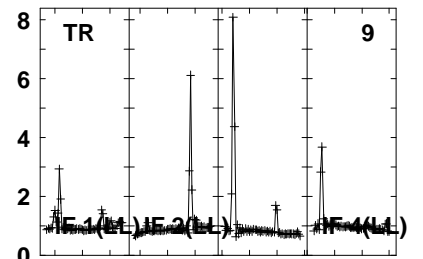
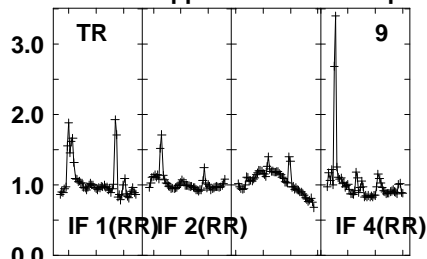
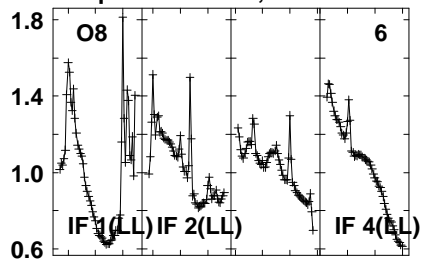

Lower frame: Real Jy
Auto-corr total-power spectrum Antenna: *
Timerange: 01/05:19:31 to 01/05:20:59

Plot file version 298 created 12-JUN-2023 14:39:26

J1548 ES106B.UVDATA.1

Freq = 1.5950 GHz, Bw = 32.000 MH No calibration applied and no bandpass applied

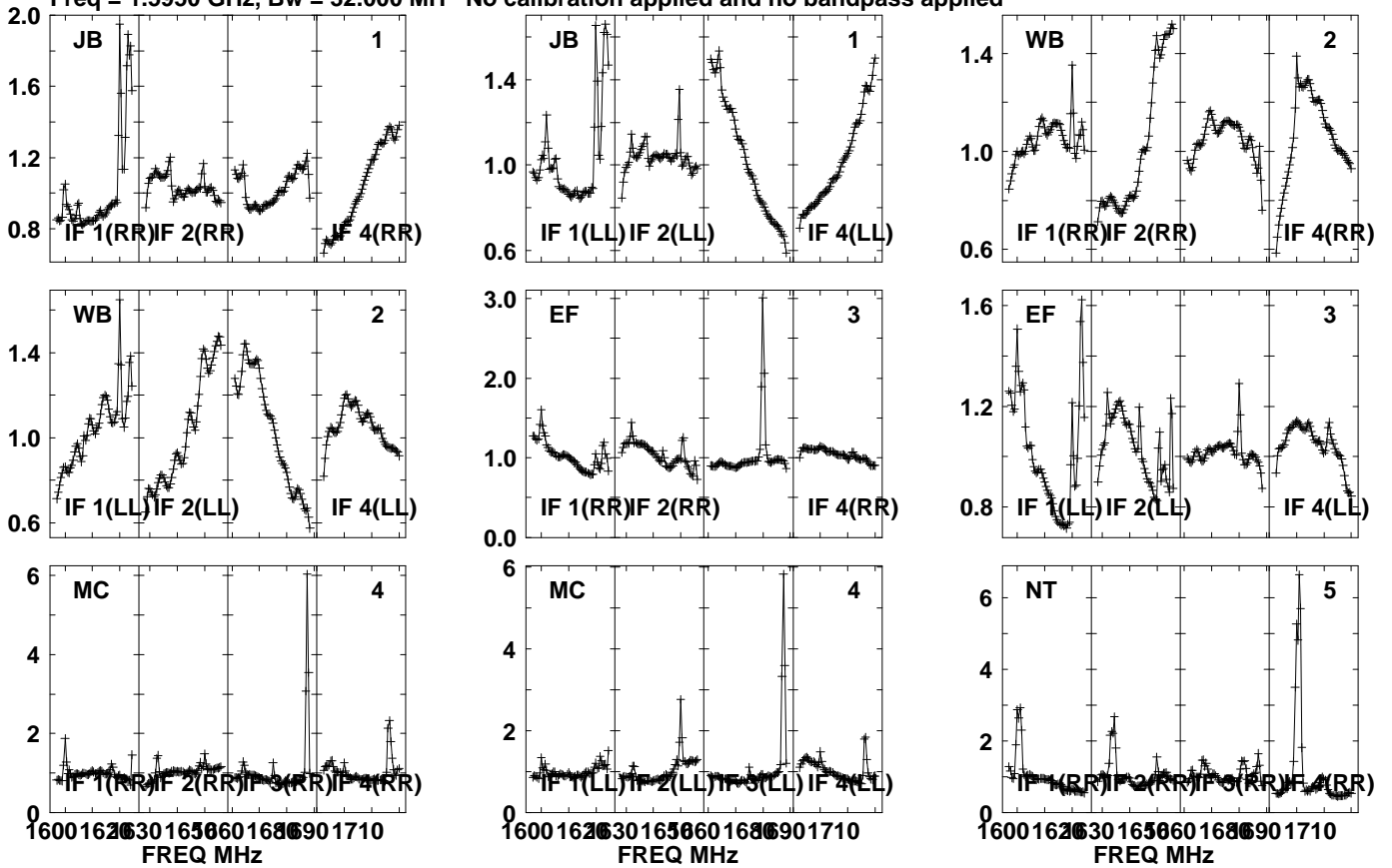

Lower frame: Real Jy
Auto-corr total-power spectrum Antenna: *
Timerange: 01/05:21:01 to 01/05:24:29

Plot file version 299 created 12-JUN-2023 14:39:26

J1548 ES106B.UVDATA.1

Freq = 1.5950 GHz, Bw = 32.000 MH No calibration applied and no bandpass applied

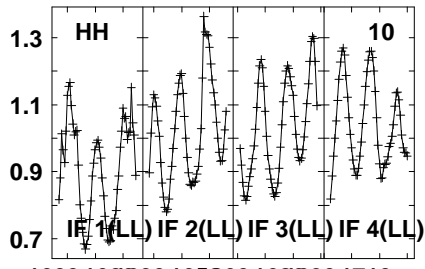
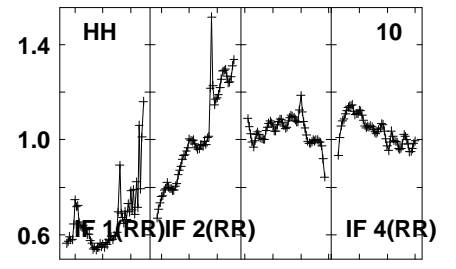
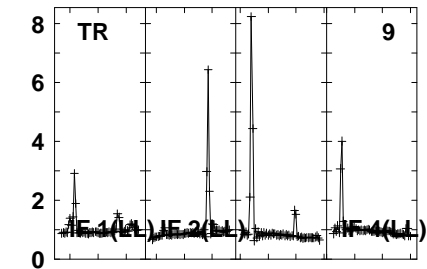
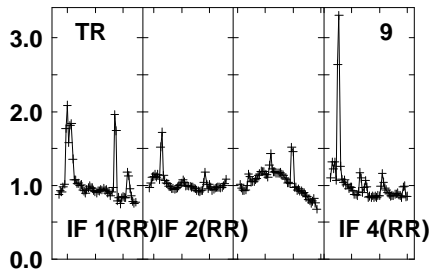
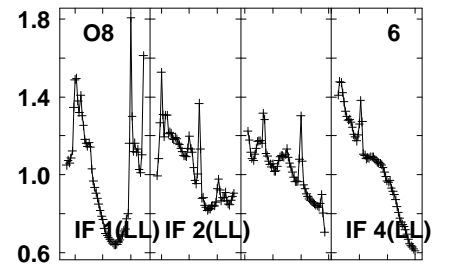
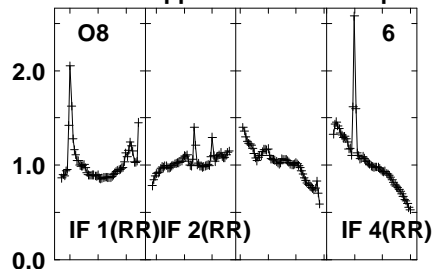
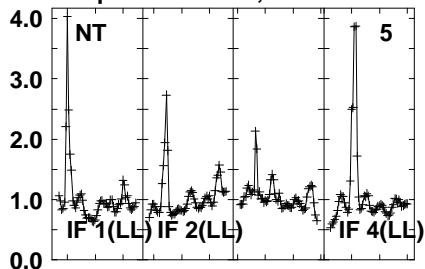

1600 1620 1630 1650 1660 1680 1690 1710

FREQ MHz

Lower frame: Real Jy

Auto-corr total-power spectrum Antenna: *

Timerange: 01/05:21:01 to 01/05:24:29

Plot file version 300 created 12-JUN-2023 14:39:26

3C345 ES106B.UVDATA.1

Freq = 1.5950 GHz, Bw = 32.000 MH No calibration applied and no bandpass applied

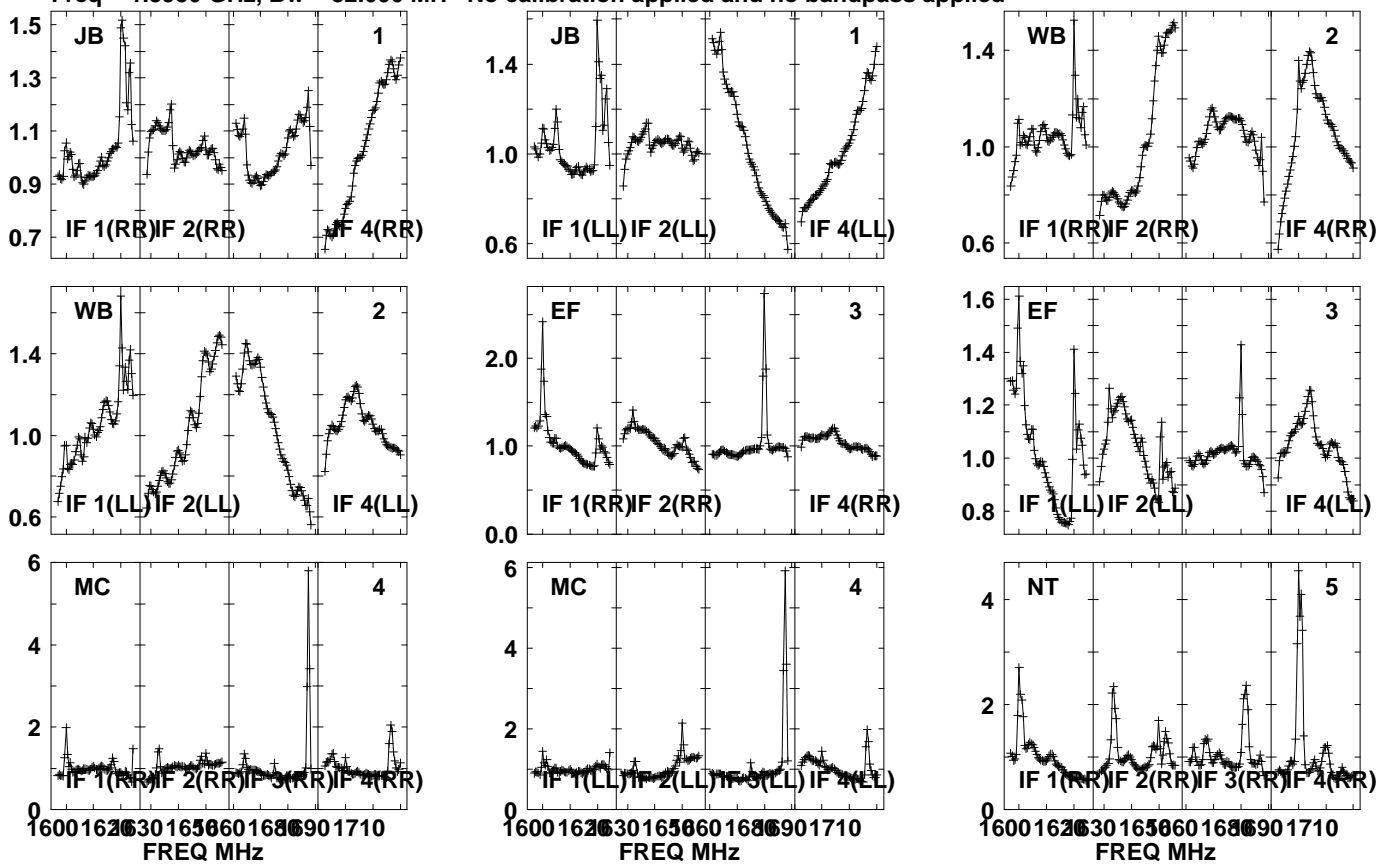

Lower frame: Real Jy
Auto-corr total-power spectrum Antenna: *
Timerange: 01/05:26:01 to 01/05:29:59

Plot file version 301 created 12-JUN-2023 14:39:26

3C345 ES106B.UVDATA.1

Freq = 1.5950 GHz, Bw = 32.000 MH No calibration applied and no bandpass applied

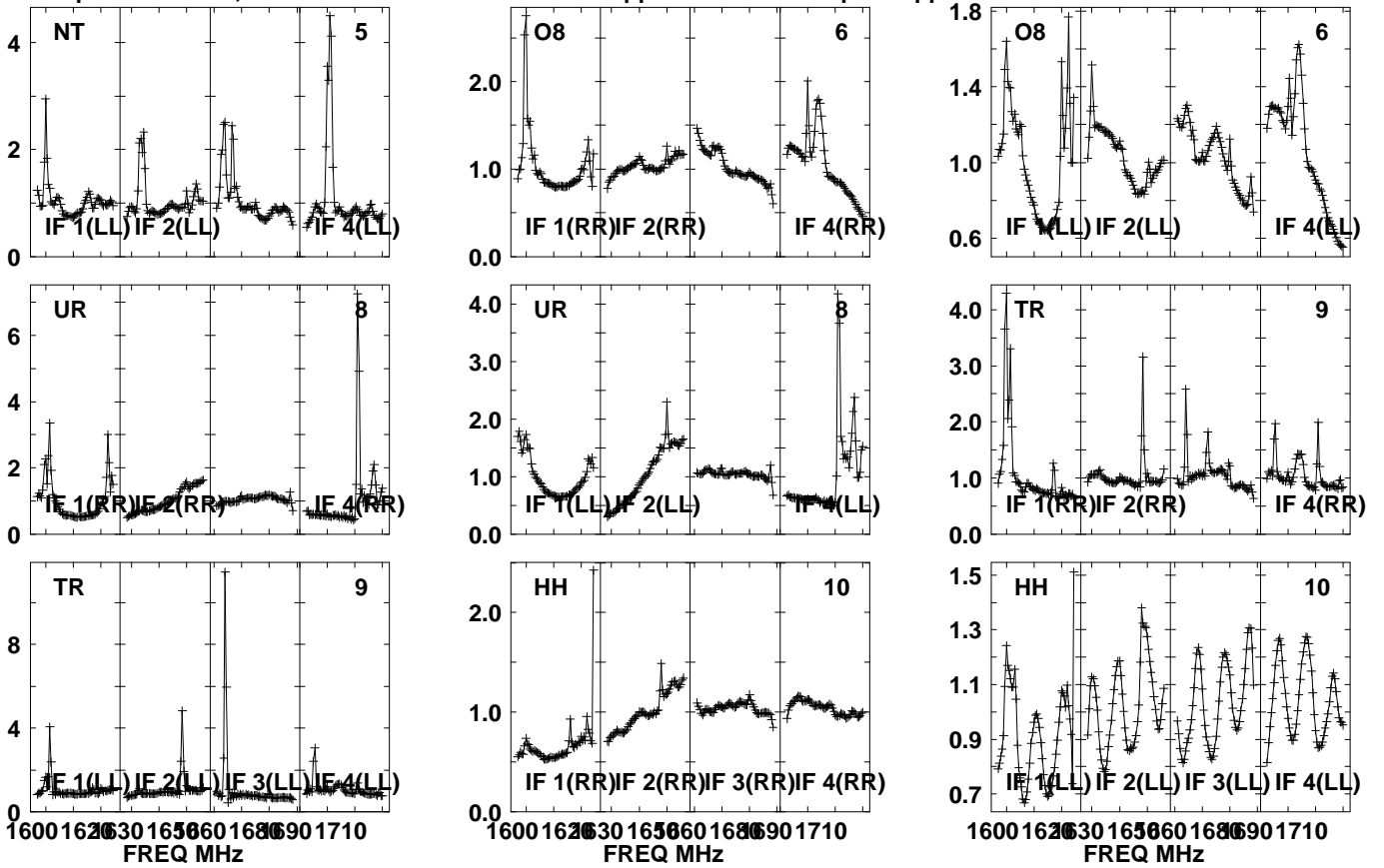

Lower frame: Real Jy
Auto-corr total-power spectrum Antenna: *
Timerange: 01/05:26:01 to 01/05:29:59