

Plot file version 1 created 06-OCT-2010 10:55:07

1749+096 ET013A.UVDATA.1

Freq = 4.9415 GHz, Bw = 16.000 MH No calibration applied and no bandpass applied

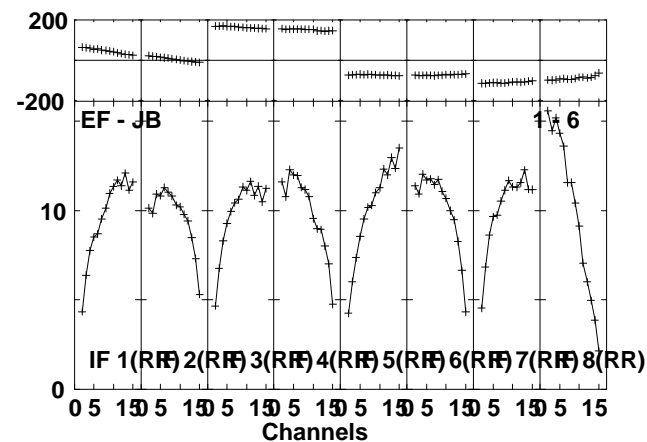
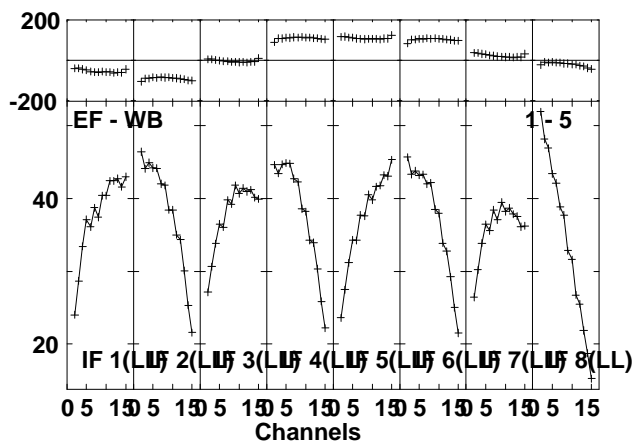
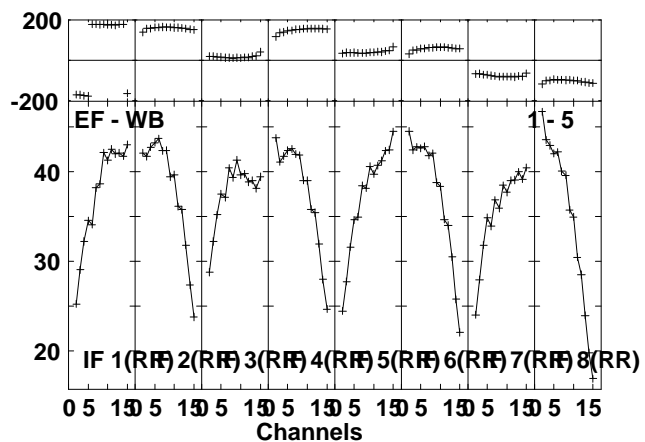
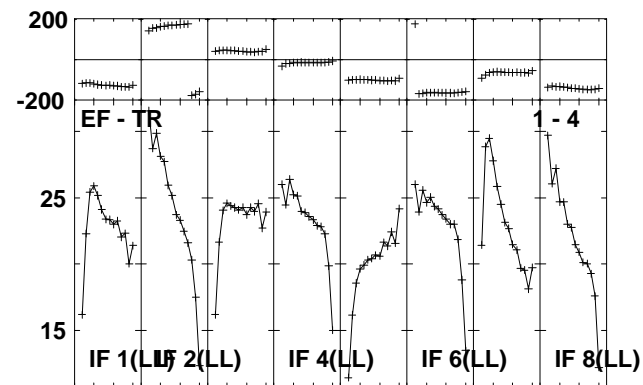
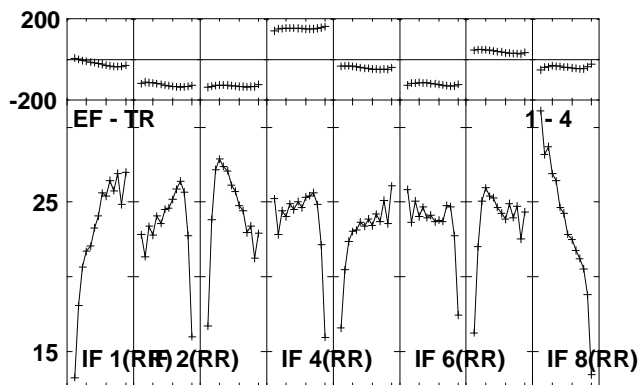
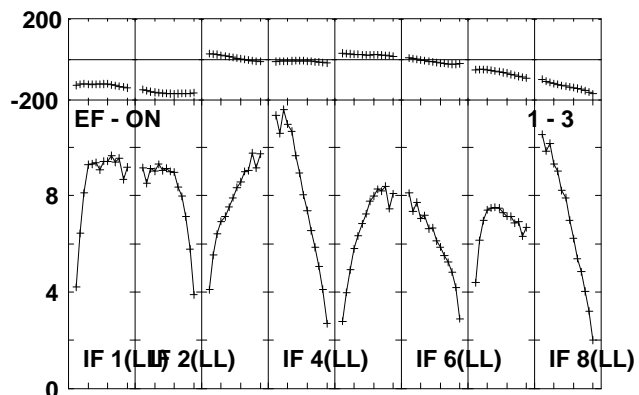
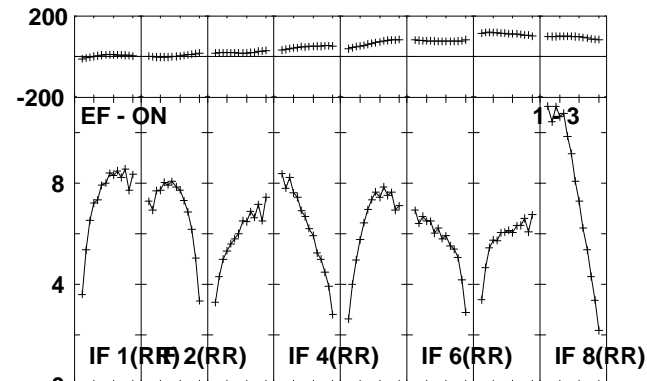
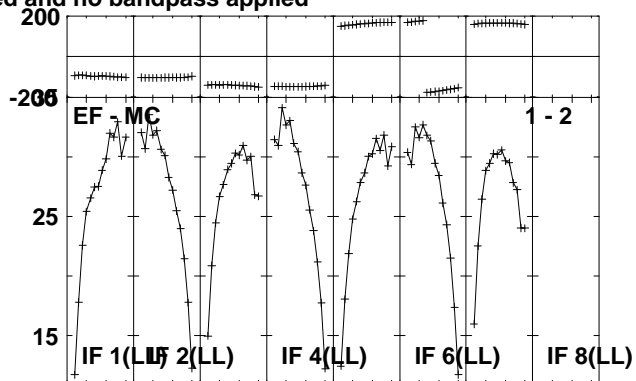
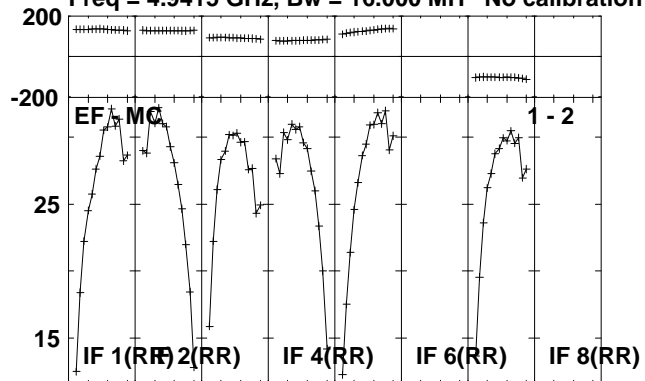

Lower frame: Milli Ampl Jy Top frame: Phas deg
Scalar averaged cross-power spectrum Several baselines displayed
Timerange: 00/18:09:01 to 00/18:14:59

Plot file version 2 created 06-OCT-2010 10:55:09
 1749+096 ET013A.UVDATA.1

Freq = 4.9415 GHz, Bw = 16.000 MH No calibration applied and no bandpass applied

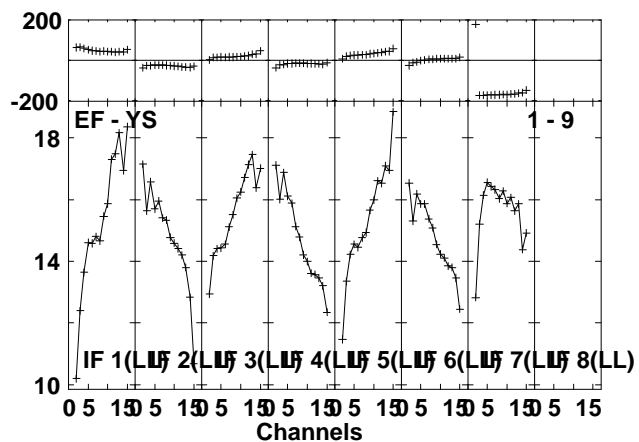
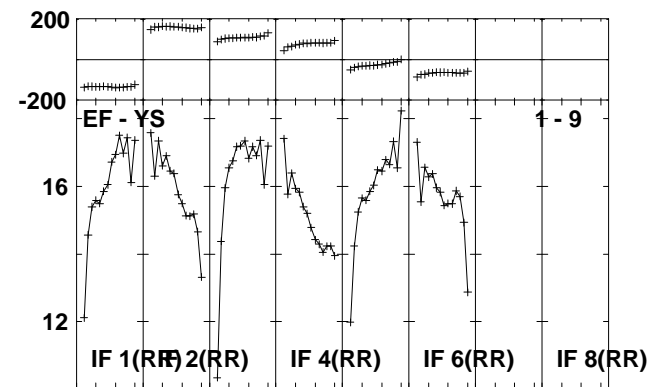
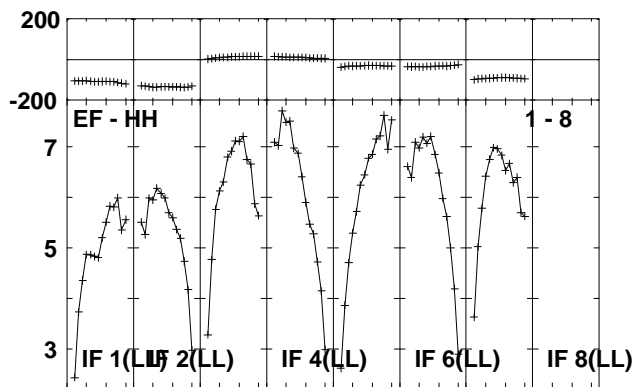
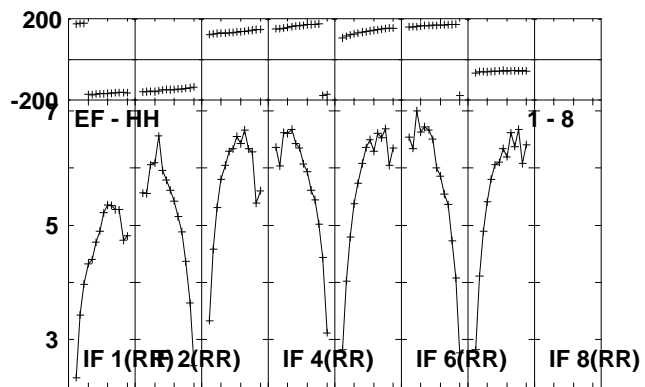
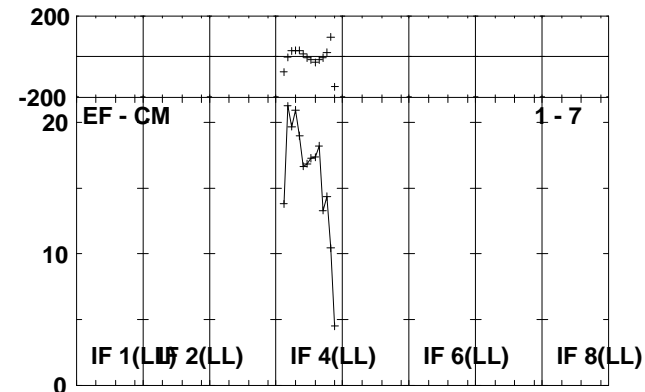
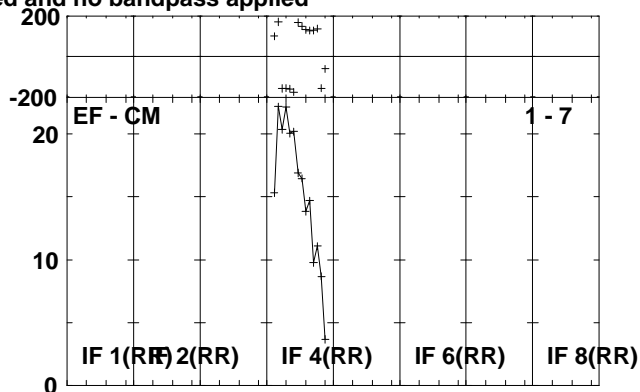
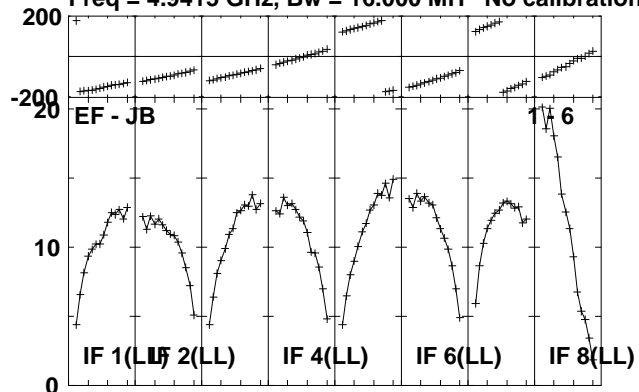

Lower frame: Milli Ampl Jy Top frame: Phas deg
 Scalar averaged cross-power spectrum Several baselines displayed
 Timerange: 00/18:09:01 to 00/18:14:59

Plot file version 3 created 06-OCT-2010 10:55:11

J1907+01 ET013A.UVDATA.1

Freq = 4.9415 GHz, Bw = 16.000 MH No calibration applied and no bandpass applied

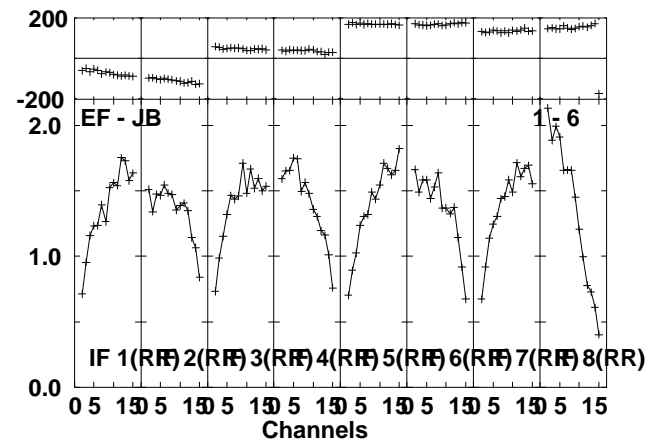
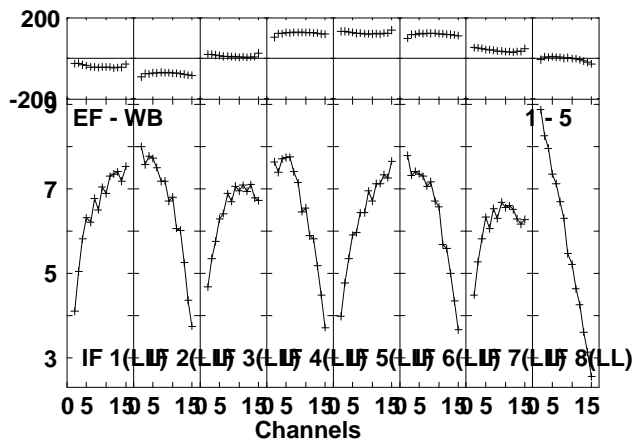
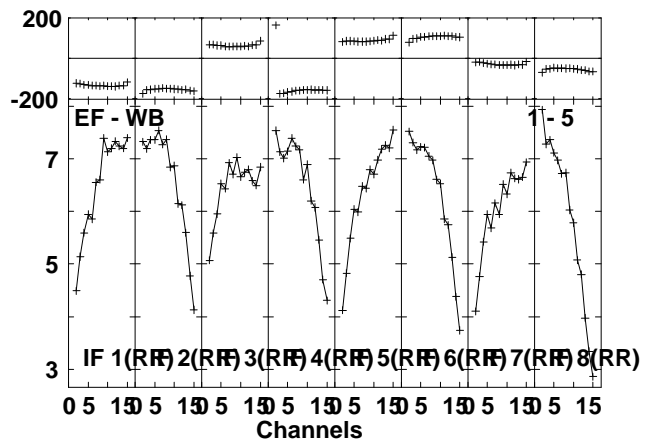
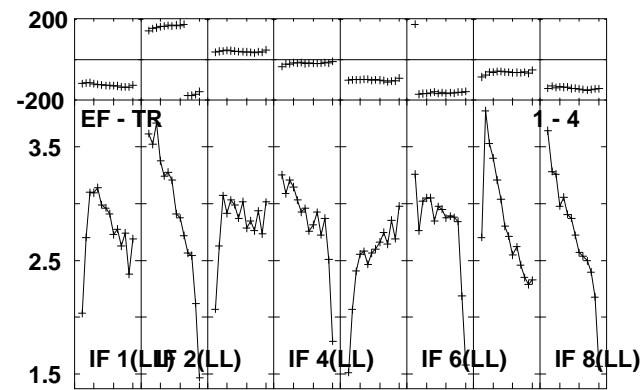
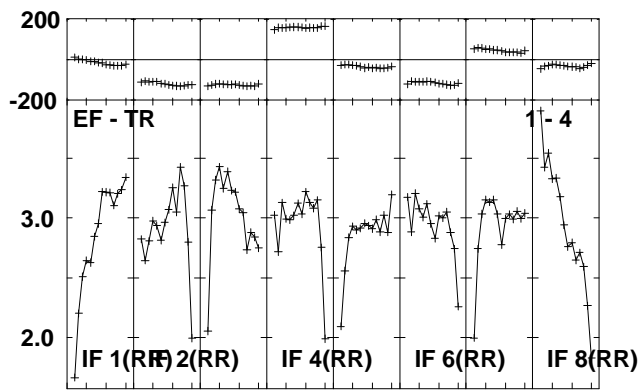
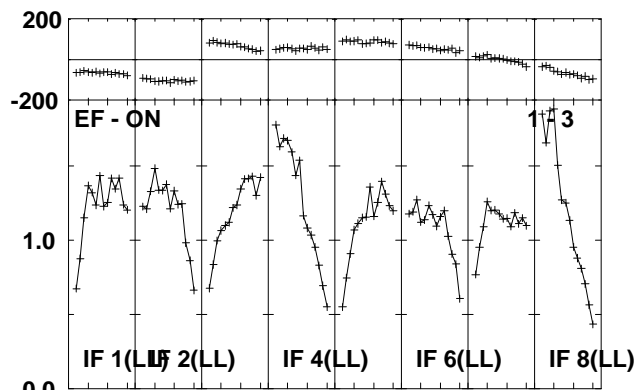
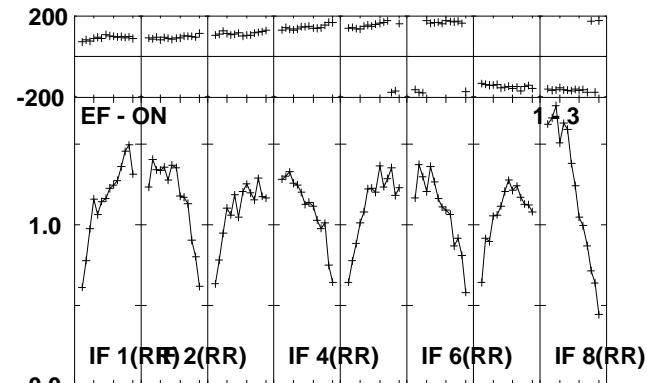
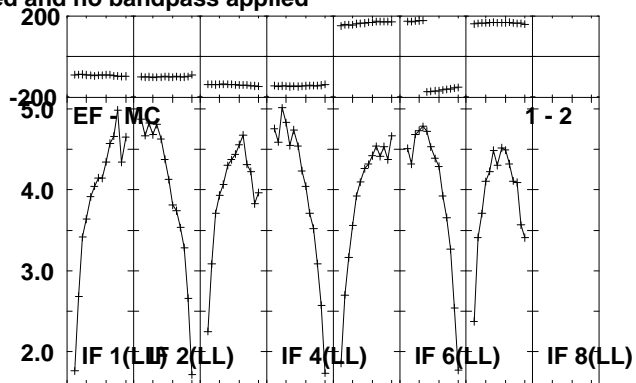
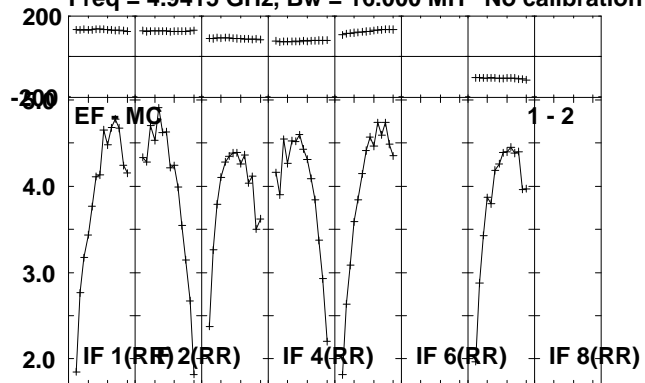

Lower frame: Milli Ampl Jy Top frame: Phas deg
Scalar averaged cross-power spectrum Several baselines displayed
Timerange: 00/18:17:01 to 00/18:19:59

Plot file version 4 created 06-OCT-2010 10:55:12
J1907+01 ET013A.UVDATA.1

Freq = 4.9415 GHz, Bw = 16.000 MH No calibration applied and no bandpass applied

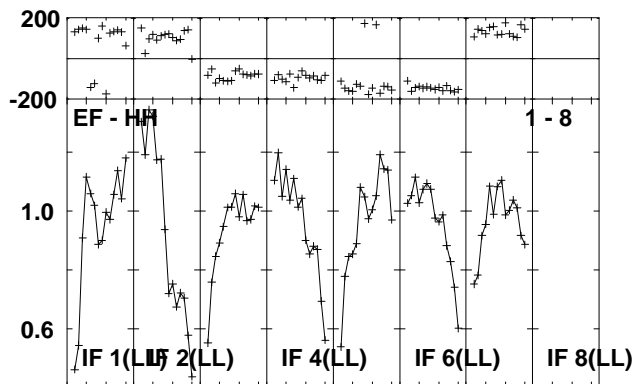
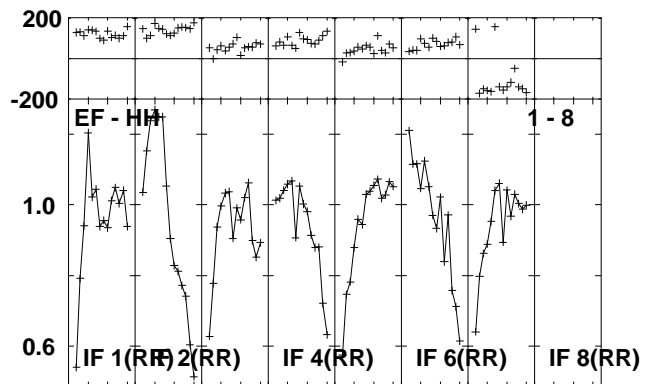
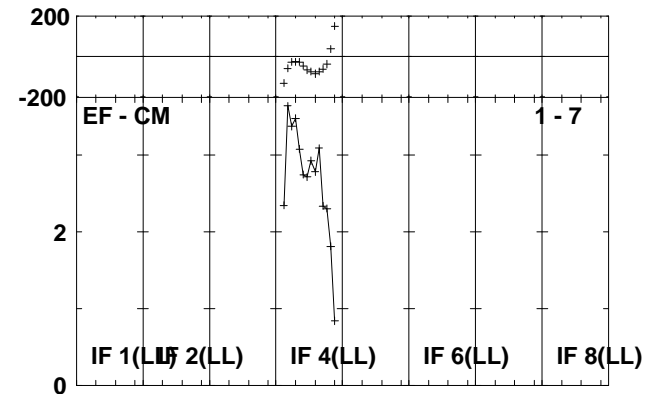
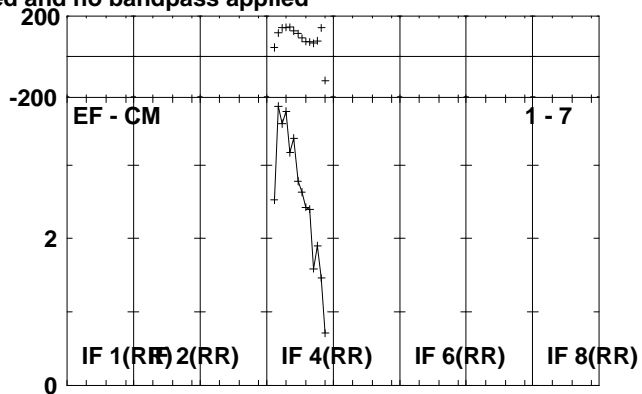
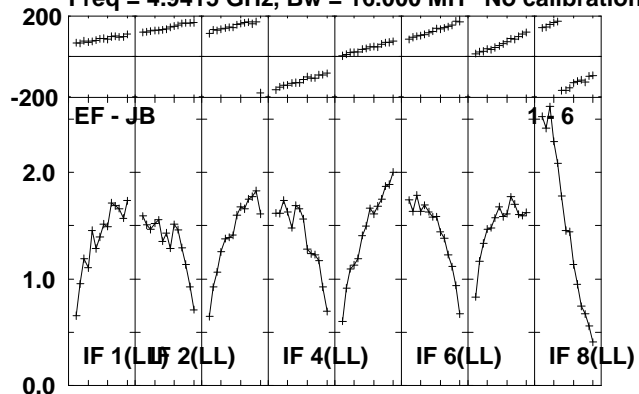

Lower frame: Milli Ampl Jy Top frame: Phas deg
Scalar averaged cross-power spectrum Several baselines displayed
Timerange: 00/18:17:01 to 00/18:19:59

Plot file version 5 created 06-OCT-2010 10:55:14

AQLX-1 ET013A.UVDATA.1

Freq = 4.9415 GHz, Bw = 16.000 MH No calibration applied and no bandpass applied

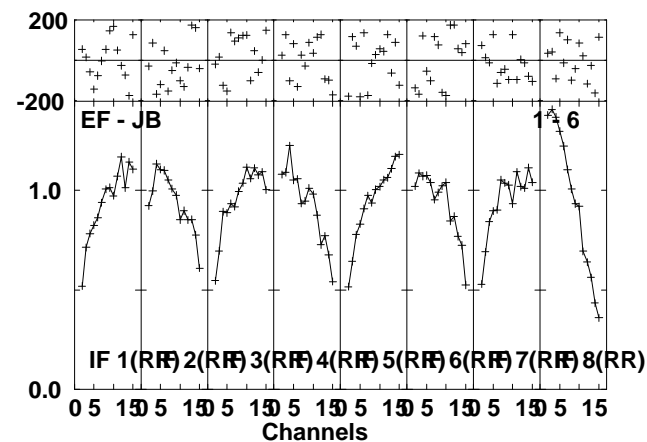
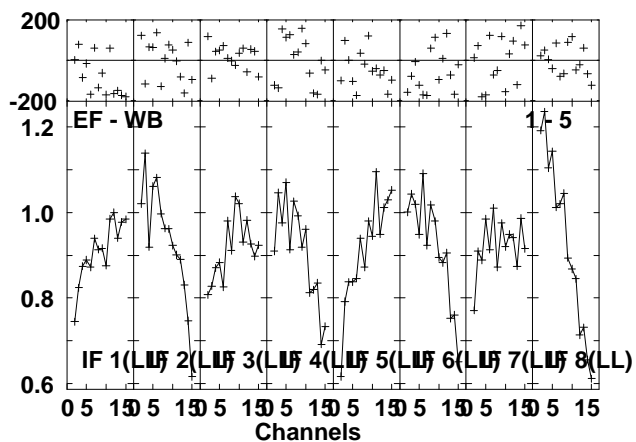
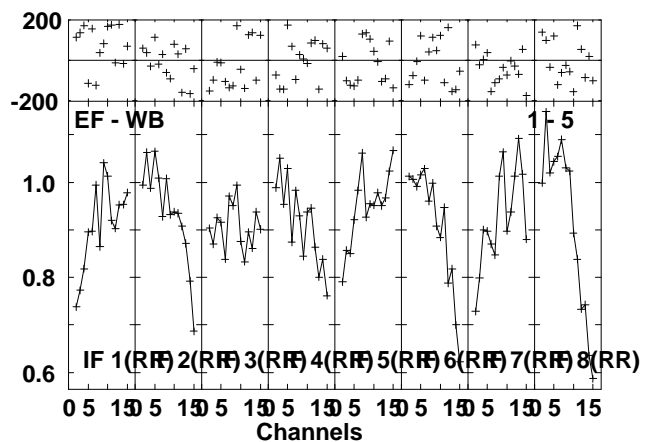
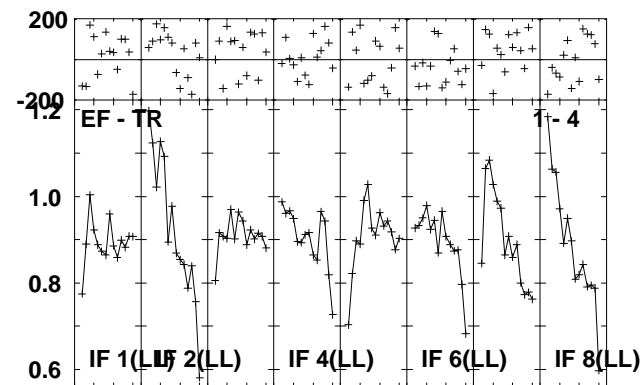
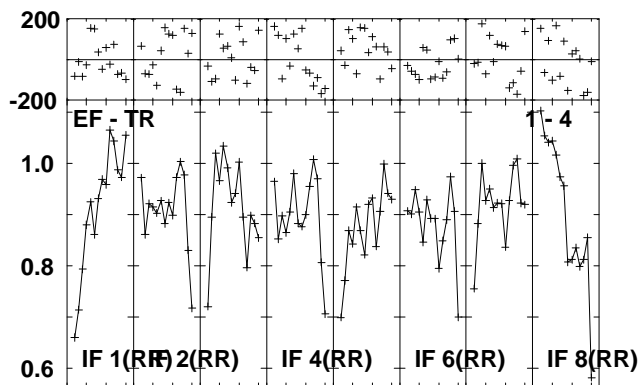
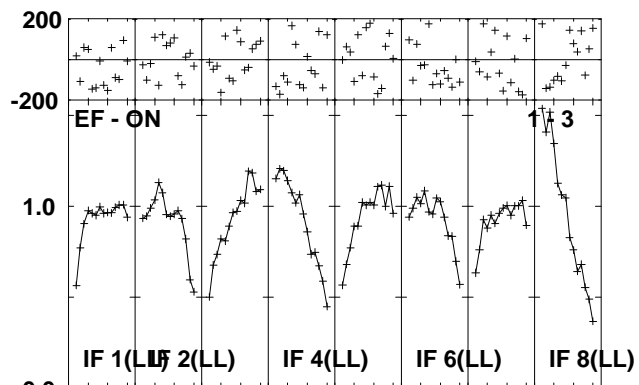
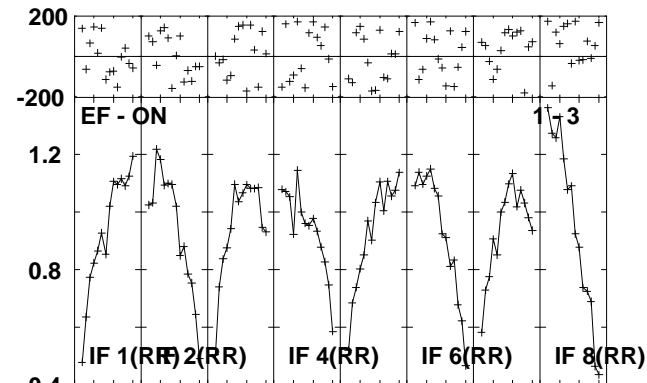
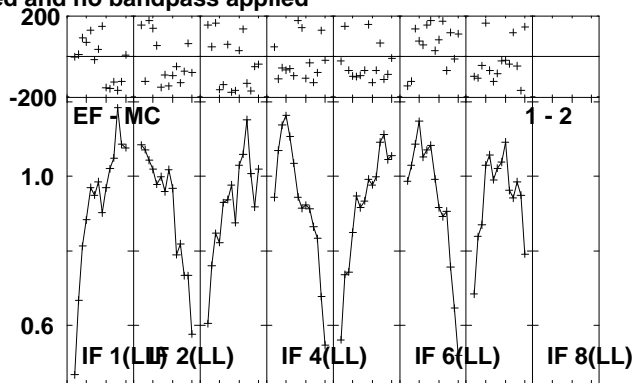
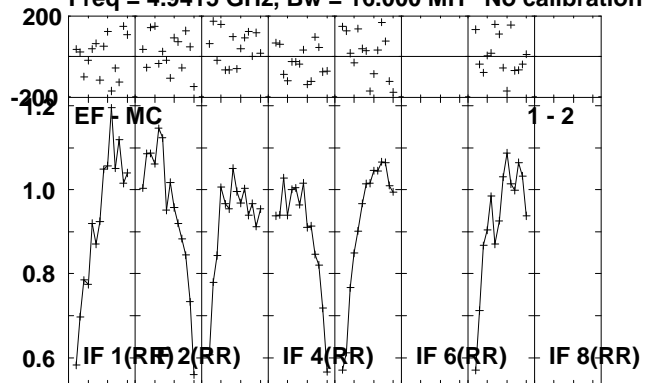

Lower frame: Milli Ampl Jy Top frame: Phas deg
Scalar averaged cross-power spectrum Several baselines displayed
Timerange: 00/18:20:01 to 00/18:24:59

Plot file version 6 created 06-OCT-2010 10:55:16

AQLX-1 ET013A.UVDATA.1

Freq = 4.9415 GHz, Bw = 16.000 MH No calibration applied and no bandpass applied

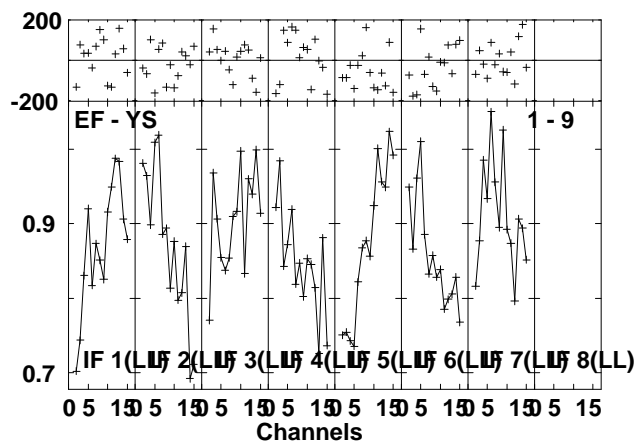
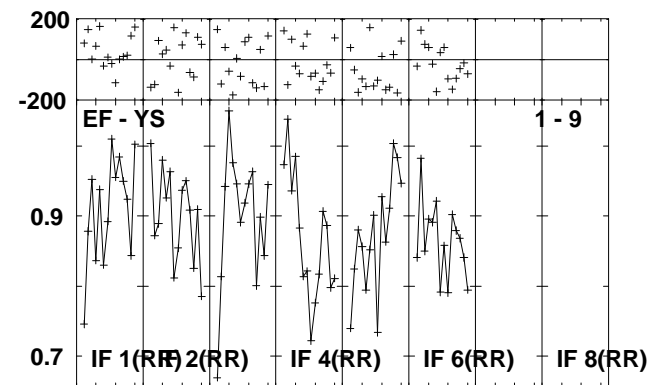
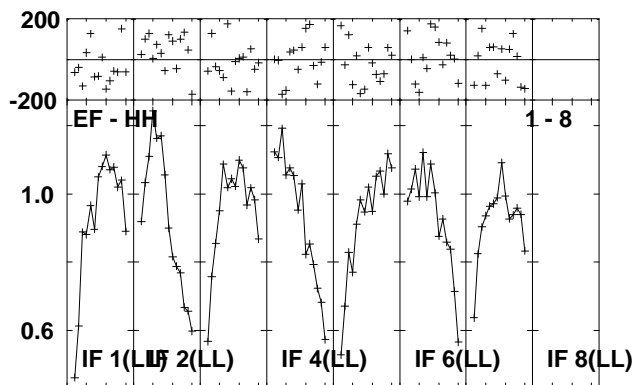
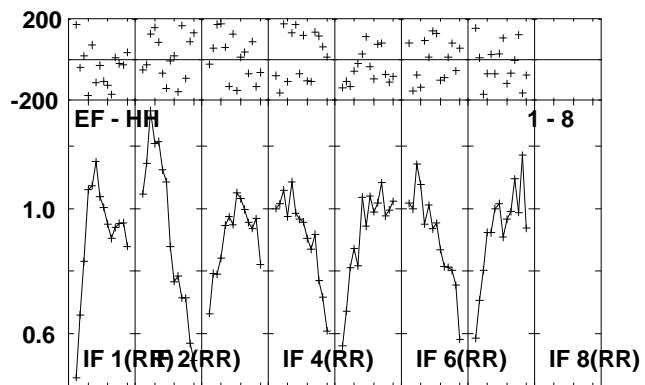
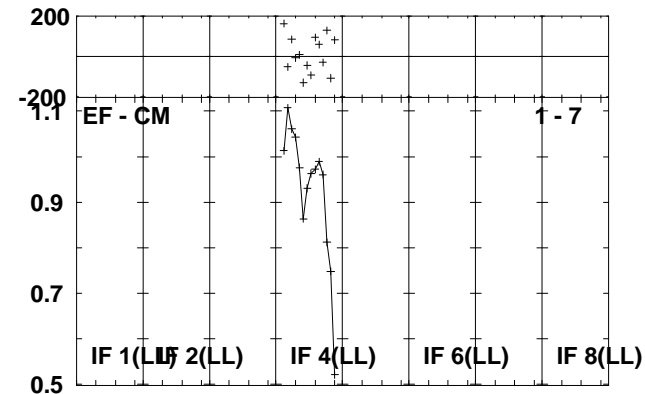
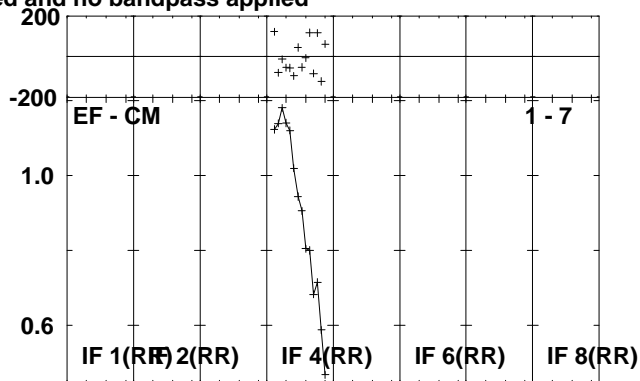
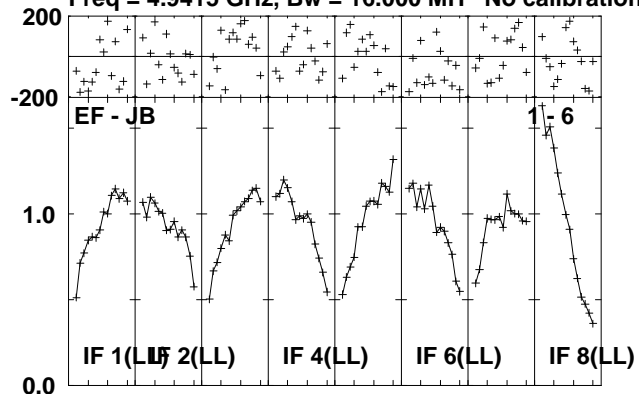

0 5 10 5 10 5 10 5 10 5 10 5 10 5 10 5 10 5 15
Channels
Lower frame: Milli Ampl Jy Top frame: Phas deg
Scalar averaged cross-power spectrum Several baselines displayed
Timerange: 00/18:20:01 to 00/18:24:59

Plot file version 7 created 06-OCT-2010 10:55:17

J1907+01 ET013A.UVDATA.1

Freq = 4.9415 GHz, Bw = 16.000 MH No calibration applied and no bandpass applied

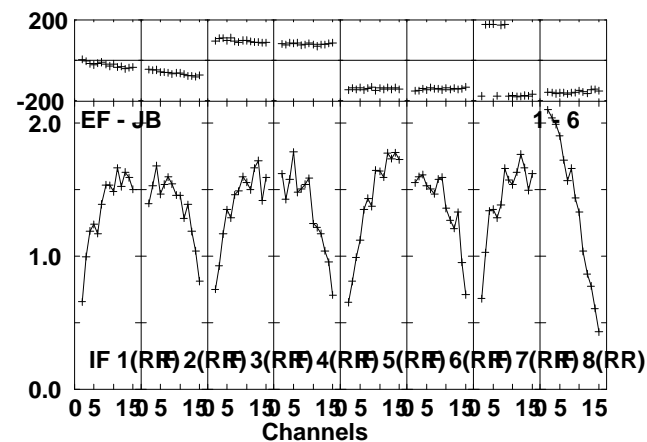
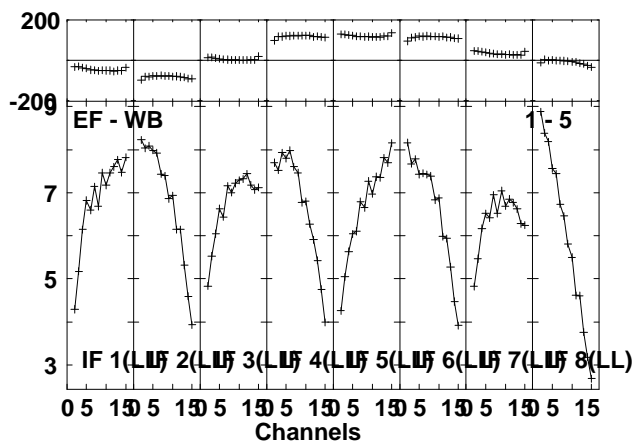
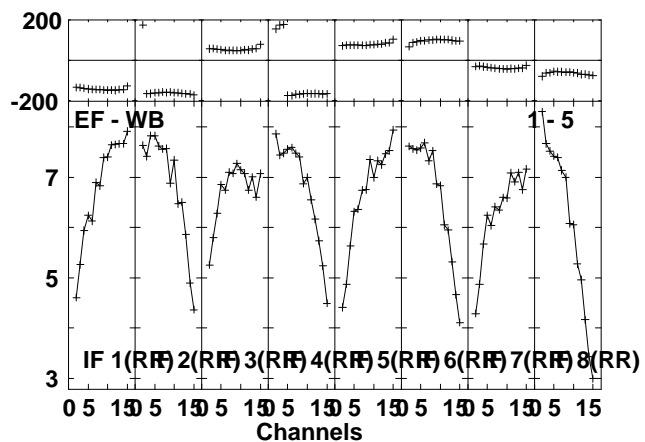
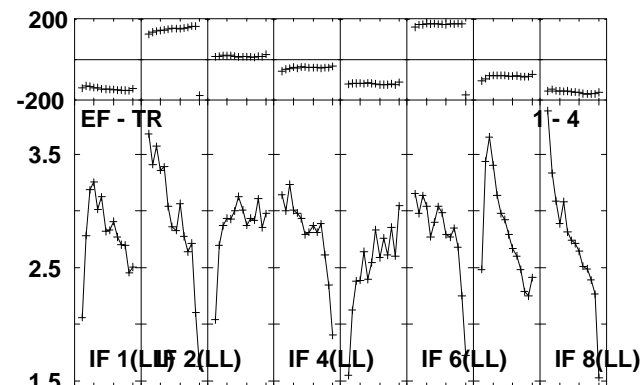
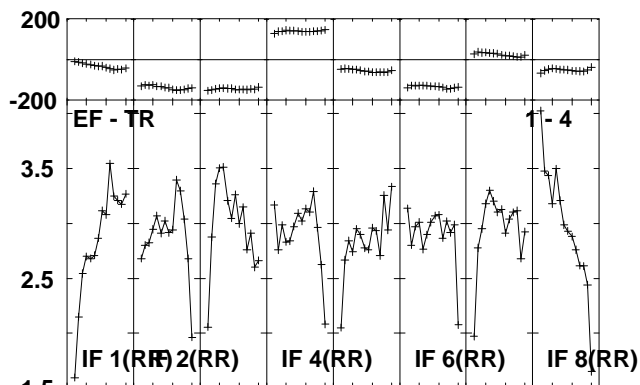
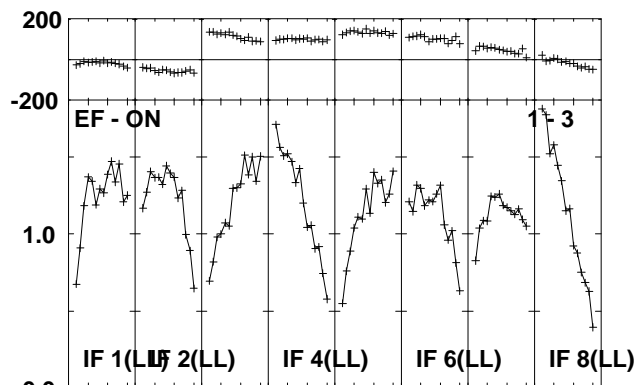
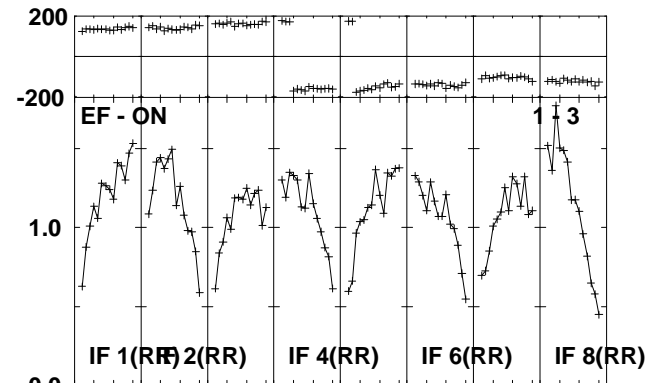
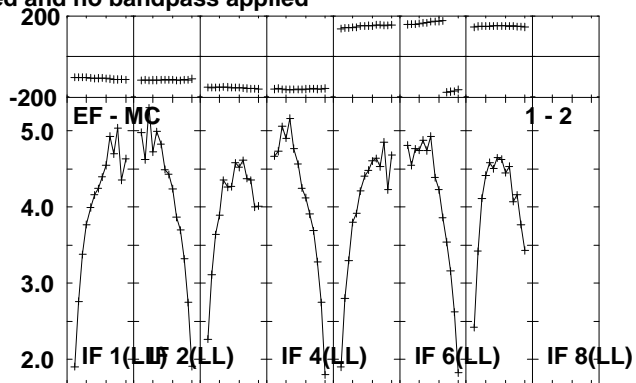
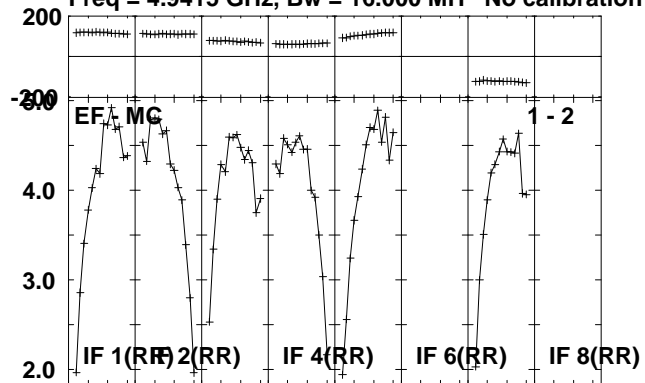

Lower frame: Milli Ampl Jy Top frame: Phas deg
Scalar averaged cross-power spectrum Several baselines displayed
Timerange: 00/18:25:41 to 00/18:27:59

Plot file version 8 created 06-OCT-2010 10:55:18
 J1907+01 ET013A.UVDATA.1

Freq = 4.9415 GHz, Bw = 16.000 MH No calibration applied and no bandpass applied

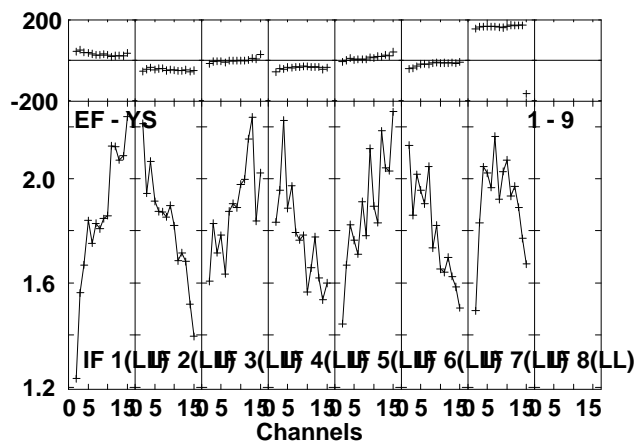
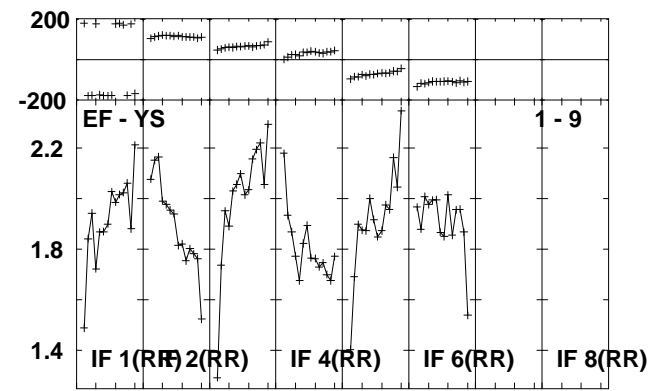
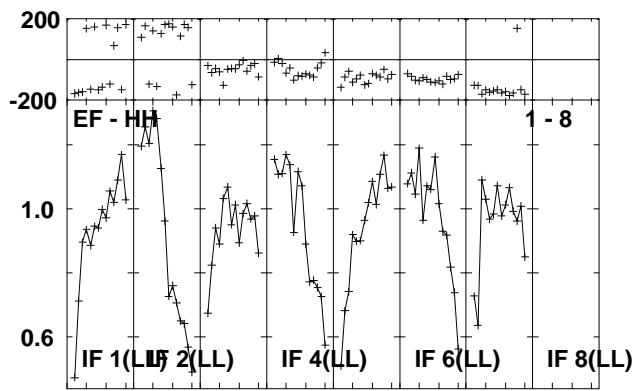
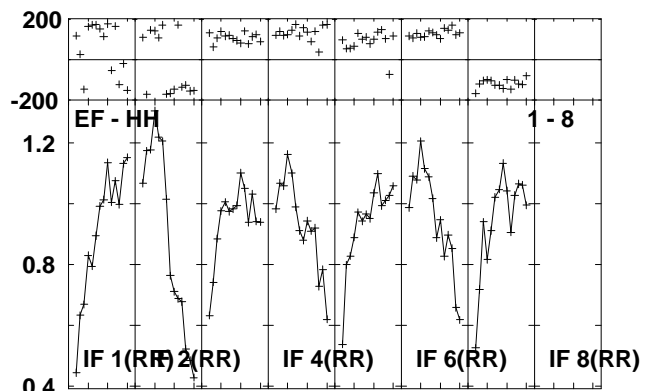
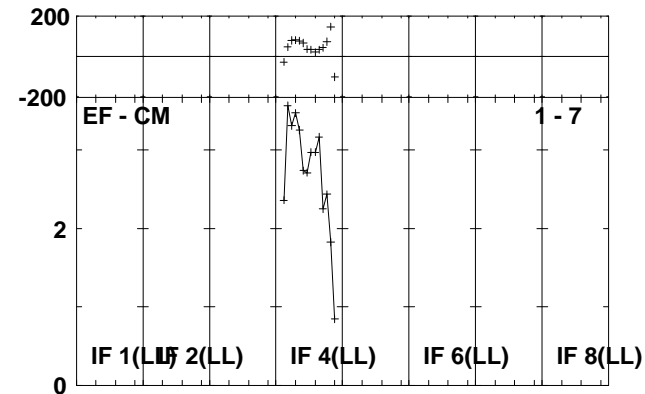
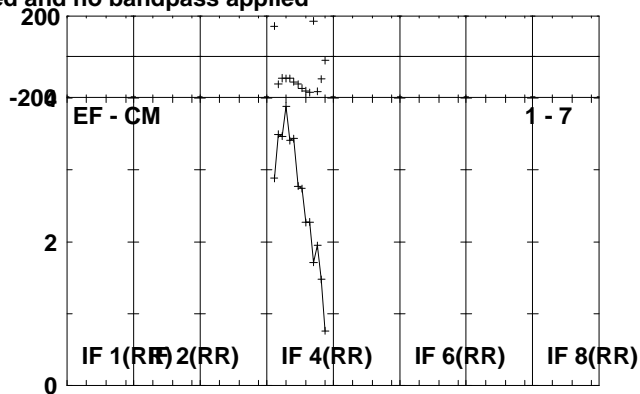
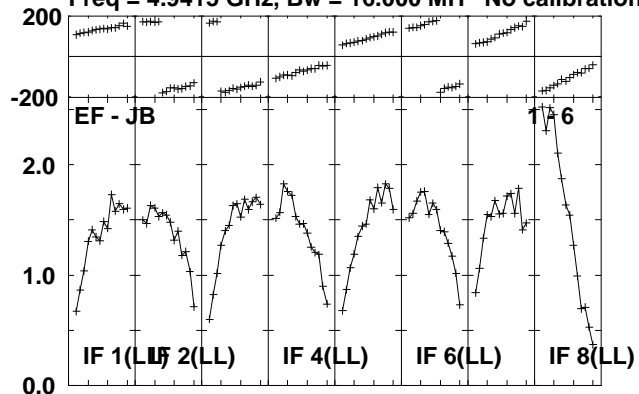

Lower frame: Milli Ampl Jy Top frame: Phas deg
 Scalar averaged cross-power spectrum Several baselines displayed
 Timerange: 00/18:25:41 to 00/18:27:59

Plot file version 9 created 06-OCT-2010 10:55:20

AQLX-1 ET013A.UVDATA.1

Freq = 4.9415 GHz, Bw = 16.000 MH No calibration applied and no bandpass applied

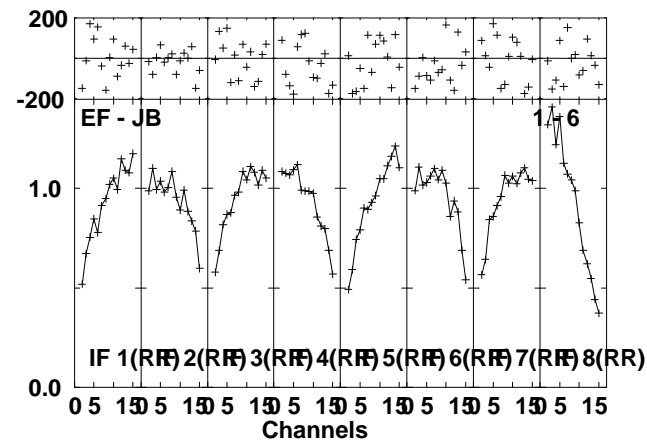
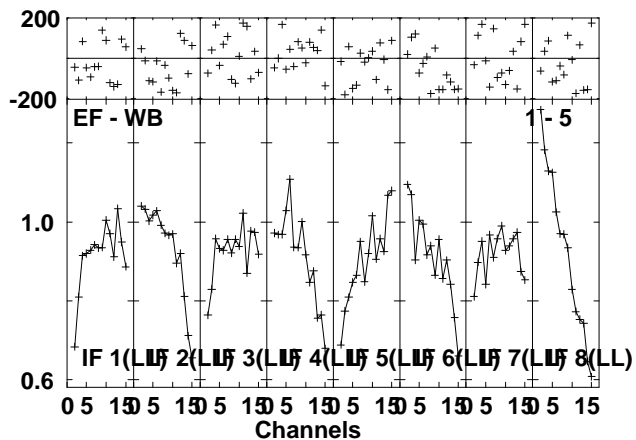
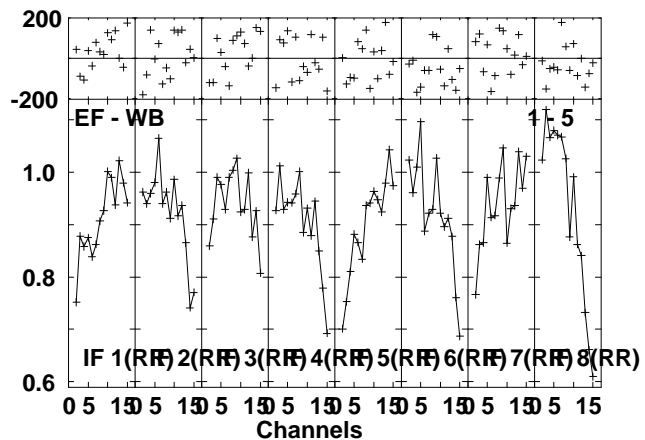
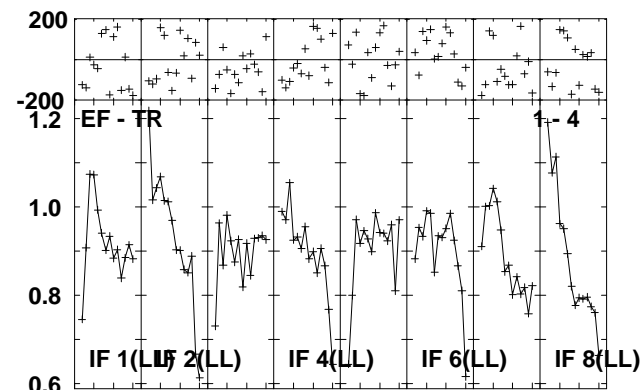
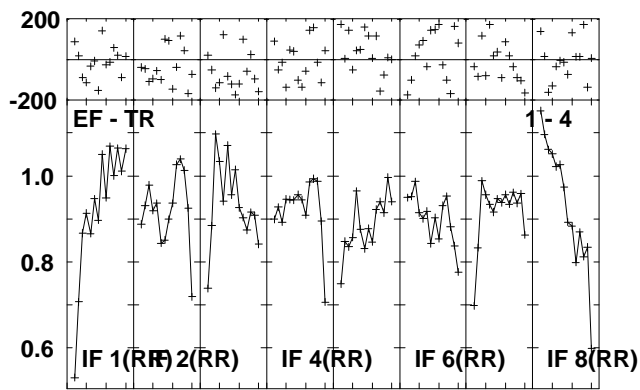
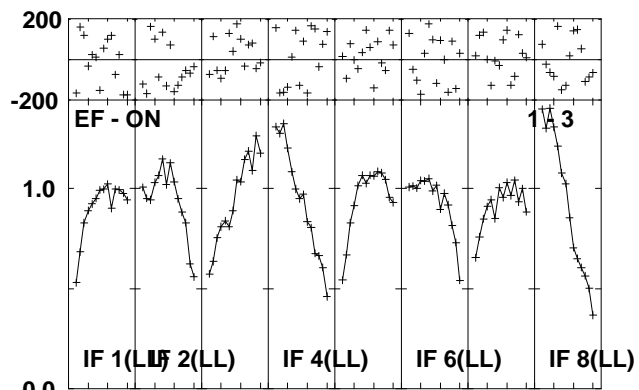
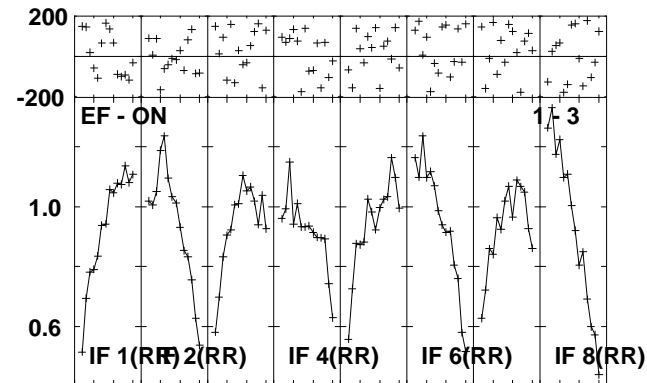
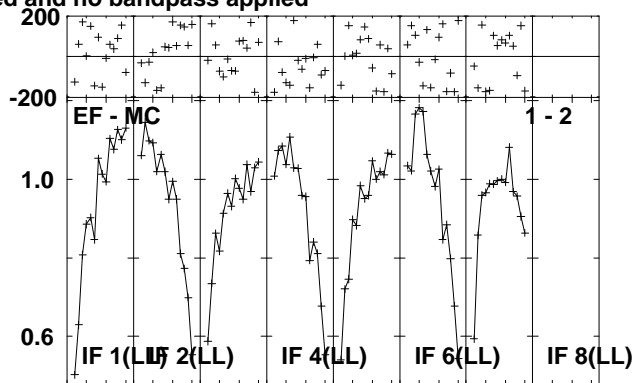
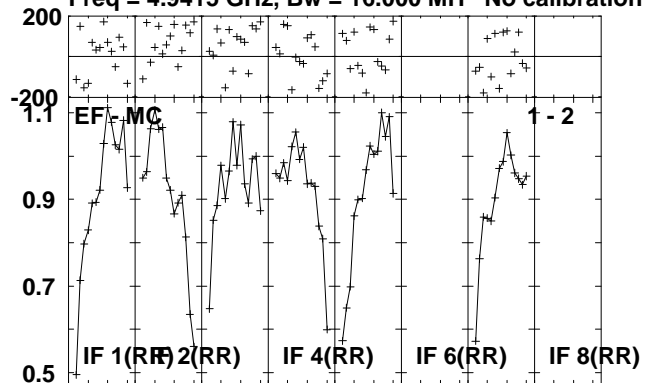

Lower frame: Milli Ampl Jy Top frame: Phas deg
Scalar averaged cross-power spectrum Several baselines displayed
Timerange: 00/18:28:01 to 00/18:32:59

Plot file version 10 created 06-OCT-2010 10:55:22

AQLX-1 ET013A.UVDATA.1

Freq = 4.9415 GHz, Bw = 16.000 MH No calibration applied and no bandpass applied

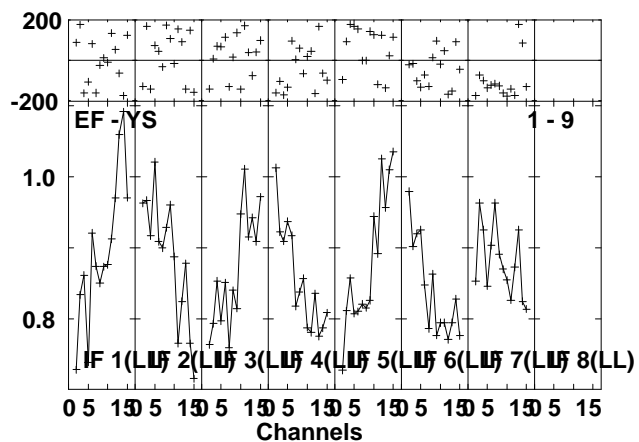
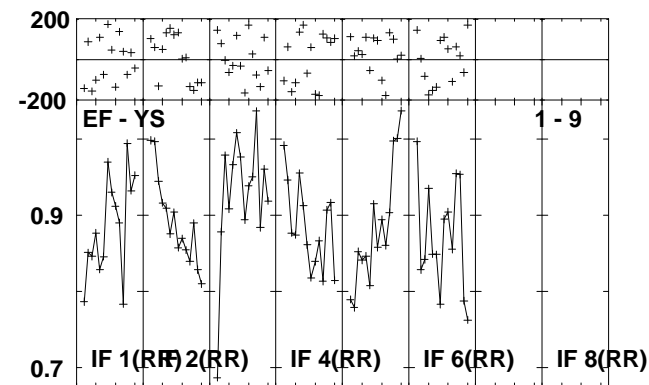
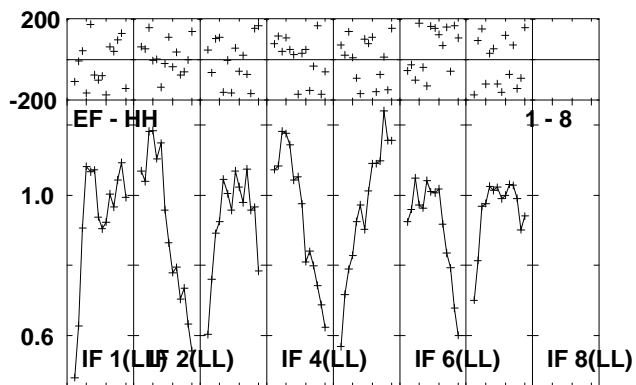
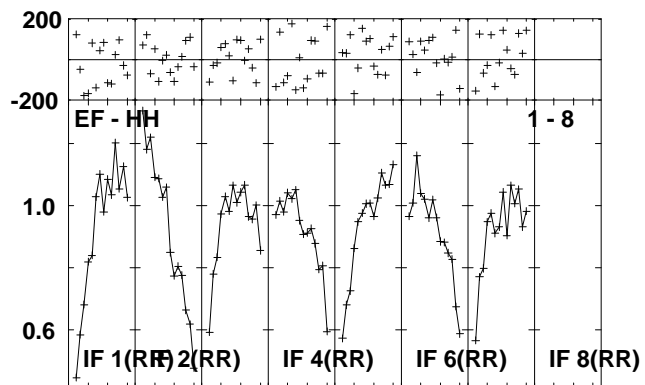
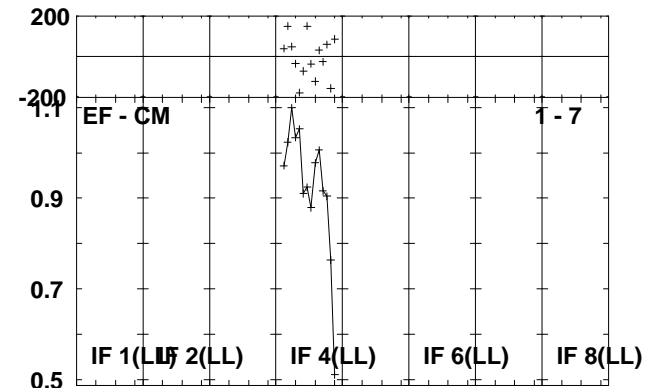
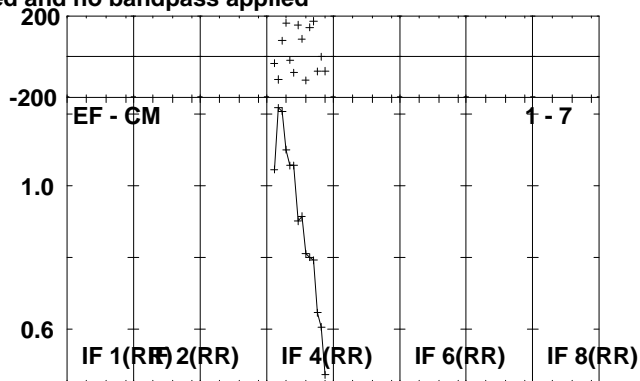
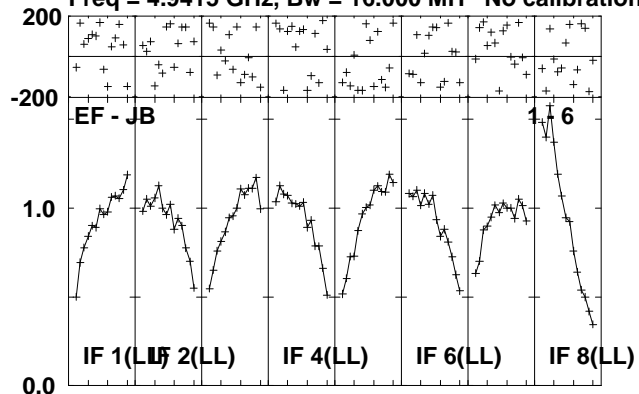

Lower frame: Milli Ampl Jy Top frame: Phas deg
Scalar averaged cross-power spectrum Several baselines displayed
Timerange: 00/18:28:01 to 00/18:32:59

Plot file version 11 created 06-OCT-2010 10:55:24

J1907+01 ET013A.UVDATA.1

Freq = 4.9415 GHz, Bw = 16.000 MH No calibration applied and no bandpass applied

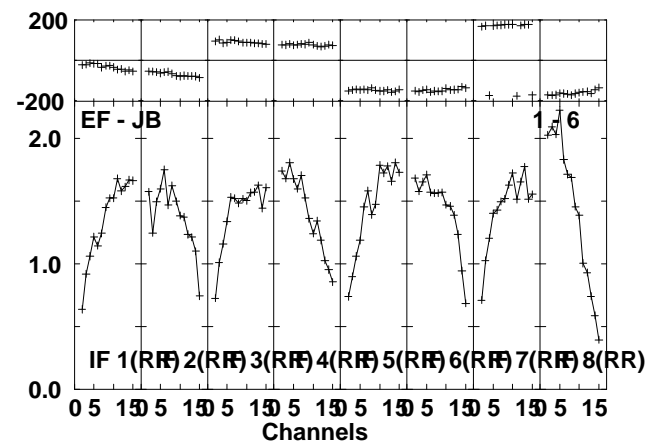
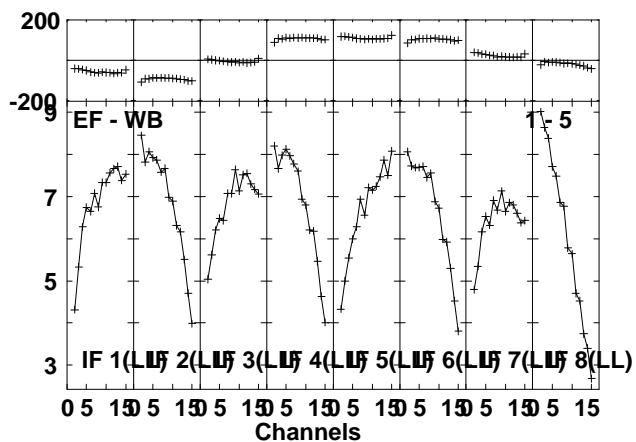
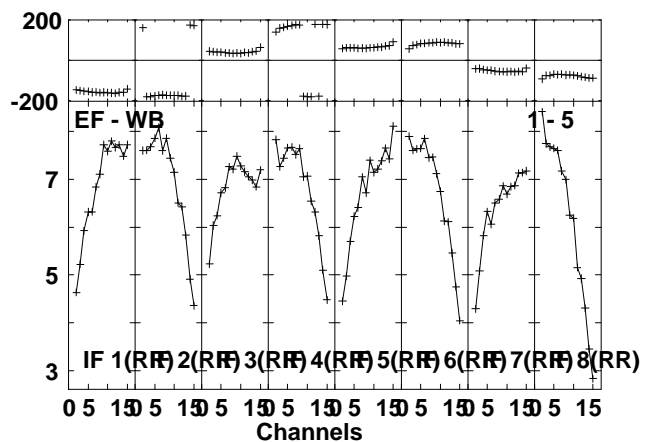
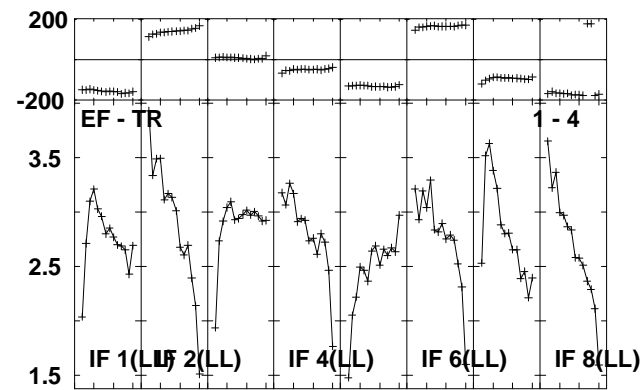
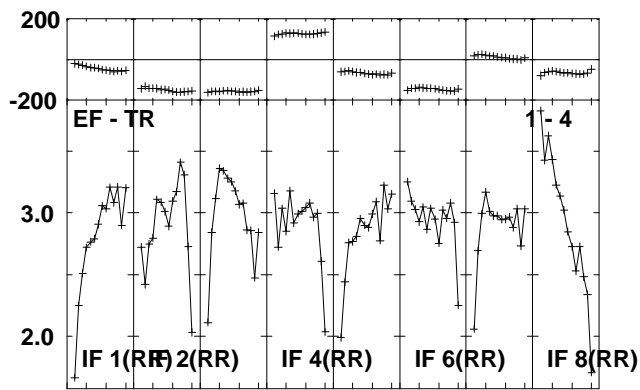
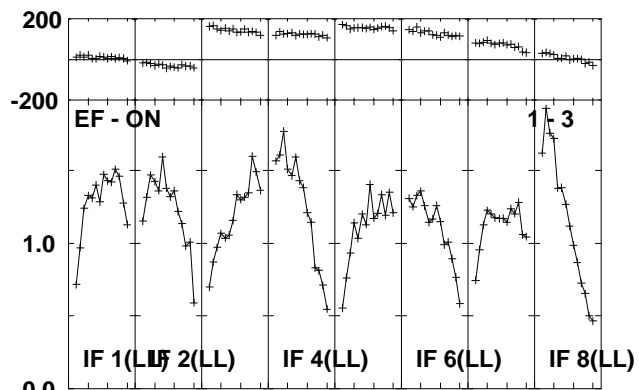
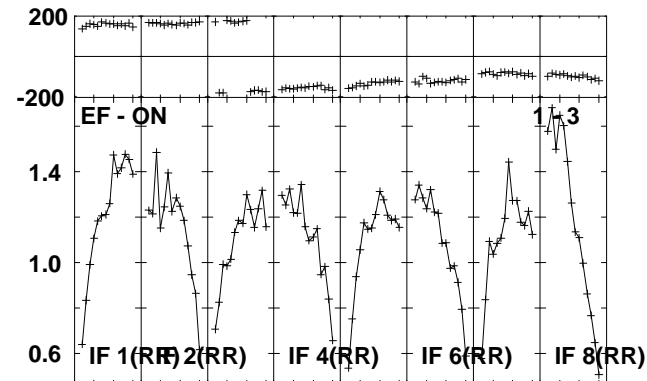
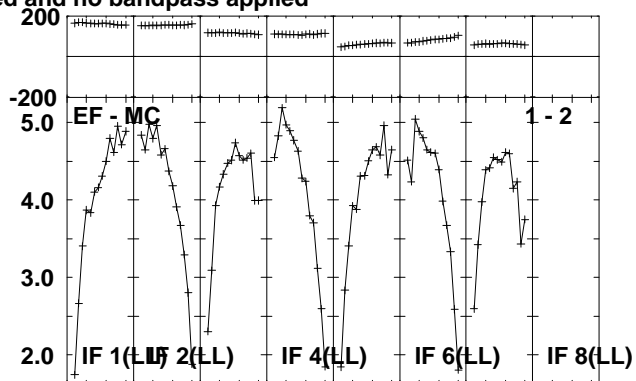
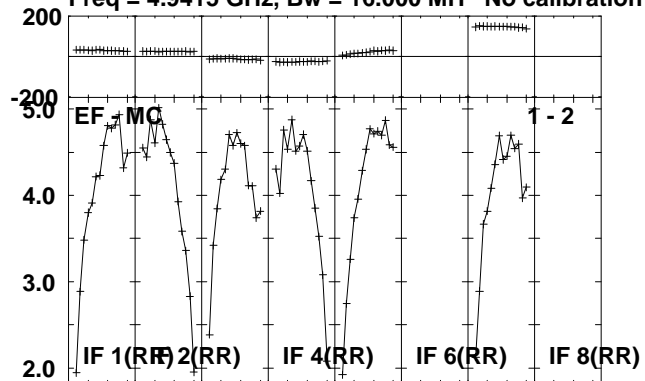

Lower frame: Milli Ampl Jy Top frame: Phas deg
Scalar averaged cross-power spectrum Several baselines displayed
Timerange: 00/18:33:41 to 00/18:35:59

Plot file version 12 created 06-OCT-2010 10:55:25

J1907+01 ET013A.UVDATA.1

Freq = 4.9415 GHz, Bw = 16.000 MH No calibration applied and no bandpass applied

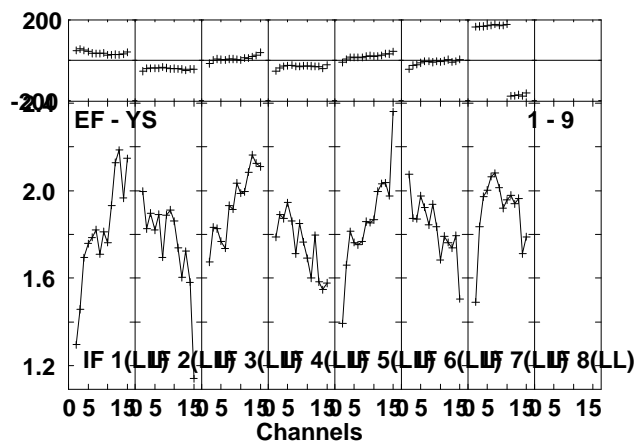
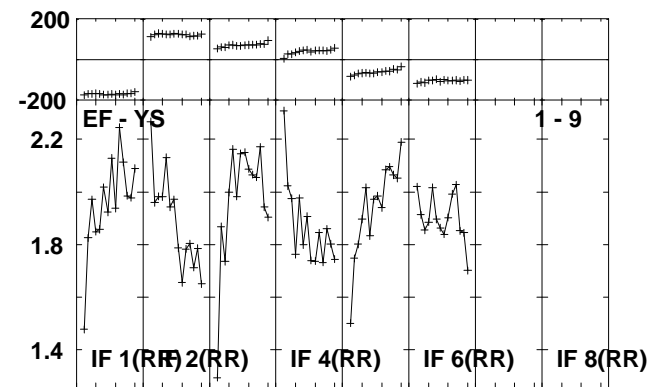
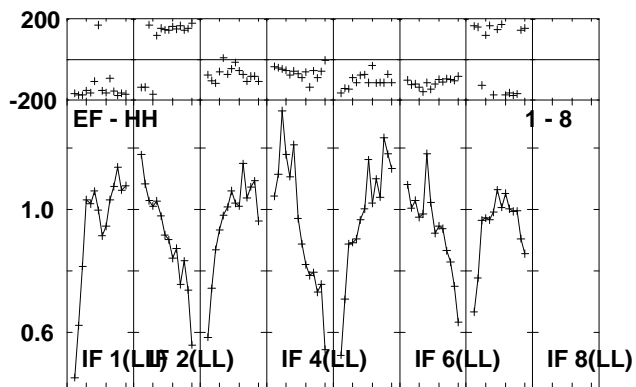
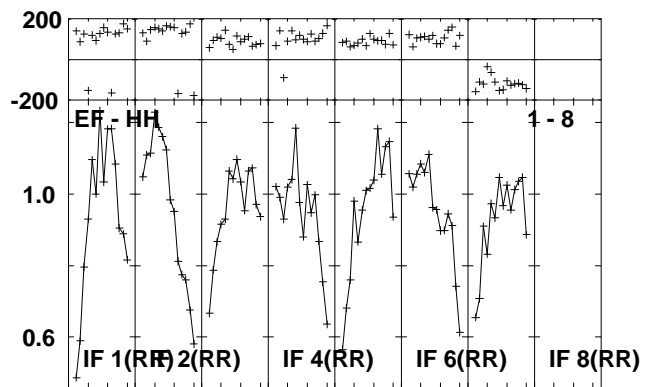
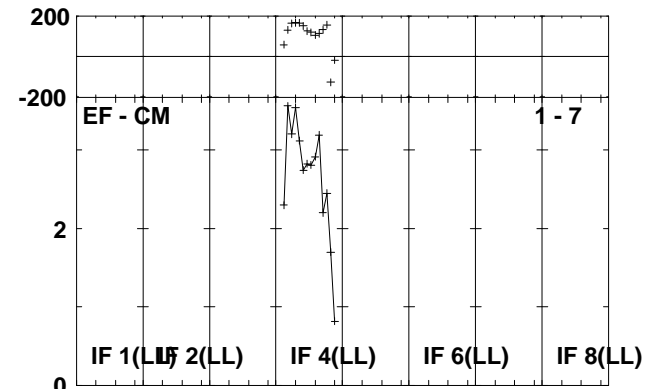
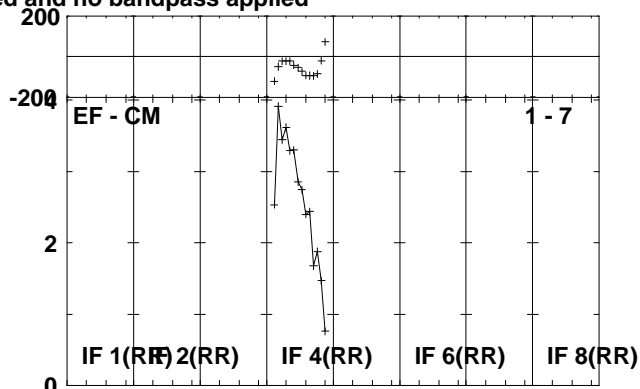
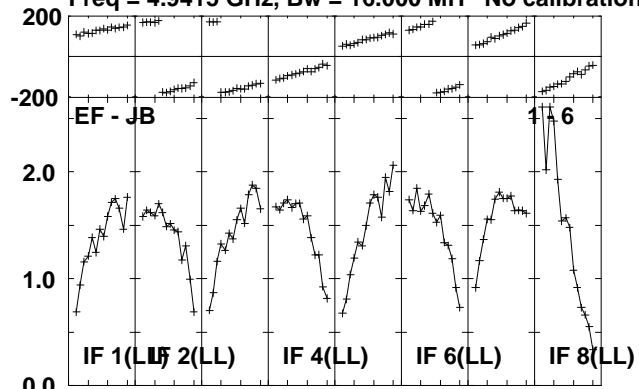

Lower frame: Milli Ampl Jy Top frame: Phas deg
Scalar averaged cross-power spectrum Several baselines displayed
Timerange: 00/18:33:41 to 00/18:35:59

Plot file version 13 created 06-OCT-2010 10:55:26

AQLX-1 ET013A.UVDATA.1

Freq = 4.9415 GHz, Bw = 16.000 MH No calibration applied and no bandpass applied

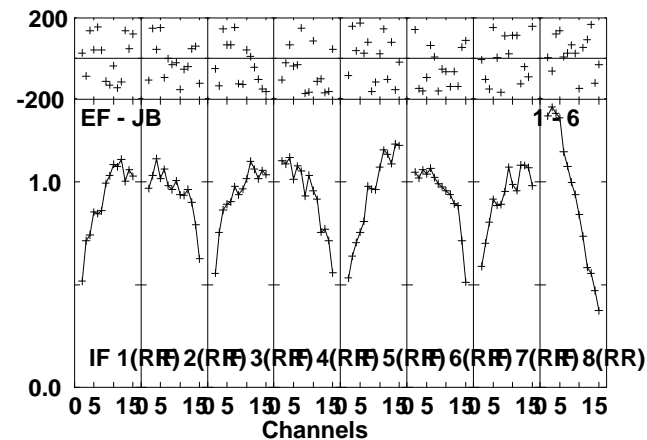
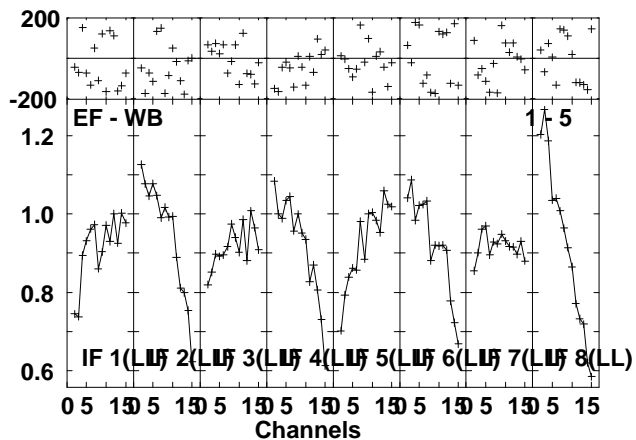
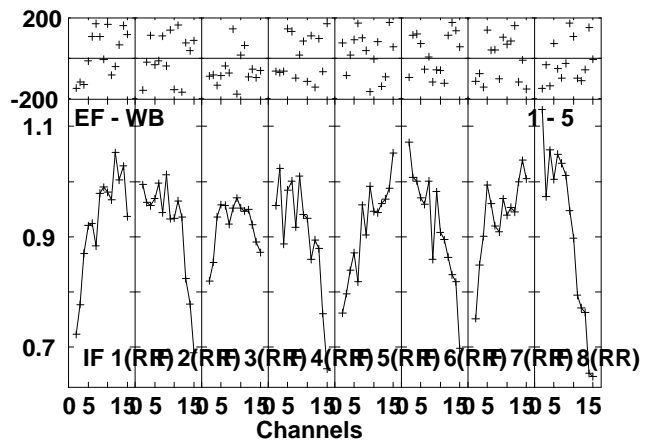
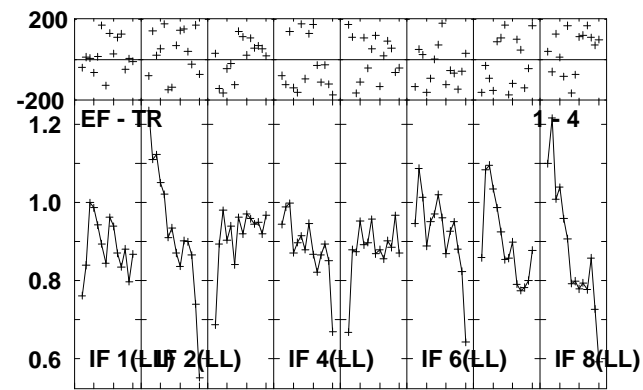
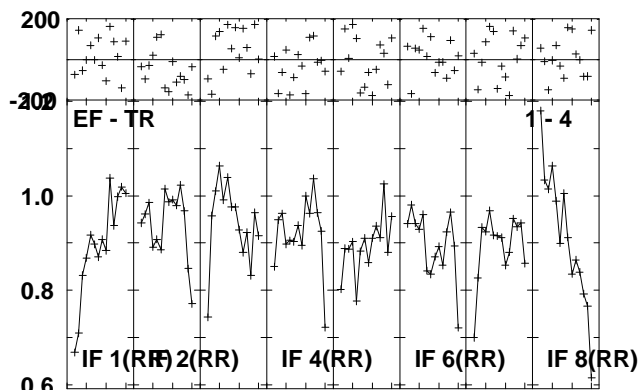
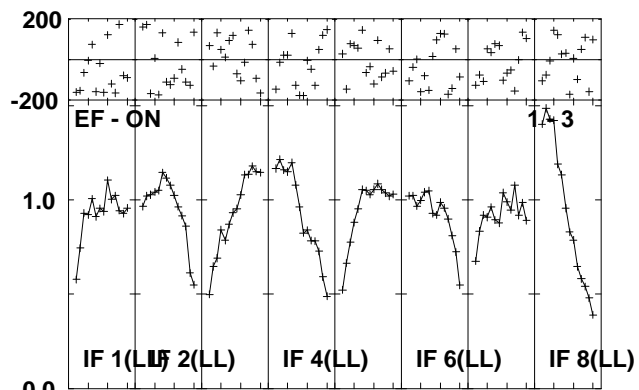
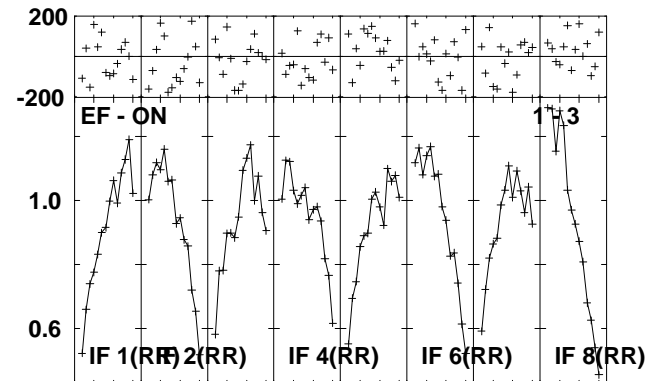
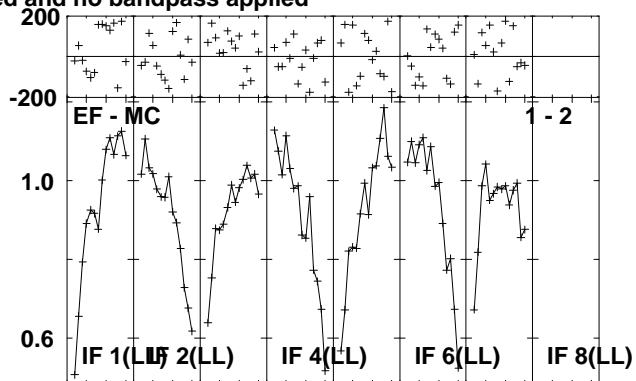
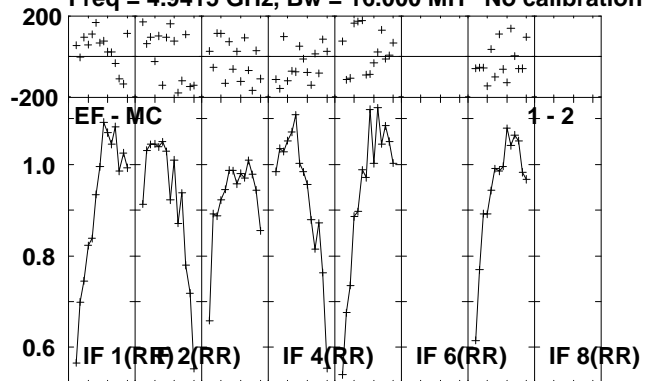

Lower frame: Milli Ampl Jy Top frame: Phas deg
Scalar averaged cross-power spectrum Several baselines displayed
Timerange: 00:18:36:01 to 00:18:40:59

Plot file version 14 created 06-OCT-2010 10:55:28

AQLX-1 ET013A.UVDATA.1

Freq = 4.9415 GHz, Bw = 16.000 MH No calibration applied and no bandpass applied

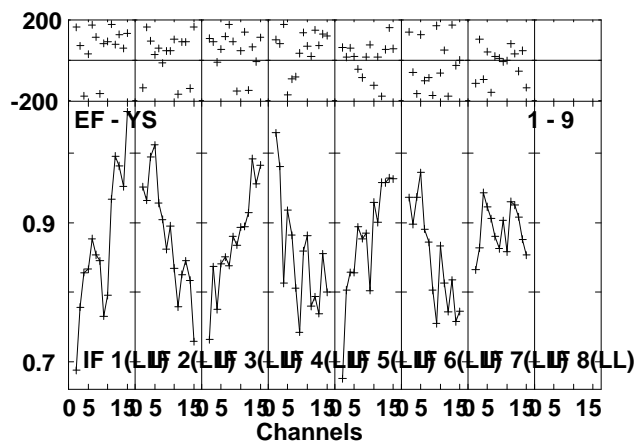
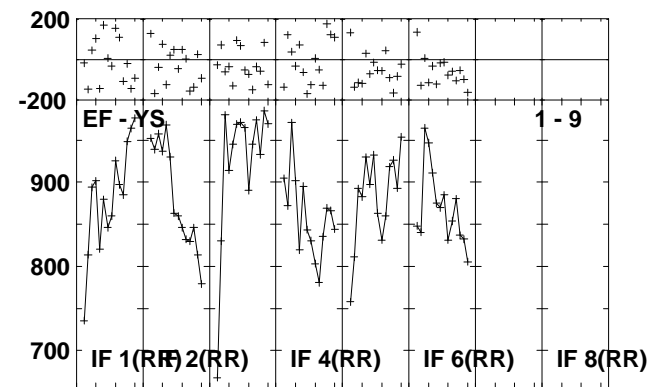
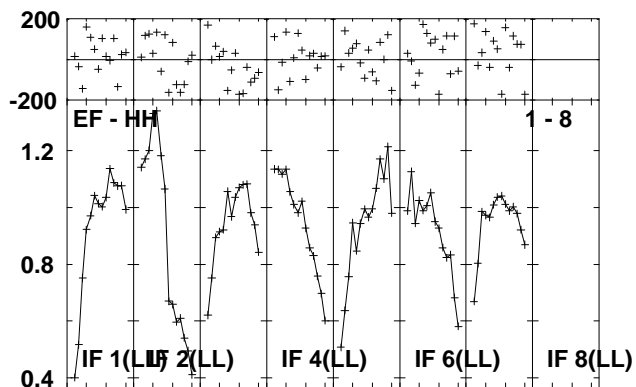
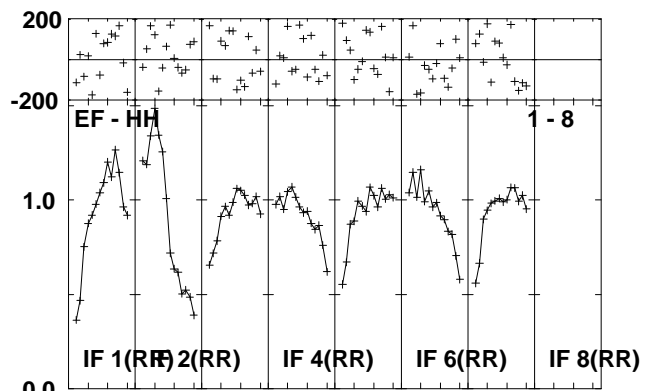
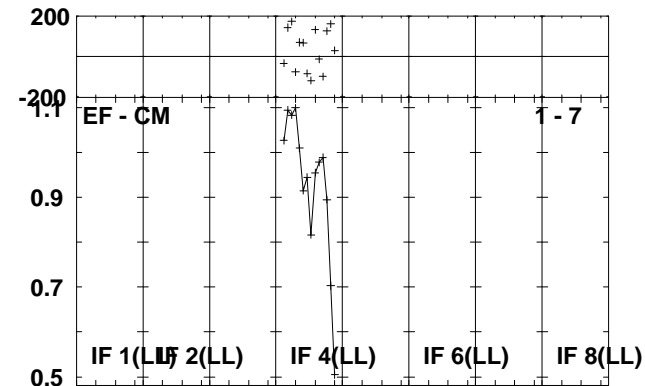
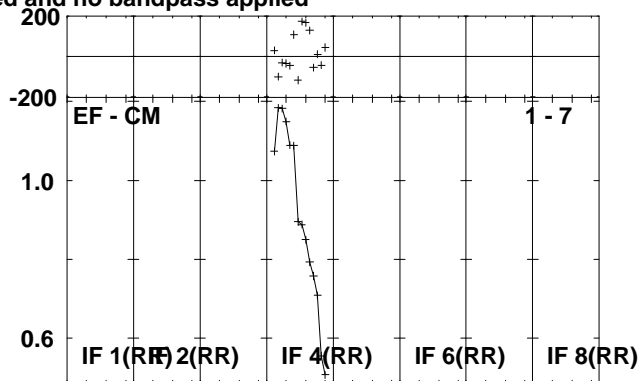
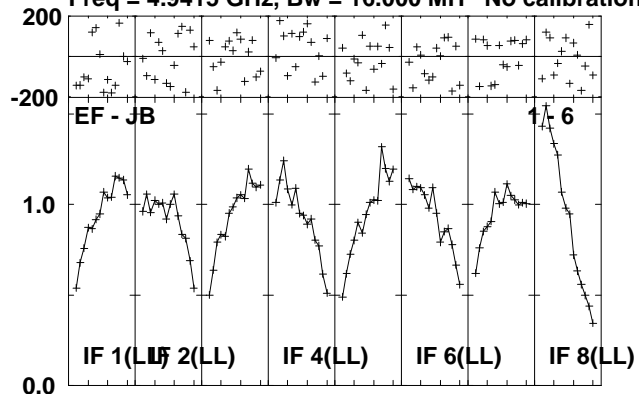

Lower frame: Milli Ampl Jy Top frame: Phas deg
Scalar averaged cross-power spectrum Several baselines displayed
Timerange: 00/18:36:01 to 00/18:40:59

Plot file version 15 created 06-OCT-2010 10:55:30

J1907+01 ET013A.UVDATA.1

Freq = 4.9415 GHz, Bw = 16.000 MH No calibration applied and no bandpass applied

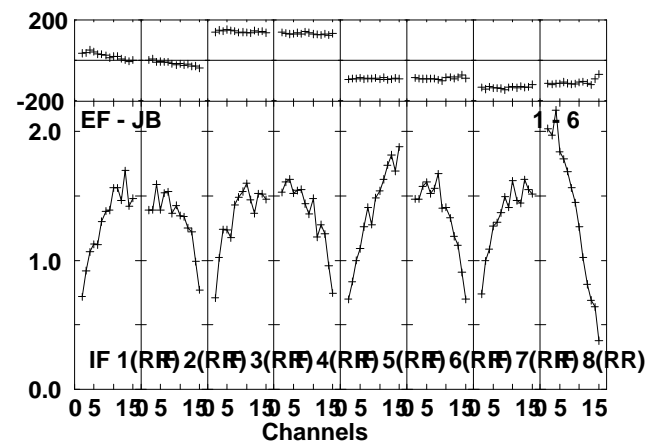
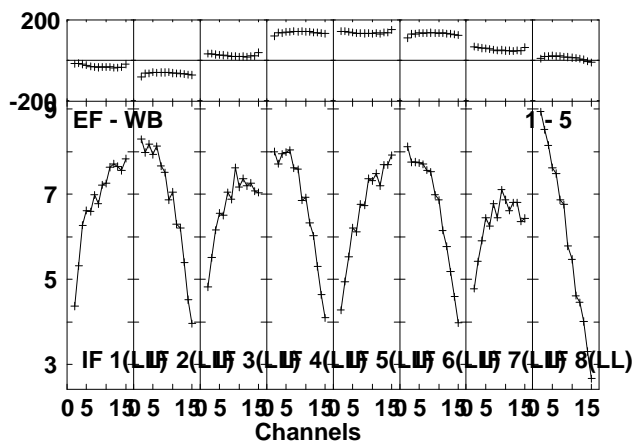
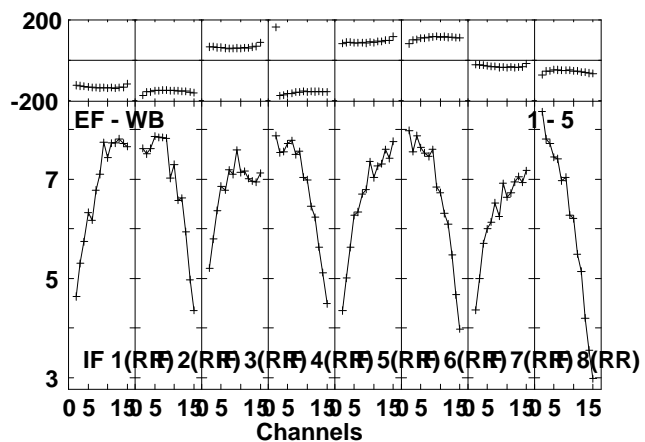
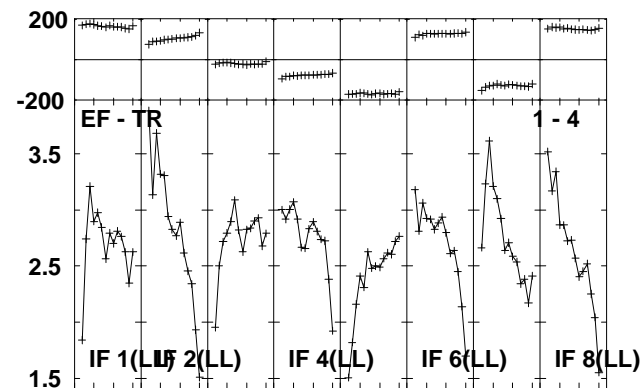
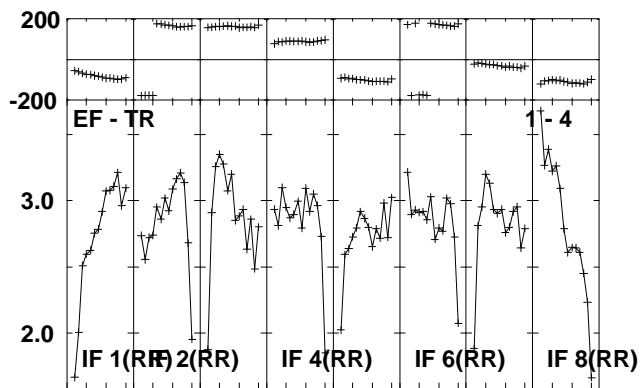
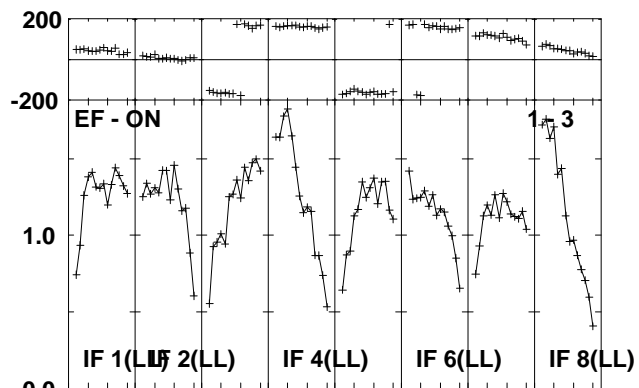
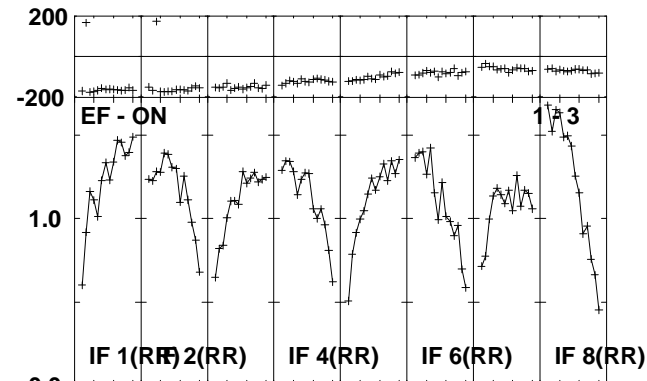
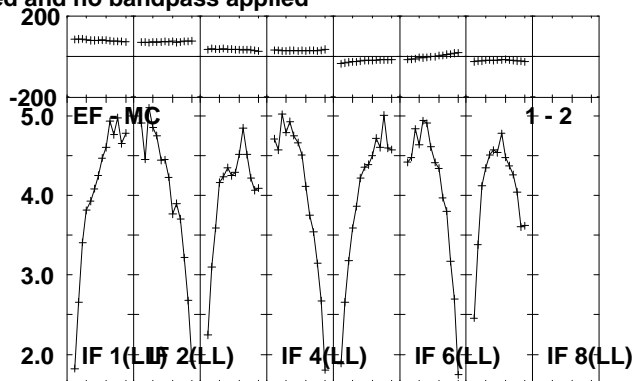
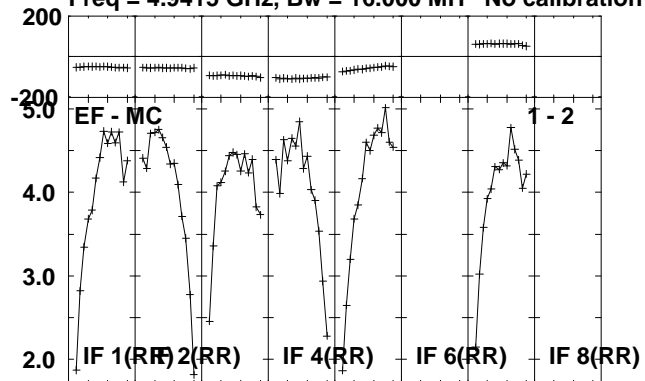

Lower frame: Milli Ampl Jy Top frame: Phas deg
Scalar averaged cross-power spectrum Several baselines displayed
Timerange: 00:18:41:41 to 00:18:43:59

Plot file version 16 created 06-OCT-2010 10:55:31

J1907+01 ET013A.UVDATA.1

Freq = 4.9415 GHz, Bw = 16.000 MH No calibration applied and no bandpass applied

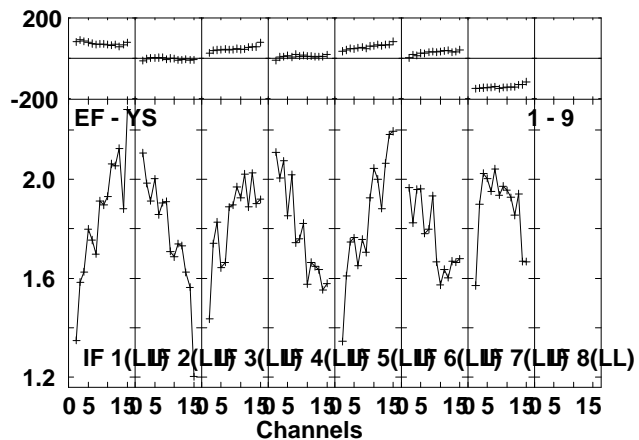
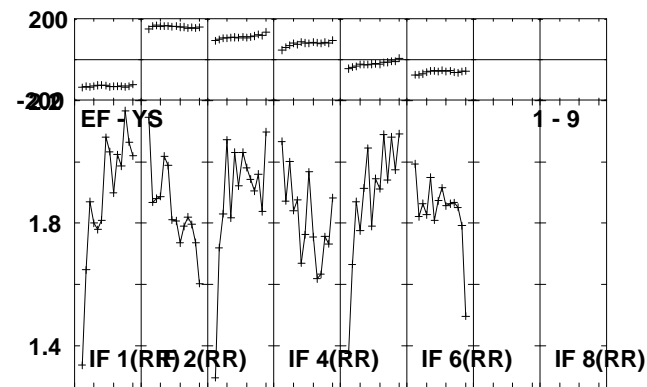
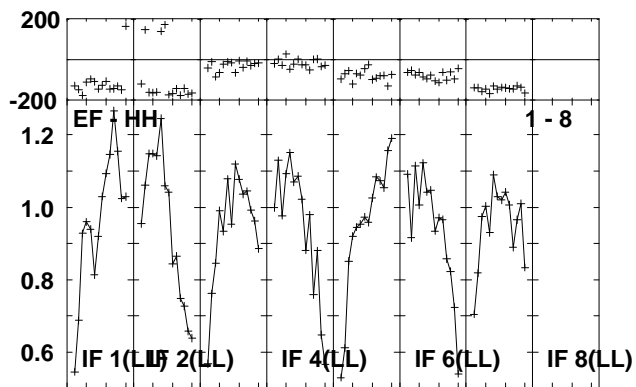
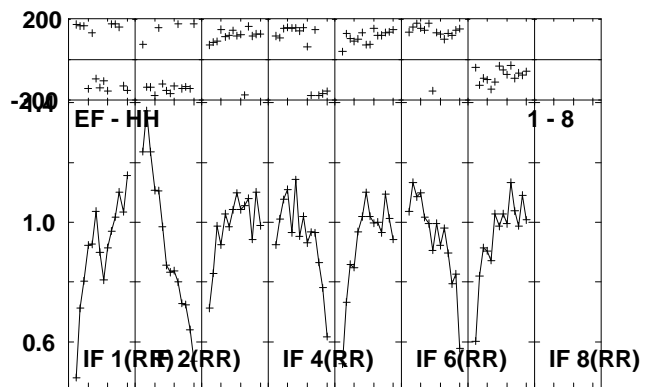
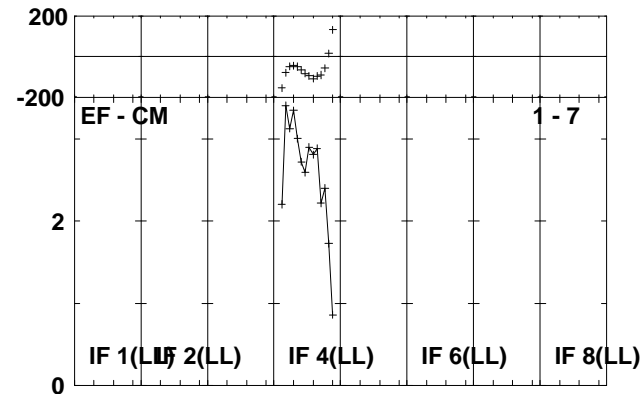
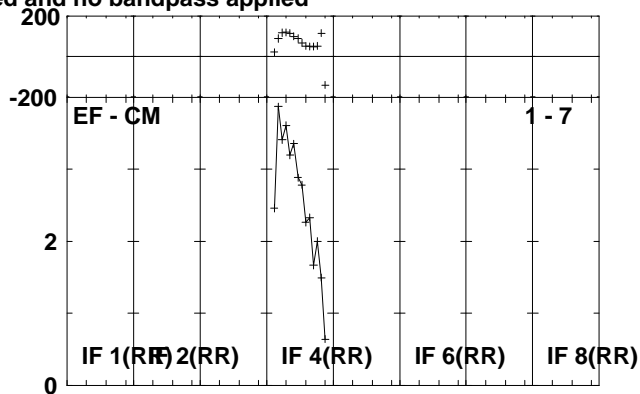
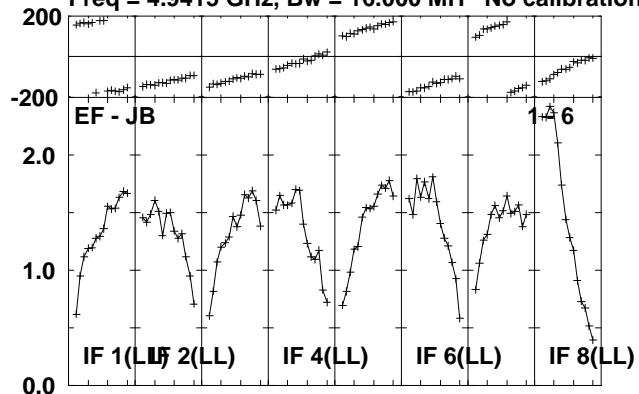

Lower frame: Milli Ampl Jy Top frame: Phas deg
Scalar averaged cross-power spectrum Several baselines displayed
Timerange: 00/18:41:41 to 00/18:43:59

Plot file version 17 created 06-OCT-2010 10:55:33

J1920-02 ET013A.UVDATA.1

Freq = 4.9415 GHz, Bw = 16.000 MH No calibration applied and no bandpass applied

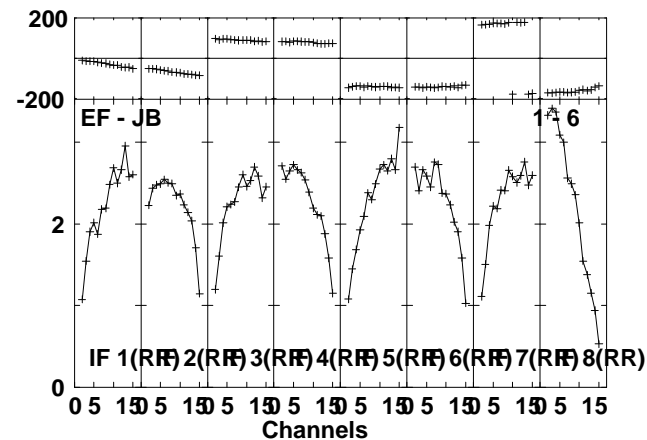
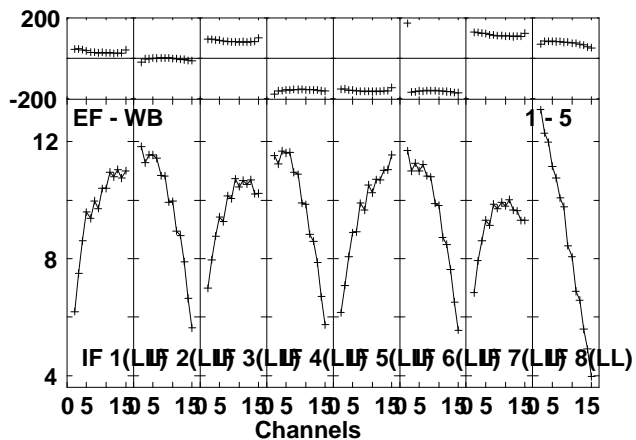
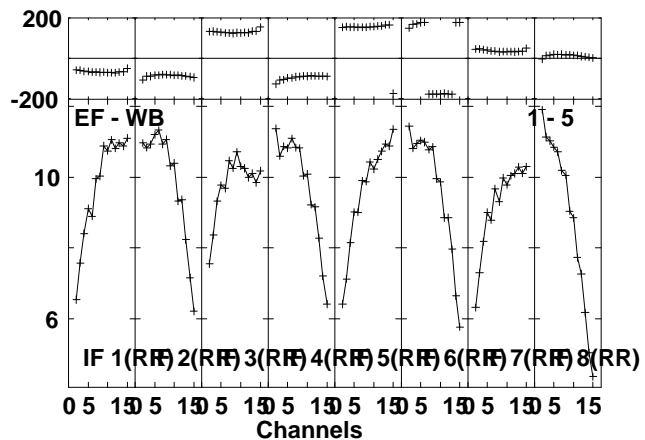
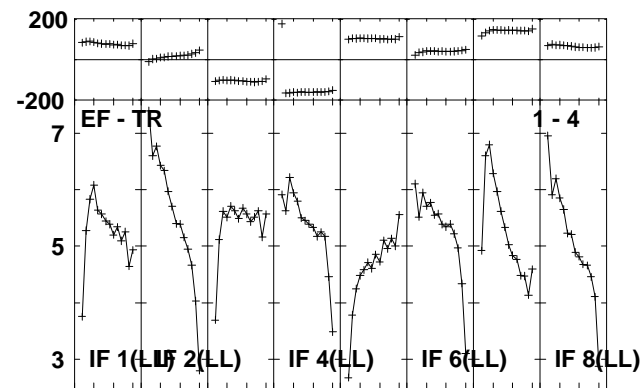
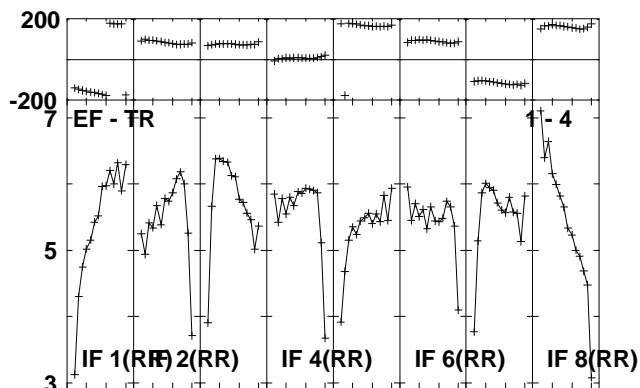
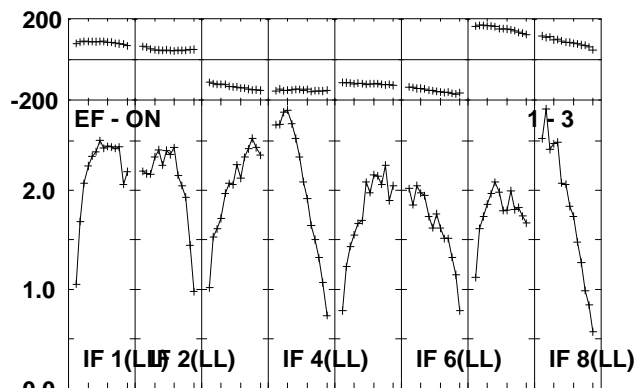
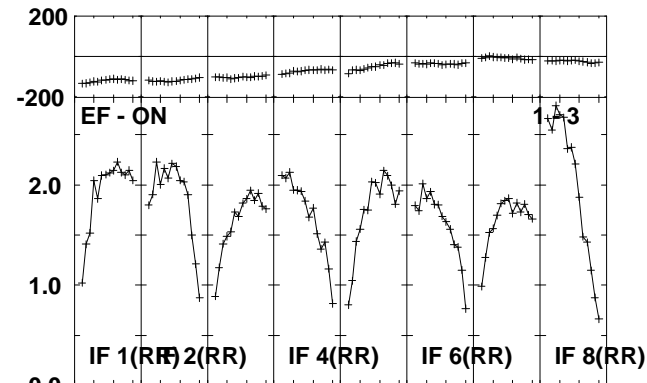
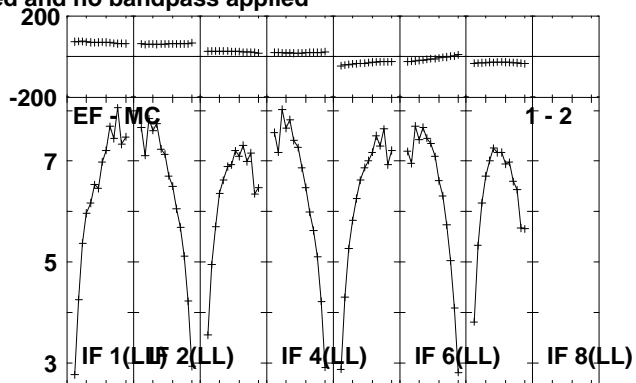
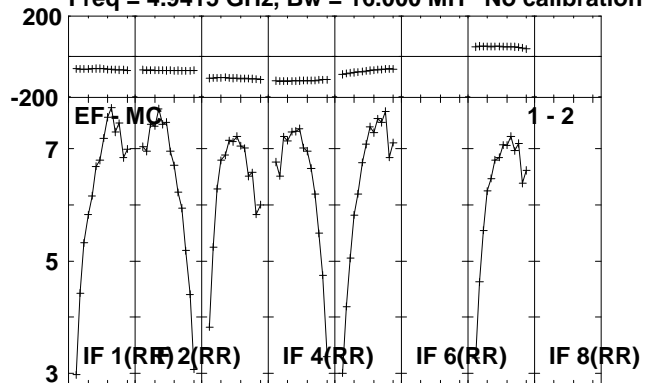

Lower frame: Milli Ampl Jy Top frame: Phas deg
Scalar averaged cross-power spectrum Several baselines displayed
Timerange: 00/18:44:01 to 00/18:48:59

Plot file version 18 created 06-OCT-2010 10:55:35

J1920-02 ET013A.UVDATA.1

Freq = 4.9415 GHz, Bw = 16.000 MH No calibration applied and no bandpass applied

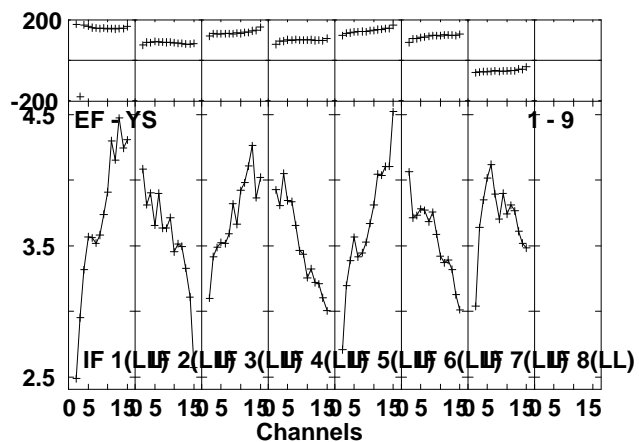
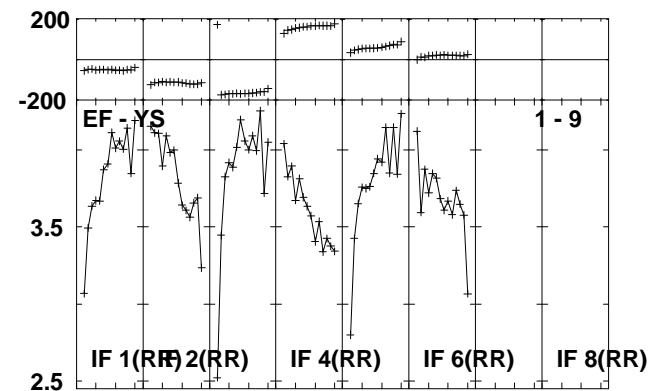
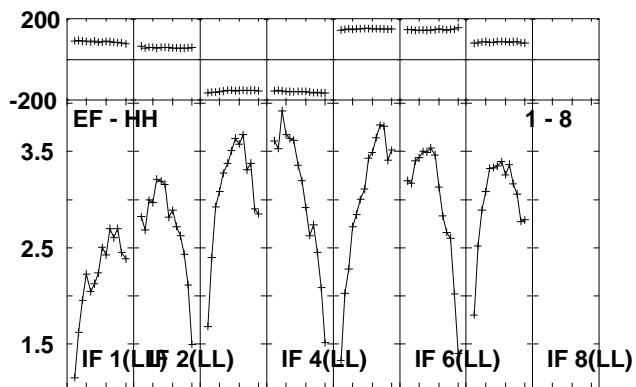
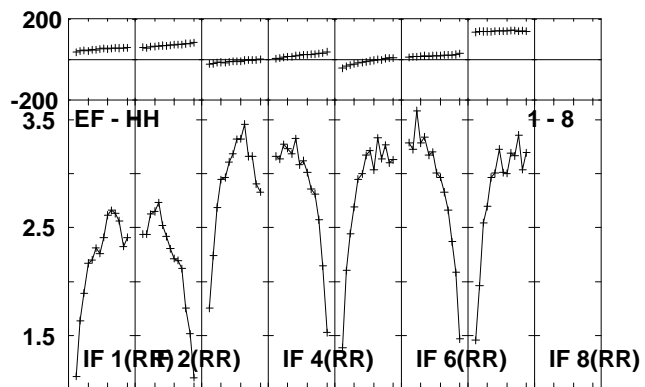
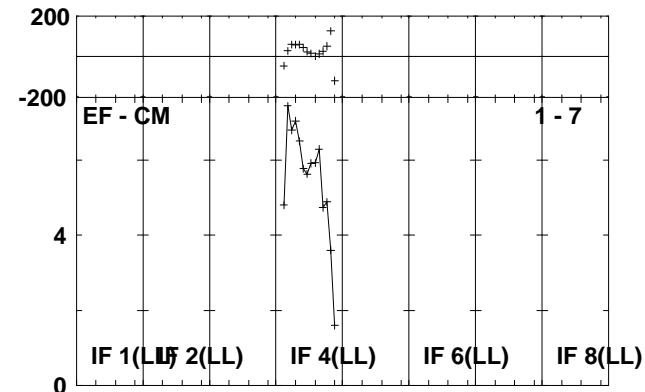
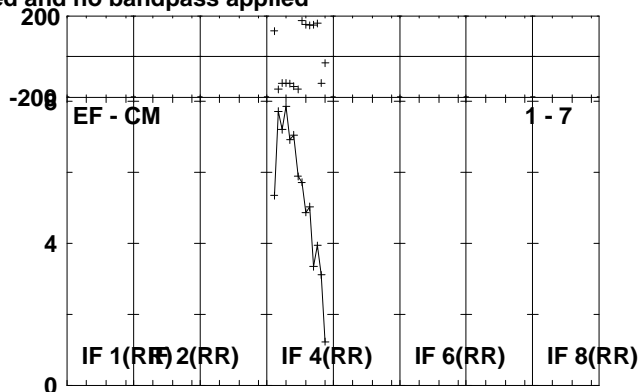
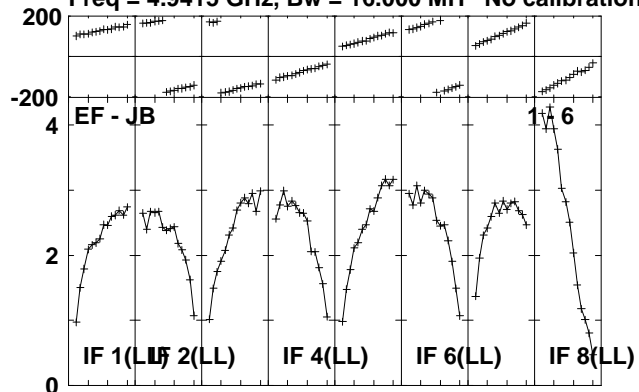

Lower frame: Milli Ampl Jy Top frame: Phas deg
Scalar averaged cross-power spectrum Several baselines displayed
Timerange: 00/18:44:01 to 00/18:48:59

Plot file version 19 created 06-OCT-2010 10:55:37

J1907+01 ET013A.UVDATA.1

Freq = 4.9415 GHz, Bw = 16.000 MH No calibration applied and no bandpass applied

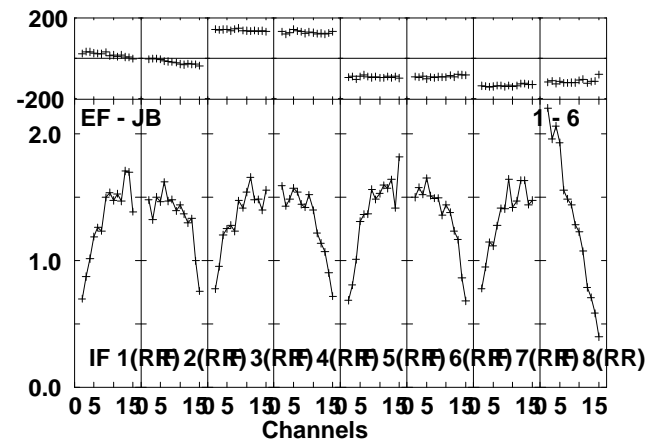
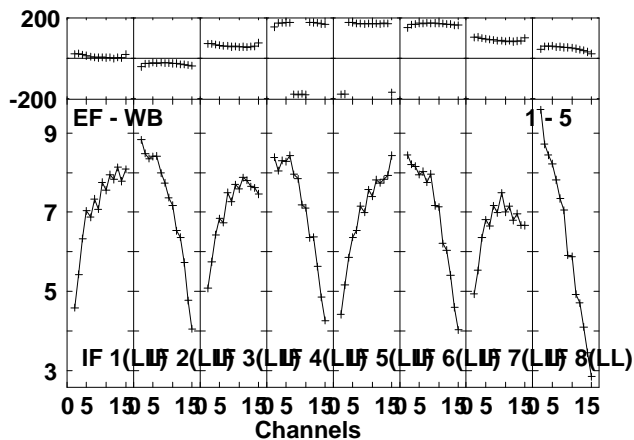
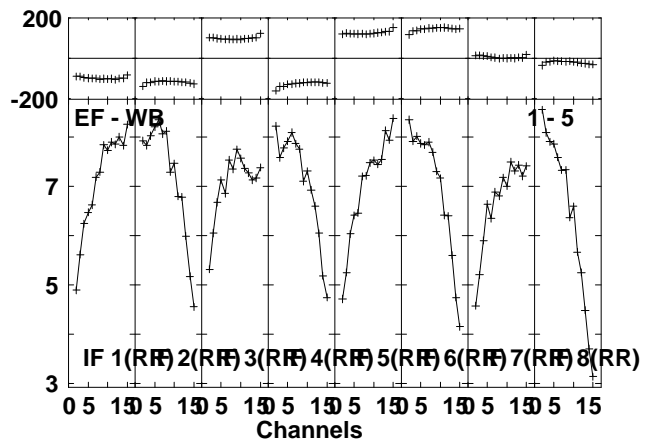
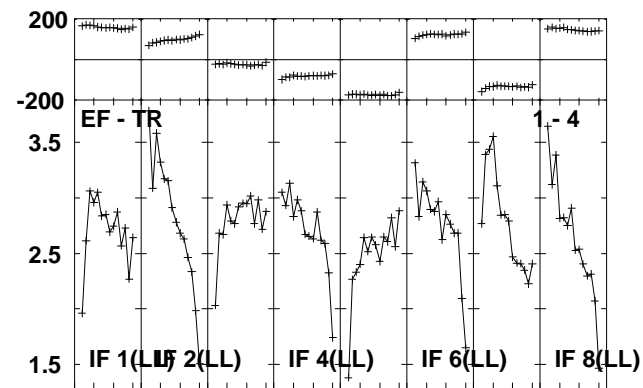
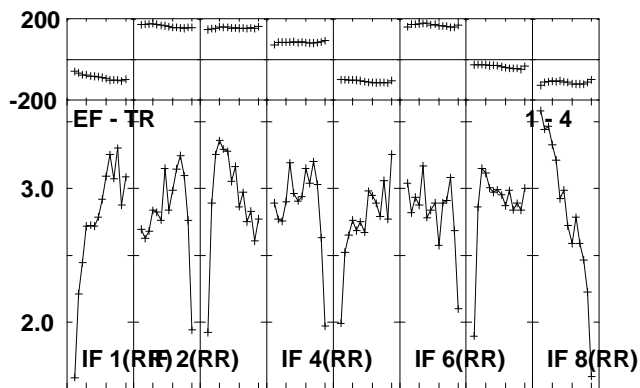
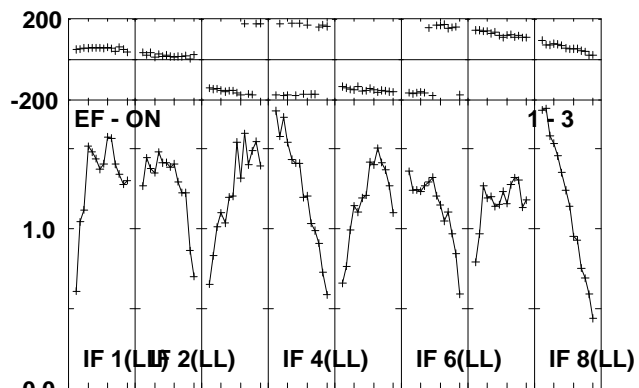
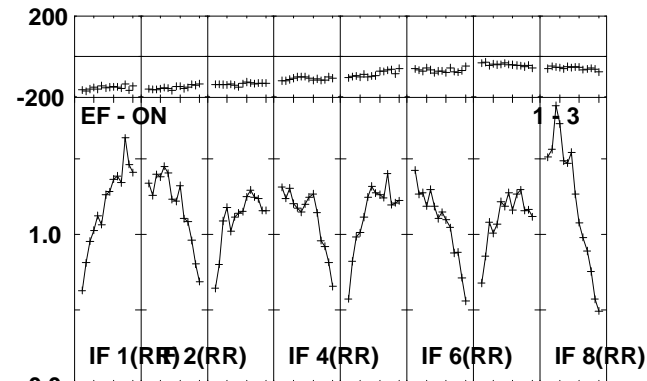
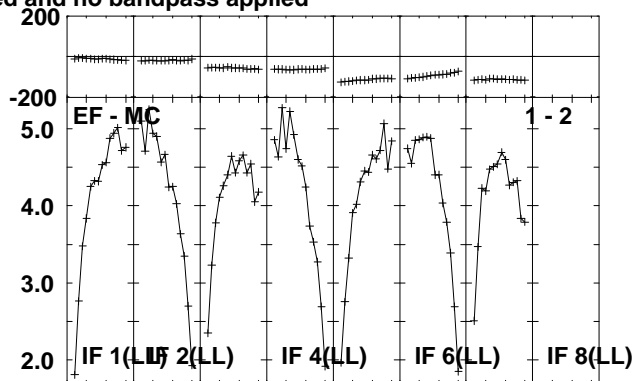
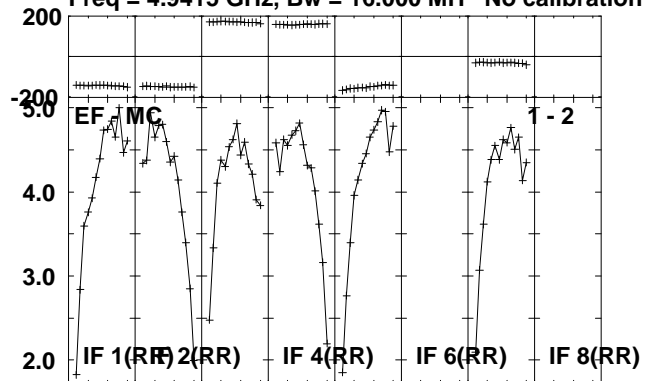

Lower frame: Milli Ampl Jy Top frame: Phas deg
Scalar averaged cross-power spectrum Several baselines displayed
Timerange: 00:18:50:01 to 00:18:52:19

Plot file version 20 created 06-OCT-2010 10:55:38

J1907+01 ET013A.UVDATA.1

Freq = 4.9415 GHz, Bw = 16.000 MH No calibration applied and no bandpass applied

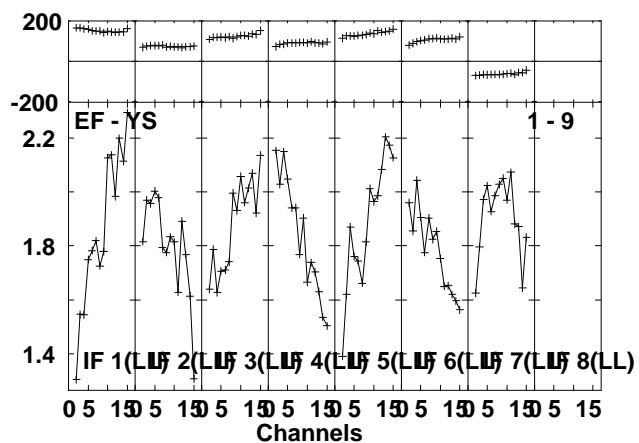
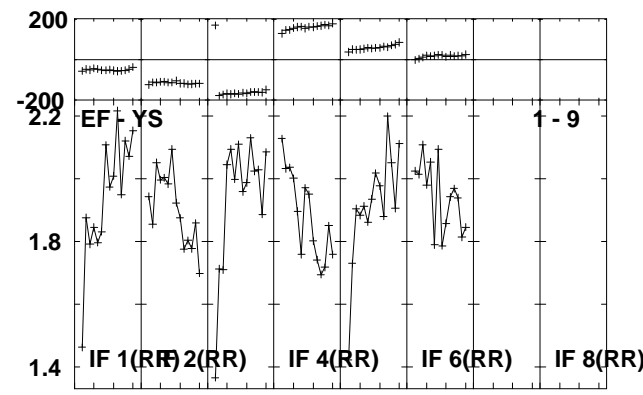
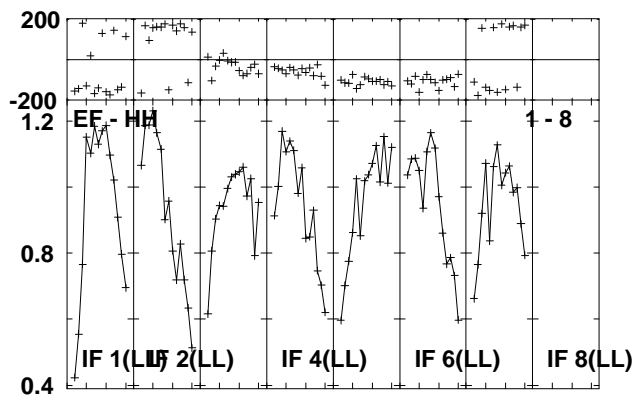
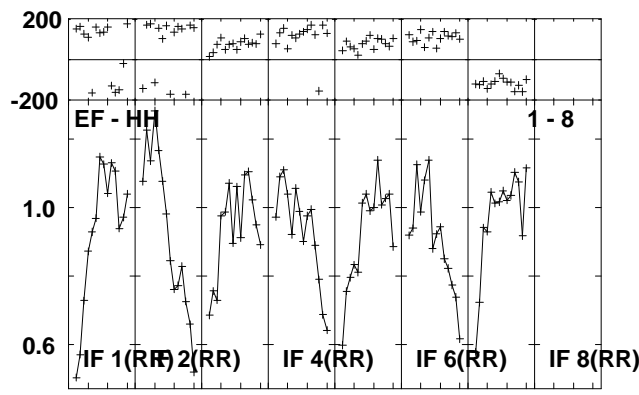
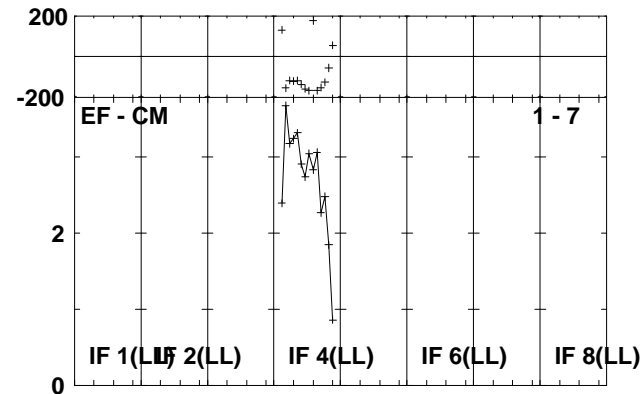
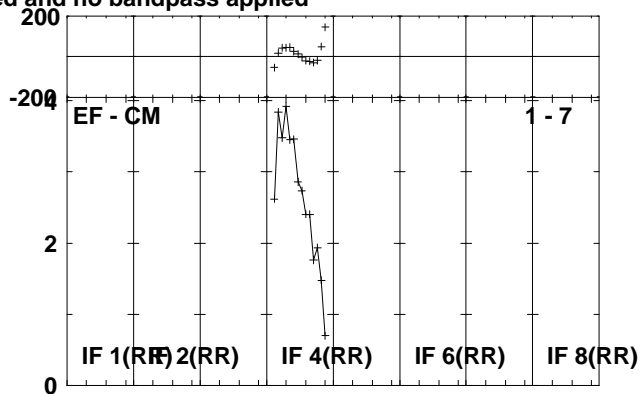
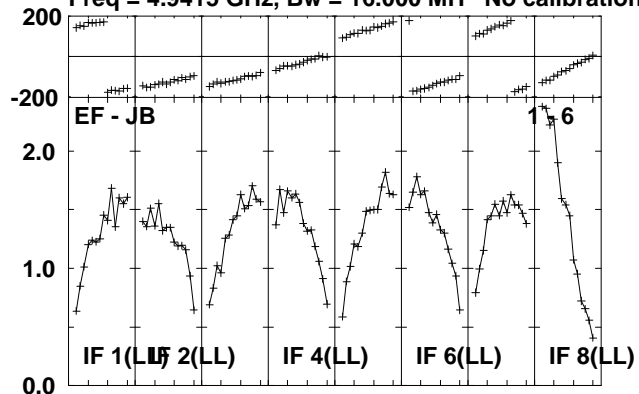

Lower frame: Milli Ampl Jy Top frame: Phas deg
Scalar averaged cross-power spectrum Several baselines displayed
Timerange: 00/18:50:01 to 00/18:52:19

Plot file version 21 created 06-OCT-2010 10:55:39

AQLX-1 ET013A.UVDATA.1

Freq = 4.9415 GHz, Bw = 16.000 MH No calibration applied and no bandpass applied

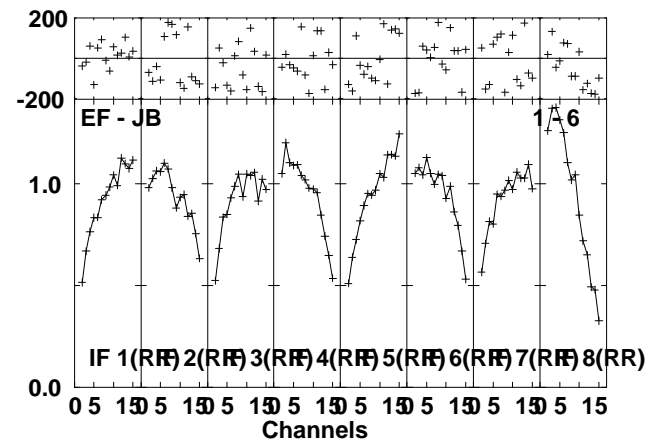
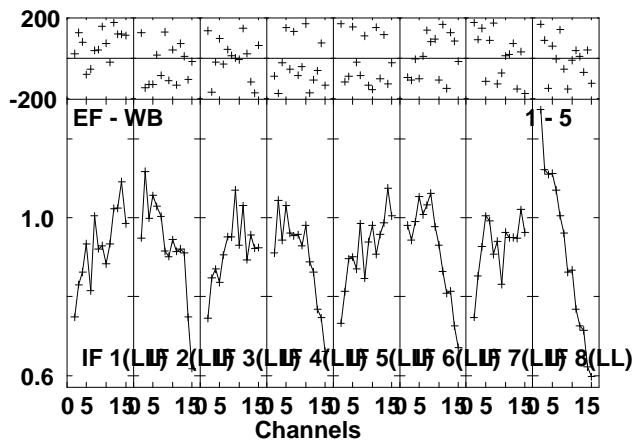
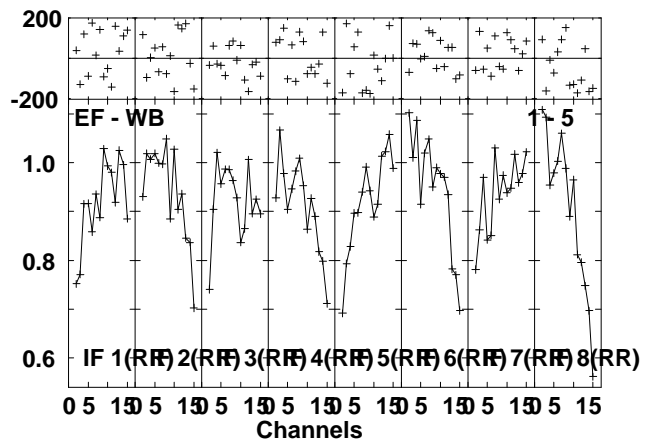
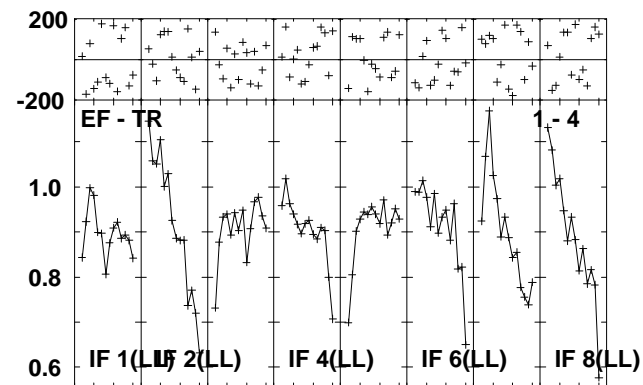
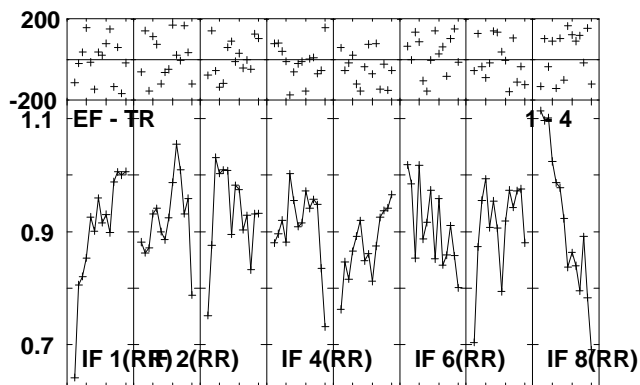
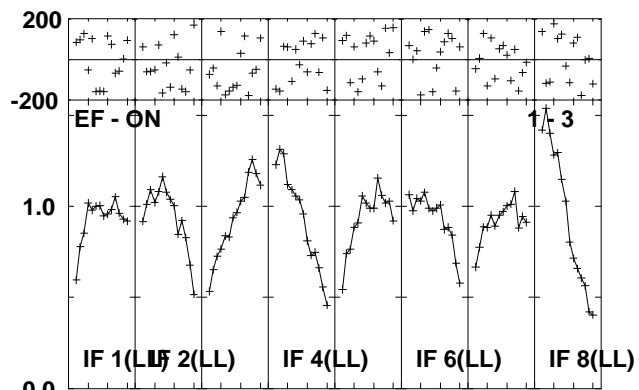
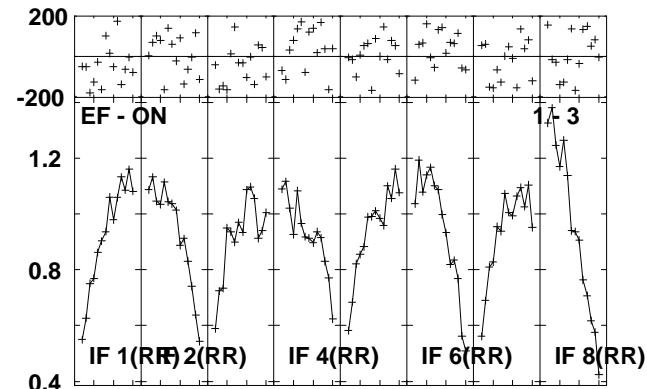
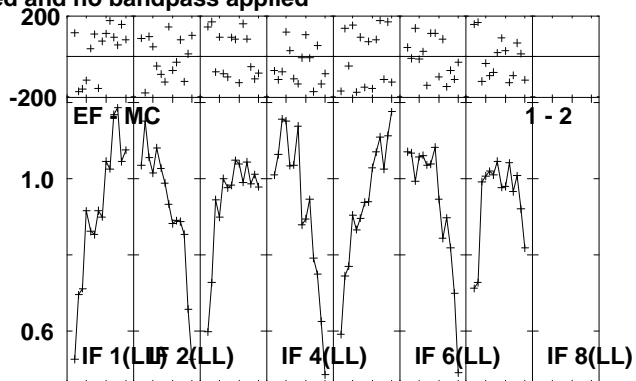
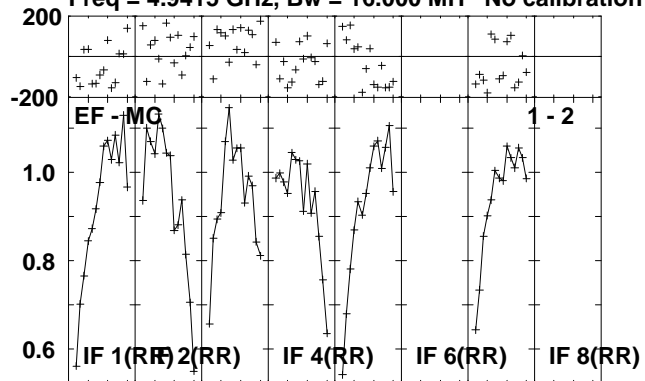

Lower frame: Milli Ampl Jy Top frame: Phas deg
Scalar averaged cross-power spectrum Several baselines displayed
Timerange: 00/18:52:21 to 00/18:57:19

Plot file version 22 created 06-OCT-2010 10:55:42

AQLX-1 ET013A.UVDATA.1

Freq = 4.9415 GHz, Bw = 16.000 MH No calibration applied and no bandpass applied

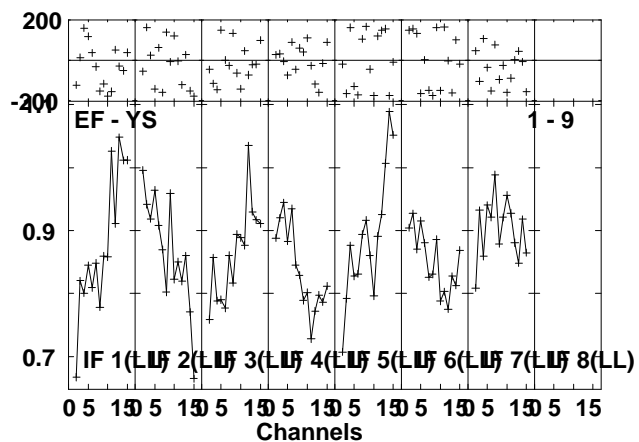
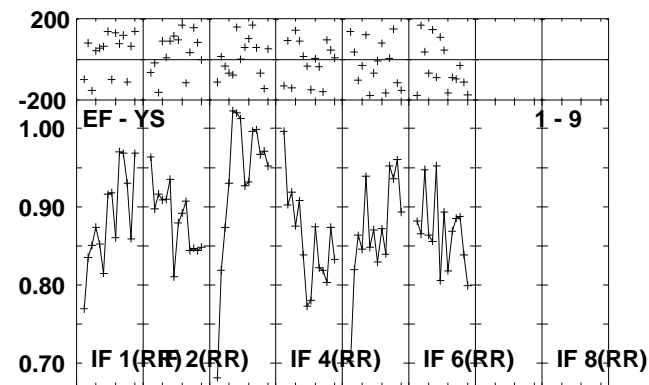
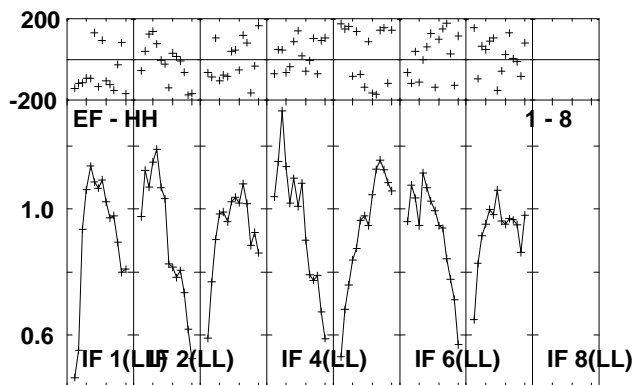
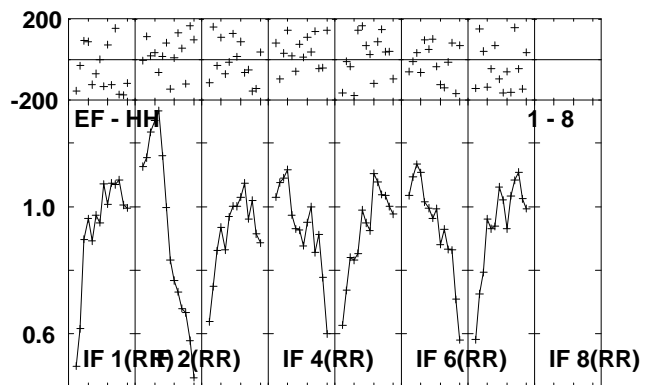
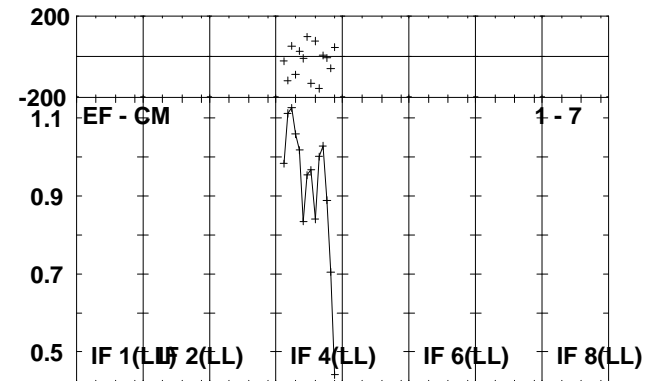
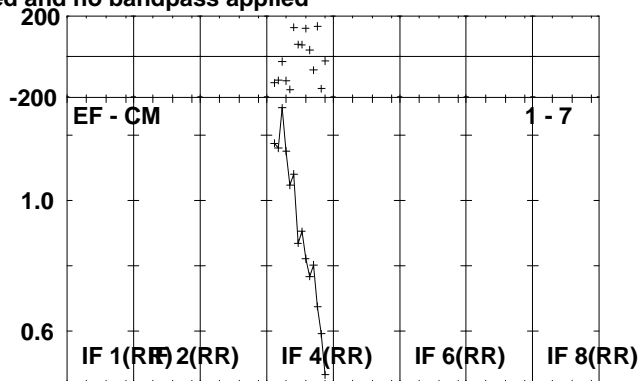
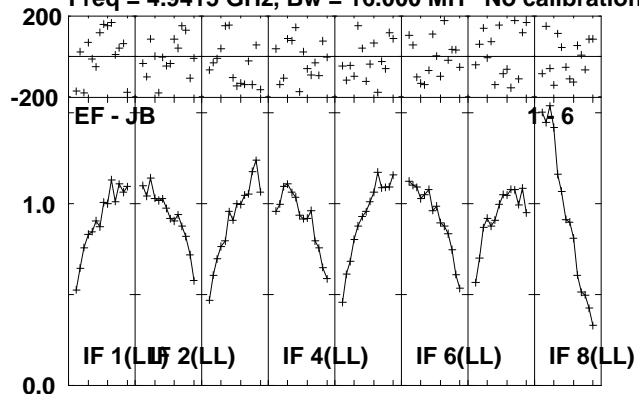

Lower frame: Milli Ampl Jy Top frame: Phas deg
Scalar averaged cross-power spectrum Several baselines displayed
Timerange: 00:18:52:21 to 00:18:57:19

Plot file version 23 created 06-OCT-2010 10:55:43

J1907+01 ET013A.UVDATA.1

Freq = 4.9415 GHz, Bw = 16.000 MH No calibration applied and no bandpass applied

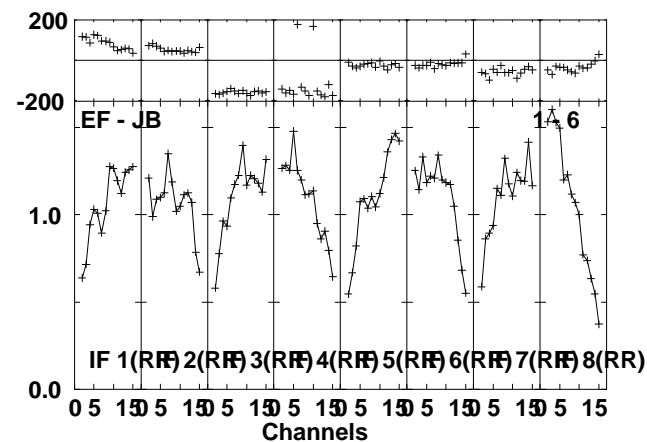
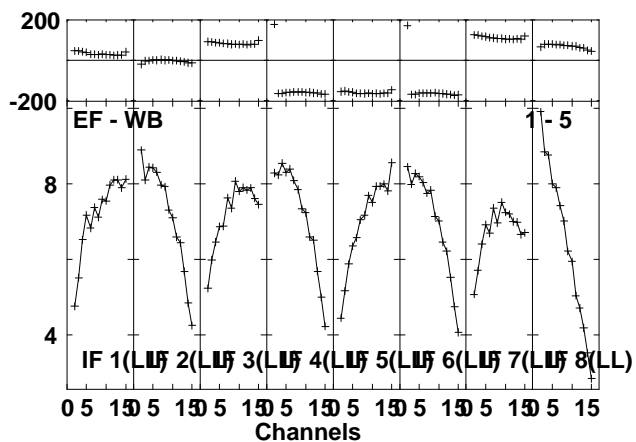
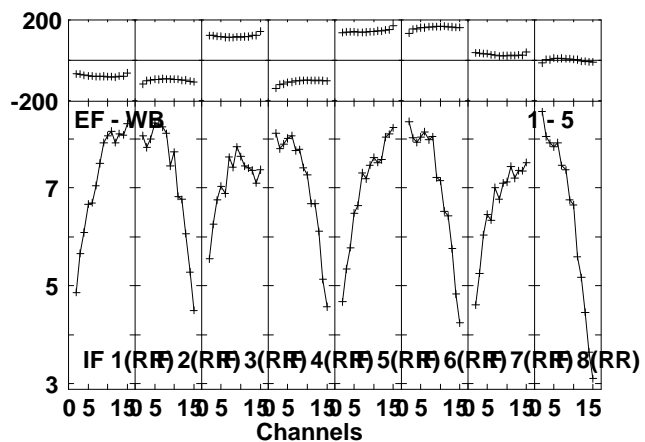
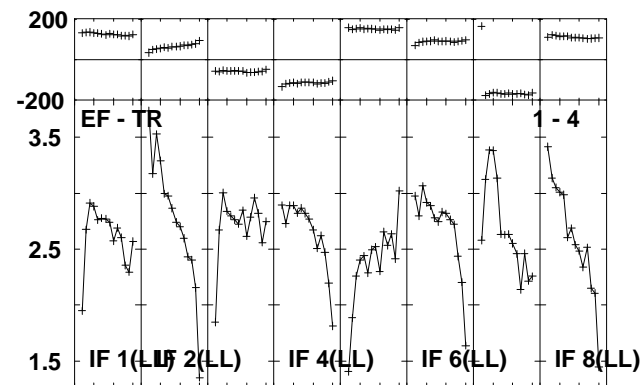
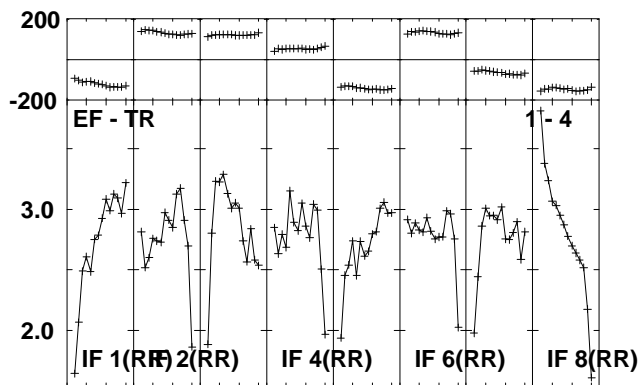
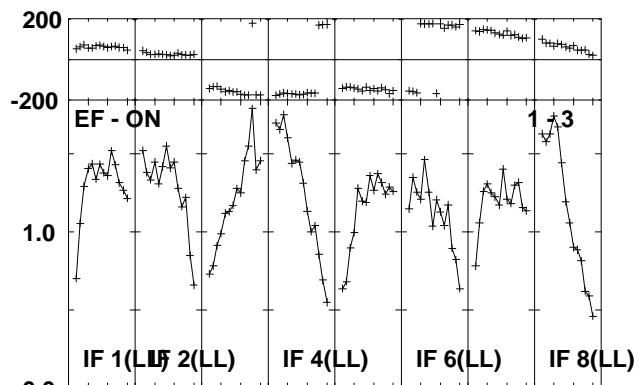
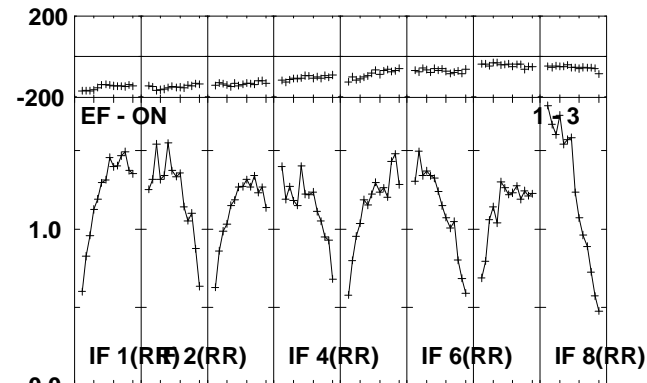
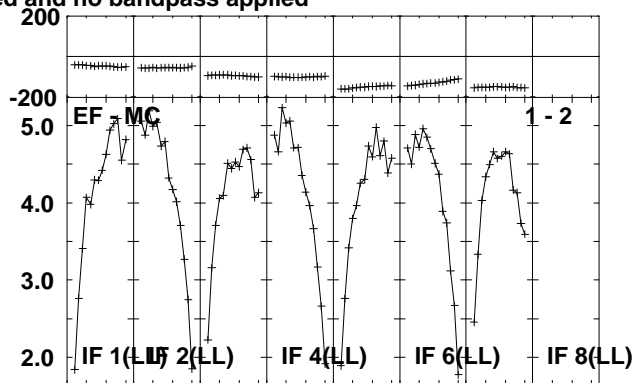
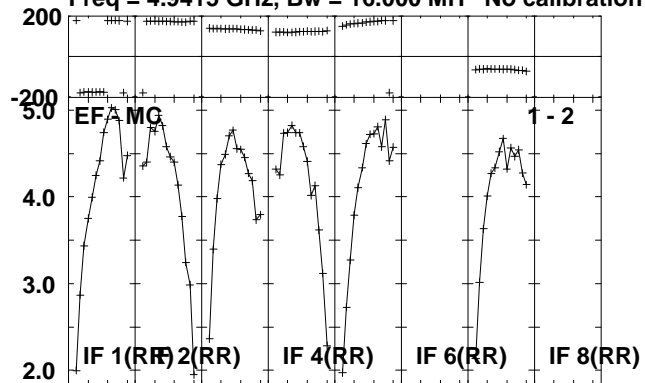

Lower frame: Milli Ampl Jy Top frame: Phas deg
Scalar averaged cross-power spectrum Several baselines displayed
Timerange: 00/18:58:01 to 00/19:00:19

Plot file version 24 created 06-OCT-2010 10:55:44

J1907+01 ET013A.UVDATA.1

Freq = 4.9415 GHz, Bw = 16.000 MH No calibration applied and no bandpass applied

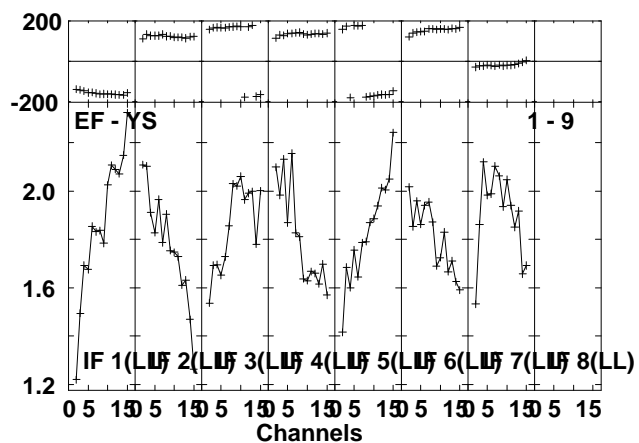
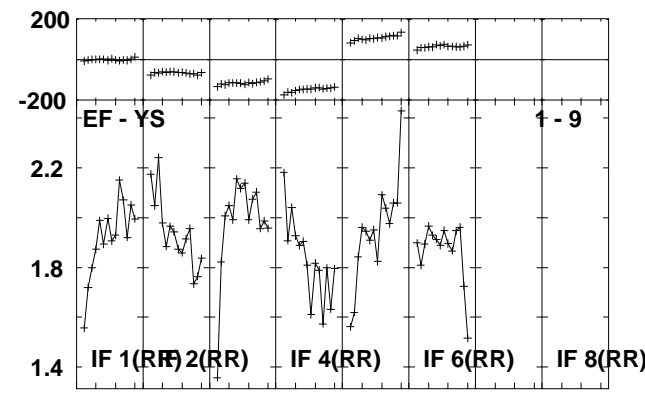
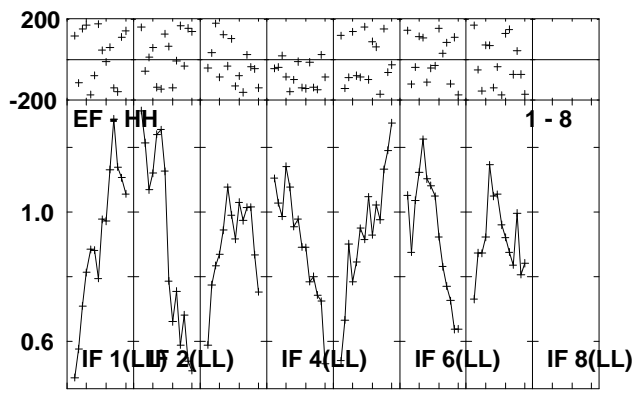
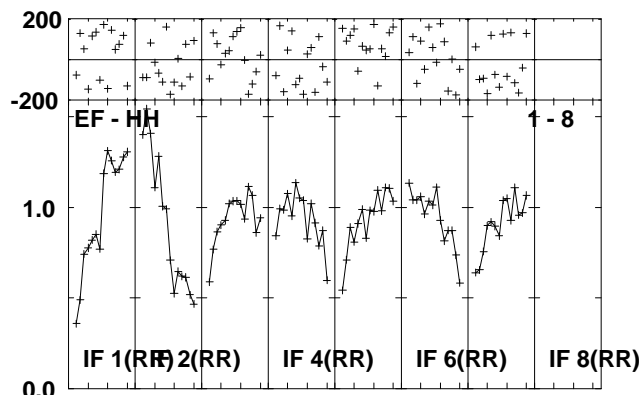
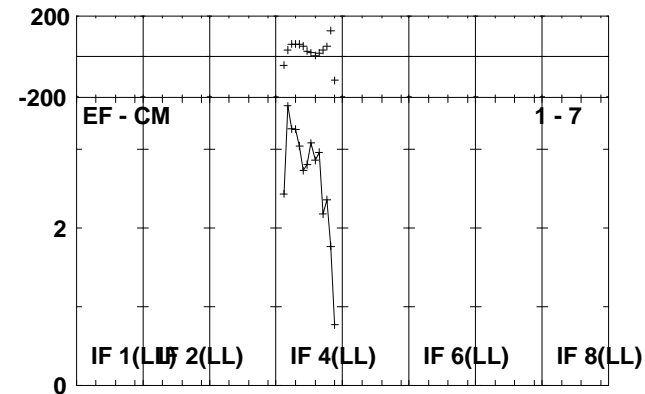
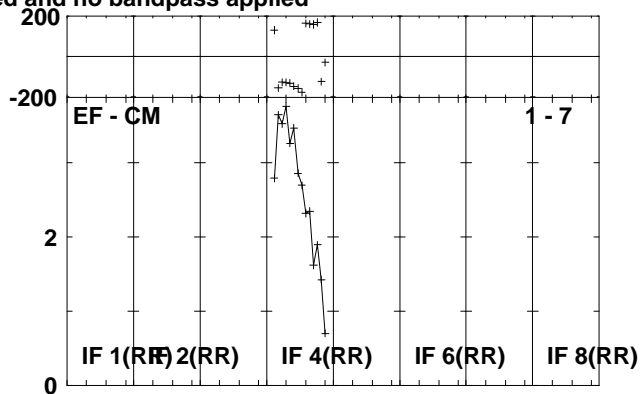
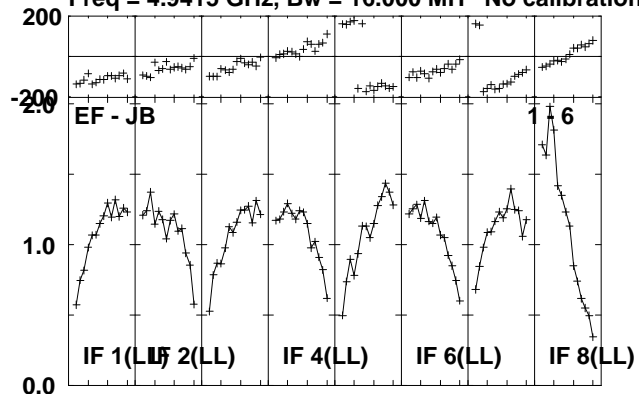

Lower frame: Milli Ampl Jy Top frame: Phas deg
Scalar averaged cross-power spectrum Several baselines displayed
Timerange: 00/18:58:01 to 00/19:00:19

Plot file version 25 created 06-OCT-2010 10:55:45

AQLX-1 ET013A.UVDATA.1

Freq = 4.9415 GHz, Bw = 16.000 MH No calibration applied and no bandpass applied

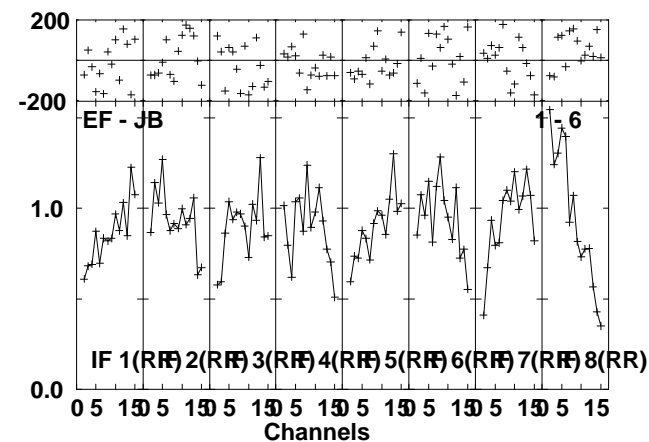
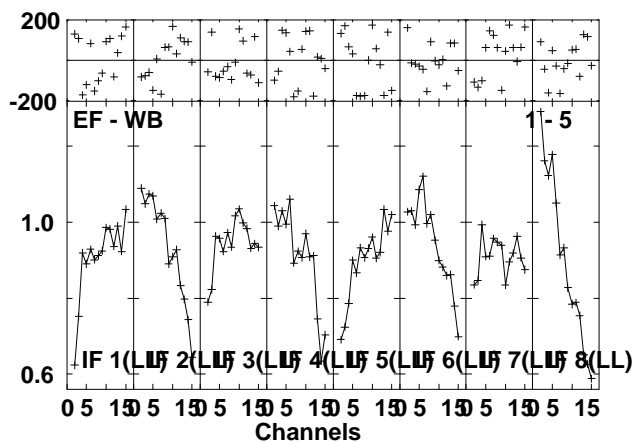
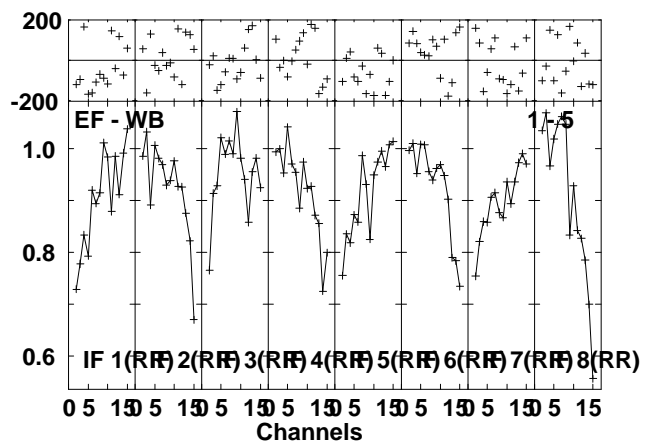
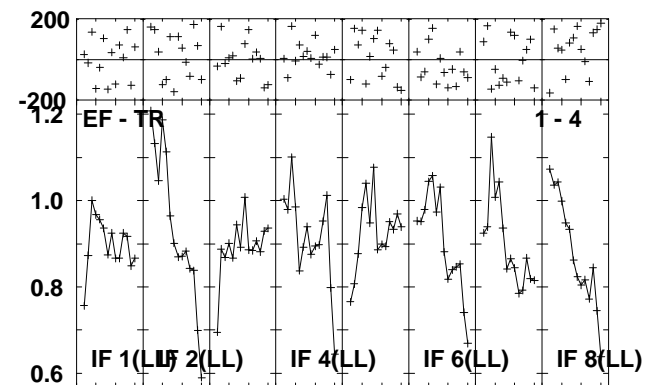
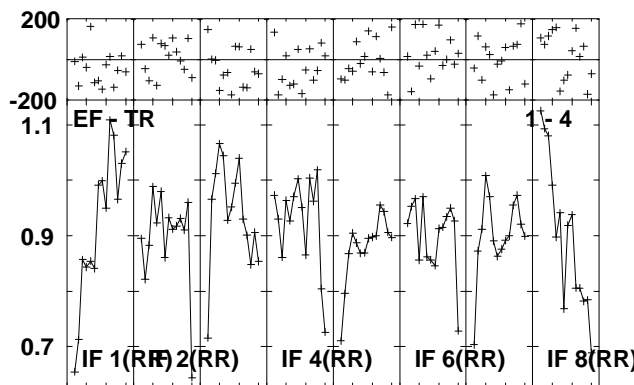
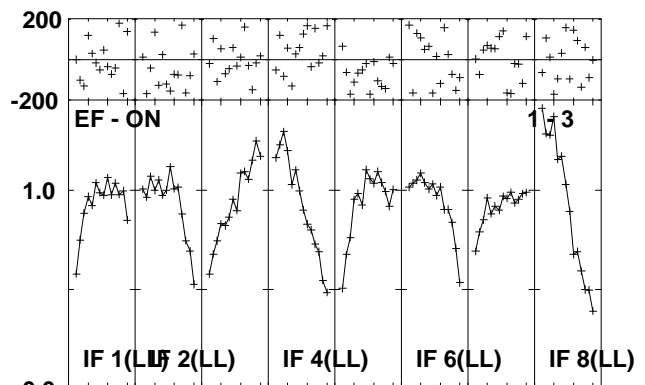
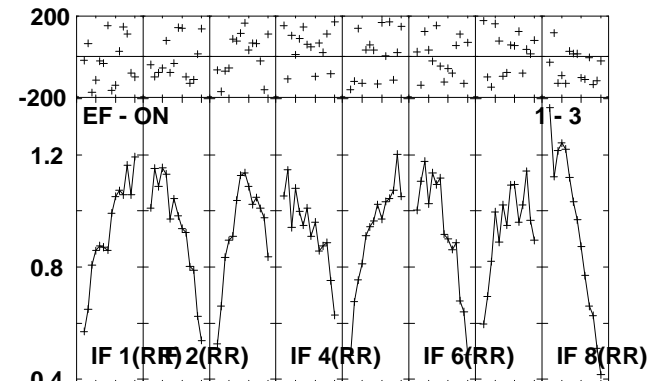
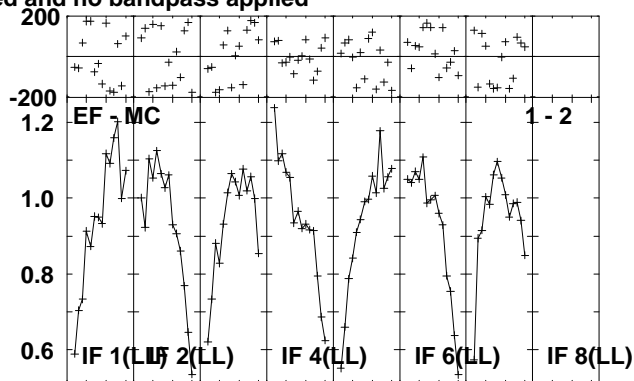
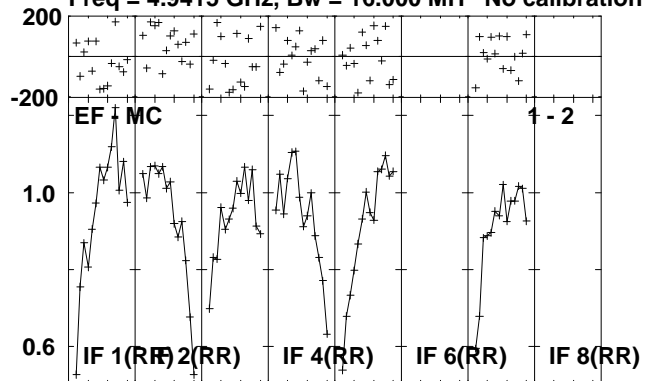

Lower frame: Milli Ampl Jy Top frame: Phas deg
Scalar averaged cross-power spectrum Several baselines displayed
Timerange: 00/19:00:21 to 00/19:05:19

Plot file version 26 created 06-OCT-2010 10:55:47

AQLX-1 ET013A.UVDATA.1

Freq = 4.9415 GHz, Bw = 16.000 MH No calibration applied and no bandpass applied

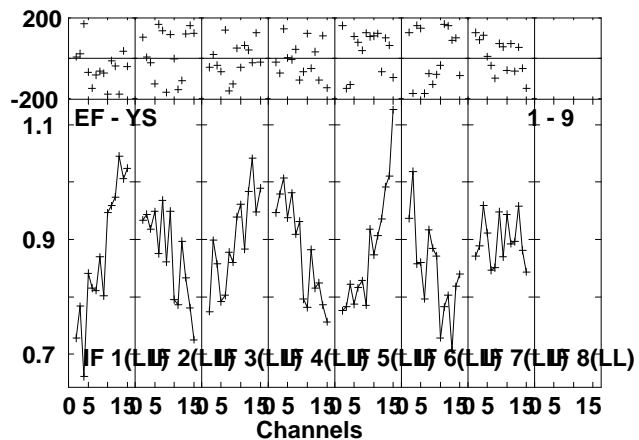
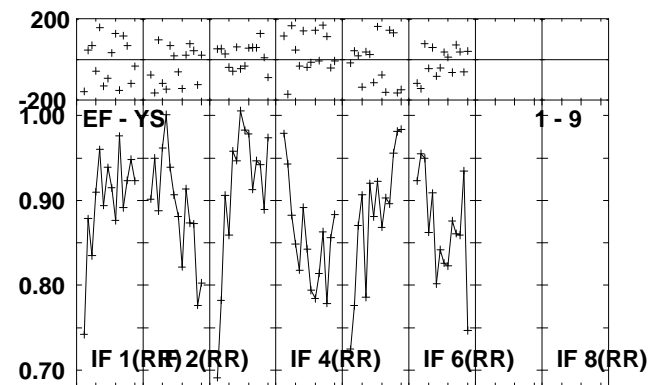
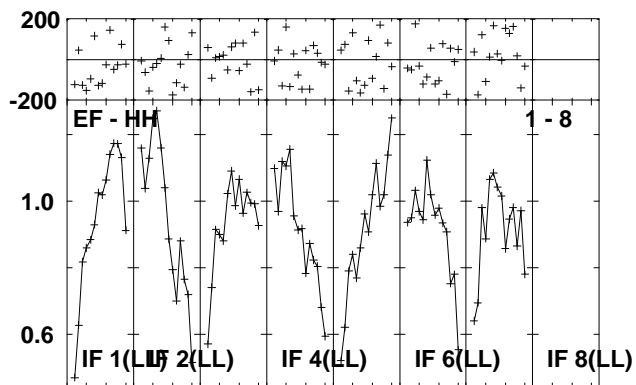
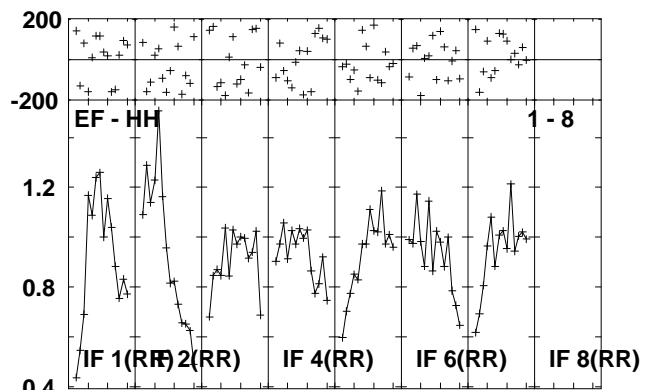
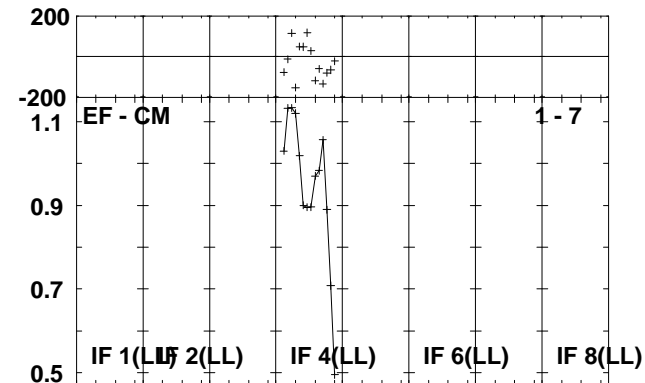
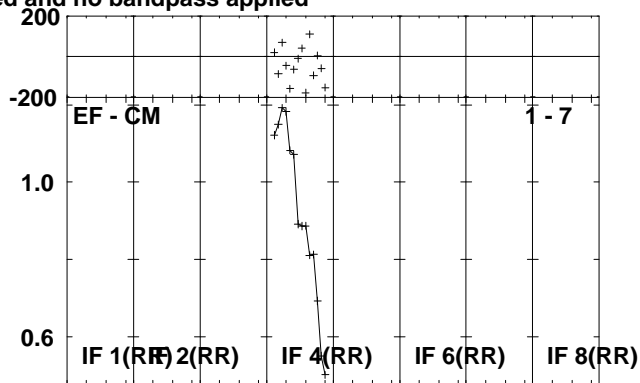
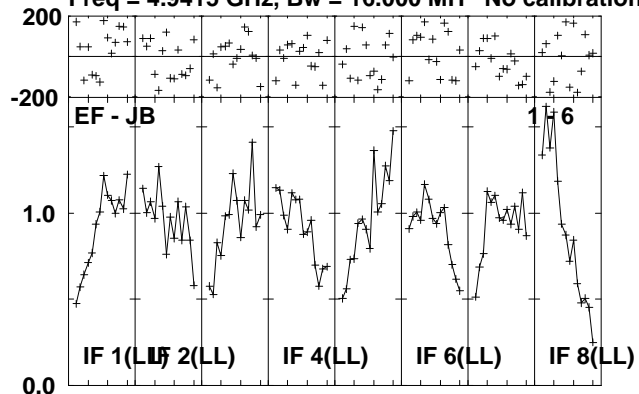

Lower frame: Milli Ampl Jy Top frame: Phas deg
Scalar averaged cross-power spectrum Several baselines displayed
Timerange: 00/19:00:21 to 00/19:05:19

Plot file version 27 created 06-OCT-2010 10:55:48

J1907+01 ET013A.UVDATA.1

Freq = 4.9415 GHz, Bw = 16.000 MH No calibration applied and no bandpass applied

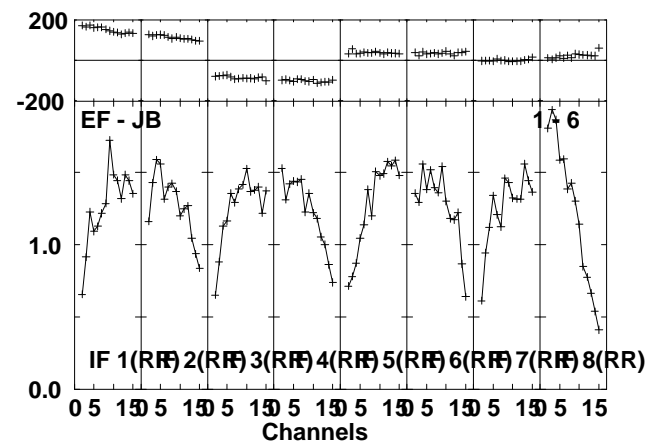
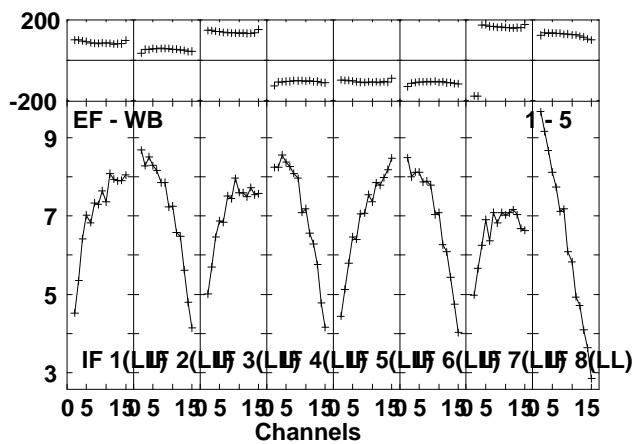
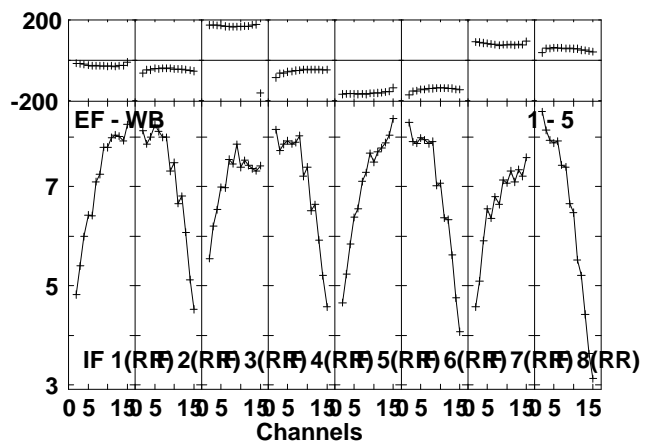
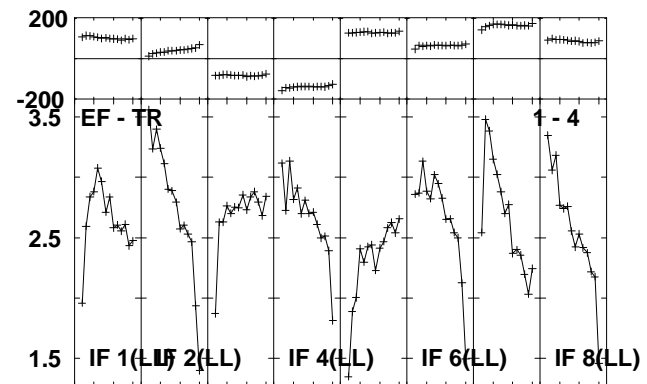
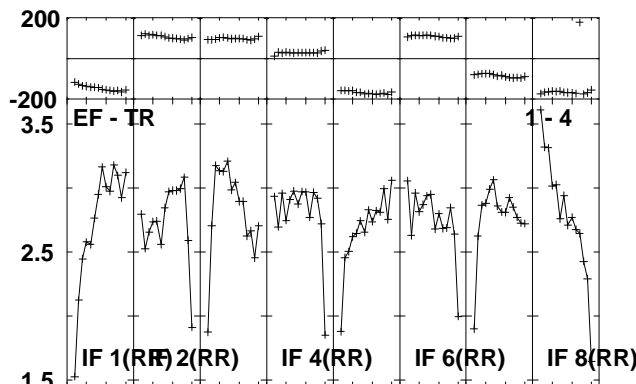
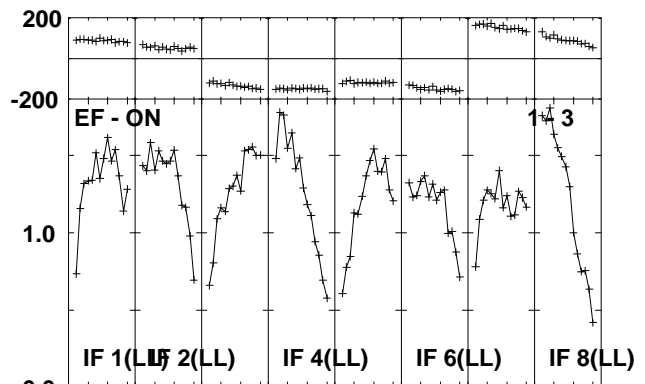
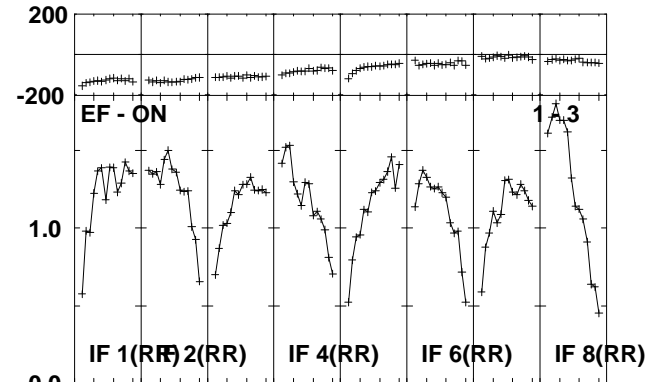
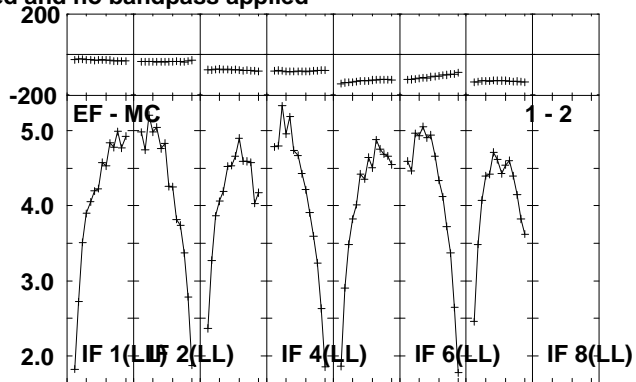
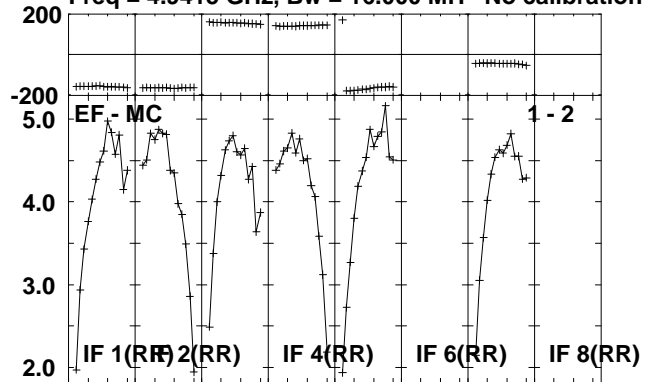

Lower frame: Milli Ampl Jy Top frame: Phas deg
 Scalar averaged cross-power spectrum Several baselines displayed
 Timerange: 00/19:06:01 to 00/19:08:19

Plot file version 28 created 06-OCT-2010 10:55:49

J1907+01 ET013A.UVDATA.1

Freq = 4.9415 GHz, Bw = 16.000 MH No calibration applied and no bandpass applied

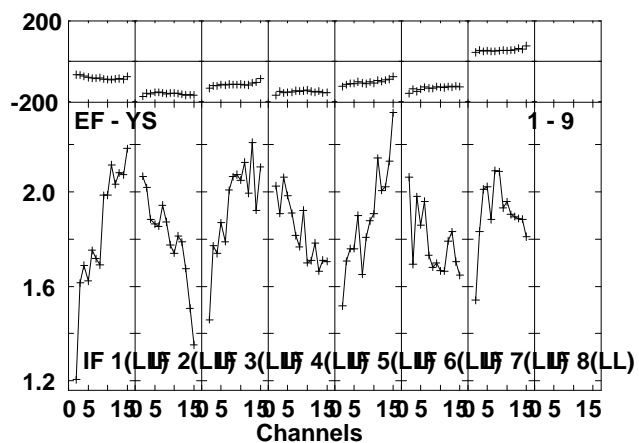
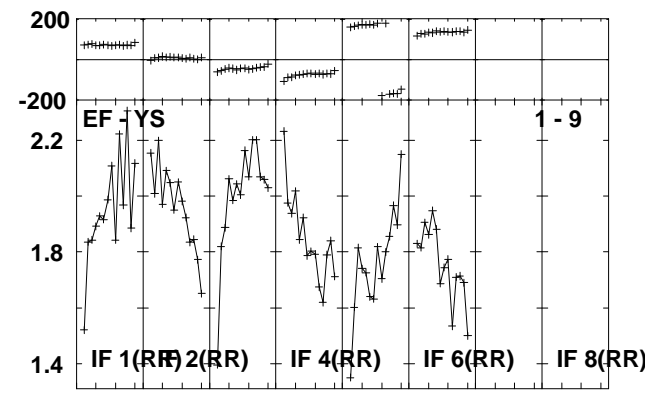
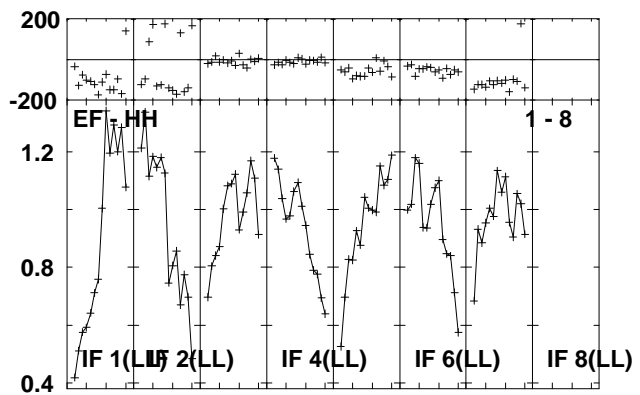
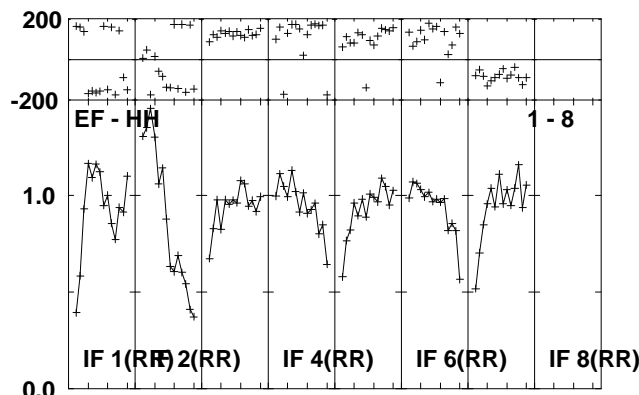
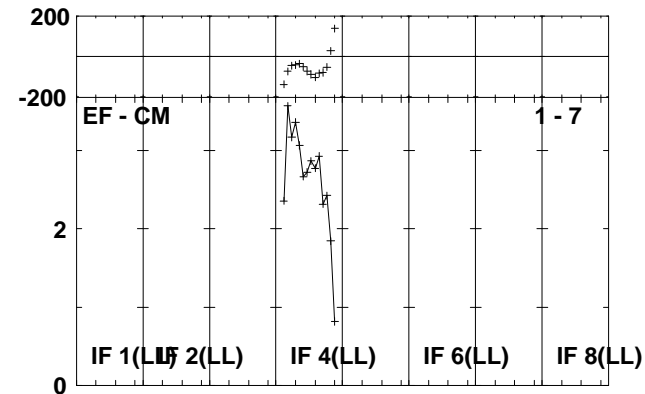
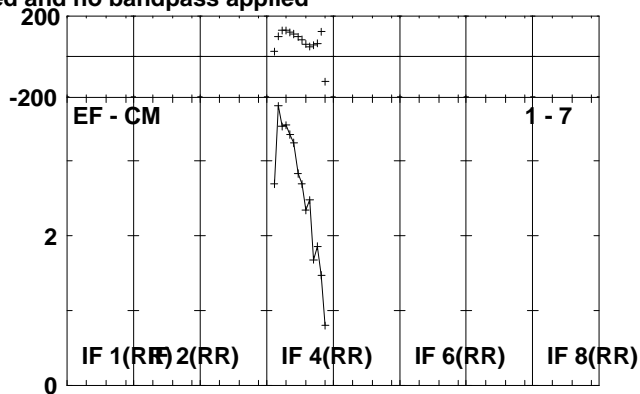
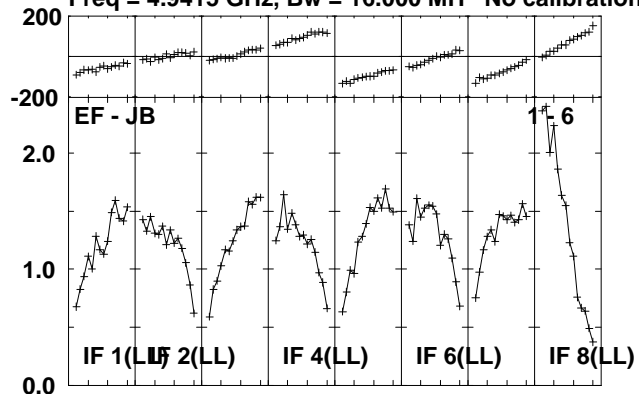

Lower frame: Milli Ampl Jy Top frame: Phas deg
Scalar averaged cross-power spectrum Several baselines displayed
Timerange: 00/19:06:01 to 00/19:08:19

Plot file version 29 created 06-OCT-2010 10:55:51

AQLX-1 ET013A.UVDATA.1

Freq = 4.9415 GHz, Bw = 16.000 MH No calibration applied and no bandpass applied

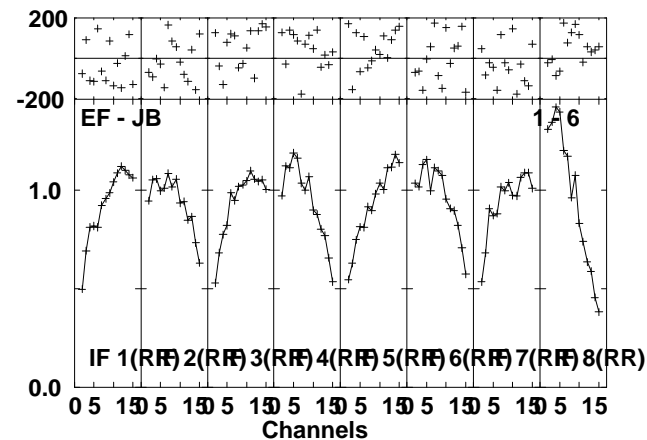
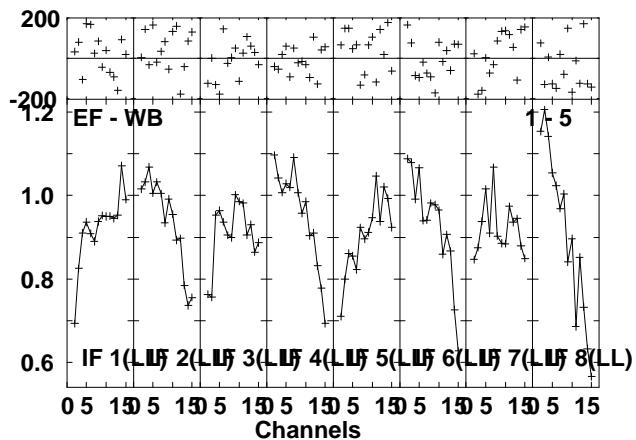
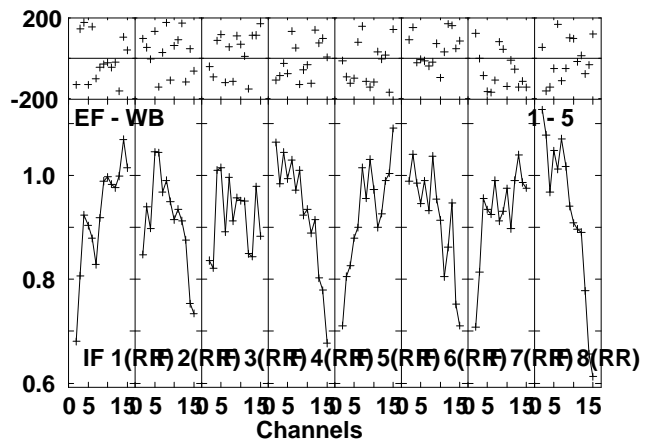
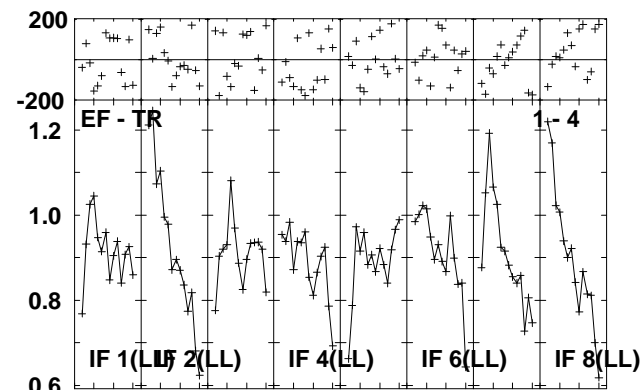
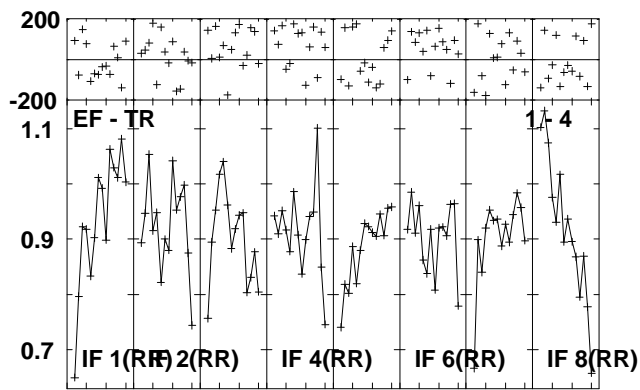
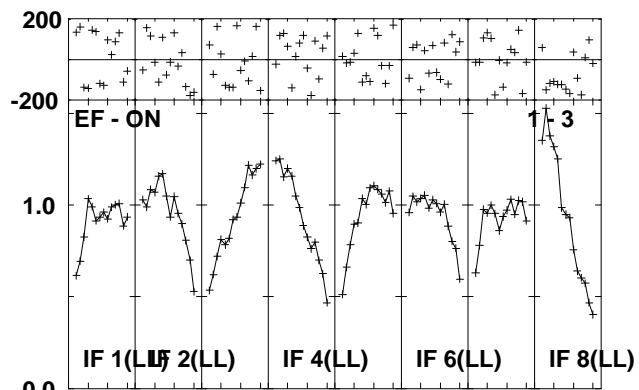
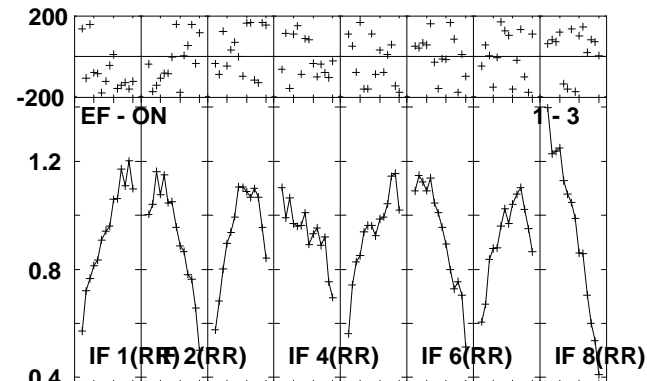
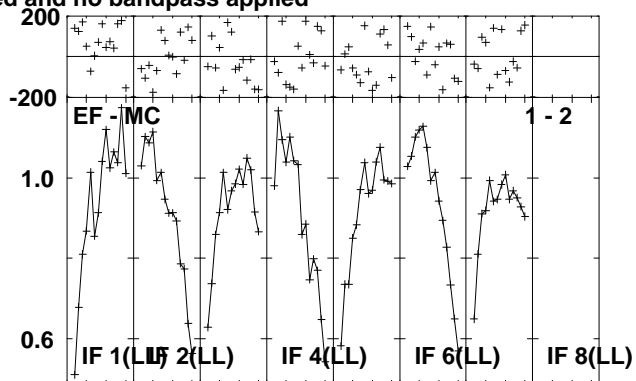
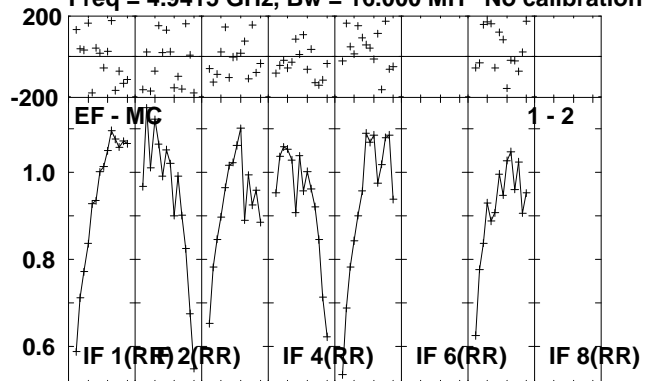

Lower frame: Milli Ampl Jy Top frame: Phas deg
Scalar averaged cross-power spectrum Several baselines displayed
Timerange: 00/19:08:21 to 00/19:13:19

Plot file version 30 created 06-OCT-2010 10:55:53

AQLX-1 ET013A.UVDATA.1

Freq = 4.9415 GHz, Bw = 16.000 MH No calibration applied and no bandpass applied

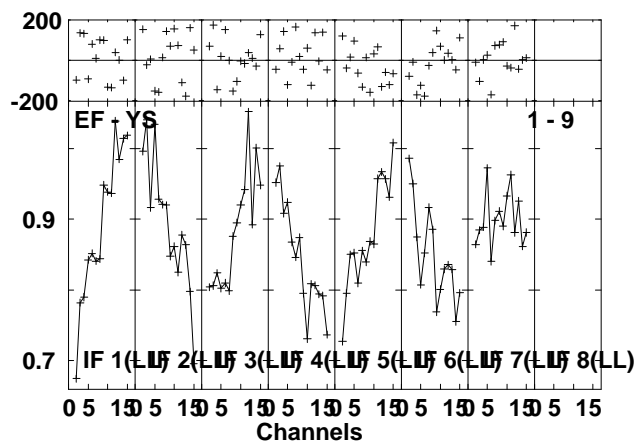
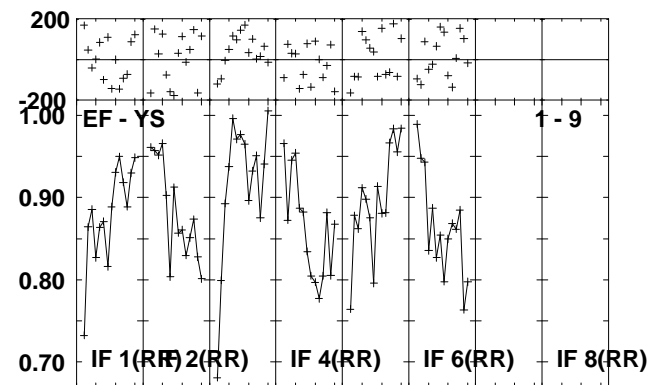
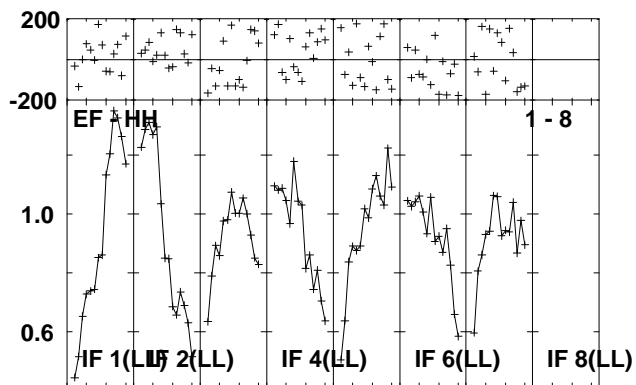
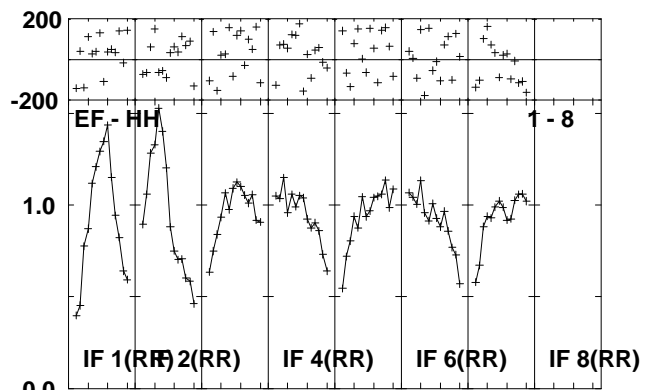
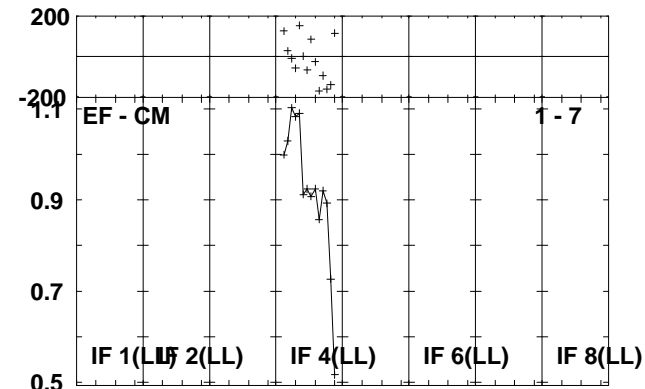
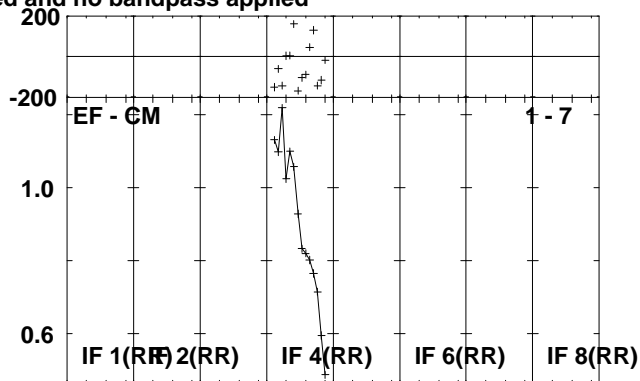
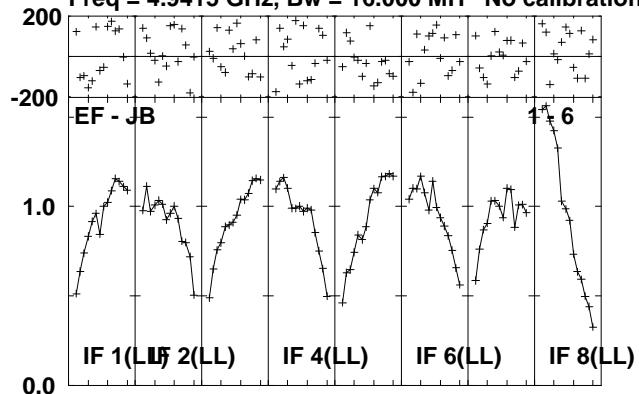

Lower frame: Milli Ampl Jy Top frame: Phas deg
Scalar averaged cross-power spectrum Several baselines displayed
Timerange: 00/19:08:21 to 00/19:13:19

Plot file version 31 created 06-OCT-2010 10:55:56

J1920-02 ET013A.UVDATA.1

Freq = 4.9415 GHz, Bw = 16.000 MH No calibration applied and no bandpass applied

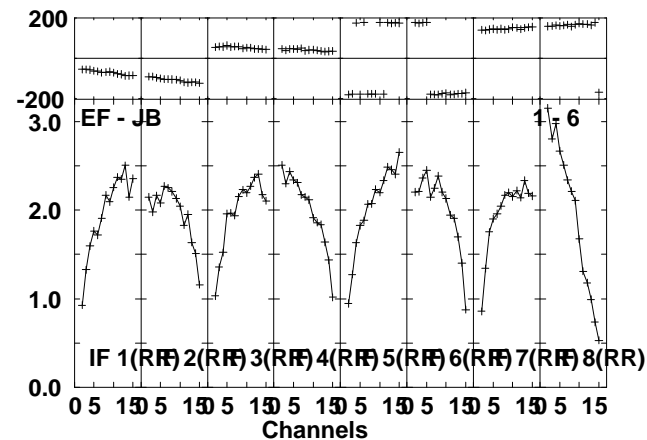
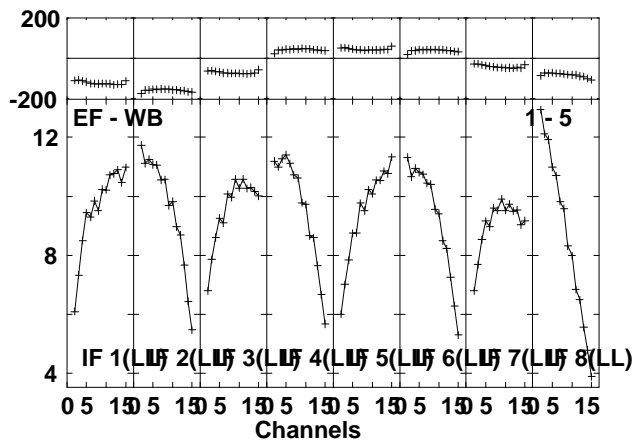
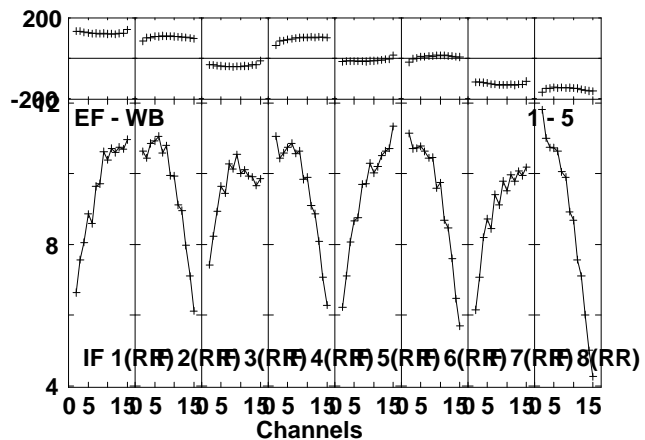
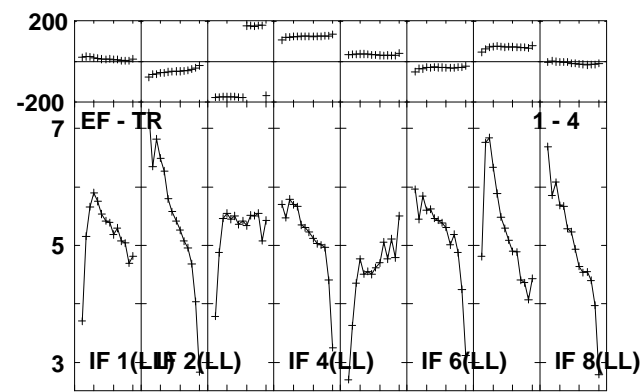
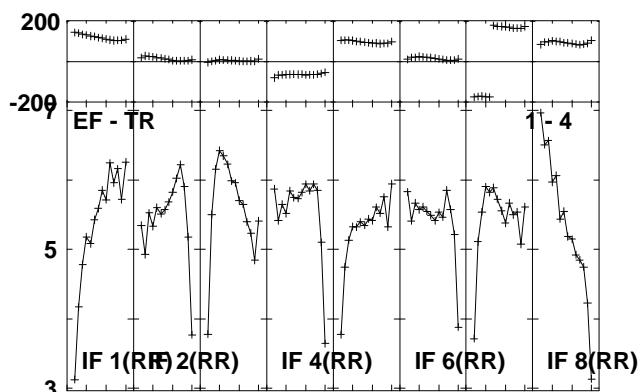
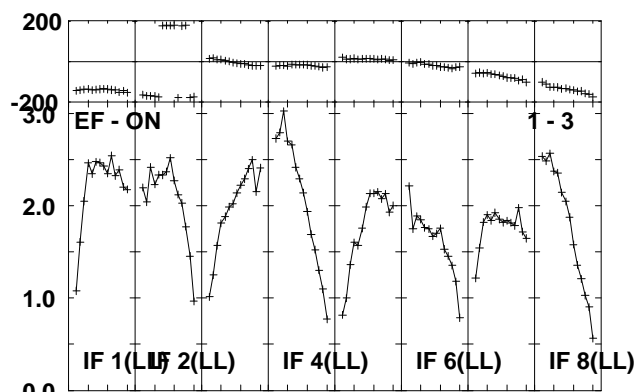
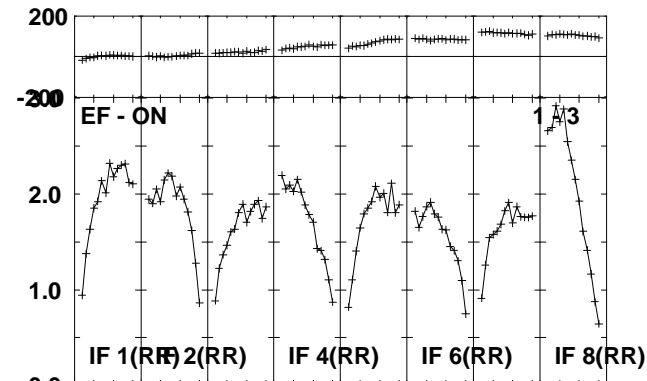
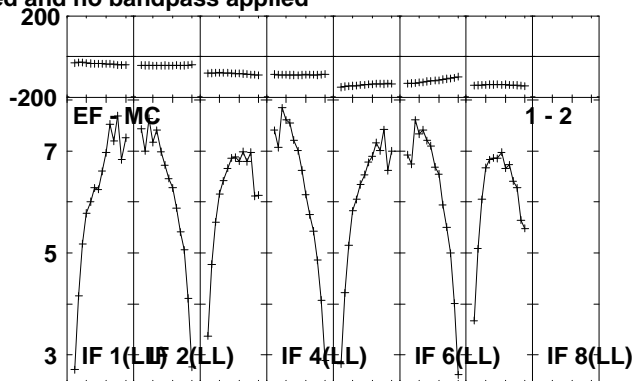
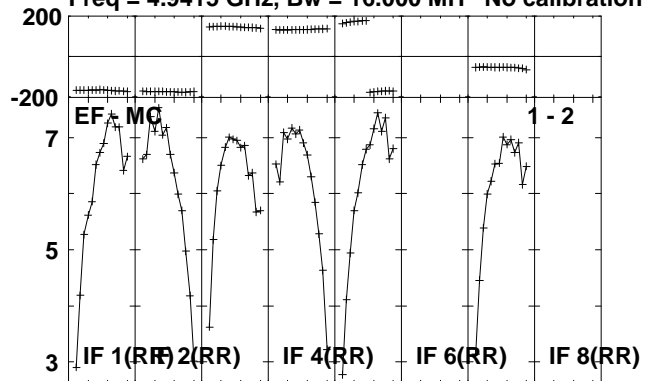

Lower frame: Milli Ampl Jy Top frame: Phas deg
Scalar averaged cross-power spectrum Several baselines displayed
Timerange: 00/19:16:21 to 00/19:21:19

Plot file version 32 created 06-OCT-2010 10:55:58

J1920-02 ET013A.UVDATA.1

Freq = 4.9415 GHz, Bw = 16.000 MH No calibration applied and no bandpass applied

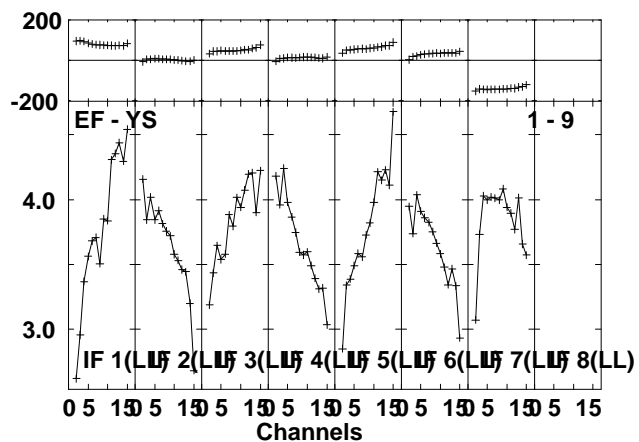
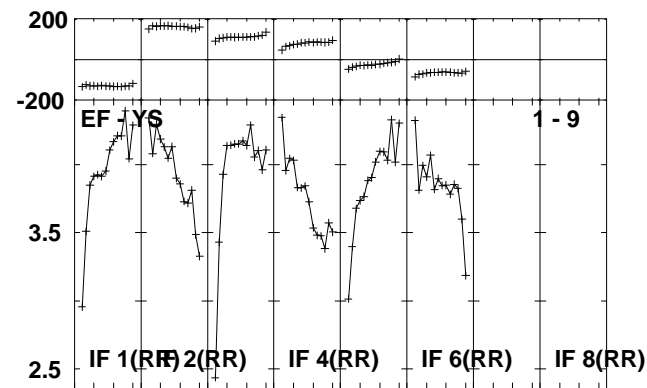
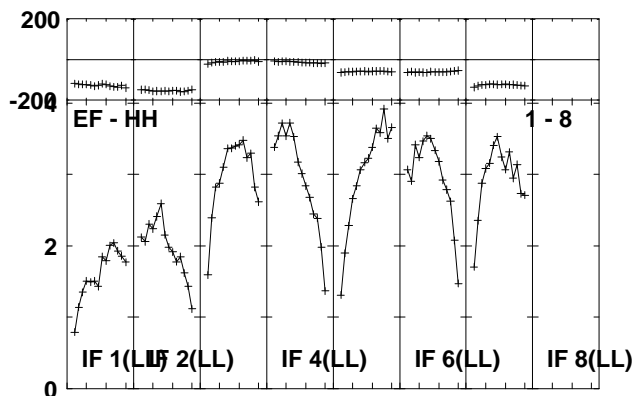
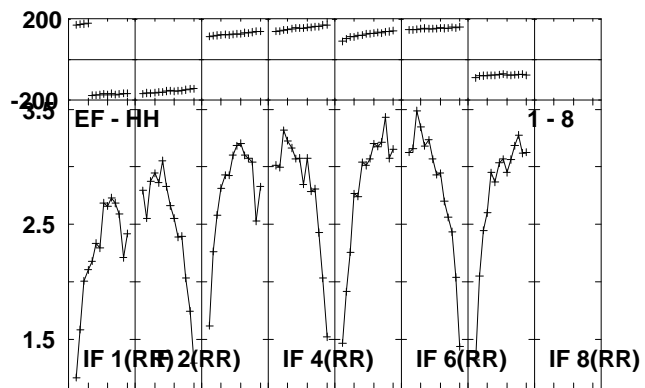
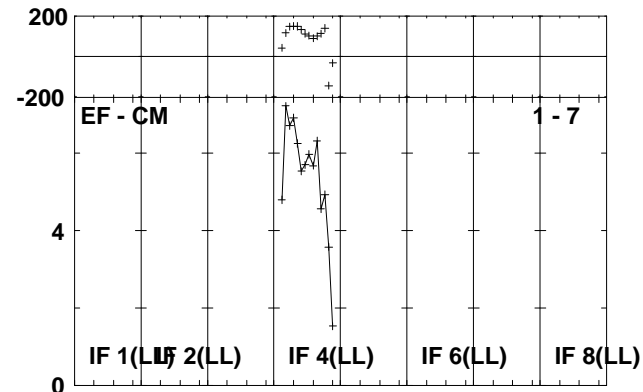
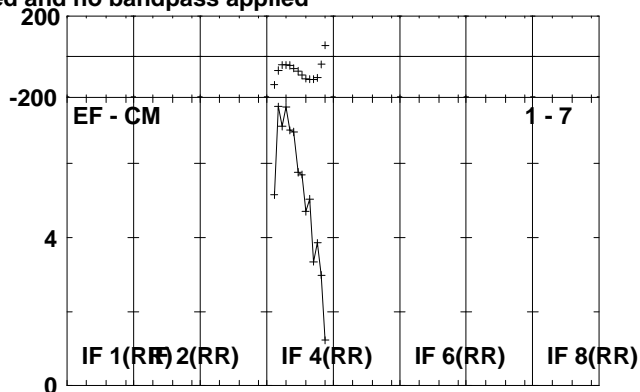
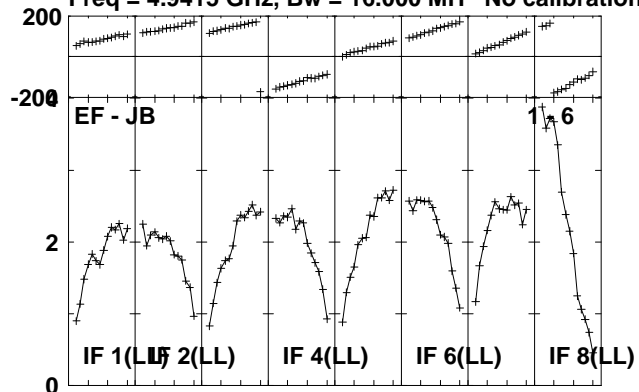

Lower frame: Milli Ampl Jy Top frame: Phas deg
Scalar averaged cross-power spectrum Several baselines displayed
Timerange: 00/19:16:21 to 00/19:21:19

Plot file version 33 created 06-OCT-2010 10:56:00

J1907+01 ET013A.UVDATA.1

Freq = 4.9415 GHz, Bw = 16.000 MH No calibration applied and no bandpass applied

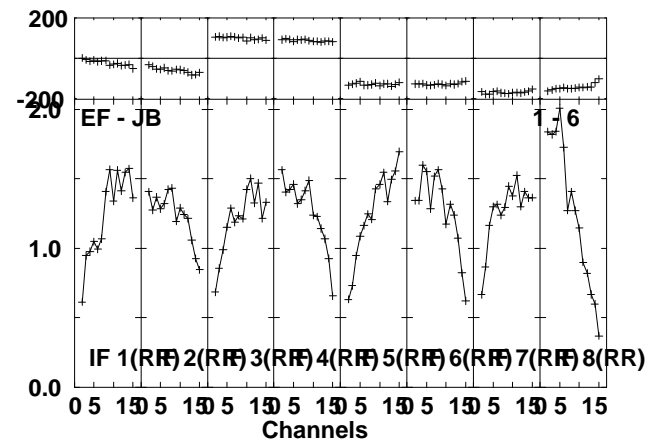
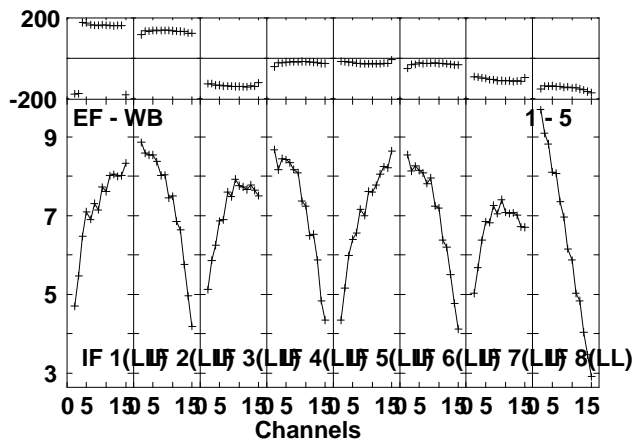
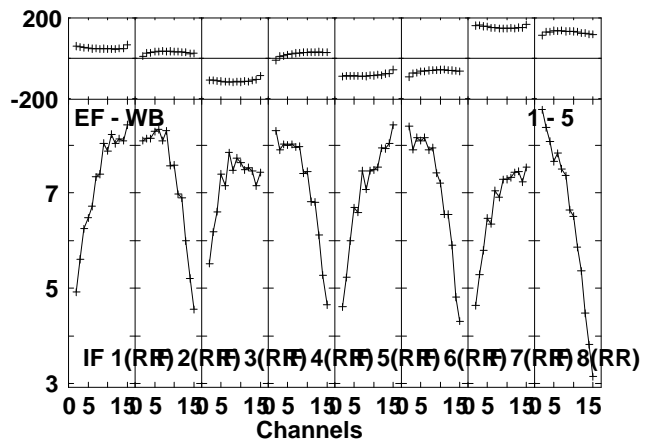
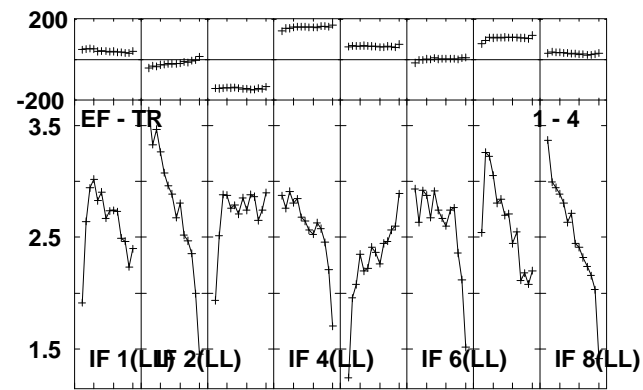
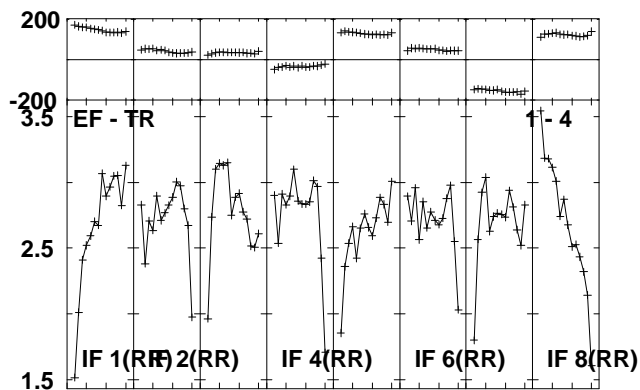
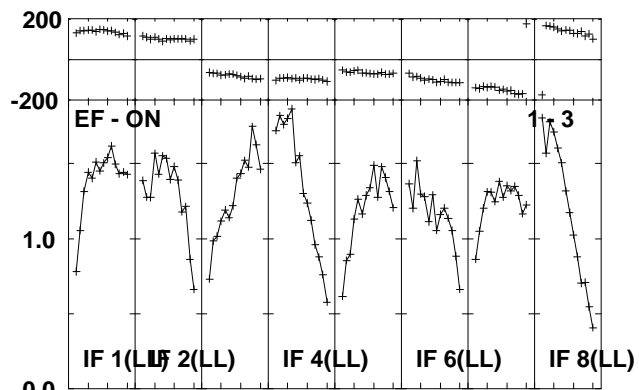
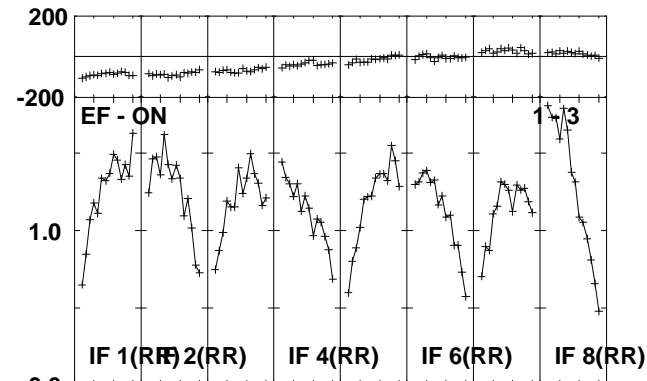
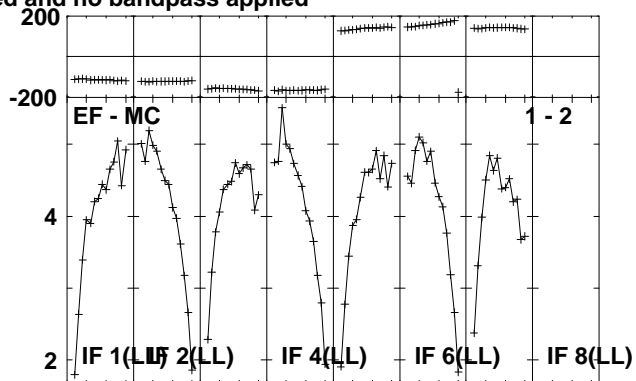
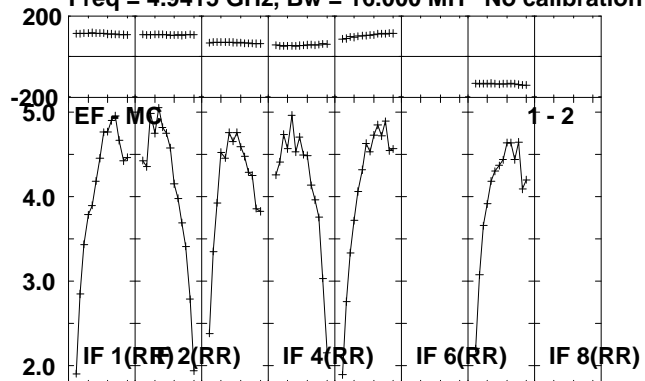

Lower frame: Milli Ampl Jy Top frame: Phas deg
Scalar averaged cross-power spectrum Several baselines displayed
Timerange: 00/19:22:21 to 00/19:24:39

Plot file version 34 created 06-OCT-2010 10:56:01
 J1907+01 ET013A.UVDATA.1

Freq = 4.9415 GHz, Bw = 16.000 MH No calibration applied and no bandpass applied

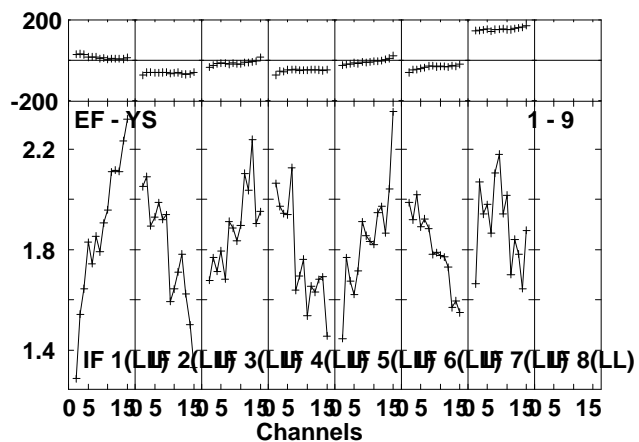
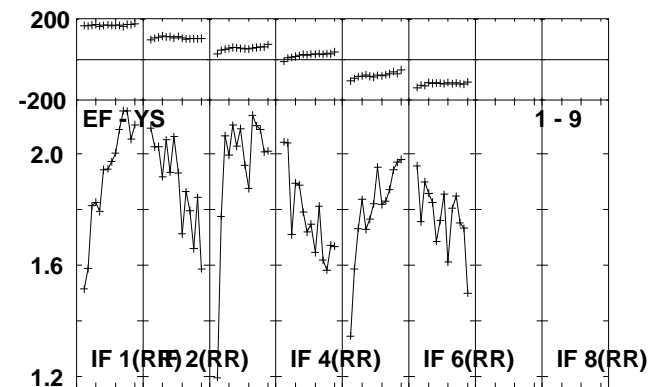
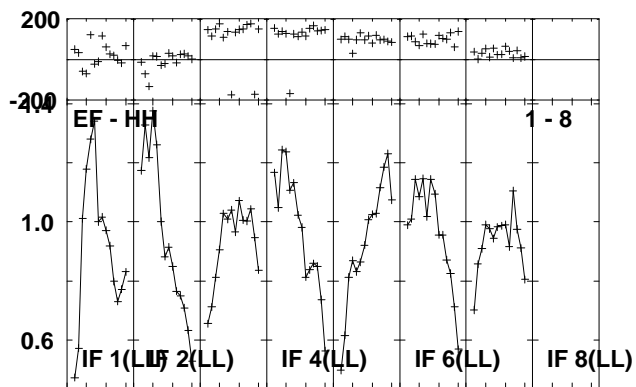
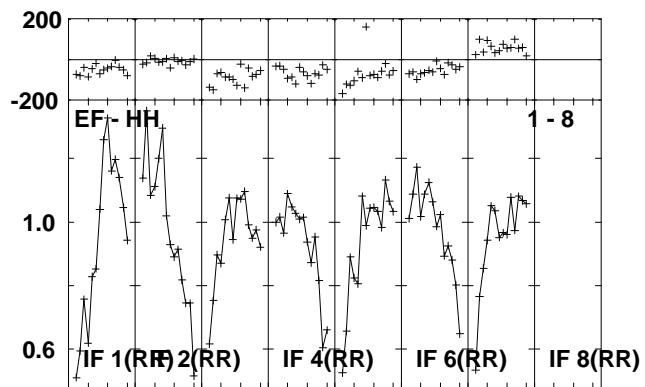
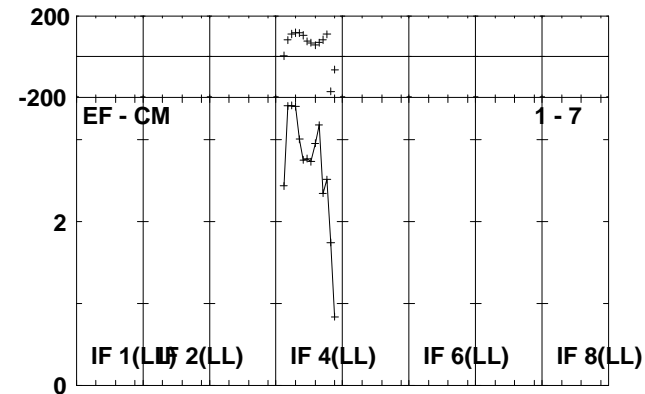
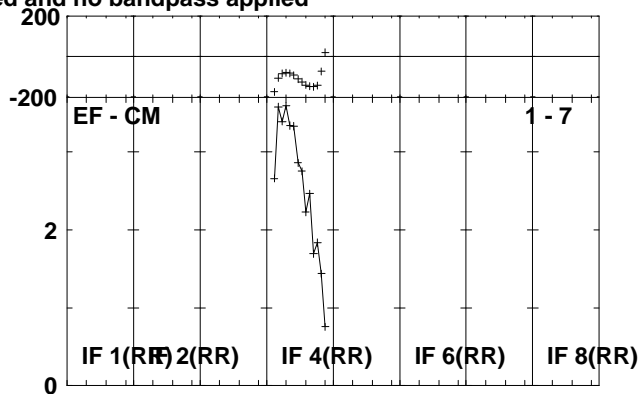
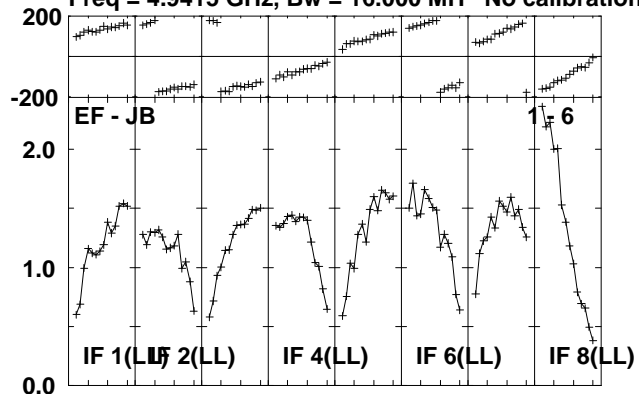

Lower frame: Milli Ampl Jy Top frame: Phas deg
 Scalar averaged cross-power spectrum Several baselines displayed
 Timerange: 00/19:22:21 to 00/19:24:39

Plot file version 35 created 06-OCT-2010 10:56:02

1749+096 ET013A.UVDATA.1

Freq = 4.9415 GHz, Bw = 16.000 MH No calibration applied and no bandpass applied

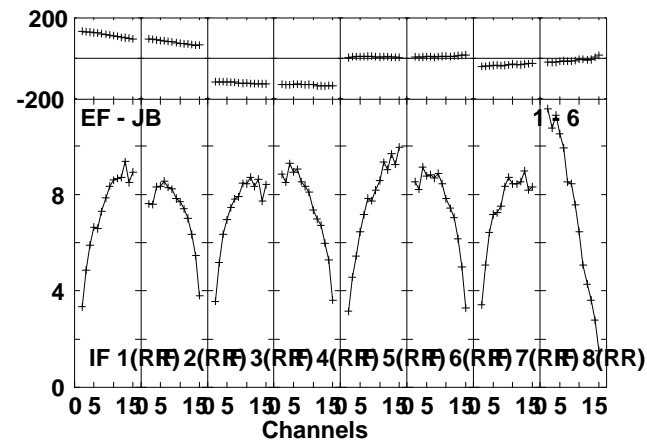
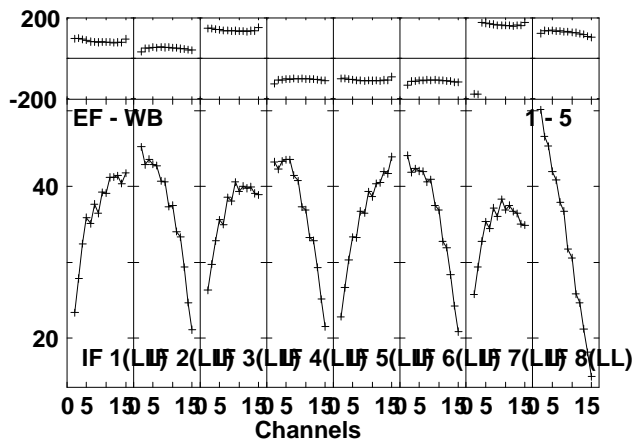
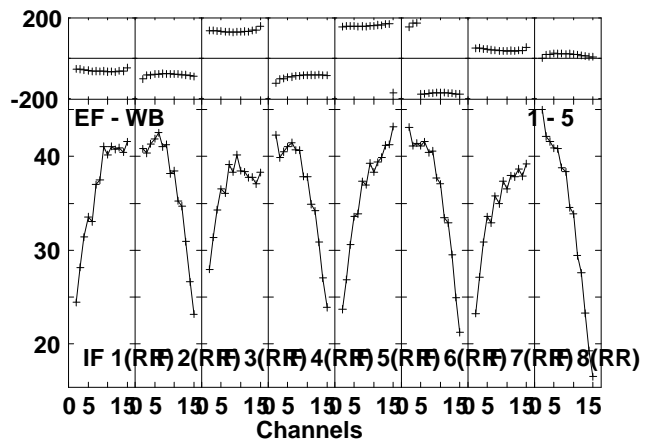
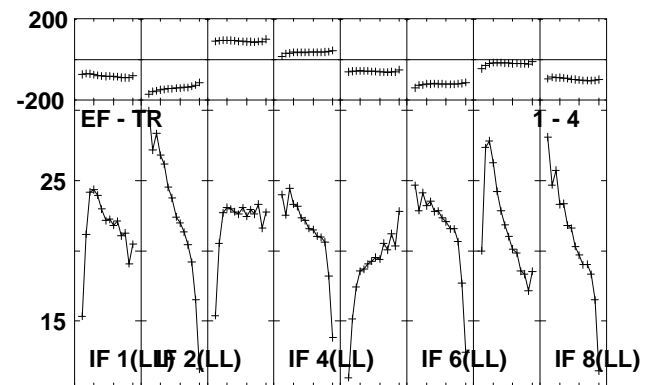
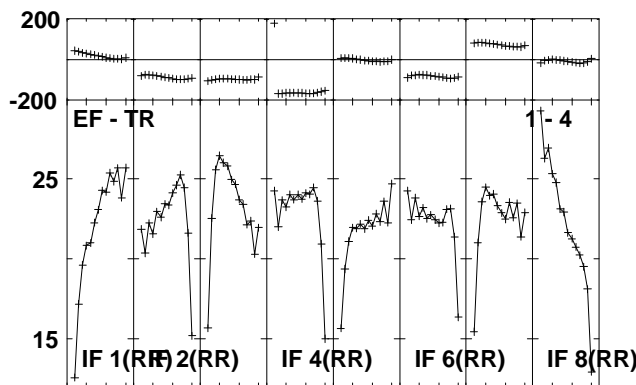
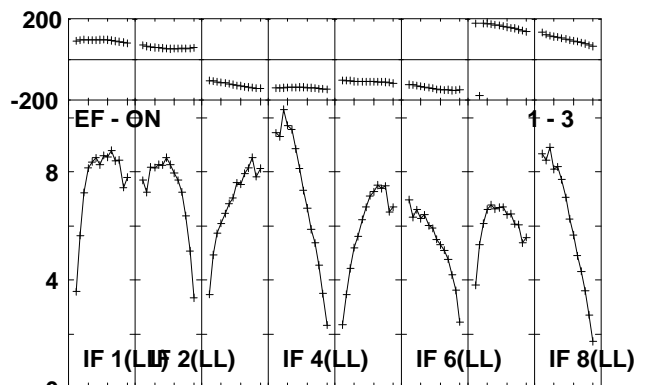
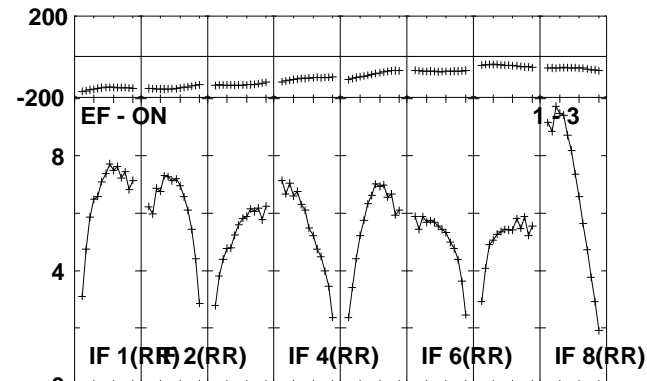
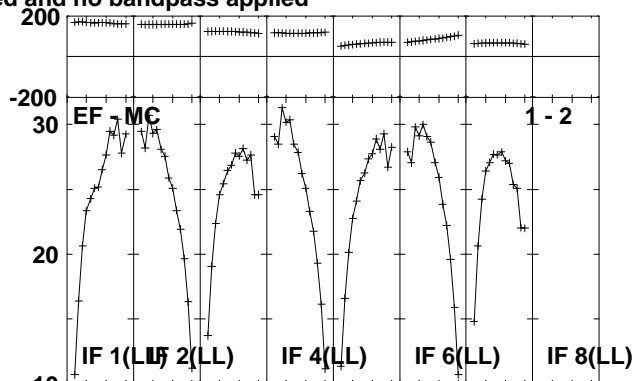
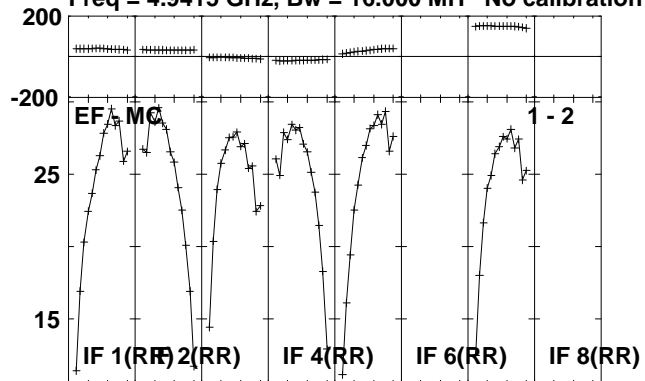

Lower frame: Milli Ampl Jy Top frame: Phas deg
Scalar averaged cross-power spectrum Several baselines displayed
Timerange: 00/19:26:41 to 00/19:30:39

Plot file version 36 created 06-OCT-2010 10:56:04

1749+096 ET013A.UVDATA.1

Freq = 4.9415 GHz, Bw = 16.000 MH No calibration applied and no bandpass applied

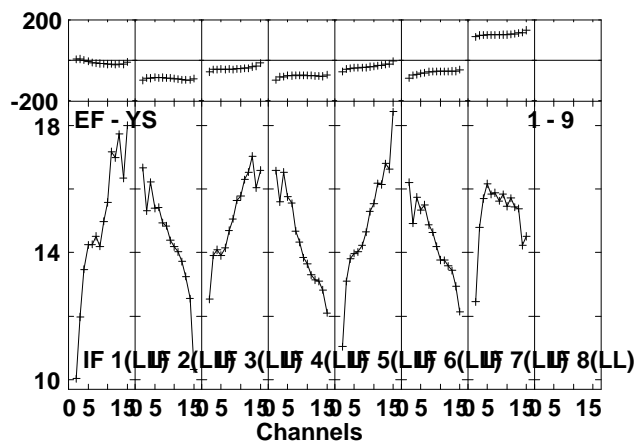
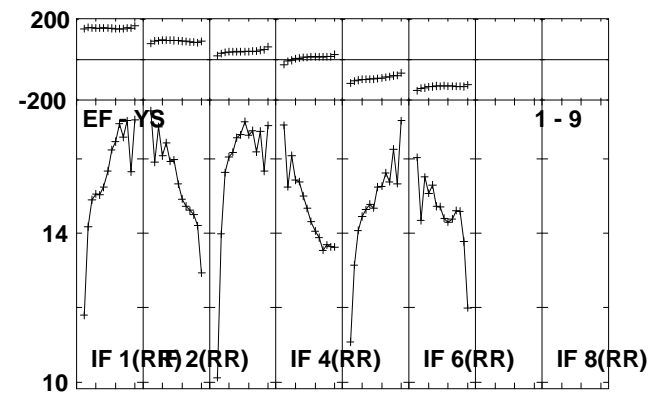
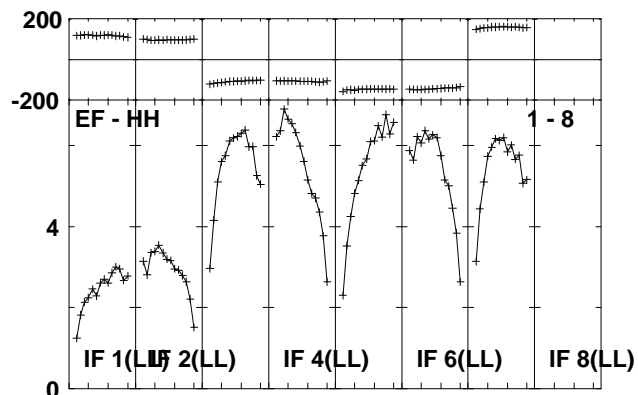
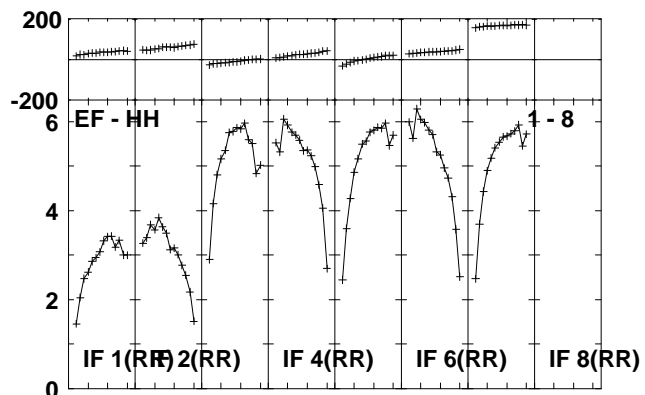
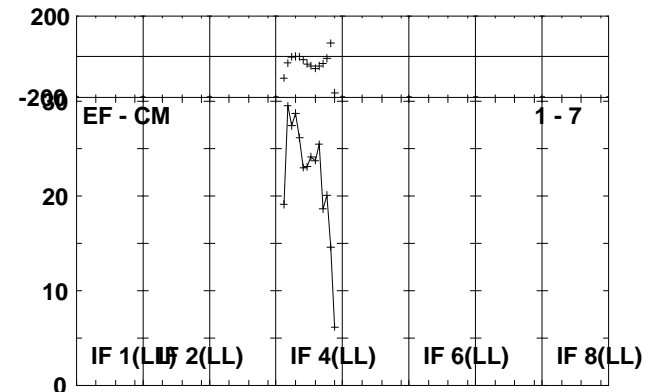
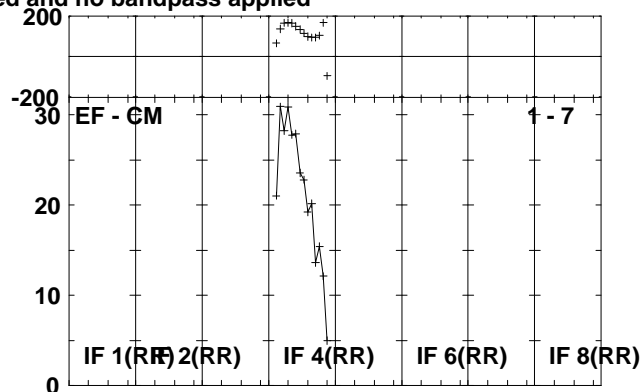
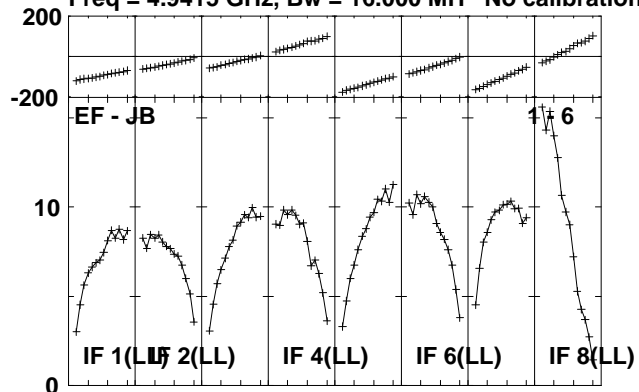

Lower frame: Milli Ampl Jy Top frame: Phas deg
Scalar averaged cross-power spectrum Several baselines displayed
Timerange: 00/19:26:41 to 00/19:30:39

Plot file version 37 created 06-OCT-2010 10:56:06

J1907+01 ET013A.UVDATA.1

Freq = 4.9415 GHz, Bw = 16.000 MH No calibration applied and no bandpass applied

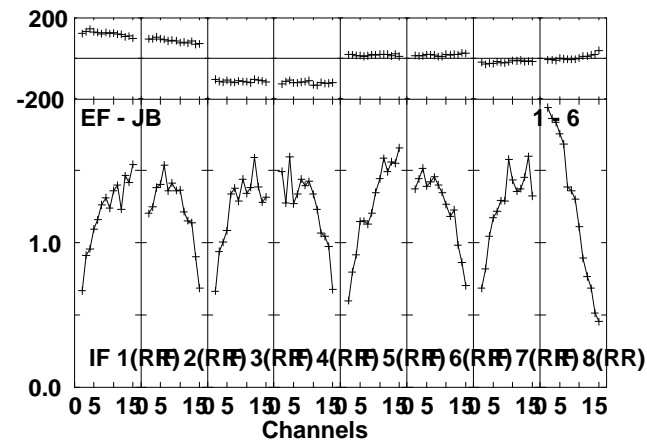
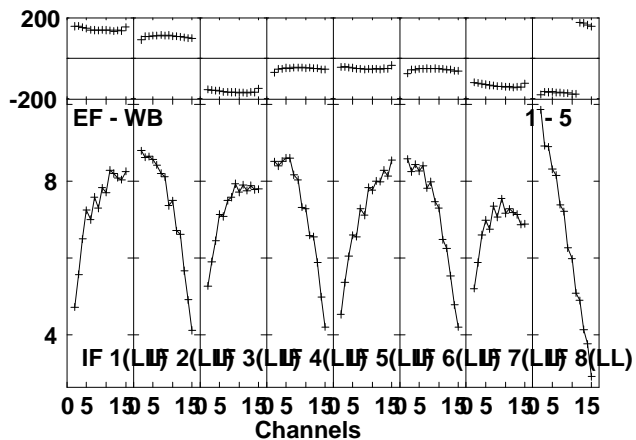
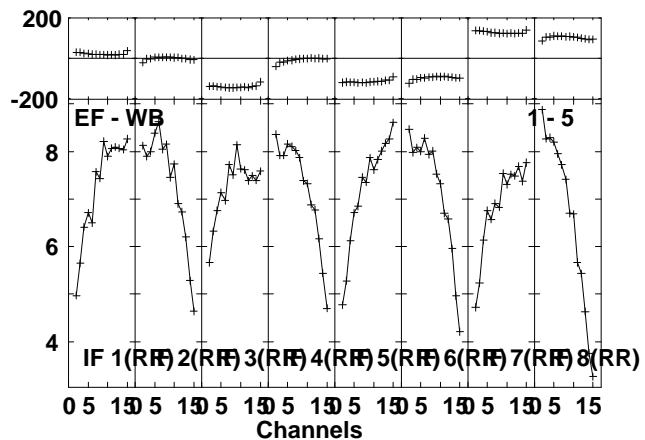
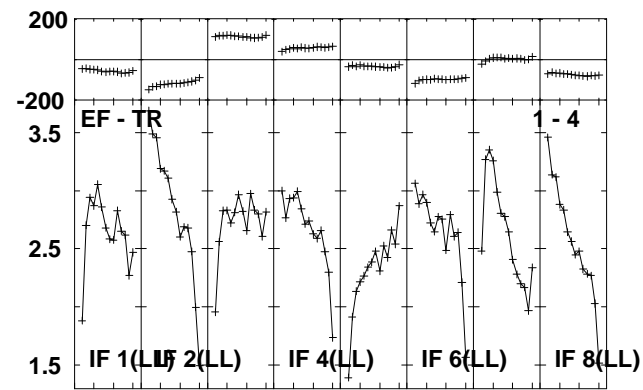
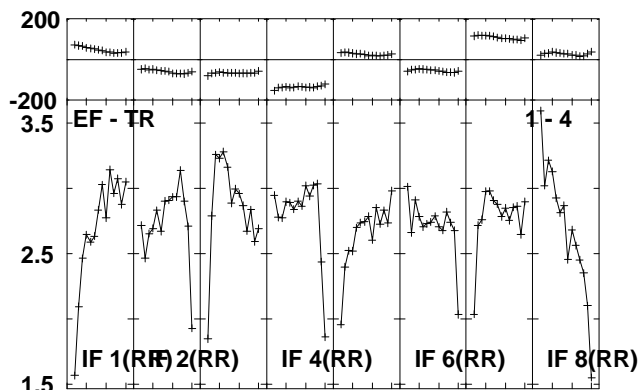
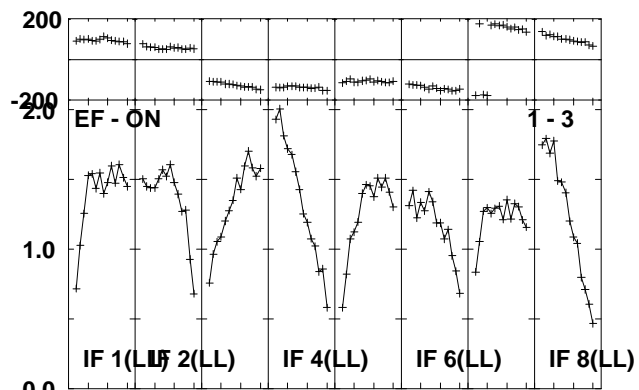
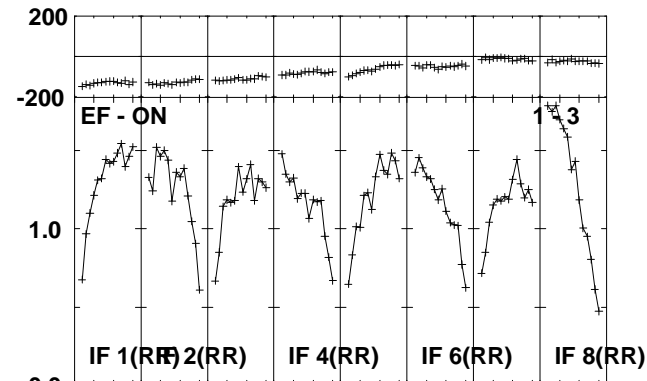
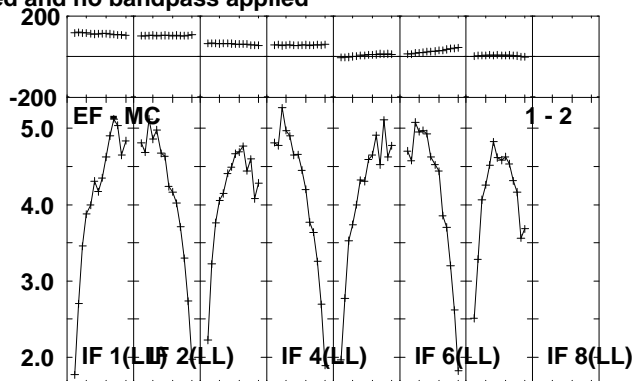
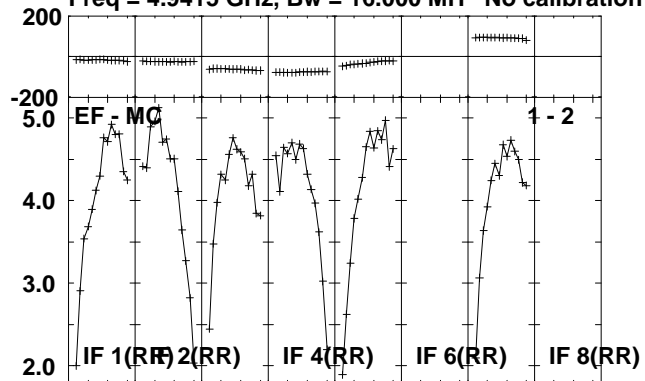

Lower frame: Milli Ampl Jy Top frame: Phas deg
Scalar averaged cross-power spectrum Several baselines displayed
Timerange: 00/19:32:41 to 00/19:35:39

Plot file version 38 created 06-OCT-2010 10:56:07

J1907+01 ET013A.UVDATA.1

Freq = 4.9415 GHz, Bw = 16.000 MH No calibration applied and no bandpass applied

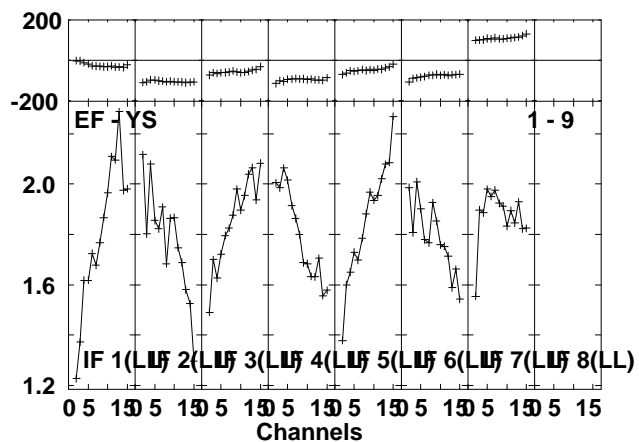
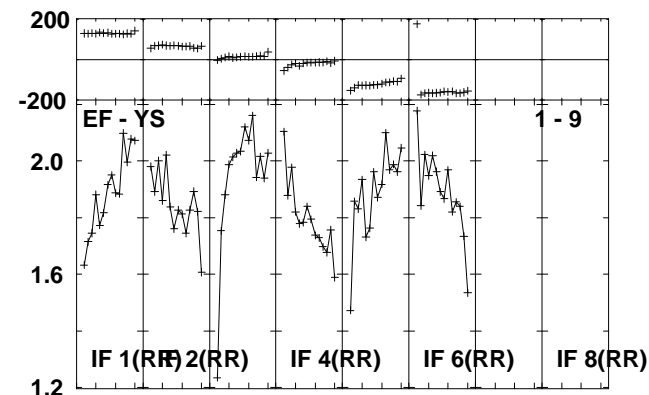
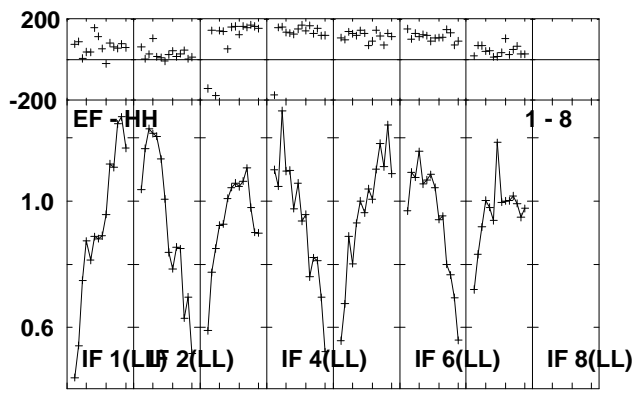
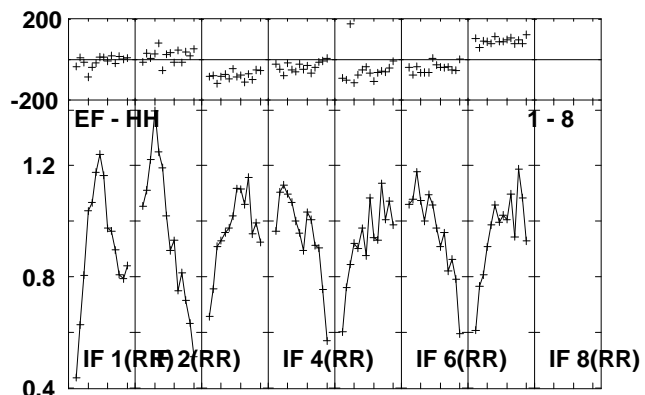
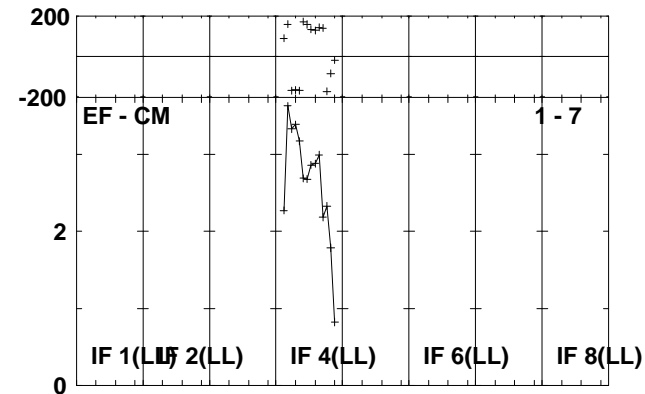
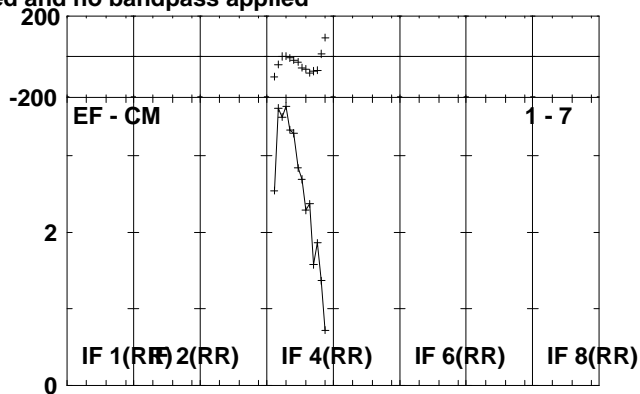
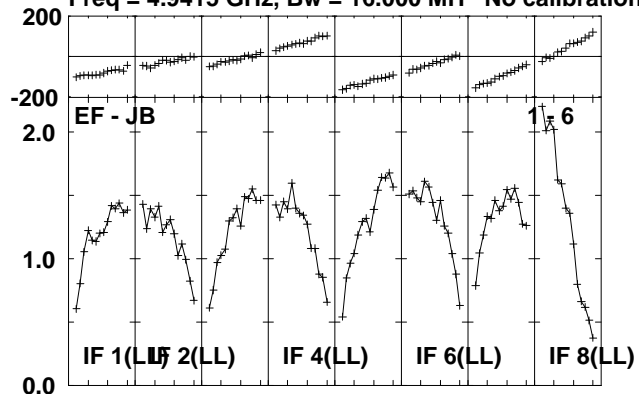

Lower frame: Milli Ampl Jy Top frame: Phas deg
Scalar averaged cross-power spectrum Several baselines displayed
Timerange: 00/19:32:41 to 00/19:35:39

Plot file version 39 created 06-OCT-2010 10:56:09

AQLX-1 ET013A.UVDATA.1

Freq = 4.9415 GHz, Bw = 16.000 MH No calibration applied and no bandpass applied

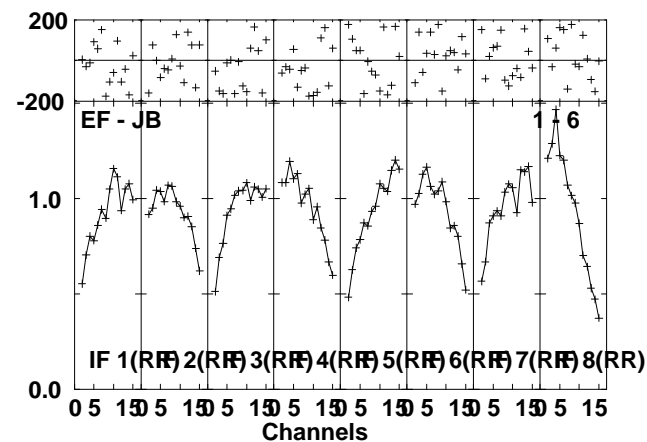
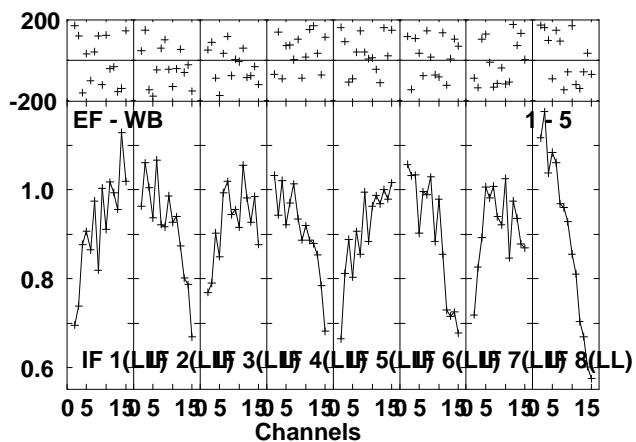
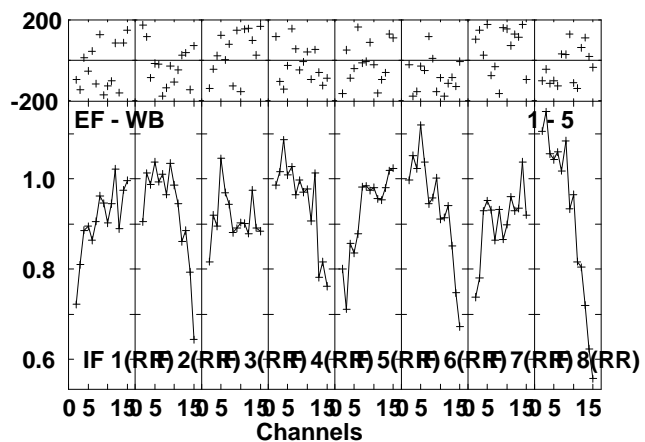
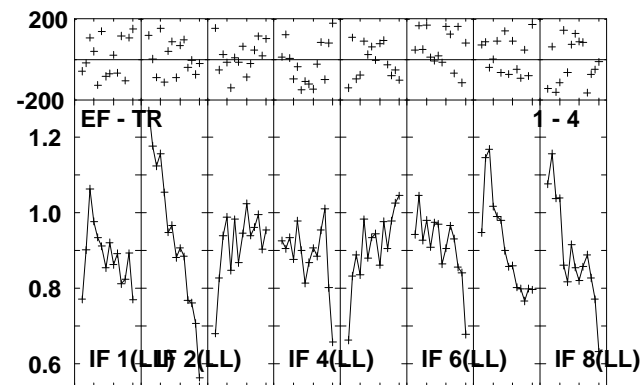
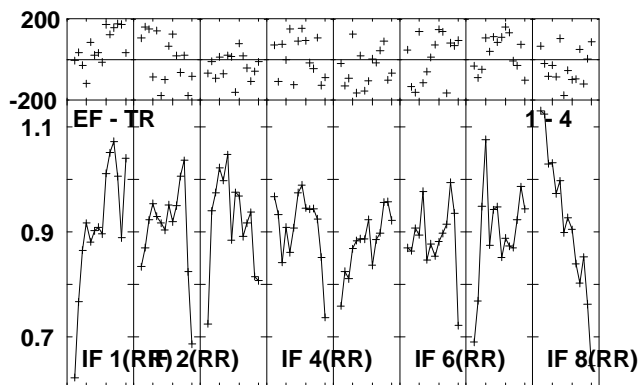
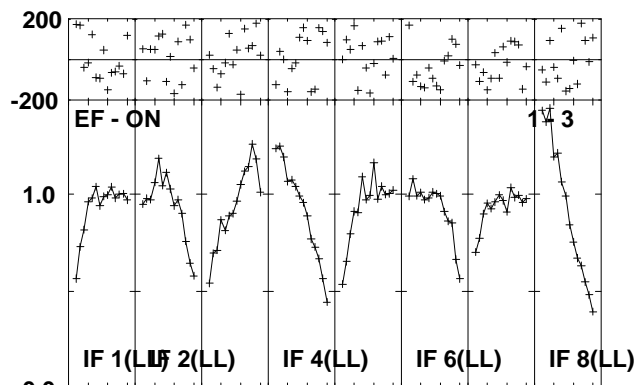
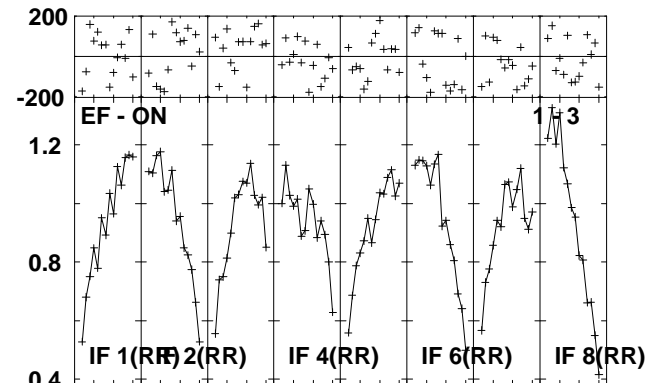
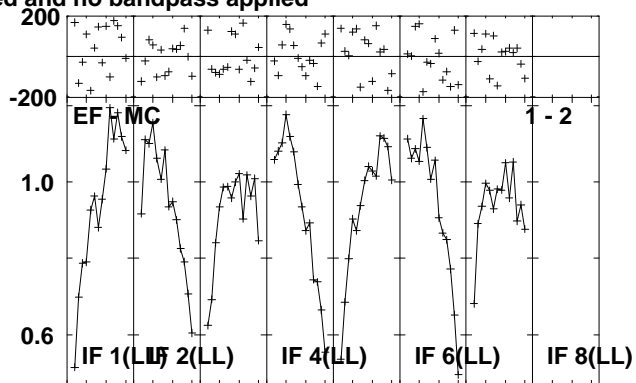
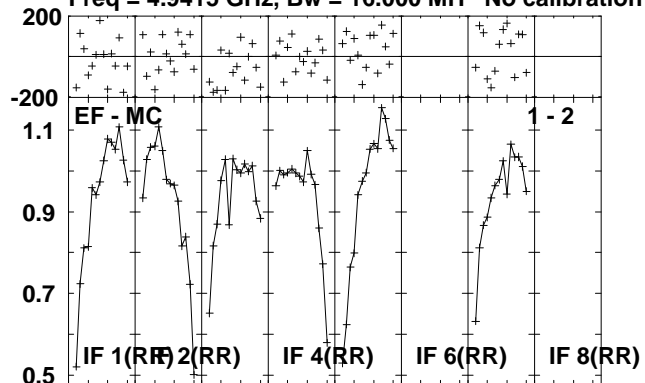

Lower frame: Milli Ampl Jy Top frame: Phas deg
Scalar averaged cross-power spectrum Several baselines displayed
Timerange: 00/19:35:41 to 00/19:40:39

Plot file version 40 created 06-OCT-2010 10:56:11

AQLX-1 ET013A.UVDATA.1

Freq = 4.9415 GHz, Bw = 16.000 MH No calibration applied and no bandpass applied

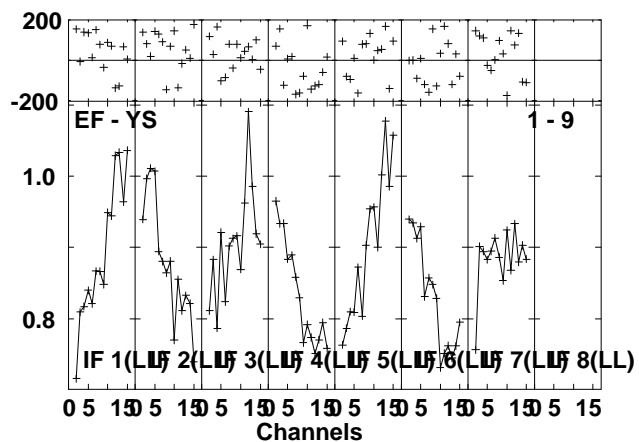
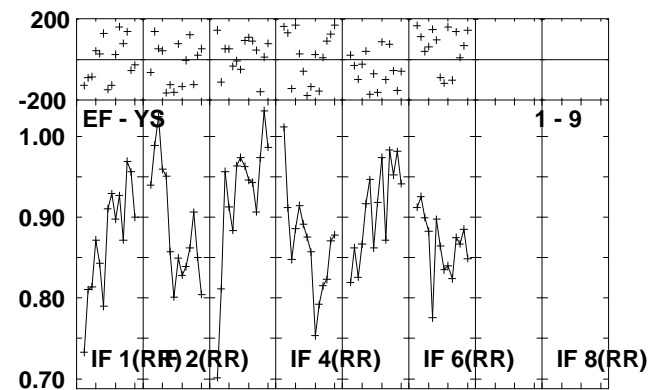
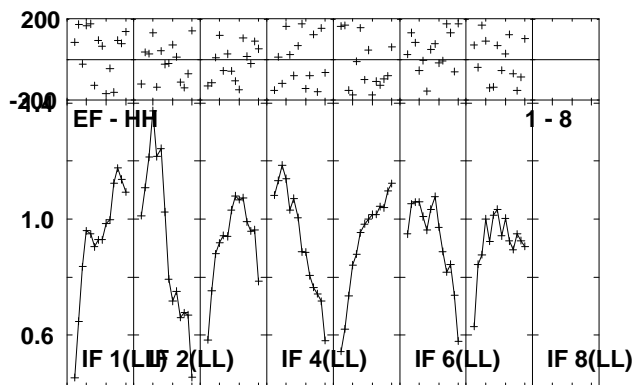
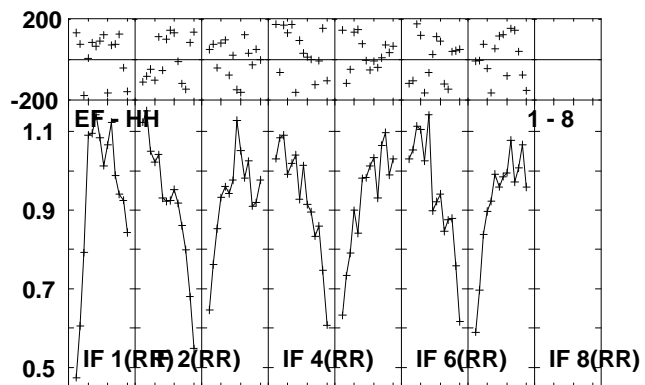
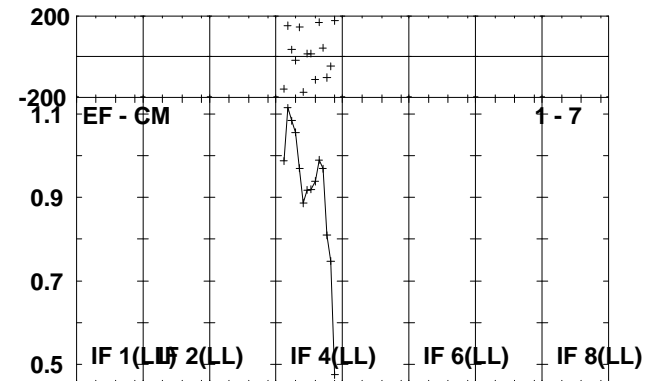
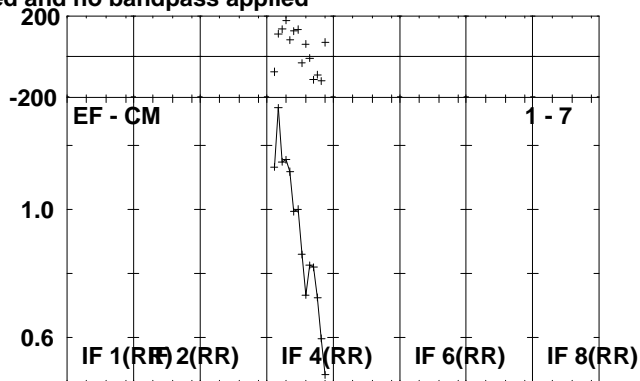
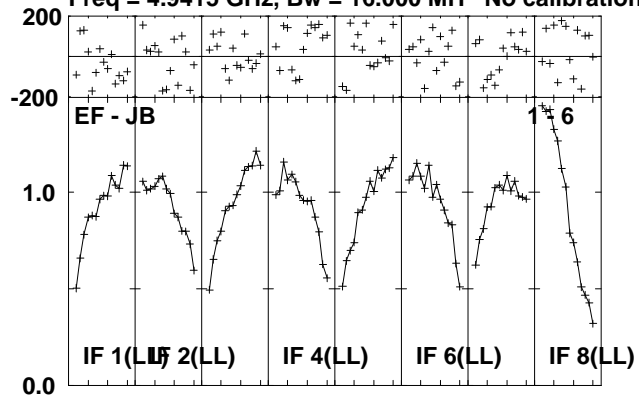

Lower frame: Milli Ampl Jy Top frame: Phas deg
Scalar averaged cross-power spectrum Several baselines displayed
Timerange: 00/19:35:41 to 00/19:40:39

Plot file version 41 created 06-OCT-2010 10:56:13

J1907+01 ET013A.UVDATA.1

Freq = 4.9415 GHz, Bw = 16.000 MH No calibration applied and no bandpass applied

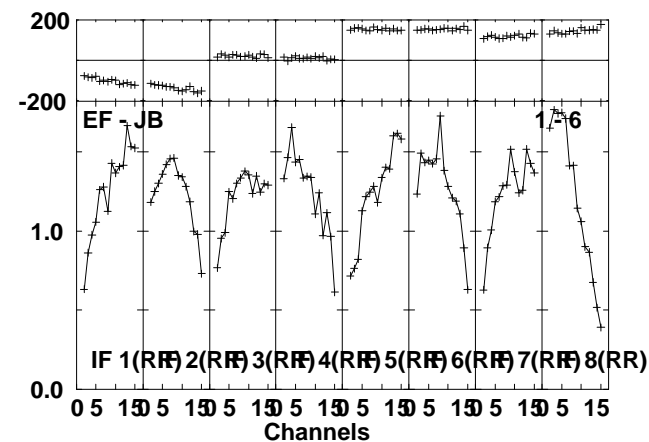
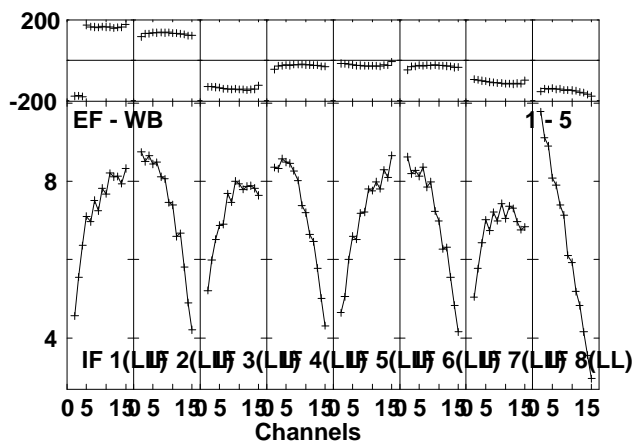
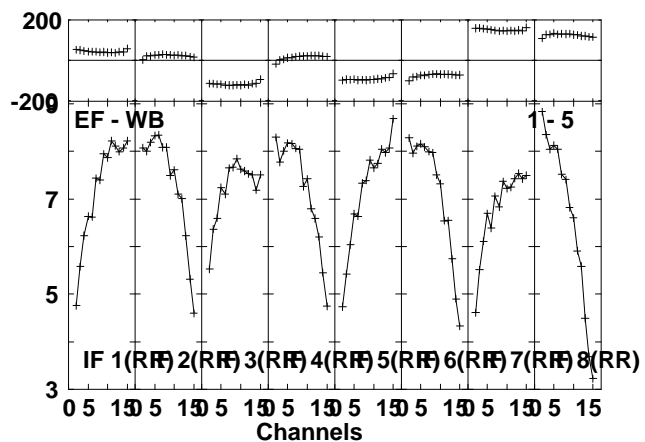
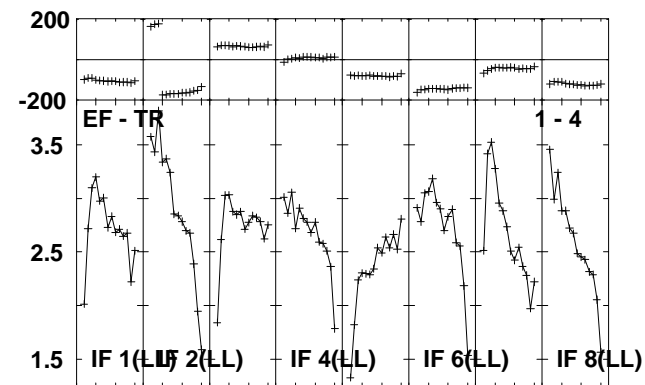
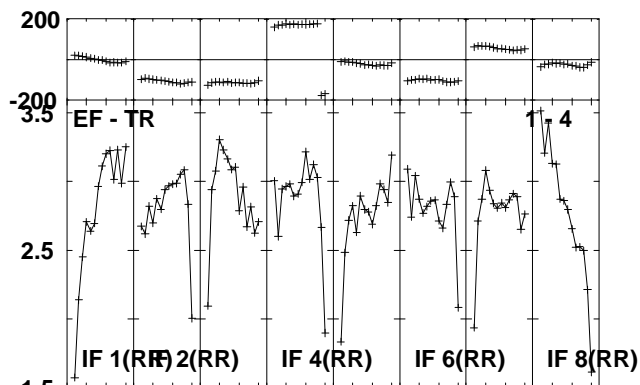
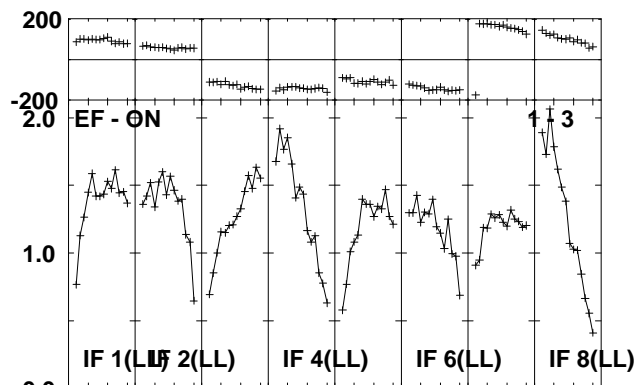
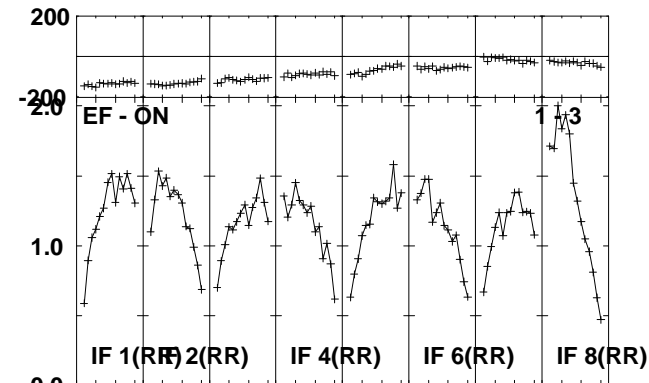
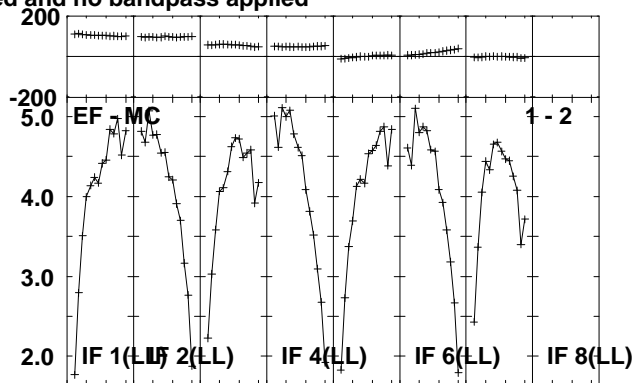
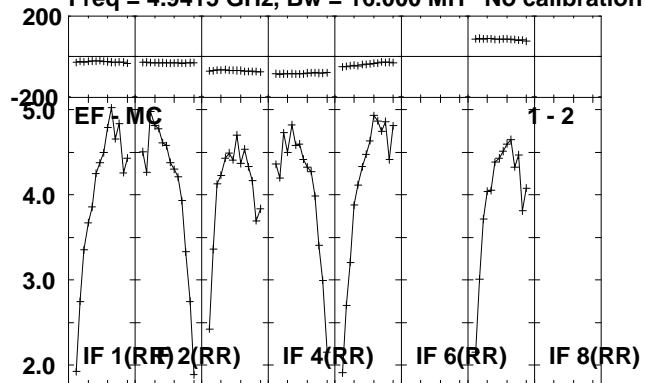

Lower frame: Milli Ampl Jy Top frame: Phas deg
Scalar averaged cross-power spectrum Several baselines displayed
Timerange: 00/19:41:21 to 00/19:43:39

Plot file version 42 created 06-OCT-2010 10:56:14

J1907+01 ET013A.UVDATA.1

Freq = 4.9415 GHz, Bw = 16.000 MH No calibration applied and no bandpass applied

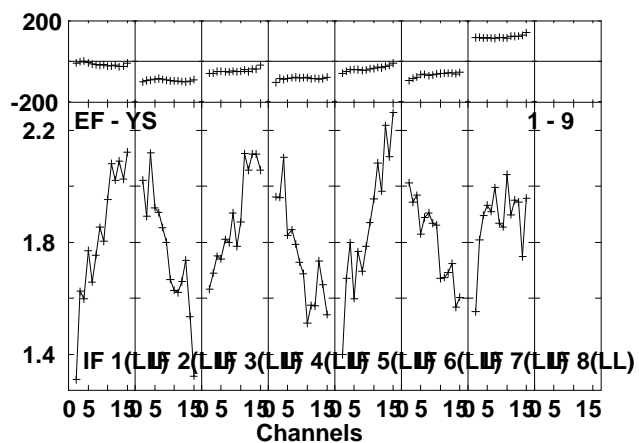
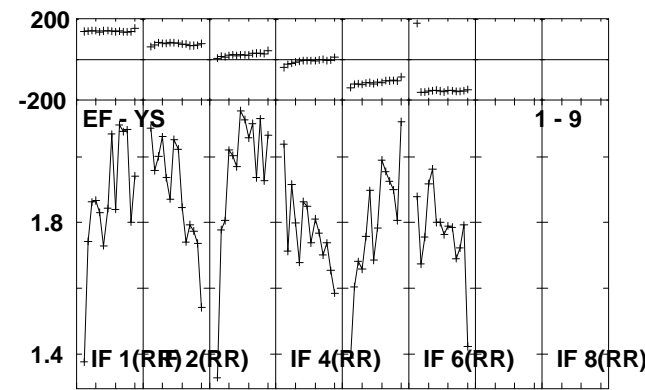
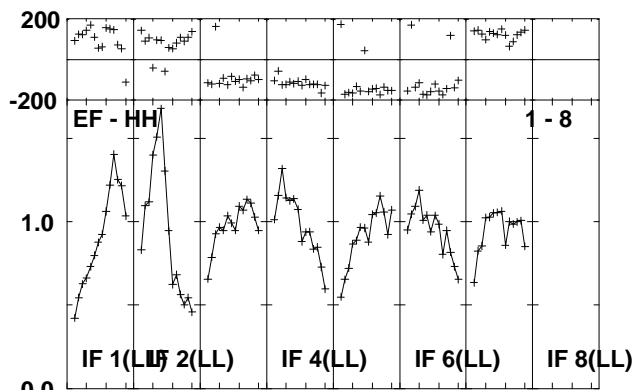
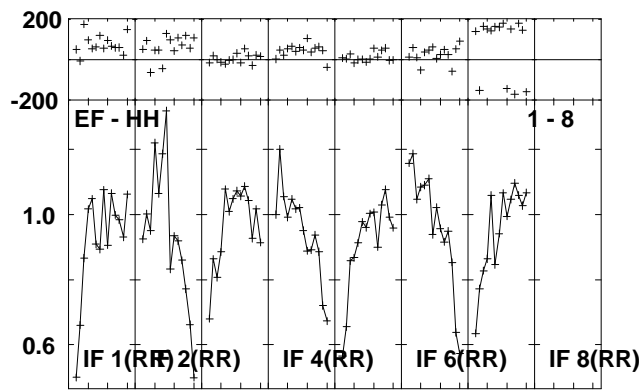
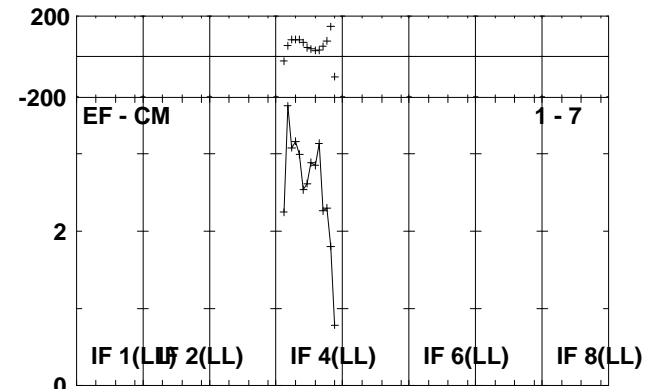
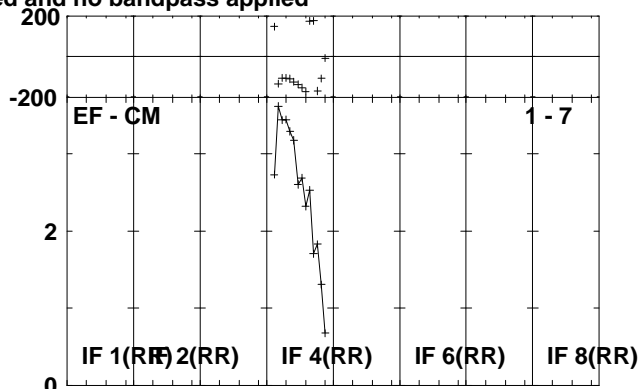
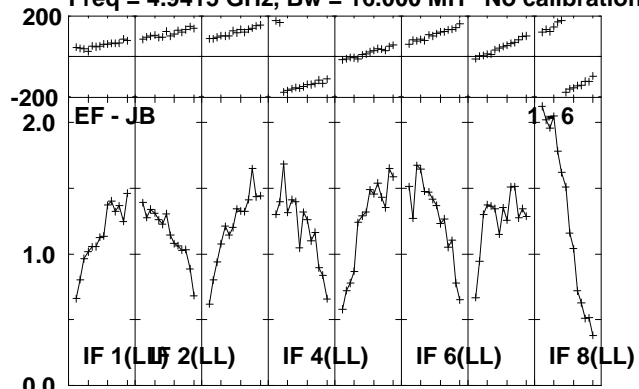

Lower frame: Milli Ampl Jy Top frame: Phas deg
Scalar averaged cross-power spectrum Several baselines displayed
Timerange: 00/19:41:21 to 00/19:43:39

Plot file version 43 created 06-OCT-2010 10:56:15

AQLX-1 ET013A.UVDATA.1

Freq = 4.9415 GHz, Bw = 16.000 MH No calibration applied and no bandpass applied

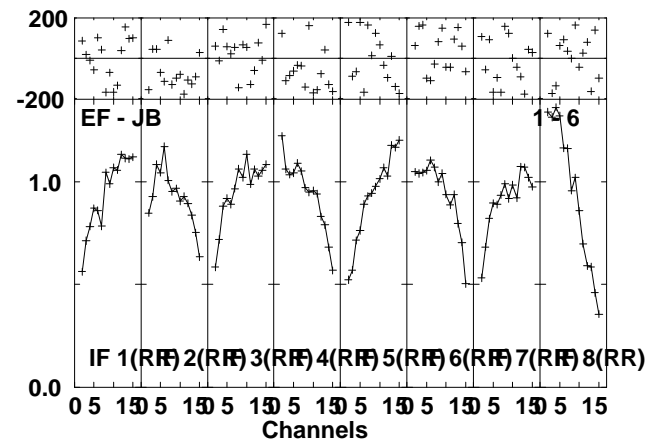
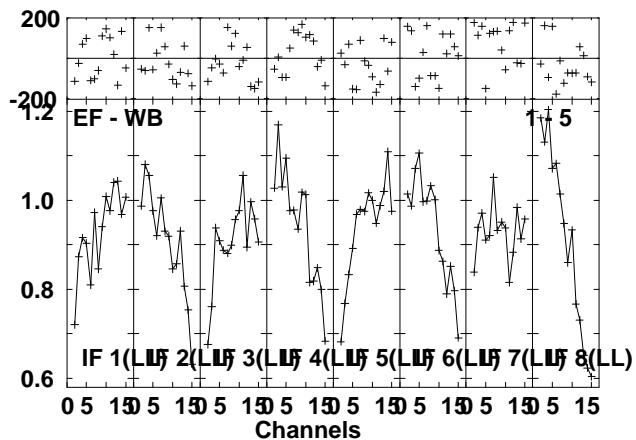
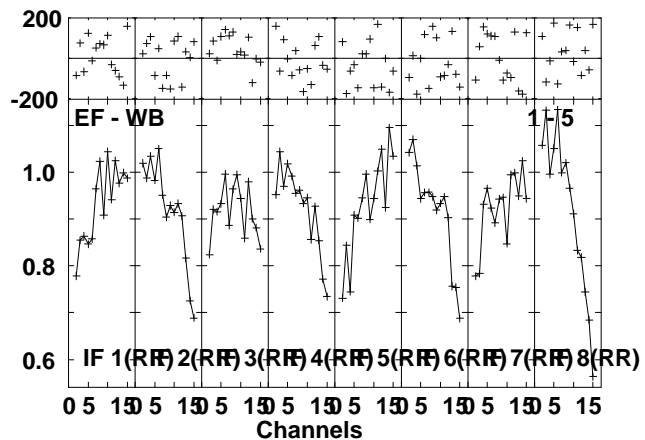
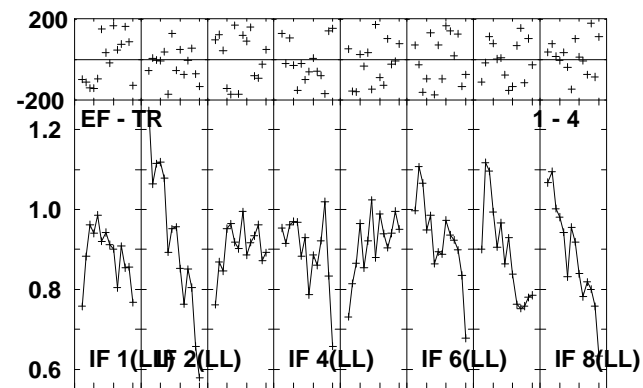
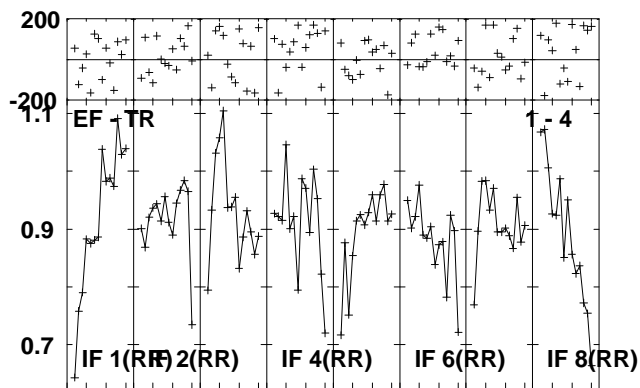
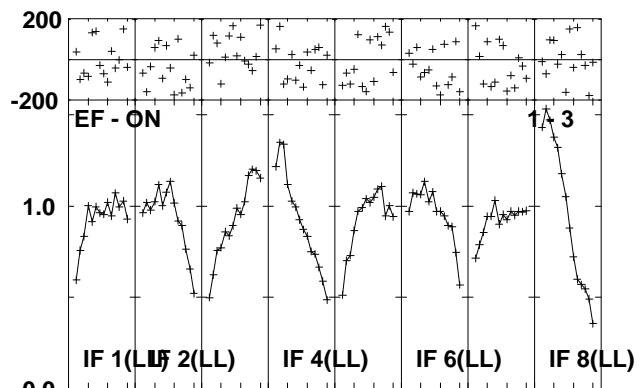
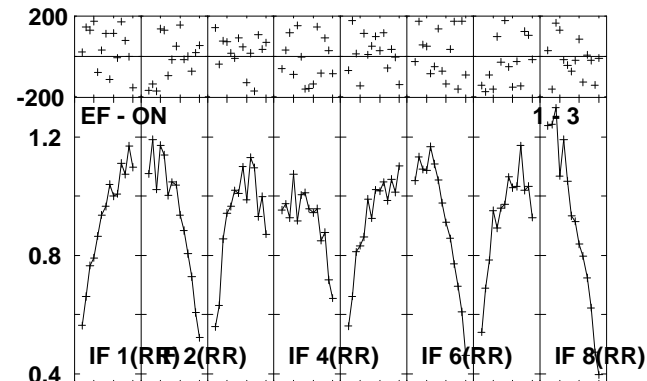
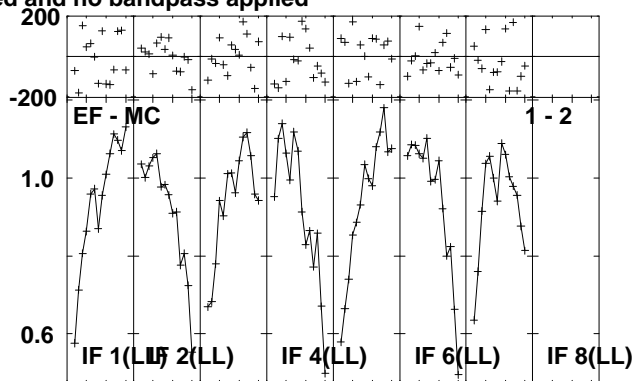
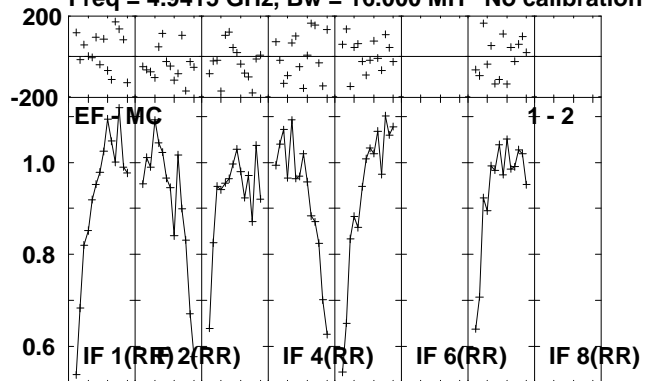

Lower frame: Milli Ampl Jy Top frame: Phas deg
Scalar averaged cross-power spectrum Several baselines displayed
Timerange: 00/19:43:41 to 00/19:48:39

Plot file version 44 created 06-OCT-2010 10:56:17

AQLX-1 ET013A.UVDATA.1

Freq = 4.9415 GHz, Bw = 16.000 MH No calibration applied and no bandpass applied

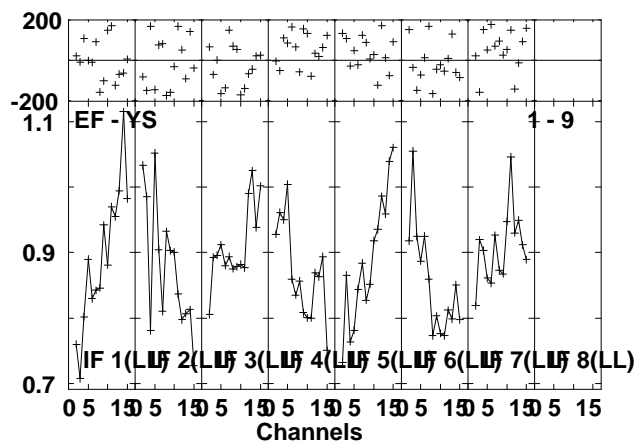
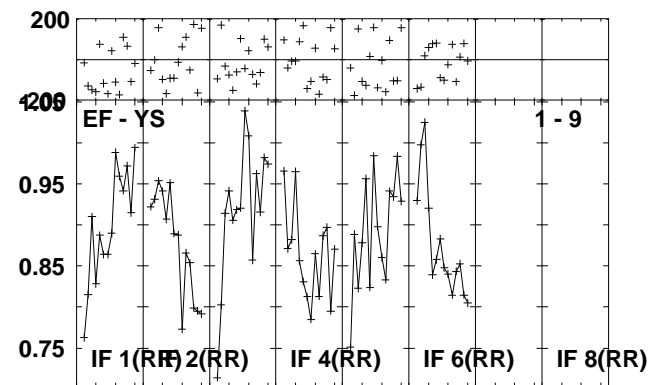
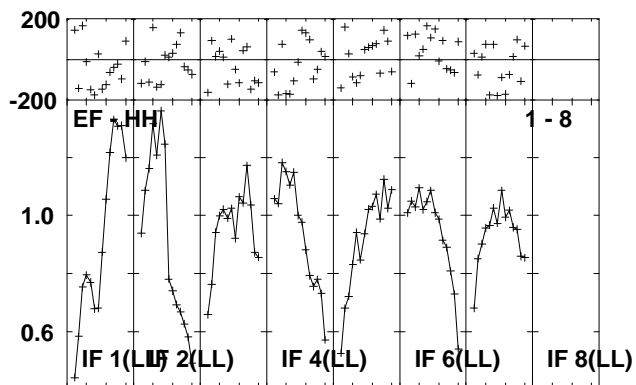
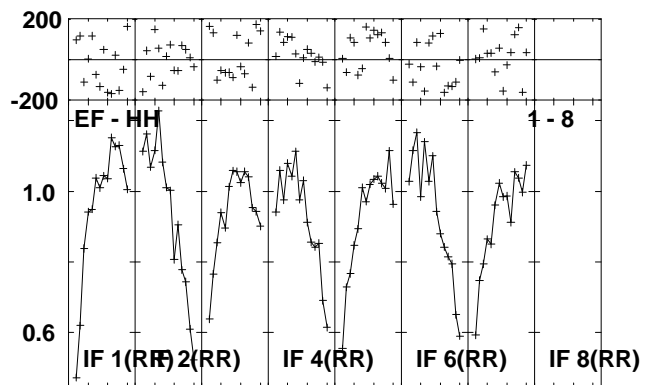
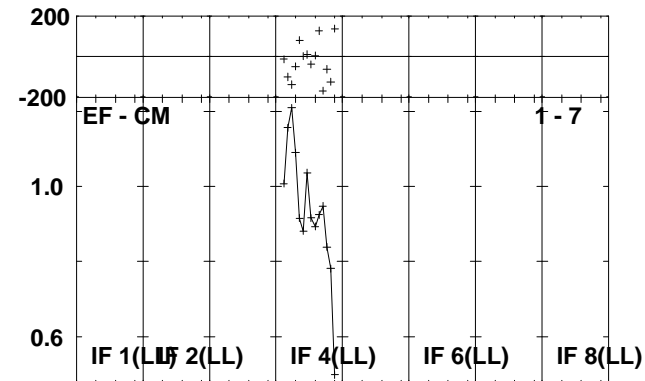
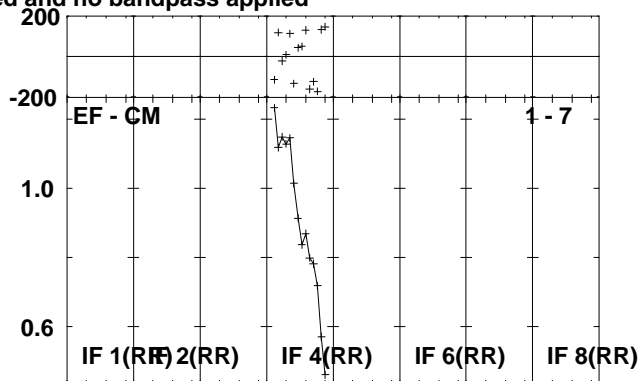
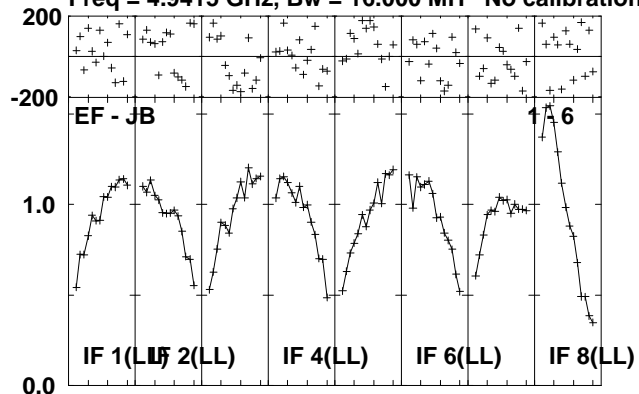

Lower frame: Milli Ampl Jy Top frame: Phas deg
Scalar averaged cross-power spectrum Several baselines displayed
Timerange: 00/19:43:41 to 00/19:48:39

Plot file version 45 created 06-OCT-2010 10:56:19

J1907+01 ET013A.UVDATA.1

Freq = 4.9415 GHz, Bw = 16.000 MH No calibration applied and no bandpass applied

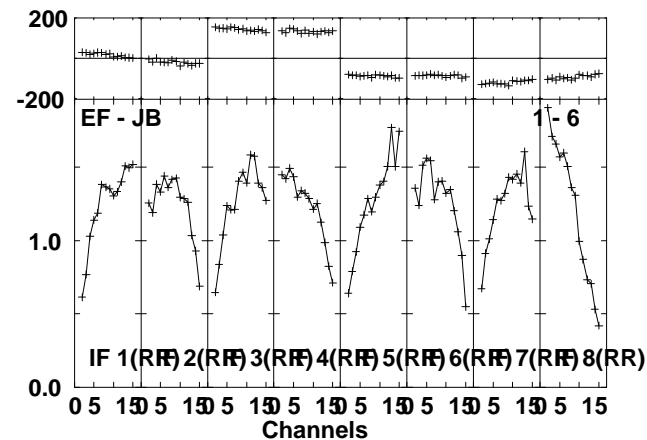
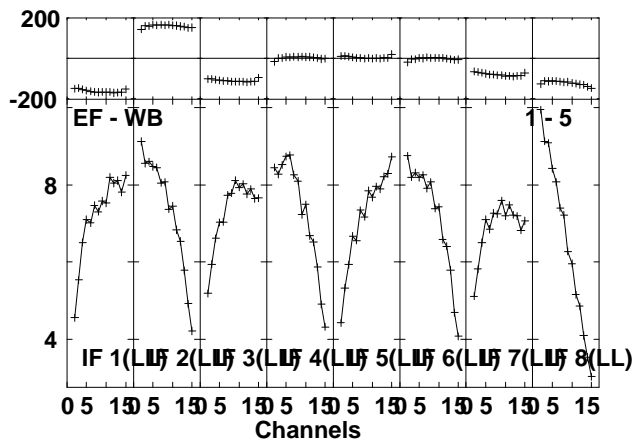
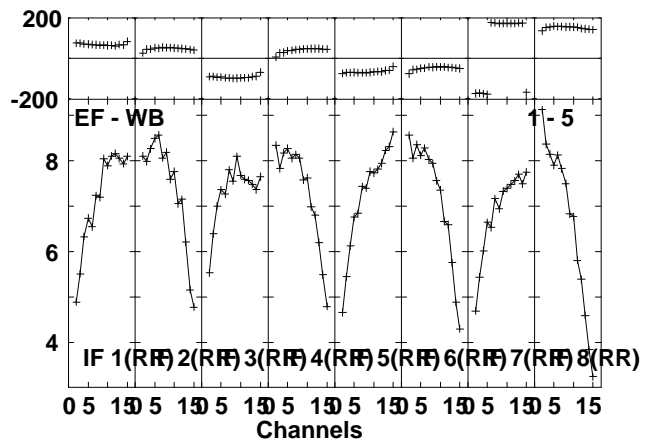
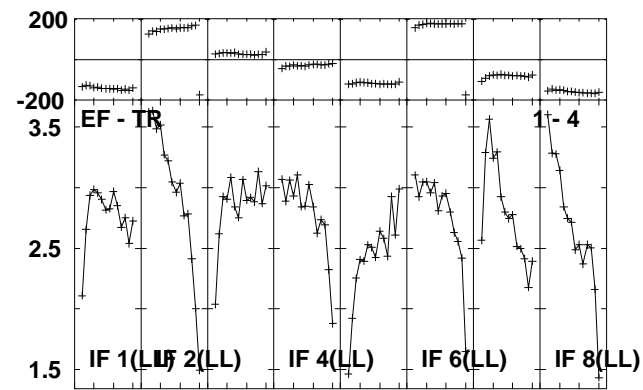
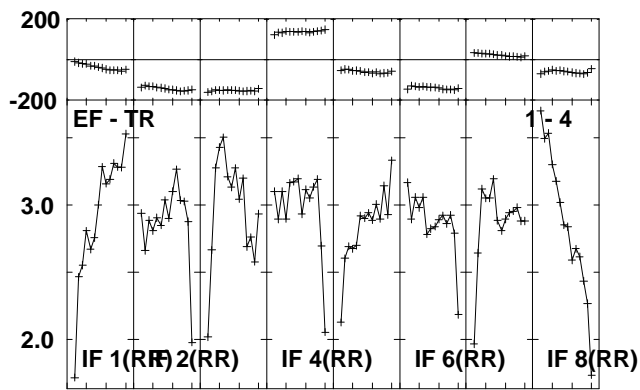
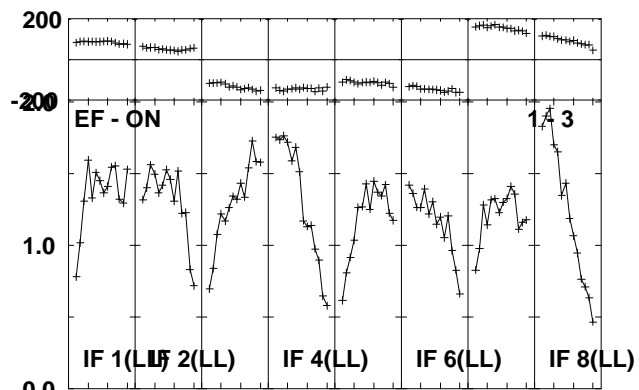
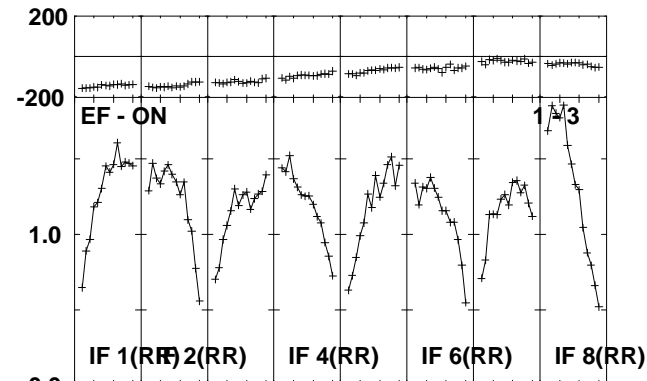
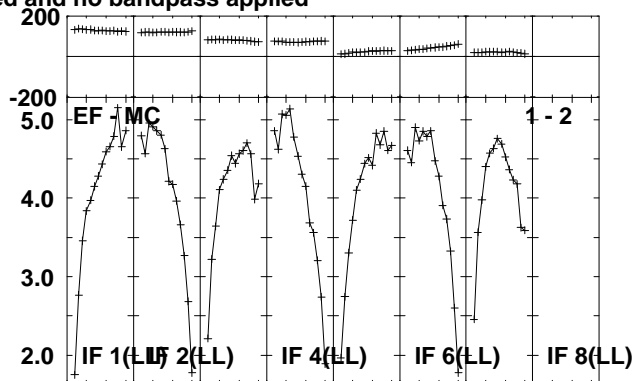
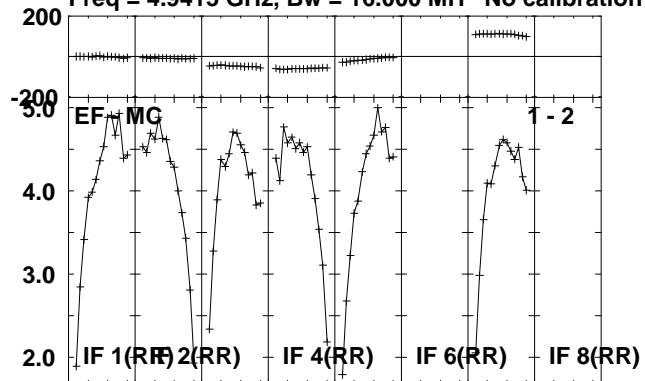

Lower frame: Milli Ampl Jy Top frame: Phas deg
Scalar averaged cross-power spectrum Several baselines displayed
Timerange: 00/19:49:21 to 00/19:51:39

Plot file version 46 created 06-OCT-2010 10:56:20

J1907+01 ET013A.UVDATA.1

Freq = 4.9415 GHz, Bw = 16.000 MH No calibration applied and no bandpass applied

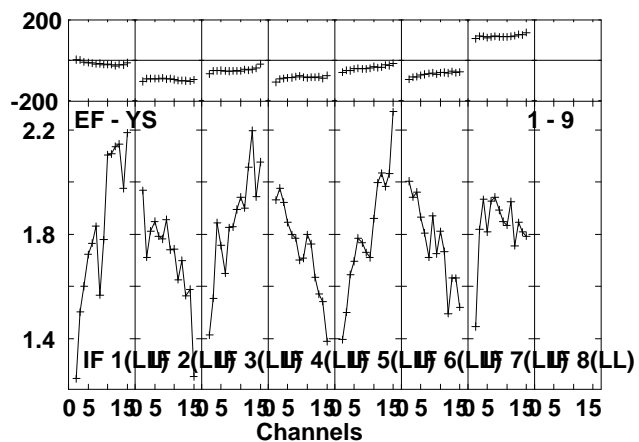
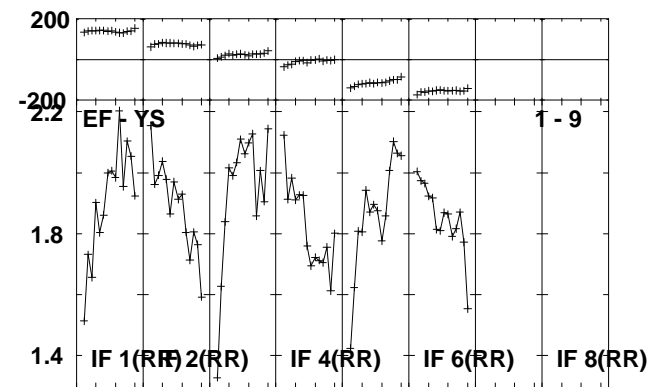
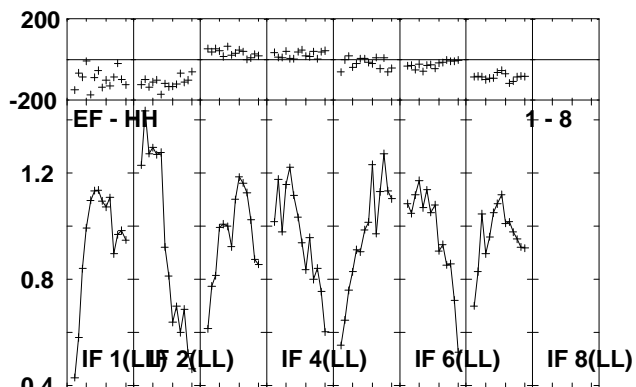
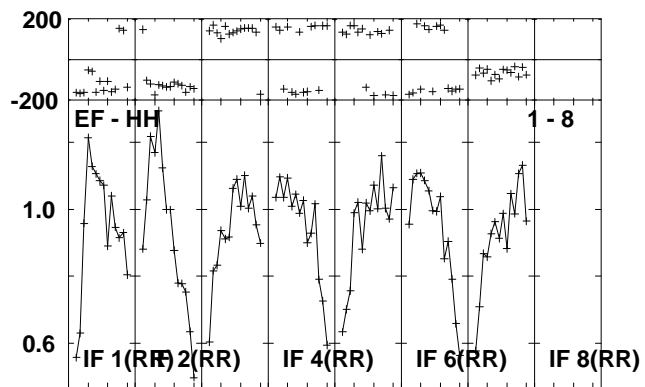
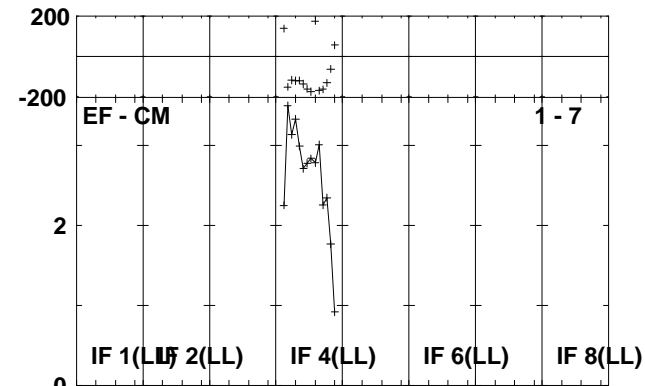
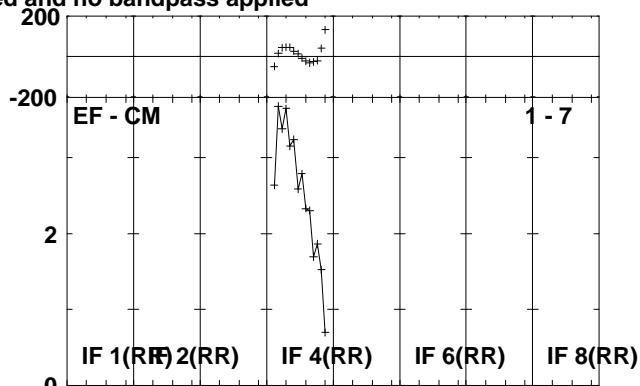
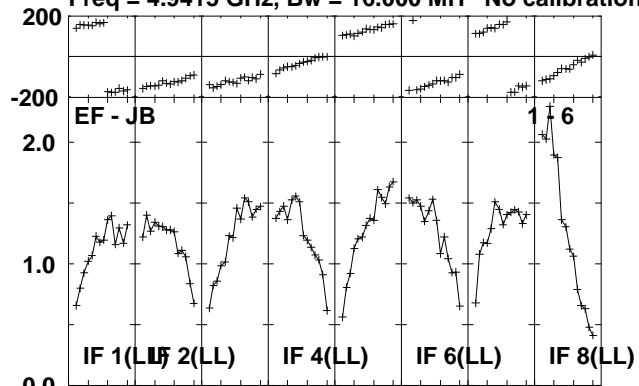

Lower frame: Milli Ampl Jy Top frame: Phas deg
Scalar averaged cross-power spectrum Several baselines displayed
Timerange: 00/19:49:21 to 00/19:51:39

Plot file version 47 created 06-OCT-2010 10:56:22

AQLX-1 ET013A.UVDATA.1

Freq = 4.9415 GHz, Bw = 16.000 MH No calibration applied and no bandpass applied

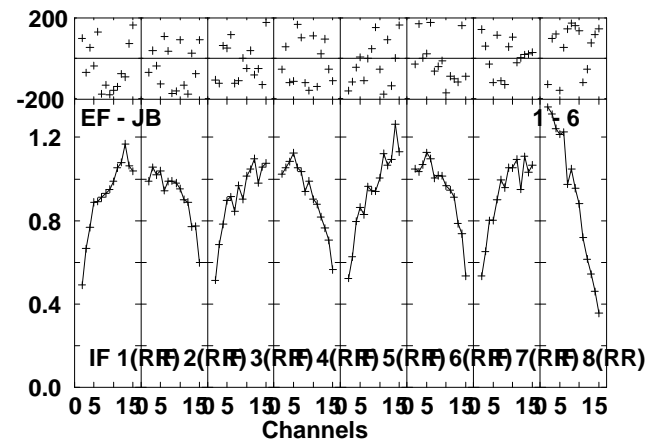
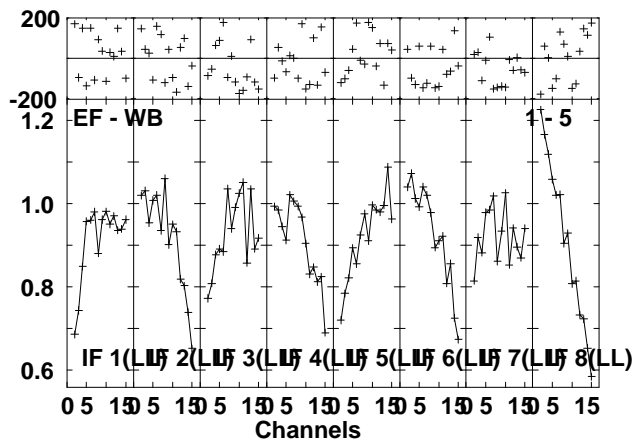
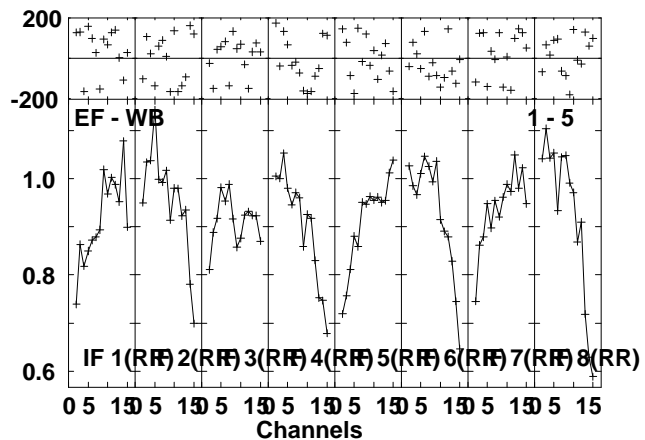
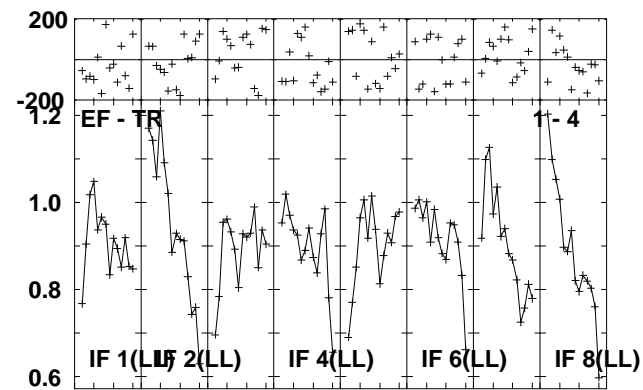
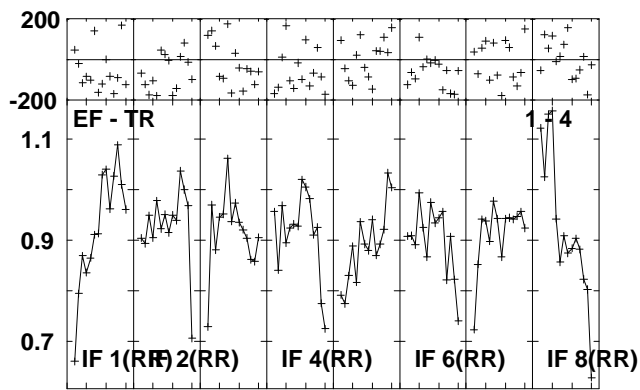
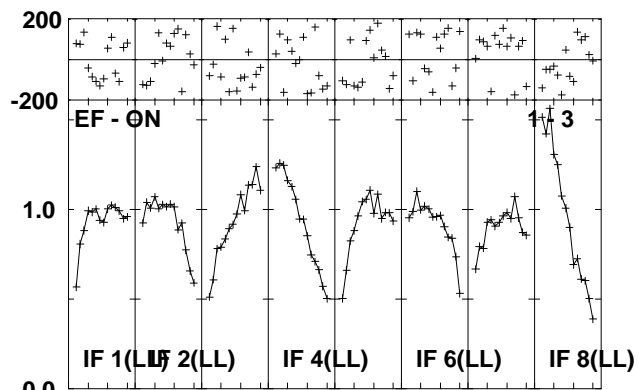
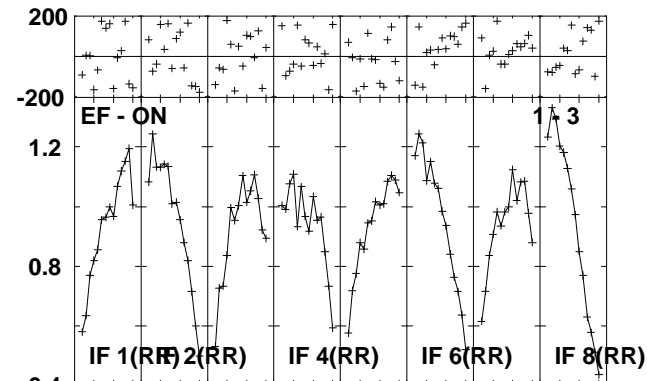
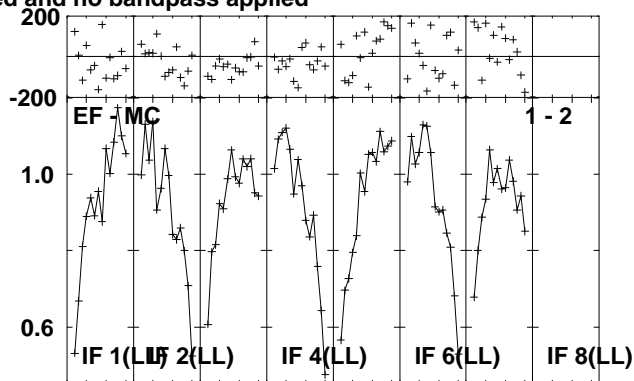
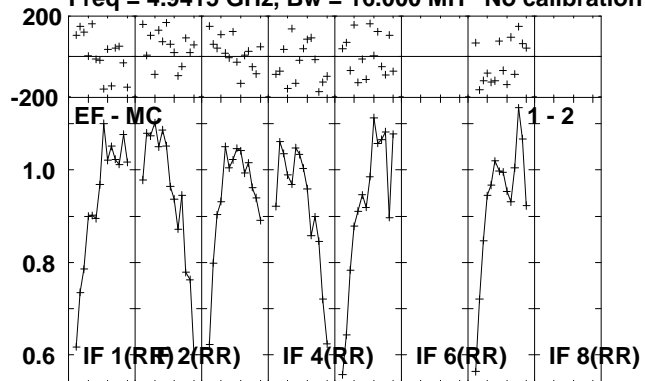

Lower frame: Milli Ampl Jy Top frame: Phas deg
Scalar averaged cross-power spectrum Several baselines displayed
Timerange: 00/19:51:41 to 00/19:56:39

Plot file version 48 created 06-OCT-2010 10:56:24

AQLX-1 ET013A.UVDATA.1

Freq = 4.9415 GHz, Bw = 16.000 MH No calibration applied and no bandpass applied

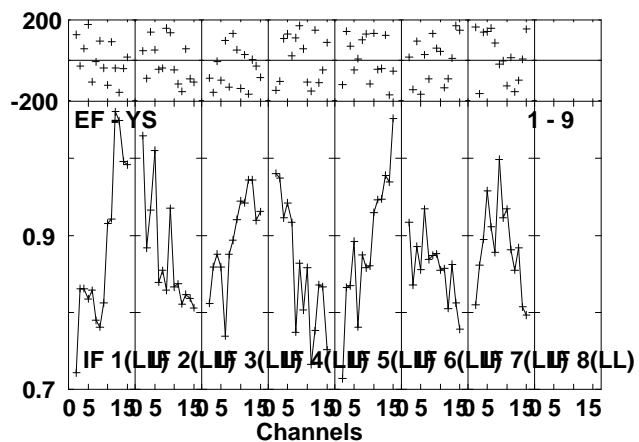
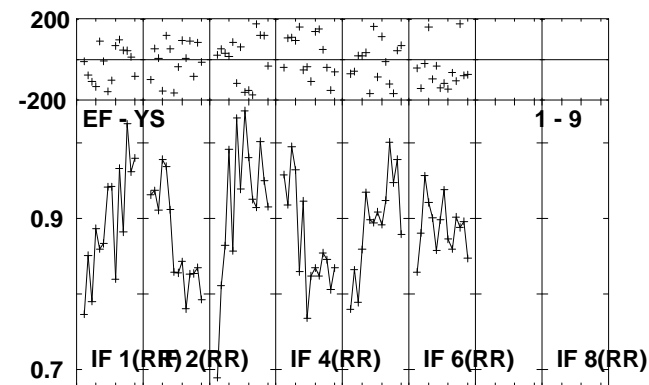
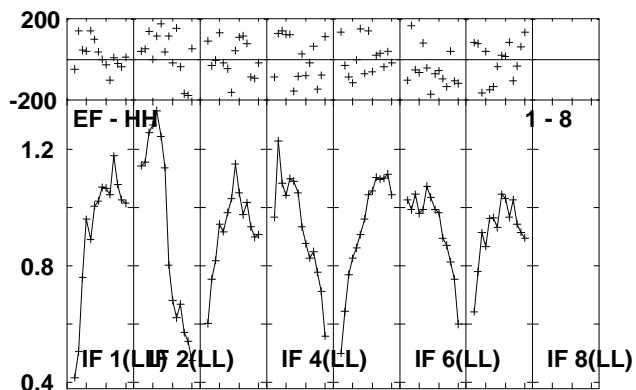
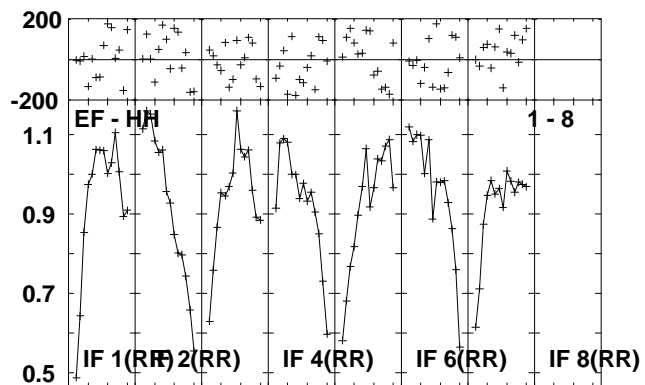
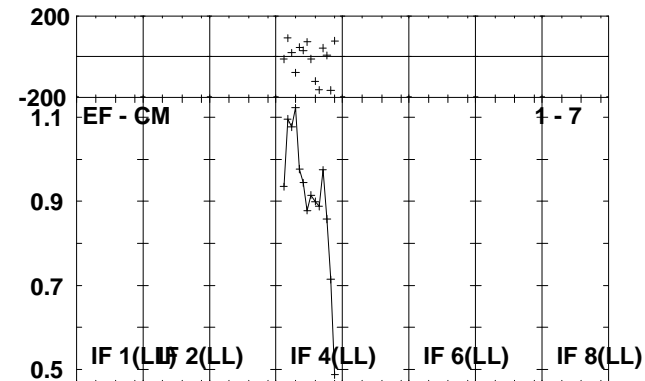
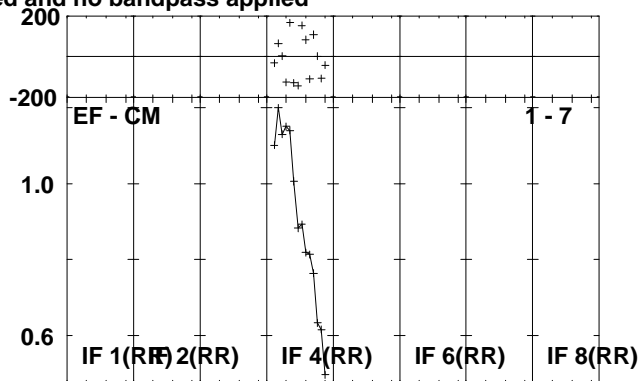
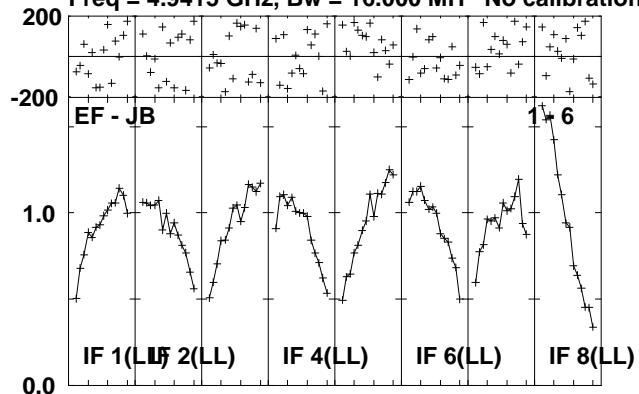

Lower frame: Milli Ampl Jy Top frame: Phas deg
Scalar averaged cross-power spectrum Several baselines displayed
Timerange: 00/19:51:41 to 00/19:56:39

Plot file version 49 created 06-OCT-2010 10:56:26

J1907+01 ET013A.UVDATA.1

Freq = 4.9415 GHz, Bw = 16.000 MH No calibration applied and no bandpass applied

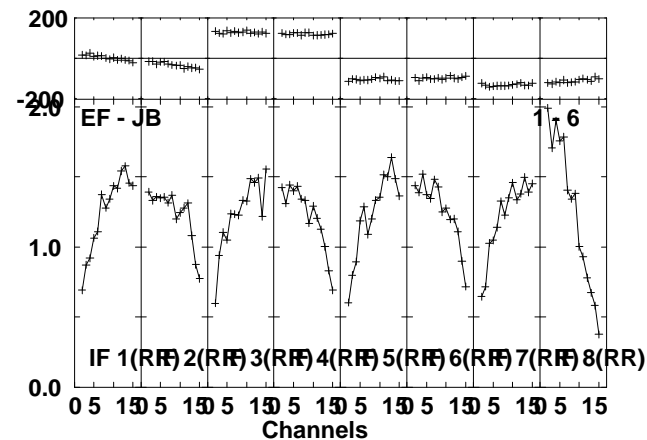
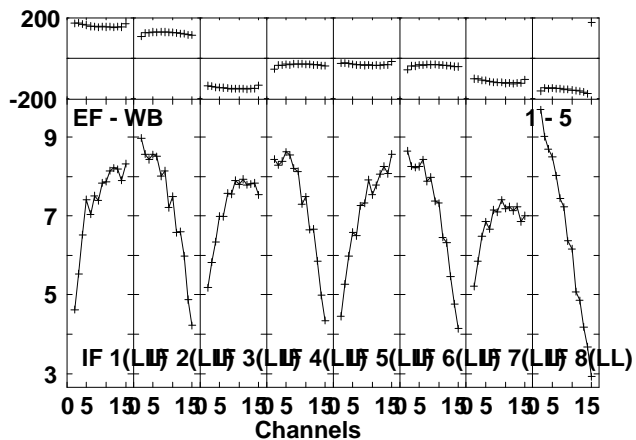
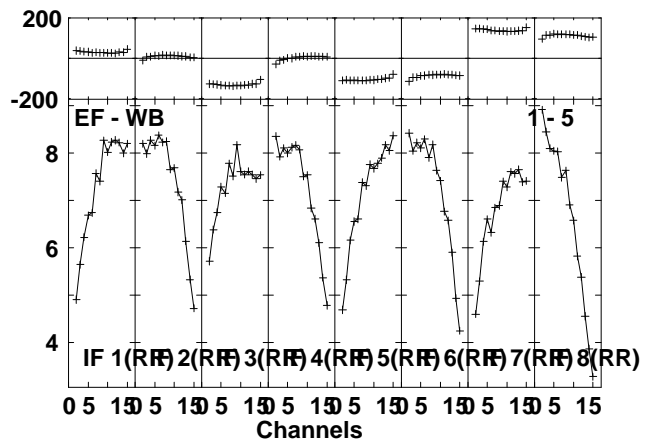
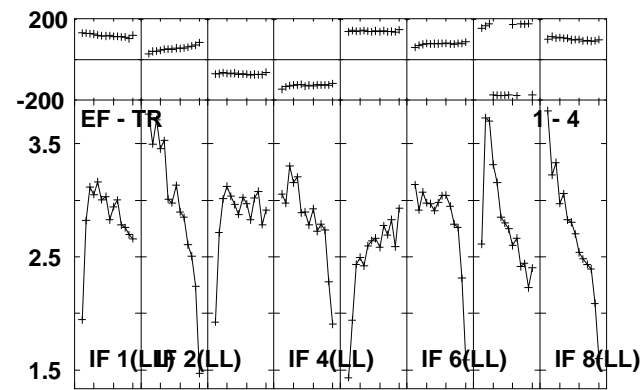
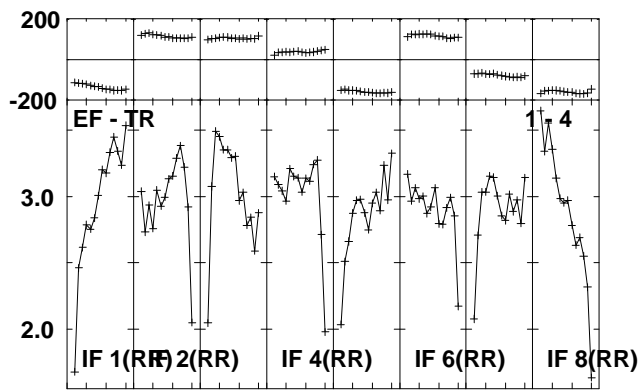
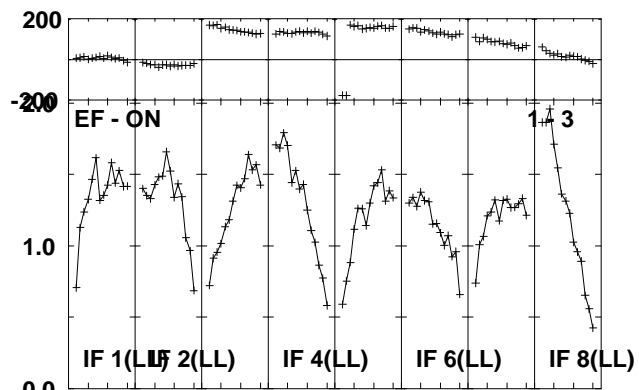
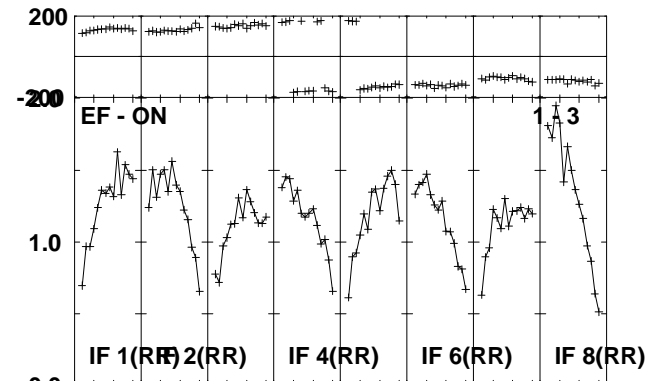
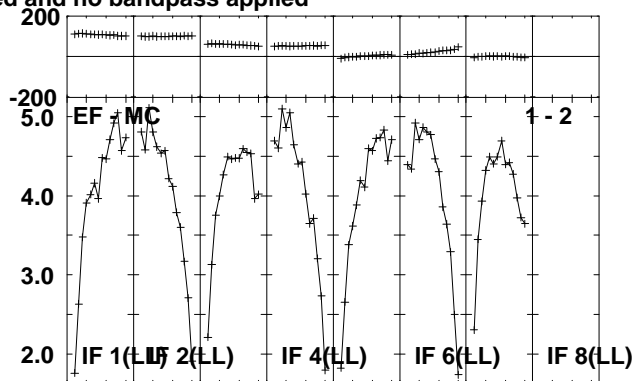
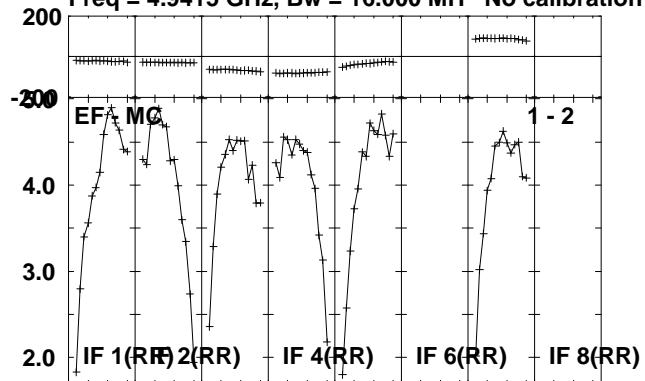

Lower frame: Milli Ampl Jy Top frame: Phas deg
Scalar averaged cross-power spectrum Several baselines displayed
Timerange: 00/19:57:21 to 00/19:59:39

Plot file version 50 created 06-OCT-2010 10:56:27

J1907+01 ET013A.UVDATA.1

Freq = 4.9415 GHz, Bw = 16.000 MH No calibration applied and no bandpass applied

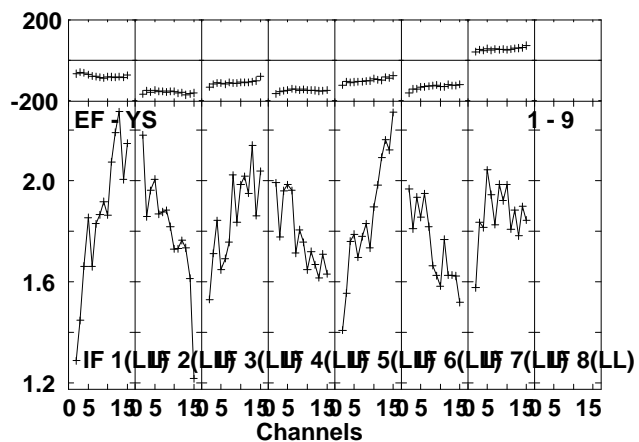
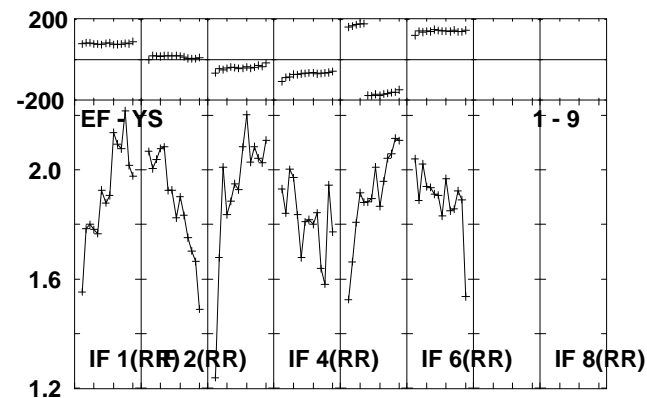
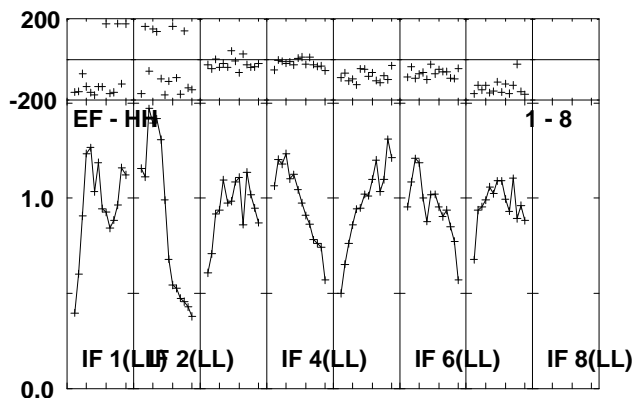
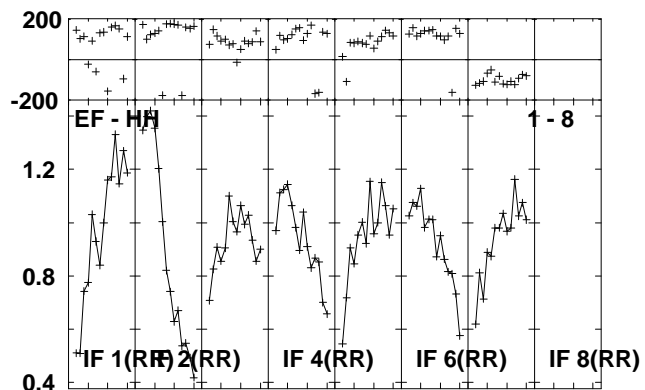
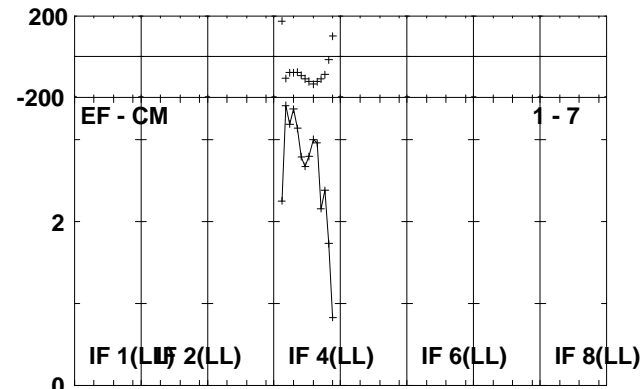
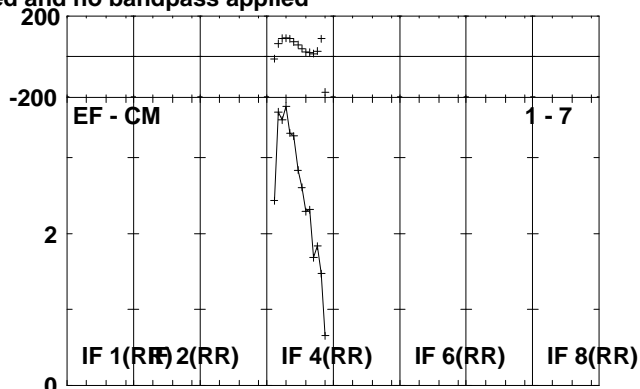
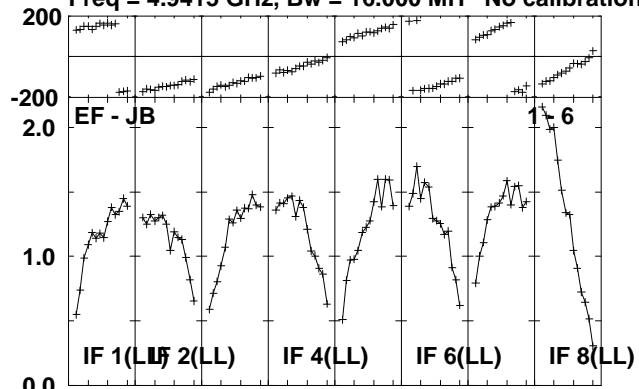

Lower frame: Milli Ampl Jy Top frame: Phas deg
Scalar averaged cross-power spectrum Several baselines displayed
Timerange: 00/19:57:21 to 00/19:59:39

Plot file version 51 created 06-OCT-2010 10:56:28

J1920-02 ET013A.UVDATA.1

Freq = 4.9415 GHz, Bw = 16.000 MH No calibration applied and no bandpass applied

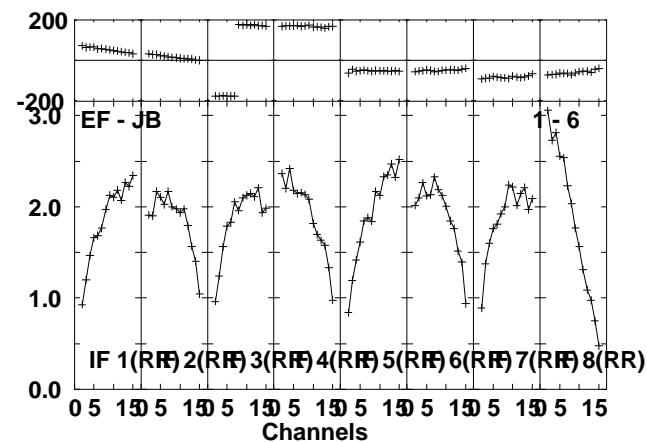
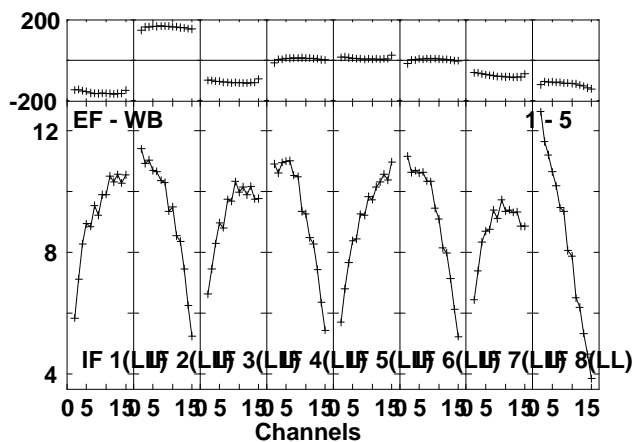
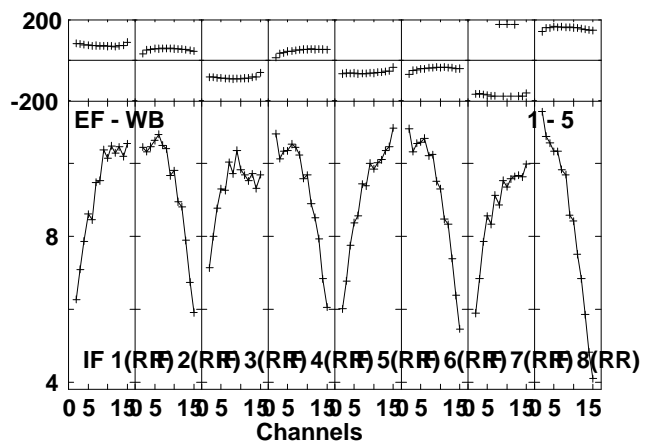
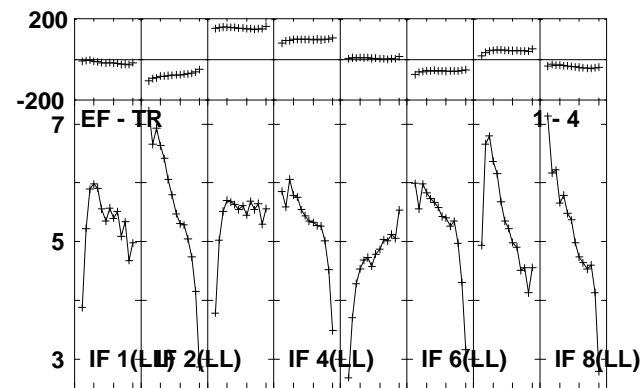
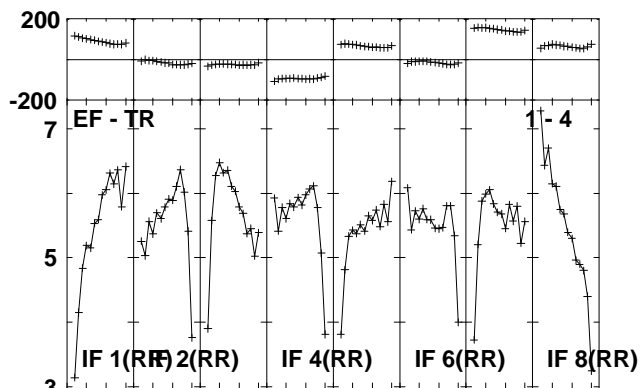
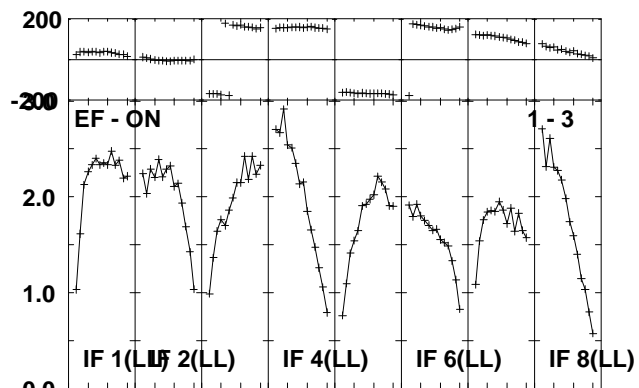
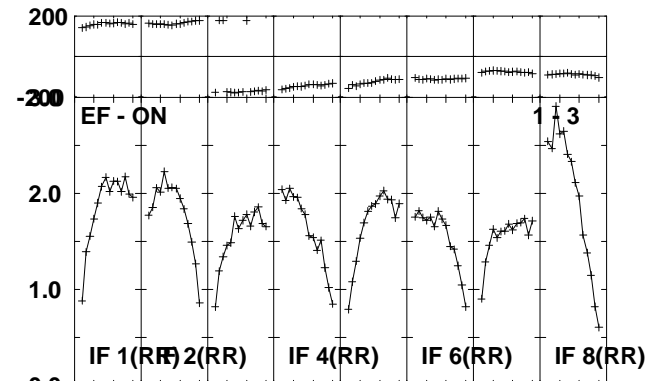
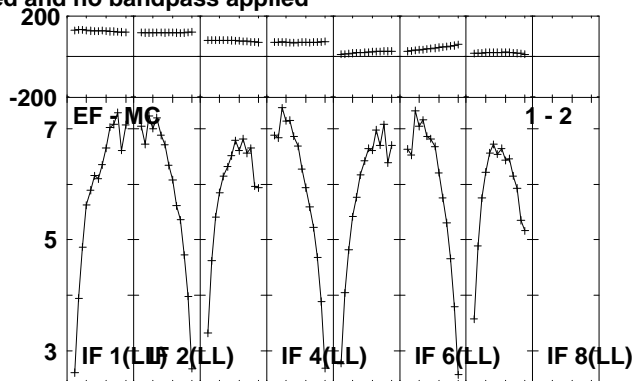
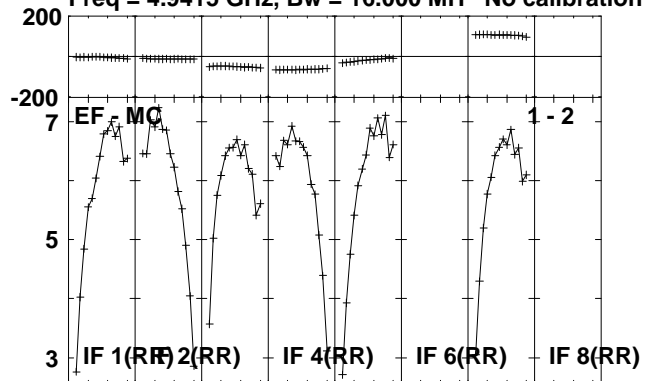

Lower frame: Milli Ampl Jy Top frame: Phas deg
Scalar averaged cross-power spectrum Several baselines displayed
Timerange: 00/19:59:41 to 00/20:04:39

Plot file version 52 created 06-OCT-2010 10:56:30

J1920-02 ET013A.UVDATA.1

Freq = 4.9415 GHz, Bw = 16.000 MH No calibration applied and no bandpass applied

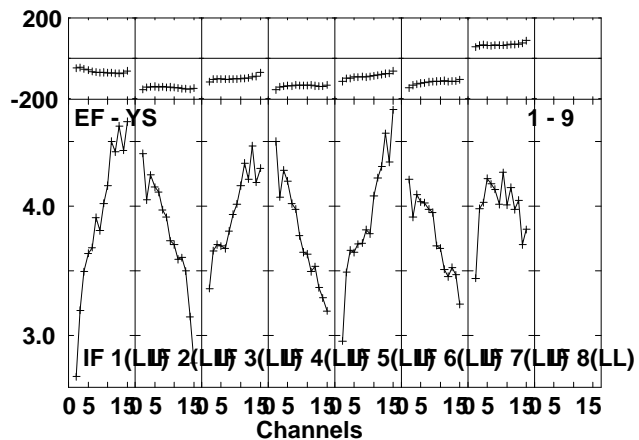
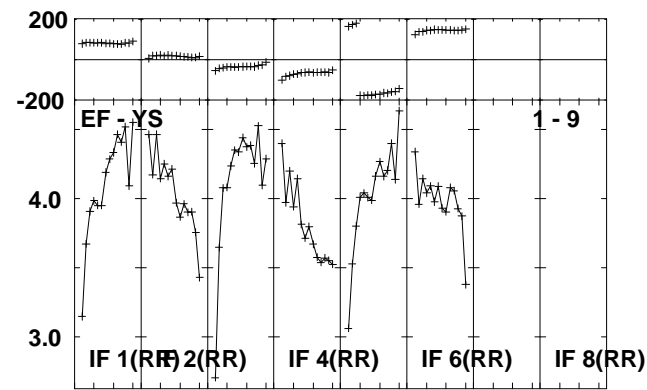
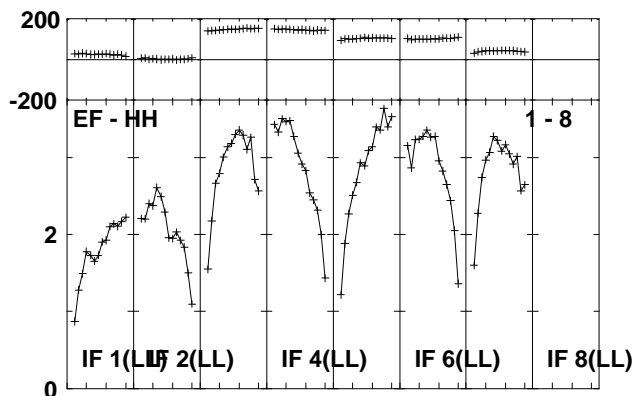
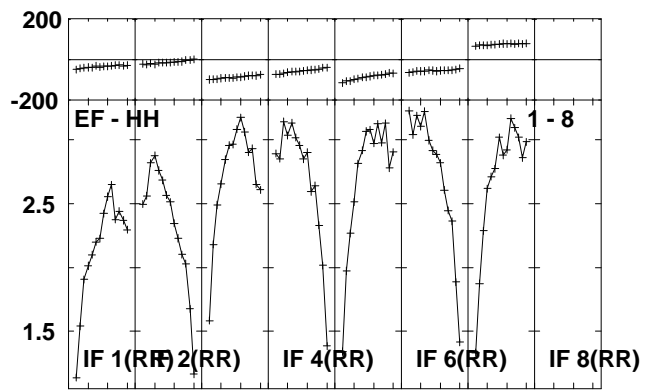
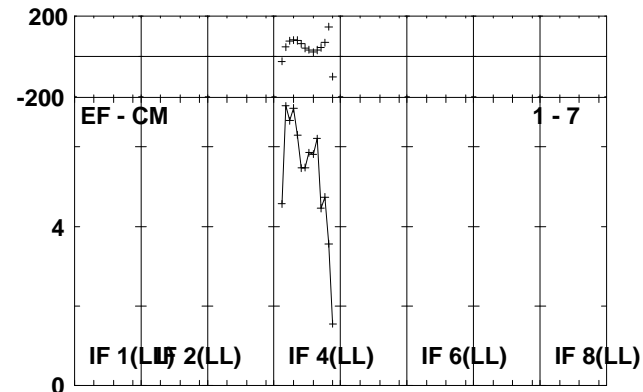
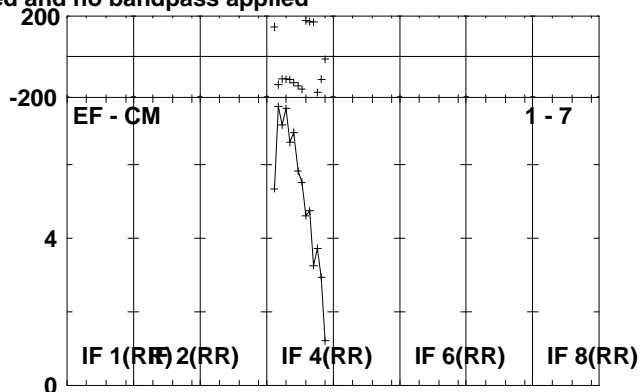
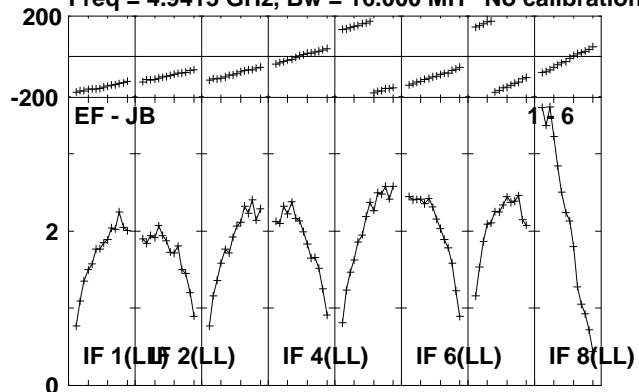

Lower frame: Milli Ampl Jy Top frame: Phas deg
Scalar averaged cross-power spectrum Several baselines displayed
Timerange: 00/19:59:41 to 00/20:04:39

Plot file version 53 created 06-OCT-2010 10:56:32

J1907+01 ET013A.UVDATA.1

Freq = 4.9415 GHz, Bw = 16.000 MH No calibration applied and no bandpass applied

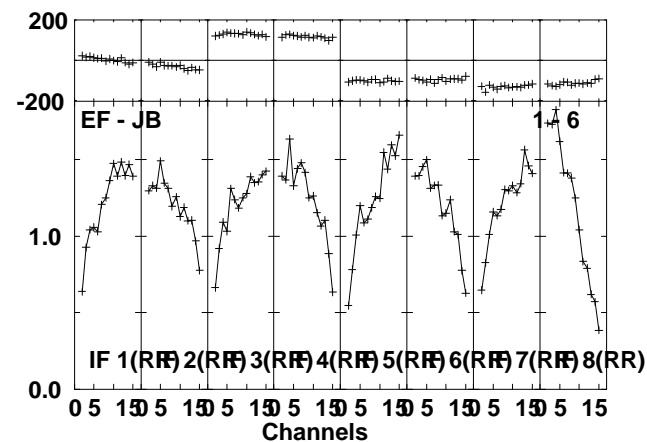
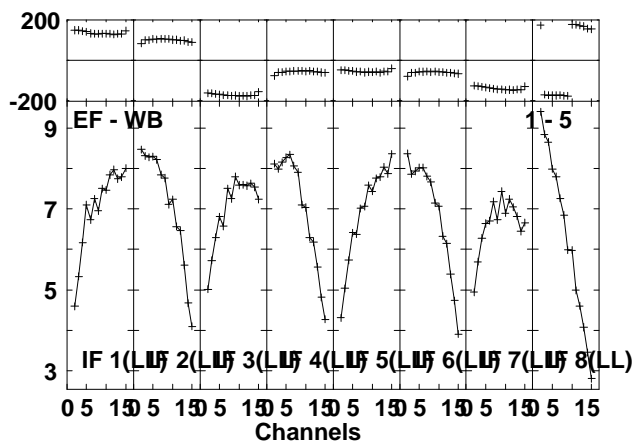
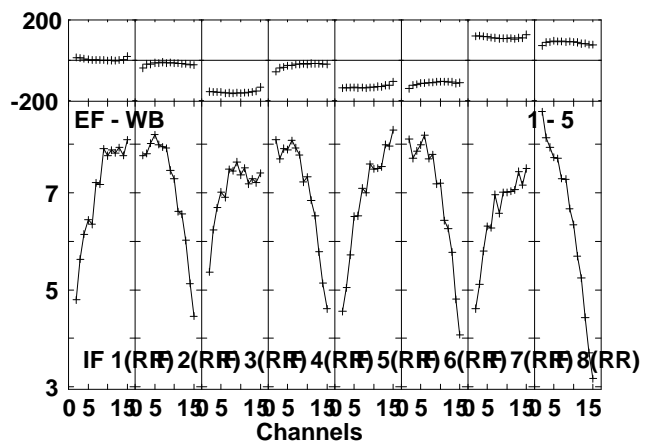
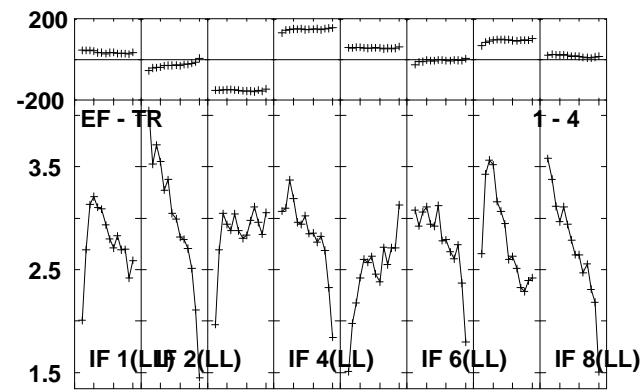
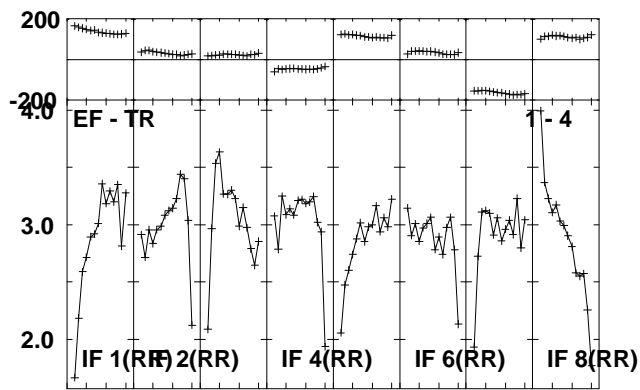
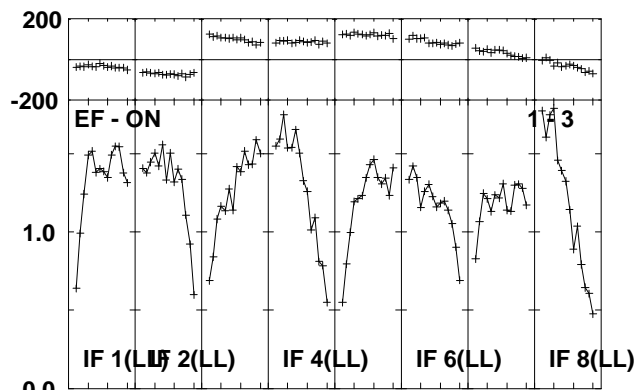
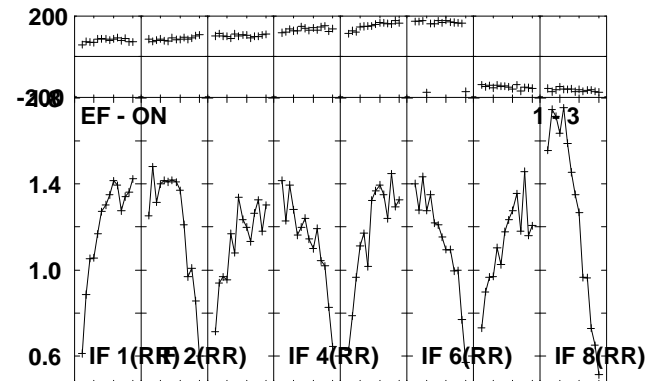
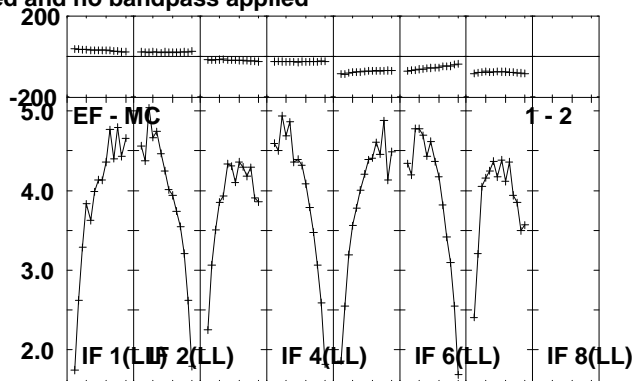
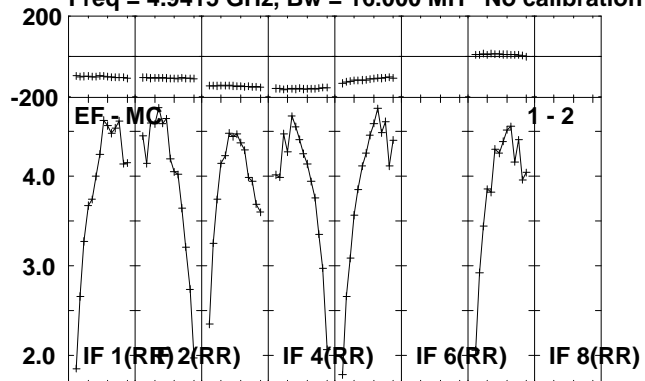

Lower frame: Milli Ampl Jy Top frame: Phas deg
Scalar averaged cross-power spectrum Several baselines displayed
Timerange: 00/20:05:41 to 00/20:07:59

Plot file version 54 created 06-OCT-2010 10:56:33

J1907+01 ET013A.UVDATA.1

Freq = 4.9415 GHz, Bw = 16.000 MH No calibration applied and no bandpass applied

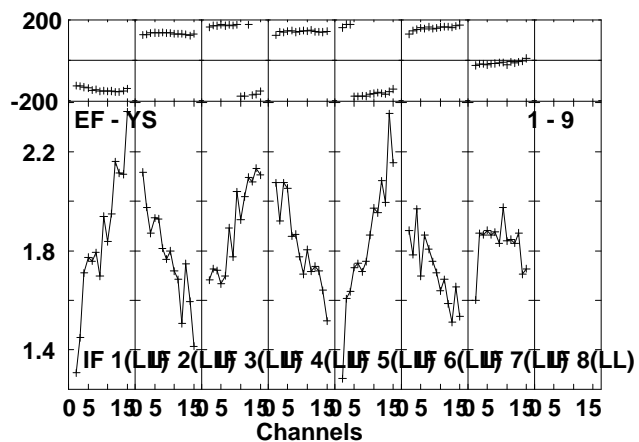
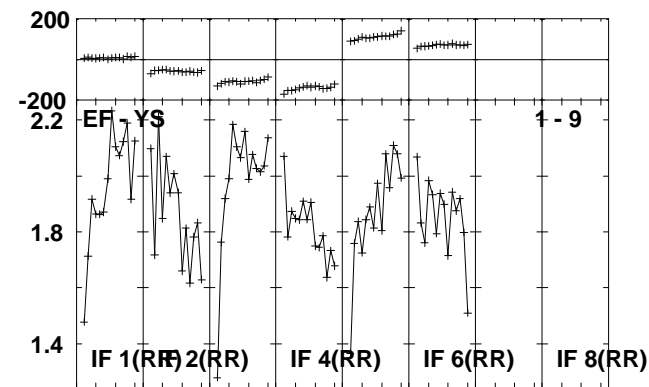
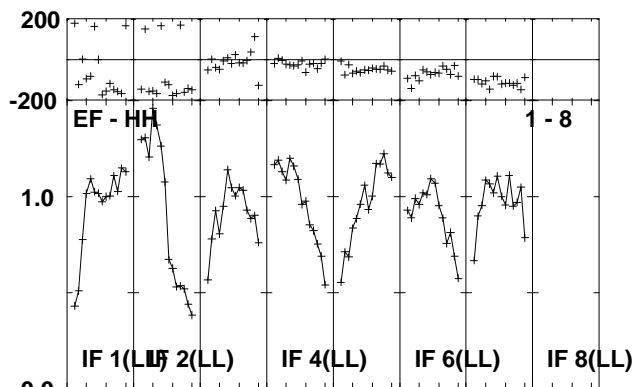
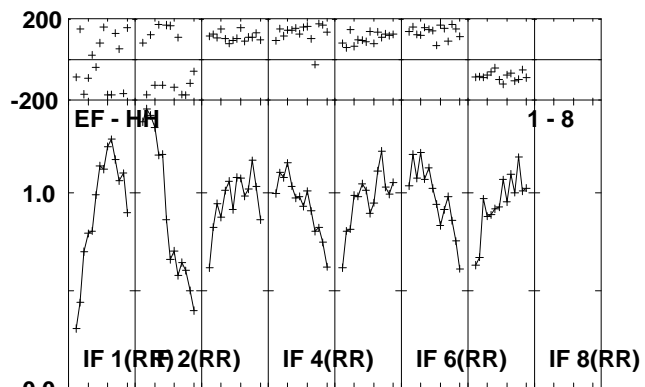
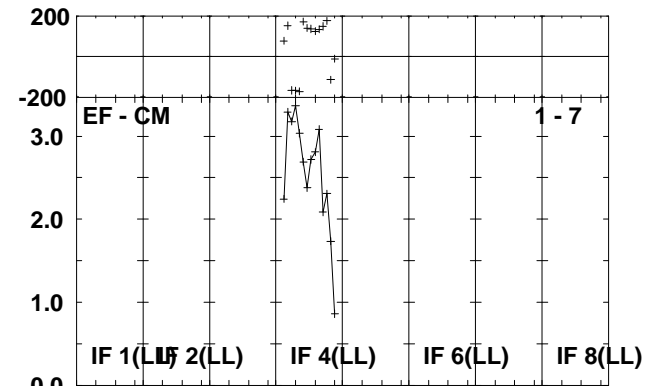
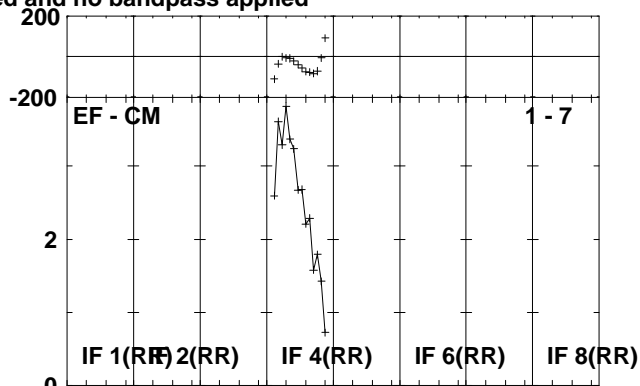
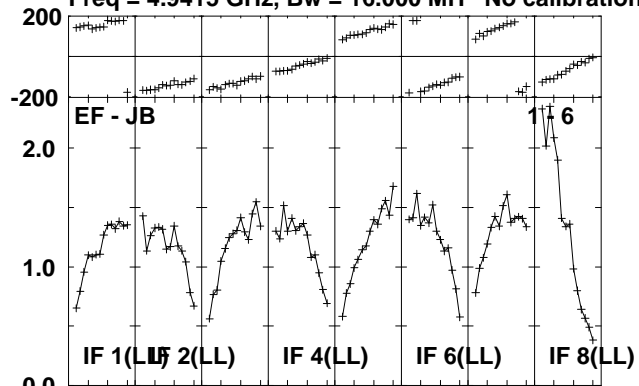

Lower frame: Milli Ampl Jy Top frame: Phas deg
Scalar averaged cross-power spectrum Several baselines displayed
Timerange: 00/20:05:41 to 00/20:07:59

Plot file version 55 created 06-OCT-2010 10:56:35

AQLX-1 ET013A.UVDATA.1

Freq = 4.9415 GHz, Bw = 16.000 MH No calibration applied and no bandpass applied

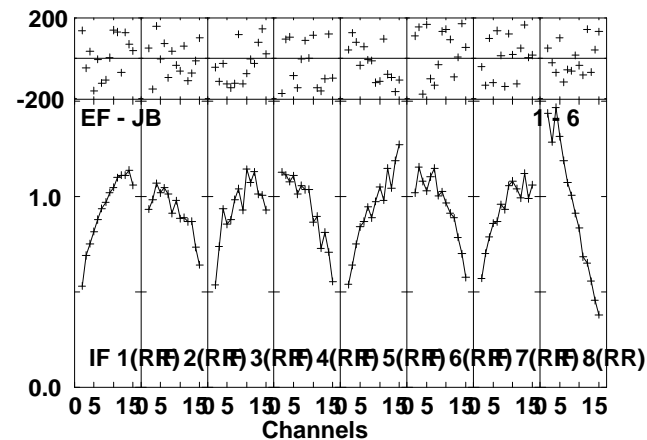
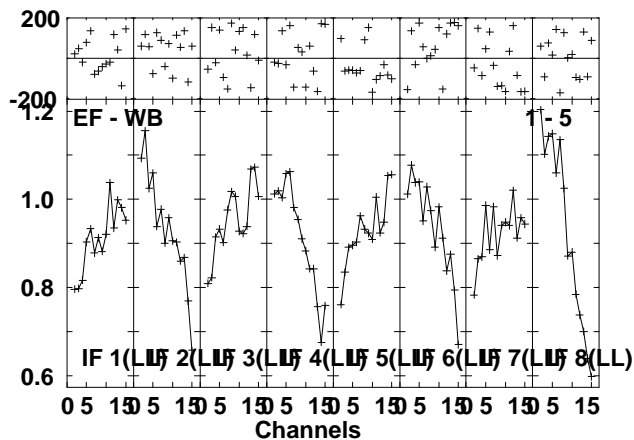
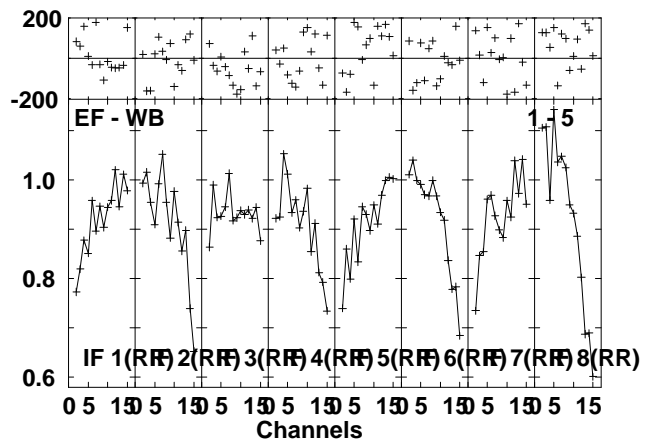
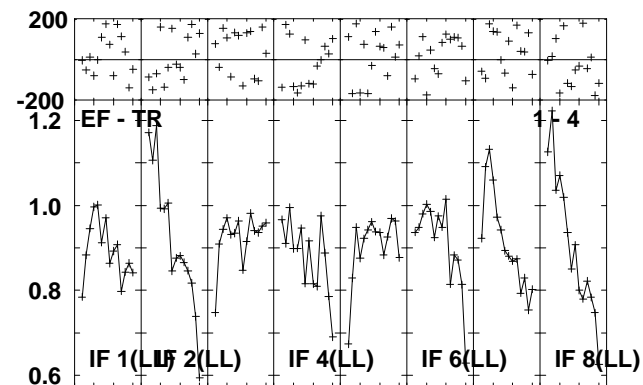
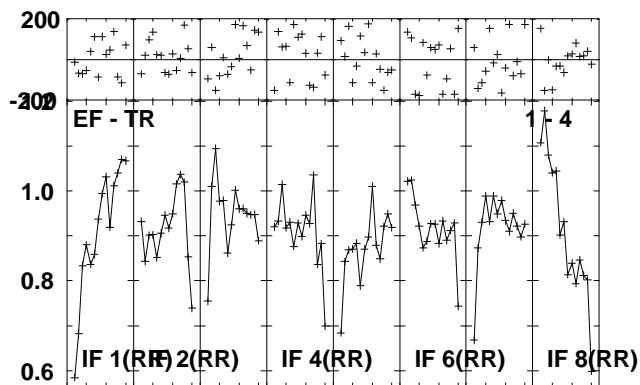
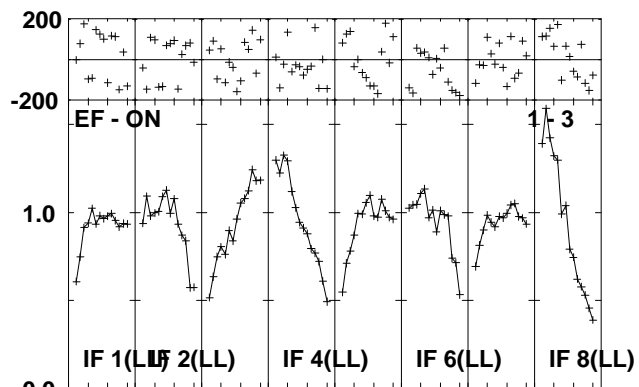
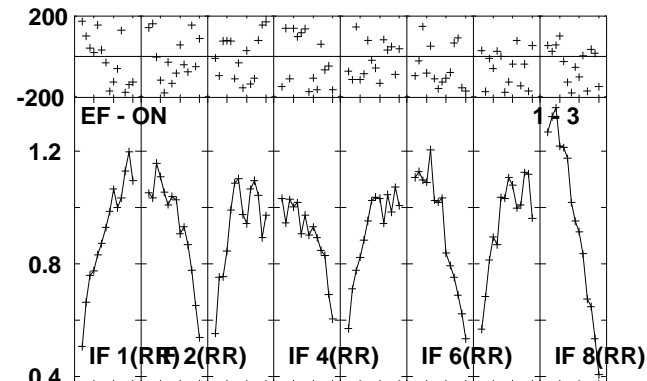
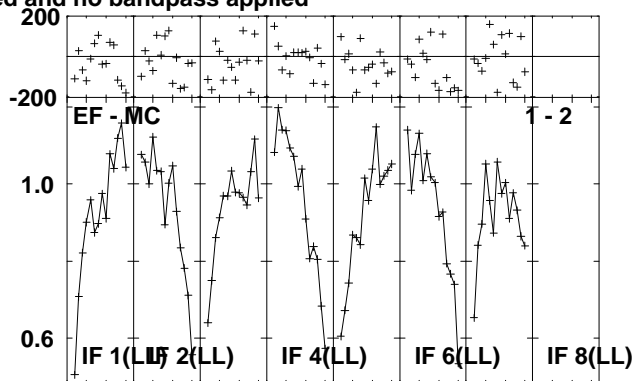
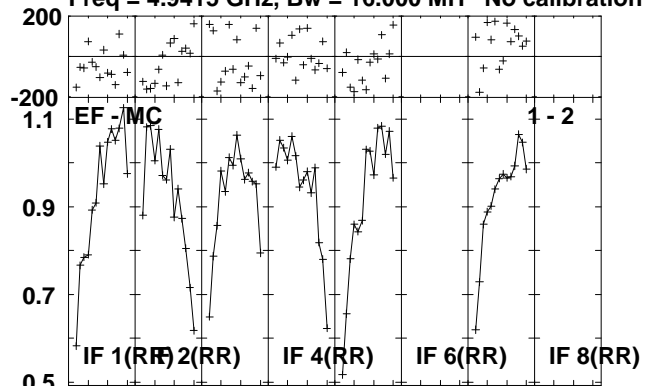

Lower frame: Milli Ampl Jy Top frame: Phas deg
Scalar averaged cross-power spectrum Several baselines displayed
Timerange: 00/20:08:01 to 00/20:12:59

Plot file version 56 created 06-OCT-2010 10:56:37

AQLX-1 ET013A.UVDATA.1

Freq = 4.9415 GHz, Bw = 16.000 MH No calibration applied and no bandpass applied

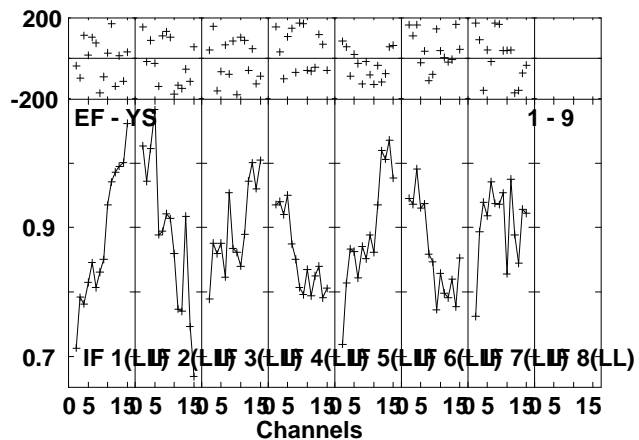
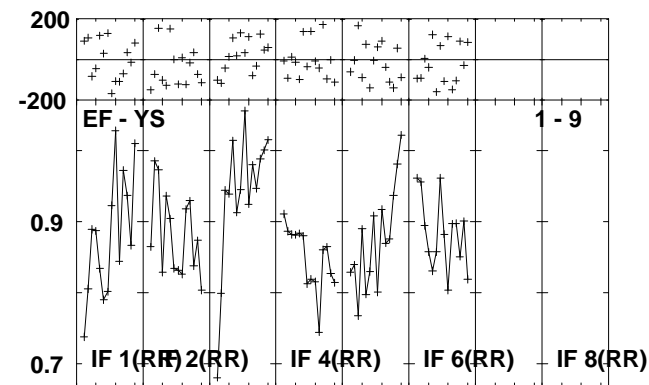
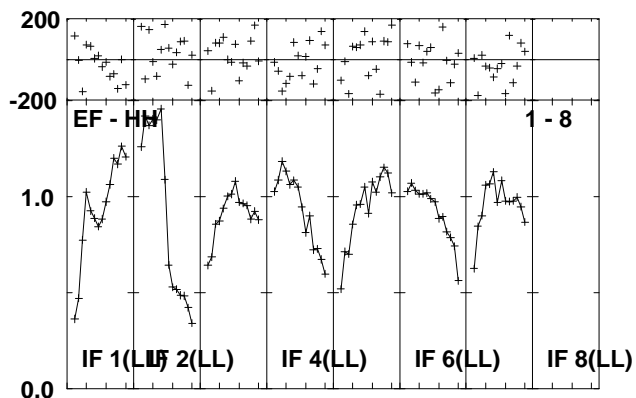
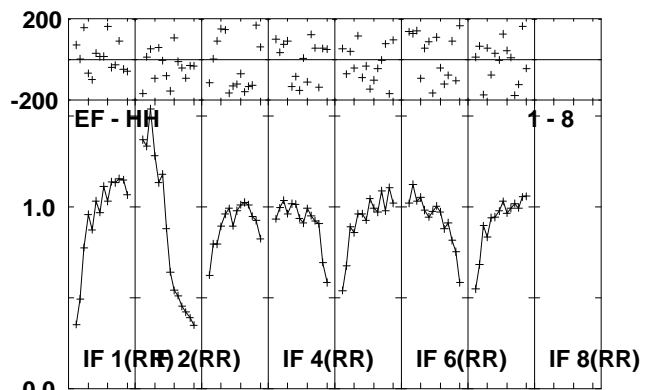
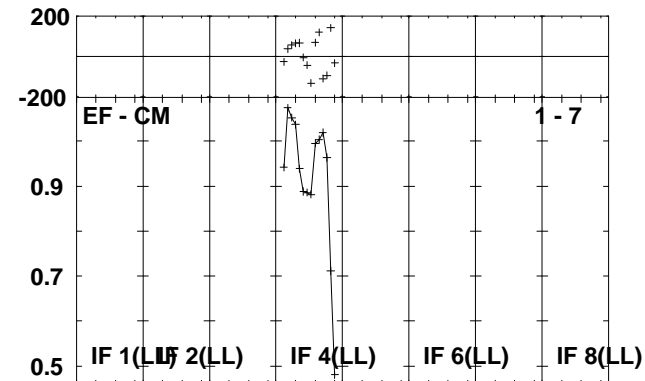
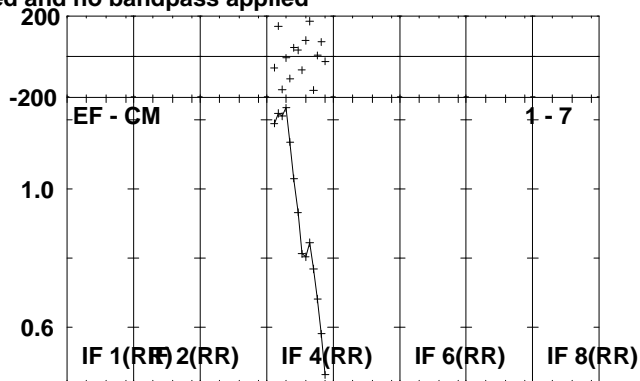
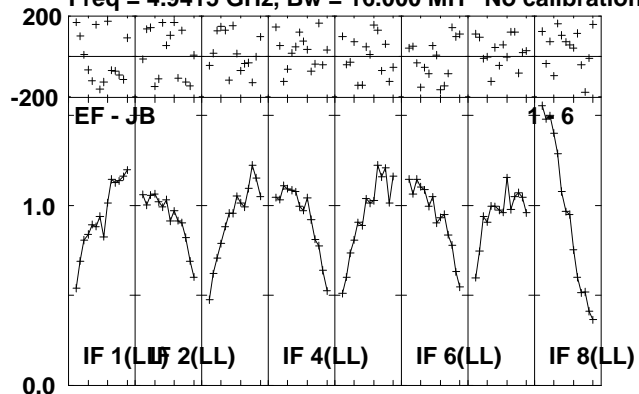

Lower frame: Milli Ampl Jy Top frame: Phas deg
Scalar averaged cross-power spectrum Several baselines displayed
Timerange: 00/20:08:01 to 00/20:12:59

Plot file version 57 created 06-OCT-2010 10:56:39

J1907+01 ET013A.UVDATA.1

Freq = 4.9415 GHz, Bw = 16.000 MH No calibration applied and no bandpass applied

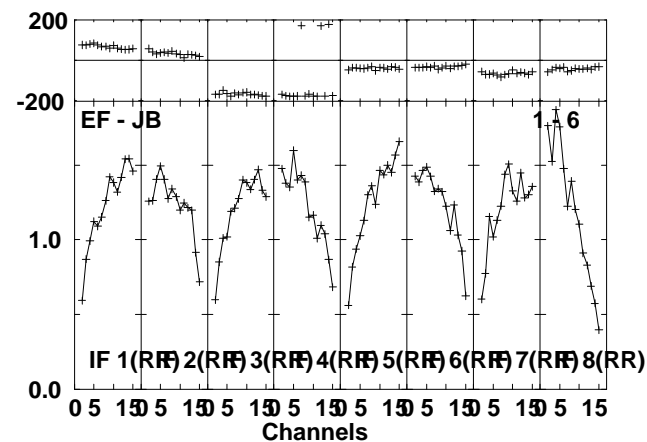
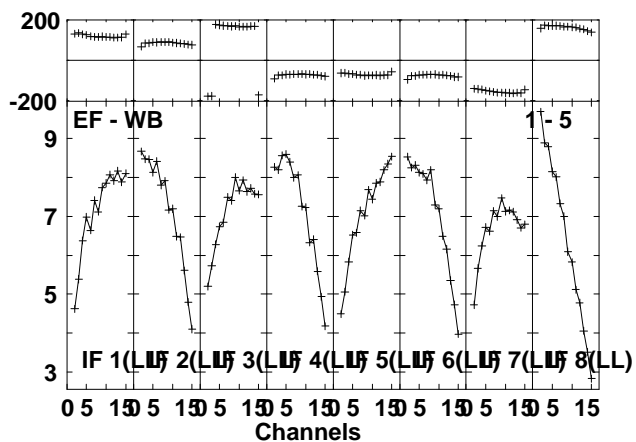
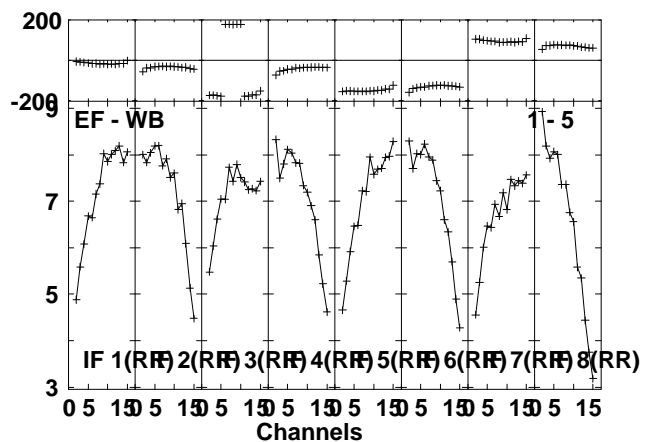
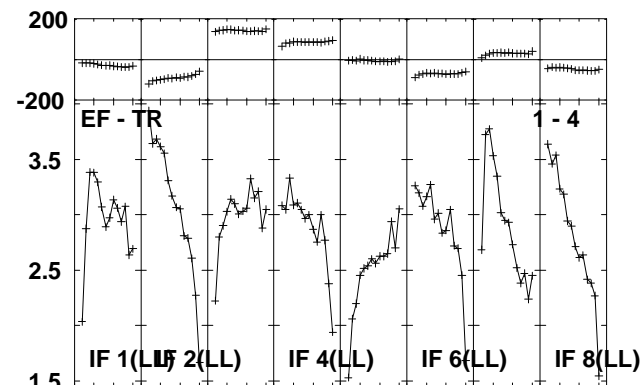
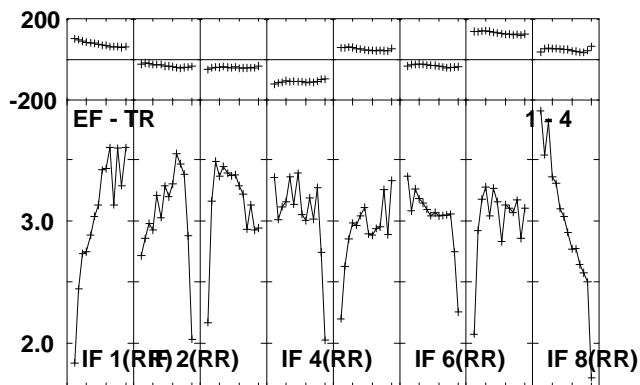
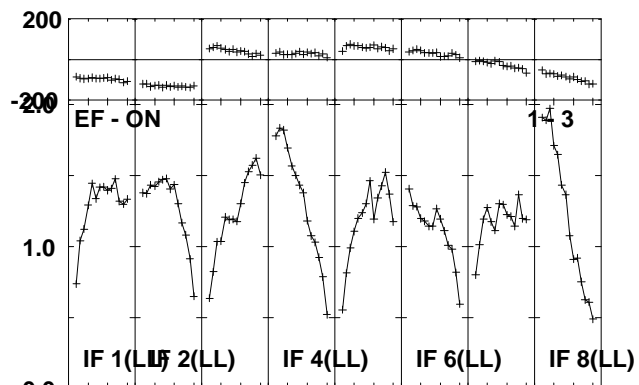
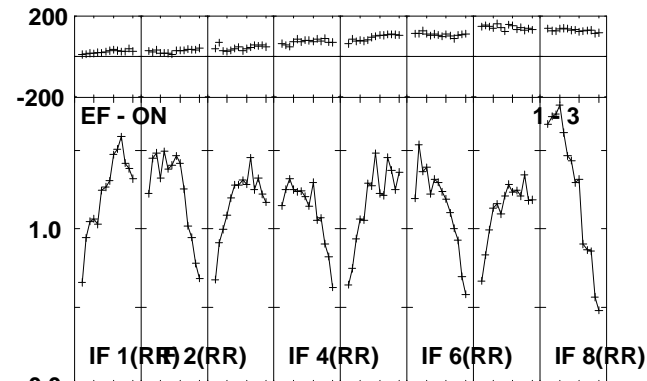
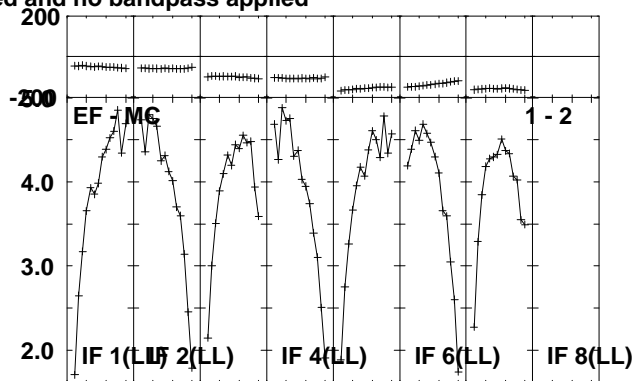
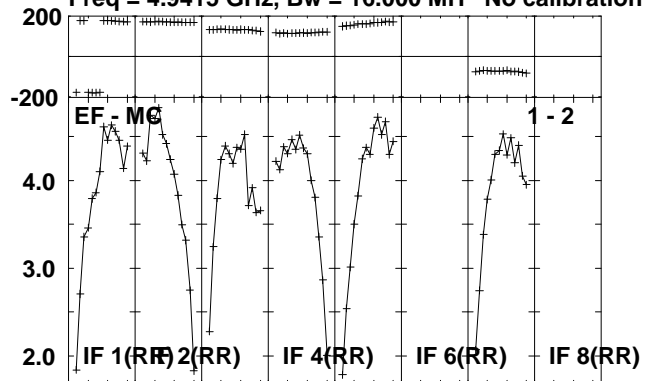

Lower frame: Milli Ampl Jy Top frame: Phas deg
Scalar averaged cross-power spectrum Several baselines displayed
Timerange: 00/20:13:41 to 00/20:15:59

Plot file version 58 created 06-OCT-2010 10:56:40

J1907+01 ET013A.UVDATA.1

Freq = 4.9415 GHz, Bw = 16.000 MH No calibration applied and no bandpass applied

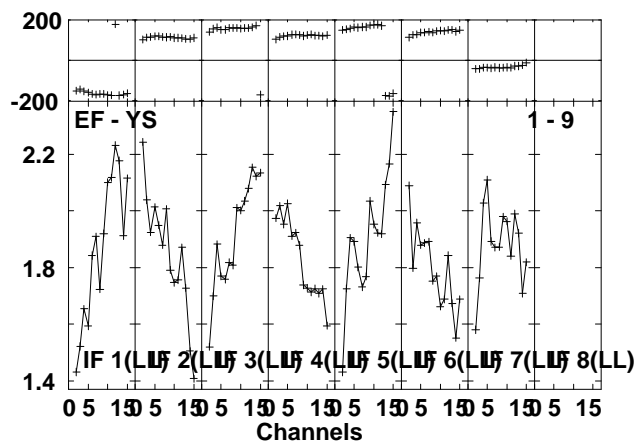
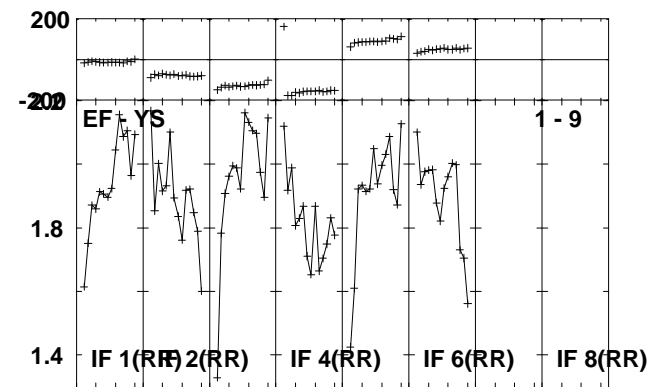
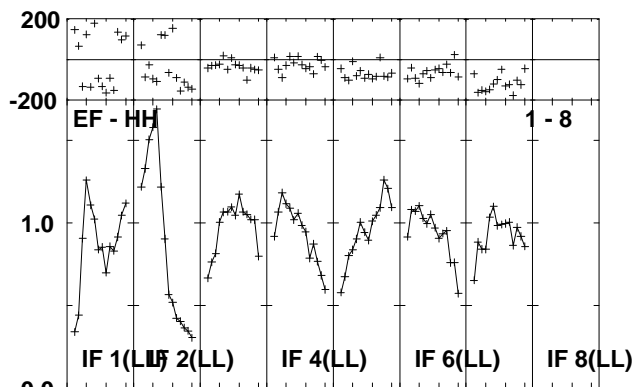
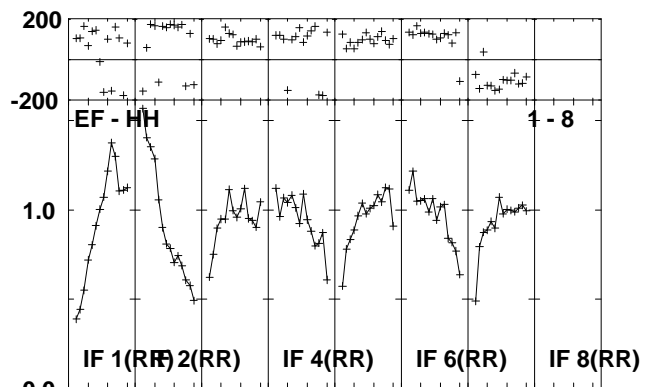
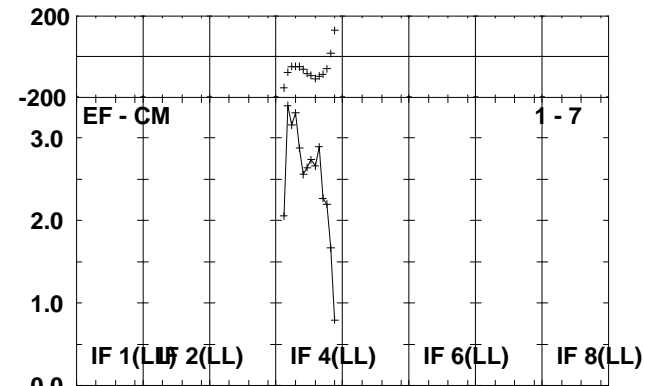
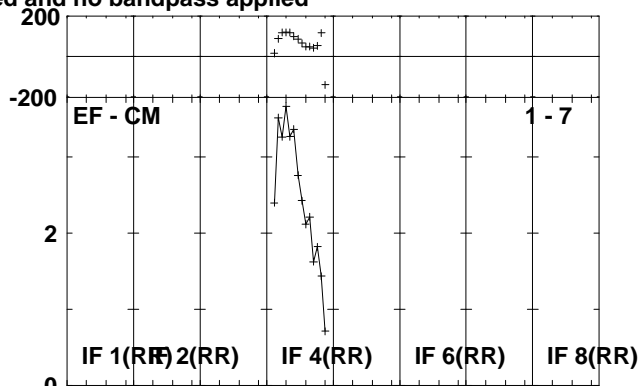
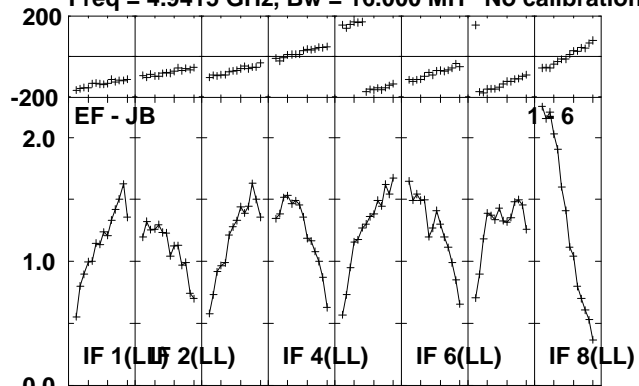

Lower frame: Milli Ampl Jy Top frame: Phas deg
Scalar averaged cross-power spectrum Several baselines displayed
Timerange: 00/20:13:41 to 00/20:15:59

Plot file version 59 created 06-OCT-2010 10:56:41

AQLX-1 ET013A.UVDATA.1

Freq = 4.9415 GHz, Bw = 16.000 MH No calibration applied and no bandpass applied

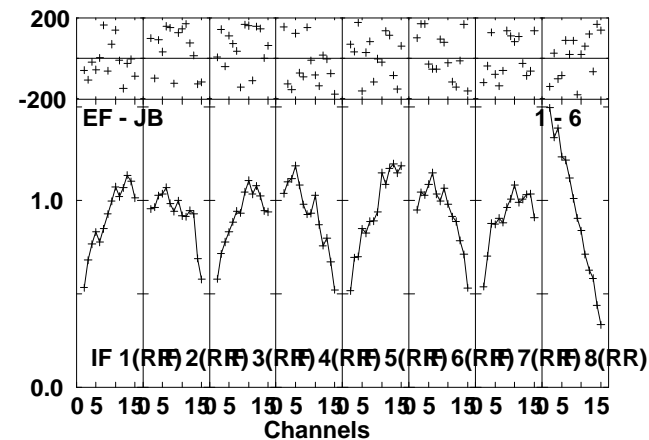
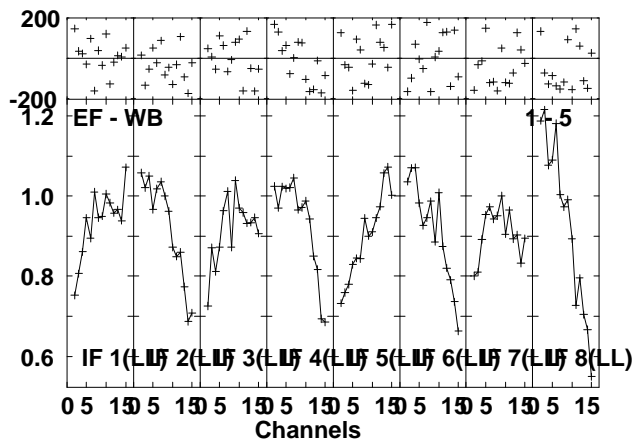
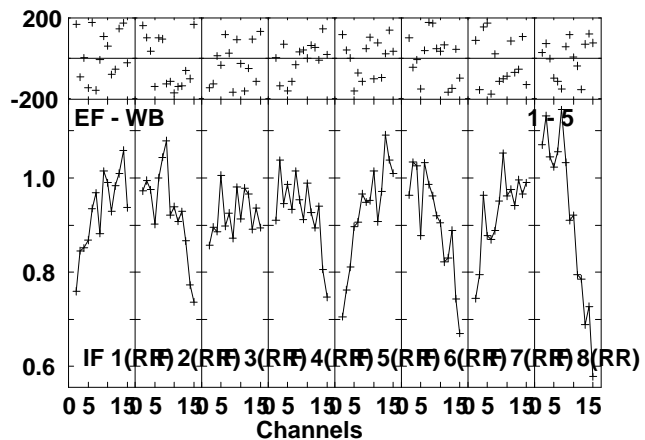
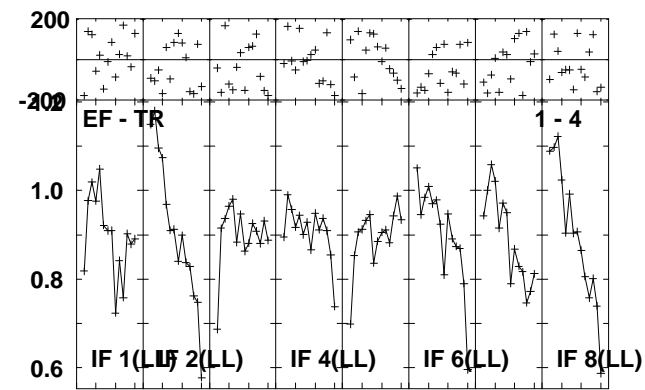
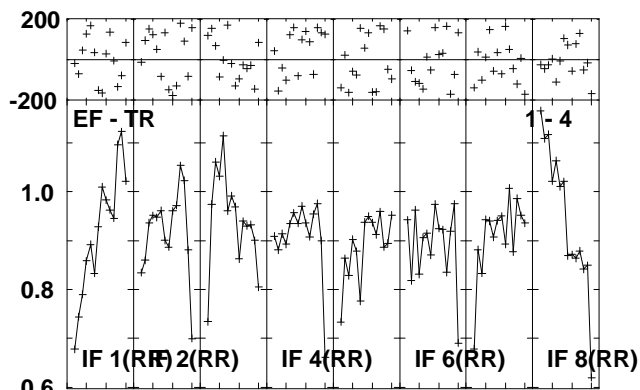
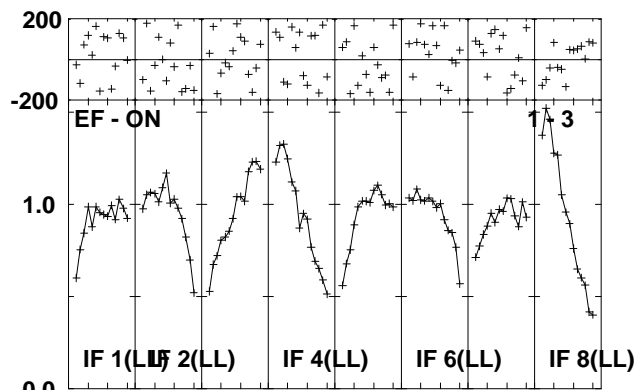
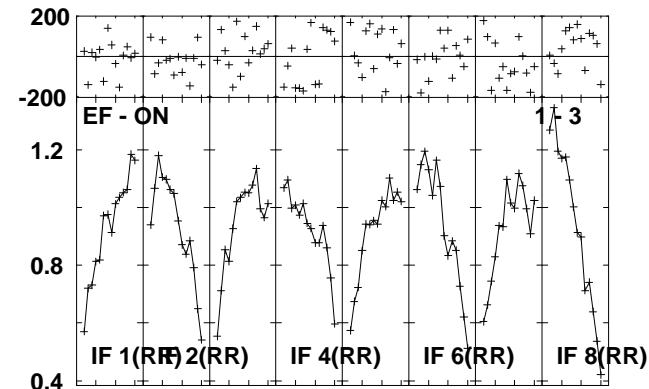
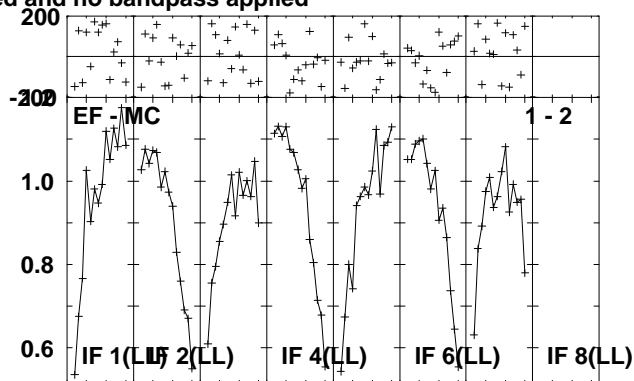
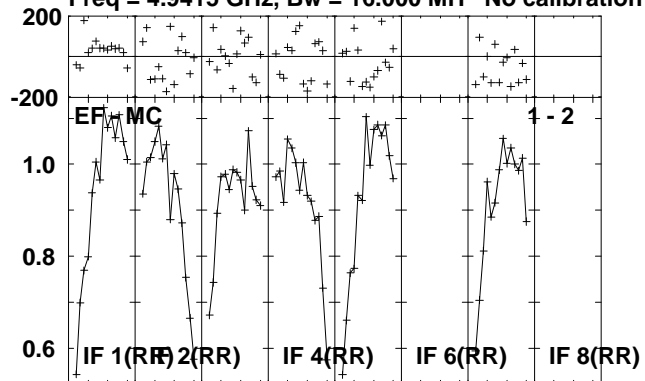

Lower frame: Milli Ampl Jy Top frame: Phas deg
Scalar averaged cross-power spectrum Several baselines displayed
Timerange: 00/20:16:01 to 00/20:20:59

Plot file version 60 created 06-OCT-2010 10:56:43

AQLX-1 ET013A.UVDATA.1

Freq = 4.9415 GHz, Bw = 16.000 MH No calibration applied and no bandpass applied

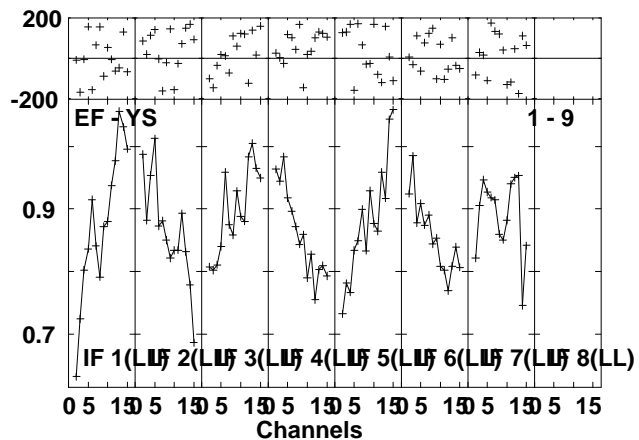
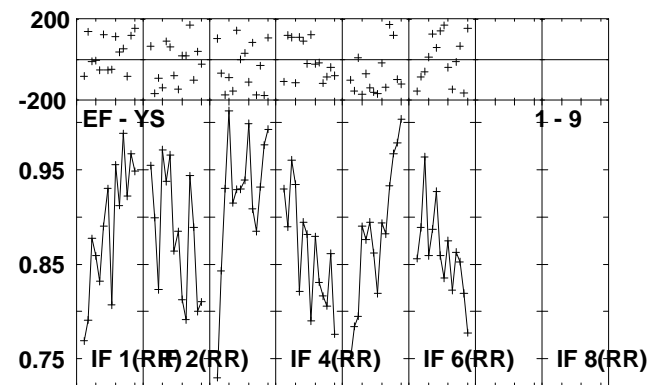
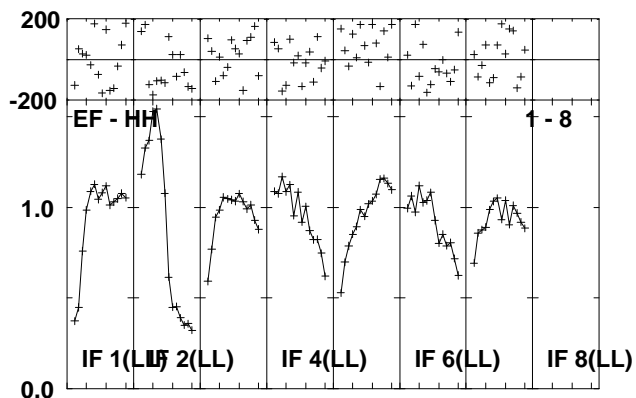
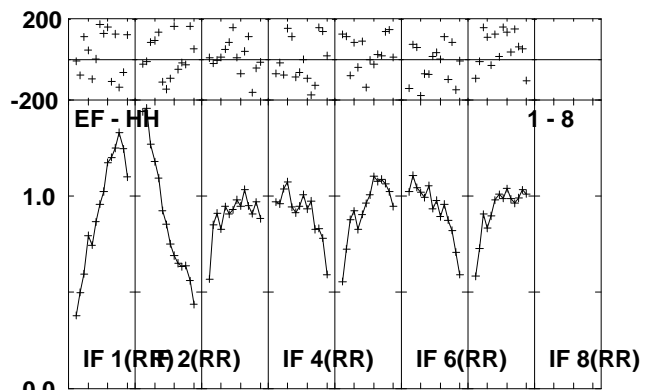
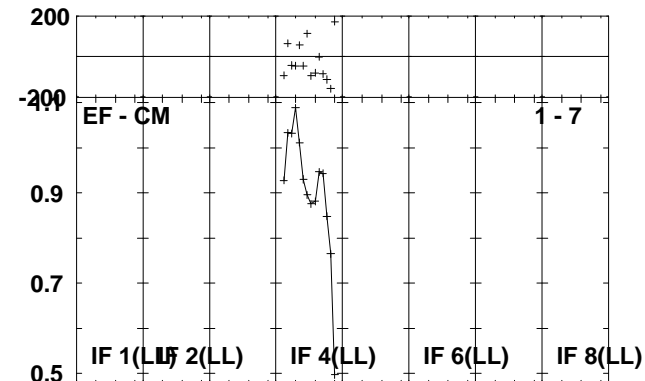
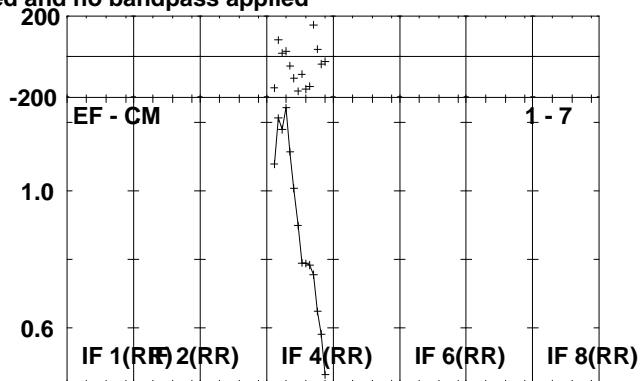
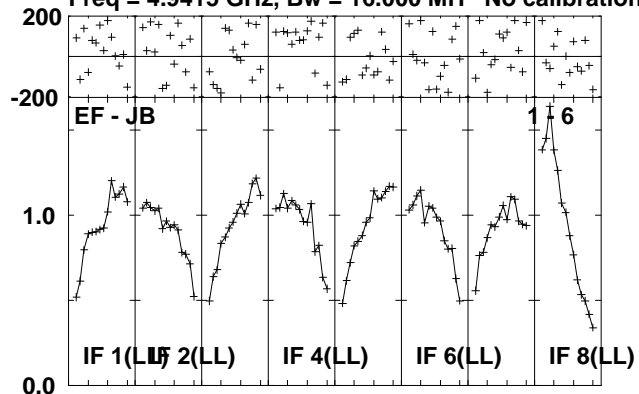

Lower frame: Milli Ampl Jy Top frame: Phas deg
Scalar averaged cross-power spectrum Several baselines displayed
Timerange: 00/20:16:01 to 00/20:20:59

Plot file version 61 created 06-OCT-2010 10:56:45

J1907+01 ET013A.UVDATA.1

Freq = 4.9415 GHz, Bw = 16.000 MH No calibration applied and no bandpass applied

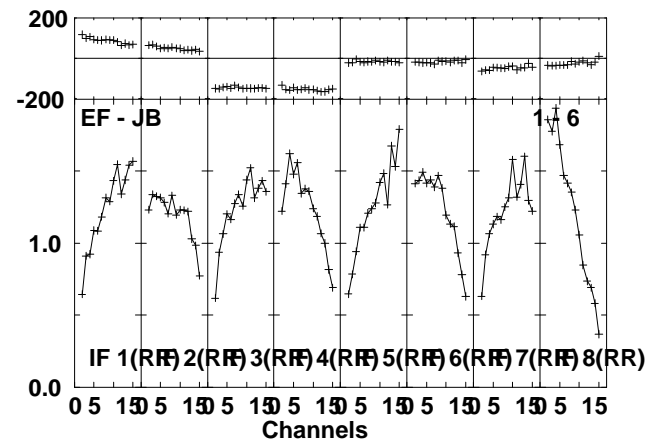
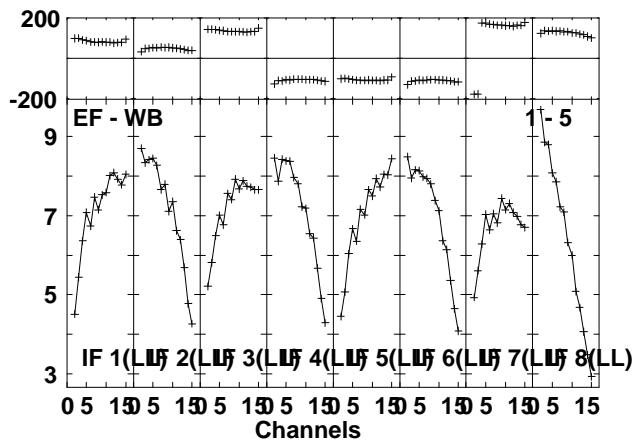
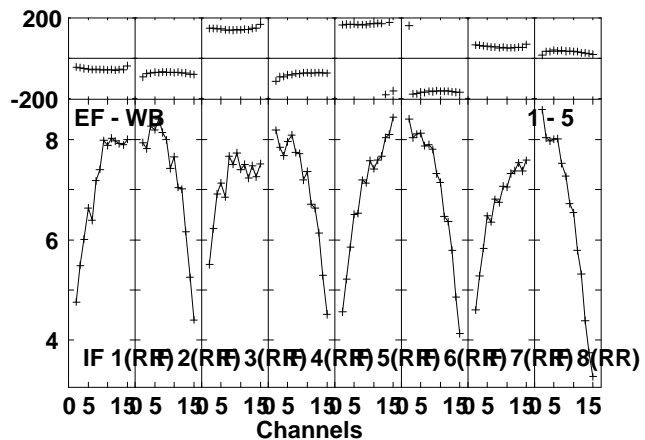
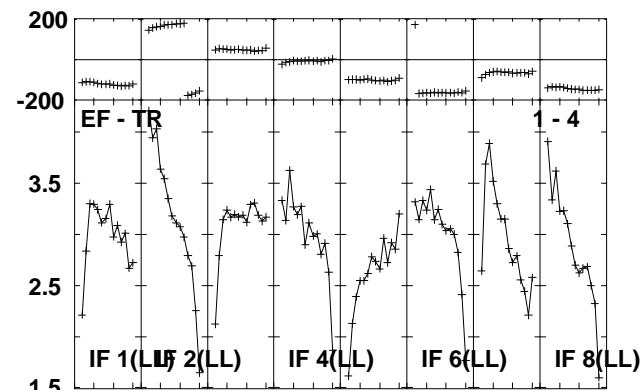
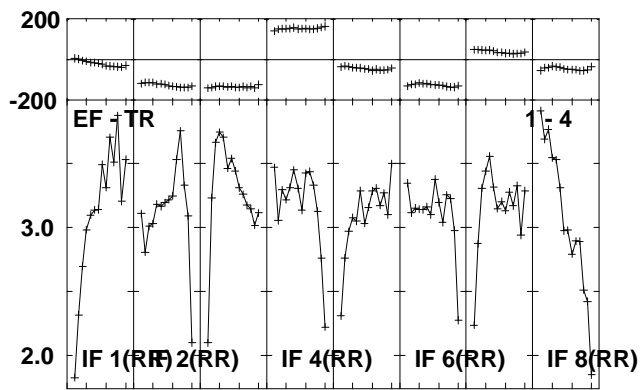
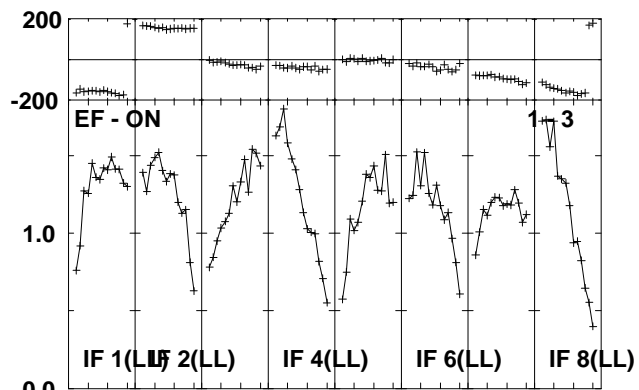
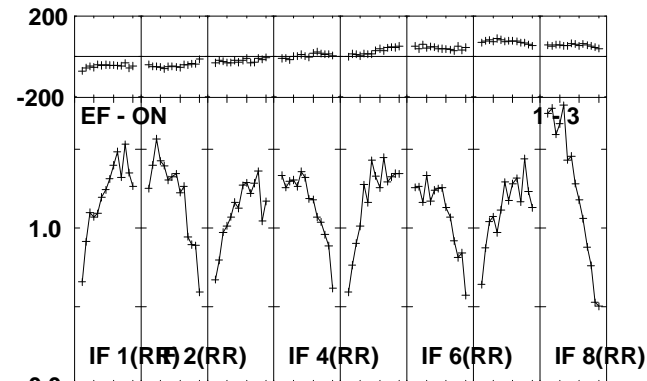
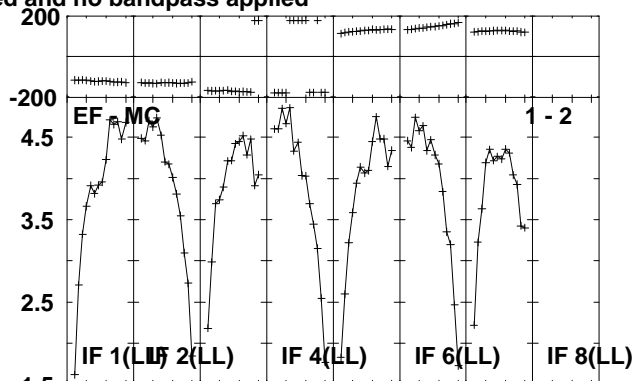
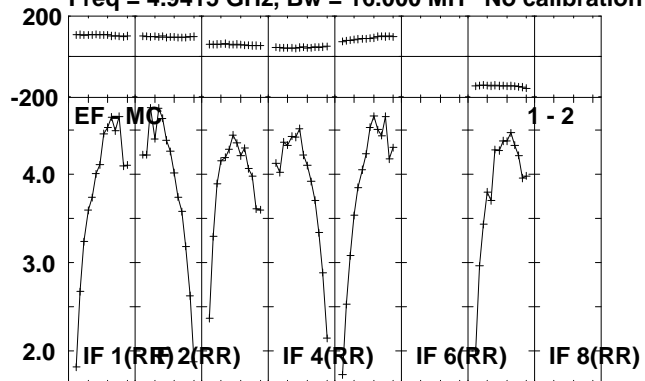

Lower frame: Milli Ampl Jy Top frame: Phas deg
Scalar averaged cross-power spectrum Several baselines displayed
Timerange: 00/20:21:41 to 00/20:23:59

Plot file version 62 created 06-OCT-2010 10:56:47

J1907+01 ET013A.UVDATA.1

Freq = 4.9415 GHz, Bw = 16.000 MH No calibration applied and no bandpass applied

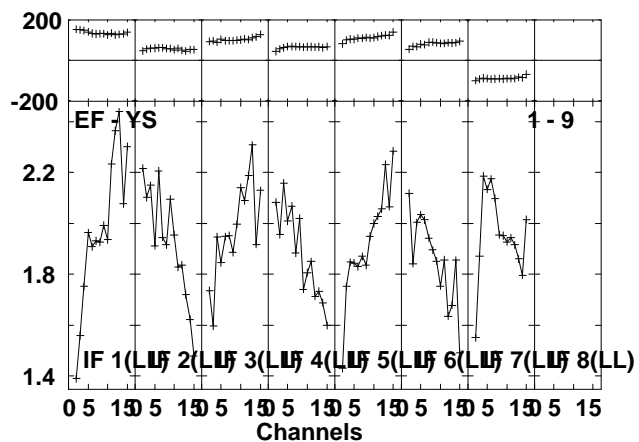
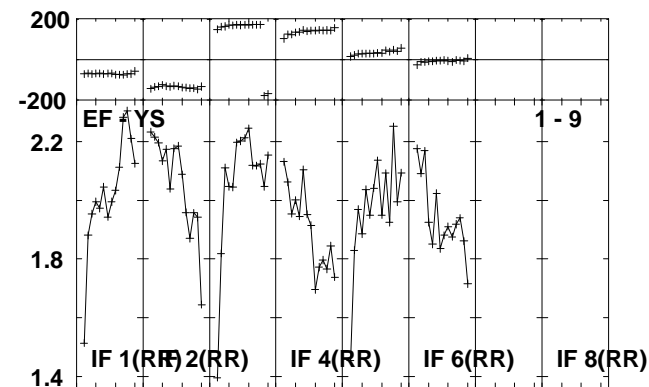
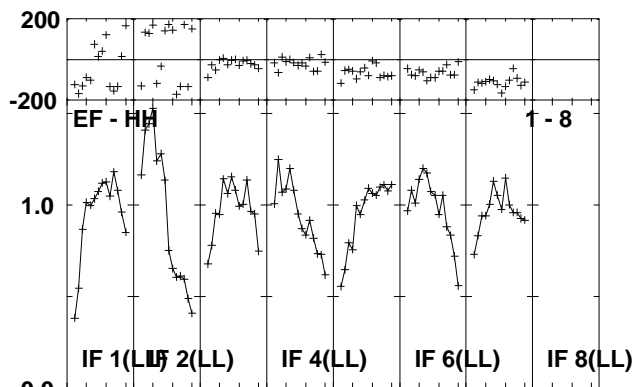
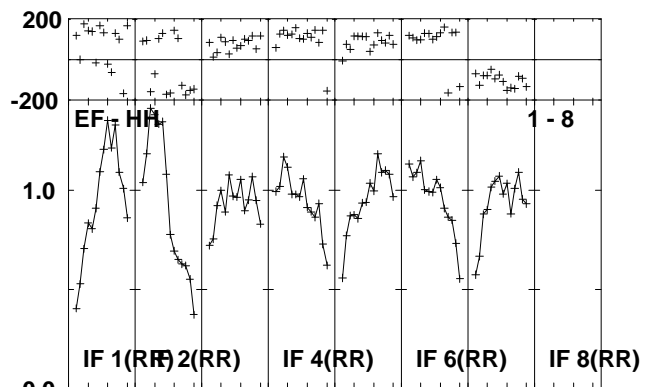
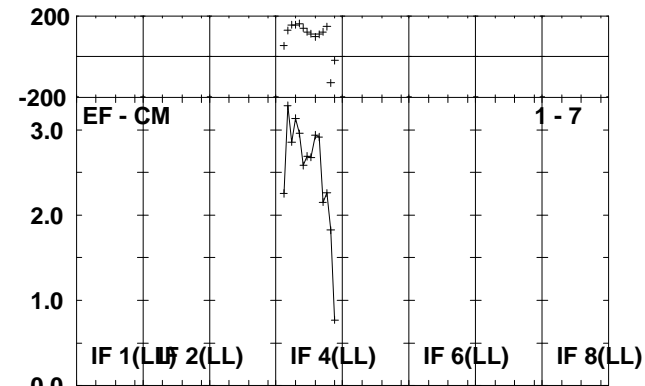
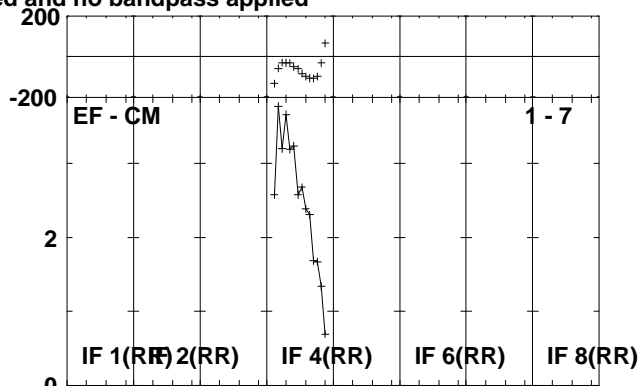
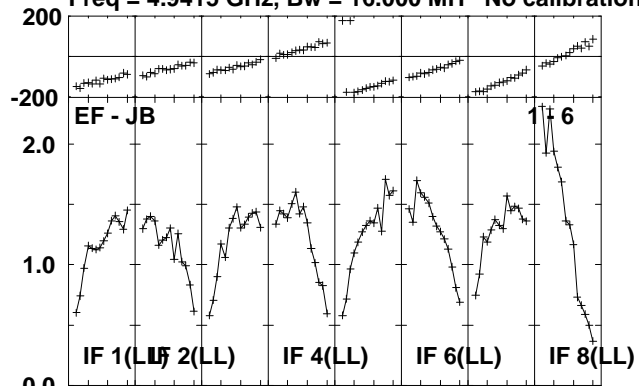

Lower frame: Milli Ampl Jy Top frame: Phas deg
Scalar averaged cross-power spectrum Several baselines displayed
Timerange: 00/20:21:41 to 00/20:23:59

Plot file version 63 created 06-OCT-2010 10:56:48

AQLX-1 ET013A.UVDATA.1

Freq = 4.9415 GHz, Bw = 16.000 MH No calibration applied and no bandpass applied

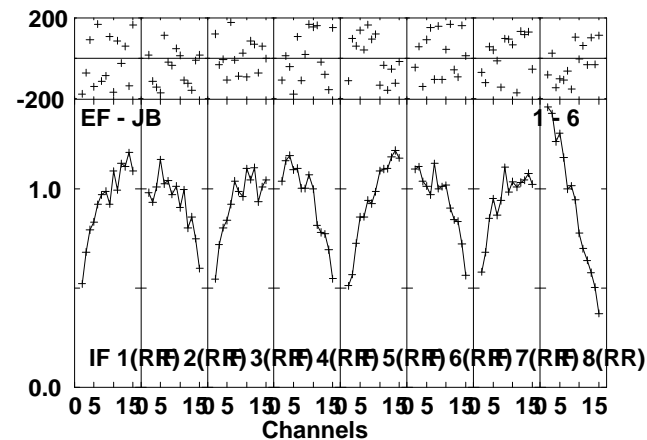
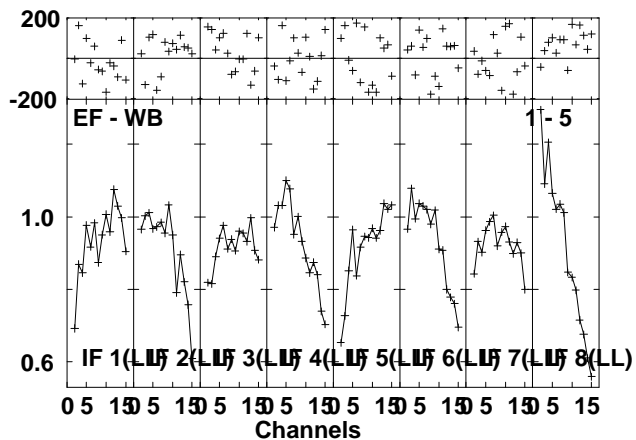
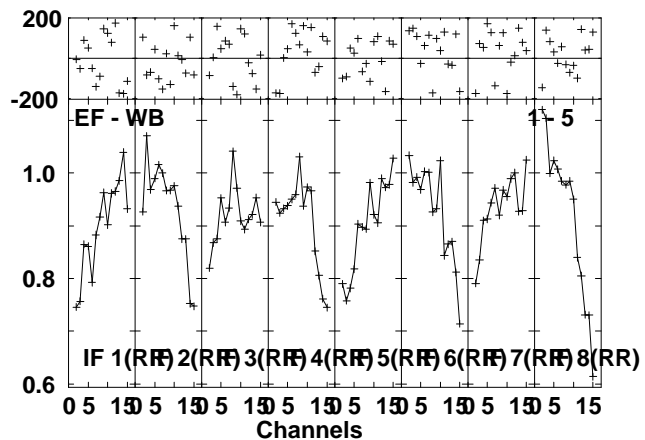
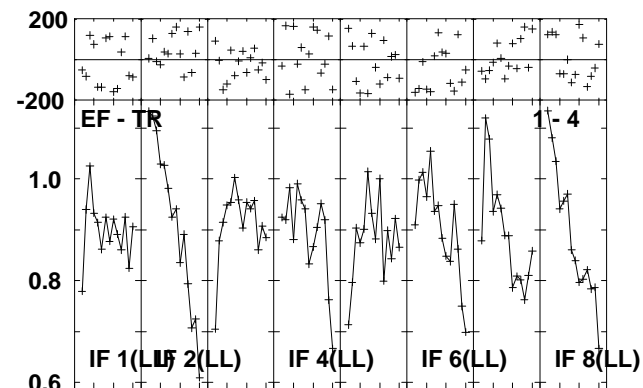
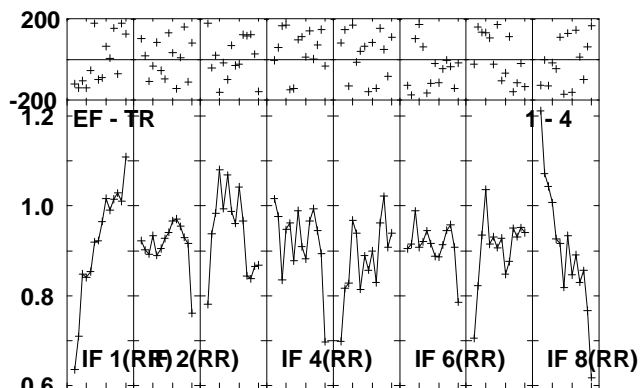
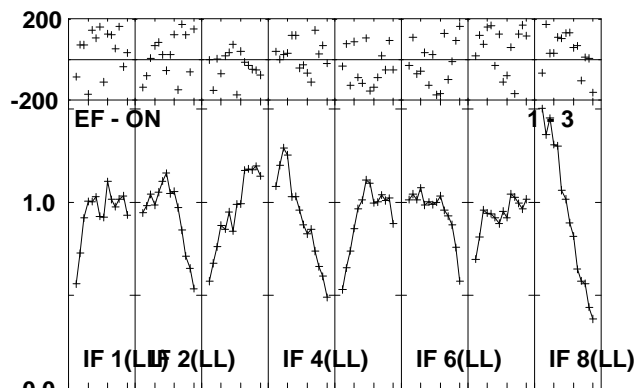
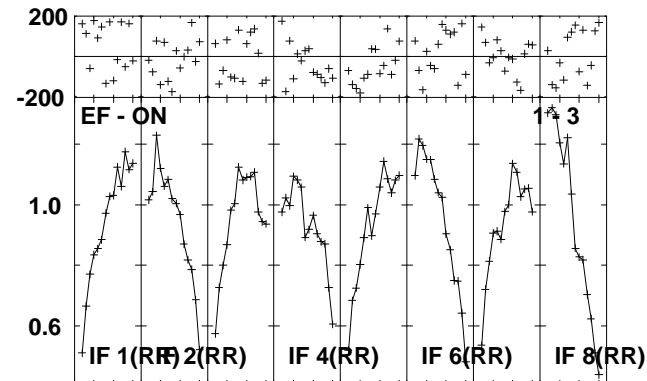
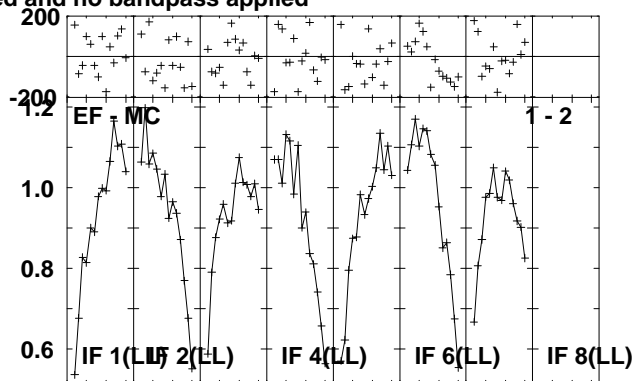
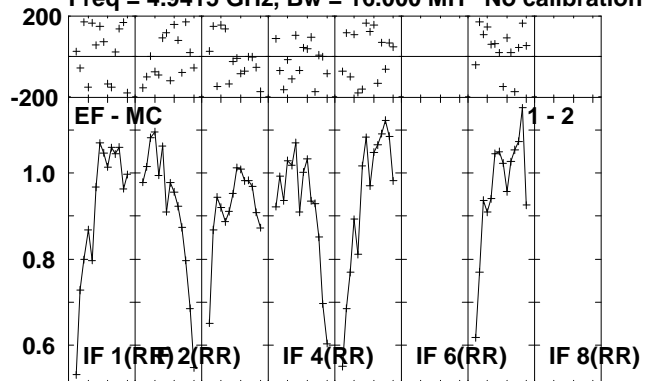

Lower frame: Milli Ampl Jy Top frame: Phas deg
Scalar averaged cross-power spectrum Several baselines displayed
Timerange: 00/20:24:01 to 00/20:28:59

Plot file version 64 created 06-OCT-2010 10:56:50

AQLX-1 ET013A.UVDATA.1

Freq = 4.9415 GHz, Bw = 16.000 MH No calibration applied and no bandpass applied

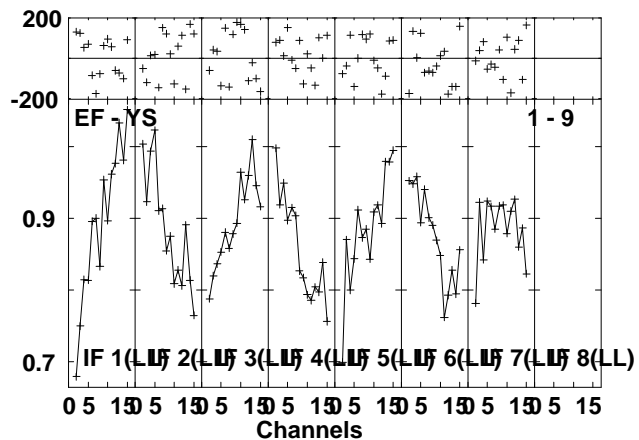
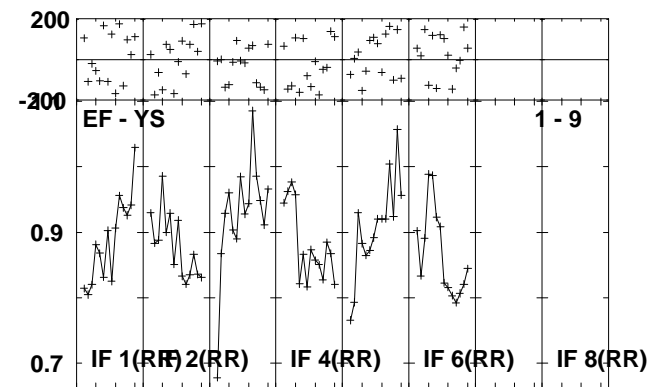
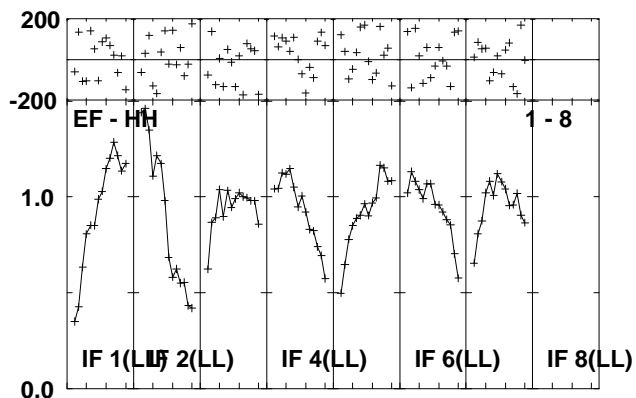
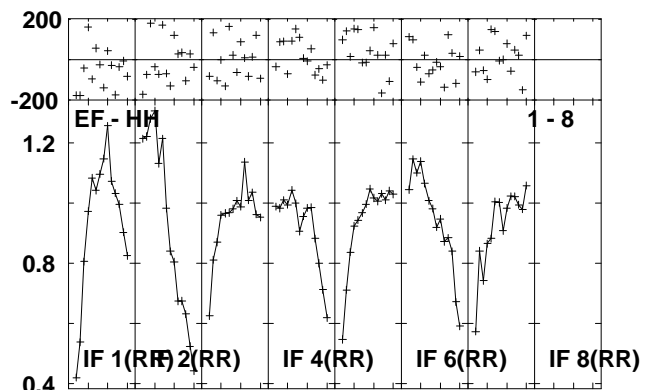
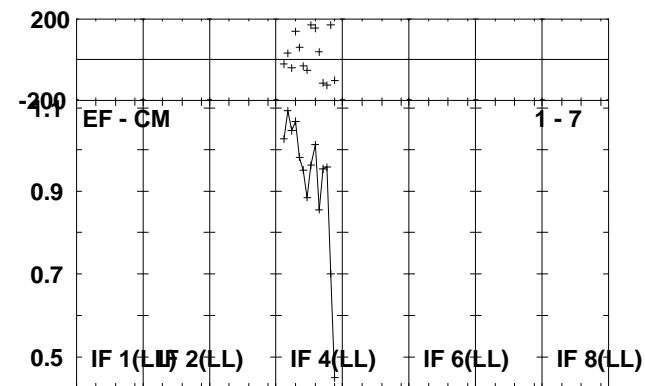
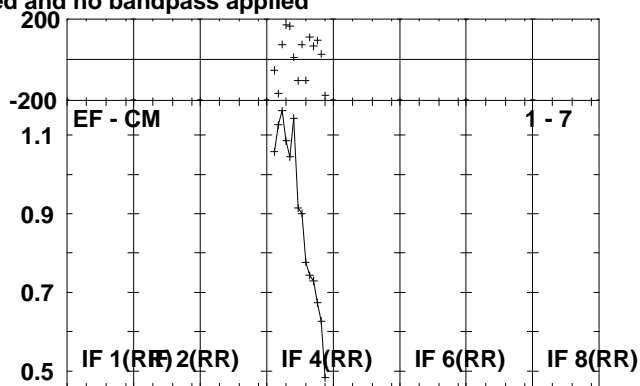
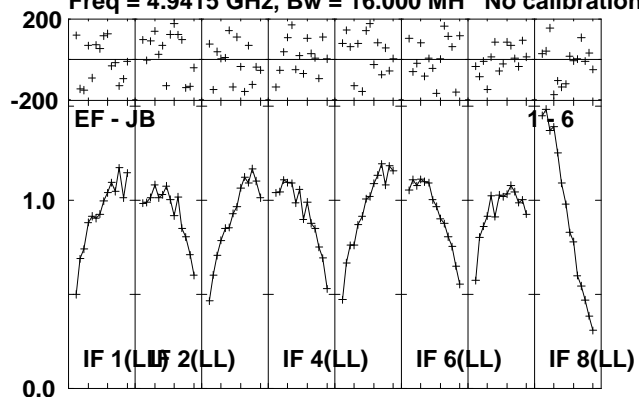

Lower frame: Milli Ampl Jy Top frame: Phas deg
Scalar averaged cross-power spectrum Several baselines displayed
Timerange: 00/20:24:01 to 00/20:28:59

Plot file version 65 created 06-OCT-2010 10:56:52

J1907+01 ET013A.UVDATA.1

Freq = 4.9415 GHz, Bw = 16.000 MH No calibration applied and no bandpass applied

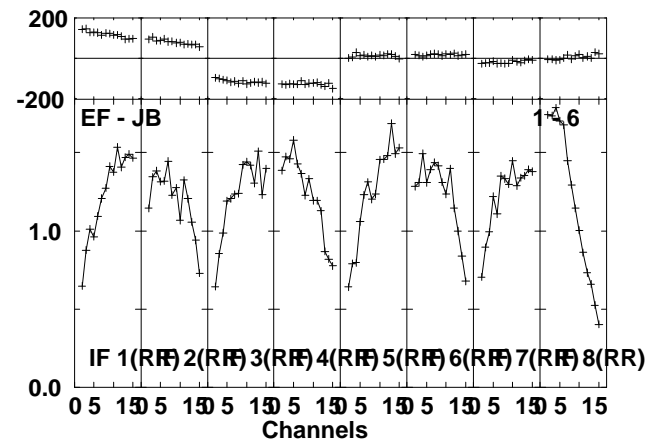
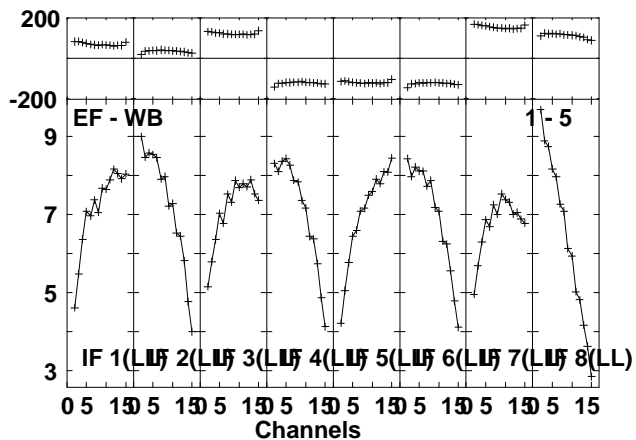
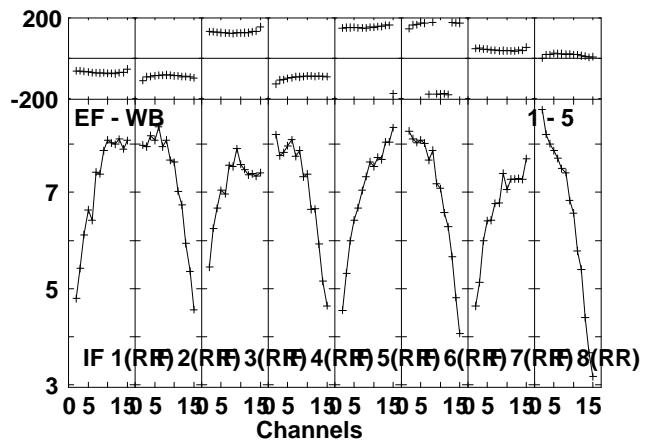
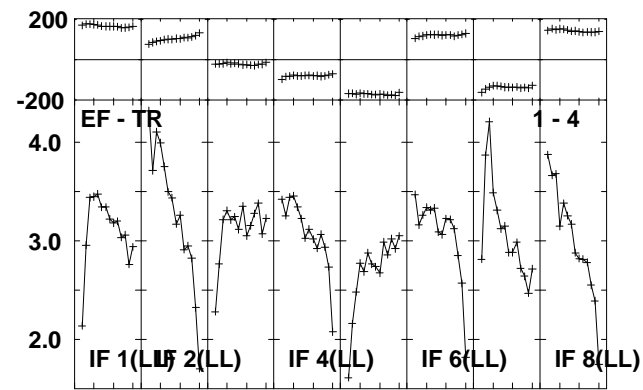
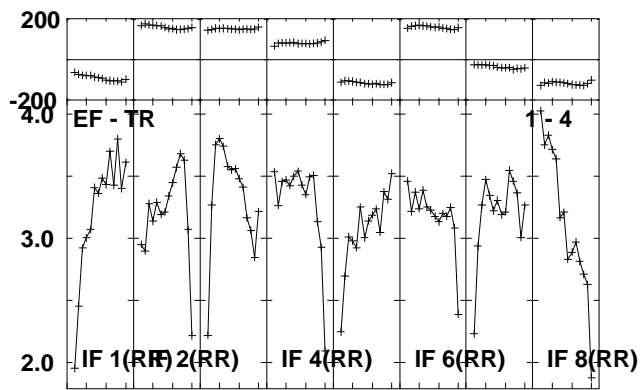
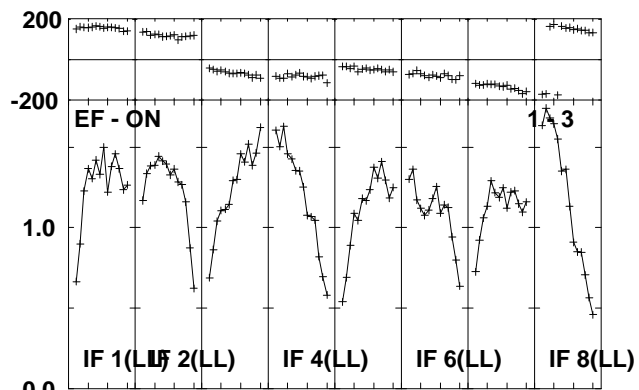
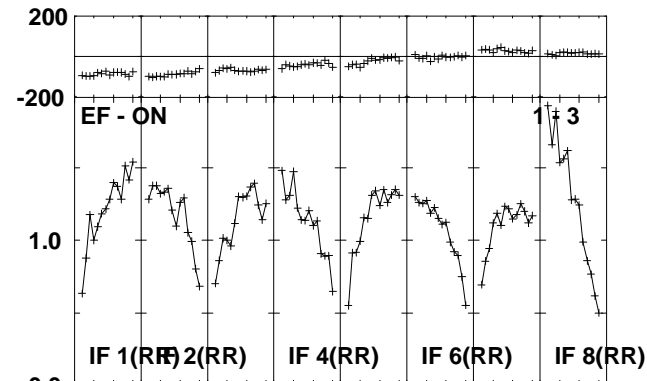
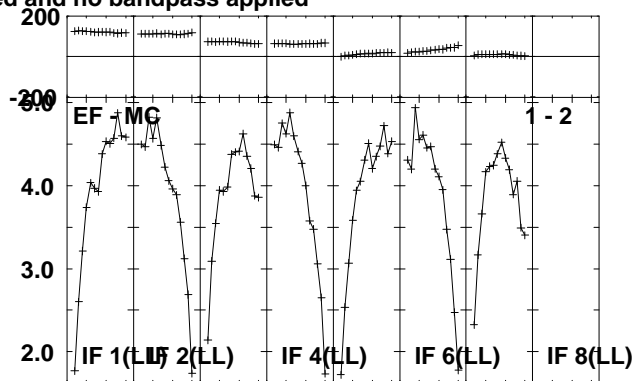
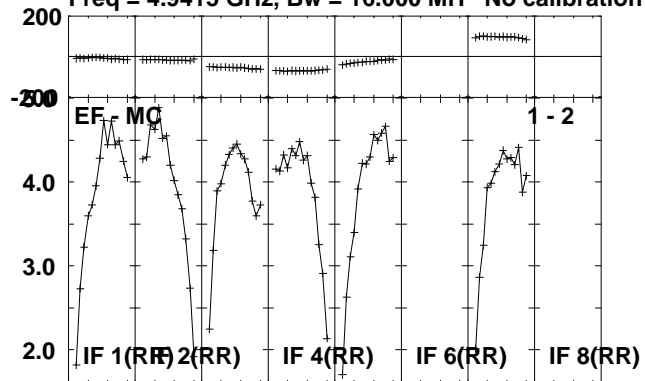

Lower frame: Milli Ampl Jy Top frame: Phas deg
Scalar averaged cross-power spectrum Several baselines displayed
Timerange: 00/20:29:41 to 00/20:31:59

Plot file version 66 created 06-OCT-2010 10:56:53

J1907+01 ET013A.UVDATA.1

Freq = 4.9415 GHz, Bw = 16.000 MH No calibration applied and no bandpass applied

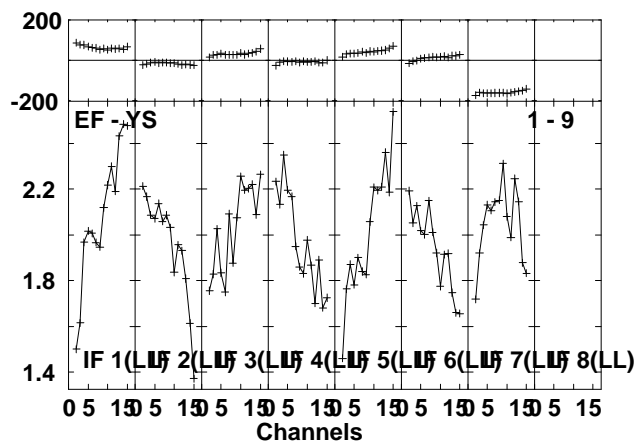
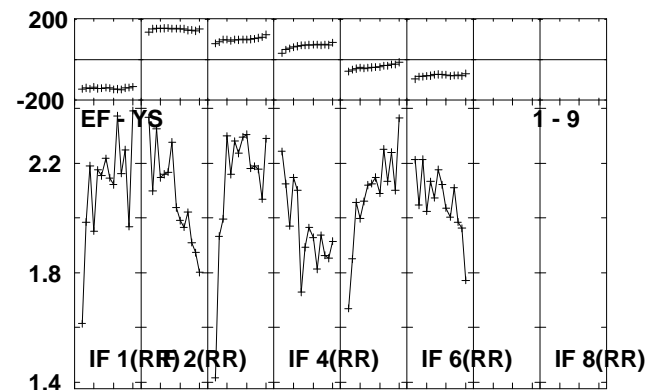
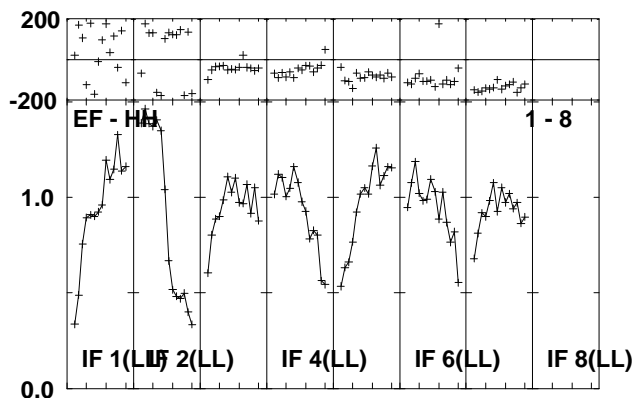
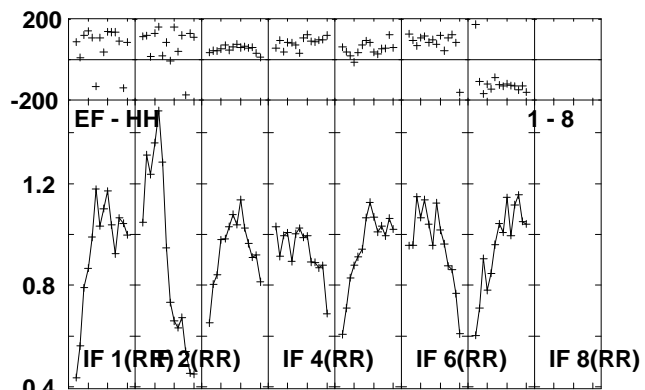
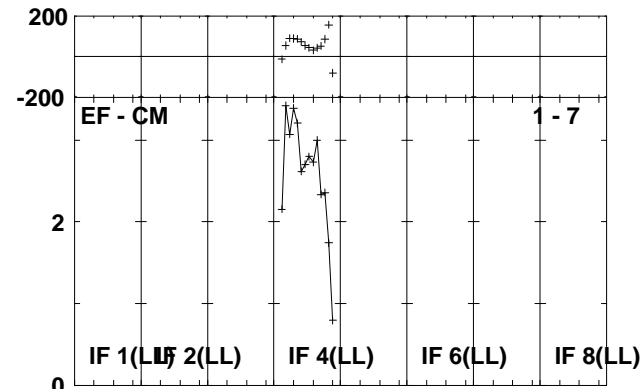
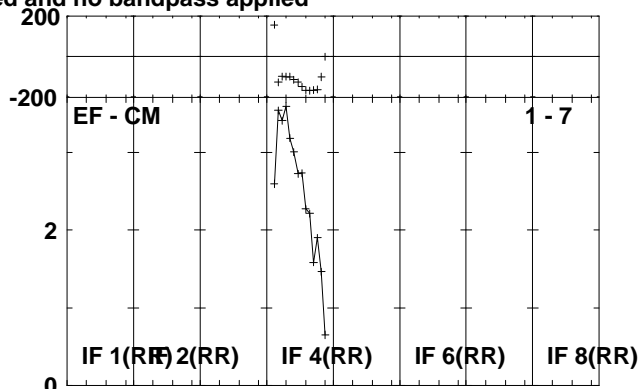
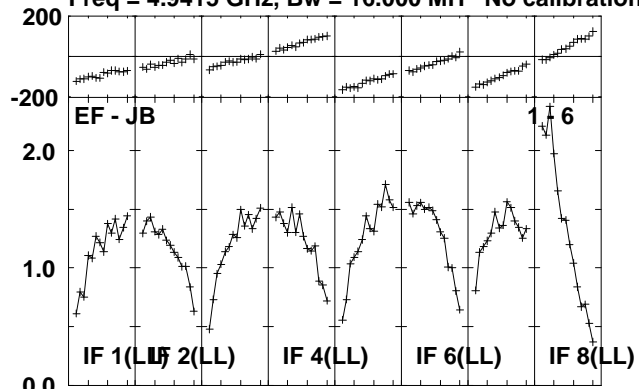

Lower frame: Milli Ampl Jy Top frame: Phas deg
Scalar averaged cross-power spectrum Several baselines displayed
Timerange: 00/20:29:41 to 00/20:31:59

Plot file version 67 created 06-OCT-2010 10:56:54

J1920-02 ET013A.UVDATA.1

Freq = 4.9415 GHz, Bw = 16.000 MH No calibration applied and no bandpass applied

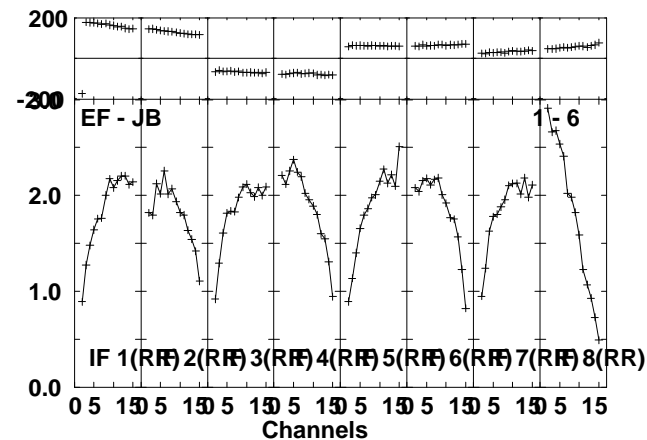
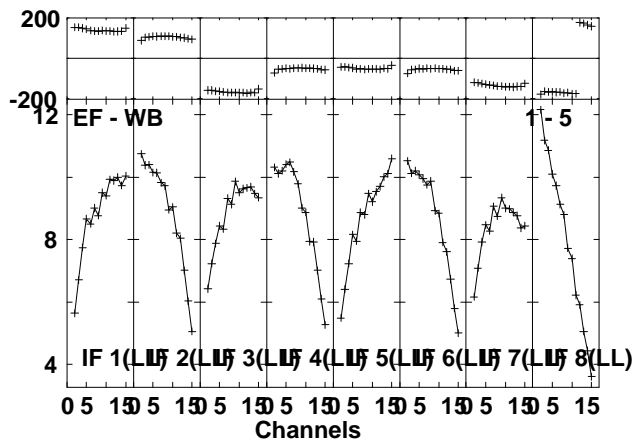
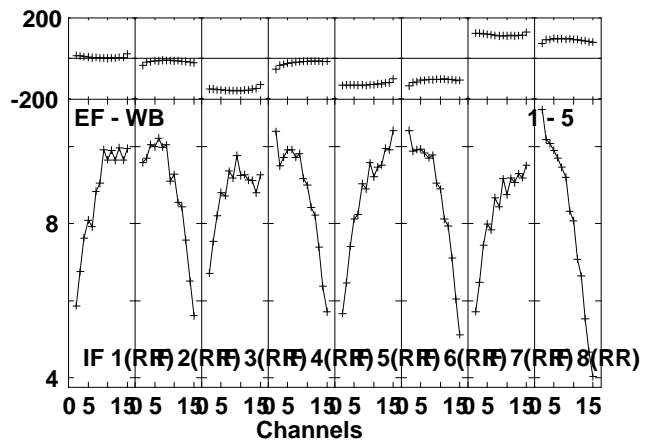
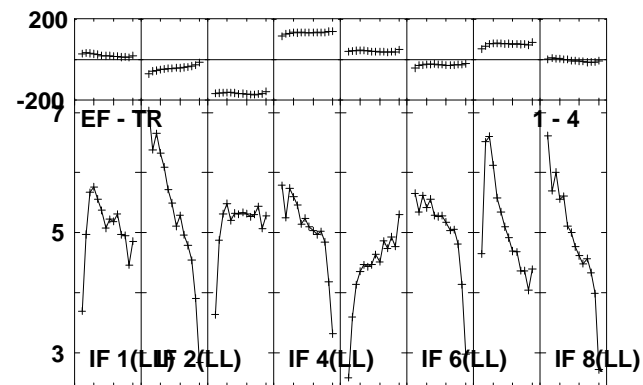
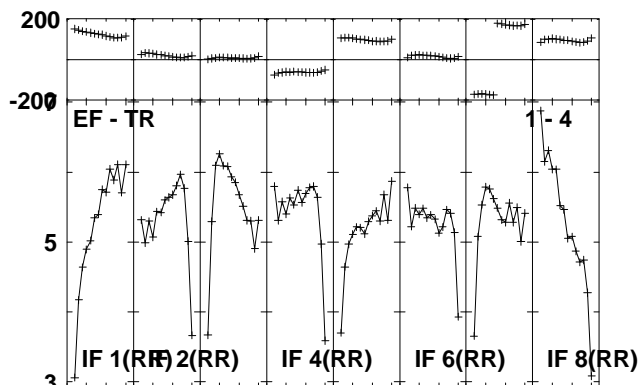
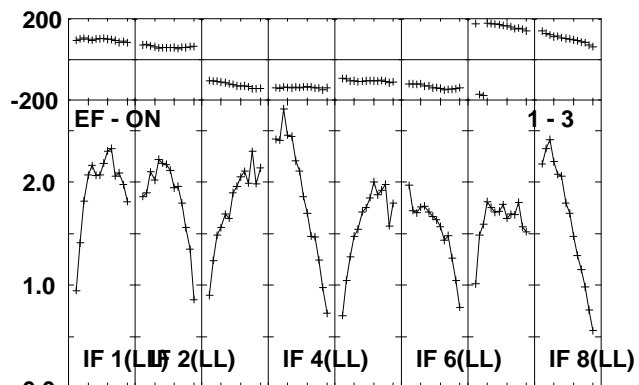
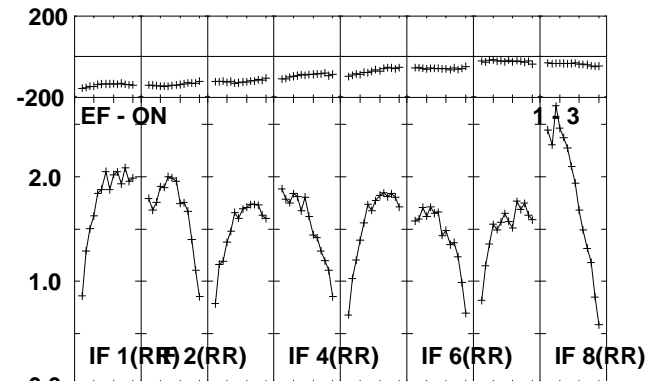
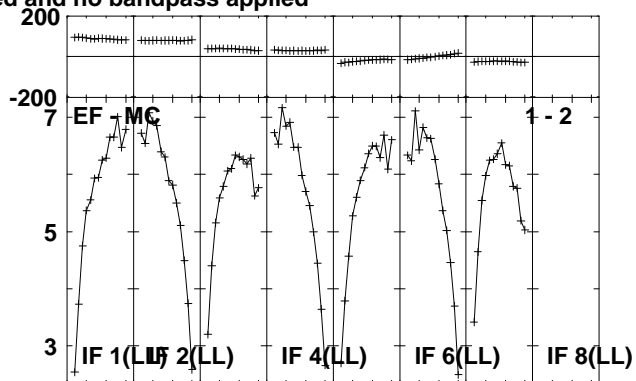
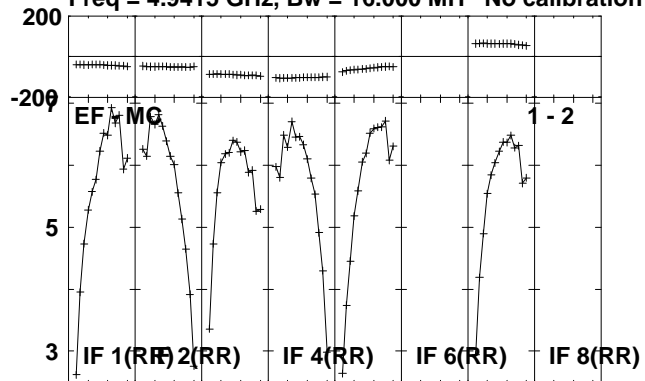

Lower frame: Milli Ampl Jy Top frame: Phas deg
Scalar averaged cross-power spectrum Several baselines displayed
Timerange: 00/20:32:01 to 00/20:36:59

Plot file version 68 created 06-OCT-2010 10:56:57

J1920-02 ET013A.UVDATA.1

Freq = 4.9415 GHz, Bw = 16.000 MH No calibration applied and no bandpass applied

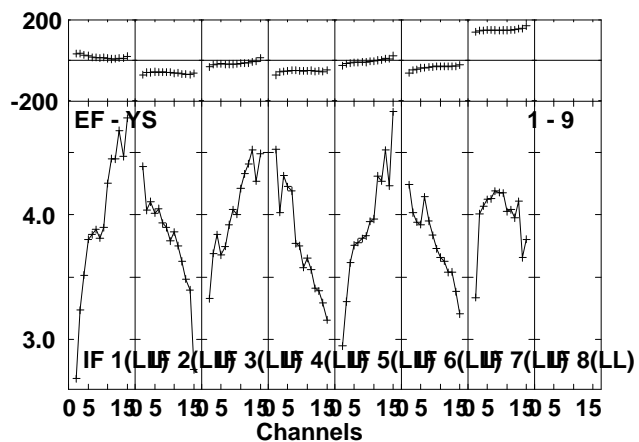
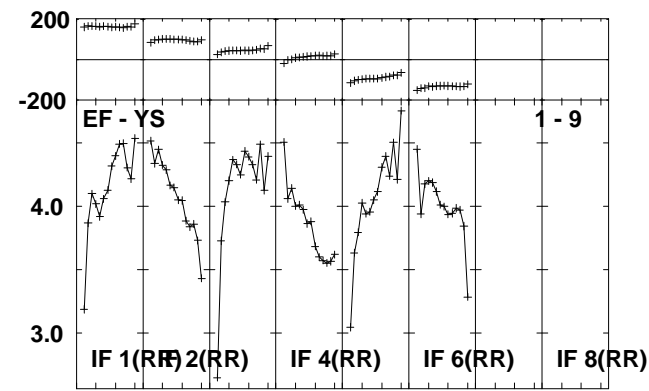
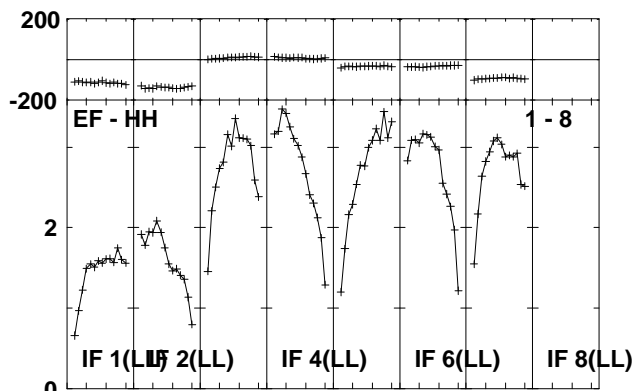
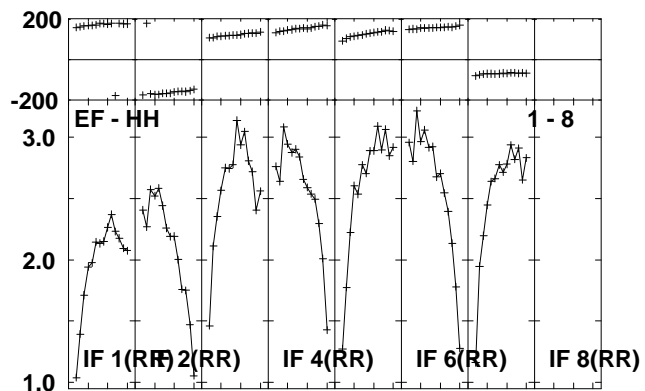
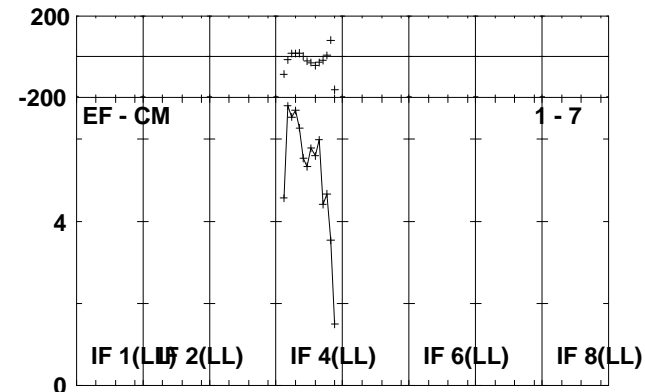
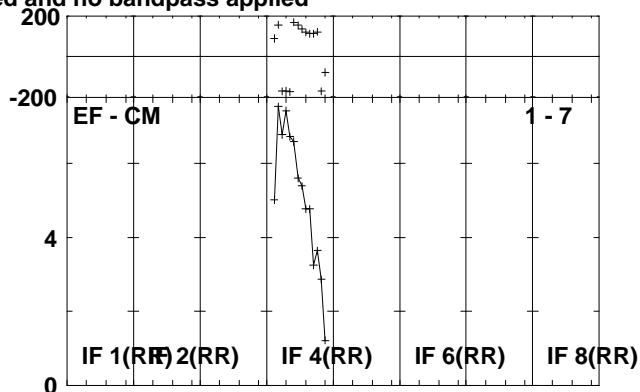
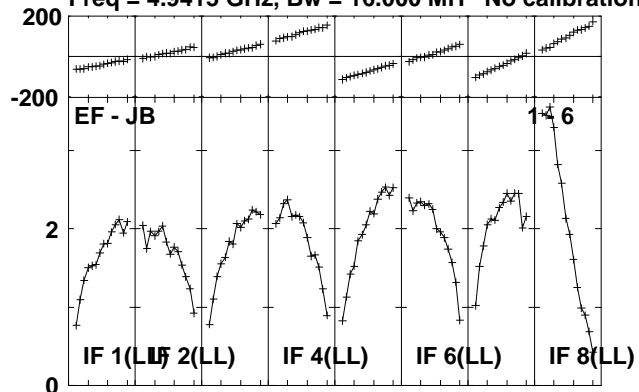

Lower frame: Milli Ampl Jy Top frame: Phas deg
Scalar averaged cross-power spectrum Several baselines displayed
Timerange: 00/20:32:01 to 00/20:36:59

Plot file version 69 created 06-OCT-2010 10:56:59

J1907+01 ET013A.UVDATA.1

Freq = 4.9415 GHz, Bw = 16.000 MH No calibration applied and no bandpass applied

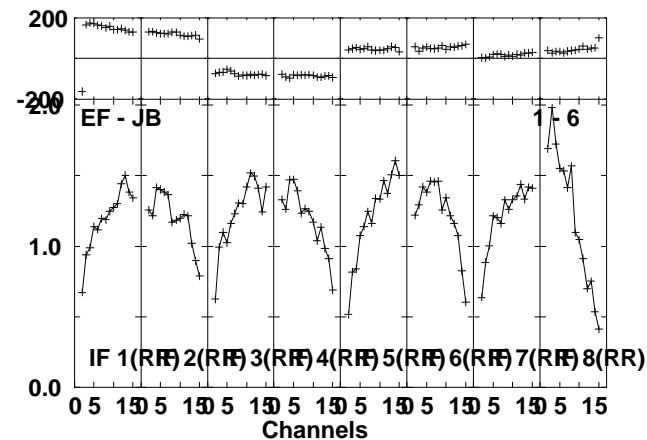
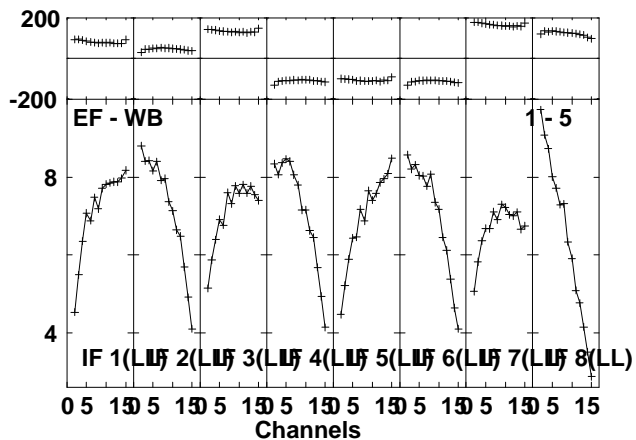
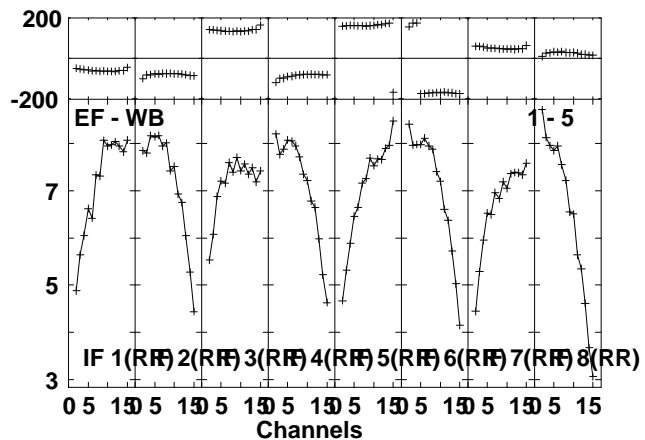
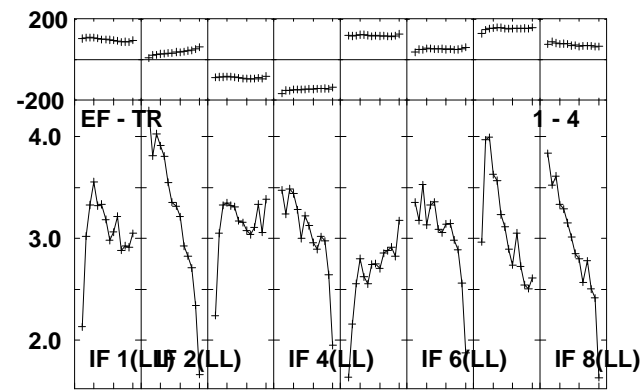
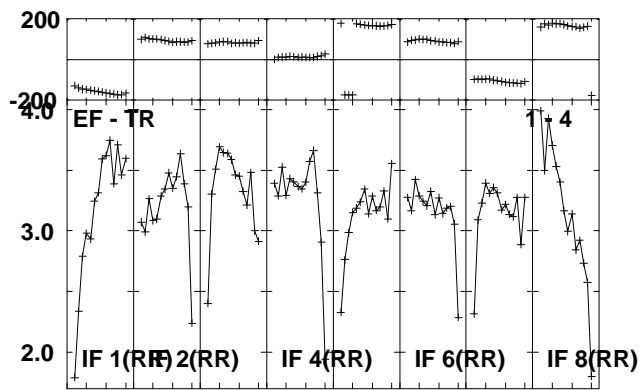
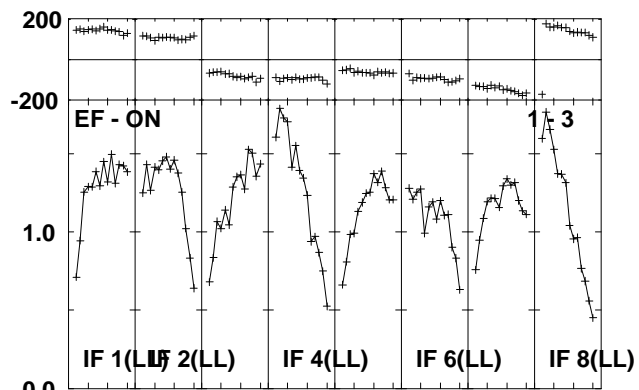
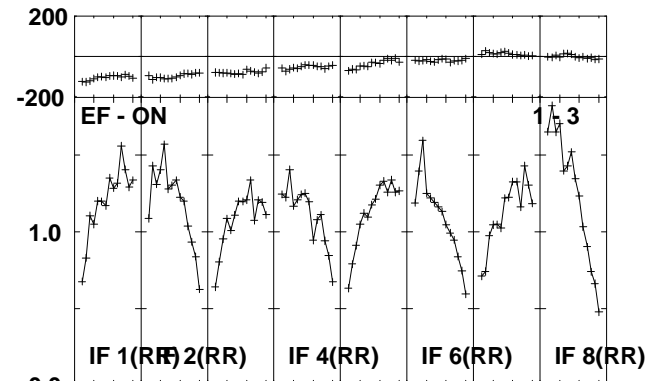
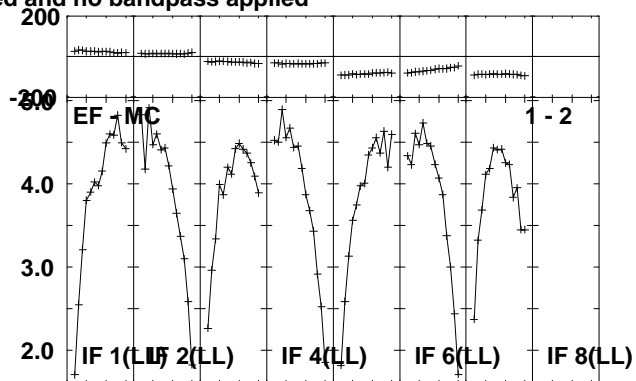
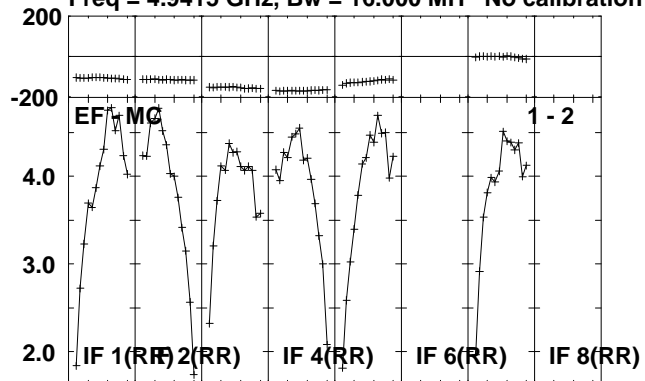

Lower frame: Milli Ampl Jy Top frame: Phas deg
Scalar averaged cross-power spectrum Several baselines displayed
Timerange: 00/20:38:01 to 00/20:40:19

Plot file version 70 created 06-OCT-2010 10:57:00

J1907+01 ET013A.UVDATA.1

Freq = 4.9415 GHz, Bw = 16.000 MH No calibration applied and no bandpass applied

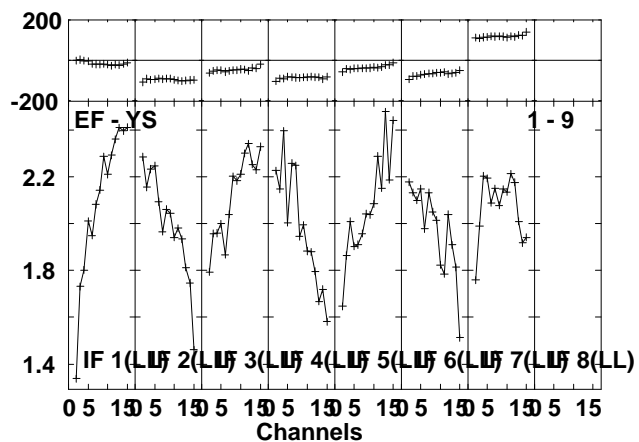
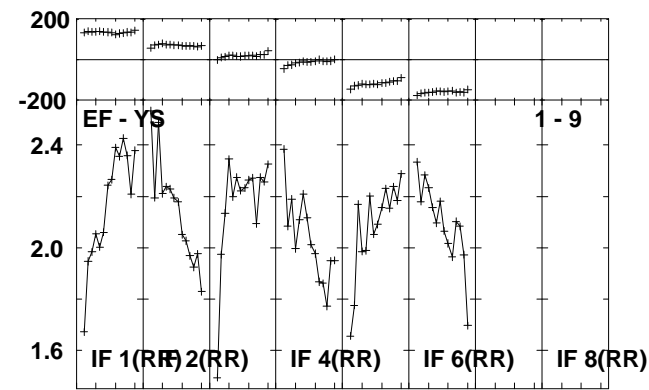
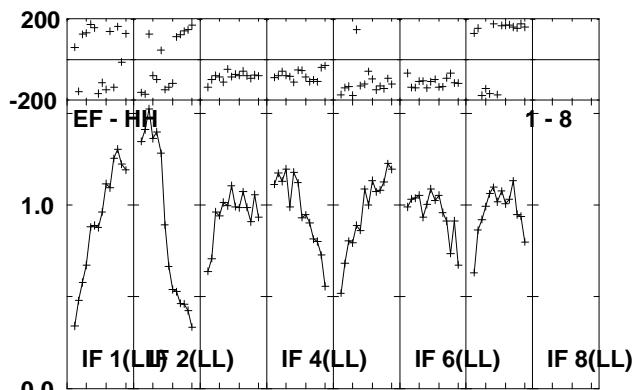
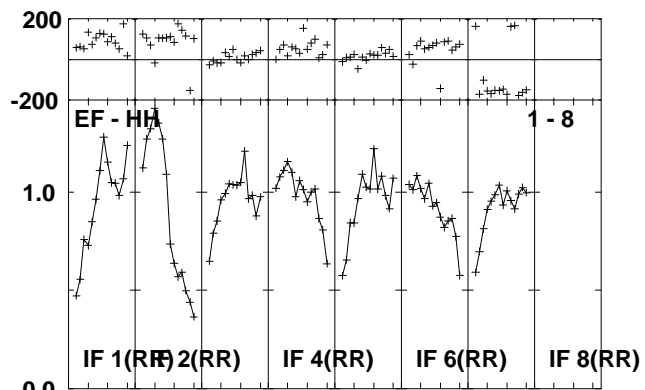
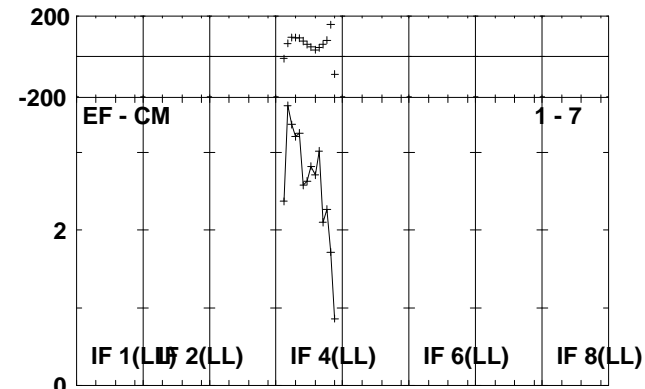
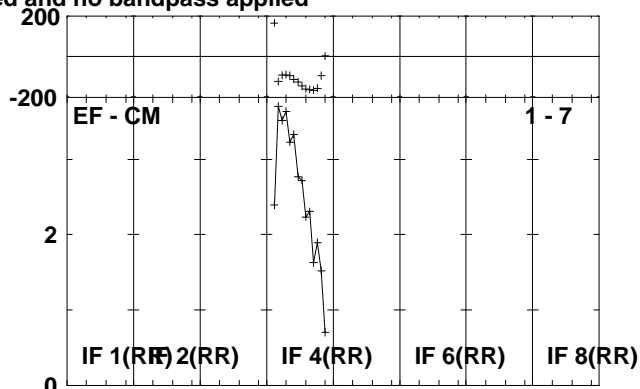
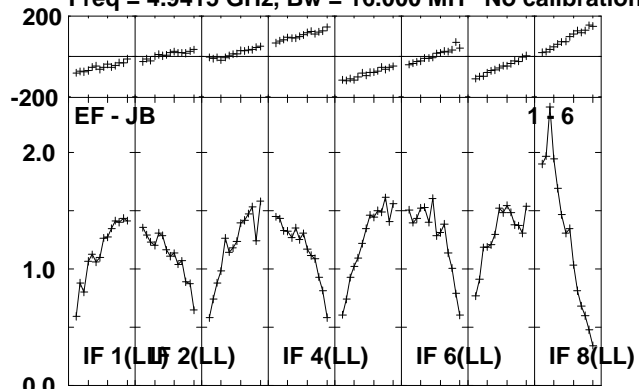

Lower frame: Milli Ampl Jy Top frame: Phas deg
Scalar averaged cross-power spectrum Several baselines displayed
Timerange: 00/20:38:01 to 00/20:40:19

Plot file version 71 created 06-OCT-2010 10:57:01

1749+096 ET013A.UVDATA.1

Freq = 4.9415 GHz, Bw = 16.000 MH No calibration applied and no bandpass applied

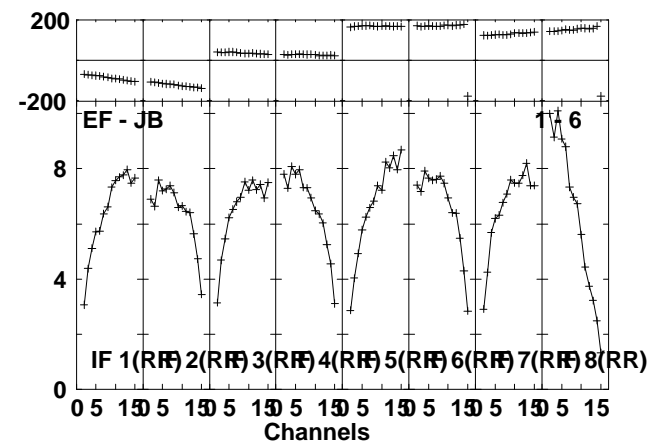
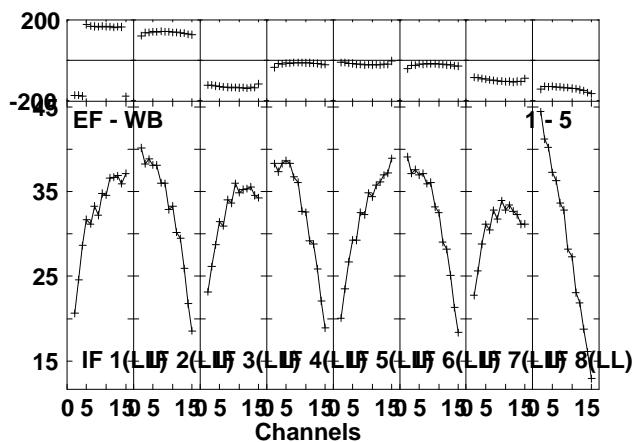
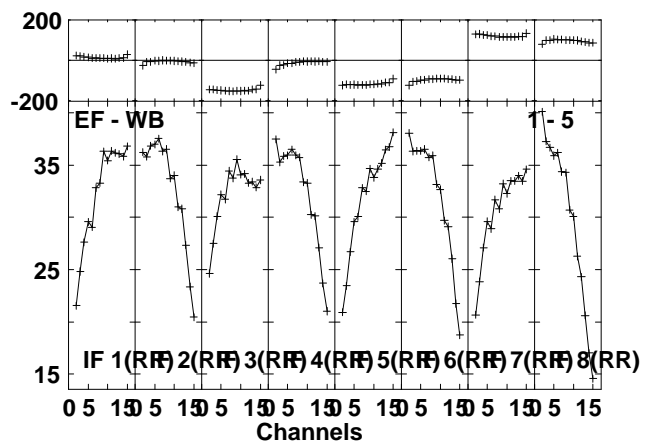
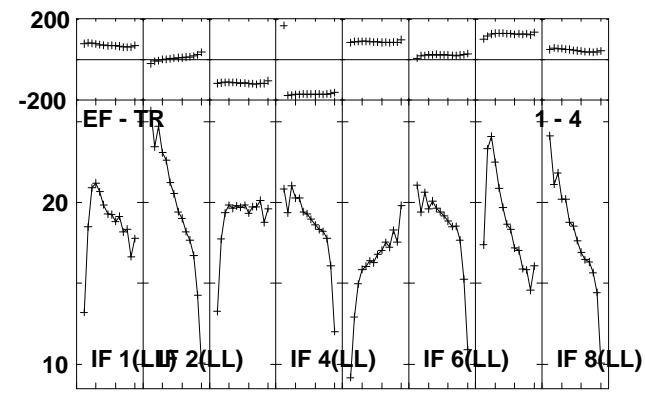
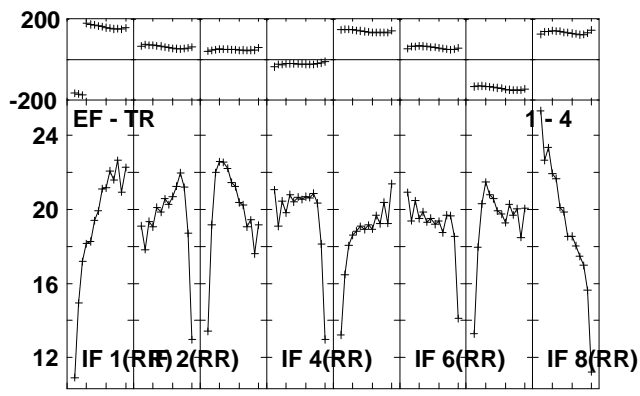
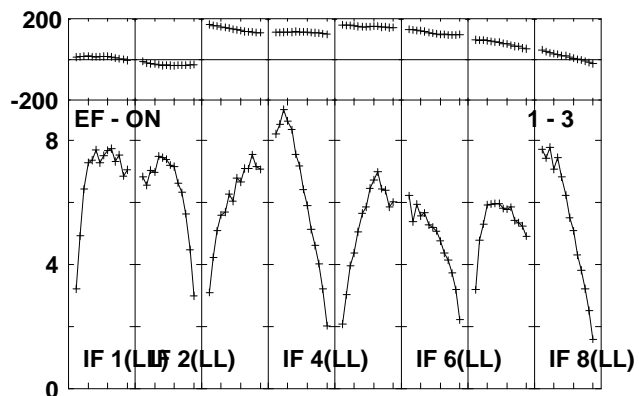
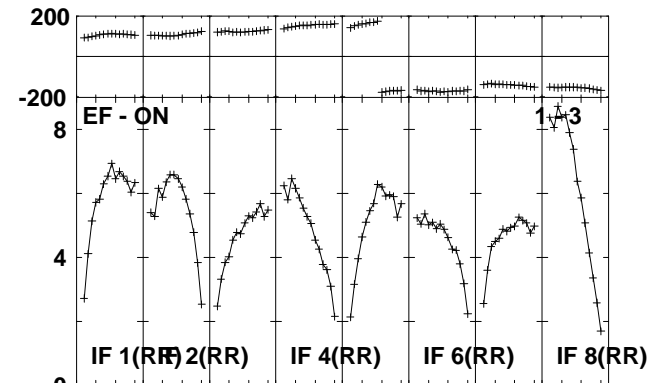
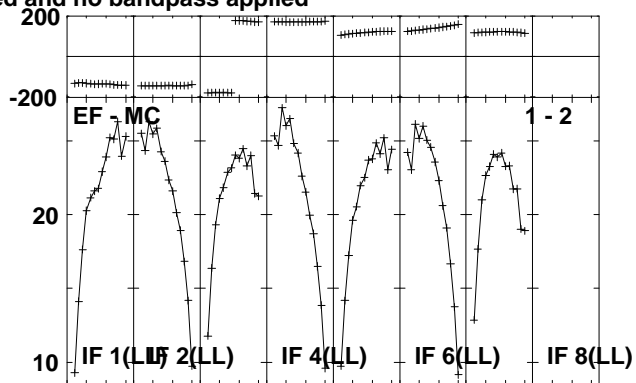
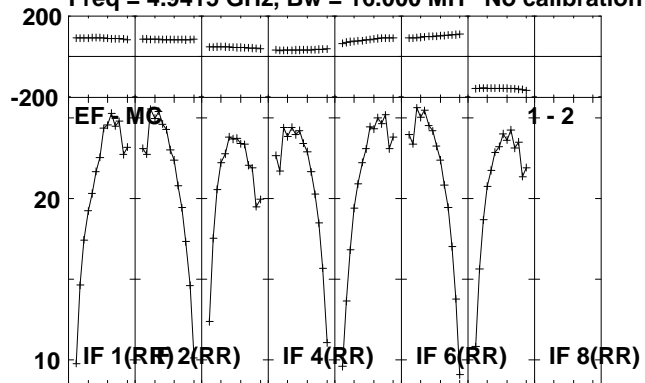

Lower frame: Milli Ampl Jy Top frame: Phas deg
Scalar averaged cross-power spectrum Several baselines displayed
Timerange: 00/20:44:48 to 00/20:46:18

Plot file version 72 created 06-OCT-2010 10:57:01
 1749+096 ET013A.UVDATA.1

Freq = 4.9415 GHz, Bw = 16.000 MH No calibration applied and no bandpass applied

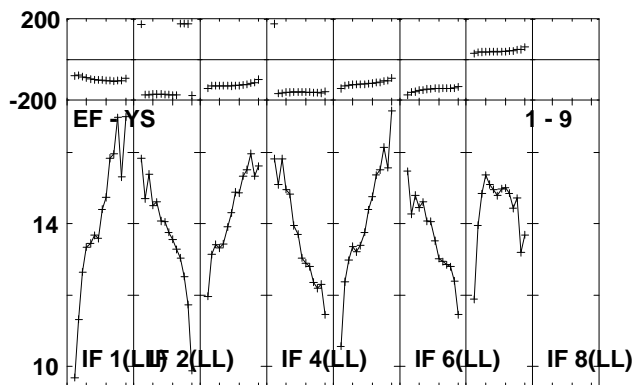
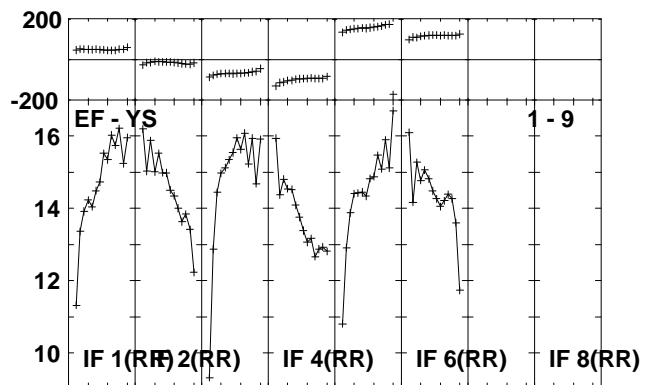
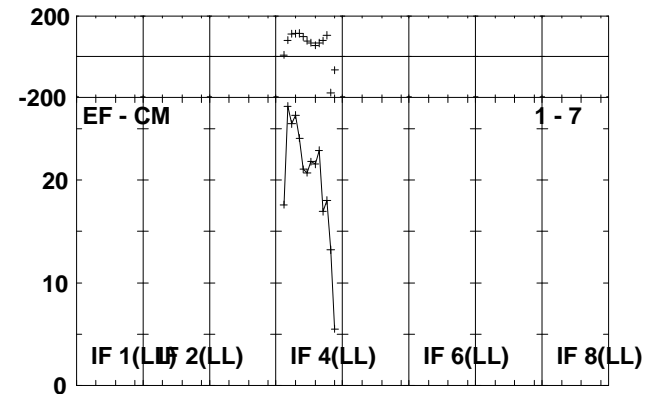
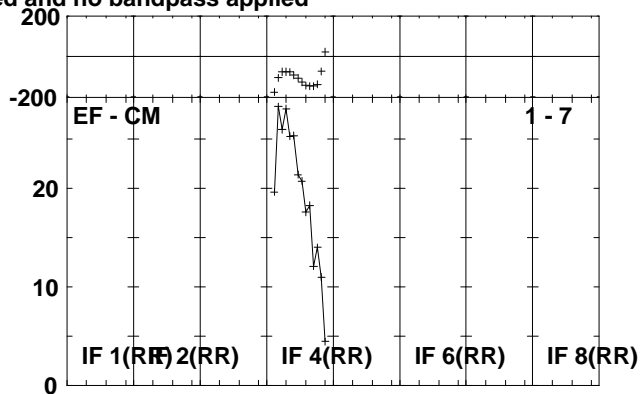
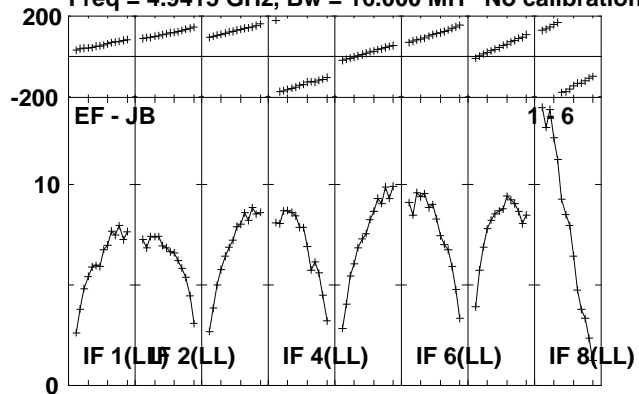

Lower frame: Milli Ampl Jy Top frame: Phas deg
 Scalar averaged cross-power spectrum Several baselines displayed
 Timerange: 00/20:44:48 to 00/20:46:18

Plot file version 73 created 06-OCT-2010 10:57:02

J1907+01 ET013A.UVDATA.1

Freq = 4.9415 GHz, Bw = 16.000 MH No calibration applied and no bandpass applied

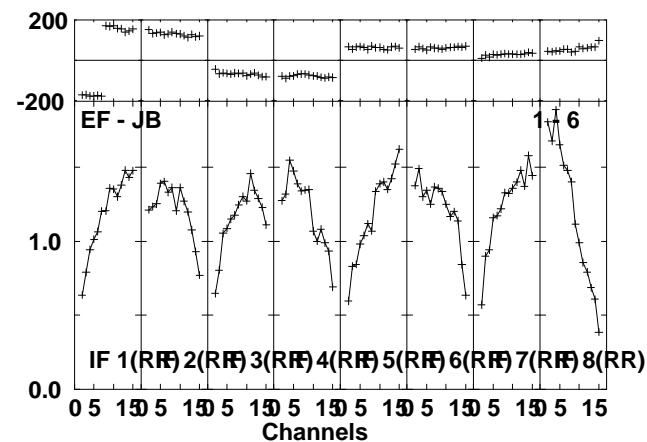
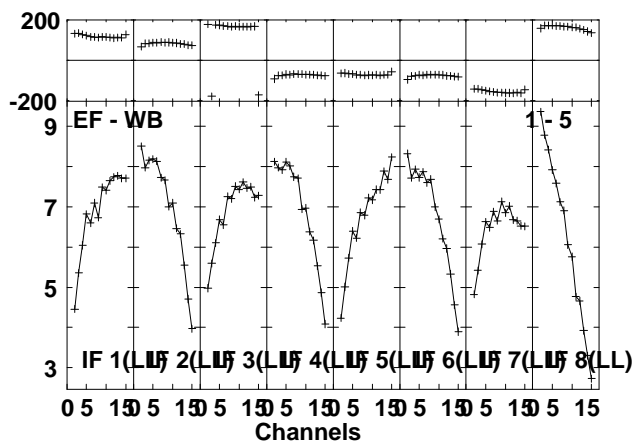
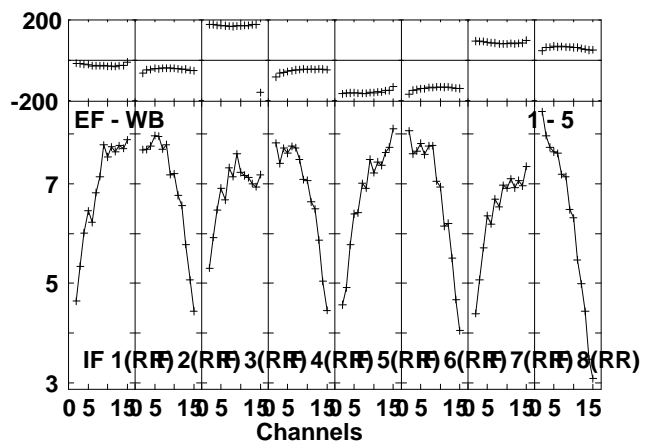
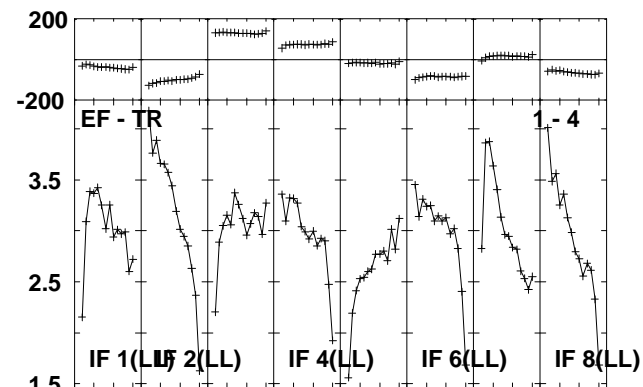
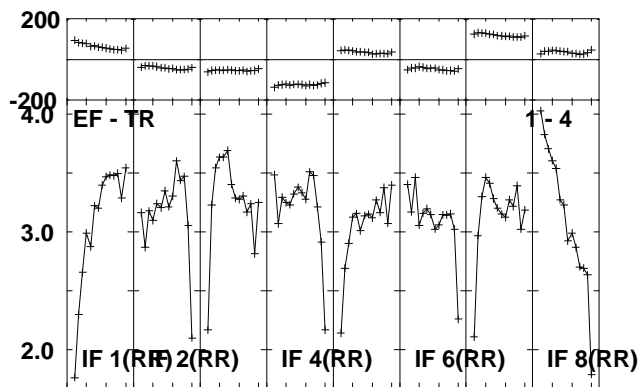
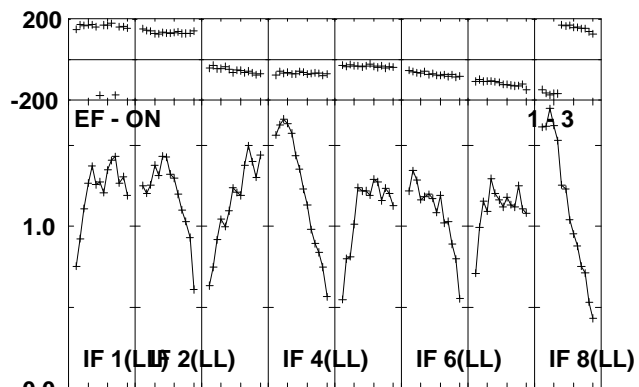
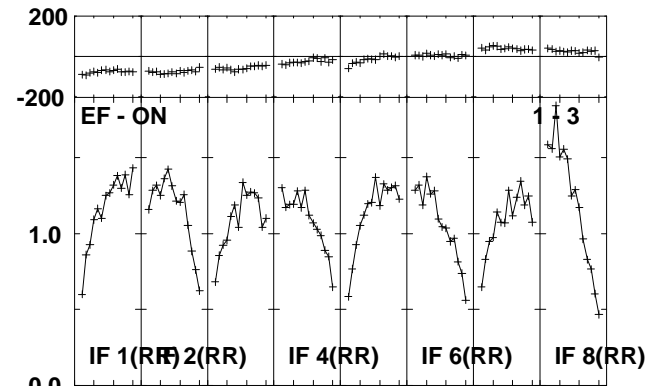
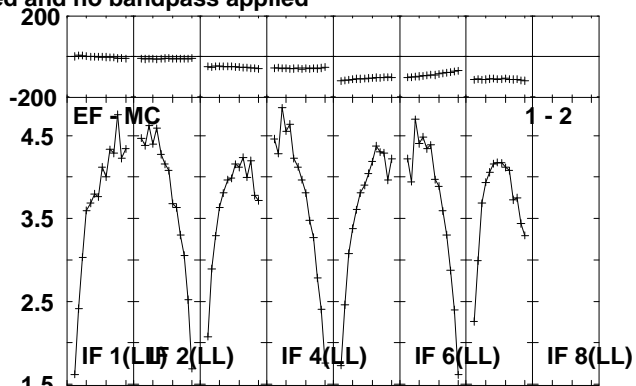
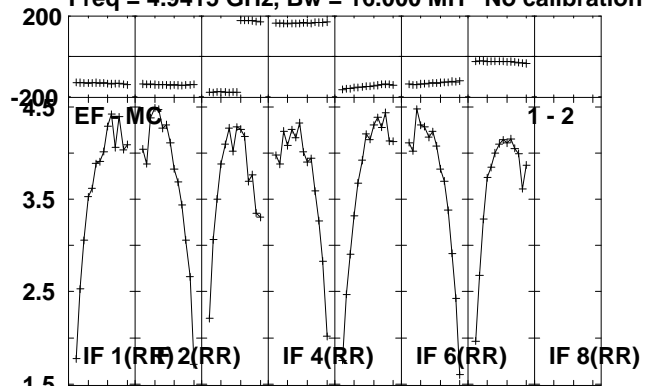

Plot file version 74 created 06-OCT-2010 10:57:03

J1907+01 ET013A.UVDATA.1

Freq = 4.9415 GHz, Bw = 16.000 MH No calibration applied and no bandpass applied

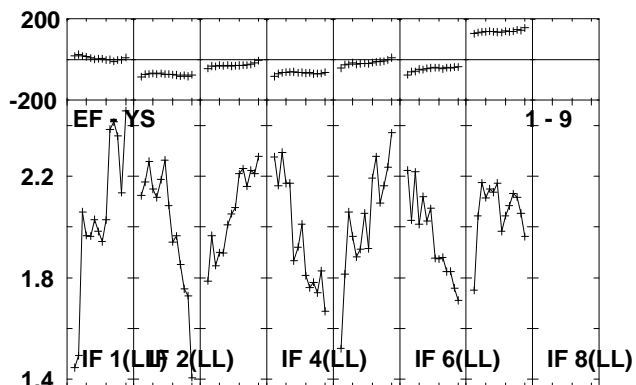
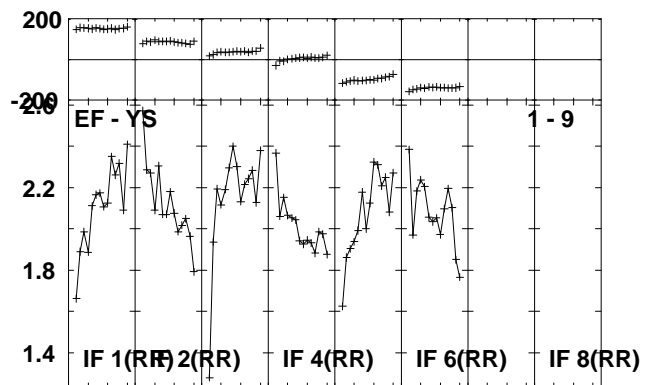
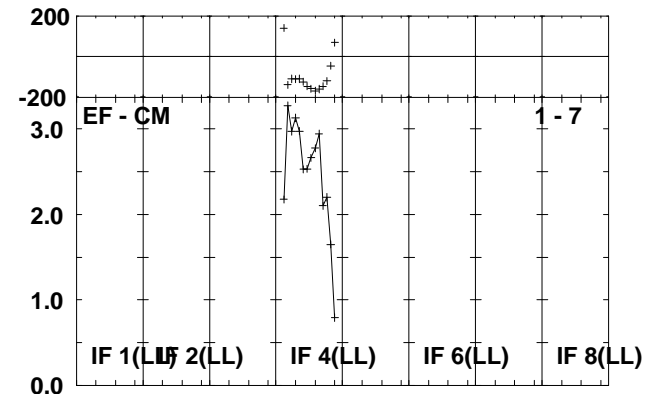
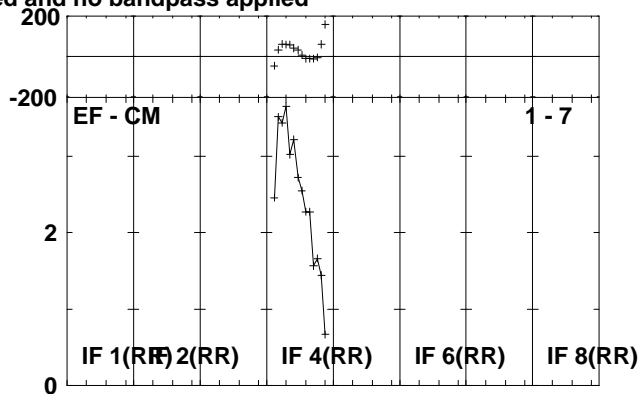
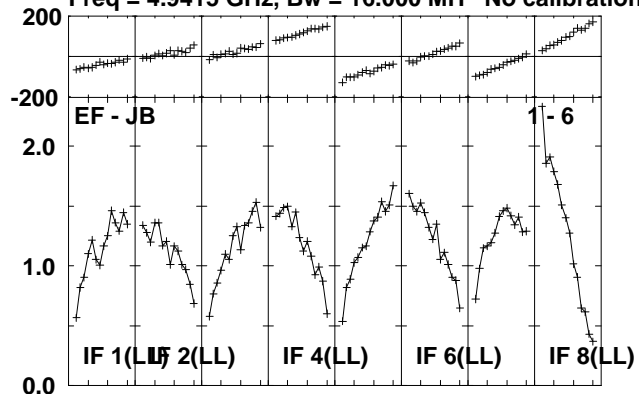

Lower frame: Milli Ampl Jy Top frame: Phas deg
Scalar averaged cross-power spectrum Several baselines displayed
Timerange: 00/20:48:20 to 00/20:51:18

Plot file version 75 created 06-OCT-2010 10:57:04

AQLX-1 ET013A.UVDATA.1

Freq = 4.9415 GHz, Bw = 16.000 MH No calibration applied and no bandpass applied

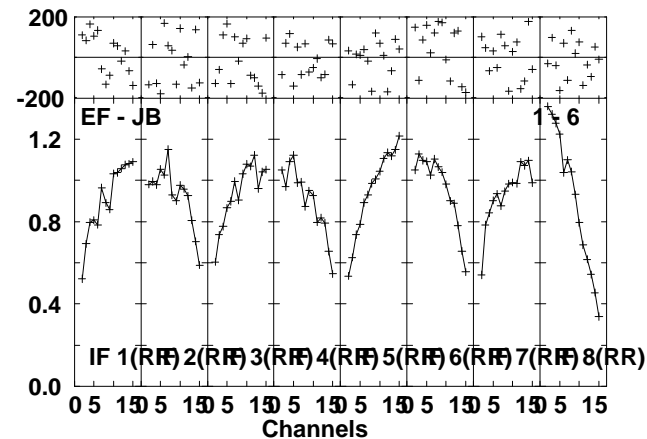
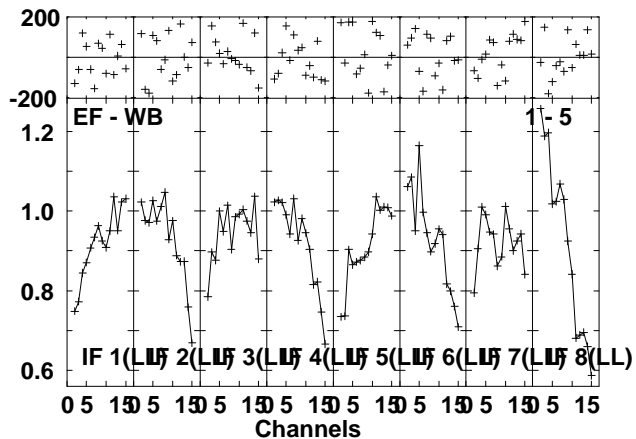
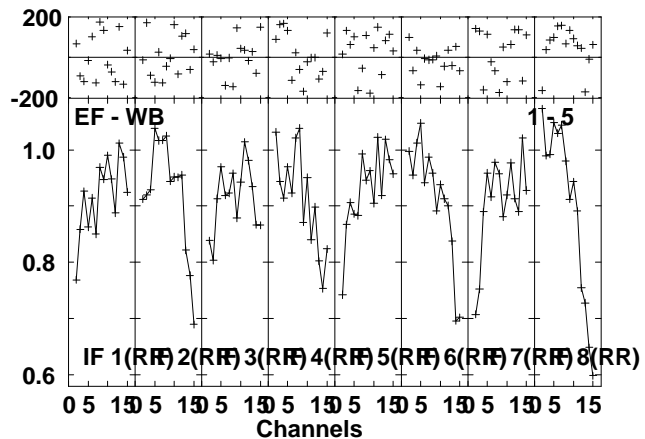
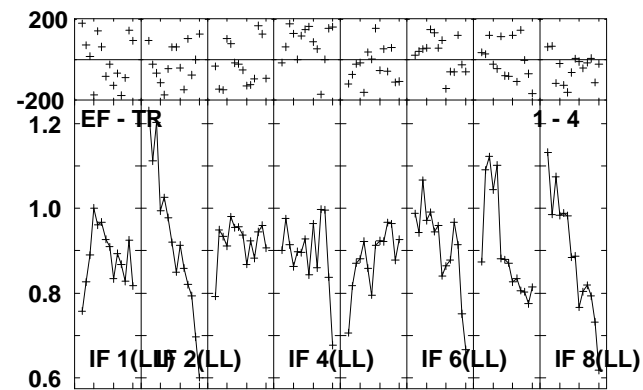
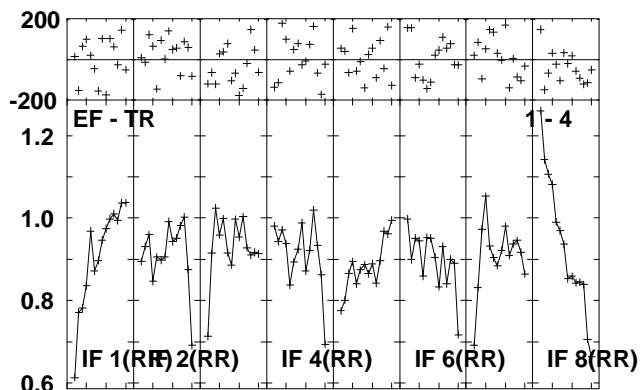
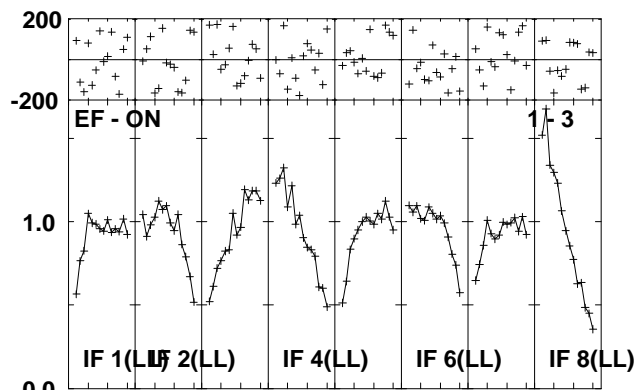
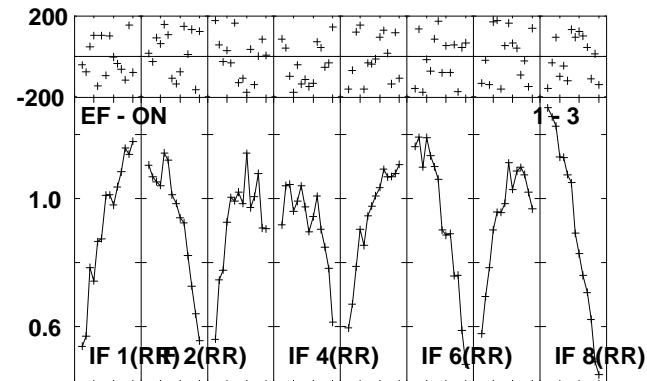
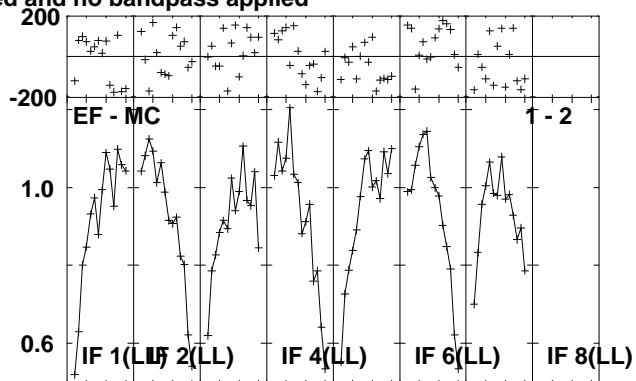
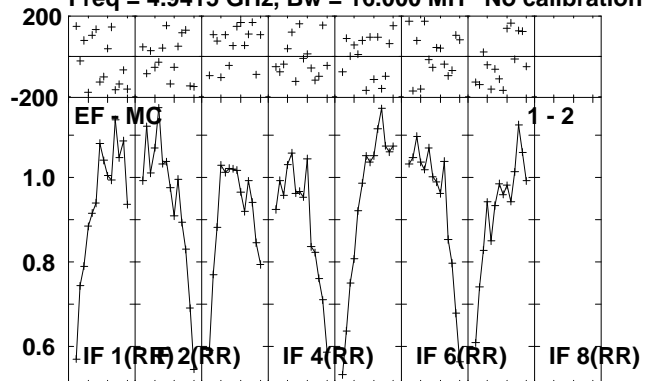

Lower frame: Milli Ampl Jy Top frame: Phas deg
Scalar averaged cross-power spectrum Several baselines displayed
Timerange: 00/20:51:20 to 00/20:56:18

Plot file version 76 created 06-OCT-2010 10:57:06

AQLX-1 ET013A.UVDATA.1

Freq = 4.9415 GHz, Bw = 16.000 MH No calibration applied and no bandpass applied

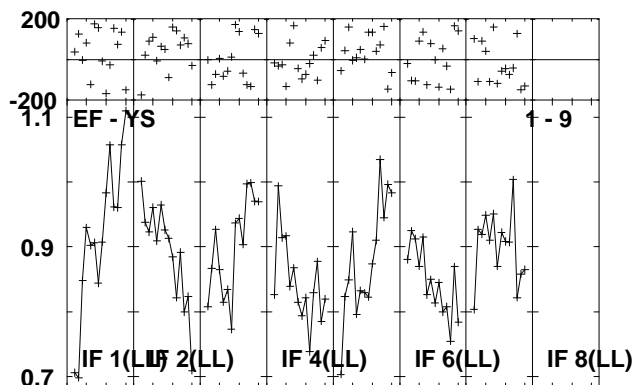
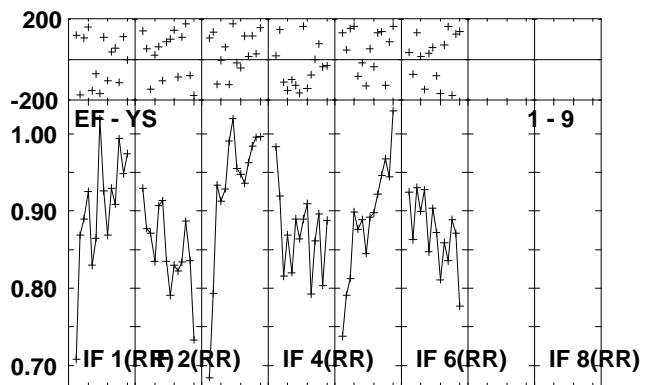
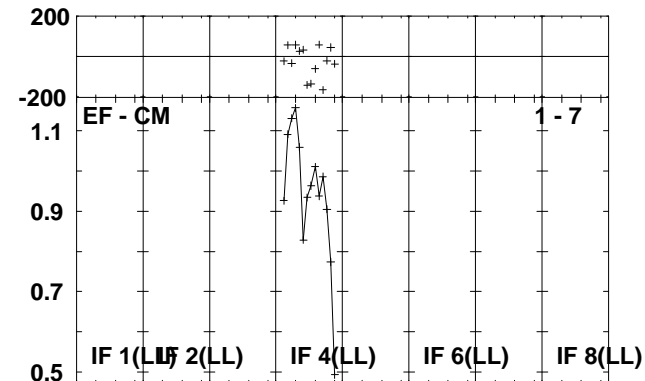
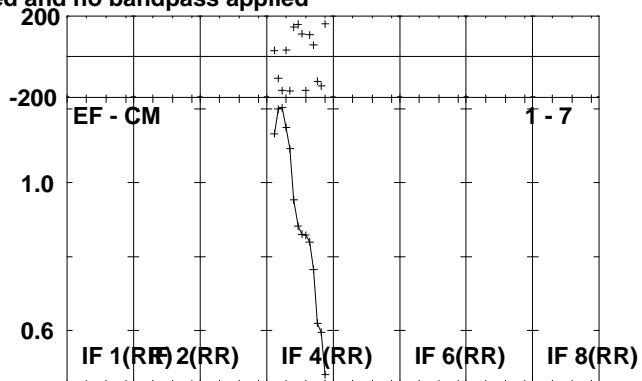
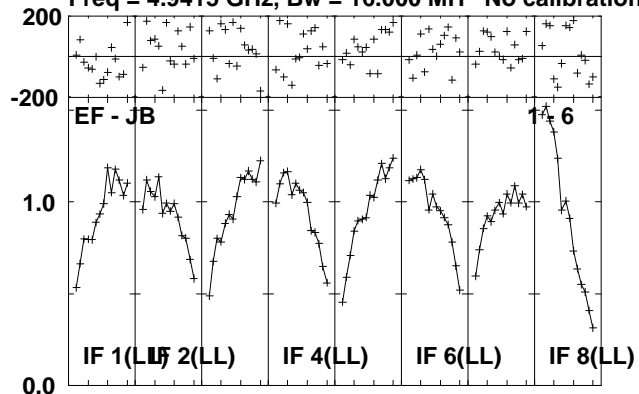

Lower frame: Milli Ampl Jy Top frame: Phas deg
Scalar averaged cross-power spectrum Several baselines displayed
Timerange: 00/20:51:20 to 00/20:56:18

Plot file version 77 created 06-OCT-2010 10:57:07

J1907+01 ET013A.UVDATA.1

Freq = 4.9415 GHz, Bw = 16.000 MH No calibration applied and no bandpass applied

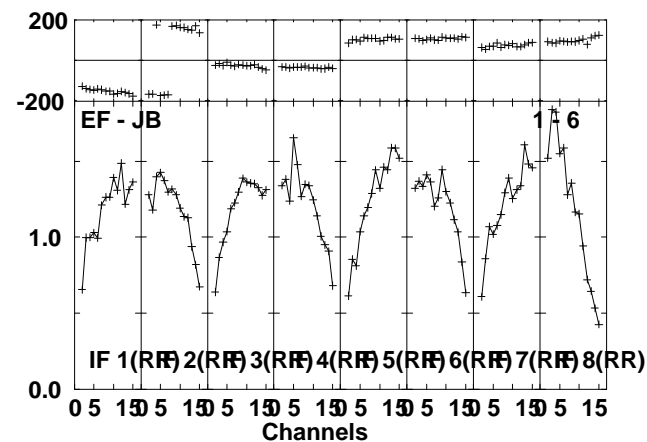
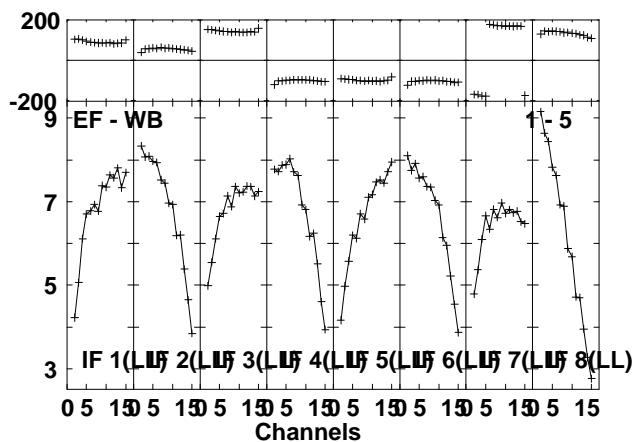
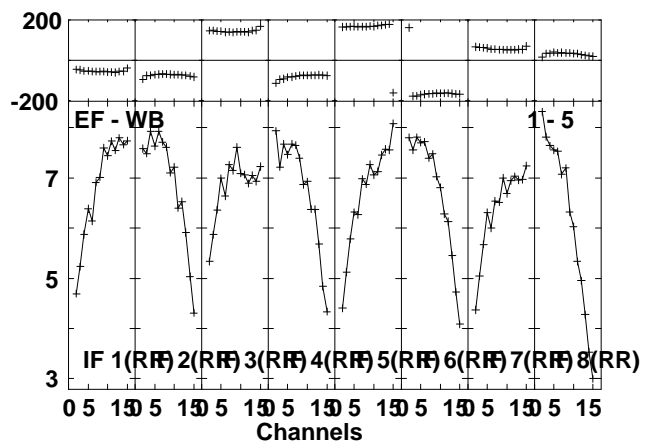
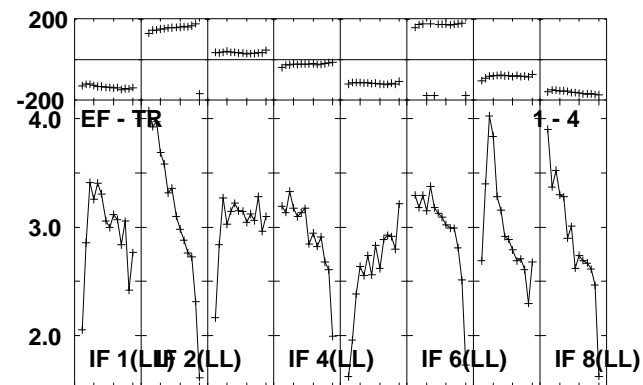
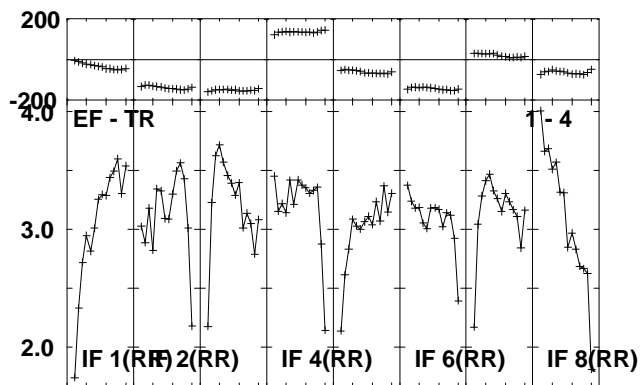
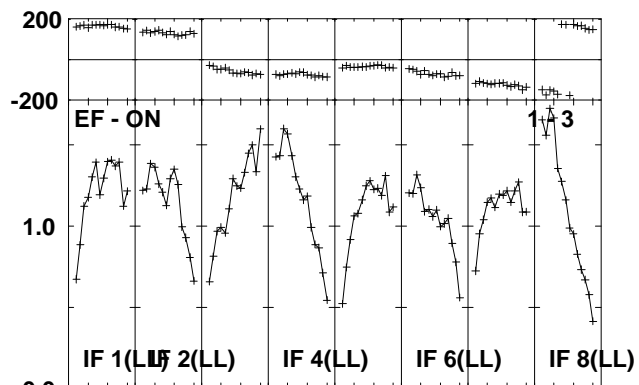
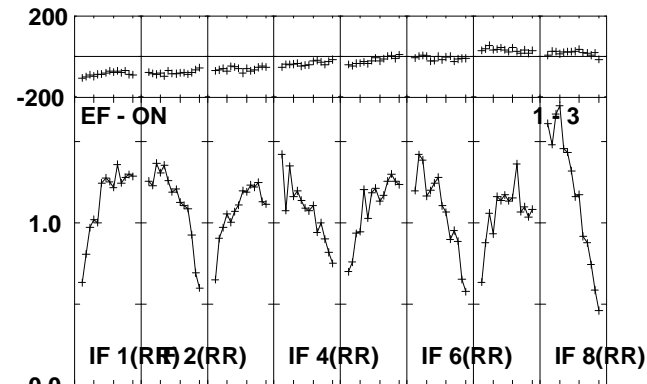
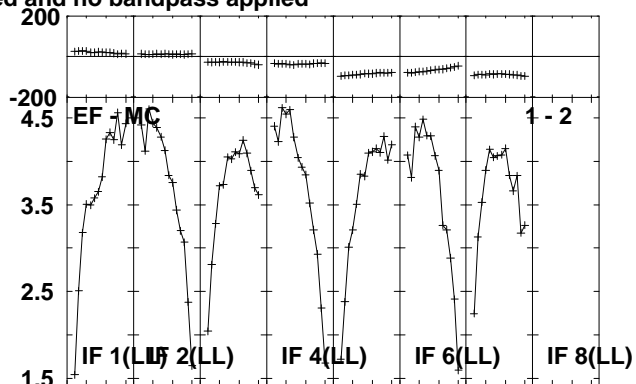
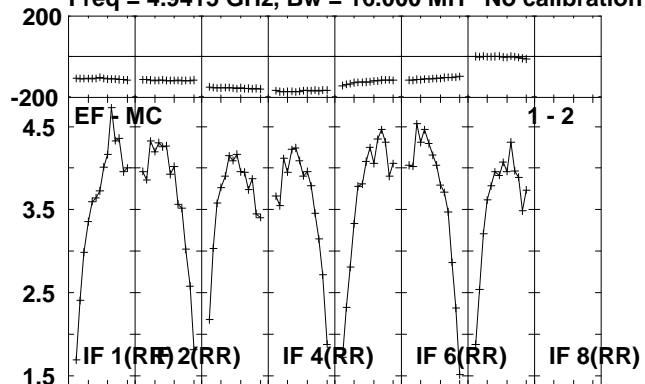

Lower frame: Milli Ampl Jy Top frame: Phas deg
Scalar averaged cross-power spectrum Several baselines displayed
Timerange: 00/20:57:00 to 00/20:59:18

Plot file version 78 created 06-OCT-2010 10:57:08

J1907+01 ET013A.UVDATA.1

Freq = 4.9415 GHz, Bw = 16.000 MH No calibration applied and no bandpass applied

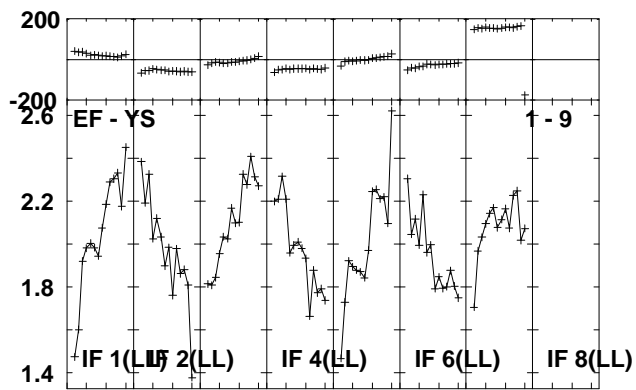
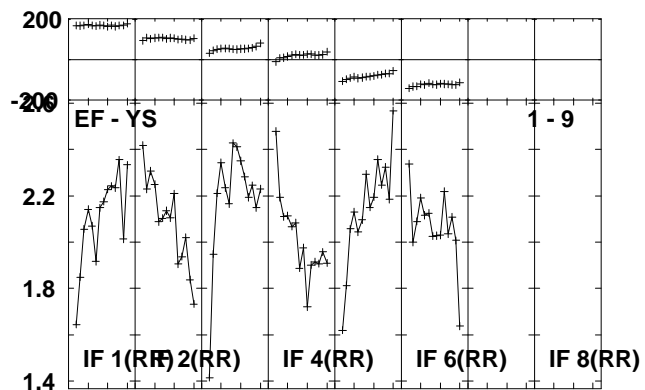
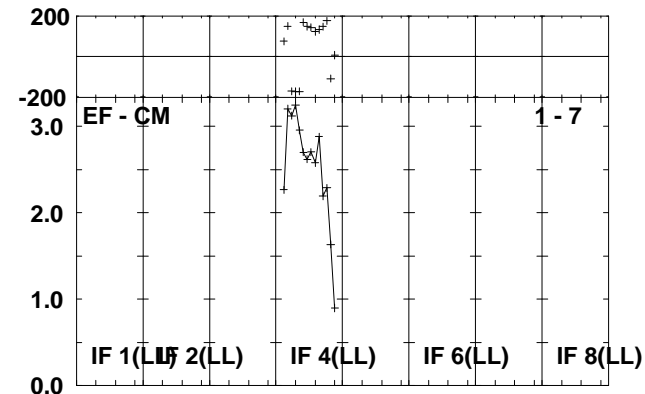
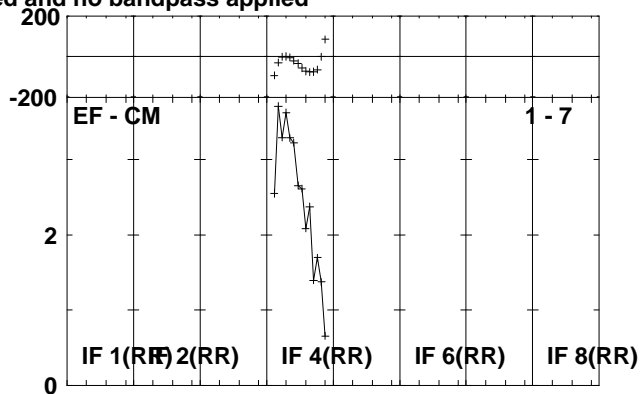
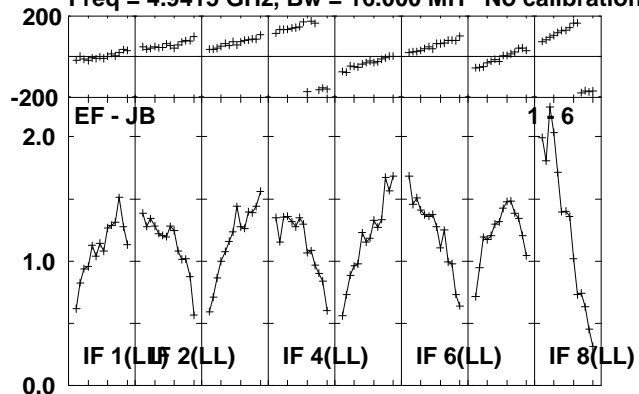

Lower frame: Milli Ampl Jy Top frame: Phas deg
Scalar averaged cross-power spectrum Several baselines displayed
Timerange: 00/20:57:00 to 00/20:59:18

Plot file version 79 created 06-OCT-2010 10:57:09

AQLX-1 ET013A.UVDATA.1

Freq = 4.9415 GHz, Bw = 16.000 MH No calibration applied and no bandpass applied

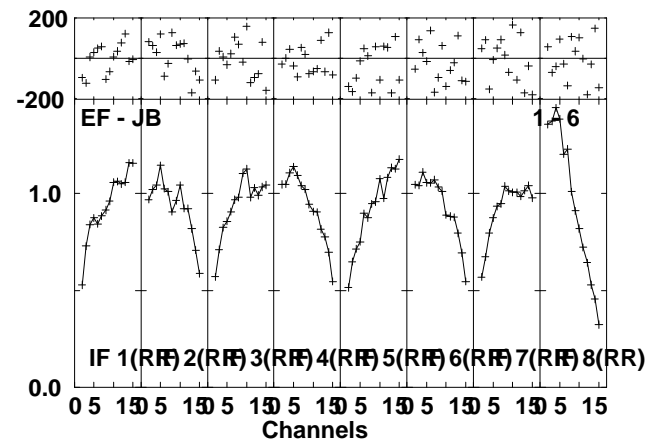
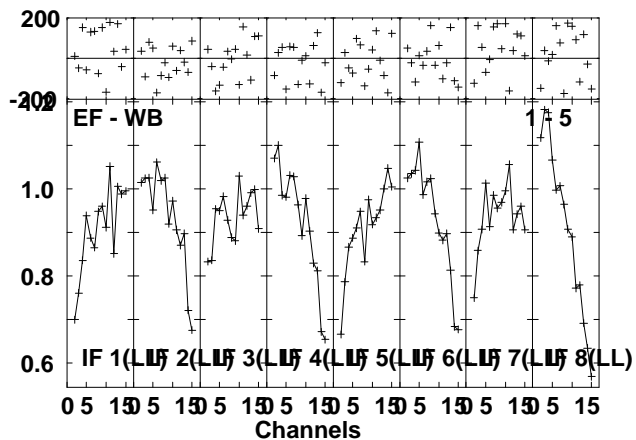
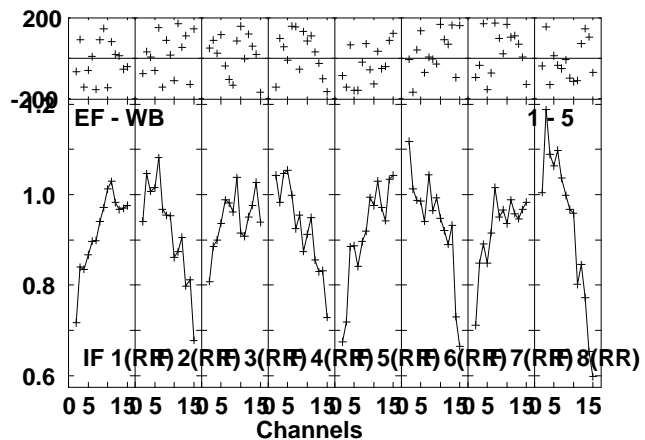
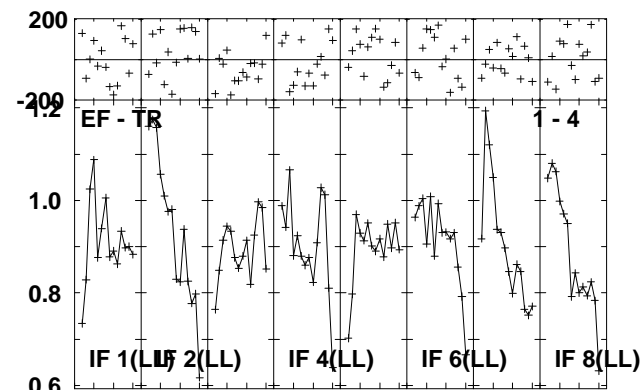
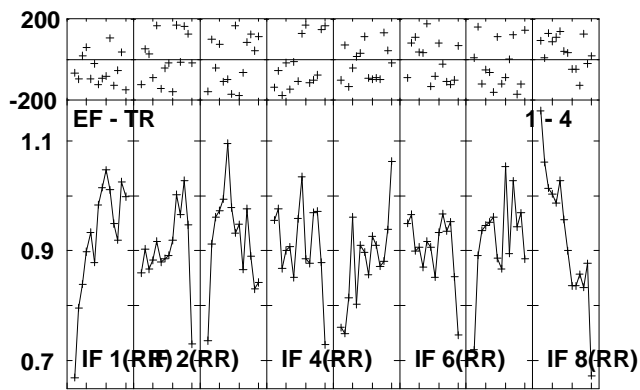
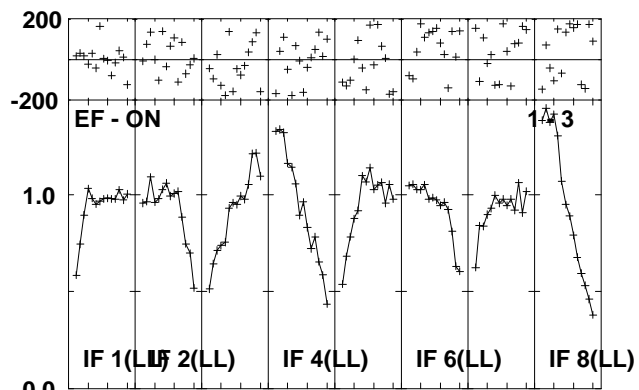
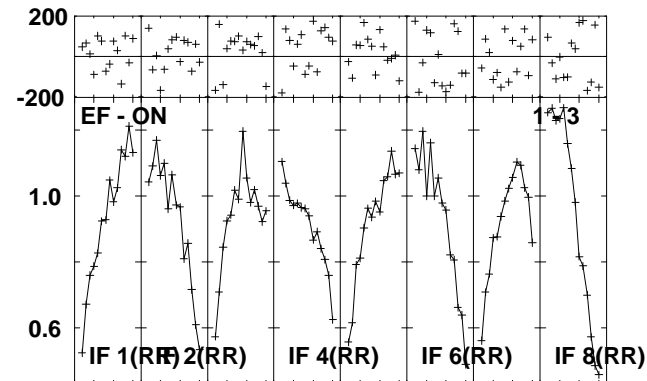
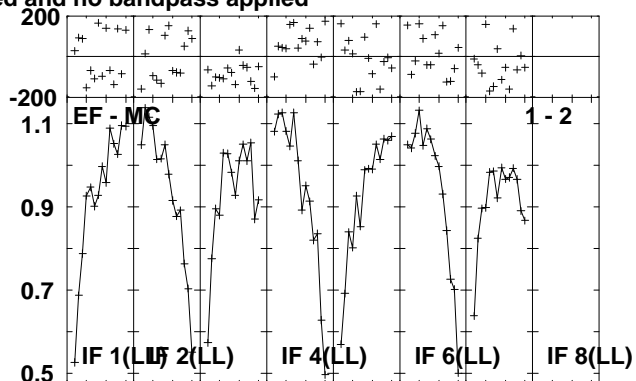
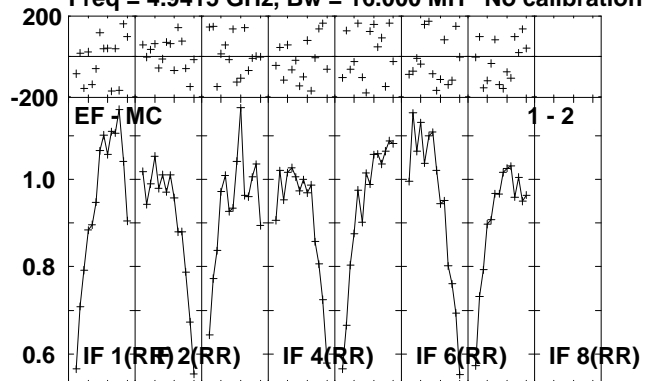

Lower frame: Milli Ampl Jy Top frame: Phas deg
Scalar averaged cross-power spectrum Several baselines displayed
Timerange: 00/20:59:20 to 00/21:04:18

Plot file version 80 created 06-OCT-2010 10:57:11
AQLX-1 ET013A.UVDATA.1

Freq = 4.9415 GHz, Bw = 16.000 MH No calibration applied and no bandpass applied

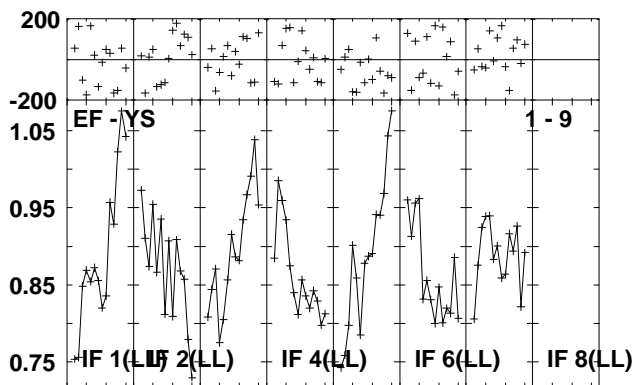
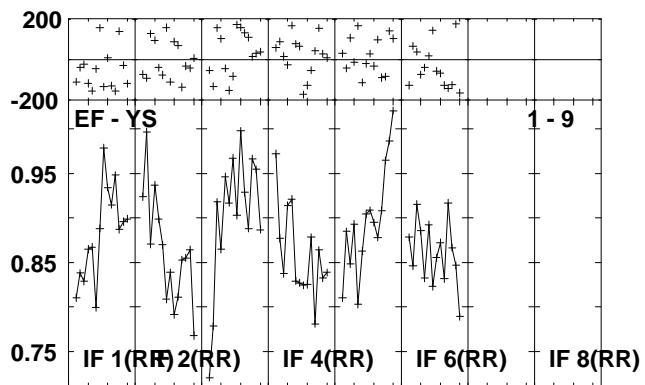
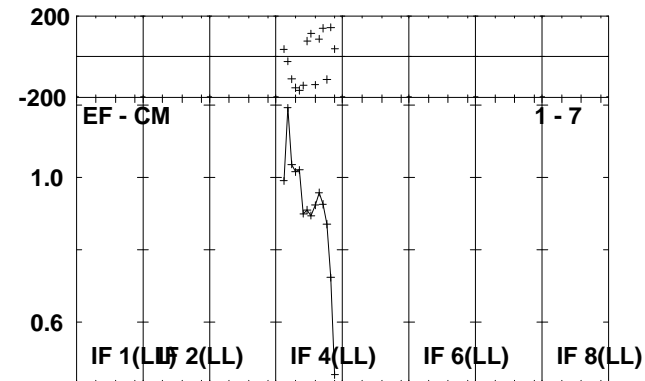
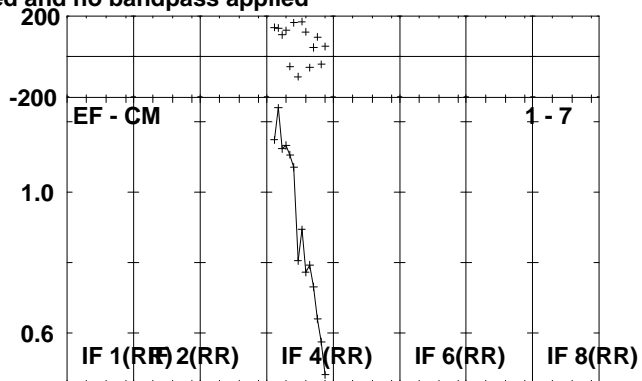
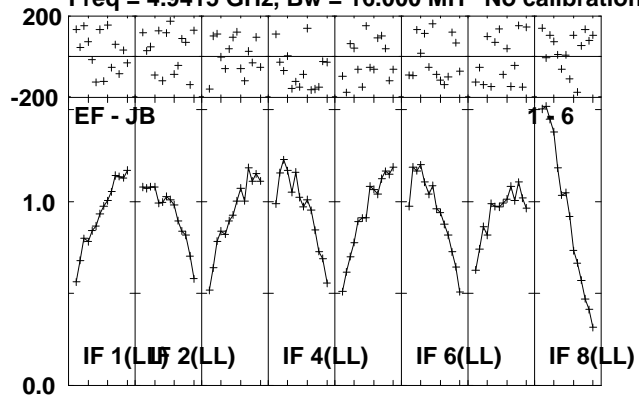

Lower frame: Milli Ampl Jy Top frame: Phas deg
Scalar averaged cross-power spectrum Several baselines displayed
Timerange: 00/20:59:20 to 00/21:04:18

Plot file version 81 created 06-OCT-2010 10:57:13

J1907+01 ET013A.UVDATA.1

Freq = 4.9415 GHz, Bw = 16.000 MH No calibration applied and no bandpass applied

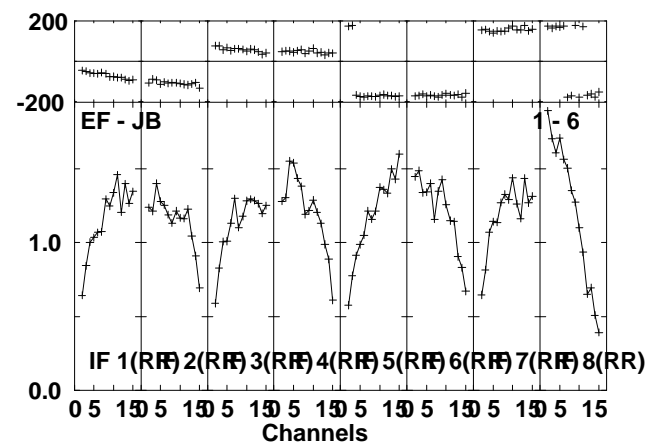
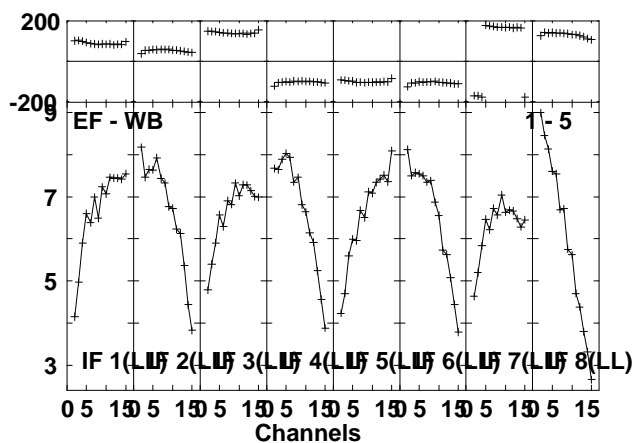
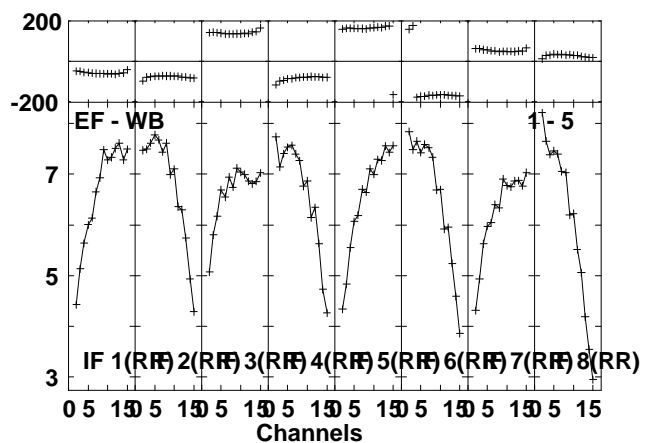
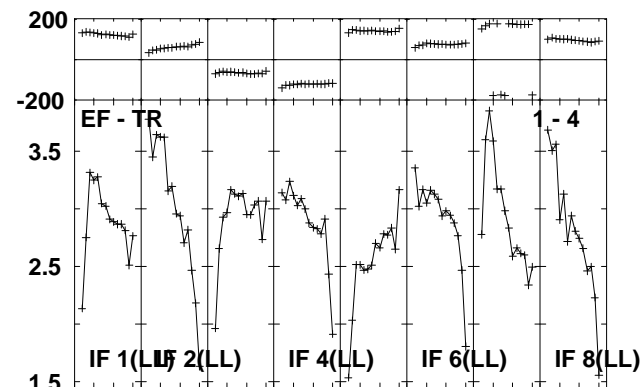
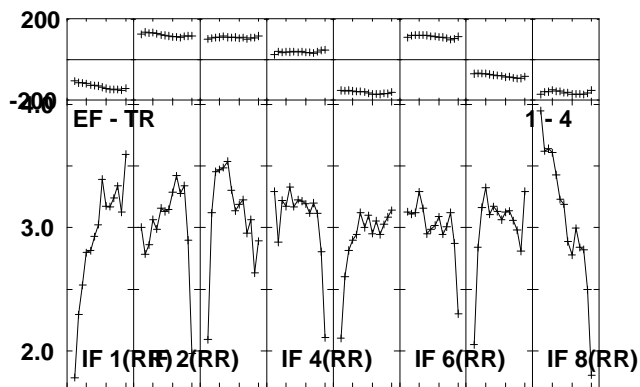
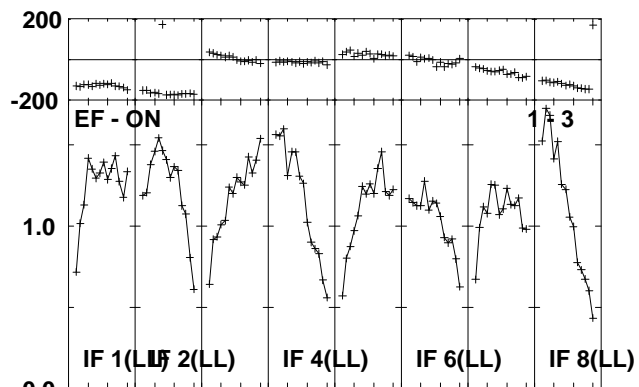
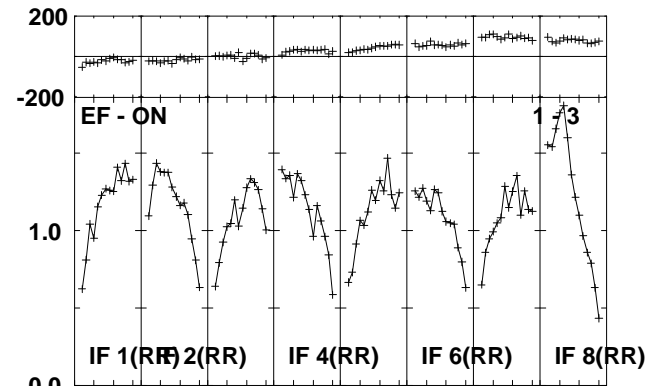
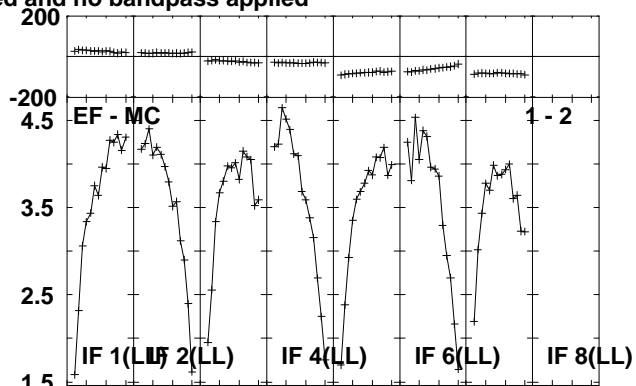
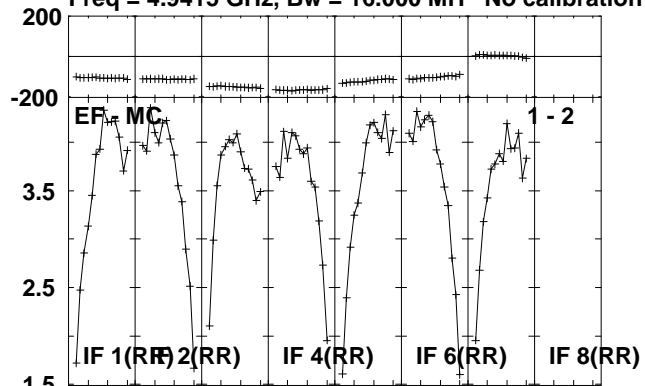

Lower frame: Milli Ampl Jy Top frame: Phas deg
Scalar averaged cross-power spectrum Several baselines displayed
Timerange: 00/21:05:00 to 00/21:07:18

Plot file version 82 created 06-OCT-2010 10:57:13
 J1907+01 ET013A.UVDATA.1

Freq = 4.9415 GHz, Bw = 16.000 MH No calibration applied and no bandpass applied

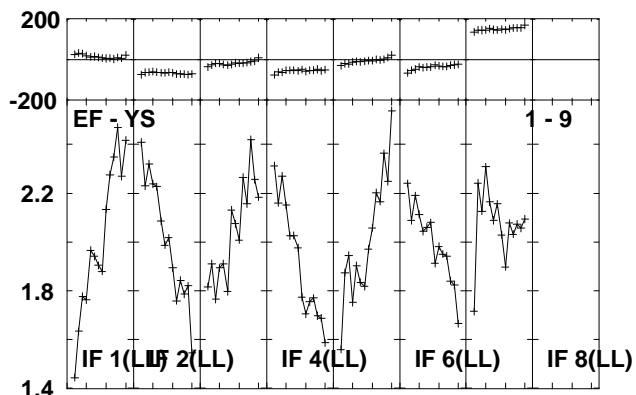
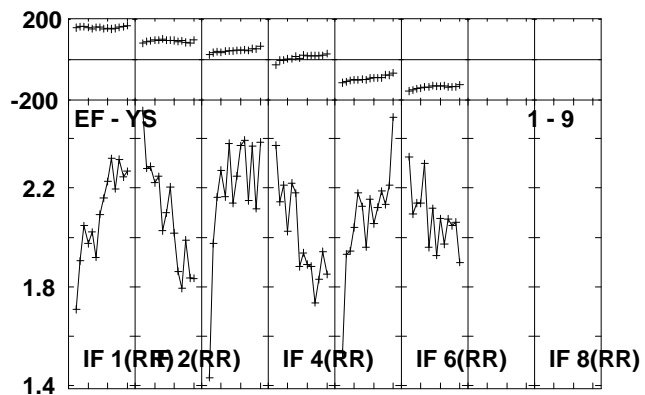
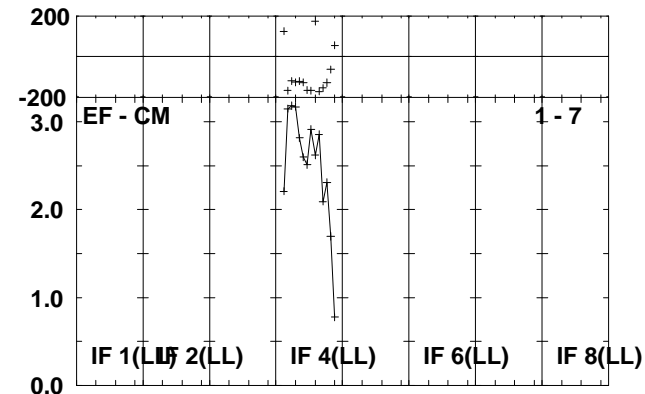
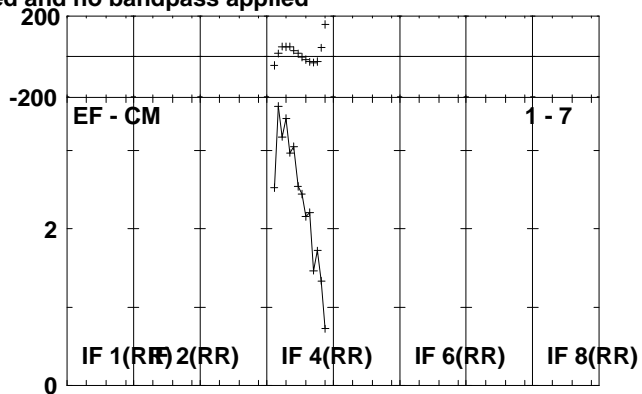
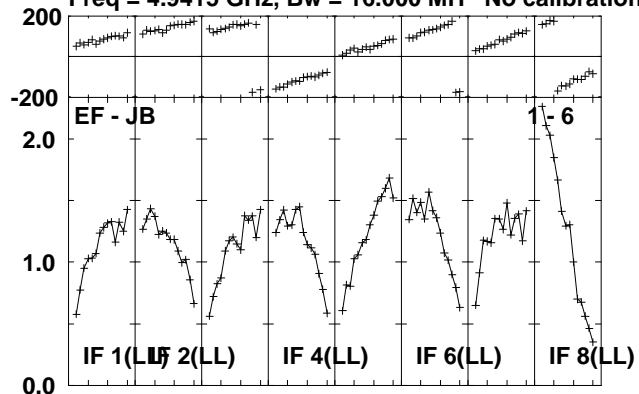

Lower frame: Milli Ampl Jy Top frame: Phas deg
 Scalar averaged cross-power spectrum Several baselines displayed
 Timerange: 00/21:05:00 to 00/21:07:18

Plot file version 83 created 06-OCT-2010 10:57:15

AQLX-1 ET013A.UVDATA.1

Freq = 4.9415 GHz, Bw = 16.000 MH No calibration applied and no bandpass applied

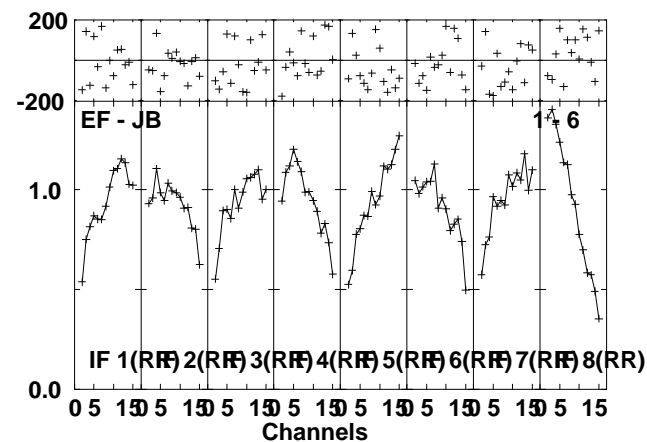
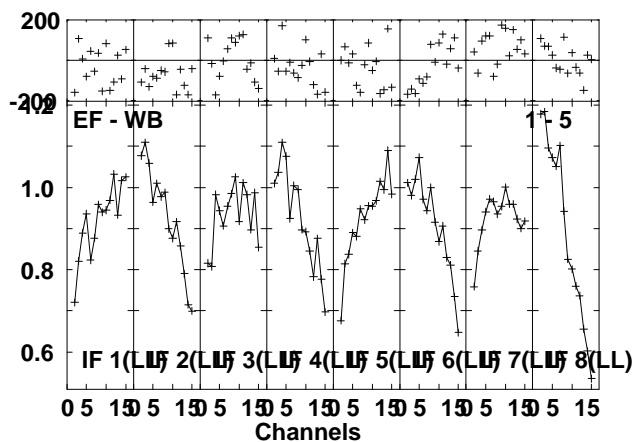
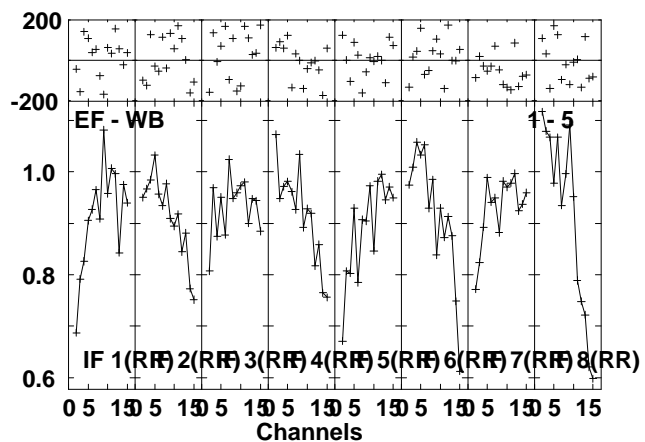
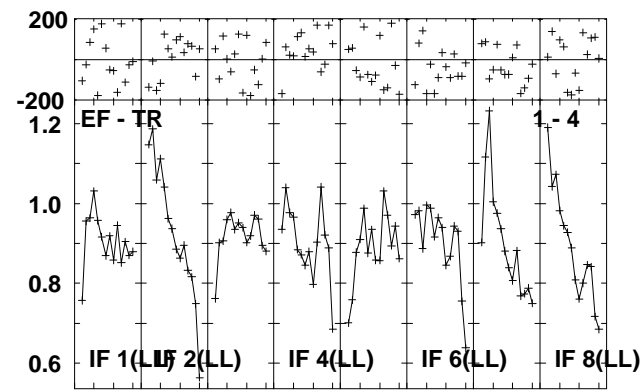
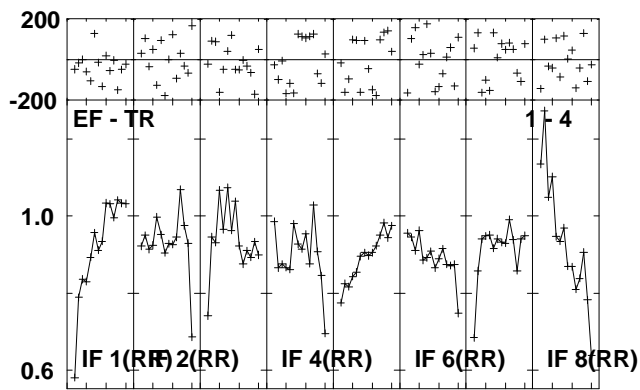
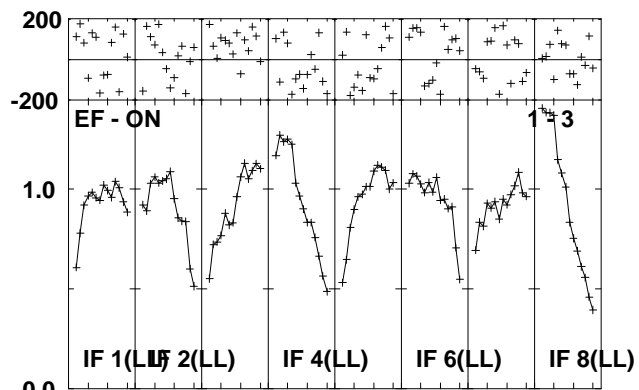
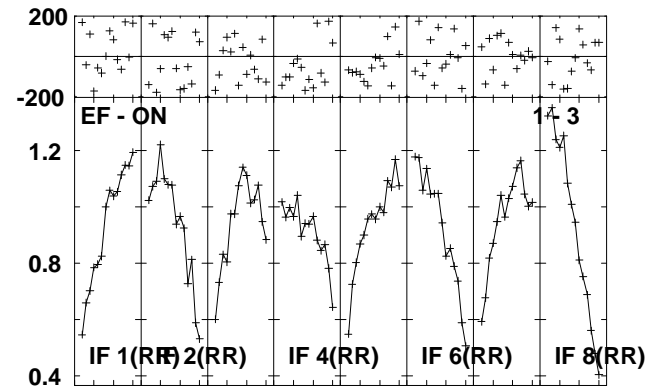
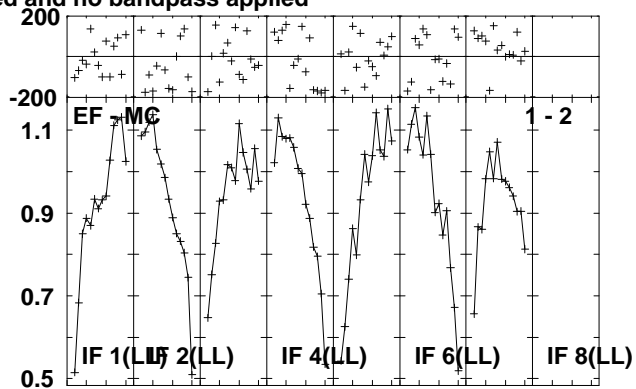
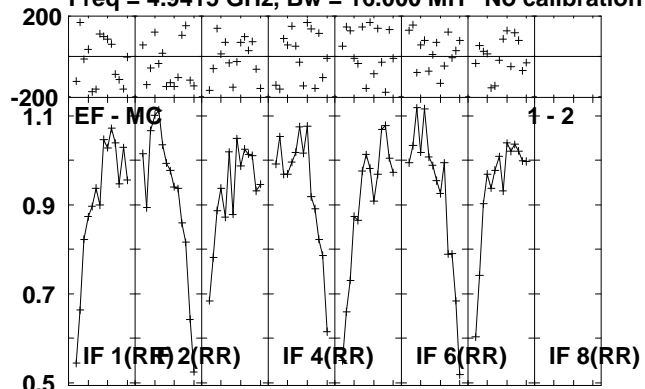

Lower frame: Milli Ampl Jy Top frame: Phas deg
Scalar averaged cross-power spectrum Several baselines displayed
Timerange: 00/21:07:20 to 00/21:12:18

Plot file version 84 created 06-OCT-2010 10:57:16

AQLX-1 ET013A.UVDATA.1

Freq = 4.9415 GHz, Bw = 16.000 MH No calibration applied and no bandpass applied

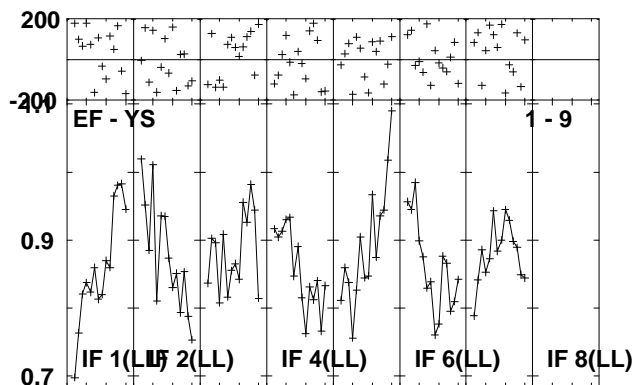
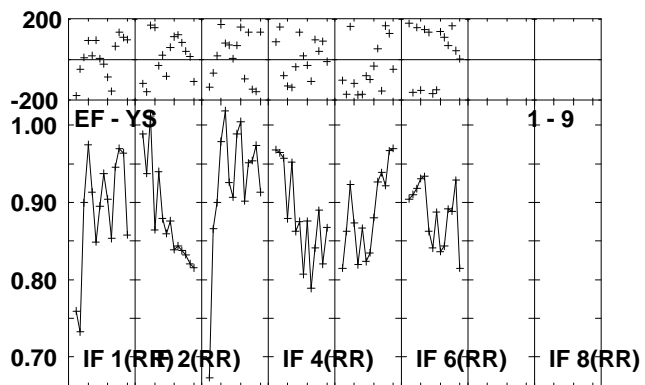
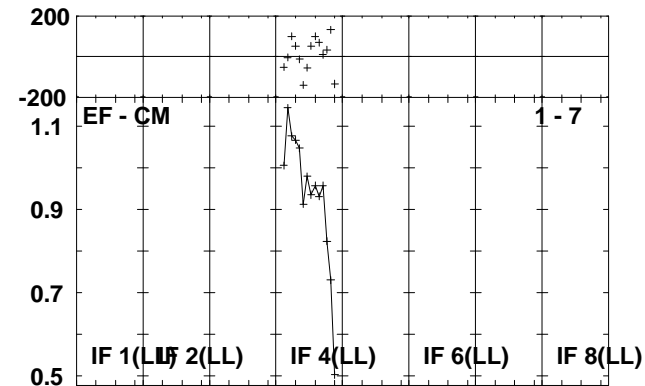
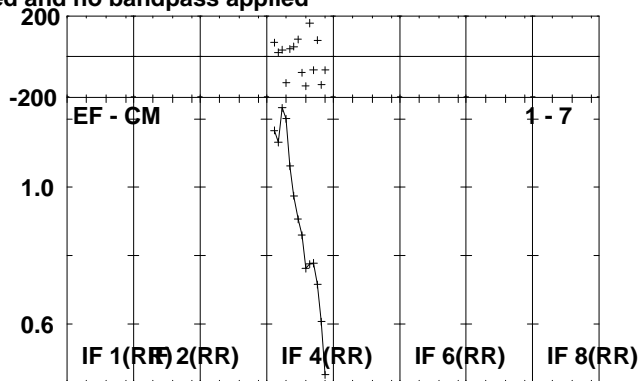
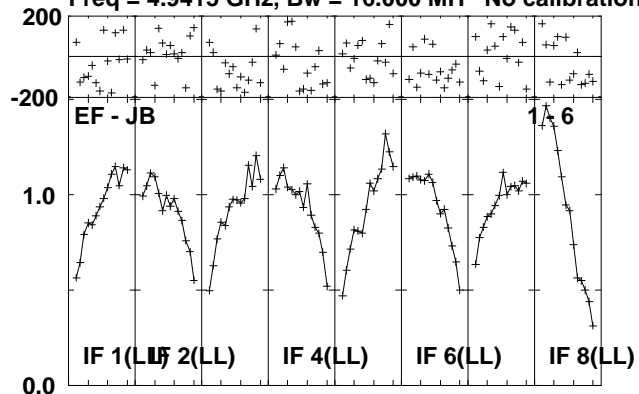

Lower frame: Milli Ampl Jy Top frame: Phas deg
Scalar averaged cross-power spectrum Several baselines displayed
Timerange: 00/21:07:20 to 00/21:12:18

Plot file version 85 created 06-OCT-2010 10:57:18

J1907+01 ET013A.UVDATA.1

Freq = 4.9415 GHz, Bw = 16.000 MH No calibration applied and no bandpass applied

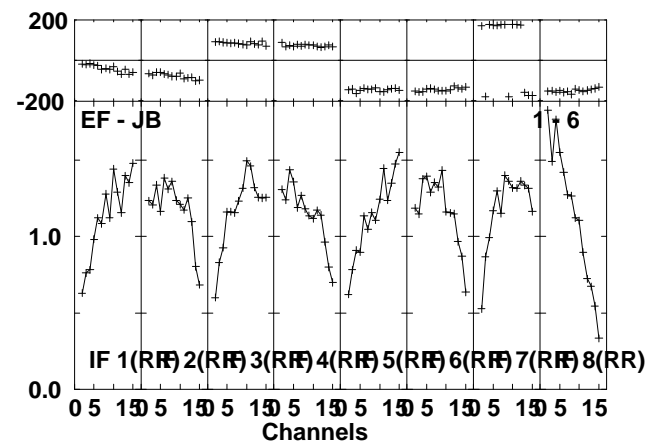
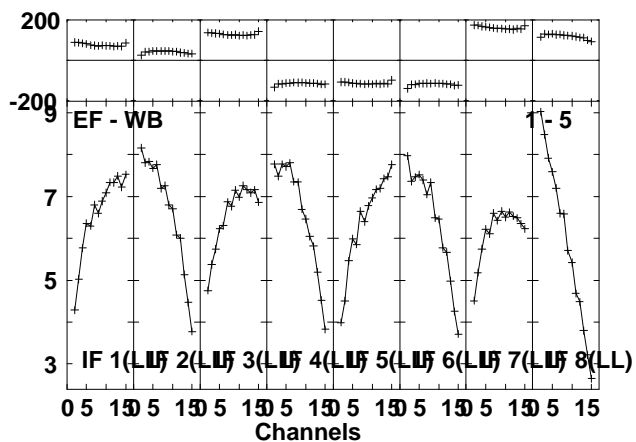
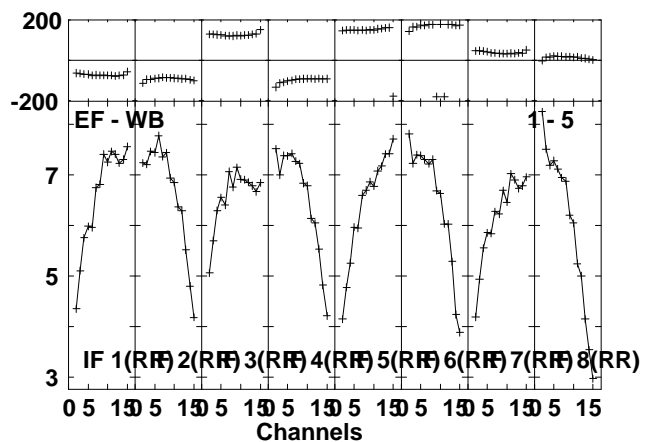
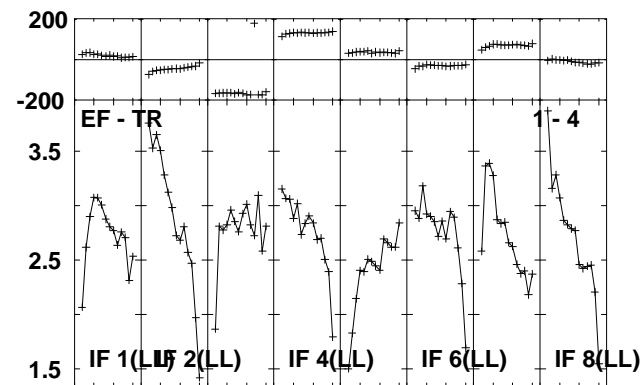
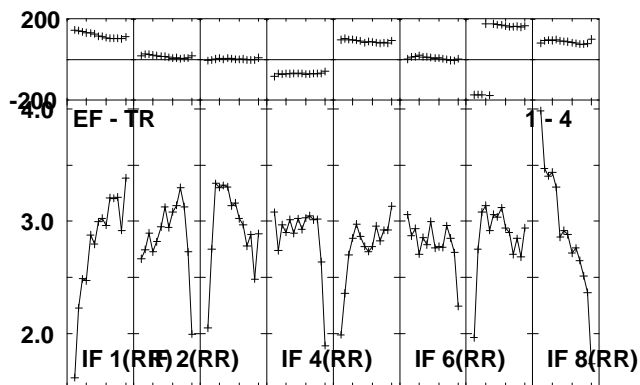
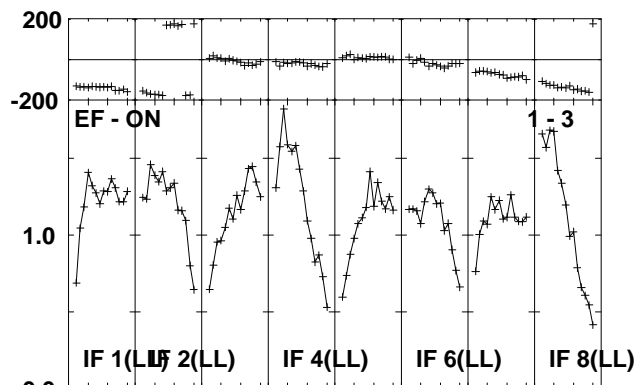
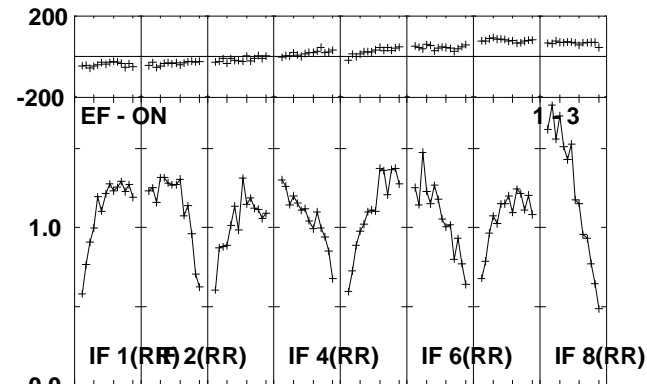
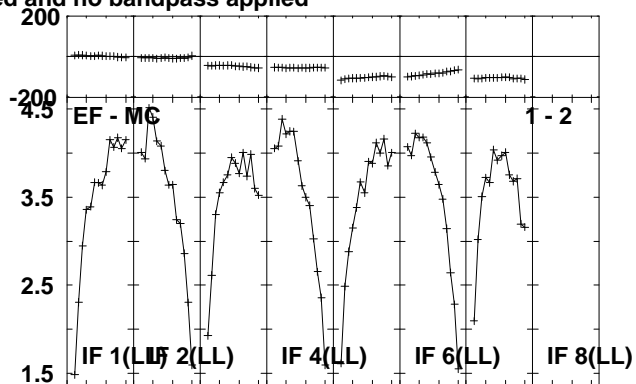
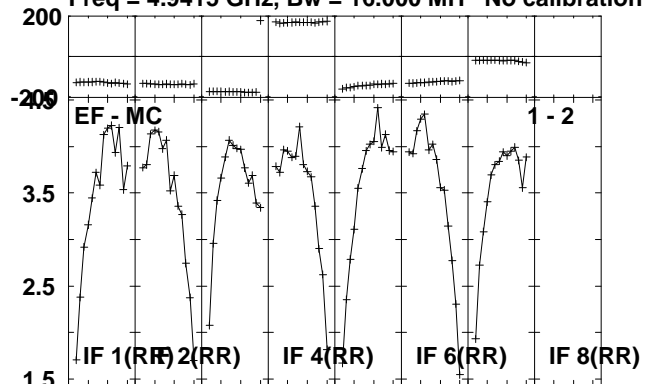

Lower frame: Milli Ampl Jy Top frame: Phas deg
Scalar averaged cross-power spectrum Several baselines displayed
Timerange: 00/21:13:00 to 00/21:15:18

Plot file version 86 created 06-OCT-2010 10:57:19

J1907+01 ET013A.UVDATA.1

Freq = 4.9415 GHz, Bw = 16.000 MH No calibration applied and no bandpass applied

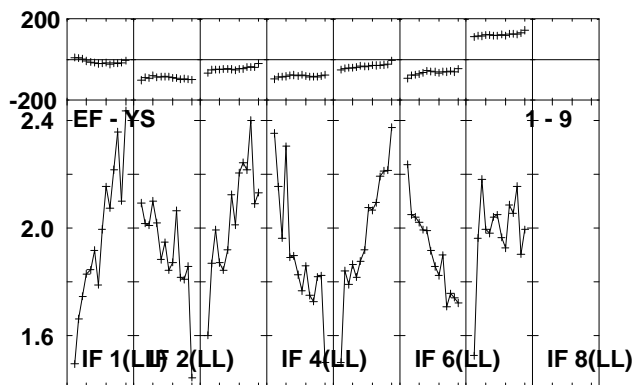
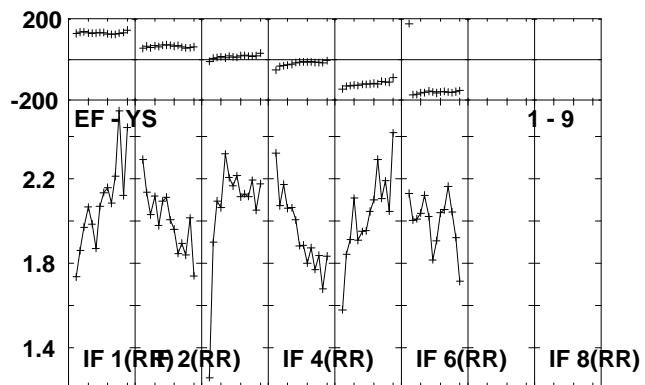
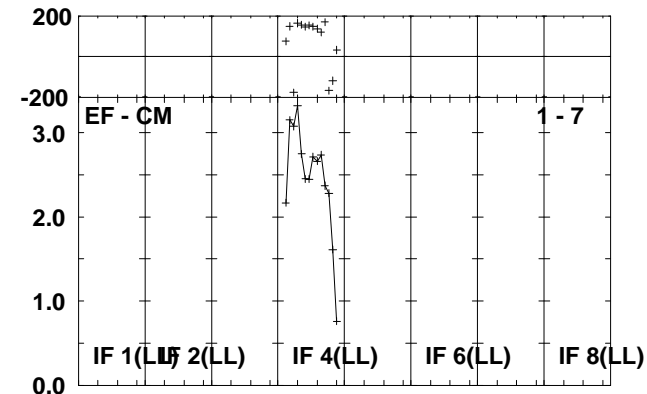
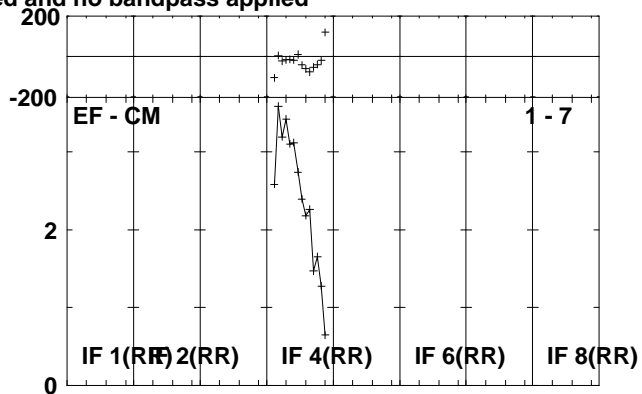
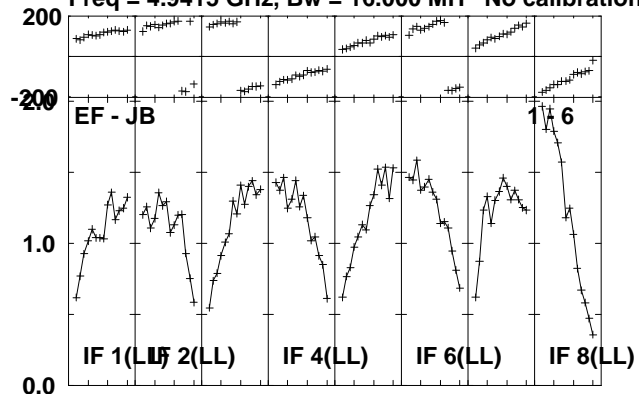

Lower frame: Milli Ampl Jy Top frame: Phas deg
Scalar averaged cross-power spectrum Several baselines displayed
Timerange: 00/21:13:00 to 00/21:15:18

Plot file version 87 created 06-OCT-2010 10:57:20

J1920-02 ET013A.UVDATA.1

Freq = 4.9415 GHz, Bw = 16.000 MH No calibration applied and no bandpass applied

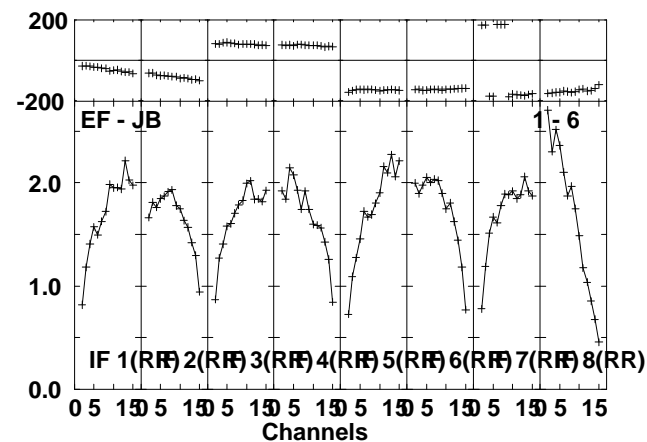
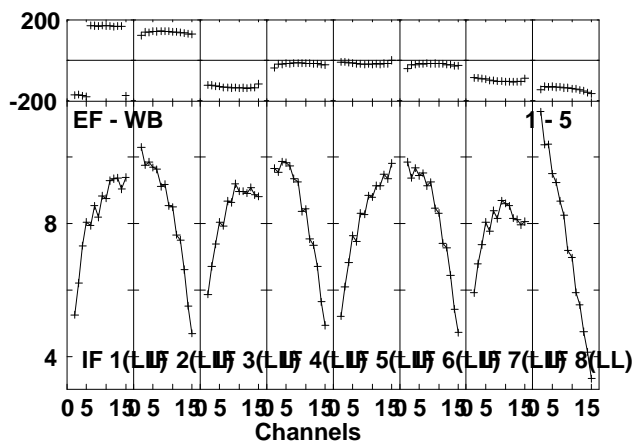
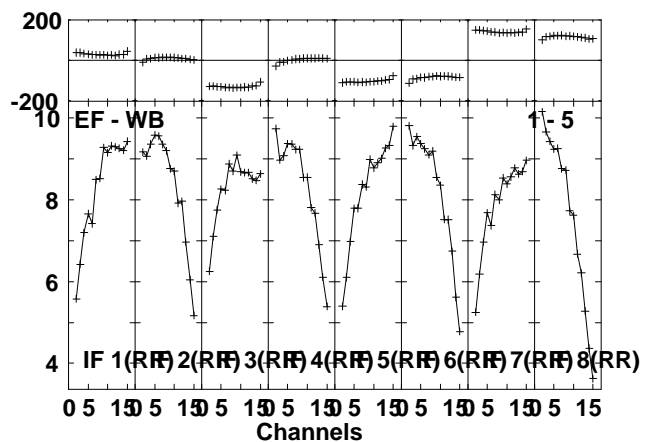
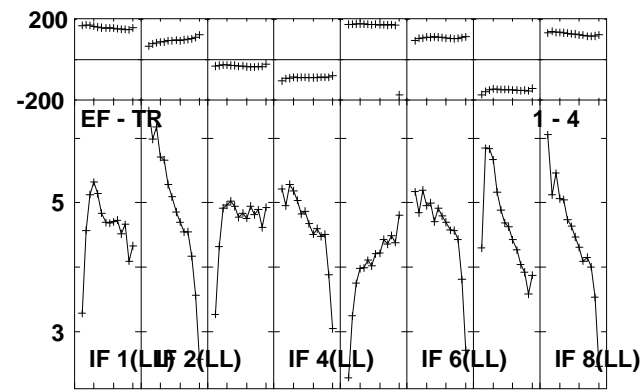
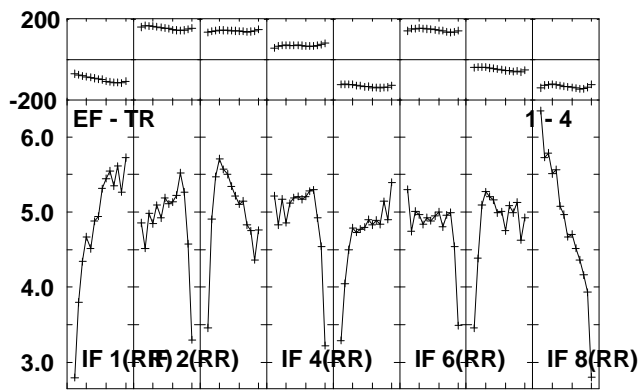
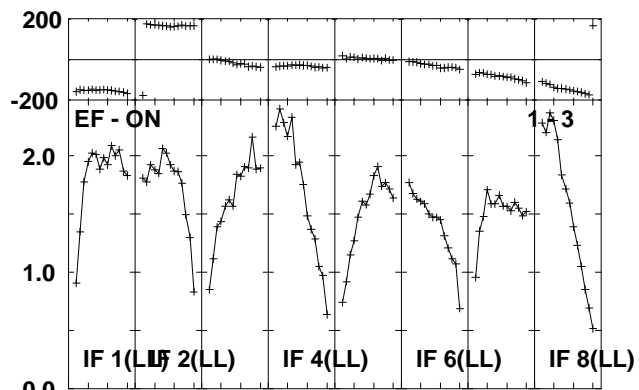
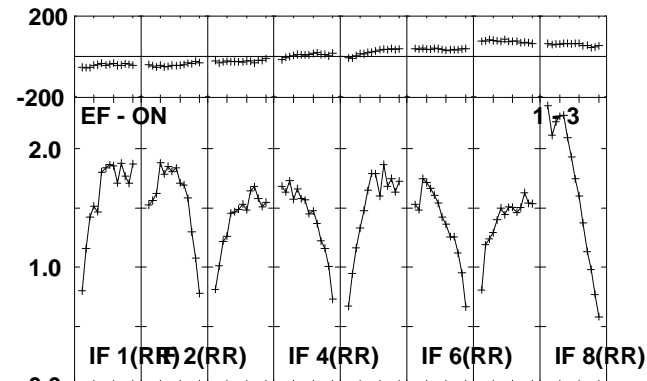
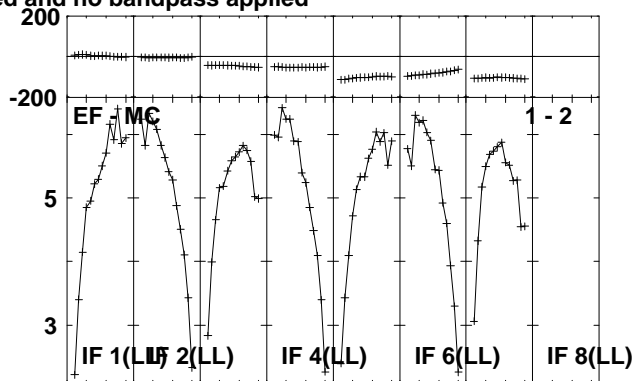
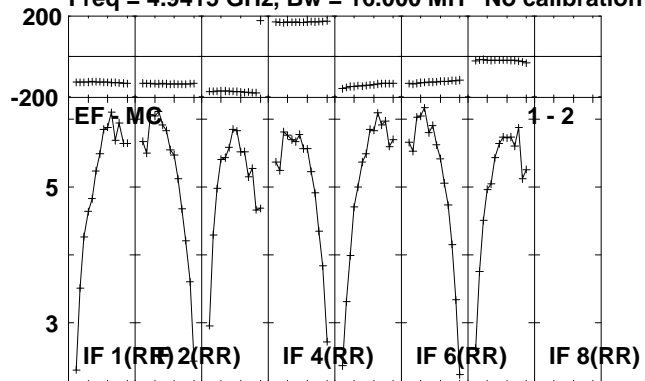

Lower frame: Milli Ampl Jy Top frame: Phas deg
Scalar averaged cross-power spectrum Several baselines displayed
Timerange: 00/21:15:20 to 00/21:20:18

Plot file version 88 created 06-OCT-2010 10:57:22
J1920-02 ET013A.UVDATA.1

Freq = 4.9415 GHz, Bw = 16.000 MH No calibration applied and no bandpass applied

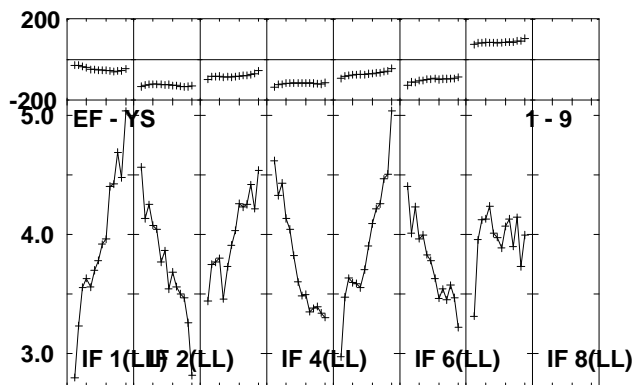
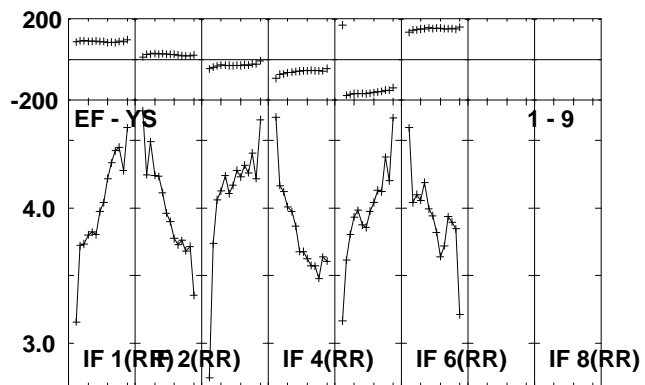
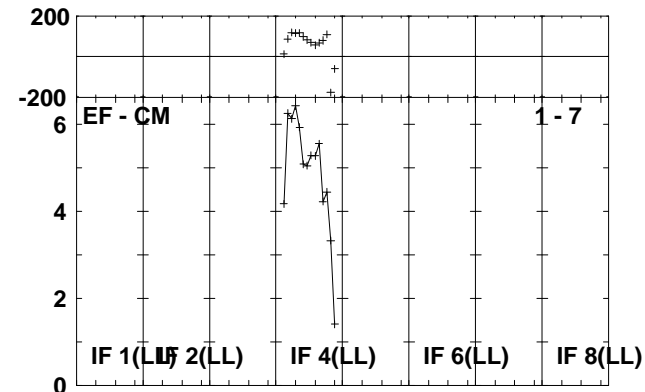
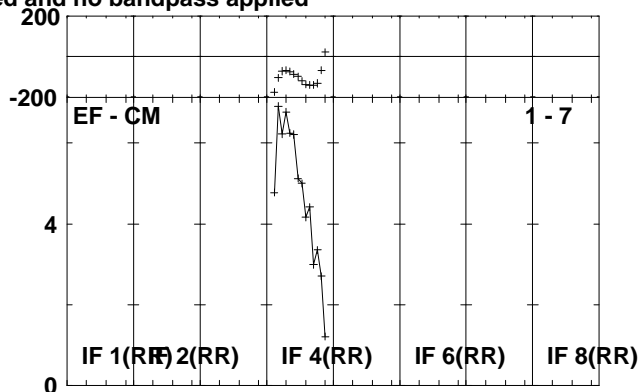
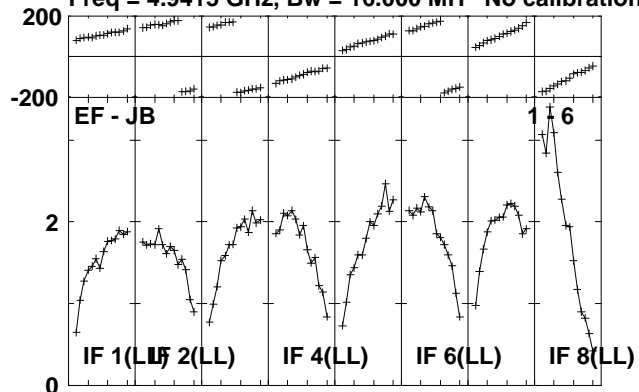

Lower frame: Milli Ampl Jy Top frame: Phas deg
Scalar averaged cross-power spectrum Several baselines displayed
Timerange: 00/21:15:20 to 00/21:20:18

Plot file version 89 created 06-OCT-2010 10:57:23

J1907+01 ET013A.UVDATA.1

Freq = 4.9415 GHz, Bw = 16.000 MH No calibration applied and no bandpass applied

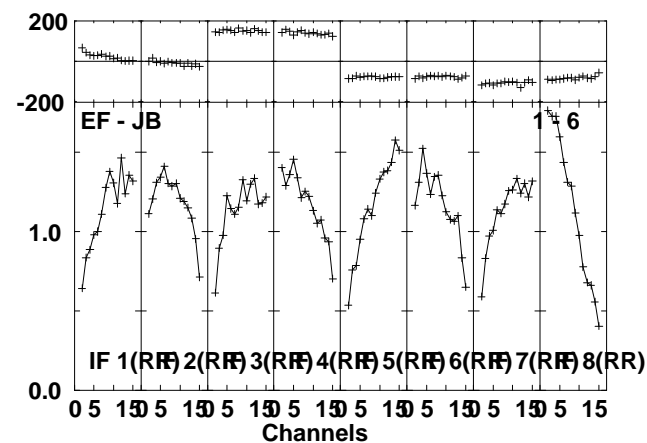
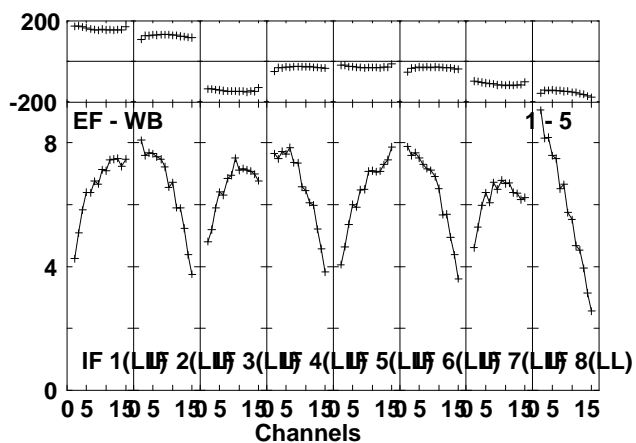
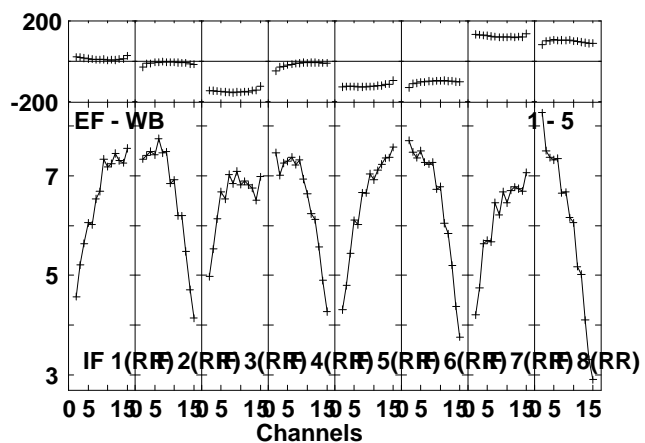
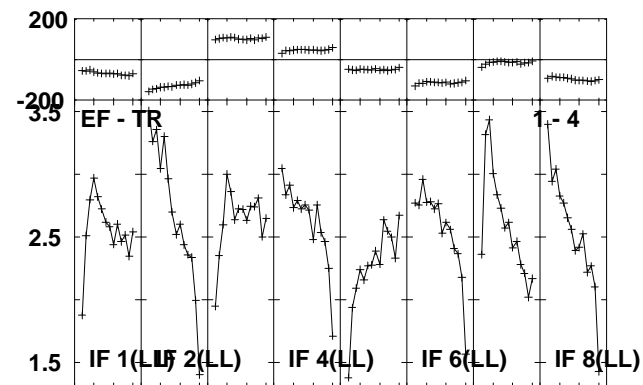
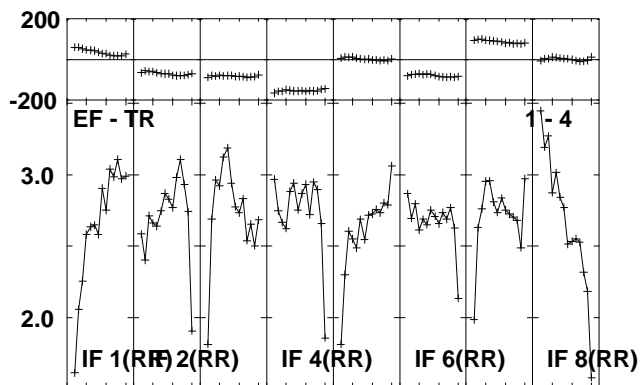
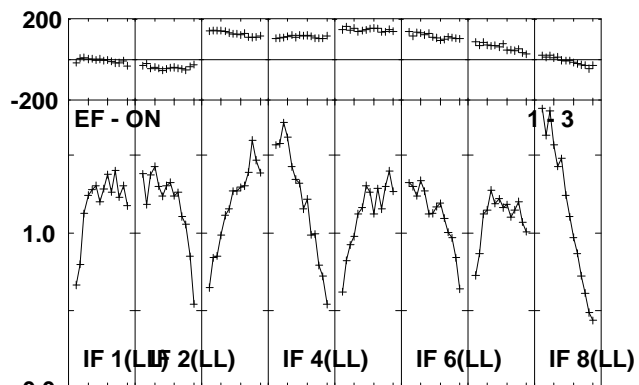
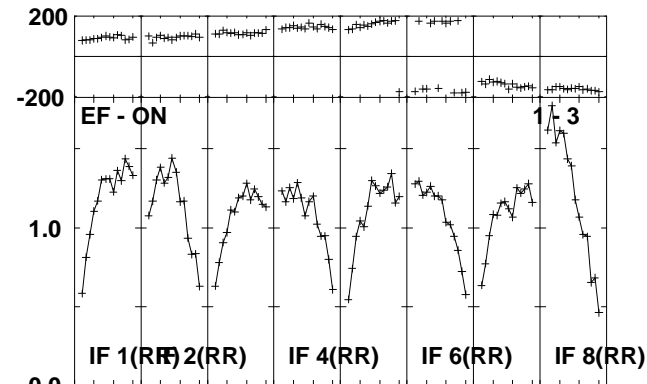
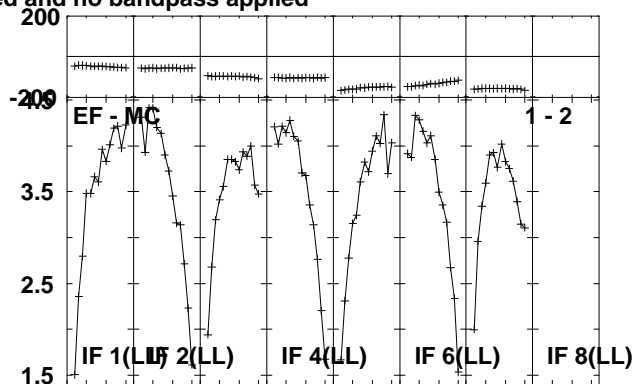
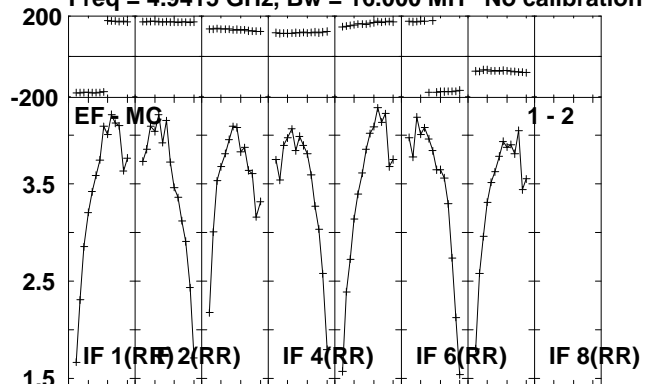

Lower frame: Milli Ampl Jy Top frame: Phas deg
Scalar averaged cross-power spectrum Several baselines displayed
Timerange: 00/21:21:20 to 00/21:23:38

Plot file version 90 created 06-OCT-2010 10:57:24

J1907+01 ET013A.UVDATA.1

Freq = 4.9415 GHz, Bw = 16.000 MH No calibration applied and no bandpass applied

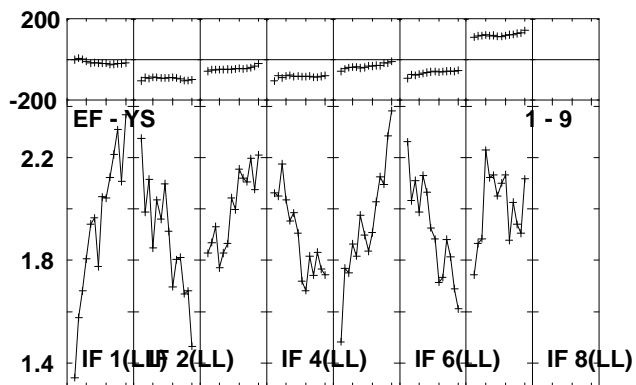
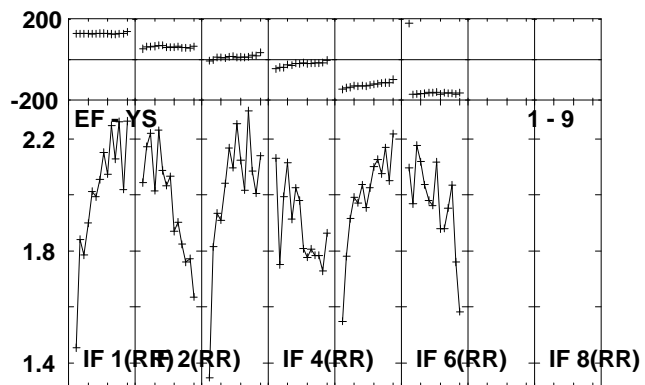
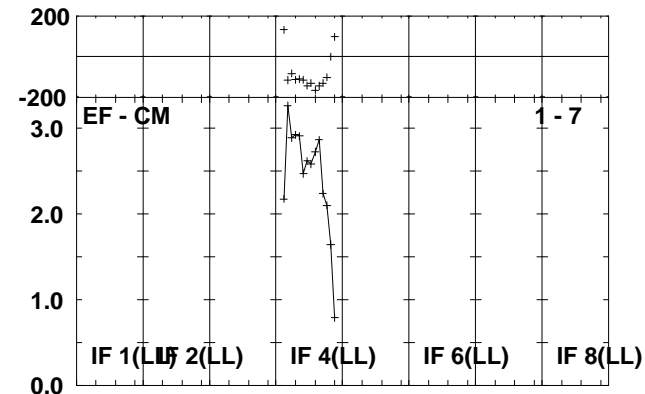
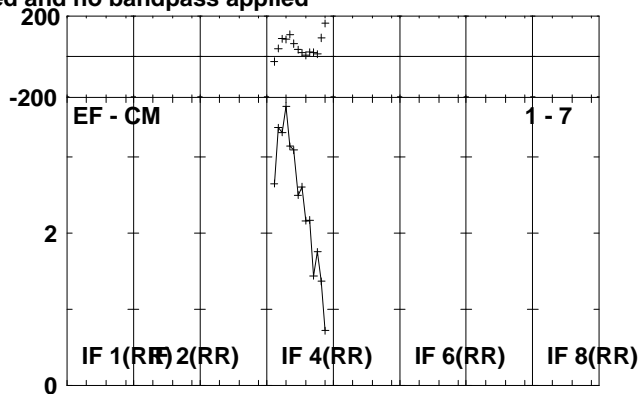
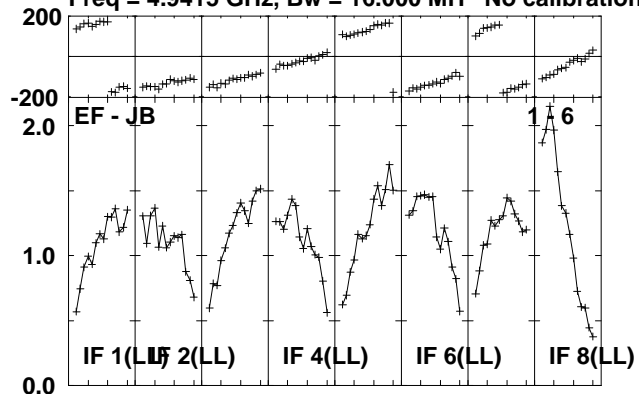

Lower frame: Milli Ampl Jy Top frame: Phas deg
Scalar averaged cross-power spectrum Several baselines displayed
Timerange: 00/21:21:20 to 00/21:23:38

Plot file version 91 created 06-OCT-2010 10:57:25

AQLX-1 ET013A.UVDATA.1

Freq = 4.9415 GHz, Bw = 16.000 MH No calibration applied and no bandpass applied

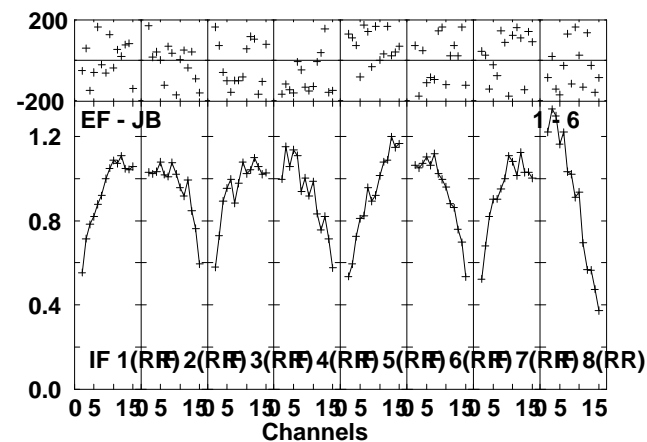
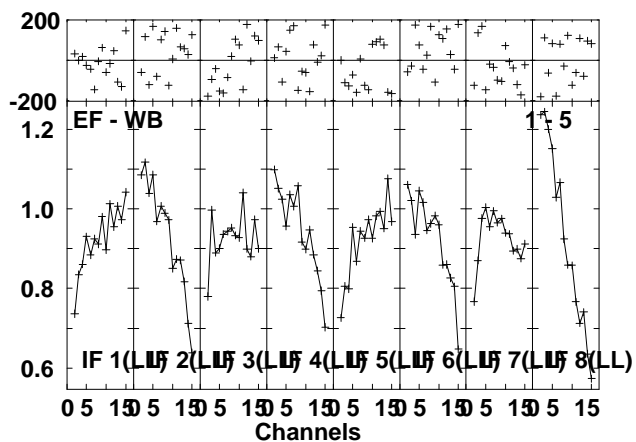
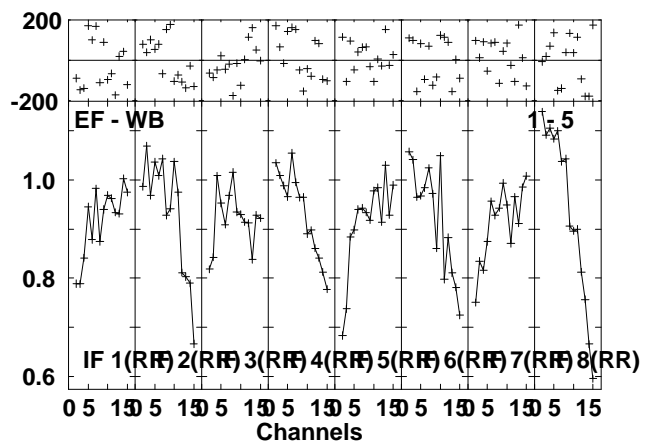
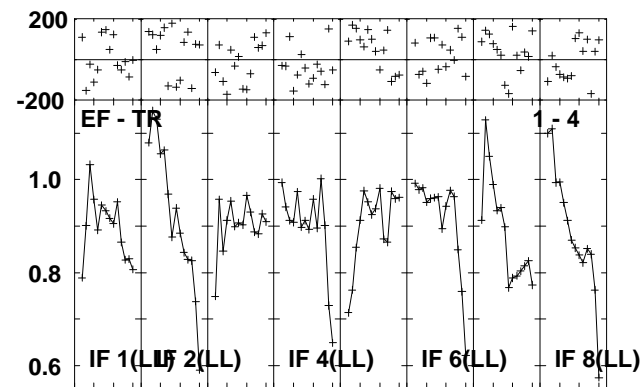
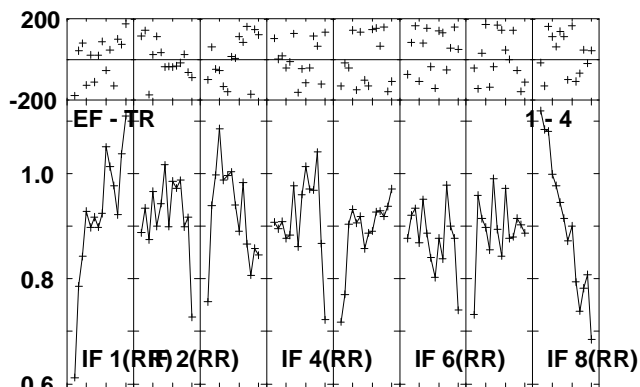
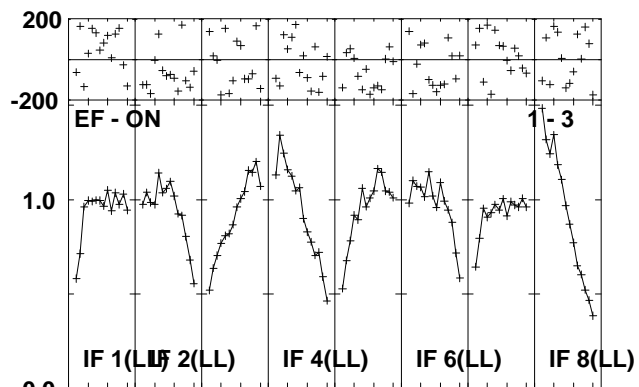
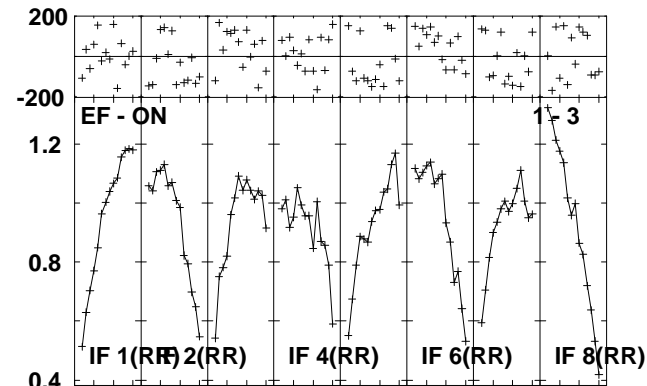
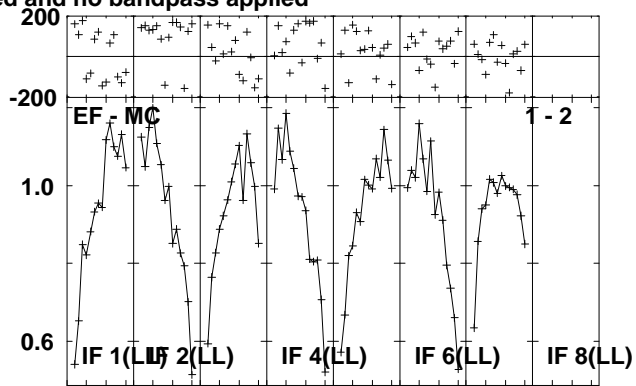
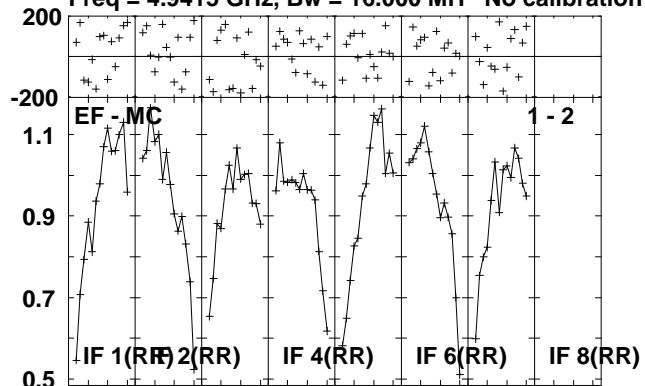

Lower frame: Milli Ampl Jy Top frame: Phas deg
Scalar averaged cross-power spectrum Several baselines displayed
Timerange: 00/21:23:40 to 00/21:28:38

Plot file version 92 created 06-OCT-2010 10:57:27

AQLX-1 ET013A.UVDATA.1

Freq = 4.9415 GHz, Bw = 16.000 MH No calibration applied and no bandpass applied

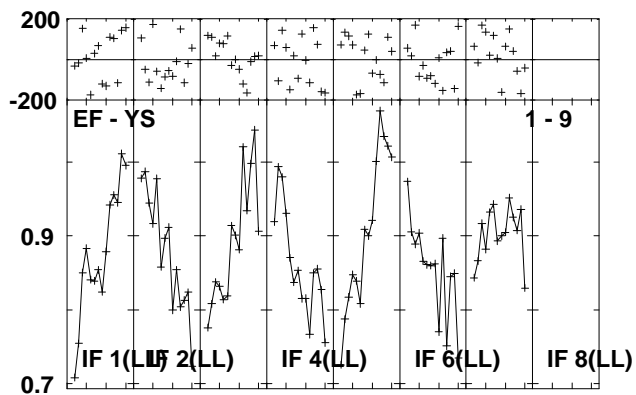
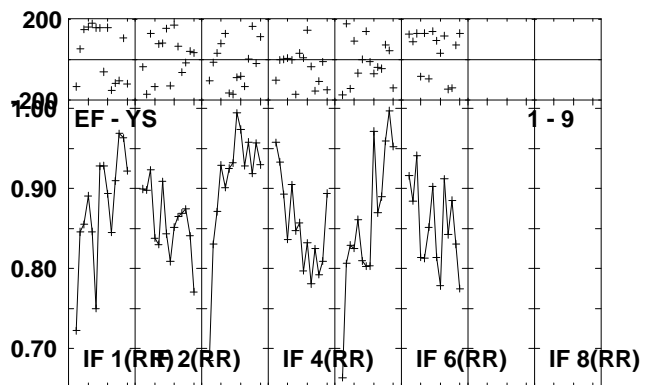
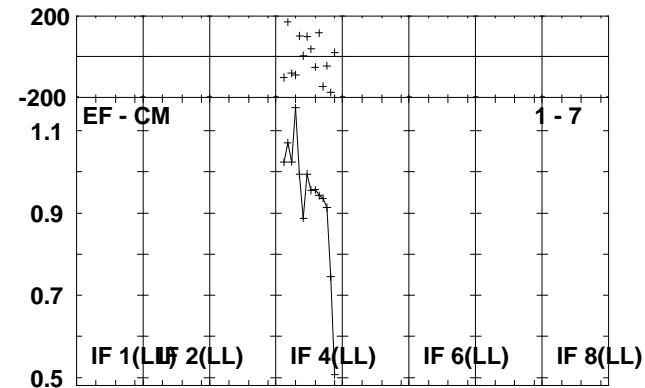
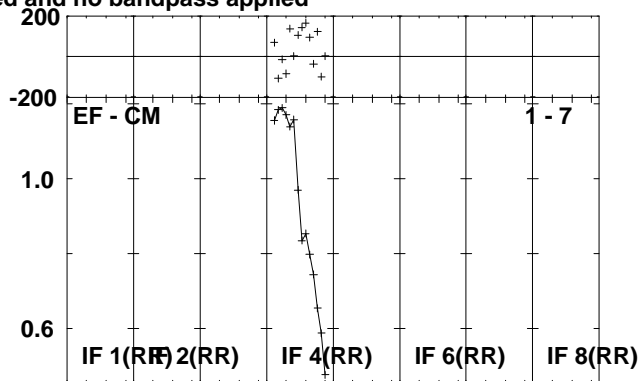
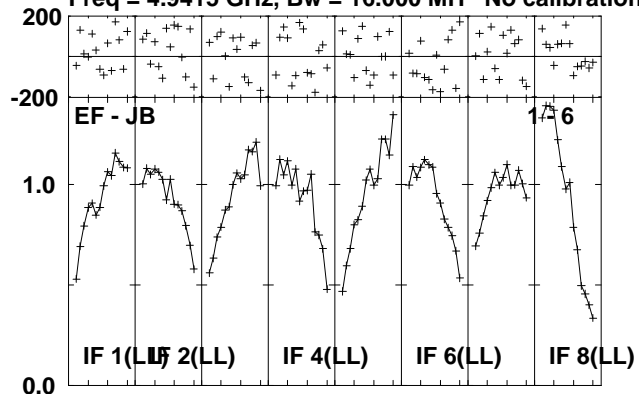

Lower frame: Milli Ampl Jy Top frame: Phas deg
Scalar averaged cross-power spectrum Several baselines displayed
Timerange: 00/21:23:40 to 00/21:28:38

Plot file version 93 created 06-OCT-2010 10:57:28

J1907+01 ET013A.UVDATA.1

Freq = 4.9415 GHz, Bw = 16.000 MH No calibration applied and no bandpass applied

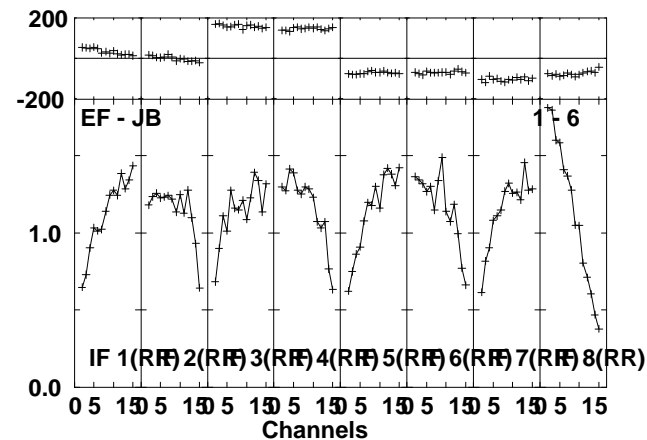
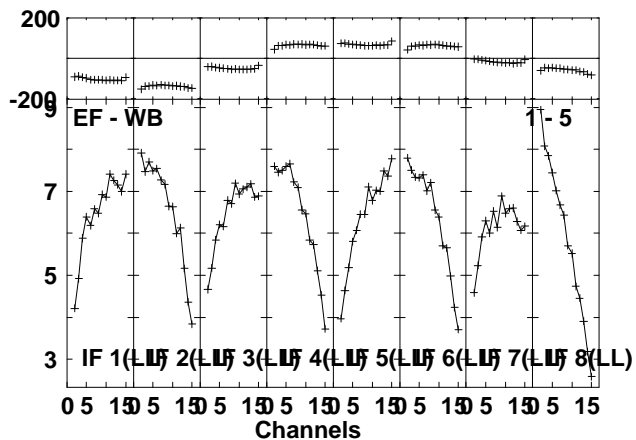
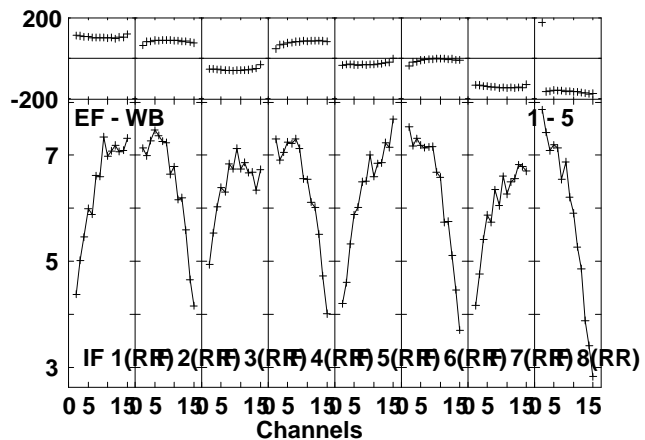
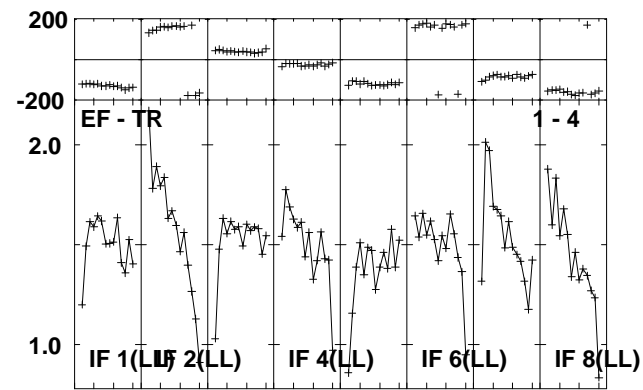
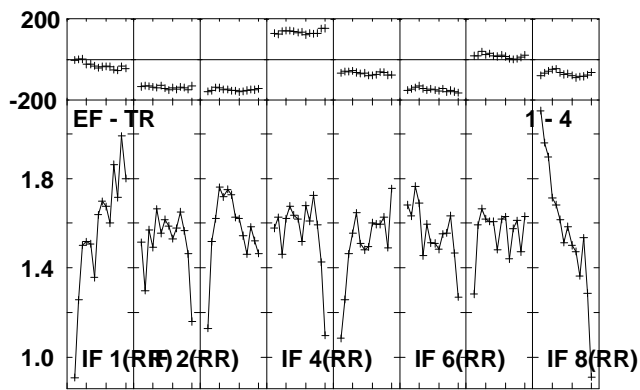
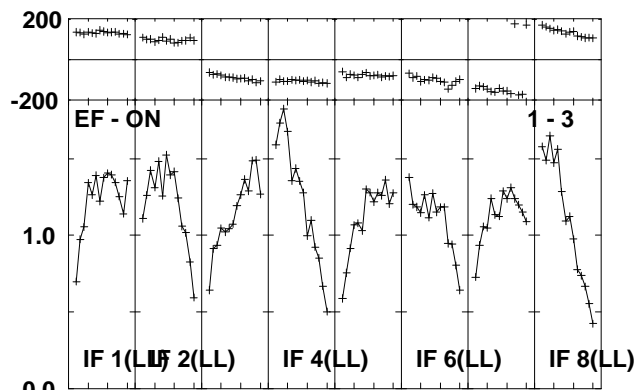
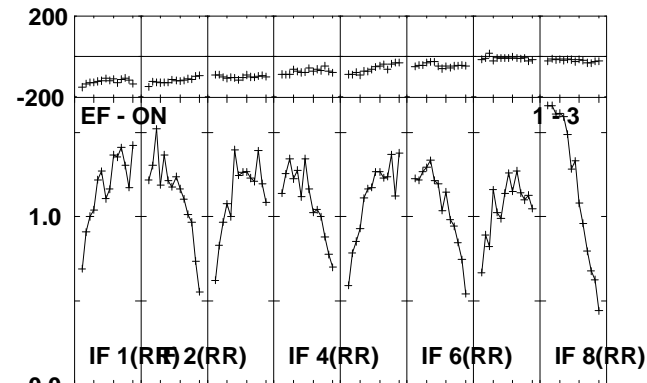
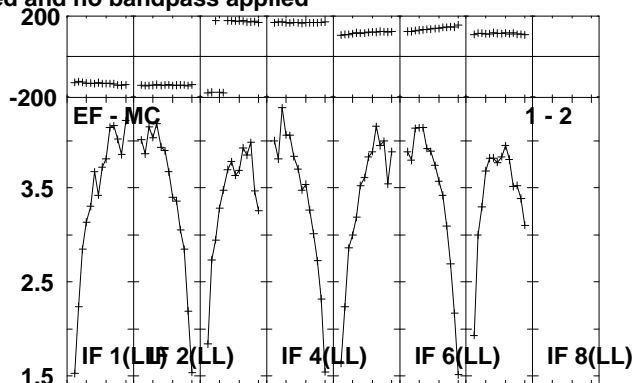
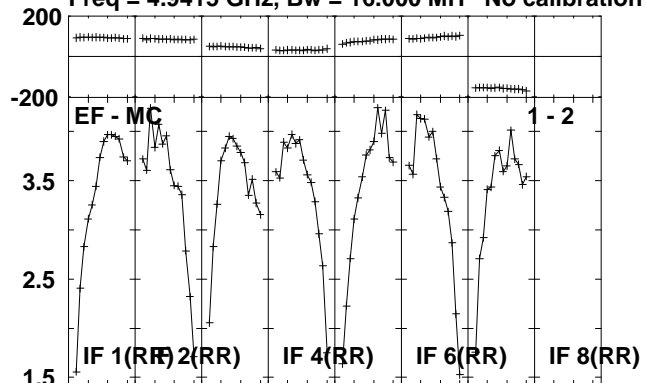

Lower frame: Milli Ampl Jy Top frame: Phas deg
Scalar averaged cross-power spectrum Several baselines displayed
Timerange: 00/21:29:20 to 00/21:31:38

Plot file version 94 created 06-OCT-2010 10:57:29

J1907+01 ET013A.UVDATA.1

Freq = 4.9415 GHz, Bw = 16.000 MH No calibration applied and no bandpass applied

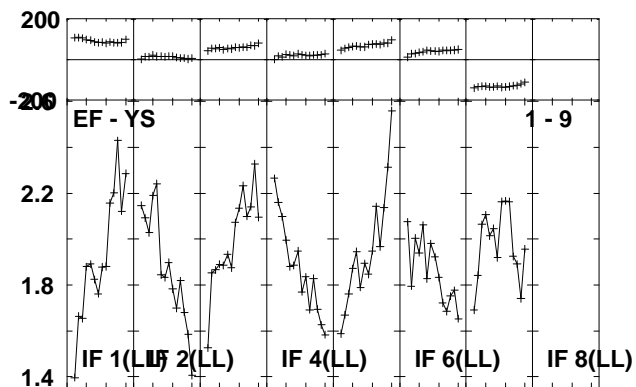
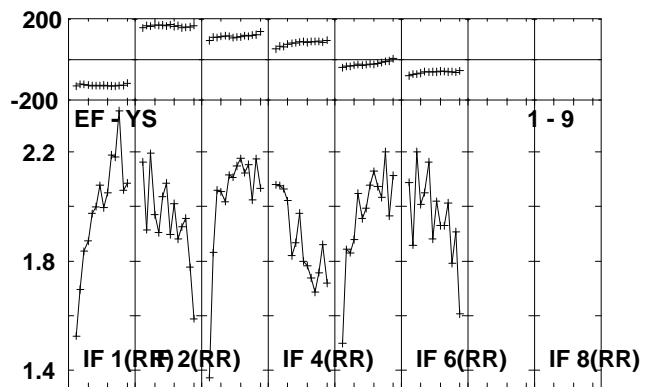
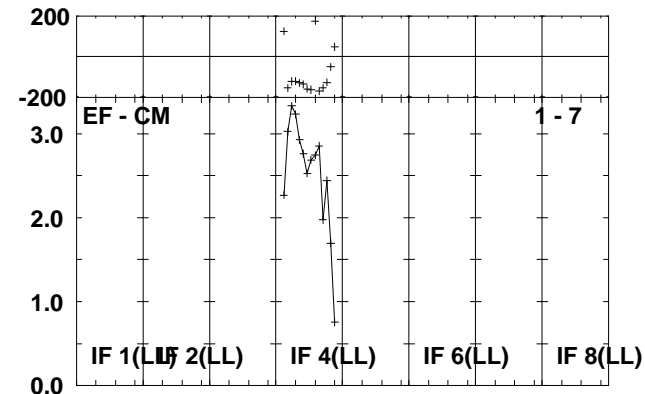
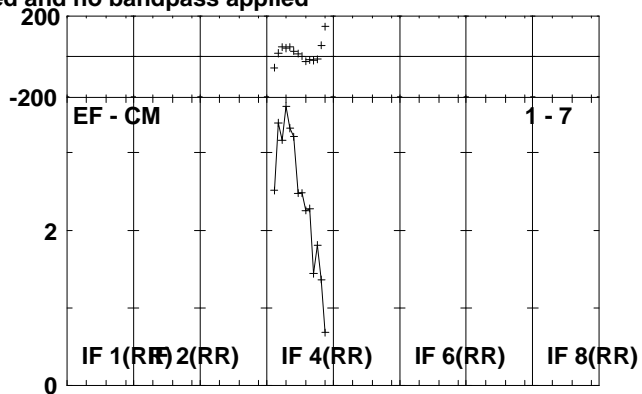
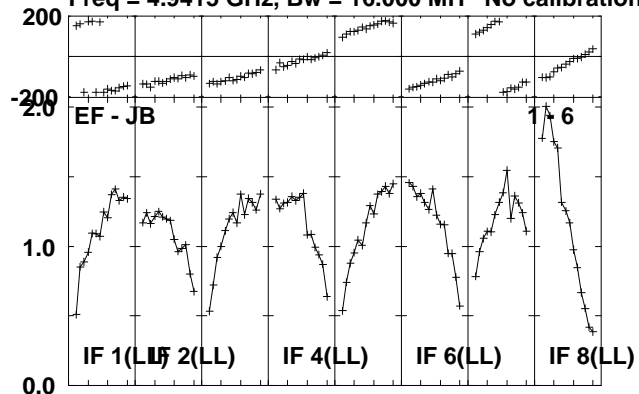

Lower frame: Milli Ampl Jy Top frame: Phas deg
Scalar averaged cross-power spectrum Several baselines displayed
Timerange: 00/21:29:20 to 00/21:31:38

Plot file version 95 created 06-OCT-2010 10:57:30

AQLX-1 ET013A.UVDATA.1

Freq = 4.9415 GHz, Bw = 16.000 MH No calibration applied and no bandpass applied

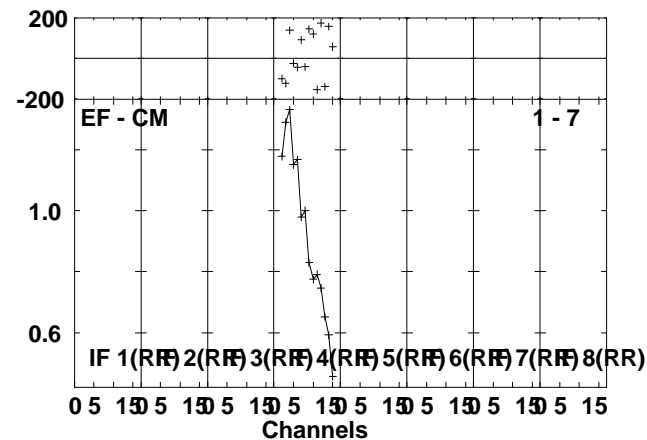
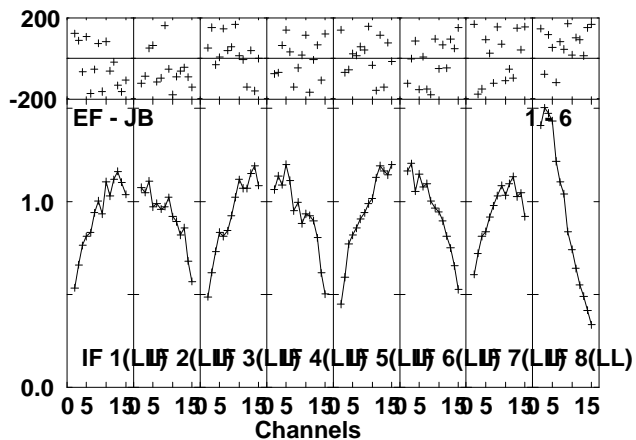
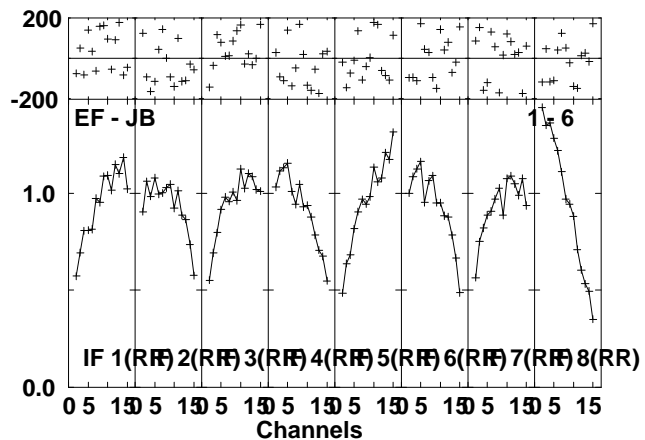
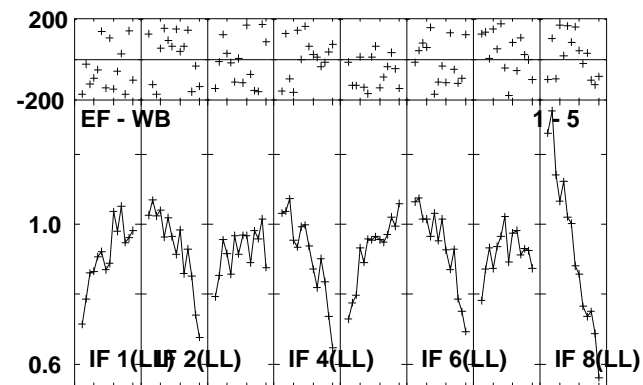
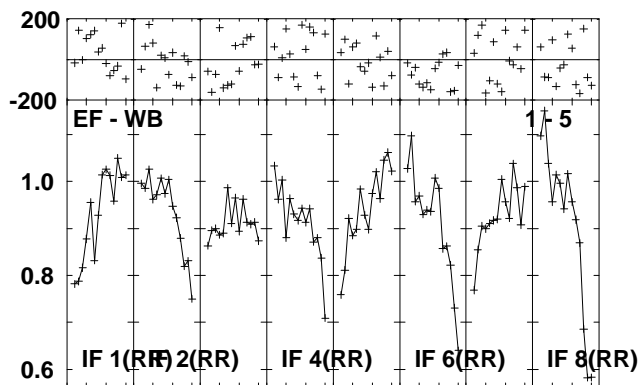
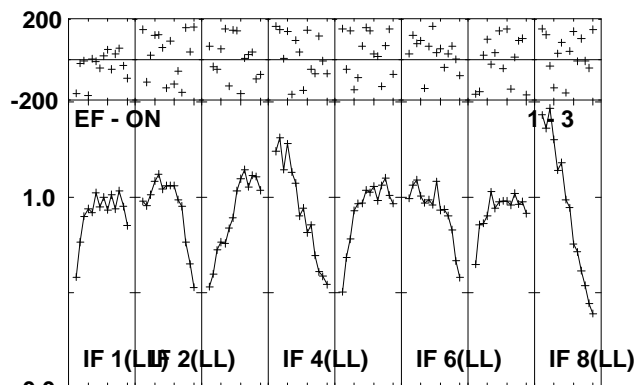
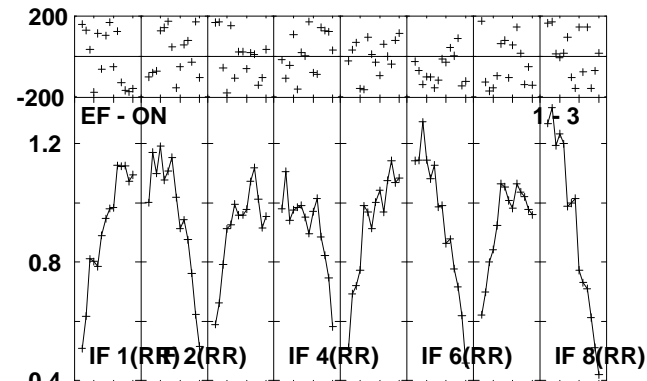
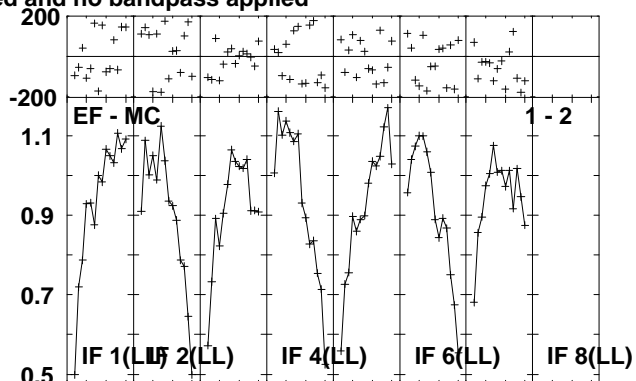
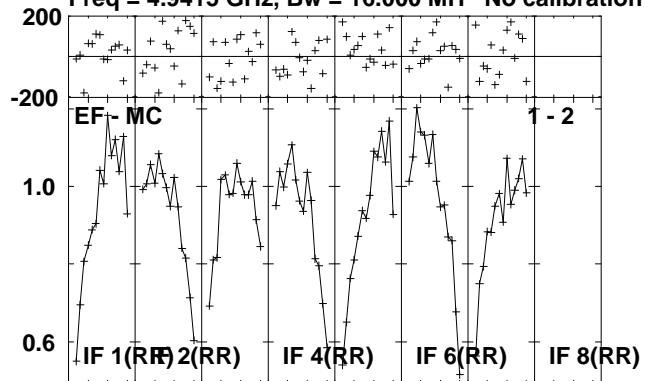

Lower frame: Milli Ampl Jy Top frame: Phas deg
Scalar averaged cross-power spectrum Several baselines displayed
Timerange: 00/21:31:40 to 00/21:36:38

Plot file version 96 created 06-OCT-2010 10:57:32

AQLX-1 ET013A.UVDATA.1

Freq = 4.9415 GHz, Bw = 16.000 MH No calibration applied and no bandpass applied

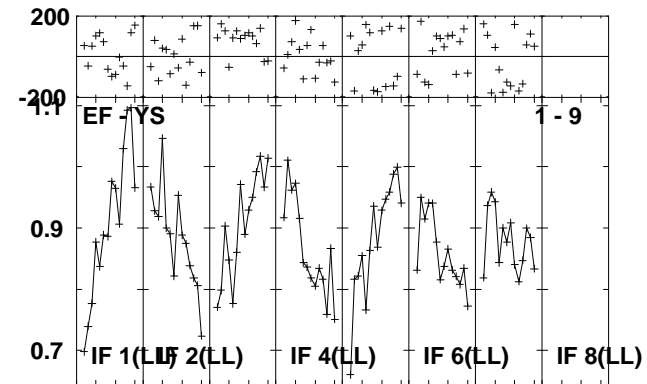
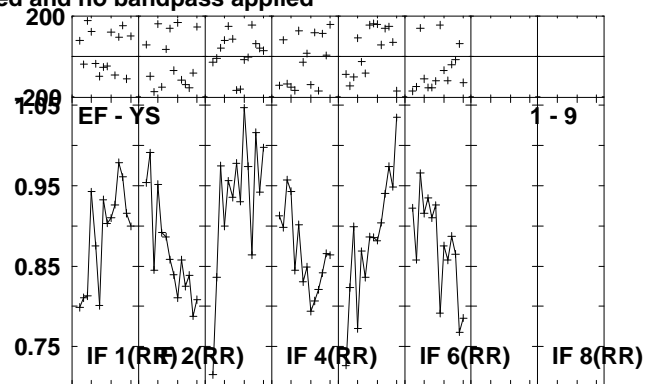
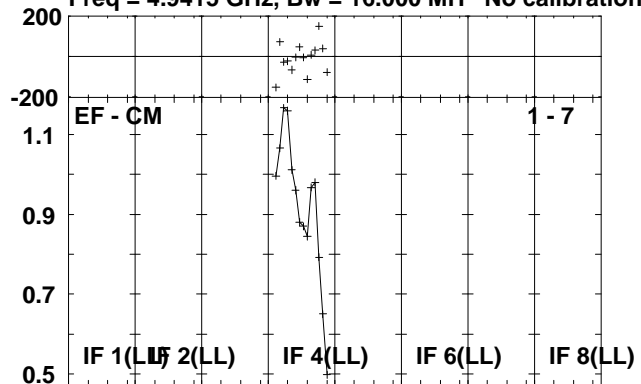

Lower frame: Milli Ampl Jy Top frame: Phas deg
Scalar averaged cross-power spectrum Several baselines displayed
Timerange: 00/21:31:40 to 00/21:36:38

Plot file version 97 created 06-OCT-2010 10:57:32

J1907+01 ET013A.UVDATA.1

Freq = 4.9415 GHz, Bw = 16.000 MH No calibration applied and no bandpass applied

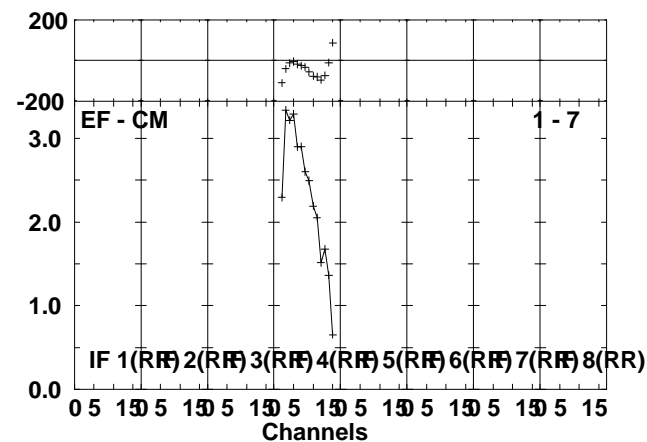
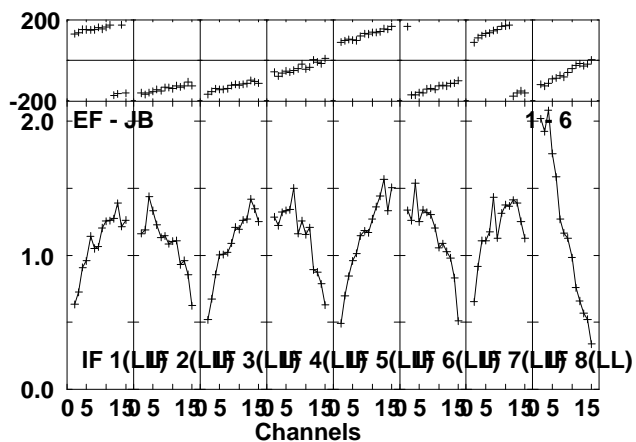
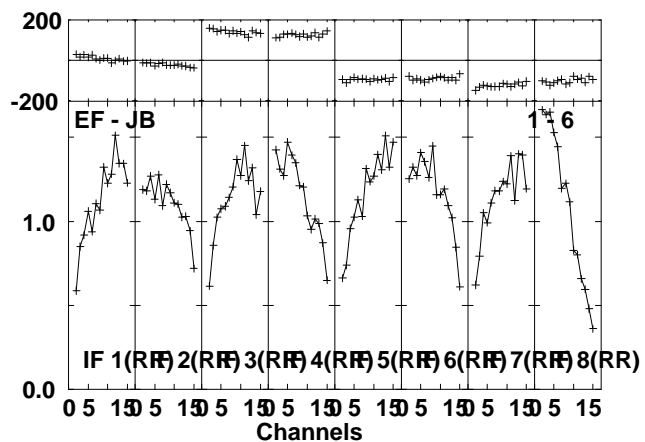
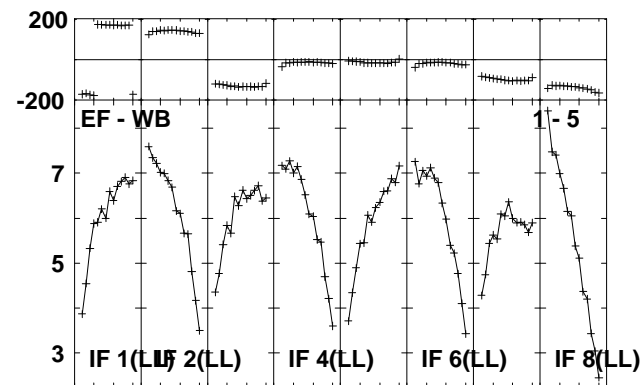
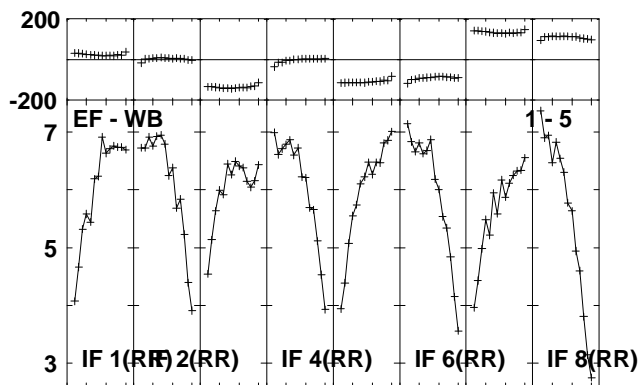
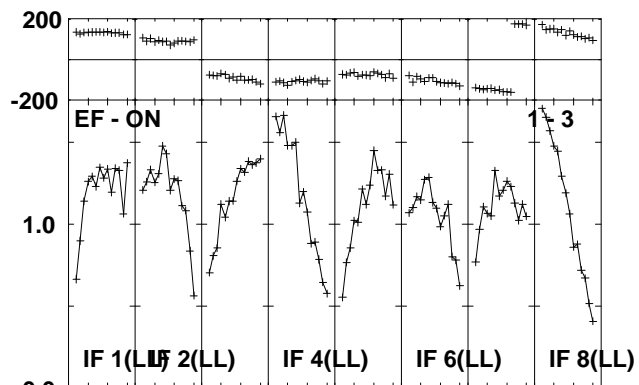
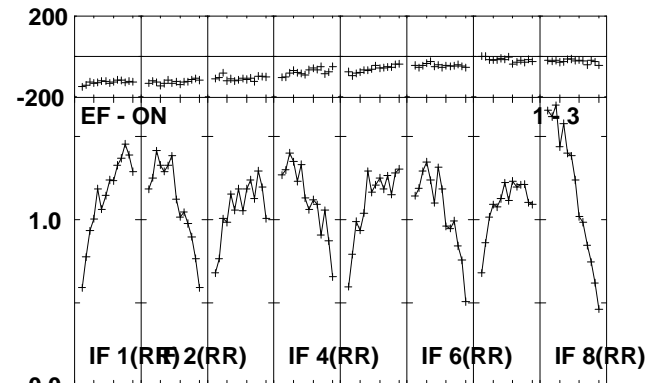
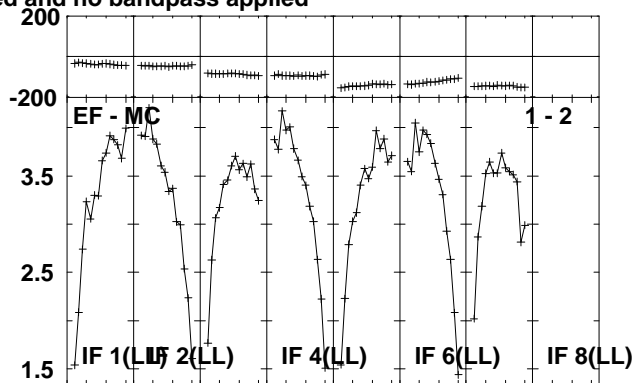
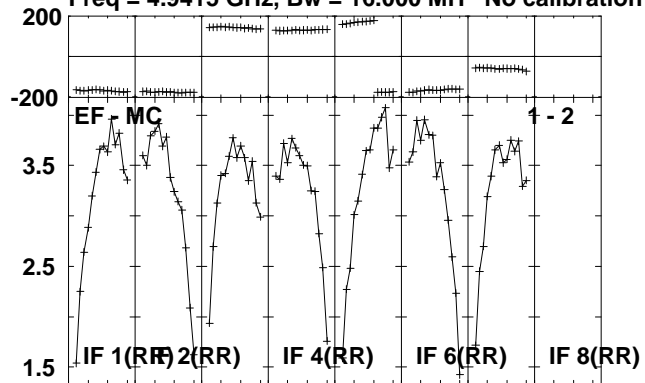

Lower frame: Milli Ampl Jy Top frame: Phas deg
Scalar averaged cross-power spectrum Several baselines displayed
Timerange: 00/21:37:20 to 00/21:39:38

Plot file version 98 created 06-OCT-2010 10:57:33

J1907+01 ET013A.UVDATA.1

Freq = 4.9415 GHz, Bw = 16.000 MH No calibration applied and no bandpass applied

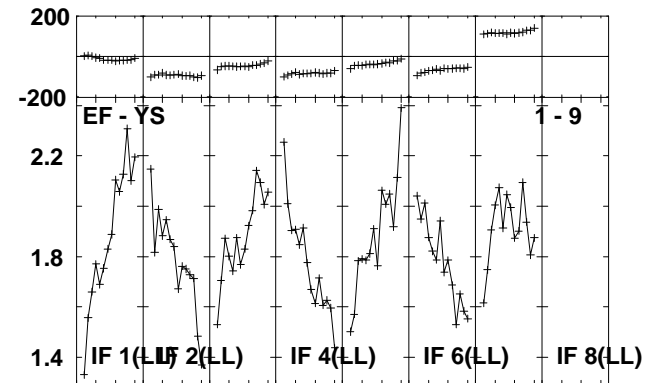
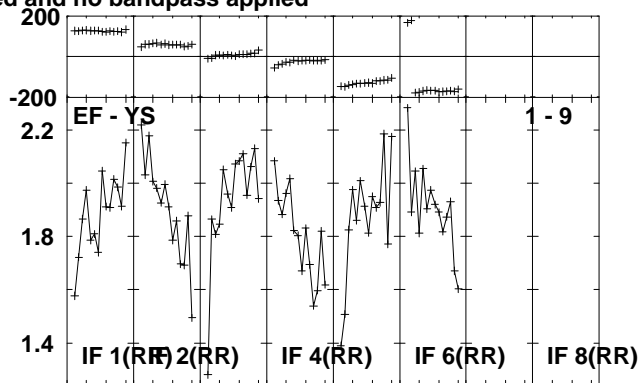
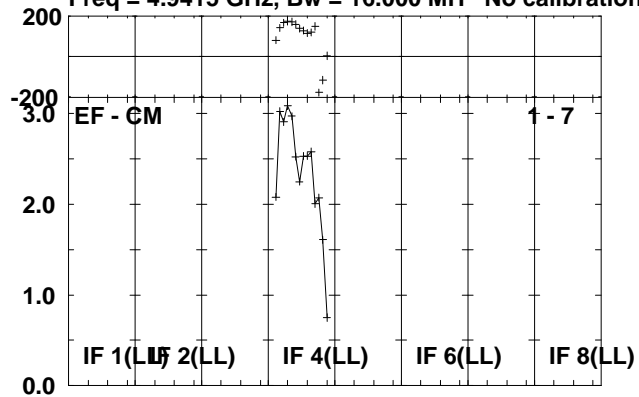

Lower frame: Milli Ampl Jy Top frame: Phas deg
Scalar averaged cross-power spectrum Several baselines displayed
Timerange: 00/21:37:20 to 00/21:39:38

Plot file version 99 created 06-OCT-2010 10:57:34

AQLX-1 ET013A.UVDATA.1

Freq = 4.9415 GHz, Bw = 16.000 MH No calibration applied and no bandpass applied

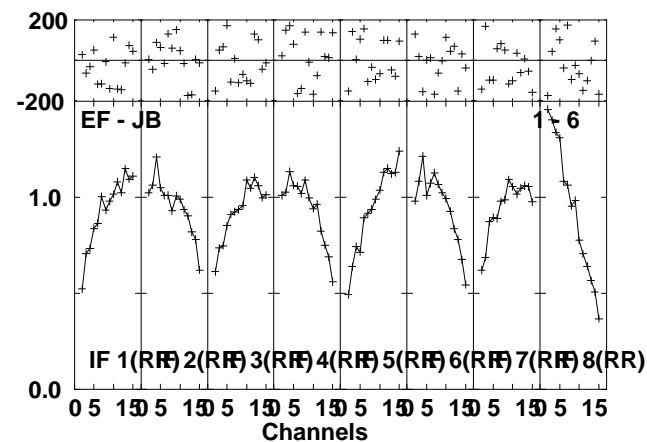
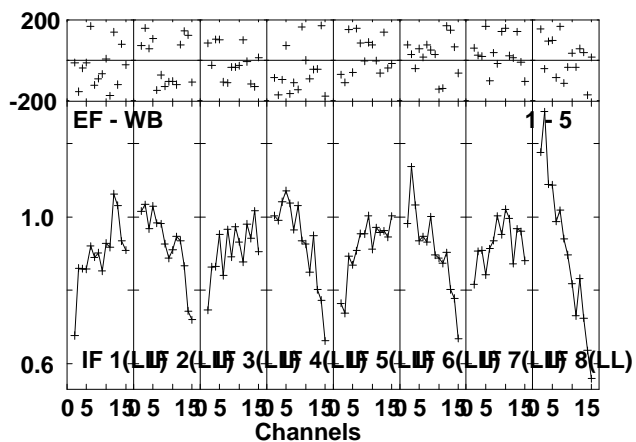
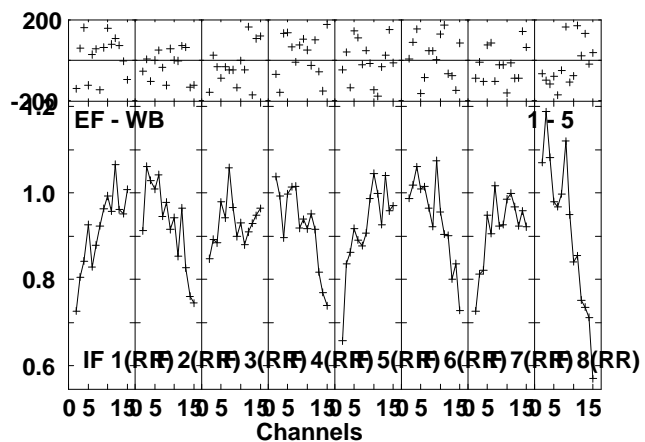
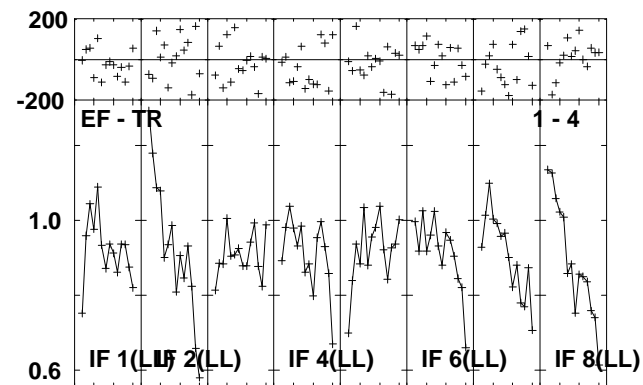
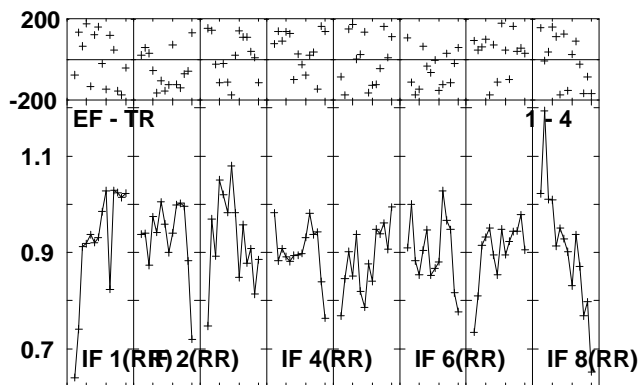
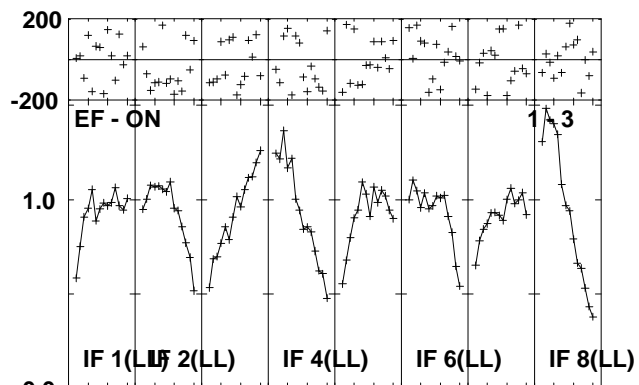
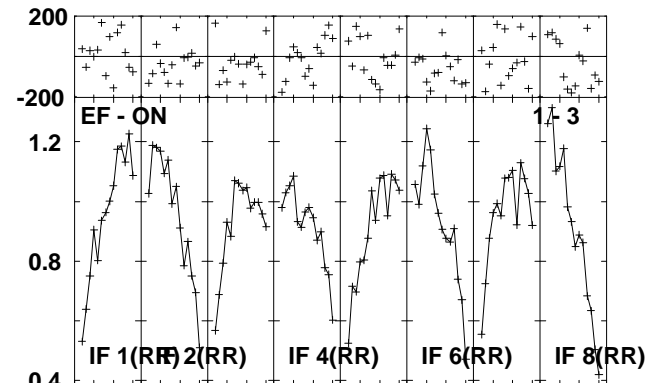
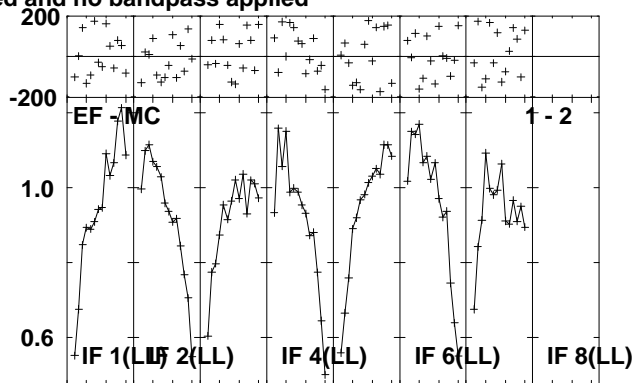
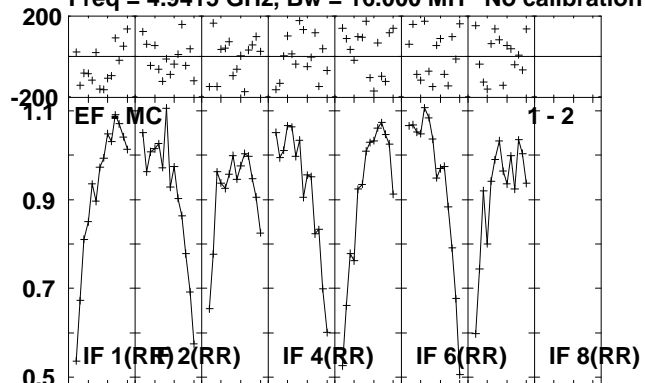

Lower frame: Milli Ampl Jy Top frame: Phas deg
Scalar averaged cross-power spectrum Several baselines displayed
Timerange: 00/21:39:40 to 00/21:44:38

Plot file version 100 created 06-OCT-2010 10:57:35

AQLX-1 ET013A.UVDATA.1

Freq = 4.9415 GHz, Bw = 16.000 MH No calibration applied and no bandpass applied

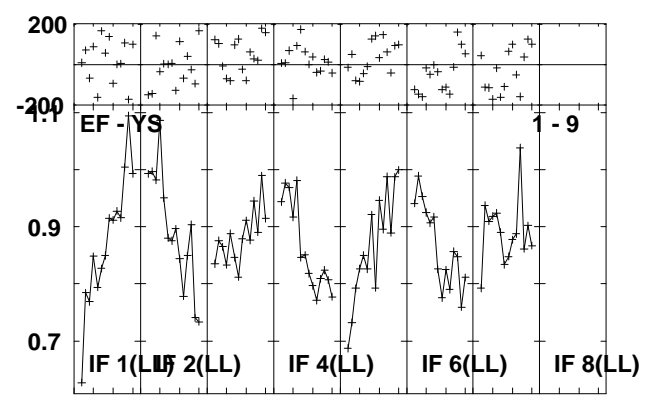
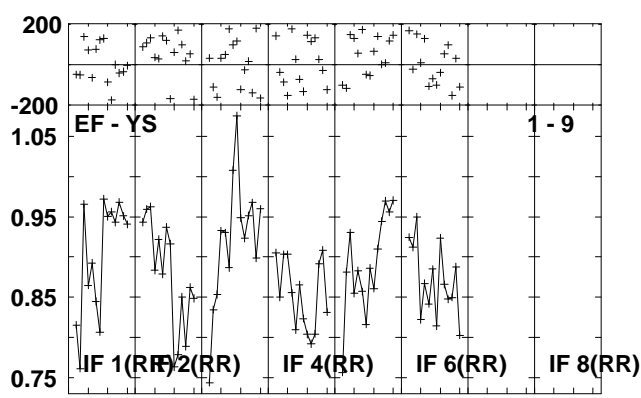
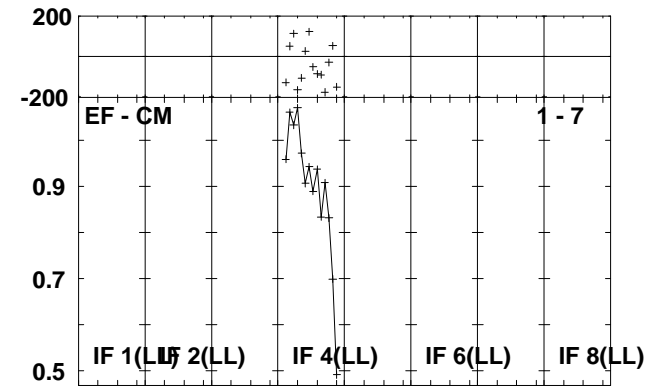
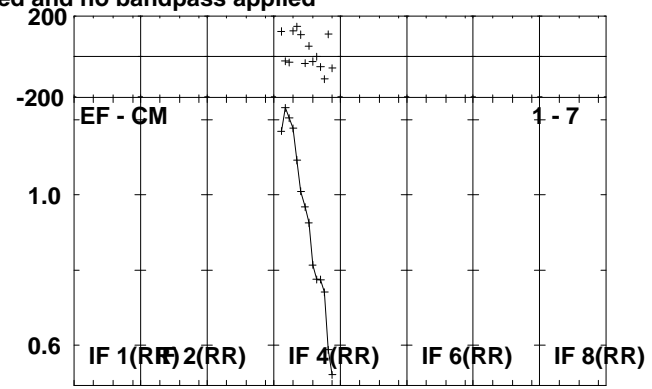
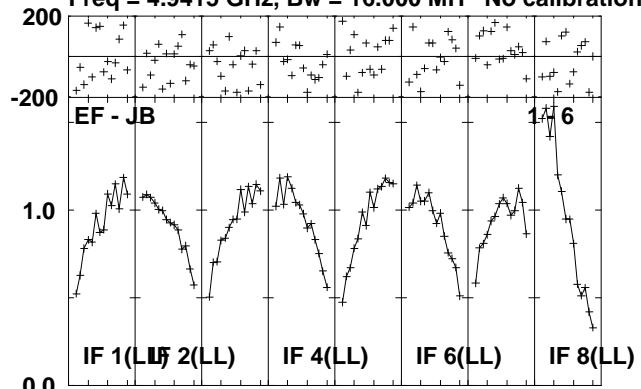

Lower frame: Milli Ampl Jy Top frame: Phas deg
Scalar averaged cross-power spectrum Several baselines displayed
Timerange: 00/21:39:40 to 00/21:44:38

Plot file version 101 created 06-OCT-2010 10:57:37

J1907+01 ET013A.UVDATA.1

Freq = 4.9415 GHz, Bw = 16.000 MH No calibration applied and no bandpass applied

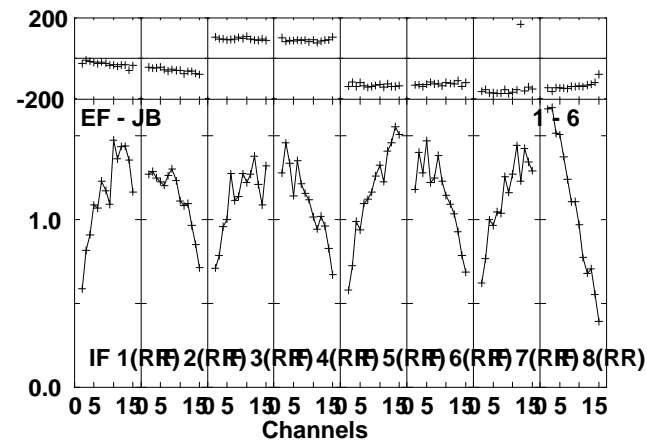
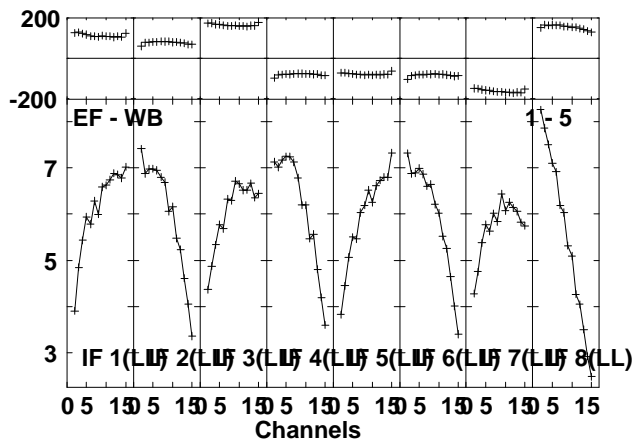
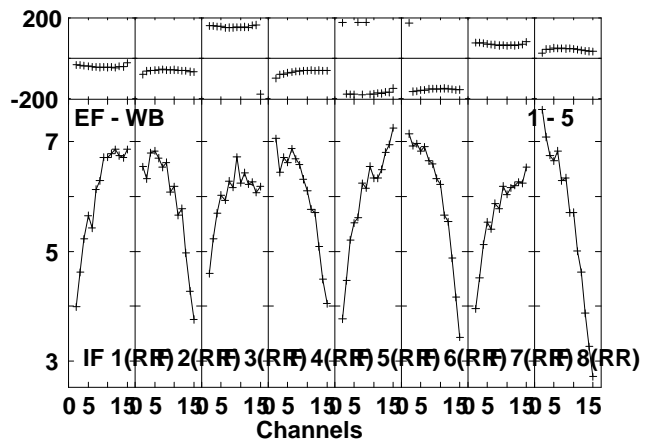
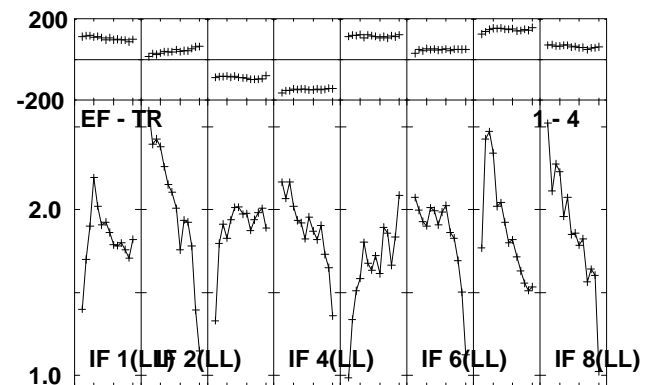
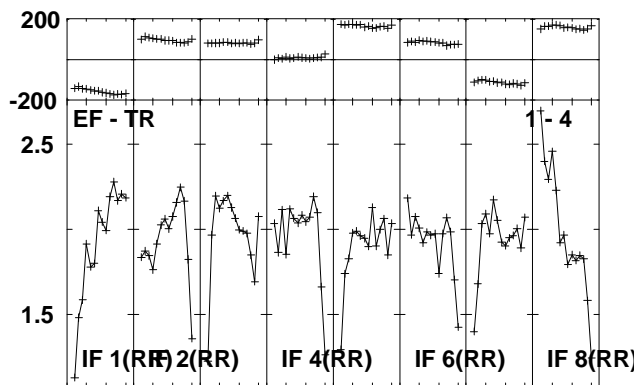
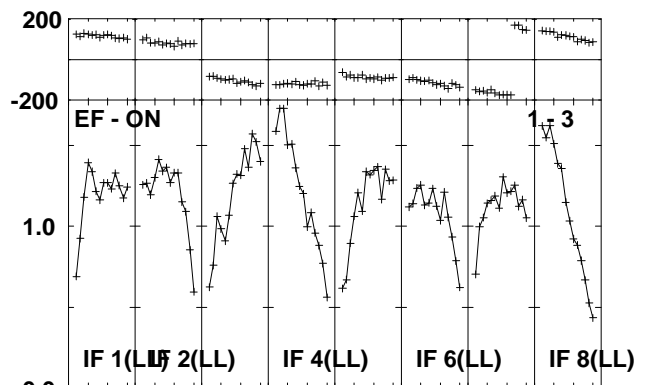
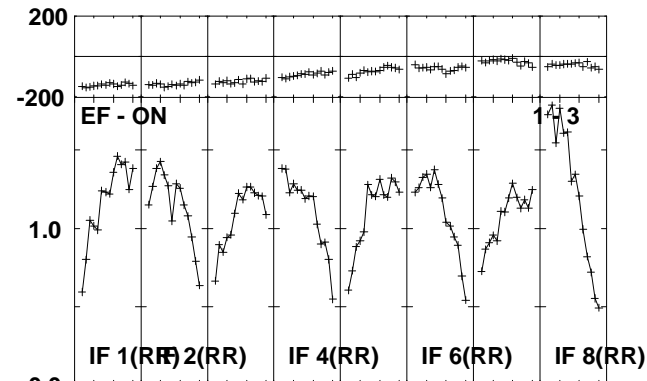
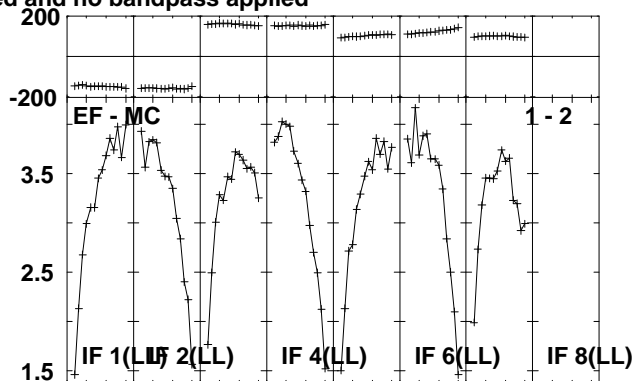
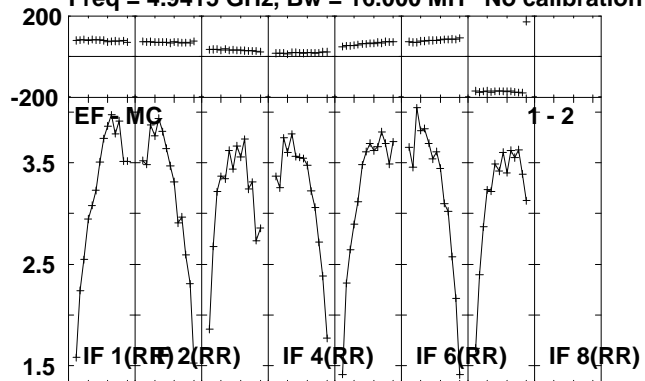

Lower frame: Milli Ampl Jy Top frame: Phas deg
Scalar averaged cross-power spectrum Several baselines displayed
Timerange: 00/21:45:20 to 00/21:47:38

Plot file version 102 created 06-OCT-2010 10:57:38

J1907+01 ET013A.UVDATA.1

Freq = 4.9415 GHz, Bw = 16.000 MH No calibration applied and no bandpass applied

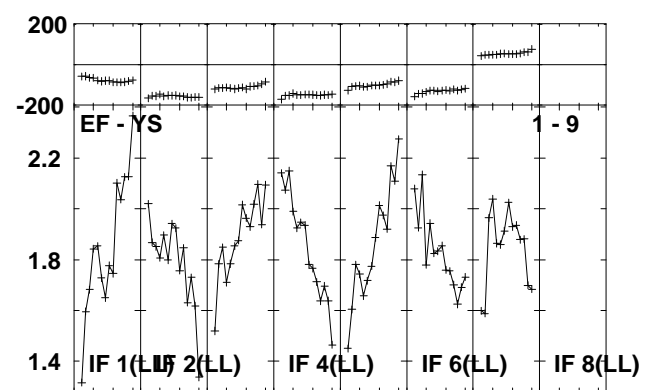
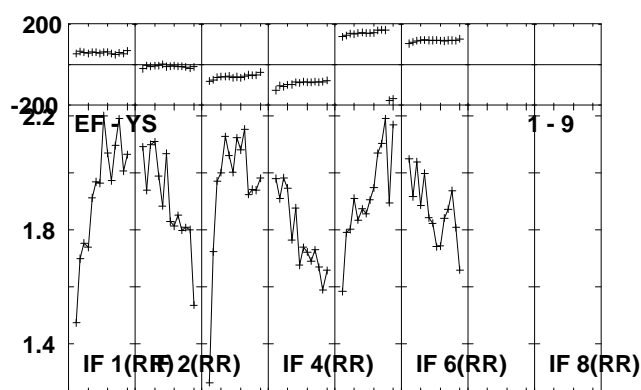
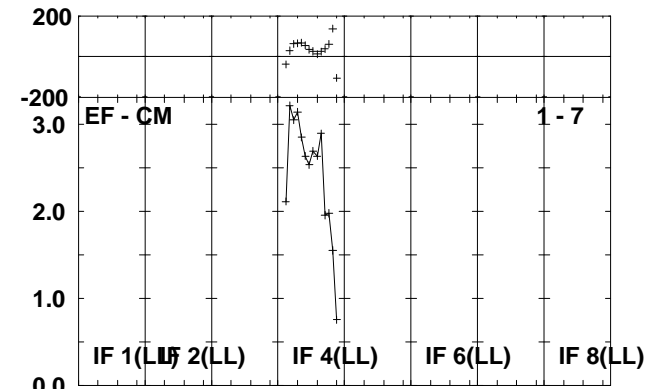
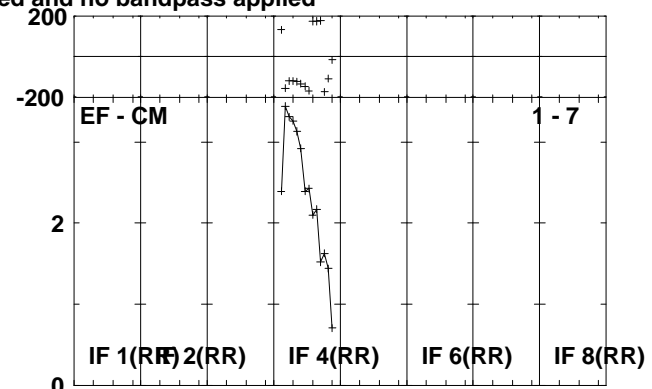
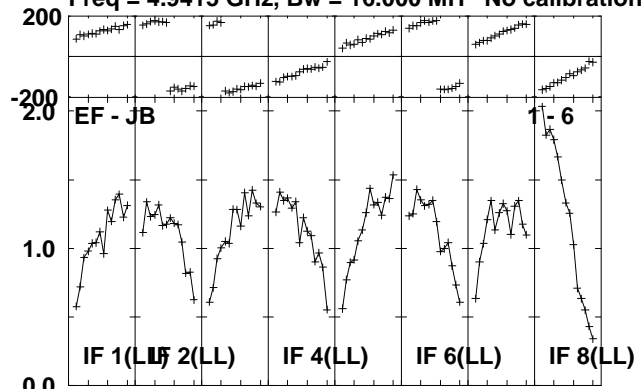

Lower frame: Milli Ampl Jy Top frame: Phas deg
Scalar averaged cross-power spectrum Several baselines displayed
Timerange: 00/21:45:20 to 00/21:47:38

Plot file version 104 created 06-OCT-2010 10:57:40
 J1920-02 ET013A.UVDATA.1

Freq = 4.9415 GHz, Bw = 16.000 MH No calibration applied and no bandpass applied

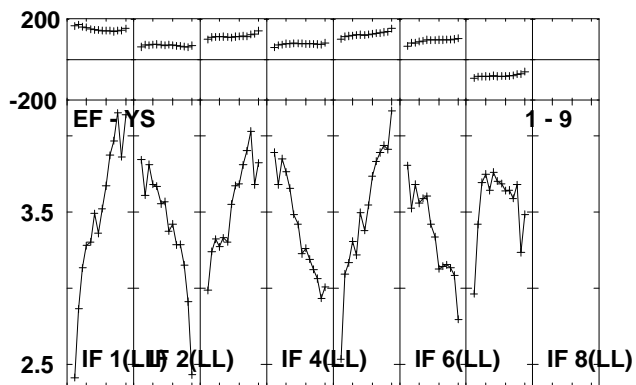
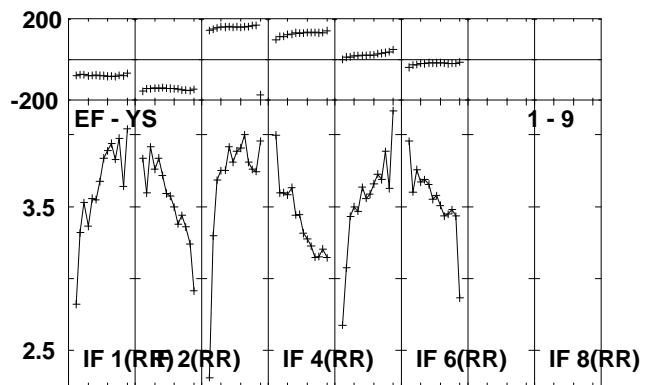
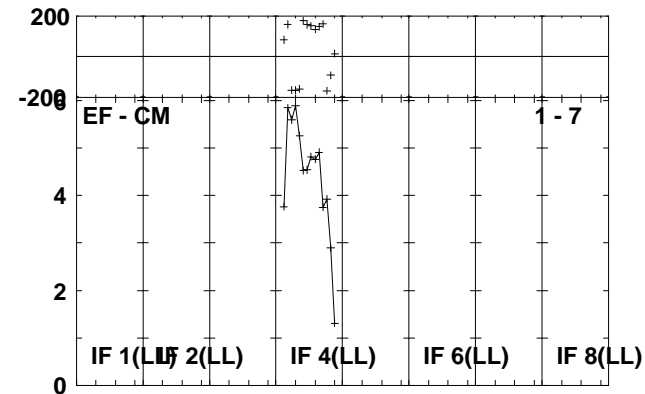
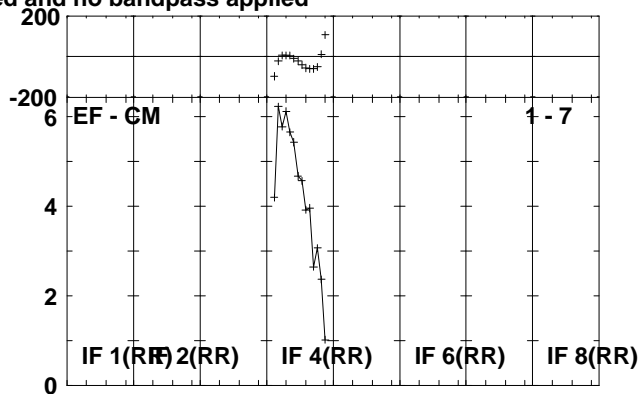
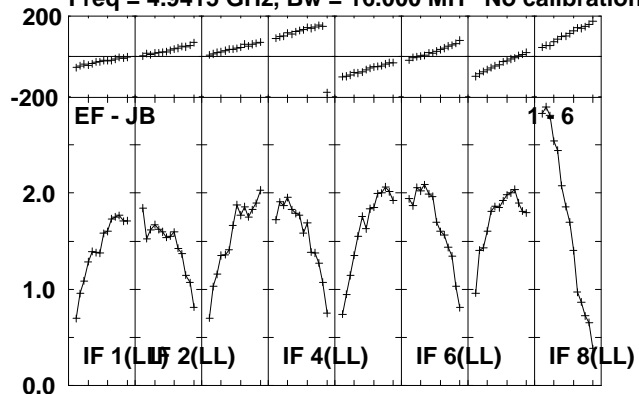

Lower frame: Milli Ampl Jy Top frame: Phas deg
 Scalar averaged cross-power spectrum Several baselines displayed
 Timerange: 00/21:47:40 to 00/21:52:38

Plot file version 105 created 06-OCT-2010 10:57:42

J1907+01 ET013A.UVDATA.1

Freq = 4.9415 GHz, Bw = 16.000 MH No calibration applied and no bandpass applied

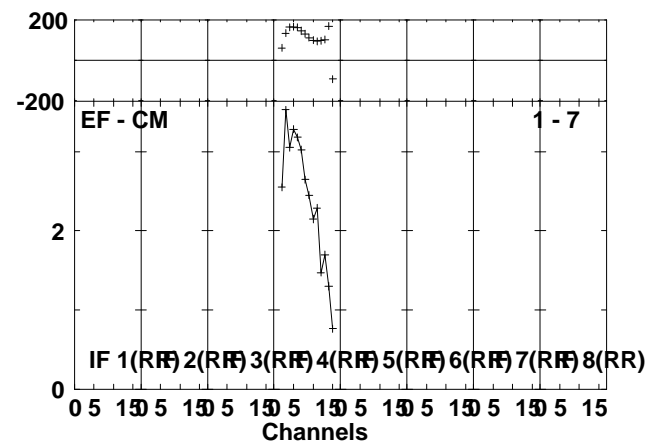
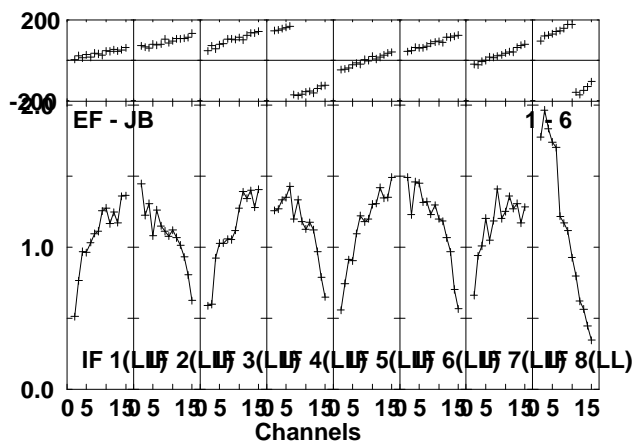
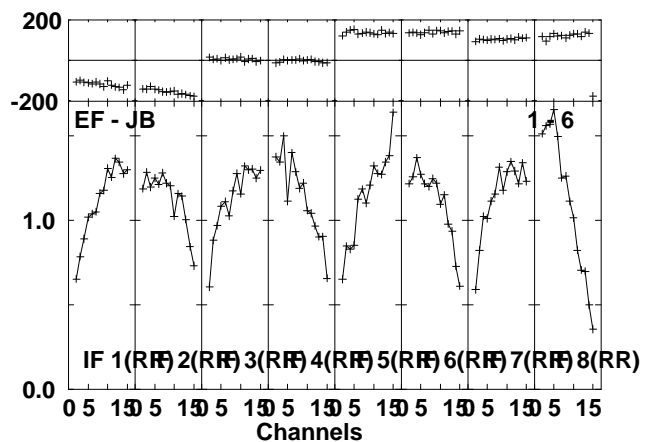
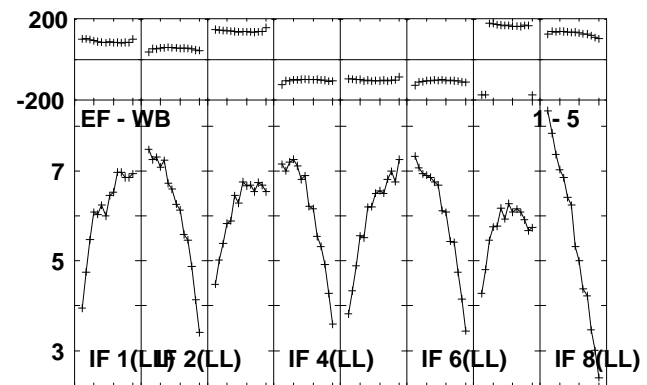
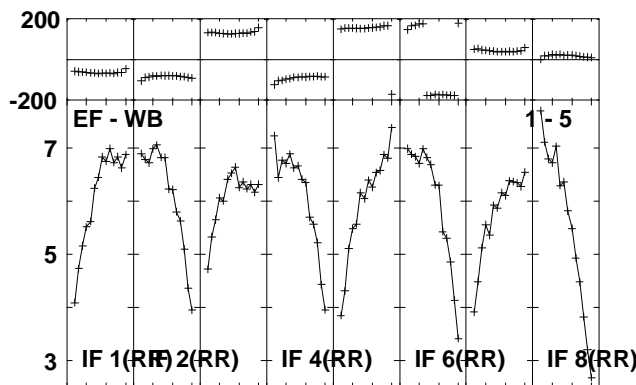
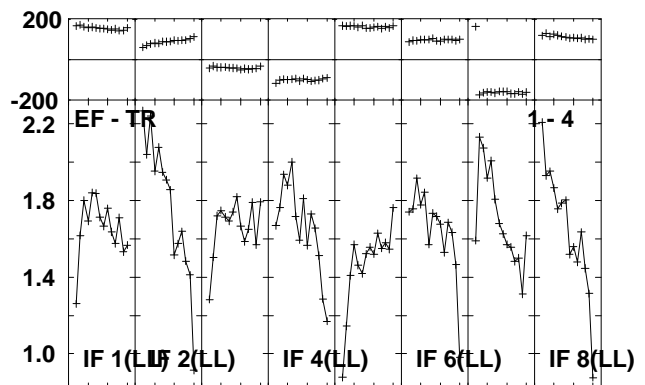
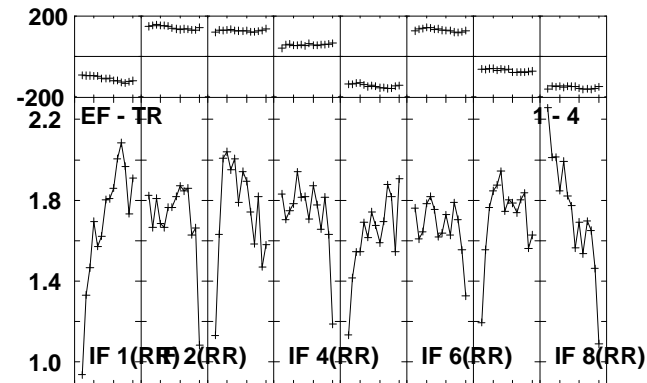
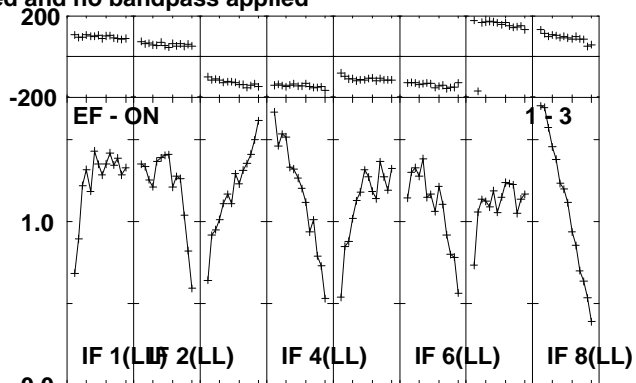
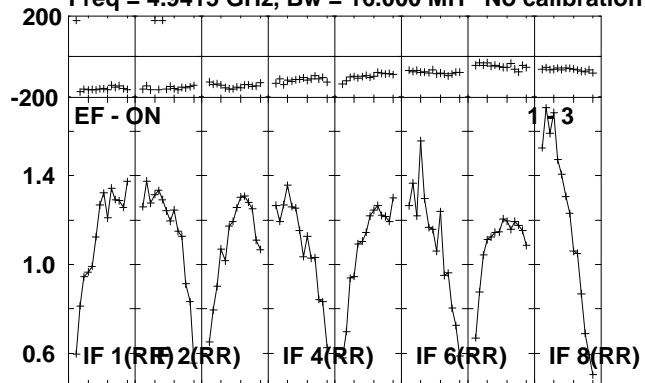

Lower frame: Milli Ampl Jy Top frame: Phas deg
Scalar averaged cross-power spectrum Several baselines displayed
Timerange: 00/21:53:40 to 00/21:55:58

Plot file version 106 created 06-OCT-2010 10:57:42

J1907+01 ET013A.UVDATA.1

Freq = 4.9415 GHz, Bw = 16.000 MH No calibration applied and no bandpass applied

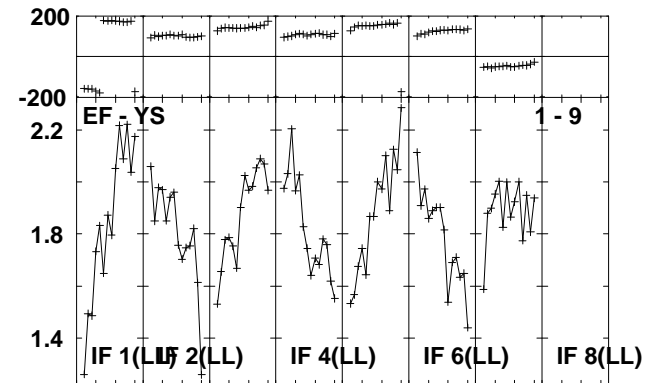
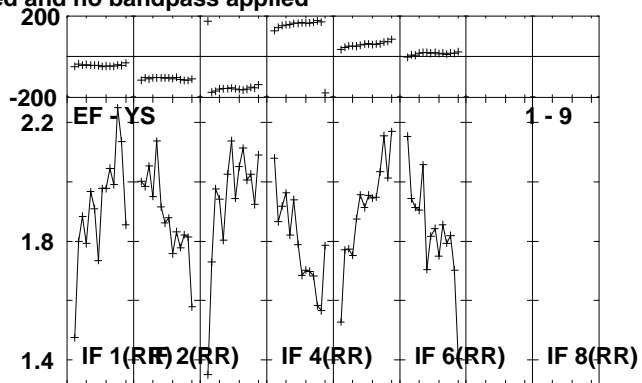
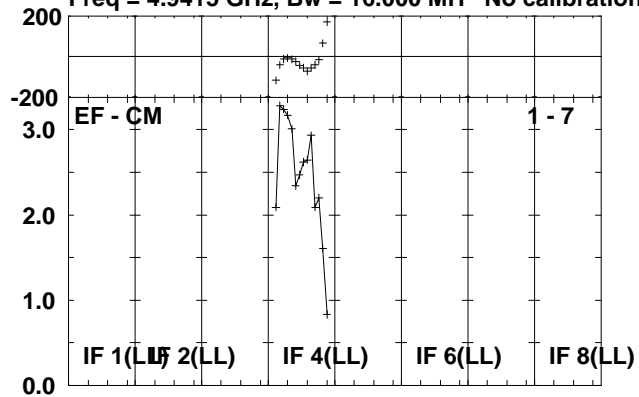

Lower frame: Milli Ampl Jy Top frame: Phas deg
Scalar averaged cross-power spectrum Several baselines displayed
Timerange: 00/21:53:40 to 00/21:55:58

Plot file version 107 created 06-OCT-2010 10:57:43

AQLX-1 ET013A.UVDATA.1

Freq = 4.9415 GHz, Bw = 16.000 MH No calibration applied and no bandpass applied

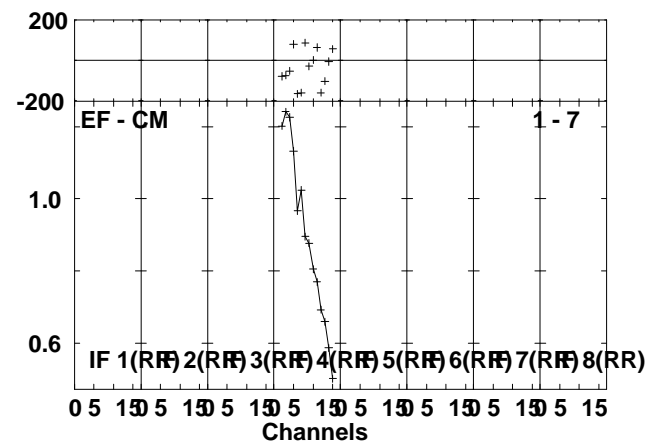
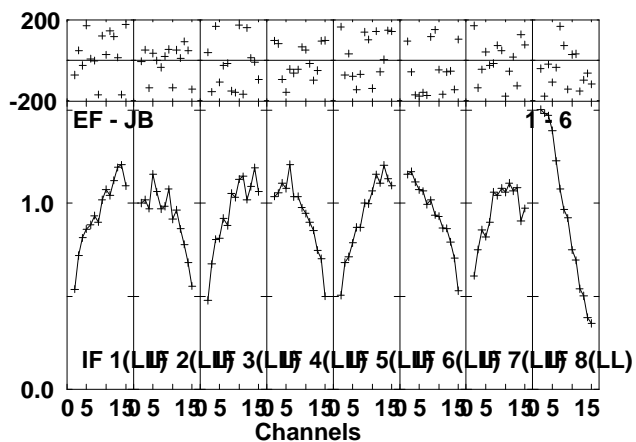
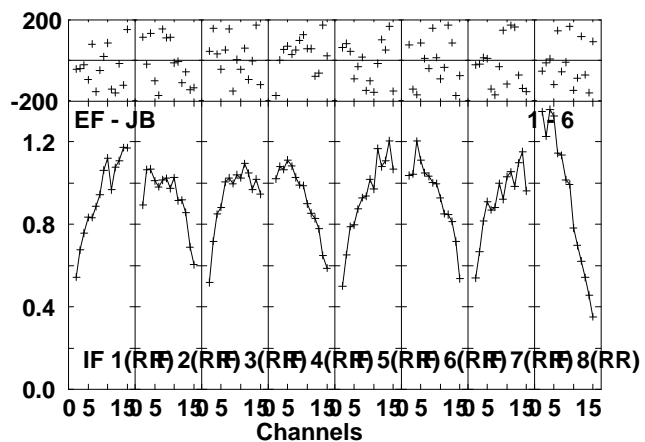
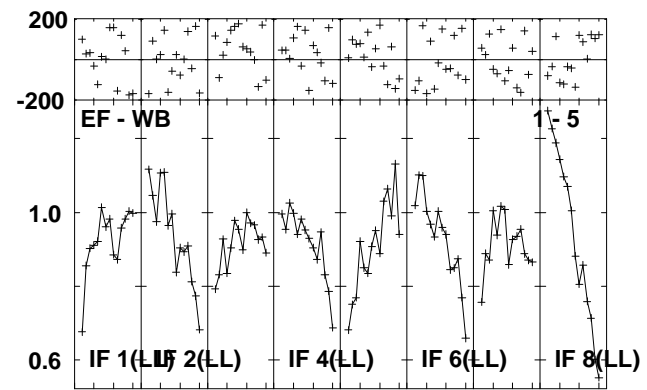
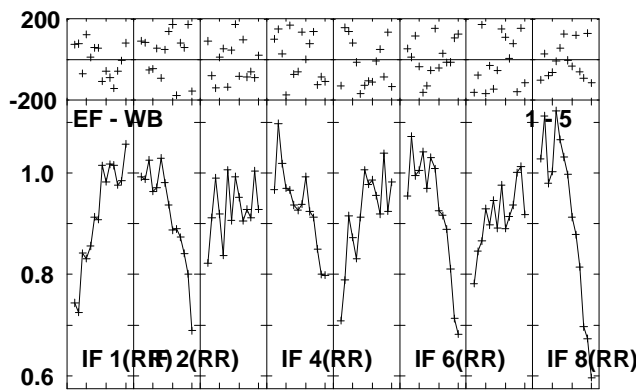
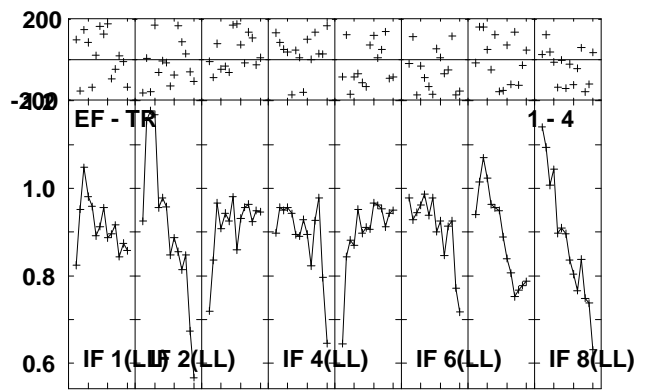
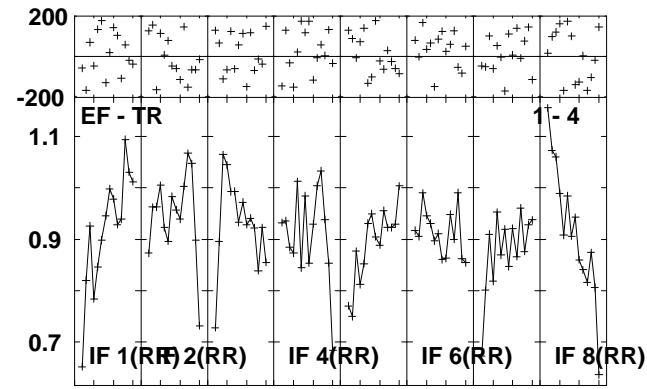
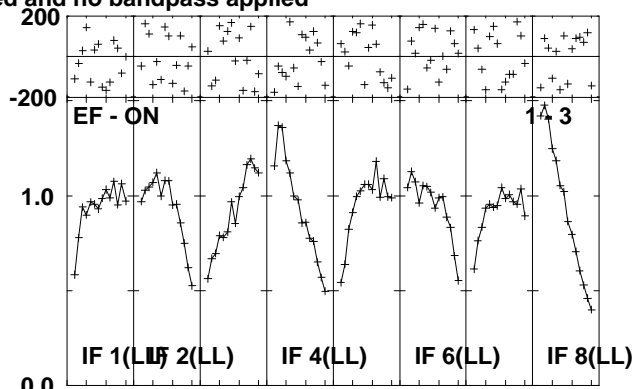
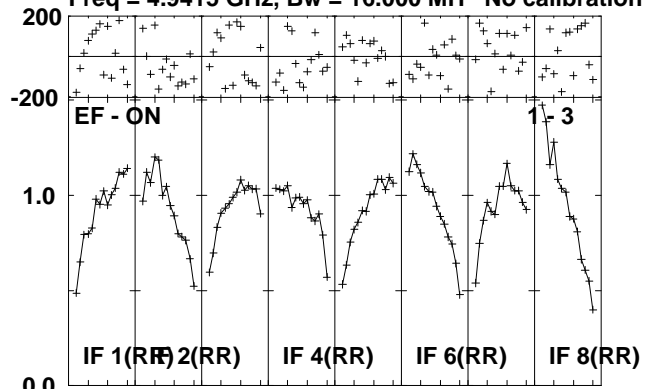

Lower frame: Milli Ampl Jy Top frame: Phas deg
Scalar averaged cross-power spectrum Several baselines displayed
Timerange: 00/21:56:00 to 00/22:00:58

Plot file version 108 created 06-OCT-2010 10:57:44

AQLX-1 ET013A.UVDATA.1

Freq = 4.9415 GHz, Bw = 16.000 MH No calibration applied and no bandpass applied

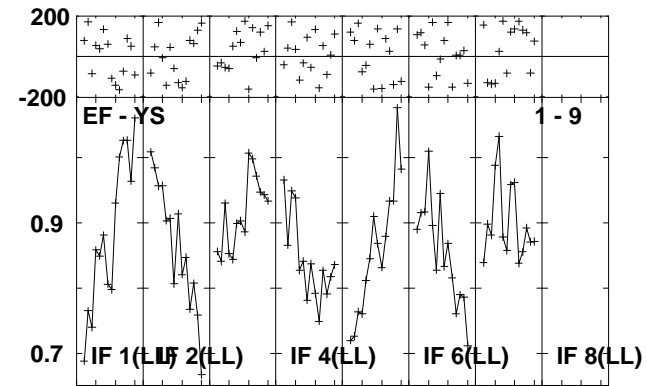
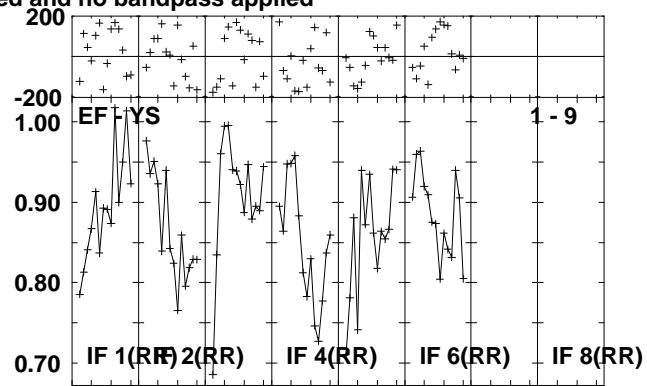
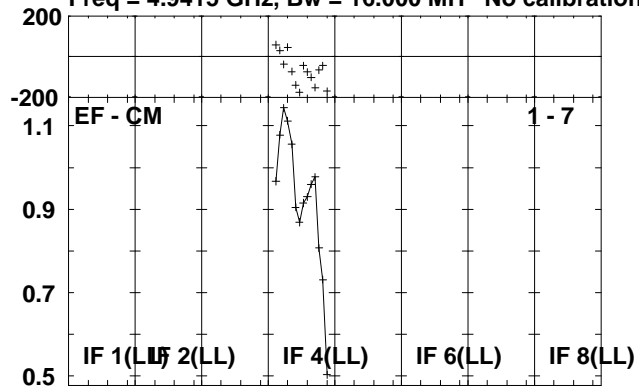

Lower frame: Milli Ampl Jy Top frame: Phas deg
Scalar averaged cross-power spectrum Several baselines displayed
Timerange: 00/21:56:00 to 00/22:00:58

Plot file version 109 created 06-OCT-2010 10:57:45

J1907+01 ET013A.UVDATA.1

Freq = 4.9415 GHz, Bw = 16.000 MH No calibration applied and no bandpass applied

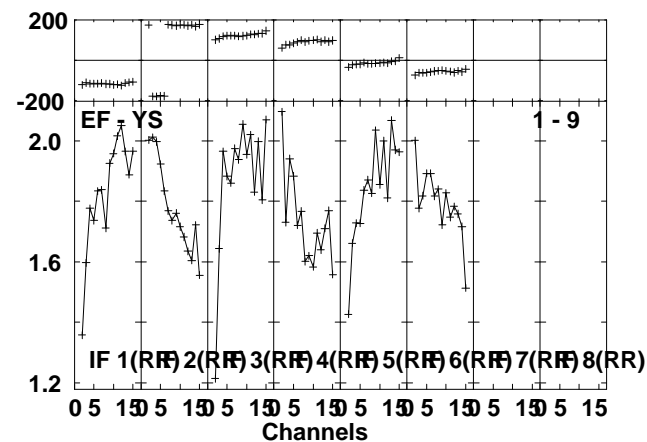
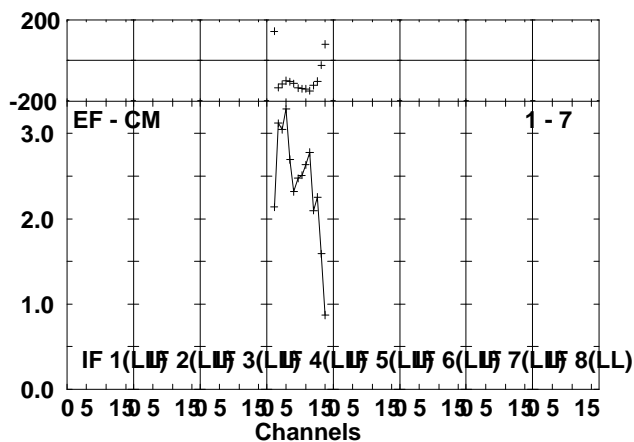
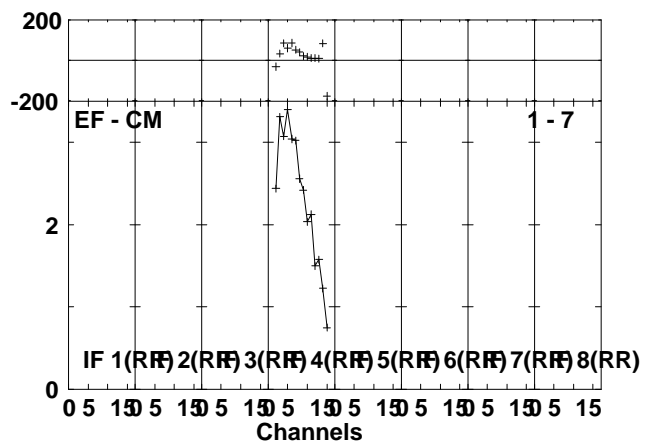
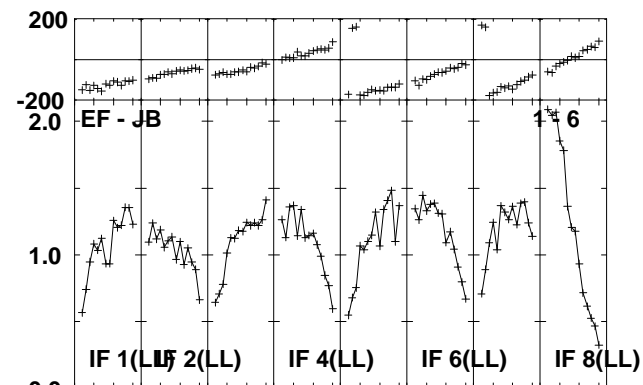
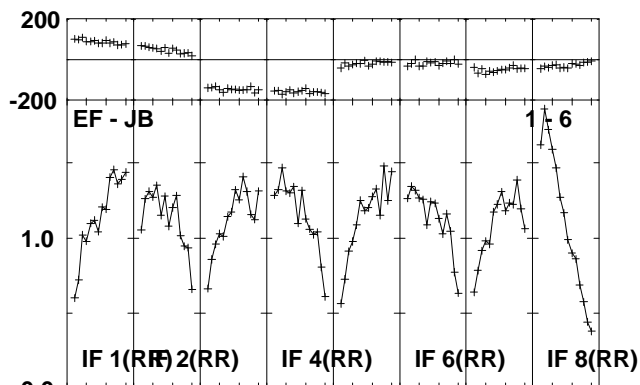
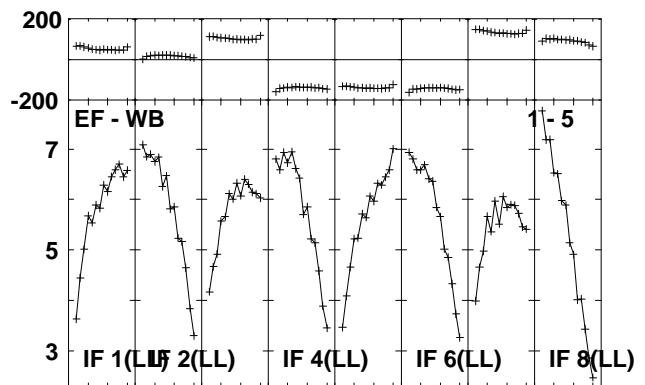
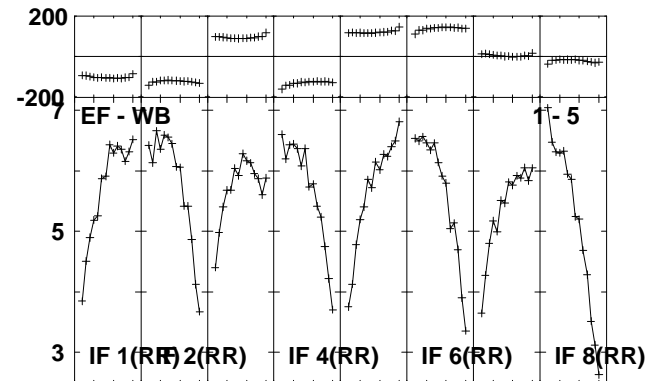
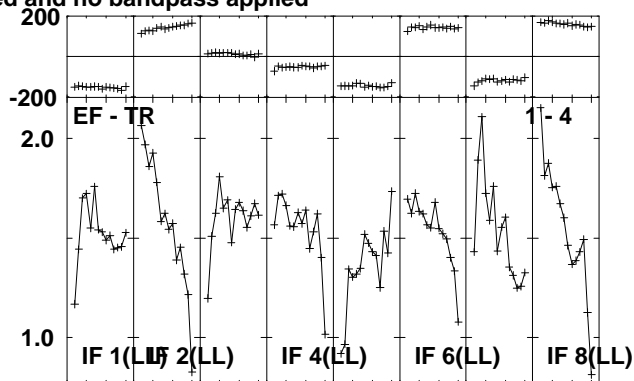
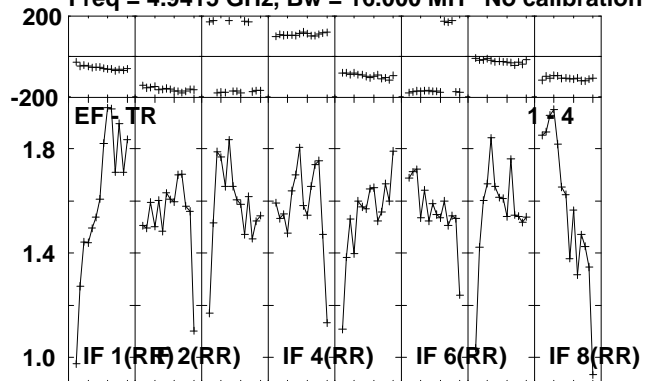

Lower frame: Milli Ampl Jy Top frame: Phas deg
Scalar averaged cross-power spectrum Several baselines displayed
Timerange: 00/22:01:40 to 00/22:03:58

Plot file version 110 created 06-OCT-2010 10:57:46
J1907+01 ET013A.UVDATA.1
Freq = 4.9415 GHz, Bw = 16.000 MH No calibration applied and no bandpass applied

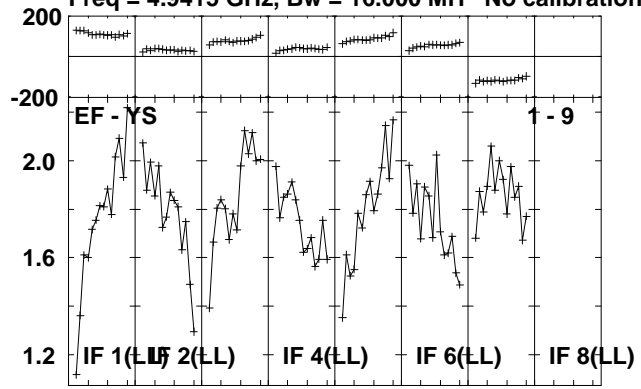

Lower frame: Milli Ampl Jy Top frame: Phas deg
Scalar averaged cross-power spectrum Several baselines displayed
Timerange: 00/22:01:40 to 00/22:03:58

Plot file version 111 created 06-OCT-2010 10:57:46

AQLX-1 ET013A.UVDATA.1

Freq = 4.9415 GHz, Bw = 16.000 MH No calibration applied and no bandpass applied

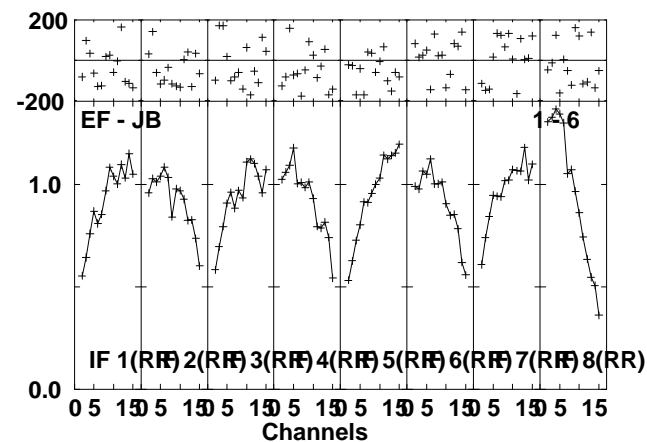
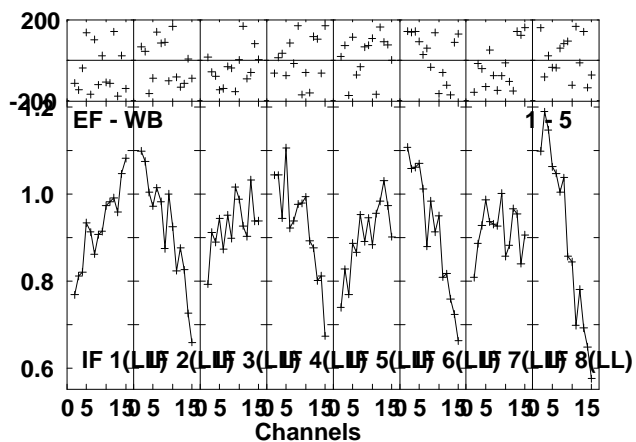
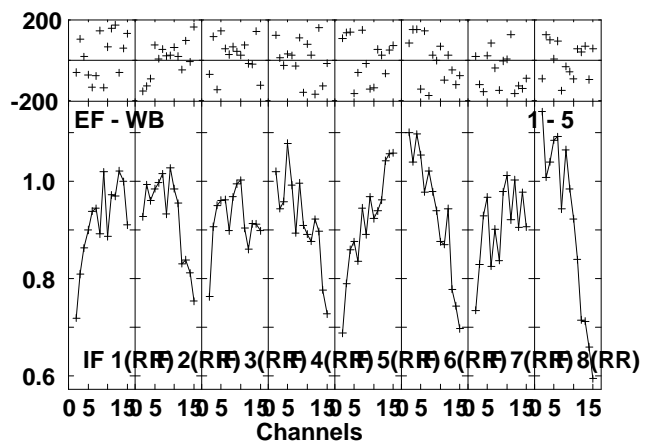
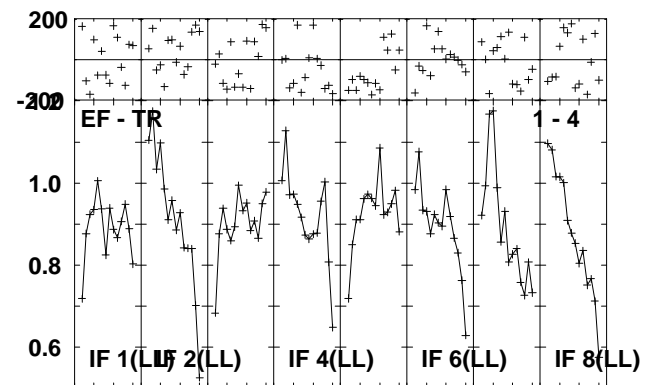
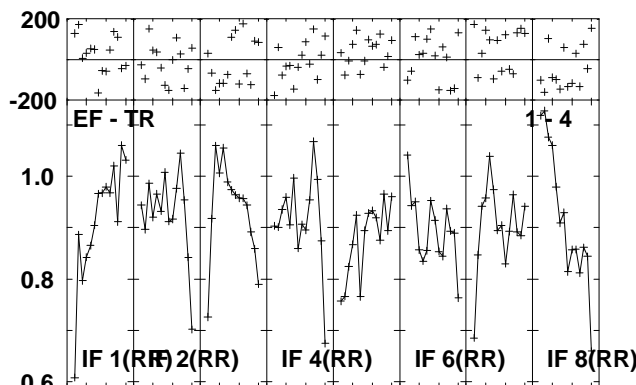
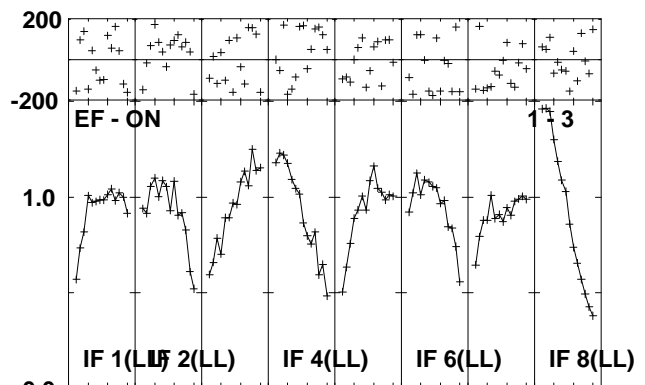
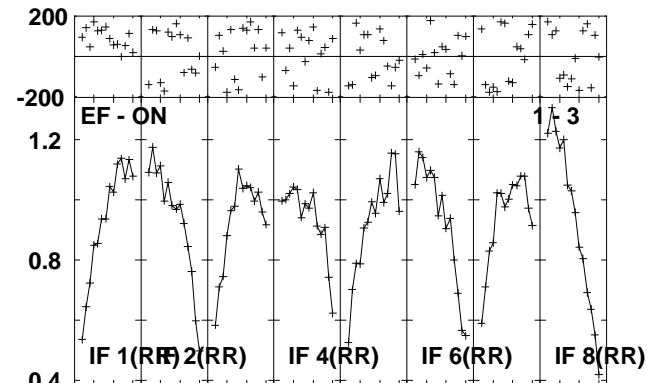
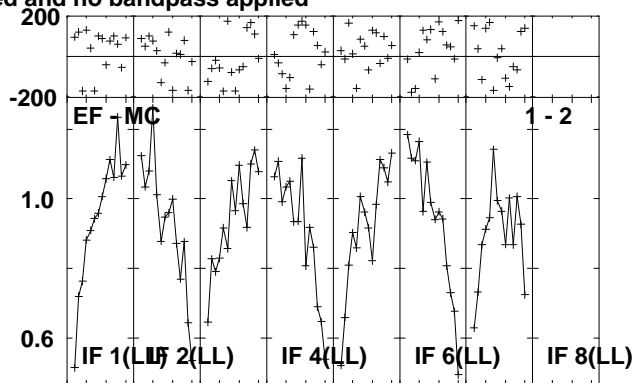
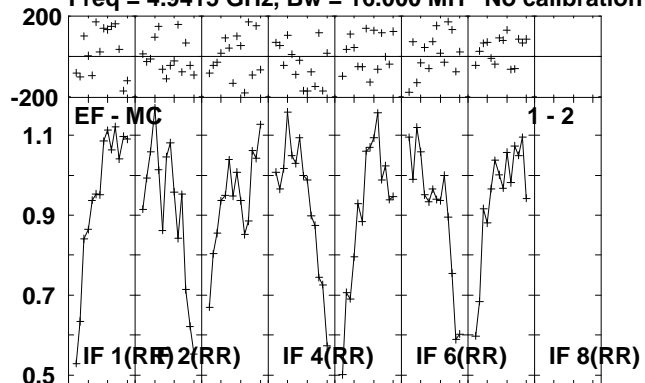

Lower frame: Milli Ampl Jy Top frame: Phas deg
Scalar averaged cross-power spectrum Several baselines displayed
Timerange: 00/22:04:00 to 00/22:08:58

Plot file version 112 created 06-OCT-2010 10:57:48

QLX-1 ET013A.UVDATA.1

Freq = 4.9415 GHz, Bw = 16.000 MH No calibration applied and no bandpass applied

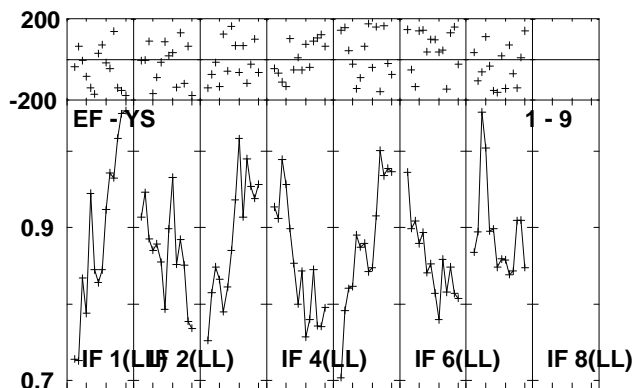
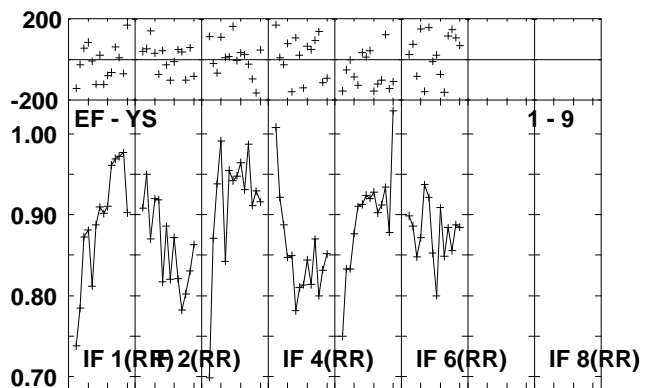
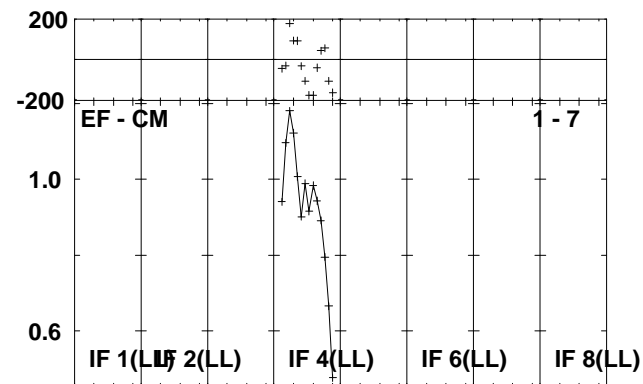
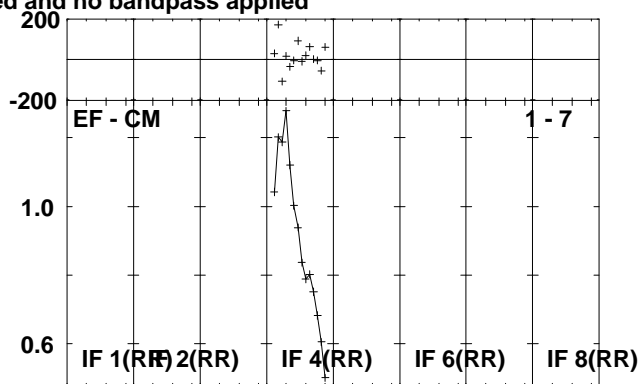
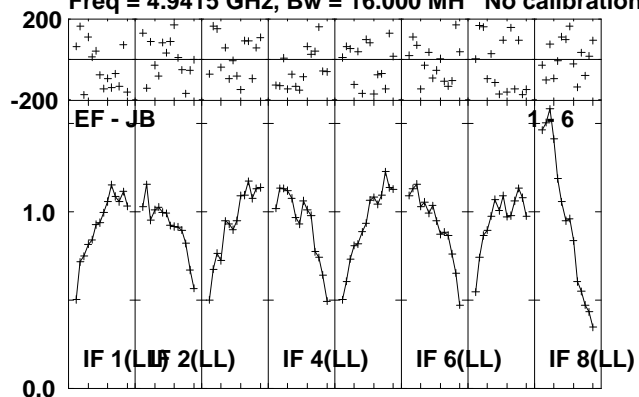

Lower frame: Milli Ampl Jy Top frame: Phas deg
Scalar averaged cross-power spectrum Several baselines displayed
Timerange: 00/22:04:00 to 00/22:08:58

Plot file version 113 created 06-OCT-2010 10:57:49

J1907+01 ET013A.UVDATA.1

Freq = 4.9415 GHz, Bw = 16.000 MH No calibration applied and no bandpass applied

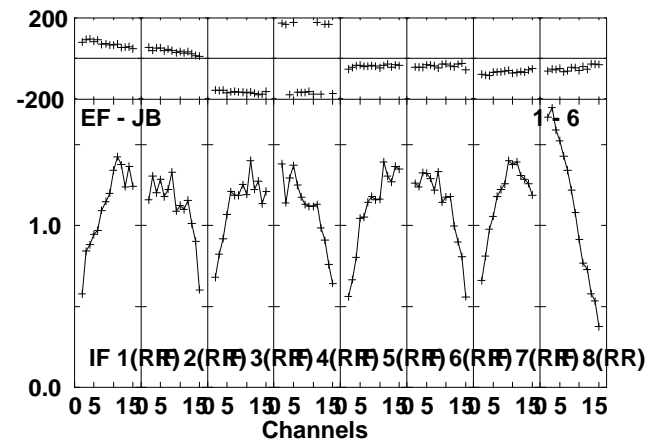
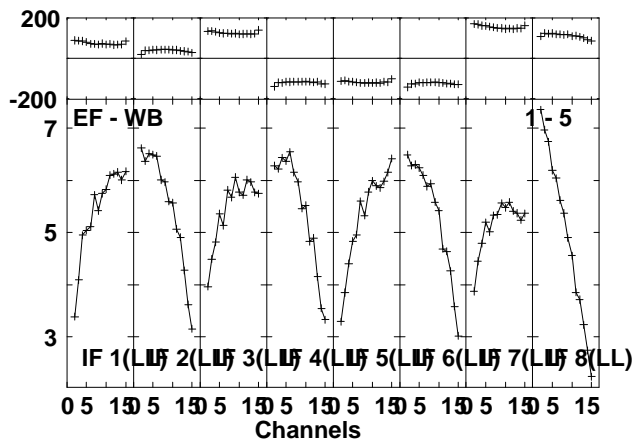
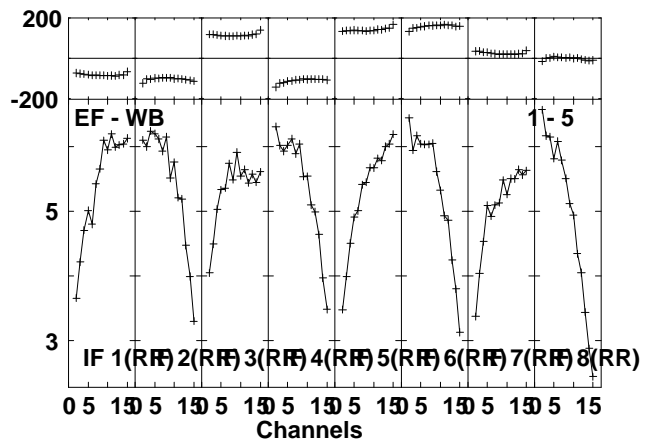
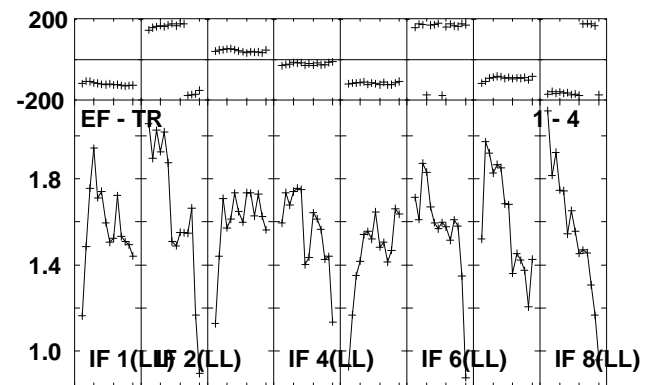
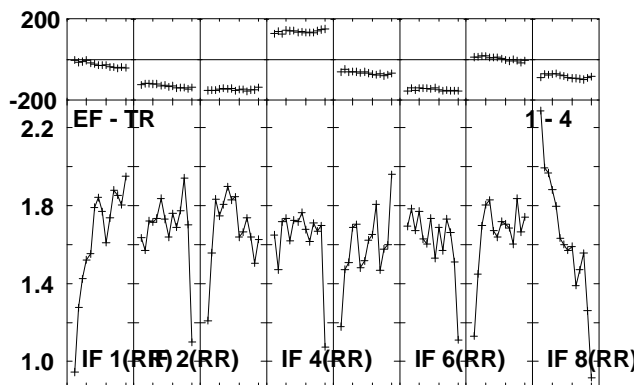
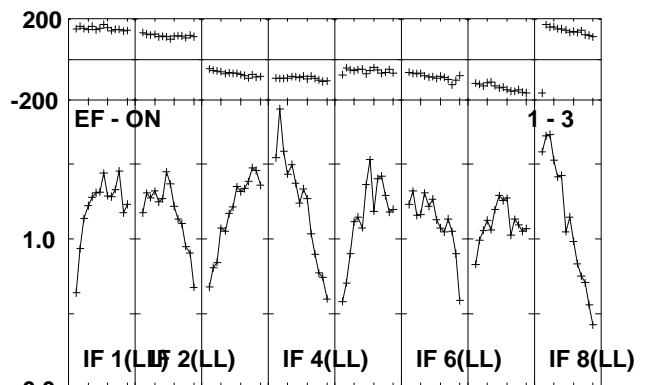
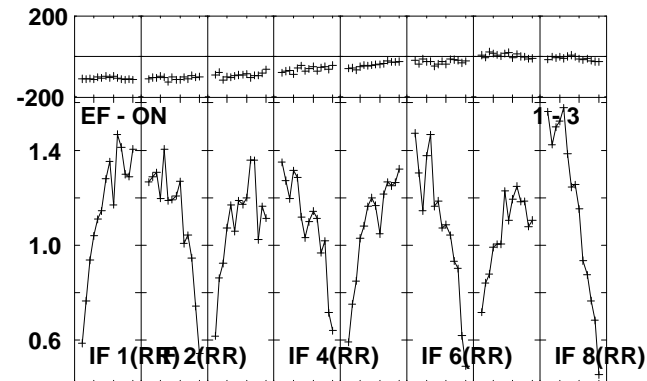
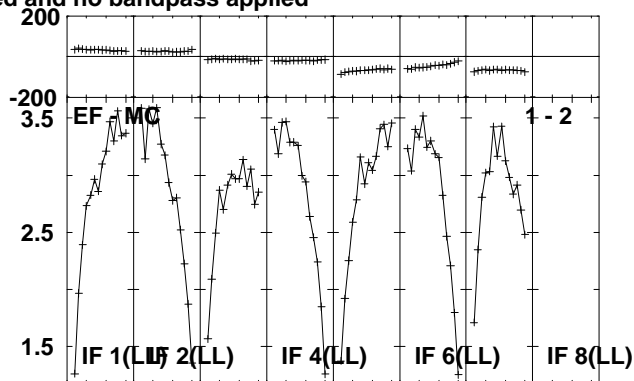
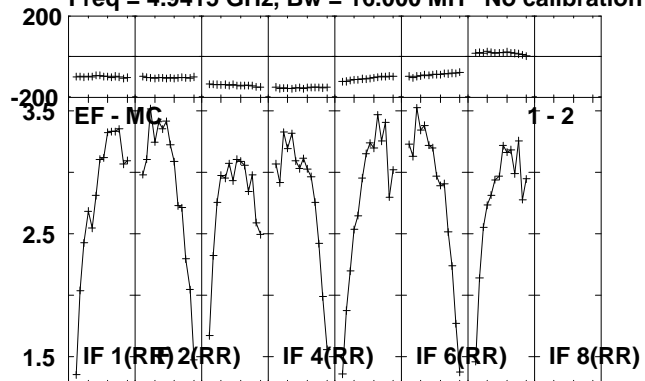

Lower frame: Milli Ampl Jy Top frame: Phas deg
Scalar averaged cross-power spectrum Several baselines displayed
Timerange: 00/22:09:40 to 00/22:11:58

Plot file version 114 created 06-OCT-2010 10:57:50
J1907+01 ET013A.UVDATA.1

Freq = 4.9415 GHz, Bw = 16.000 MH No calibration applied and no bandpass applied

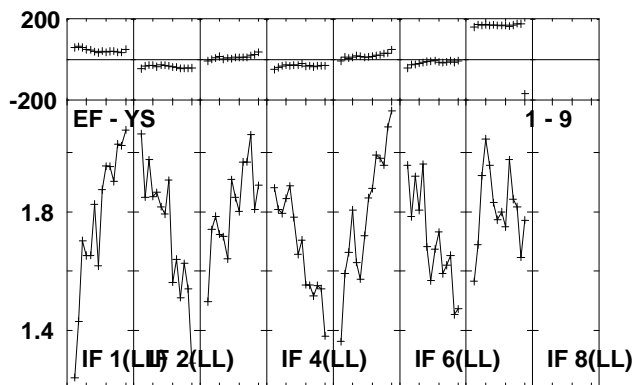
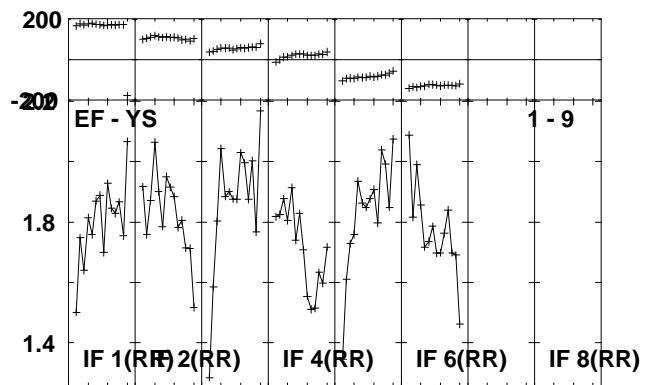
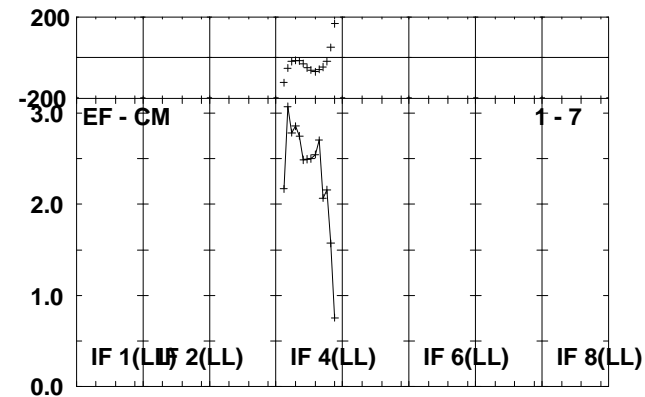
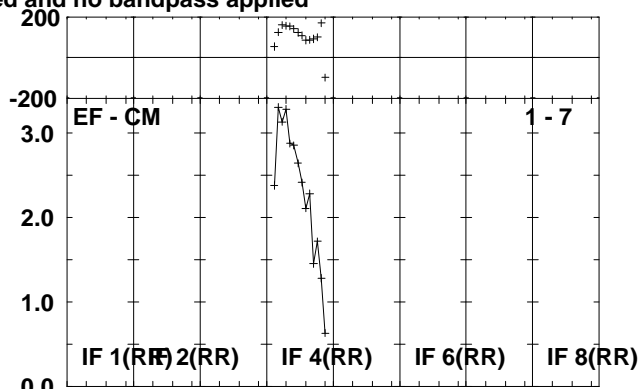
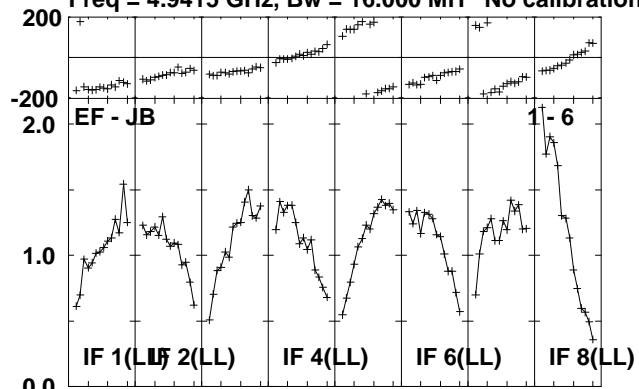

Lower frame: Milli Ampl Jy Top frame: Phas deg
Scalar averaged cross-power spectrum Several baselines displayed
Timerange: 00/22:09:40 to 00/22:11:58

Plot file version 115 created 06-OCT-2010 10:57:51

0234+285 ET013A.UVDATA.1

Freq = 4.9415 GHz, Bw = 16.000 MH No calibration applied and no bandpass applied

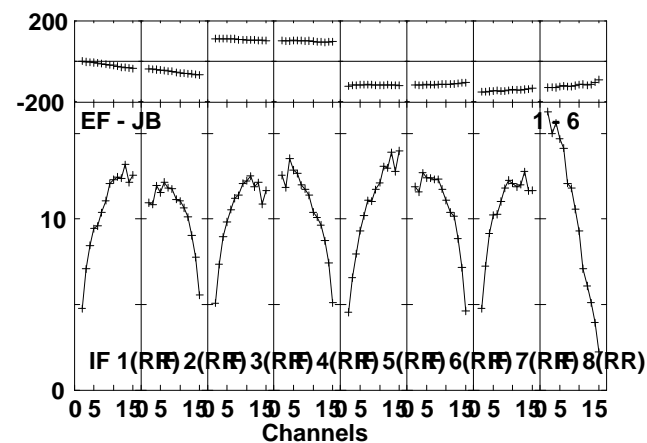
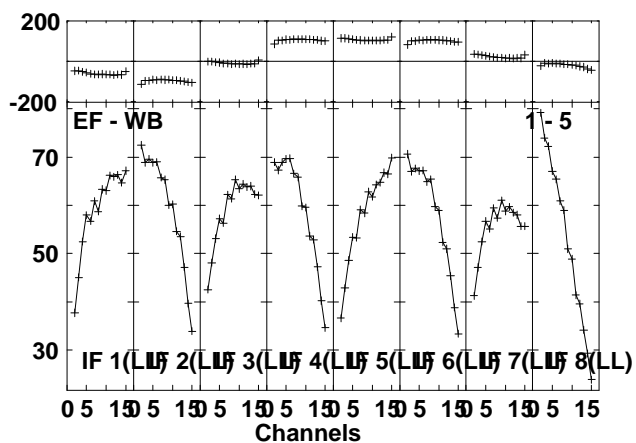
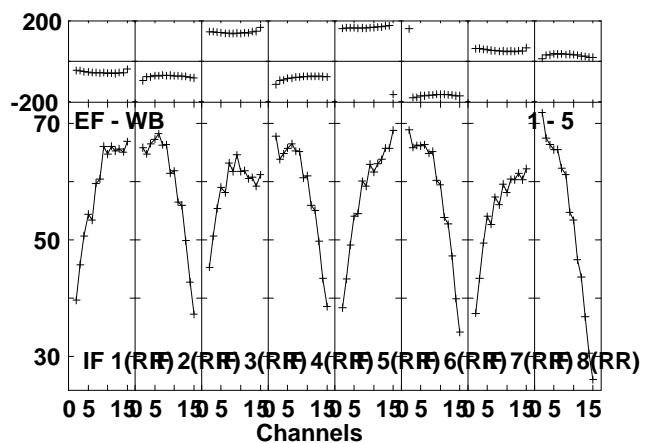
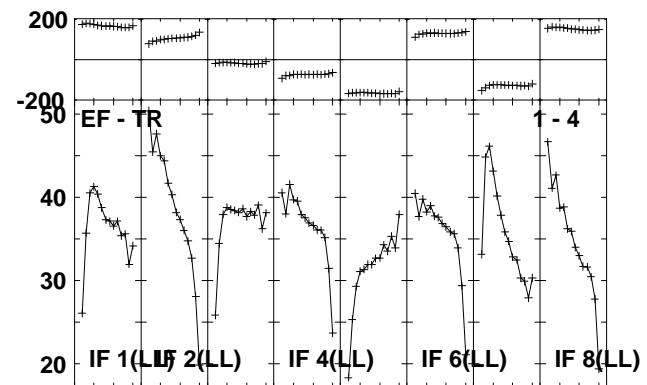
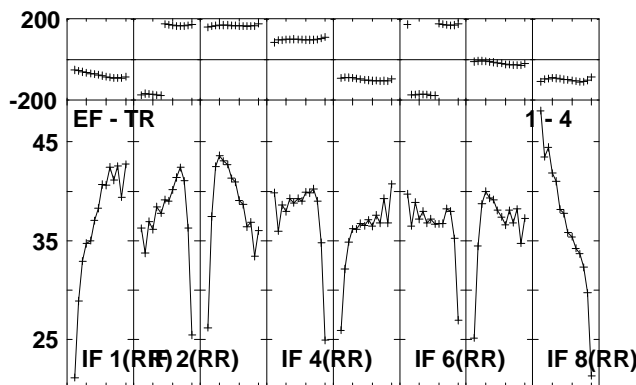
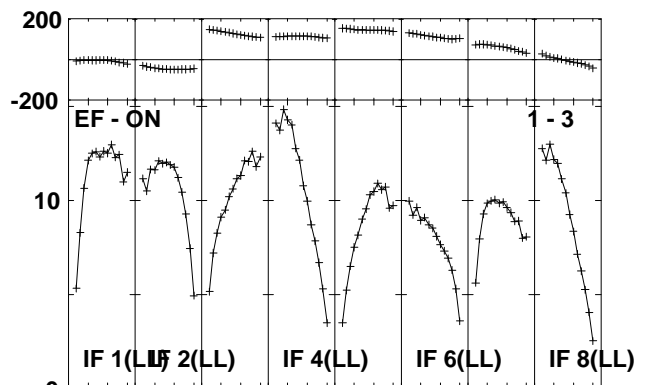
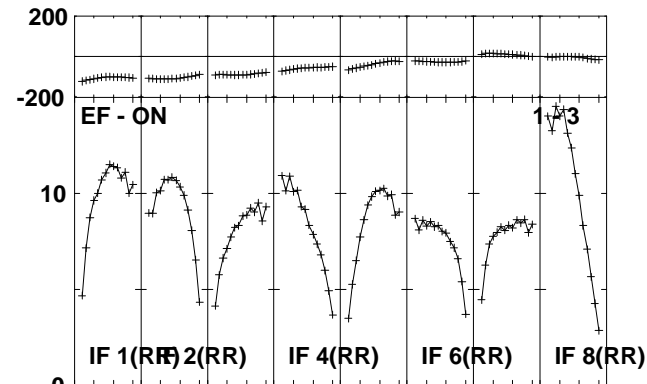
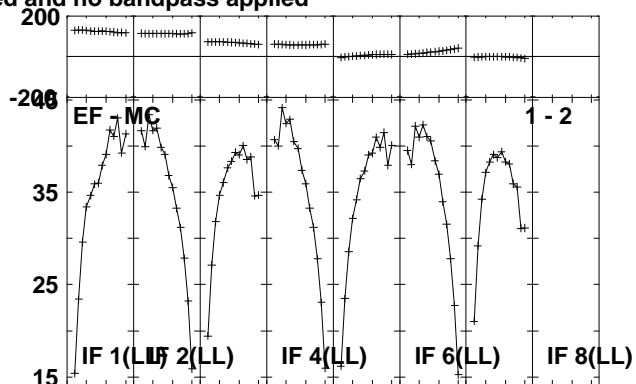
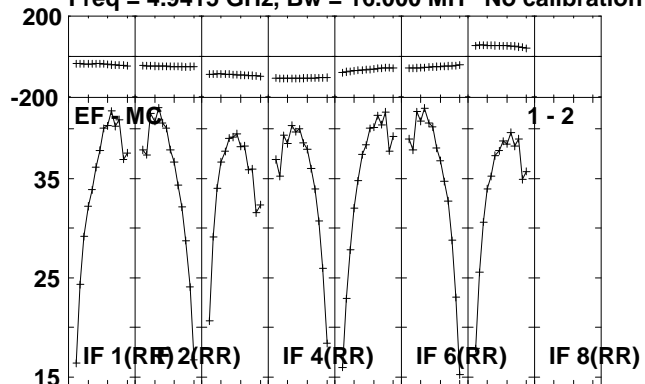

Lower frame: Milli Ampl Jy Top frame: Phas deg
Scalar averaged cross-power spectrum Several baselines displayed
Timerange: 00/22:14:00 to 00/22:23:58

Plot file version 116 created 06-OCT-2010 10:57:55

0234+285 ET013A.UVDATA.1

Freq = 4.9415 GHz, Bw = 16.000 MH No calibration applied and no bandpass applied

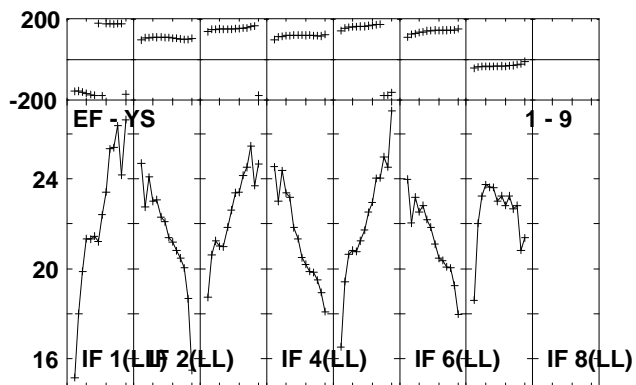
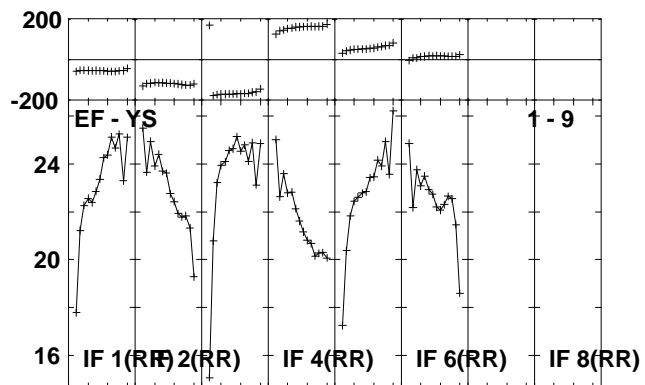
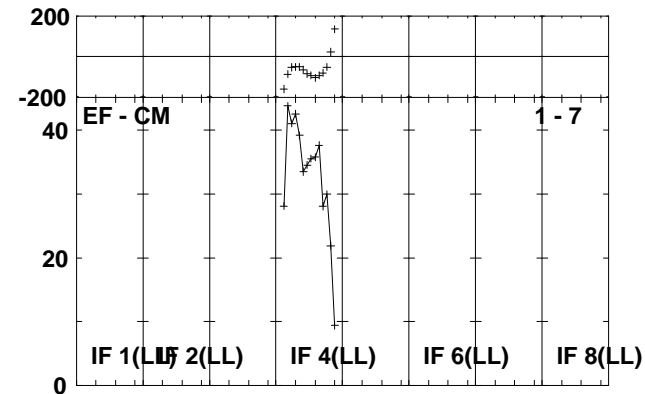
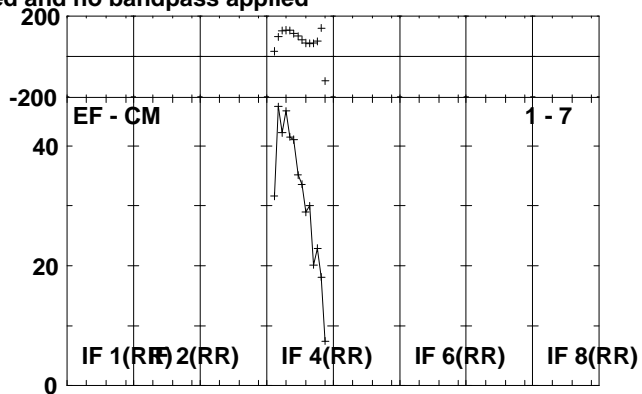
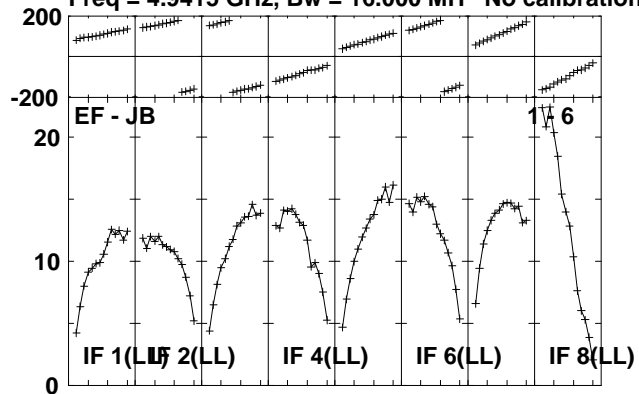

Lower frame: Milli Ampl Jy Top frame: Phas deg
Scalar averaged cross-power spectrum Several baselines displayed
Timerange: 00/22:14:00 to 00/22:23:58

Plot file version 117 created 06-OCT-2010 10:57:58

3C84 ET013A.UVDATA.1

Freq = 4.9415 GHz, Bw = 16.000 MH No calibration applied and no bandpass applied

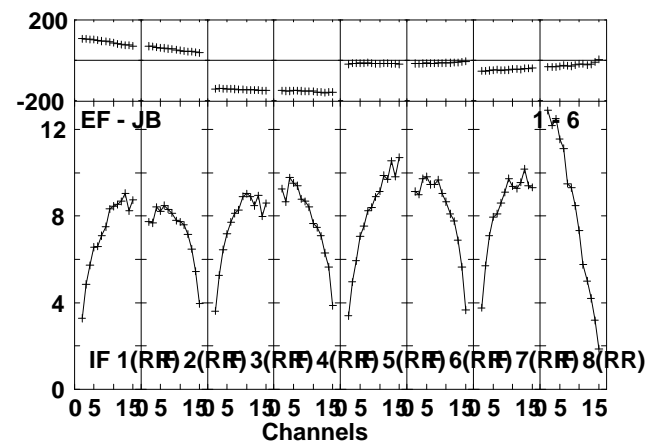
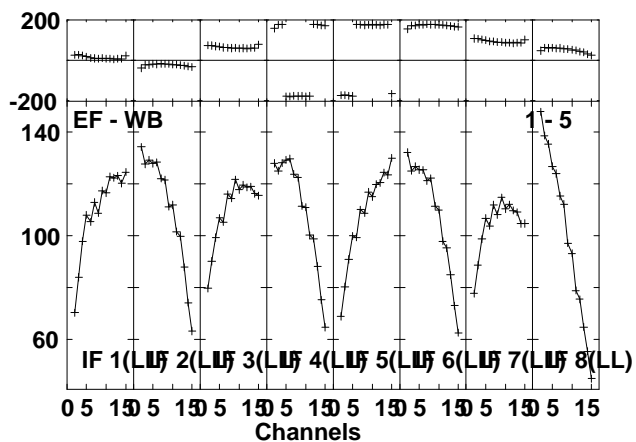
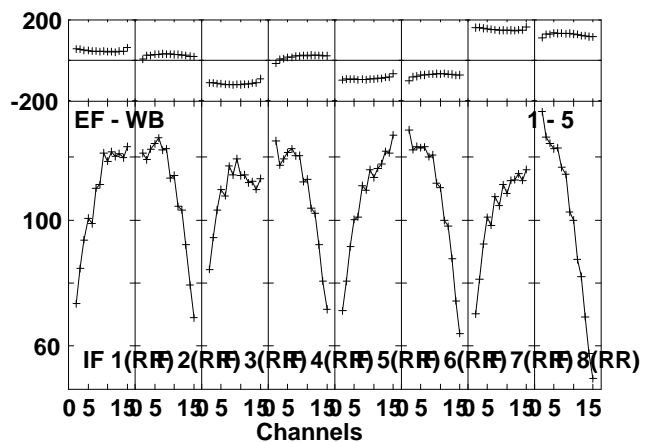
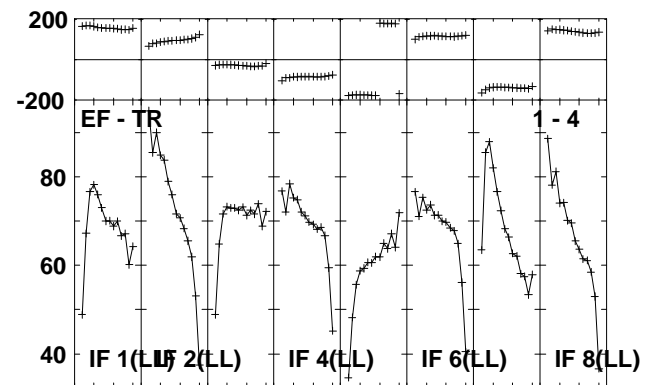
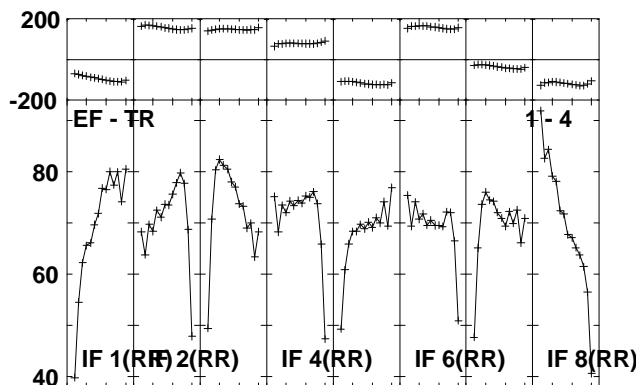
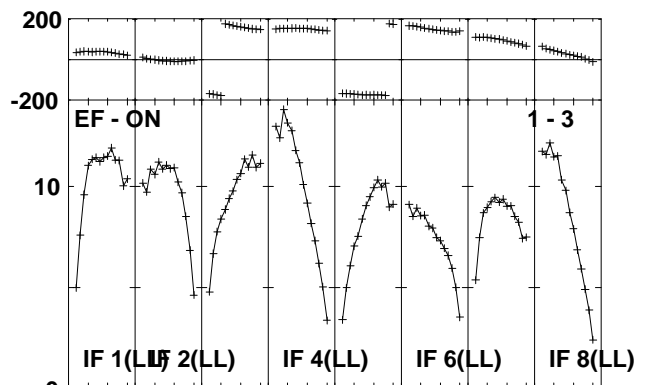
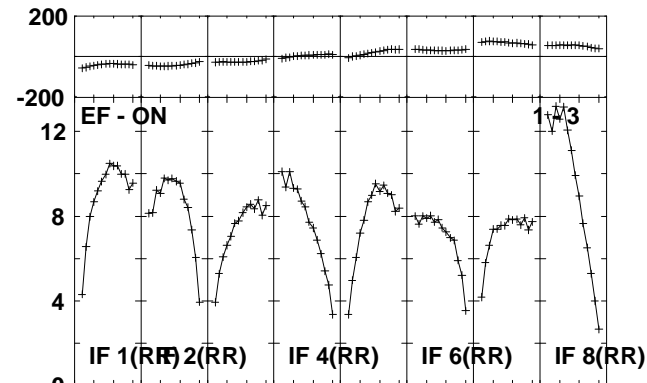
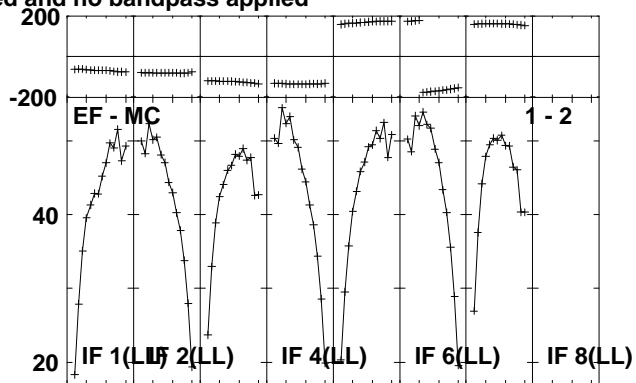
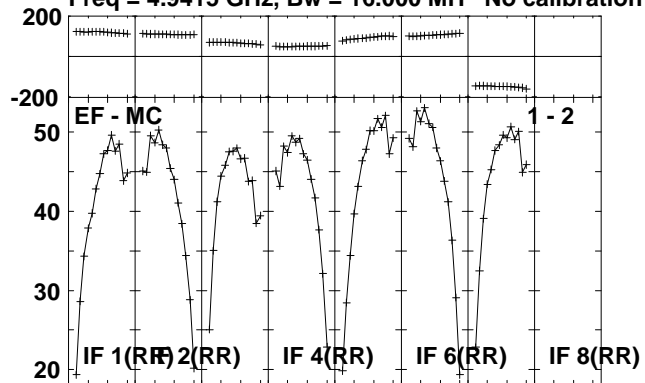

Lower frame: Milli Ampl Jy Top frame: Phas deg
Scalar averaged cross-power spectrum Several baselines displayed
Timerange: 00/22:26:00 to 00/22:35:58

Plot file version 118 created 06-OCT-2010 10:58:01

3C84 ET013A.UVDATA.1

Freq = 4.9415 GHz, Bw = 16.000 MH No calibration applied and no bandpass applied

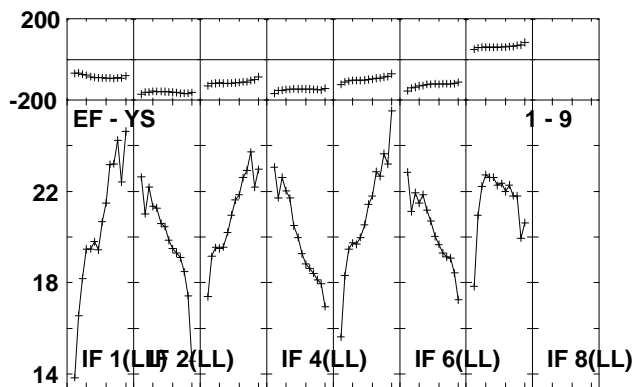
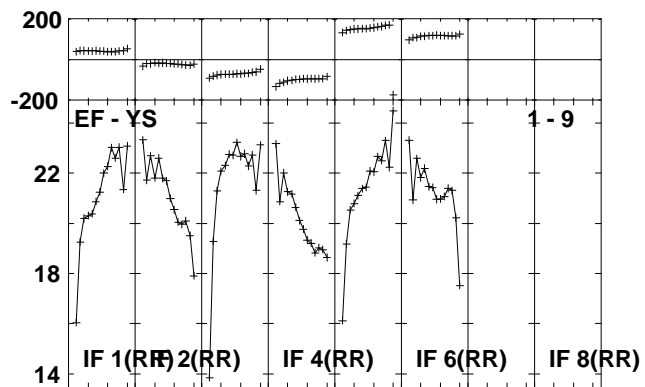
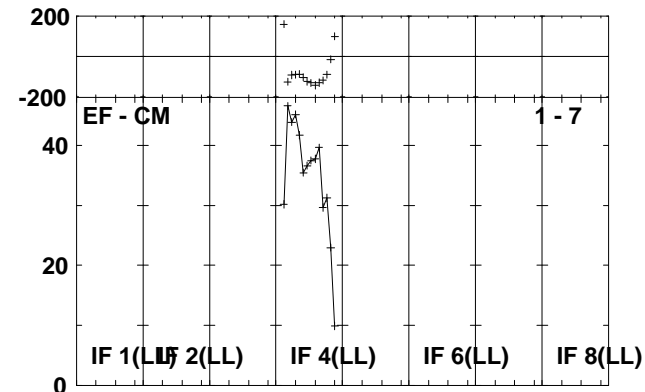
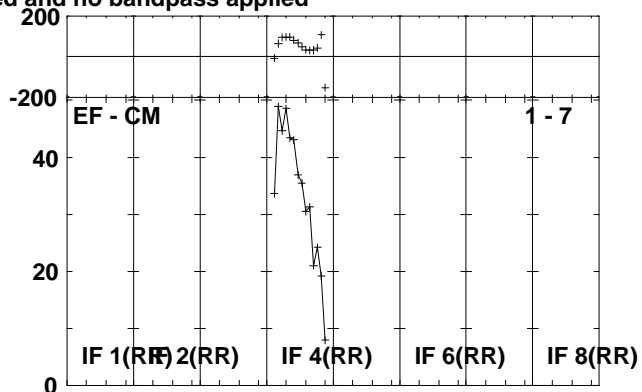
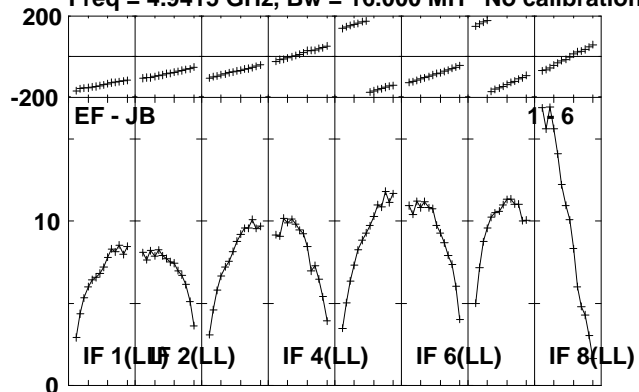

Lower frame: Milli Ampl Jy Top frame: Phas deg
Scalar averaged cross-power spectrum Several baselines displayed
Timerange: 00/22:26:00 to 00/22:35:58

Plot file version 119 created 06-OCT-2010 10:58:04

3C147 ET013A.UVDATA.1

Freq = 4.9415 GHz, Bw = 16.000 MH No calibration applied and no bandpass applied

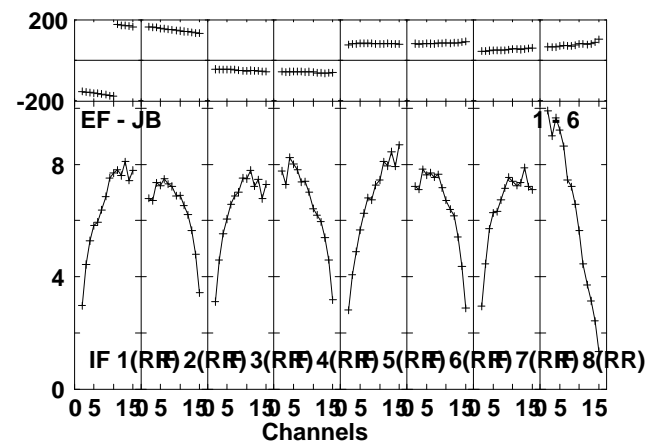
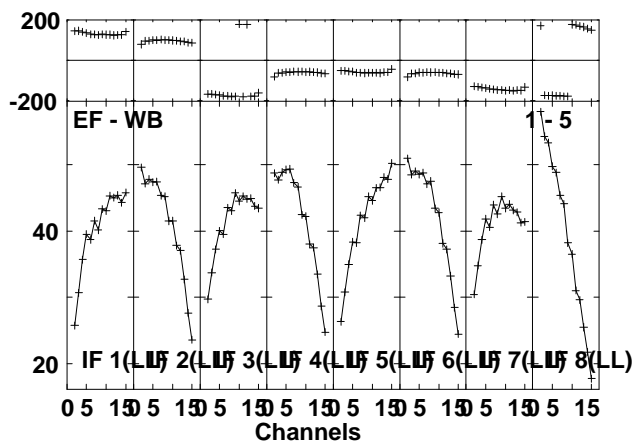
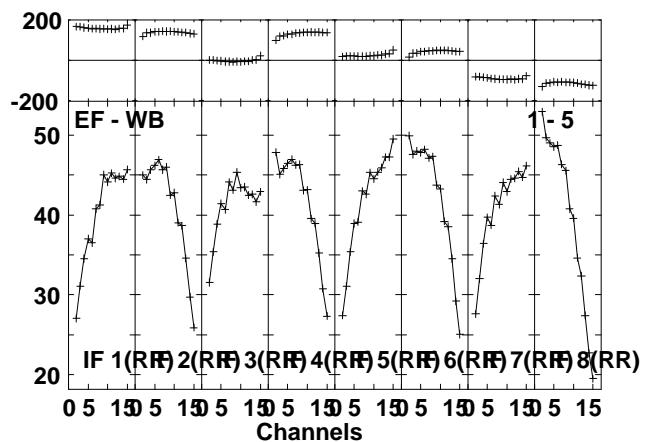
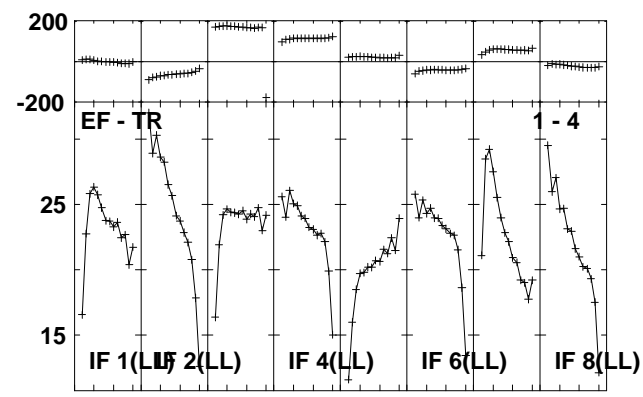
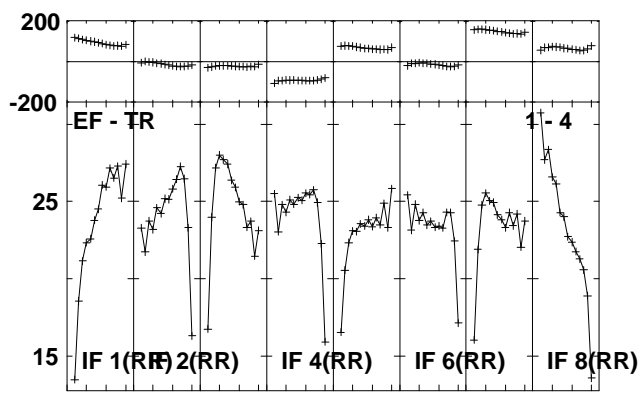
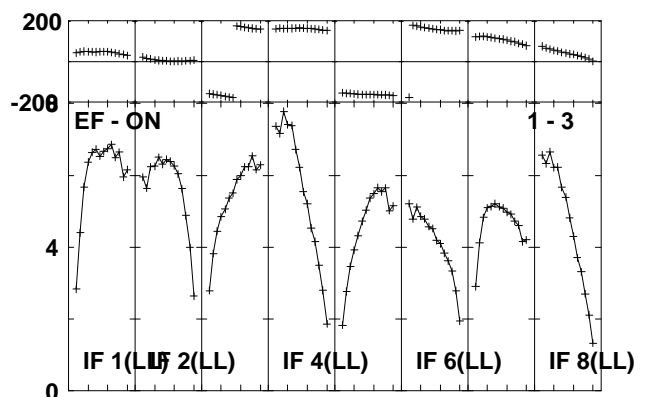
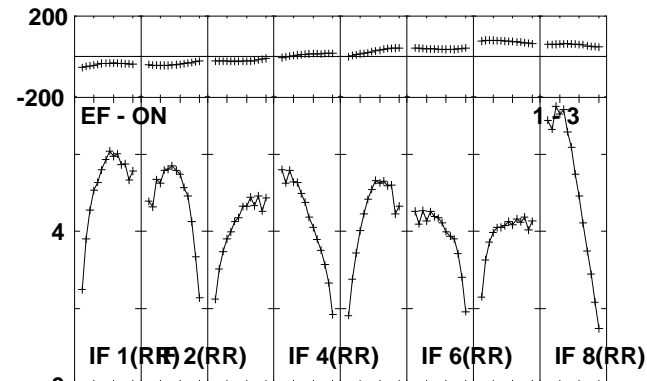
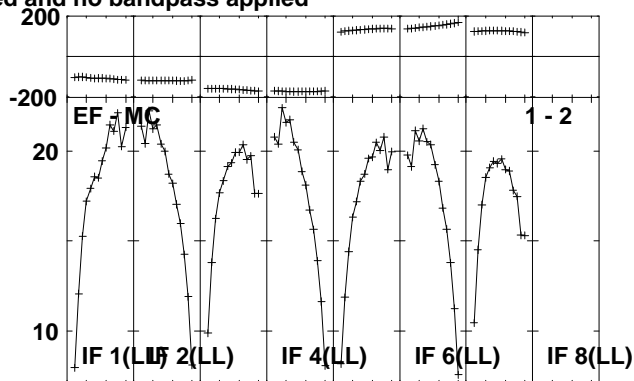
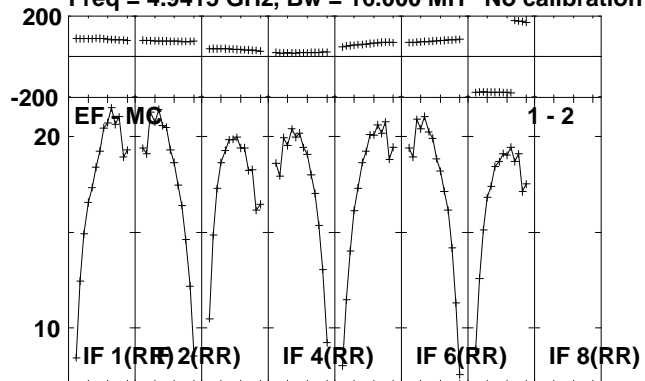

Lower frame: Milli Ampl Jy Top frame: Phas deg
Scalar averaged cross-power spectrum Several baselines displayed
Timerange: 00/22:38:00 to 00/22:47:58

Plot file version 120 created 06-OCT-2010 10:58:07

3C147 ET013A.UVDATA.1

Freq = 4.9415 GHz, Bw = 16.000 MH No calibration applied and no bandpass applied

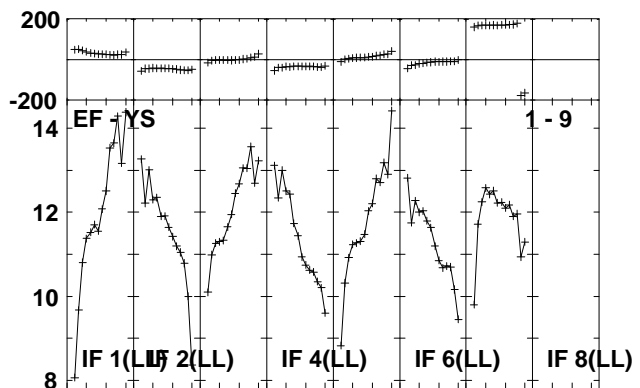
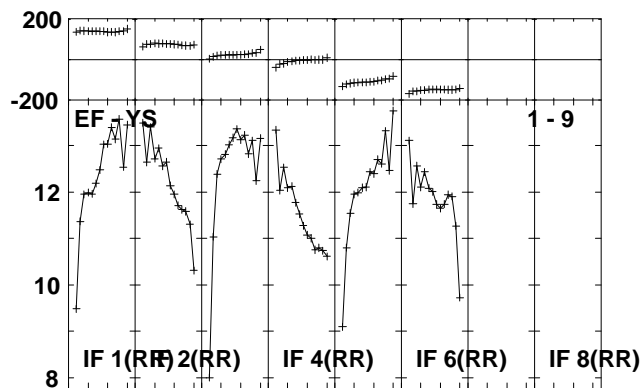
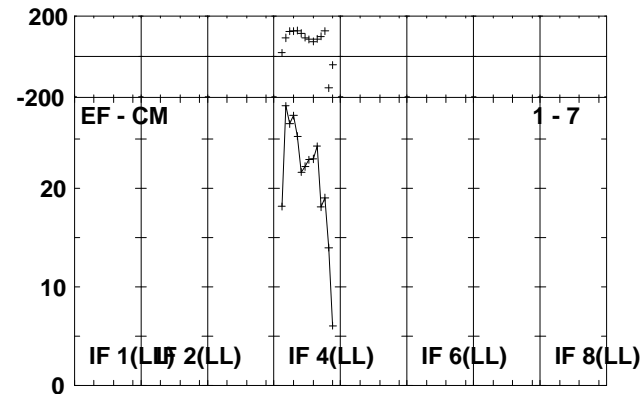
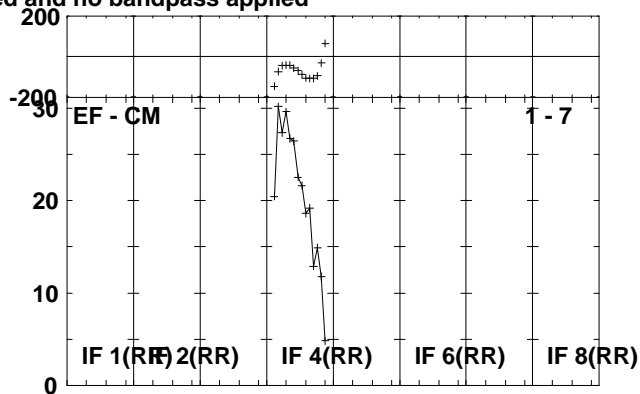
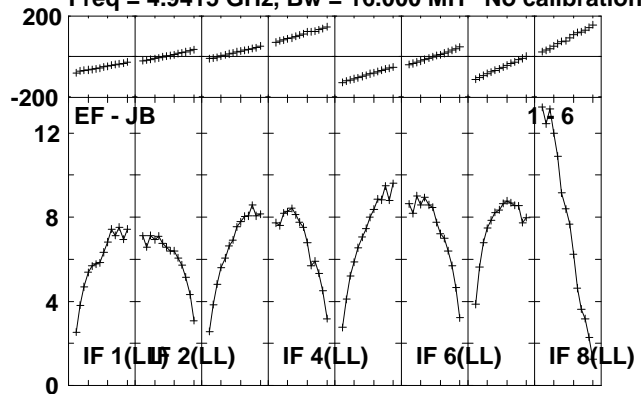

Lower frame: Milli Ampl Jy Top frame: Phas deg
Scalar averaged cross-power spectrum Several baselines displayed
Timerange: 00/22:38:00 to 00/22:47:58