

Plot file version 1 created 02-DEC-2011 14:47:05

3C345 ET018A.UVDATA.1

Freq = 4.9270 GHz, Bw = 16.000 MH No calibration applied and no bandpass applied

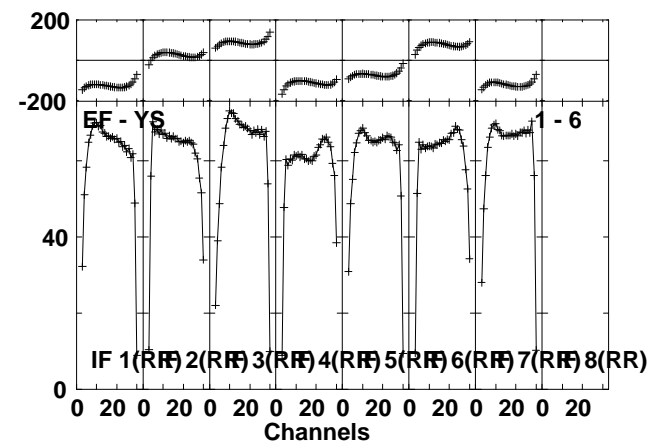
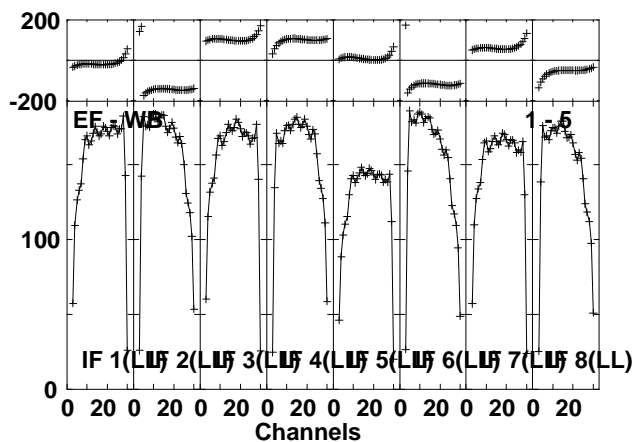
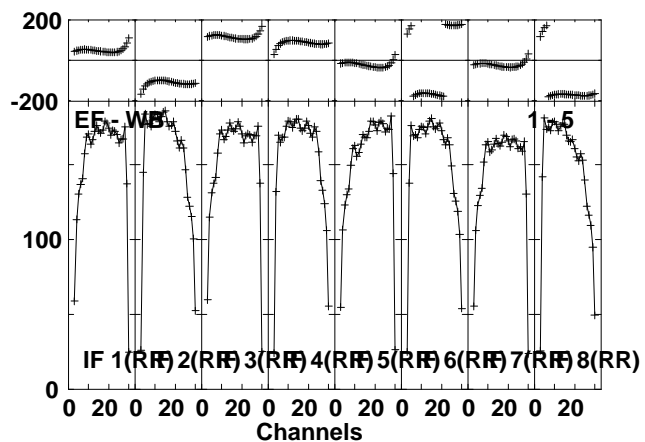
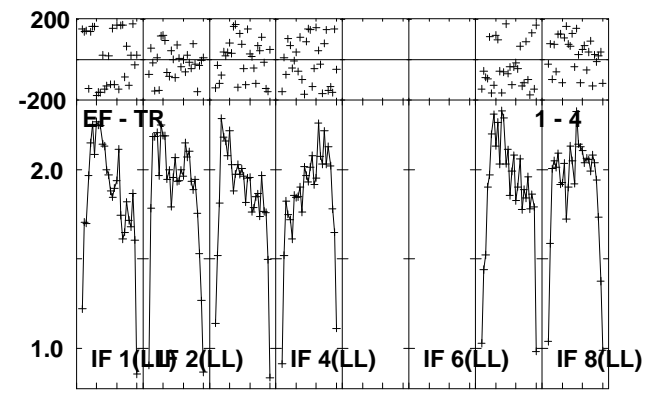
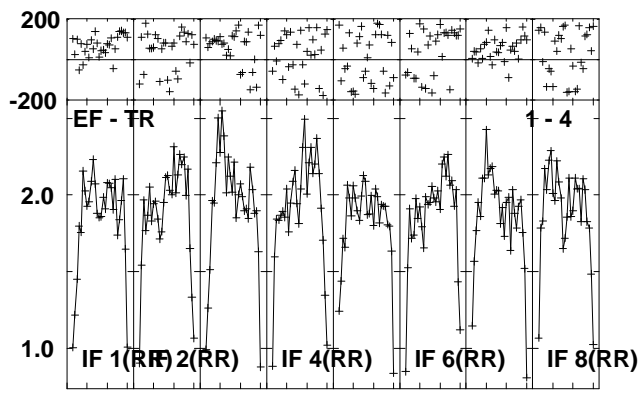
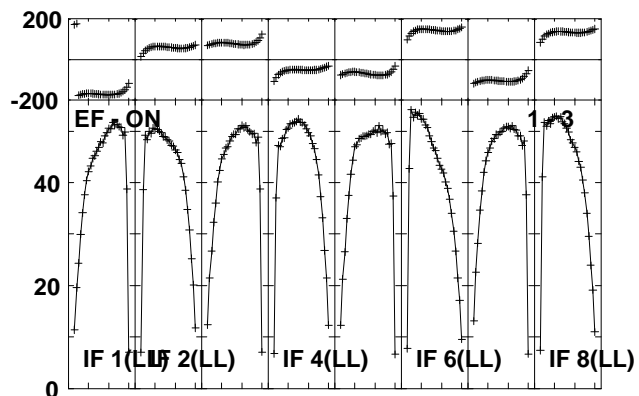
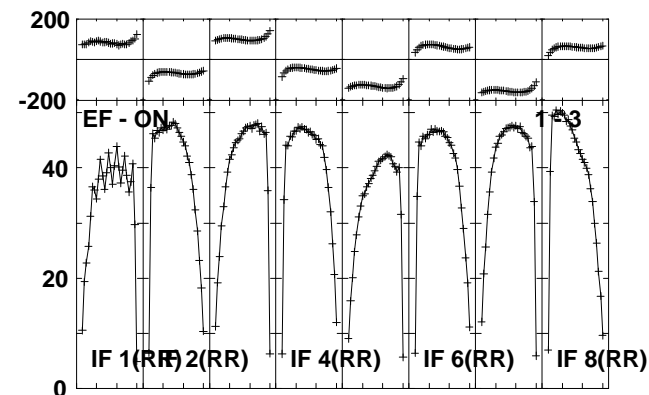
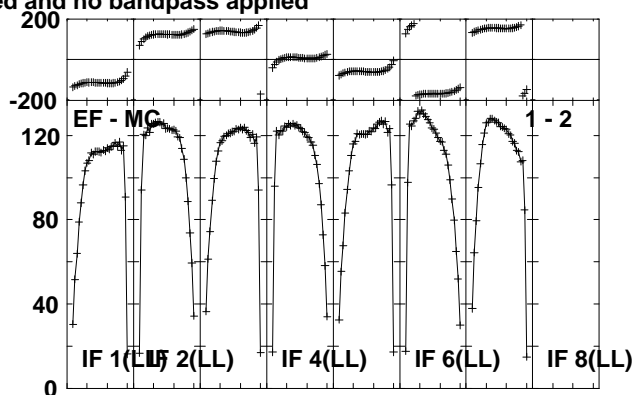
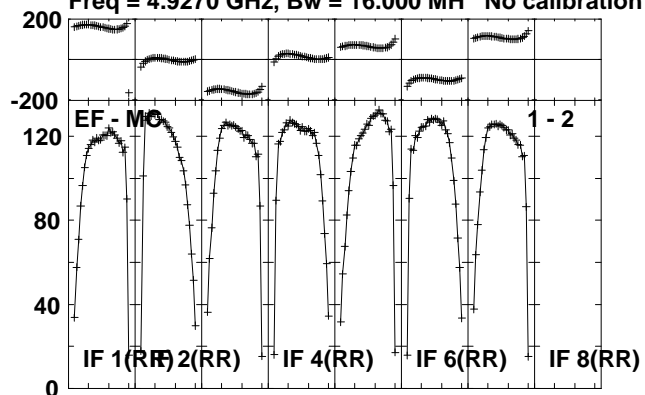

Lower frame: Milli Ampl Jy Top frame: Phas deg
Scalar averaged cross-power spectrum Several baselines displayed
Timerange: 00/11:57:41 to 00/11:59:19

Plot file version 2 created 02-DEC-2011 14:47:07
3C345 ET018A.UVDATA.1

Freq = 4.9270 GHz, Bw = 16.000 MH No calibration applied and no bandpass applied

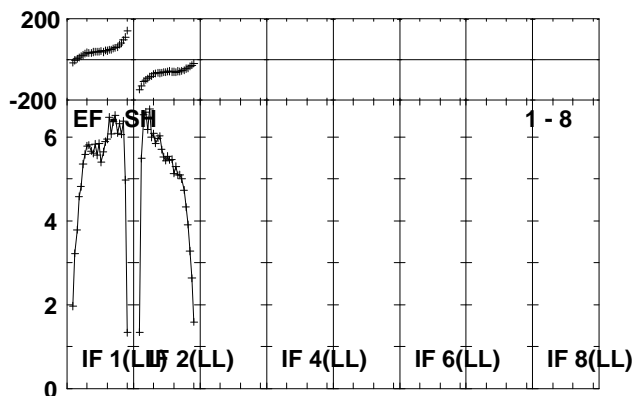
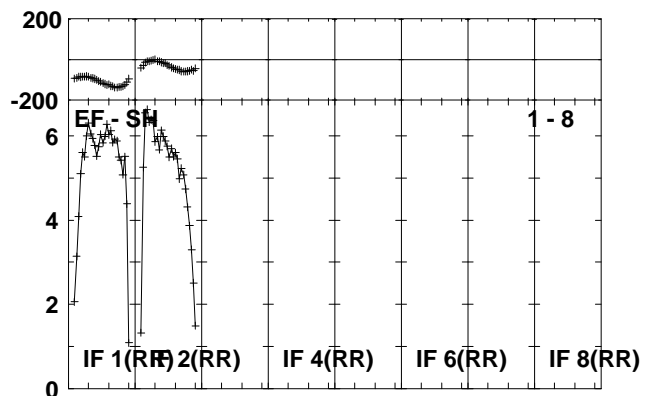
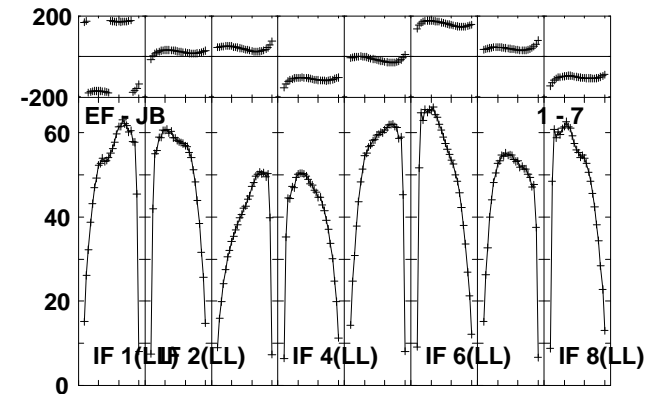
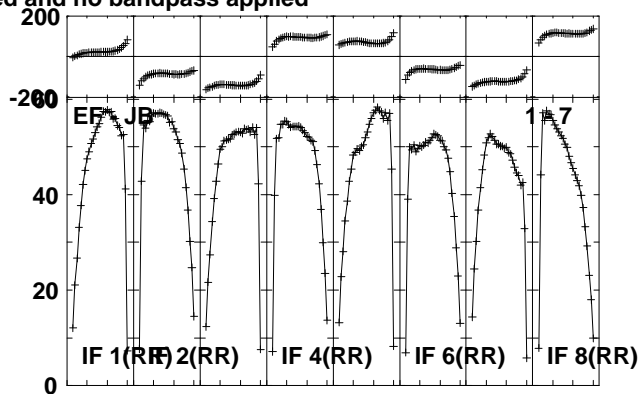
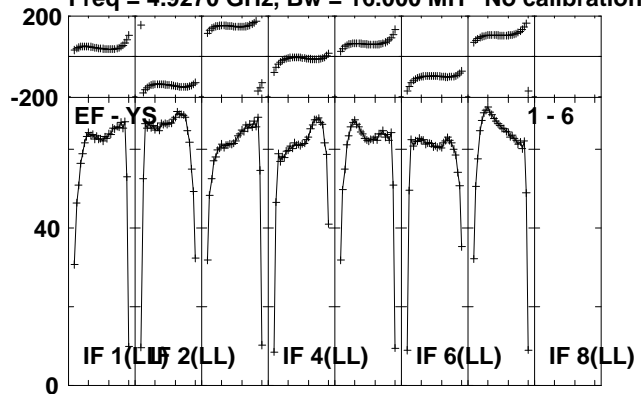

Lower frame: Milli Ampl Jy Top frame: Phas deg
Scalar averaged cross-power spectrum Several baselines displayed
Timerange: 00/11:57:41 to 00/11:59:19

Plot file version 3 created 02-DEC-2011 14:47:09

QQ208 ET018A.UVDATA.1

Freq = 4.9270 GHz, Bw = 16.000 MH No calibration applied and no bandpass applied

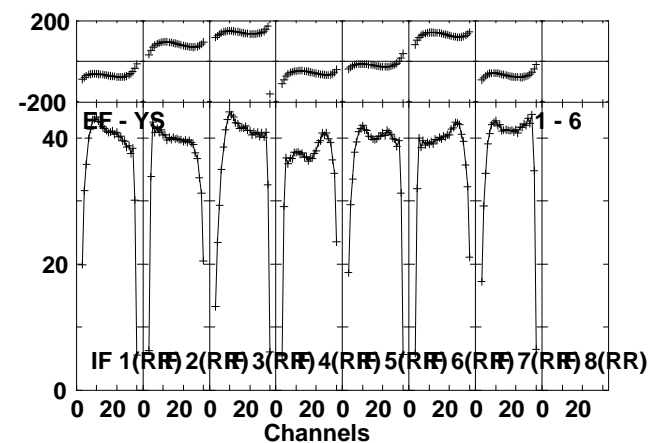
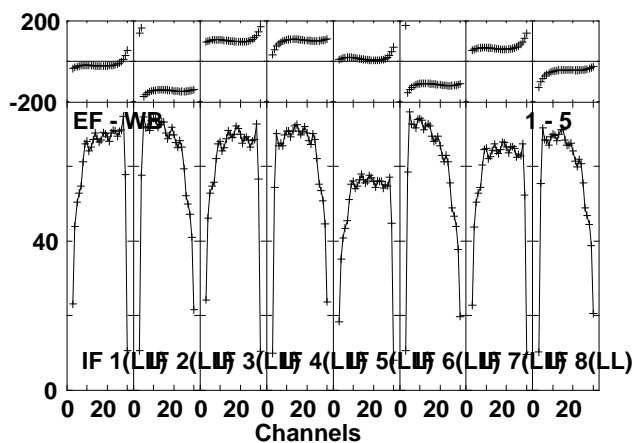
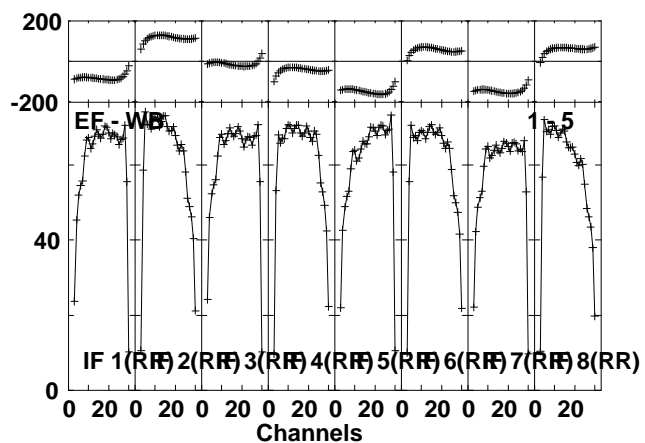
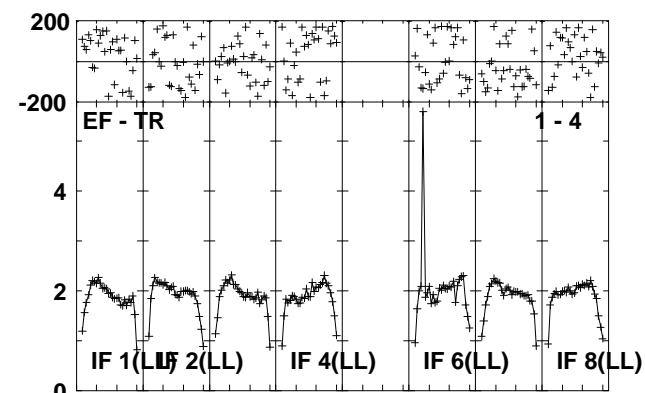
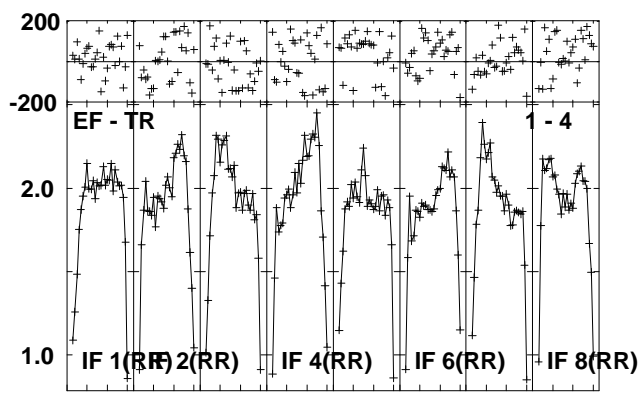
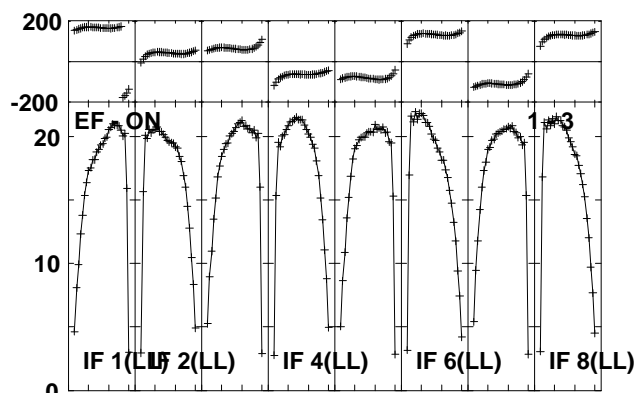
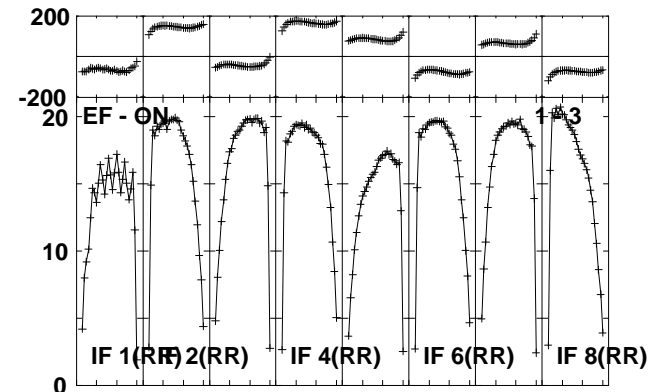
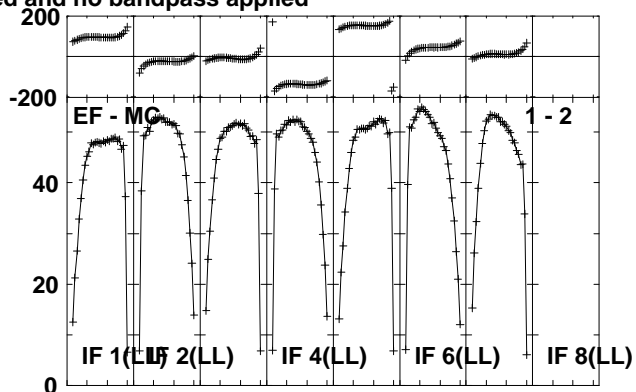
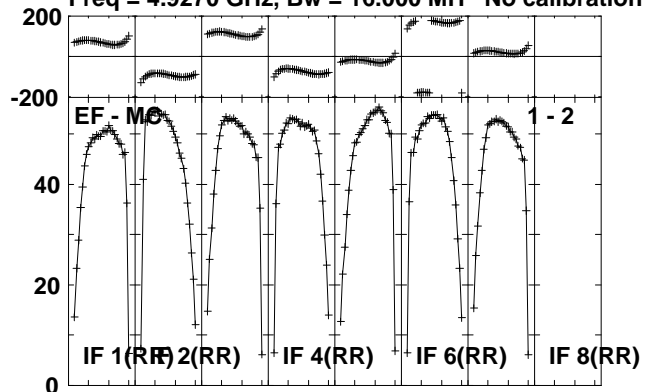

Lower frame: Milli Ampl Jy Top frame: Phas deg
Scalar averaged cross-power spectrum Several baselines displayed
Timerange: 00/12:04:16 to 00/12:09:19

Plot file version 4 created 02-DEC-2011 14:47:13

OQ208 ET018A.UVDATA.1

Freq = 4.9270 GHz, Bw = 16.000 MH No calibration applied and no bandpass applied

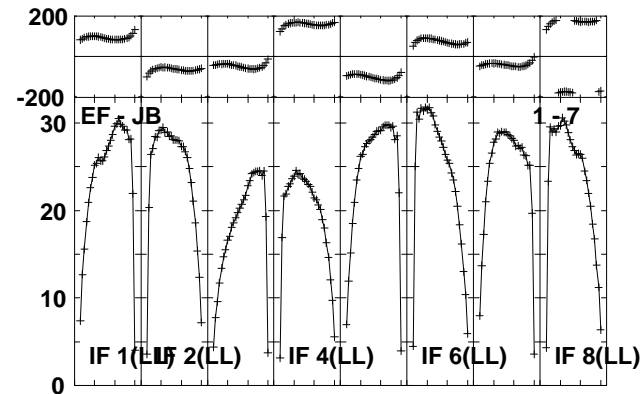
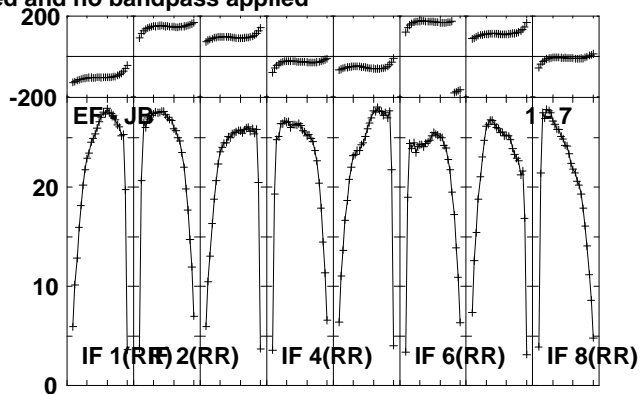
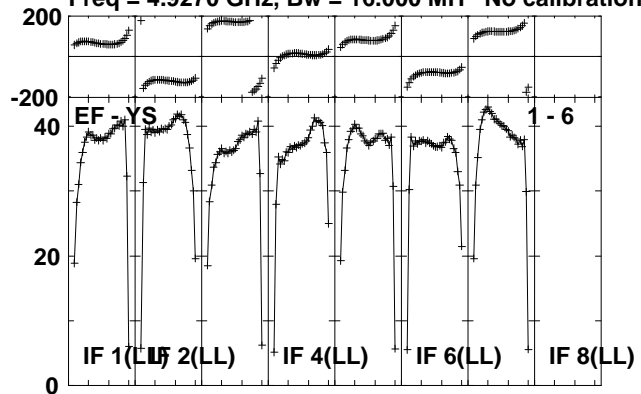

Lower frame: Milli Ampl Jy Top frame: Phas deg
Scalar averaged cross-power spectrum Several baselines displayed
Timerange: 00/12:04:16 to 00/12:09:19

Plot file version 5 created 02-DEC-2011 14:47:14

J1953+35 ET018A.UVDATA.1

Freq = 4.9270 GHz, Bw = 16.000 MH No calibration applied and no bandpass applied

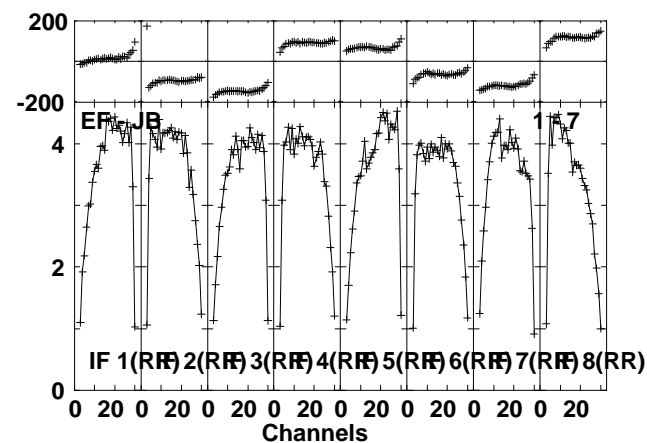
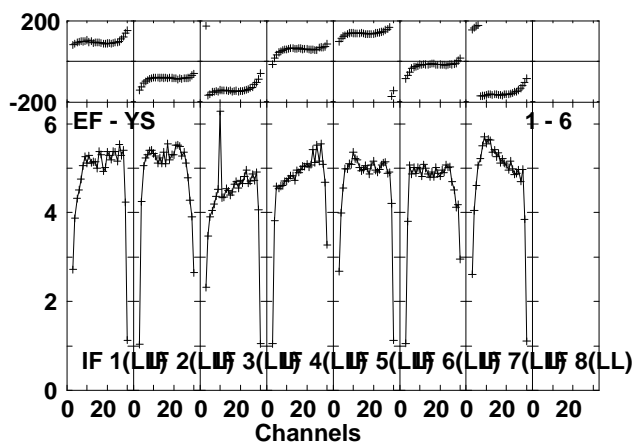
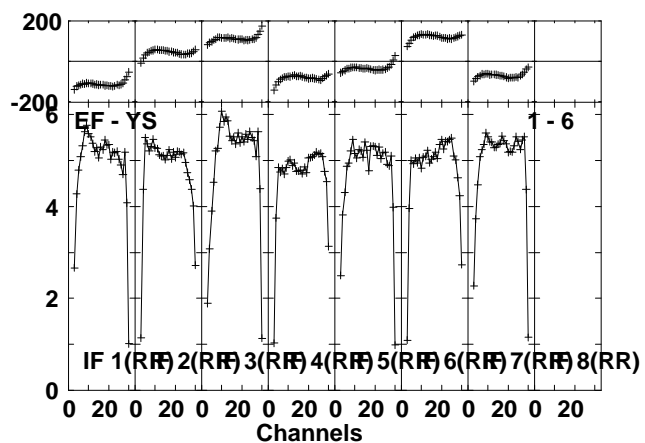
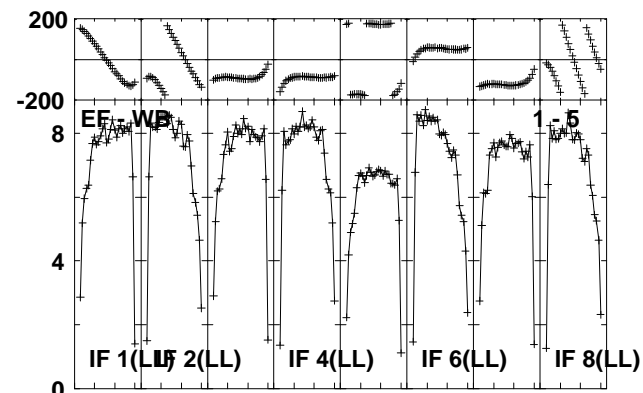
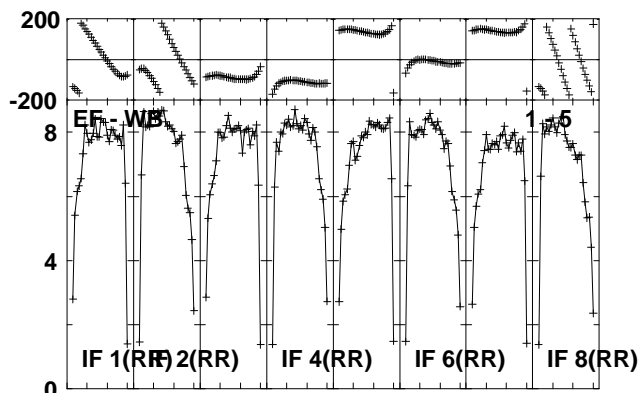
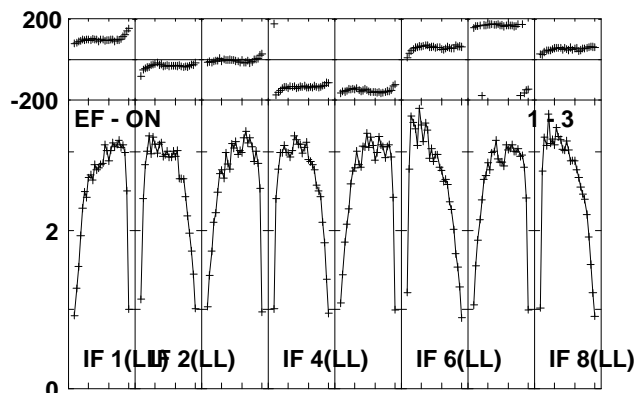
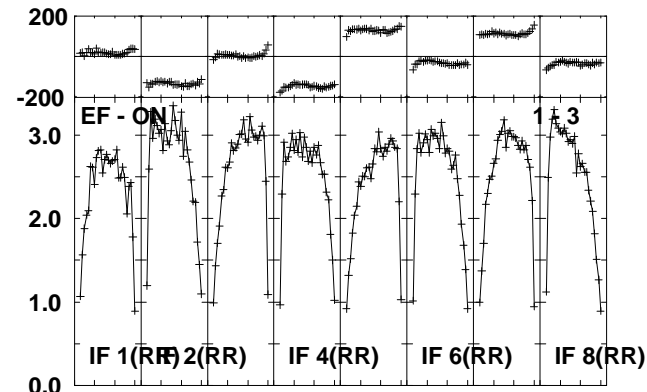
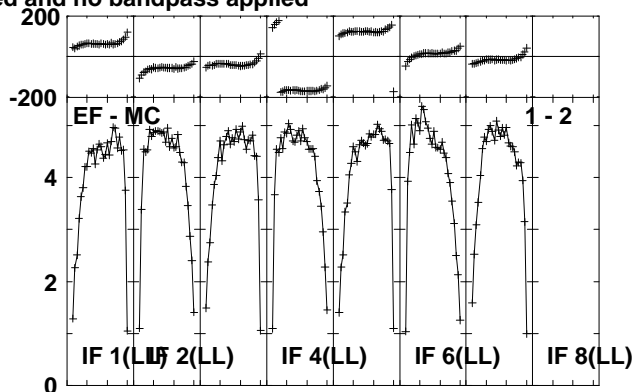
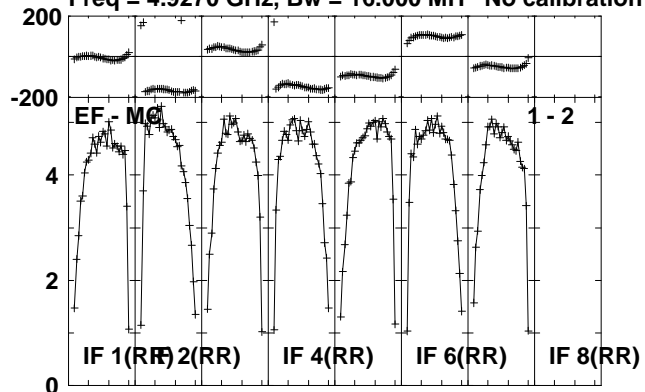

Lower frame: Milli Ampl Jy Top frame: Phas deg
Scalar averaged cross-power spectrum Several baselines displayed
Timerange: 00/12:16:17 to 00/12:19:18

Plot file version 6 created 02-DEC-2011 14:47:16
J1953+35 ET018A.UVDATA.1

Freq = 4.9270 GHz, Bw = 16.000 MH No calibration applied and no bandpass applied

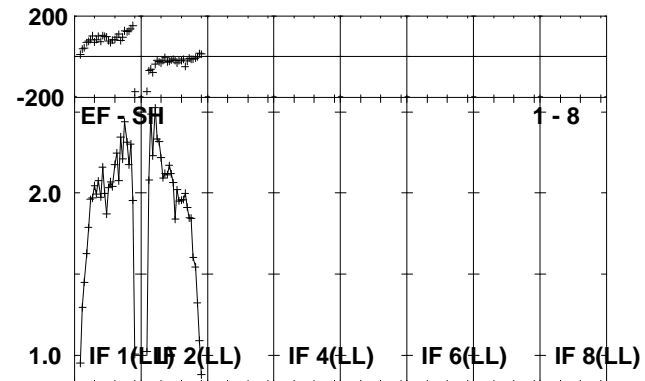
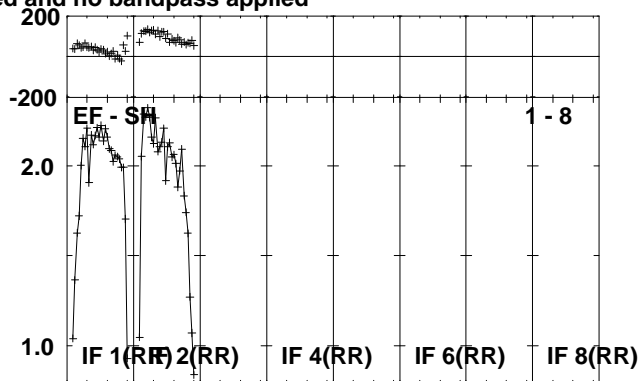
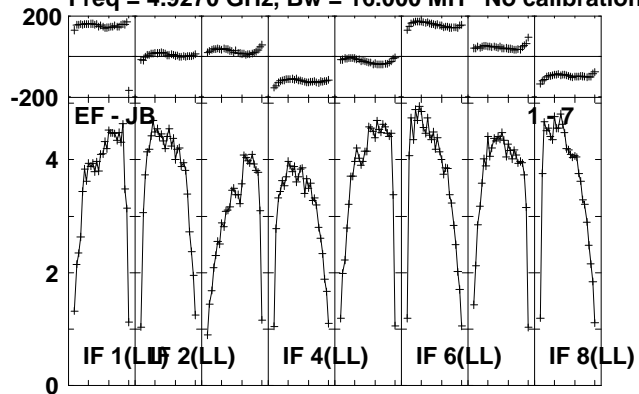

Lower frame: Milli Ampl Jy Top frame: Phas deg
Scalar averaged cross-power spectrum Several baselines displayed
Timerange: 00/12:16:17 to 00/12:19:18

Plot file version 7 created 02-DEC-2011 14:47:17

CYGX-1 ET018A.UVDATA.1

Freq = 4.9270 GHz, Bw = 16.000 MH No calibration applied and no bandpass applied

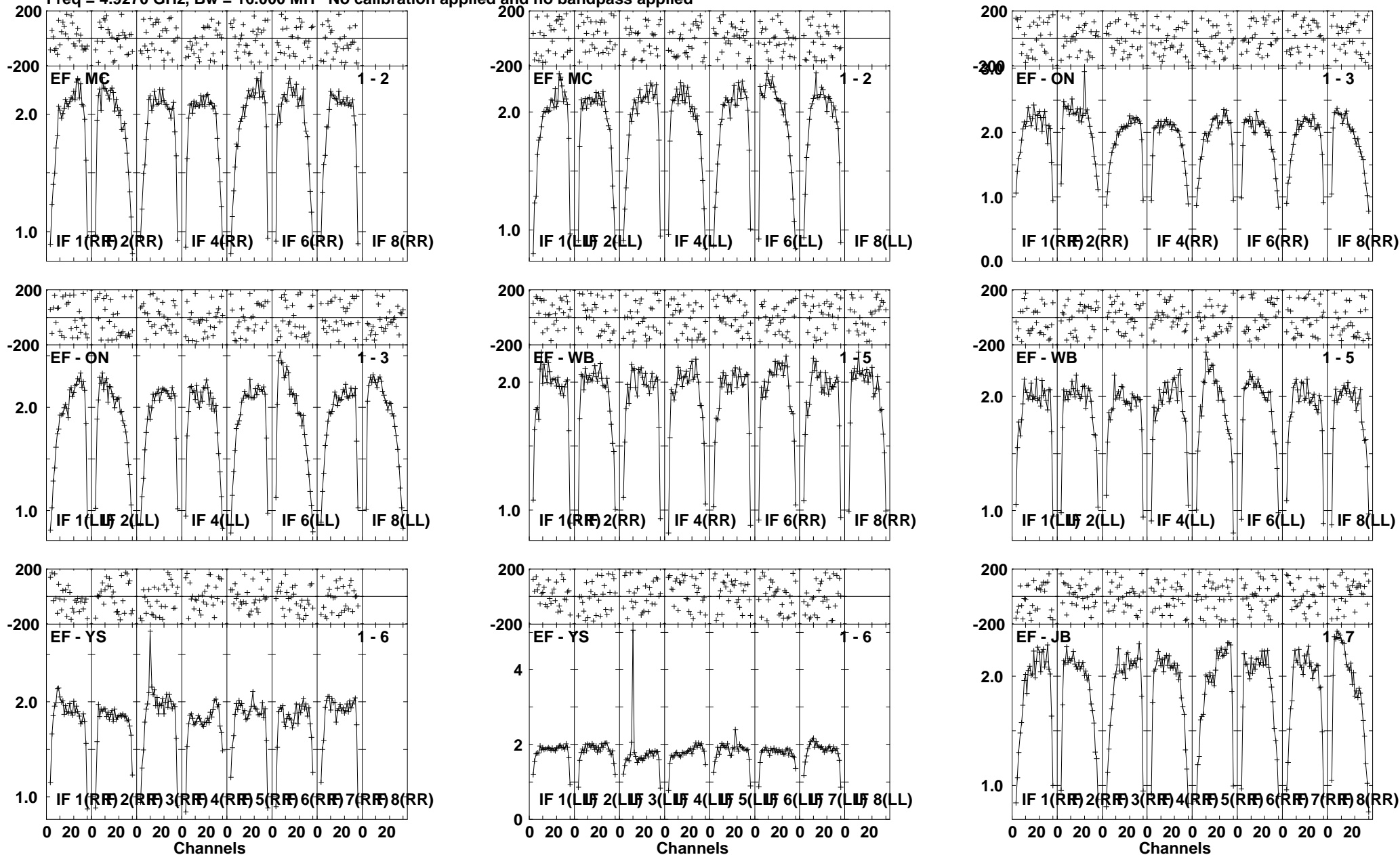

Lower frame: Milli Ampl Jy Top frame: Phas deg
Scalar averaged cross-power spectrum Several baselines displayed
Timerange: 00/12:19:22 to 00/12:24:48

Plot file version 8 created 02-DEC-2011 14:47:21

CYGX-1 ET018A.UVDATA.1

Freq = 4.9270 GHz, Bw = 16.000 MH No calibration applied and no bandpass applied

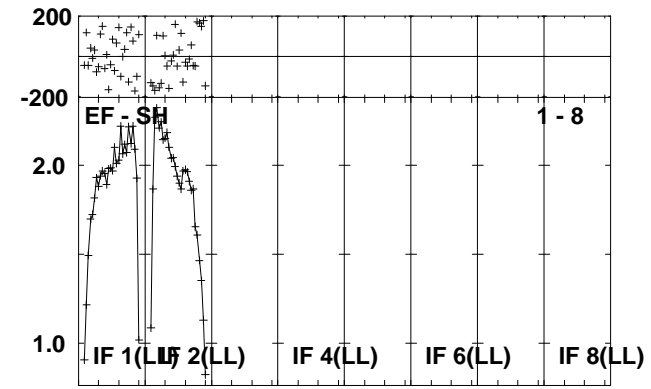
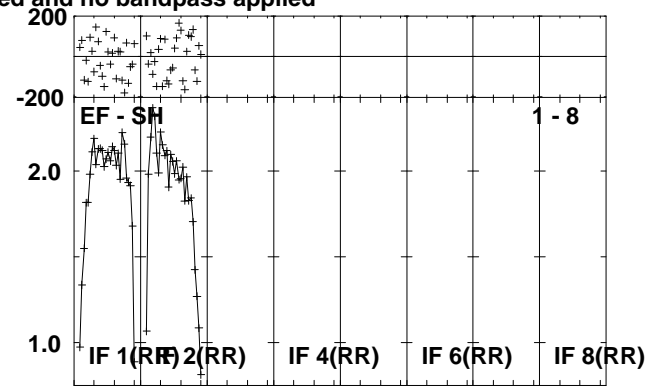
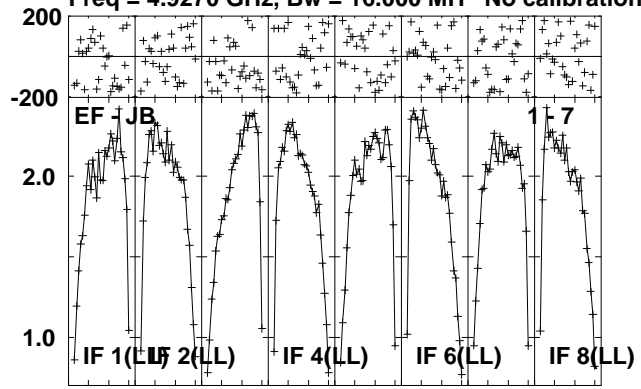

Lower frame: Milli Ampl Jy Top frame: Phas deg
Scalar averaged cross-power spectrum Several baselines displayed
Timerange: 00/12:19:22 to 00/12:24:48

Plot file version 9 created 02-DEC-2011 14:47:22

J1953+35 ET018A.UVDATA.1

Freq = 4.9270 GHz, Bw = 16.000 MH No calibration applied and no bandpass applied

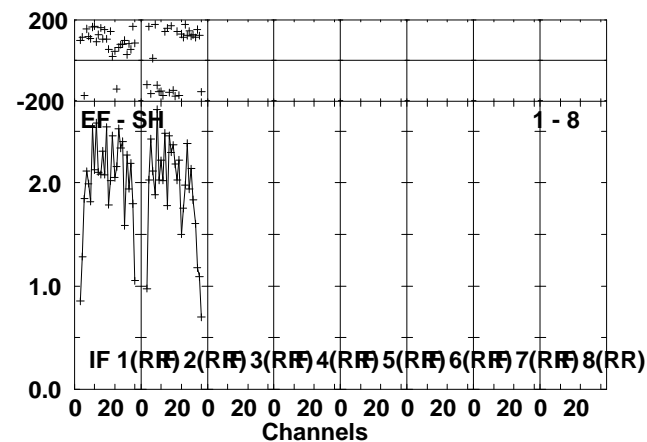
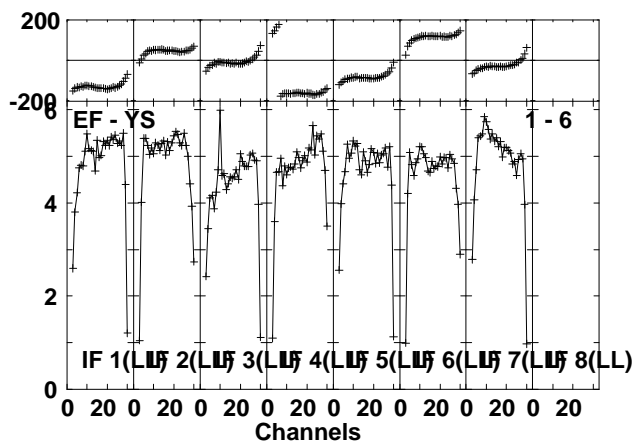
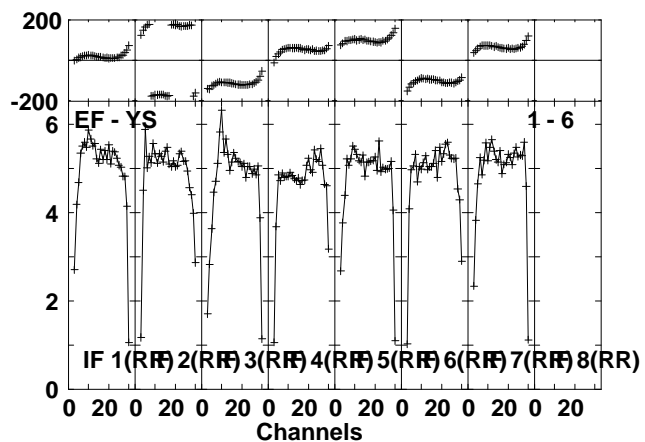
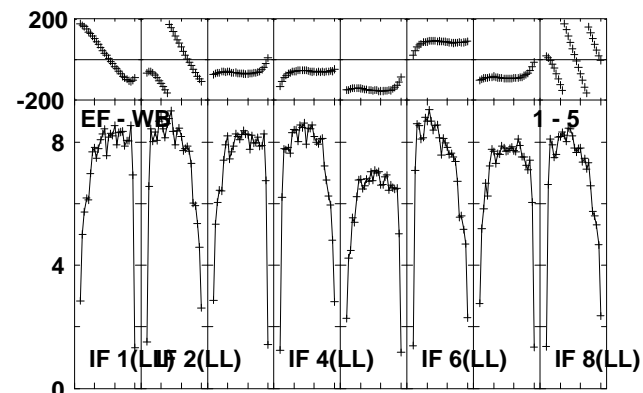
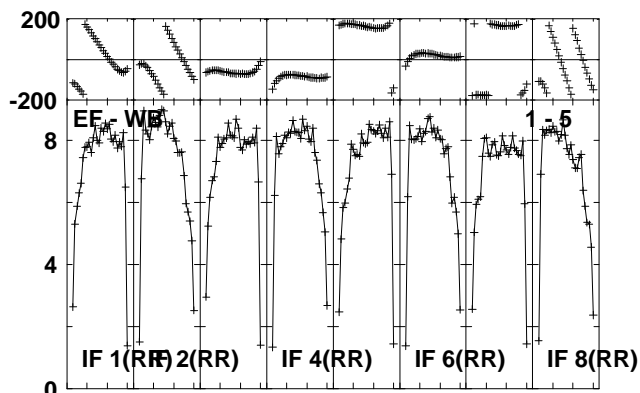
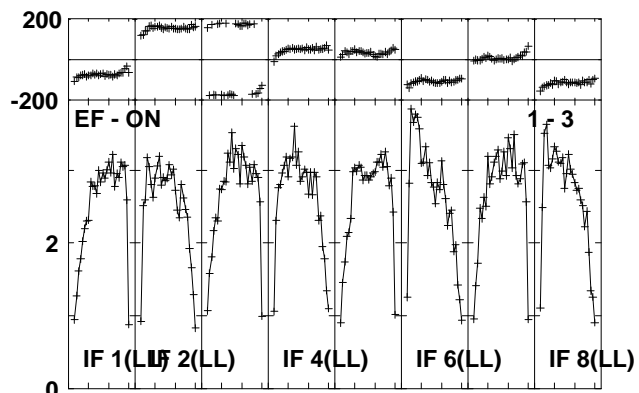
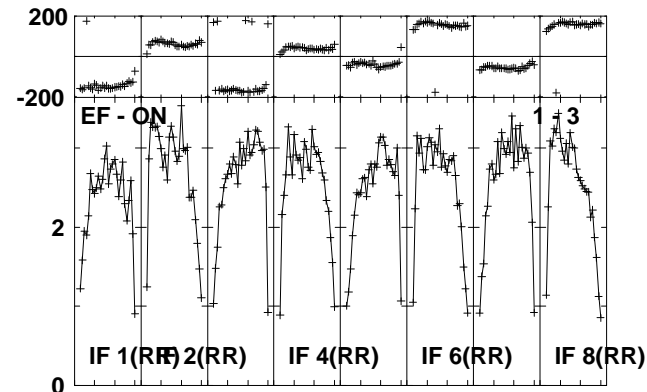
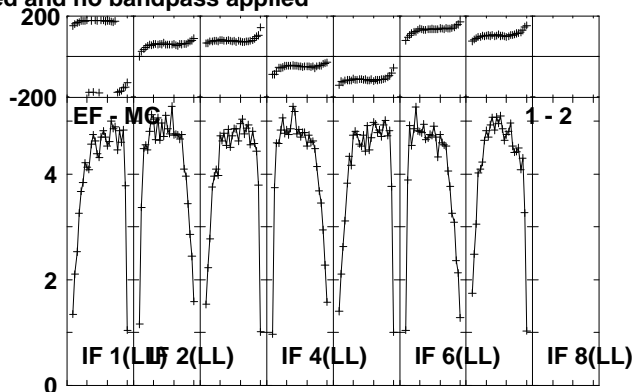
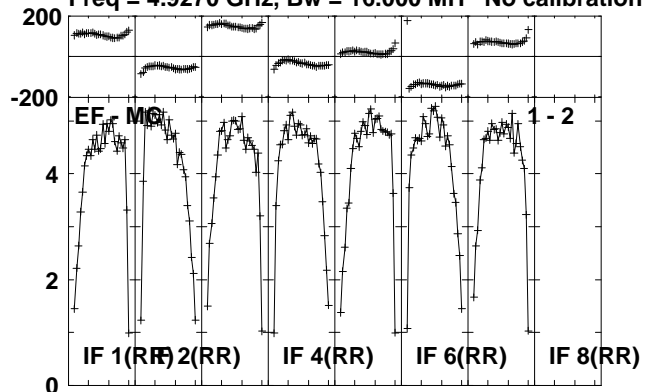

Lower frame: Milli Ampl Jy Top frame: Phas deg
Scalar averaged cross-power spectrum Several baselines displayed
Timerange: 00/12:24:52 to 00/12:26:35

Plot file version 10 created 02-DEC-2011 14:47:23

J1953+35 ET018A.UVDATA.1

Freq = 4.9270 GHz, Bw = 16.000 MH No calibration applied and no bandpass applied

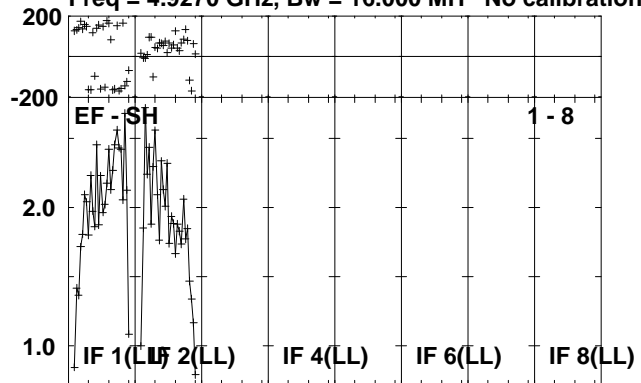

Lower frame: Milli Ampl Jy Top frame: Phas deg
Scalar averaged cross-power spectrum Several baselines displayed
Timerange: 00/12:24:52 to 00/12:26:35

Plot file version 11 created 02-DEC-2011 14:47:23

CYGX-1 ET018A.UVDATA.1

Freq = 4.9270 GHz, Bw = 16.000 MH No calibration applied and no bandpass applied

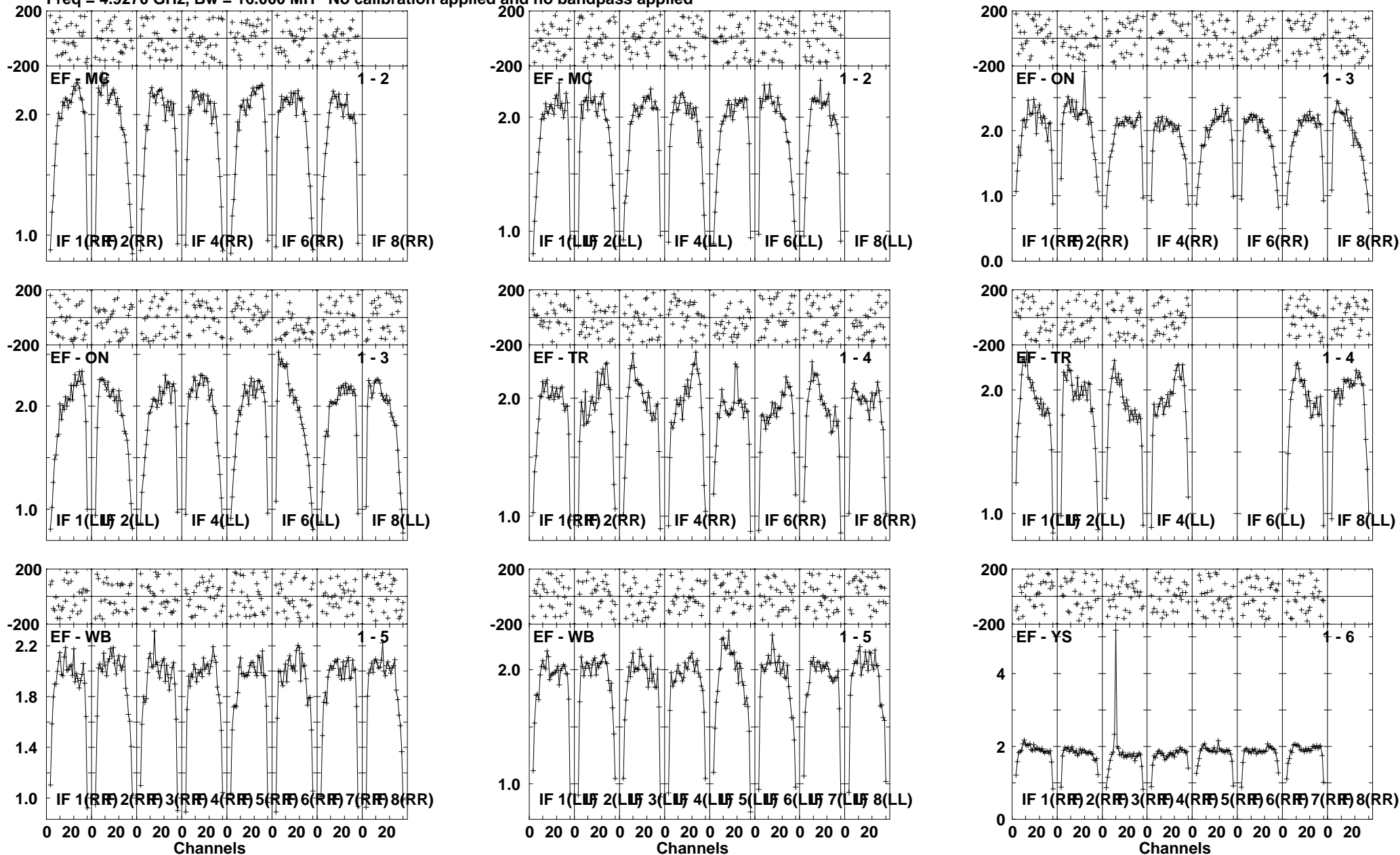

Lower frame: Milli Ampl Jy Top frame: Phas deg
Scalar averaged cross-power spectrum Several baselines displayed
Timerange: 00/12:45:21 to 00/12:50:38

Plot file version 12 created 02-DEC-2011 14:47:26

CYGX-1 ET018A.UVDATA.1

Freq = 4.9270 GHz, Bw = 16.000 MH No calibration applied and no bandpass applied

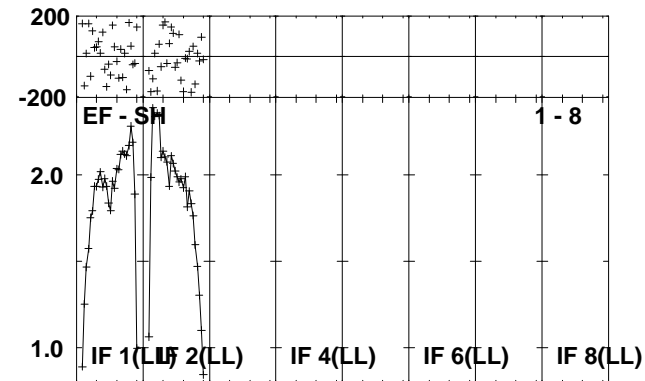
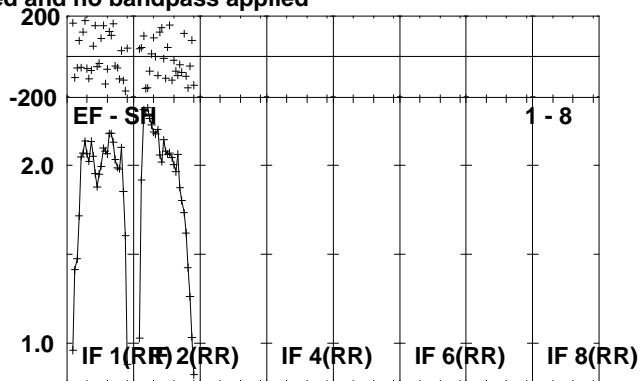
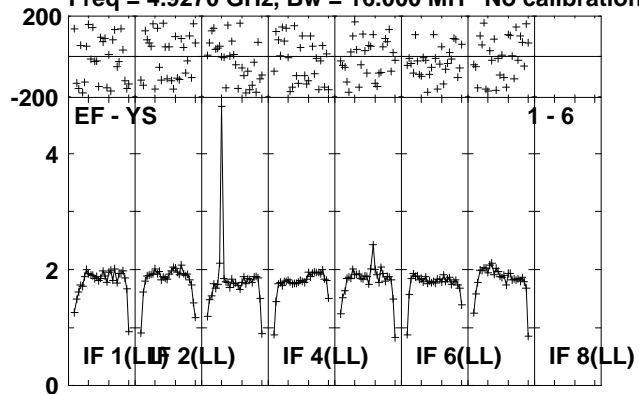

Lower frame: Milli Ampl Jy Top frame: Phas deg
Scalar averaged cross-power spectrum Several baselines displayed
Timerange: 00/12:45:21 to 00/12:50:38

Plot file version 13 created 02-DEC-2011 14:47:28

J1953+35 ET018A.UVDATA.1

Freq = 4.9270 GHz, Bw = 16.000 MH No calibration applied and no bandpass applied

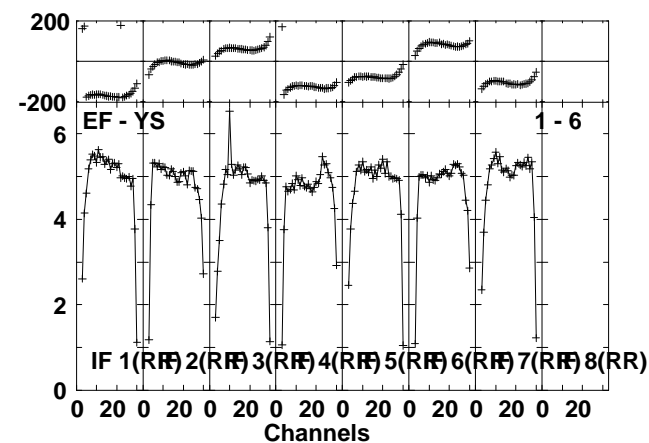
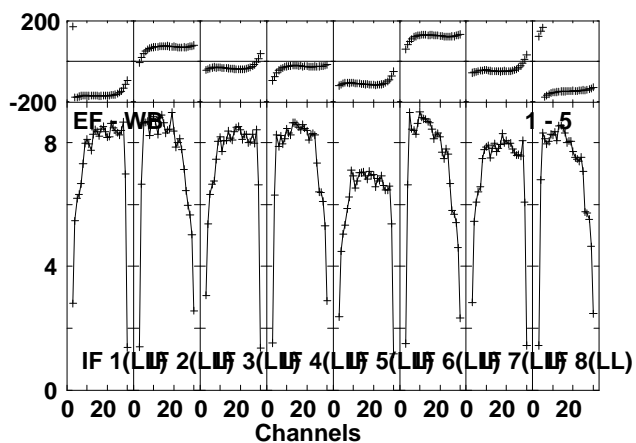
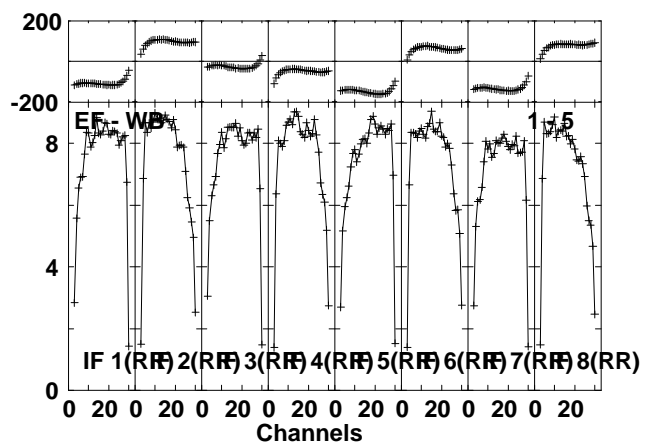
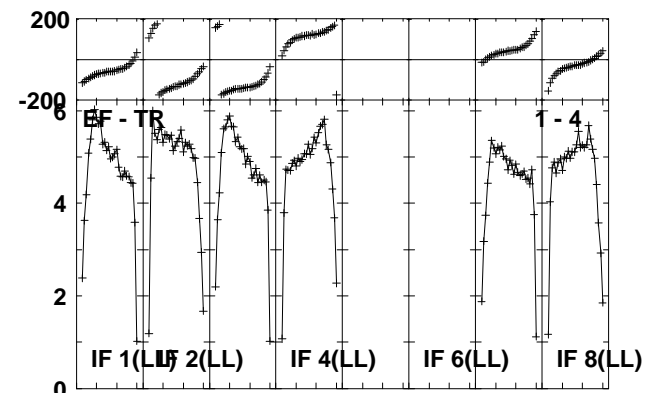
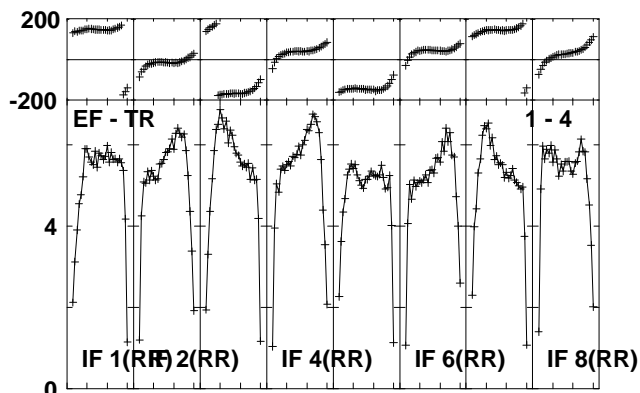
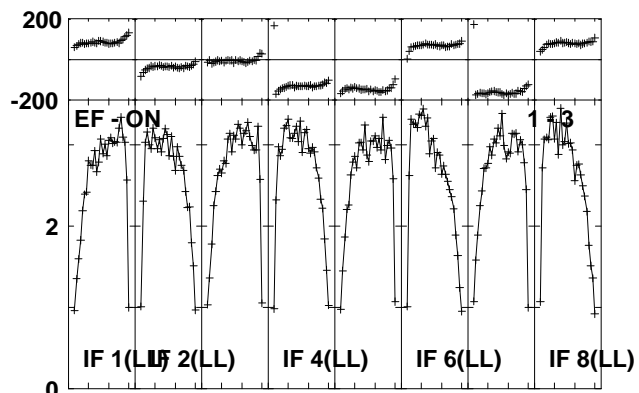
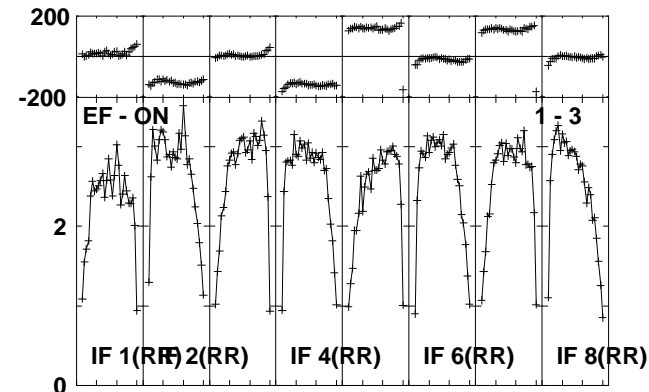
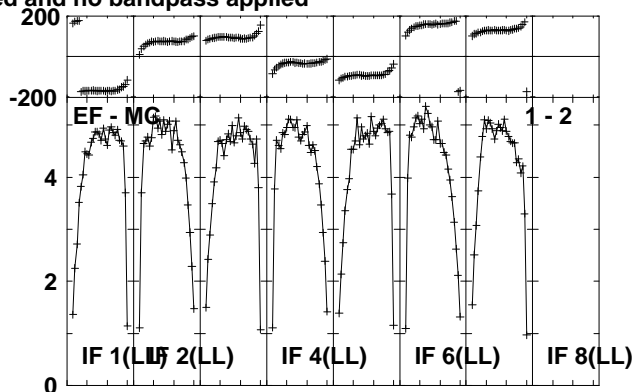
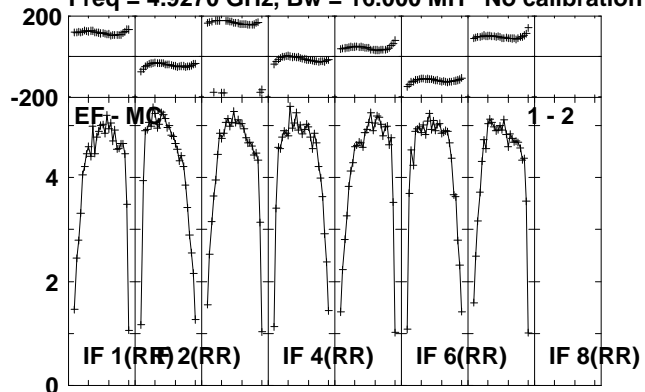

Lower frame: Milli Ampl Jy Top frame: Phas deg
Scalar averaged cross-power spectrum Several baselines displayed
Timerange: 00/12:51:26 to 00/12:53:58

Plot file version 14 created 02-DEC-2011 14:47:29

J1953+35 ET018A.UVDATA.1

Freq = 4.9270 GHz, Bw = 16.000 MH No calibration applied and no bandpass applied

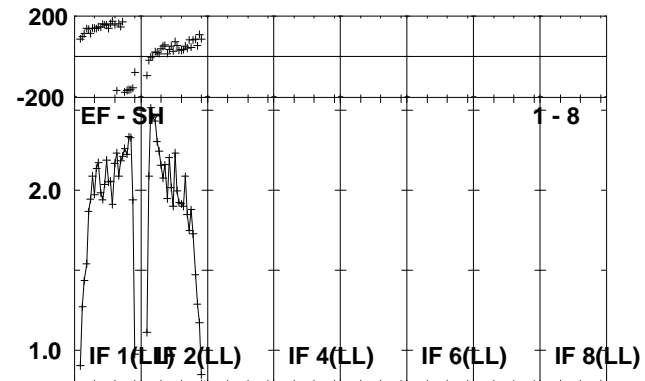
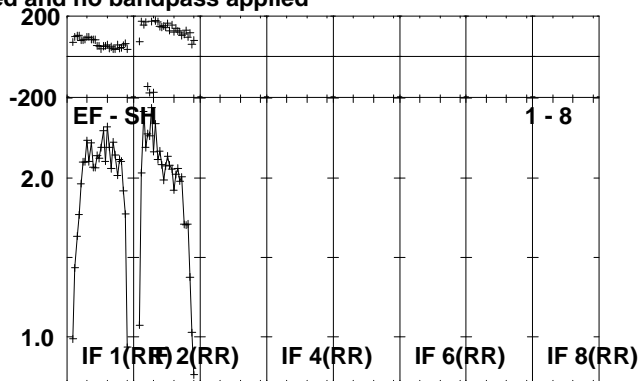
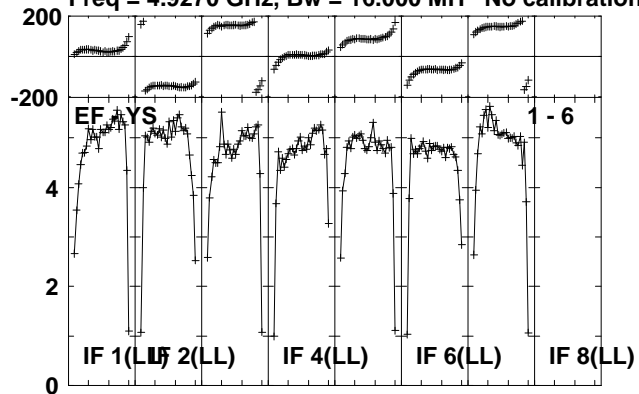

Lower frame: Milli Ampl Jy Top frame: Phas deg
Scalar averaged cross-power spectrum Several baselines displayed
Timerange: 00/12:51:26 to 00/12:53:58

Plot file version 15 created 02-DEC-2011 14:47:31

CYGX-1 ET018A.UVDATA.1

Freq = 4.9270 GHz, Bw = 16.000 MH No calibration applied and no bandpass applied

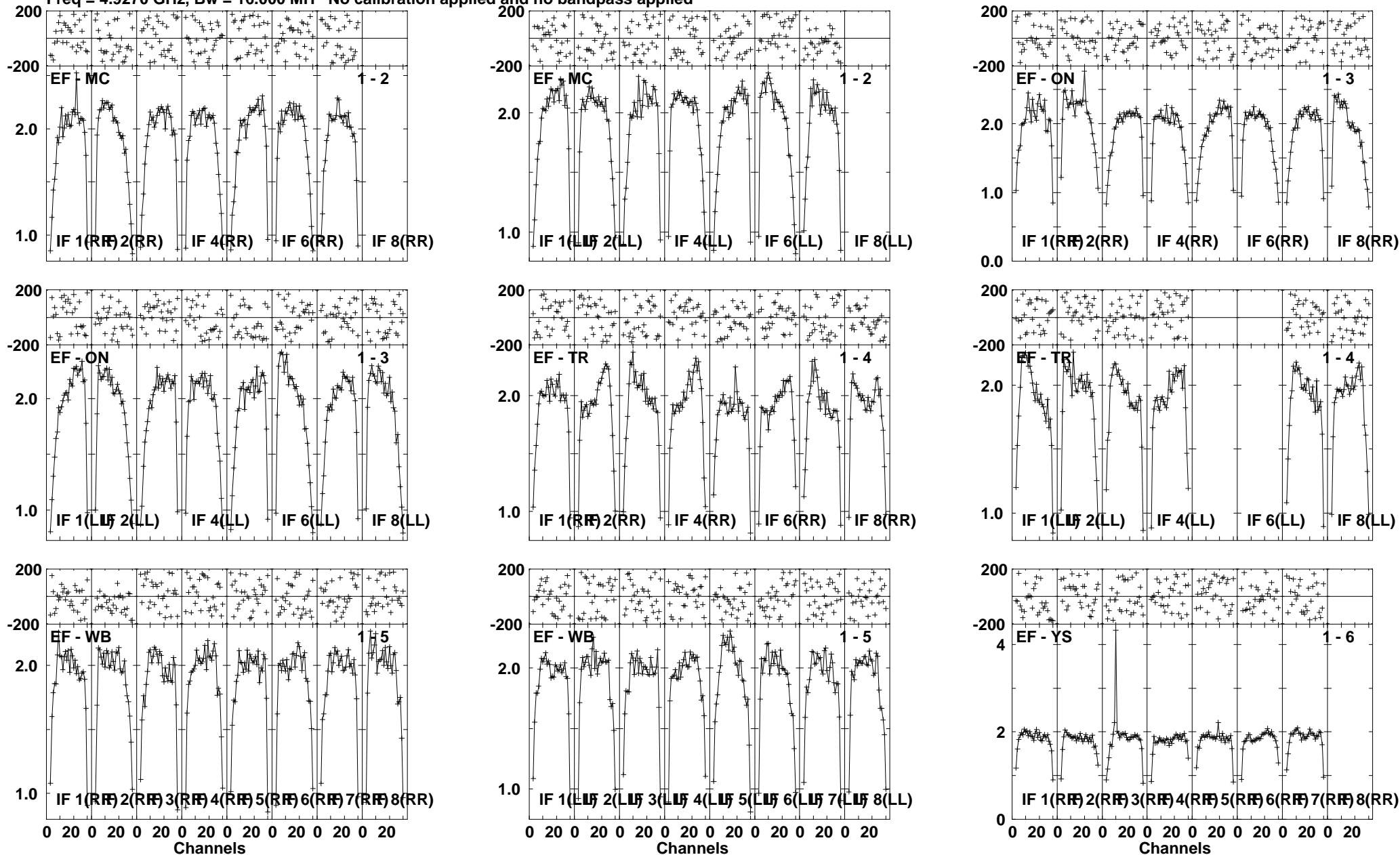

Lower frame: Milli Ampl Jy Top frame: Phas deg
Scalar averaged cross-power spectrum Several baselines displayed
Timerange: 00/12:54:02 to 00/12:59:23

Plot file version 16 created 02-DEC-2011 14:47:34

CYGX-1 ET018A.UVDATA.1

Freq = 4.9270 GHz, Bw = 16.000 MH No calibration applied and no bandpass applied

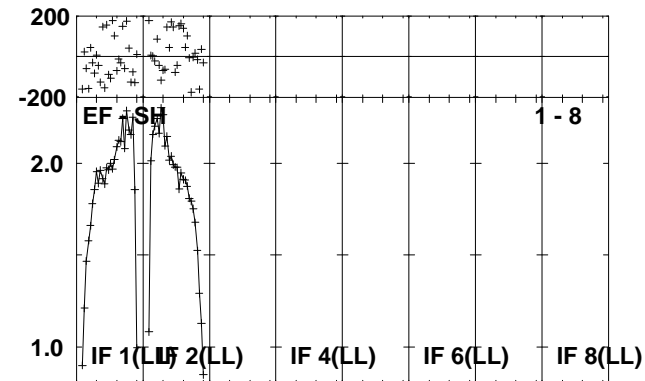
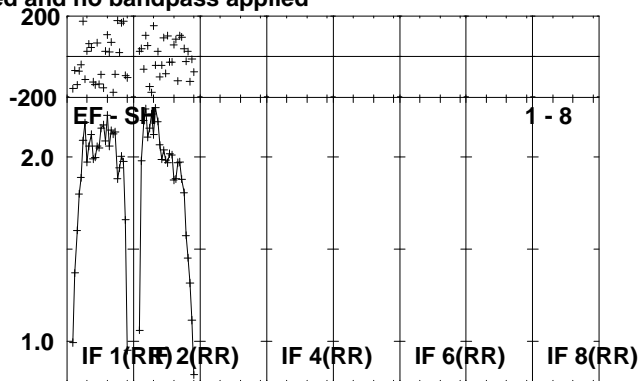
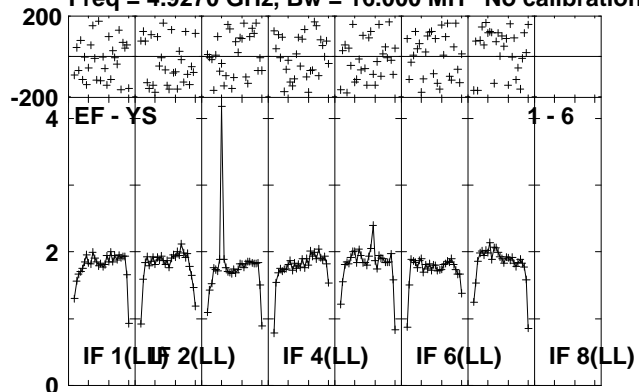

Lower frame: Milli Ampl Jy Top frame: Phas deg
Scalar averaged cross-power spectrum Several baselines displayed
Timerange: 00/12:54:02 to 00/12:59:23

Plot file version 17 created 02-DEC-2011 14:47:35

J1953+35 ET018A.UVDATA.1

Freq = 4.9270 GHz, Bw = 16.000 MH No calibration applied and no bandpass applied

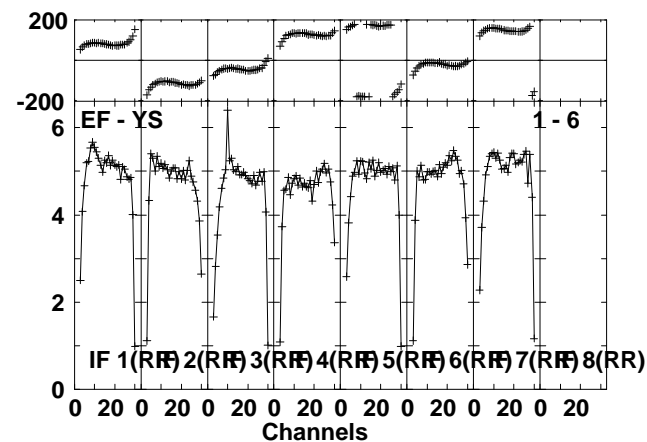
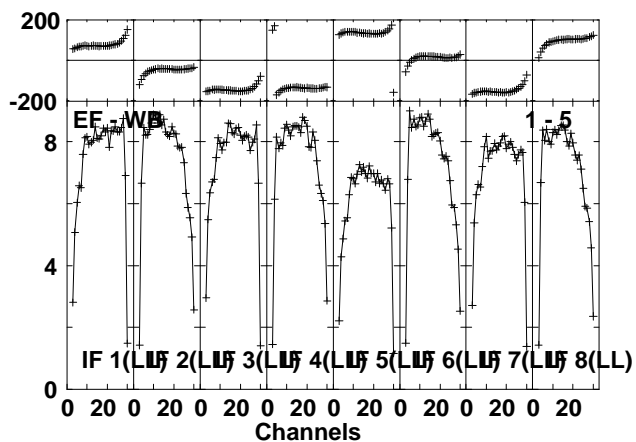
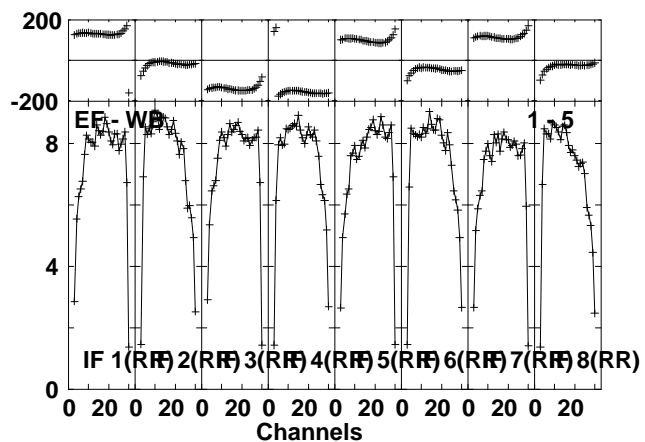
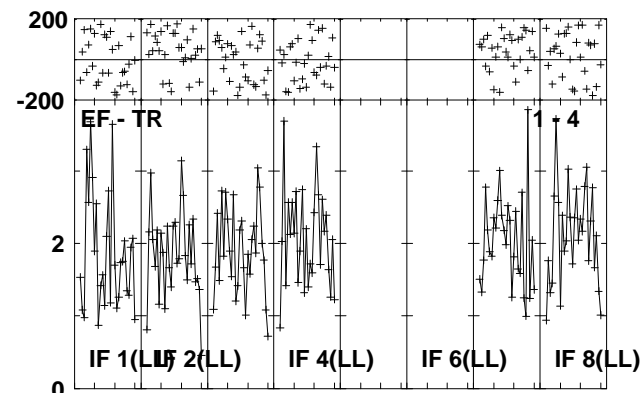
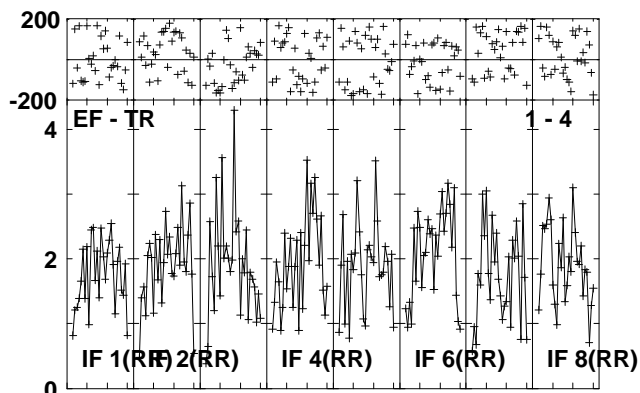
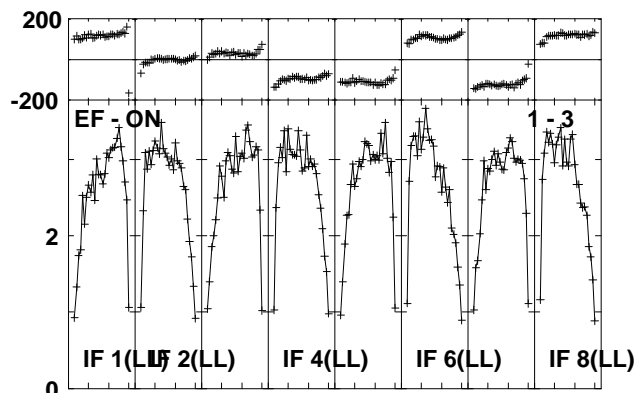
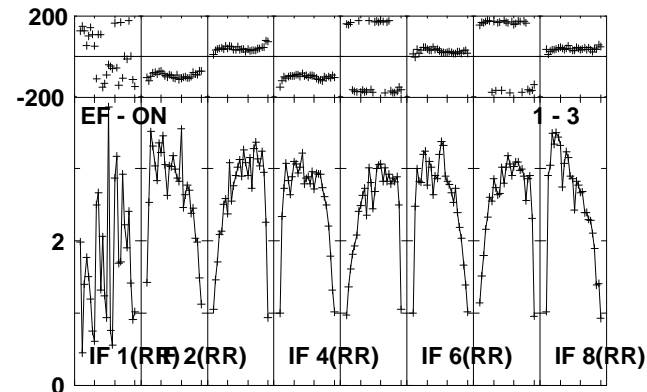
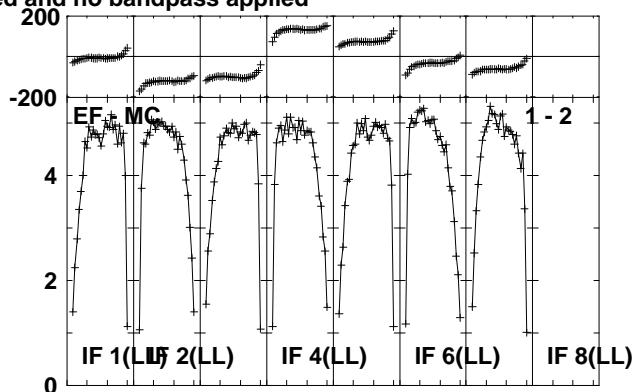
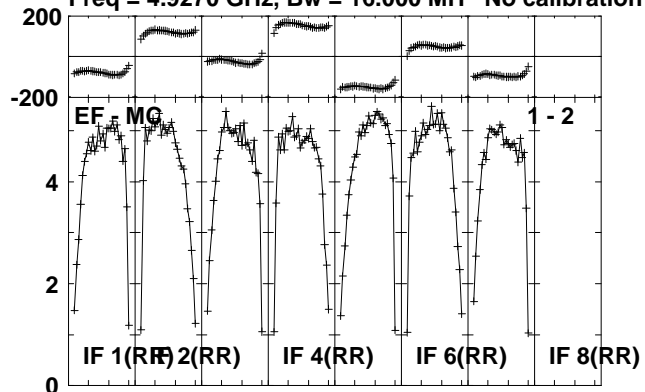

Lower frame: Milli Ampl Jy Top frame: Phas deg
Scalar averaged cross-power spectrum Several baselines displayed
Timerange: 00/12:59:32 to 00/13:02:29

Plot file version 18 created 02-DEC-2011 14:47:36

J1953+35 ET018A.UVDATA.1

Freq = 4.9270 GHz, Bw = 16.000 MH No calibration applied and no bandpass applied

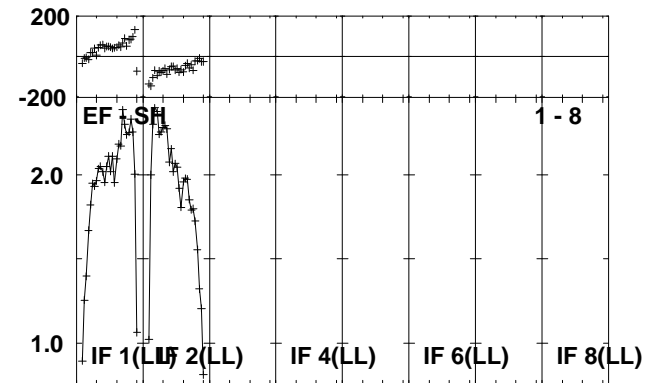
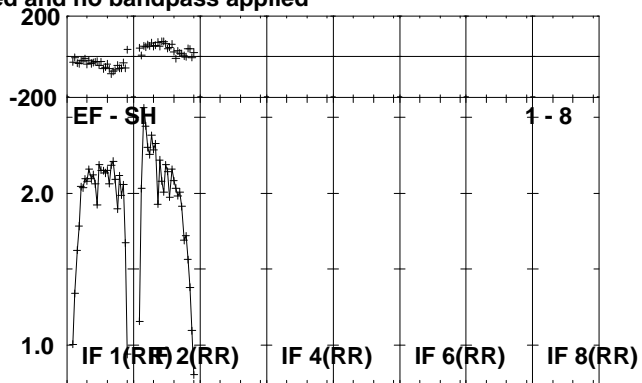
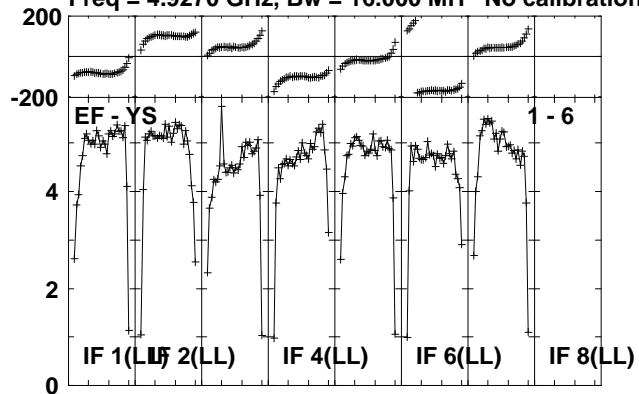

Lower frame: Milli Ampl Jy Top frame: Phas deg
Scalar averaged cross-power spectrum Several baselines displayed
Timerange: 00/12:59:32 to 00/13:02:29

Plot file version 19 created 02-DEC-2011 14:47:38

CYGX-1 ET018A.UVDATA.1

Freq = 4.9270 GHz, Bw = 16.000 MH No calibration applied and no bandpass applied

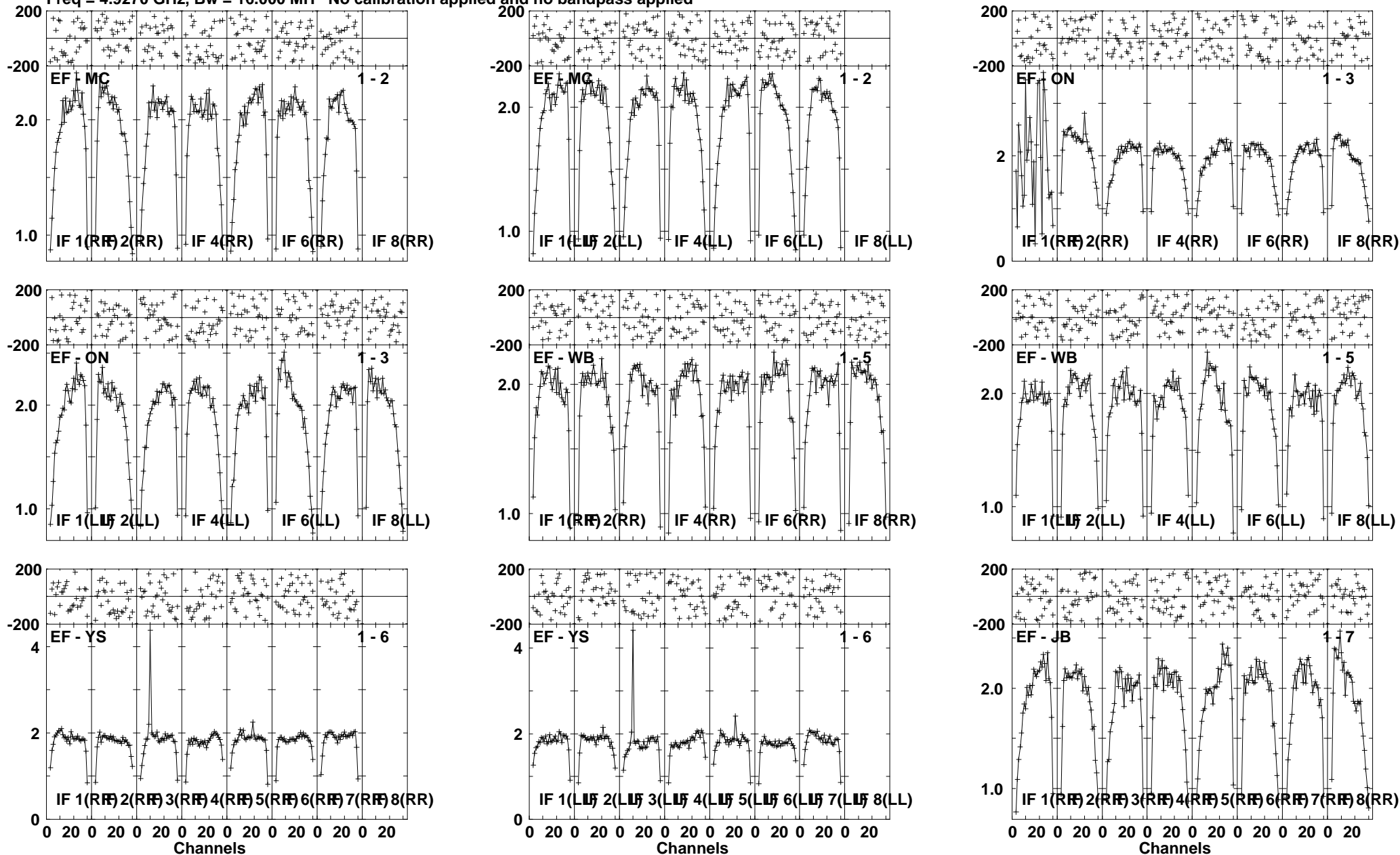

Lower frame: Milli Ampl Jy Top frame: Phas deg
Scalar averaged cross-power spectrum Several baselines displayed
Timerange: 00/13:02:32 to 00/13:07:58

Plot file version 20 created 02-DEC-2011 14:47:41

CYGX-1 ET018A.UVDATA.1

Freq = 4.9270 GHz, Bw = 16.000 MH No calibration applied and no bandpass applied

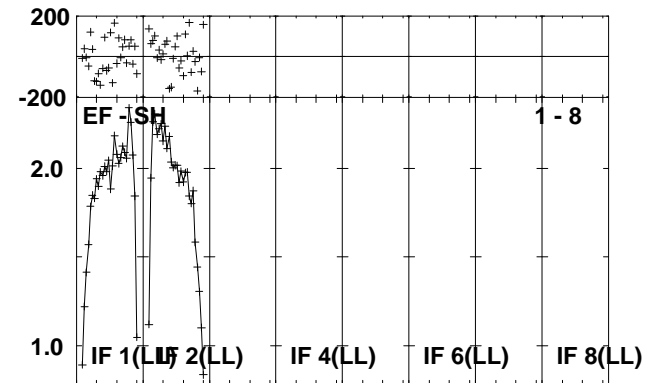
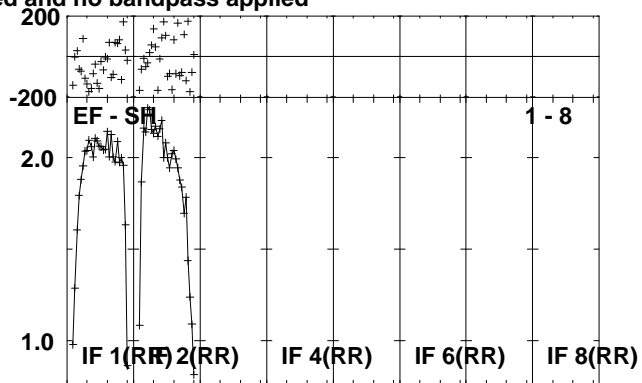
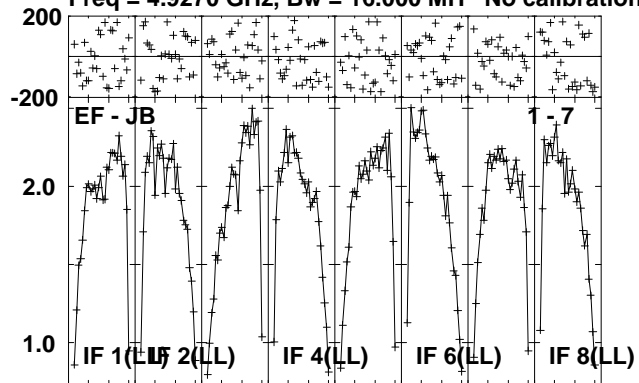

Lower frame: Milli Ampl Jy Top frame: Phas deg
Scalar averaged cross-power spectrum Several baselines displayed
Timerange: 00/13:02:32 to 00/13:07:58

Plot file version 21 created 02-DEC-2011 14:47:43

J1953+35 ET018A.UVDATA.1

Freq = 4.9270 GHz, Bw = 16.000 MH No calibration applied and no bandpass applied

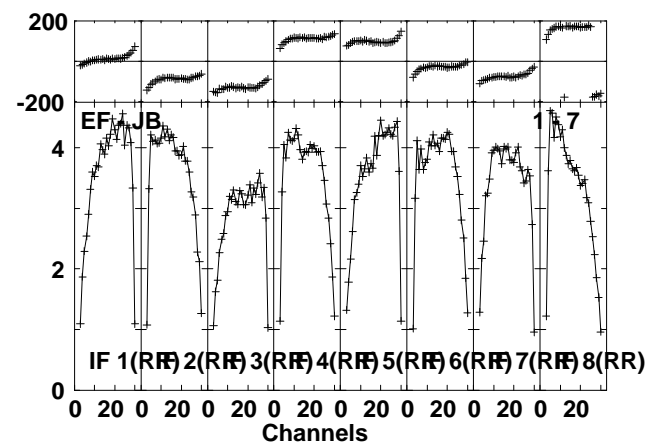
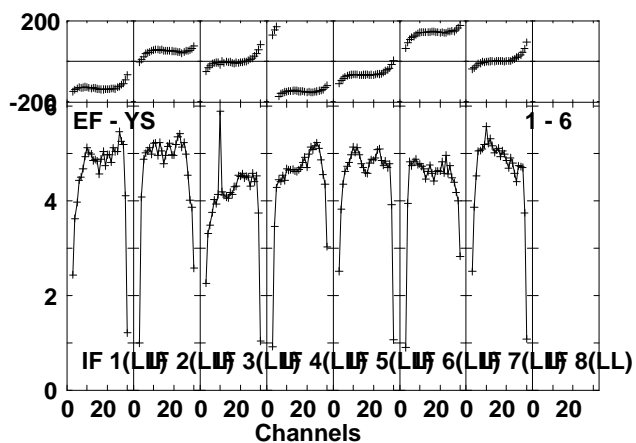
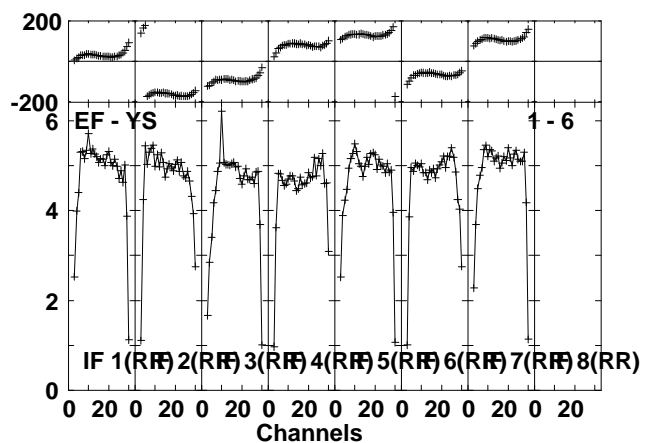
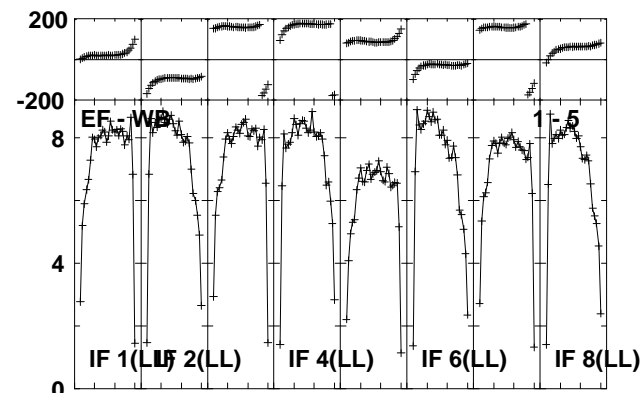
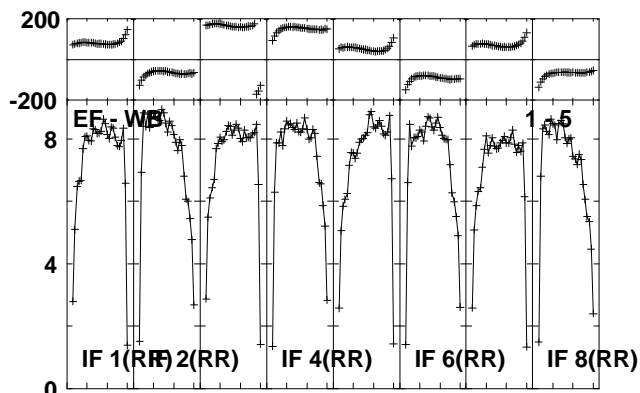
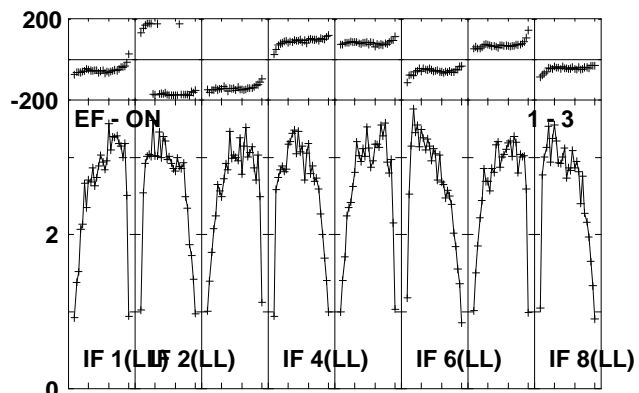
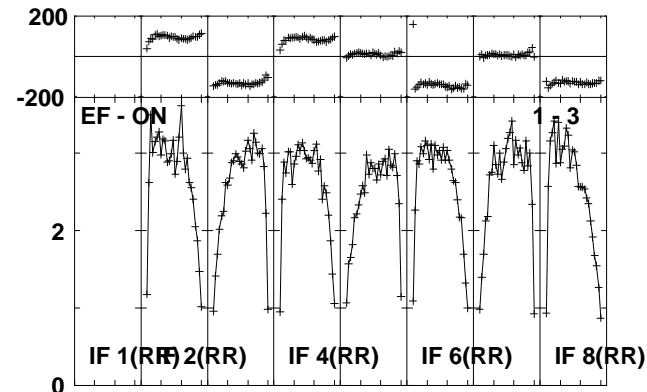
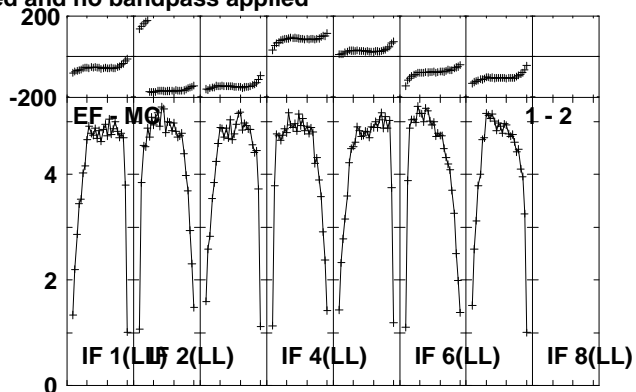
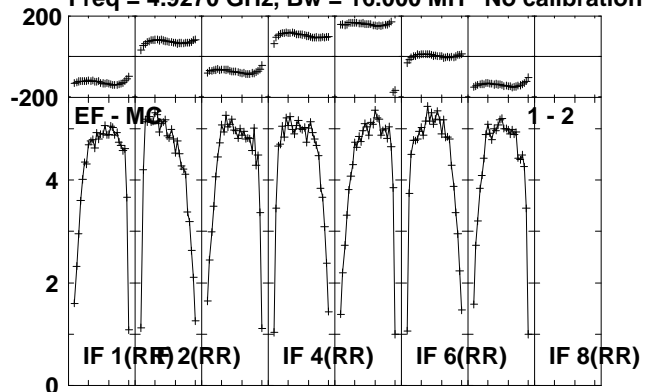

Lower frame: Milli Ampl Jy Top frame: Phas deg
Scalar averaged cross-power spectrum Several baselines displayed
Timerange: 00/13:08:46 to 00/13:11:18

Plot file version 22 created 02-DEC-2011 14:47:45

J1953+35 ET018A.UVDATA.1

Freq = 4.9270 GHz, Bw = 16.000 MH No calibration applied and no bandpass applied

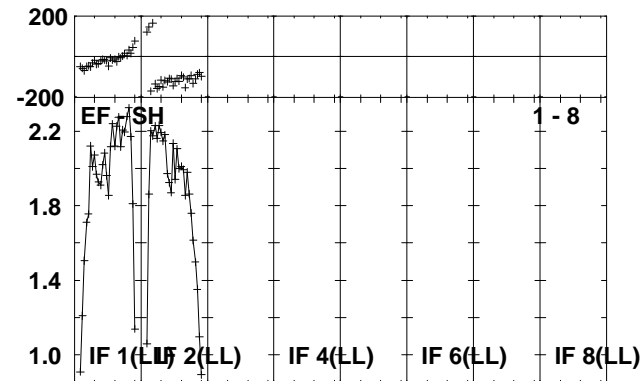
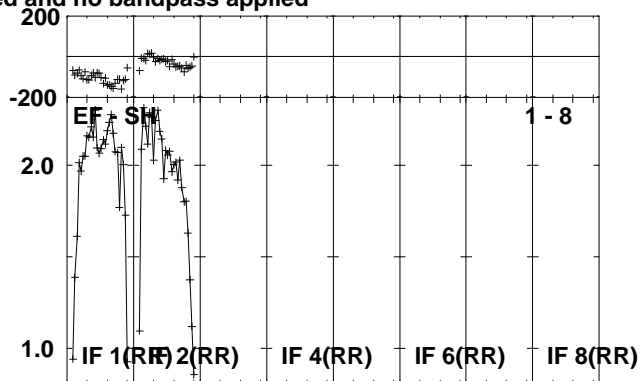
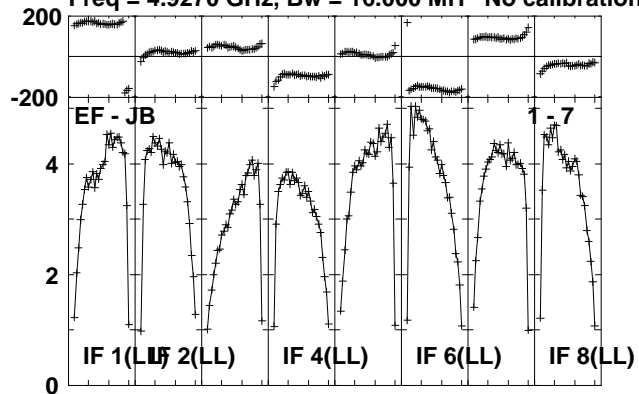

Lower frame: Milli Ampl Jy Top frame: Phas deg
Scalar averaged cross-power spectrum Several baselines displayed
Timerange: 00/13:08:46 to 00/13:11:18

Plot file version 23 created 02-DEC-2011 14:47:46

CYGX-1 ET018A.UVDATA.1

Freq = 4.9270 GHz, Bw = 16.000 MH No calibration applied and no bandpass applied

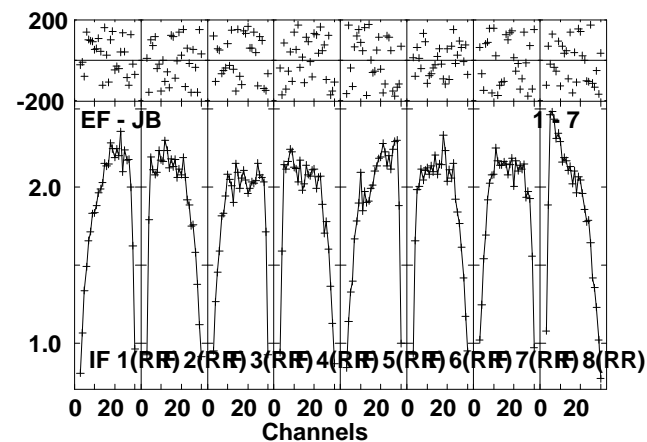
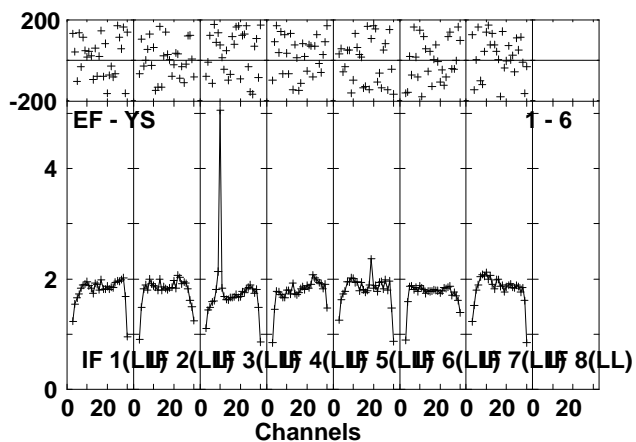
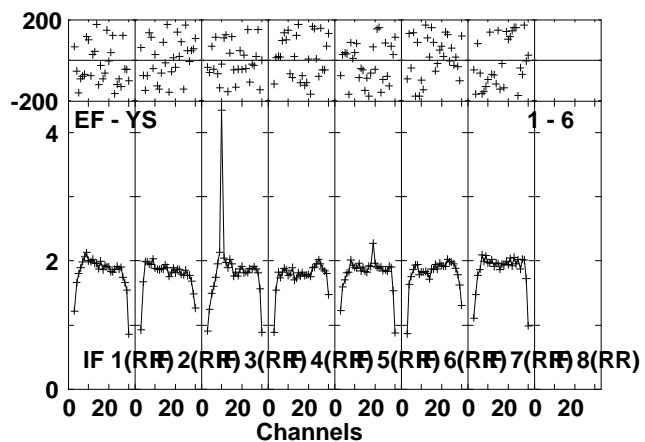
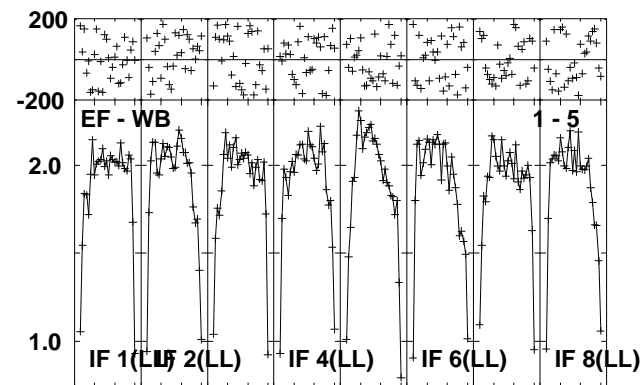
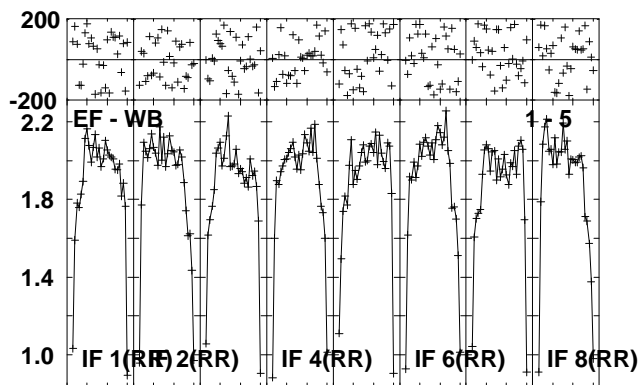
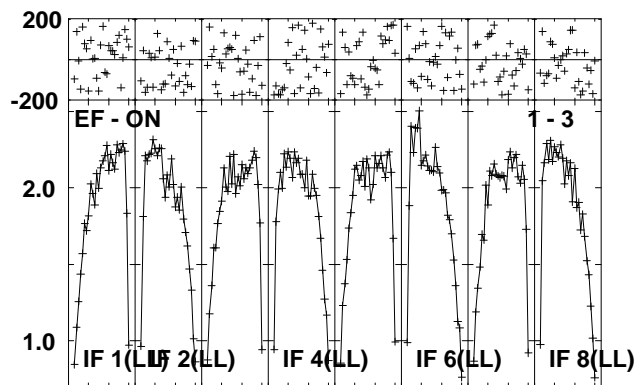
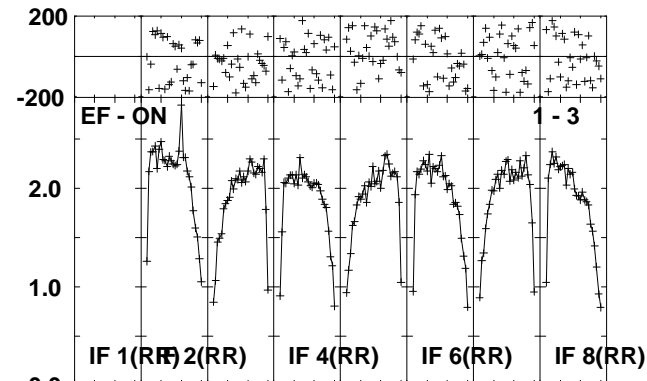
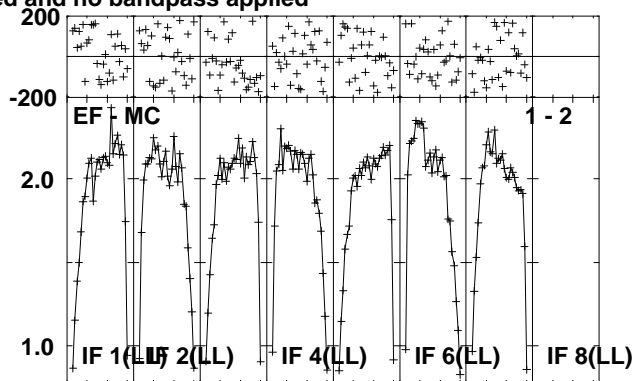
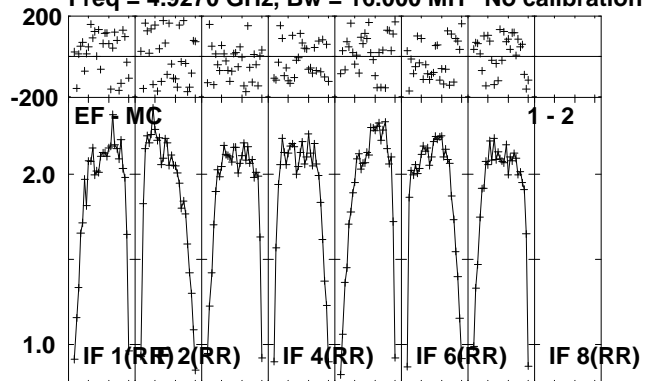

Lower frame: Milli Ampl Jy Top frame: Phas deg
Scalar averaged cross-power spectrum Several baselines displayed
Timerange: 00/13:11:22 to 00/13:16:49

Plot file version 24 created 02-DEC-2011 14:47:50

CYGX-1 ET018A.UVDATA.1

Freq = 4.9270 GHz, Bw = 16.000 MH No calibration applied and no bandpass applied

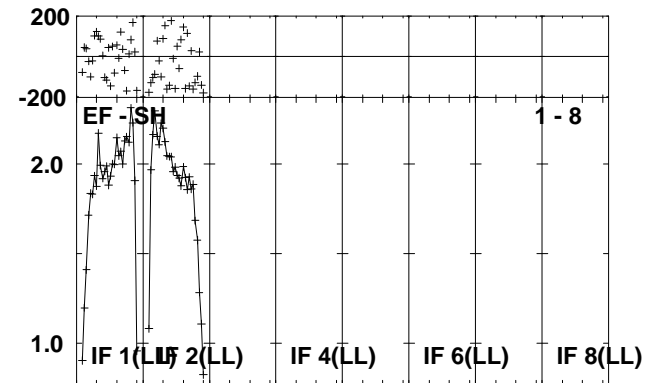
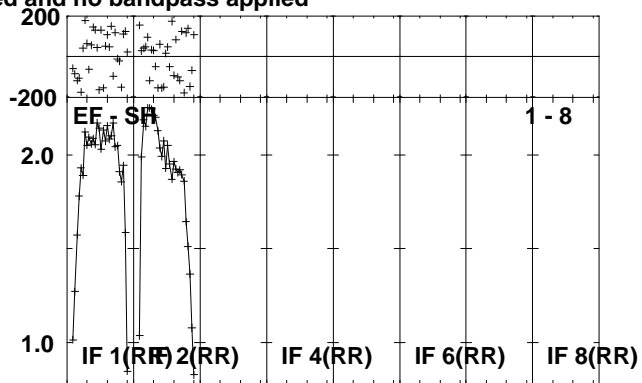
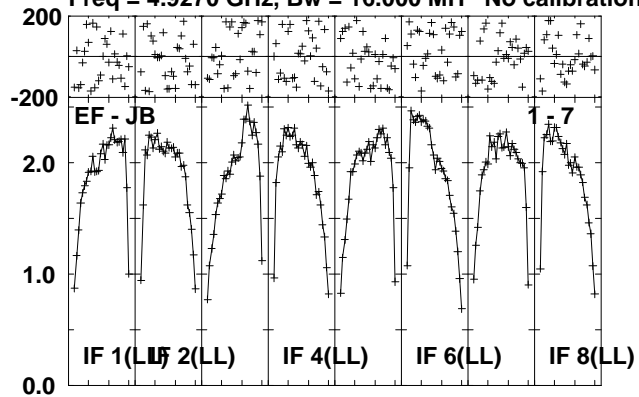

Lower frame: Milli Ampl Jy Top frame: Phas deg
Scalar averaged cross-power spectrum Several baselines displayed
Timerange: 00/13:11:22 to 00/13:16:49

Plot file version 25 created 02-DEC-2011 14:47:51

J1953+35 ET018A.UVDATA.1

Freq = 4.9270 GHz, Bw = 16.000 MH No calibration applied and no bandpass applied

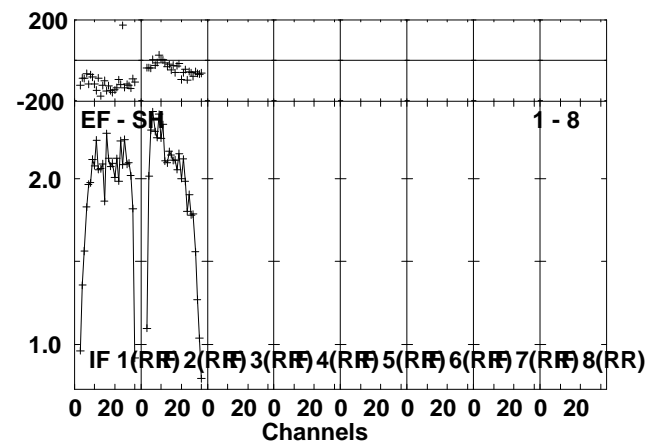
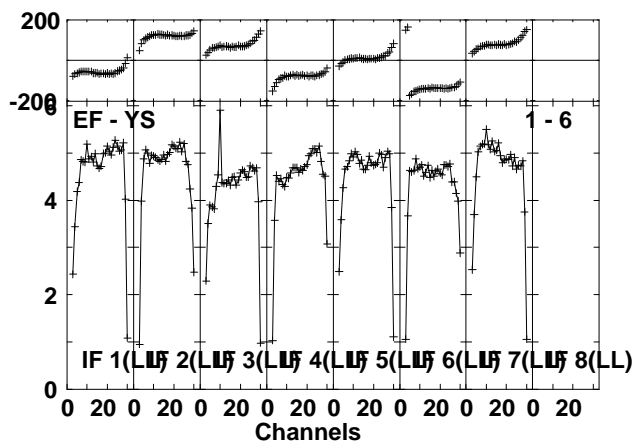
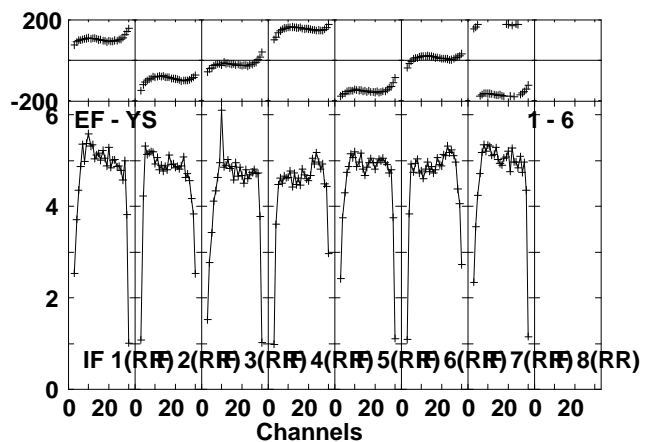
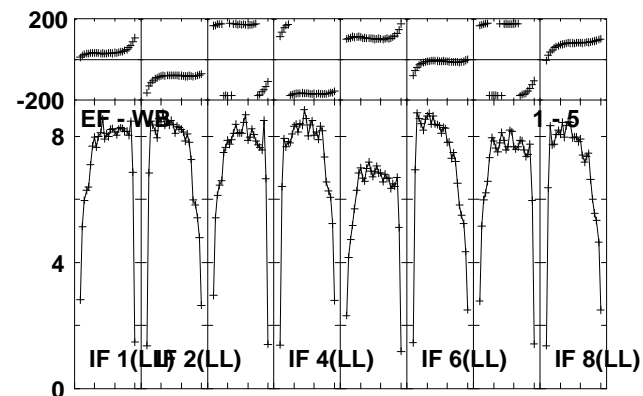
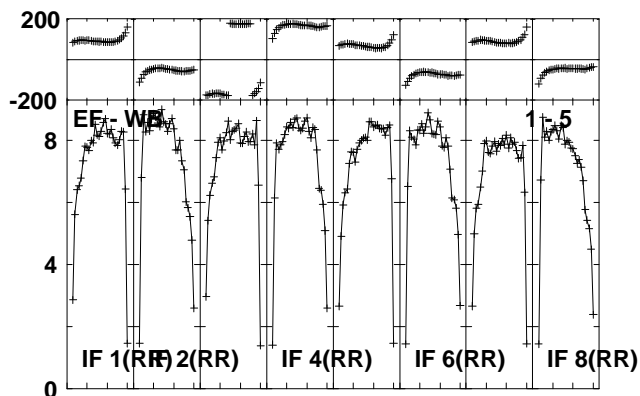
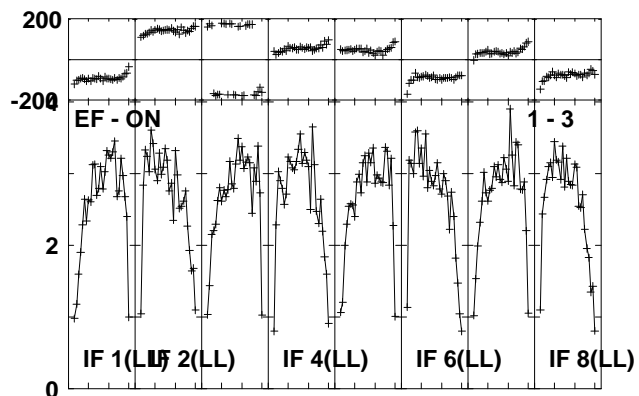
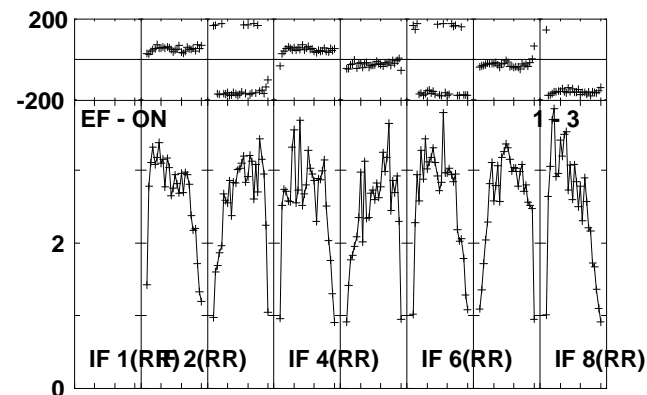
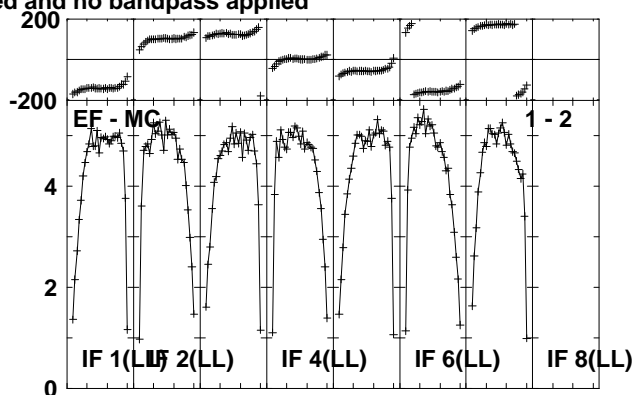
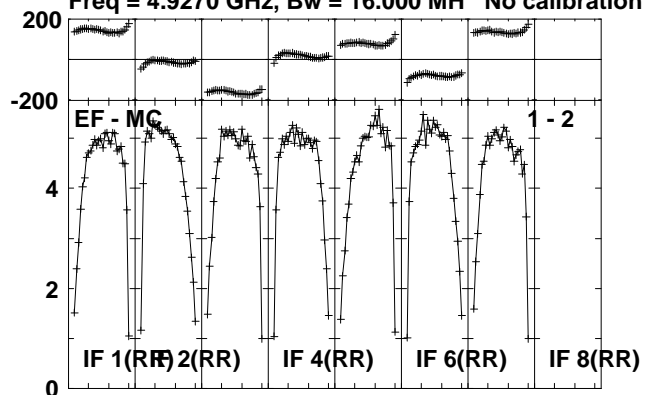

Lower frame: Milli Ampl Jy Top frame: Phas deg
Scalar averaged cross-power spectrum Several baselines displayed
Timerange: 00/13:16:51 to 00/13:19:48

Plot file version 26 created 02-DEC-2011 14:47:53

J1953+35 ET018A.UVDATA.1

Freq = 4.9270 GHz, Bw = 16.000 MH No calibration applied and no bandpass applied

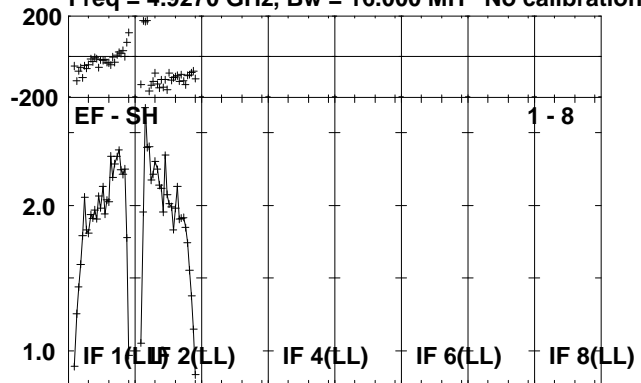

Lower frame: Milli Ampl Jy Top frame: Phas deg
Scalar averaged cross-power spectrum Several baselines displayed
Timerange: 00/13:16:51 to 00/13:19:48

Plot file version 27 created 02-DEC-2011 14:47:54

CYGX-1 ET018A.UVDATA.1

Freq = 4.9270 GHz, Bw = 16.000 MH No calibration applied and no bandpass applied

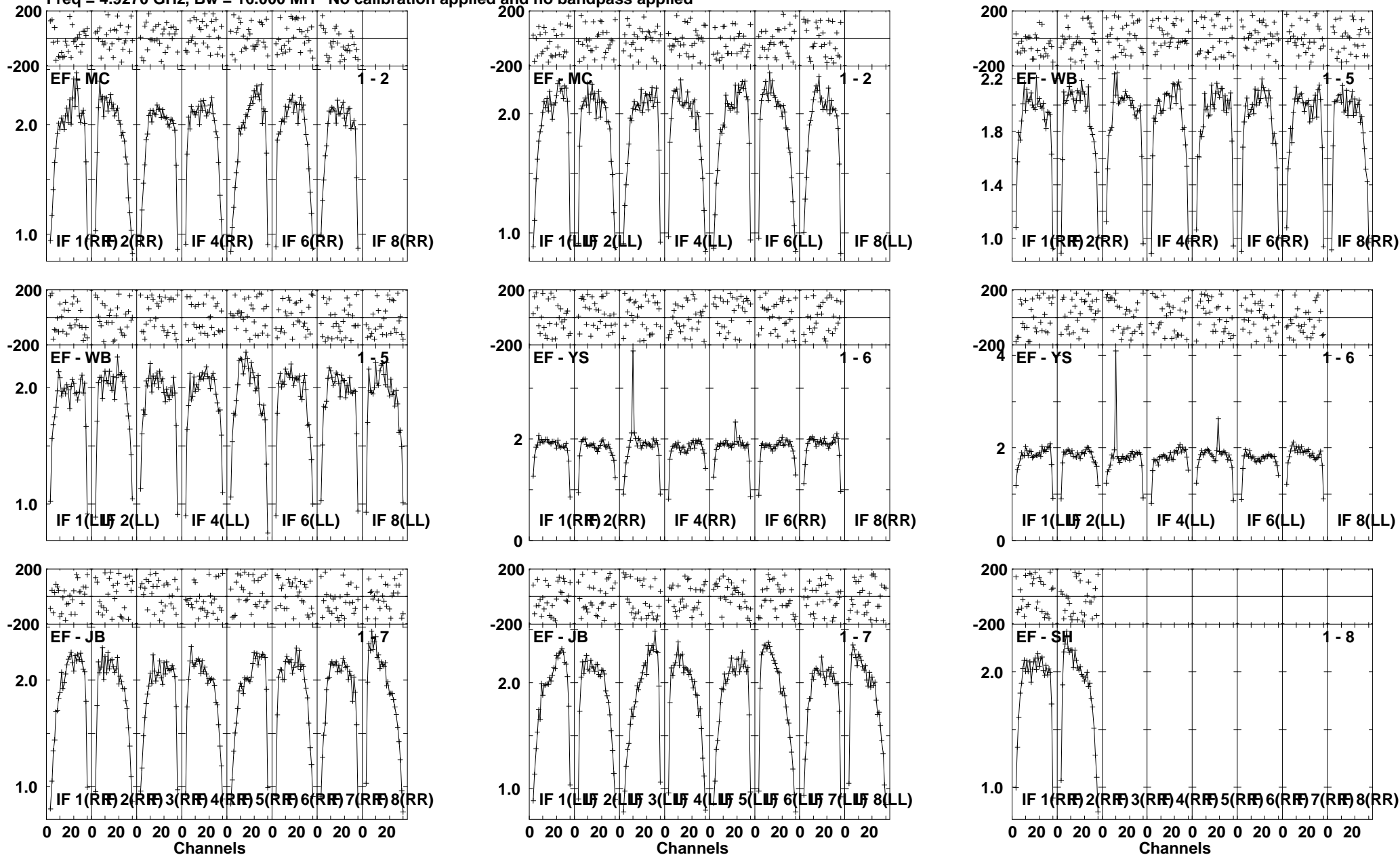

Lower frame: Milli Ampl Jy Top frame: Phas deg
Scalar averaged cross-power spectrum Several baselines displayed
Timerange: 00/13:19:52 to 00/13:25:18

Plot file version 28 created 02-DEC-2011 14:47:59

CYGX-1 ET018A.UVDATA.1

Freq = 4.9270 GHz, Bw = 16.000 MH No calibration applied and no bandpass applied

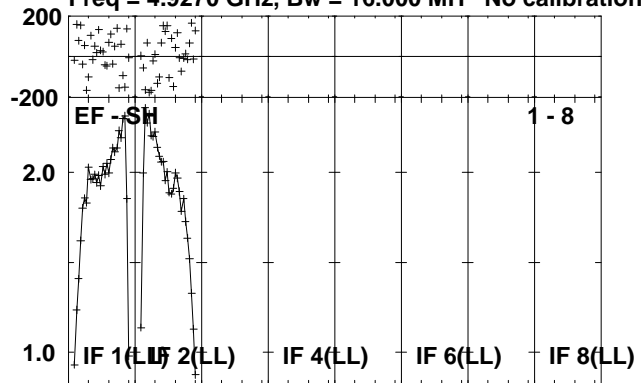

Lower frame: Milli Ampl Jy Top frame: Phas deg
Scalar averaged cross-power spectrum Several baselines displayed
Timerange: 00/13:19:52 to 00/13:25:18

Plot file version 29 created 02-DEC-2011 14:47:59

J2002+47 ET018A.UVDATA.1

Freq = 4.9270 GHz, Bw = 16.000 MH No calibration applied and no bandpass applied

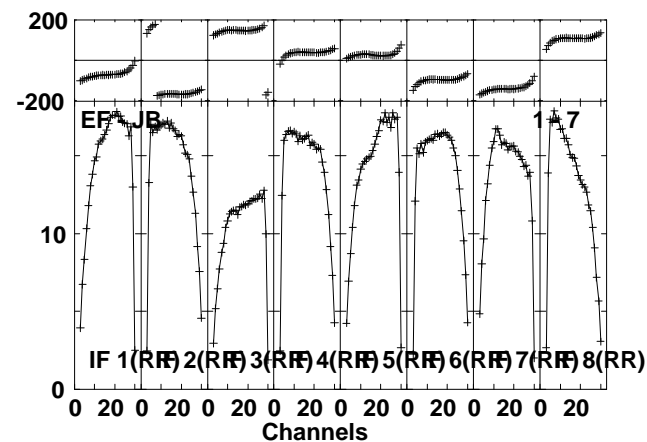
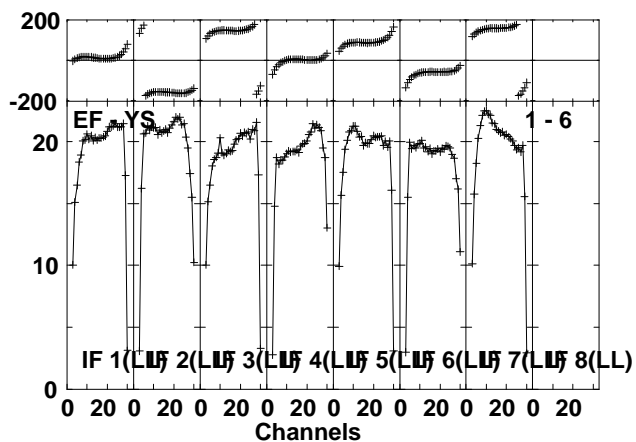
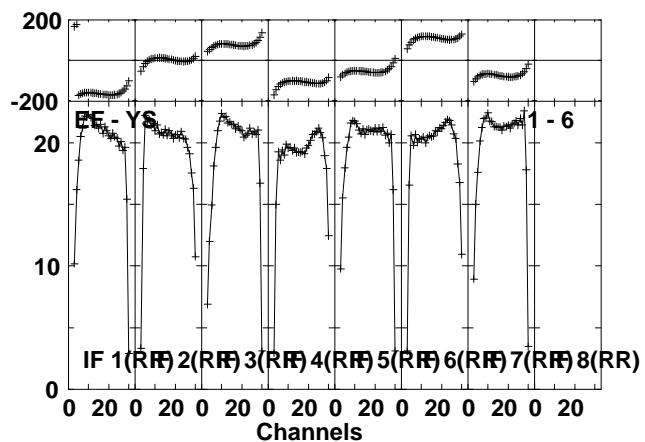
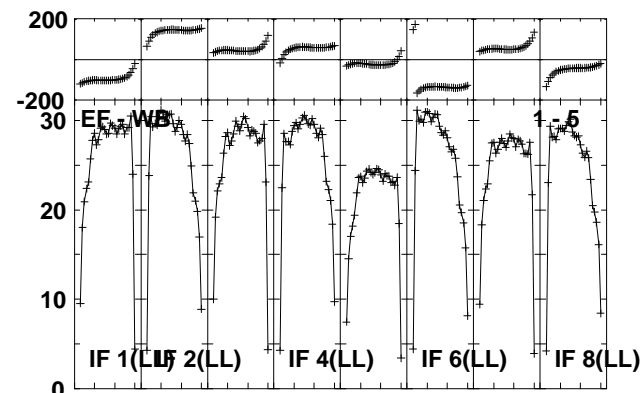
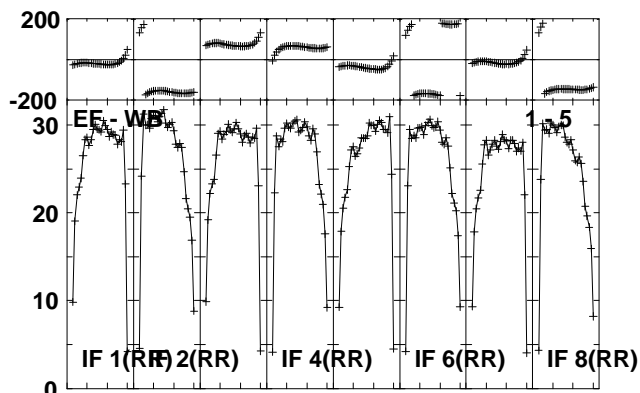
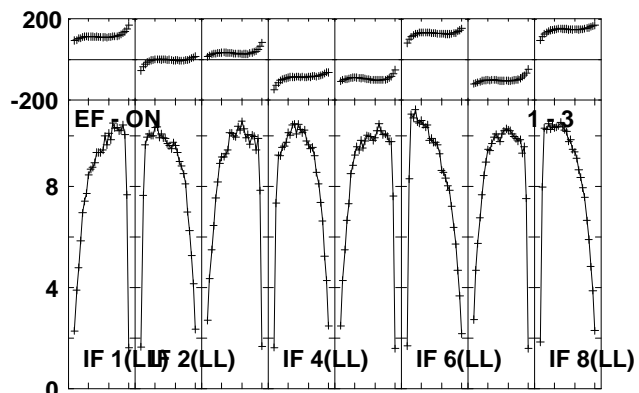
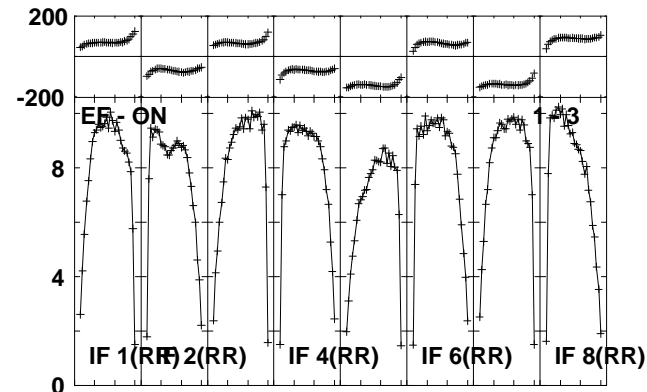
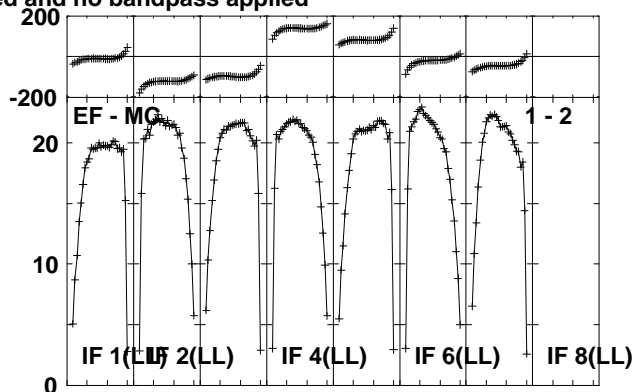
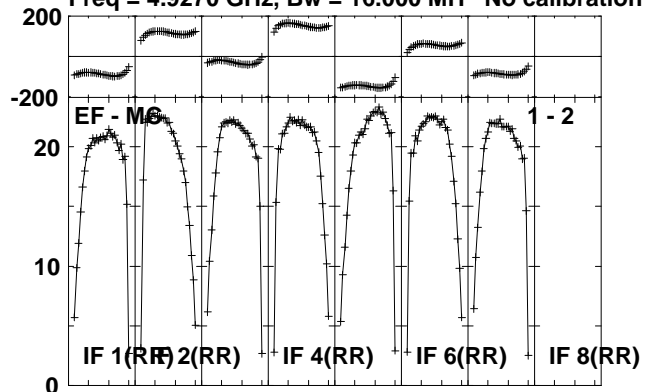

Lower frame: Milli Ampl Jy Top frame: Phas deg
Scalar averaged cross-power spectrum Several baselines displayed
Timerange: 00/13:32:11 to 00/13:34:09

Plot file version 30 created 02-DEC-2011 14:48:01
J2002+47 ET018A.UVDATA.1

Freq = 4.9270 GHz, Bw = 16.000 MH No calibration applied and no bandpass applied

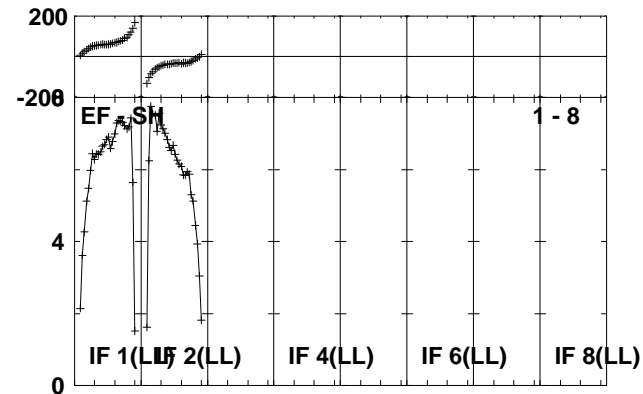
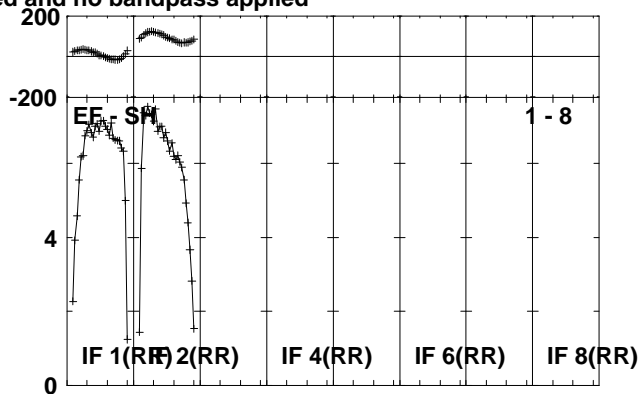
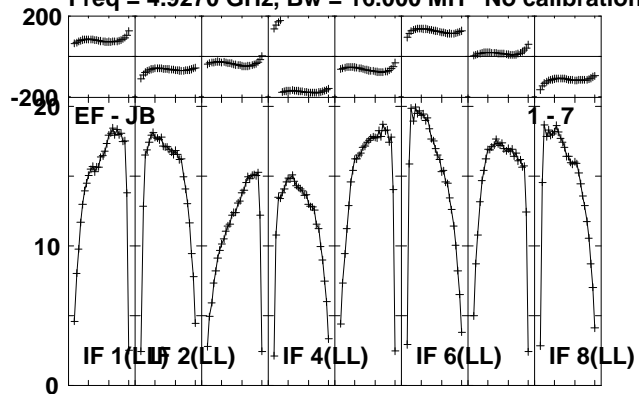

Lower frame: Milli Ampl Jy Top frame: Phas deg
Scalar averaged cross-power spectrum Several baselines displayed
Timerange: 00/13:32:11 to 00/13:34:09

Plot file version 31 created 02-DEC-2011 14:48:02

J1953+35 ET018A.UVDATA.1

Freq = 4.9270 GHz, Bw = 16.000 MH No calibration applied and no bandpass applied

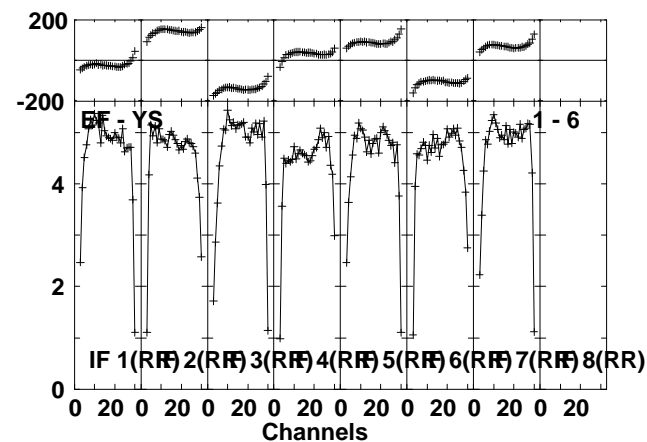
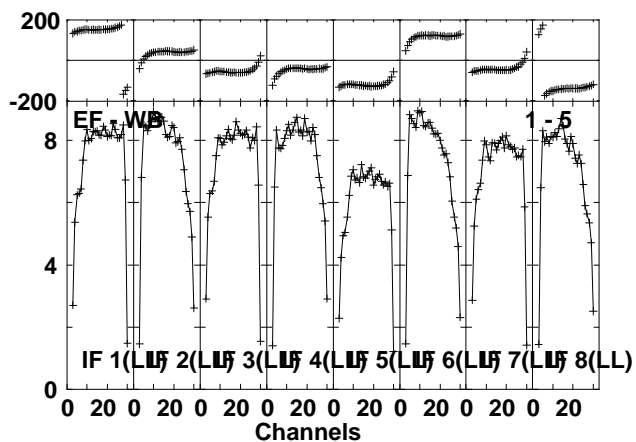
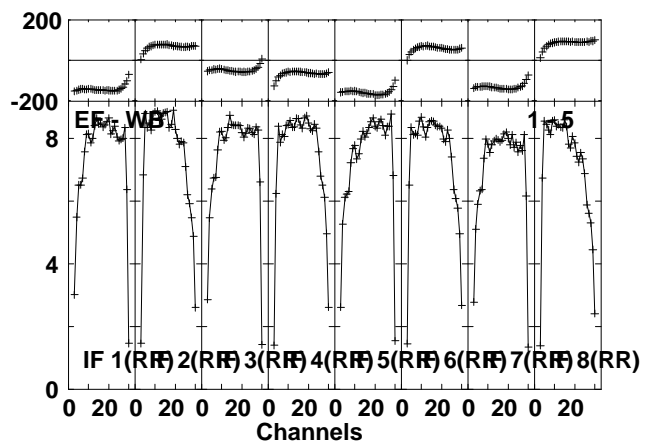
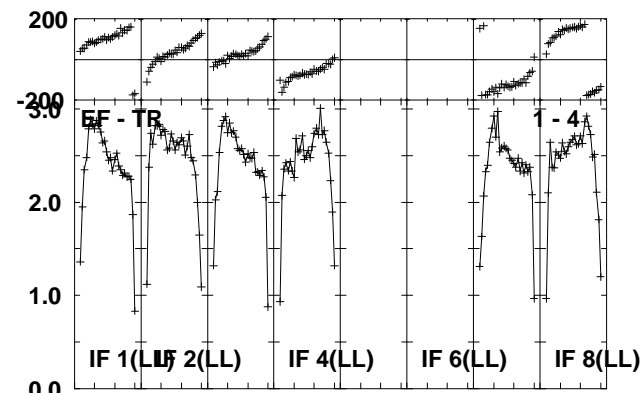
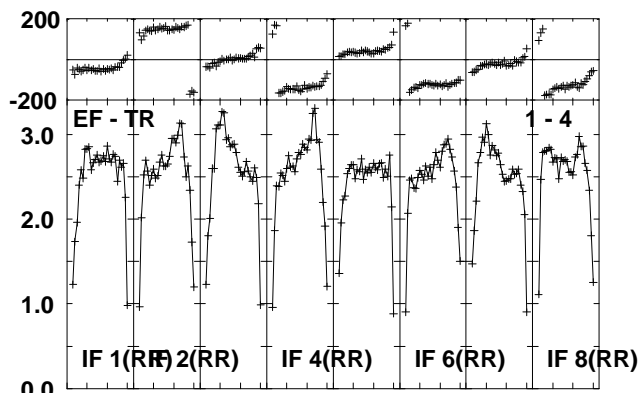
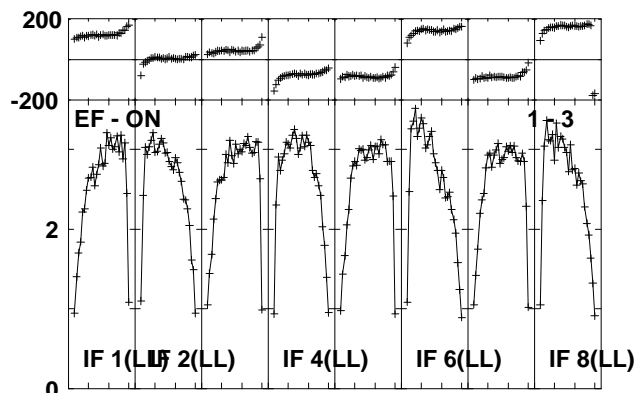
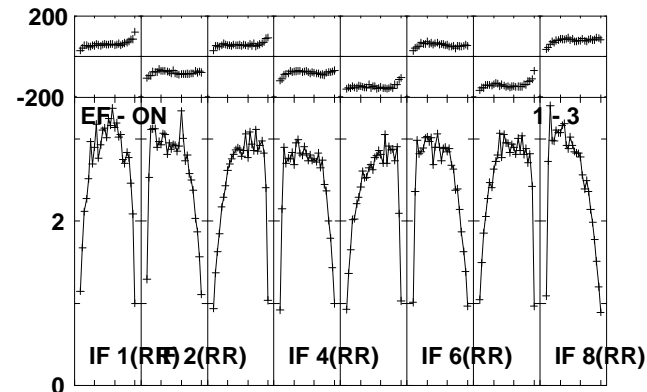
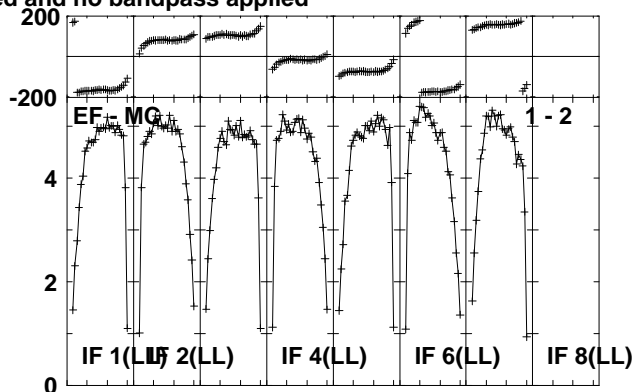
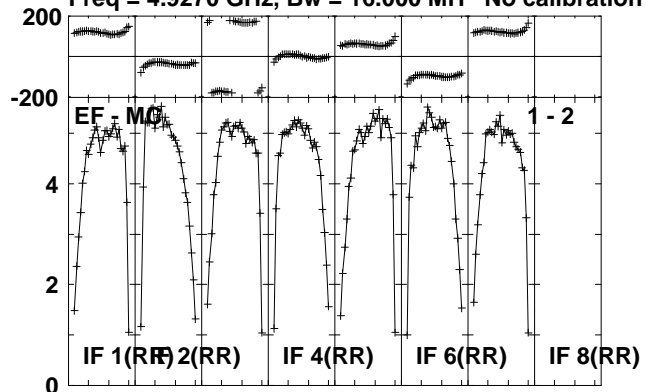

Lower frame: Milli Ampl Jy Top frame: Phas deg
Scalar averaged cross-power spectrum Several baselines displayed
Timerange: 00/13:35:06 to 00/13:38:39

Plot file version 32 created 02-DEC-2011 14:48:05

J1953+35 ET018A.UVDATA.1

Freq = 4.9270 GHz, Bw = 16.000 MH No calibration applied and no bandpass applied

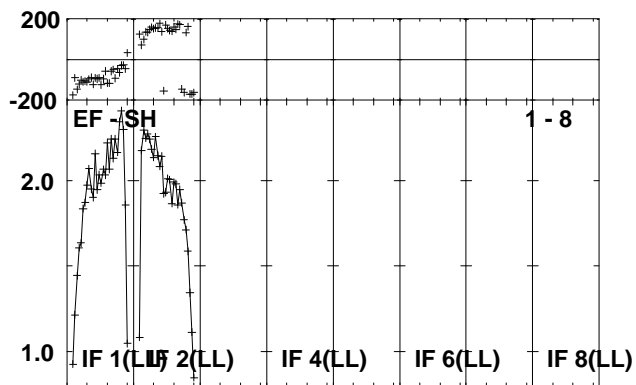
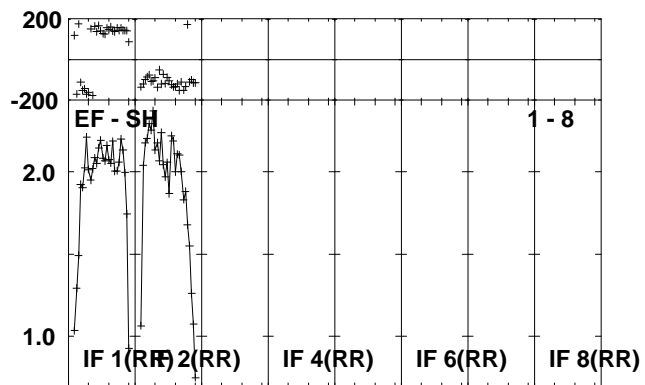
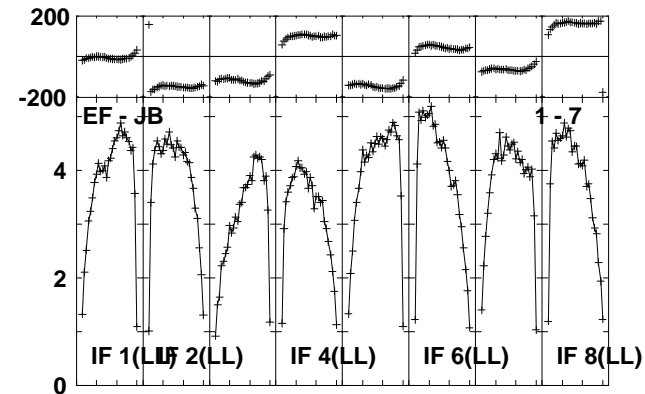
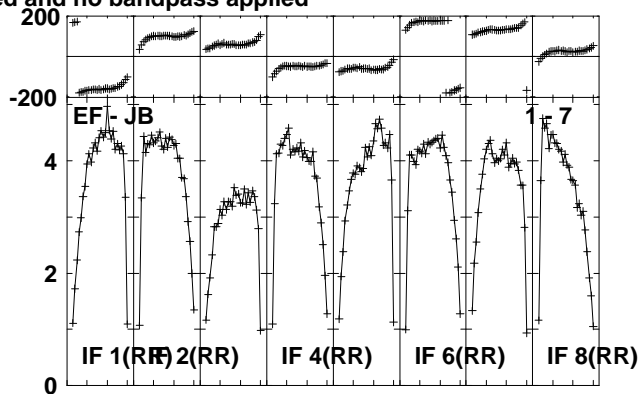
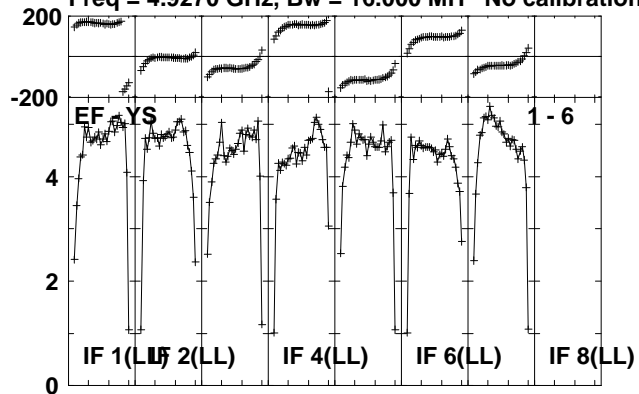

Lower frame: Milli Ampl Jy Top frame: Phas deg
Scalar averaged cross-power spectrum Several baselines displayed
Timerange: 00/13:35:06 to 00/13:38:39

Plot file version 33 created 02-DEC-2011 14:48:07

CYGX-1 ET018A.UVDATA.1

Freq = 4.9270 GHz, Bw = 16.000 MH No calibration applied and no bandpass applied

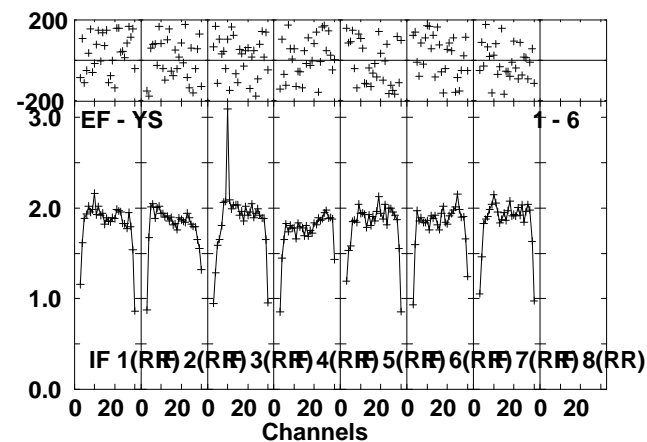
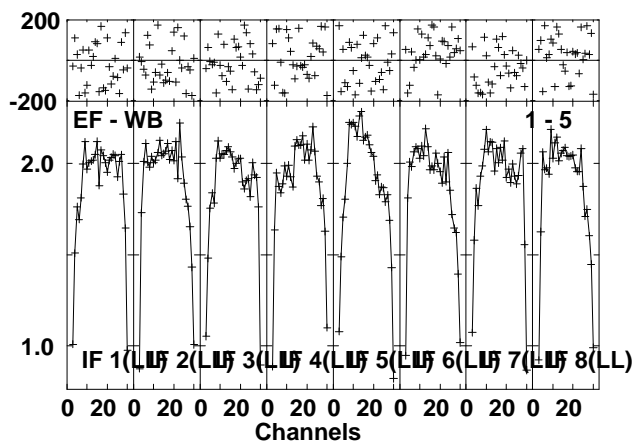
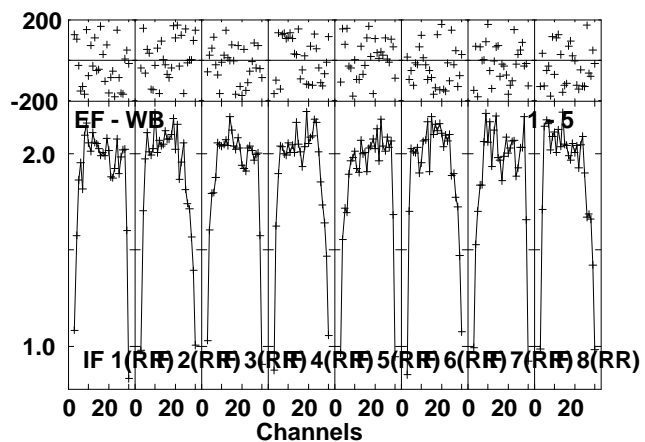
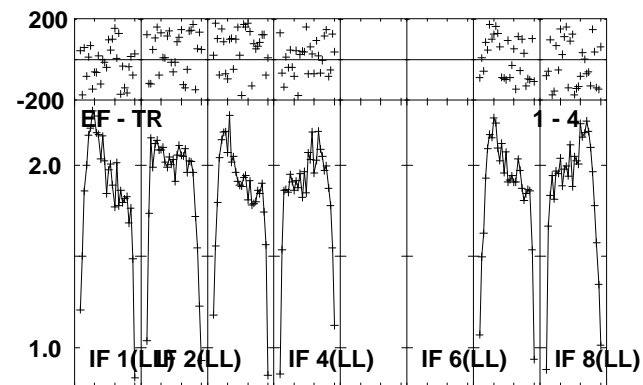
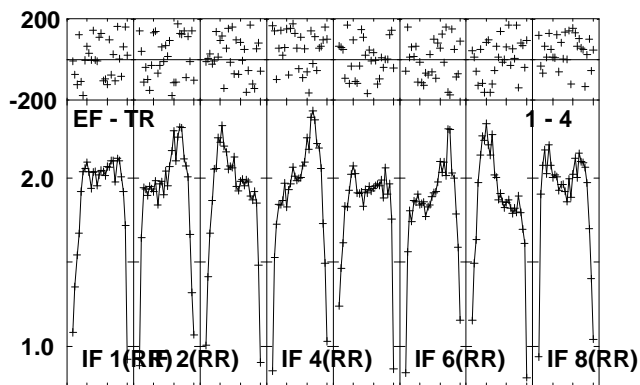
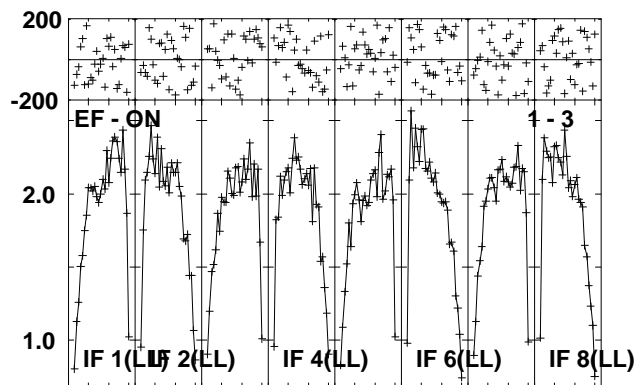
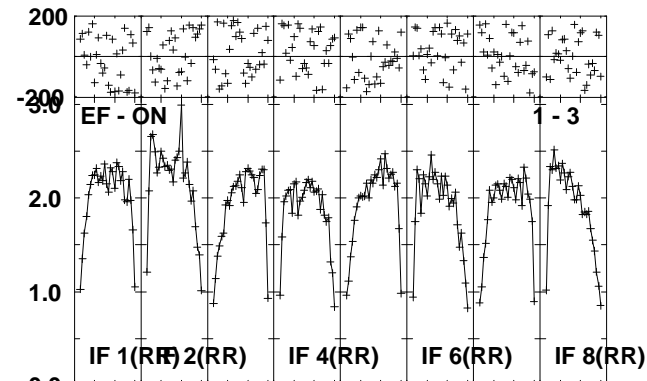
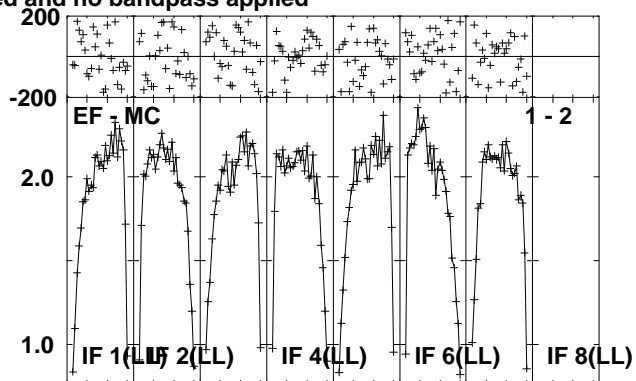
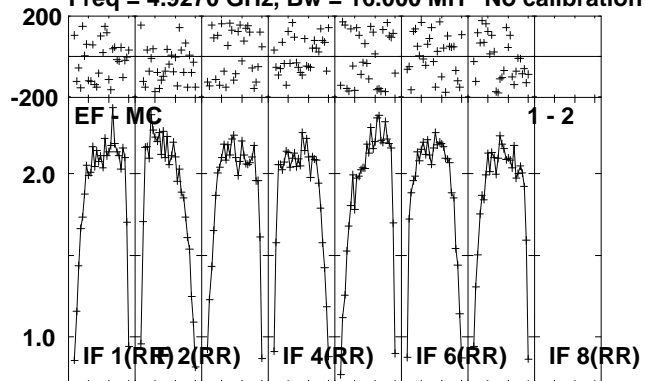

Lower frame: Milli Ampl Jy Top frame: Phas deg
Scalar averaged cross-power spectrum Several baselines displayed
Timerange: 00/13:38:42 to 00/13:44:08

Plot file version 34 created 02-DEC-2011 14:48:10

CYGX-1 ET018A.UVDATA.1

Freq = 4.9270 GHz, Bw = 16.000 MH No calibration applied and no bandpass applied

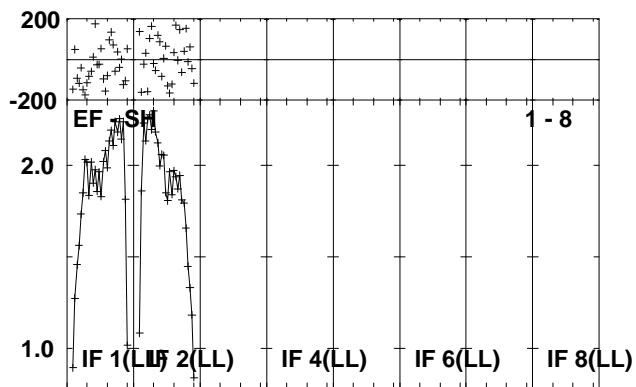
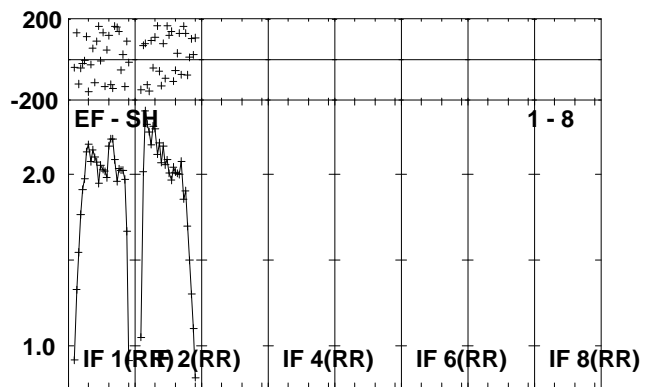
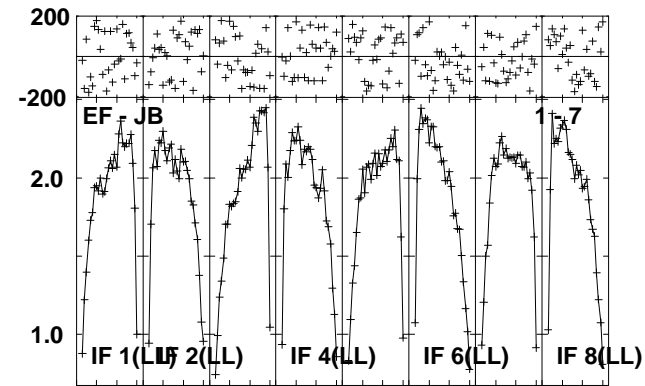
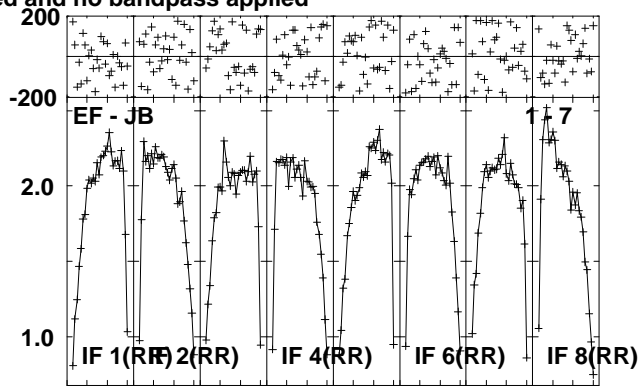
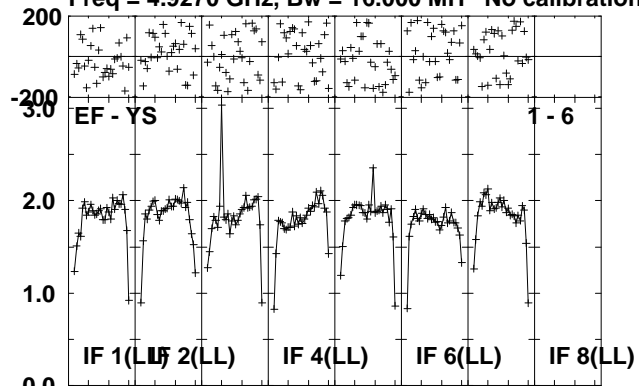

Lower frame: Milli Ampl Jy Top frame: Phas deg
Scalar averaged cross-power spectrum Several baselines displayed
Timerange: 00/13:38:42 to 00/13:44:08

Plot file version 35 created 02-DEC-2011 14:48:13

J1953+35 ET018A.UVDATA.1

Freq = 4.9270 GHz, Bw = 16.000 MH No calibration applied and no bandpass applied

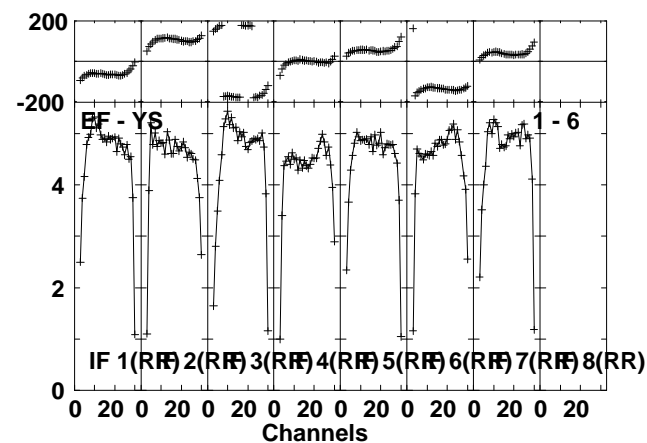
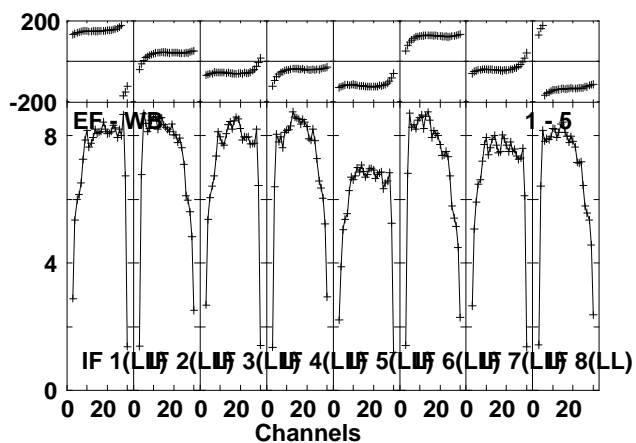
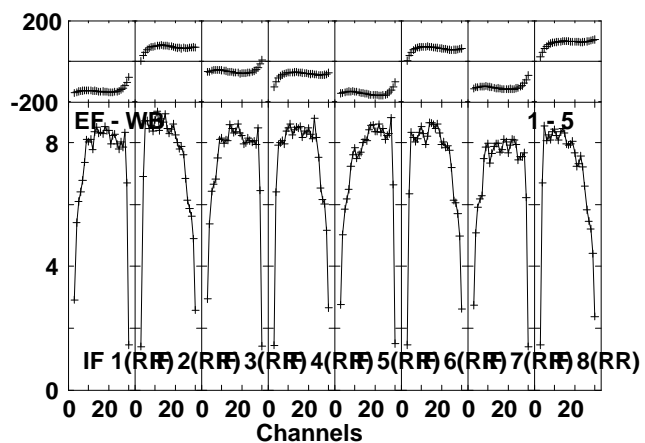
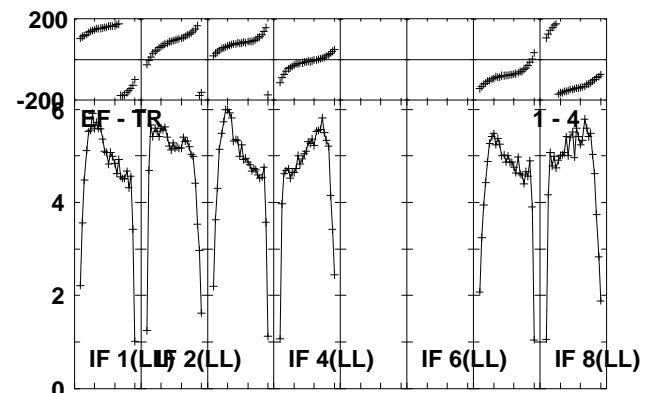
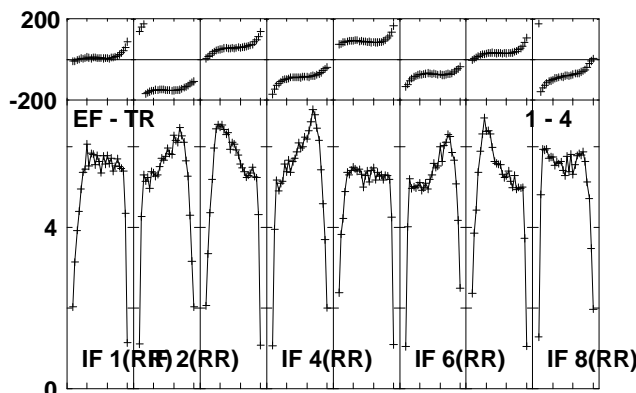
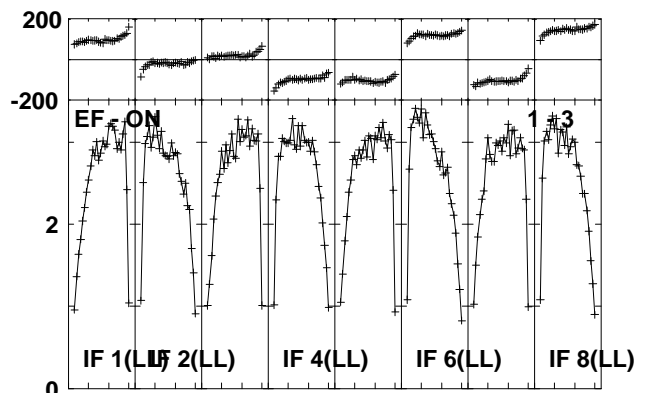
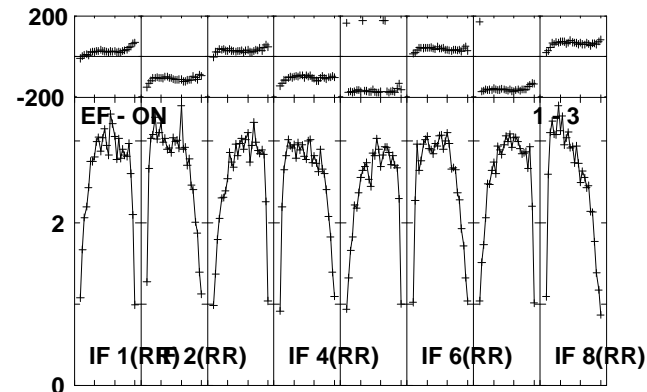
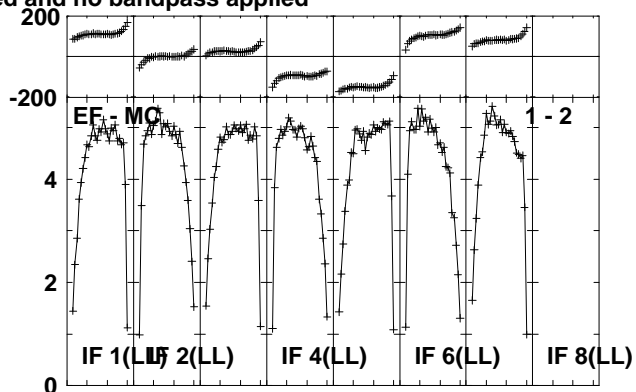
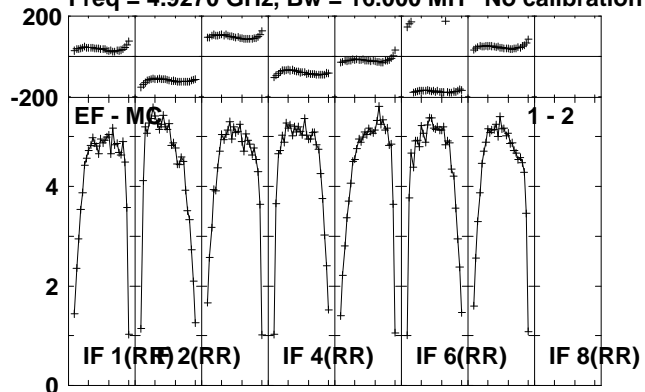

Lower frame: Milli Ampl Jy Top frame: Phas deg
Scalar averaged cross-power spectrum Several baselines displayed
Timerange: 00/13:44:12 to 00/13:47:09

Plot file version 36 created 02-DEC-2011 14:48:16

J1953+35 ET018A.UVDATA.1

Freq = 4.9270 GHz, Bw = 16.000 MH No calibration applied and no bandpass applied

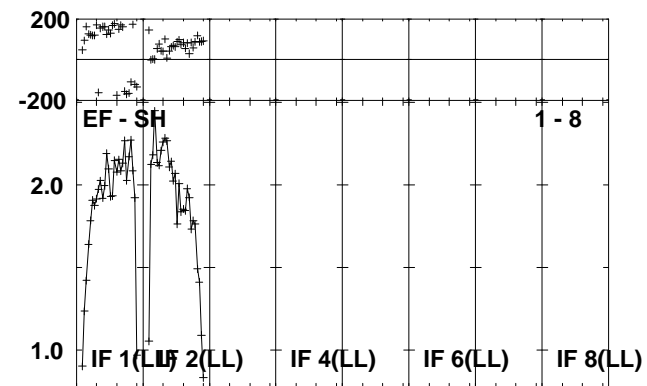
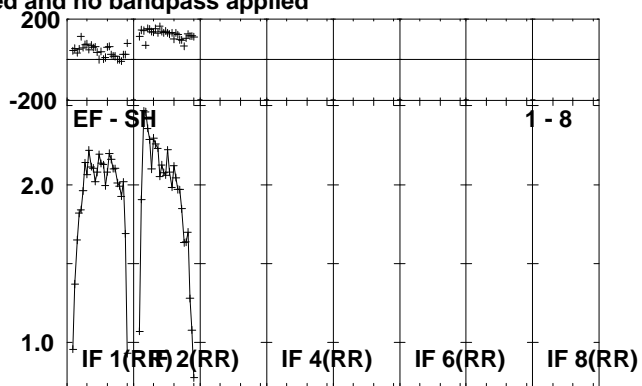
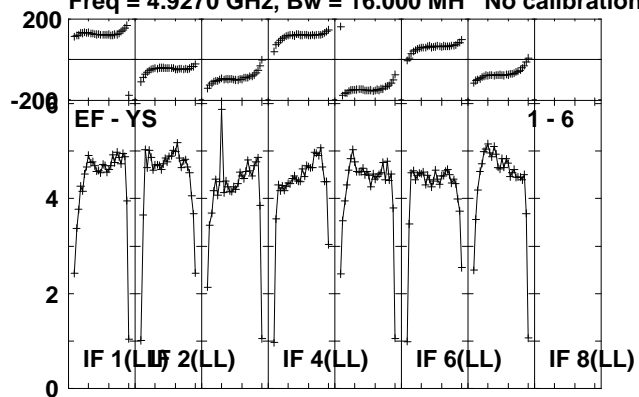

Lower frame: Milli Ampl Jy Top frame: Phas deg
Scalar averaged cross-power spectrum Several baselines displayed
Timerange: 00/13:44:12 to 00/13:47:09

Plot file version 37 created 02-DEC-2011 14:48:18

CYGX-1 ET018A.UVDATA.1

Freq = 4.9270 GHz, Bw = 16.000 MH No calibration applied and no bandpass applied

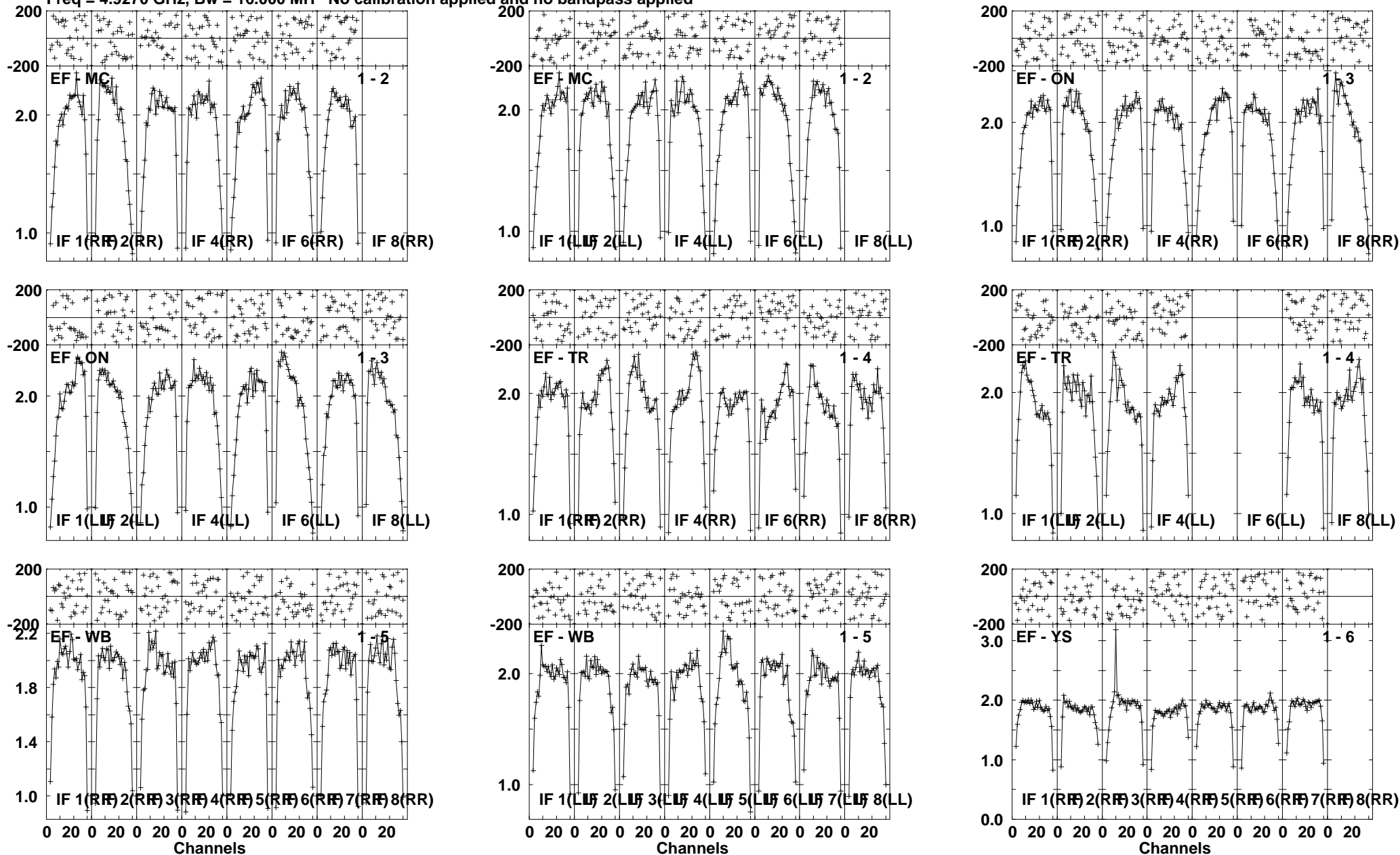

Lower frame: Milli Ampl Jy Top frame: Phas deg
Scalar averaged cross-power spectrum Several baselines displayed
Timerange: 00/13:47:11 to 00/13:52:39

Plot file version 38 created 02-DEC-2011 14:48:22

CYGX-1 ET018A.UVDATA.1

Freq = 4.9270 GHz, Bw = 16.000 MH No calibration applied and no bandpass applied

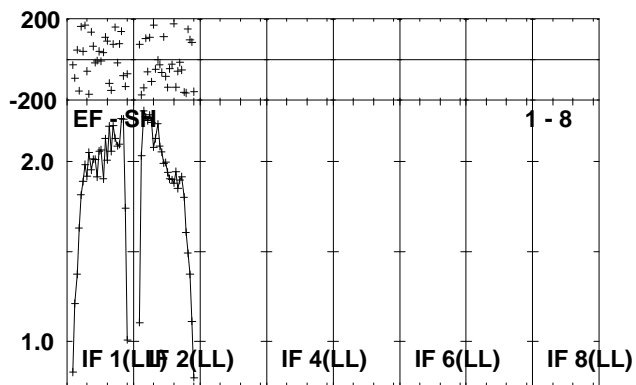
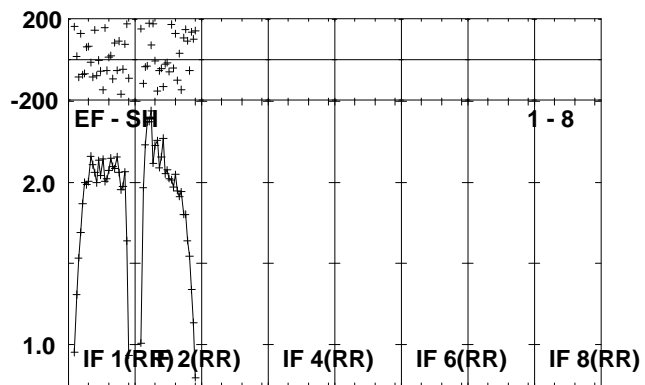
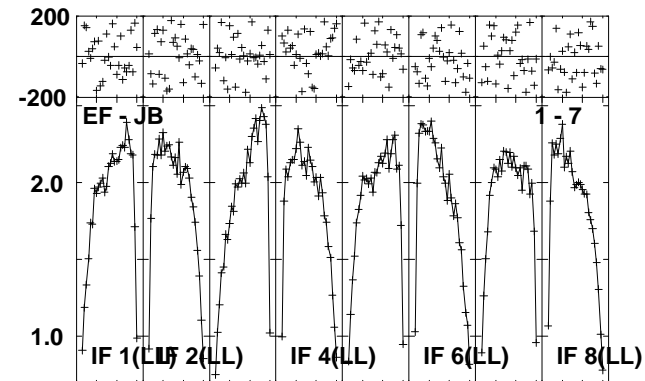
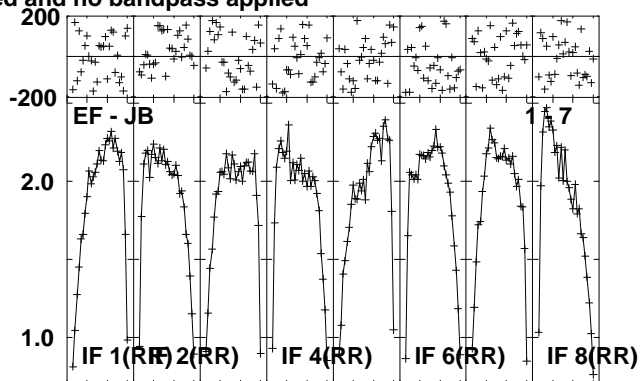
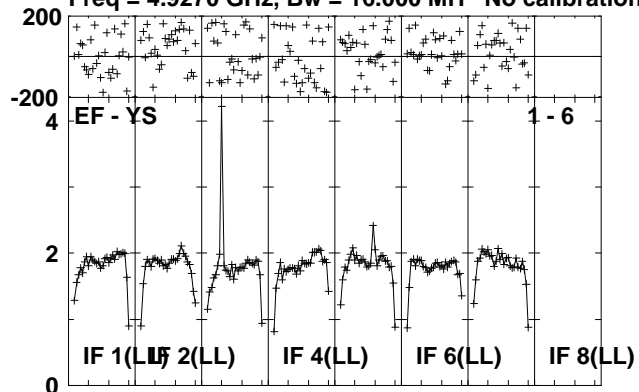

Lower frame: Milli Ampl Jy Top frame: Phas deg
Scalar averaged cross-power spectrum Several baselines displayed
Timerange: 00/13:47:11 to 00/13:52:39

Plot file version 39 created 02-DEC-2011 14:48:24

J1953+35 ET018A.UVDATA.1

Freq = 4.9270 GHz, Bw = 16.000 MH No calibration applied and no bandpass applied

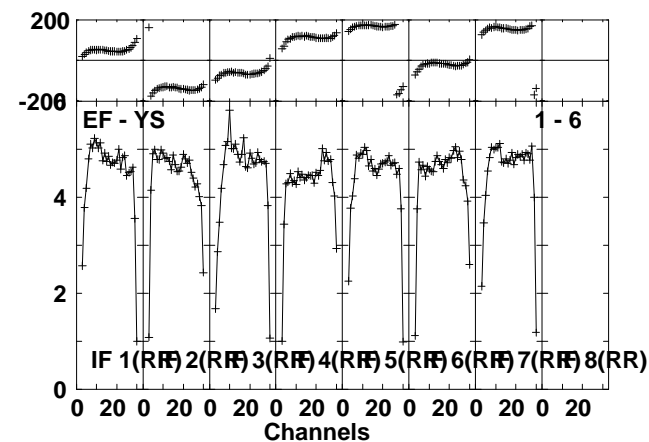
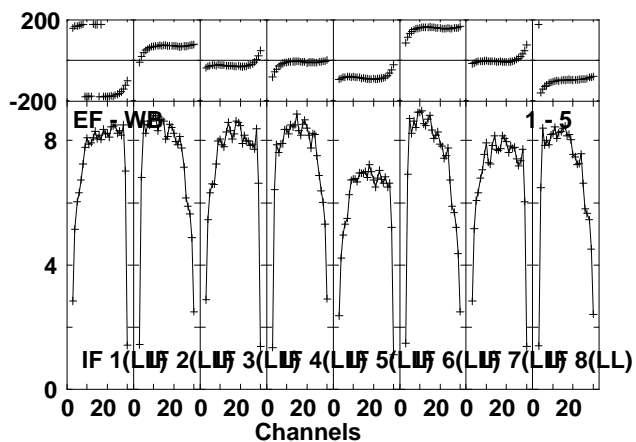
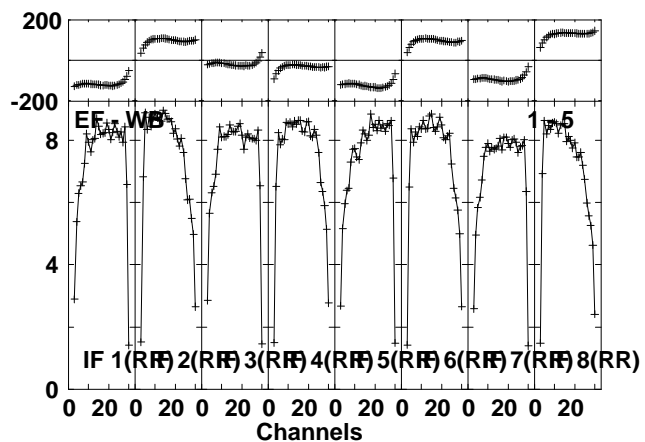
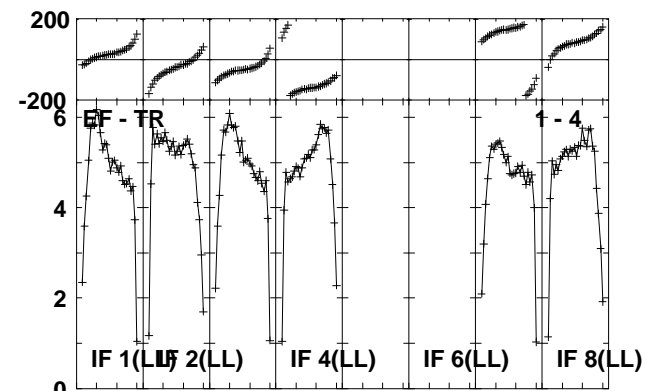
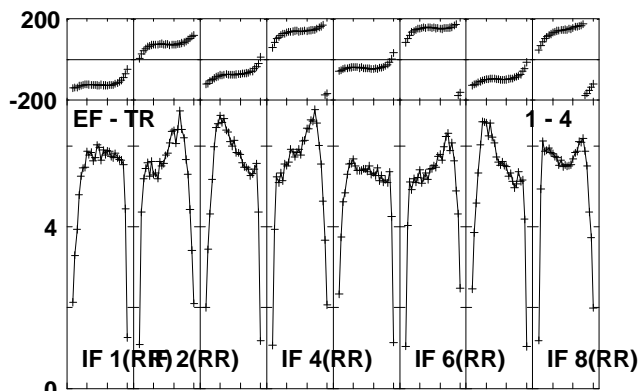
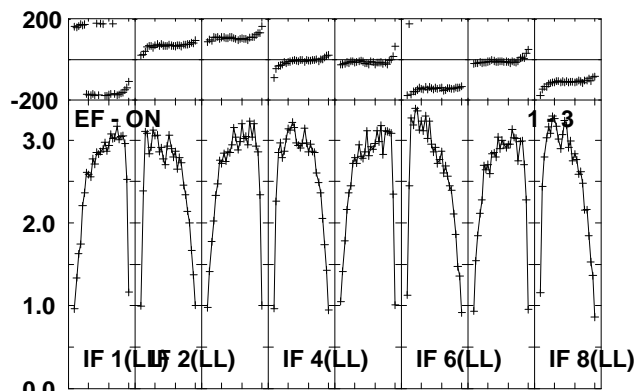
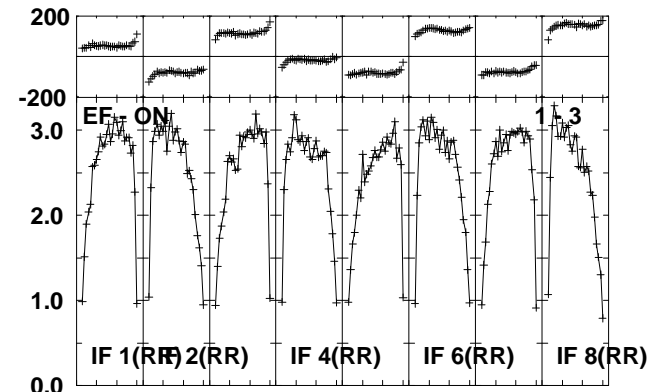
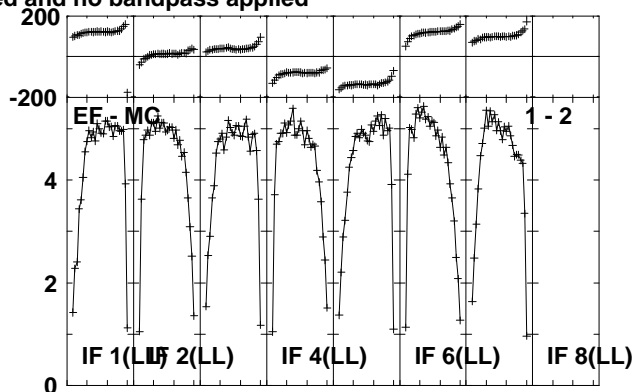
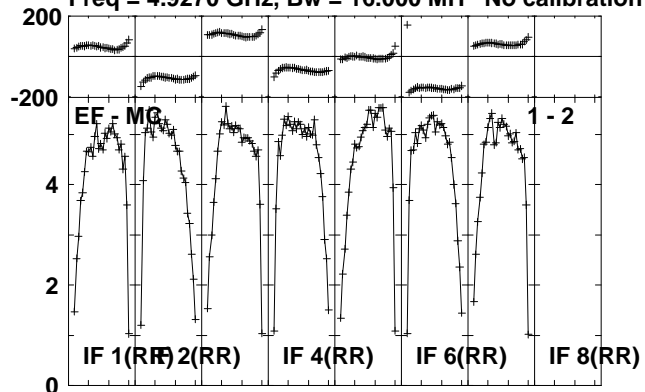

Lower frame: Milli Ampl Jy Top frame: Phas deg
Scalar averaged cross-power spectrum Several baselines displayed
Timerange: 00/13:53:26 to 00/13:55:59

Plot file version 40 created 02-DEC-2011 14:48:26

J1953+35 ET018A.UVDATA.1

Freq = 4.9270 GHz, Bw = 16.000 MH No calibration applied and no bandpass applied

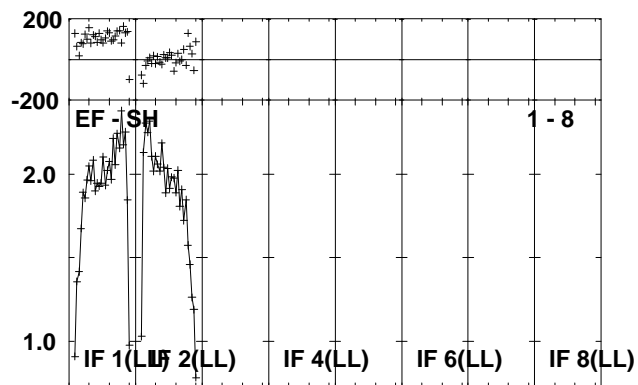
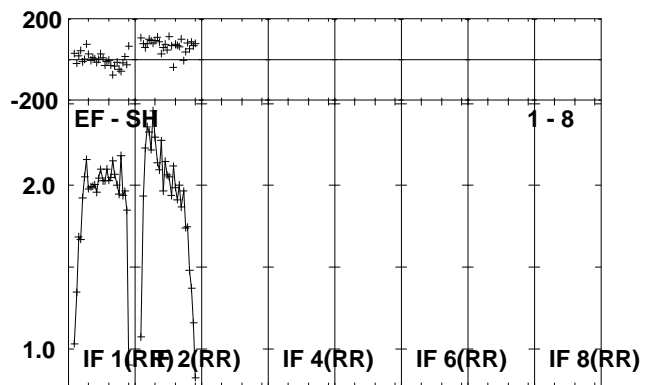
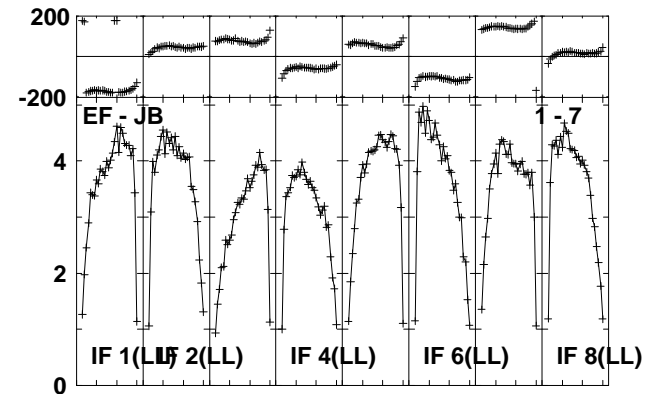
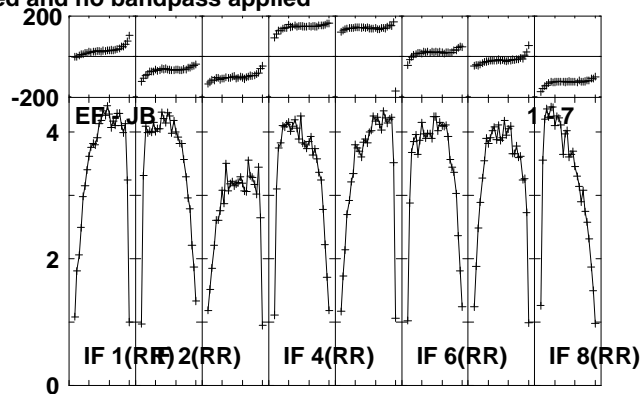
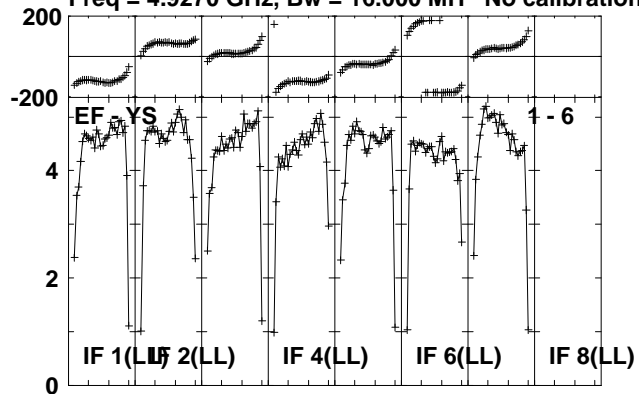

Lower frame: Milli Ampl Jy Top frame: Phas deg
Scalar averaged cross-power spectrum Several baselines displayed
Timerange: 00/13:53:26 to 00/13:55:59

Plot file version 41 created 02-DEC-2011 14:48:28

CYGX-1 ET018A.UVDATA.1

Freq = 4.9270 GHz, Bw = 16.000 MH No calibration applied and no bandpass applied

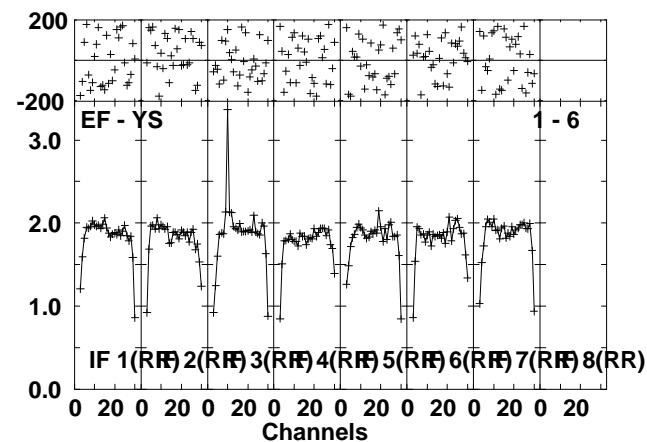
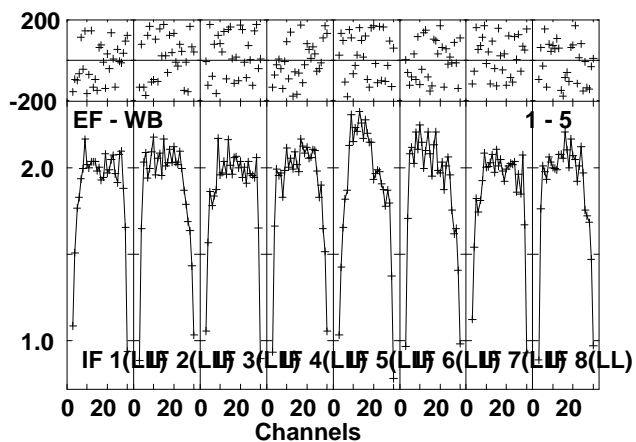
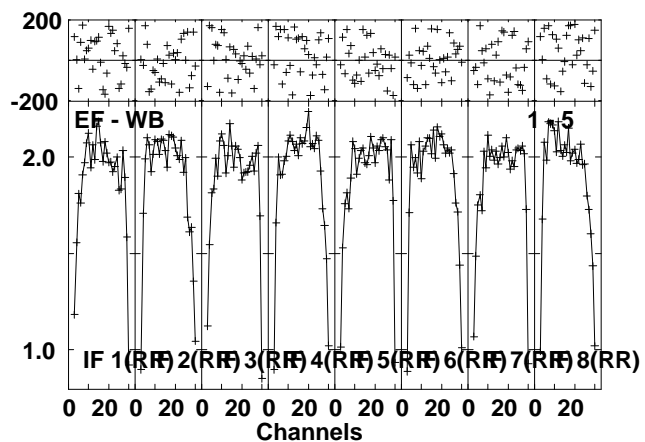
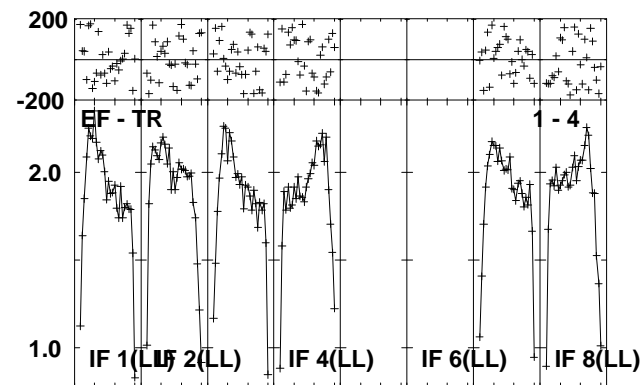
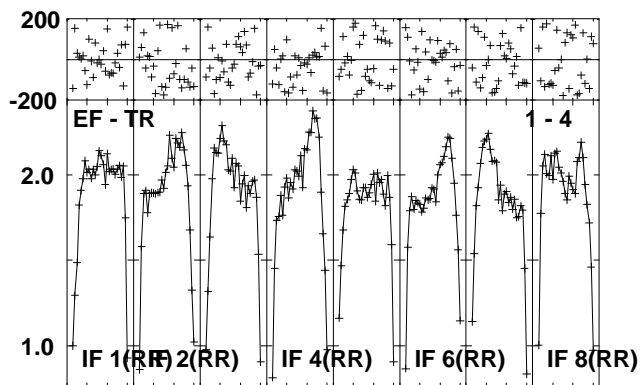
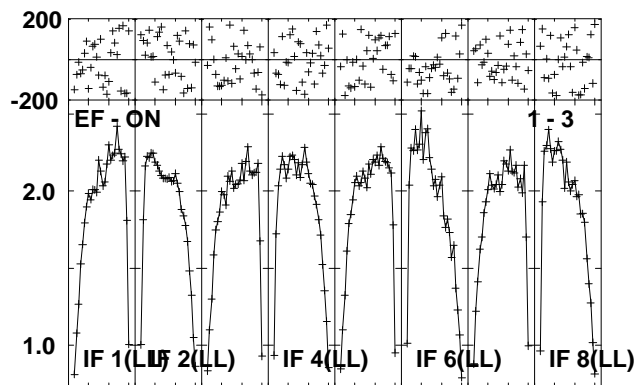
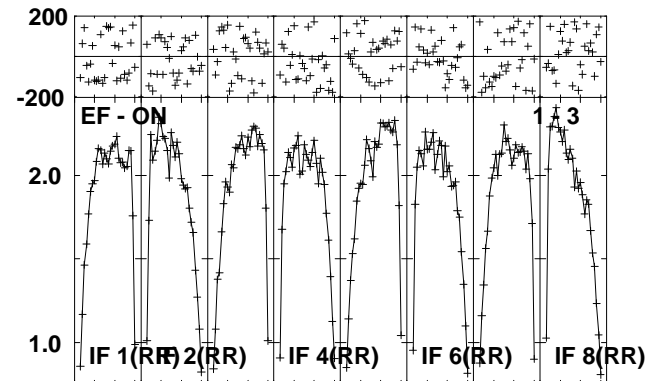
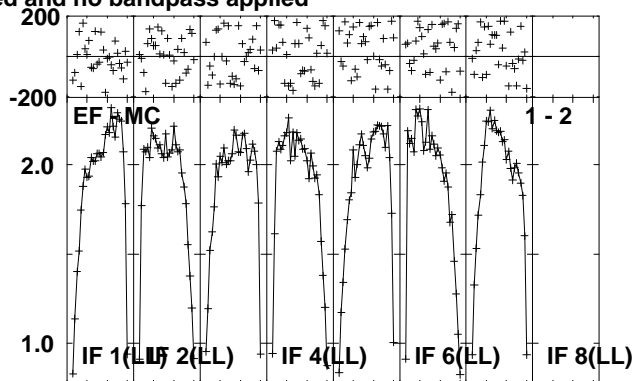
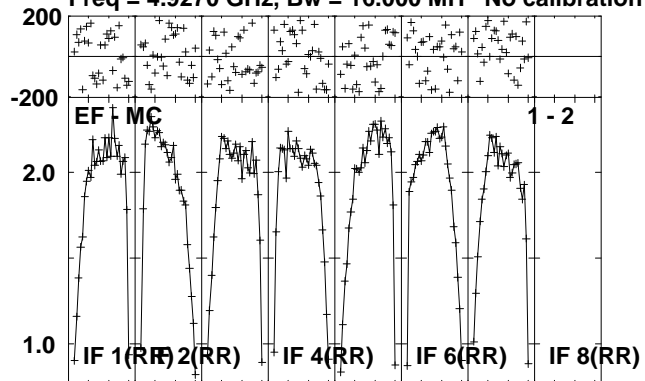

Lower frame: Milli Ampl Jy Top frame: Phas deg
Scalar averaged cross-power spectrum Several baselines displayed
Timerange: 00/13:56:02 to 00/14:01:28

Plot file version 42 created 02-DEC-2011 14:48:32

CYGX-1 ET018A.UVDATA.1

Freq = 4.9270 GHz, Bw = 16.000 MH No calibration applied and no bandpass applied

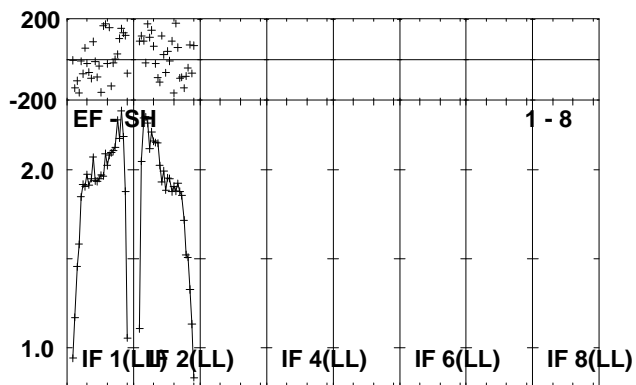
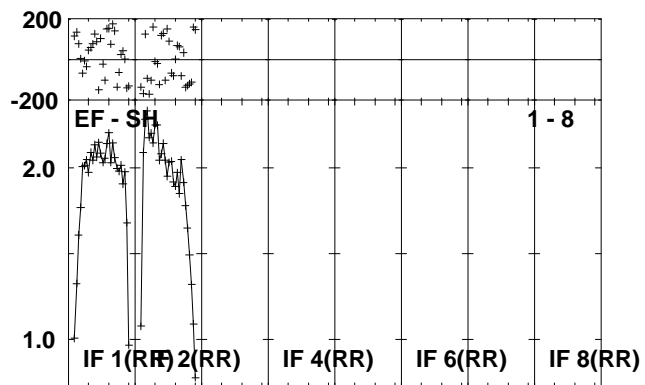
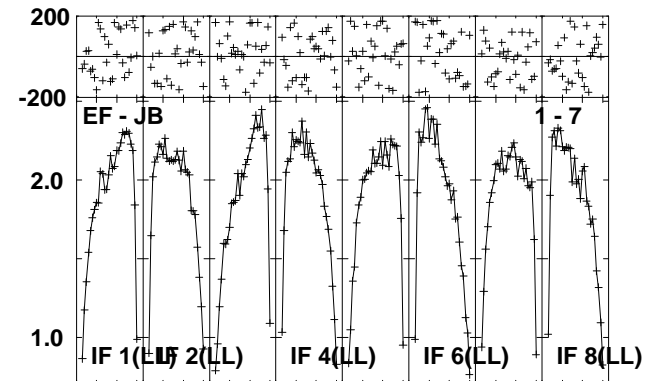
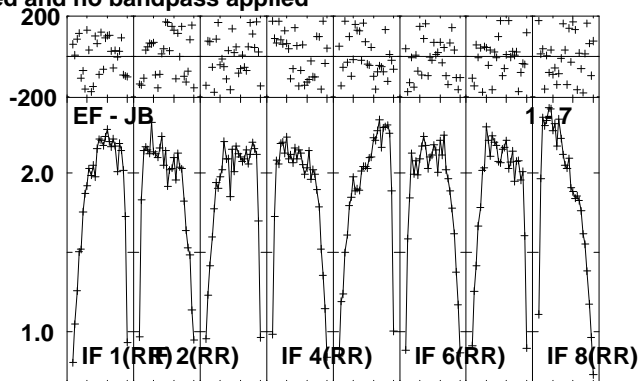
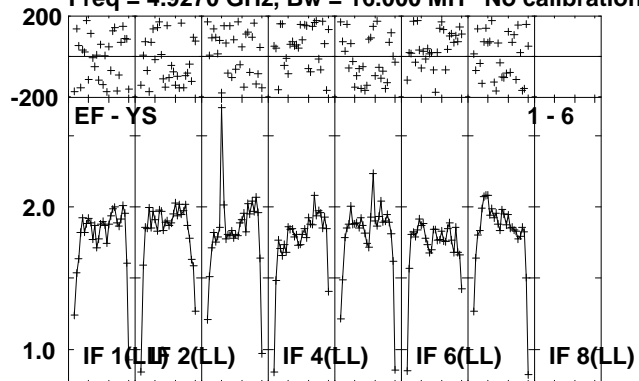

Lower frame: Milli Ampl Jy Top frame: Phas deg
Scalar averaged cross-power spectrum Several baselines displayed
Timerange: 00/13:56:02 to 00/14:01:28

Plot file version 43 created 02-DEC-2011 14:48:34

J1953+35 ET018A.UVDATA.1

Freq = 4.9270 GHz, Bw = 16.000 MH No calibration applied and no bandpass applied

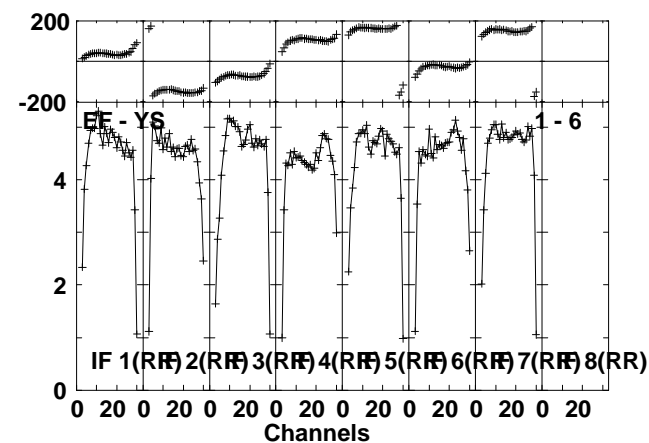
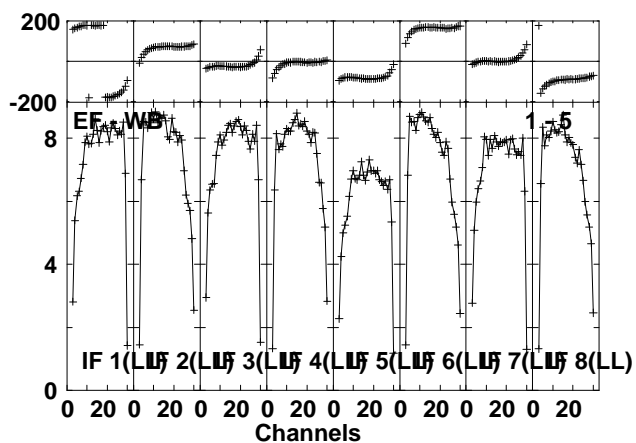
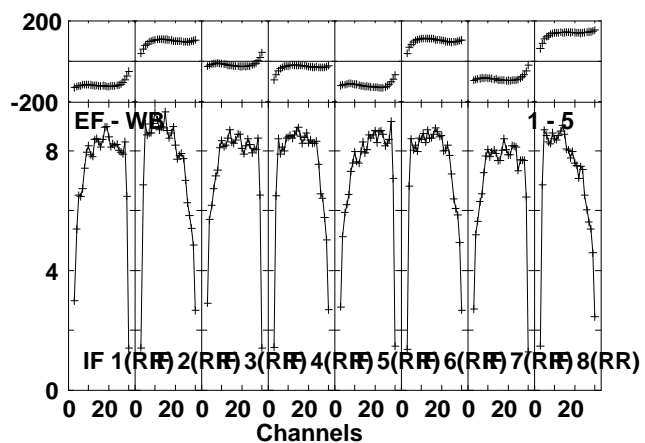
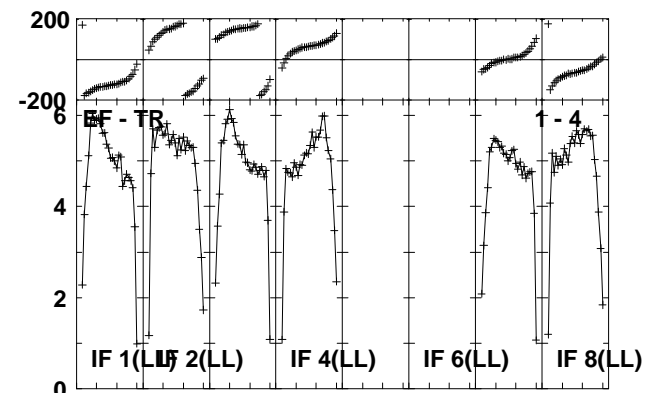
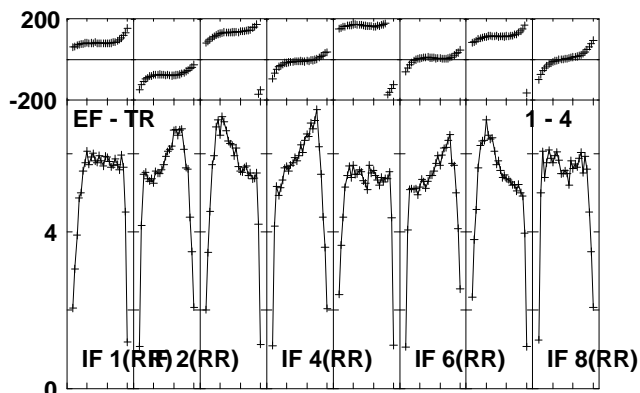
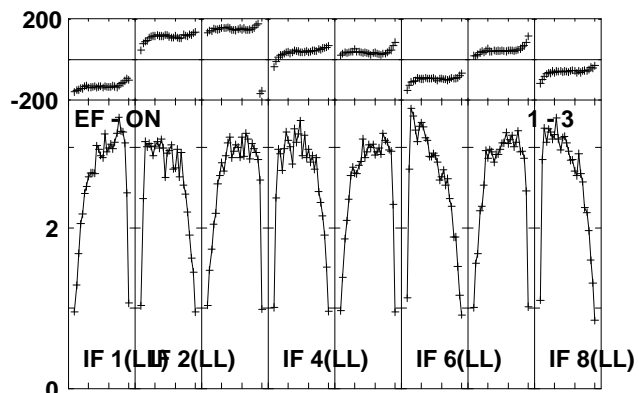
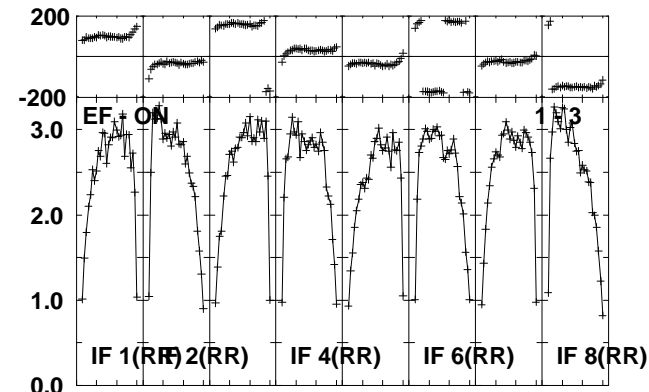
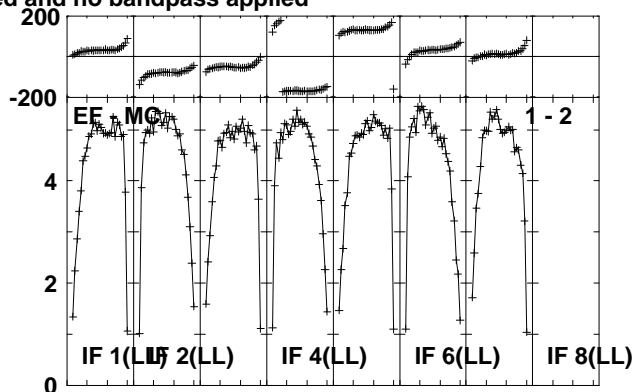
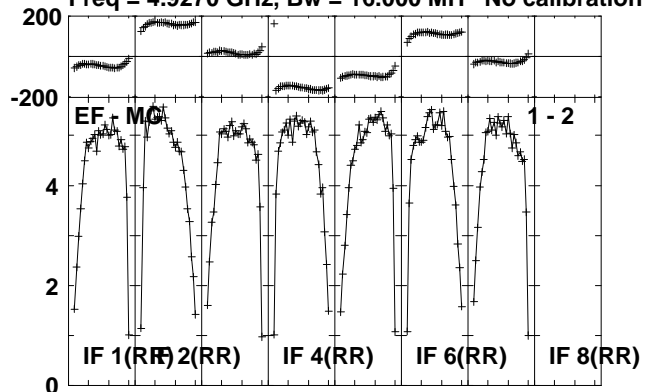

Lower frame: Milli Ampl Jy Top frame: Phas deg
Scalar averaged cross-power spectrum Several baselines displayed
Timerange: 00/14:01:32 to 00/14:04:29

Plot file version 44 created 02-DEC-2011 14:48:36

J1953+35 ET018A.UVDATA.1

Freq = 4.9270 GHz, Bw = 16.000 MH No calibration applied and no bandpass applied

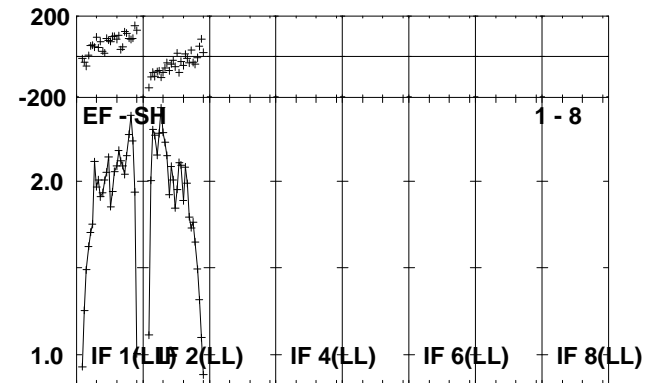
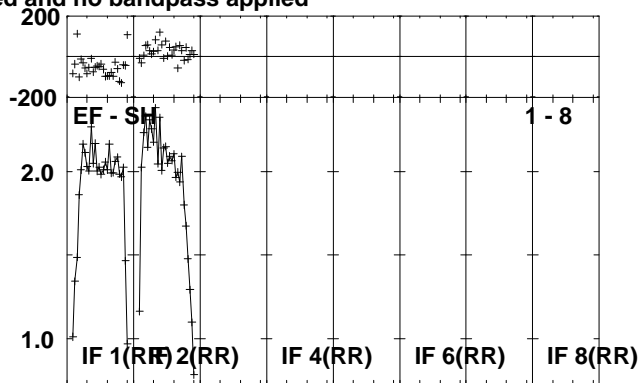
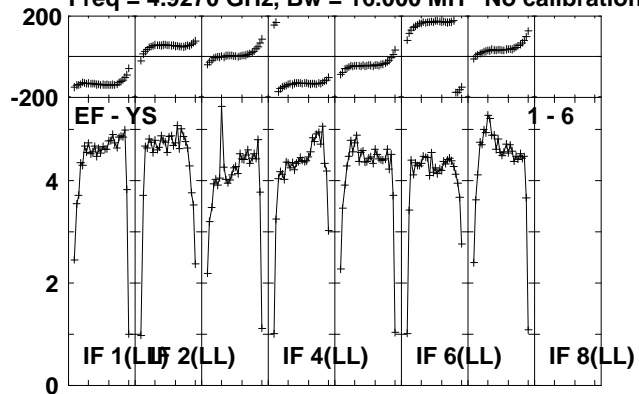

Lower frame: Milli Ampl Jy Top frame: Phas deg
Scalar averaged cross-power spectrum Several baselines displayed
Timerange: 00/14:01:32 to 00/14:04:29

Plot file version 45 created 02-DEC-2011 14:48:38

CYGX-1 ET018A.UVDATA.1

Freq = 4.9270 GHz, Bw = 16.000 MH No calibration applied and no bandpass applied

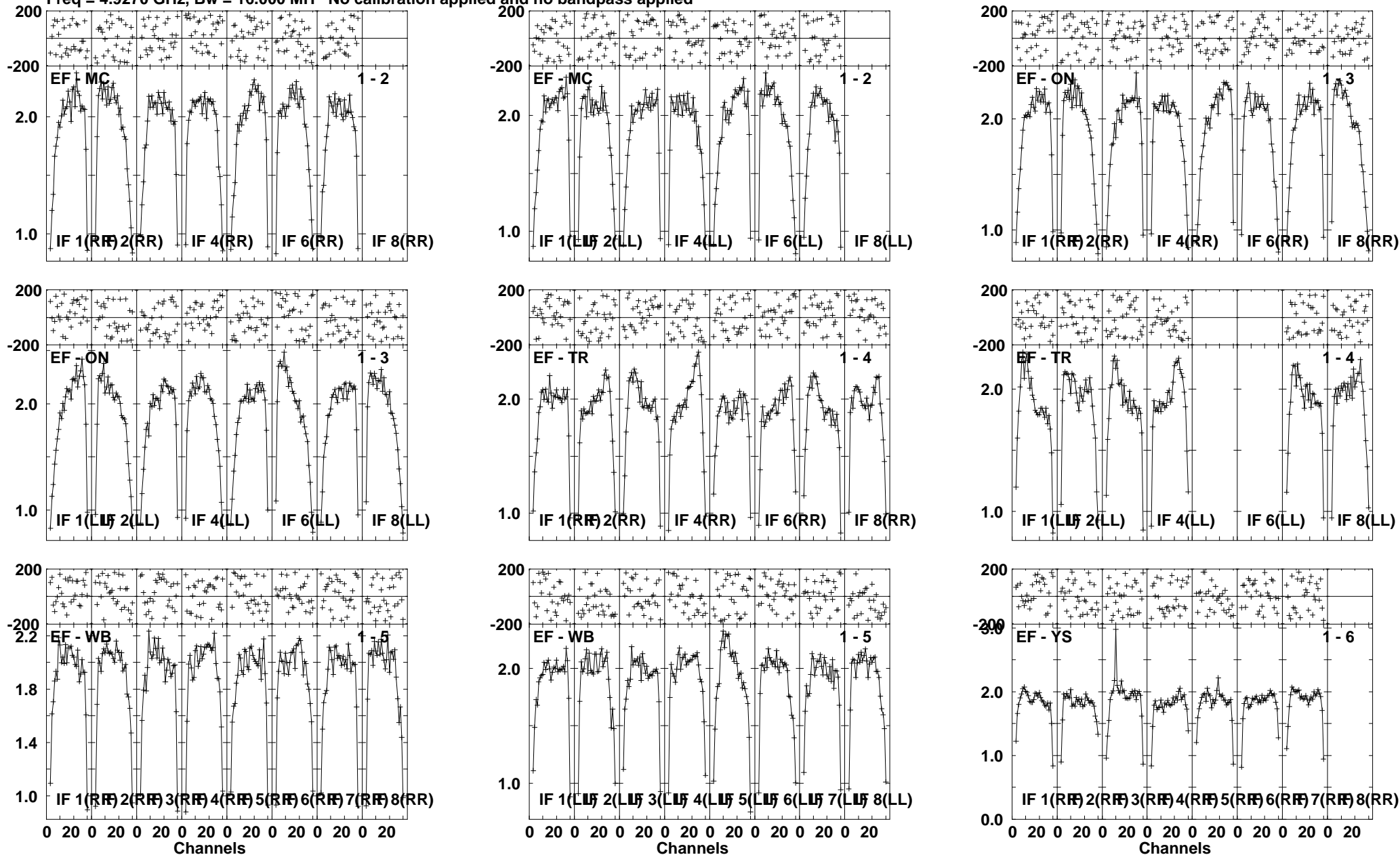

Lower frame: Milli Ampl Jy Top frame: Phas deg
Scalar averaged cross-power spectrum Several baselines displayed
Timerange: 00/14:04:31 to 00/14:09:59

Plot file version 46 created 02-DEC-2011 14:48:42

CYGX-1 ET018A.UVDATA.1

Freq = 4.9270 GHz, Bw = 16.000 MH No calibration applied and no bandpass applied

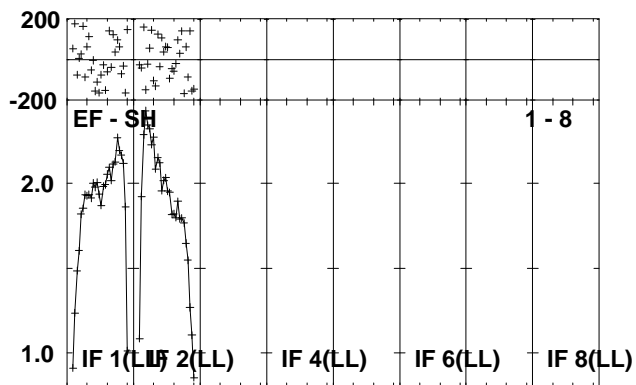
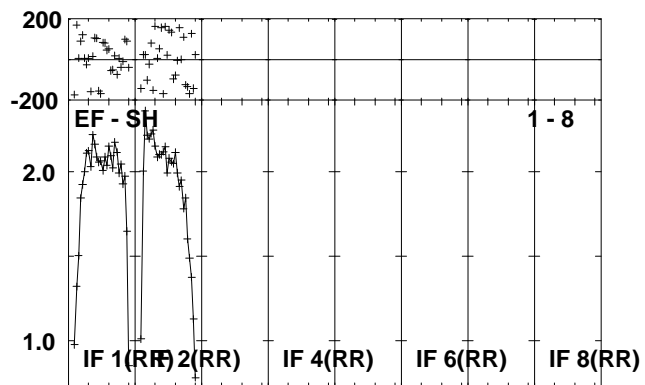
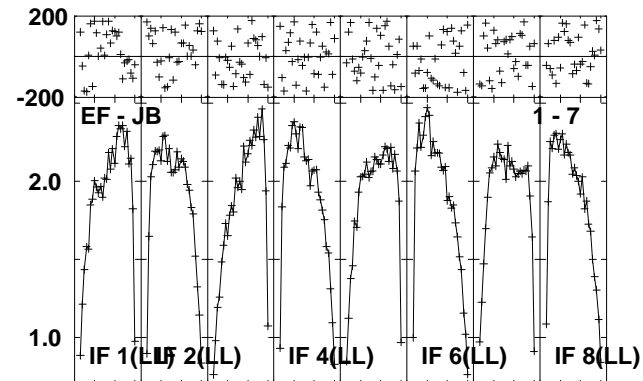
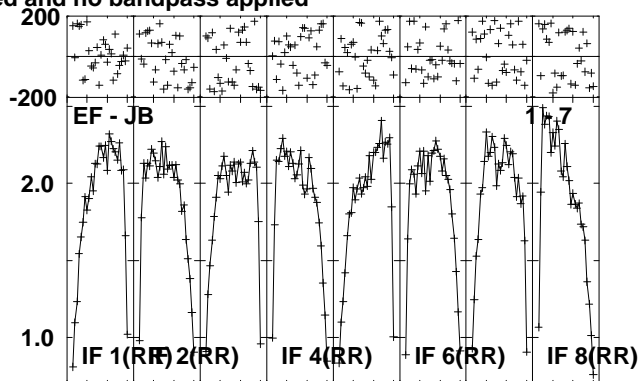
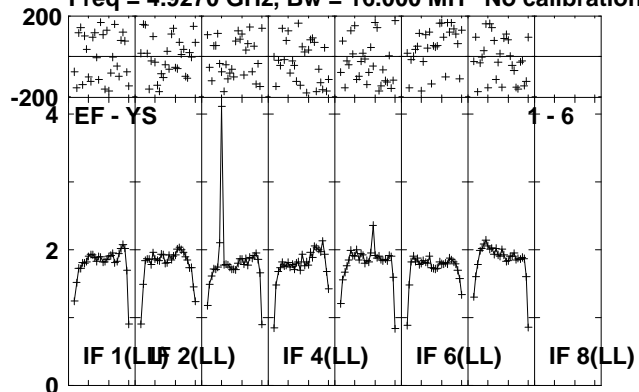

Lower frame: Milli Ampl Jy Top frame: Phas deg
Scalar averaged cross-power spectrum Several baselines displayed
Timerange: 00/14:04:31 to 00/14:09:59

Plot file version 47 created 02-DEC-2011 14:48:44

J1953+35 ET018A.UVDATA.1

Freq = 4.9270 GHz, Bw = 16.000 MH No calibration applied and no bandpass applied

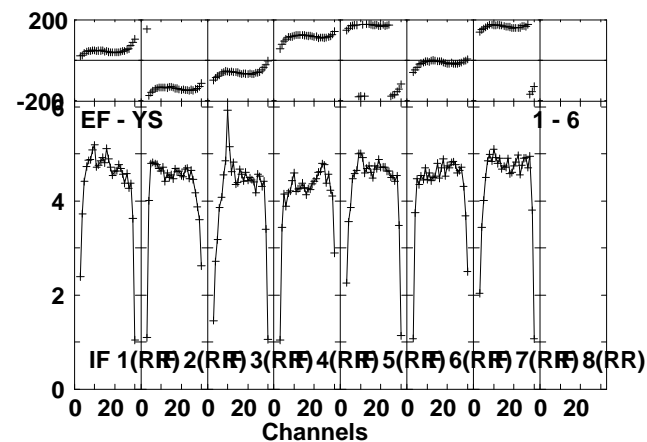
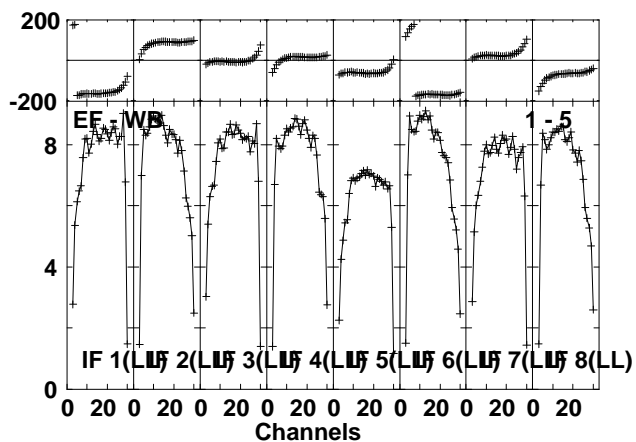
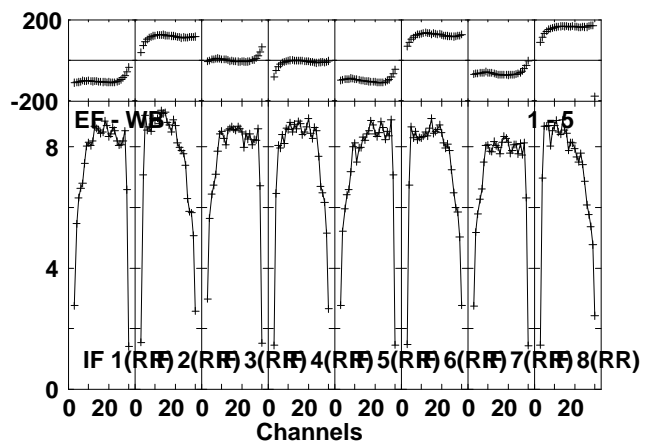
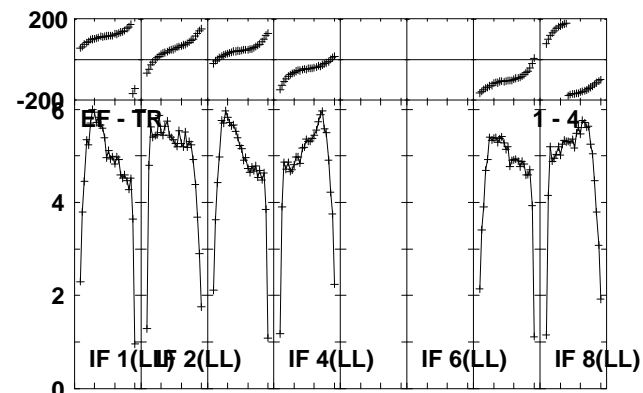
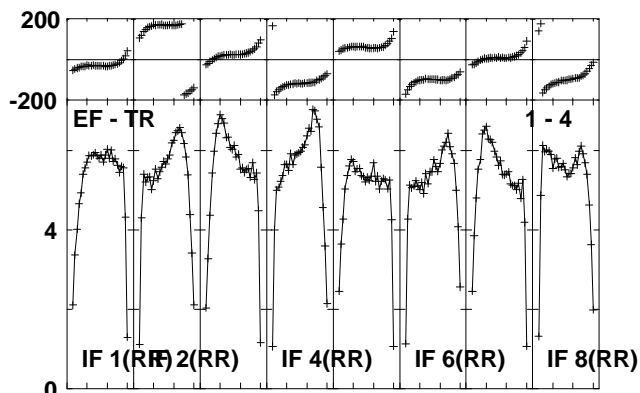
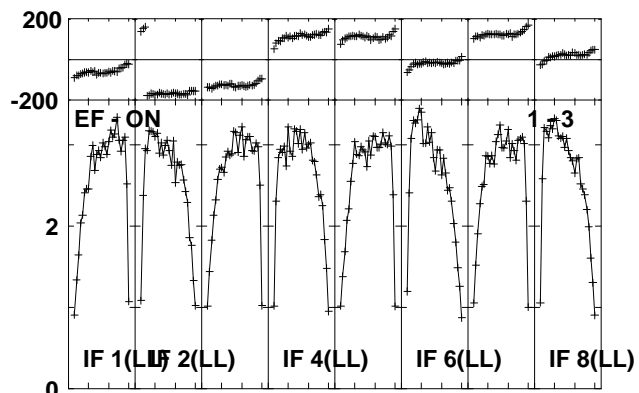
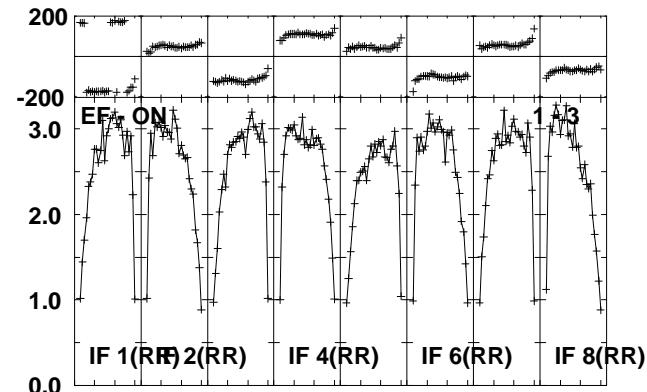
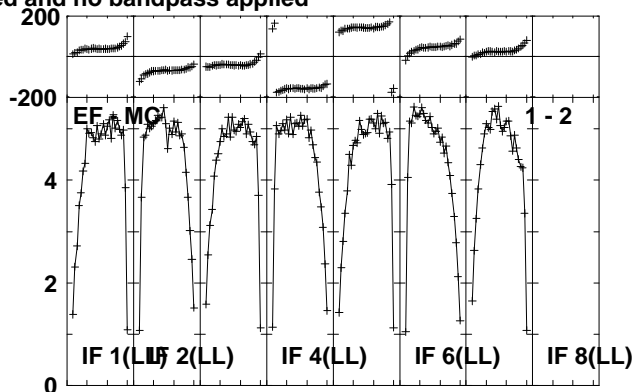
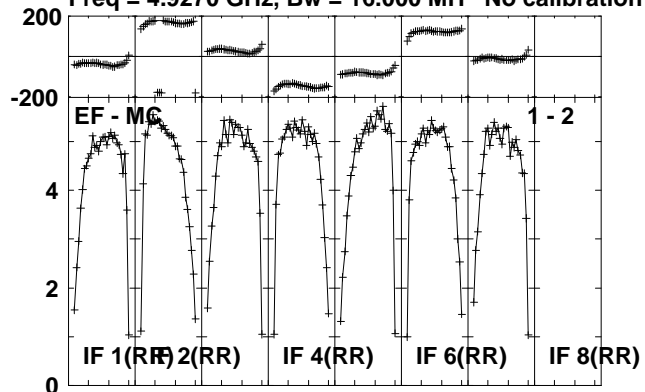

Lower frame: Milli Ampl Jy Top frame: Phas deg
Scalar averaged cross-power spectrum Several baselines displayed
Timerange: 00/14:10:46 to 00/14:13:19

Plot file version 48 created 02-DEC-2011 14:48:46

J1953+35 ET018A.UVDATA.1

Freq = 4.9270 GHz, Bw = 16.000 MH No calibration applied and no bandpass applied

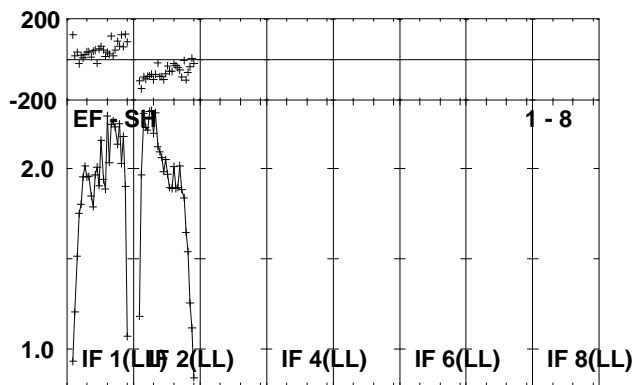
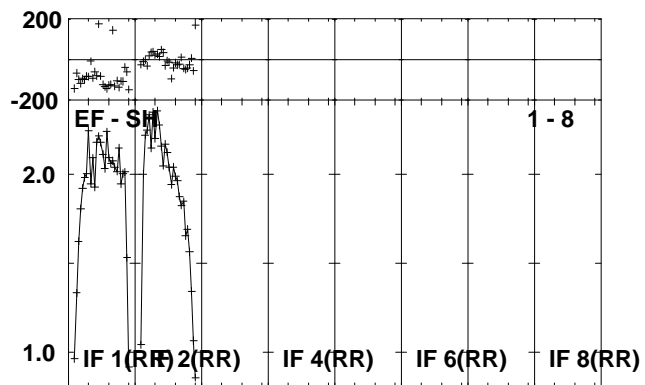
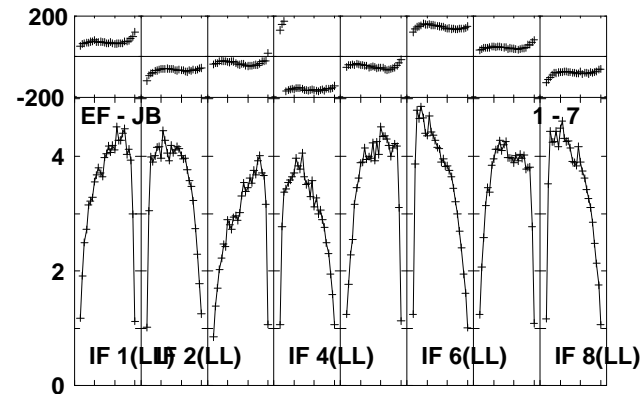
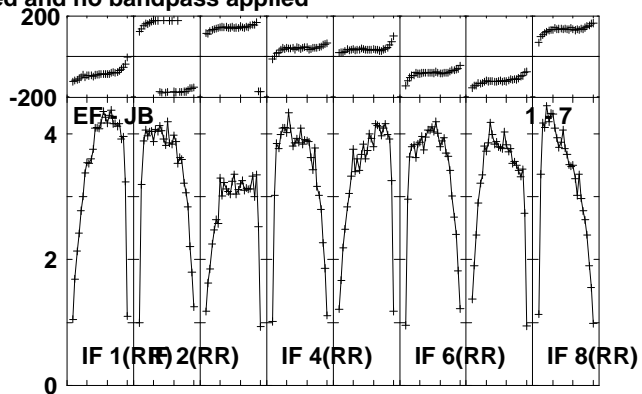
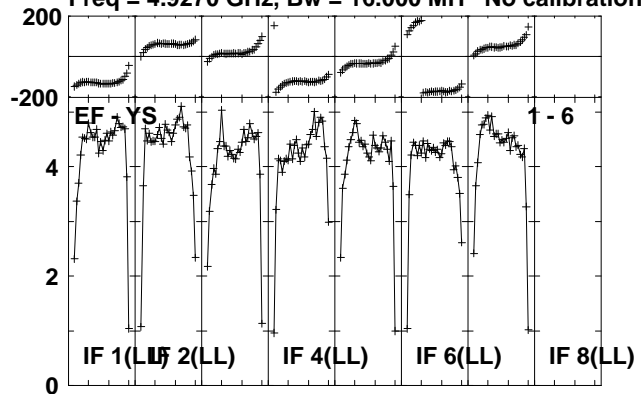

Lower frame: Milli Ampl Jy Top frame: Phas deg
Scalar averaged cross-power spectrum Several baselines displayed
Timerange: 00/14:10:46 to 00/14:13:19

Plot file version 49 created 02-DEC-2011 14:48:48

CYGX-1 ET018A.UVDATA.1

Freq = 4.9270 GHz, Bw = 16.000 MH No calibration applied and no bandpass applied

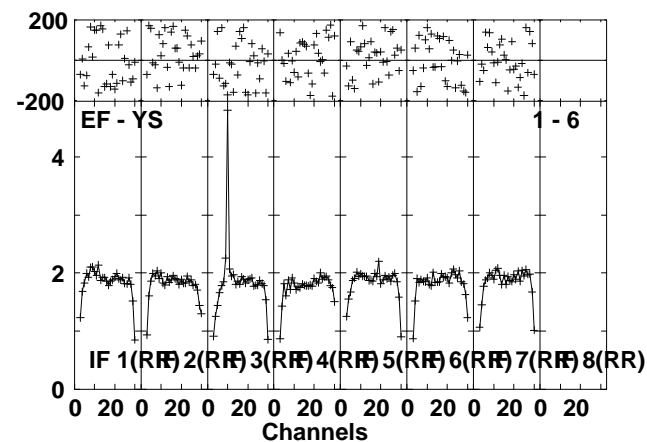
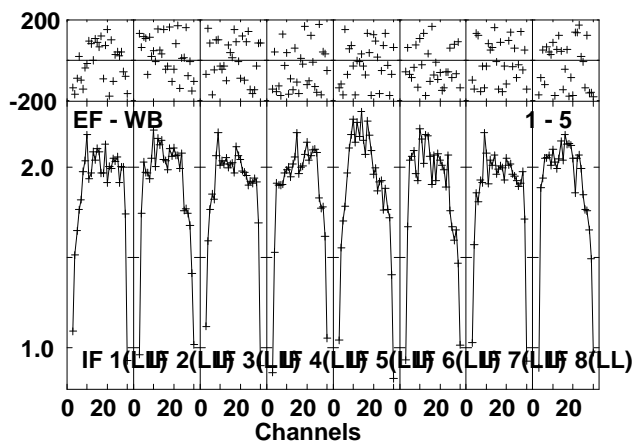
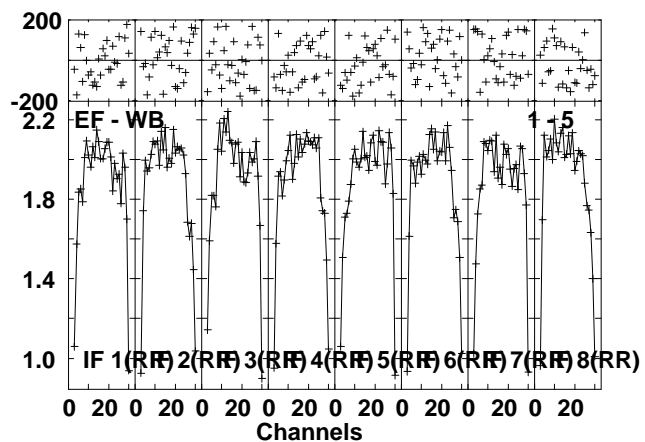
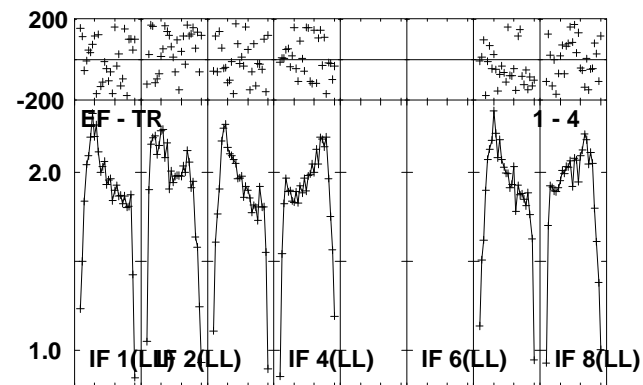
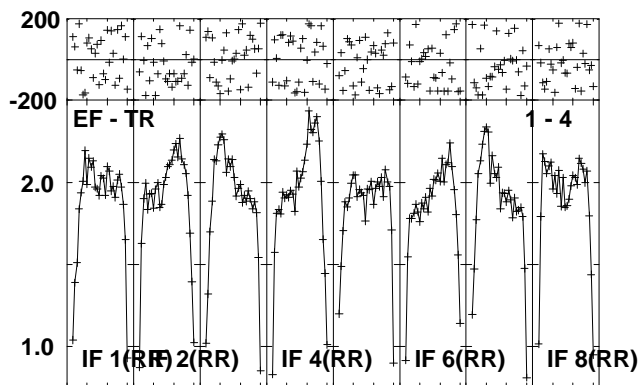
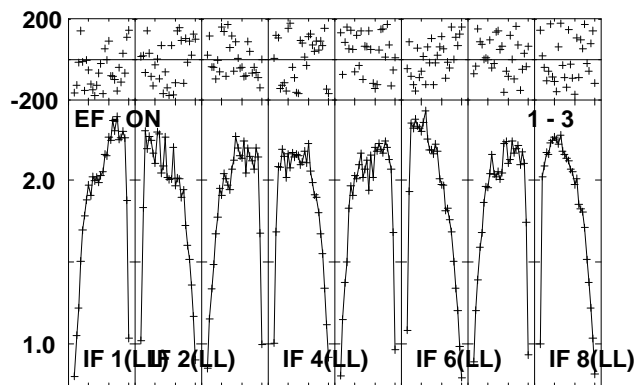
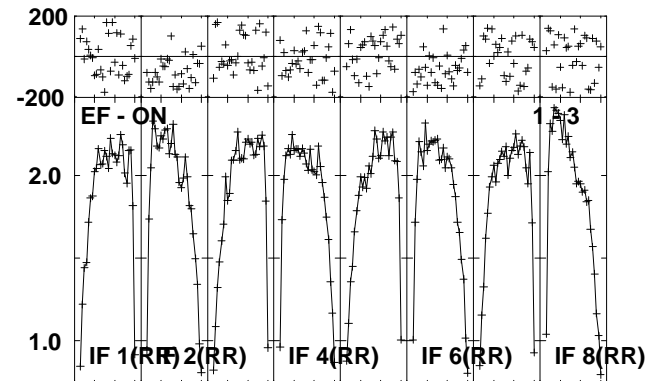
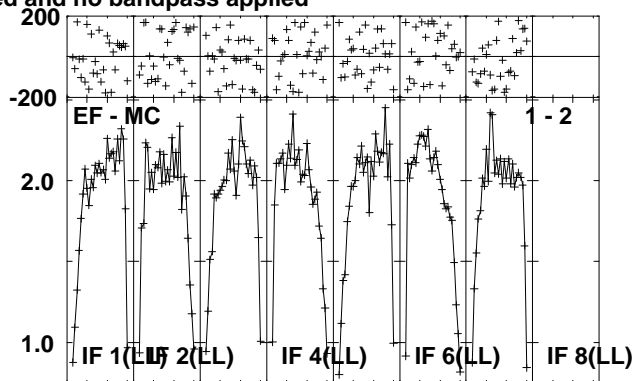
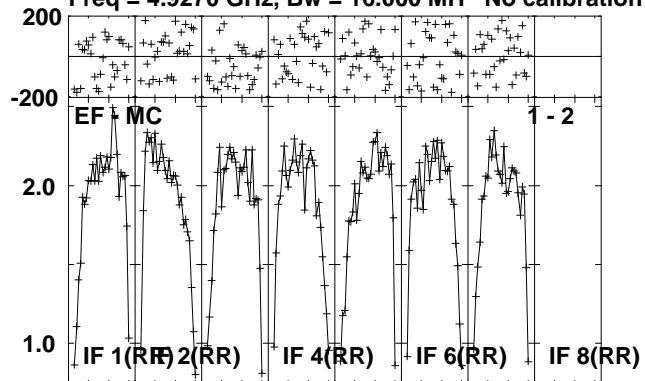

Lower frame: Milli Ampl Jy Top frame: Phas deg
Scalar averaged cross-power spectrum Several baselines displayed
Timerange: 00/14:13:22 to 00/14:18:48

Plot file version 50 created 02-DEC-2011 14:48:51

CYGX-1 ET018A.UVDATA.1

Freq = 4.9270 GHz, Bw = 16.000 MH No calibration applied and no bandpass applied

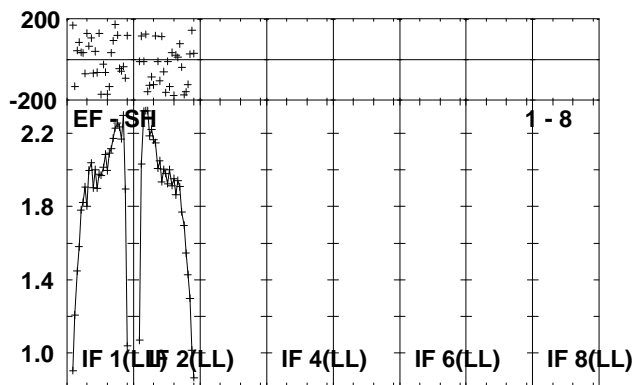
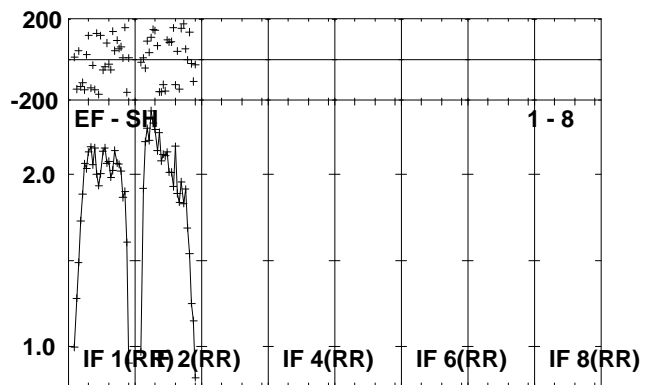
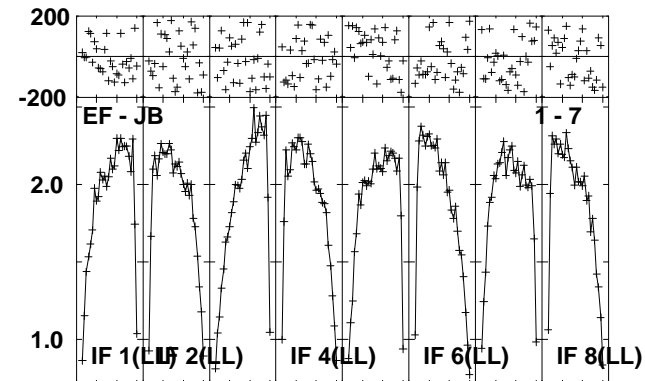
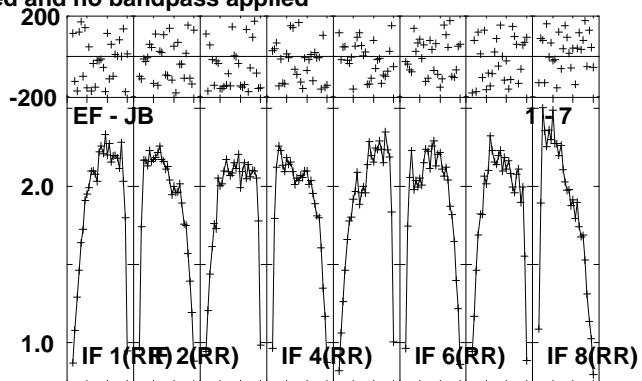
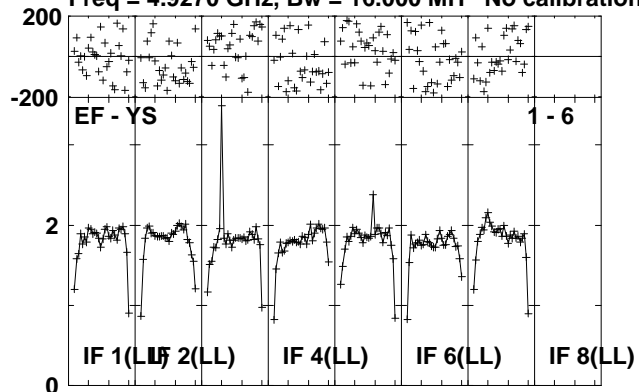

Lower frame: Milli Ampl Jy Top frame: Phas deg
Scalar averaged cross-power spectrum Several baselines displayed
Timerange: 00/14:13:22 to 00/14:18:48

Plot file version 51 created 02-DEC-2011 14:48:54

J1953+35 ET018A.UVDATA.1

Freq = 4.9270 GHz, Bw = 16.000 MH No calibration applied and no bandpass applied

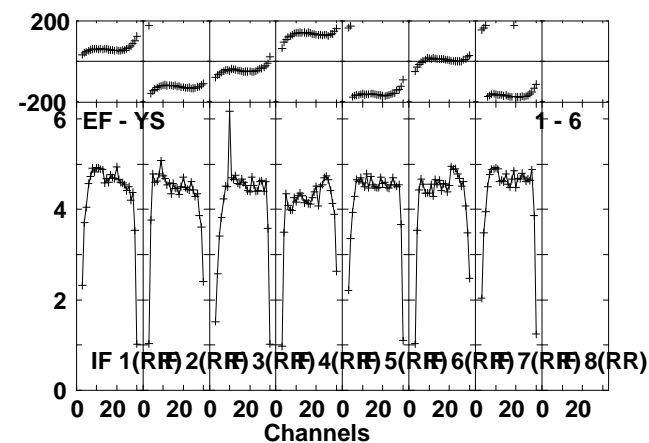
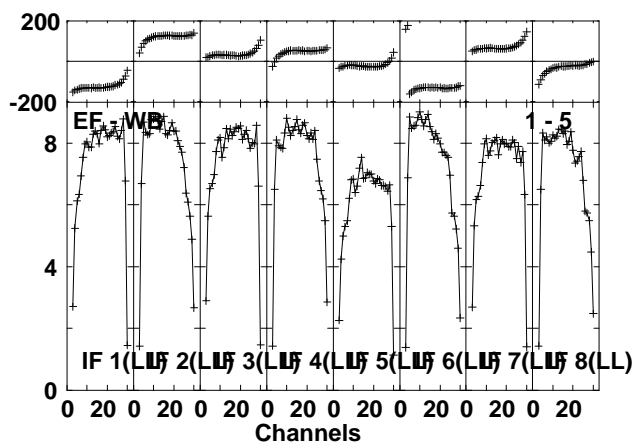
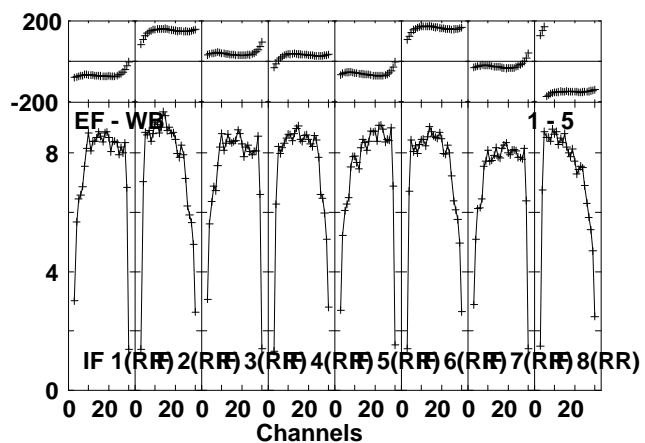
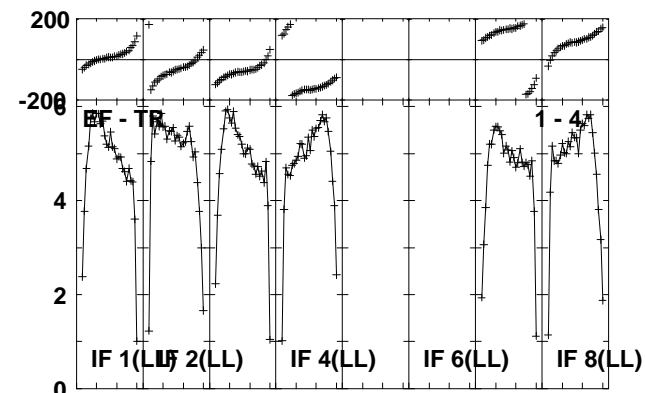
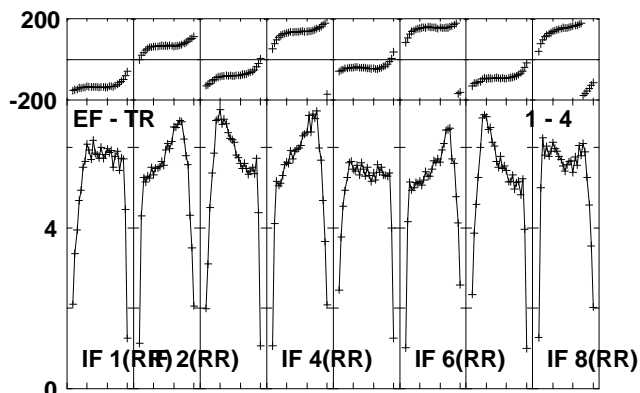
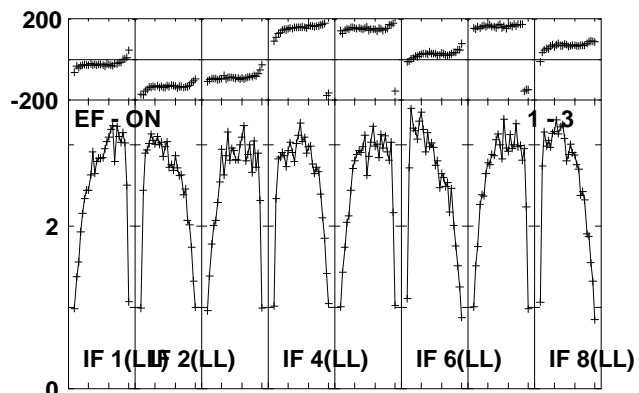
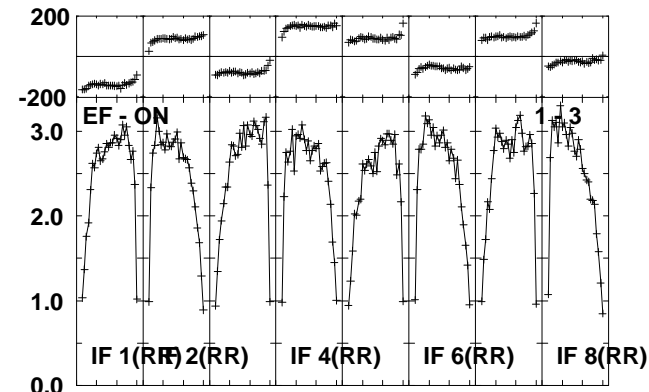
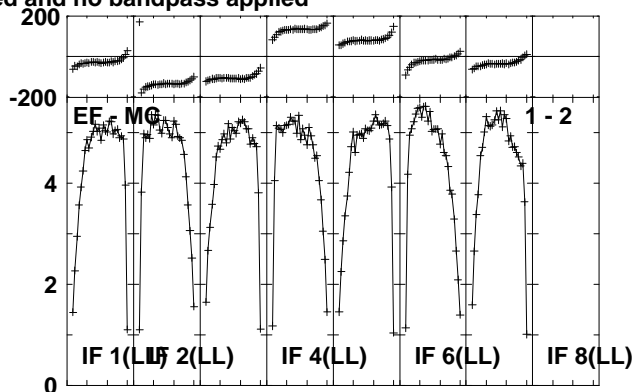
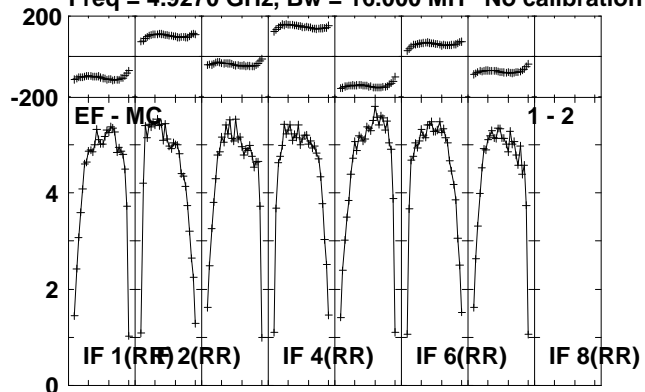

Lower frame: Milli Ampl Jy Top frame: Phas deg
Scalar averaged cross-power spectrum Several baselines displayed
Timerange: 00/14:18:52 to 00/14:21:49

Plot file version 52 created 02-DEC-2011 14:48:55

J1953+35 ET018A.UVDATA.1

Freq = 4.9270 GHz, Bw = 16.000 MH No calibration applied and no bandpass applied

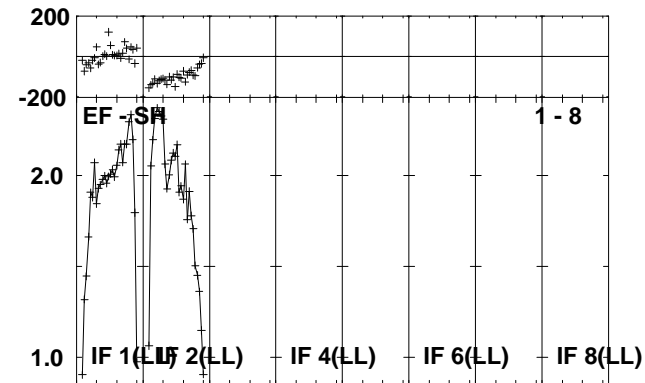
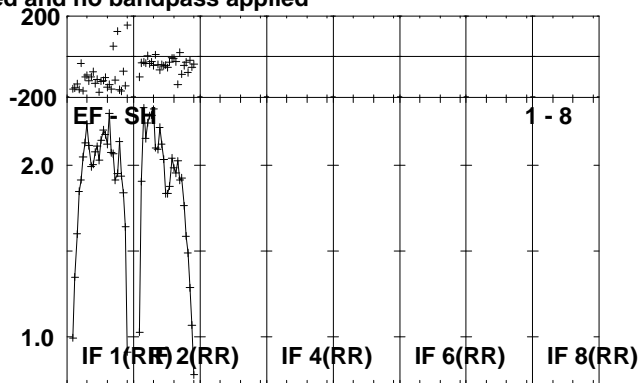
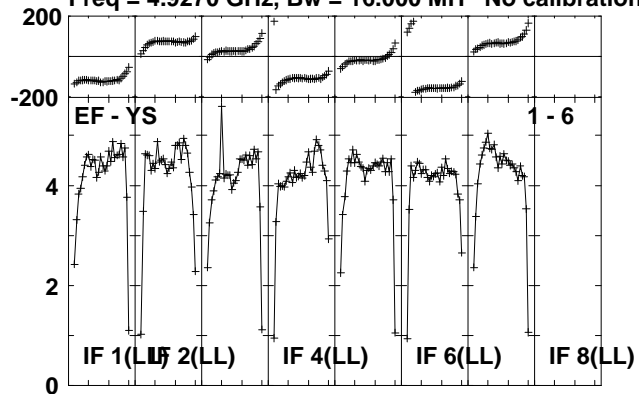

Lower frame: Milli Ampl Jy Top frame: Phas deg
Scalar averaged cross-power spectrum Several baselines displayed
Timerange: 00/14:18:52 to 00/14:21:49

Plot file version 53 created 02-DEC-2011 14:48:57

CYGX-1 ET018A.UVDATA.1

Freq = 4.9270 GHz, Bw = 16.000 MH No calibration applied and no bandpass applied

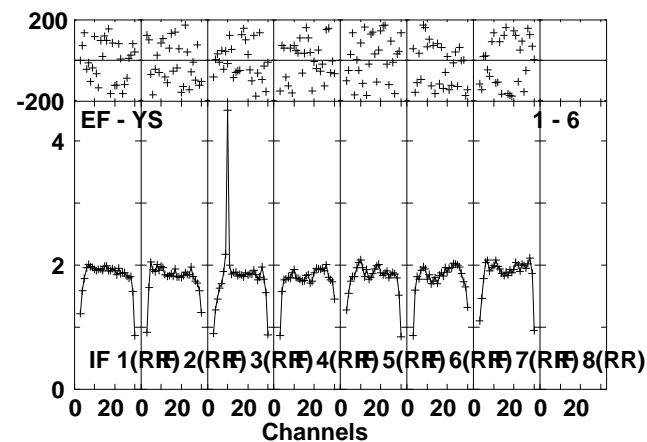
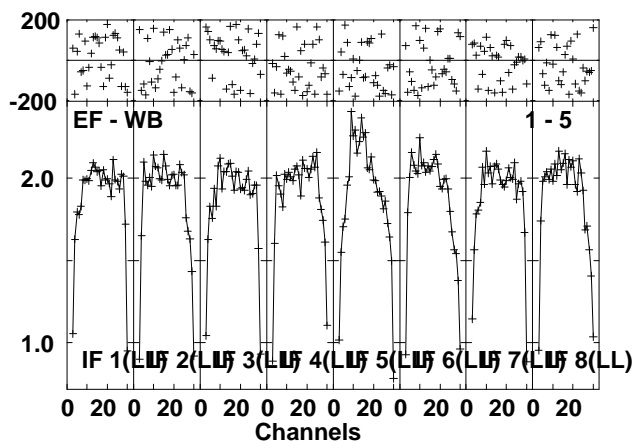
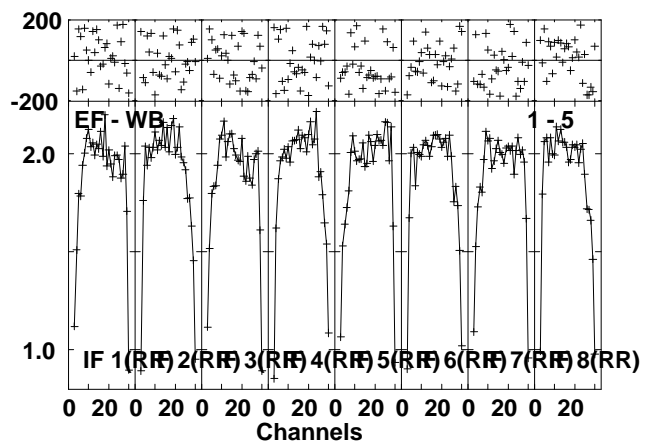
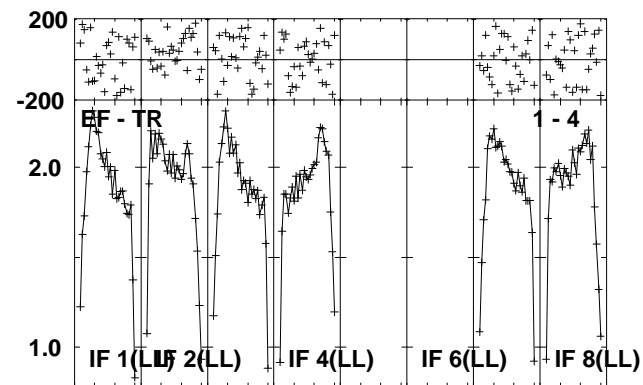
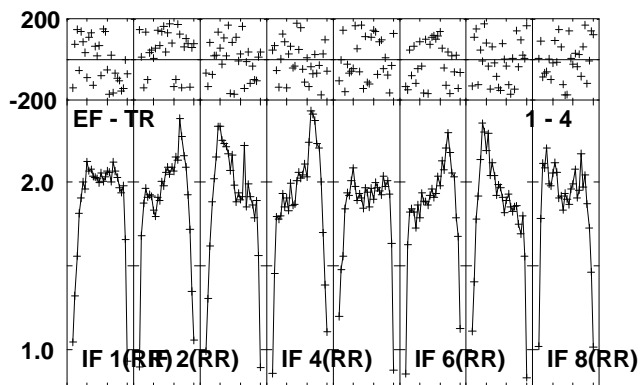
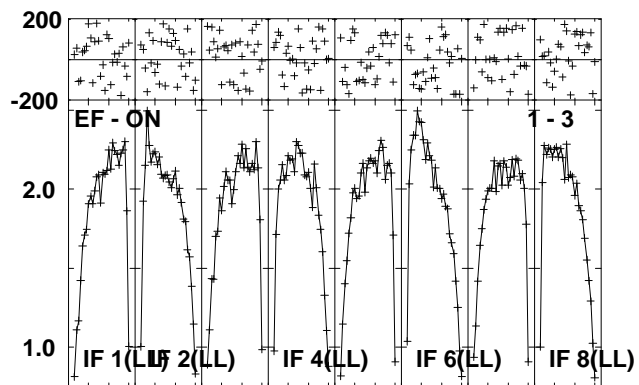
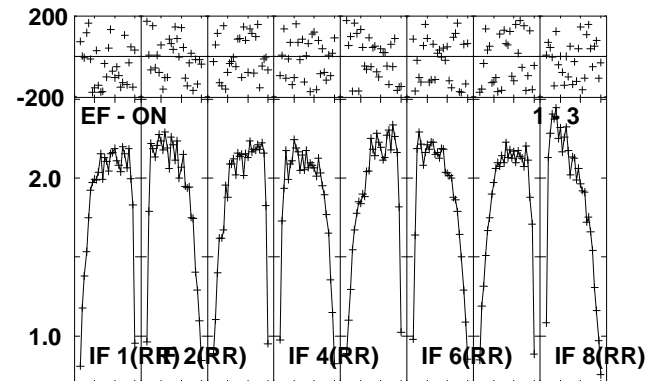
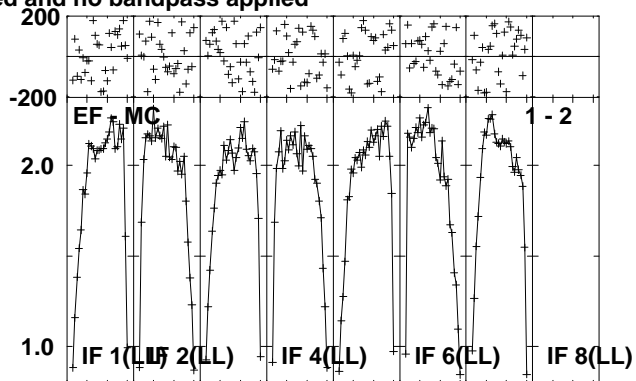
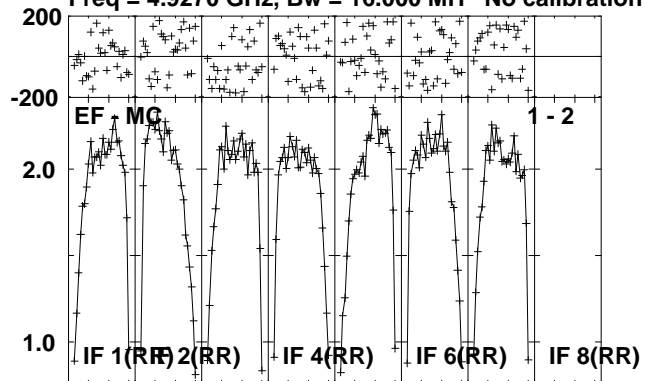

Lower frame: Milli Ampl Jy Top frame: Phas deg
Scalar averaged cross-power spectrum Several baselines displayed
Timerange: 00/14:21:52 to 00/14:27:18

Plot file version 54 created 02-DEC-2011 14:49:01

CYGX-1 ET018A.UVDATA.1

Freq = 4.9270 GHz, Bw = 16.000 MH No calibration applied and no bandpass applied

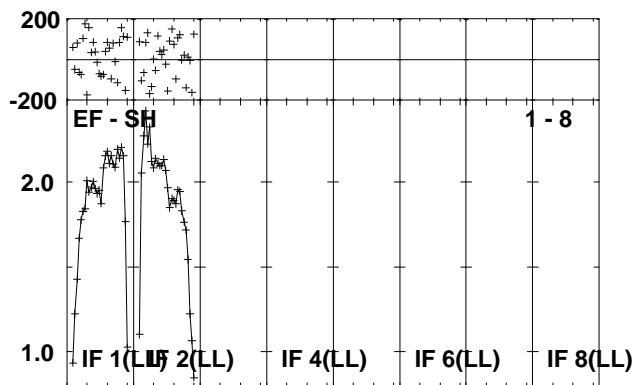
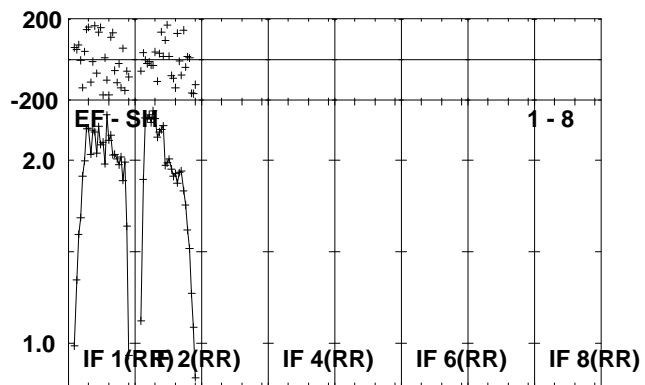
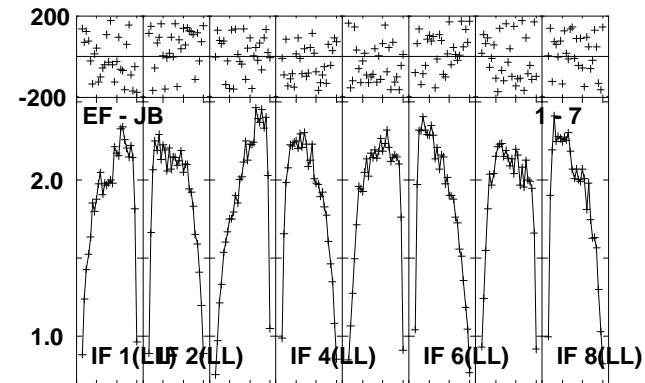
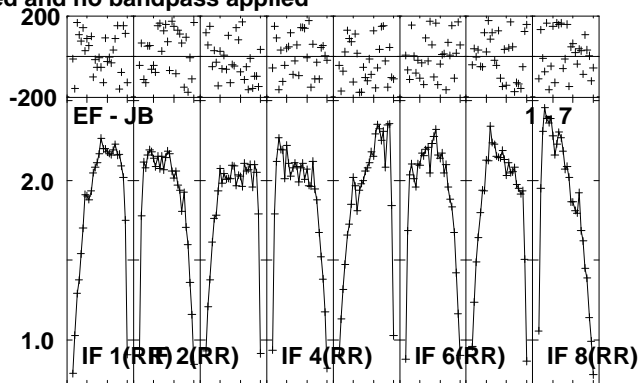
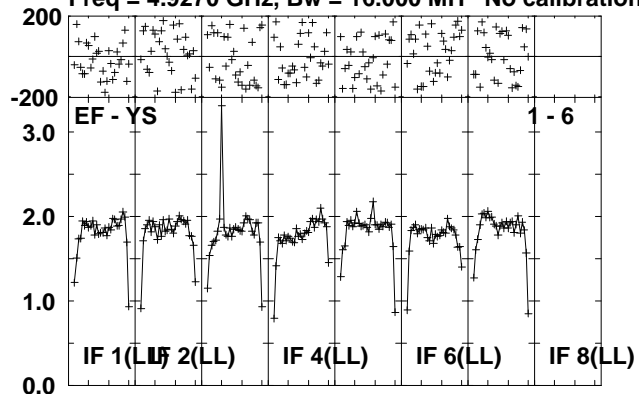

Lower frame: Milli Ampl Jy Top frame: Phas deg
Scalar averaged cross-power spectrum Several baselines displayed
Timerange: 00/14:21:52 to 00/14:27:18

Plot file version 55 created 02-DEC-2011 14:49:04

J1953+35 ET018A.UVDATA.1

Freq = 4.9270 GHz, Bw = 16.000 MH No calibration applied and no bandpass applied

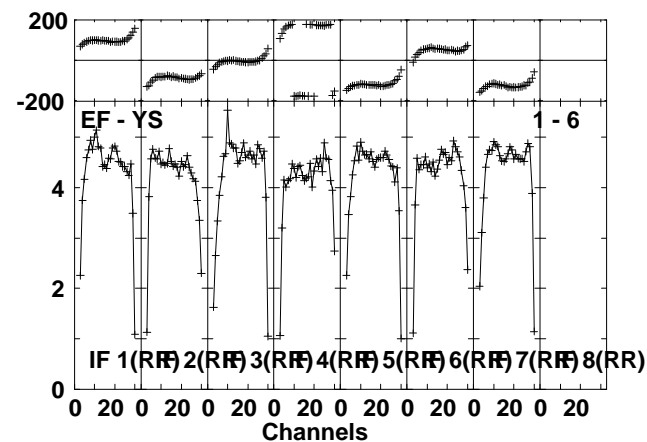
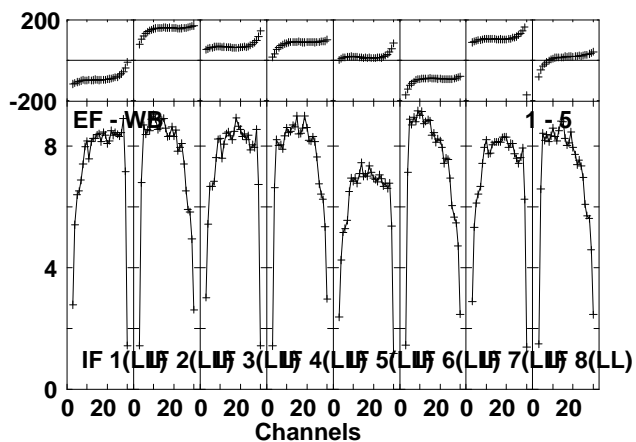
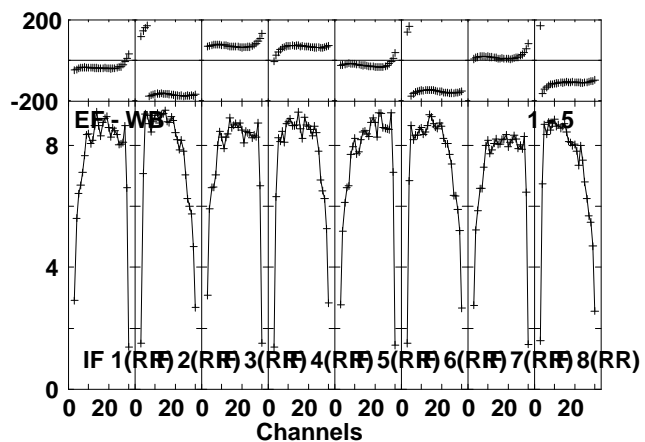
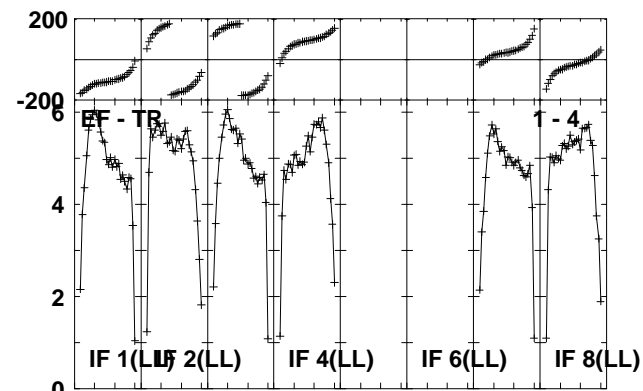
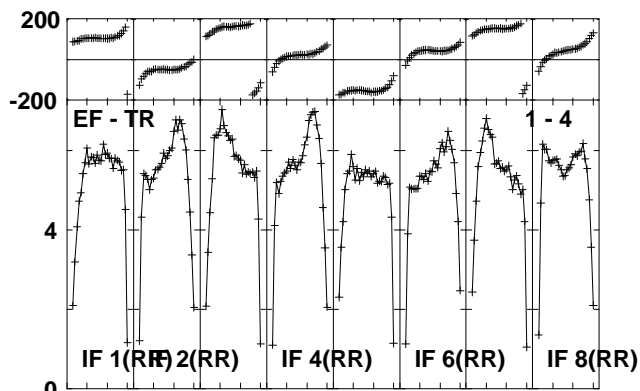
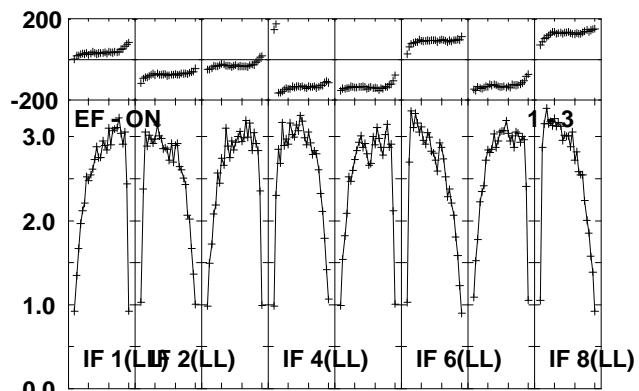
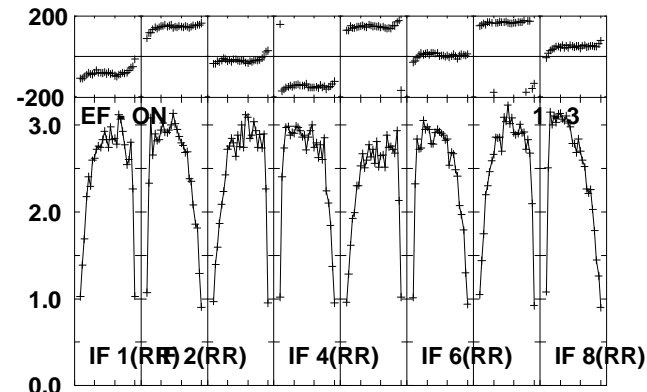
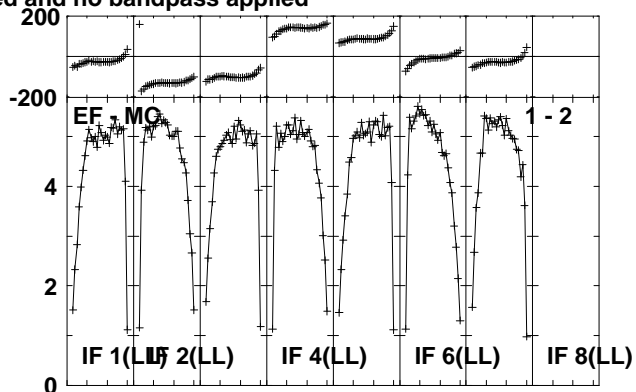
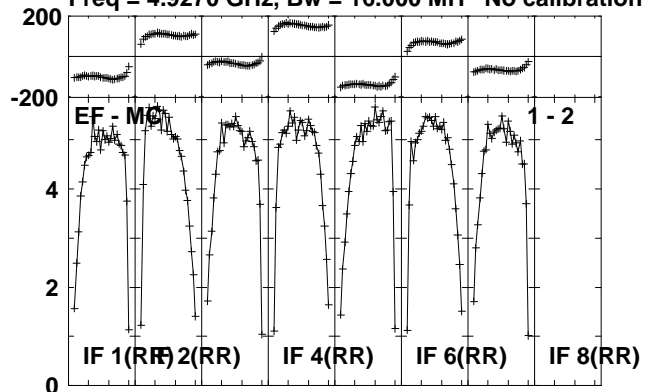

Lower frame: Milli Ampl Jy Top frame: Phas deg
Scalar averaged cross-power spectrum Several baselines displayed
Timerange: 00/14:28:06 to 00/14:30:39

Plot file version 56 created 02-DEC-2011 14:49:06

J1953+35 ET018A.UVDATA.1

Freq = 4.9270 GHz, Bw = 16.000 MH No calibration applied and no bandpass applied

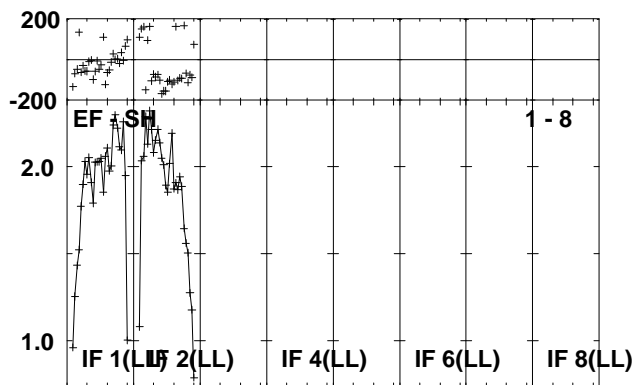
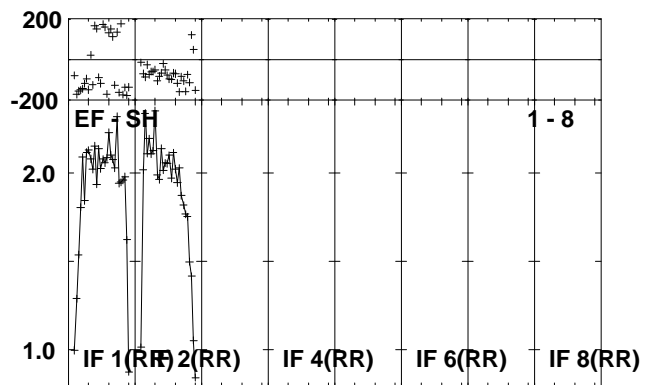
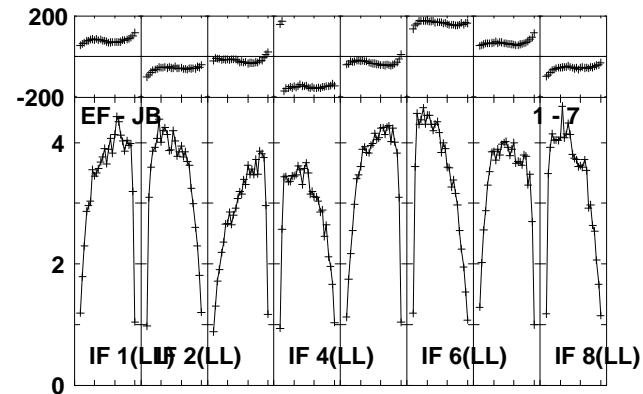
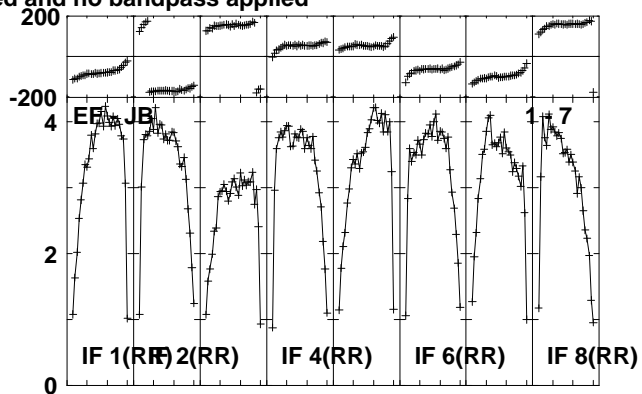
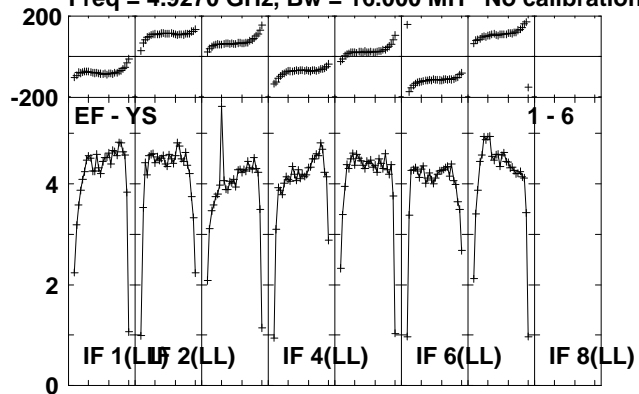

Lower frame: Milli Ampl Jy Top frame: Phas deg
Scalar averaged cross-power spectrum Several baselines displayed
Timerange: 00/14:28:06 to 00/14:30:39

Plot file version 57 created 02-DEC-2011 14:49:07

CYGX-1 ET018A.UVDATA.1

Freq = 4.9270 GHz, Bw = 16.000 MH No calibration applied and no bandpass applied

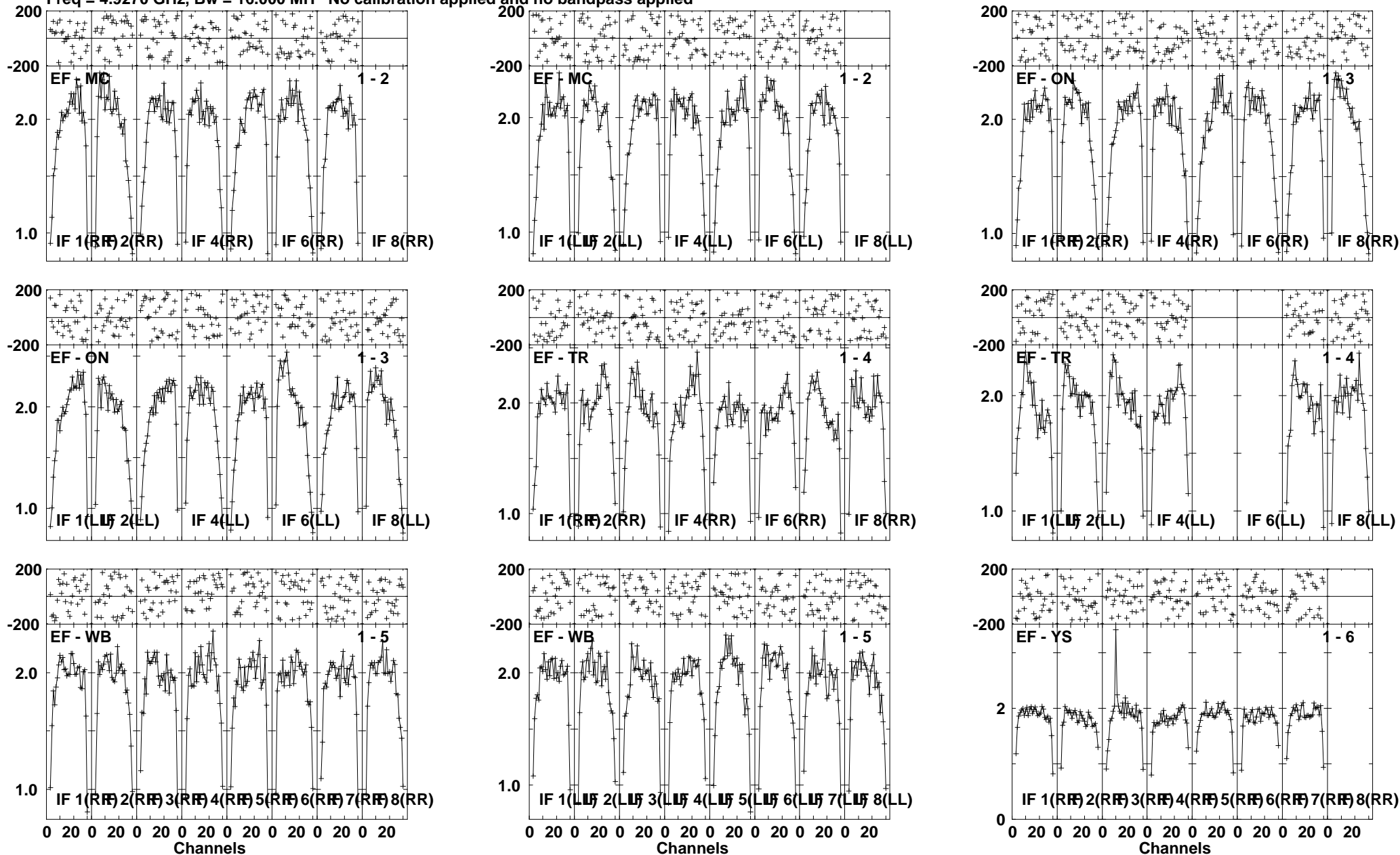

Lower frame: Milli Ampl Jy Top frame: Phas deg
Scalar averaged cross-power spectrum Several baselines displayed
Timerange: 00/14:30:42 to 00/14:36:08

Plot file version 58 created 02-DEC-2011 14:49:11

CYGX-1 ET018A.UVDATA.1

Freq = 4.9270 GHz, Bw = 16.000 MH No calibration applied and no bandpass applied

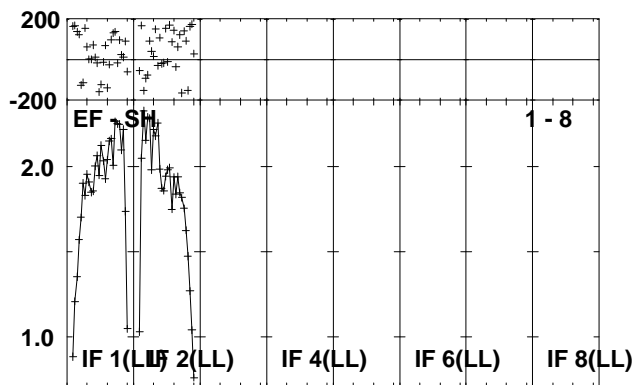
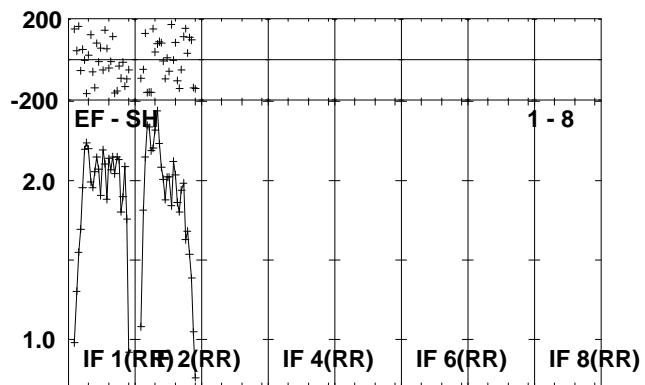
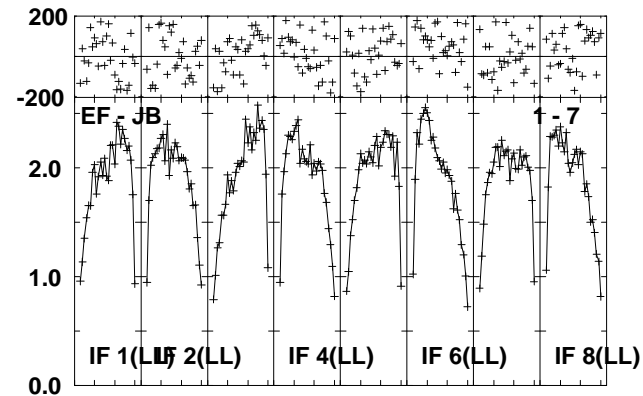
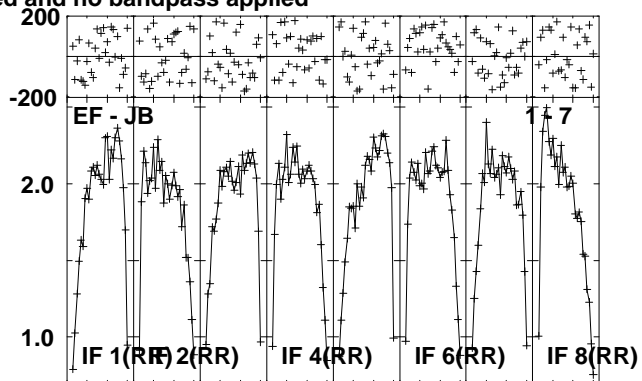
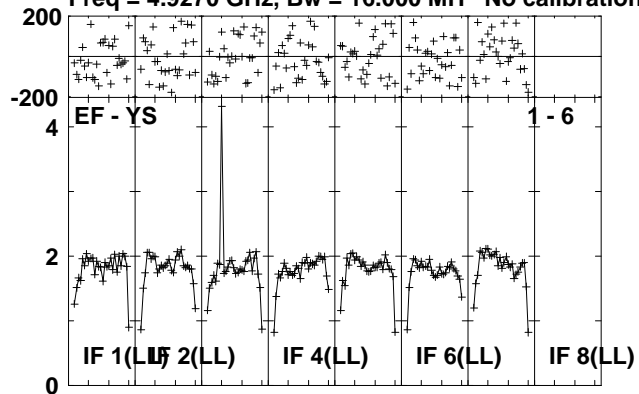

Lower frame: Milli Ampl Jy Top frame: Phas deg
Scalar averaged cross-power spectrum Several baselines displayed
Timerange: 00/14:30:42 to 00/14:36:08

Plot file version 59 created 02-DEC-2011 14:49:14

J1953+35 ET018A.UVDATA.1

Freq = 4.9270 GHz, Bw = 16.000 MH No calibration applied and no bandpass applied

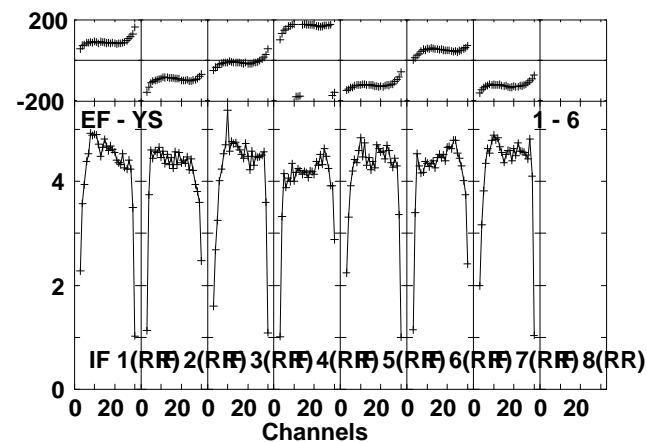
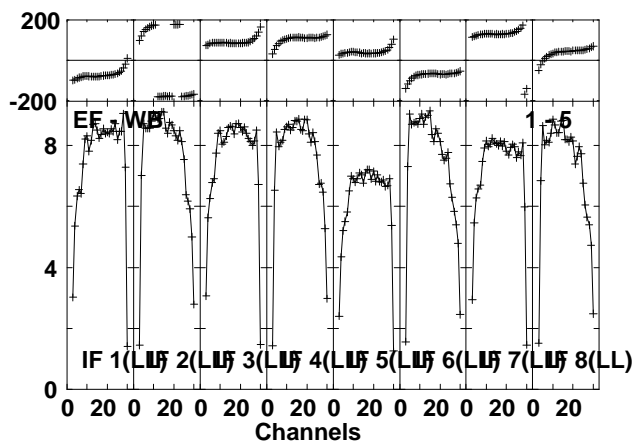
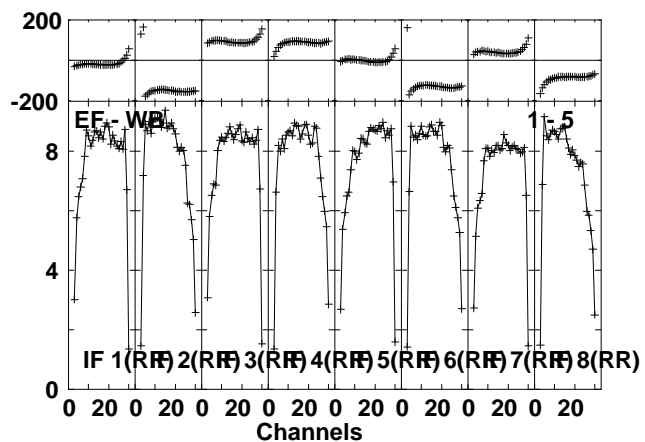
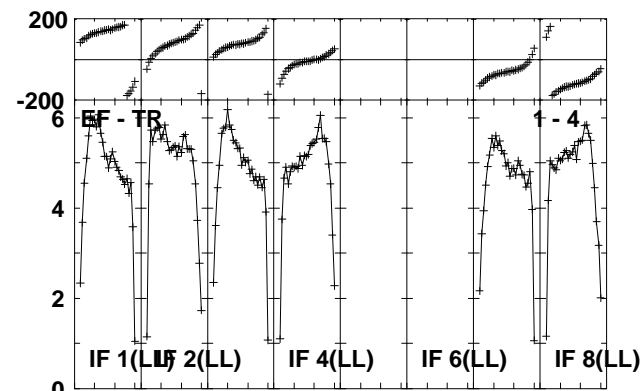
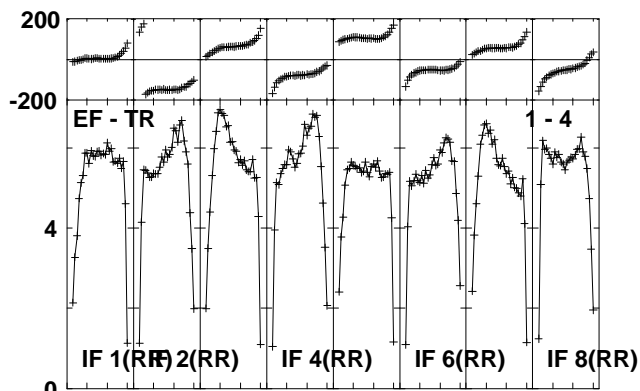
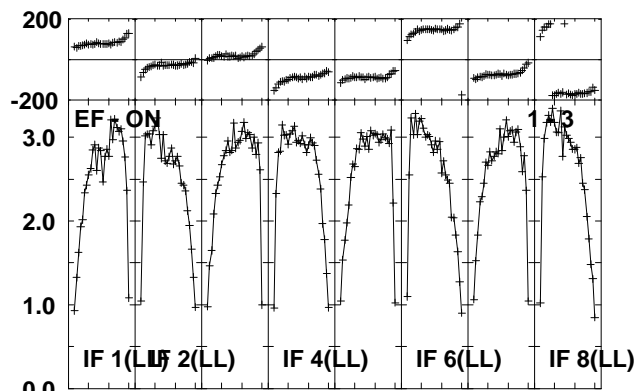
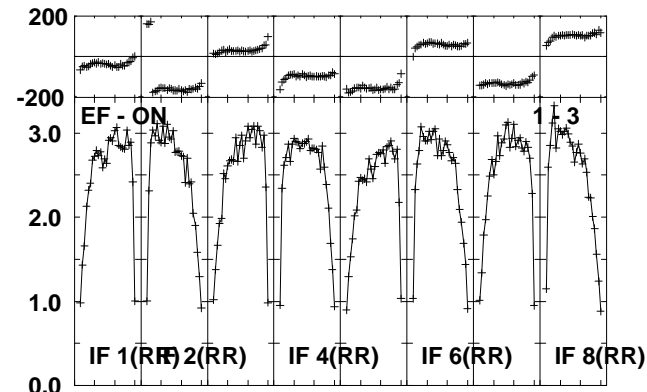
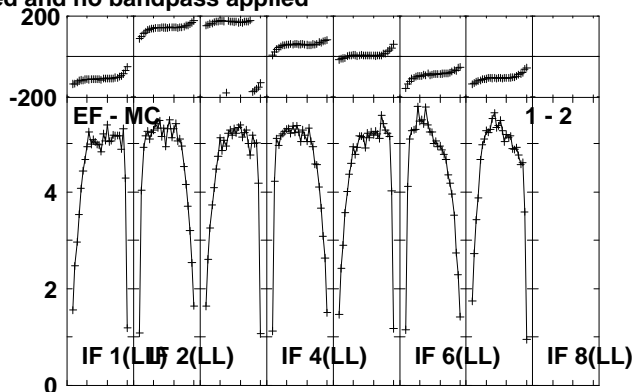
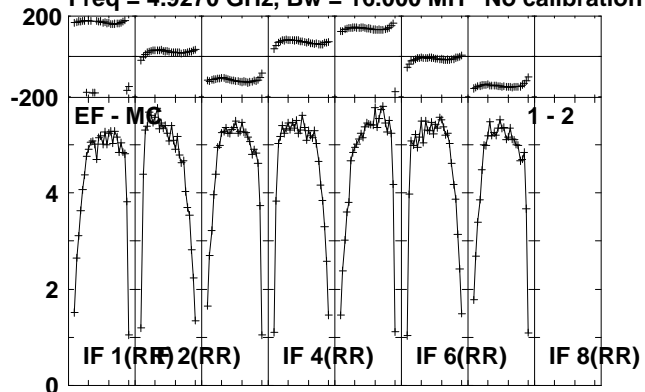

Lower frame: Milli Ampl Jy Top frame: Phas deg
Scalar averaged cross-power spectrum Several baselines displayed
Timerange: 00/14:36:12 to 00/14:39:09

Plot file version 60 created 02-DEC-2011 14:49:16

J1953+35 ET018A.UVDATA.1

Freq = 4.9270 GHz, Bw = 16.000 MH No calibration applied and no bandpass applied

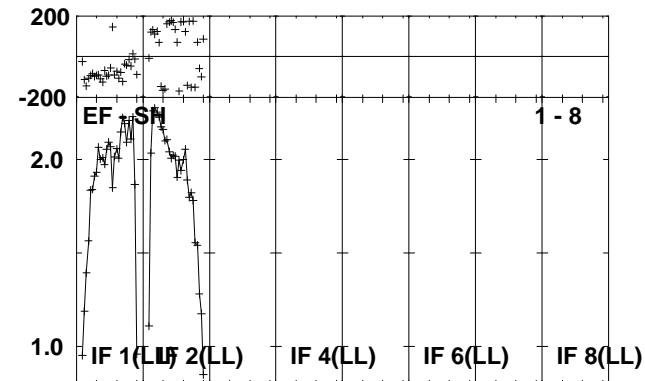
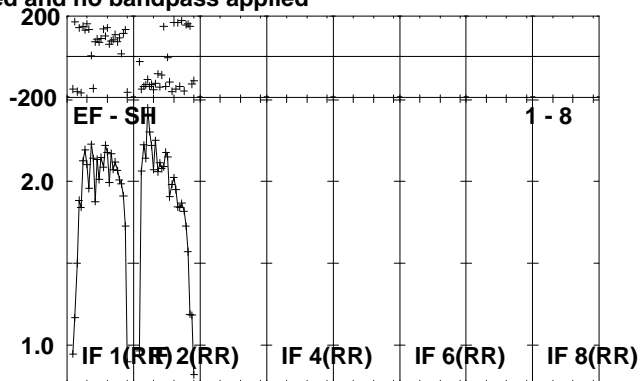
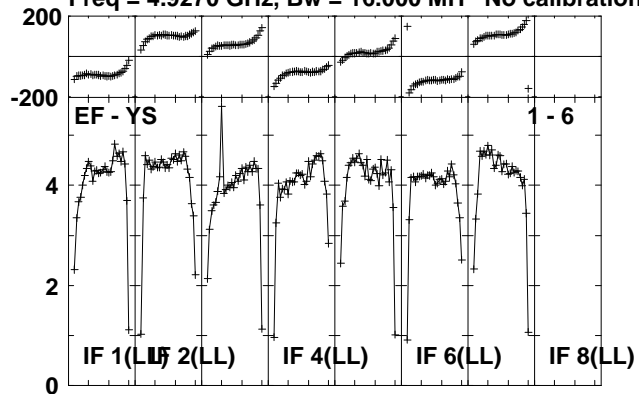

Lower frame: Milli Ampl Jy Top frame: Phas deg
Scalar averaged cross-power spectrum Several baselines displayed
Timerange: 00/14:36:12 to 00/14:39:09

Plot file version 61 created 02-DEC-2011 14:49:18

CYGX-1 ET018A.UVDATA.1

Freq = 4.9270 GHz, Bw = 16.000 MH No calibration applied and no bandpass applied

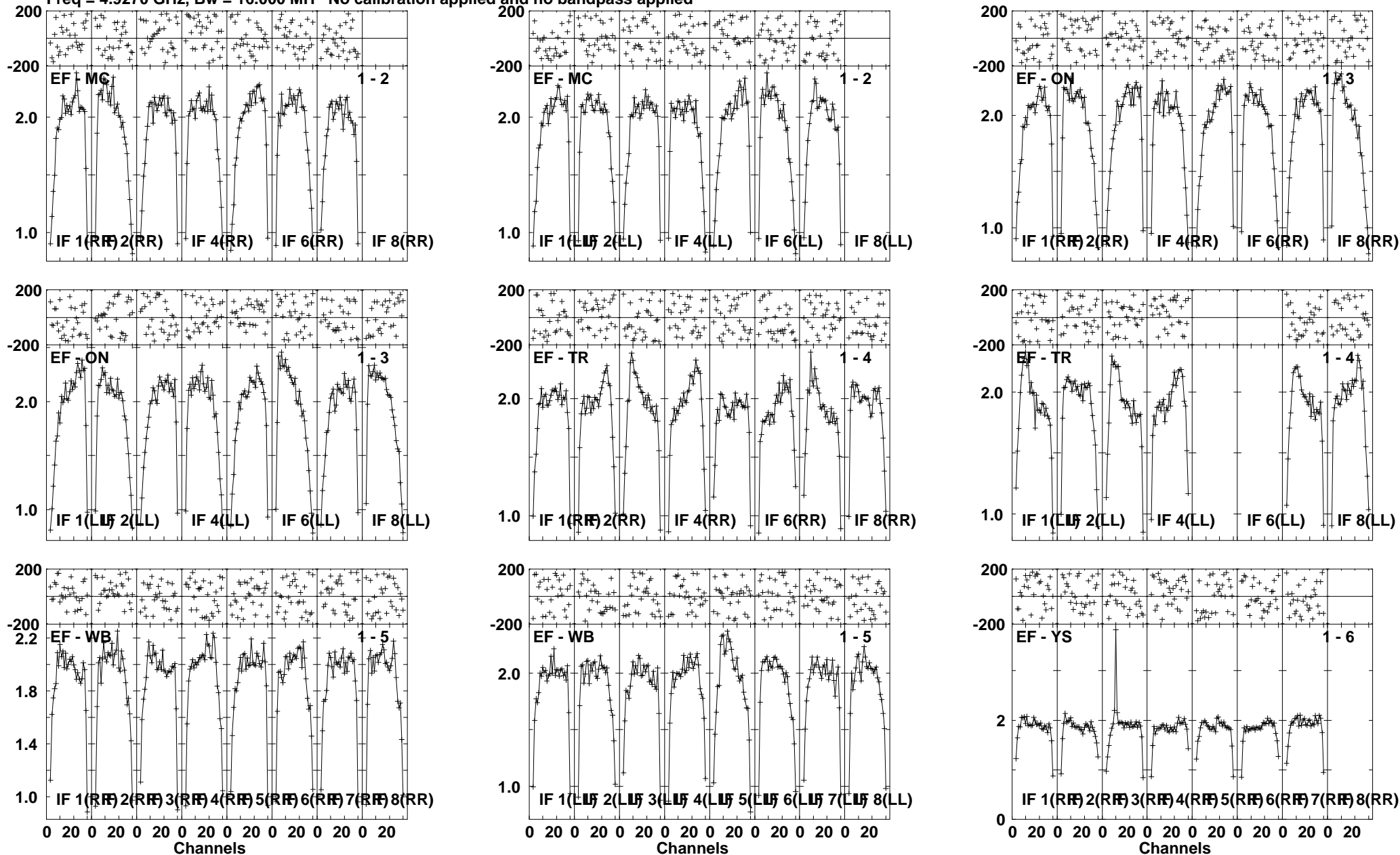

Lower frame: Milli Ampl Jy Top frame: Phas deg
Scalar averaged cross-power spectrum Several baselines displayed
Timerange: 00/14:39:12 to 00/14:44:38

Plot file version 62 created 02-DEC-2011 14:49:22

CYGX-1 ET018A.UVDATA.1

Freq = 4.9270 GHz, Bw = 16.000 MH No calibration applied and no bandpass applied

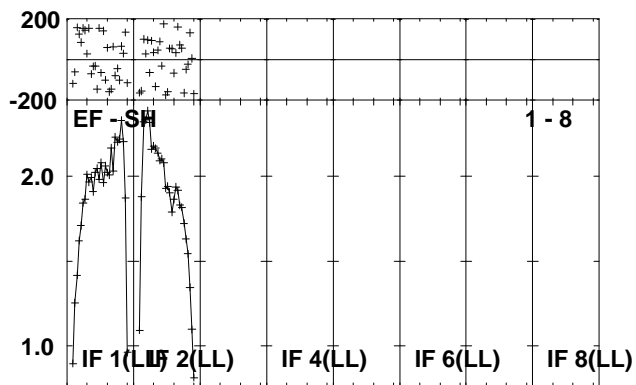
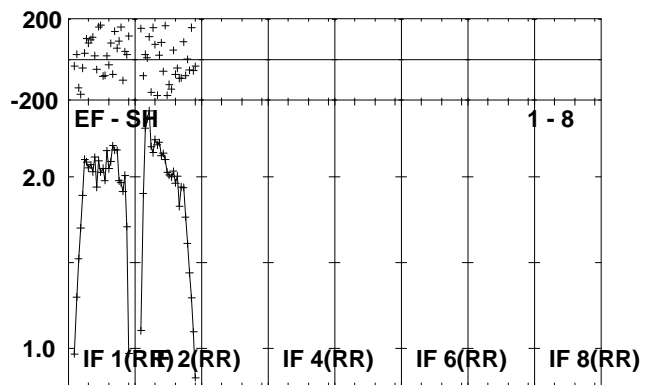
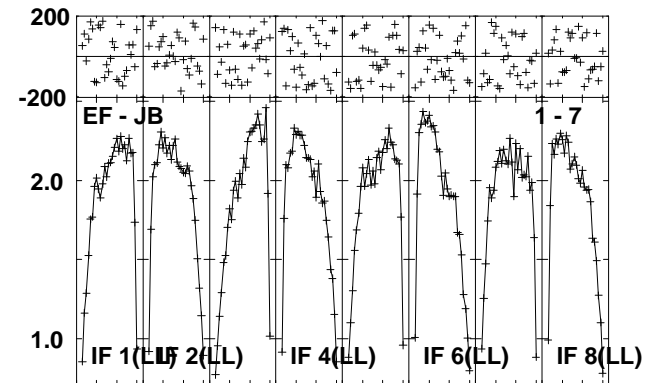
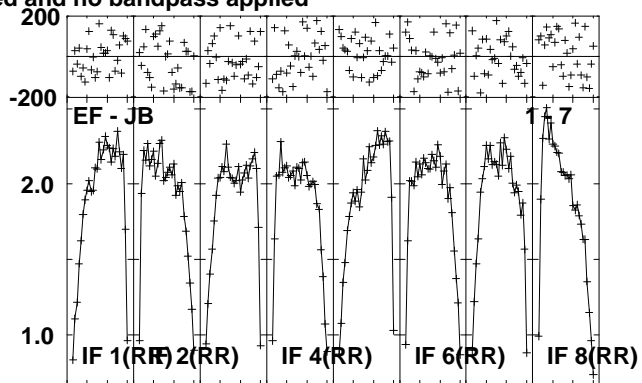
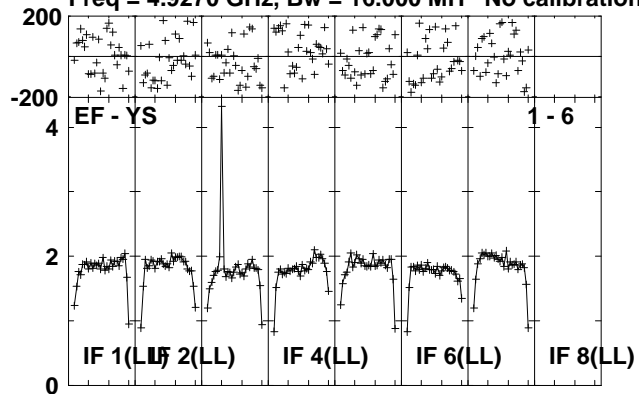

Lower frame: Milli Ampl Jy Top frame: Phas deg
Scalar averaged cross-power spectrum Several baselines displayed
Timerange: 00/14:39:12 to 00/14:44:38

Plot file version 63 created 02-DEC-2011 14:49:25

J1953+35 ET018A.UVDATA.1

Freq = 4.9270 GHz, Bw = 16.000 MH No calibration applied and no bandpass applied

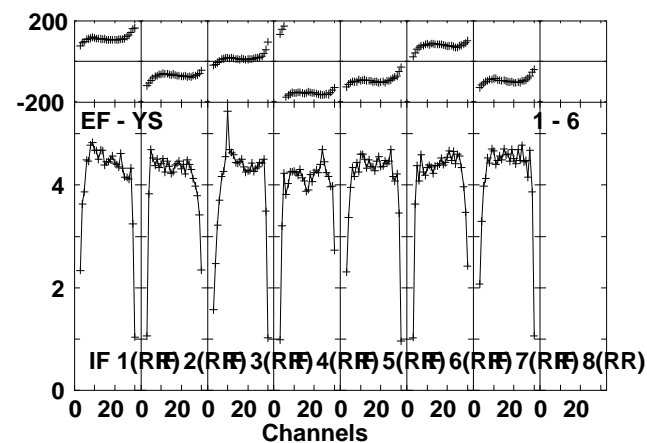
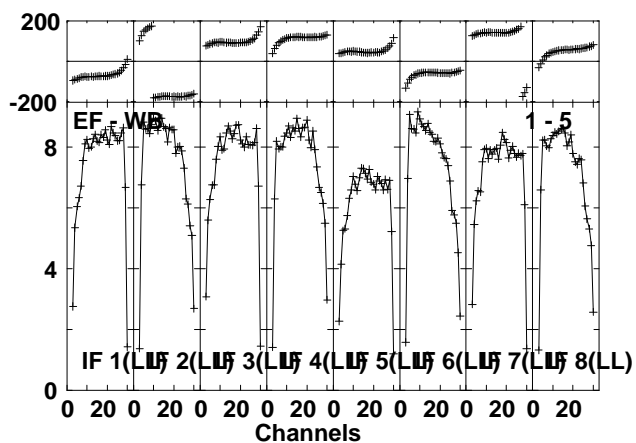
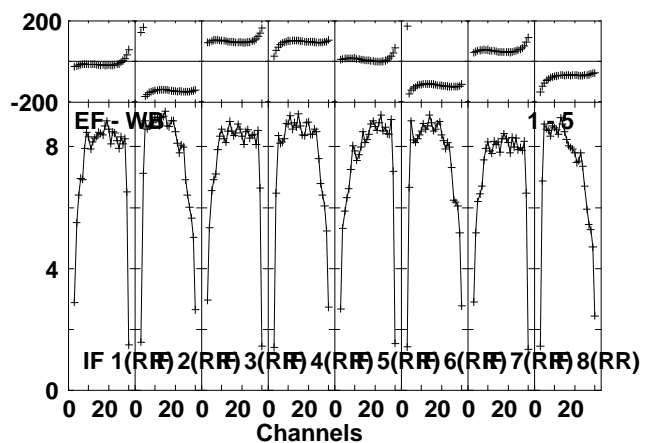
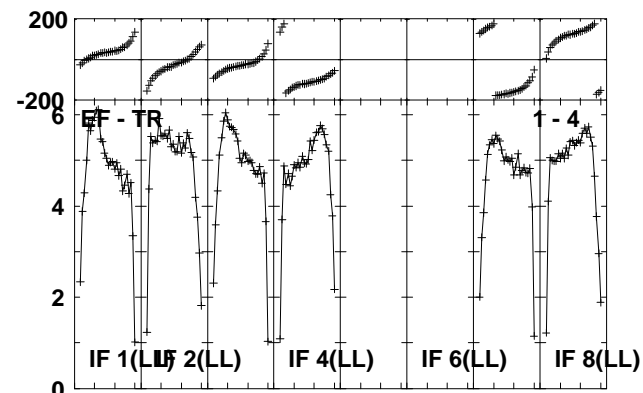
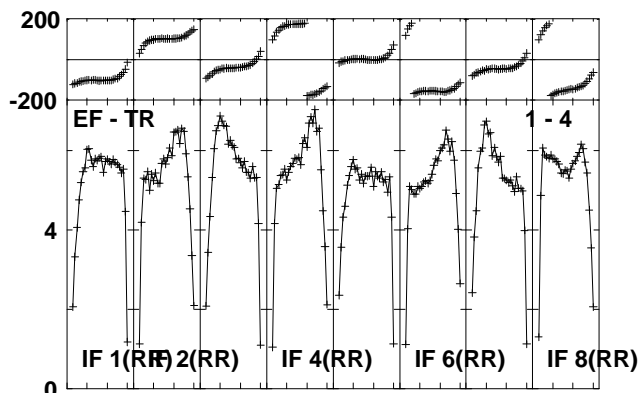
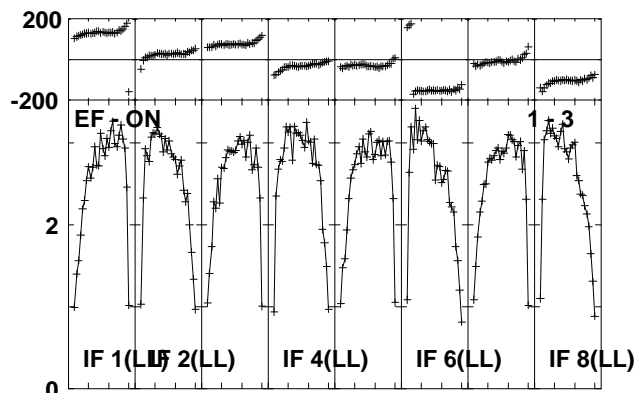
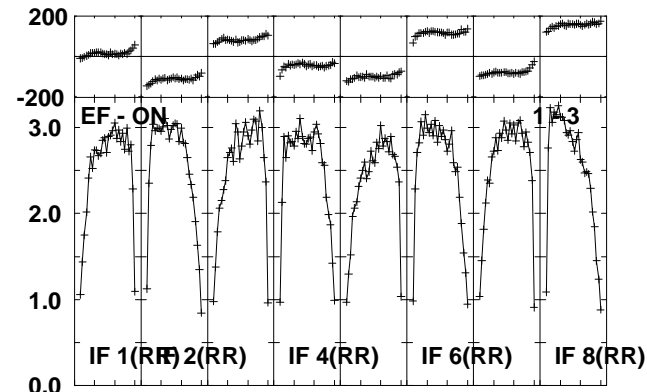
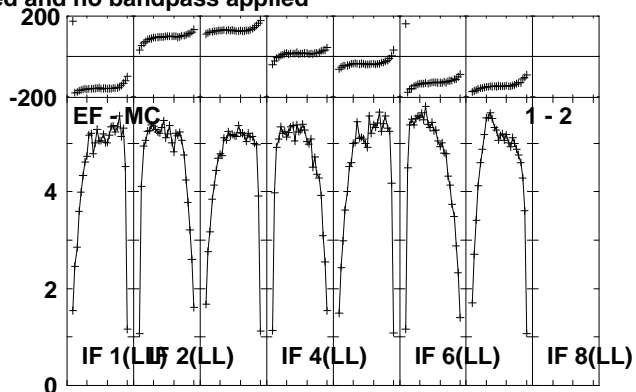
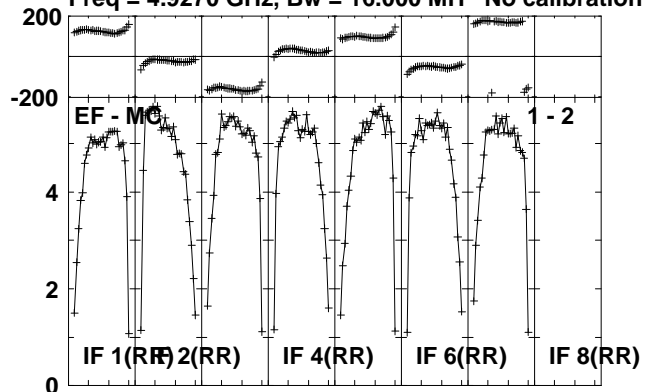

Lower frame: Milli Ampl Jy Top frame: Phas deg
Scalar averaged cross-power spectrum Several baselines displayed
Timerange: 00/14:45:26 to 00/14:47:59

Plot file version 64 created 02-DEC-2011 14:49:27

J1953+35 ET018A.UVDATA.1

Freq = 4.9270 GHz, Bw = 16.000 MH No calibration applied and no bandpass applied

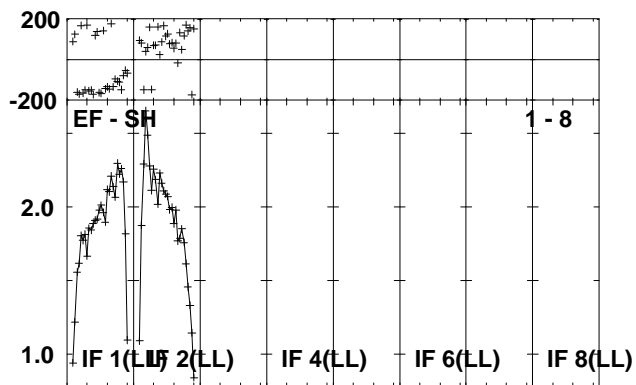
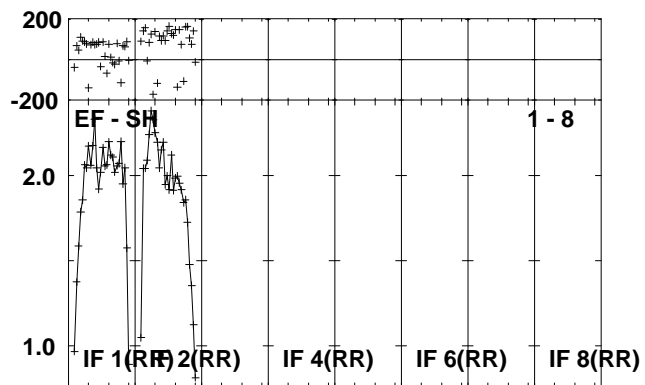
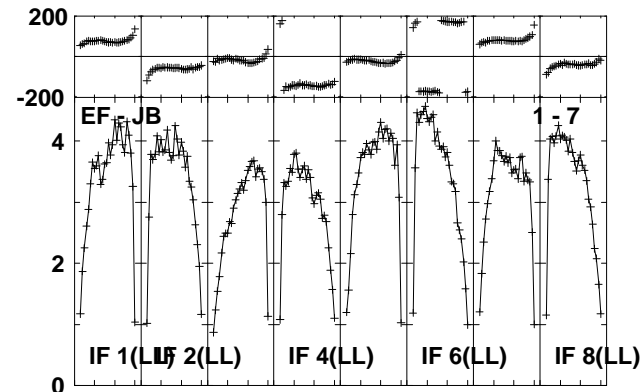
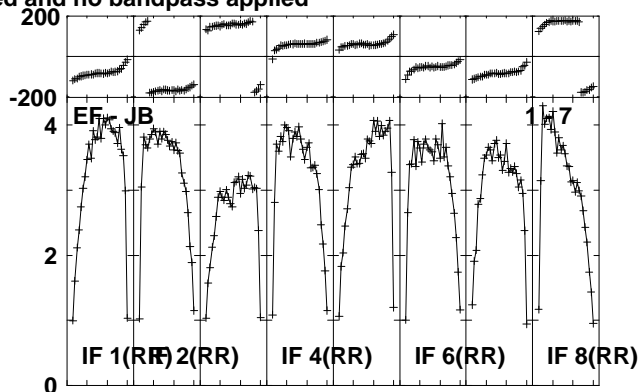
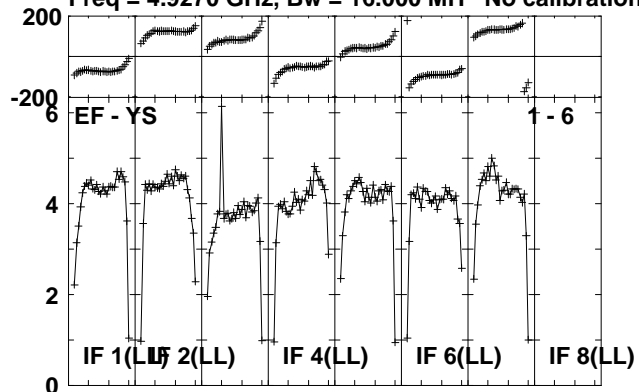

Lower frame: Milli Ampl Jy Top frame: Phas deg
Scalar averaged cross-power spectrum Several baselines displayed
Timerange: 00/14:45:26 to 00/14:47:59

Plot file version 65 created 02-DEC-2011 14:49:29

J2002+47 ET018A.UVDATA.1

Freq = 4.9270 GHz, Bw = 16.000 MH No calibration applied and no bandpass applied

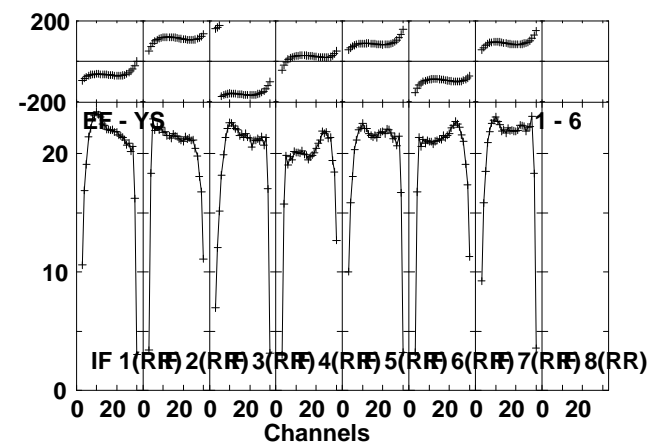
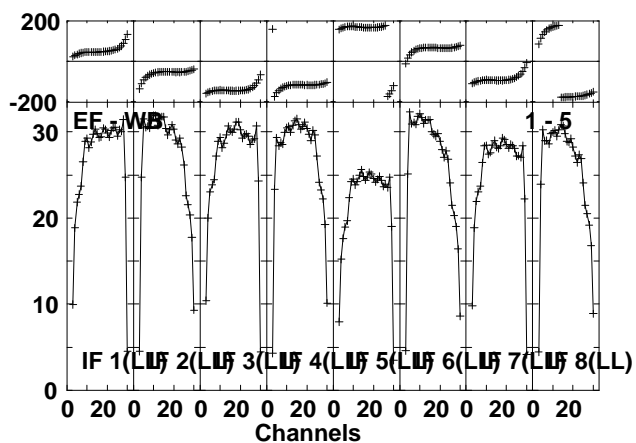
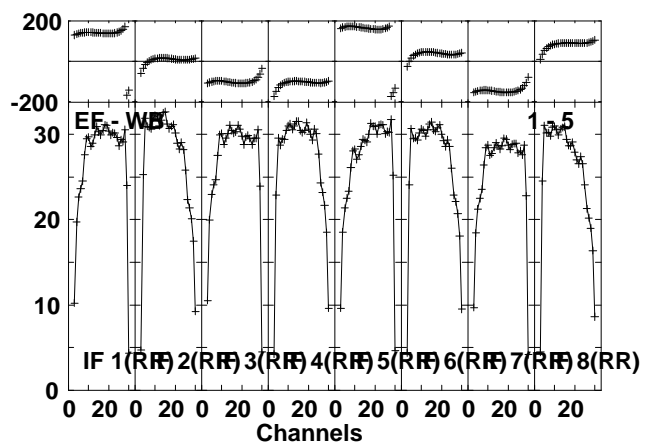
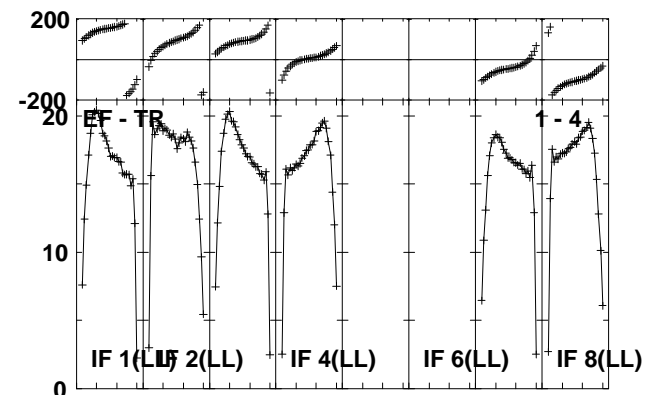
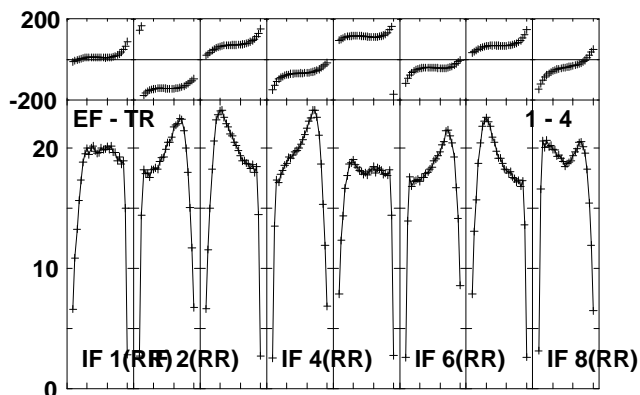
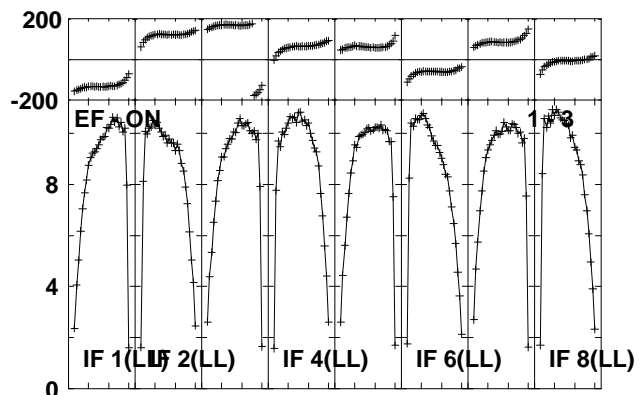
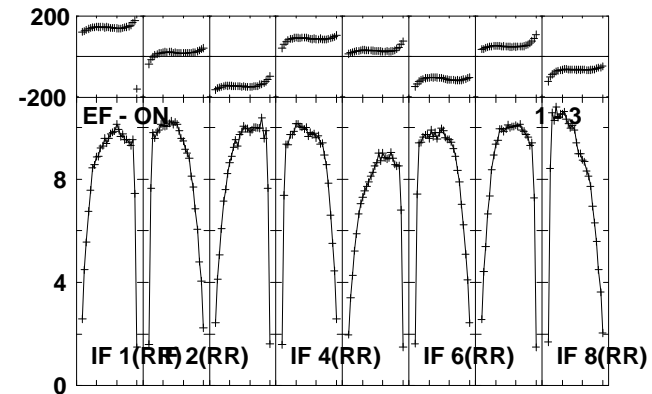
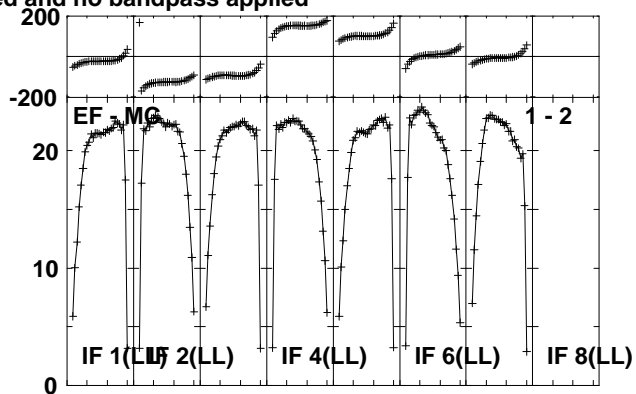
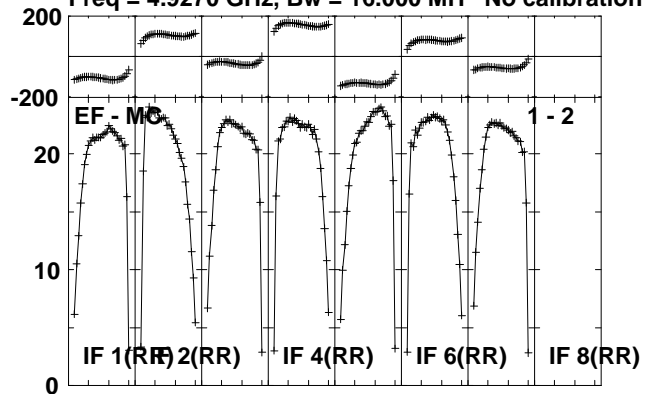

Lower frame: Milli Ampl Jy Top frame: Phas deg
Scalar averaged cross-power spectrum Several baselines displayed
Timerange: 00/14:49:26 to 00/14:53:28

Plot file version 66 created 02-DEC-2011 14:49:32

J2002+47 ET018A.UVDATA.1

Freq = 4.9270 GHz, Bw = 16.000 MH No calibration applied and no bandpass applied

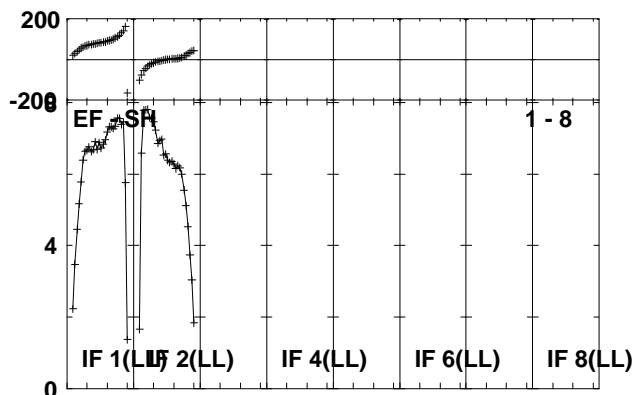
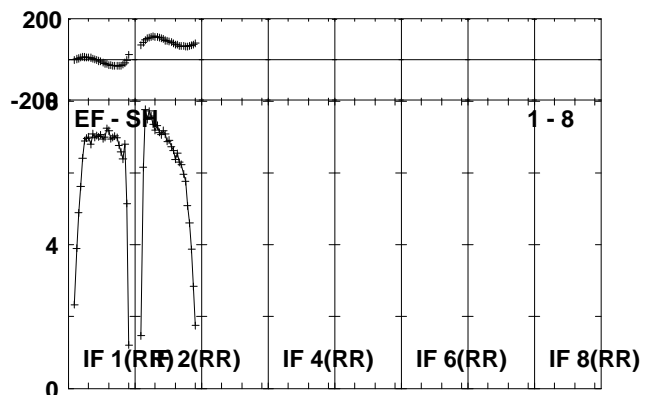
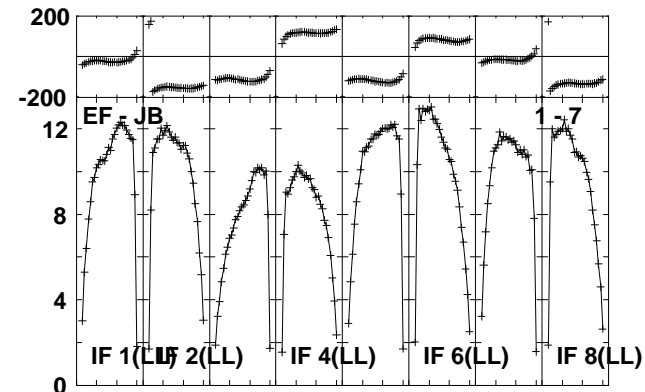
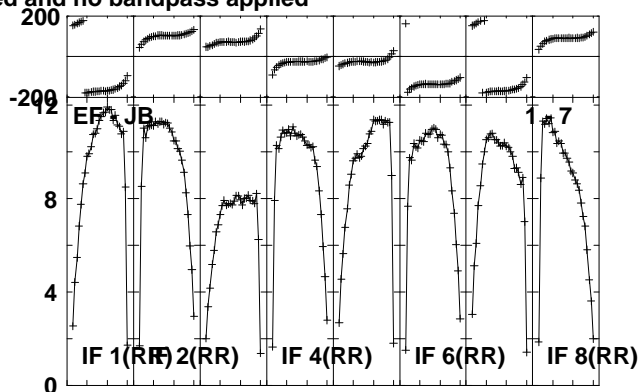
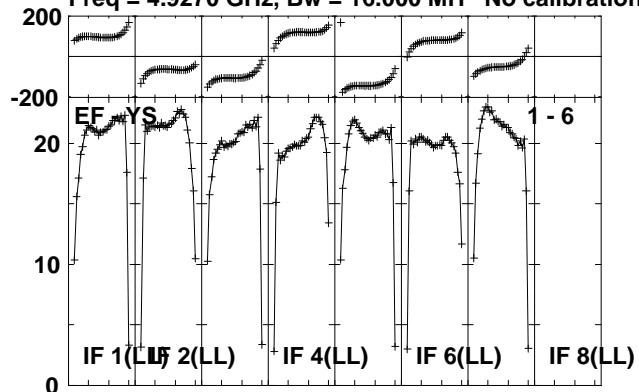

Lower frame: Milli Ampl Jy Top frame: Phas deg
Scalar averaged cross-power spectrum Several baselines displayed
Timerange: 00/14:49:26 to 00/14:53:28

Plot file version 67 created 02-DEC-2011 14:49:34

J1953+35 ET018A.UVDATA.1

Freq = 4.9270 GHz, Bw = 16.000 MH No calibration applied and no bandpass applied

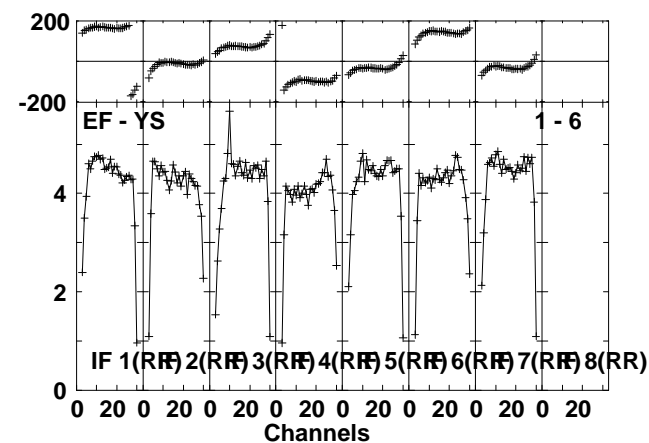
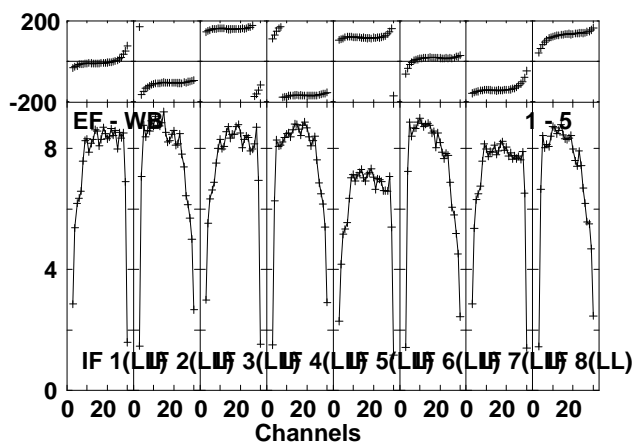
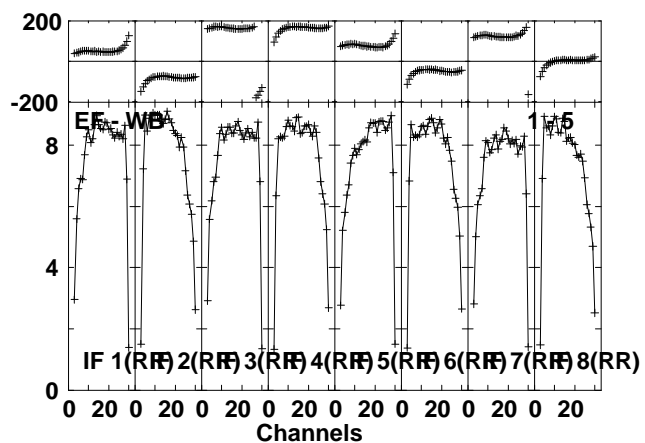
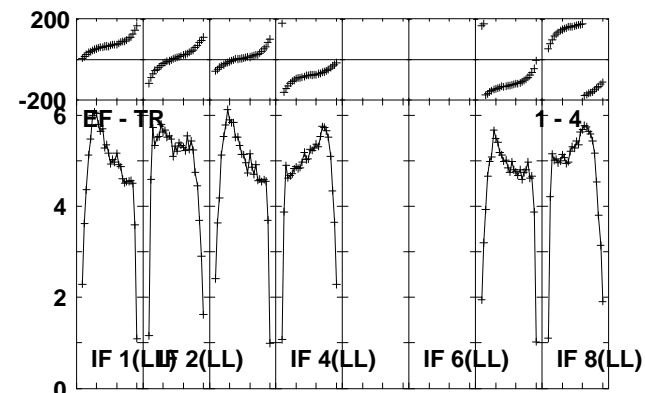
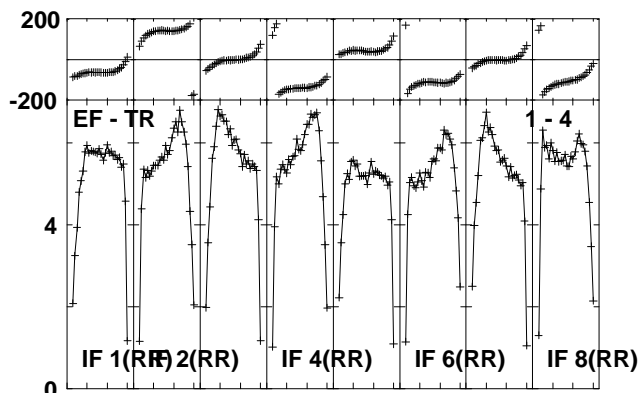
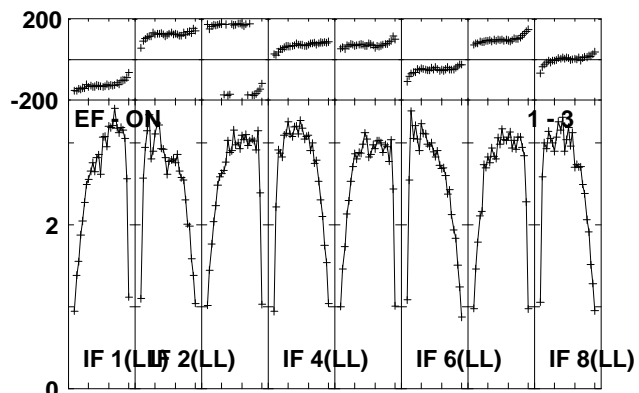
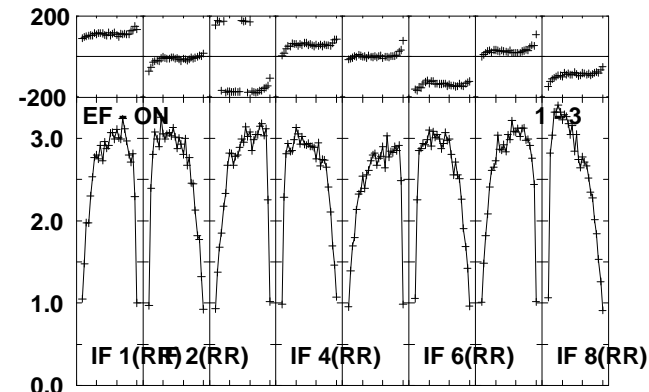
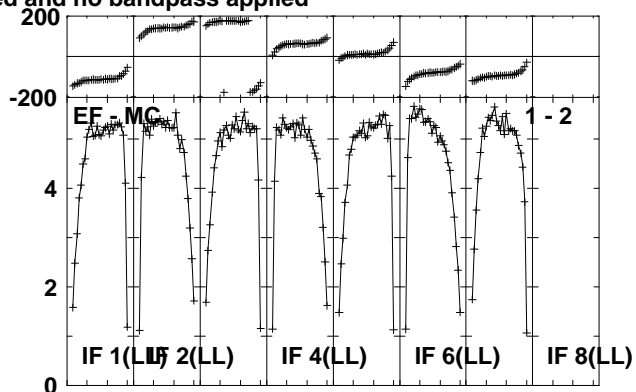
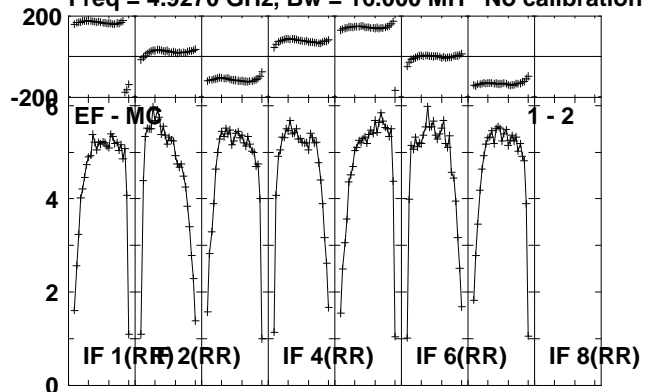

Lower frame: Milli Ampl Jy Top frame: Phas deg
Scalar averaged cross-power spectrum Several baselines displayed
Timerange: 00/14:54:27 to 00/14:57:58

Plot file version 68 created 02-DEC-2011 14:49:37

J1953+35 ET018A.UVDATA.1

Freq = 4.9270 GHz, Bw = 16.000 MH No calibration applied and no bandpass applied

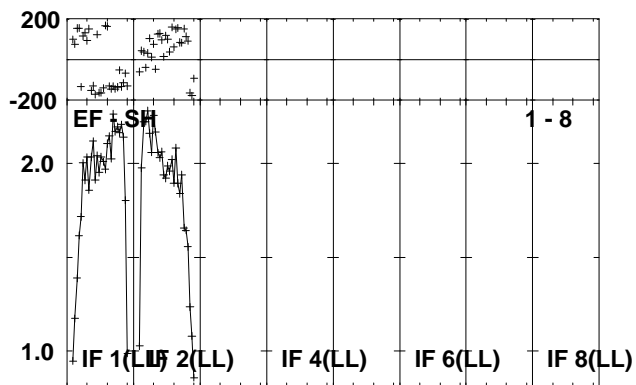
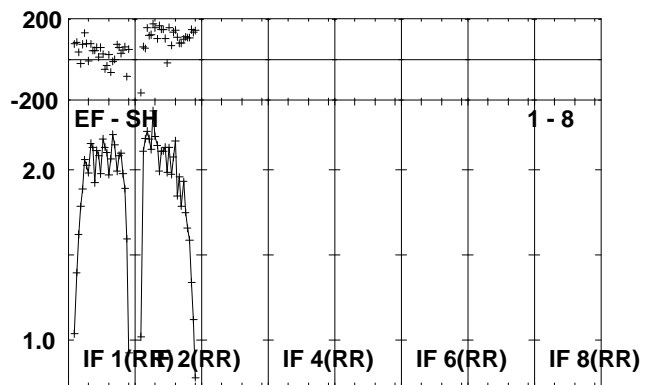
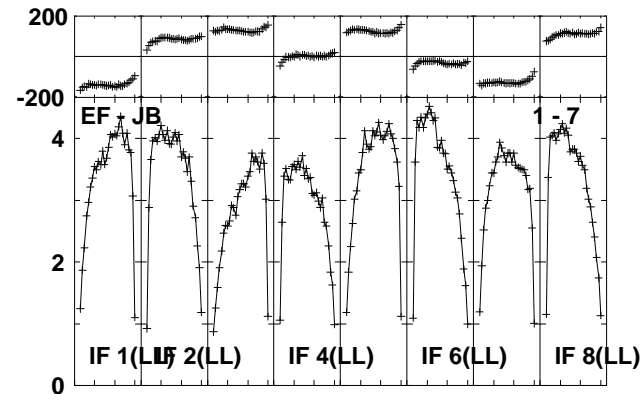
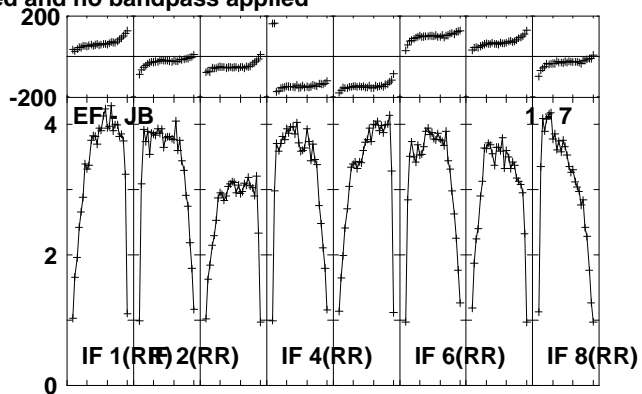
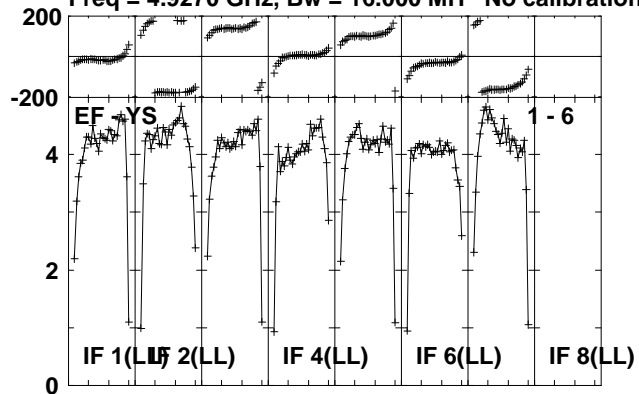

Lower frame: Milli Ampl Jy Top frame: Phas deg
Scalar averaged cross-power spectrum Several baselines displayed
Timerange: 00/14:54:27 to 00/14:57:58

Plot file version 69 created 02-DEC-2011 14:49:39

CYGX-1 ET018A.UVDATA.1

Freq = 4.9270 GHz, Bw = 16.000 MH No calibration applied and no bandpass applied

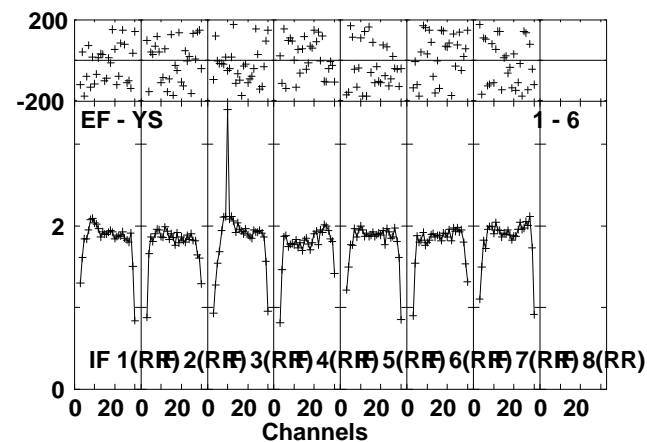
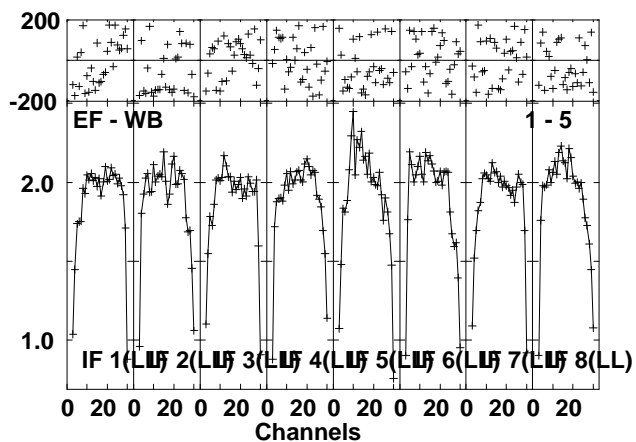
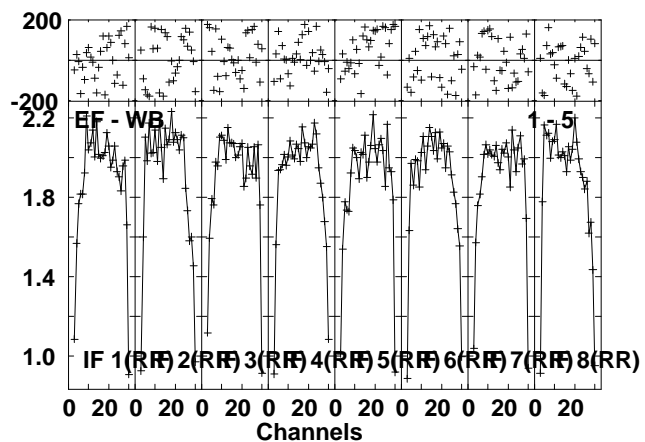
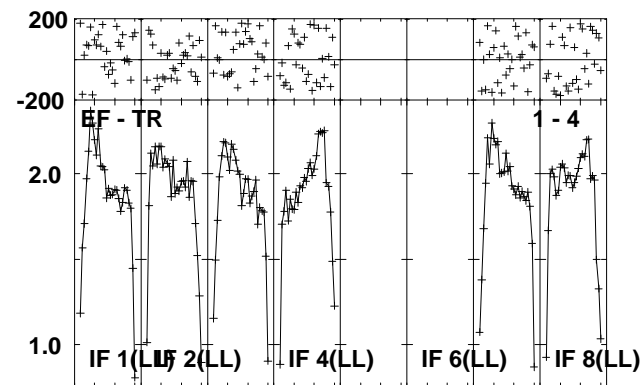
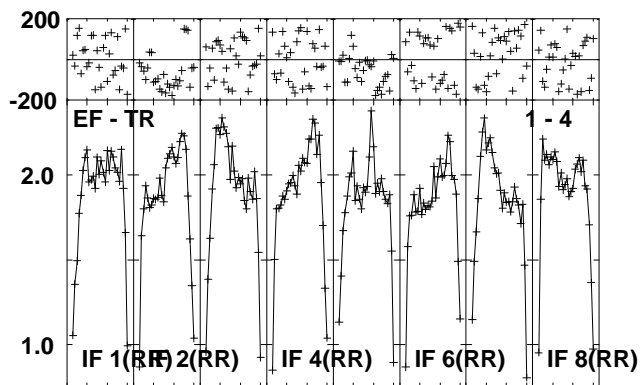
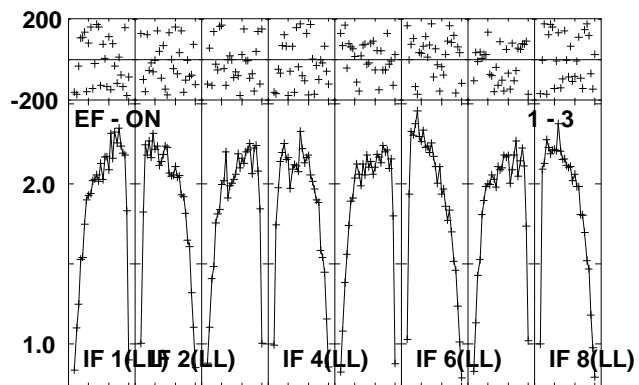
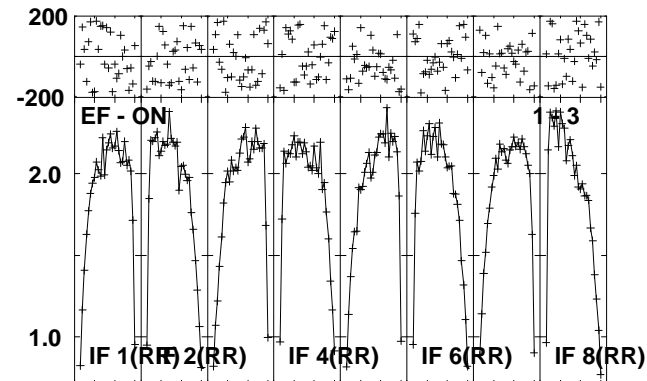
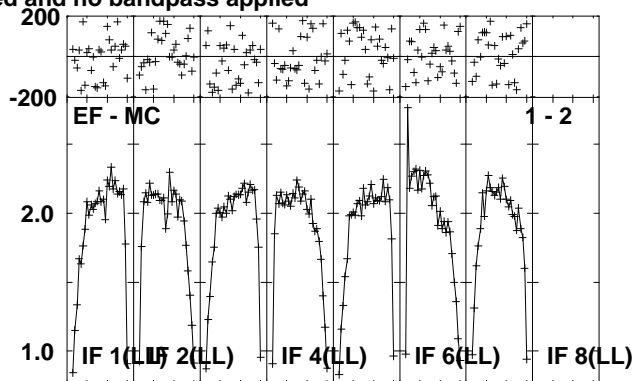
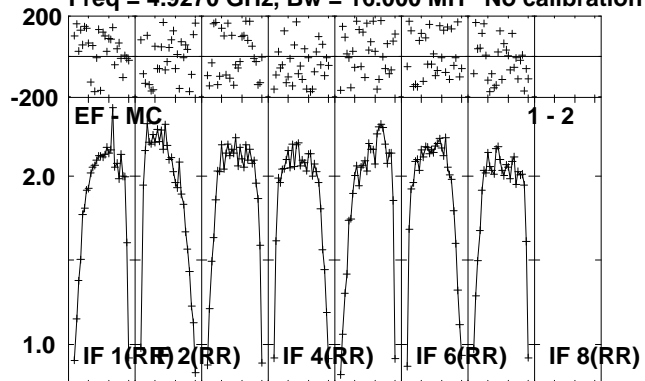

Lower frame: Milli Ampl Jy Top frame: Phas deg
Scalar averaged cross-power spectrum Several baselines displayed
Timerange: 00/14:58:02 to 00/15:03:28

Plot file version 70 created 02-DEC-2011 14:49:43

CYGX-1 ET018A.UVDATA.1

Freq = 4.9270 GHz, Bw = 16.000 MH No calibration applied and no bandpass applied

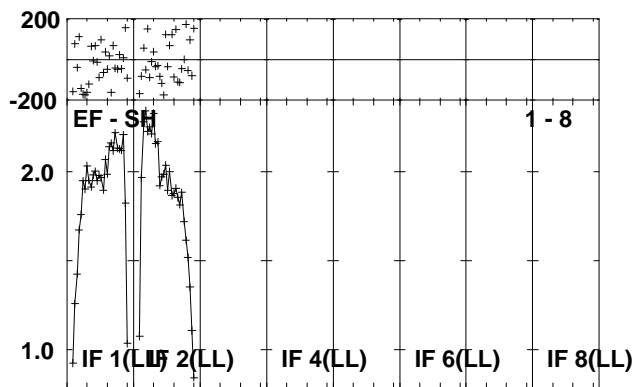
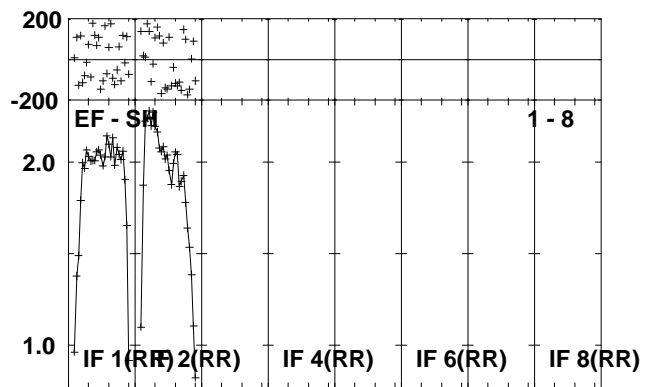
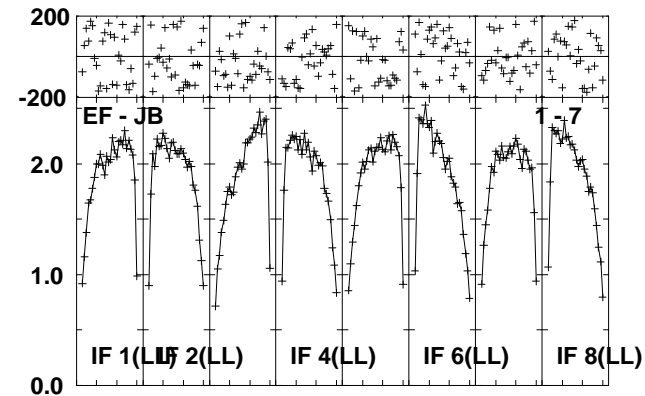
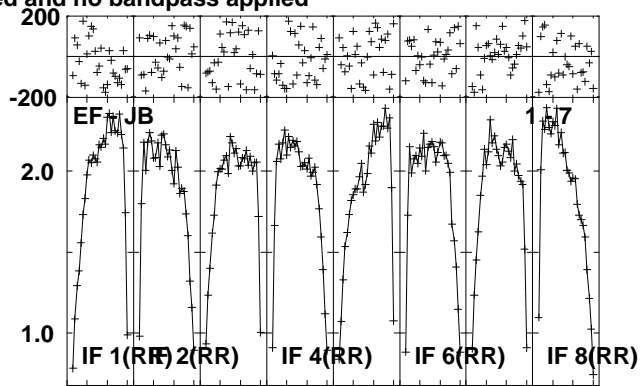
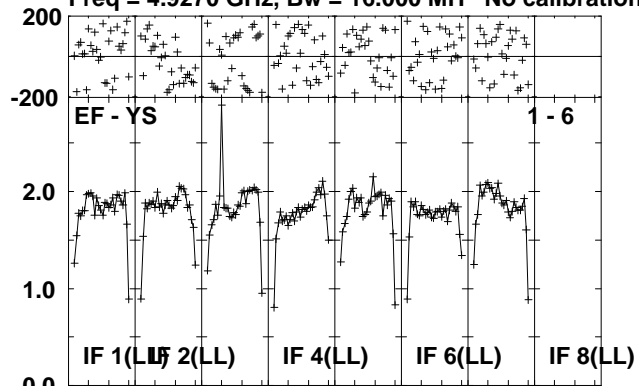

Lower frame: Milli Ampl Jy Top frame: Phas deg
Scalar averaged cross-power spectrum Several baselines displayed
Timerange: 00/14:58:02 to 00/15:03:28

Plot file version 71 created 02-DEC-2011 14:49:45

J1953+35 ET018A.UVDATA.1

Freq = 4.9270 GHz, Bw = 16.000 MH No calibration applied and no bandpass applied

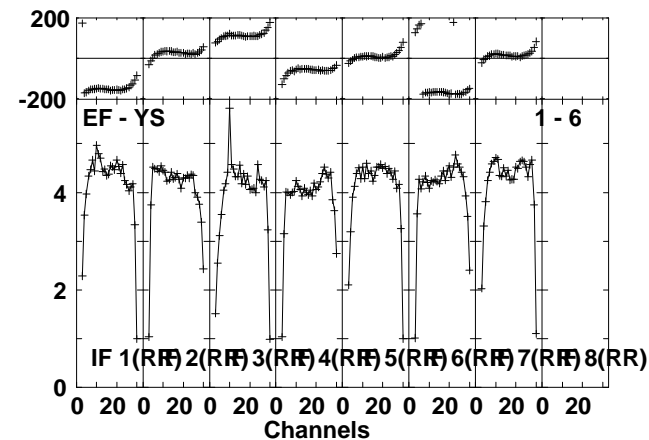
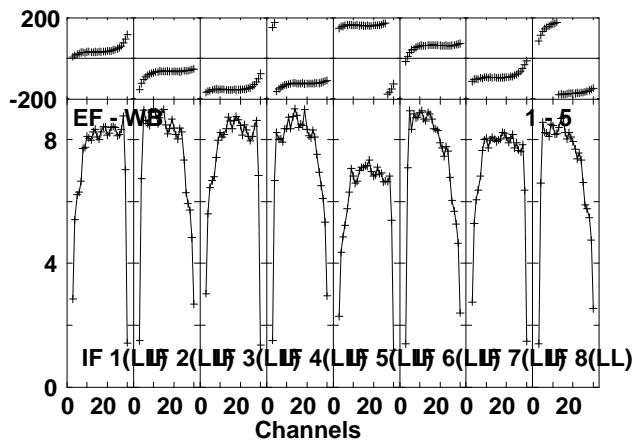
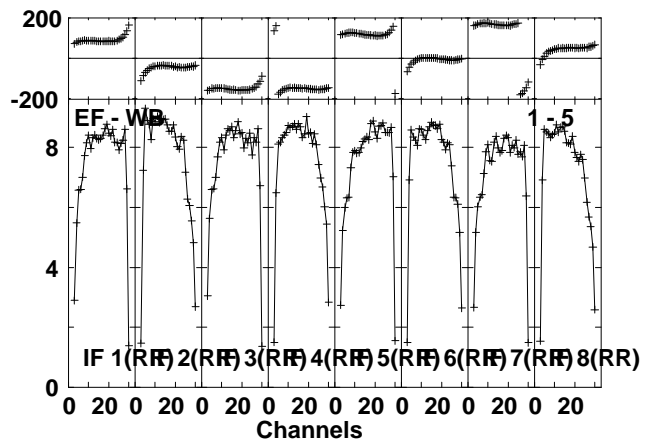
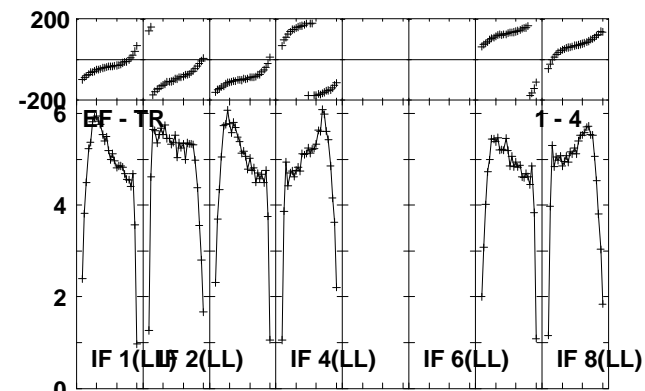
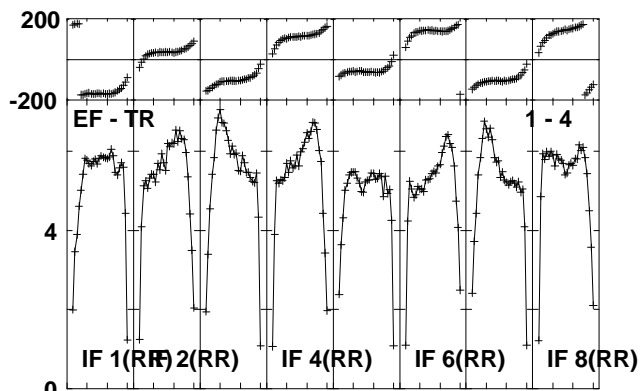
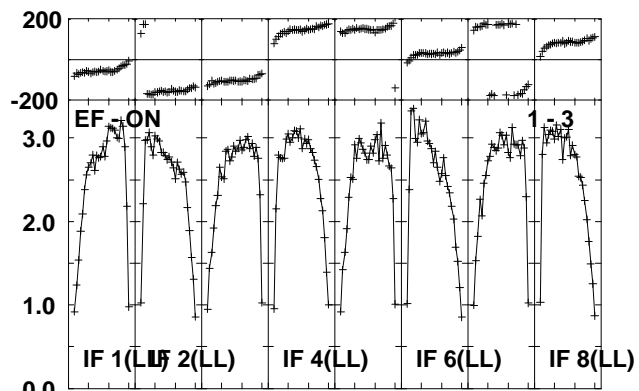
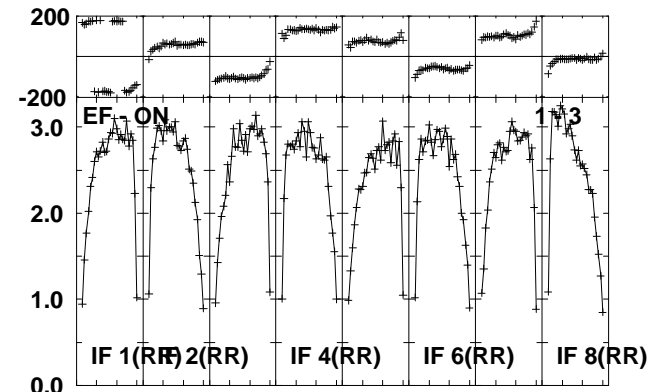
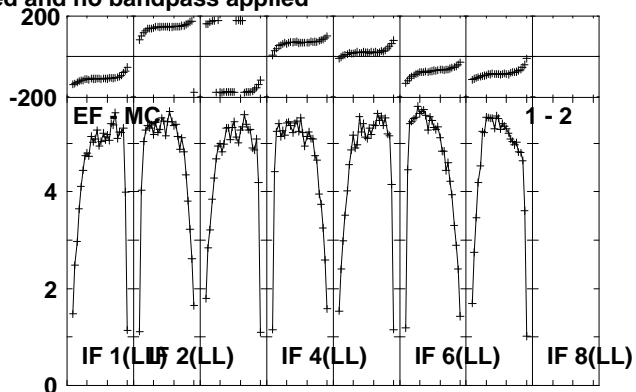
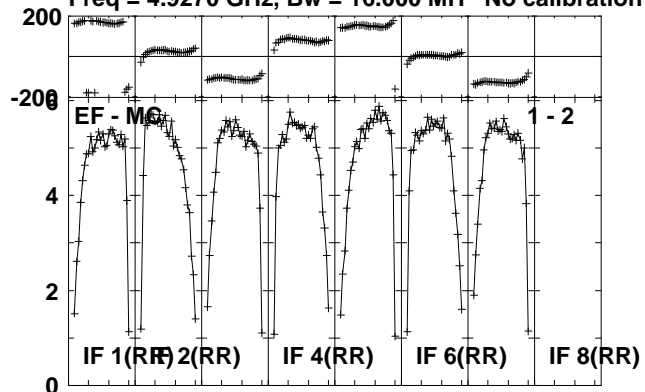

Lower frame: Milli Ampl Jy Top frame: Phas deg
Scalar averaged cross-power spectrum Several baselines displayed
Timerange: 00/15:03:31 to 00/15:06:28

Plot file version 72 created 02-DEC-2011 14:49:47

J1953+35 ET018A.UVDATA.1

Freq = 4.9270 GHz, Bw = 16.000 MH No calibration applied and no bandpass applied

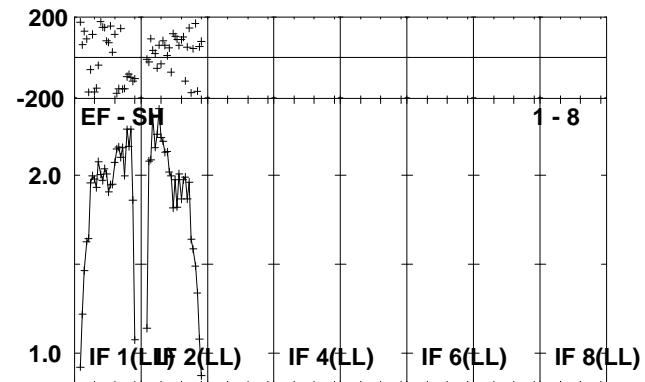
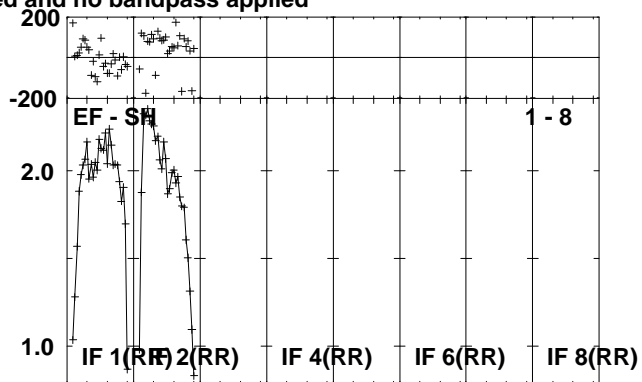
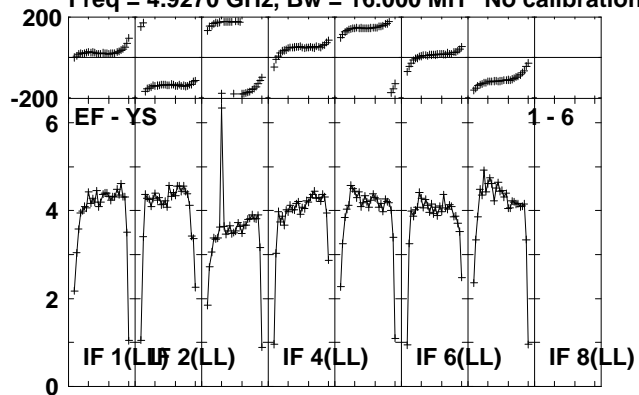

Lower frame: Milli Ampl Jy Top frame: Phas deg
Scalar averaged cross-power spectrum Several baselines displayed
Timerange: 00/15:03:31 to 00/15:06:28

Plot file version 73 created 02-DEC-2011 14:49:49

CYGX-1 ET018A.UVDATA.1

Freq = 4.9270 GHz, Bw = 16.000 MH No calibration applied and no bandpass applied

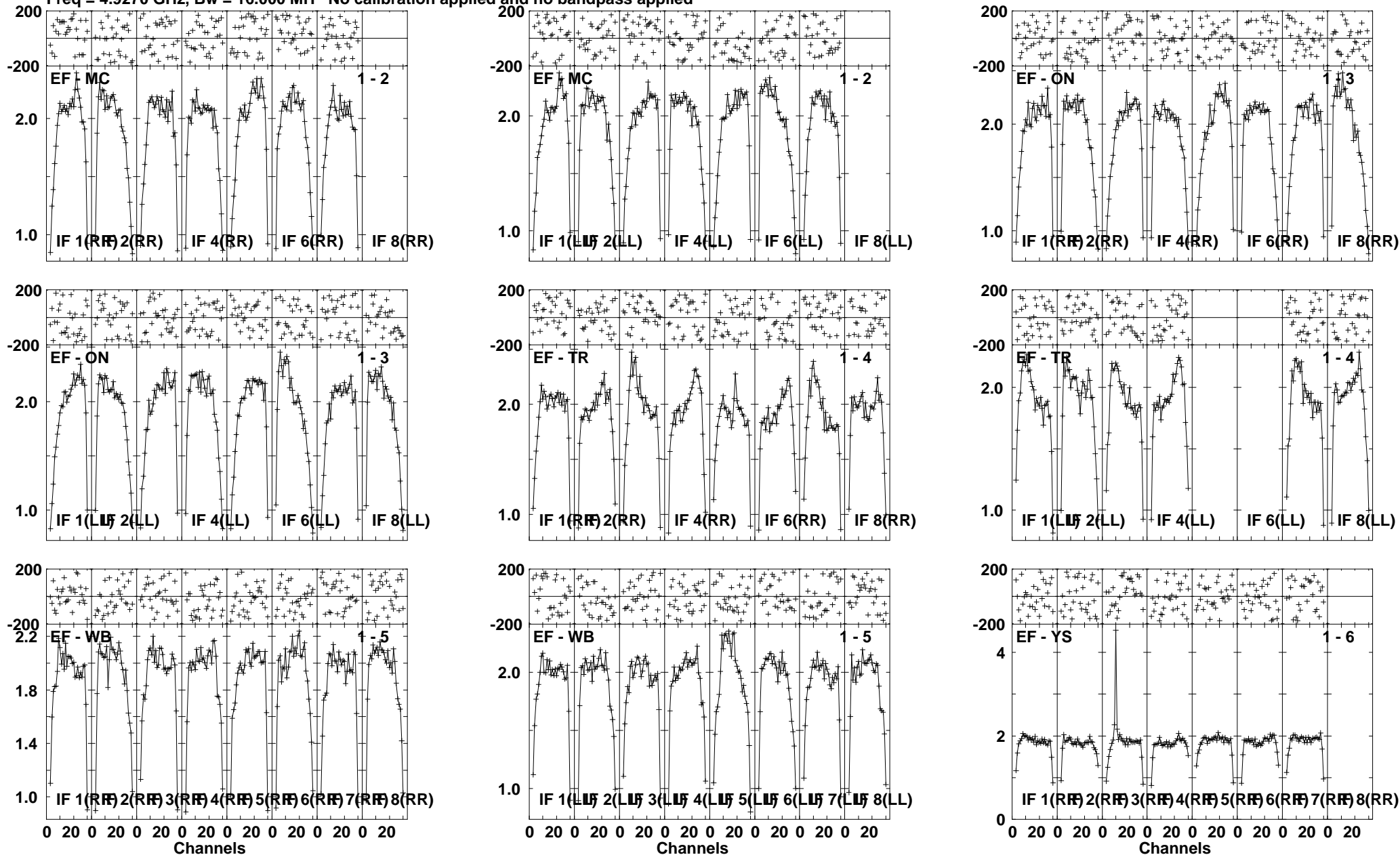

Lower frame: Milli Ampl Jy Top frame: Phas deg
Scalar averaged cross-power spectrum Several baselines displayed
Timerange: 00/15:06:32 to 00/15:11:58

Plot file version 74 created 02-DEC-2011 14:49:53

CYGX-1 ET018A.UVDATA.1

Freq = 4.9270 GHz, Bw = 16.000 MH No calibration applied and no bandpass applied

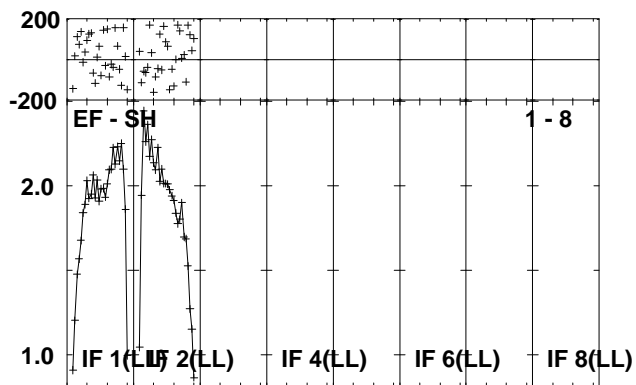
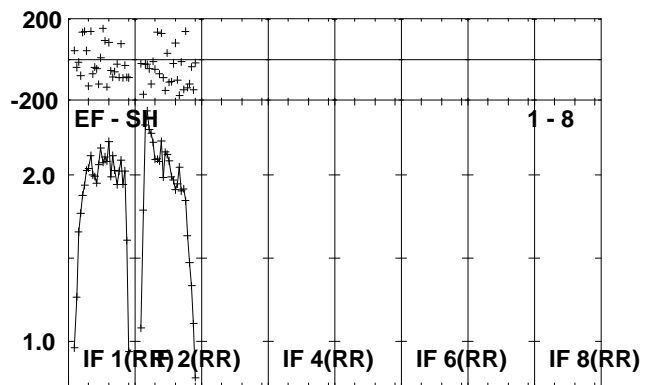
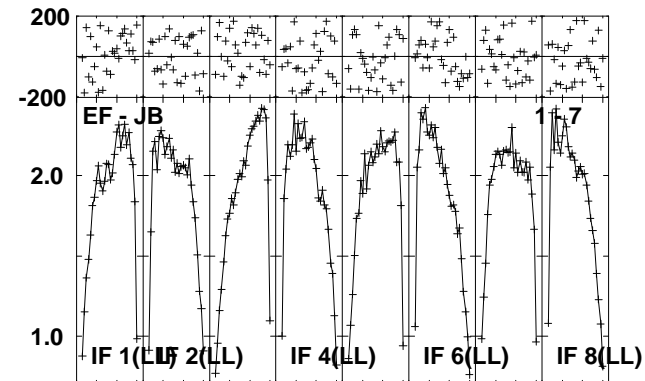
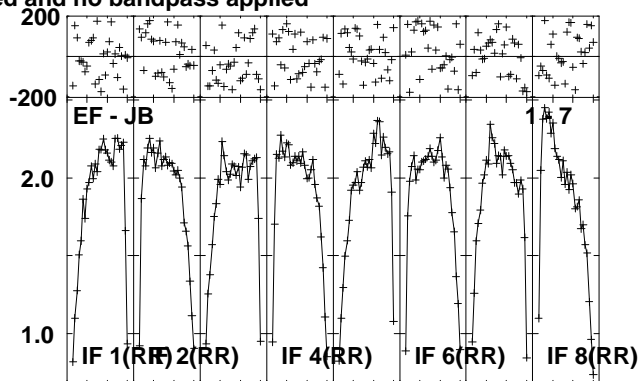
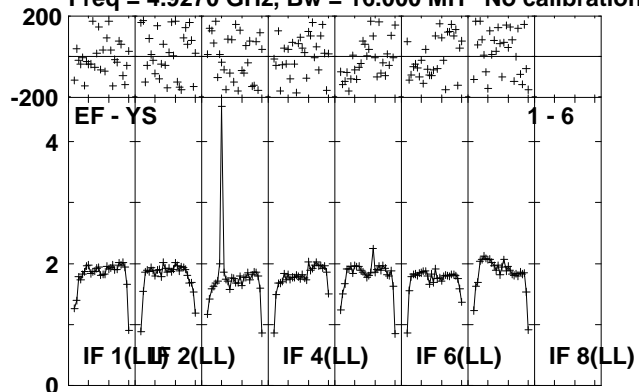

Lower frame: Milli Ampl Jy Top frame: Phas deg
Scalar averaged cross-power spectrum Several baselines displayed
Timerange: 00/15:06:32 to 00/15:11:58

Plot file version 75 created 02-DEC-2011 14:49:55

J1953+35 ET018A.UVDATA.1

Freq = 4.9270 GHz, Bw = 16.000 MH No calibration applied and no bandpass applied

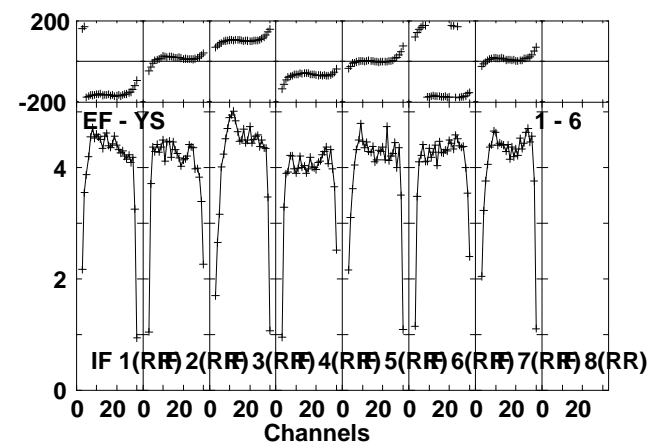
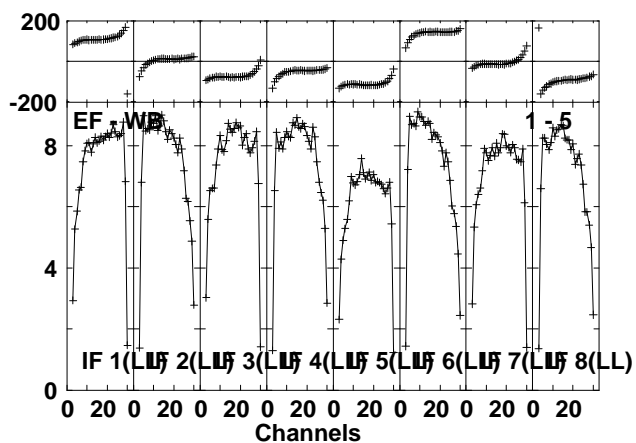
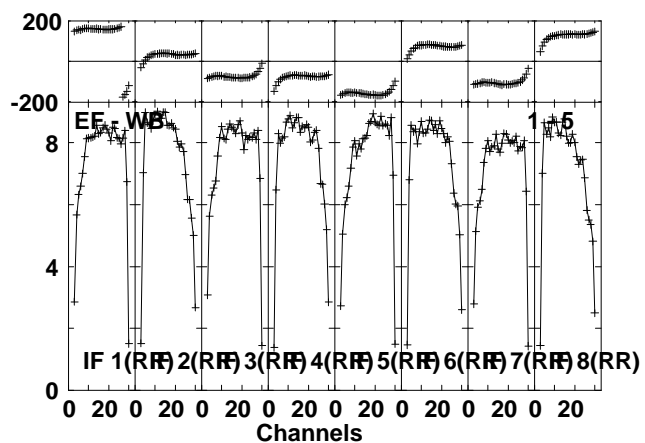
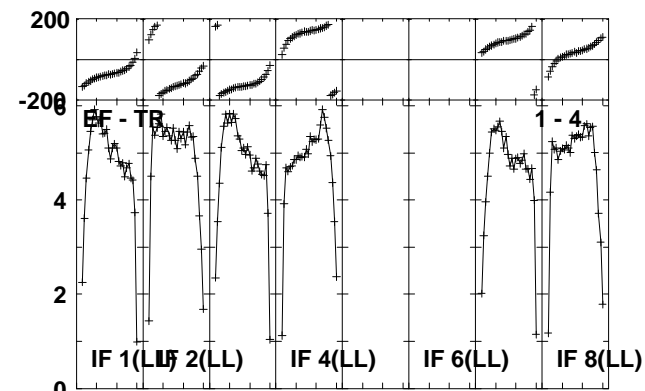
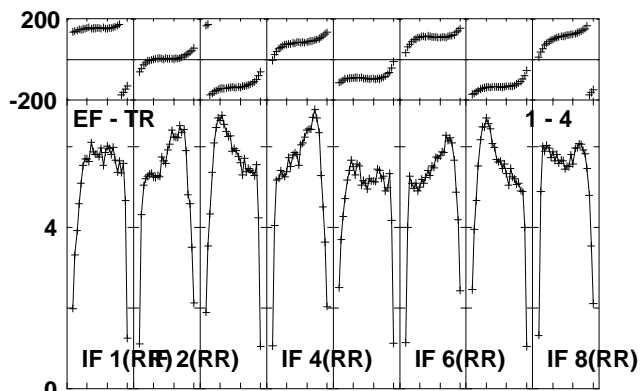
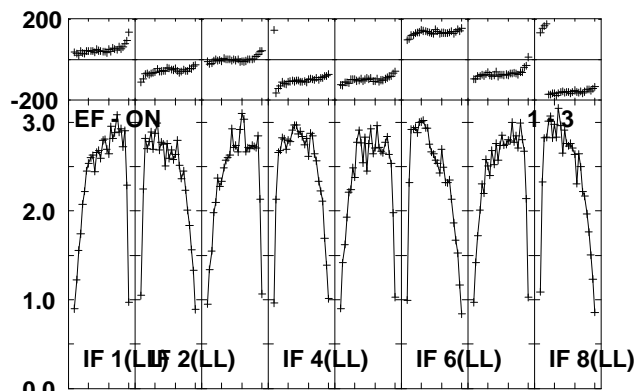
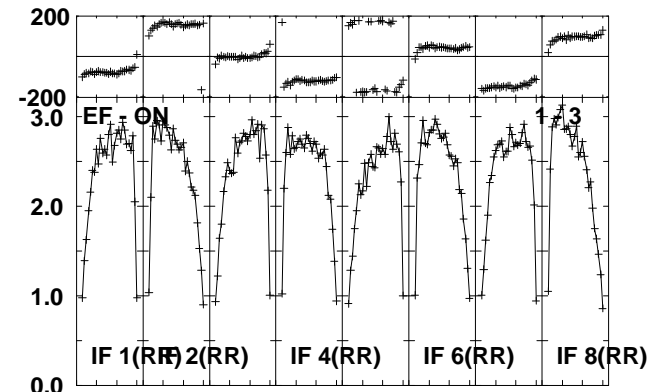
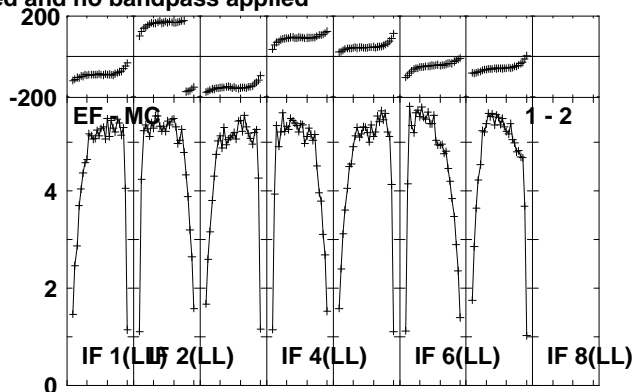
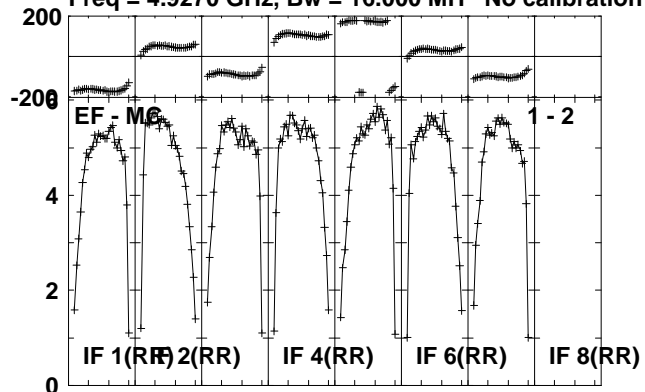

Lower frame: Milli Ampl Jy Top frame: Phas deg
Scalar averaged cross-power spectrum Several baselines displayed
Timerange: 00/15:12:47 to 00/15:15:19

Plot file version 76 created 02-DEC-2011 14:49:57
J1953+35 ET018A.UVDATA.1

Freq = 4.9270 GHz, Bw = 16.000 MH No calibration applied and no bandpass applied

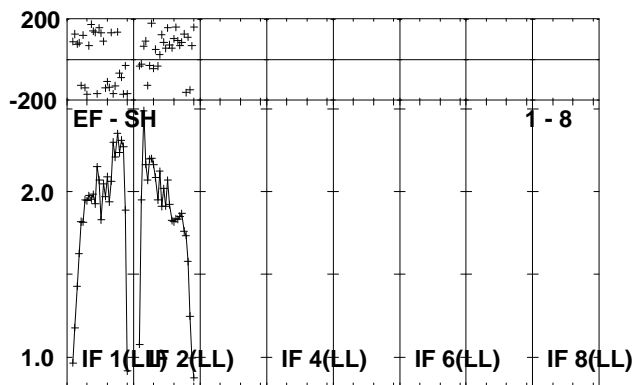
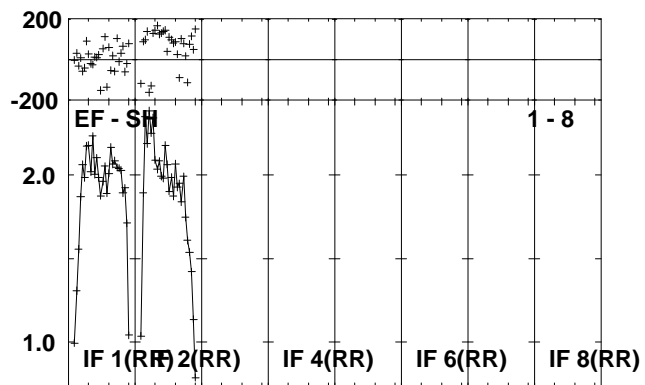
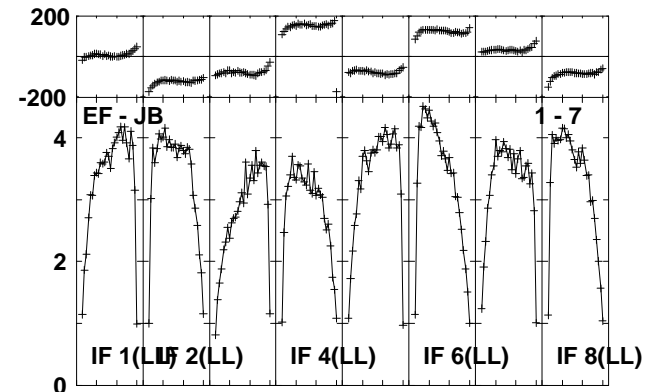
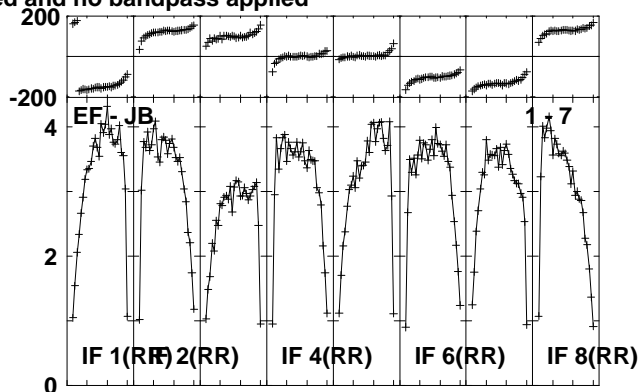
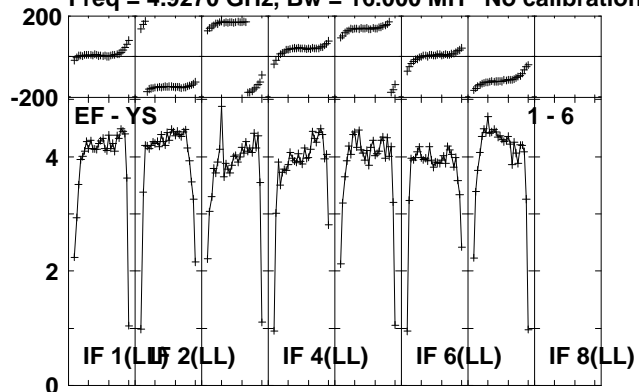

Lower frame: Milli Ampl Jy Top frame: Phas deg
Scalar averaged cross-power spectrum Several baselines displayed
Timerange: 00/15:12:47 to 00/15:15:19

Plot file version 77 created 02-DEC-2011 14:49:59

CYGX-1 ET018A.UVDATA.1

Freq = 4.9270 GHz, Bw = 16.000 MH No calibration applied and no bandpass applied

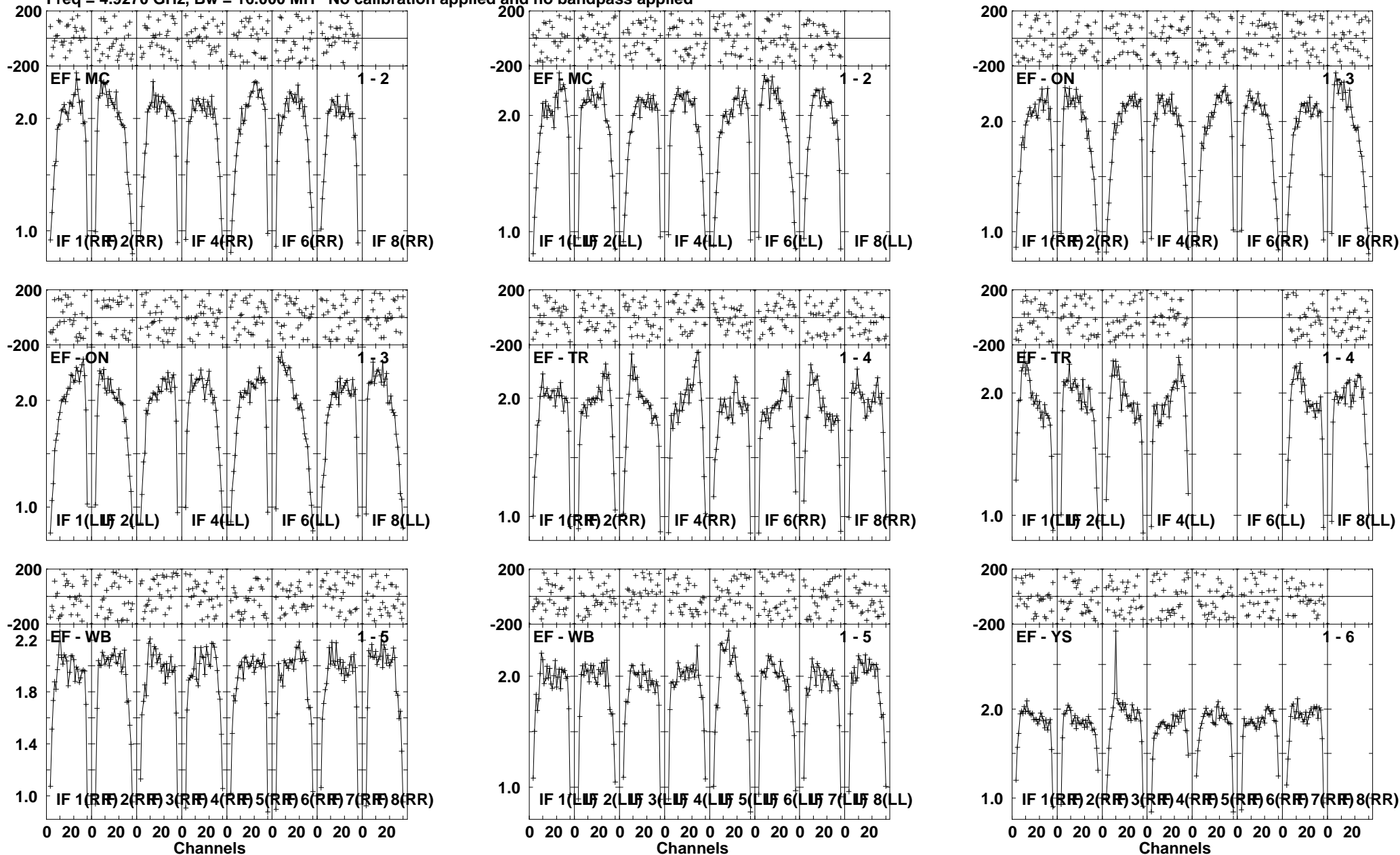

Lower frame: Milli Ampl Jy Top frame: Phas deg
Scalar averaged cross-power spectrum Several baselines displayed
Timerange: 00/15:15:22 to 00/15:20:48

Plot file version 78 created 02-DEC-2011 14:50:03

CYGX-1 ET018A.UVDATA.1

Freq = 4.9270 GHz, Bw = 16.000 MH No calibration applied and no bandpass applied

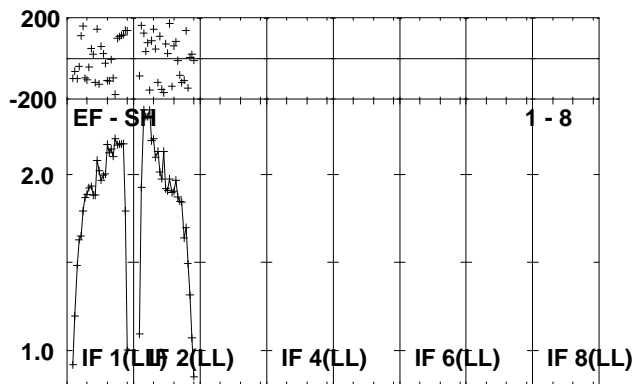
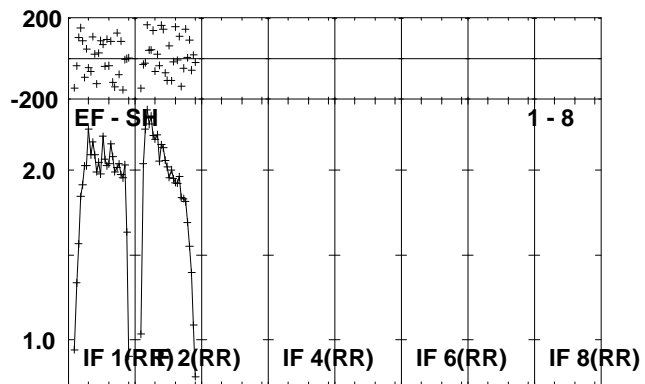
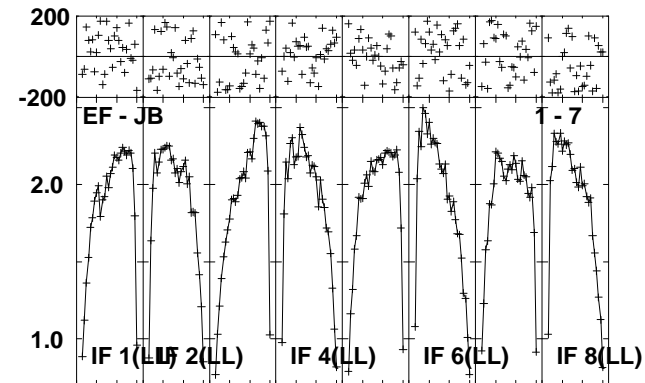
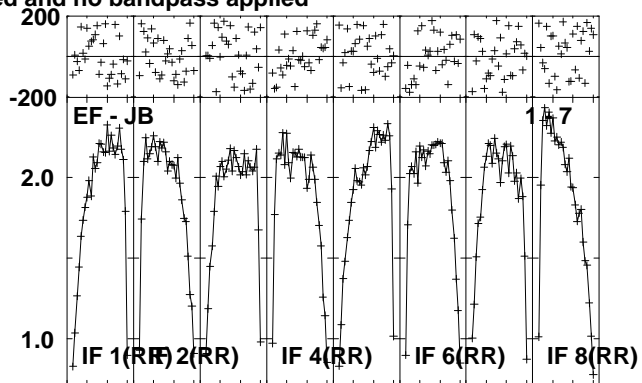
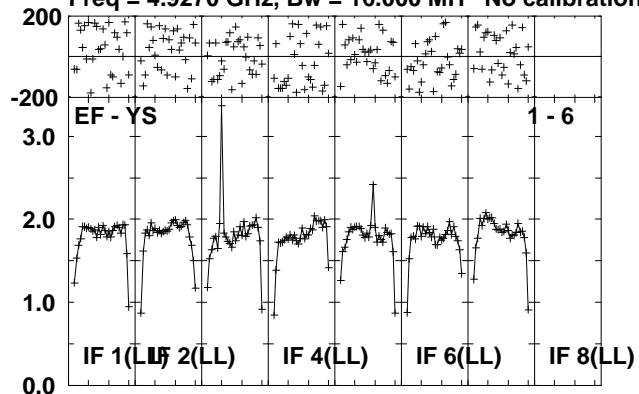

Lower frame: Milli Ampl Jy Top frame: Phas deg
Scalar averaged cross-power spectrum Several baselines displayed
Timerange: 00/15:15:22 to 00/15:20:48

Plot file version 79 created 02-DEC-2011 14:50:06

J1953+35 ET018A.UVDATA.1

Freq = 4.9270 GHz, Bw = 16.000 MH No calibration applied and no bandpass applied

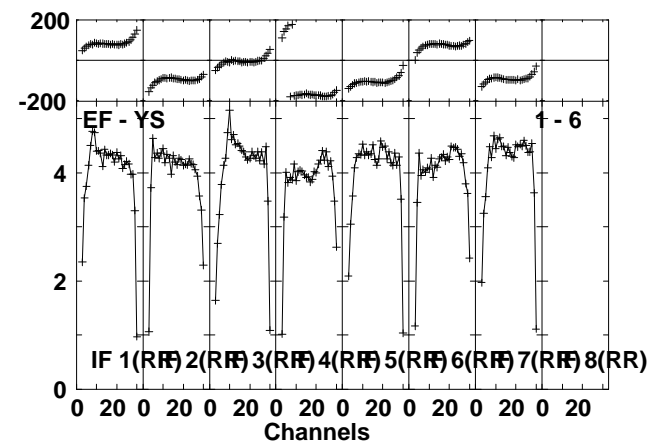
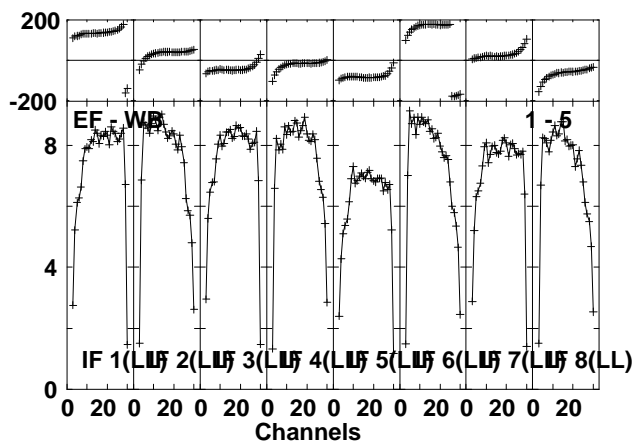
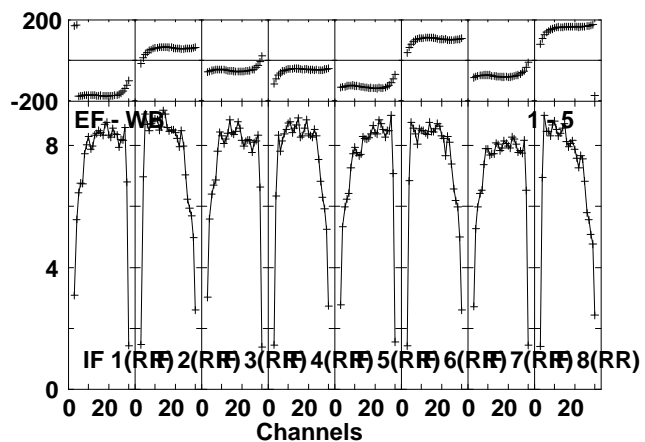
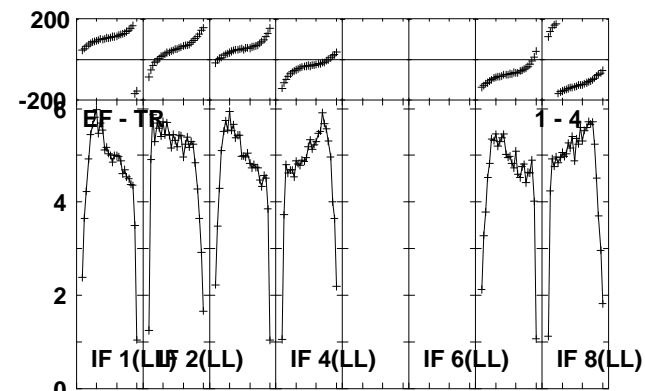
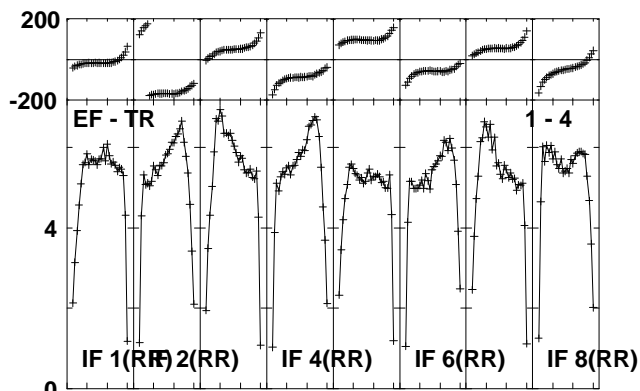
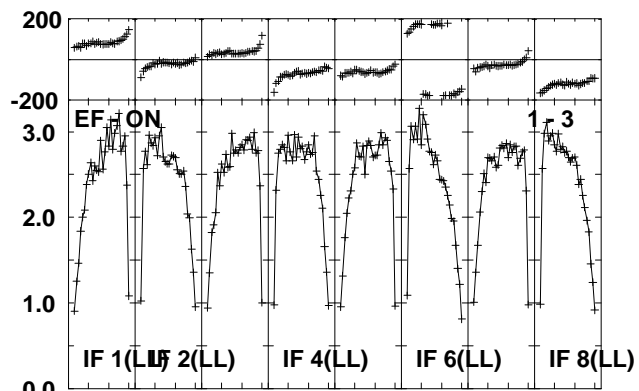
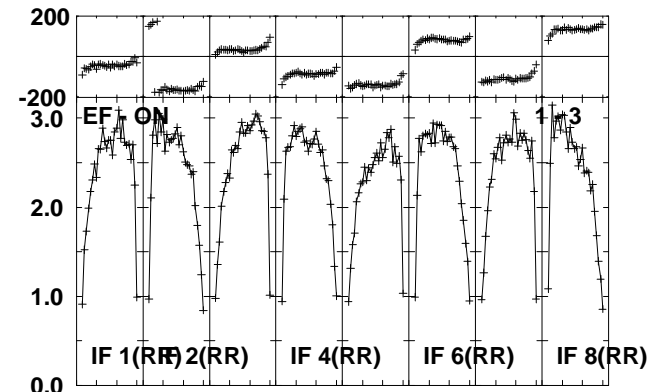
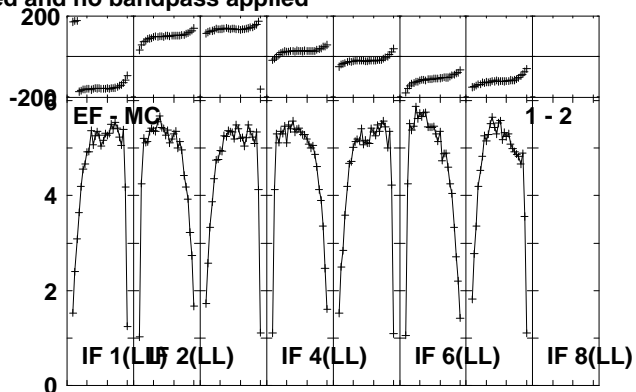
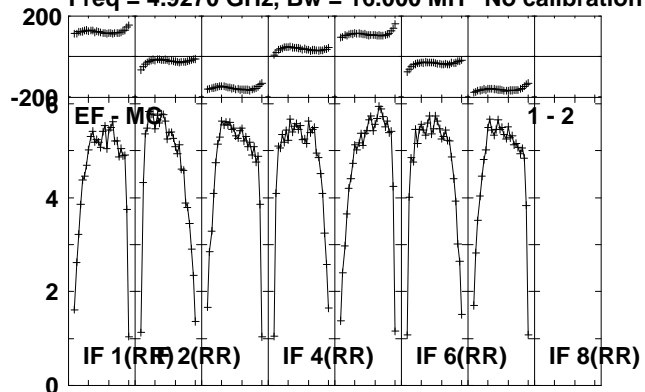

Lower frame: Milli Ampl Jy Top frame: Phas deg
Scalar averaged cross-power spectrum Several baselines displayed
Timerange: 00/15:20:51 to 00/15:23:48

Plot file version 80 created 02-DEC-2011 14:50:08

J1953+35 ET018A.UVDATA.1

Freq = 4.9270 GHz, Bw = 16.000 MH No calibration applied and no bandpass applied

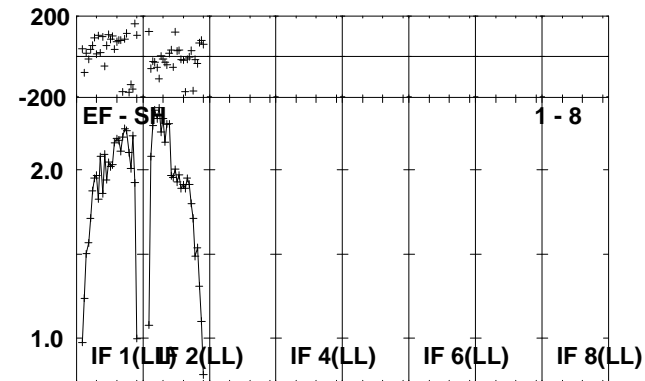
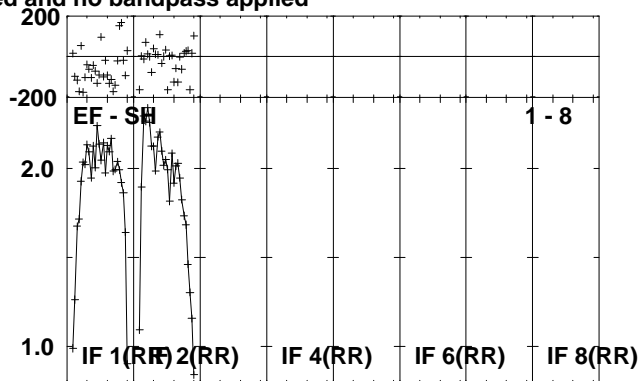
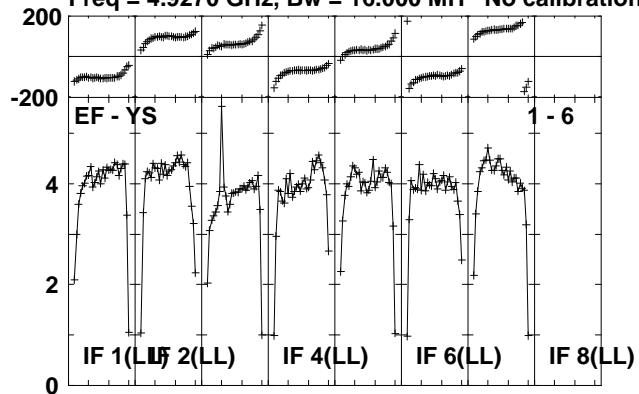

Lower frame: Milli Ampl Jy Top frame: Phas deg
Scalar averaged cross-power spectrum Several baselines displayed
Timerange: 00/15:20:51 to 00/15:23:48

Plot file version 81 created 02-DEC-2011 14:50:09

CYGX-1 ET018A.UVDATA.1

Freq = 4.9270 GHz, Bw = 16.000 MH No calibration applied and no bandpass applied

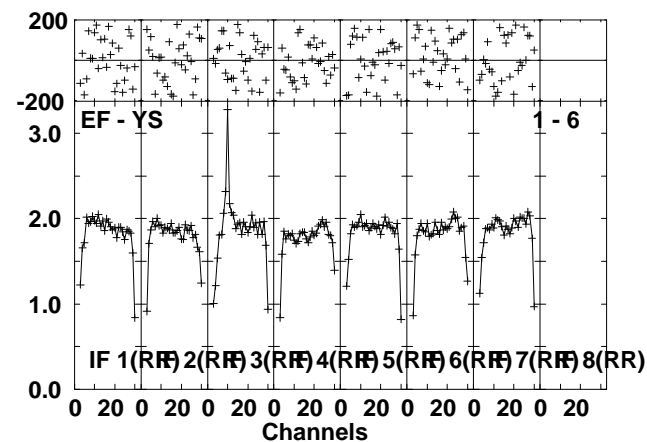
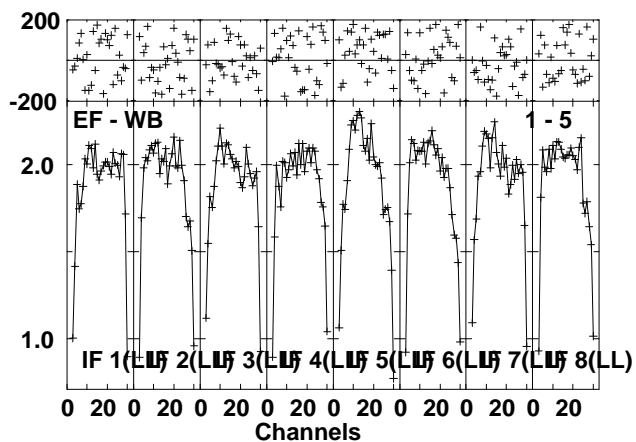
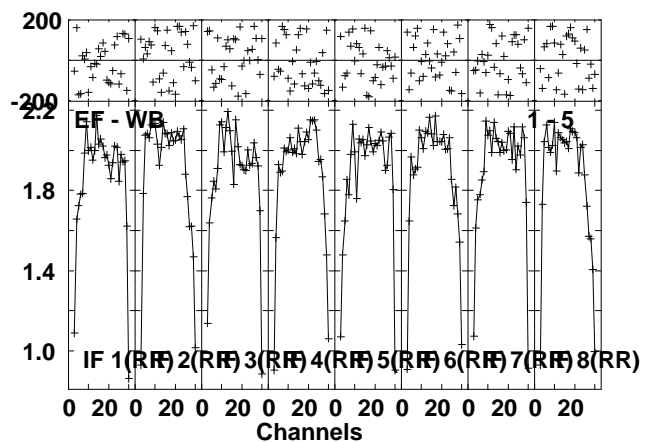
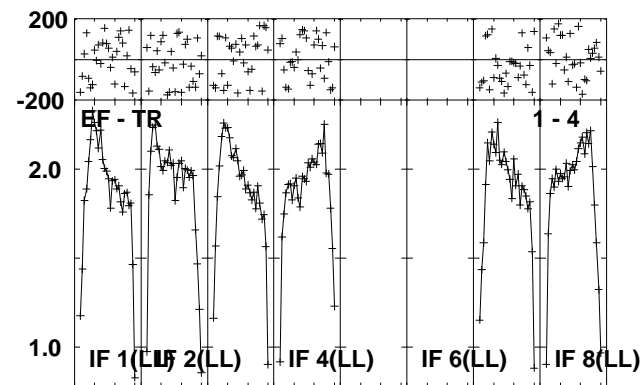
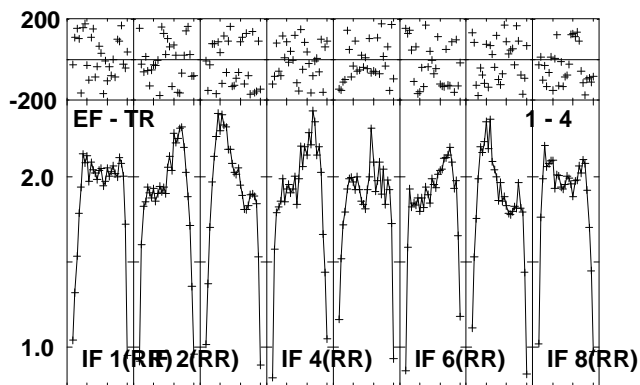
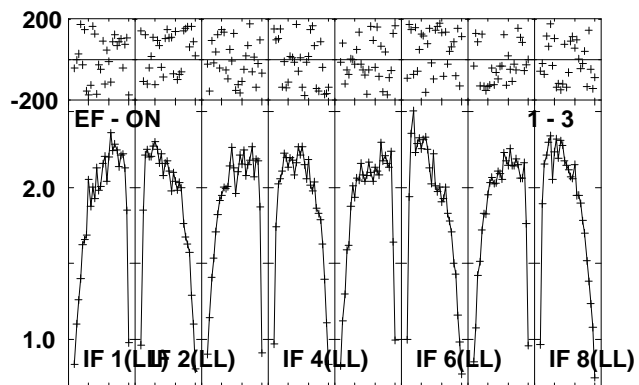
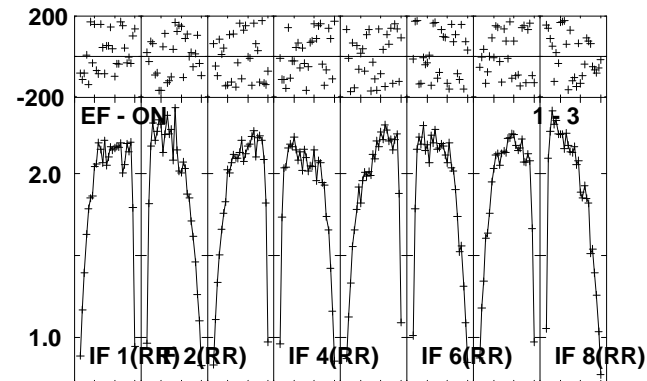
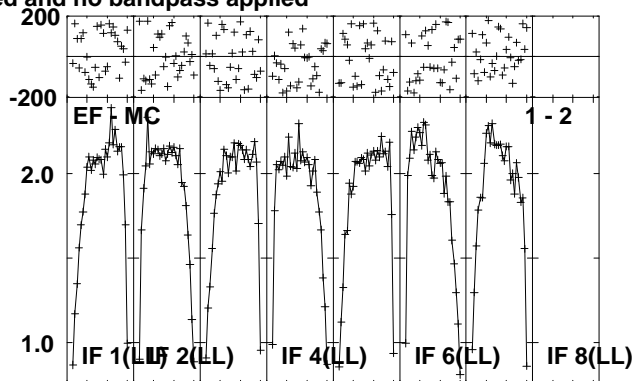
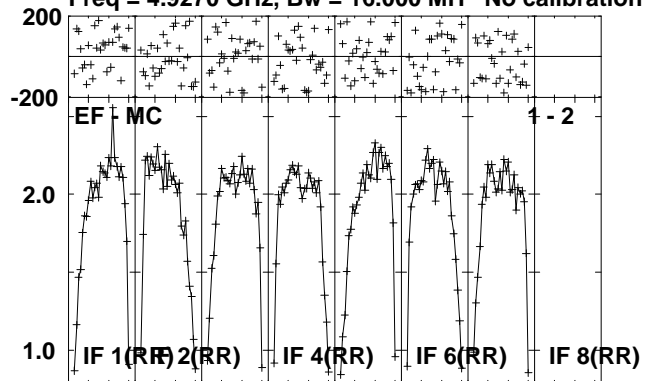

Lower frame: Milli Ampl Jy Top frame: Phas deg
Scalar averaged cross-power spectrum Several baselines displayed
Timerange: 00/15:23:52 to 00/15:29:18

Plot file version 82 created 02-DEC-2011 14:50:13

CYGX-1 ET018A.UVDATA.1

Freq = 4.9270 GHz, Bw = 16.000 MH No calibration applied and no bandpass applied

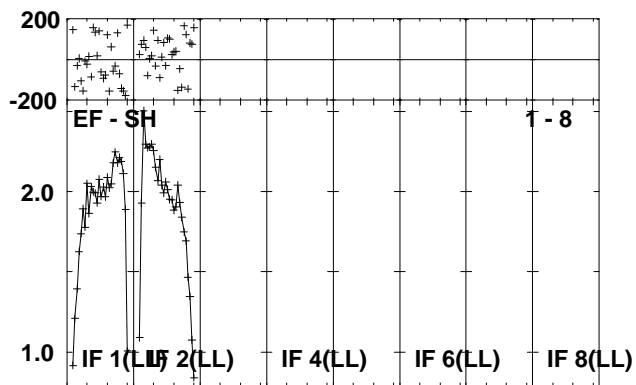
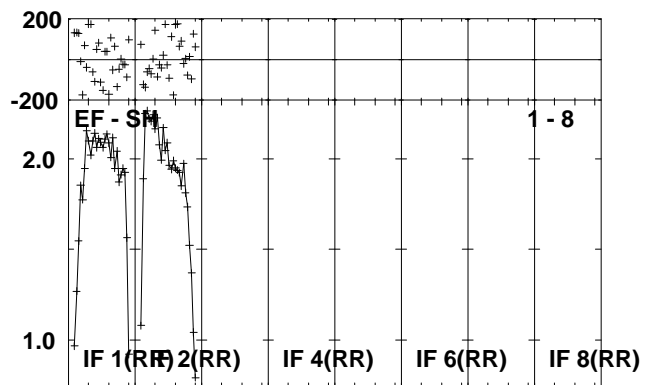
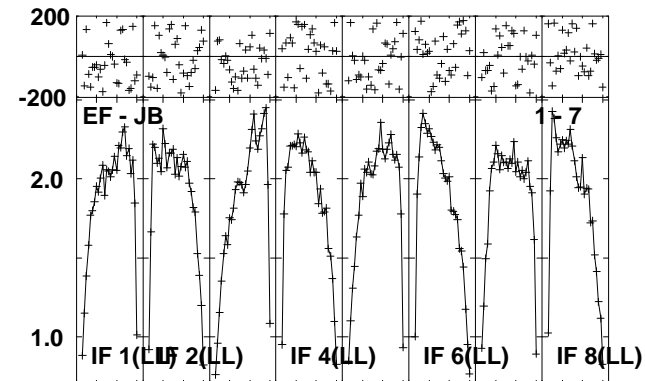
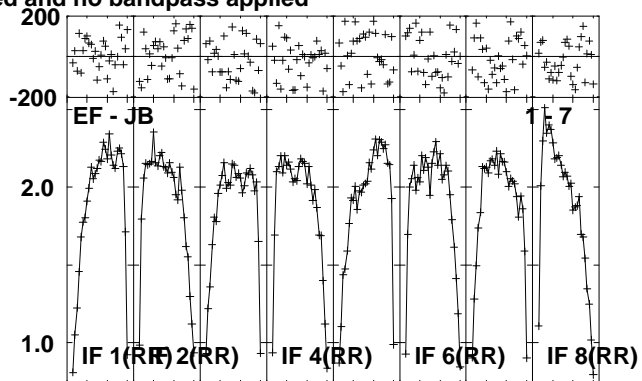
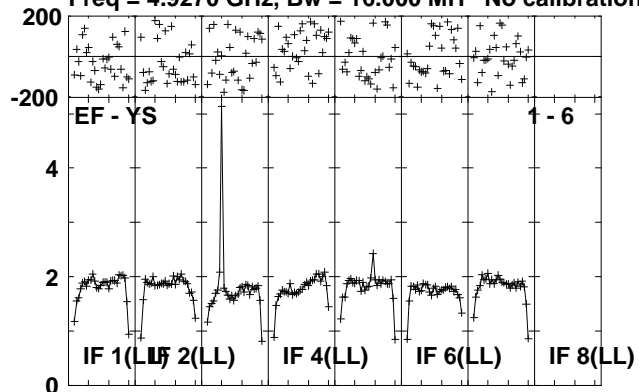

Lower frame: Milli Ampl Jy Top frame: Phas deg
Scalar averaged cross-power spectrum Several baselines displayed
Timerange: 00/15:23:52 to 00/15:29:18

Plot file version 83 created 02-DEC-2011 14:50:16

J1953+35 ET018A.UVDATA.1

Freq = 4.9270 GHz, Bw = 16.000 MH No calibration applied and no bandpass applied

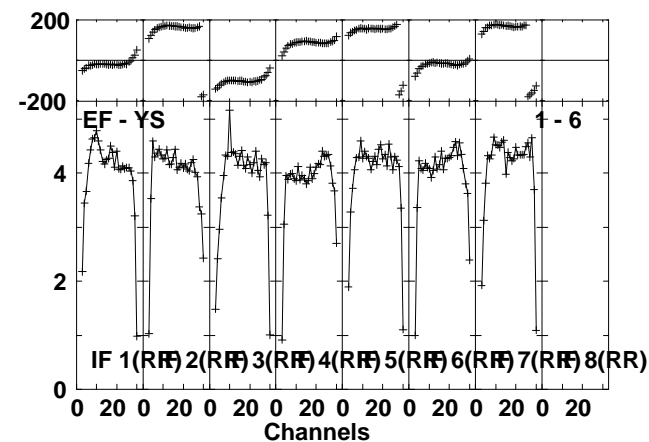
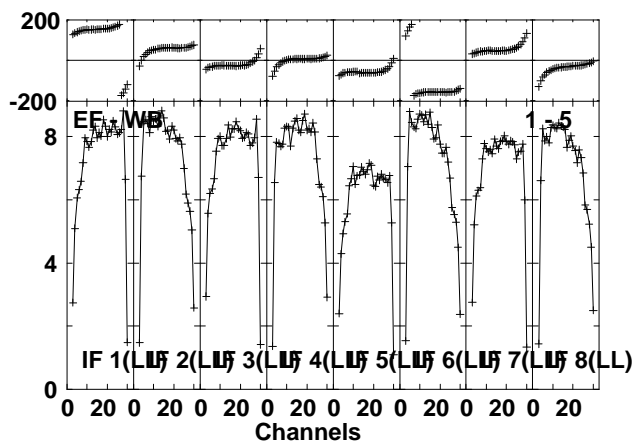
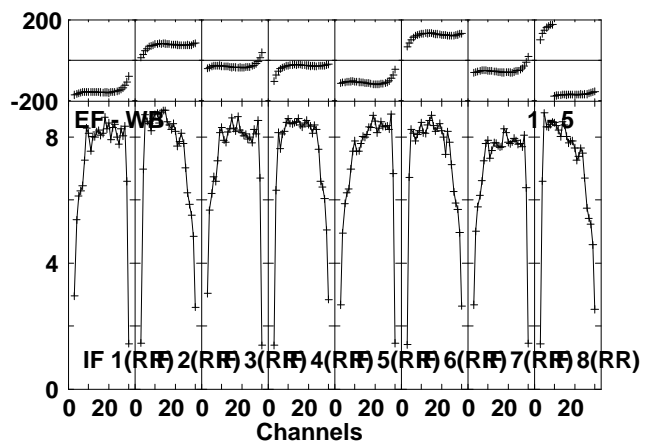
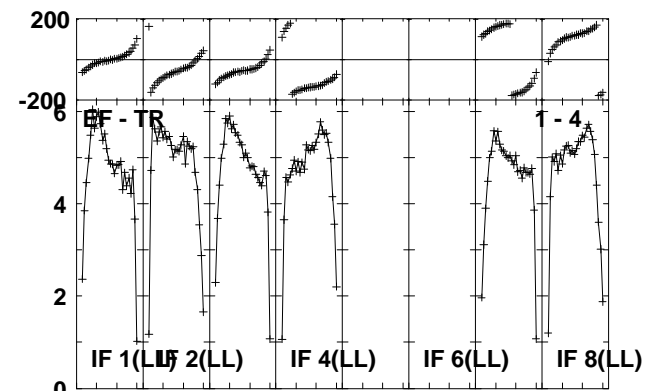
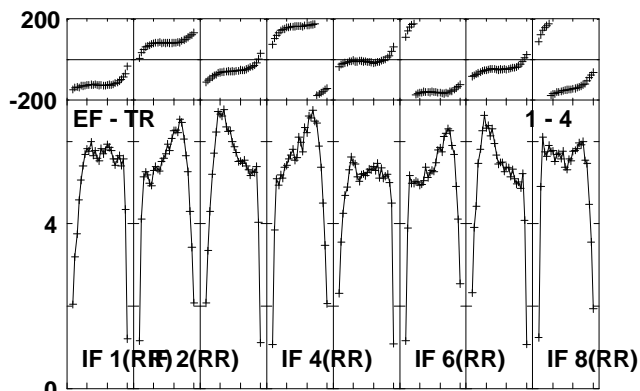
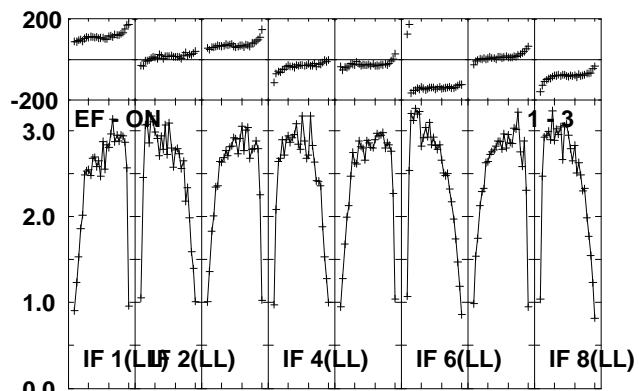
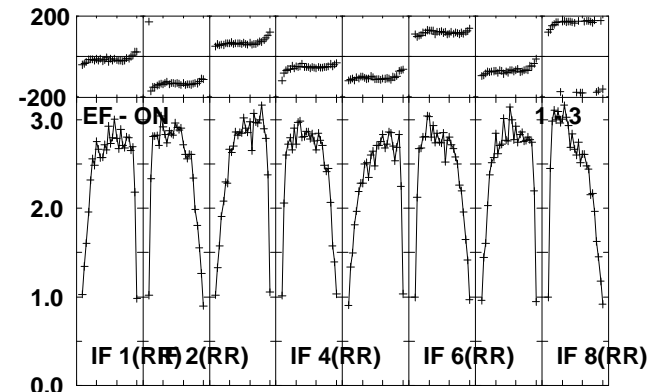
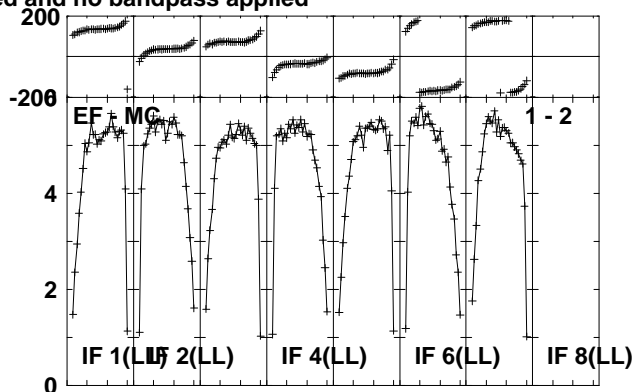
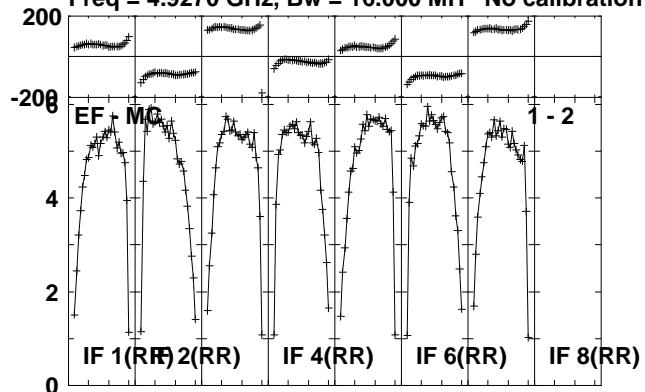

Lower frame: Milli Ampl Jy Top frame: Phas deg
Scalar averaged cross-power spectrum Several baselines displayed
Timerange: 00/15:30:07 to 00/15:32:39

Plot file version 84 created 02-DEC-2011 14:50:18

J1953+35 ET018A.UVDATA.1

Freq = 4.9270 GHz, Bw = 16.000 MH No calibration applied and no bandpass applied

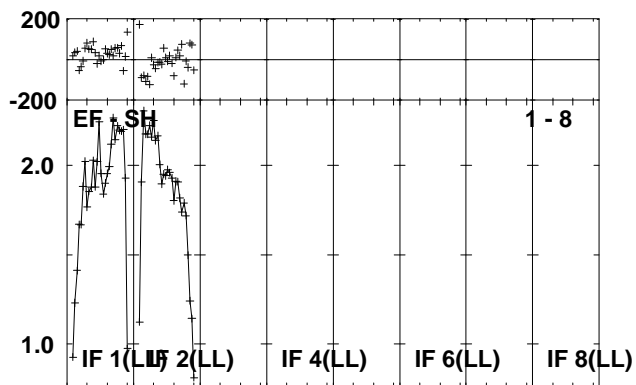
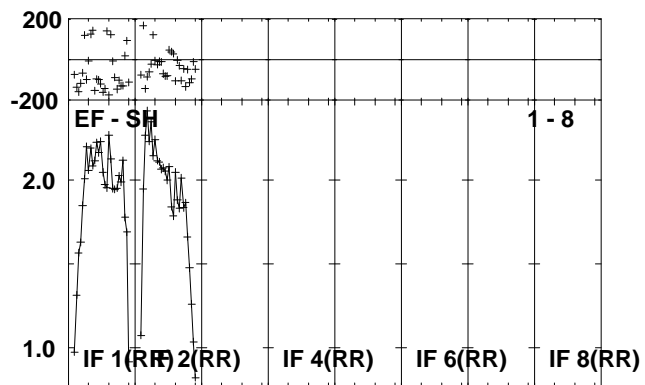
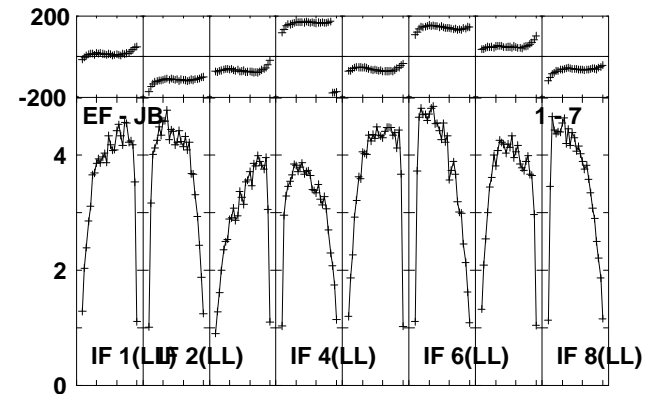
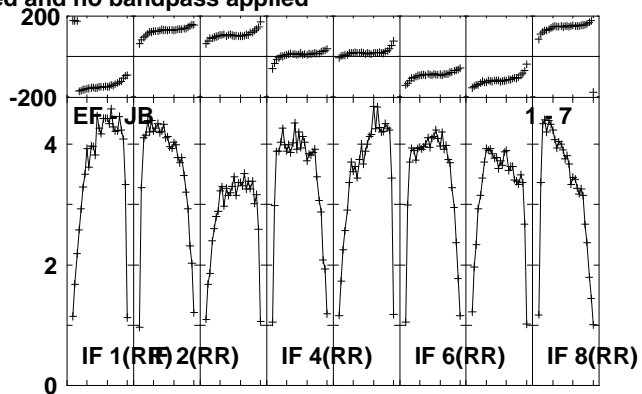
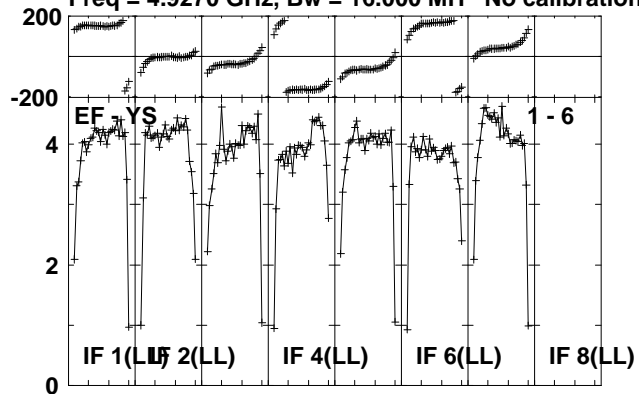

Lower frame: Milli Ampl Jy Top frame: Phas deg
Scalar averaged cross-power spectrum Several baselines displayed
Timerange: 00/15:30:07 to 00/15:32:39

Plot file version 85 created 02-DEC-2011 14:50:20

CYGX-1 ET018A.UVDATA.1

Freq = 4.9270 GHz, Bw = 16.000 MH No calibration applied and no bandpass applied

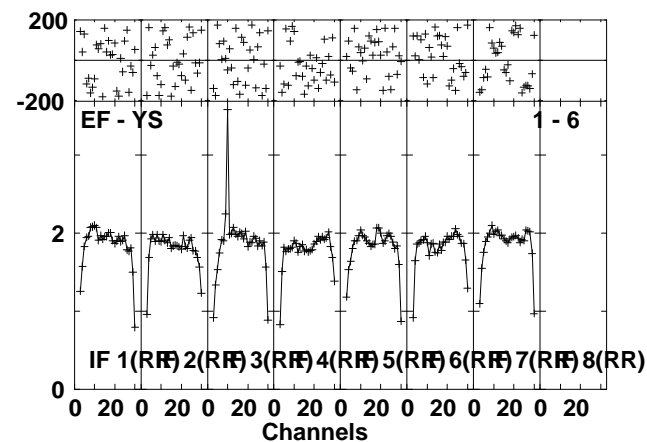
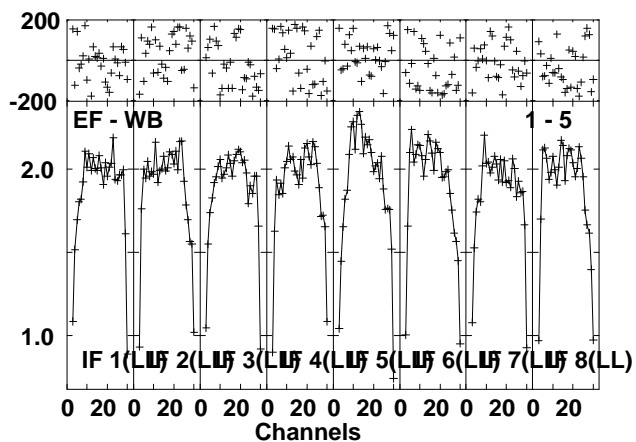
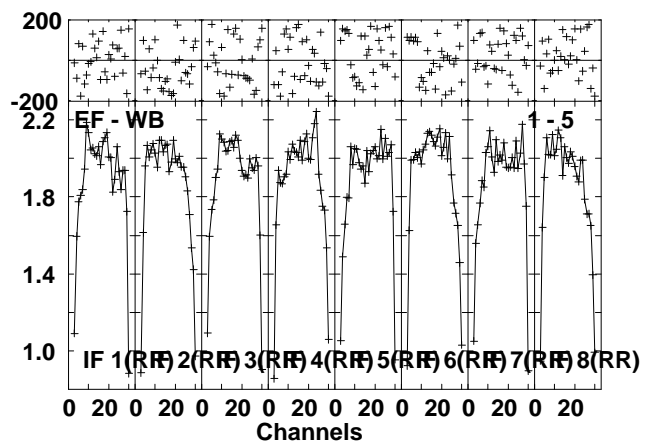
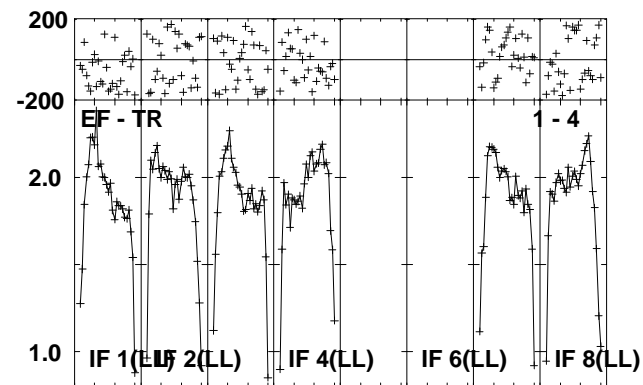
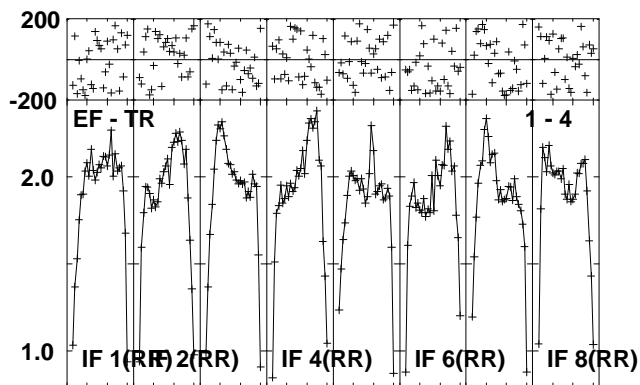
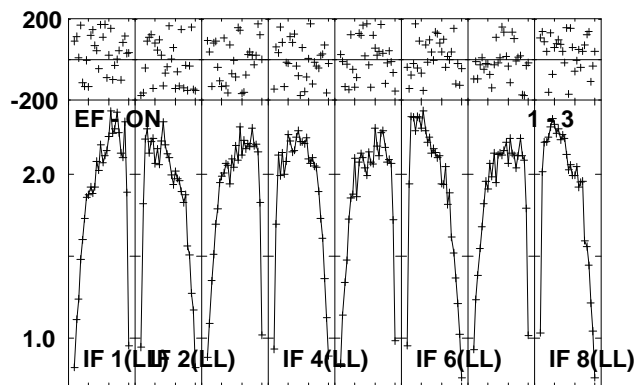
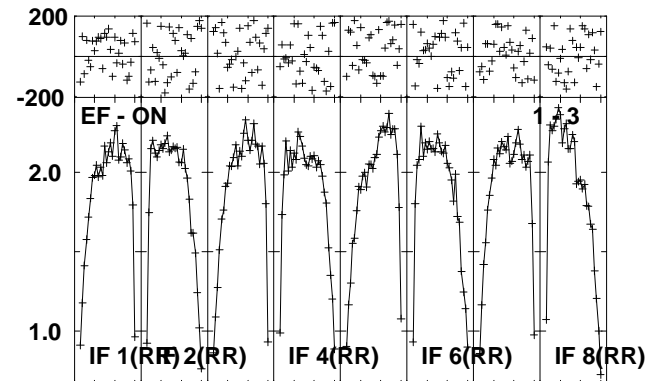
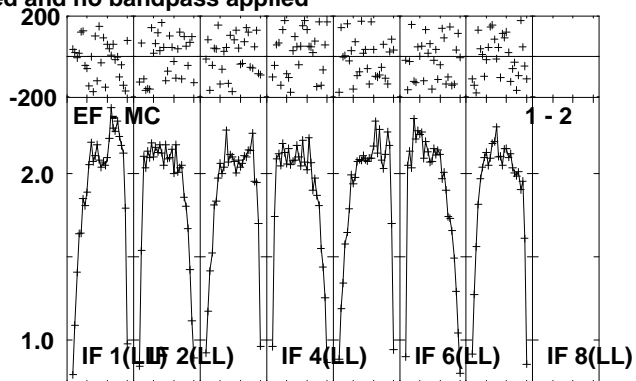
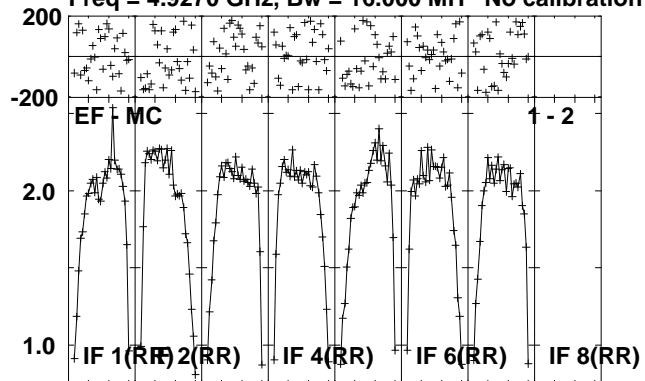

Lower frame: Milli Ampl Jy Top frame: Phas deg
Scalar averaged cross-power spectrum Several baselines displayed
Timerange: 00/15:32:42 to 00/15:38:08

Plot file version 86 created 02-DEC-2011 14:50:24

CYGX-1 ET018A.UVDATA.1

Freq = 4.9270 GHz, Bw = 16.000 MH No calibration applied and no bandpass applied

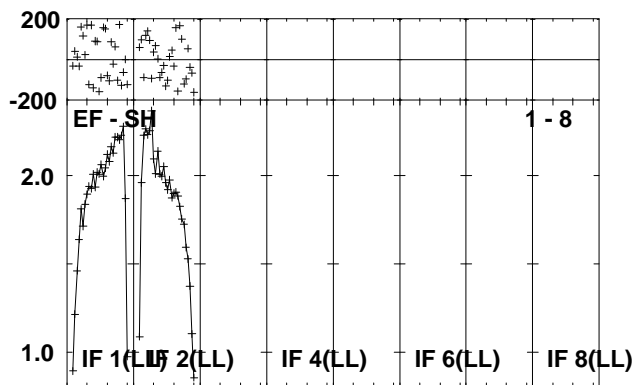
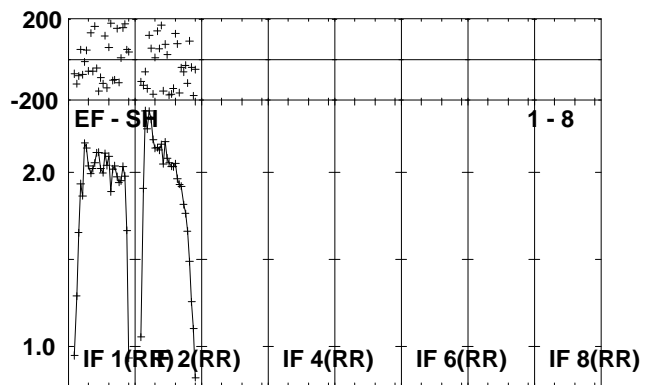
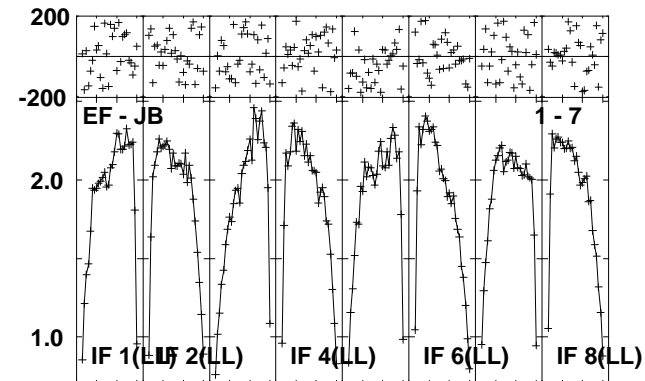
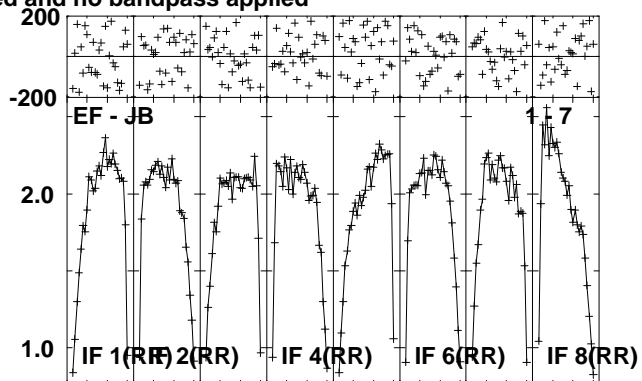
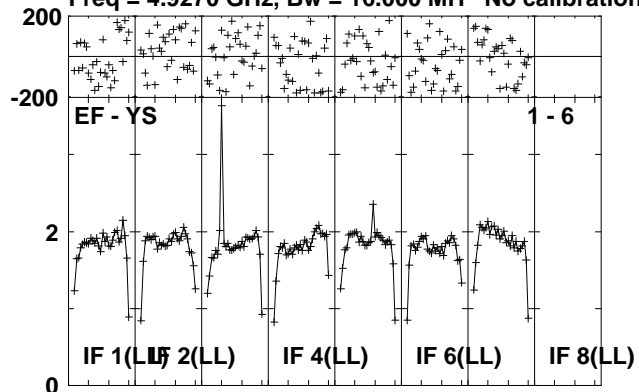

Lower frame: Milli Ampl Jy Top frame: Phas deg
Scalar averaged cross-power spectrum Several baselines displayed
Timerange: 00/15:32:42 to 00/15:38:08

Plot file version 87 created 02-DEC-2011 14:50:27

J1953+35 ET018A.UVDATA.1

Freq = 4.9270 GHz, Bw = 16.000 MH No calibration applied and no bandpass applied

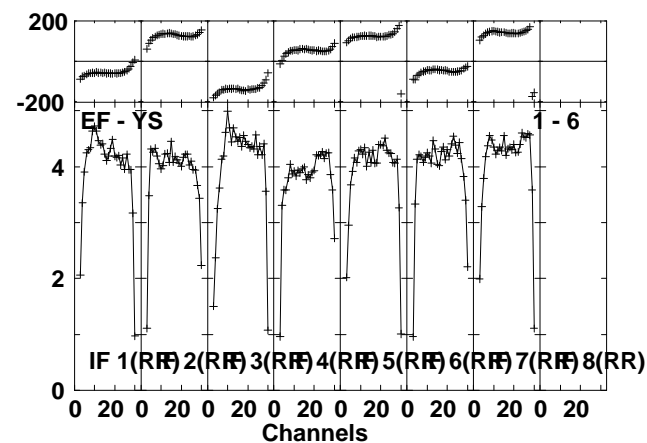
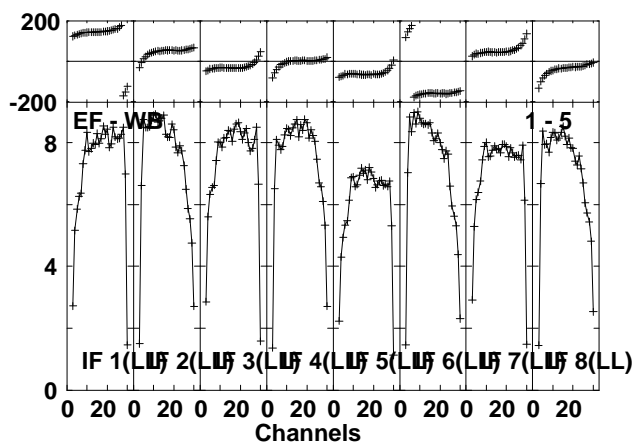
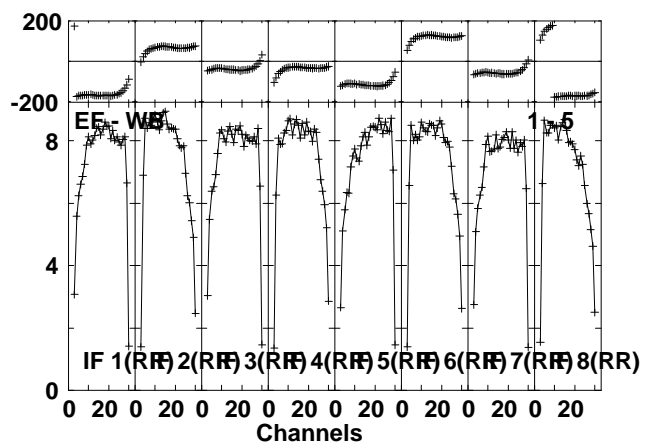
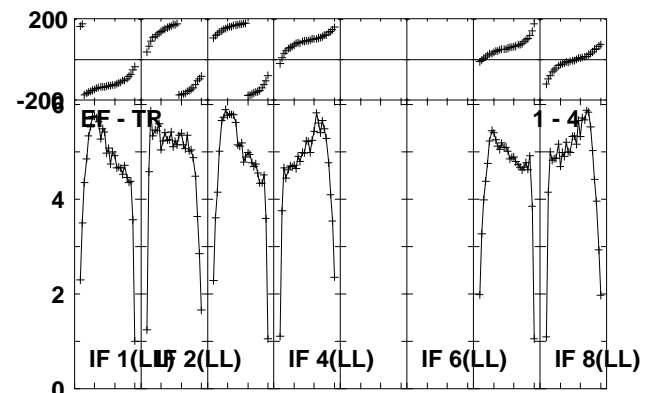
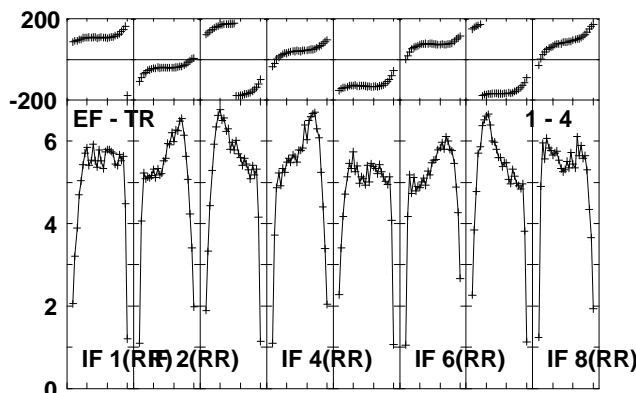
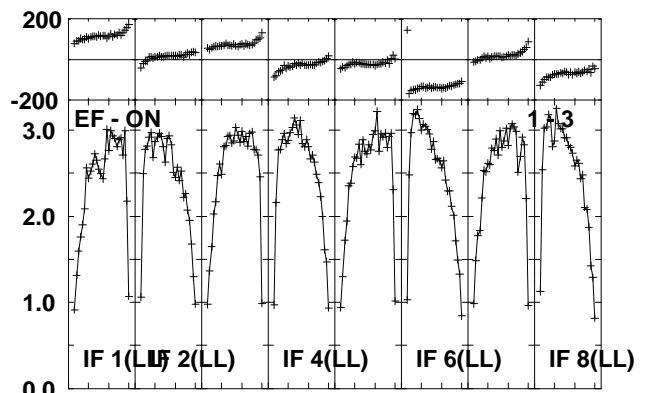
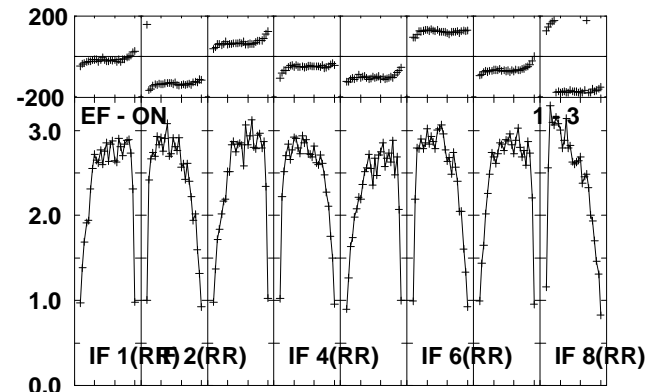
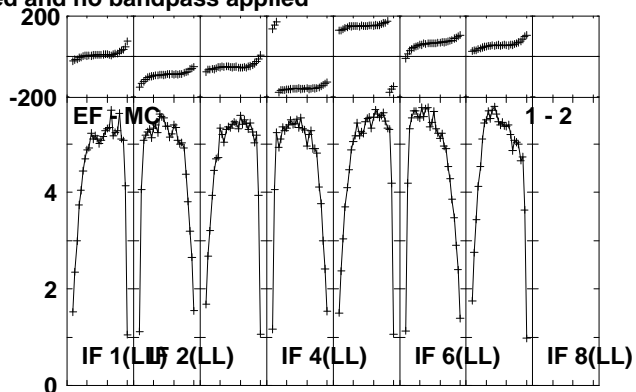
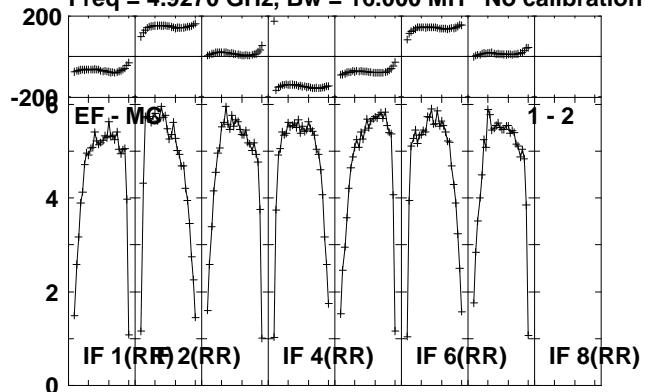

Lower frame: Milli Ampl Jy Top frame: Phas deg
 Scalar averaged cross-power spectrum Several baselines displayed
 Timerange: 00/15:38:11 to 00/15:41:08

Plot file version 88 created 02-DEC-2011 14:50:29

J1953+35 ET018A.UVDATA.1

Freq = 4.9270 GHz, Bw = 16.000 MH No calibration applied and no bandpass applied

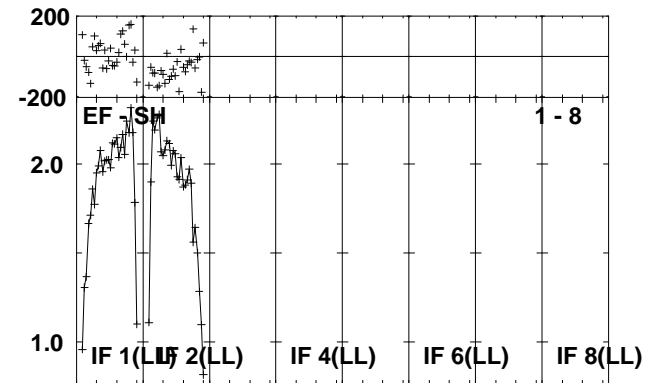
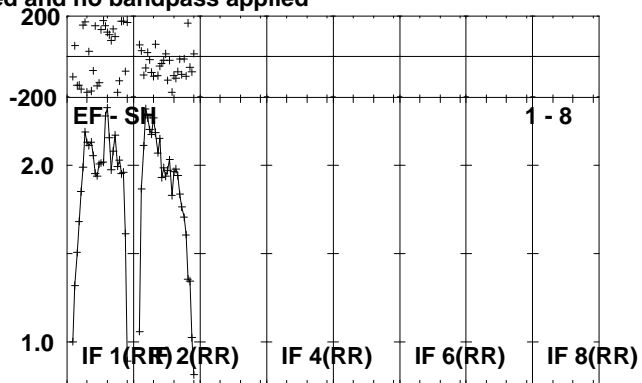
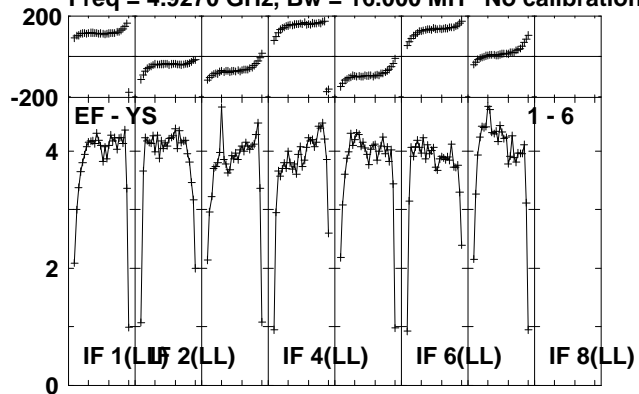

Lower frame: Milli Ampl Jy Top frame: Phas deg
Scalar averaged cross-power spectrum Several baselines displayed
Timerange: 00/15:38:11 to 00/15:41:08

Plot file version 89 created 02-DEC-2011 14:50:30

CYGX-1 ET018A.UVDATA.1

Freq = 4.9270 GHz, Bw = 16.000 MH No calibration applied and no bandpass applied

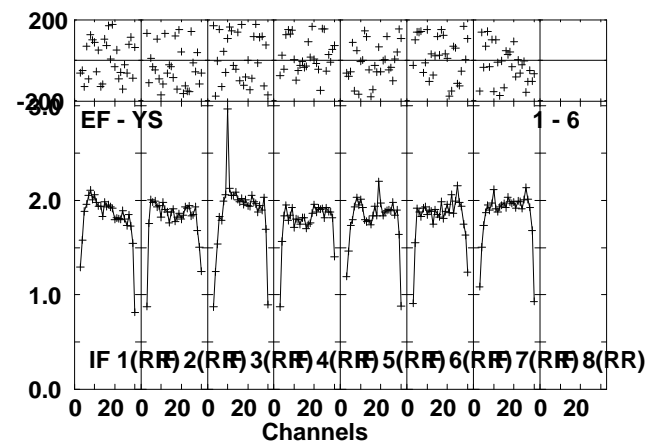
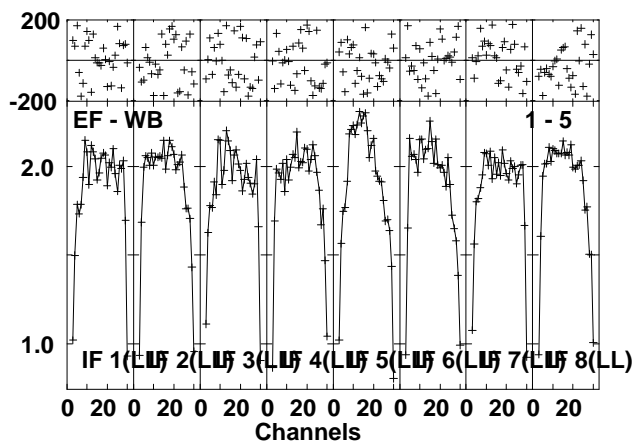
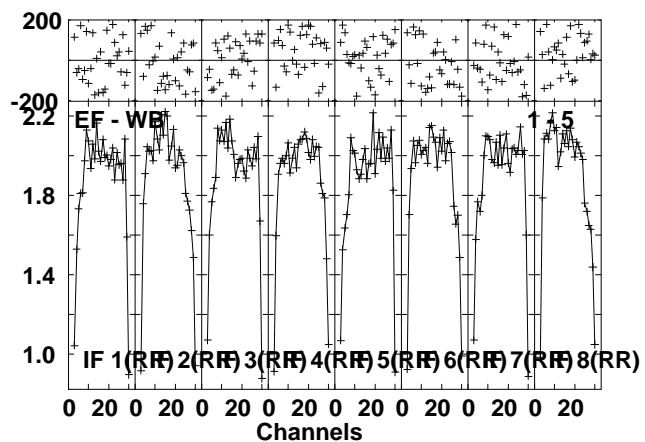
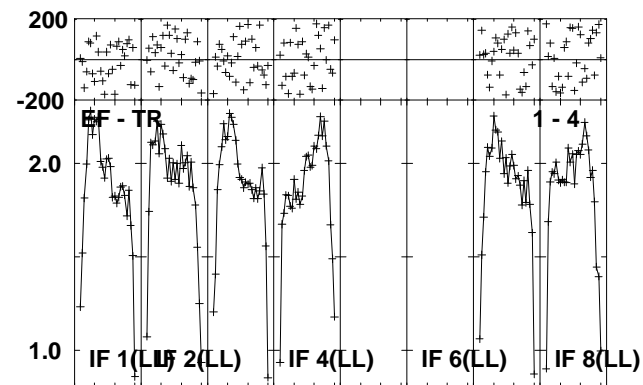
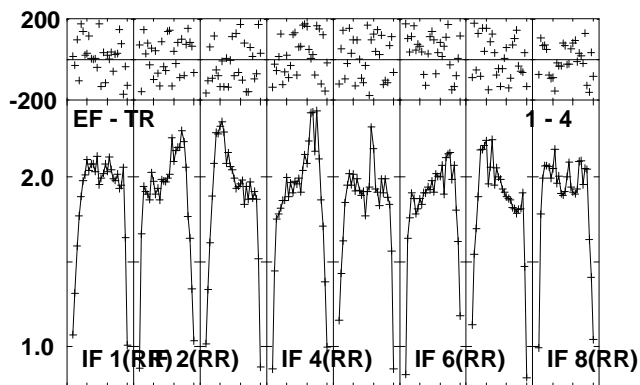
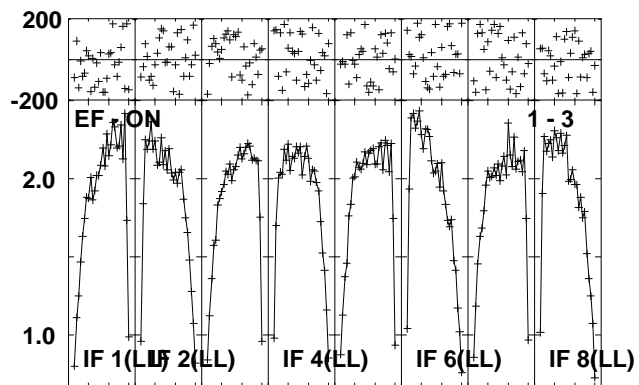
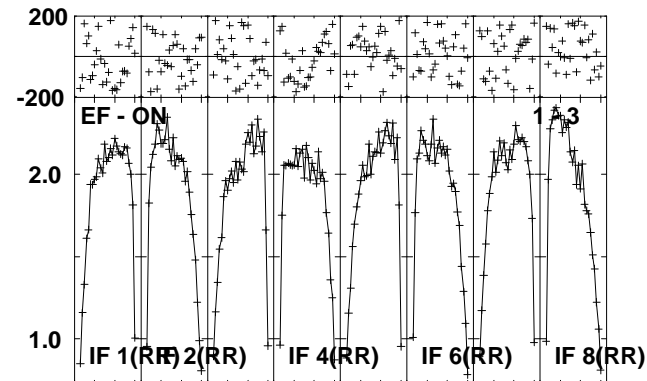
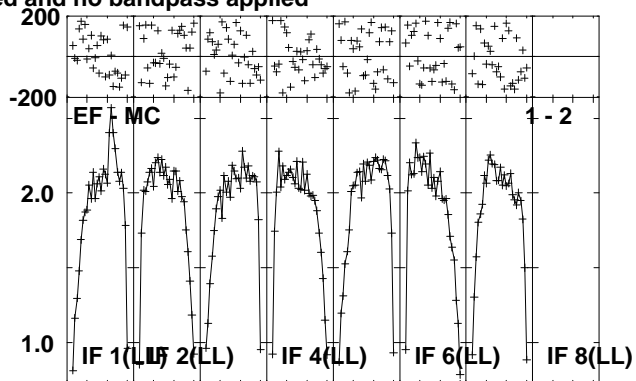
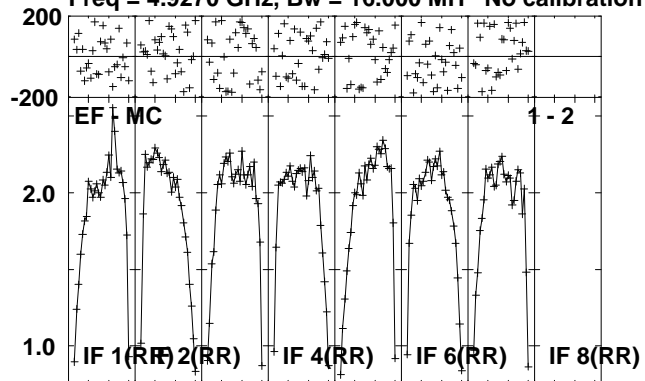

Lower frame: Milli Ampl Jy Top frame: Phas deg
Scalar averaged cross-power spectrum Several baselines displayed
Timerange: 00/15:41:12 to 00/15:46:38

Plot file version 90 created 02-DEC-2011 14:50:34

CYGX-1 ET018A.UVDATA.1

Freq = 4.9270 GHz, Bw = 16.000 MH No calibration applied and no bandpass applied

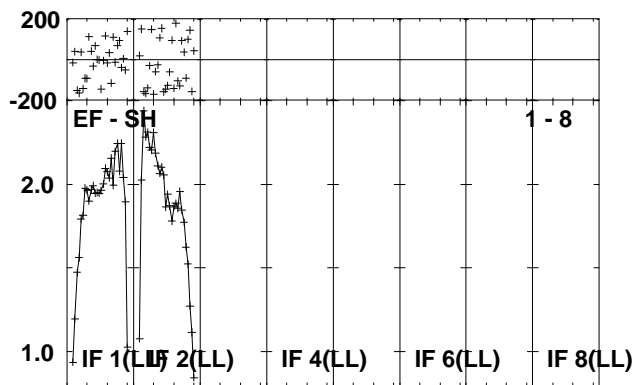
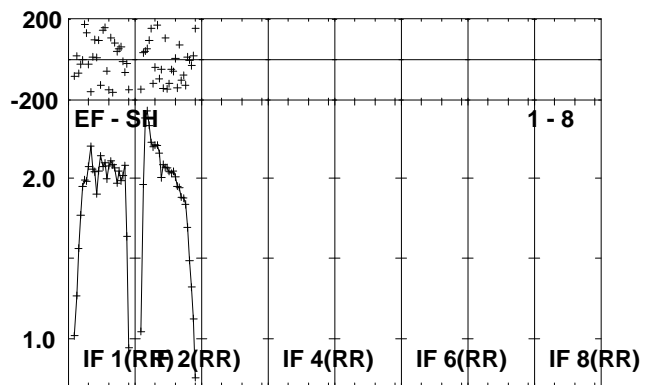
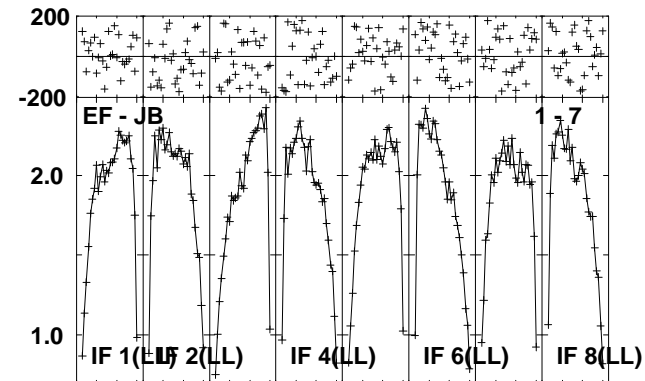
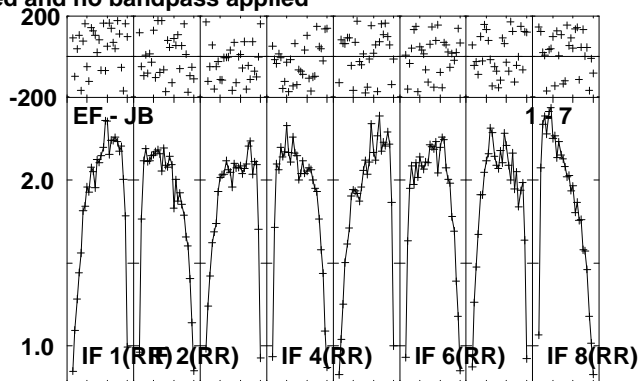
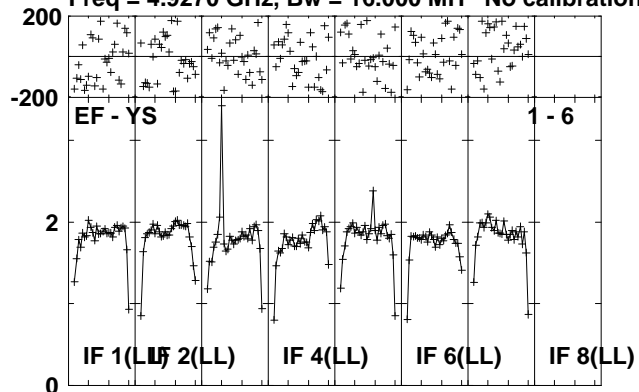

Lower frame: Milli Ampl Jy Top frame: Phas deg
Scalar averaged cross-power spectrum Several baselines displayed
Timerange: 00/15:41:12 to 00/15:46:38

Plot file version 91 created 02-DEC-2011 14:50:37

J1953+35 ET018A.UVDATA.1

Freq = 4.9270 GHz, Bw = 16.000 MH No calibration applied and no bandpass applied

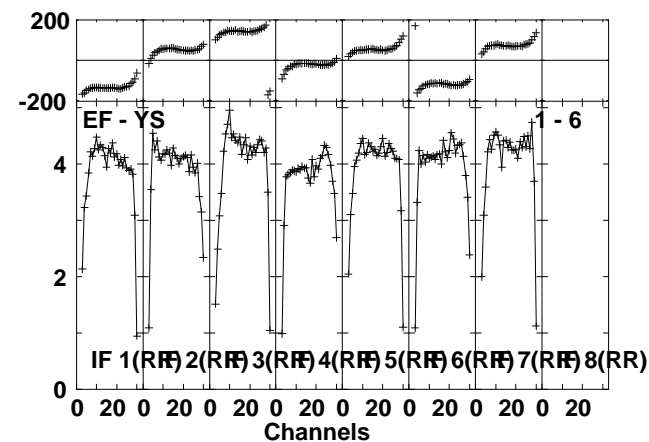
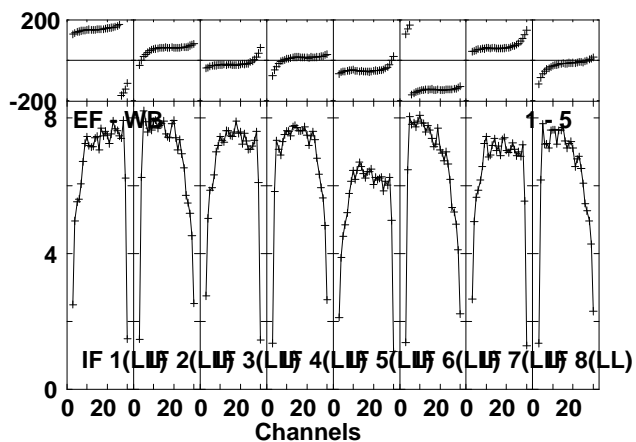
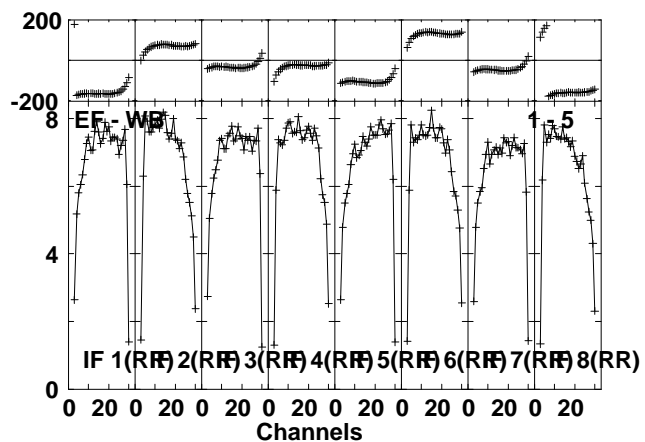
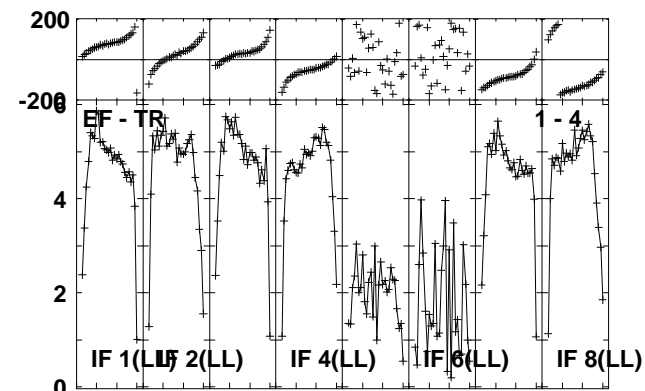
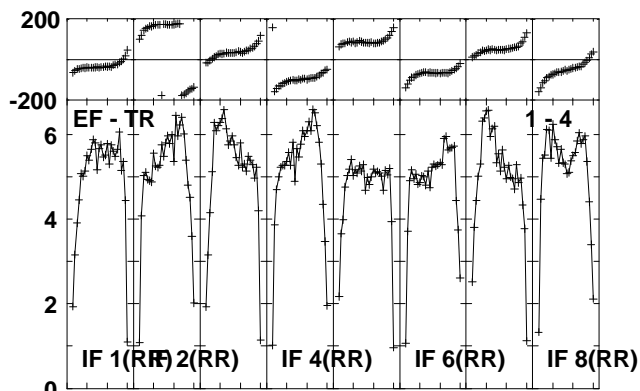
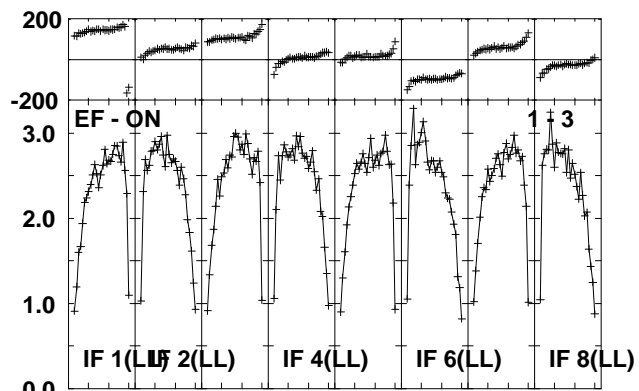
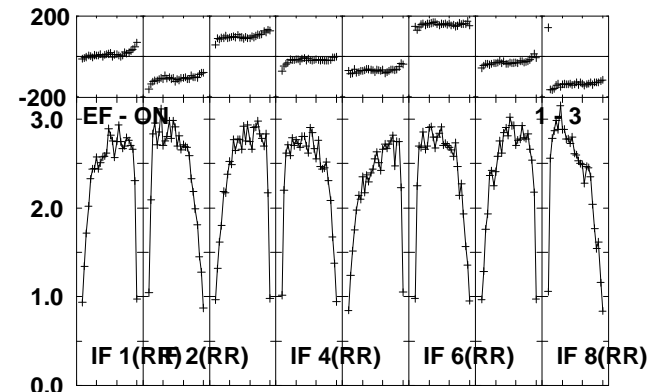
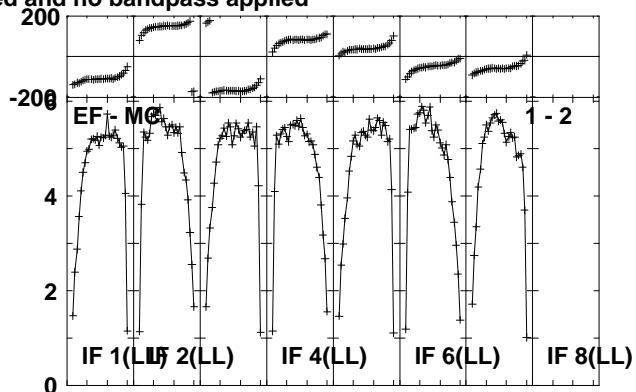
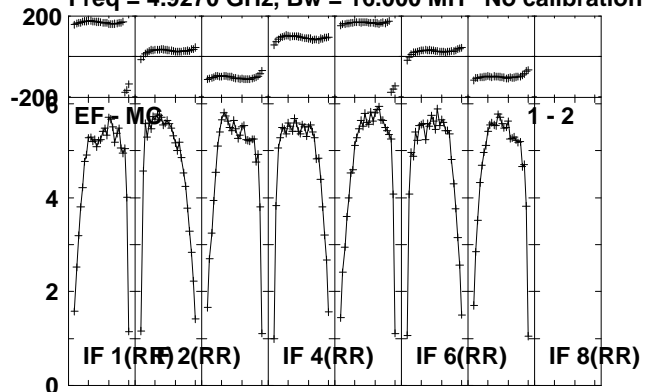

Lower frame: Milli Ampl Jy Top frame: Phas deg
Scalar averaged cross-power spectrum Several baselines displayed
Timerange: 00/15:47:26 to 00/15:49:59

Plot file version 92 created 02-DEC-2011 14:50:39

J1953+35 ET018A.UVDATA.1

Freq = 4.9270 GHz, Bw = 16.000 MH No calibration applied and no bandpass applied

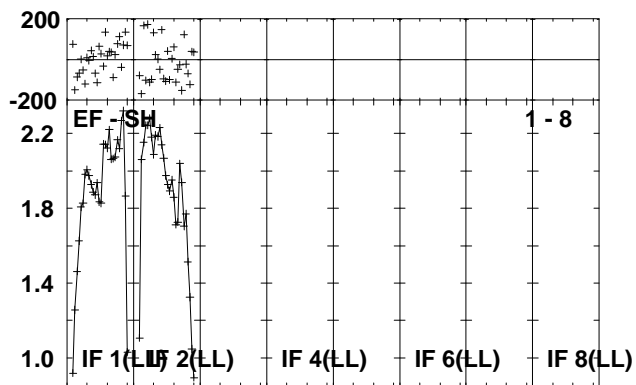
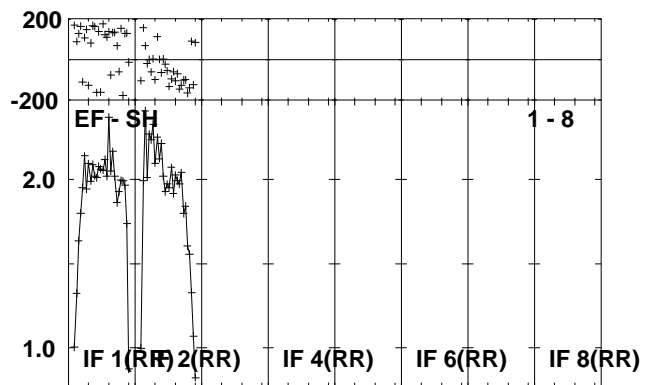
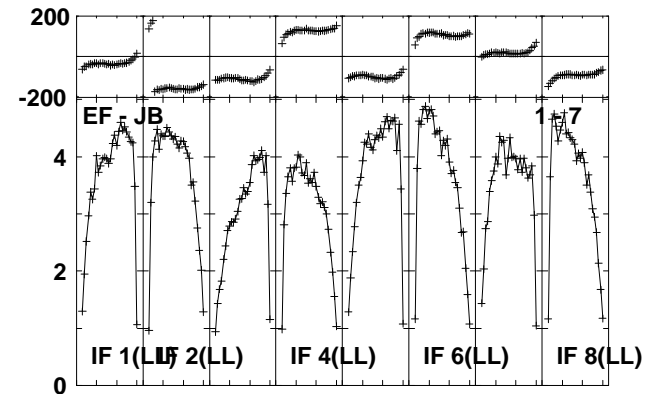
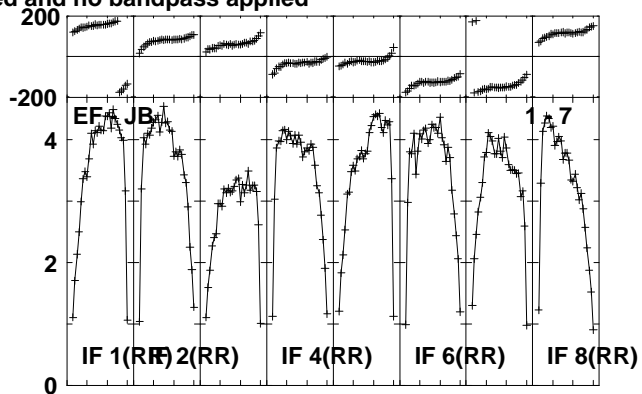
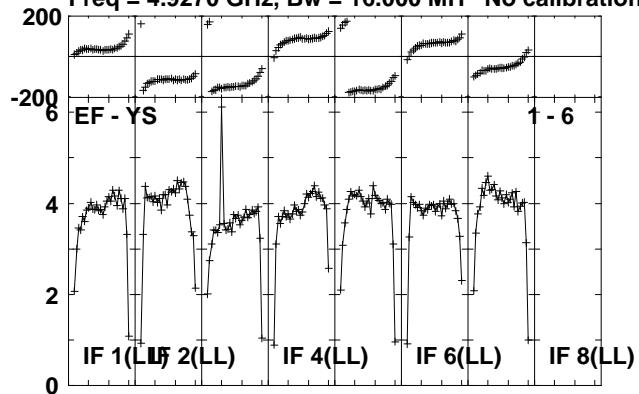

Lower frame: Milli Ampl Jy Top frame: Phas deg
Scalar averaged cross-power spectrum Several baselines displayed
Timerange: 00/15:47:26 to 00/15:49:59

Plot file version 93 created 02-DEC-2011 14:50:40

CYGX-1 ET018A.UVDATA.1

Freq = 4.9270 GHz, Bw = 16.000 MH No calibration applied and no bandpass applied

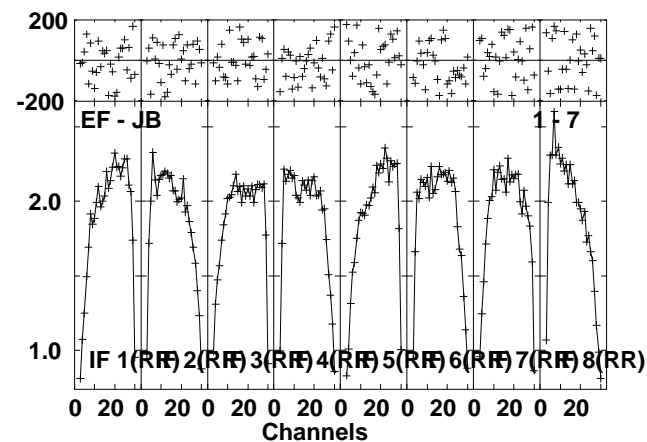
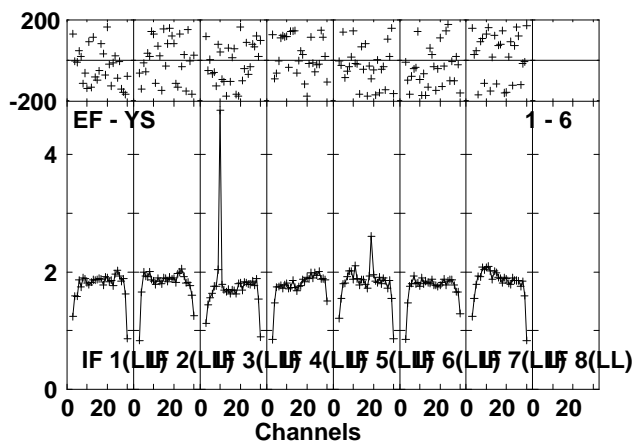
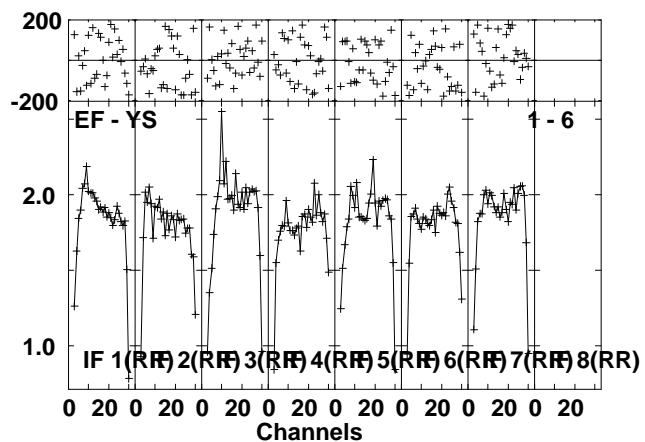
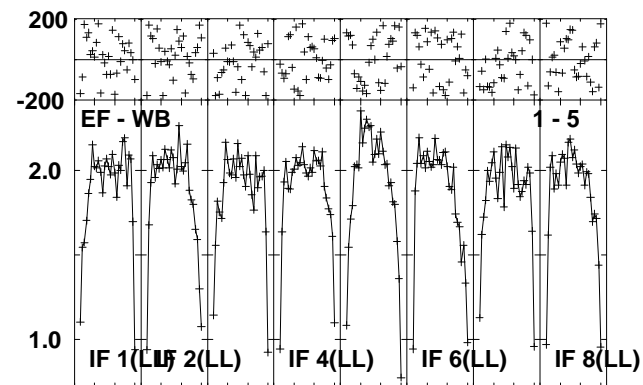
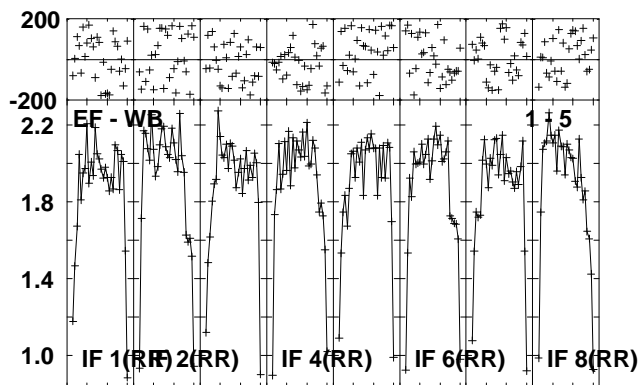
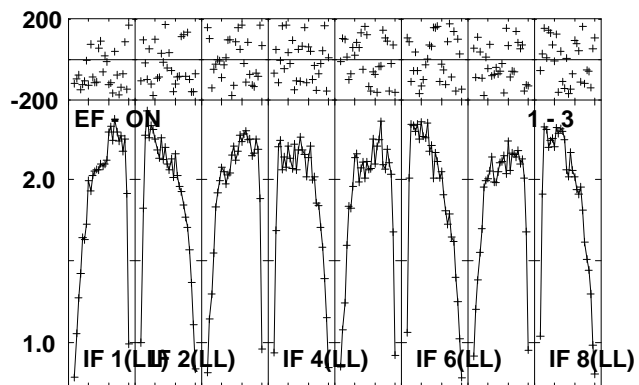
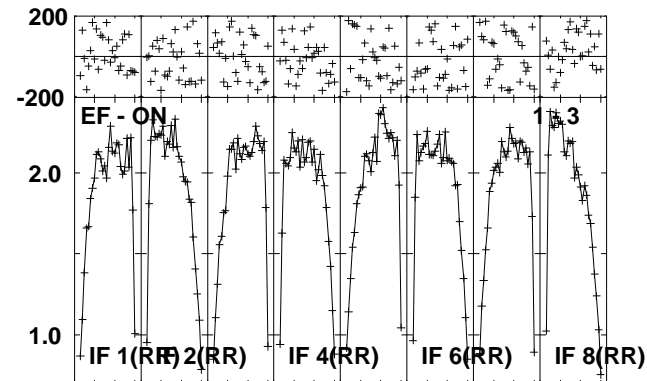
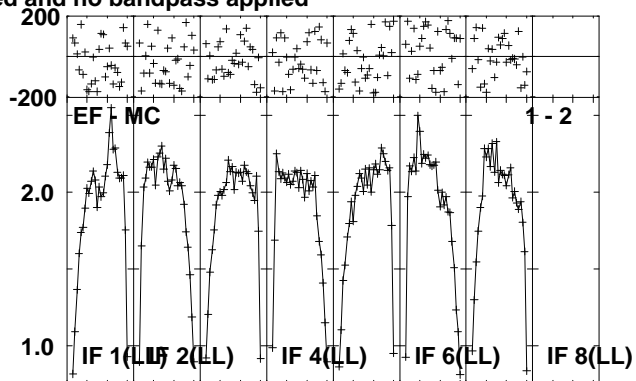
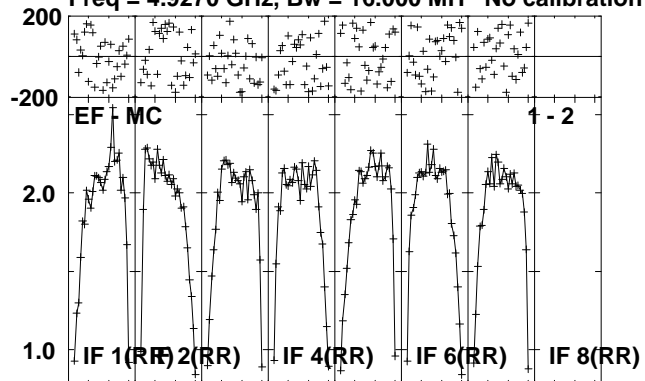

Lower frame: Milli Ampl Jy Top frame: Phas deg
Scalar averaged cross-power spectrum Several baselines displayed
Timerange: 00/15:50:01 to 00/15:55:29

Plot file version 94 created 02-DEC-2011 14:50:43

CYGX-1 ET018A.UVDATA.1

Freq = 4.9270 GHz, Bw = 16.000 MH No calibration applied and no bandpass applied

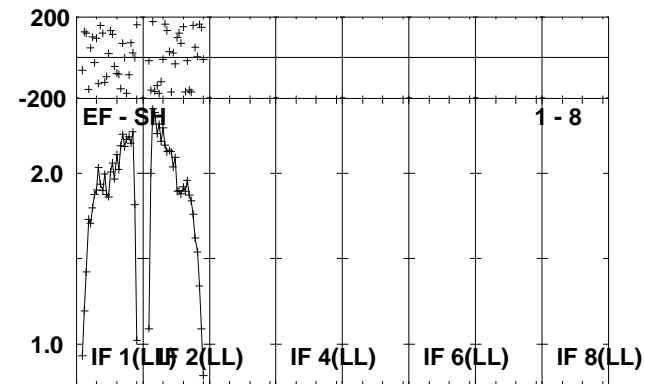
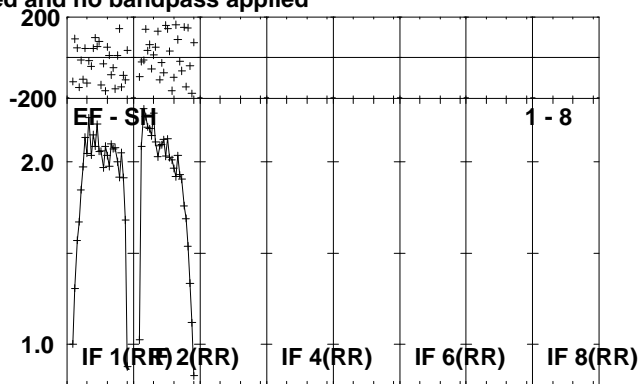
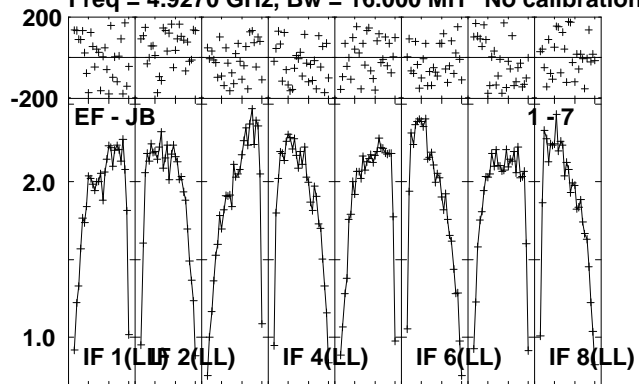

Lower frame: Milli Ampl Jy Top frame: Phas deg
Scalar averaged cross-power spectrum Several baselines displayed
Timerange: 00/15:50:01 to 00/15:55:29

Plot file version 95 created 02-DEC-2011 14:50:45

J1953+35 ET018A.UVDATA.1

Freq = 4.9270 GHz, Bw = 16.000 MH No calibration applied and no bandpass applied

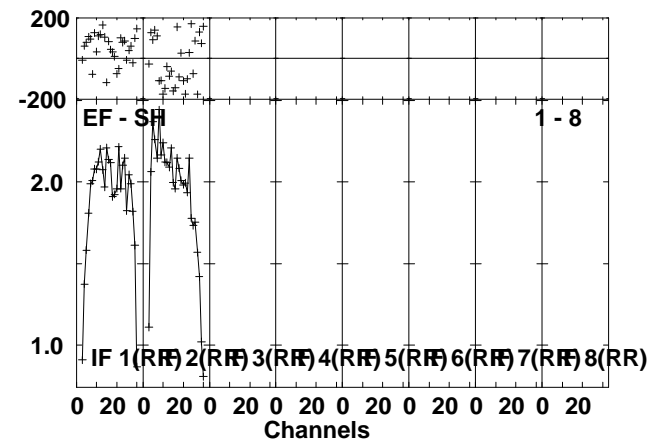
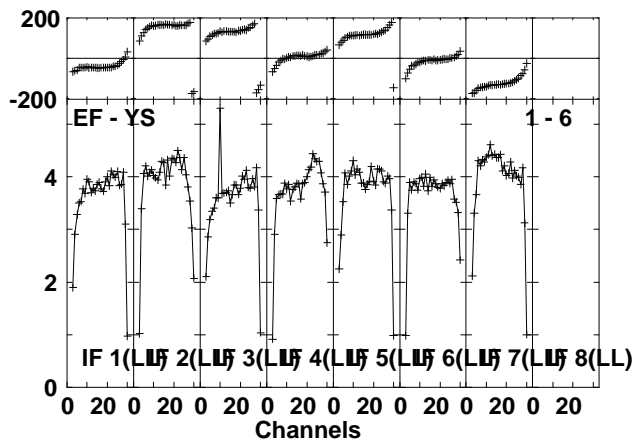
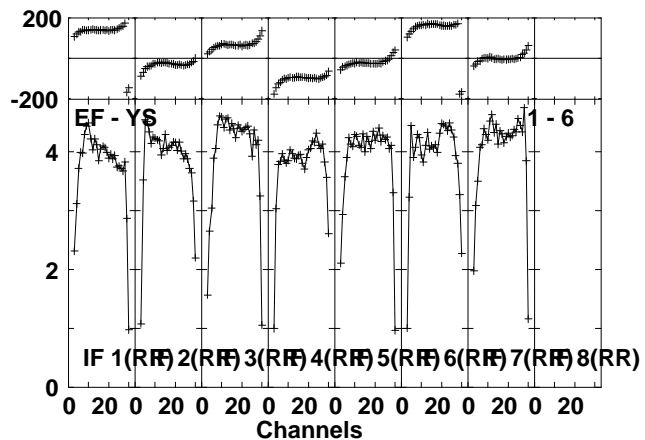
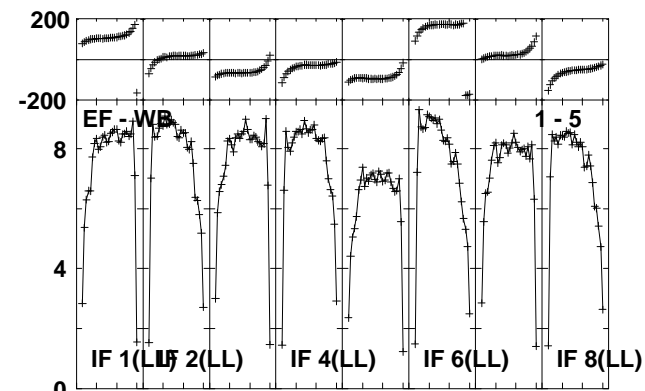
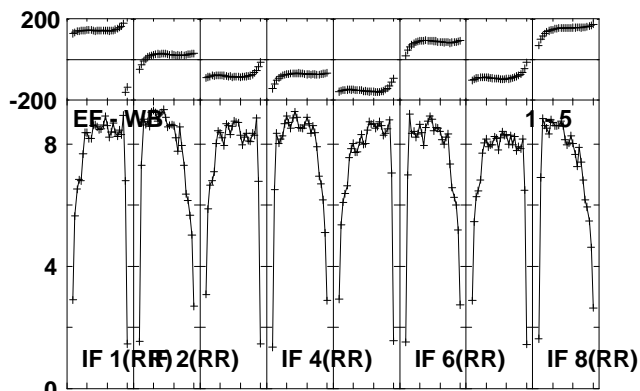
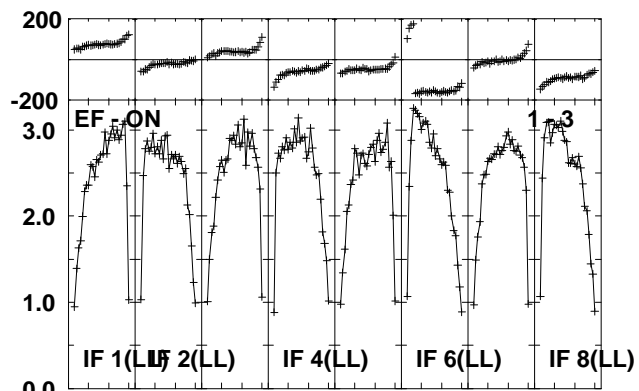
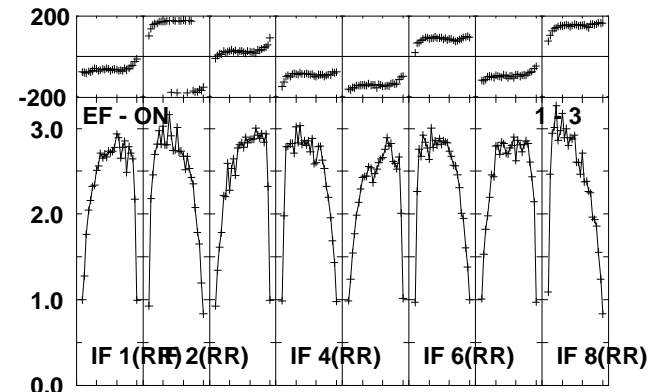
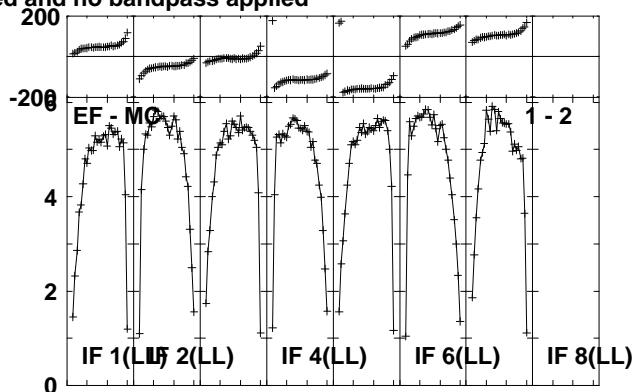
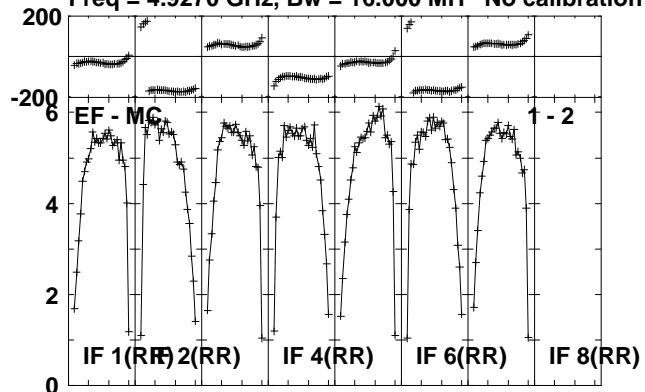

Lower frame: Milli Ampl Jy Top frame: Phas deg
Scalar averaged cross-power spectrum Several baselines displayed
Timerange: 00/15:55:31 to 00/15:58:28

Plot file version 96 created 02-DEC-2011 14:50:47

J1953+35 ET018A.UVDATA.1

Freq = 4.9270 GHz, Bw = 16.000 MH No calibration applied and no bandpass applied

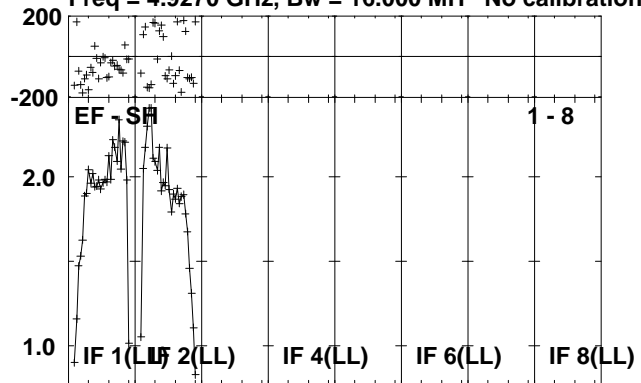

Lower frame: Milli Ampl Jy Top frame: Phas deg
Scalar averaged cross-power spectrum Several baselines displayed
Timerange: 00/15:55:31 to 00/15:58:28

Plot file version 97 created 02-DEC-2011 14:50:48

CYGX-1 ET018A.UVDATA.1

Freq = 4.9270 GHz, Bw = 16.000 MH No calibration applied and no bandpass applied

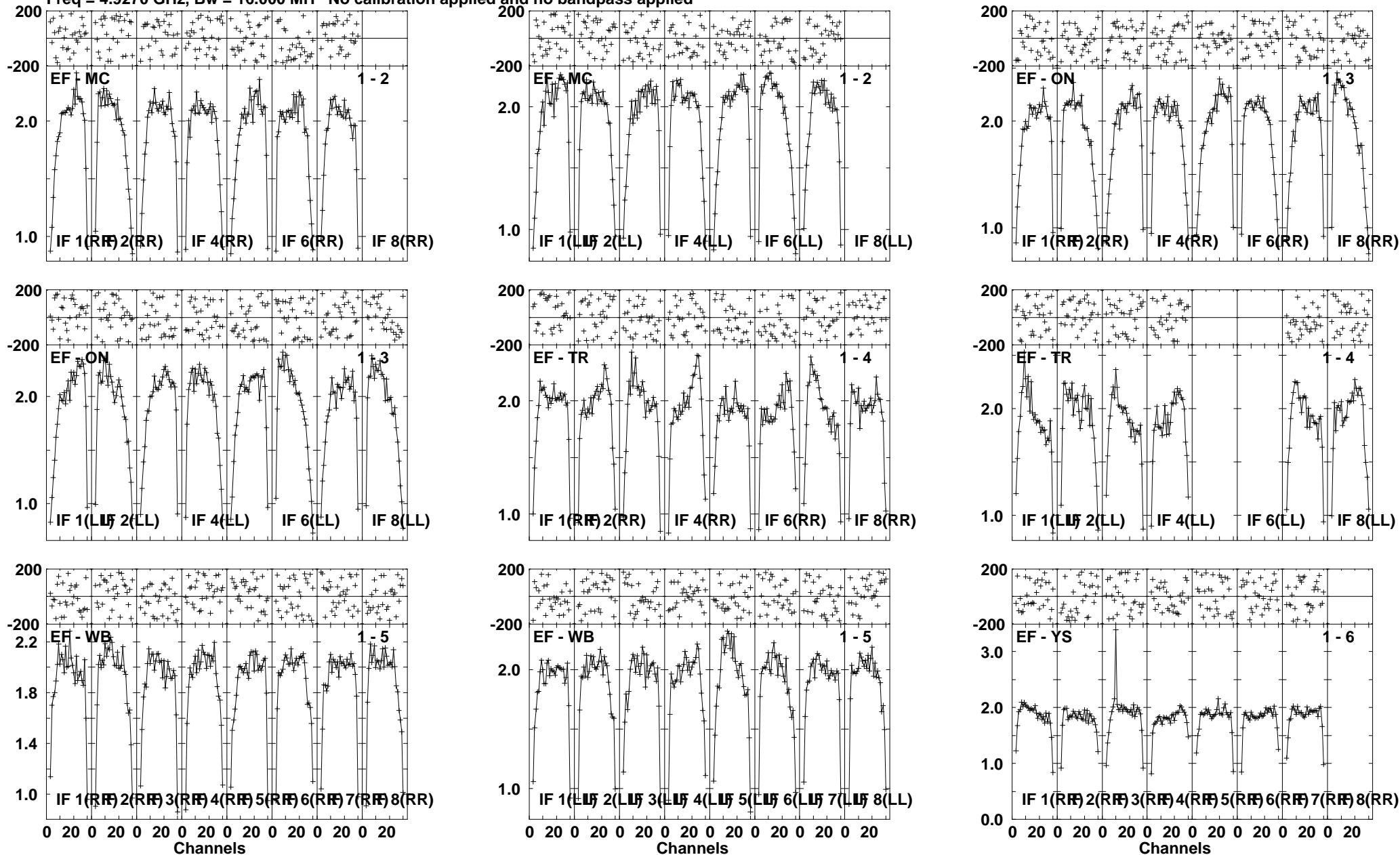

Lower frame: Milli Ampl Jy Top frame: Phas deg
Scalar averaged cross-power spectrum Several baselines displayed
Timerange: 00/15:58:32 to 00/16:03:58

Plot file version 98 created 02-DEC-2011 14:50:51

CYGX-1 ET018A.UVDATA.1

Freq = 4.9270 GHz, Bw = 16.000 MH No calibration applied and no bandpass applied

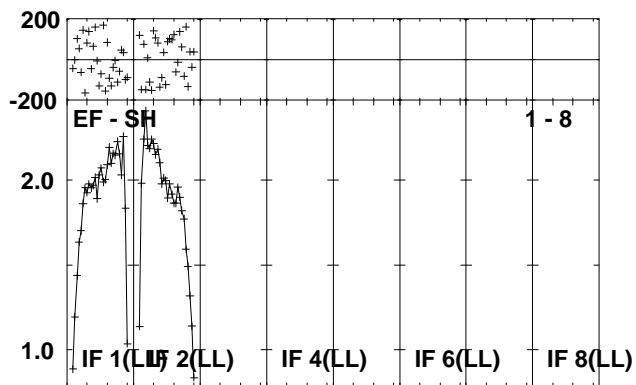
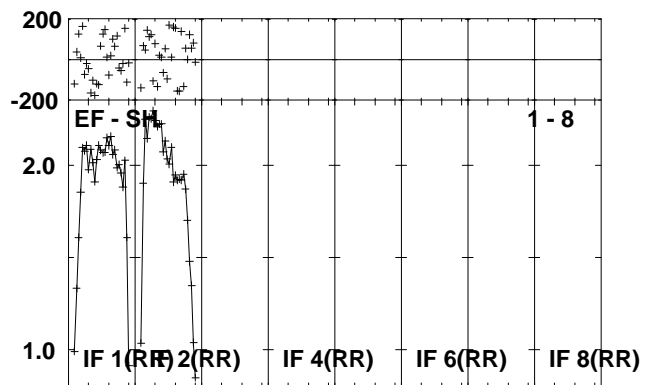
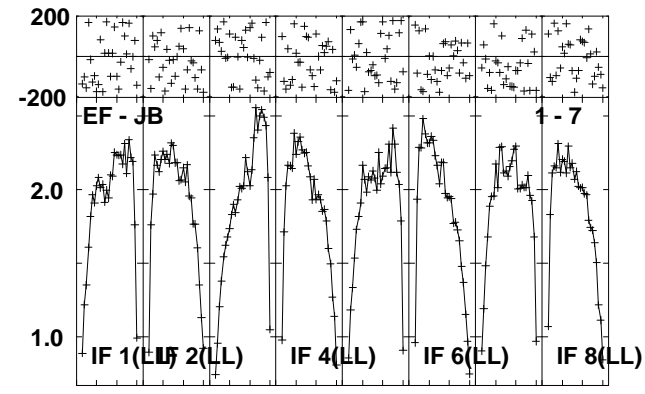
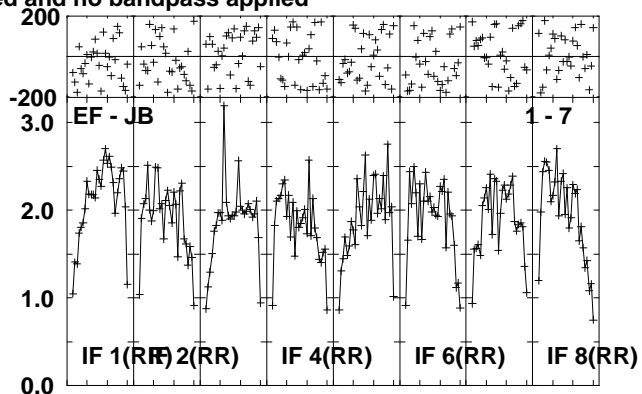
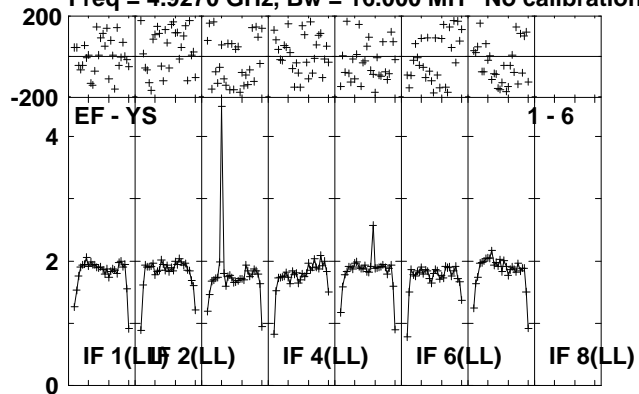

Lower frame: Milli Ampl Jy Top frame: Phas deg
Scalar averaged cross-power spectrum Several baselines displayed
Timerange: 00/15:58:32 to 00/16:03:58

Plot file version 99 created 02-DEC-2011 14:50:53

J1953+35 ET018A.UVDATA.1

Freq = 4.9270 GHz, Bw = 16.000 MH No calibration applied and no bandpass applied

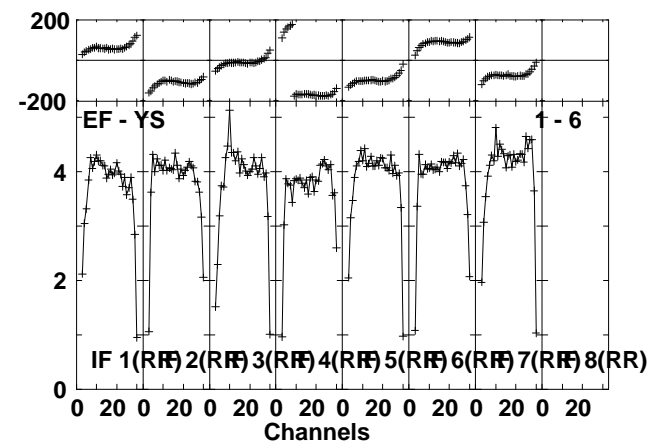
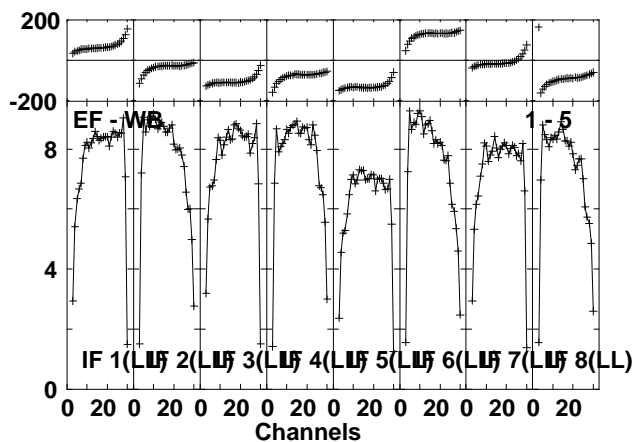
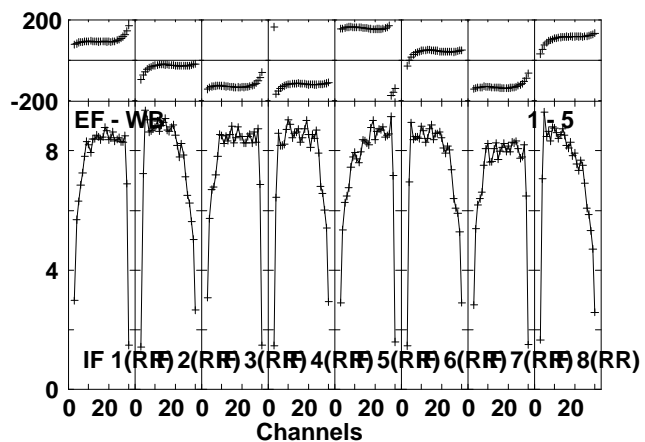
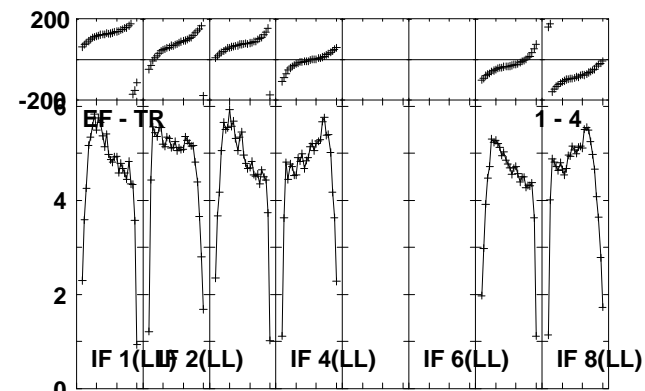
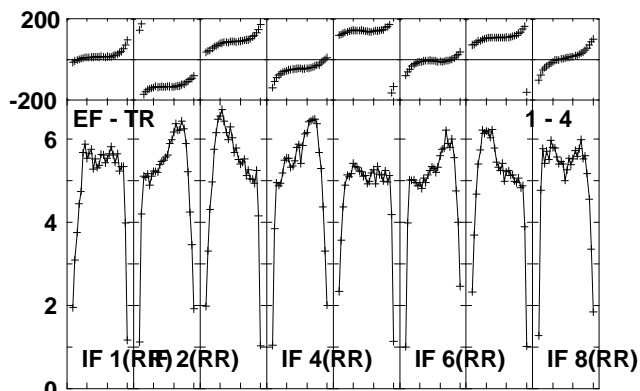
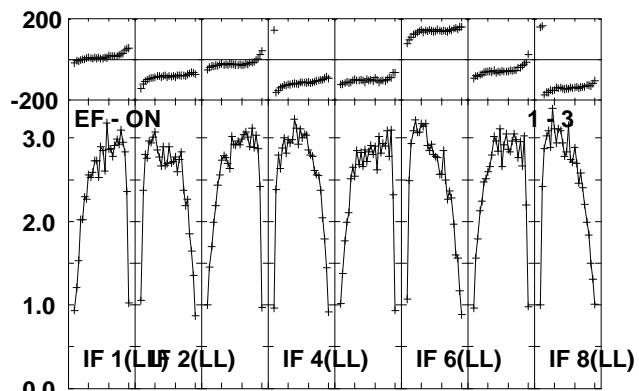
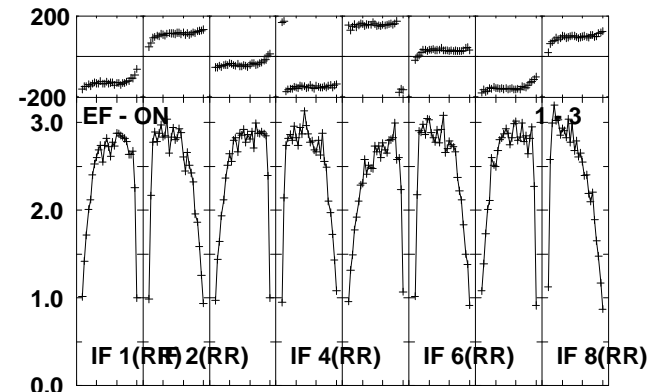
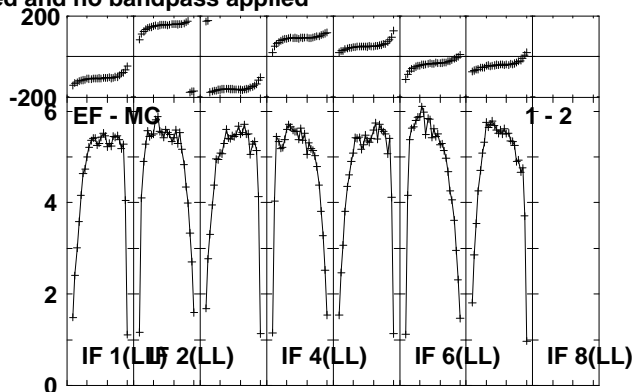
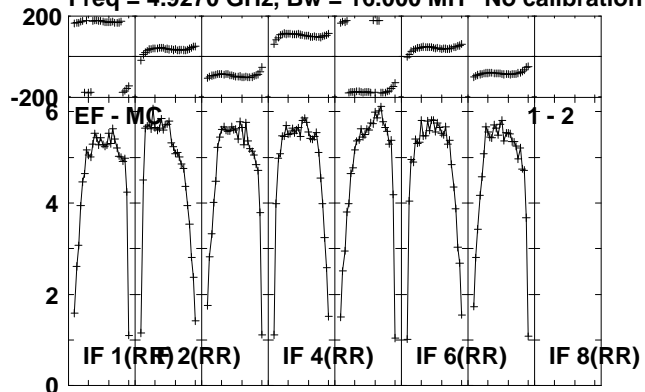

Lower frame: Milli Ampl Jy Top frame: Phas deg
Scalar averaged cross-power spectrum Several baselines displayed
Timerange: 00/16:04:46 to 00/16:07:19

Plot file version 100 created 02-DEC-2011 14:50:55

J1953+35 ET018A.UVDATA.1

Freq = 4.9270 GHz, Bw = 16.000 MH No calibration applied and no bandpass applied

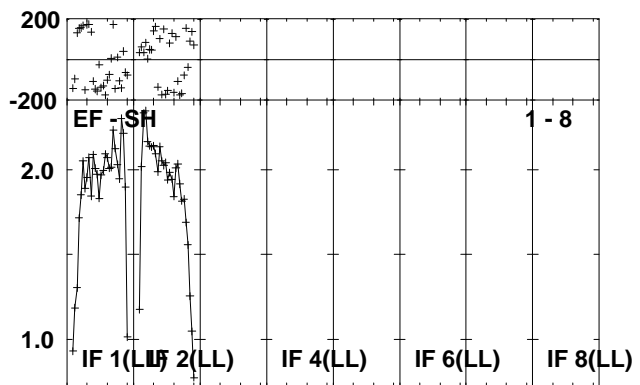
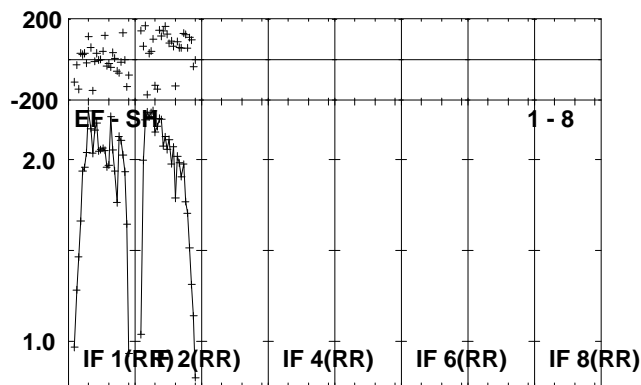
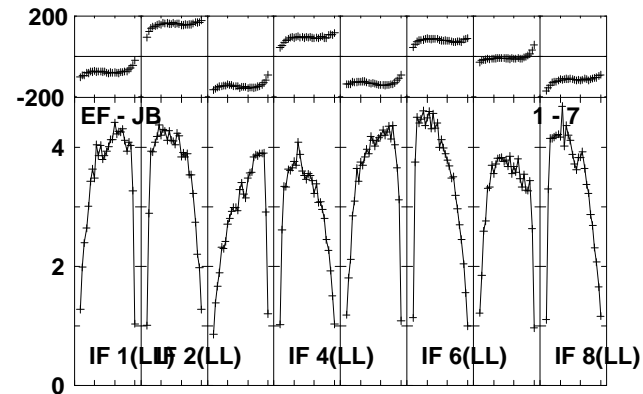
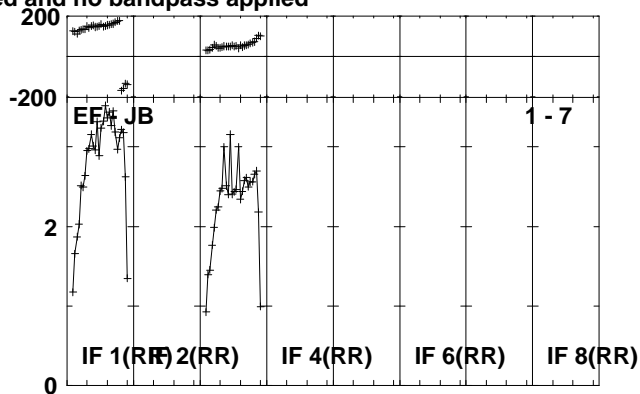
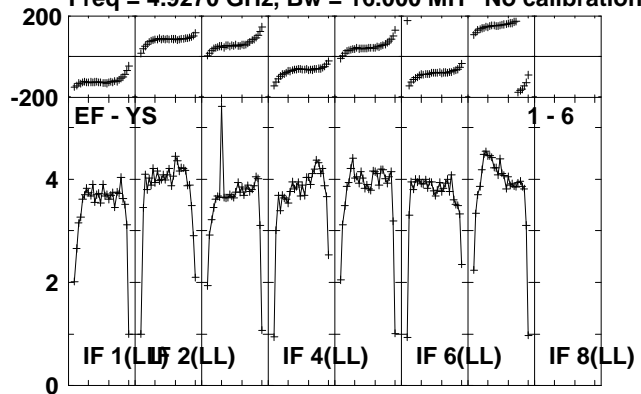

Lower frame: Milli Ampl Jy Top frame: Phas deg
Scalar averaged cross-power spectrum Several baselines displayed
Timerange: 00/16:04:46 to 00/16:07:19

Plot file version 101 created 02-DEC-2011 14:50:57

J2002+47 ET018A.UVDATA.1

Freq = 4.9270 GHz, Bw = 16.000 MH No calibration applied and no bandpass applied

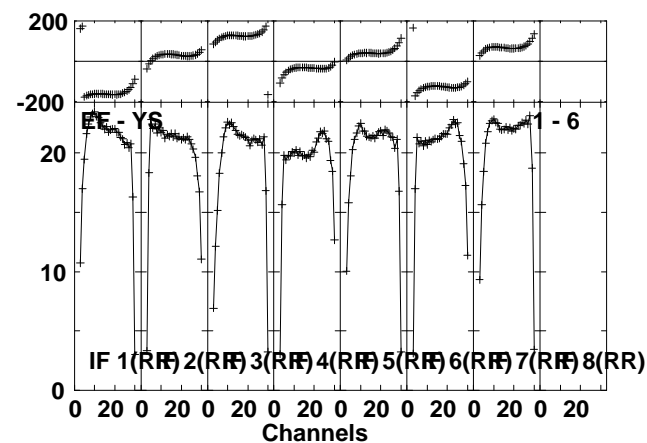
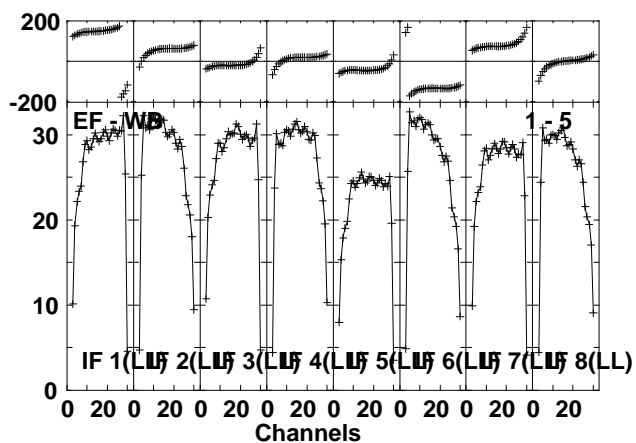
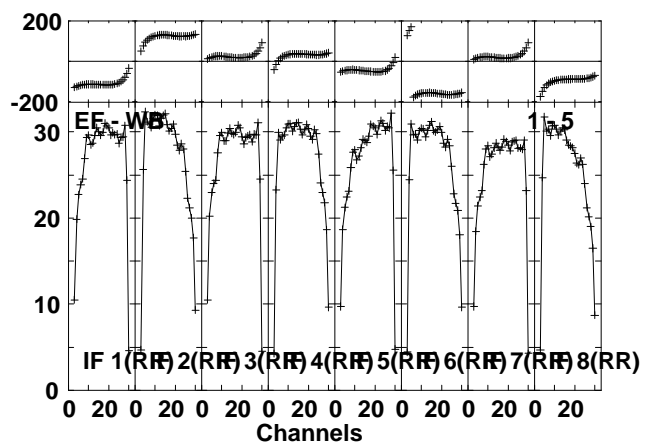
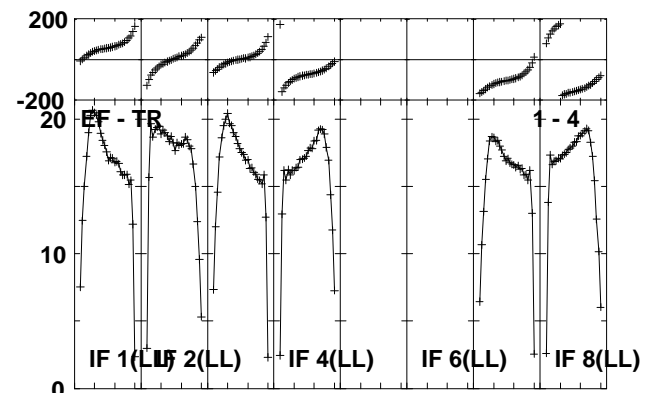
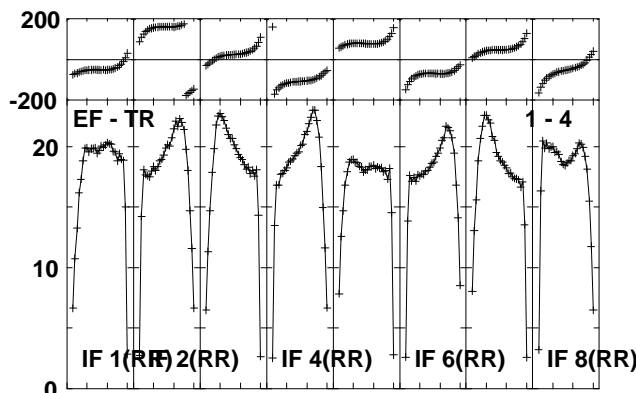
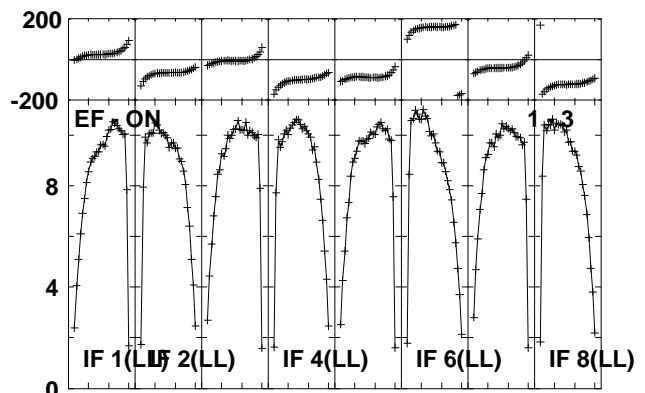
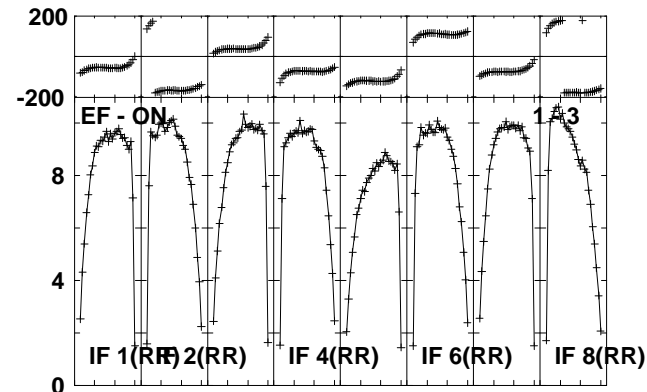
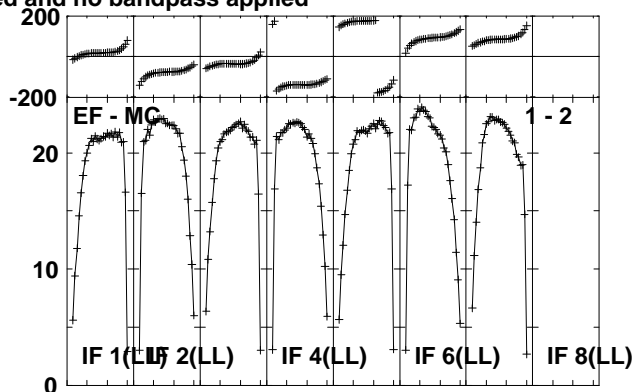
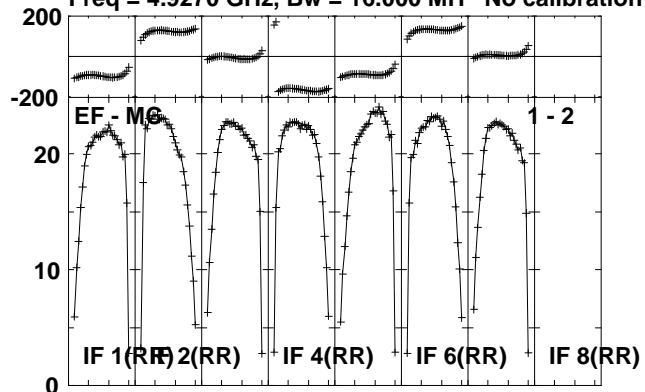

Lower frame: Milli Ampl Jy Top frame: Phas deg
Scalar averaged cross-power spectrum Several baselines displayed
Timerange: 00/16:08:47 to 00/16:12:49

Plot file version 102 created 02-DEC-2011 14:51:00

J2002+47 ET018A.UVDATA.1

Freq = 4.9270 GHz, Bw = 16.000 MH No calibration applied and no bandpass applied

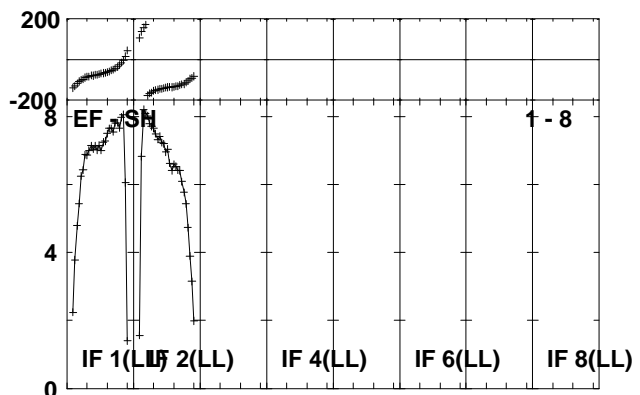
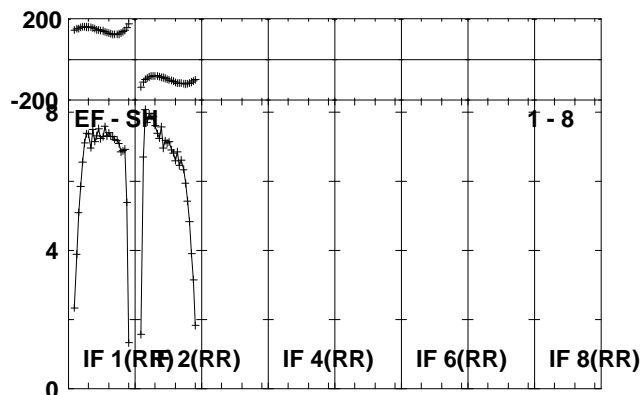
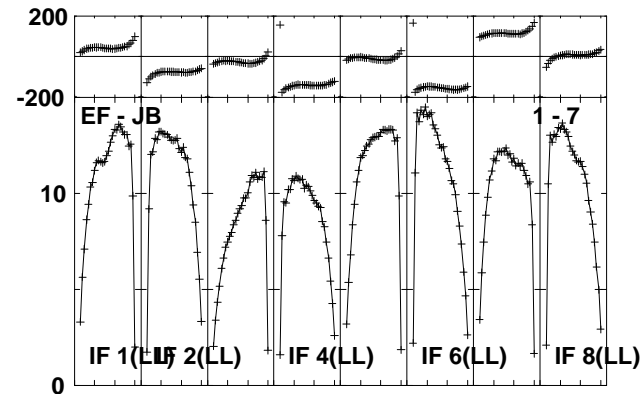
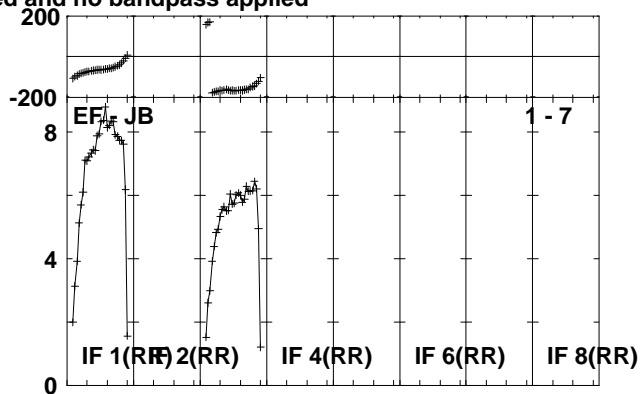
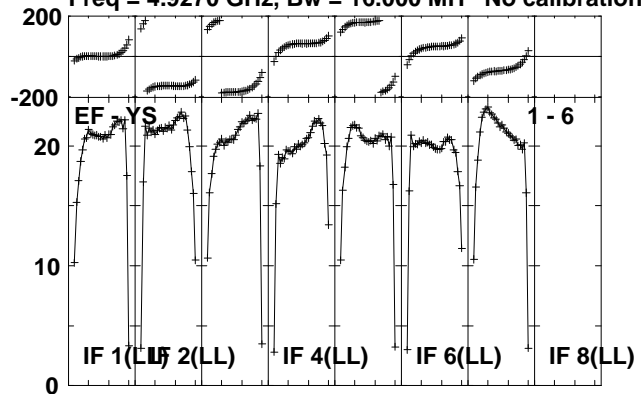

Lower frame: Milli Ampl Jy Top frame: Phas deg
Scalar averaged cross-power spectrum Several baselines displayed
Timerange: 00/16:08:47 to 00/16:12:49

Plot file version 103 created 02-DEC-2011 14:51:01

CYGX-1 ET018A.UVDATA.1

Freq = 4.9270 GHz, Bw = 16.000 MH No calibration applied and no bandpass applied

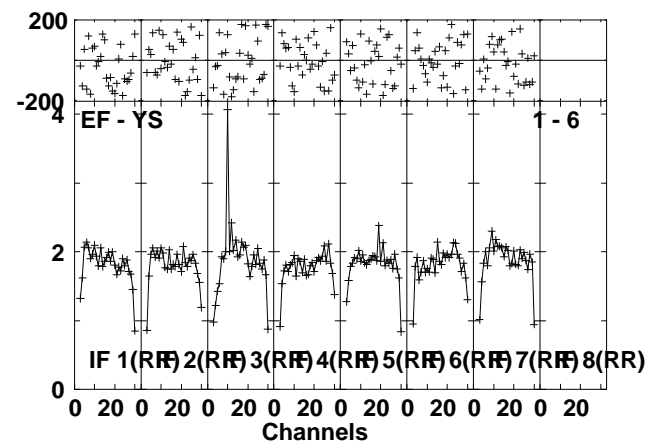
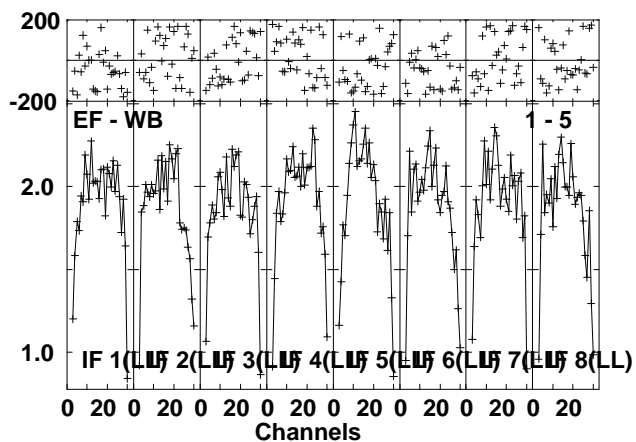
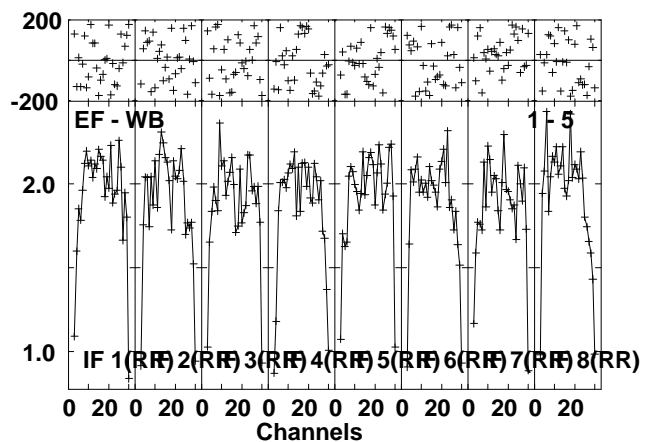
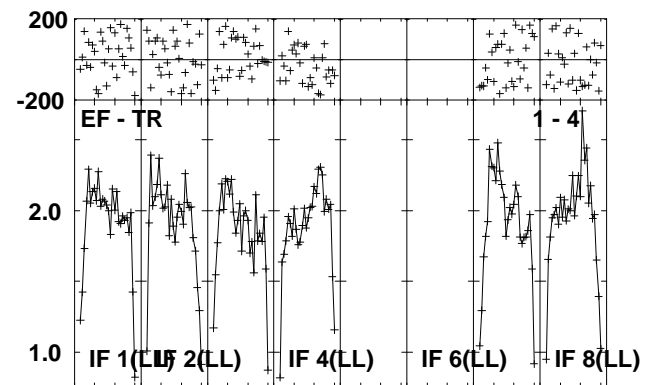
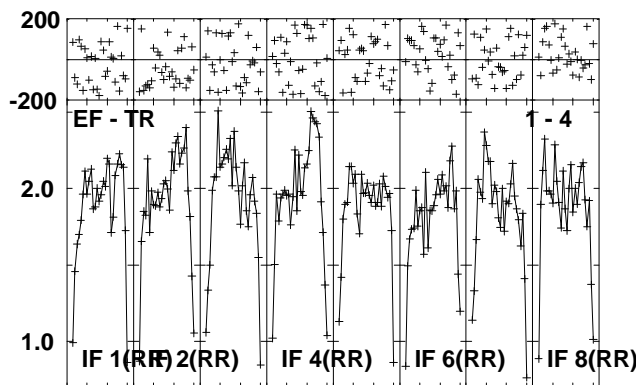
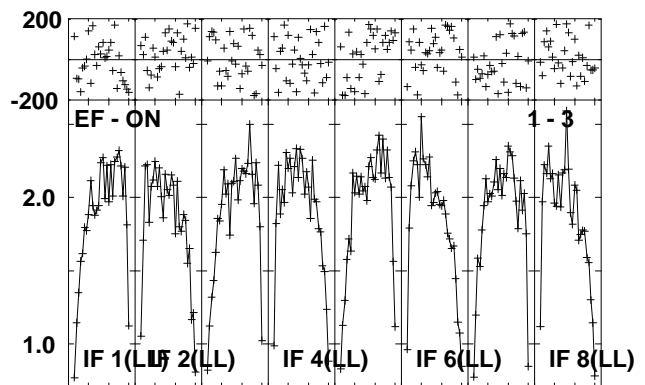
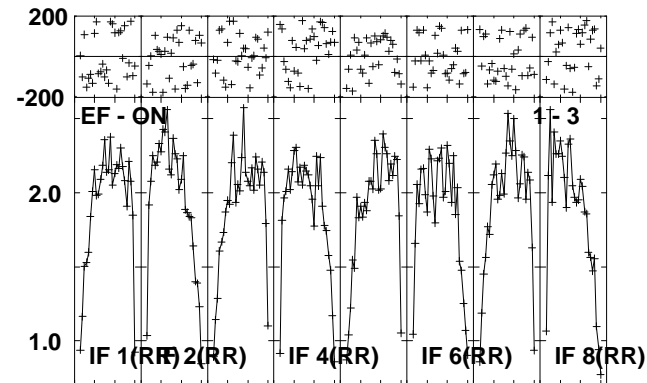
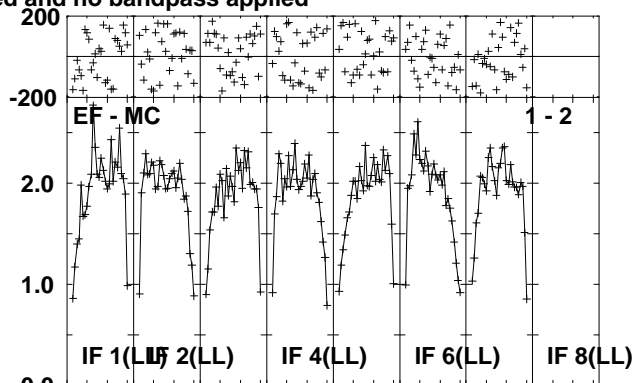
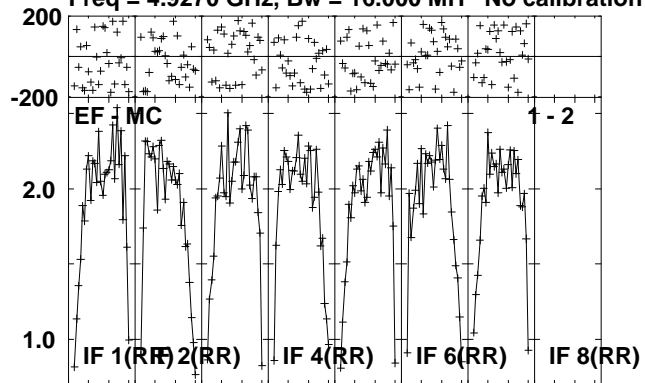

Lower frame: Milli Ampl Jy Top frame: Phas deg
Scalar averaged cross-power spectrum Several baselines displayed
Timerange: 00/16:21:43 to 00/16:22:48

Plot file version 104 created 02-DEC-2011 14:51:02

CYGX-1 ET018A.UVDATA.1

Freq = 4.9270 GHz, Bw = 16.000 MH No calibration applied and no bandpass applied

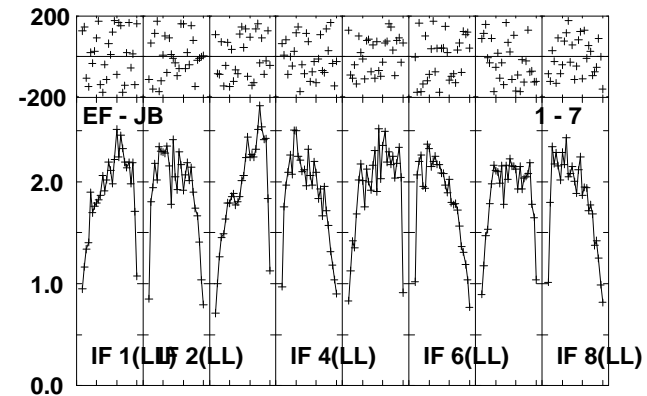
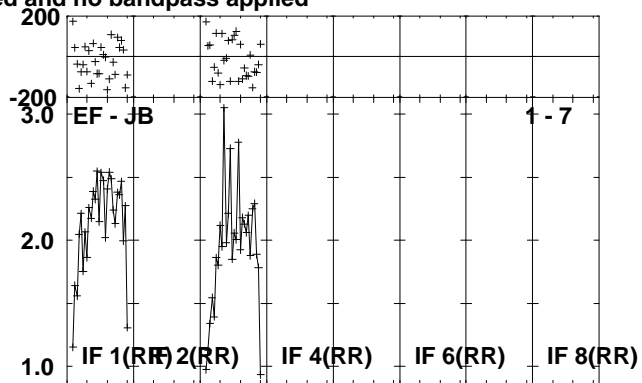
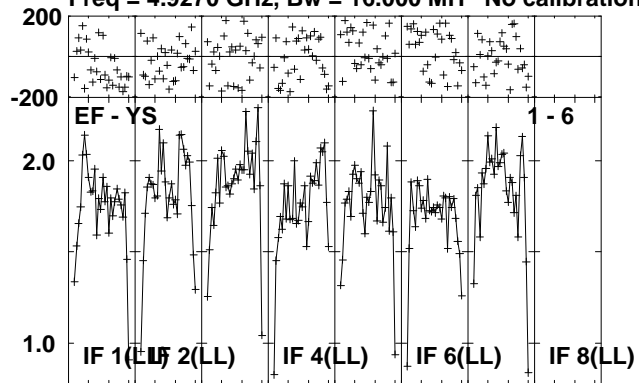

Lower frame: Milli Ampl Jy Top frame: Phas deg
Scalar averaged cross-power spectrum Several baselines displayed
Timerange: 00/16:21:43 to 00/16:22:48

Plot file version 105 created 02-DEC-2011 14:51:03

J1953+35 ET018A.UVDATA.1

Freq = 4.9270 GHz, Bw = 16.000 MH No calibration applied and no bandpass applied

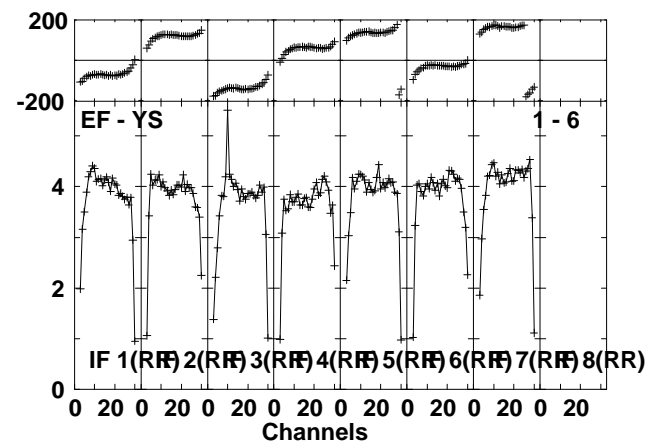
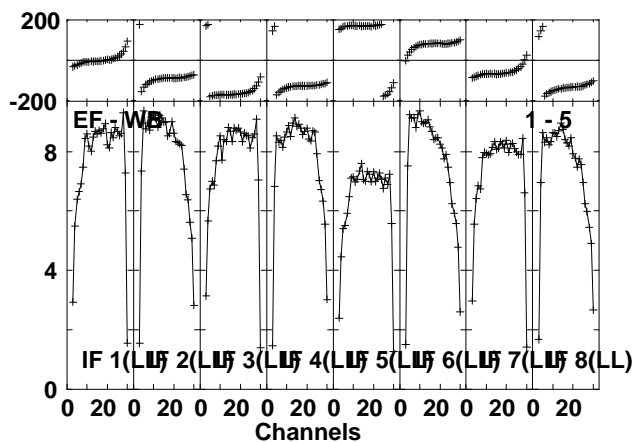
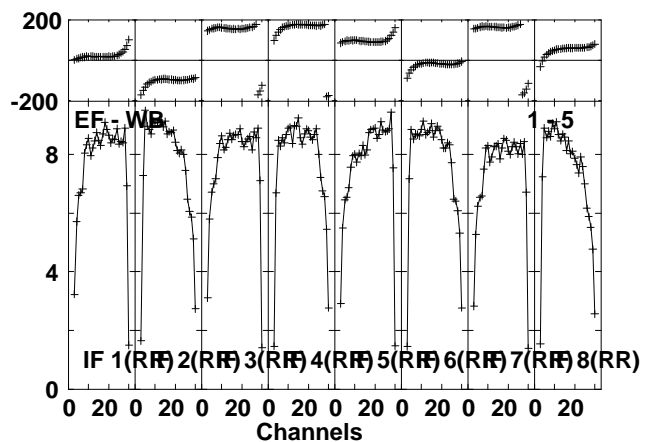
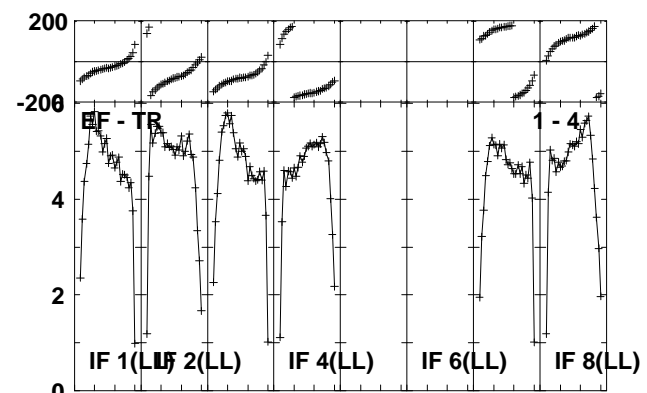
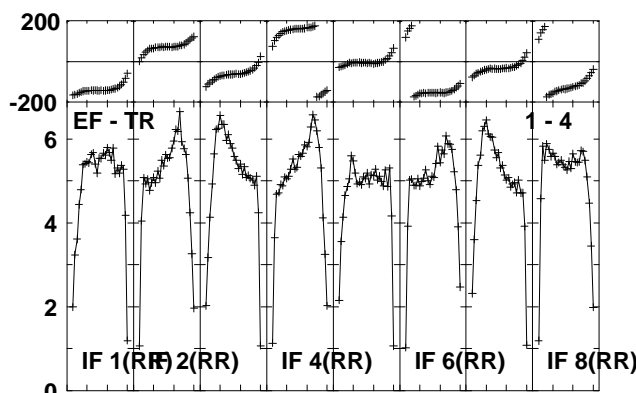
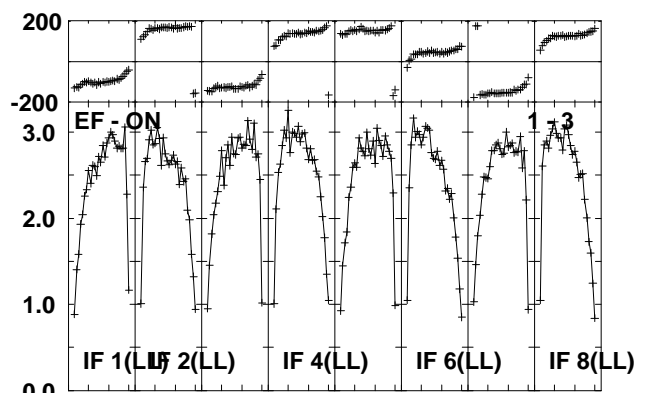
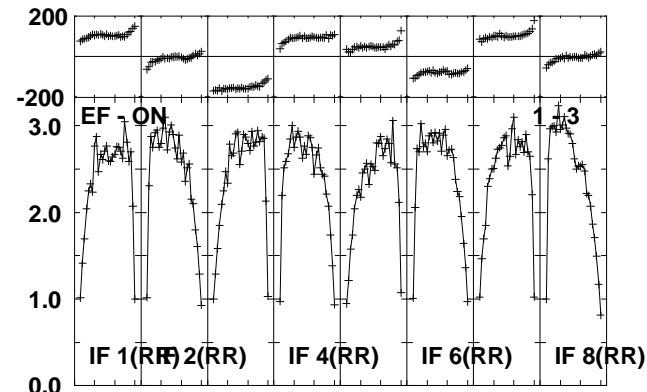
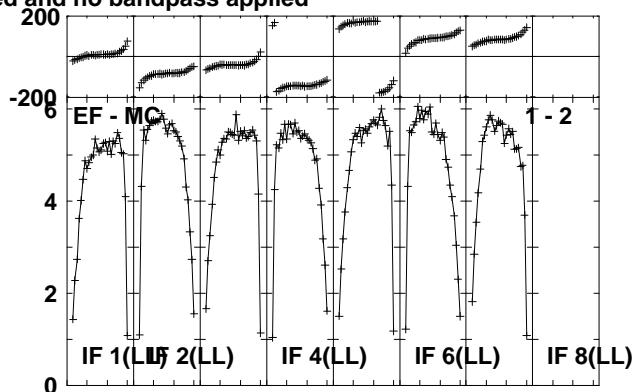
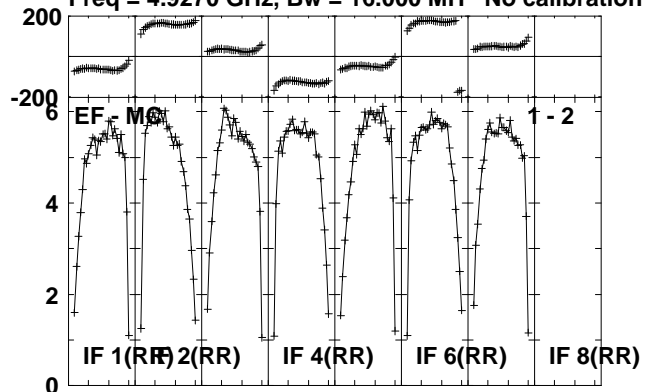

Lower frame: Milli Ampl Jy Top frame: Phas deg
Scalar averaged cross-power spectrum Several baselines displayed
Timerange: 00/16:22:52 to 00/16:25:49

Plot file version 106 created 02-DEC-2011 14:51:04

J1953+35 ET018A.UVDATA.1

Freq = 4.9270 GHz, Bw = 16.000 MH No calibration applied and no bandpass applied

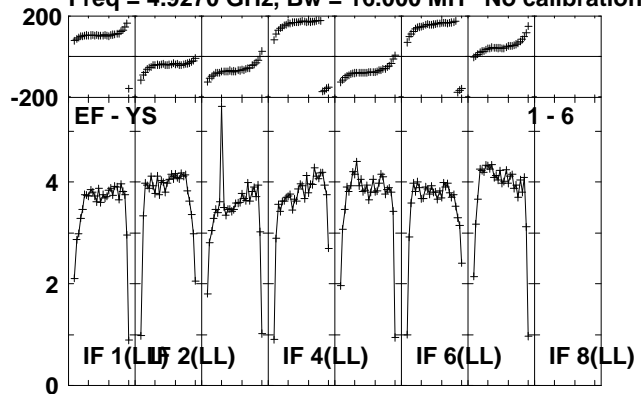

Lower frame: Milli Ampl Jy Top frame: Phas deg
Scalar averaged cross-power spectrum Several baselines displayed
Timerange: 00/16:22:52 to 00/16:25:49

Plot file version 107 created 02-DEC-2011 14:51:06

CYGX-1 ET018A.UVDATA.1

Freq = 4.9270 GHz, Bw = 16.000 MH No calibration applied and no bandpass applied

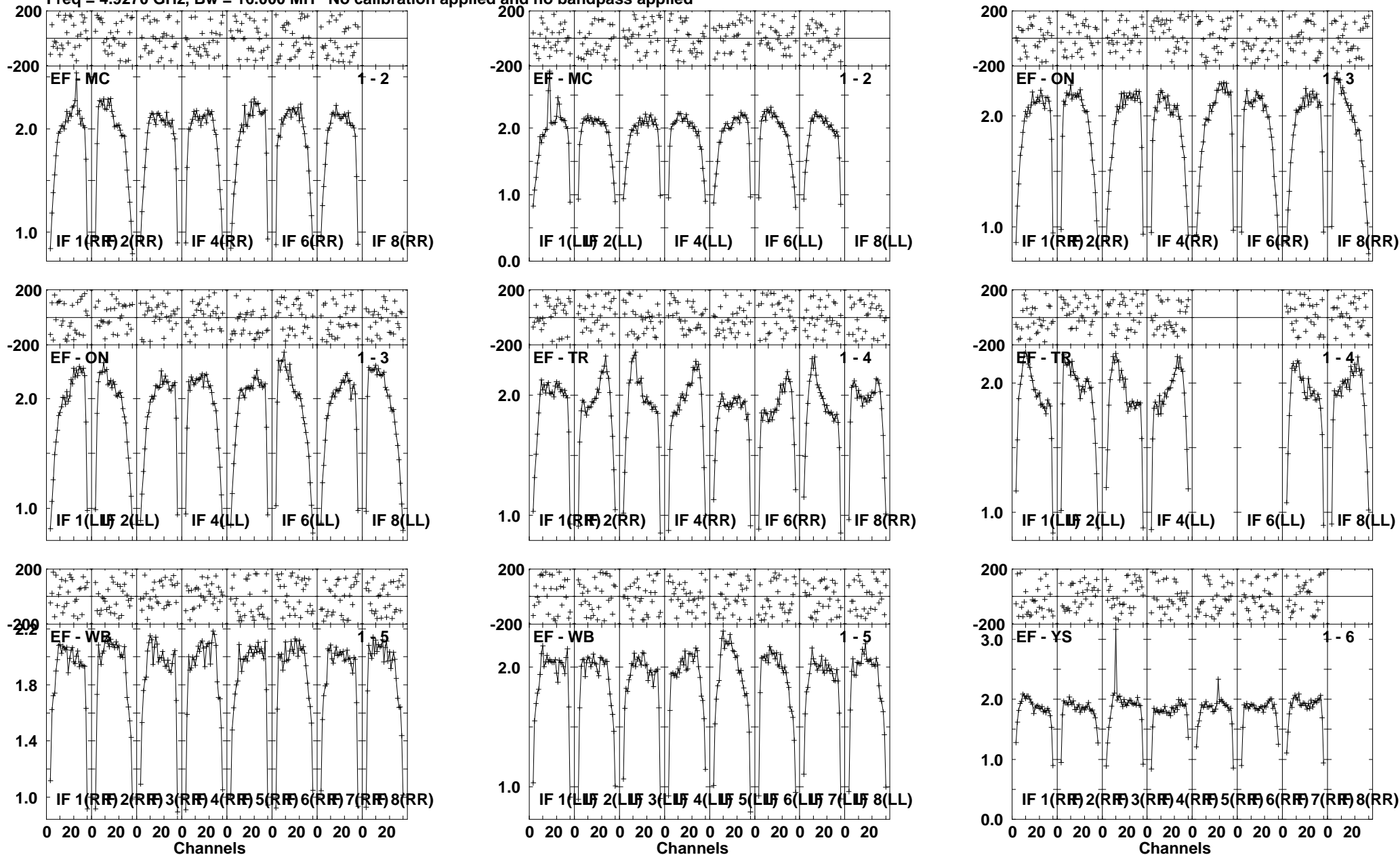

Lower frame: Milli Ampl Jy Top frame: Phas deg
Scalar averaged cross-power spectrum Several baselines displayed
Timerange: 00/16:25:51 to 00/16:40:08

Plot file version 108 created 02-DEC-2011 14:51:12

CYGX-1 ET018A.UVDATA.1

Freq = 4.9270 GHz, Bw = 16.000 MH No calibration applied and no bandpass applied

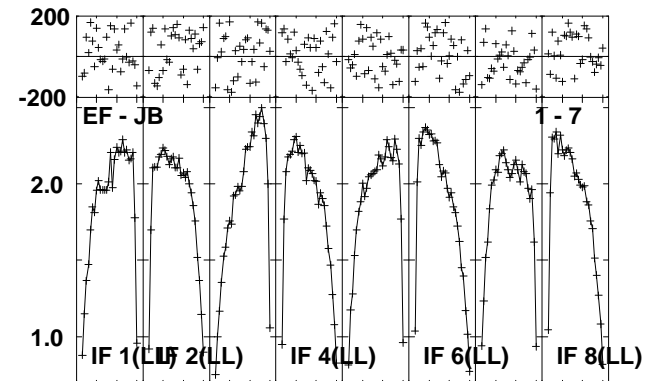
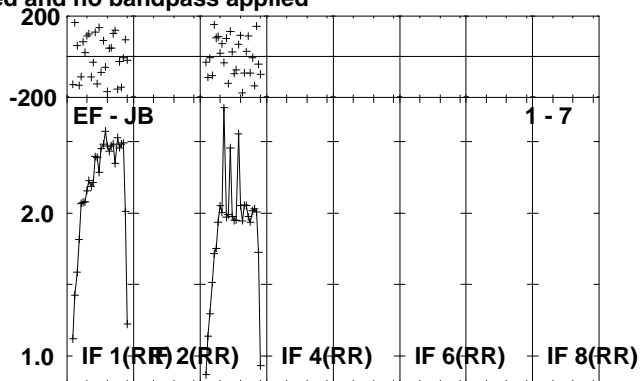
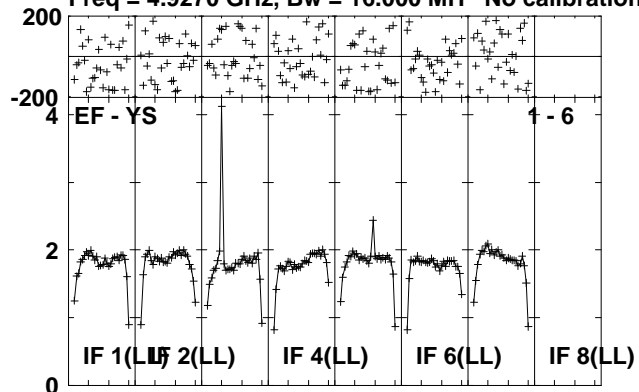

Lower frame: Milli Ampl Jy Top frame: Phas deg
Scalar averaged cross-power spectrum Several baselines displayed
Timerange: 00/16:25:51 to 00/16:40:08

Plot file version 109 created 02-DEC-2011 14:51:15

J1953+35 ET018A.UVDATA.1

Freq = 4.9270 GHz, Bw = 16.000 MH No calibration applied and no bandpass applied

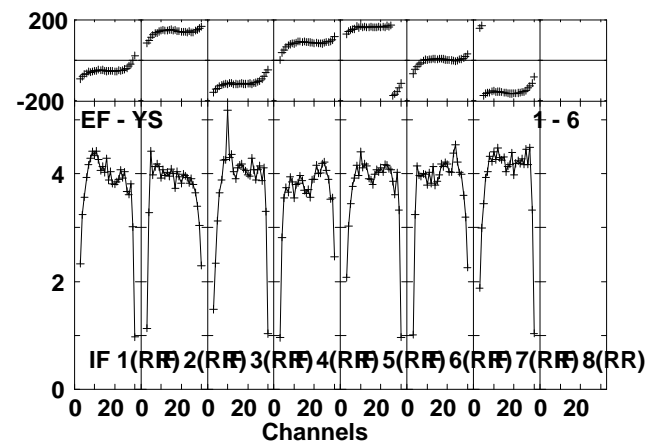
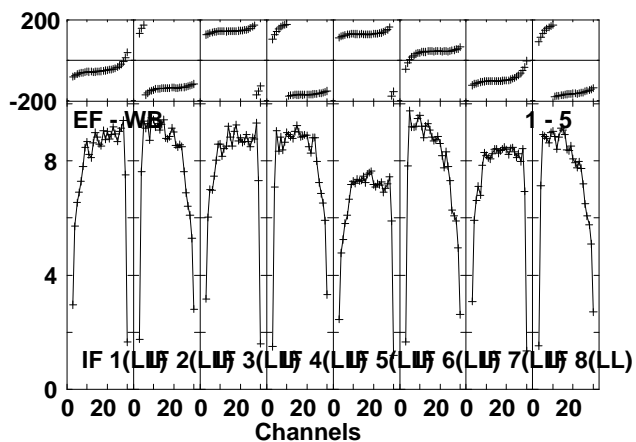
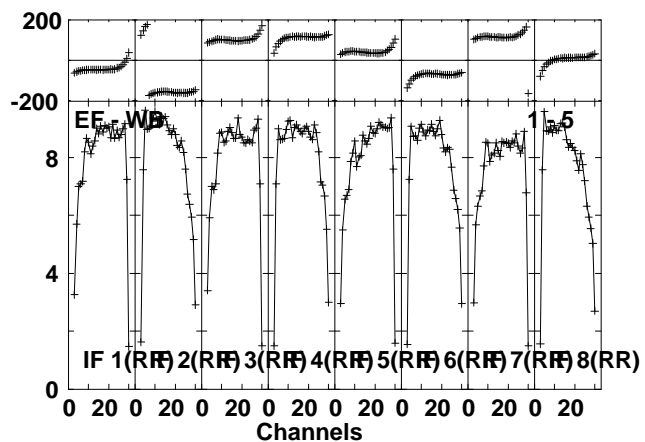
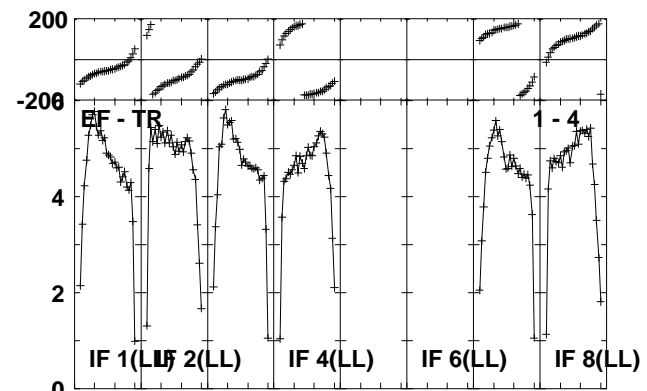
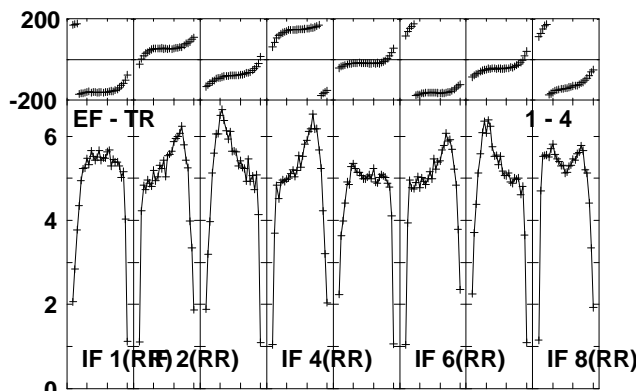
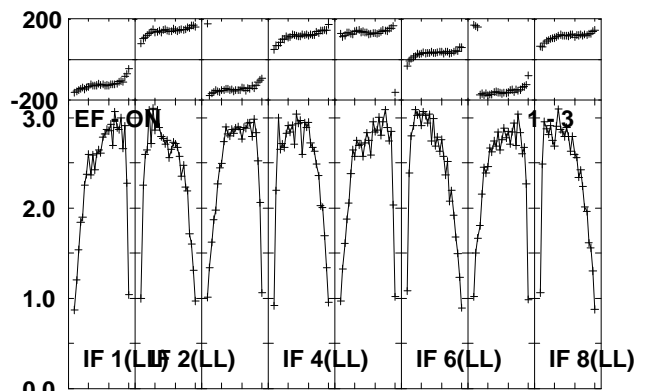
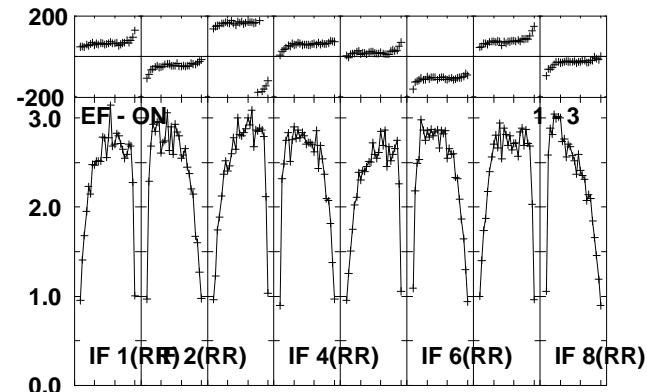
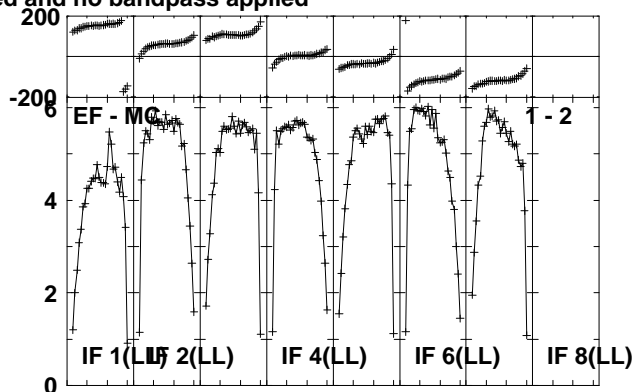
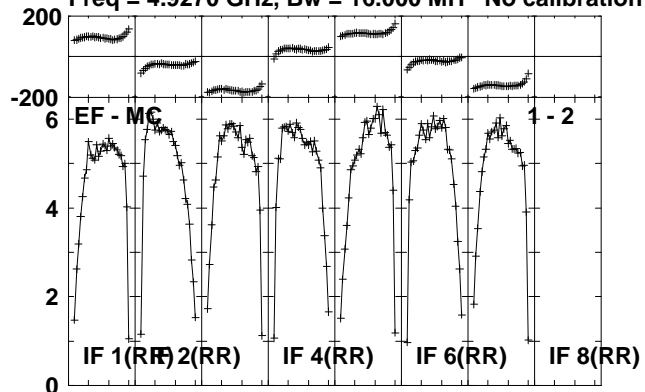

Lower frame: Milli Ampl Jy Top frame: Phas deg
Scalar averaged cross-power spectrum Several baselines displayed
Timerange: 00/16:40:12 to 00/16:43:09

Plot file version 110 created 02-DEC-2011 14:51:16

J1953+35 ET018A.UVDATA.1

Freq = 4.9270 GHz, Bw = 16.000 MH No calibration applied and no bandpass applied

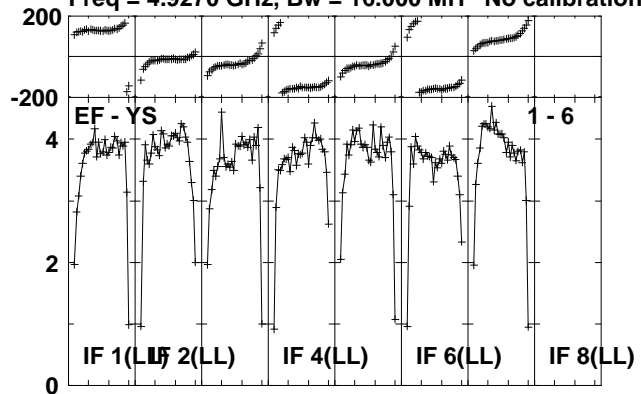

Lower frame: Milli Ampl Jy Top frame: Phas deg
Scalar averaged cross-power spectrum Several baselines displayed
Timerange: 00/16:40:12 to 00/16:43:09

Plot file version 111 created 02-DEC-2011 14:51:17

CYGX-1 ET018A.UVDATA.1

Freq = 4.9270 GHz, Bw = 16.000 MH No calibration applied and no bandpass applied

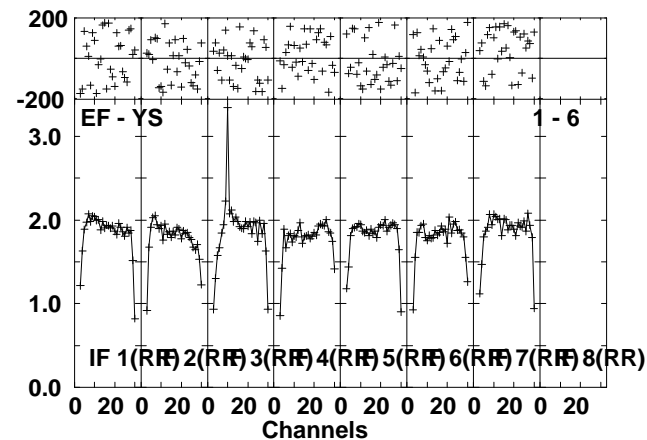
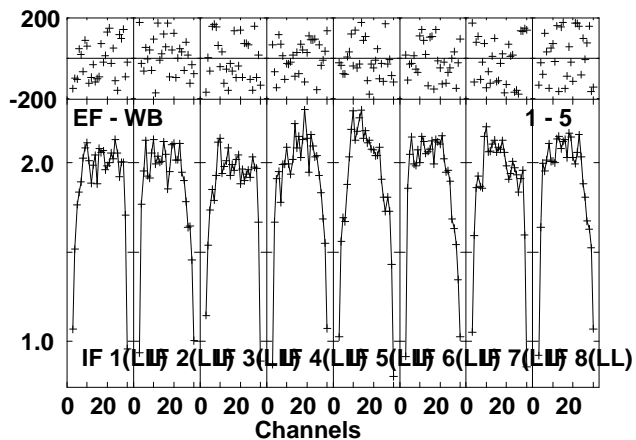
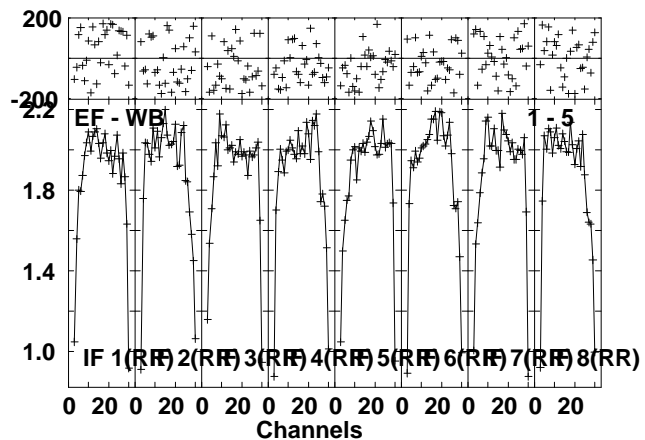
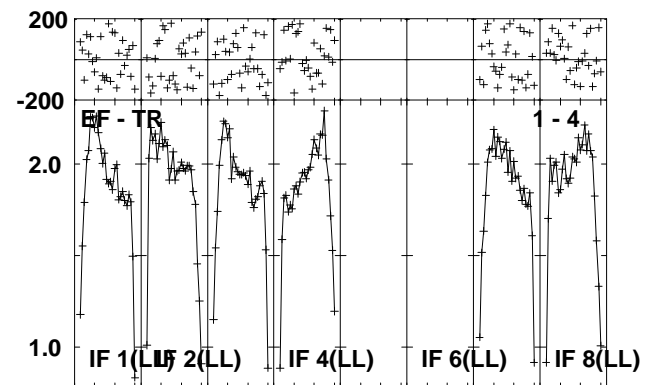
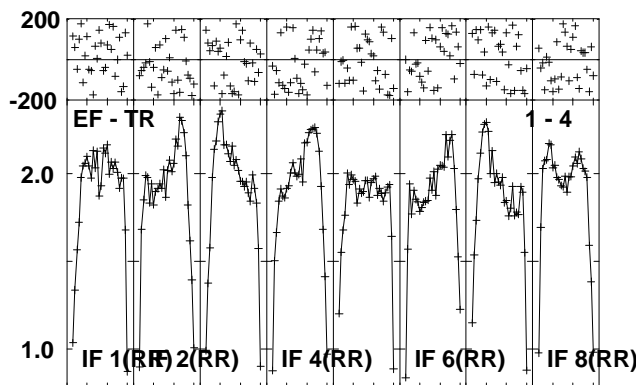
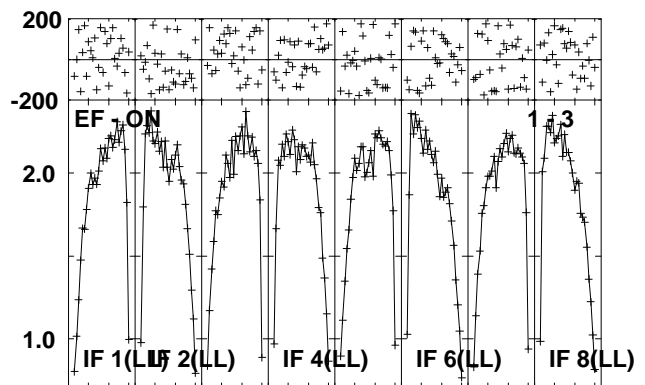
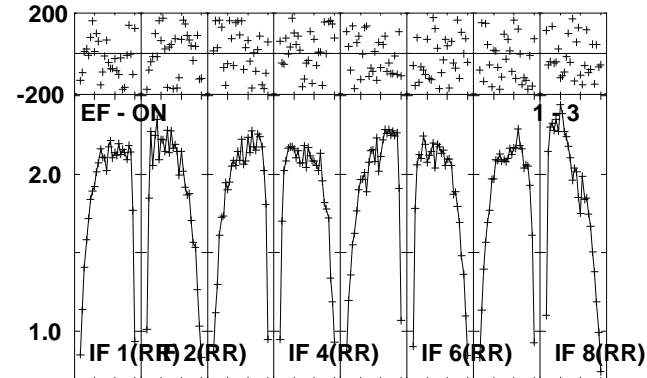
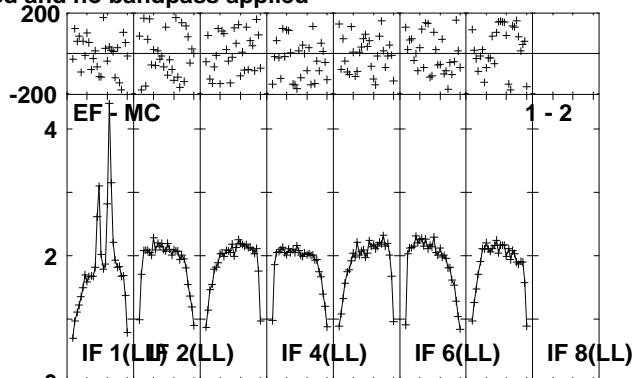
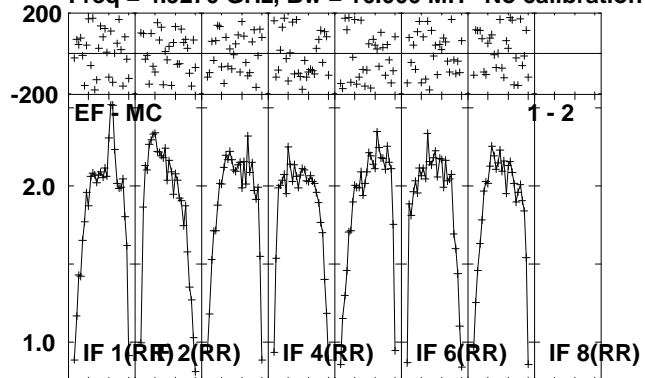

Lower frame: Milli Ampl Jy Top frame: Phas deg
Scalar averaged cross-power spectrum Several baselines displayed
Timerange: 00/16:43:11 to 00/16:48:38

Plot file version 112 created 02-DEC-2011 14:51:20

CYGX-1 ET018A.UVDATA.1

Freq = 4.9270 GHz, Bw = 16.000 MH No calibration applied and no bandpass applied

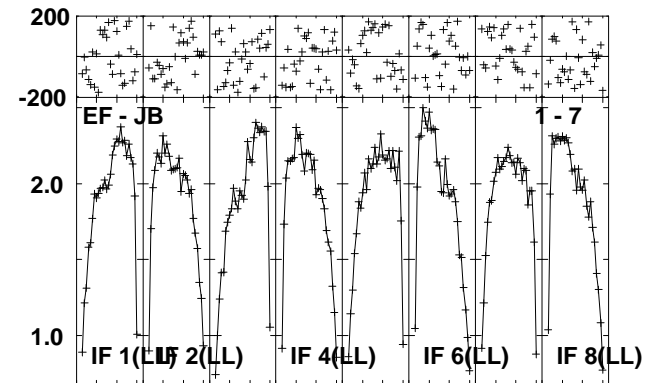
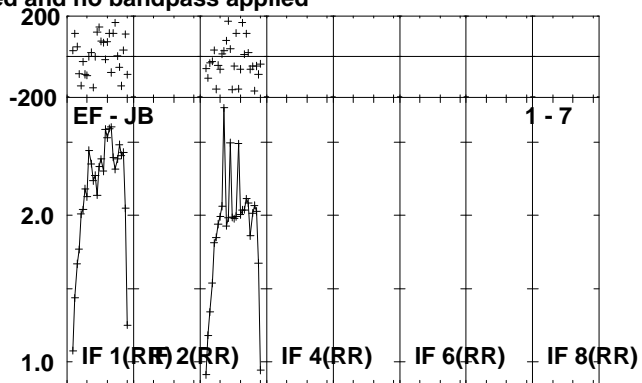
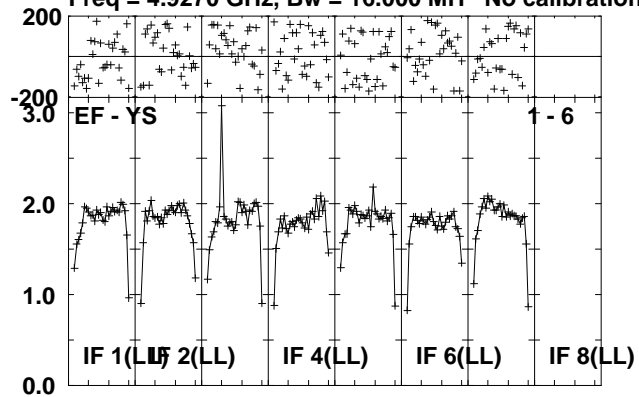

Lower frame: Milli Ampl Jy Top frame: Phas deg
Scalar averaged cross-power spectrum Several baselines displayed
Timerange: 00/16:43:11 to 00/16:48:38

Plot file version 113 created 02-DEC-2011 14:51:22

J1953+35 ET018A.UVDATA.1

Freq = 4.9270 GHz, Bw = 16.000 MH No calibration applied and no bandpass applied

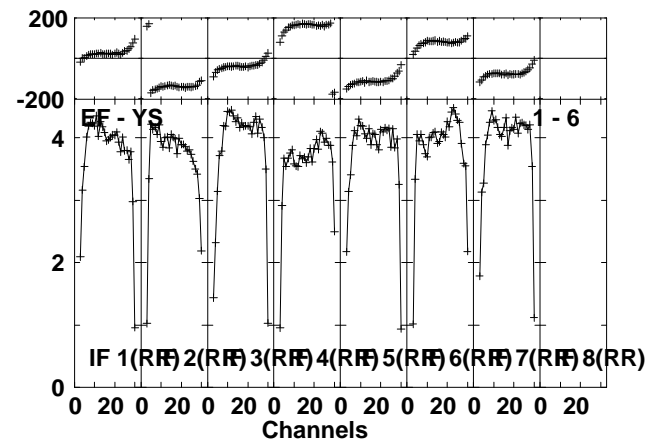
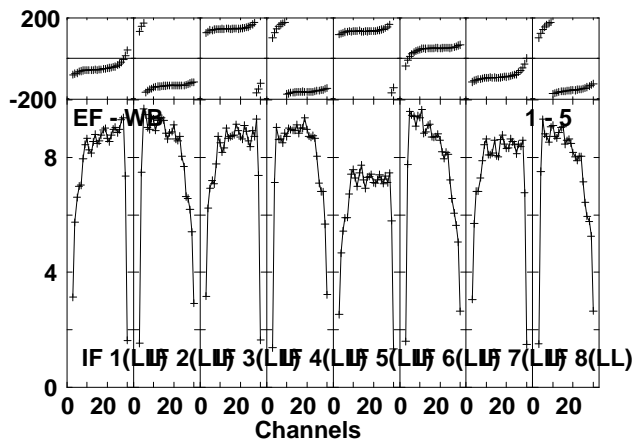
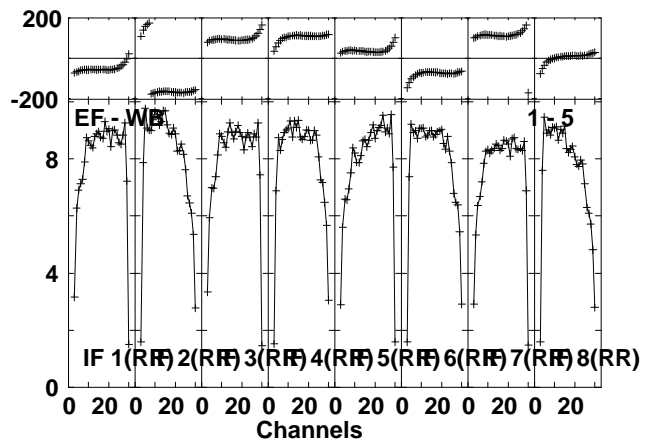
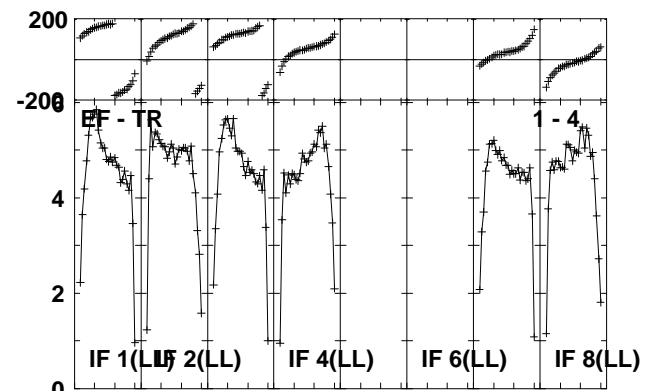
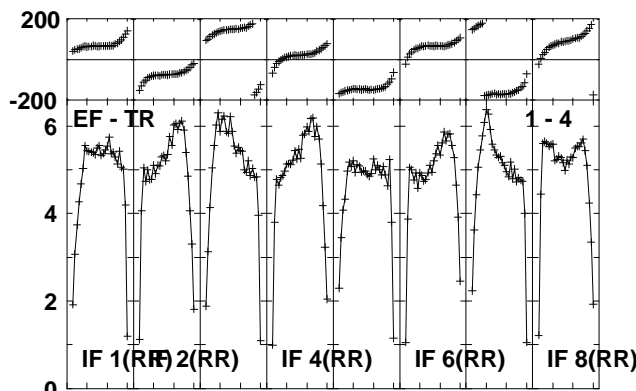
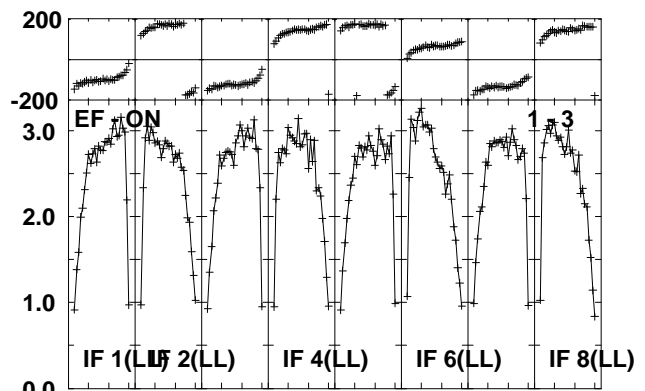
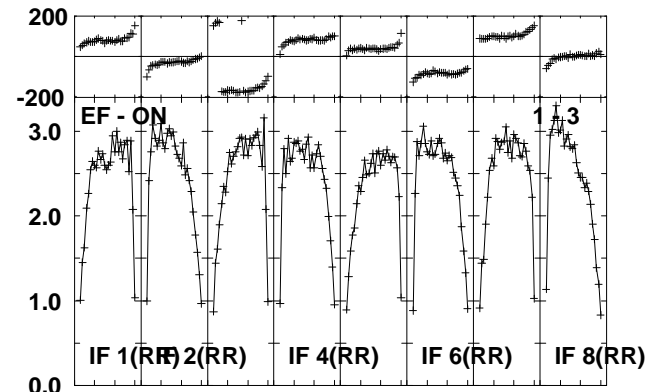
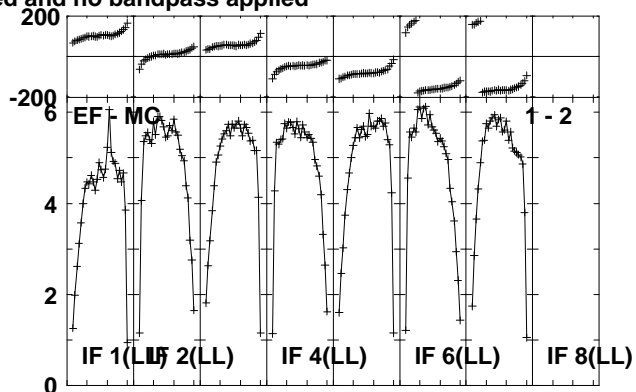
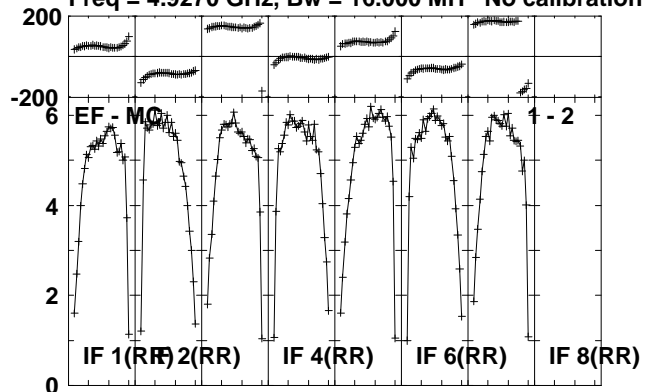

Lower frame: Milli Ampl Jy Top frame: Phas deg
Scalar averaged cross-power spectrum Several baselines displayed
Timerange: 00/16:49:27 to 00/16:51:59

Plot file version 114 created 02-DEC-2011 14:51:25

J1953+35 ET018A.UVDATA.1

Freq = 4.9270 GHz, Bw = 16.000 MH No calibration applied and no bandpass applied

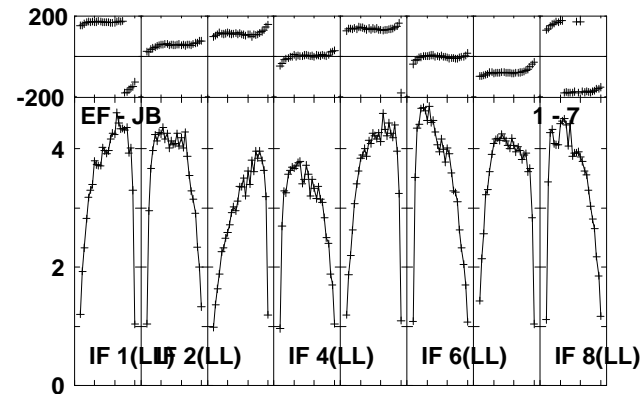
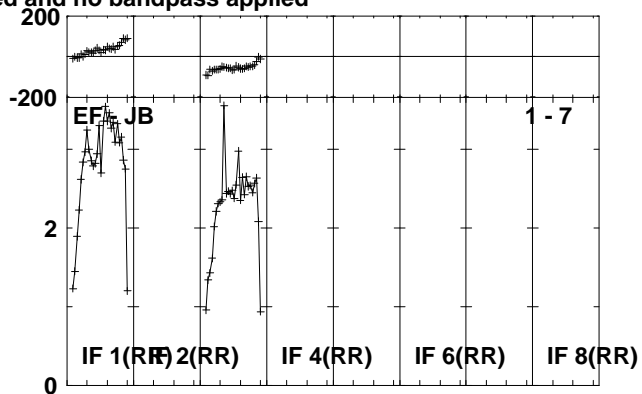
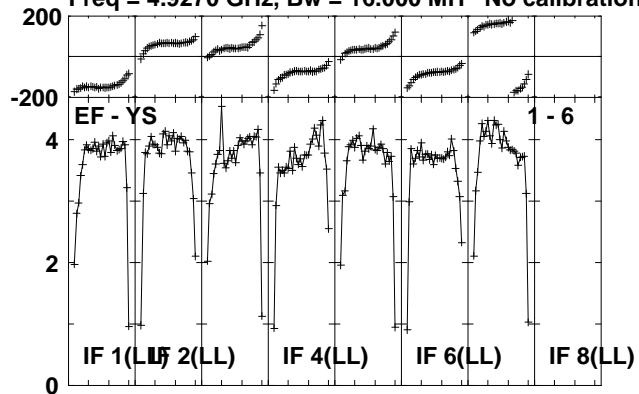

Lower frame: Milli Ampl Jy Top frame: Phas deg
Scalar averaged cross-power spectrum Several baselines displayed
Timerange: 00/16:49:27 to 00/16:51:59

Plot file version 115 created 02-DEC-2011 14:51:28

CYGX-1 ET018A.UVDATA.1

Freq = 4.9270 GHz, Bw = 16.000 MH No calibration applied and no bandpass applied

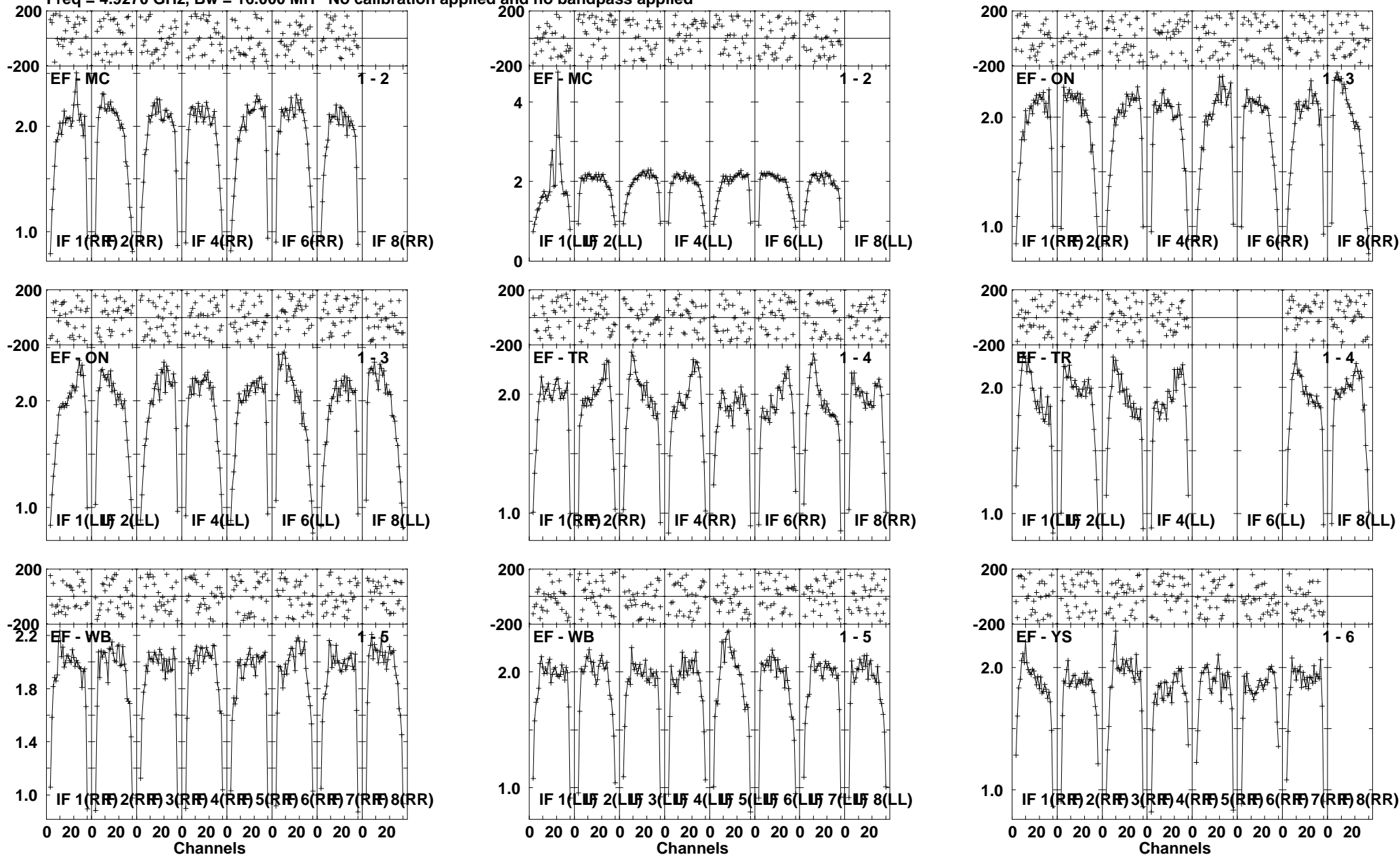

Lower frame: Milli Ampl Jy Top frame: Phas deg
Scalar averaged cross-power spectrum Several baselines displayed
Timerange: 00/16:52:02 to 00/16:57:28

Plot file version 116 created 02-DEC-2011 14:51:31

CYGX-1 ET018A.UVDATA.1

Freq = 4.9270 GHz, Bw = 16.000 MH No calibration applied and no bandpass applied

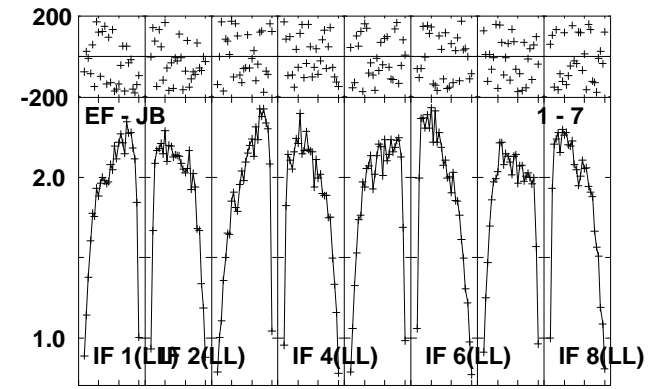
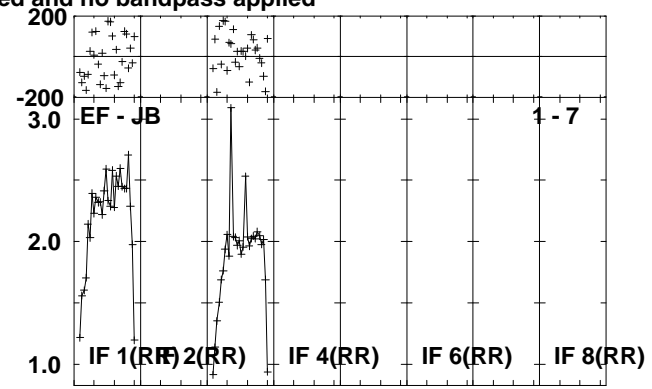
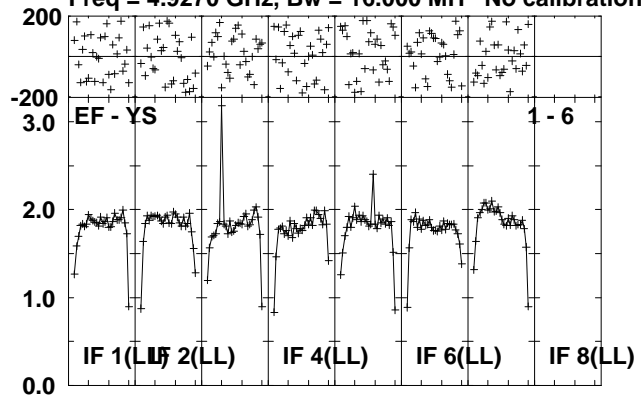

Lower frame: Milli Ampl Jy Top frame: Phas deg
Scalar averaged cross-power spectrum Several baselines displayed
Timerange: 00/16:52:02 to 00/16:57:28

Plot file version 117 created 02-DEC-2011 14:51:33

J1953+35 ET018A.UVDATA.1

Freq = 4.9270 GHz, Bw = 16.000 MH No calibration applied and no bandpass applied

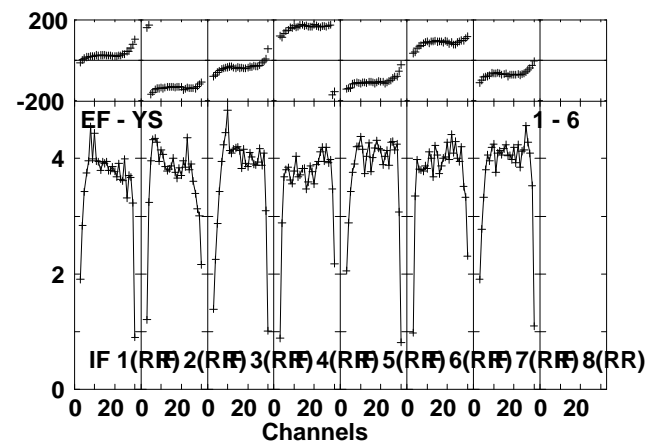
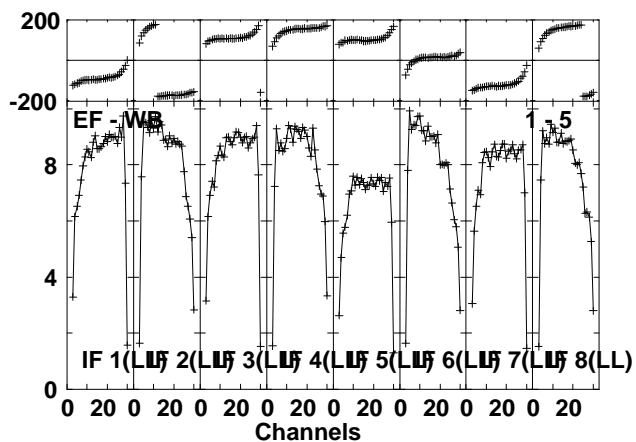
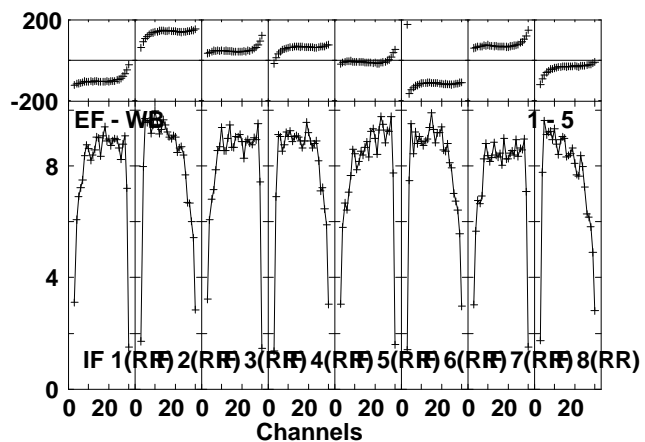
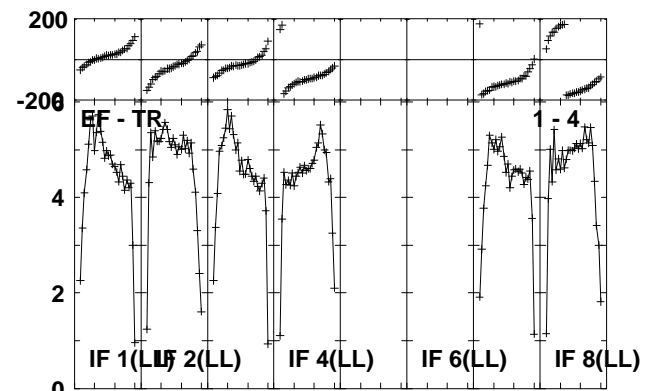
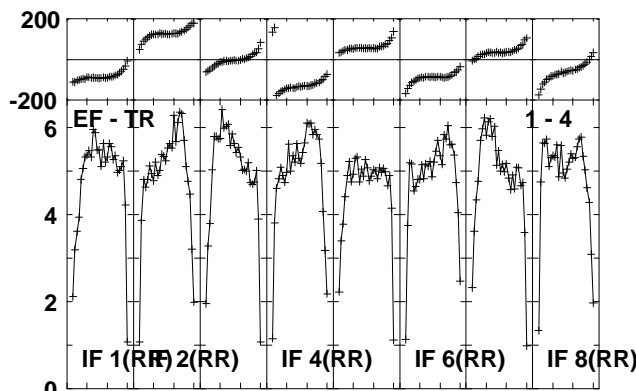
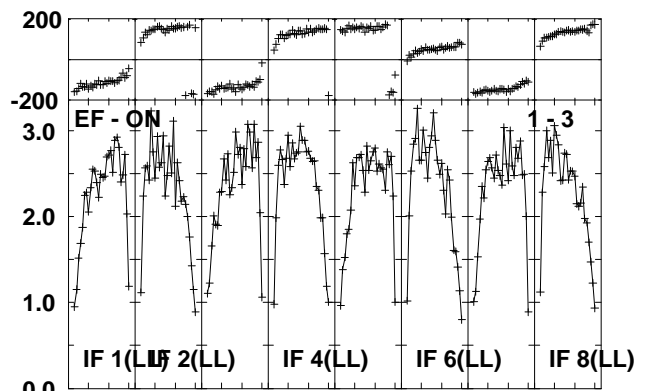
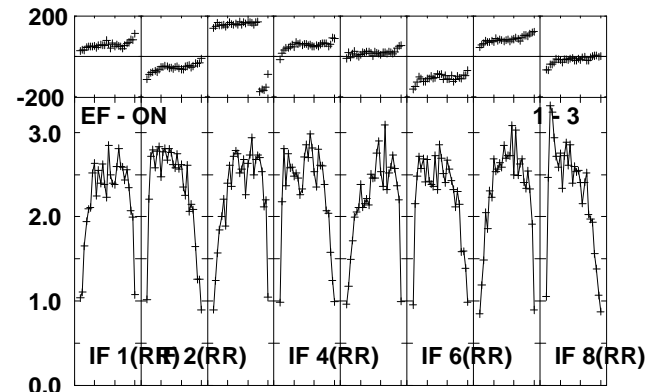
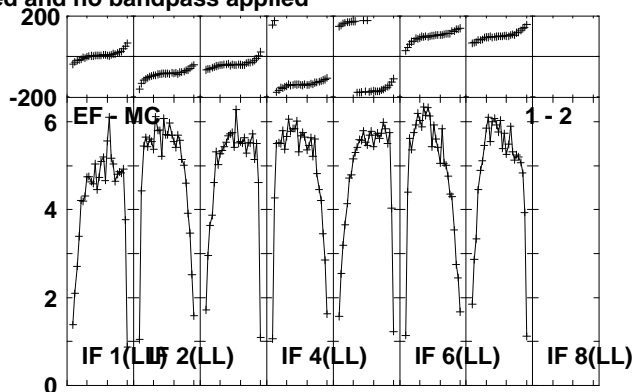
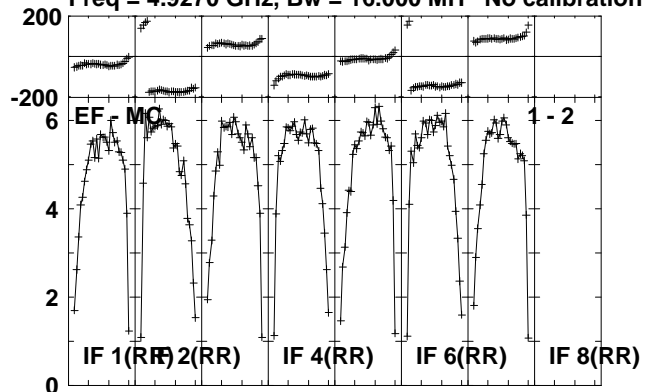

Lower frame: Milli Ampl Jy Top frame: Phas deg
Scalar averaged cross-power spectrum Several baselines displayed
Timerange: 00/16:57:31 to 00/17:00:28

Plot file version 118 created 02-DEC-2011 14:51:35

J1953+35 ET018A.UVDATA.1

Freq = 4.9270 GHz, Bw = 16.000 MH No calibration applied and no bandpass applied

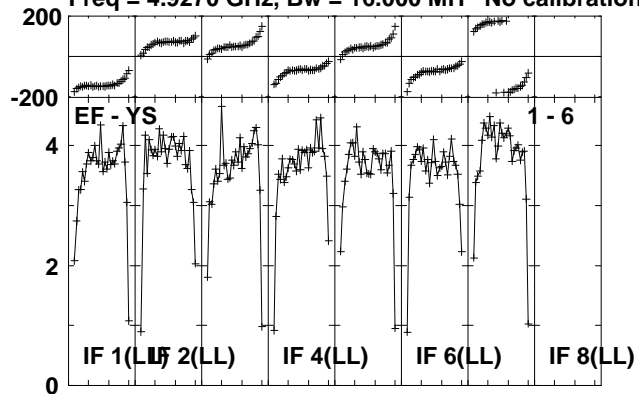

Lower frame: Milli Ampl Jy Top frame: Phas deg
Scalar averaged cross-power spectrum Several baselines displayed
Timerange: 00/16:57:31 to 00/17:00:28

Plot file version 119 created 02-DEC-2011 14:51:36

CYGX-1 ET018A.UVDATA.1

Freq = 4.9270 GHz, Bw = 16.000 MH No calibration applied and no bandpass applied

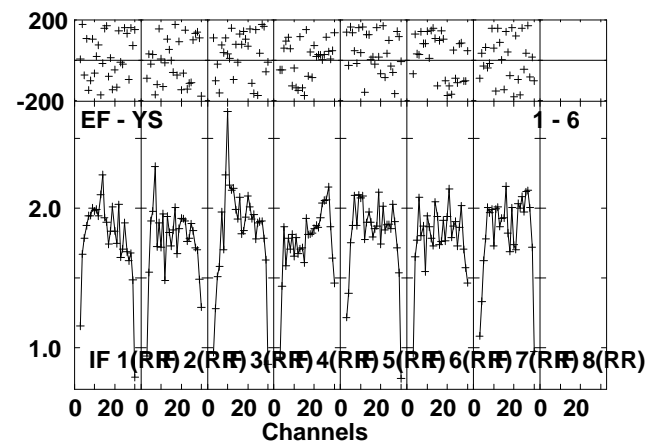
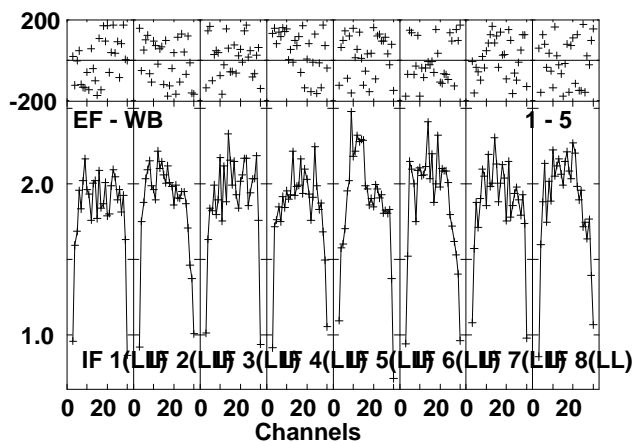
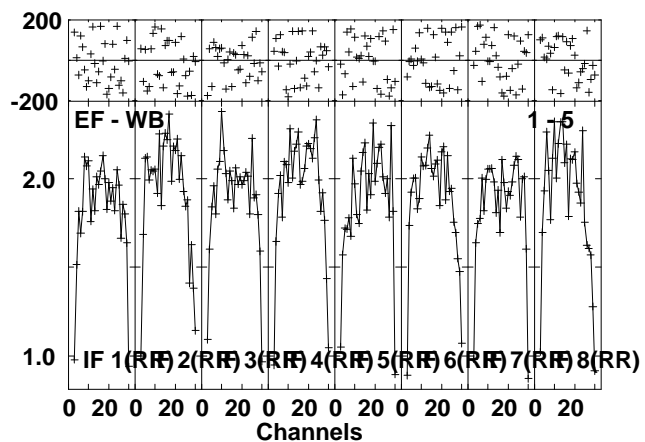
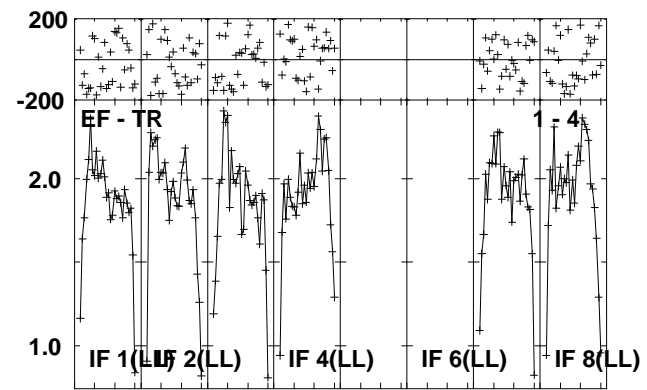
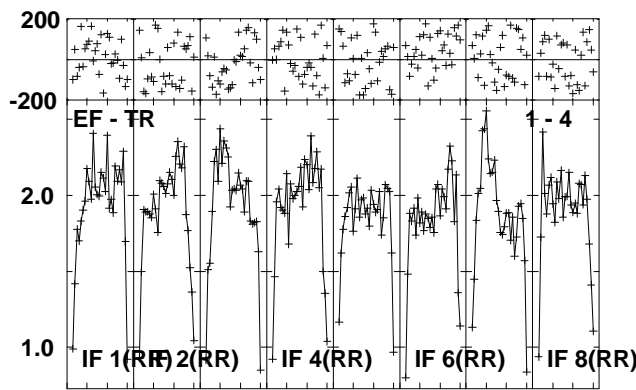
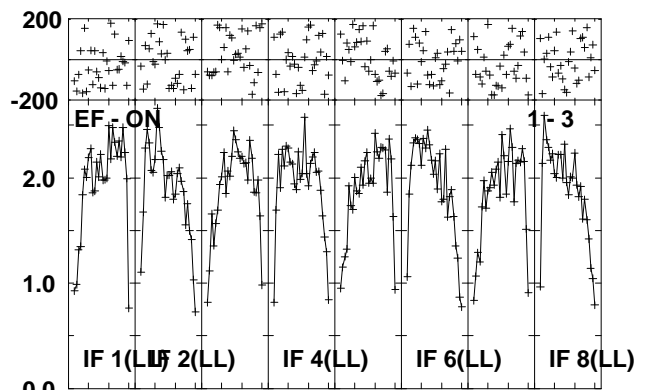
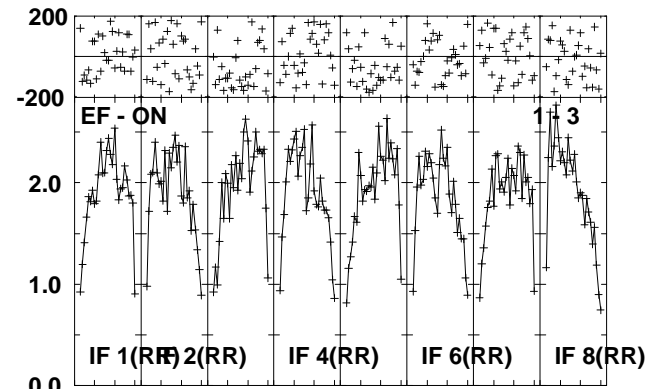
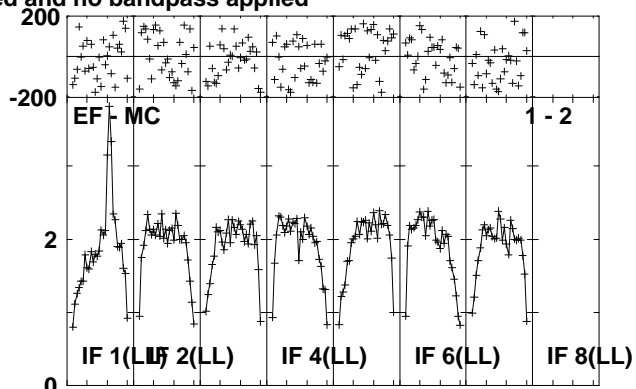
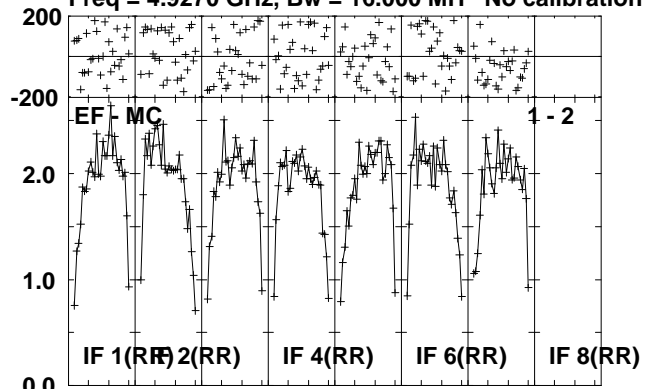

Lower frame: Milli Ampl Jy Top frame: Phas deg
Scalar averaged cross-power spectrum Several baselines displayed
Timerange: 00/17:00:31 to 00/17:05:58

Plot file version 120 created 02-DEC-2011 14:51:38

CYGX-1 ET018A.UVDATA.1

Freq = 4.9270 GHz, Bw = 16.000 MH No calibration applied and no bandpass applied

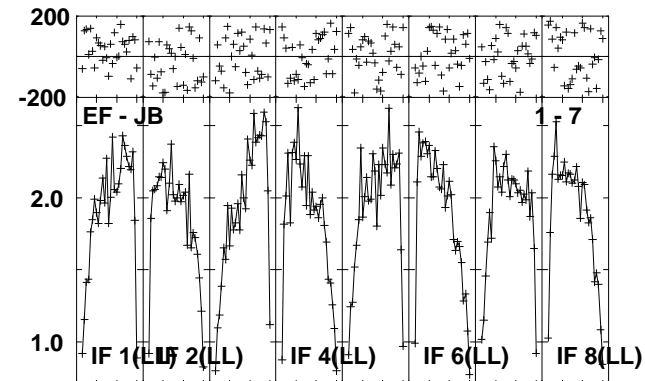
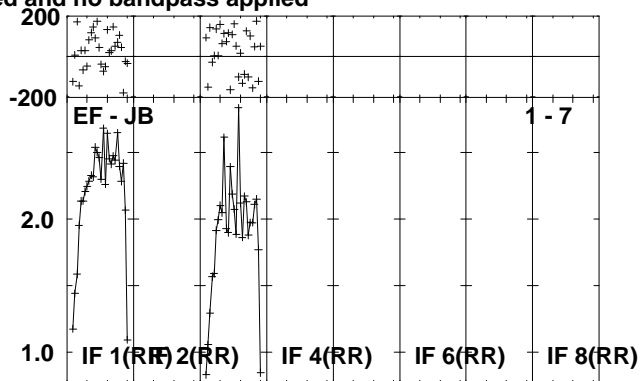
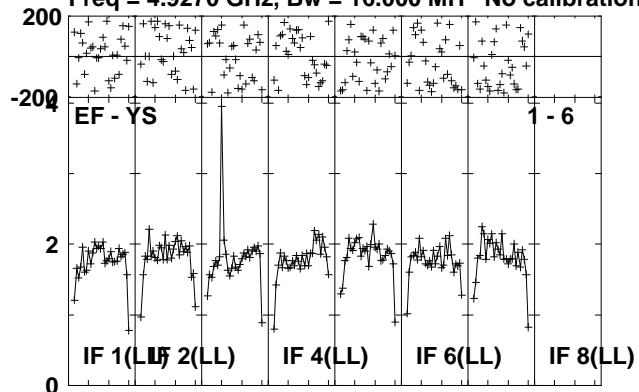

Lower frame: Milli Ampl Jy Top frame: Phas deg
Scalar averaged cross-power spectrum Several baselines displayed
Timerange: 00/17:00:31 to 00/17:05:58

Plot file version 121 created 02-DEC-2011 14:51:41

J1953+35 ET018A.UVDATA.1

Freq = 4.9270 GHz, Bw = 16.000 MH No calibration applied and no bandpass applied

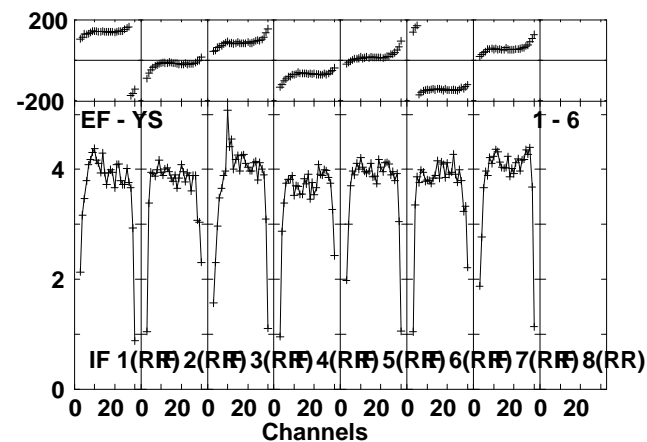
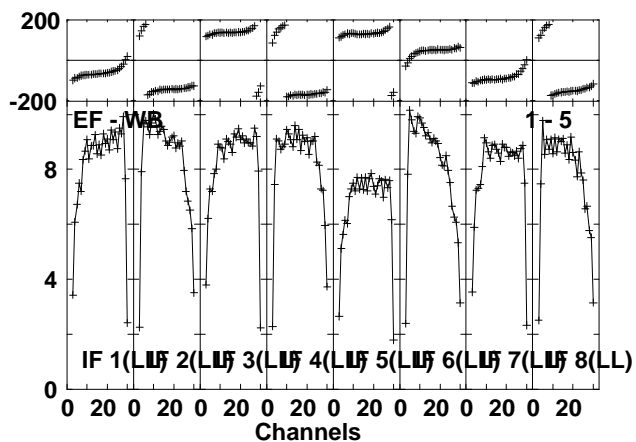
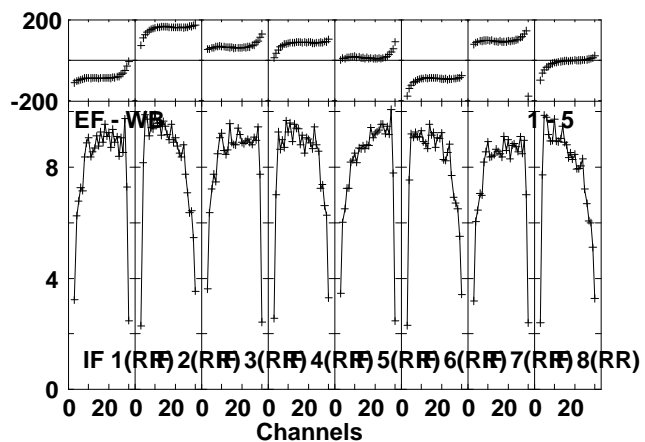
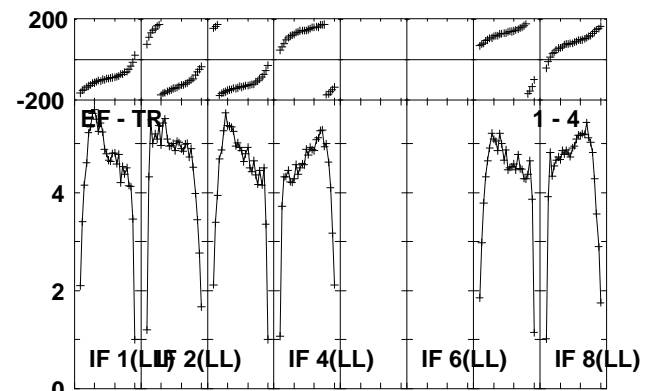
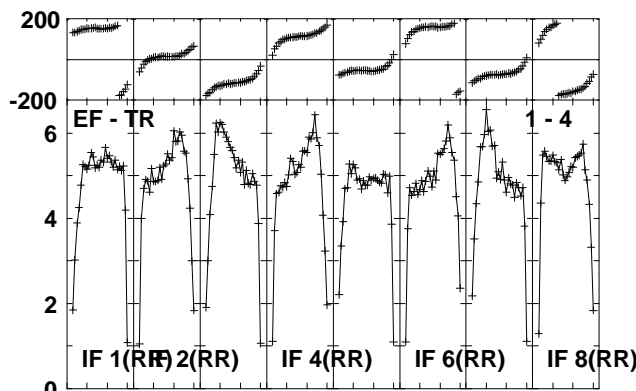
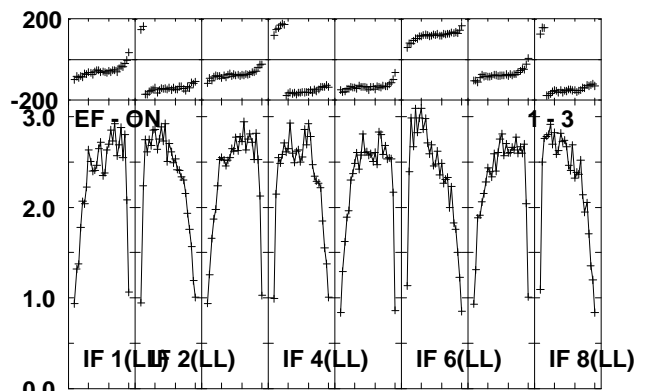
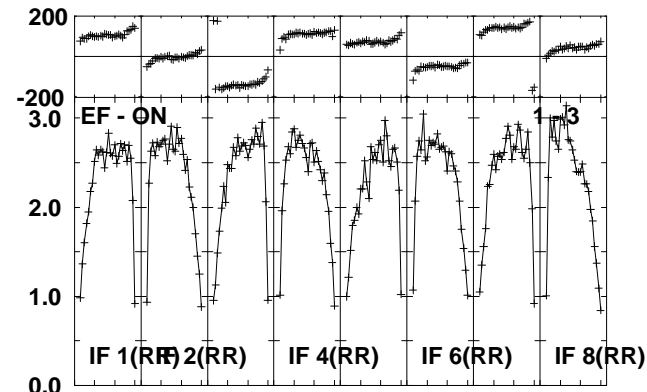
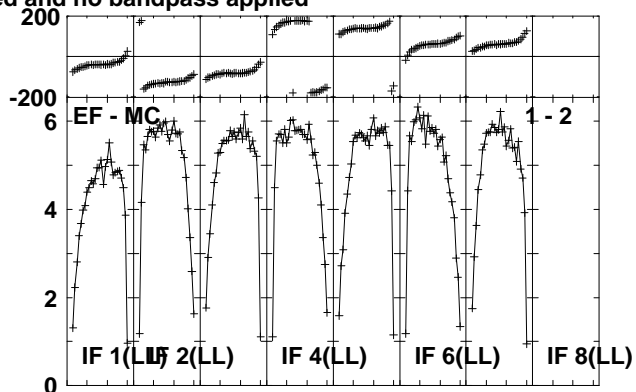
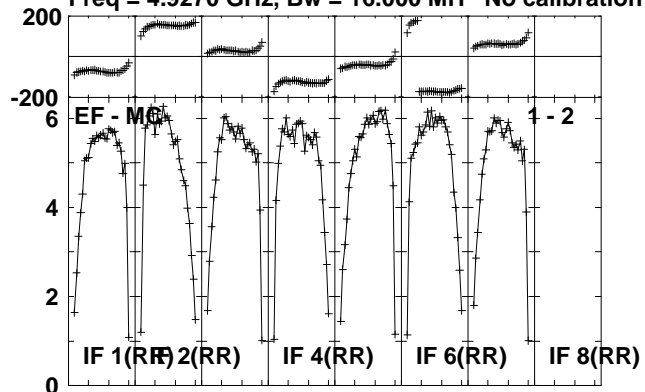

Lower frame: Milli Ampl Jy Top frame: Phas deg
Scalar averaged cross-power spectrum Several baselines displayed
Timerange: 00/17:06:47 to 00/17:09:19

Plot file version 122 created 02-DEC-2011 14:51:42

J1953+35 ET018A.UVDATA.1

Freq = 4.9270 GHz, Bw = 16.000 MH No calibration applied and no bandpass applied

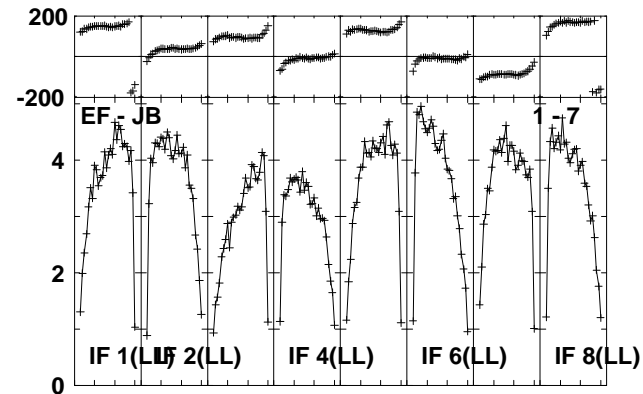
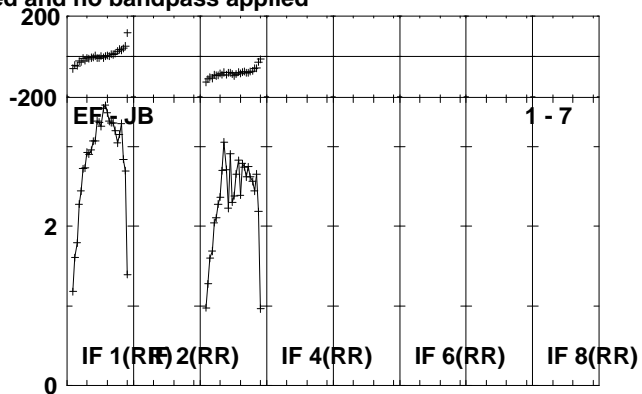
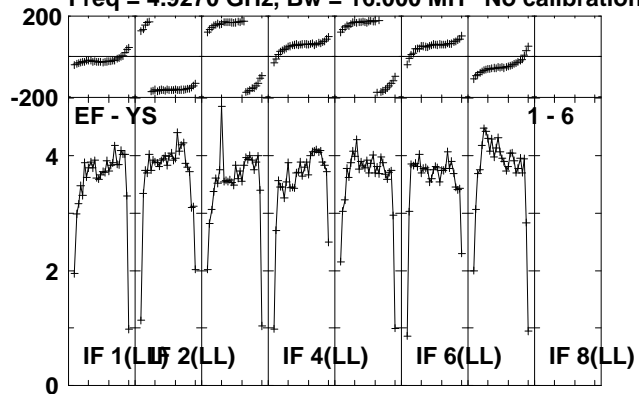

Lower frame: Milli Ampl Jy Top frame: Phas deg
Scalar averaged cross-power spectrum Several baselines displayed
Timerange: 00/17:06:47 to 00/17:09:19

Plot file version 123 created 02-DEC-2011 14:51:44

CYGX-1 ET018A.UVDATA.1

Freq = 4.9270 GHz, Bw = 16.000 MH No calibration applied and no bandpass applied

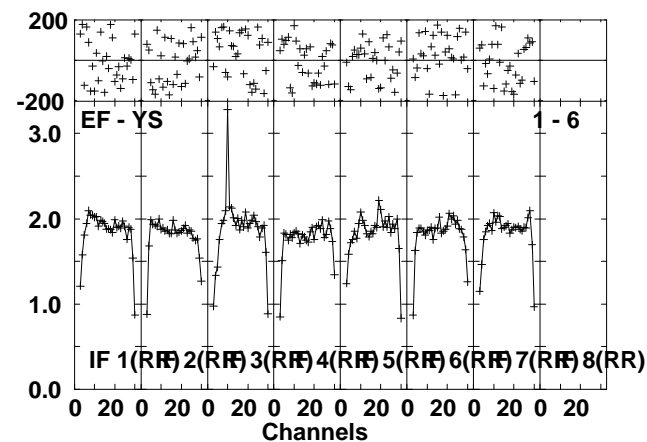
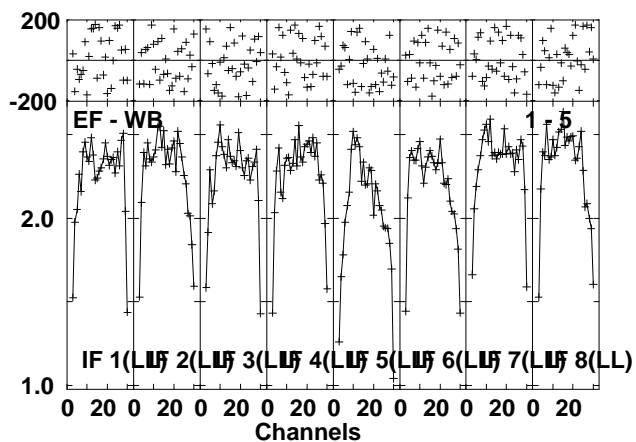
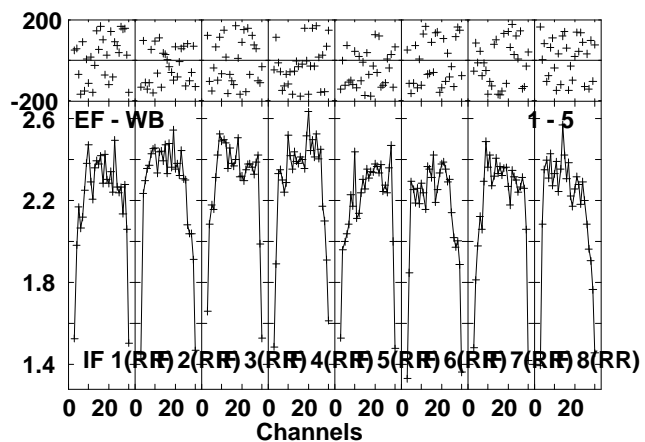
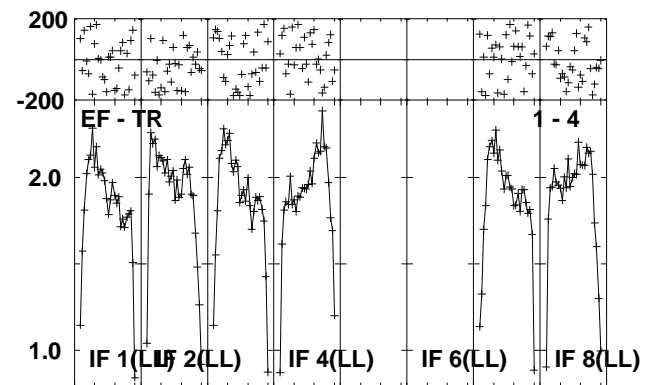
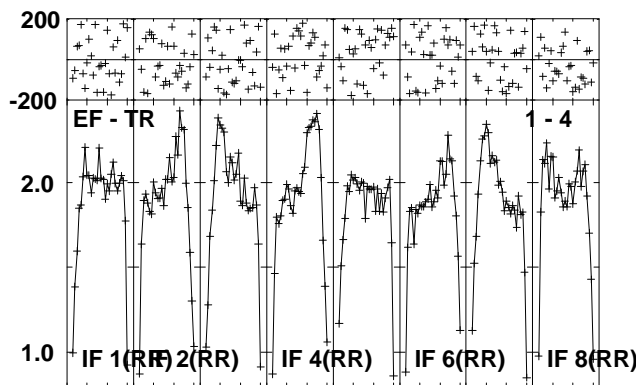
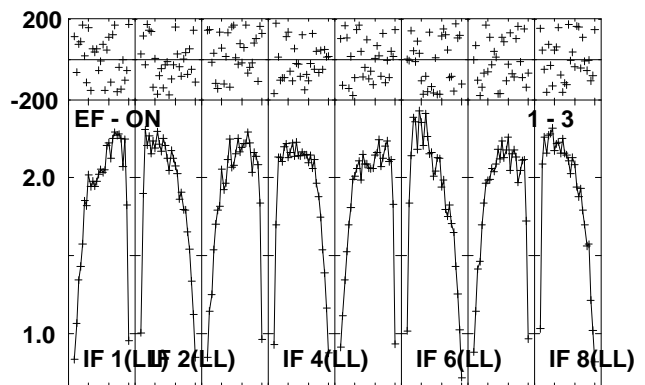
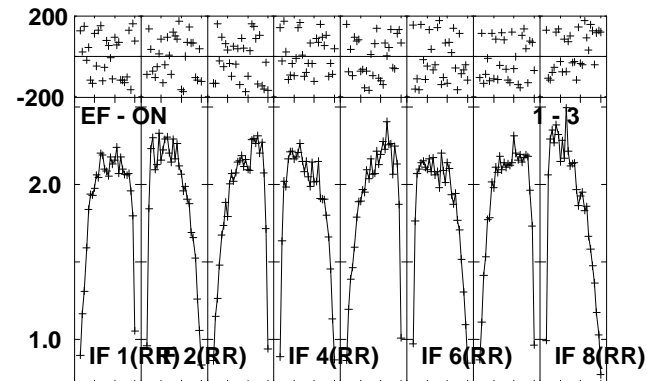
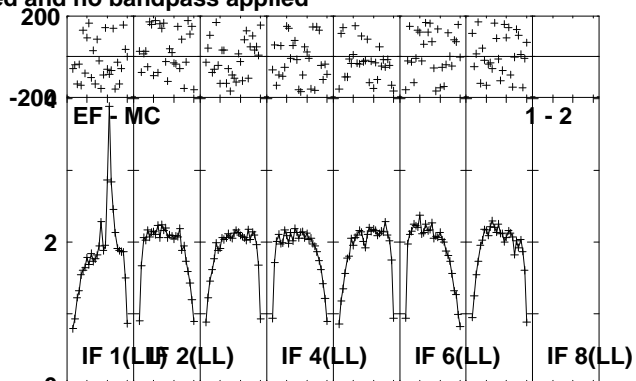
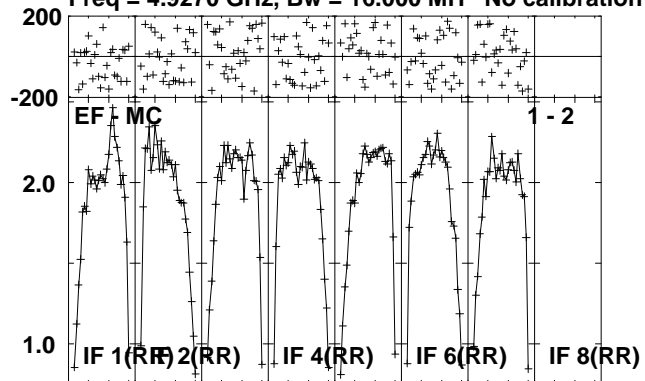

Lower frame: Milli Ampl Jy Top frame: Phas deg
Scalar averaged cross-power spectrum Several baselines displayed
Timerange: 00/17:09:22 to 00/17:14:48

Plot file version 124 created 02-DEC-2011 14:51:47

CYGX-1 ET018A.UVDATA.1

Freq = 4.9270 GHz, Bw = 16.000 MH No calibration applied and no bandpass applied

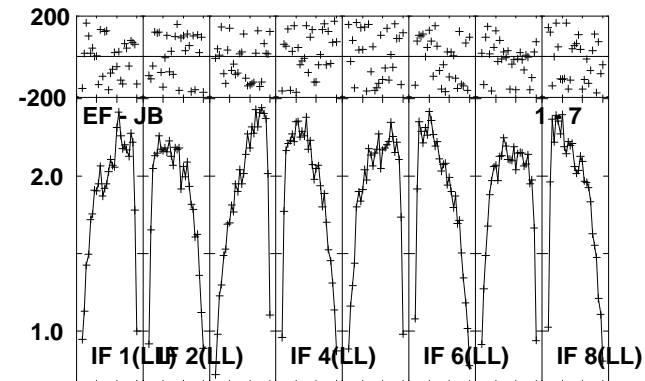
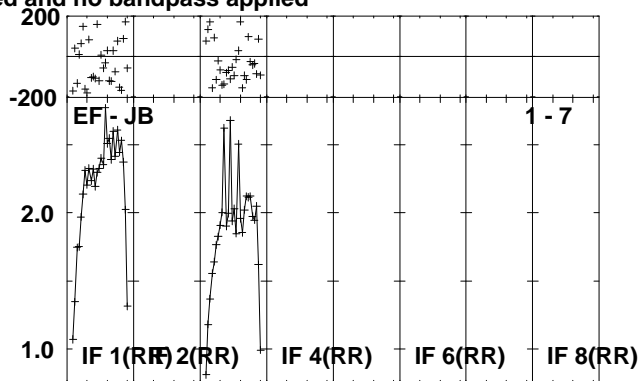
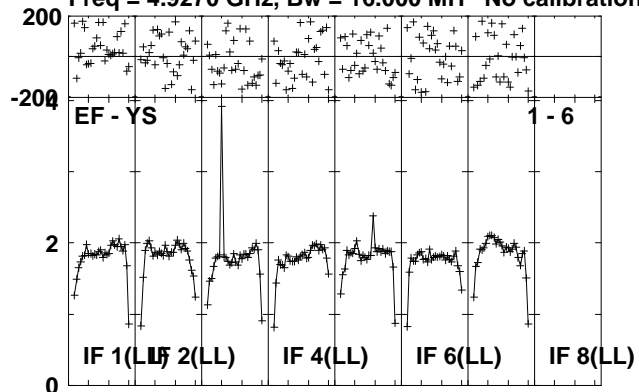

Lower frame: Milli Ampl Jy Top frame: Phas deg
Scalar averaged cross-power spectrum Several baselines displayed
Timerange: 00/17:09:22 to 00/17:14:48

Plot file version 125 created 02-DEC-2011 14:51:49

J1953+35 ET018A.UVDATA.1

Freq = 4.9270 GHz, Bw = 16.000 MH No calibration applied and no bandpass applied

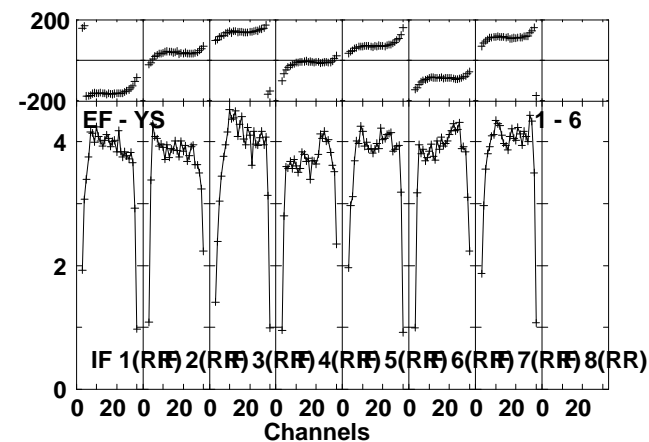
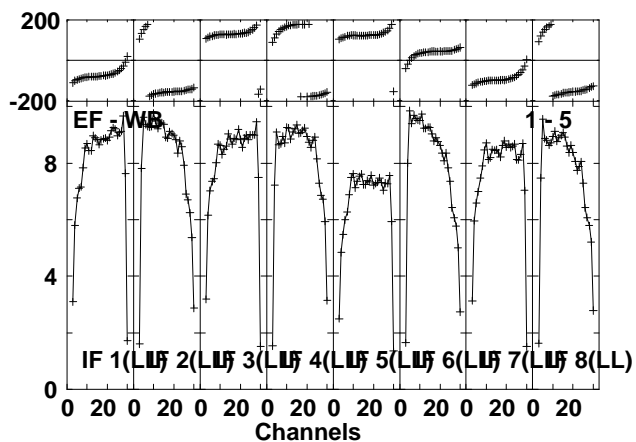
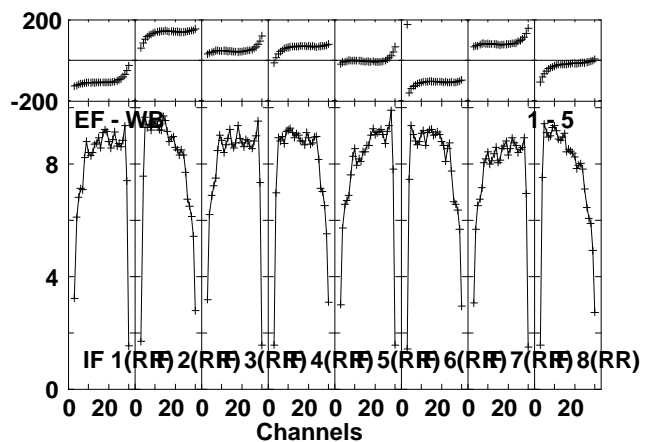
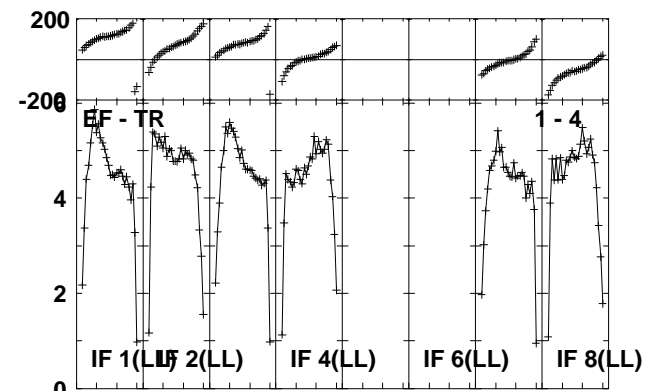
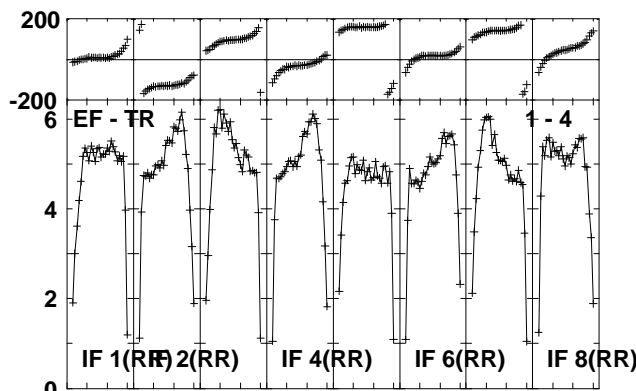
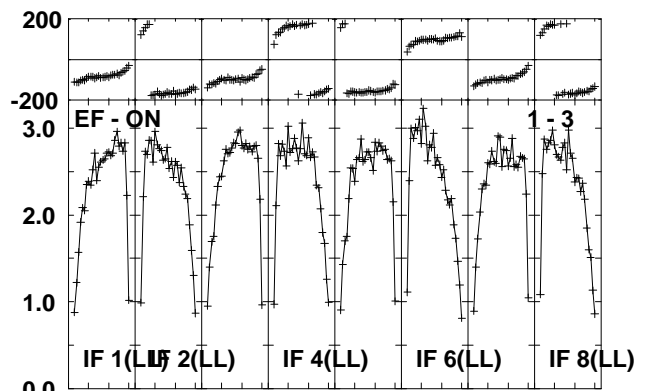
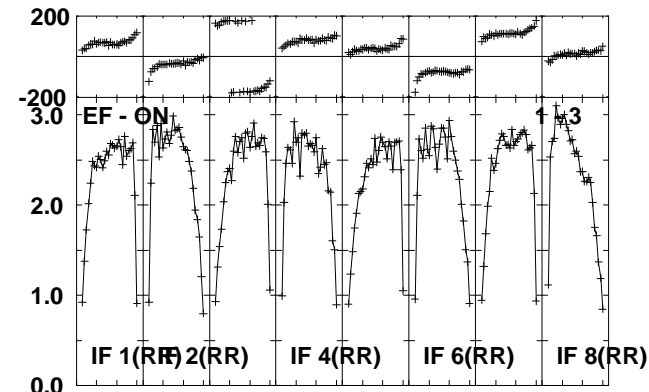
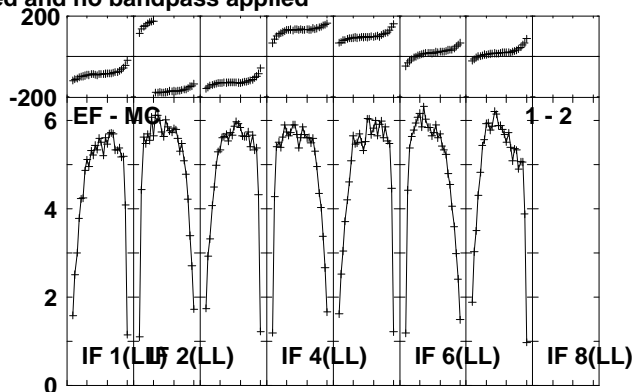
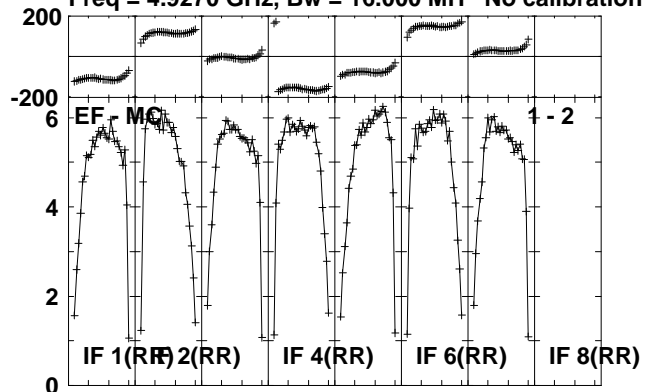

Lower frame: Milli Ampl Jy Top frame: Phas deg
Scalar averaged cross-power spectrum Several baselines displayed
Timerange: 00/17:14:51 to 00/17:17:48

Plot file version 126 created 02-DEC-2011 14:51:51
J1953+35 ET018A.UVDATA.1
Freq = 4.9270 GHz, Bw = 16.000 MH No calibration applied and no bandpass applied

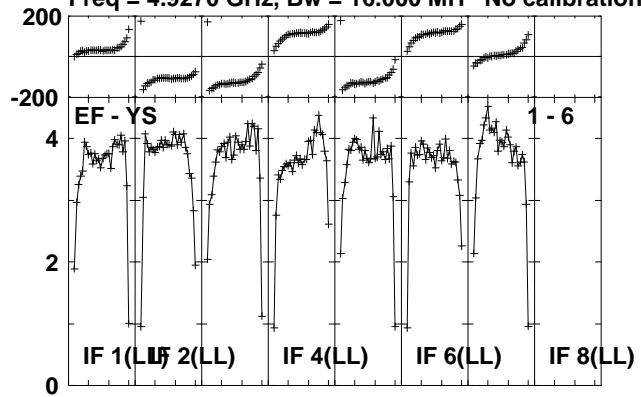

Lower frame: Milli Ampl Jy Top frame: Phas deg
Scalar averaged cross-power spectrum Several baselines displayed
Timerange: 00/17:14:51 to 00/17:17:48

Plot file version 127 created 02-DEC-2011 14:51:52

CYGX-1 ET018A.UVDATA.1

Freq = 4.9270 GHz, Bw = 16.000 MH No calibration applied and no bandpass applied

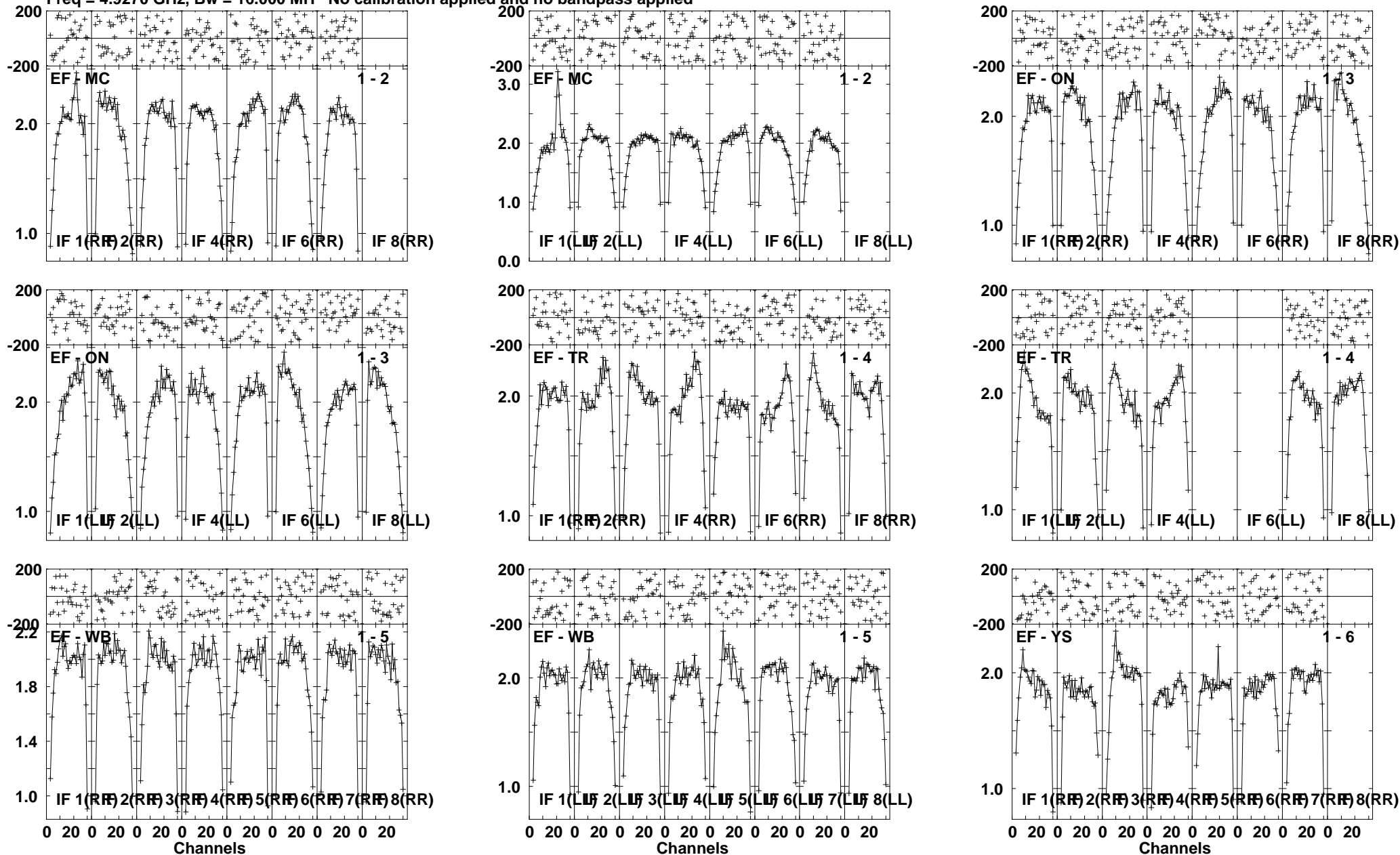

Lower frame: Milli Ampl Jy Top frame: Phas deg
Scalar averaged cross-power spectrum Several baselines displayed
Timerange: 00/17:17:52 to 00/17:23:18

Plot file version 128 created 02-DEC-2011 14:51:55

CYGX-1 ET018A.UVDATA.1

Freq = 4.9270 GHz, Bw = 16.000 MH No calibration applied and no bandpass applied

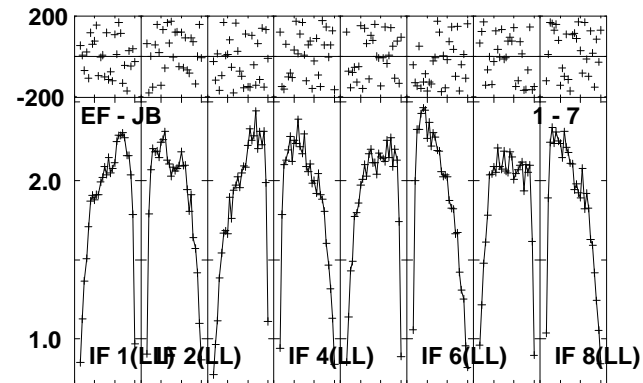
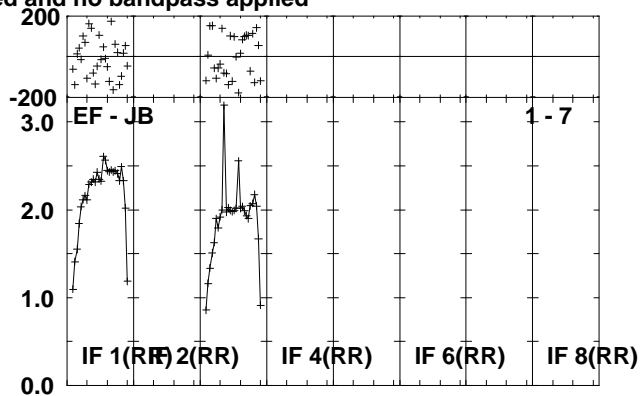
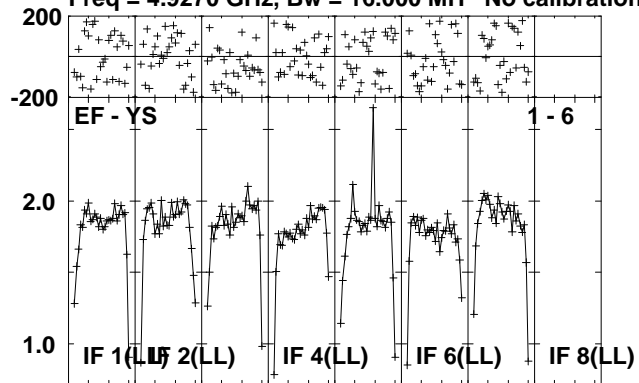

Lower frame: Milli Ampl Jy Top frame: Phas deg
Scalar averaged cross-power spectrum Several baselines displayed
Timerange: 00/17:17:52 to 00/17:23:18

Plot file version 129 created 02-DEC-2011 14:51:58

J1953+35 ET018A.UVDATA.1

Freq = 4.9270 GHz, Bw = 16.000 MH No calibration applied and no bandpass applied

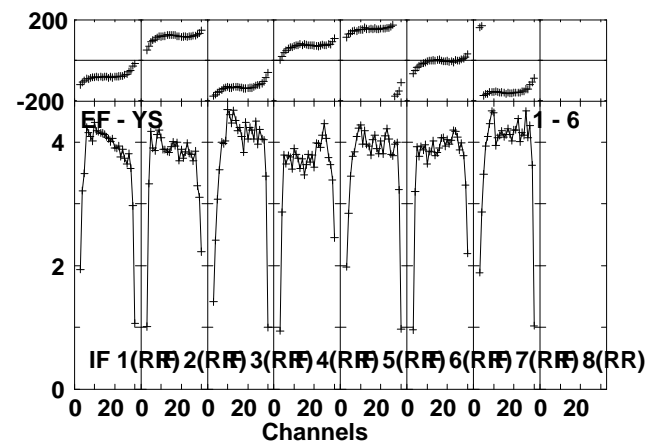
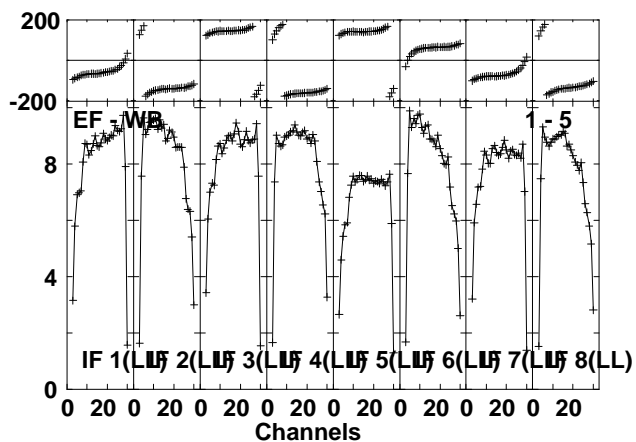
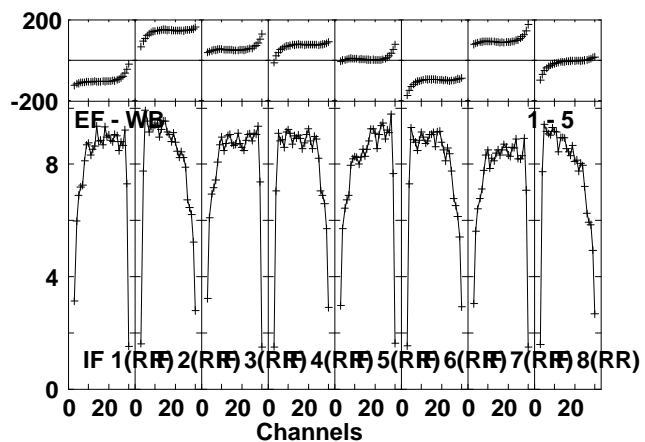
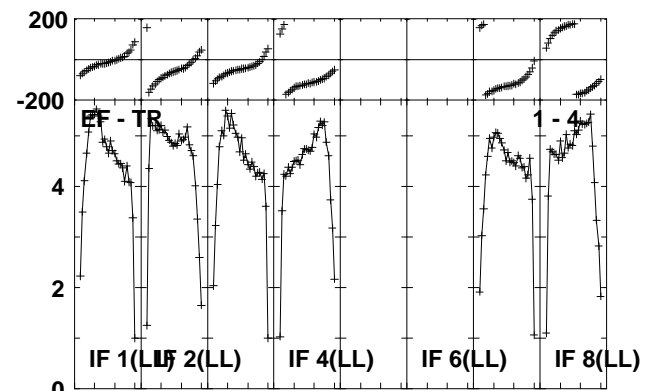
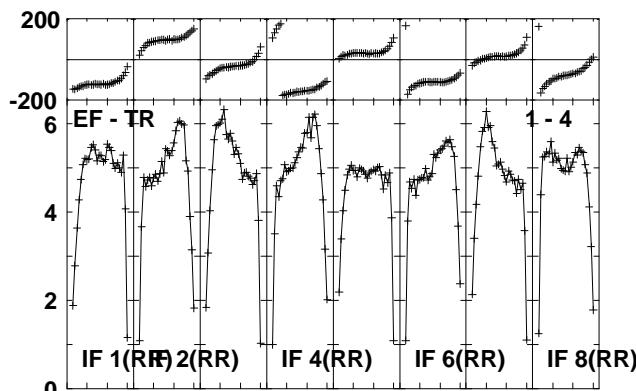
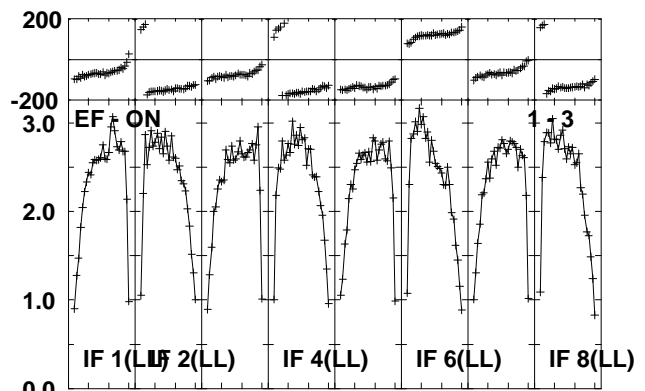
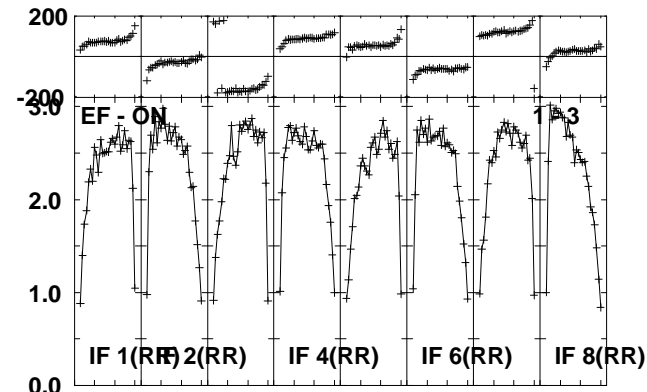
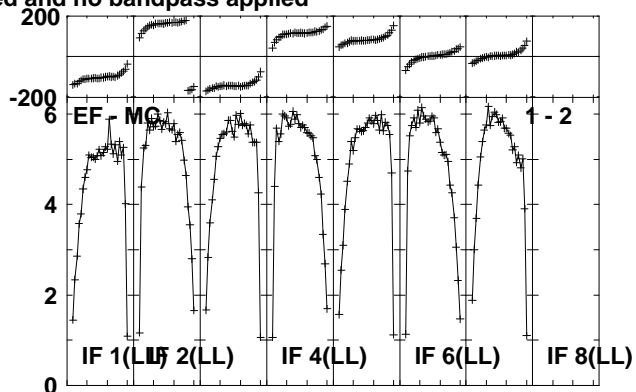
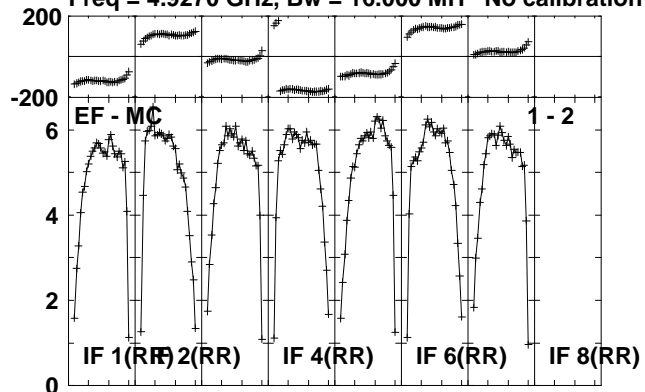

Lower frame: Milli Ampl Jy Top frame: Phas deg
Scalar averaged cross-power spectrum Several baselines displayed
Timerange: 00/17:24:07 to 00/17:26:39

Plot file version 130 created 02-DEC-2011 14:51:59

J1953+35 ET018A.UVDATA.1

Freq = 4.9270 GHz, Bw = 16.000 MH No calibration applied and no bandpass applied

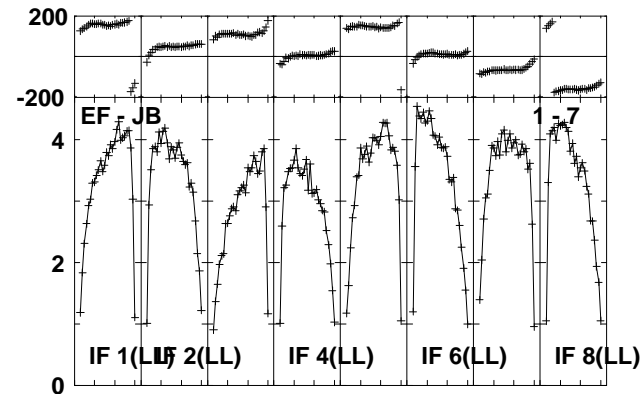
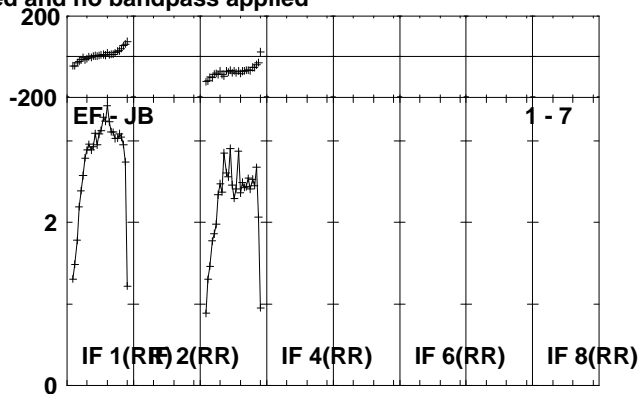
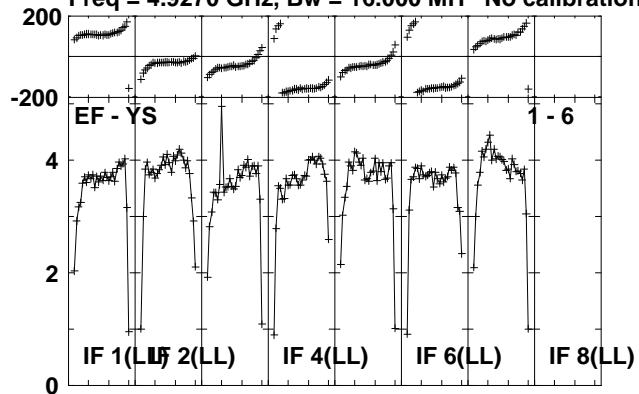

Lower frame: Milli Ampl Jy Top frame: Phas deg
Scalar averaged cross-power spectrum Several baselines displayed
Timerange: 00/17:24:07 to 00/17:26:39

Plot file version 131 created 02-DEC-2011 14:52:01

BLLAC ET018A.UVDATA.1

Freq = 4.9270 GHz, Bw = 16.000 MH No calibration applied and no bandpass applied

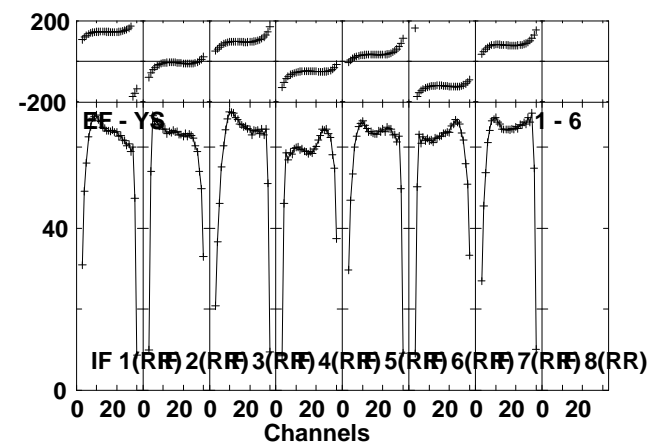
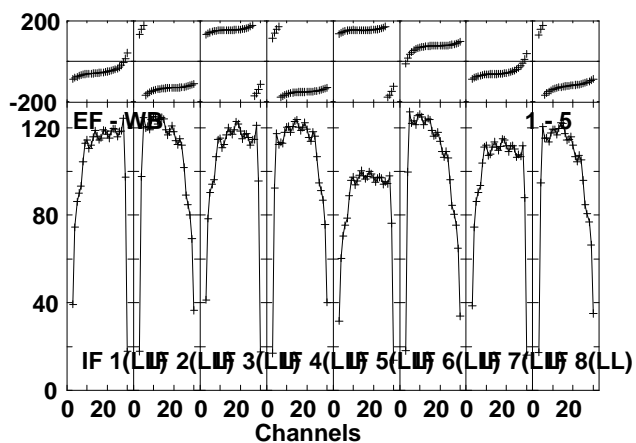
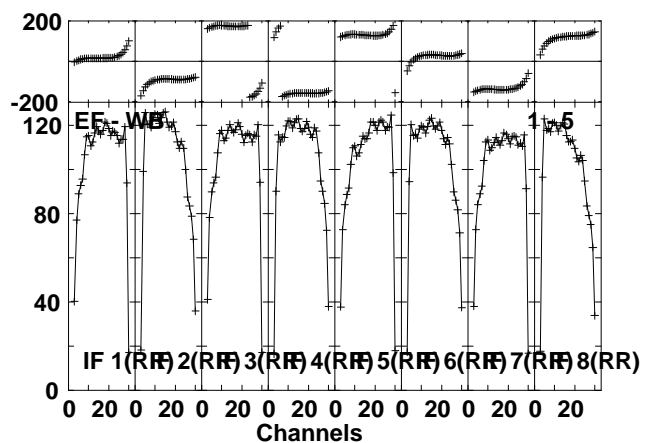
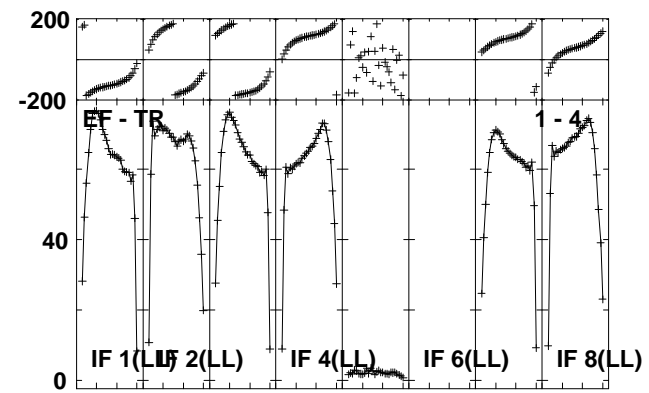
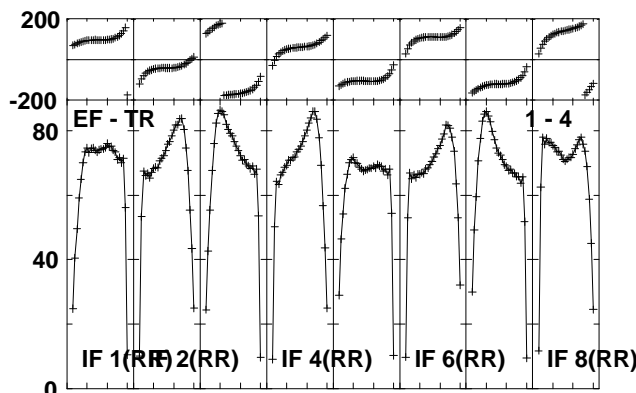
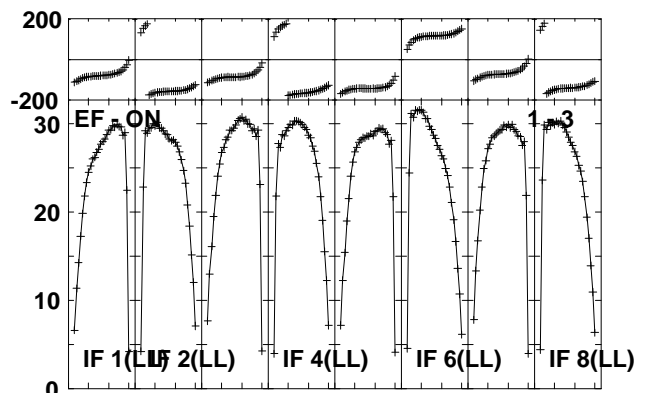
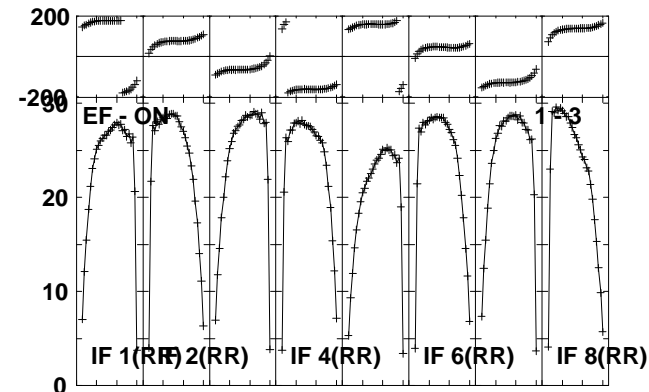
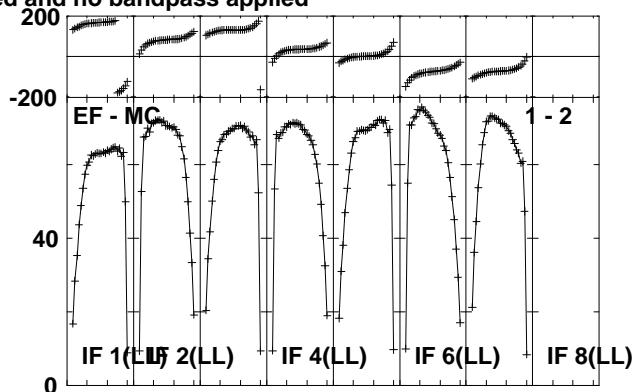
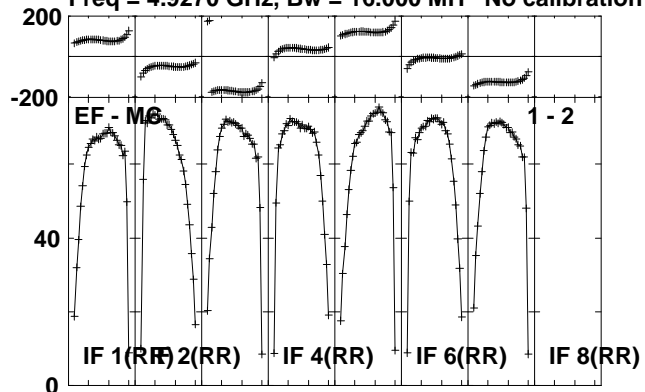

Lower frame: Milli Ampl Jy Top frame: Phas deg
Scalar averaged cross-power spectrum Several baselines displayed
Timerange: 00/17:31:36 to 00/17:36:39

Plot file version 132 created 02-DEC-2011 14:52:04

BLLAC ET018A.UVDATA.1

Freq = 4.9270 GHz, Bw = 16.000 MH No calibration applied and no bandpass applied

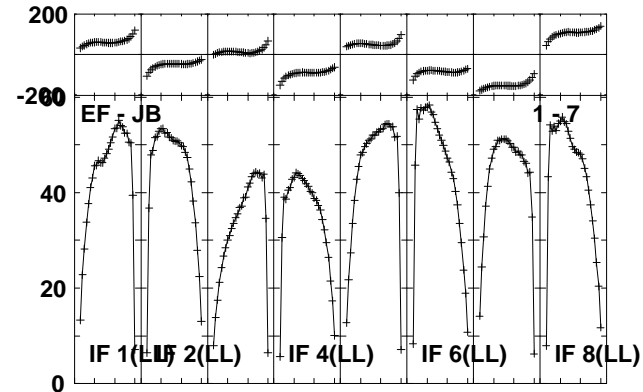
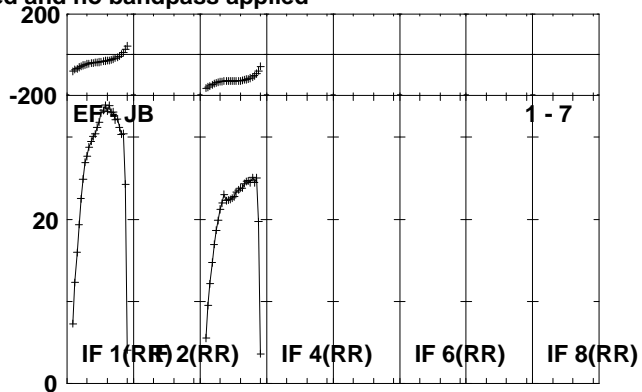
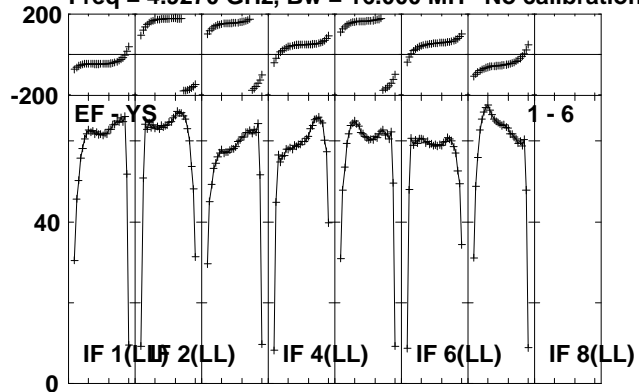

Lower frame: Milli Ampl Jy Top frame: Phas deg
Scalar averaged cross-power spectrum Several baselines displayed
Timerange: 00/17:31:36 to 00/17:36:39

Plot file version 133 created 02-DEC-2011 14:52:06

J2002+47 ET018A.UVDATA.1

Freq = 4.9270 GHz, Bw = 16.000 MH No calibration applied and no bandpass applied

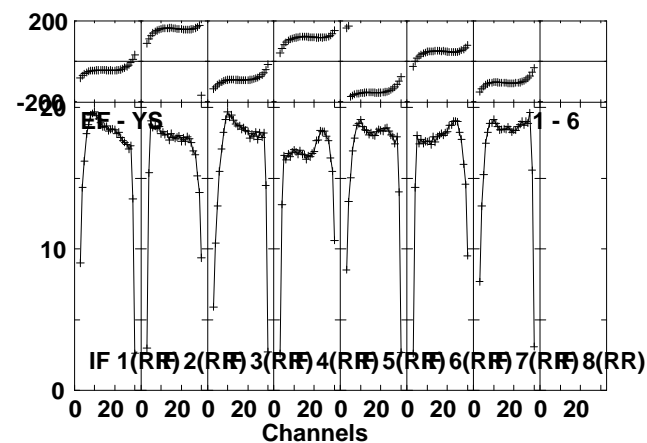
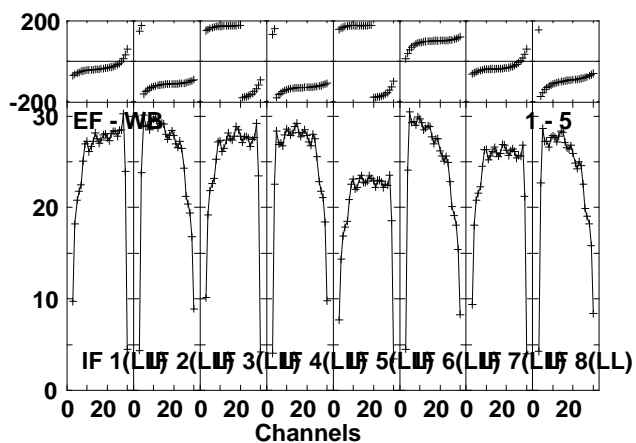
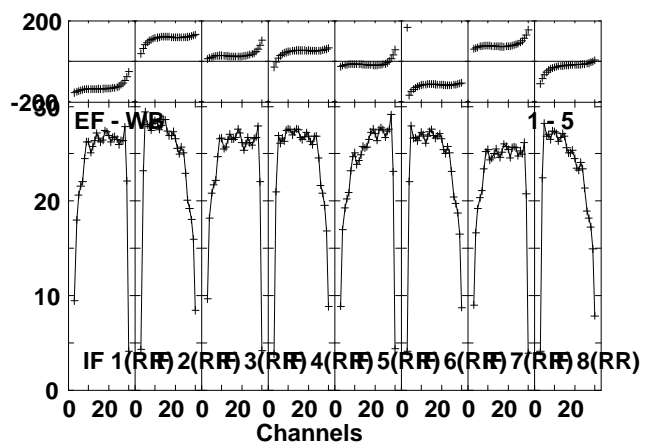
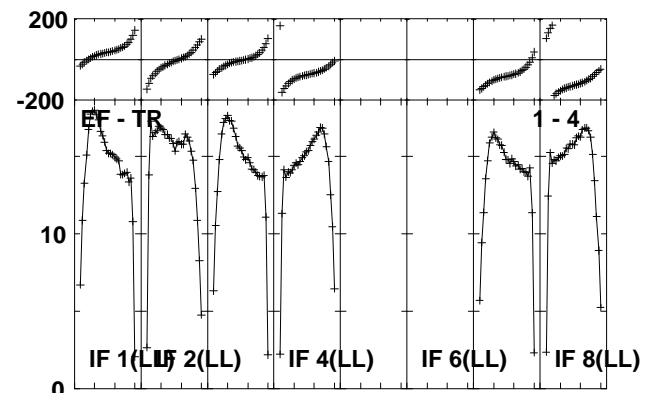
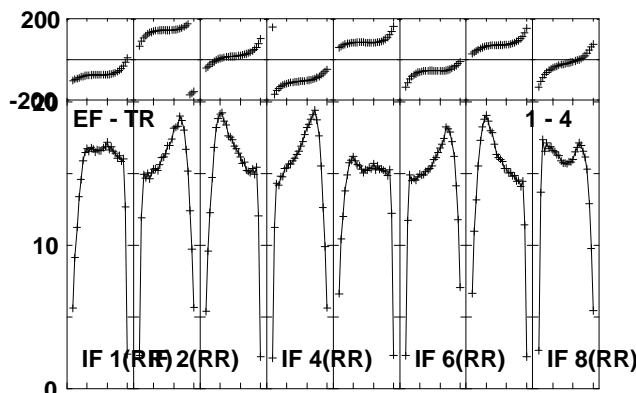
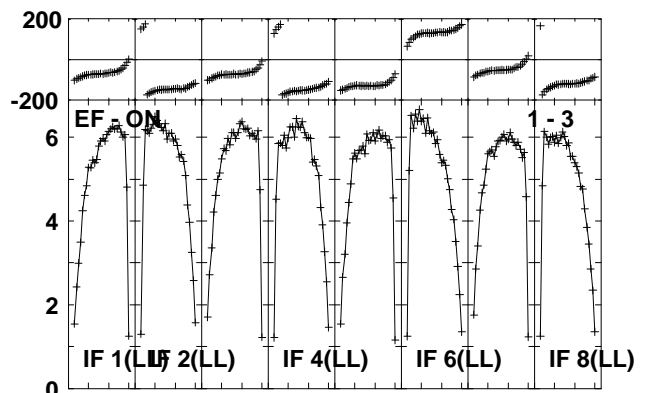
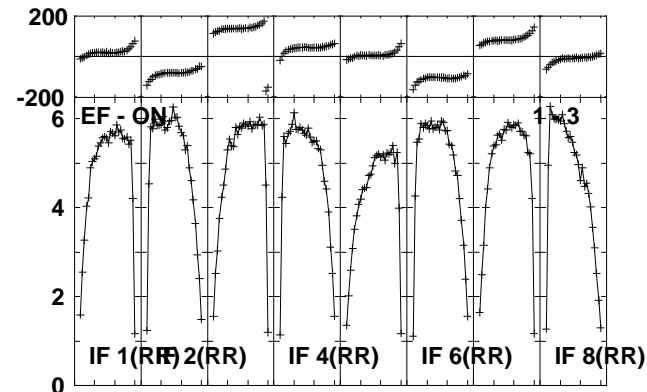
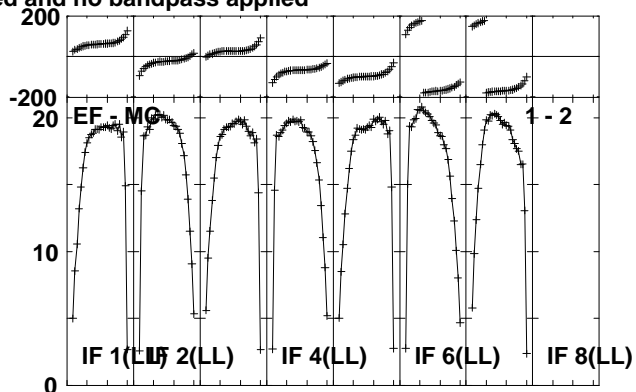
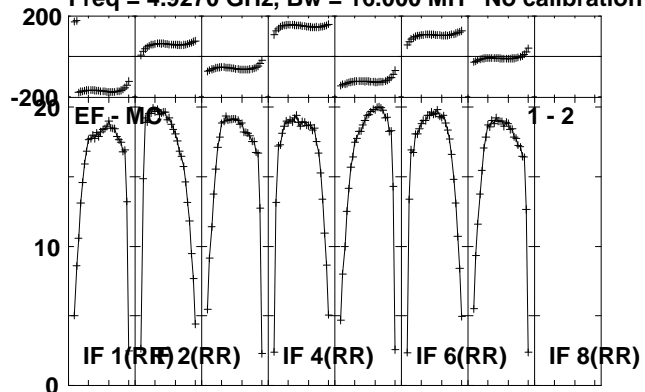

Lower frame: Milli Ampl Jy Top frame: Phas deg
Scalar averaged cross-power spectrum Several baselines displayed
Timerange: 00/17:43:07 to 00/17:47:09

Plot file version 134 created 02-DEC-2011 14:52:07

J2002+47 ET018A.UVDATA.1

Freq = 4.9270 GHz, Bw = 16.000 MH No calibration applied and no bandpass applied

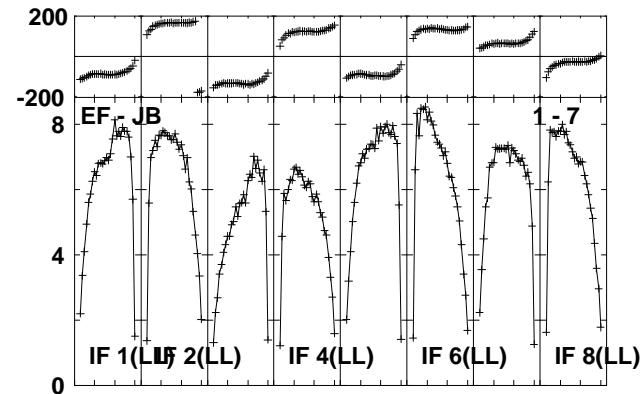
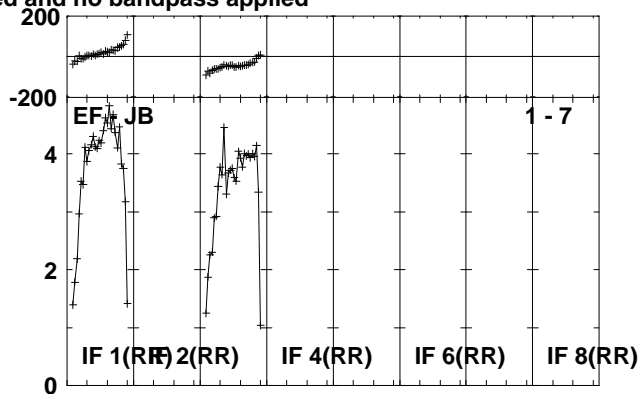
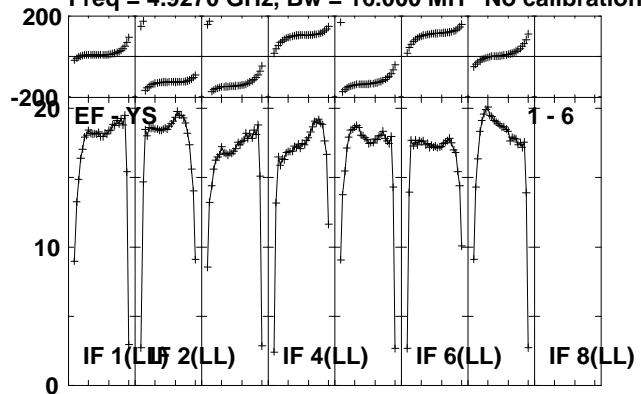

Lower frame: Milli Ampl Jy Top frame: Phas deg
Scalar averaged cross-power spectrum Several baselines displayed
Timerange: 00/17:43:07 to 00/17:47:09

Plot file version 135 created 02-DEC-2011 14:52:10

J1953+35 ET018A.UVDATA.1

Freq = 4.9270 GHz, Bw = 16.000 MH No calibration applied and no bandpass applied

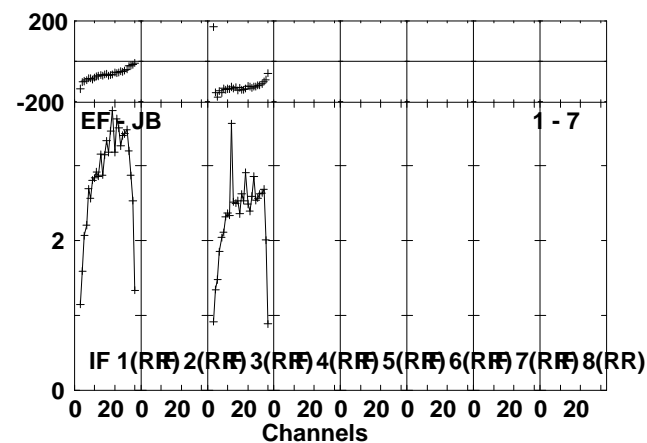
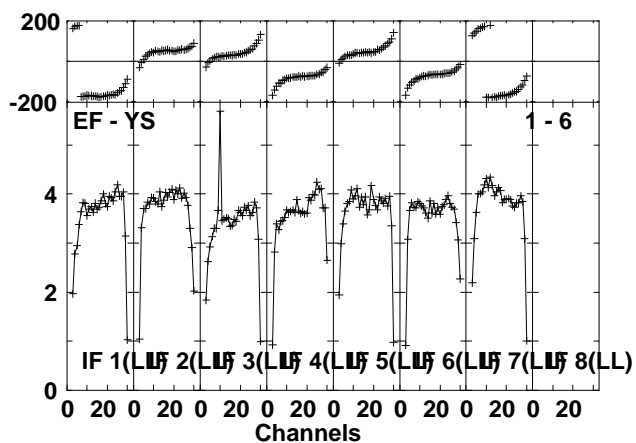
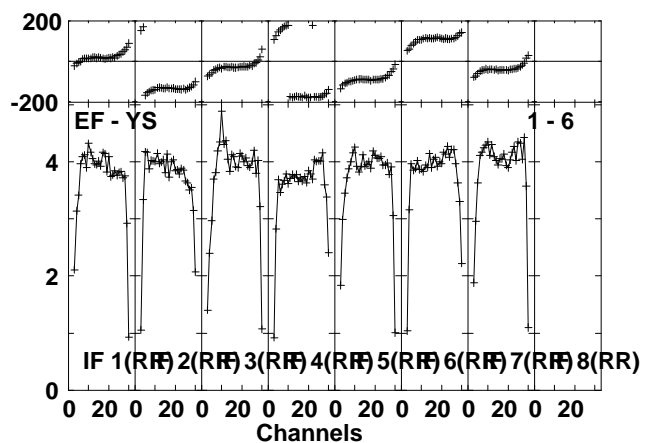
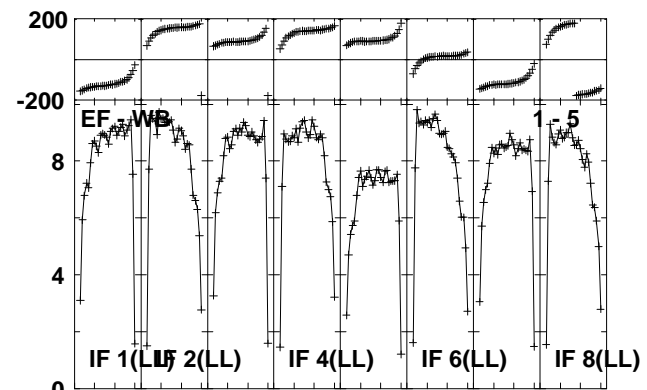
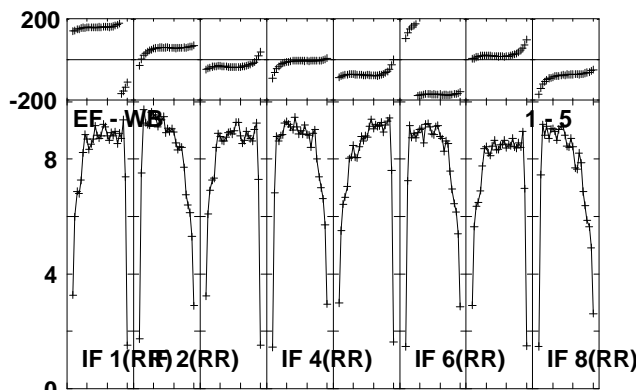
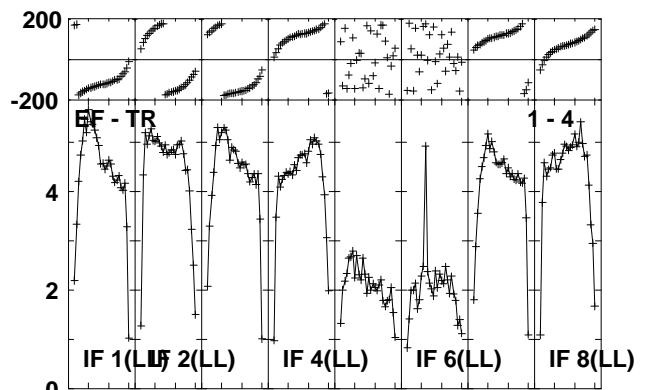
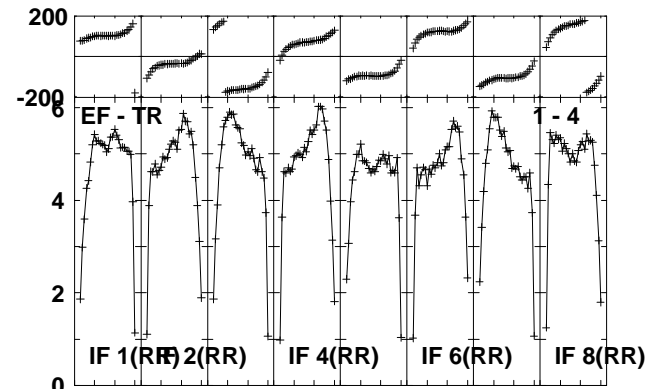
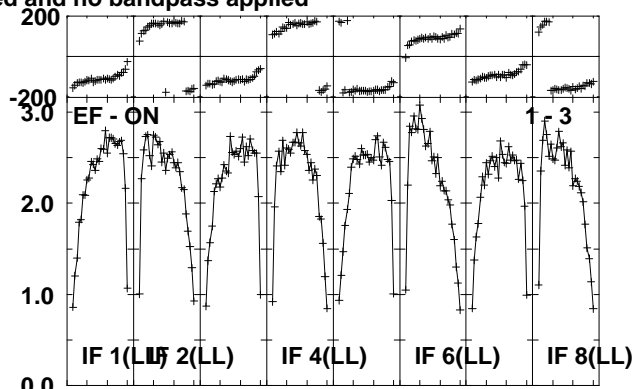
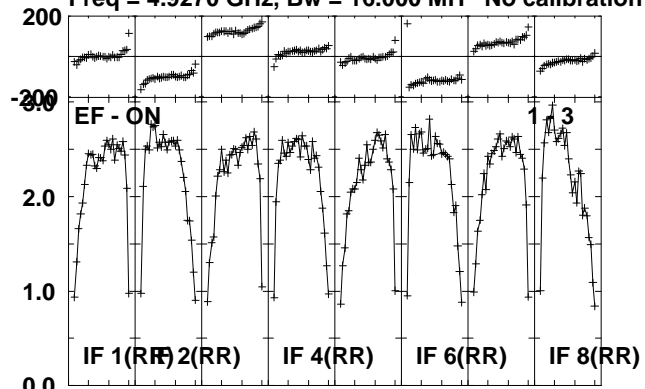

Lower frame: Milli Ampl Jy Top frame: Phas deg
Scalar averaged cross-power spectrum Several baselines displayed
Timerange: 00/17:48:06 to 00/17:51:38

Plot file version 136 created 02-DEC-2011 14:52:11

J1953+35 ET018A.UVDATA.1

Freq = 4.9270 GHz, Bw = 16.000 MH No calibration applied and no bandpass applied

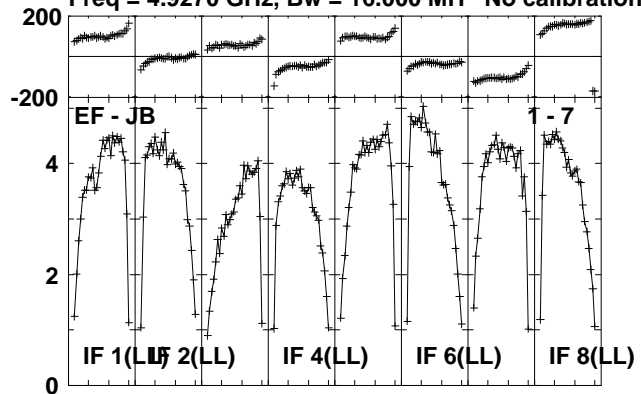

Lower frame: Milli Ampl Jy Top frame: Phas deg
Scalar averaged cross-power spectrum Several baselines displayed
Timerange: 00/17:48:06 to 00/17:51:38

Plot file version 137 created 02-DEC-2011 14:52:13

CYGX-1 ET018A.UVDATA.1

Freq = 4.9270 GHz, Bw = 16.000 MH No calibration applied and no bandpass applied

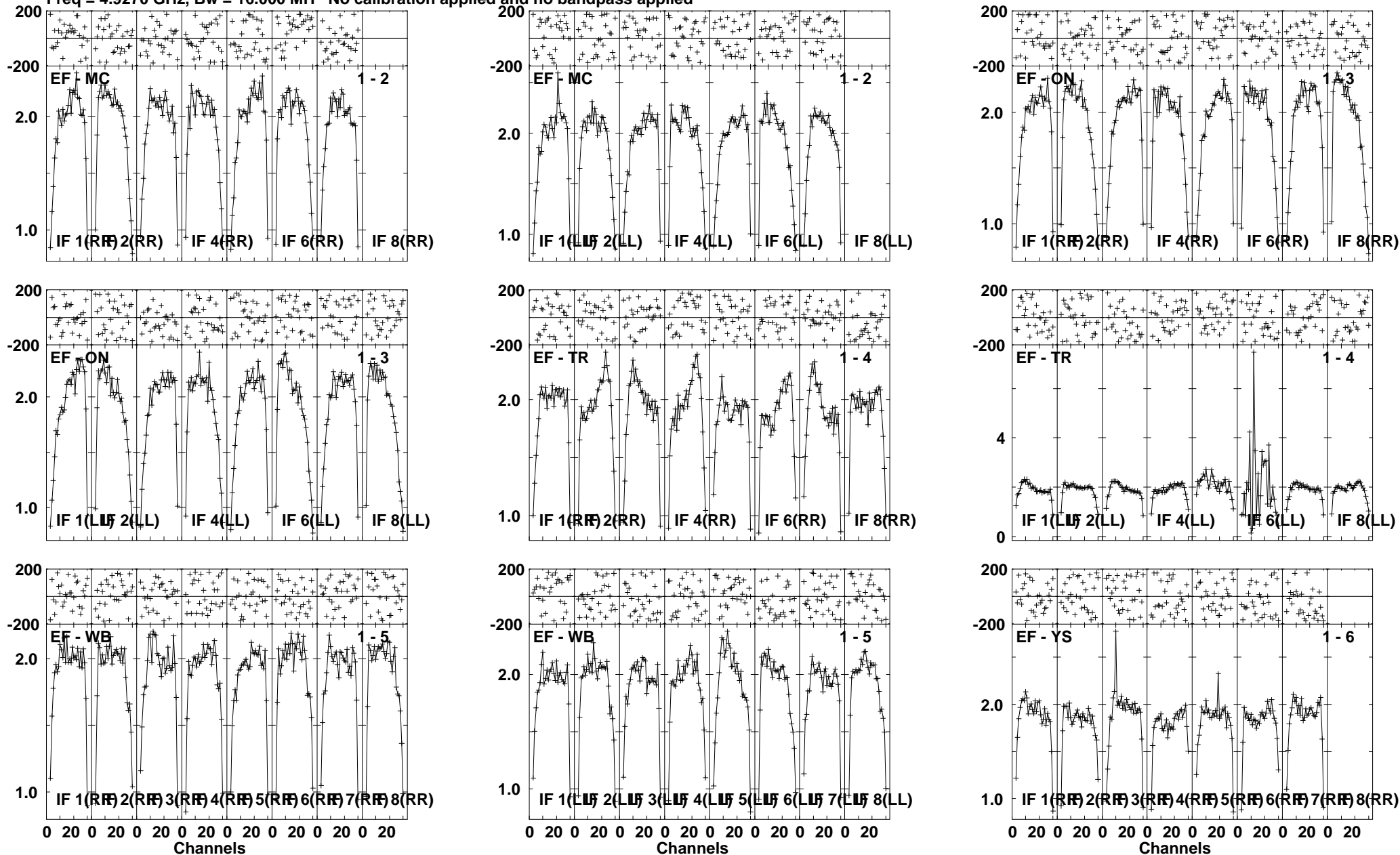

Lower frame: Milli Ampl Jy Top frame: Phas deg
Scalar averaged cross-power spectrum Several baselines displayed
Timerange: 00/17:51:42 to 00/17:57:08

Plot file version 138 created 02-DEC-2011 14:52:16

CYGX-1 ET018A.UVDATA.1

Freq = 4.9270 GHz, Bw = 16.000 MH No calibration applied and no bandpass applied

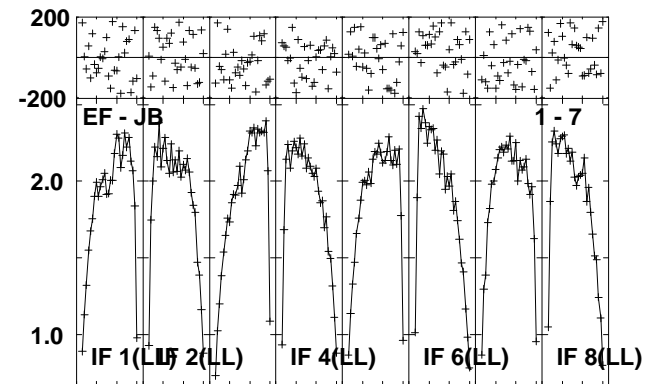
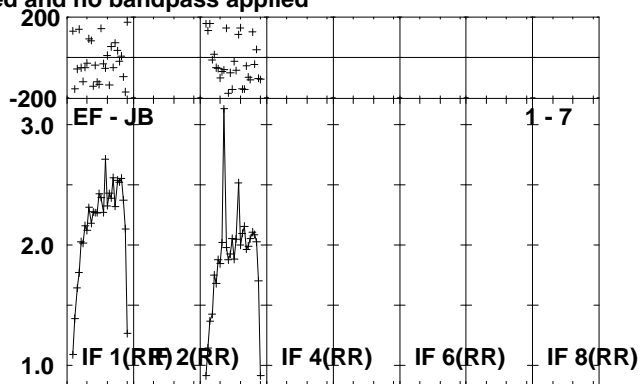
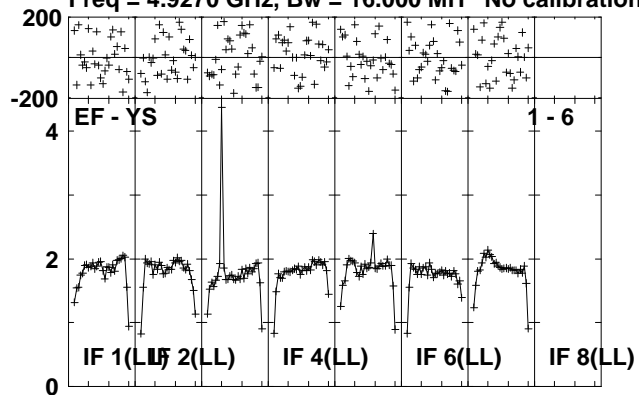

Lower frame: Milli Ampl Jy Top frame: Phas deg
Scalar averaged cross-power spectrum Several baselines displayed
Timerange: 00/17:51:42 to 00/17:57:08

Plot file version 139 created 02-DEC-2011 14:52:19

J1953+35 ET018A.UVDATA.1

Freq = 4.9270 GHz, Bw = 16.000 MH No calibration applied and no bandpass applied

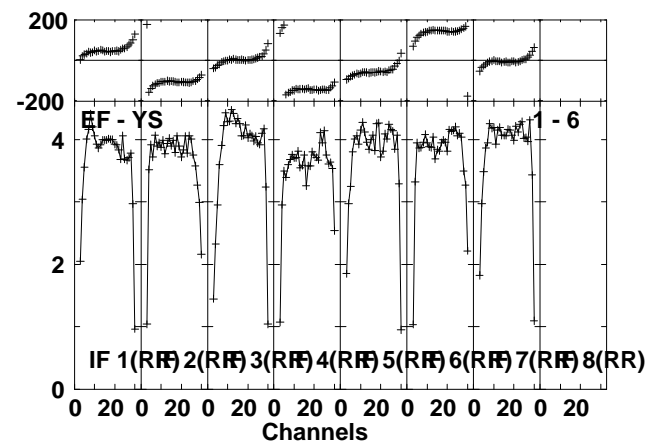
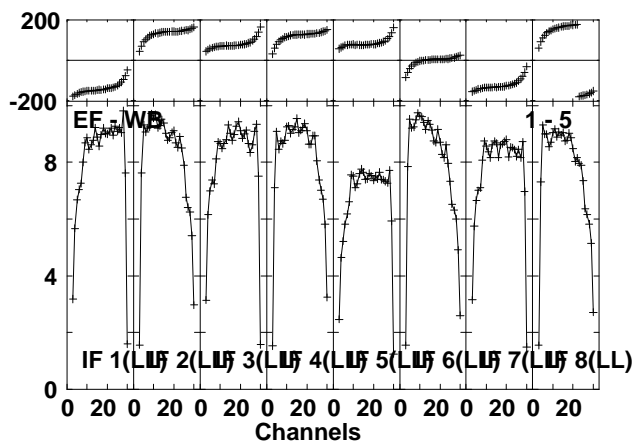
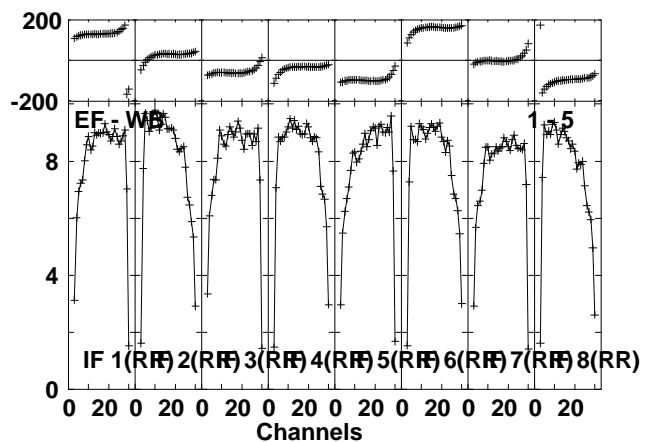
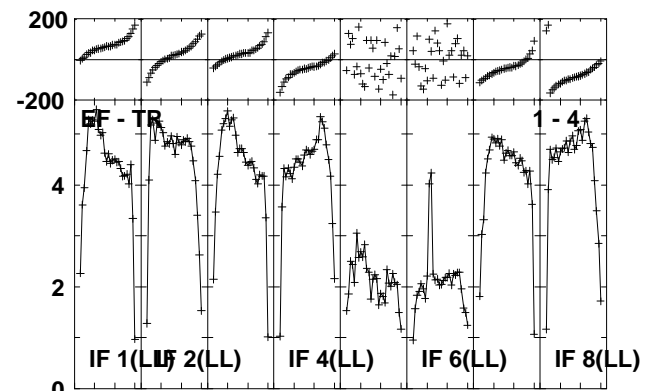
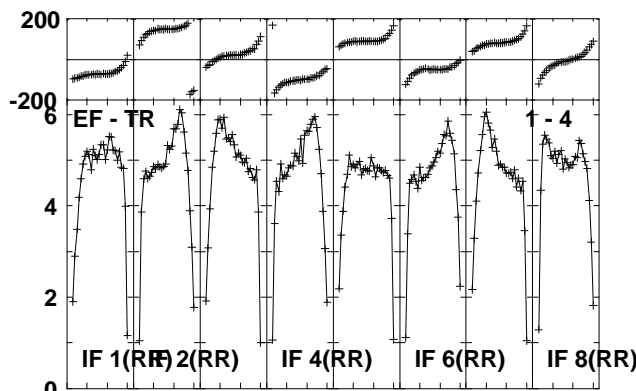
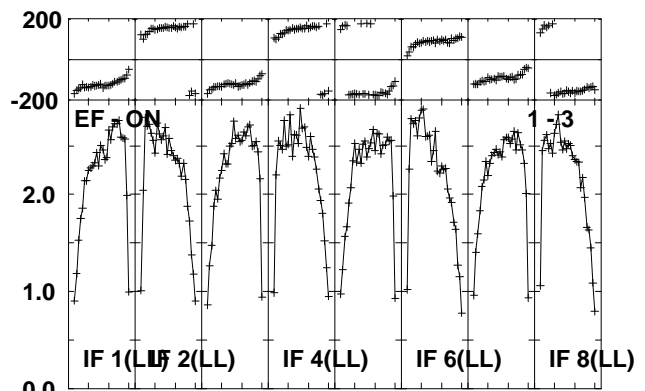
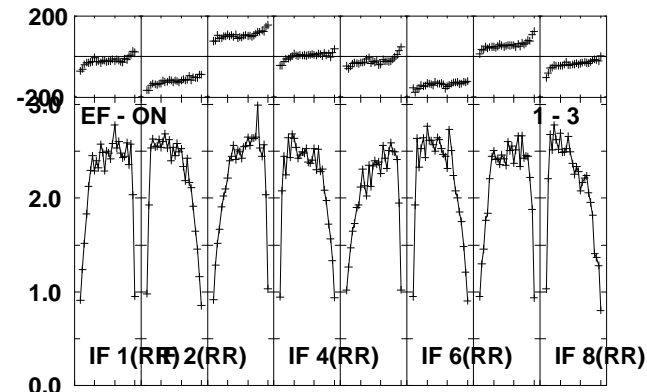
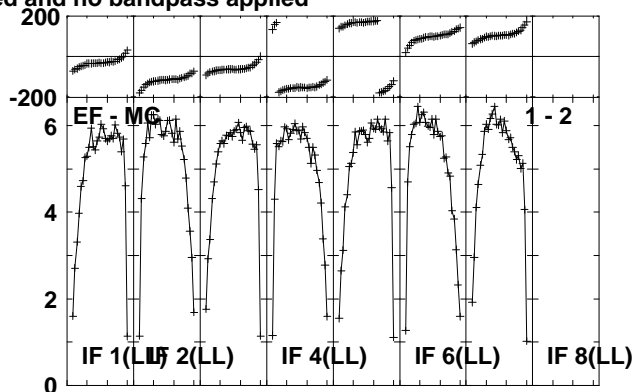
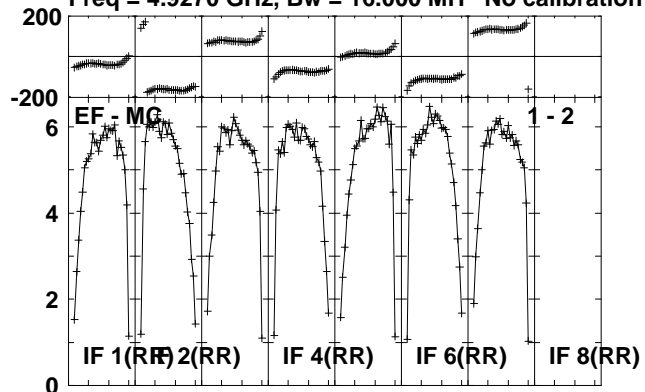

Lower frame: Milli Ampl Jy Top frame: Phas deg
Scalar averaged cross-power spectrum Several baselines displayed
Timerange: 00/17:57:12 to 00/18:00:09

Plot file version 140 created 02-DEC-2011 14:52:20

J1953+35 ET018A.UVDATA.1

Freq = 4.9270 GHz, Bw = 16.000 MH No calibration applied and no bandpass applied

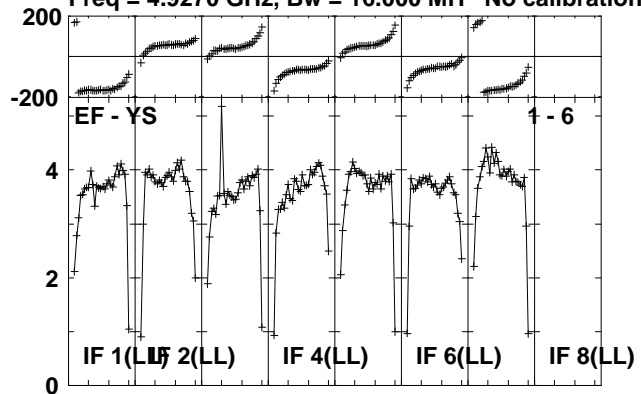

Lower frame: Milli Ampl Jy Top frame: Phas deg
Scalar averaged cross-power spectrum Several baselines displayed
Timerange: 00/17:57:12 to 00/18:00:09

Plot file version 141 created 02-DEC-2011 14:52:22

CYGX-1 ET018A.UVDATA.1

Freq = 4.9270 GHz, Bw = 16.000 MH No calibration applied and no bandpass applied

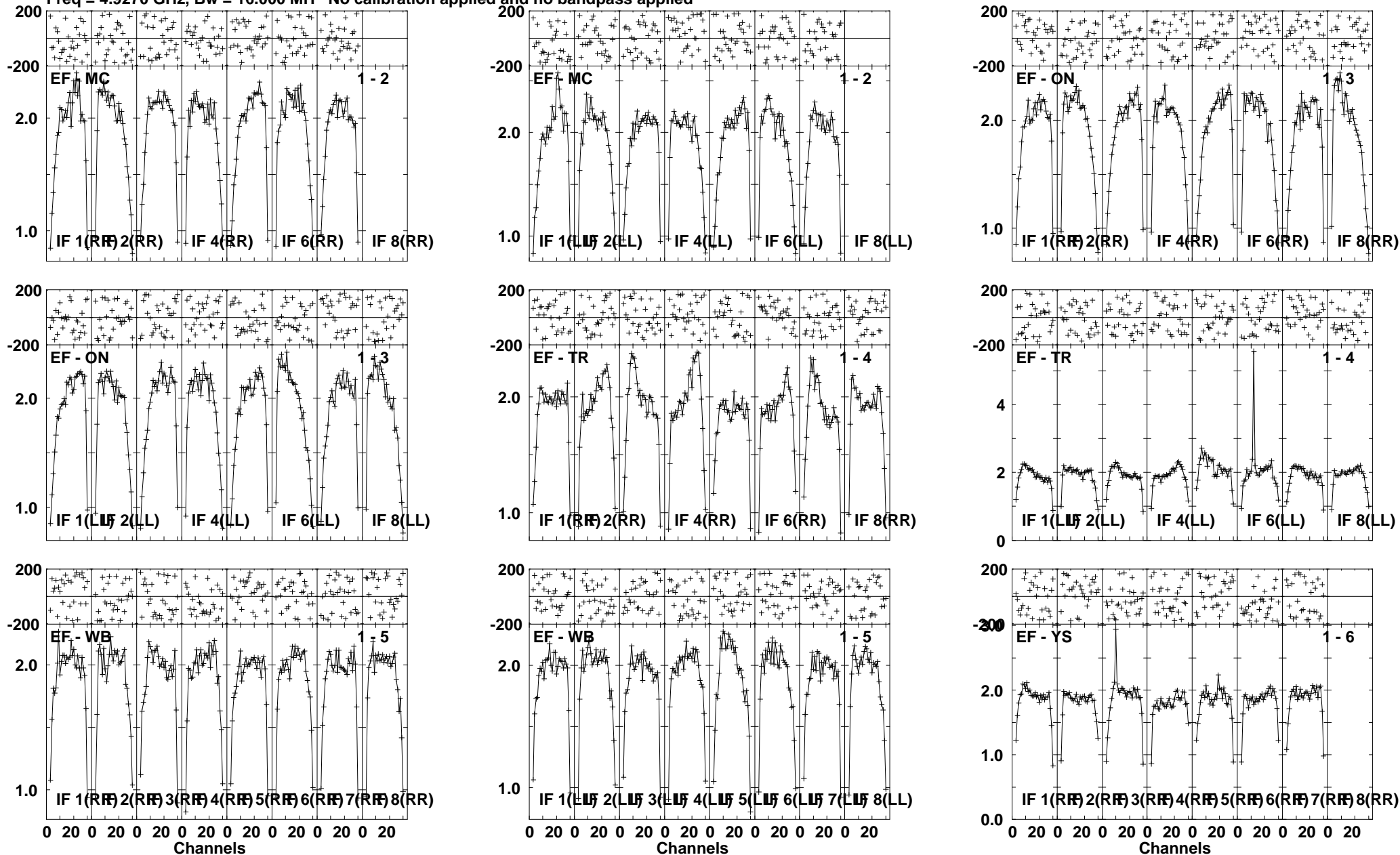

Lower frame: Milli Ampl Jy Top frame: Phas deg
Scalar averaged cross-power spectrum Several baselines displayed
Timerange: 00/18:00:12 to 00/18:05:38

Plot file version 142 created 02-DEC-2011 14:52:25

CYGX-1 ET018A.UVDATA.1

Freq = 4.9270 GHz, Bw = 16.000 MH No calibration applied and no bandpass applied

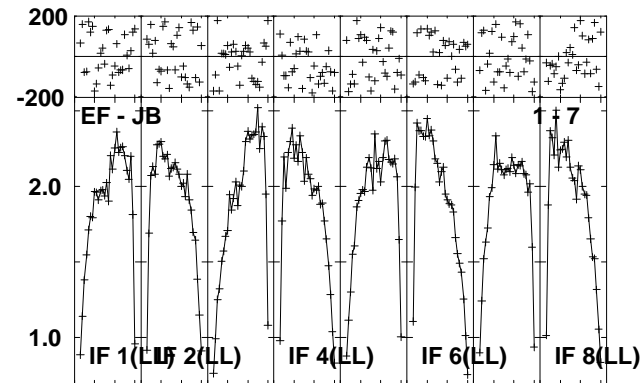
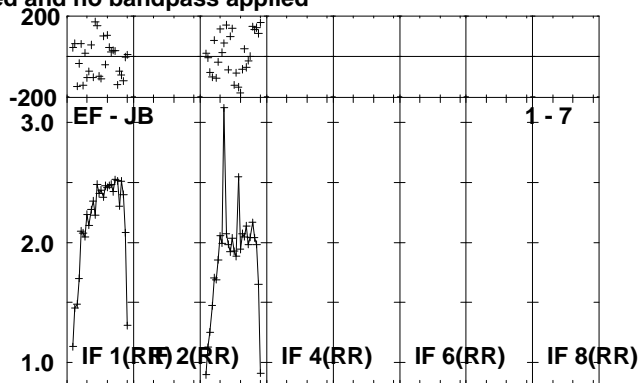
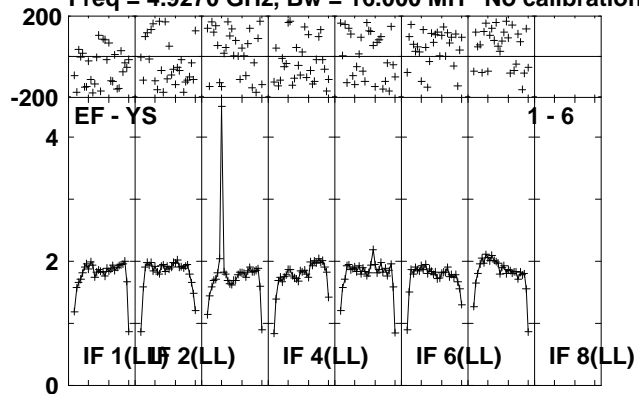

Lower frame: Milli Ampl Jy Top frame: Phas deg
Scalar averaged cross-power spectrum Several baselines displayed
Timerange: 00/18:00:12 to 00/18:05:38

Plot file version 143 created 02-DEC-2011 14:52:27

J1953+35 ET018A.UVDATA.1

Freq = 4.9270 GHz, Bw = 16.000 MH No calibration applied and no bandpass applied

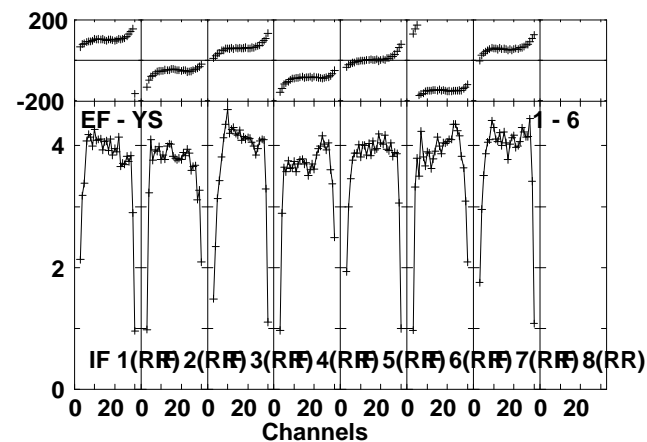
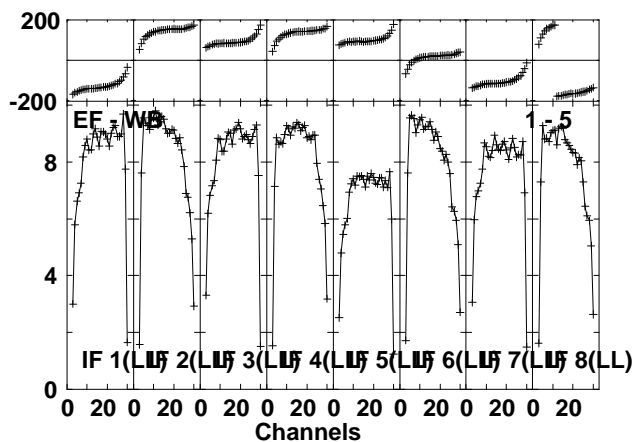
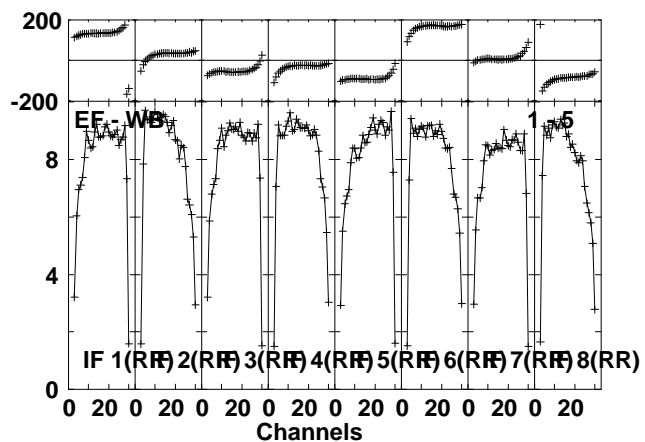
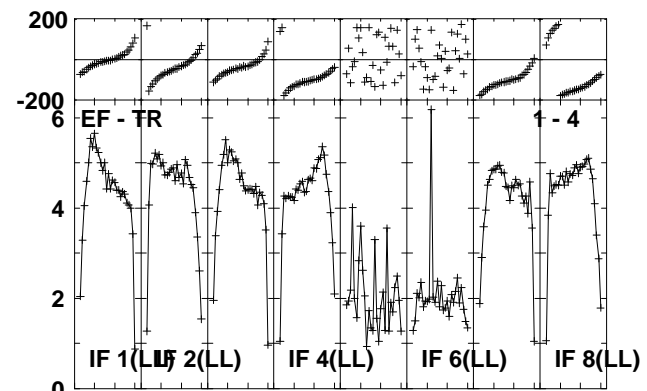
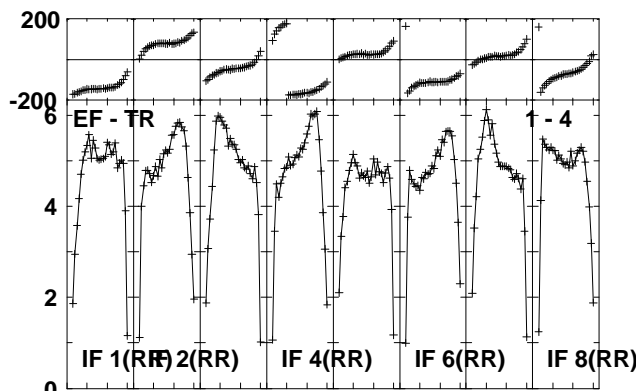
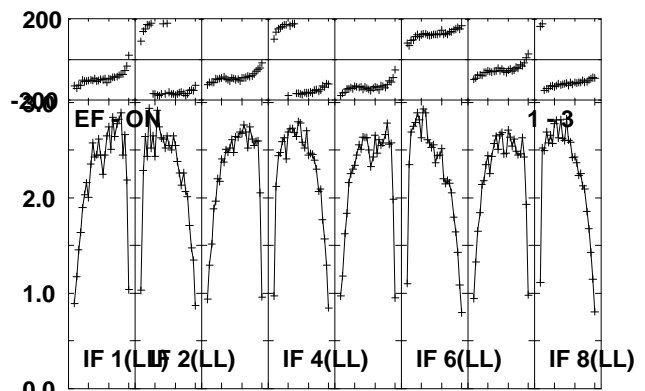
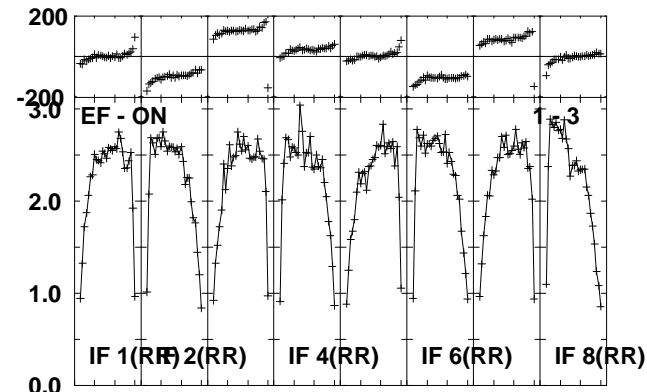
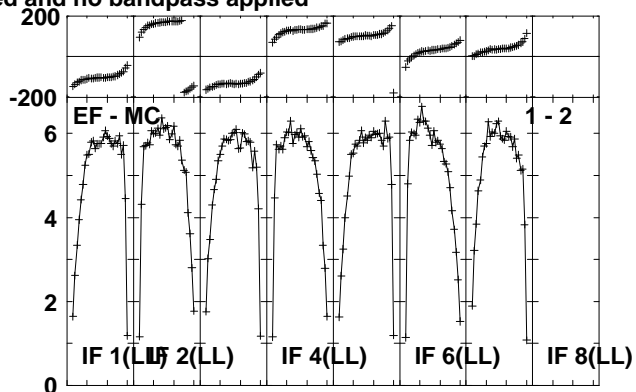
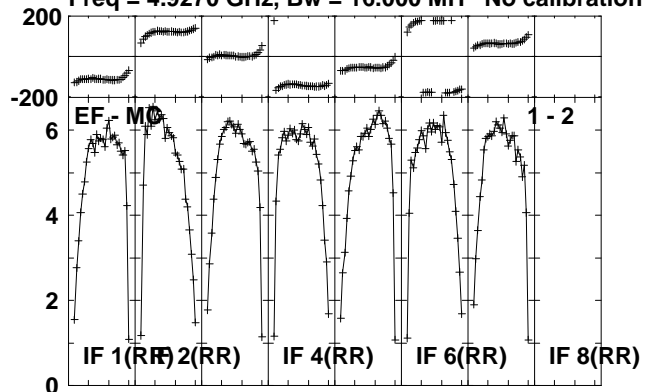

Lower frame: Milli Ampl Jy Top frame: Phas deg
Scalar averaged cross-power spectrum Several baselines displayed
Timerange: 00/18:06:26 to 00/18:08:58

Plot file version 144 created 02-DEC-2011 14:52:29

J1953+35 ET018A.UVDATA.1

Freq = 4.9270 GHz, Bw = 16.000 MH No calibration applied and no bandpass applied

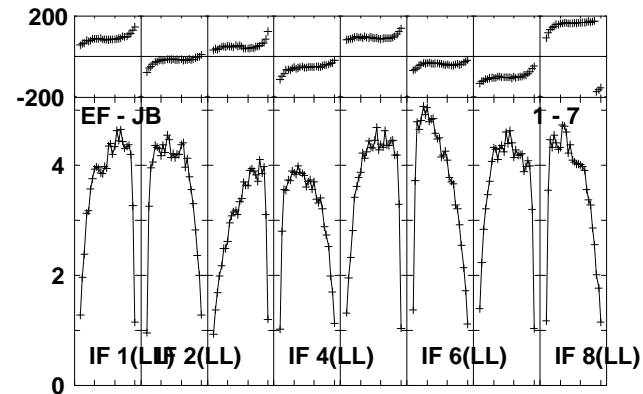
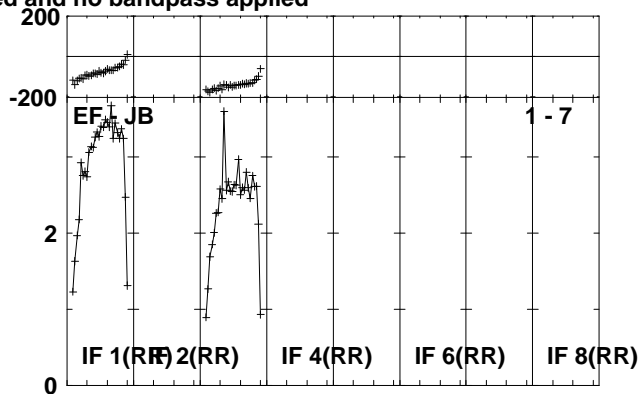
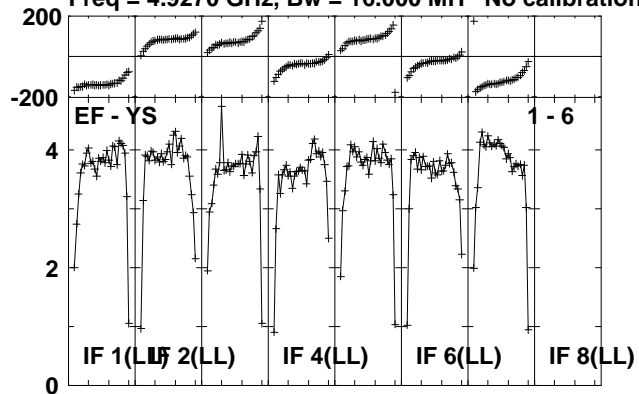

Lower frame: Milli Ampl Jy Top frame: Phas deg
Scalar averaged cross-power spectrum Several baselines displayed
Timerange: 00/18:06:26 to 00/18:08:58

Plot file version 145 created 02-DEC-2011 14:52:30

CYGX-1 ET018A.UVDATA.1

Freq = 4.9270 GHz, Bw = 16.000 MH No calibration applied and no bandpass applied

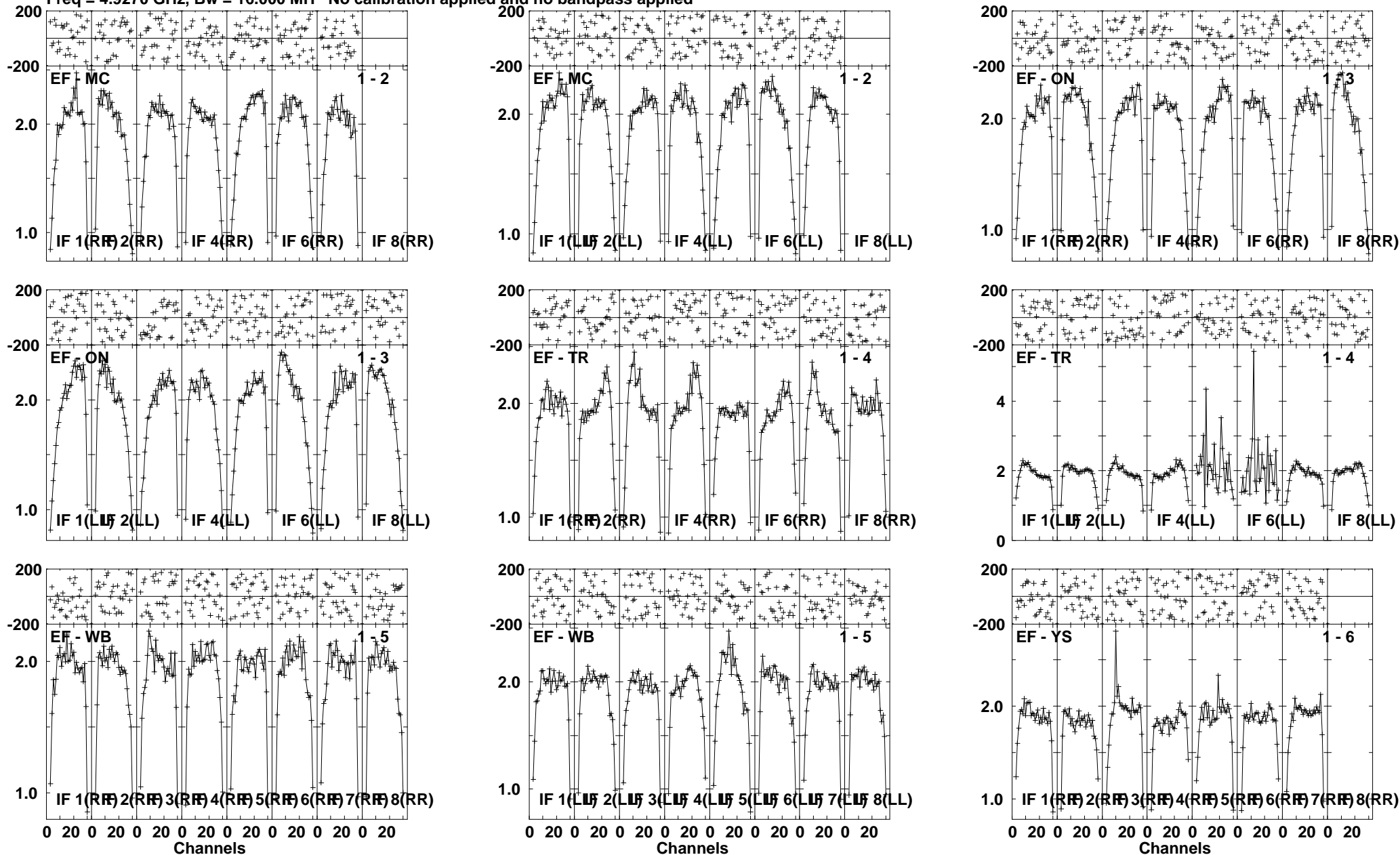

Lower frame: Milli Ampl Jy Top frame: Phas deg
Scalar averaged cross-power spectrum Several baselines displayed
Timerange: 00/18:09:02 to 00/18:14:29

Plot file version 146 created 02-DEC-2011 14:52:34

CYGX-1 ET018A.UVDATA.1

Freq = 4.9270 GHz, Bw = 16.000 MH No calibration applied and no bandpass applied

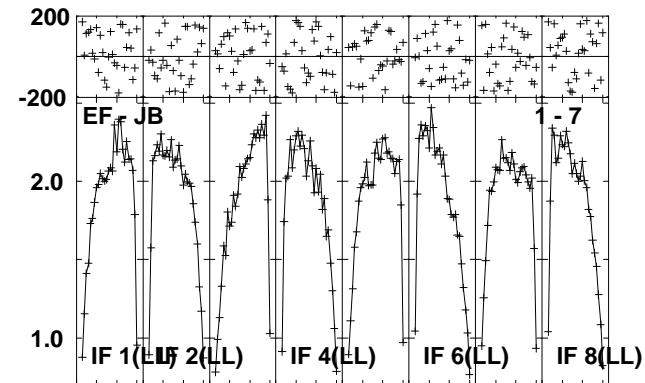
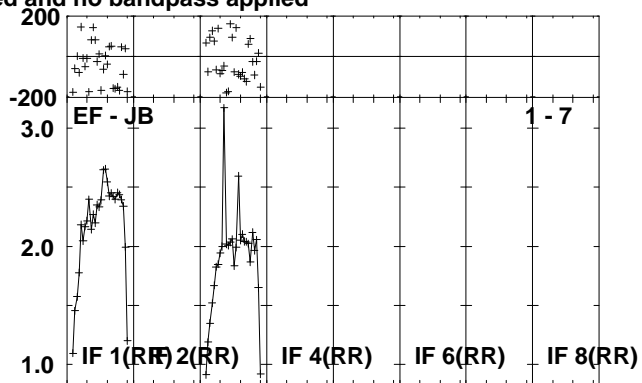
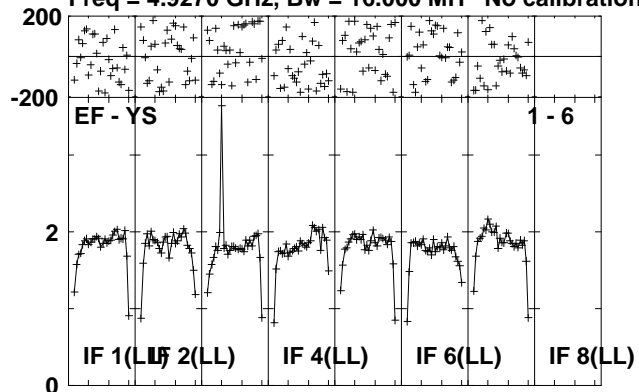

Lower frame: Milli Ampl Jy Top frame: Phas deg
Scalar averaged cross-power spectrum Several baselines displayed
Timerange: 00/18:09:02 to 00/18:14:29

Plot file version 147 created 02-DEC-2011 14:52:36

J1953+35 ET018A.UVDATA.1

Freq = 4.9270 GHz, Bw = 16.000 MH No calibration applied and no bandpass applied

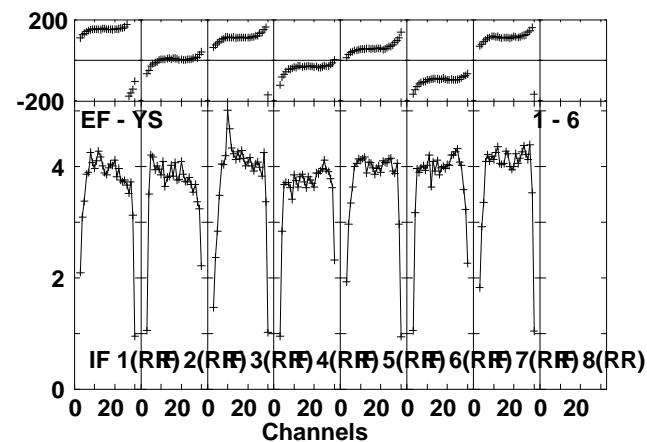
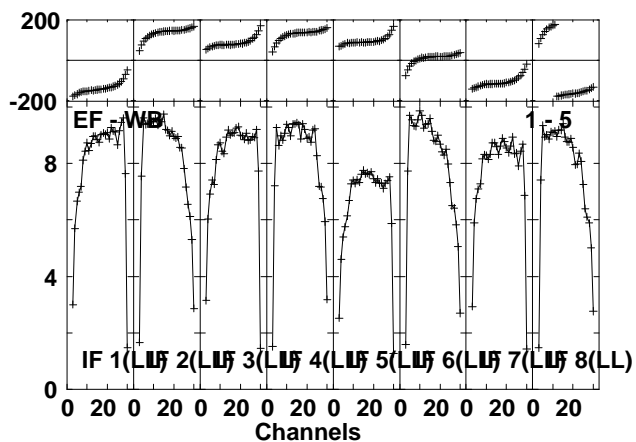
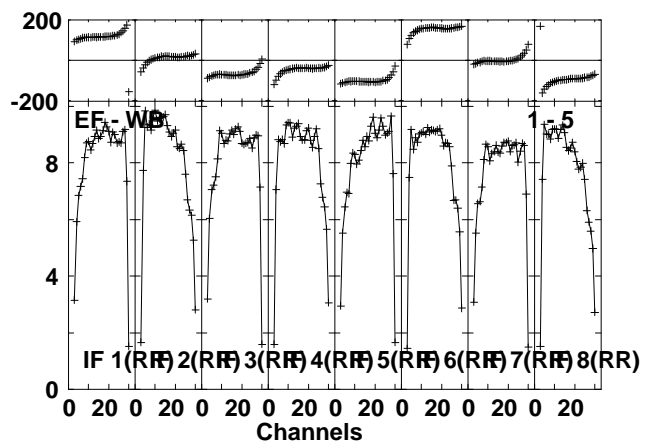
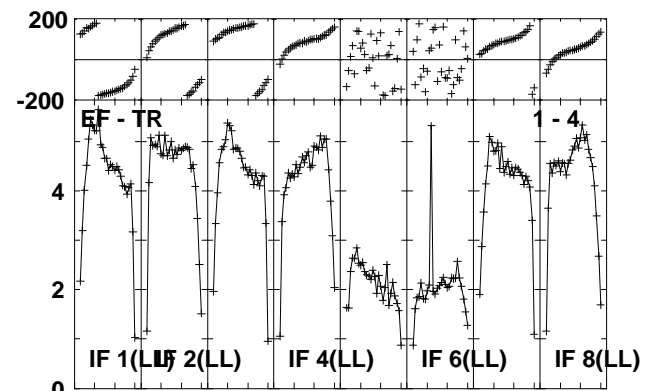
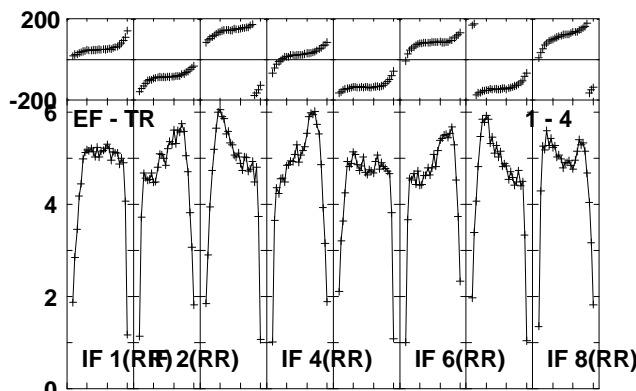
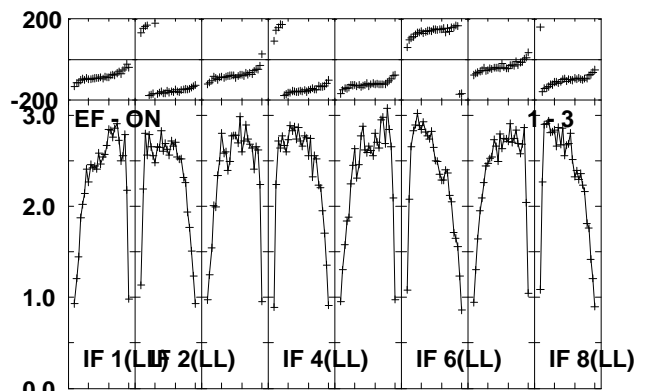
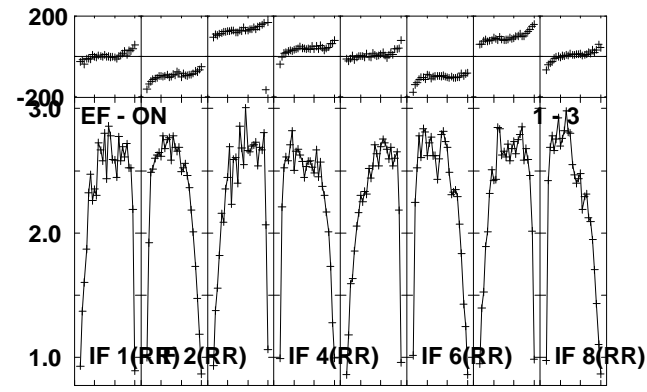
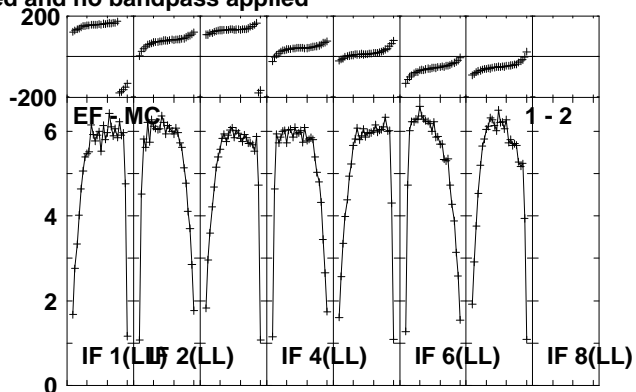
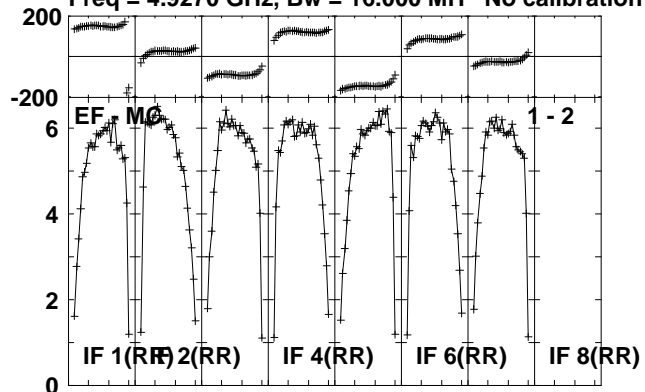

Lower frame: Milli Ampl Jy Top frame: Phas deg
Scalar averaged cross-power spectrum Several baselines displayed
Timerange: 00/18:14:32 to 00/18:17:29

Plot file version 148 created 02-DEC-2011 14:52:37

J1953+35 ET018A.UVDATA.1

Freq = 4.9270 GHz, Bw = 16.000 MH No calibration applied and no bandpass applied

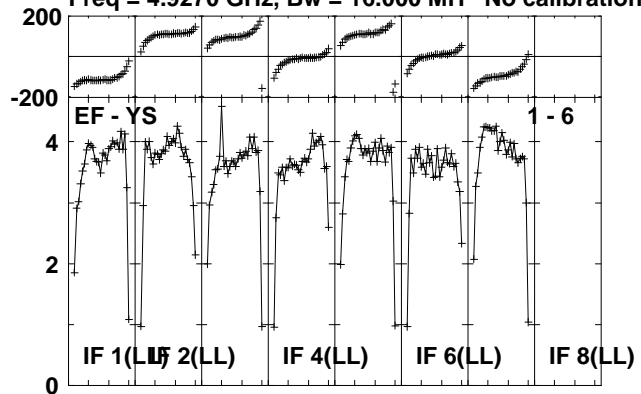

Lower frame: Milli Ampl Jy Top frame: Phas deg
Scalar averaged cross-power spectrum Several baselines displayed
Timerange: 00/18:14:32 to 00/18:17:29

Plot file version 149 created 02-DEC-2011 14:52:39

CYGX-1 ET018A.UVDATA.1

Freq = 4.9270 GHz, Bw = 16.000 MH No calibration applied and no bandpass applied

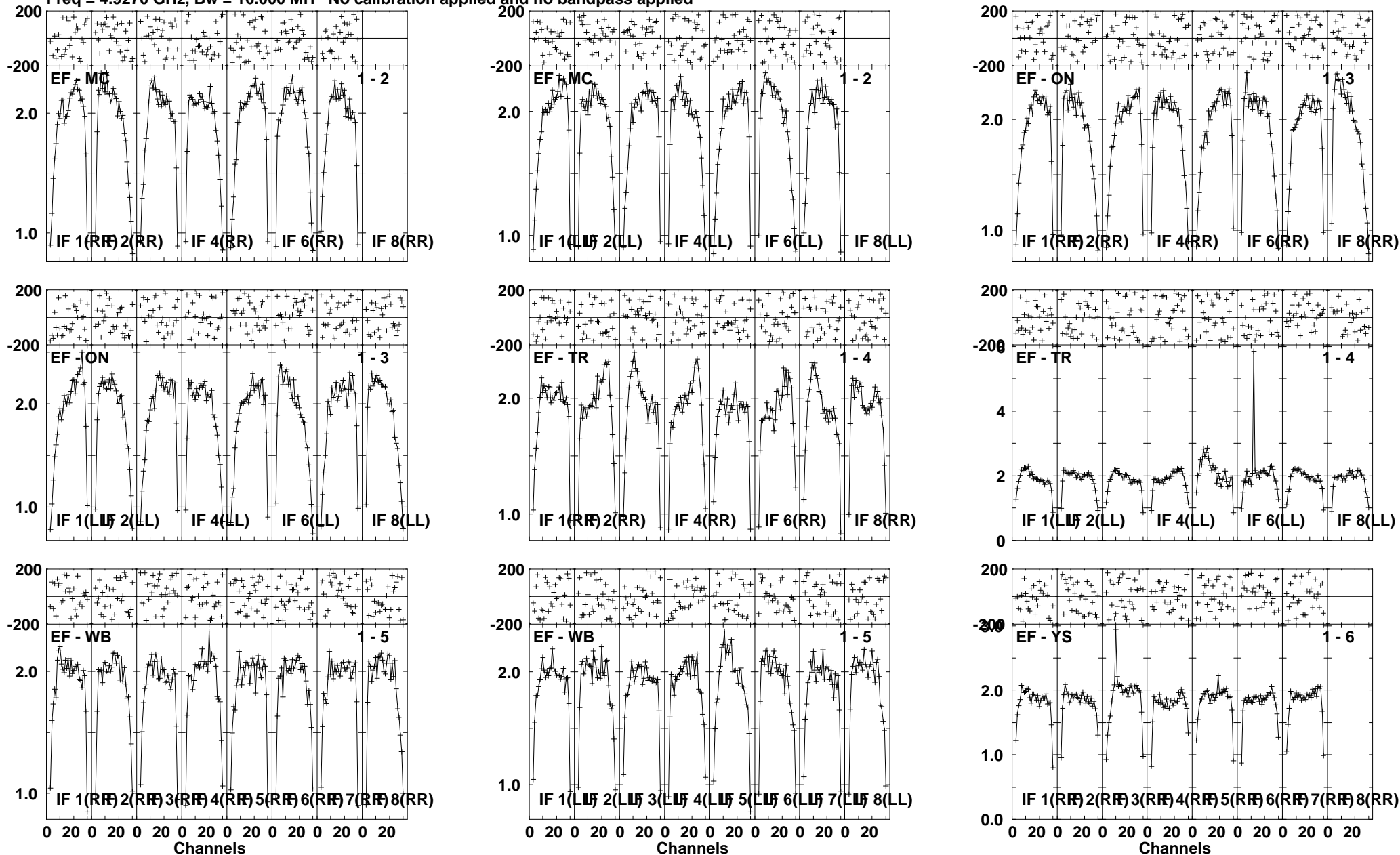

Lower frame: Milli Ampl Jy Top frame: Phas deg
Scalar averaged cross-power spectrum Several baselines displayed
Timerange: 00/18:17:32 to 00/18:22:58

Plot file version 150 created 02-DEC-2011 14:52:42

CYGX-1 ET018A.UVDATA.1

Freq = 4.9270 GHz, Bw = 16.000 MH No calibration applied and no bandpass applied

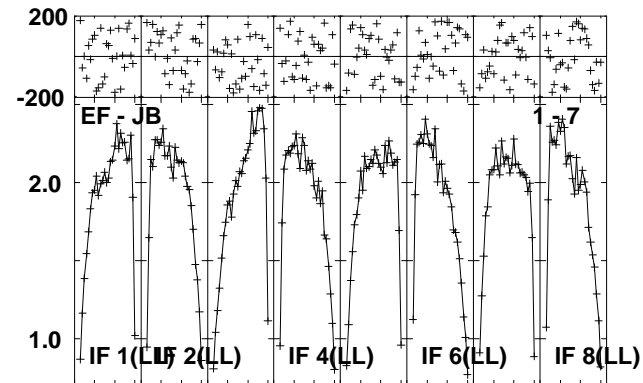
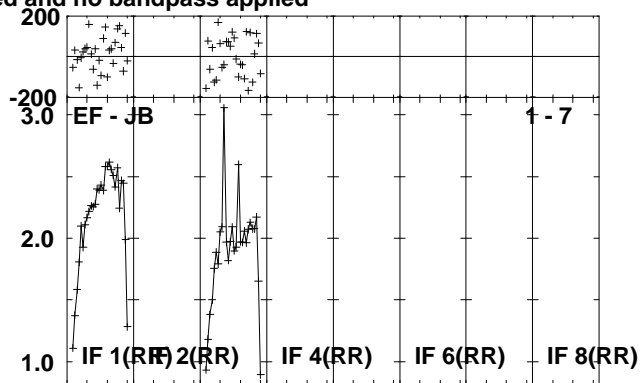
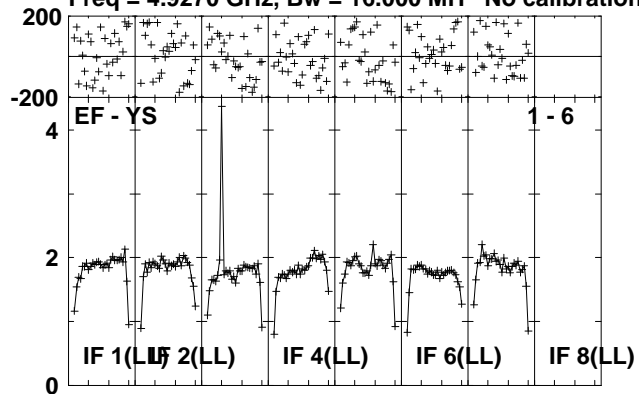

Lower frame: Milli Ampl Jy Top frame: Phas deg
Scalar averaged cross-power spectrum Several baselines displayed
Timerange: 00/18:17:32 to 00/18:22:58

Plot file version 151 created 02-DEC-2011 14:52:44

J1953+35 ET018A.UVDATA.1

Freq = 4.9270 GHz, Bw = 16.000 MH No calibration applied and no bandpass applied

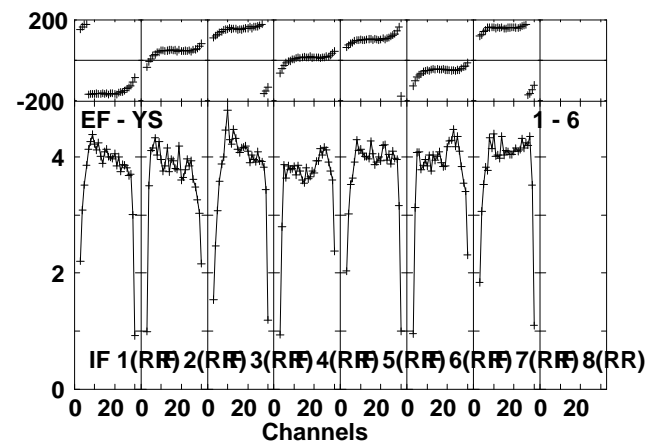
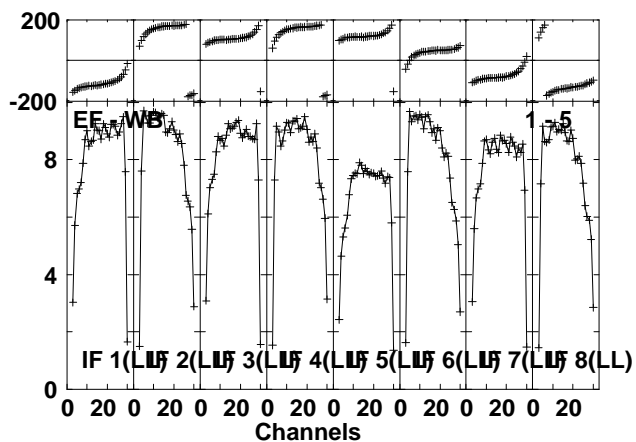
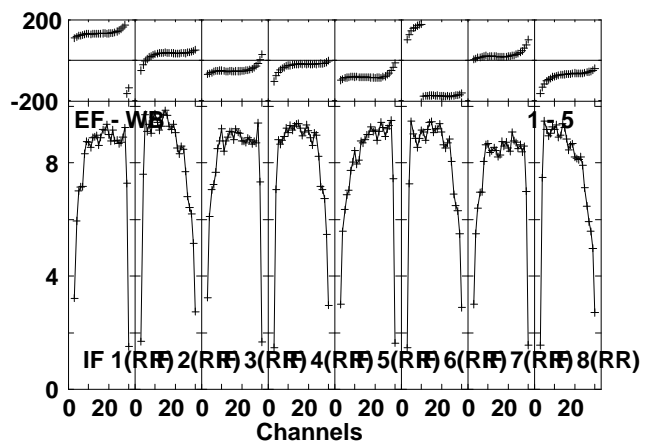
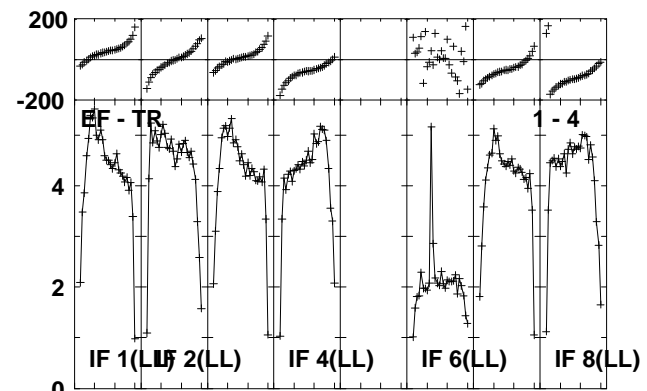
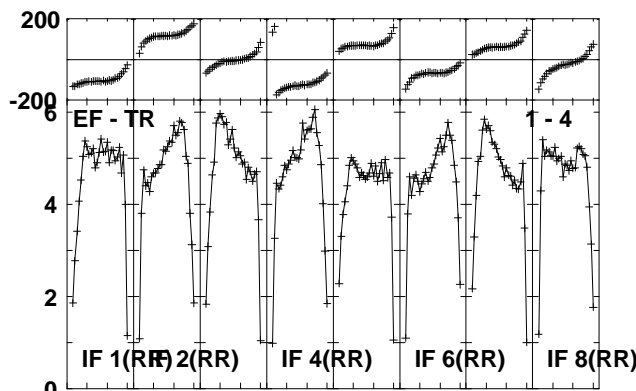
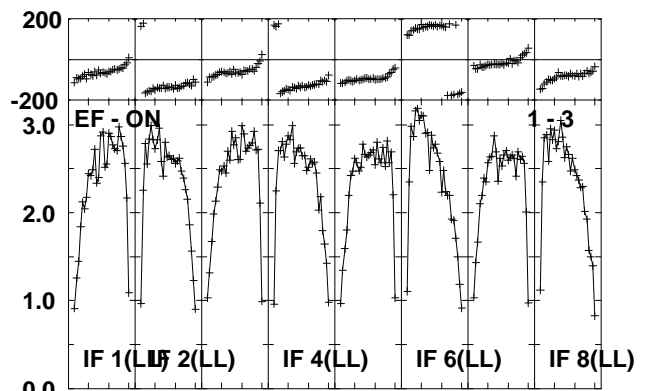
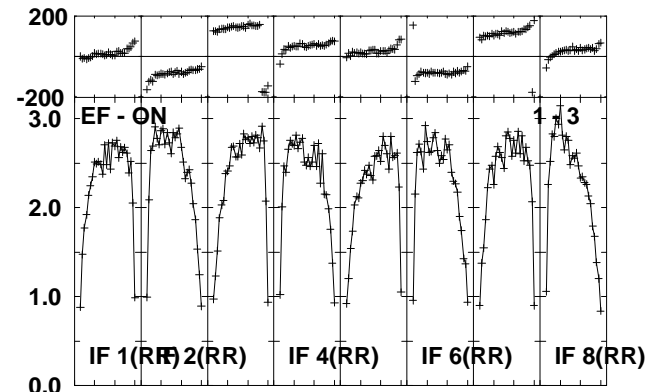
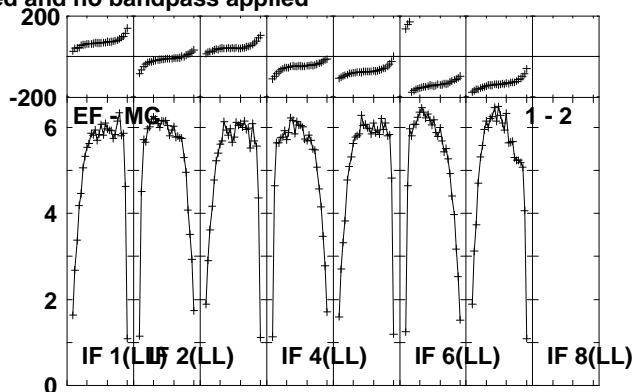
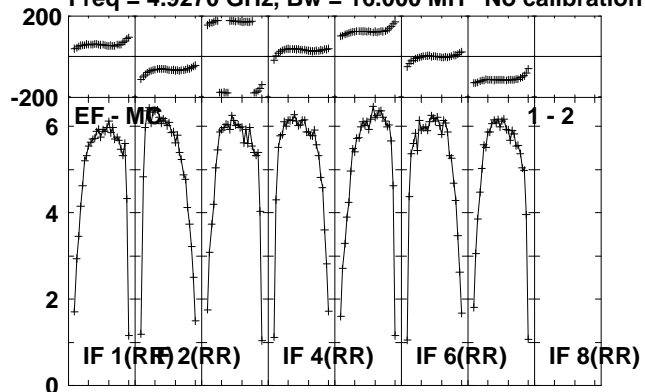

Lower frame: Milli Ampl Jy Top frame: Phas deg
Scalar averaged cross-power spectrum Several baselines displayed
Timerange: 00/18:23:46 to 00/18:26:18

Plot file version 152 created 02-DEC-2011 14:52:46

J1953+35 ET018A.UVDATA.1

Freq = 4.9270 GHz, Bw = 16.000 MH No calibration applied and no bandpass applied

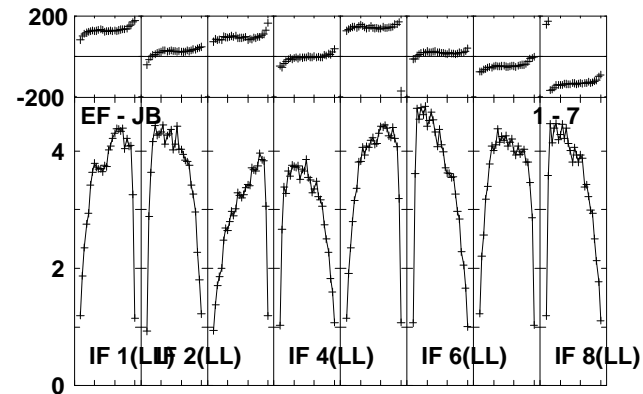
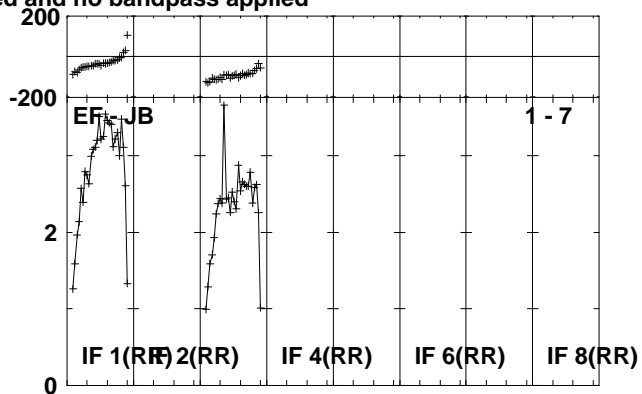
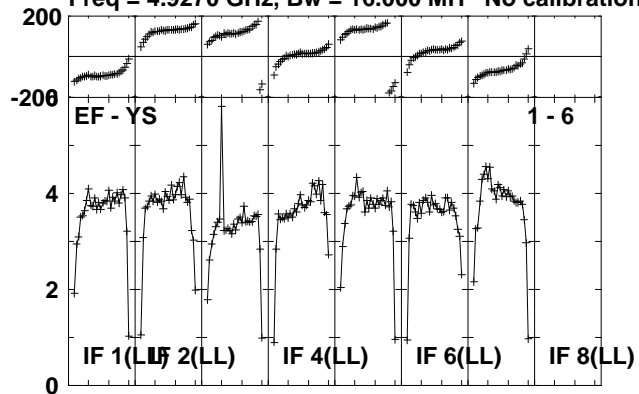

Lower frame: Milli Ampl Jy Top frame: Phas deg
Scalar averaged cross-power spectrum Several baselines displayed
Timerange: 00/18:23:46 to 00/18:26:18

Plot file version 153 created 02-DEC-2011 14:52:48

CYGX-1 ET018A.UVDATA.1

Freq = 4.9270 GHz, Bw = 16.000 MH No calibration applied and no bandpass applied

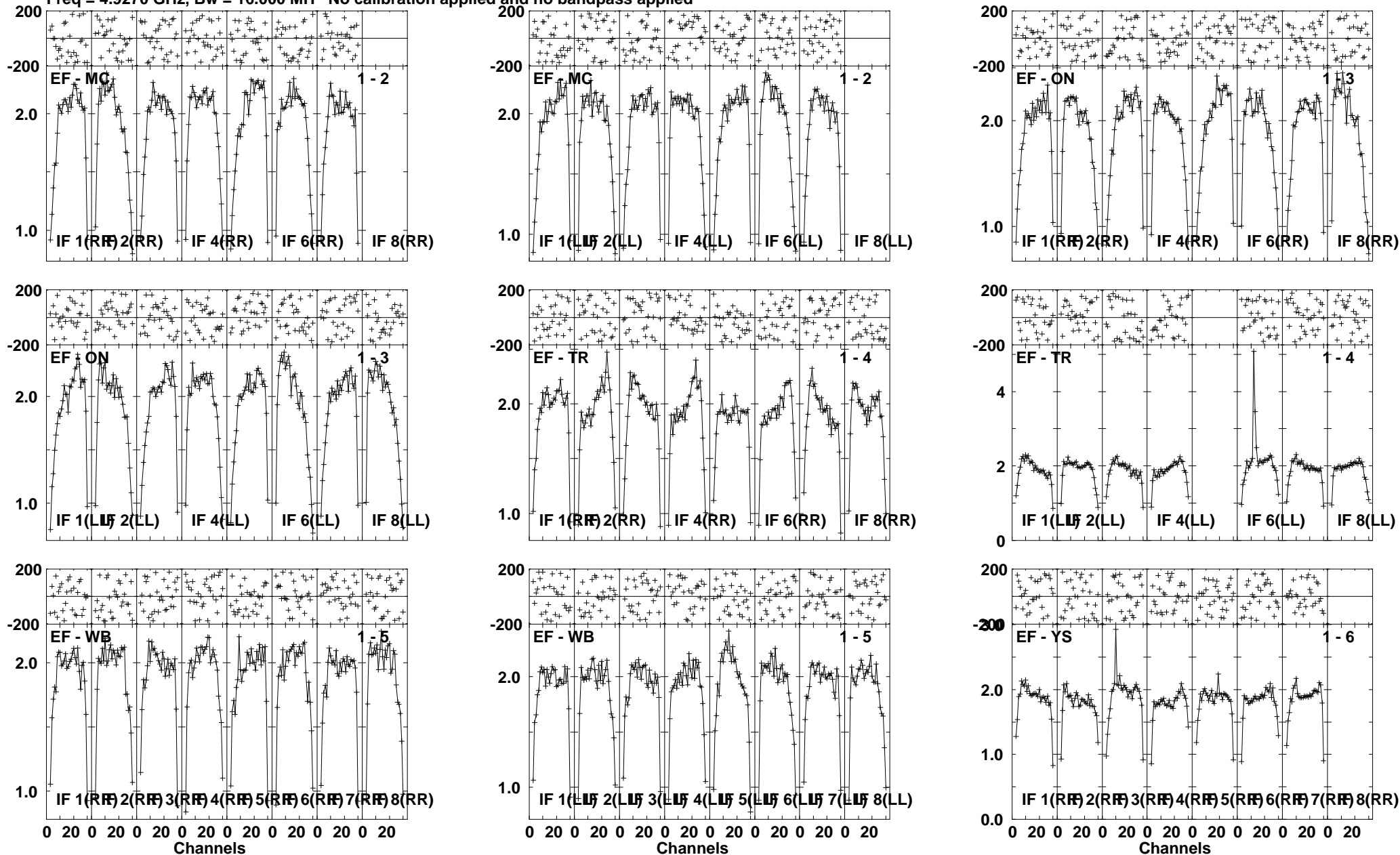

Lower frame: Milli Ampl Jy Top frame: Phas deg
Scalar averaged cross-power spectrum Several baselines displayed
Timerange: 00/18:26:22 to 00/18:31:49

Plot file version 154 created 02-DEC-2011 14:52:50

CYGX-1 ET018A.UVDATA.1

Freq = 4.9270 GHz, Bw = 16.000 MH No calibration applied and no bandpass applied

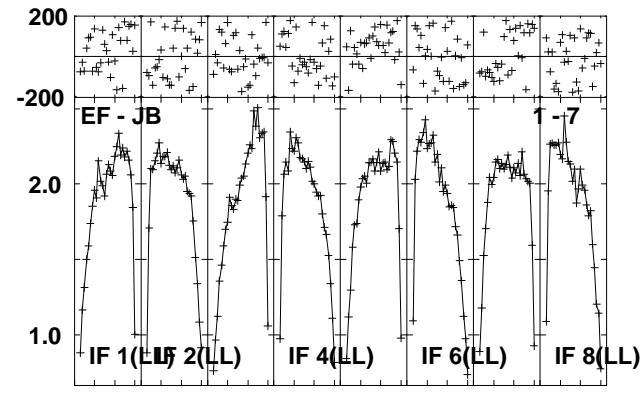
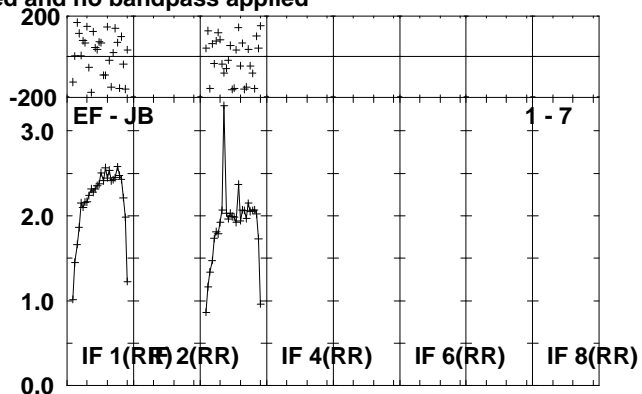
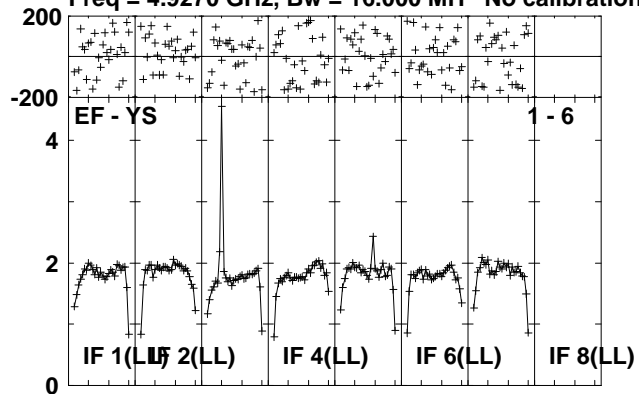

Lower frame: Milli Ampl Jy Top frame: Phas deg
Scalar averaged cross-power spectrum Several baselines displayed
Timerange: 00/18:26:22 to 00/18:31:49

Plot file version 155 created 02-DEC-2011 14:52:53

J1953+35 ET018A.UVDATA.1

Freq = 4.9270 GHz, Bw = 16.000 MH No calibration applied and no bandpass applied

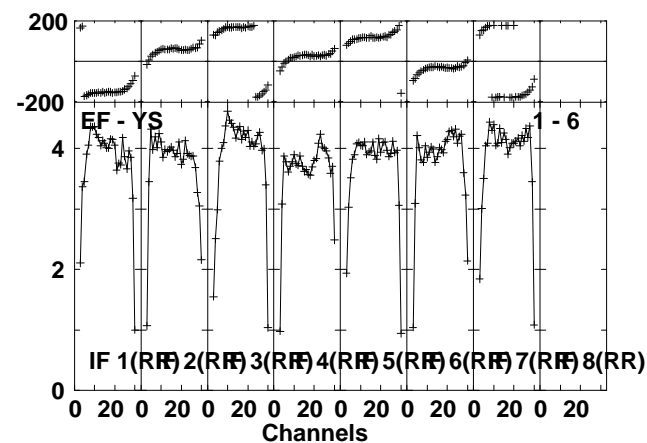
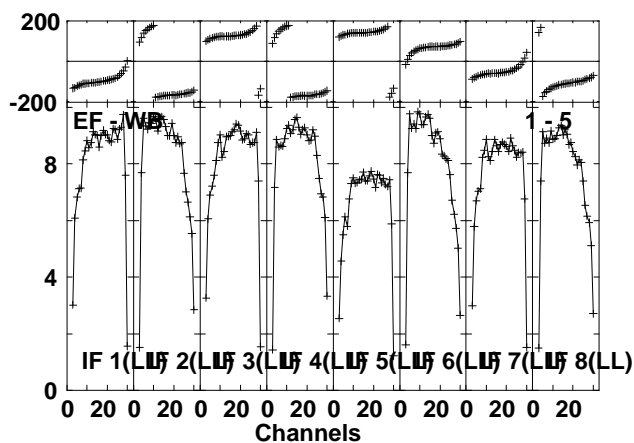
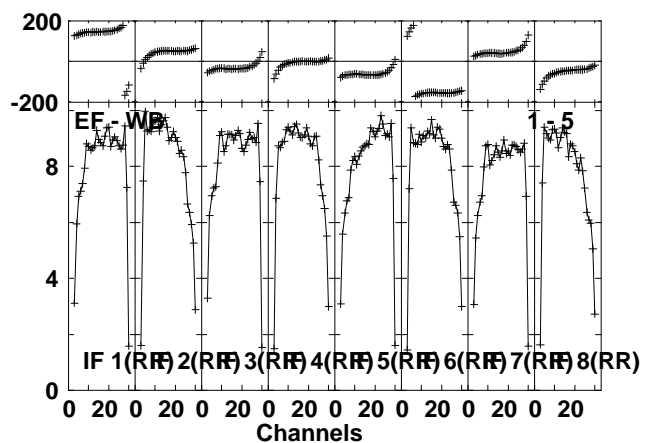
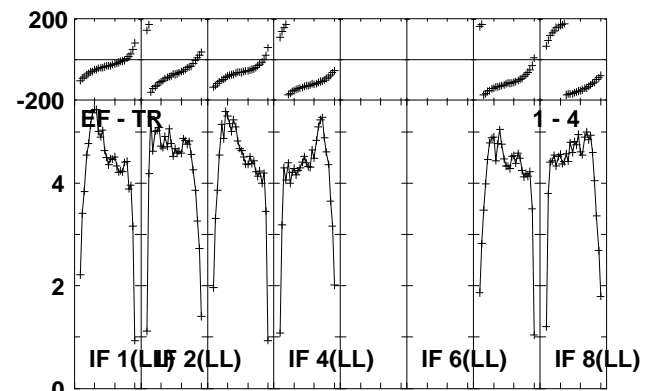
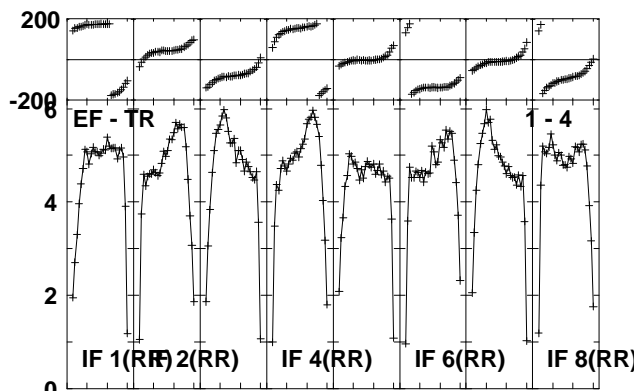
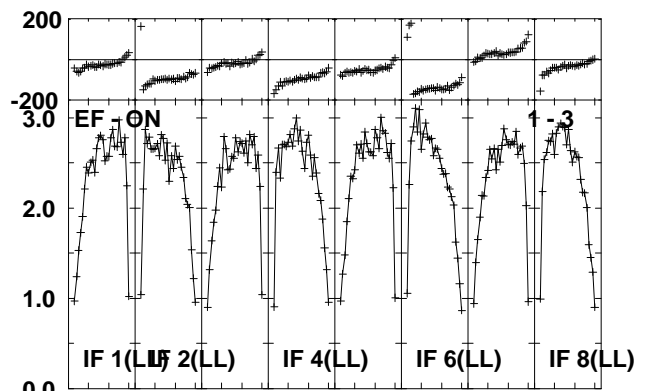
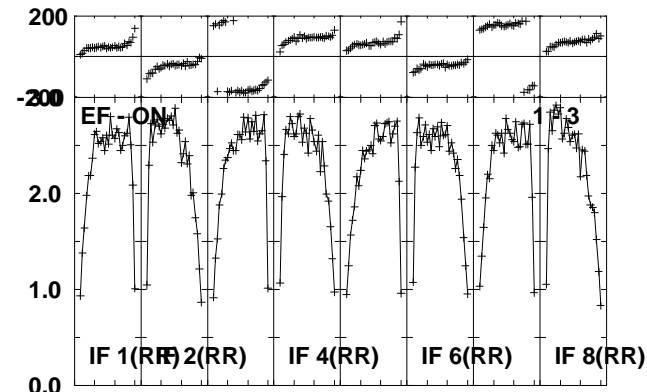
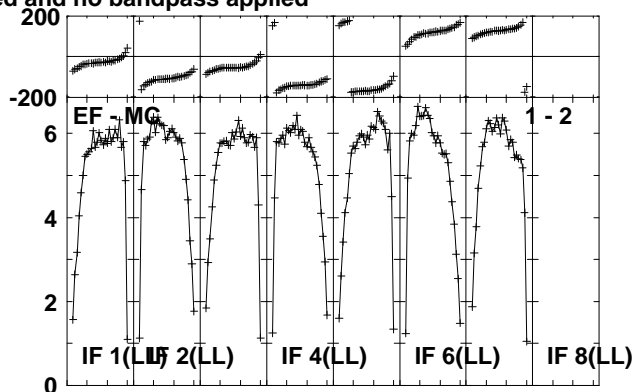
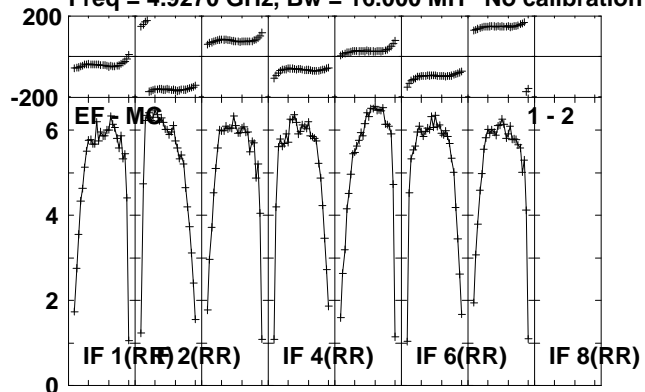

Lower frame: Milli Ampl Jy Top frame: Phas deg
Scalar averaged cross-power spectrum Several baselines displayed
Timerange: 00/18:31:51 to 00/18:34:48

Plot file version 156 created 02-DEC-2011 14:52:54

J1953+35 ET018A.UVDATA.1

Freq = 4.9270 GHz, Bw = 16.000 MH No calibration applied and no bandpass applied

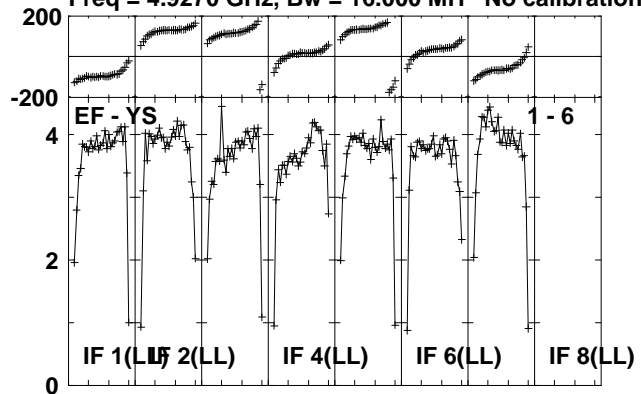

Lower frame: Milli Ampl Jy Top frame: Phas deg
Scalar averaged cross-power spectrum Several baselines displayed
Timerange: 00/18:31:51 to 00/18:34:48

Plot file version 157 created 02-DEC-2011 14:52:56

CYGX-1 ET018A.UVDATA.1

Freq = 4.9270 GHz, Bw = 16.000 MH No calibration applied and no bandpass applied

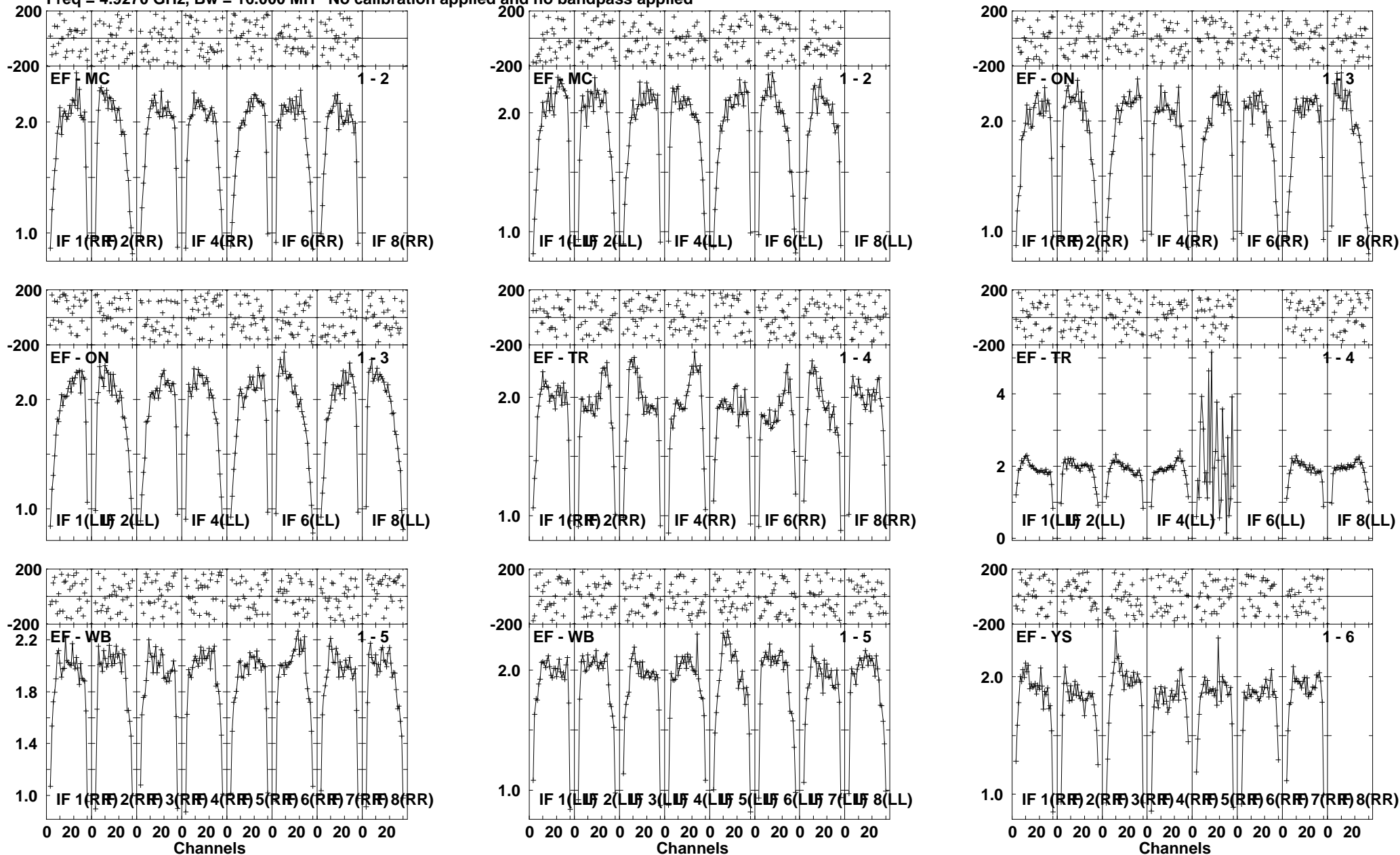

Lower frame: Milli Ampl Jy Top frame: Phas deg
Scalar averaged cross-power spectrum Several baselines displayed
Timerange: 00:18:34:52 to 00:18:40:18

Plot file version 158 created 02-DEC-2011 14:52:59

CYGX-1 ET018A.UVDATA.1

Freq = 4.9270 GHz, Bw = 16.000 MH No calibration applied and no bandpass applied

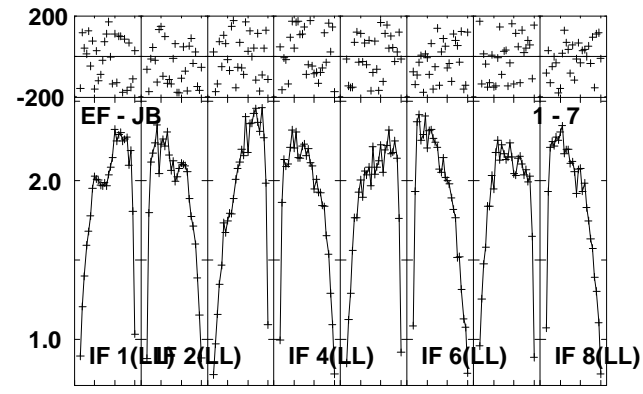
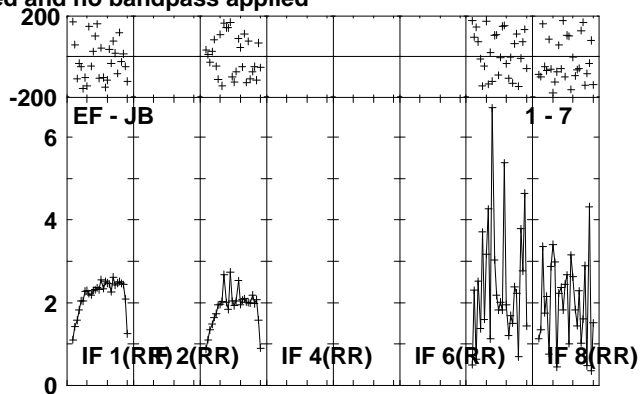
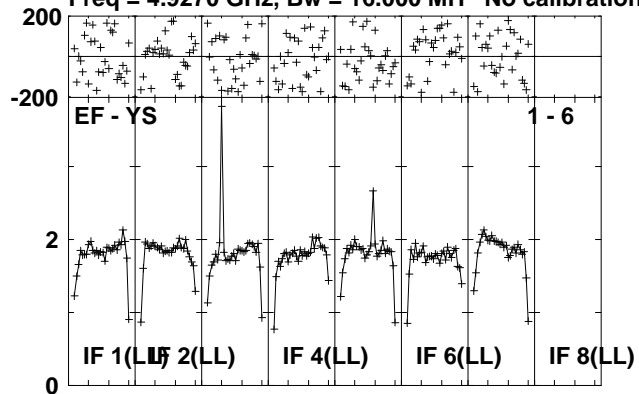

Lower frame: Milli Ampl Jy Top frame: Phas deg
Scalar averaged cross-power spectrum Several baselines displayed
Timerange: 00/18:34:52 to 00/18:40:18

Plot file version 159 created 02-DEC-2011 14:53:01

J1953+35 ET018A.UVDATA.1

Freq = 4.9270 GHz, Bw = 16.000 MH No calibration applied and no bandpass applied

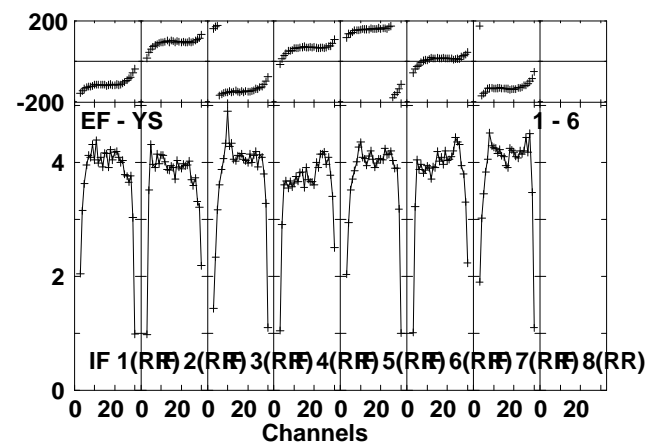
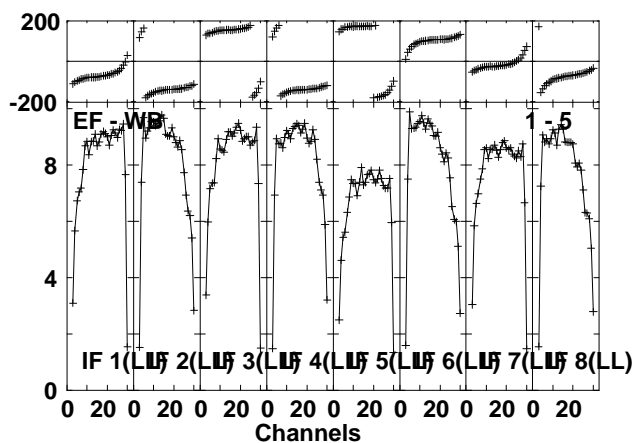
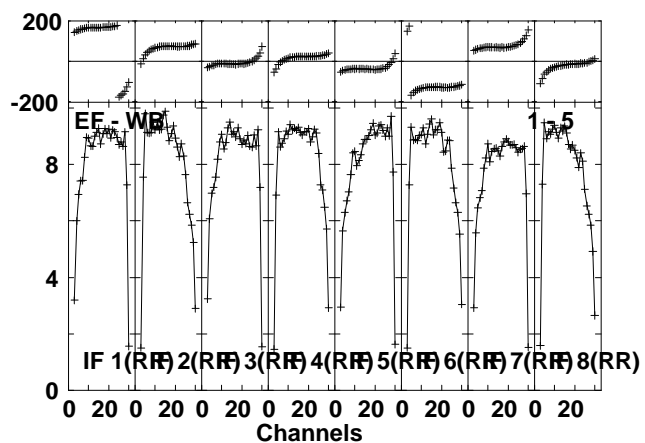
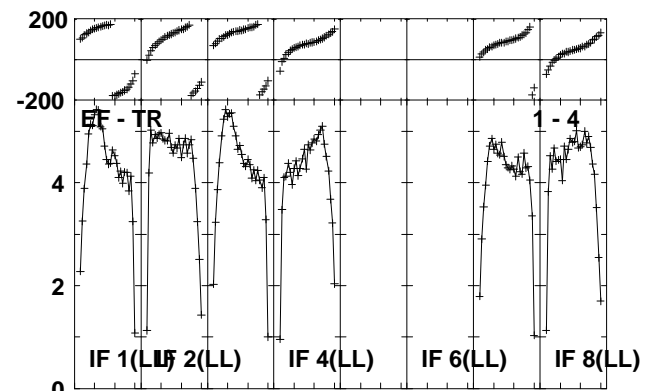
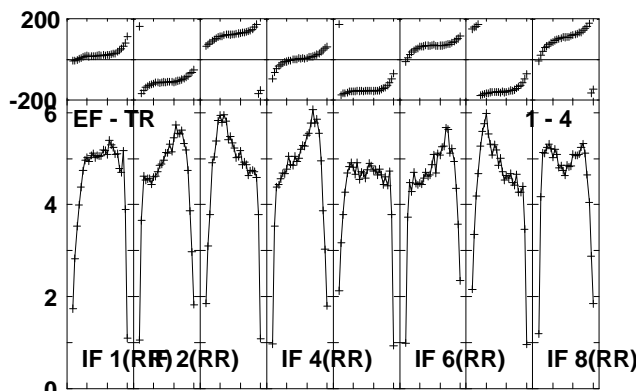
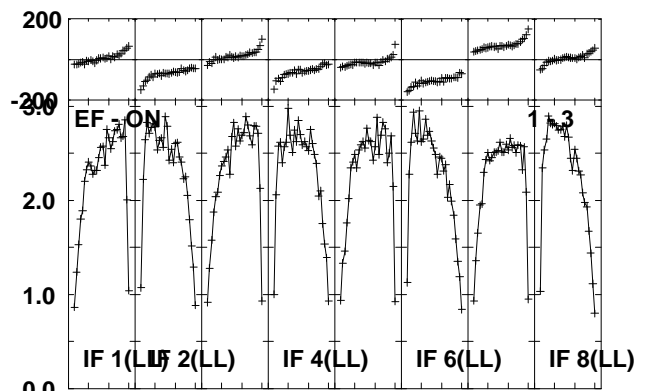
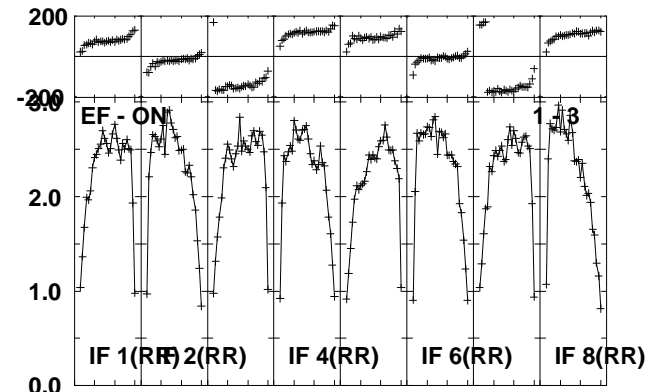
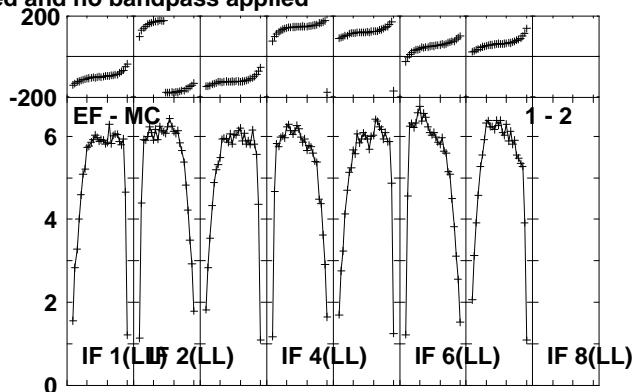
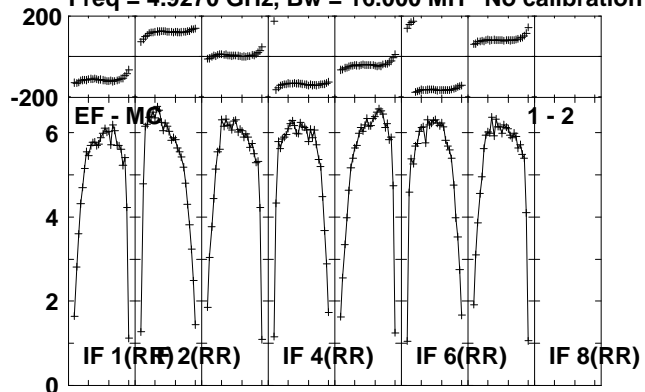

Lower frame: Milli Ampl Jy Top frame: Phas deg
Scalar averaged cross-power spectrum Several baselines displayed
Timerange: 00/18:41:06 to 00/18:43:38

Plot file version 160 created 02-DEC-2011 14:53:03

J1953+35 ET018A.UVDATA.1

Freq = 4.9270 GHz, Bw = 16.000 MH No calibration applied and no bandpass applied

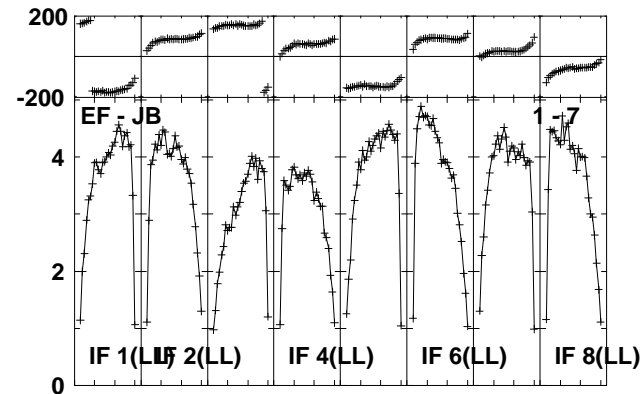
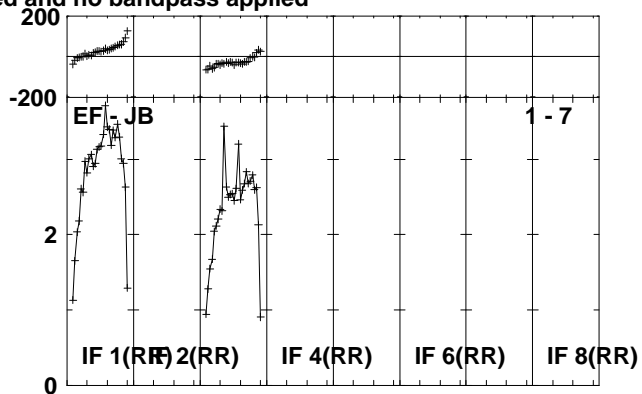
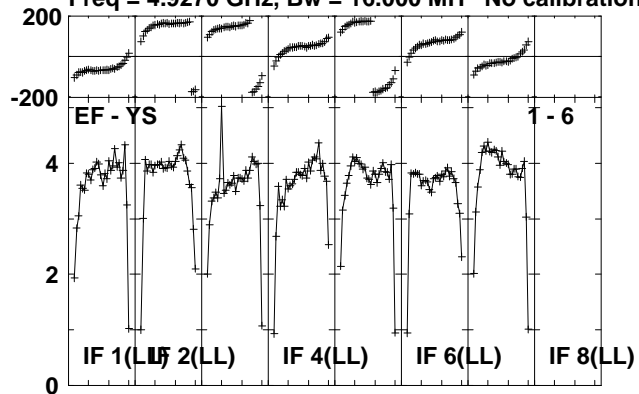

Lower frame: Milli Ampl Jy Top frame: Phas deg
Scalar averaged cross-power spectrum Several baselines displayed
Timerange: 00/18:41:06 to 00/18:43:38

Plot file version 161 created 02-DEC-2011 14:53:04

CYGX-1 ET018A.UVDATA.1

Freq = 4.9270 GHz, Bw = 16.000 MH No calibration applied and no bandpass applied

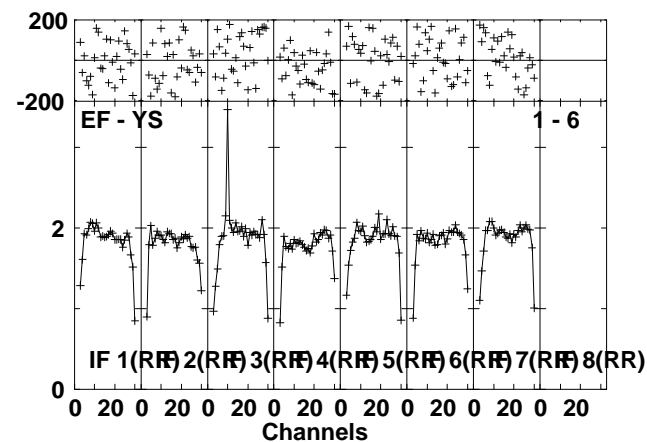
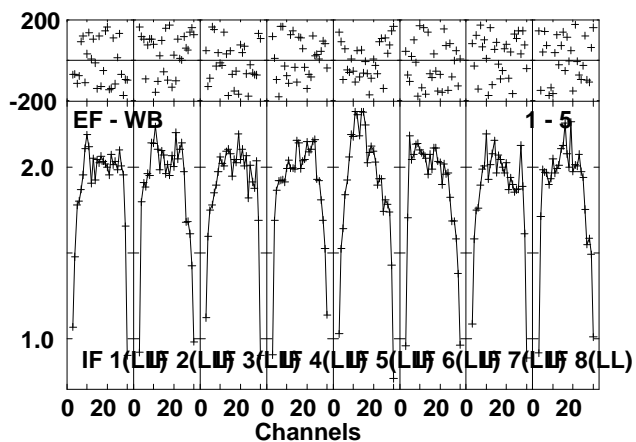
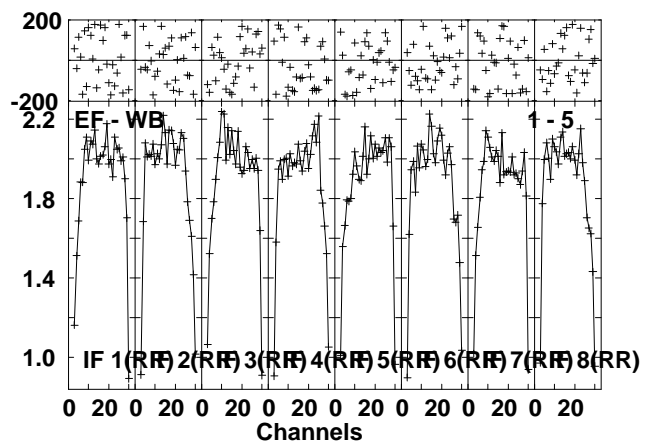
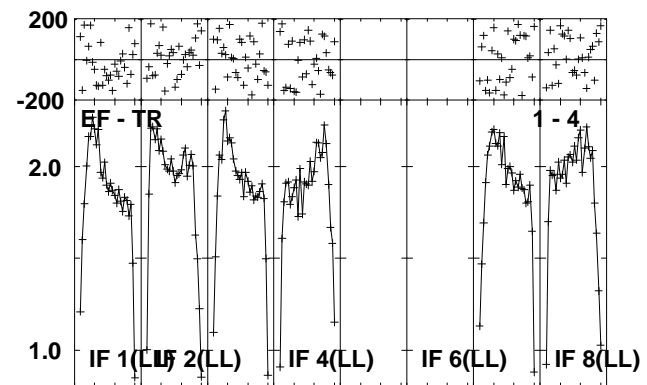
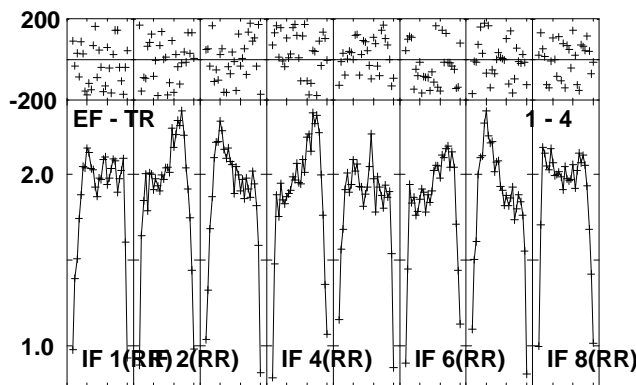
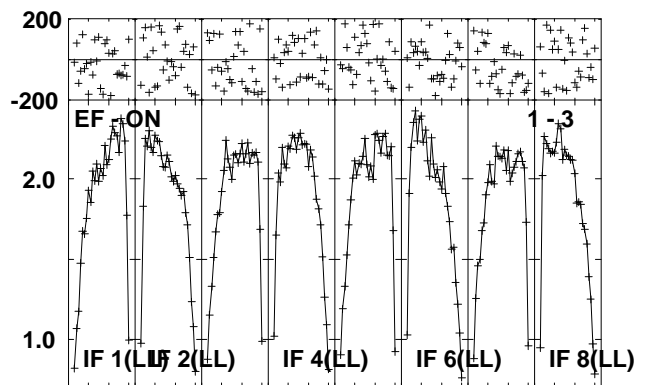
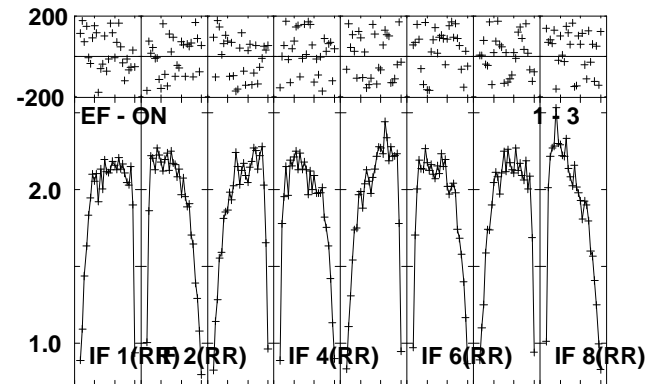
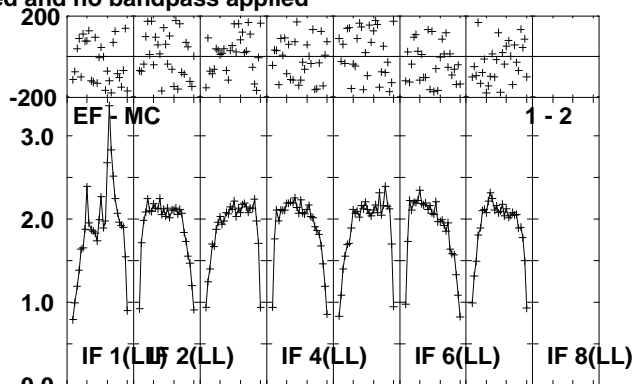
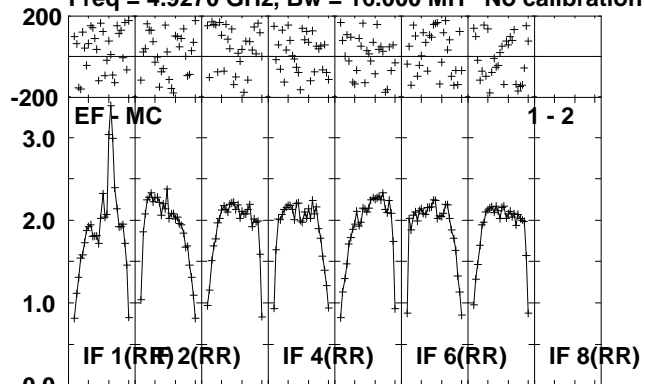

Lower frame: Milli Ampl Jy Top frame: Phas deg
Scalar averaged cross-power spectrum Several baselines displayed
Timerange: 00:18:43:42 to 00:18:49:09

Plot file version 162 created 02-DEC-2011 14:53:07

CYGX-1 ET018A.UVDATA.1

Freq = 4.9270 GHz, Bw = 16.000 MH No calibration applied and no bandpass applied

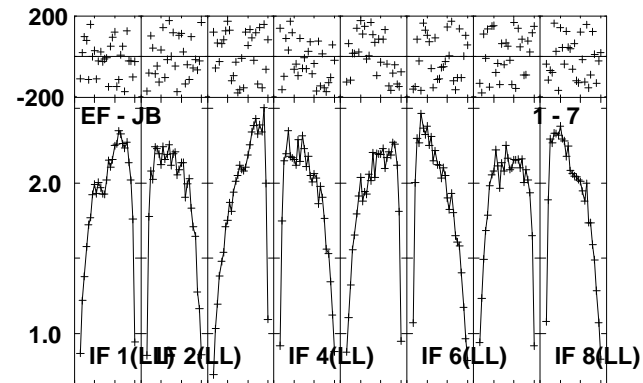
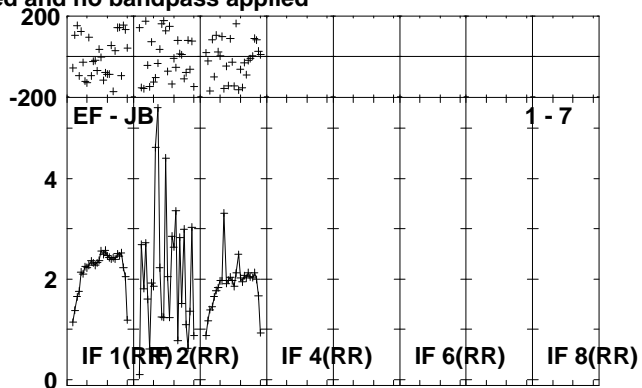
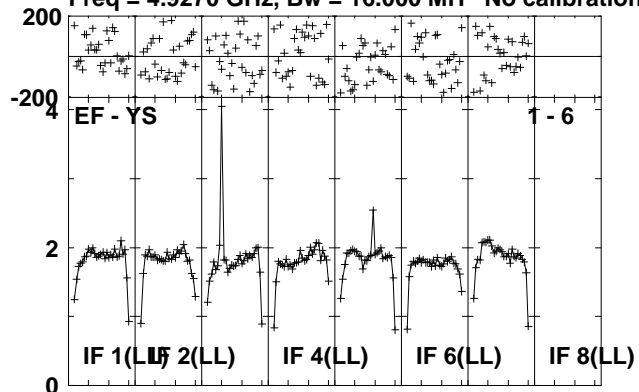

Lower frame: Milli Ampl Jy Top frame: Phas deg
Scalar averaged cross-power spectrum Several baselines displayed
Timerange: 00/18:43:42 to 00/18:49:09

Plot file version 163 created 02-DEC-2011 14:53:10

J1953+35 ET018A.UVDATA.1

Freq = 4.9270 GHz, Bw = 16.000 MH No calibration applied and no bandpass applied

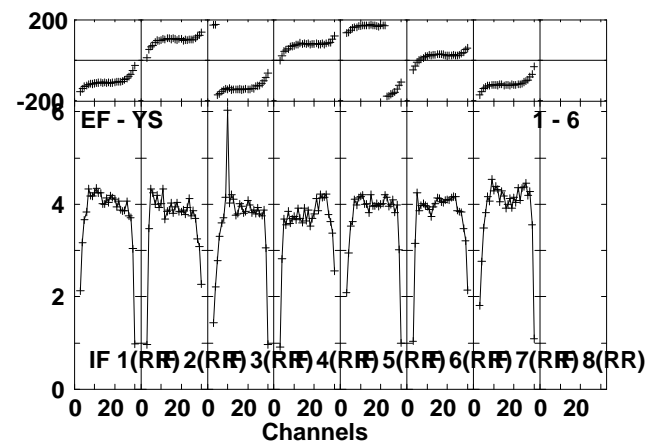
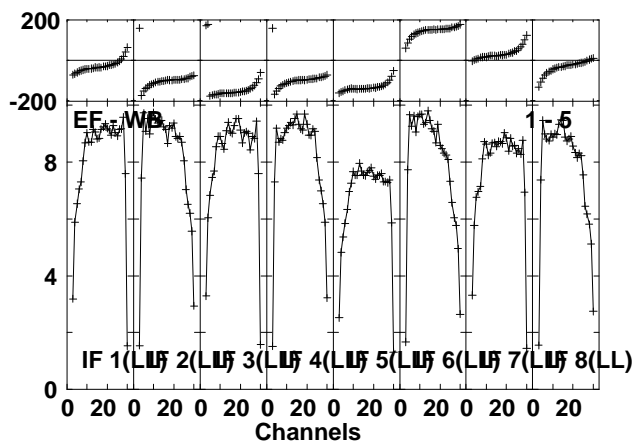
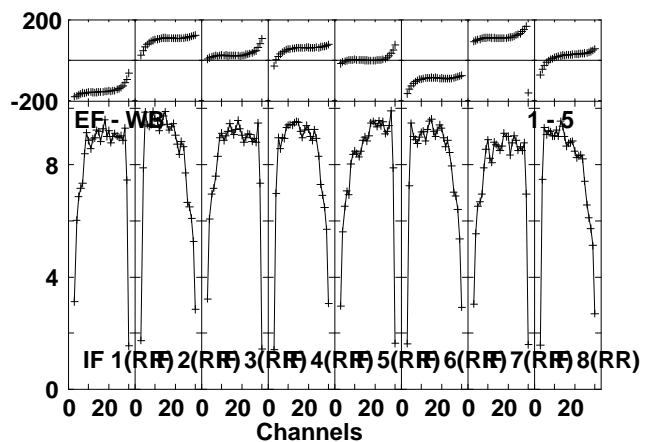
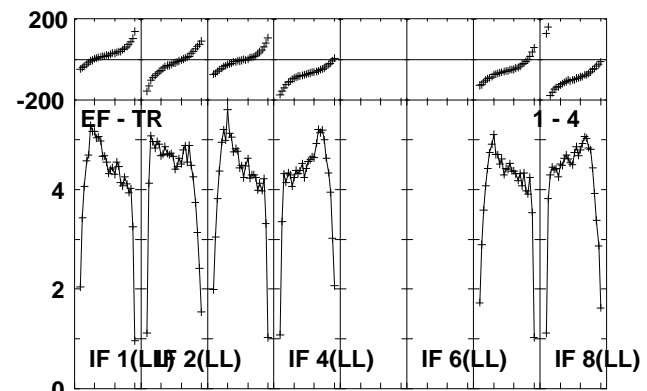
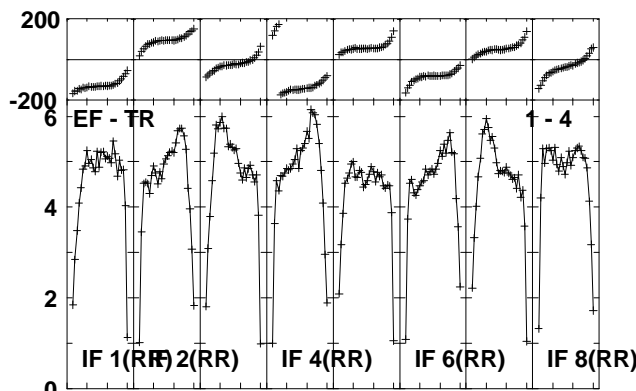
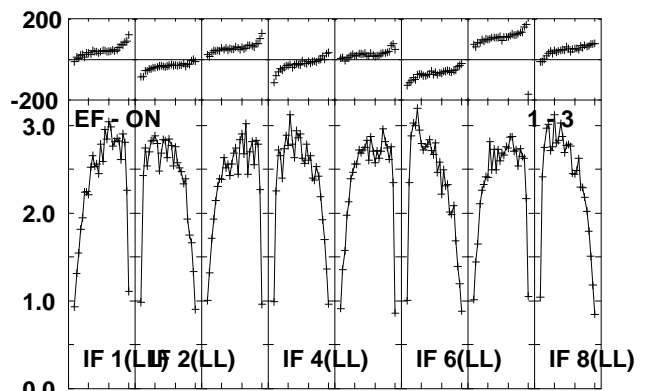
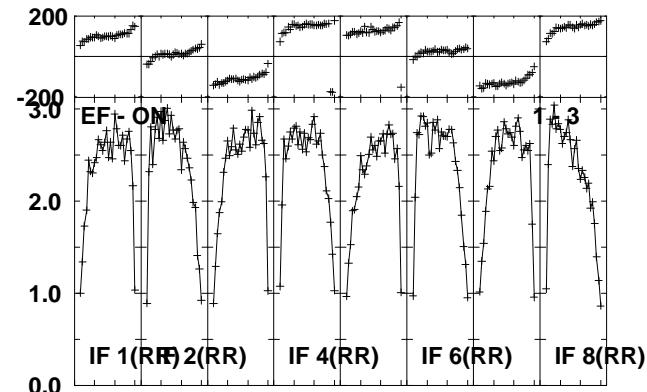
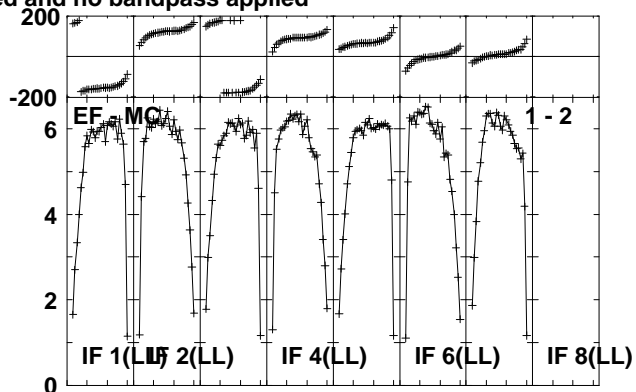
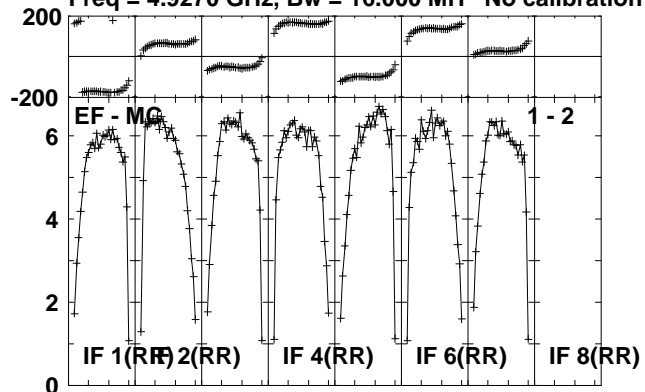

Lower frame: Milli Ampl Jy Top frame: Phas deg
Scalar averaged cross-power spectrum Several baselines displayed
Timerange: 00:18:49:11 to 00:18:52:08

Plot file version 164 created 02-DEC-2011 14:53:12

J1953+35 ET018A.UVDATA.1

Freq = 4.9270 GHz, Bw = 16.000 MH No calibration applied and no bandpass applied

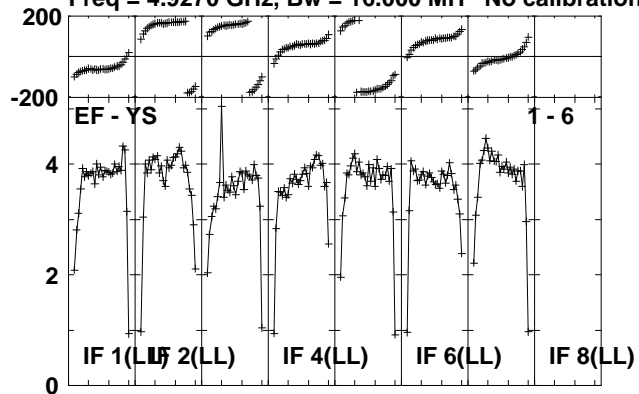

Lower frame: Milli Ampl Jy Top frame: Phas deg
Scalar averaged cross-power spectrum Several baselines displayed
Timerange: 00/18:49:11 to 00/18:52:08

Plot file version 165 created 02-DEC-2011 14:53:15

CYGX-1 ET018A.UVDATA.1

Freq = 4.9270 GHz, Bw = 16.000 MH No calibration applied and no bandpass applied

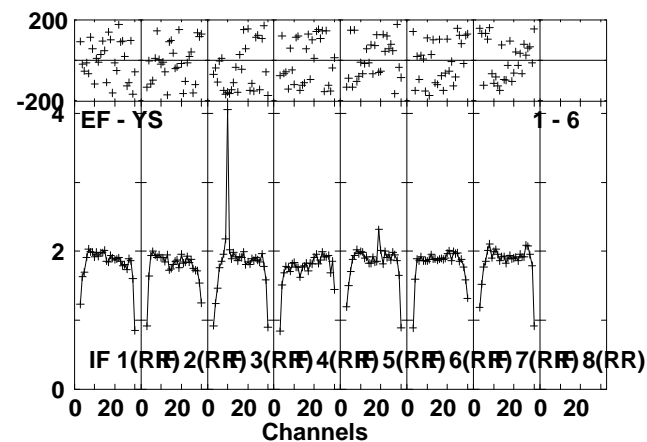
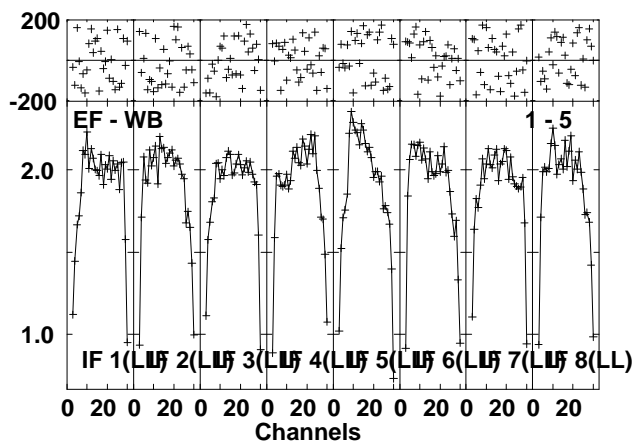
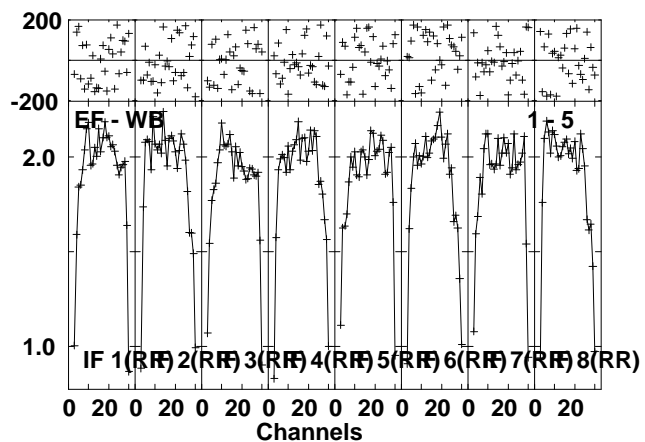
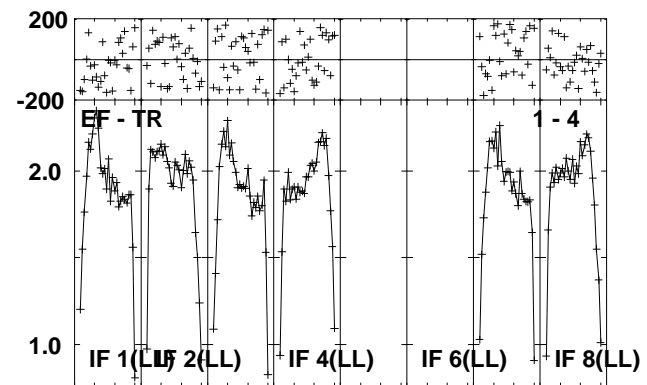
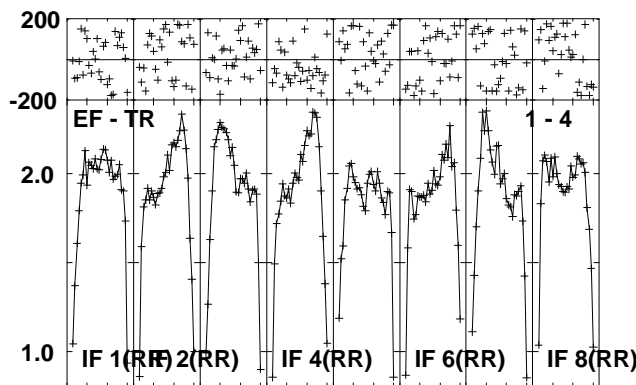
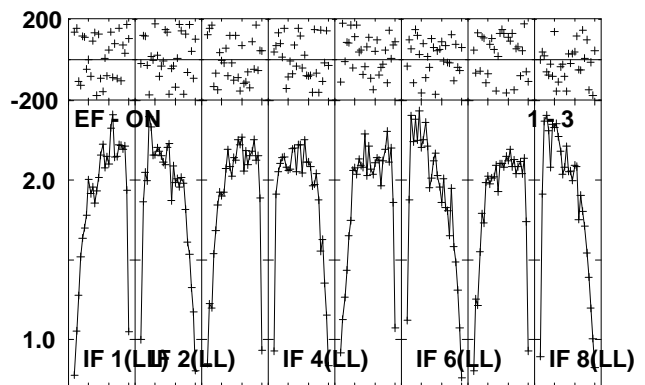
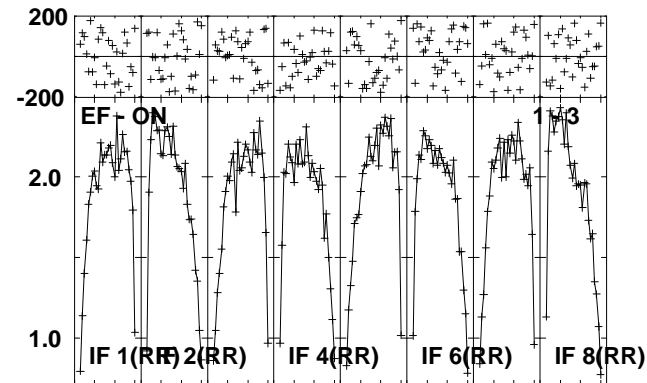
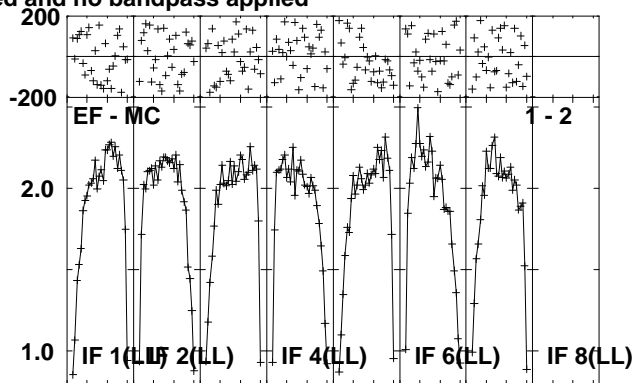
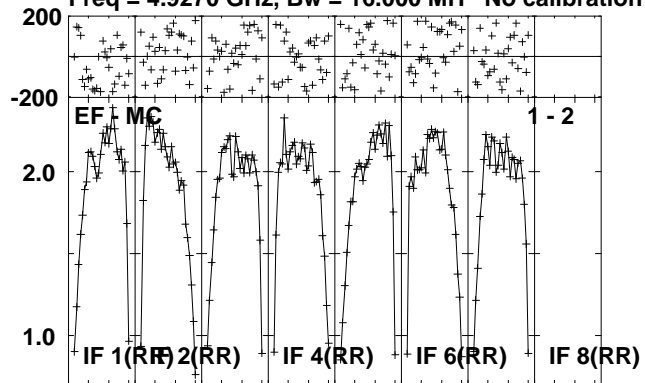

Lower frame: Milli Ampl Jy Top frame: Phas deg
Scalar averaged cross-power spectrum Several baselines displayed
Timerange: 00/18:52:12 to 00/18:57:38

Plot file version 166 created 02-DEC-2011 14:53:17

CYGX-1 ET018A.UVDATA.1

Freq = 4.9270 GHz, Bw = 16.000 MH No calibration applied and no bandpass applied

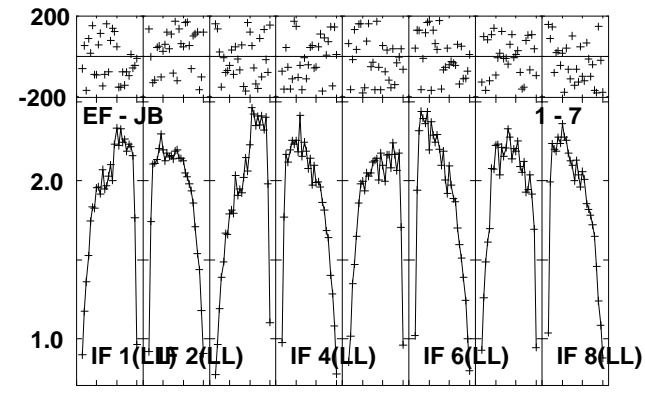
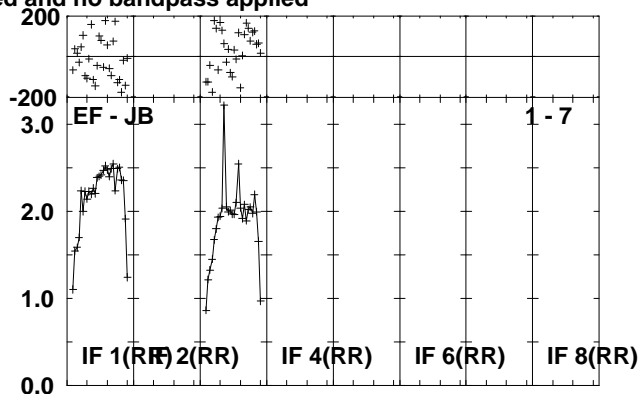
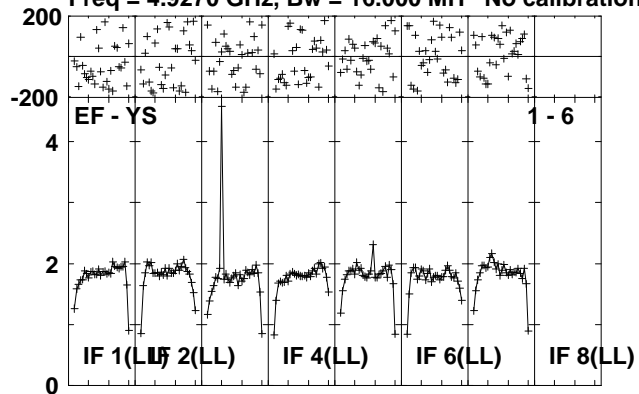

Lower frame: Milli Ampl Jy Top frame: Phas deg
Scalar averaged cross-power spectrum Several baselines displayed
Timerange: 00/18:52:12 to 00/18:57:38

Plot file version 167 created 02-DEC-2011 14:53:20

J1953+35 ET018A.UVDATA.1

Freq = 4.9270 GHz, Bw = 16.000 MH No calibration applied and no bandpass applied

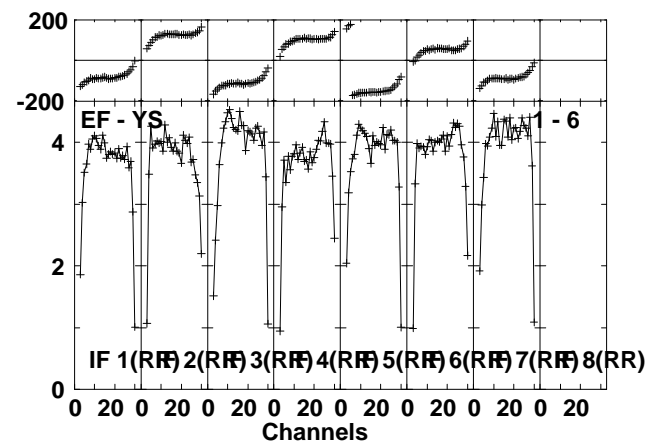
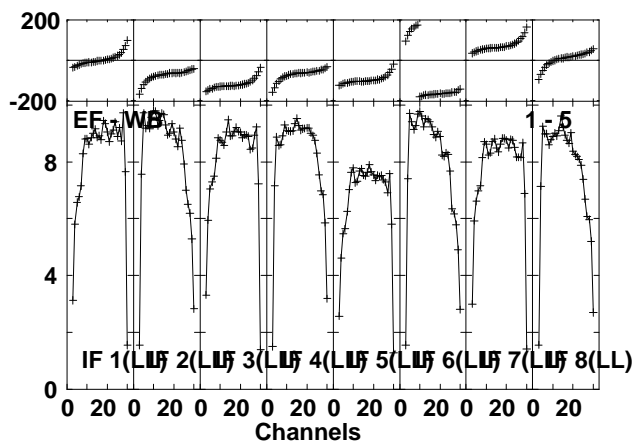
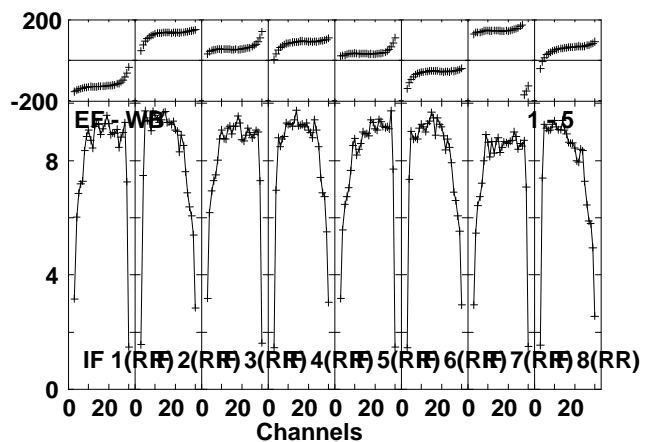
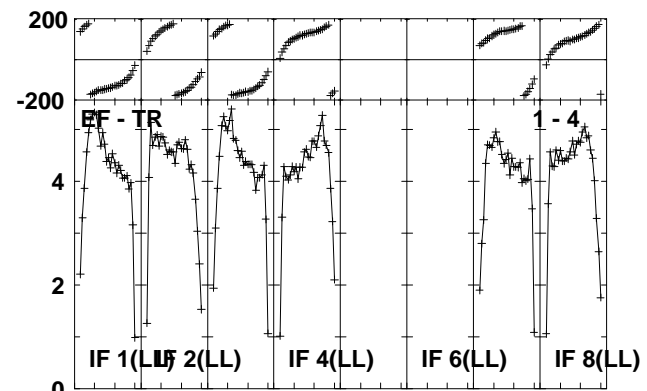
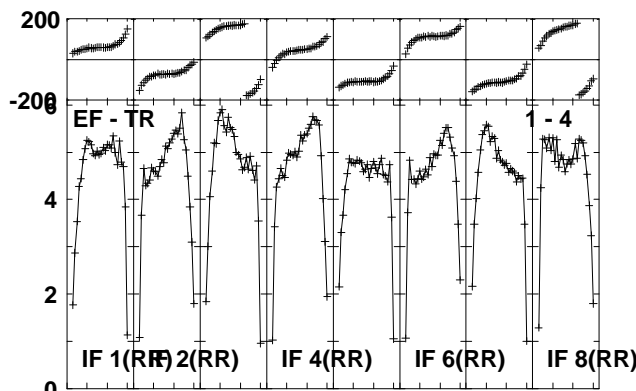
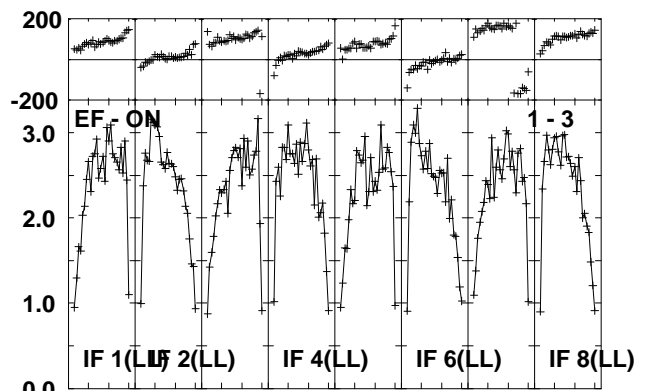
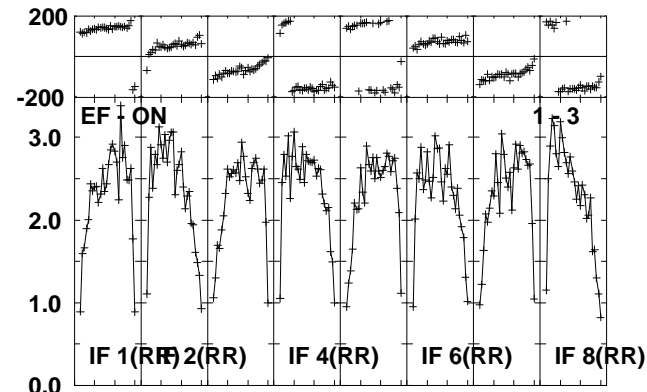
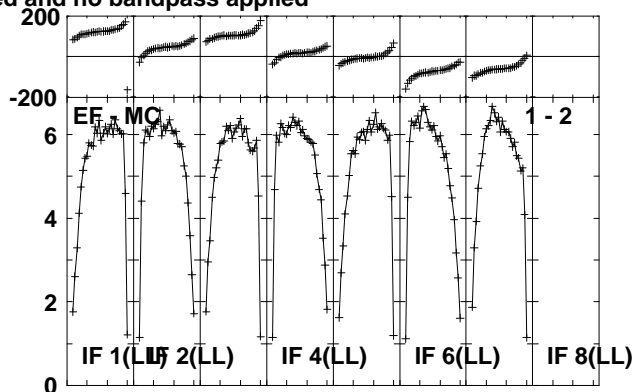
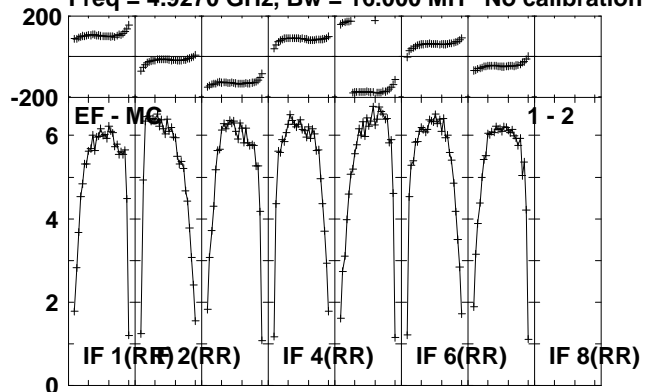

Lower frame: Milli Ampl Jy Top frame: Phas deg
Scalar averaged cross-power spectrum Several baselines displayed
Timerange: 00/18:58:26 to 00/19:00:58

Plot file version 168 created 02-DEC-2011 14:53:21

J1953+35 ET018A.UVDATA.1

Freq = 4.9270 GHz, Bw = 16.000 MH No calibration applied and no bandpass applied

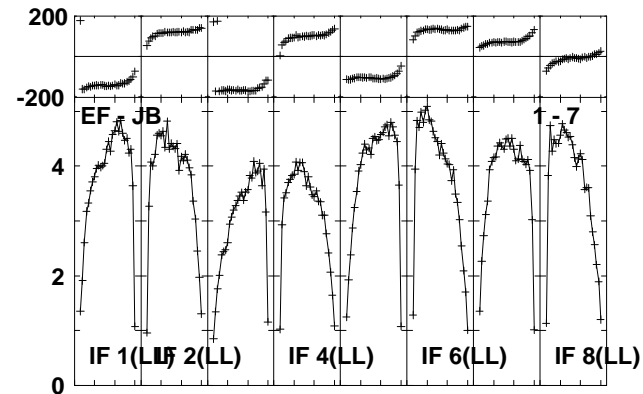
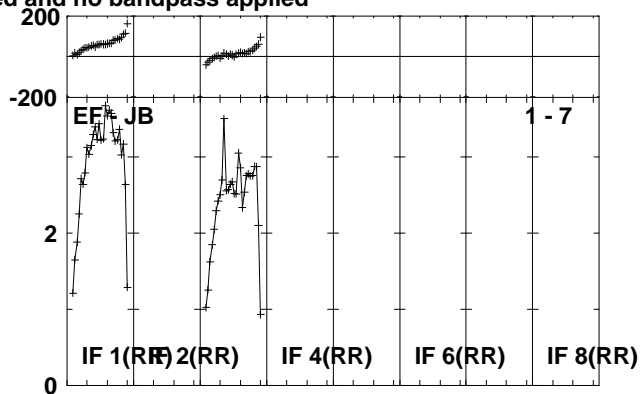
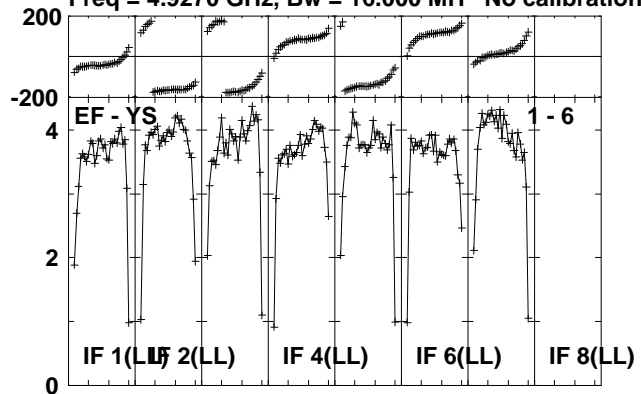

Lower frame: Milli Ampl Jy Top frame: Phas deg
Scalar averaged cross-power spectrum Several baselines displayed
Timerange: 00/18:58:26 to 00/19:00:58

Plot file version 169 created 02-DEC-2011 14:53:23

J2002+47 ET018A.UVDATA.1

Freq = 4.9270 GHz, Bw = 16.000 MH No calibration applied and no bandpass applied

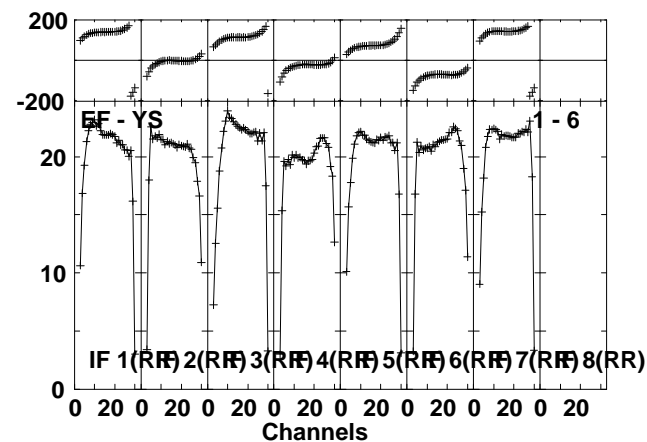
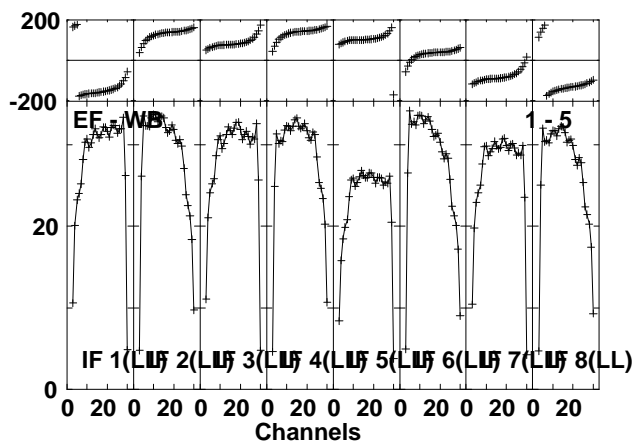
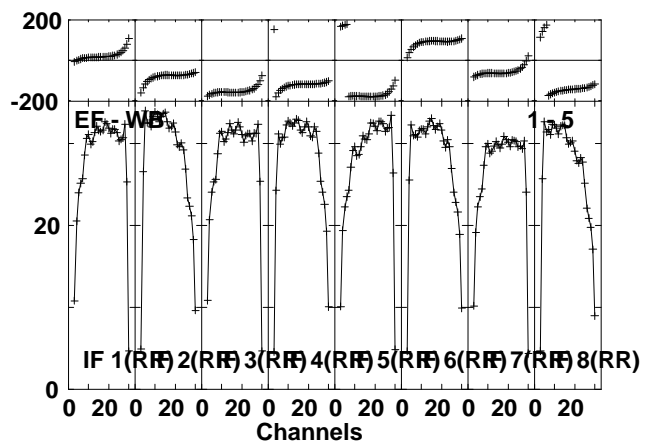
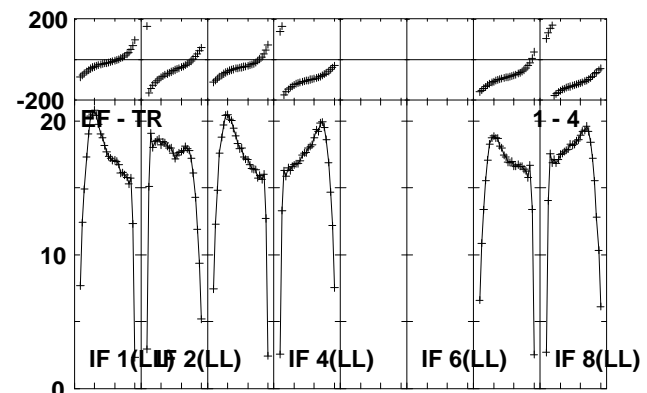
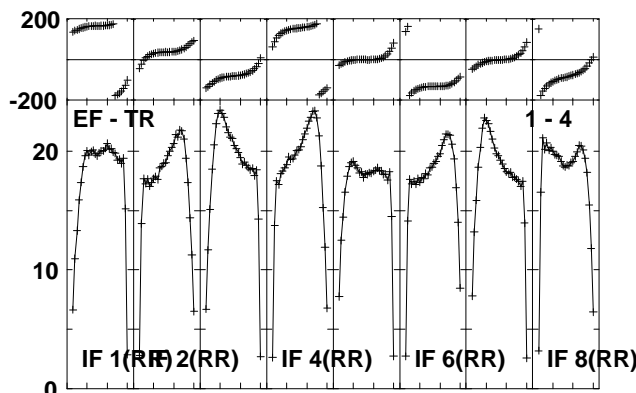
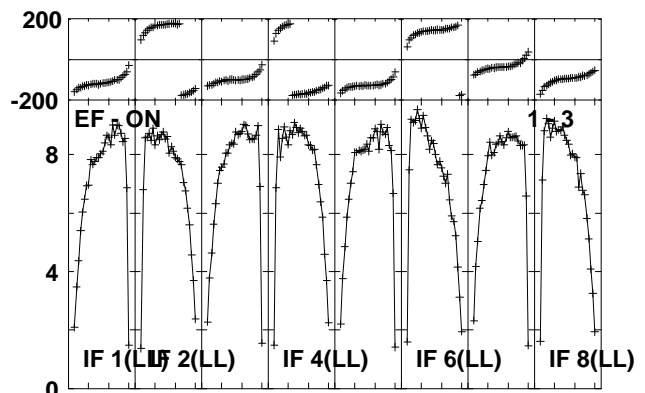
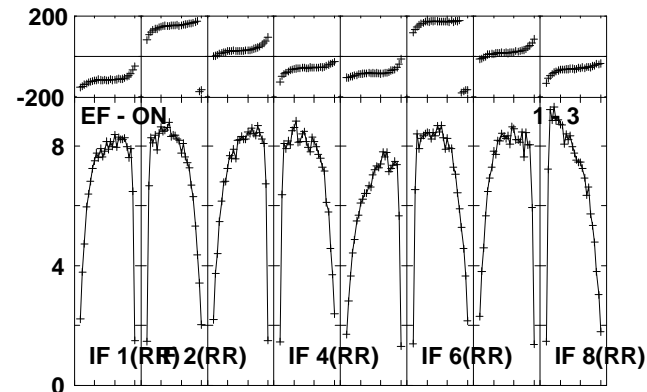
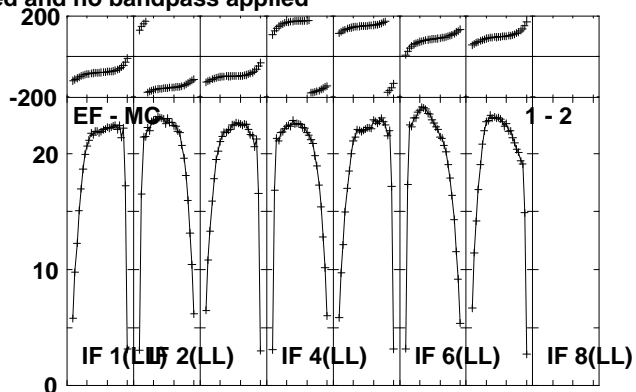
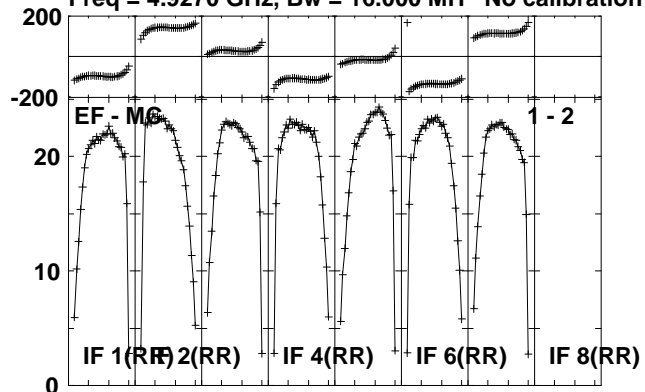

Lower frame: Milli Ampl Jy Top frame: Phas deg
Scalar averaged cross-power spectrum Several baselines displayed
Timerange: 00/19:02:26 to 00/19:06:29

Plot file version 170 created 02-DEC-2011 14:53:24

J2002+47 ET018A.UVDATA.1

Freq = 4.9270 GHz, Bw = 16.000 MH No calibration applied and no bandpass applied

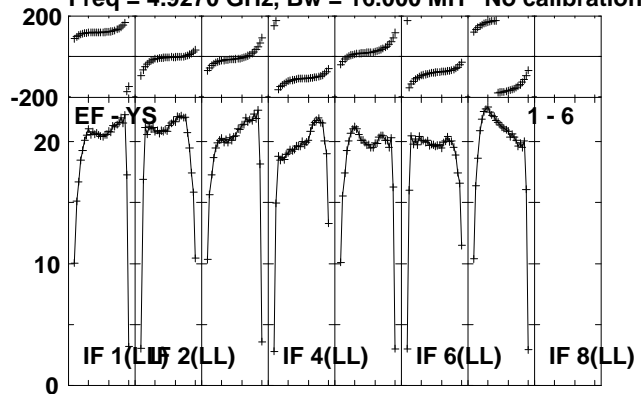

Lower frame: Milli Ampl Jy Top frame: Phas deg
Scalar averaged cross-power spectrum Several baselines displayed
Timerange: 00/19:02:26 to 00/19:06:29

Plot file version 171 created 02-DEC-2011 14:53:26

J1953+35 ET018A.UVDATA.1

Freq = 4.9270 GHz, Bw = 16.000 MH No calibration applied and no bandpass applied

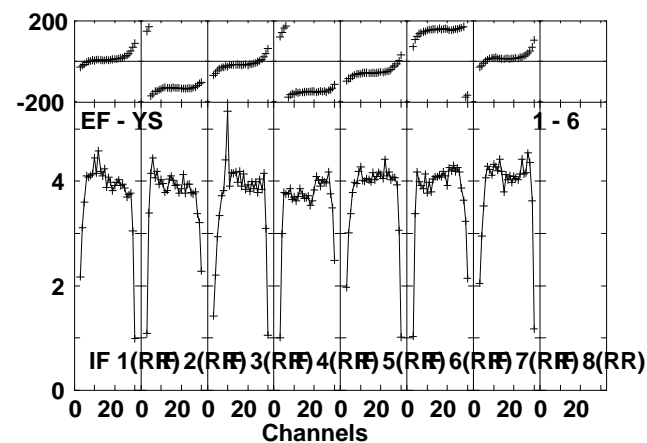
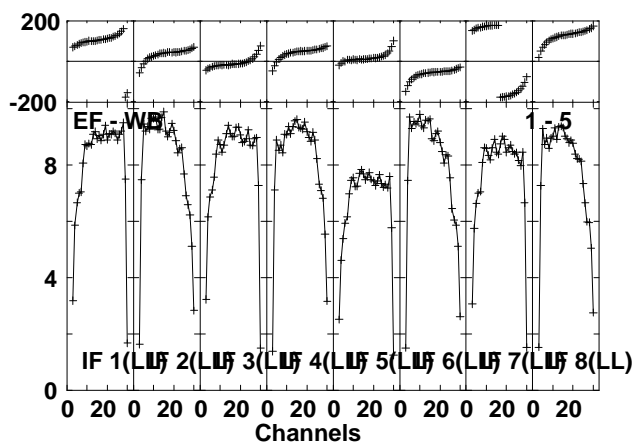
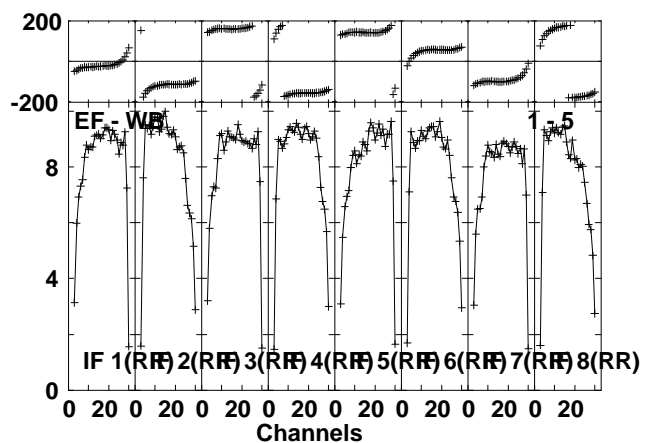
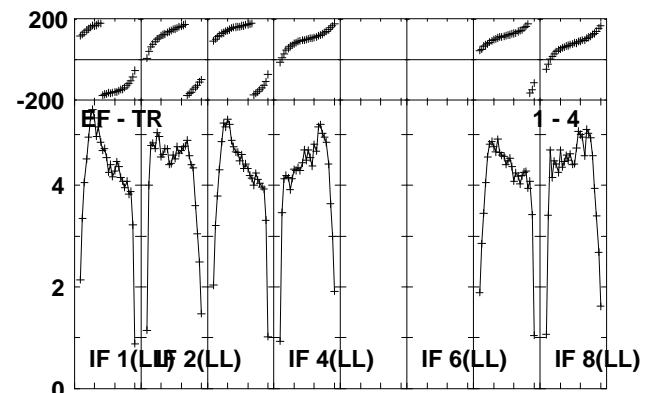
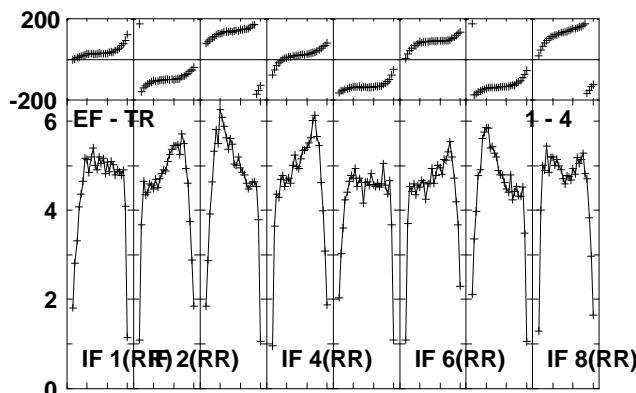
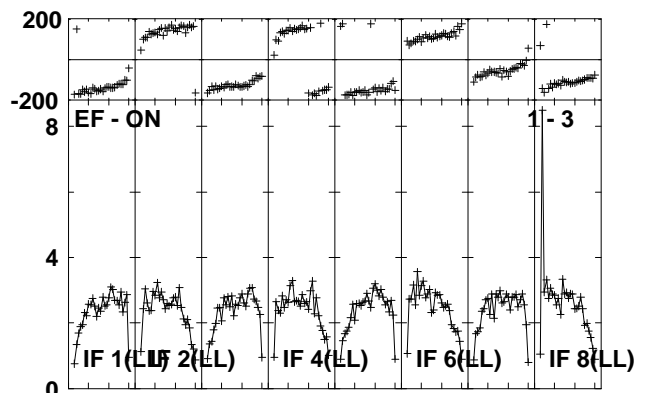
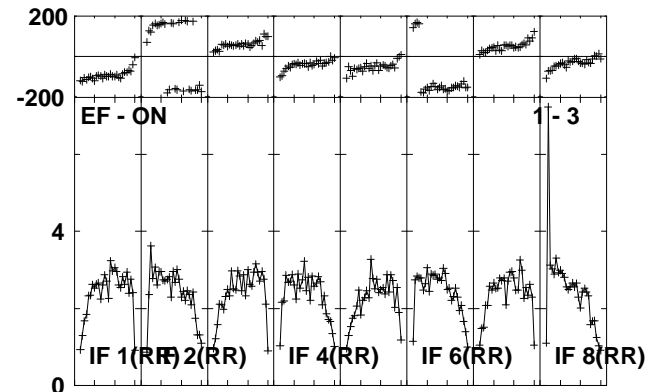
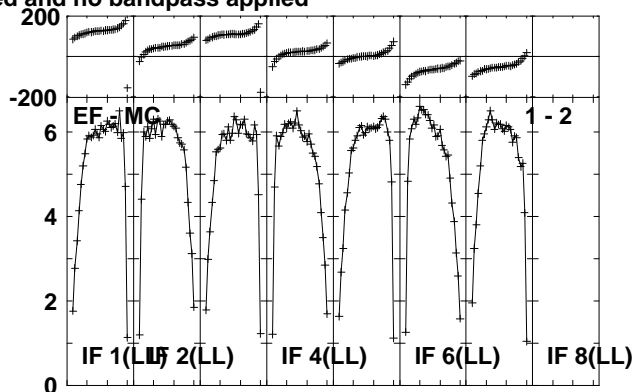
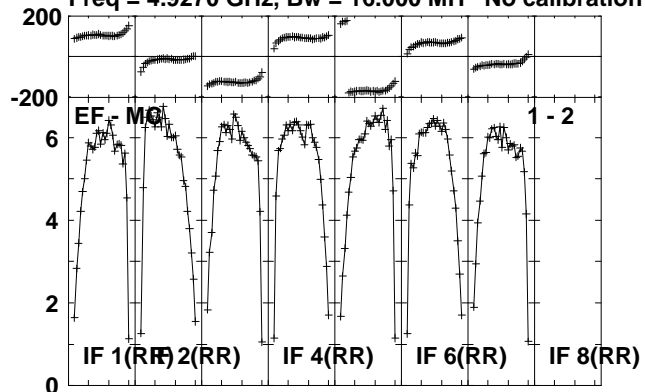

Lower frame: Milli Ampl Jy Top frame: Phas deg
Scalar averaged cross-power spectrum Several baselines displayed
Timerange: 00/19:07:26 to 00/19:10:59

Plot file version 172 created 02-DEC-2011 14:53:29

J1953+35 ET018A.UVDATA.1

Freq = 4.9270 GHz, Bw = 16.000 MH No calibration applied and no bandpass applied

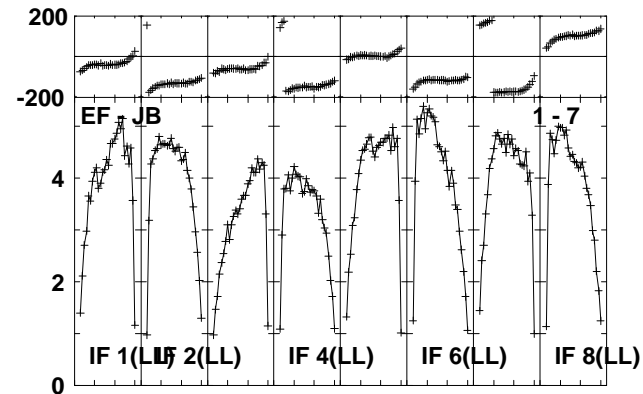
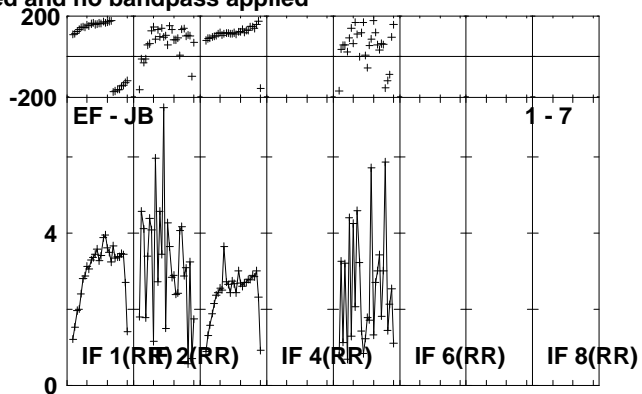
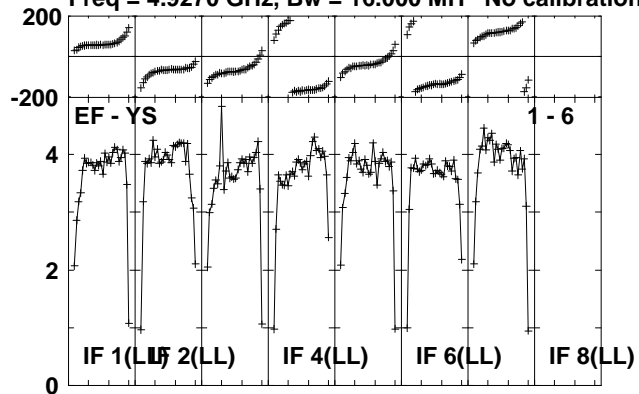

Lower frame: Milli Ampl Jy Top frame: Phas deg
Scalar averaged cross-power spectrum Several baselines displayed
Timerange: 00/19:07:26 to 00/19:10:59

Plot file version 173 created 02-DEC-2011 14:53:32

CYGX-1 ET018A.UVDATA.1

Freq = 4.9270 GHz, Bw = 16.000 MH No calibration applied and no bandpass applied

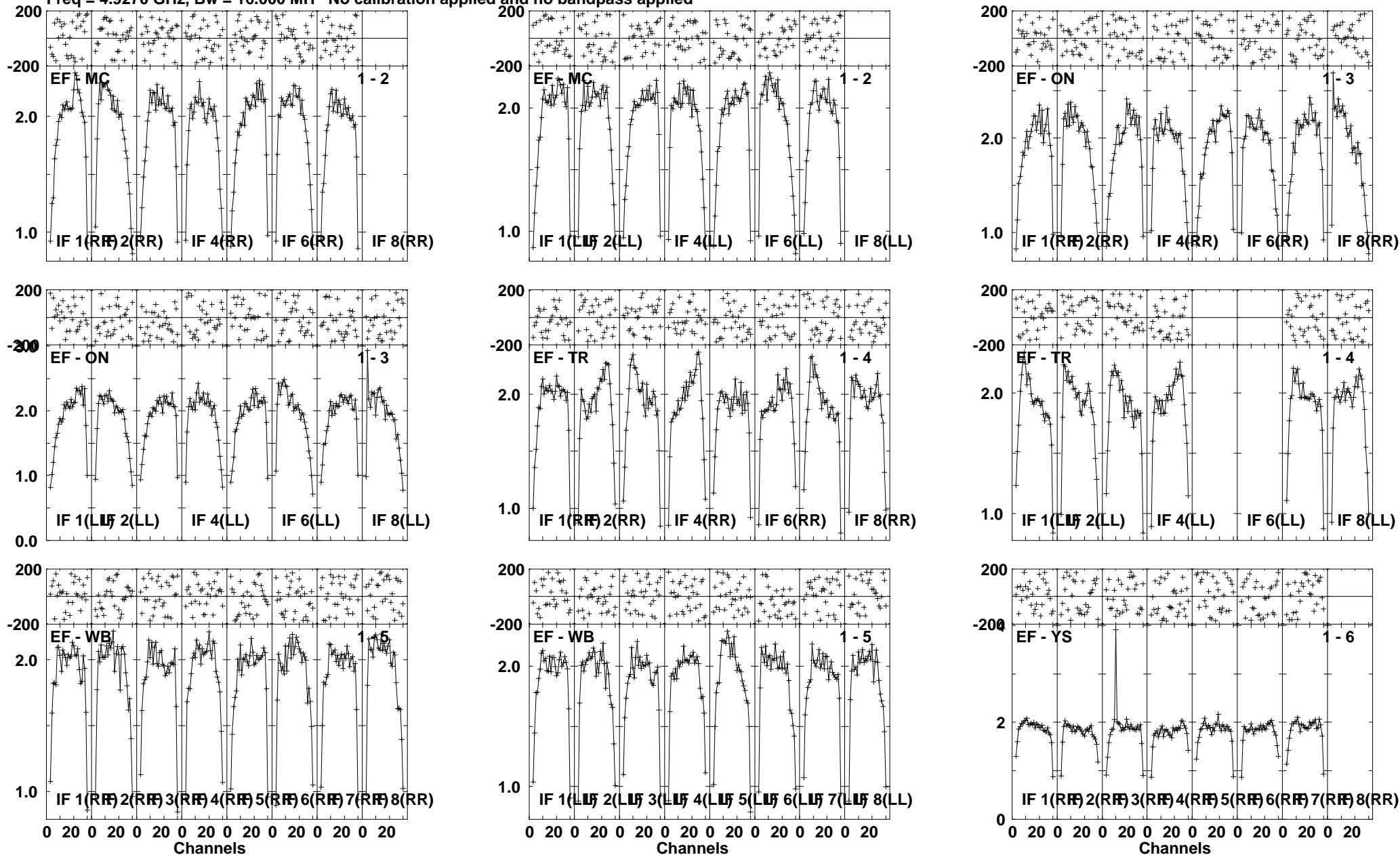

Lower frame: Milli Ampl Jy Top frame: Phas deg
Scalar averaged cross-power spectrum Several baselines displayed
Timerange: 00/19:11:02 to 00/19:16:28

Plot file version 174 created 02-DEC-2011 14:53:35

CYGX-1 ET018A.UVDATA.1

Freq = 4.9270 GHz, Bw = 16.000 MH No calibration applied and no bandpass applied

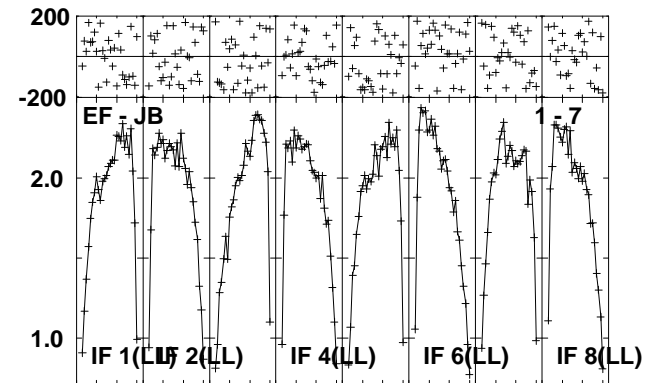
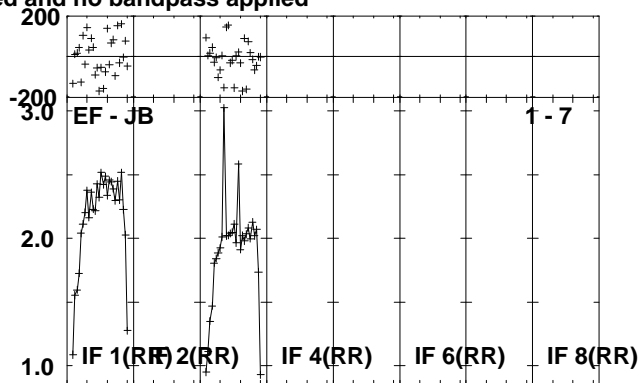
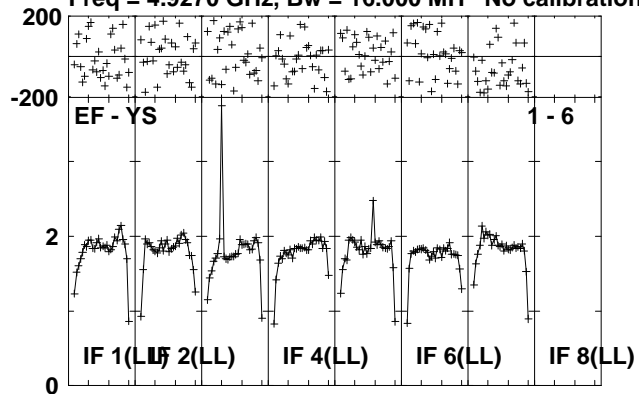

Lower frame: Milli Ampl Jy Top frame: Phas deg
Scalar averaged cross-power spectrum Several baselines displayed
Timerange: 00/19:11:02 to 00/19:16:28

Plot file version 175 created 02-DEC-2011 14:53:38

J1953+35 ET018A.UVDATA.1

Freq = 4.9270 GHz, Bw = 16.000 MH No calibration applied and no bandpass applied

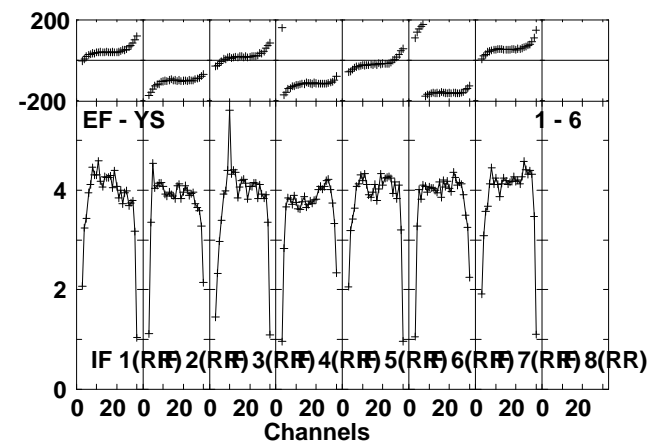
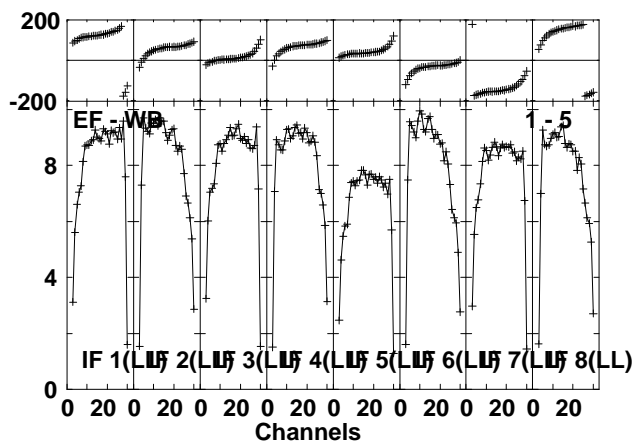
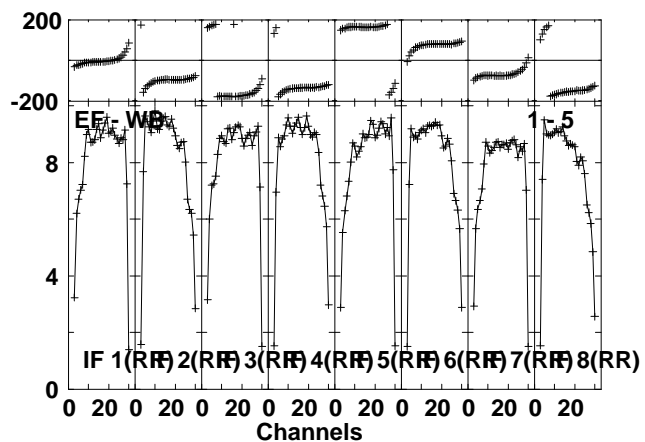
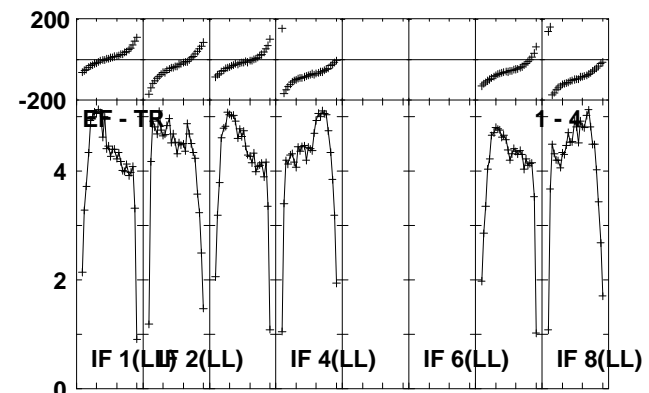
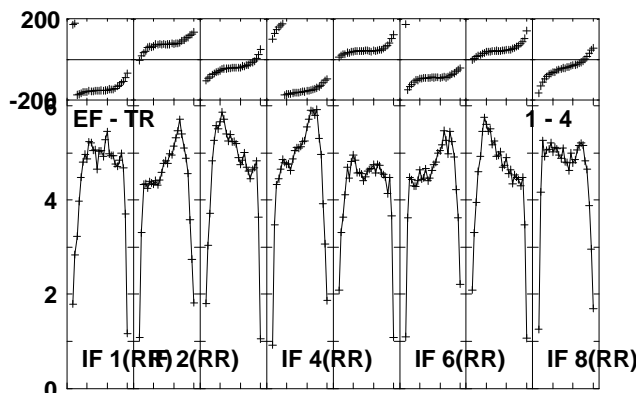
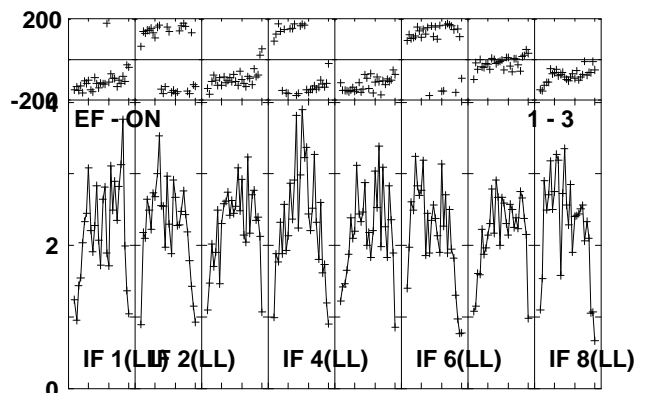
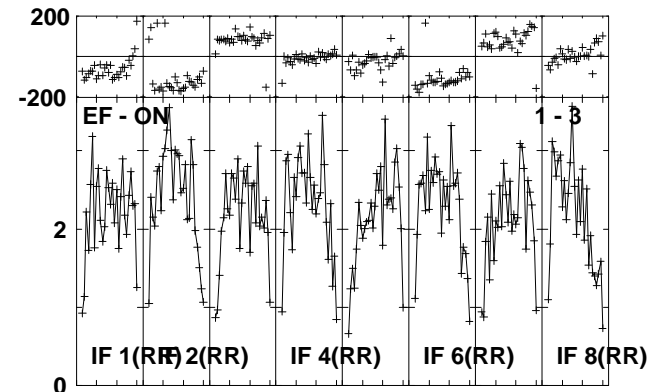
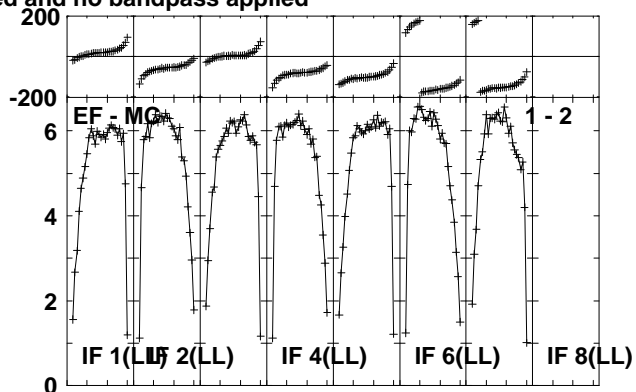
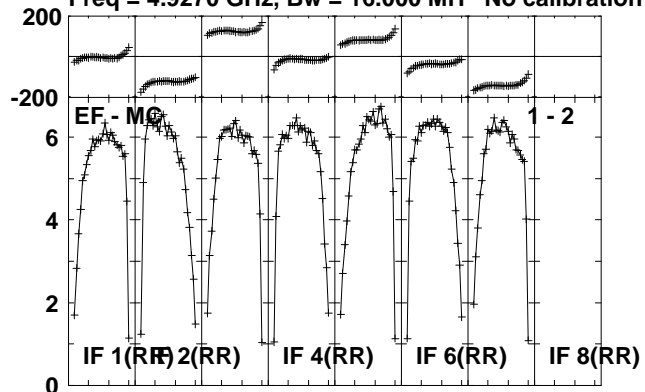

Lower frame: Milli Ampl Jy Top frame: Phas deg
Scalar averaged cross-power spectrum Several baselines displayed
Timerange: 00/19:16:32 to 00/19:19:29

Plot file version 176 created 02-DEC-2011 14:53:40
J1953+35 ET018A.UVDATA.1
Freq = 4.9270 GHz, Bw = 16.000 MH No calibration applied and no bandpass applied

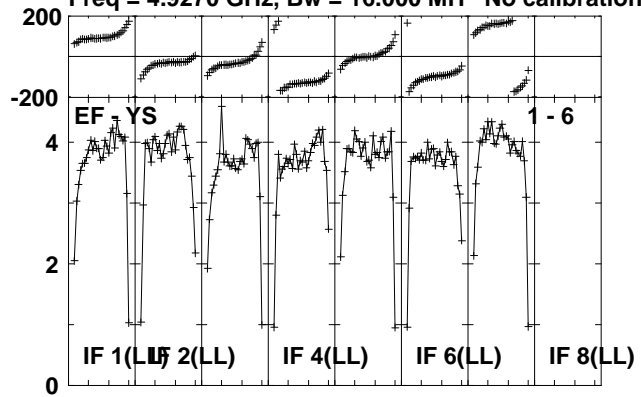

Lower frame: Milli Ampl Jy Top frame: Phas deg
Scalar averaged cross-power spectrum Several baselines displayed
Timerange: 00/19:16:32 to 00/19:19:29

Plot file version 177 created 02-DEC-2011 14:53:42

CYGX-1 ET018A.UVDATA.1

Freq = 4.9270 GHz, Bw = 16.000 MH No calibration applied and no bandpass applied

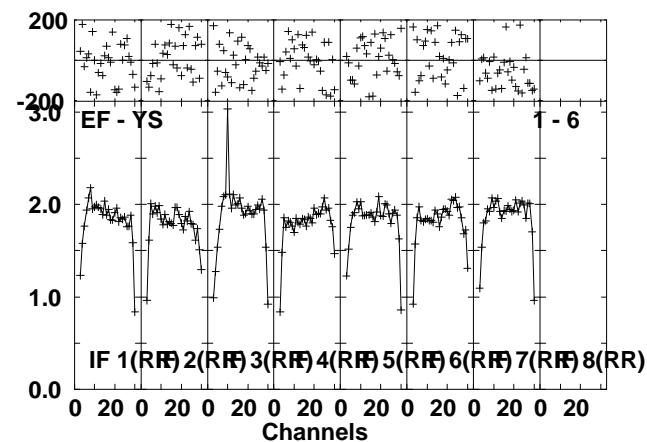
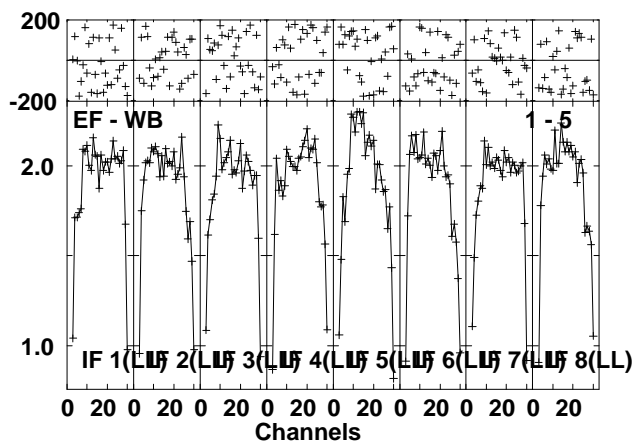
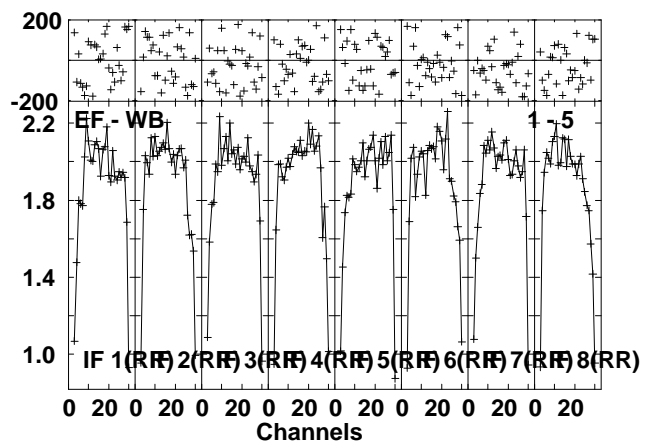
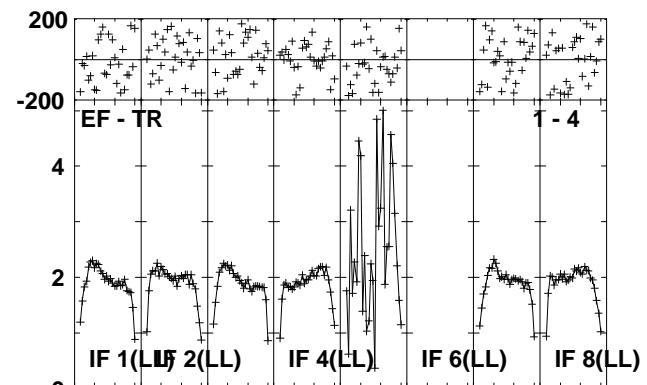
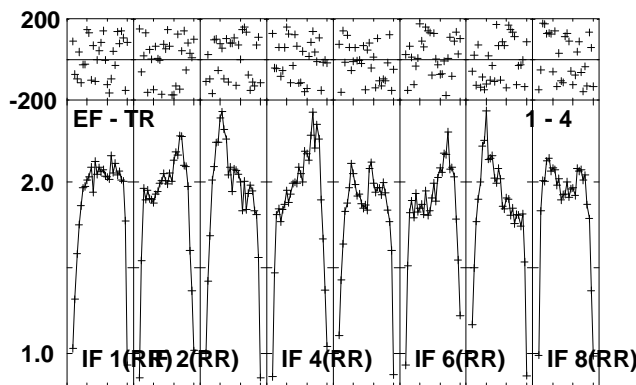
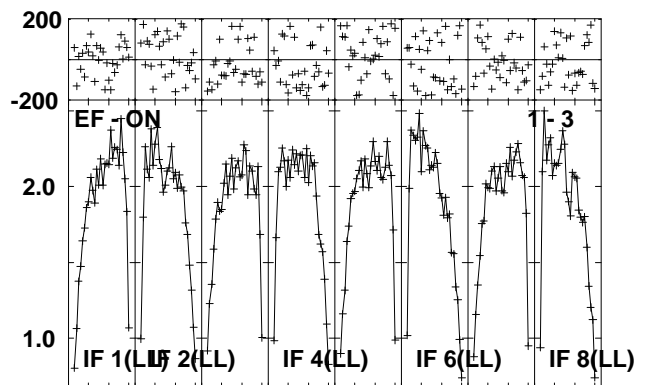
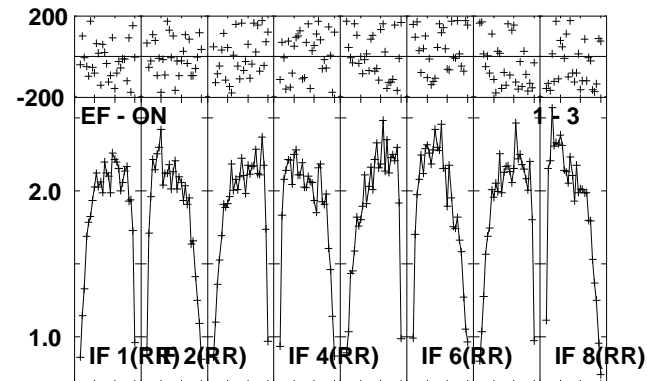
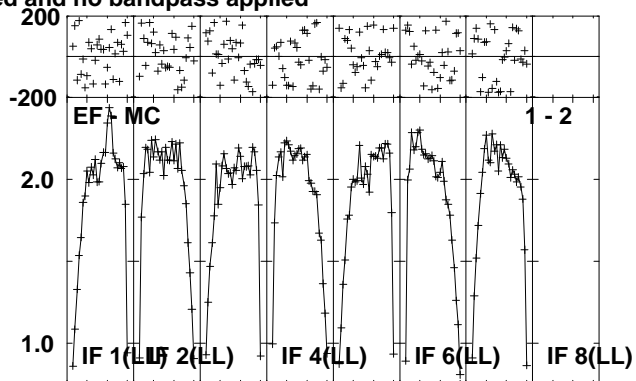
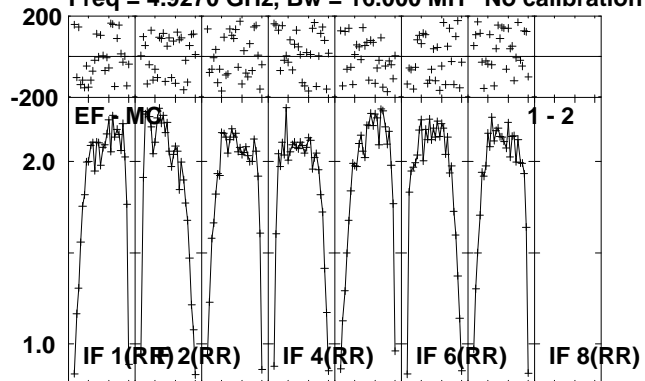

Lower frame: Milli Ampl Jy Top frame: Phas deg
Scalar averaged cross-power spectrum Several baselines displayed
Timerange: 00/19:19:31 to 00/19:24:59

Plot file version 178 created 02-DEC-2011 14:53:48

CYGX-1 ET018A.UVDATA.1

Freq = 4.9270 GHz, Bw = 16.000 MH No calibration applied and no bandpass applied

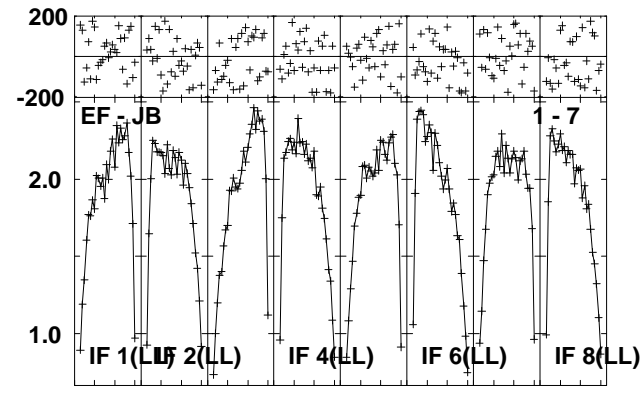
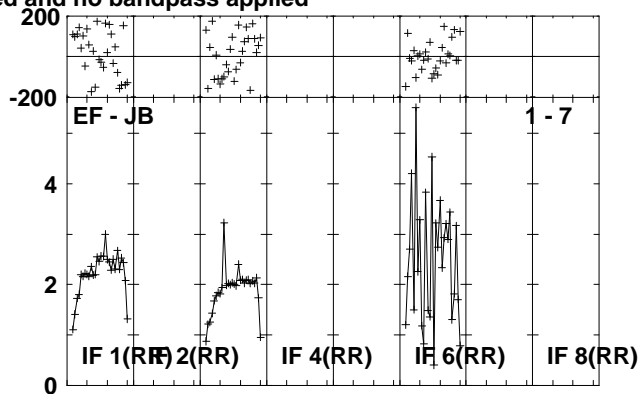
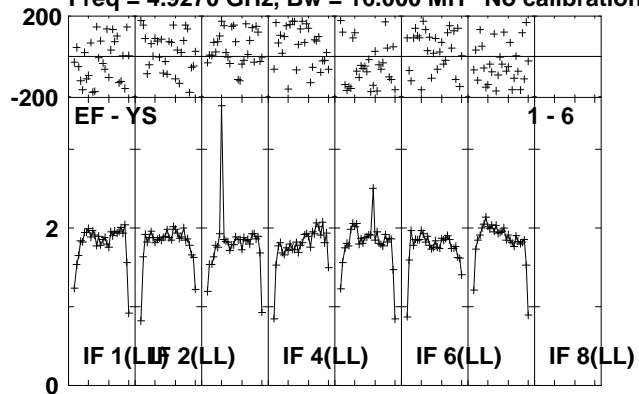

Lower frame: Milli Ampl Jy Top frame: Phas deg
Scalar averaged cross-power spectrum Several baselines displayed
Timerange: 00/19:19:31 to 00/19:24:59

Plot file version 179 created 02-DEC-2011 14:53:52

J1953+35 ET018A.UVDATA.1

Freq = 4.9270 GHz, Bw = 16.000 MH No calibration applied and no bandpass applied

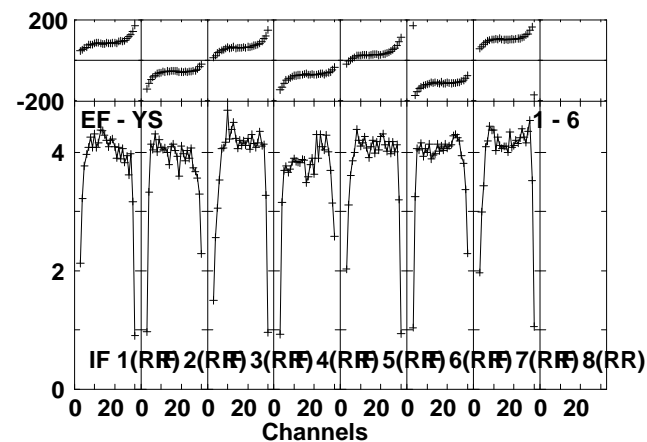
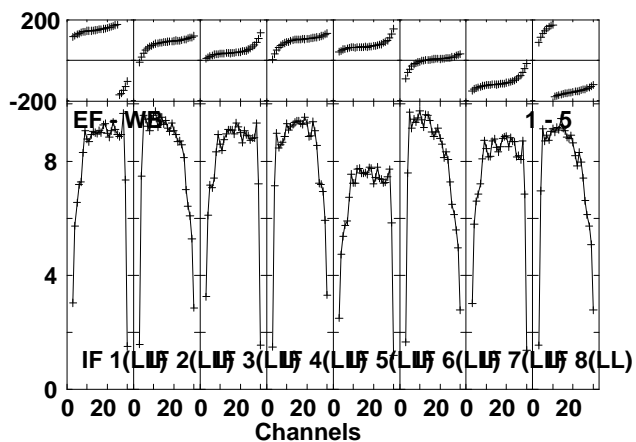
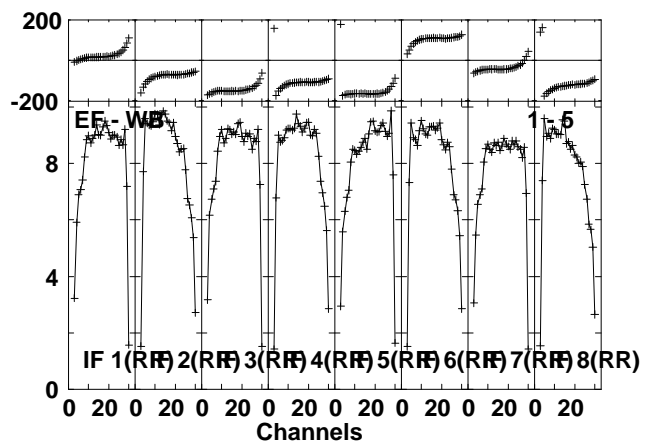
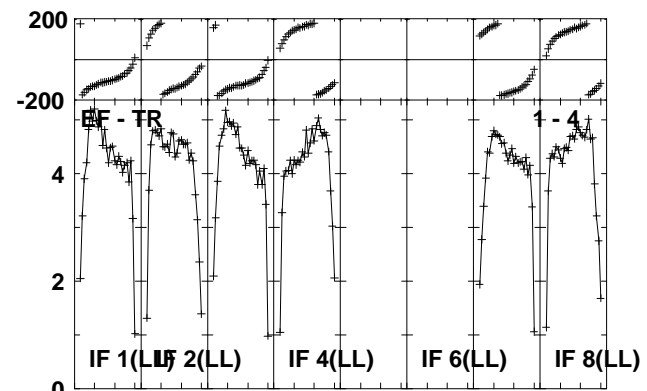
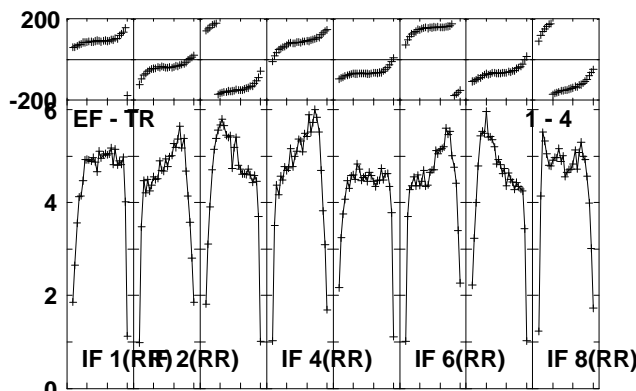
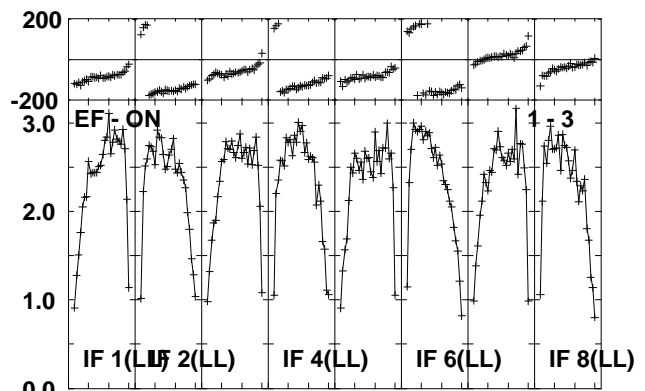
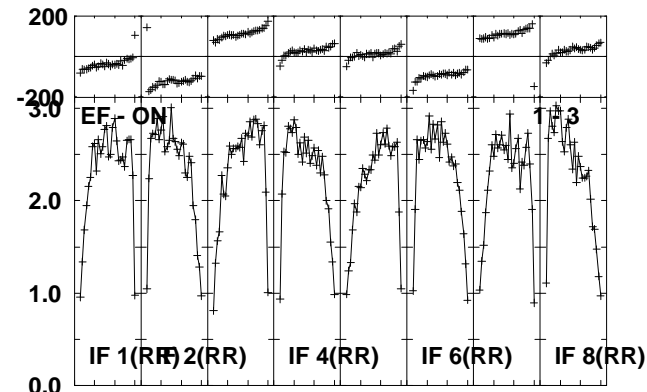
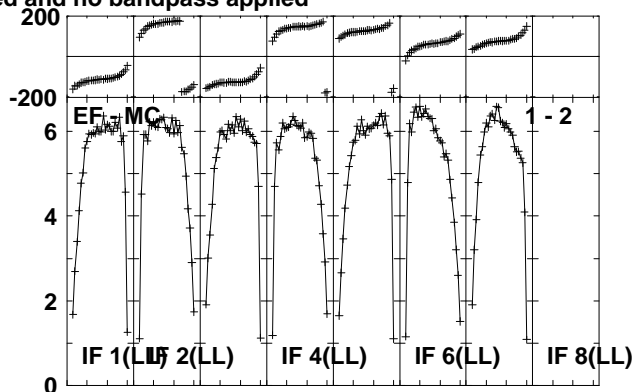
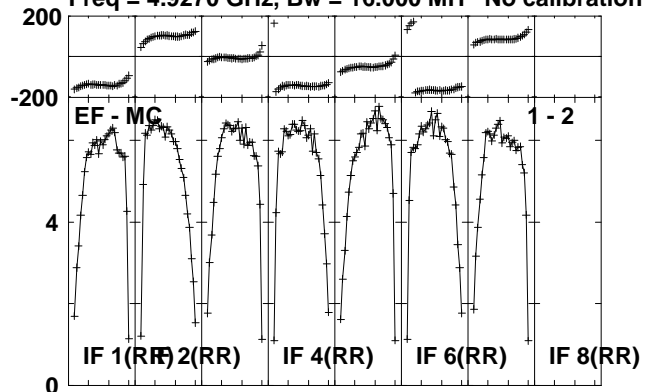

Lower frame: Milli Ampl Jy Top frame: Phas deg
Scalar averaged cross-power spectrum Several baselines displayed
Timerange: 00/19:25:46 to 00/19:28:19

Plot file version 180 created 02-DEC-2011 14:53:55

J1953+35 ET018A.UVDATA.1

Freq = 4.9270 GHz, Bw = 16.000 MH No calibration applied and no bandpass applied

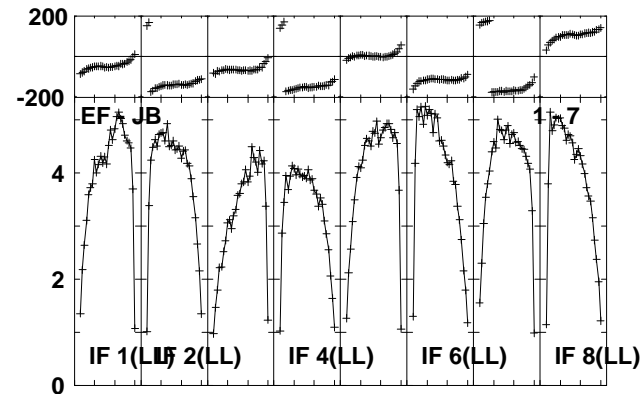
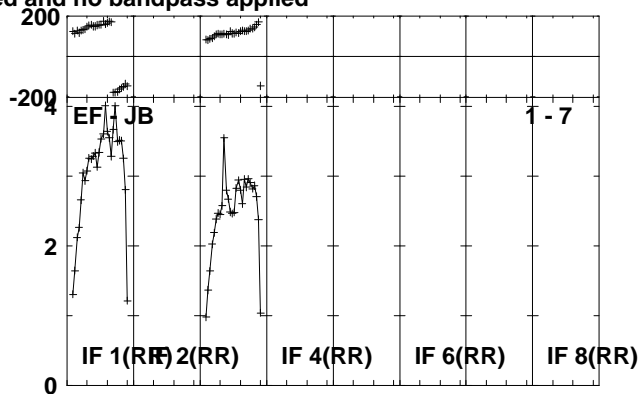
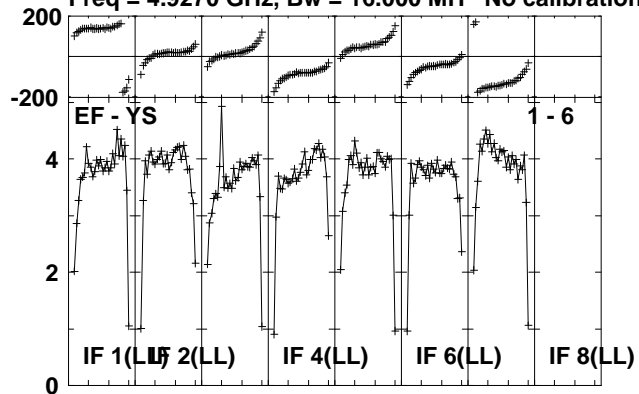

Lower frame: Milli Ampl Jy Top frame: Phas deg
Scalar averaged cross-power spectrum Several baselines displayed
Timerange: 00/19:25:46 to 00/19:28:19

Plot file version 181 created 02-DEC-2011 14:53:58

CYGX-1 ET018A.UVDATA.1

Freq = 4.9270 GHz, Bw = 16.000 MH No calibration applied and no bandpass applied

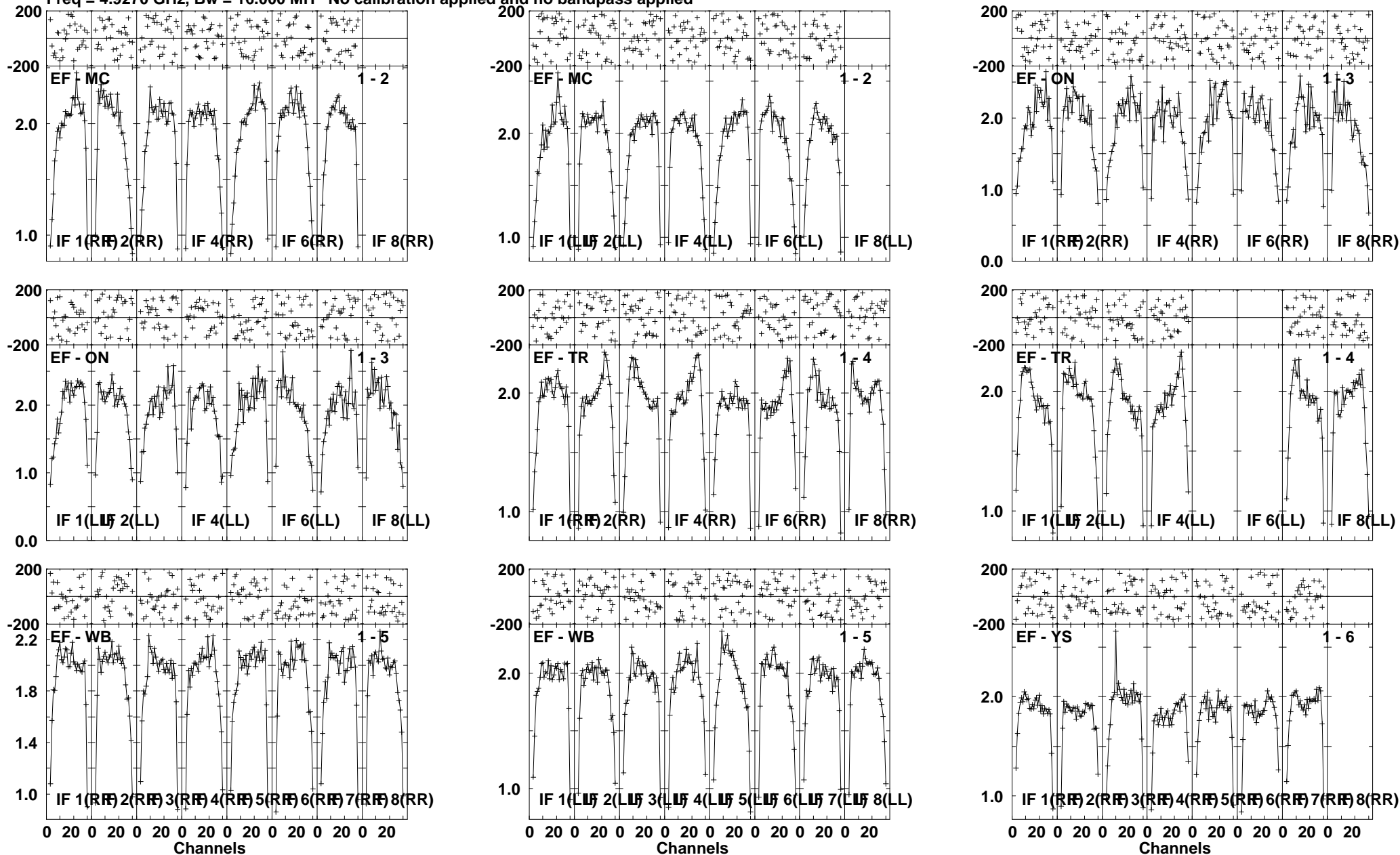

Lower frame: Milli Ampl Jy Top frame: Phas deg
Scalar averaged cross-power spectrum Several baselines displayed
Timerange: 00/19:28:22 to 00/19:33:48

Plot file version 182 created 02-DEC-2011 14:54:04

CYGX-1 ET018A.UVDATA.1

Freq = 4.9270 GHz, Bw = 16.000 MH No calibration applied and no bandpass applied

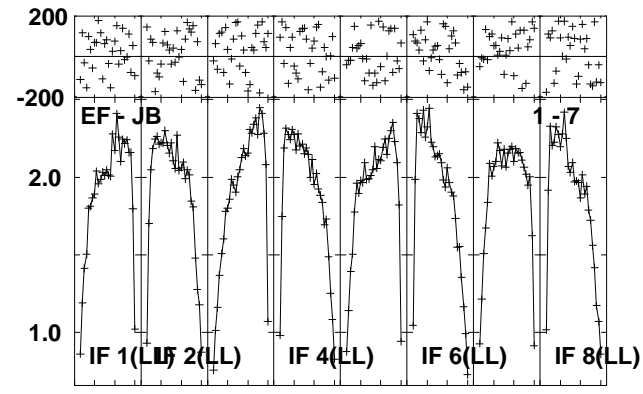
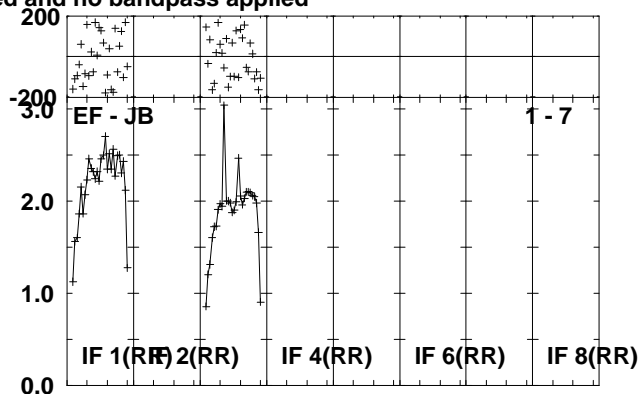
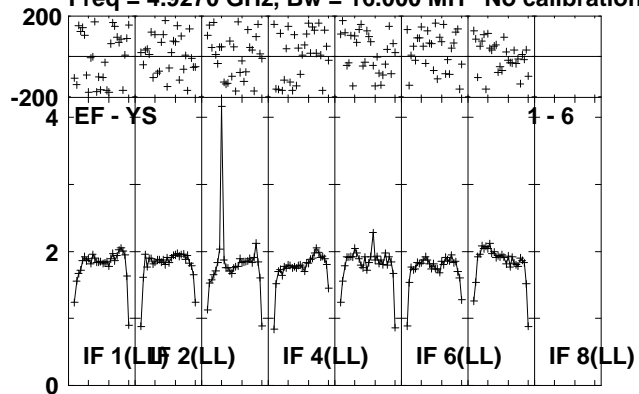

Lower frame: Milli Ampl Jy Top frame: Phase deg
Scalar averaged cross-power spectrum Several baselines displayed
Timerange: 00/19:28:22 to 00/19:33:48

Plot file version 183 created 02-DEC-2011 14:54:08

J1953+35 ET018A.UVDATA.1

Freq = 4.9270 GHz, Bw = 16.000 MH No calibration applied and no bandpass applied

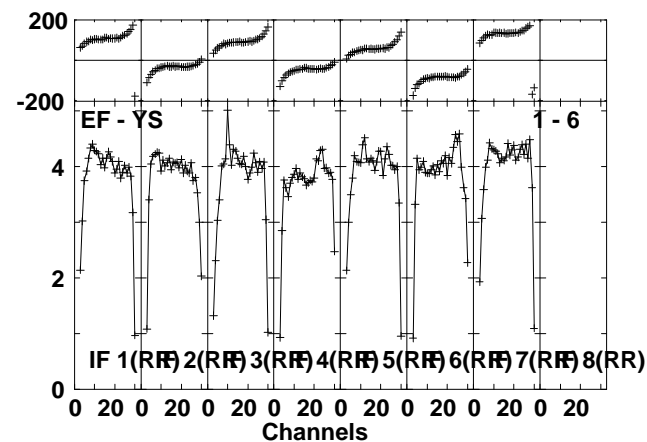
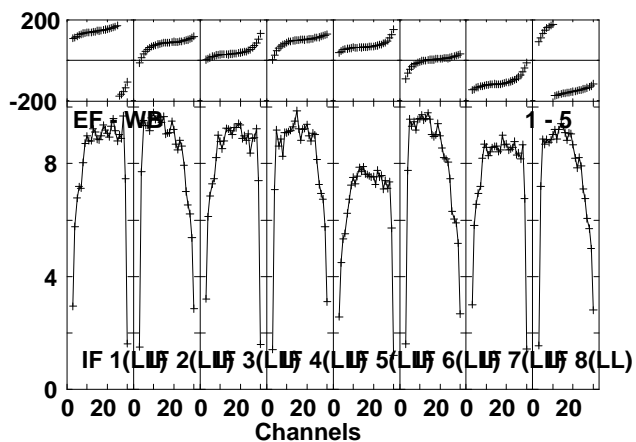
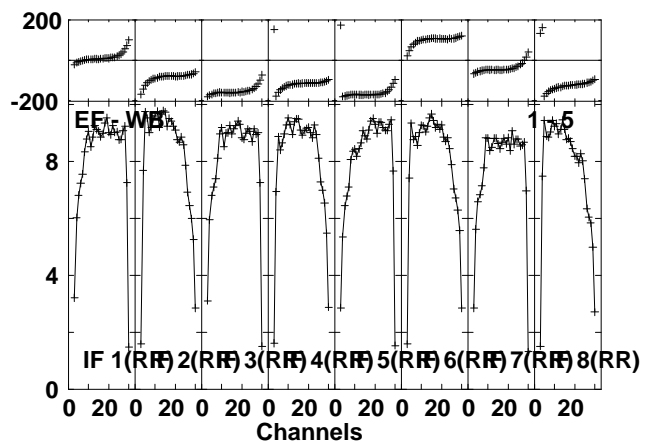
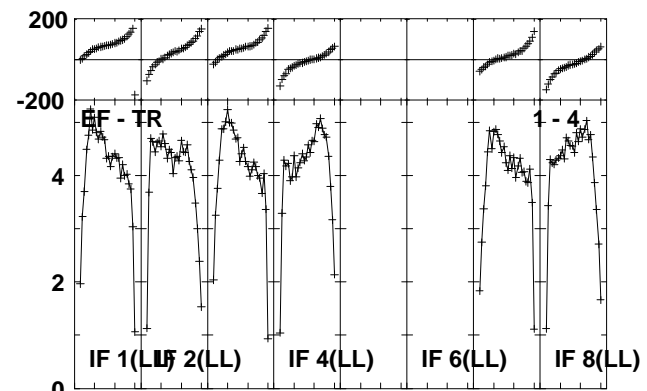
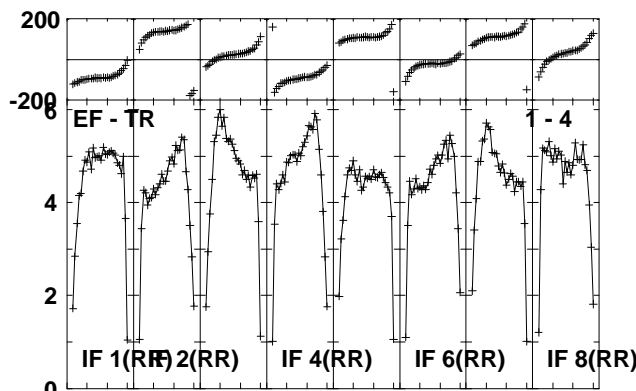
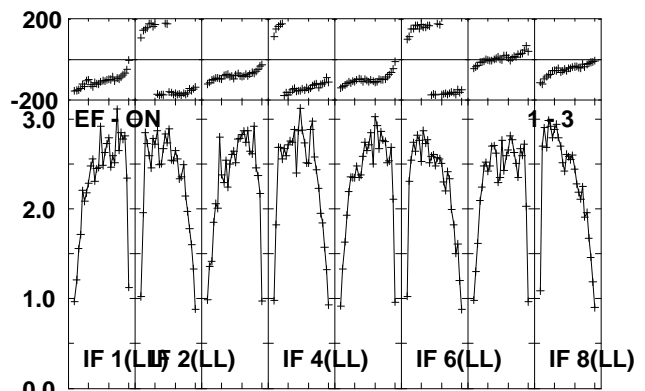
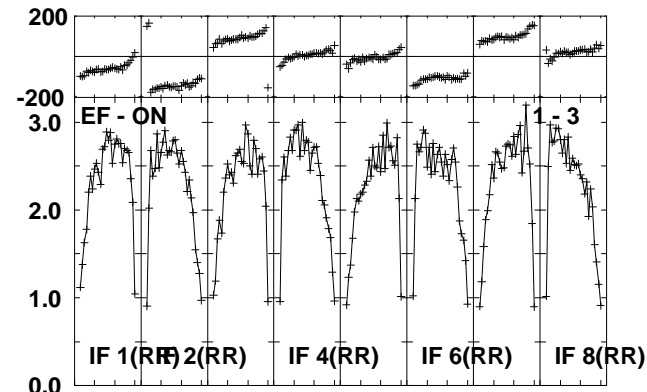
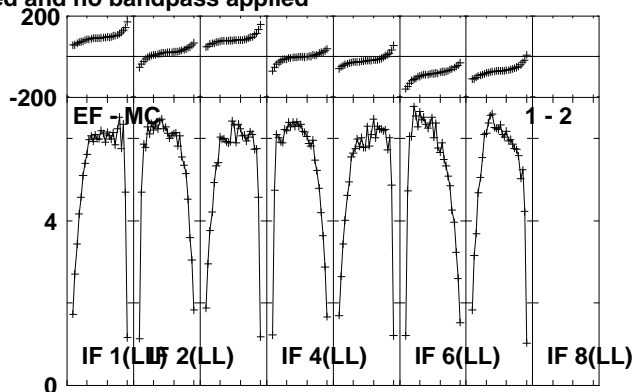
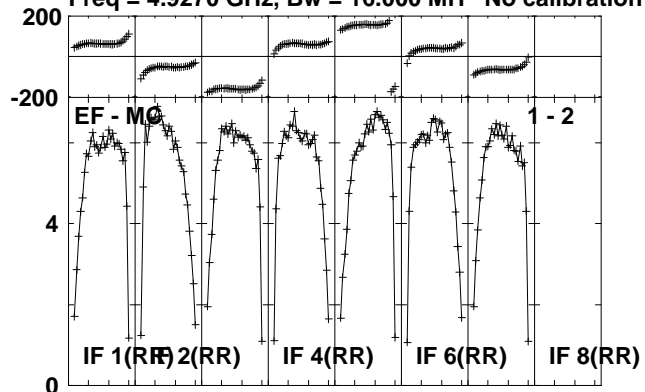

Lower frame: Milli Ampl Jy Top frame: Phas deg
Scalar averaged cross-power spectrum Several baselines displayed
Timerange: 00/19:33:52 to 00/19:36:49

Plot file version 184 created 02-DEC-2011 14:54:11

J1953+35 ET018A.UVDATA.1

Freq = 4.9270 GHz, Bw = 16.000 MH No calibration applied and no bandpass applied

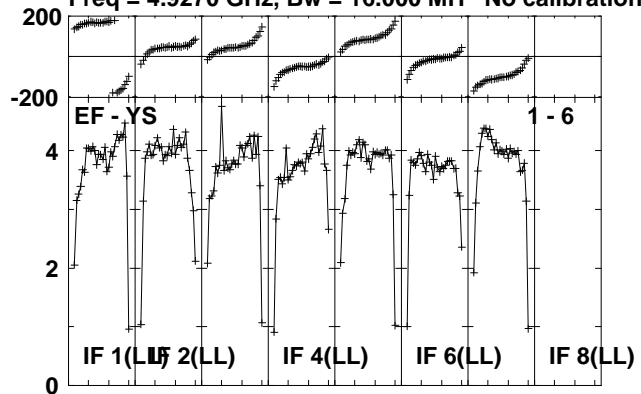

Lower frame: Milli Ampl Jy Top frame: Phas deg
Scalar averaged cross-power spectrum Several baselines displayed
Timerange: 00/19:33:52 to 00/19:36:49

Plot file version 185 created 02-DEC-2011 14:54:14

CYGX-1 ET018A.UVDATA.1

Freq = 4.9270 GHz, Bw = 16.000 MH No calibration applied and no bandpass applied

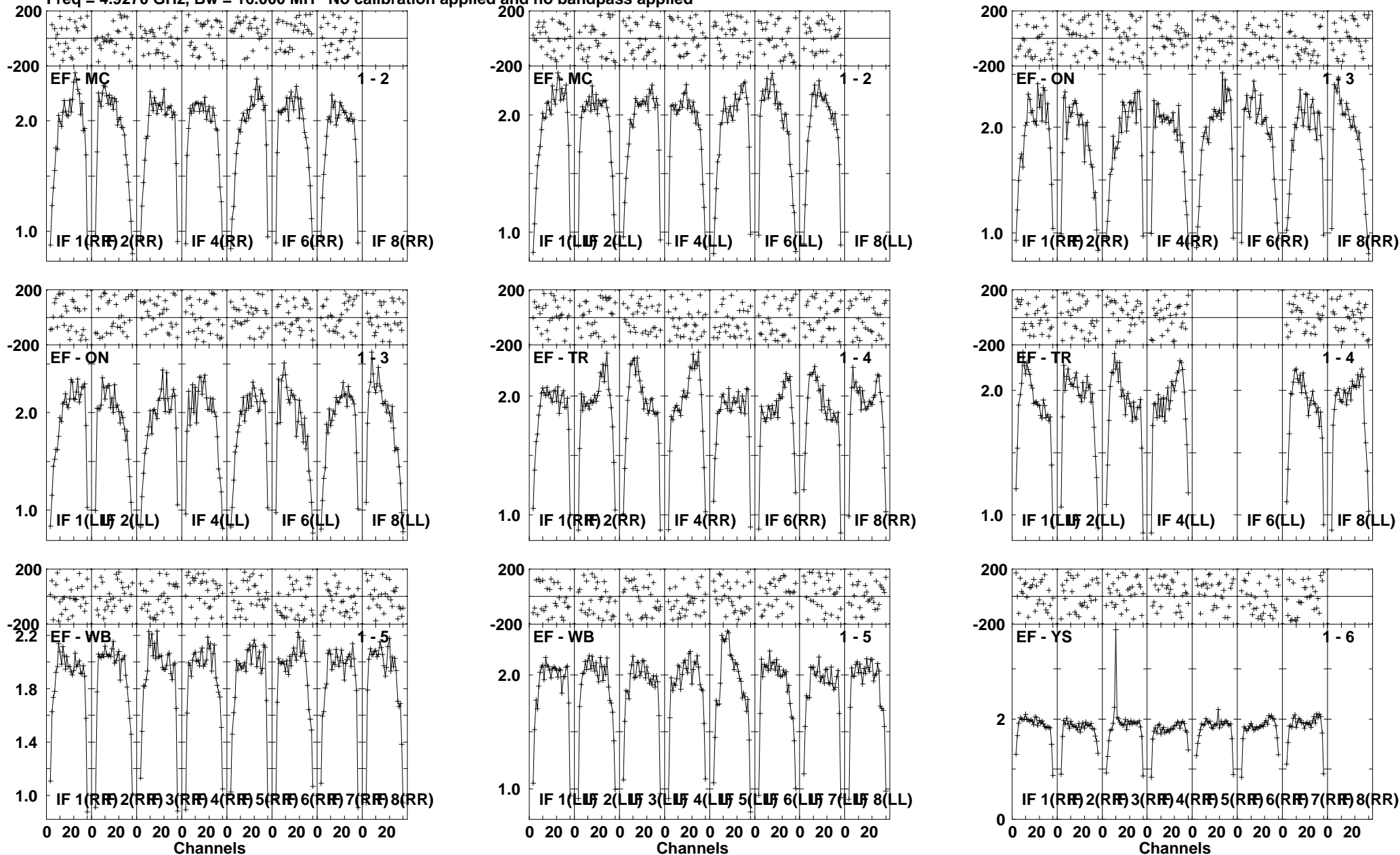

Lower frame: Milli Ampl Jy Top frame: Phas deg
Scalar averaged cross-power spectrum Several baselines displayed
Timerange: 00/19:36:52 to 00/19:42:18

Plot file version 186 created 02-DEC-2011 14:54:20

CYGX-1 ET018A.UVDATA.1

Freq = 4.9270 GHz, Bw = 16.000 MH No calibration applied and no bandpass applied

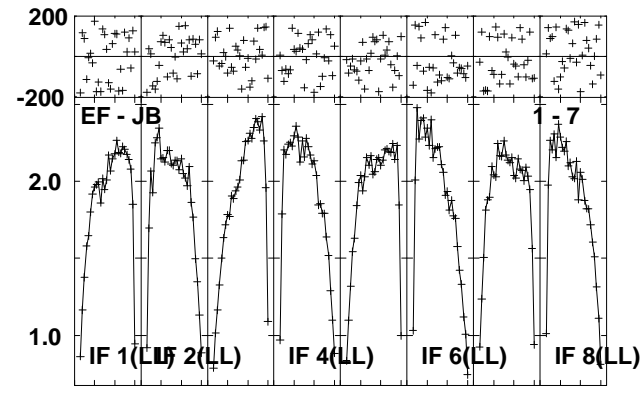
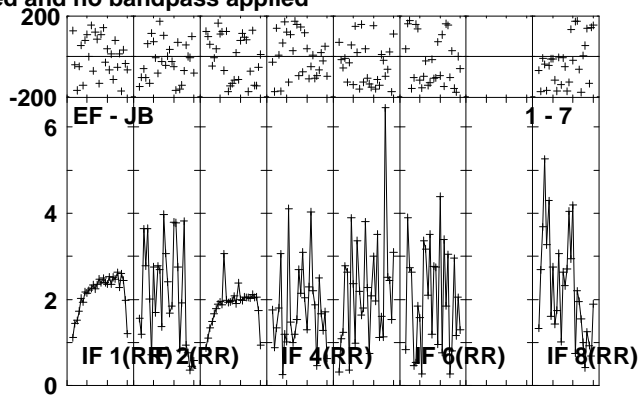
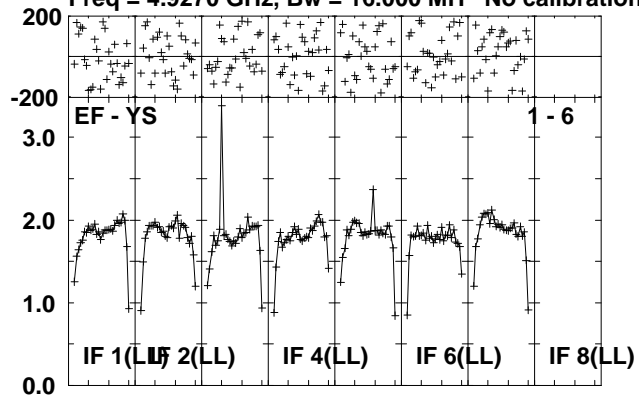

Lower frame: Milli Ampl Jy Top frame: Phas deg
Scalar averaged cross-power spectrum Several baselines displayed
Timerange: 00/19:36:52 to 00/19:42:18

Plot file version 187 created 02-DEC-2011 14:54:24

J1953+35 ET018A.UVDATA.1

Freq = 4.9270 GHz, Bw = 16.000 MH No calibration applied and no bandpass applied

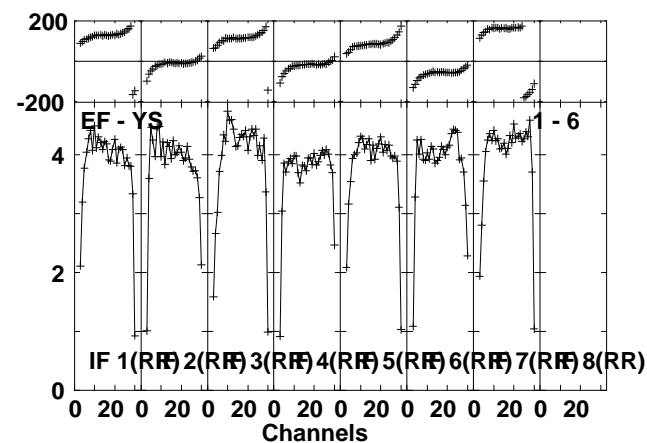
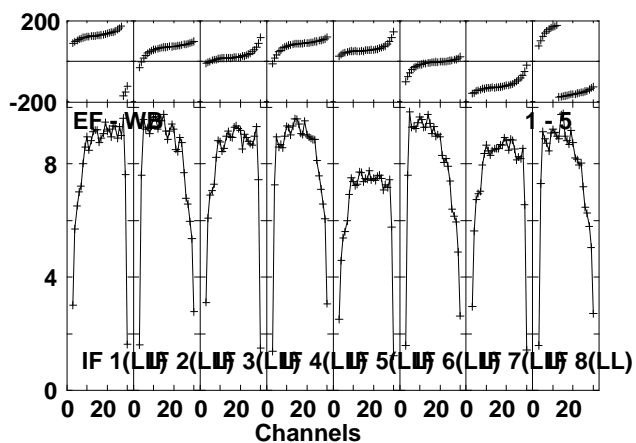
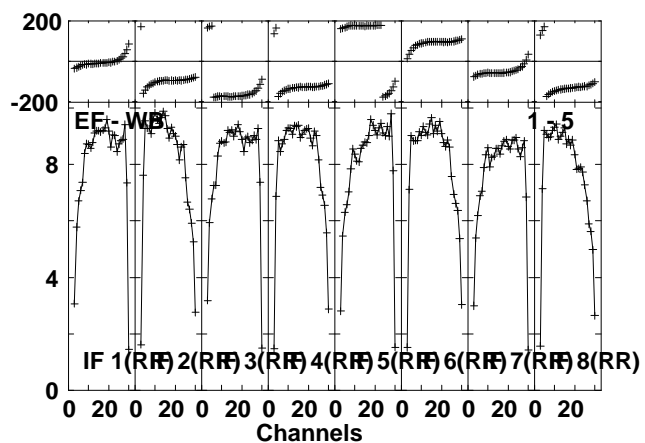
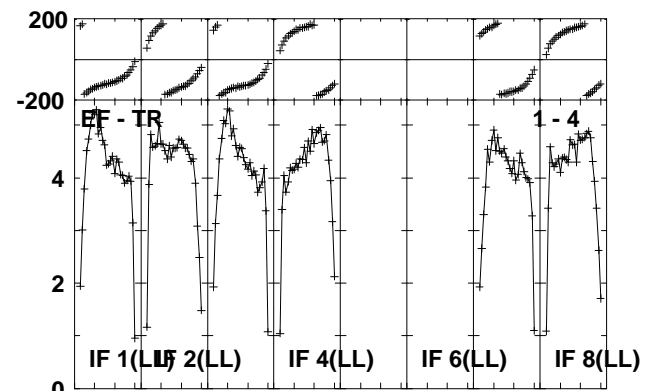
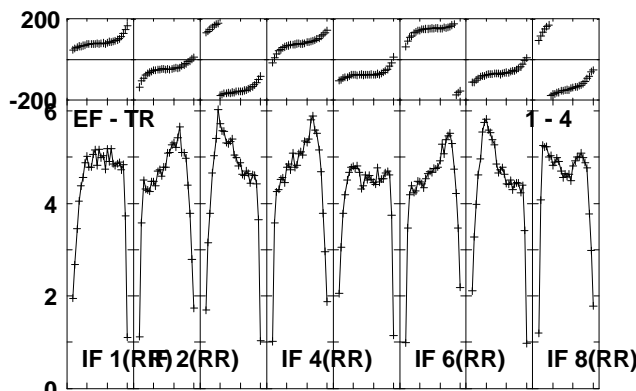
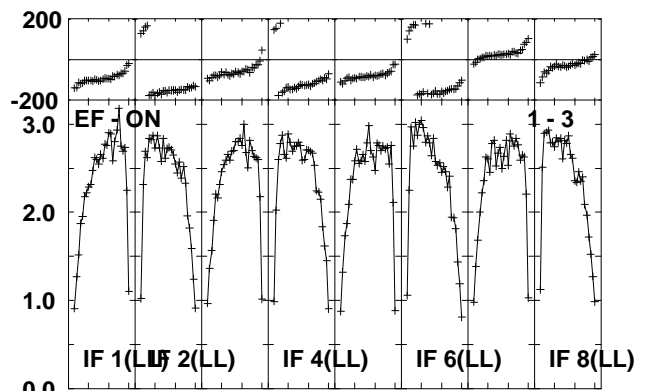
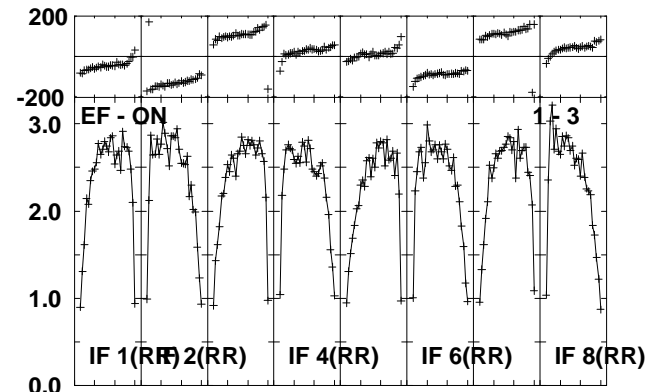
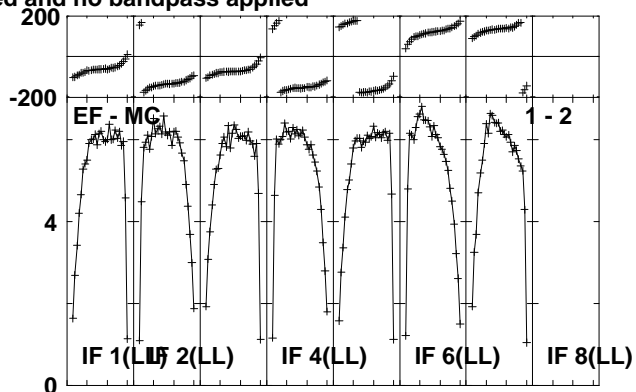
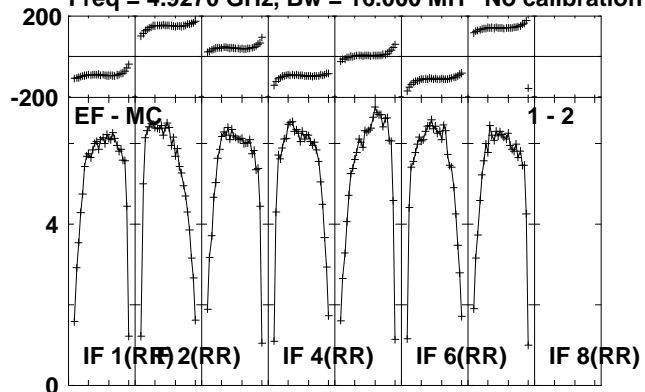

Lower frame: Milli Ampl Jy Top frame: Phas deg
Scalar averaged cross-power spectrum Several baselines displayed
Timerange: 00/19:43:06 to 00/19:45:39

Plot file version 188 created 02-DEC-2011 14:54:26

J1953+35 ET018A.UVDATA.1

Freq = 4.9270 GHz, Bw = 16.000 MH No calibration applied and no bandpass applied

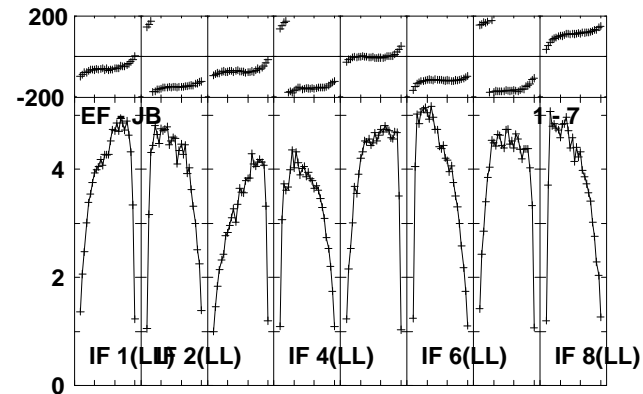
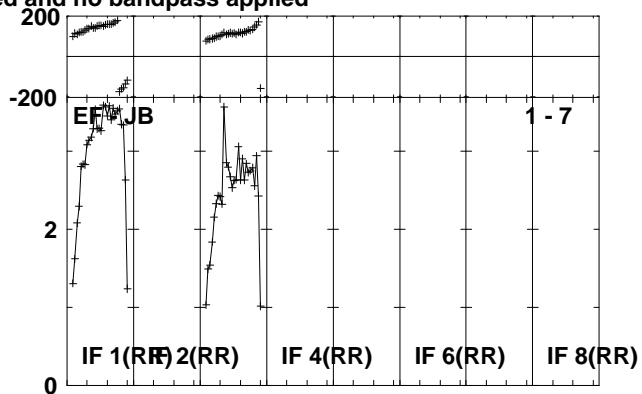
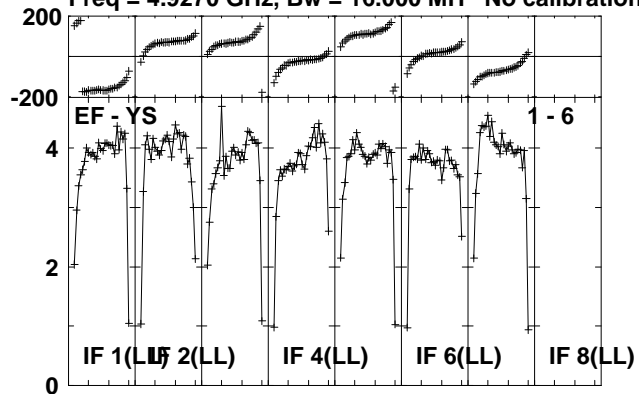

Lower frame: Milli Ampl Jy Top frame: Phas deg
Scalar averaged cross-power spectrum Several baselines displayed
Timerange: 00/19:43:06 to 00/19:45:39

Plot file version 189 created 02-DEC-2011 14:54:29

CYGX-1 ET018A.UVDATA.1

Freq = 4.9270 GHz, Bw = 16.000 MH No calibration applied and no bandpass applied

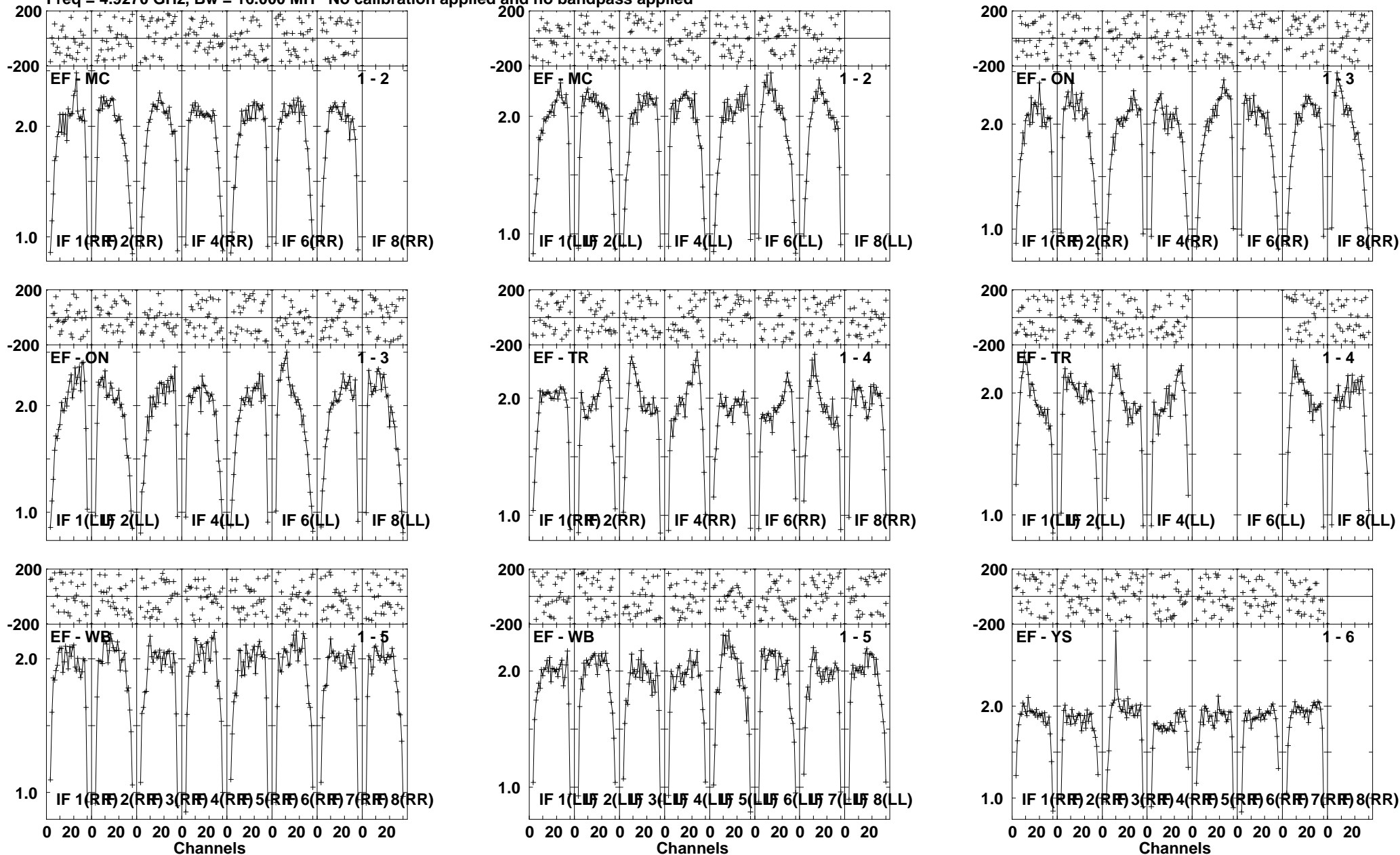

Lower frame: Milli Ampl Jy Top frame: Phas deg
Scalar averaged cross-power spectrum Several baselines displayed
Timerange: 00/19:45:42 to 00/19:51:08

Plot file version 190 created 02-DEC-2011 14:54:35

CYGX-1 ET018A.UVDATA.1

Freq = 4.9270 GHz, Bw = 16.000 MH No calibration applied and no bandpass applied

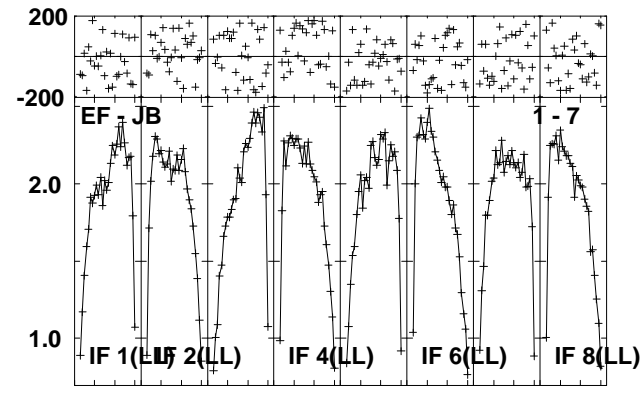
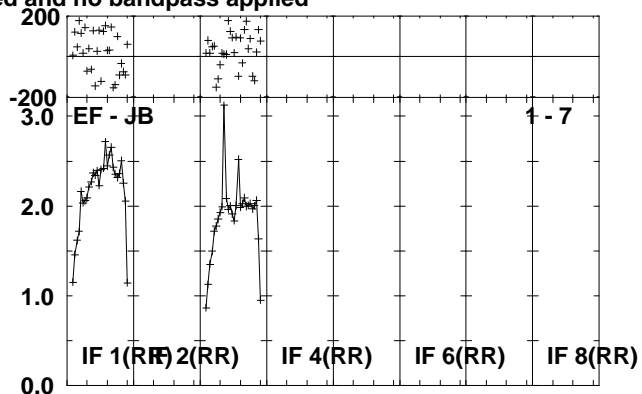
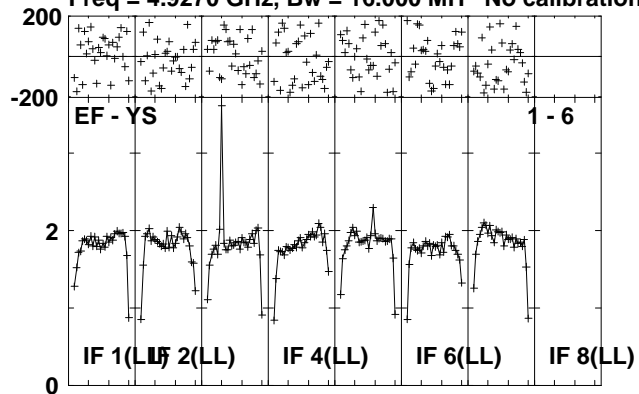

Lower frame: Milli Ampl Jy Top frame: Phas deg
Scalar averaged cross-power spectrum Several baselines displayed
Timerange: 00/19:45:42 to 00/19:51:08

Plot file version 191 created 02-DEC-2011 14:54:39

J1953+35 ET018A.UVDATA.1

Freq = 4.9270 GHz, Bw = 16.000 MH No calibration applied and no bandpass applied

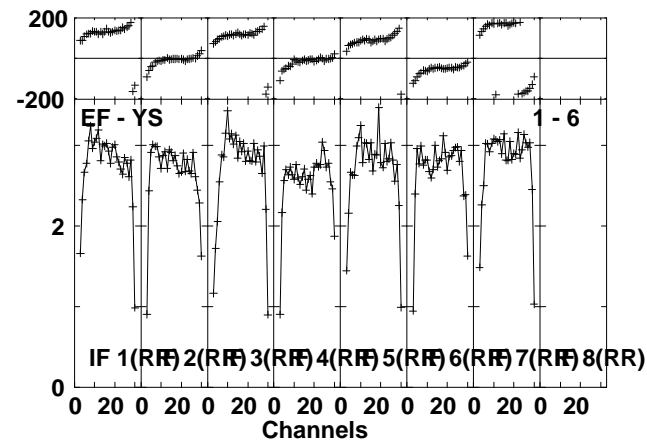
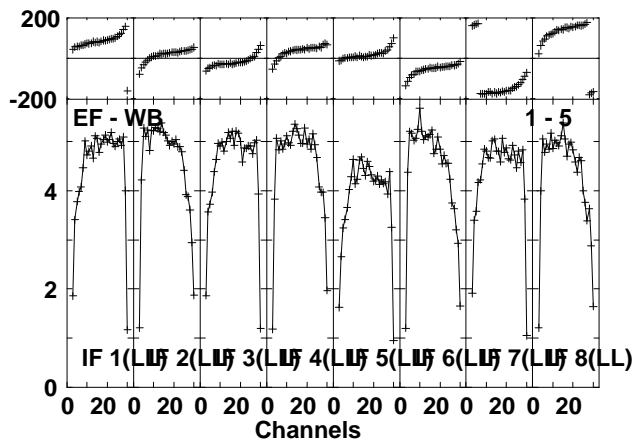
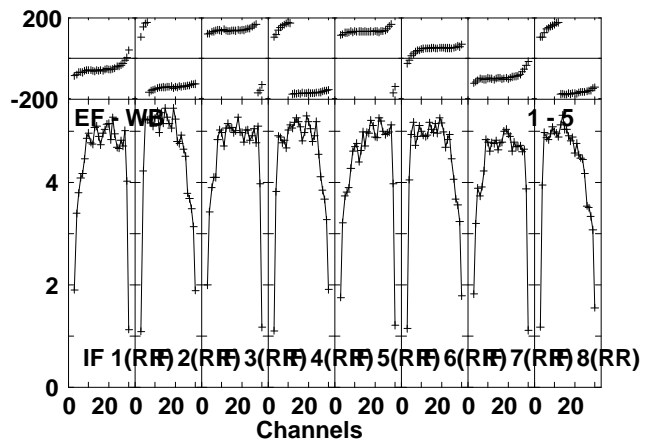
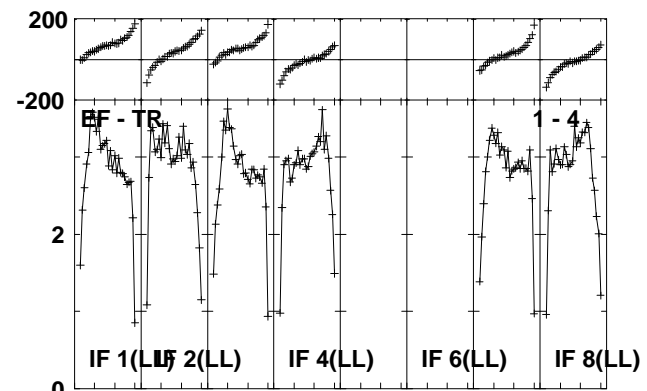
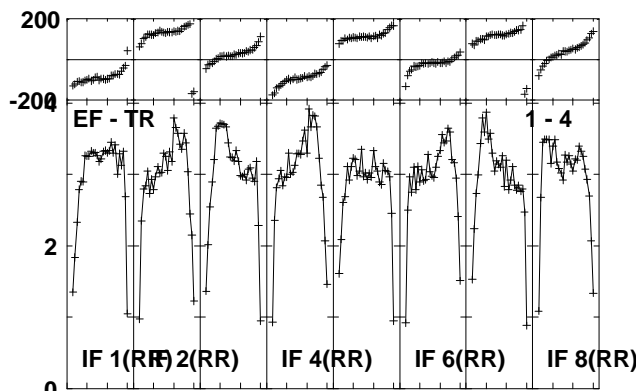
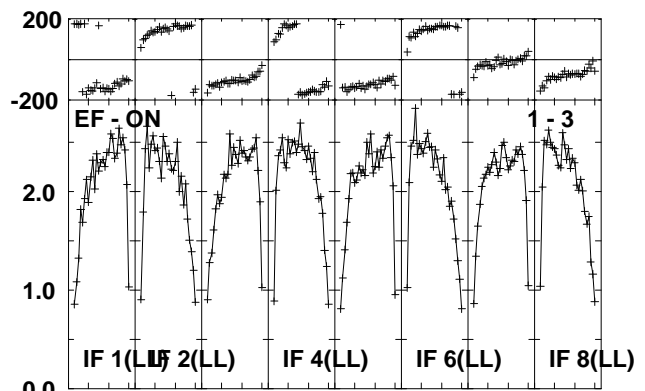
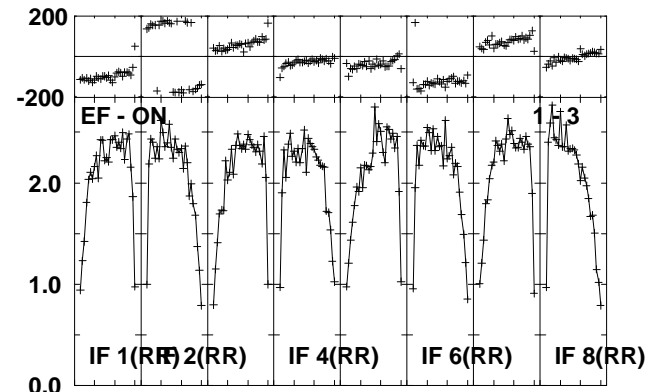
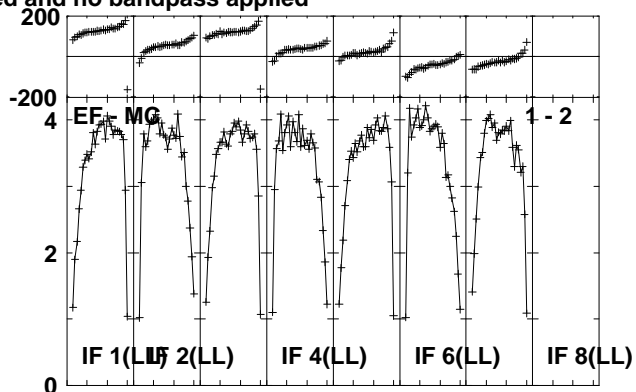
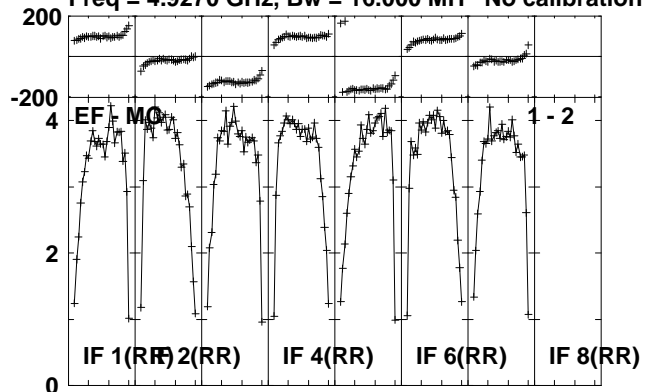

Lower frame: Milli Ampl Jy Top frame: Phas deg
Scalar averaged cross-power spectrum Several baselines displayed
Timerange: 00/19:51:12 to 00/19:54:09

Plot file version 192 created 02-DEC-2011 14:54:46

J1953+35 ET018A.UVDATA.1

Freq = 4.9270 GHz, Bw = 16.000 MH No calibration applied and no bandpass applied

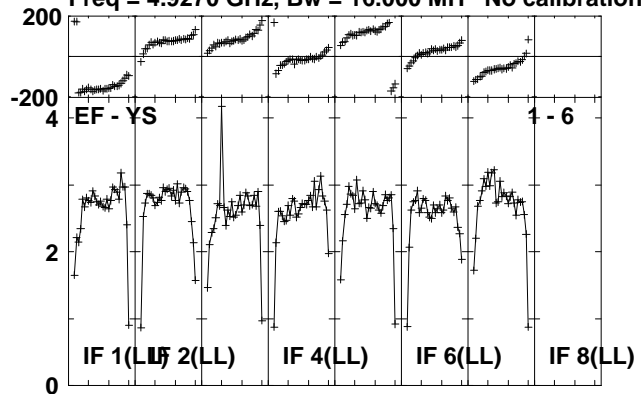

Lower frame: Milli Ampl Jy Top frame: Phas deg
Scalar averaged cross-power spectrum Several baselines displayed
Timerange: 00/19:51:12 to 00/19:54:09

Plot file version 193 created 02-DEC-2011 14:54:49

CYGX-1 ET018A.UVDATA.1

Freq = 4.9270 GHz, Bw = 16.000 MH No calibration applied and no bandpass applied

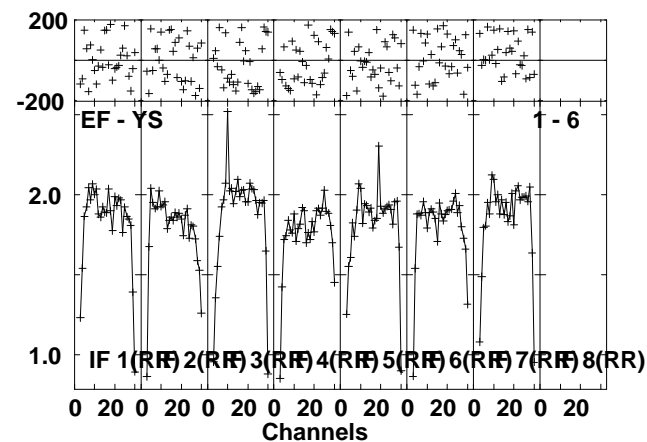
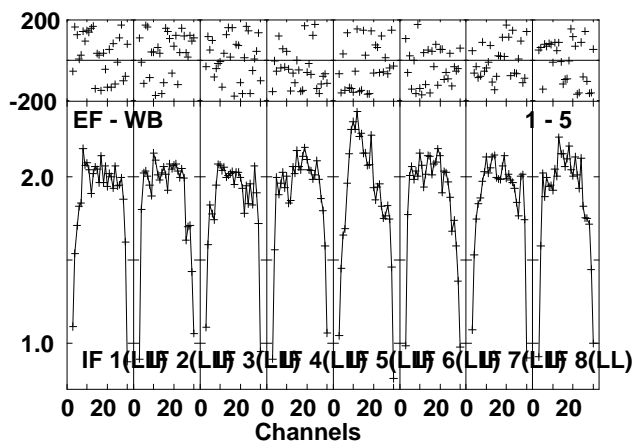
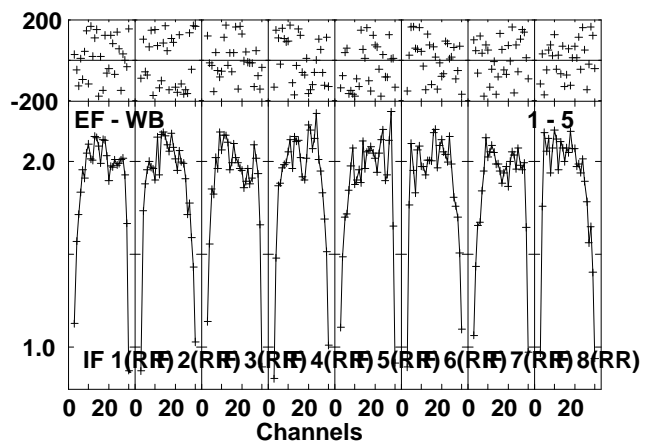
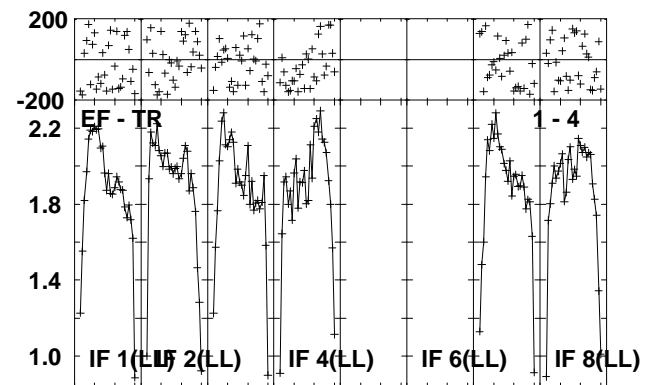
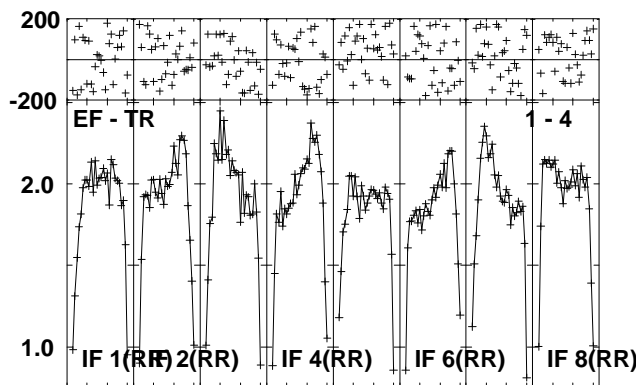
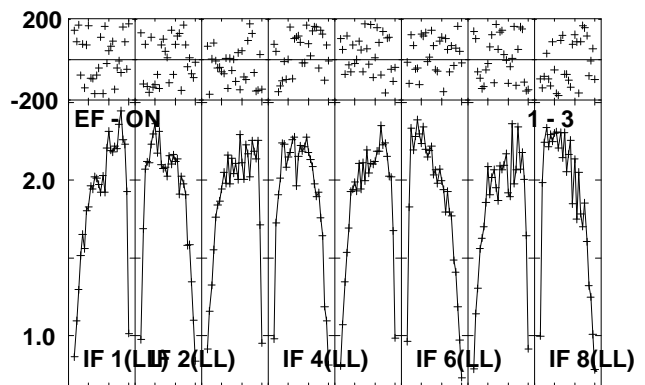
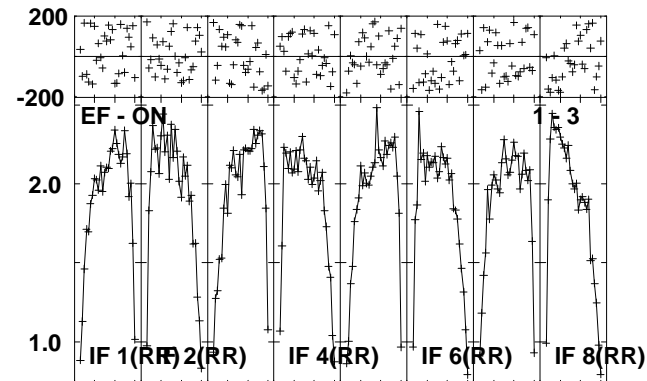
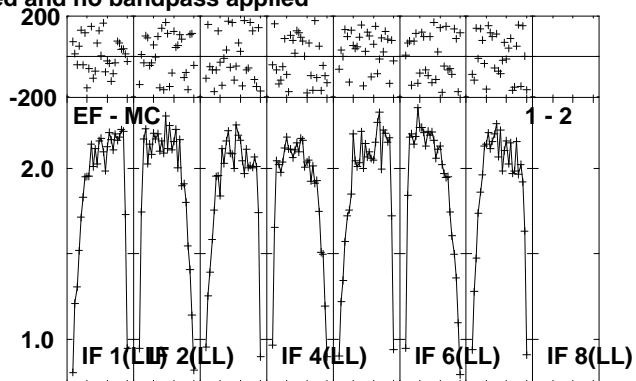
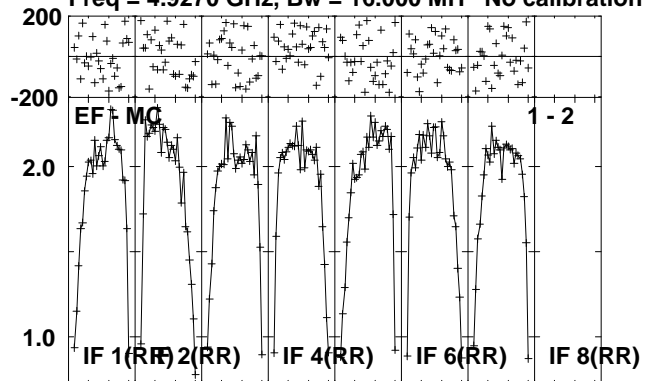

Lower frame: Milli Ampl Jy Top frame: Phas deg
Scalar averaged cross-power spectrum Several baselines displayed
Timerange: 00/19:54:12 to 00/19:59:38

Plot file version 194 created 02-DEC-2011 14:54:54

CYGX-1 ET018A.UVDATA.1

Freq = 4.9270 GHz, Bw = 16.000 MH No calibration applied and no bandpass applied

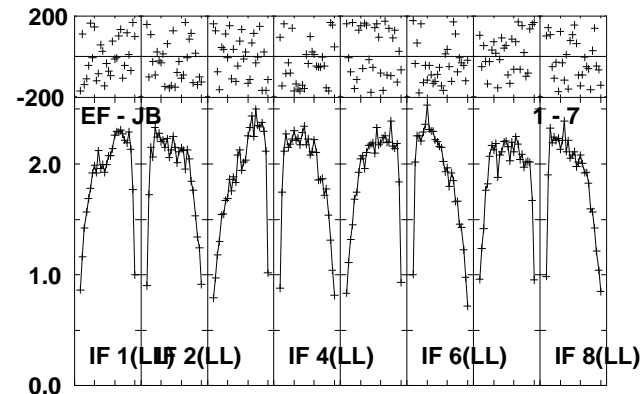
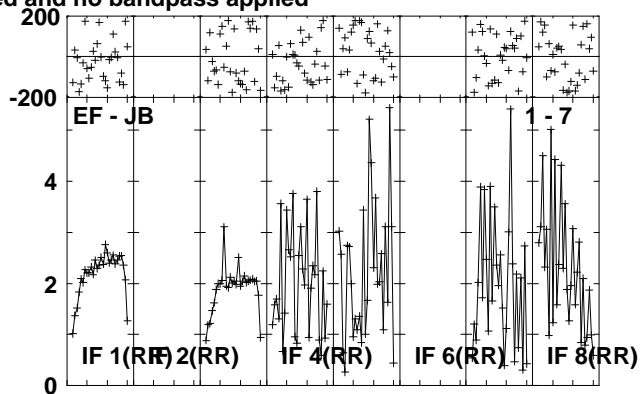
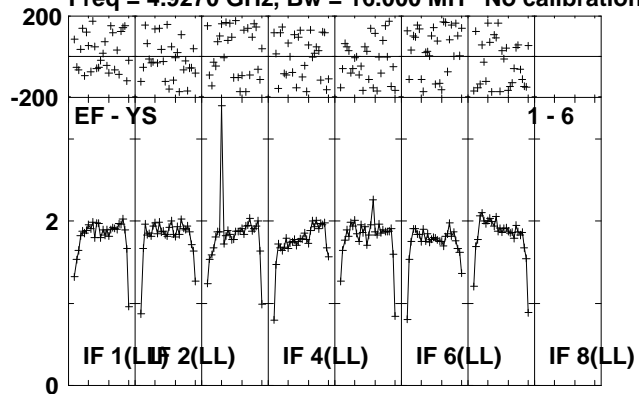

Lower frame: Milli Ampl Jy Top frame: Phas deg
Scalar averaged cross-power spectrum Several baselines displayed
Timerange: 00/19:54:12 to 00/19:59:38

Plot file version 195 created 02-DEC-2011 14:54:58

J1953+35 ET018A.UVDATA.1

Freq = 4.9270 GHz, Bw = 16.000 MH No calibration applied and no bandpass applied

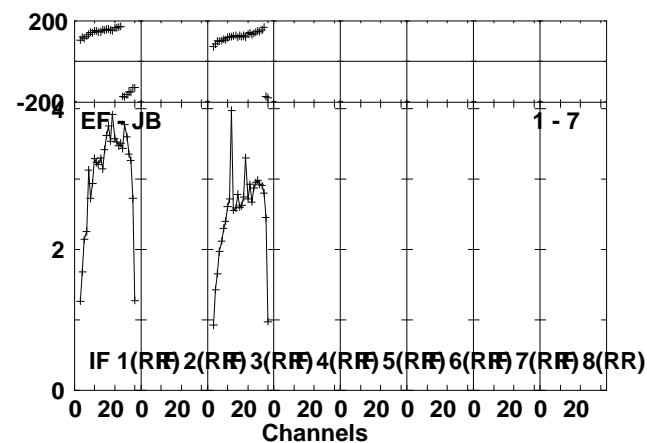
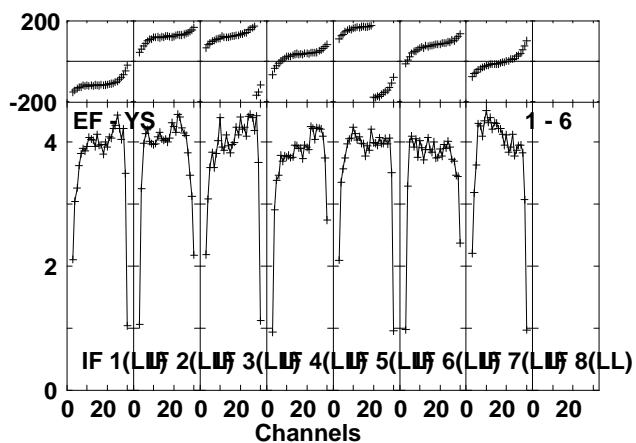
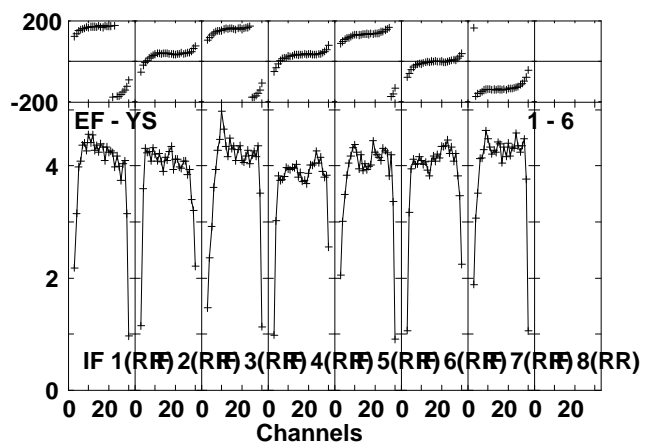
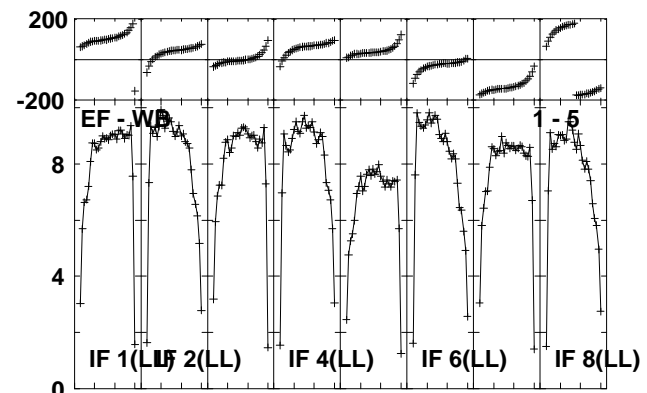
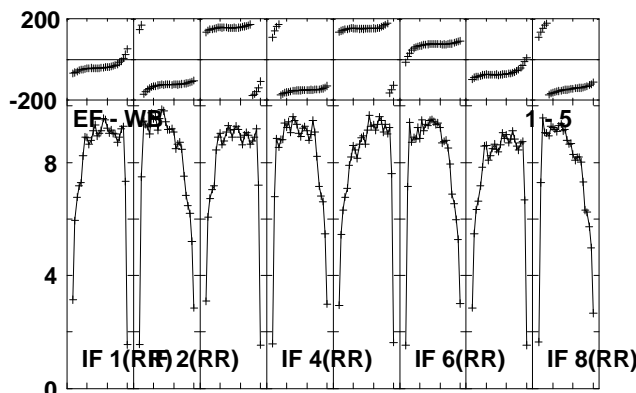
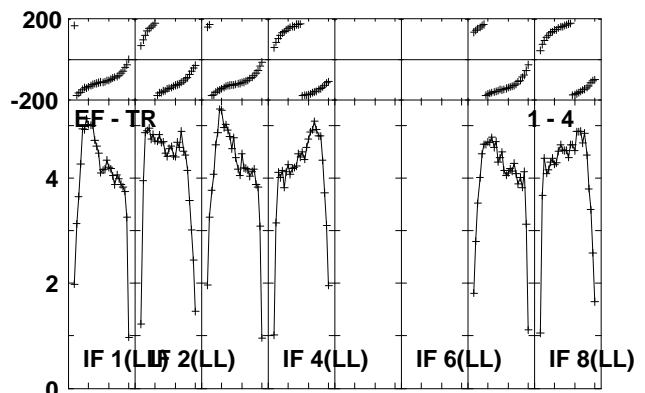
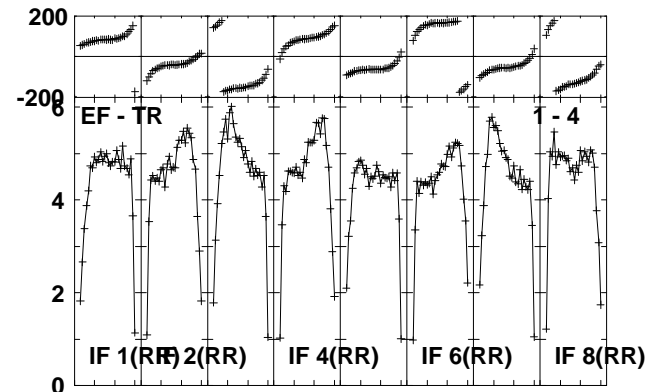
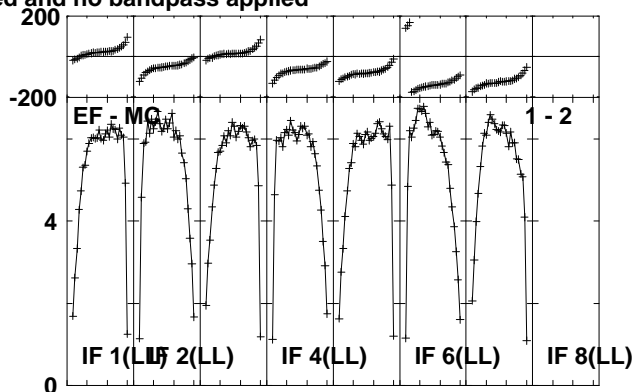
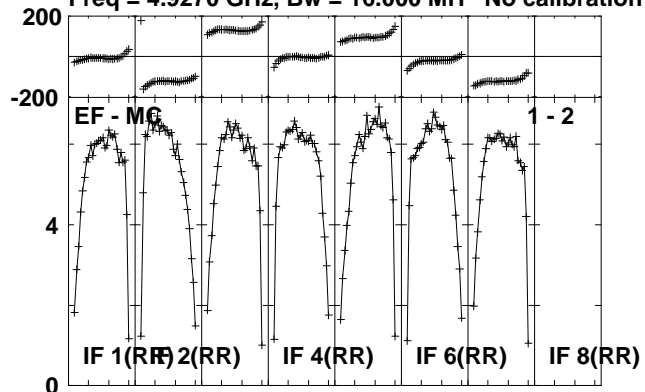

Lower frame: Milli Ampl Jy Top frame: Phas deg
Scalar averaged cross-power spectrum Several baselines displayed
Timerange: 00/20:00:26 to 00/20:02:59

Plot file version 196 created 02-DEC-2011 14:55:02

J1953+35 ET018A.UVDATA.1

Freq = 4.9270 GHz, Bw = 16.000 MH No calibration applied and no bandpass applied

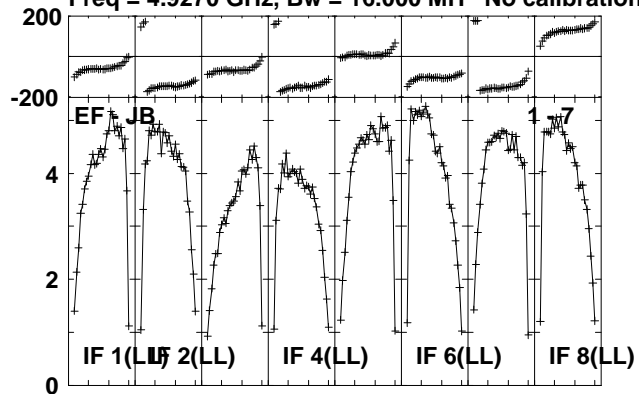

Lower frame: Milli Ampl Jy Top frame: Phas deg
Scalar averaged cross-power spectrum Several baselines displayed
Timerange: 00/20:00:26 to 00/20:02:59

Plot file version 197 created 02-DEC-2011 14:55:05

CYGX-1 ET018A.UVDATA.1

Freq = 4.9270 GHz, Bw = 16.000 MH No calibration applied and no bandpass applied

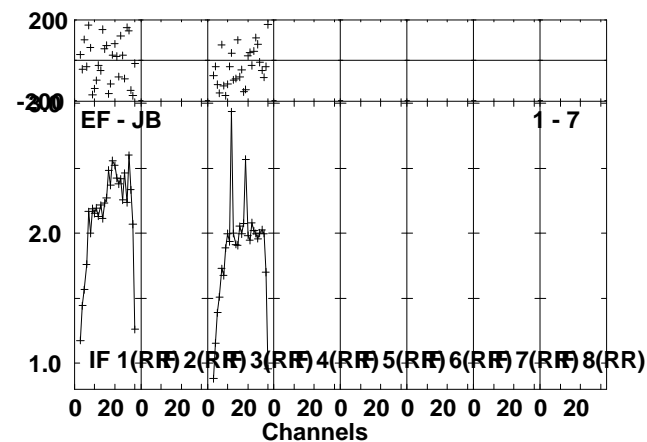
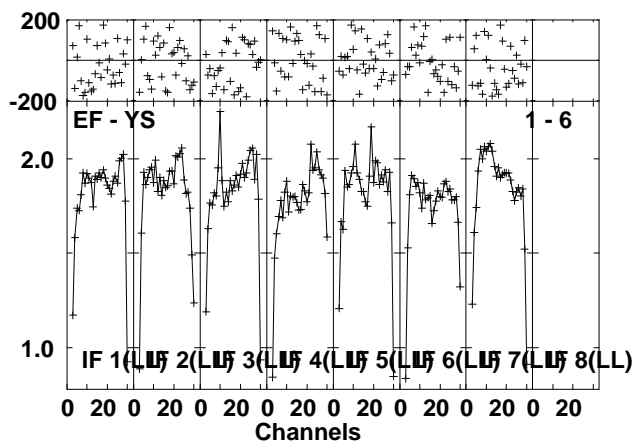
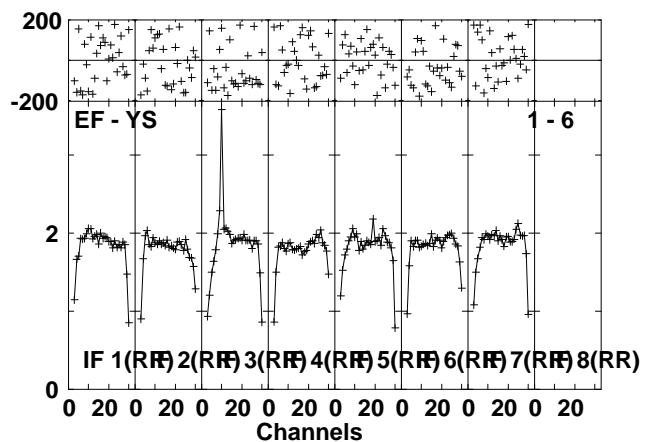
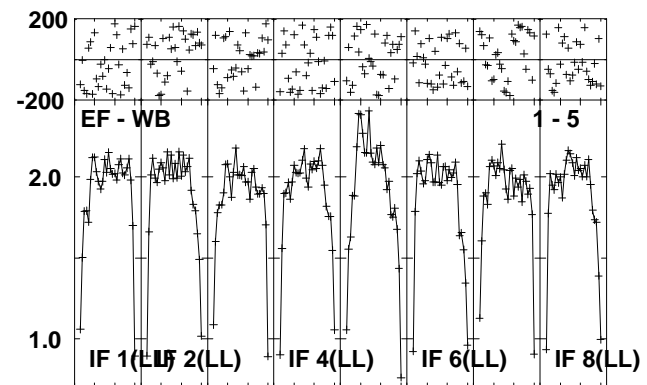
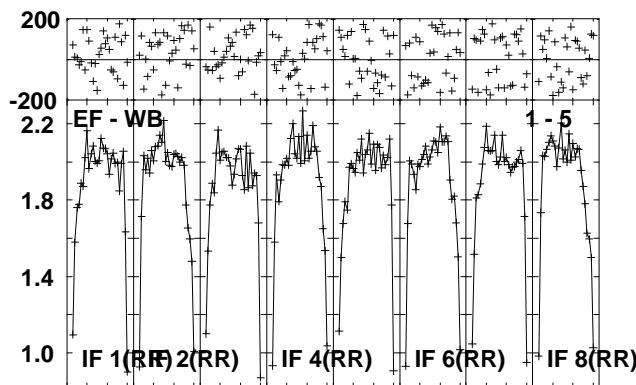
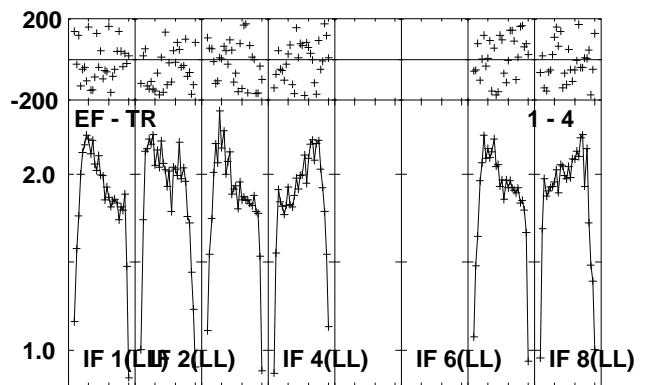
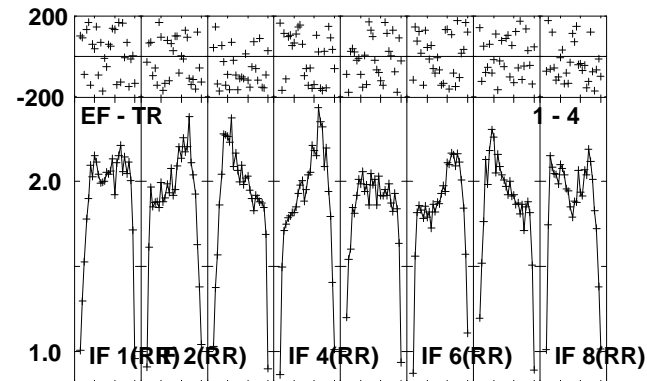
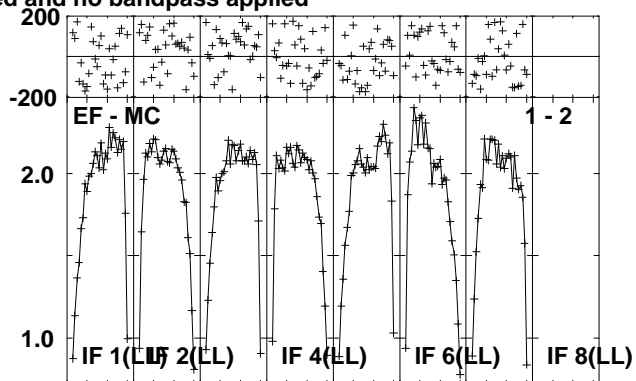
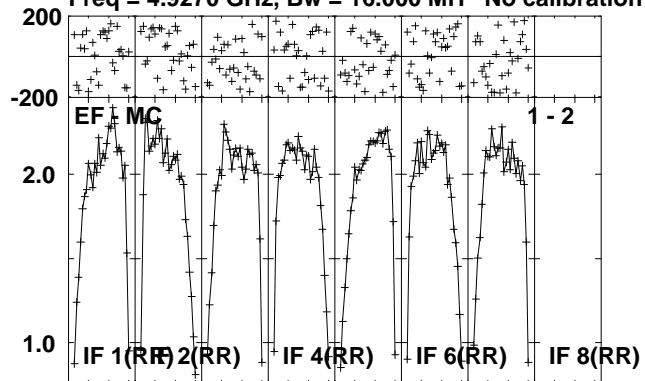

Lower frame: Milli Ampl Jy Top frame: Phas deg
Scalar averaged cross-power spectrum Several baselines displayed
Timerange: 00/20:03:02 to 00/20:08:28

Plot file version 198 created 02-DEC-2011 14:55:09

CYGX-1 ET018A.UVDATA.1

Freq = 4.9270 GHz, Bw = 16.000 MH No calibration applied and no bandpass applied

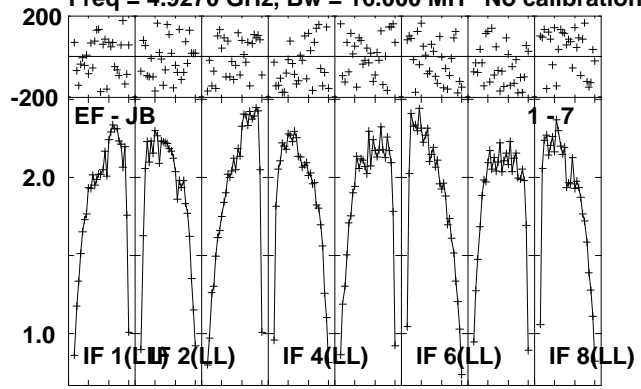

Lower frame: Milli Ampl Jy Top frame: Phas deg
Scalar averaged cross-power spectrum Several baselines displayed
Timerange: 00/20:03:02 to 00/20:08:28

Plot file version 199 created 02-DEC-2011 14:55:11

J1953+35 ET018A.UVDATA.1

Freq = 4.9270 GHz, Bw = 16.000 MH No calibration applied and no bandpass applied

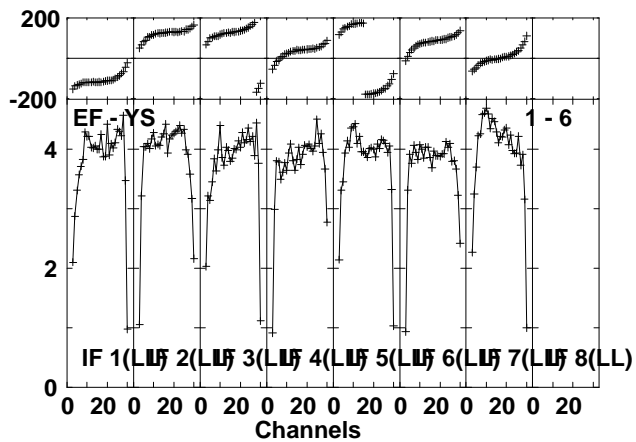
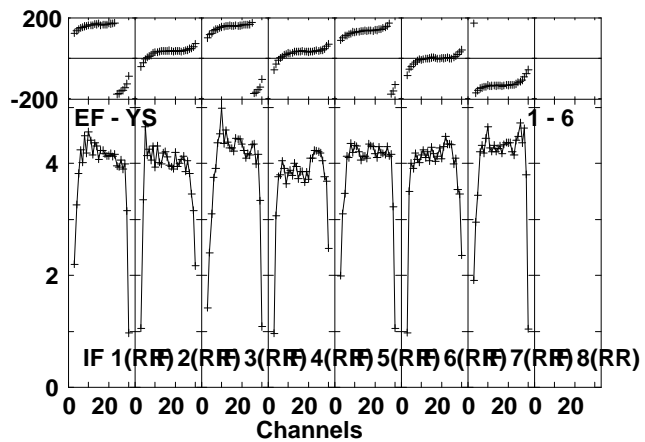
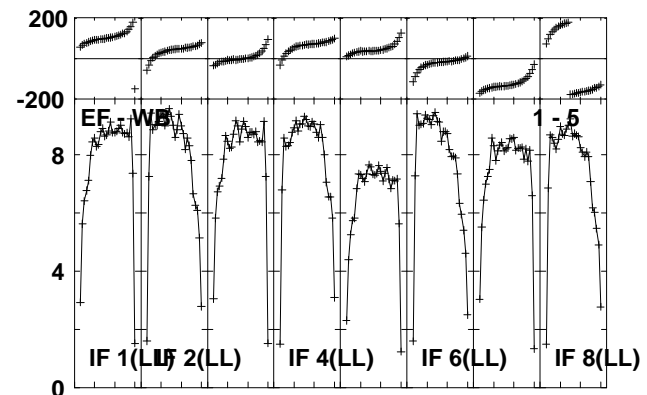
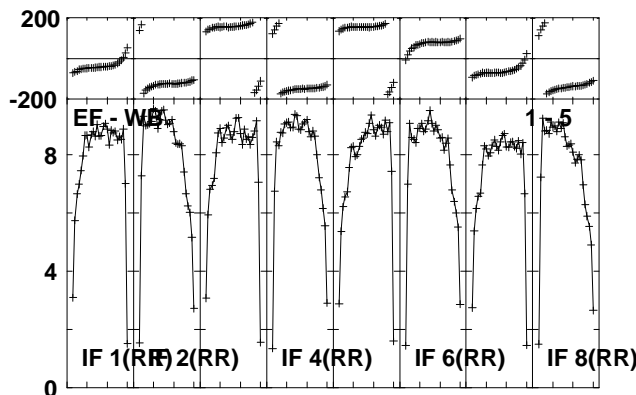
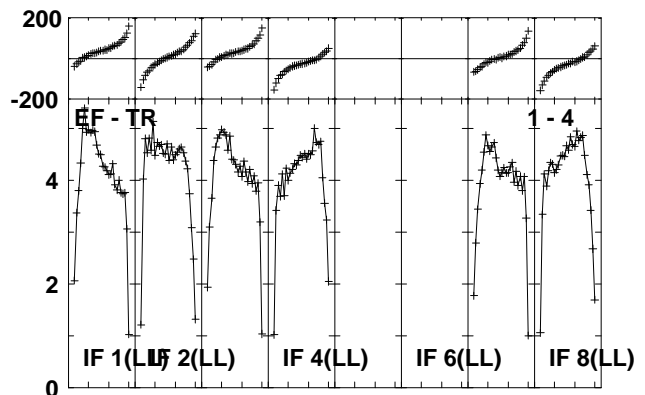
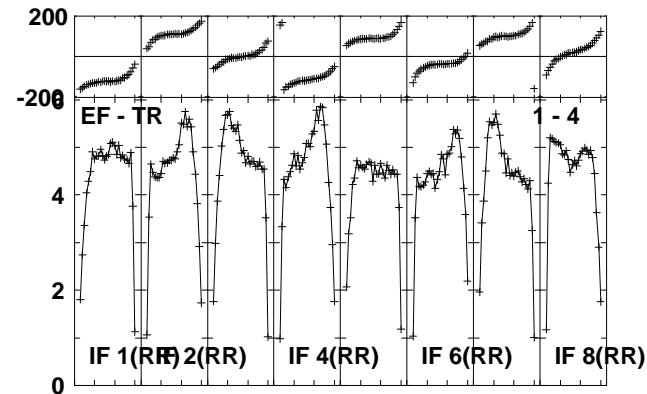
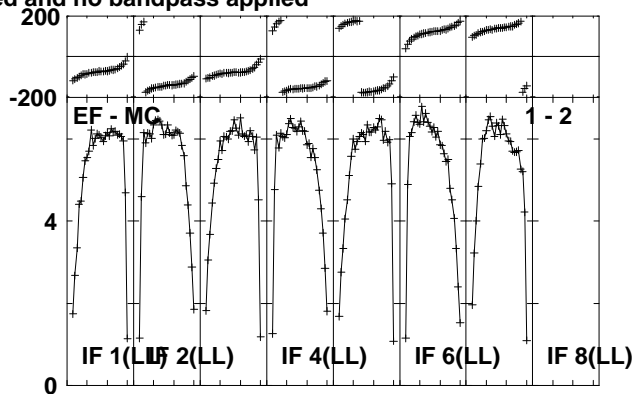
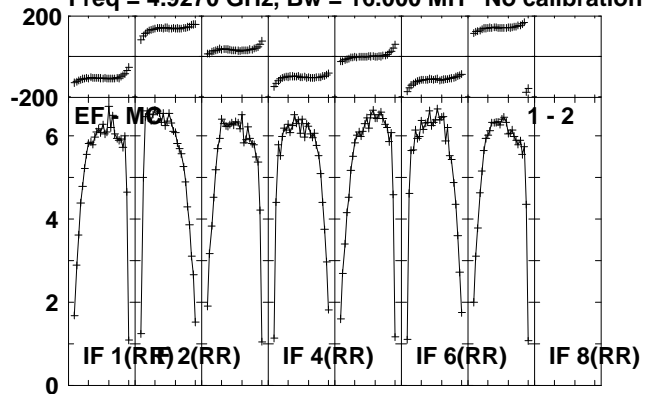

Lower frame: Milli Ampl Jy Top frame: Phas deg
 Scalar averaged cross-power spectrum Several baselines displayed
 Timerange: 00/20:08:32 to 00/20:11:29

Plot file version 200 created 02-DEC-2011 14:55:13

CYGX-1 ET018A.UVDATA.1

Freq = 4.9270 GHz, Bw = 16.000 MH No calibration applied and no bandpass applied

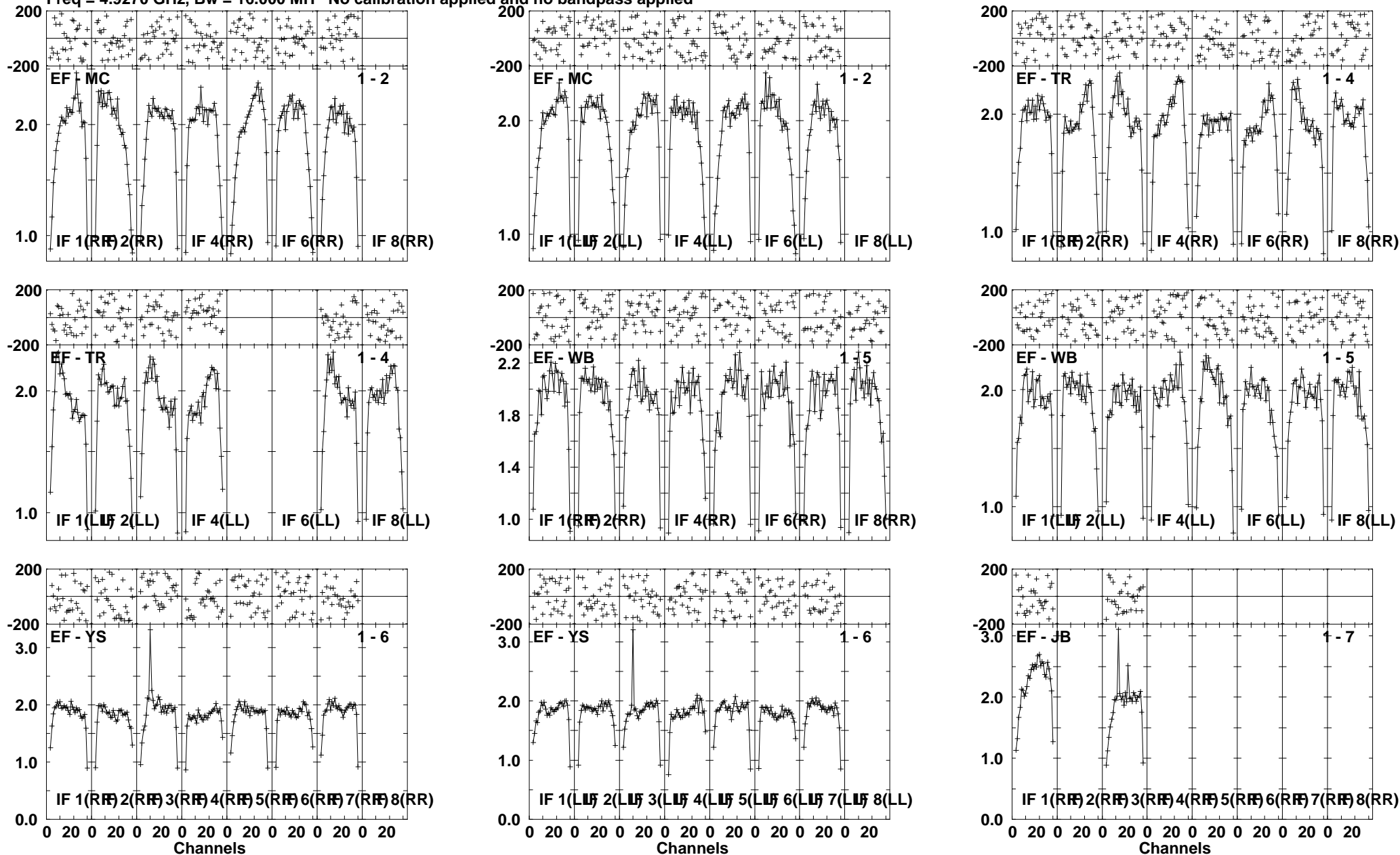

Lower frame: Milli Ampl Jy Top frame: Phas deg
Scalar averaged cross-power spectrum Several baselines displayed
Timerange: 00/20:11:32 to 00/20:16:58

Plot file version 201 created 02-DEC-2011 14:55:16

CYGX-1 ET018A.UVDATA.1

Freq = 4.9270 GHz, Bw = 16.000 MH No calibration applied and no bandpass applied

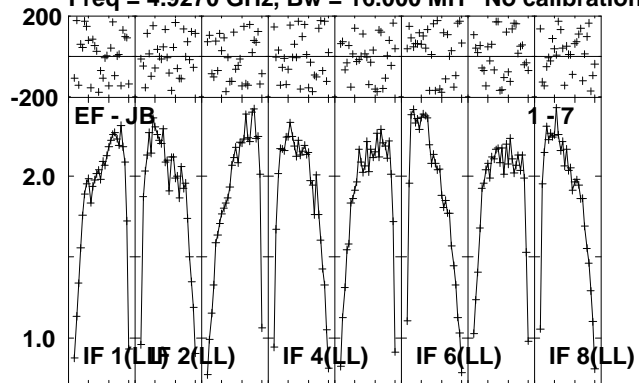

Lower frame: Milli Ampl Jy Top frame: Phas deg
Scalar averaged cross-power spectrum Several baselines displayed
Timerange: 00/20:11:32 to 00/20:16:58

Plot file version 202 created 02-DEC-2011 14:55:18

J1953+35 ET018A.UVDATA.1

Freq = 4.9270 GHz, Bw = 16.000 MH No calibration applied and no bandpass applied

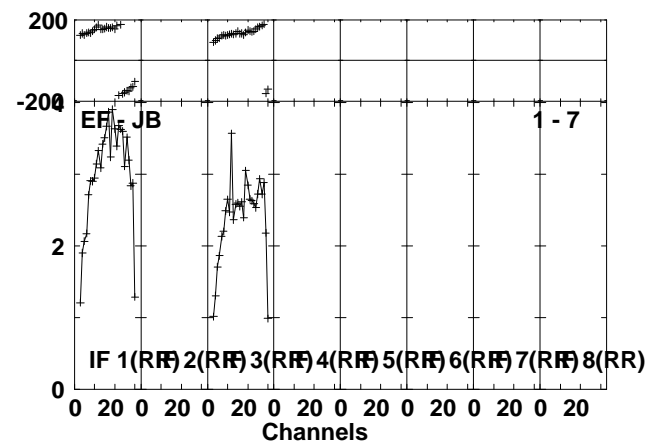
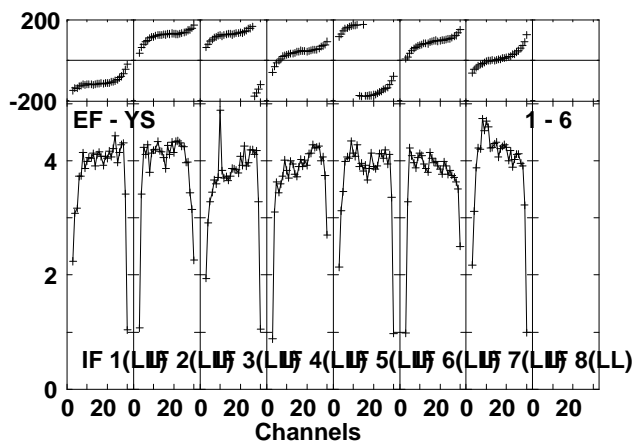
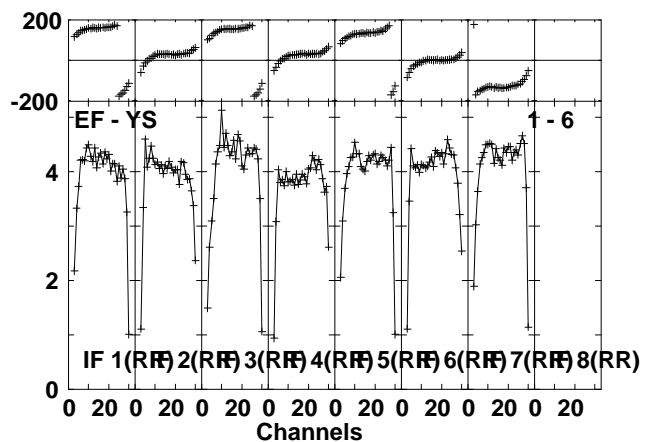
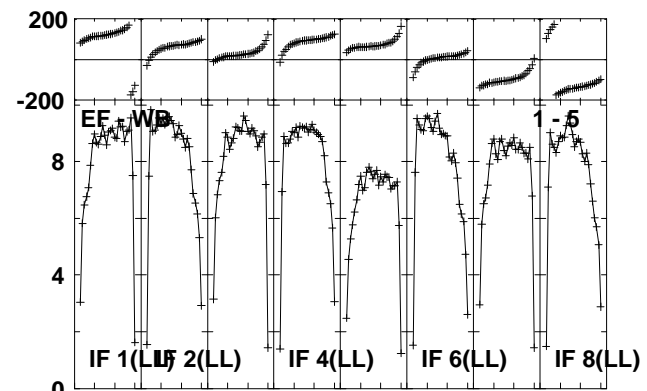
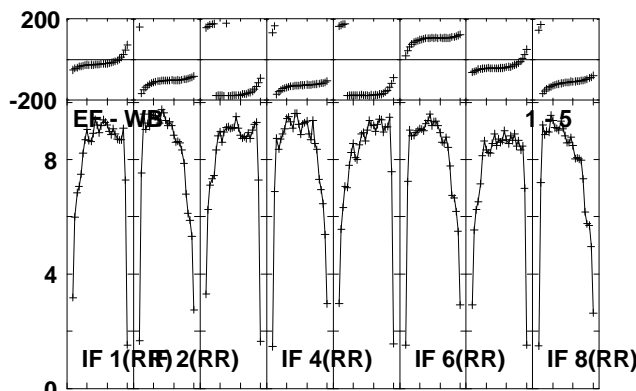
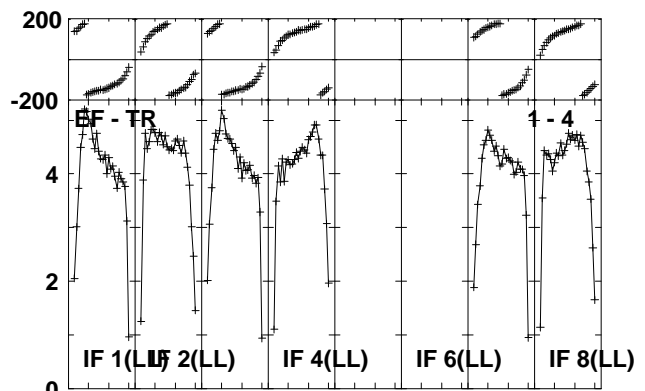
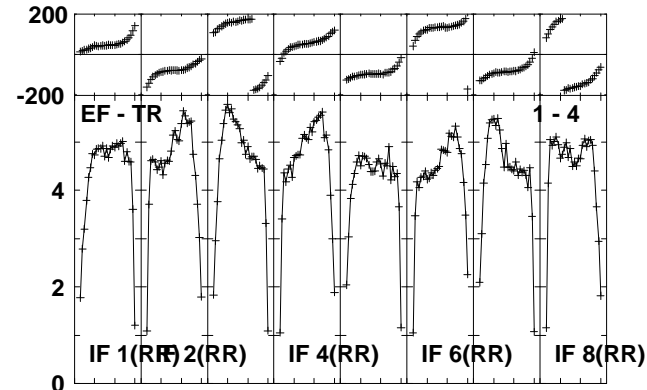
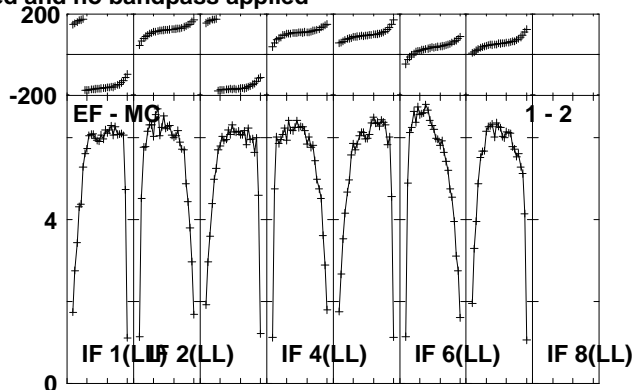
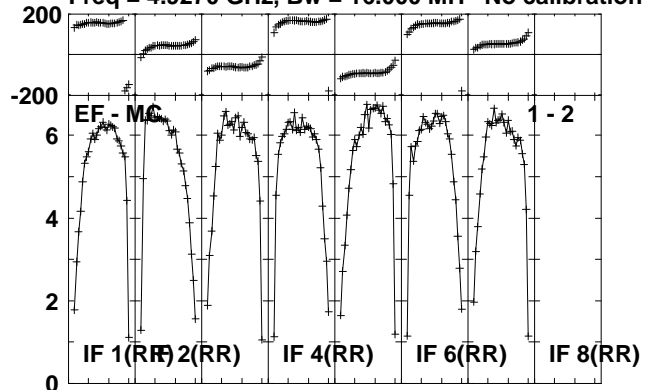

Lower frame: Milli Ampl Jy Top frame: Phas deg
Scalar averaged cross-power spectrum Several baselines displayed
Timerange: 00/20:17:46 to 00/20:20:19

Plot file version 203 created 02-DEC-2011 14:55:19

J1953+35 ET018A.UVDATA.1

Freq = 4.9270 GHz, Bw = 16.000 MH No calibration applied and no bandpass applied

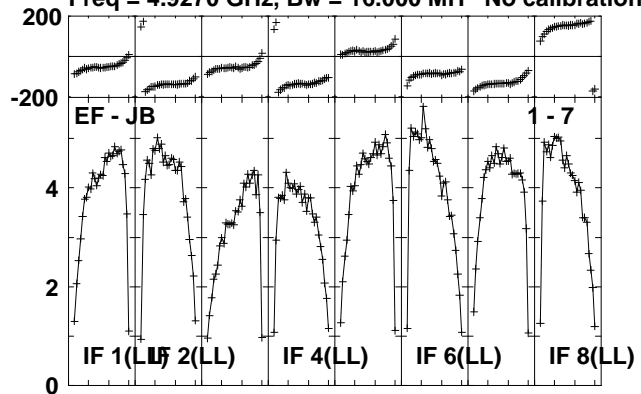

Lower frame: Milli Ampl Jy Top frame: Phas deg
Scalar averaged cross-power spectrum Several baselines displayed
Timerange: 00/20:17:46 to 00/20:20:19

Plot file version 204 created 02-DEC-2011 14:55:20

J2002+47 ET018A.UVDATA.1

Freq = 4.9270 GHz, Bw = 16.000 MH No calibration applied and no bandpass applied

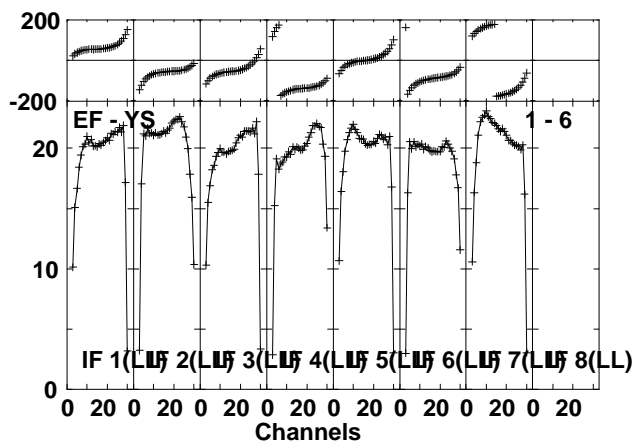
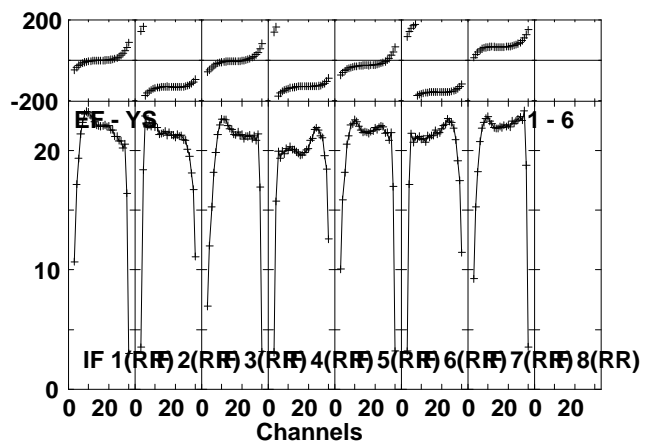
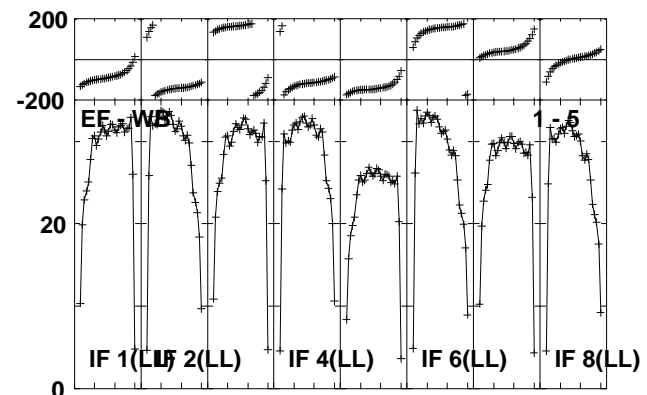
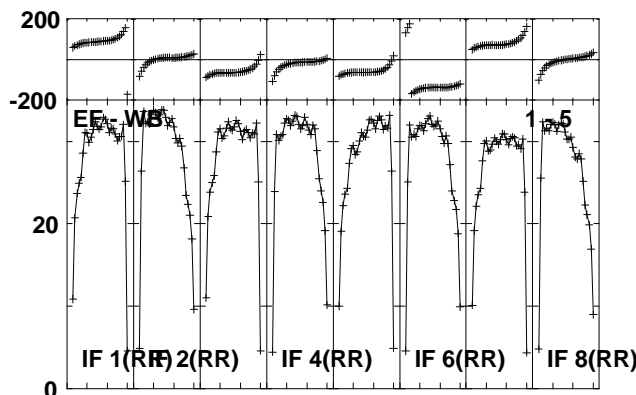
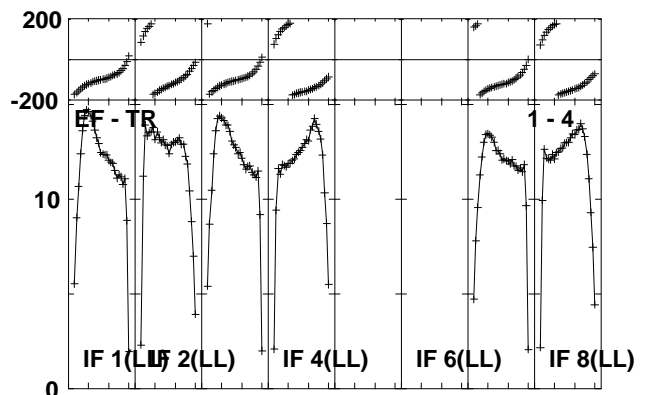
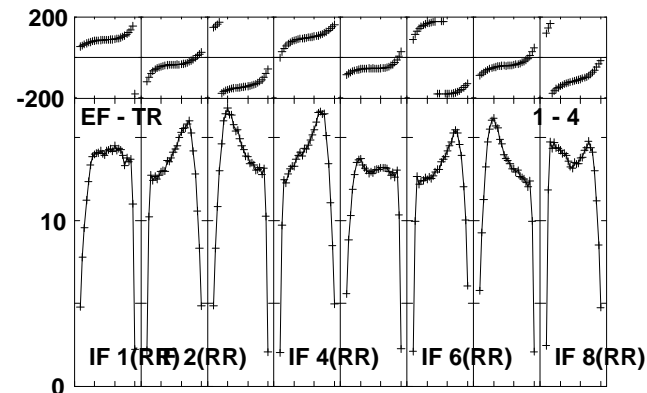
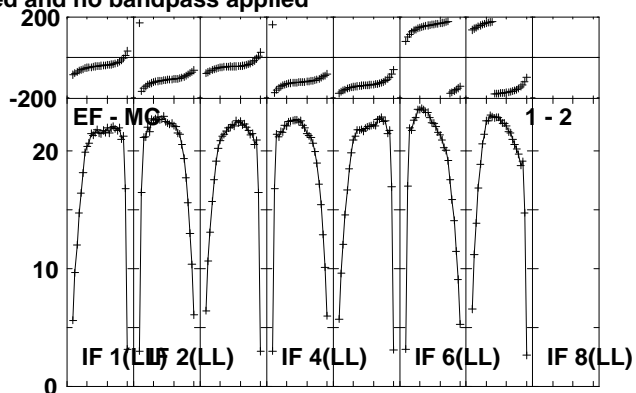
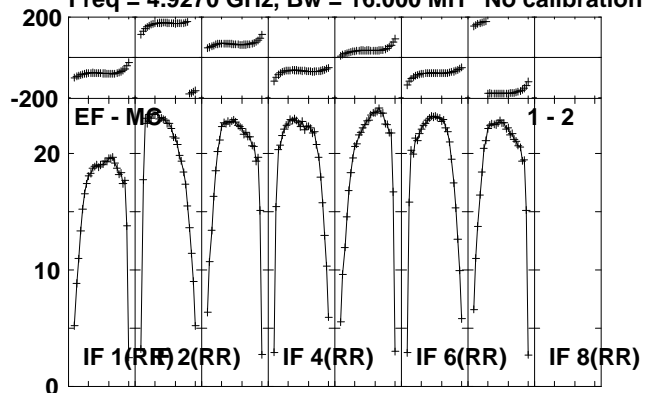

Lower frame: Milli Ampl Jy Top frame: Phas deg
Scalar averaged cross-power spectrum Several baselines displayed
Timerange: 00/20:21:46 to 00/20:25:48

Plot file version 205 created 02-DEC-2011 14:55:24

J1953+35 ET018A.UVDATA.1

Freq = 4.9270 GHz, Bw = 16.000 MH No calibration applied and no bandpass applied

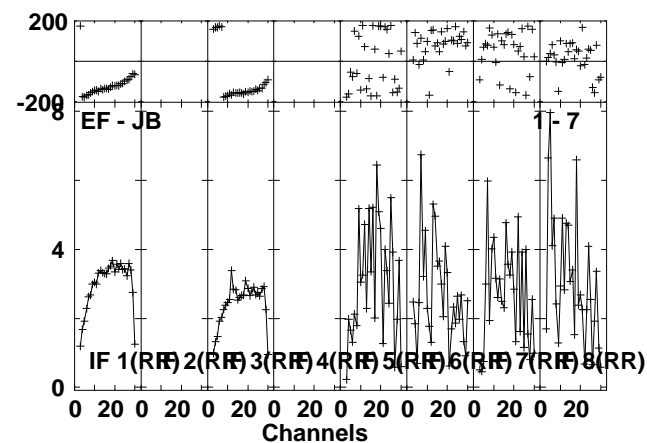
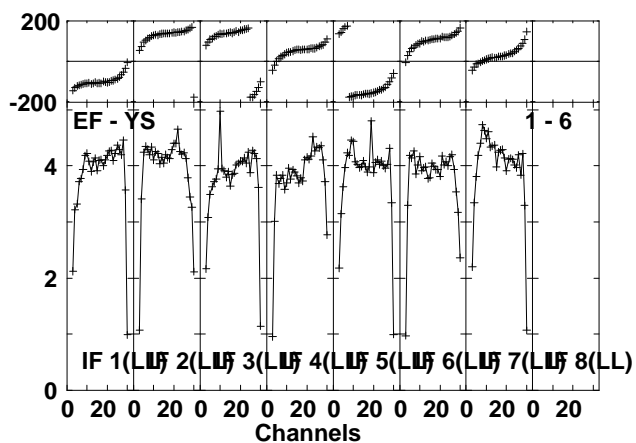
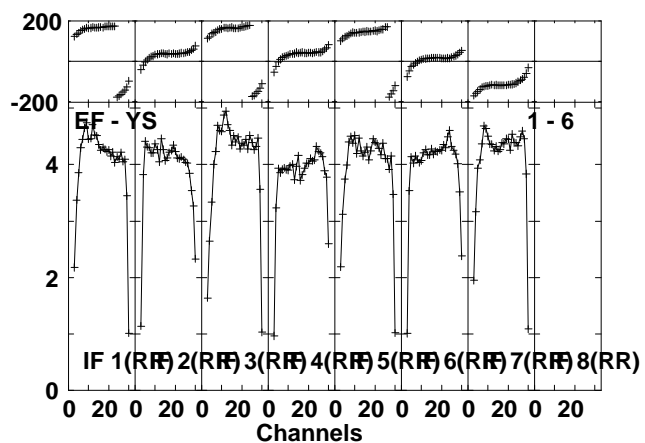
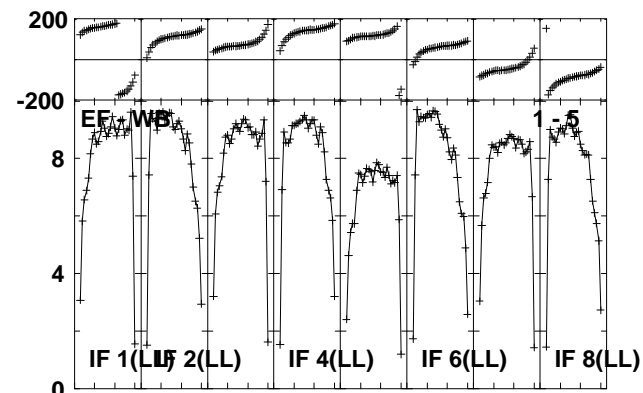
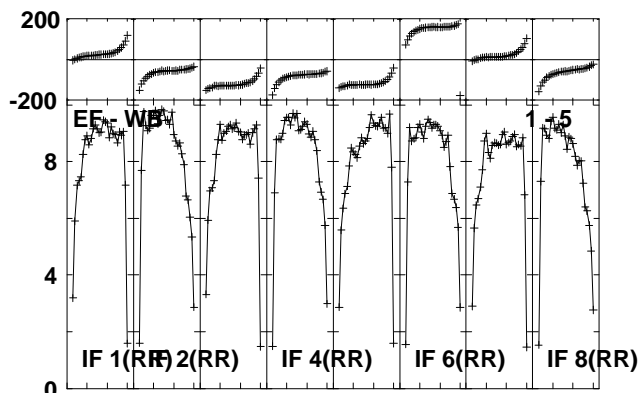
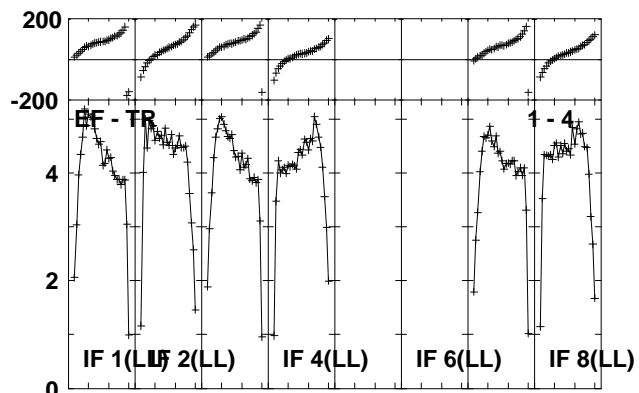
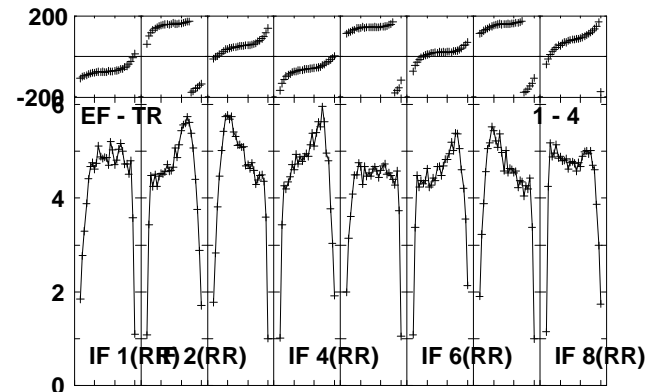
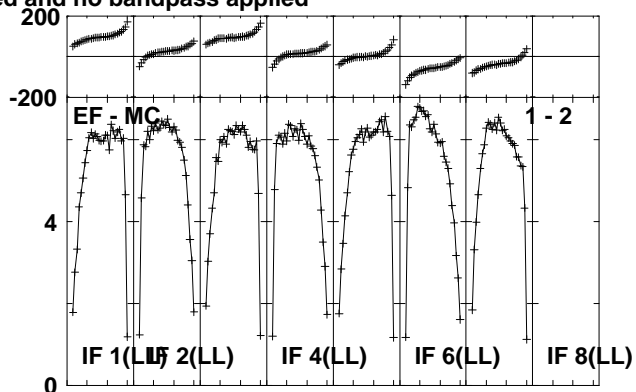
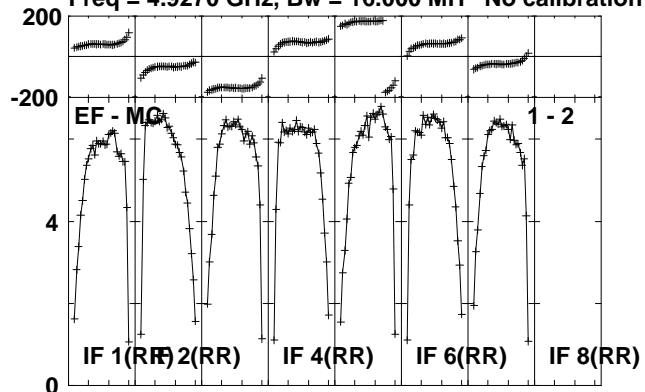

Lower frame: Milli Ampl Jy Top frame: Phas deg
Scalar averaged cross-power spectrum Several baselines displayed
Timerange: 00/20:26:47 to 00/20:30:18

Plot file version 206 created 02-DEC-2011 14:55:28

J1953+35 ET018A.UVDATA.1

Freq = 4.9270 GHz, Bw = 16.000 MH No calibration applied and no bandpass applied

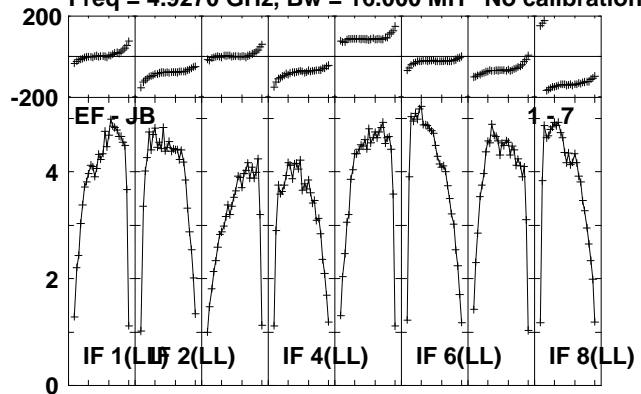

Lower frame: Milli Ampl Jy Top frame: Phas deg
Scalar averaged cross-power spectrum Several baselines displayed
Timerange: 00/20:26:47 to 00/20:30:18

Plot file version 207 created 02-DEC-2011 14:55:30

CYGX-1 ET018A.UVDATA.1

Freq = 4.9270 GHz, Bw = 16.000 MH No calibration applied and no bandpass applied

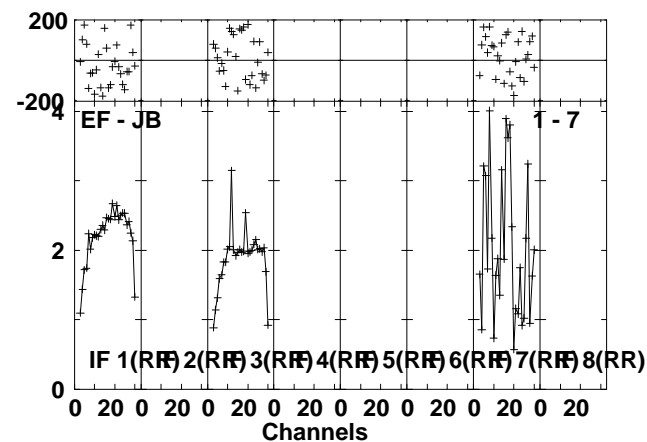
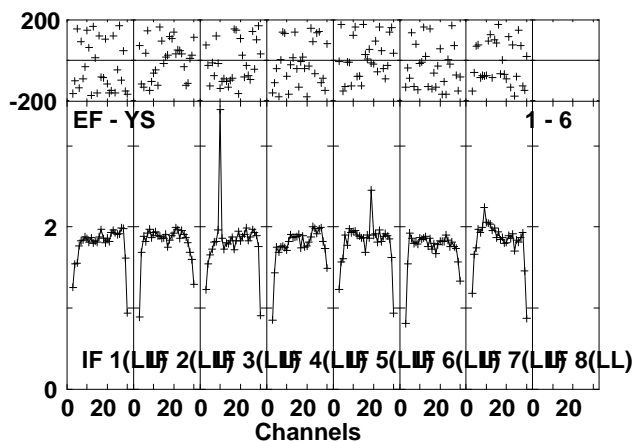
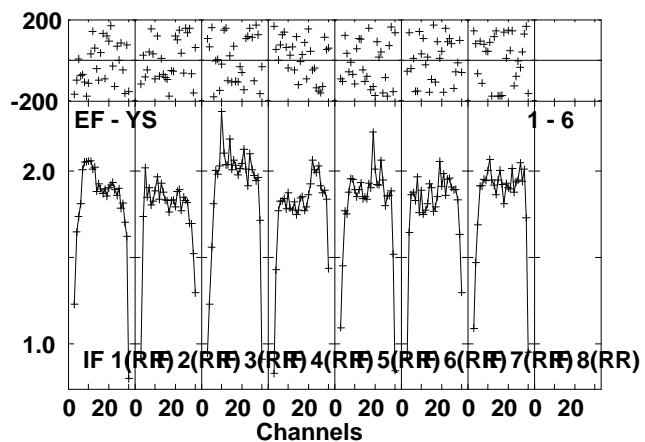
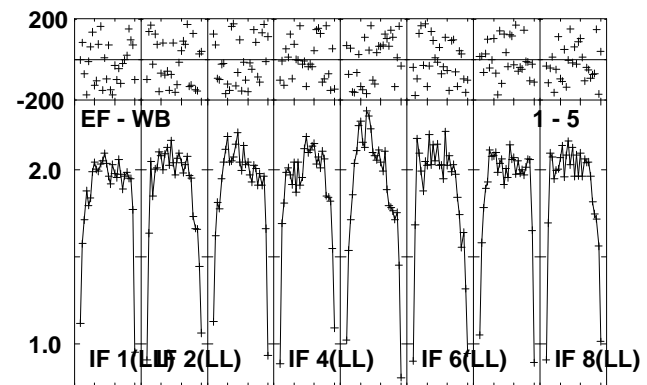
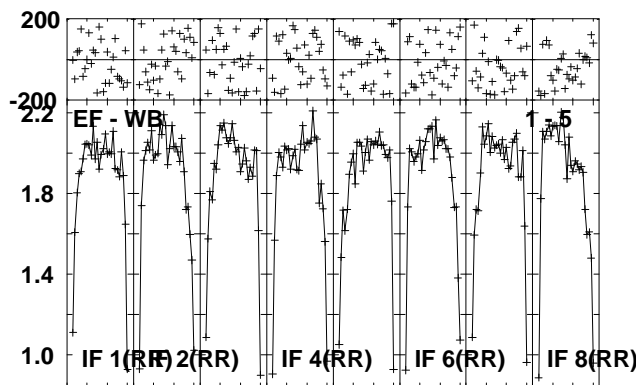
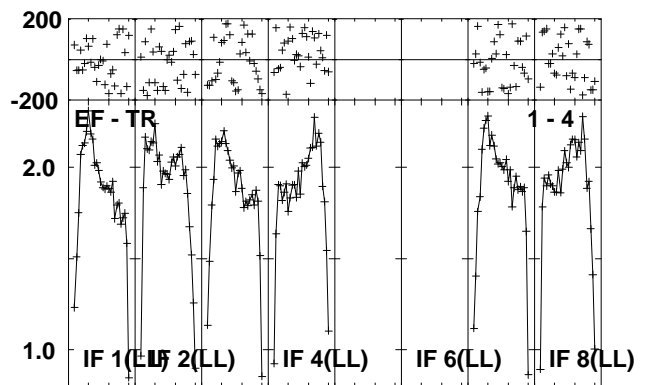
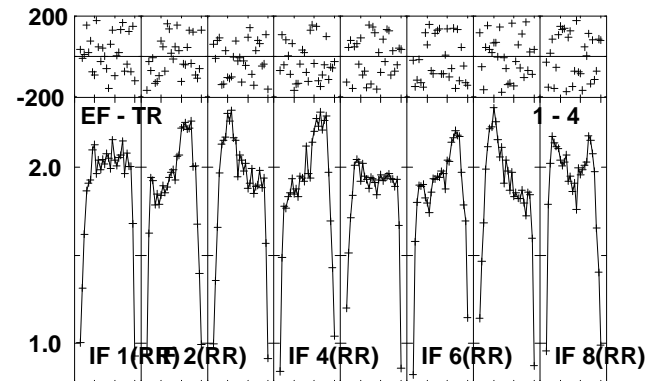
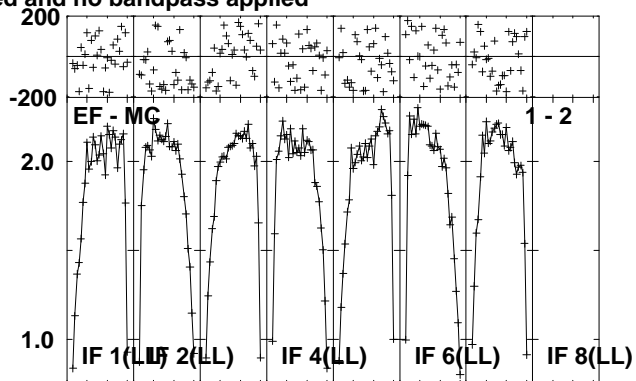
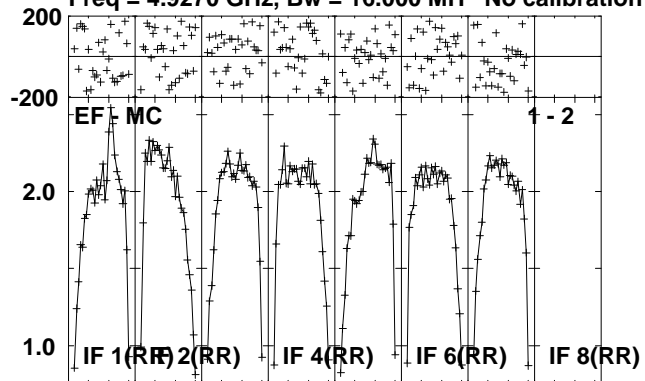

Lower frame: Milli Ampl Jy Top frame: Phas deg
Scalar averaged cross-power spectrum Several baselines displayed
Timerange: 00/20:30:22 to 00/20:35:48

Plot file version 208 created 02-DEC-2011 14:55:33

CYGX-1 ET018A.UVDATA.1

Freq = 4.9270 GHz, Bw = 16.000 MH No calibration applied and no bandpass applied

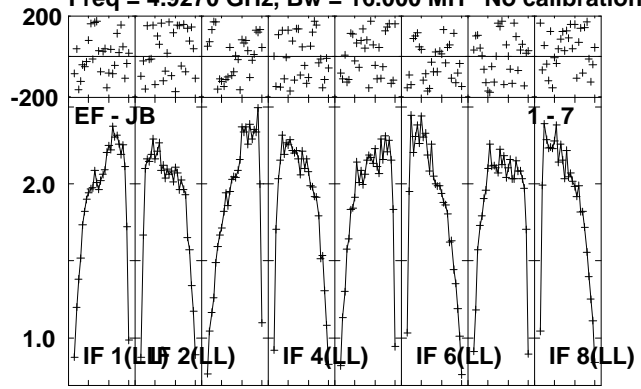

Lower frame: Milli Ampl Jy Top frame: Phas deg
Scalar averaged cross-power spectrum Several baselines displayed
Timerange: 00/20:30:22 to 00/20:35:48

Plot file version 209 created 02-DEC-2011 14:55:35

J1953+35 ET018A.UVDATA.1

Freq = 4.9270 GHz, Bw = 16.000 MH No calibration applied and no bandpass applied

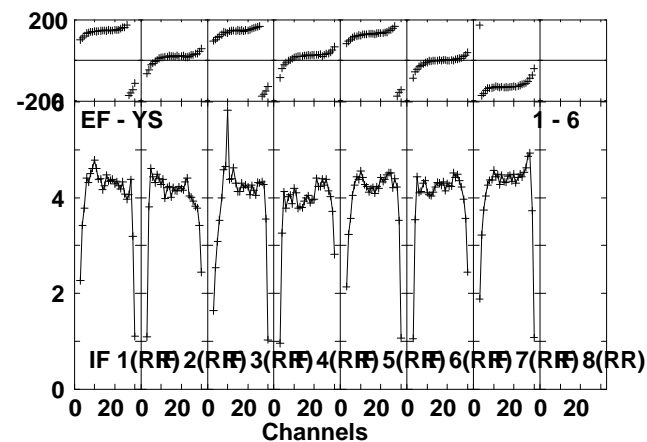
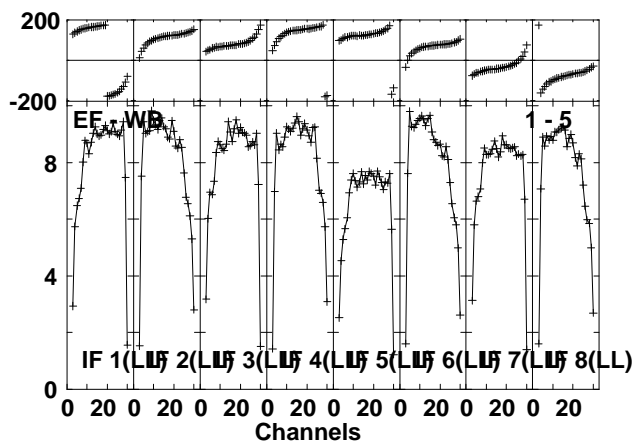
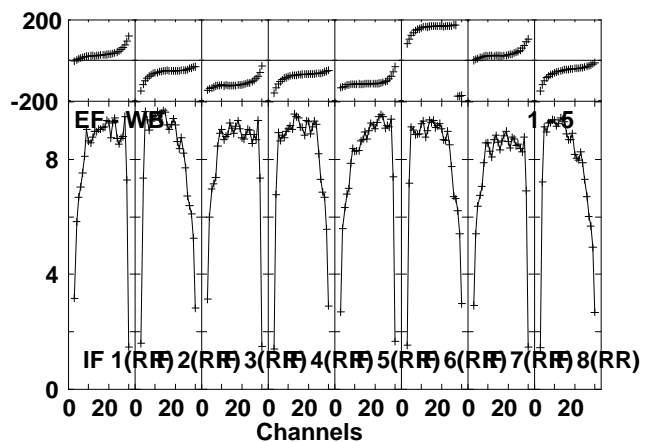
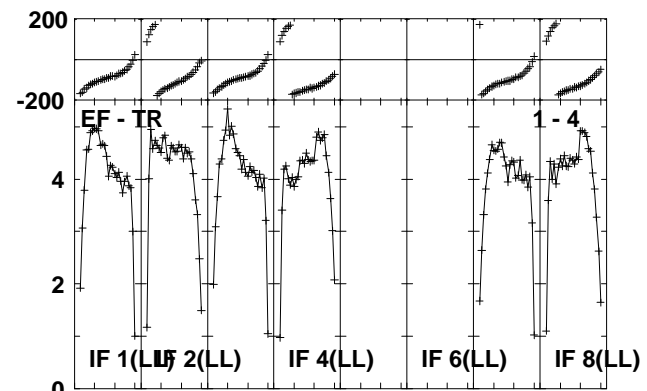
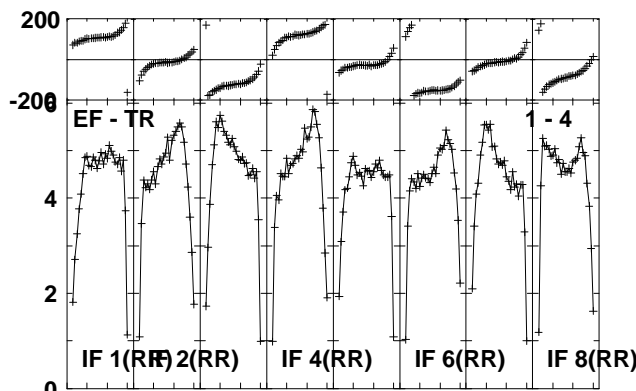
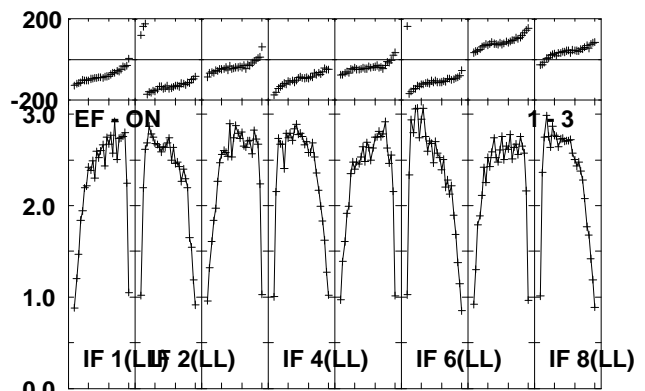
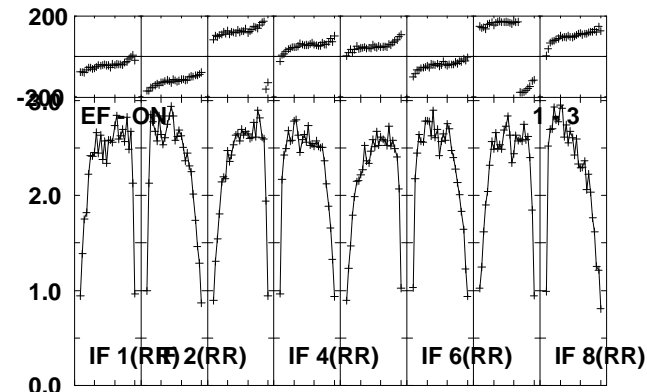
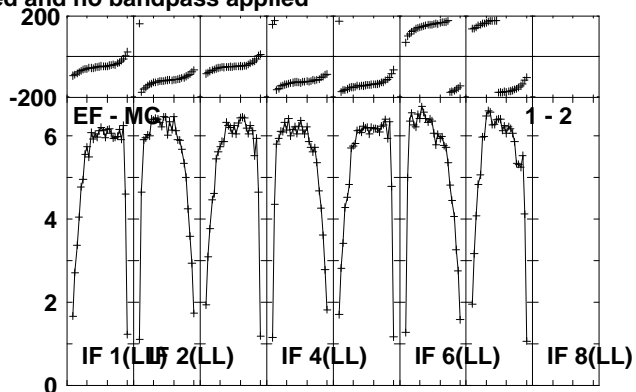
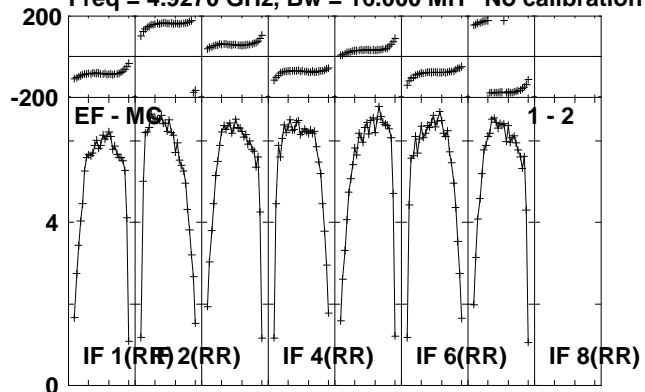

Lower frame: Milli Ampl Jy Top frame: Phas deg
Scalar averaged cross-power spectrum Several baselines displayed
Timerange: 00/20:35:51 to 00/20:38:48

Plot file version 210 created 02-DEC-2011 14:55:36

J1953+35 ET018A.UVDATA.1

Freq = 4.9270 GHz, Bw = 16.000 MH No calibration applied and no bandpass applied

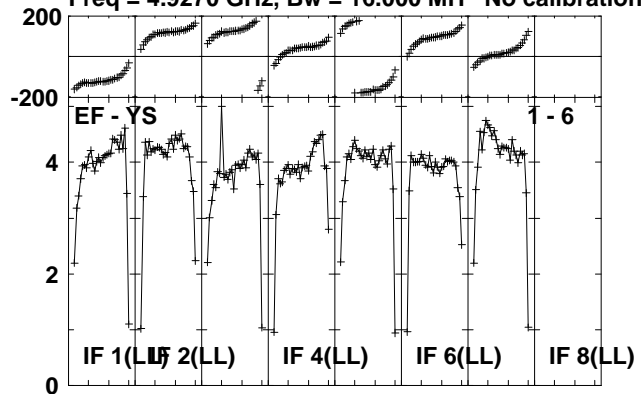

Lower frame: Milli Ampl Jy Top frame: Phas deg
Scalar averaged cross-power spectrum Several baselines displayed
Timerange: 00/20:35:51 to 00/20:38:48

Plot file version 211 created 02-DEC-2011 14:55:38

CYGX-1 ET018A.UVDATA.1

Freq = 4.9270 GHz, Bw = 16.000 MH No calibration applied and no bandpass applied

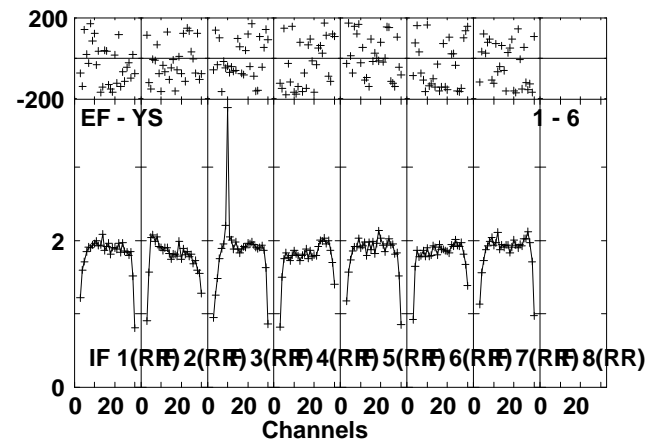
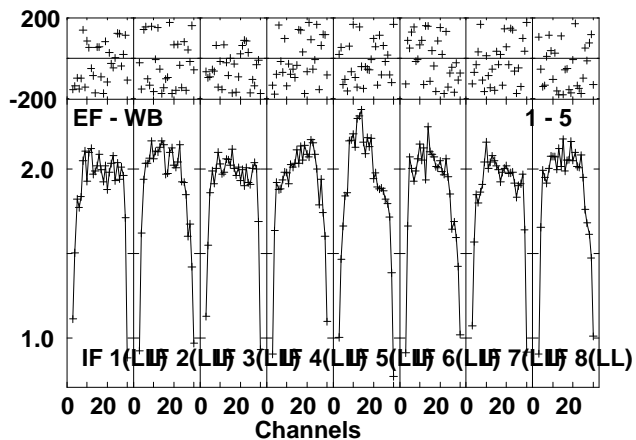
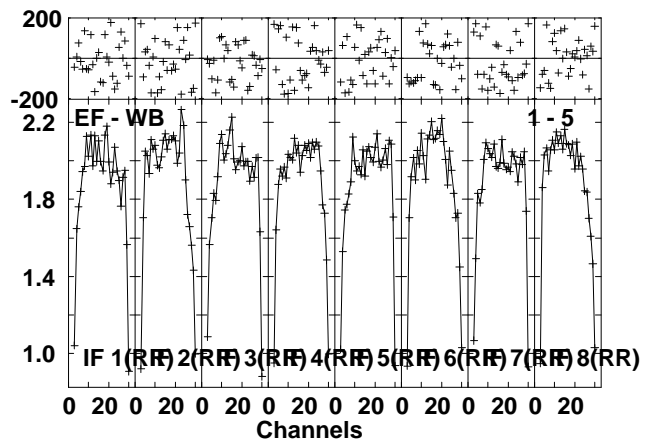
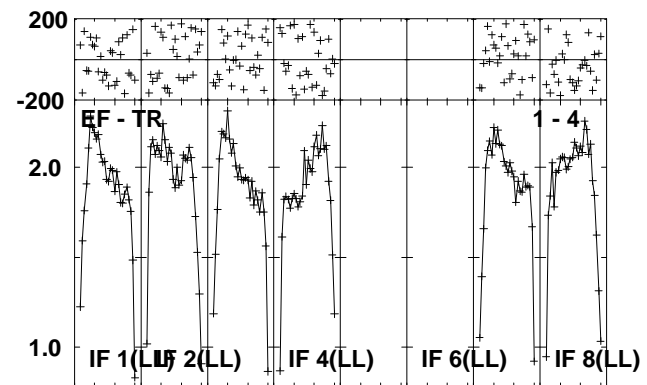
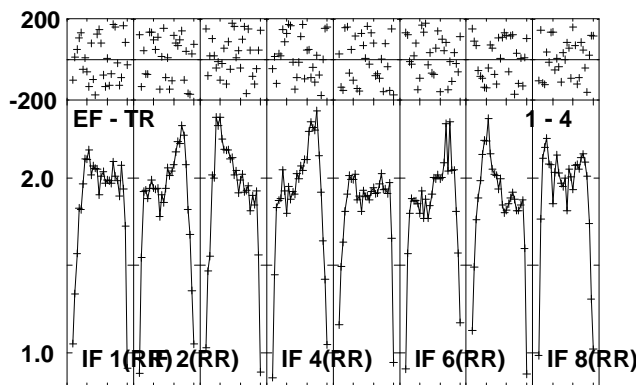
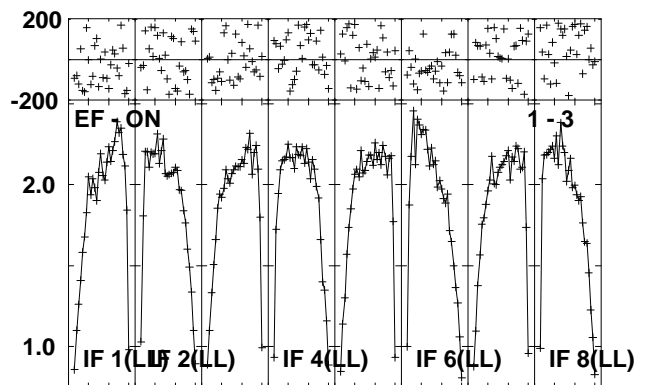
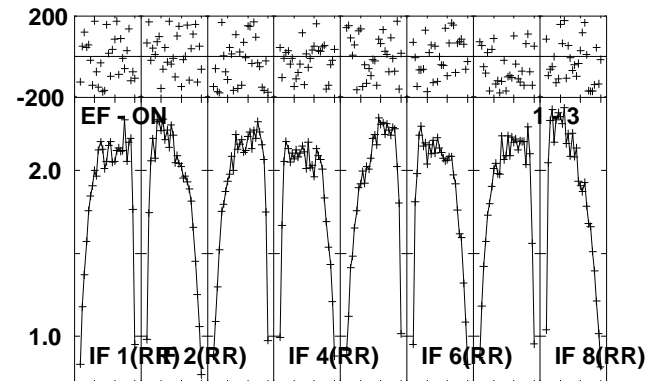
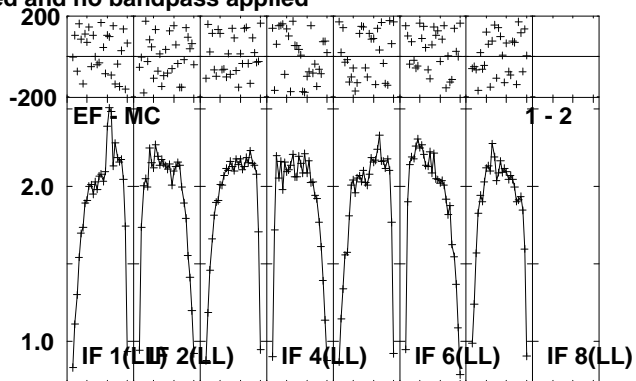
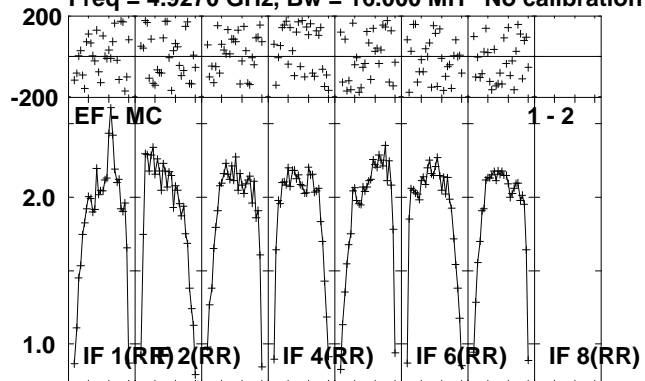

Lower frame: Milli Ampl Jy Top frame: Phas deg
Scalar averaged cross-power spectrum Several baselines displayed
Timerange: 00/20:38:52 to 00/20:44:18

Plot file version 212 created 02-DEC-2011 14:55:41

CYGX-1 ET018A.UVDATA.1

Freq = 4.9270 GHz, Bw = 16.000 MH No calibration applied and no bandpass applied

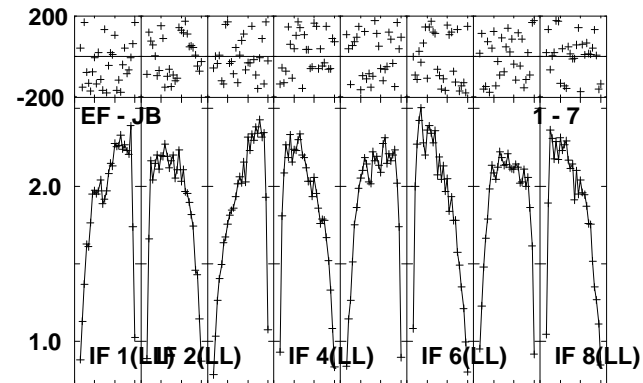
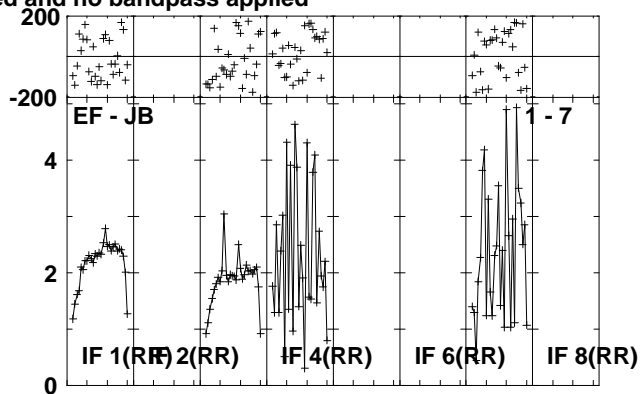
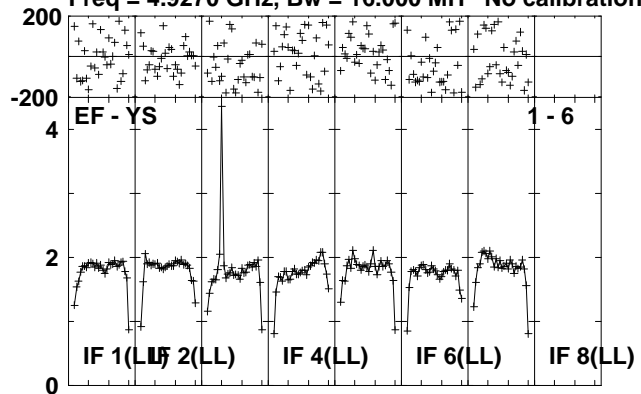

Lower frame: Milli Ampl Jy Top frame: Phas deg
Scalar averaged cross-power spectrum Several baselines displayed
Timerange: 00/20:38:52 to 00/20:44:18

Plot file version 213 created 02-DEC-2011 14:55:43

J1953+35 ET018A.UVDATA.1

Freq = 4.9270 GHz, Bw = 16.000 MH No calibration applied and no bandpass applied

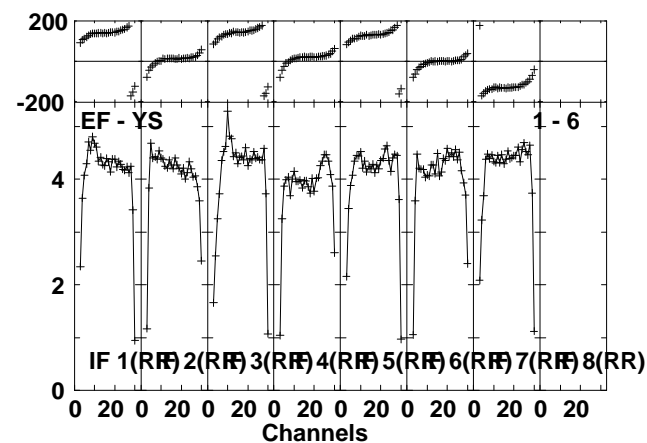
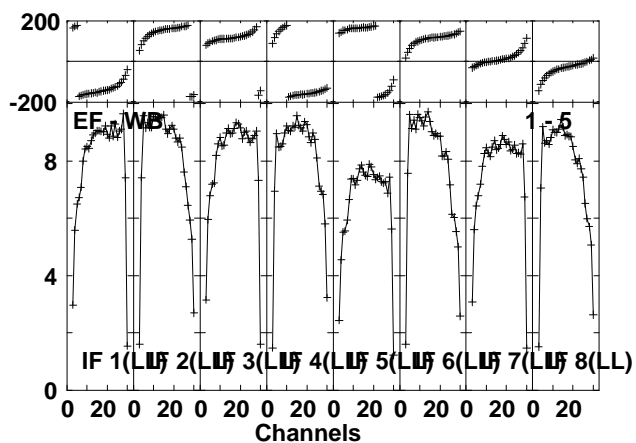
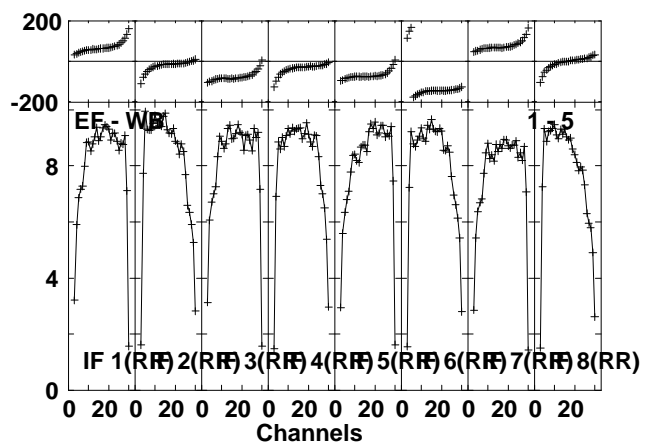
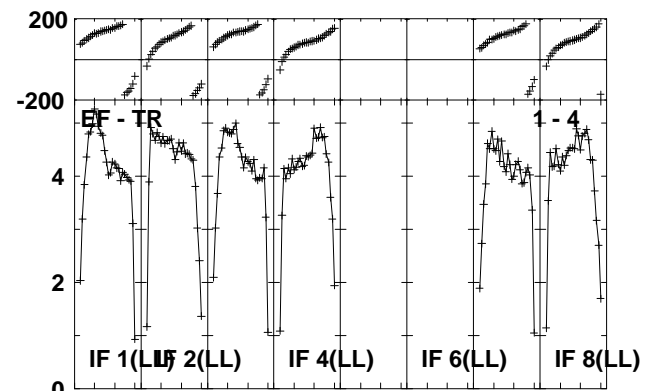
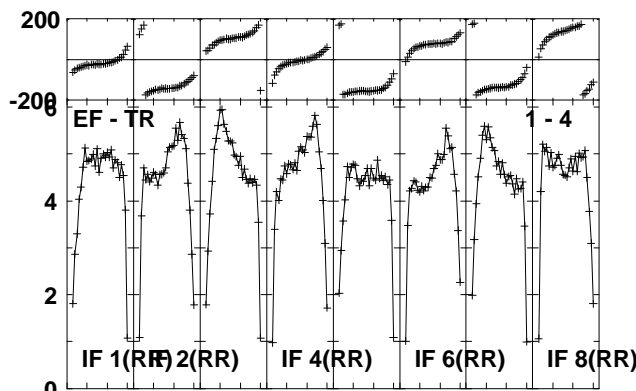
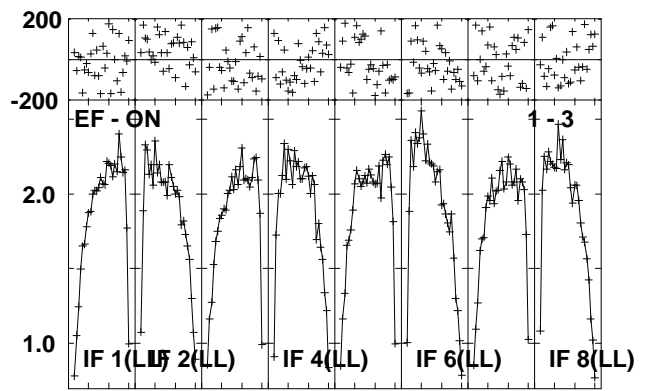
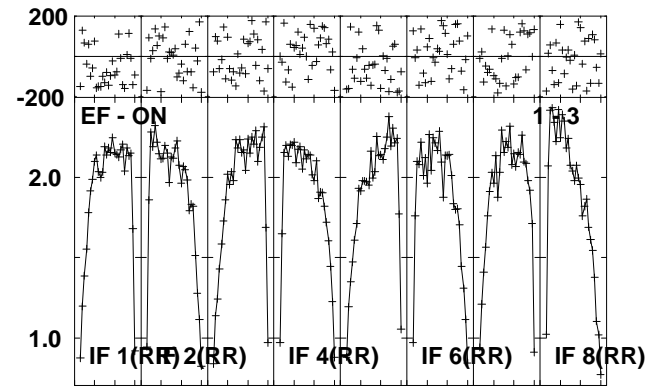
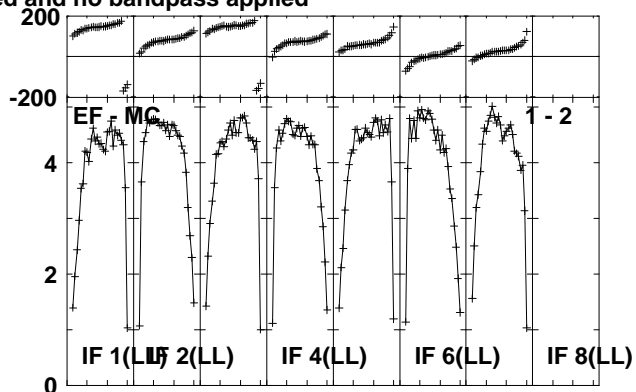
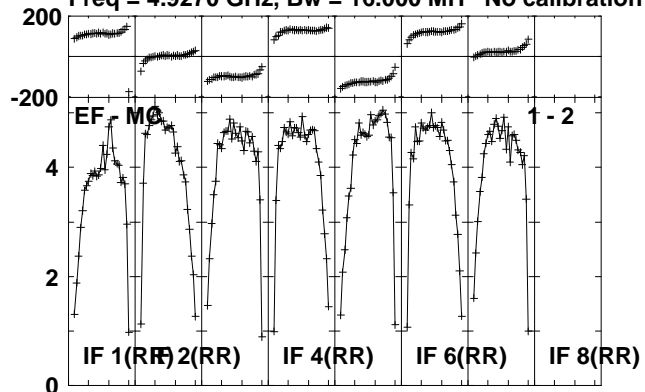

Lower frame: Milli Ampl Jy Top frame: Phas deg
Scalar averaged cross-power spectrum Several baselines displayed
Timerange: 00/20:45:07 to 00/20:47:39

Plot file version 214 created 02-DEC-2011 14:55:45

J1953+35 ET018A.UVDATA.1

Freq = 4.9270 GHz, Bw = 16.000 MH No calibration applied and no bandpass applied

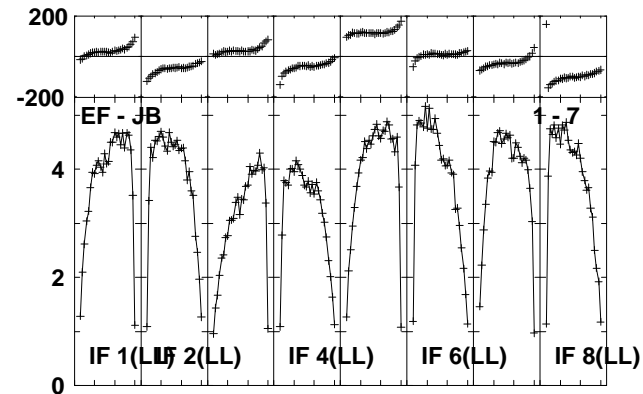
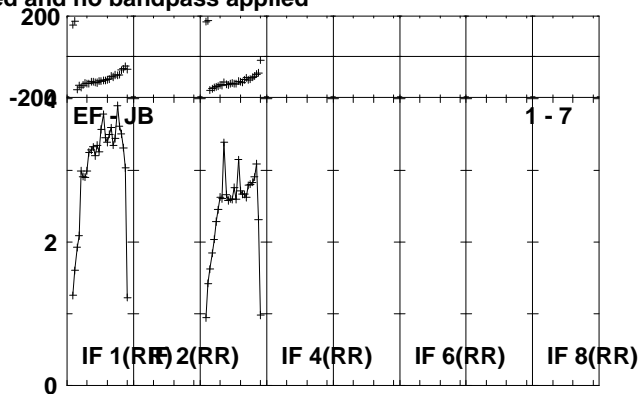
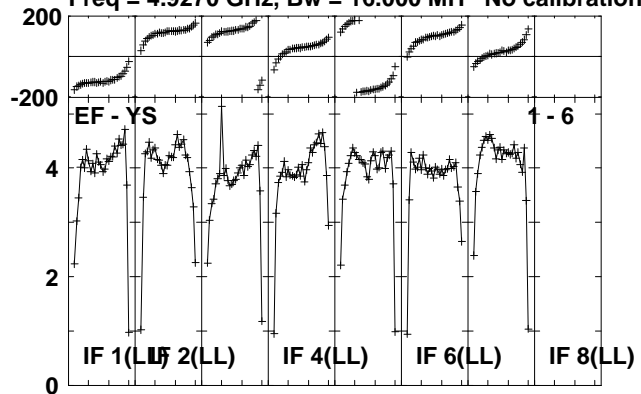

Lower frame: Milli Ampl Jy Top frame: Phas deg
Scalar averaged cross-power spectrum Several baselines displayed
Timerange: 00/20:45:07 to 00/20:47:39

Plot file version 215 created 02-DEC-2011 14:55:46

CYGX-1 ET018A.UVDATA.1

Freq = 4.9270 GHz, Bw = 16.000 MH No calibration applied and no bandpass applied

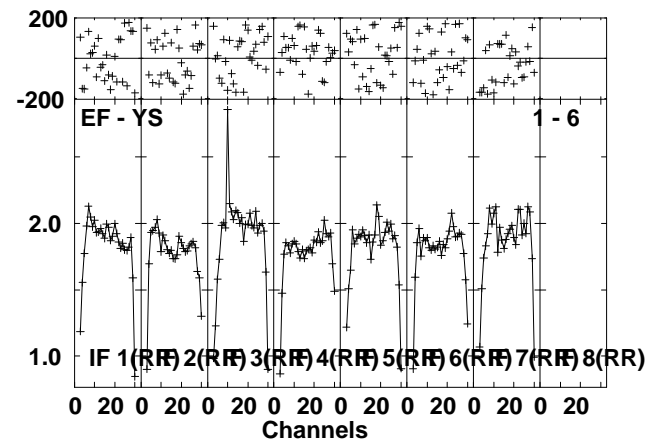
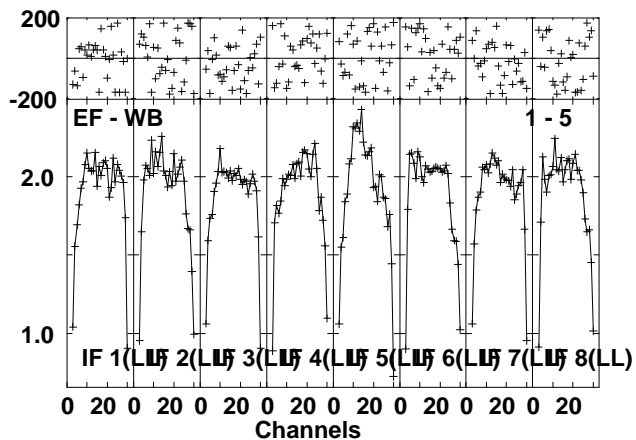
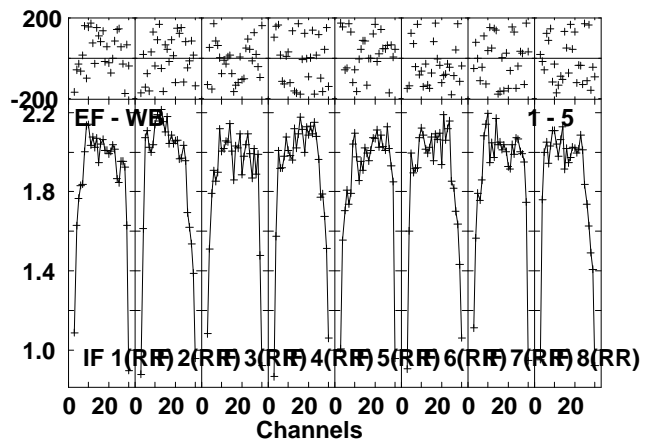
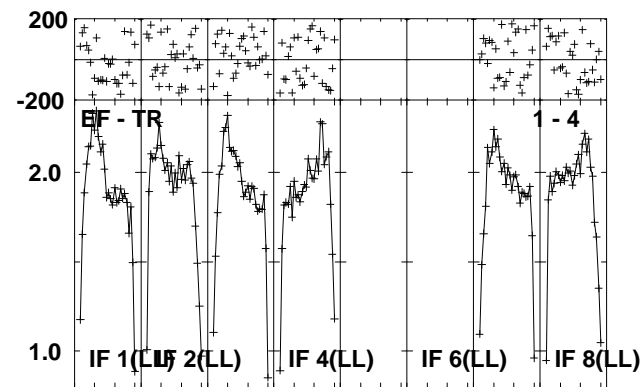
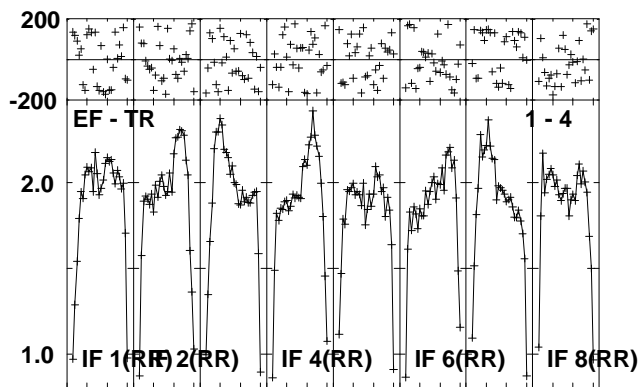
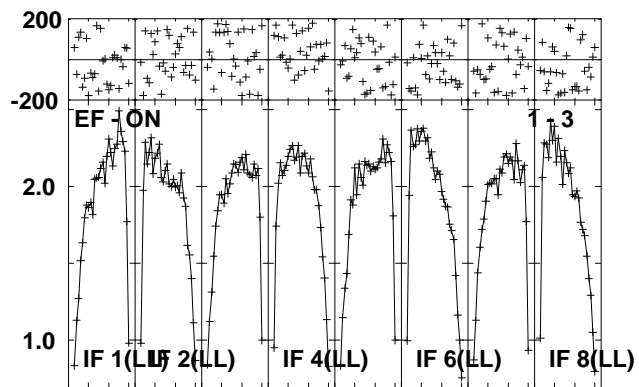
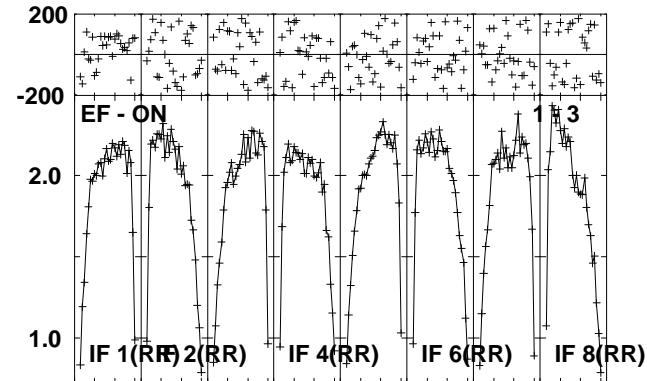
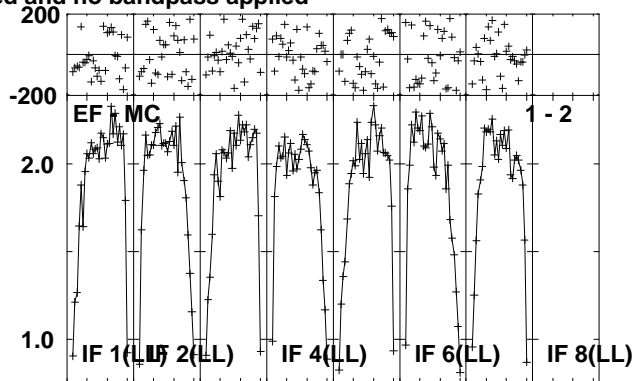
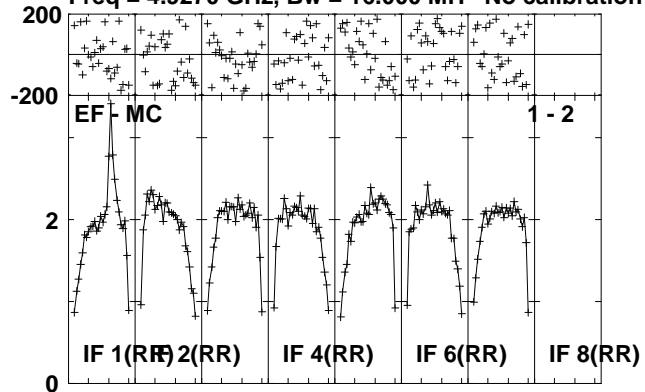

Lower frame: Milli Ampl Jy Top frame: Phas deg
Scalar averaged cross-power spectrum Several baselines displayed
Timerange: 00/20:47:42 to 00/20:53:08

Plot file version 216 created 02-DEC-2011 14:55:49

CYGX-1 ET018A.UVDATA.1

Freq = 4.9270 GHz, Bw = 16.000 MH No calibration applied and no bandpass applied

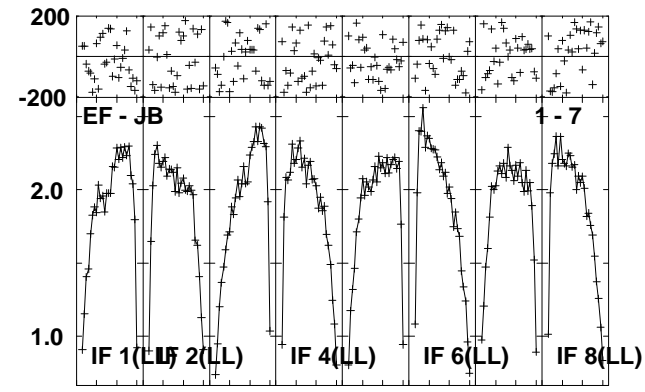
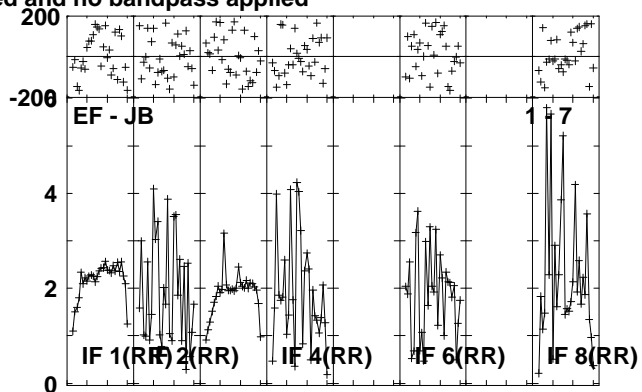
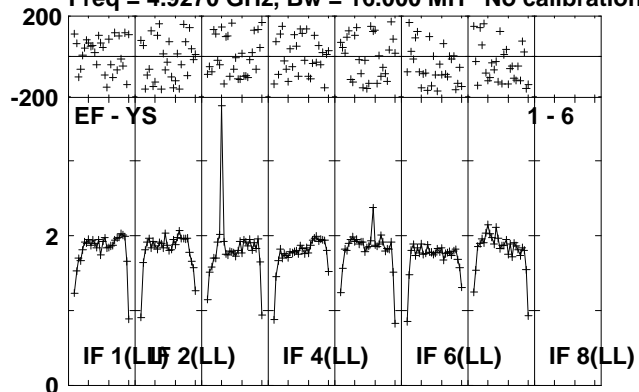

Lower frame: Milli Ampl Jy Top frame: Phas deg
Scalar averaged cross-power spectrum Several baselines displayed
Timerange: 00/20:47:42 to 00/20:53:08

Plot file version 217 created 02-DEC-2011 14:55:51

J1953+35 ET018A.UVDATA.1

Freq = 4.9270 GHz, Bw = 16.000 MH No calibration applied and no bandpass applied

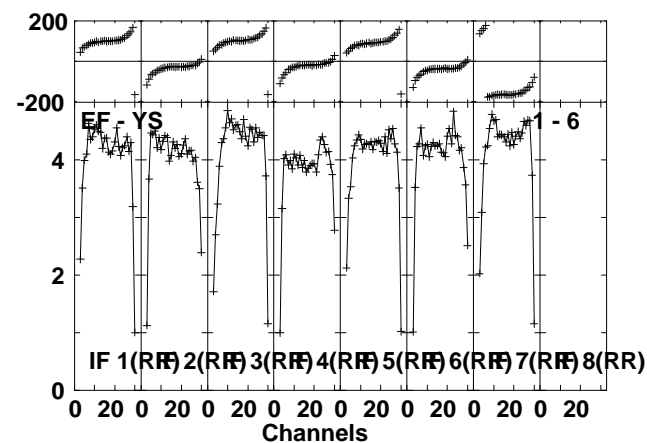
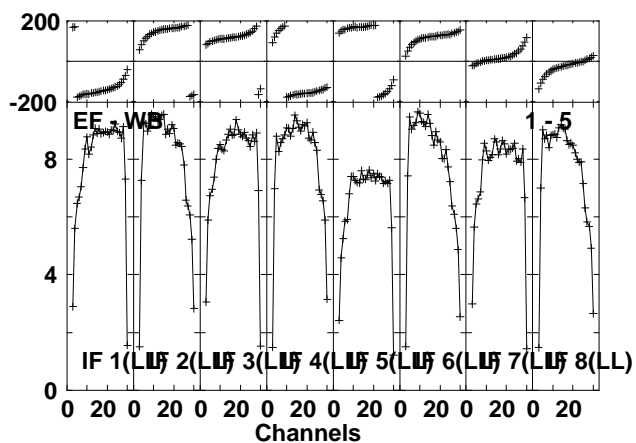
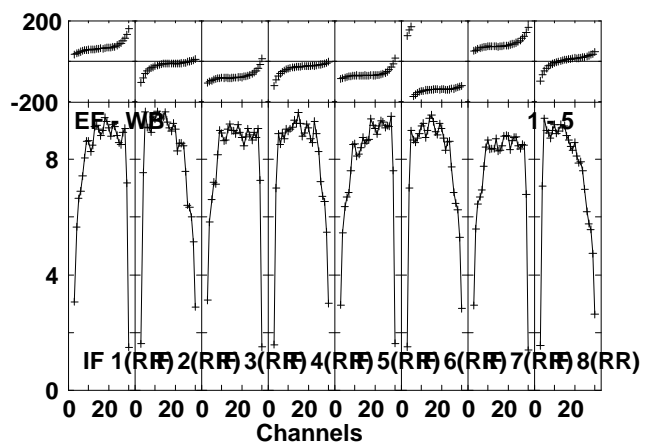
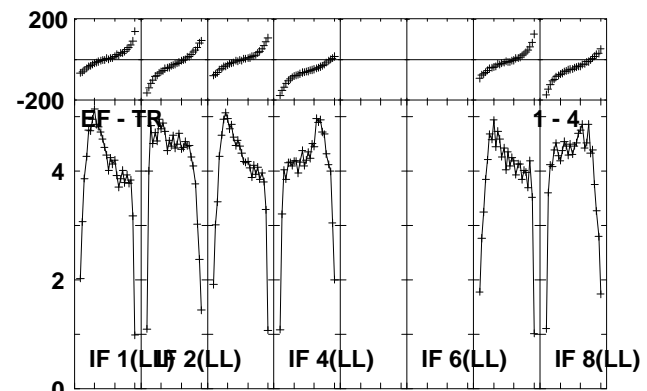
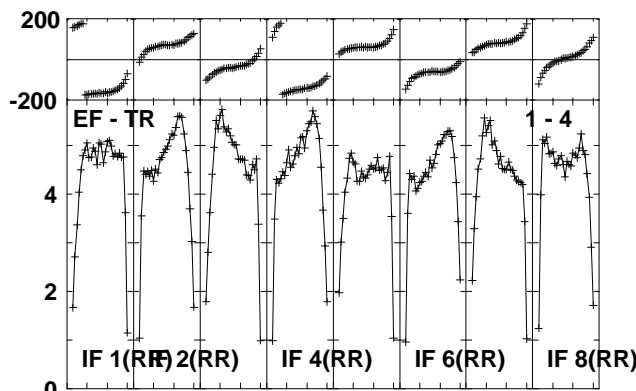
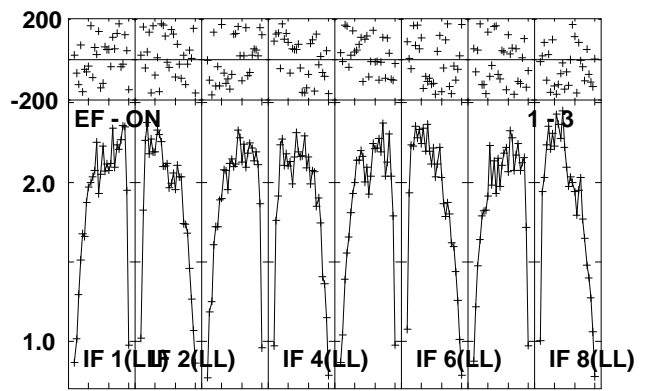
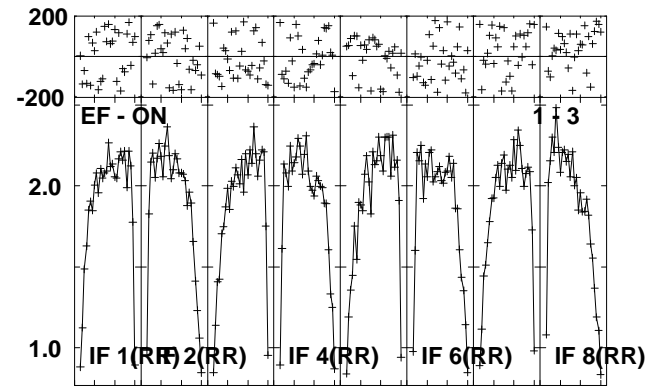
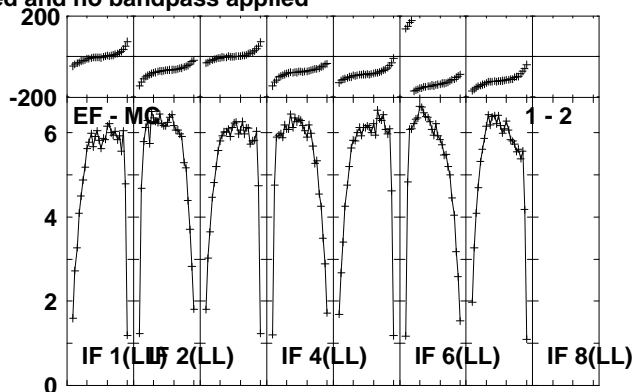
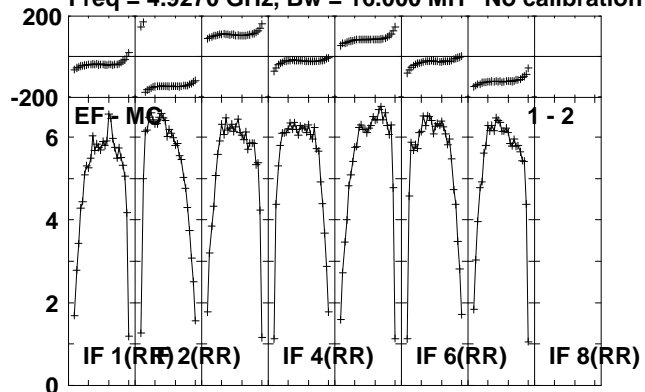

Lower frame: Milli Ampl Jy Top frame: Phas deg
Scalar averaged cross-power spectrum Several baselines displayed
Timerange: 00/20:53:11 to 00/20:56:08

Plot file version 218 created 02-DEC-2011 14:55:53

J1953+35 ET018A.UVDATA.1

Freq = 4.9270 GHz, Bw = 16.000 MH No calibration applied and no bandpass applied

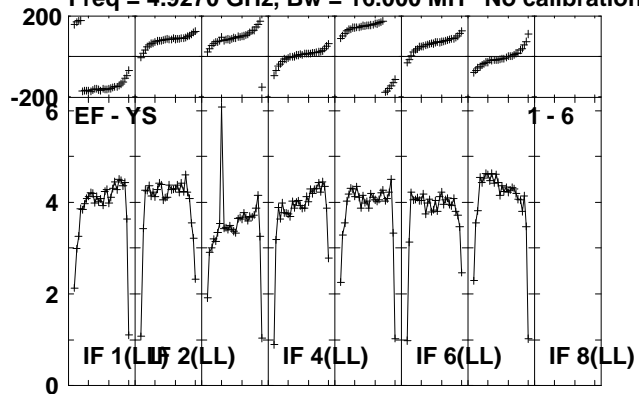

Lower frame: Milli Ampl Jy Top frame: Phas deg
Scalar averaged cross-power spectrum Several baselines displayed
Timerange: 00/20:53:11 to 00/20:56:08

Plot file version 219 created 02-DEC-2011 14:55:54

CYGX-1 ET018A.UVDATA.1

Freq = 4.9270 GHz, Bw = 16.000 MH No calibration applied and no bandpass applied

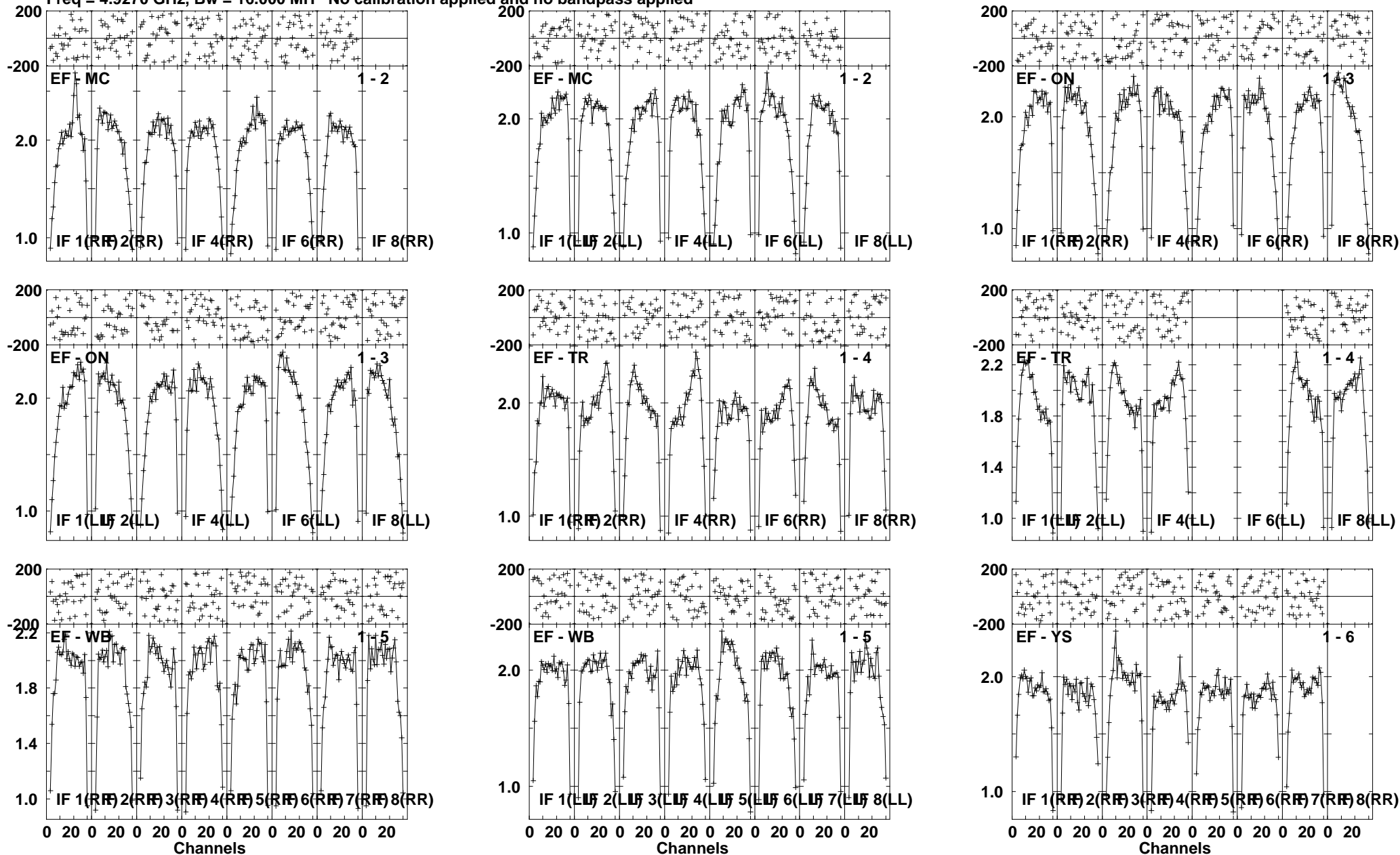

Lower frame: Milli Ampl Jy Top frame: Phas deg
Scalar averaged cross-power spectrum Several baselines displayed
Timerange: 00/20:56:12 to 00/21:01:38

Plot file version 220 created 02-DEC-2011 14:55:57

CYGX-1 ET018A.UVDATA.1

Freq = 4.9270 GHz, Bw = 16.000 MH No calibration applied and no bandpass applied

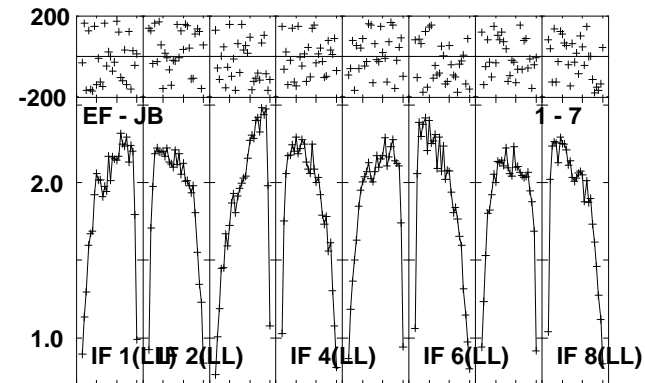
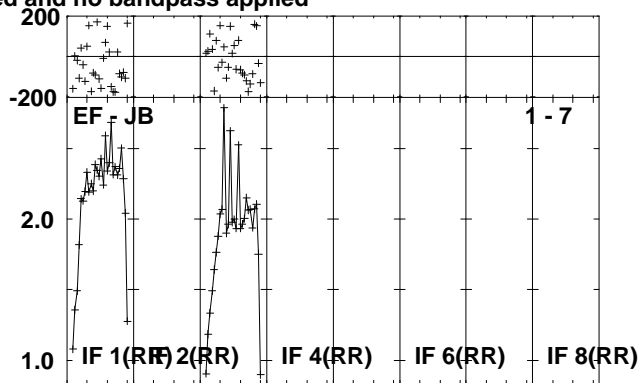
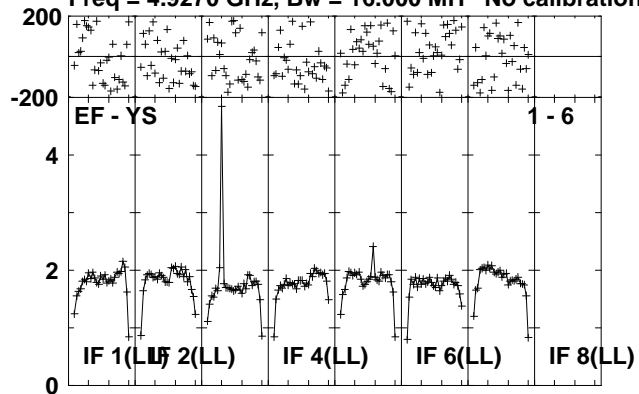

Lower frame: Milli Ampl Jy Top frame: Phas deg
Scalar averaged cross-power spectrum Several baselines displayed
Timerange: 00/20:56:12 to 00/21:01:38

Plot file version 221 created 02-DEC-2011 14:56:03

J1953+35 ET018A.UVDATA.1

Freq = 4.9270 GHz, Bw = 16.000 MH No calibration applied and no bandpass applied

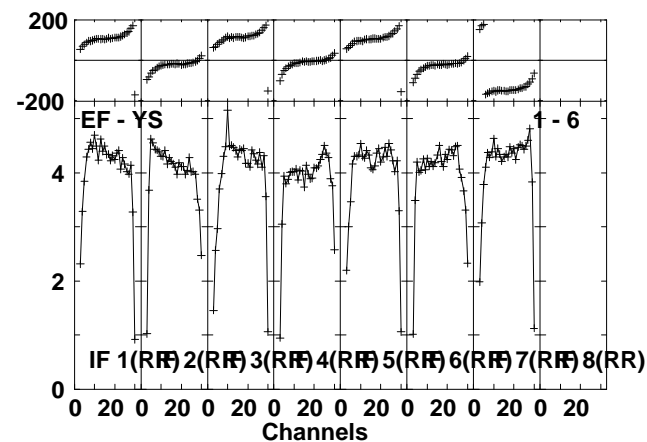
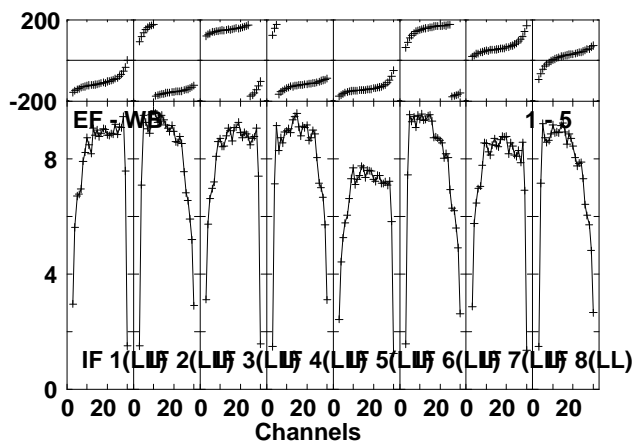
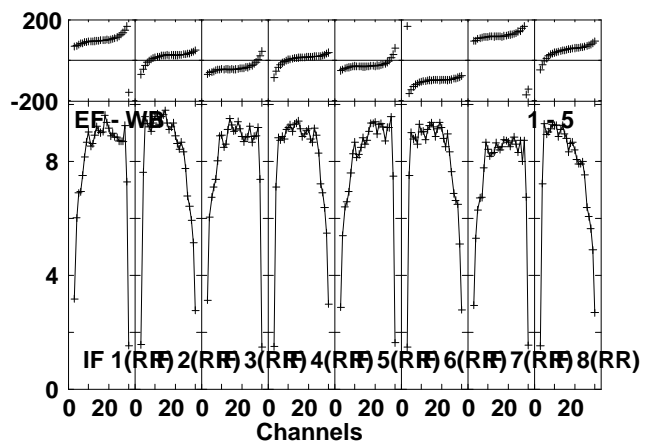
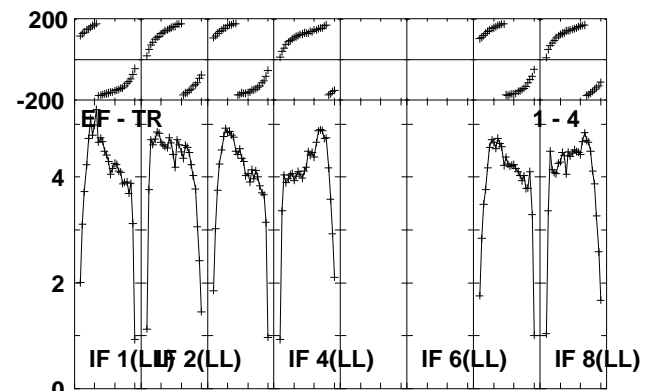
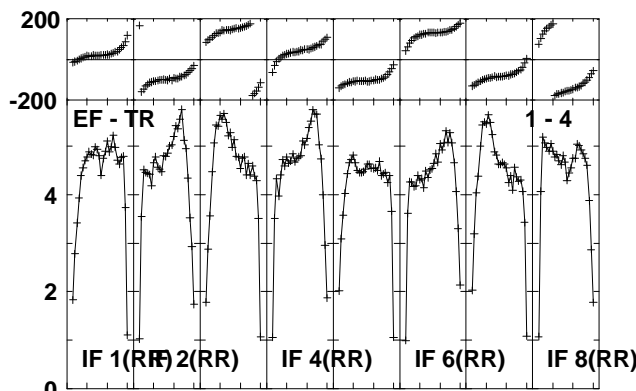
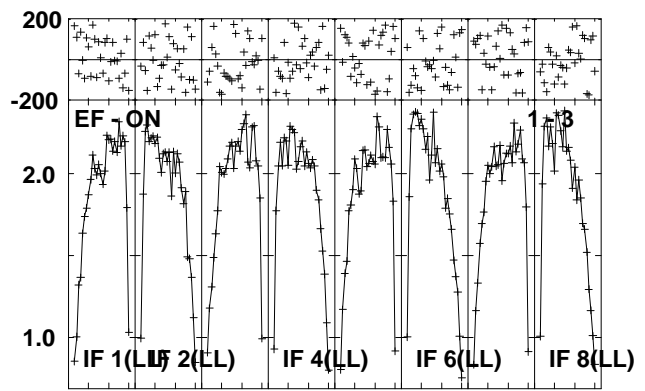
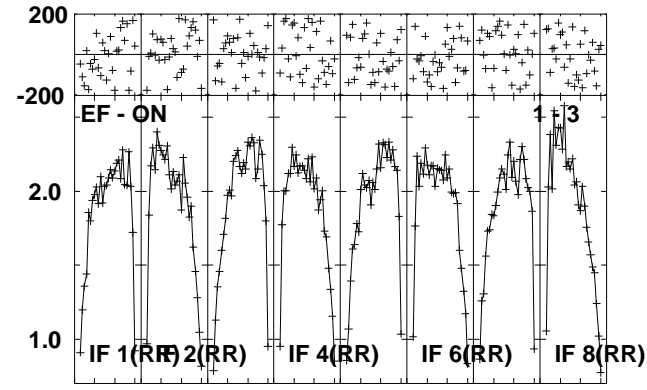
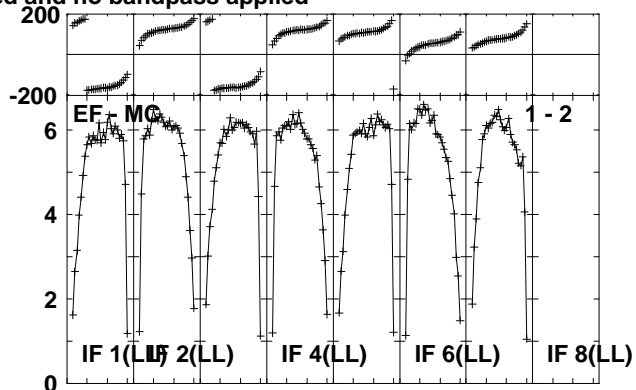
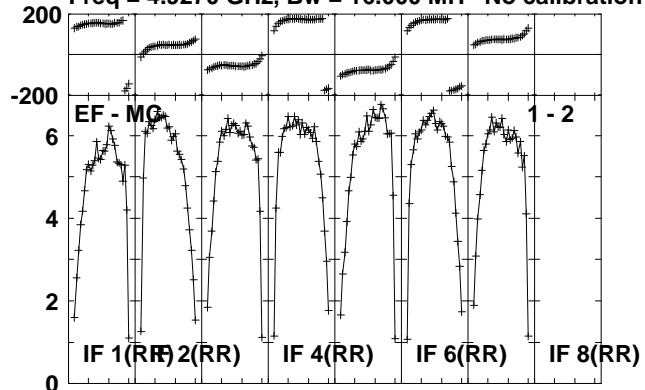

Lower frame: Milli Ampl Jy Top frame: Phas deg
Scalar averaged cross-power spectrum Several baselines displayed
Timerange: 00/21:02:26 to 00/21:04:59

Plot file version 222 created 02-DEC-2011 14:56:05

J1953+35 ET018A.UVDATA.1

Freq = 4.9270 GHz, Bw = 16.000 MH No calibration applied and no bandpass applied

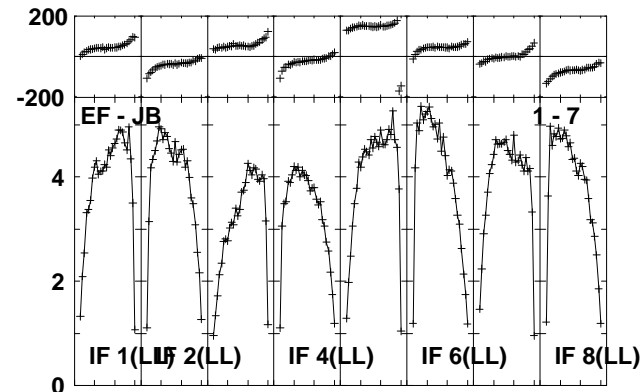
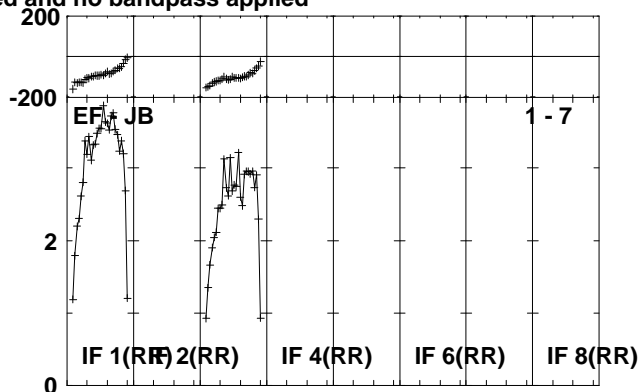
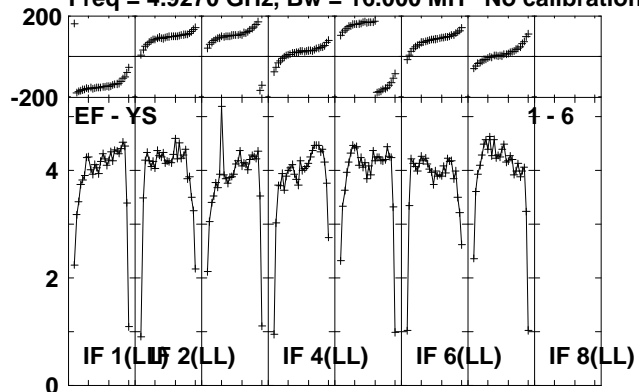

Lower frame: Milli Ampl Jy Top frame: Phas deg
Scalar averaged cross-power spectrum Several baselines displayed
Timerange: 00/21:02:26 to 00/21:04:59

Plot file version 223 created 02-DEC-2011 14:56:07

CYGX-1 ET018A.UVDATA.1

Freq = 4.9270 GHz, Bw = 16.000 MH No calibration applied and no bandpass applied

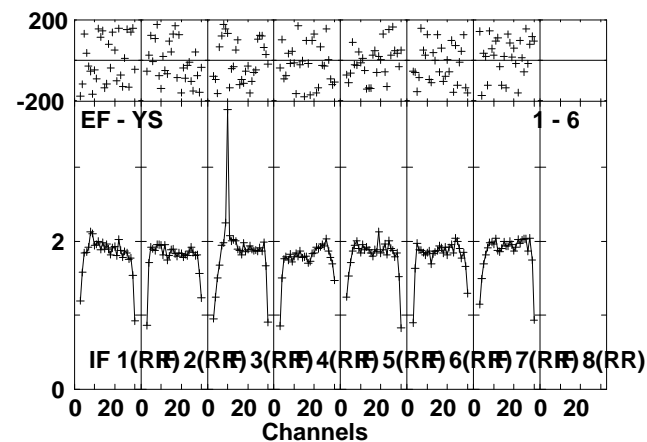
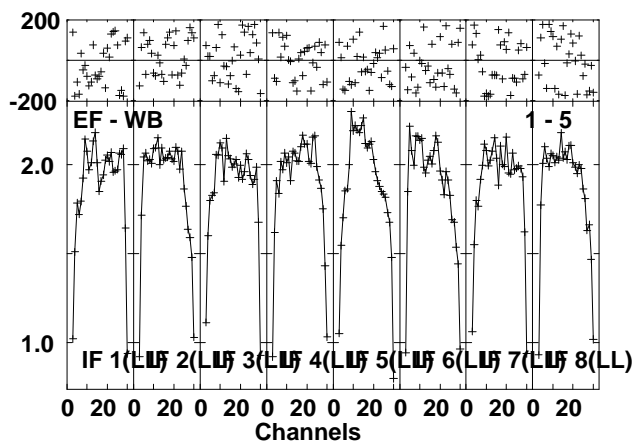
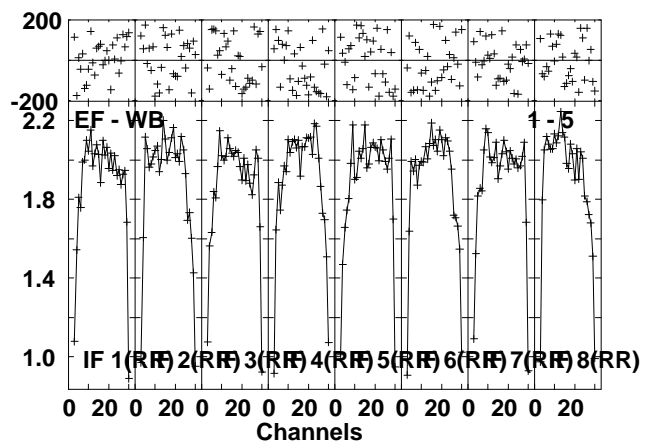
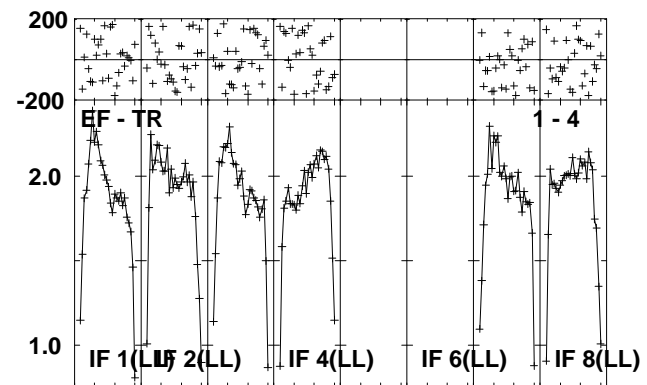
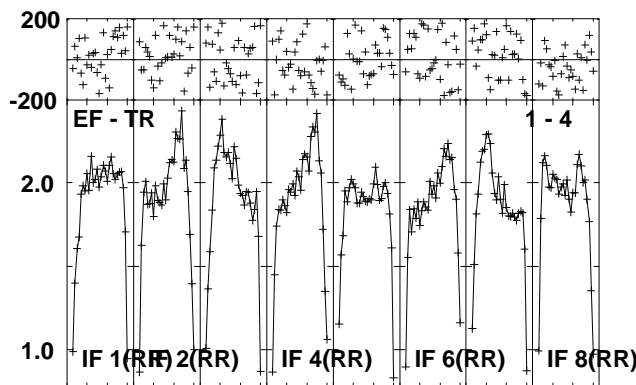
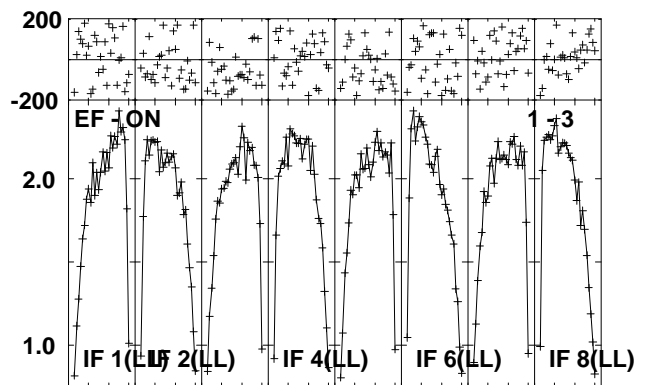
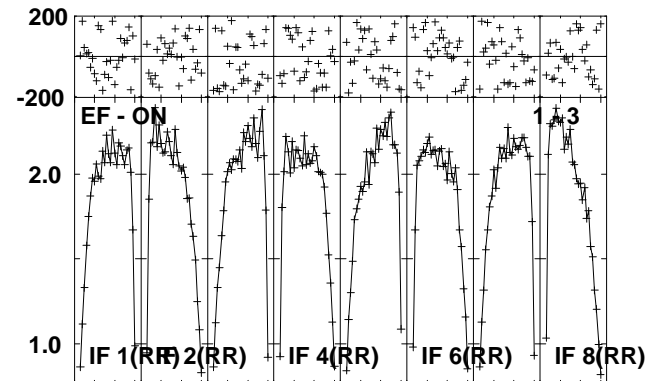
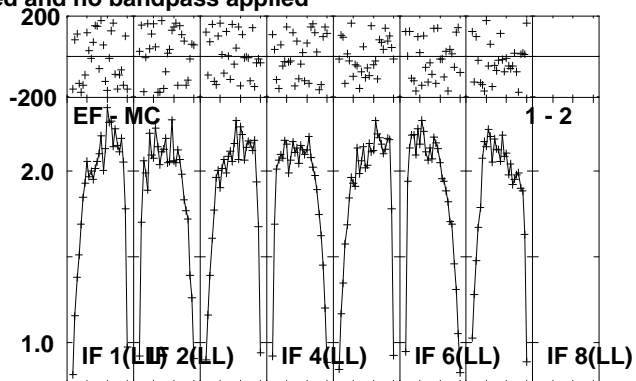
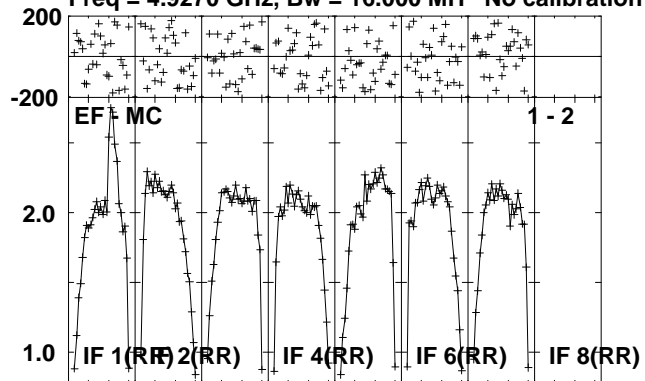

Lower frame: Milli Ampl Jy Top frame: Phas deg
Scalar averaged cross-power spectrum Several baselines displayed
Timerange: 00/21:05:01 to 00/21:10:29

Plot file version 224 created 02-DEC-2011 14:56:10

CYGX-1 ET018A.UVDATA.1

Freq = 4.9270 GHz, Bw = 16.000 MH No calibration applied and no bandpass applied

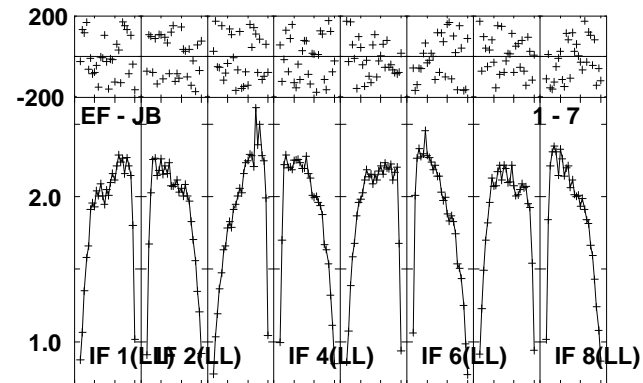
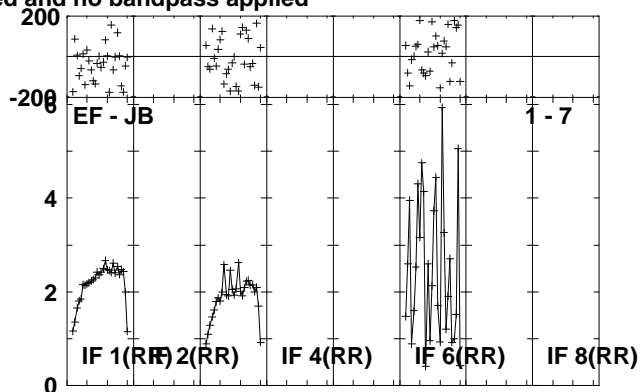
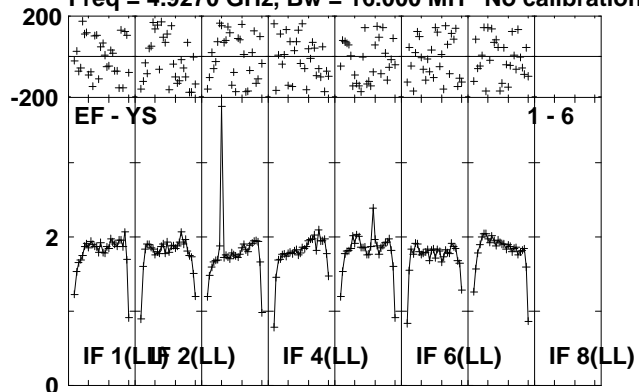

Lower frame: Milli Ampl Jy Top frame: Phas deg
Scalar averaged cross-power spectrum Several baselines displayed
Timerange: 00/21:05:01 to 00/21:10:29

Plot file version 225 created 02-DEC-2011 14:56:12

J1953+35 ET018A.UVDATA.1

Freq = 4.9270 GHz, Bw = 16.000 MH No calibration applied and no bandpass applied

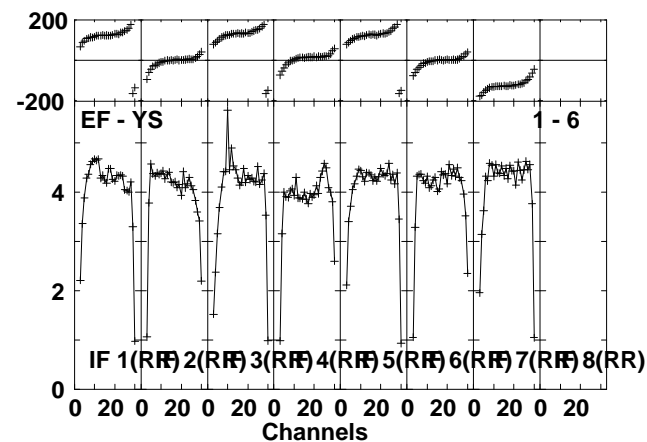
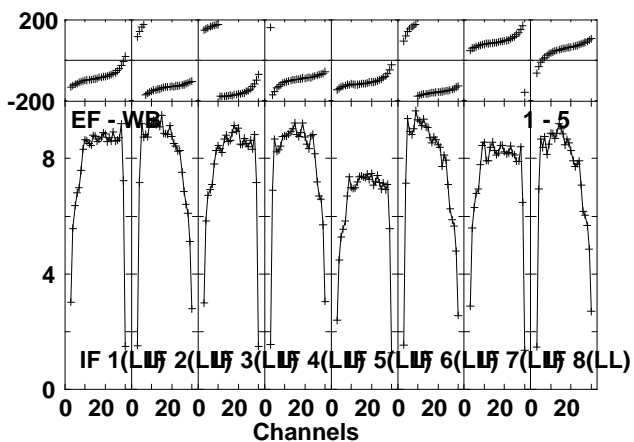
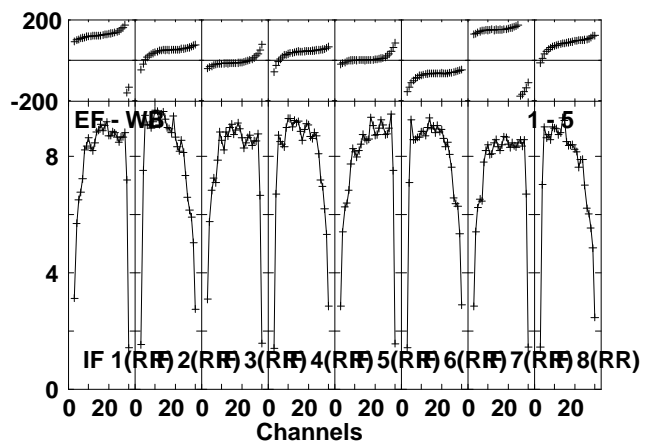
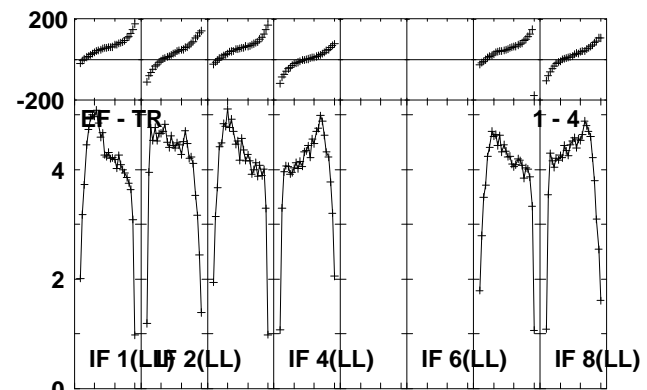
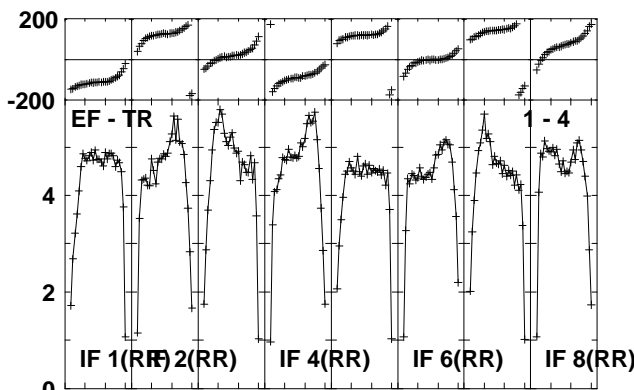
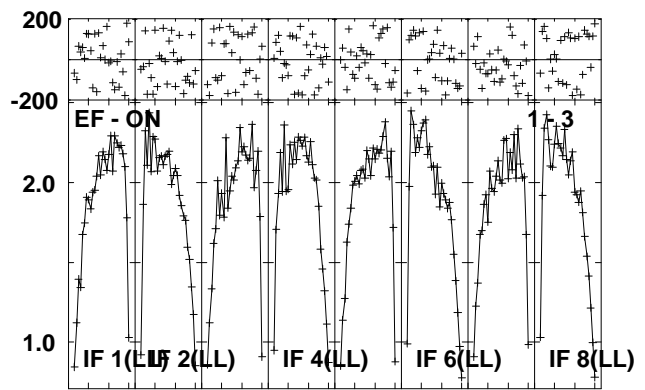
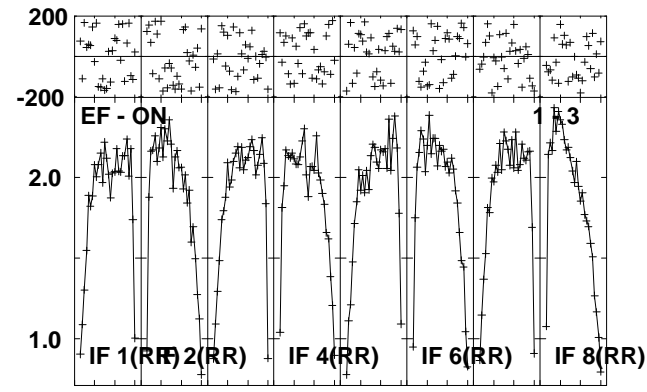
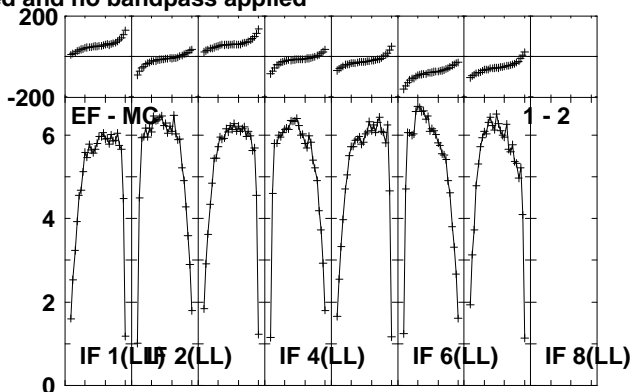
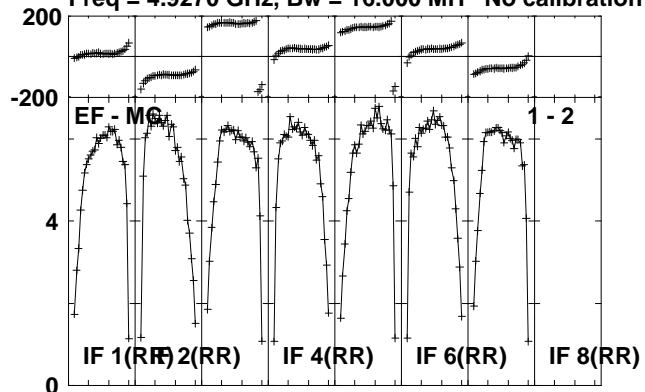

Lower frame: Milli Ampl Jy Top frame: Phas deg
Scalar averaged cross-power spectrum Several baselines displayed
Timerange: 00/21:10:31 to 00/21:13:28

Plot file version 226 created 02-DEC-2011 14:56:13

J1953+35 ET018A.UVDATA.1

Freq = 4.9270 GHz, Bw = 16.000 MH No calibration applied and no bandpass applied

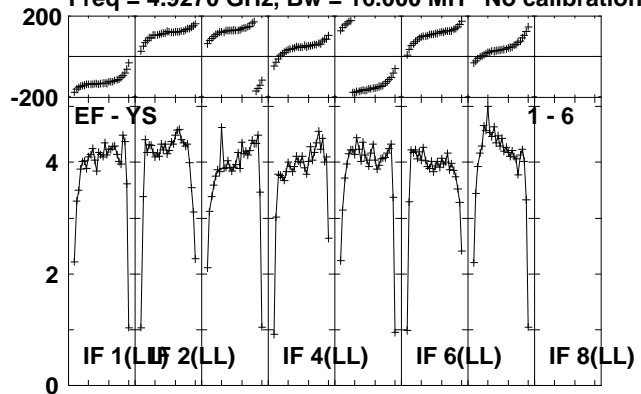

Lower frame: Milli Ampl Jy Top frame: Phas deg
Scalar averaged cross-power spectrum Several baselines displayed
Timerange: 00/21:10:31 to 00/21:13:28

Plot file version 227 created 02-DEC-2011 14:56:15

CYGX-1 ET018A.UVDATA.1

Freq = 4.9270 GHz, Bw = 16.000 MH No calibration applied and no bandpass applied

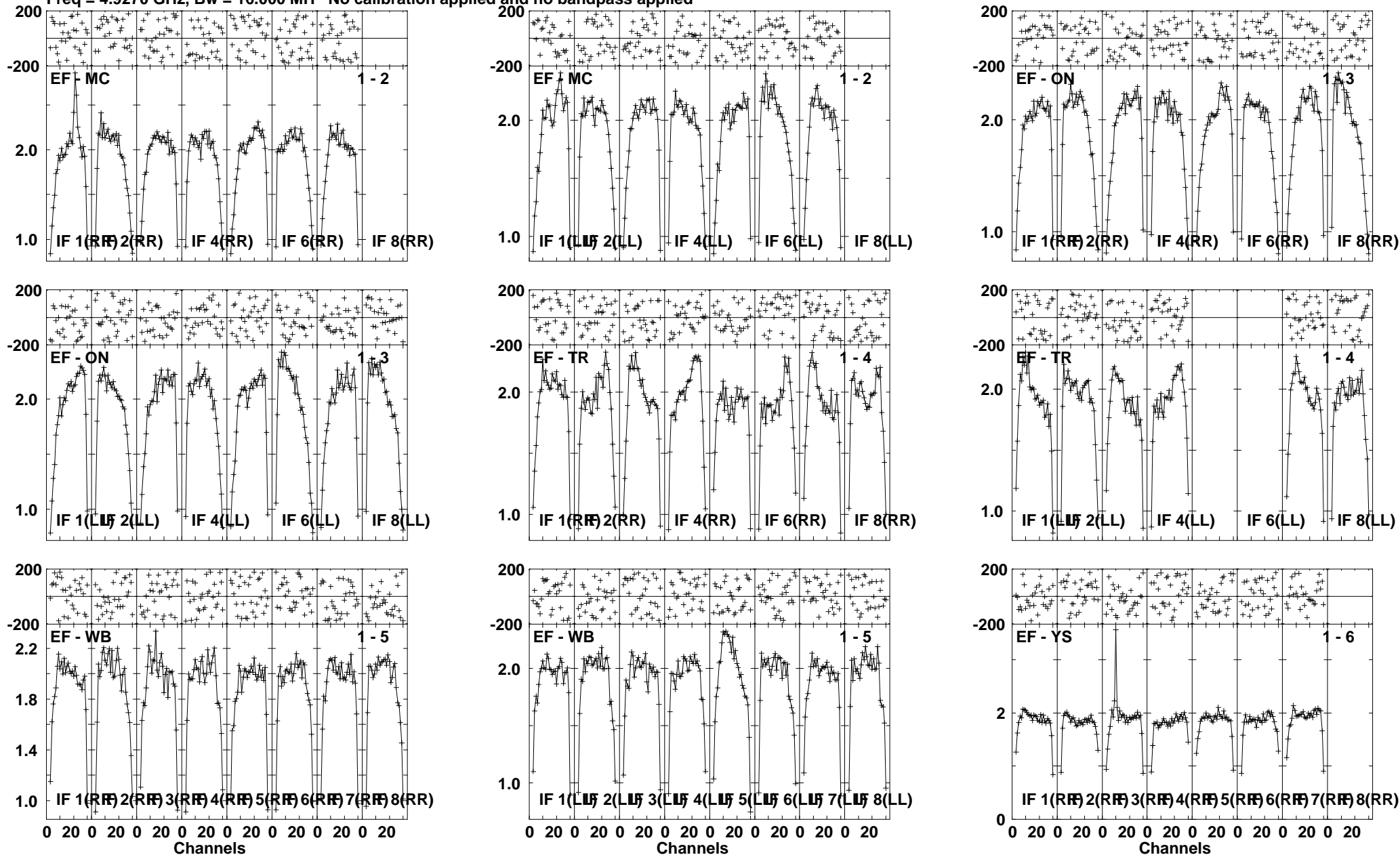

Lower frame: Milli Ampl Jy Top frame: Phas deg
Scalar averaged cross-power spectrum Several baselines displayed
Timerange: 00/21:13:32 to 00/21:18:58

Plot file version 228 created 02-DEC-2011 14:56:17

CYGX-1 ET018A.UVDATA.1

Freq = 4.9270 GHz, Bw = 16.000 MH No calibration applied and no bandpass applied

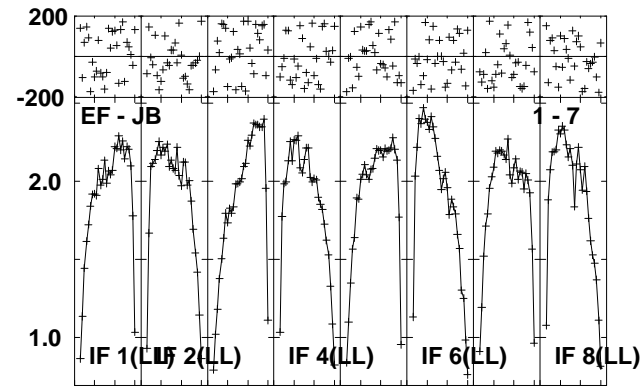
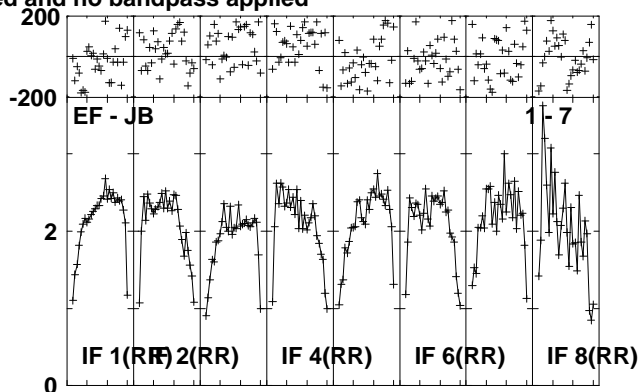
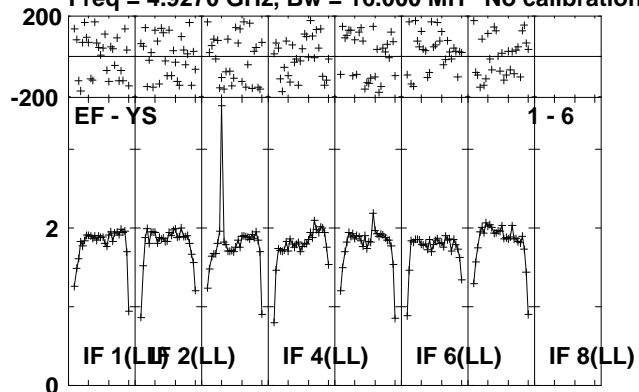

Lower frame: Milli Ampl Jy Top frame: Phas deg
Scalar averaged cross-power spectrum Several baselines displayed
Timerange: 00/21:13:32 to 00/21:18:58

Plot file version 229 created 02-DEC-2011 14:56:20

J1953+35 ET018A.UVDATA.1

Freq = 4.9270 GHz, Bw = 16.000 MH No calibration applied and no bandpass applied

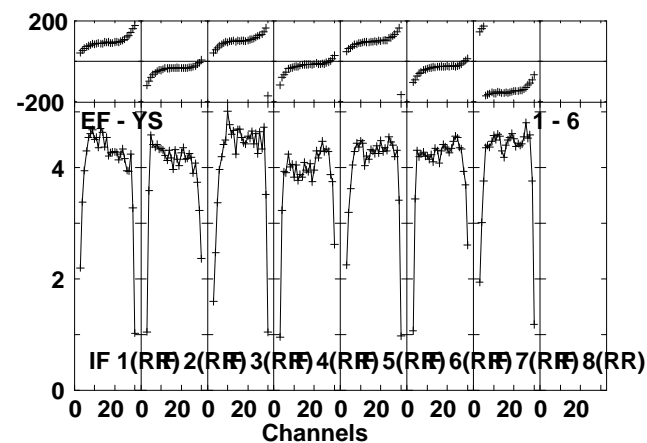
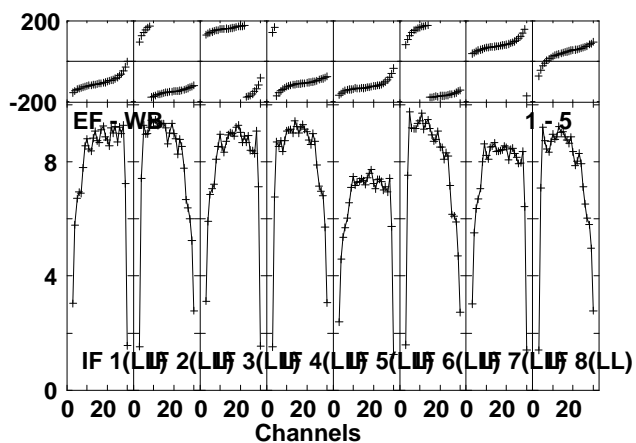
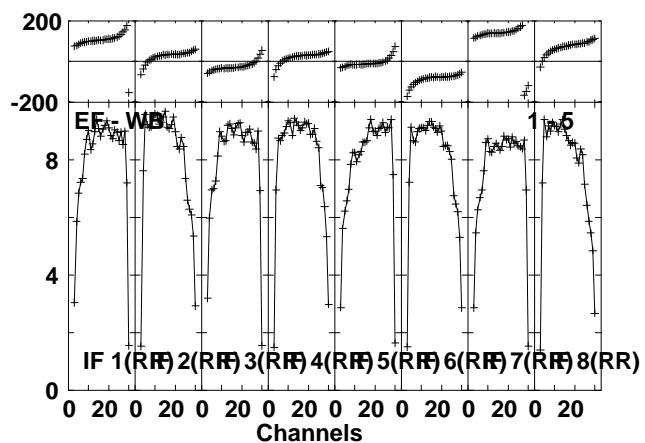
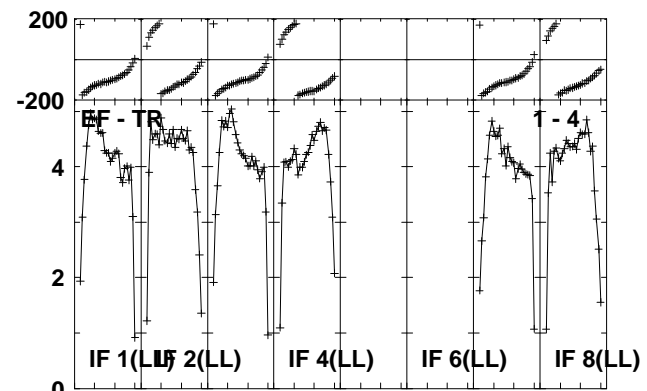
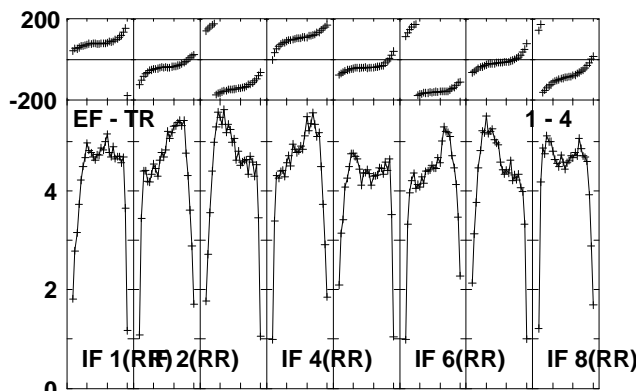
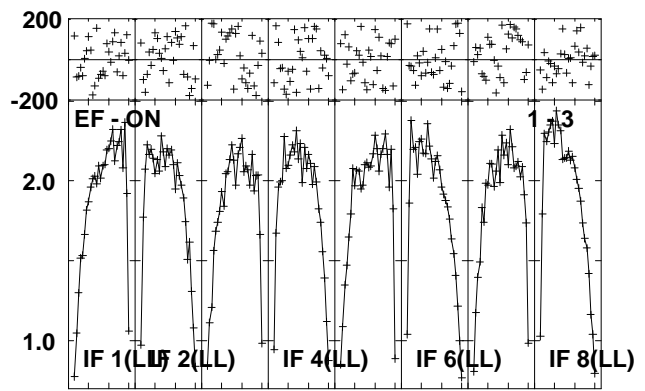
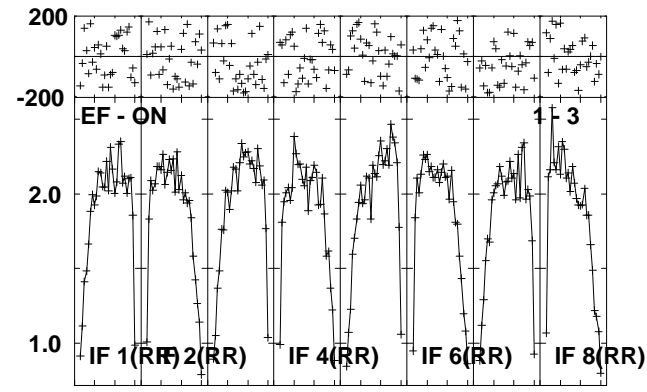
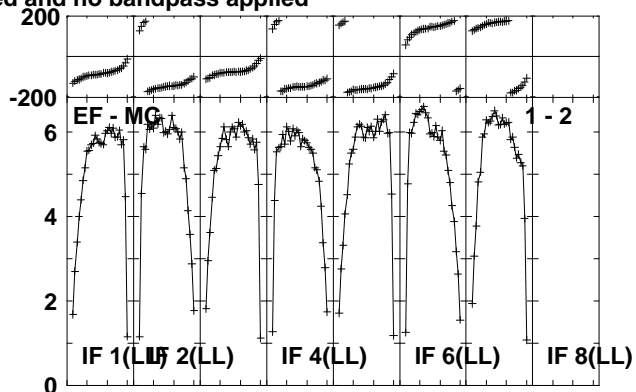
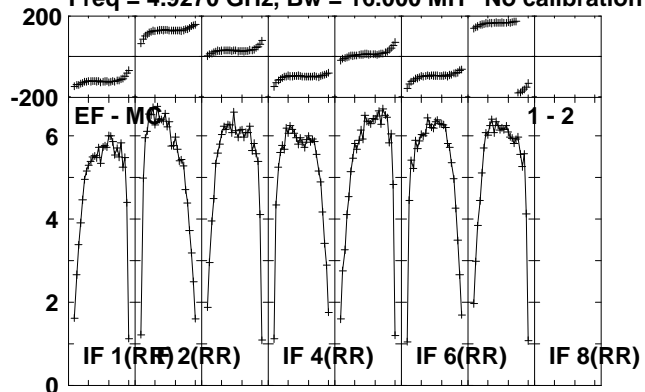

Lower frame: Milli Ampl Jy Top frame: Phas deg
Scalar averaged cross-power spectrum Several baselines displayed
Timerange: 00/21:19:46 to 00/21:22:19

Plot file version 230 created 02-DEC-2011 14:56:22

J1953+35 ET018A.UVDATA.1

Freq = 4.9270 GHz, Bw = 16.000 MH No calibration applied and no bandpass applied

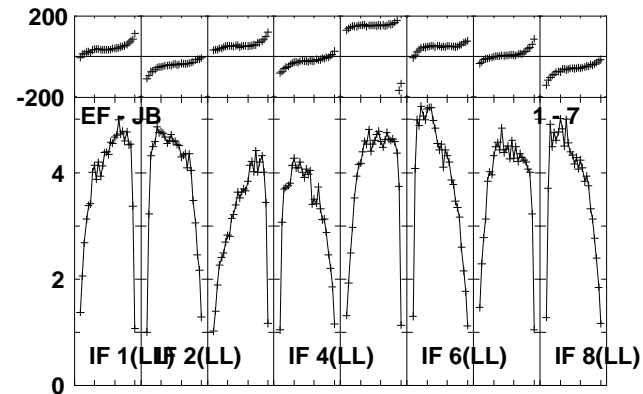
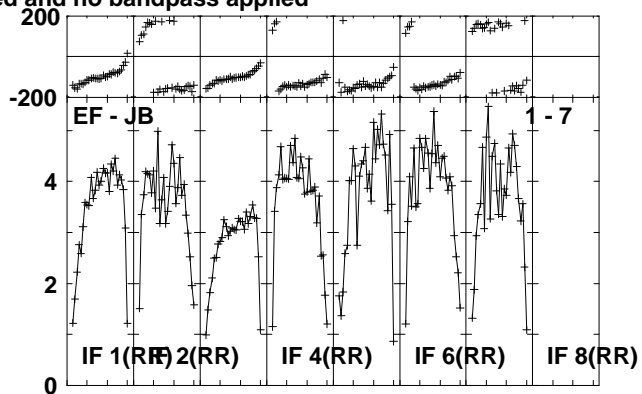
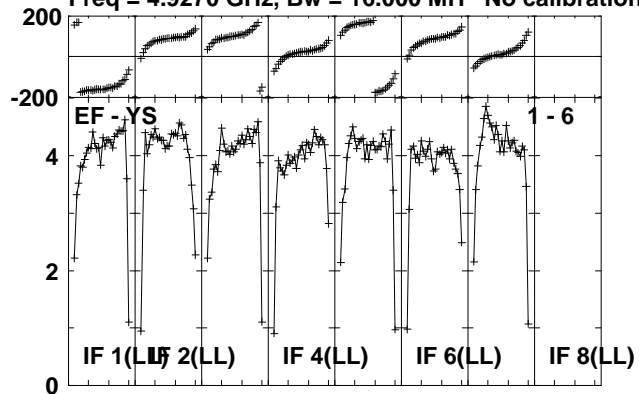

Lower frame: Milli Ampl Jy Top frame: Phas deg
Scalar averaged cross-power spectrum Several baselines displayed
Timerange: 00/21:19:46 to 00/21:22:19

Plot file version 231 created 02-DEC-2011 14:56:24

CYGX-1 ET018A.UVDATA.1

Freq = 4.9270 GHz, Bw = 16.000 MH No calibration applied and no bandpass applied

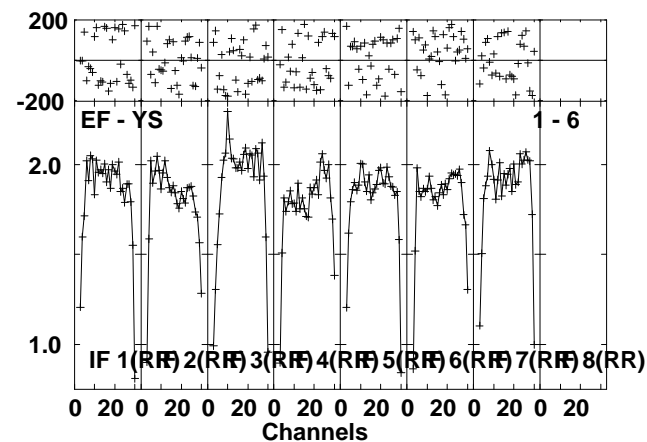
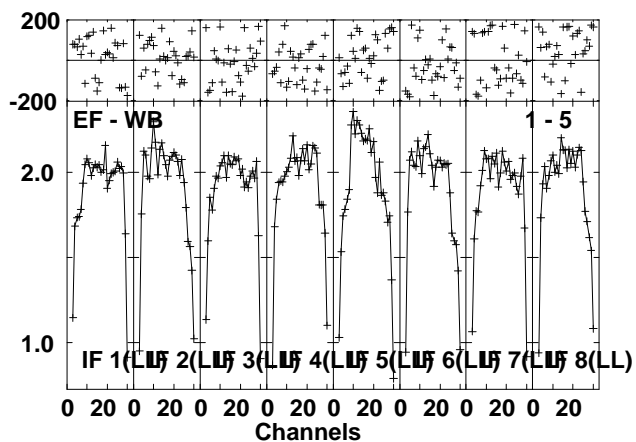
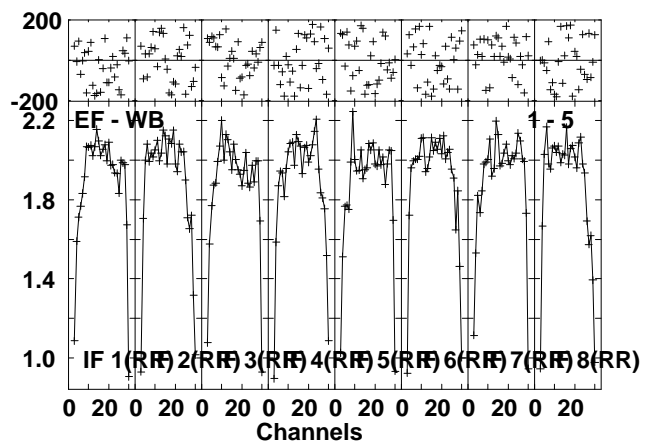
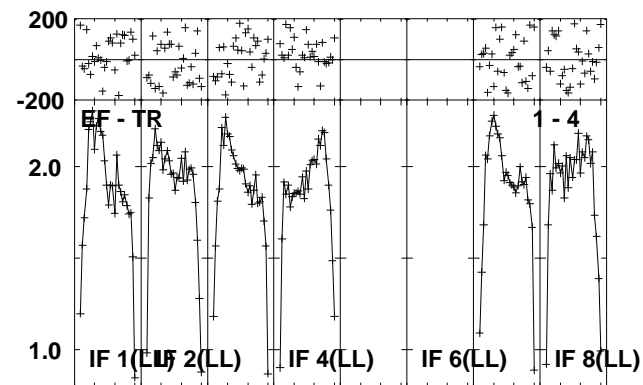
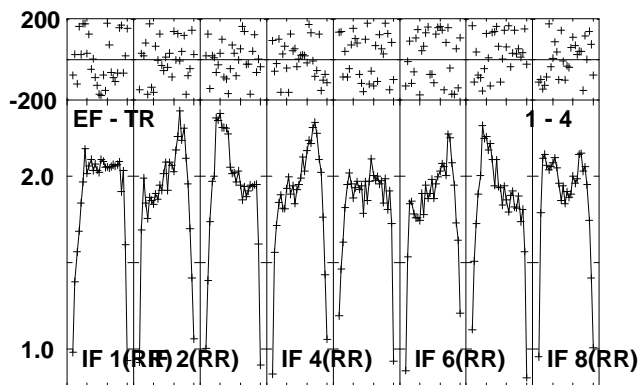
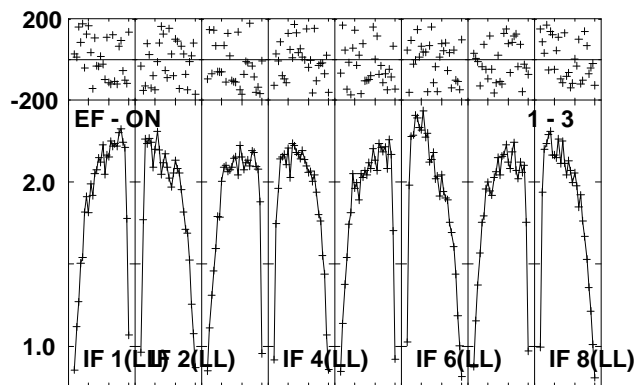
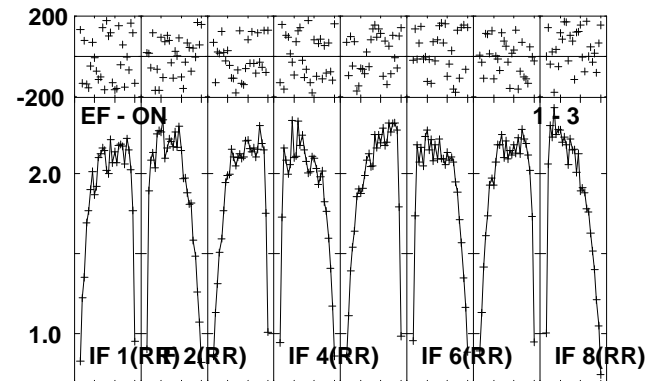
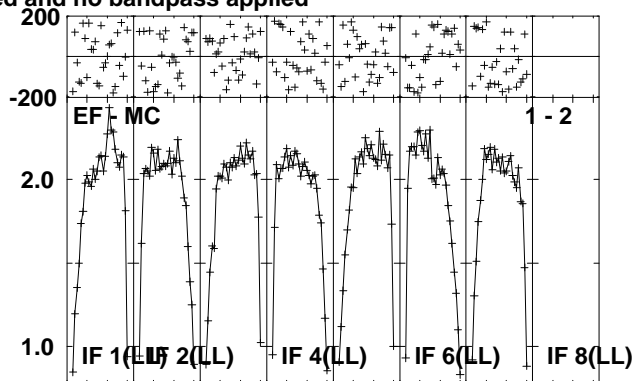
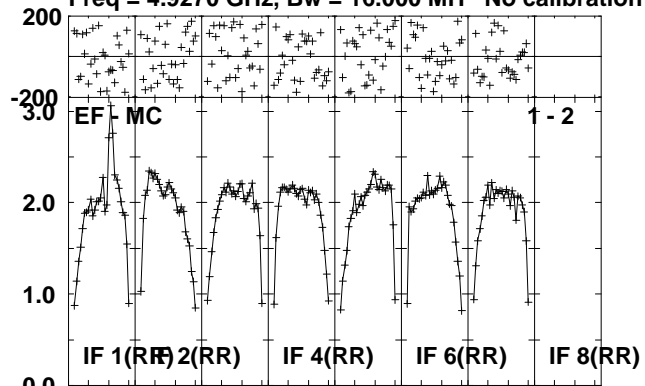

Lower frame: Milli Ampl Jy Top frame: Phas deg
Scalar averaged cross-power spectrum Several baselines displayed
Timerange: 00/21:22:21 to 00/21:27:49

Plot file version 232 created 02-DEC-2011 14:56:26

CYGX-1 ET018A.UVDATA.1

Freq = 4.9270 GHz, Bw = 16.000 MH No calibration applied and no bandpass applied

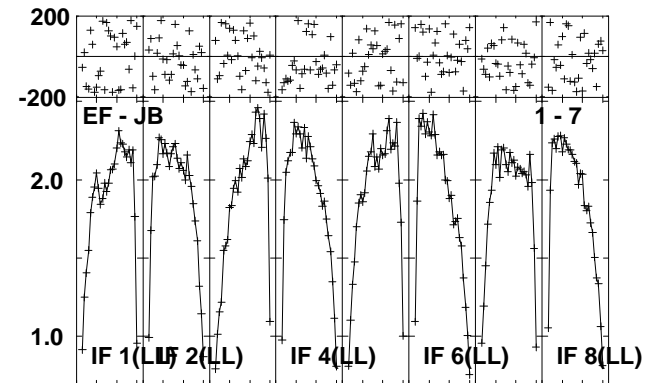
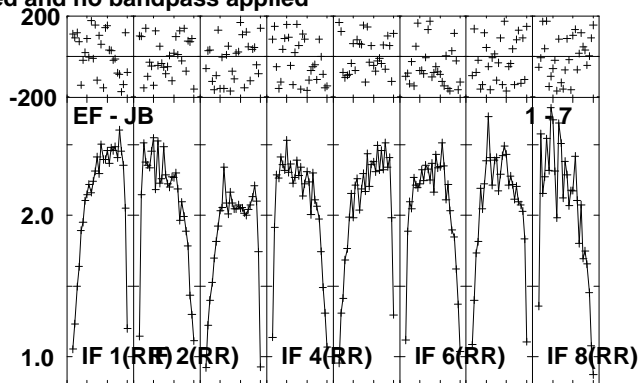
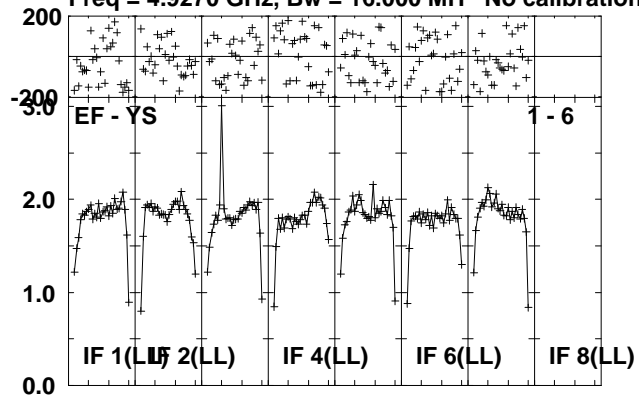

Lower frame: Milli Ampl Jy Top frame: Phas deg
Scalar averaged cross-power spectrum Several baselines displayed
Timerange: 00/21:22:21 to 00/21:27:49

Plot file version 233 created 02-DEC-2011 14:56:29

J1953+35 ET018A.UVDATA.1

Freq = 4.9270 GHz, Bw = 16.000 MH No calibration applied and no bandpass applied

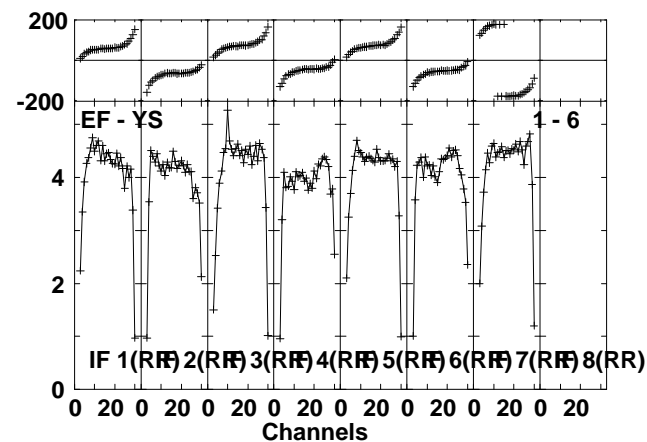
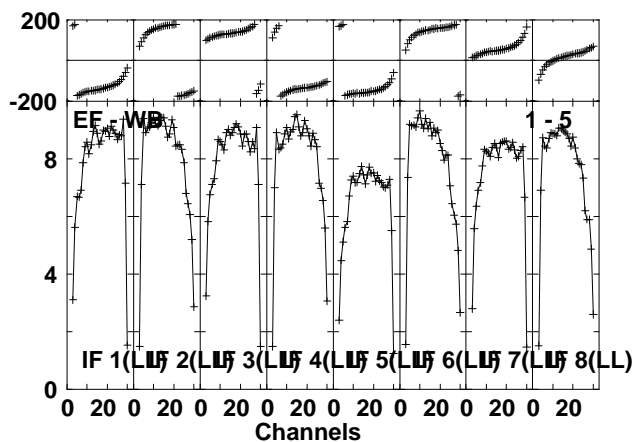
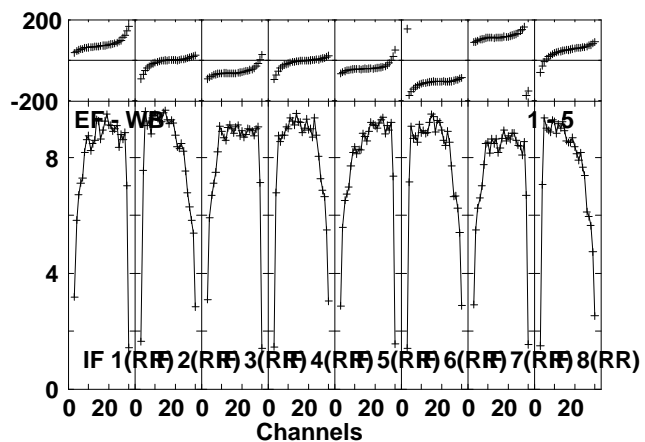
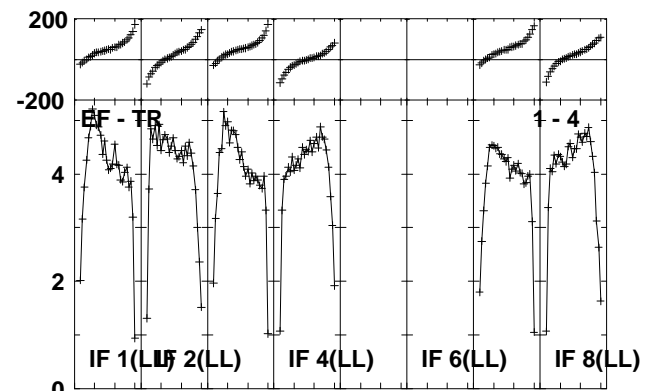
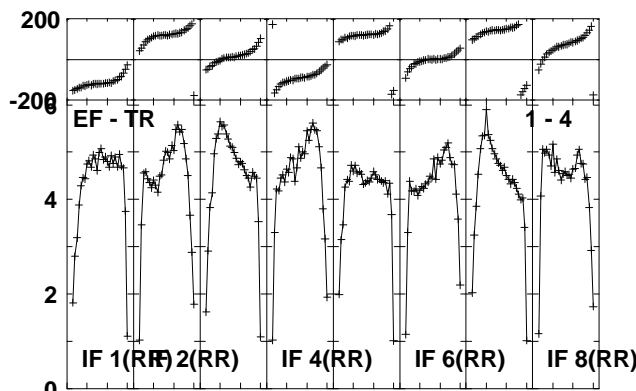
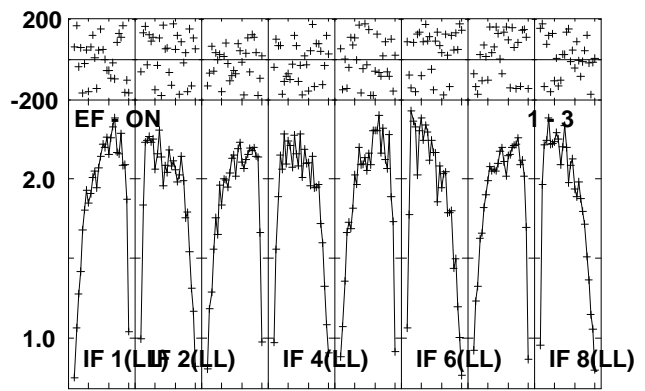
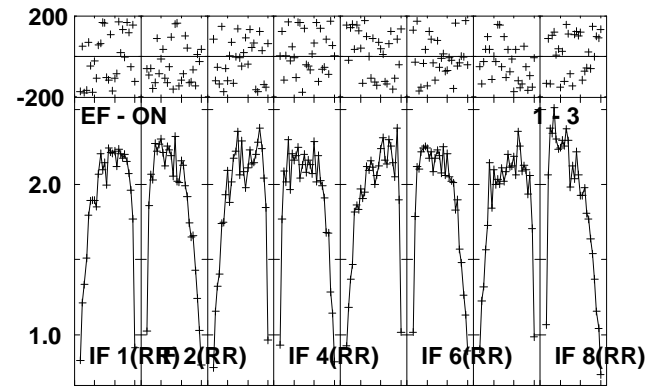
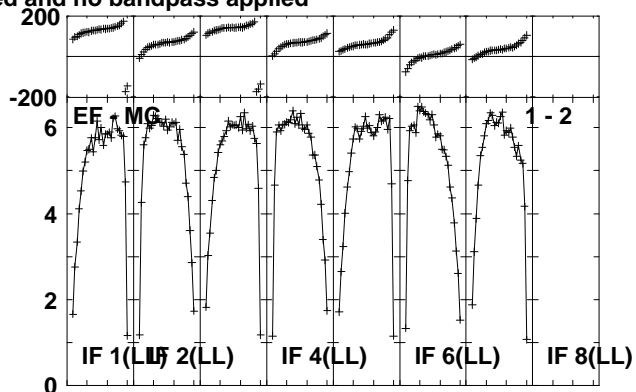
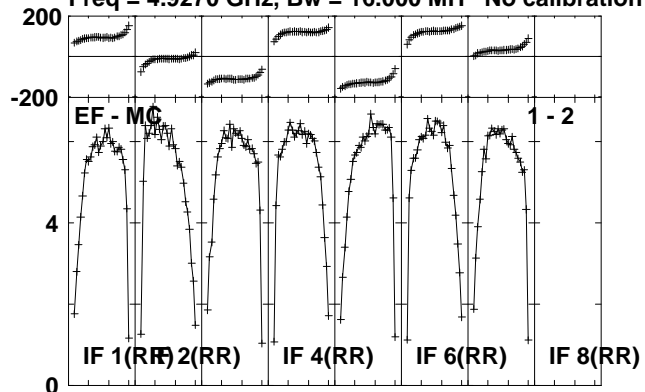

Lower frame: Milli Ampl Jy Top frame: Phas deg
Scalar averaged cross-power spectrum Several baselines displayed
Timerange: 00/21:27:51 to 00/21:30:48

Plot file version 234 created 02-DEC-2011 14:56:30
J1953+35 ET018A.UVDATA.1
Freq = 4.9270 GHz, Bw = 16.000 MH No calibration applied and no bandpass applied

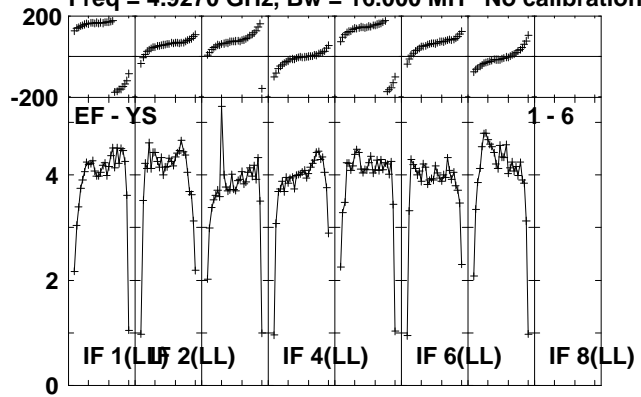

Lower frame: Milli Ampl Jy Top frame: Phas deg
Scalar averaged cross-power spectrum Several baselines displayed
Timerange: 00/21:27:51 to 00/21:30:48

Plot file version 235 created 02-DEC-2011 14:56:32

CYGX-1 ET018A.UVDATA.1

Freq = 4.9270 GHz, Bw = 16.000 MH No calibration applied and no bandpass applied

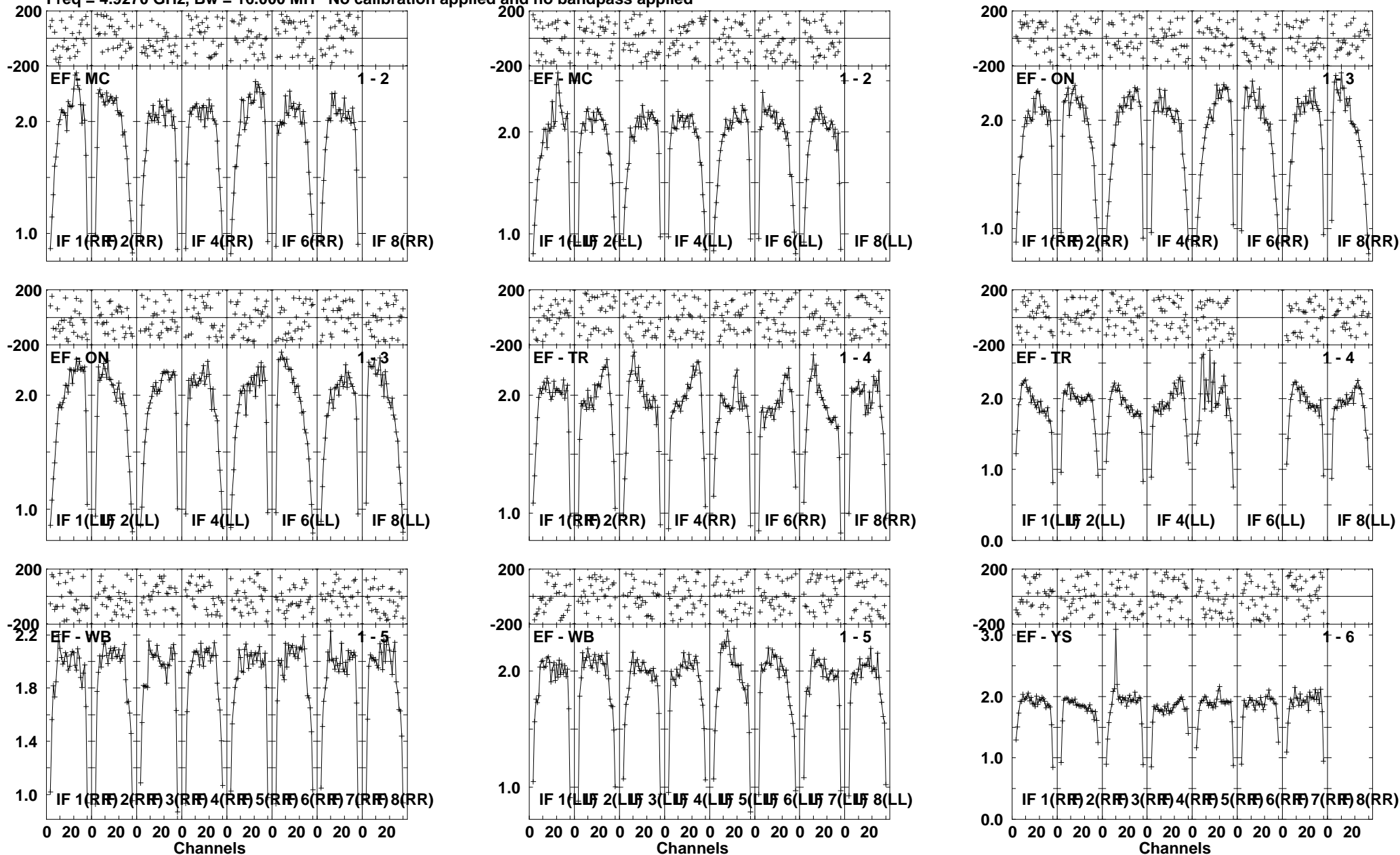

Lower frame: Milli Ampl Jy Top frame: Phas deg
Scalar averaged cross-power spectrum Several baselines displayed
Timerange: 00/21:30:52 to 00/21:36:18

Plot file version 236 created 02-DEC-2011 14:56:35

CYGX-1 ET018A.UVDATA.1

Freq = 4.9270 GHz, Bw = 16.000 MH No calibration applied and no bandpass applied

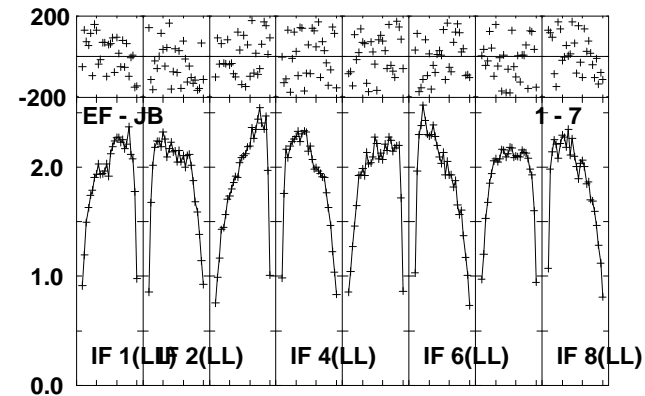
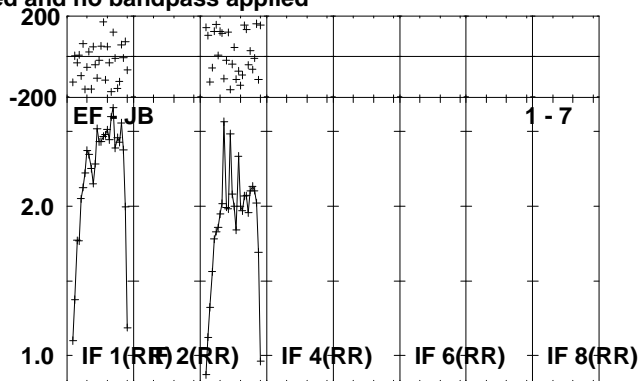
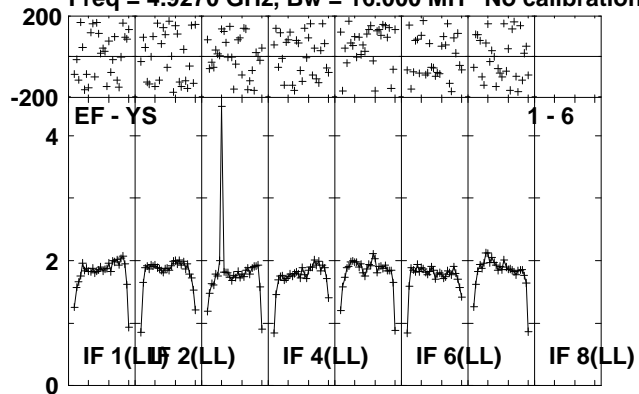

Lower frame: Milli Ampl Jy Top frame: Phas deg
Scalar averaged cross-power spectrum Several baselines displayed
Timerange: 00/21:30:52 to 00/21:36:18

Plot file version 237 created 02-DEC-2011 14:56:38

J1953+35 ET018A.UVDATA.1

Freq = 4.9270 GHz, Bw = 16.000 MH No calibration applied and no bandpass applied

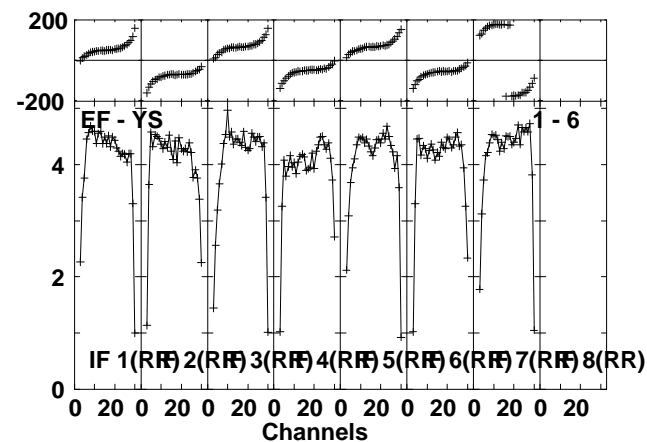
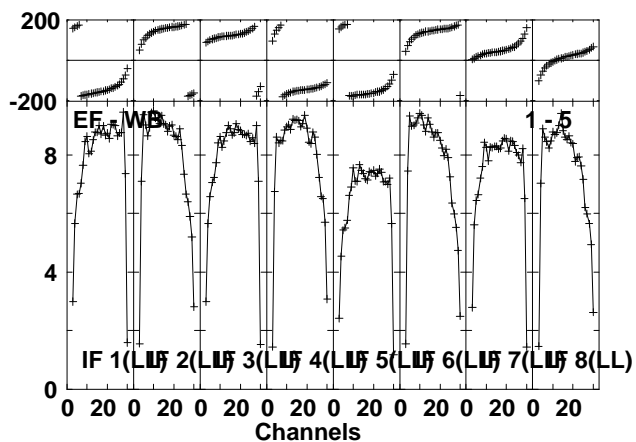
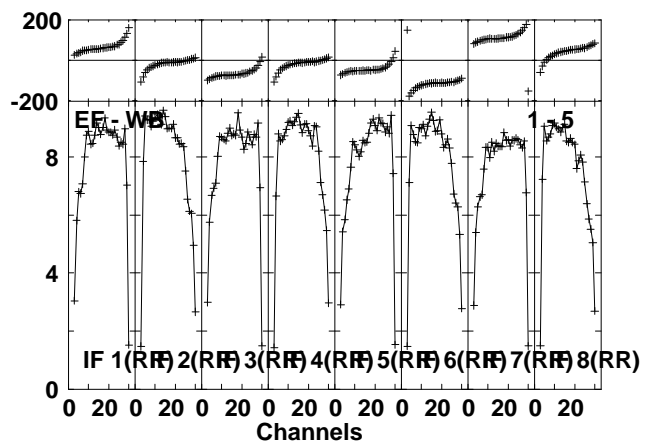
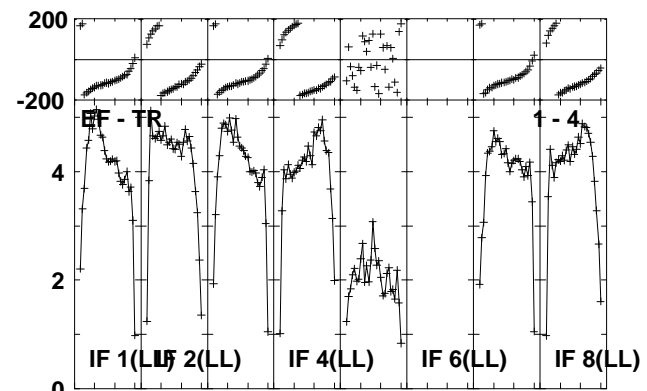
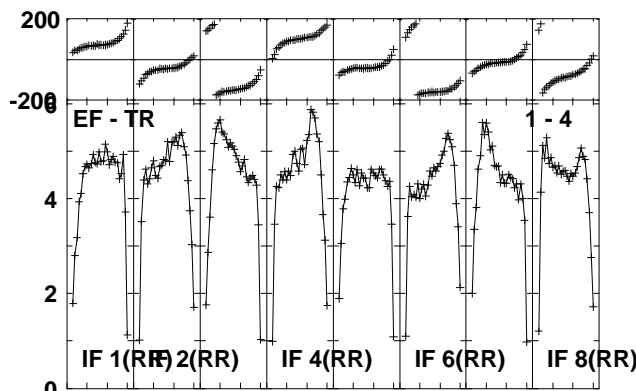
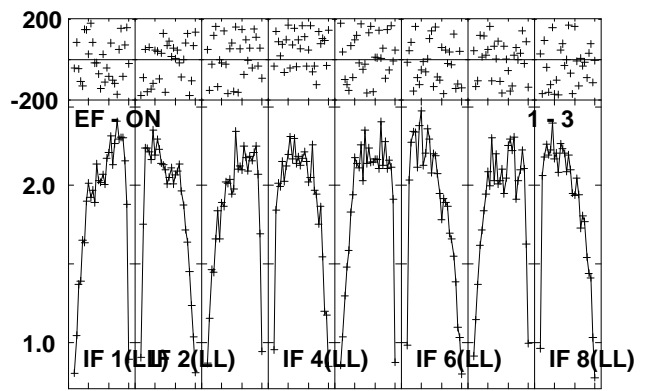
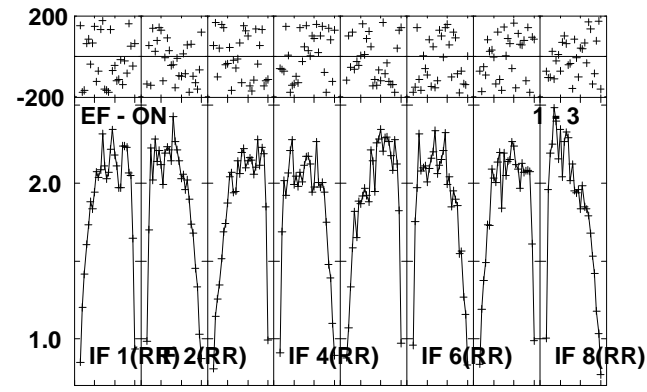
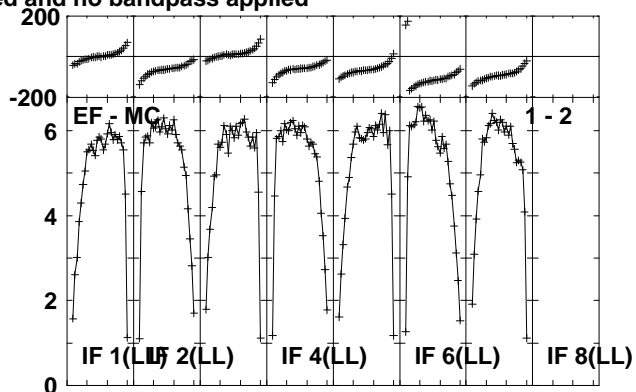
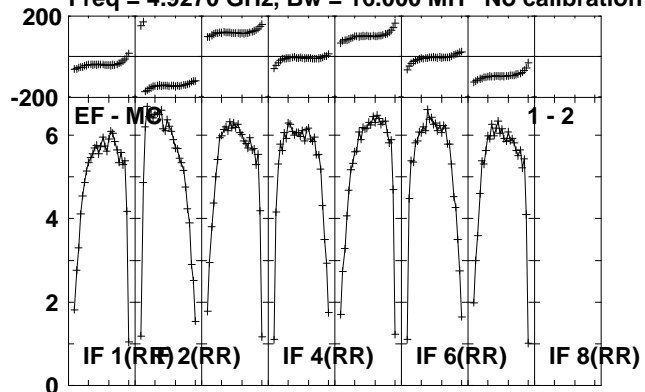

Lower frame: Milli Ampl Jy Top frame: Phas deg
Scalar averaged cross-power spectrum Several baselines displayed
Timerange: 00/21:37:06 to 00/21:39:39

Plot file version 238 created 02-DEC-2011 14:56:39

J1953+35 ET018A.UVDATA.1

Freq = 4.9270 GHz, Bw = 16.000 MH No calibration applied and no bandpass applied

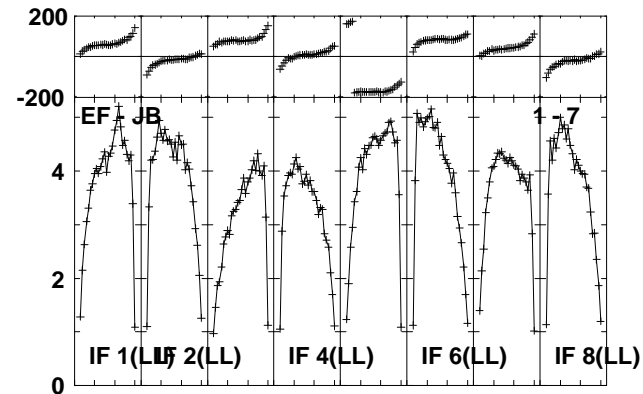
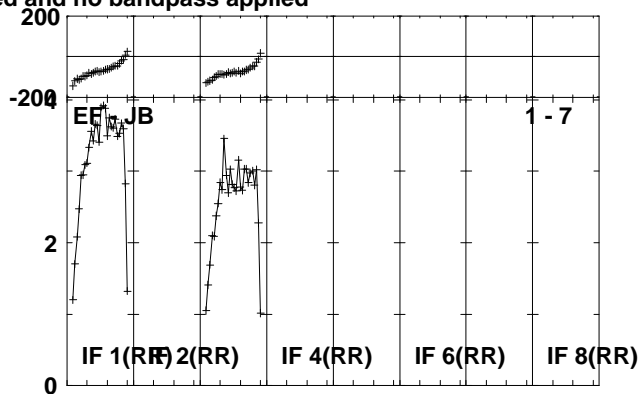
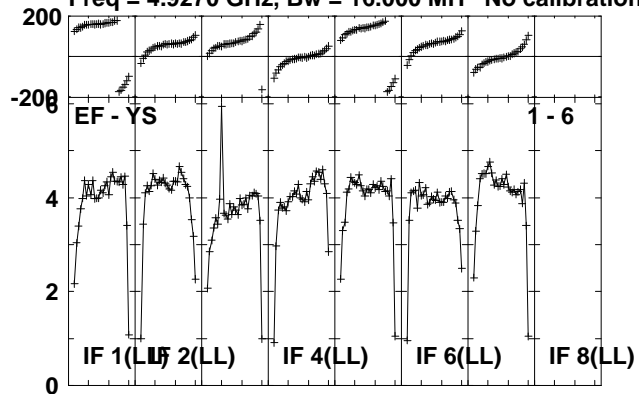

Lower frame: Milli Ampl Jy Top frame: Phas deg
Scalar averaged cross-power spectrum Several baselines displayed
Timerange: 00/21:37:06 to 00/21:39:39

Plot file version 239 created 02-DEC-2011 14:56:41

J2002+47 ET018A.UVDATA.1

Freq = 4.9270 GHz, Bw = 16.000 MH No calibration applied and no bandpass applied

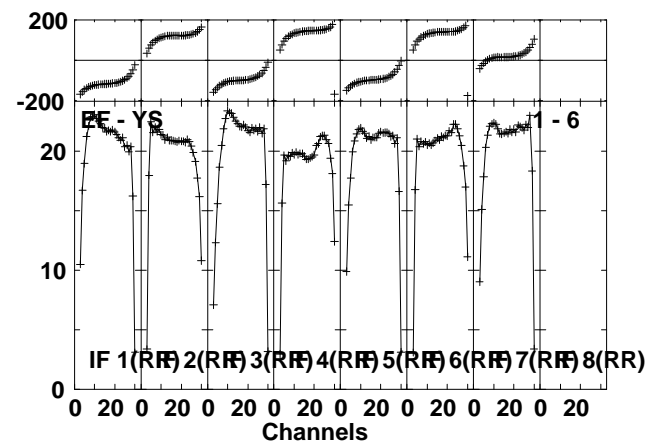
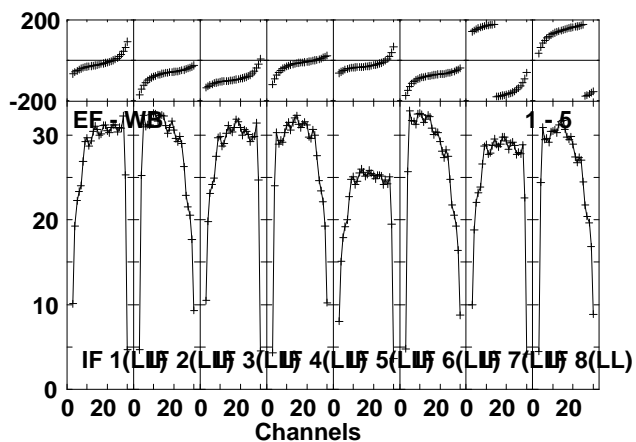
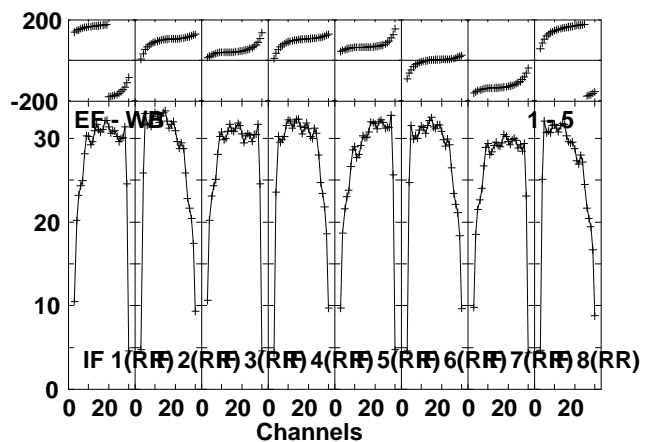
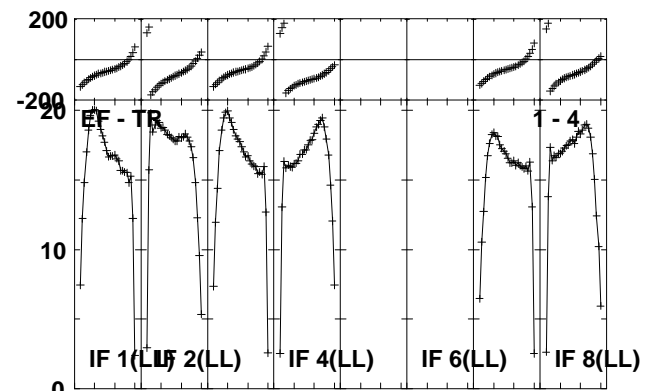
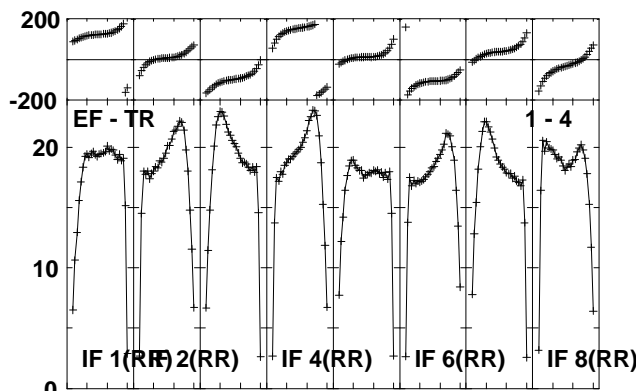
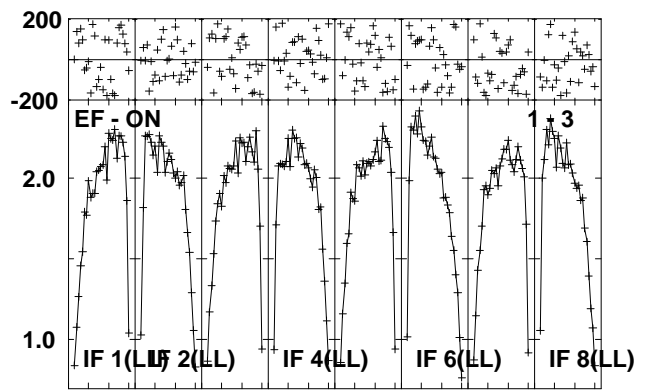
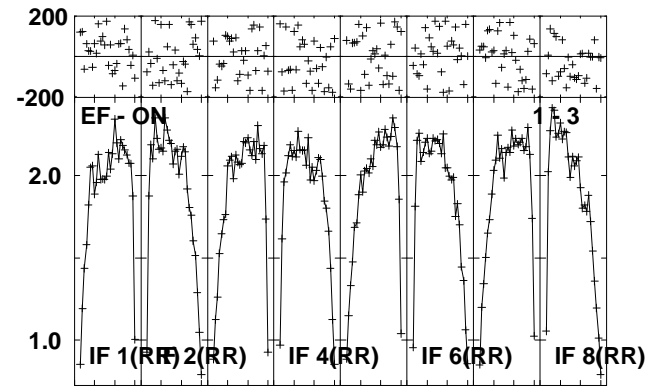
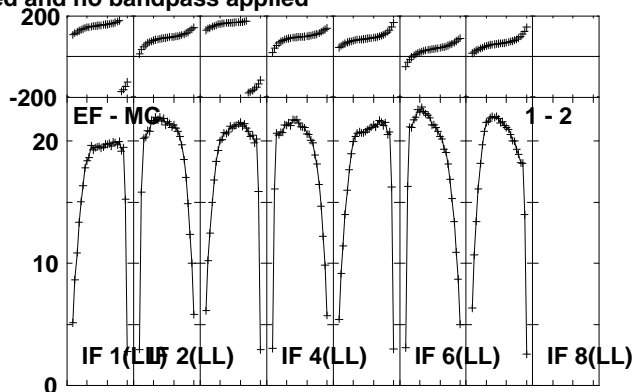
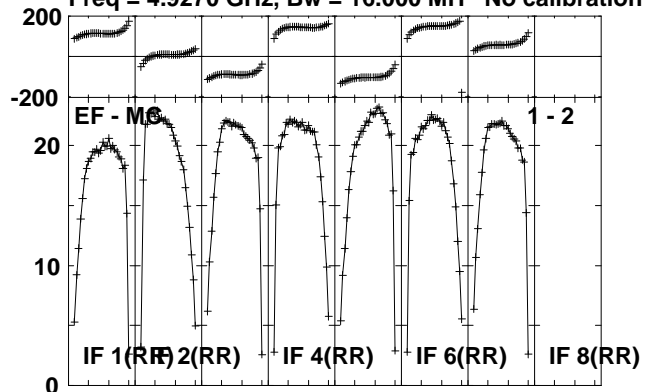

Lower frame: Milli Ampl Jy Top frame: Phas deg
Scalar averaged cross-power spectrum Several baselines displayed
Timerange: 00/21:41:07 to 00/21:45:09

Plot file version 240 created 02-DEC-2011 14:56:44

J2002+47 ET018A.UVDATA.1

Freq = 4.9270 GHz, Bw = 16.000 MH No calibration applied and no bandpass applied

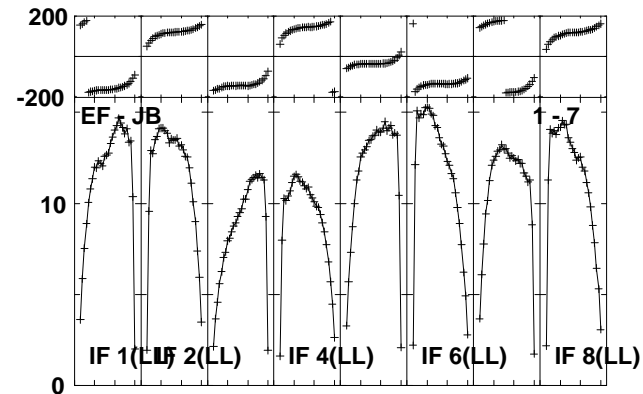
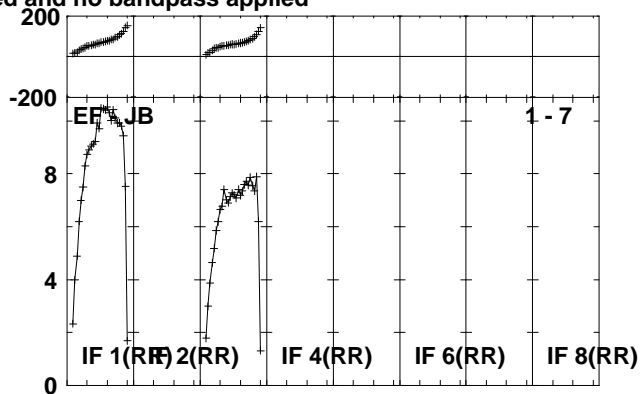
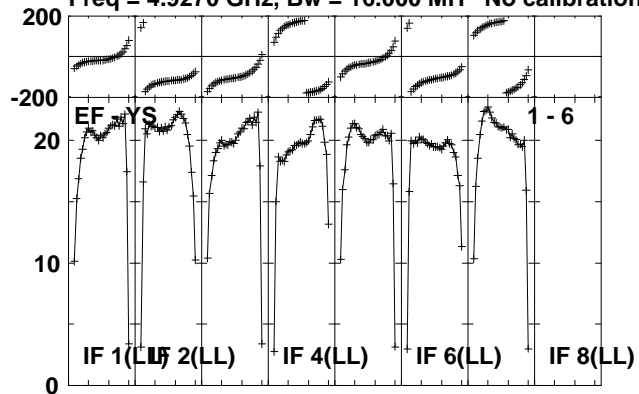

Lower frame: Milli Ampl Jy Top frame: Phas deg
Scalar averaged cross-power spectrum Several baselines displayed
Timerange: 00/21:41:07 to 00/21:45:09

Plot file version 241 created 02-DEC-2011 14:56:48

J1953+35 ET018A.UVDATA.1

Freq = 4.9270 GHz, Bw = 16.000 MH No calibration applied and no bandpass applied

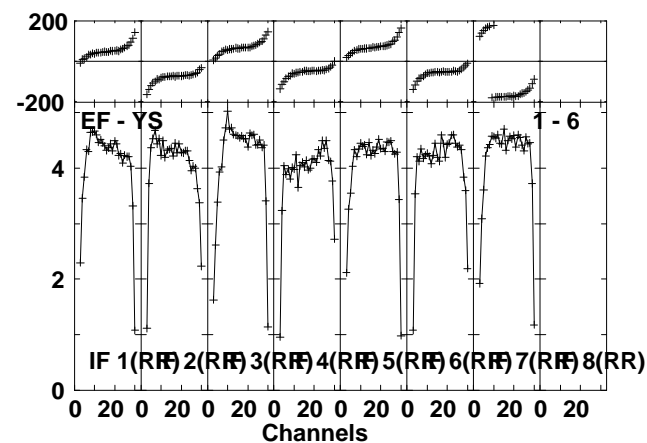
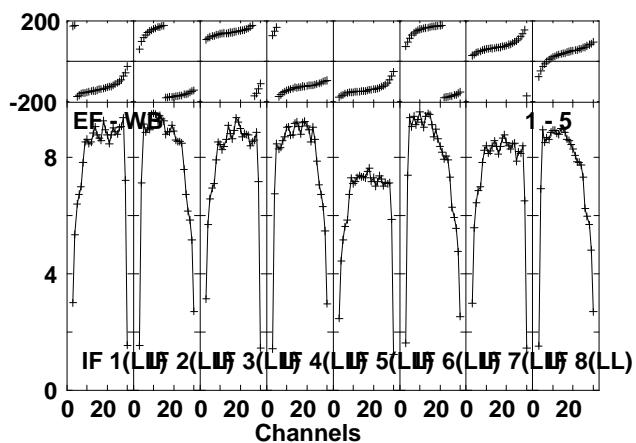
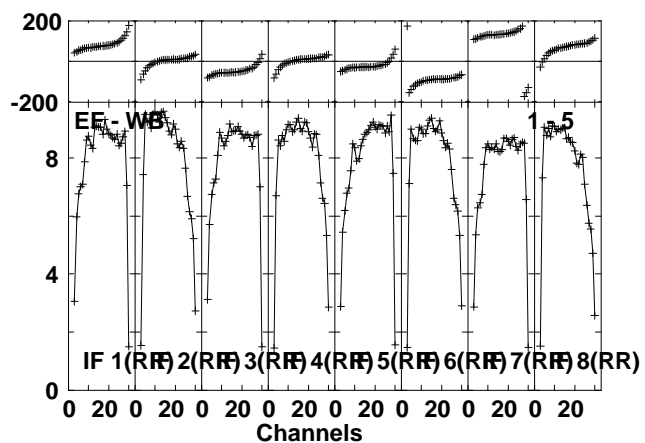
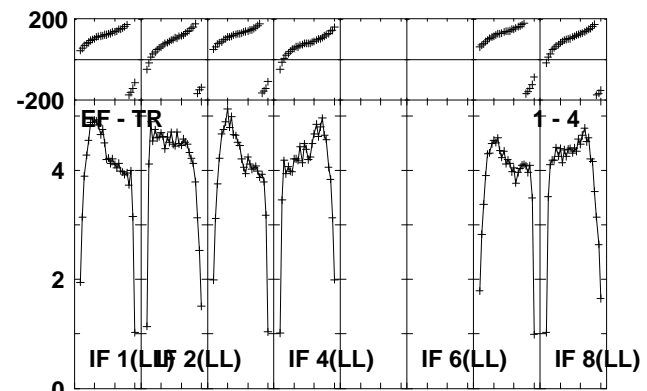
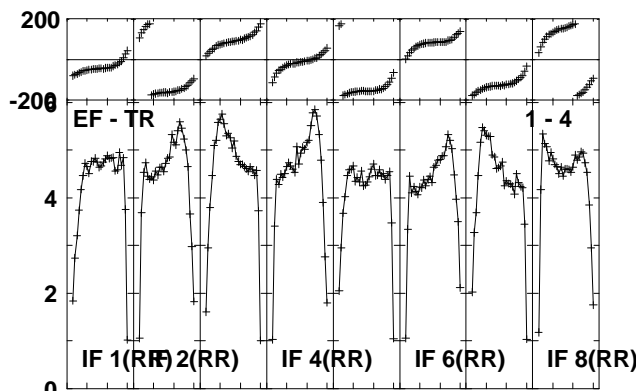
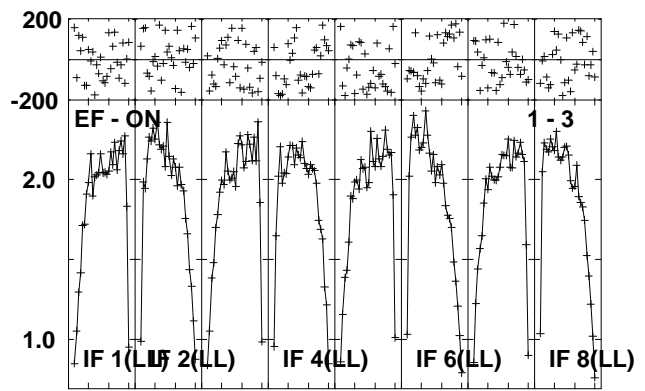
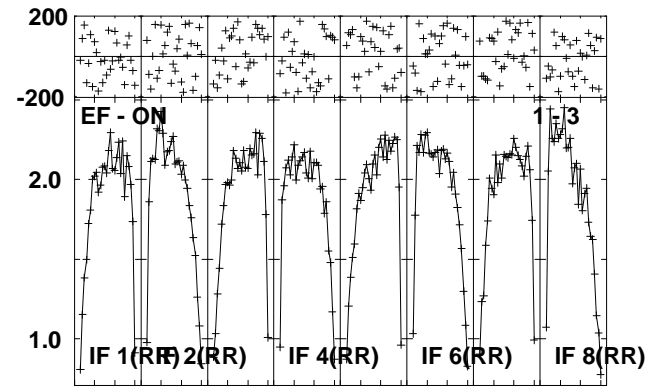
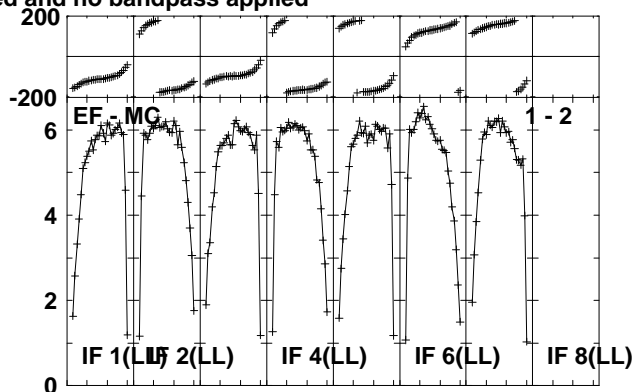
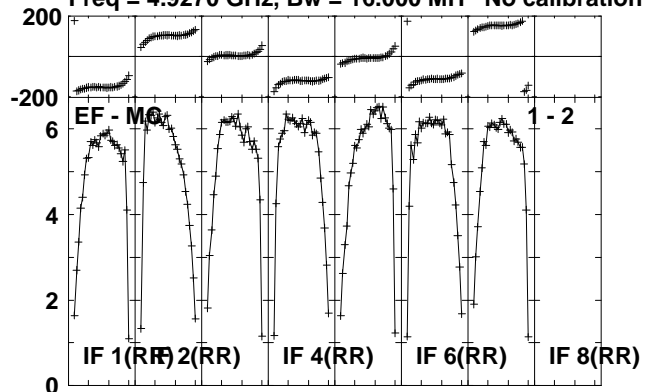

Lower frame: Milli Ampl Jy Top frame: Phas deg
Scalar averaged cross-power spectrum Several baselines displayed
Timerange: 00/21:45:11 to 00/21:49:38

Plot file version 242 created 02-DEC-2011 14:56:53

J1953+35 ET018A.UVDATA.1

Freq = 4.9270 GHz, Bw = 16.000 MH No calibration applied and no bandpass applied

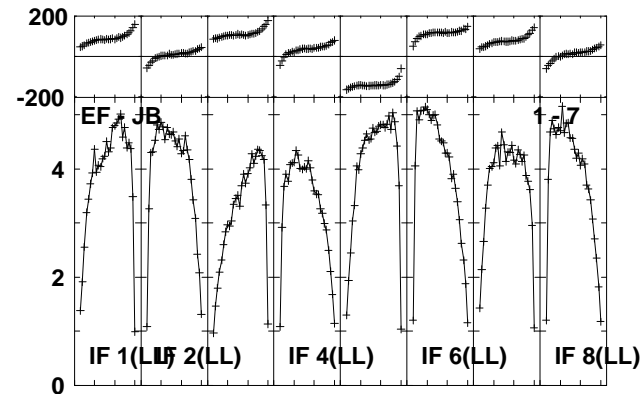
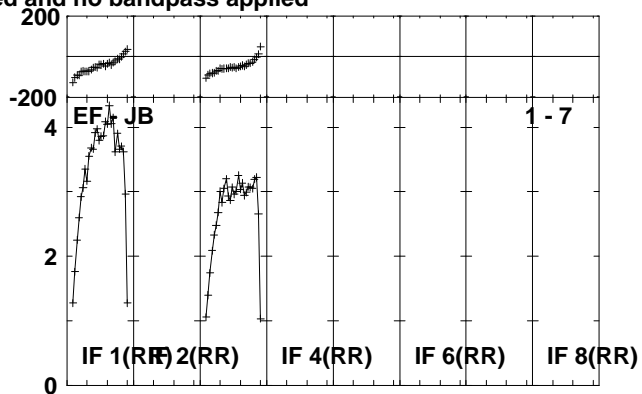
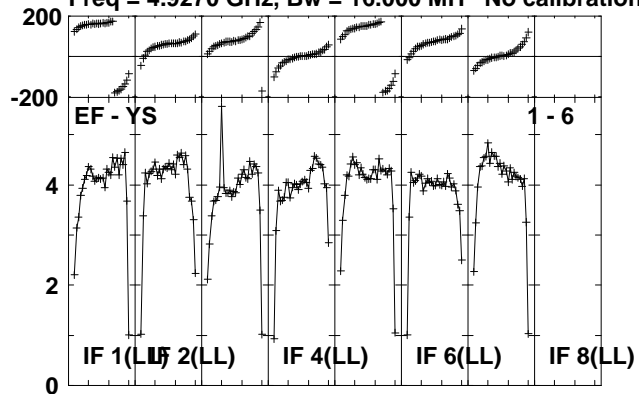

Lower frame: Milli Ampl Jy Top frame: Phas deg
Scalar averaged cross-power spectrum Several baselines displayed
Timerange: 00/21:45:11 to 00/21:49:38

Plot file version 243 created 02-DEC-2011 14:56:55

CYGX-1 ET018A.UVDATA.1

Freq = 4.9270 GHz, Bw = 16.000 MH No calibration applied and no bandpass applied

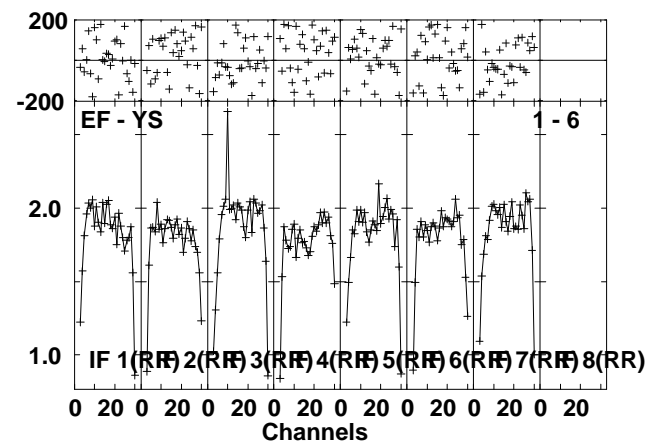
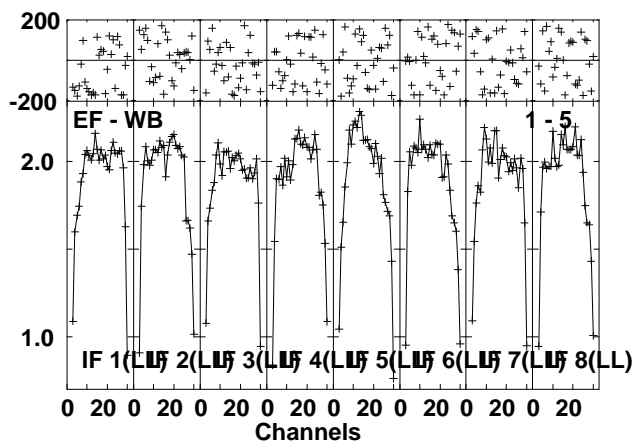
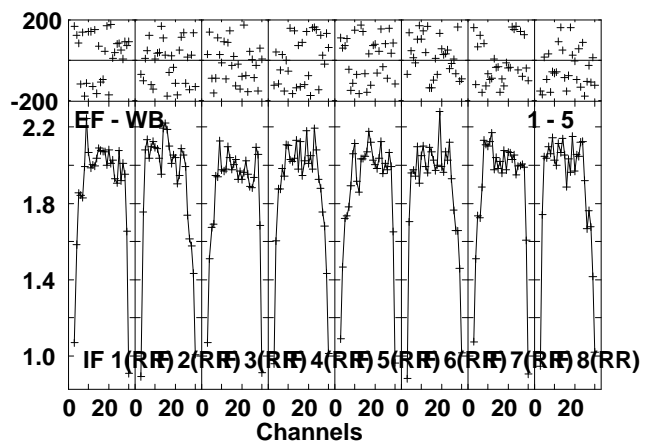
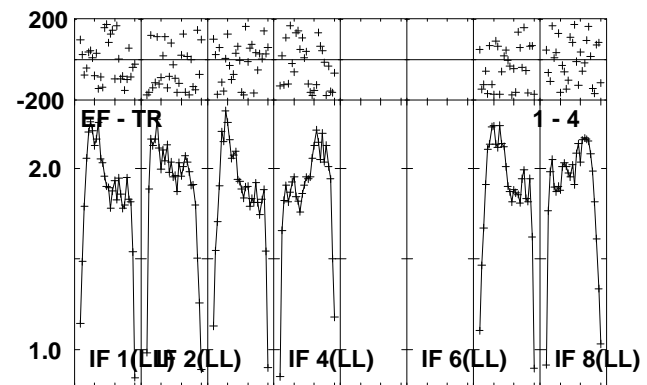
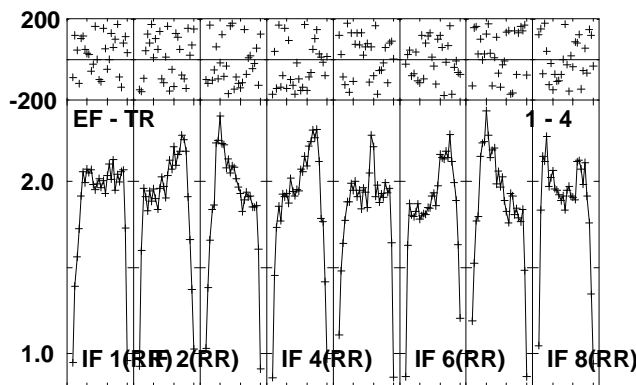
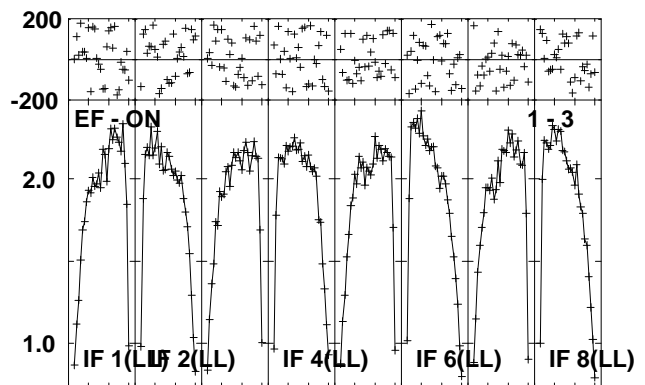
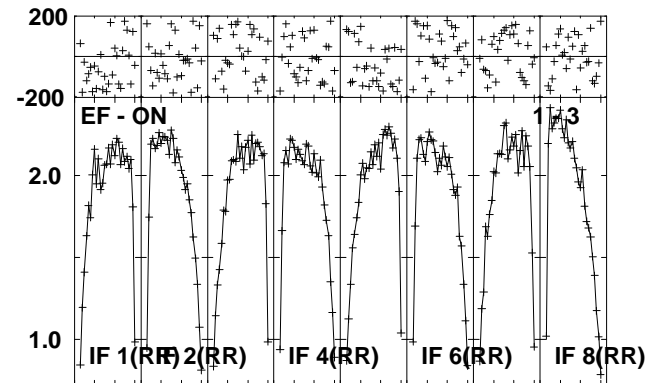
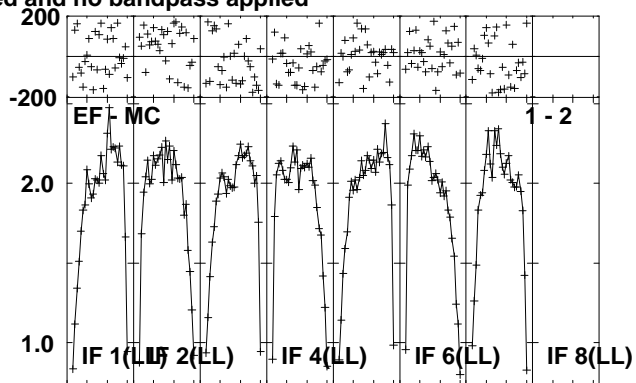
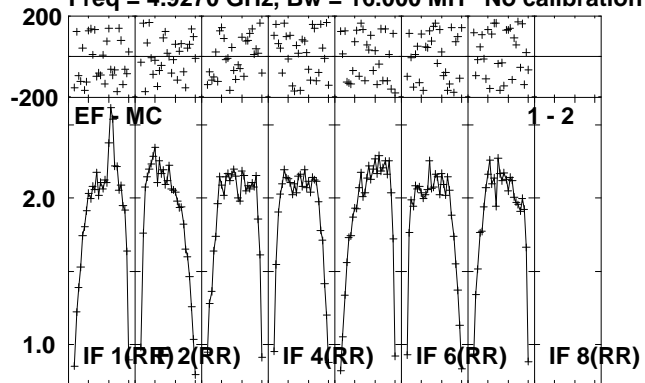

Lower frame: Milli Ampl Jy Top frame: Phas deg
Scalar averaged cross-power spectrum Several baselines displayed
Timerange: 00/21:49:42 to 00/21:55:08

Plot file version 244 created 02-DEC-2011 14:56:58

CYGX-1 ET018A.UVDATA.1

Freq = 4.9270 GHz, Bw = 16.000 MH No calibration applied and no bandpass applied

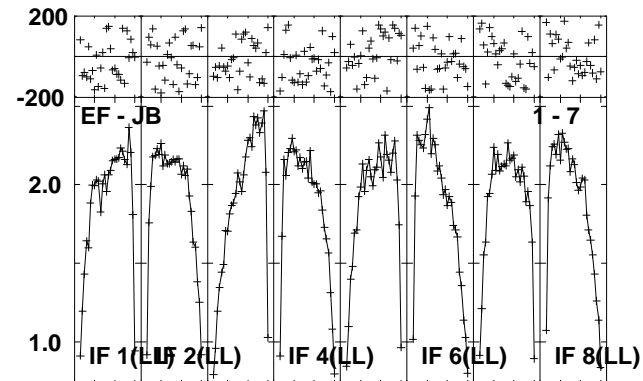
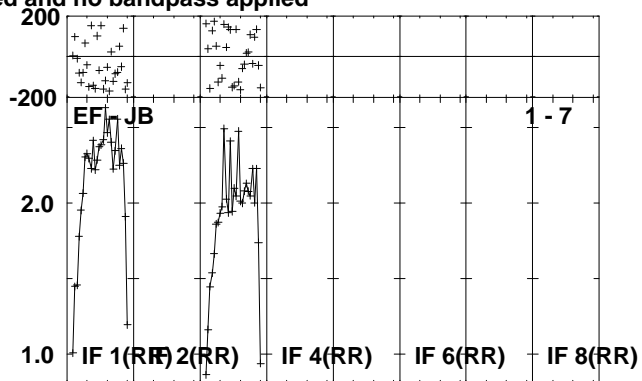
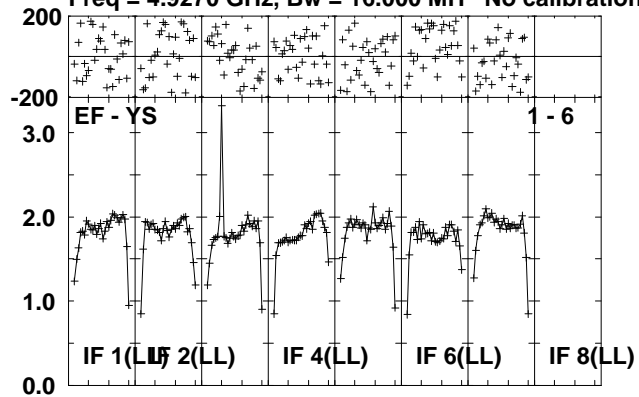

Lower frame: Milli Ampl Jy Top frame: Phas deg
Scalar averaged cross-power spectrum Several baselines displayed
Timerange: 00/21:49:42 to 00/21:55:08

Plot file version 245 created 02-DEC-2011 14:57:02

J1953+35 ET018A.UVDATA.1

Freq = 4.9270 GHz, Bw = 16.000 MH No calibration applied and no bandpass applied

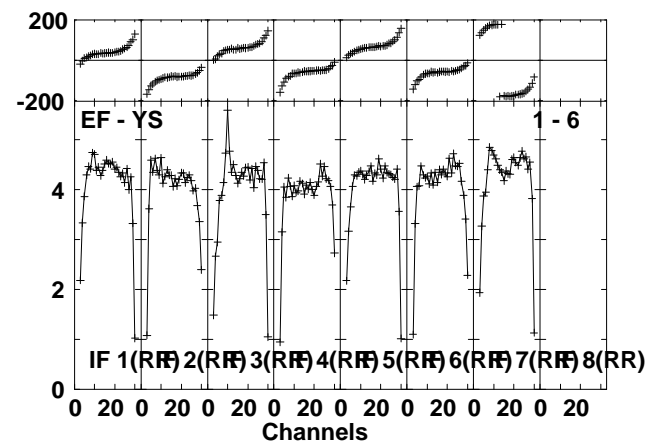
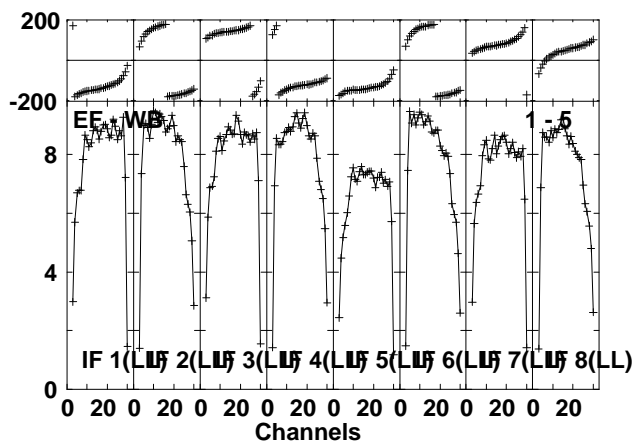
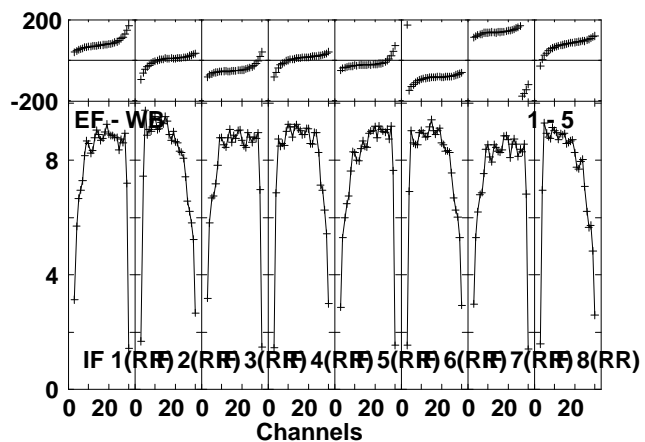
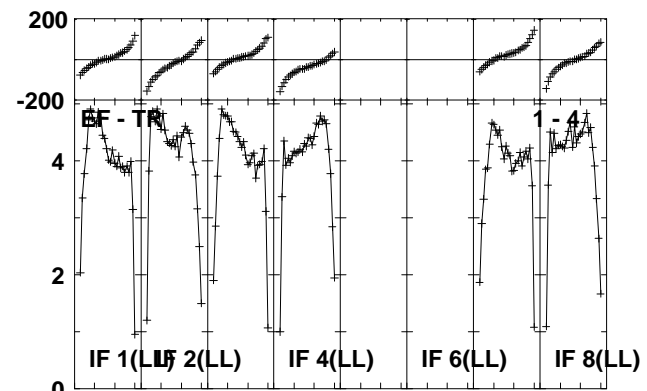
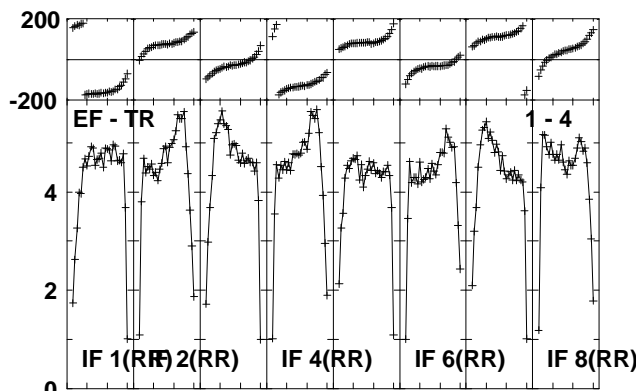
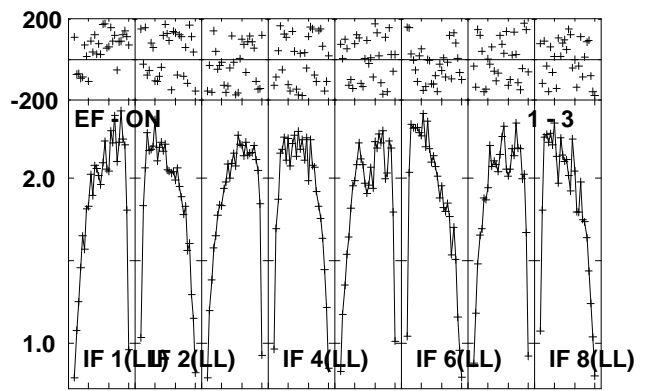
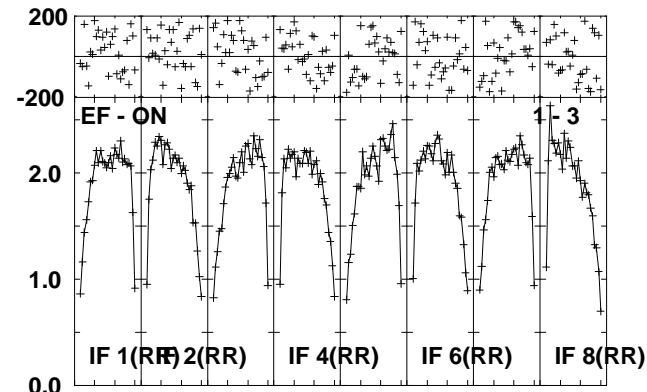
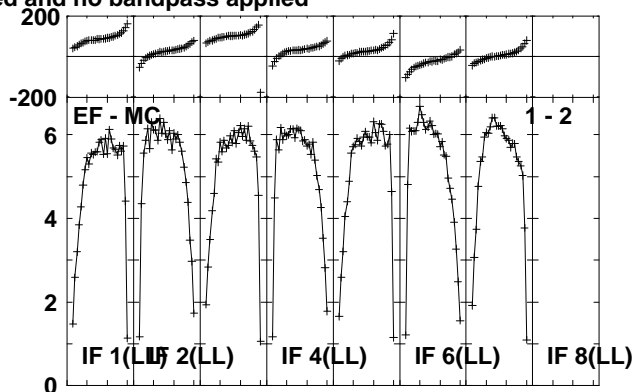
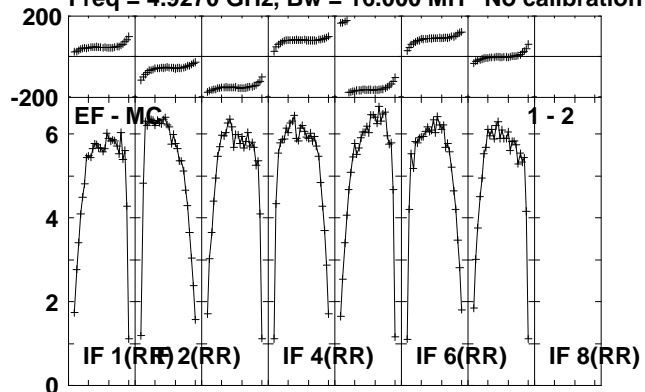

Lower frame: Milli Ampl Jy Top frame: Phas deg
Scalar averaged cross-power spectrum Several baselines displayed
Timerange: 00/21:55:12 to 00/21:58:09

Plot file version 246 created 02-DEC-2011 14:57:03

J1953+35 ET018A.UVDATA.1

Freq = 4.9270 GHz, Bw = 16.000 MH No calibration applied and no bandpass applied

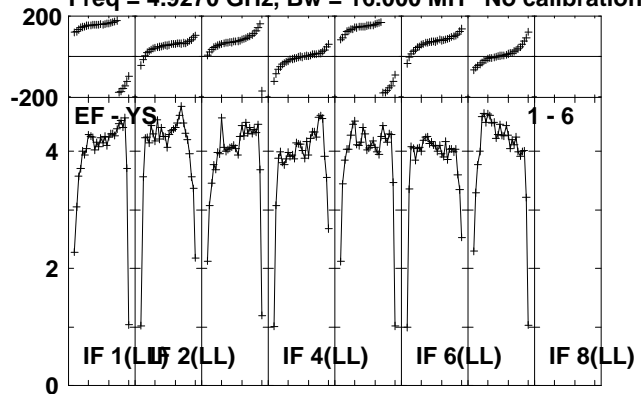

Lower frame: Milli Ampl Jy Top frame: Phas deg
Scalar averaged cross-power spectrum Several baselines displayed
Timerange: 00/21:55:12 to 00/21:58:09

Plot file version 247 created 02-DEC-2011 14:57:05

CYGX-1 ET018A.UVDATA.1

Freq = 4.9270 GHz, Bw = 16.000 MH No calibration applied and no bandpass applied

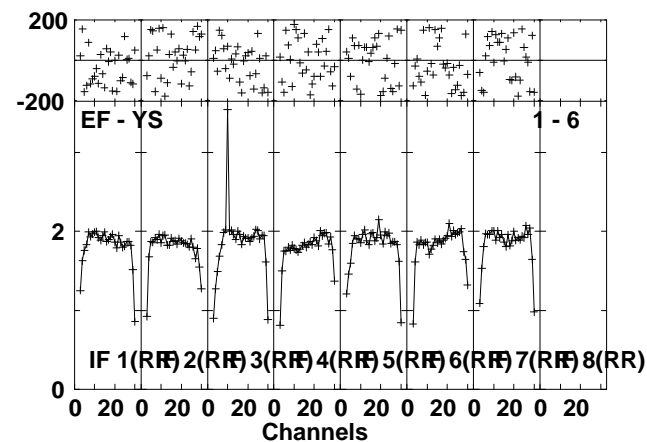
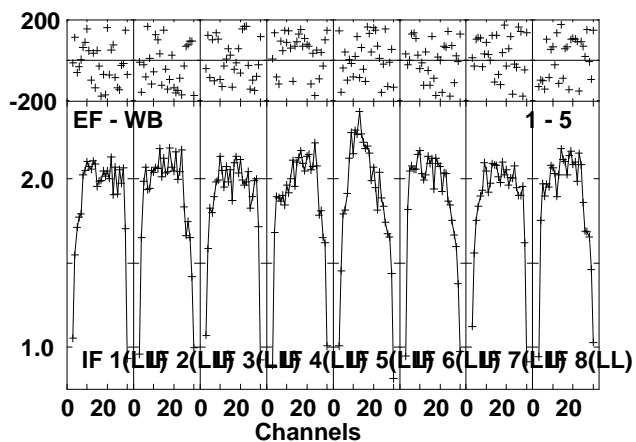
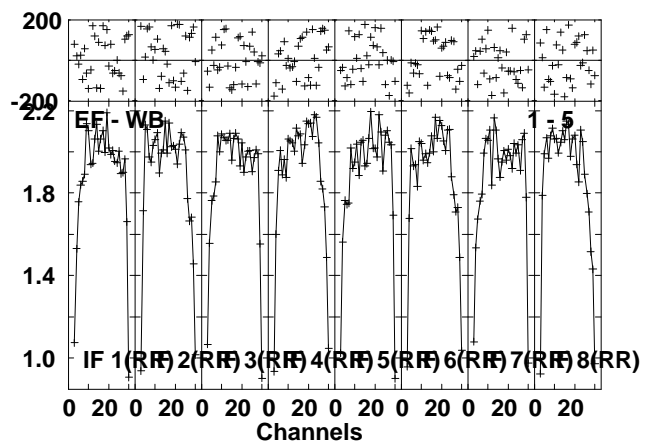
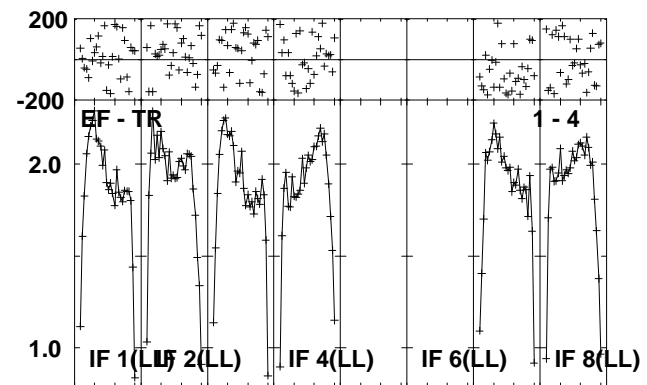
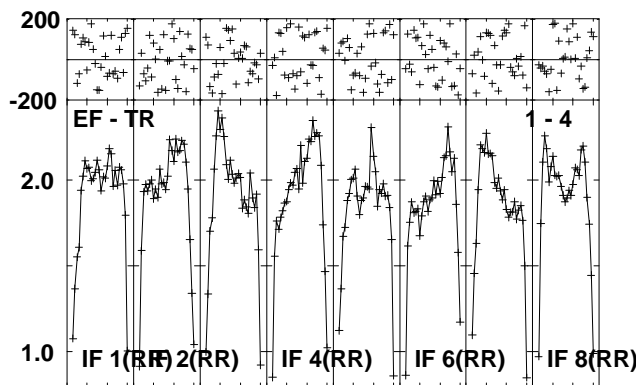
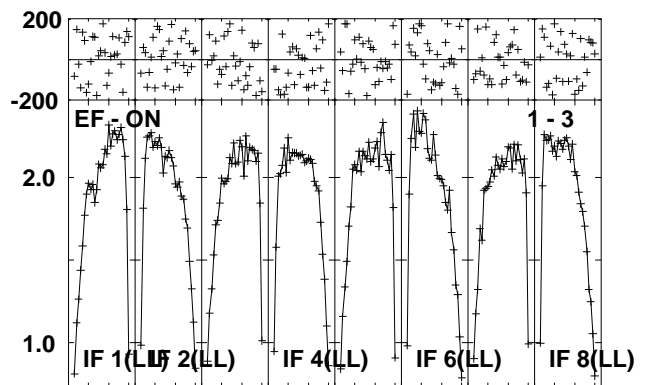
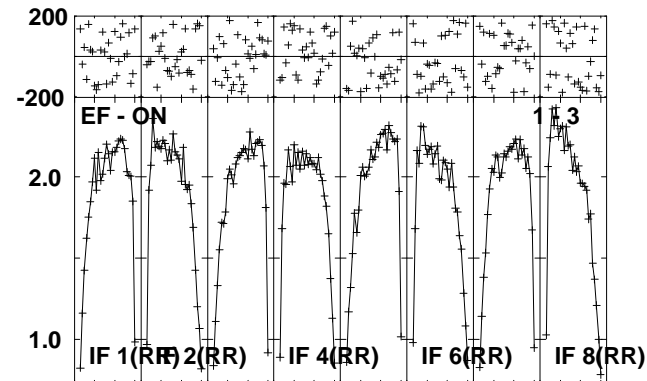
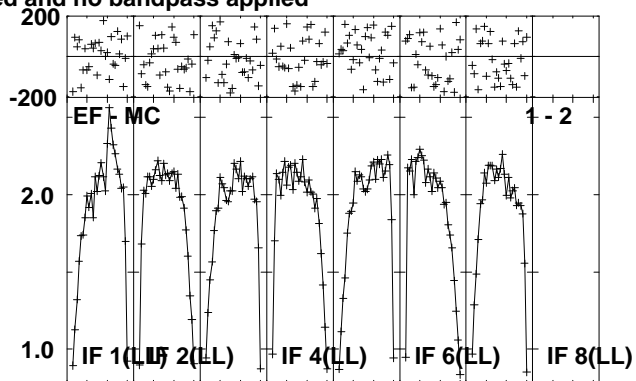
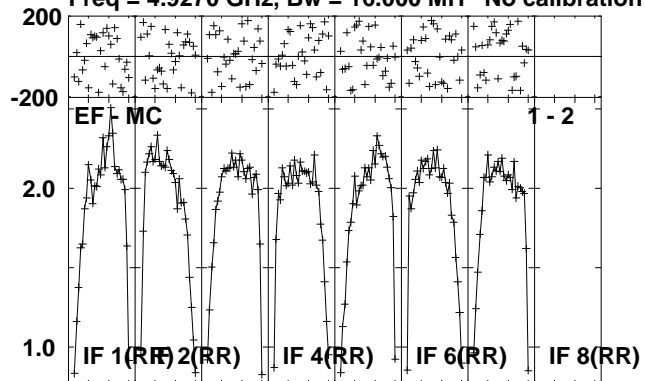

Lower frame: Milli Ampl Jy Top frame: Phas deg
Scalar averaged cross-power spectrum Several baselines displayed
Timerange: 00/21:58:11 to 00/22:03:38

Plot file version 248 created 02-DEC-2011 14:57:08

CYGX-1 ET018A.UVDATA.1

Freq = 4.9270 GHz, Bw = 16.000 MH No calibration applied and no bandpass applied

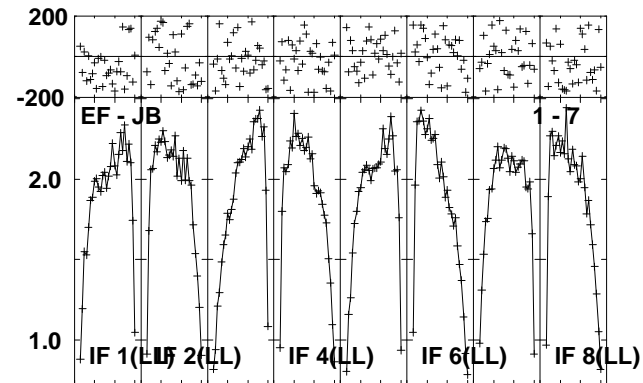
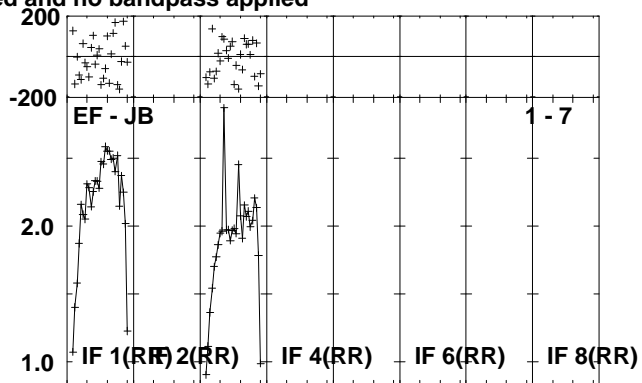
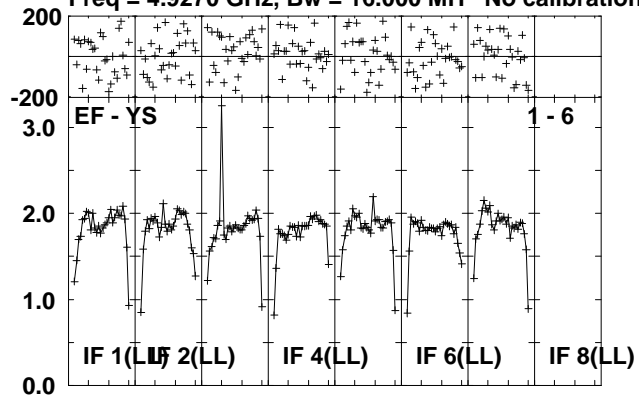

Lower frame: Milli Ampl Jy Top frame: Phas deg
Scalar averaged cross-power spectrum Several baselines displayed
Timerange: 00/21:58:11 to 00/22:03:38

Plot file version 249 created 02-DEC-2011 14:57:10

J1953+35 ET018A.UVDATA.1

Freq = 4.9270 GHz, Bw = 16.000 MH No calibration applied and no bandpass applied

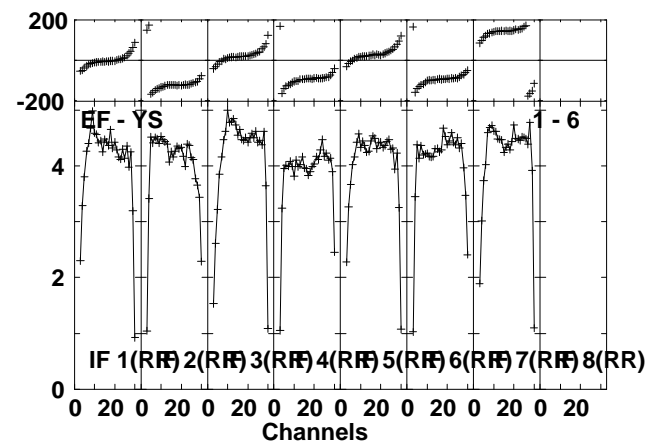
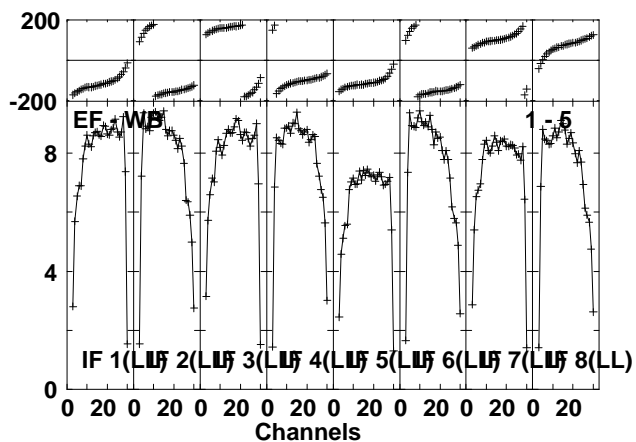
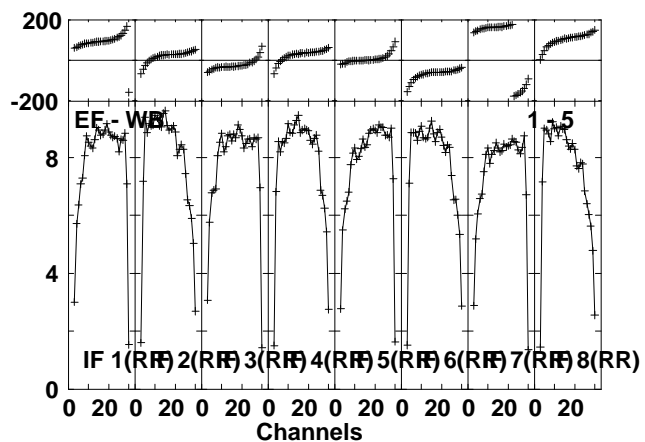
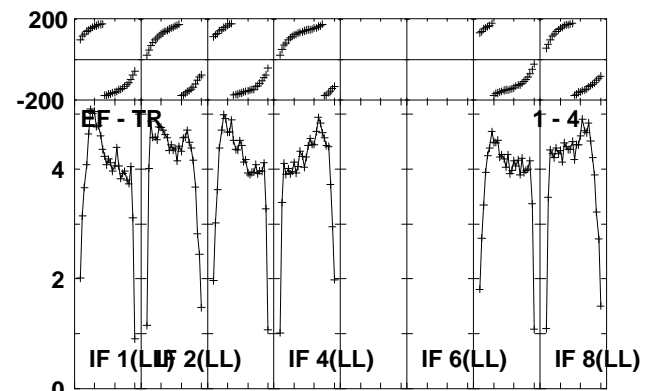
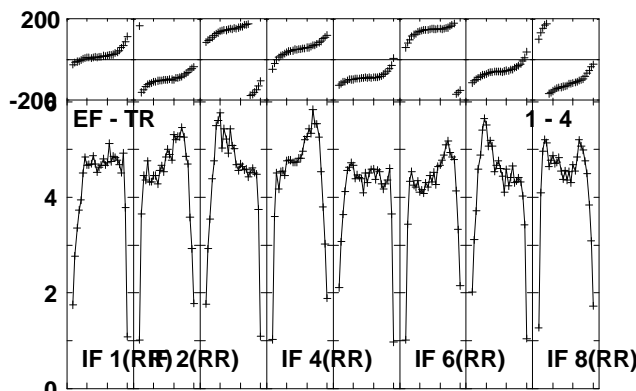
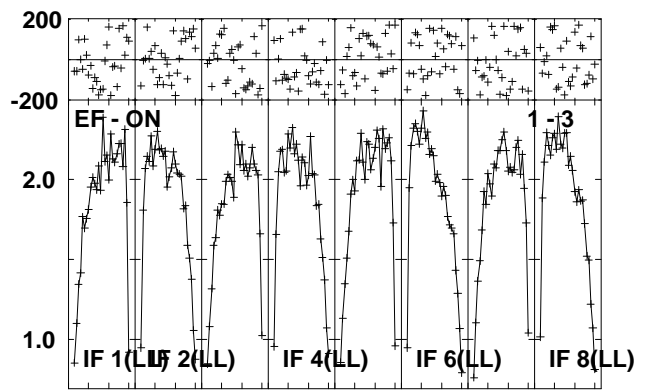
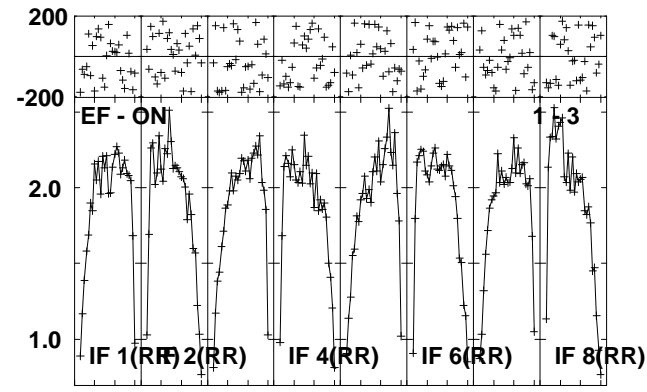
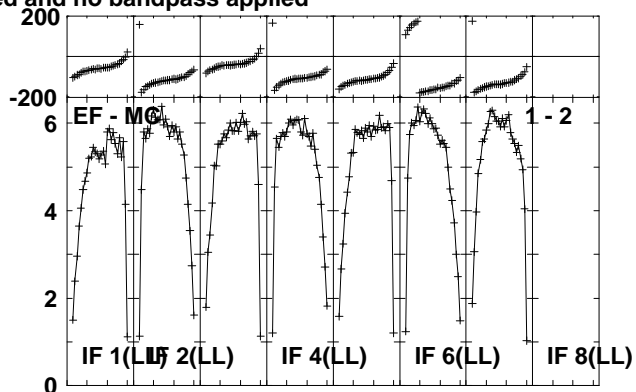
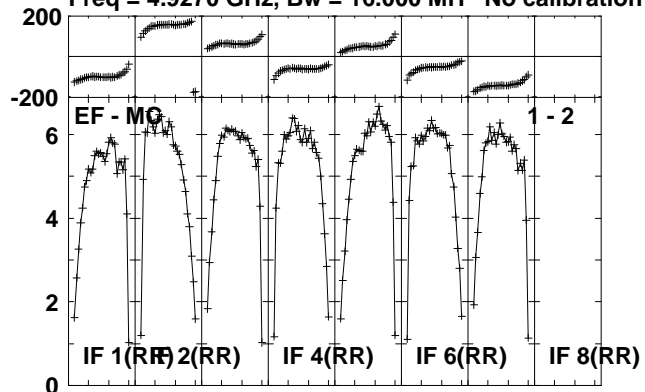

Lower frame: Milli Ampl Jy Top frame: Phas deg
Scalar averaged cross-power spectrum Several baselines displayed
Timerange: 00/22:04:27 to 00/22:06:59

Plot file version 250 created 02-DEC-2011 14:57:11
J1953+35 ET018A.UVDATA.1

Freq = 4.9270 GHz, Bw = 16.000 MH No calibration applied and no bandpass applied

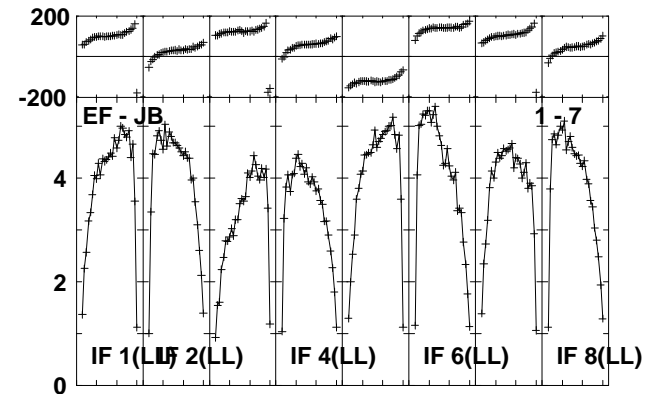
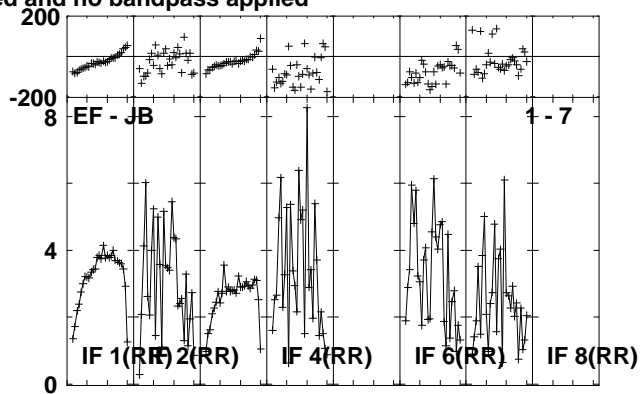
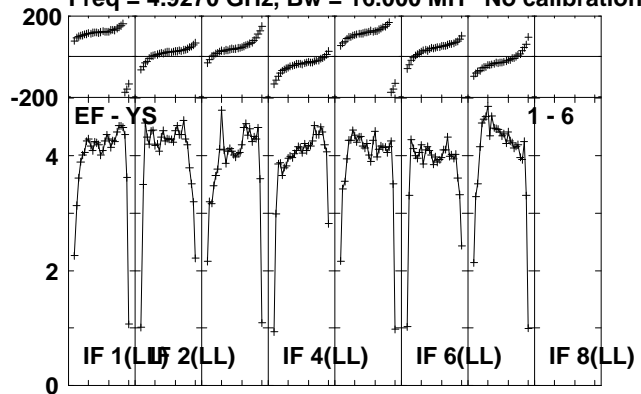

Lower frame: Milli Ampl Jy Top frame: Phas deg
Scalar averaged cross-power spectrum Several baselines displayed
Timerange: 00/22:04:27 to 00/22:06:59

Plot file version 251 created 02-DEC-2011 14:57:13

CYGX-1 ET018A.UVDATA.1

Freq = 4.9270 GHz, Bw = 16.000 MH No calibration applied and no bandpass applied

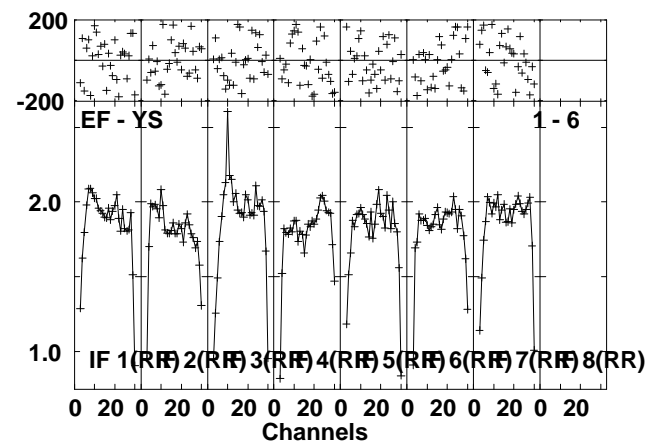
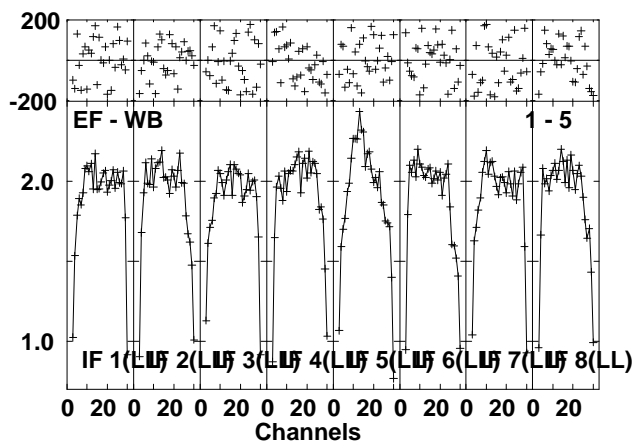
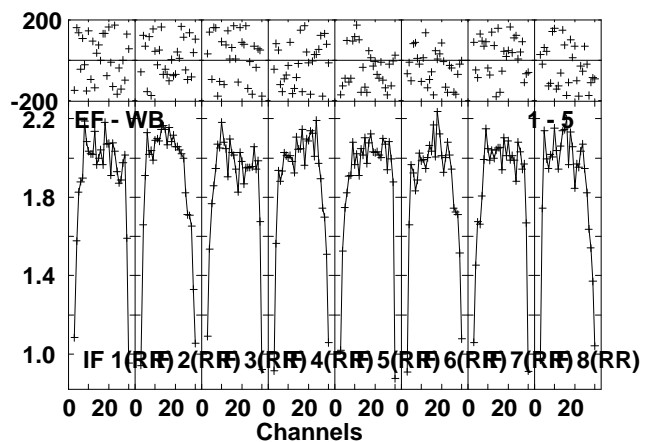
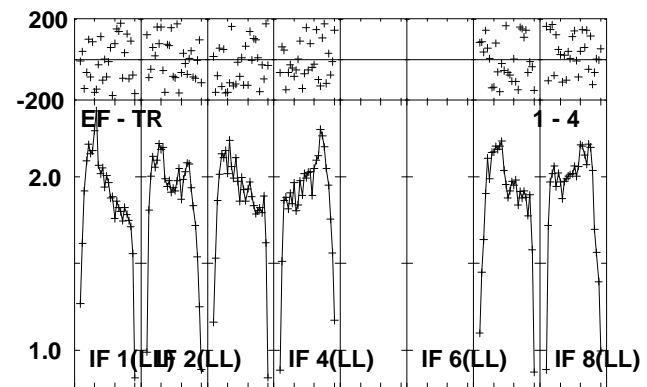
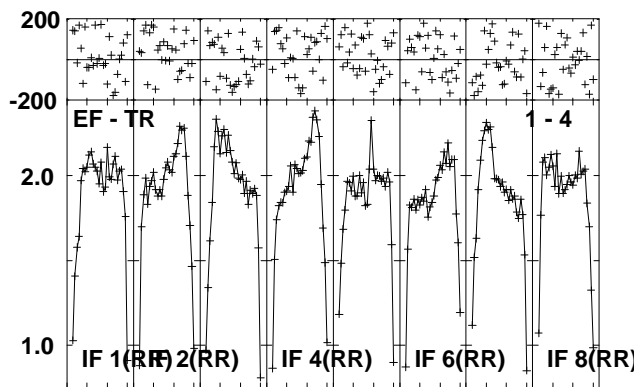
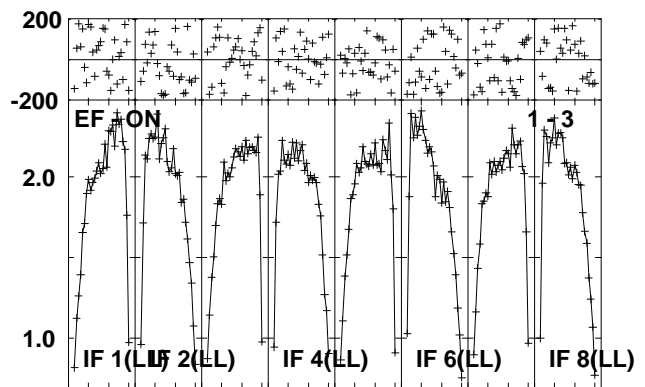
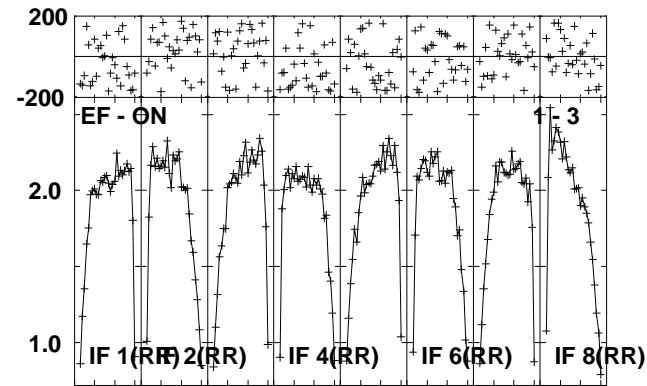
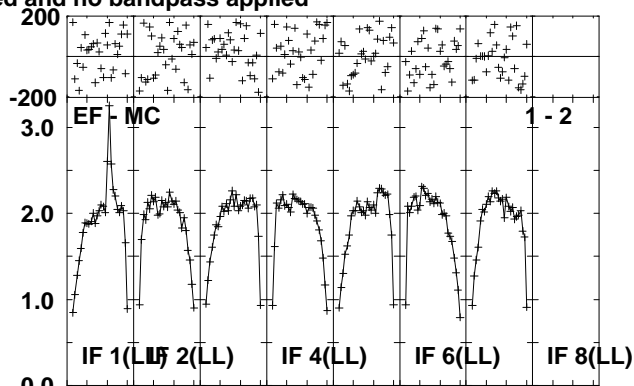
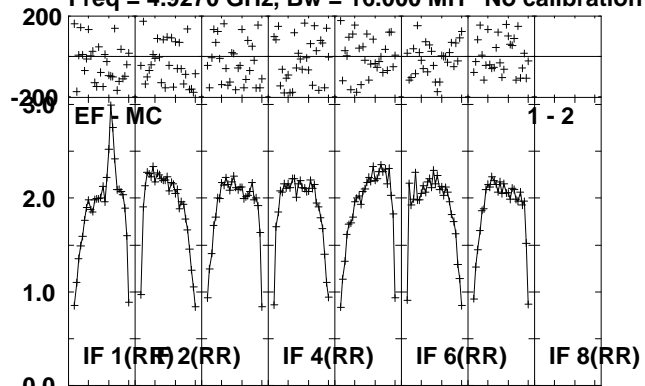

Lower frame: Milli Ampl Jy Top frame: Phas deg
Scalar averaged cross-power spectrum Several baselines displayed
Timerange: 00/22:07:02 to 00/22:12:28

Plot file version 252 created 02-DEC-2011 14:57:16

CYGX-1 ET018A.UVDATA.1

Freq = 4.9270 GHz, Bw = 16.000 MH No calibration applied and no bandpass applied

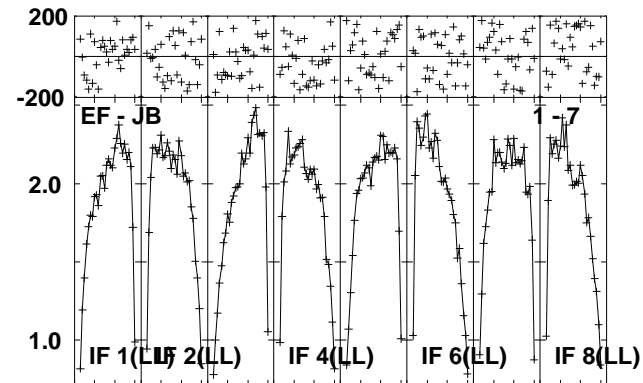
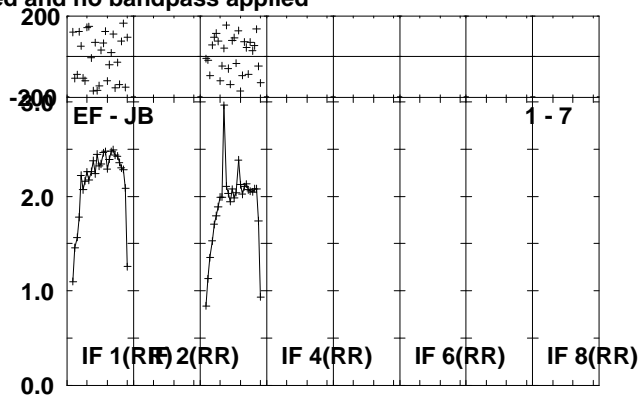
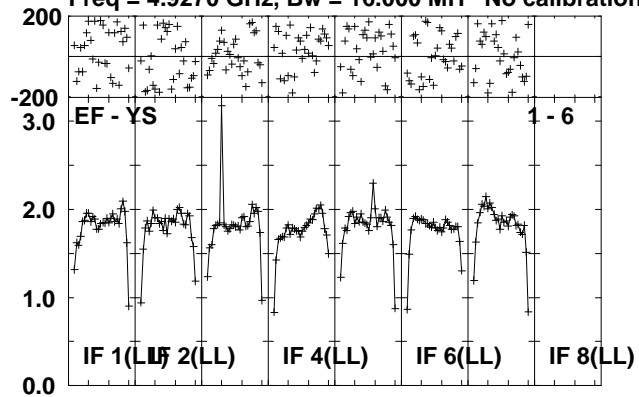

Lower frame: Milli Ampl Jy Top frame: Phas deg
Scalar averaged cross-power spectrum Several baselines displayed
Timerange: 00/22:07:02 to 00/22:12:28

Plot file version 253 created 02-DEC-2011 14:57:19

J1953+35 ET018A.UVDATA.1

Freq = 4.9270 GHz, Bw = 16.000 MH No calibration applied and no bandpass applied

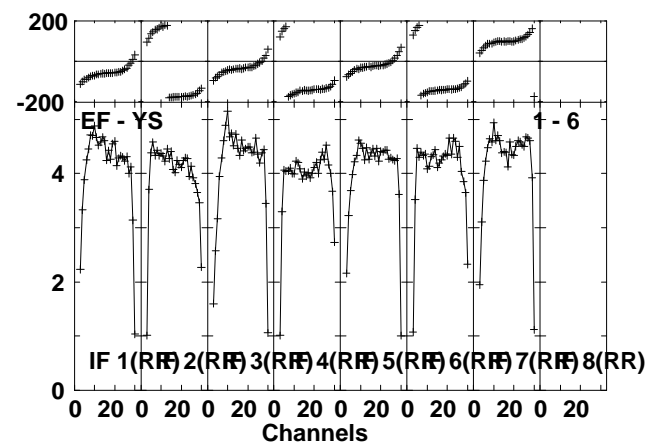
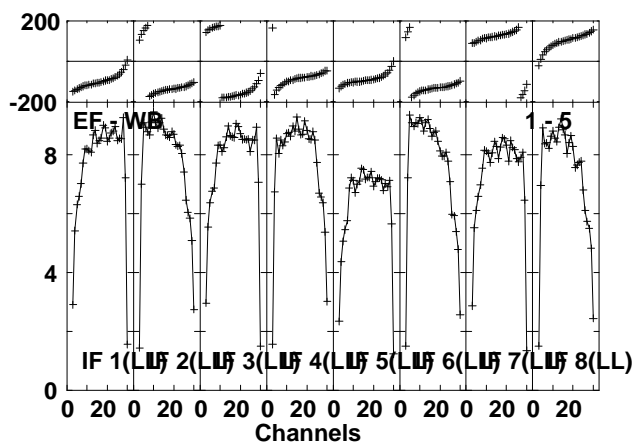
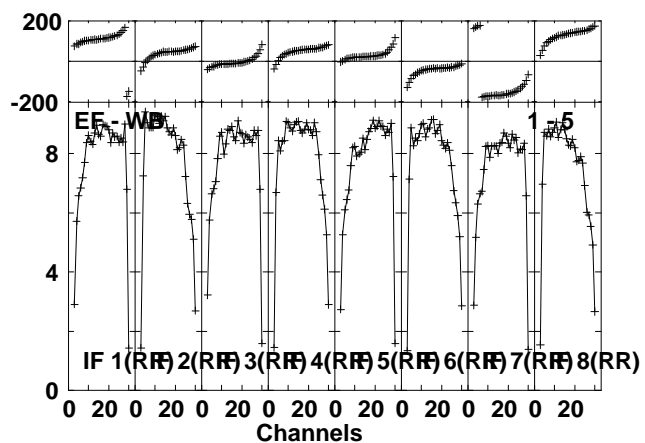
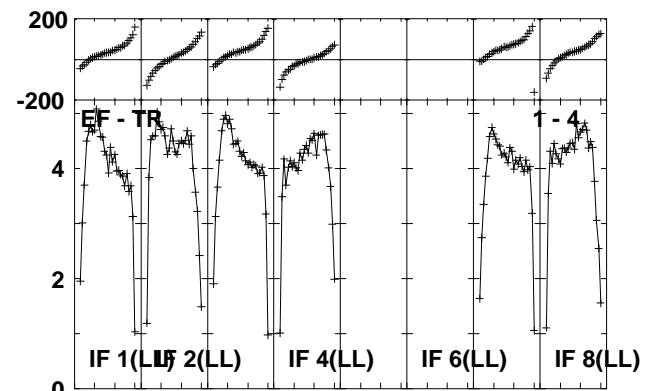
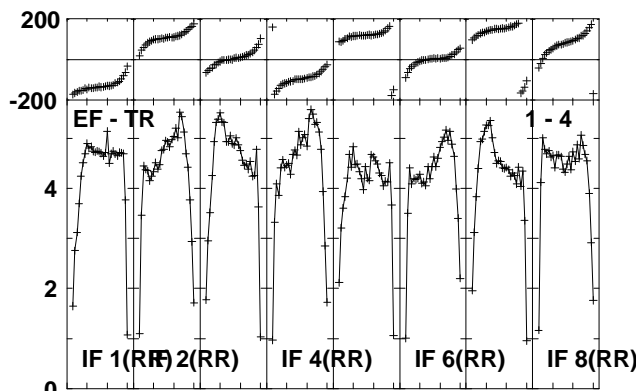
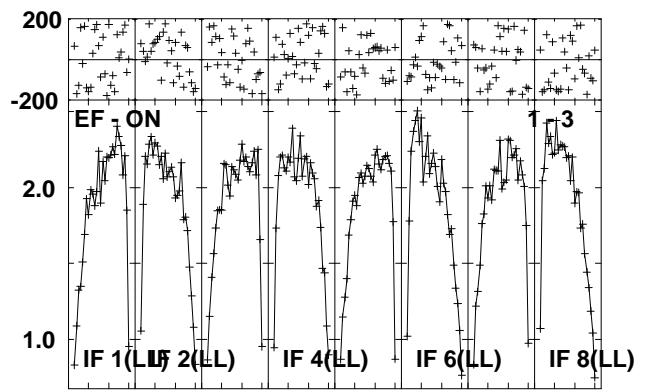
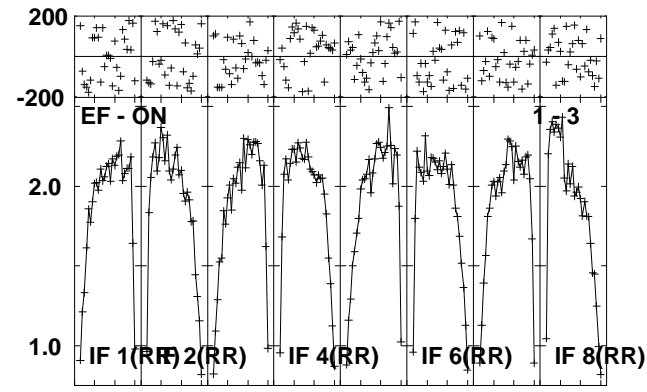
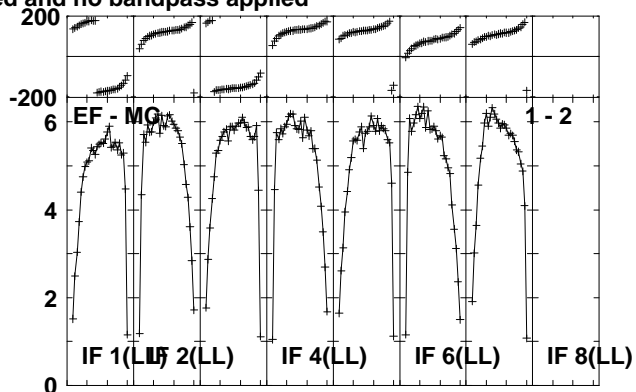
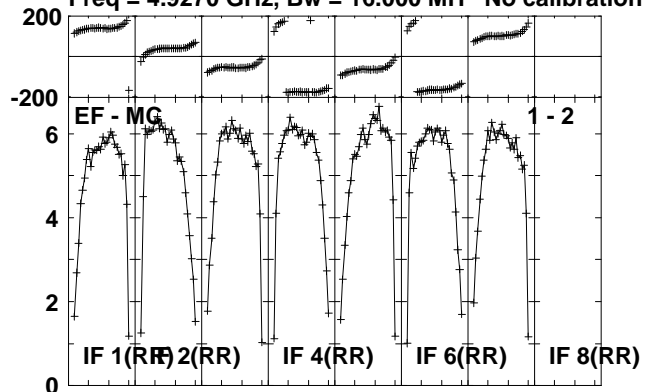

Lower frame: Milli Ampl Jy Top frame: Phas deg
Scalar averaged cross-power spectrum Several baselines displayed
Timerange: 00/22:12:31 to 00/22:15:28

Plot file version 254 created 02-DEC-2011 14:57:20

J1953+35 ET018A.UVDATA.1

Freq = 4.9270 GHz, Bw = 16.000 MH No calibration applied and no bandpass applied

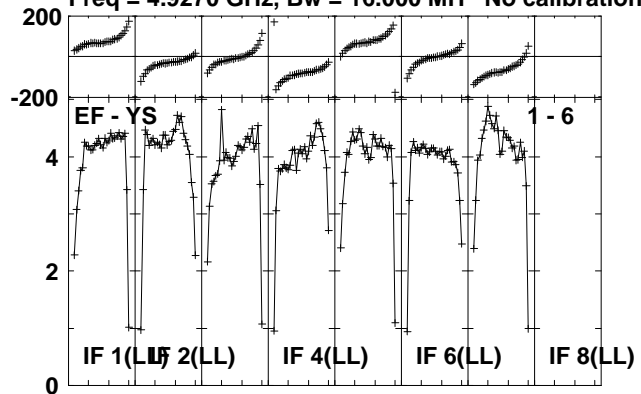

Lower frame: Milli Ampl Jy Top frame: Phas deg
Scalar averaged cross-power spectrum Several baselines displayed
Timerange: 00/22:12:31 to 00/22:15:28

Plot file version 255 created 02-DEC-2011 14:57:21

CYGX-1 ET018A.UVDATA.1

Freq = 4.9270 GHz, Bw = 16.000 MH No calibration applied and no bandpass applied

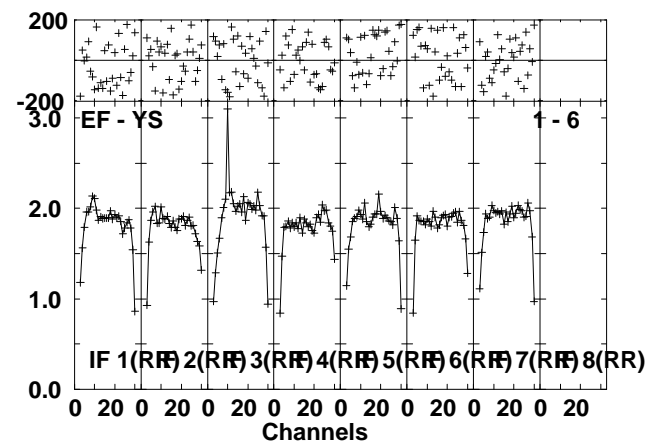
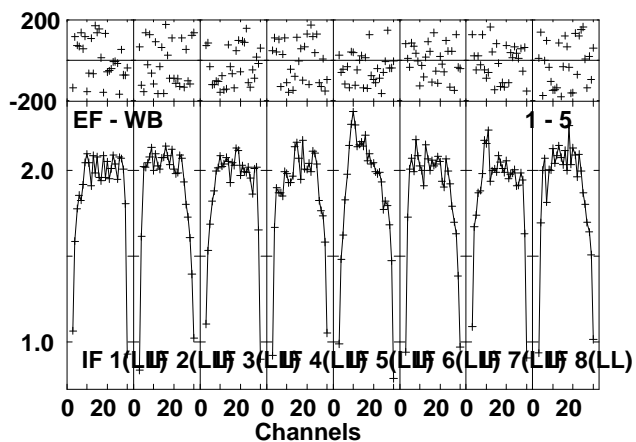
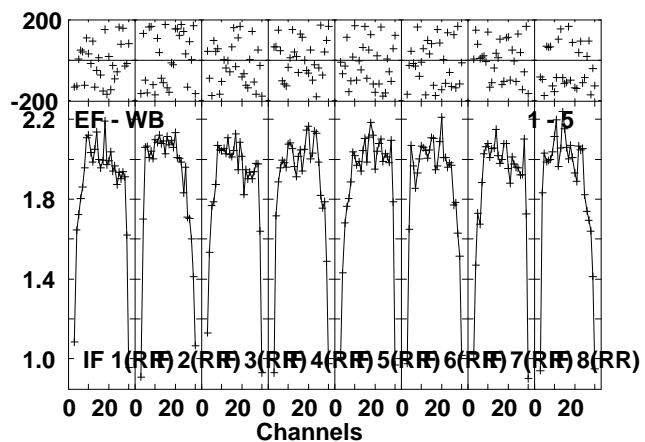
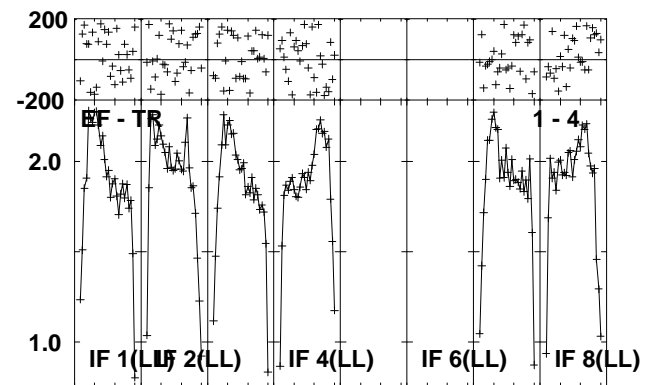
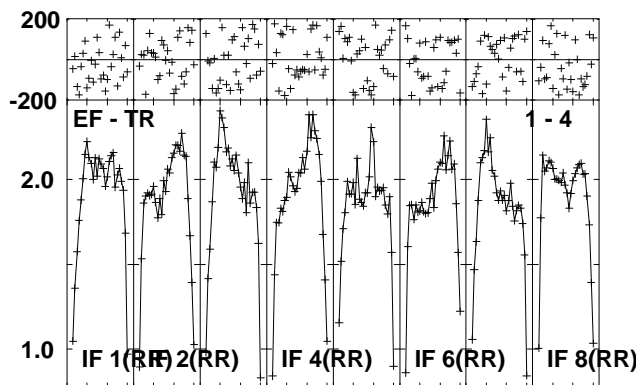
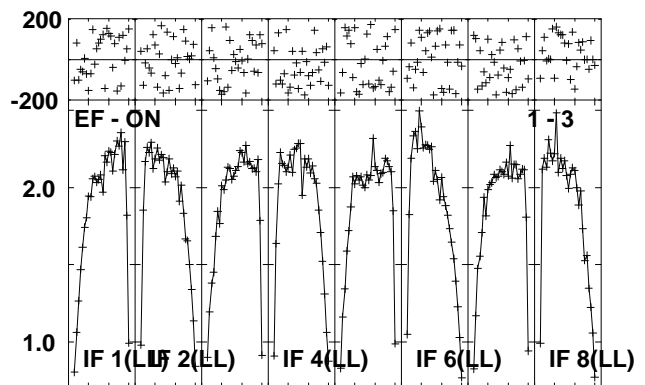
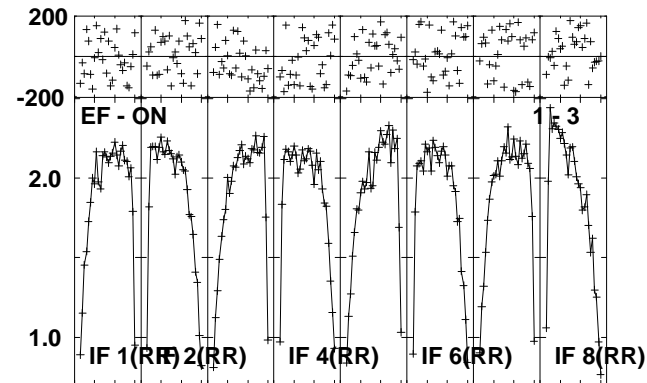
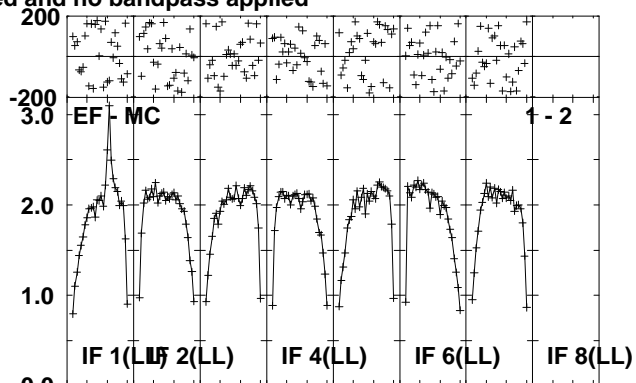
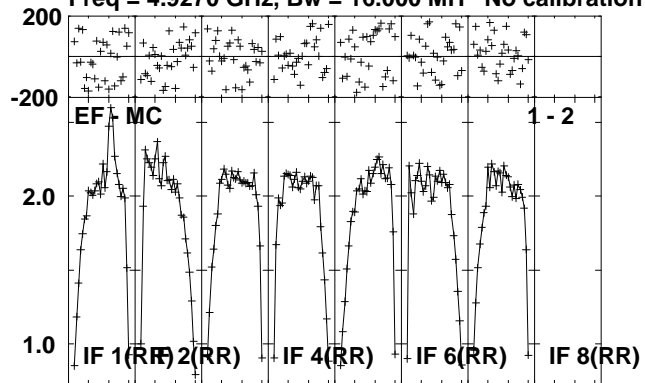

Lower frame: Milli Ampl Jy Top frame: Phas deg
Scalar averaged cross-power spectrum Several baselines displayed
Timerange: 00/22:15:31 to 00/22:20:58

Plot file version 256 created 02-DEC-2011 14:57:24

CYGX-1 ET018A.UVDATA.1

Freq = 4.9270 GHz, Bw = 16.000 MH No calibration applied and no bandpass applied

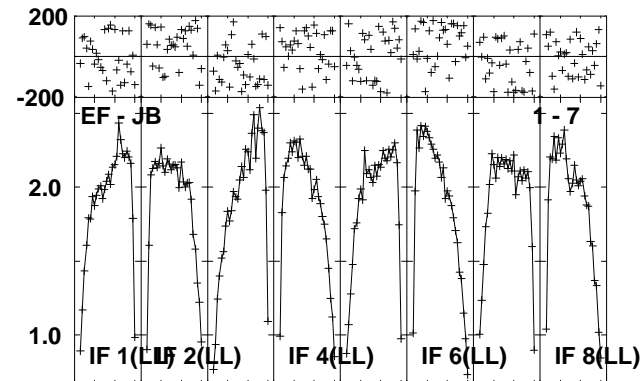
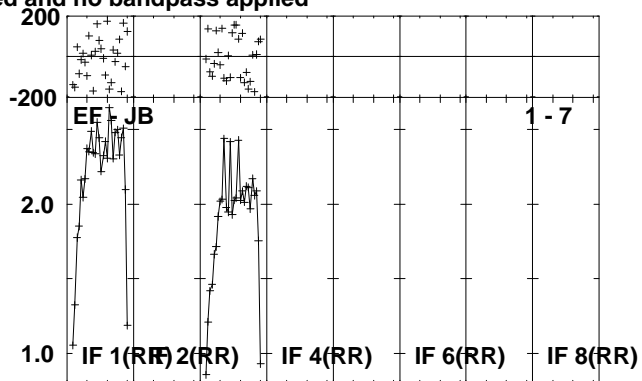
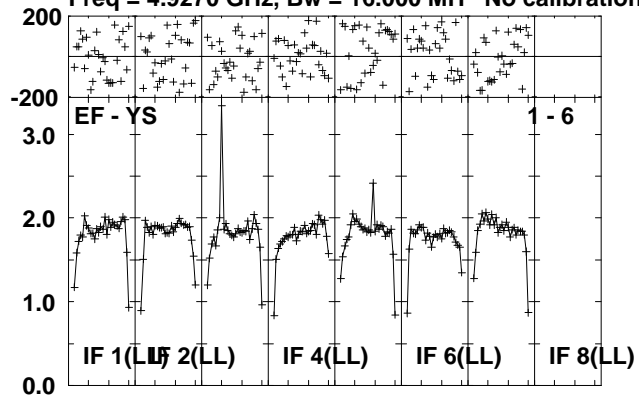

Lower frame: Milli Ampl Jy Top frame: Phas deg
Scalar averaged cross-power spectrum Several baselines displayed
Timerange: 00/22:15:31 to 00/22:20:58

Plot file version 257 created 02-DEC-2011 14:57:27

J1953+35 ET018A.UVDATA.1

Freq = 4.9270 GHz, Bw = 16.000 MH No calibration applied and no bandpass applied

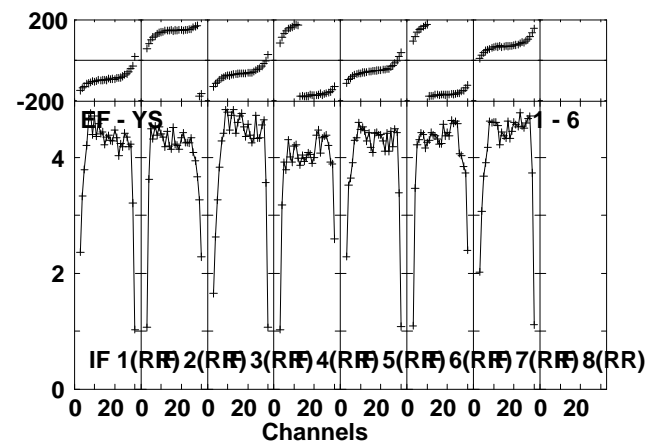
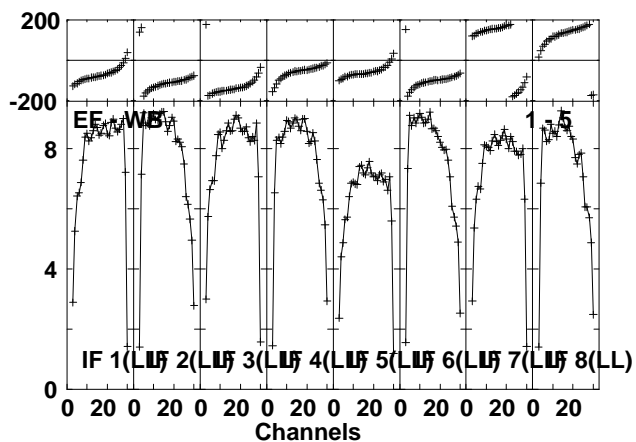
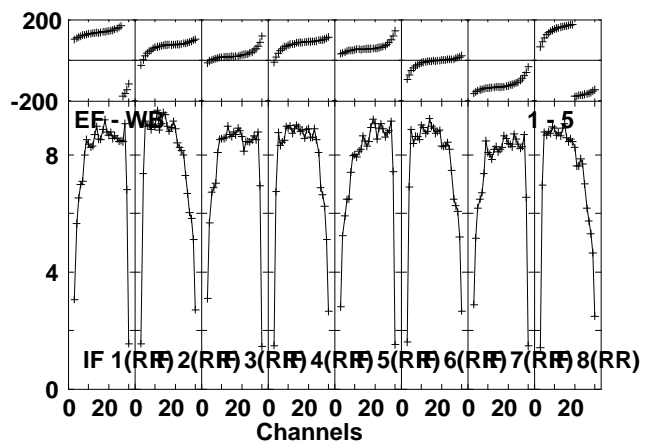
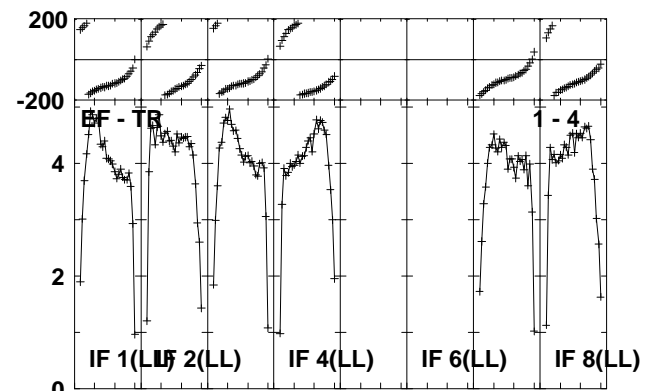
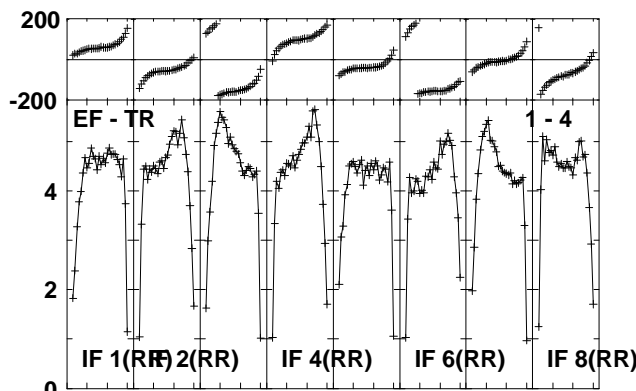
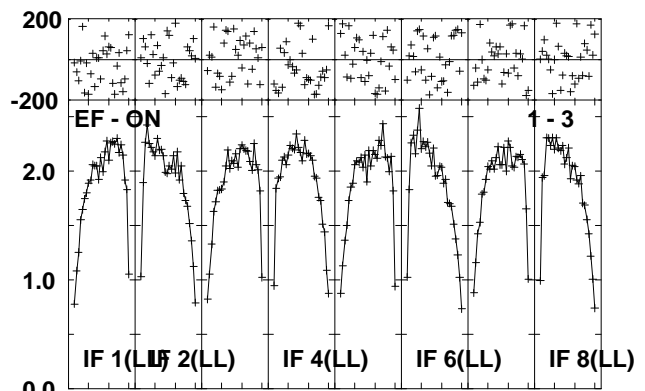
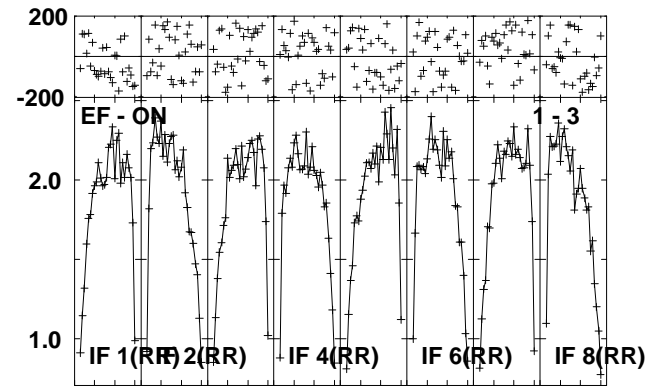
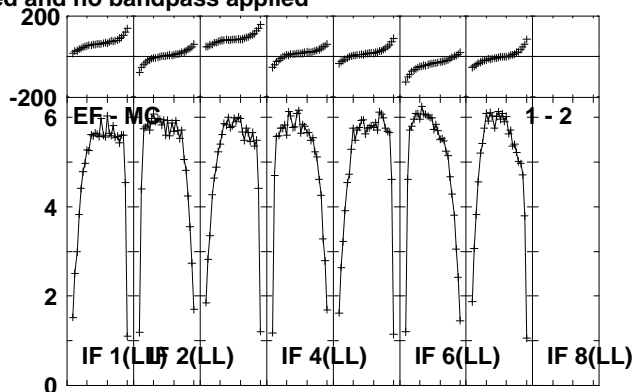
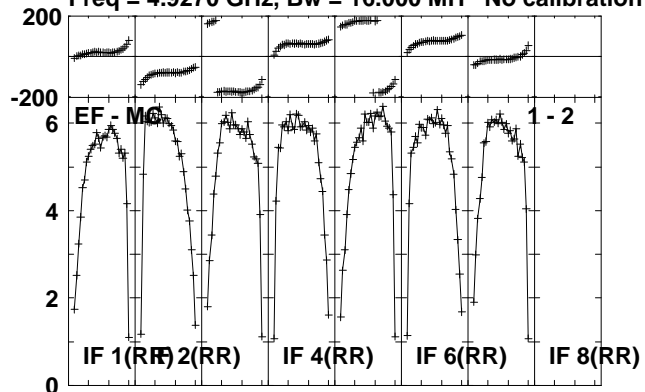

Lower frame: Milli Ampl Jy Top frame: Phas deg
Scalar averaged cross-power spectrum Several baselines displayed
Timerange: 00/22:21:47 to 00/22:24:19

Plot file version 258 created 02-DEC-2011 14:57:28

J1953+35 ET018A.UVDATA.1

Freq = 4.9270 GHz, Bw = 16.000 MH No calibration applied and no bandpass applied

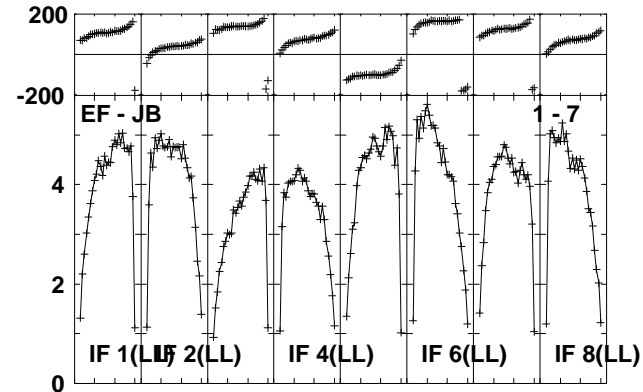
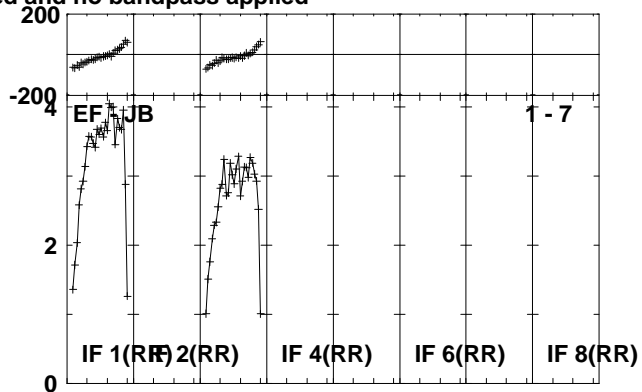
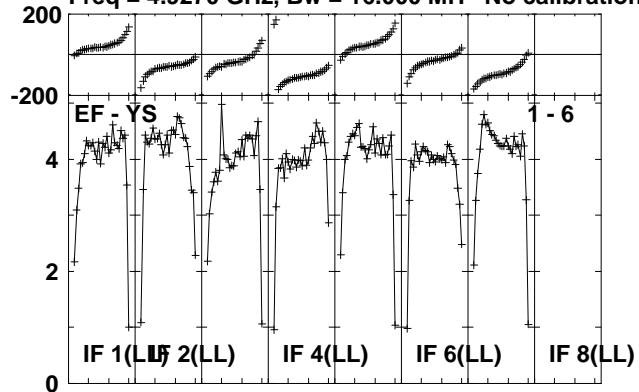

Lower frame: Milli Ampl Jy Top frame: Phas deg
Scalar averaged cross-power spectrum Several baselines displayed
Timerange: 00/22:21:47 to 00/22:24:19

Plot file version 259 created 02-DEC-2011 14:57:30

CYGX-1 ET018A.UVDATA.1

Freq = 4.9270 GHz, Bw = 16.000 MH No calibration applied and no bandpass applied

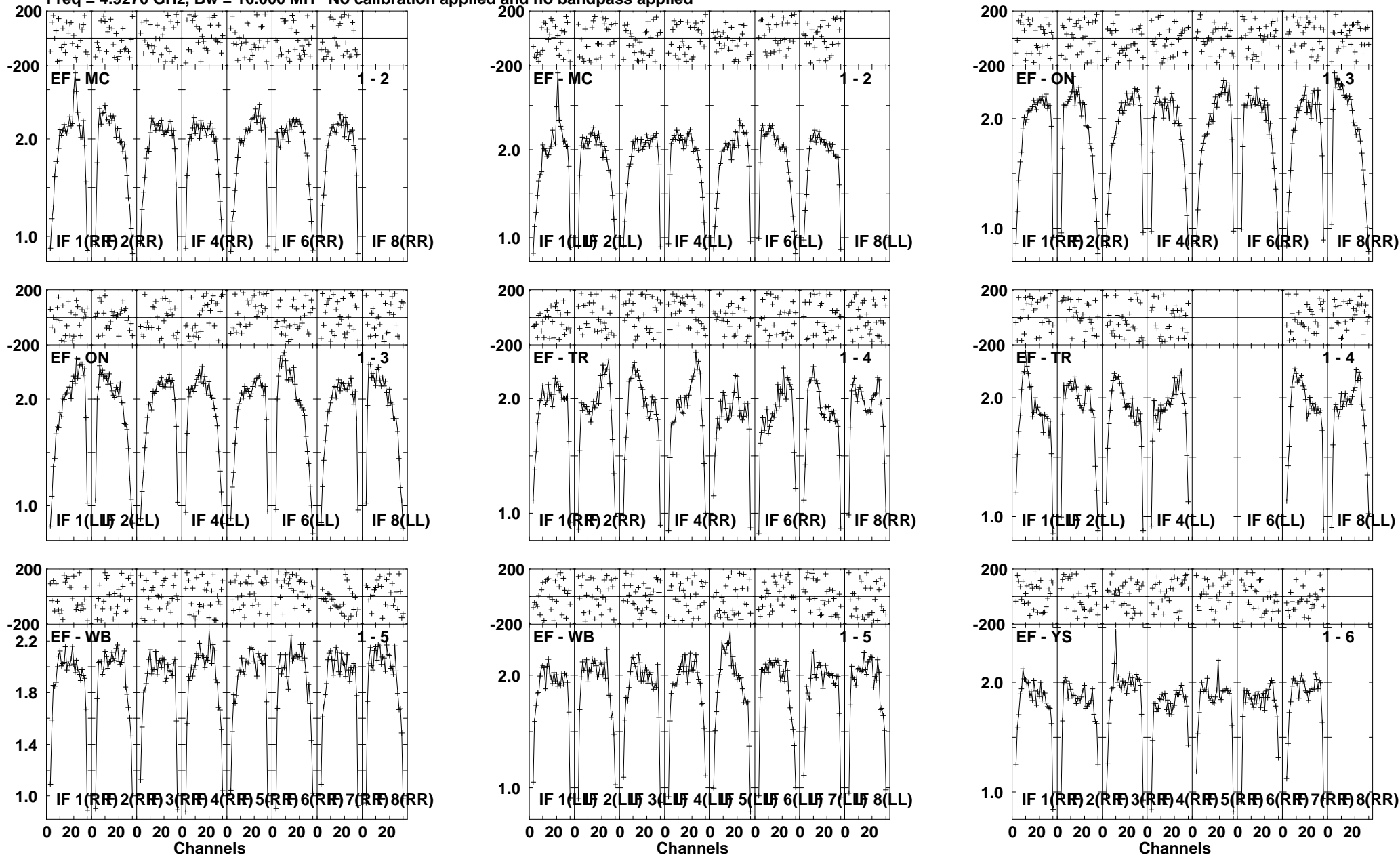

Lower frame: Milli Ampl Jy Top frame: Phas deg
Scalar averaged cross-power spectrum Several baselines displayed
Timerange: 00/22:24:22 to 00/22:29:48

Plot file version 260 created 02-DEC-2011 14:57:32

CYGX-1 ET018A.UVDATA.1

Freq = 4.9270 GHz, Bw = 16.000 MH No calibration applied and no bandpass applied

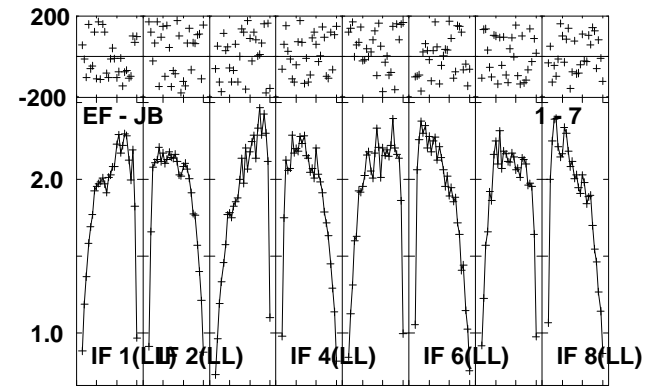
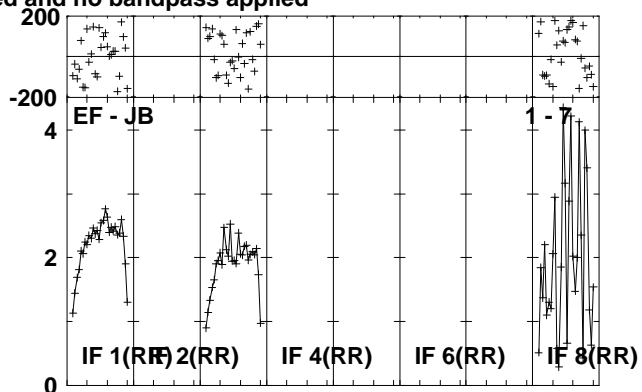
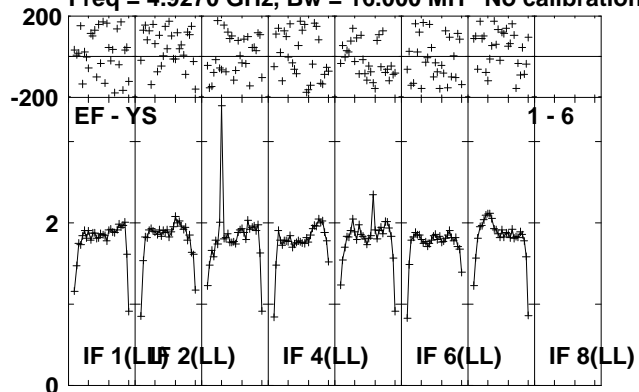

Lower frame: Milli Ampl Jy Top frame: Phas deg
Scalar averaged cross-power spectrum Several baselines displayed
Timerange: 00/22:24:22 to 00/22:29:48

Plot file version 261 created 02-DEC-2011 14:57:35

J1953+35 ET018A.UVDATA.1

Freq = 4.9270 GHz, Bw = 16.000 MH No calibration applied and no bandpass applied

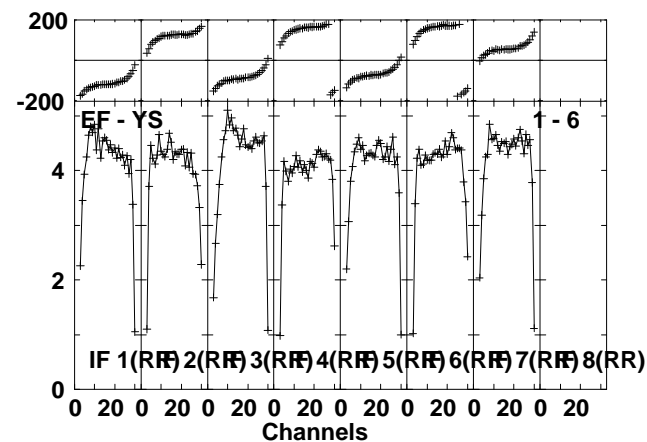
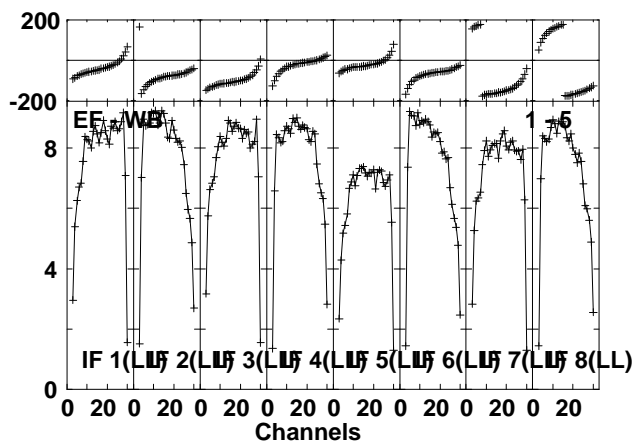
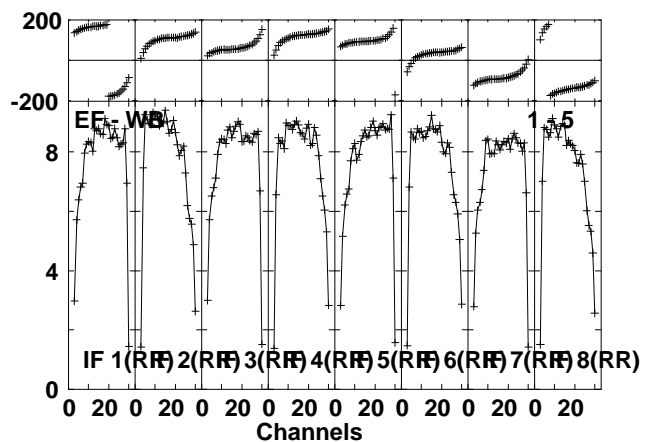
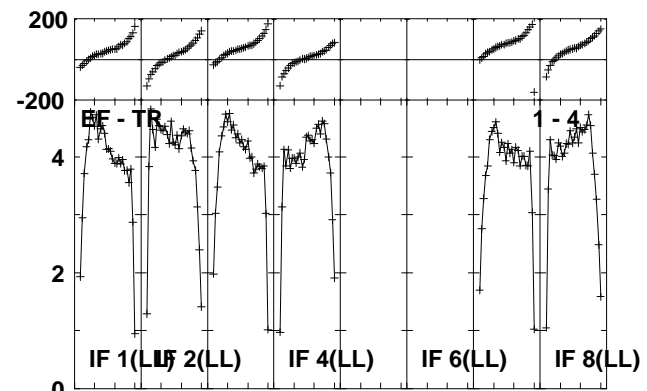
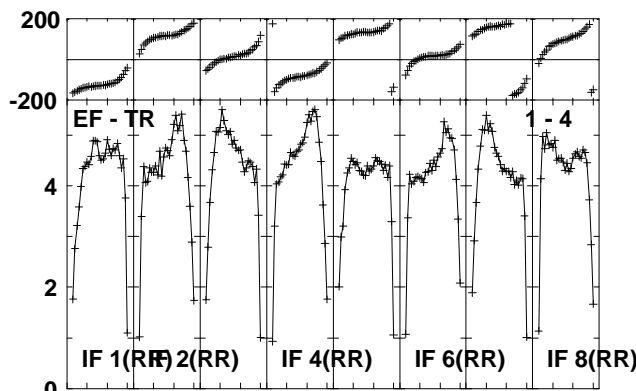
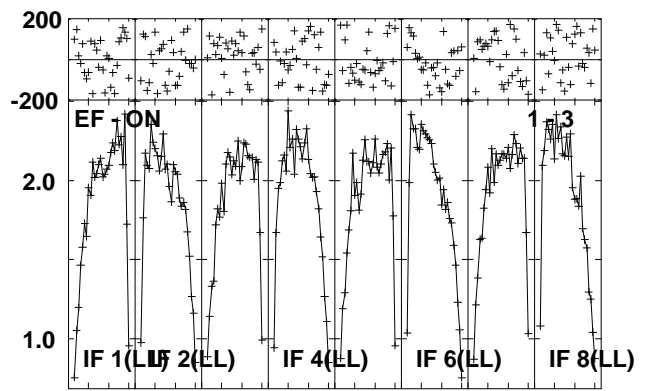
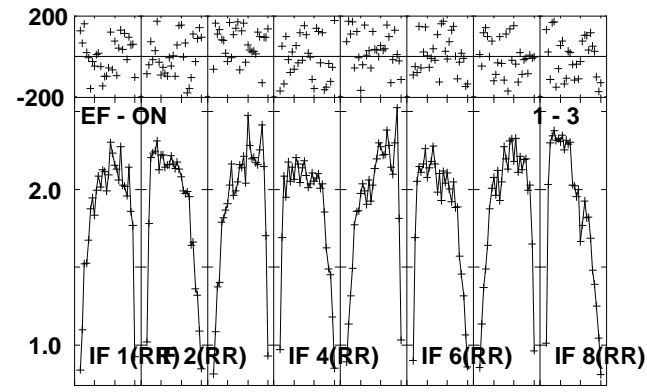
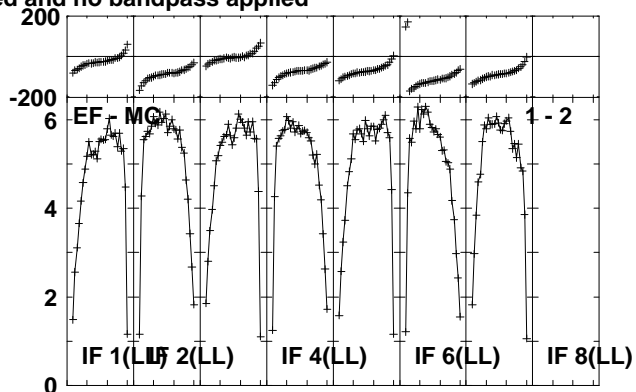
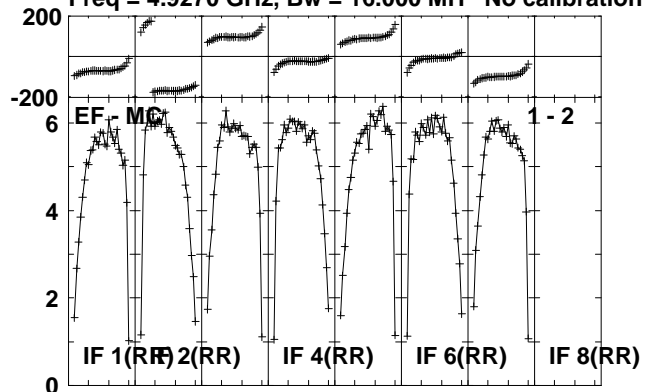

Lower frame: Milli Ampl Jy Top frame: Phas deg
Scalar averaged cross-power spectrum Several baselines displayed
Timerange: 00/22:29:51 to 00/22:32:48

Plot file version 262 created 02-DEC-2011 14:57:36

J1953+35 ET018A.UVDATA.1

Freq = 4.9270 GHz, Bw = 16.000 MH No calibration applied and no bandpass applied

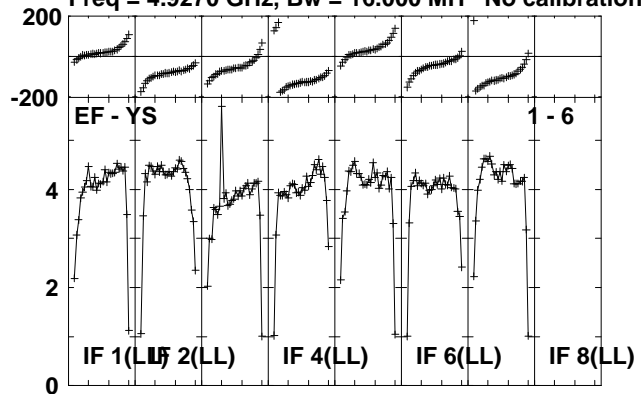

Lower frame: Milli Ampl Jy Top frame: Phas deg
Scalar averaged cross-power spectrum Several baselines displayed
Timerange: 00/22:29:51 to 00/22:32:48

Plot file version 263 created 02-DEC-2011 14:57:38

CYGX-1 ET018A.UVDATA.1

Freq = 4.9270 GHz, Bw = 16.000 MH No calibration applied and no bandpass applied

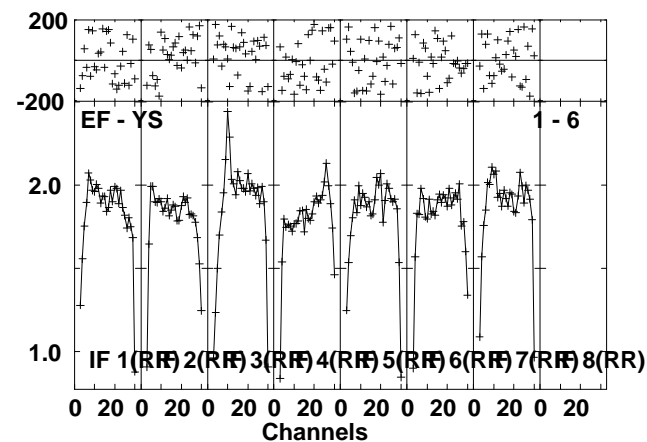
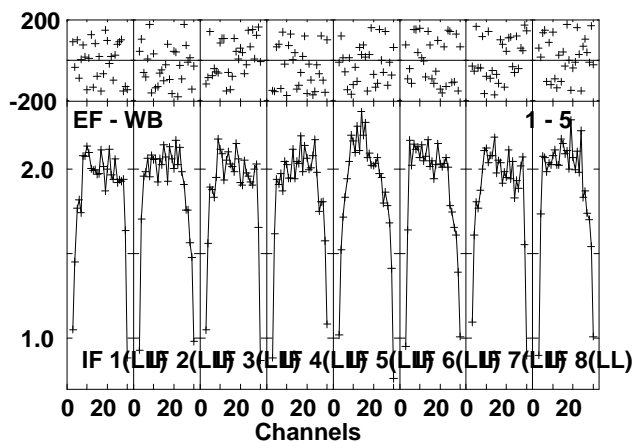
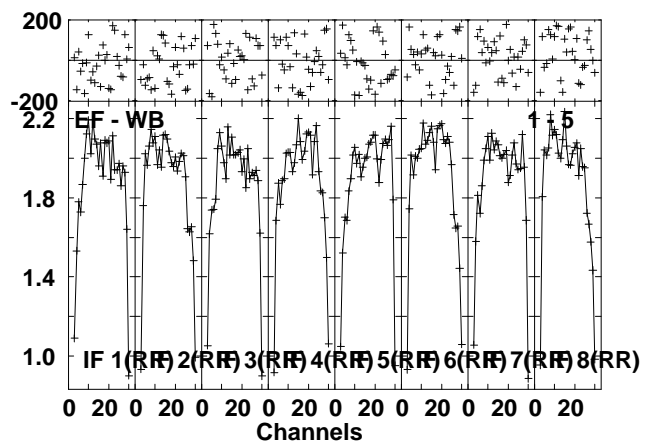
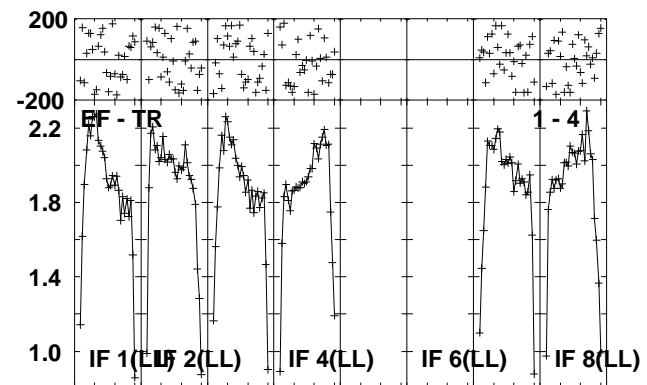
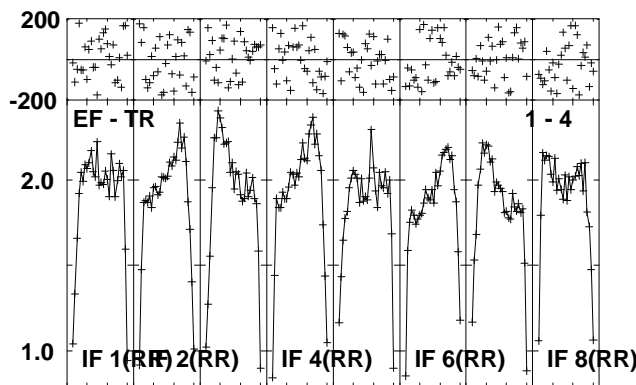
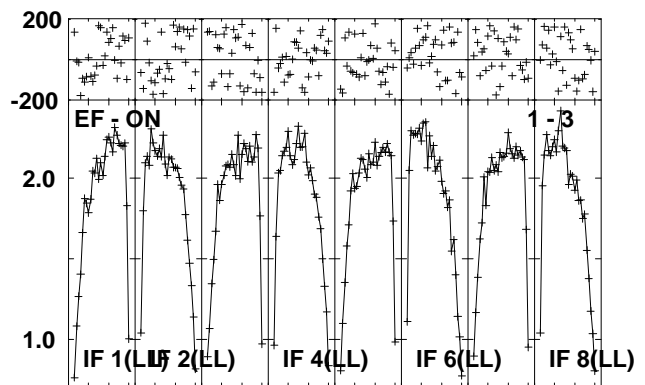
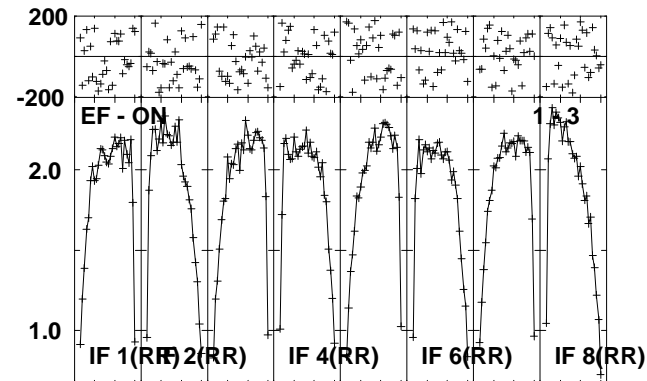
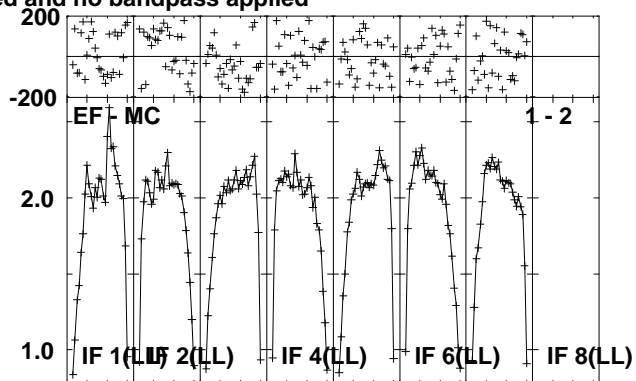
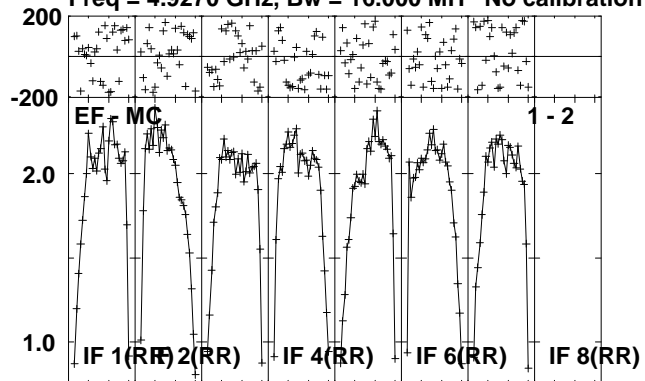

Lower frame: Milli Ampl Jy Top frame: Phas deg
Scalar averaged cross-power spectrum Several baselines displayed
Timerange: 00/22:32:52 to 00/22:38:18

Plot file version 264 created 02-DEC-2011 14:57:41

CYGX-1 ET018A.UVDATA.1

Freq = 4.9270 GHz, Bw = 16.000 MH No calibration applied and no bandpass applied

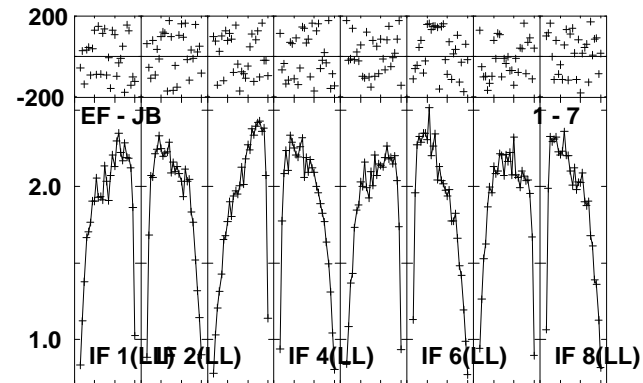
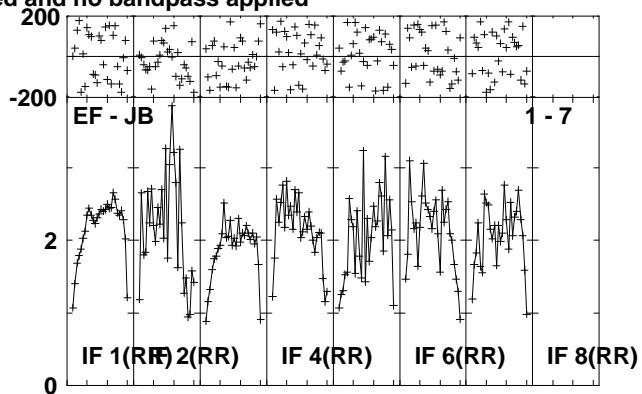
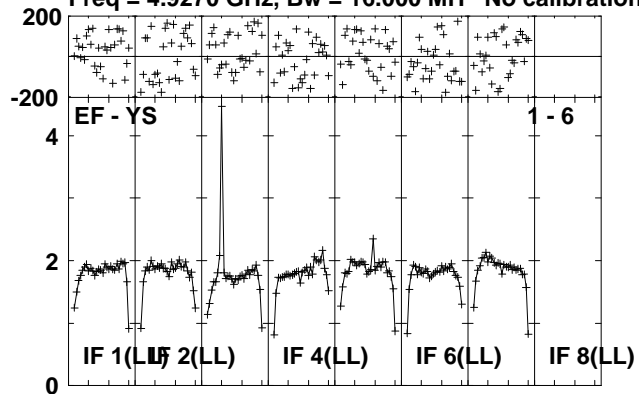

Lower frame: Milli Ampl Jy Top frame: Phas deg
Scalar averaged cross-power spectrum Several baselines displayed
Timerange: 00/22:32:52 to 00/22:38:18

Plot file version 265 created 02-DEC-2011 14:57:44

J1953+35 ET018A.UVDATA.1

Freq = 4.9270 GHz, Bw = 16.000 MH No calibration applied and no bandpass applied

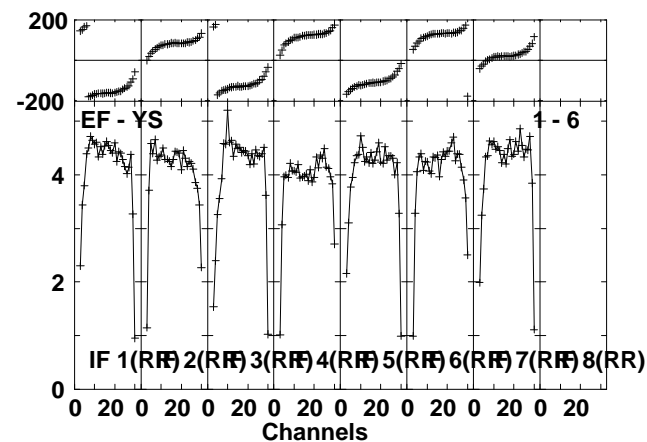
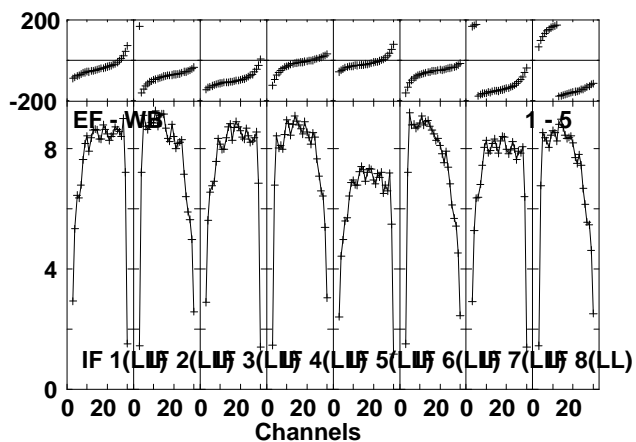
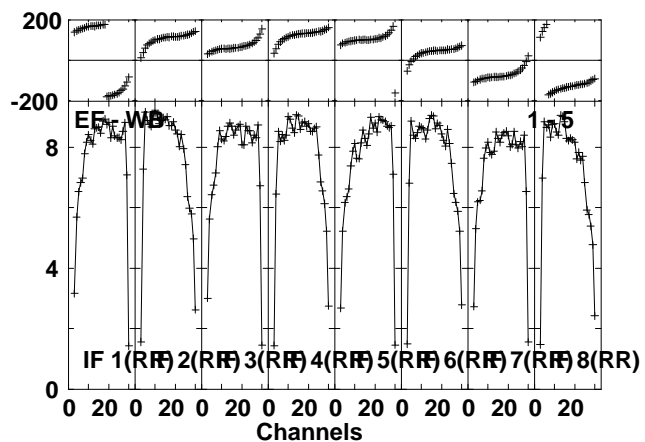
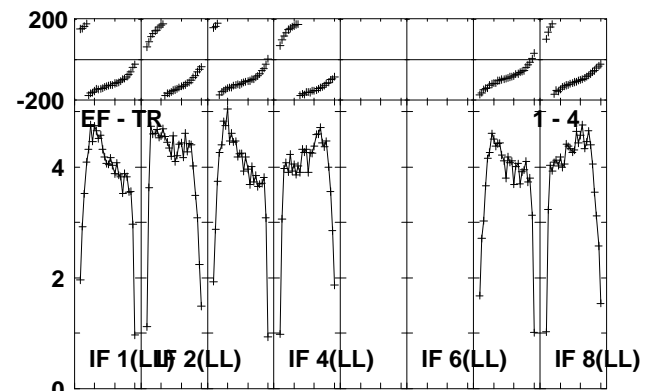
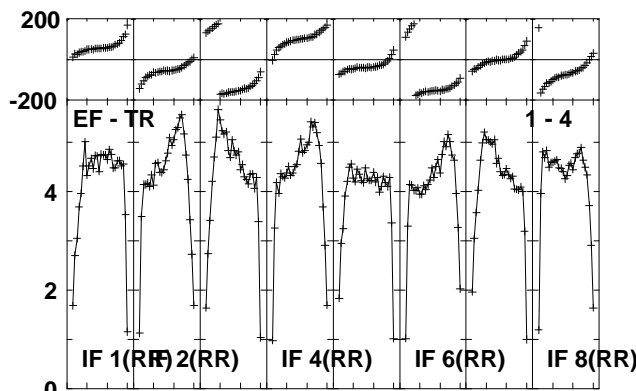
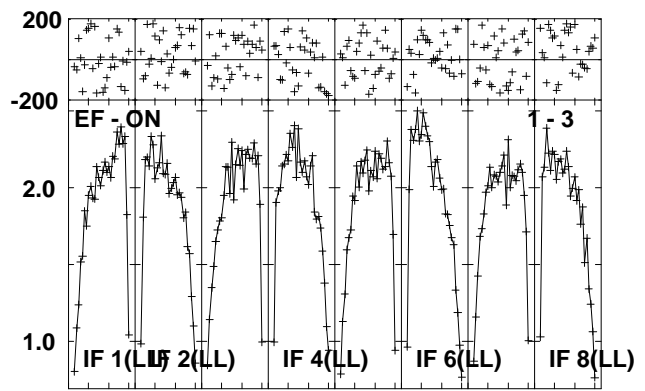
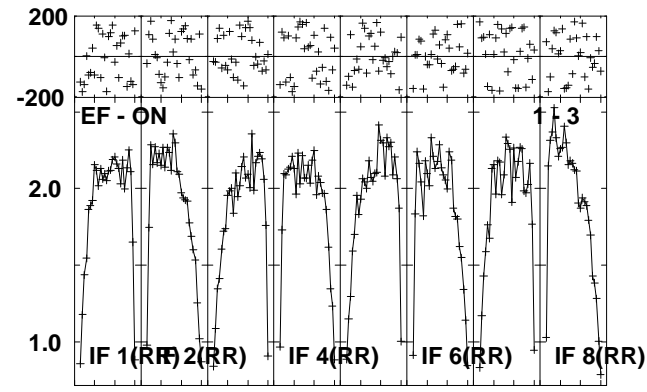
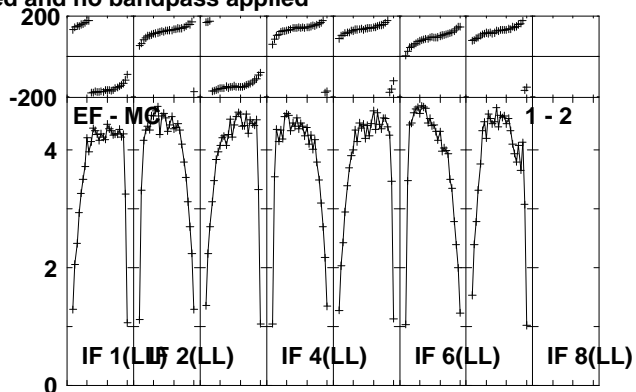
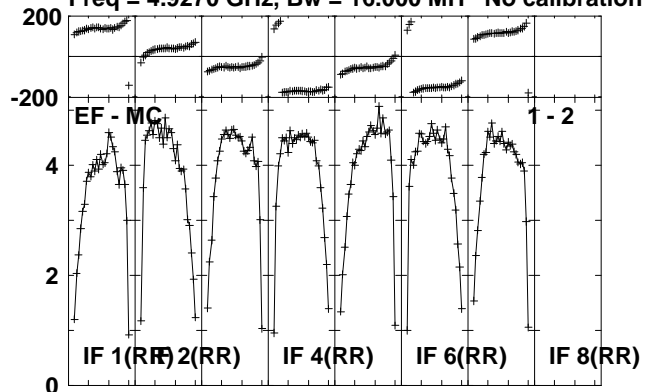

Lower frame: Milli Ampl Jy Top frame: Phas deg
Scalar averaged cross-power spectrum Several baselines displayed
Timerange: 00/22:39:07 to 00/22:41:39

Plot file version 266 created 02-DEC-2011 14:57:46

J1953+35 ET018A.UVDATA.1

Freq = 4.9270 GHz, Bw = 16.000 MH No calibration applied and no bandpass applied

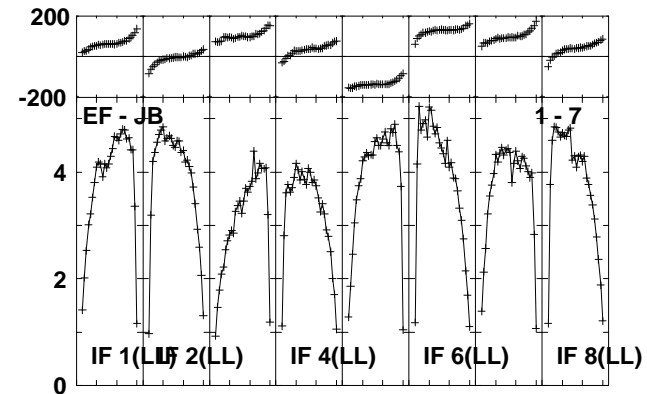
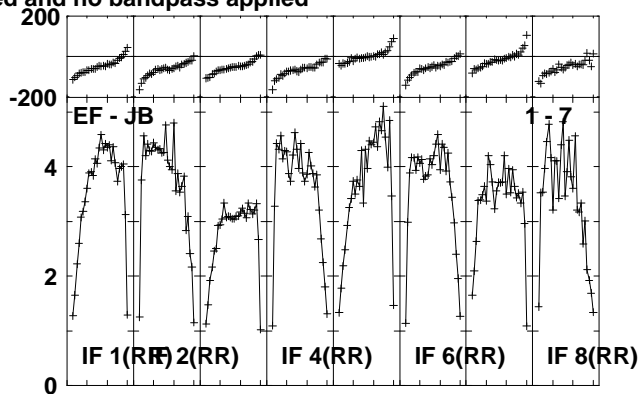
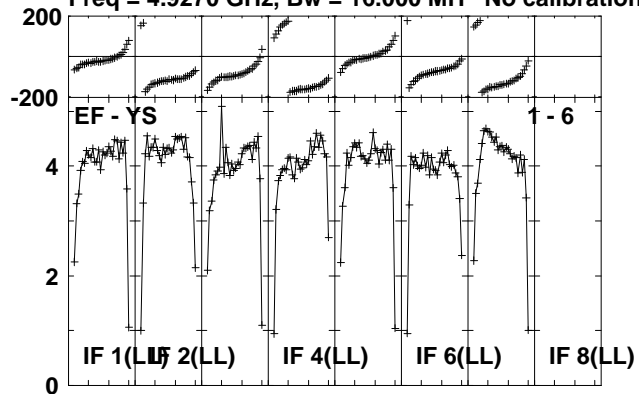

Lower frame: Milli Ampl Jy Top frame: Phas deg
Scalar averaged cross-power spectrum Several baselines displayed
Timerange: 00/22:39:07 to 00/22:41:39

Plot file version 267 created 02-DEC-2011 14:57:48

DA193 ET018A.UVDATA.1

Freq = 4.9270 GHz, Bw = 16.000 MH No calibration applied and no bandpass applied

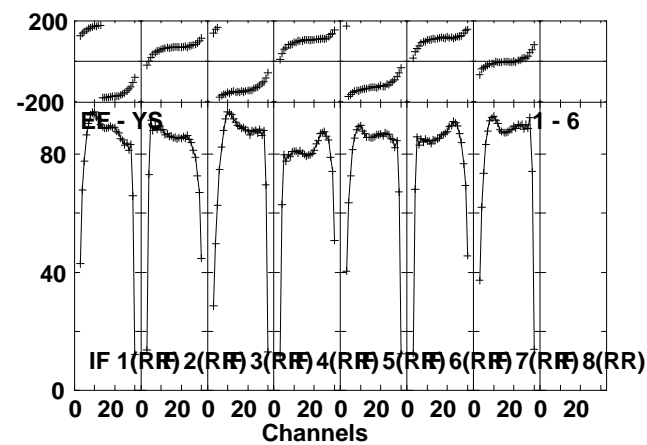
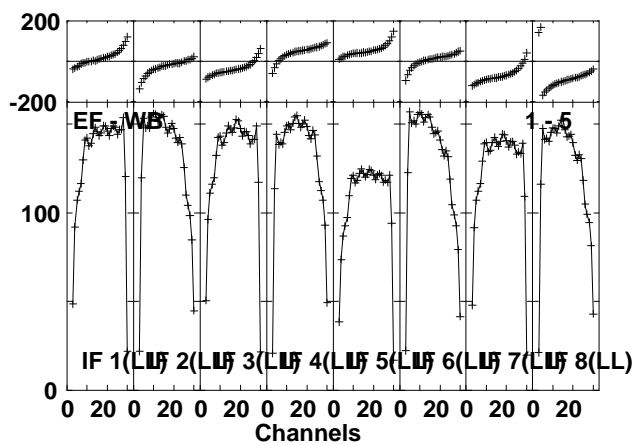
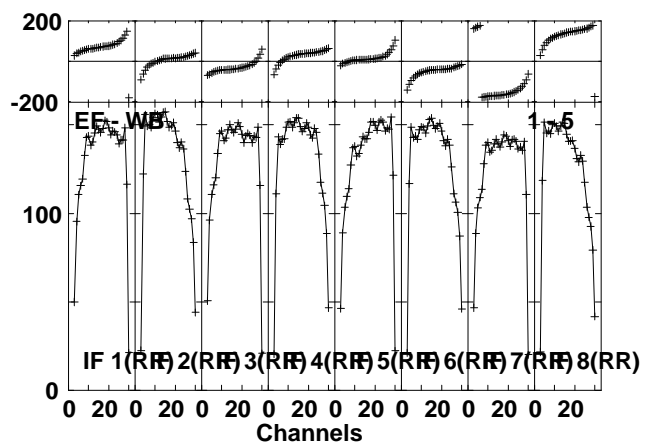
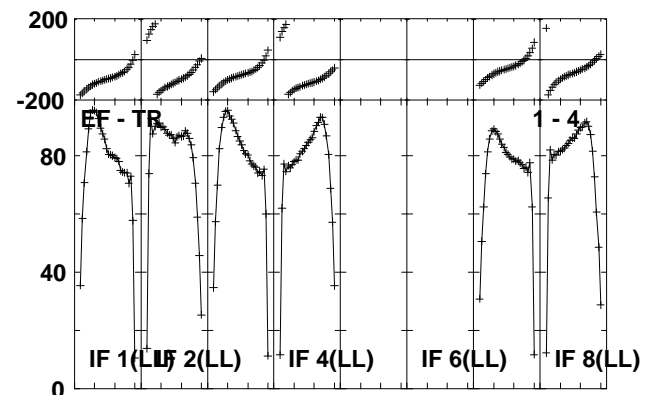
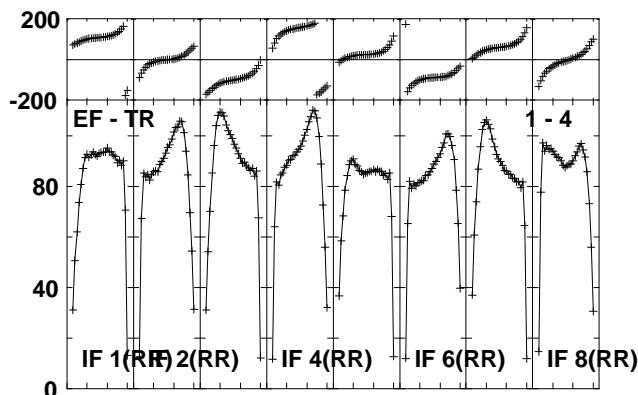
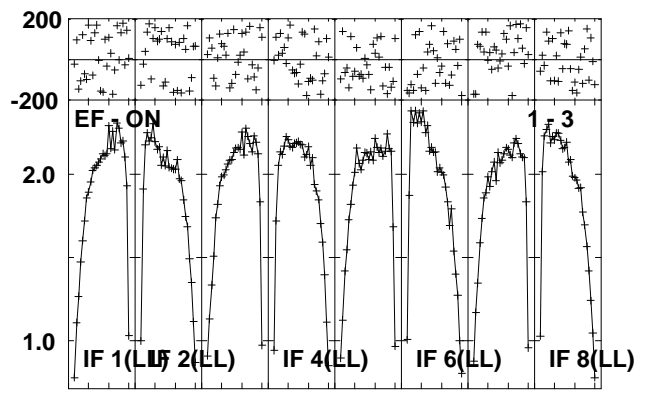
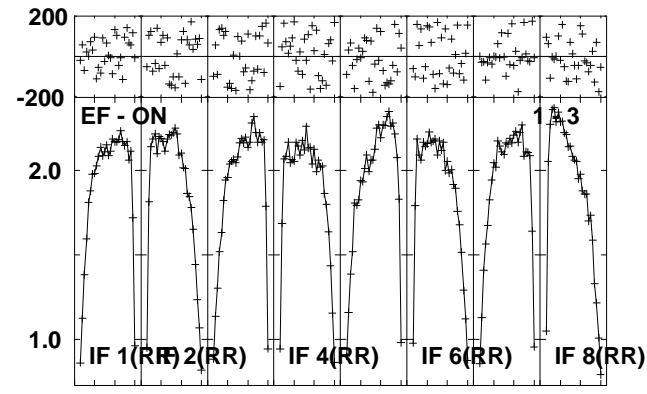
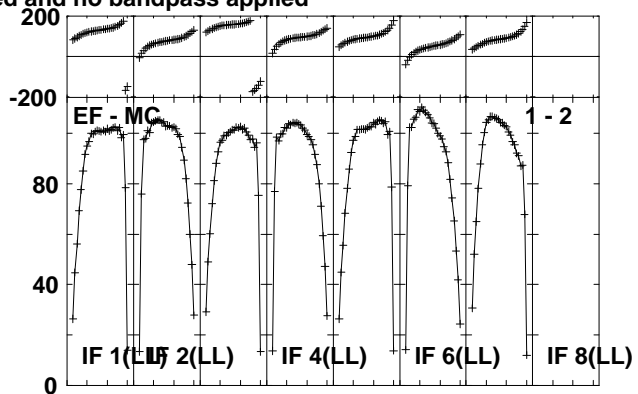
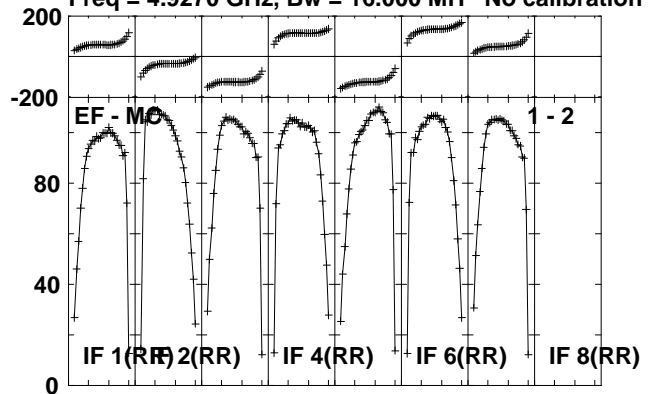

Lower frame: Milli Ampl Jy Top frame: Phas deg
Scalar averaged cross-power spectrum Several baselines displayed
Timerange: 00/22:53:37 to 00/23:03:39

Plot file version 268 created 02-DEC-2011 14:57:53

DA193 ET018A.UVDATA.1

Freq = 4.9270 GHz, Bw = 16.000 MH No calibration applied and no bandpass applied

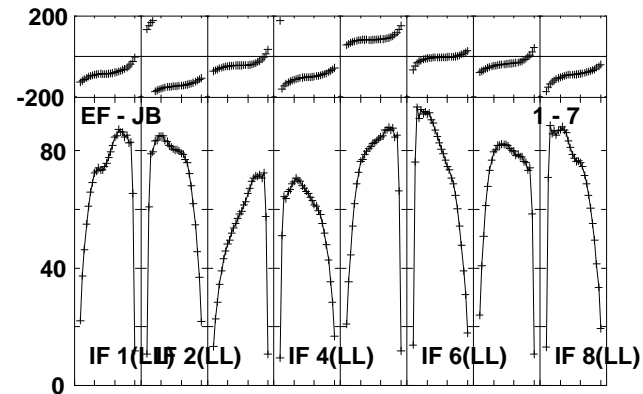
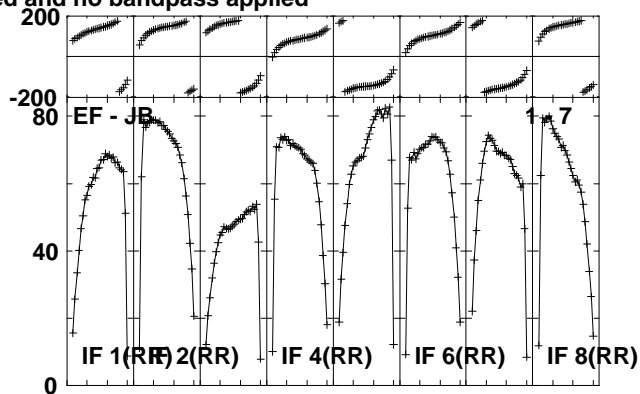
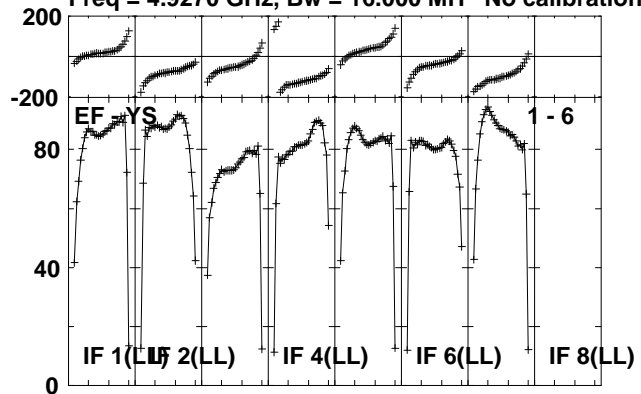

Lower frame: Milli Ampl Jy Top frame: Phas deg
Scalar averaged cross-power spectrum Several baselines displayed
Timerange: 00/22:53:37 to 00/23:03:39