

Plot file version 1 created 26-JUN-2015 10:51:15  
 3C395 ET031A.UVDATA.1  
 Freq = 1.5950 GHz, Bw = 16.000 MH No calibration applied and no bandpass applied

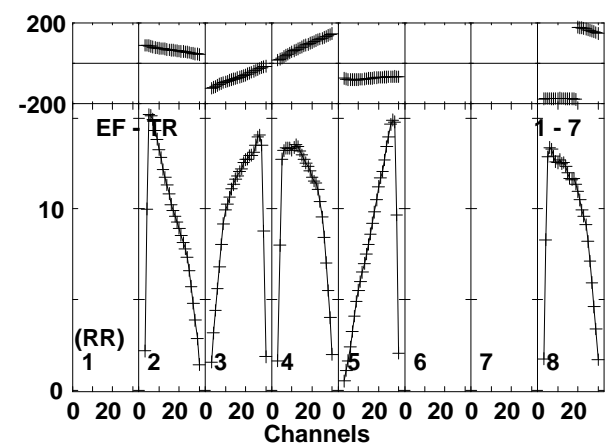

Lower frame: Milli Ampl Jy Top frame: Phas deg  
 Vector averaged cross-power spectrum Baseline: EF (01) - HH (02)  
 Timerange: 00/21:53:18 to 00/21:59:58

Plot file version 2 created 26-JUN-2015 10:51:15  
 3C395 ET031A.UVDATA.1  
 Freq = 1.5950 GHz, Bw = 16.000 MH No calibration applied and no bandpass applied

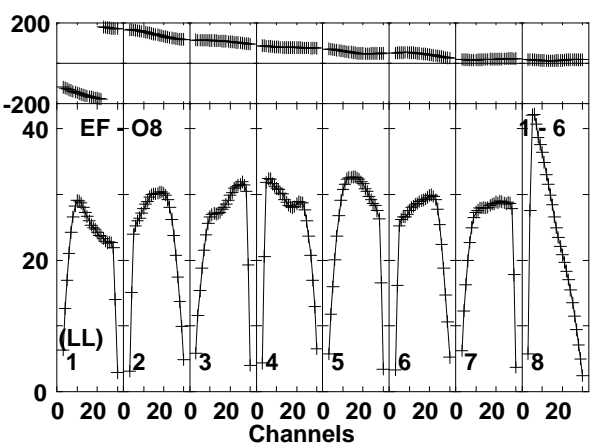
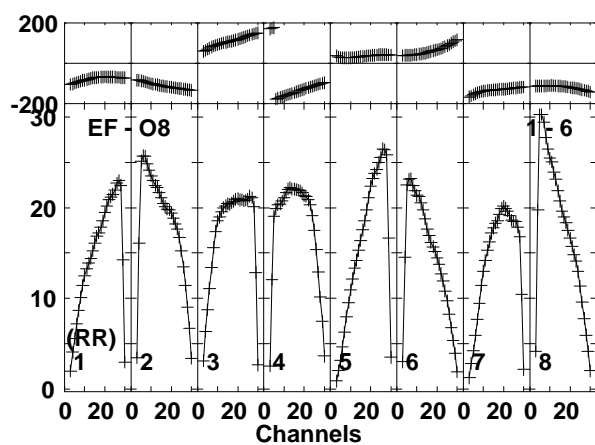
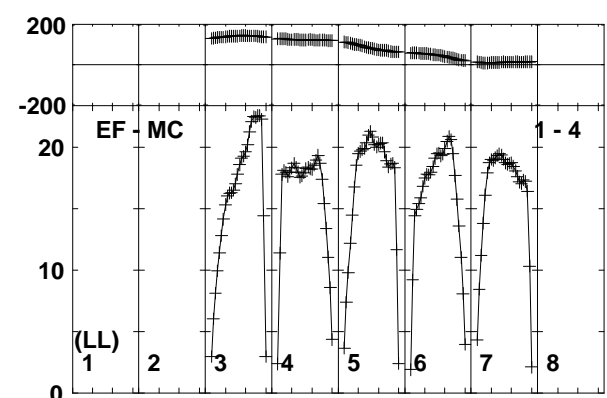
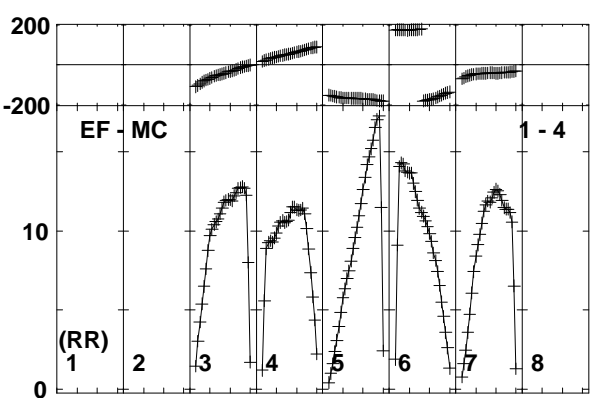
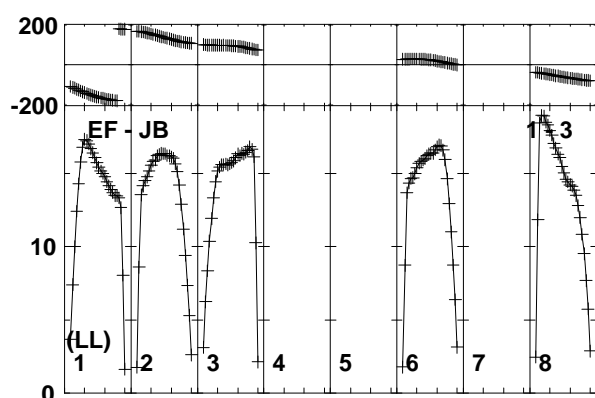
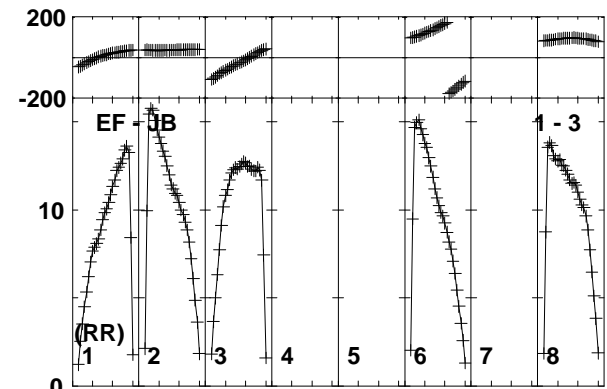
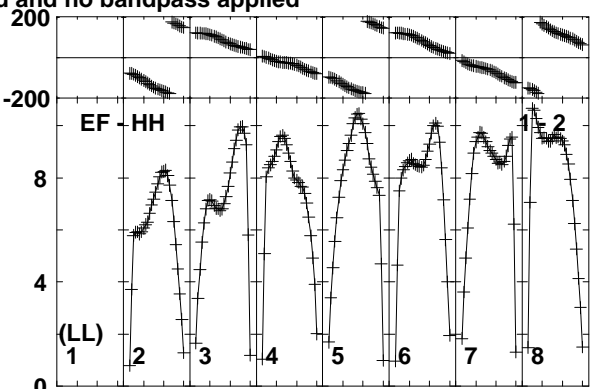
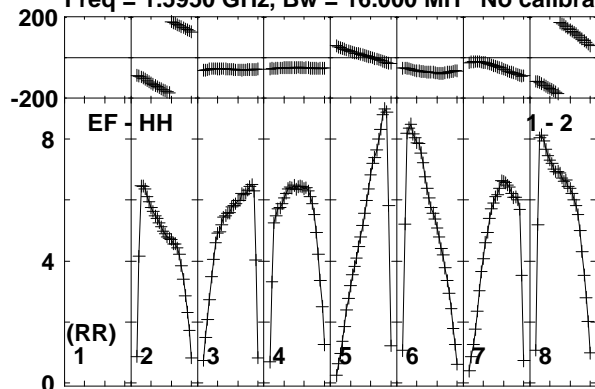
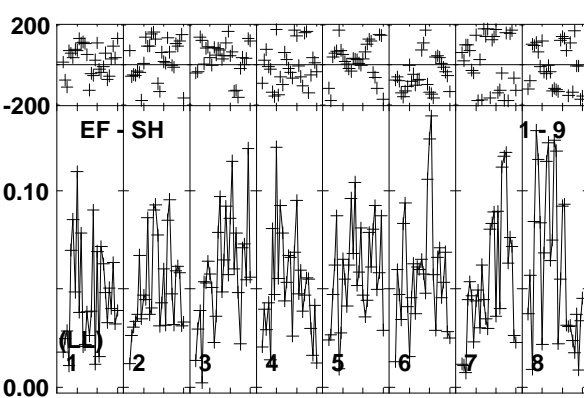
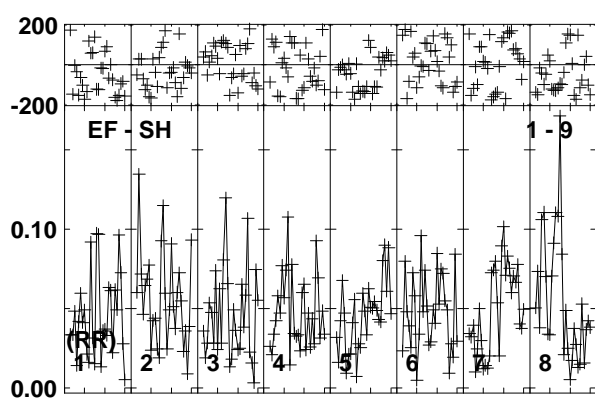
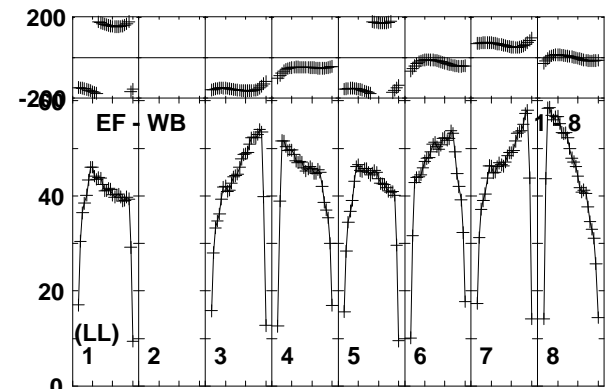
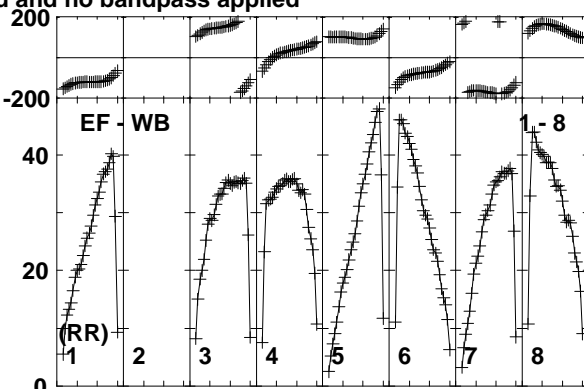
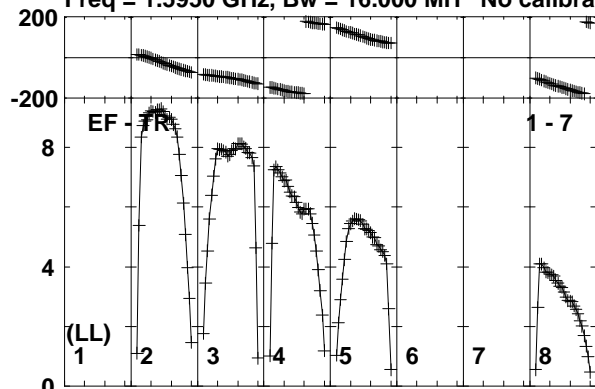

Channels

Lower frame: Milli Ampl Jy Top frame: Phas deg  
 Vector averaged cross-power spectrum Baseline: EF (01) - TR (07)  
 Timerange: 00/21:53:18 to 00/21:59:58

Plot file version 3 created 26-JUN-2015 10:51:15

J2025+3343 ET031A.UVDATA.1

Freq = 1.5950 GHz, Bw = 16.000 MH No calibration applied and no bandpass applied

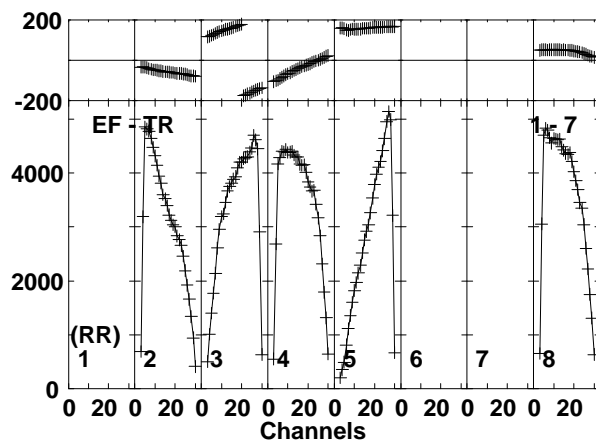
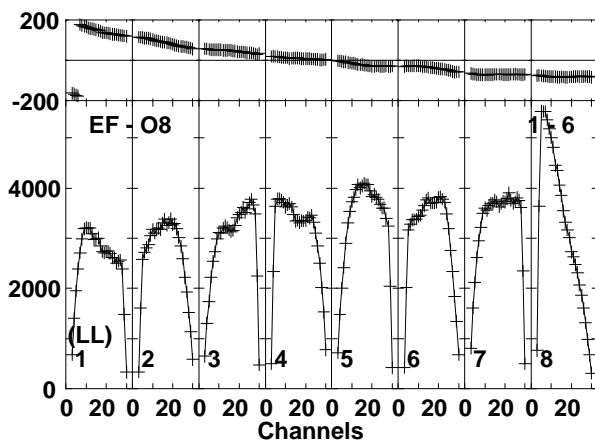
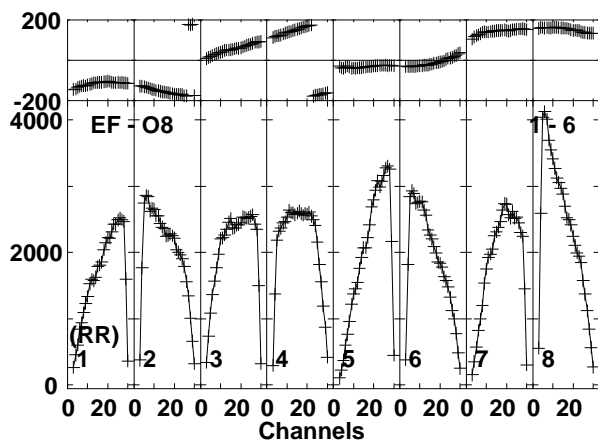
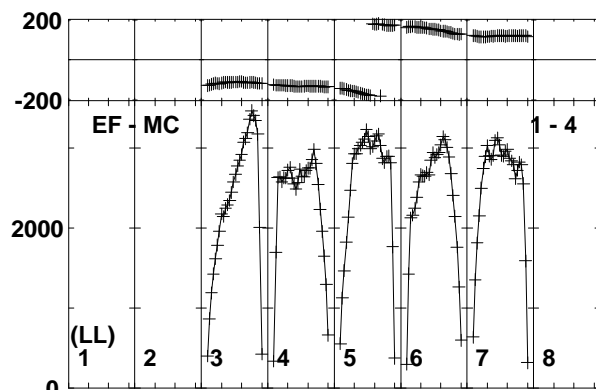
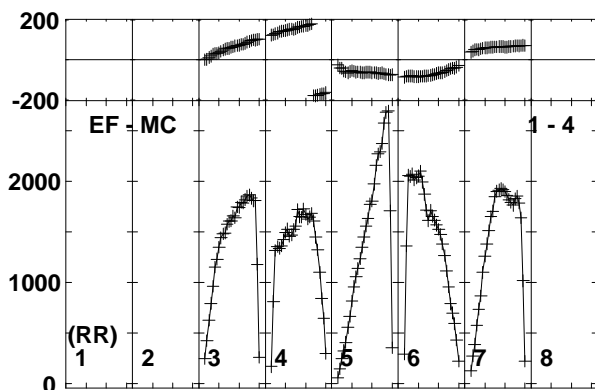
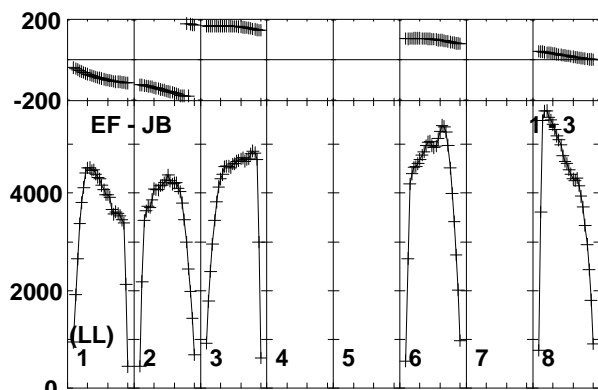
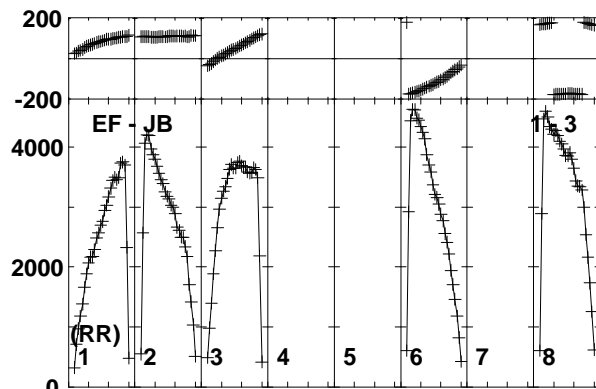
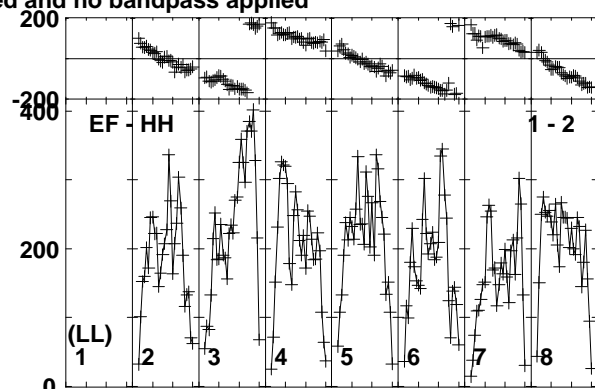
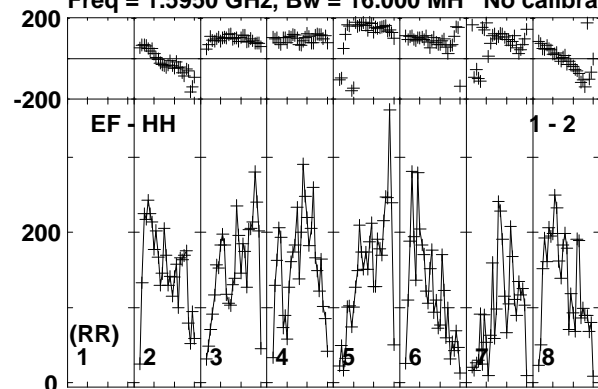

Lower frame: Micro Ampl Jy Top frame: Phas deg  
Vector averaged cross-power spectrum Baseline: EF (01) - HH (02)  
Timerange: 00:22:02:02 to 00:22:07:58

Plot file version 4 created 26-JUN-2015 10:51:15

J2025+3343 ET031A.UVDATA.1

Freq = 1.5950 GHz, Bw = 16.000 MH No calibration applied and no bandpass applied

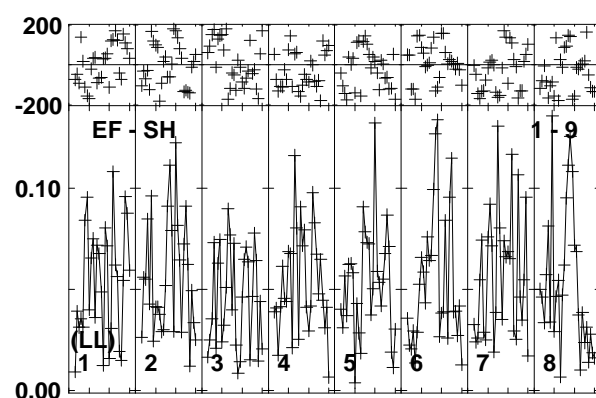
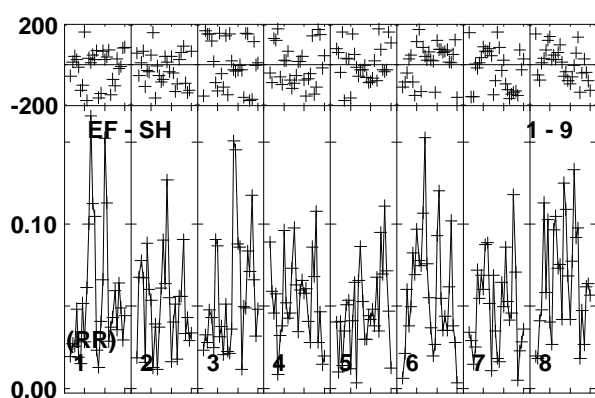
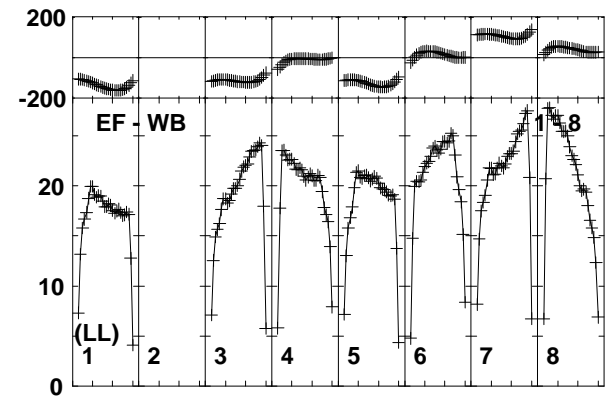
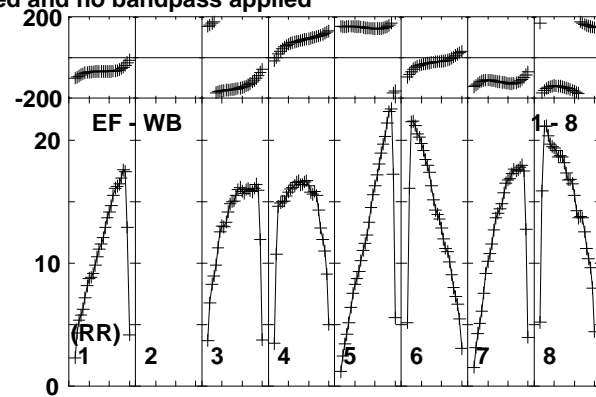
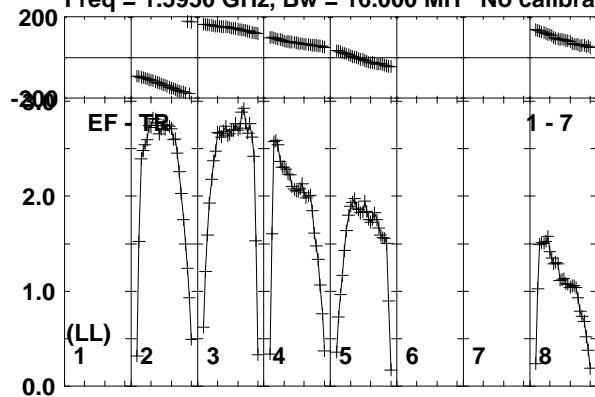

Channels

Lower frame: Milli Ampl Jy Top frame: Phas deg  
Vector averaged cross-power spectrum Baseline: EF (01) - TR (07)  
Timerange: 00/22:02:02 to 00/22:07:58

Plot file version 5 created 26-JUN-2015 10:51:15

V404CYG ET031A.UVDATA.1

Freq = 1.5950 GHz, Bw = 16.000 MH No calibration applied and no bandpass applied

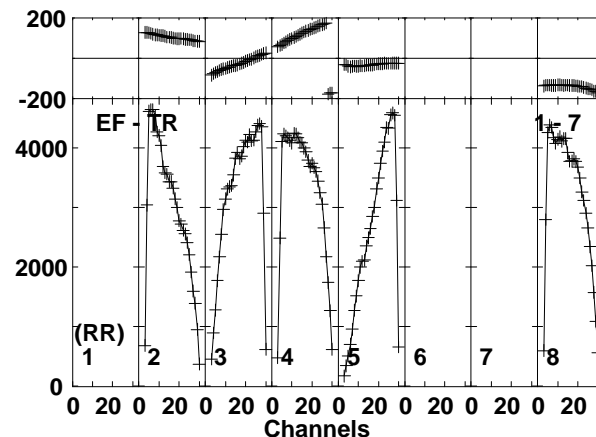
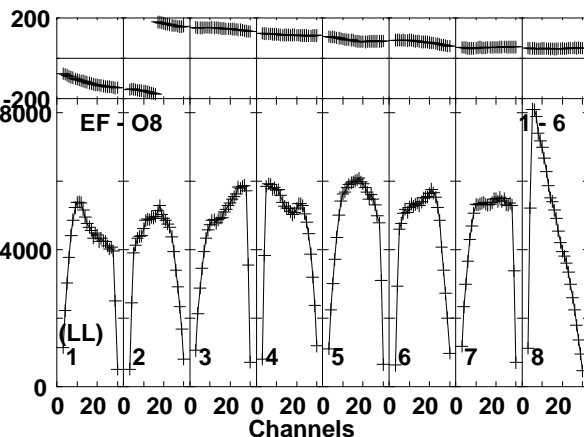
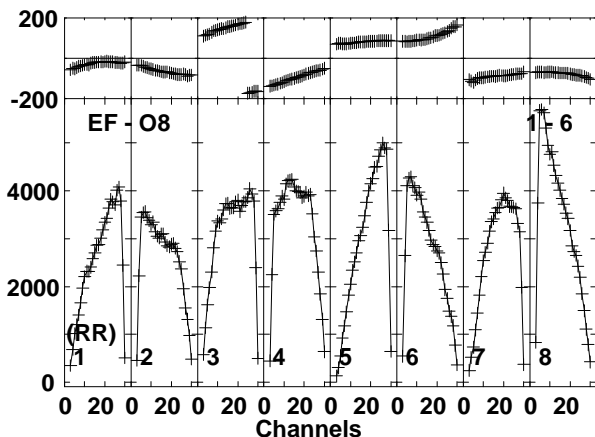
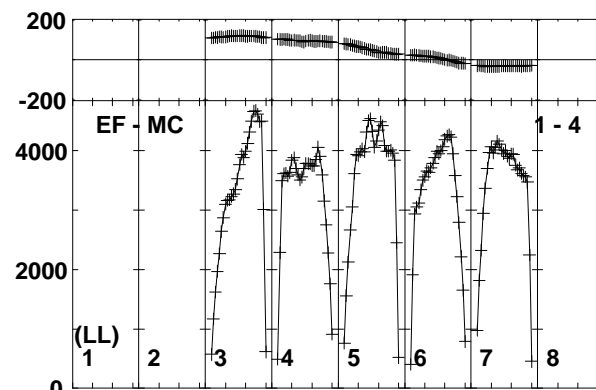
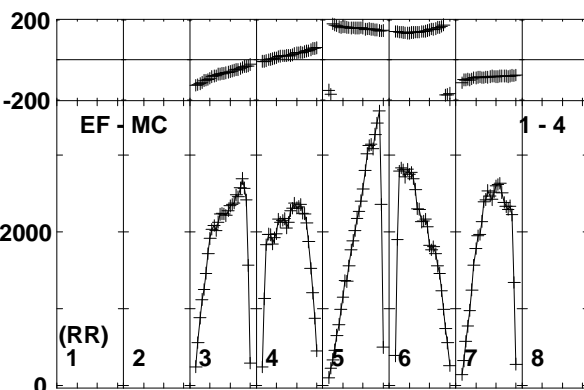
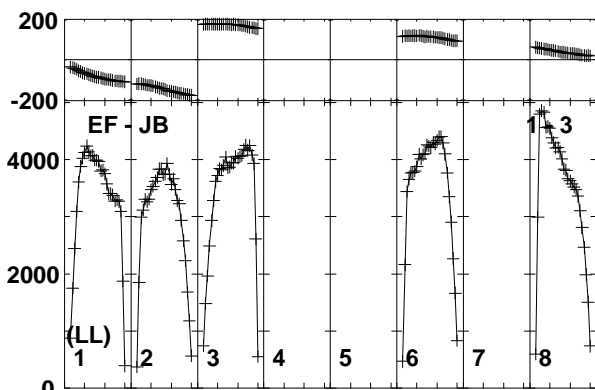
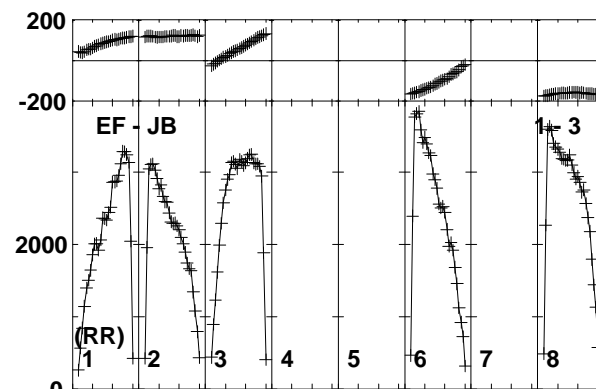
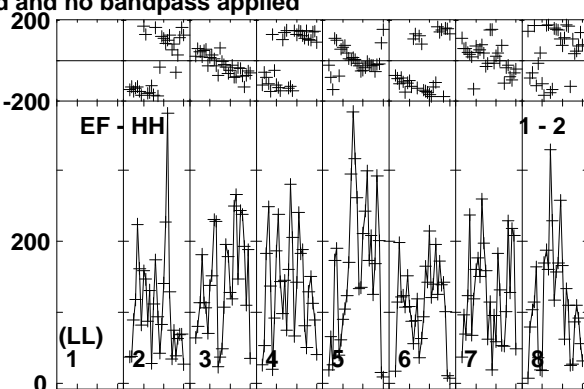
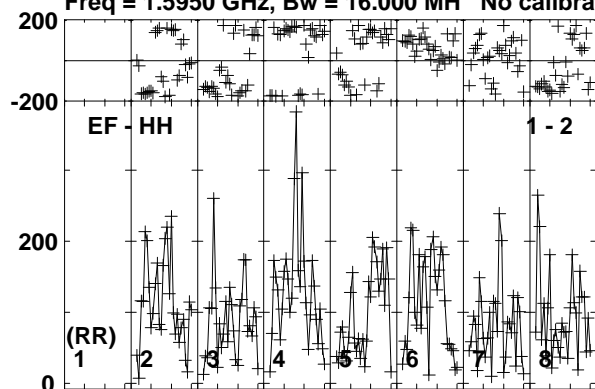

Lower frame: Micro Ampl Jy Top frame: Phas deg  
Vector averaged cross-power spectrum Baseline: EF (01) - HH (02)  
Timerange: 00/22:08:02 to 00/22:11:28

Plot file version 6 created 26-JUN-2015 10:51:15

V404CYG ET031A.UVDATA.1

Freq = 1.5950 GHz, Bw = 16.000 MH No calibration applied and no bandpass applied

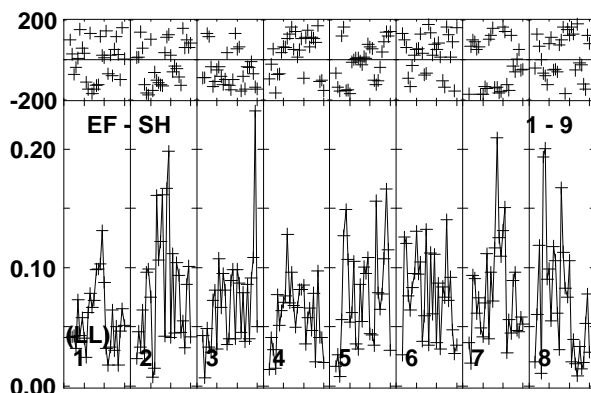
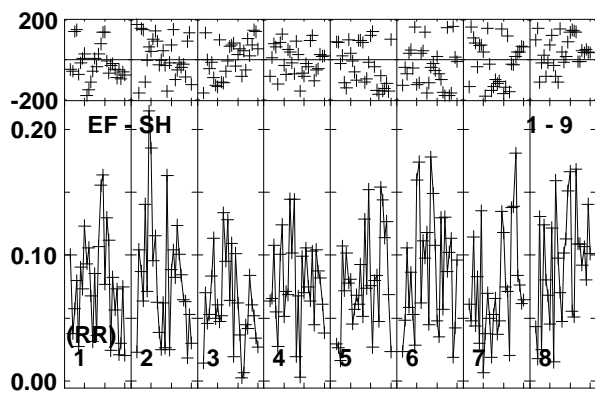
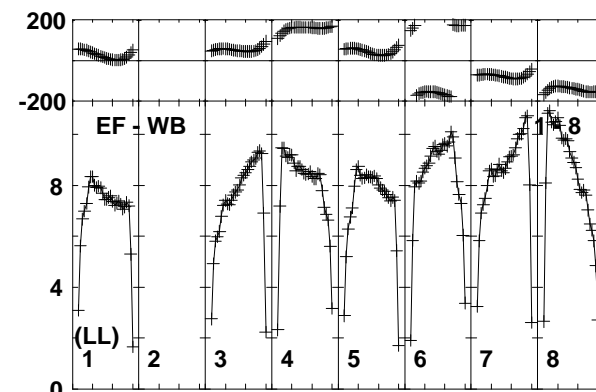
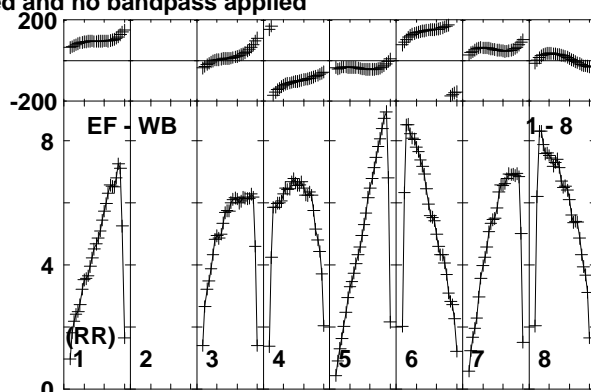
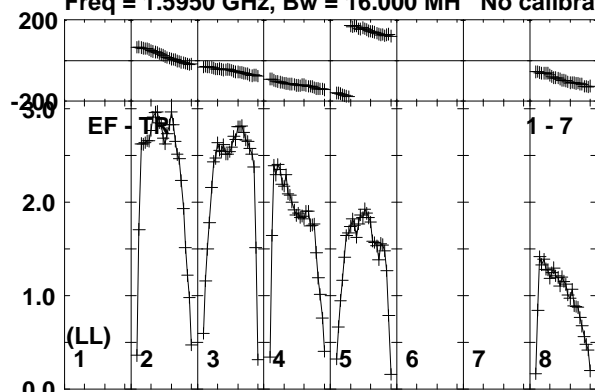

Channels

Lower frame: Milli Ampl Jy Top frame: Phas deg  
Vector averaged cross-power spectrum Baseline: EF (01) - TR (07)  
Timerange: 00/22:08:02 to 00/22:11:28

Plot file version 7 created 26-JUN-2015 10:51:15

J2025+3343 ET031A.UVDATA.1

Freq = 1.5950 GHz, Bw = 16.000 MH No calibration applied and no bandpass applied

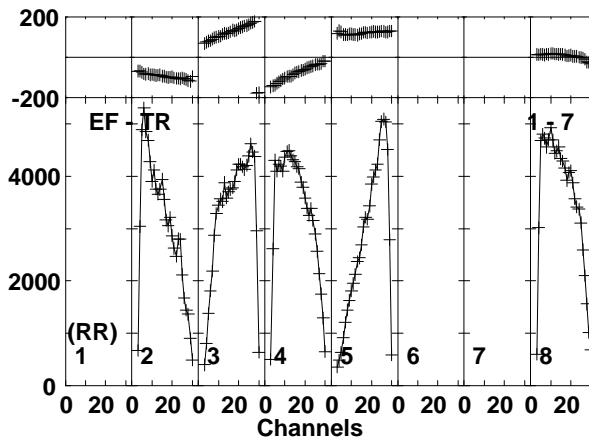
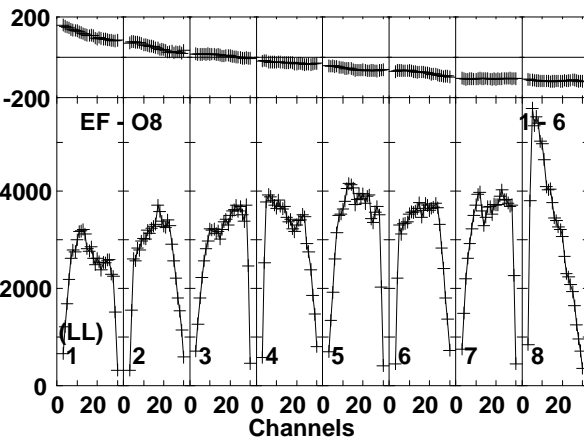
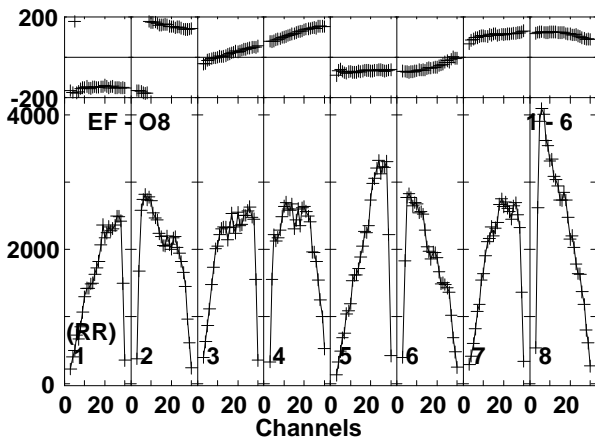
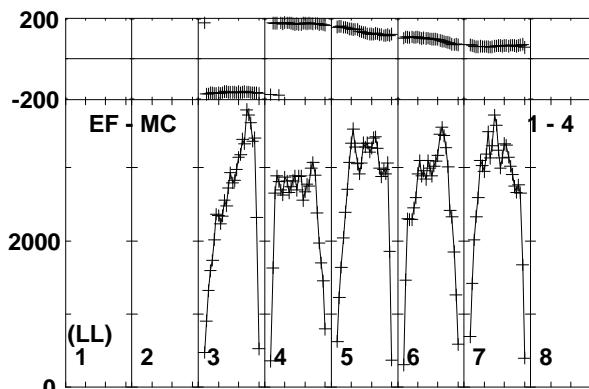
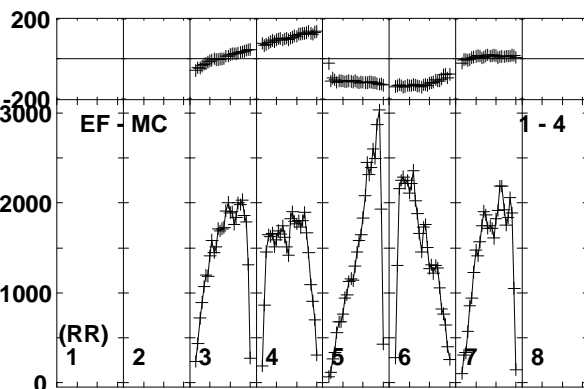
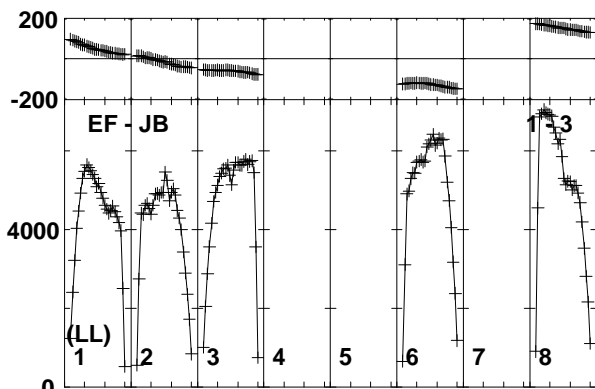
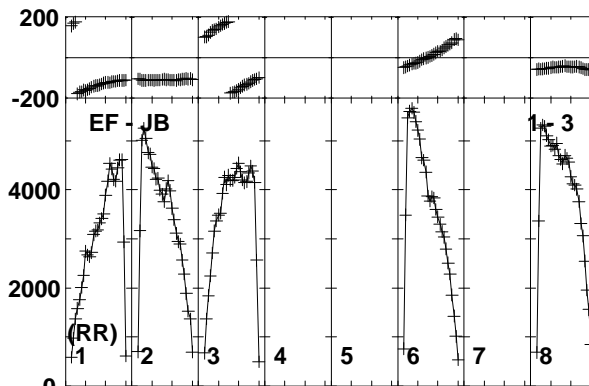
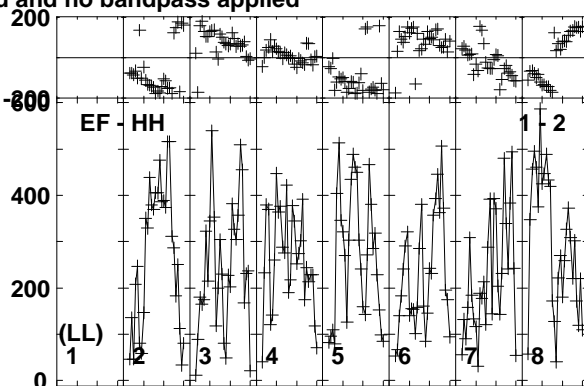
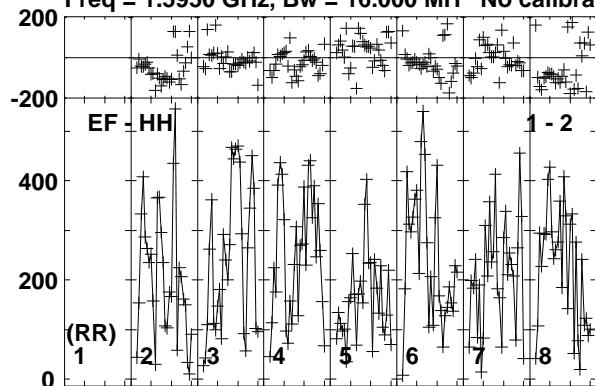

Lower frame: Micro Ampl Jy Top frame: Phas deg  
Vector averaged cross-power spectrum Baseline: EF (01) - HH (02)  
Timerange: 00:22:11:32 to 00:22:12:48





Plot file version 9 created 26-JUN-2015 10:51:15

V404CYG ET031A.UVDATA.1

Freq = 1.5950 GHz, Bw = 16.000 MH No calibration applied and no bandpass applied

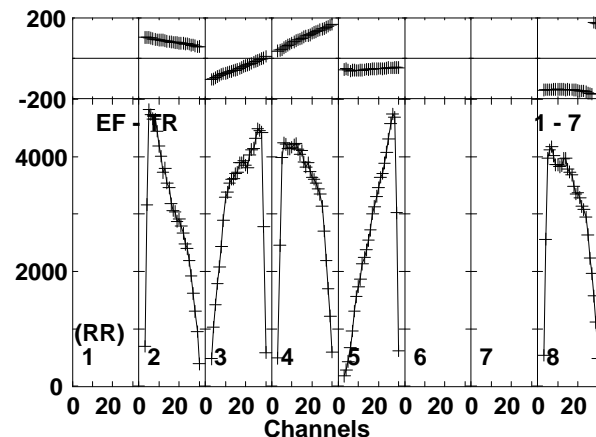
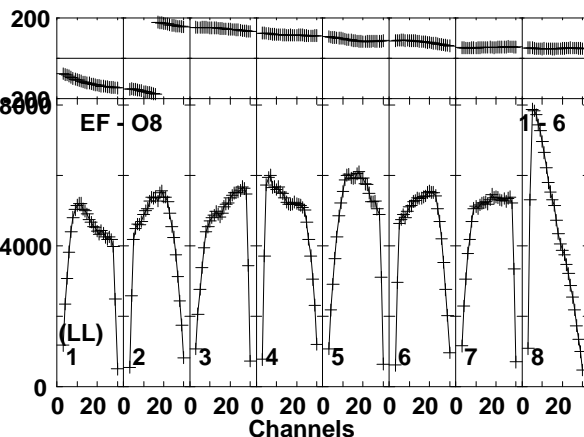
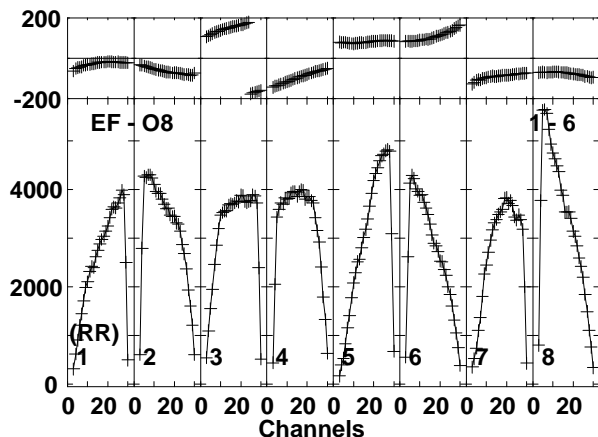
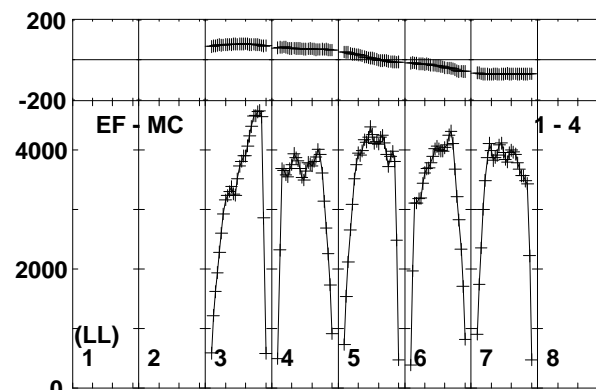
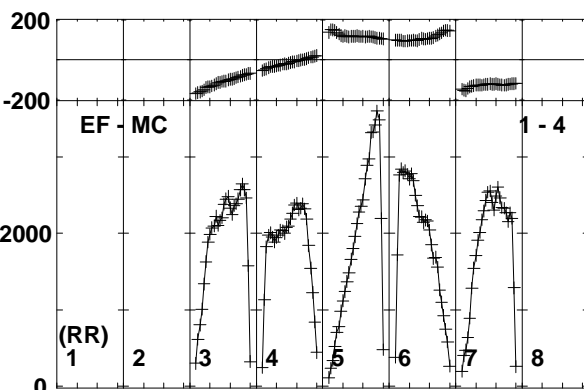
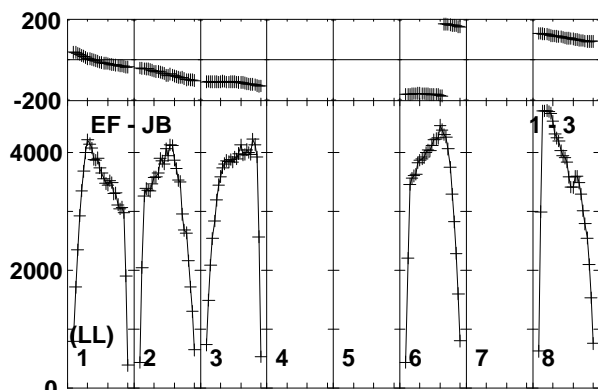
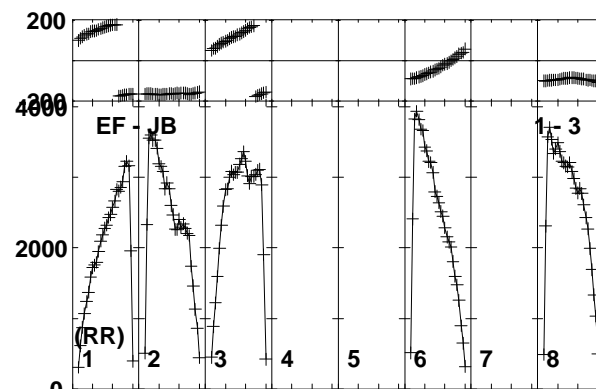
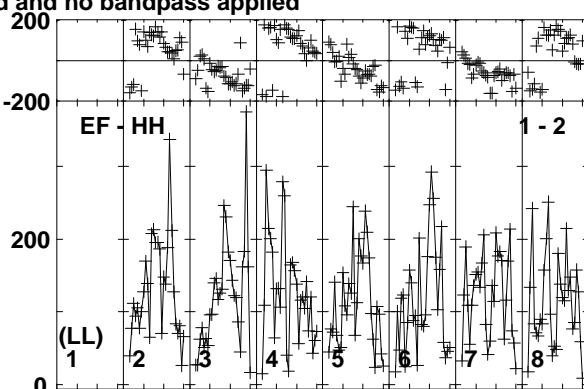
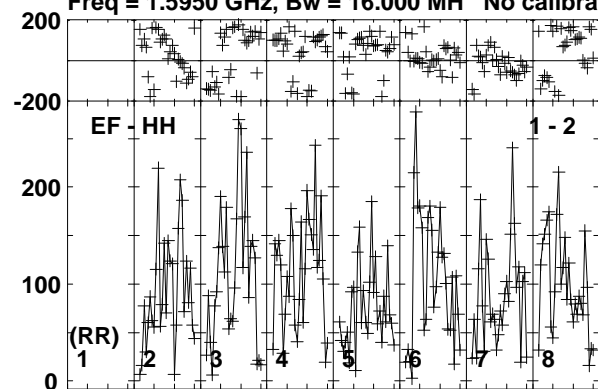

Lower frame: Micro Ampl Jy Top frame: Phas deg  
Vector averaged cross-power spectrum Baseline: EF (01) - HH (02)  
Timerange: 00:22:12:52 to 00:22:16:18

Plot file version 10 created 26-JUN-2015 10:51:15

V404CYG ET031A.UVDATA.1

Freq = 1.5950 GHz, Bw = 16.000 MH No calibration applied and no bandpass applied

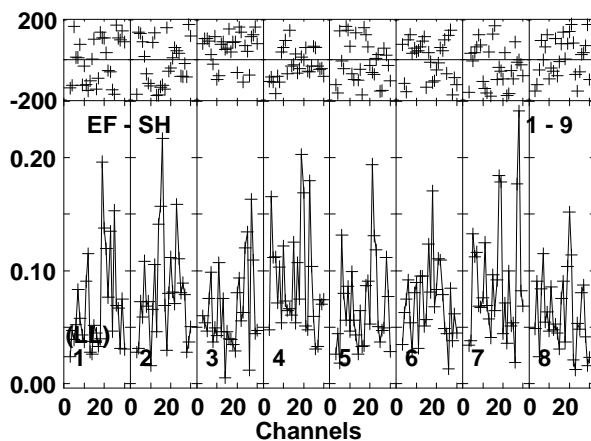
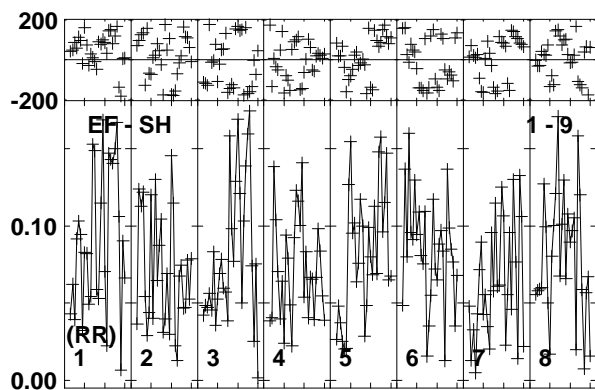
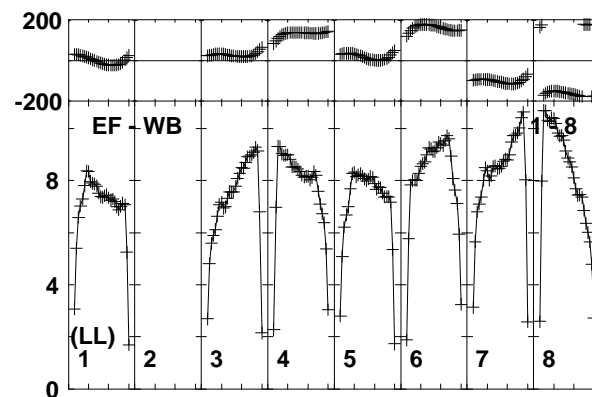
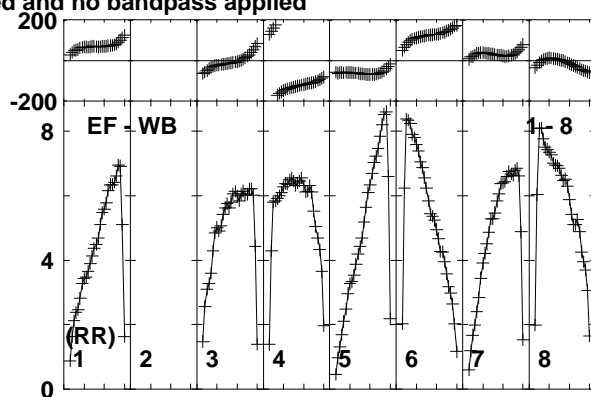
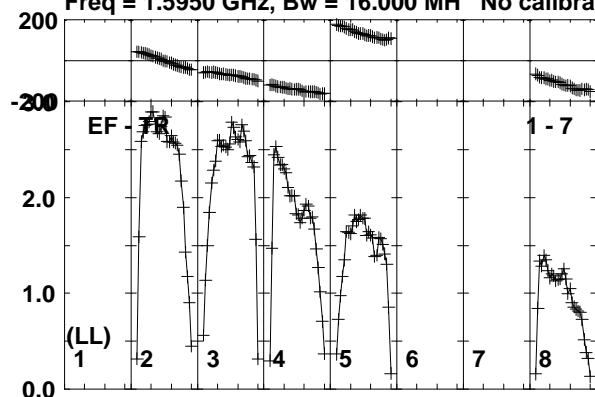

Lower frame: Milli Ampl Jy Top frame: Phas deg  
Vector averaged cross-power spectrum Baseline: EF (01) - TR (07)  
Timerange: 00/22:12:52 to 00/22:16:18

Plot file version 11 created 26-JUN-2015 10:51:15

J2025+3343 ET031A.UVDATA.1

Freq = 1.5950 GHz, Bw = 16.000 MH No calibration applied and no bandpass applied

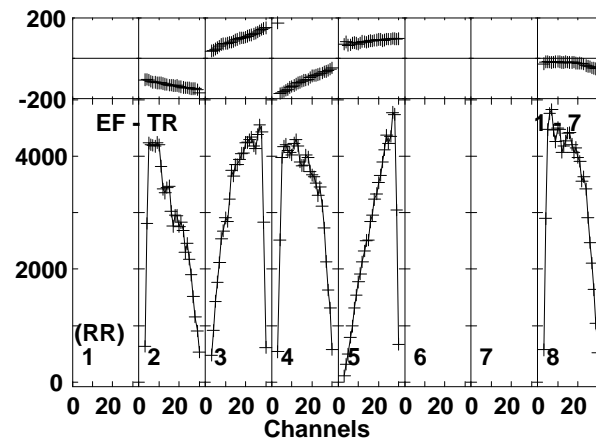
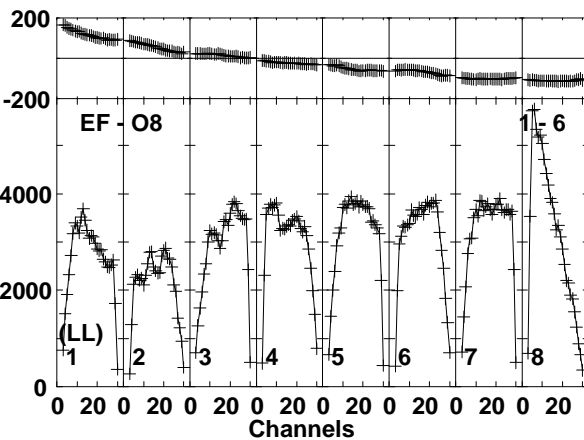
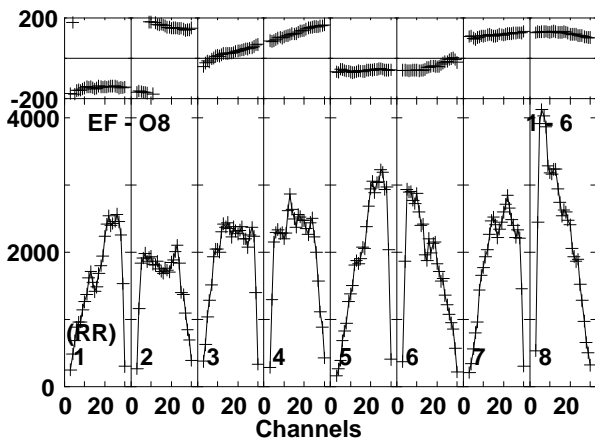
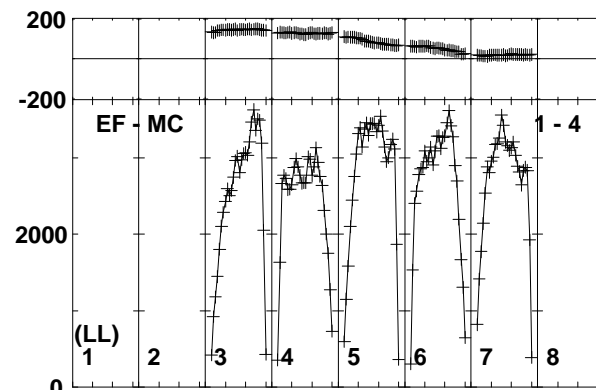
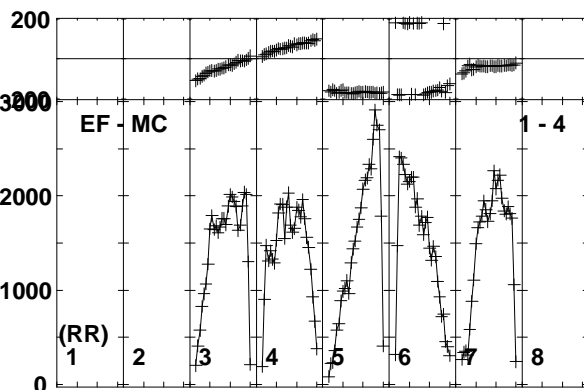
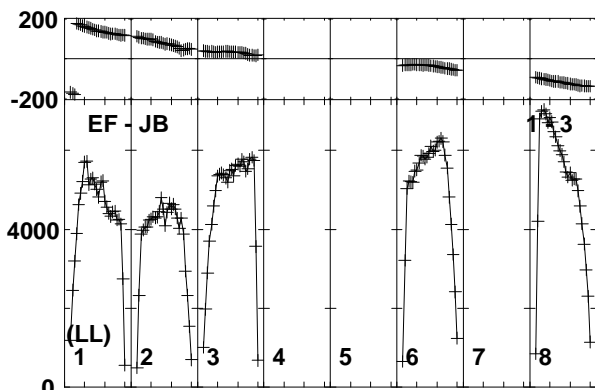
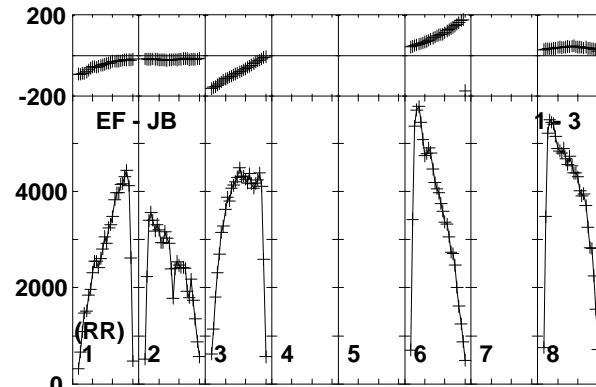
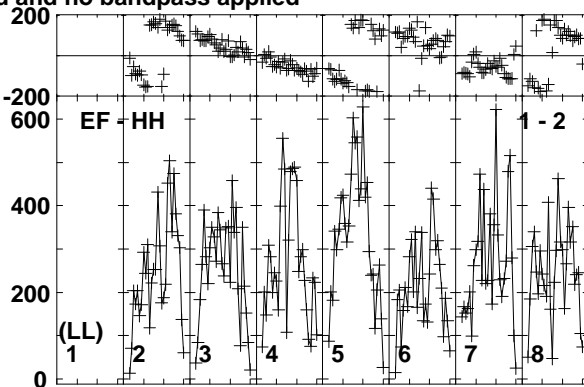
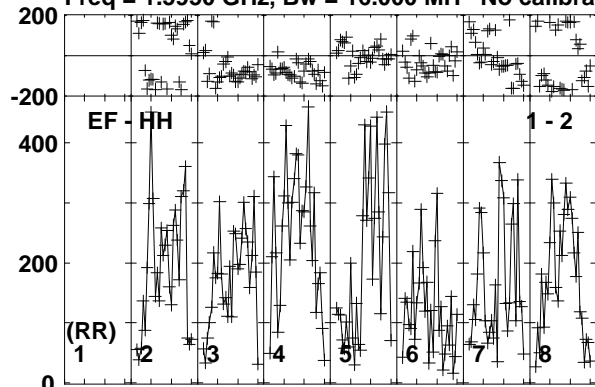

Lower frame: Micro Ampl Jy Top frame: Phas deg  
Vector averaged cross-power spectrum Baseline: EF (01) - HH (02)  
Timerange: 00:22:17:02 to 00:22:17:58

Plot file version 12 created 26-JUN-2015 10:51:15

J2025+3343 ET031A.UVDATA.1

Freq = 1.5950 GHz, Bw = 16.000 MH No calibration applied and no bandpass applied

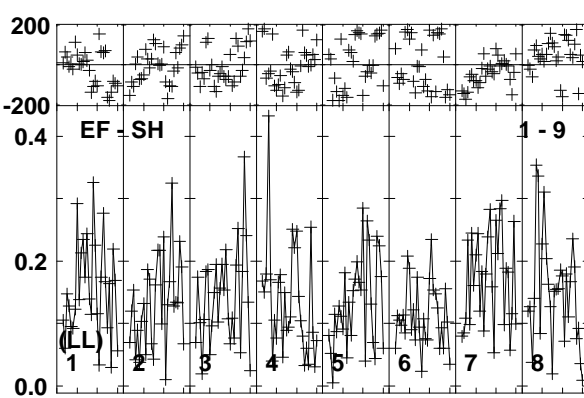
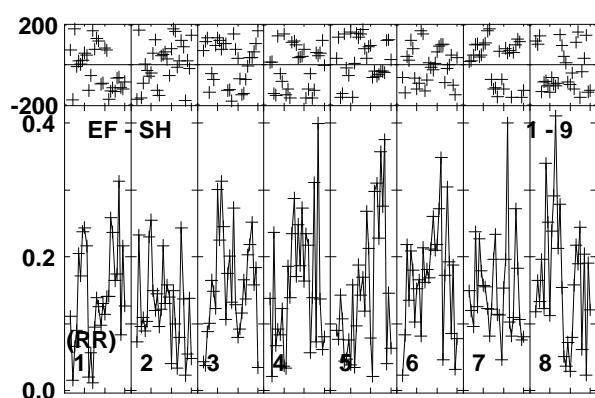
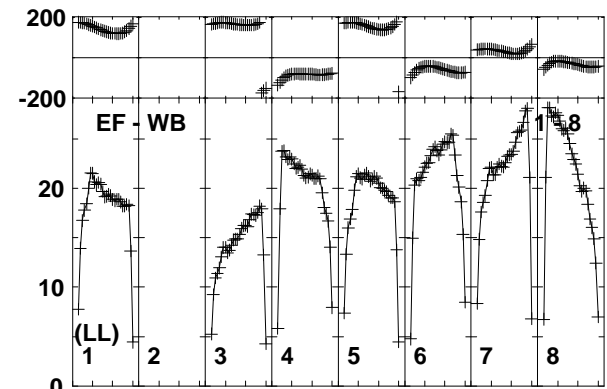
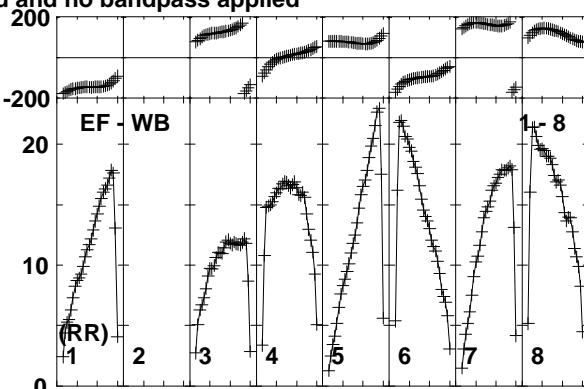
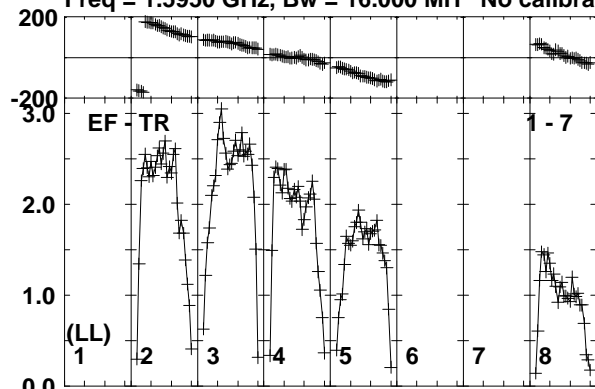

Channels

Lower frame: Milli Ampl Jy Top frame: Phas deg  
Vector averaged cross-power spectrum Baseline: EF (01) - TR (07)  
Timerange: 00/22:17:02 to 00/22:17:58

Plot file version 13 created 26-JUN-2015 10:51:15

V404CYG ET031A.UVDATA.1

Freq = 1.5950 GHz, Bw = 16.000 MH No calibration applied and no bandpass applied

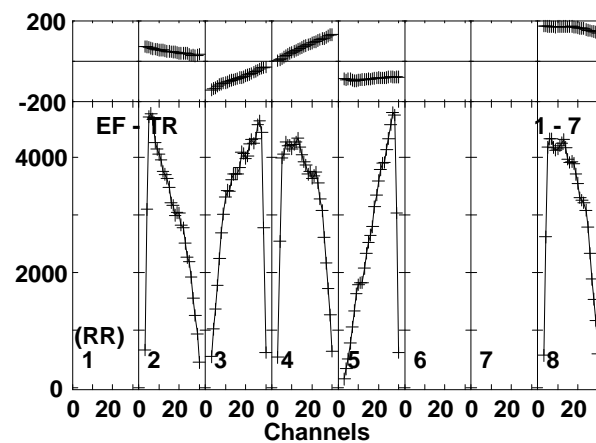
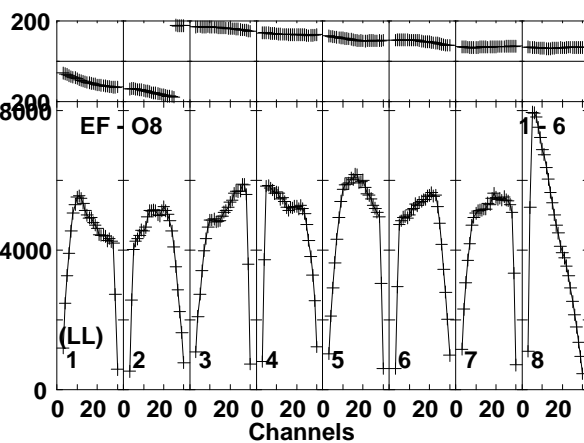
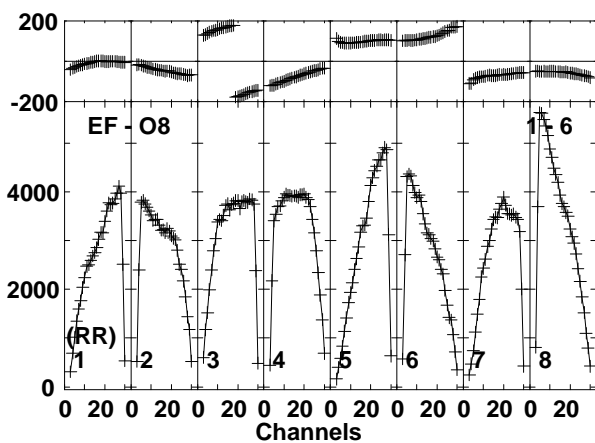
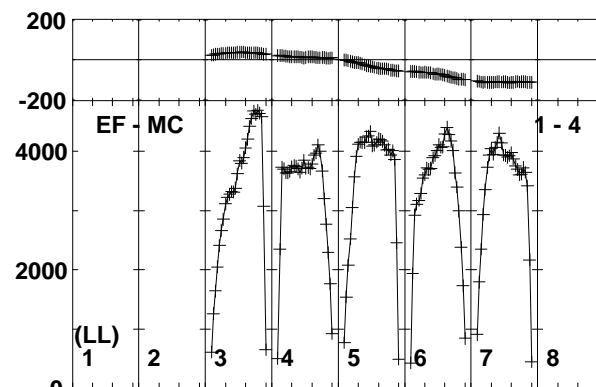
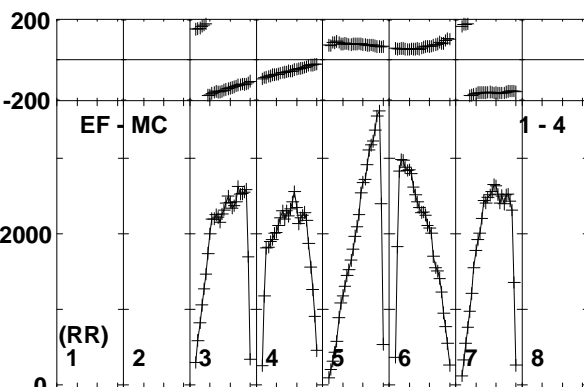
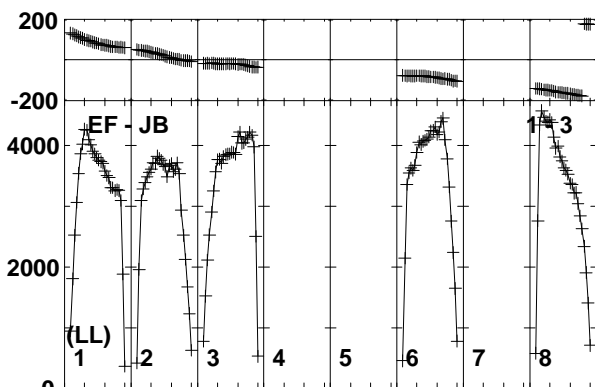
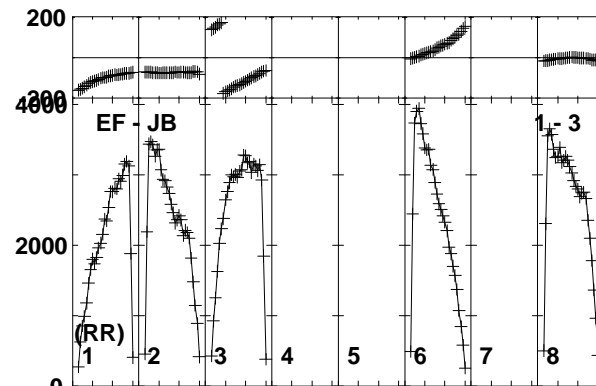
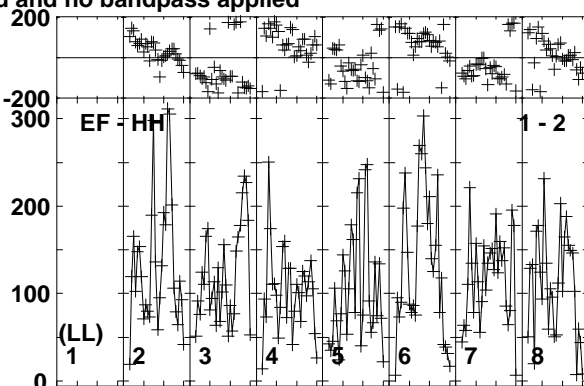
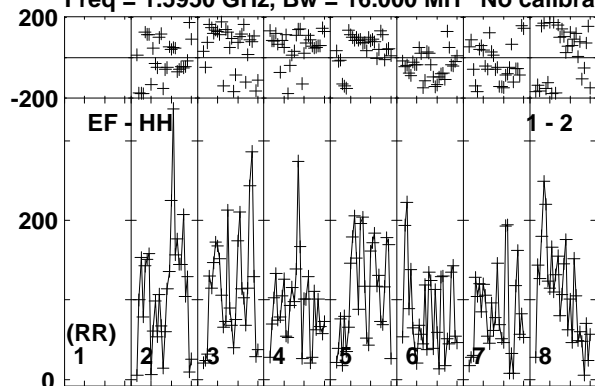

Lower frame: Micro Ampl Jy Top frame: Phas deg  
Vector averaged cross-power spectrum Baseline: EF (01) - HH (02)  
Timerange: 00/22:18:02 to 00/22:21:28

Plot file version 14 created 26-JUN-2015 10:51:16

V404CYG ET031A.UVDATA.1

Freq = 1.5950 GHz, Bw = 16.000 MH No calibration applied and no bandpass applied

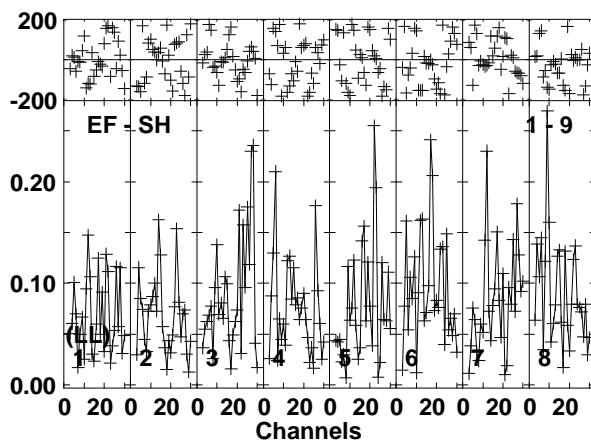
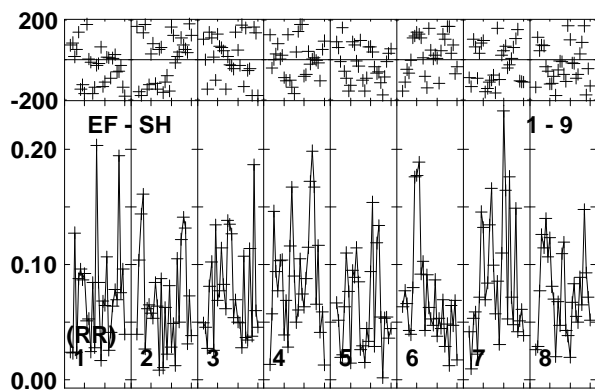
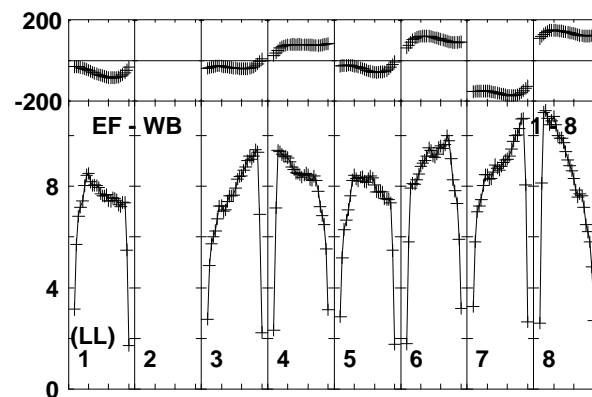
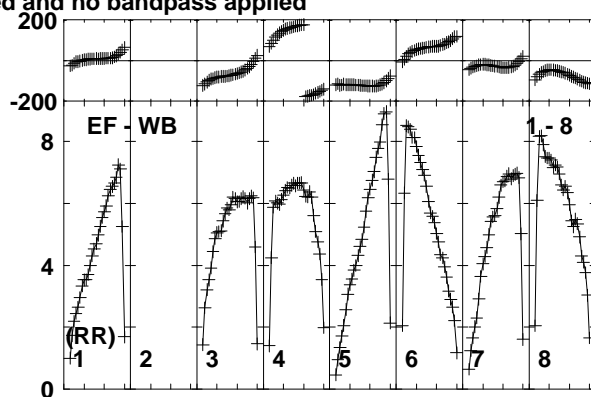
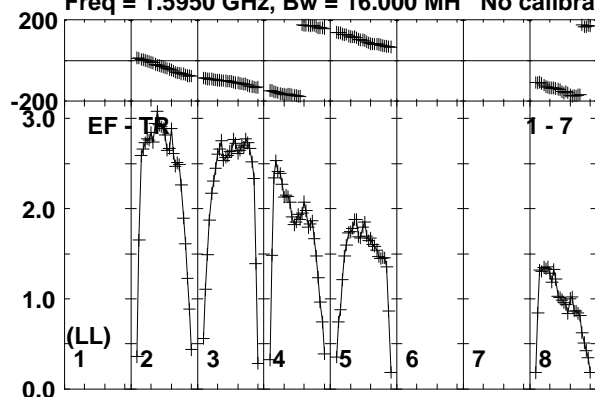

Lower frame: Milli Ampl Jy Top frame: Phas deg  
Vector averaged cross-power spectrum Baseline: EF (01) - TR (07)  
Timerange: 00/22:18:02 to 00/22:21:28

Plot file version 15 created 26-JUN-2015 10:51:16

J2025+3343 ET031A.UVDATA.1

Freq = 1.5950 GHz, Bw = 16.000 MH No calibration applied and no bandpass applied

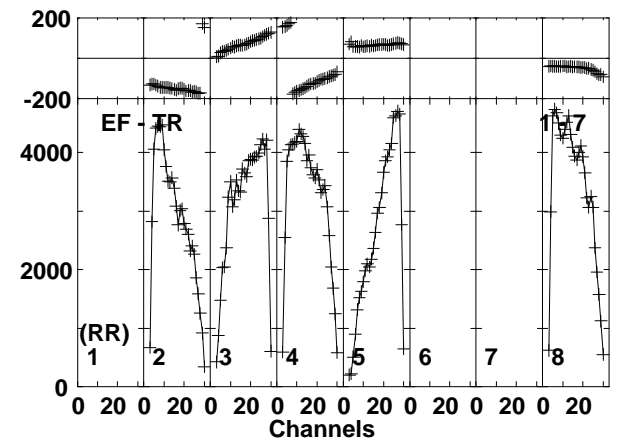
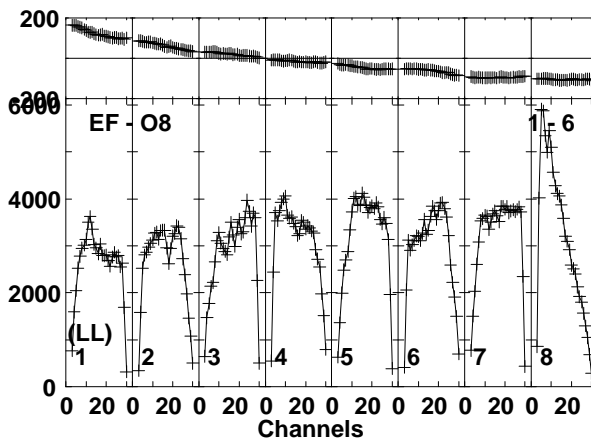
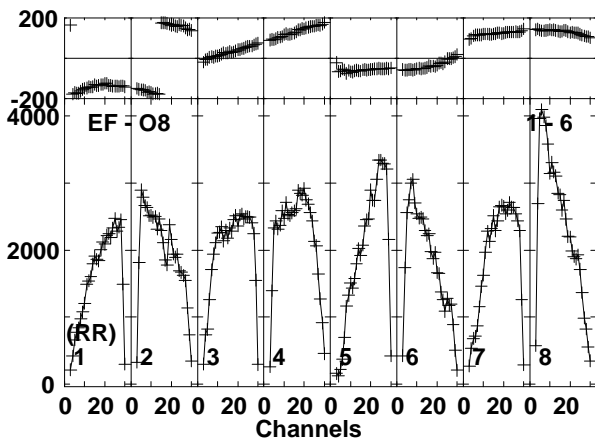
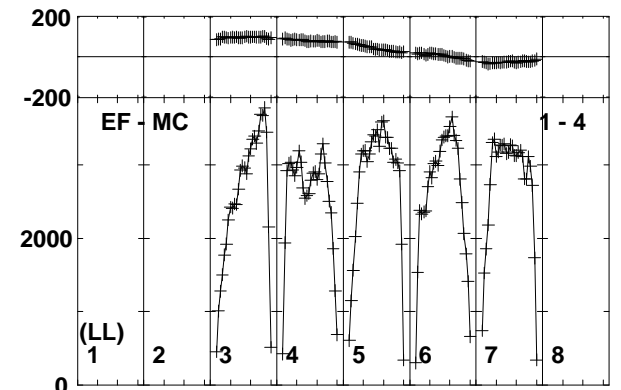
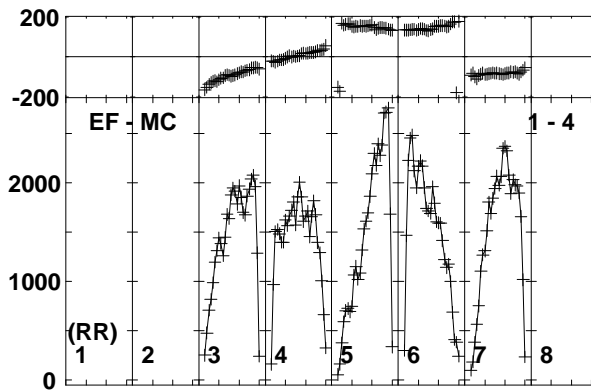
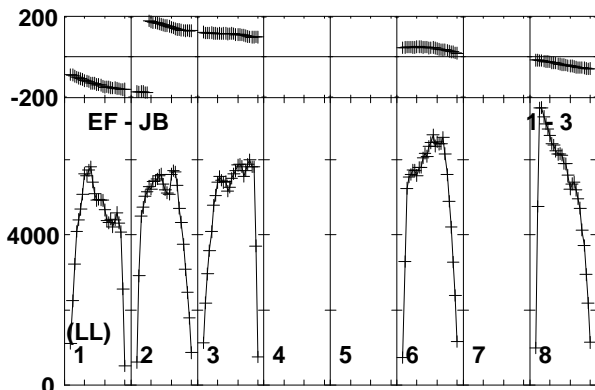
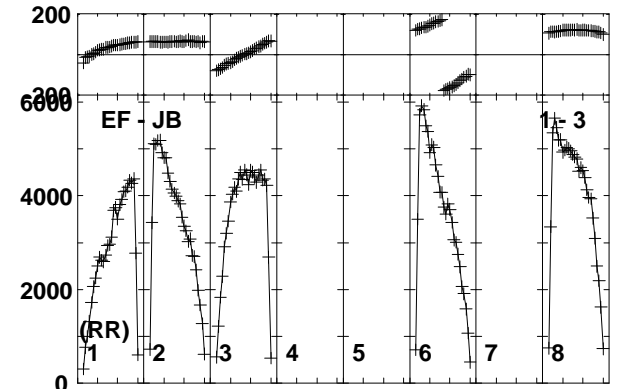
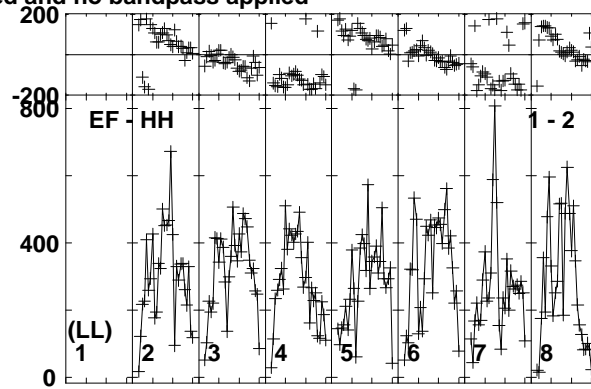
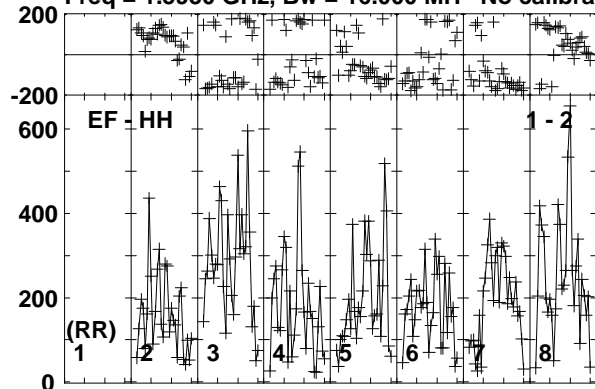

Lower frame: Micro Ampl Jy Top frame: Phas deg  
Vector averaged cross-power spectrum Baseline: EF (01) - HH (02)  
Timerange: 00/22:21:32 to 00/22:22:48

Plot file version 16 created 26-JUN-2015 10:51:16

J2025+3343 ET031A.UVDATA.1

Freq = 1.5950 GHz, Bw = 16.000 MH No calibration applied and no bandpass applied

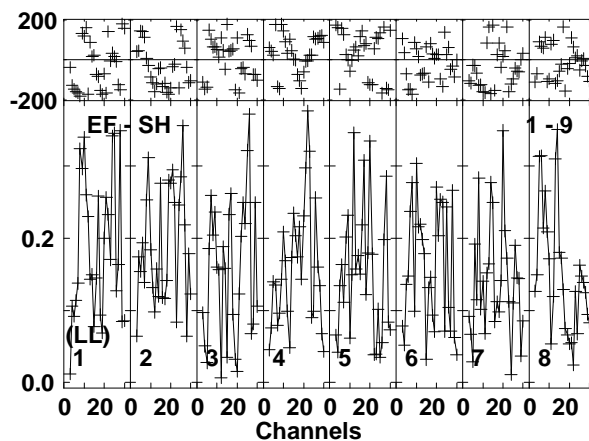
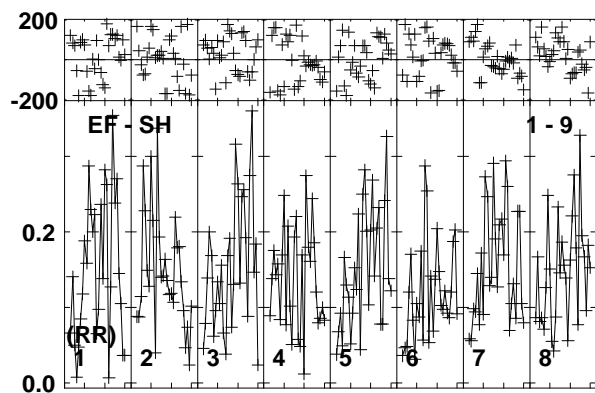
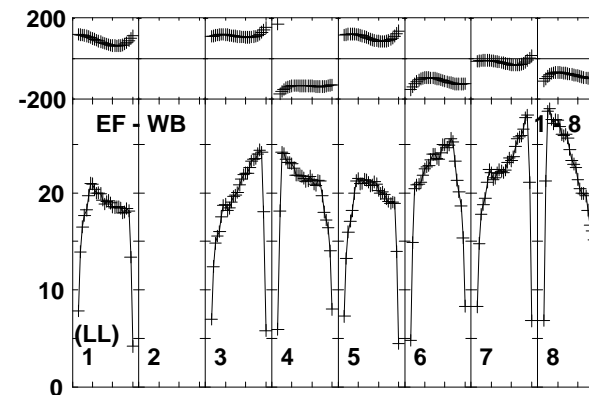
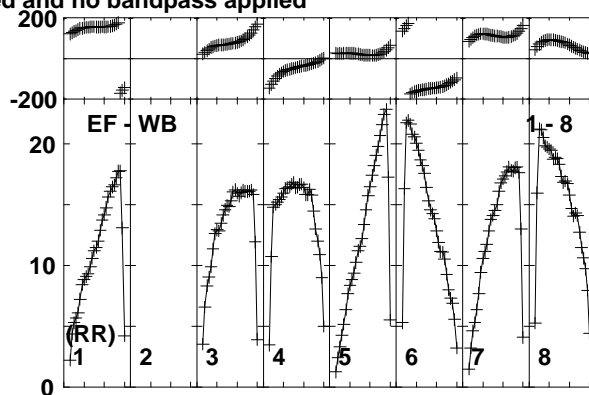
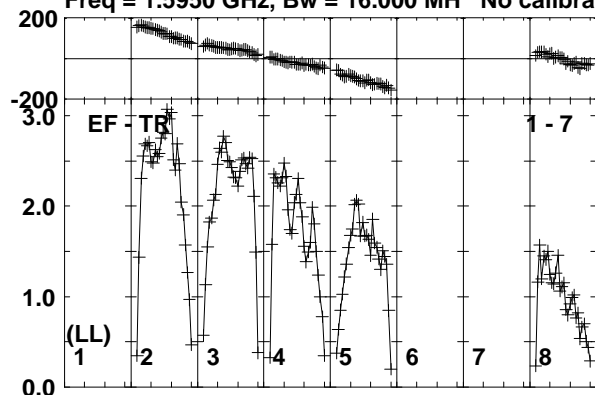

Lower frame: Milli Ampl Jy Top frame: Phas deg  
Vector averaged cross-power spectrum Baseline: EF (01) - TR (07)  
Timerange: 00/22:21:32 to 00/22:22:48



Plot file version 17 created 26-JUN-2015 10:51:16

V404CYG ET031A.UVDATA.1

Freq = 1.5950 GHz, Bw = 16.000 MH No calibration applied and no bandpass applied

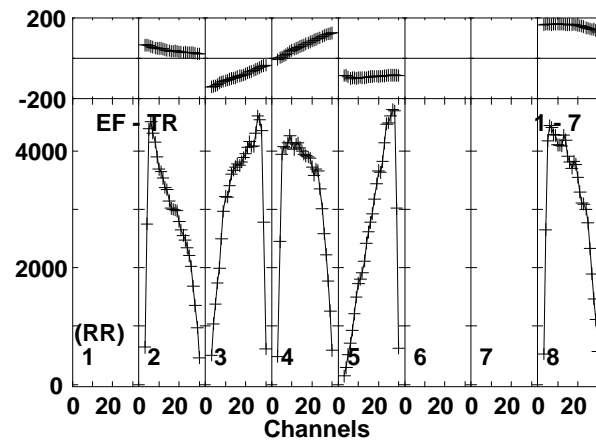
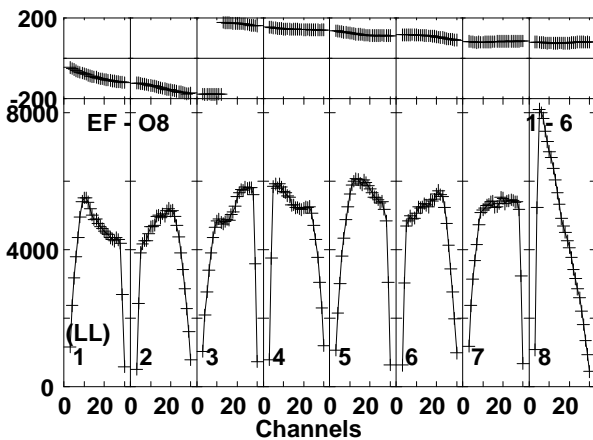
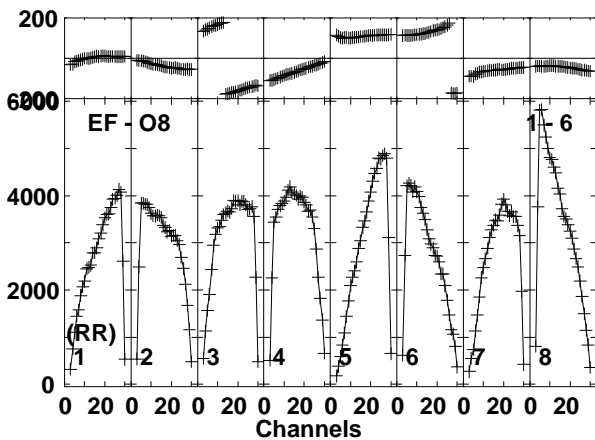
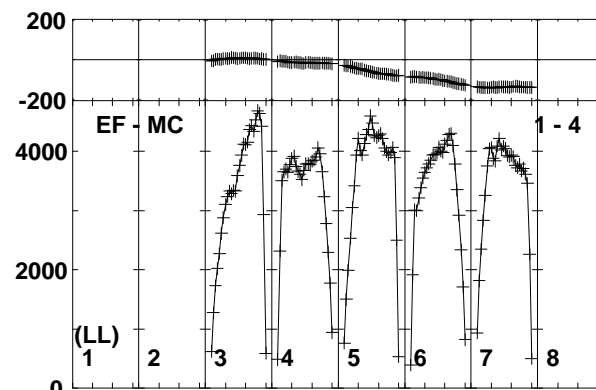
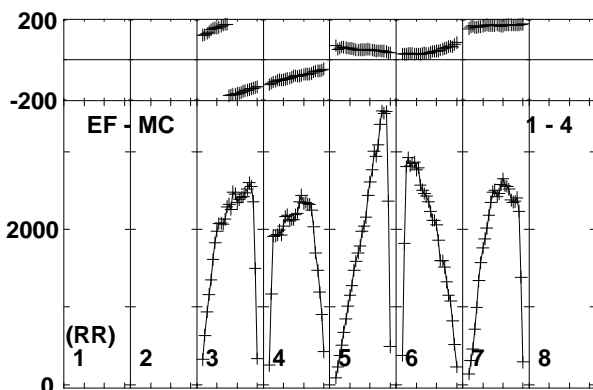
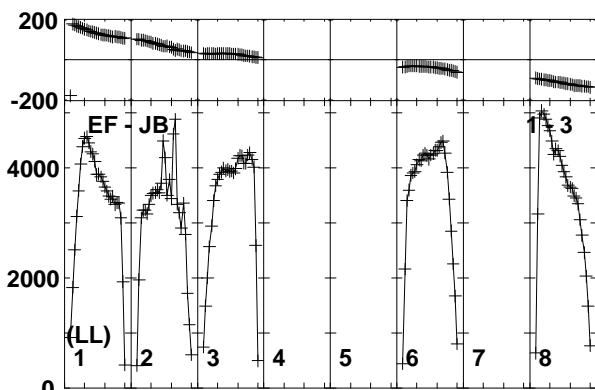
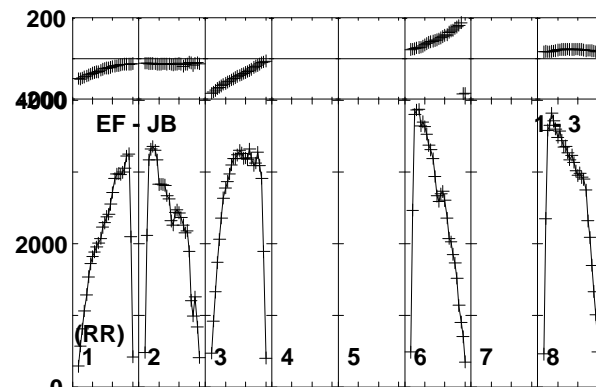
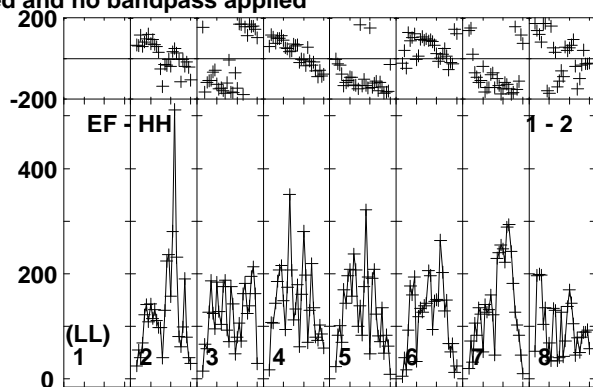
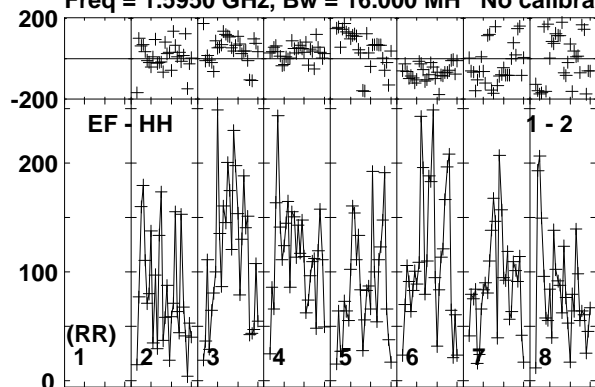

Lower frame: Micro Ampl Jy Top frame: Phas deg  
Vector averaged cross-power spectrum Baseline: EF (01) - HH (02)  
Timerange: 00:22:22:52 to 00:22:26:18

Plot file version 18 created 26-JUN-2015 10:51:16

V404CYG ET031A.UVDATA.1

Freq = 1.5950 GHz, Bw = 16.000 MH No calibration applied and no bandpass applied

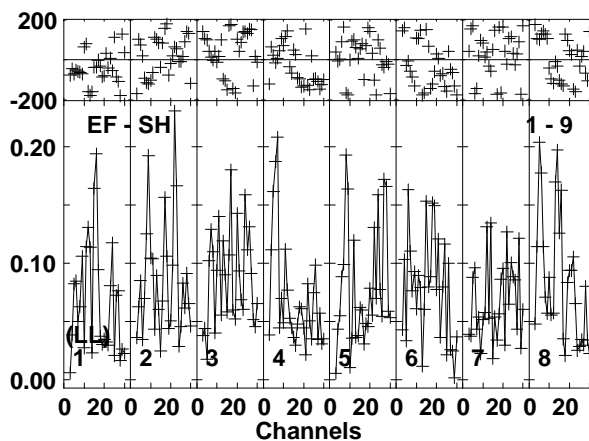
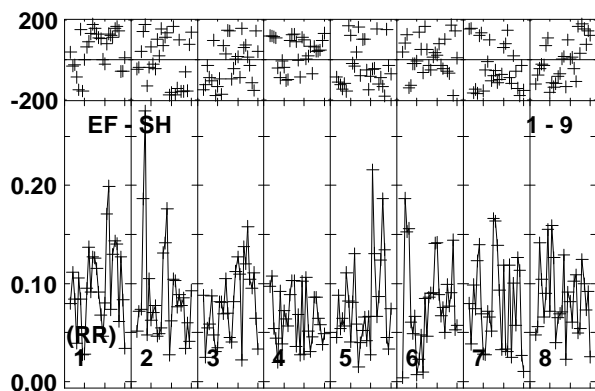
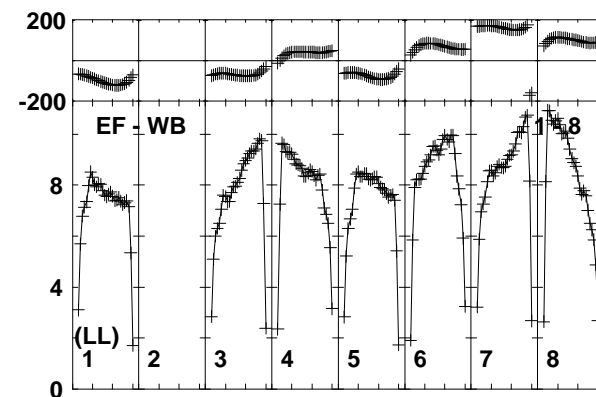
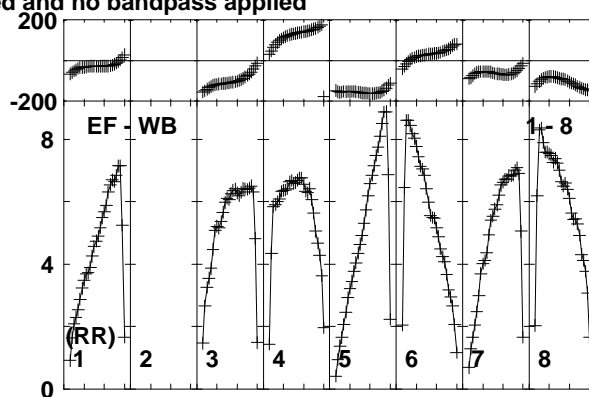
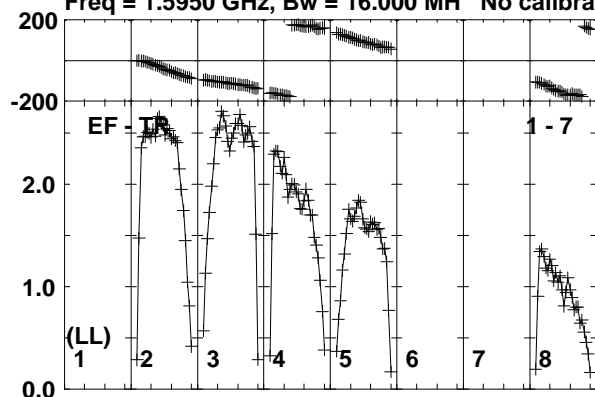

Lower frame: Milli Ampl Jy Top frame: Phas deg  
Vector averaged cross-power spectrum Baseline: EF (01) - TR (07)  
Timerange: 00/22:22:52 to 00/22:26:18

Plot file version 19 created 26-JUN-2015 10:51:16

J2025+3343 ET031A.UVDATA.1

Freq = 1.5950 GHz, Bw = 16.000 MH No calibration applied and no bandpass applied

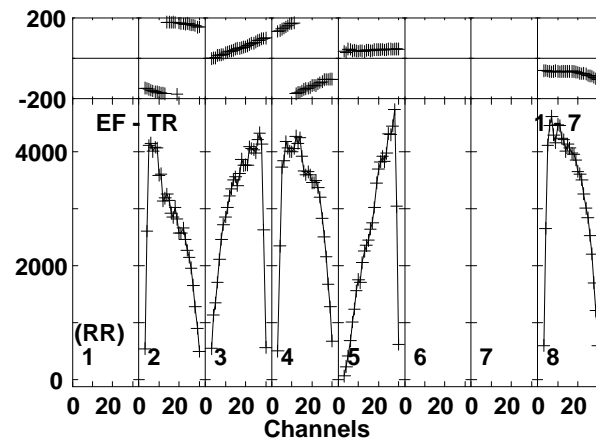
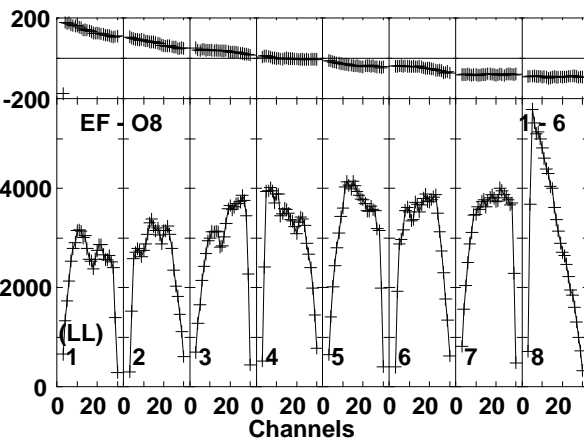
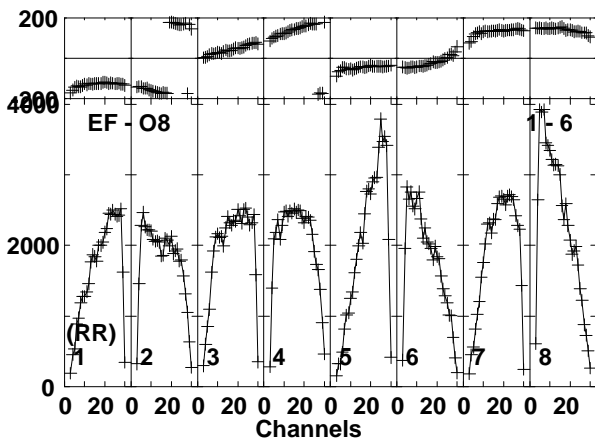
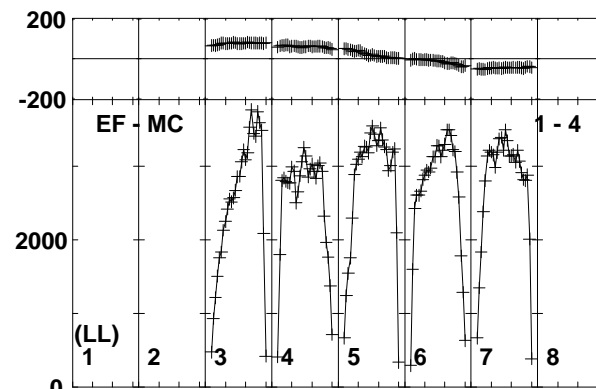
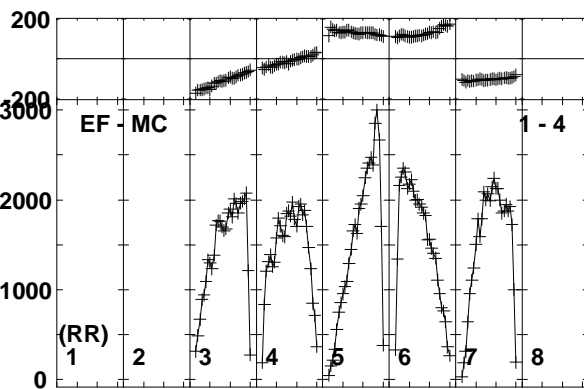
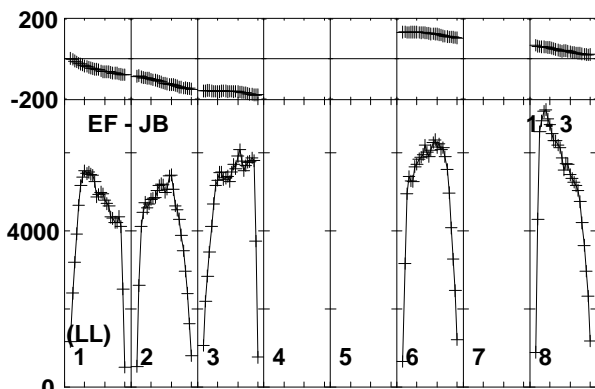
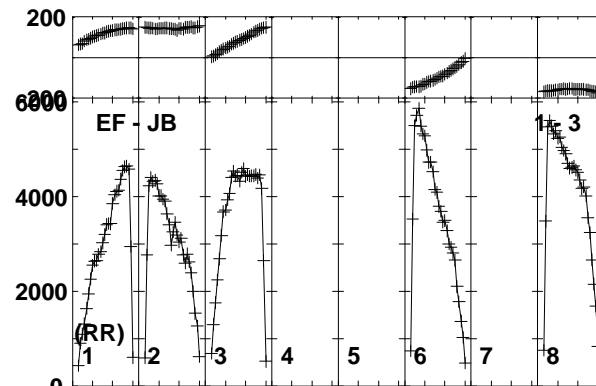
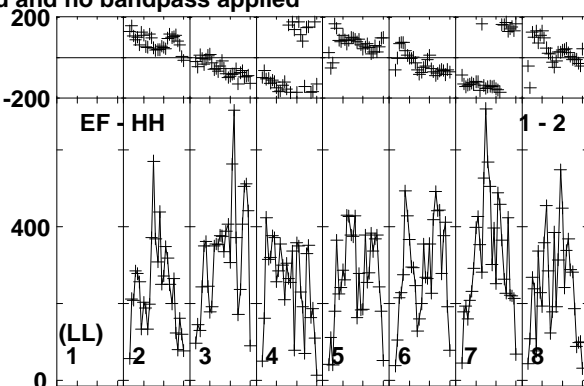
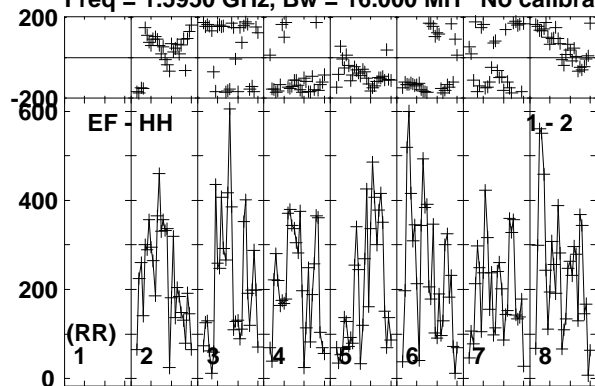

Lower frame: Micro Ampl Jy Top frame: Phas deg  
Vector averaged cross-power spectrum Baseline: EF (01) - HH (02)  
Timerange: 00/22:27:02 to 00/22:27:58

Plot file version 20 created 26-JUN-2015 10:51:16

J2025+3343 ET031A.UVDATA.1

Freq = 1.5950 GHz, Bw = 16.000 MH No calibration applied and no bandpass applied

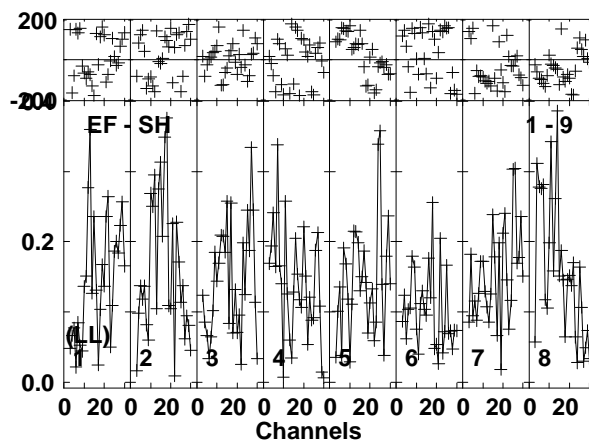
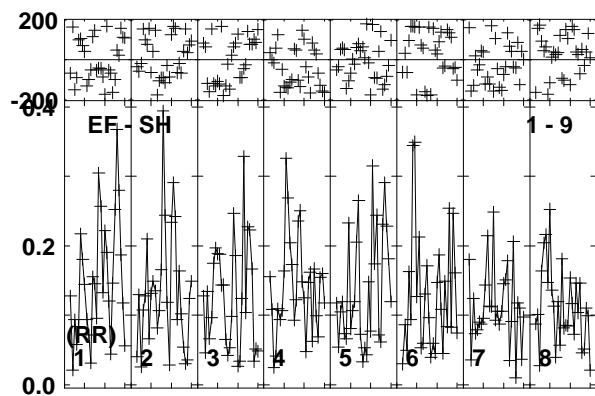
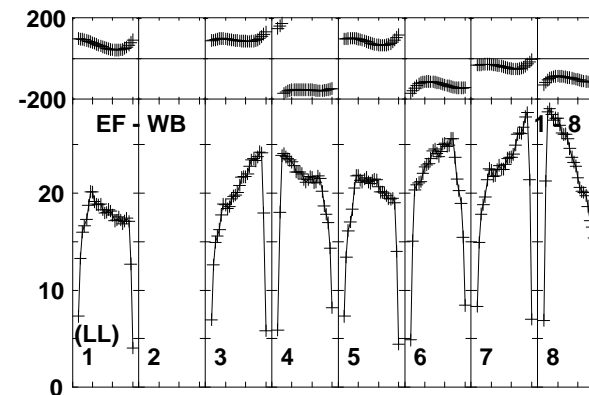
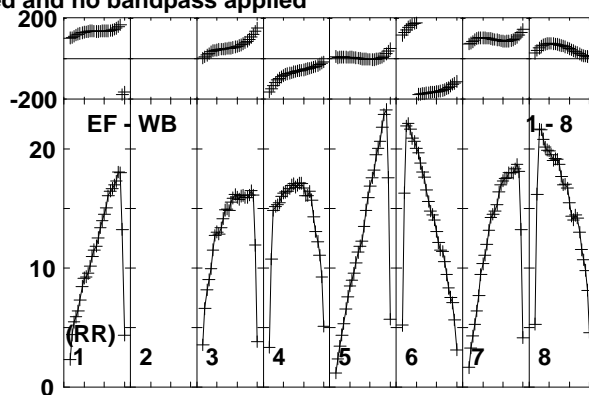
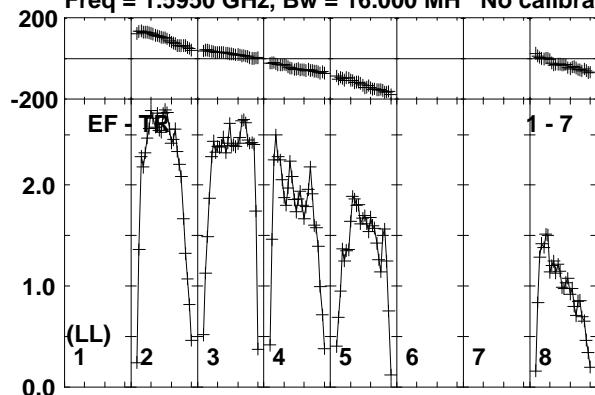

Lower frame: Milli Ampl Jy Top frame: Phas deg  
Vector averaged cross-power spectrum Baseline: EF (01) - TR (07)  
Timerange: 00/22:27:02 to 00/22:27:58

Plot file version 21 created 26-JUN-2015 10:51:16

V404CYG ET031A.UVDATA.1

Freq = 1.5950 GHz, Bw = 16.000 MH No calibration applied and no bandpass applied

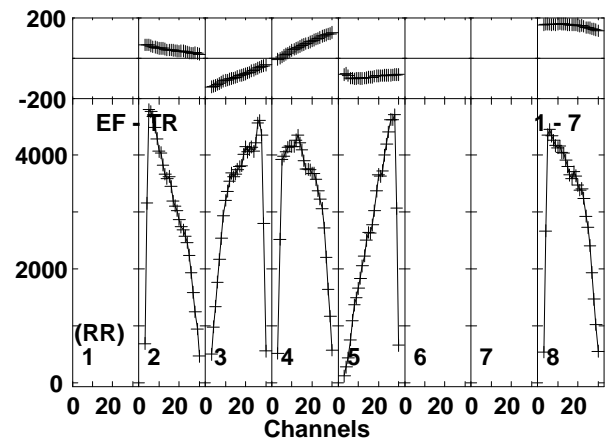
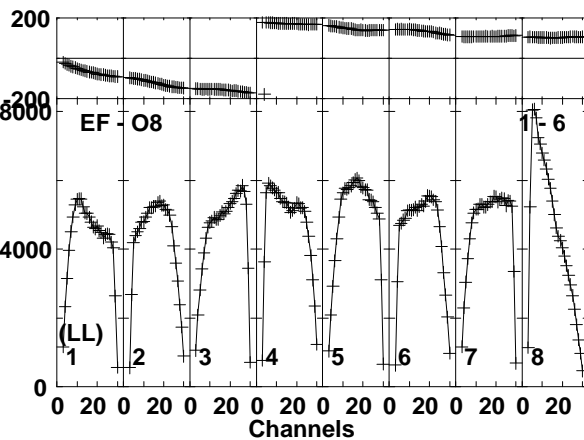
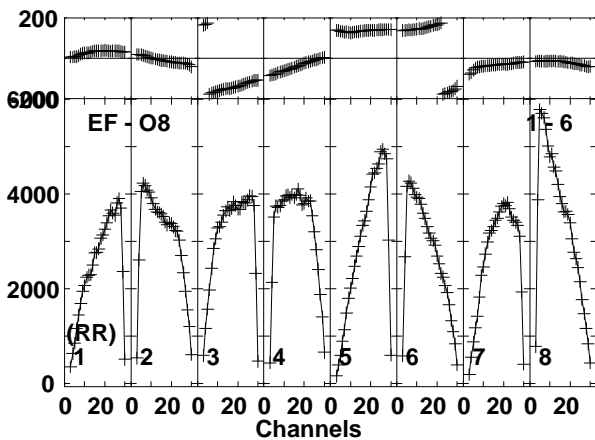
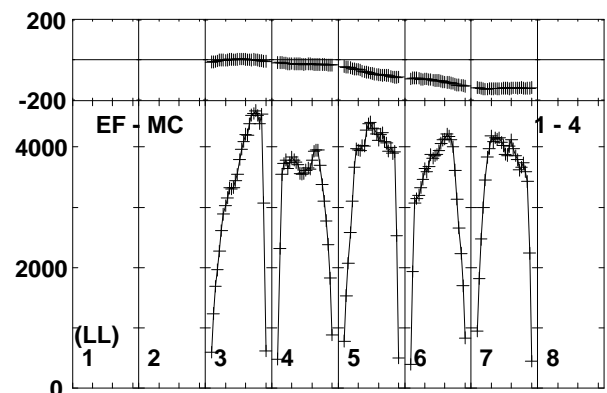
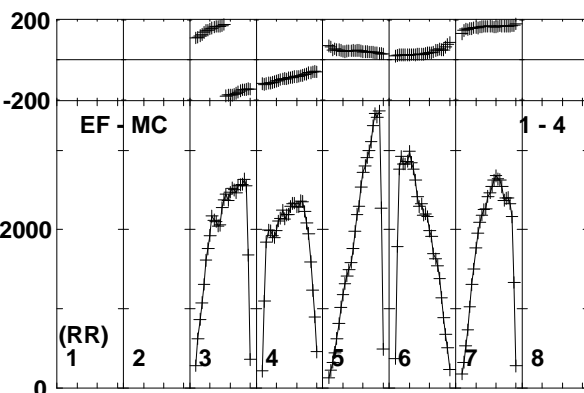
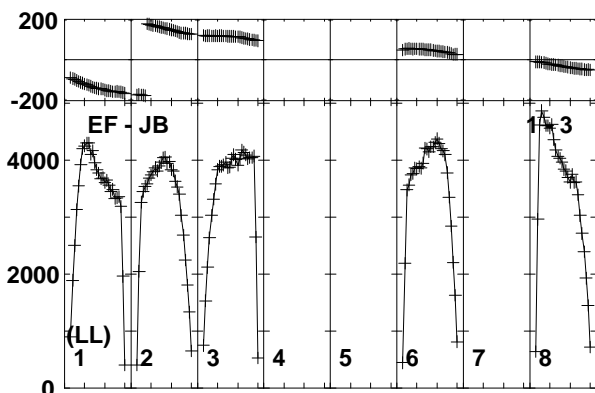
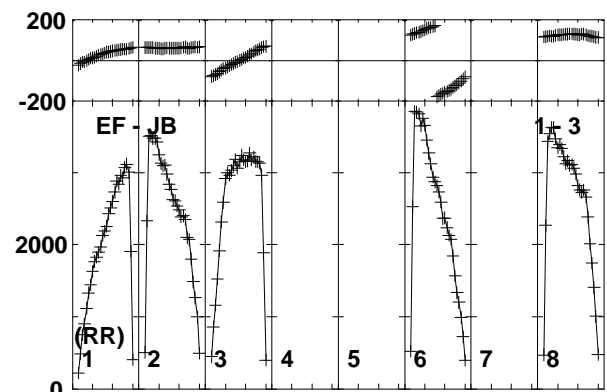
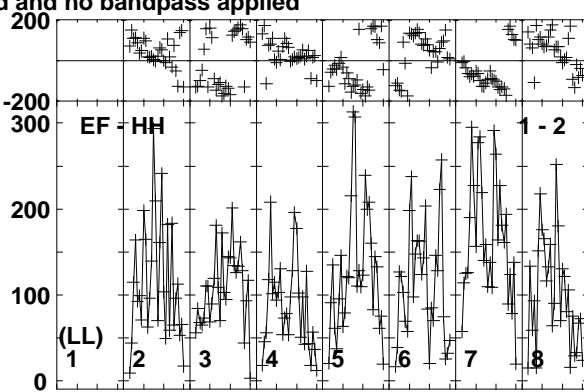
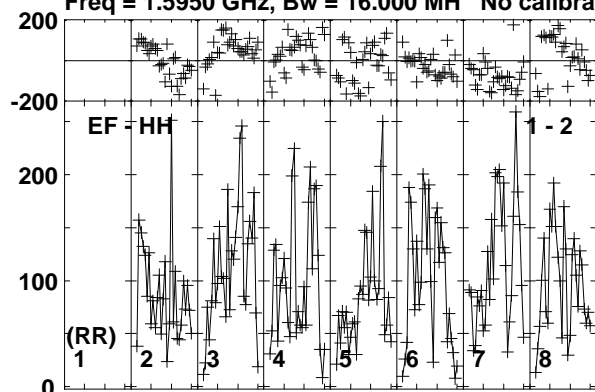

Lower frame: Micro Ampl Jy Top frame: Phas deg  
Vector averaged cross-power spectrum Baseline: EF (01) - HH (02)  
Timerange: 00/22:28:02 to 00/22:31:28

Plot file version 22 created 26-JUN-2015 10:51:16

V404CYG ET031A.UVDATA.1

Freq = 1.5950 GHz, Bw = 16.000 MH No calibration applied and no bandpass applied

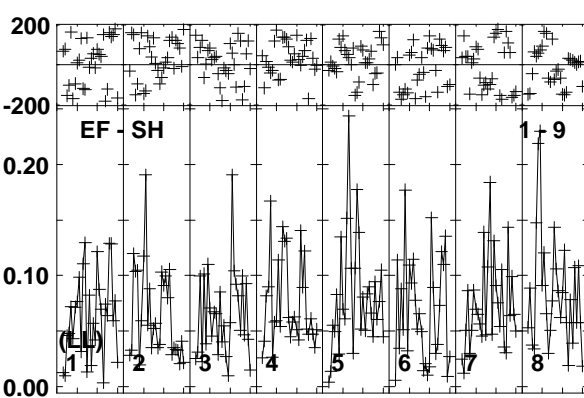
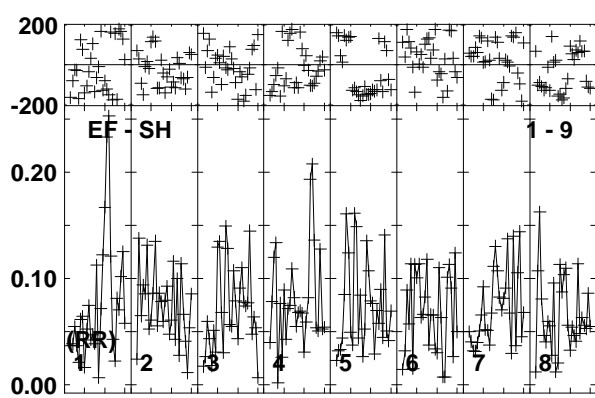
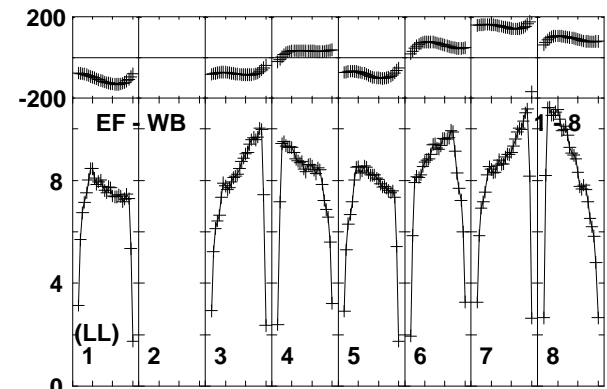
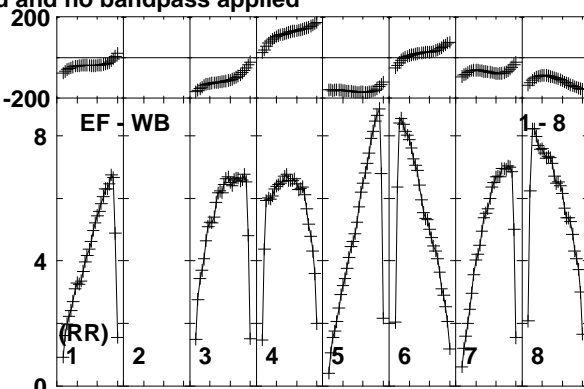
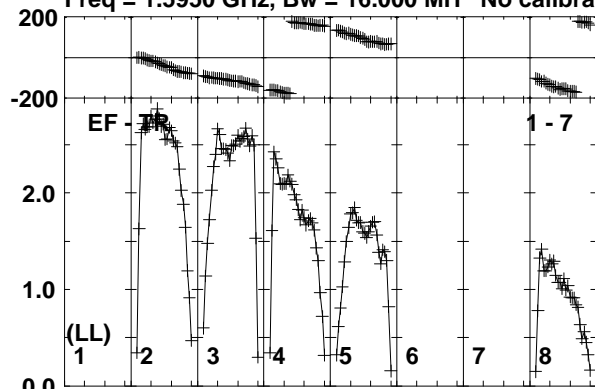

Channels

Lower frame: Milli Ampl Jy Top frame: Phas deg  
Vector averaged cross-power spectrum Baseline: EF (01) - TR (07)  
Timerange: 00/22:28:02 to 00/22:31:28

Plot file version 23 created 26-JUN-2015 10:51:16

J2025+3343 ET031A.UVDATA.1

Freq = 1.5950 GHz, Bw = 16.000 MH No calibration applied and no bandpass applied

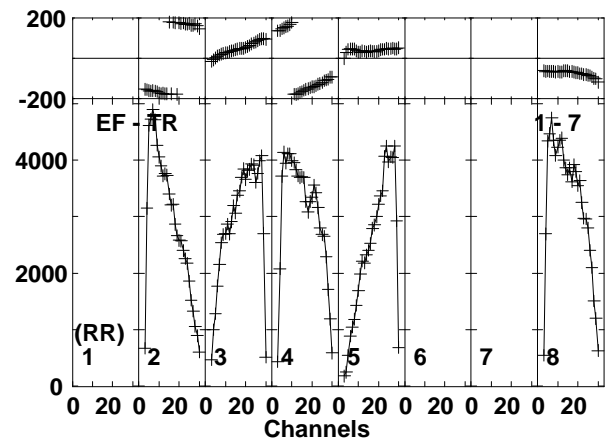
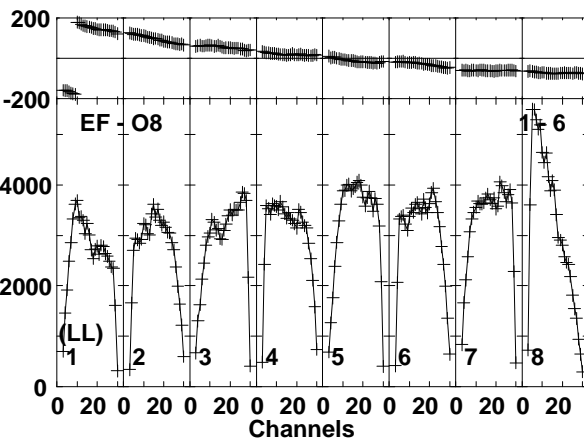
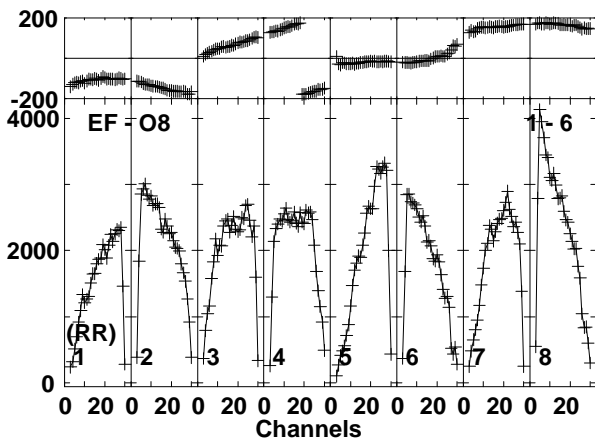
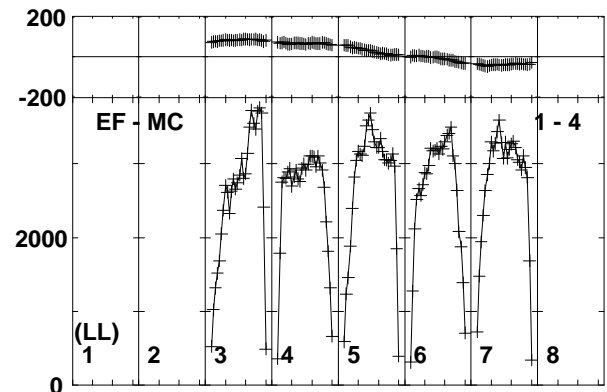
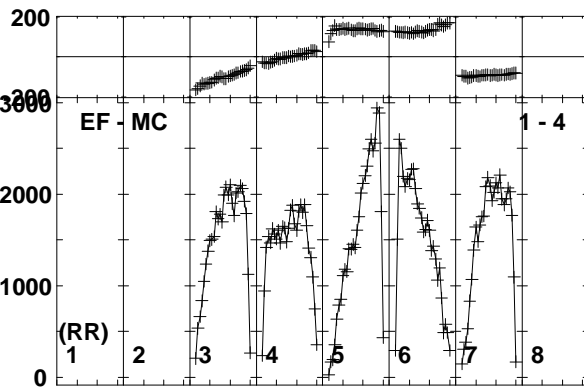
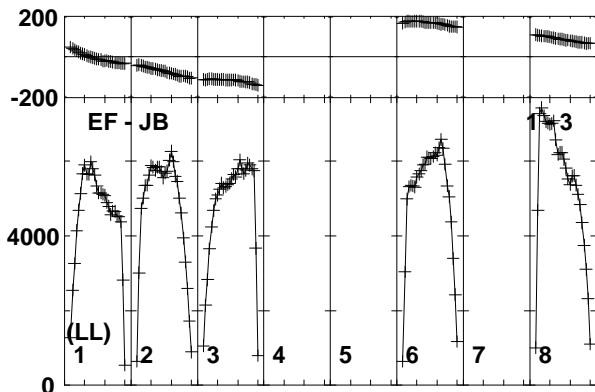
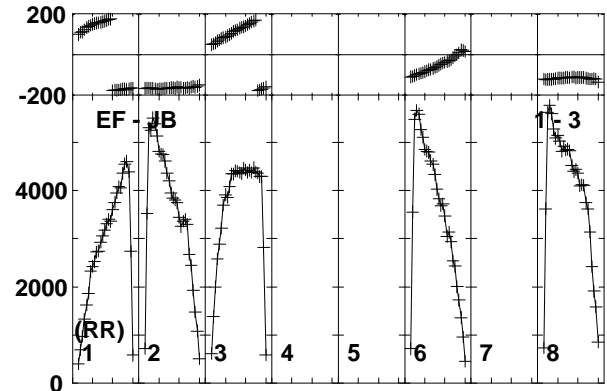
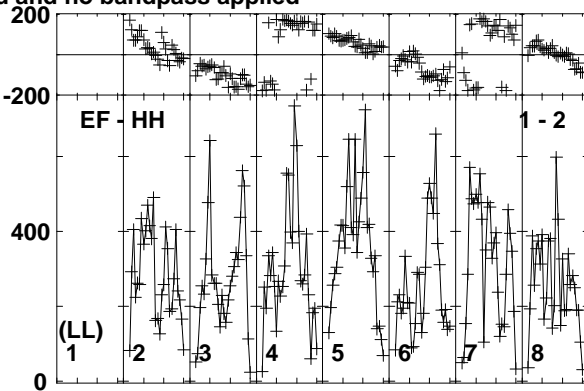
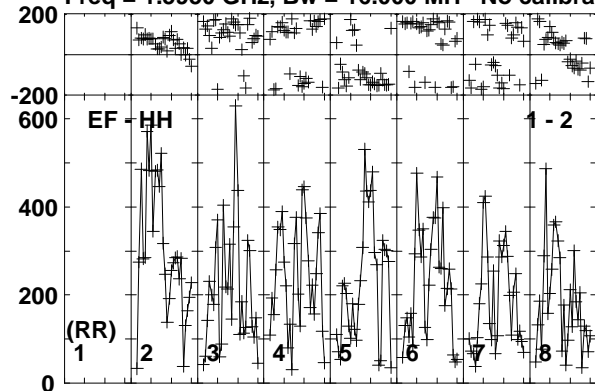

Lower frame: Micro Ampl Jy Top frame: Phas deg  
Vector averaged cross-power spectrum Baseline: EF (01) - HH (02)  
Timerange: 00:22:31:32 to 00:22:32:48

Plot file version 24 created 26-JUN-2015 10:51:16

J2025+3343 ET031A.UVDATA.1

Freq = 1.5950 GHz, Bw = 16.000 MH No calibration applied and no bandpass applied

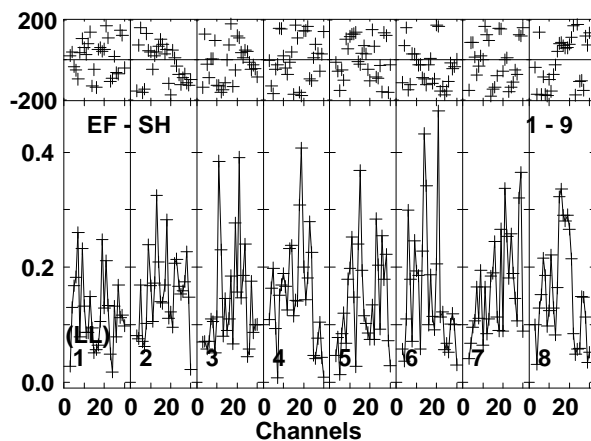
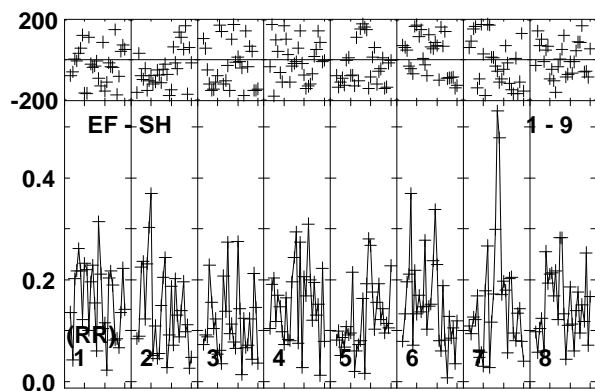
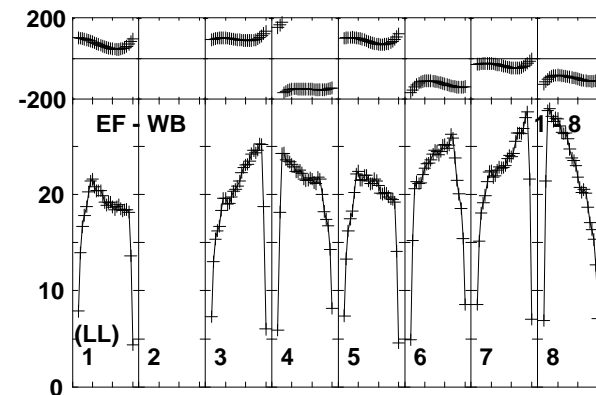
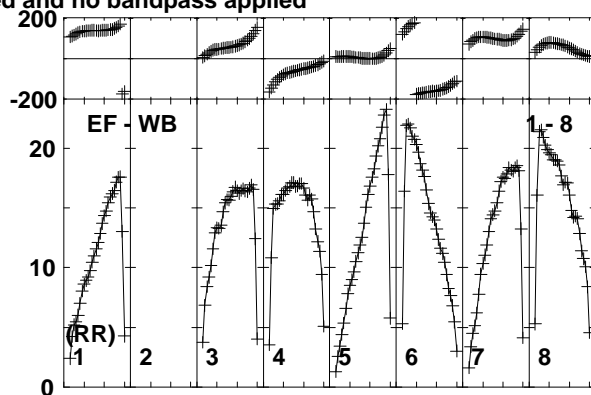
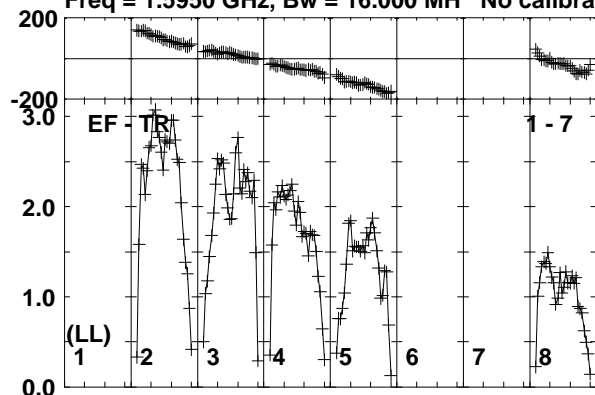

Lower frame: Milli Ampl Jy Top frame: Phas deg  
Vector averaged cross-power spectrum Baseline: EF (01) - TR (07)  
Timerange: 00:22:31:32 to 00:22:32:48



Plot file version 25 created 26-JUN-2015 10:51:16

V404CYG ET031A.UVDATA.1

Freq = 1.5950 GHz, Bw = 16.000 MH No calibration applied and no bandpass applied

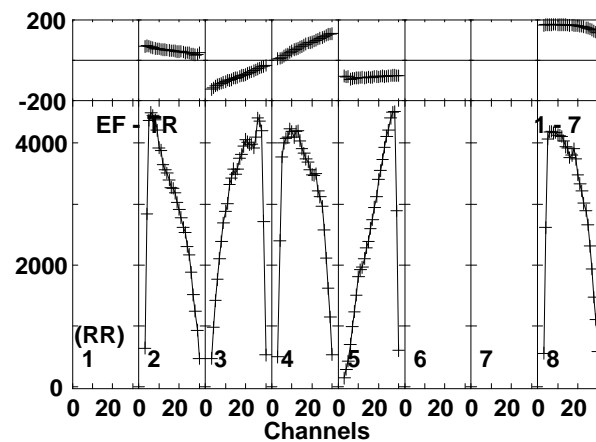
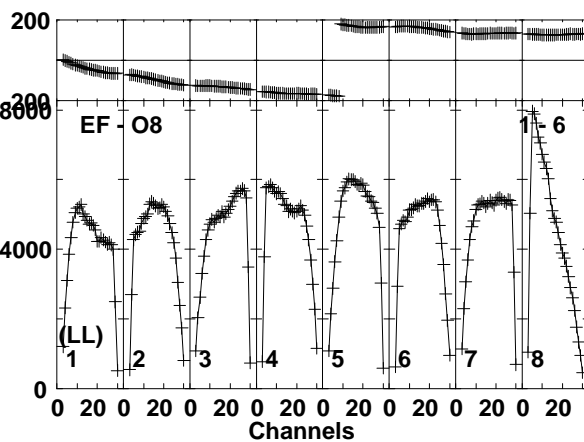
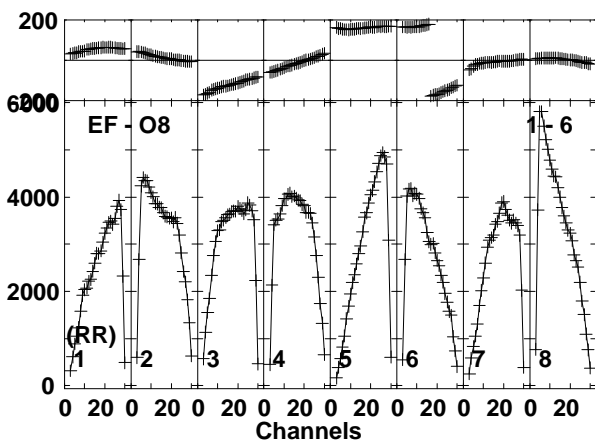
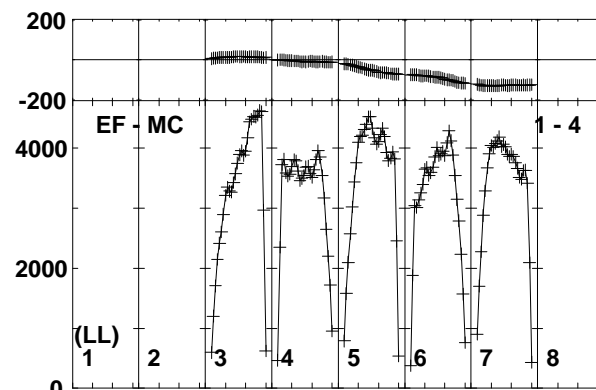
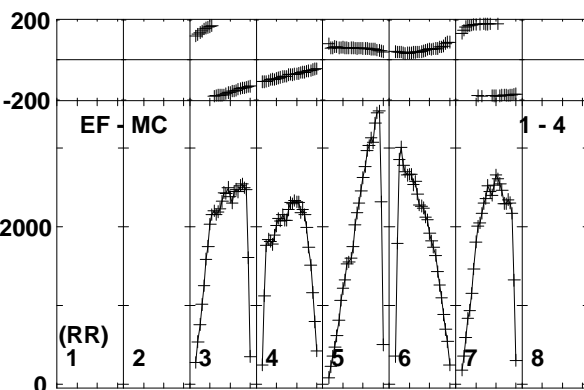
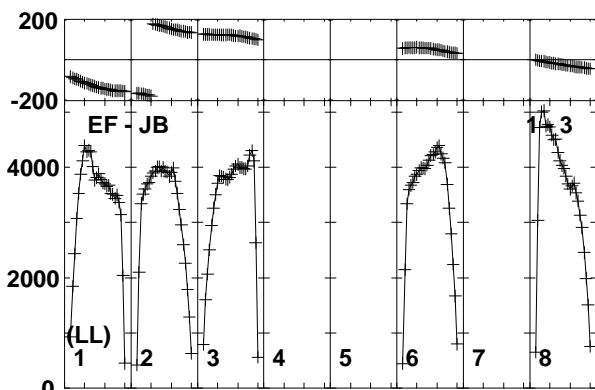
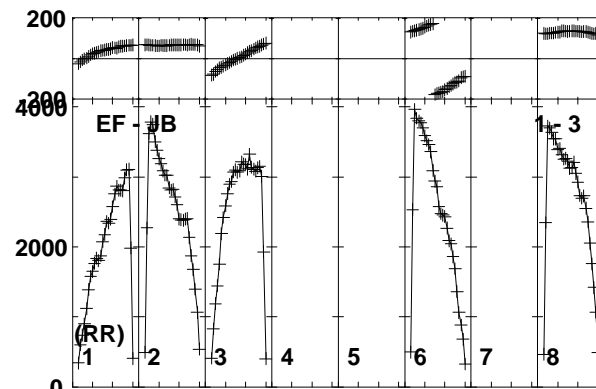
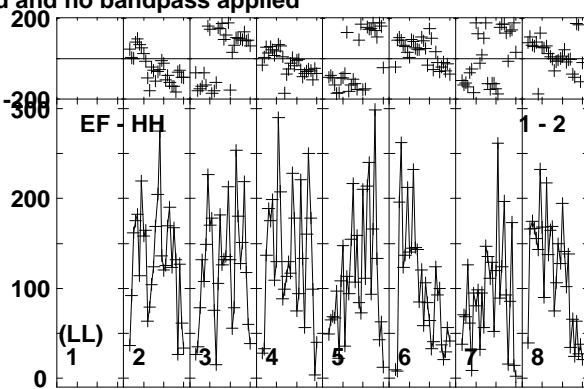
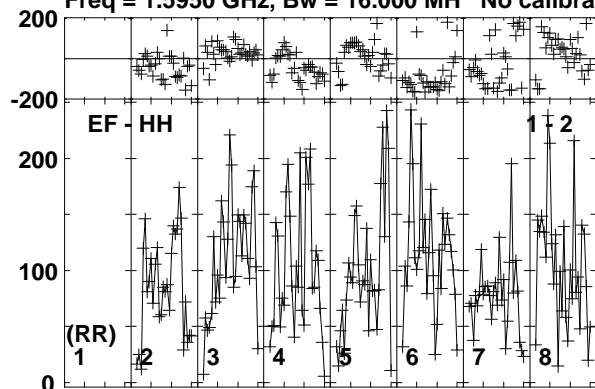

Lower frame: Micro Ampl Jy Top frame: Phas deg  
Vector averaged cross-power spectrum Baseline: EF (01) - HH (02)  
Timerange: 00:22:32:52 to 00:22:36:18

Plot file version 26 created 26-JUN-2015 10:51:16  
 V404CYG ET031A.UVDATA.1  
 Freq = 1.5950 GHz, Bw = 16.000 MH No calibration applied and no bandpass applied

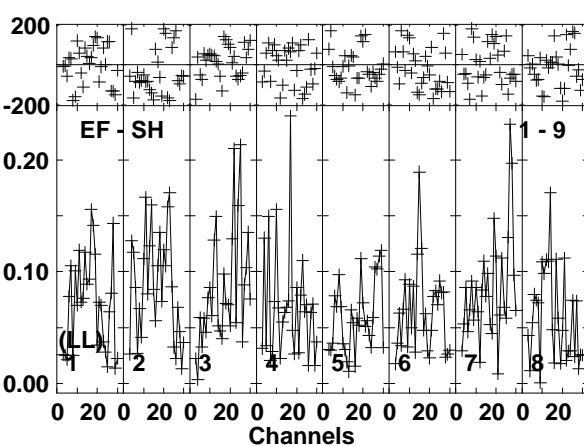
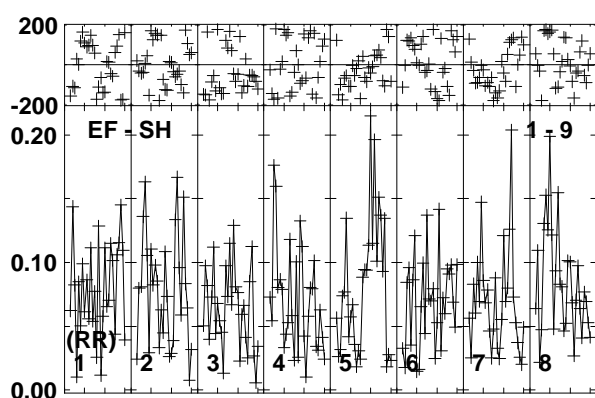
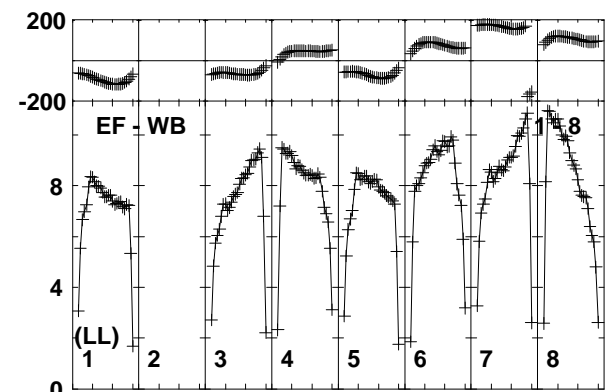
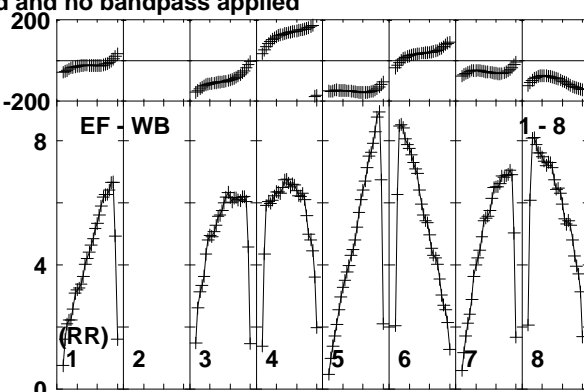
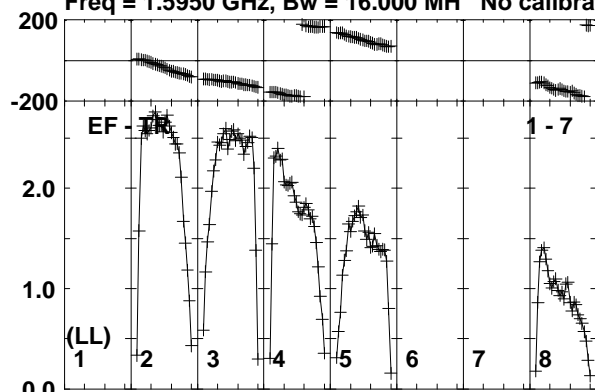

Lower frame: Milli Ampl Jy Top frame: Phas deg  
 Vector averaged cross-power spectrum Baseline: EF (01) - TR (07)  
 Timerange: 00:22:32:52 to 00:22:36:18

Plot file version 27 created 26-JUN-2015 10:51:16

J2025+3343 ET031A.UVDATA.1

Freq = 1.5950 GHz, Bw = 16.000 MH No calibration applied and no bandpass applied

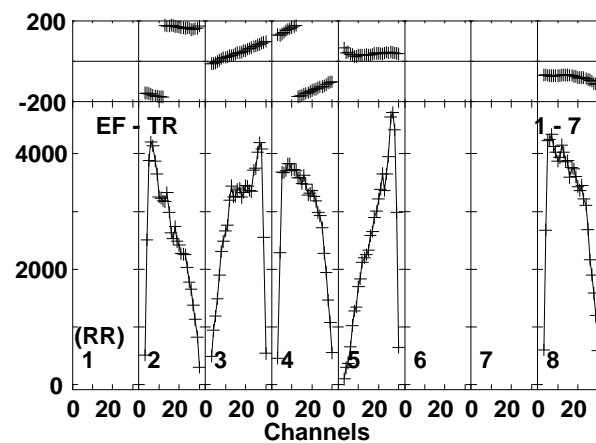
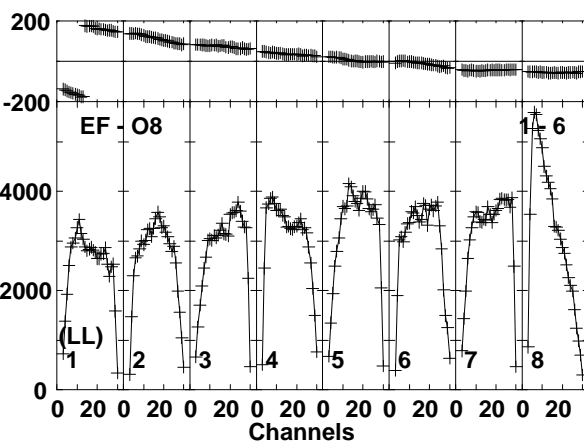
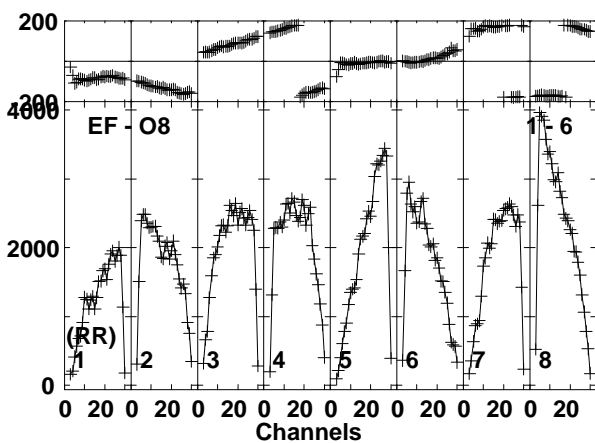
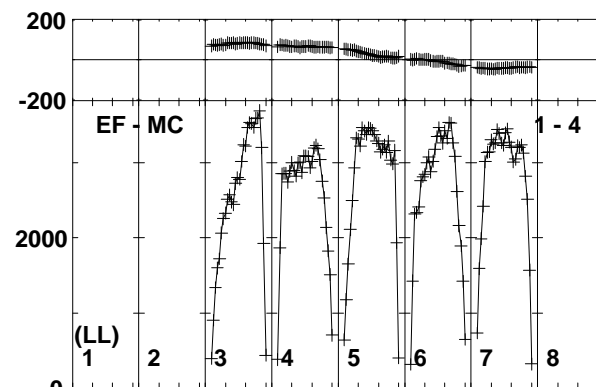
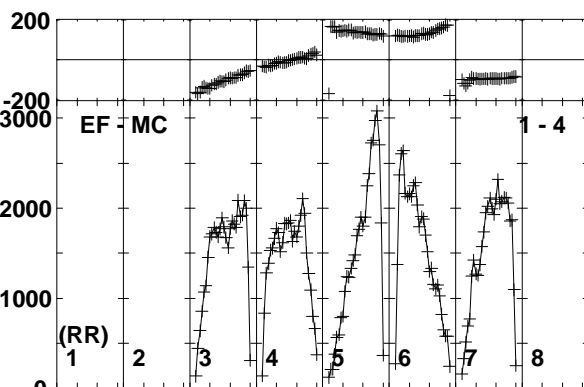
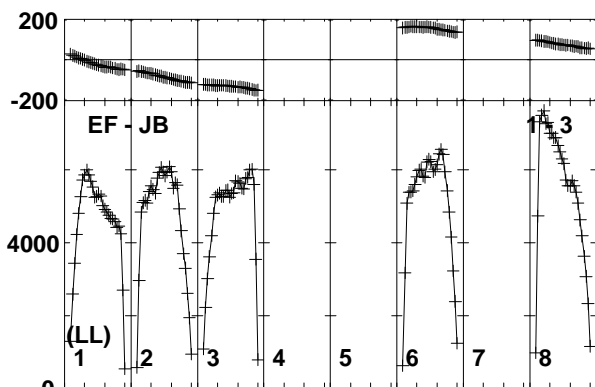
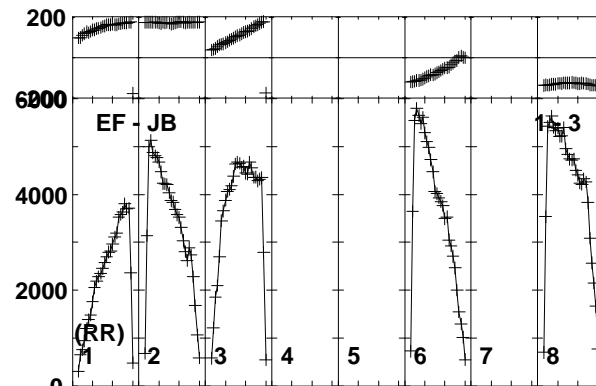
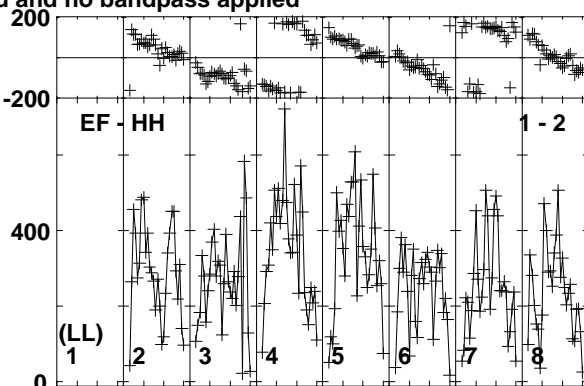
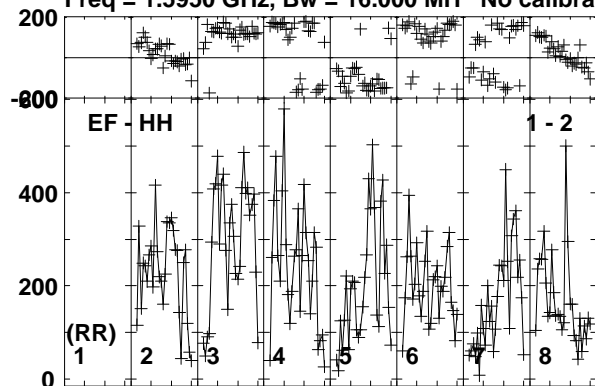

Lower frame: Micro Ampl Jy Top frame: Phas deg  
Vector averaged cross-power spectrum Baseline: EF (01) - HH (02)  
Timerange: 00:22:37:02 to 00:22:37:58

Plot file version 28 created 26-JUN-2015 10:51:16

J2025+3343 ET031A.UVDATA.1

Freq = 1.5950 GHz, Bw = 16.000 MH No calibration applied and no bandpass applied

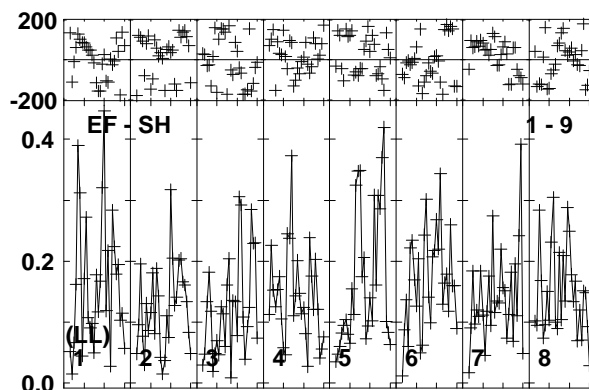
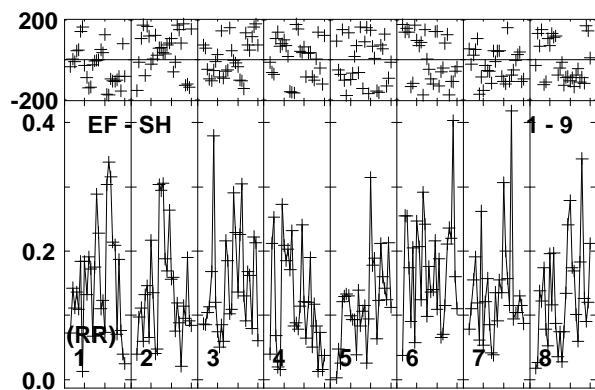
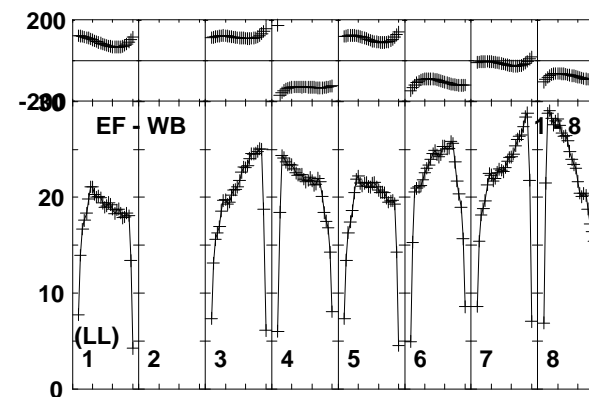
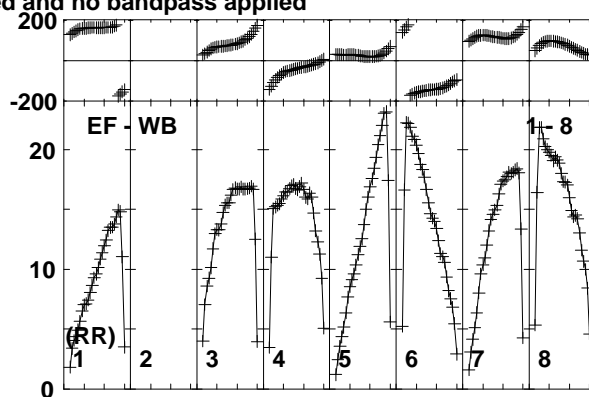
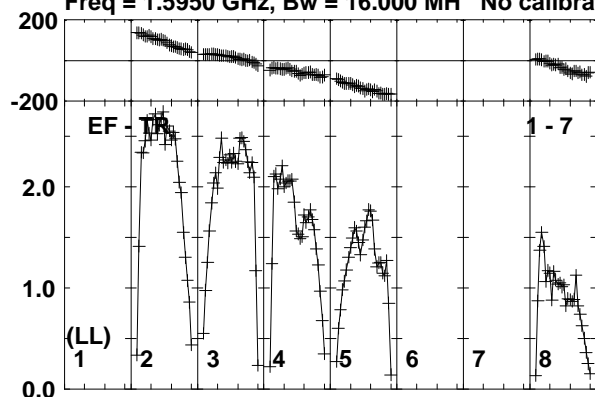

Channels

Lower frame: Milli Ampl Jy Top frame: Phas deg  
Vector averaged cross-power spectrum Baseline: EF (01) - TR (07)  
Timerange: 00/22:37:02 to 00/22:37:58

Plot file version 29 created 26-JUN-2015 10:51:16

V404CYG ET031A.UVDATA.1

Freq = 1.5950 GHz, Bw = 16.000 MH No calibration applied and no bandpass applied

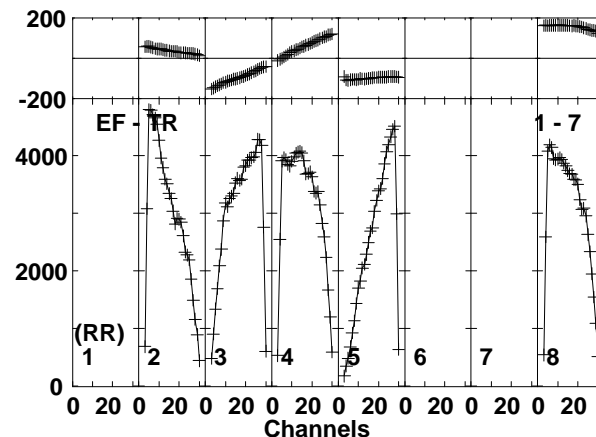
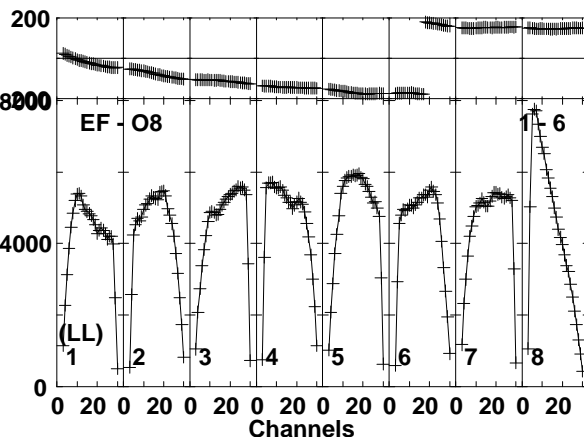
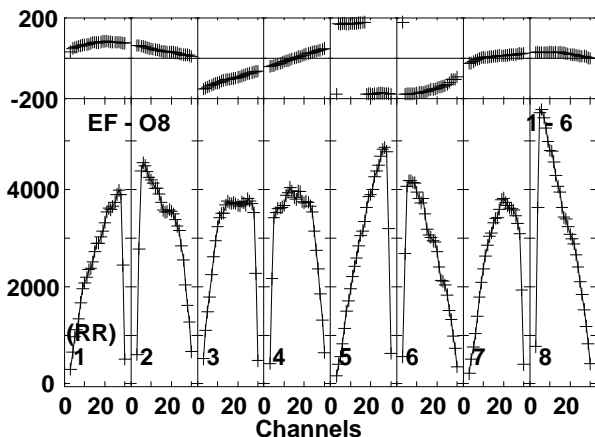
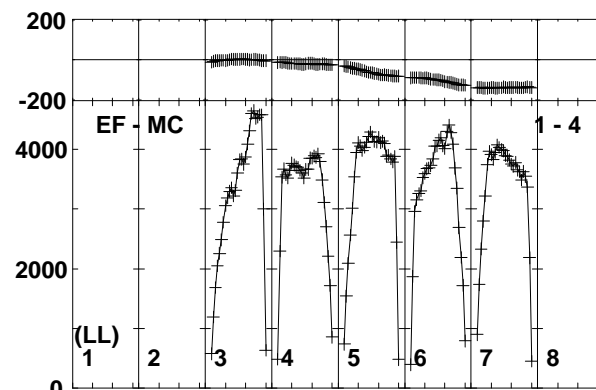
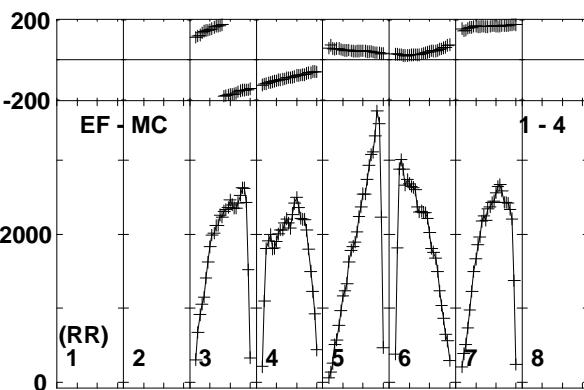
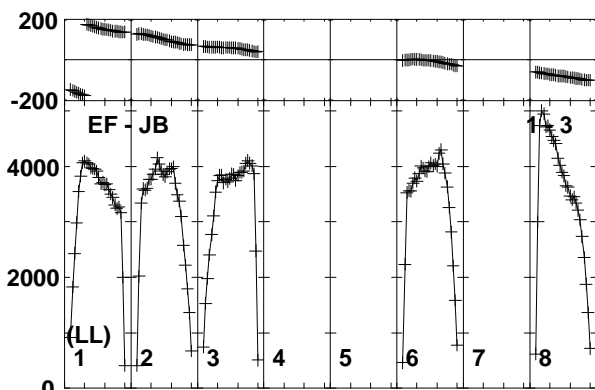
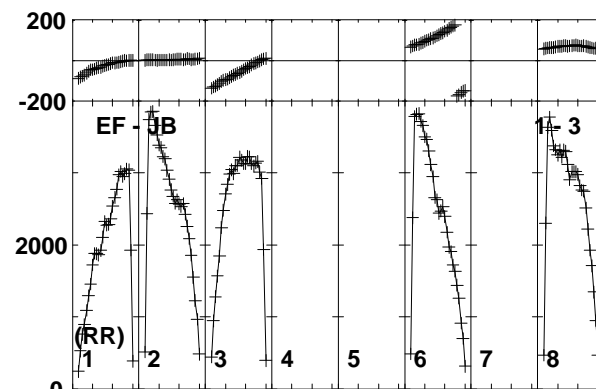
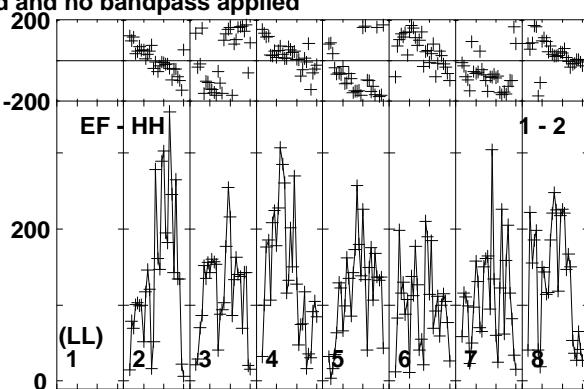
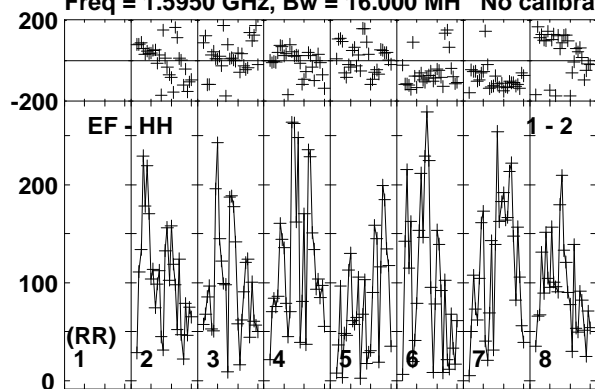

Lower frame: Micro Ampl Jy Top frame: Phas deg  
Vector averaged cross-power spectrum Baseline: EF (01) - HH (02)  
Timerange: 00:22:38:02 to 00:22:41:28

Plot file version 30 created 26-JUN-2015 10:51:17

V404CYG ET031A.UVDATA.1

Freq = 1.5950 GHz, Bw = 16.000 MH No calibration applied and no bandpass applied

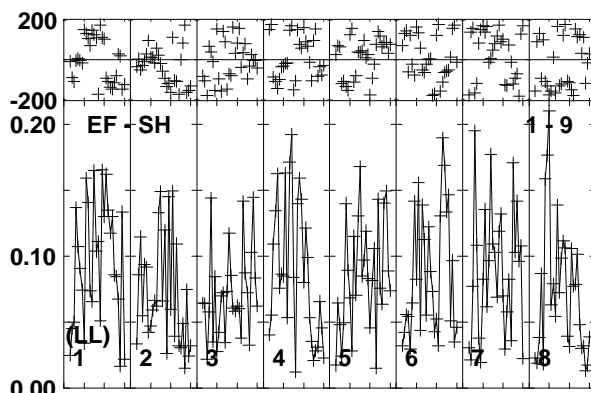
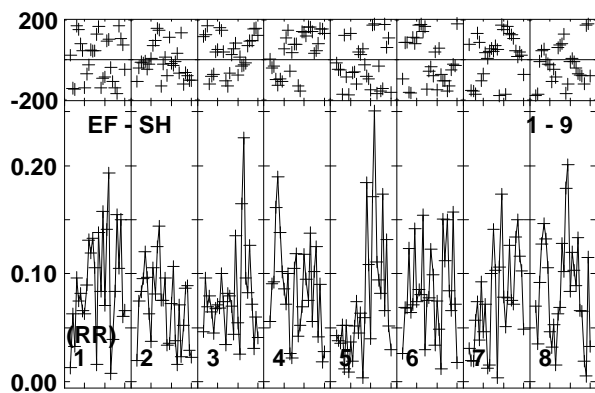
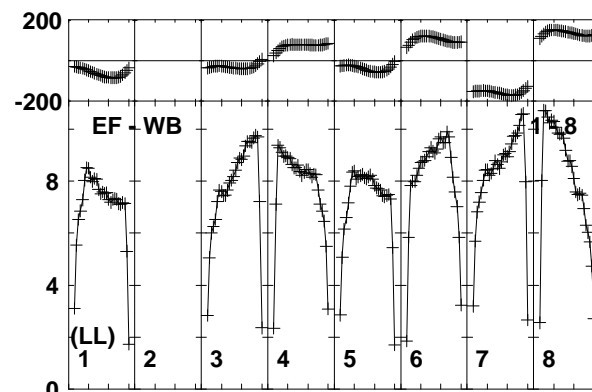
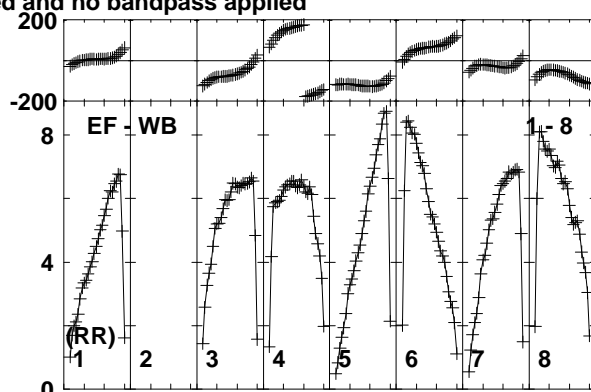
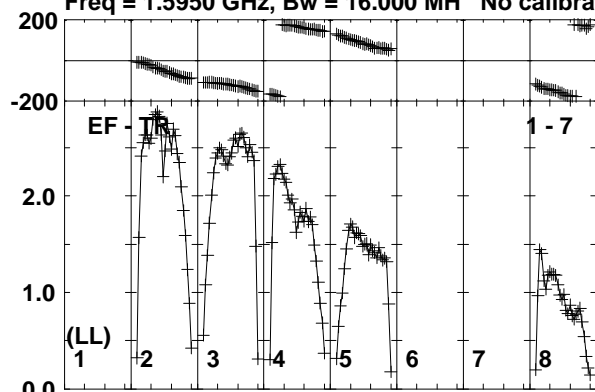

Channels

Lower frame: Milli Ampl Jy Top frame: Phas deg  
Vector averaged cross-power spectrum Baseline: EF (01) - TR (07)  
Timerange: 00/22:38:02 to 00/22:41:28

Plot file version 31 created 26-JUN-2015 10:51:17

J2025+3343 ET031A.UVDATA.1

Freq = 1.5950 GHz, Bw = 16.000 MH No calibration applied and no bandpass applied

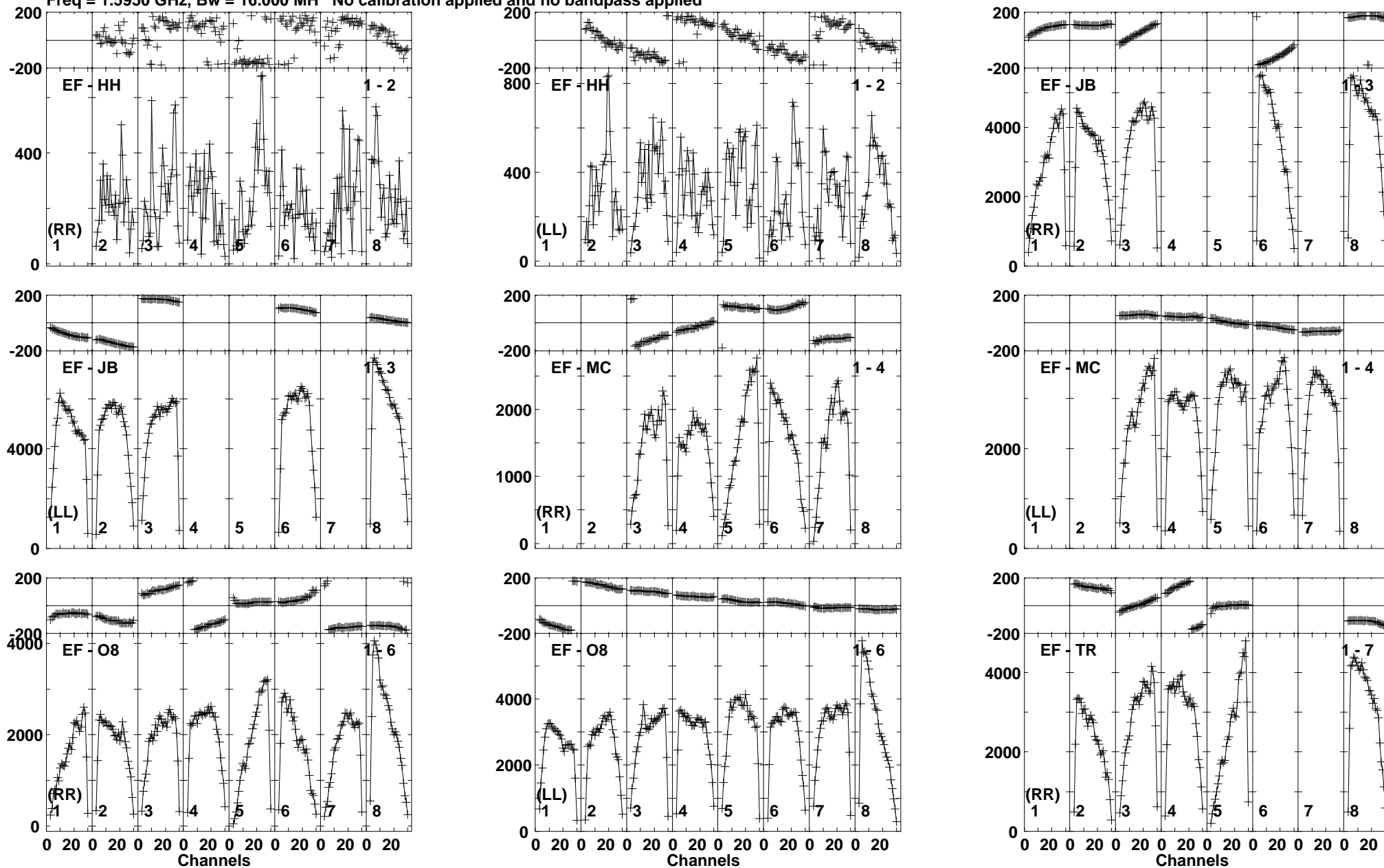

Lower frame: Micro Ampl Jy Top frame: Phas deg  
Vector averaged cross-power spectrum Baseline: EF (01) - HH (02)  
Timerange: 00:22:41:32 to 00:22:42:48

Plot file version 32 created 26-JUN-2015 10:51:17

J2025+3343 ET031A.UVDATA.1

Freq = 1.5950 GHz, Bw = 16.000 MH No calibration applied and no bandpass applied

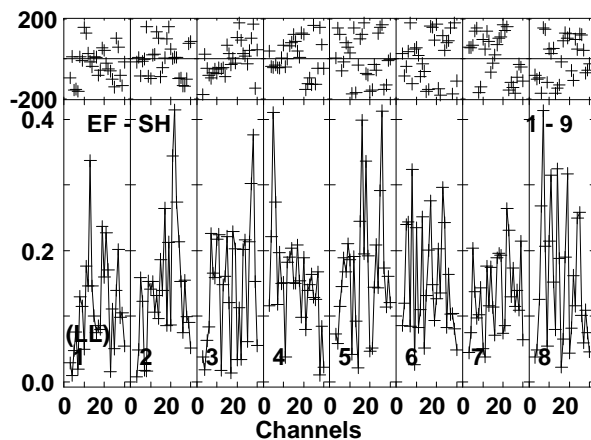
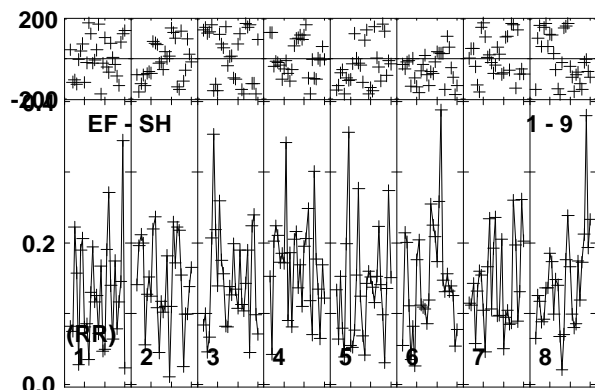
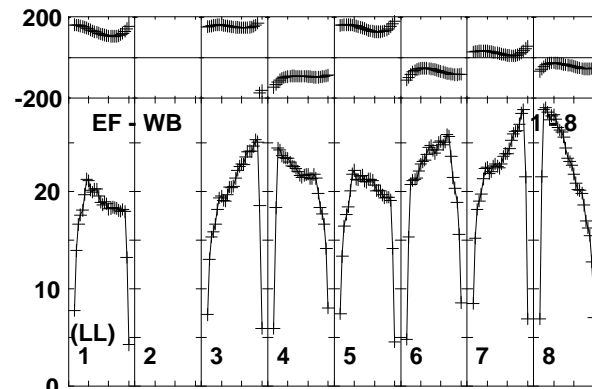
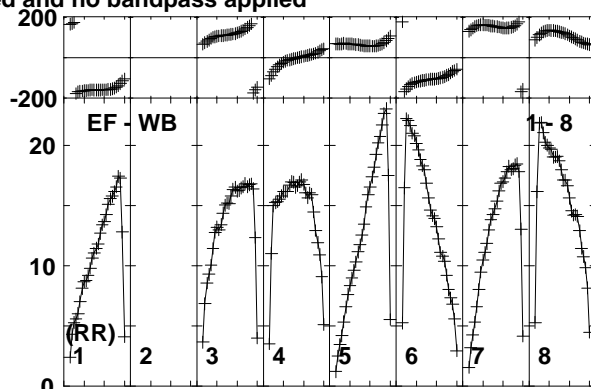
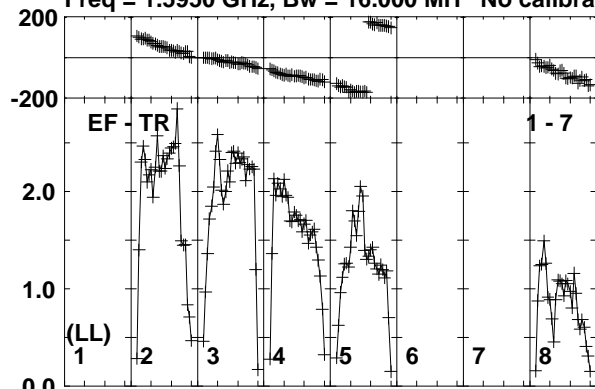

Lower frame: Milli Ampl Jy Top frame: Phas deg  
Vector averaged cross-power spectrum Baseline: EF (01) - TR (07)  
Timerange: 00/22:41:32 to 00/22:42:48



Plot file version 33 created 26-JUN-2015 10:51:17

V404CYG ET031A.UVDATA.1

Freq = 1.5950 GHz, Bw = 16.000 MH No calibration applied and no bandpass applied

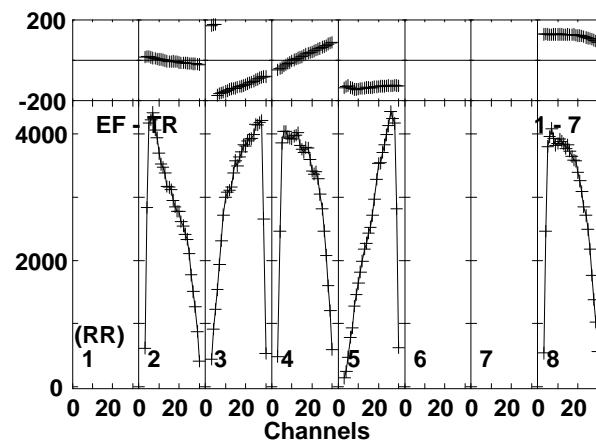
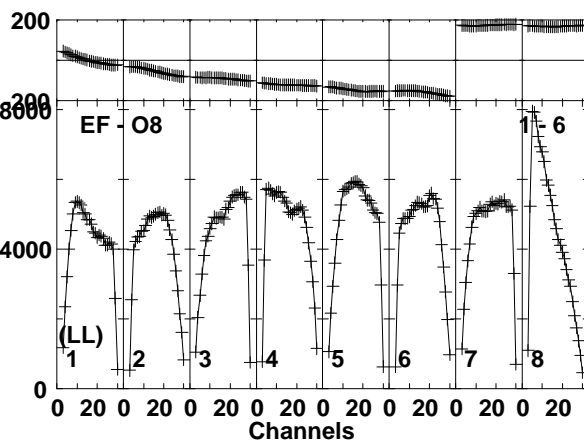
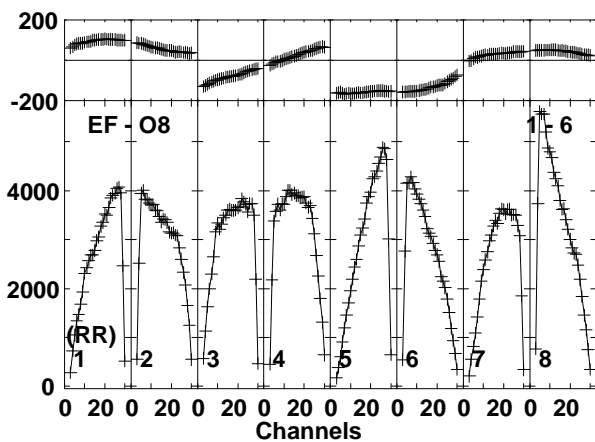
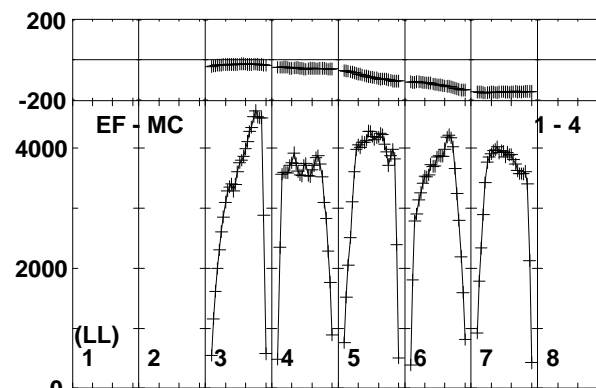
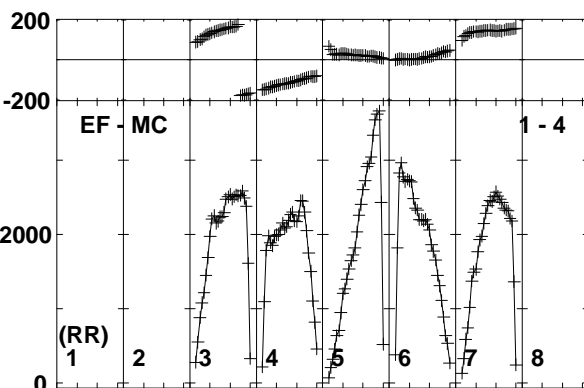
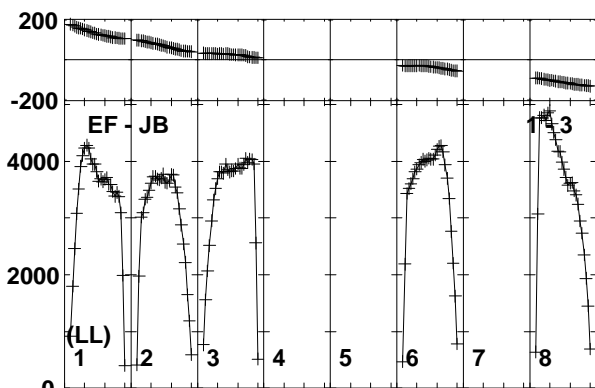
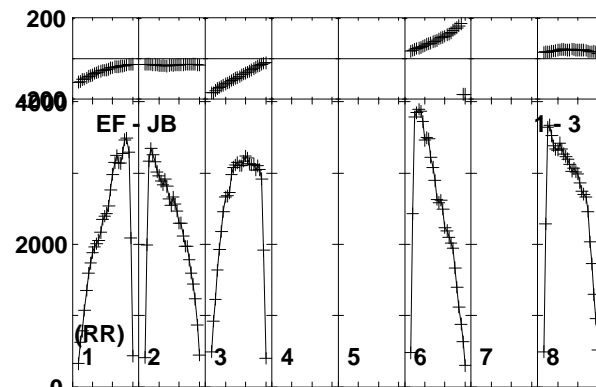
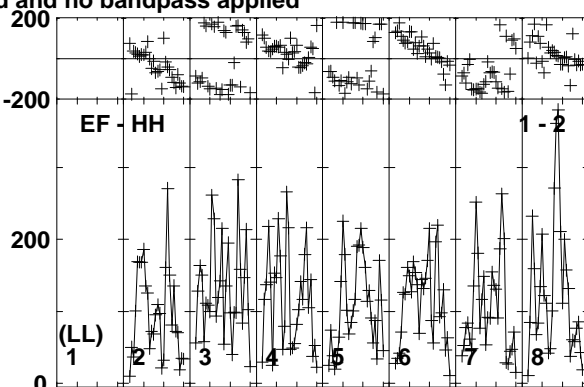
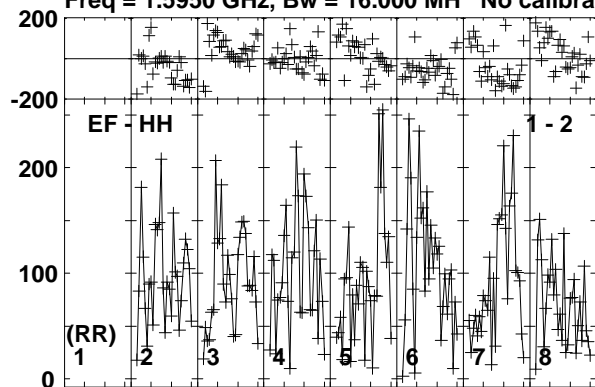

Lower frame: Micro Ampl Jy Top frame: Phas deg  
Vector averaged cross-power spectrum Baseline: EF (01) - HH (02)  
Timerange: 00:22:42:52 to 00:22:46:18

Plot file version 34 created 26-JUN-2015 10:51:17

V404CYG ET031A.UVDATA.1

Freq = 1.5950 GHz, Bw = 16.000 MH No calibration applied and no bandpass applied

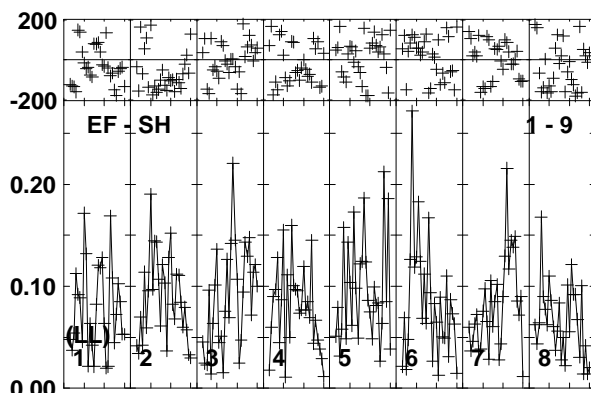
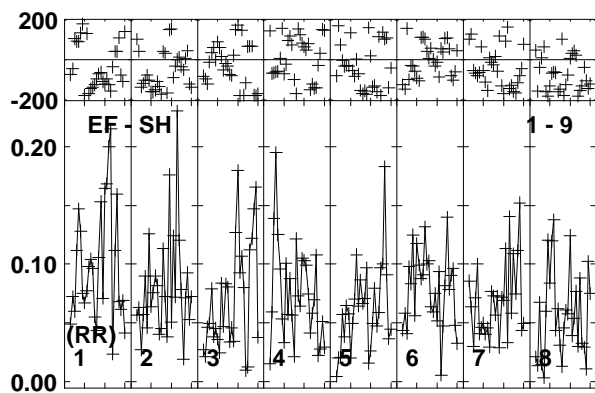
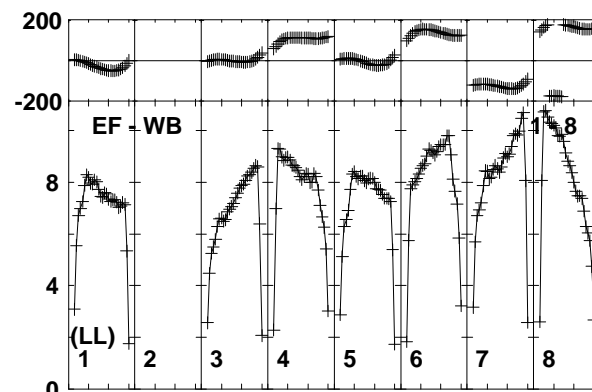
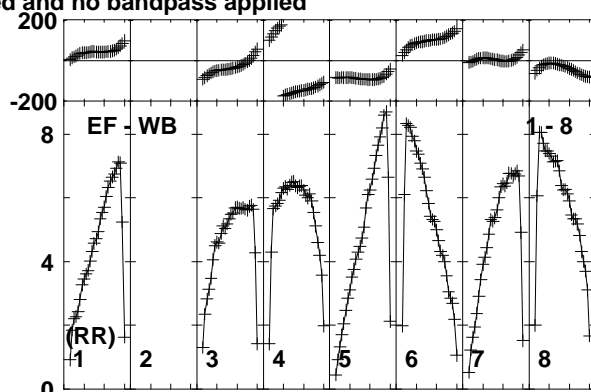
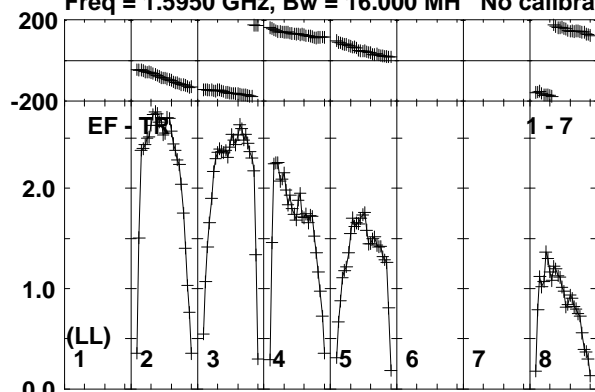

Channels

Lower frame: Milli Ampl Jy Top frame: Phas deg  
Vector averaged cross-power spectrum Baseline: EF (01) - TR (07)  
Timerange: 00:22:42:52 to 00:22:46:18

Plot file version 35 created 26-JUN-2015 10:51:17

J2025+3343 ET031A.UVDATA.1

Freq = 1.5950 GHz, Bw = 16.000 MH No calibration applied and no bandpass applied

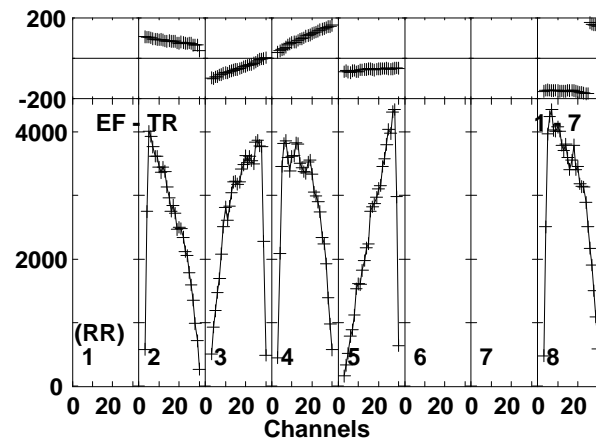
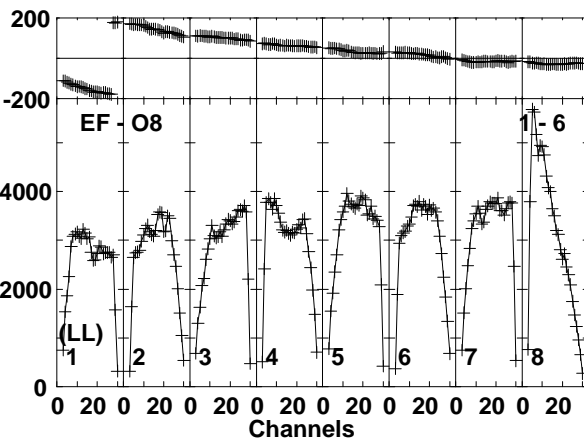
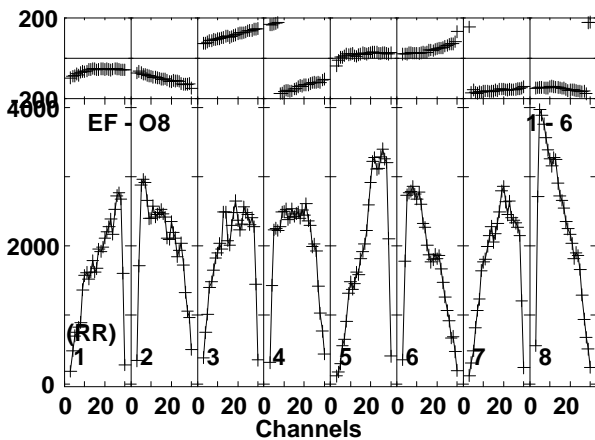
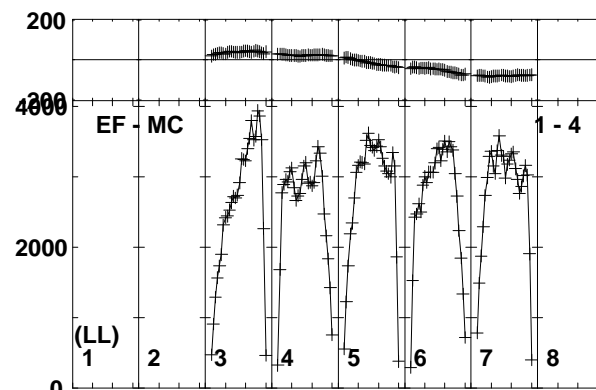
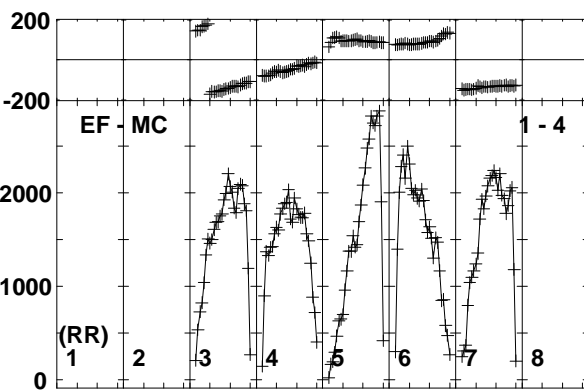
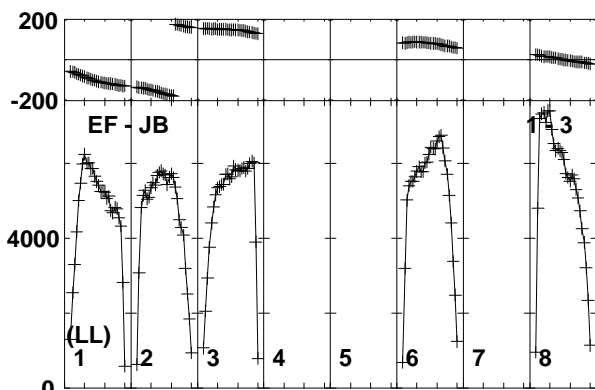
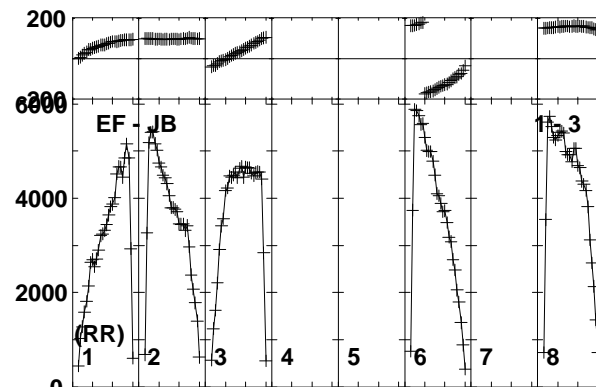
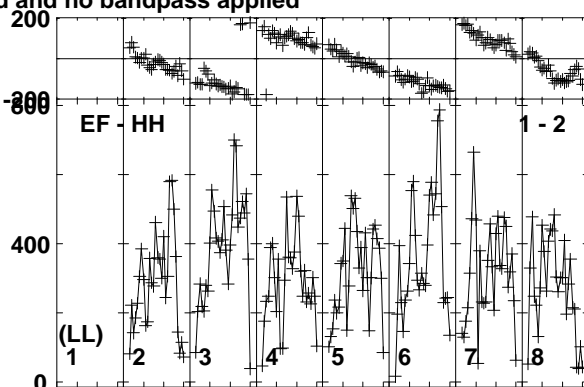
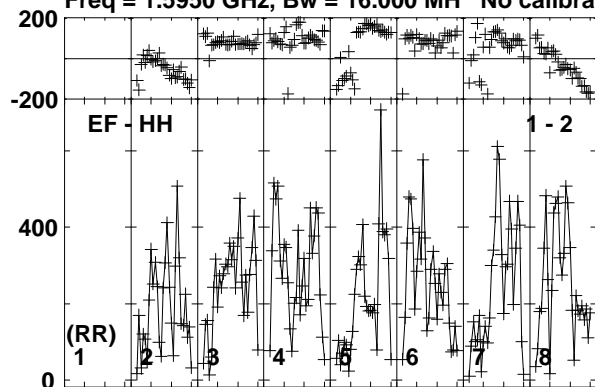

Lower frame: Micro Ampl Jy Top frame: Phas deg  
Vector averaged cross-power spectrum Baseline: EF (01) - HH (02)  
Timerange: 00:22:47:02 to 00:22:47:58

Plot file version 36 created 26-JUN-2015 10:51:17

J2025+3343 ET031A.UVDATA.1

Freq = 1.5950 GHz, Bw = 16.000 MH No calibration applied and no bandpass applied

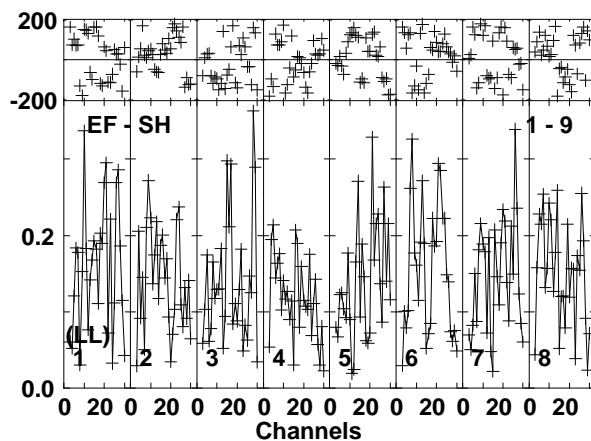
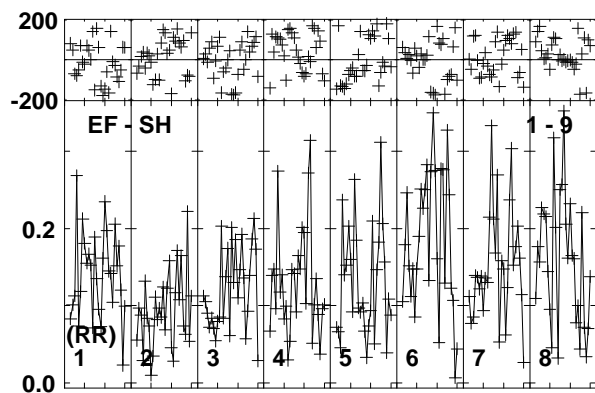
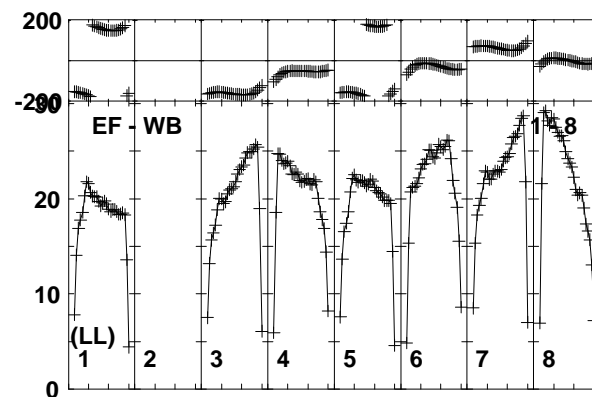
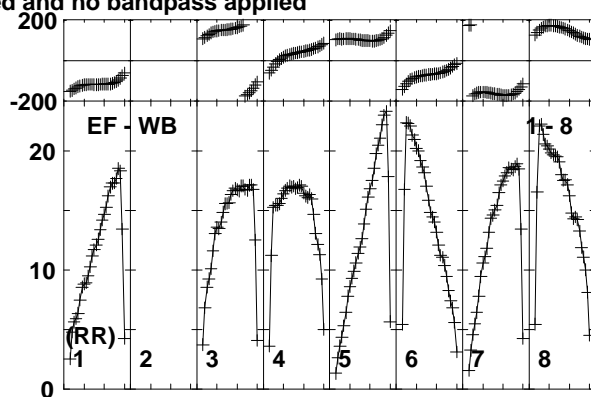
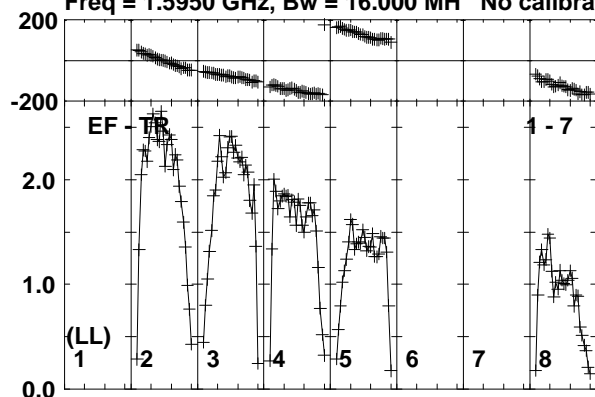

Lower frame: Milli Ampl Jy Top frame: Phas deg  
Vector averaged cross-power spectrum Baseline: EF (01) - TR (07)  
Timerange: 00:22:47:02 to 00:22:47:58

Plot file version 37 created 26-JUN-2015 10:51:17

V404CYG ET031A.UVDATA.1

Freq = 1.5950 GHz, Bw = 16.000 MH No calibration applied and no bandpass applied

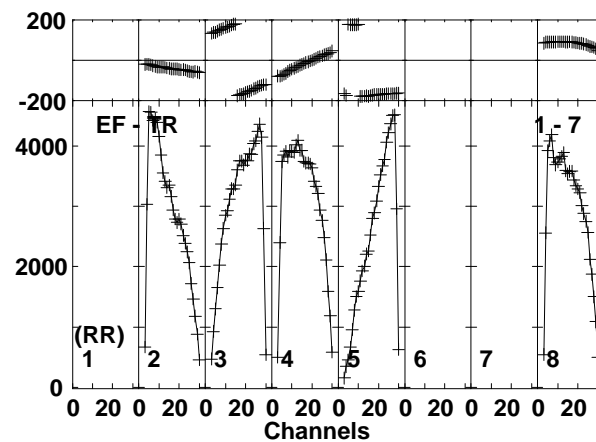
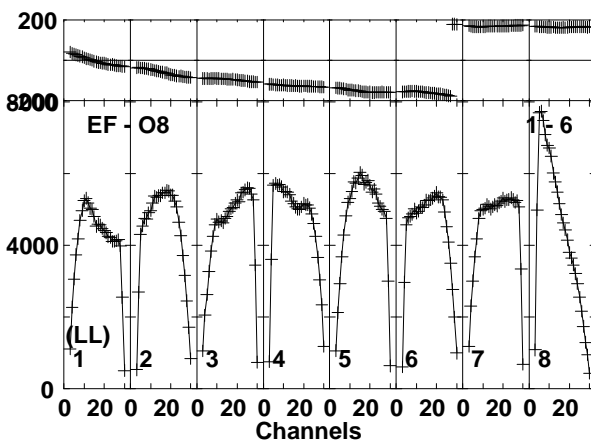
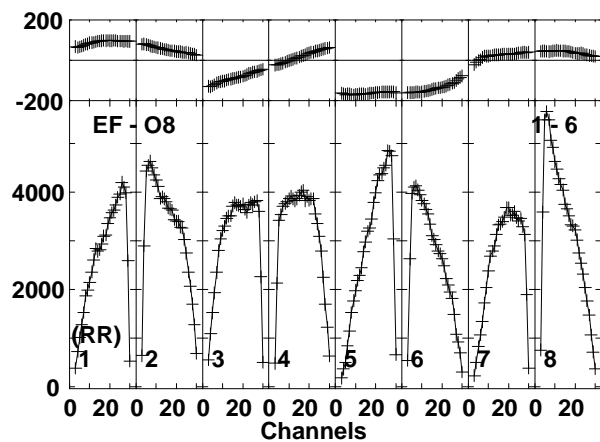
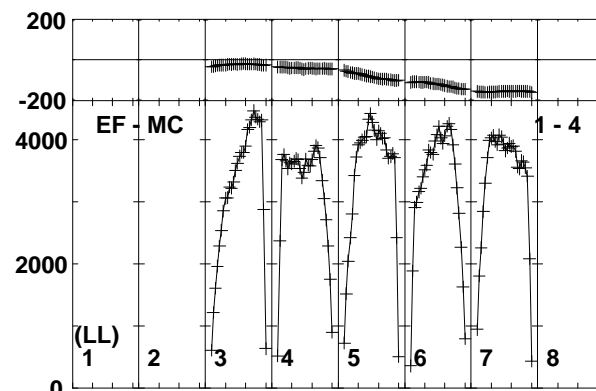
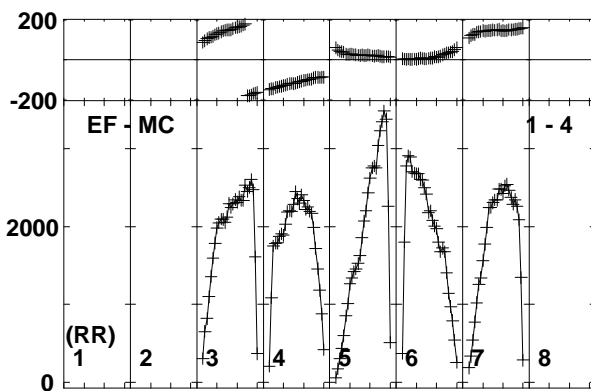
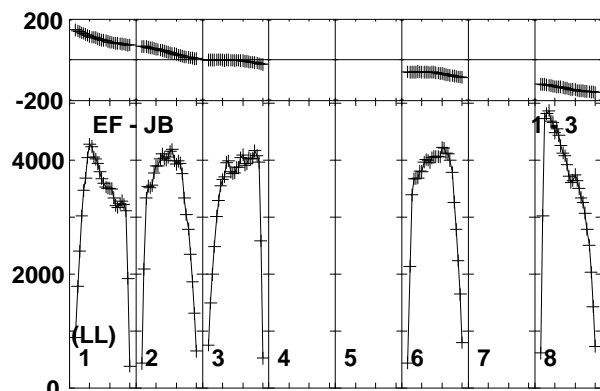
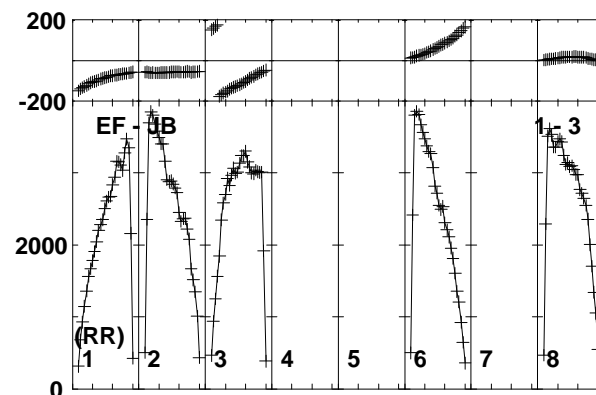
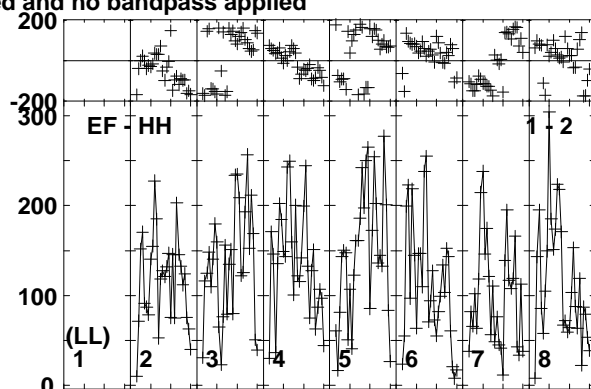
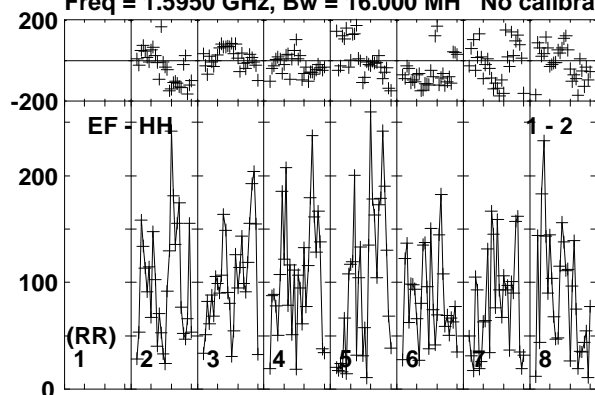

Lower frame: Micro Ampl Jy Top frame: Phas deg  
Vector averaged cross-power spectrum Baseline: EF (01) - HH (02)  
Timerange: 00:22:48:02 to 00:22:51:28

Plot file version 38 created 26-JUN-2015 10:51:17

V404CYG ET031A.UVDATA.1

Freq = 1.5950 GHz, Bw = 16.000 MH No calibration applied and no bandpass applied

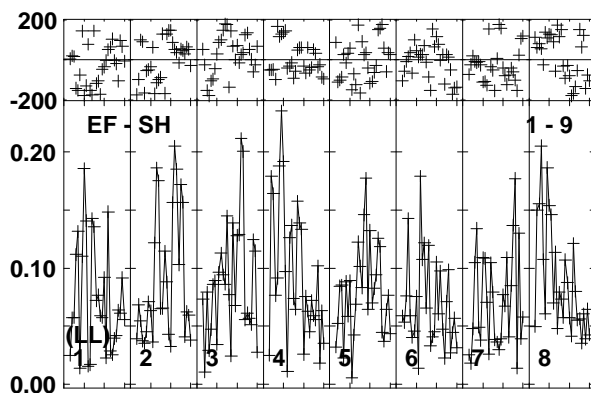
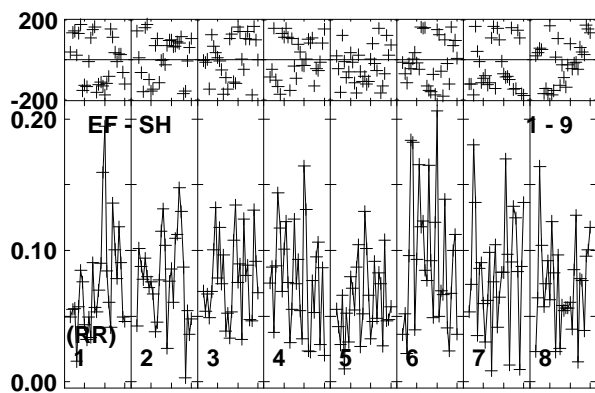
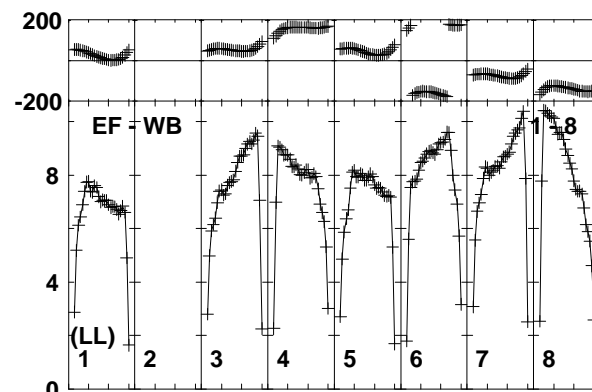
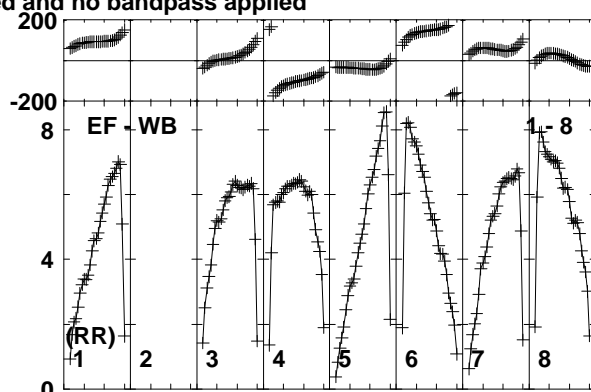
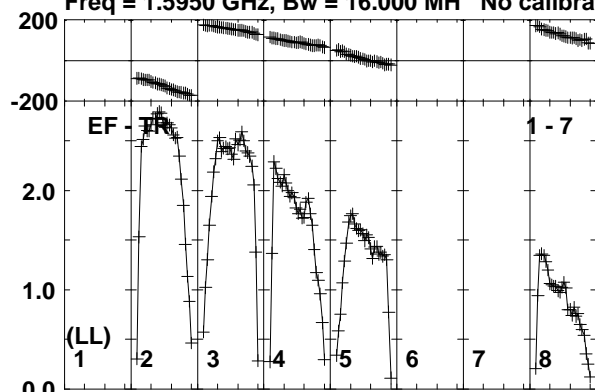

Channels

Lower frame: Milli Ampl Jy Top frame: Phas deg  
Vector averaged cross-power spectrum Baseline: EF (01) - TR (07)  
Timerange: 00:22:48:02 to 00:22:51:28

Plot file version 39 created 26-JUN-2015 10:51:17

J2025+3343 ET031A.UVDATA.1

Freq = 1.5950 GHz, Bw = 16.000 MH No calibration applied and no bandpass applied

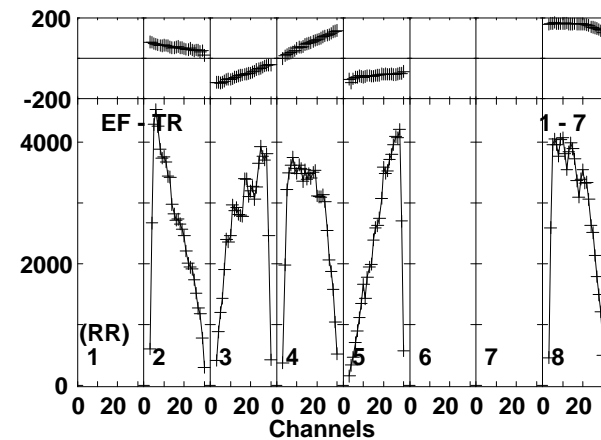
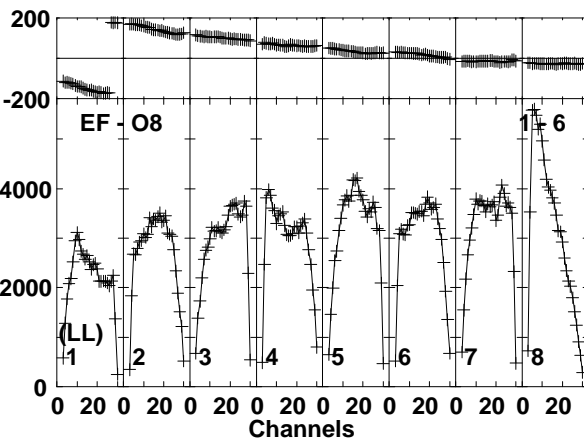
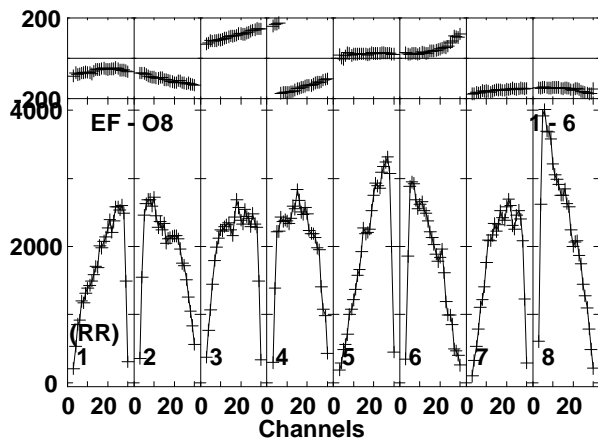
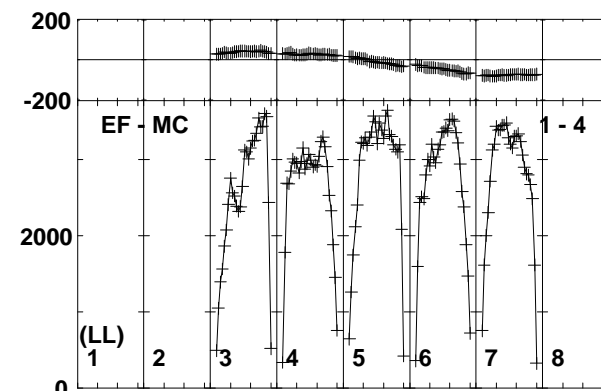
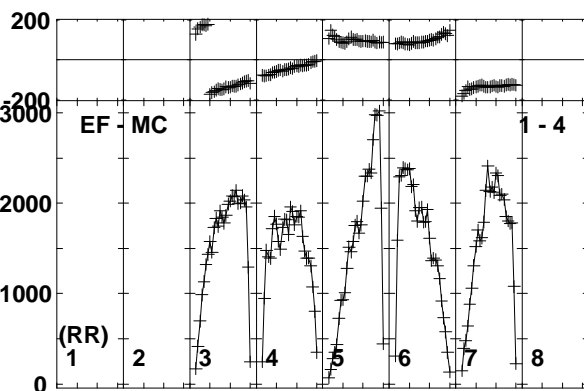
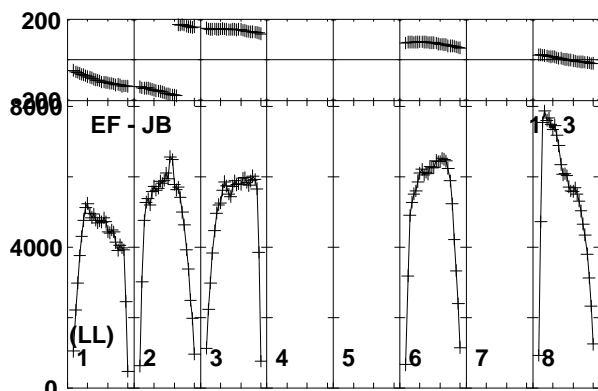
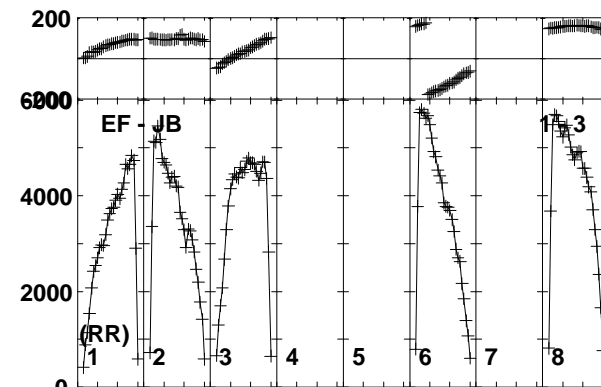
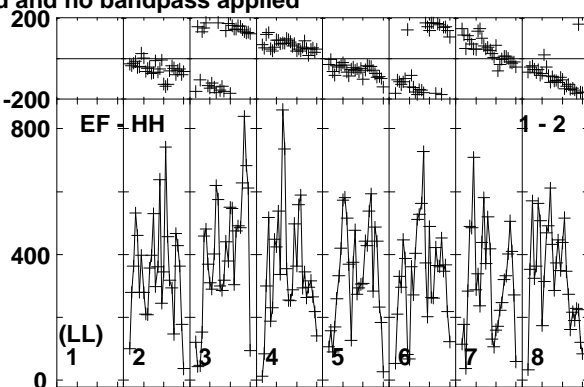
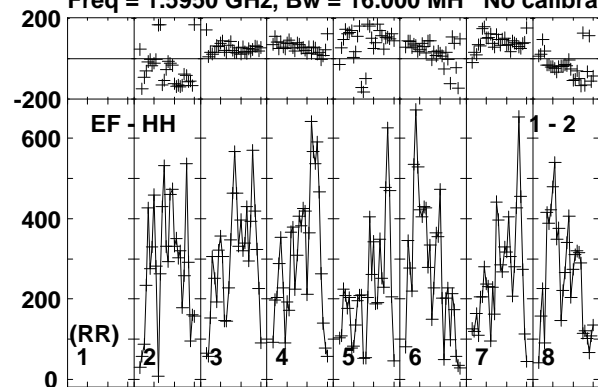

Lower frame: Micro Ampl Jy Top frame: Phas deg  
Vector averaged cross-power spectrum Baseline: EF (01) - HH (02)  
Timerange: 00:22:51:32 to 00:22:52:48

Plot file version 40 created 26-JUN-2015 10:51:17  
 J2025+3343 ET031A.UVDATA.1  
 Freq = 1.5950 GHz, Bw = 16.000 MH No calibration applied and no bandpass applied

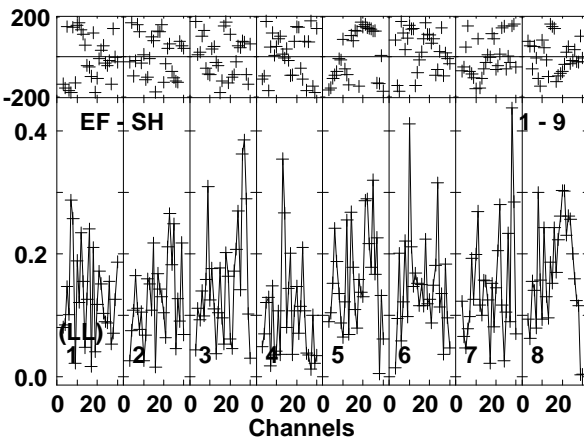
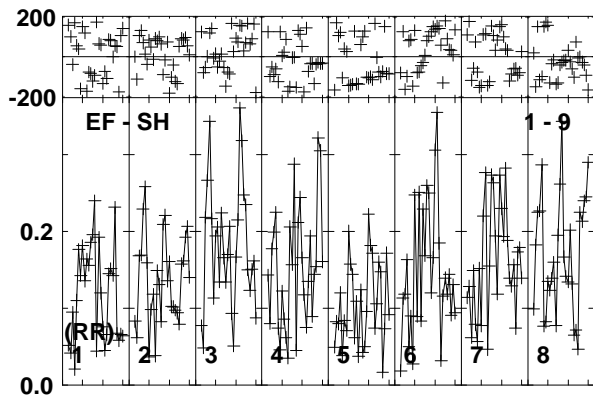
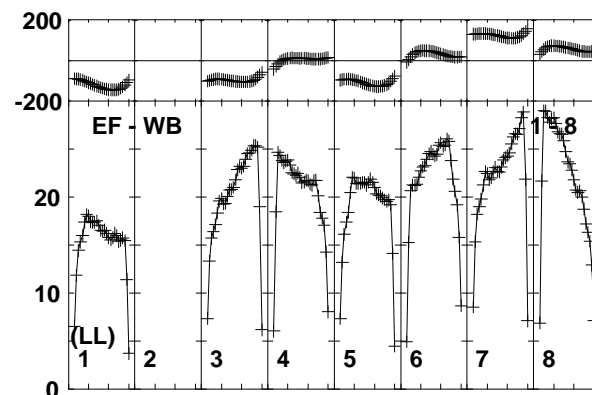
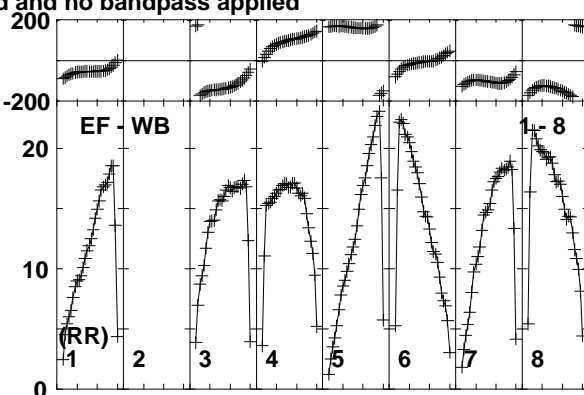
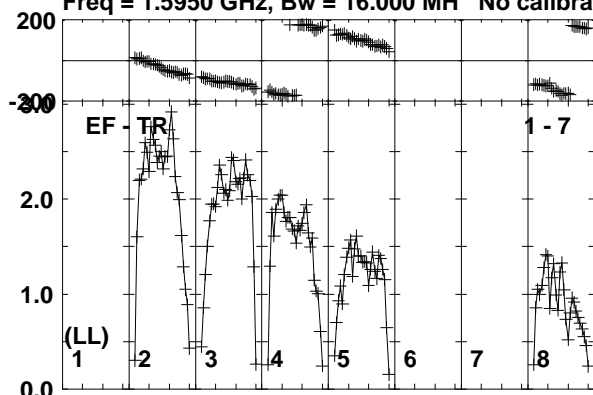

Lower frame: Milli Ampl Jy Top frame: Phas deg  
 Vector averaged cross-power spectrum Baseline: EF (01) - TR (07)  
 Timerange: 00:22:51:32 to 00:22:52:48



Plot file version 41 created 26-JUN-2015 10:51:17

V404CYG ET031A.UVDATA.1

Freq = 1.5950 GHz, Bw = 16.000 MH No calibration applied and no bandpass applied

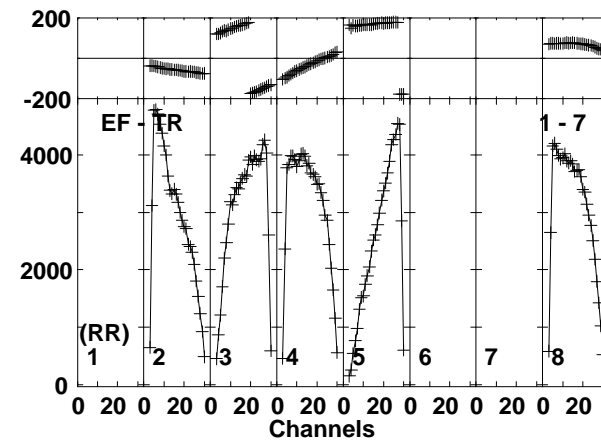
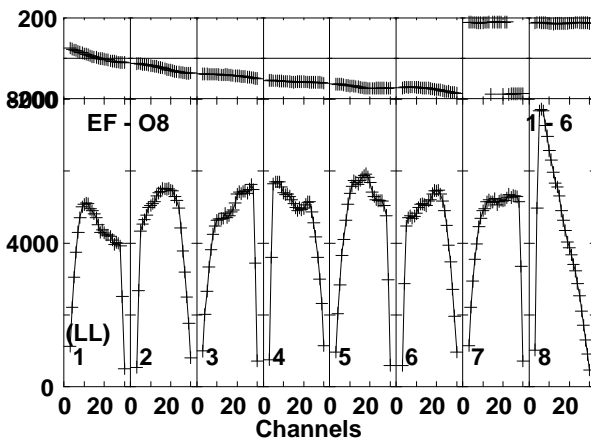
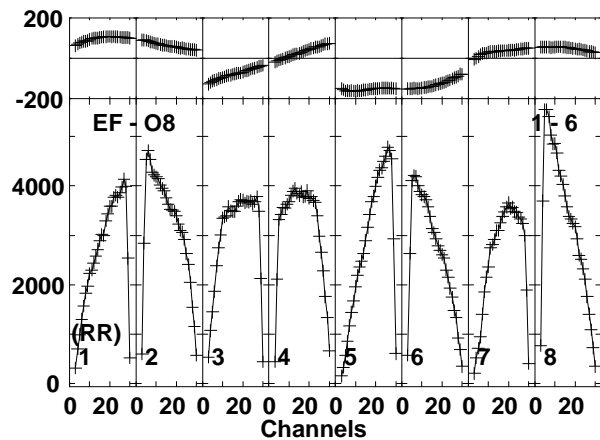
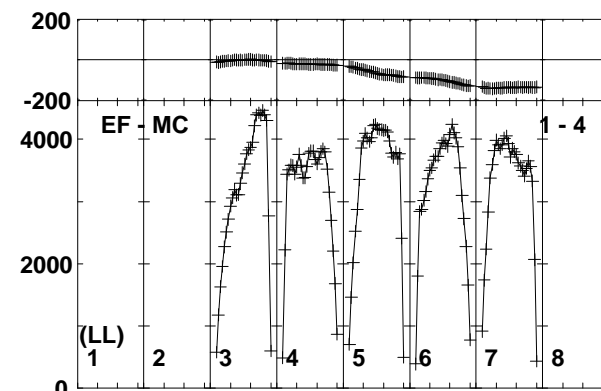
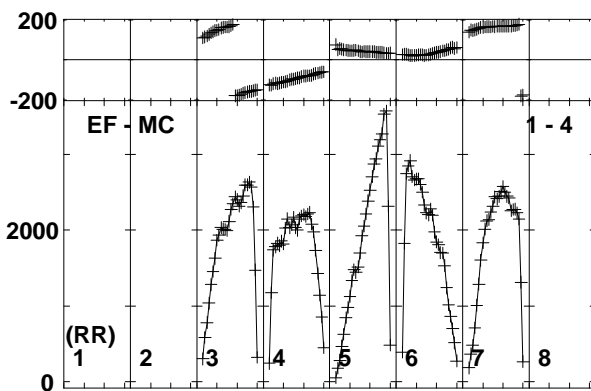
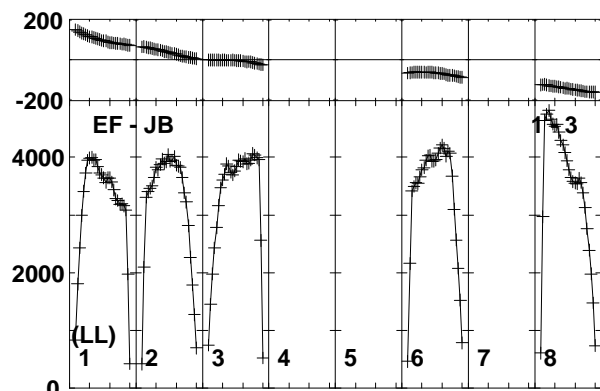
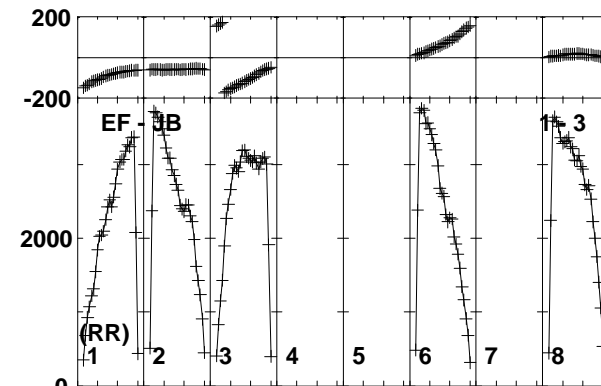
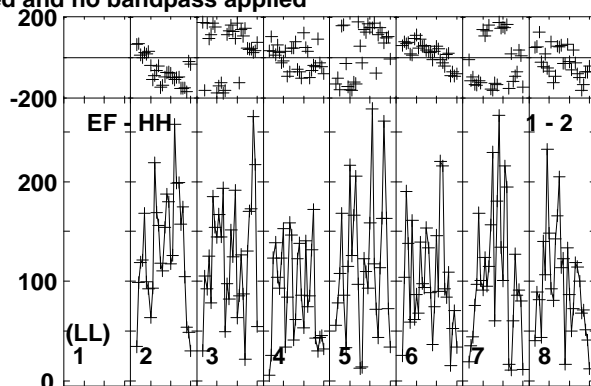
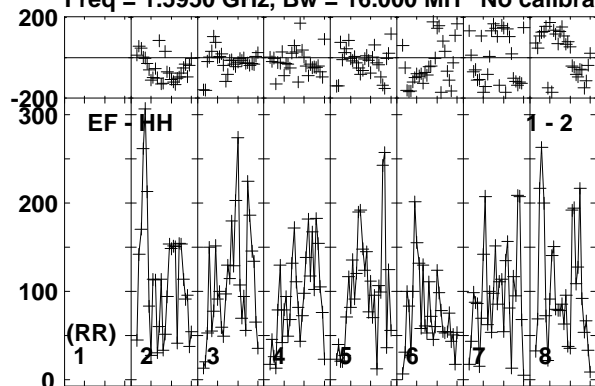

Lower frame: Micro Ampl Jy Top frame: Phas deg  
Vector averaged cross-power spectrum Baseline: EF (01) - HH (02)  
Timerange: 00:22:52:52 to 00:22:56:18

Plot file version 42 created 26-JUN-2015 10:51:17

V404CYG ET031A.UVDATA.1

Freq = 1.5950 GHz, Bw = 16.000 MH No calibration applied and no bandpass applied

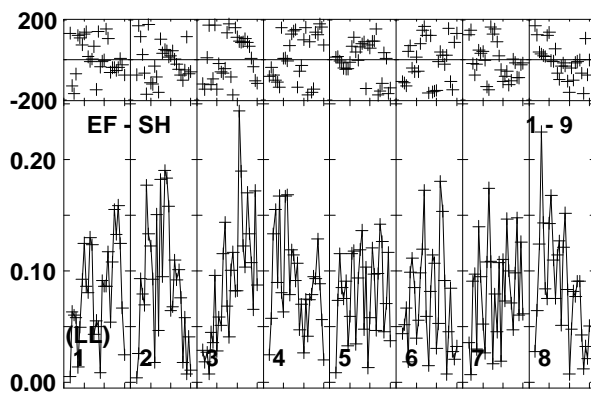
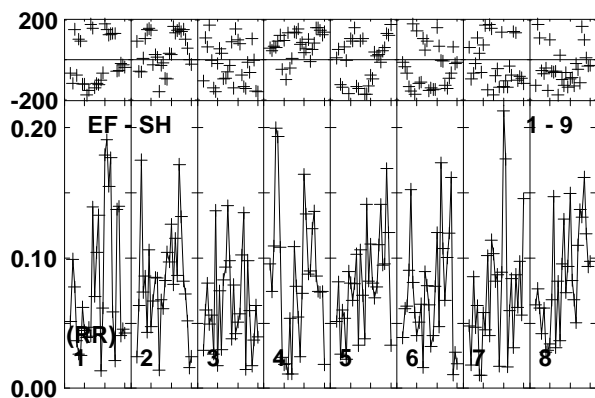
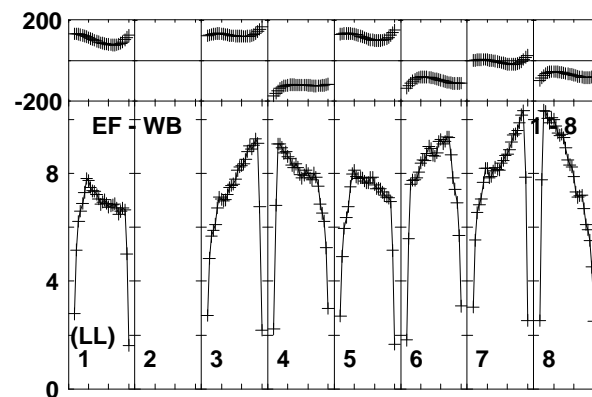
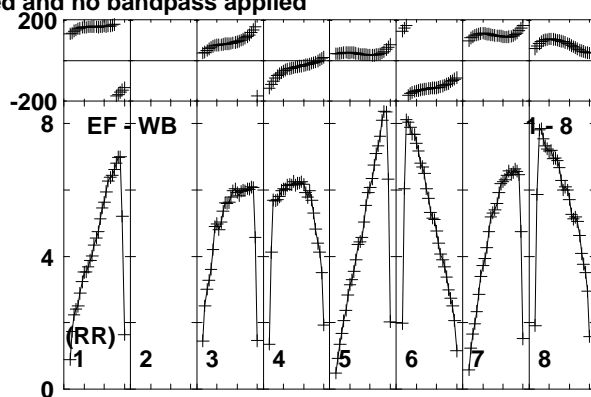
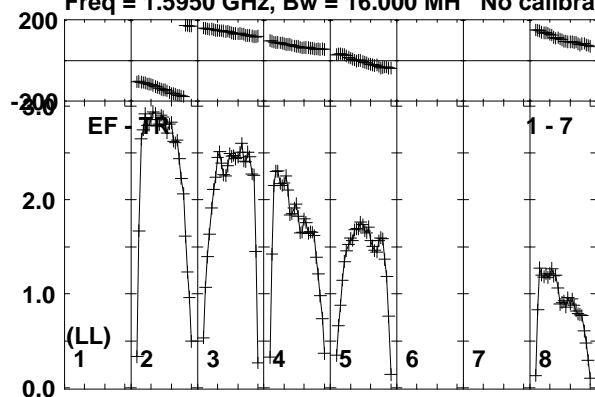

Channels

Lower frame: Milli Ampl Jy Top frame: Phas deg  
Vector averaged cross-power spectrum Baseline: EF (01) - TR (07)  
Timerange: 00/22:52:52 to 00/22:56:18

Plot file version 43 created 26-JUN-2015 10:51:17

J2025+3343 ET031A.UVDATA.1

Freq = 1.5950 GHz, Bw = 16.000 MH No calibration applied and no bandpass applied

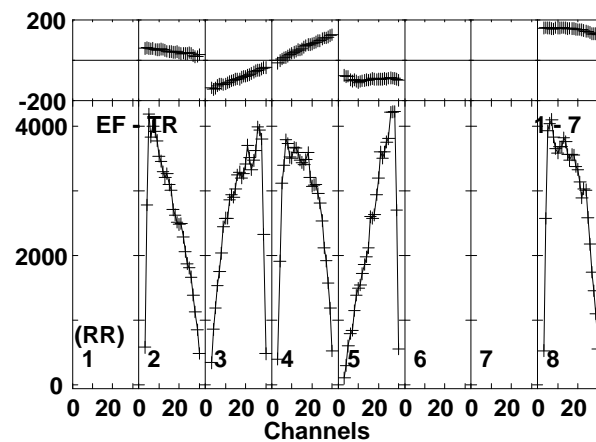
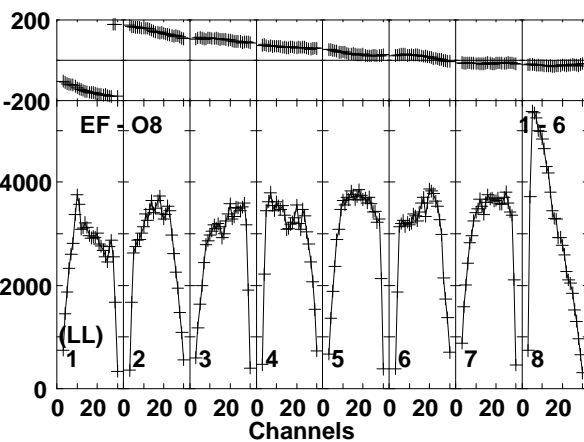
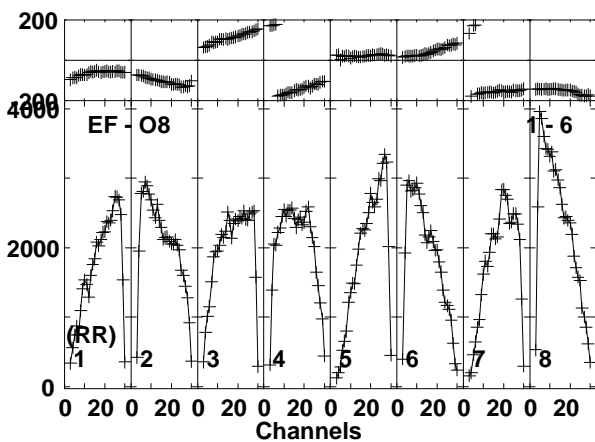
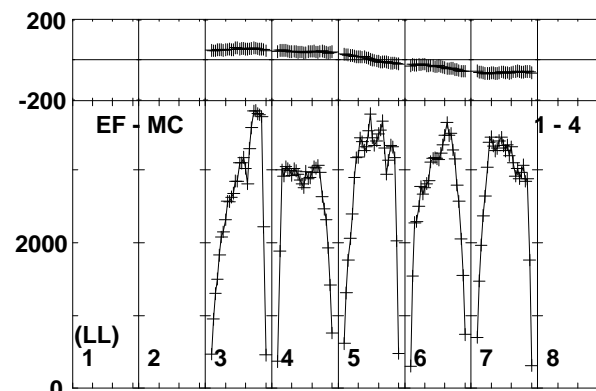
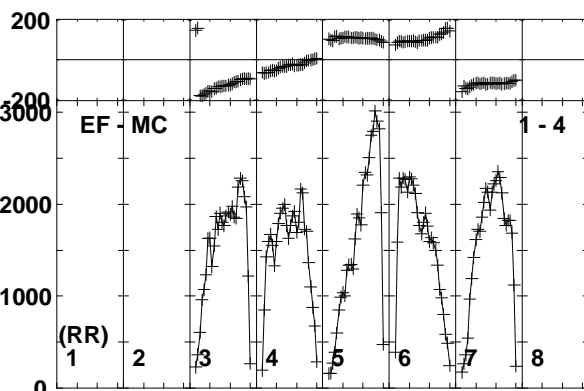
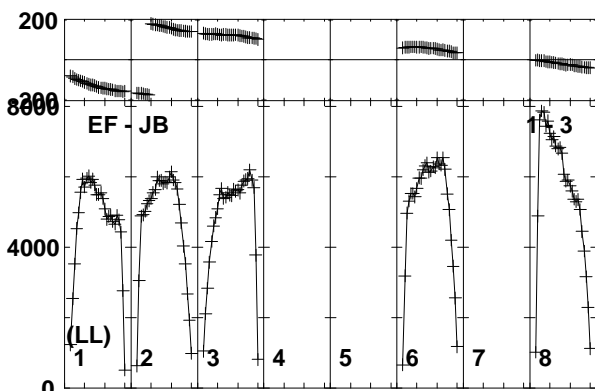
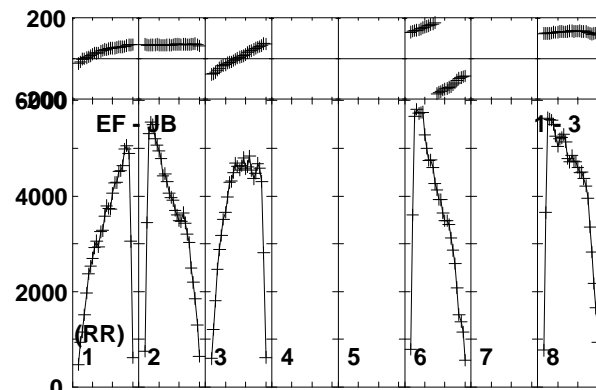
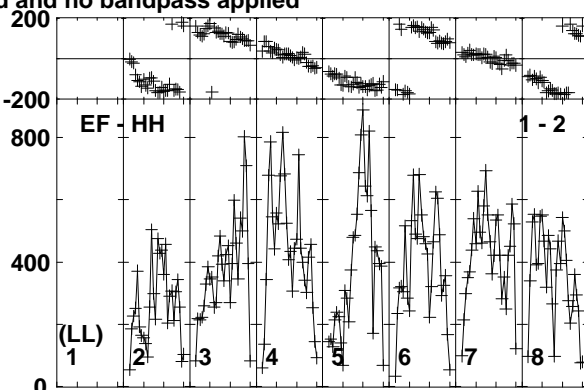
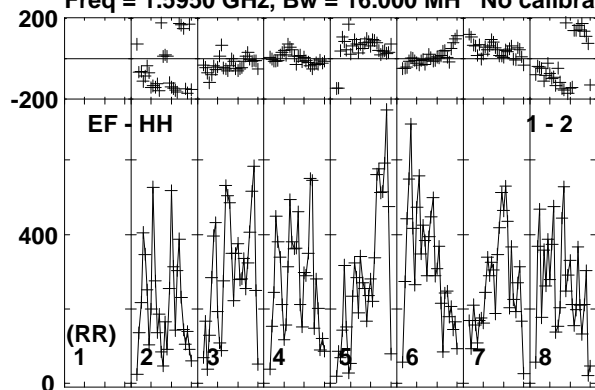

Lower frame: Micro Ampl Jy Top frame: Phas deg  
Vector averaged cross-power spectrum Baseline: EF (01) - HH (02)  
Timerange: 00:22:57:02 to 00:22:57:58

Plot file version 44 created 26-JUN-2015 10:51:17

J2025+3343 ET031A.UVDATA.1

Freq = 1.5950 GHz, Bw = 16.000 MH No calibration applied and no bandpass applied

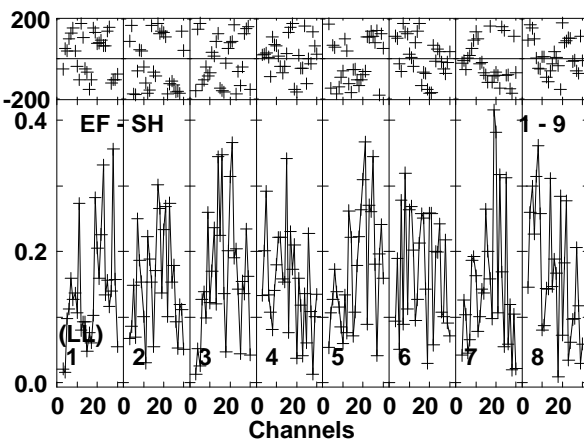
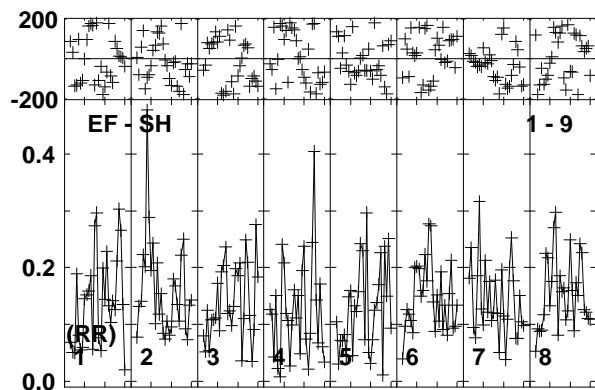
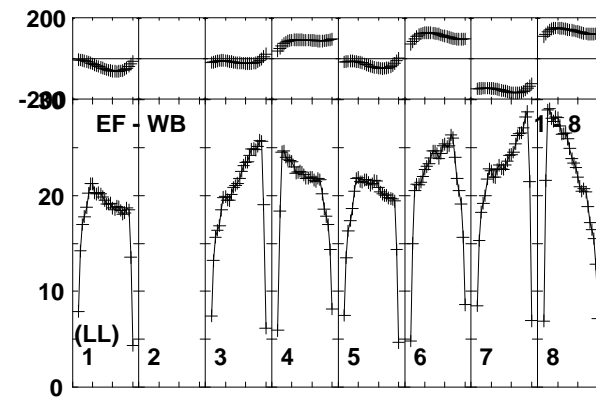
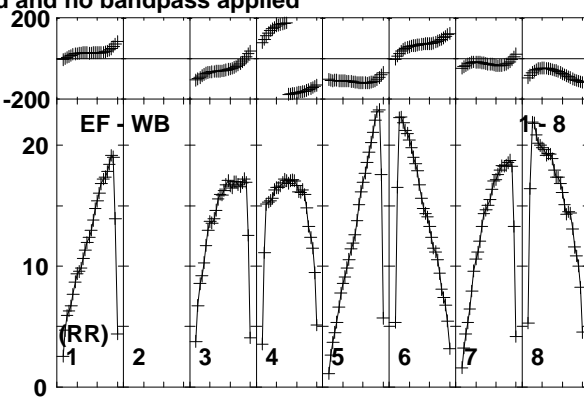
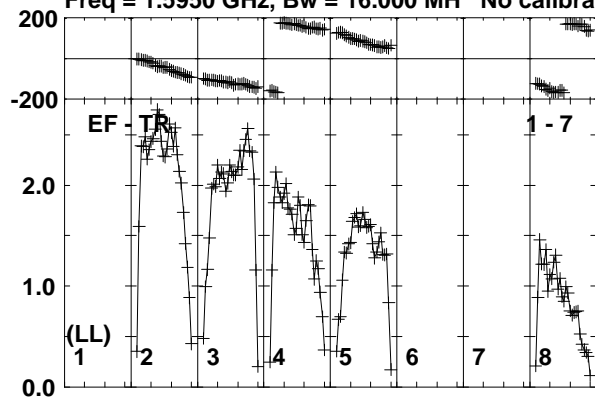

Lower frame: Milli Ampl Jy Top frame: Phas deg  
Vector averaged cross-power spectrum Baseline: EF (01) - TR (07)  
Timerange: 00/22:57:02 to 00/22:57:58

Plot file version 45 created 26-JUN-2015 10:51:17

V404CYG ET031A.UVDATA.1

Freq = 1.5950 GHz, Bw = 16.000 MH No calibration applied and no bandpass applied

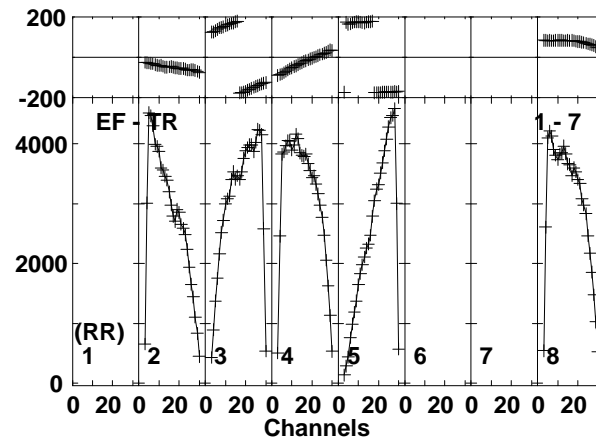
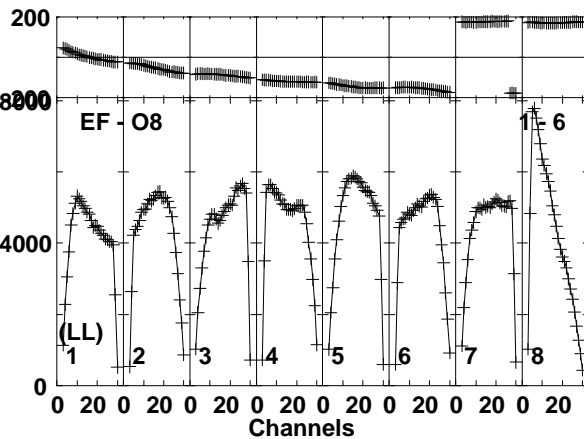
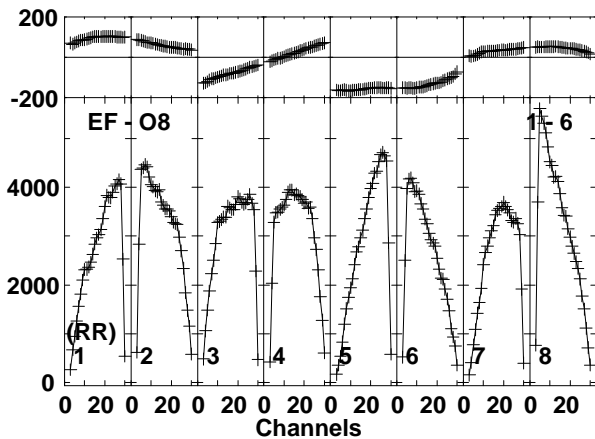
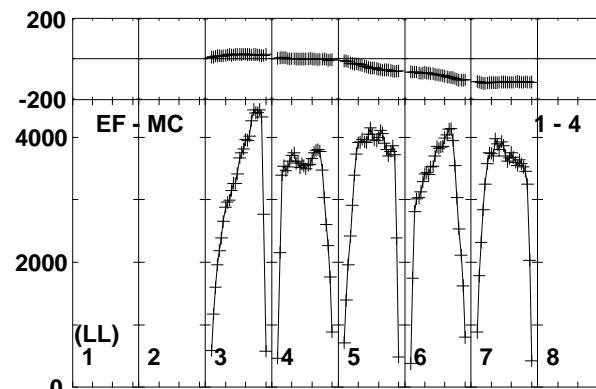
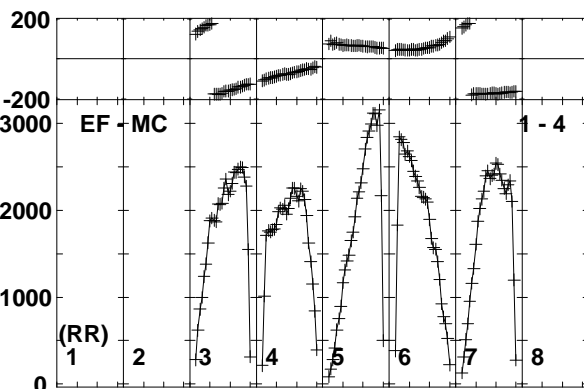
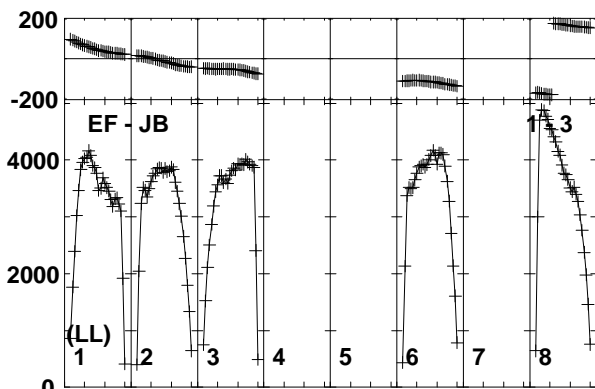
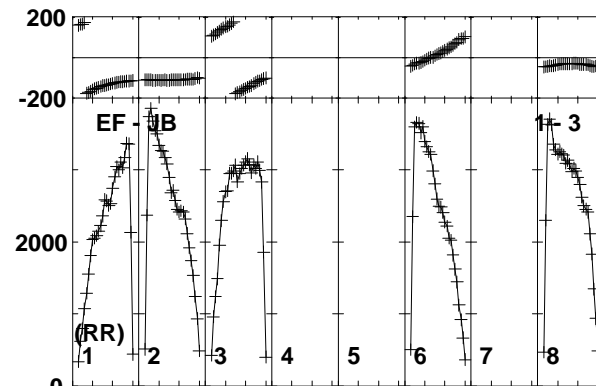
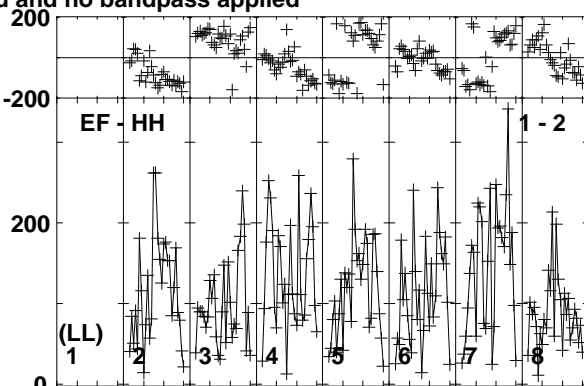
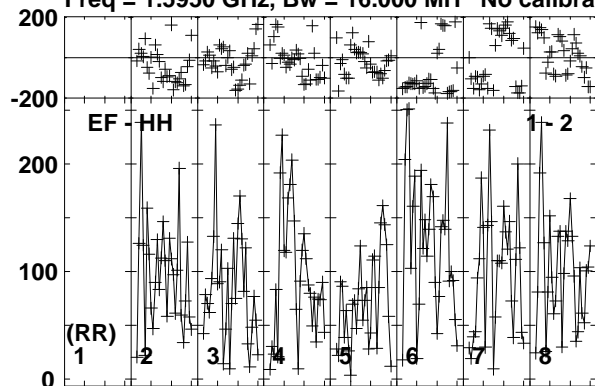

Lower frame: Micro Ampl Jy Top frame: Phas deg  
Vector averaged cross-power spectrum Baseline: EF (01) - HH (02)  
Timerange: 00/22:58:02 to 00/23:01:28

Plot file version 46 created 26-JUN-2015 10:51:17

V404CYG ET031A.UVDATA.1

Freq = 1.5950 GHz, Bw = 16.000 MH No calibration applied and no bandpass applied

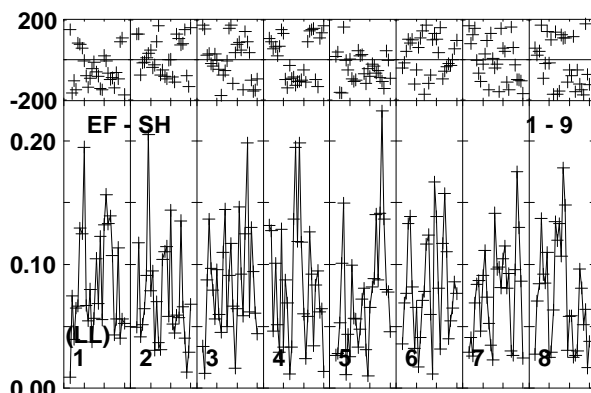
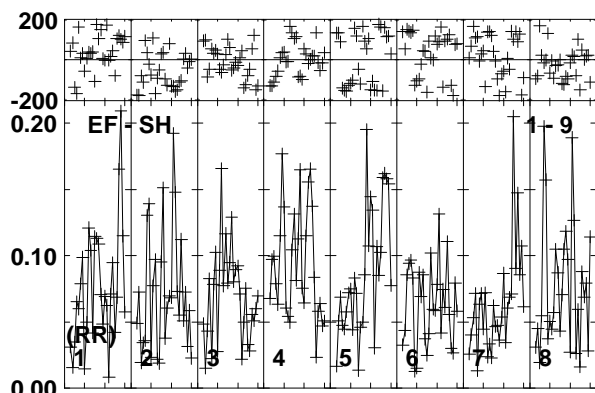
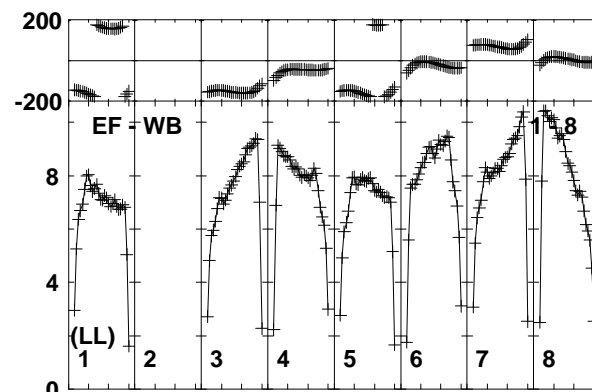
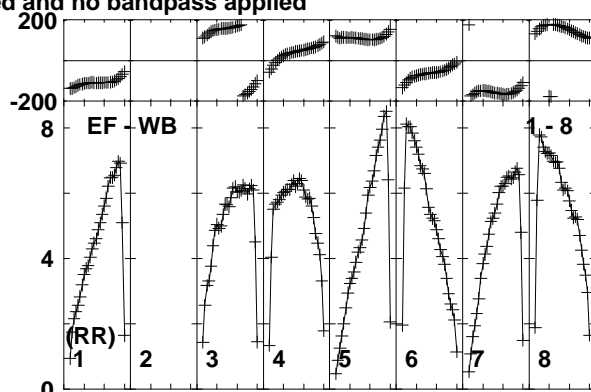
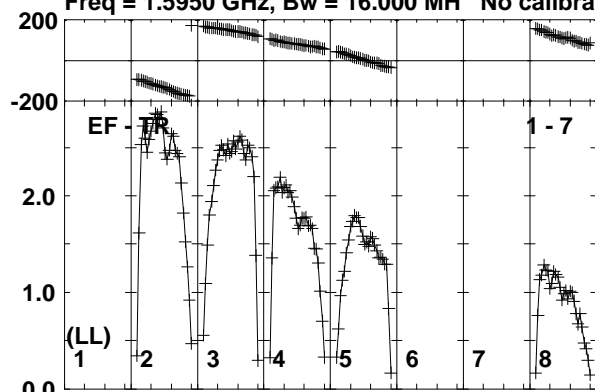

Channels

Lower frame: Milli Ampl Jy Top frame: Phas deg  
Vector averaged cross-power spectrum Baseline: EF (01) - TR (07)  
Timerange: 00/22:58:02 to 00/23:01:28

Plot file version 47 created 26-JUN-2015 10:51:17

J2025+3343 ET031A.UVDATA.1

Freq = 1.5950 GHz, Bw = 16.000 MH No calibration applied and no bandpass applied

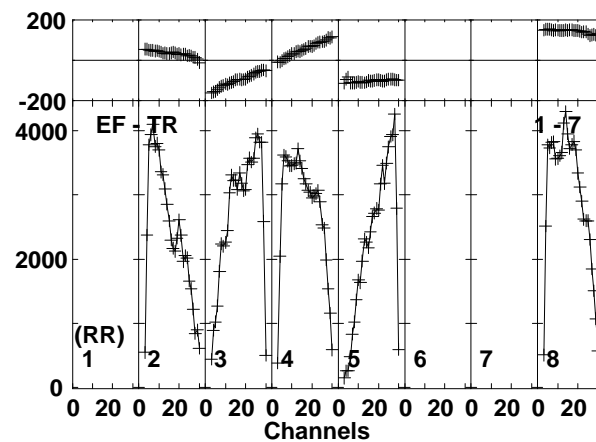
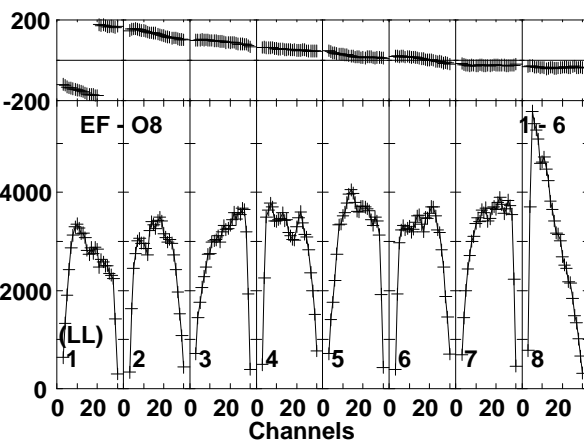
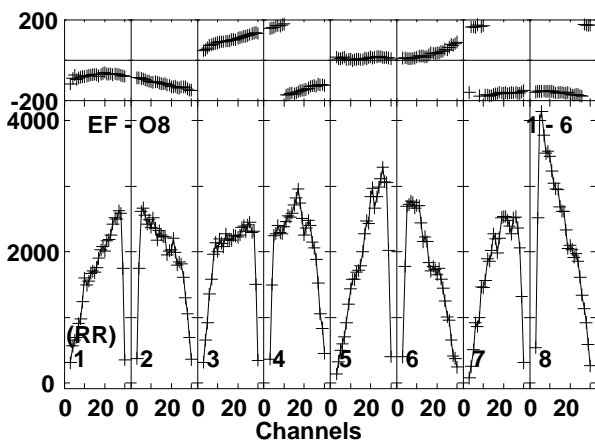
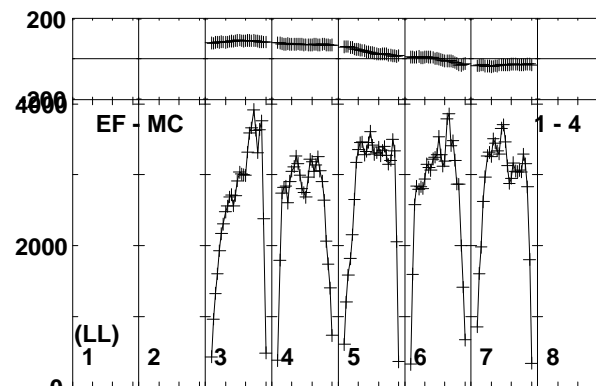
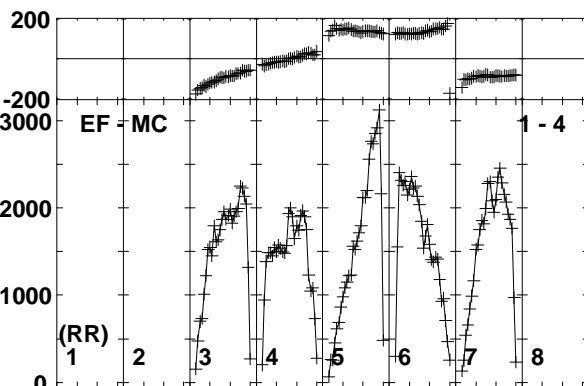
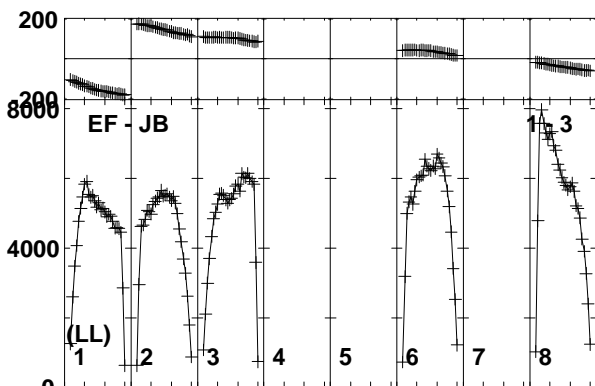
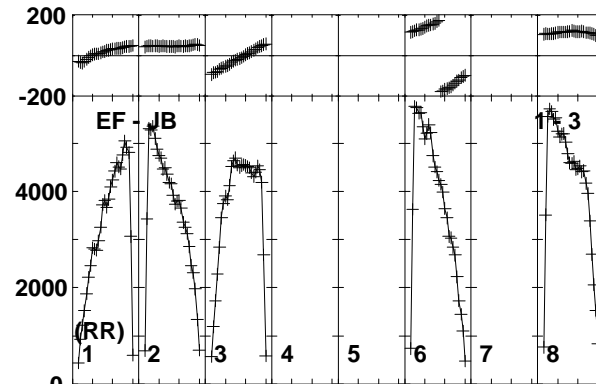
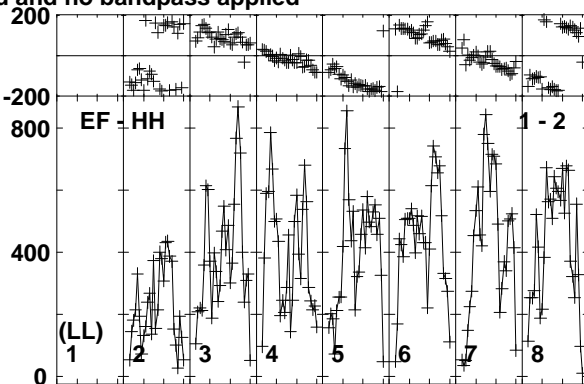
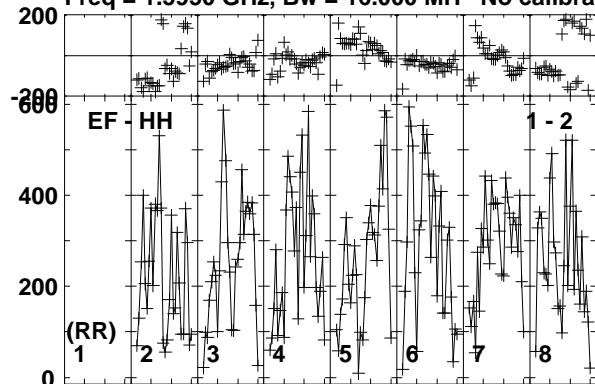

Lower frame: Micro Ampl Jy Top frame: Phas deg  
Vector averaged cross-power spectrum Baseline: EF (01) - HH (02)  
Timerange: 00/23:01:32 to 00/23:02:48

Plot file version 48 created 26-JUN-2015 10:51:18

J2025+3343 ET031A.UVDATA.1

Freq = 1.5950 GHz, Bw = 16.000 MH No calibration applied and no bandpass applied

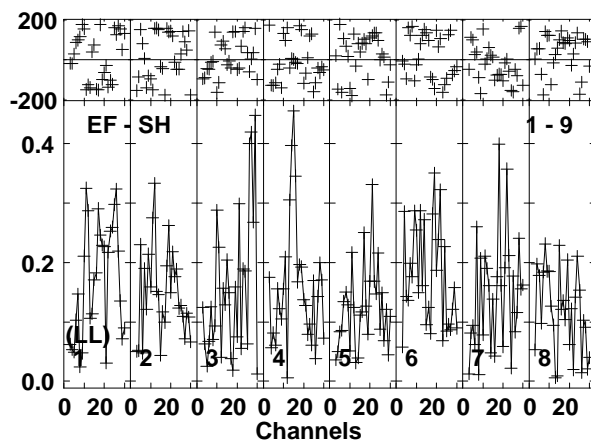
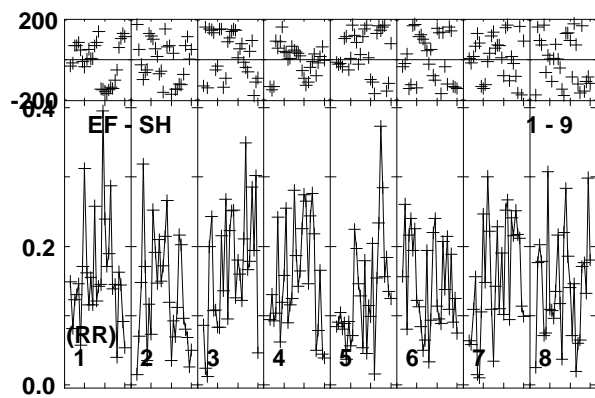
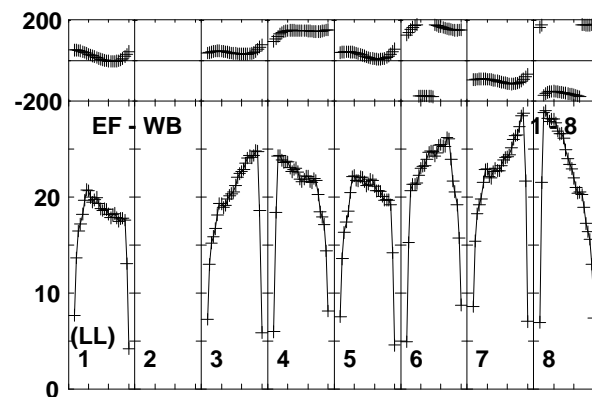
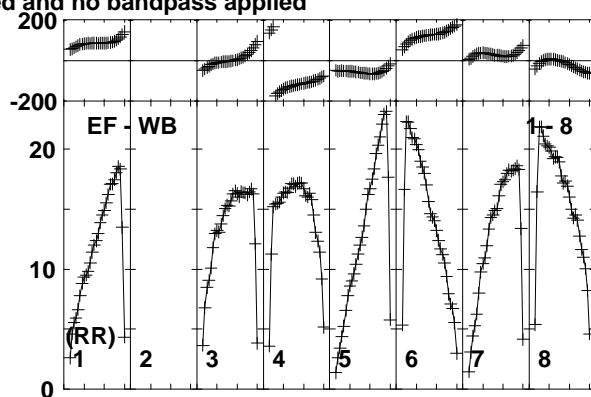
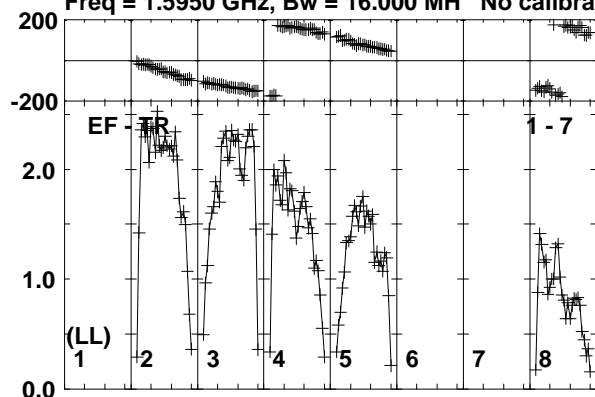

Lower frame: Milli Ampl Jy Top frame: Phas deg  
Vector averaged cross-power spectrum Baseline: EF (01) - TR (07)  
Timerange: 00/23:01:32 to 00/23:02:48



Plot file version 49 created 26-JUN-2015 10:51:18

V404CYG ET031A.UVDATA.1

Freq = 1.5950 GHz, Bw = 16.000 MH No calibration applied and no bandpass applied

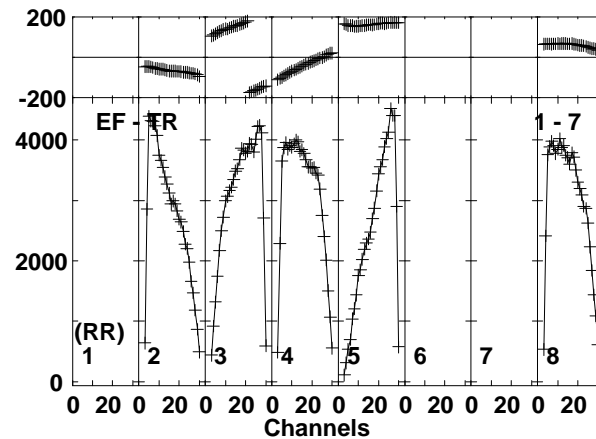
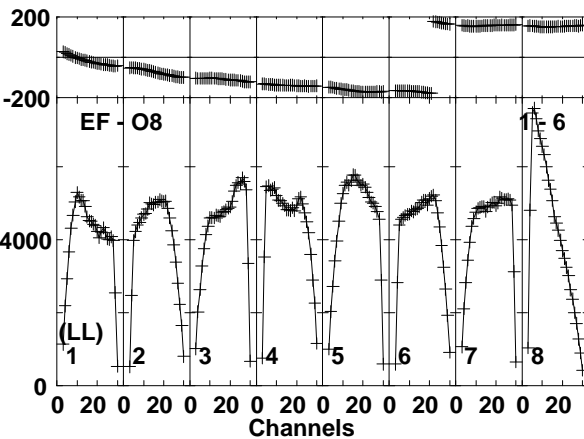
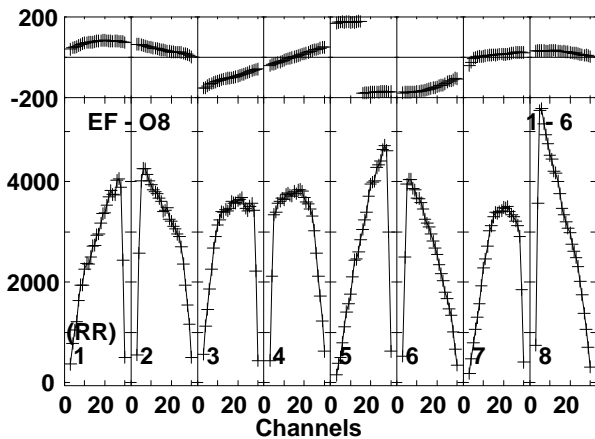
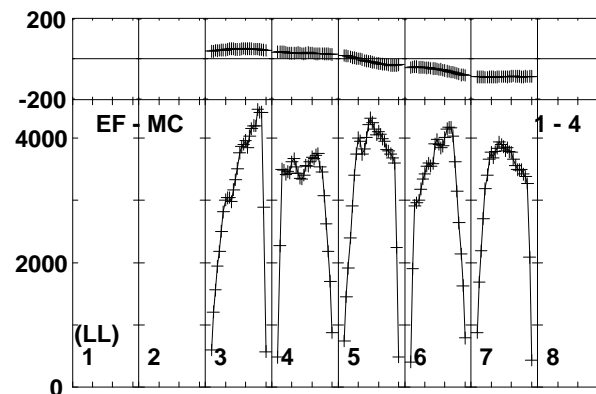
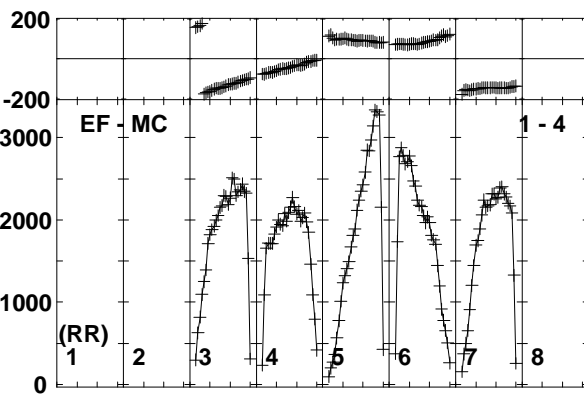
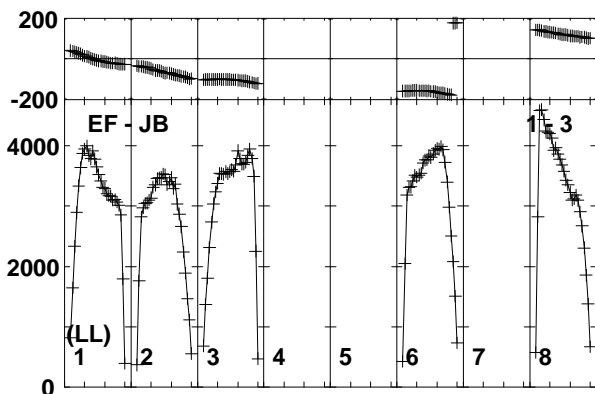
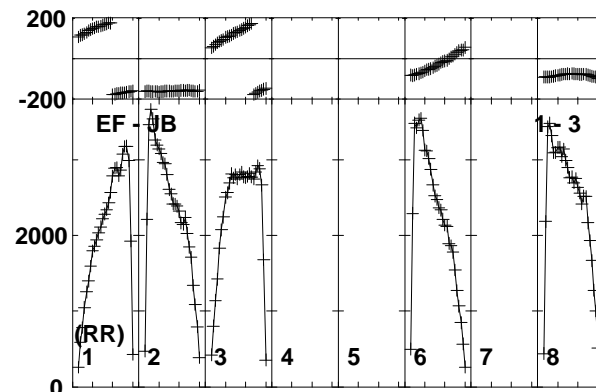
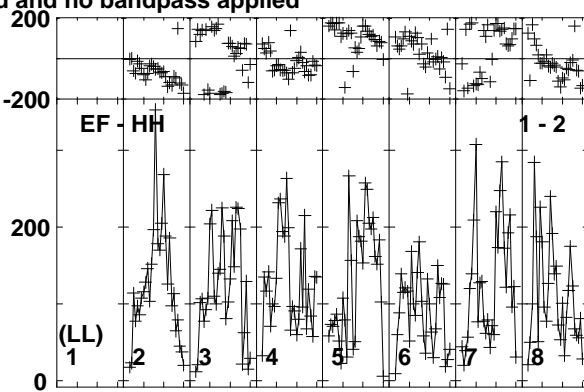
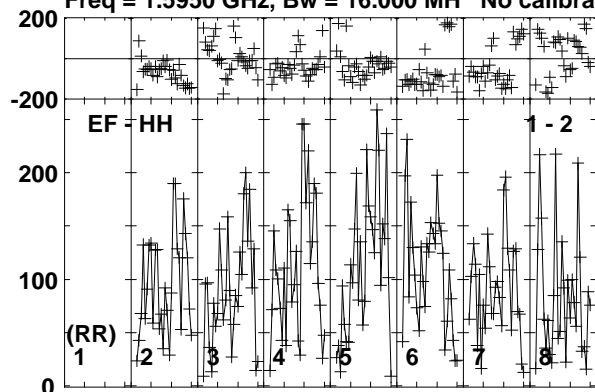

Lower frame: Micro Ampl Jy Top frame: Phas deg  
Vector averaged cross-power spectrum Baseline: EF (01) - HH (02)  
Timerange: 00/23:02:52 to 00/23:06:18

Plot file version 50 created 26-JUN-2015 10:51:18

V404CYG ET031A.UVDATA.1

Freq = 1.5950 GHz, Bw = 16.000 MH No calibration applied and no bandpass applied

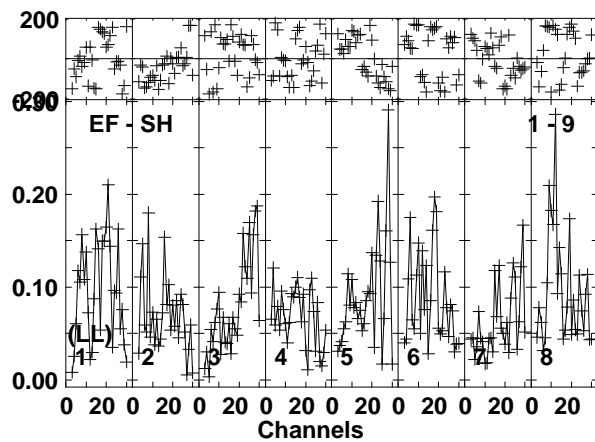
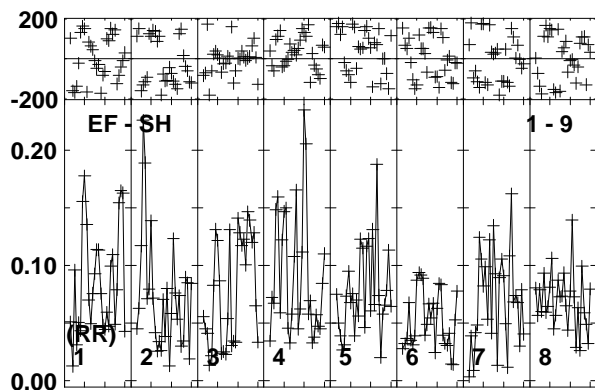
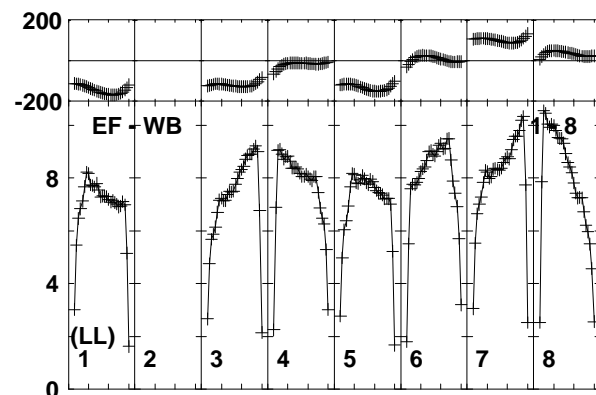
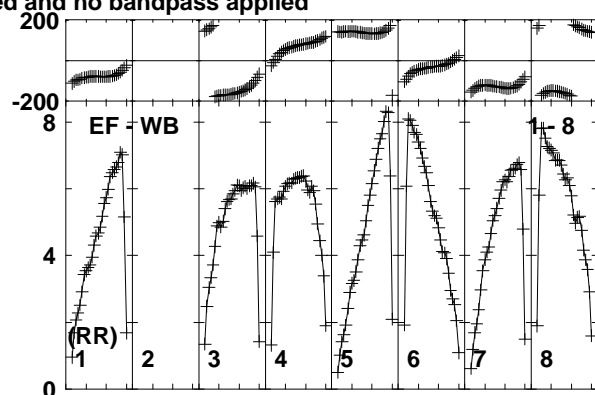
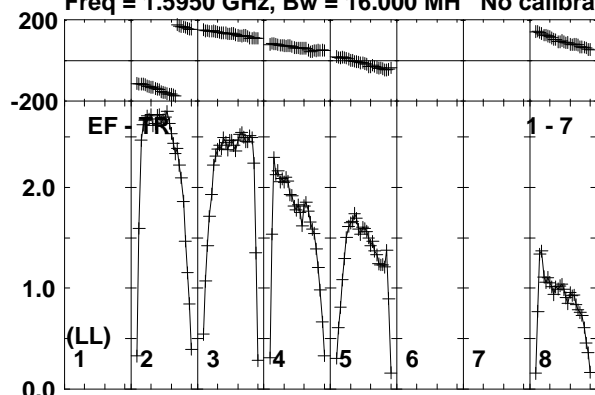

Lower frame: Milli Ampl Jy Top frame: Phas deg  
 Vector averaged cross-power spectrum Baseline: EF (01) - TR (07)  
 Timerange: 00/23:02:52 to 00/23:06:18

Plot file version 51 created 26-JUN-2015 10:51:18

J2025+3343 ET031A.UVDATA.1

Freq = 1.5950 GHz, Bw = 16.000 MH No calibration applied and no bandpass applied

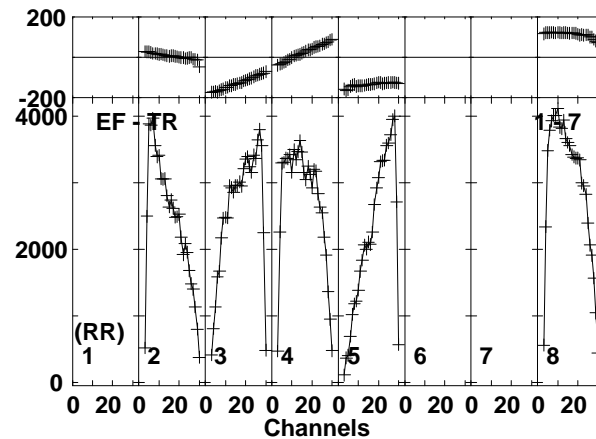
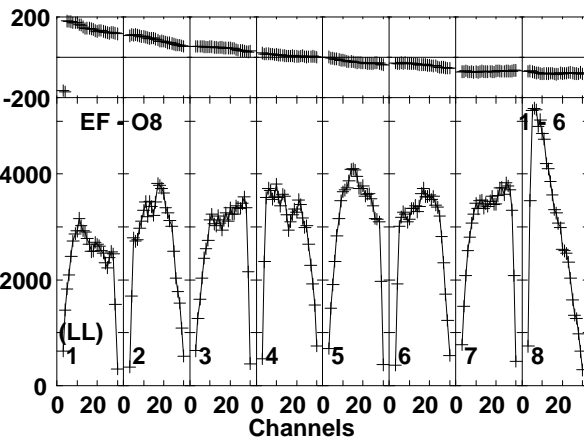
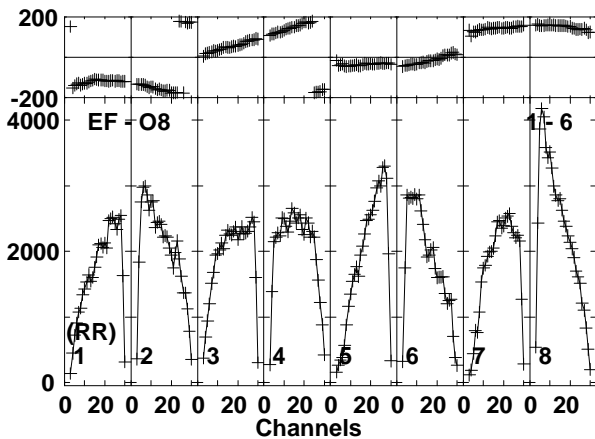
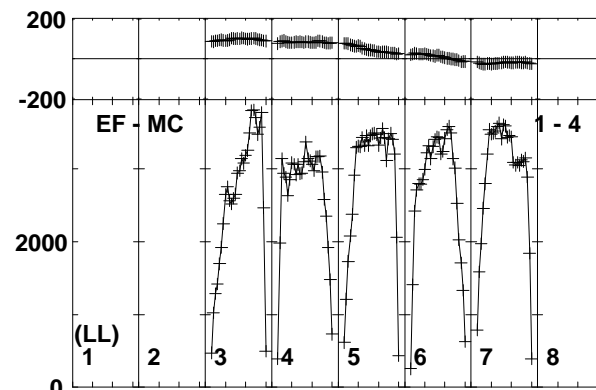
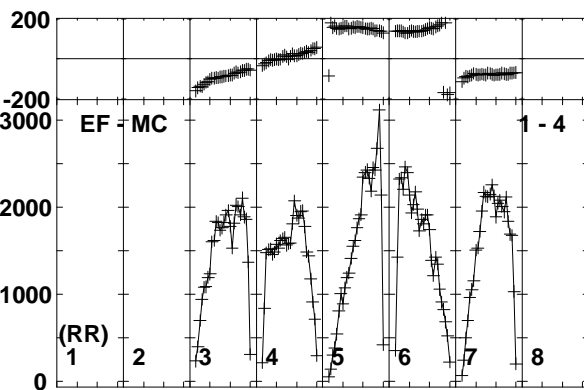
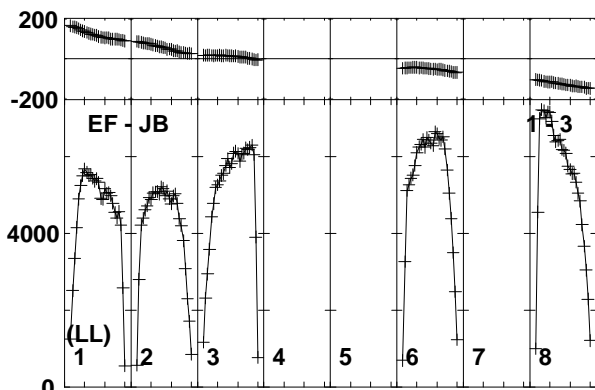
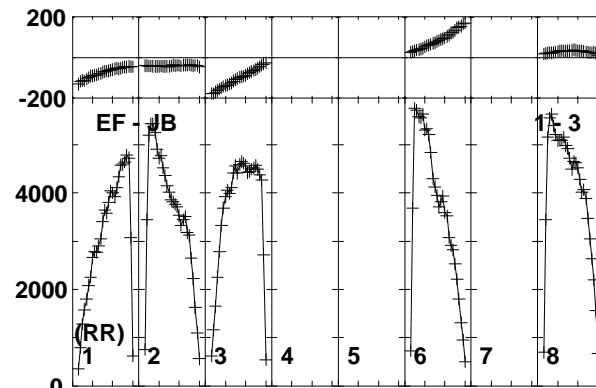
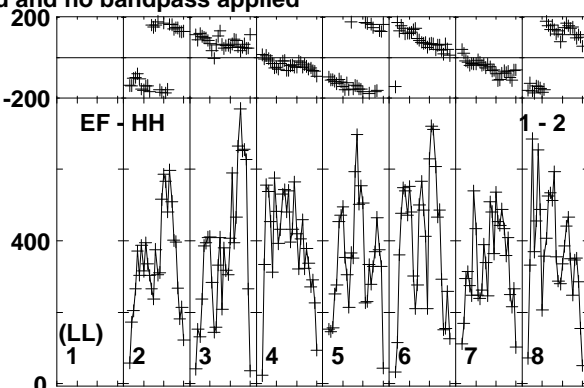
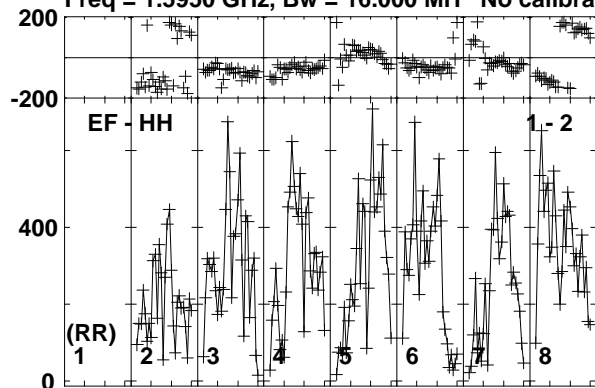

Lower frame: Micro Ampl Jy Top frame: Phas deg  
Vector averaged cross-power spectrum Baseline: EF (01) - HH (02)  
Timerange: 00/23:07:02 to 00/23:07:58

Plot file version 52 created 26-JUN-2015 10:51:18

J2025+3343 ET031A.UVDATA.1

Freq = 1.5950 GHz, Bw = 16.000 MH No calibration applied and no bandpass applied

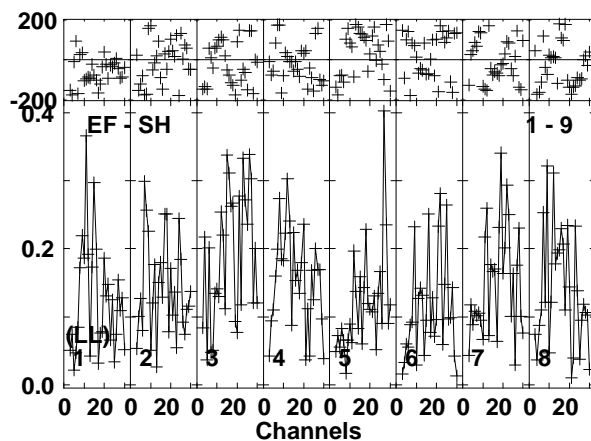
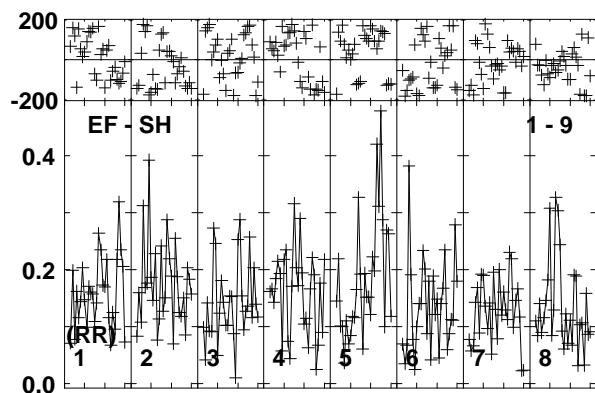
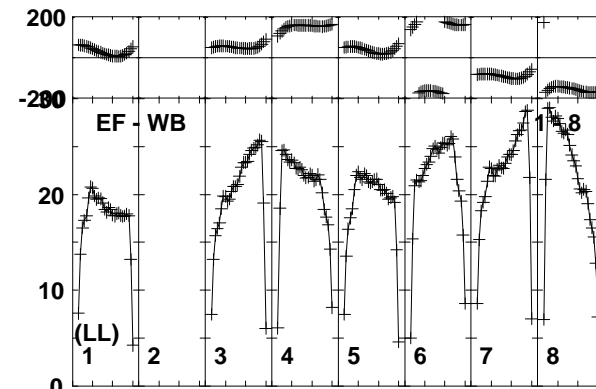
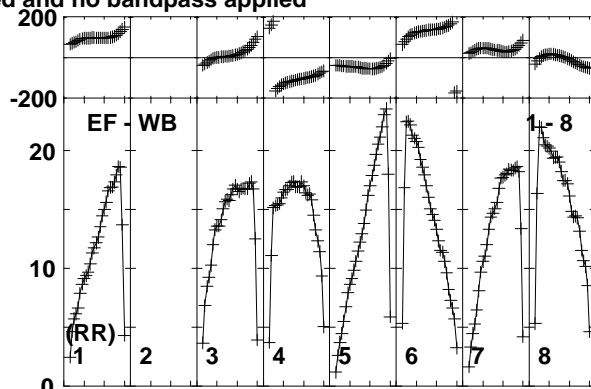
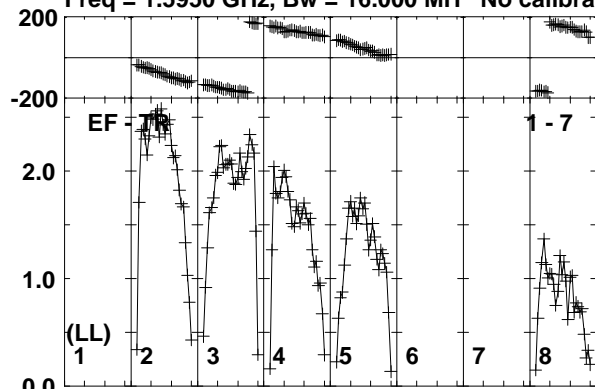

Lower frame: Milli Ampl Jy Top frame: Phas deg  
Vector averaged cross-power spectrum Baseline: EF (01) - TR (07)  
Timerange: 00/23:07:02 to 00/23:07:58

Plot file version 53 created 26-JUN-2015 10:51:18

V404CYG ET031A.UVDATA.1

Freq = 1.5950 GHz, Bw = 16.000 MH No calibration applied and no bandpass applied

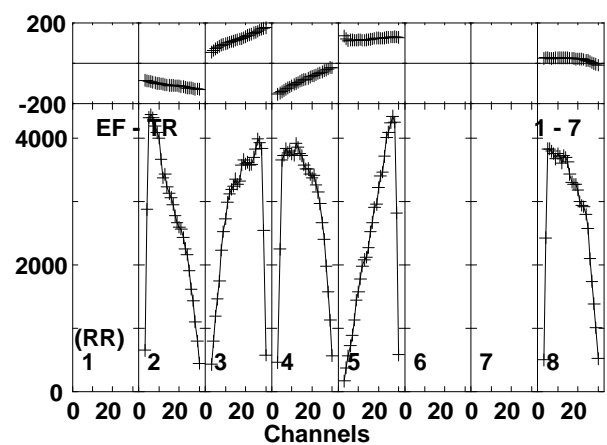
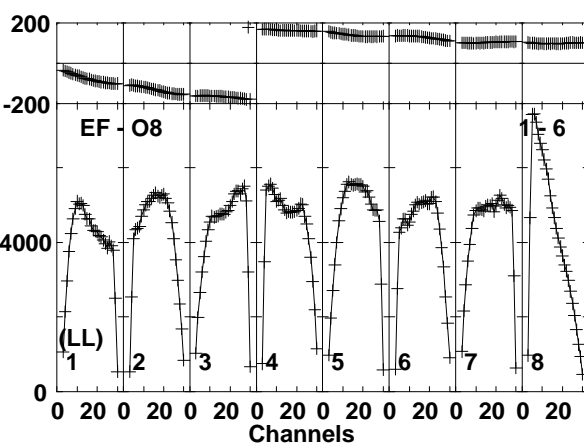
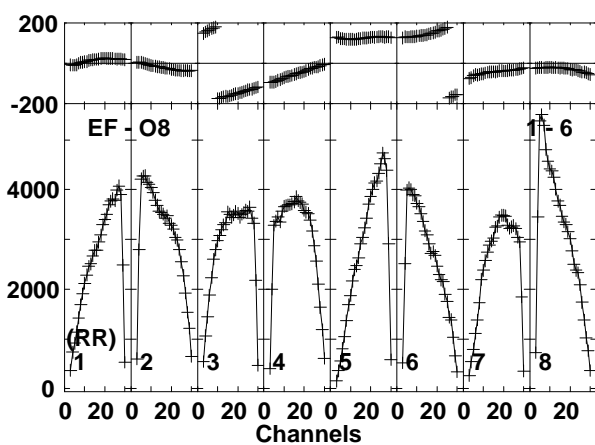
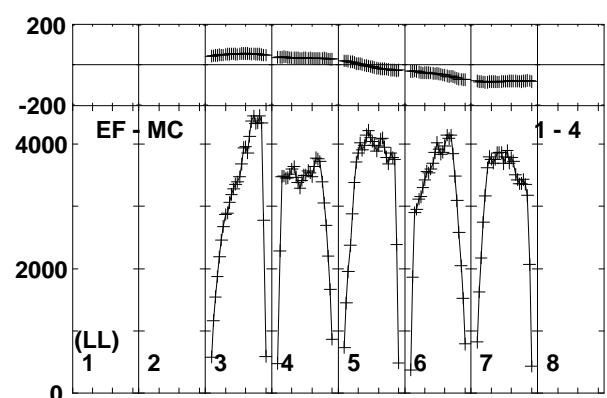
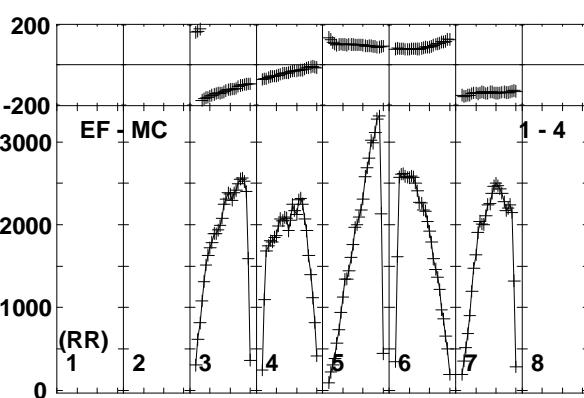
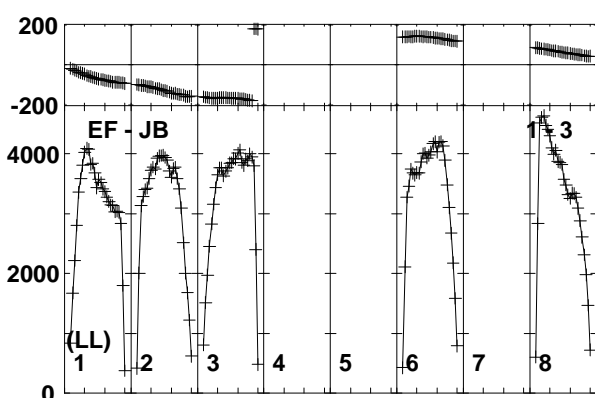
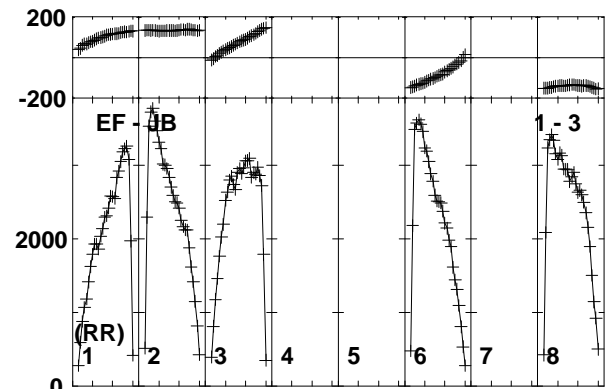
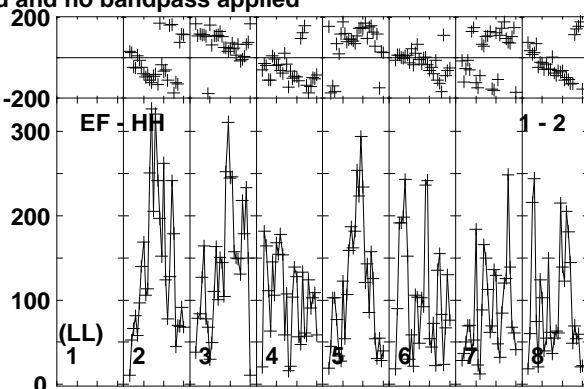
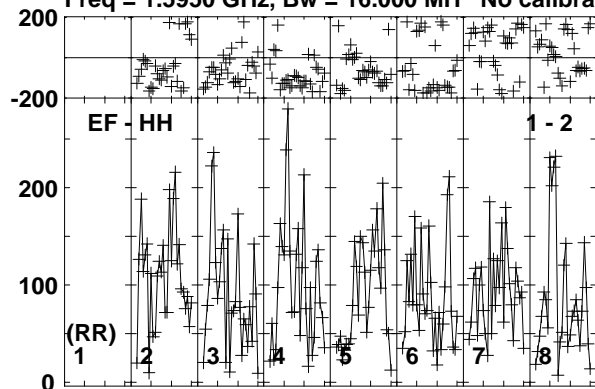

Lower frame: Micro Ampl Jy Top frame: Phas deg  
Vector averaged cross-power spectrum Baseline: EF (01) - HH (02)  
Timerange: 00/23:08:02 to 00/23:11:28

Plot file version 54 created 26-JUN-2015 10:51:18

V404CYG ET031A.UVDATA.1

Freq = 1.5950 GHz, Bw = 16.000 MH No calibration applied and no bandpass applied

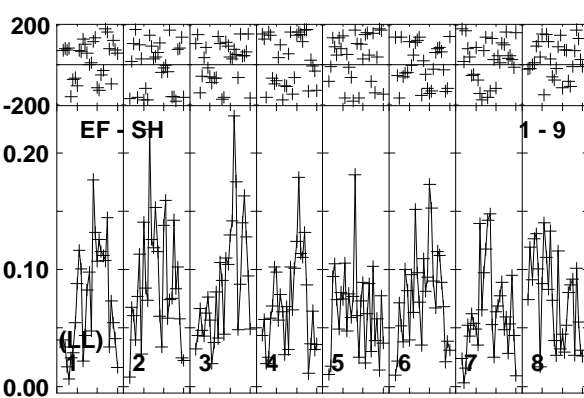
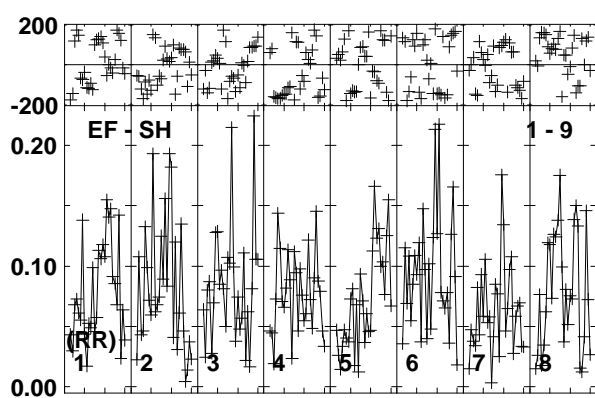
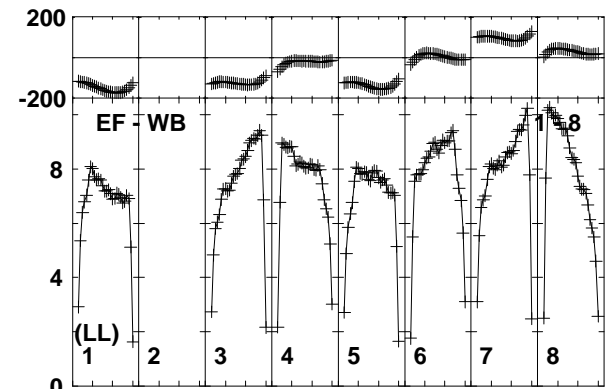
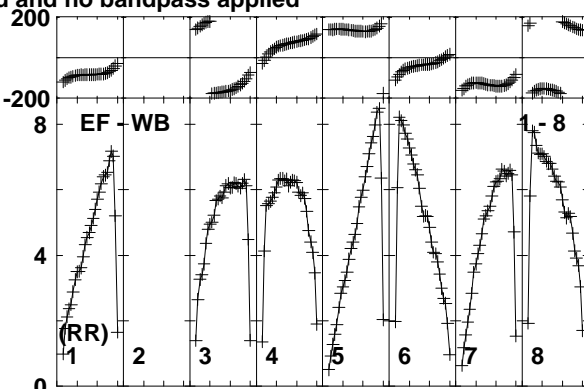
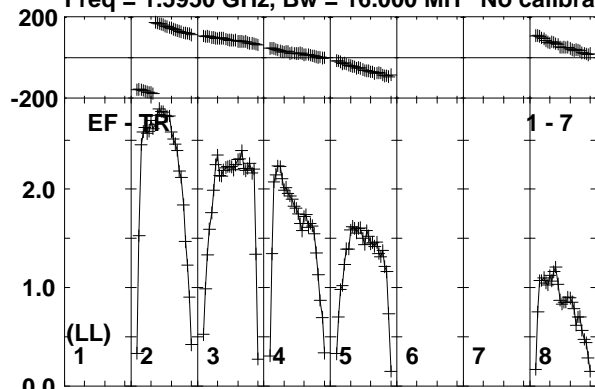

Lower frame: Milli Ampl Jy Top frame: Phas deg  
Vector averaged cross-power spectrum Baseline: EF (01) - TR (07)  
Timerange: 00/23:08:02 to 00/23:11:28

Plot file version 55 created 26-JUN-2015 10:51:18

J2025+3343 ET031A.UVDATA.1

Freq = 1.5950 GHz, Bw = 16.000 MH No calibration applied and no bandpass applied

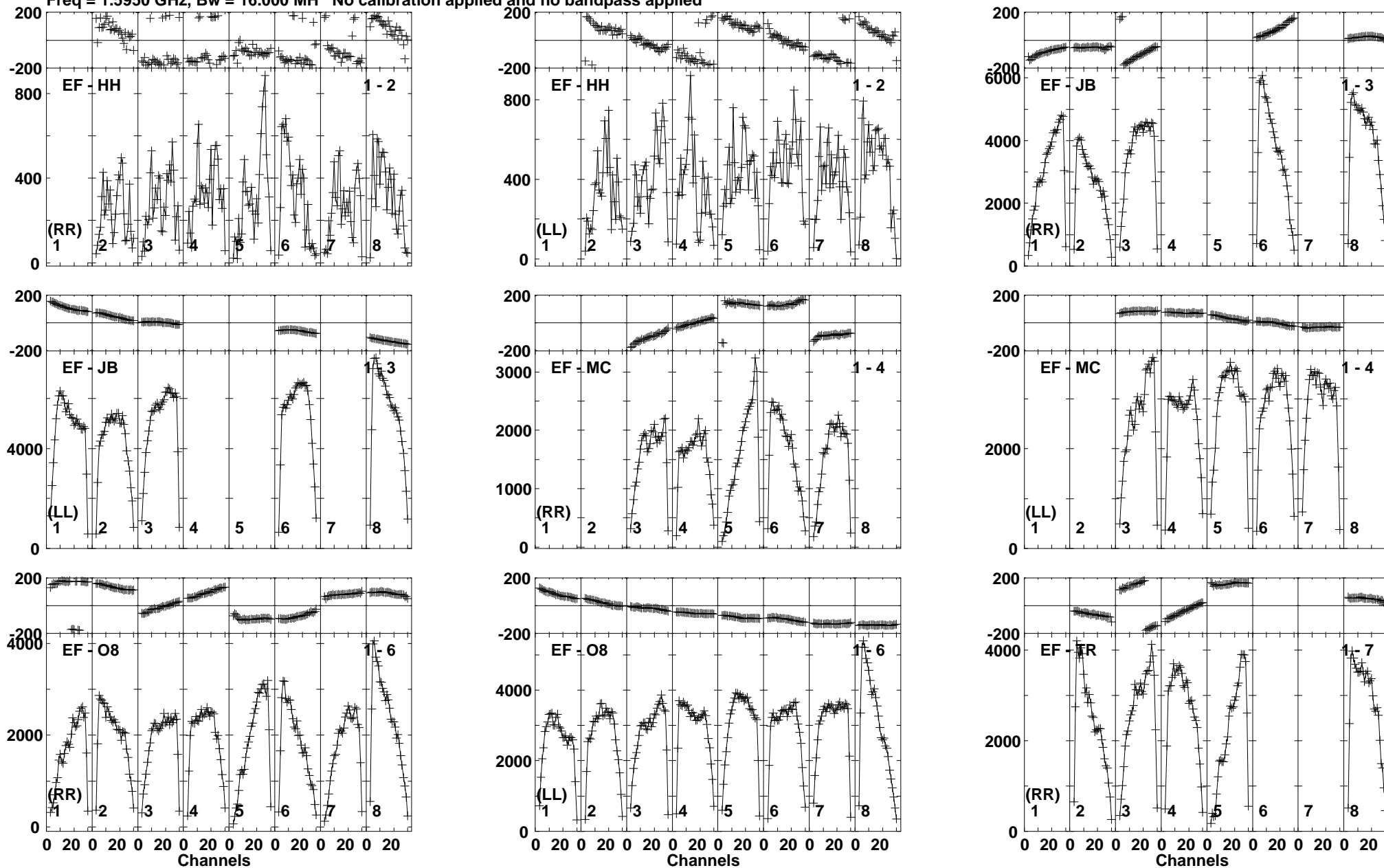

Lower frame: Micro Ampl Jy Top frame: Phas deg  
Vector averaged cross-power spectrum Baseline: EF (01) - HH (02)  
Timerange: 00/23:11:32 to 00/23:12:48

Plot file version 56 created 26-JUN-2015 10:51:18

J2025+3343 ET031A.UVDATA.1

Freq = 1.5950 GHz, Bw = 16.000 MH No calibration applied and no bandpass applied

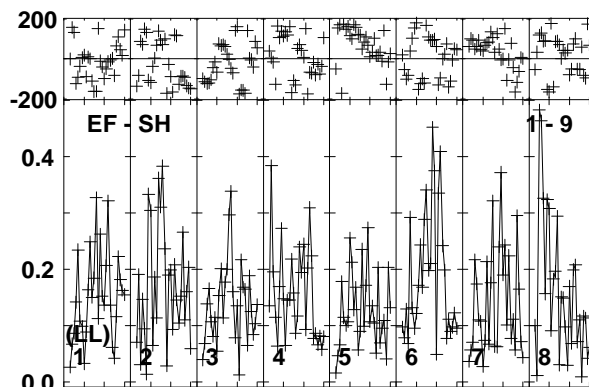
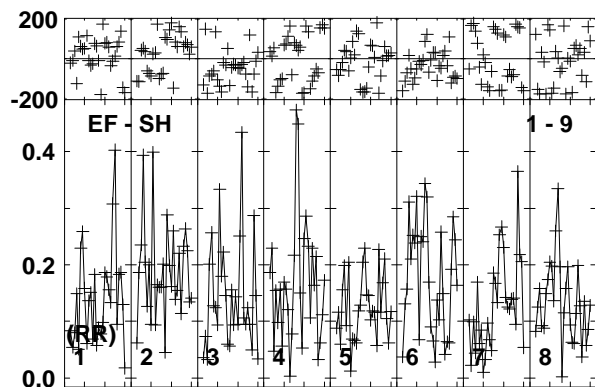
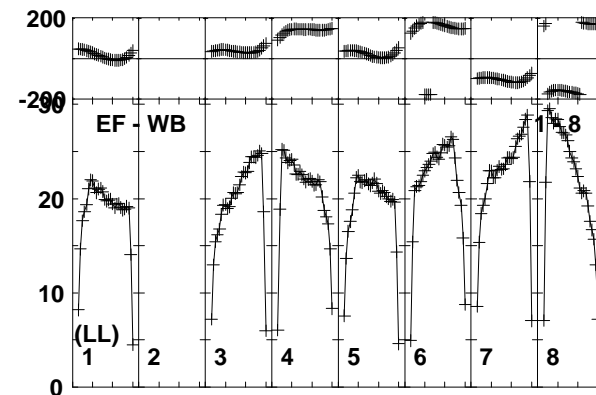
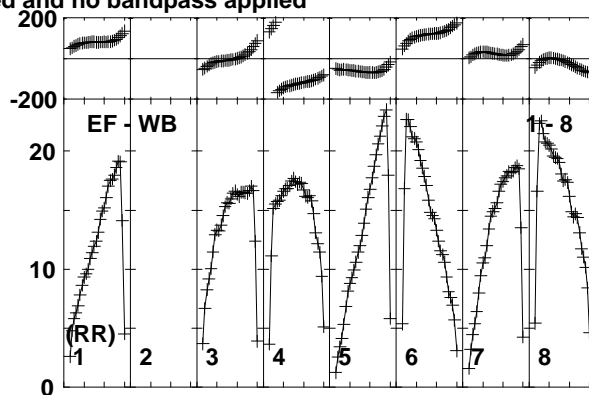
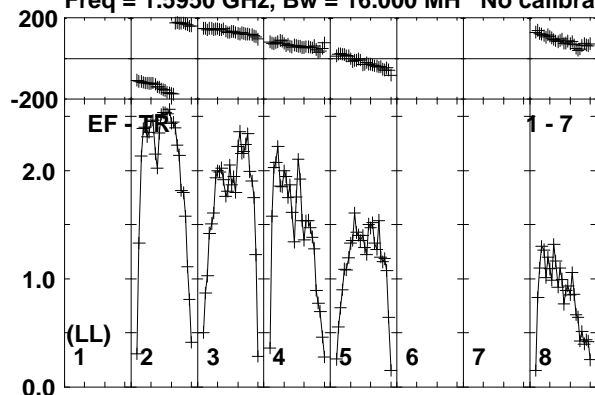

Channels

Lower frame: Milli Ampl Jy Top frame: Phas deg  
Vector averaged cross-power spectrum Baseline: EF (01) - TR (07)  
Timerange: 00/23:11:32 to 00/23:12:48



Plot file version 57 created 26-JUN-2015 10:51:18

V404CYG ET031A.UVDATA.1

Freq = 1.5950 GHz, Bw = 16.000 MH No calibration applied and no bandpass applied

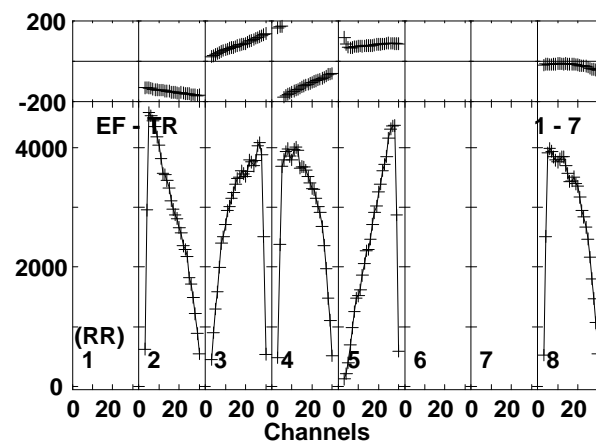
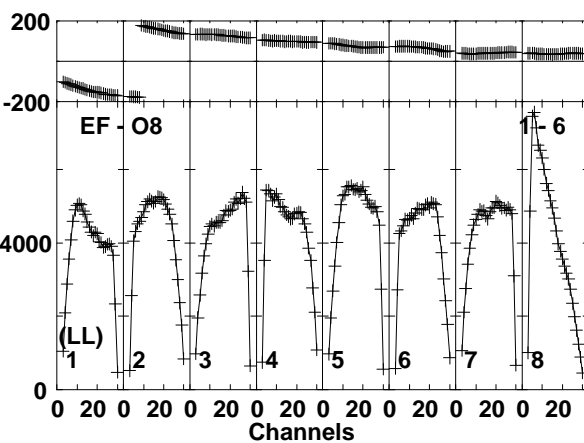
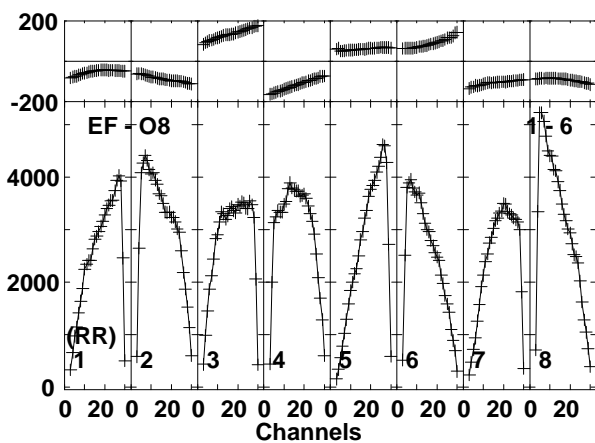
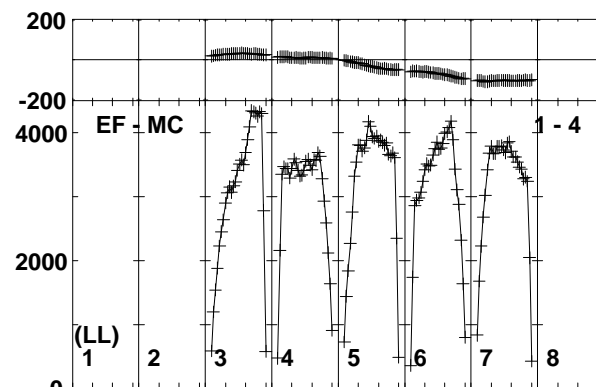
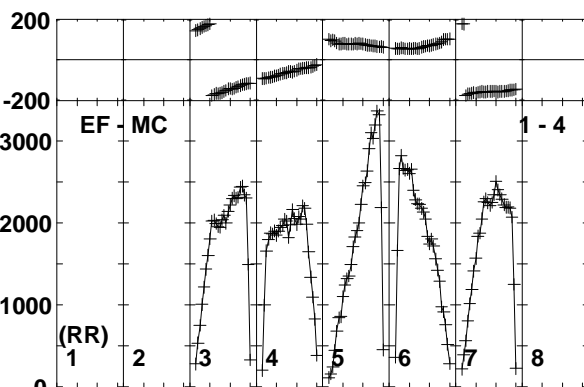
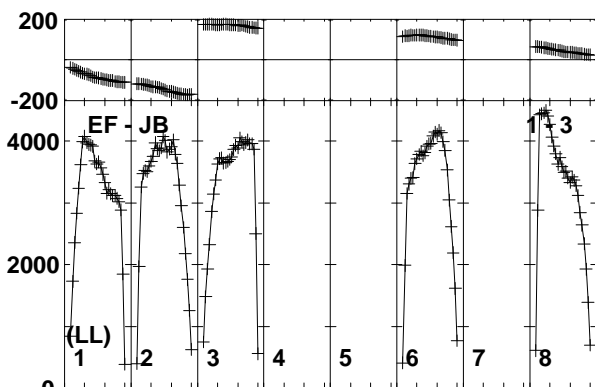
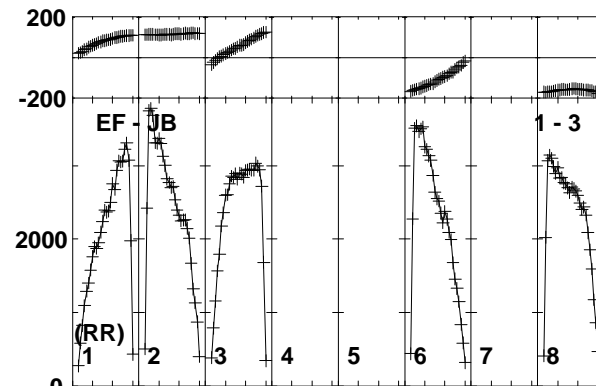
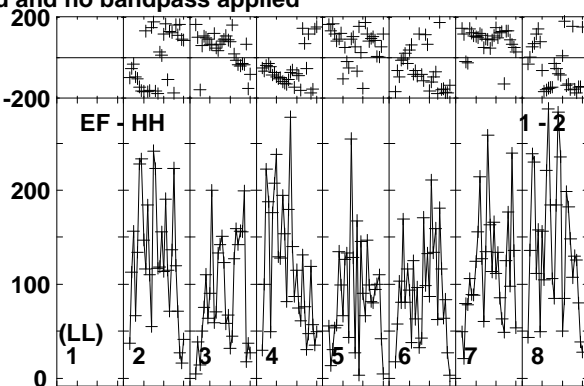
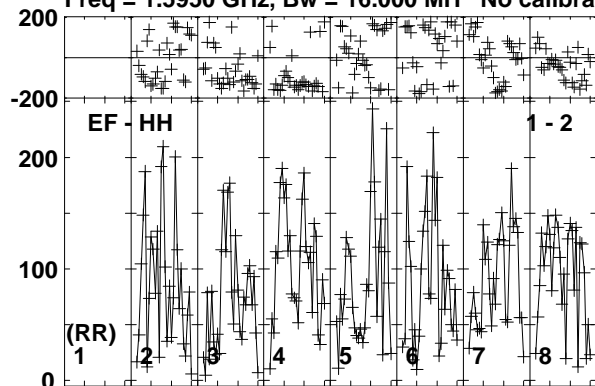

Lower frame: Micro Ampl Jy Top frame: Phas deg  
Vector averaged cross-power spectrum Baseline: EF (01) - HH (02)  
Timerange: 00/23:12:52 to 00/23:16:18

Plot file version 58 created 26-JUN-2015 10:51:18

V404CYG ET031A.UVDATA.1

Freq = 1.5950 GHz, Bw = 16.000 MH No calibration applied and no bandpass applied

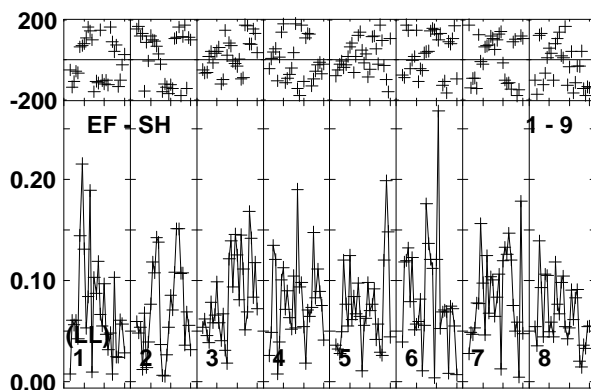
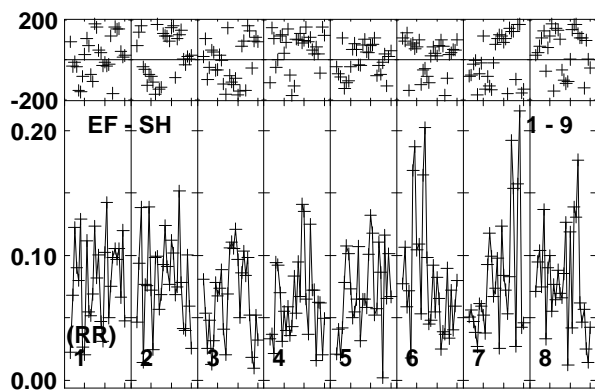
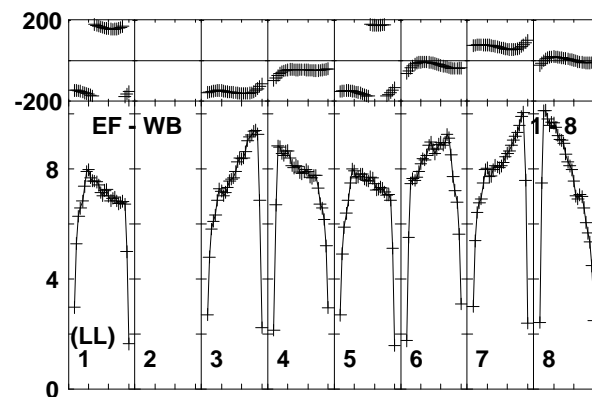
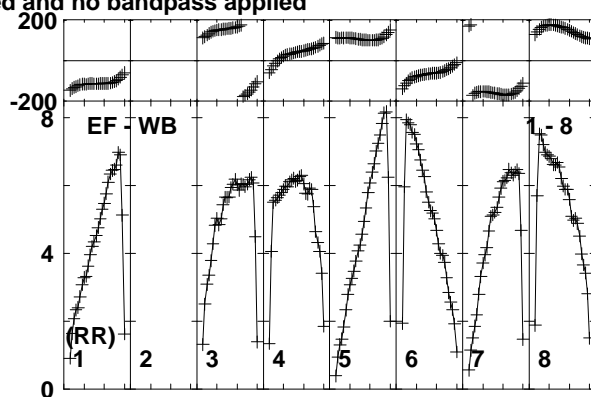
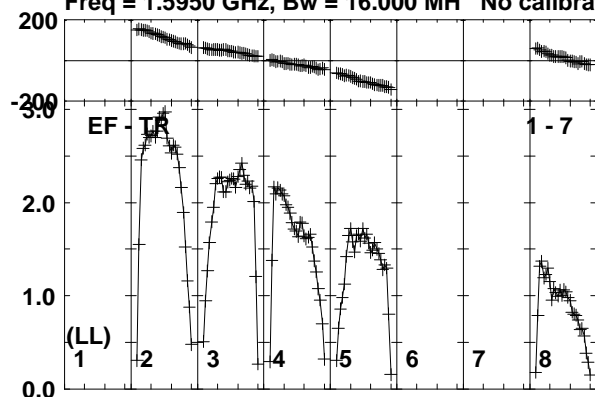

Channels

Lower frame: Milli Ampl Jy Top frame: Phas deg  
Vector averaged cross-power spectrum Baseline: EF (01) - TR (07)  
Timerange: 00/23:12:52 to 00/23:16:18

Plot file version 59 created 26-JUN-2015 10:51:18

J2025+3343 ET031A.UVDATA.1

Freq = 1.5950 GHz, Bw = 16.000 MH No calibration applied and no bandpass applied

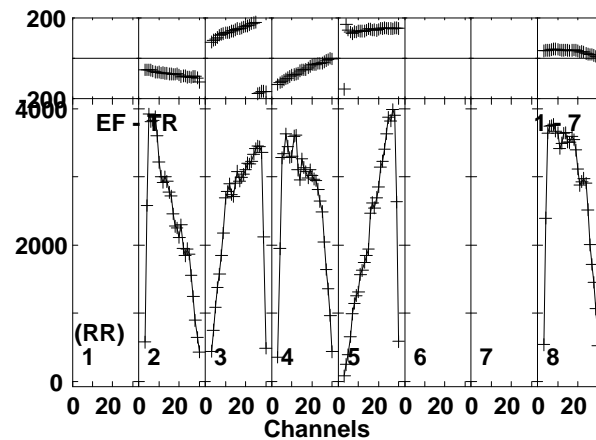
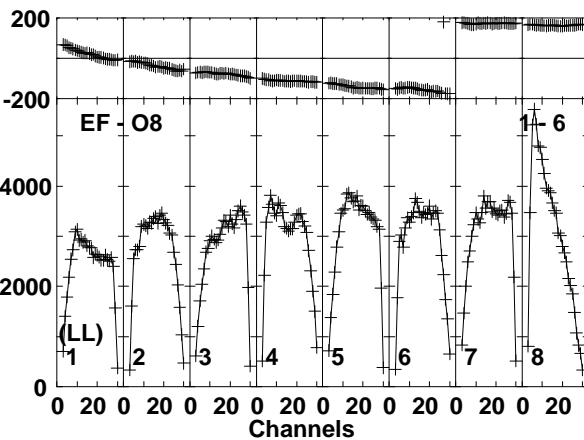
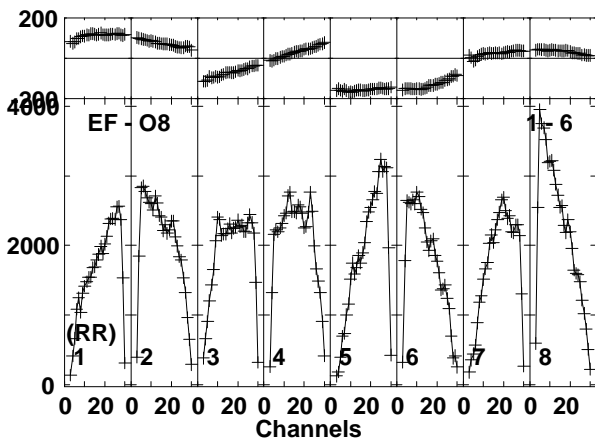
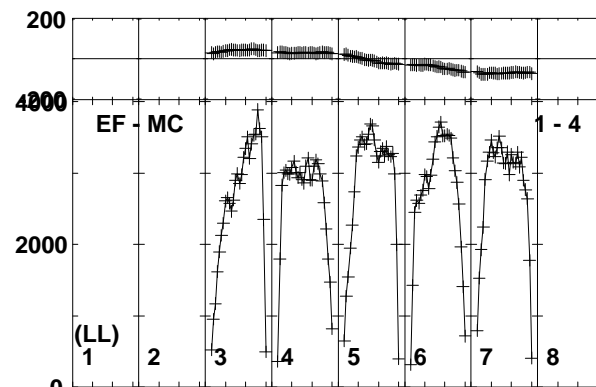
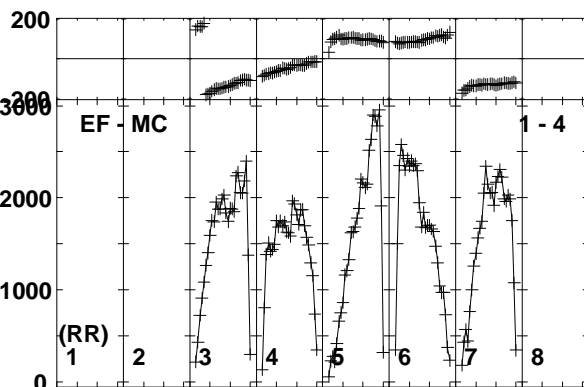
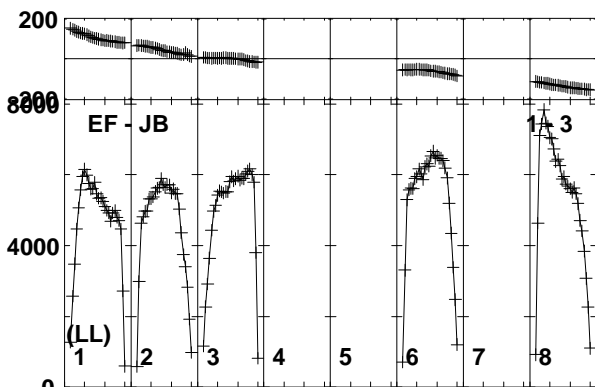
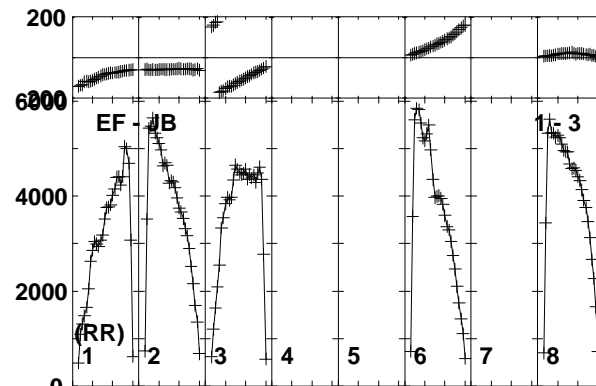
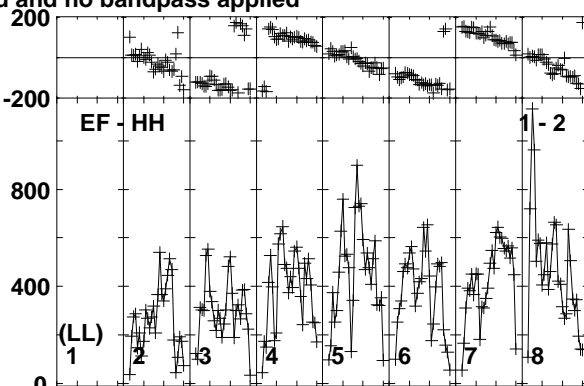
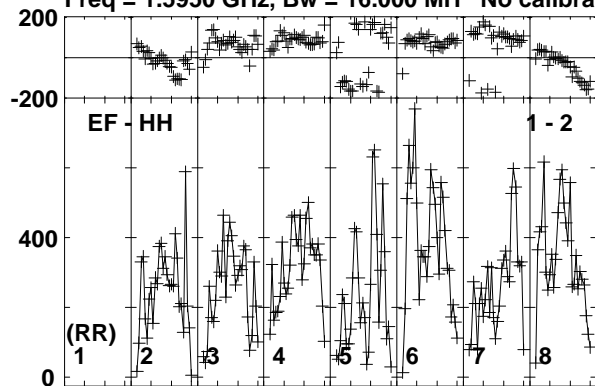

Lower frame: Micro Ampl Jy Top frame: Phas deg  
Vector averaged cross-power spectrum Baseline: EF (01) - HH (02)  
Timerange: 00/23:17:02 to 00/23:17:58

Plot file version 60 created 26-JUN-2015 10:51:18

J2025+3343 ET031A.UVDATA.1

Freq = 1.5950 GHz, Bw = 16.000 MH No calibration applied and no bandpass applied

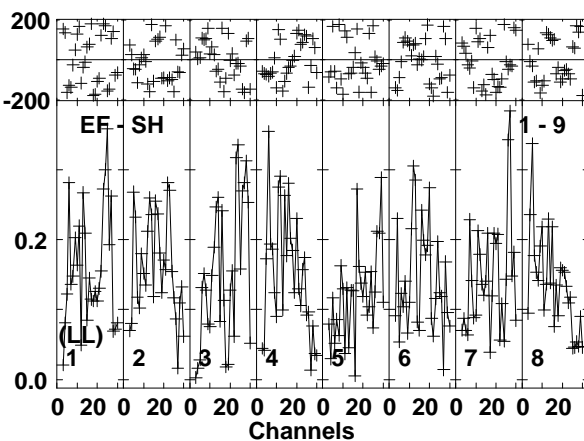
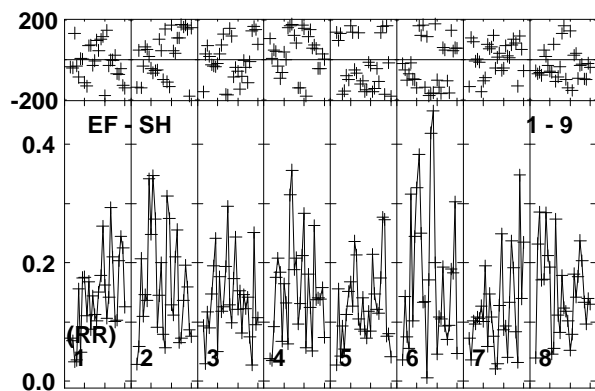
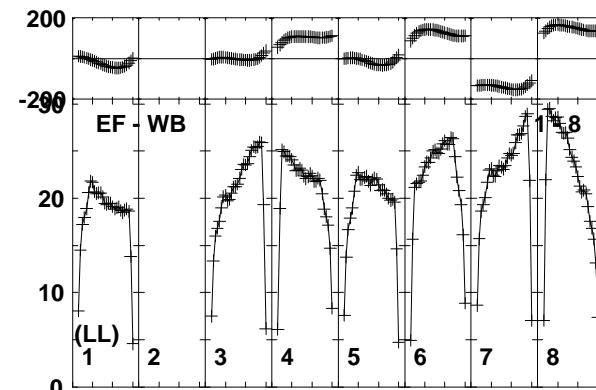
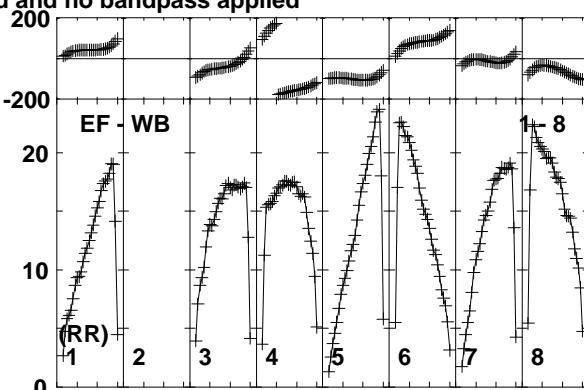
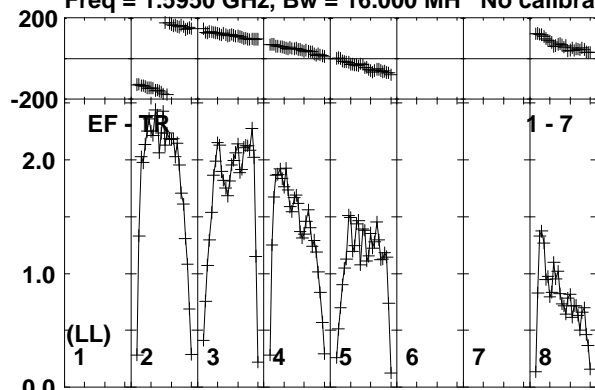

Lower frame: Milli Ampl Jy Top frame: Phas deg  
Vector averaged cross-power spectrum Baseline: EF (01) - TR (07)  
Timerange: 00/23:17:02 to 00/23:17:58

Plot file version 61 created 26-JUN-2015 10:51:18

V404CYG ET031A.UVDATA.1

Freq = 1.5950 GHz, Bw = 16.000 MH No calibration applied and no bandpass applied

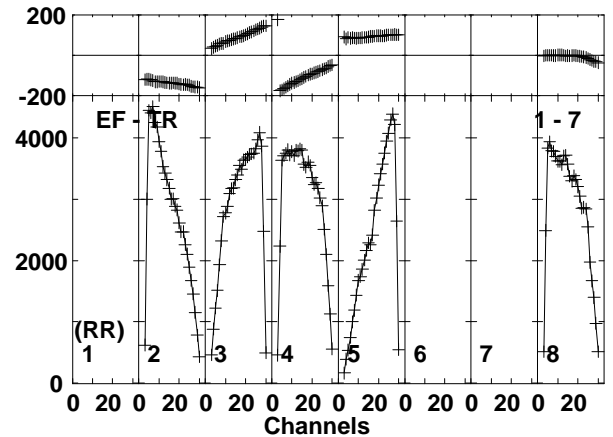
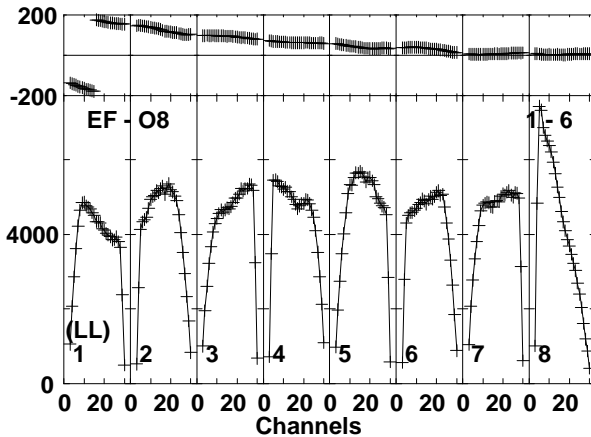
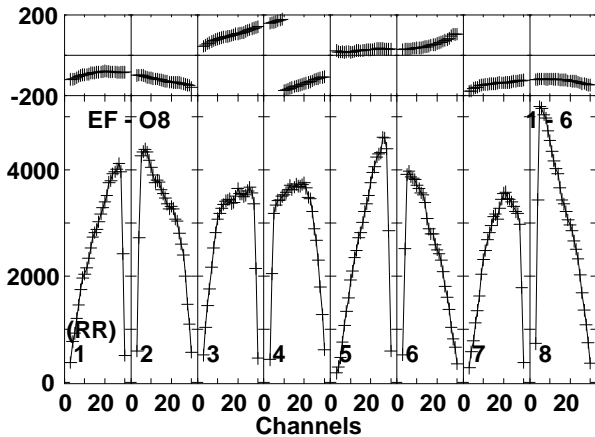
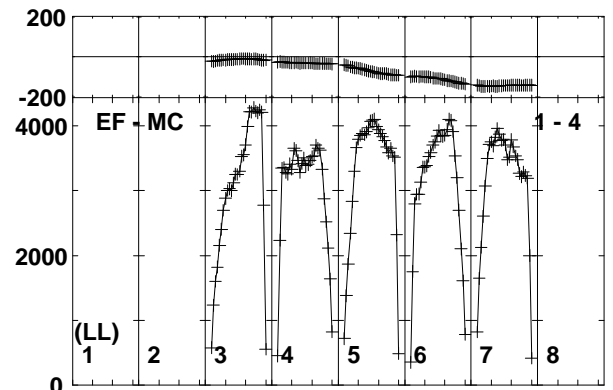
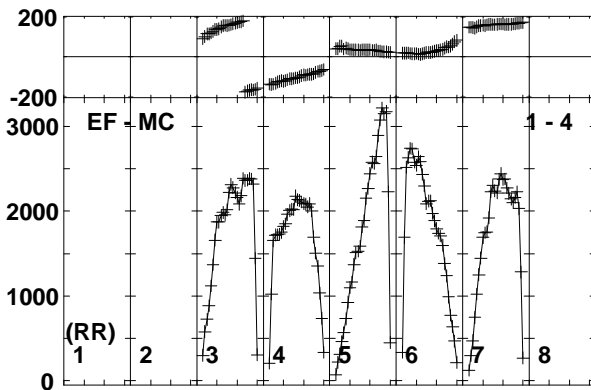
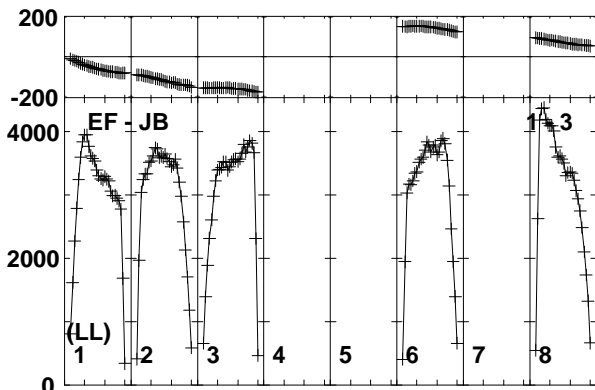
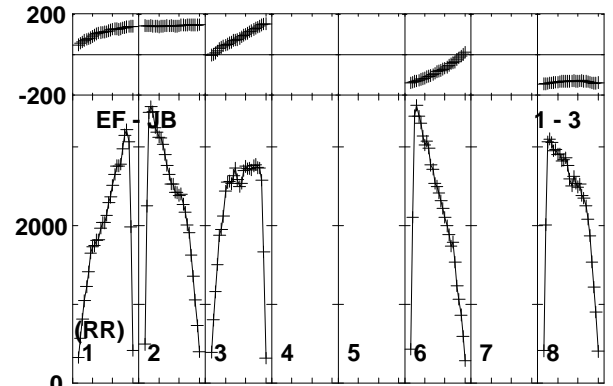
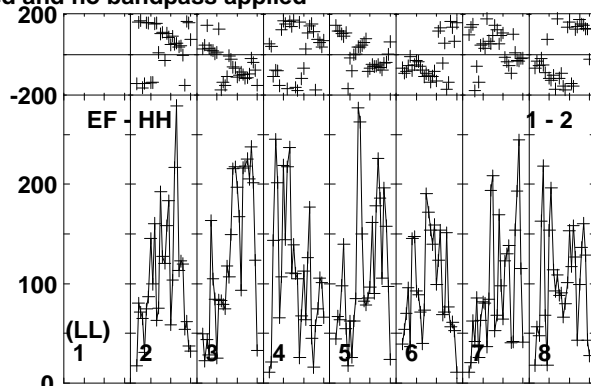
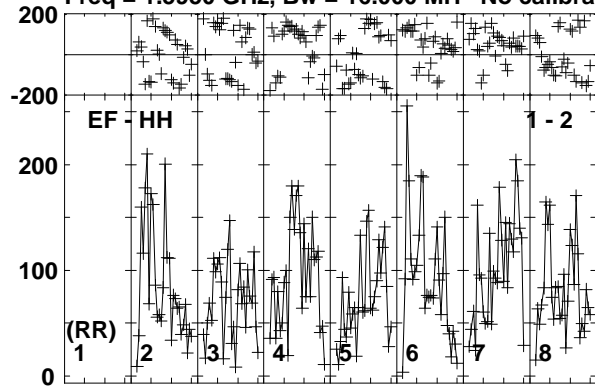

Lower frame: Micro Ampl Jy Top frame: Phas deg  
Vector averaged cross-power spectrum Baseline: EF (01) - HH (02)  
Timerange: 00/23:18:02 to 00/23:21:28

Plot file version 62 created 26-JUN-2015 10:51:18

V404CYG ET031A.UVDATA.1

Freq = 1.5950 GHz, Bw = 16.000 MH No calibration applied and no bandpass applied

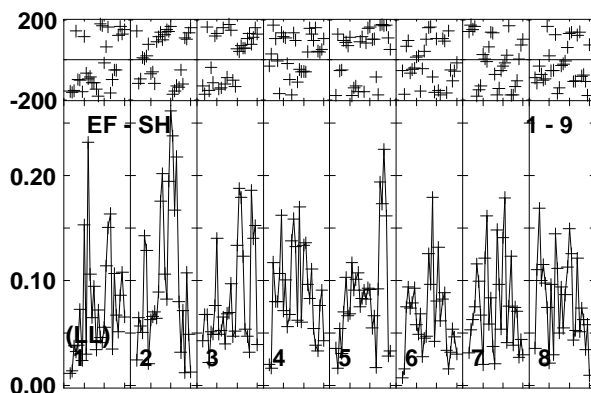
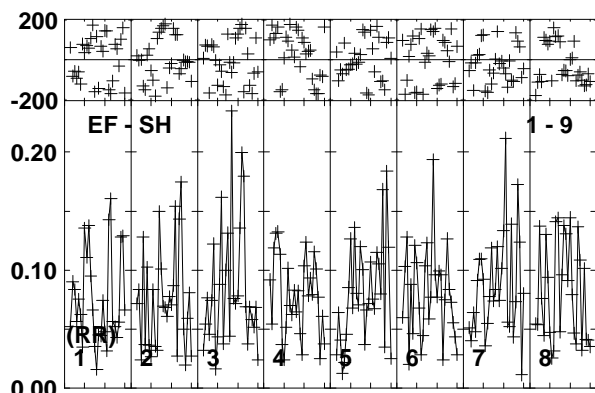
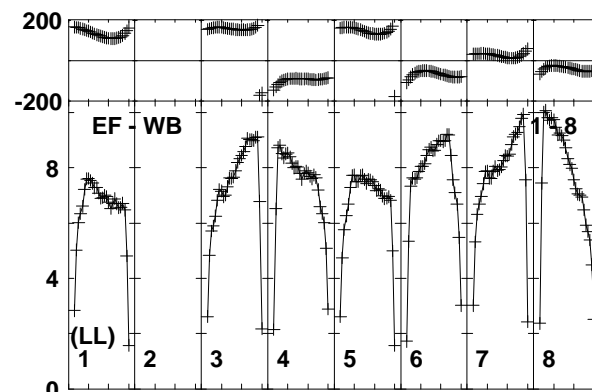
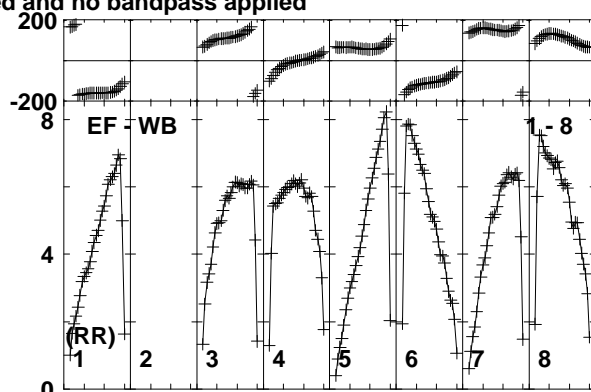
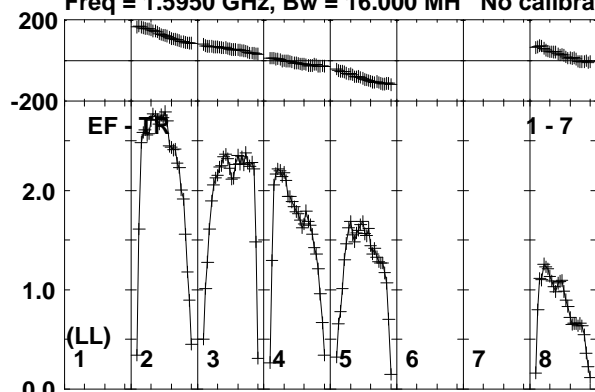

Channels

Lower frame: Milli Ampl Jy Top frame: Phas deg  
Vector averaged cross-power spectrum Baseline: EF (01) - TR (07)  
Timerange: 00/23:18:02 to 00/23:21:28

Plot file version 63 created 26-JUN-2015 10:51:18

J2025+3343 ET031A.UVDATA.1

Freq = 1.5950 GHz, Bw = 16.000 MH No calibration applied and no bandpass applied

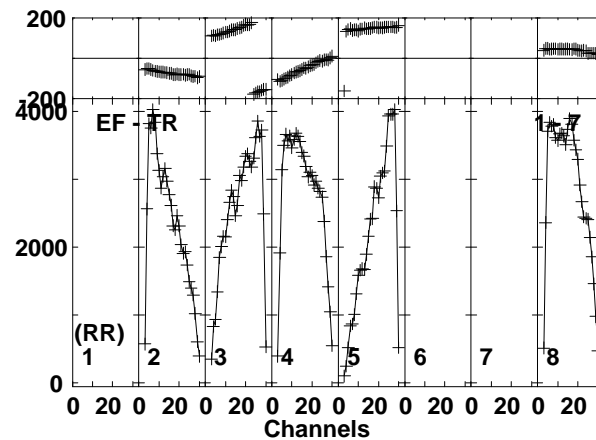
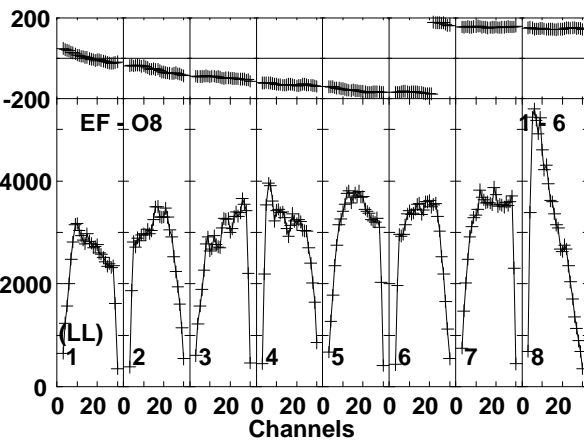
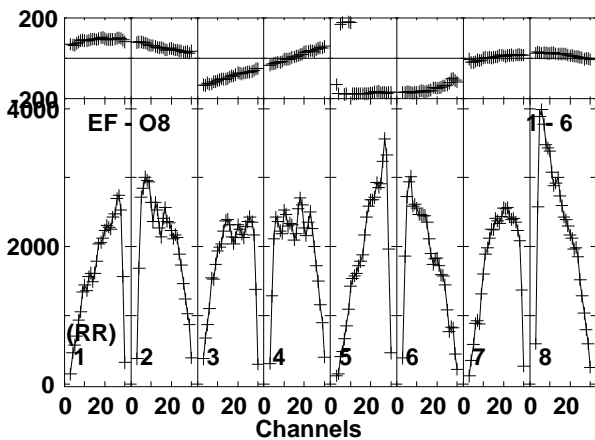
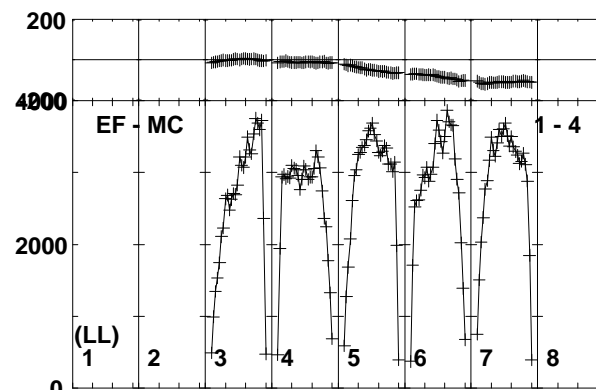
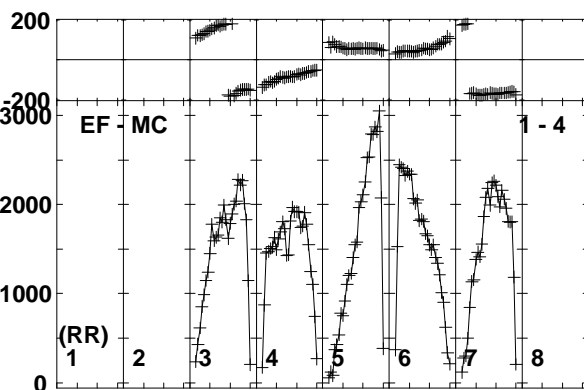
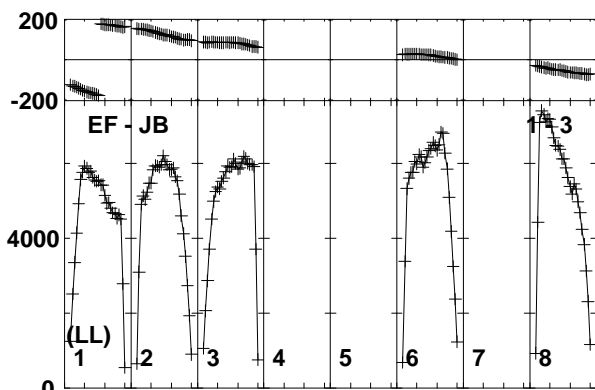
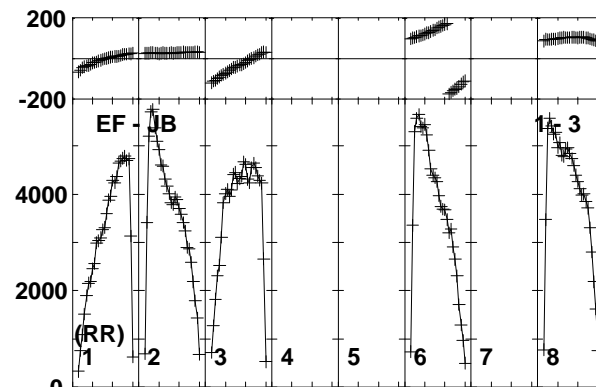
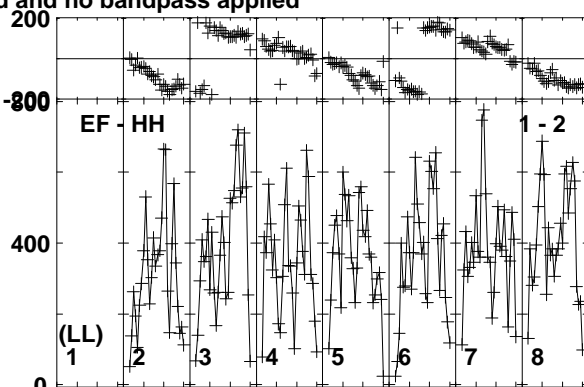
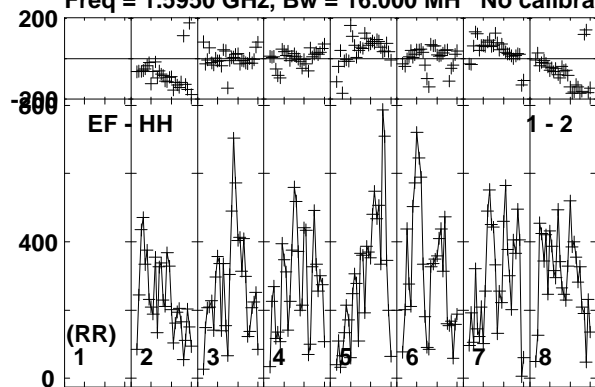

Lower frame: Micro Ampl Jy Top frame: Phas deg  
Vector averaged cross-power spectrum Baseline: EF (01) - HH (02)  
Timerange: 00/23:21:32 to 00/23:22:48

Plot file version 64 created 26-JUN-2015 10:51:18

J2025+3343 ET031A.UVDATA.1

Freq = 1.5950 GHz, Bw = 16.000 MH No calibration applied and no bandpass applied

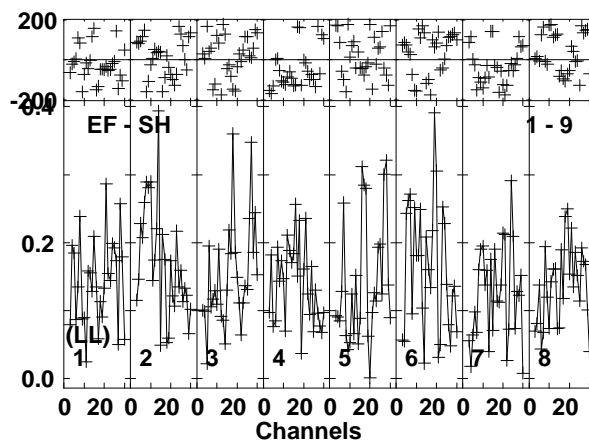
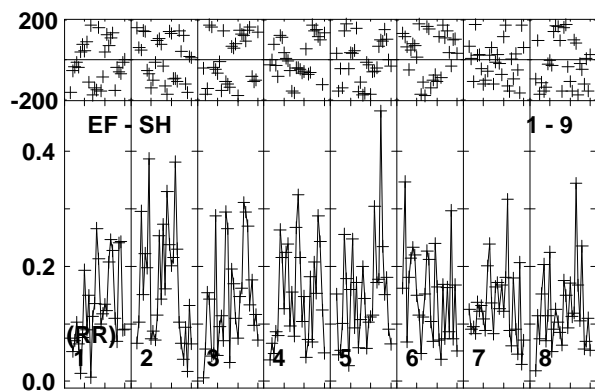
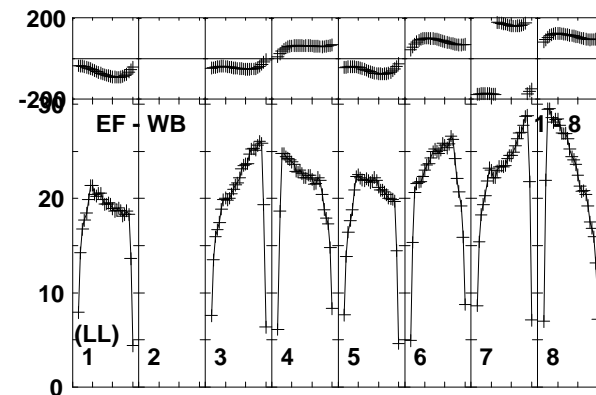
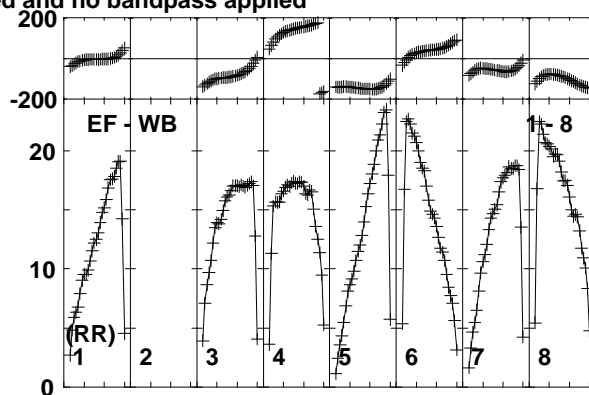
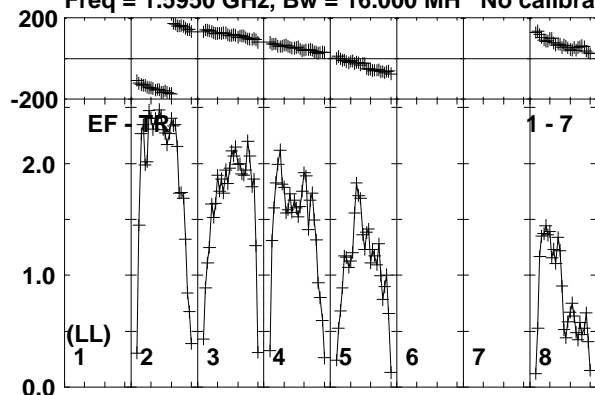

Lower frame: Milli Ampl Jy Top frame: Phas deg  
Vector averaged cross-power spectrum Baseline: EF (01) - TR (07)  
Timerange: 00/23:21:32 to 00/23:22:48



Plot file version 65 created 26-JUN-2015 10:51:18

V404CYG ET031A.UVDATA.1

Freq = 1.5950 GHz, Bw = 16.000 MH No calibration applied and no bandpass applied

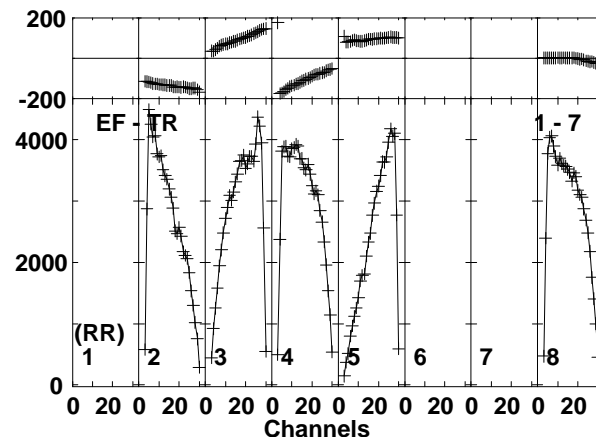
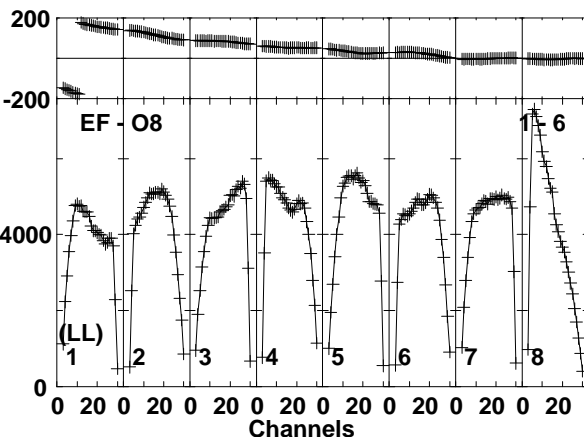
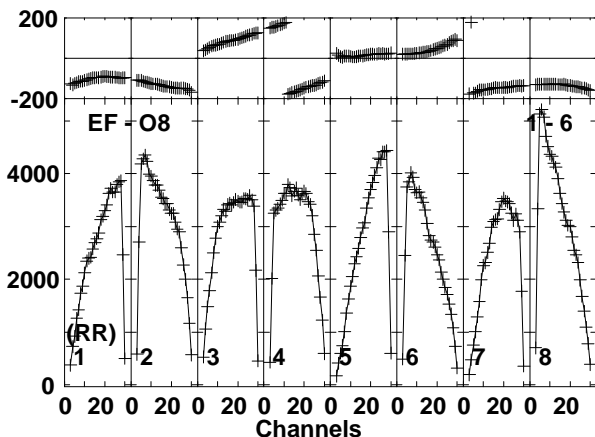
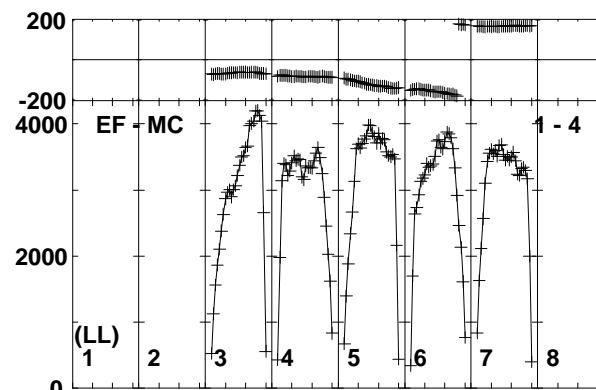
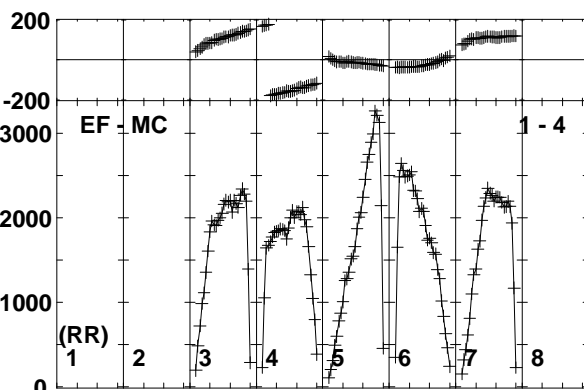
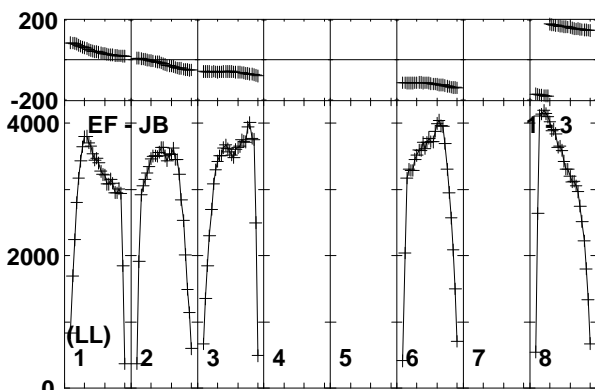
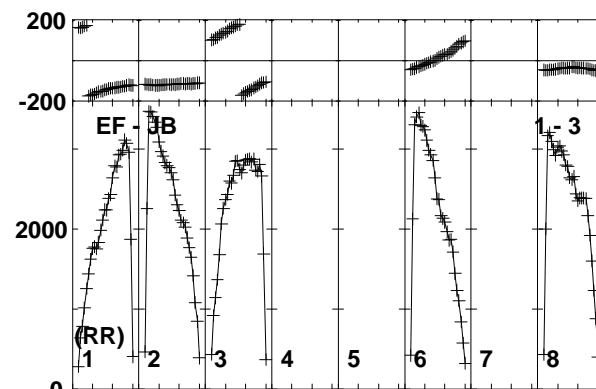
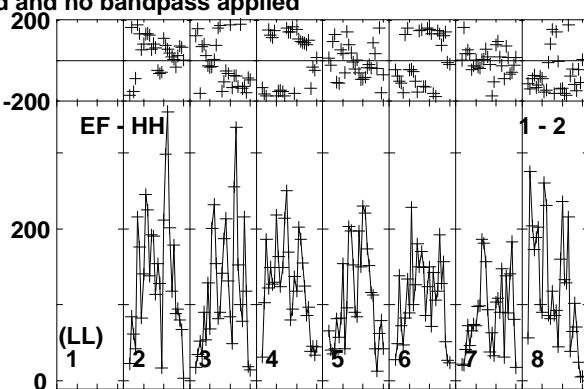
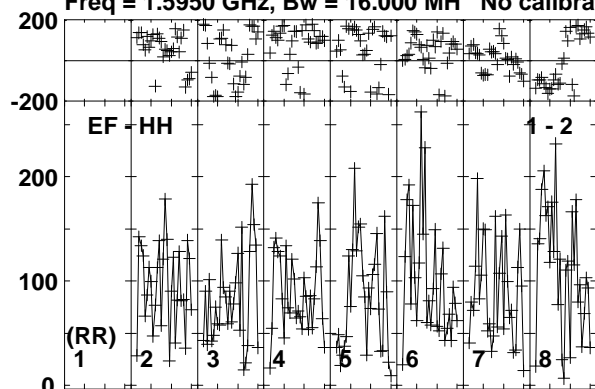

Lower frame: Micro Ampl Jy Top frame: Phas deg  
Vector averaged cross-power spectrum Baseline: EF (01) - HH (02)  
Timerange: 00/23:22:52 to 00/23:26:18

Plot file version 66 created 26-JUN-2015 10:51:19

V404CYG ET031A.UVDATA.1

Freq = 1.5950 GHz, Bw = 16.000 MH No calibration applied and no bandpass applied

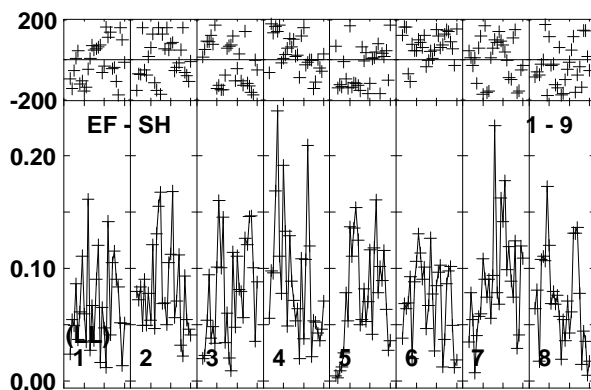
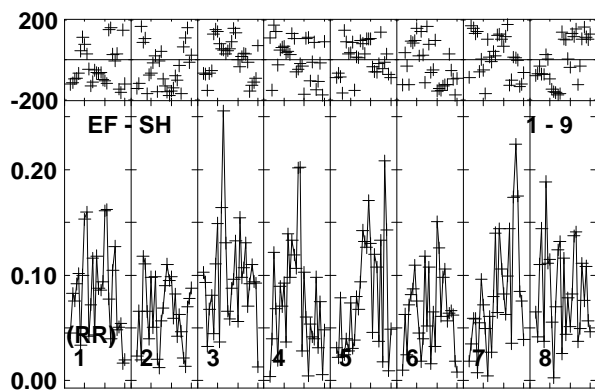
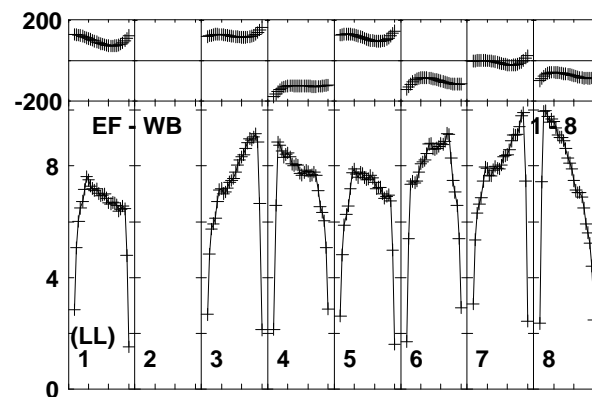
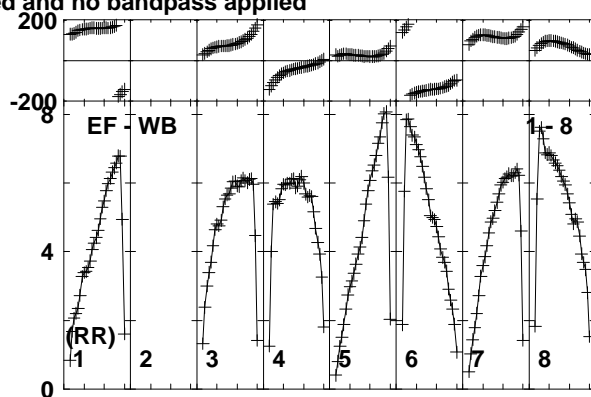
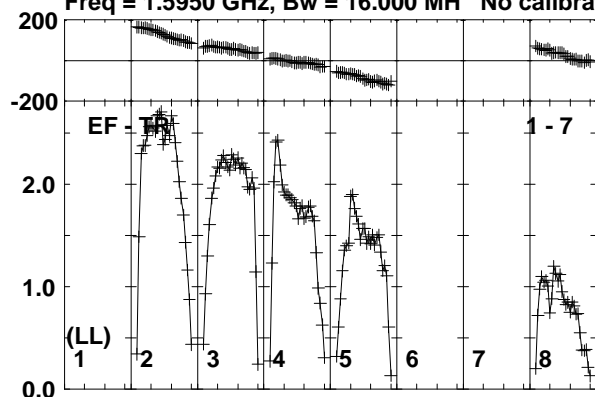

Channels

Lower frame: Milli Ampl Jy Top frame: Phas deg  
Vector averaged cross-power spectrum Baseline: EF (01) - TR (07)  
Timerange: 00/23:22:52 to 00/23:26:18

Plot file version 67 created 26-JUN-2015 10:51:19

J2025+3343 ET031A.UVDATA.1

Freq = 1.5950 GHz, Bw = 16.000 MH No calibration applied and no bandpass applied

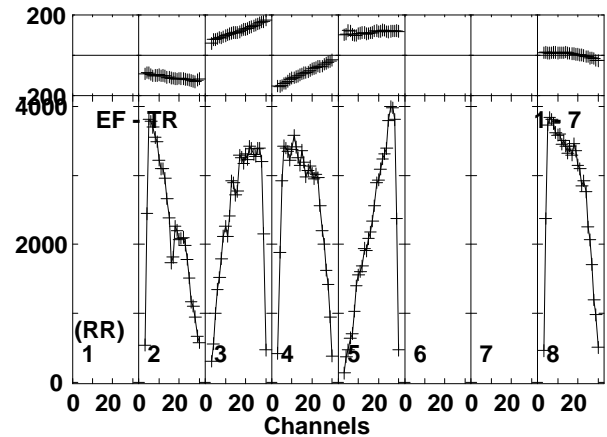
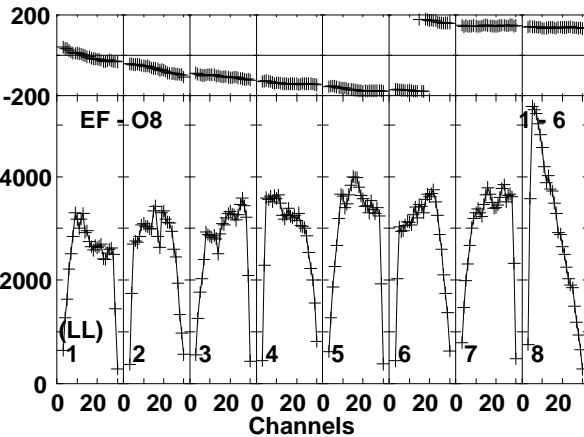
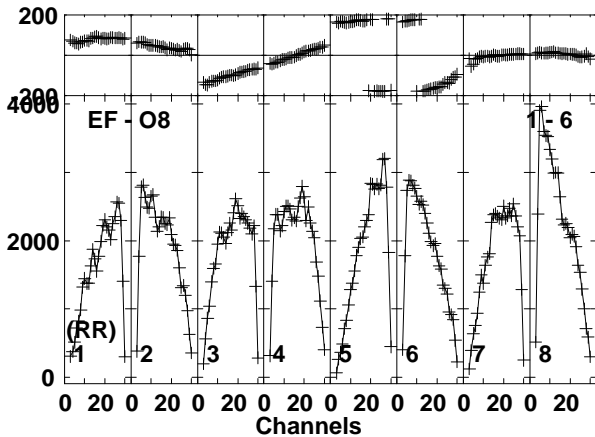
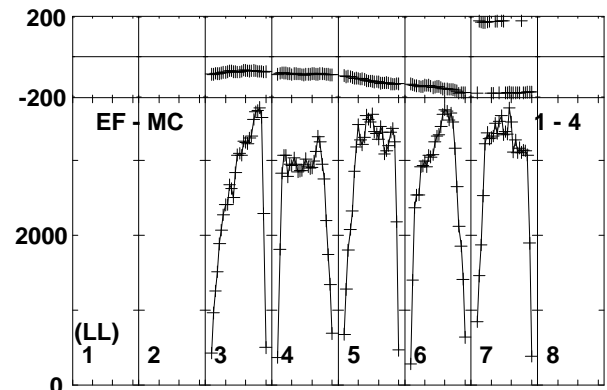
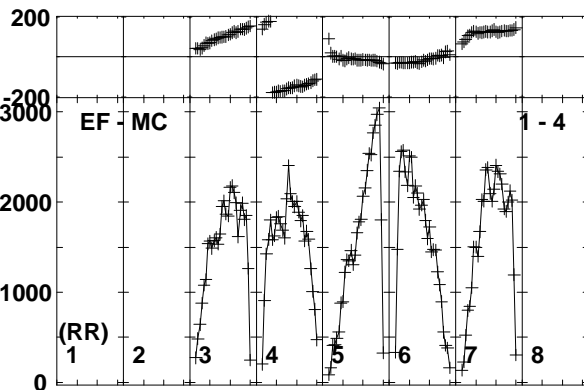
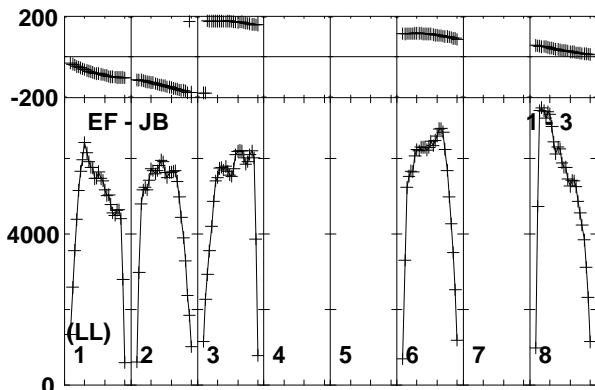
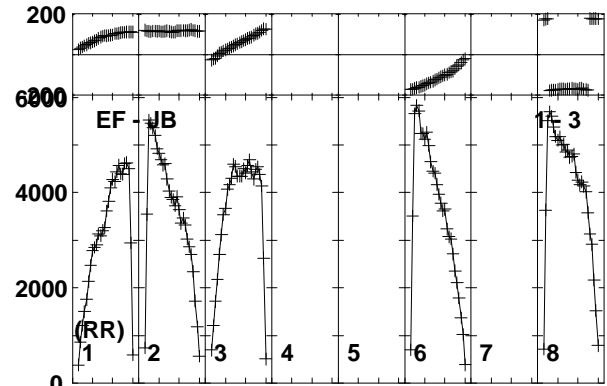
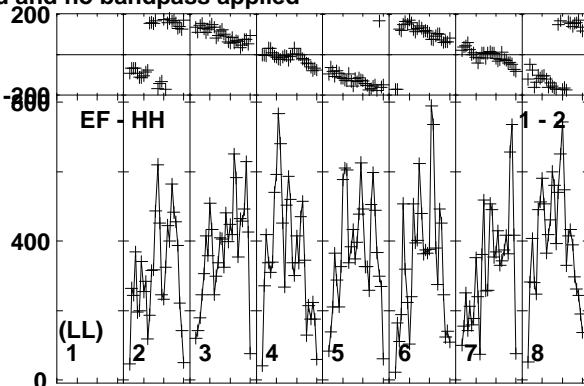
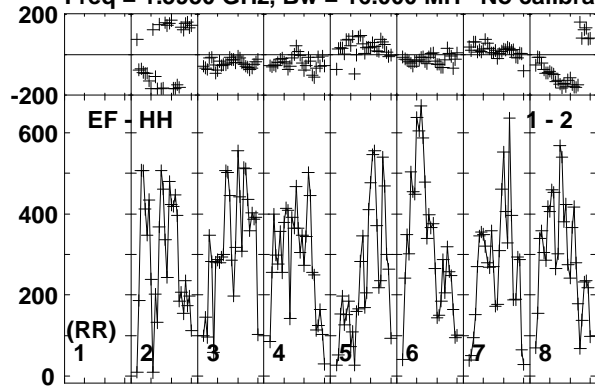

Lower frame: Micro Ampl Jy Top frame: Phas deg  
Vector averaged cross-power spectrum Baseline: EF (01) - HH (02)  
Timerange: 00/23:27:02 to 00/23:27:58

Plot file version 68 created 26-JUN-2015 10:51:19

J2025+3343 ET031A.UVDATA.1

Freq = 1.5950 GHz, Bw = 16.000 MH No calibration applied and no bandpass applied

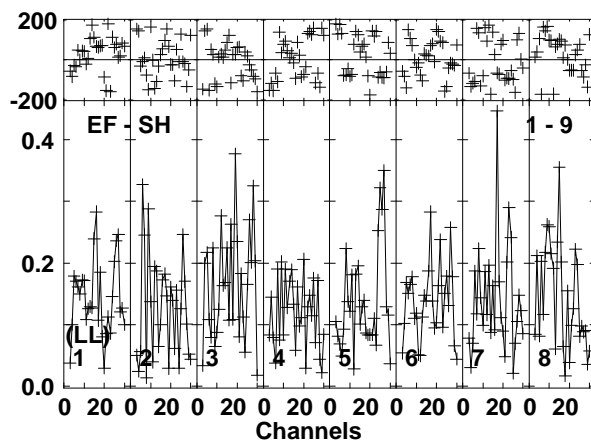
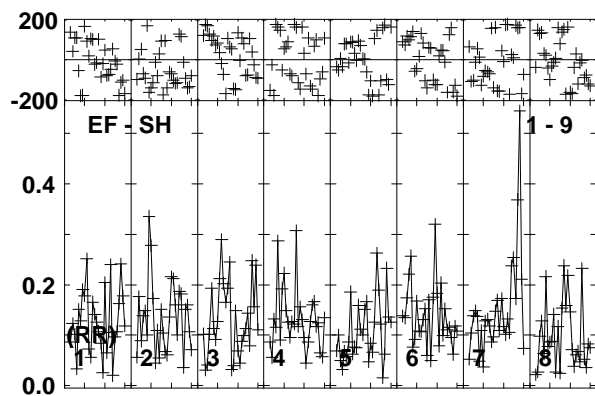
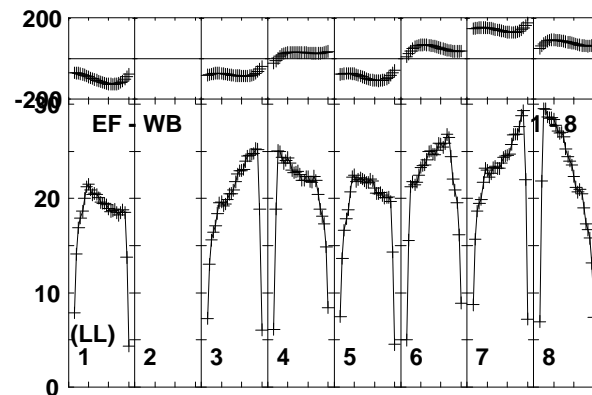
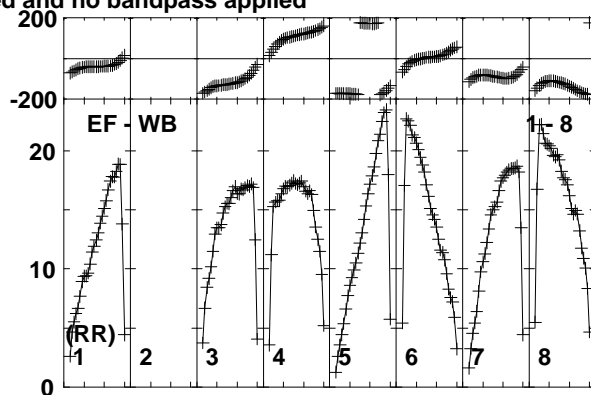
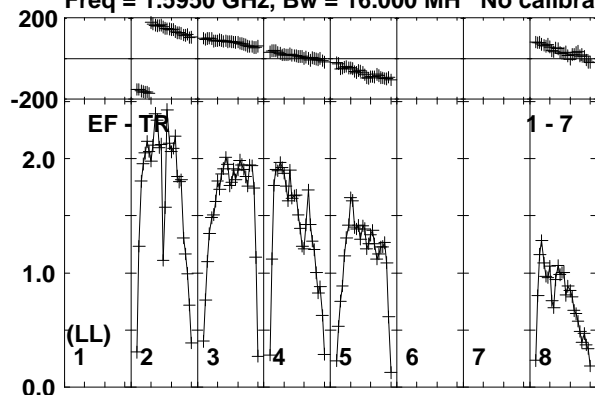

Lower frame: Milli Ampl Jy Top frame: Phas deg  
Vector averaged cross-power spectrum Baseline: EF (01) - TR (07)  
Timerange: 00/23:27:02 to 00/23:27:58

Plot file version 69 created 26-JUN-2015 10:51:19

V404CYG ET031A.UVDATA.1

Freq = 1.5950 GHz, Bw = 16.000 MH No calibration applied and no bandpass applied

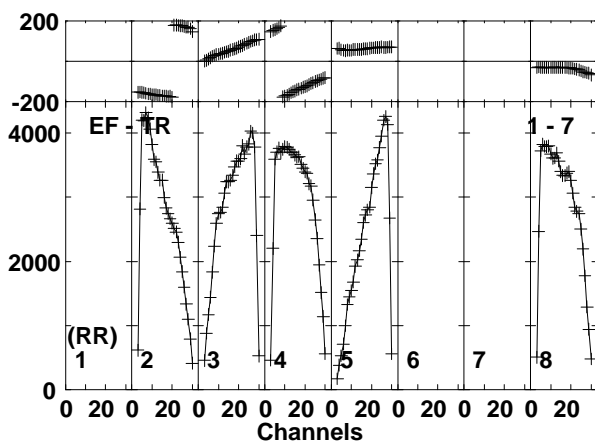
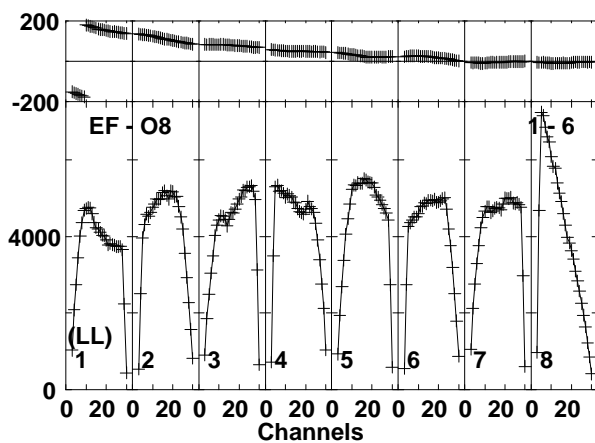
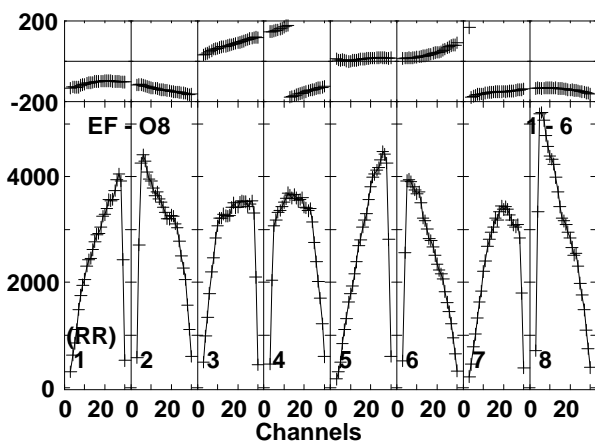
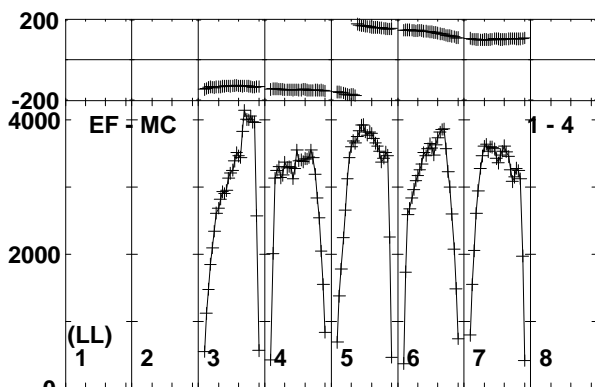
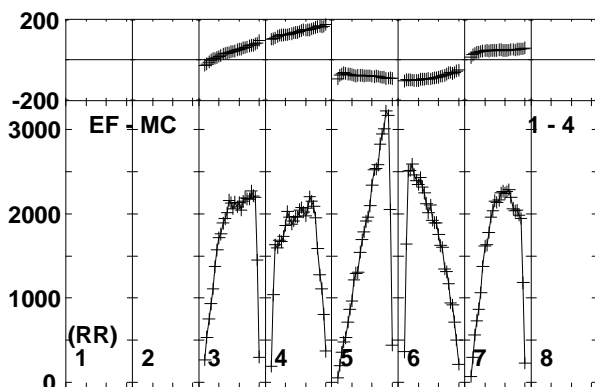
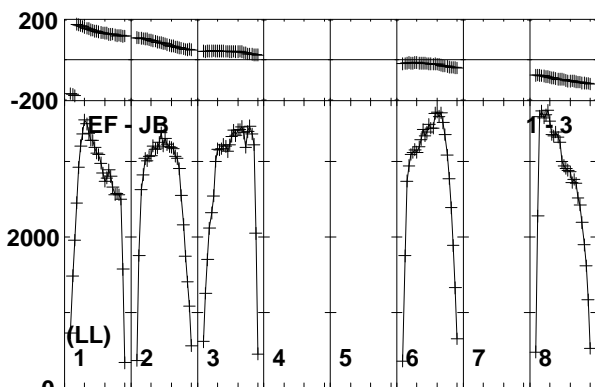
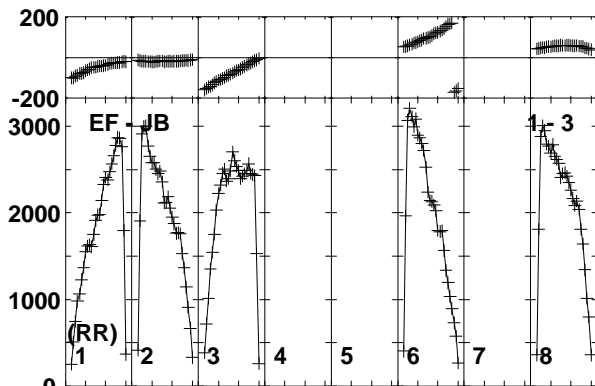
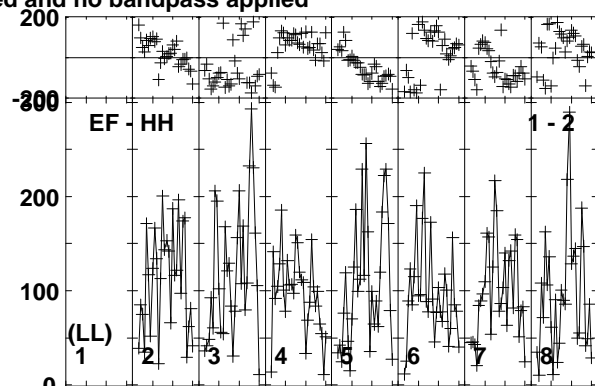
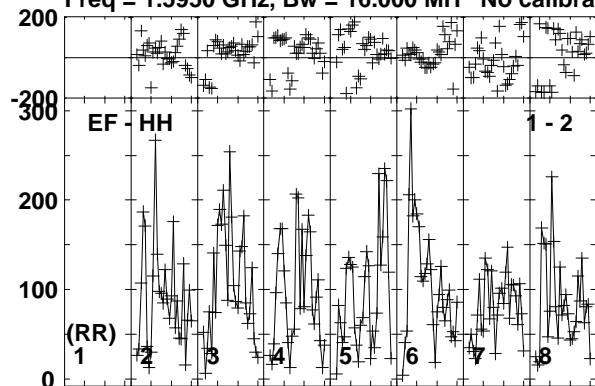

Lower frame: Micro Ampl Jy Top frame: Phas deg  
Vector averaged cross-power spectrum Baseline: EF (01) - HH (02)  
Timerange: 00/23:28:02 to 00/23:31:28

Plot file version 70 created 26-JUN-2015 10:51:19

V404CYG ET031A.UVDATA.1

Freq = 1.5950 GHz, Bw = 16.000 MH No calibration applied and no bandpass applied

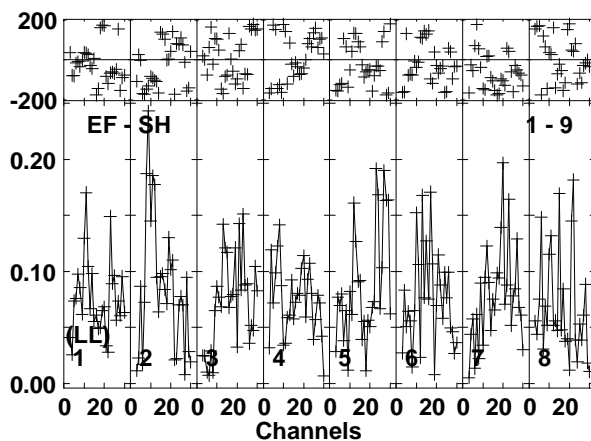
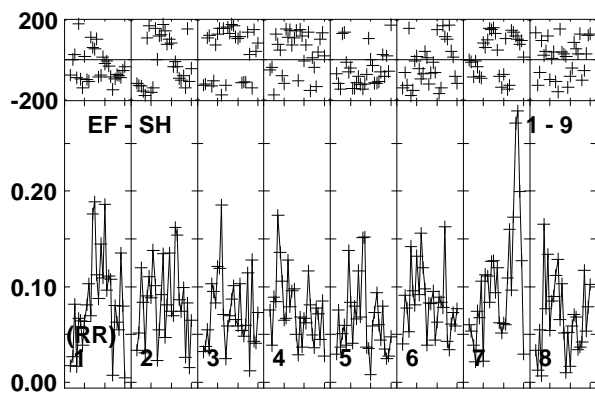
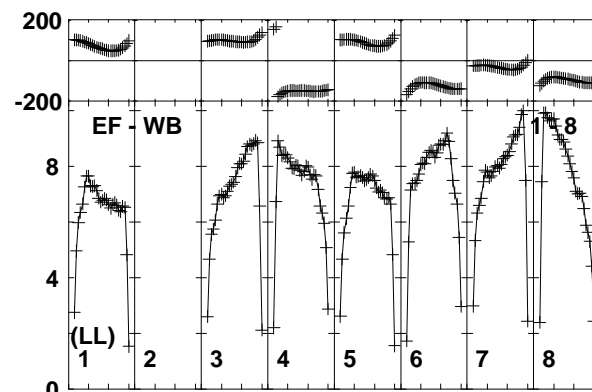
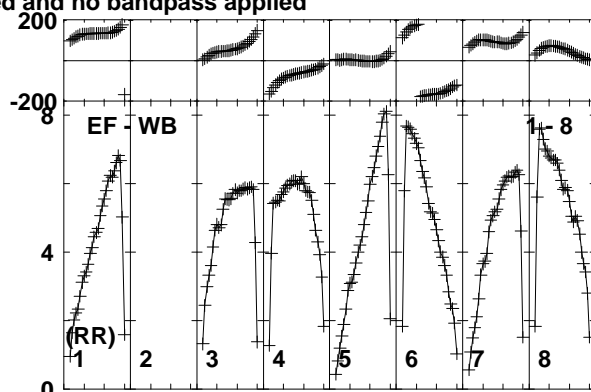
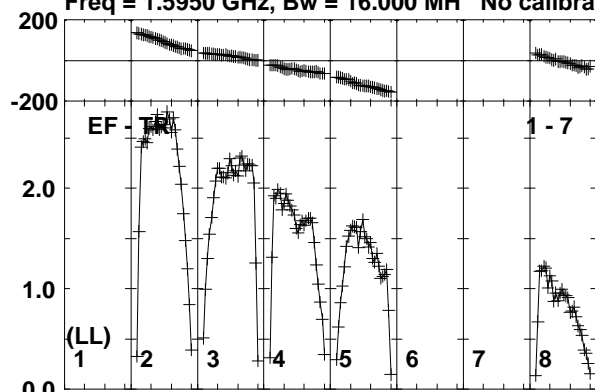

Lower frame: Milli Ampl Jy Top frame: Phas deg  
Vector averaged cross-power spectrum Baseline: EF (01) - TR (07)  
Timerange: 00/23:28:02 to 00/23:31:28

Plot file version 71 created 26-JUN-2015 10:51:19

J2025+3343 ET031A.UVDATA.1

Freq = 1.5950 GHz, Bw = 16.000 MH No calibration applied and no bandpass applied

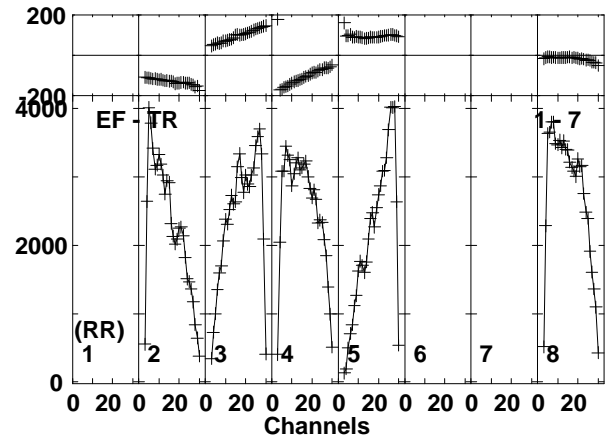
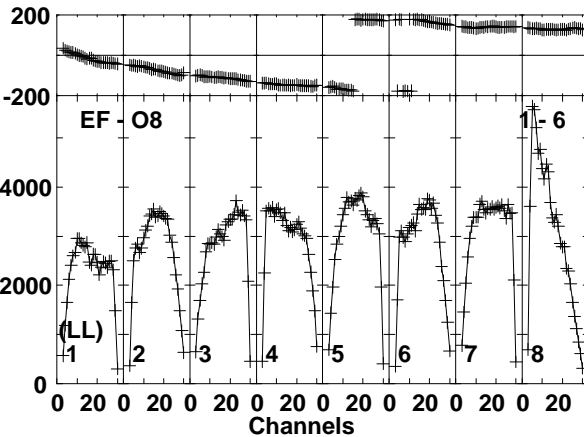
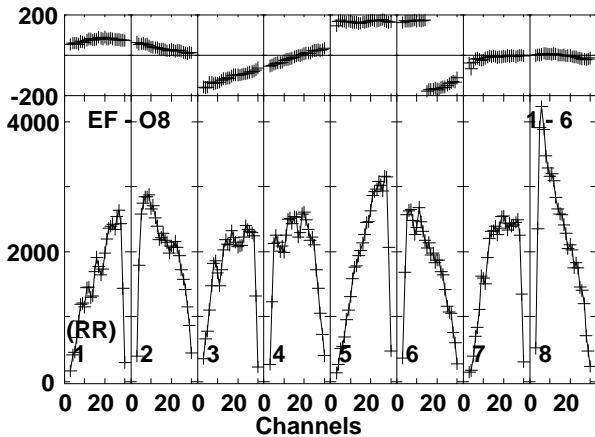
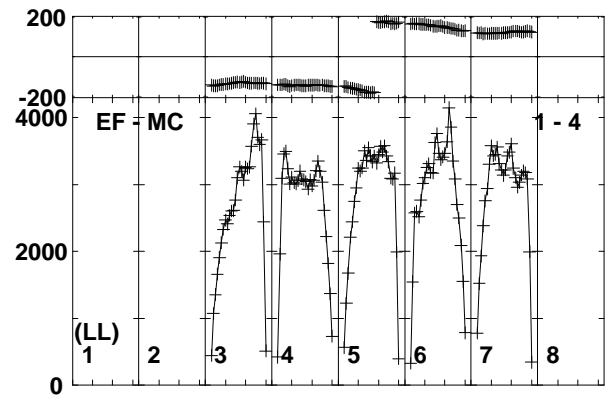
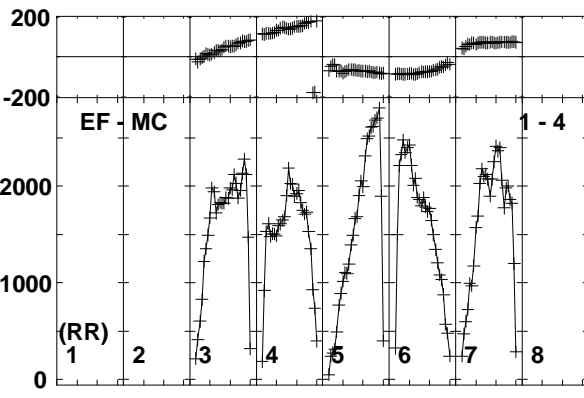
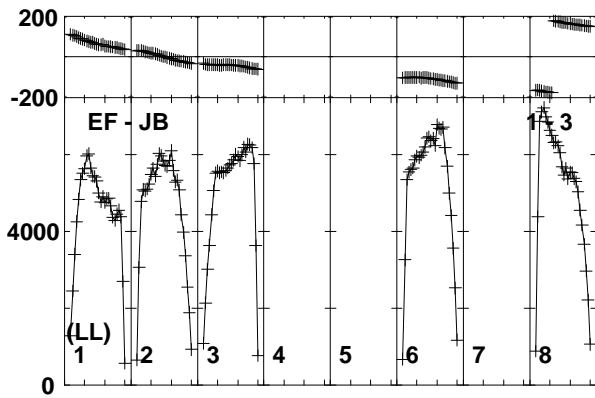
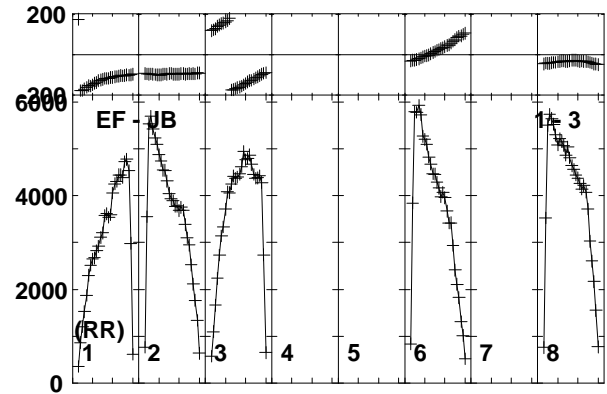
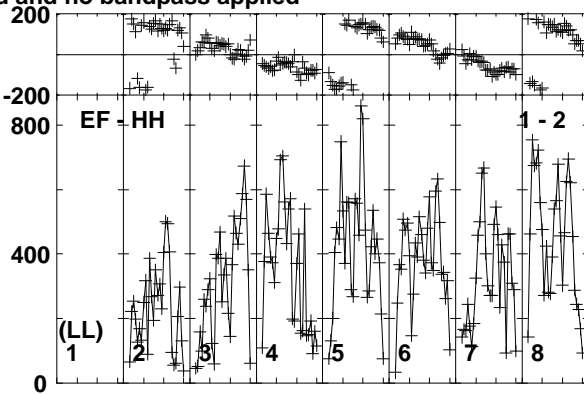
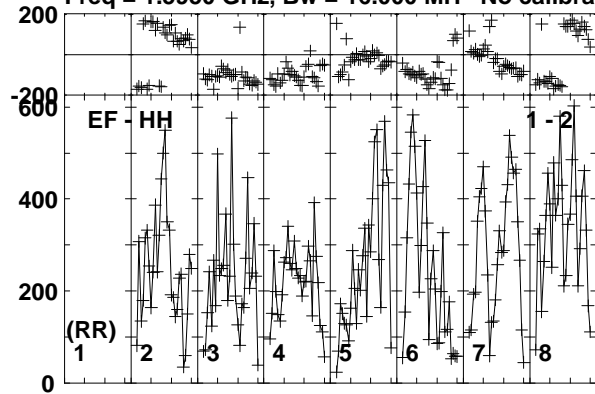

Lower frame: Micro Ampl Jy Top frame: Phas deg  
Vector averaged cross-power spectrum Baseline: EF (01) - HH (02)  
Timerange: 00/23:31:32 to 00/23:32:48

Plot file version 72 created 26-JUN-2015 10:51:19

J2025+3343 ET031A.UVDATA.1

Freq = 1.5950 GHz, Bw = 16.000 MH No calibration applied and no bandpass applied

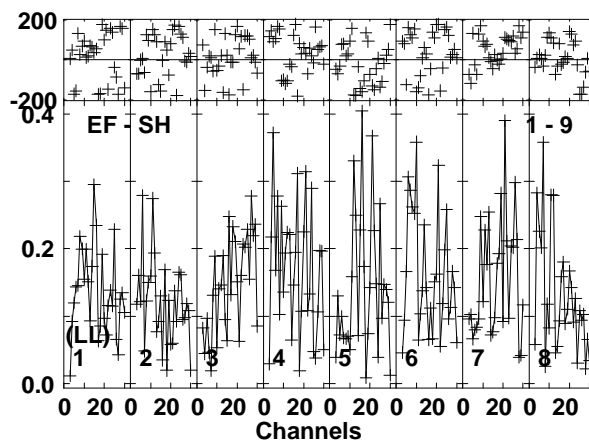
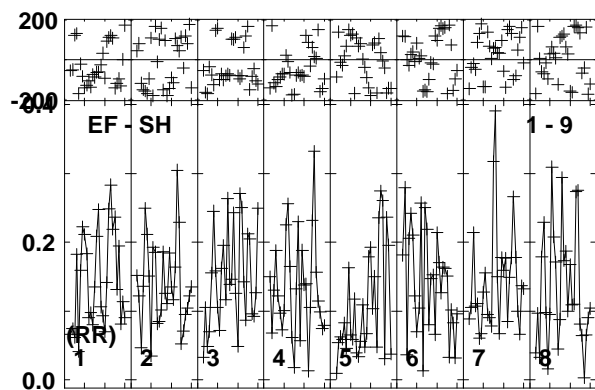
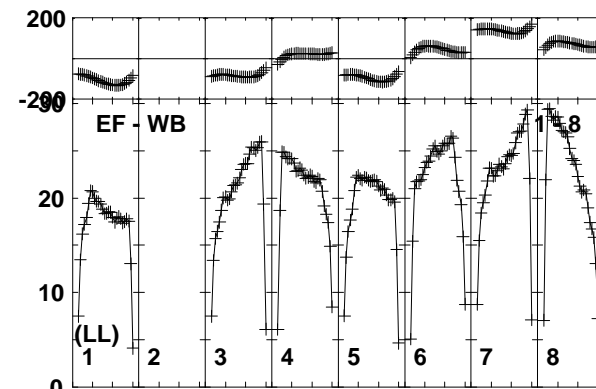
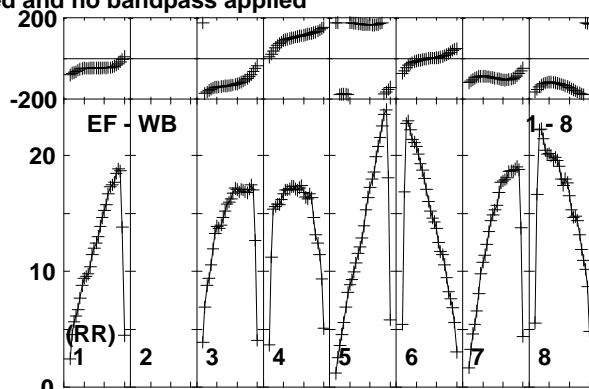
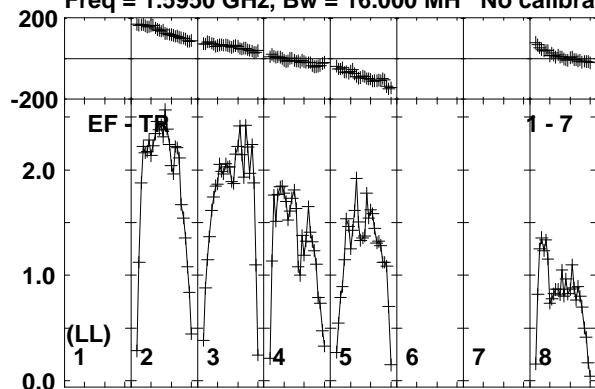

Lower frame: Milli Ampl Jy Top frame: Phas deg  
Vector averaged cross-power spectrum Baseline: EF (01) - TR (07)  
Timerange: 00/23:31:32 to 00/23:32:48



Plot file version 73 created 26-JUN-2015 10:51:19

V404CYG ET031A.UVDATA.1

Freq = 1.5950 GHz, Bw = 16.000 MH No calibration applied and no bandpass applied

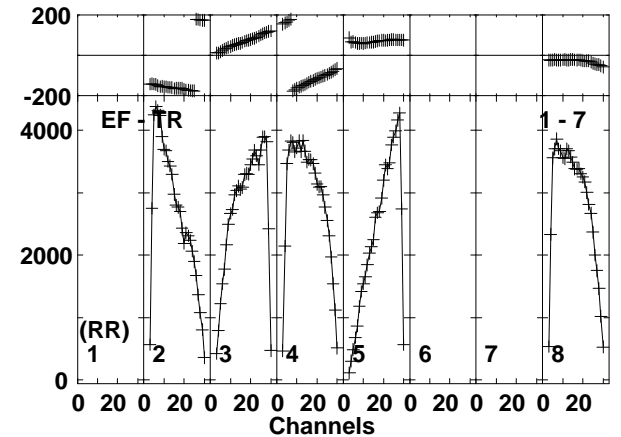
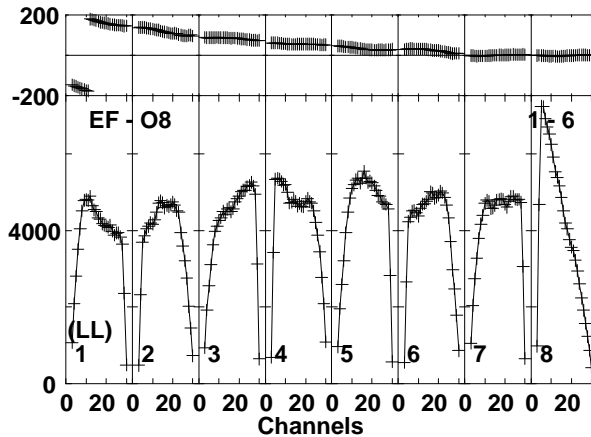
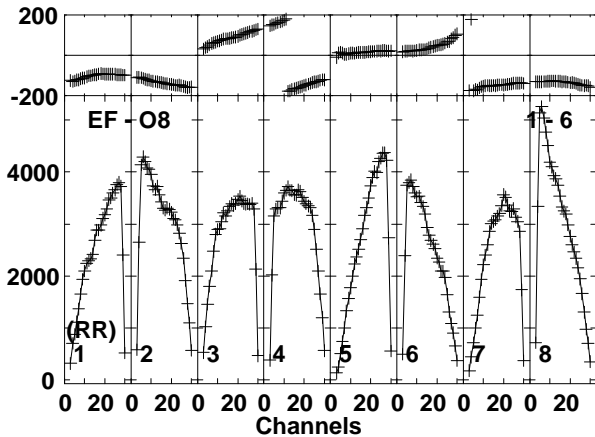
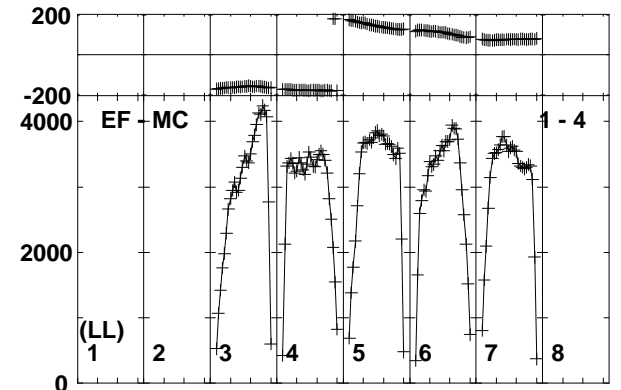
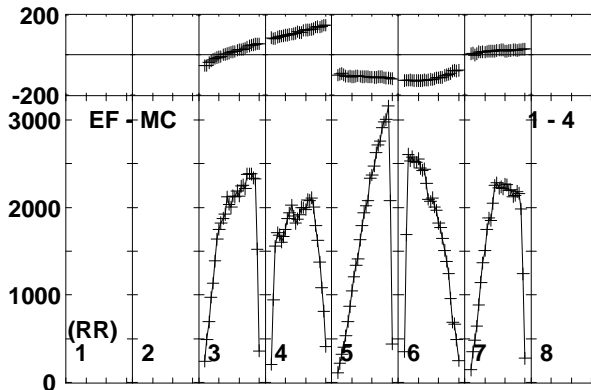
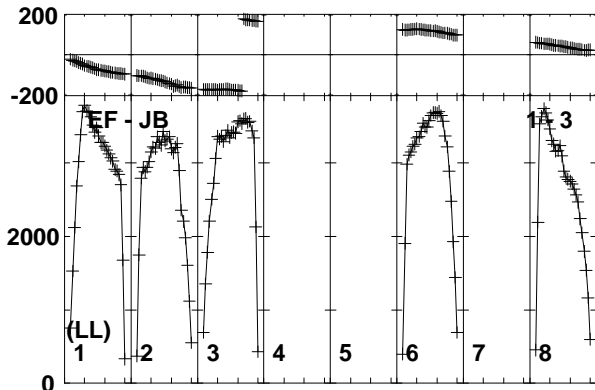
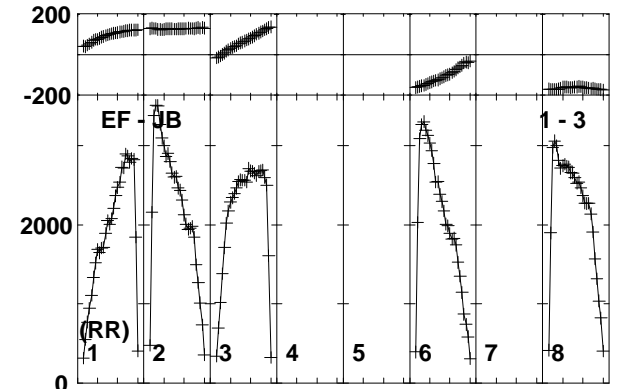
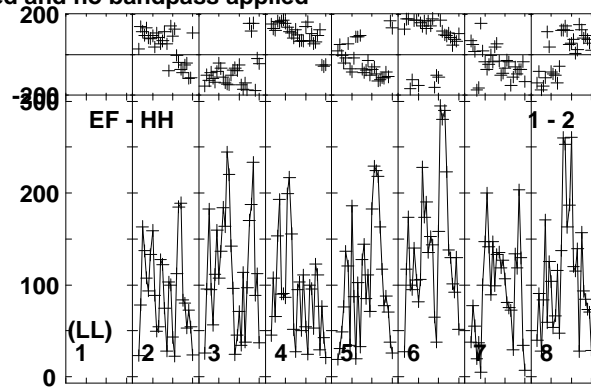
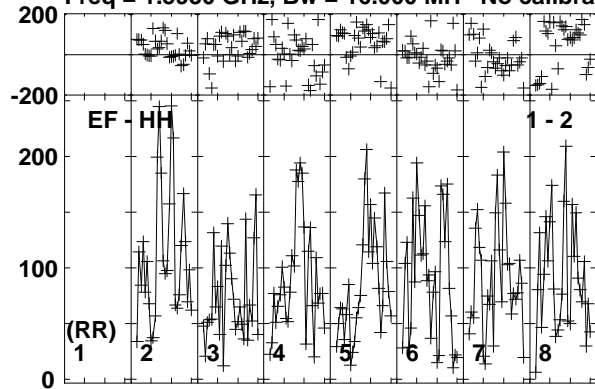

Lower frame: Micro Ampl Jy Top frame: Phas deg  
Vector averaged cross-power spectrum Baseline: EF (01) - HH (02)  
Timerange: 00/23:32:52 to 00/23:36:18

Plot file version 74 created 26-JUN-2015 10:51:19

V404CYG ET031A.UVDATA.1

Freq = 1.5950 GHz, Bw = 16.000 MH No calibration applied and no bandpass applied

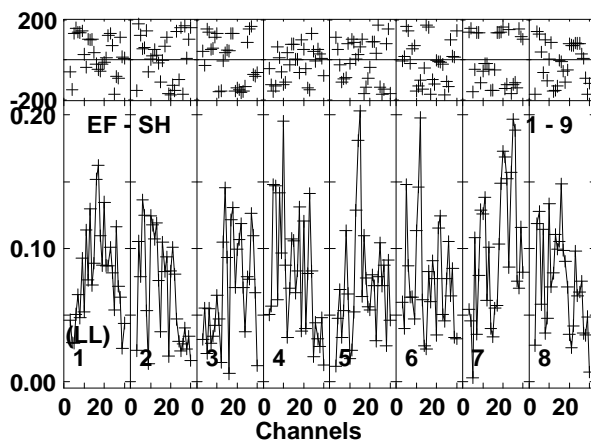
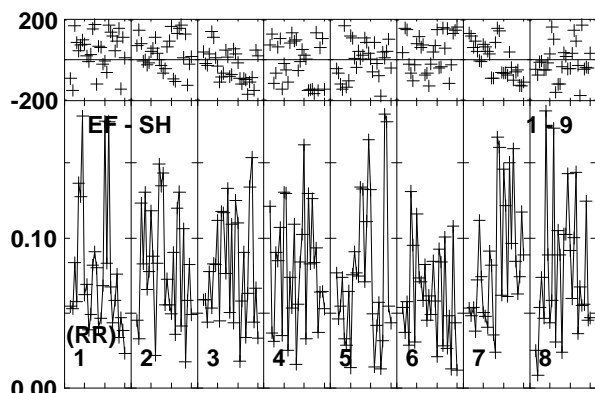
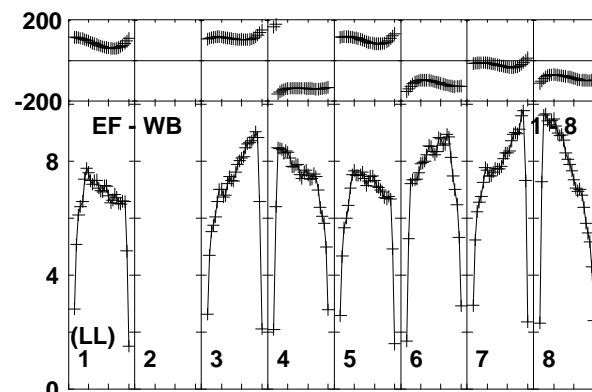
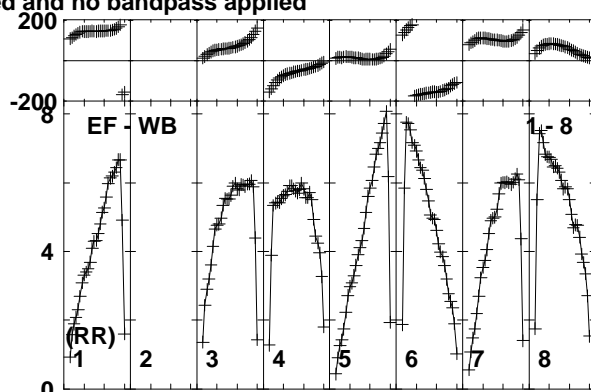
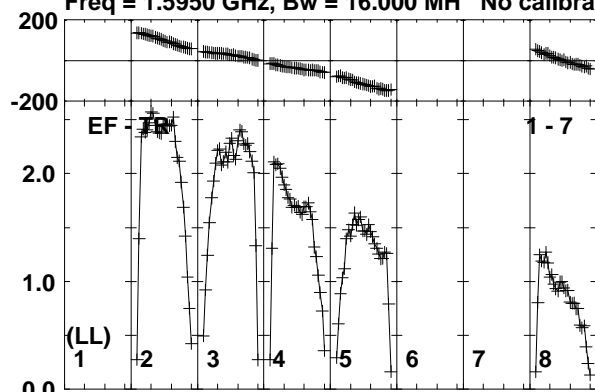

Lower frame: Milli Ampl Jy Top frame: Phas deg  
Vector averaged cross-power spectrum Baseline: EF (01) - TR (07)  
Timerange: 00/23:32:52 to 00/23:36:18

Plot file version 75 created 26-JUN-2015 10:51:19

J2025+3343 ET031A.UVDATA.1

Freq = 1.5950 GHz, Bw = 16.000 MH No calibration applied and no bandpass applied

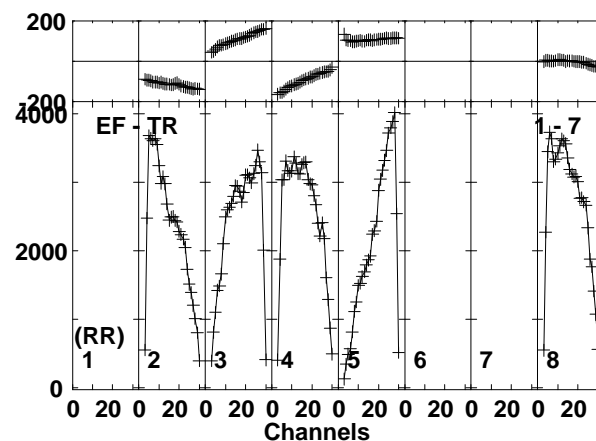
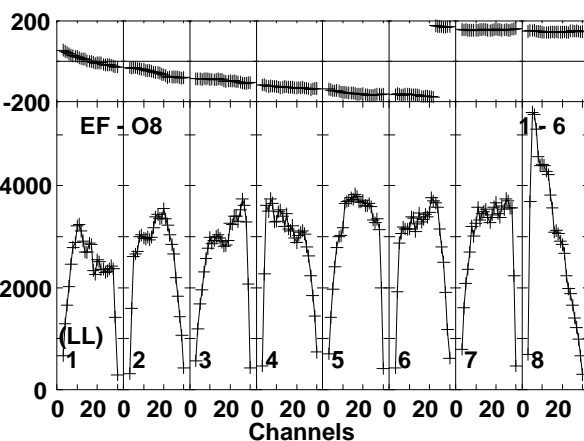
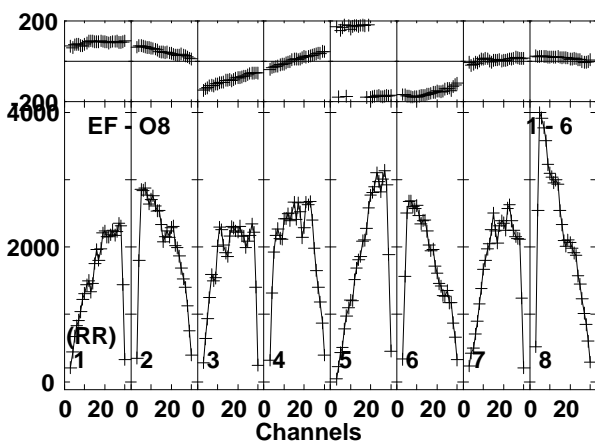
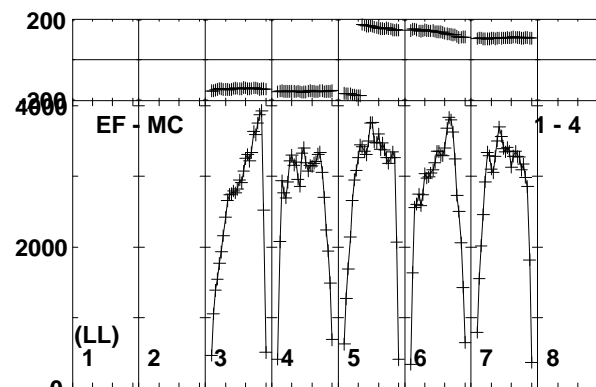
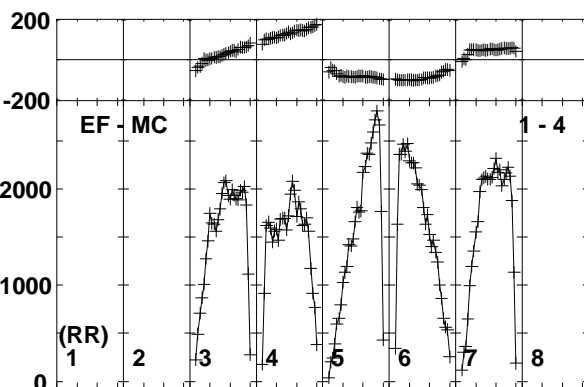
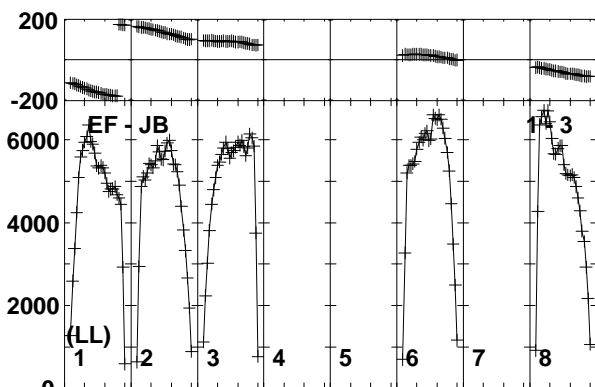
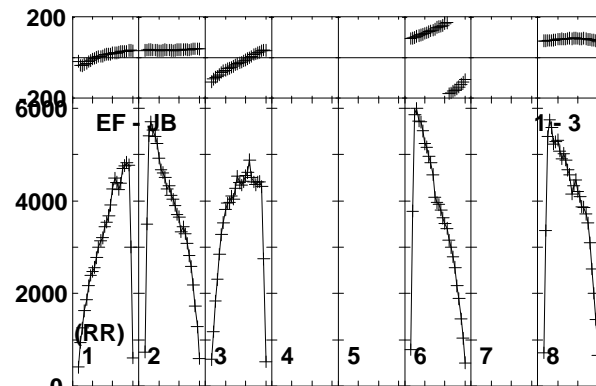
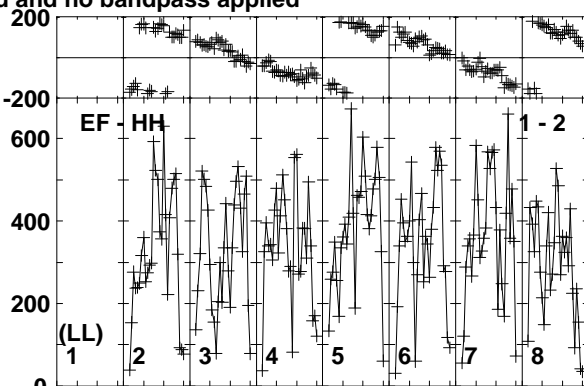
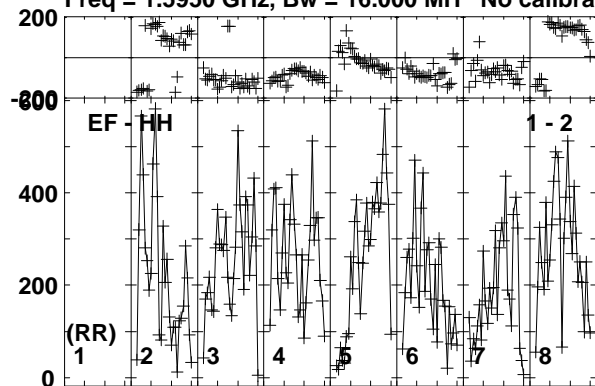

Lower frame: Micro Ampl Jy Top frame: Phas deg  
Vector averaged cross-power spectrum Baseline: EF (01) - HH (02)  
Timerange: 00/23:37:02 to 00/23:37:58

Plot file version 76 created 26-JUN-2015 10:51:19

J2025+3343 ET031A.UVDATA.1

Freq = 1.5950 GHz, Bw = 16.000 MH No calibration applied and no bandpass applied

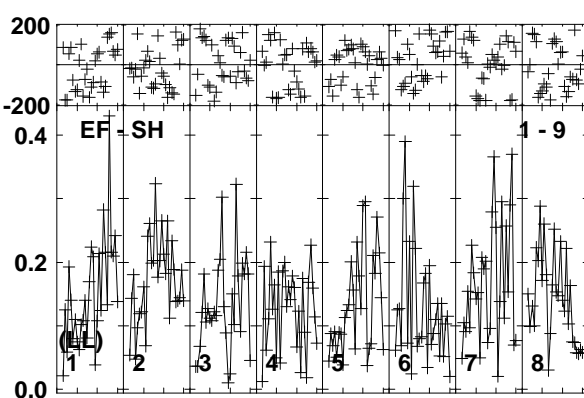
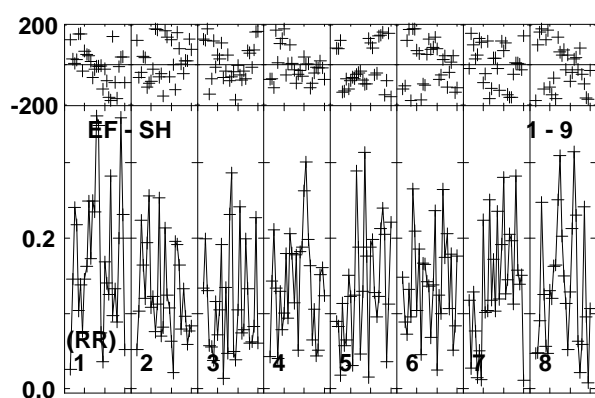
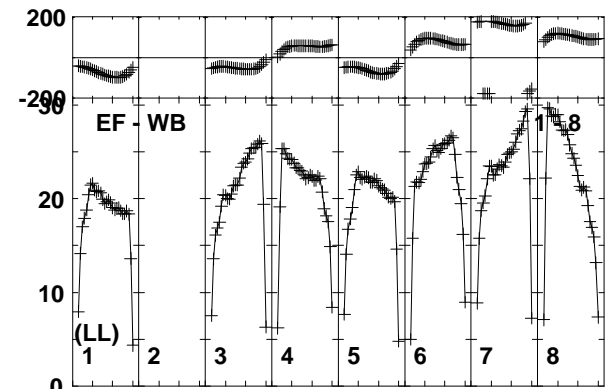
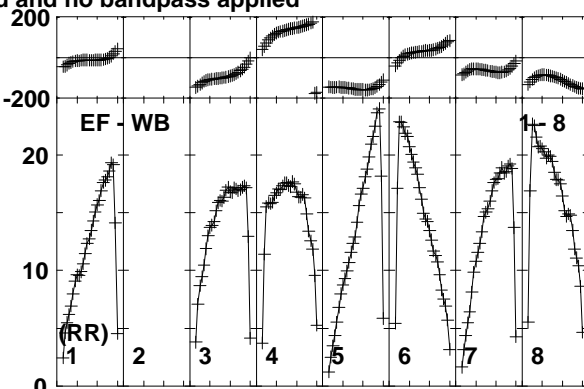
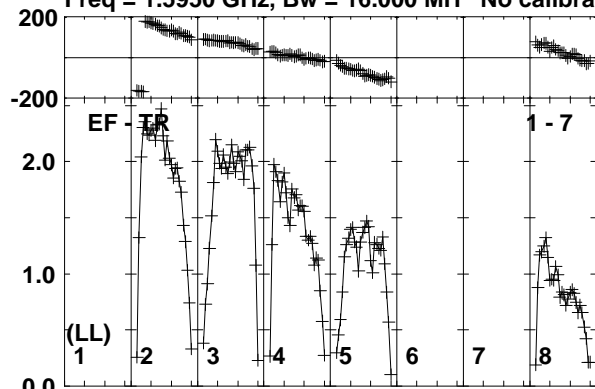

Channels

Lower frame: Milli Ampl Jy Top frame: Phas deg  
Vector averaged cross-power spectrum Baseline: EF (01) - TR (07)  
Timerange: 00/23:37:02 to 00/23:37:58

Plot file version 77 created 26-JUN-2015 10:51:19

V404CYG ET031A.UVDATA.1

Freq = 1.5950 GHz, Bw = 16.000 MH No calibration applied and no bandpass applied

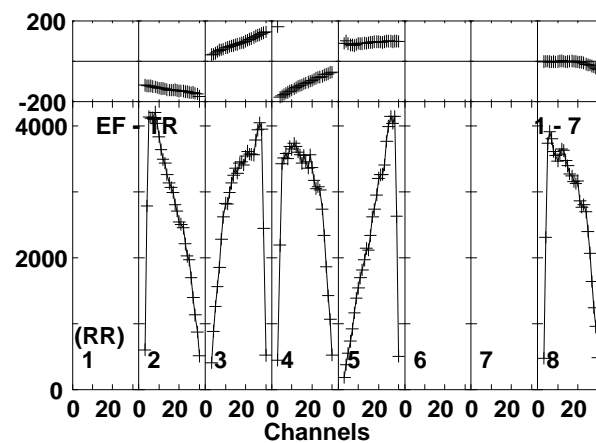
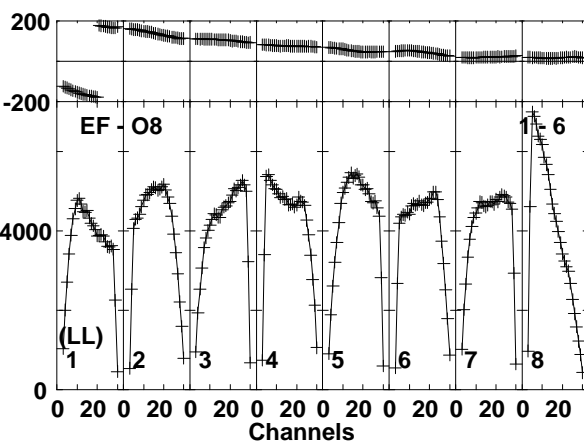
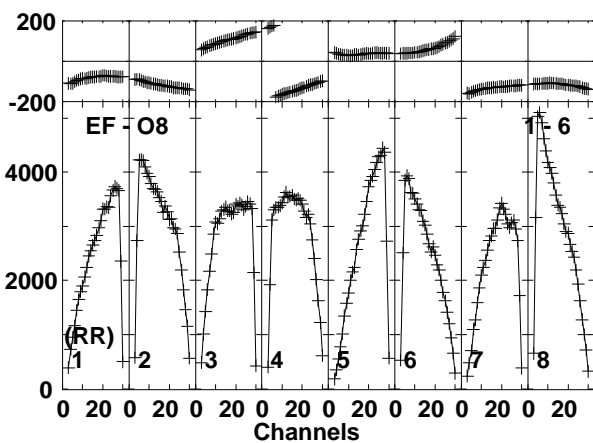
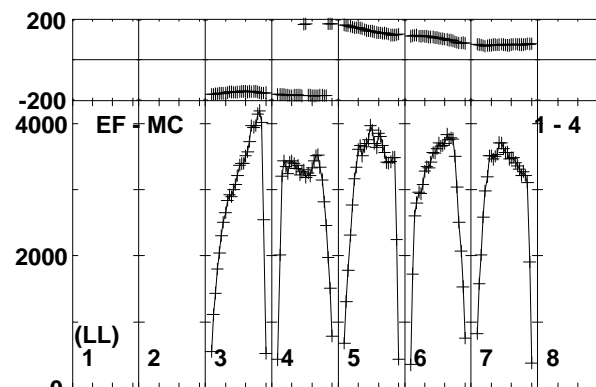
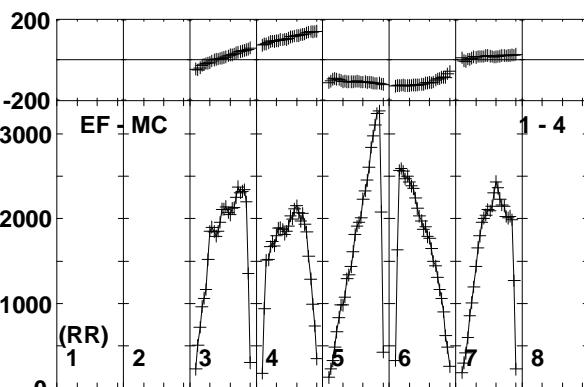
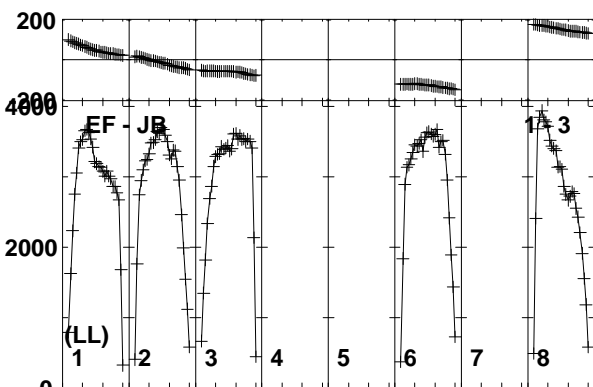
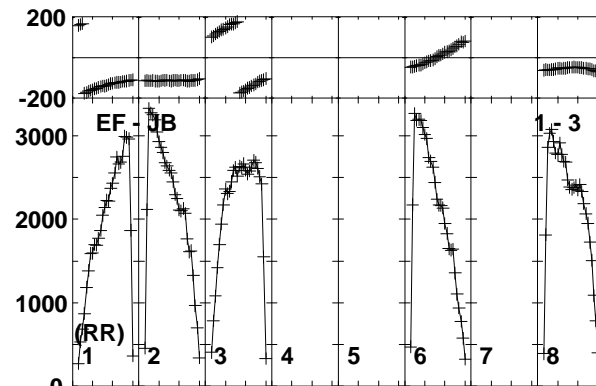
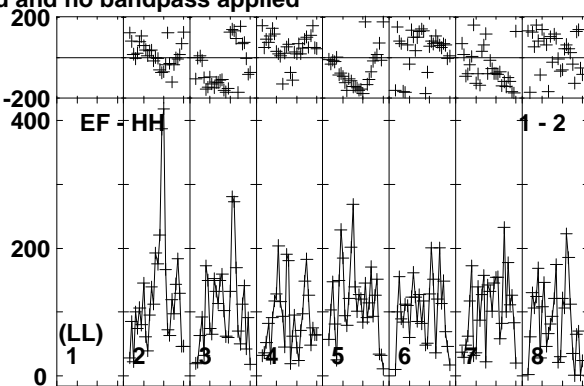
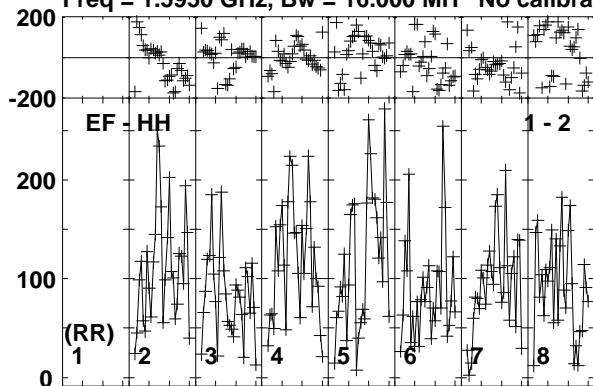

Lower frame: Micro Ampl Jy Top frame: Phas deg  
Vector averaged cross-power spectrum Baseline: EF (01) - HH (02)  
Timerange: 00/23:38:02 to 00/23:41:28

Plot file version 78 created 26-JUN-2015 10:51:19

V404CYG ET031A.UVDATA.1

Freq = 1.5950 GHz, Bw = 16.000 MH No calibration applied and no bandpass applied

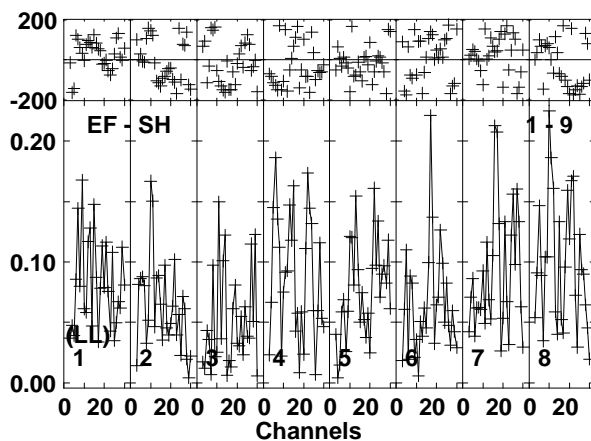
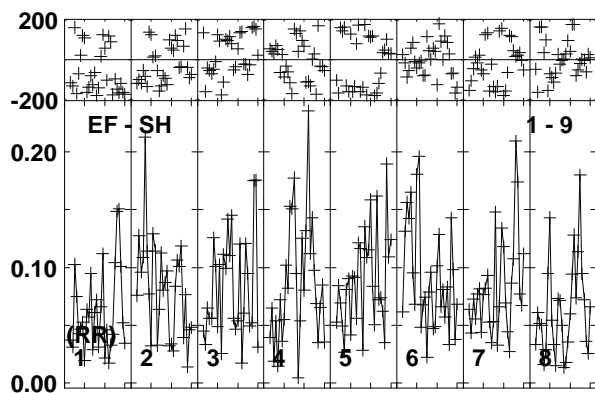
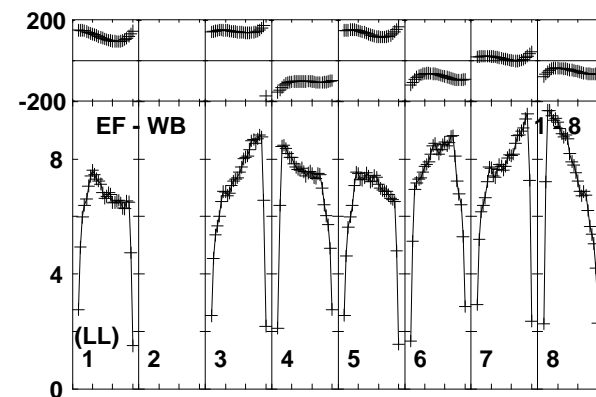
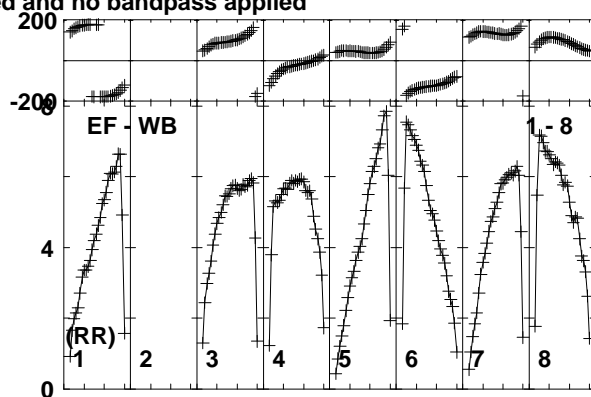
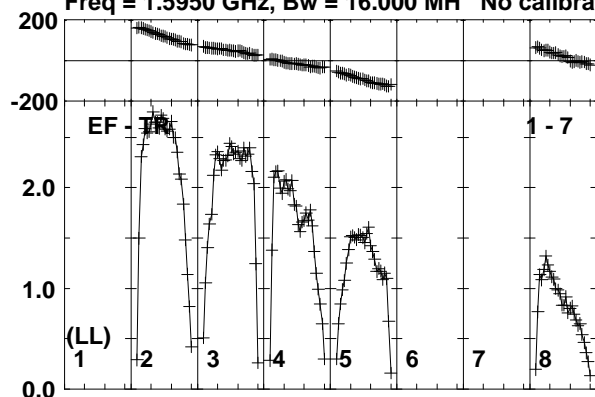

Lower frame: Milli Ampl Jy Top frame: Phas deg  
Vector averaged cross-power spectrum Baseline: EF (01) - TR (07)  
Timerange: 00/23:38:02 to 00/23:41:28

Plot file version 79 created 26-JUN-2015 10:51:19

J2025+3343 ET031A.UVDATA.1

Freq = 1.5950 GHz, Bw = 16.000 MH No calibration applied and no bandpass applied

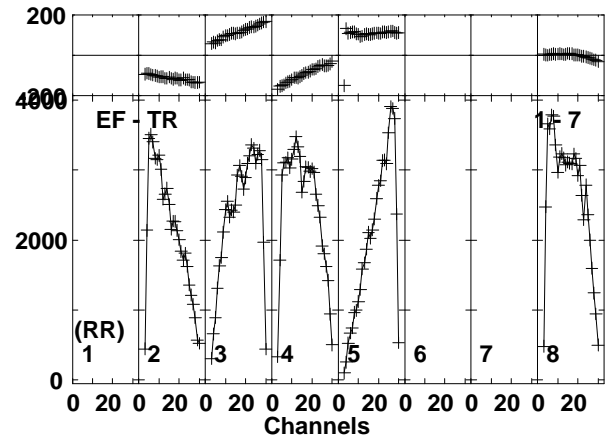
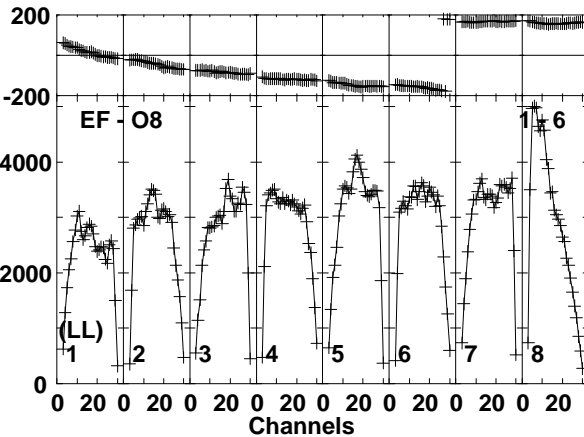
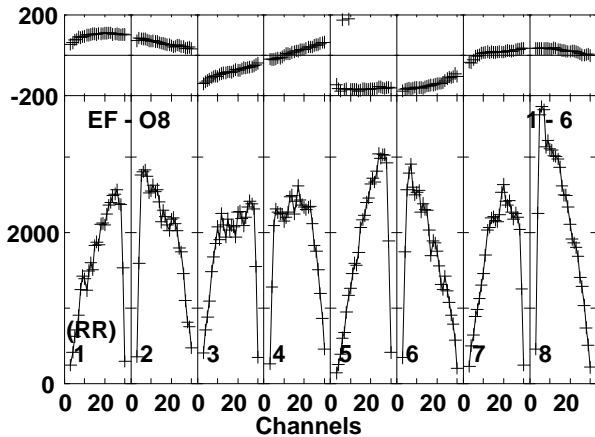
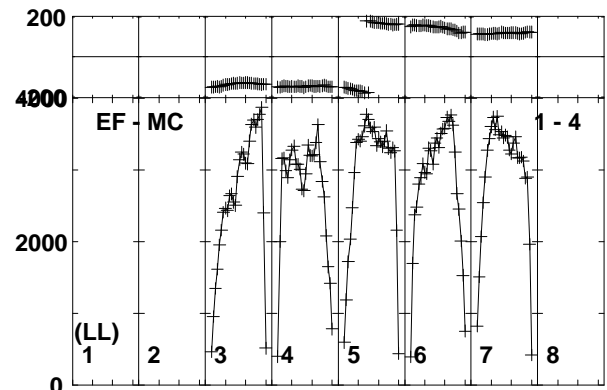
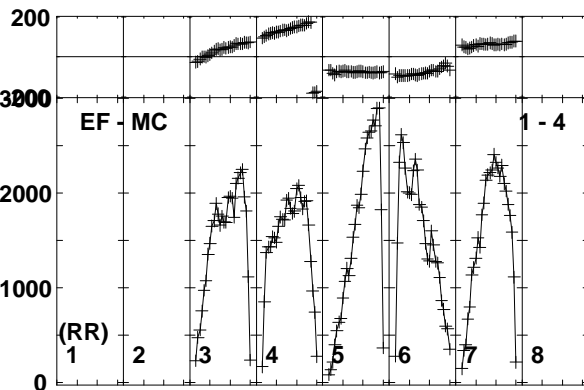
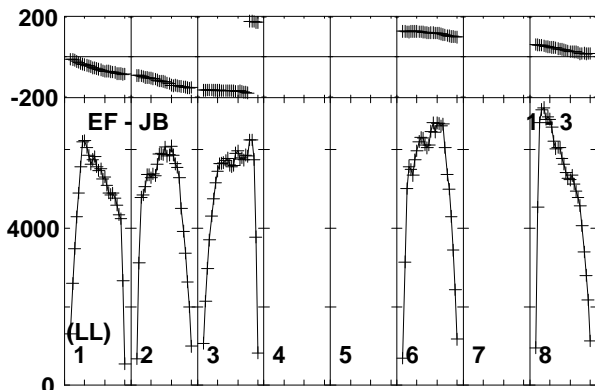
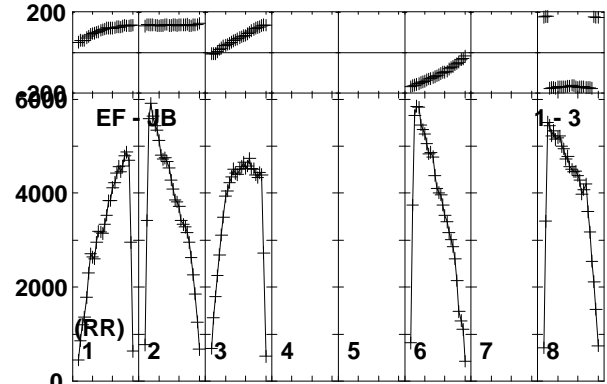
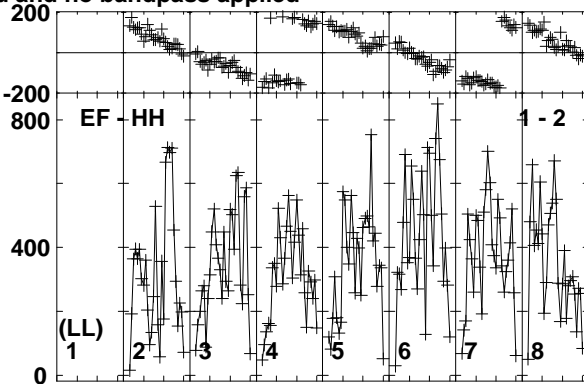
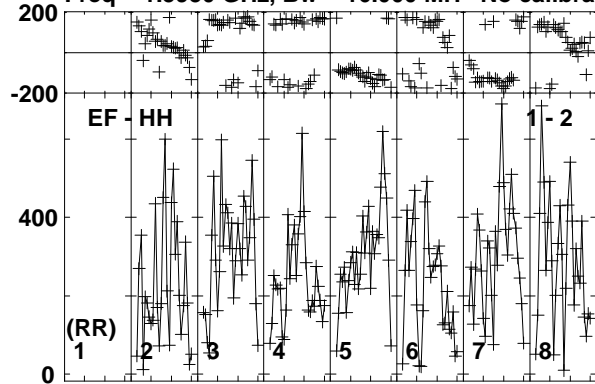

Lower frame: Micro Ampl Jy Top frame: Phas deg  
Vector averaged cross-power spectrum Baseline: EF (01) - HH (02)  
Timerange: 00/23:41:32 to 00/23:42:48

Plot file version 80 created 26-JUN-2015 10:51:19

J2025+3343 ET031A.UVDATA.1

Freq = 1.5950 GHz, Bw = 16.000 MH No calibration applied and no bandpass applied

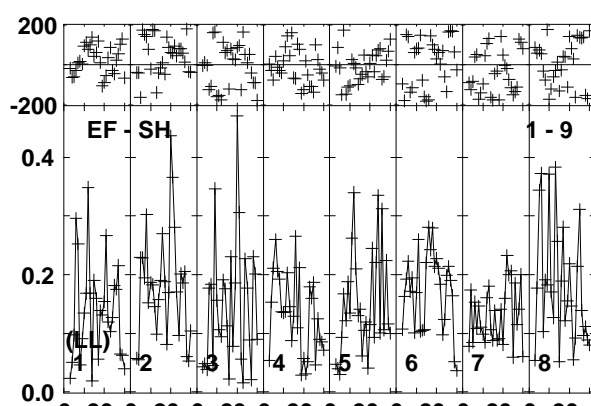
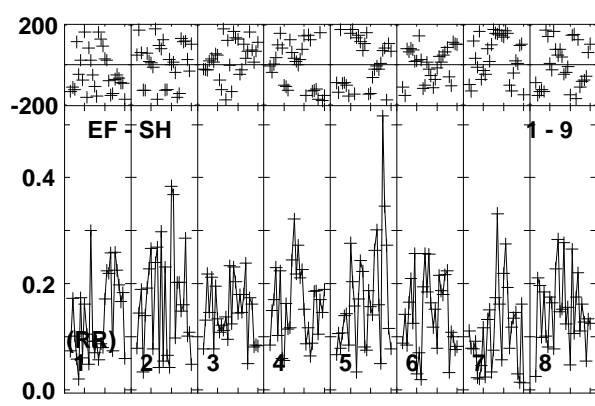
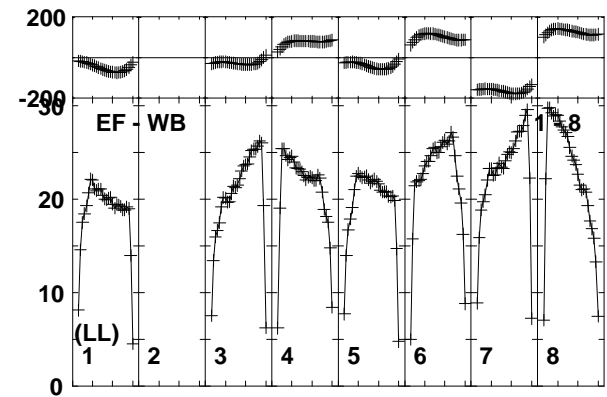
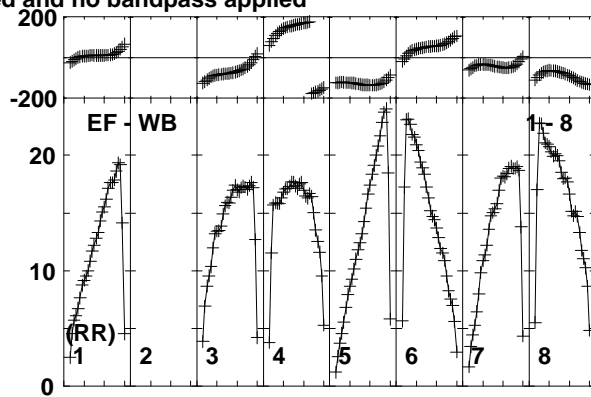
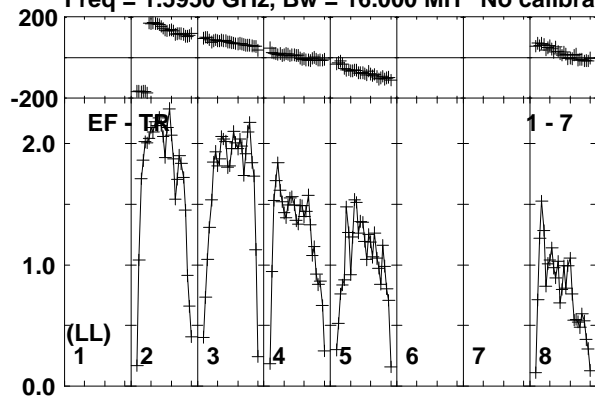

Channels

Lower frame: Milli Ampl Jy Top frame: Phas deg  
 Vector averaged cross-power spectrum Baseline: EF (01) - TR (07)  
 Timerange: 00/23:41:32 to 00/23:42:48



Plot file version 81 created 26-JUN-2015 10:51:19

V404CYG ET031A.UVDATA.1

Freq = 1.5950 GHz, Bw = 16.000 MH No calibration applied and no bandpass applied

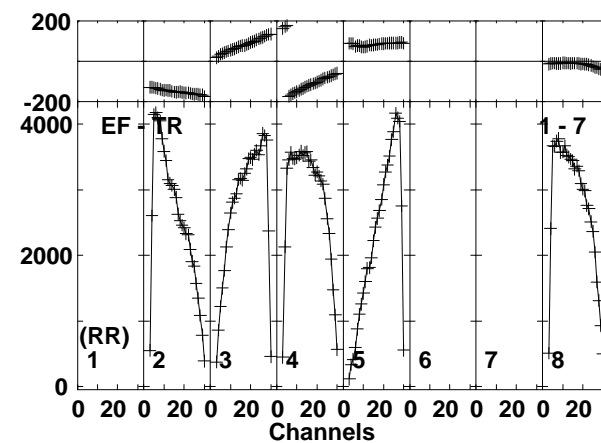
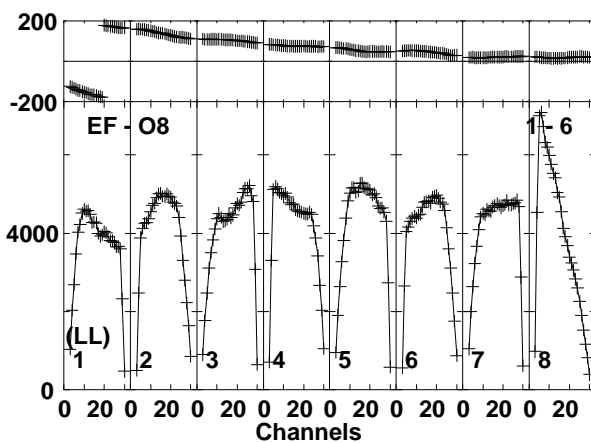
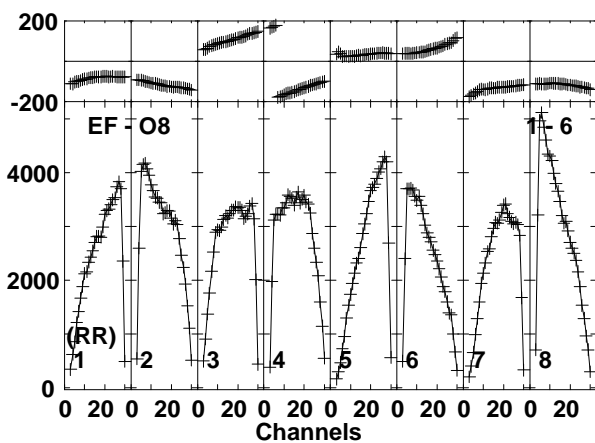
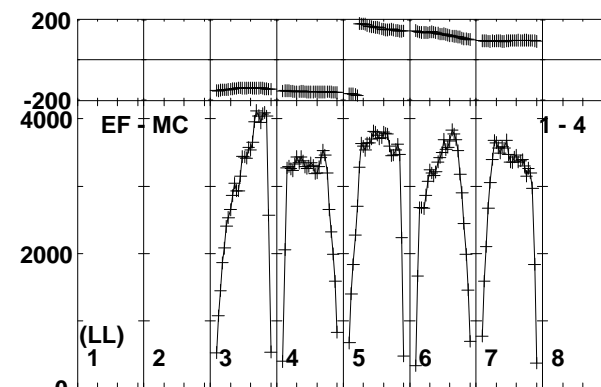
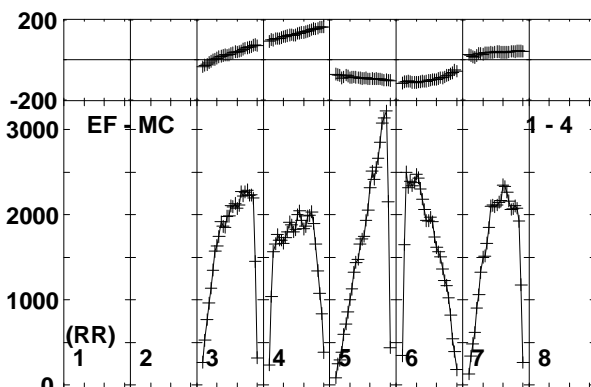
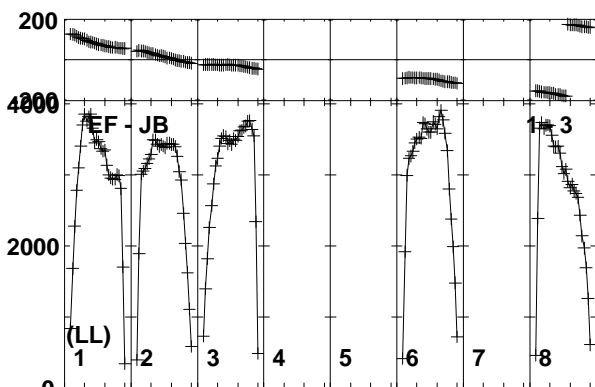
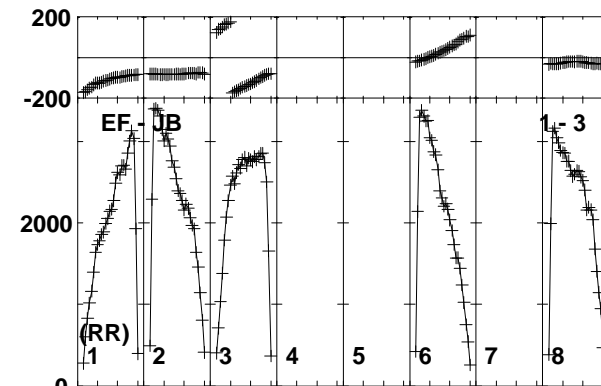
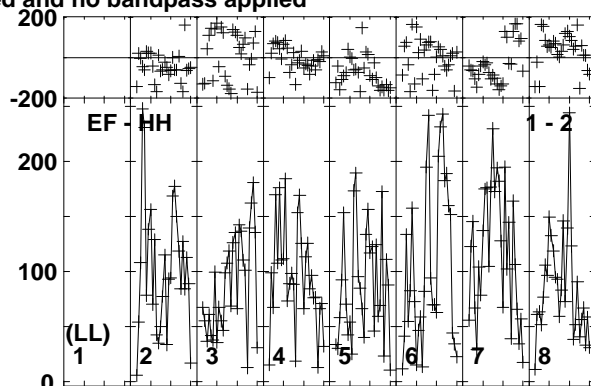
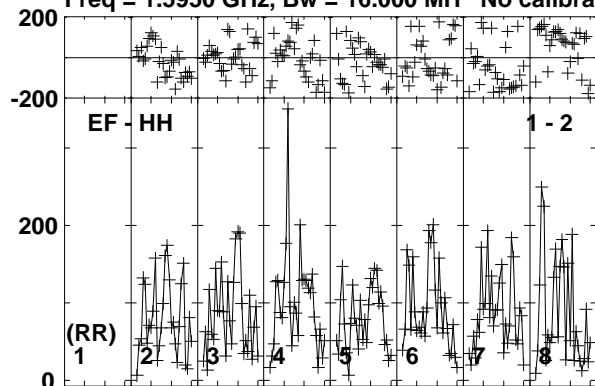

Lower frame: Micro Ampl Jy Top frame: Phas deg  
Vector averaged cross-power spectrum Baseline: EF (01) - HH (02)  
Timerange: 00/23:42:52 to 00/23:46:18

Plot file version 82 created 26-JUN-2015 10:51:19

V404CYG ET031A.UVDATA.1

Freq = 1.5950 GHz, Bw = 16.000 MH No calibration applied and no bandpass applied

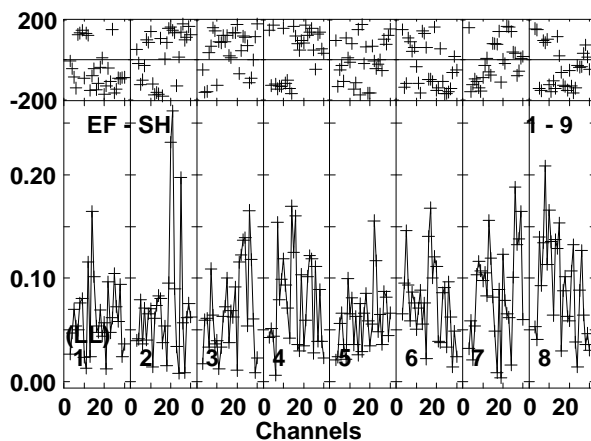
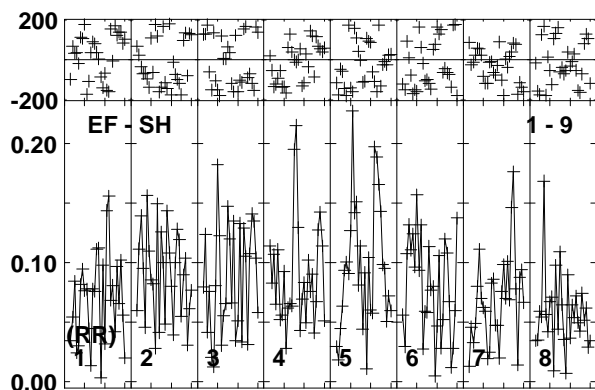
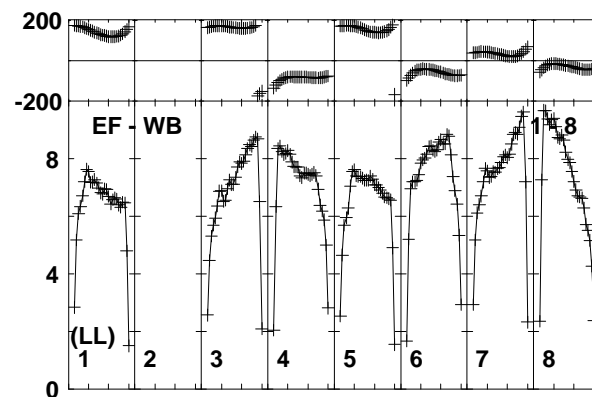
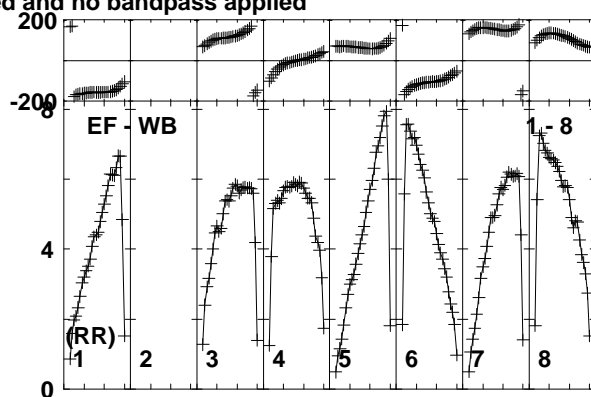
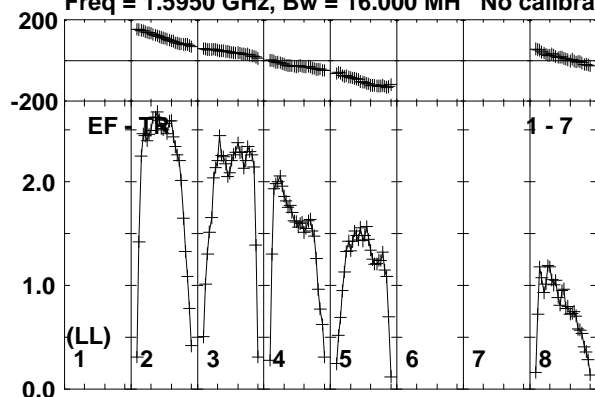

Lower frame: Milli Ampl Jy Top frame: Phas deg  
Vector averaged cross-power spectrum Baseline: EF (01) - TR (07)  
Timerange: 00/23:42:52 to 00/23:46:18

Plot file version 83 created 26-JUN-2015 10:51:20

J2025+3343 ET031A.UVDATA.1

Freq = 1.5950 GHz, Bw = 16.000 MH No calibration applied and no bandpass applied

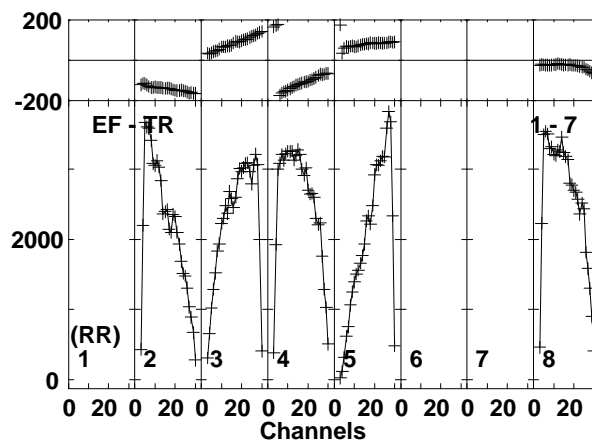
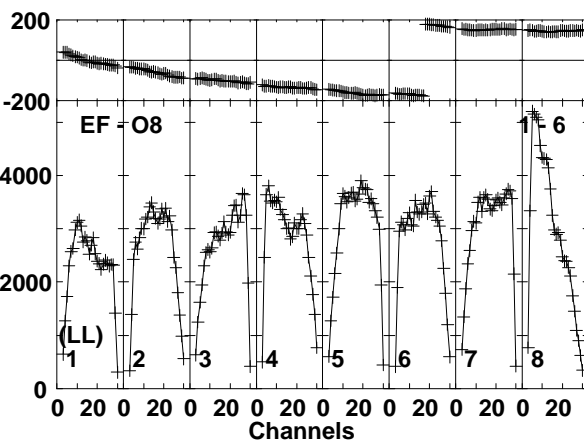
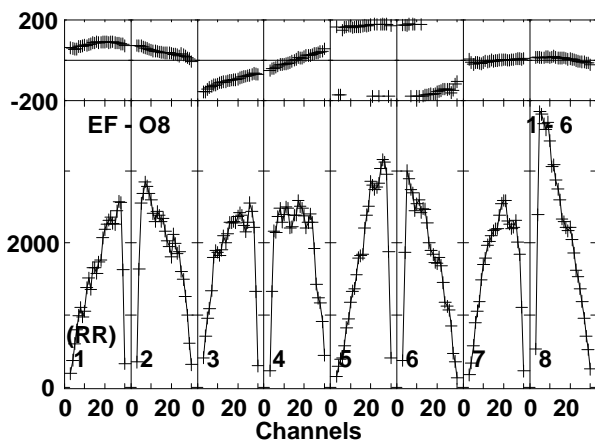
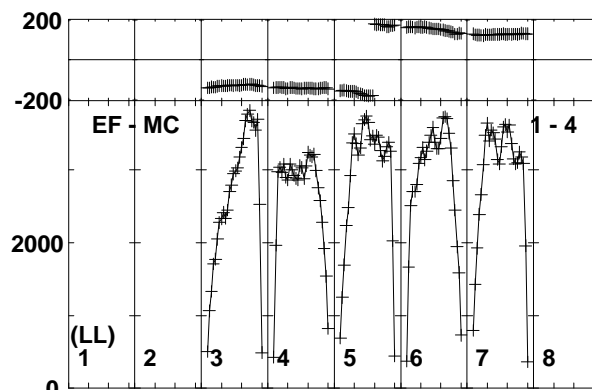
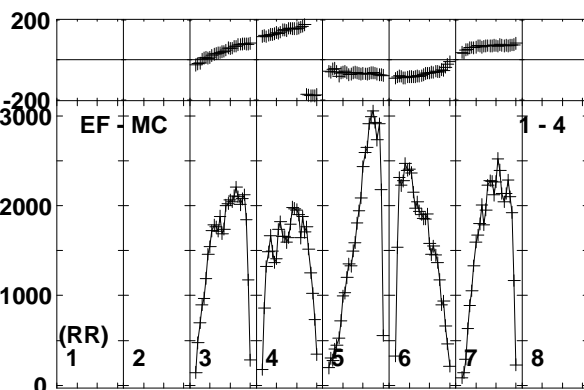
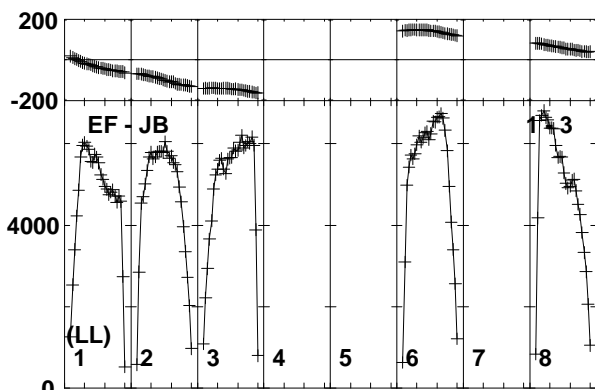
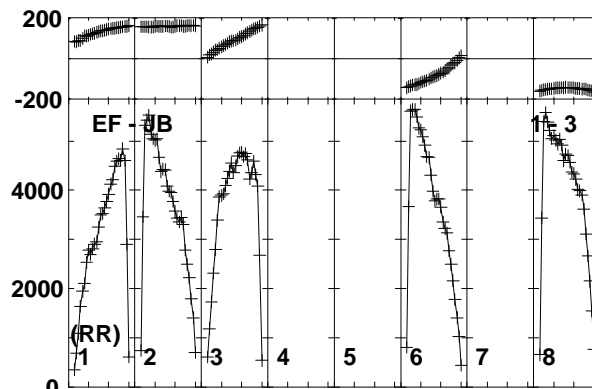
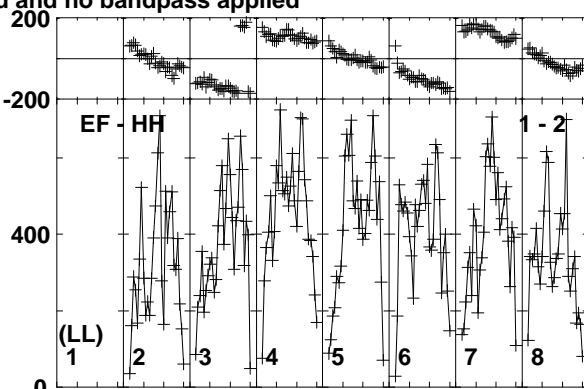
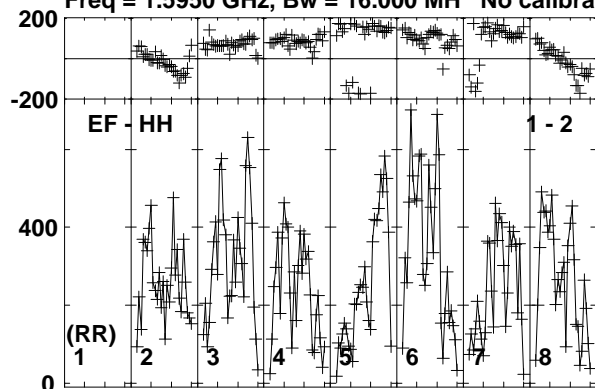

Lower frame: Micro Ampl Jy Top frame: Phas deg  
Vector averaged cross-power spectrum Baseline: EF (01) - HH (02)  
Timerange: 00/23:47:02 to 00/23:47:58

Plot file version 84 created 26-JUN-2015 10:51:20

J2025+3343 ET031A.UVDATA.1

Freq = 1.5950 GHz, Bw = 16.000 MH No calibration applied and no bandpass applied

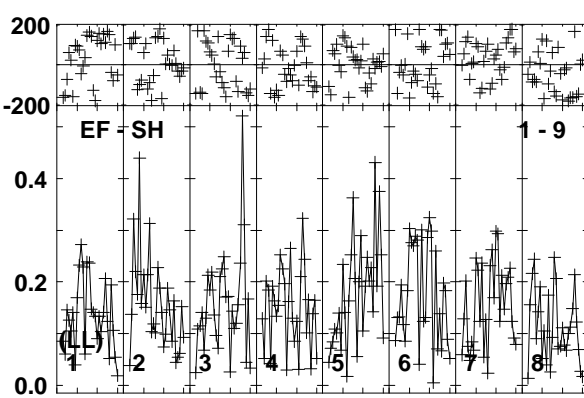
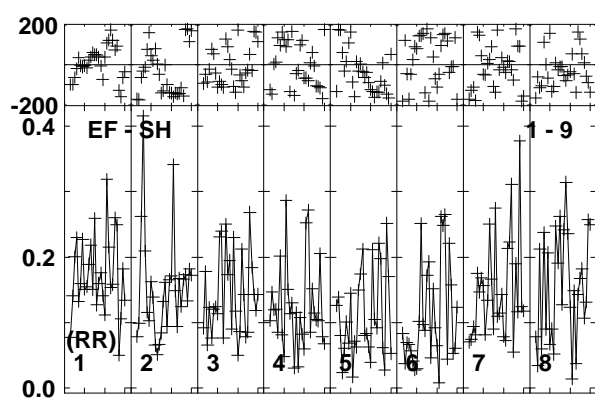
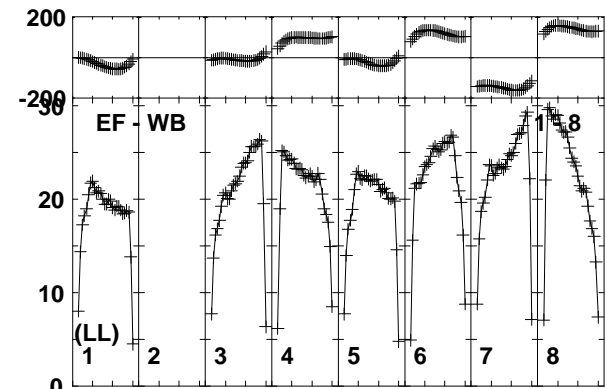
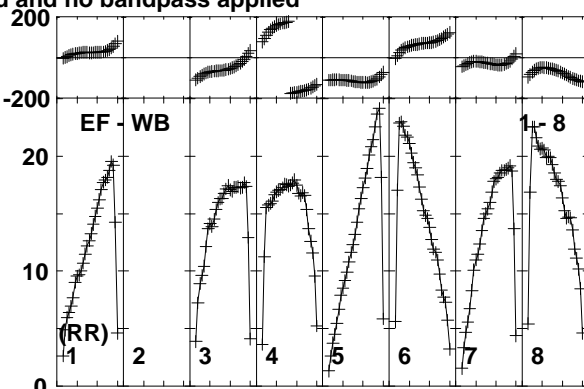
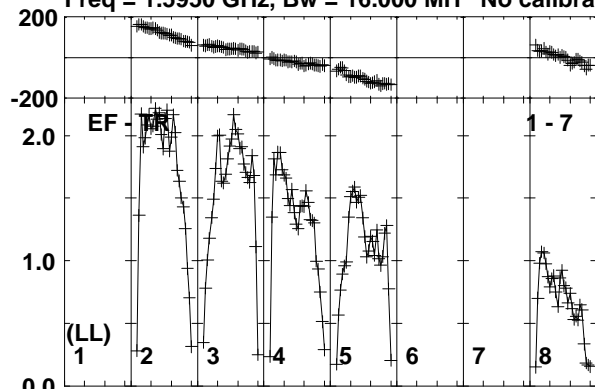

Channels

Lower frame: Milli Ampl Jy Top frame: Phas deg  
Vector averaged cross-power spectrum Baseline: EF (01) - TR (07)  
Timerange: 00/23:47:02 to 00/23:47:58

Plot file version 85 created 26-JUN-2015 10:51:20

V404CYG ET031A.UVDATA.1

Freq = 1.5950 GHz, Bw = 16.000 MH No calibration applied and no bandpass applied

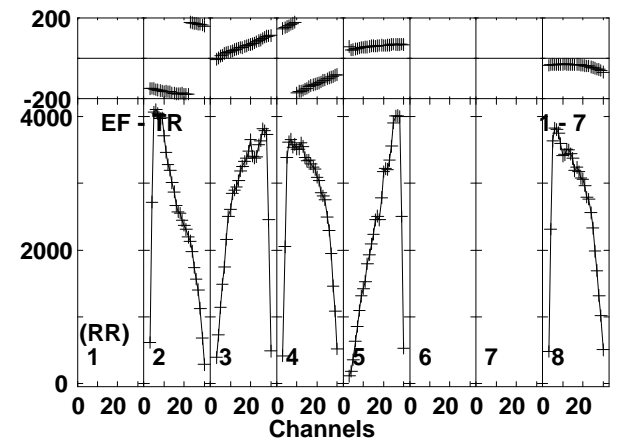
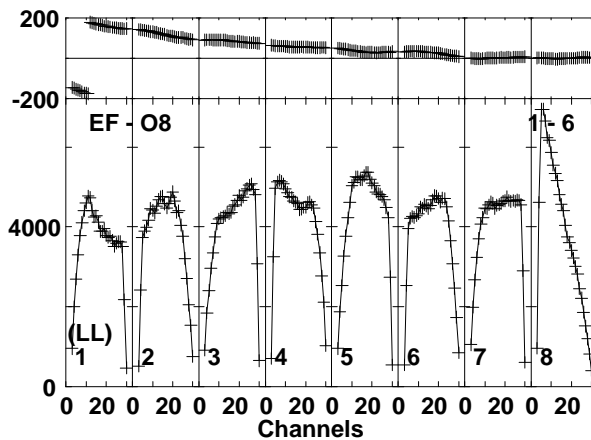
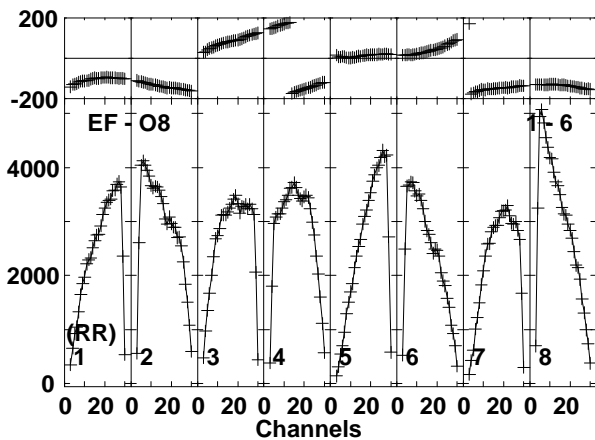
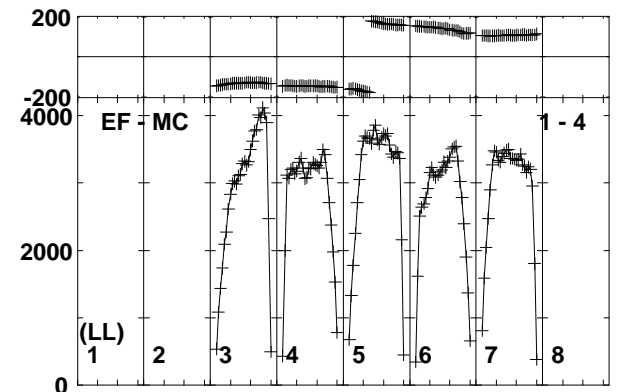
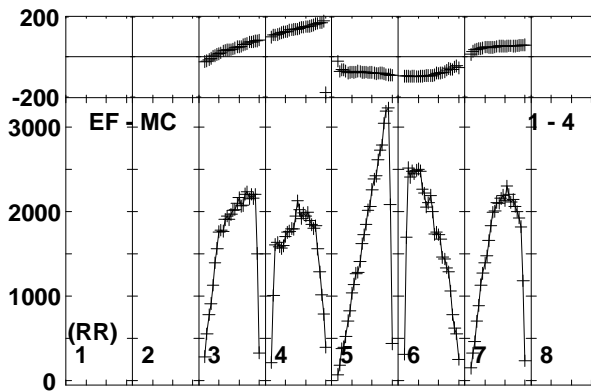
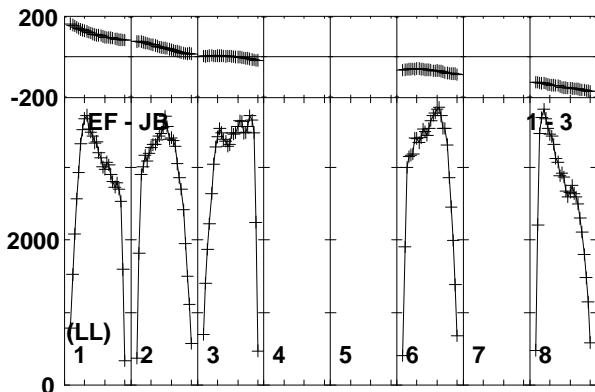
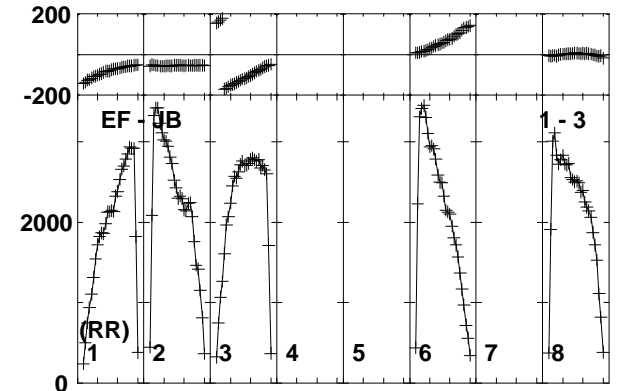
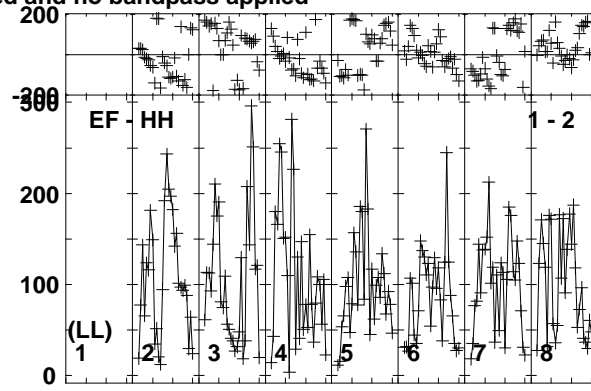
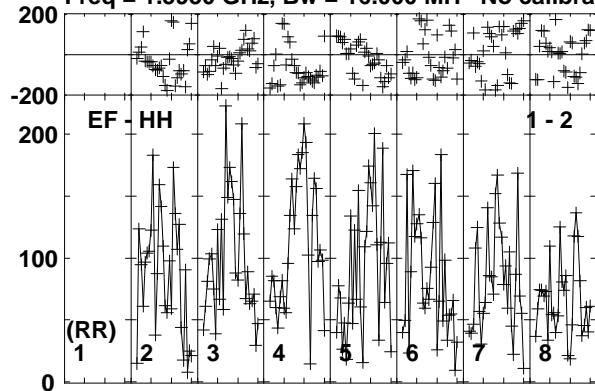

Lower frame: Micro Ampl Jy Top frame: Phas deg  
Vector averaged cross-power spectrum Baseline: EF (01) - HH (02)  
Timerange: 00/23:48:02 to 00/23:51:28

Plot file version 86 created 26-JUN-2015 10:51:20

V404CYG ET031A.UVDATA.1

Freq = 1.5950 GHz, Bw = 16.000 MH No calibration applied and no bandpass applied

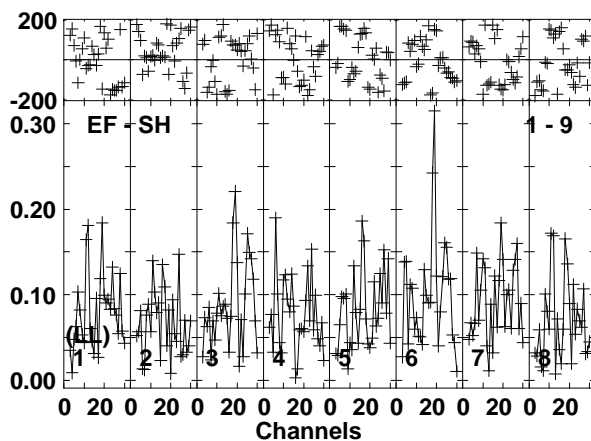
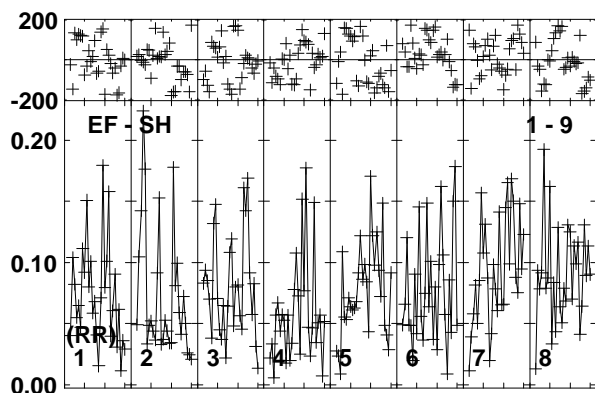
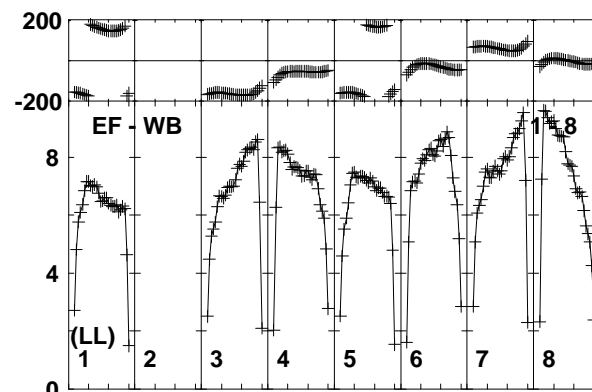
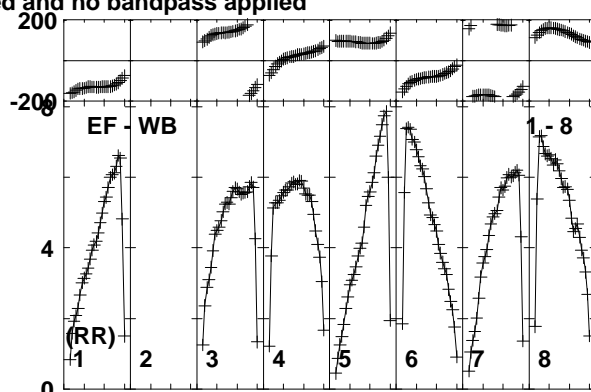
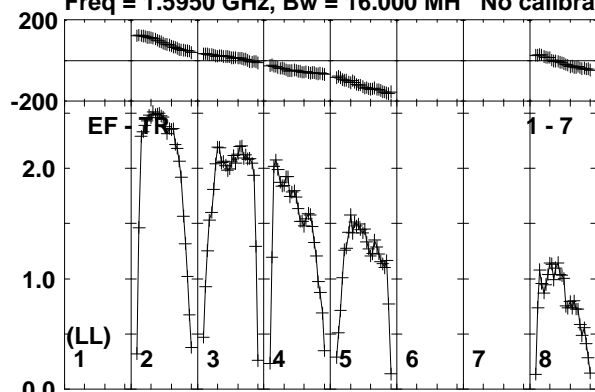

Lower frame: Milli Ampl Jy Top frame: Phas deg  
Vector averaged cross-power spectrum Baseline: EF (01) - TR (07)  
Timerange: 00/23:48:02 to 00/23:51:28

Plot file version 87 created 26-JUN-2015 10:51:20

J2025+3343 ET031A.UVDATA.1

Freq = 1.5950 GHz, Bw = 16.000 MH No calibration applied and no bandpass applied

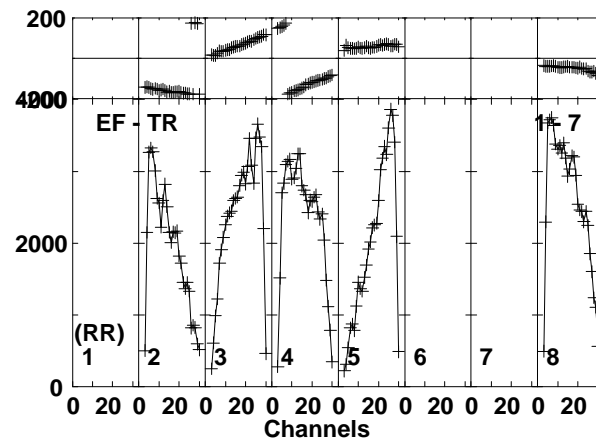
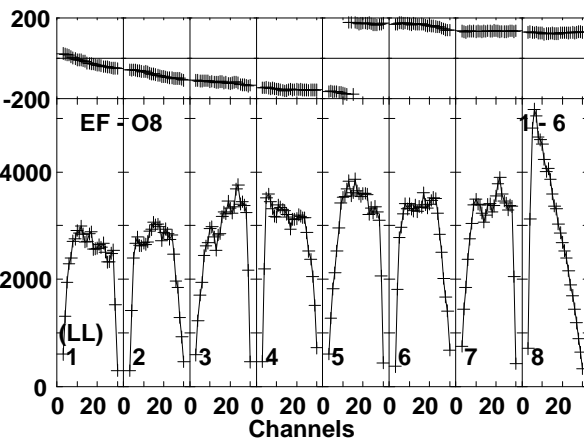
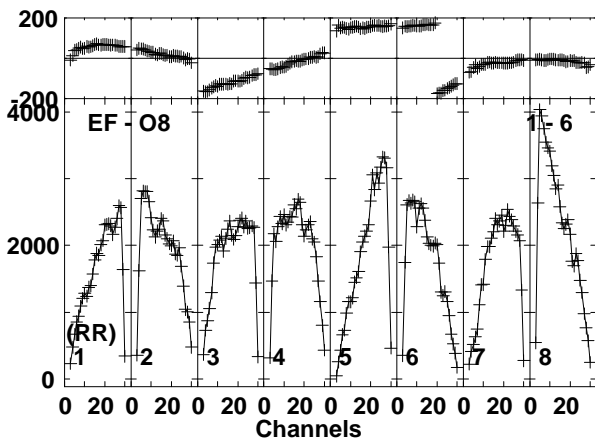
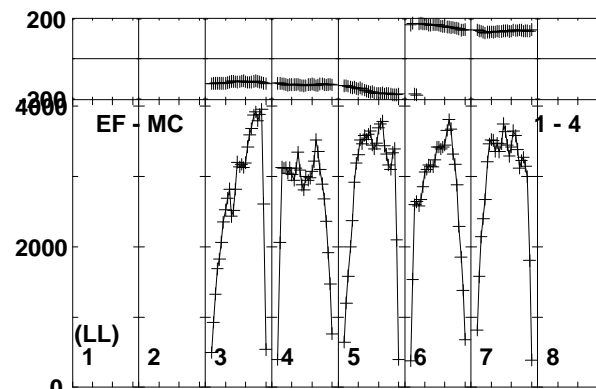
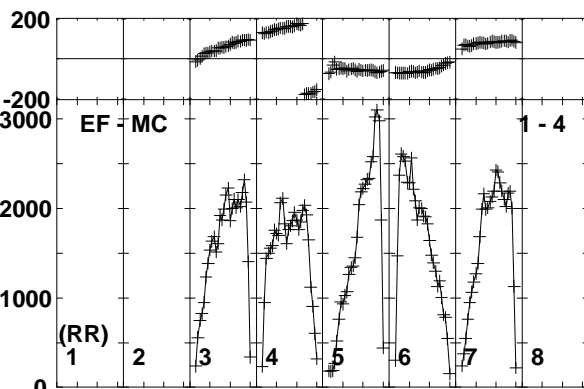
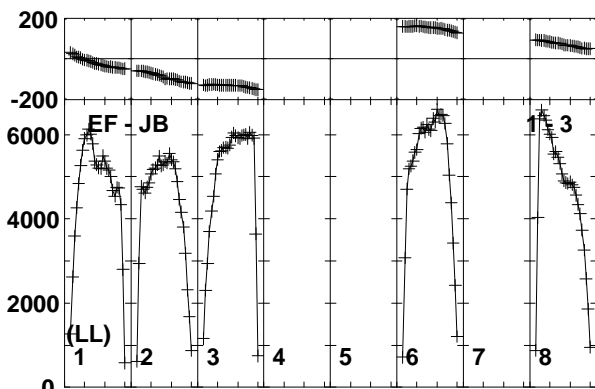
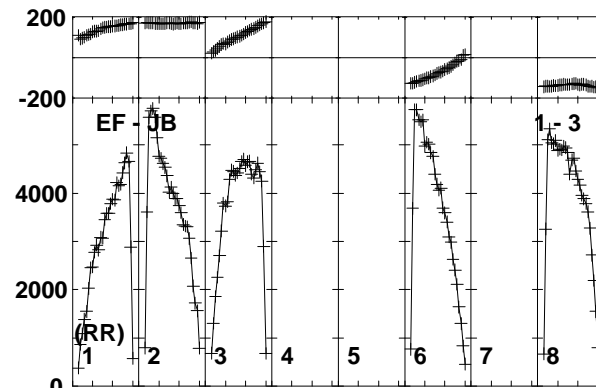
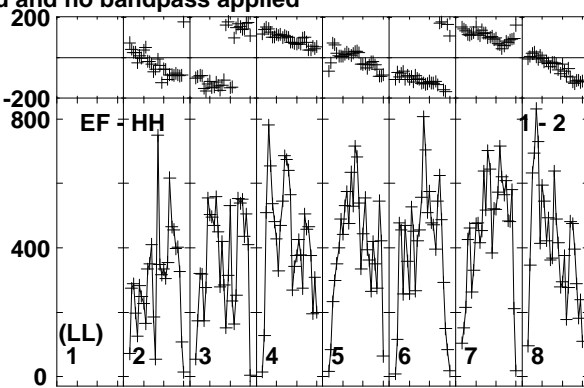
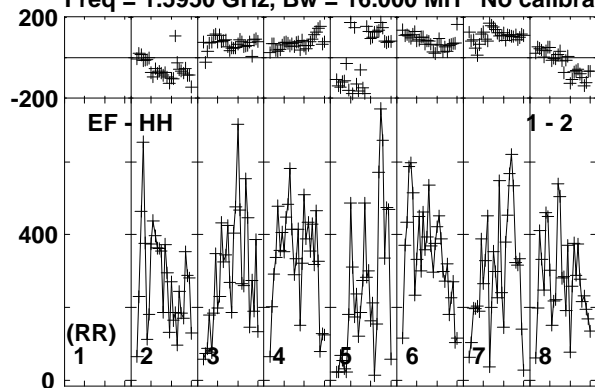

Lower frame: Micro Ampl Jy Top frame: Phas deg  
Vector averaged cross-power spectrum Baseline: EF (01) - HH (02)  
Timerange: 00/23:51:32 to 00/23:52:48

Plot file version 88 created 26-JUN-2015 10:51:20  
 J2025+3343 ET031A.UVDATA.1  
 Freq = 1.5950 GHz, Bw = 16.000 MH No calibration applied and no bandpass applied

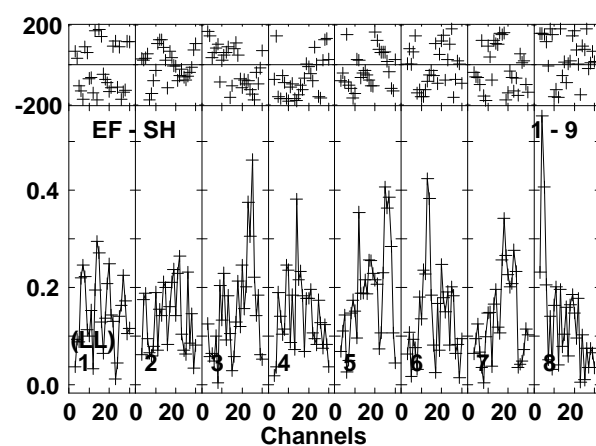
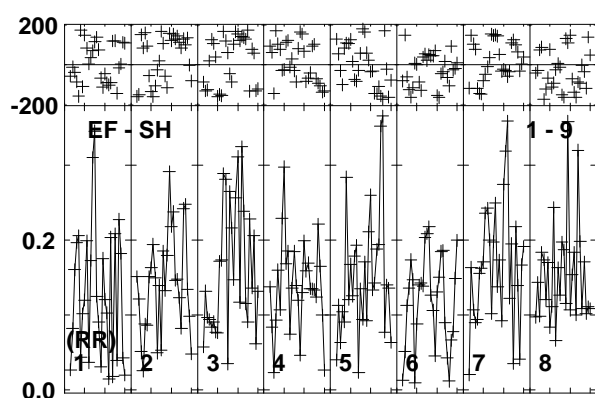
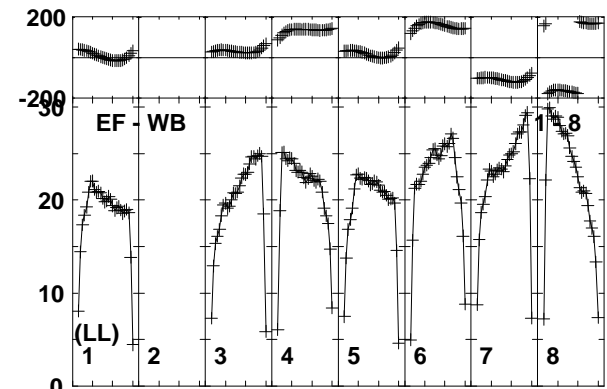
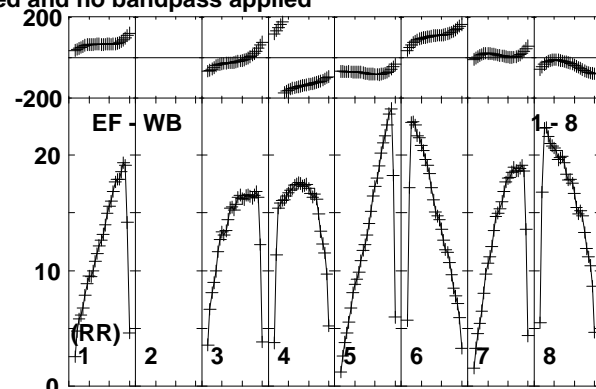
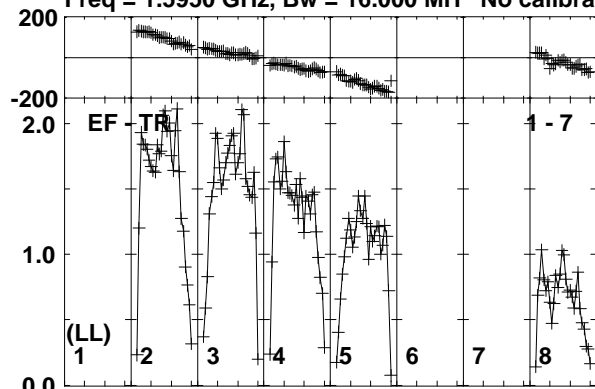

Lower frame: Milli Ampl Jy Top frame: Phas deg  
 Vector averaged cross-power spectrum Baseline: EF (01) - TR (07)  
 Timerange: 00:23:51:32 to 00:23:52:48



Plot file version 89 created 26-JUN-2015 10:51:20

V404CYG ET031A.UVDATA.1

Freq = 1.5950 GHz, Bw = 16.000 MH No calibration applied and no bandpass applied

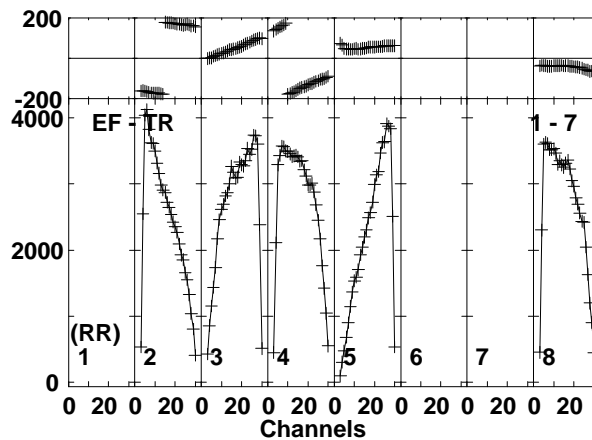
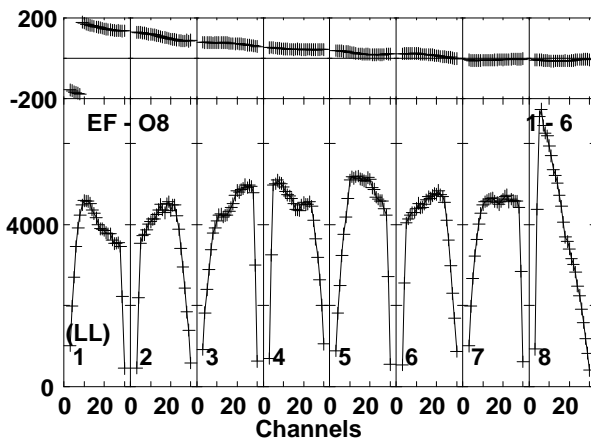
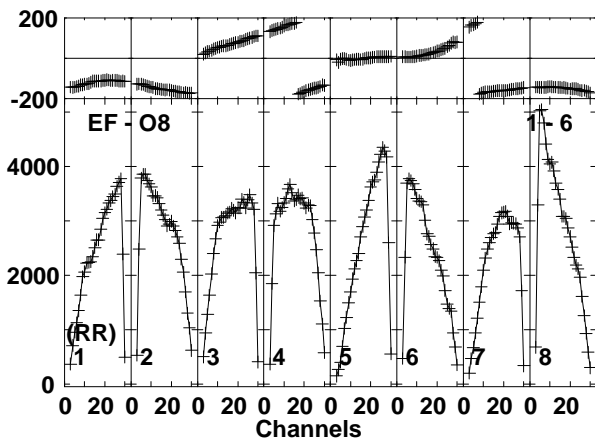
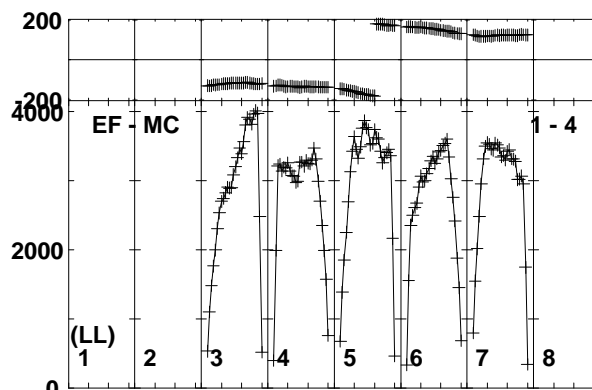
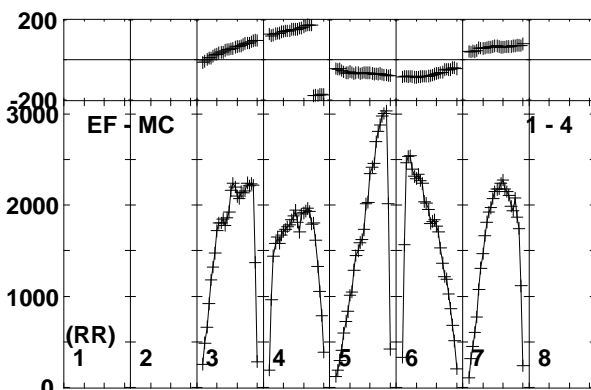
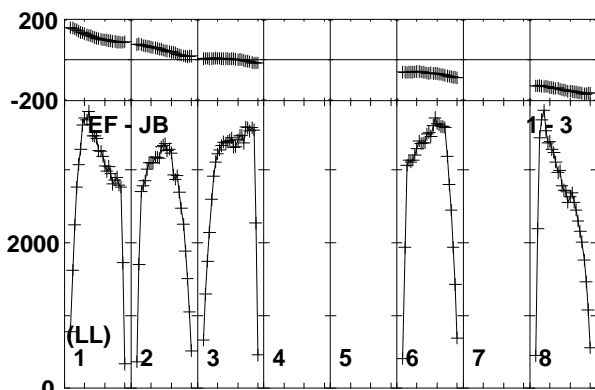
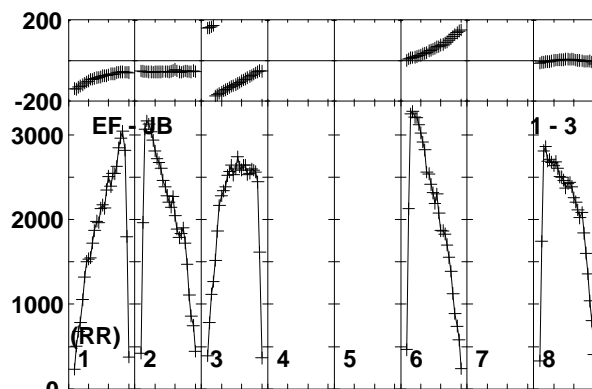
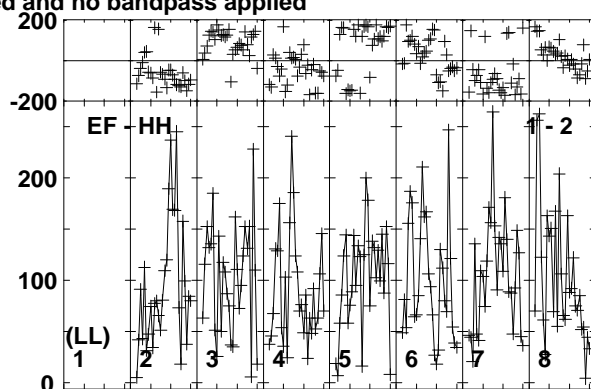
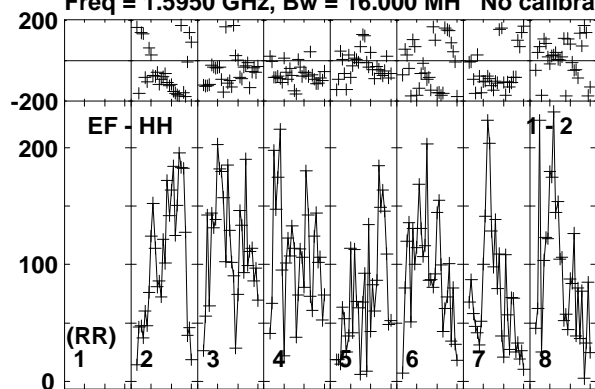

Lower frame: Micro Ampl Jy Top frame: Phas deg  
Vector averaged cross-power spectrum Baseline: EF (01) - HH (02)  
Timerange: 00/23:52:52 to 00/23:56:18

Plot file version 90 created 26-JUN-2015 10:51:20

V404CYG ET031A.UVDATA.1

Freq = 1.5950 GHz, Bw = 16.000 MH No calibration applied and no bandpass applied

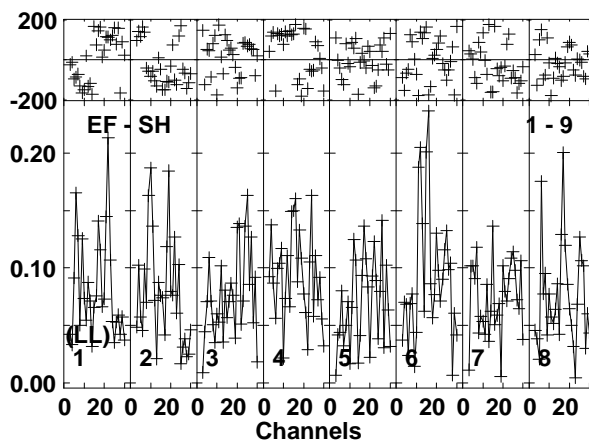
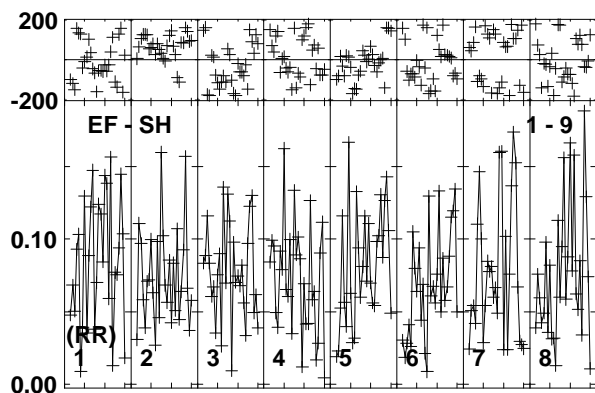
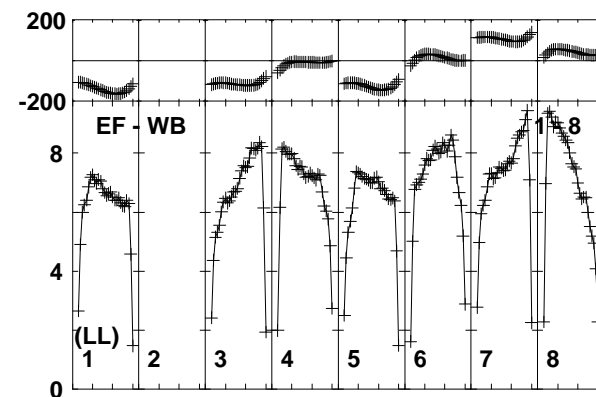
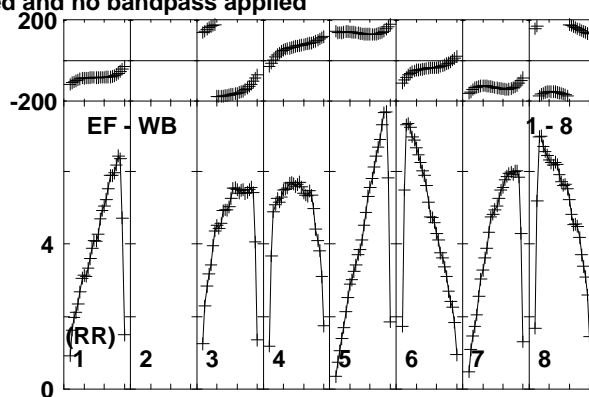
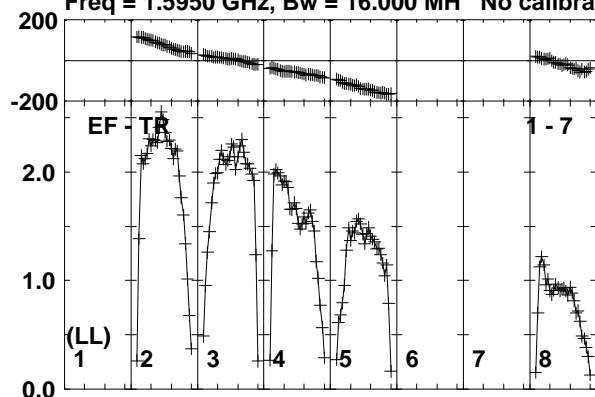

Lower frame: Milli Ampl Jy Top frame: Phas deg  
Vector averaged cross-power spectrum Baseline: EF (01) - TR (07)  
Timerange: 00/23:52:52 to 00/23:56:18

Plot file version 91 created 26-JUN-2015 10:51:20

J2025+3343 ET031A.UVDATA.1

Freq = 1.5950 GHz, Bw = 16.000 MH No calibration applied and no bandpass applied

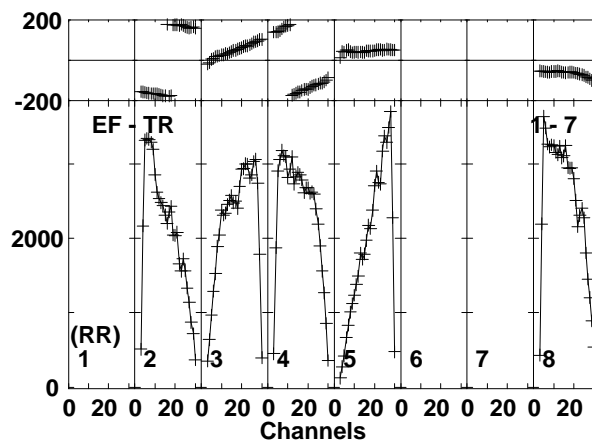
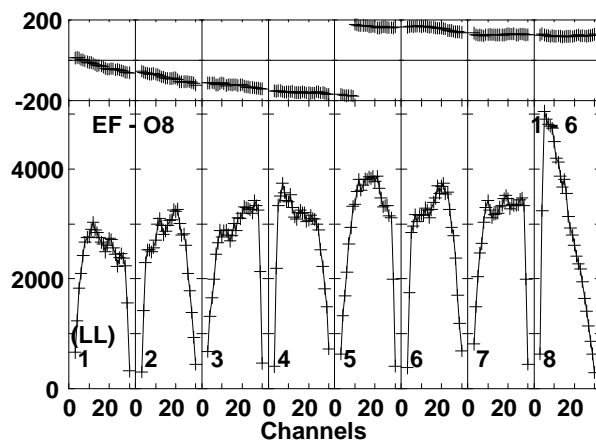
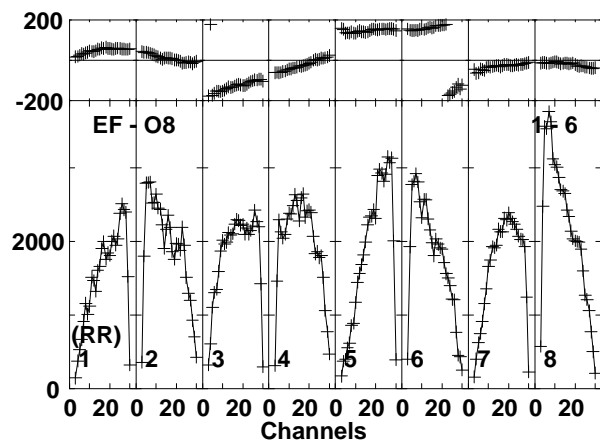
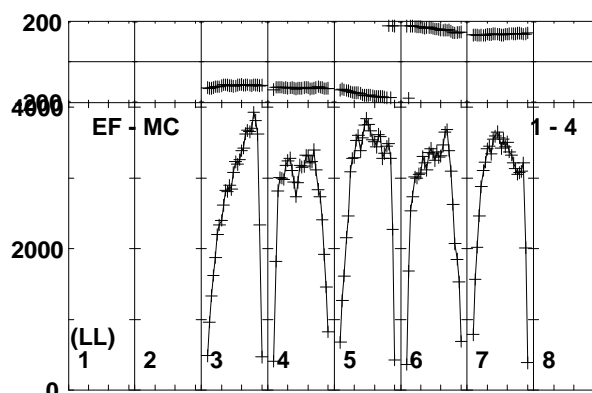
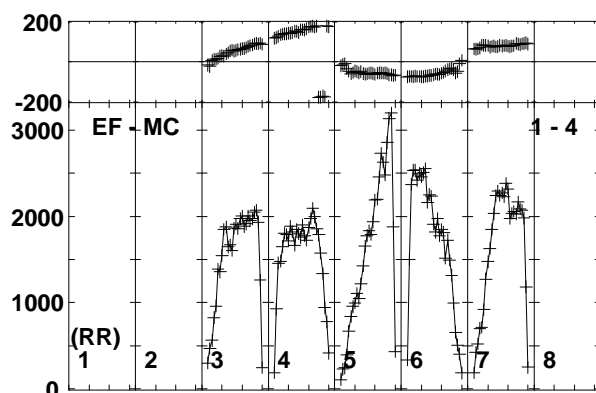
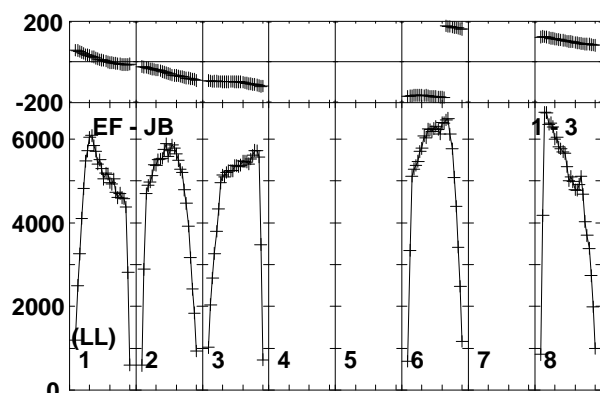
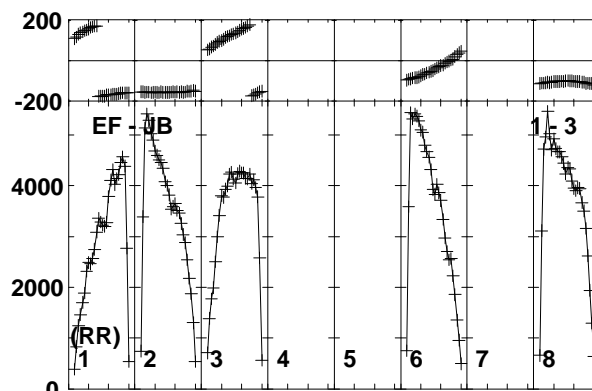
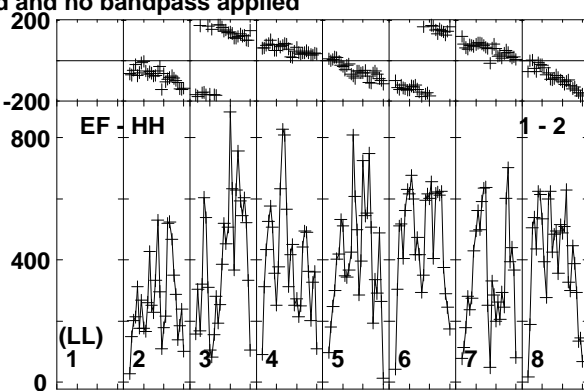
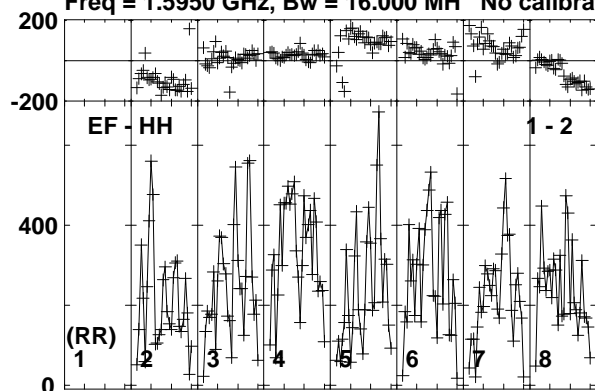

Lower frame: Micro Ampl Jy Top frame: Phas deg  
Vector averaged cross-power spectrum Baseline: EF (01) - HH (02)  
Timerange: 00/23:57:02 to 00/23:57:58

Plot file version 92 created 26-JUN-2015 10:51:20

J2025+3343 ET031A.UVDATA.1

Freq = 1.5950 GHz, Bw = 16.000 MH No calibration applied and no bandpass applied

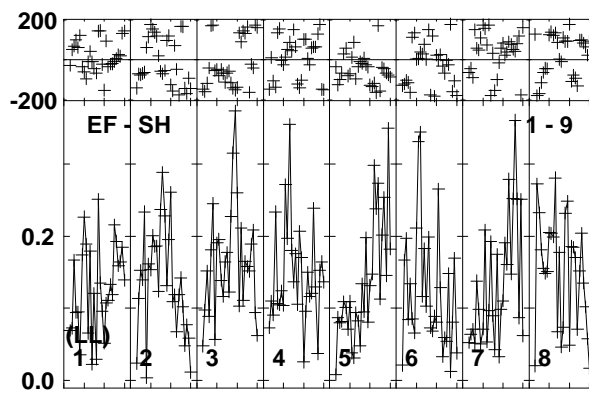
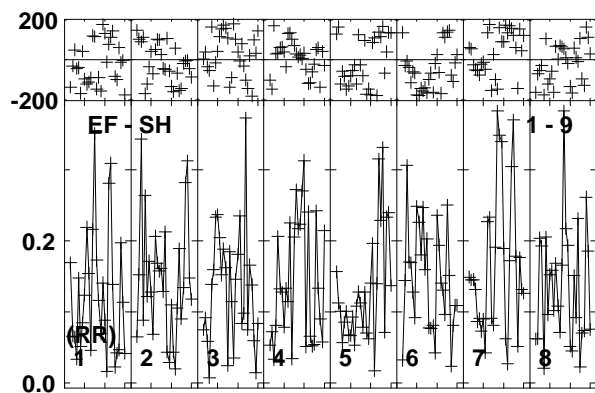
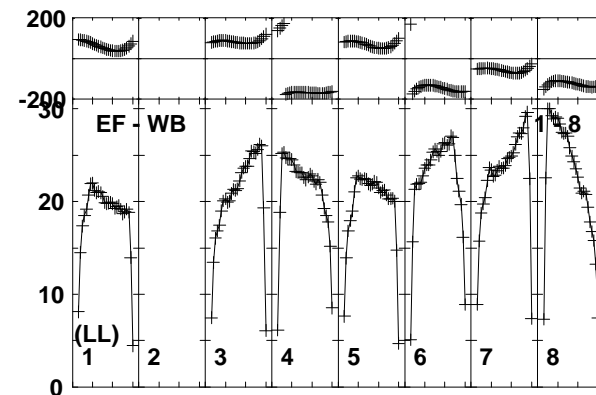
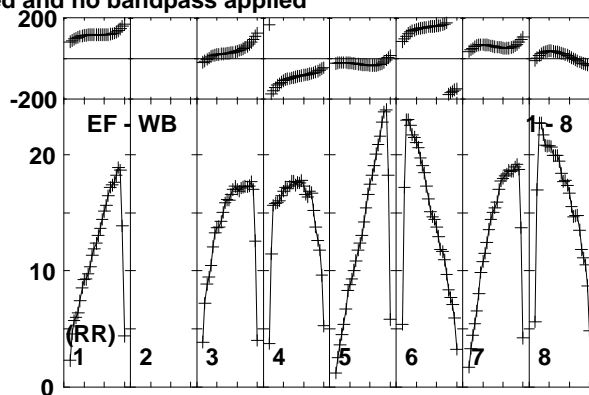
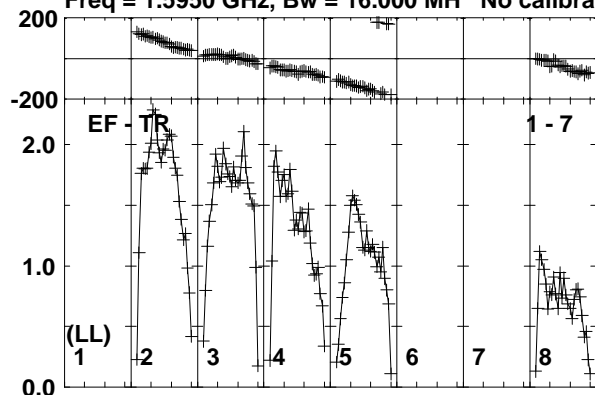

Channels

Lower frame: Milli Ampl Jy Top frame: Phas deg  
Vector averaged cross-power spectrum Baseline: EF (01) - TR (07)  
Timerange: 00/23:57:02 to 00/23:57:58

Plot file version 93 created 26-JUN-2015 10:51:20

V404CYG ET031A.UVDATA.1

Freq = 1.5950 GHz, Bw = 16.000 MH No calibration applied and no bandpass applied

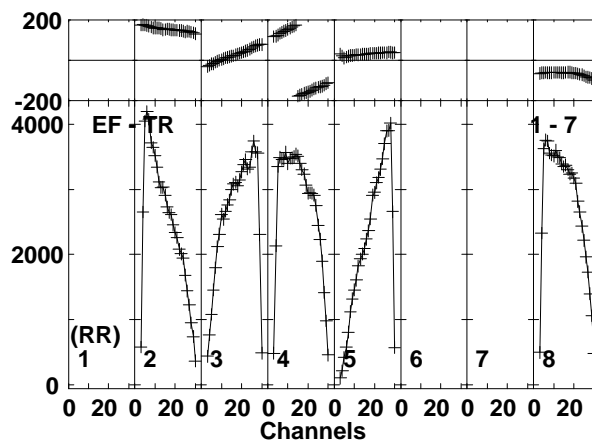
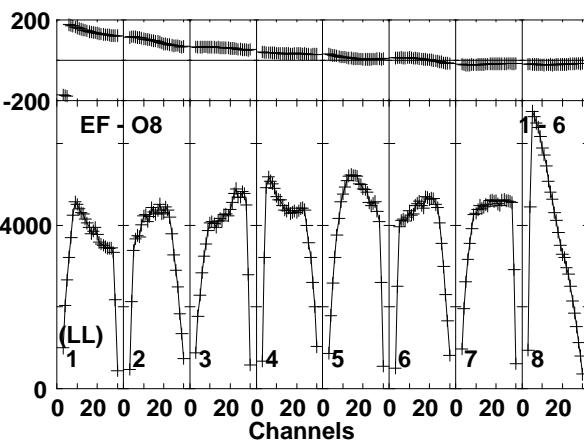
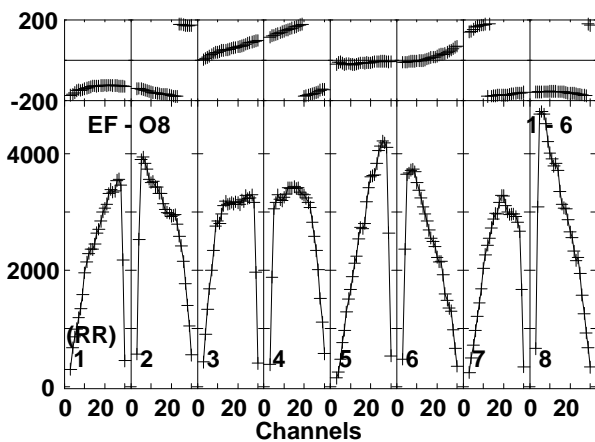
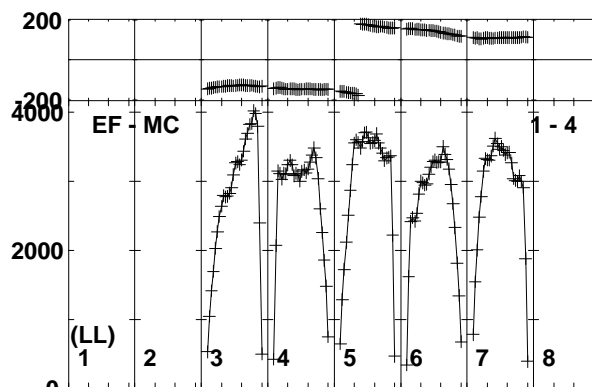
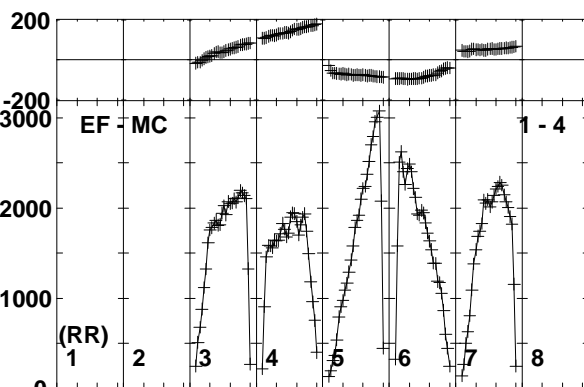
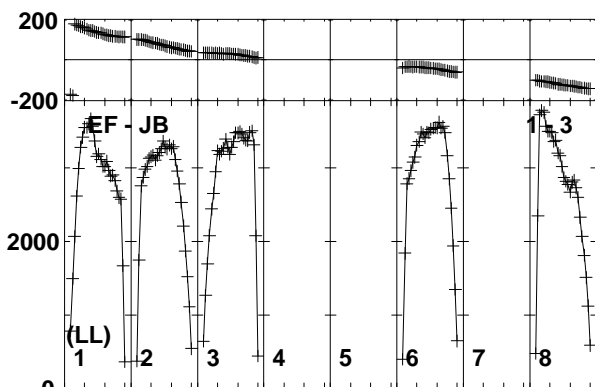
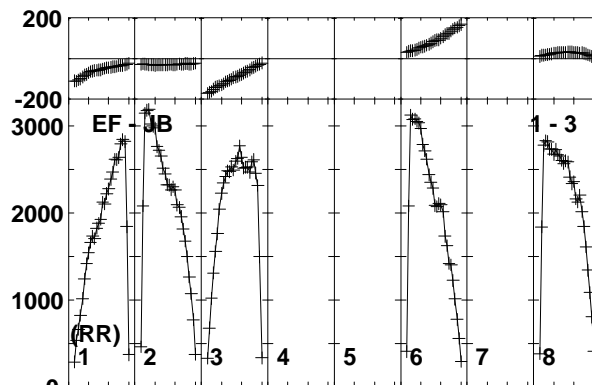
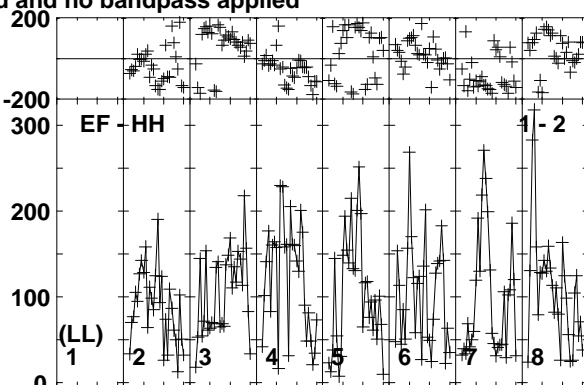
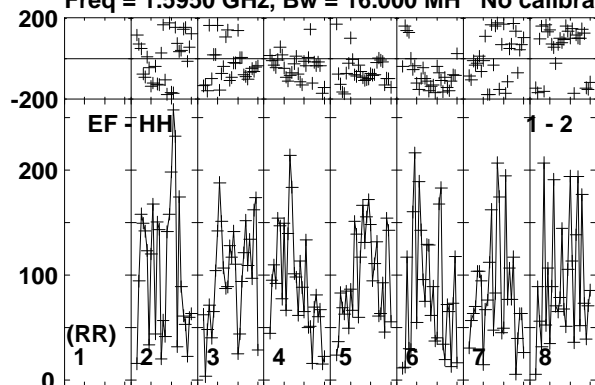

Lower frame: Micro Ampl Jy Top frame: Phas deg  
Vector averaged cross-power spectrum Baseline: EF (01) - HH (02)  
Timerange: 00/23:58:02 to 01/00:01:28

Plot file version 94 created 26-JUN-2015 10:51:20

V404CYG ET031A.UVDATA.1

Freq = 1.5950 GHz, Bw = 16.000 MH No calibration applied and no bandpass applied

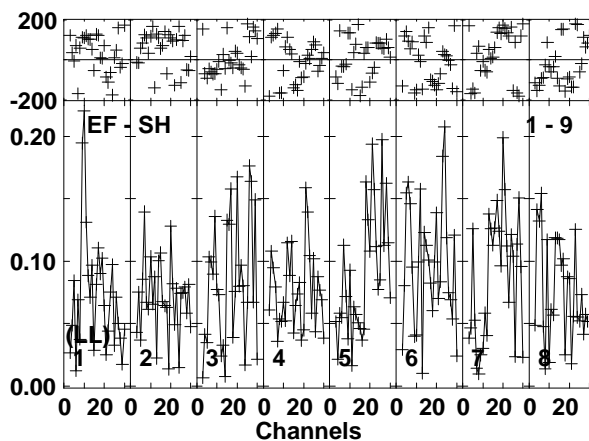
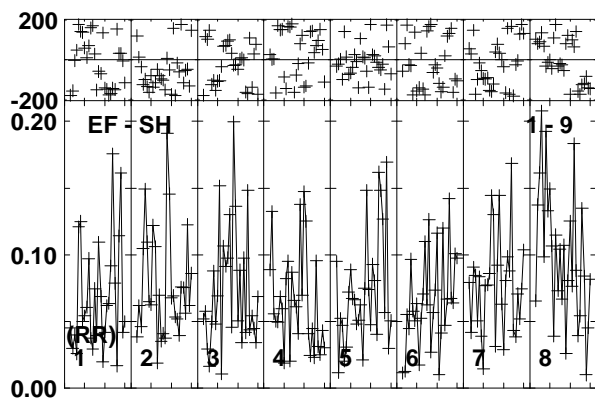
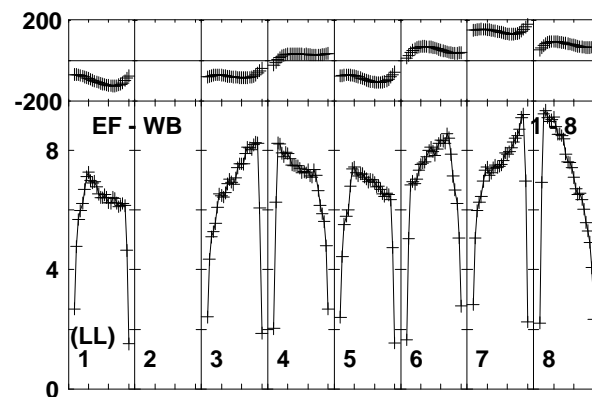
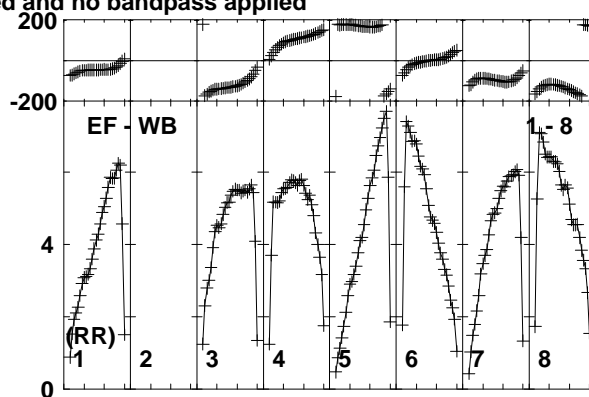
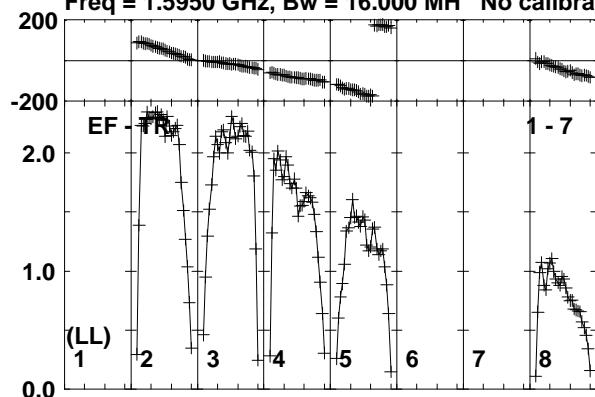

Lower frame: Milli Ampl Jy Top frame: Phas deg  
Vector averaged cross-power spectrum Baseline: EF (01) - TR (07)  
Timerange: 00/23:58:02 to 01/00:01:28

Plot file version 95 created 26-JUN-2015 10:51:20

J2025+3343 ET031A.UVDATA.1

Freq = 1.5950 GHz, Bw = 16.000 MH No calibration applied and no bandpass applied

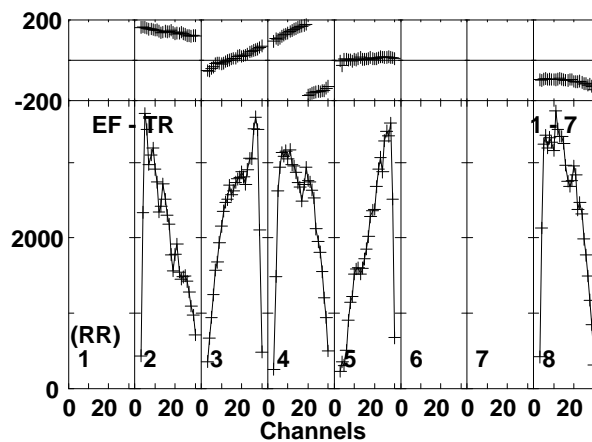
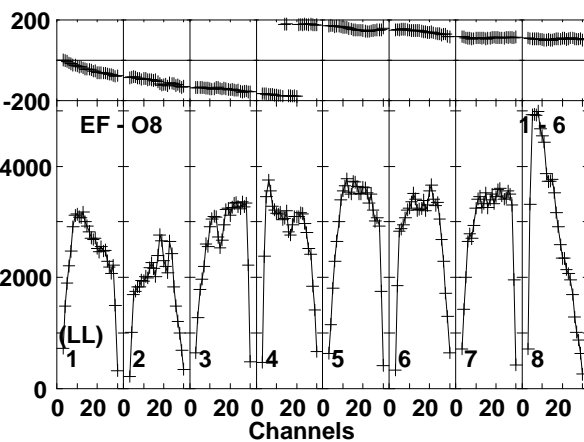
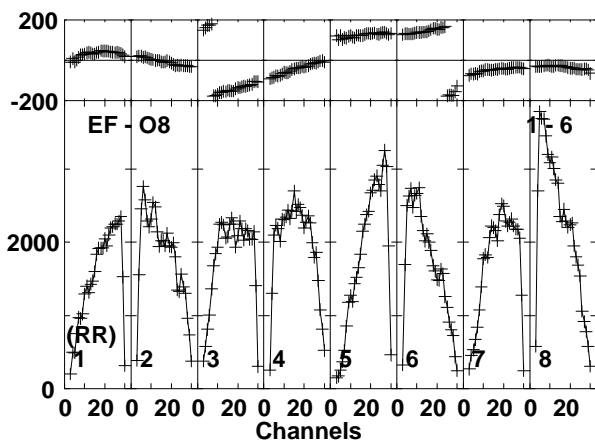
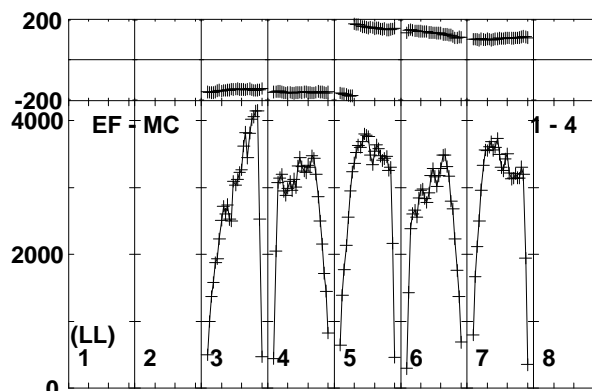
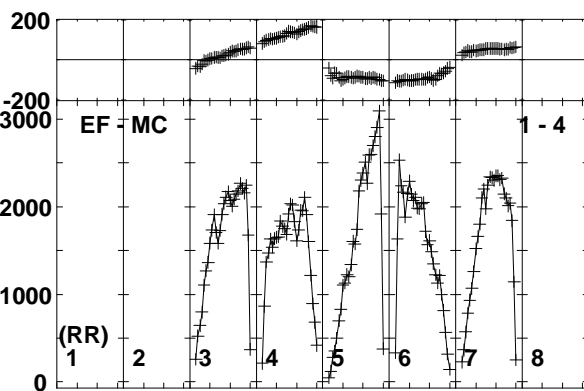
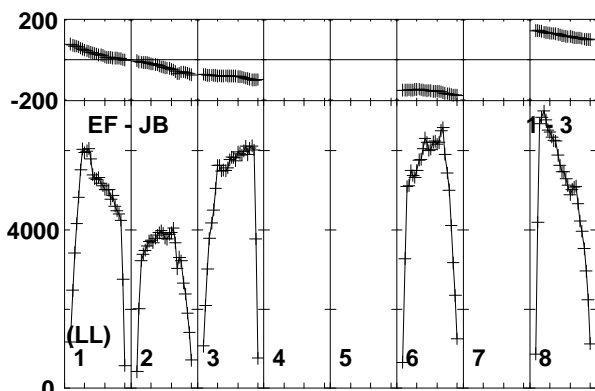
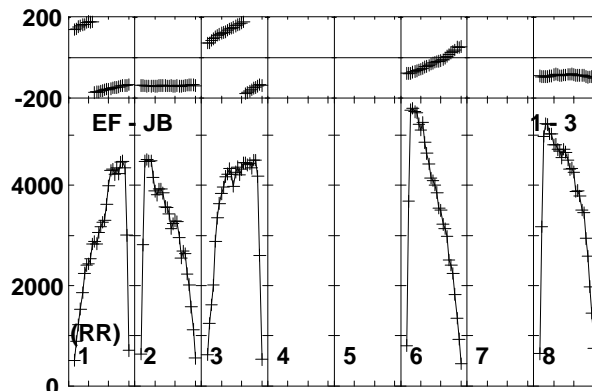
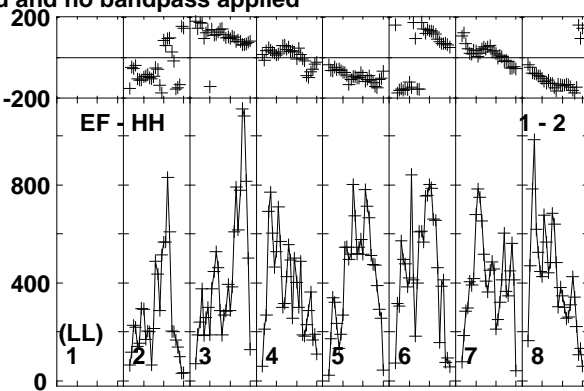
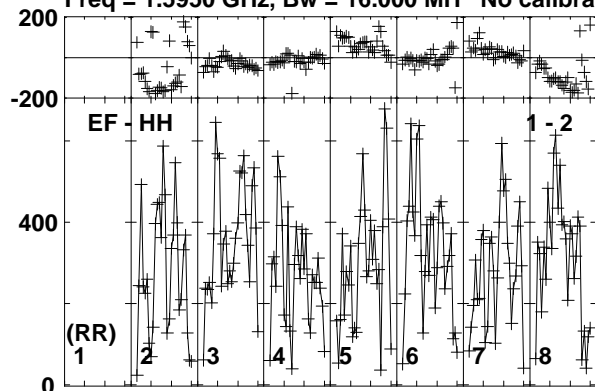

Lower frame: Micro Ampl Jy Top frame: Phas deg  
Vector averaged cross-power spectrum Baseline: EF (01) - HH (02)  
Timerange: 01/00:01:32 to 01/00:02:48

Plot file version 96 created 26-JUN-2015 10:51:20

J2025+3343 ET031A.UVDATA.1

Freq = 1.5950 GHz, Bw = 16.000 MH No calibration applied and no bandpass applied

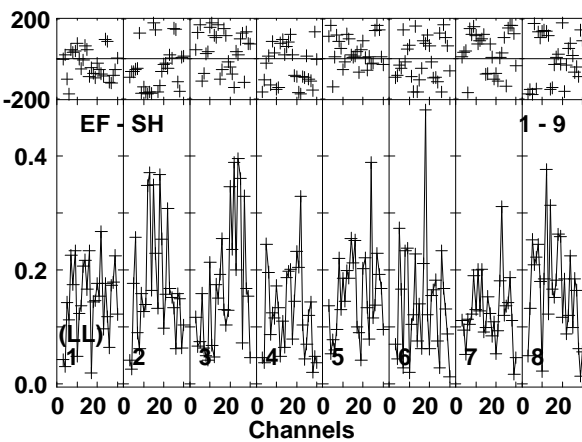
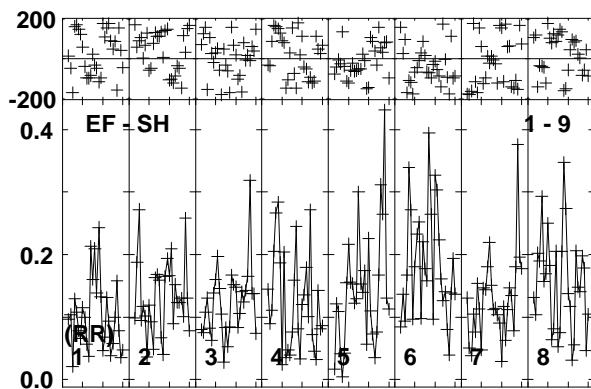
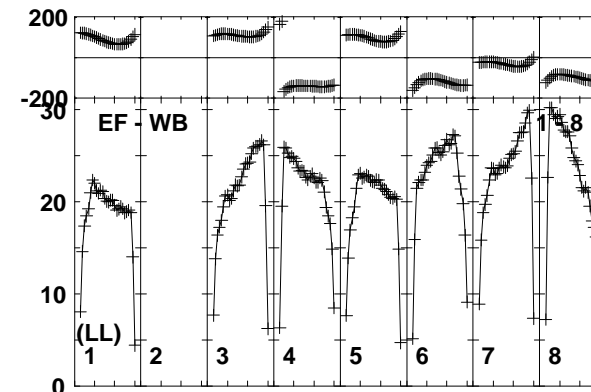
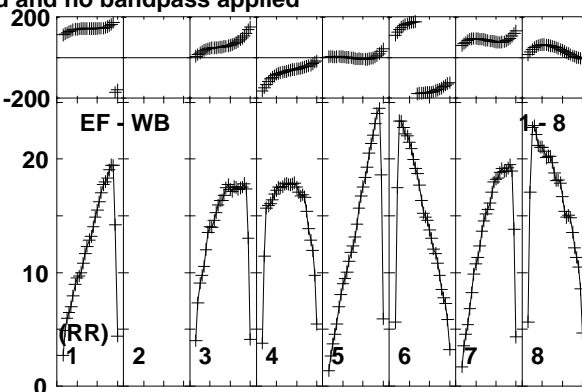
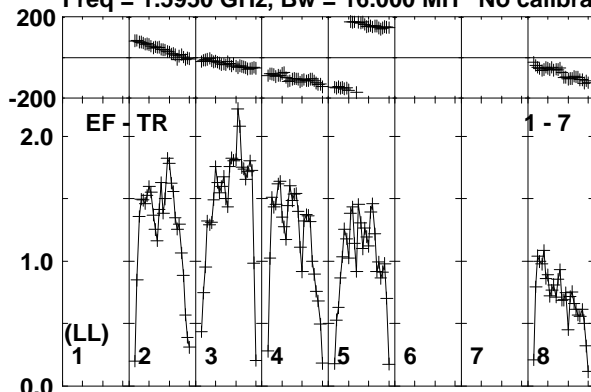

Lower frame: Milli Ampl Jy Top frame: Phas deg  
Vector averaged cross-power spectrum Baseline: EF (01) - TR (07)  
Timerange: 01/00:01:32 to 01/00:02:48



Plot file version 97 created 26-JUN-2015 10:51:20

V404CYG ET031A.UVDATA.1

Freq = 1.5950 GHz, Bw = 16.000 MH No calibration applied and no bandpass applied

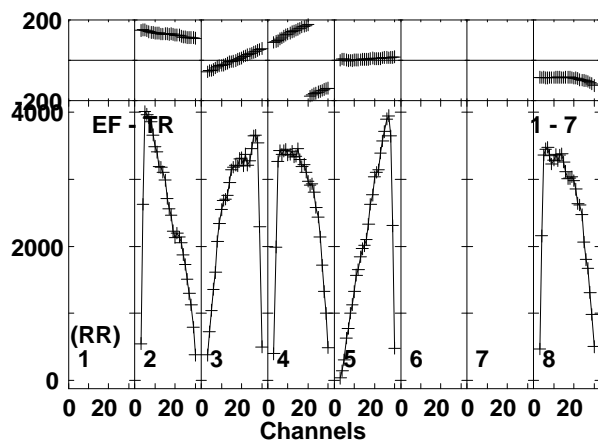
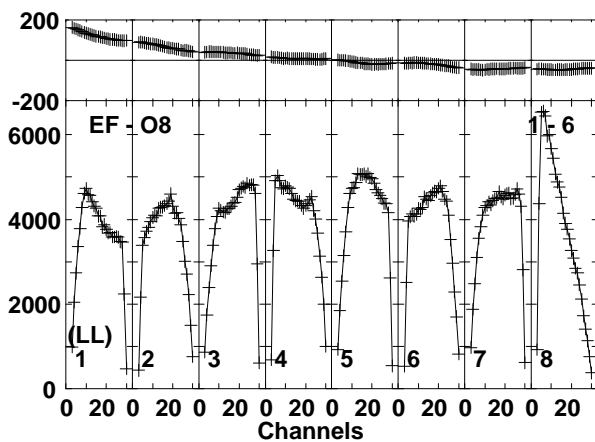
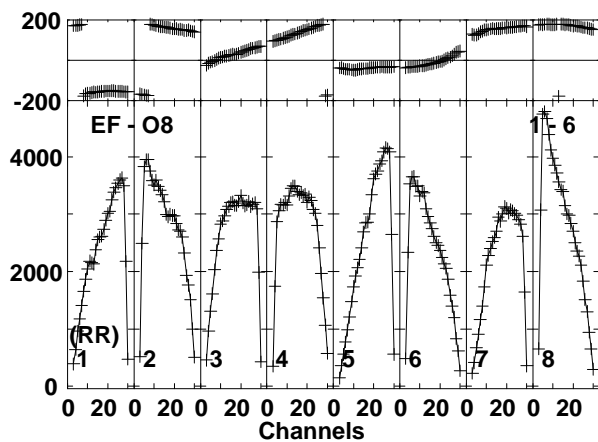
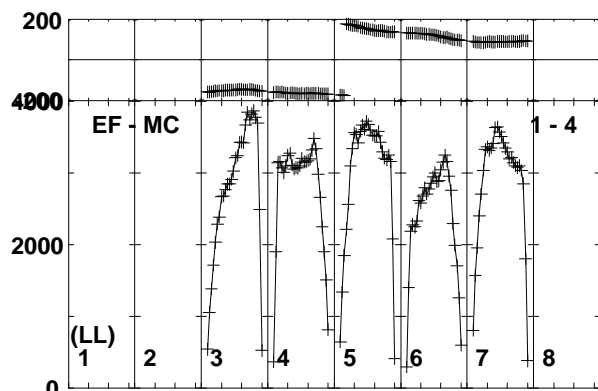
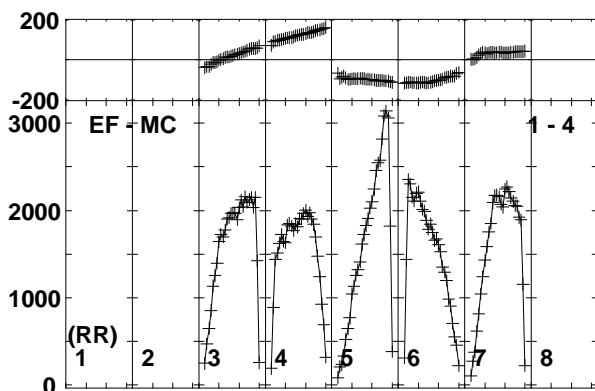
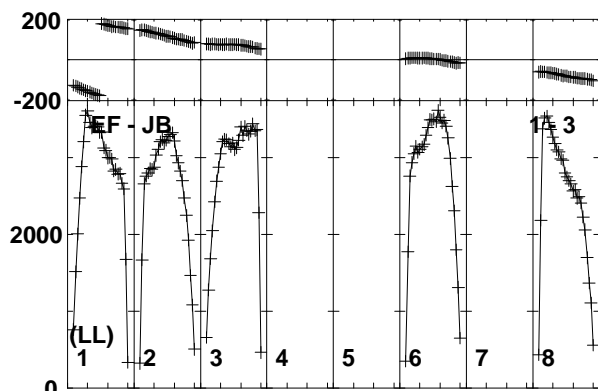
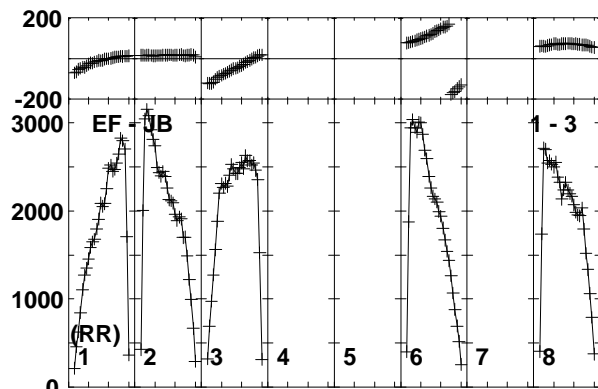
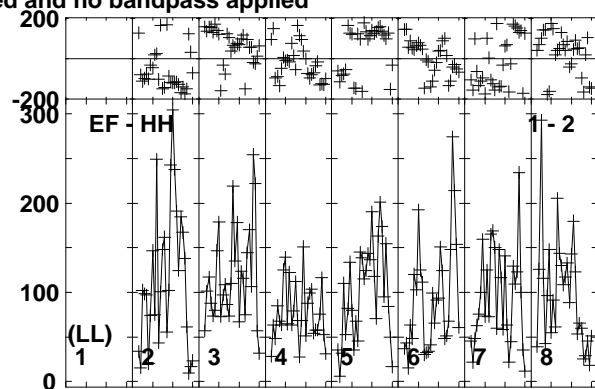
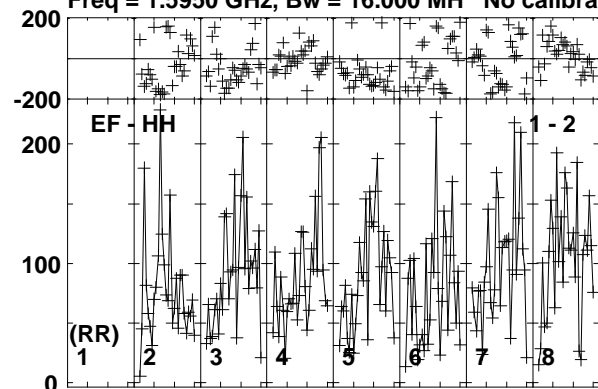

Lower frame: Micro Ampl Jy Top frame: Phas deg  
Vector averaged cross-power spectrum Baseline: EF (01) - HH (02)  
Timerange: 01/00:02:52 to 01/00:06:18

Plot file version 98 created 26-JUN-2015 10:51:20

V404CYG ET031A.UVDATA.1

Freq = 1.5950 GHz, Bw = 16.000 MH No calibration applied and no bandpass applied

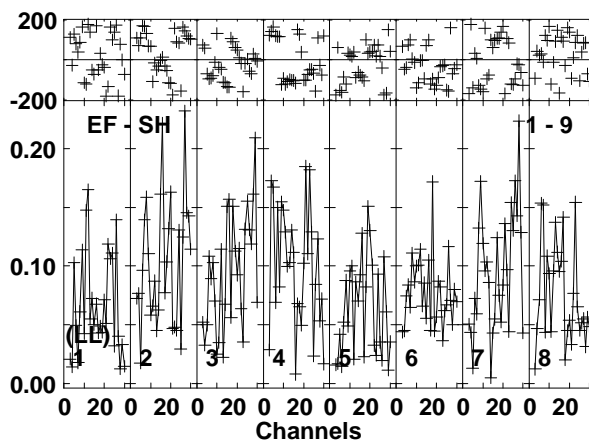
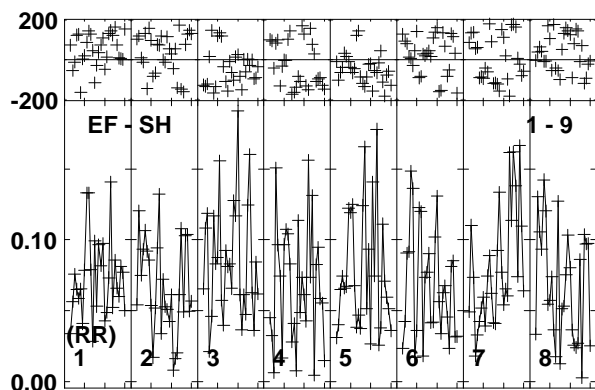
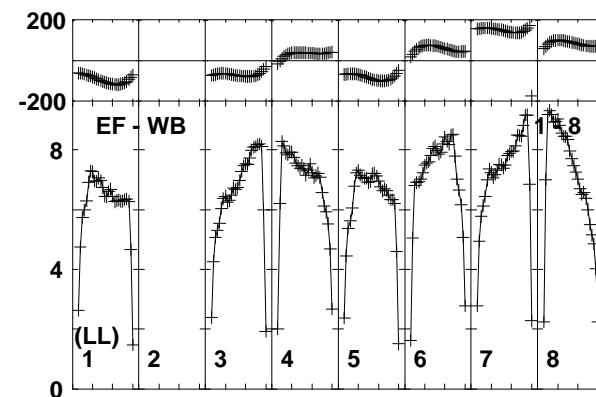
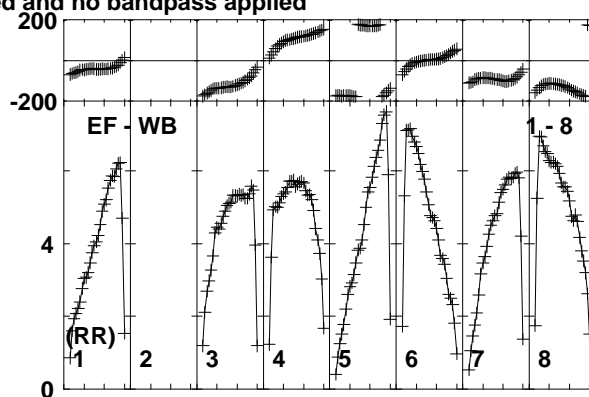
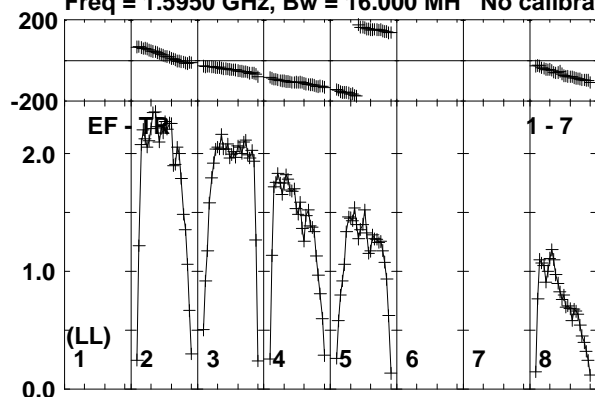

Lower frame: Milli Ampl Jy Top frame: Phas deg  
Vector averaged cross-power spectrum Baseline: EF (01) - TR (07)  
Timerange: 01/00:02:52 to 01/00:06:18

Plot file version 99 created 26-JUN-2015 10:51:20

J2025+3343 ET031A.UVDATA.1

Freq = 1.5950 GHz, Bw = 16.000 MH No calibration applied and no bandpass applied

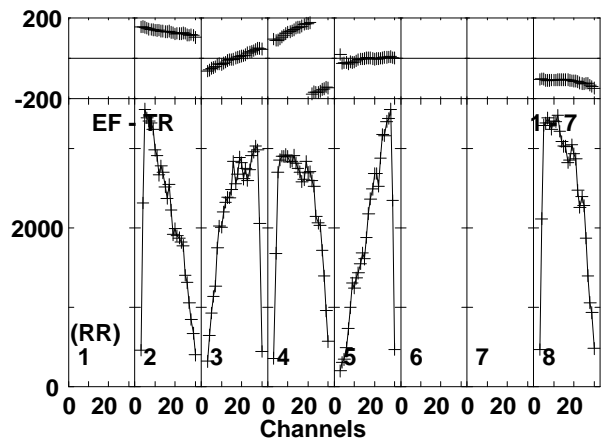
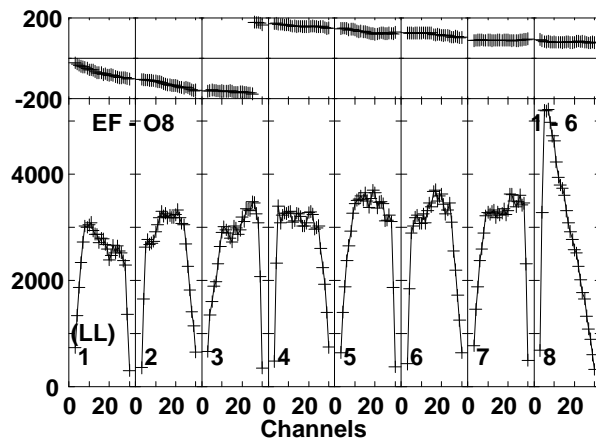
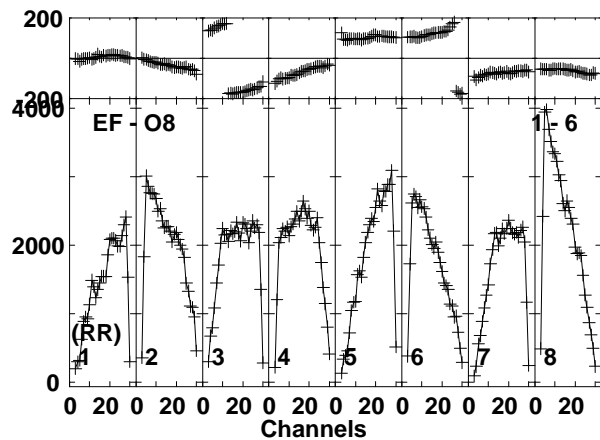
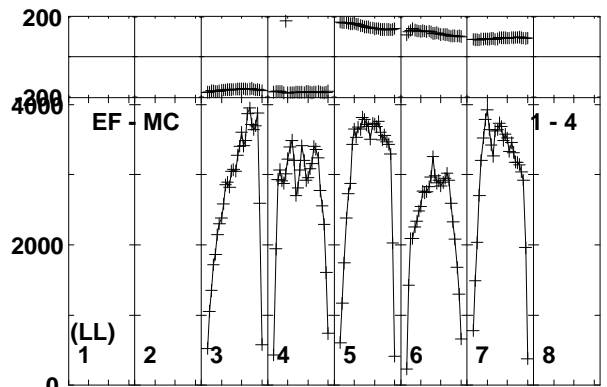
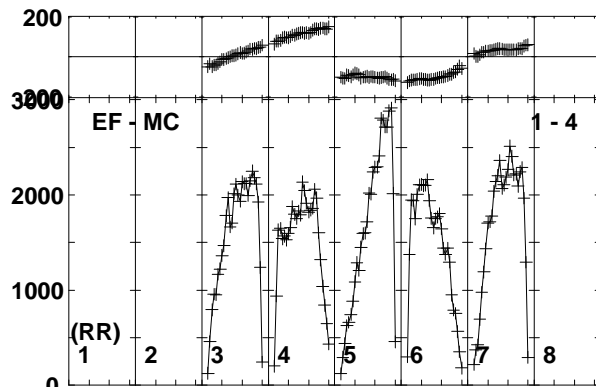
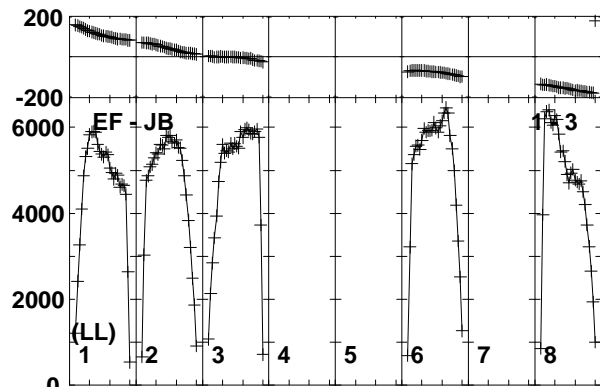
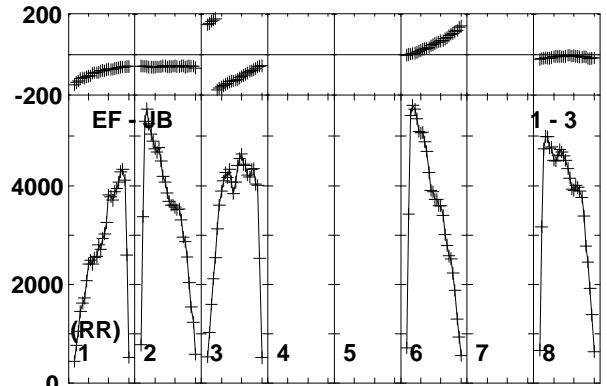
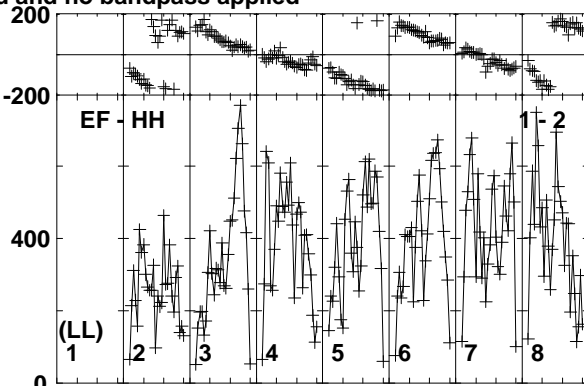
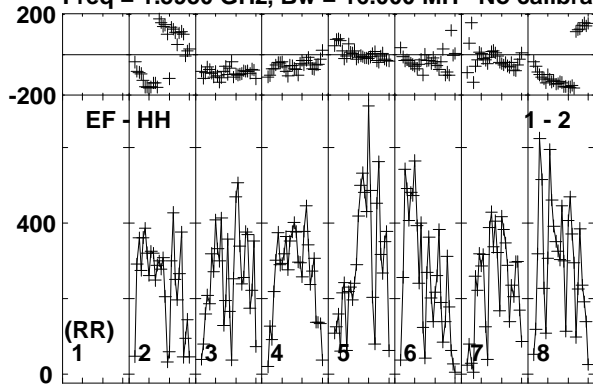

Lower frame: Micro Ampl Jy Top frame: Phas deg  
Vector averaged cross-power spectrum Baseline: EF (01) - HH (02)  
Timerange: 01/00:07:02 to 01/00:07:58

Plot file version 100 created 26-JUN-2015 10:51:21

J2025+3343 ET031A.UVDATA.1

Freq = 1.5950 GHz, Bw = 16.000 MH No calibration applied and no bandpass applied

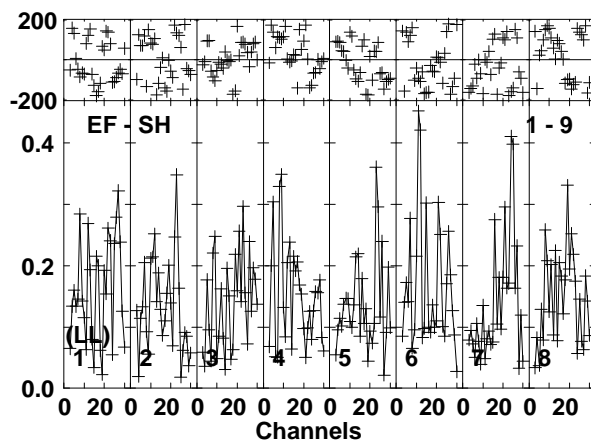
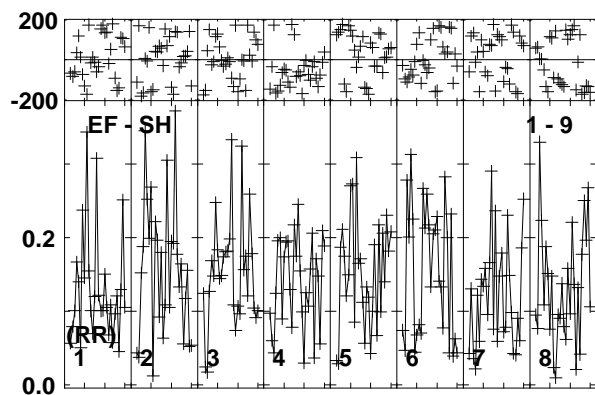
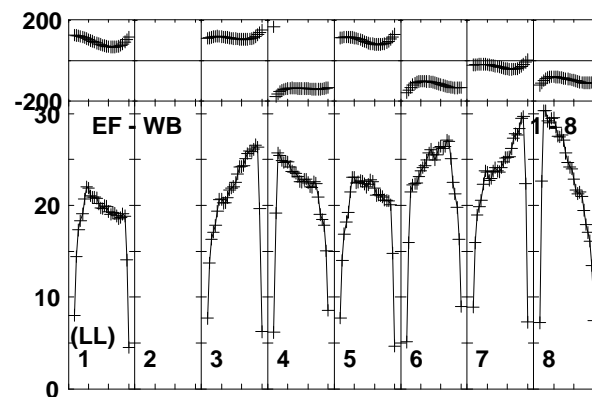
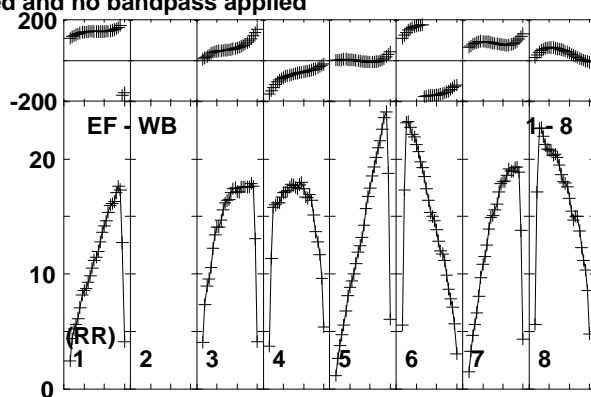
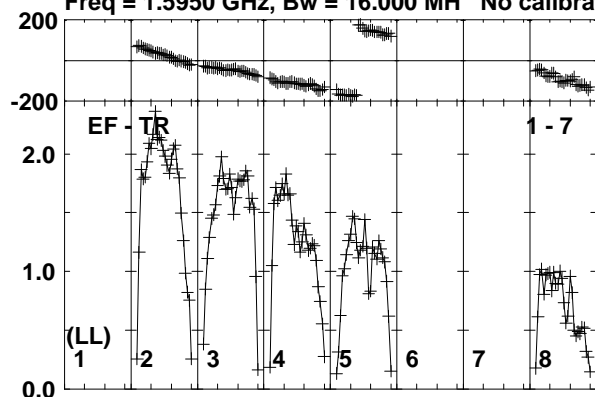

Lower frame: Milli Ampl Jy Top frame: Phas deg  
Vector averaged cross-power spectrum Baseline: EF (01) - TR (07)  
Timerange: 01/00:07:02 to 01/00:07:58

Plot file version 101 created 26-JUN-2015 10:51:21

V404CYG ET031A.UVDATA.1

Freq = 1.5950 GHz, Bw = 16.000 MH No calibration applied and no bandpass applied

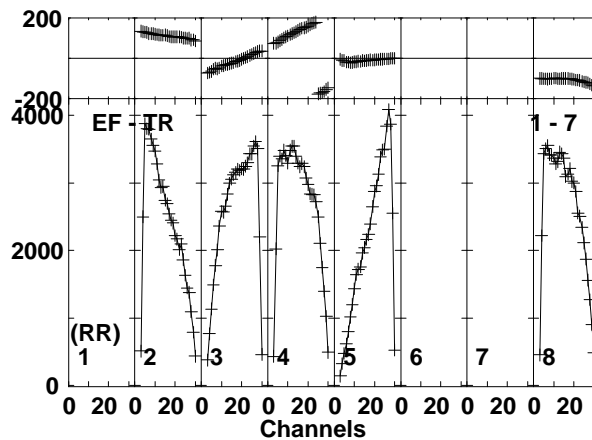
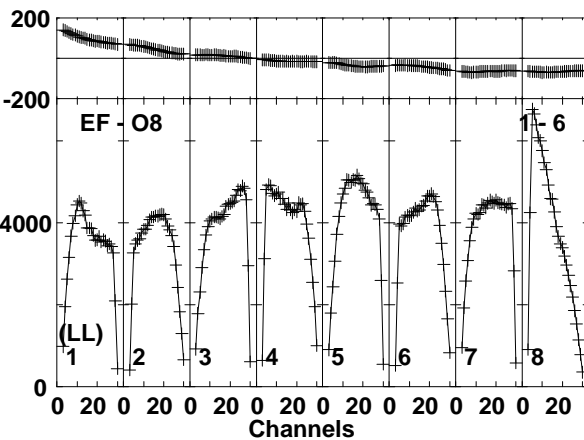
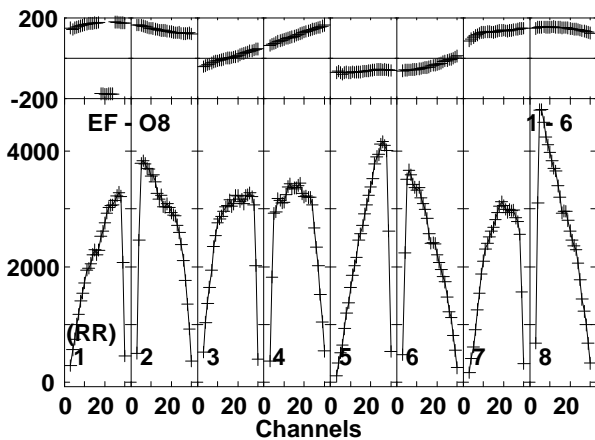
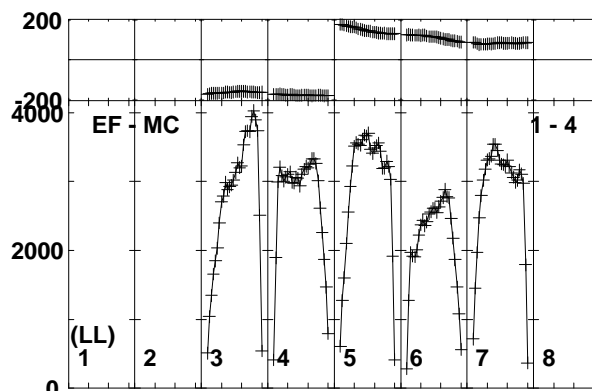
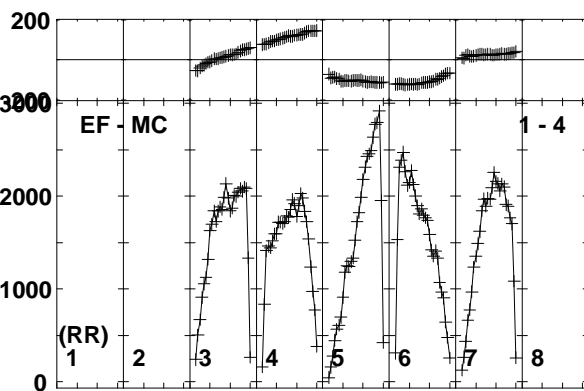
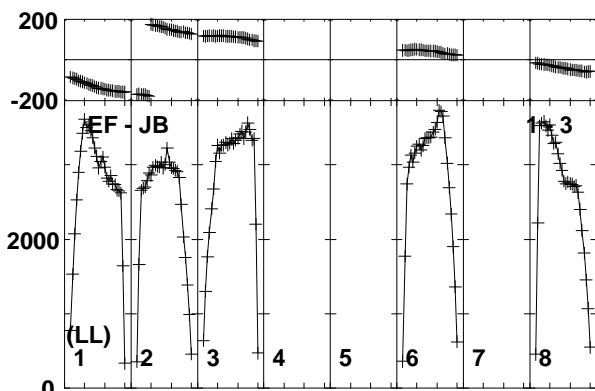
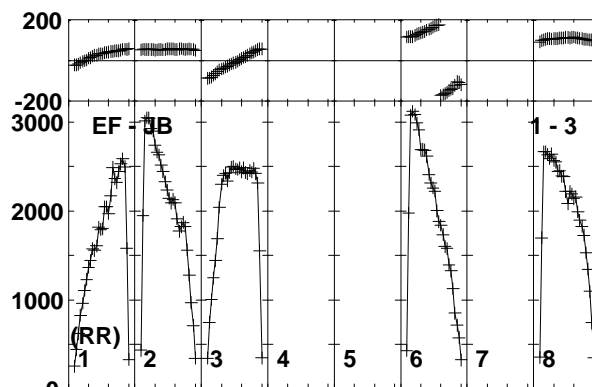
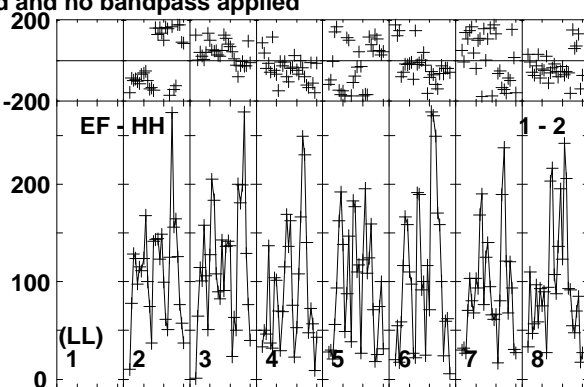
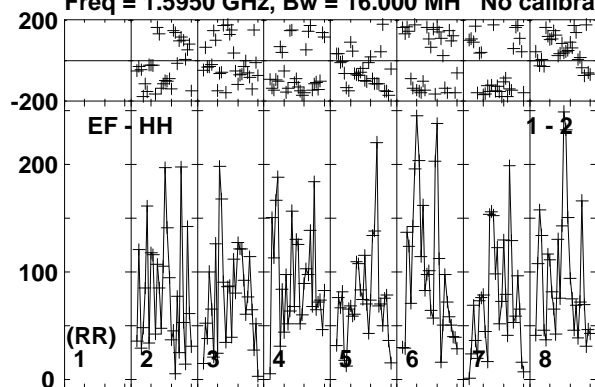

Lower frame: Micro Ampl Jy Top frame: Phas deg  
Vector averaged cross-power spectrum Baseline: EF (01) - HH (02)  
Timerange: 01/00:08:02 to 01/00:11:28

Plot file version 102 created 26-JUN-2015 10:51:21

V404CYG ET031A.UVDATA.1

Freq = 1.5950 GHz, Bw = 16.000 MH No calibration applied and no bandpass applied

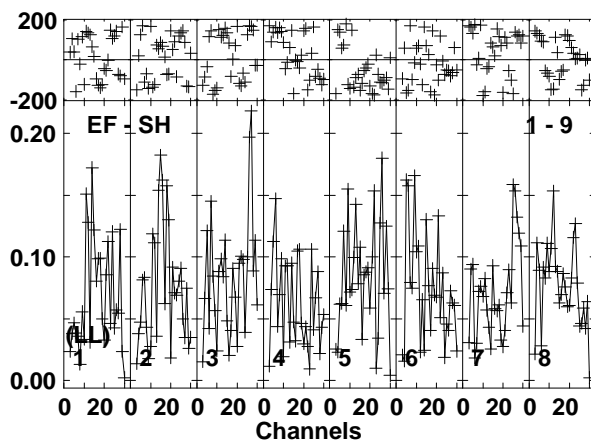
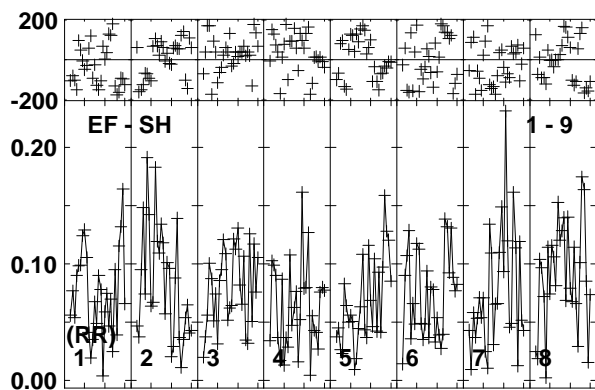
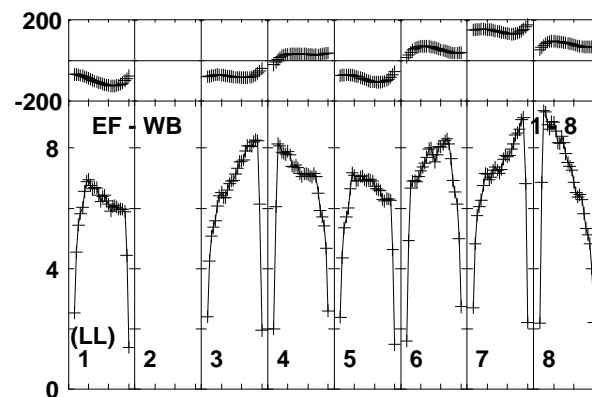
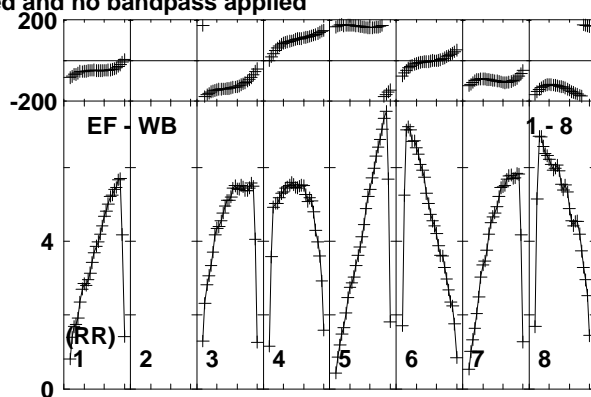
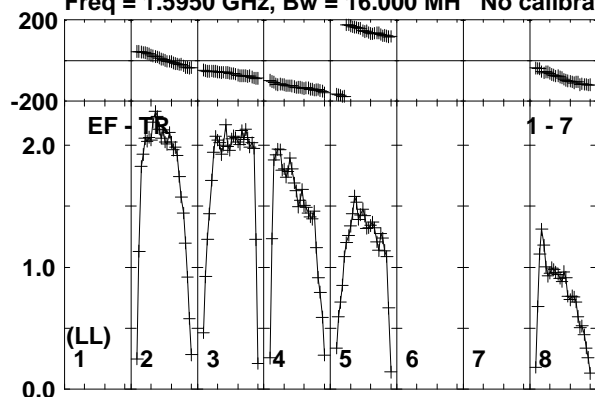

Lower frame: Milli Ampl Jy Top frame: Phas deg  
Vector averaged cross-power spectrum Baseline: EF (01) - TR (07)  
Timerange: 01/00:08:02 to 01/00:11:28

Plot file version 103 created 26-JUN-2015 10:51:21

J2025+3343 ET031A.UVDATA.1

Freq = 1.5950 GHz, Bw = 16.000 MH No calibration applied and no bandpass applied

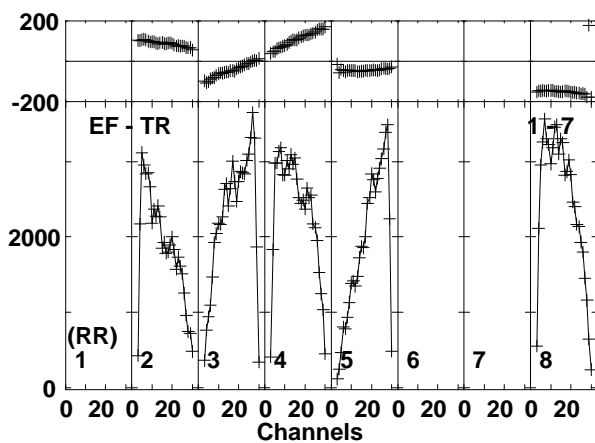
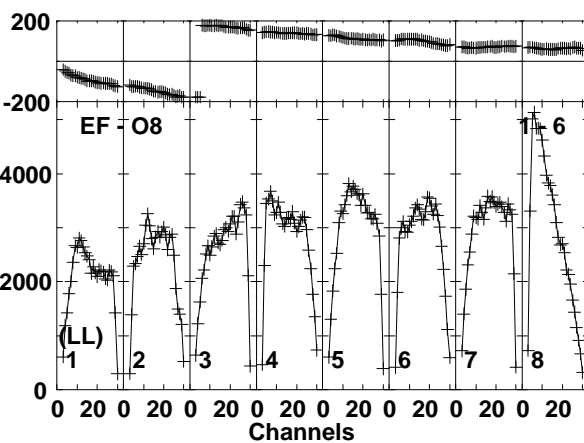
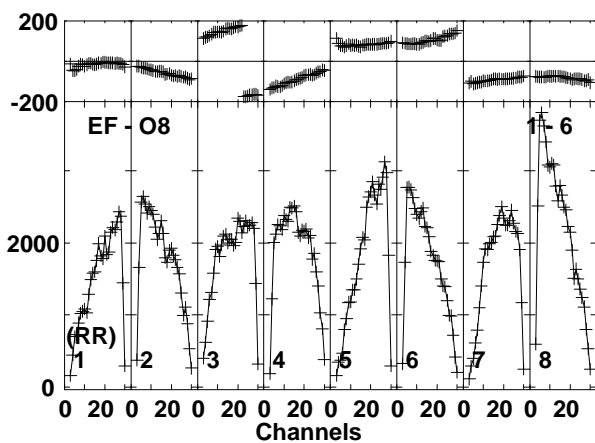
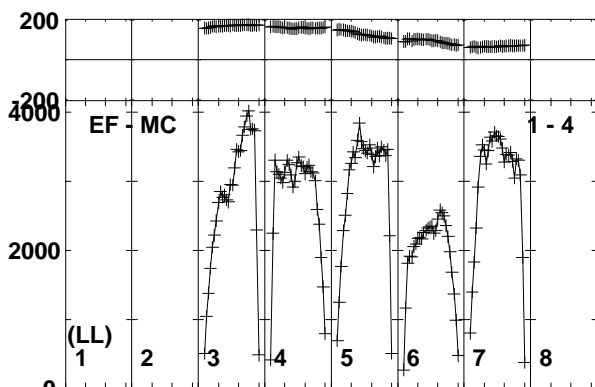
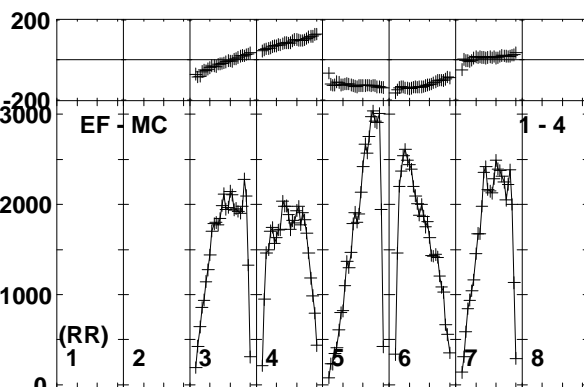
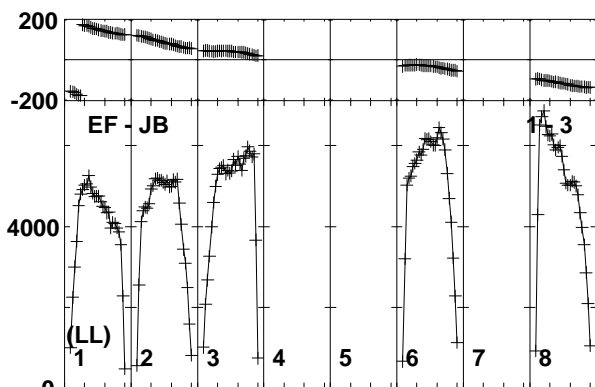
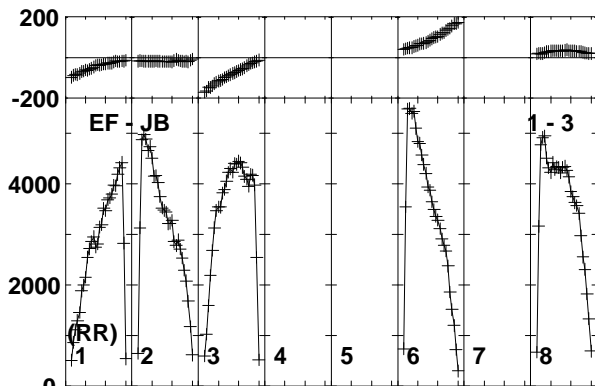
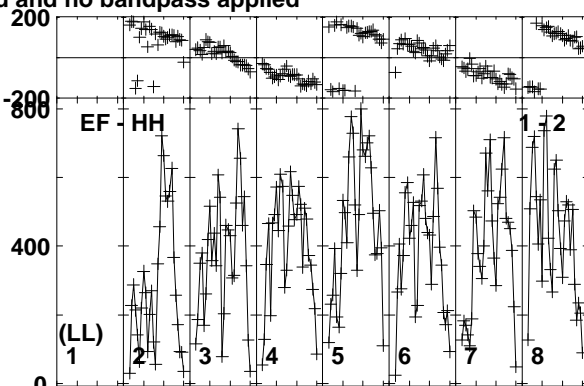
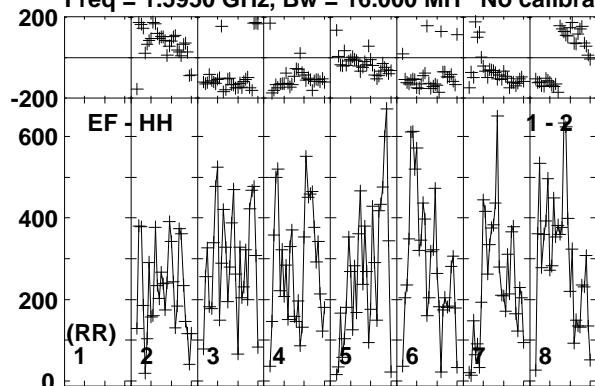

Lower frame: Micro Ampl Jy Top frame: Phas deg  
Vector averaged cross-power spectrum Baseline: EF (01) - HH (02)  
Timerange: 01/00:11:32 to 01/00:12:48

Plot file version 104 created 26-JUN-2015 10:51:21

J2025+3343 ET031A.UVDATA.1

Freq = 1.5950 GHz, Bw = 16.000 MH No calibration applied and no bandpass applied

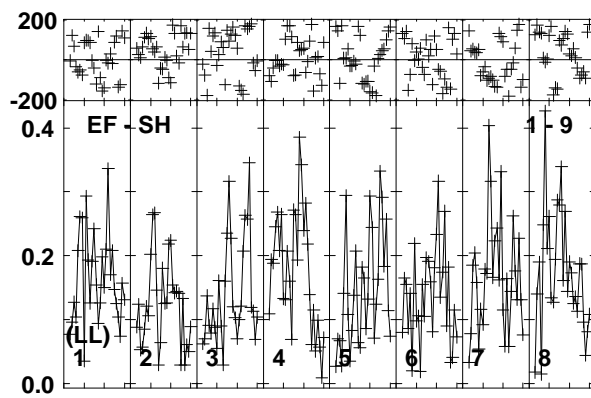
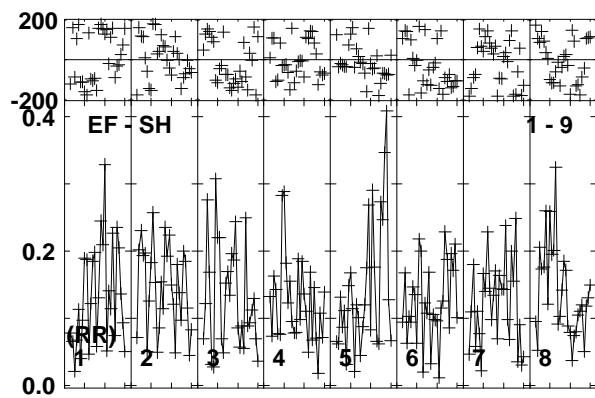
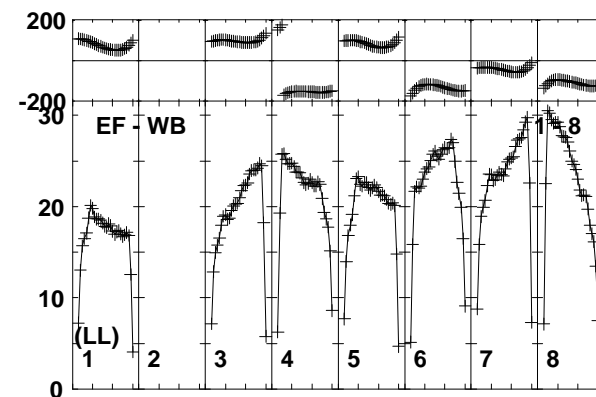
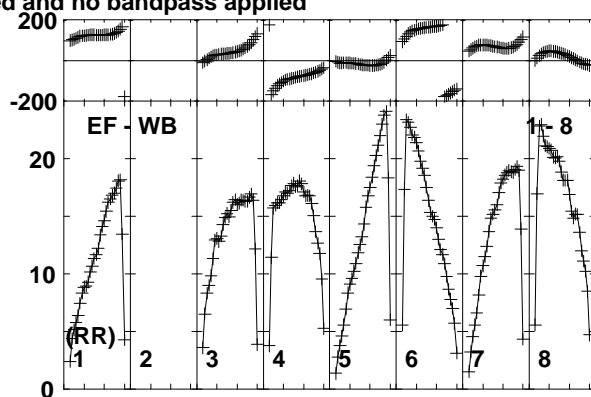
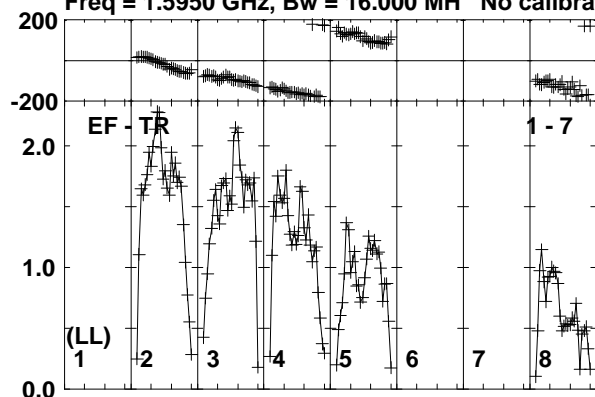

Channels

Lower frame: Milli Ampl Jy Top frame: Phas deg  
Vector averaged cross-power spectrum Baseline: EF (01) - TR (07)  
Timerange: 01/00:11:32 to 01/00:12:48



Plot file version 105 created 26-JUN-2015 10:51:21

V404CYG ET031A.UVDATA.1

Freq = 1.5950 GHz, Bw = 16.000 MH No calibration applied and no bandpass applied

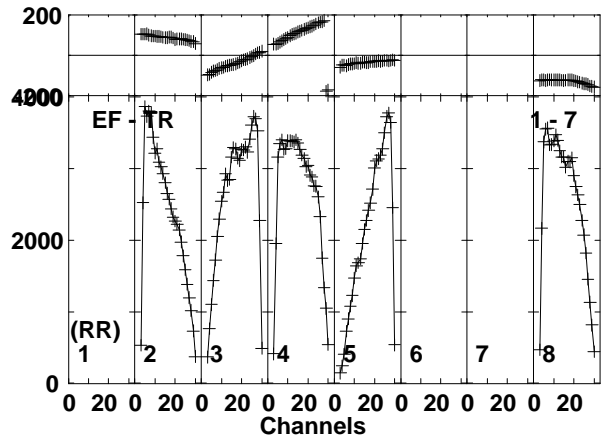
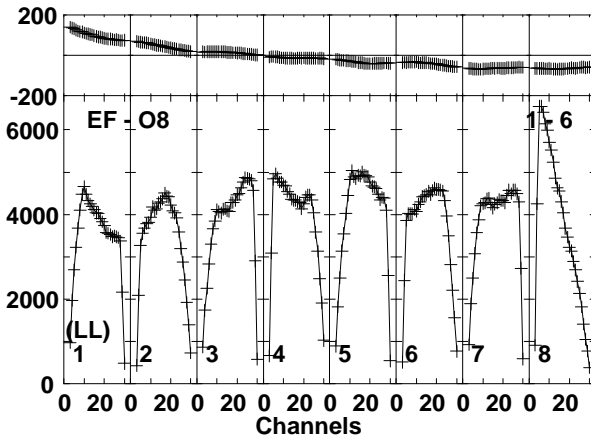
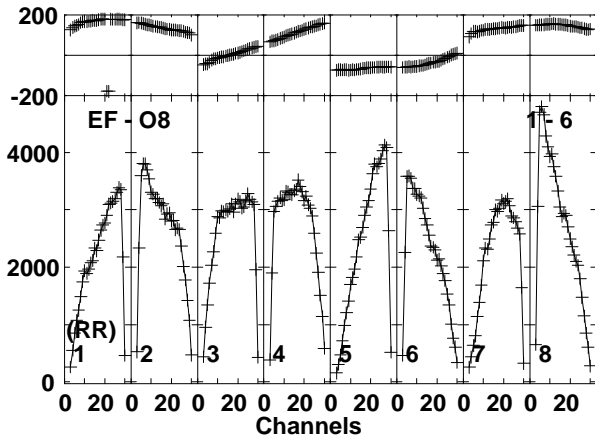
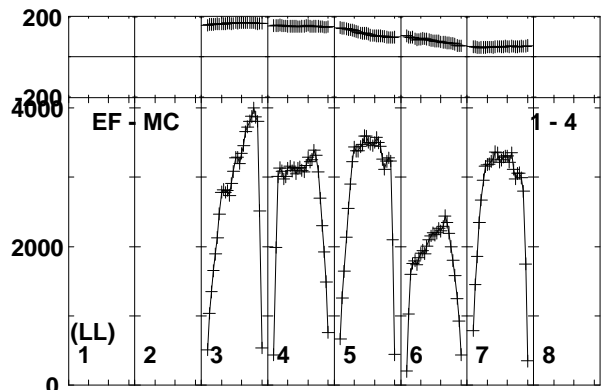
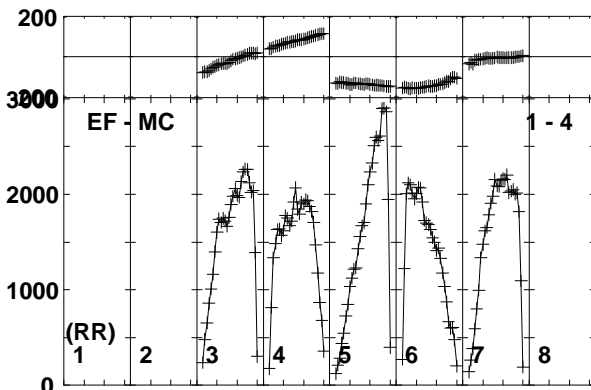
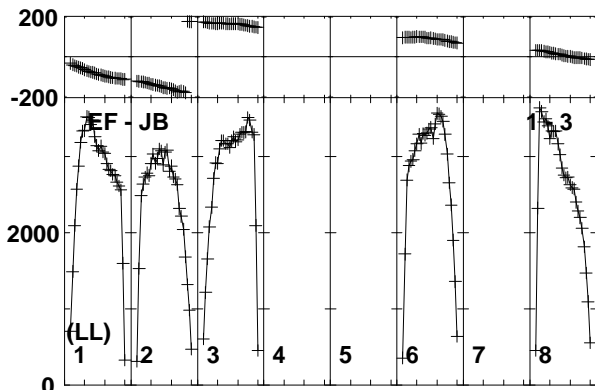
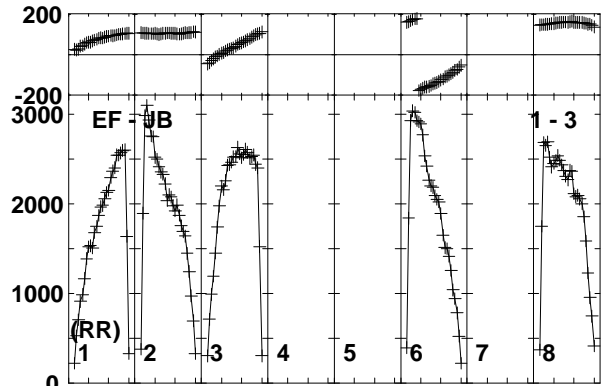
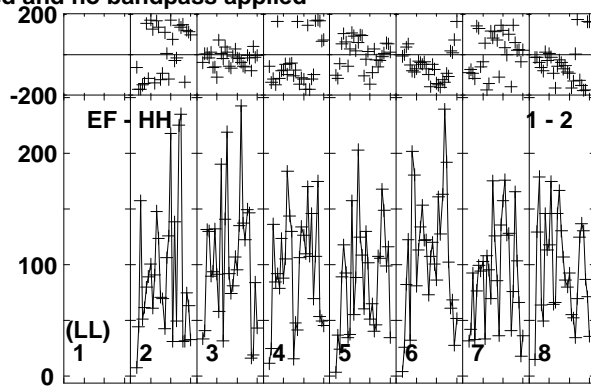
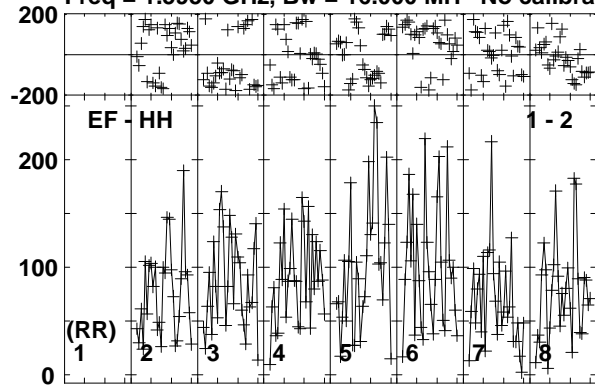

Lower frame: Micro Ampl Jy Top frame: Phas deg  
Vector averaged cross-power spectrum Baseline: EF (01) - HH (02)  
Timerange: 01/00:12:52 to 01/00:16:18

Plot file version 106 created 26-JUN-2015 10:51:21

V404CYG ET031A.UVDATA.1

Freq = 1.5950 GHz, Bw = 16.000 MH No calibration applied and no bandpass applied

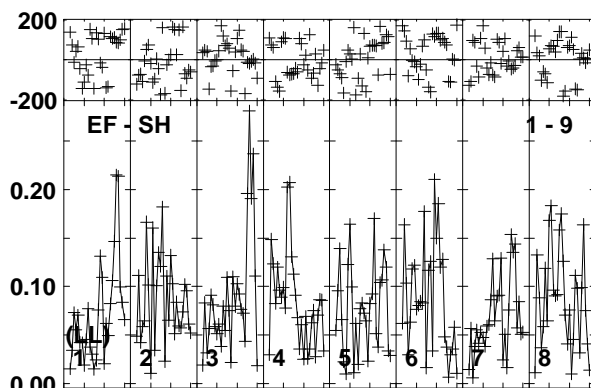
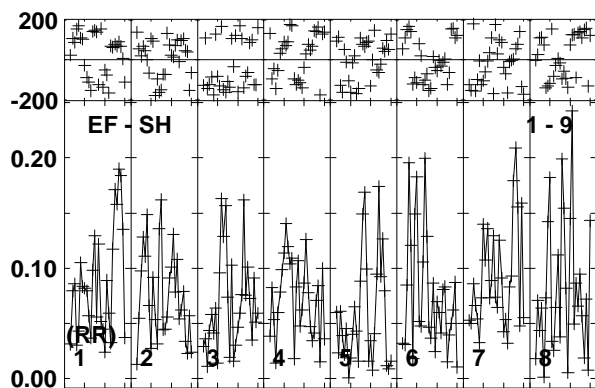
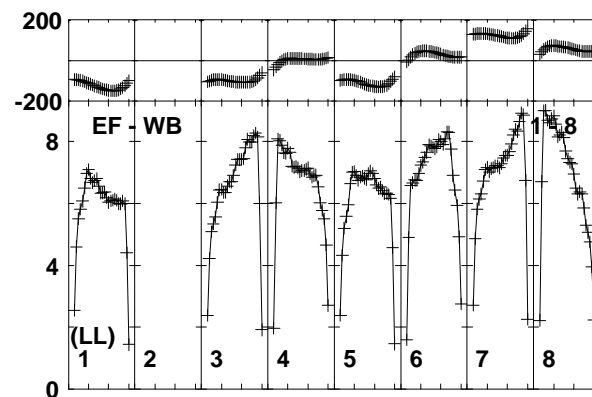
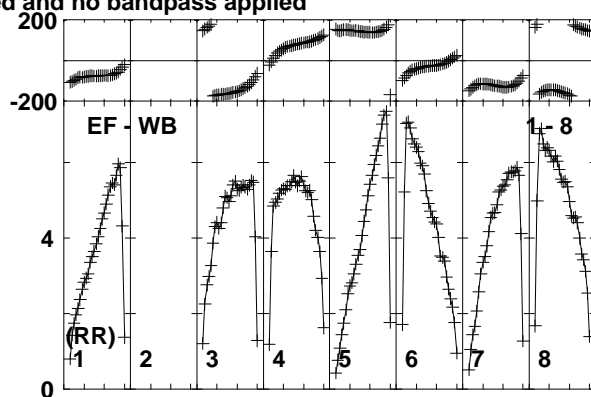
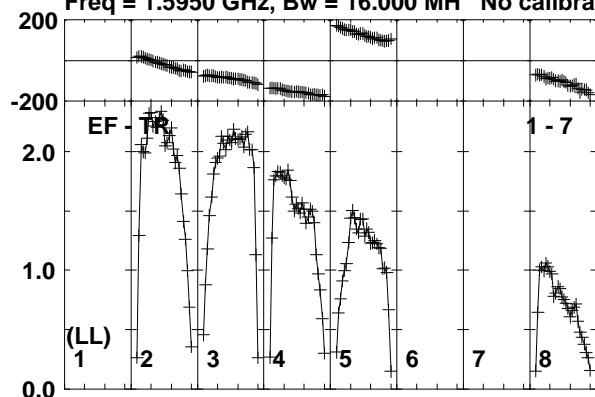

Channels

Lower frame: Milli Ampl Jy Top frame: Phas deg  
Vector averaged cross-power spectrum Baseline: EF (01) - TR (07)  
Timerange: 01/00:12:52 to 01/00:16:18

Plot file version 107 created 26-JUN-2015 10:51:21

J2025+3343 ET031A.UVDATA.1

Freq = 1.5950 GHz, Bw = 16.000 MH No calibration applied and no bandpass applied

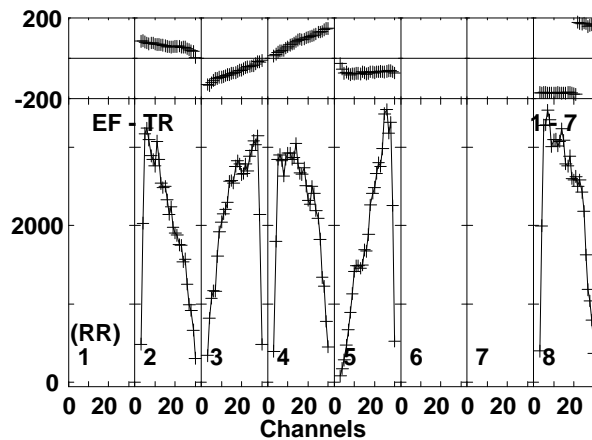
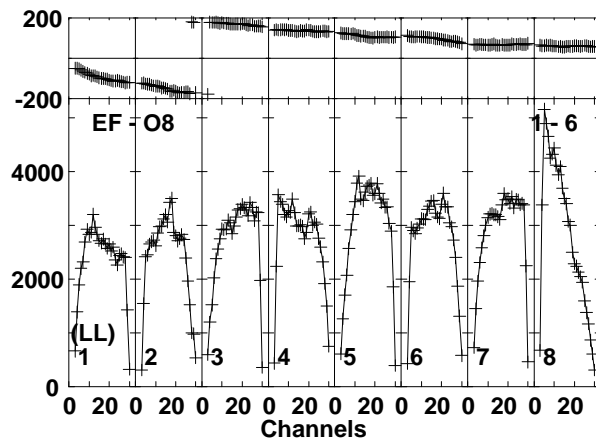
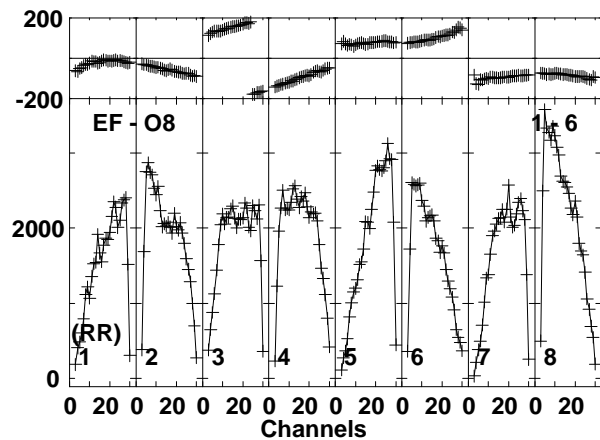
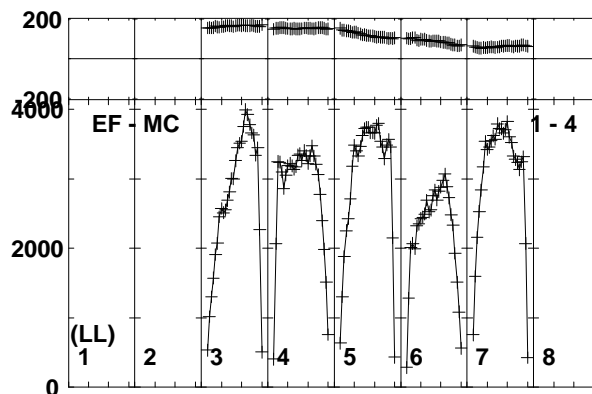
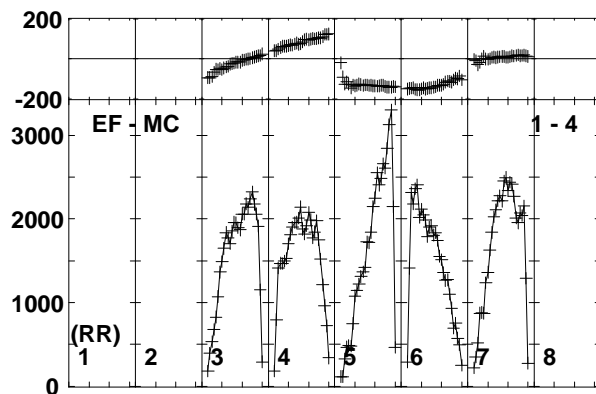
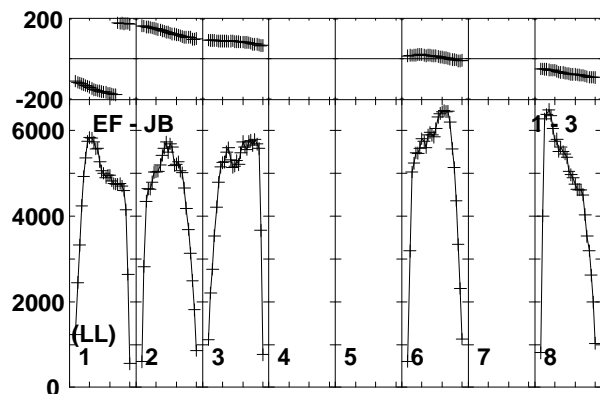
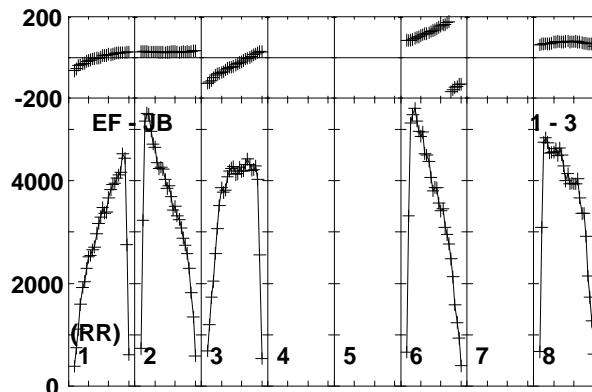
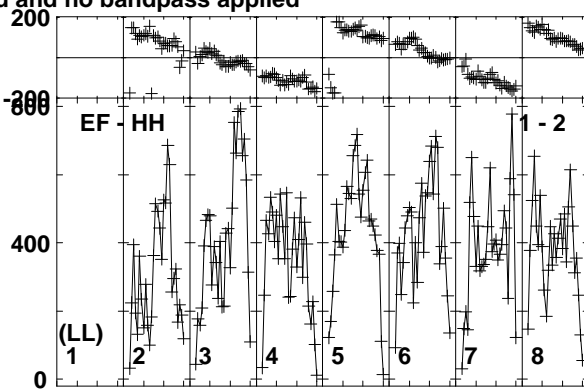
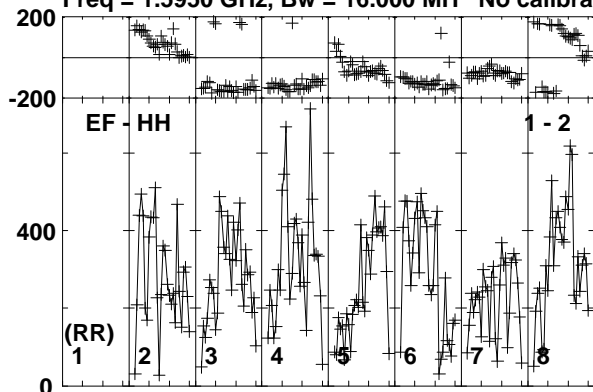

Lower frame: Micro Ampl Jy Top frame: Phas deg  
Vector averaged cross-power spectrum Baseline: EF (01) - HH (02)  
Timerange: 01/00:17:02 to 01/00:17:58

Plot file version 108 created 26-JUN-2015 10:51:21

J2025+3343 ET031A.UVDATA.1

Freq = 1.5950 GHz, Bw = 16.000 MH No calibration applied and no bandpass applied

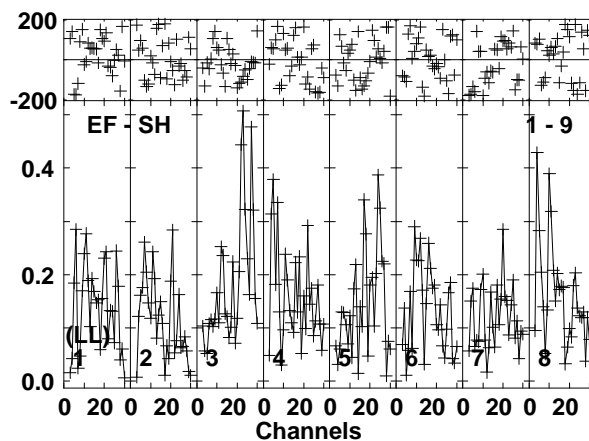
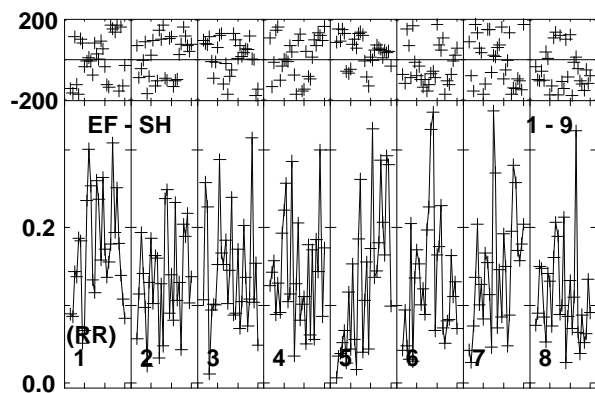
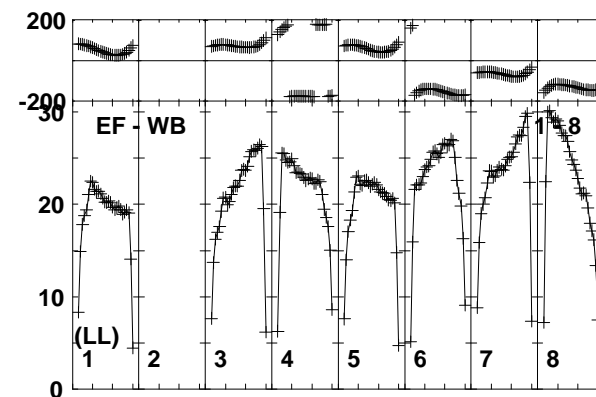
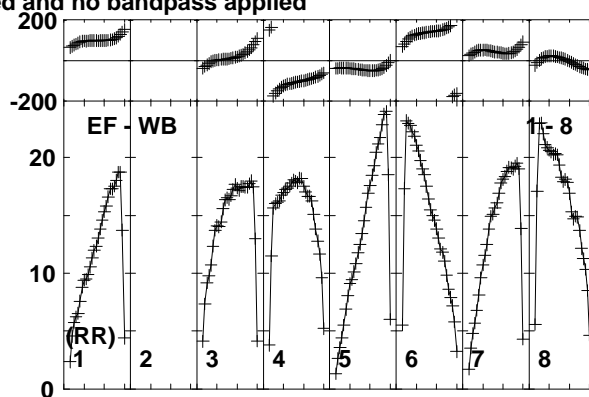
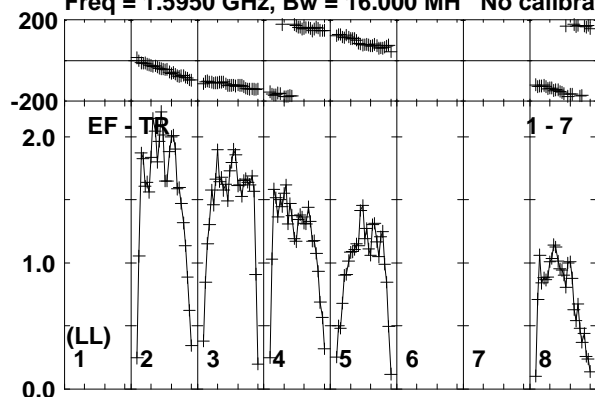

Lower frame: Milli Ampl Jy Top frame: Phas deg  
Vector averaged cross-power spectrum Baseline: EF (01) - TR (07)  
Timerange: 01/00:17:02 to 01/00:17:58

Plot file version 109 created 26-JUN-2015 10:51:21

3C454.3 ET031A.UVDATA.1

Freq = 1.5950 GHz, Bw = 16.000 MH No calibration applied and no bandpass applied

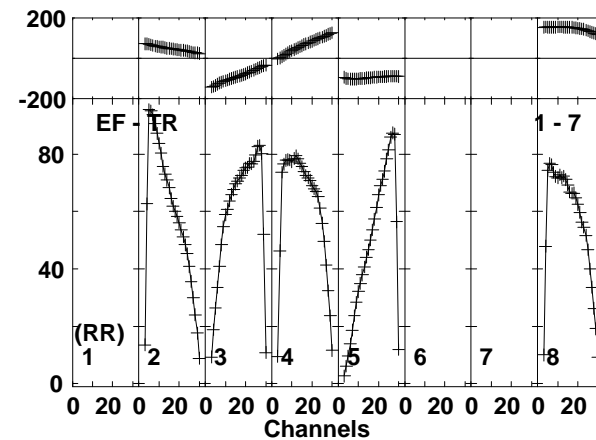
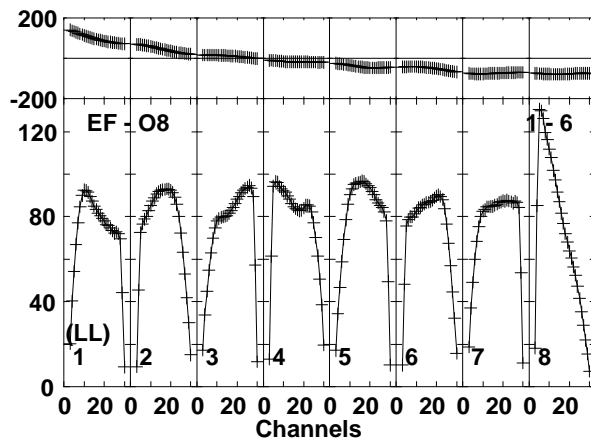
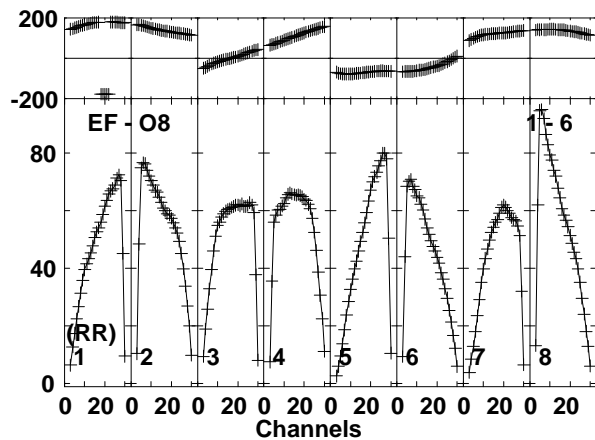
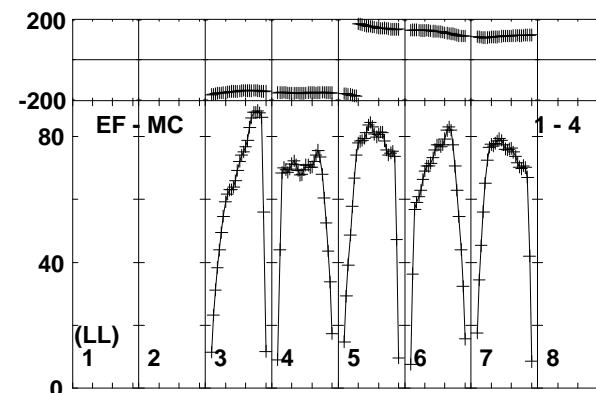
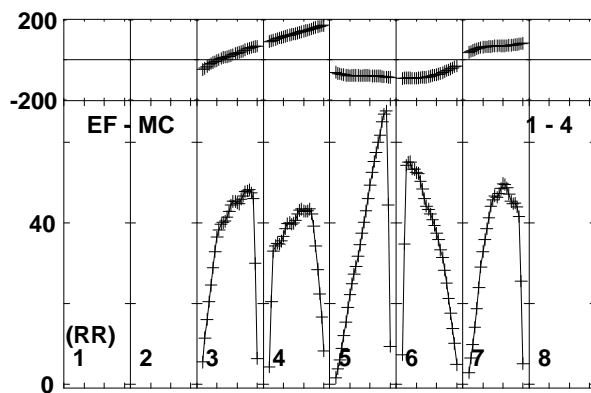
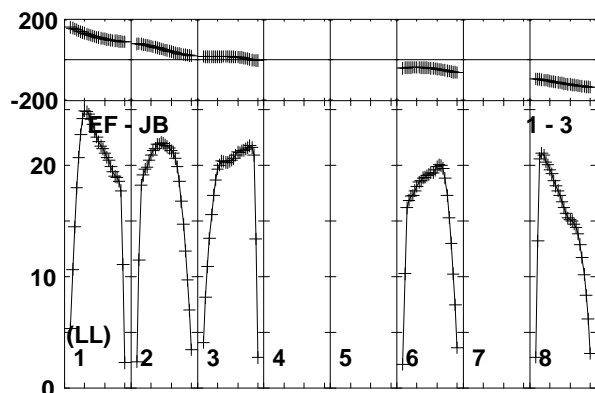
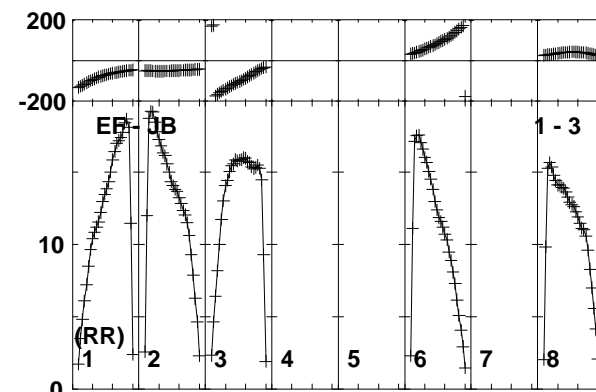
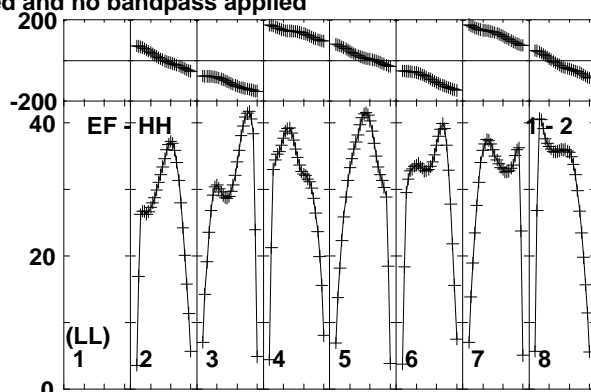
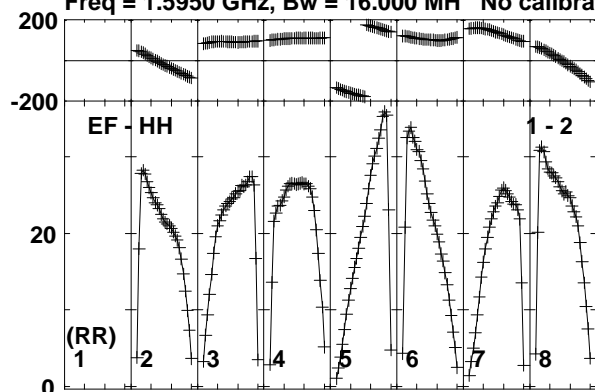

Lower frame: Milli Ampl Jy Top frame: Phas deg  
Vector averaged cross-power spectrum Baseline: EF (01) - HH (02)  
Timerange: 01/00:21:02 to 01/00:27:58

Plot file version 110 created 26-JUN-2015 10:51:21

3C454.3 ET031A.UVDATA.1

Freq = 1.5950 GHz, Bw = 16.000 MH No calibration applied and no bandpass applied

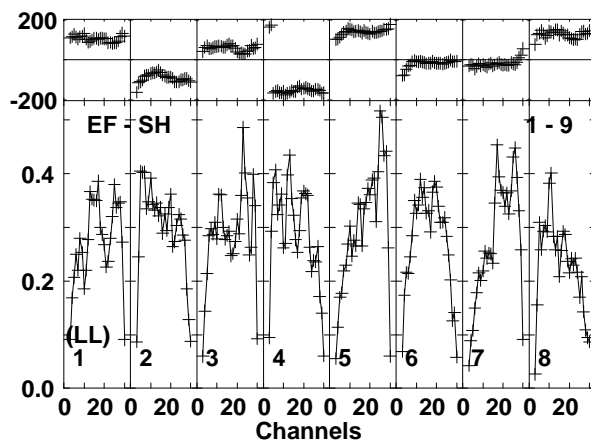
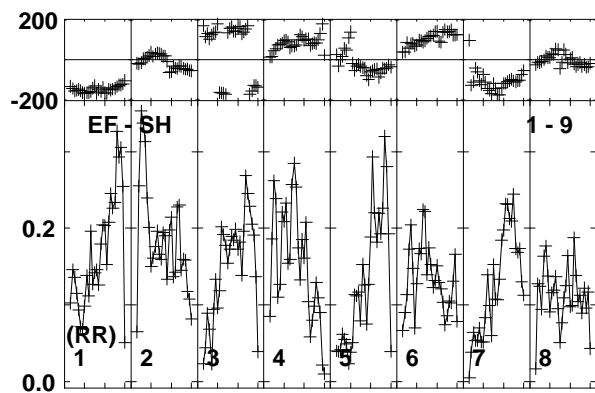
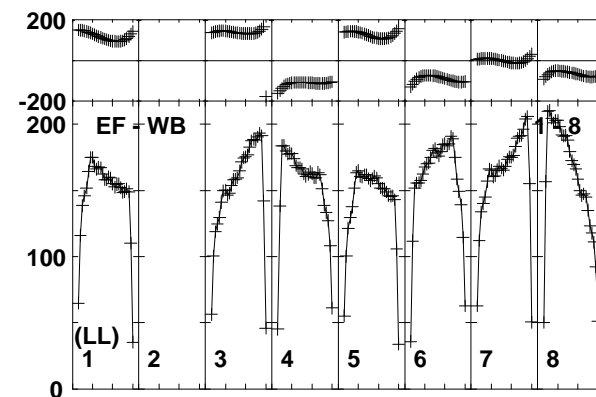
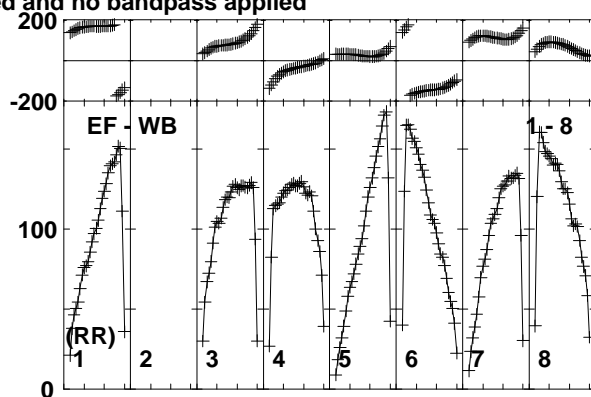
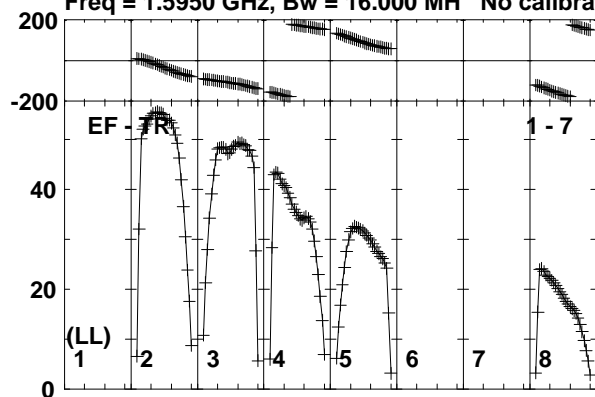

Lower frame: Milli Ampl Jy Top frame: Phas deg  
Vector averaged cross-power spectrum Baseline: EF (01) - TR (07)  
Timerange: 01/00:21:02 to 01/00:27:58

Plot file version 111 created 26-JUN-2015 10:51:21

J2025+3343 ET031A.UVDATA.1

Freq = 1.5950 GHz, Bw = 16.000 MH No calibration applied and no bandpass applied

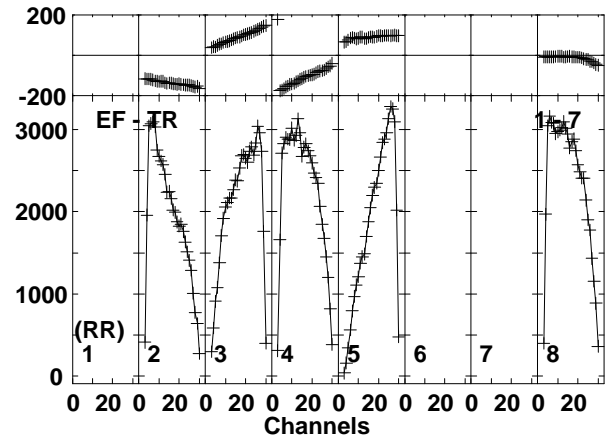
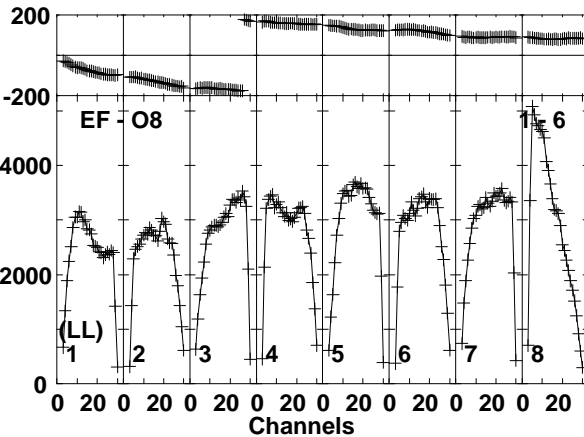
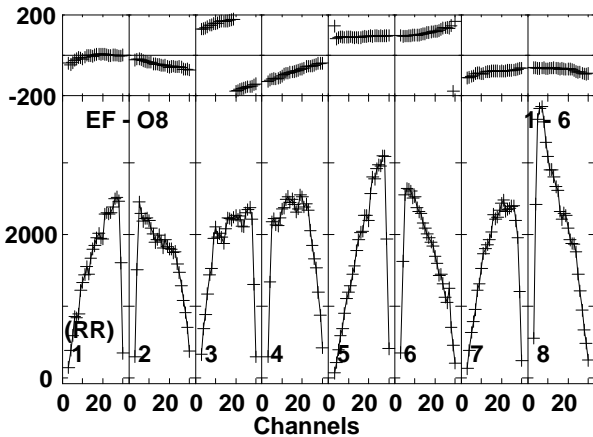
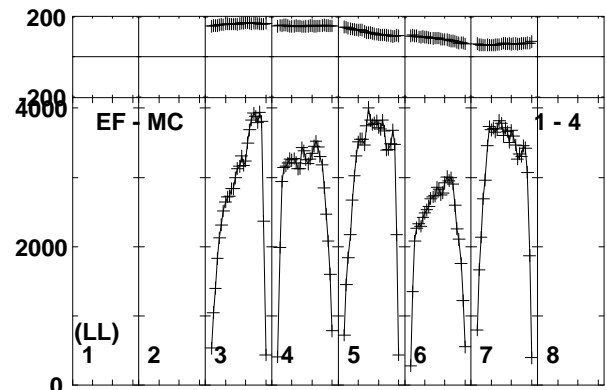
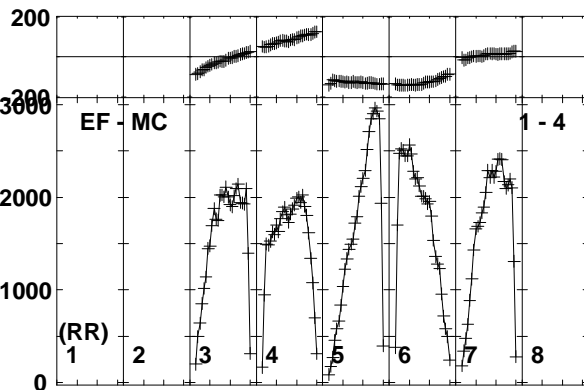
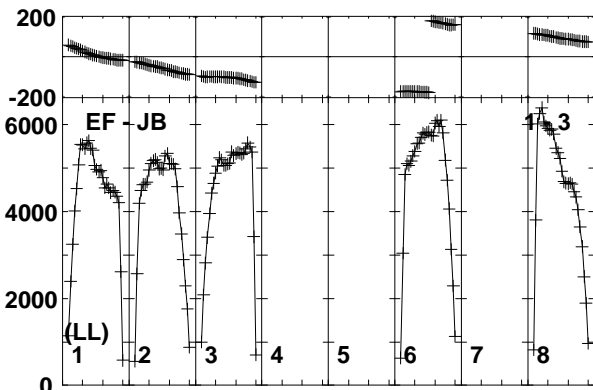
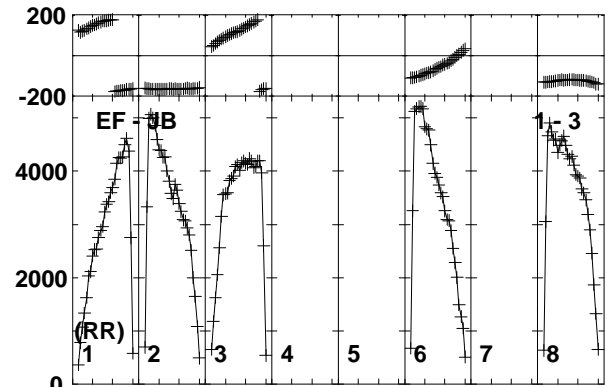
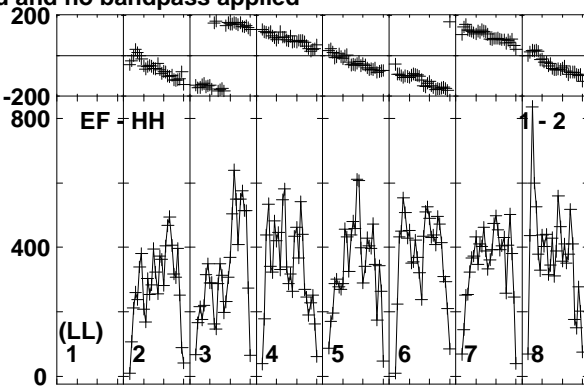
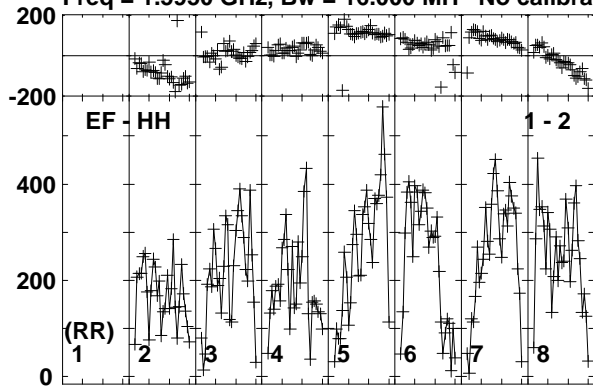

Lower frame: Micro Ampl Jy Top frame: Phas deg  
Vector averaged cross-power spectrum Baseline: EF (01) - HH (02)  
Timerange: 01/00:30:02 to 01/00:32:58

Plot file version 112 created 26-JUN-2015 10:51:21

J2025+3343 ET031A.UVDATA.1

Freq = 1.5950 GHz, Bw = 16.000 MH No calibration applied and no bandpass applied

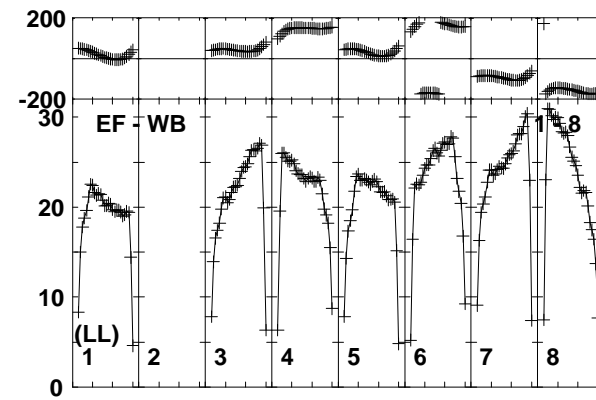
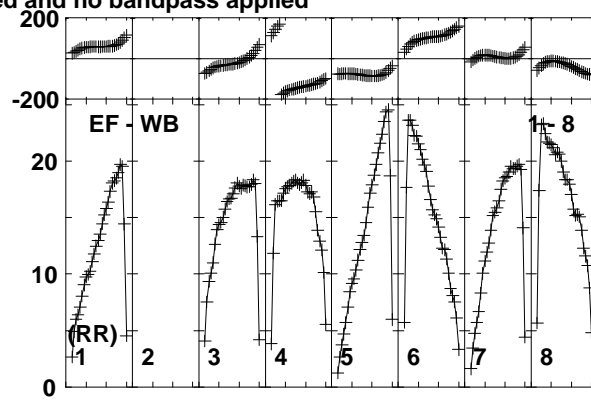
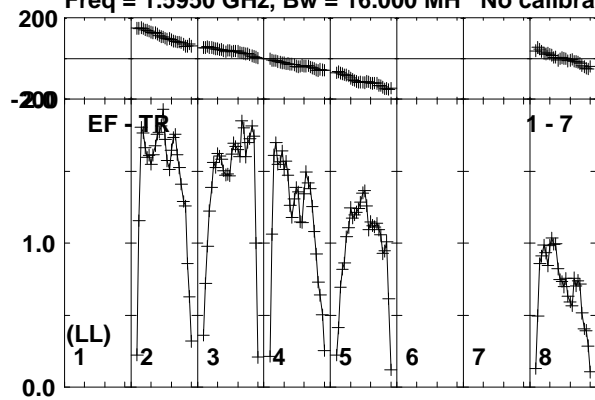

Lower frame: Milli Ampl Jy Top frame: Phas deg  
Vector averaged cross-power spectrum Baseline: EF (01) - TR (07)  
Timerange: 01/00:30:02 to 01/00:32:58



Plot file version 113 created 26-JUN-2015 10:51:21

V404CYG ET031A.UVDATA.1

Freq = 1.5950 GHz, Bw = 16.000 MH No calibration applied and no bandpass applied

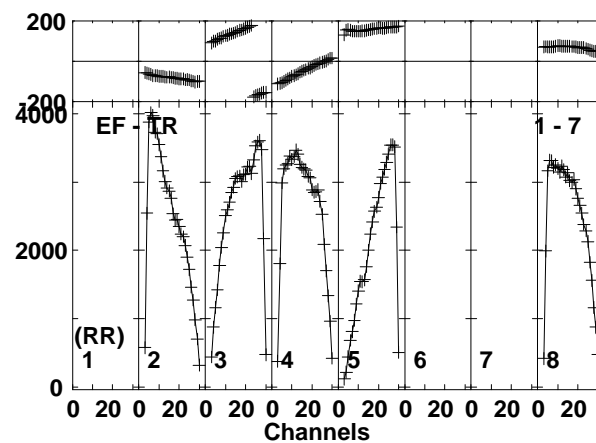
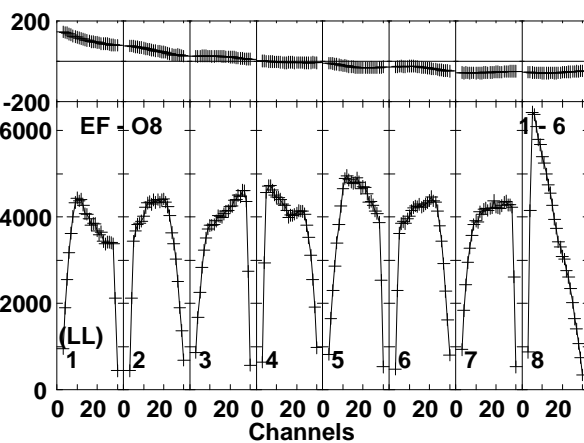
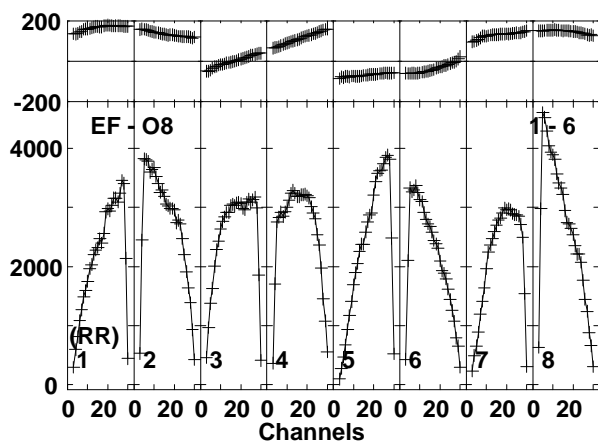
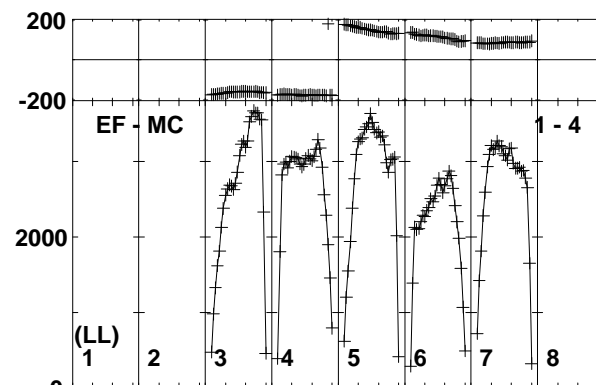
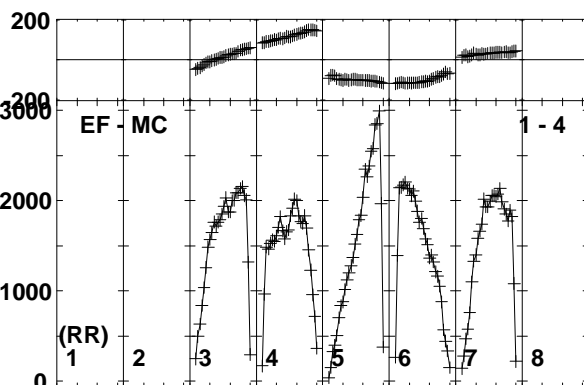
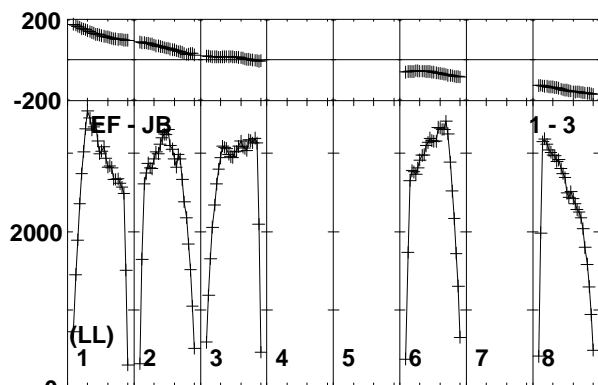
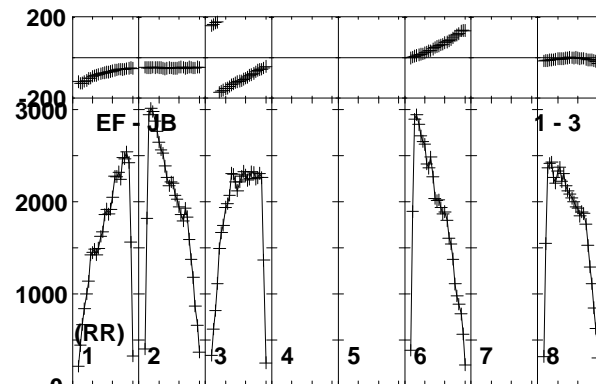
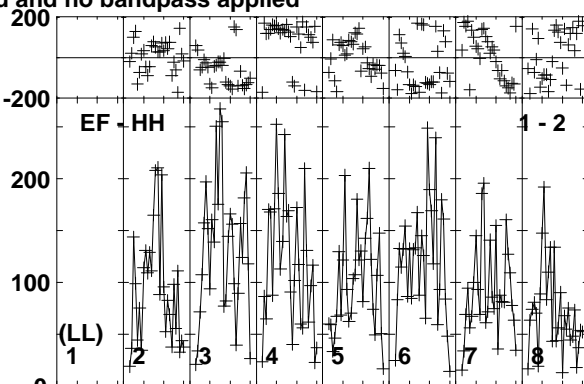
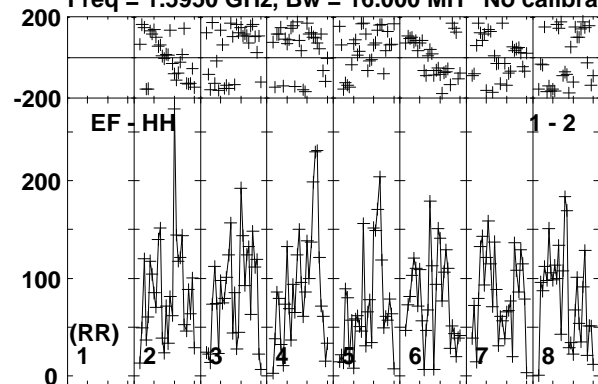

Lower frame: Micro Ampl Jy Top frame: Phas deg  
Vector averaged cross-power spectrum Baseline: EF (01) - HH (02)  
Timerange: 01/00:33:02 to 01/00:36:28

Plot file version 114 created 26-JUN-2015 10:51:22

V404CYG ET031A.UVDATA.1

Freq = 1.5950 GHz, Bw = 16.000 MH No calibration applied and no bandpass applied

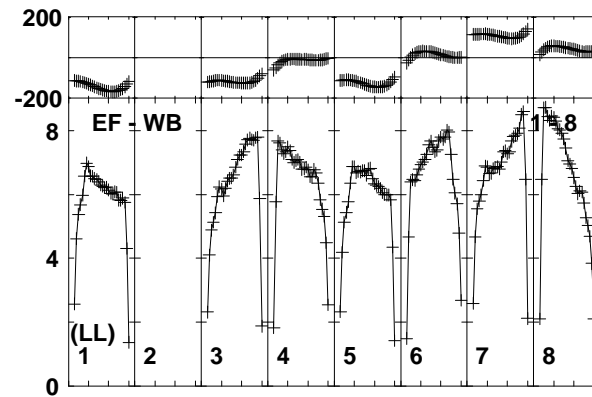
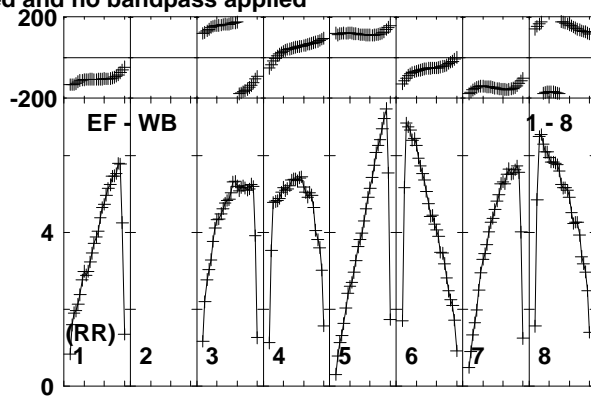
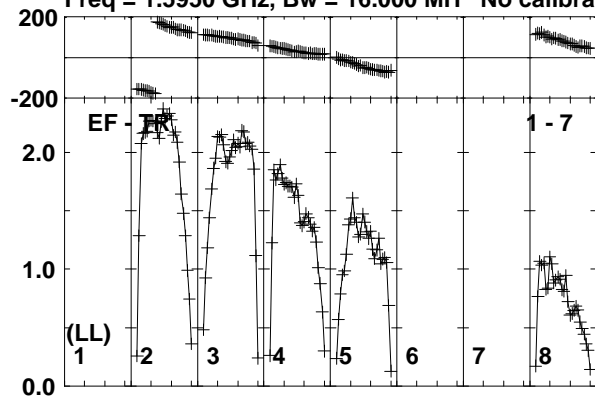

Lower frame: Milli Ampl Jy Top frame: Phas deg  
Vector averaged cross-power spectrum Baseline: EF (01) - TR (07)  
Timerange: 01/00:33:02 to 01/00:36:28

Plot file version 115 created 26-JUN-2015 10:51:22

J2025+3343 ET031A.UVDATA.1

Freq = 1.5950 GHz, Bw = 16.000 MH No calibration applied and no bandpass applied

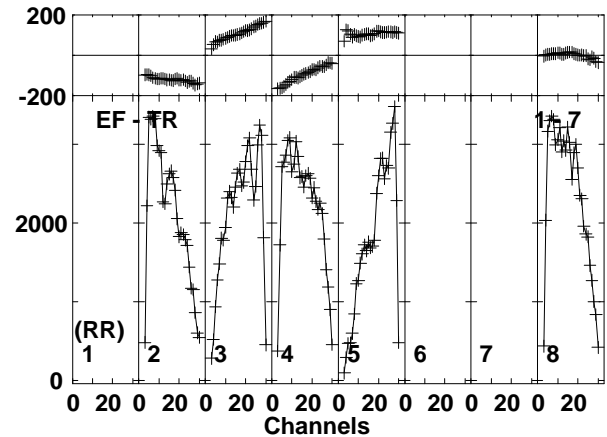
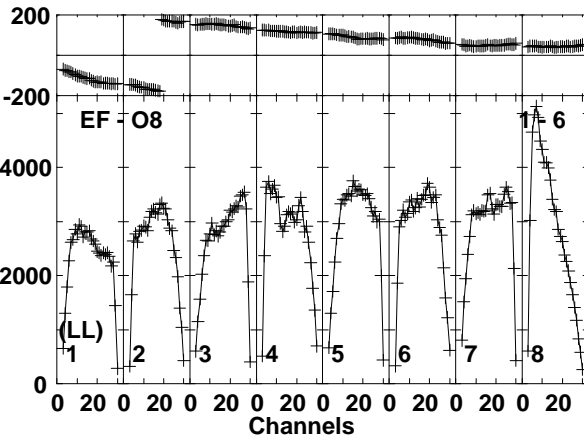
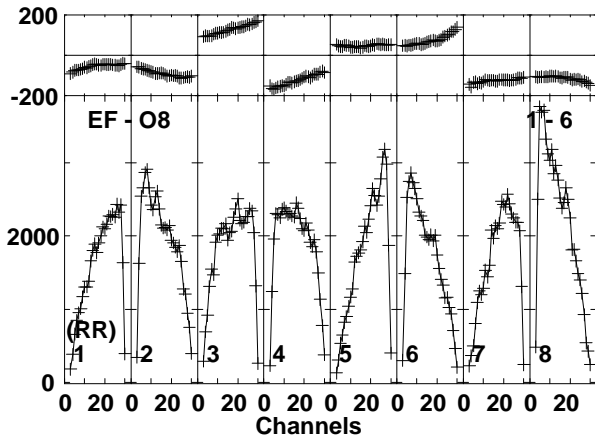
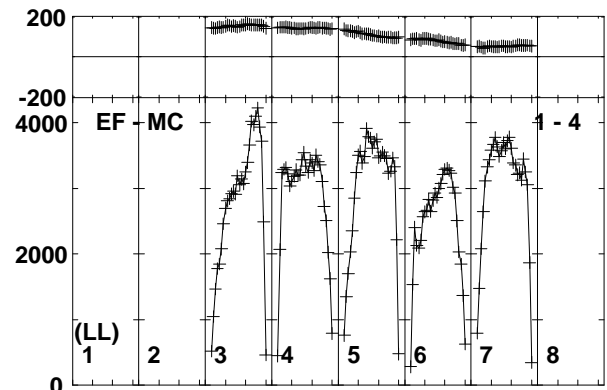
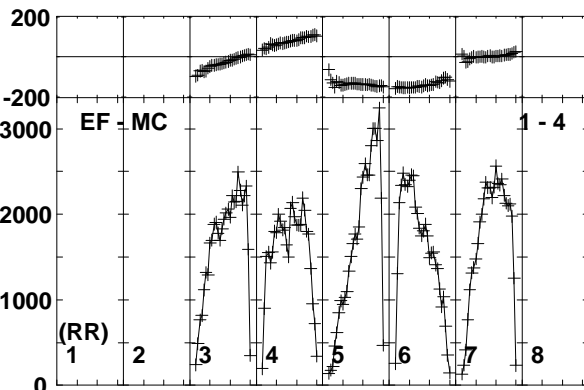
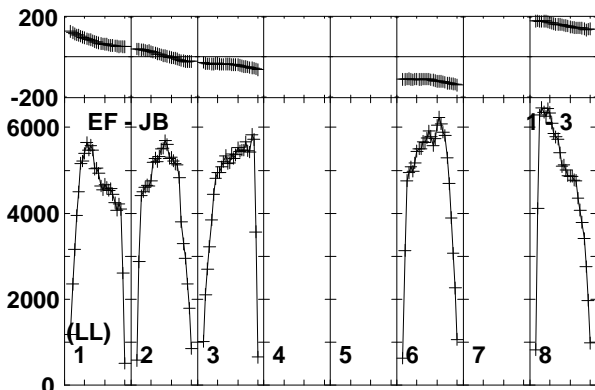
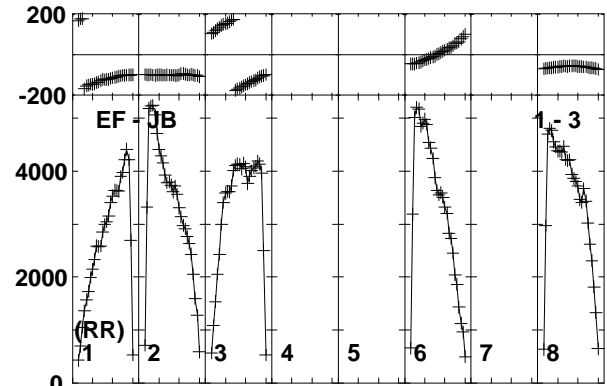
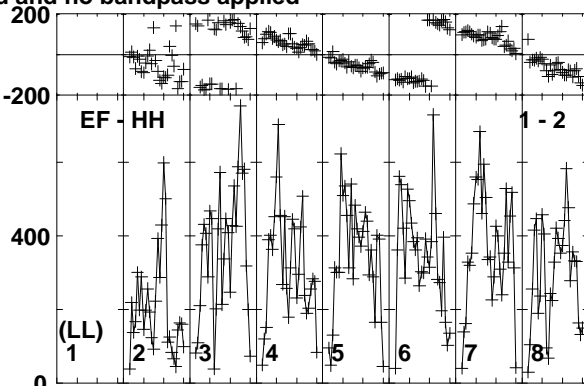
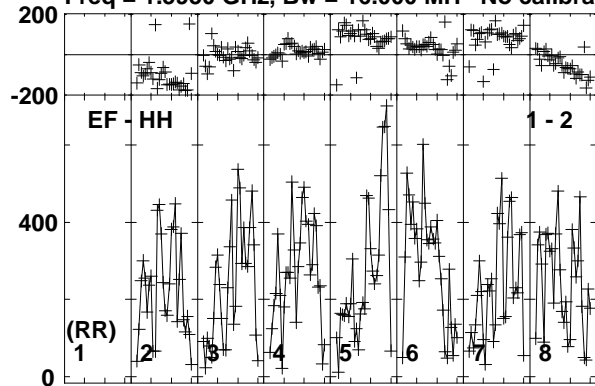

Lower frame: Micro Ampl Jy Top frame: Phas deg  
Vector averaged cross-power spectrum Baseline: EF (01) - HH (02)  
Timerange: 01/00:36:32 to 01/00:37:48

Plot file version 116 created 26-JUN-2015 10:51:22

J2025+3343 ET031A.UVDATA.1

Freq = 1.5950 GHz, Bw = 16.000 MH No calibration applied and no bandpass applied

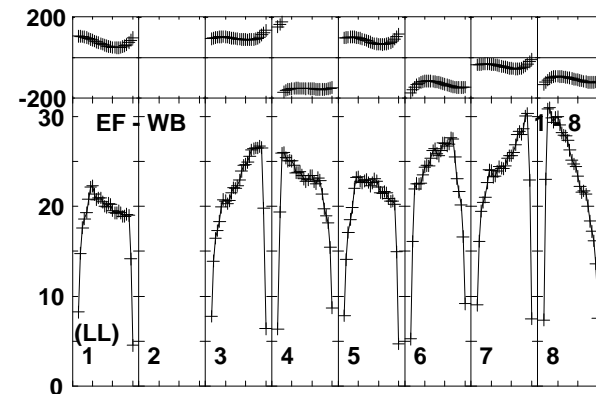
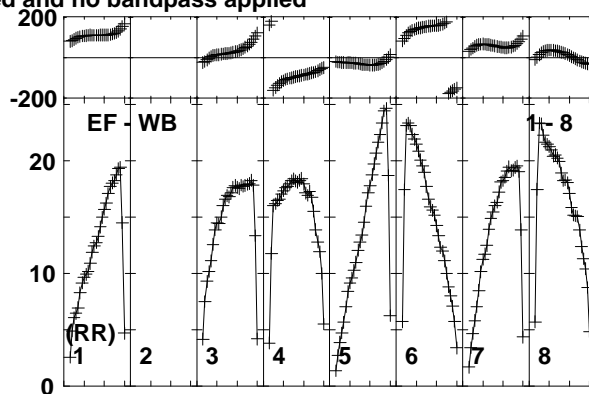
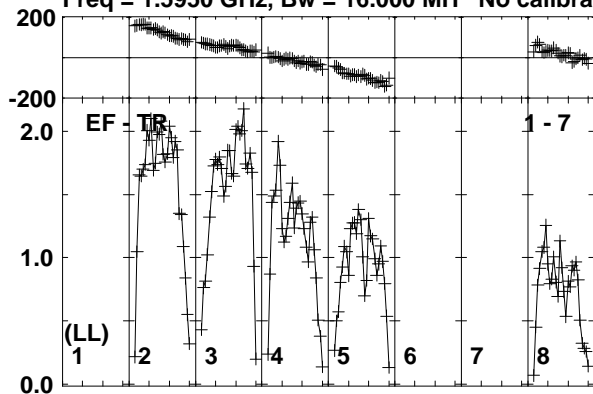

Lower frame: Milli Ampl Jy Top frame: Phas deg  
Vector averaged cross-power spectrum Baseline: EF (01) - TR (07)  
Timerange: 01/00:36:32 to 01/00:37:48

Plot file version 117 created 26-JUN-2015 10:51:22

V404CYG ET031A.UVDATA.1

Freq = 1.5950 GHz, Bw = 16.000 MH No calibration applied and no bandpass applied

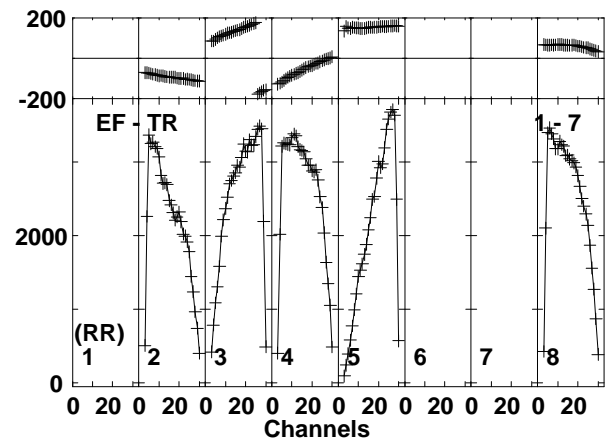
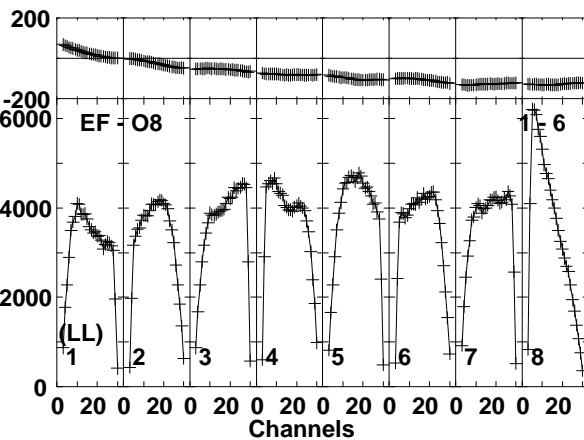
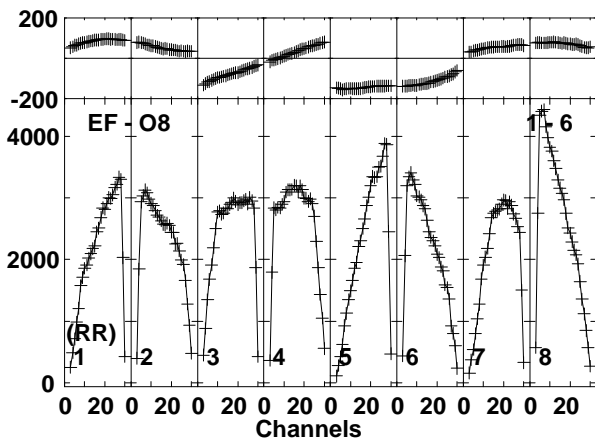
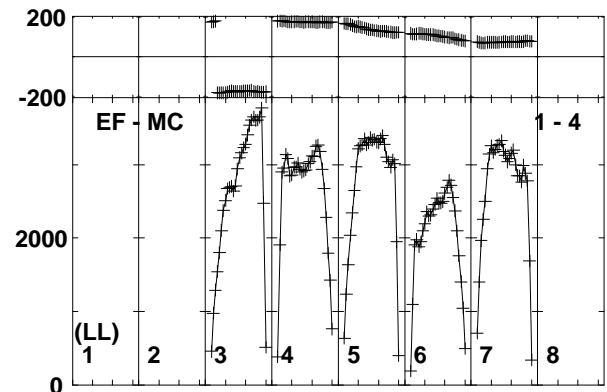
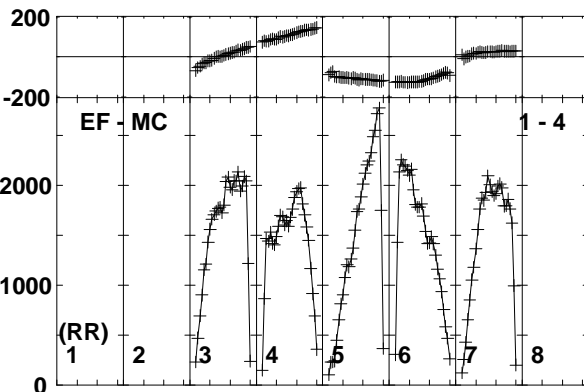
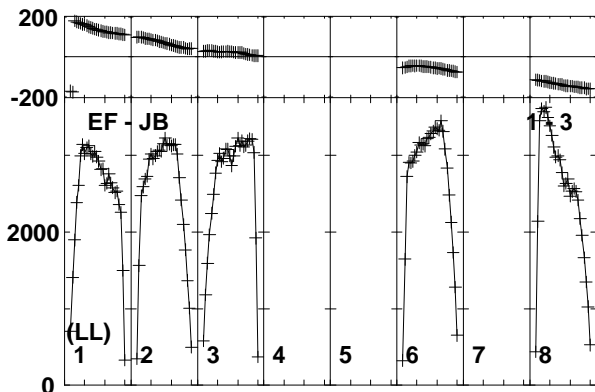
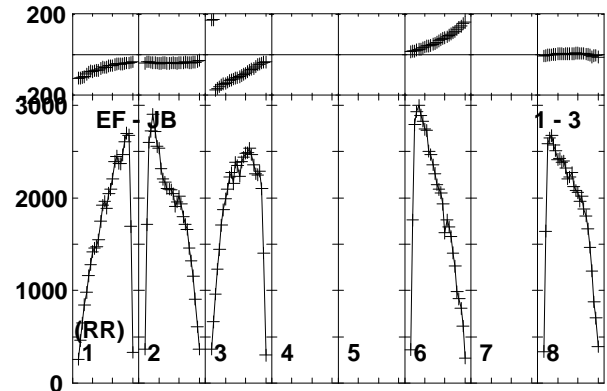
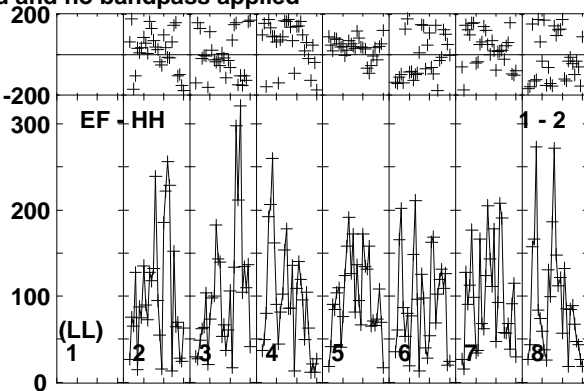
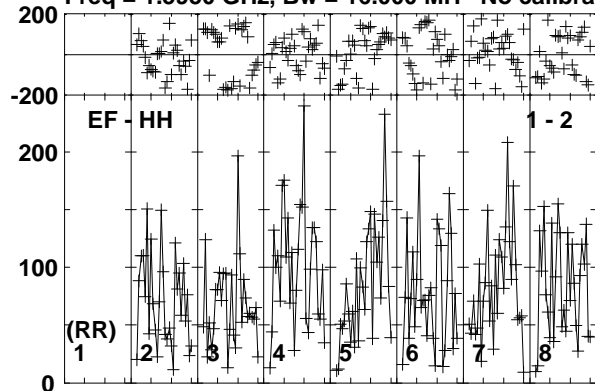

Lower frame: Micro Ampl Jy Top frame: Phas deg  
Vector averaged cross-power spectrum Baseline: EF (01) - HH (02)  
Timerange: 01/00:37:52 to 01/00:41:18

Plot file version 118 created 26-JUN-2015 10:51:22

V404CYG ET031A.UVDATA.1

Freq = 1.5950 GHz, Bw = 16.000 MH No calibration applied and no bandpass applied

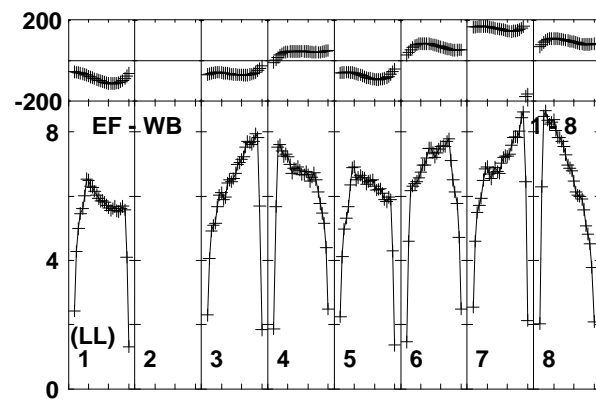
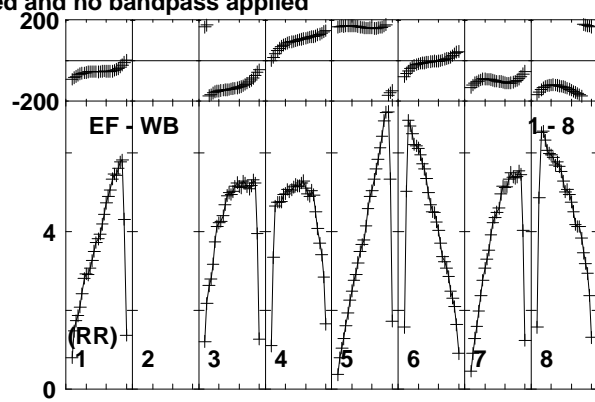
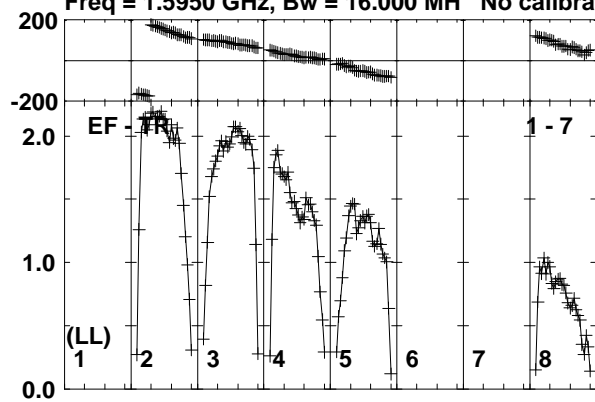

Lower frame: Milli Ampl Jy Top frame: Phas deg  
Vector averaged cross-power spectrum Baseline: EF (01) - TR (07)  
Timerange: 01/00:37:52 to 01/00:41:18

Plot file version 119 created 26-JUN-2015 10:51:22

J2025+3343 ET031A.UVDATA.1

Freq = 1.5950 GHz, Bw = 16.000 MH No calibration applied and no bandpass applied

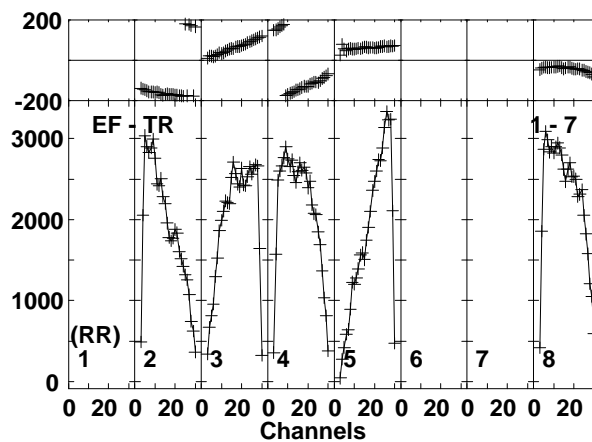
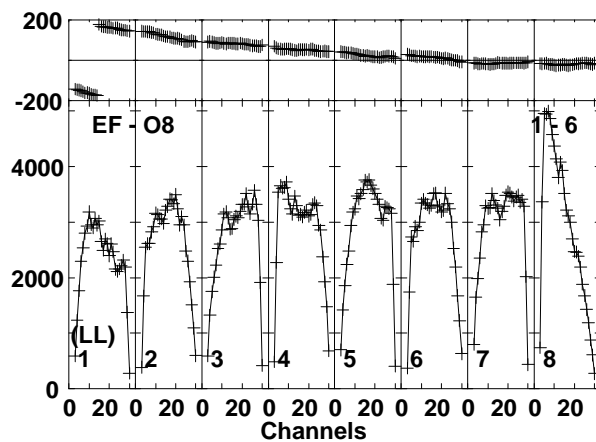
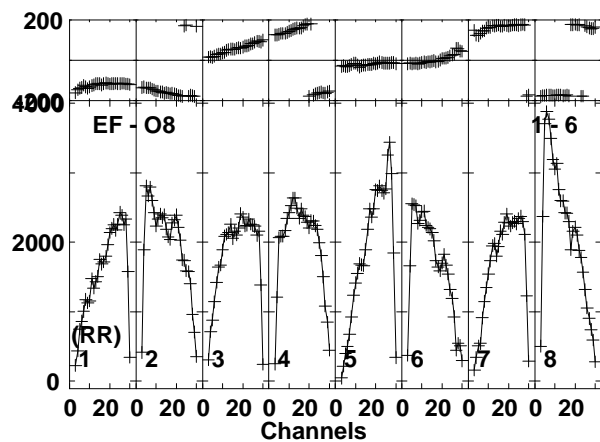
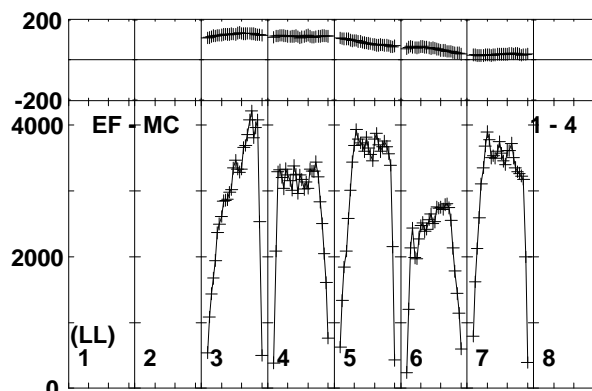
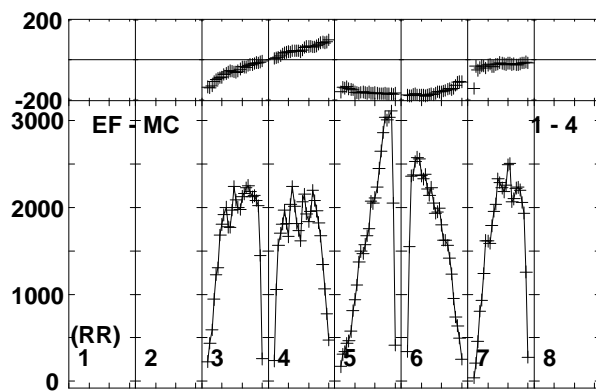
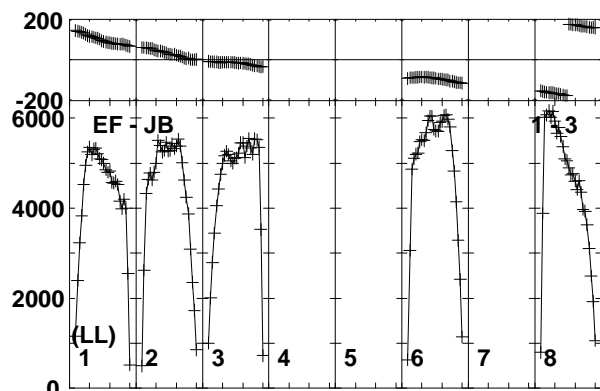
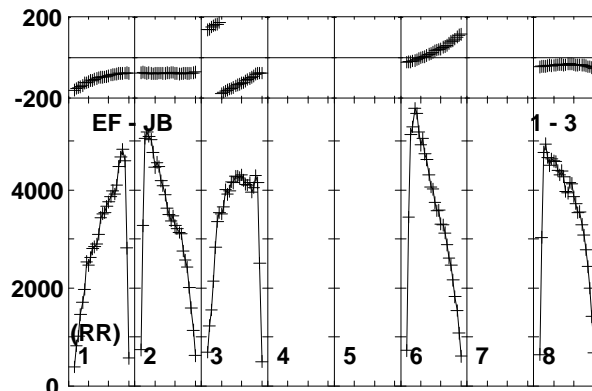
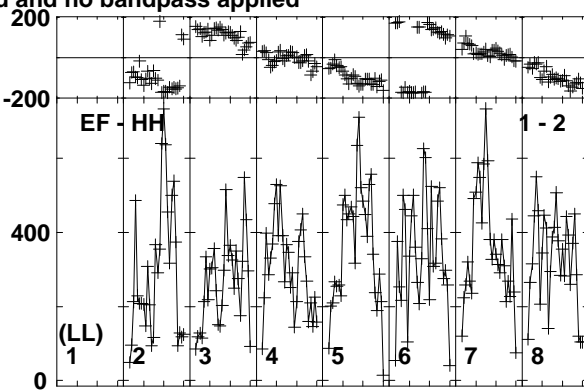
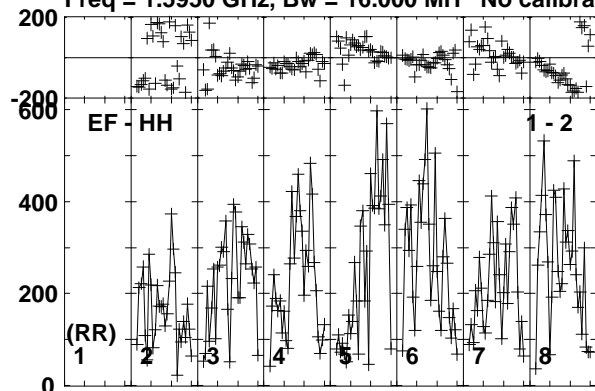

Lower frame: Micro Ampl Jy Top frame: Phas deg  
Vector averaged cross-power spectrum Baseline: EF (01) - HH (02)  
Timerange: 01/00:42:02 to 01/00:42:58

Plot file version 120 created 26-JUN-2015 10:51:22

J2025+3343 ET031A.UVDATA.1

Freq = 1.5950 GHz, Bw = 16.000 MH No calibration applied and no bandpass applied

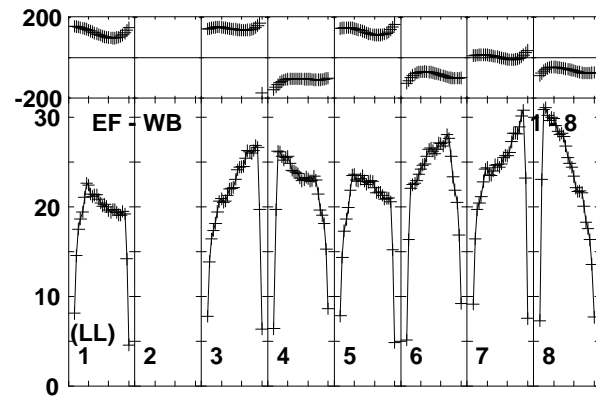
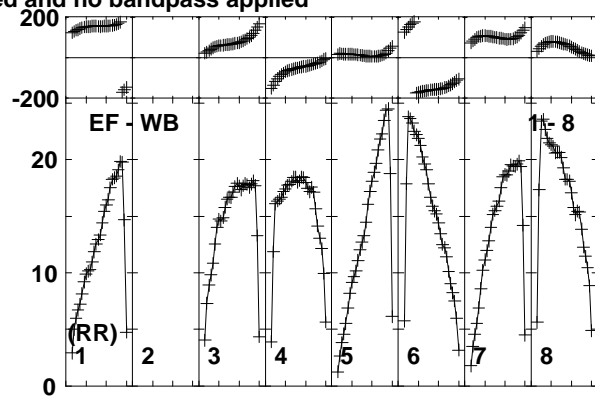
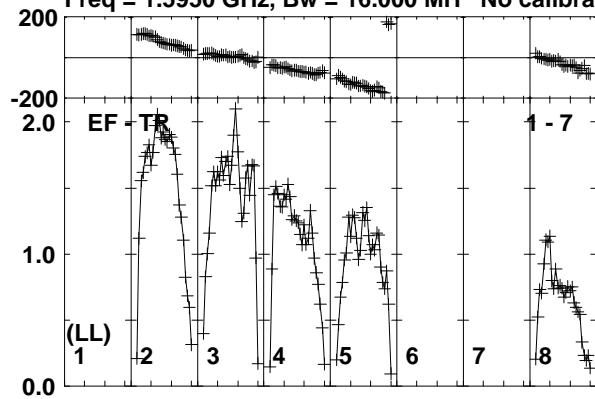

Lower frame: Milli Ampl Jy Top frame: Phas deg  
Vector averaged cross-power spectrum Baseline: EF (01) - TR (07)  
Timerange: 01/00:42:02 to 01/00:42:58



Plot file version 121 created 26-JUN-2015 10:51:22

V404CYG ET031A.UVDATA.1

Freq = 1.5950 GHz, Bw = 16.000 MH No calibration applied and no bandpass applied

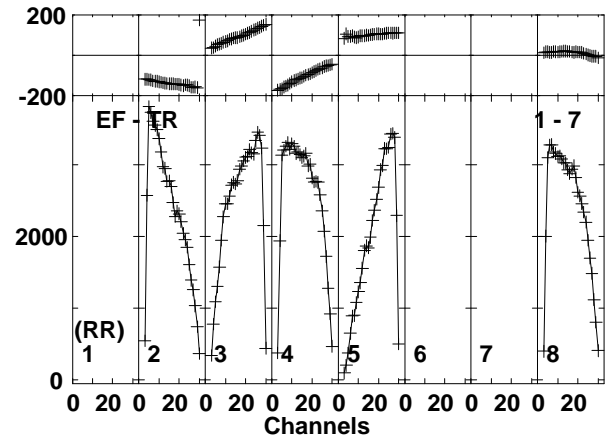
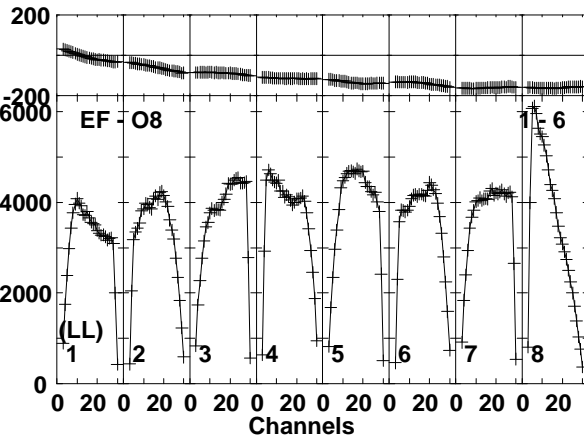
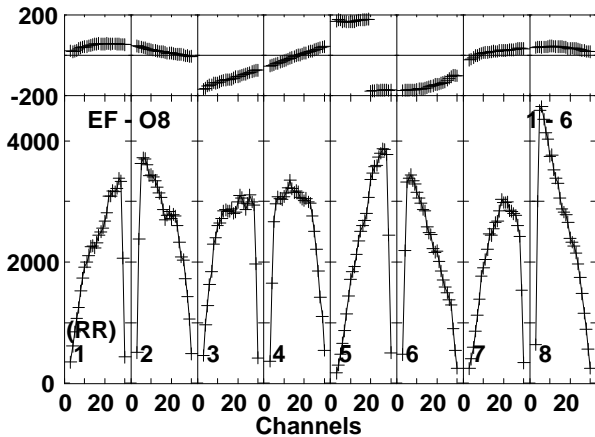
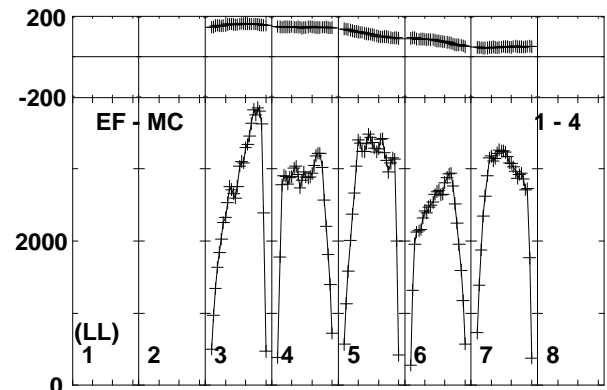
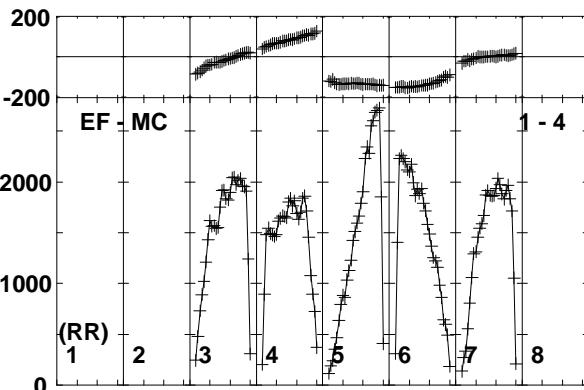
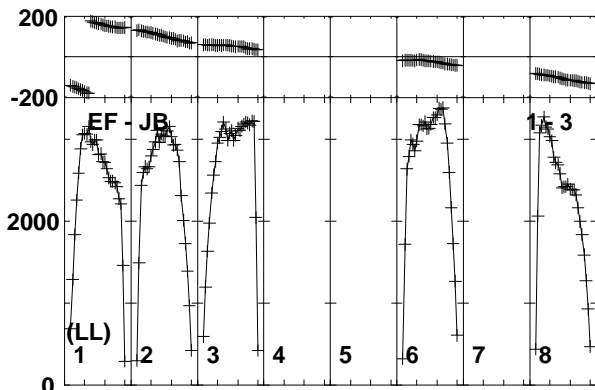
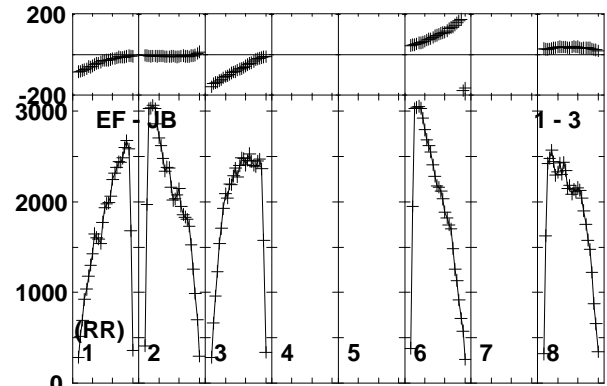
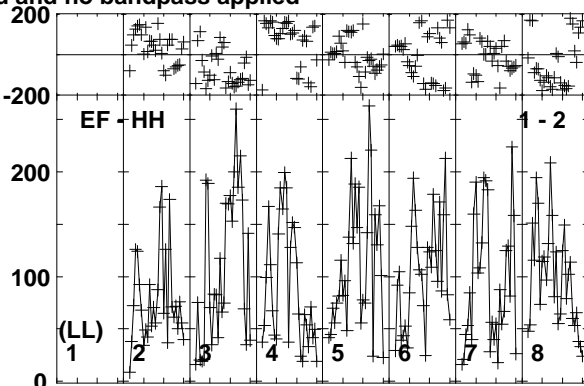
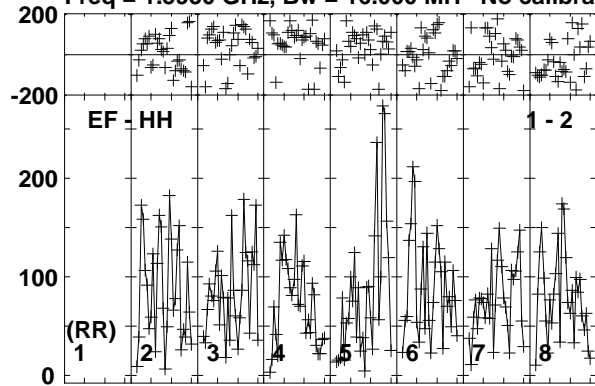

Lower frame: Micro Ampl Jy Top frame: Phas deg  
Vector averaged cross-power spectrum Baseline: EF (01) - HH (02)  
Timerange: 01/00:43:02 to 01/00:46:28

Plot file version 122 created 26-JUN-2015 10:51:22

V404CYG ET031A.UVDATA.1

Freq = 1.5950 GHz, Bw = 16.000 MH No calibration applied and no bandpass applied

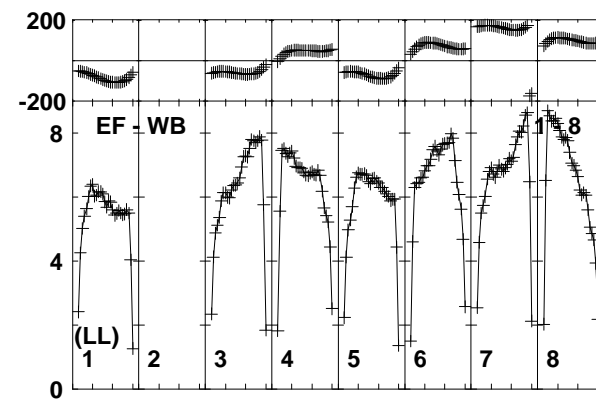
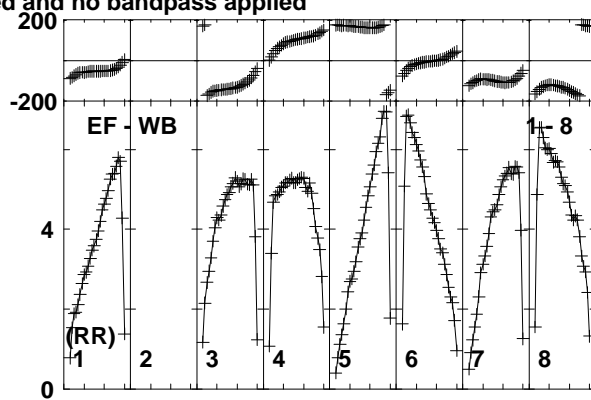
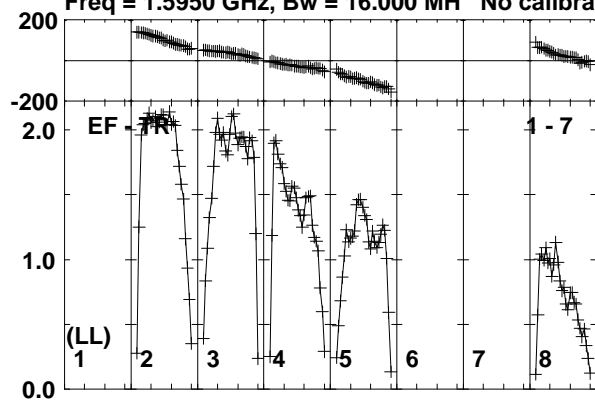

Lower frame: Milli Ampl Jy Top frame: Phas deg  
Vector averaged cross-power spectrum Baseline: EF (01) - TR (07)  
Timerange: 01/00:43:02 to 01/00:46:28

Plot file version 123 created 26-JUN-2015 10:51:22

J2025+3343 ET031A.UVDATA.1

Freq = 1.5950 GHz, Bw = 16.000 MH No calibration applied and no bandpass applied

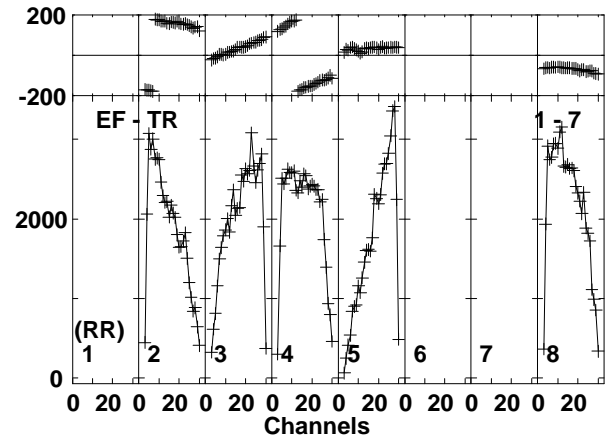
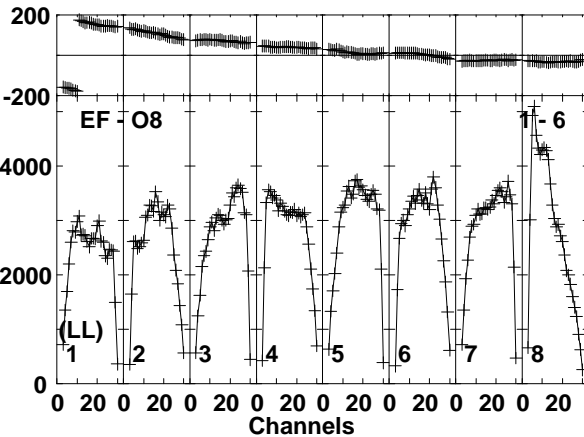
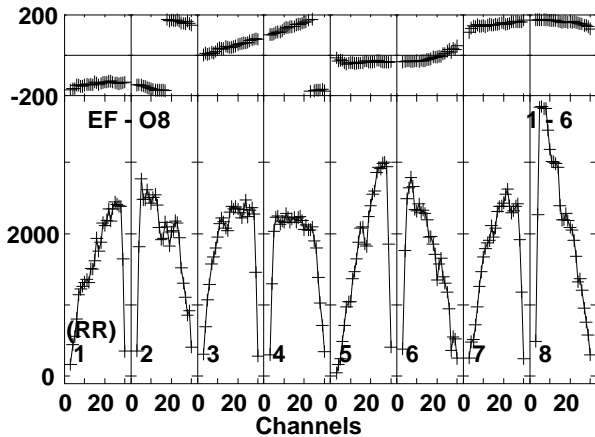
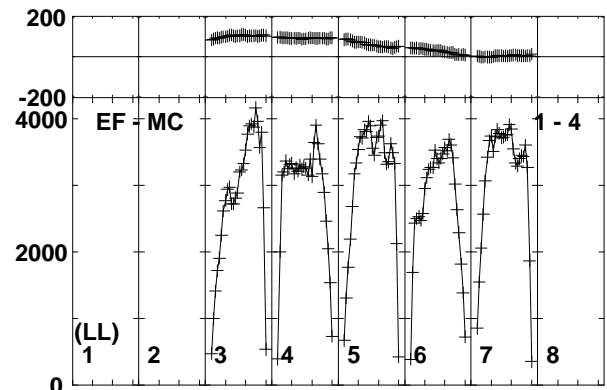
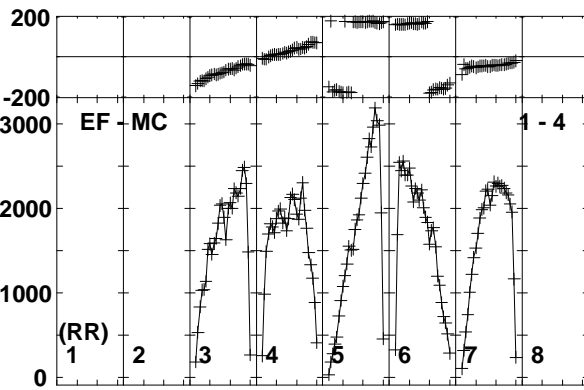
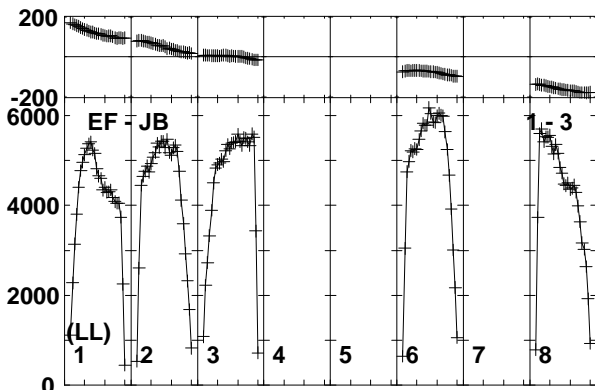
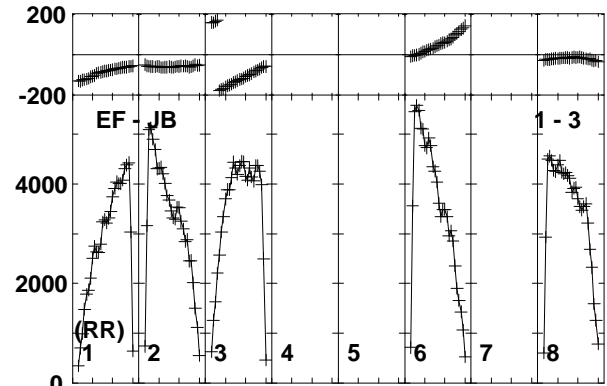
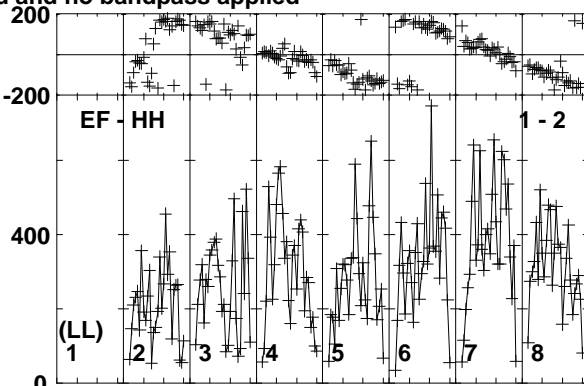
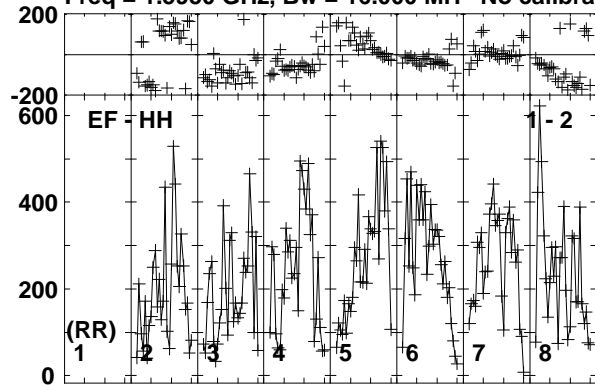

Lower frame: Micro Ampl Jy Top frame: Phas deg  
Vector averaged cross-power spectrum Baseline: EF (01) - HH (02)  
Timerange: 01/00:46:32 to 01/00:47:48

Plot file version 124 created 26-JUN-2015 10:51:22

J2025+3343 ET031A.UVDATA.1

Freq = 1.5950 GHz, Bw = 16.000 MH No calibration applied and no bandpass applied

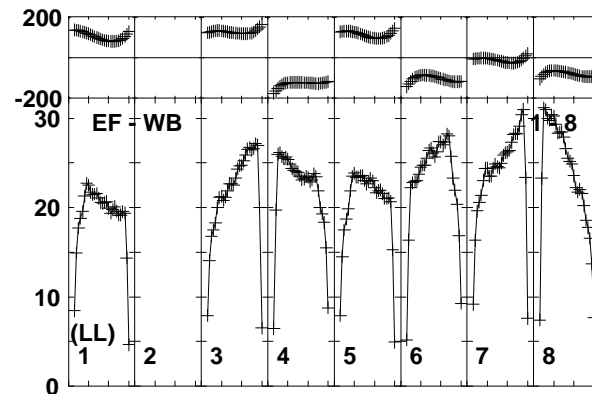
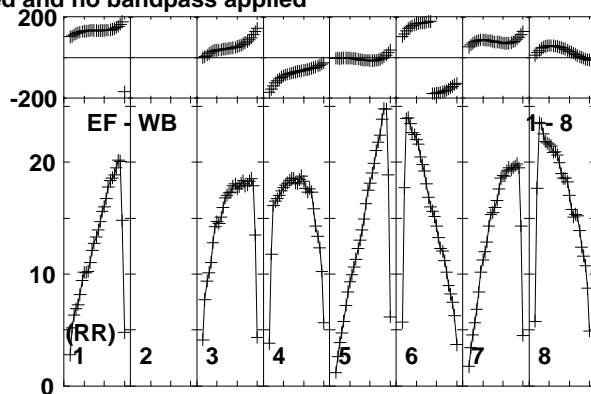
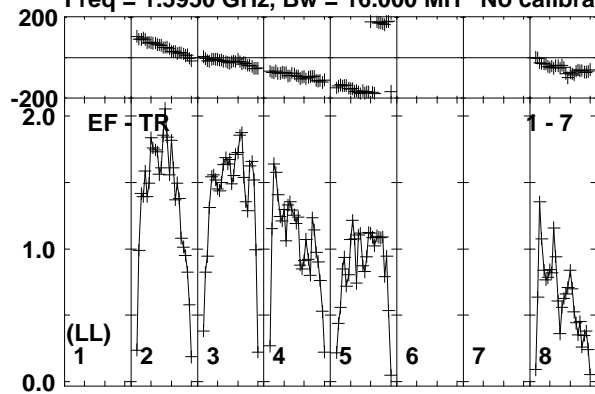

Lower frame: Milli Ampl Jy Top frame: Phas deg  
Vector averaged cross-power spectrum Baseline: EF (01) - TR (07)  
Timerange: 01/00:46:32 to 01/00:47:48

Plot file version 125 created 26-JUN-2015 10:51:22

V404CYG ET031A.UVDATA.1

Freq = 1.5950 GHz, Bw = 16.000 MH No calibration applied and no bandpass applied

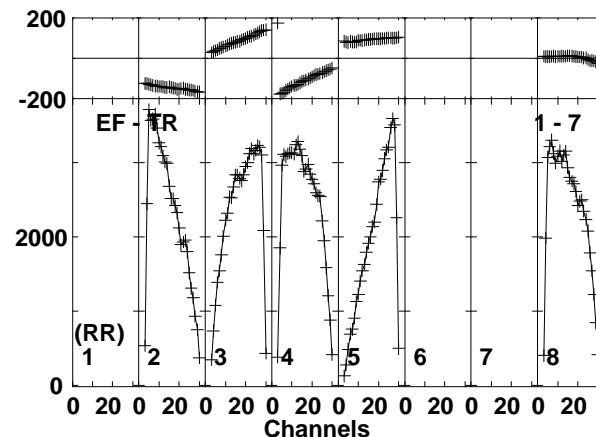
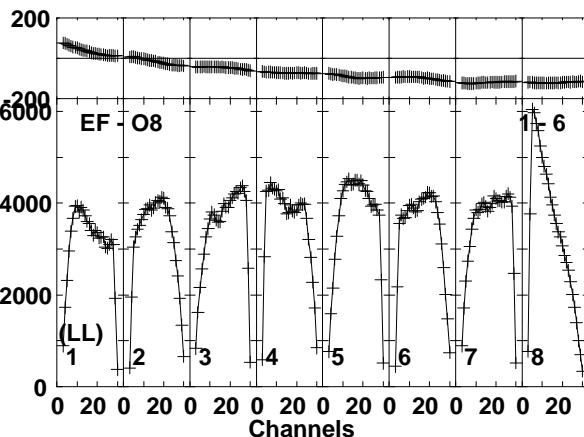
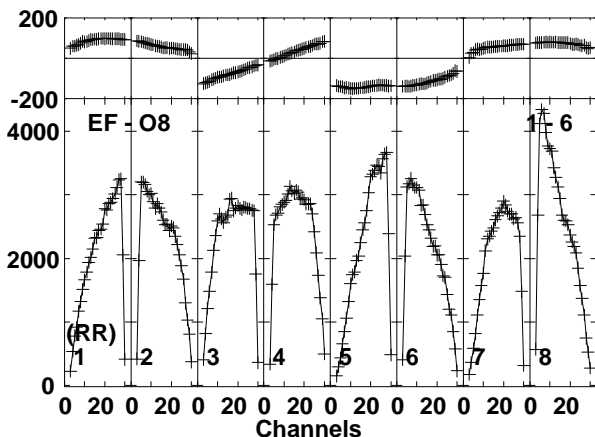
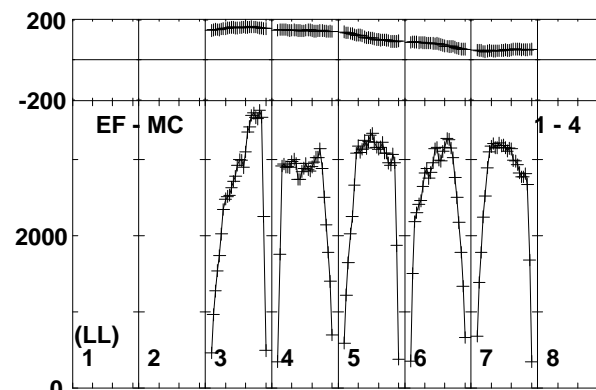
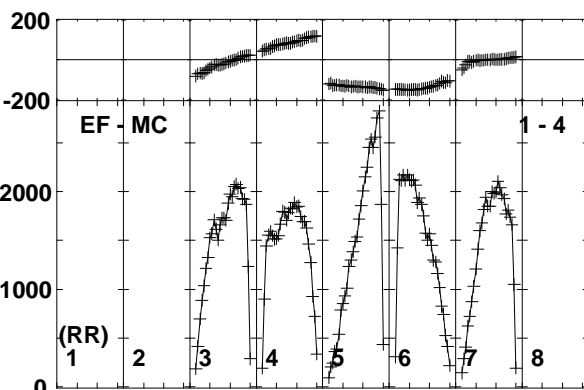
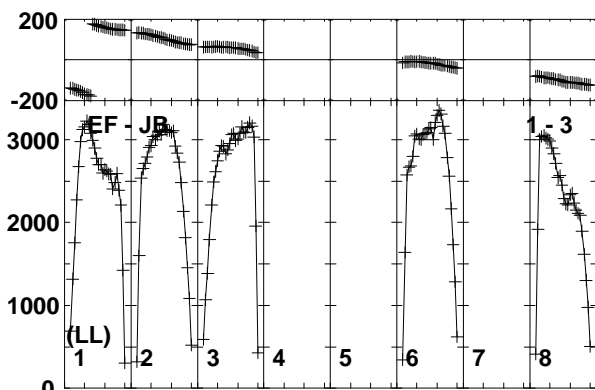
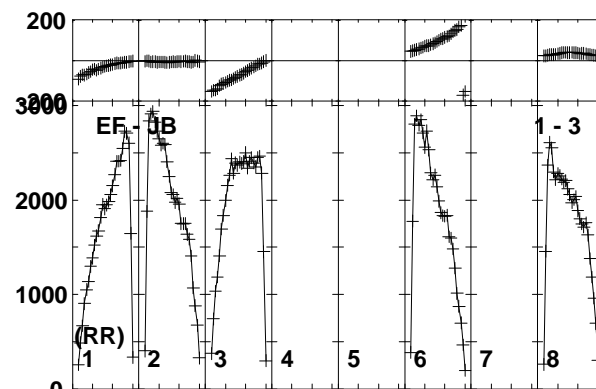
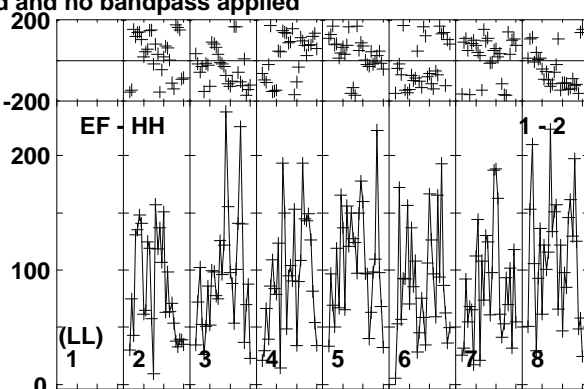
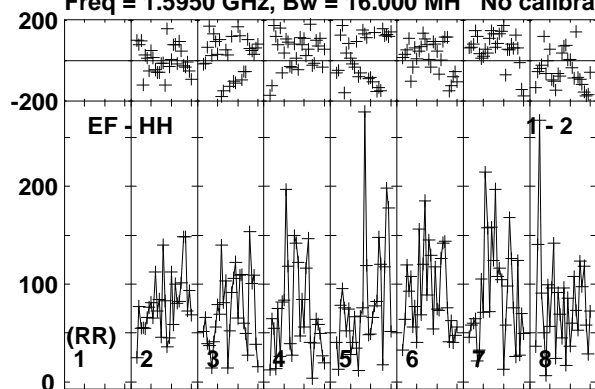

Lower frame: Micro Ampl Jy Top frame: Phas deg  
Vector averaged cross-power spectrum Baseline: EF (01) - HH (02)  
Timerange: 01/00:47:52 to 01/00:51:18

Plot file version 126 created 26-JUN-2015 10:51:22

V404CYG ET031A.UVDATA.1

Freq = 1.5950 GHz, Bw = 16.000 MH No calibration applied and no bandpass applied

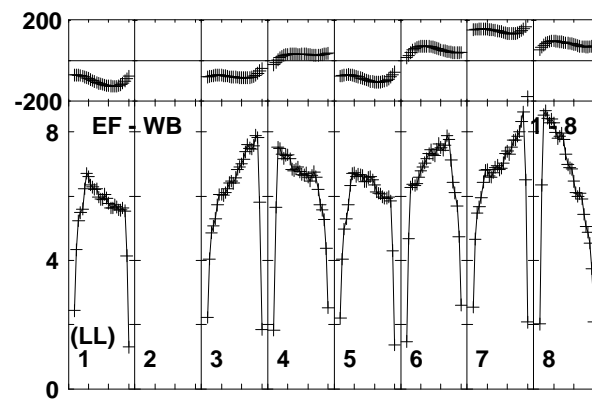
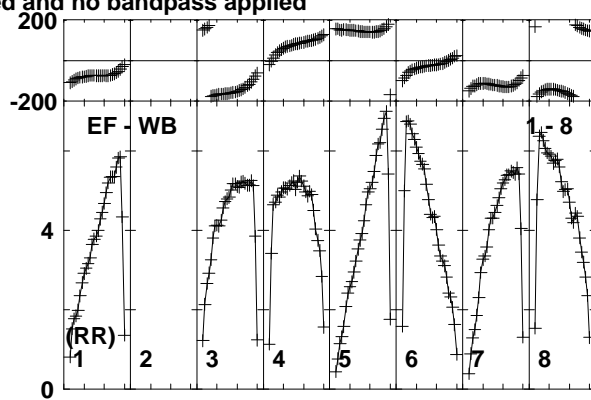
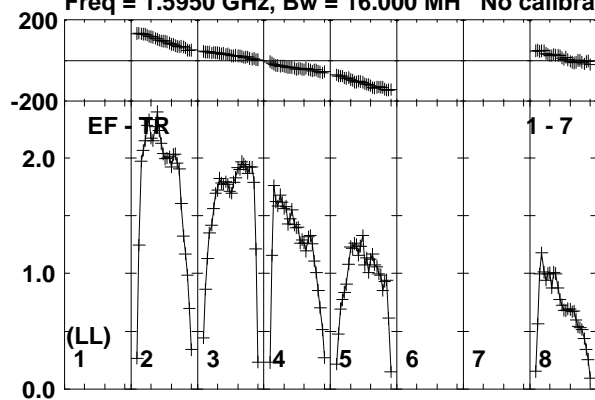

Lower frame: Milli Ampl Jy Top frame: Phas deg  
Vector averaged cross-power spectrum Baseline: EF (01) - TR (07)  
Timerange: 01/00:47:52 to 01/00:51:18

Plot file version 127 created 26-JUN-2015 10:51:22

J2025+3343 ET031A.UVDATA.1

Freq = 1.5950 GHz, Bw = 16.000 MH No calibration applied and no bandpass applied

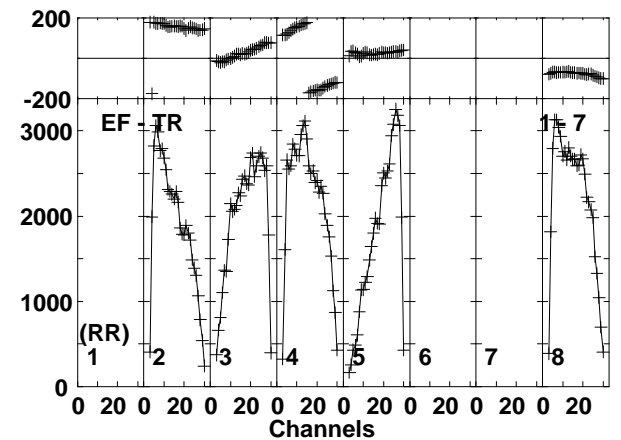
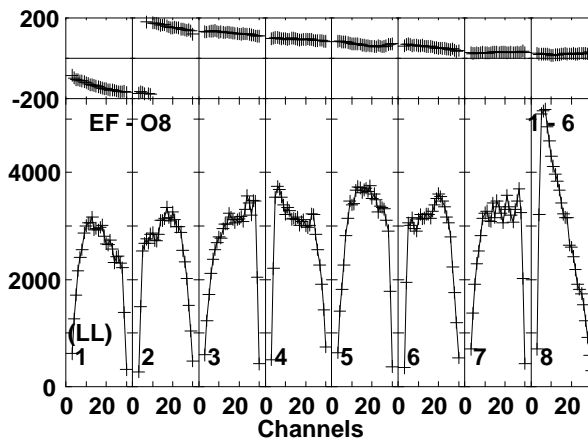
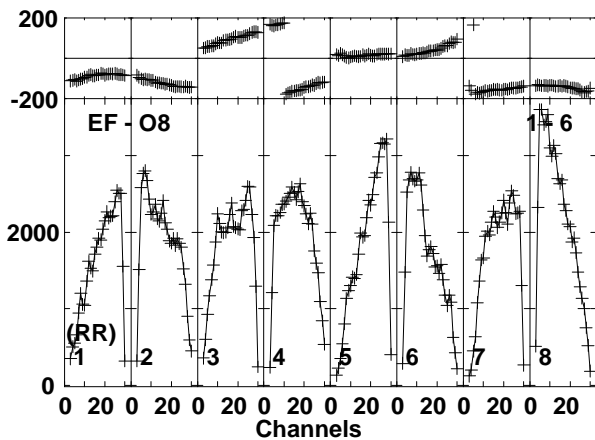
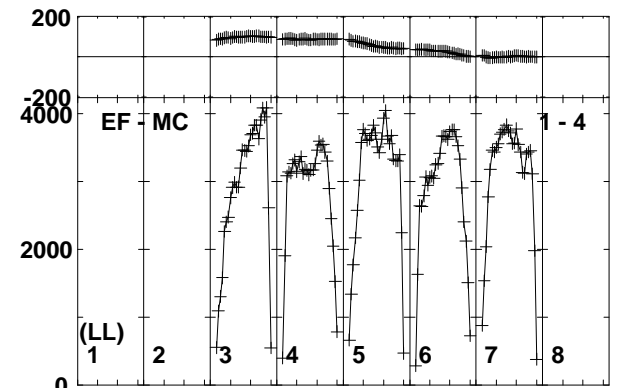
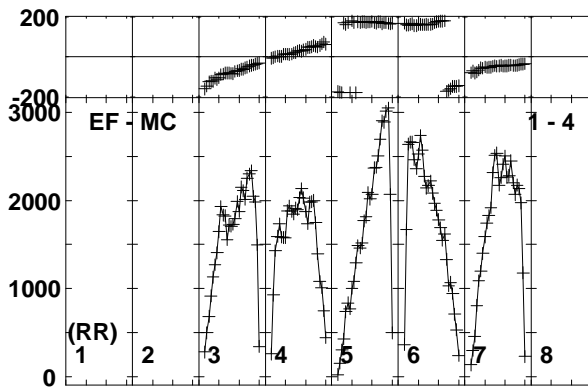
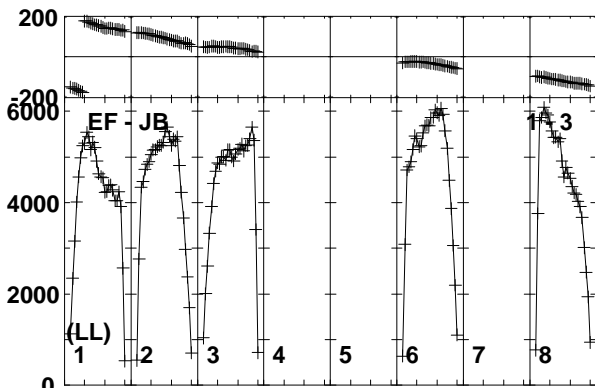
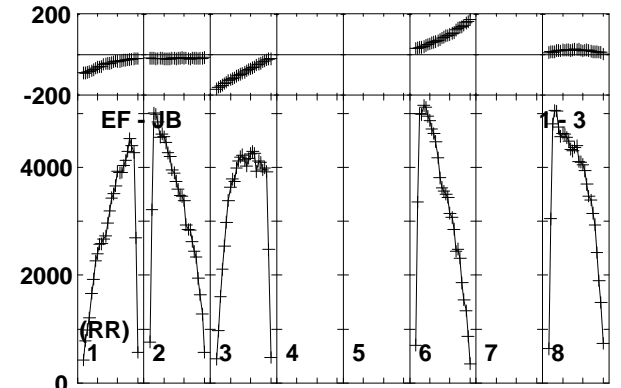
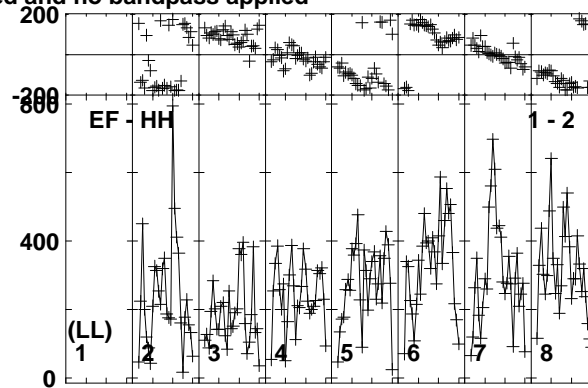
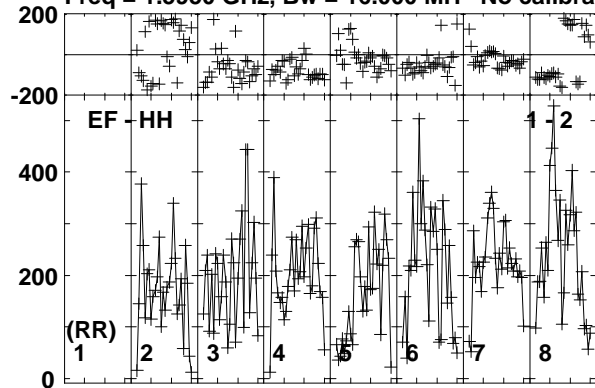

Lower frame: Micro Ampl Jy Top frame: Phas deg  
Vector averaged cross-power spectrum Baseline: EF (01) - HH (02)  
Timerange: 01/00:52:02 to 01/00:52:58

Plot file version 128 created 26-JUN-2015 10:51:22

J2025+3343 ET031A.UVDATA.1

Freq = 1.5950 GHz, Bw = 16.000 MH No calibration applied and no bandpass applied

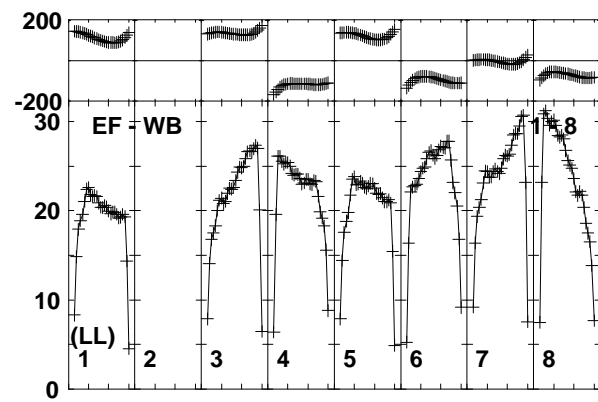
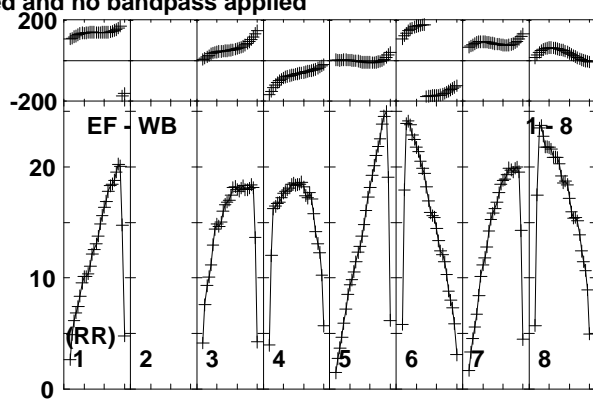
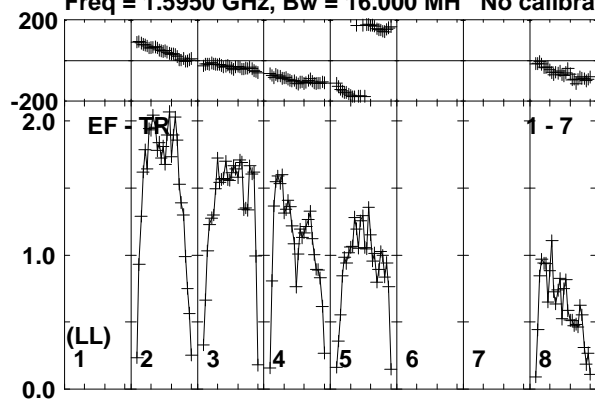

Lower frame: Milli Ampl Jy Top frame: Phas deg  
Vector averaged cross-power spectrum Baseline: EF (01) - TR (07)  
Timerange: 01/00:52:02 to 01/00:52:58



Plot file version 129 created 26-JUN-2015 10:51:22

V404CYG ET031A.UVDATA.1

Freq = 1.5950 GHz, Bw = 16.000 MH No calibration applied and no bandpass applied

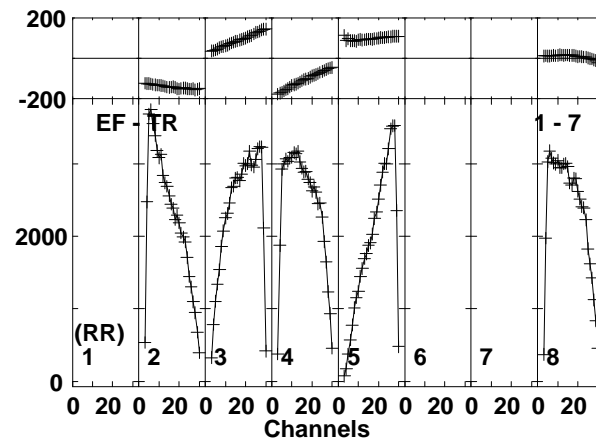
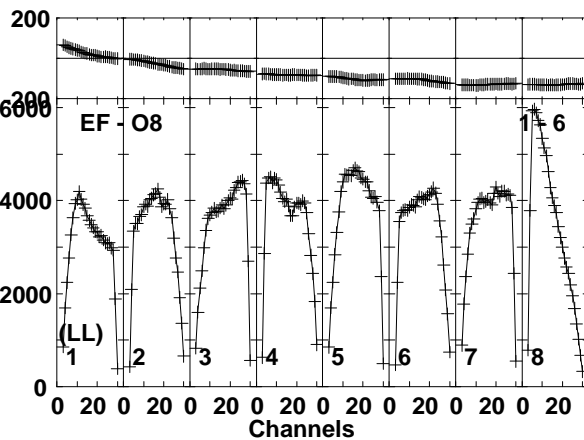
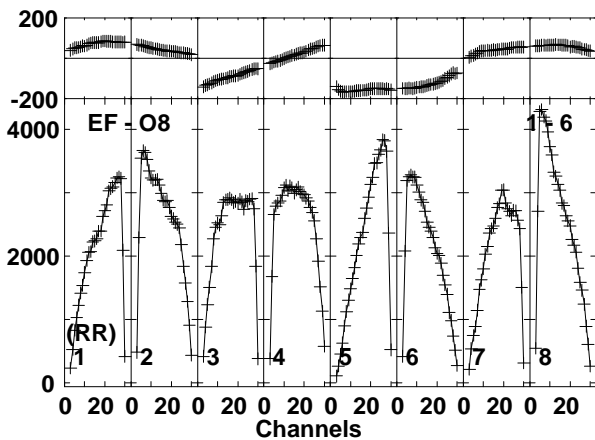
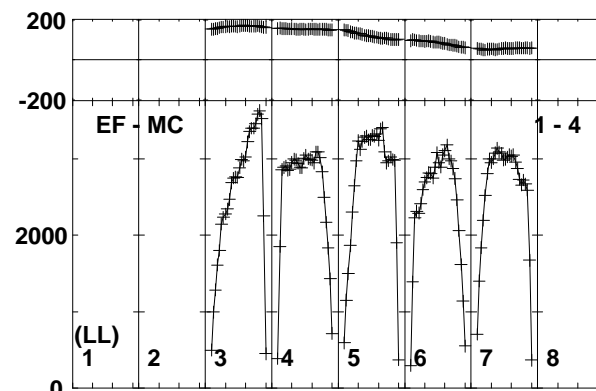
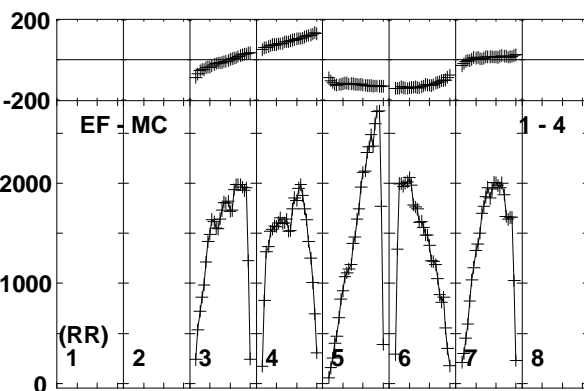
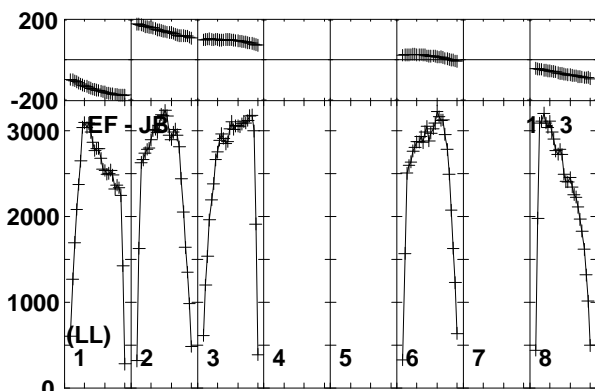
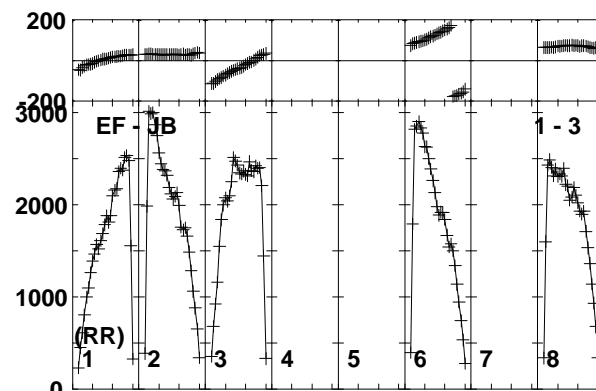
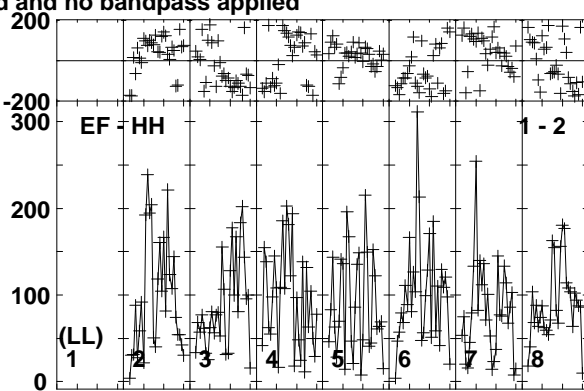
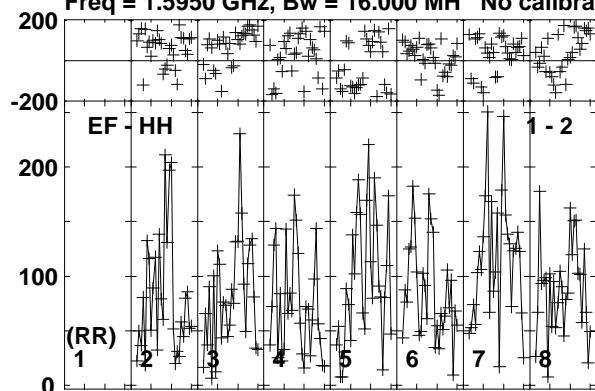

Lower frame: Micro Ampl Jy Top frame: Phas deg  
Vector averaged cross-power spectrum Baseline: EF (01) - HH (02)  
Timerange: 01/00:53:02 to 01/00:56:28

Plot file version 130 created 26-JUN-2015 10:51:22

V404CYG ET031A.UVDATA.1

Freq = 1.5950 GHz, Bw = 16.000 MH No calibration applied and no bandpass applied

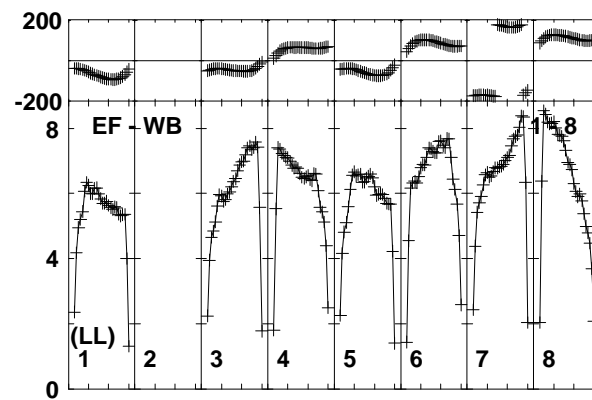
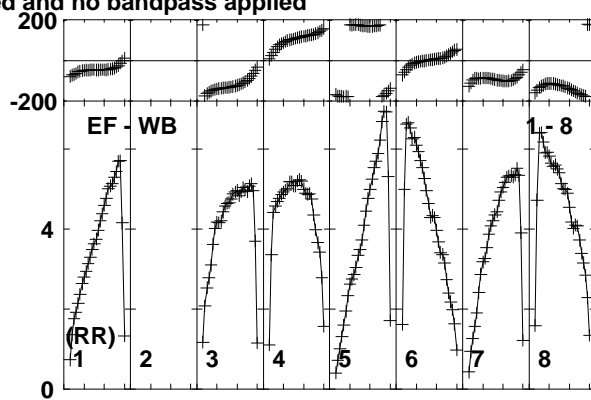
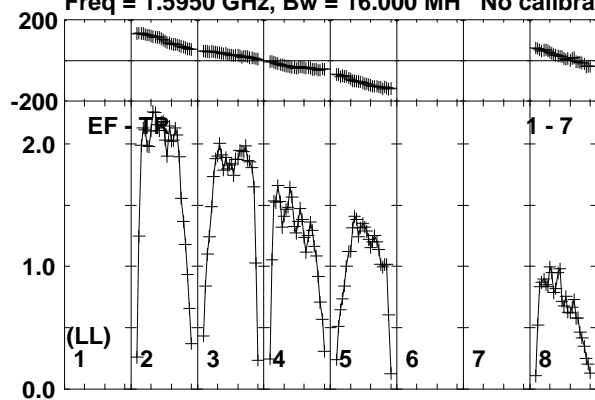

Lower frame: Milli Ampl Jy Top frame: Phas deg  
Vector averaged cross-power spectrum Baseline: EF (01) - TR (07)  
Timerange: 01/00:53:02 to 01/00:56:28

Plot file version 131 created 26-JUN-2015 10:51:22

J2025+3343 ET031A.UVDATA.1

Freq = 1.5950 GHz, Bw = 16.000 MH No calibration applied and no bandpass applied

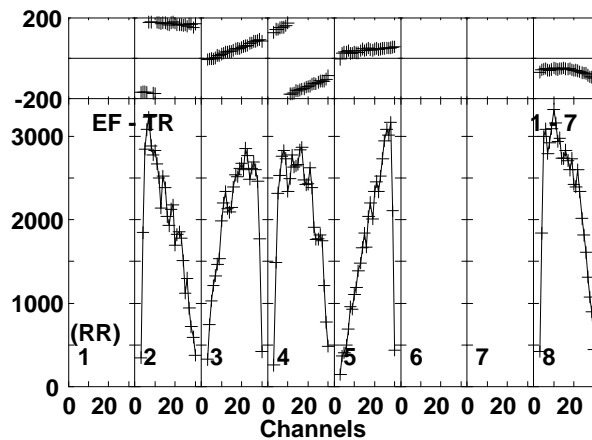
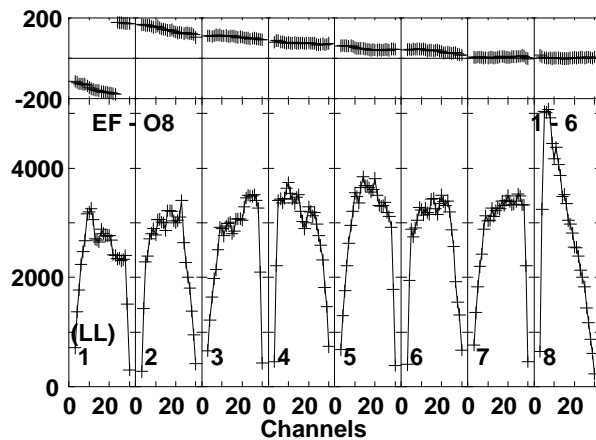
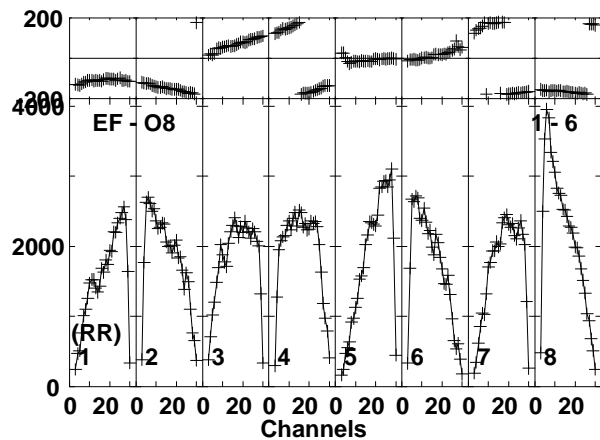
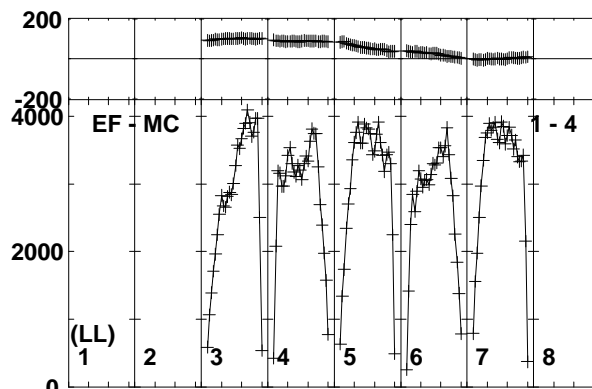
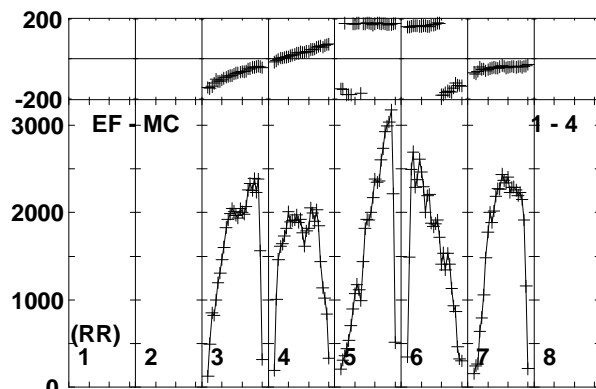
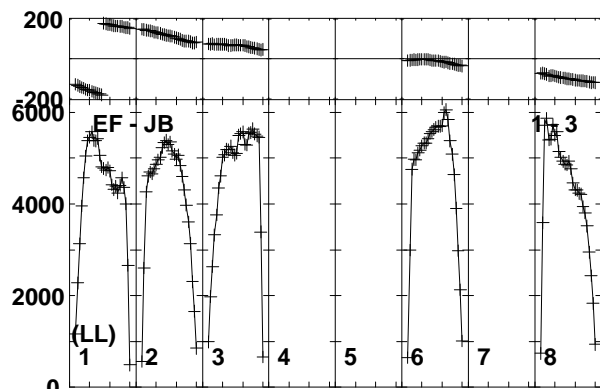
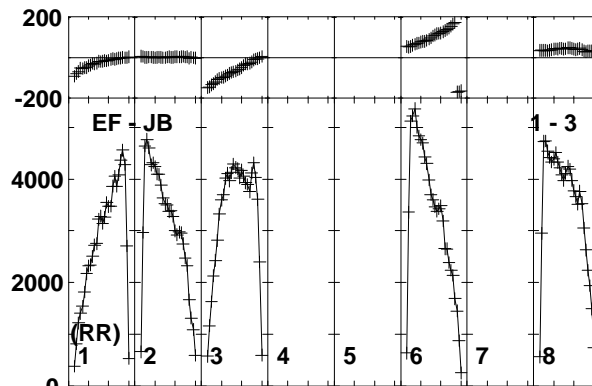
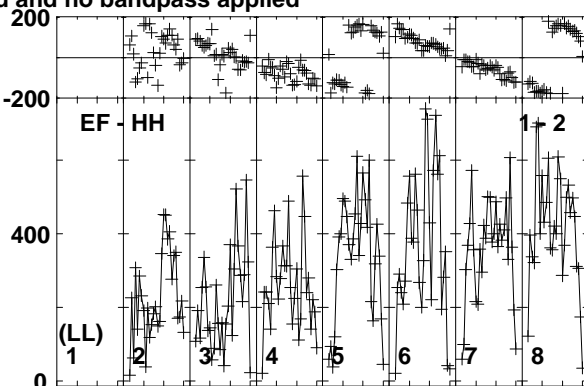
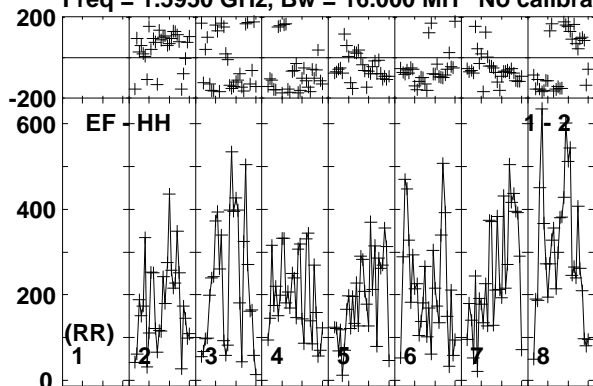

Lower frame: Micro Ampl Jy Top frame: Phas deg  
Vector averaged cross-power spectrum Baseline: EF (01) - HH (02)  
Timerange: 01/00:56:32 to 01/00:57:48

Plot file version 132 created 26-JUN-2015 10:51:22

J2025+3343 ET031A.UVDATA.1

Freq = 1.5950 GHz, Bw = 16.000 MH No calibration applied and no bandpass applied

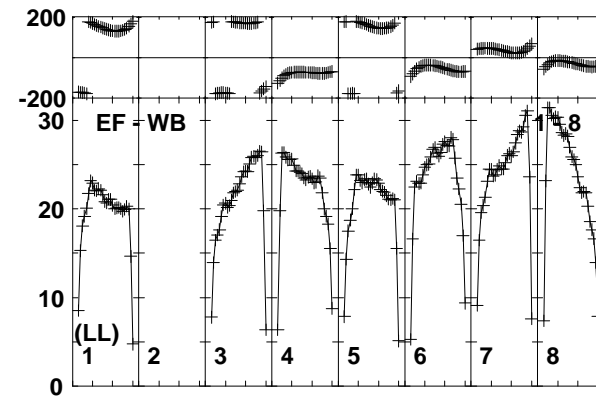
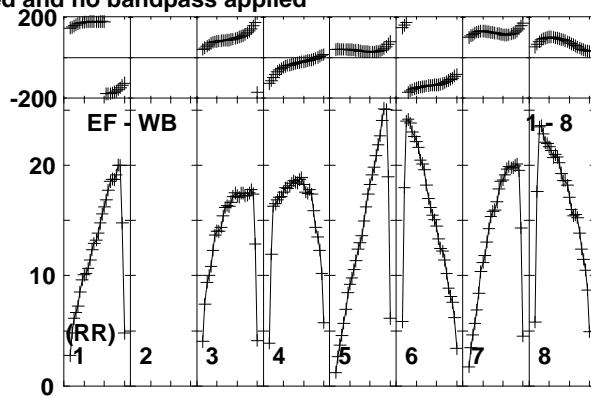
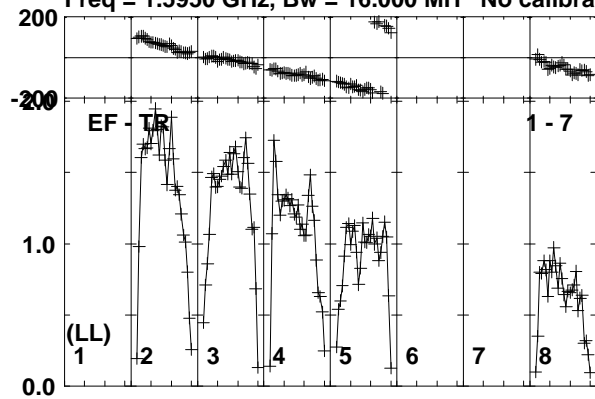

Lower frame: Milli Ampl Jy Top frame: Phas deg  
Vector averaged cross-power spectrum Baseline: EF (01) - TR (07)  
Timerange: 01/00:56:32 to 01/00:57:48

Plot file version 133 created 26-JUN-2015 10:51:22

V404CYG ET031A.UVDATA.1

Freq = 1.5950 GHz, Bw = 16.000 MH No calibration applied and no bandpass applied

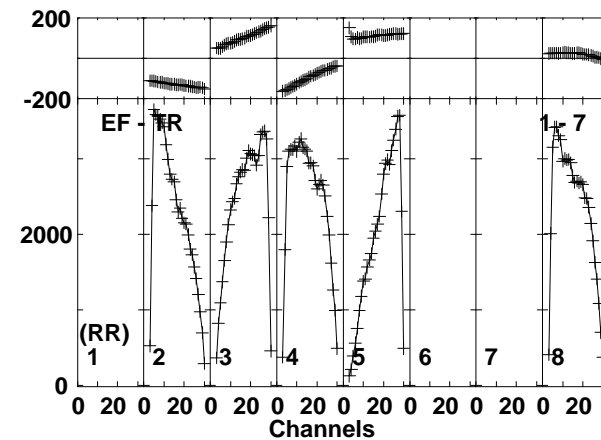
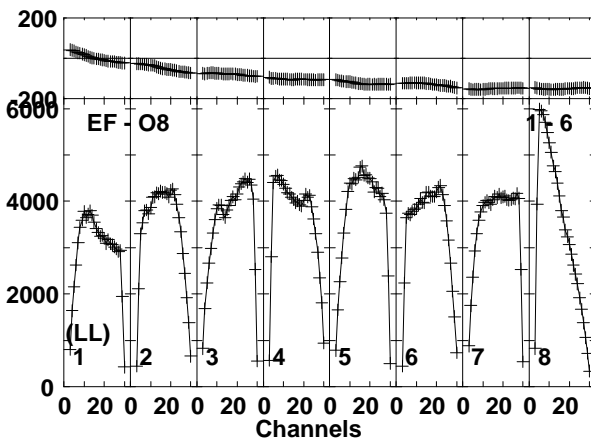
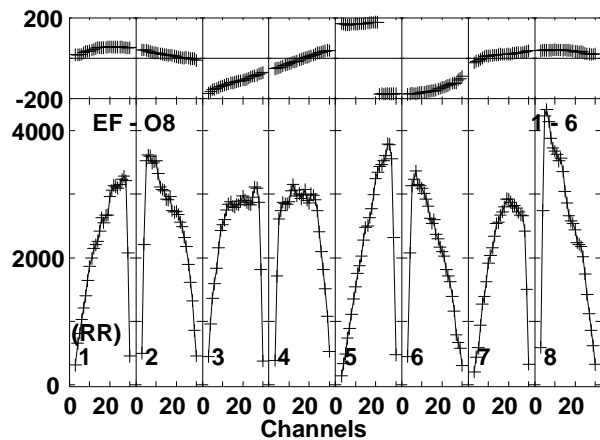
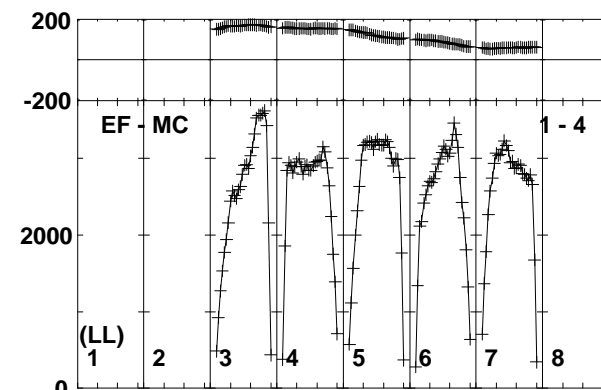
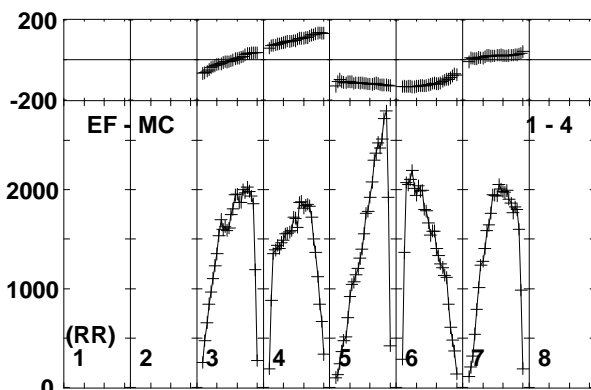
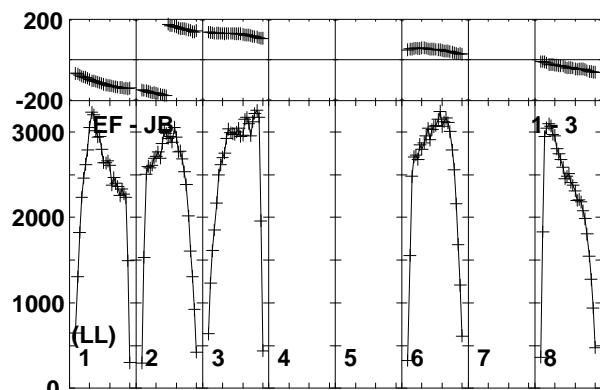
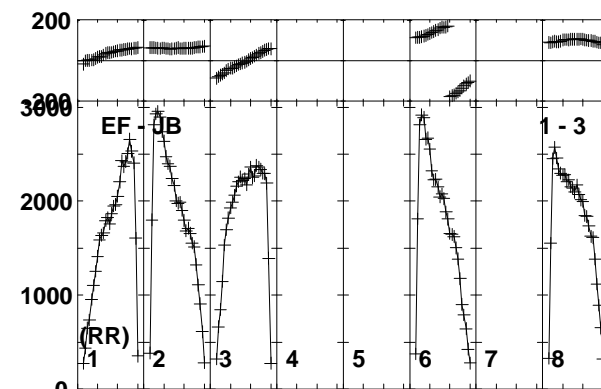
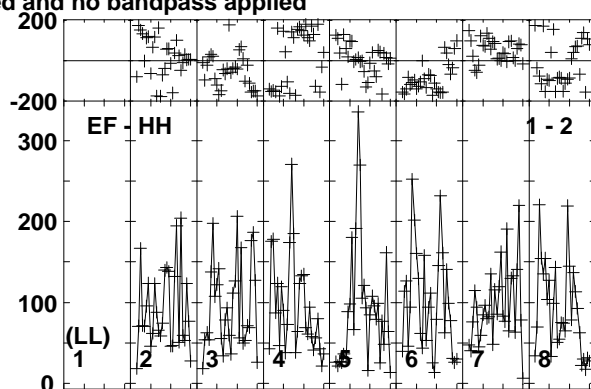
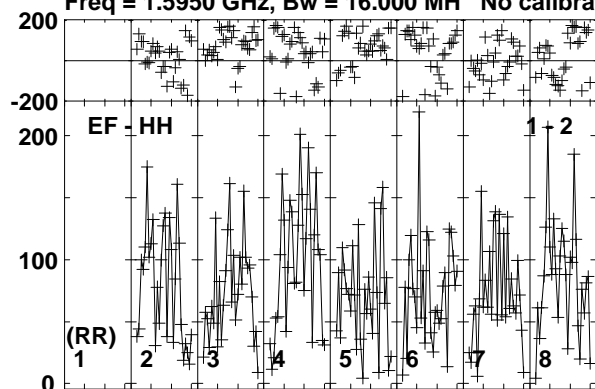

Lower frame: Micro Ampl Jy Top frame: Phas deg  
Vector averaged cross-power spectrum Baseline: EF (01) - HH (02)  
Timerange: 01/00:57:52 to 01/01:01:18

Plot file version 134 created 26-JUN-2015 10:51:22

V404CYG ET031A.UVDATA.1

Freq = 1.5950 GHz, Bw = 16.000 MH No calibration applied and no bandpass applied

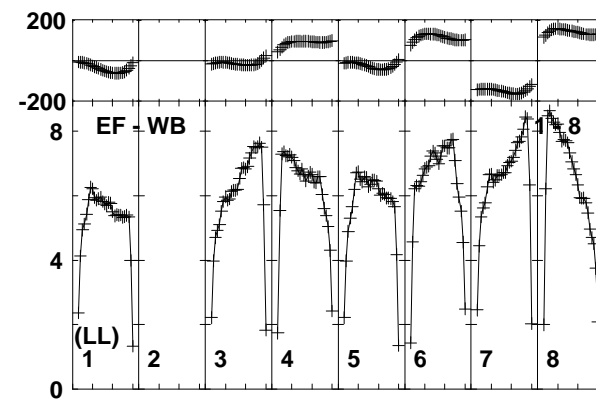
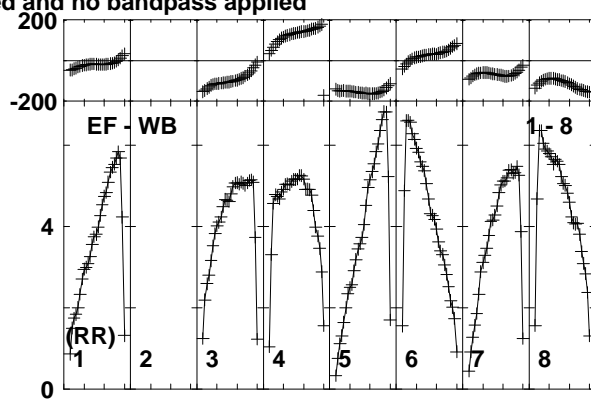
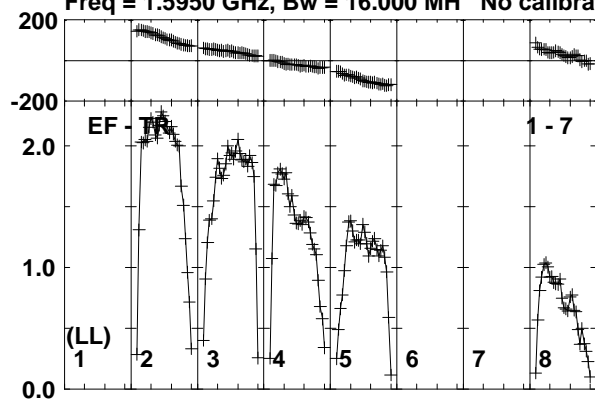

Lower frame: Milli Ampl Jy Top frame: Phas deg  
Vector averaged cross-power spectrum Baseline: EF (01) - TR (07)  
Timerange: 01/00:57:52 to 01/01:01:18

Plot file version 135 created 26-JUN-2015 10:51:23

J2025+3343 ET031A.UVDATA.1

Freq = 1.5950 GHz, Bw = 16.000 MH No calibration applied and no bandpass applied

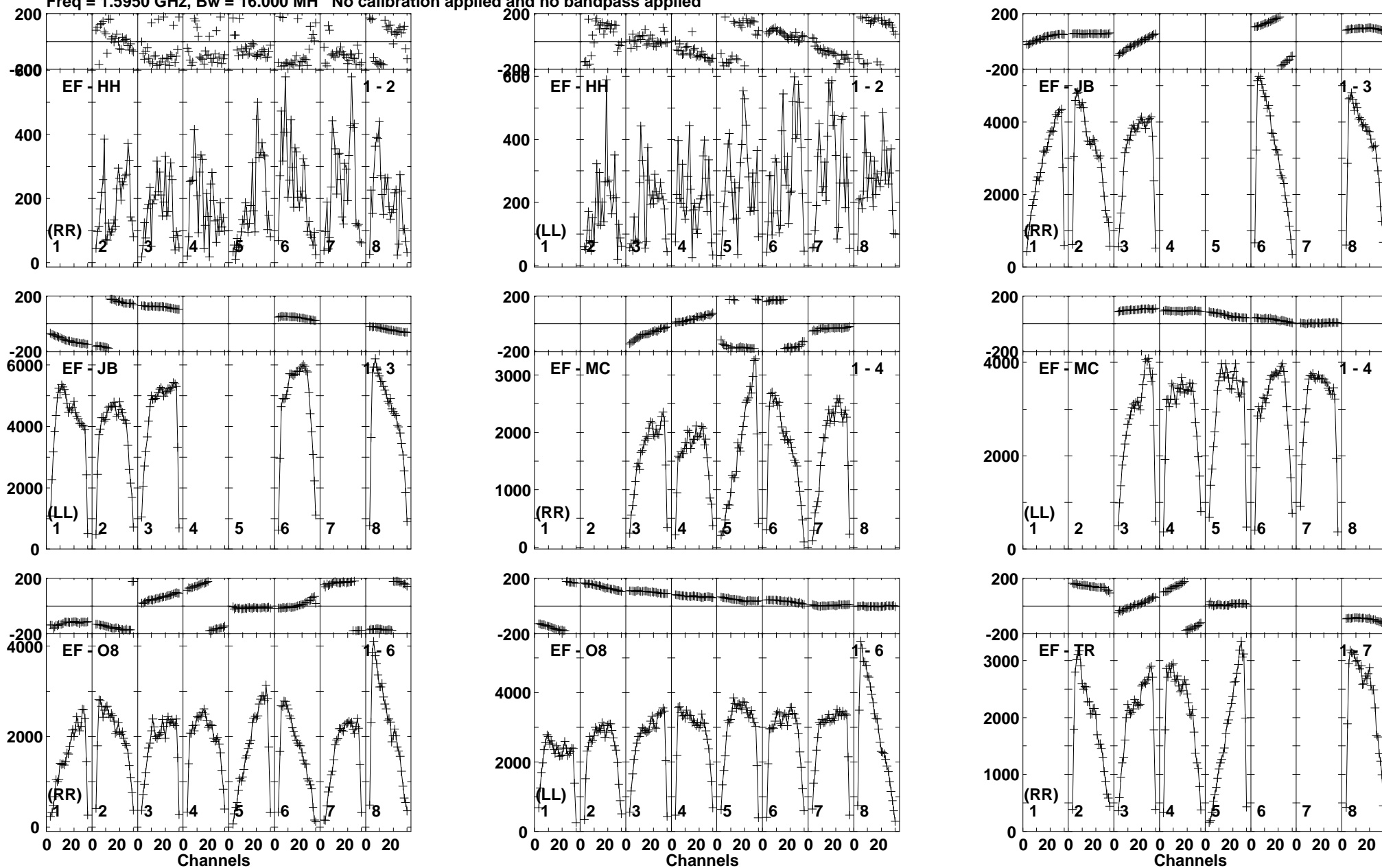

Lower frame: Micro Ampl Jy Top frame: Phas deg  
Vector averaged cross-power spectrum Baseline: EF (01) - HH (02)  
Timerange: 01/01:02:02 to 01/01:02:58

Plot file version 136 created 26-JUN-2015 10:51:23

J2025+3343 ET031A.UVDATA.1

Freq = 1.5950 GHz, Bw = 16.000 MH No calibration applied and no bandpass applied

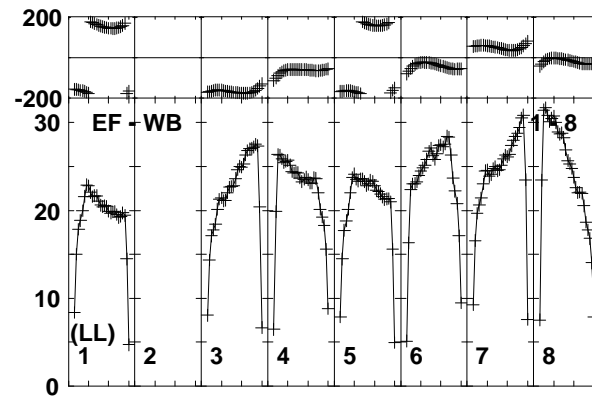
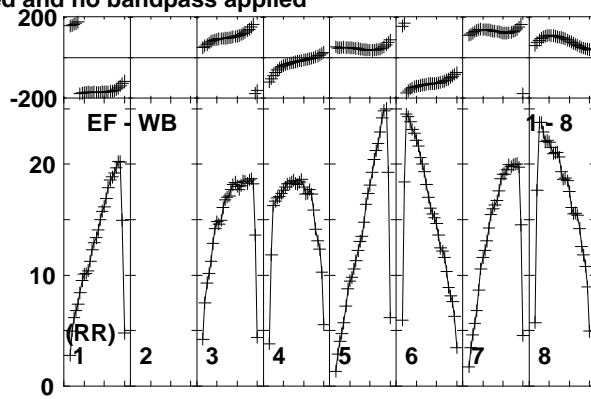
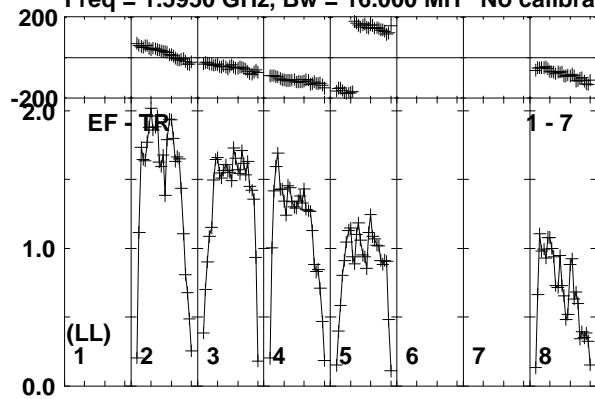

Lower frame: Milli Ampl Jy Top frame: Phas deg  
Vector averaged cross-power spectrum Baseline: EF (01) - TR (07)  
Timerange: 01/01:02:02 to 01/01:02:58



Plot file version 137 created 26-JUN-2015 10:51:23

V404CYG ET031A.UVDATA.1

Freq = 1.5950 GHz, Bw = 16.000 MH No calibration applied and no bandpass applied

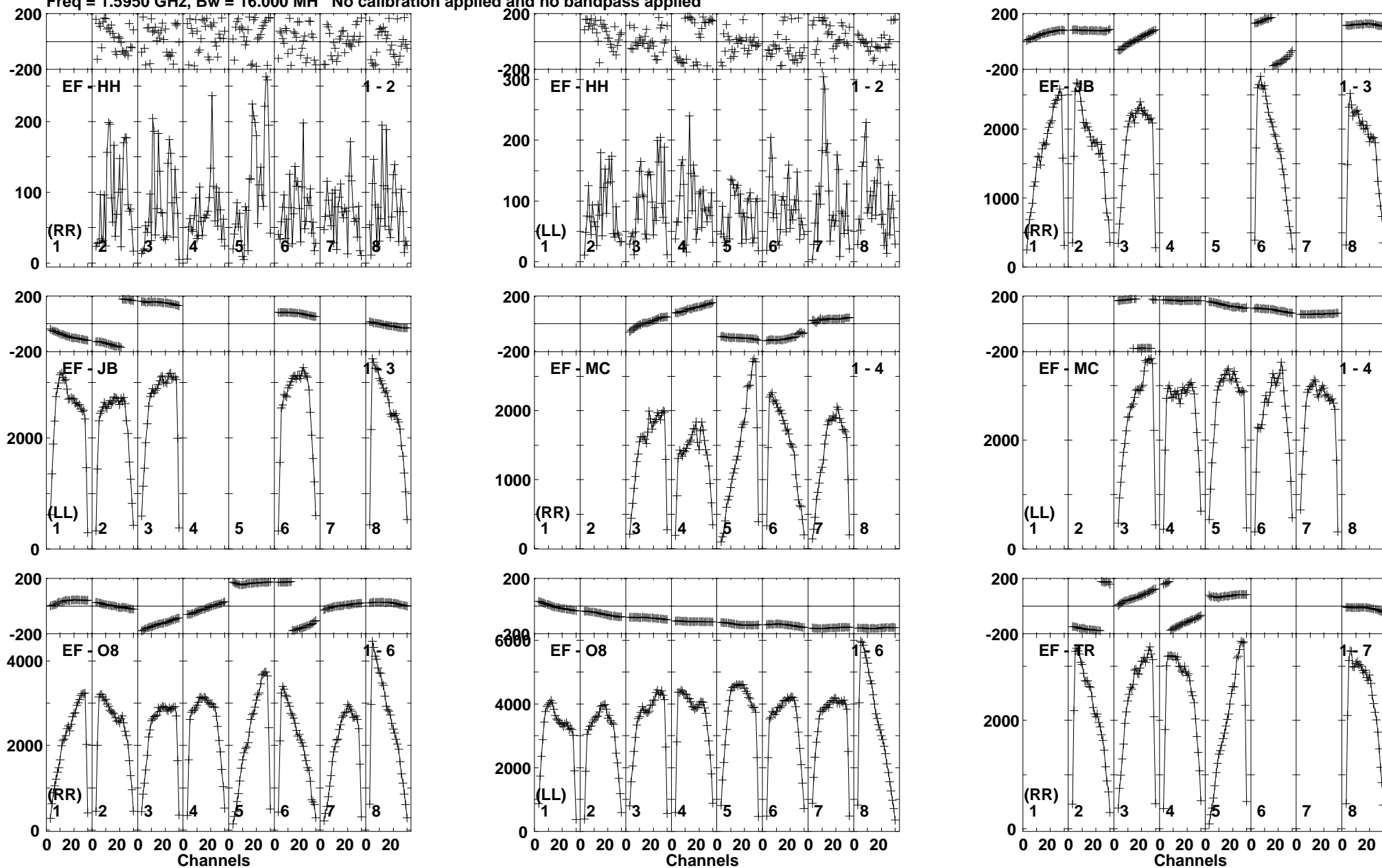

Lower frame: Micro Ampl Jy Top frame: Phas deg  
Vector averaged cross-power spectrum Baseline: EF (01) - HH (02)  
Timerange: 01/01:03:02 to 01/01:06:28

Plot file version 138 created 26-JUN-2015 10:51:23

V404CYG ET031A.UVDATA.1

Freq = 1.5950 GHz, Bw = 16.000 MH No calibration applied and no bandpass applied

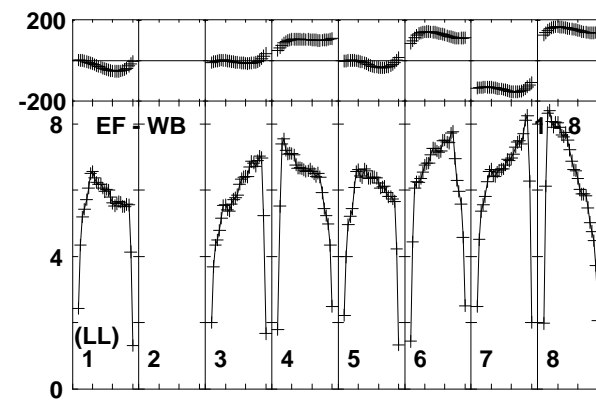
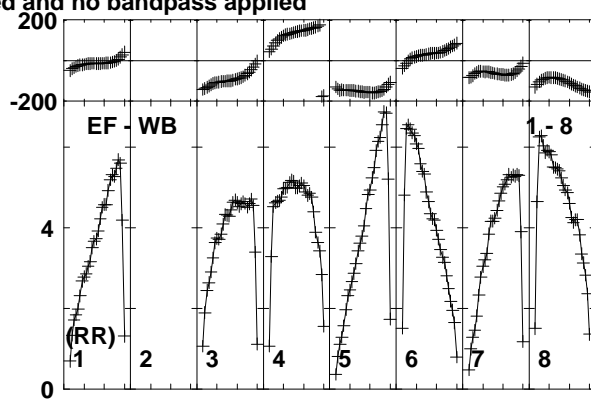
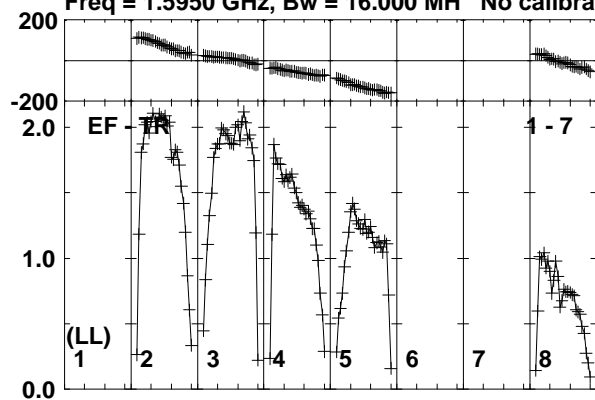

Lower frame: Milli Ampl Jy Top frame: Phas deg  
Vector averaged cross-power spectrum Baseline: EF (01) - TR (07)  
Timerange: 01/01:03:02 to 01/01:06:28

Plot file version 139 created 26-JUN-2015 10:51:23

J2025+3343 ET031A.UVDATA.1

Freq = 1.5950 GHz, Bw = 16.000 MH No calibration applied and no bandpass applied

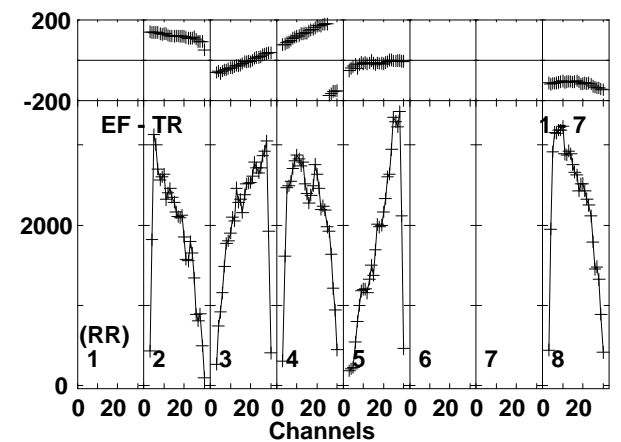
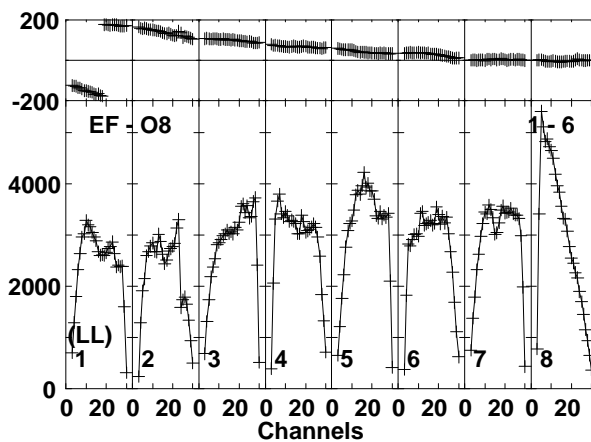
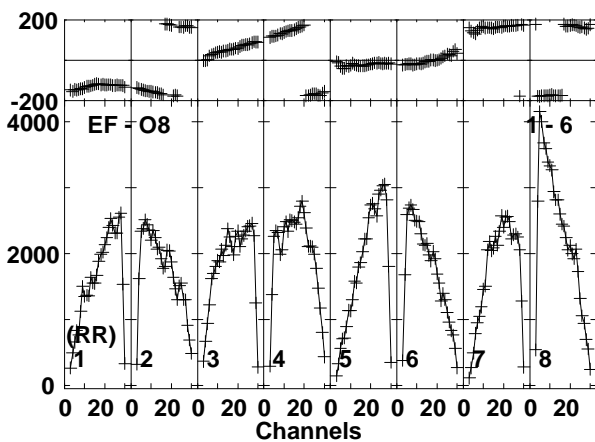
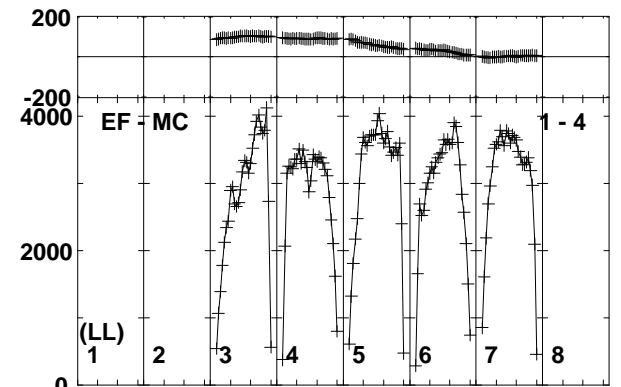
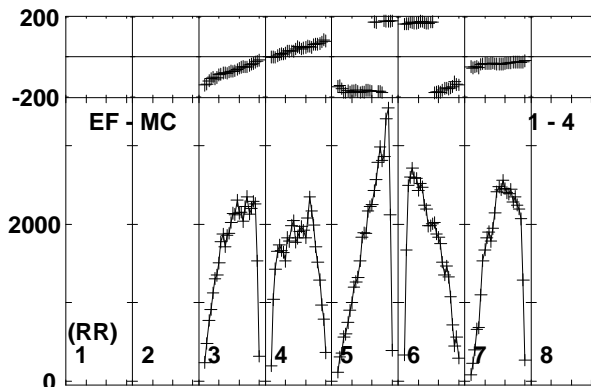
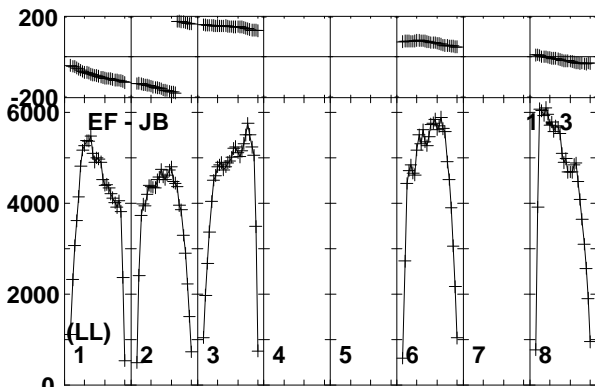
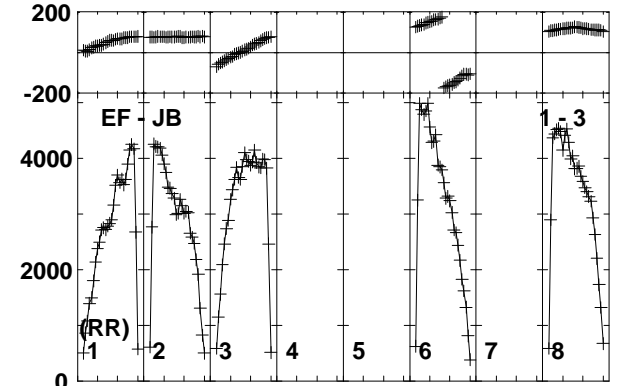
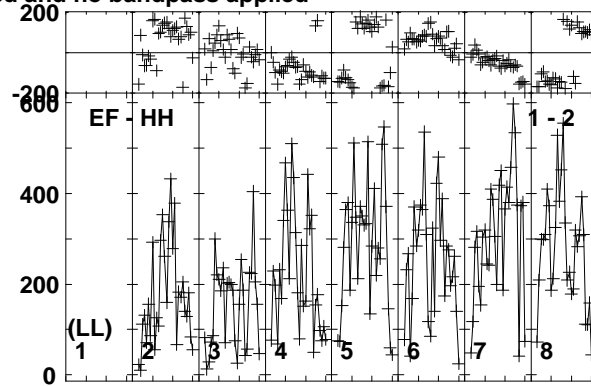
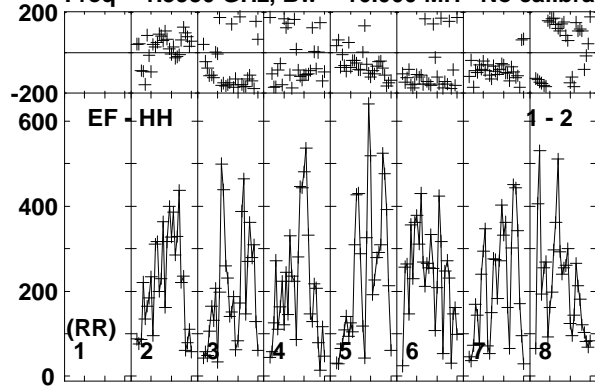

Lower frame: Micro Ampl Jy Top frame: Phas deg  
Vector averaged cross-power spectrum Baseline: EF (01) - HH (02)  
Timerange: 01/01:06:32 to 01/01:07:48

Plot file version 140 created 26-JUN-2015 10:51:23

J2025+3343 ET031A.UVDATA.1

Freq = 1.5950 GHz, Bw = 16.000 MH No calibration applied and no bandpass applied

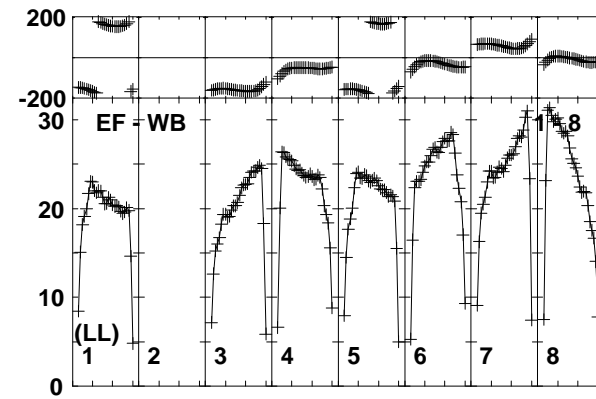
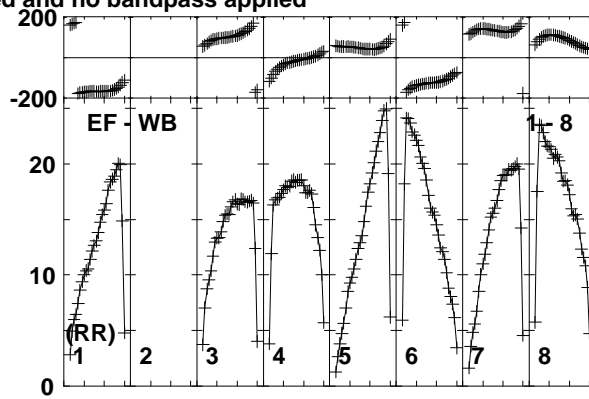
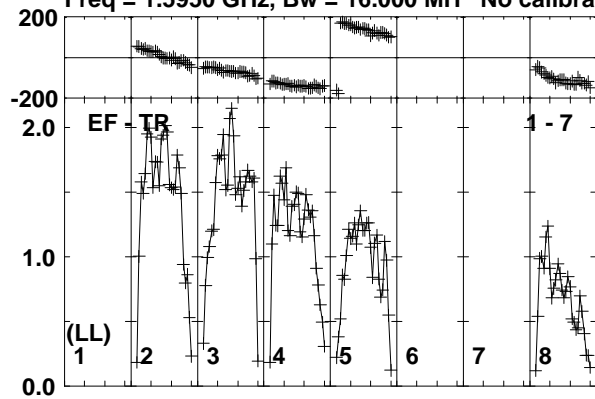

Lower frame: Milli Ampl Jy Top frame: Phas deg  
Vector averaged cross-power spectrum Baseline: EF (01) - TR (07)  
Timerange: 01/01:06:32 to 01/01:07:48

Plot file version 141 created 26-JUN-2015 10:51:23

V404CYG ET031A.UVDATA.1

Freq = 1.5950 GHz, Bw = 16.000 MH No calibration applied and no bandpass applied

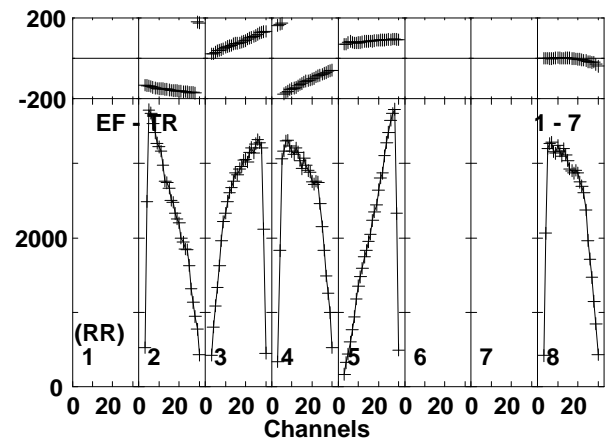
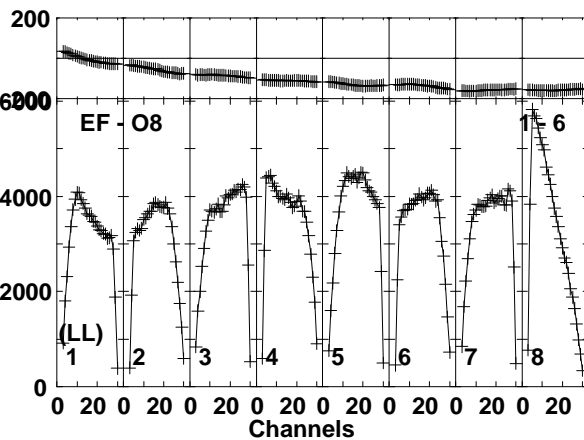
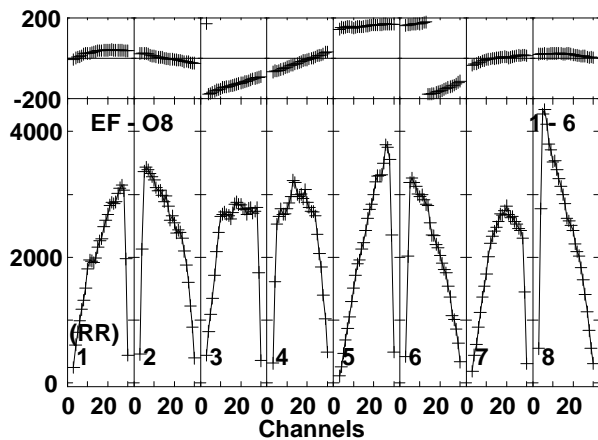
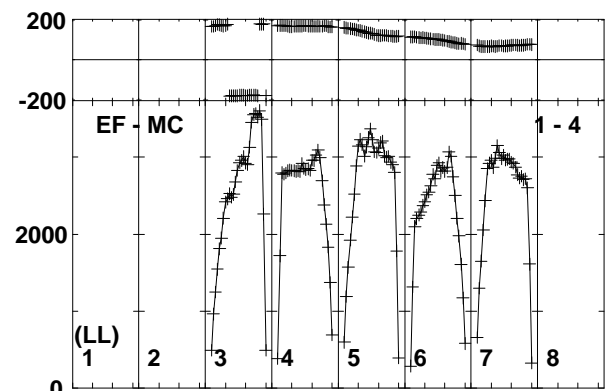
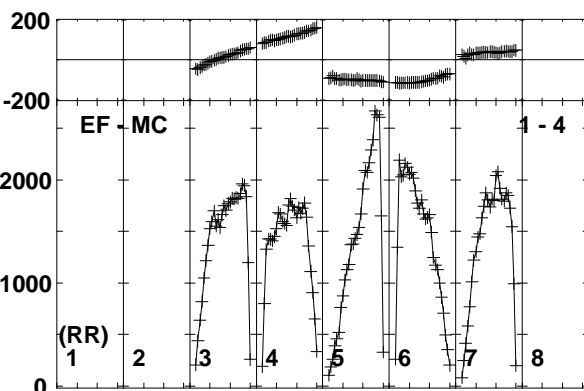
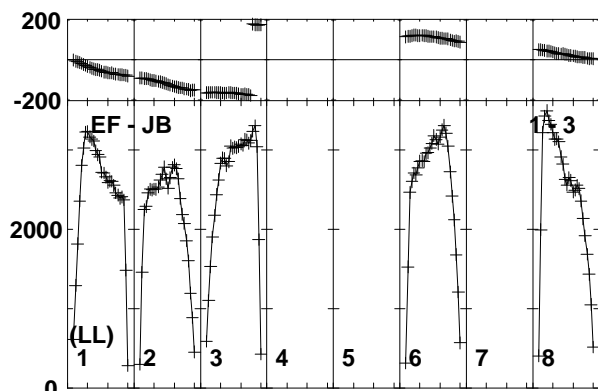
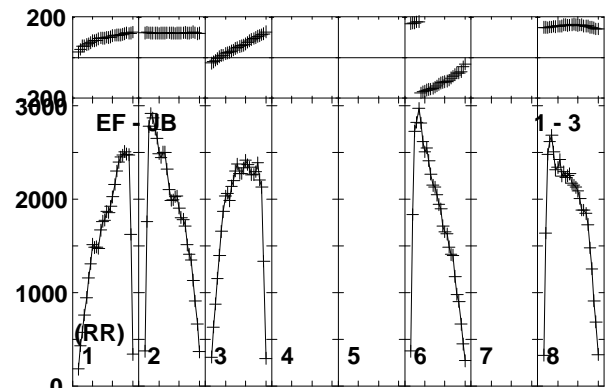
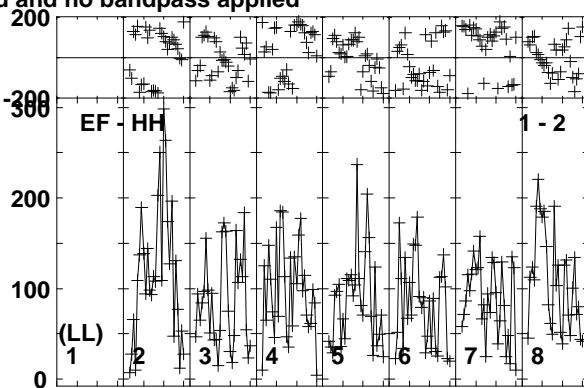
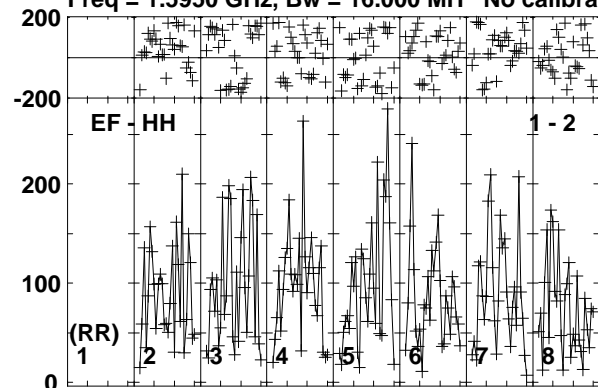

Lower frame: Micro Ampl Jy Top frame: Phas deg  
Vector averaged cross-power spectrum Baseline: EF (01) - HH (02)  
Timerange: 01/01:07:52 to 01/01:11:18

Plot file version 142 created 26-JUN-2015 10:51:23

V404CYG ET031A.UVDATA.1

Freq = 1.5950 GHz, Bw = 16.000 MH No calibration applied and no bandpass applied

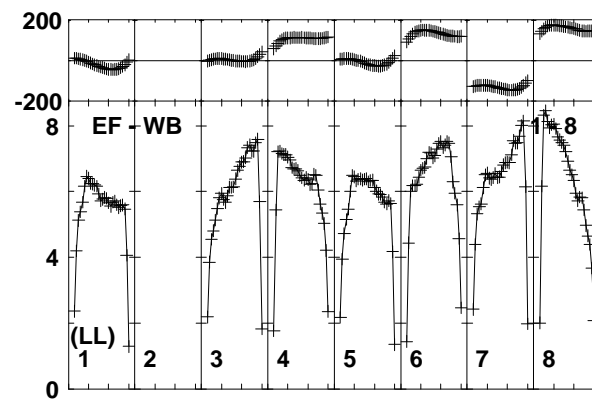
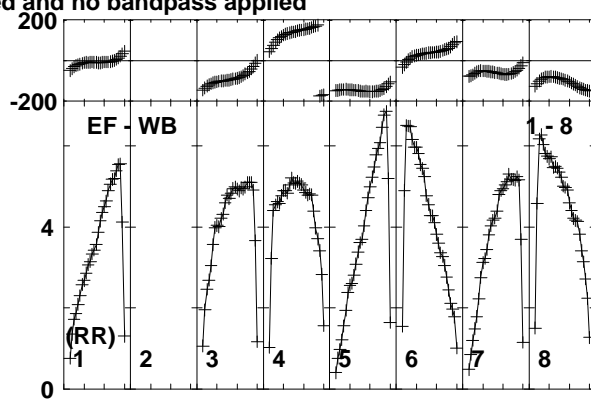
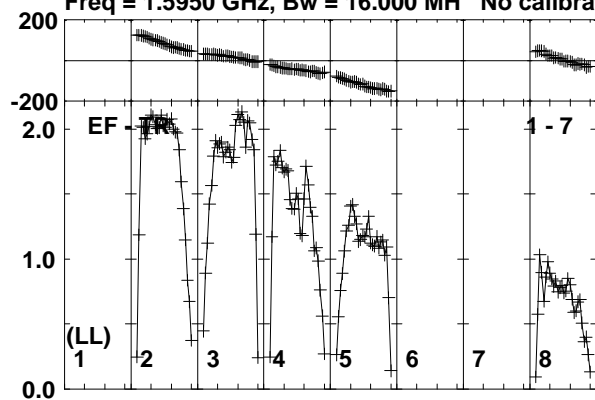

Lower frame: Milli Ampl Jy Top frame: Phas deg  
Vector averaged cross-power spectrum Baseline: EF (01) - TR (07)  
Timerange: 01/01:07:52 to 01/01:11:18

Plot file version 143 created 26-JUN-2015 10:51:23

J2025+3343 ET031A.UVDATA.1

Freq = 1.5950 GHz, Bw = 16.000 MH No calibration applied and no bandpass applied

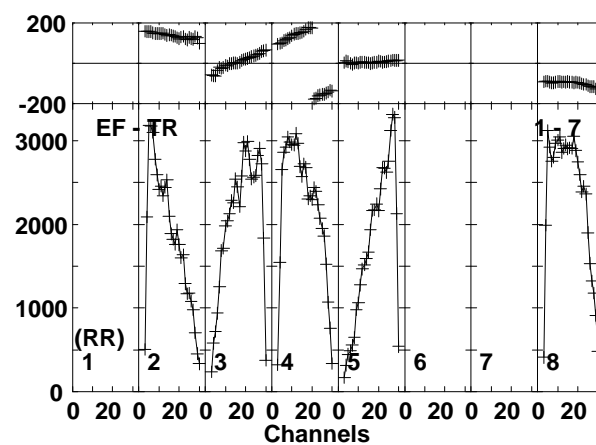
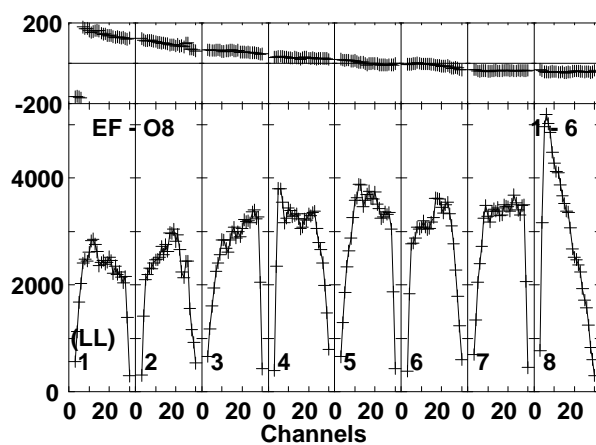
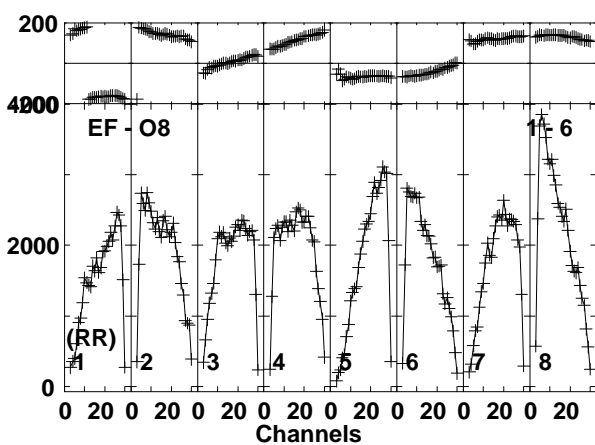
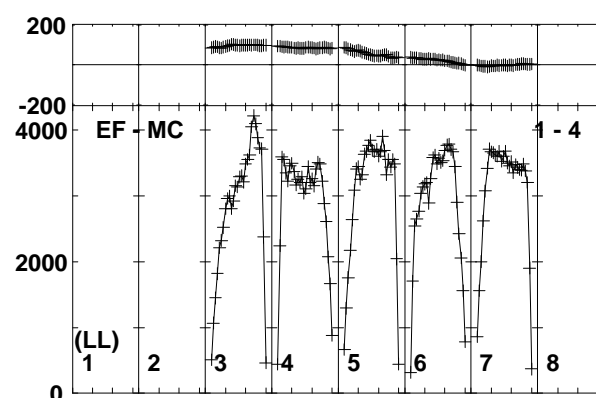
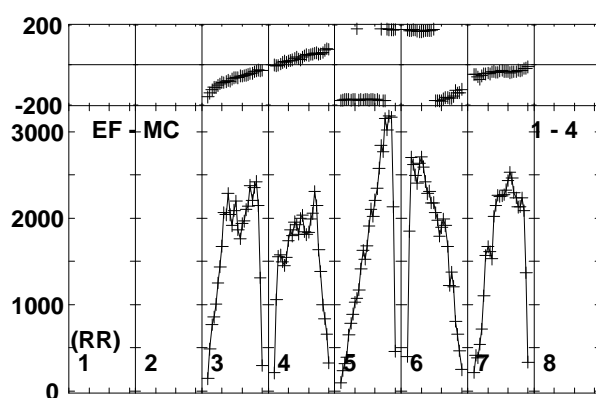
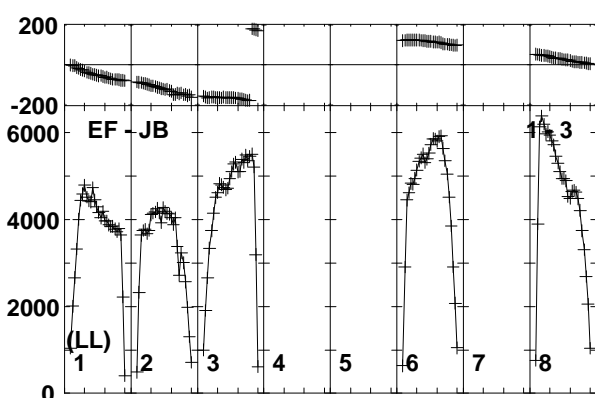
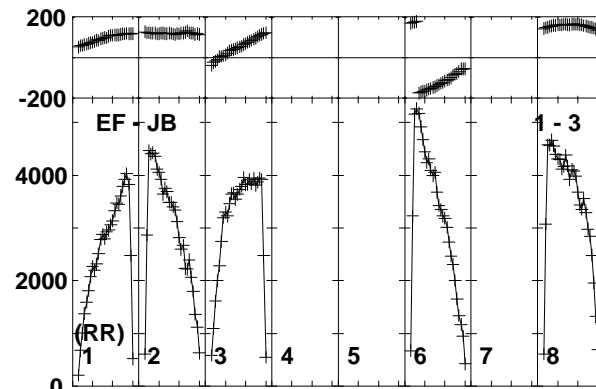
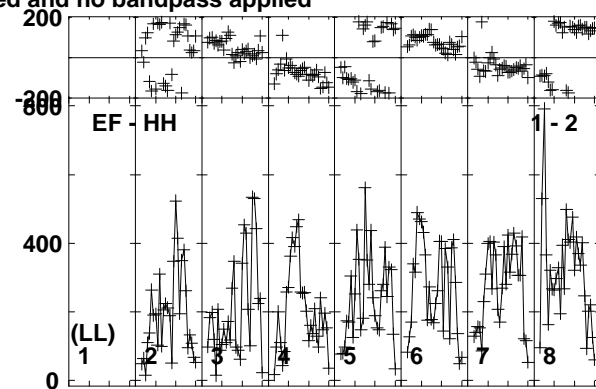
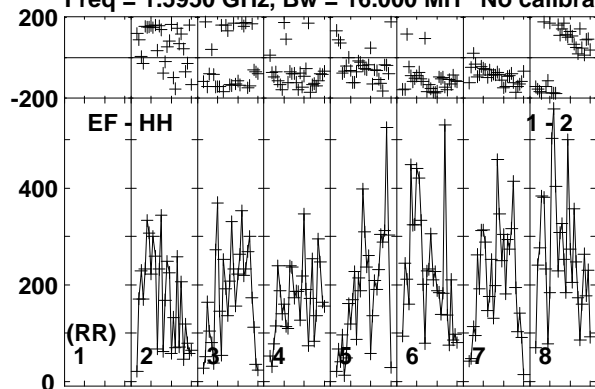

Lower frame: Micro Ampl Jy Top frame: Phas deg  
Vector averaged cross-power spectrum Baseline: EF (01) - HH (02)  
Timerange: 01/01:12:02 to 01/01:12:58

Plot file version 144 created 26-JUN-2015 10:51:23

J2025+3343 ET031A.UVDATA.1

Freq = 1.5950 GHz, Bw = 16.000 MH No calibration applied and no bandpass applied

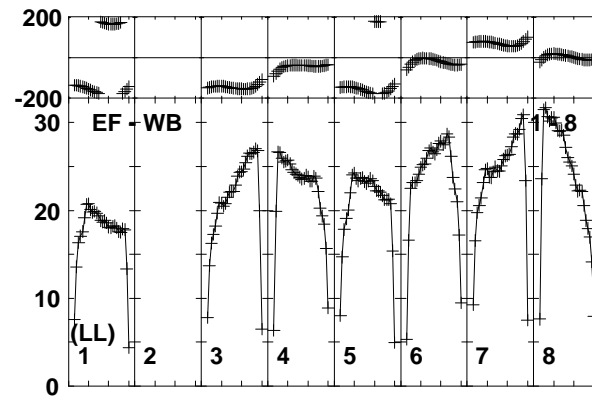
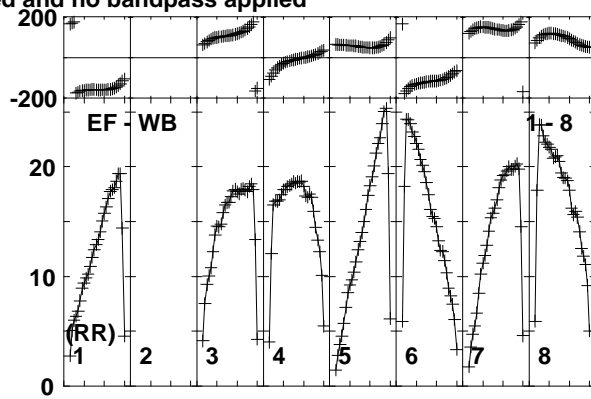
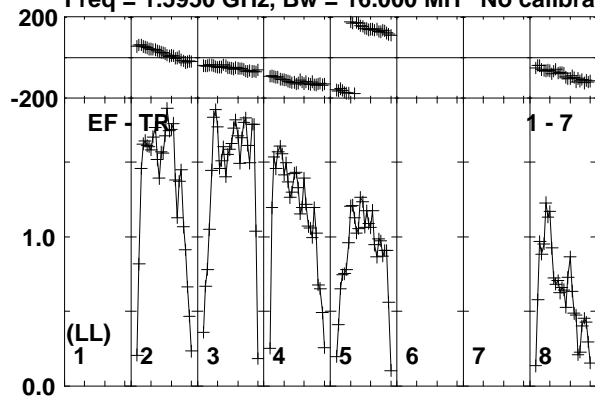

Lower frame: Milli Ampl Jy Top frame: Phas deg  
Vector averaged cross-power spectrum Baseline: EF (01) - TR (07)  
Timerange: 01/01:12:02 to 01/01:12:58



Plot file version 145 created 26-JUN-2015 10:51:23

V404CYG ET031A.UVDATA.1

Freq = 1.5950 GHz, Bw = 16.000 MH No calibration applied and no bandpass applied

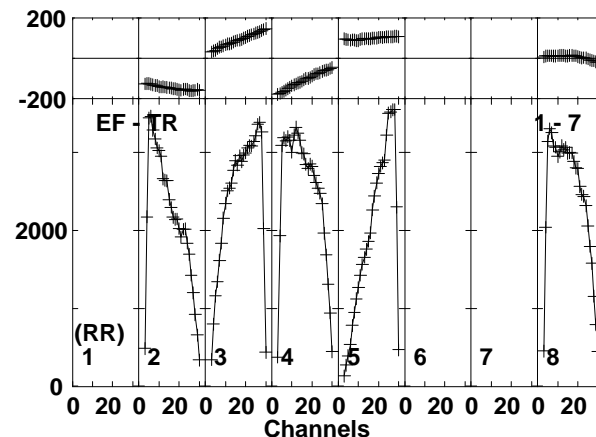
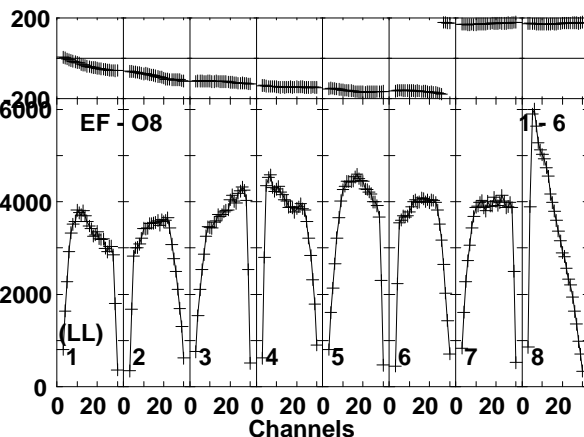
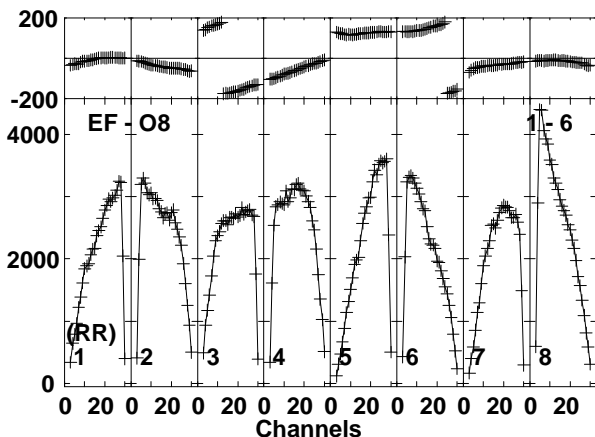
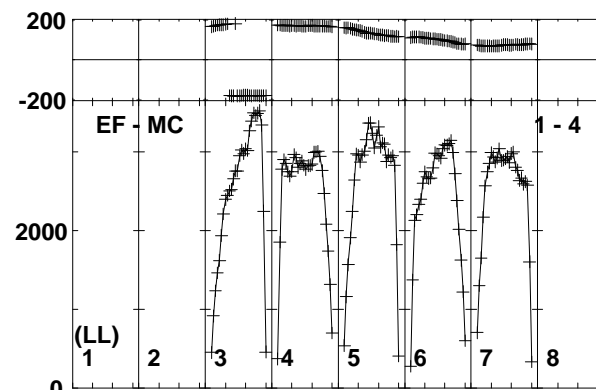
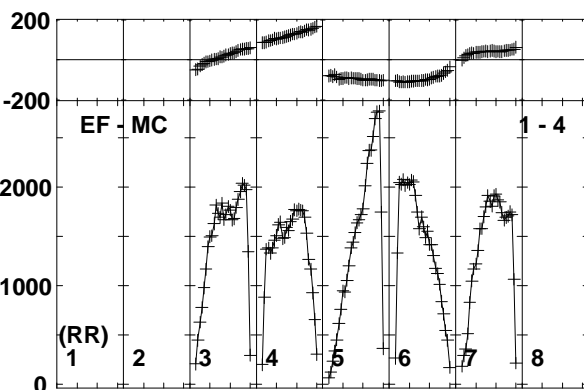
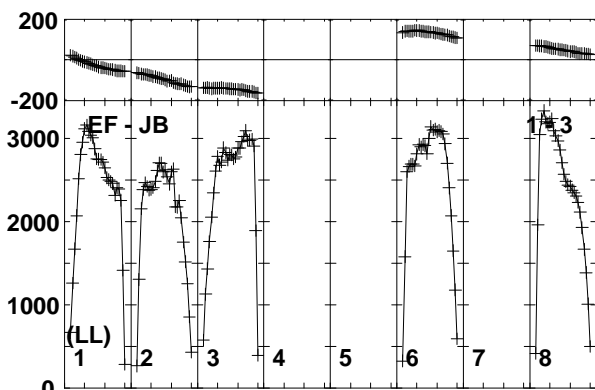
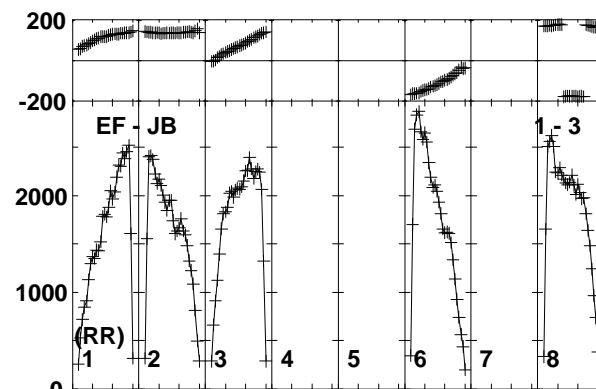
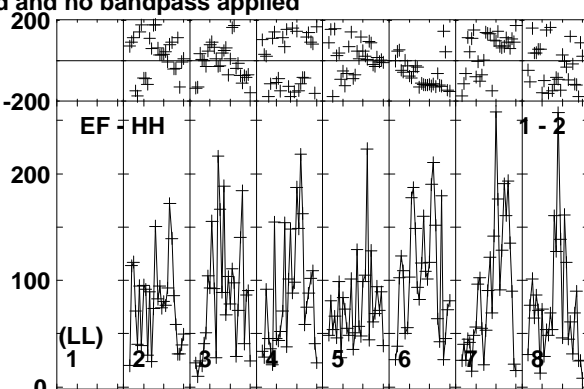
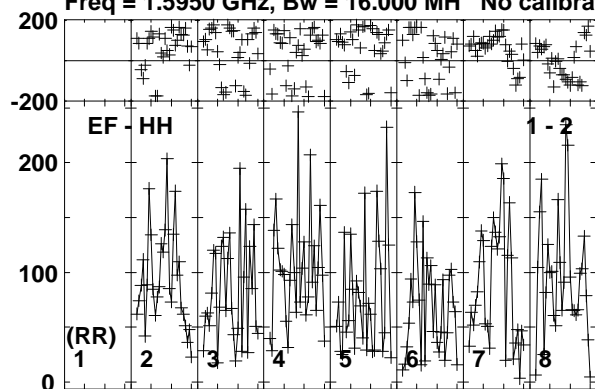

Lower frame: Micro Ampl Jy Top frame: Phas deg  
Vector averaged cross-power spectrum Baseline: EF (01) - HH (02)  
Timerange: 01/01:13:02 to 01/01:16:28

Plot file version 146 created 26-JUN-2015 10:51:23

V404CYG ET031A.UVDATA.1

Freq = 1.5950 GHz, Bw = 16.000 MH No calibration applied and no bandpass applied

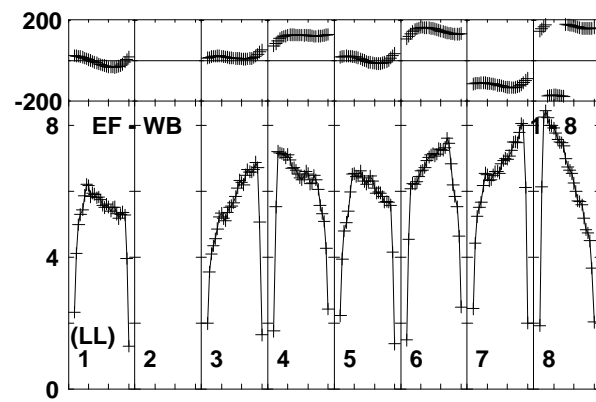
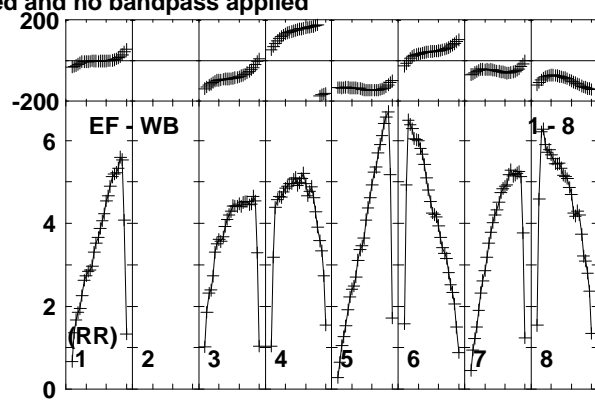
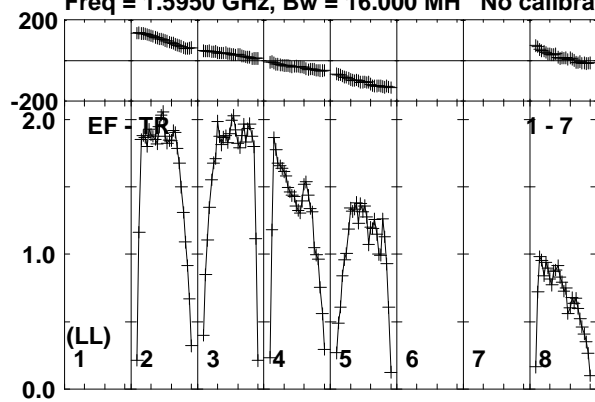

Lower frame: Milli Ampl Jy Top frame: Phas deg  
Vector averaged cross-power spectrum Baseline: EF (01) - TR (07)  
Timerange: 01/01:13:02 to 01/01:16:28

Plot file version 147 created 26-JUN-2015 10:51:23

J2025+3343 ET031A.UVDATA.1

Freq = 1.5950 GHz, Bw = 16.000 MH No calibration applied and no bandpass applied

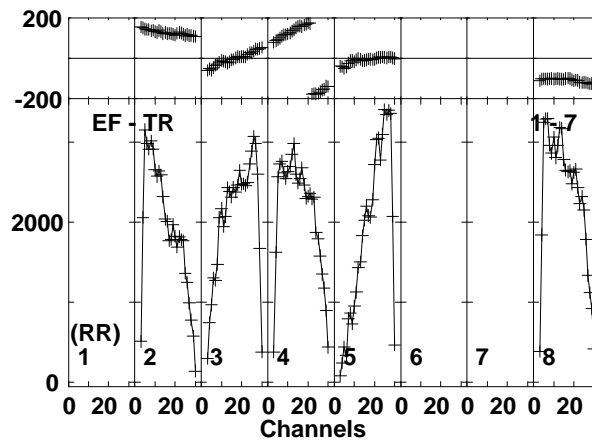
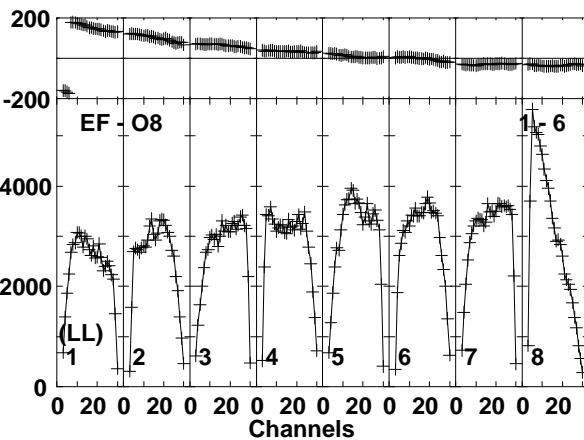
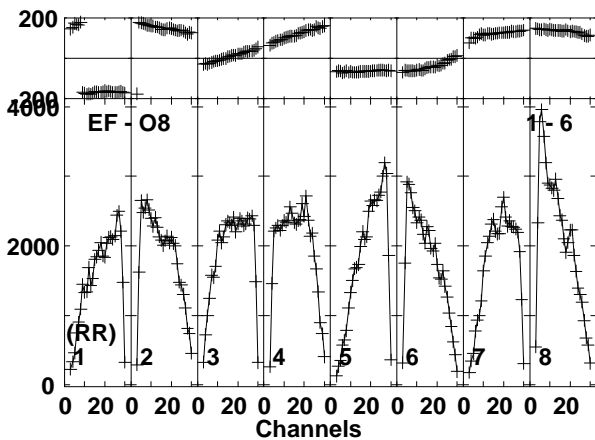
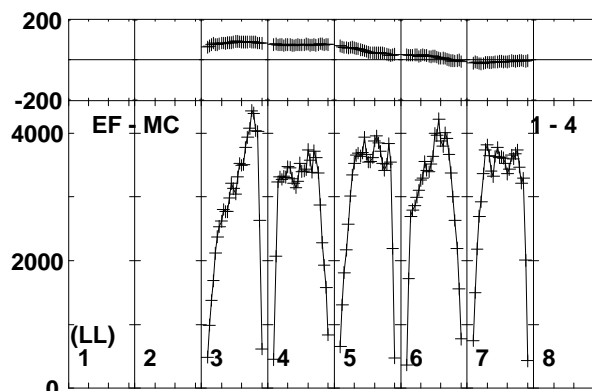
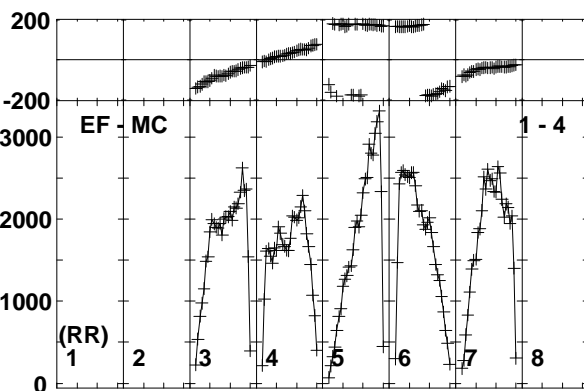
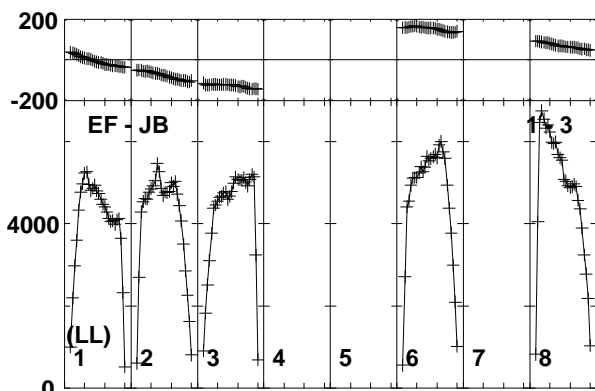
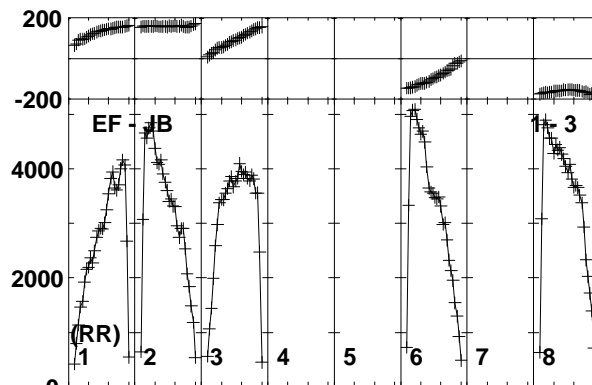
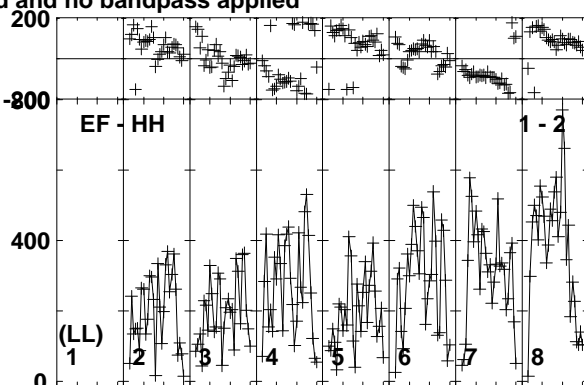
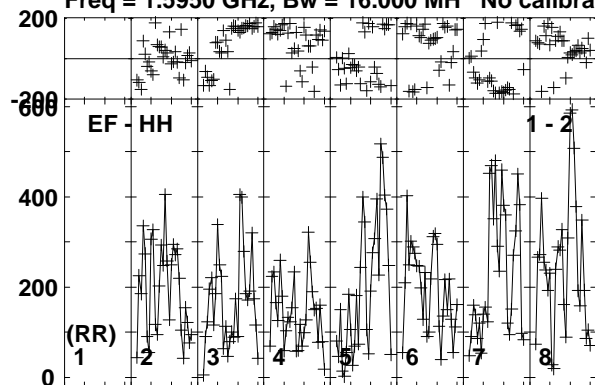

Lower frame: Micro Ampl Jy Top frame: Phas deg  
Vector averaged cross-power spectrum Baseline: EF (01) - HH (02)  
Timerange: 01/01:16:32 to 01/01:17:48

Plot file version 148 created 26-JUN-2015 10:51:23

J2025+3343 ET031A.UVDATA.1

Freq = 1.5950 GHz, Bw = 16.000 MH No calibration applied and no bandpass applied

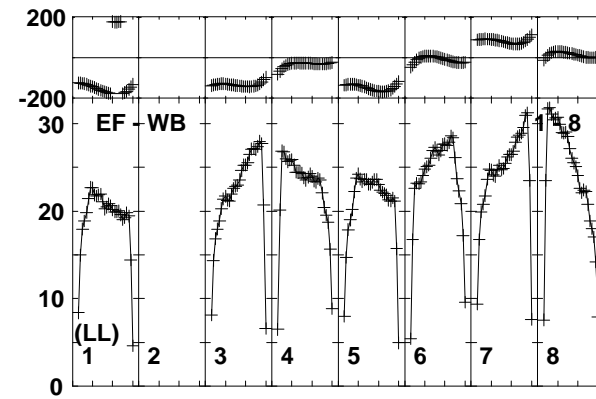
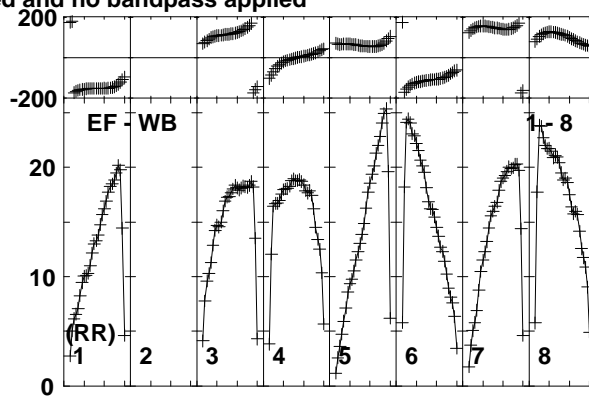
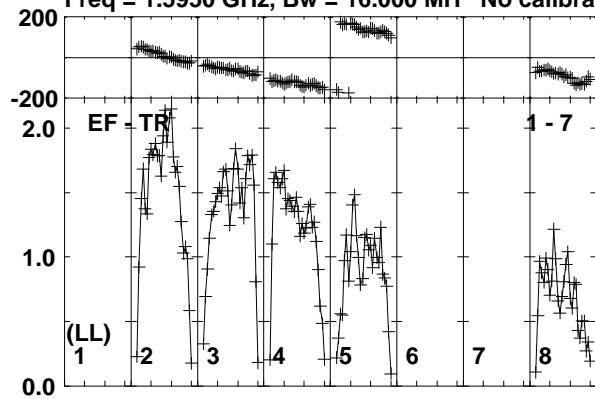

Lower frame: Milli Ampl Jy Top frame: Phas deg  
Vector averaged cross-power spectrum Baseline: EF (01) - TR (07)  
Timerange: 01/01:16:32 to 01/01:17:48

Plot file version 149 created 26-JUN-2015 10:51:23

V404CYG ET031A.UVDATA.1

Freq = 1.5950 GHz, Bw = 16.000 MH No calibration applied and no bandpass applied

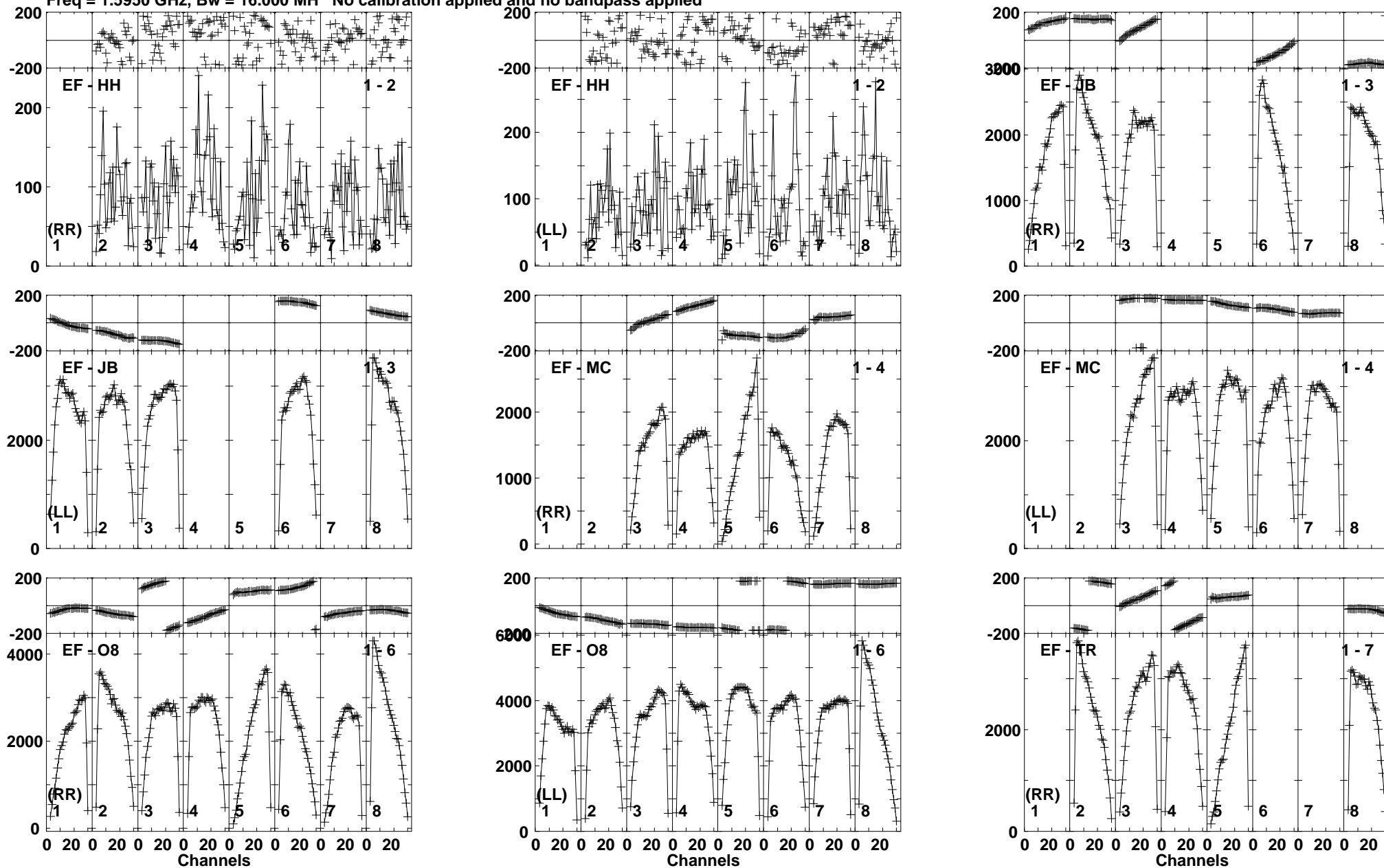

Lower frame: Micro Ampl Jy Top frame: Phas deg  
Vector averaged cross-power spectrum Baseline: EF (01) - HH (02)  
Timerange: 01/01:17:52 to 01/01:21:18

Plot file version 150 created 26-JUN-2015 10:51:23

V404CYG ET031A.UVDATA.1

Freq = 1.5950 GHz, Bw = 16.000 MH No calibration applied and no bandpass applied

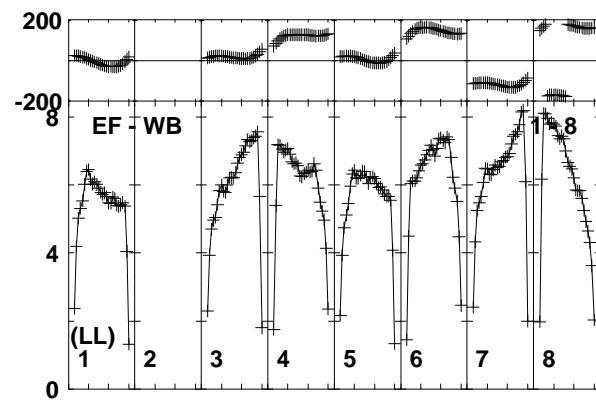
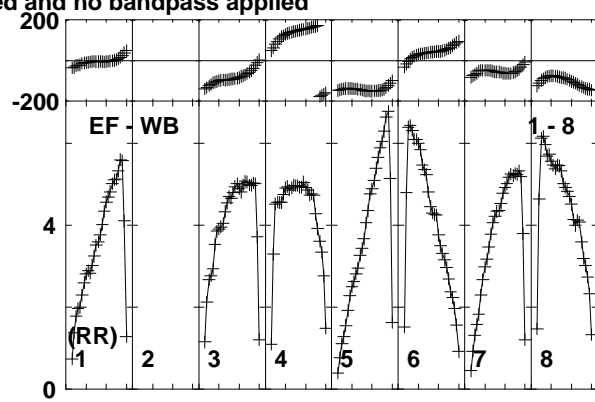
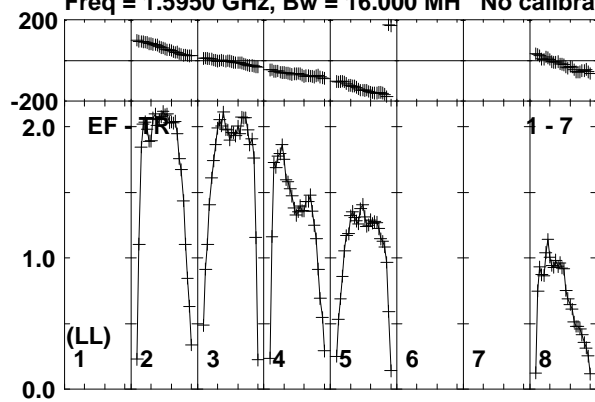

Lower frame: Milli Ampl Jy Top frame: Phas deg  
Vector averaged cross-power spectrum Baseline: EF (01) - TR (07)  
Timerange: 01/01:17:52 to 01/01:21:18

Plot file version 151 created 26-JUN-2015 10:51:23

J2025+3343 ET031A.UVDATA.1

Freq = 1.5950 GHz, Bw = 16.000 MH No calibration applied and no bandpass applied

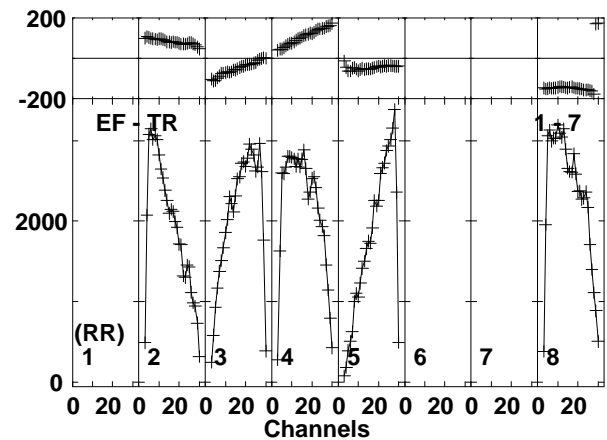
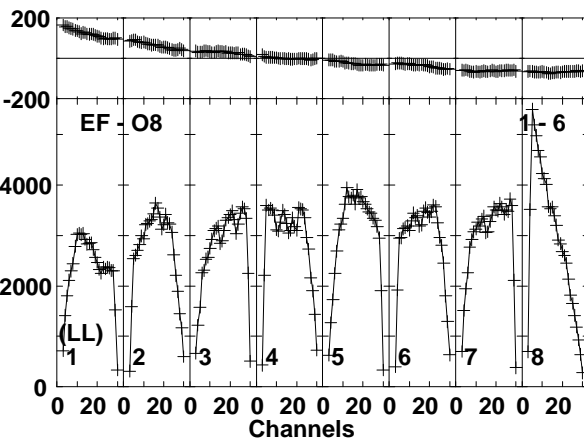
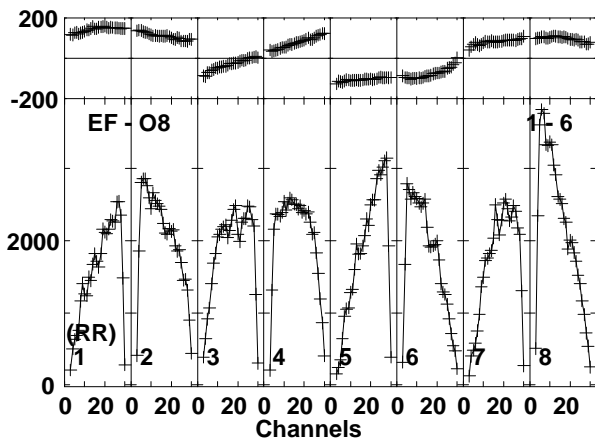
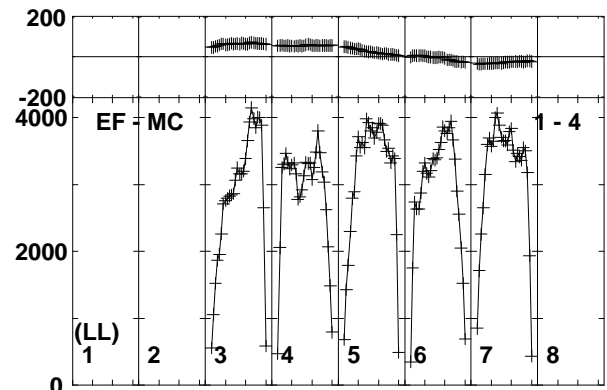
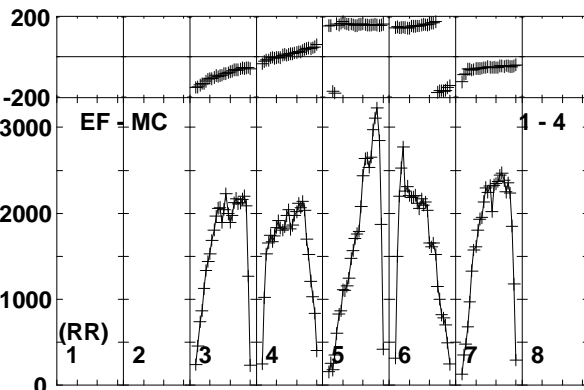
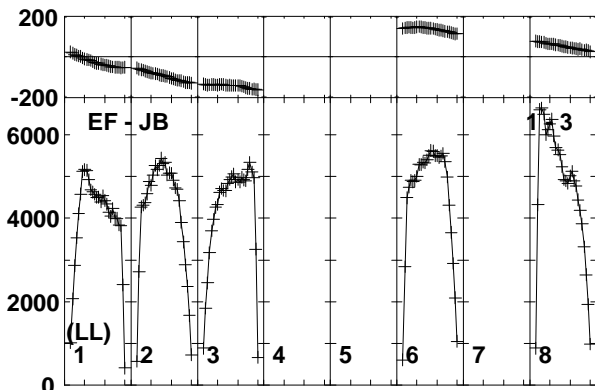
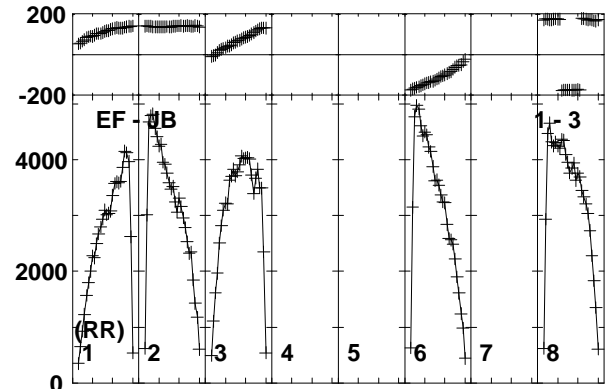
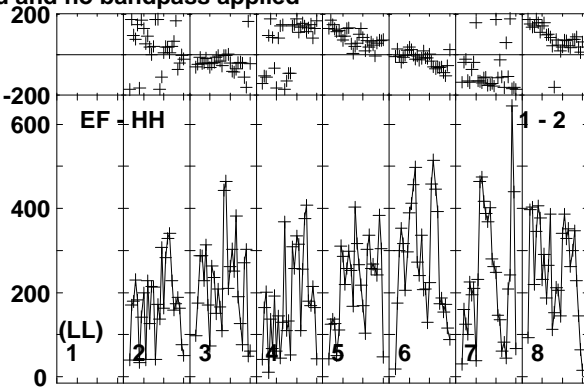
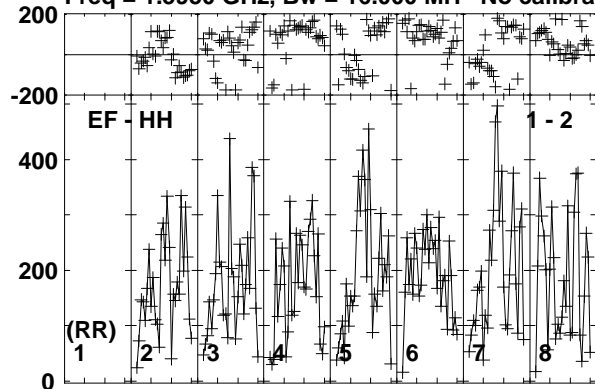

Lower frame: Micro Ampl Jy Top frame: Phas deg  
Vector averaged cross-power spectrum Baseline: EF (01) - HH (02)  
Timerange: 01/01:22:02 to 01/01:22:58

Plot file version 152 created 26-JUN-2015 10:51:23

J2025+3343 ET031A.UVDATA.1

Freq = 1.5950 GHz, Bw = 16.000 MH No calibration applied and no bandpass applied

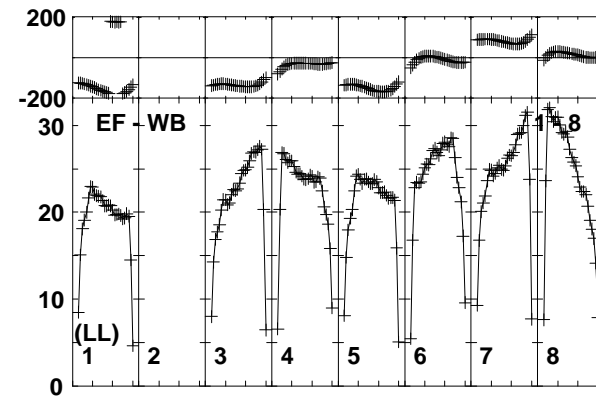
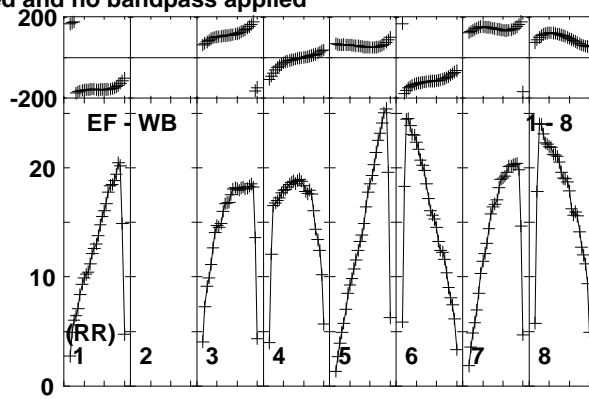
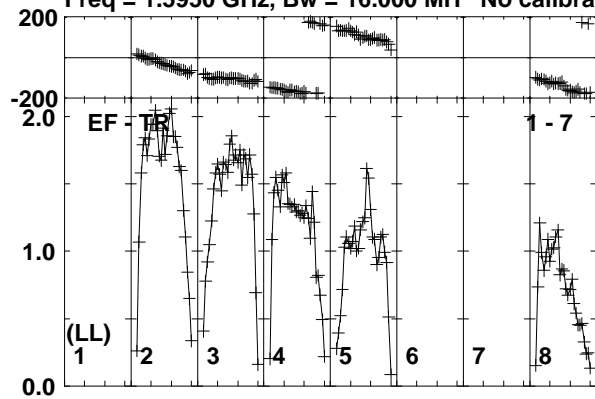

Lower frame: Milli Ampl Jy Top frame: Phas deg  
Vector averaged cross-power spectrum Baseline: EF (01) - TR (07)  
Timerange: 01/01:22:02 to 01/01:22:58



Plot file version 153 created 26-JUN-2015 10:51:23

V404CYG ET031A.UVDATA.1

Freq = 1.5950 GHz, Bw = 16.000 MH No calibration applied and no bandpass applied

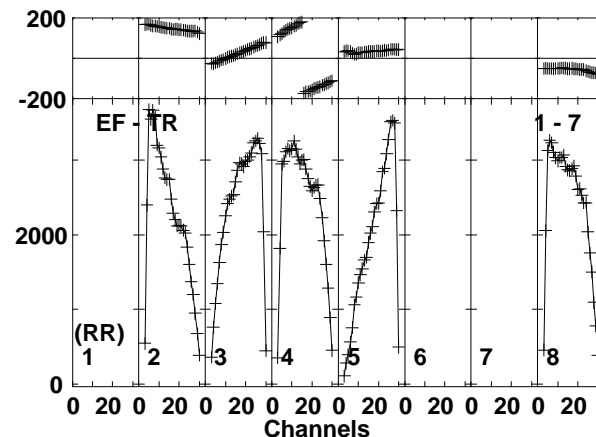
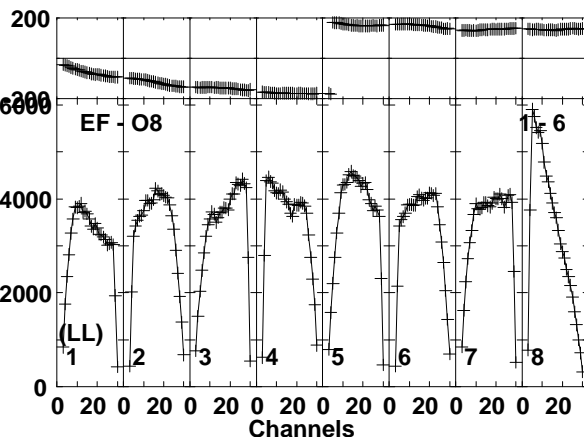
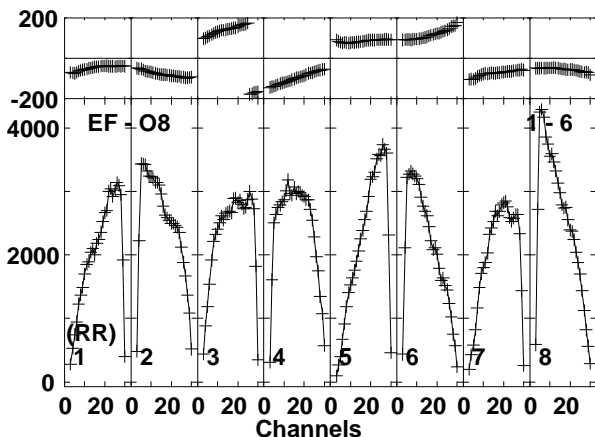
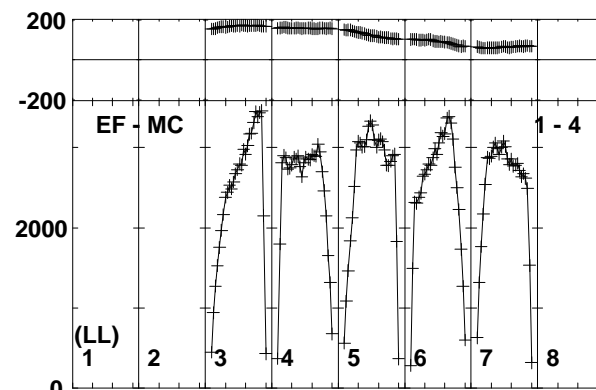
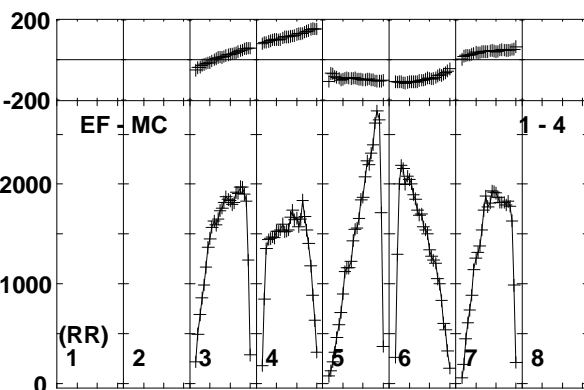
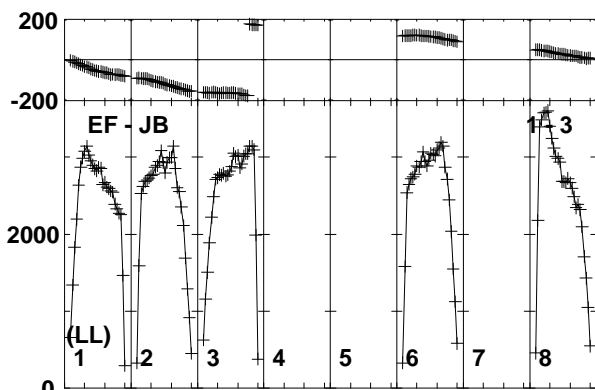
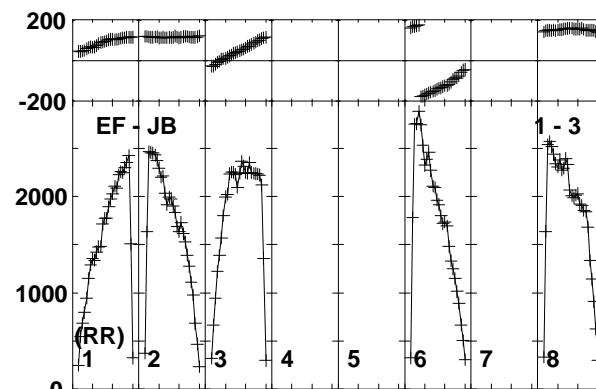
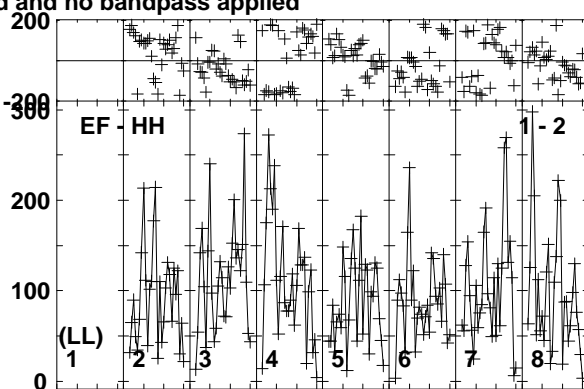
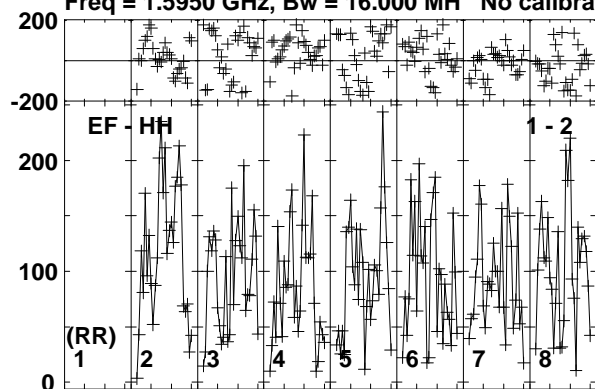

Lower frame: Micro Ampl Jy Top frame: Phas deg  
Vector averaged cross-power spectrum Baseline: EF (01) - HH (02)  
Timerange: 01/01:23:02 to 01/01:26:28

Plot file version 154 created 26-JUN-2015 10:51:23

V404CYG ET031A.UVDATA.1

Freq = 1.5950 GHz, Bw = 16.000 MH No calibration applied and no bandpass applied

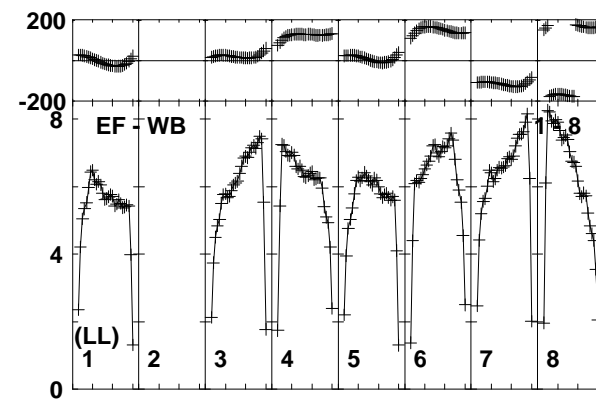
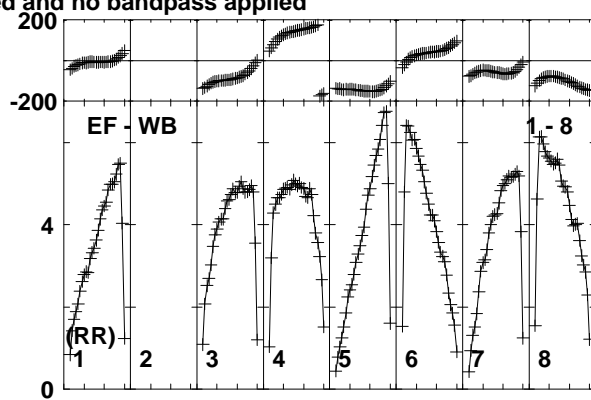
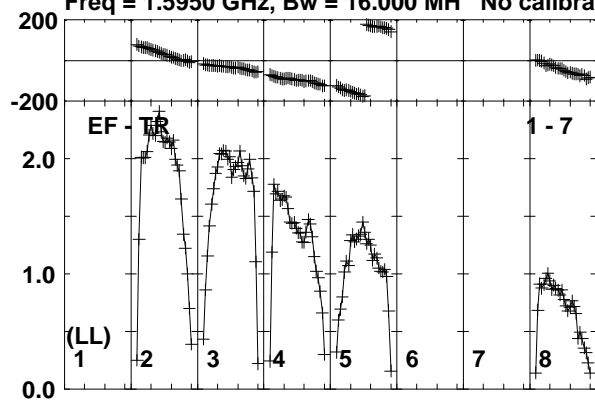

Lower frame: Milli Ampl Jy Top frame: Phas deg  
Vector averaged cross-power spectrum Baseline: EF (01) - TR (07)  
Timerange: 01/01:23:02 to 01/01:26:28

Plot file version 155 created 26-JUN-2015 10:51:23

J2025+3343 ET031A.UVDATA.1

Freq = 1.5950 GHz, Bw = 16.000 MH No calibration applied and no bandpass applied

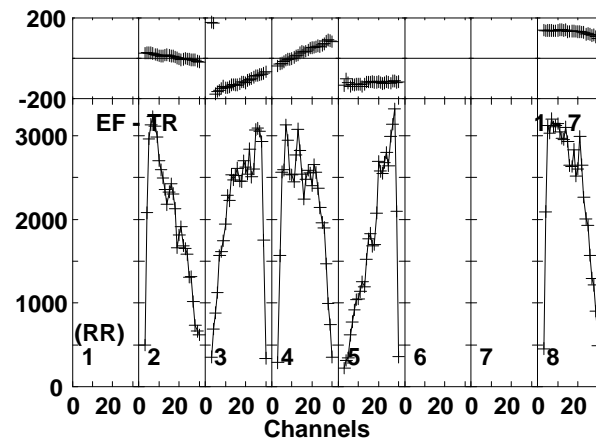
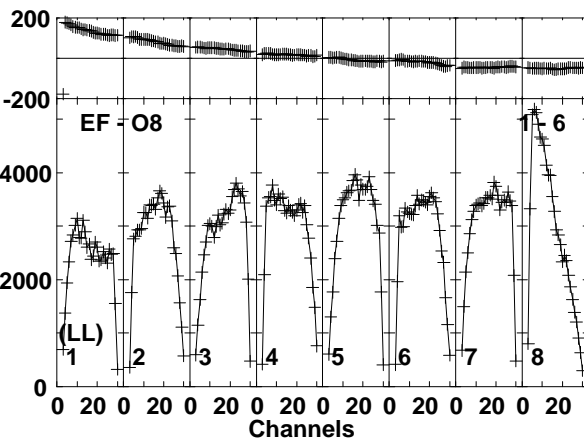
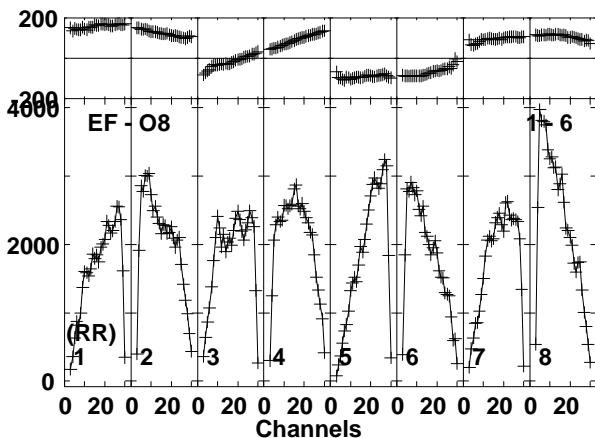
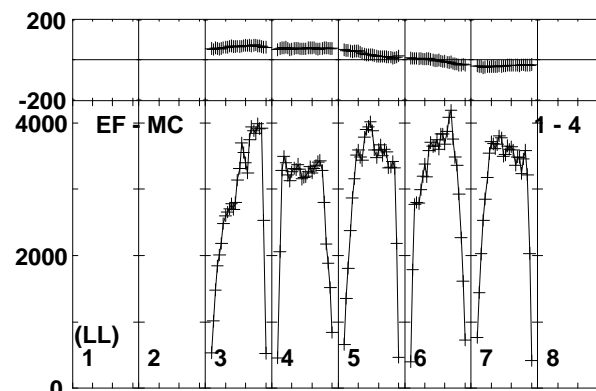
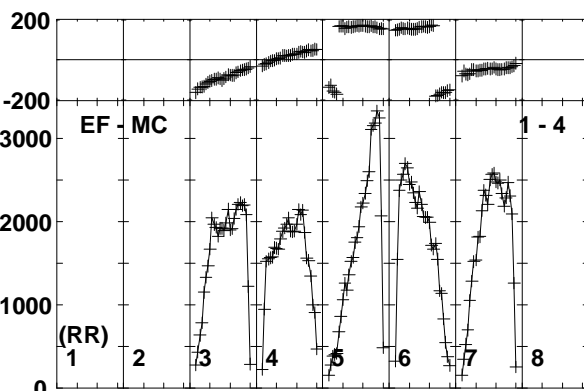
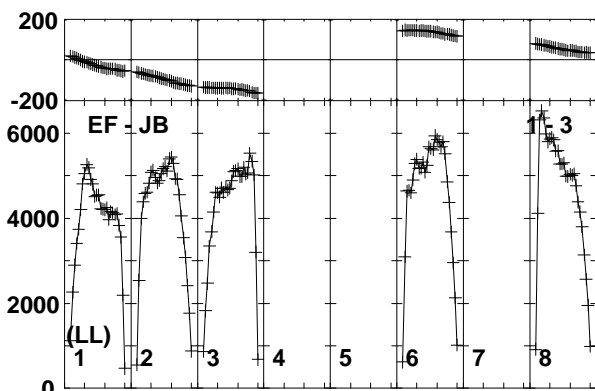
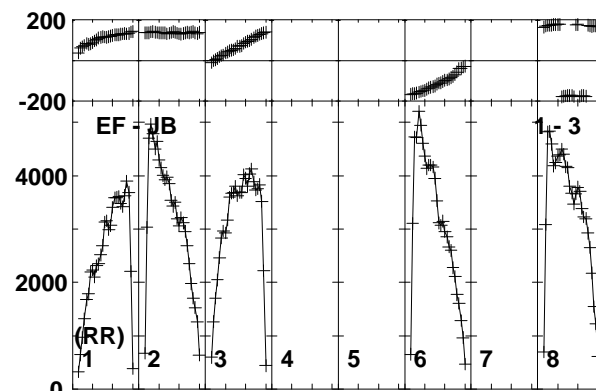
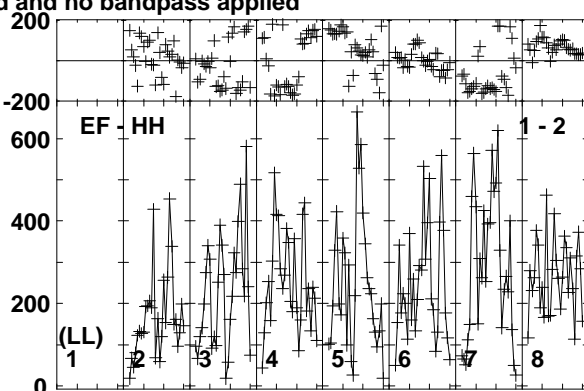
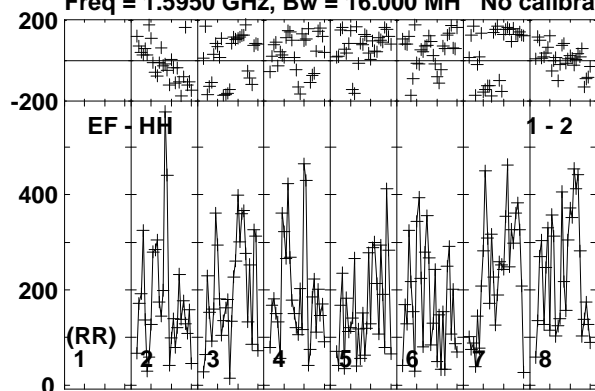

Lower frame: Micro Ampl Jy Top frame: Phas deg  
Vector averaged cross-power spectrum Baseline: EF (01) - HH (02)  
Timerange: 01/01:26:32 to 01/01:27:48

Plot file version 156 created 26-JUN-2015 10:51:23

J2025+3343 ET031A.UVDATA.1

Freq = 1.5950 GHz, Bw = 16.000 MH No calibration applied and no bandpass applied

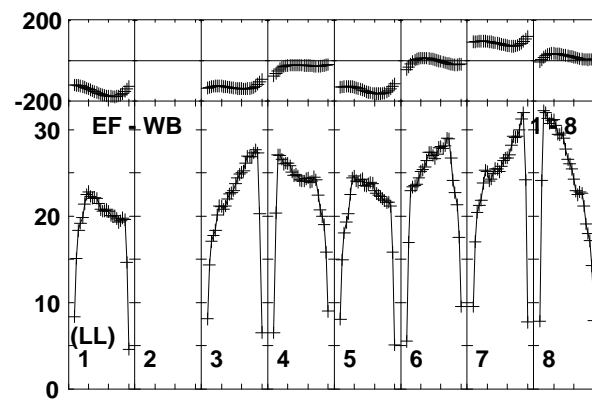
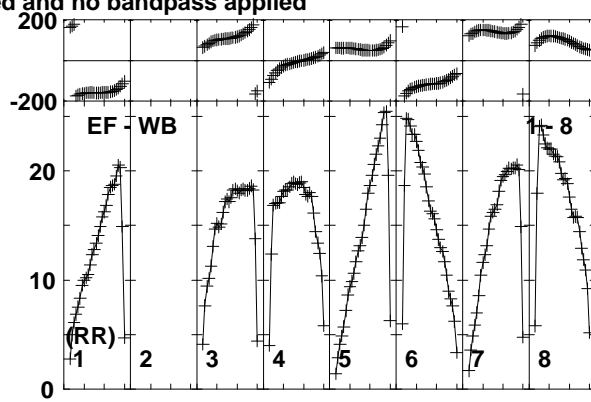
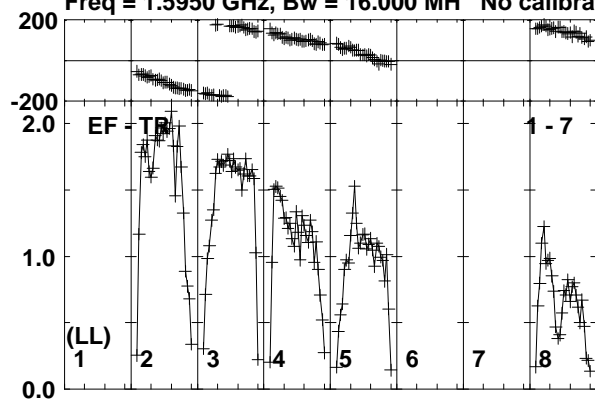

Lower frame: Milli Ampl Jy Top frame: Phas deg  
Vector averaged cross-power spectrum Baseline: EF (01) - TR (07)  
Timerange: 01/01:26:32 to 01/01:27:48

Plot file version 157 created 26-JUN-2015 10:51:24

V404CYG ET031A.UVDATA.1

Freq = 1.5950 GHz, Bw = 16.000 MH No calibration applied and no bandpass applied

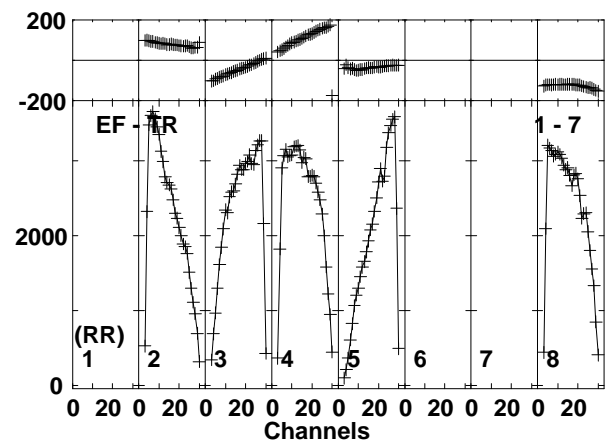
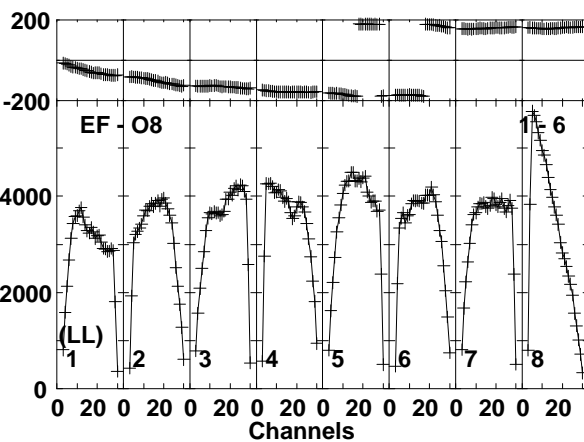
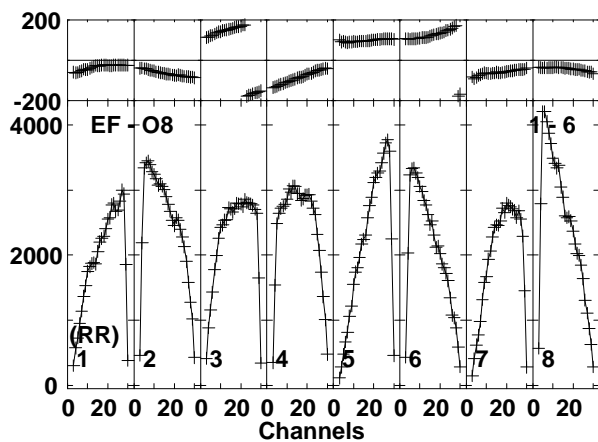
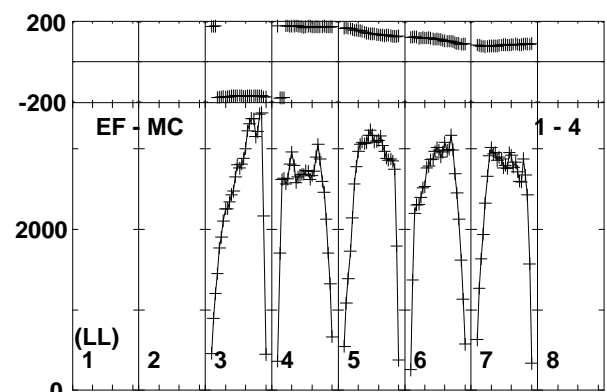
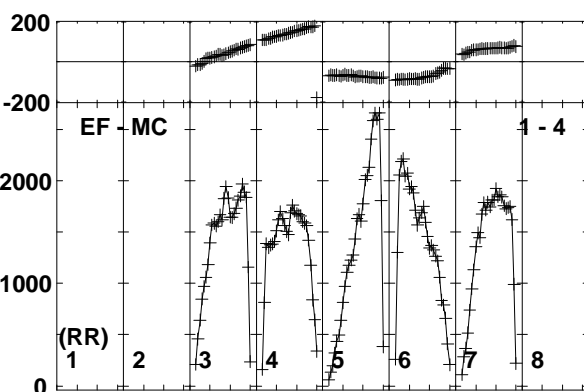
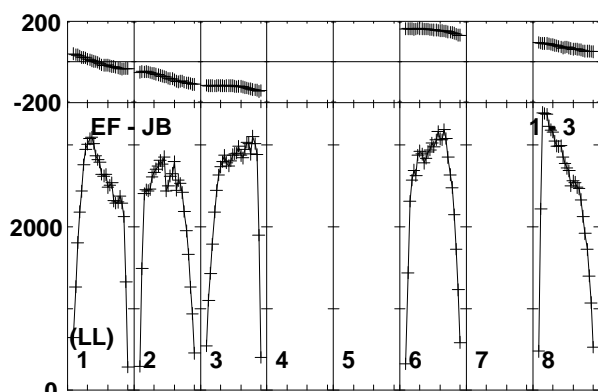
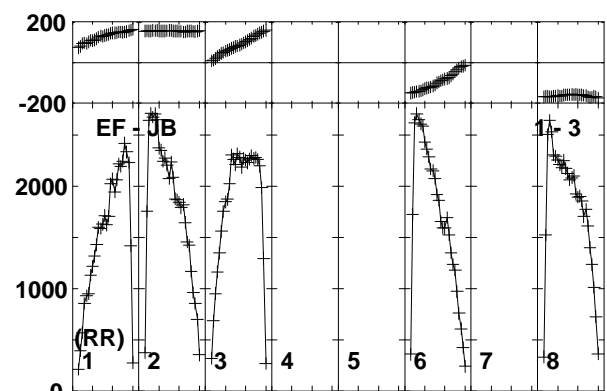
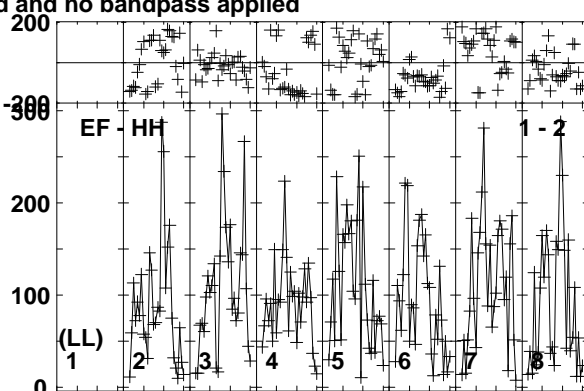
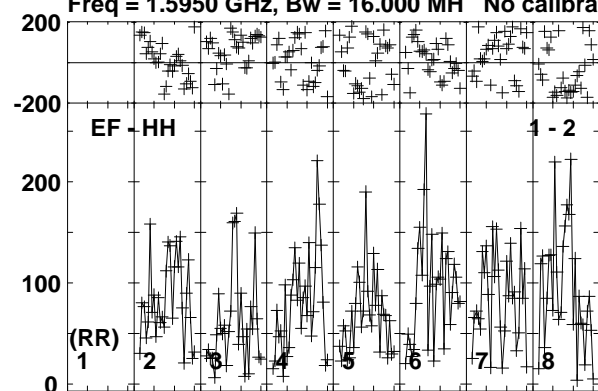

Lower frame: Micro Ampl Jy Top frame: Phas deg  
Vector averaged cross-power spectrum Baseline: EF (01) - HH (02)  
Timerange: 01/01:27:52 to 01/01:31:18

Plot file version 158 created 26-JUN-2015 10:51:24

V404CYG ET031A.UVDATA.1

Freq = 1.5950 GHz, Bw = 16.000 MH No calibration applied and no bandpass applied

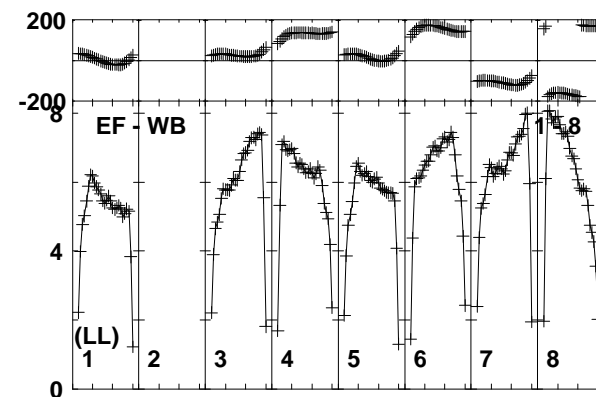
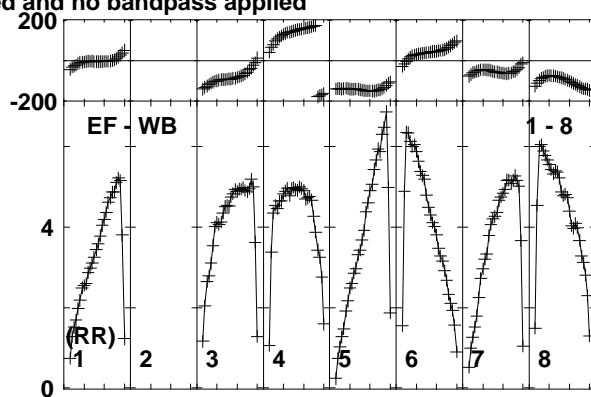
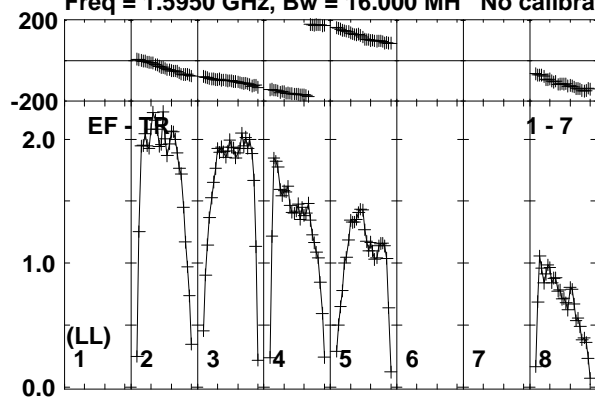

Lower frame: Milli Ampl Jy Top frame: Phas deg  
Vector averaged cross-power spectrum Baseline: EF (01) - TR (07)  
Timerange: 01/01:27:52 to 01/01:31:18

Plot file version 159 created 26-JUN-2015 10:51:24

J2025+3343 ET031A.UVDATA.1

Freq = 1.5950 GHz, Bw = 16.000 MH No calibration applied and no bandpass applied

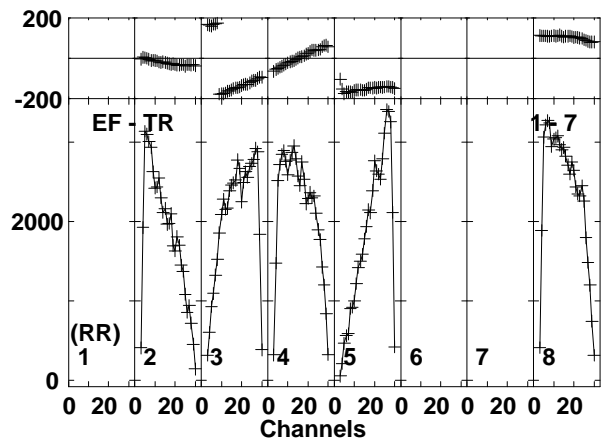
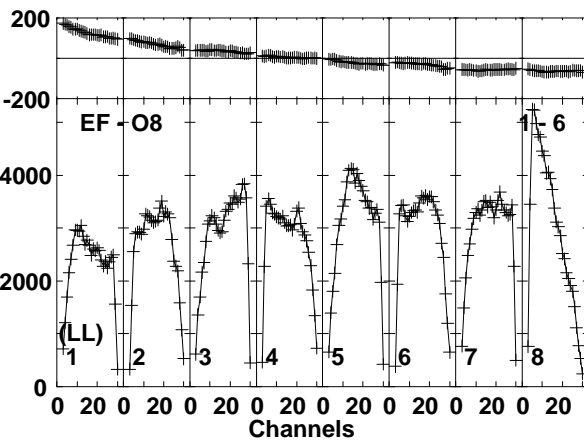
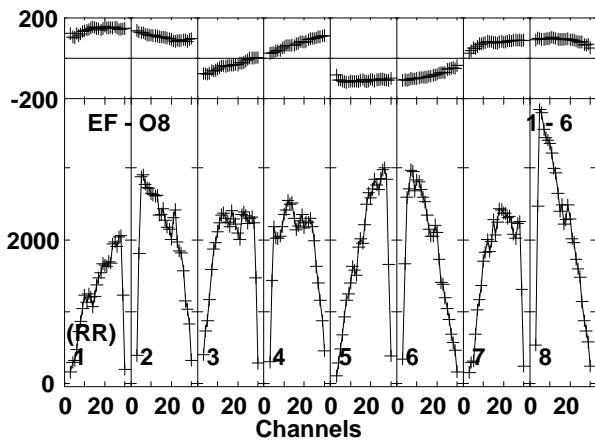
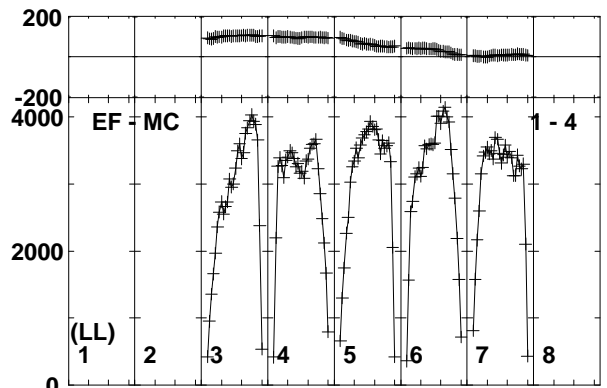
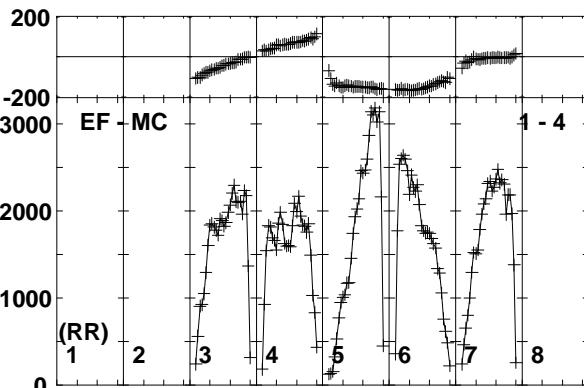
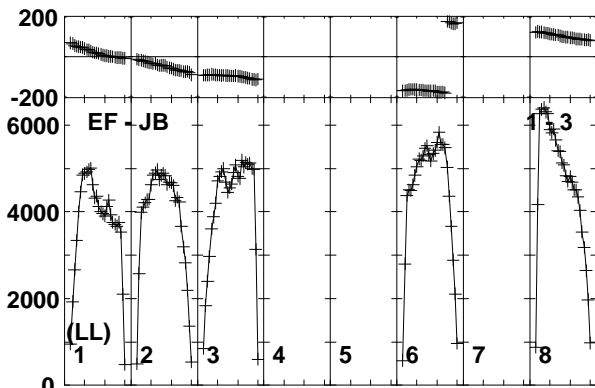
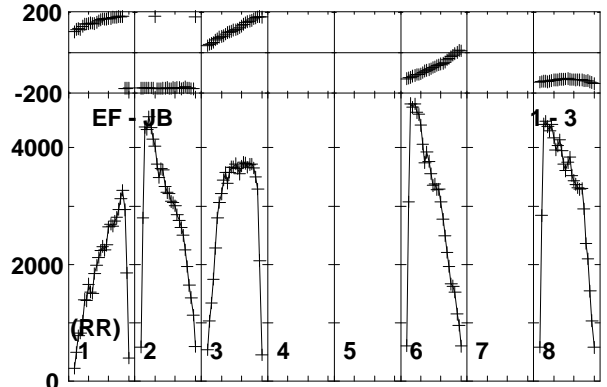
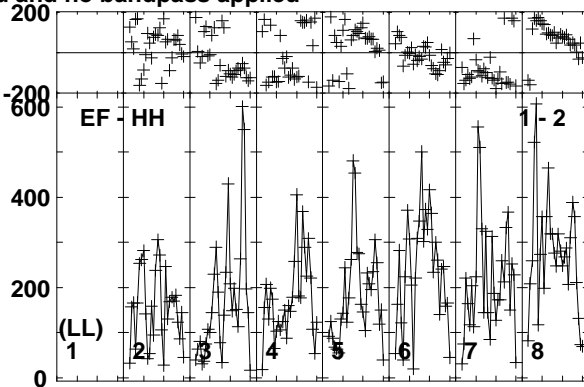
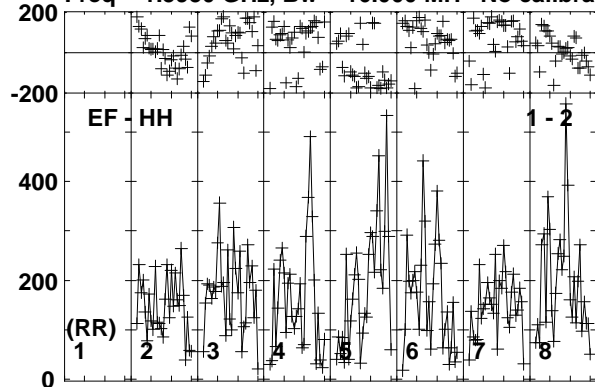

Lower frame: Micro Ampl Jy Top frame: Phas deg  
Vector averaged cross-power spectrum Baseline: EF (01) - HH (02)  
Timerange: 01/01:32:02 to 01/01:32:58

Plot file version 160 created 26-JUN-2015 10:51:24

J2025+3343 ET031A.UVDATA.1

Freq = 1.5950 GHz, Bw = 16.000 MH No calibration applied and no bandpass applied

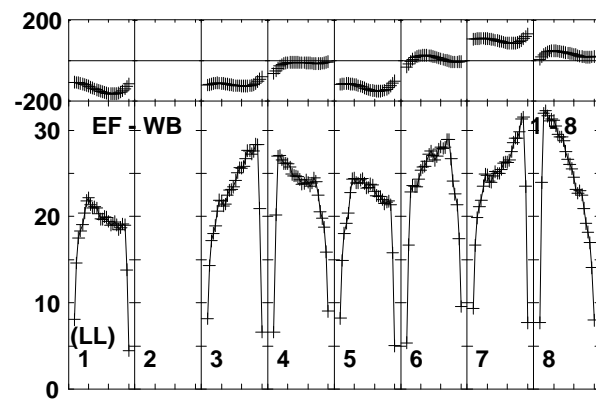
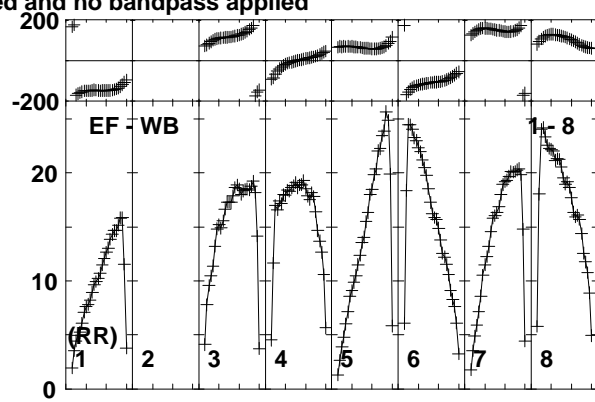
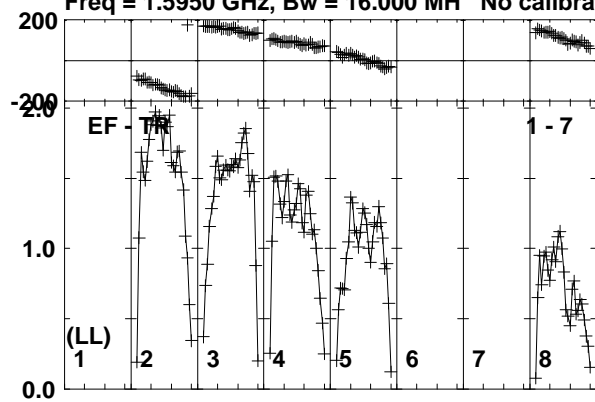

Lower frame: Milli Ampl Jy Top frame: Phas deg  
Vector averaged cross-power spectrum Baseline: EF (01) - TR (07)  
Timerange: 01/01:32:02 to 01/01:32:58



Plot file version 161 created 26-JUN-2015 10:51:24

V404CYG ET031A.UVDATA.1

Freq = 1.5950 GHz, Bw = 16.000 MH No calibration applied and no bandpass applied

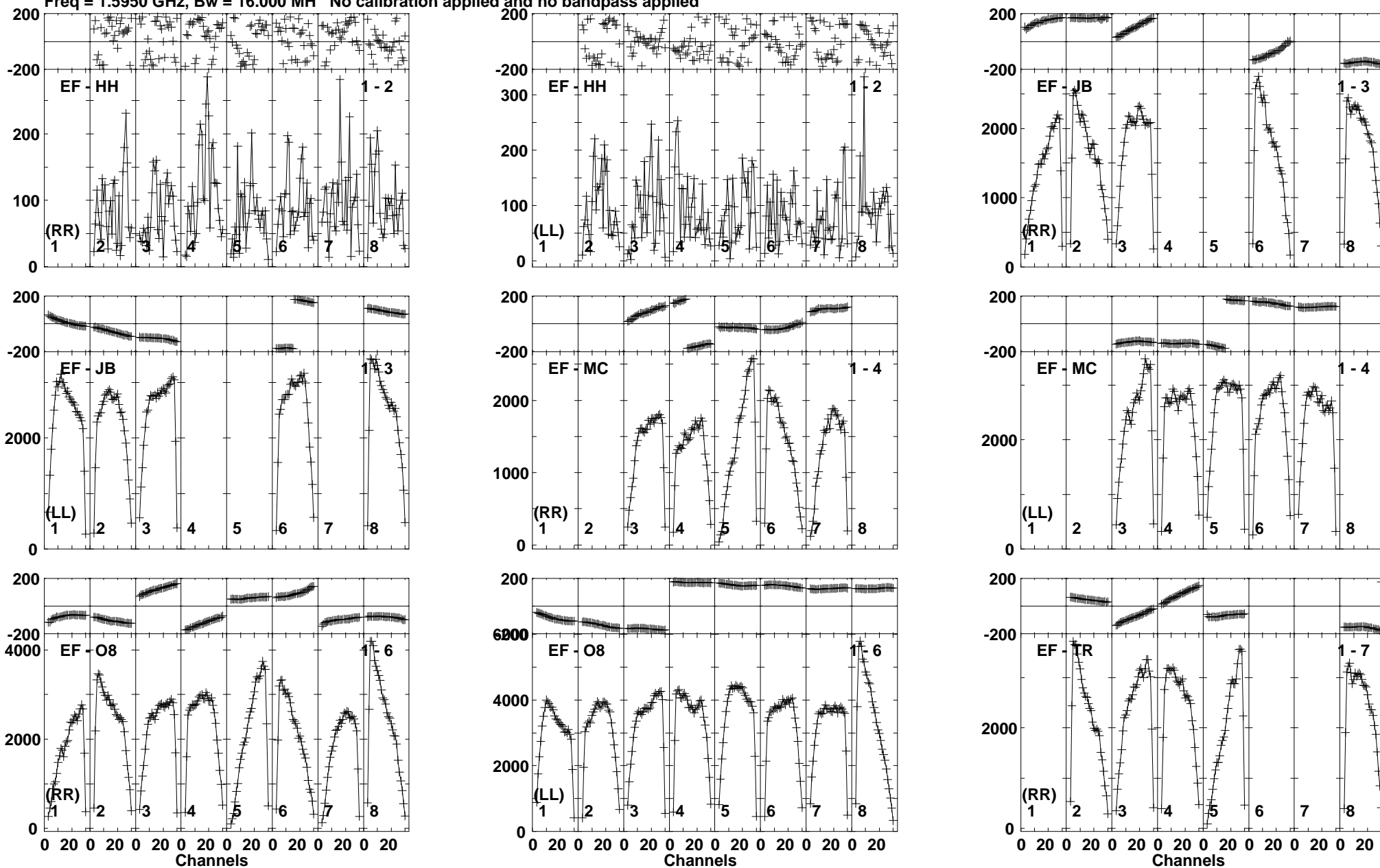

Lower frame: Micro Ampl Jy Top frame: Phas deg  
Vector averaged cross-power spectrum Baseline: EF (01) - HH (02)  
Timerange: 01/01:33:02 to 01/01:36:28

Plot file version 162 created 26-JUN-2015 10:51:24

V404CYG ET031A.UVDATA.1

Freq = 1.5950 GHz, Bw = 16.000 MH No calibration applied and no bandpass applied

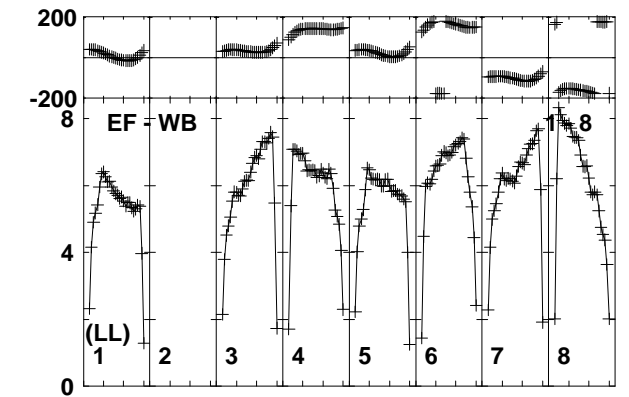
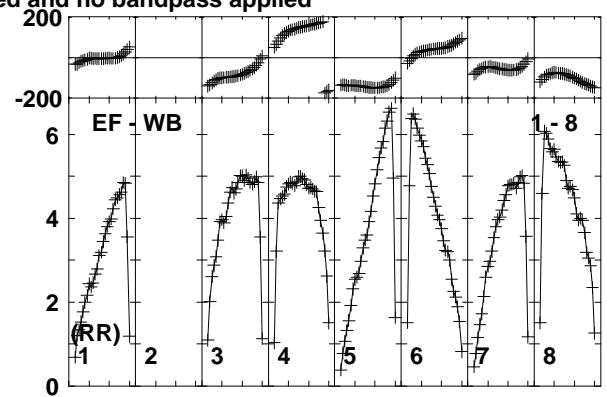
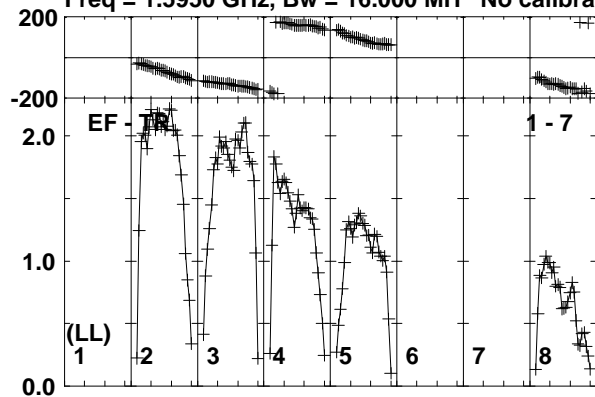

Lower frame: Milli Ampl Jy Top frame: Phas deg  
Vector averaged cross-power spectrum Baseline: EF (01) - TR (07)  
Timerange: 01/01:33:02 to 01/01:36:28

Plot file version 163 created 26-JUN-2015 10:51:24

J2025+3343 ET031A.UVDATA.1

Freq = 1.5950 GHz, Bw = 16.000 MH No calibration applied and no bandpass applied

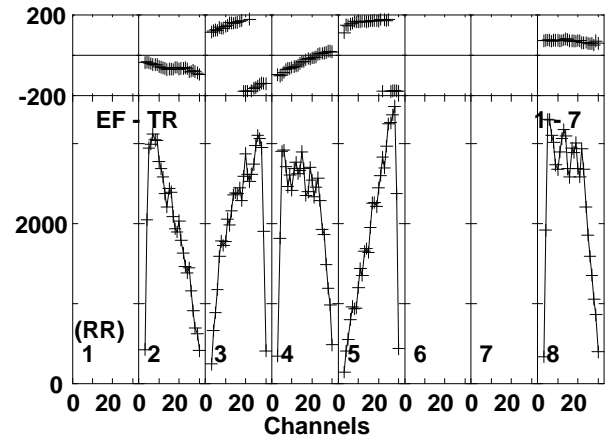
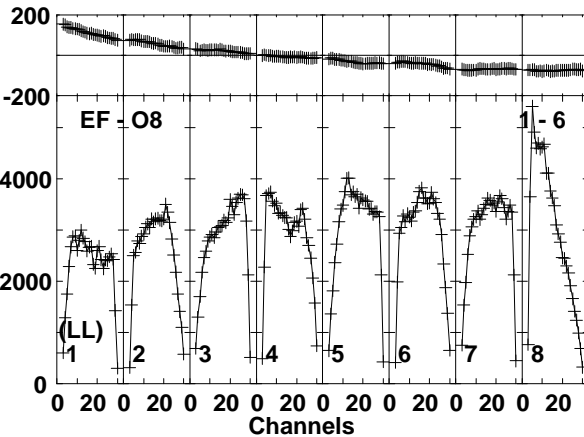
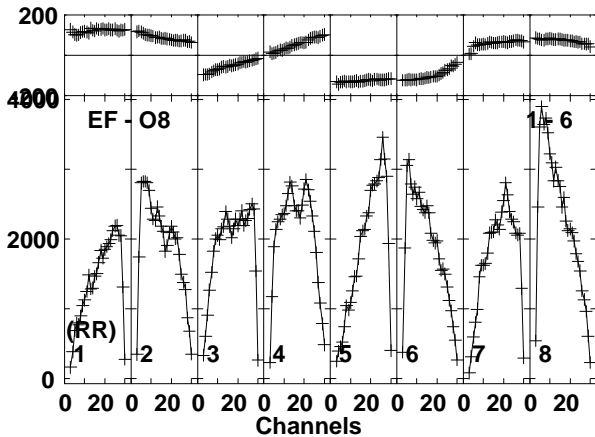
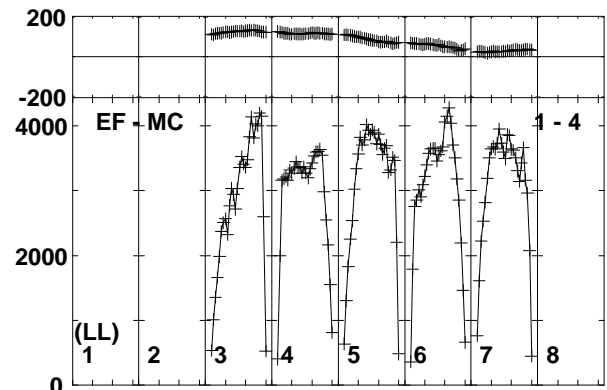
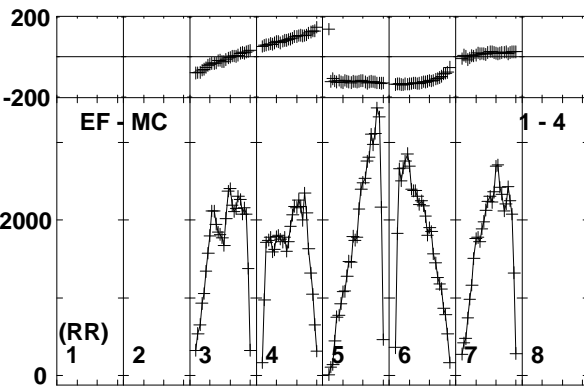
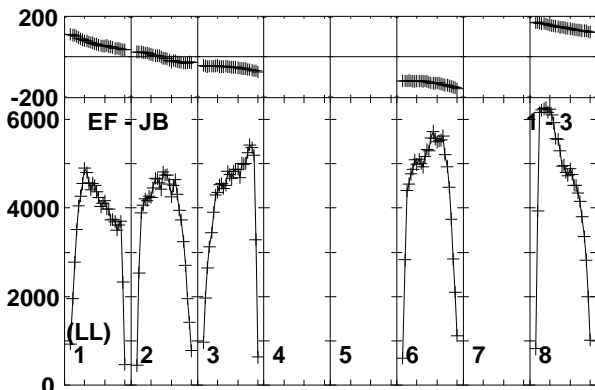
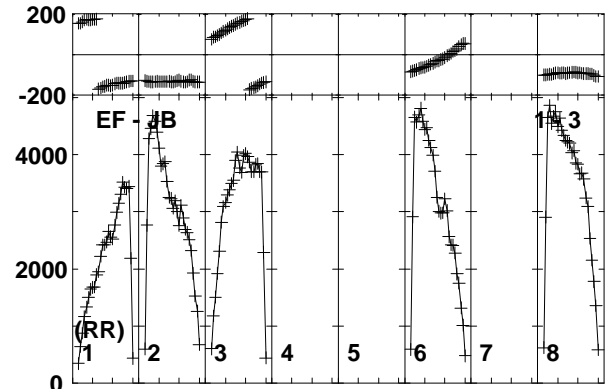
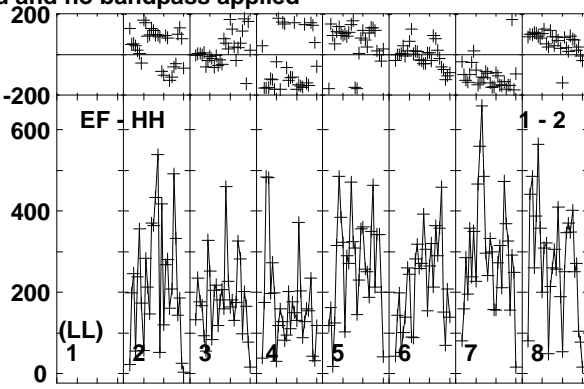
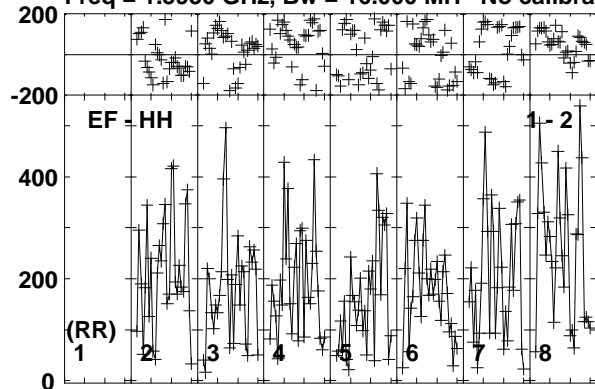

Lower frame: Micro Ampl Jy Top frame: Phas deg  
Vector averaged cross-power spectrum Baseline: EF (01) - HH (02)  
Timerange: 01/01:36:32 to 01/01:37:48

Plot file version 164 created 26-JUN-2015 10:51:24

J2025+3343 ET031A.UVDATA.1

Freq = 1.5950 GHz, Bw = 16.000 MH No calibration applied and no bandpass applied

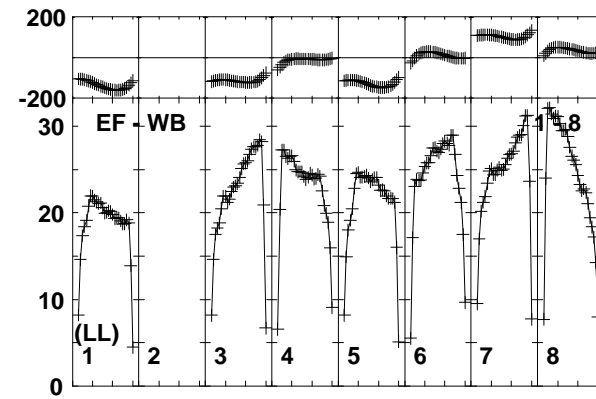
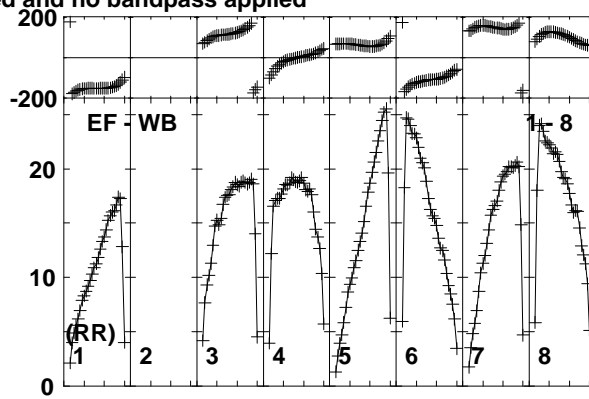
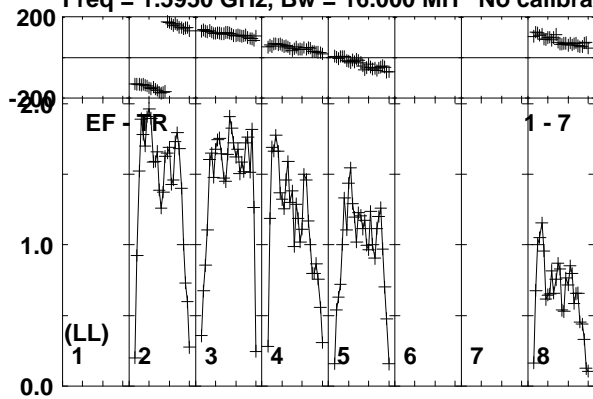

Lower frame: Milli Ampl Jy Top frame: Phas deg  
Vector averaged cross-power spectrum Baseline: EF (01) - TR (07)  
Timerange: 01/01:36:32 to 01/01:37:48

Plot file version 165 created 26-JUN-2015 10:51:24

V404CYG ET031A.UVDATA.1

Freq = 1.5950 GHz, Bw = 16.000 MH No calibration applied and no bandpass applied

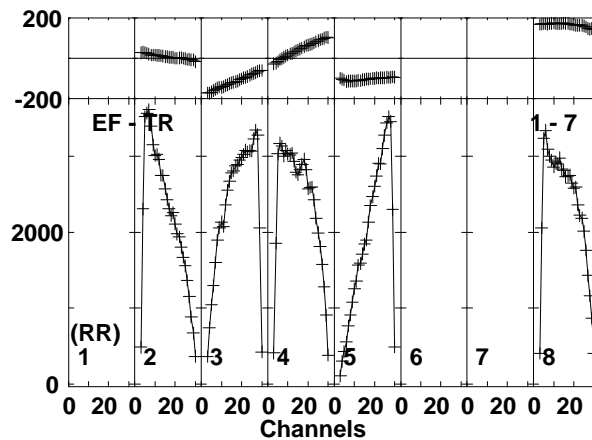
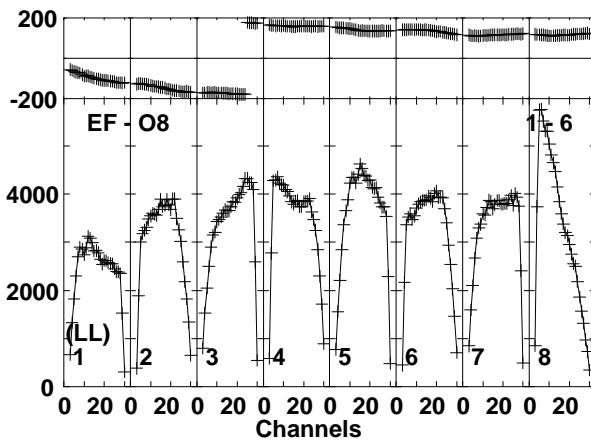
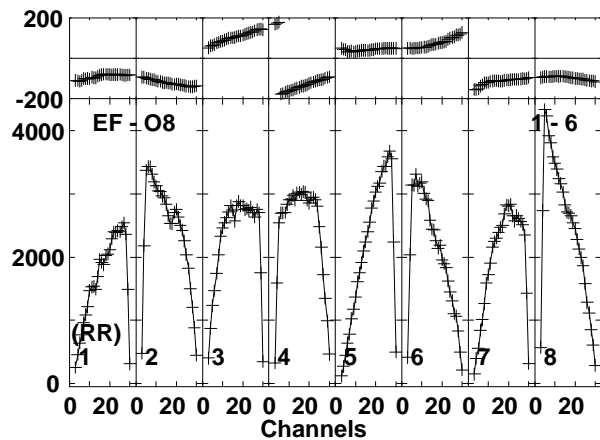
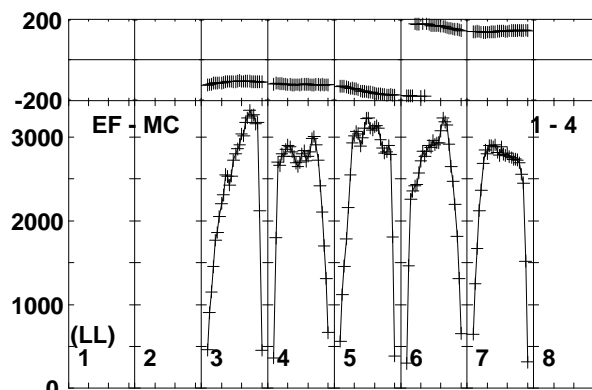
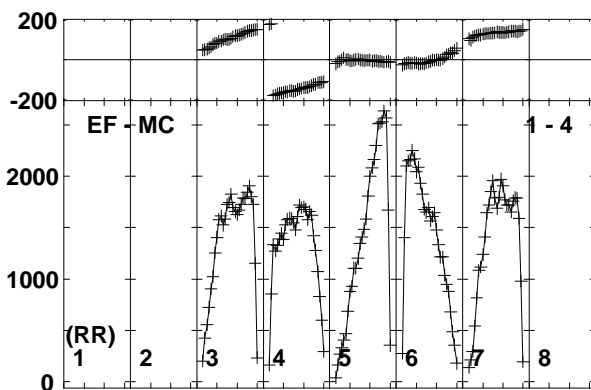
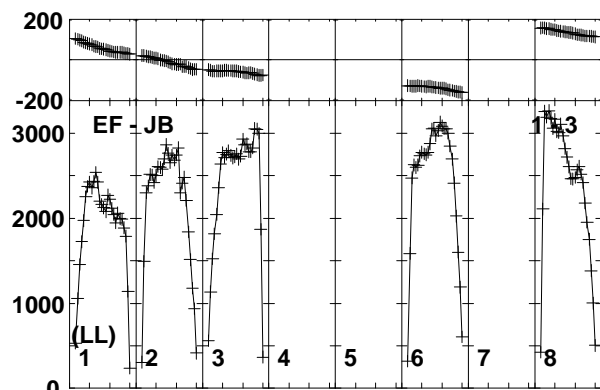
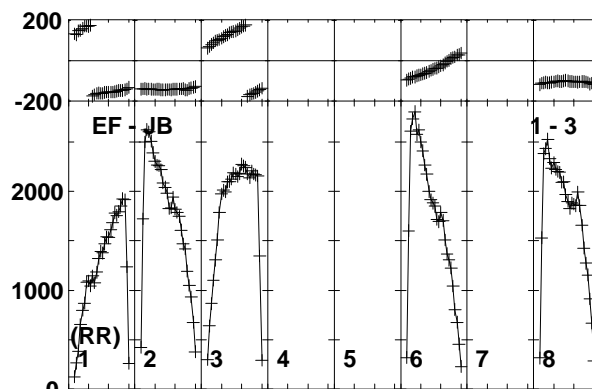
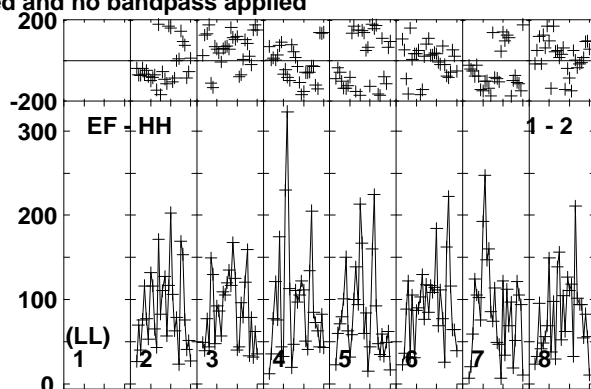
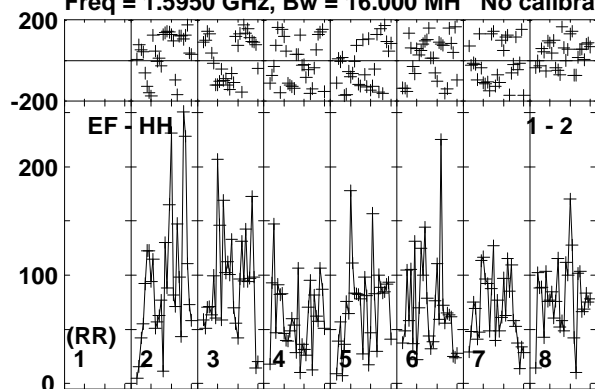

Lower frame: Micro Ampl Jy Top frame: Phas deg  
Vector averaged cross-power spectrum Baseline: EF (01) - HH (02)  
Timerange: 01/01:37:52 to 01/01:41:18

Plot file version 166 created 26-JUN-2015 10:51:24

V404CYG ET031A.UVDATA.1

Freq = 1.5950 GHz, Bw = 16.000 MH No calibration applied and no bandpass applied

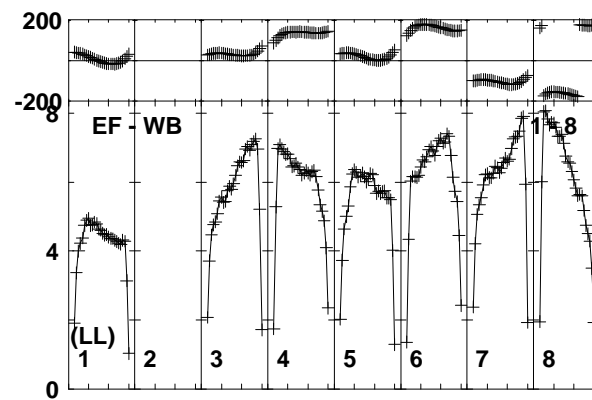
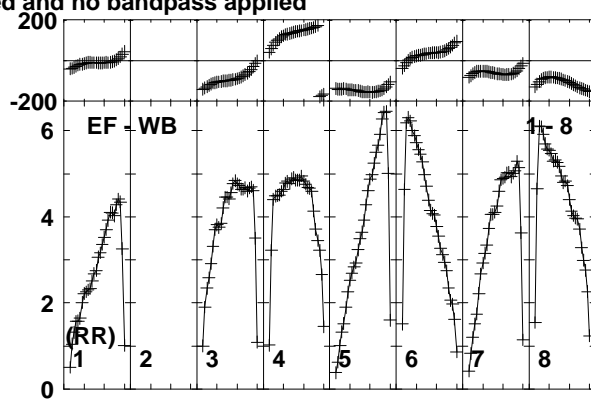
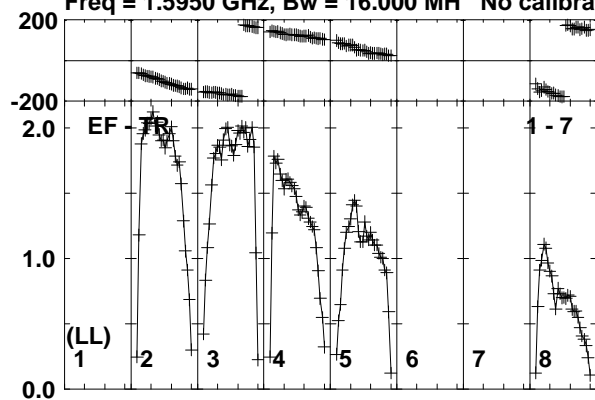

Lower frame: Milli Ampl Jy Top frame: Phas deg  
Vector averaged cross-power spectrum Baseline: EF (01) - TR (07)  
Timerange: 01/01:37:52 to 01/01:41:18

Plot file version 167 created 26-JUN-2015 10:51:24

J2025+3343 ET031A.UVDATA.1

Freq = 1.5950 GHz, Bw = 16.000 MH No calibration applied and no bandpass applied

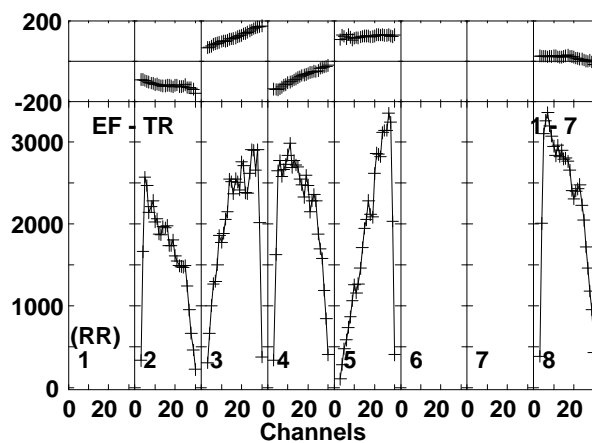
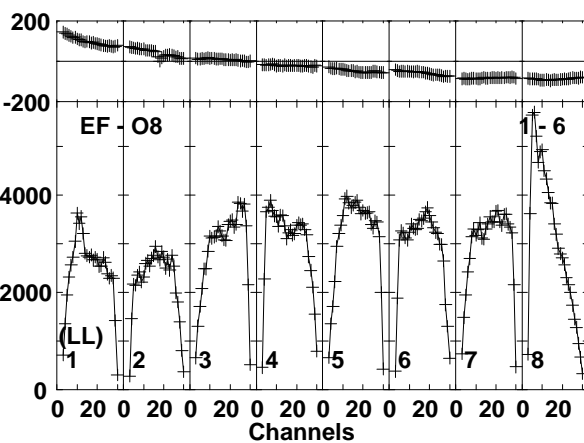
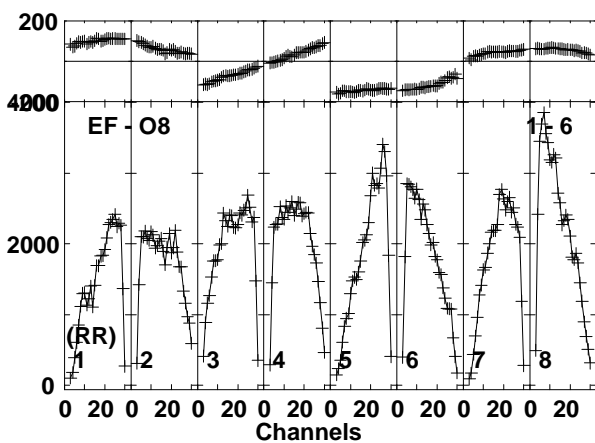
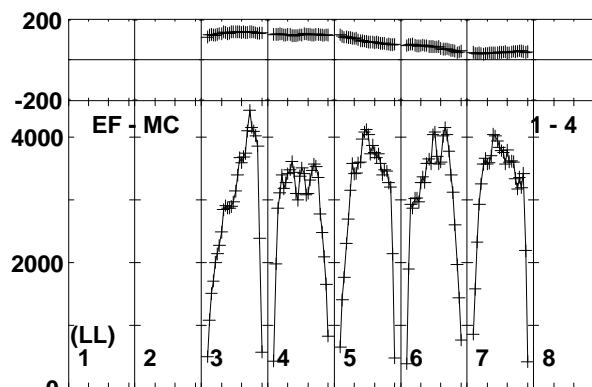
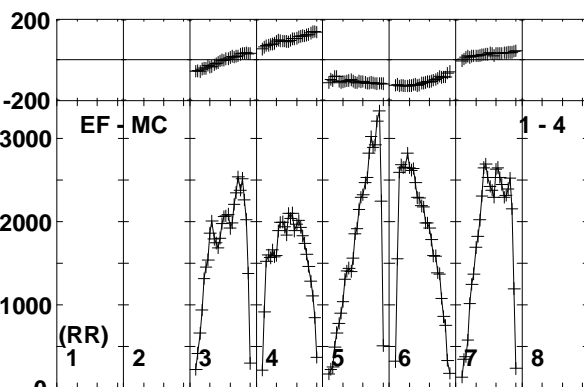
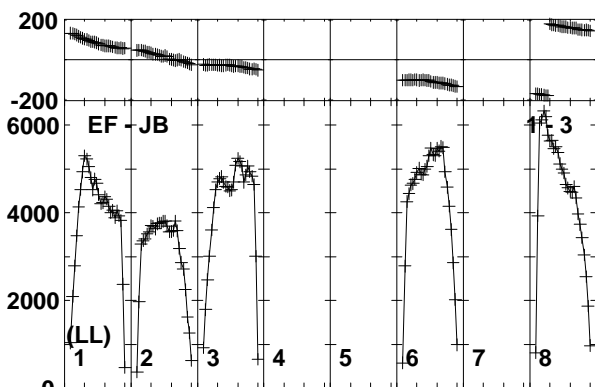
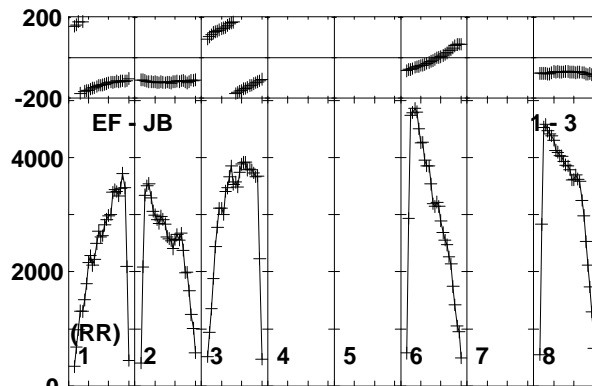
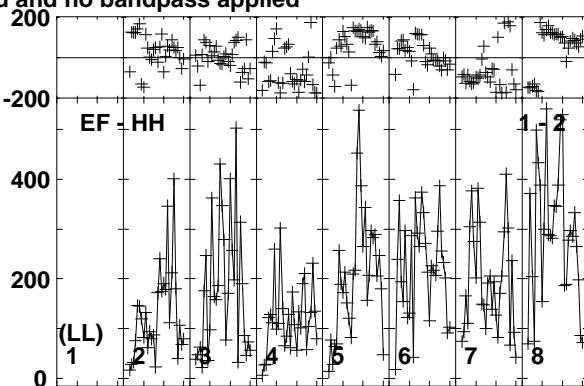
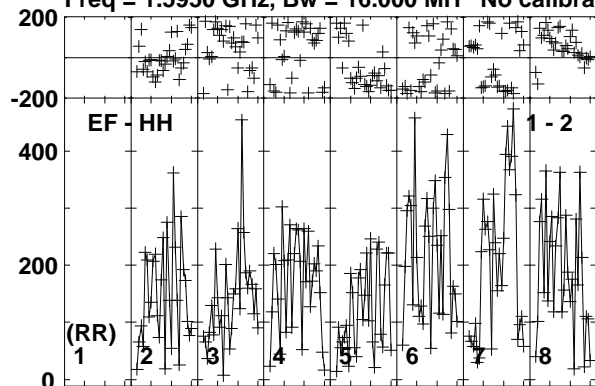

Lower frame: Micro Ampl Jy Top frame: Phas deg  
Vector averaged cross-power spectrum Baseline: EF (01) - HH (02)  
Timerange: 01/01:42:02 to 01/01:42:58

Plot file version 168 created 26-JUN-2015 10:51:24

J2025+3343 ET031A.UVDATA.1

Freq = 1.5950 GHz, Bw = 16.000 MH No calibration applied and no bandpass applied

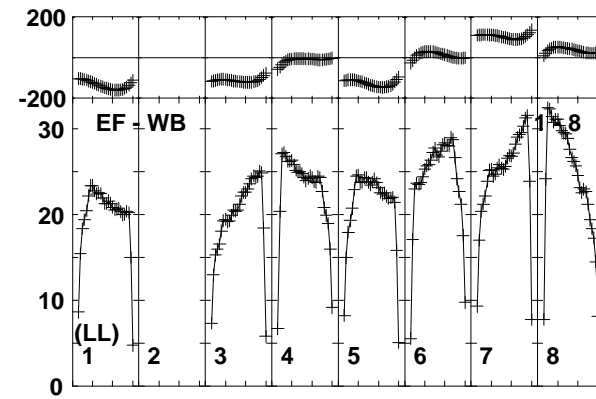
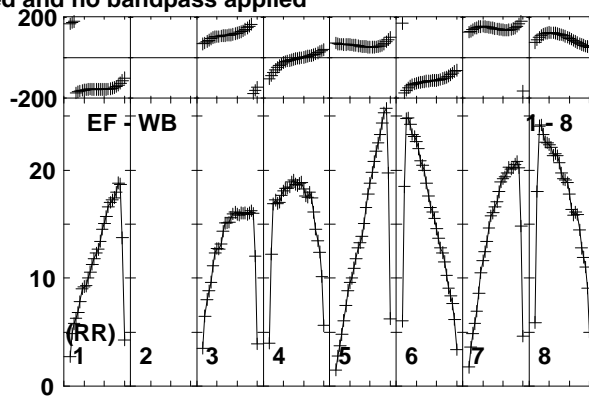
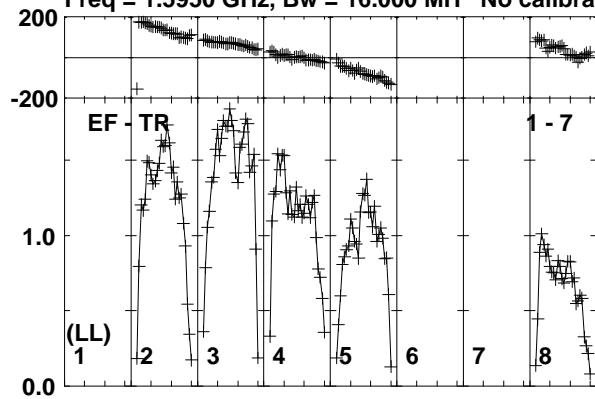

Lower frame: Milli Ampl Jy Top frame: Phas deg  
Vector averaged cross-power spectrum Baseline: EF (01) - TR (07)  
Timerange: 01/01:42:02 to 01/01:42:58



Plot file version 169 created 26-JUN-2015 10:51:24

V404CYG ET031A.UVDATA.1

Freq = 1.5950 GHz, Bw = 16.000 MH No calibration applied and no bandpass applied

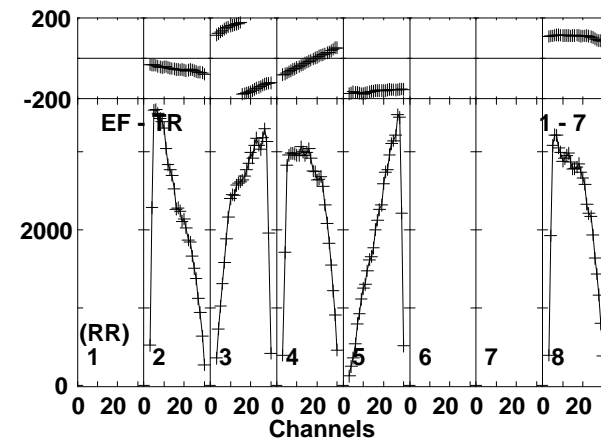
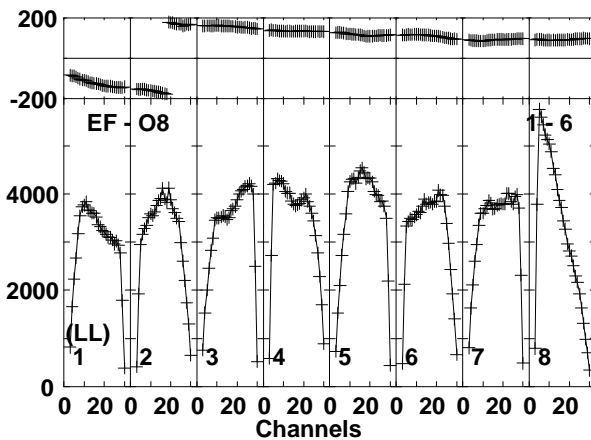
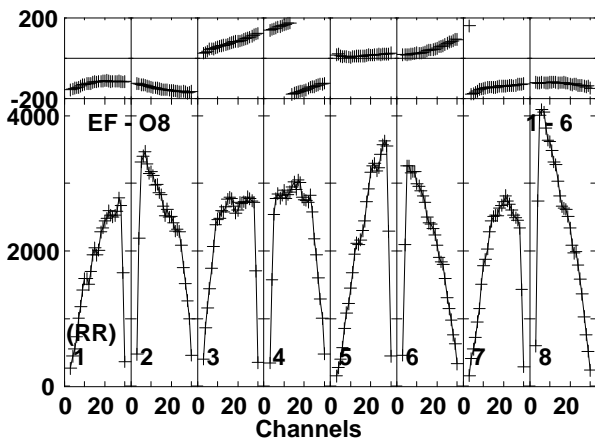
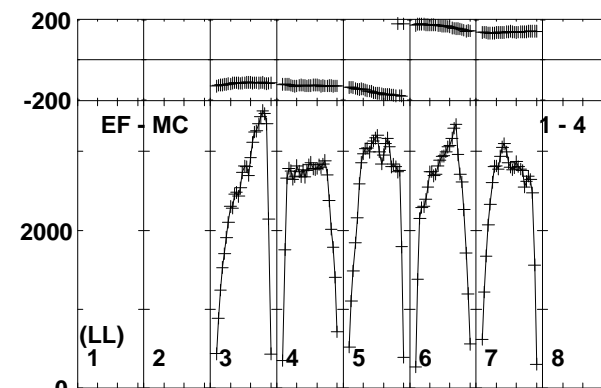
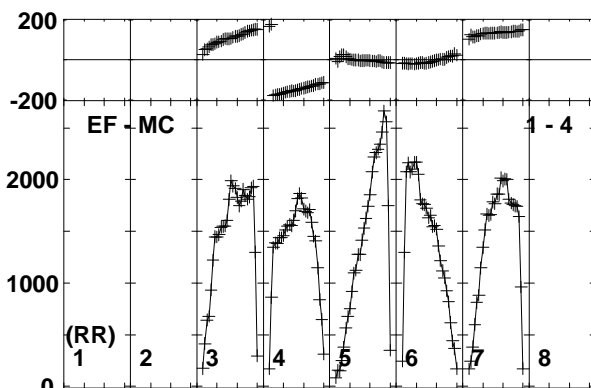
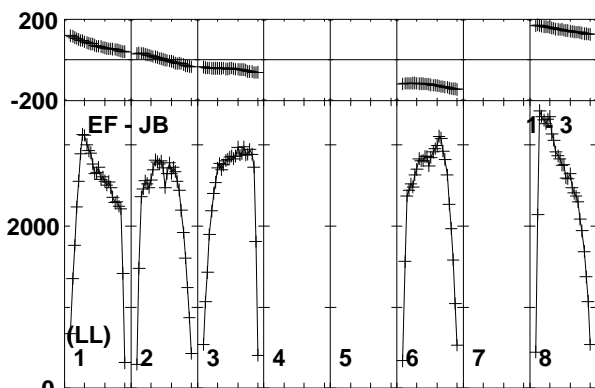
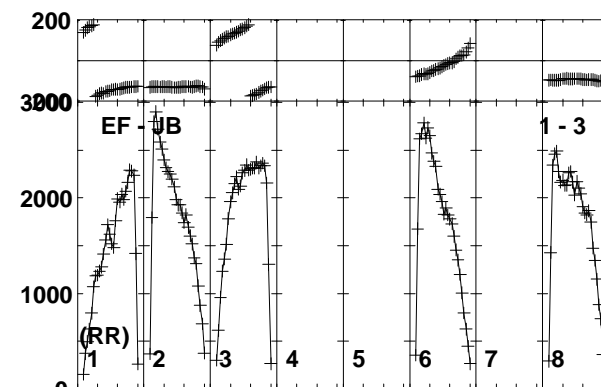
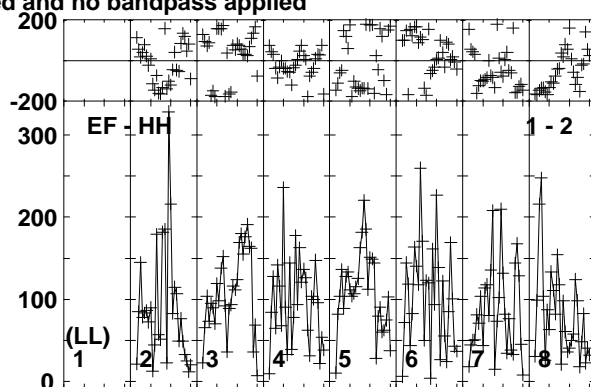
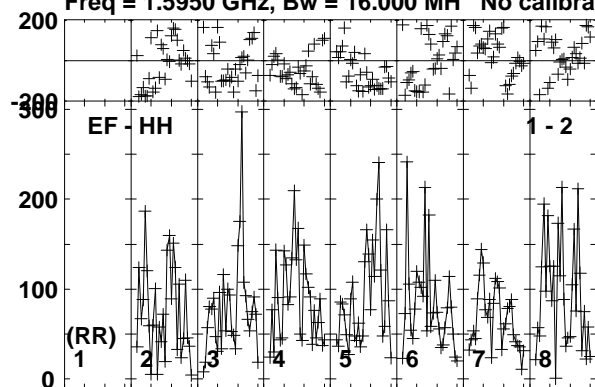

Lower frame: Micro Ampl Jy Top frame: Phas deg  
Vector averaged cross-power spectrum Baseline: EF (01) - HH (02)  
Timerange: 01/01:43:02 to 01/01:46:28

Plot file version 170 created 26-JUN-2015 10:51:24

V404CYG ET031A.UVDATA.1

Freq = 1.5950 GHz, Bw = 16.000 MH No calibration applied and no bandpass applied

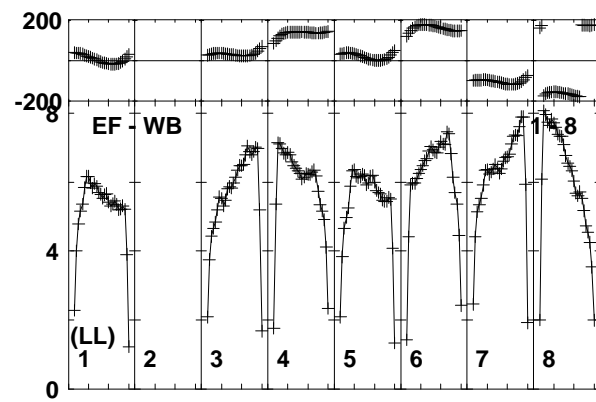
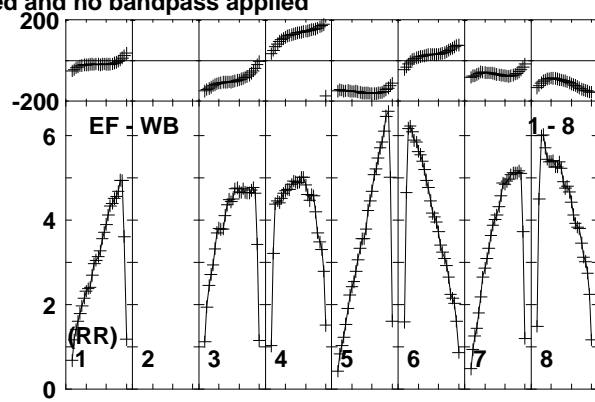
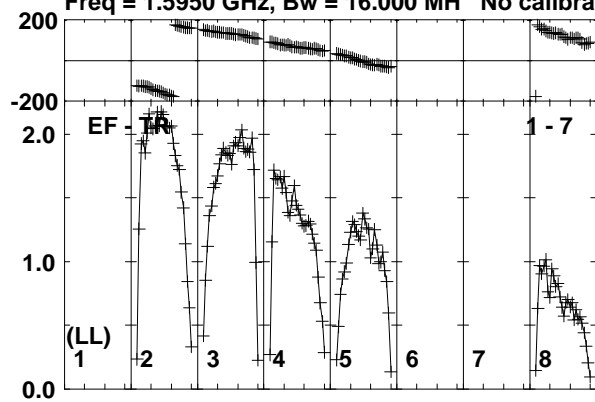

Lower frame: Milli Ampl Jy Top frame: Phas deg  
Vector averaged cross-power spectrum Baseline: EF (01) - TR (07)  
Timerange: 01/01:43:02 to 01/01:46:28

Plot file version 171 created 26-JUN-2015 10:51:24

J2025+3343 ET031A.UVDATA.1

Freq = 1.5950 GHz, Bw = 16.000 MH No calibration applied and no bandpass applied

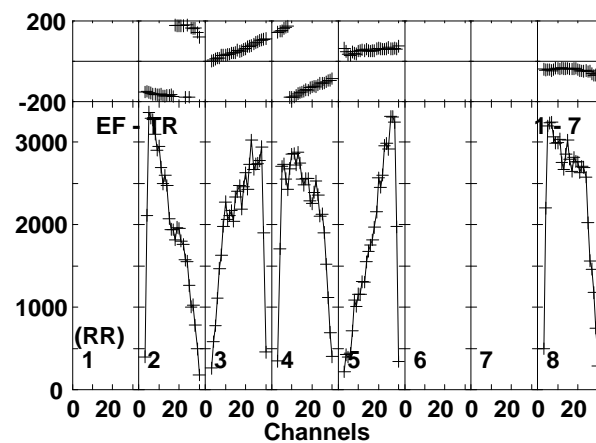
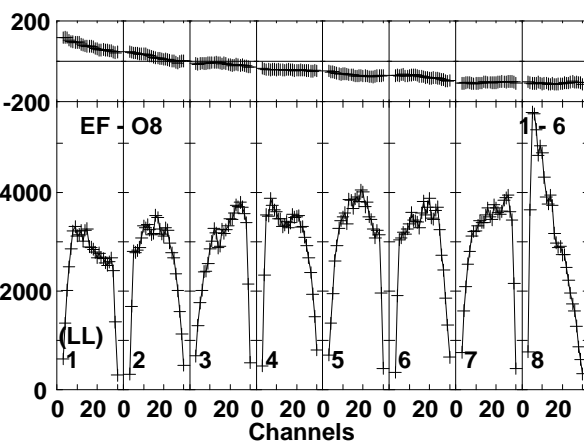
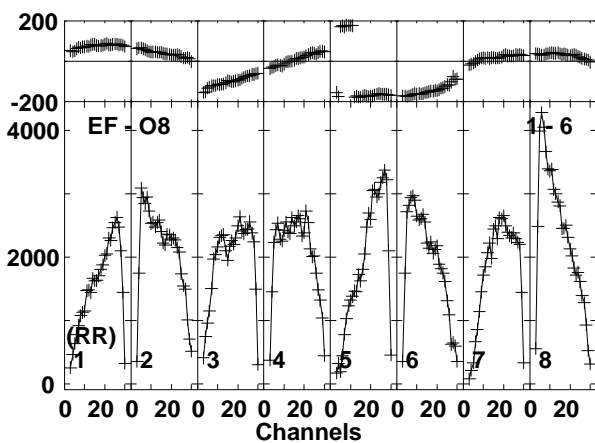
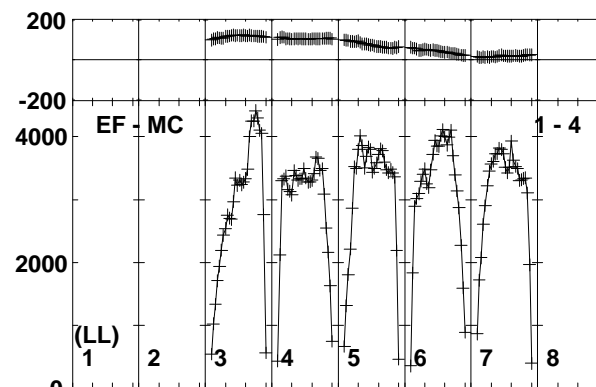
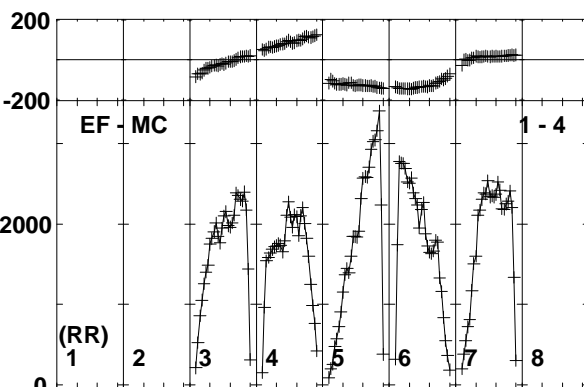
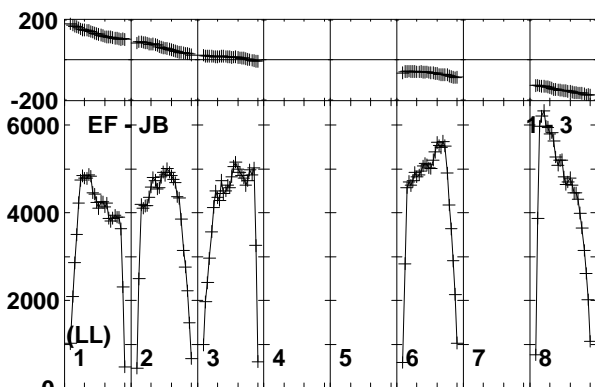
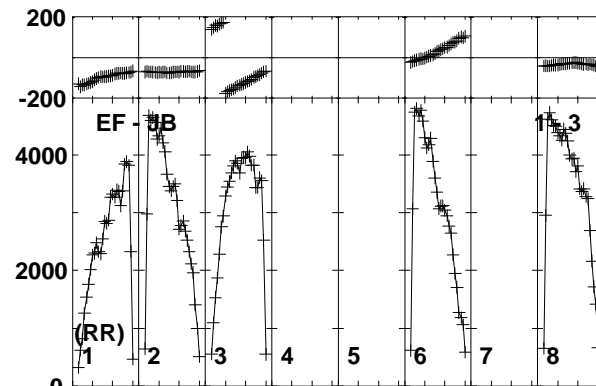
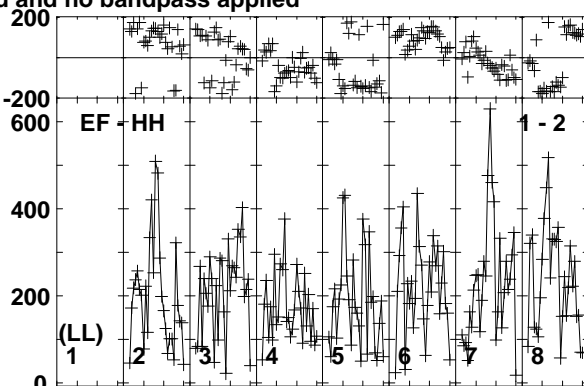
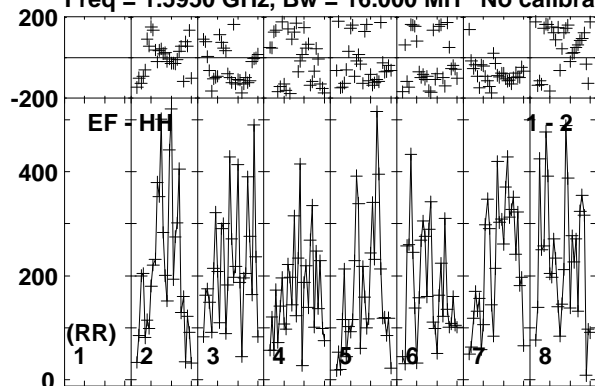

Lower frame: Micro Ampl Jy Top frame: Phas deg  
Vector averaged cross-power spectrum Baseline: EF (01) - HH (02)  
Timerange: 01/01:46:32 to 01/01:47:48

Plot file version 172 created 26-JUN-2015 10:51:24

J2025+3343 ET031A.UVDATA.1

Freq = 1.5950 GHz, Bw = 16.000 MH No calibration applied and no bandpass applied

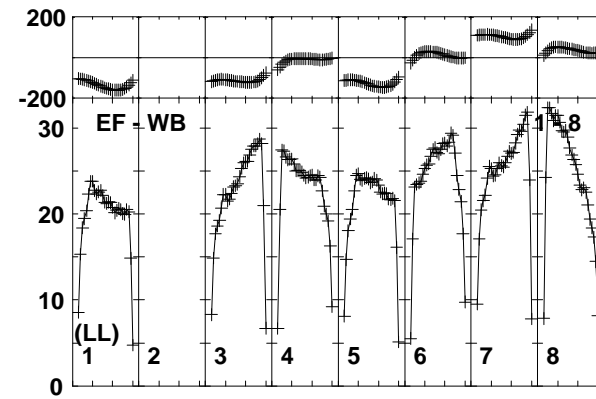
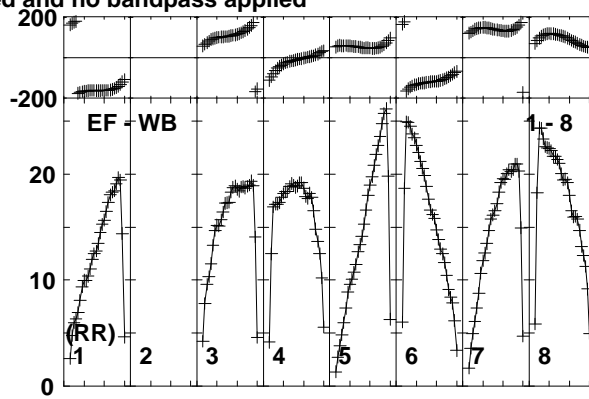
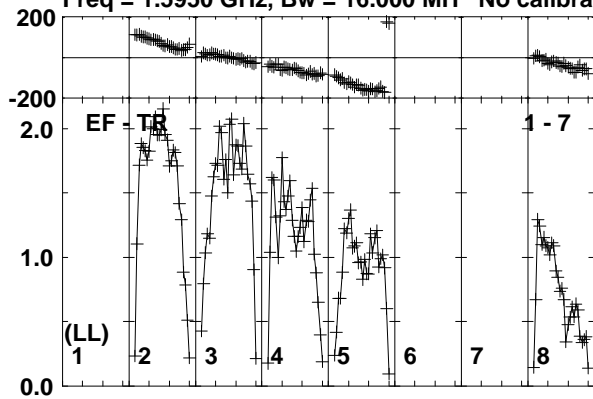

Lower frame: Milli Ampl Jy Top frame: Phas deg  
Vector averaged cross-power spectrum Baseline: EF (01) - TR (07)  
Timerange: 01/01:46:32 to 01/01:47:48

Plot file version 173 created 26-JUN-2015 10:51:24

V404CYG ET031A.UVDATA.1

Freq = 1.5950 GHz, Bw = 16.000 MH No calibration applied and no bandpass applied

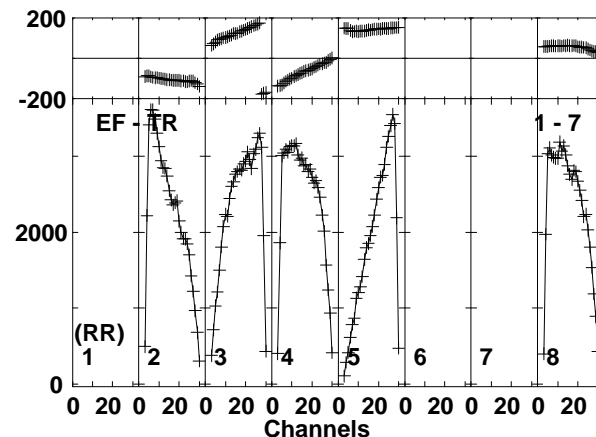
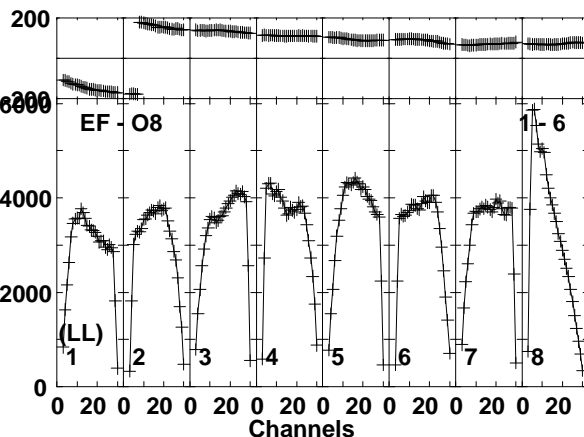
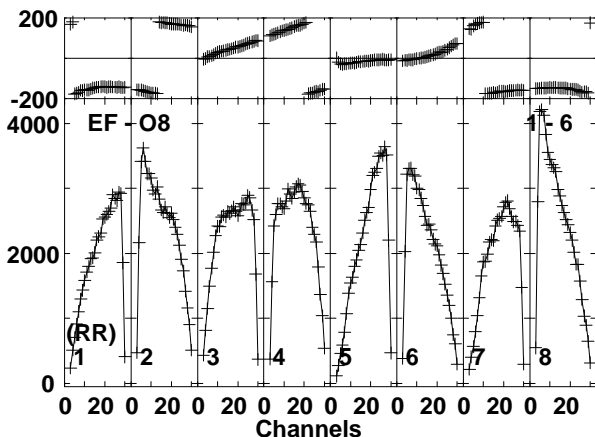
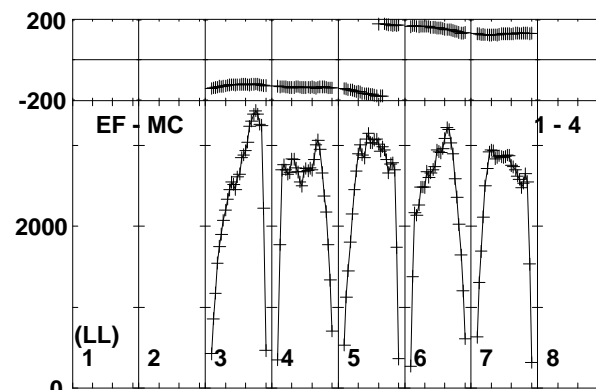
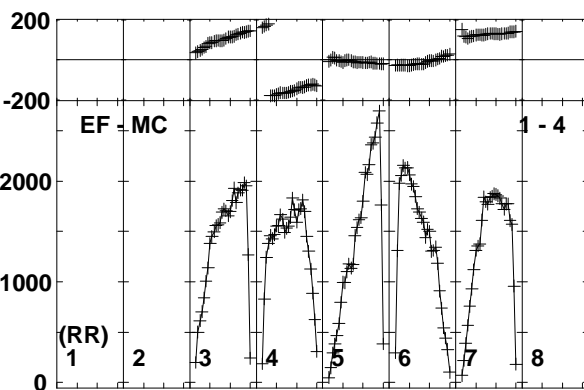
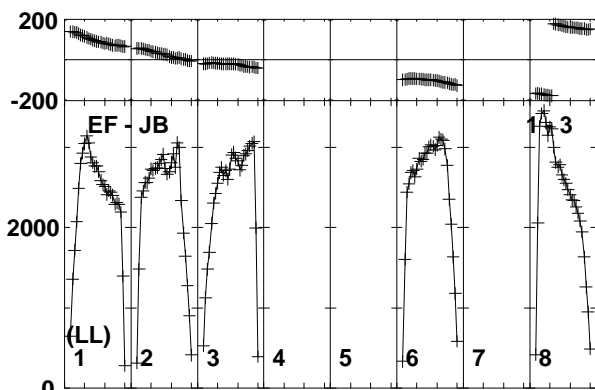
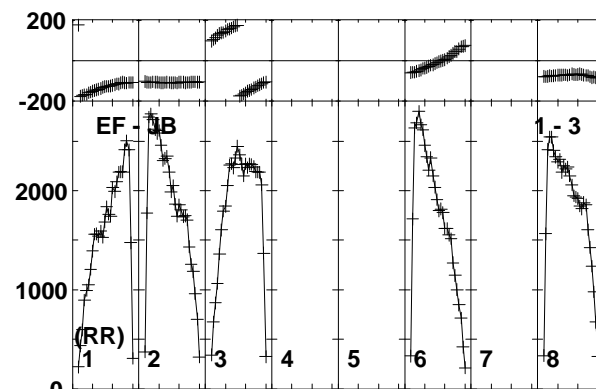
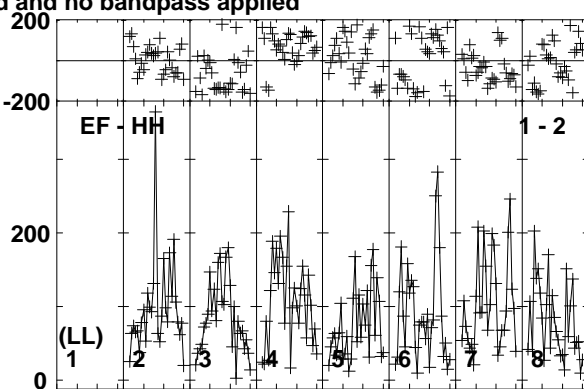
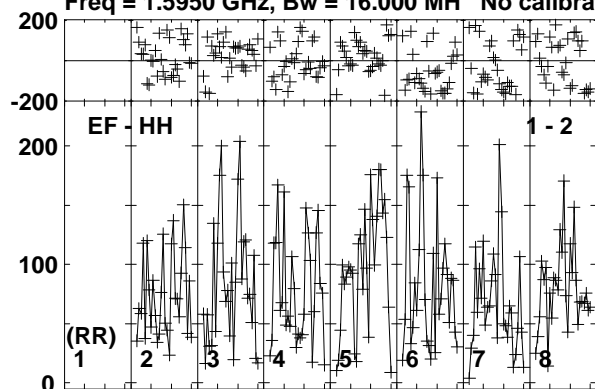

Lower frame: Micro Ampl Jy Top frame: Phas deg  
Vector averaged cross-power spectrum Baseline: EF (01) - HH (02)  
Timerange: 01/01:47:52 to 01/01:51:18

Plot file version 174 created 26-JUN-2015 10:51:24

V404CYG ET031A.UVDATA.1

Freq = 1.5950 GHz, Bw = 16.000 MH No calibration applied and no bandpass applied

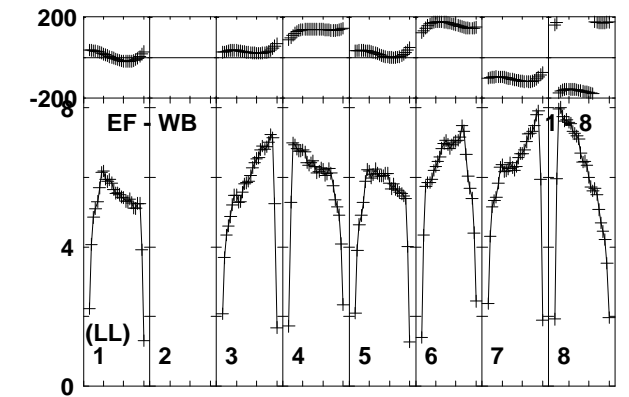
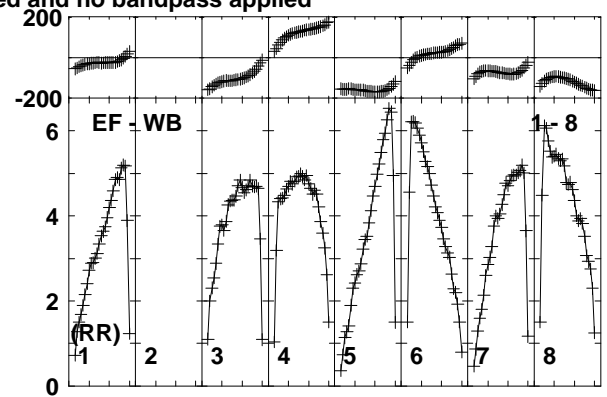
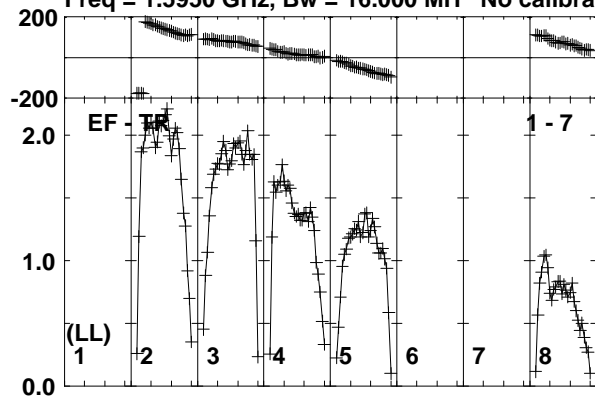

Lower frame: Milli Ampl Jy Top frame: Phas deg  
Vector averaged cross-power spectrum Baseline: EF (01) - TR (07)  
Timerange: 01/01:47:52 to 01/01:51:18

Plot file version 175 created 26-JUN-2015 10:51:24

J2025+3343 ET031A.UVDATA.1

Freq = 1.5950 GHz, Bw = 16.000 MH No calibration applied and no bandpass applied

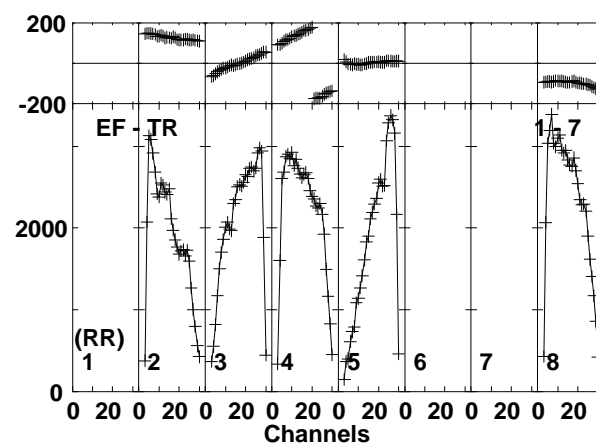
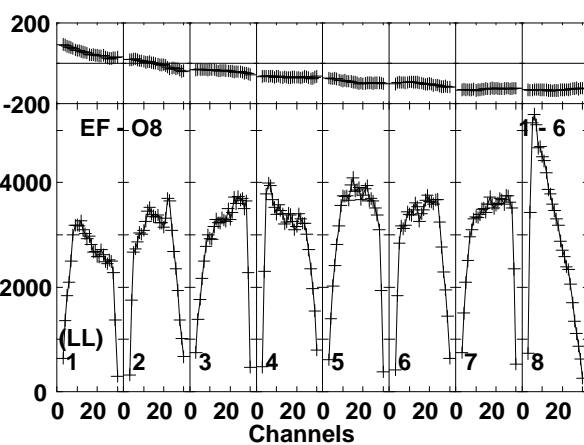
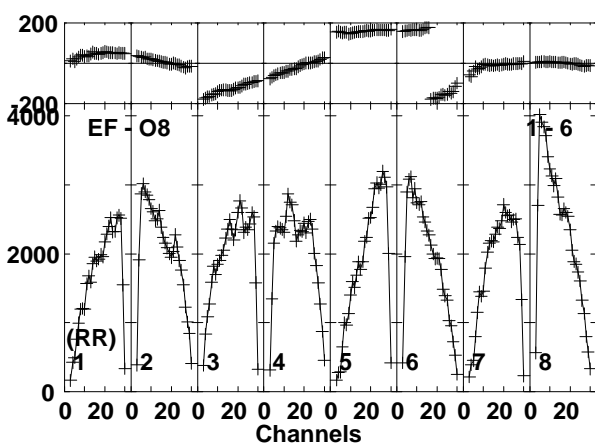
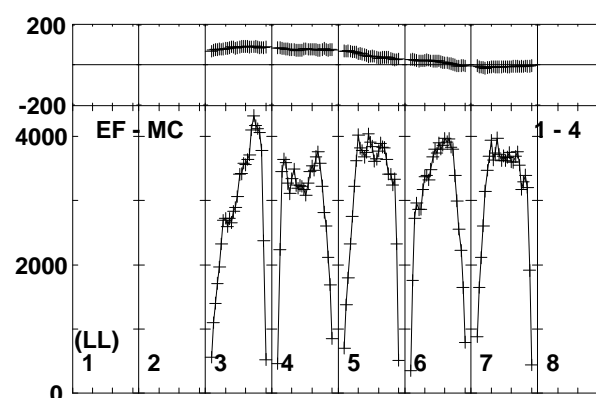
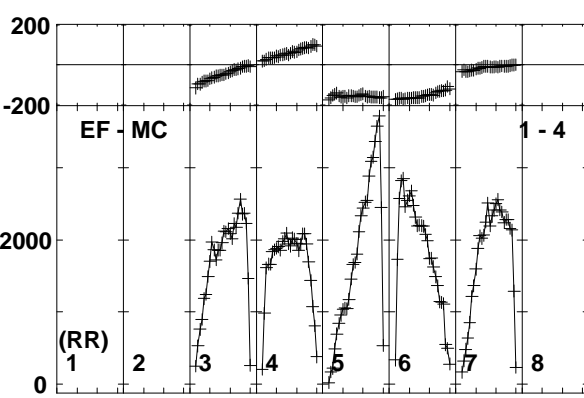
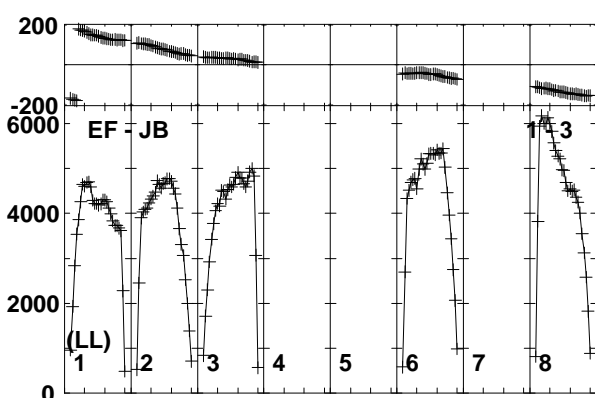
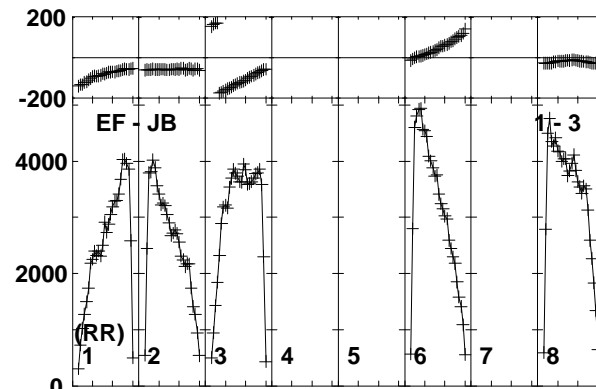
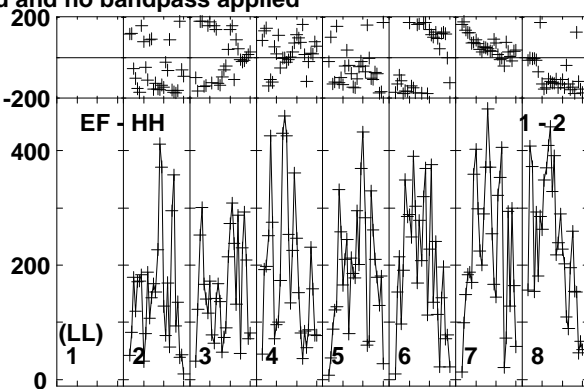
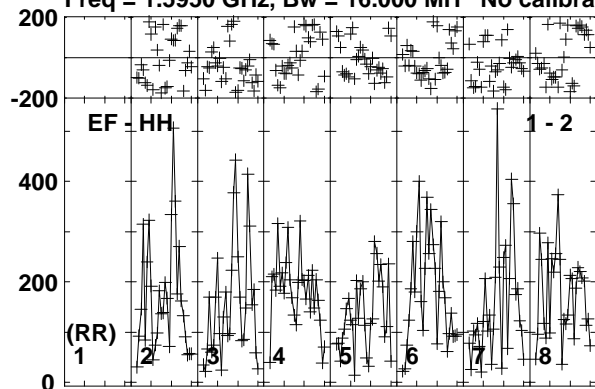

Lower frame: Micro Ampl Jy Top frame: Phas deg  
Vector averaged cross-power spectrum Baseline: EF (01) - HH (02)  
Timerange: 01/01:52:02 to 01/01:52:58

Plot file version 176 created 26-JUN-2015 10:51:24

J2025+3343 ET031A.UVDATA.1

Freq = 1.5950 GHz, Bw = 16.000 MH No calibration applied and no bandpass applied

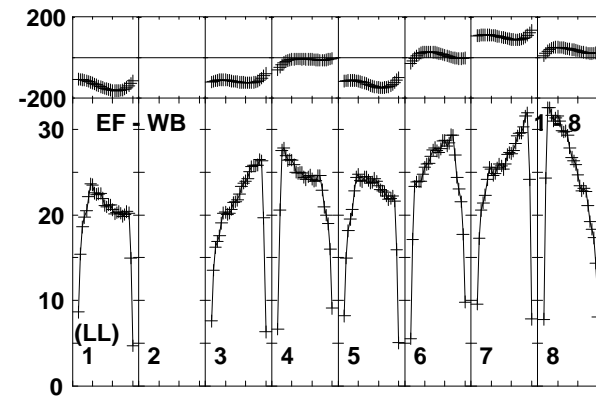
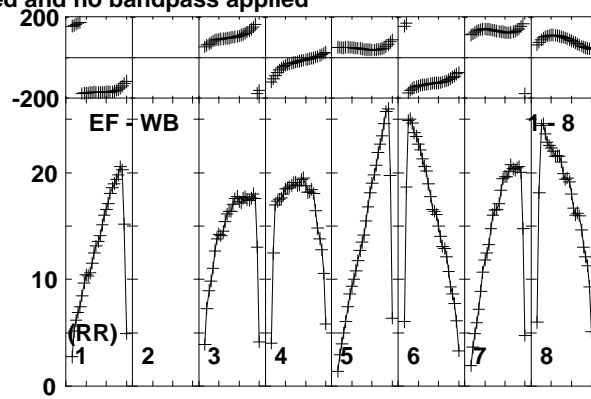
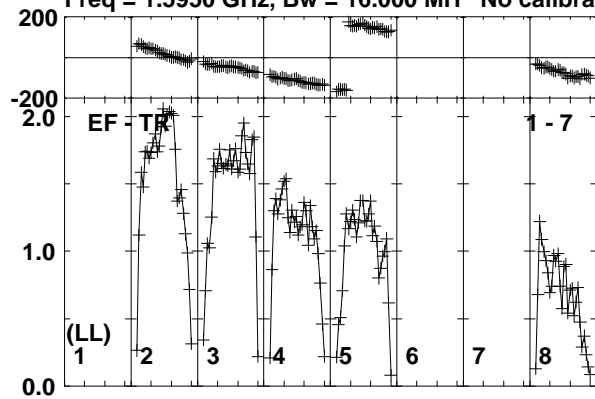

Lower frame: Milli Ampl Jy Top frame: Phas deg  
Vector averaged cross-power spectrum Baseline: EF (01) - TR (07)  
Timerange: 01/01:52:02 to 01/01:52:58



Plot file version 177 created 26-JUN-2015 10:51:24

V404CYG ET031A.UVDATA.1

Freq = 1.5950 GHz, Bw = 16.000 MH No calibration applied and no bandpass applied

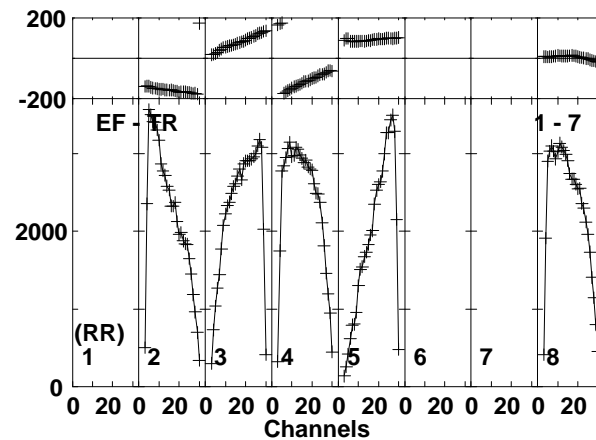
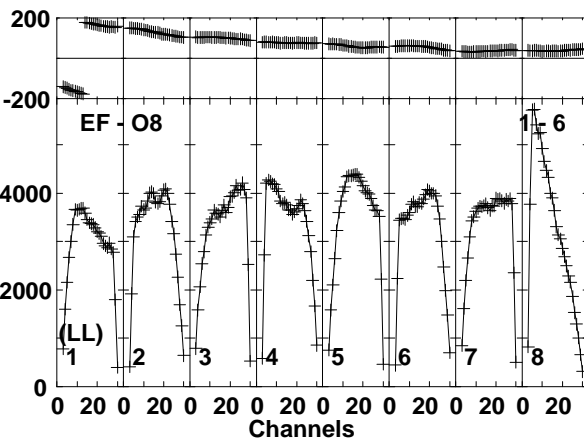
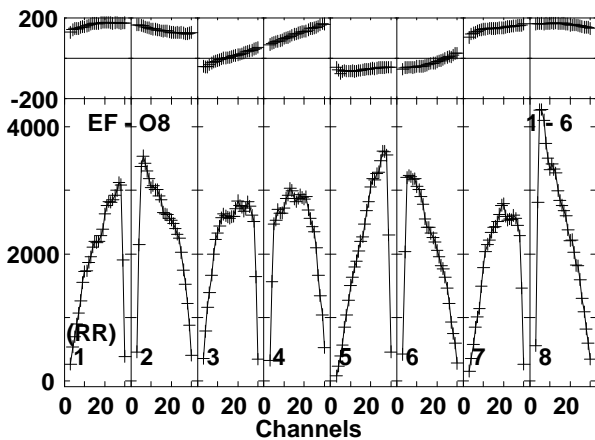
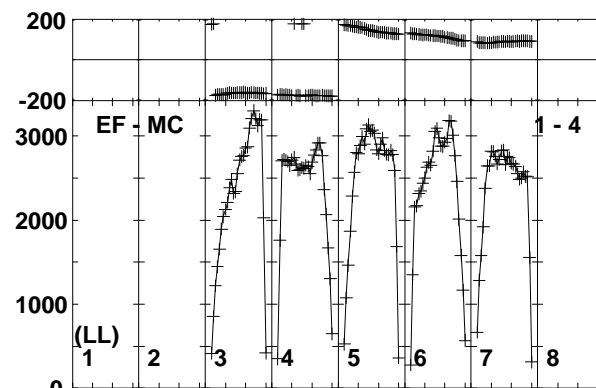
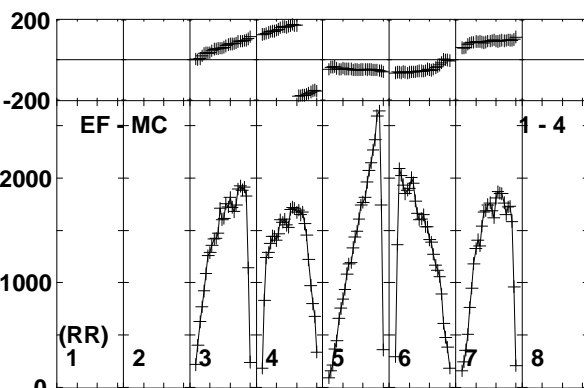
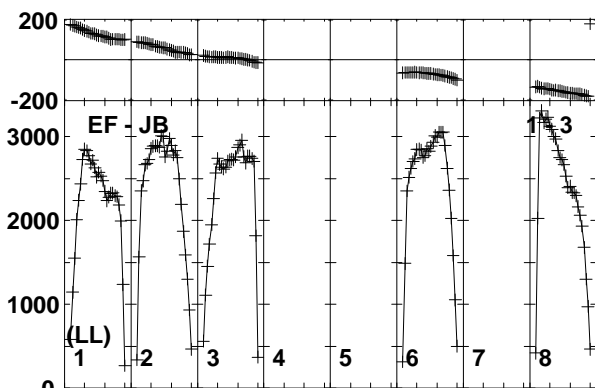
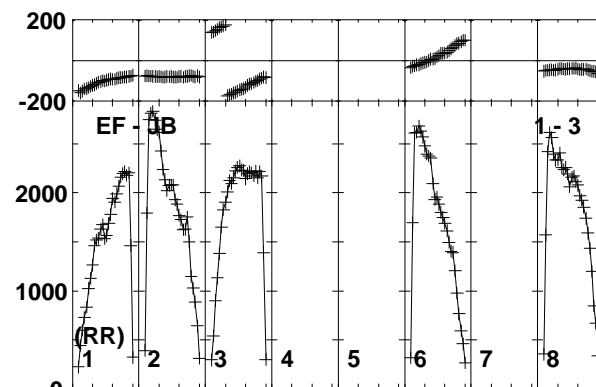
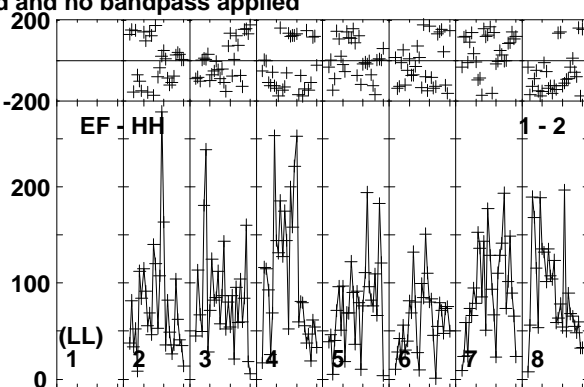
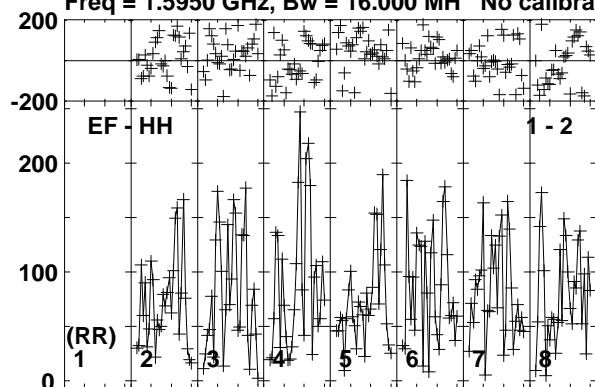

Lower frame: Micro Ampl Jy Top frame: Phas deg  
Vector averaged cross-power spectrum Baseline: EF (01) - HH (02)  
Timerange: 01/01:53:02 to 01/01:56:28

Plot file version 178 created 26-JUN-2015 10:51:24

V404CYG ET031A.UVDATA.1

Freq = 1.5950 GHz, Bw = 16.000 MH No calibration applied and no bandpass applied

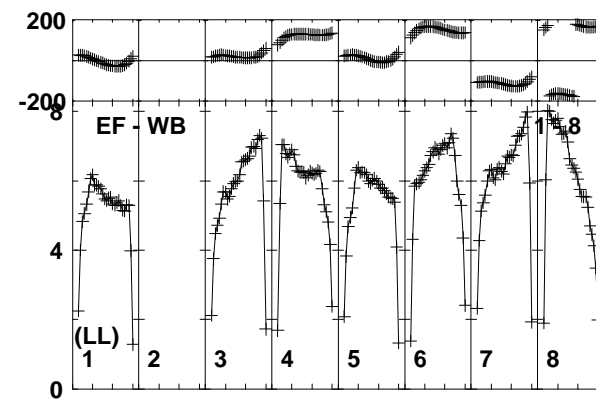
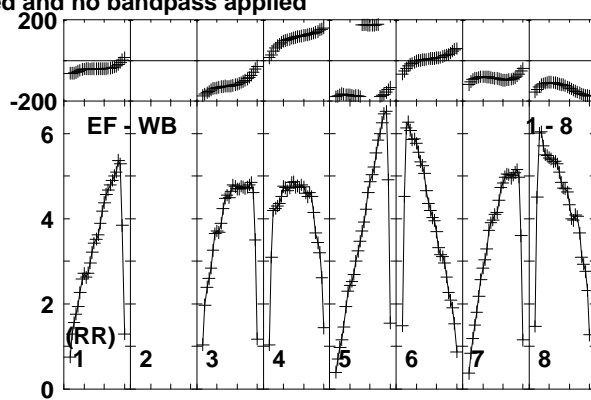
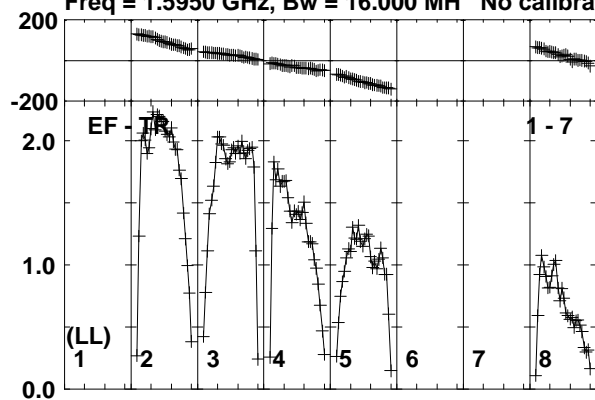

Lower frame: Milli Ampl Jy Top frame: Phas deg  
Vector averaged cross-power spectrum Baseline: EF (01) - TR (07)  
Timerange: 01/01:53:02 to 01/01:56:28

Plot file version 179 created 26-JUN-2015 10:51:25

J2025+3343 ET031A.UVDATA.1

Freq = 1.5950 GHz, Bw = 16.000 MH No calibration applied and no bandpass applied

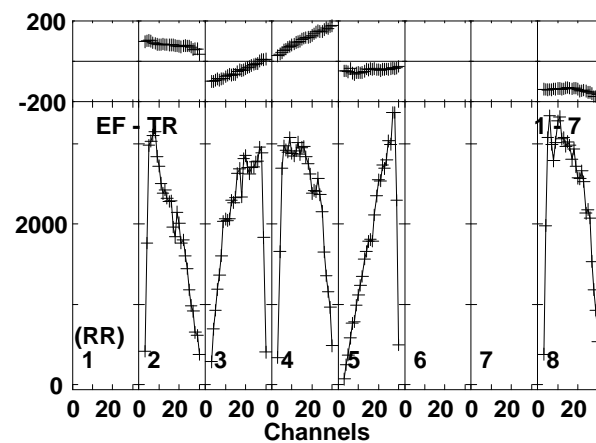
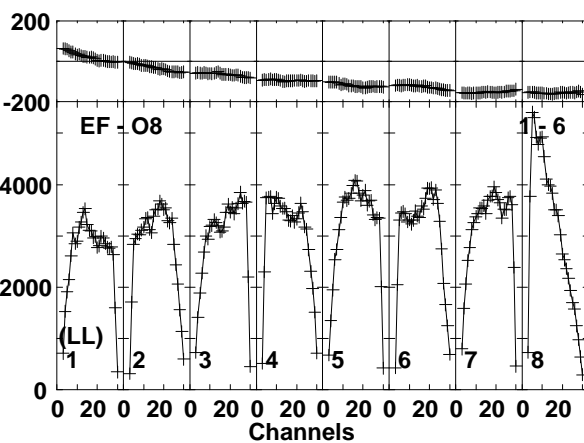
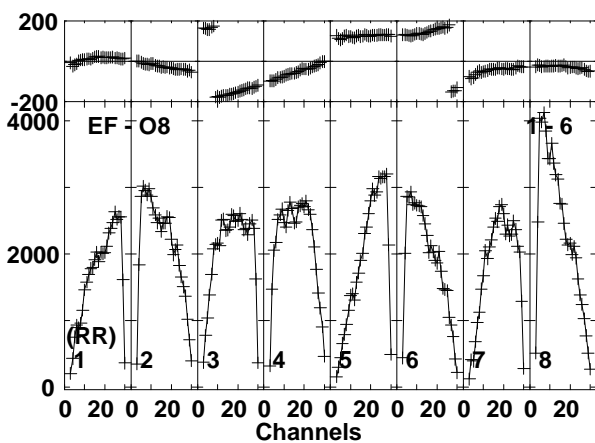
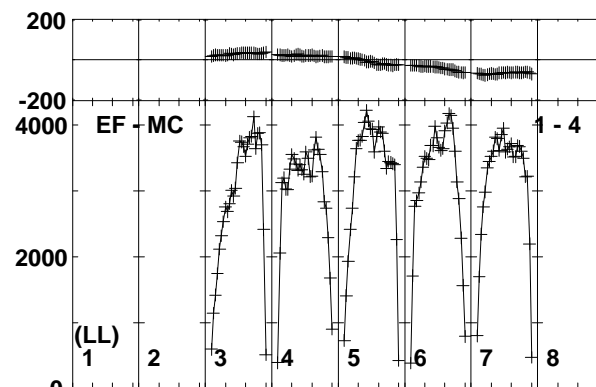
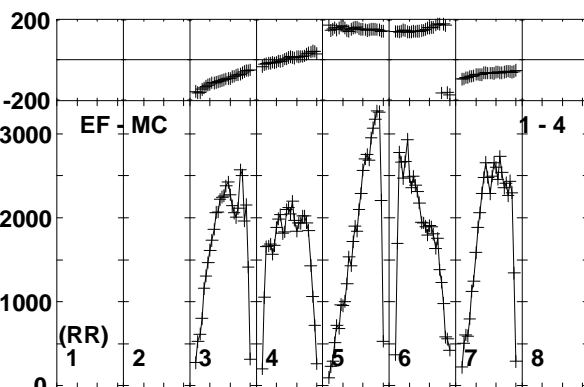
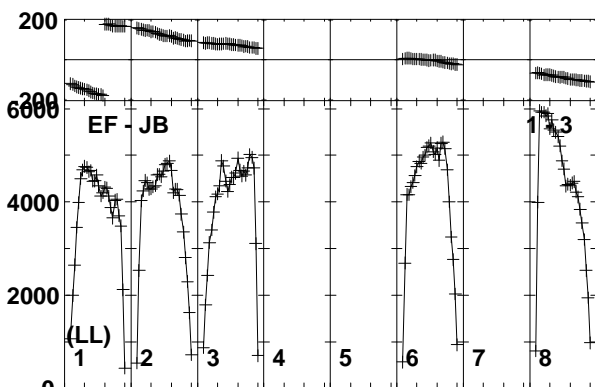
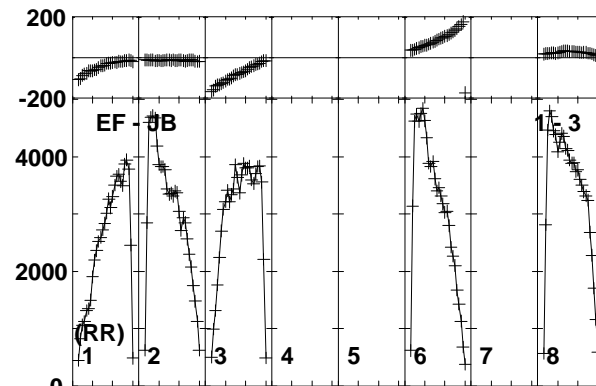
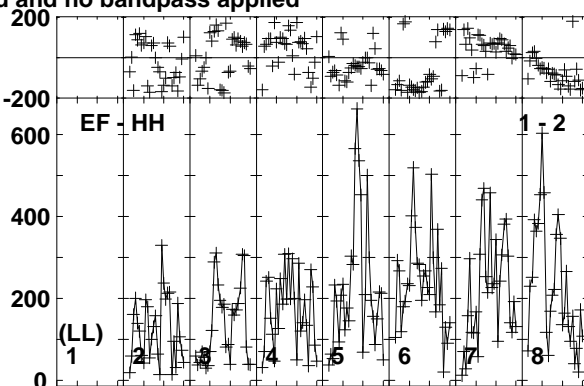
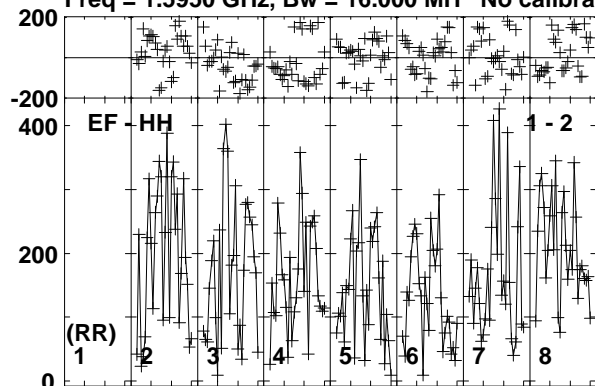

Lower frame: Micro Ampl Jy Top frame: Phas deg  
Vector averaged cross-power spectrum Baseline: EF (01) - HH (02)  
Timerange: 01/01:56:32 to 01/01:57:48

Plot file version 180 created 26-JUN-2015 10:51:25

J2025+3343 ET031A.UVDATA.1

Freq = 1.5950 GHz, Bw = 16.000 MH No calibration applied and no bandpass applied

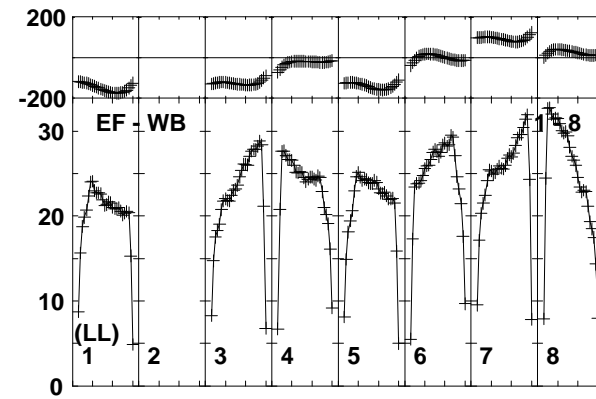
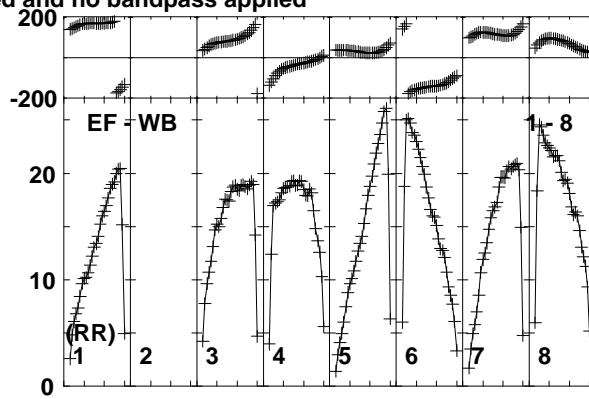
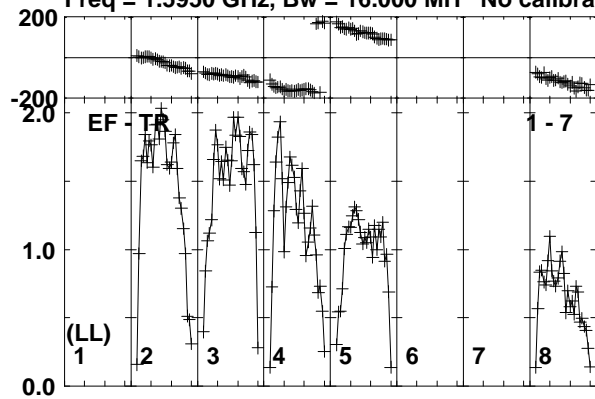

Lower frame: Milli Ampl Jy Top frame: Phas deg  
Vector averaged cross-power spectrum Baseline: EF (01) - TR (07)  
Timerange: 01/01:56:32 to 01/01:57:48

Plot file version 181 created 26-JUN-2015 10:51:25

V404CYG ET031A.UVDATA.1

Freq = 1.5950 GHz, Bw = 16.000 MH No calibration applied and no bandpass applied

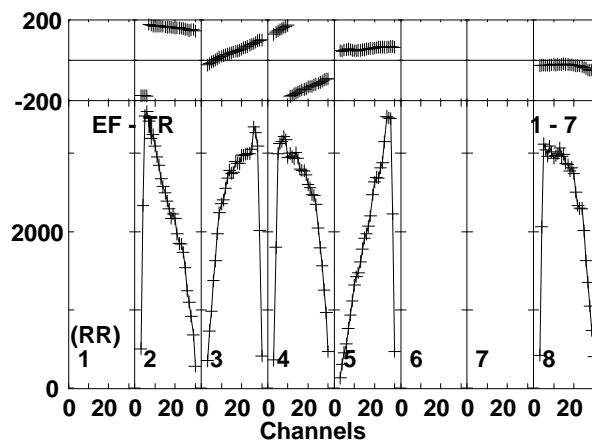
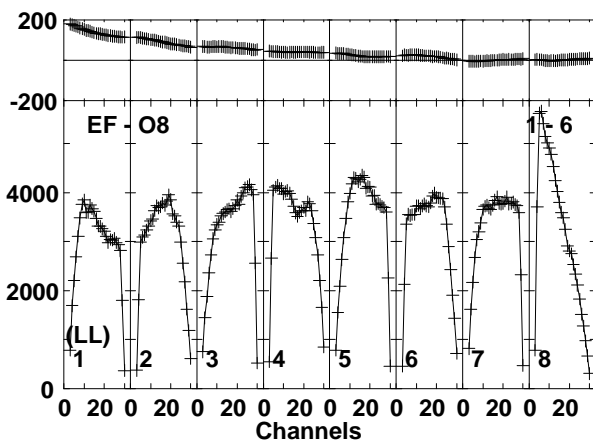
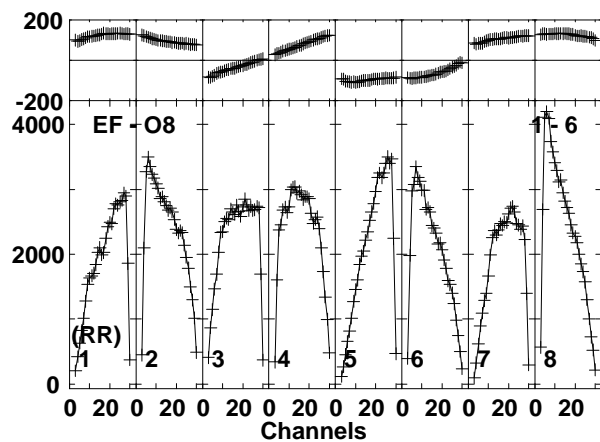
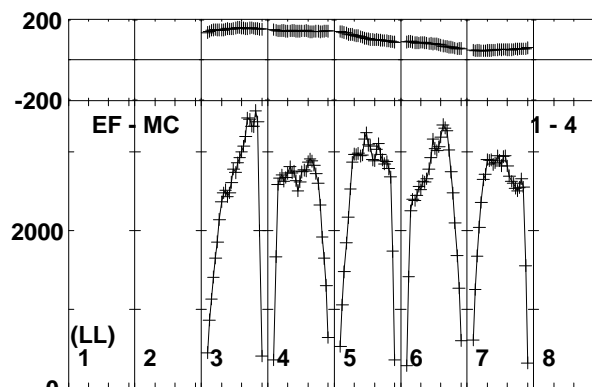
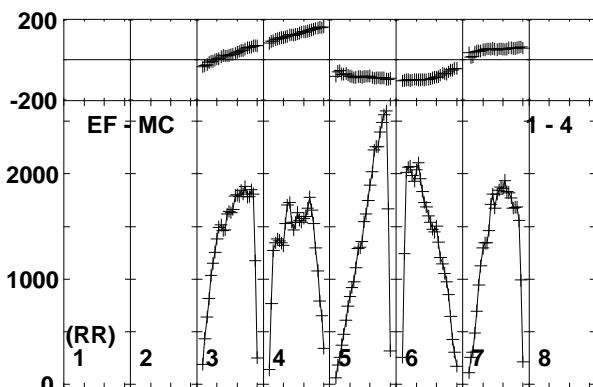
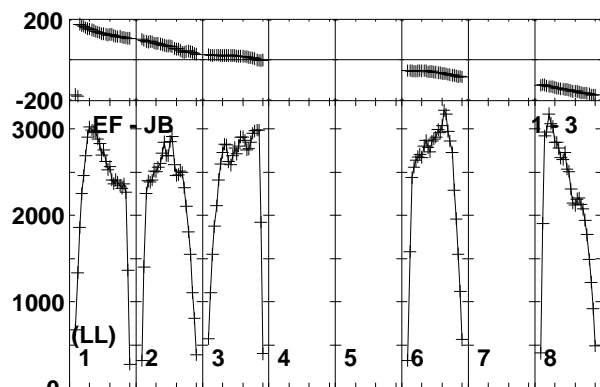
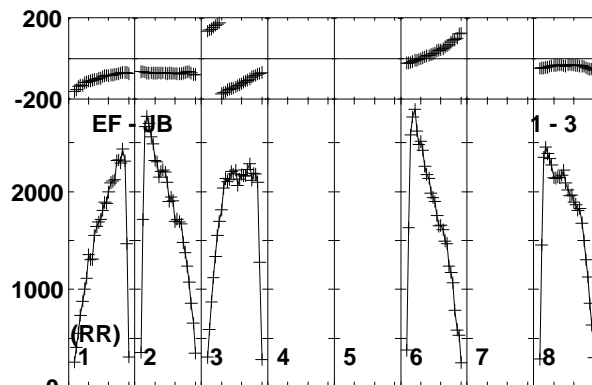
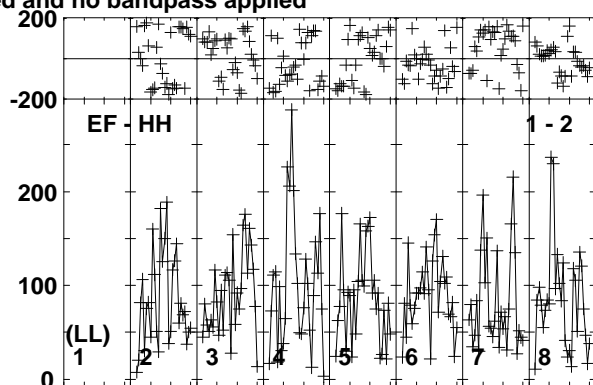
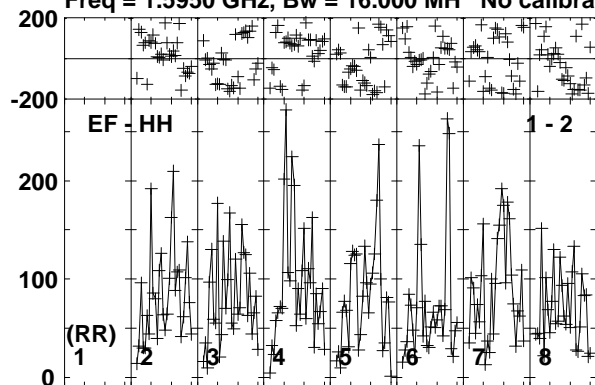

Lower frame: Micro Ampl Jy Top frame: Phas deg  
Vector averaged cross-power spectrum Baseline: EF (01) - HH (02)  
Timerange: 01/01:57:52 to 01/02:01:18

Plot file version 182 created 26-JUN-2015 10:51:25

V404CYG ET031A.UVDATA.1

Freq = 1.5950 GHz, Bw = 16.000 MH No calibration applied and no bandpass applied

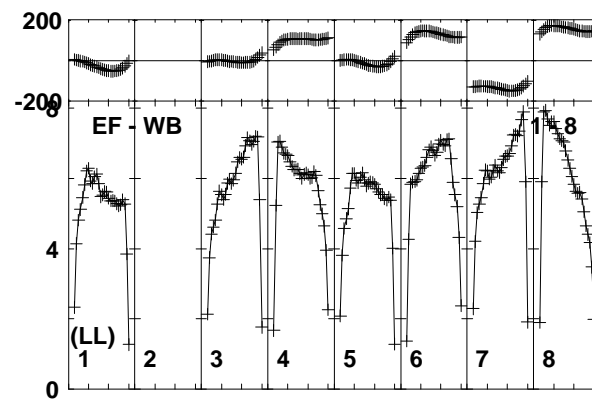
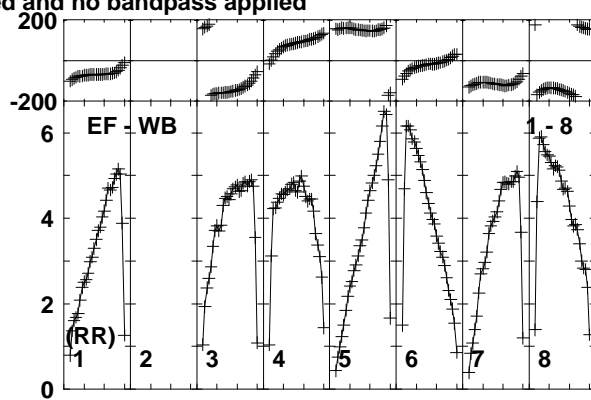
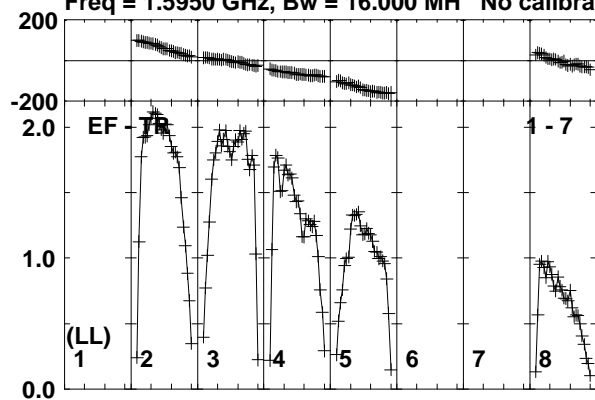

Lower frame: Milli Ampl Jy Top frame: Phas deg  
Vector averaged cross-power spectrum Baseline: EF (01) - TR (07)  
Timerange: 01/01:57:52 to 01/02:01:18

Plot file version 183 created 26-JUN-2015 10:51:25

J2025+3343 ET031A.UVDATA.1

Freq = 1.5950 GHz, Bw = 16.000 MH No calibration applied and no bandpass applied

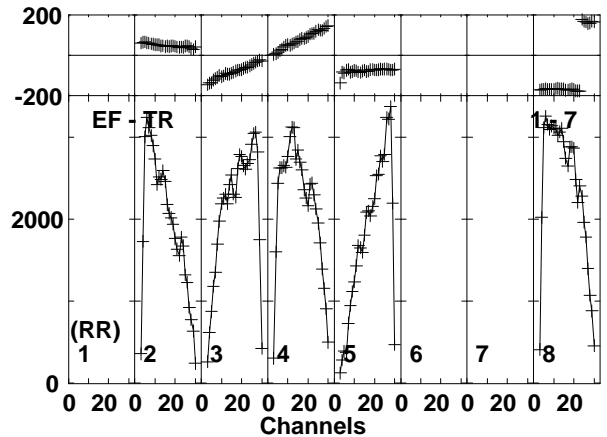
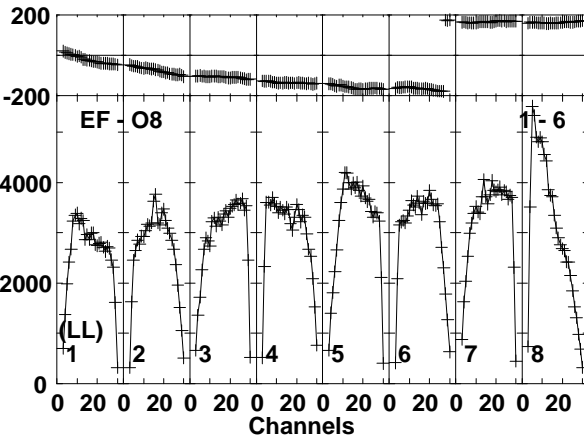
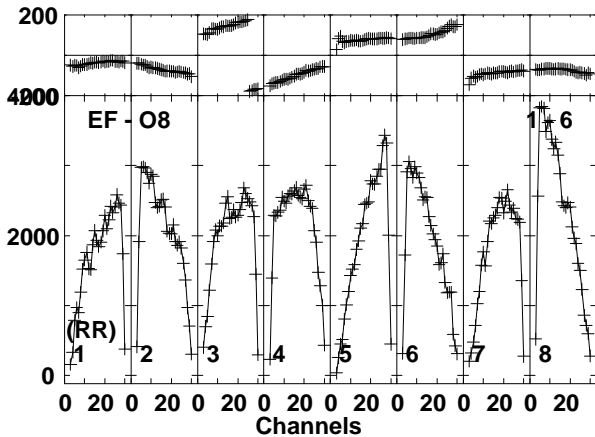
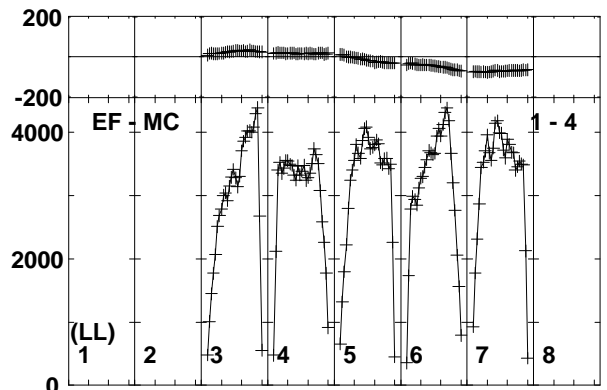
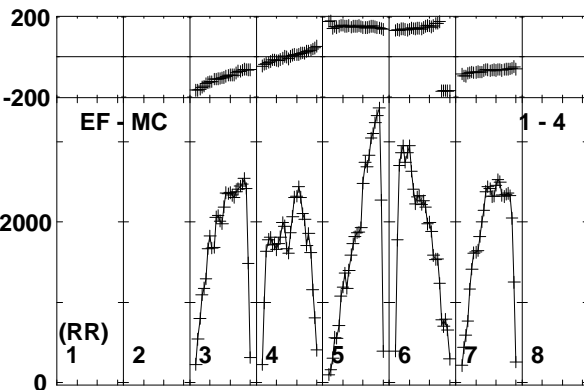
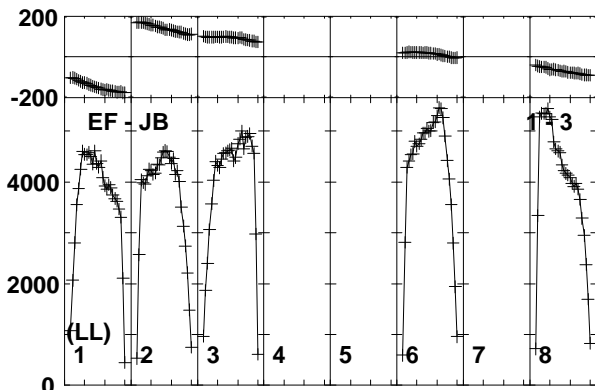
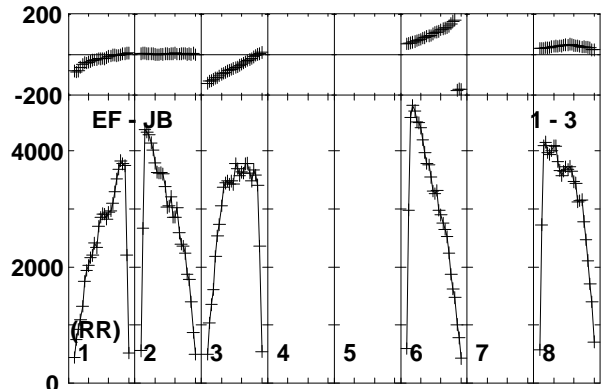
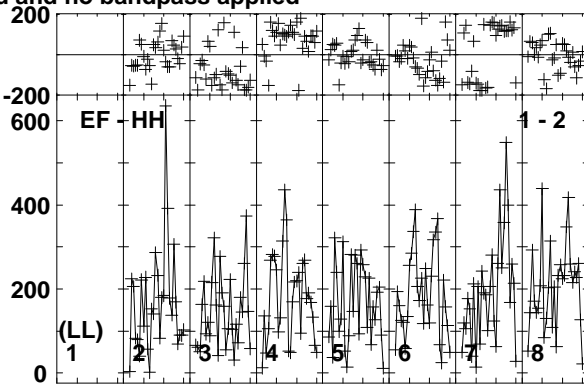
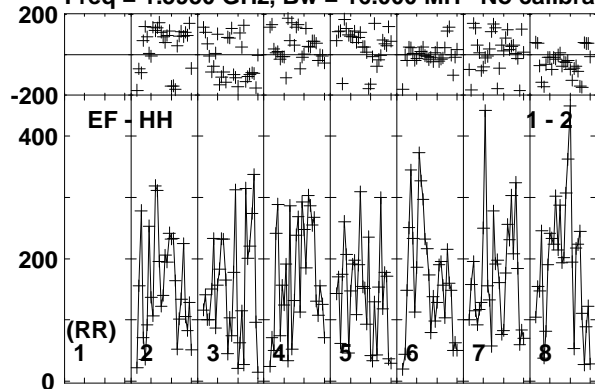

Lower frame: Micro Ampl Jy Top frame: Phas deg  
Vector averaged cross-power spectrum Baseline: EF (01) - HH (02)  
Timerange: 01/02:02:02 to 01/02:02:58

Plot file version 184 created 26-JUN-2015 10:51:25

J2025+3343 ET031A.UVDATA.1

Freq = 1.5950 GHz, Bw = 16.000 MH No calibration applied and no bandpass applied

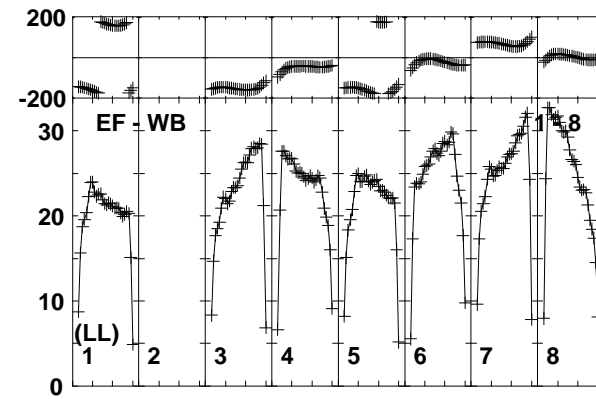
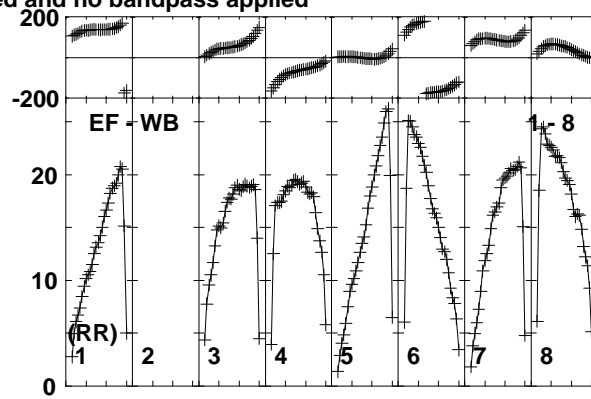
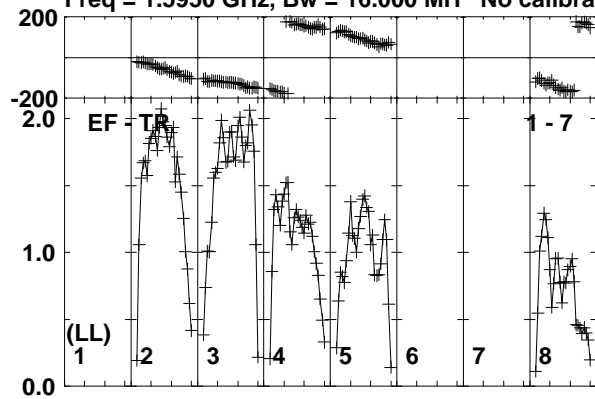

Lower frame: Milli Ampl Jy Top frame: Phas deg  
Vector averaged cross-power spectrum Baseline: EF (01) - TR (07)  
Timerange: 01/02:02:02 to 01/02:02:58



Plot file version 185 created 26-JUN-2015 10:51:25

V404CYG ET031A.UVDATA.1

Freq = 1.5950 GHz, Bw = 16.000 MH No calibration applied and no bandpass applied

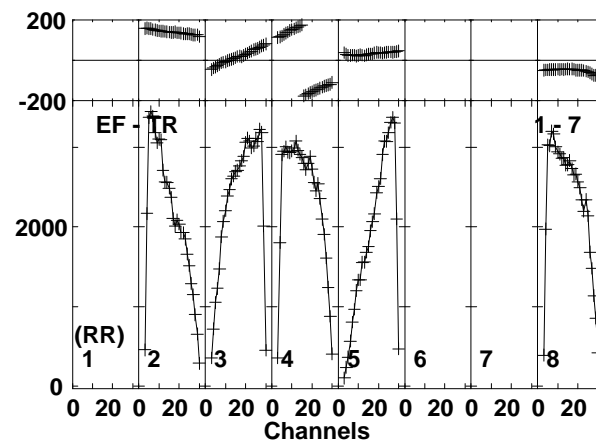
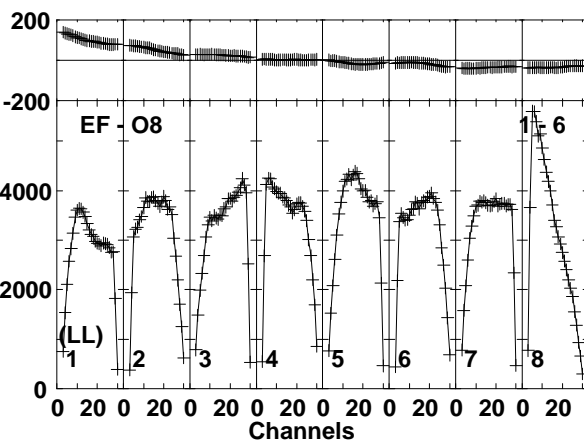
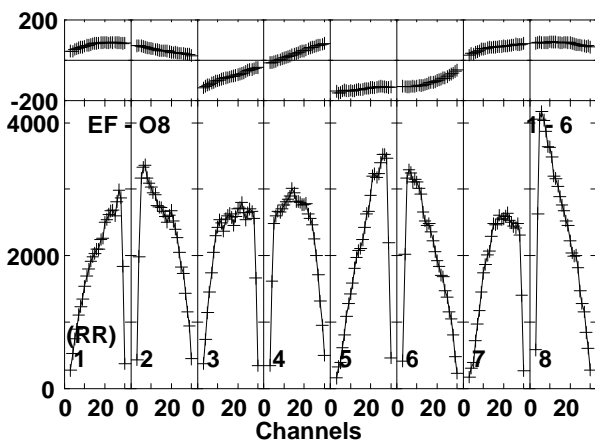
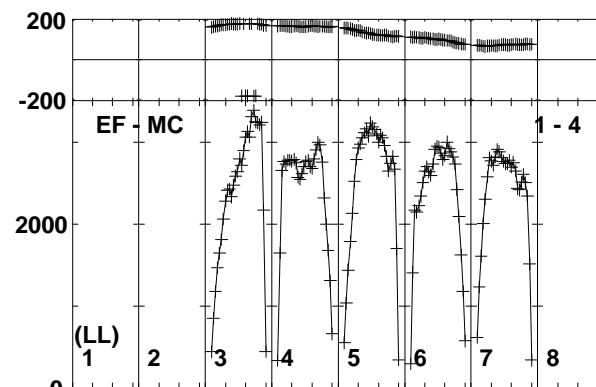
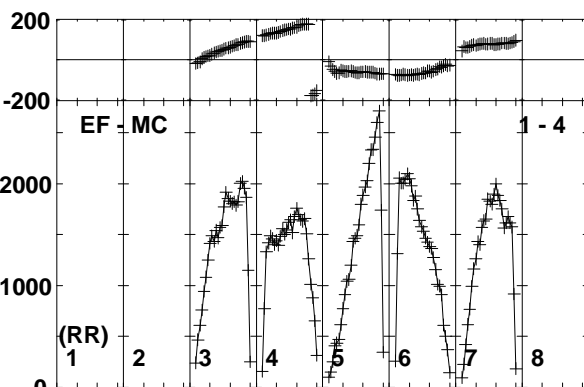
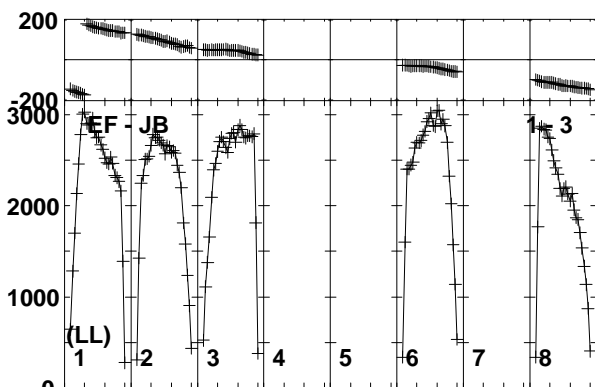
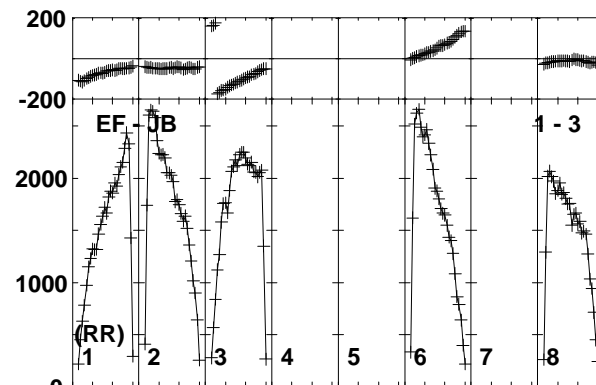
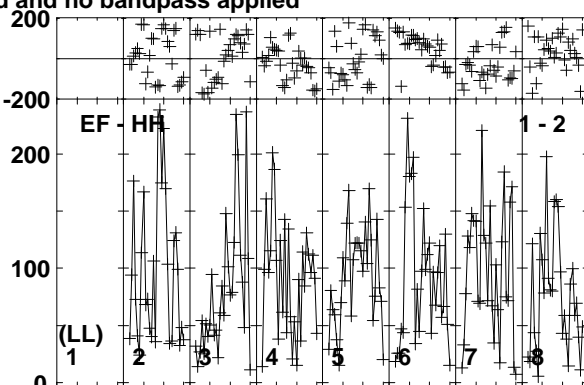
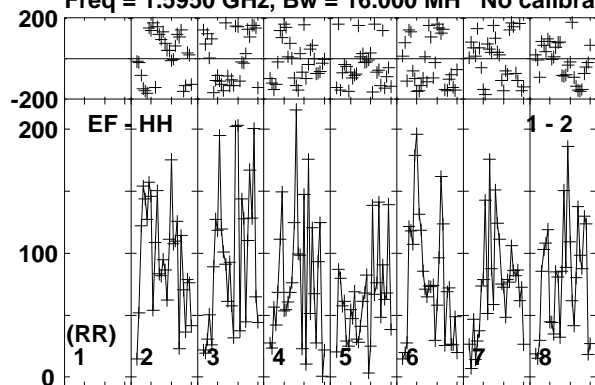

Lower frame: Micro Ampl Jy Top frame: Phas deg  
Vector averaged cross-power spectrum Baseline: EF (01) - HH (02)  
Timerange: 01/02:03:02 to 01/02:06:28

Plot file version 186 created 26-JUN-2015 10:51:25

V404CYG ET031A.UVDATA.1

Freq = 1.5950 GHz, Bw = 16.000 MH No calibration applied and no bandpass applied

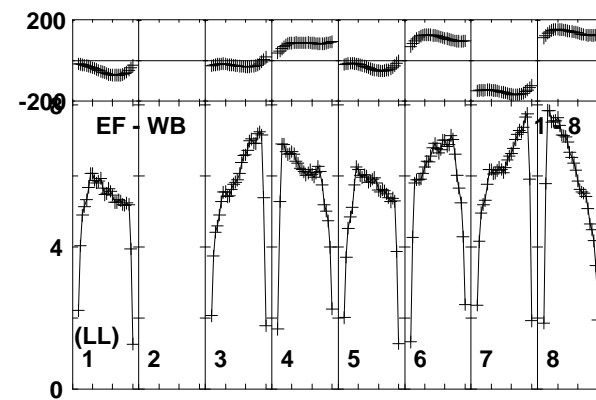
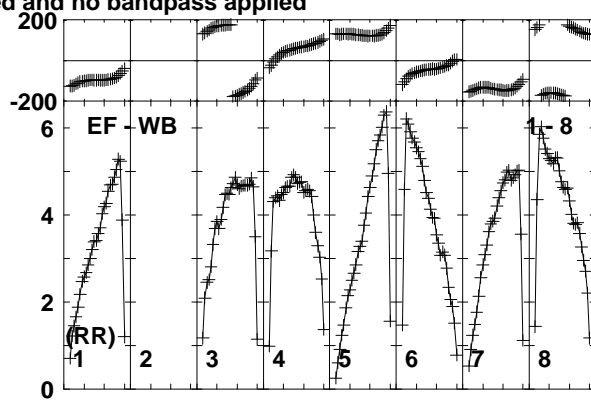
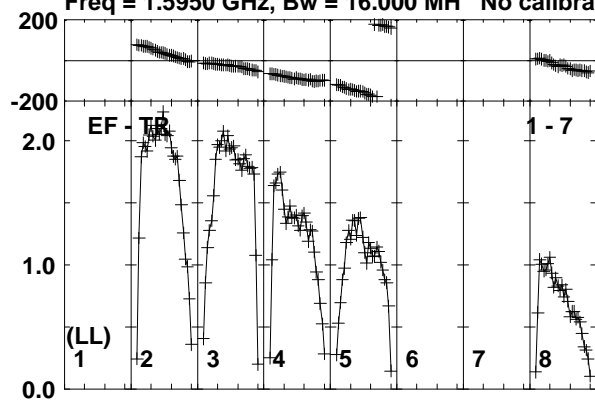

Lower frame: Milli Ampl Jy Top frame: Phas deg  
Vector averaged cross-power spectrum Baseline: EF (01) - TR (07)  
Timerange: 01/02:03:02 to 01/02:06:28

Plot file version 187 created 26-JUN-2015 10:51:25

J2025+3343 ET031A.UVDATA.1

Freq = 1.5950 GHz, Bw = 16.000 MH No calibration applied and no bandpass applied

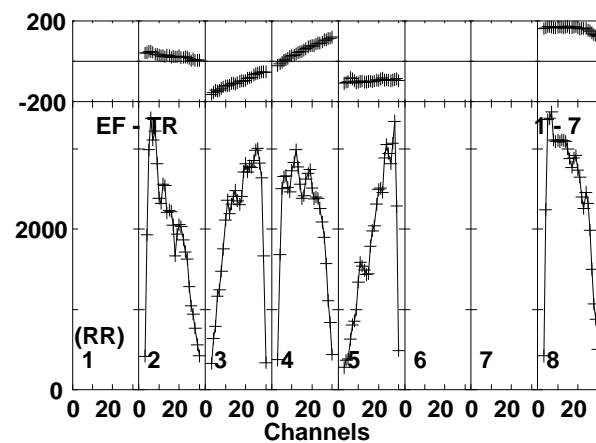
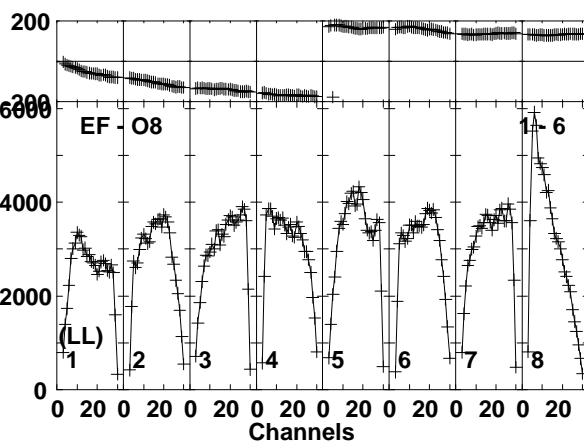
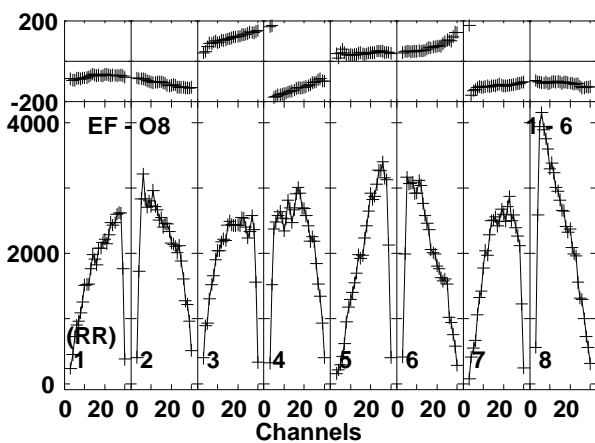
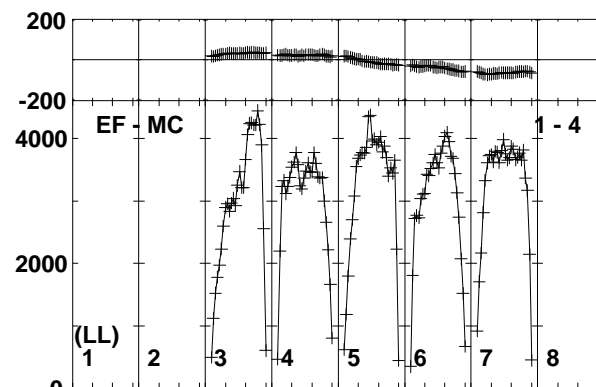
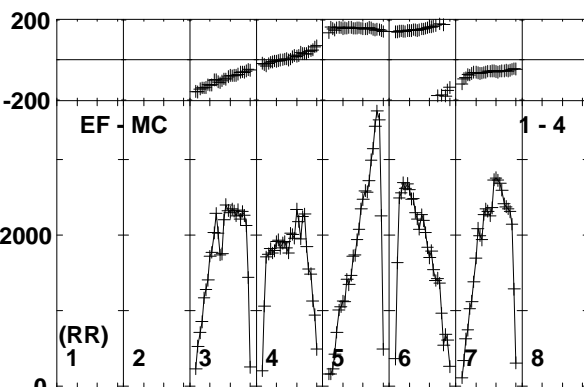
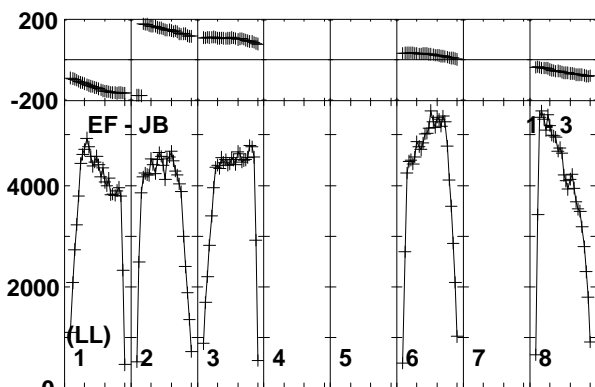
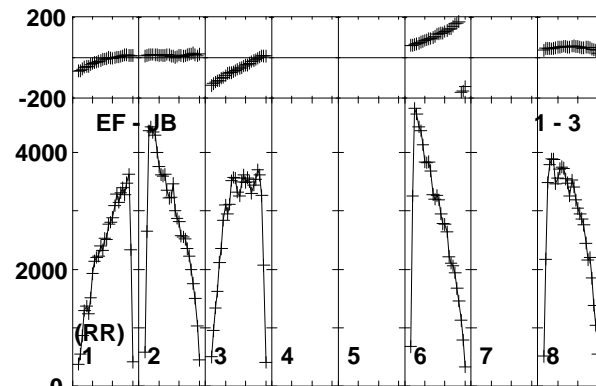
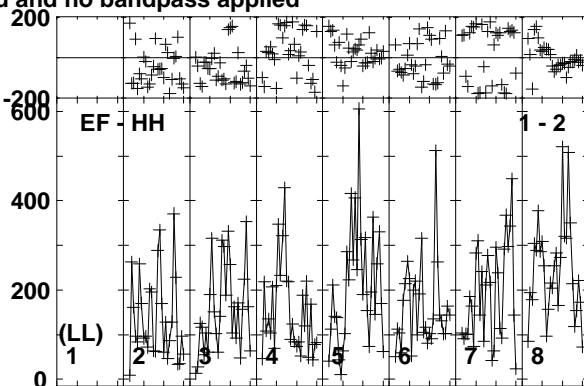
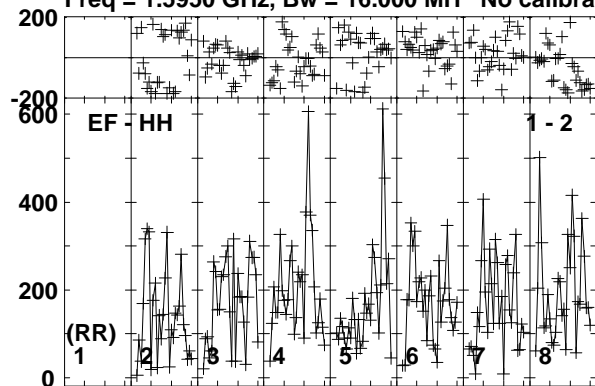

Lower frame: Micro Ampl Jy Top frame: Phas deg  
Vector averaged cross-power spectrum Baseline: EF (01) - HH (02)  
Timerange: 01/02:06:32 to 01/02:07:48

Plot file version 188 created 26-JUN-2015 10:51:25

J2025+3343 ET031A.UVDATA.1

Freq = 1.5950 GHz, Bw = 16.000 MH No calibration applied and no bandpass applied

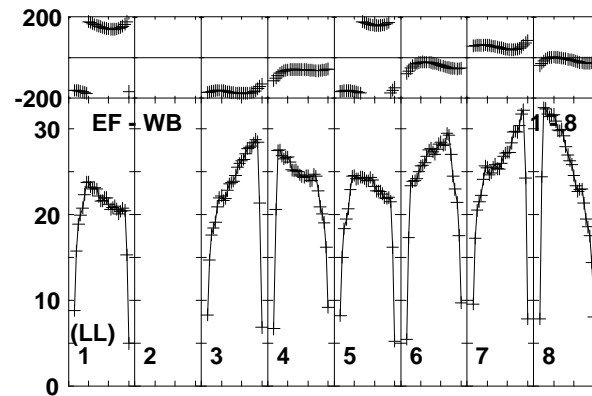
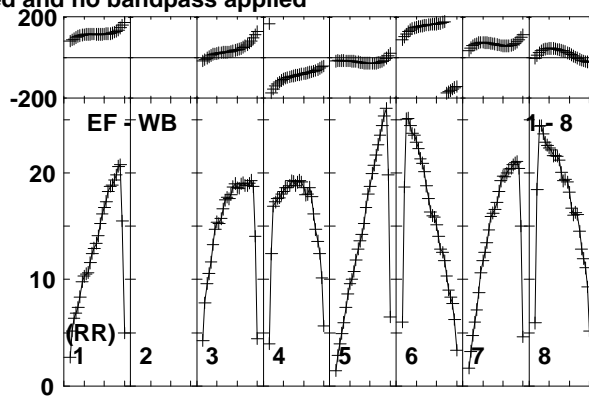
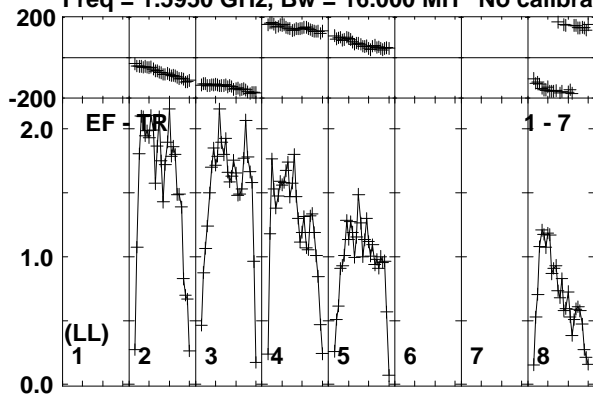

Lower frame: Milli Ampl Jy Top frame: Phas deg  
Vector averaged cross-power spectrum Baseline: EF (01) - TR (07)  
Timerange: 01/02:06:32 to 01/02:07:48

Plot file version 189 created 26-JUN-2015 10:51:25

V404CYG ET031A.UVDATA.1

Freq = 1.5950 GHz, Bw = 16.000 MH No calibration applied and no bandpass applied

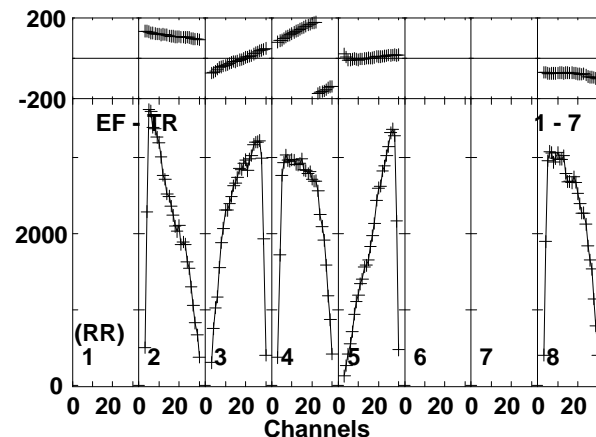
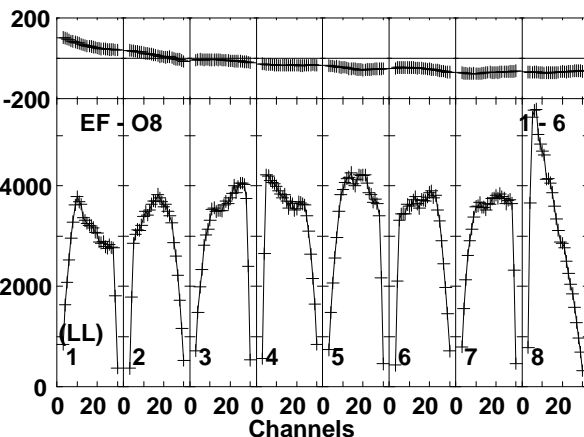
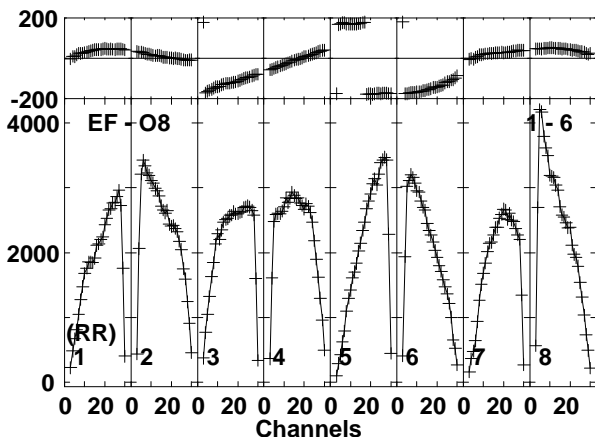
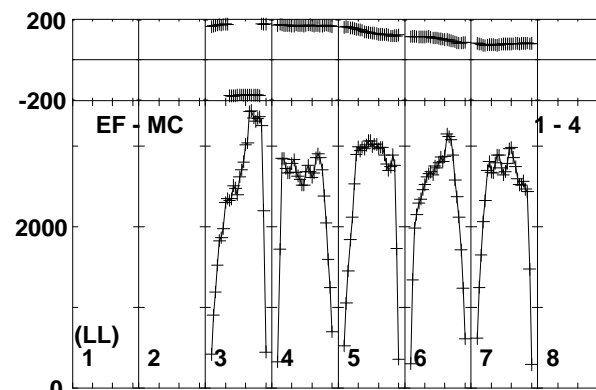
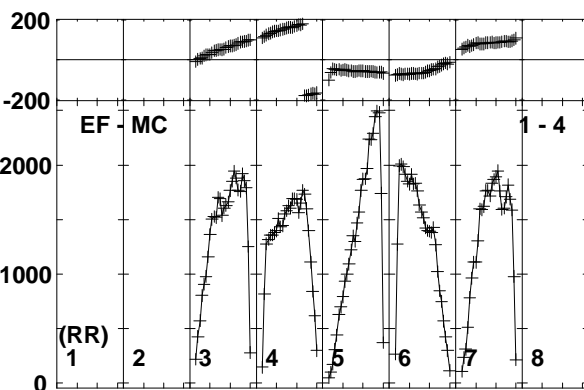
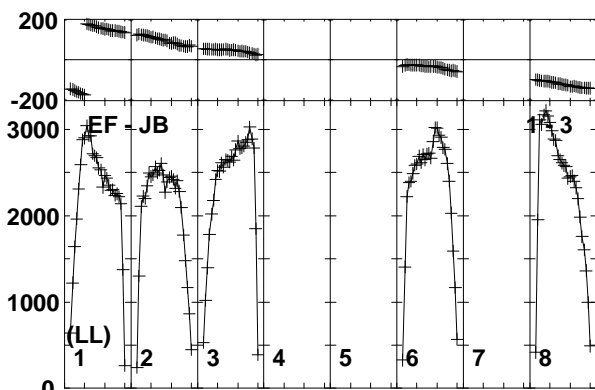
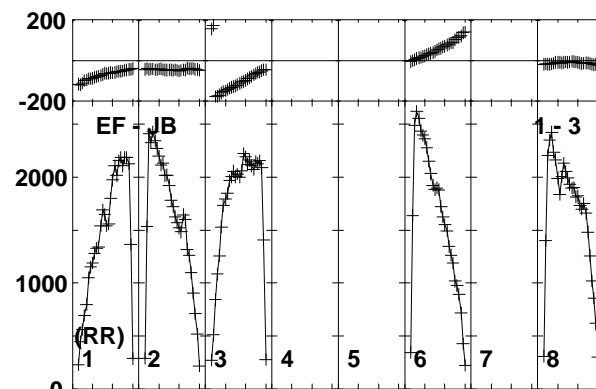
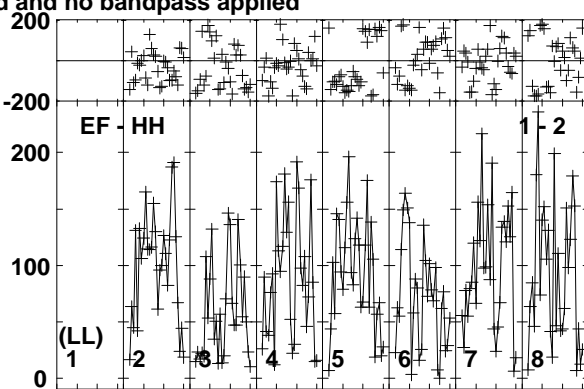
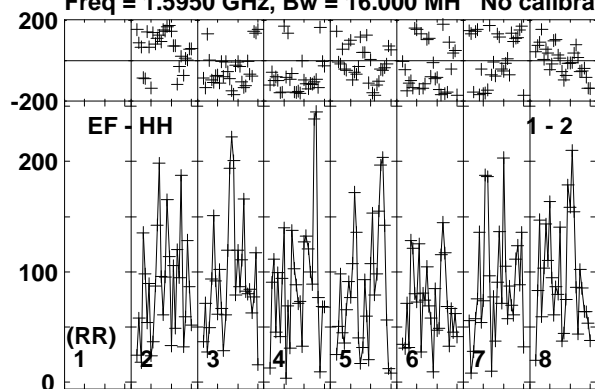

Lower frame: Micro Ampl Jy Top frame: Phas deg  
Vector averaged cross-power spectrum Baseline: EF (01) - HH (02)  
Timerange: 01/02:07:52 to 01/02:11:18

Plot file version 190 created 26-JUN-2015 10:51:25

V404CYG ET031A.UVDATA.1

Freq = 1.5950 GHz, Bw = 16.000 MH No calibration applied and no bandpass applied

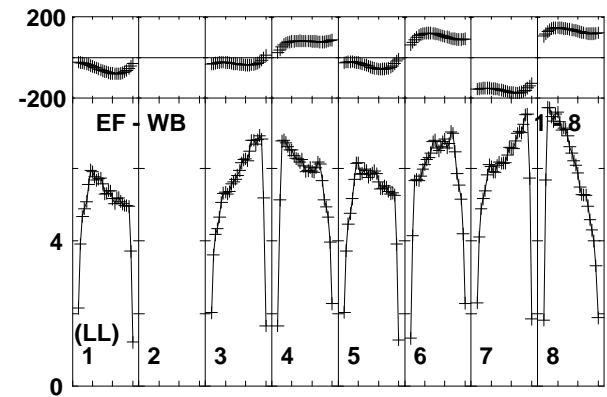
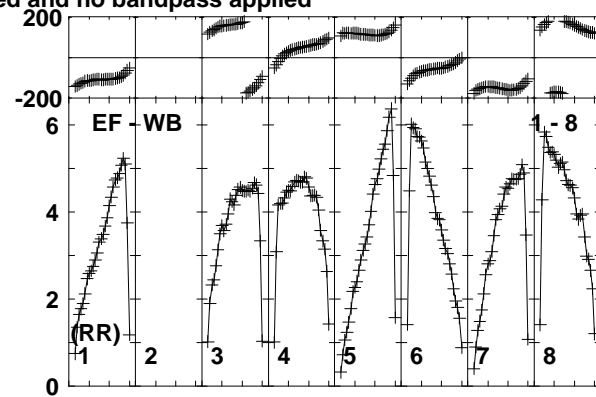
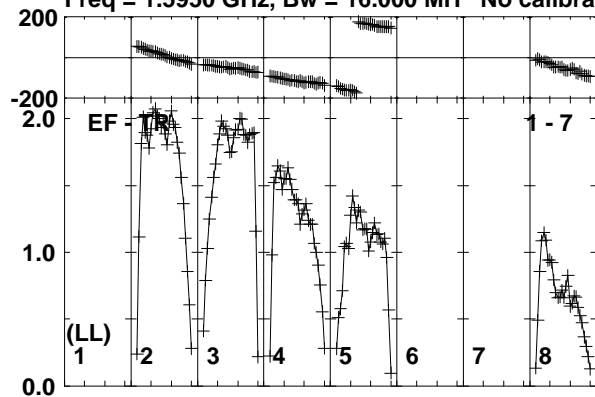

Lower frame: Milli Ampl Jy Top frame: Phas deg  
Vector averaged cross-power spectrum Baseline: EF (01) - TR (07)  
Timerange: 01/02:07:52 to 01/02:11:18

Plot file version 191 created 26-JUN-2015 10:51:25

J2025+3343 ET031A.UVDATA.1

Freq = 1.5950 GHz, Bw = 16.000 MH No calibration applied and no bandpass applied

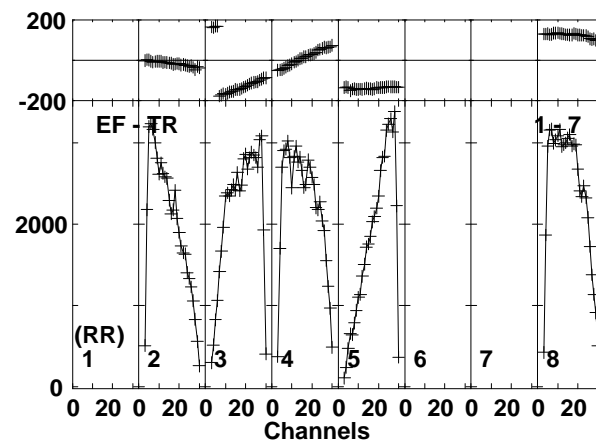
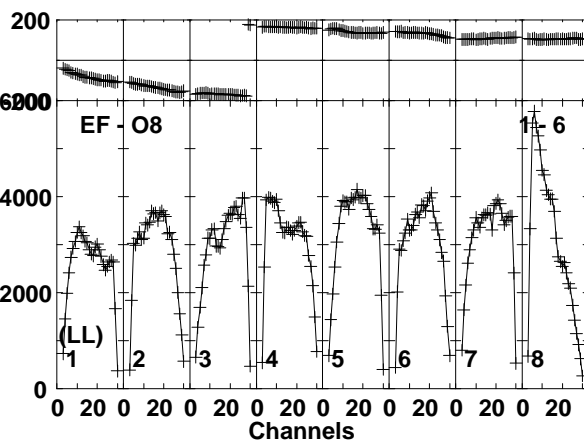
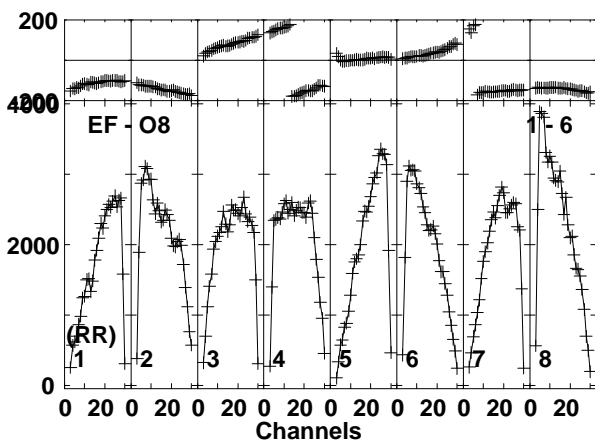
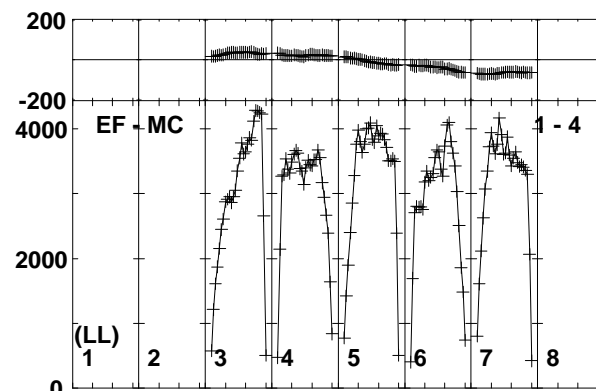
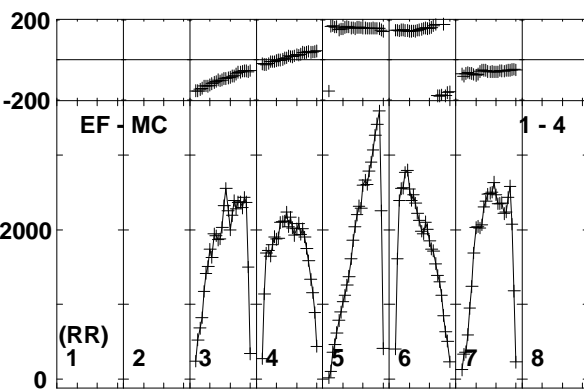
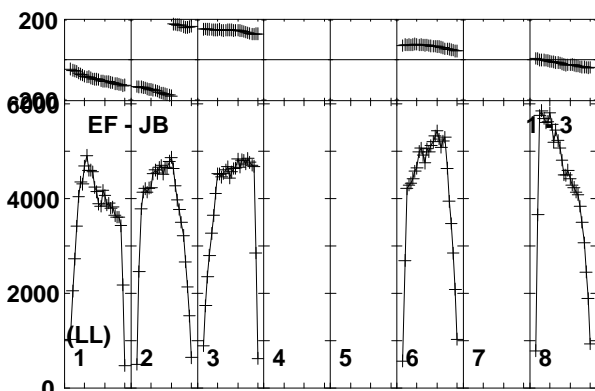
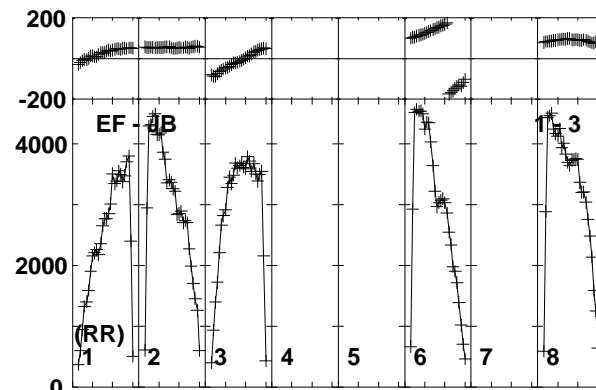
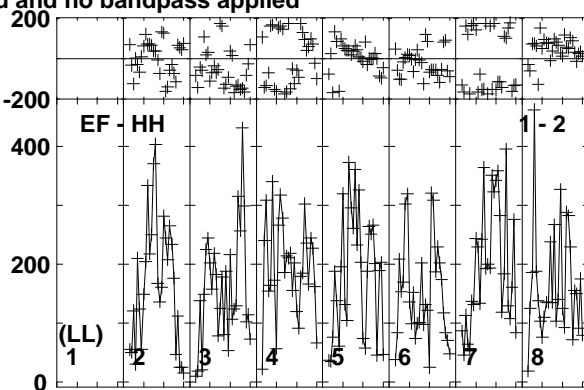
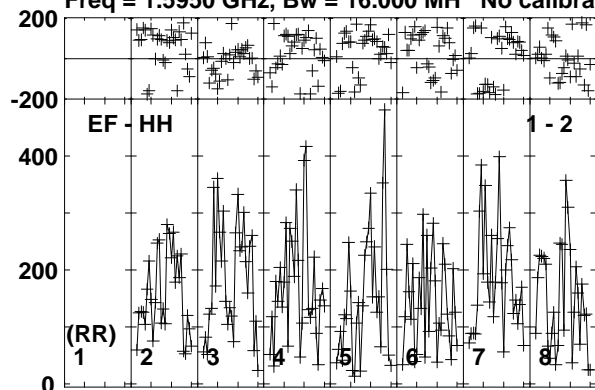

Lower frame: Micro Ampl Jy Top frame: Phas deg  
Vector averaged cross-power spectrum Baseline: EF (01) - HH (02)  
Timerange: 01/02:12:02 to 01/02:12:58

Plot file version 192 created 26-JUN-2015 10:51:25

J2025+3343 ET031A.UVDATA.1

Freq = 1.5950 GHz, Bw = 16.000 MH No calibration applied and no bandpass applied

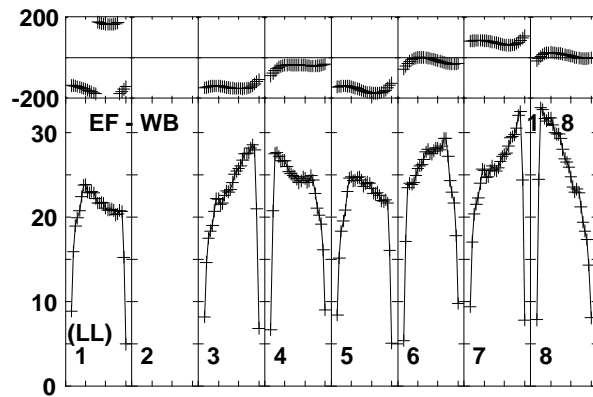
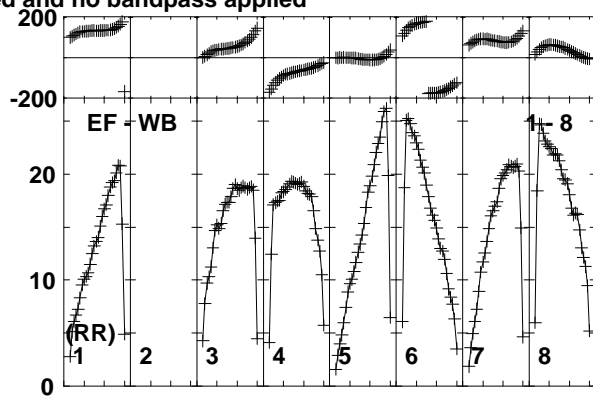
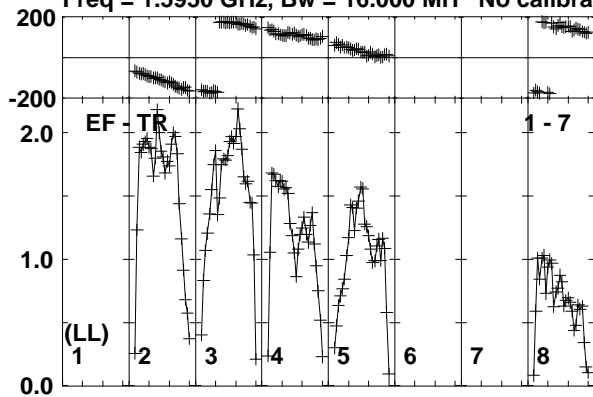

Lower frame: Milli Ampl Jy Top frame: Phas deg  
Vector averaged cross-power spectrum Baseline: EF (01) - TR (07)  
Timerange: 01/02:12:02 to 01/02:12:58



Plot file version 193 created 26-JUN-2015 10:51:25

V404CYG ET031A.UVDATA.1

Freq = 1.5950 GHz, Bw = 16.000 MH No calibration applied and no bandpass applied

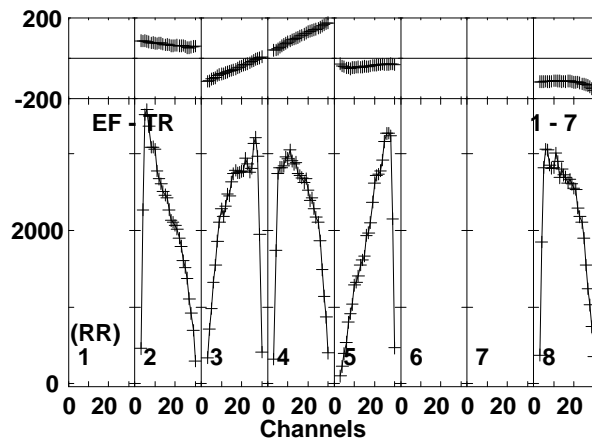
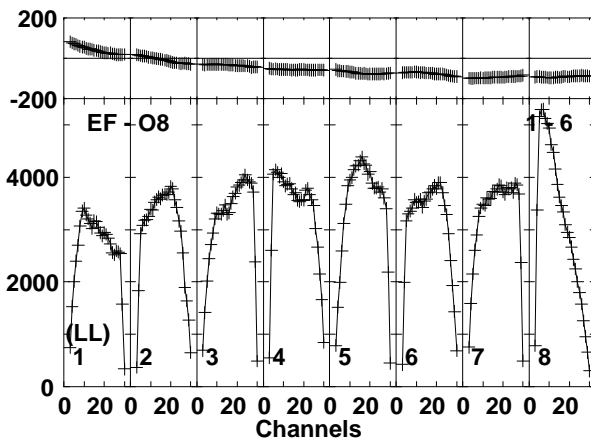
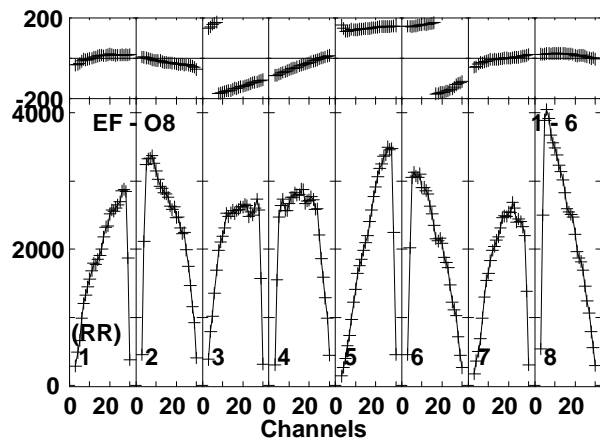
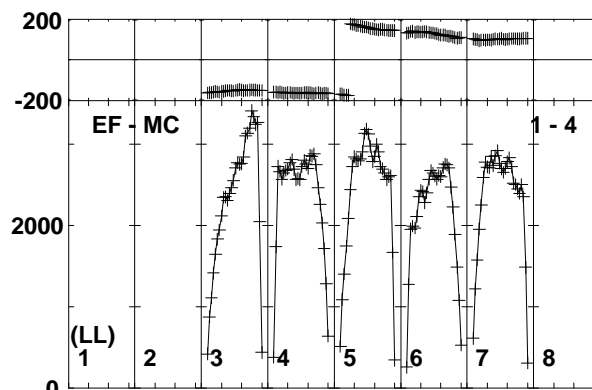
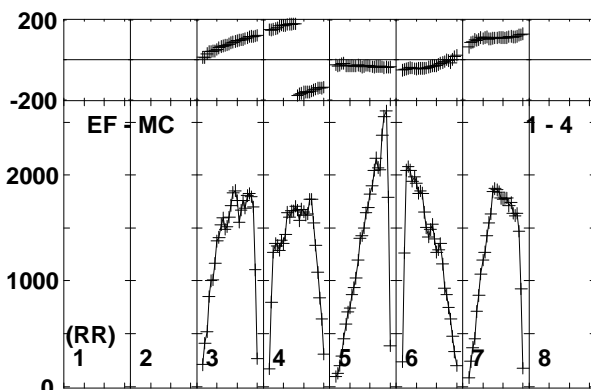
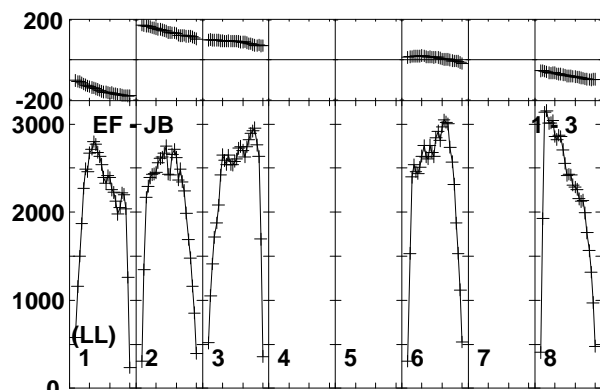
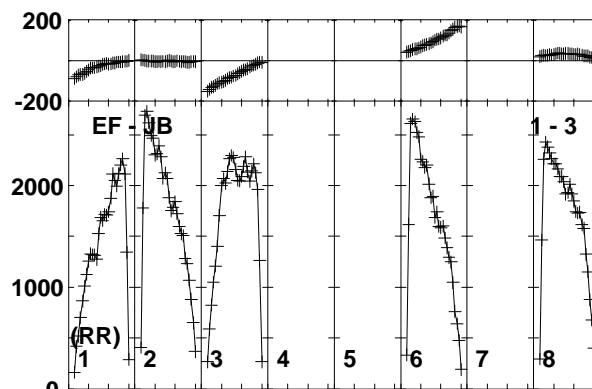
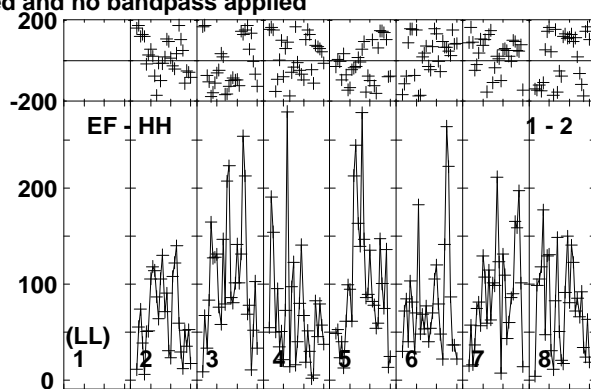
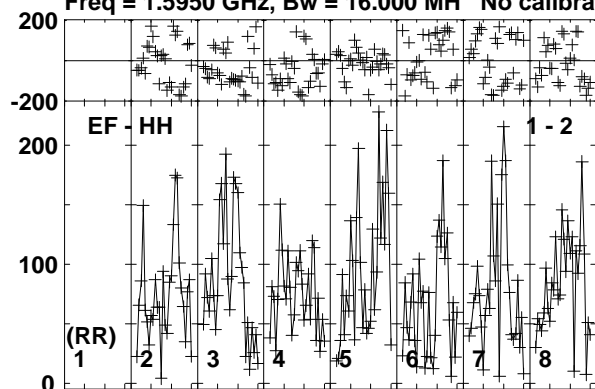

Lower frame: Micro Ampl Jy Top frame: Phas deg  
Vector averaged cross-power spectrum Baseline: EF (01) - HH (02)  
Timerange: 01/02:13:02 to 01/02:16:28

Plot file version 194 created 26-JUN-2015 10:51:25

V404CYG ET031A.UVDATA.1

Freq = 1.5950 GHz, Bw = 16.000 MH No calibration applied and no bandpass applied

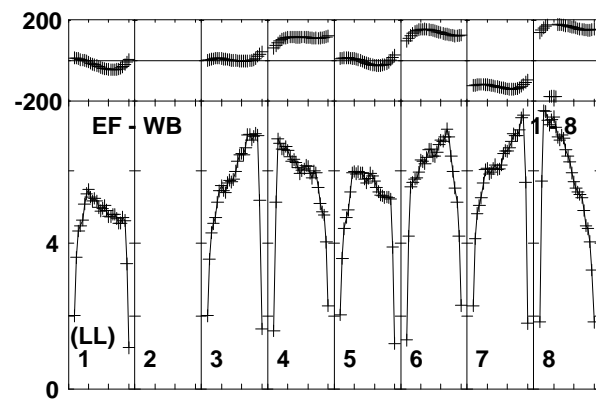
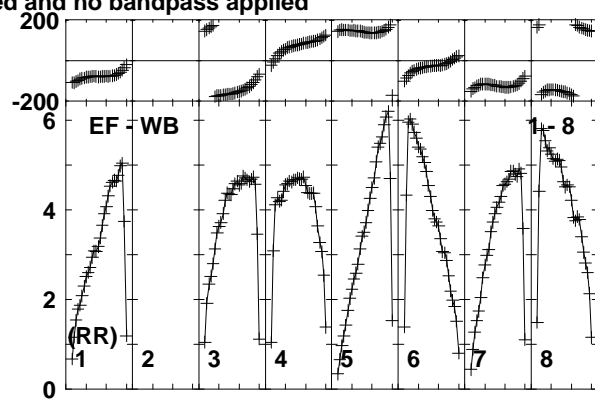
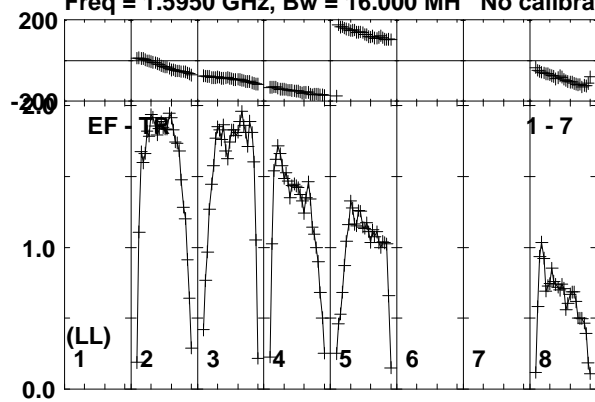

Lower frame: Milli Ampl Jy Top frame: Phas deg  
Vector averaged cross-power spectrum Baseline: EF (01) - TR (07)  
Timerange: 01/02:13:02 to 01/02:16:28

Plot file version 195 created 26-JUN-2015 10:51:25

J2025+3343 ET031A.UVDATA.1

Freq = 1.5950 GHz, Bw = 16.000 MH No calibration applied and no bandpass applied

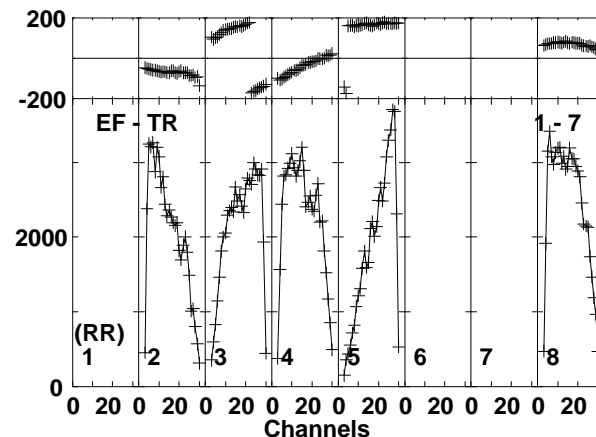
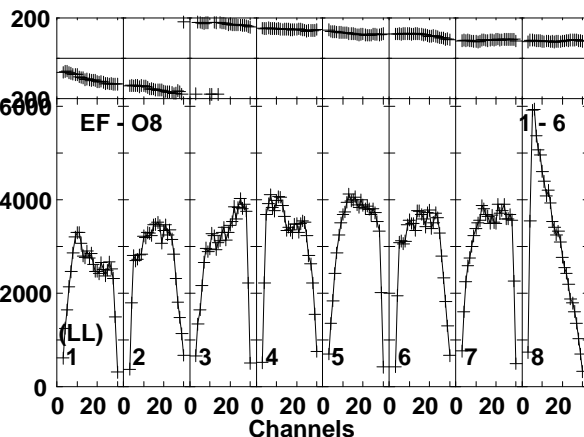
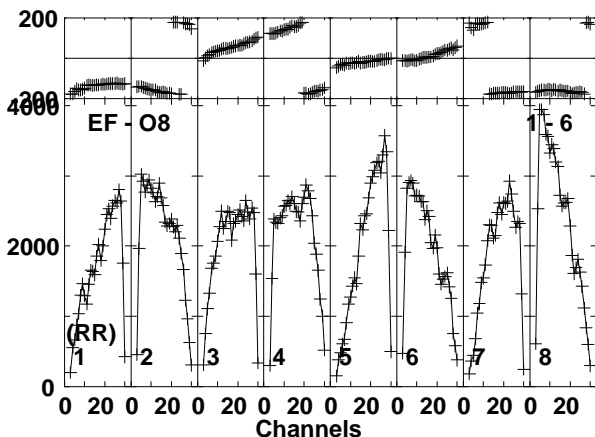
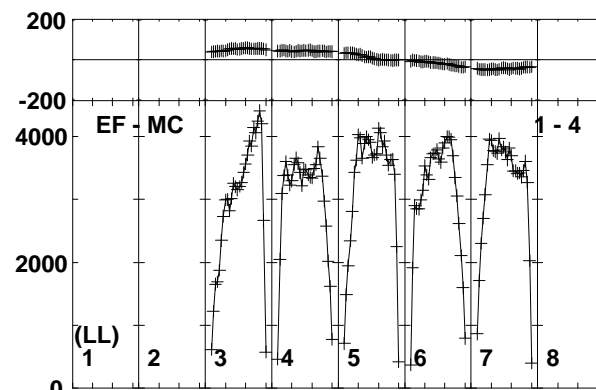
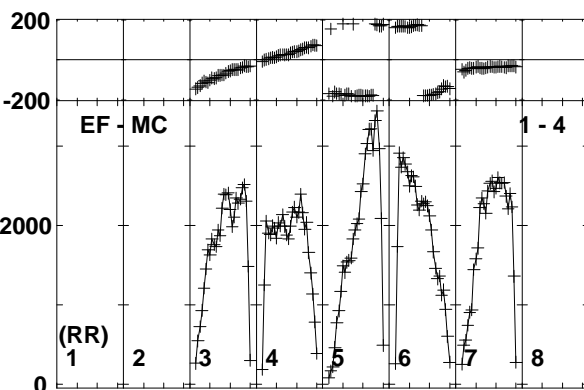
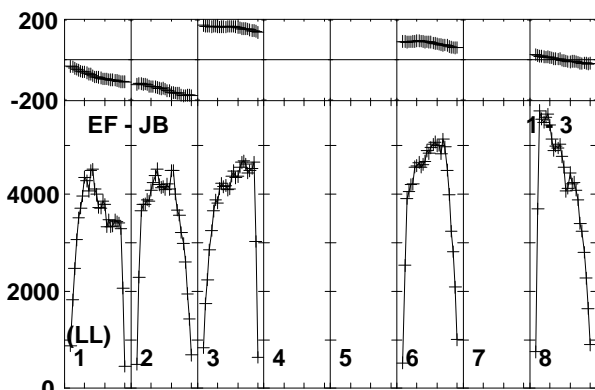
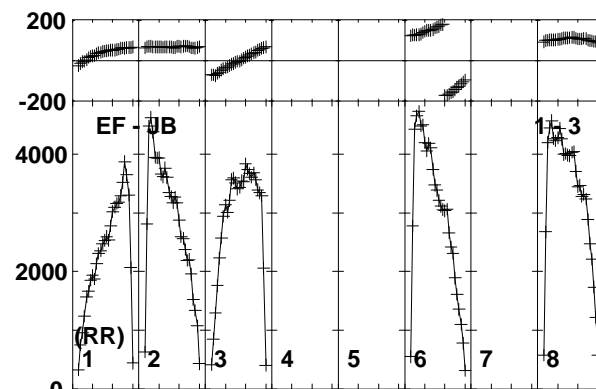
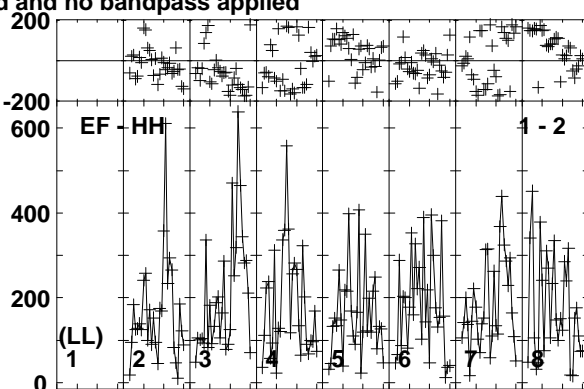
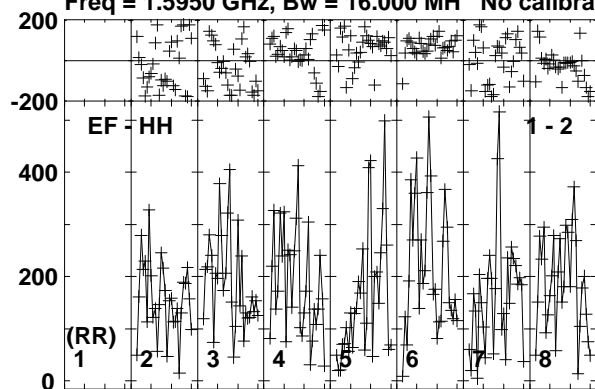

Lower frame: Micro Ampl Jy Top frame: Phas deg  
Vector averaged cross-power spectrum Baseline: EF (01) - HH (02)  
Timerange: 01/02:16:32 to 01/02:17:48

Plot file version 196 created 26-JUN-2015 10:51:25

J2025+3343 ET031A.UVDATA.1

Freq = 1.5950 GHz, Bw = 16.000 MH No calibration applied and no bandpass applied

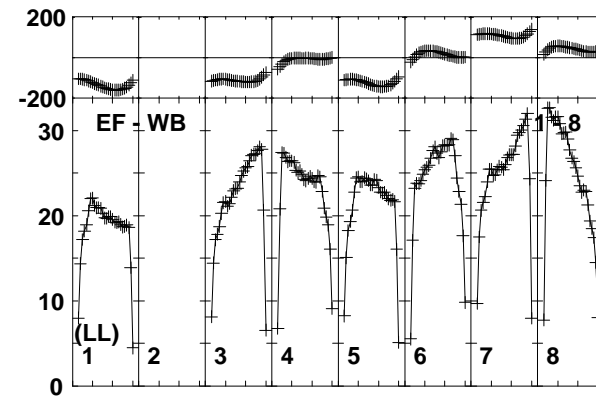
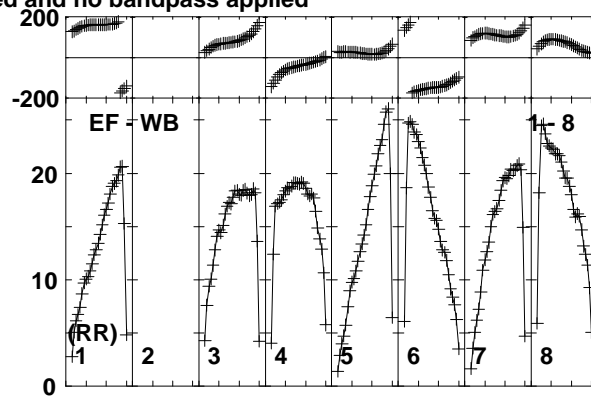
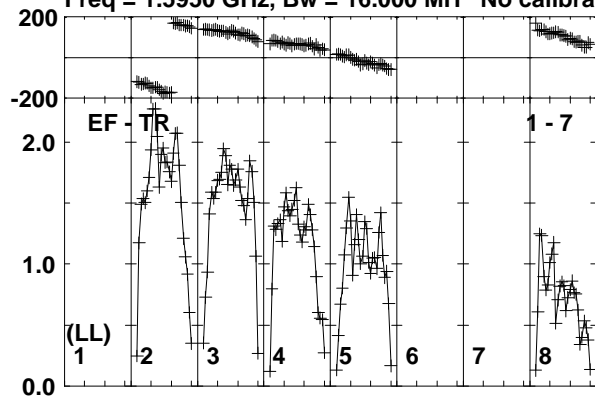

Lower frame: Milli Ampl Jy Top frame: Phas deg  
Vector averaged cross-power spectrum Baseline: EF (01) - TR (07)  
Timerange: 01/02:16:32 to 01/02:17:48

Plot file version 197 created 26-JUN-2015 10:51:25

V404CYG ET031A.UVDATA.1

Freq = 1.5950 GHz, Bw = 16.000 MH No calibration applied and no bandpass applied

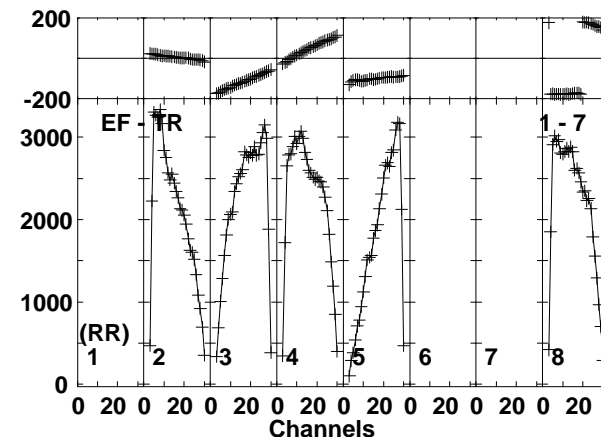
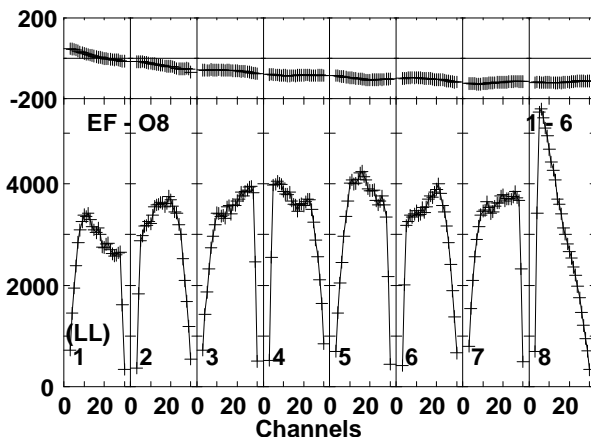
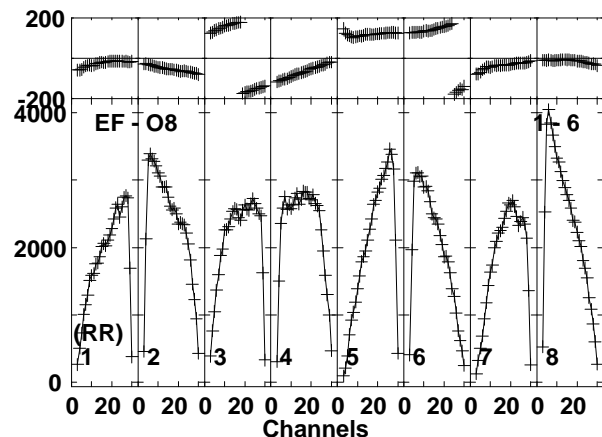
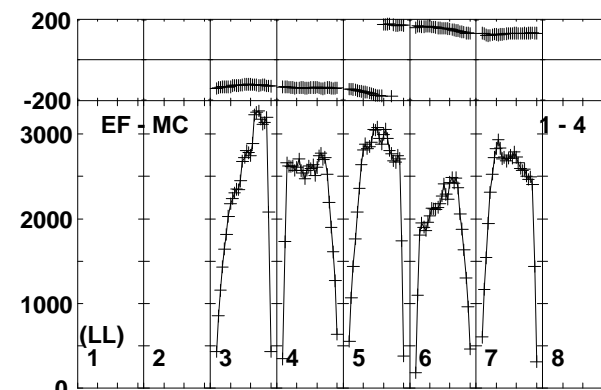
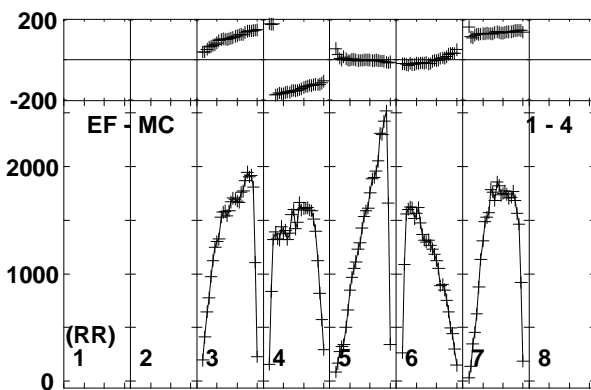
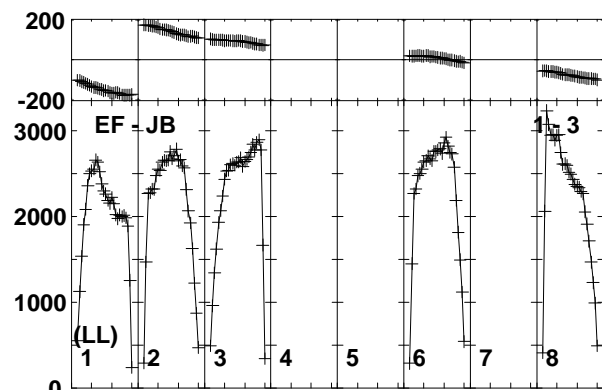
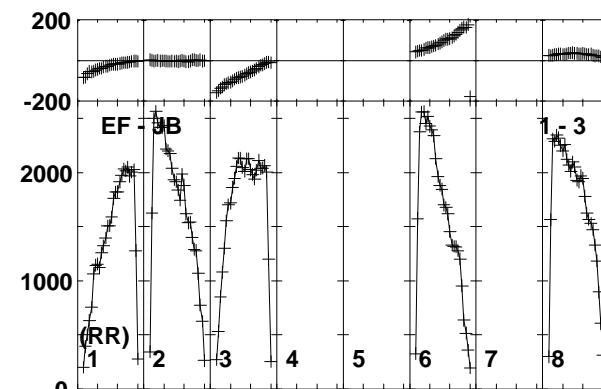
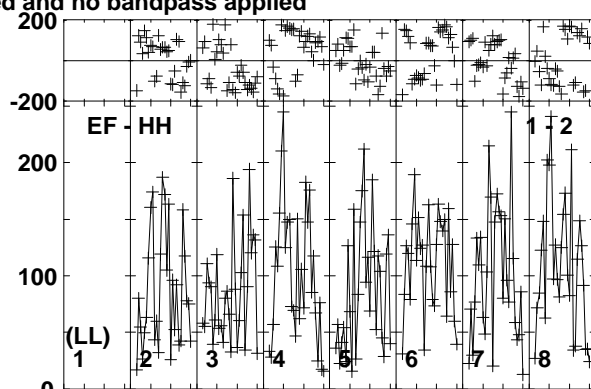
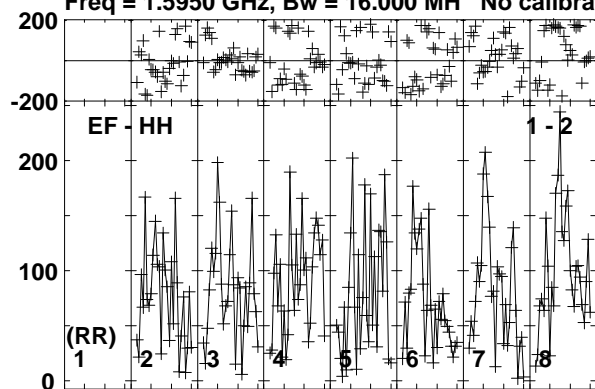

Lower frame: Micro Ampl Jy Top frame: Phas deg  
Vector averaged cross-power spectrum Baseline: EF (01) - HH (02)  
Timerange: 01/02:17:52 to 01/02:21:18

Plot file version 198 created 26-JUN-2015 10:51:25

V404CYG ET031A.UVDATA.1

Freq = 1.5950 GHz, Bw = 16.000 MH No calibration applied and no bandpass applied

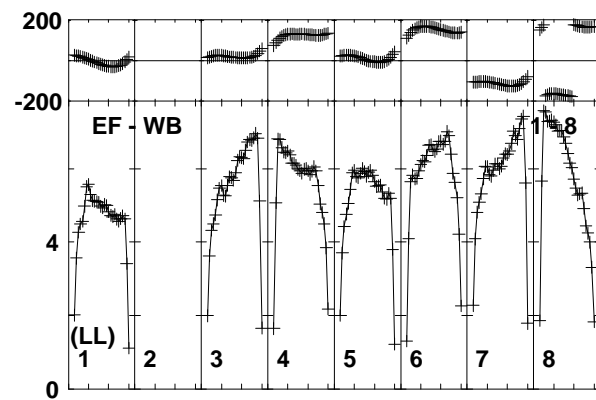
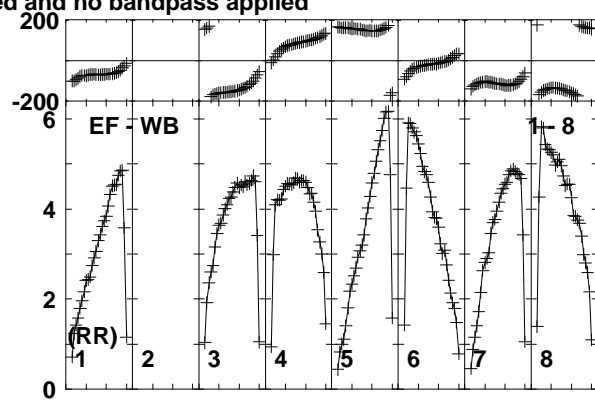
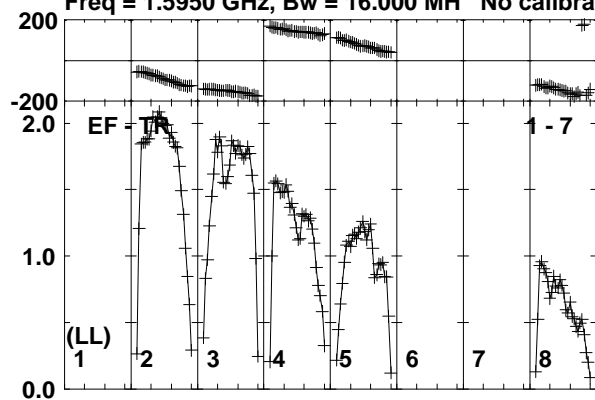

Lower frame: Milli Ampl Jy Top frame: Phas deg  
Vector averaged cross-power spectrum Baseline: EF (01) - TR (07)  
Timerange: 01/02:17:52 to 01/02:21:18

Plot file version 199 created 26-JUN-2015 10:51:25

J2025+3343 ET031A.UVDATA.1

Freq = 1.5950 GHz, Bw = 16.000 MH No calibration applied and no bandpass applied

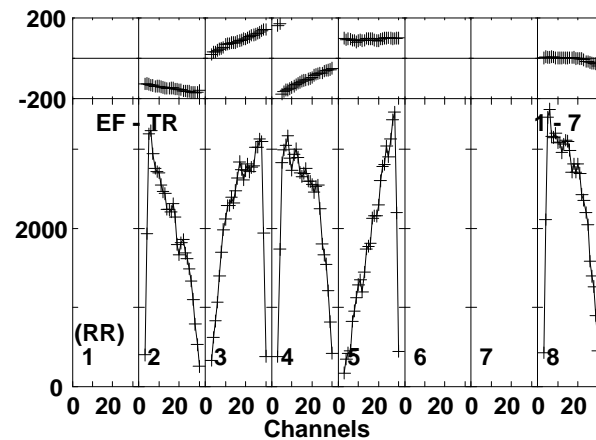
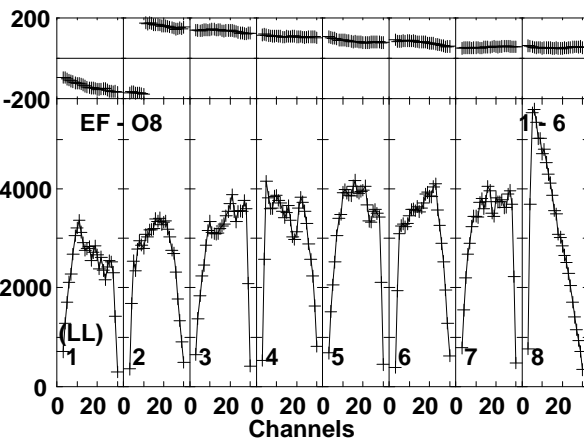
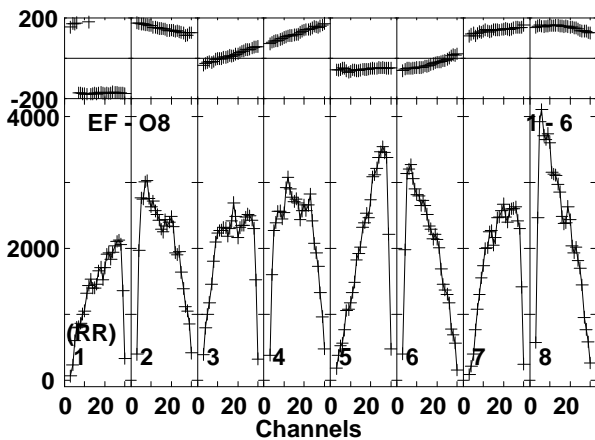
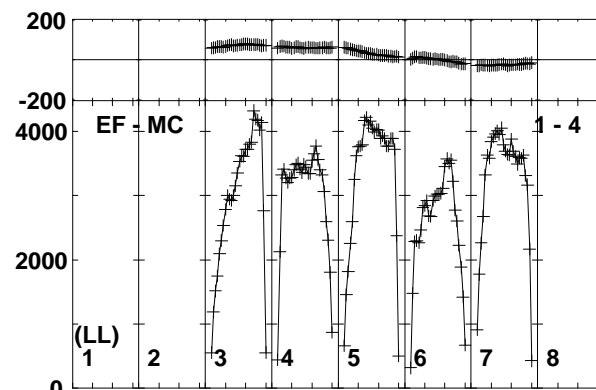
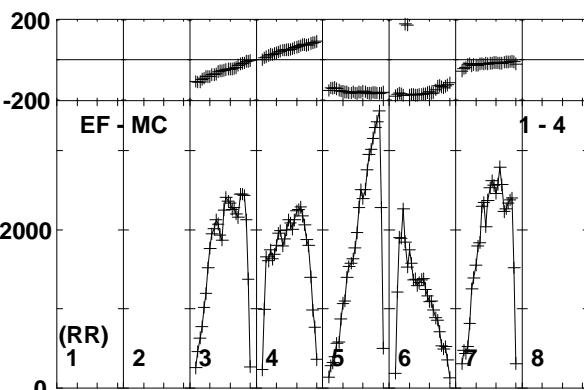
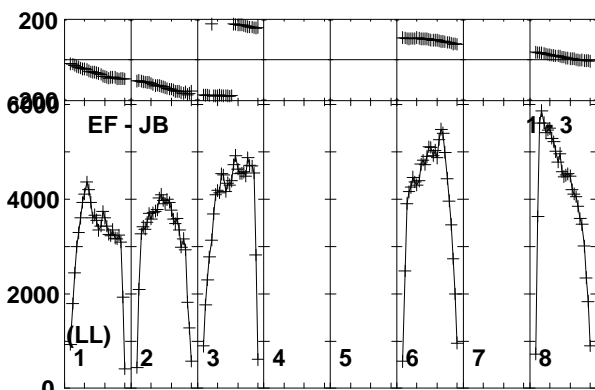
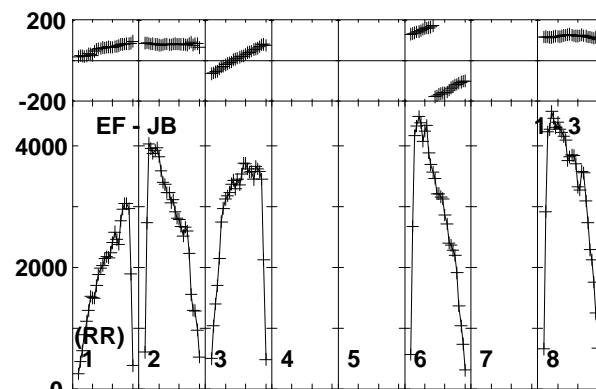
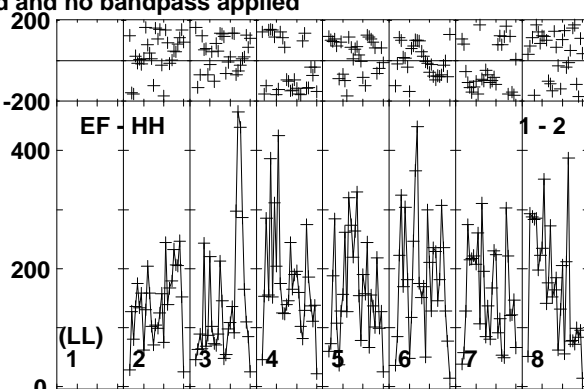
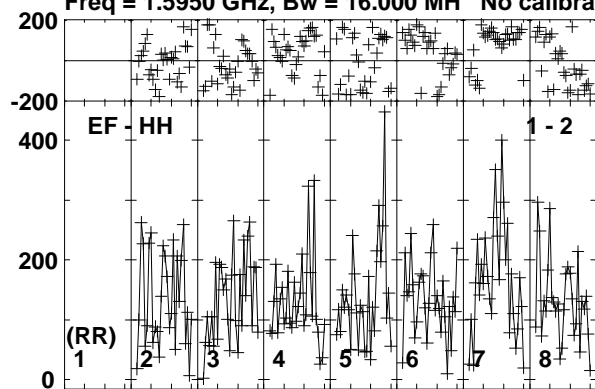

Lower frame: Micro Ampl Jy Top frame: Phas deg  
Vector averaged cross-power spectrum Baseline: EF (01) - HH (02)  
Timerange: 01/02:22:02 to 01/02:22:58

Plot file version 200 created 26-JUN-2015 10:51:25

J2025+3343 ET031A.UVDATA.1

Freq = 1.5950 GHz, Bw = 16.000 MH No calibration applied and no bandpass applied

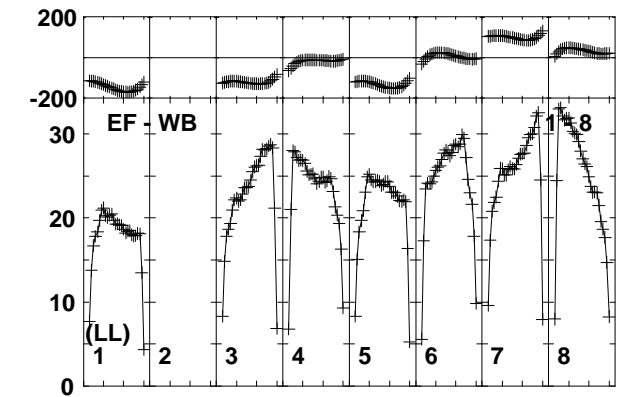
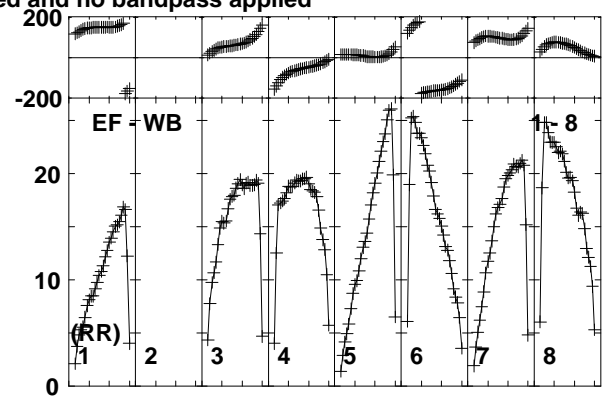
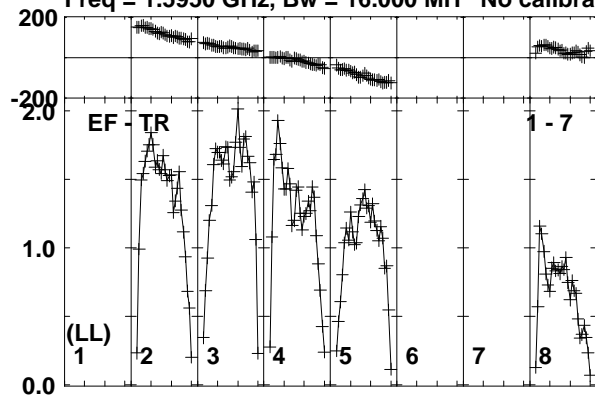

Lower frame: Milli Ampl Jy Top frame: Phas deg  
Vector averaged cross-power spectrum Baseline: EF (01) - TR (07)  
Timerange: 01/02:22:02 to 01/02:22:58



Plot file version 201 created 26-JUN-2015 10:51:26

V404CYG ET031A.UVDATA.1

Freq = 1.5950 GHz, Bw = 16.000 MH No calibration applied and no bandpass applied

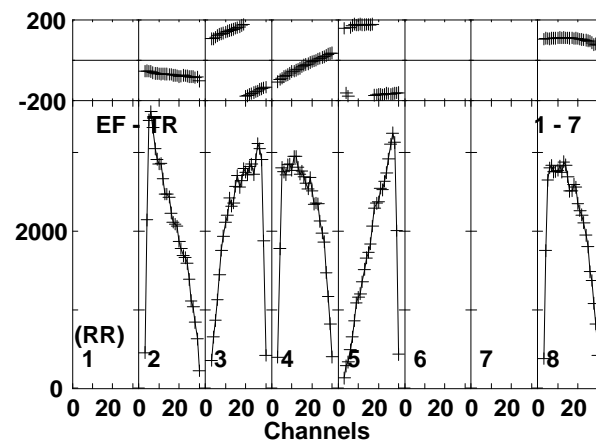
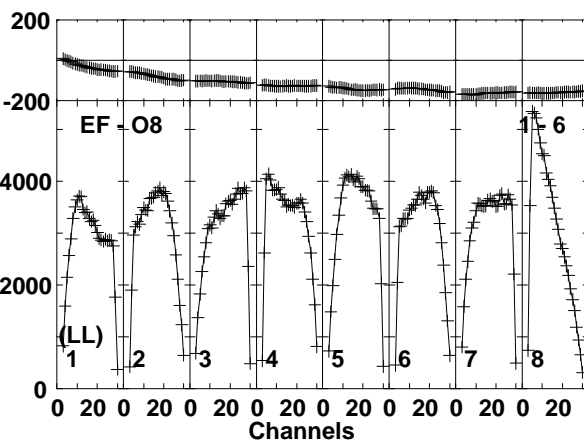
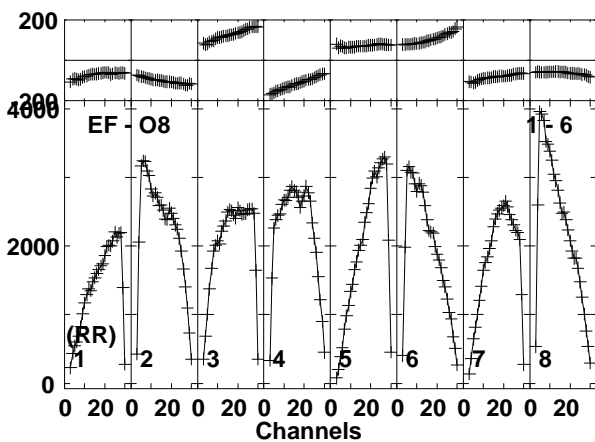
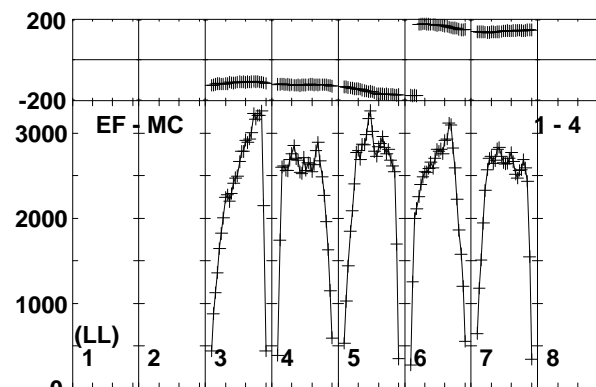
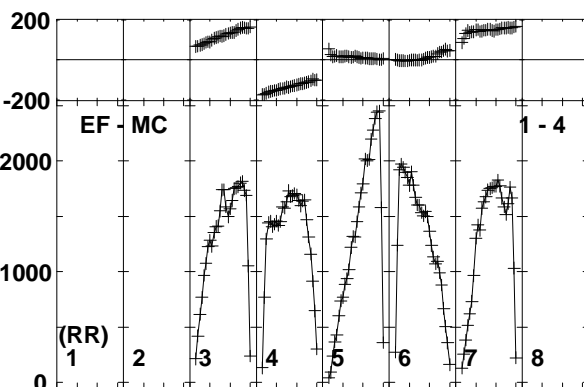
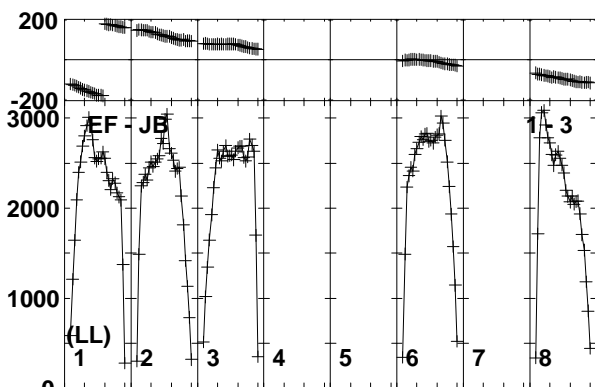
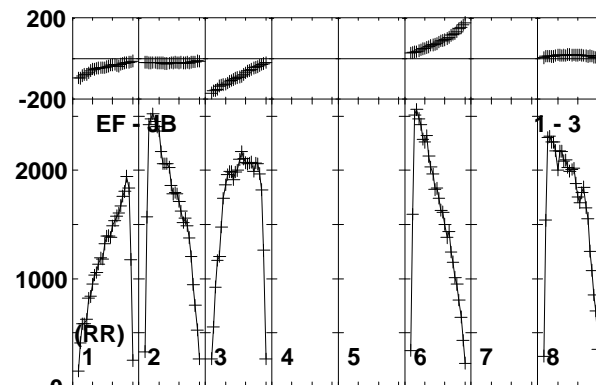
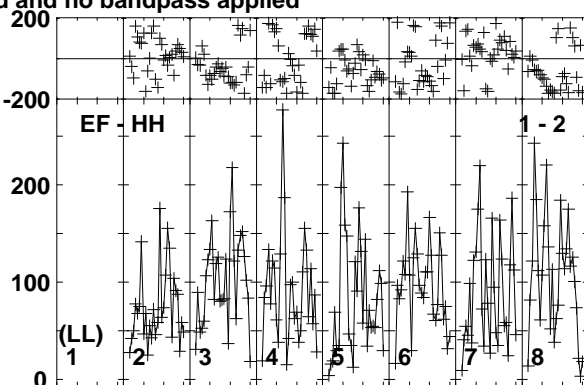
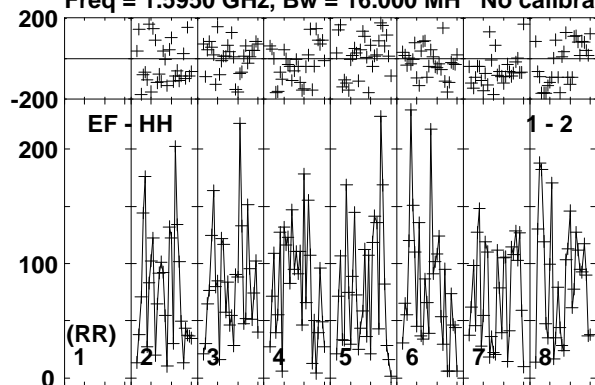

Lower frame: Micro Ampl Jy Top frame: Phas deg  
Vector averaged cross-power spectrum Baseline: EF (01) - HH (02)  
Timerange: 01/02:23:02 to 01/02:26:28

Plot file version 202 created 26-JUN-2015 10:51:26

V404CYG ET031A.UVDATA.1

Freq = 1.5950 GHz, Bw = 16.000 MH No calibration applied and no bandpass applied

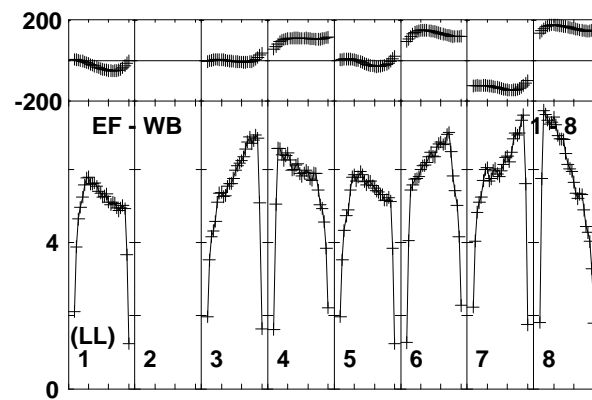
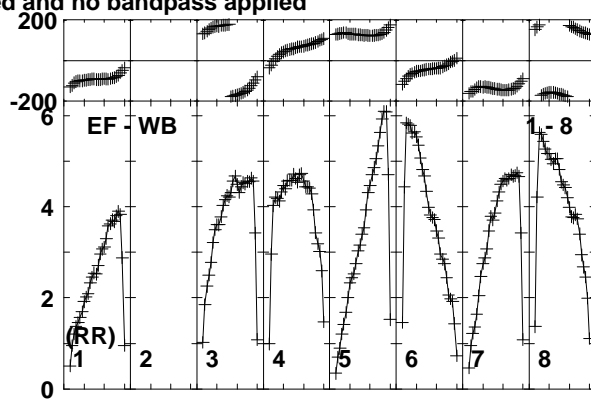
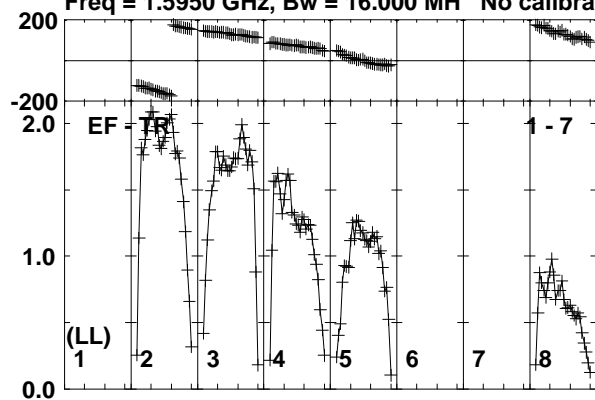

Lower frame: Milli Ampl Jy Top frame: Phas deg  
Vector averaged cross-power spectrum Baseline: EF (01) - TR (07)  
Timerange: 01/02:23:02 to 01/02:26:28

Plot file version 203 created 26-JUN-2015 10:51:26

J2025+3343 ET031A.UVDATA.1

Freq = 1.5950 GHz, Bw = 16.000 MH No calibration applied and no bandpass applied

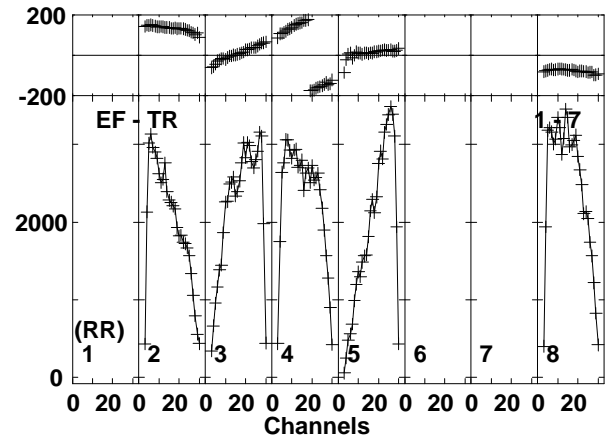
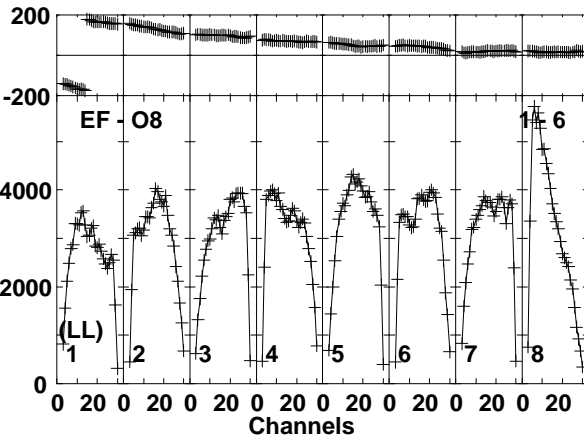
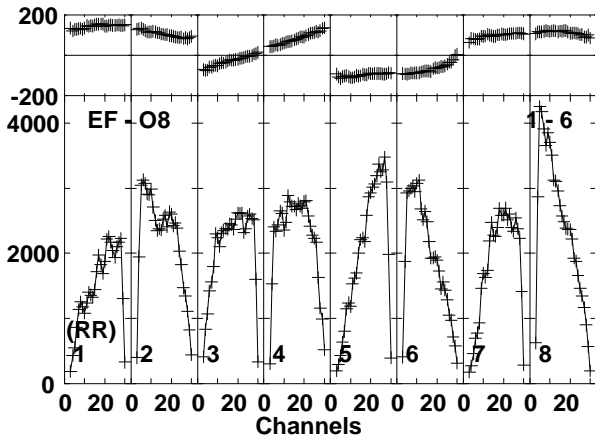
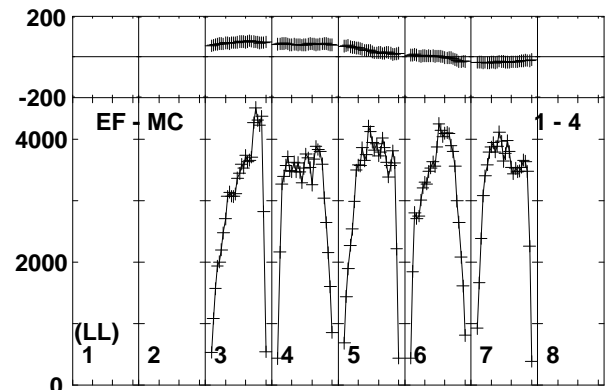
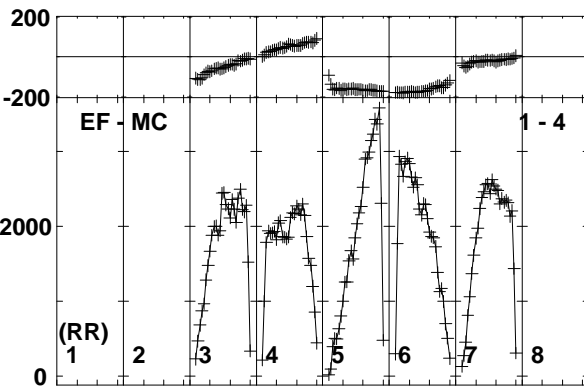
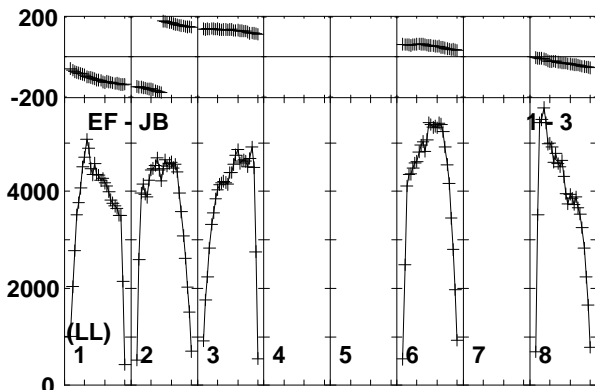
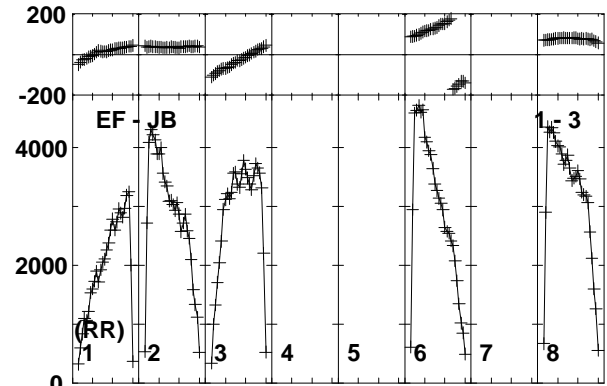
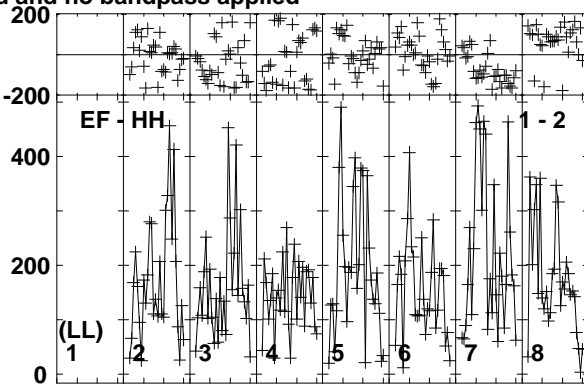
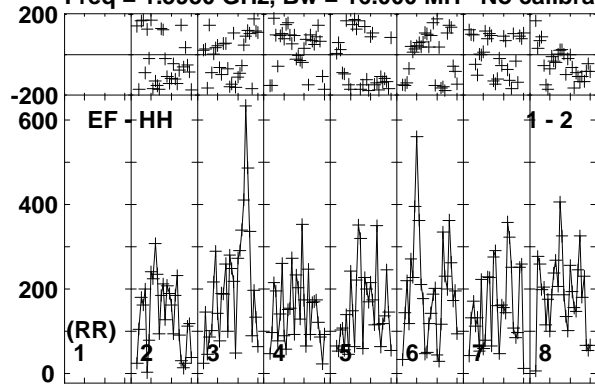

Lower frame: Micro Ampl Jy Top frame: Phas deg  
Vector averaged cross-power spectrum Baseline: EF (01) - HH (02)  
Timerange: 01/02:26:32 to 01/02:27:48

Plot file version 204 created 26-JUN-2015 10:51:26

J2025+3343 ET031A.UVDATA.1

Freq = 1.5950 GHz, Bw = 16.000 MH No calibration applied and no bandpass applied

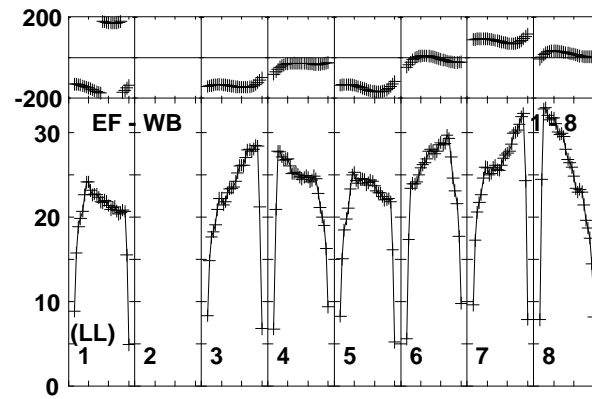
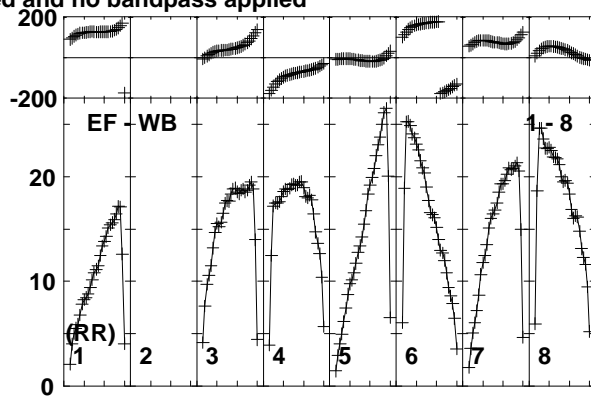
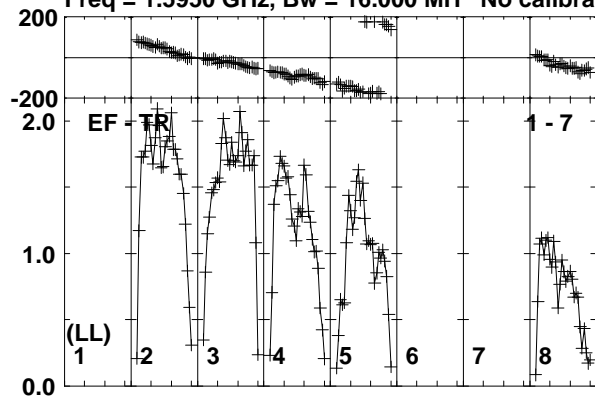

Lower frame: Milli Ampl Jy Top frame: Phas deg  
Vector averaged cross-power spectrum Baseline: EF (01) - TR (07)  
Timerange: 01/02:26:32 to 01/02:27:48

Plot file version 205 created 26-JUN-2015 10:51:26

V404CYG ET031A.UVDATA.1

Freq = 1.5950 GHz, Bw = 16.000 MH No calibration applied and no bandpass applied

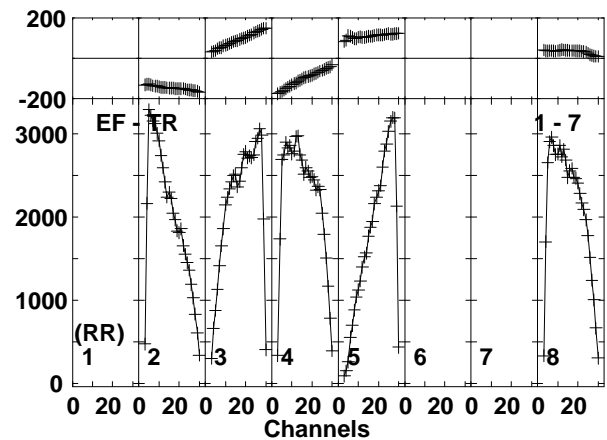
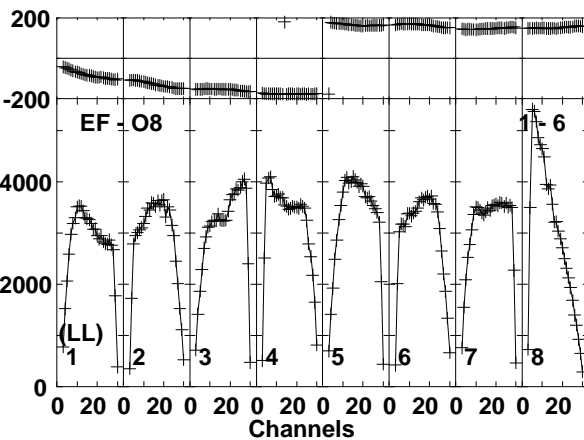
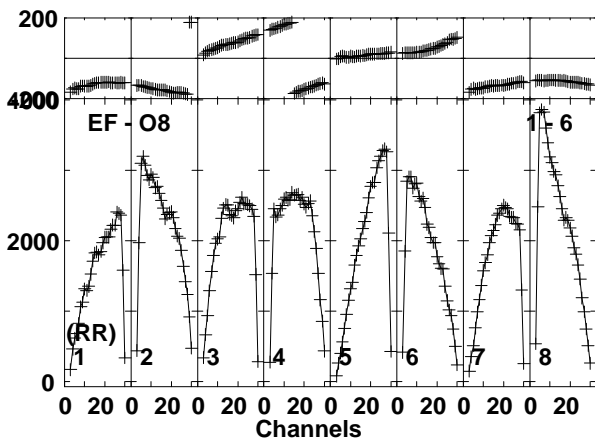
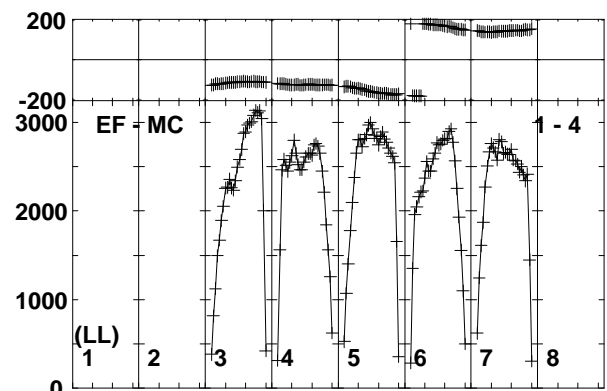
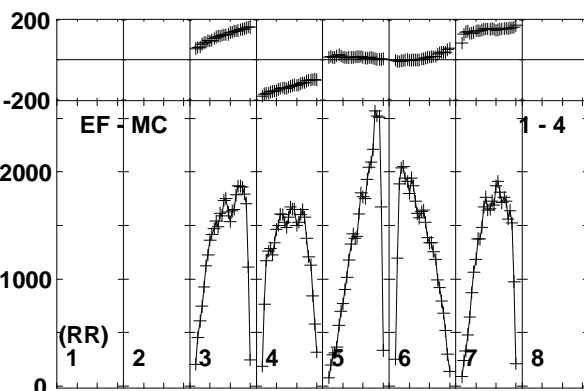
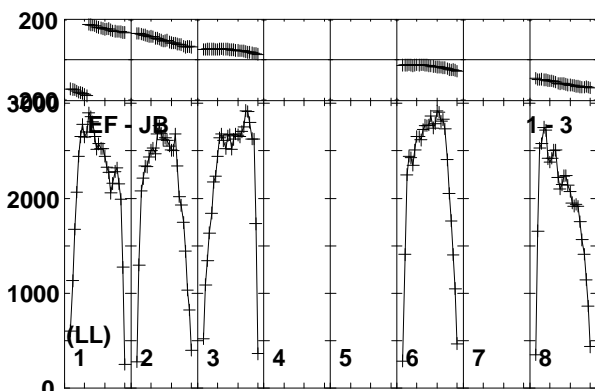
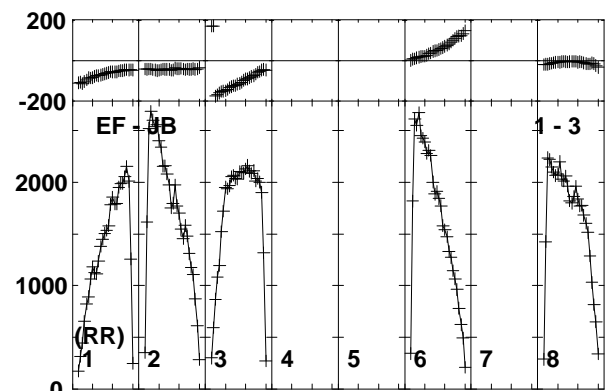
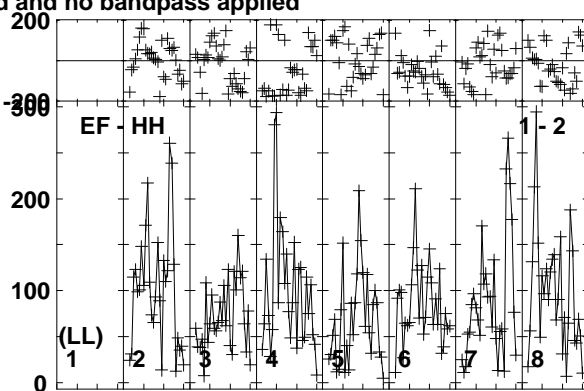
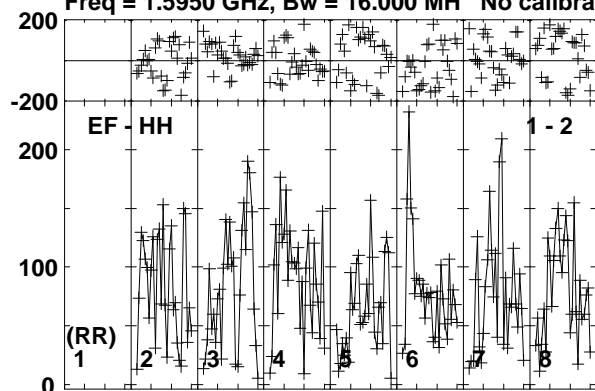

Lower frame: Micro Ampl Jy Top frame: Phas deg  
Vector averaged cross-power spectrum Baseline: EF (01) - HH (02)  
Timerange: 01/02:27:52 to 01/02:31:18

Plot file version 206 created 26-JUN-2015 10:51:26

V404CYG ET031A.UVDATA.1

Freq = 1.5950 GHz, Bw = 16.000 MH No calibration applied and no bandpass applied

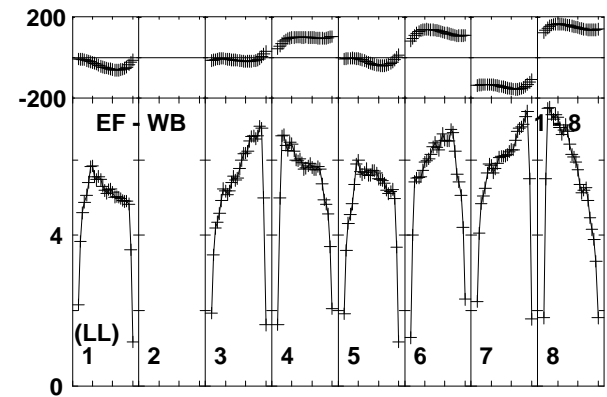
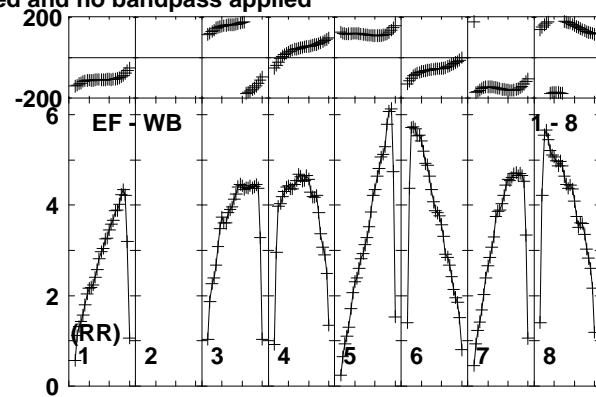
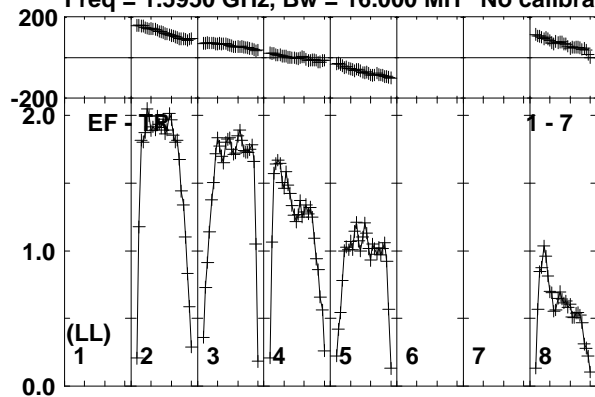

Lower frame: Milli Ampl Jy Top frame: Phas deg  
Vector averaged cross-power spectrum Baseline: EF (01) - TR (07)  
Timerange: 01/02:27:52 to 01/02:31:18

Plot file version 207 created 26-JUN-2015 10:51:26

J2025+3343 ET031A.UVDATA.1

Freq = 1.5950 GHz, Bw = 16.000 MH No calibration applied and no bandpass applied

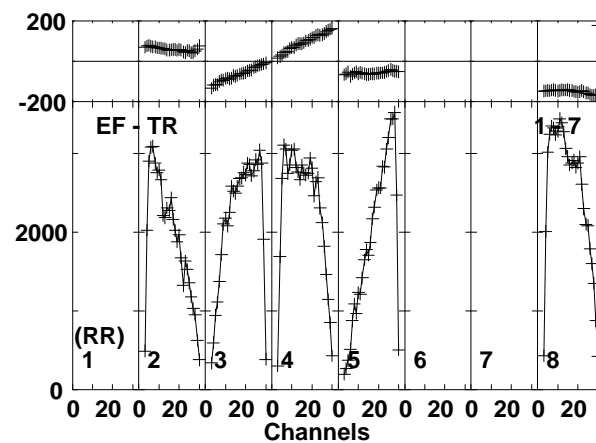
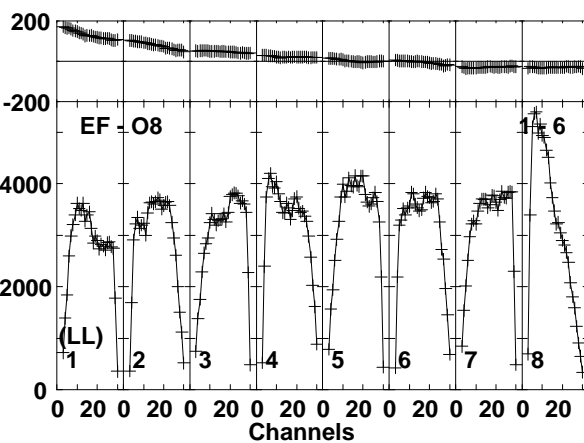
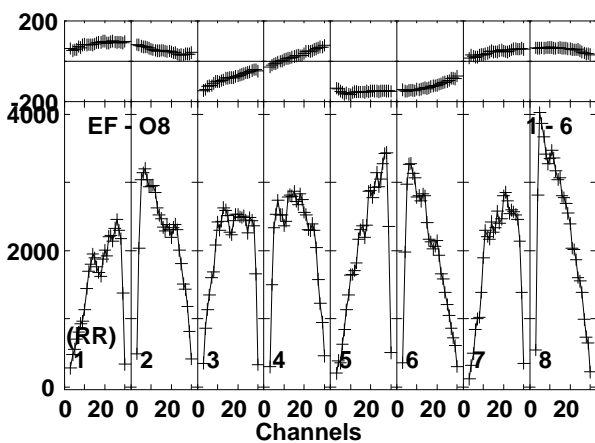
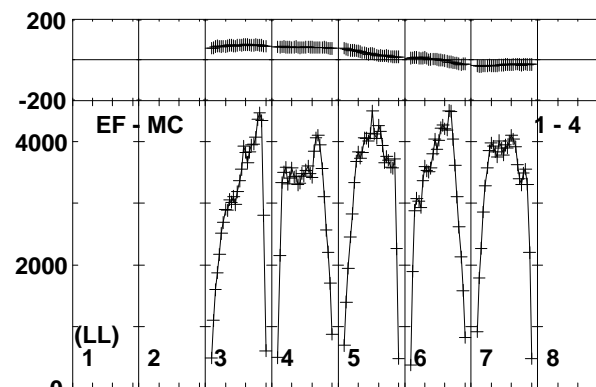
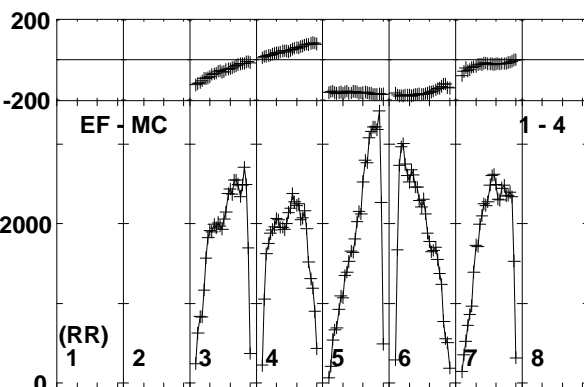
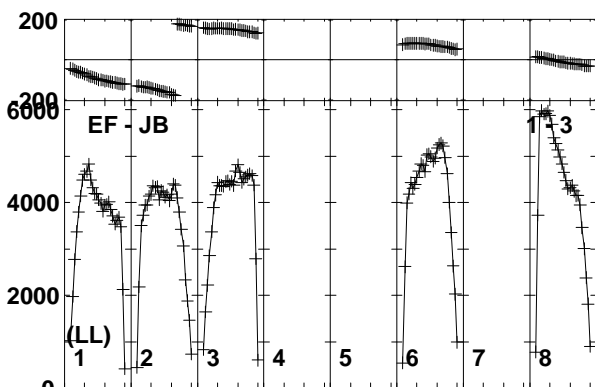
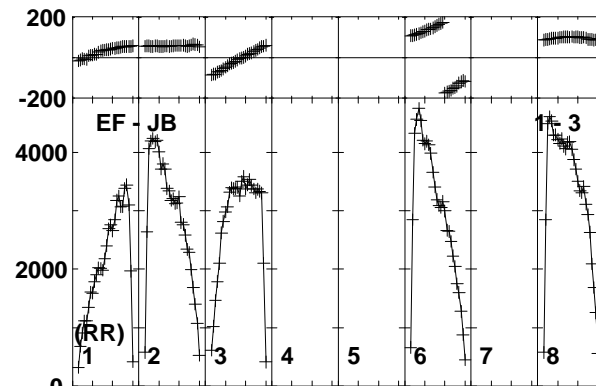
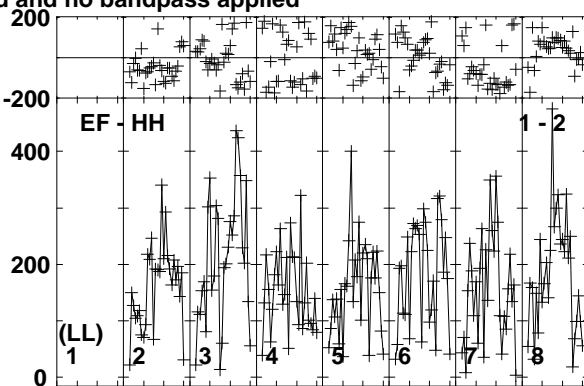
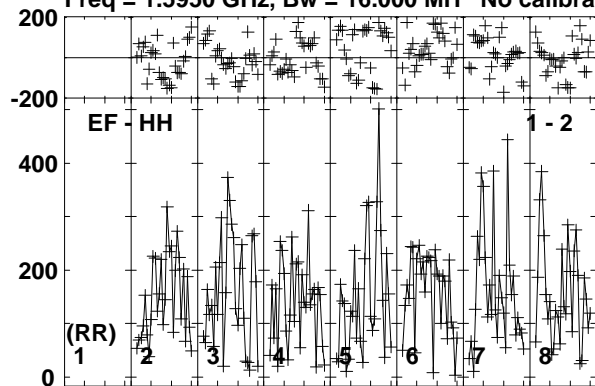

Lower frame: Micro Ampl Jy Top frame: Phas deg  
Vector averaged cross-power spectrum Baseline: EF (01) - HH (02)  
Timerange: 01/02:32:02 to 01/02:32:58

Plot file version 208 created 26-JUN-2015 10:51:26

J2025+3343 ET031A.UVDATA.1

Freq = 1.5950 GHz, Bw = 16.000 MH No calibration applied and no bandpass applied

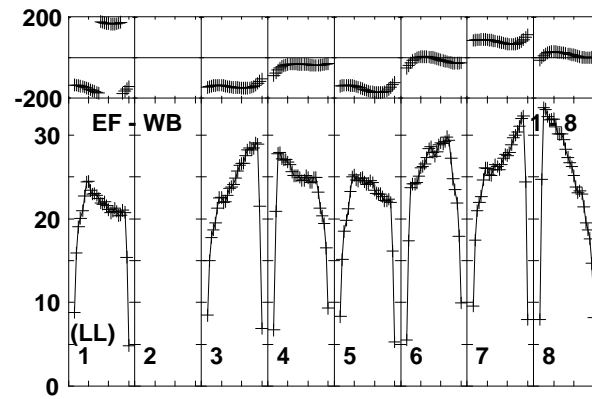
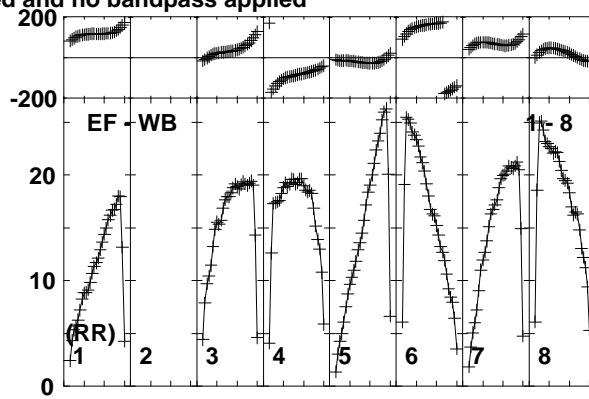
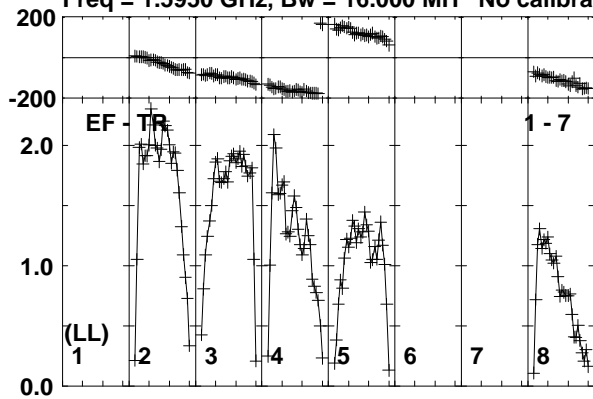

Lower frame: Milli Ampl Jy Top frame: Phas deg  
Vector averaged cross-power spectrum Baseline: EF (01) - TR (07)  
Timerange: 01/02:32:02 to 01/02:32:58



Plot file version 209 created 26-JUN-2015 10:51:26

V404CYG ET031A.UVDATA.1

Freq = 1.5950 GHz, Bw = 16.000 MH No calibration applied and no bandpass applied

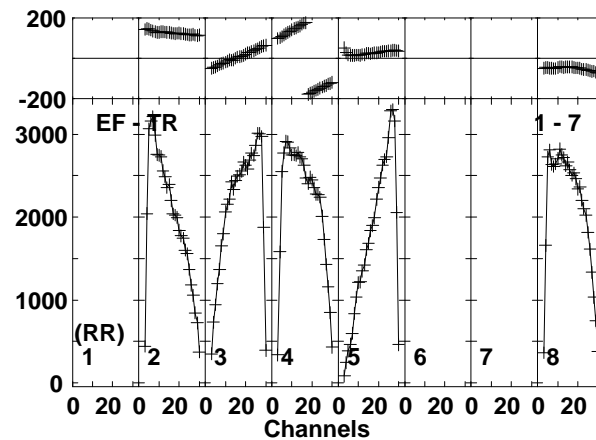
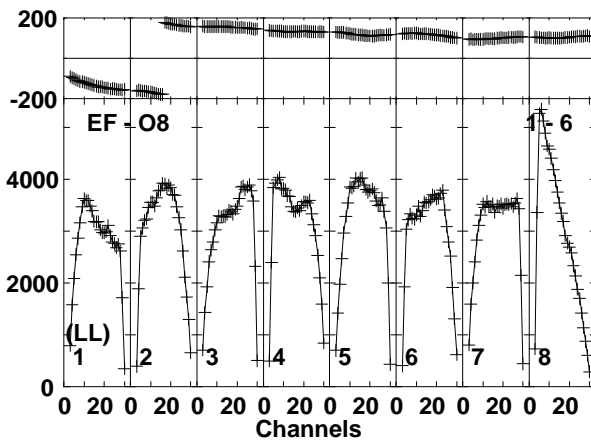
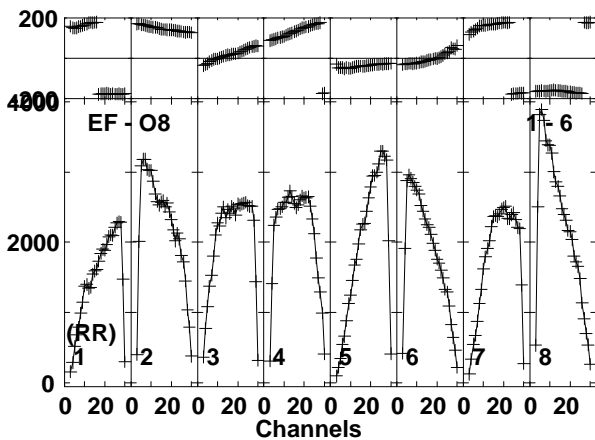
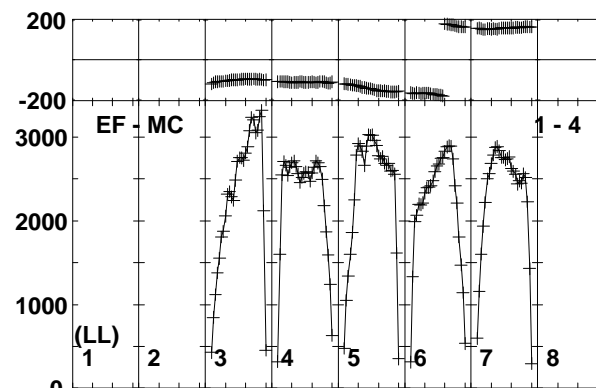
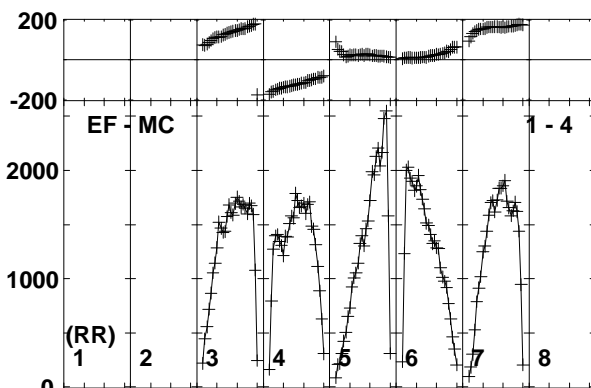
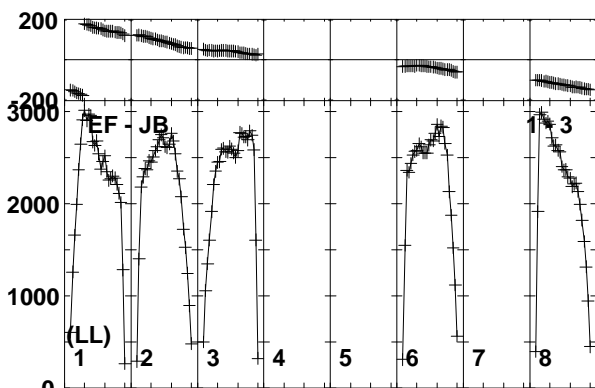
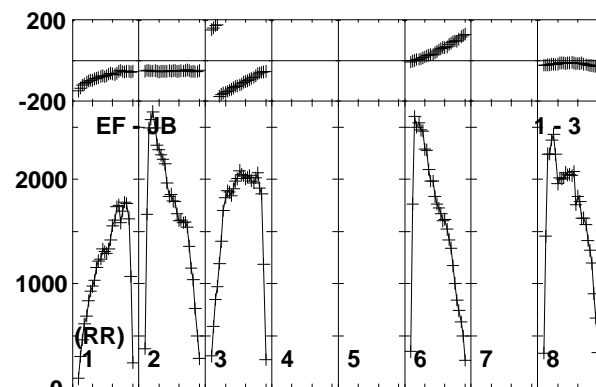
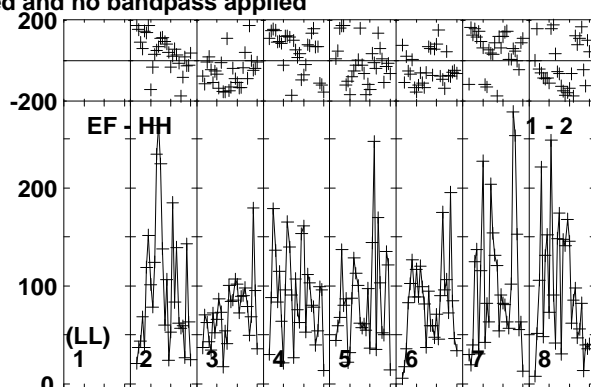
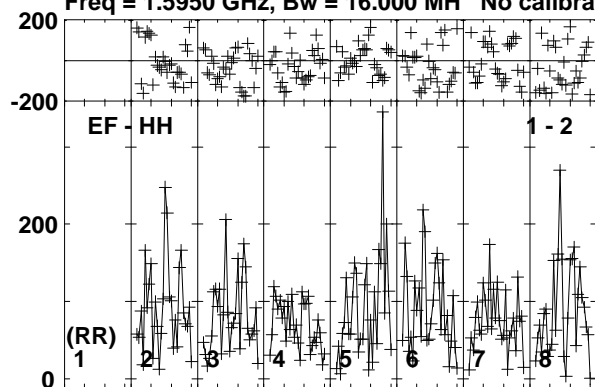

Lower frame: Micro Ampl Jy Top frame: Phas deg  
Vector averaged cross-power spectrum Baseline: EF (01) - HH (02)  
Timerange: 01/02:33:02 to 01/02:36:28

Plot file version 210 created 26-JUN-2015 10:51:26

V404CYG ET031A.UVDATA.1

Freq = 1.5950 GHz, Bw = 16.000 MH No calibration applied and no bandpass applied

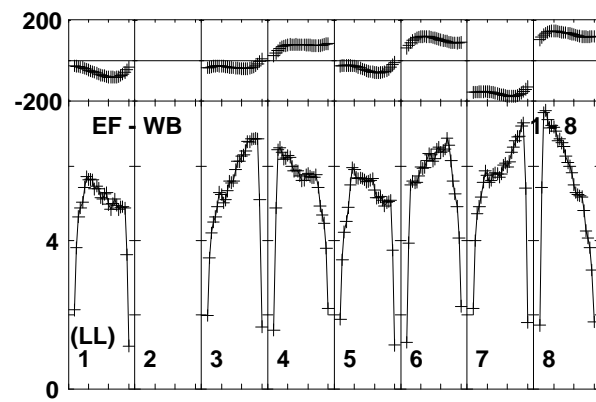
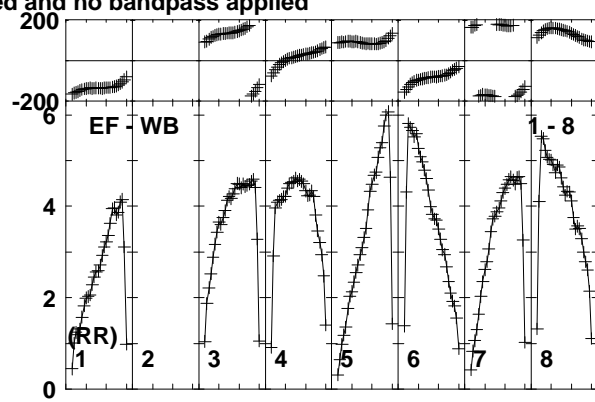
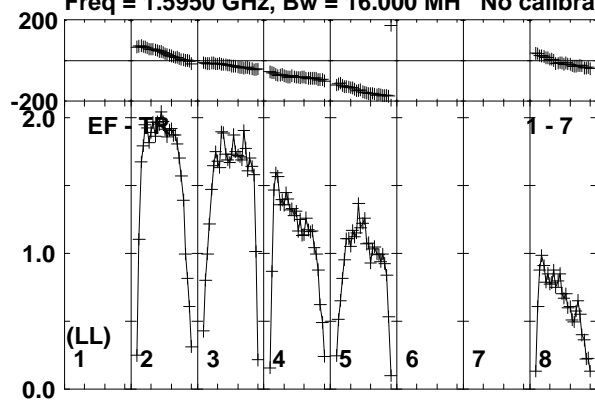

Lower frame: Milli Ampl Jy Top frame: Phas deg  
Vector averaged cross-power spectrum Baseline: EF (01) - TR (07)  
Timerange: 01/02:33:02 to 01/02:36:28

Plot file version 211 created 26-JUN-2015 10:51:26

J2025+3343 ET031A.UVDATA.1

Freq = 1.5950 GHz, Bw = 16.000 MH No calibration applied and no bandpass applied

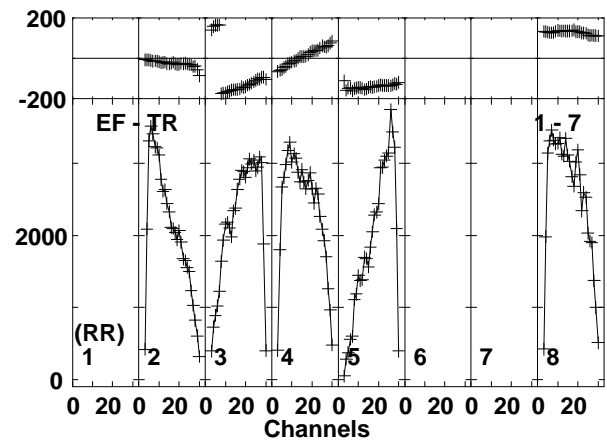
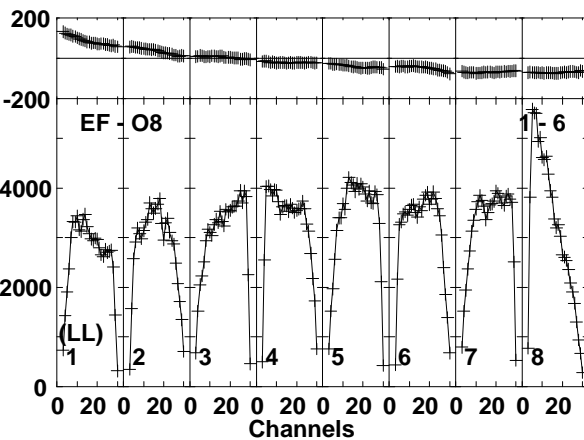
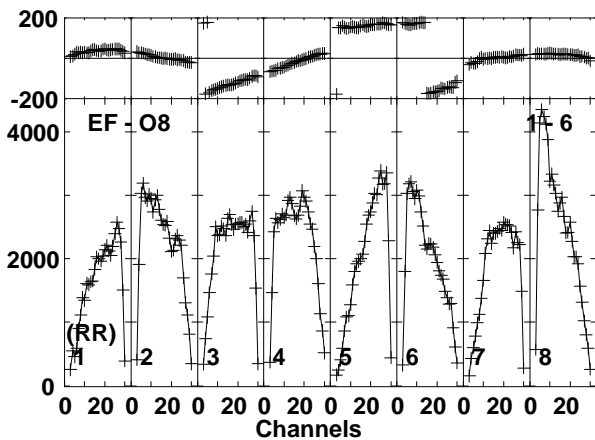
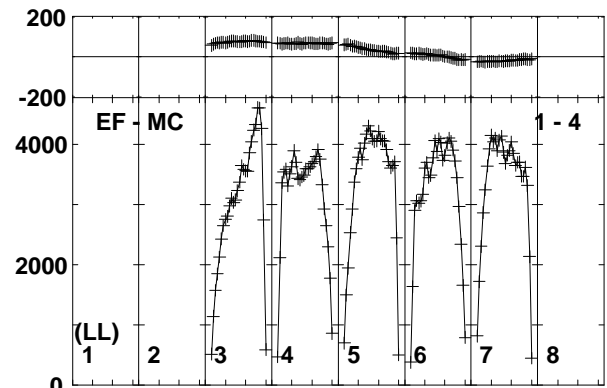
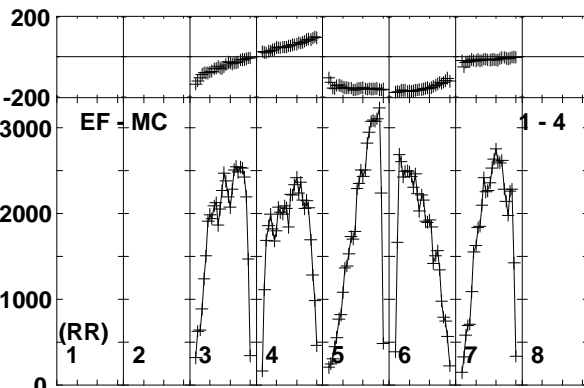
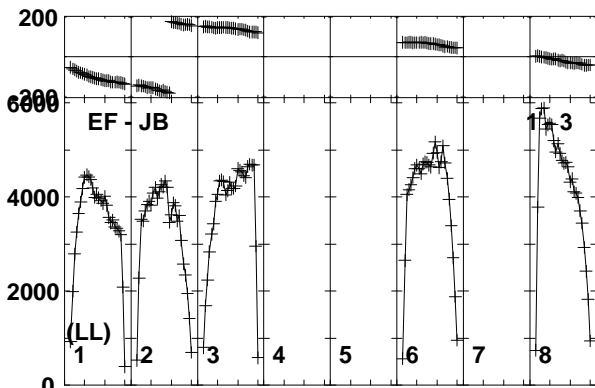
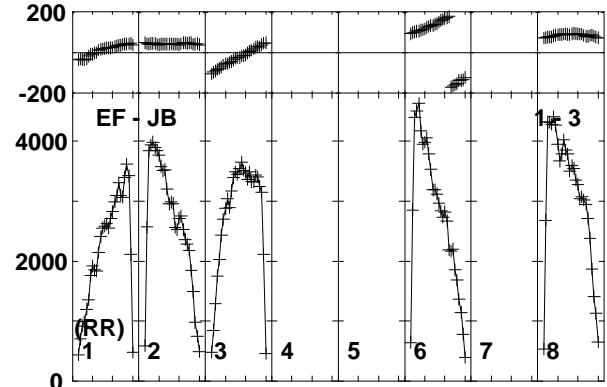
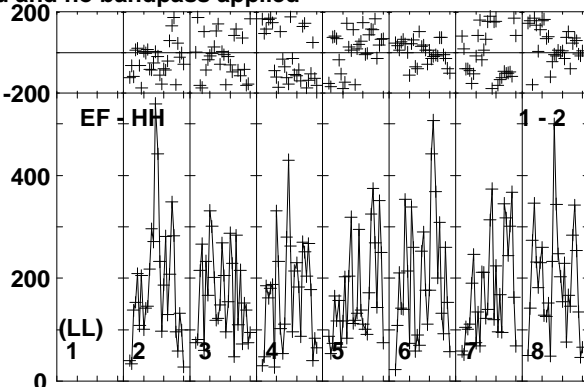
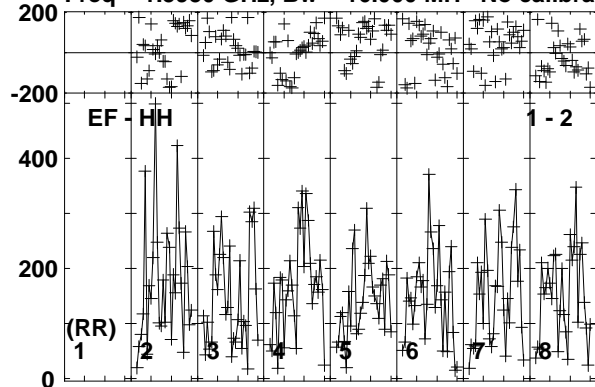

Lower frame: Micro Ampl Jy Top frame: Phas deg  
Vector averaged cross-power spectrum Baseline: EF (01) - HH (02)  
Timerange: 01/02:36:32 to 01/02:37:48

Plot file version 212 created 26-JUN-2015 10:51:26

J2025+3343 ET031A.UVDATA.1

Freq = 1.5950 GHz, Bw = 16.000 MH No calibration applied and no bandpass applied

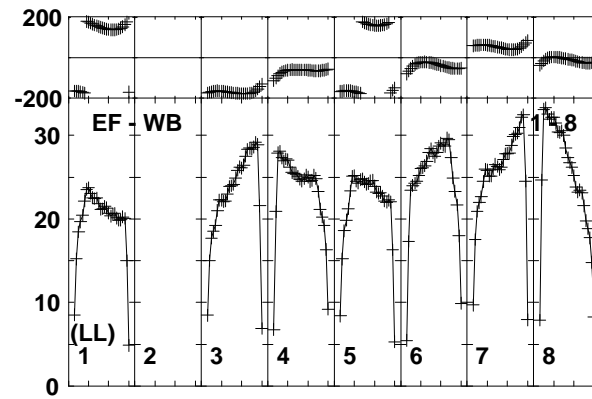
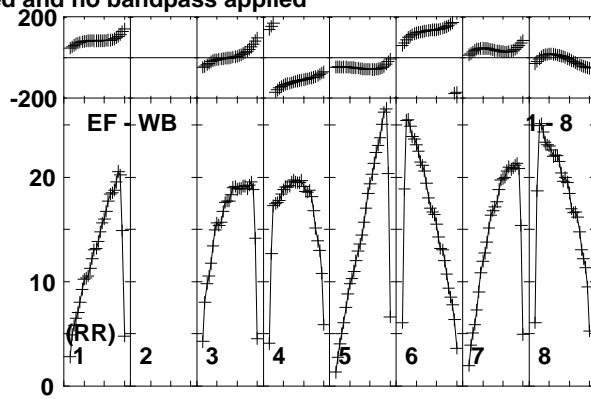
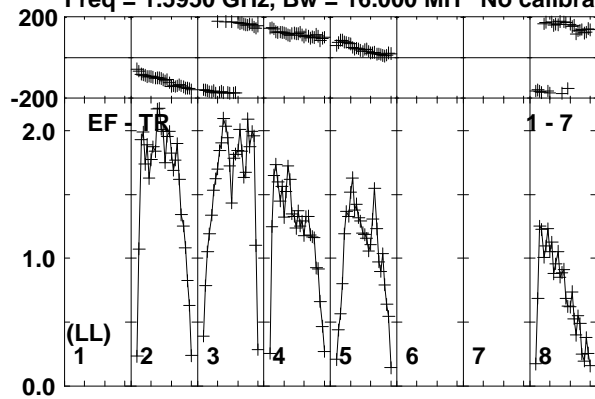

Lower frame: Milli Ampl Jy Top frame: Phas deg  
Vector averaged cross-power spectrum Baseline: EF (01) - TR (07)  
Timerange: 01/02:36:32 to 01/02:37:48

Plot file version 213 created 26-JUN-2015 10:51:26

V404CYG ET031A.UVDATA.1

Freq = 1.5950 GHz, Bw = 16.000 MH No calibration applied and no bandpass applied

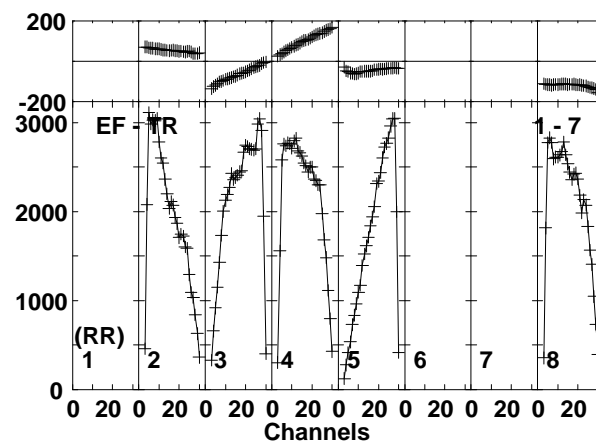
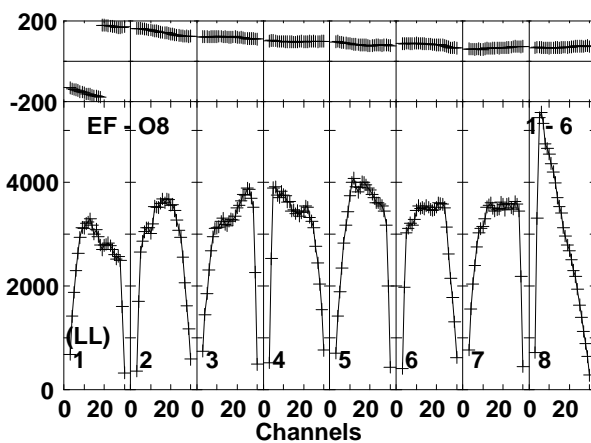
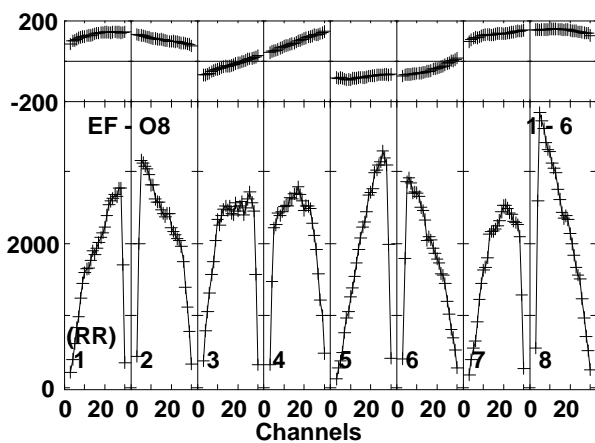
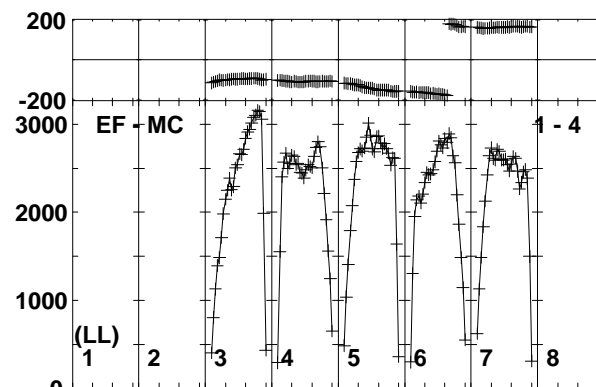
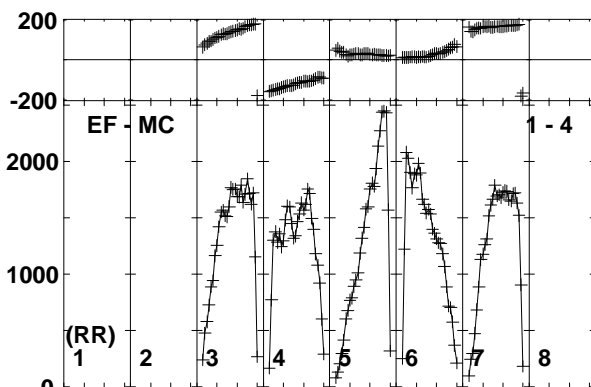
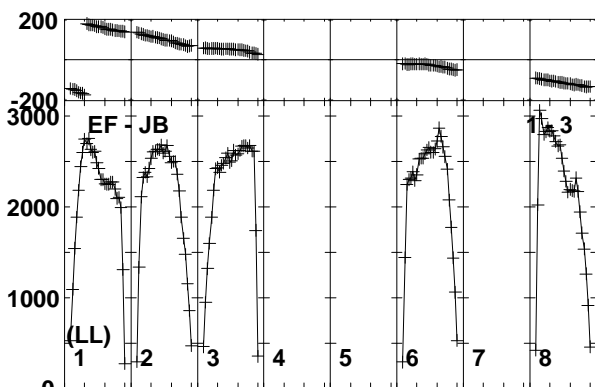
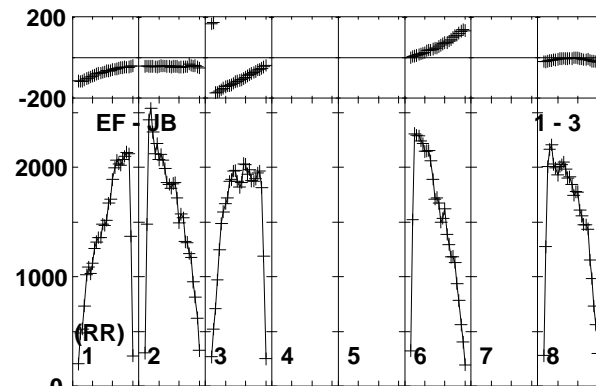
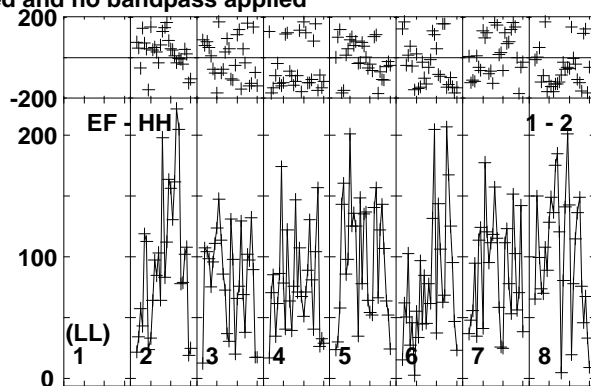
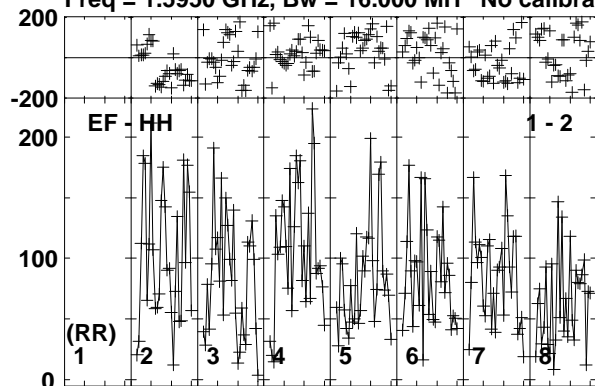

Lower frame: Micro Ampl Jy Top frame: Phas deg  
Vector averaged cross-power spectrum Baseline: EF (01) - HH (02)  
Timerange: 01/02:37:52 to 01/02:41:18

Plot file version 214 created 26-JUN-2015 10:51:26

V404CYG ET031A.UVDATA.1

Freq = 1.5950 GHz, Bw = 16.000 MH No calibration applied and no bandpass applied

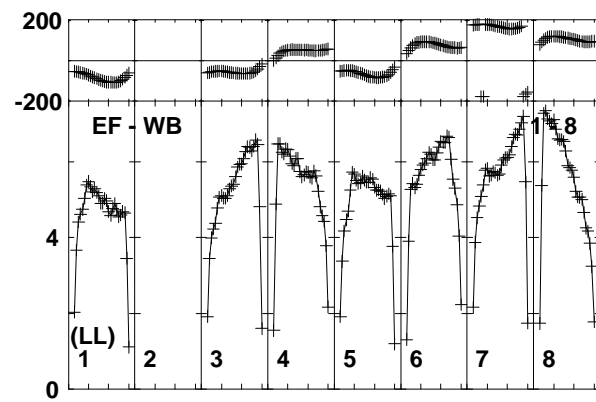
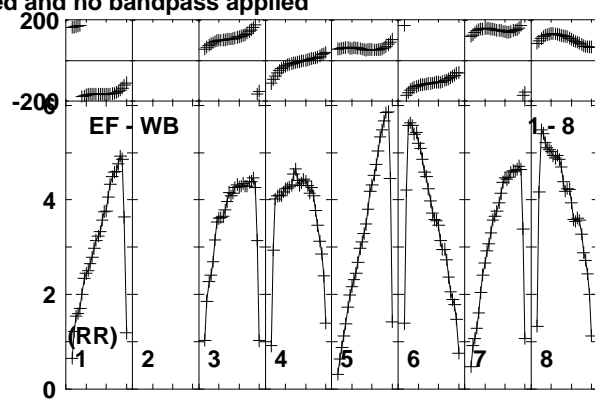
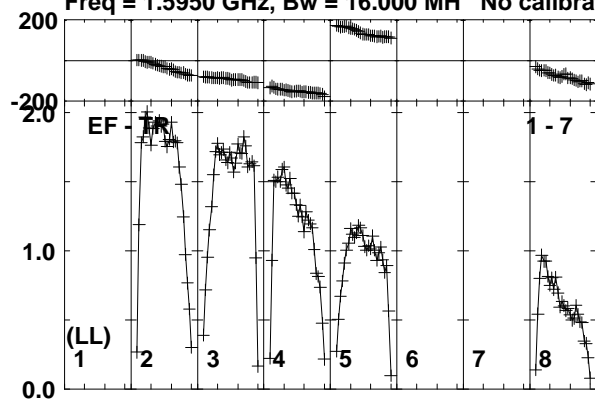

Lower frame: Milli Ampl Jy Top frame: Phas deg  
Vector averaged cross-power spectrum Baseline: EF (01) - TR (07)  
Timerange: 01/02:37:52 to 01/02:41:18

Plot file version 215 created 26-JUN-2015 10:51:26

J2025+3343 ET031A.UVDATA.1

Freq = 1.5950 GHz, Bw = 16.000 MH No calibration applied and no bandpass applied

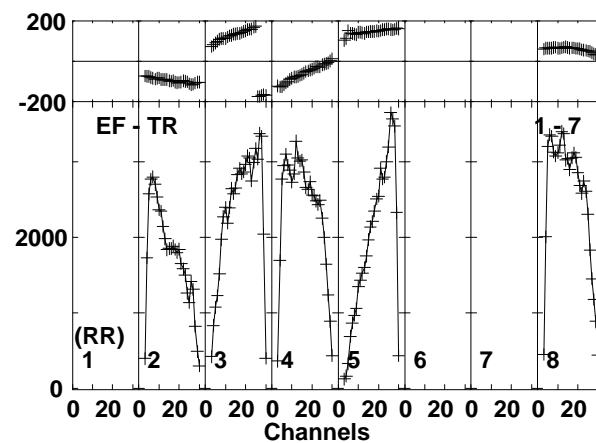
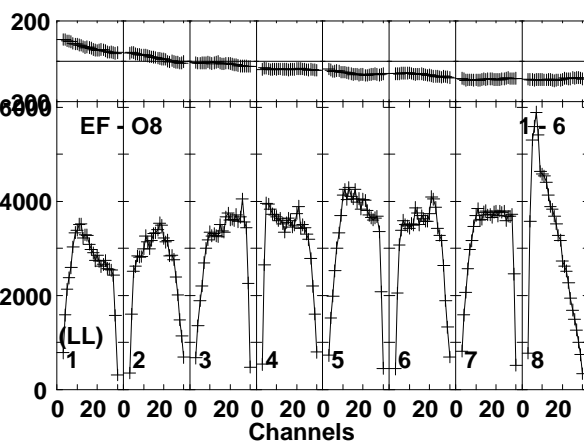
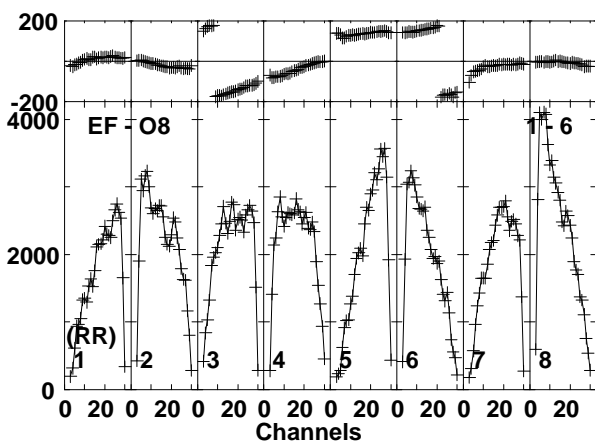
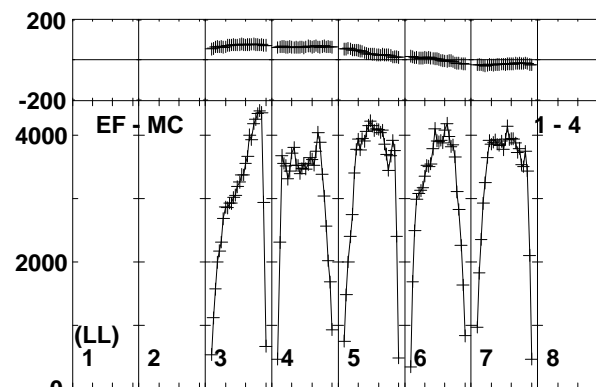
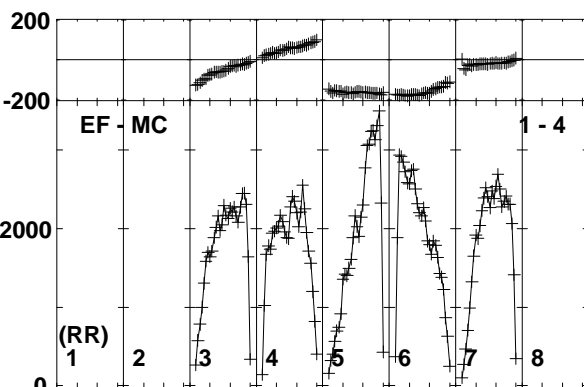
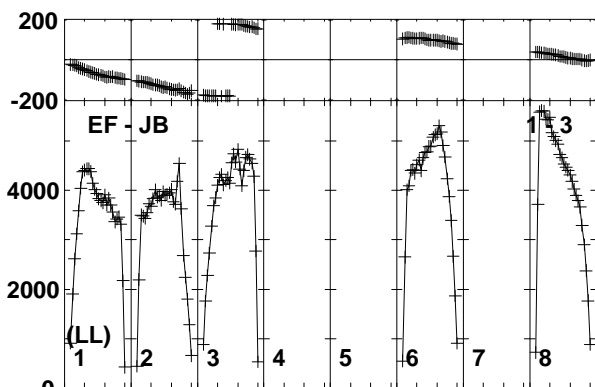
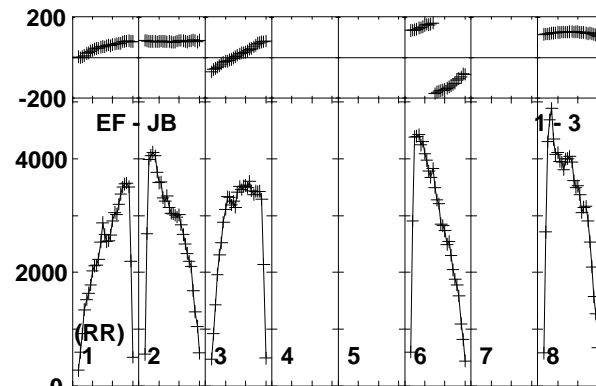
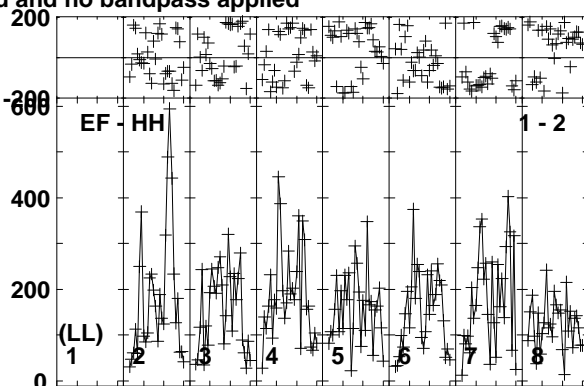
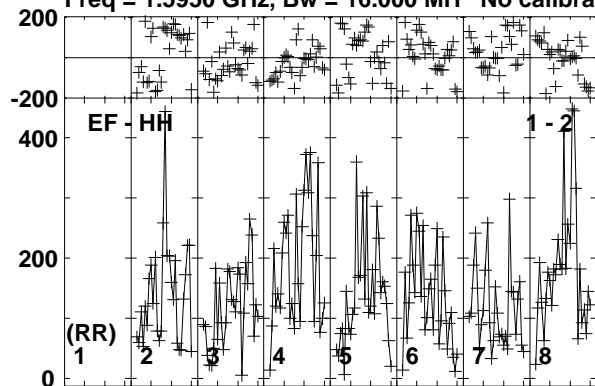

Lower frame: Micro Ampl Jy Top frame: Phas deg  
Vector averaged cross-power spectrum Baseline: EF (01) - HH (02)  
Timerange: 01/02:42:02 to 01/02:42:58

Plot file version 216 created 26-JUN-2015 10:51:26

J2025+3343 ET031A.UVDATA.1

Freq = 1.5950 GHz, Bw = 16.000 MH No calibration applied and no bandpass applied

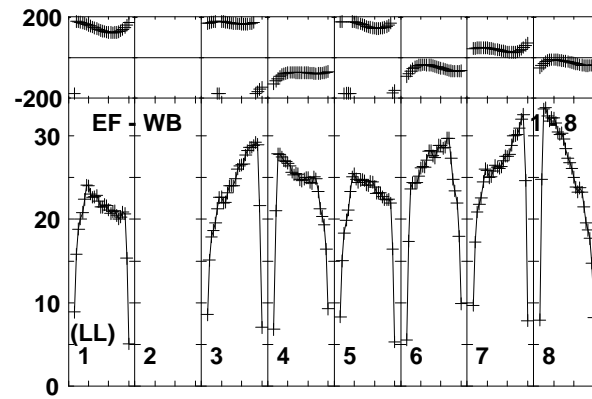
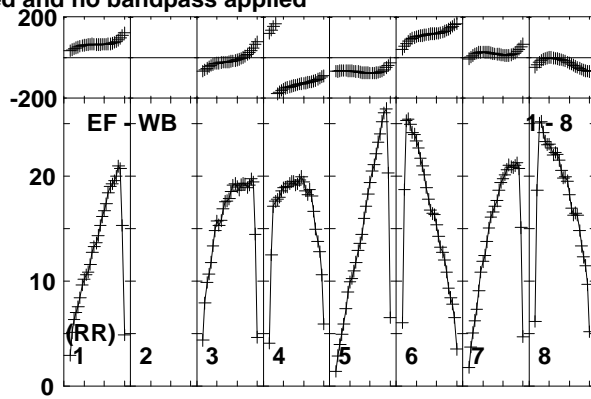
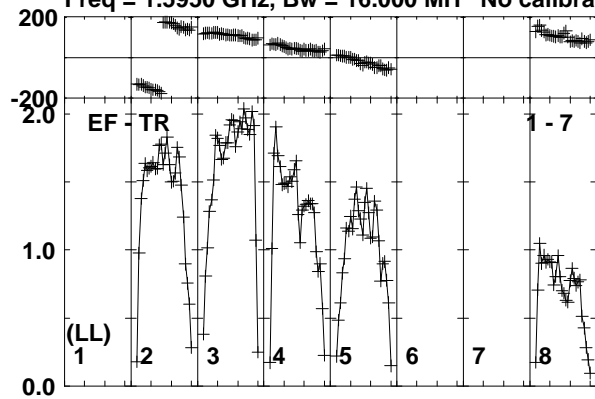

Lower frame: Milli Ampl Jy Top frame: Phas deg  
Vector averaged cross-power spectrum Baseline: EF (01) - TR (07)  
Timerange: 01/02:42:02 to 01/02:42:58



Plot file version 217 created 26-JUN-2015 10:51:26

V404CYG ET031A.UVDATA.1

Freq = 1.5950 GHz, Bw = 16.000 MH No calibration applied and no bandpass applied

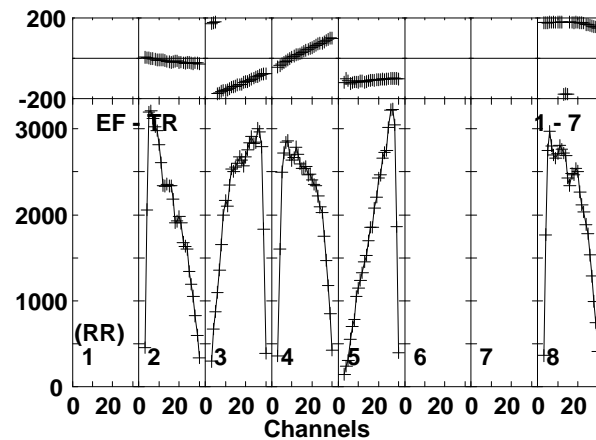
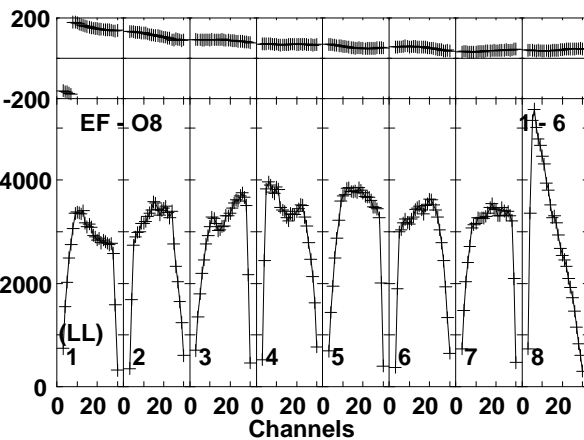
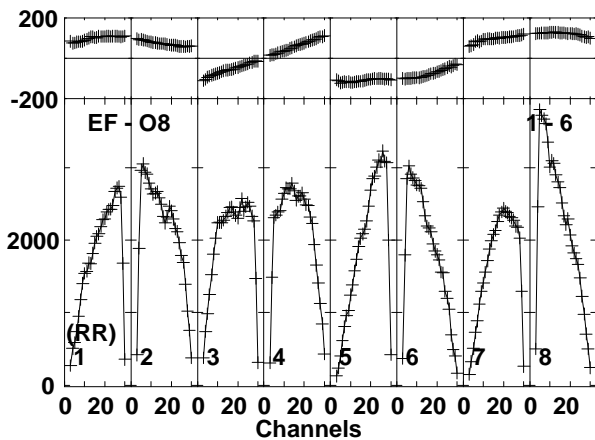
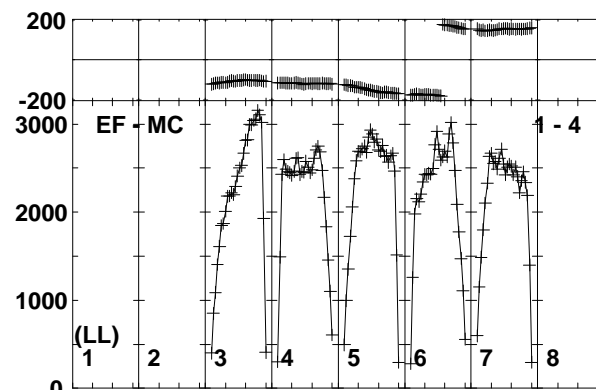
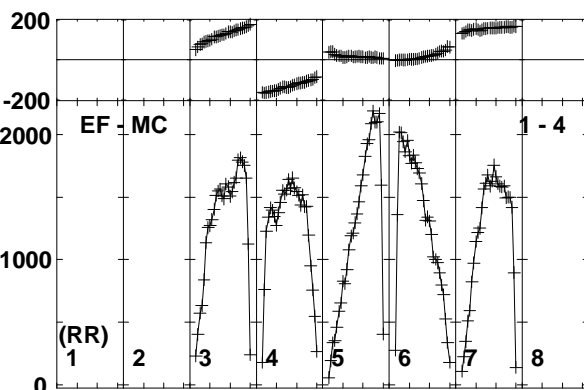
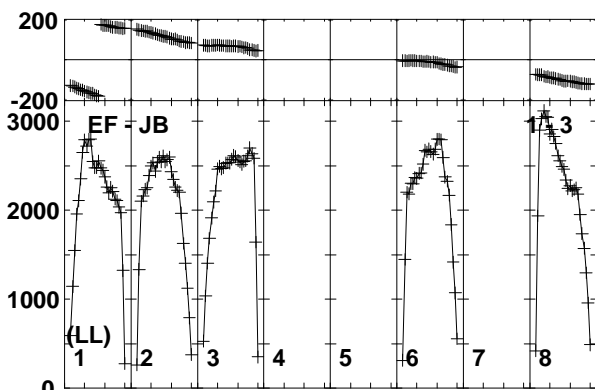
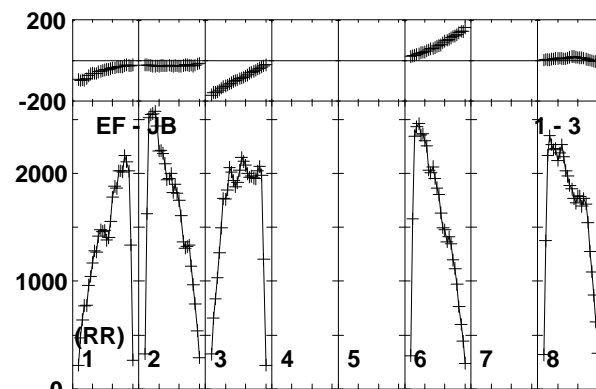
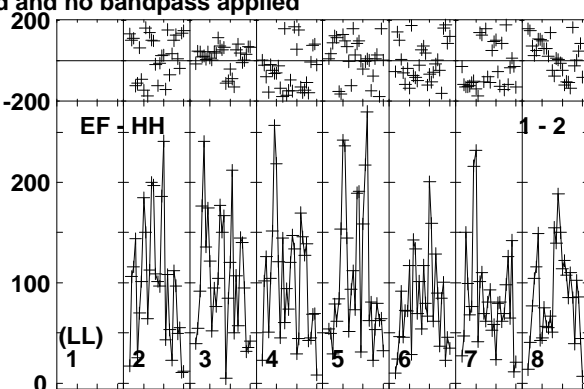
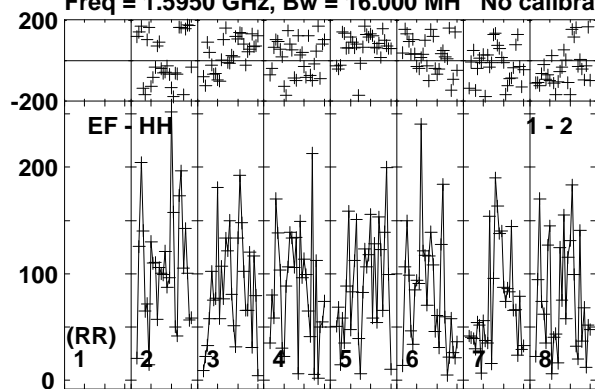

Lower frame: Micro Ampl Jy Top frame: Phas deg  
Vector averaged cross-power spectrum Baseline: EF (01) - HH (02)  
Timerange: 01/02:43:02 to 01/02:46:28

Plot file version 218 created 26-JUN-2015 10:51:26

V404CYG ET031A.UVDATA.1

Freq = 1.5950 GHz, Bw = 16.000 MH No calibration applied and no bandpass applied

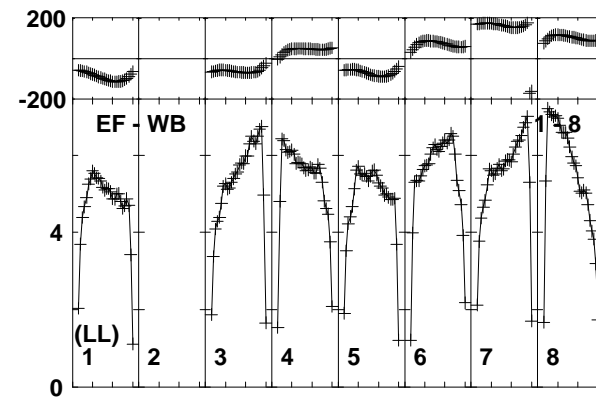
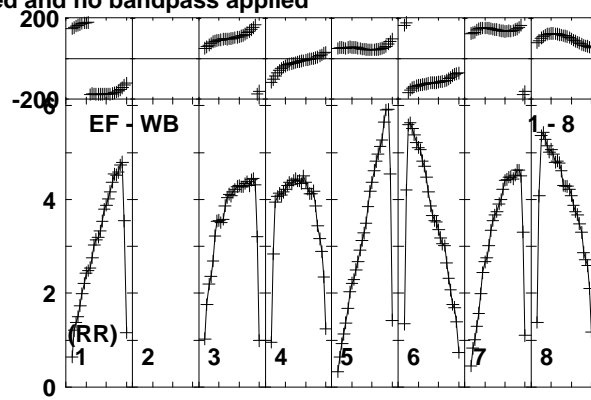
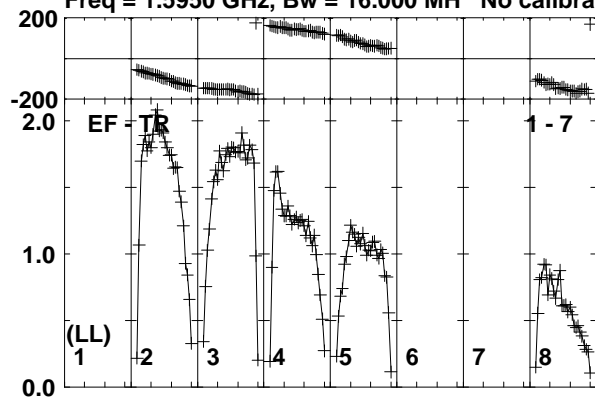

Lower frame: Milli Ampl Jy Top frame: Phas deg  
Vector averaged cross-power spectrum Baseline: EF (01) - TR (07)  
Timerange: 01/02:43:02 to 01/02:46:28

Plot file version 219 created 26-JUN-2015 10:51:26

J2025+3343 ET031A.UVDATA.1

Freq = 1.5950 GHz, Bw = 16.000 MH No calibration applied and no bandpass applied

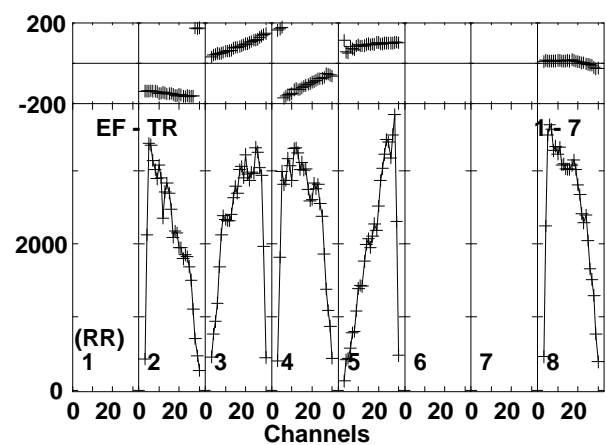
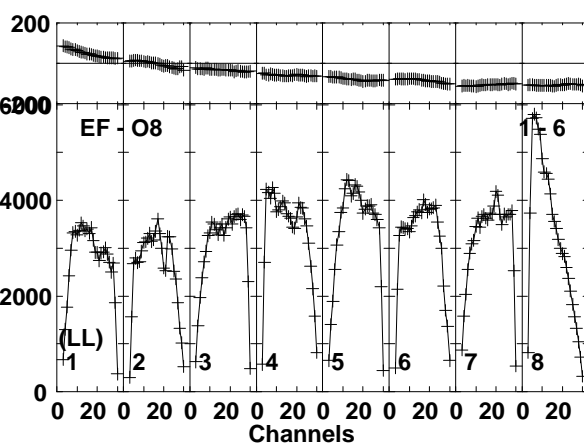
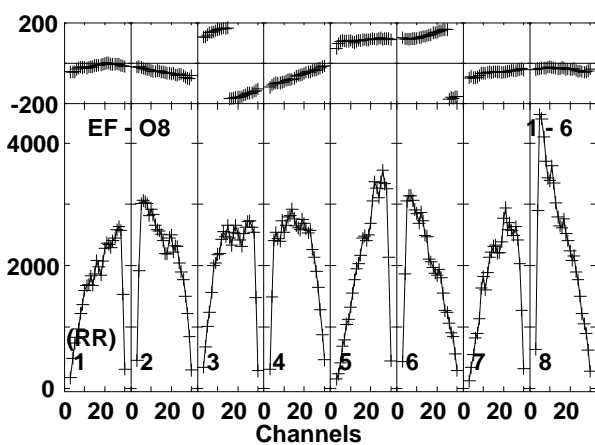
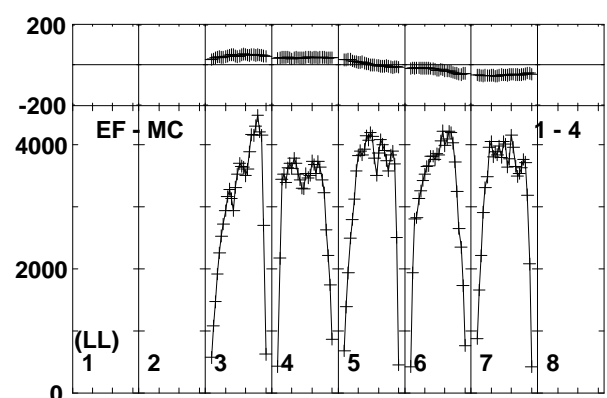
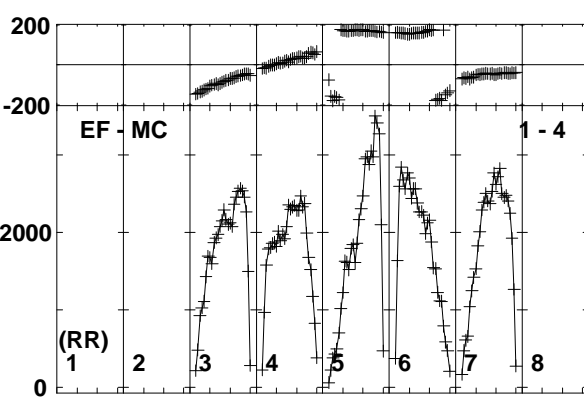
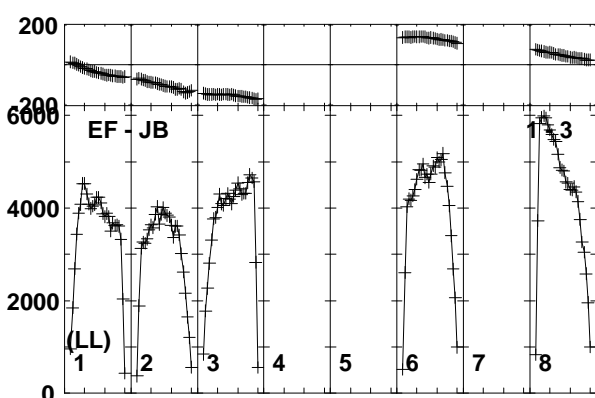
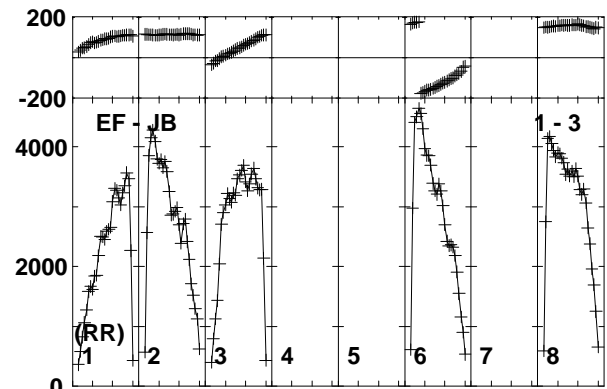
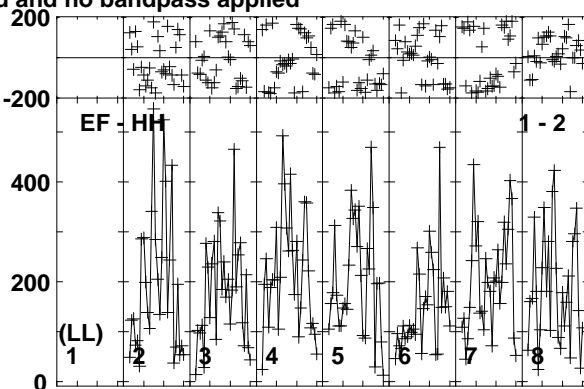
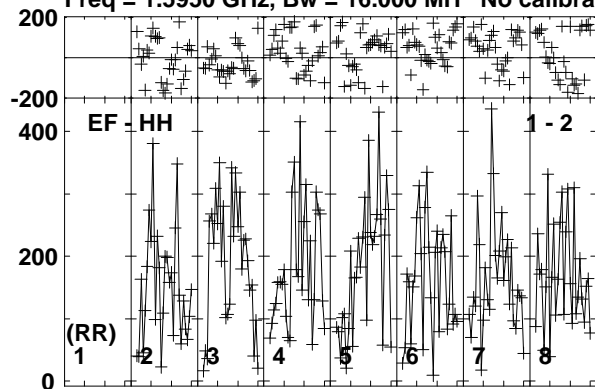

Lower frame: Micro Ampl Jy Top frame: Phas deg  
Vector averaged cross-power spectrum Baseline: EF (01) - HH (02)  
Timerange: 01/02:46:32 to 01/02:47:48

Plot file version 220 created 26-JUN-2015 10:51:26

J2025+3343 ET031A.UVDATA.1

Freq = 1.5950 GHz, Bw = 16.000 MH No calibration applied and no bandpass applied

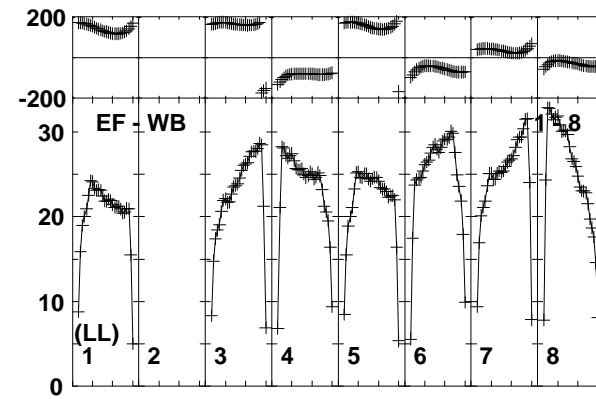
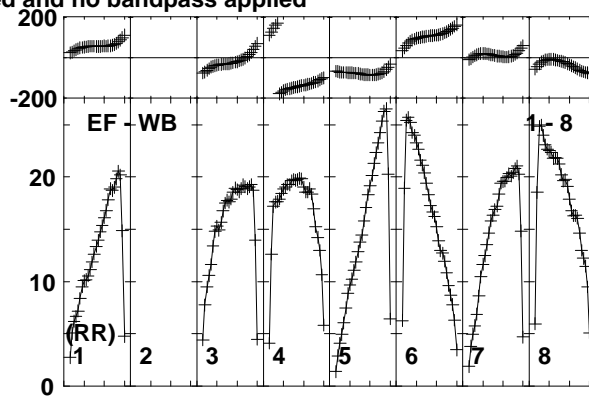
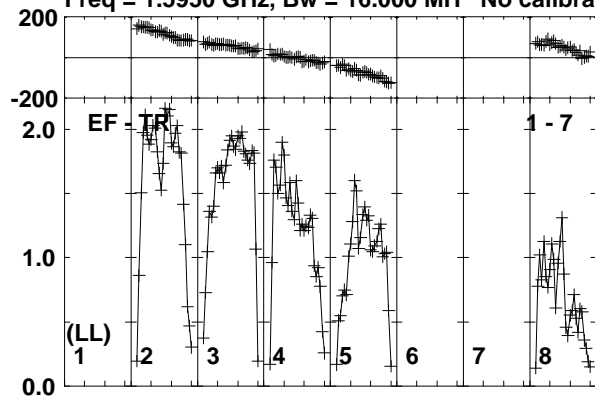

Lower frame: Milli Ampl Jy Top frame: Phas deg  
Vector averaged cross-power spectrum Baseline: EF (01) - TR (07)  
Timerange: 01/02:46:32 to 01/02:47:48

Plot file version 221 created 26-JUN-2015 10:51:27

V404CYG ET031A.UVDATA.1

Freq = 1.5950 GHz, Bw = 16.000 MH No calibration applied and no bandpass applied

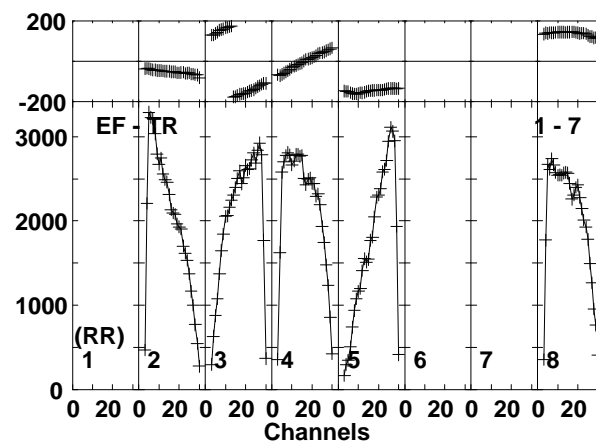
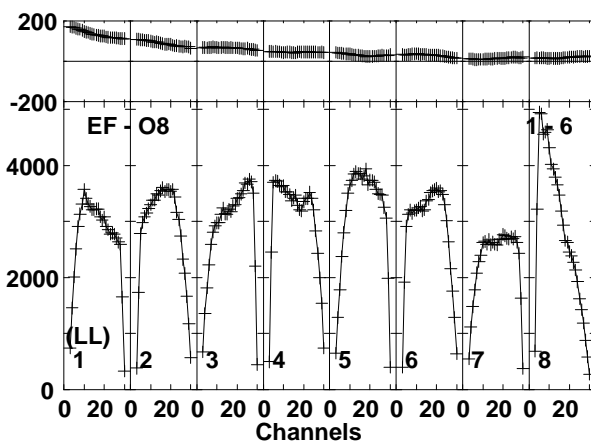
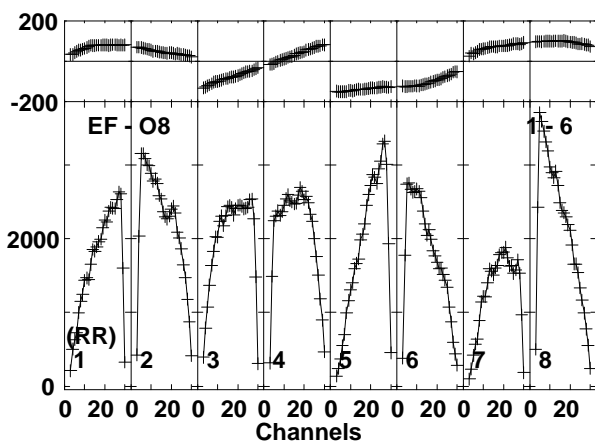
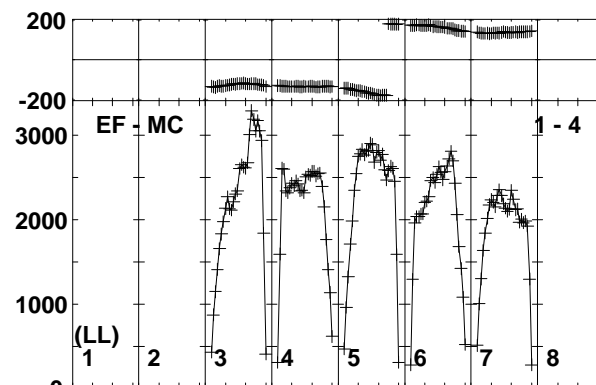
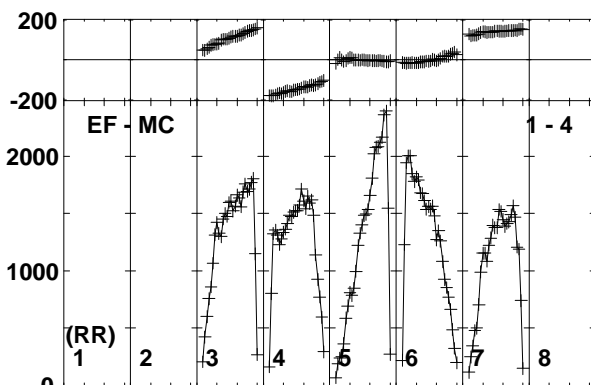
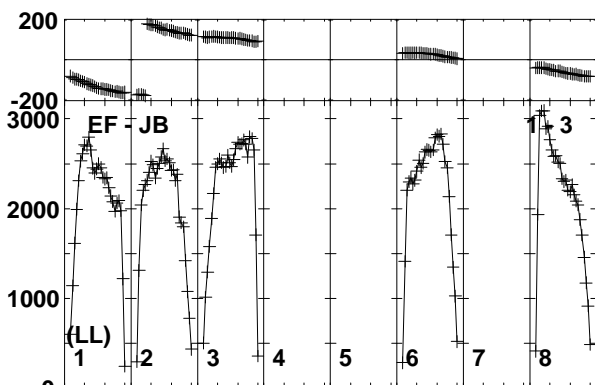
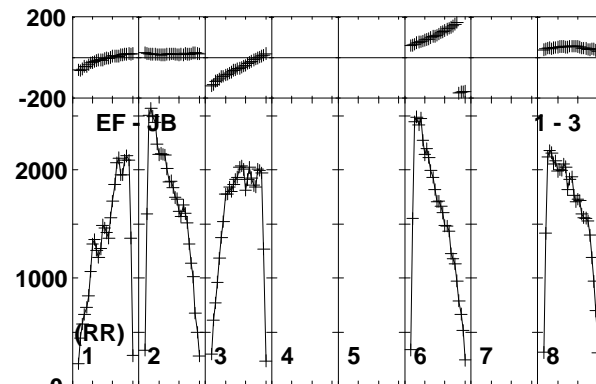
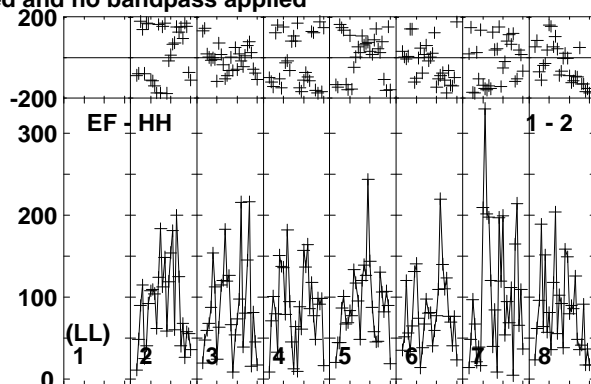
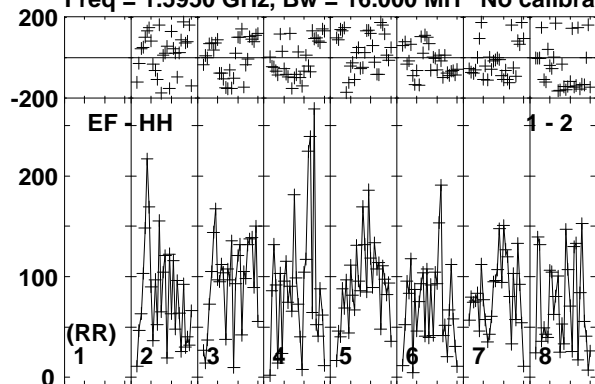

Lower frame: Micro Ampl Jy Top frame: Phas deg  
Vector averaged cross-power spectrum Baseline: EF (01) - HH (02)  
Timerange: 01/02:47:52 to 01/02:51:18

Plot file version 222 created 26-JUN-2015 10:51:27

V404CYG ET031A.UVDATA.1

Freq = 1.5950 GHz, Bw = 16.000 MH No calibration applied and no bandpass applied

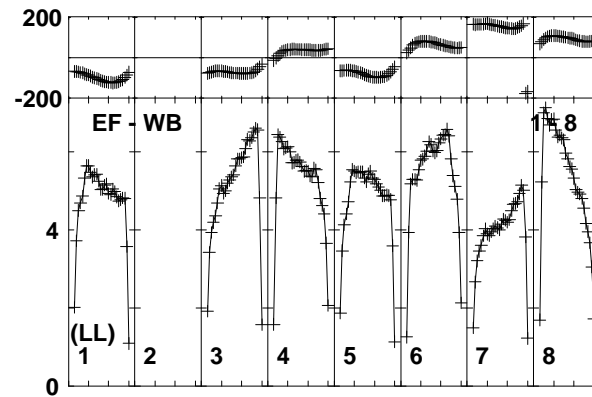
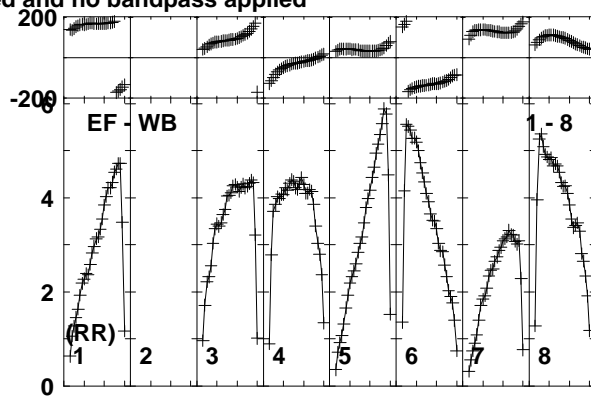
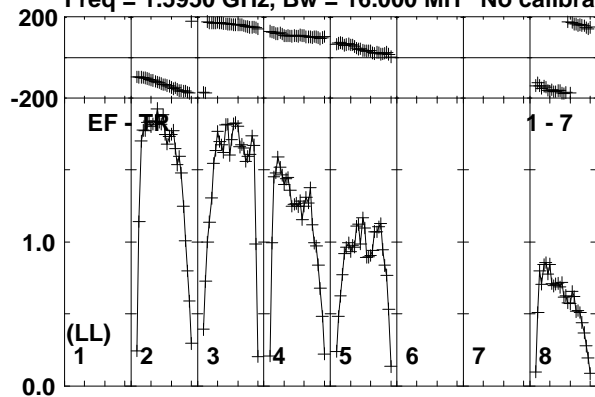

Lower frame: Milli Ampl Jy Top frame: Phas deg  
Vector averaged cross-power spectrum Baseline: EF (01) - TR (07)  
Timerange: 01/02:47:52 to 01/02:51:18

Plot file version 223 created 26-JUN-2015 10:51:27

J2025+3343 ET031A.UVDATA.1

Freq = 1.5950 GHz, Bw = 16.000 MH No calibration applied and no bandpass applied

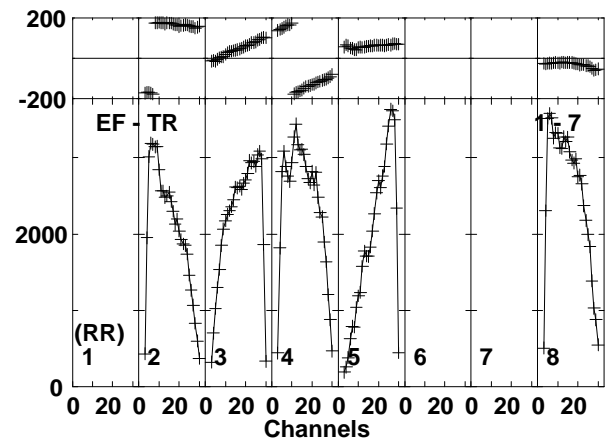
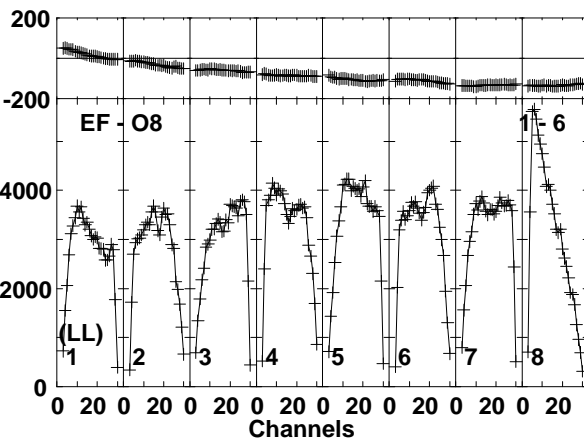
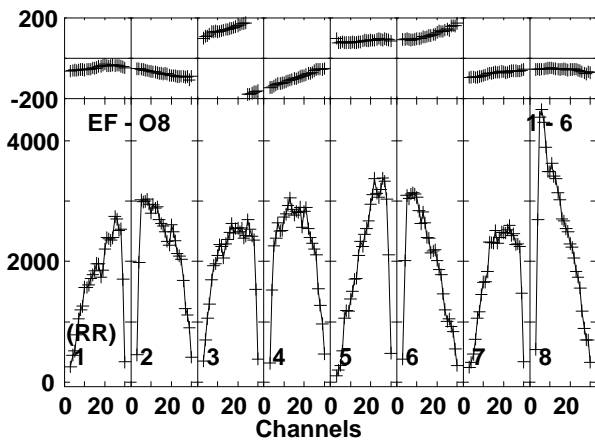
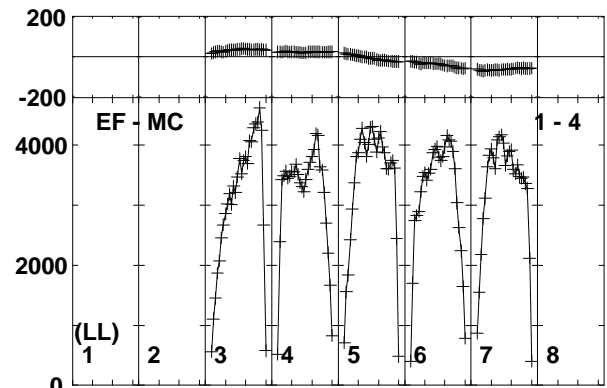
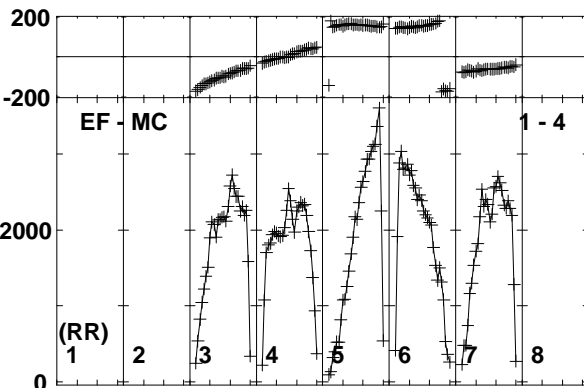
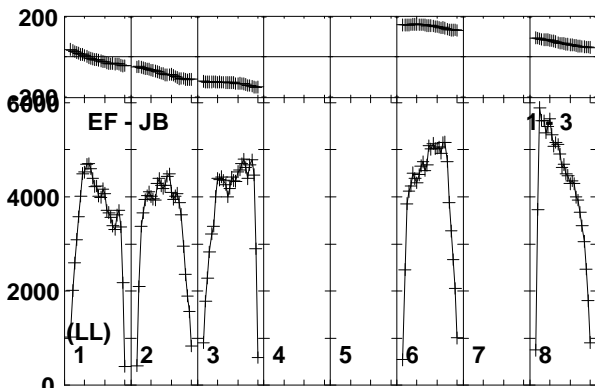
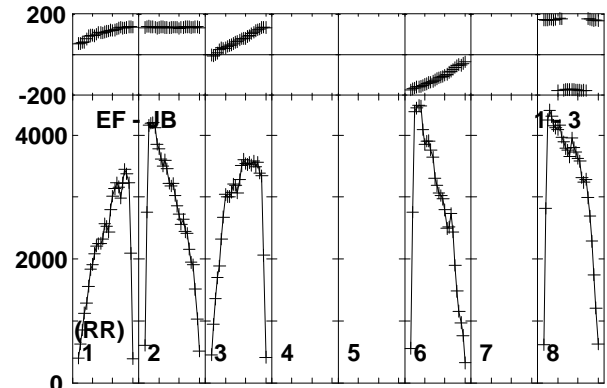
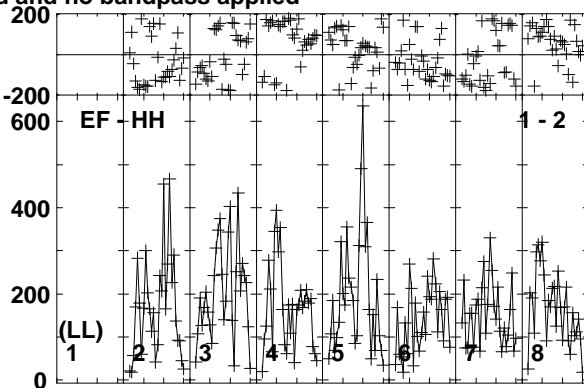
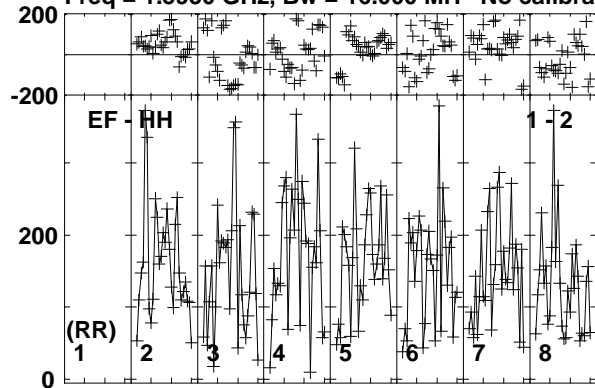

Lower frame: Micro Ampl Jy Top frame: Phas deg  
Vector averaged cross-power spectrum Baseline: EF (01) - HH (02)  
Timerange: 01/02:52:02 to 01/02:52:58

Plot file version 224 created 26-JUN-2015 10:51:27

J2025+3343 ET031A.UVDATA.1

Freq = 1.5950 GHz, Bw = 16.000 MH No calibration applied and no bandpass applied

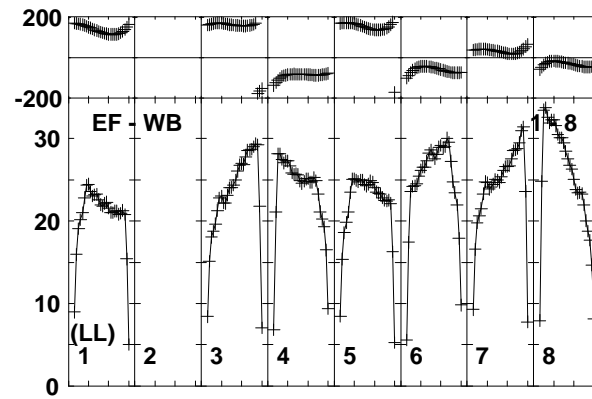
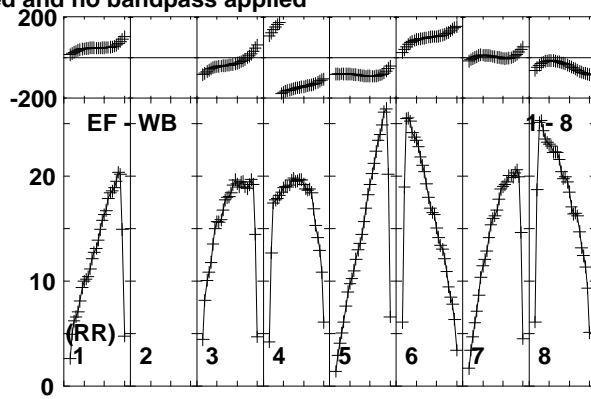
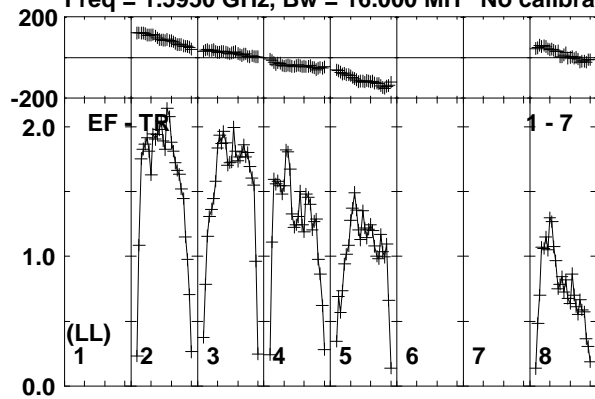

Lower frame: Milli Ampl Jy Top frame: Phas deg  
Vector averaged cross-power spectrum Baseline: EF (01) - TR (07)  
Timerange: 01/02:52:02 to 01/02:52:58



Plot file version 225 created 26-JUN-2015 10:51:27

V404CYG ET031A.UVDATA.1

Freq = 1.5950 GHz, Bw = 16.000 MH No calibration applied and no bandpass applied

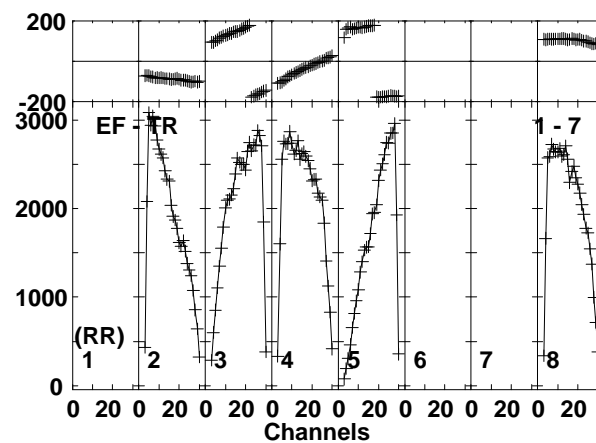
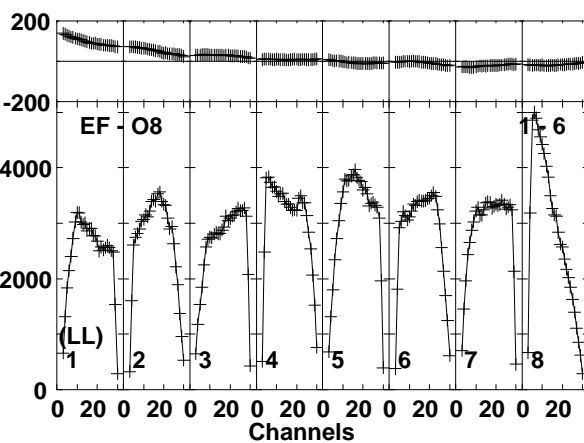
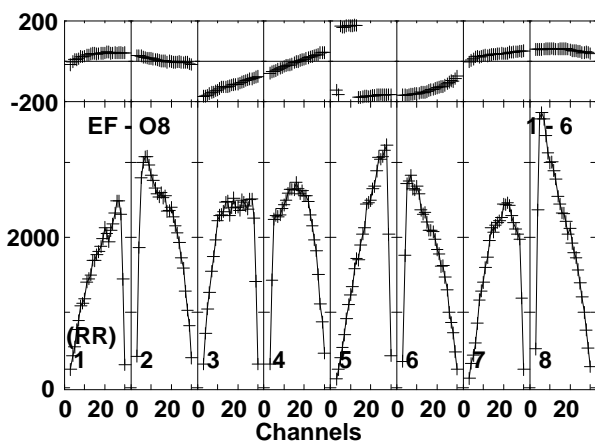
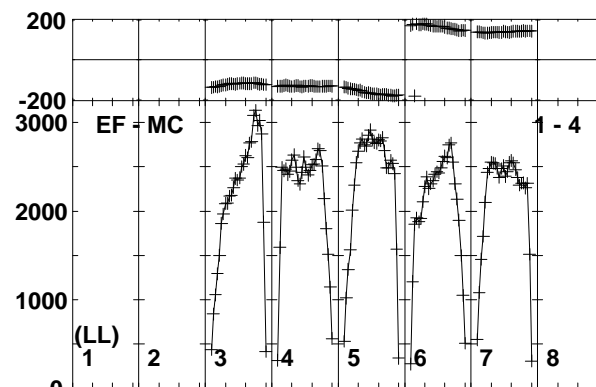
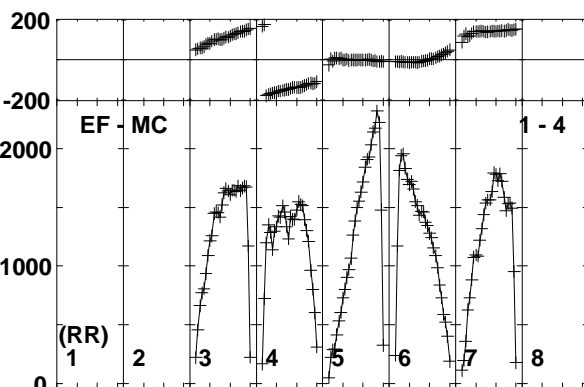
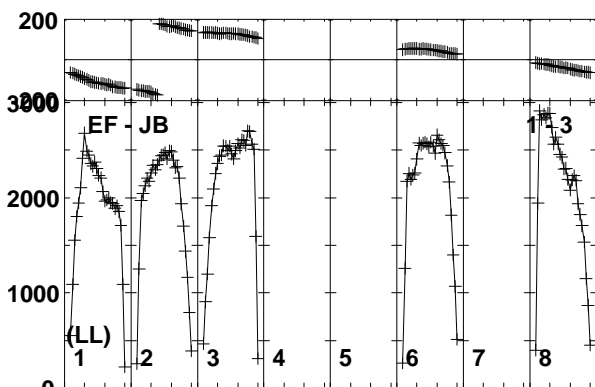
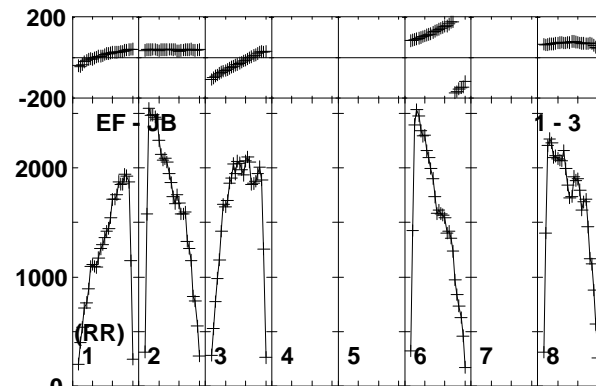
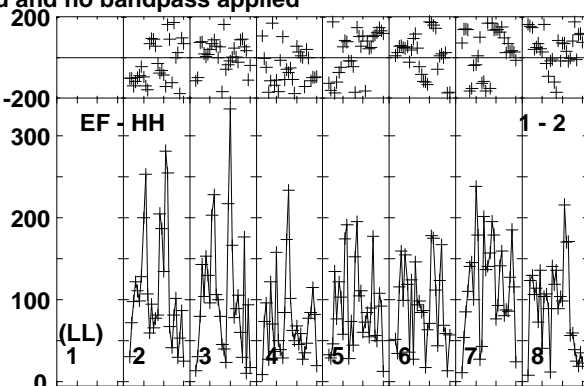
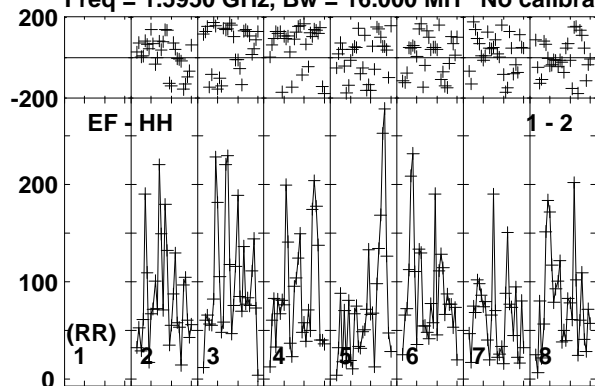

Lower frame: Micro Ampl Jy Top frame: Phas deg  
Vector averaged cross-power spectrum Baseline: EF (01) - HH (02)  
Timerange: 01/02:53:02 to 01/02:56:28

Plot file version 226 created 26-JUN-2015 10:51:27

V404CYG ET031A.UVDATA.1

Freq = 1.5950 GHz, Bw = 16.000 MH No calibration applied and no bandpass applied

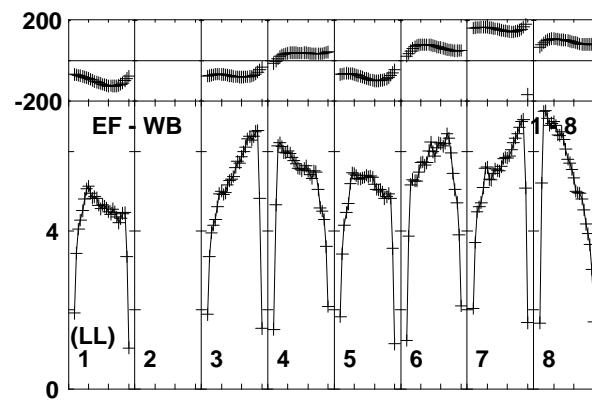
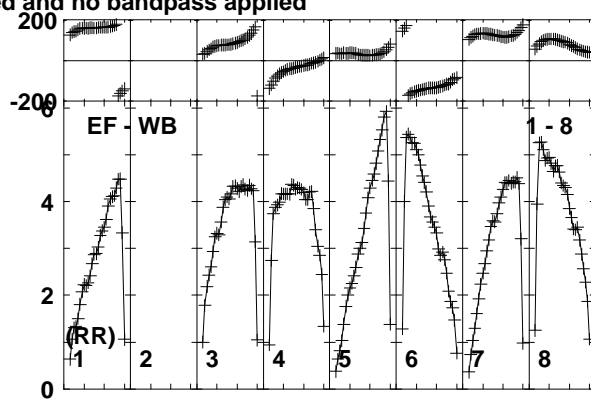
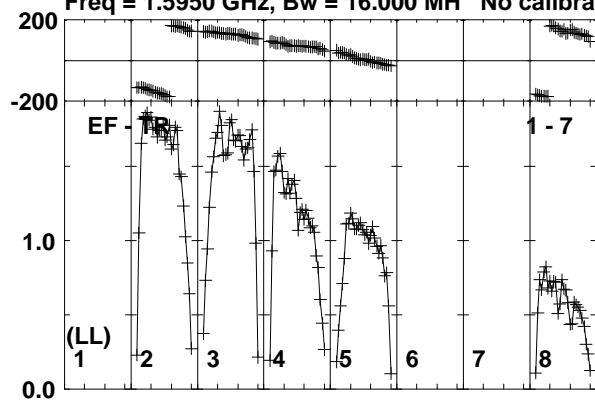

Lower frame: Milli Ampl Jy Top frame: Phas deg  
Vector averaged cross-power spectrum Baseline: EF (01) - TR (07)  
Timerange: 01/02:53:02 to 01/02:56:28

Plot file version 227 created 26-JUN-2015 10:51:27

J2025+3343 ET031A.UVDATA.1

Freq = 1.5950 GHz, Bw = 16.000 MH No calibration applied and no bandpass applied

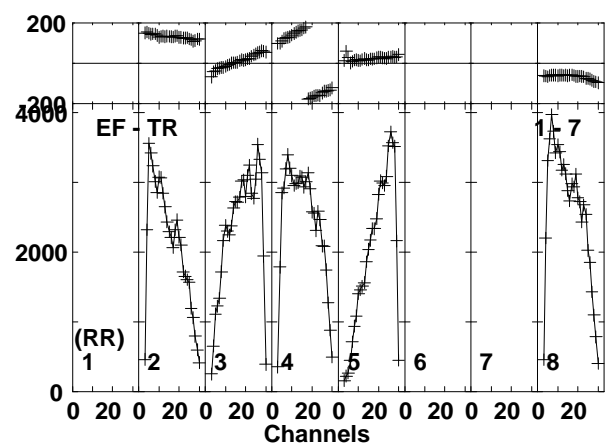
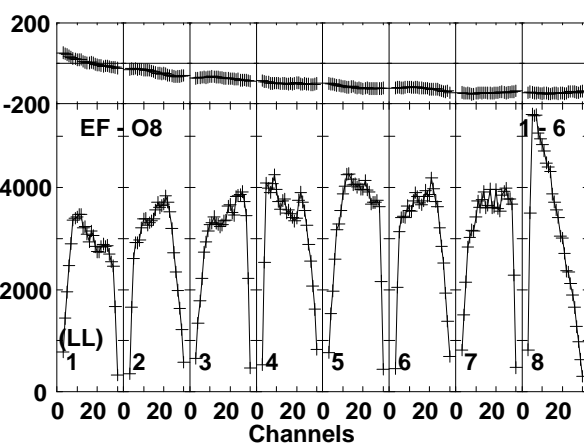
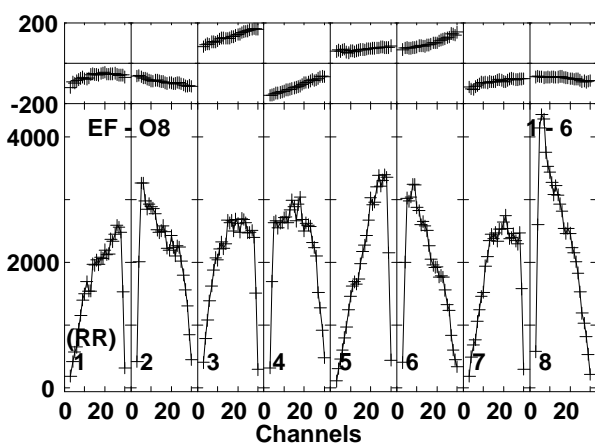
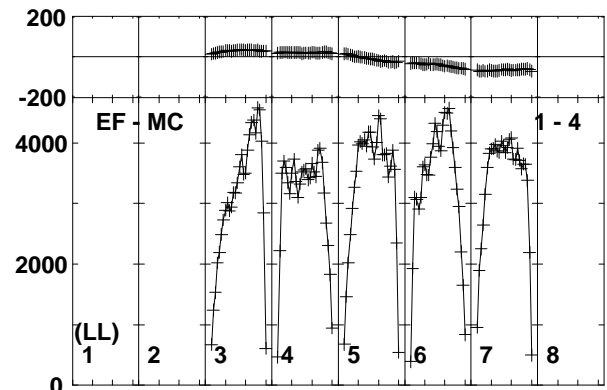
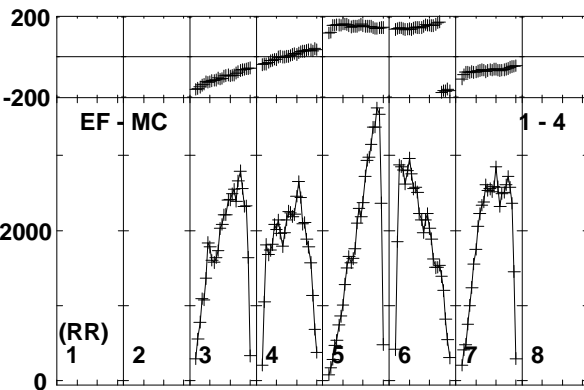
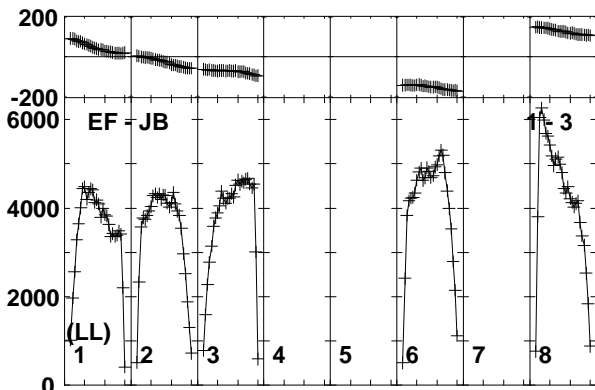
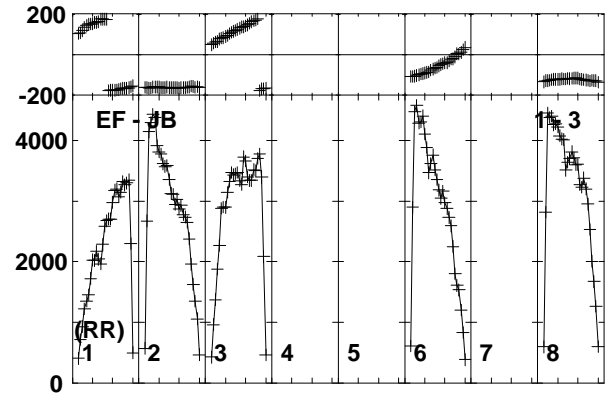
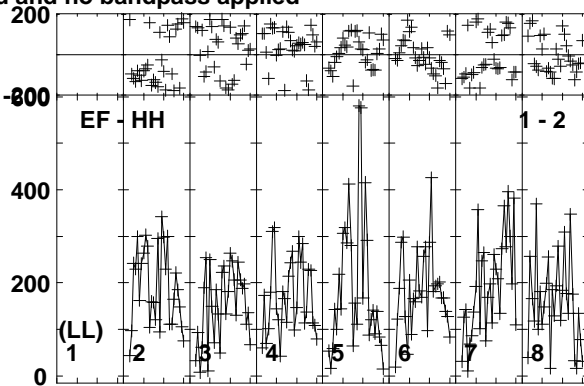
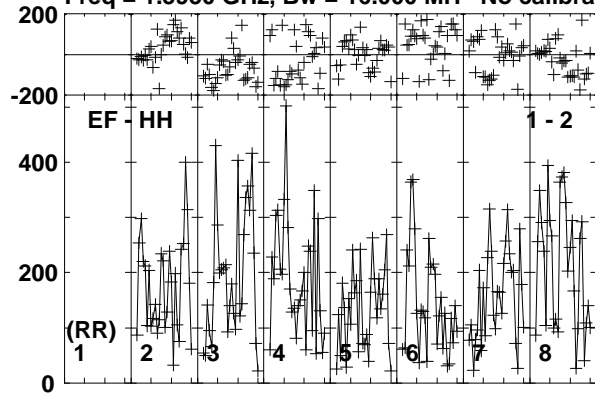

Lower frame: Micro Ampl Jy Top frame: Phas deg  
Vector averaged cross-power spectrum Baseline: EF (01) - HH (02)  
Timerange: 01/02:56:32 to 01/02:57:48

Plot file version 228 created 26-JUN-2015 10:51:27

J2025+3343 ET031A.UVDATA.1

Freq = 1.5950 GHz, Bw = 16.000 MH No calibration applied and no bandpass applied

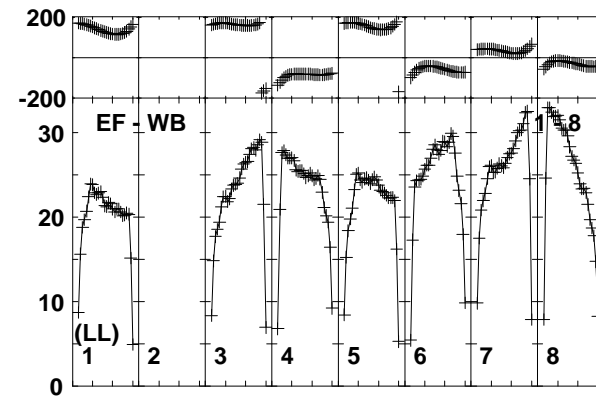
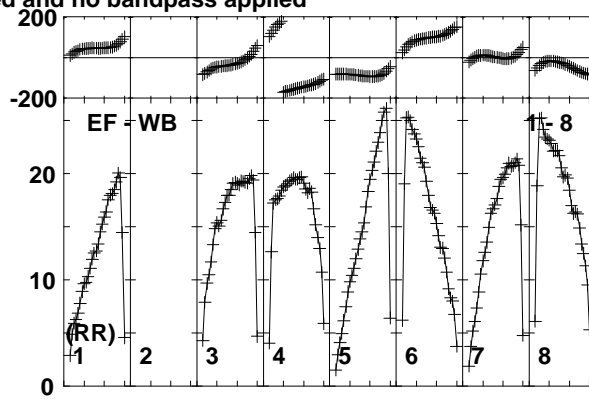
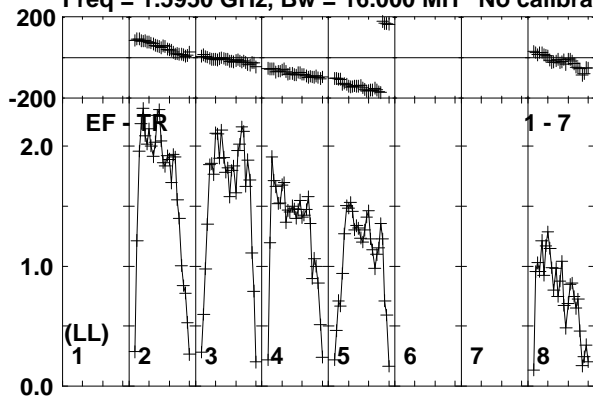

Lower frame: Milli Ampl Jy Top frame: Phas deg  
Vector averaged cross-power spectrum Baseline: EF (01) - TR (07)  
Timerange: 01/02:56:32 to 01/02:57:48

Plot file version 229 created 26-JUN-2015 10:51:27

V404CYG ET031A.UVDATA.1

Freq = 1.5950 GHz, Bw = 16.000 MH No calibration applied and no bandpass applied

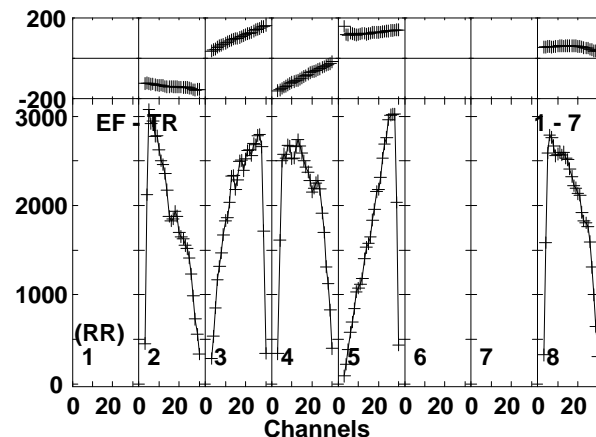
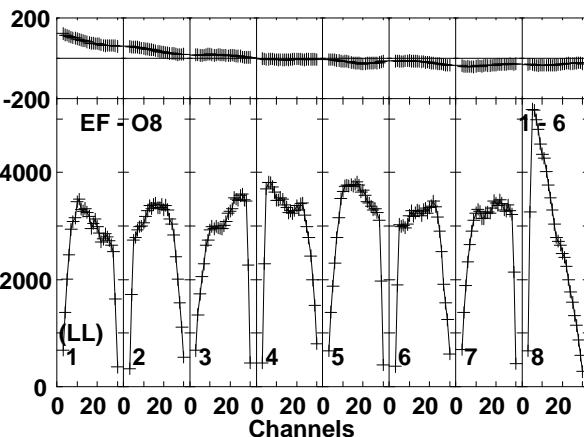
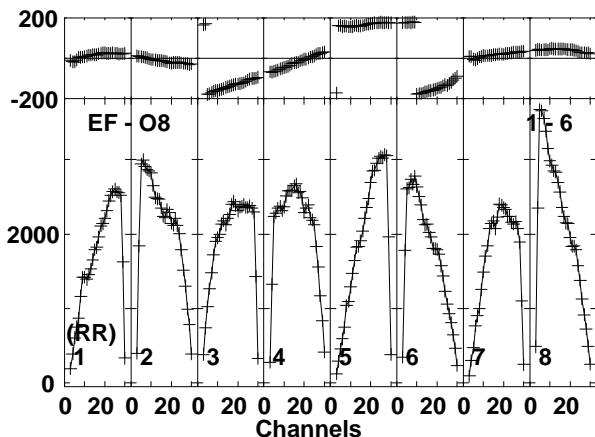
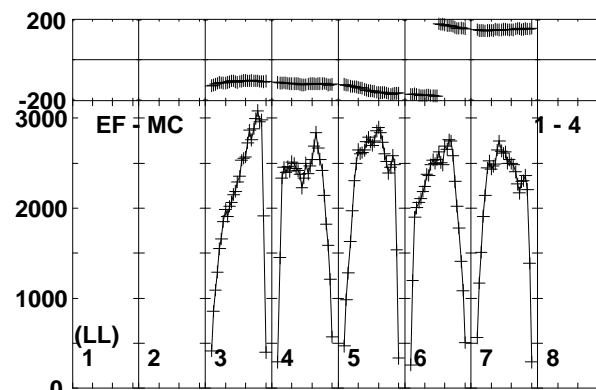
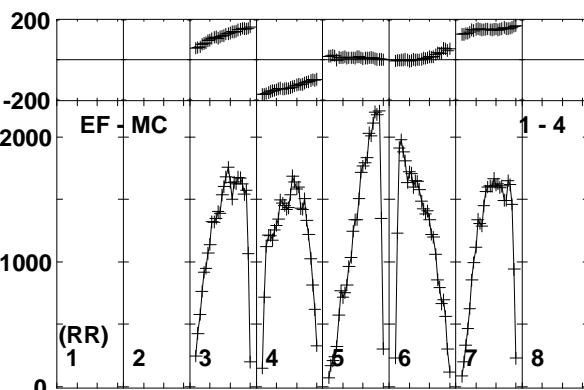
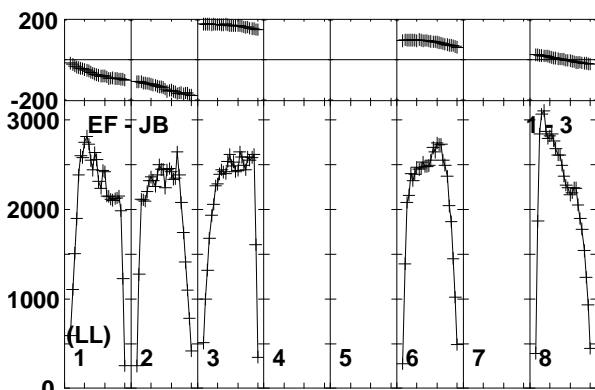
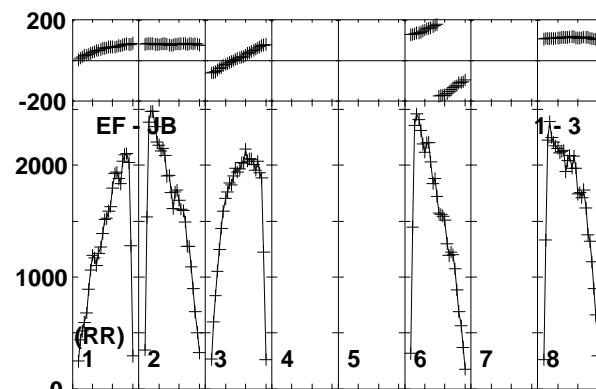
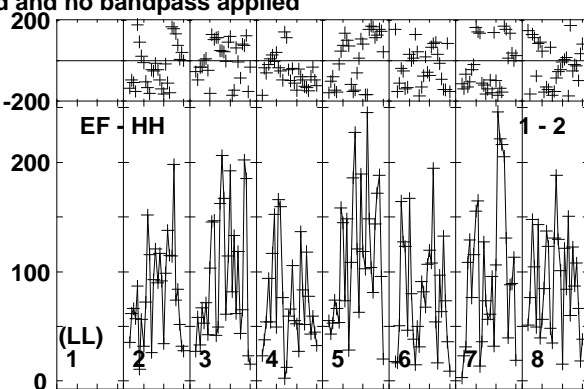
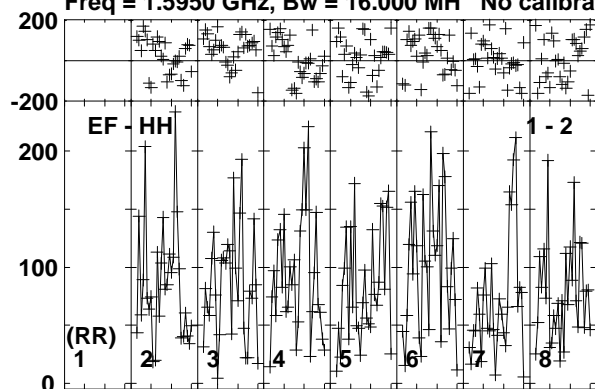

Lower frame: Micro Ampl Jy Top frame: Phas deg  
Vector averaged cross-power spectrum Baseline: EF (01) - HH (02)  
Timerange: 01/02:57:52 to 01/03:01:18

Plot file version 230 created 26-JUN-2015 10:51:27

V404CYG ET031A.UVDATA.1

Freq = 1.5950 GHz, Bw = 16.000 MH No calibration applied and no bandpass applied

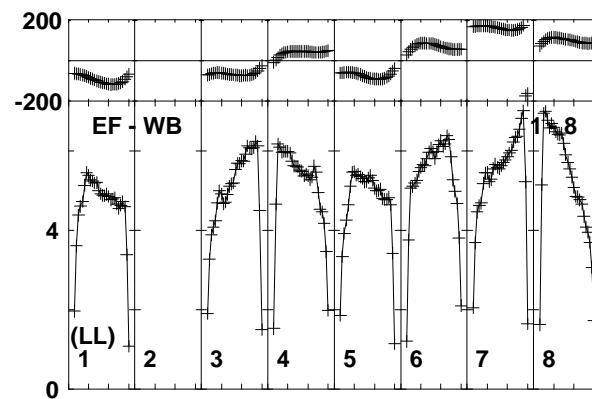
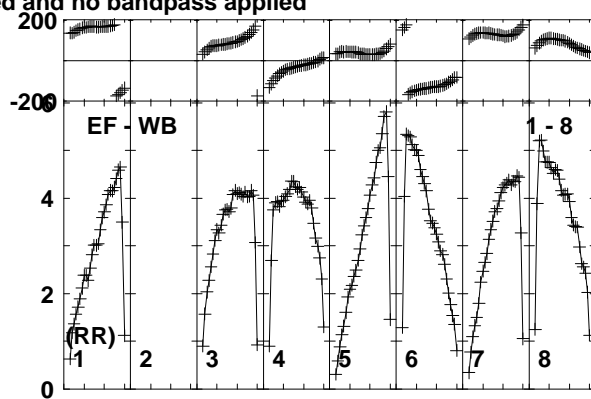
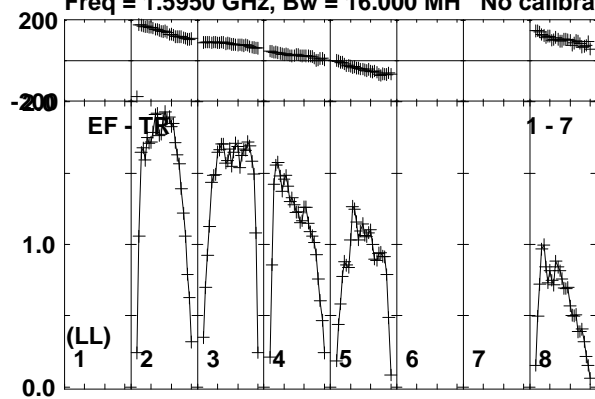

Lower frame: Milli Ampl Jy Top frame: Phas deg  
Vector averaged cross-power spectrum Baseline: EF (01) - TR (07)  
Timerange: 01/02:57:52 to 01/03:01:18

Plot file version 231 created 26-JUN-2015 10:51:27

J2025+3343 ET031A.UVDATA.1

Freq = 1.5950 GHz, Bw = 16.000 MH No calibration applied and no bandpass applied

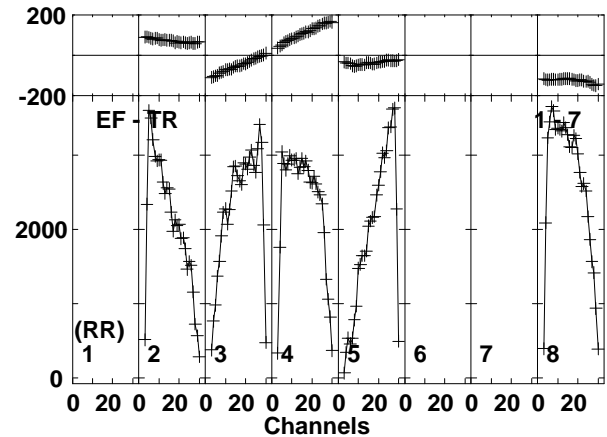
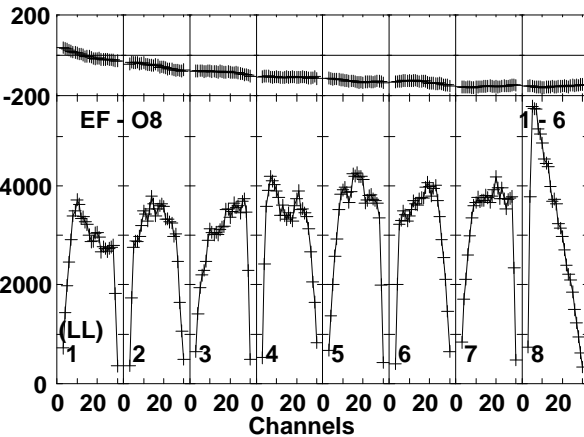
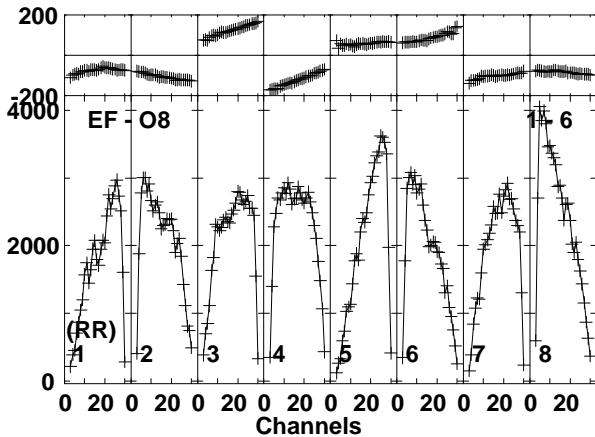
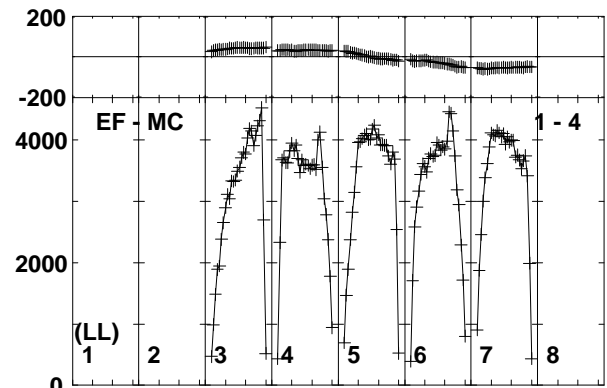
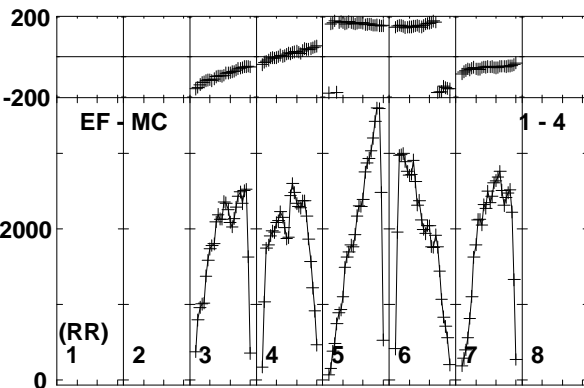
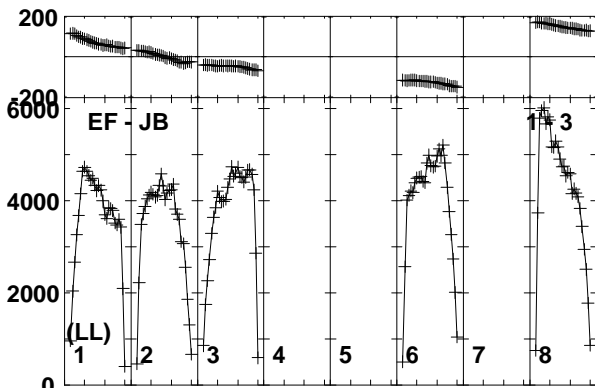
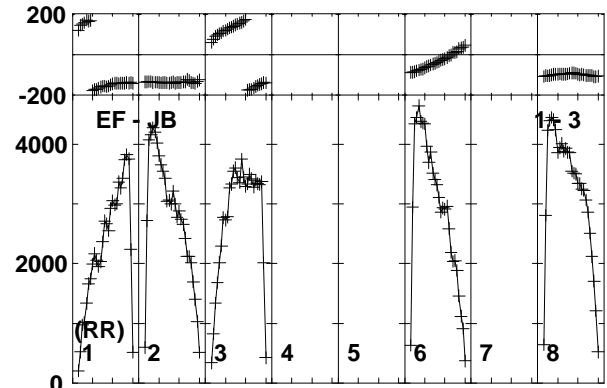
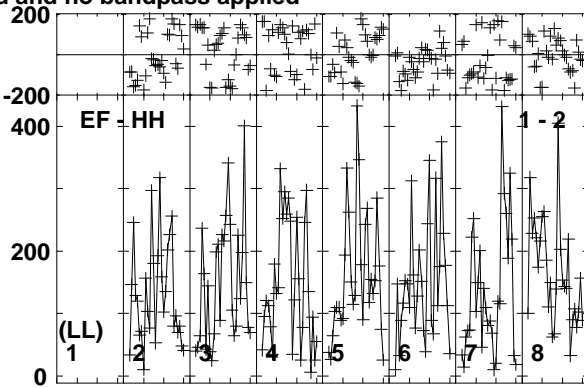
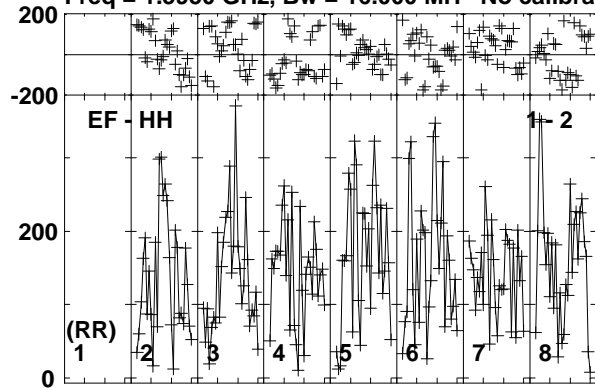

Lower frame: Micro Ampl Jy Top frame: Phas deg  
Vector averaged cross-power spectrum Baseline: EF (01) - HH (02)  
Timerange: 01/03:02:02 to 01/03:02:58

Plot file version 232 created 26-JUN-2015 10:51:27

J2025+3343 ET031A.UVDATA.1

Freq = 1.5950 GHz, Bw = 16.000 MH No calibration applied and no bandpass applied

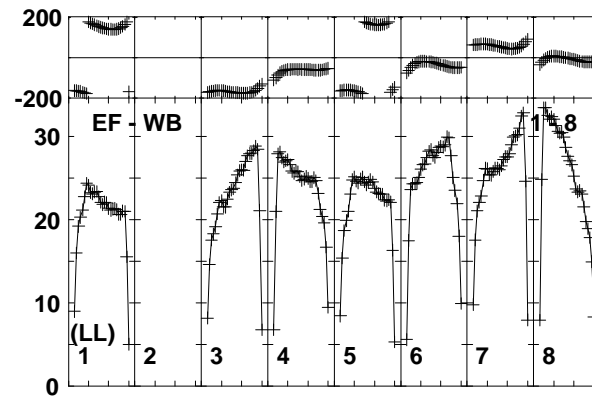
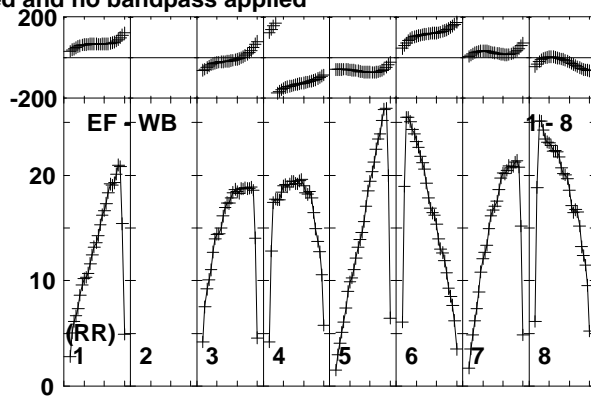
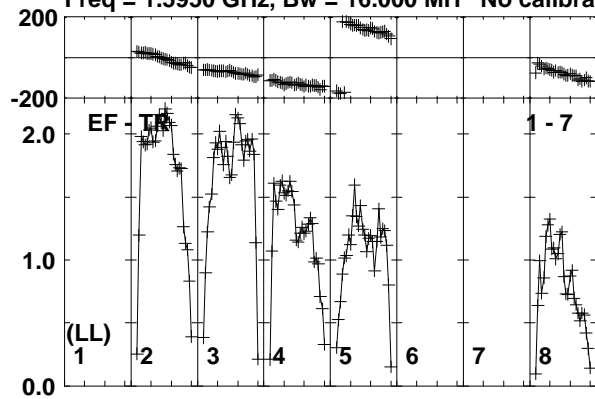

Lower frame: Milli Ampl Jy Top frame: Phas deg  
Vector averaged cross-power spectrum Baseline: EF (01) - TR (07)  
Timerange: 01/03:02:02 to 01/03:02:58



Plot file version 233 created 26-JUN-2015 10:51:27

V404CYG ET031A.UVDATA.1

Freq = 1.5950 GHz, Bw = 16.000 MH No calibration applied and no bandpass applied

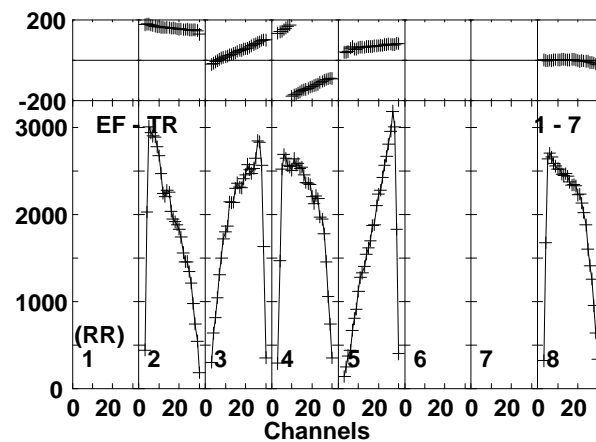
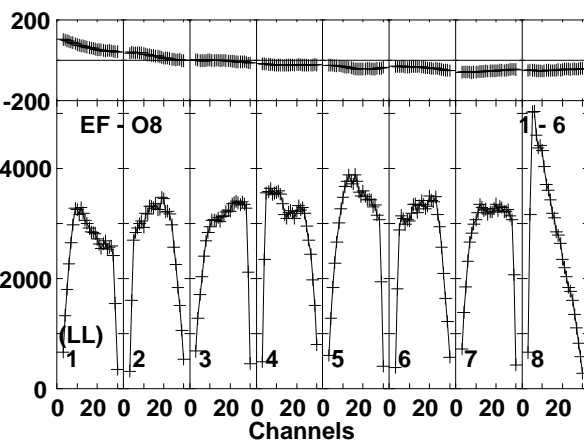
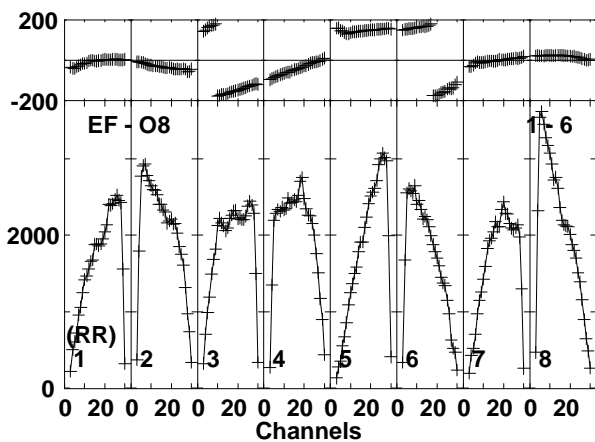
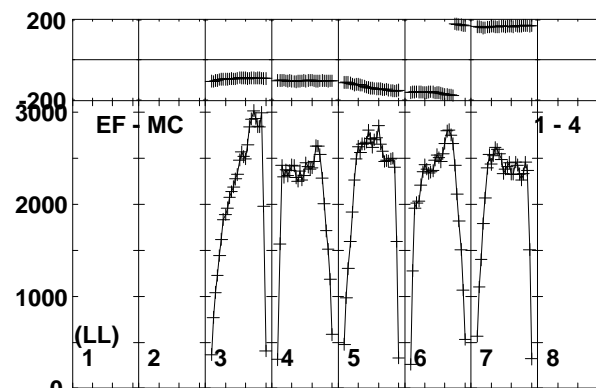
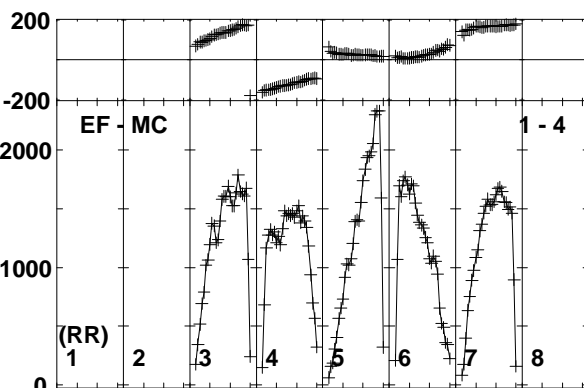
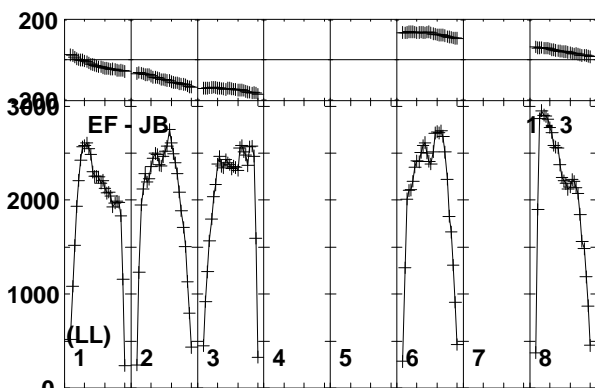
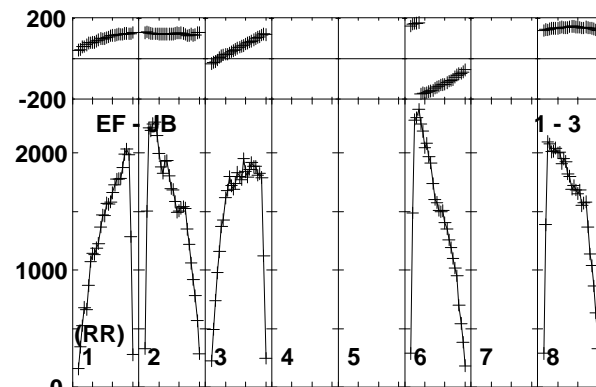
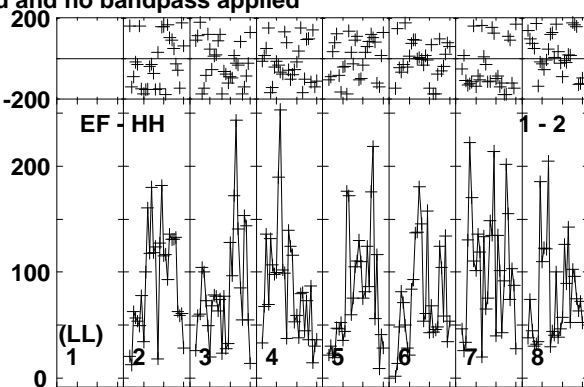
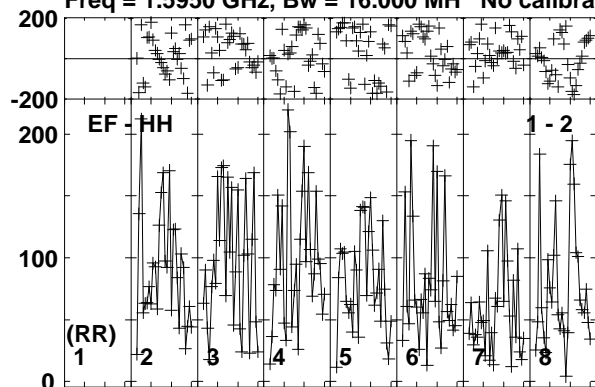

Lower frame: Micro Ampl Jy Top frame: Phas deg  
Vector averaged cross-power spectrum Baseline: EF (01) - HH (02)  
Timerange: 01/03:03:02 to 01/03:06:28

Plot file version 234 created 26-JUN-2015 10:51:27

V404CYG ET031A.UVDATA.1

Freq = 1.5950 GHz, Bw = 16.000 MH No calibration applied and no bandpass applied

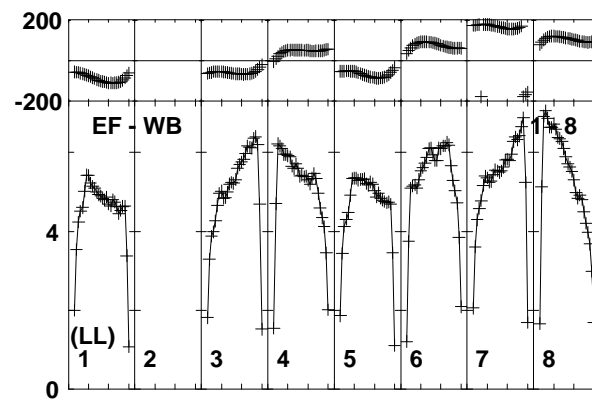
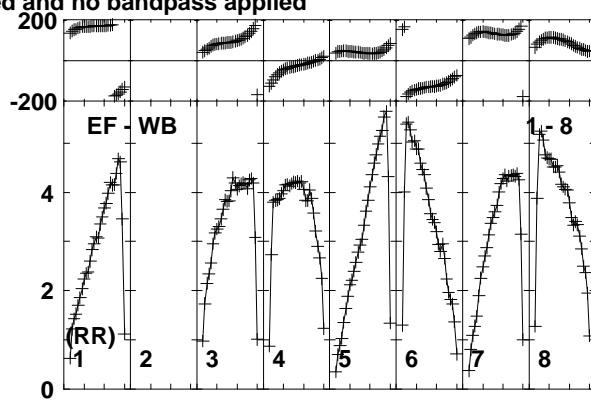
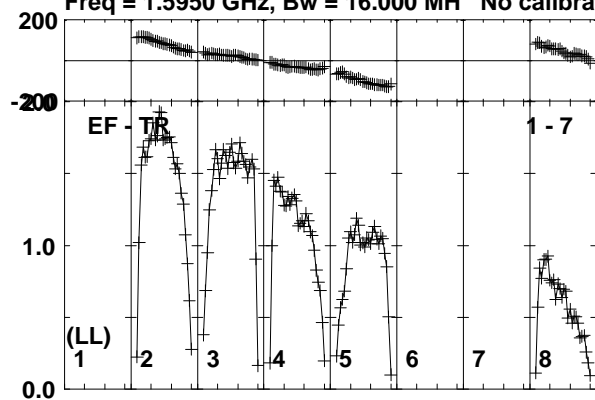

Lower frame: Milli Ampl Jy Top frame: Phas deg  
Vector averaged cross-power spectrum Baseline: EF (01) - TR (07)  
Timerange: 01/03:03:02 to 01/03:06:28

Plot file version 235 created 26-JUN-2015 10:51:27

J2025+3343 ET031A.UVDATA.1

Freq = 1.5950 GHz, Bw = 16.000 MH No calibration applied and no bandpass applied

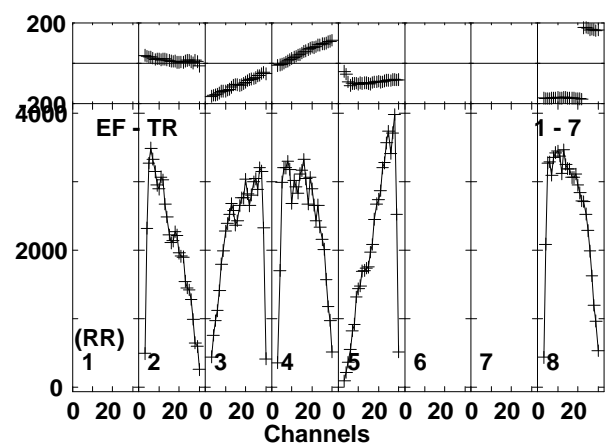
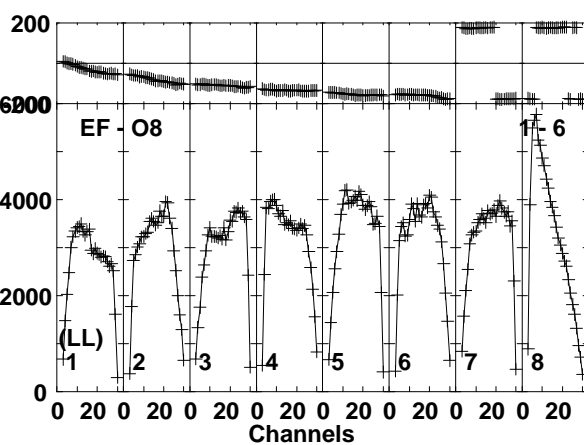
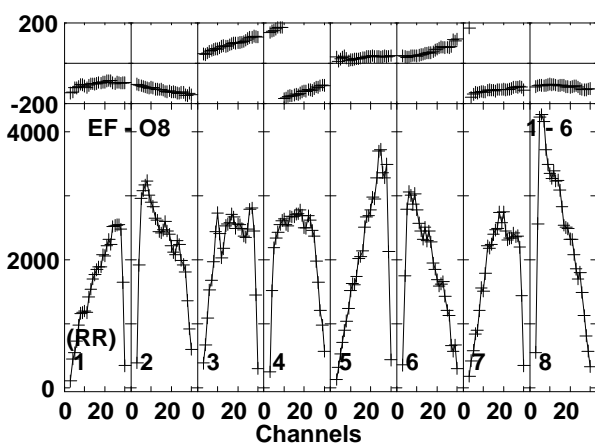
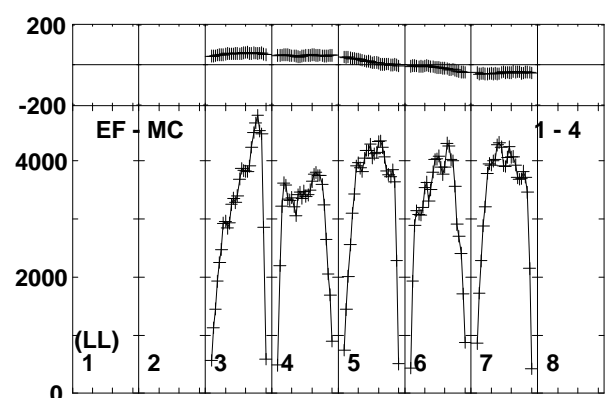
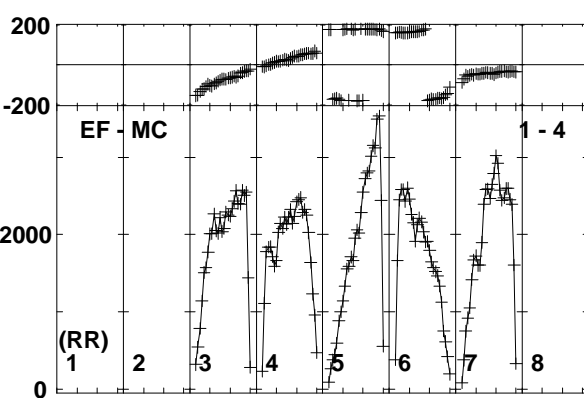
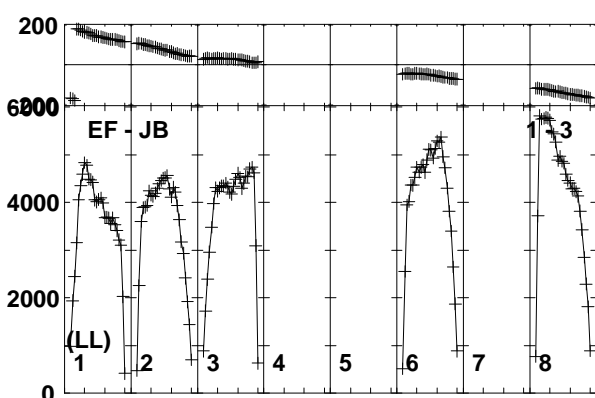
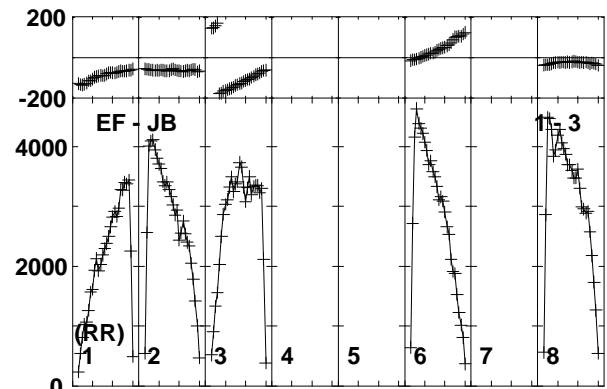
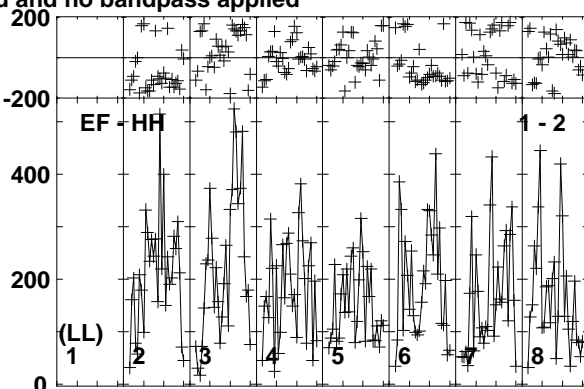
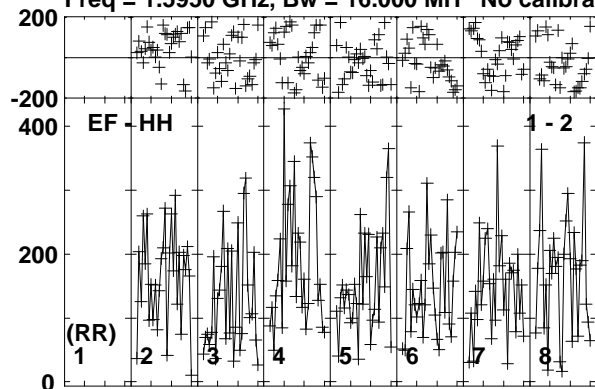

Lower frame: Micro Ampl Jy Top frame: Phas deg  
Vector averaged cross-power spectrum Baseline: EF (01) - HH (02)  
Timerange: 01/03:06:32 to 01/03:07:48

Plot file version 236 created 26-JUN-2015 10:51:27

J2025+3343 ET031A.UVDATA.1

Freq = 1.5950 GHz, Bw = 16.000 MH No calibration applied and no bandpass applied

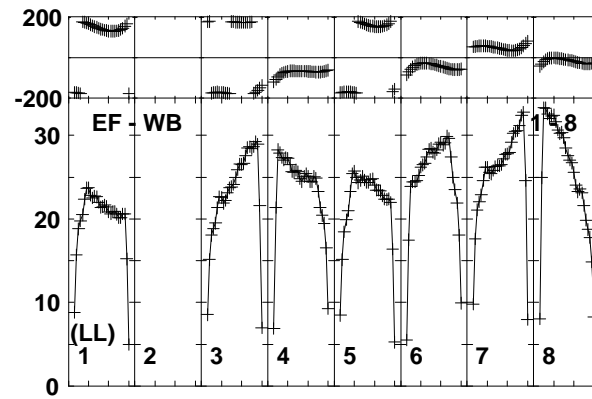
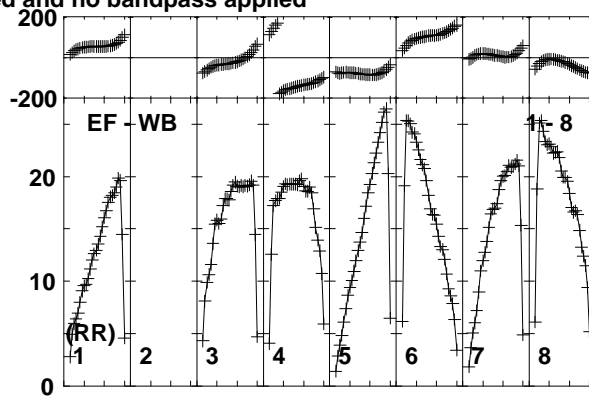
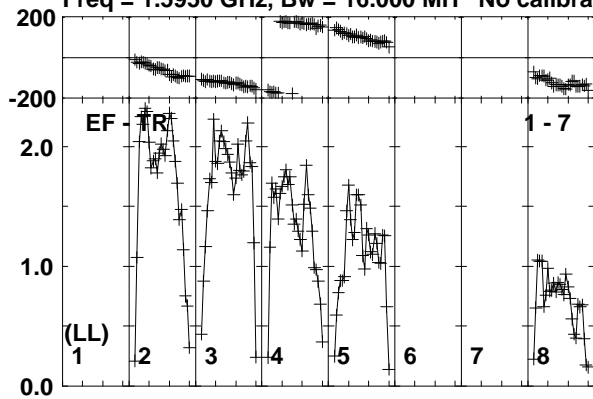

Lower frame: Milli Ampl Jy Top frame: Phas deg  
Vector averaged cross-power spectrum Baseline: EF (01) - TR (07)  
Timerange: 01/03:06:32 to 01/03:07:48

Plot file version 237 created 26-JUN-2015 10:51:27

V404CYG ET031A.UVDATA.1

Freq = 1.5950 GHz, Bw = 16.000 MH No calibration applied and no bandpass applied

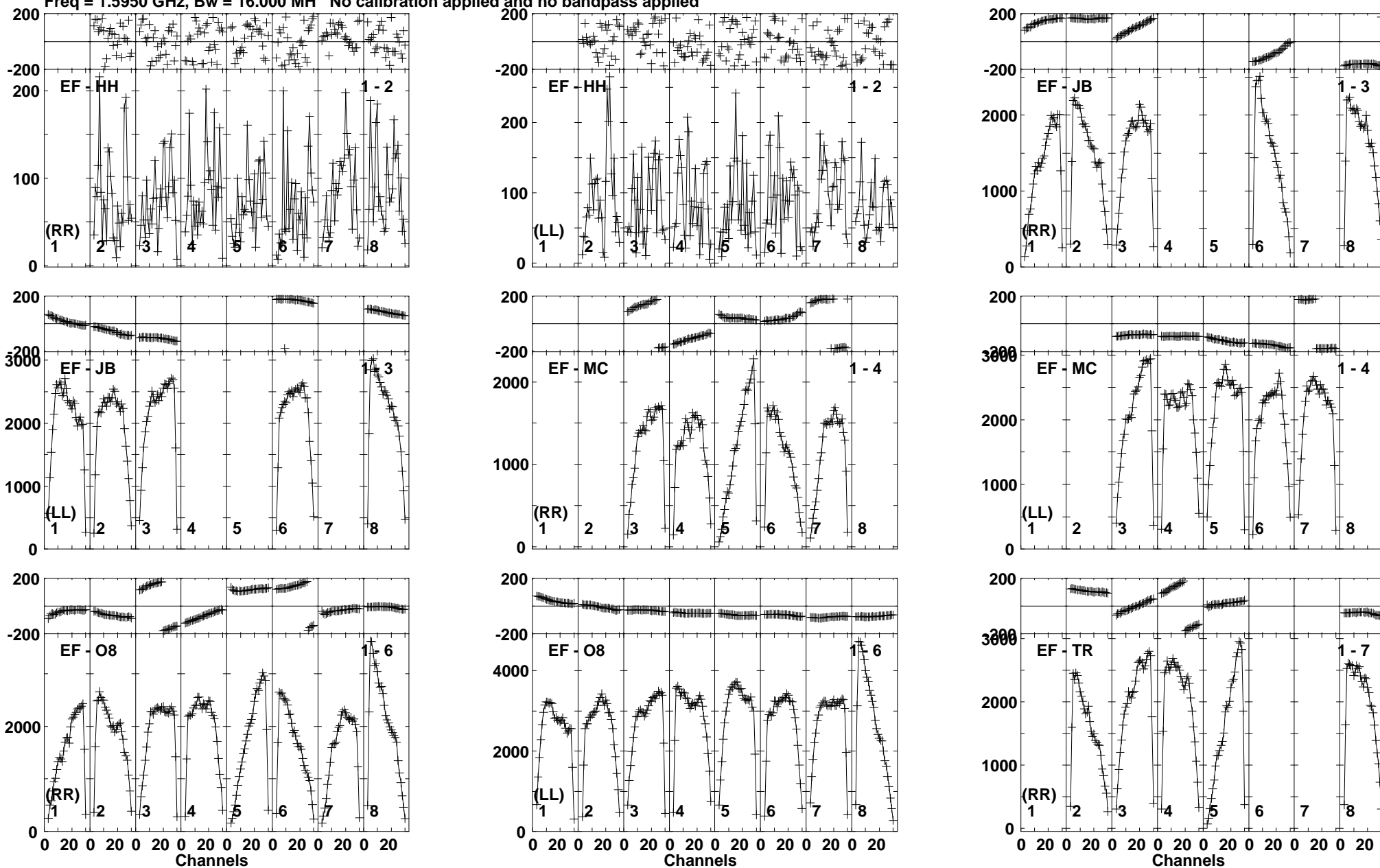

Lower frame: Micro Ampl Jy Top frame: Phas deg  
Vector averaged cross-power spectrum Baseline: EF (01) - HH (02)  
Timerange: 01/03:07:52 to 01/03:11:18

Plot file version 238 created 26-JUN-2015 10:51:27

V404CYG ET031A.UVDATA.1

Freq = 1.5950 GHz, Bw = 16.000 MH No calibration applied and no bandpass applied

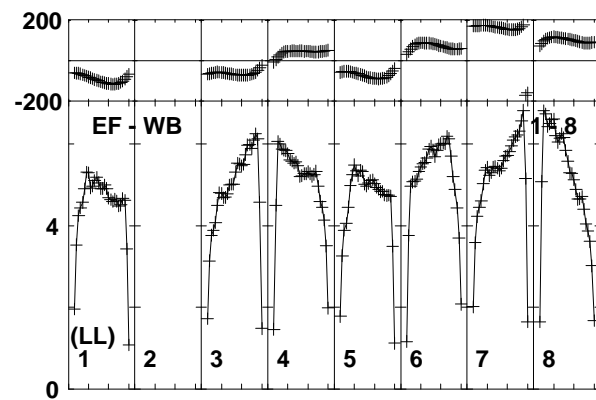
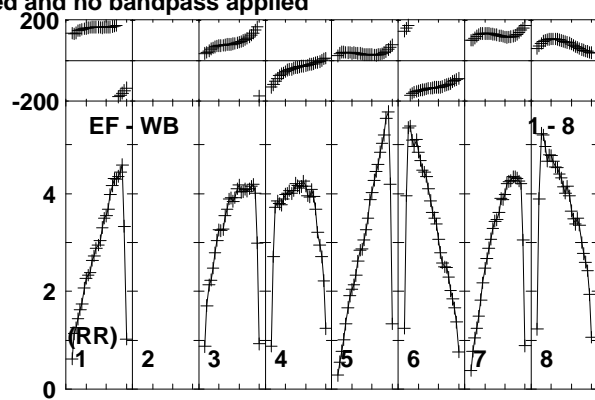
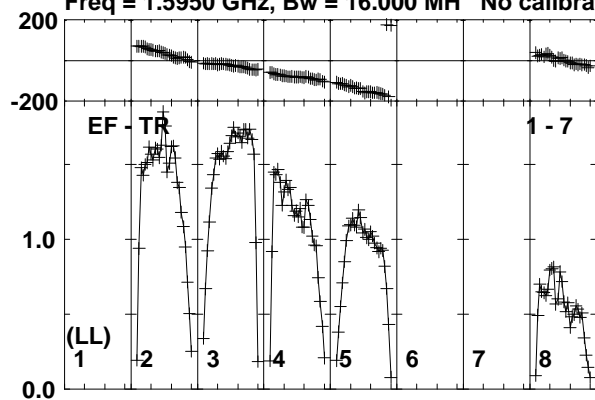

Lower frame: Milli Ampl Jy Top frame: Phas deg  
Vector averaged cross-power spectrum Baseline: EF (01) - TR (07)  
Timerange: 01/03:07:52 to 01/03:11:18

Plot file version 239 created 26-JUN-2015 10:51:27

J2025+3343 ET031A.UVDATA.1

Freq = 1.5950 GHz, Bw = 16.000 MH No calibration applied and no bandpass applied

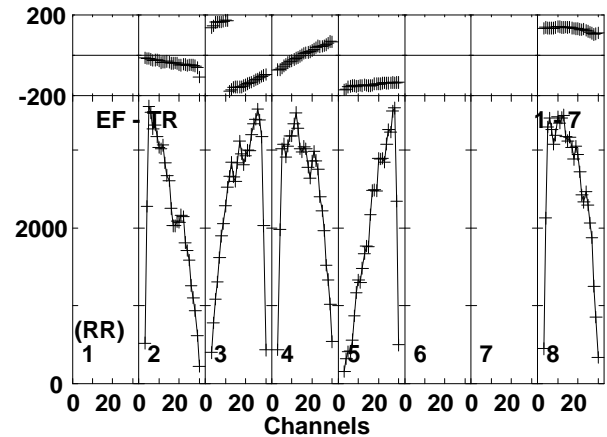
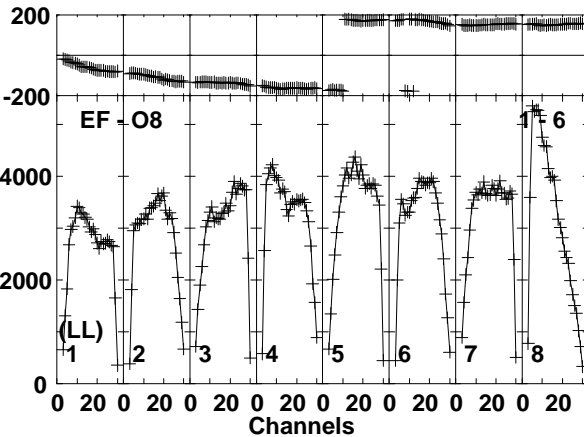
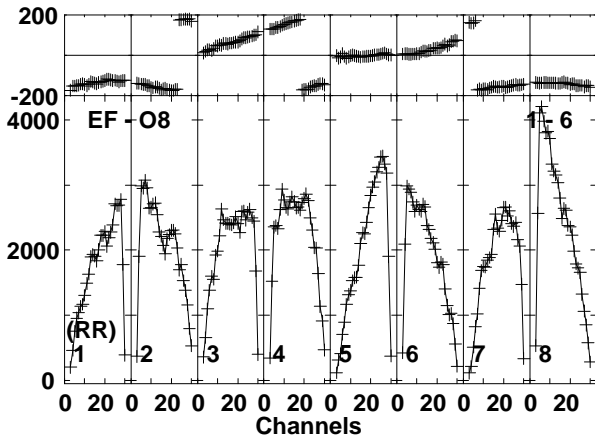
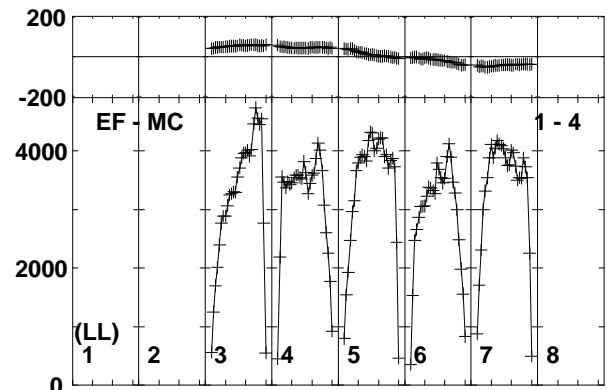
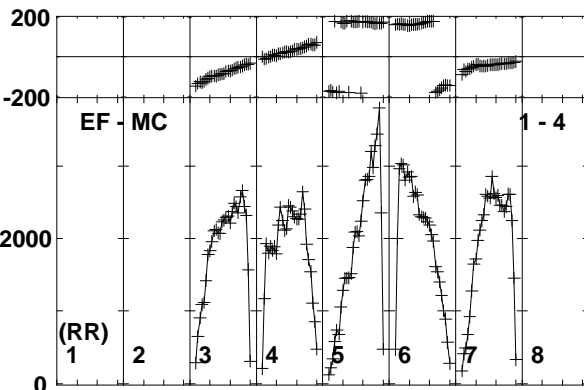
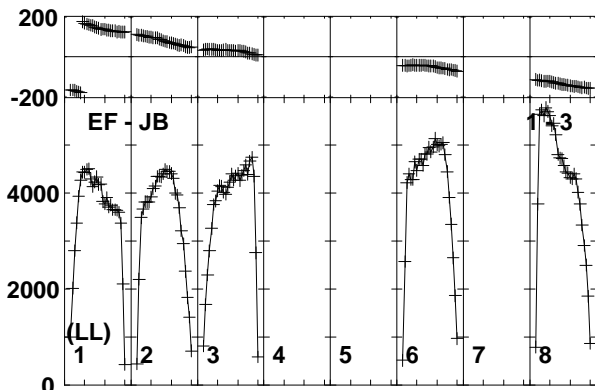
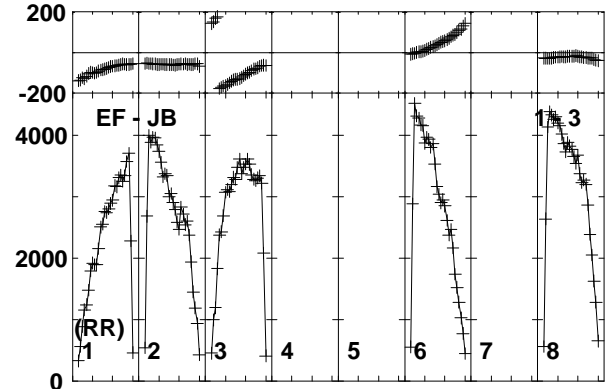
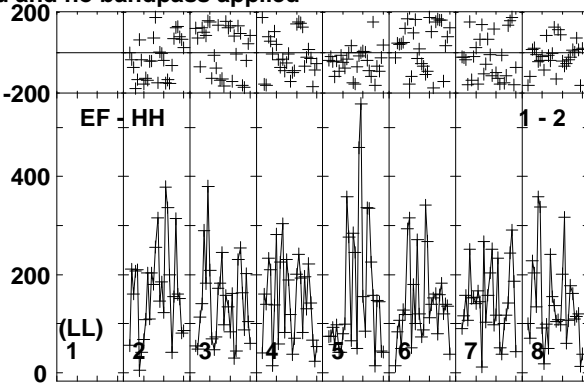
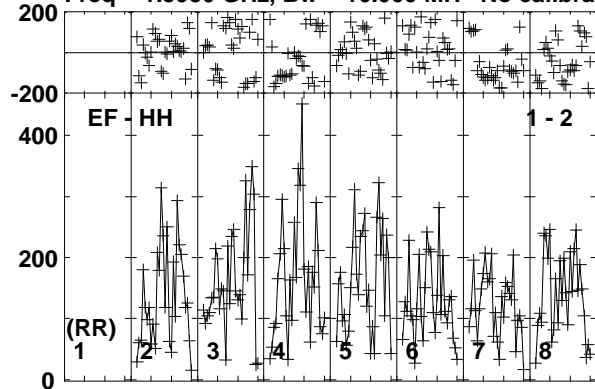

Lower frame: Micro Ampl Jy Top frame: Phas deg  
Vector averaged cross-power spectrum Baseline: EF (01) - HH (02)  
Timerange: 01/03:12:02 to 01/03:12:58

Plot file version 240 created 26-JUN-2015 10:51:27

J2025+3343 ET031A.UVDATA.1

Freq = 1.5950 GHz, Bw = 16.000 MH No calibration applied and no bandpass applied

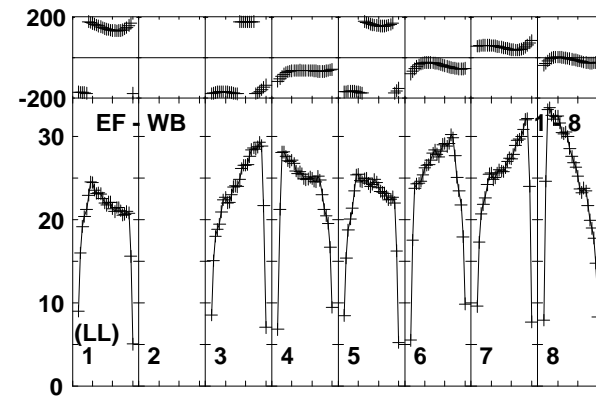
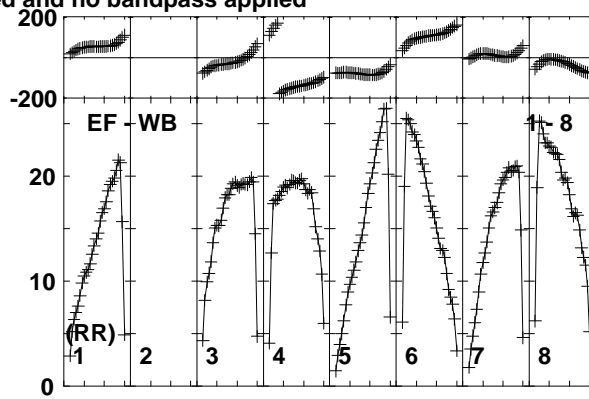
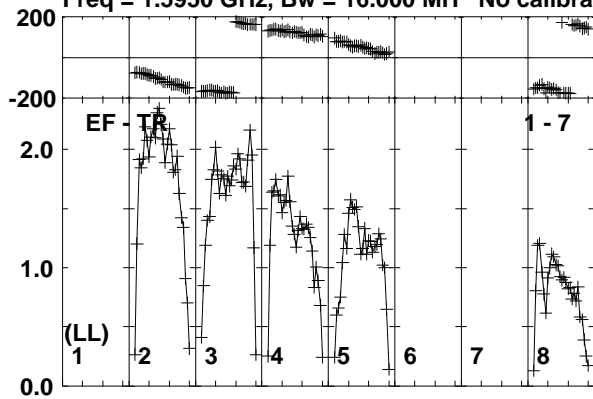

Lower frame: Milli Ampl Jy Top frame: Phas deg  
Vector averaged cross-power spectrum Baseline: EF (01) - TR (07)  
Timerange: 01/03:12:02 to 01/03:12:58



Plot file version 241 created 26-JUN-2015 10:51:27

V404CYG ET031A.UVDATA.1

Freq = 1.5950 GHz, Bw = 16.000 MH No calibration applied and no bandpass applied

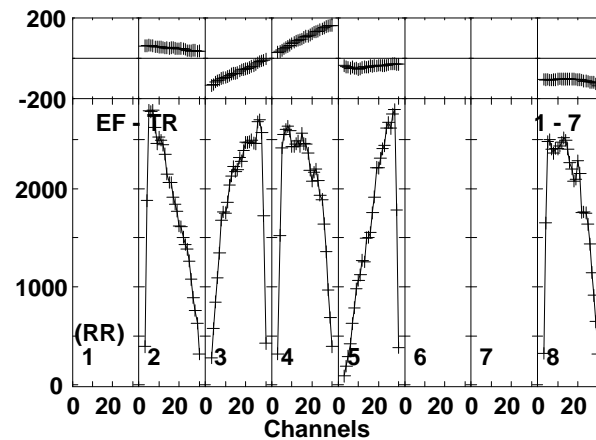
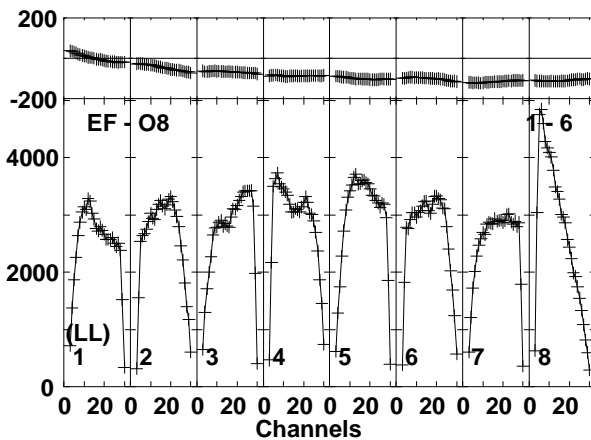
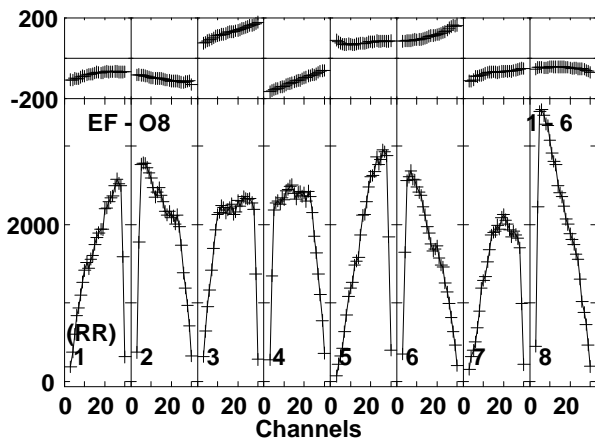
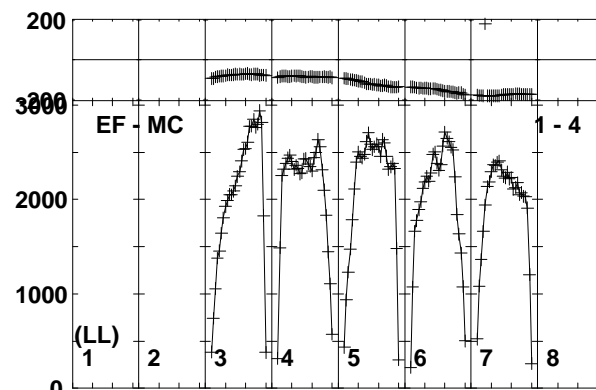
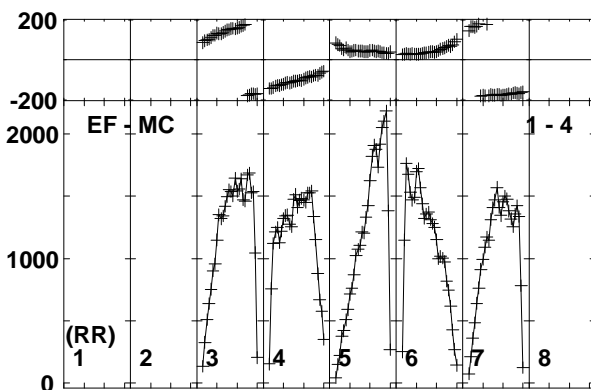
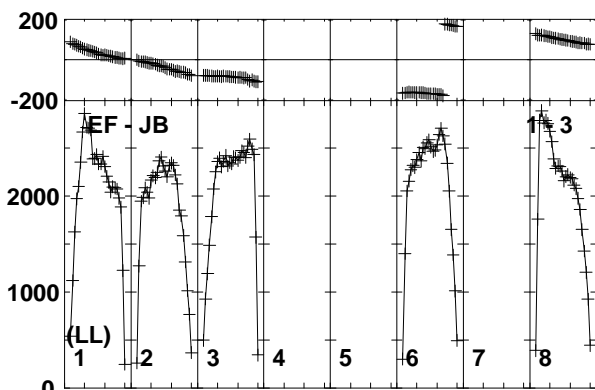
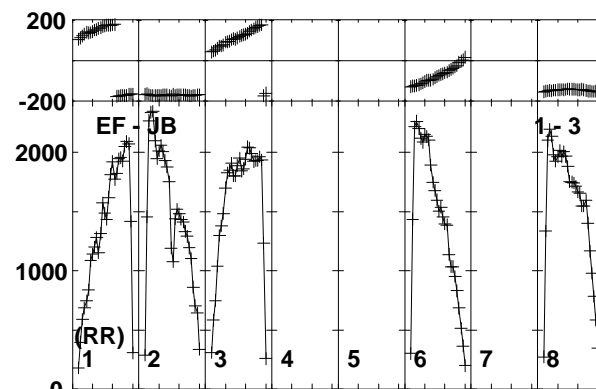
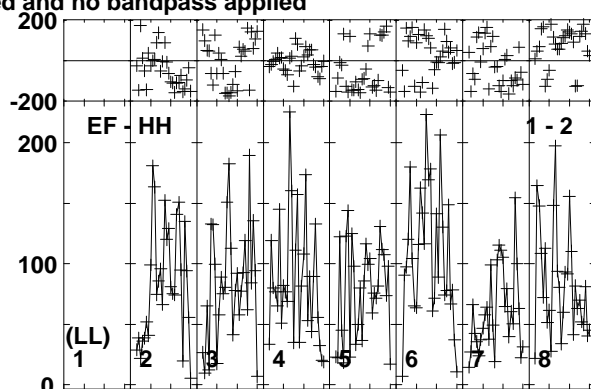
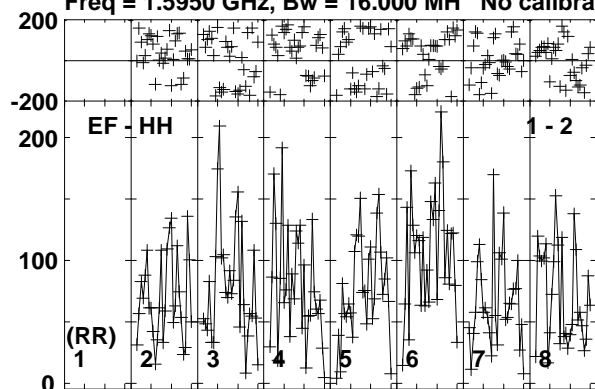

Lower frame: Micro Ampl Jy Top frame: Phas deg  
Vector averaged cross-power spectrum Baseline: EF (01) - HH (02)  
Timerange: 01/03:13:02 to 01/03:16:28

Plot file version 242 created 26-JUN-2015 10:51:28

V404CYG ET031A.UVDATA.1

Freq = 1.5950 GHz, Bw = 16.000 MH No calibration applied and no bandpass applied

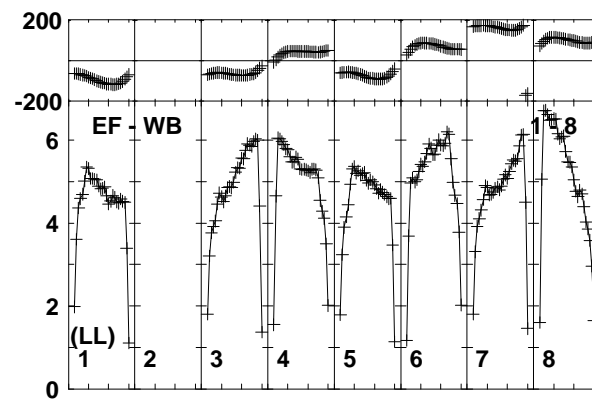
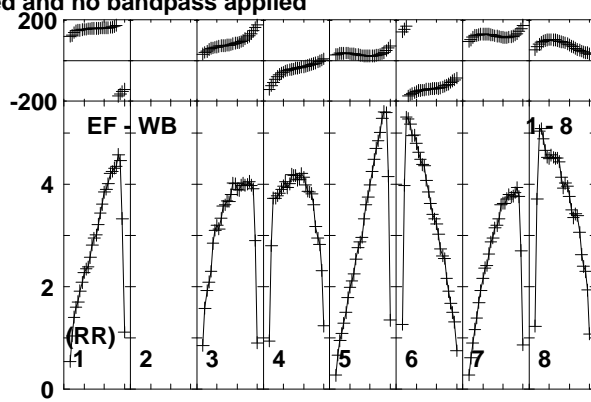
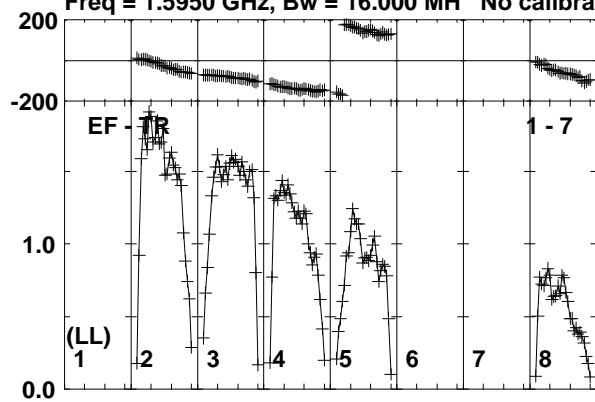

Lower frame: Milli Ampl Jy Top frame: Phas deg  
Vector averaged cross-power spectrum Baseline: EF (01) - TR (07)  
Timerange: 01/03:13:02 to 01/03:16:28

Plot file version 243 created 26-JUN-2015 10:51:28

J2025+3343 ET031A.UVDATA.1

Freq = 1.5950 GHz, Bw = 16.000 MH No calibration applied and no bandpass applied

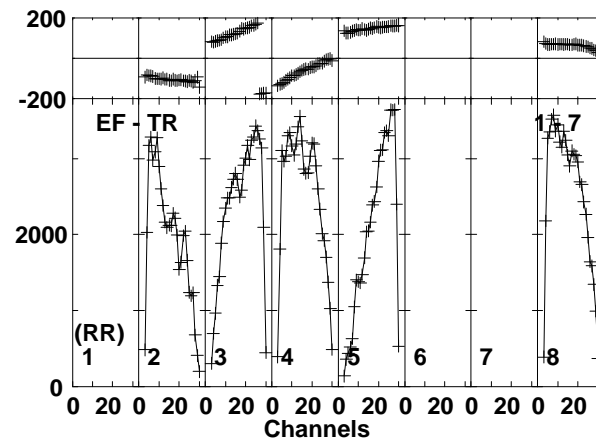
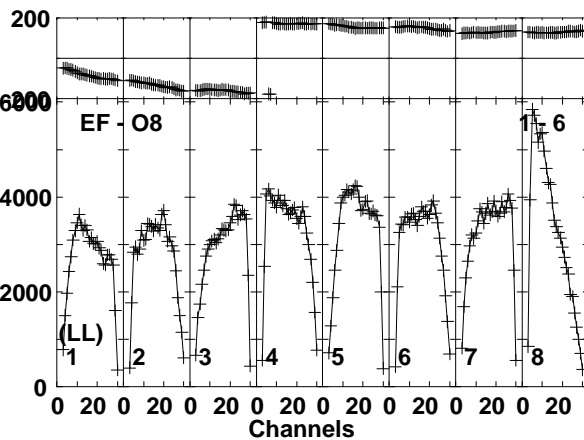
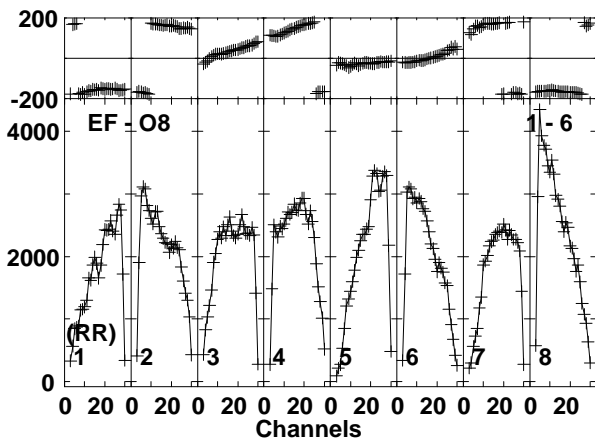
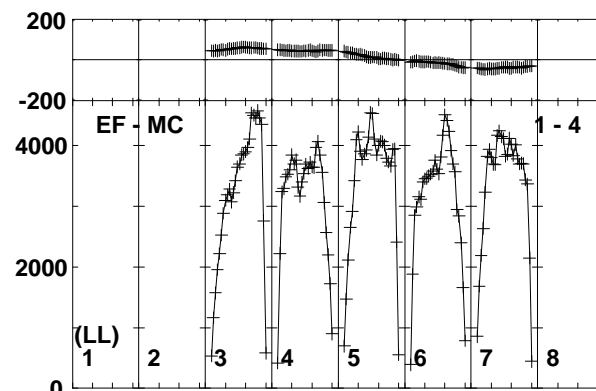
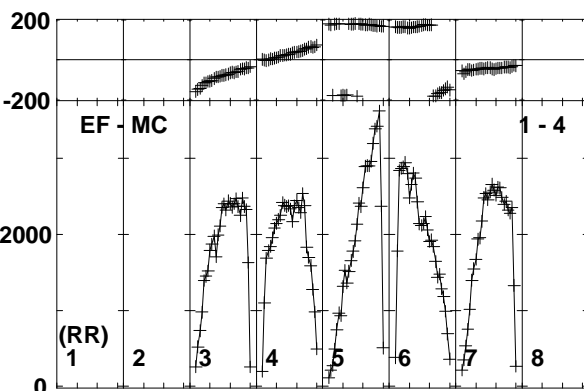
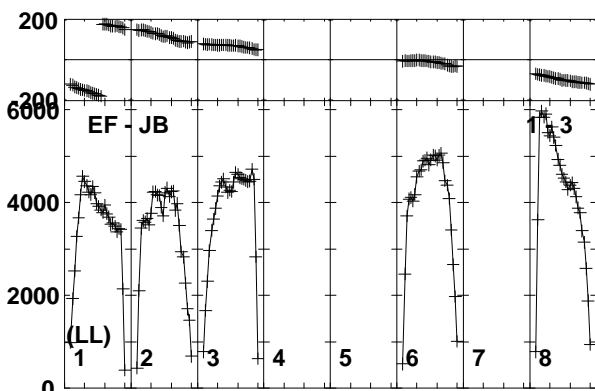
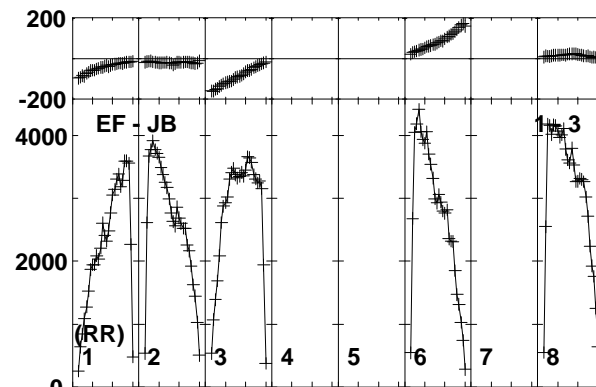
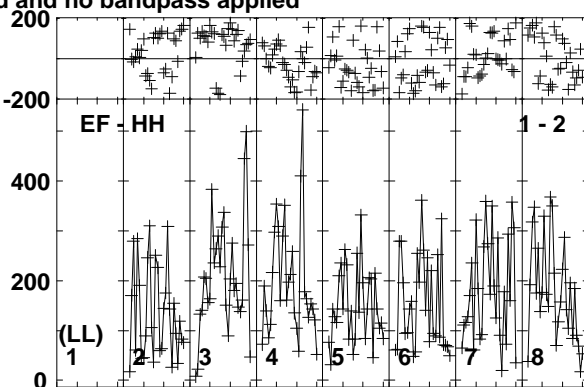
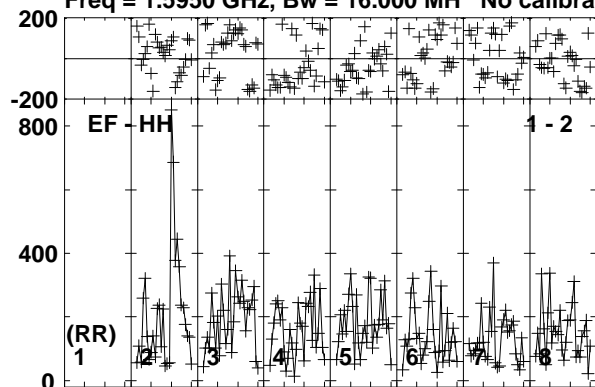

Lower frame: Micro Ampl Jy Top frame: Phas deg  
Vector averaged cross-power spectrum Baseline: EF (01) - HH (02)  
Timerange: 01/03:16:32 to 01/03:17:48

Plot file version 244 created 26-JUN-2015 10:51:28

J2025+3343 ET031A.UVDATA.1

Freq = 1.5950 GHz, Bw = 16.000 MH No calibration applied and no bandpass applied

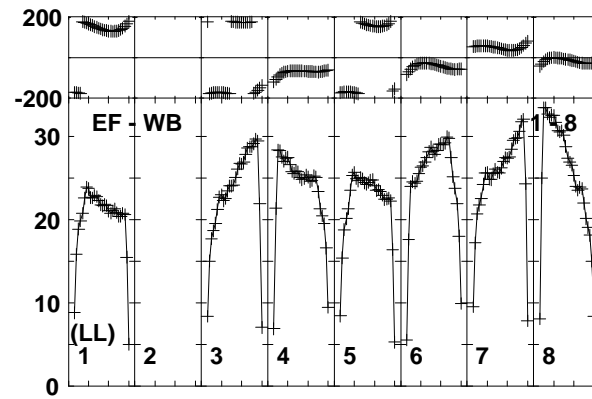
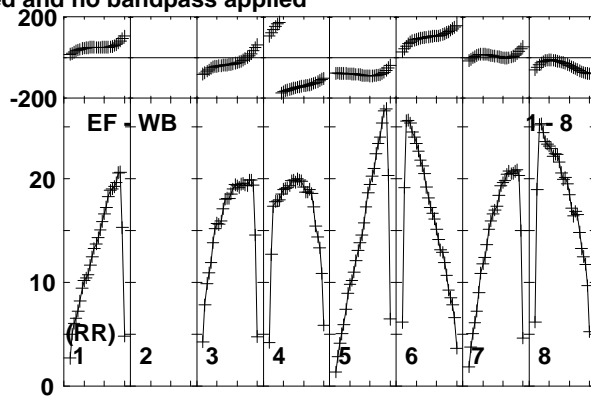
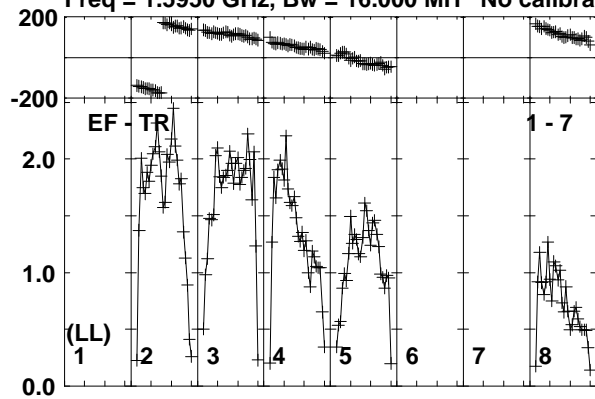

Lower frame: Milli Ampl Jy Top frame: Phas deg  
Vector averaged cross-power spectrum Baseline: EF (01) - TR (07)  
Timerange: 01/03:16:32 to 01/03:17:48

Plot file version 245 created 26-JUN-2015 10:51:28

V404CYG ET031A.UVDATA.1

Freq = 1.5950 GHz, Bw = 16.000 MH No calibration applied and no bandpass applied

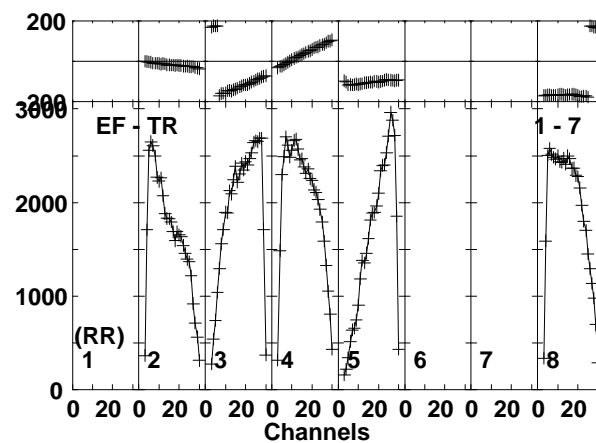
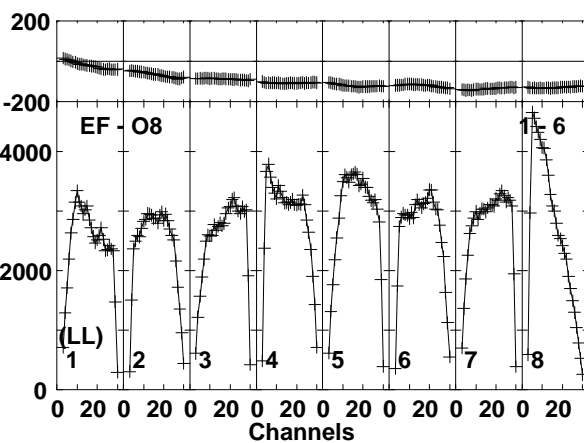
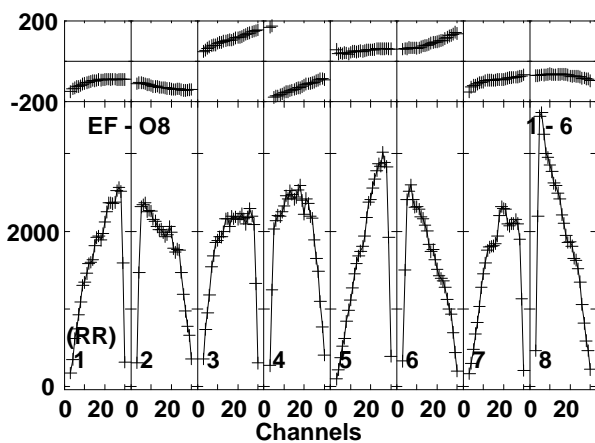
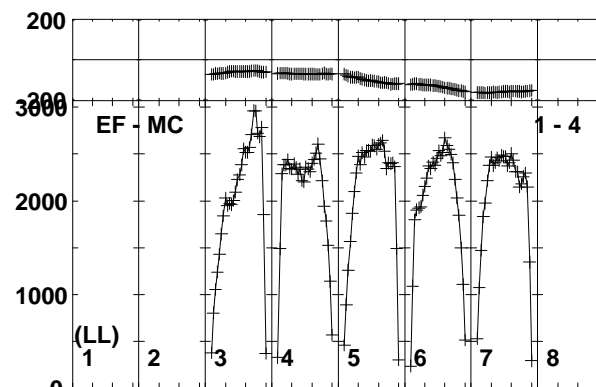
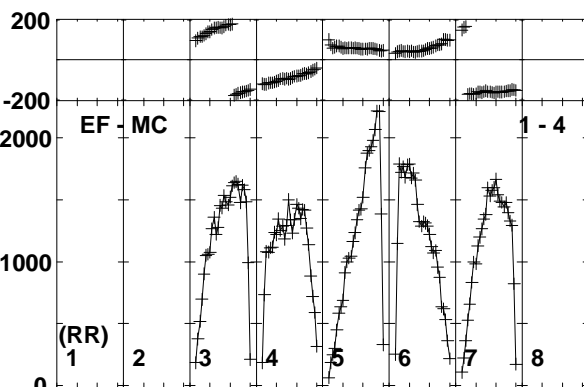
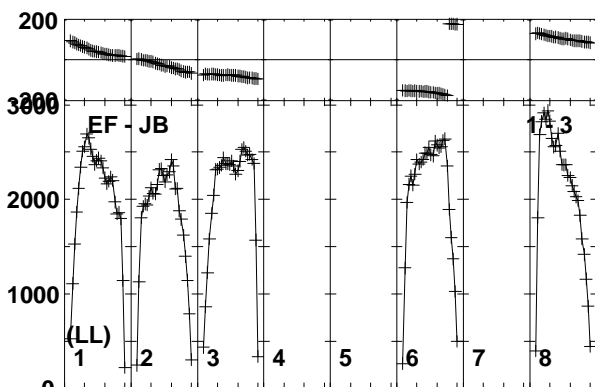
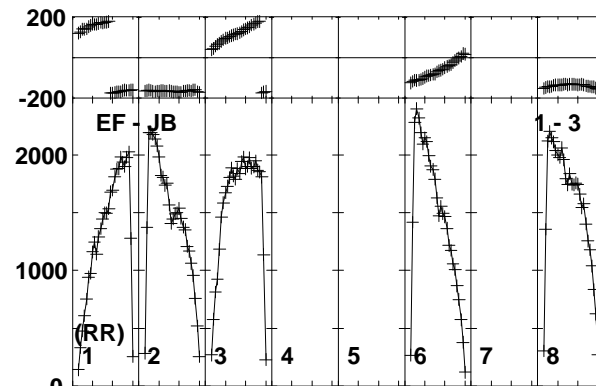
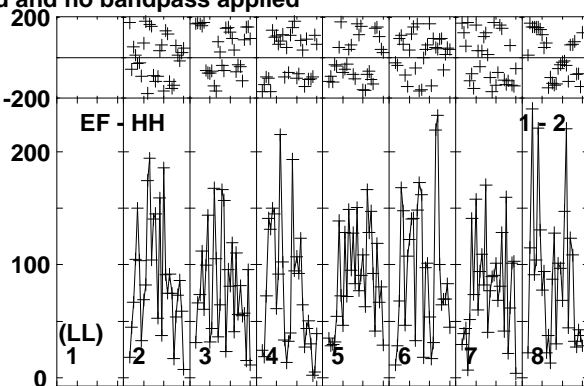
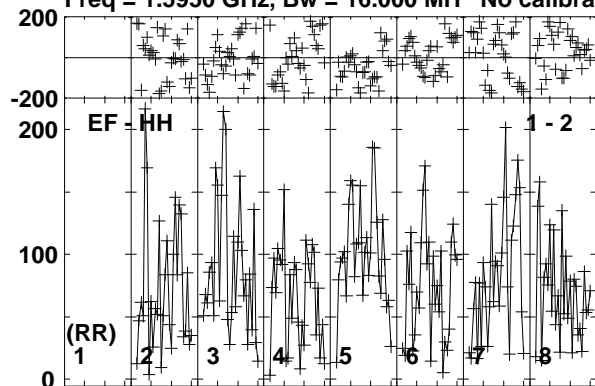

Lower frame: Micro Ampl Jy Top frame: Phas deg  
Vector averaged cross-power spectrum Baseline: EF (01) - HH (02)  
Timerange: 01/03:17:52 to 01/03:21:18

Plot file version 246 created 26-JUN-2015 10:51:28

V404CYG ET031A.UVDATA.1

Freq = 1.5950 GHz, Bw = 16.000 MH No calibration applied and no bandpass applied

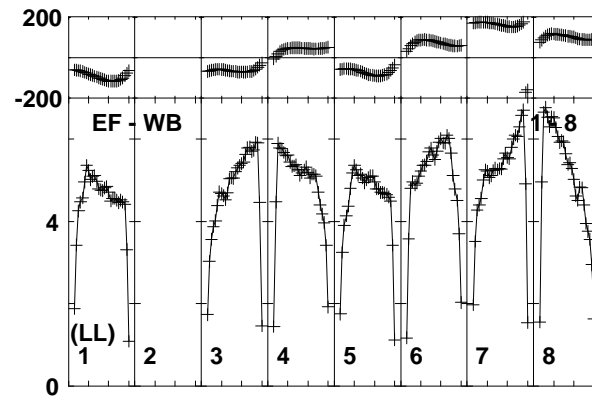
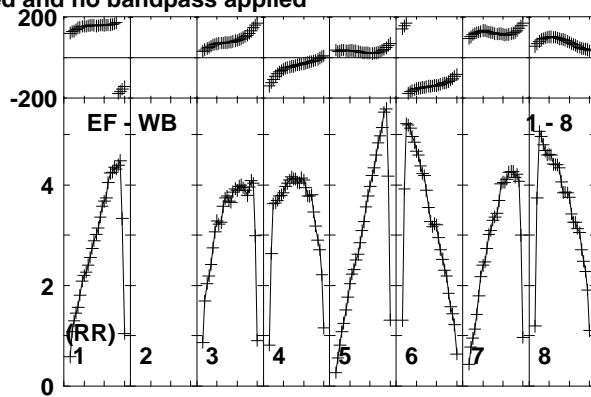
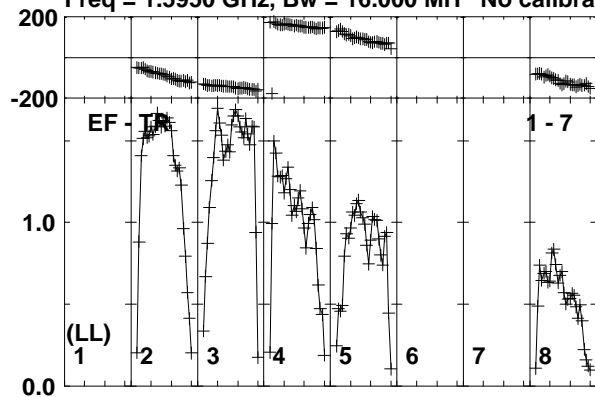

Lower frame: Milli Ampl Jy Top frame: Phas deg  
Vector averaged cross-power spectrum Baseline: EF (01) - TR (07)  
Timerange: 01/03:17:52 to 01/03:21:18

Plot file version 247 created 26-JUN-2015 10:51:28

J2025+3343 ET031A.UVDATA.1

Freq = 1.5950 GHz, Bw = 16.000 MH No calibration applied and no bandpass applied

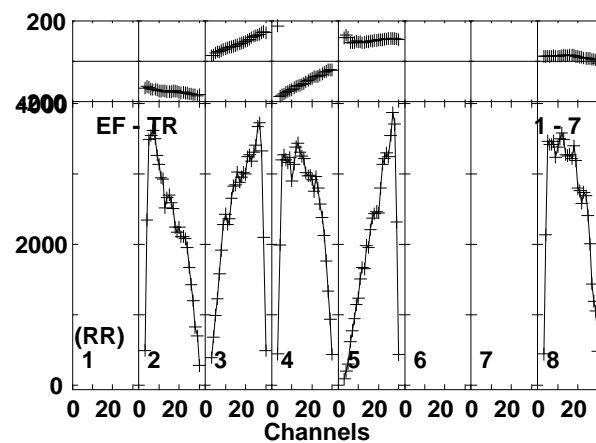
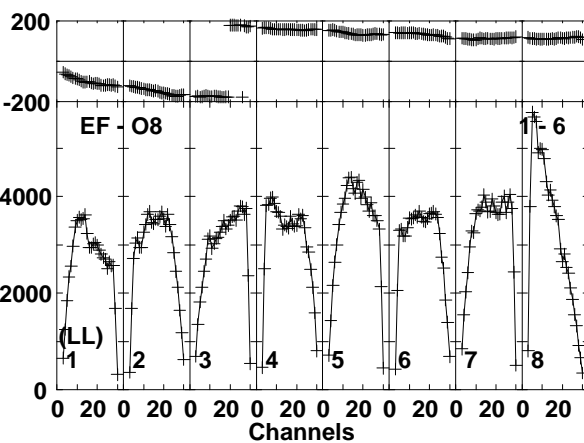
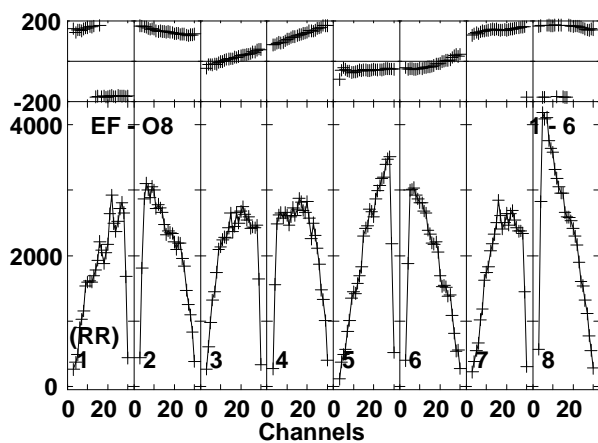
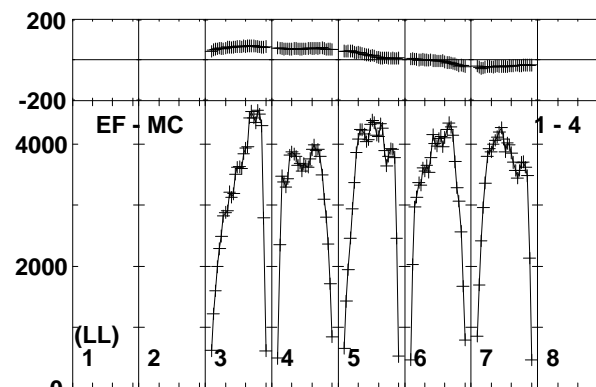
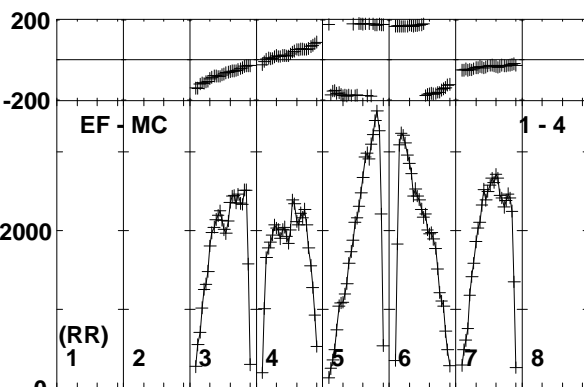
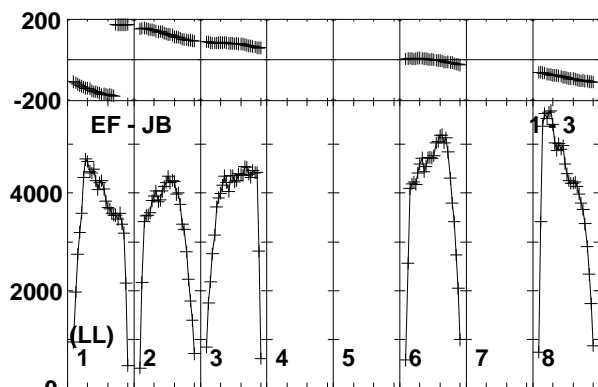
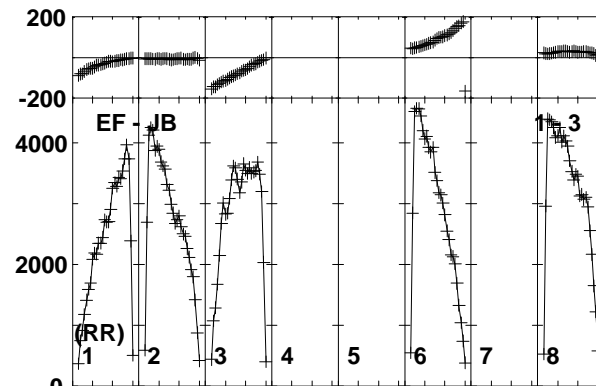
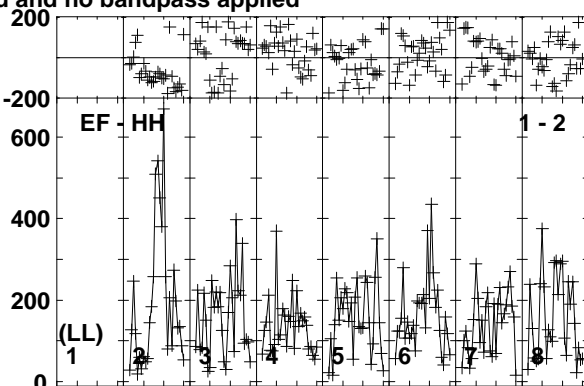
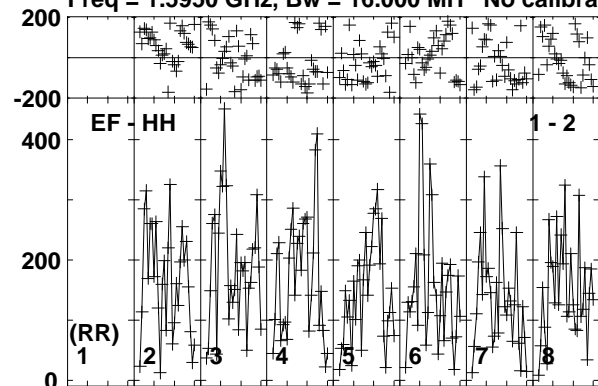

Lower frame: Micro Ampl Jy Top frame: Phas deg  
Vector averaged cross-power spectrum Baseline: EF (01) - HH (02)  
Timerange: 01/03:22:02 to 01/03:22:58

Plot file version 248 created 26-JUN-2015 10:51:28

J2025+3343 ET031A.UVDATA.1

Freq = 1.5950 GHz, Bw = 16.000 MH No calibration applied and no bandpass applied

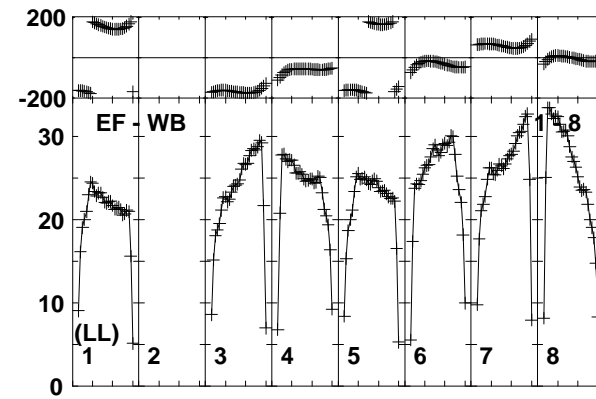
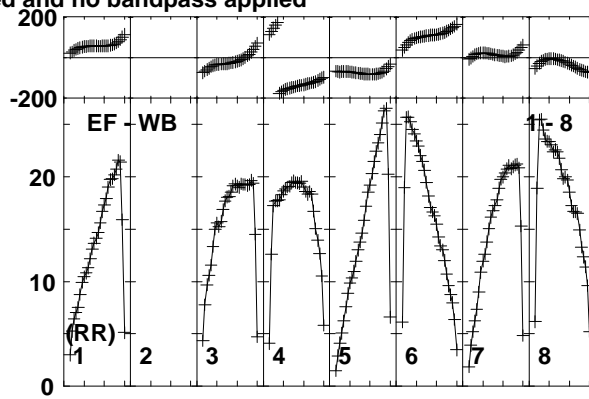
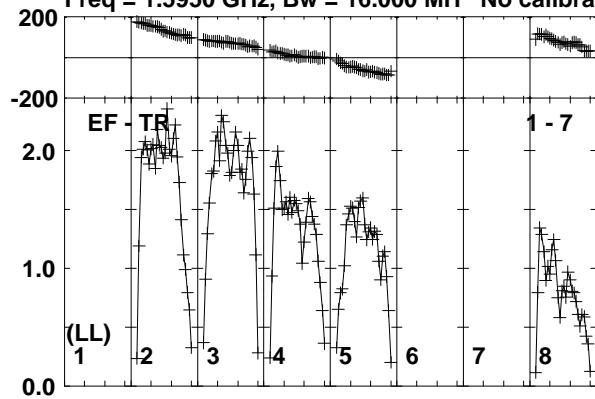

Lower frame: Milli Ampl Jy Top frame: Phas deg  
Vector averaged cross-power spectrum Baseline: EF (01) - TR (07)  
Timerange: 01/03:22:02 to 01/03:22:58



Plot file version 249 created 26-JUN-2015 10:51:28

V404CYG ET031A.UVDATA.1

Freq = 1.5950 GHz, Bw = 16.000 MH No calibration applied and no bandpass applied

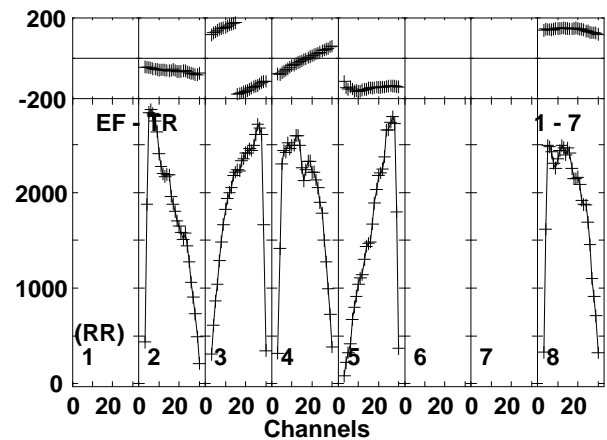
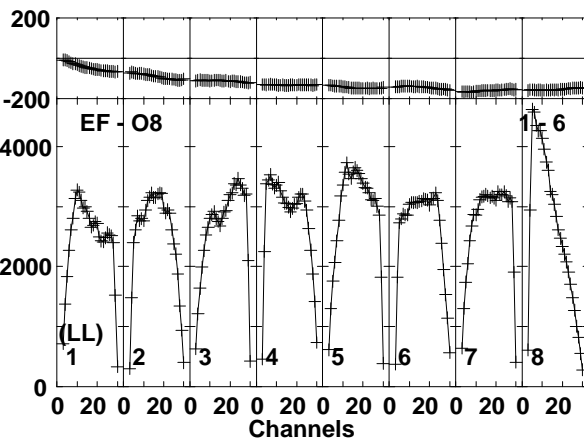
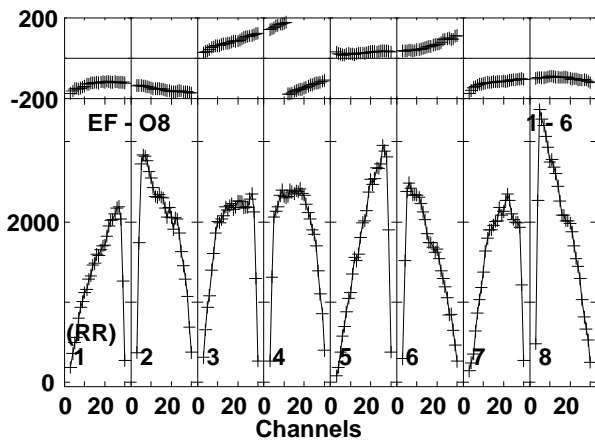
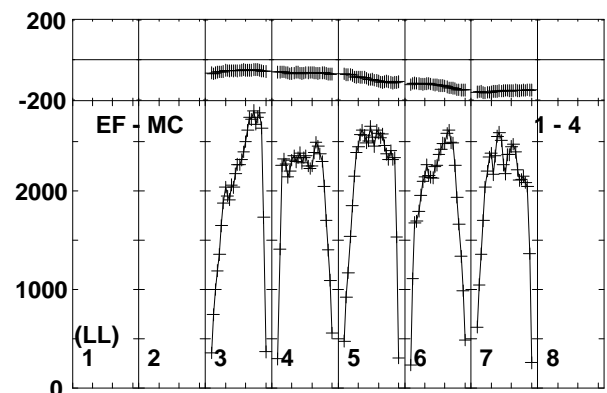
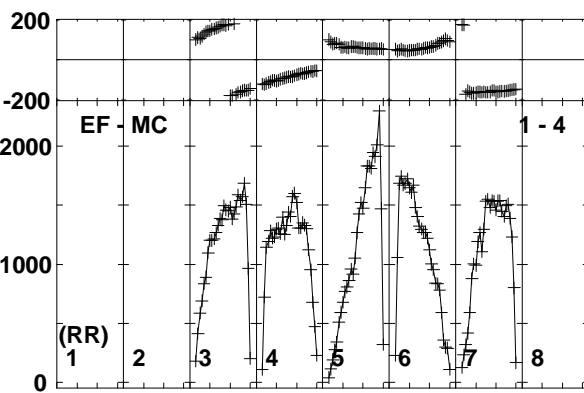
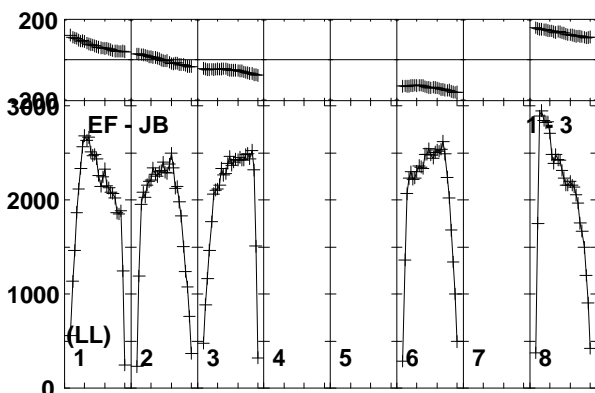
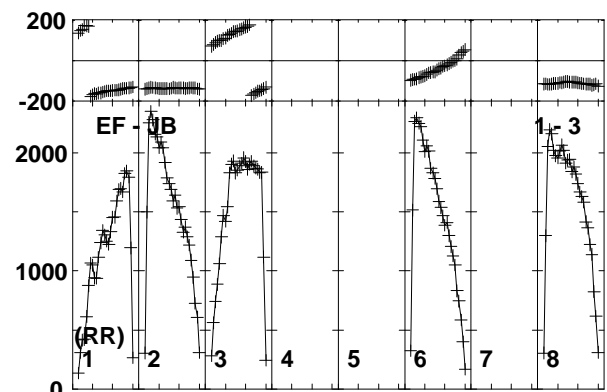
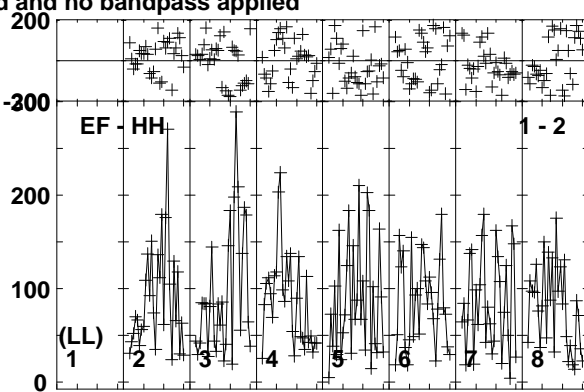
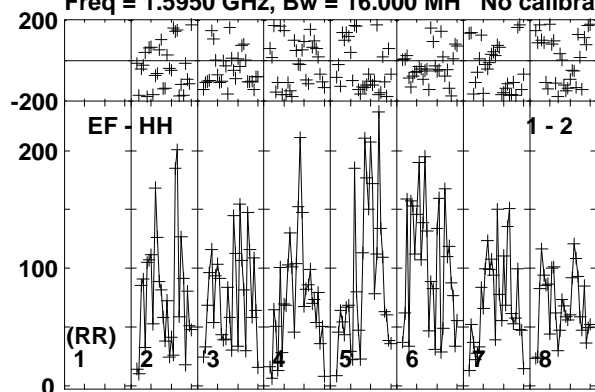

Lower frame: Micro Ampl Jy Top frame: Phas deg  
Vector averaged cross-power spectrum Baseline: EF (01) - HH (02)  
Timerange: 01/03:23:02 to 01/03:26:28

Plot file version 250 created 26-JUN-2015 10:51:28

V404CYG ET031A.UVDATA.1

Freq = 1.5950 GHz, Bw = 16.000 MH No calibration applied and no bandpass applied

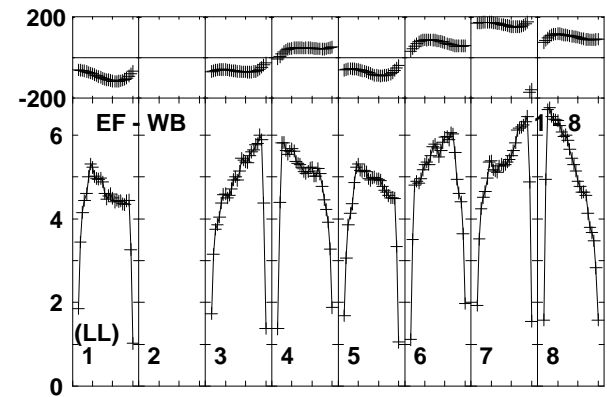
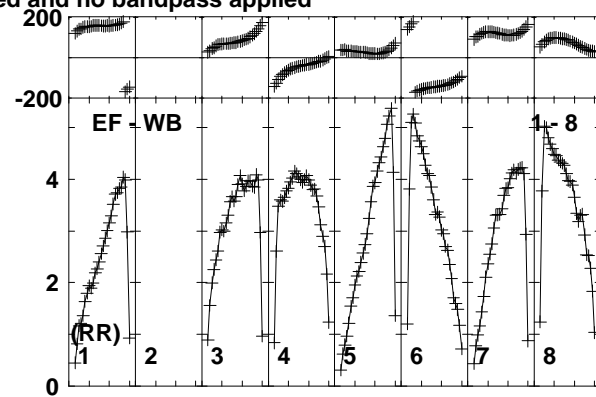
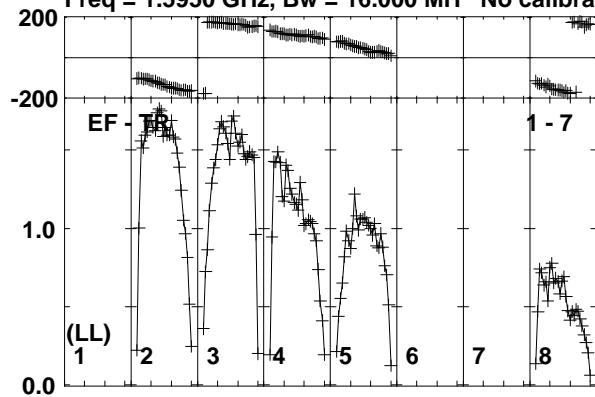

Lower frame: Milli Ampl Jy Top frame: Phas deg  
Vector averaged cross-power spectrum Baseline: EF (01) - TR (07)  
Timerange: 01/03:23:02 to 01/03:26:28

Plot file version 251 created 26-JUN-2015 10:51:28

J2025+3343 ET031A.UVDATA.1

Freq = 1.5950 GHz, Bw = 16.000 MH No calibration applied and no bandpass applied

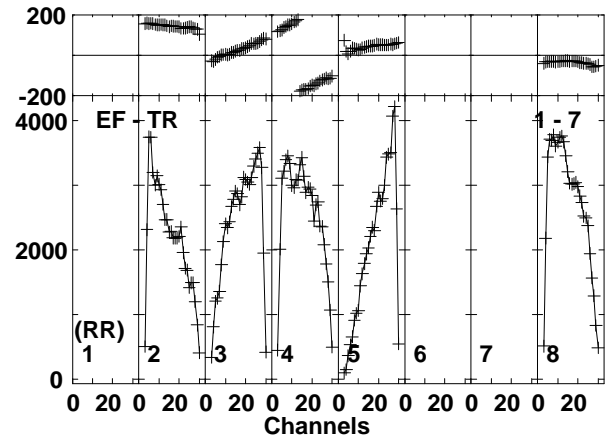
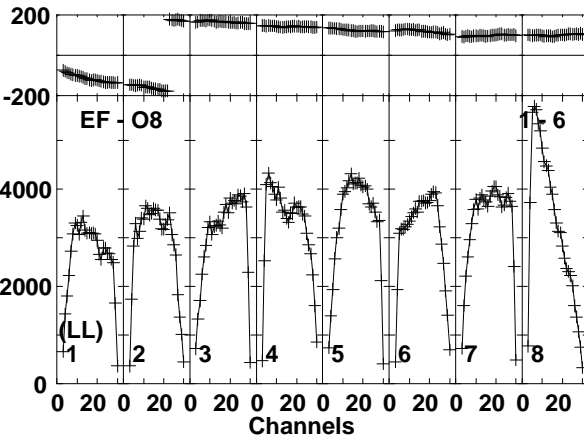
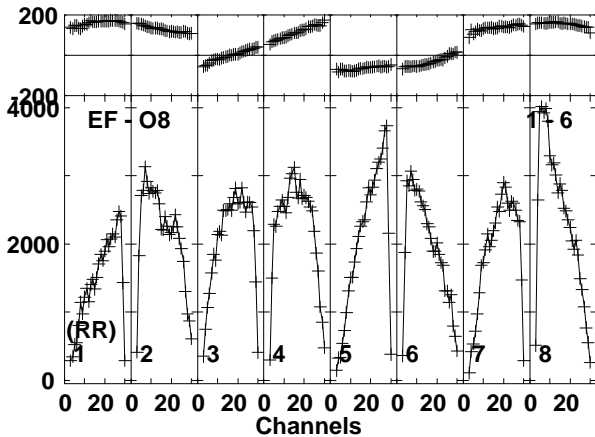
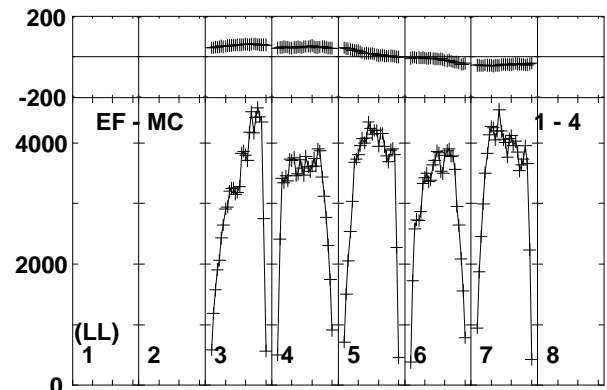
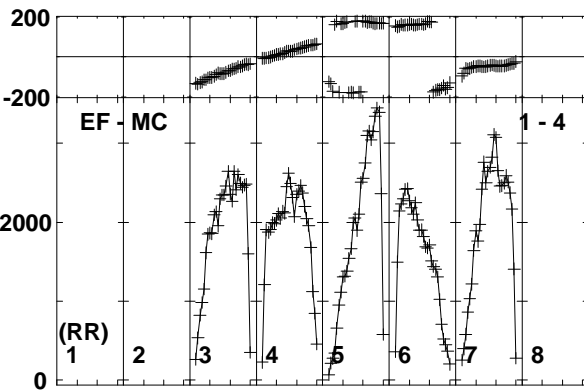
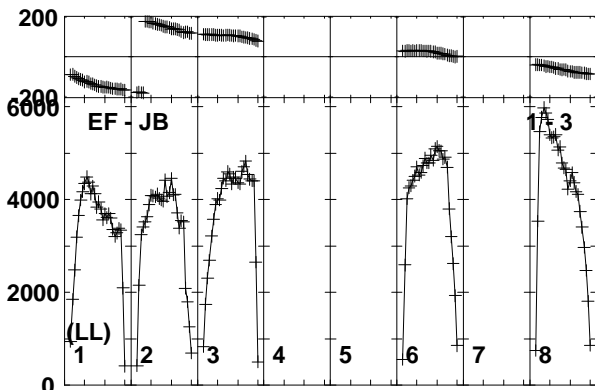
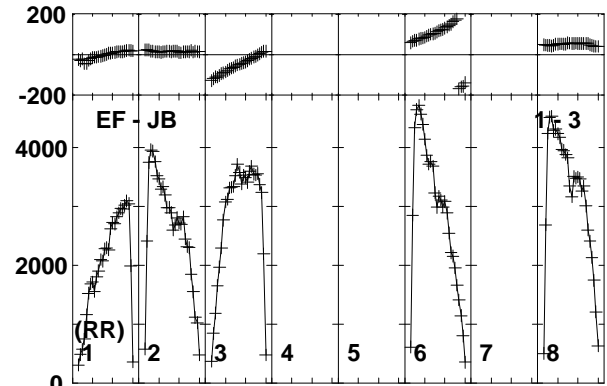
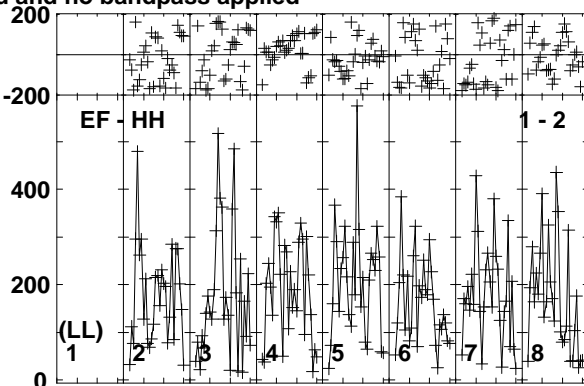
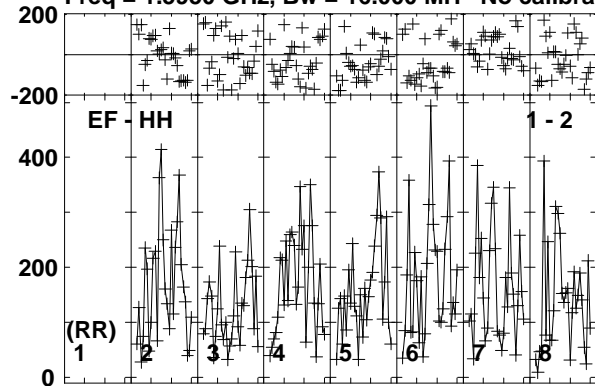

Lower frame: Micro Ampl Jy Top frame: Phas deg  
Vector averaged cross-power spectrum Baseline: EF (01) - HH (02)  
Timerange: 01/03:26:32 to 01/03:27:48

Plot file version 252 created 26-JUN-2015 10:51:28

J2025+3343 ET031A.UVDATA.1

Freq = 1.5950 GHz, Bw = 16.000 MH No calibration applied and no bandpass applied

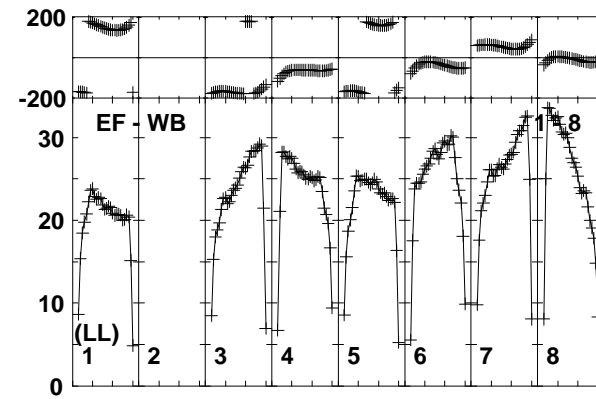
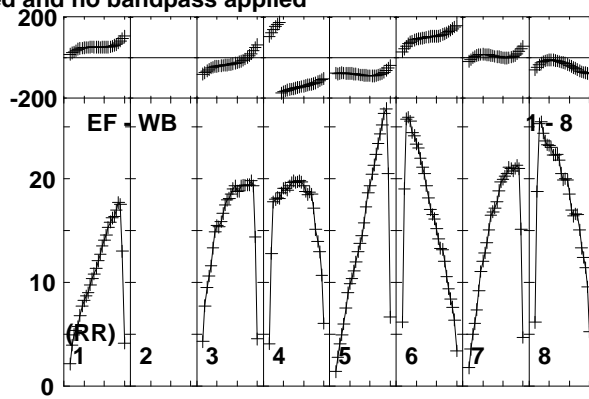
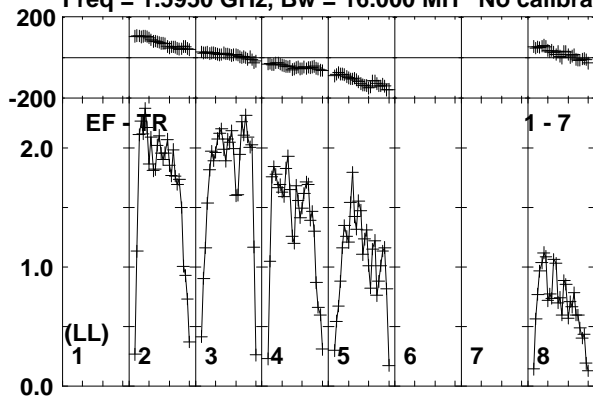

Lower frame: Milli Ampl Jy Top frame: Phas deg  
Vector averaged cross-power spectrum Baseline: EF (01) - TR (07)  
Timerange: 01/03:26:32 to 01/03:27:48

Plot file version 253 created 26-JUN-2015 10:51:28

V404CYG ET031A.UVDATA.1

Freq = 1.5950 GHz, Bw = 16.000 MH No calibration applied and no bandpass applied

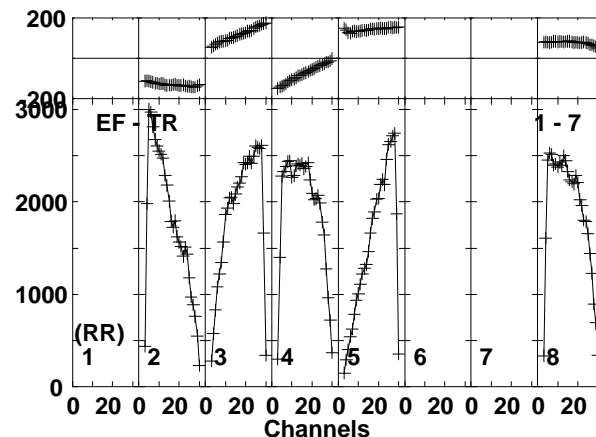
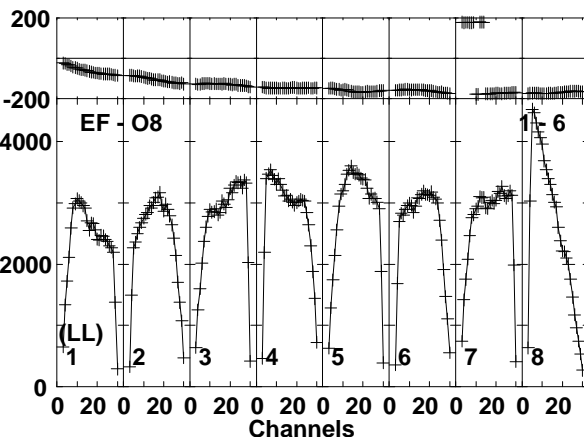
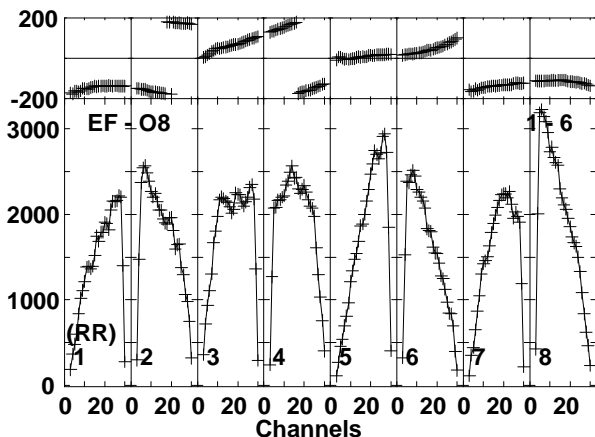
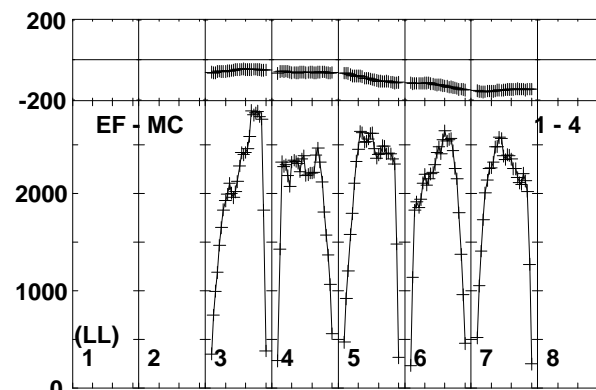
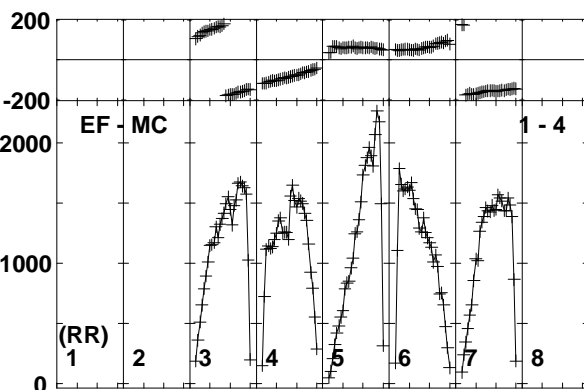
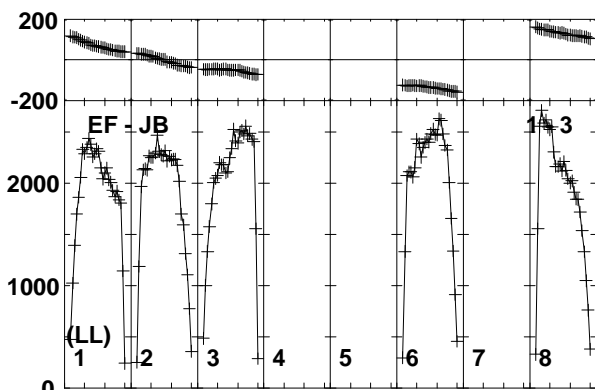
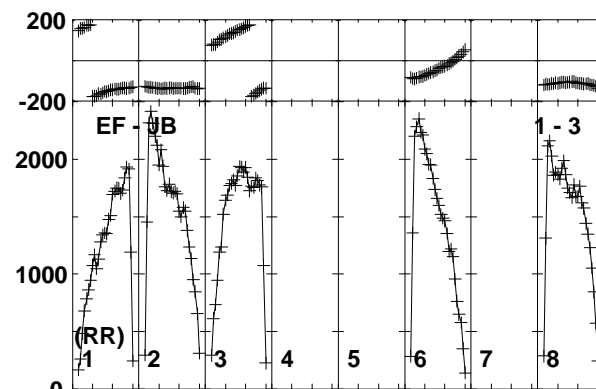
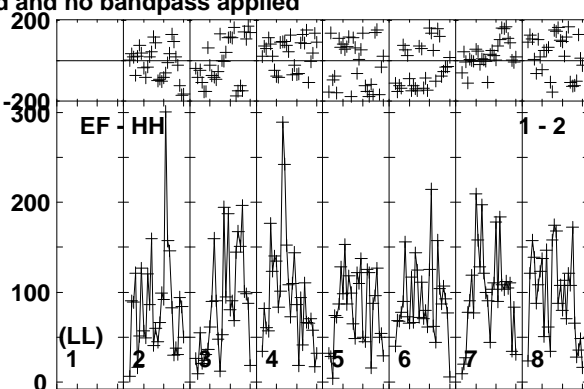
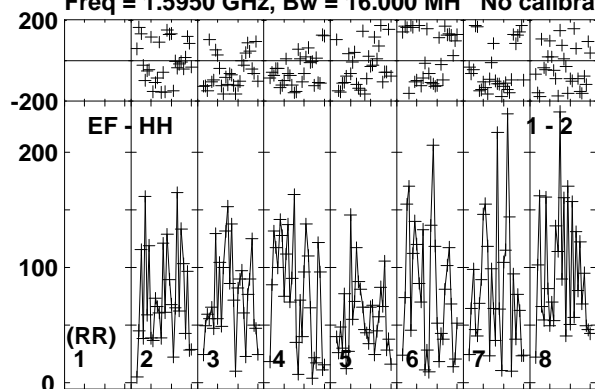

Lower frame: Micro Ampl Jy Top frame: Phas deg  
Vector averaged cross-power spectrum Baseline: EF (01) - HH (02)  
Timerange: 01/03:27:52 to 01/03:31:18

Plot file version 254 created 26-JUN-2015 10:51:28

V404CYG ET031A.UVDATA.1

Freq = 1.5950 GHz, Bw = 16.000 MH No calibration applied and no bandpass applied

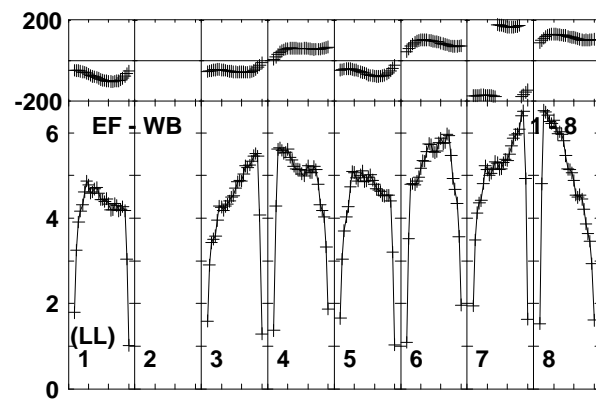
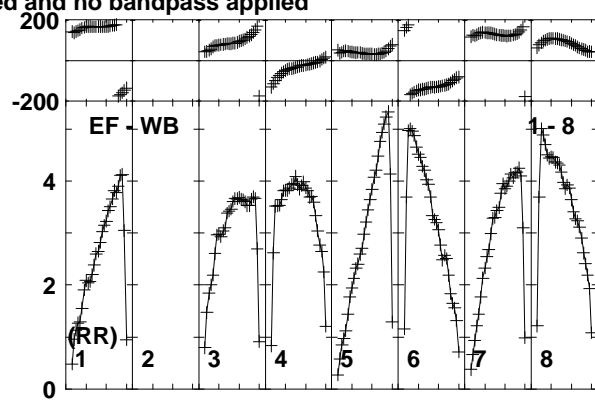
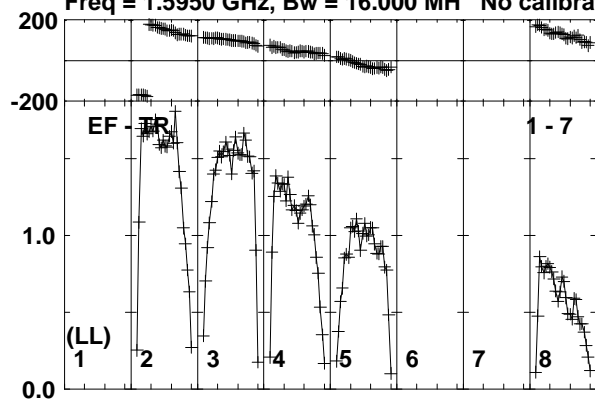

Lower frame: Milli Ampl Jy Top frame: Phas deg  
Vector averaged cross-power spectrum Baseline: EF (01) - TR (07)  
Timerange: 01/03:27:52 to 01/03:31:18

Plot file version 255 created 26-JUN-2015 10:51:28

J2025+3343 ET031A.UVDATA.1

Freq = 1.5950 GHz, Bw = 16.000 MH No calibration applied and no bandpass applied

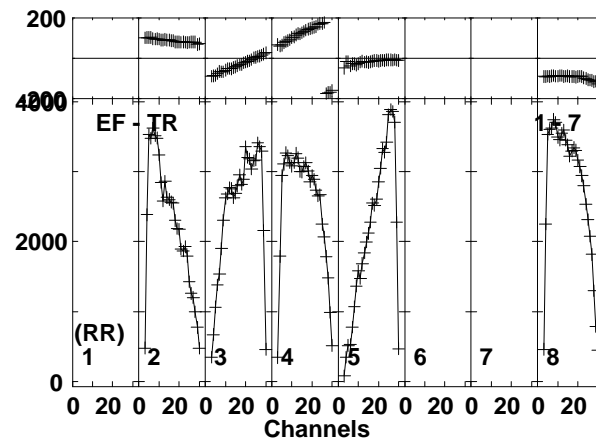
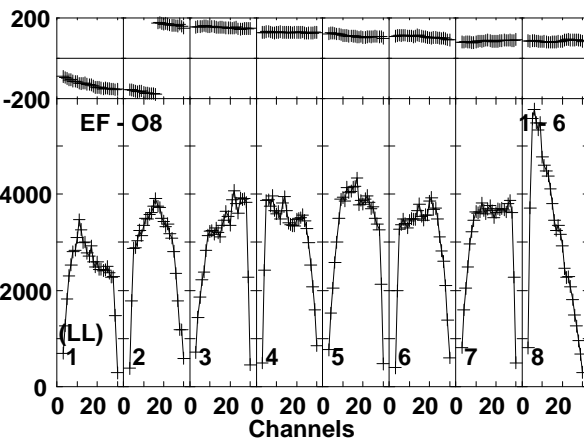
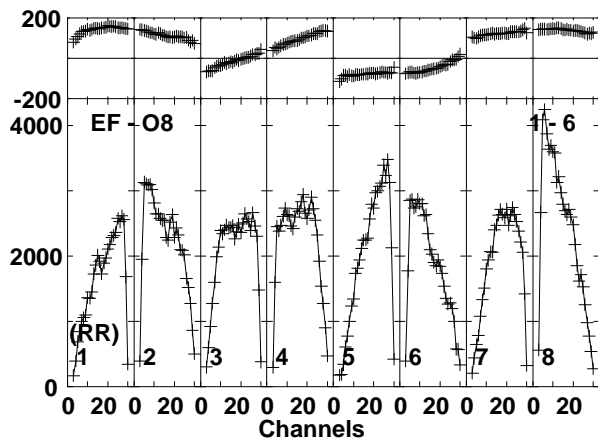
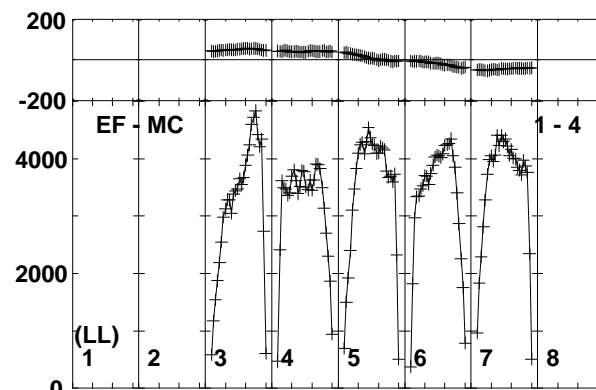
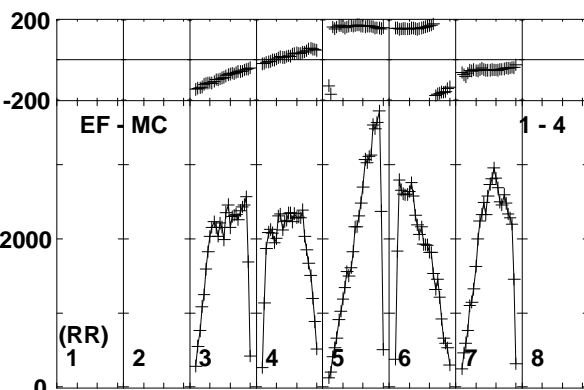
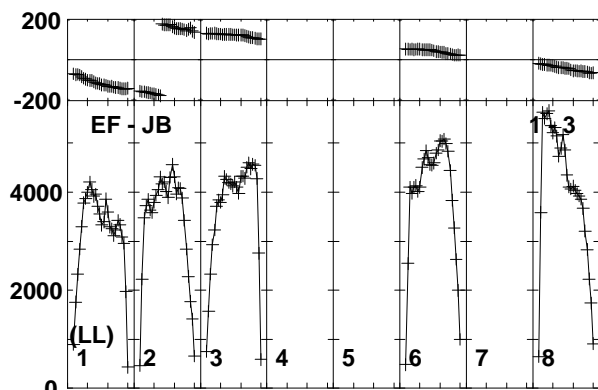
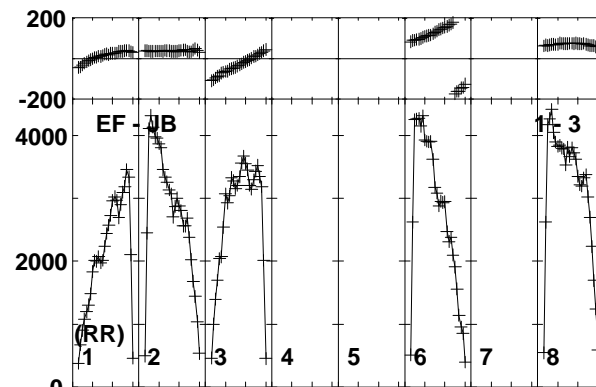
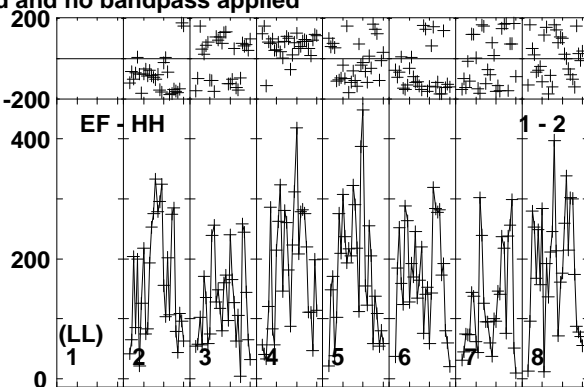
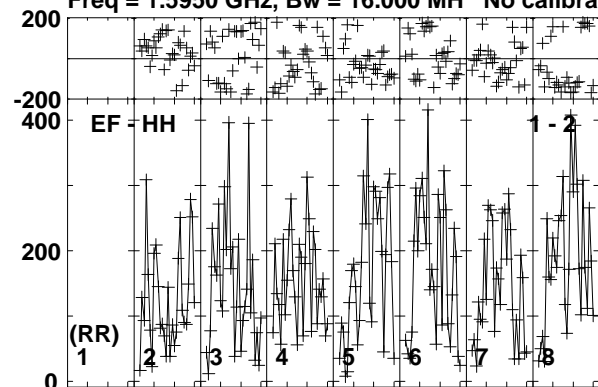

Lower frame: Micro Ampl Jy Top frame: Phas deg  
Vector averaged cross-power spectrum Baseline: EF (01) - HH (02)  
Timerange: 01/03:32:02 to 01/03:32:58

Plot file version 256 created 26-JUN-2015 10:51:28

J2025+3343 ET031A.UVDATA.1

Freq = 1.5950 GHz, Bw = 16.000 MH No calibration applied and no bandpass applied

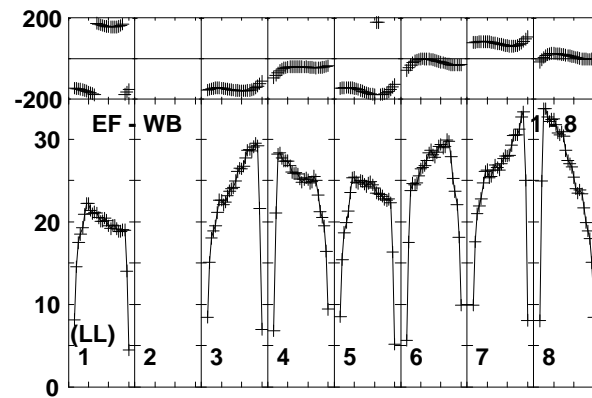
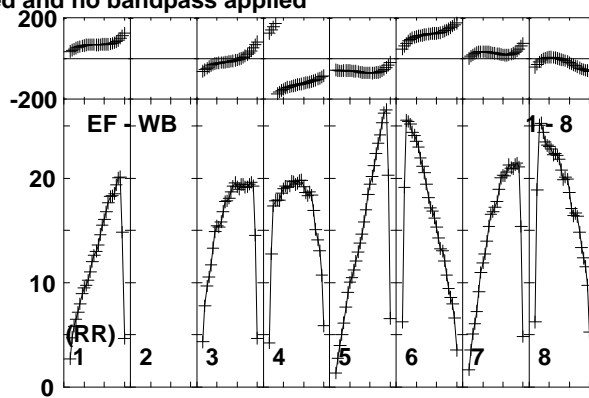
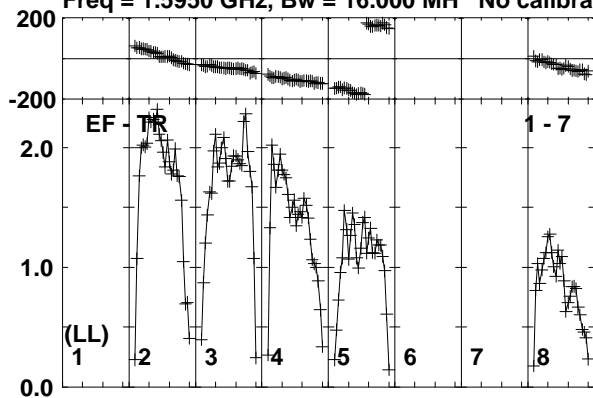

Lower frame: Milli Ampl Jy Top frame: Phas deg  
Vector averaged cross-power spectrum Baseline: EF (01) - TR (07)  
Timerange: 01/03:32:02 to 01/03:32:58



Plot file version 257 created 26-JUN-2015 10:51:28

V404CYG ET031A.UVDATA.1

Freq = 1.5950 GHz, Bw = 16.000 MH No calibration applied and no bandpass applied

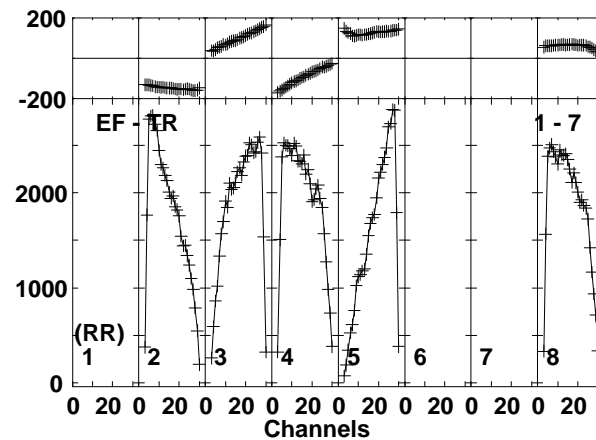
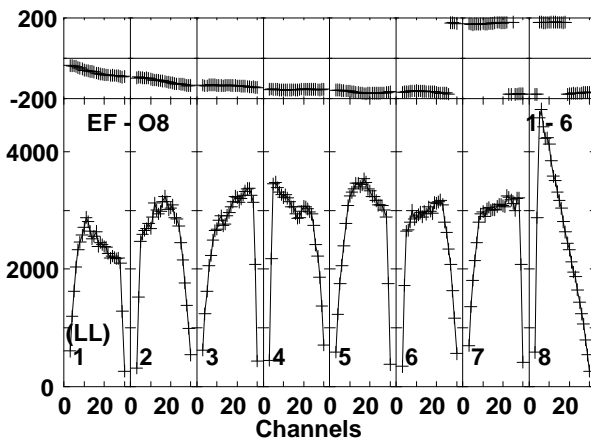
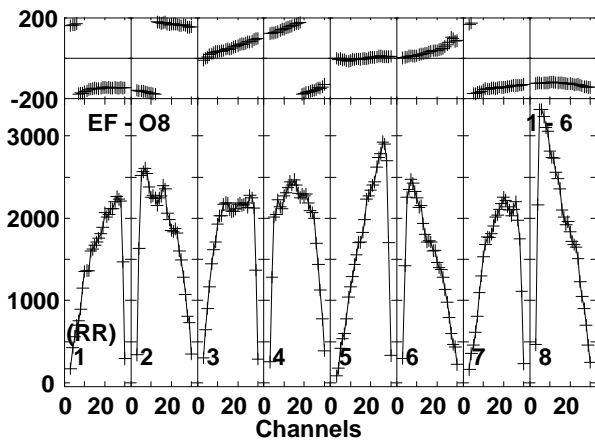
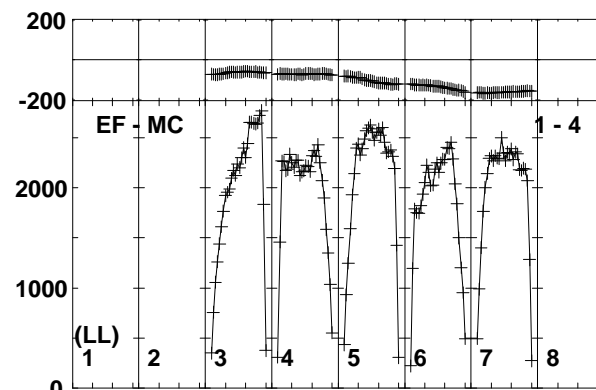
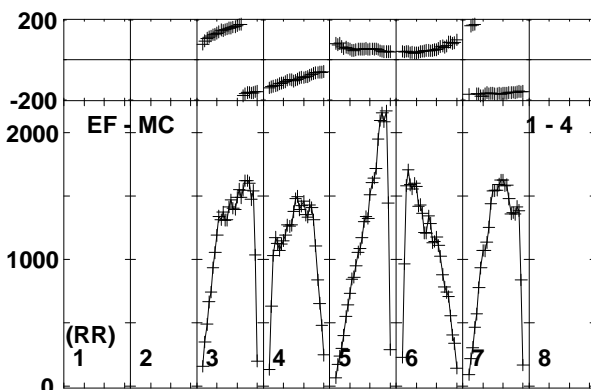
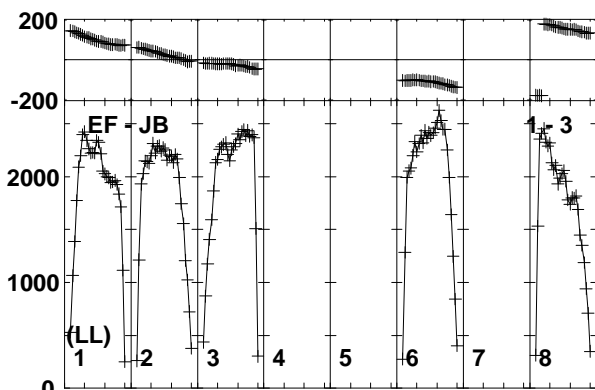
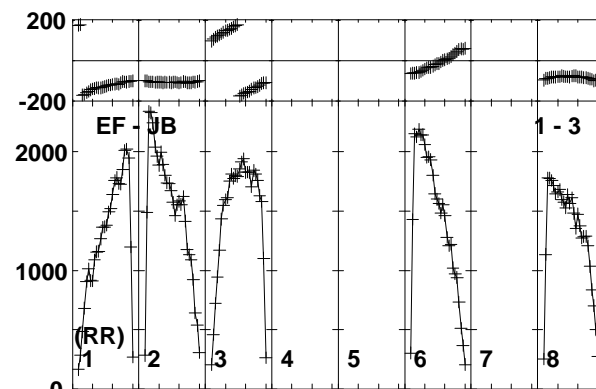
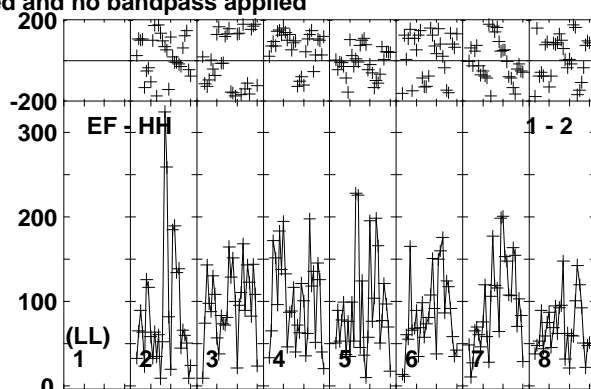
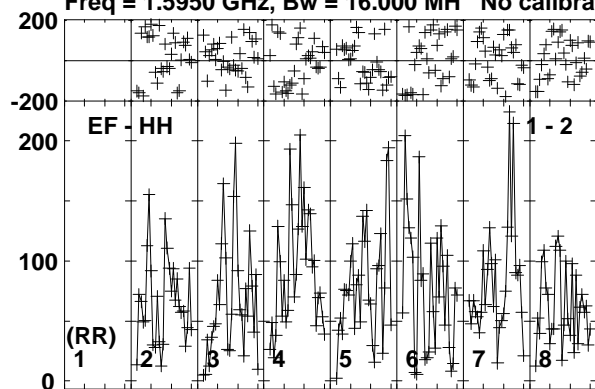

Lower frame: Micro Ampl Jy Top frame: Phas deg  
Vector averaged cross-power spectrum Baseline: EF (01) - HH (02)  
Timerange: 01/03:33:02 to 01/03:36:28

Plot file version 258 created 26-JUN-2015 10:51:28

V404CYG ET031A.UVDATA.1

Freq = 1.5950 GHz, Bw = 16.000 MH No calibration applied and no bandpass applied

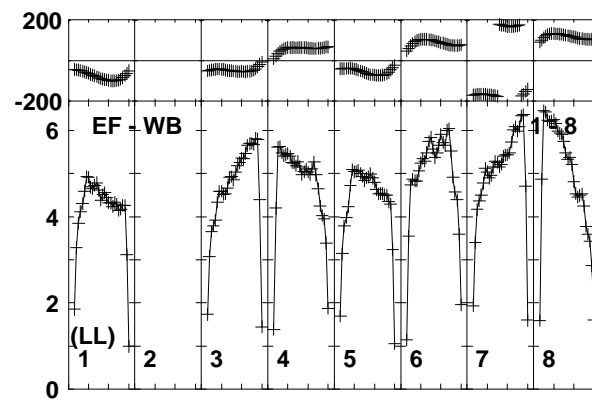
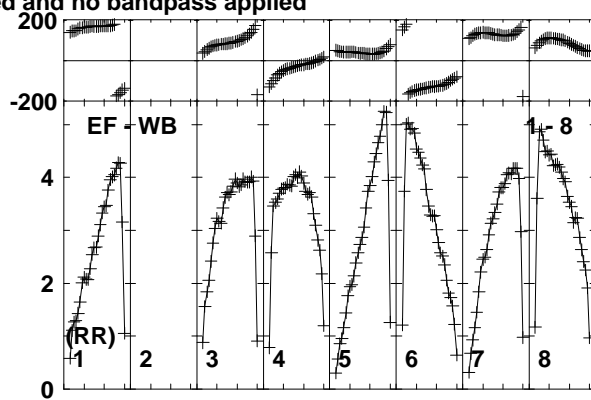
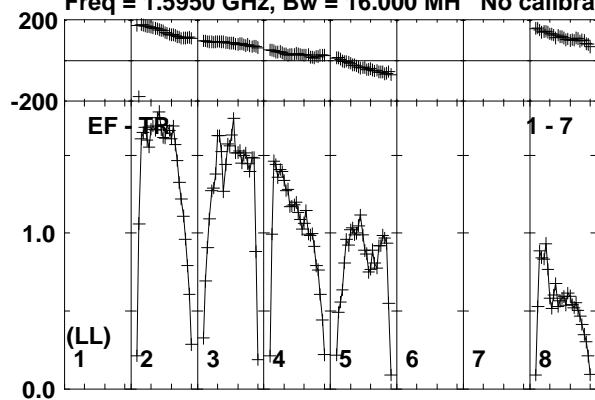

Lower frame: Milli Ampl Jy Top frame: Phas deg  
Vector averaged cross-power spectrum Baseline: EF (01) - TR (07)  
Timerange: 01/03:33:02 to 01/03:36:28

Plot file version 259 created 26-JUN-2015 10:51:28

J2025+3343 ET031A.UVDATA.1

Freq = 1.5950 GHz, Bw = 16.000 MH No calibration applied and no bandpass applied

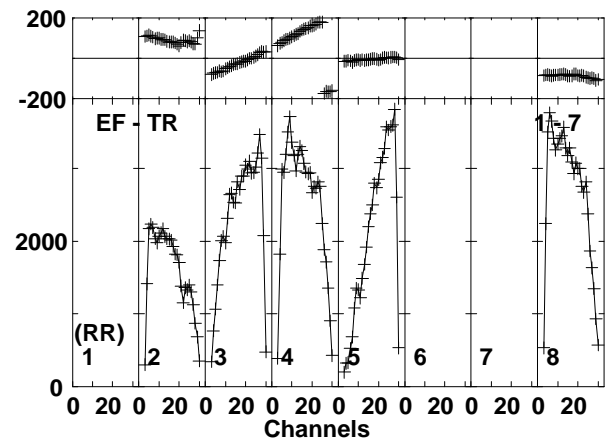
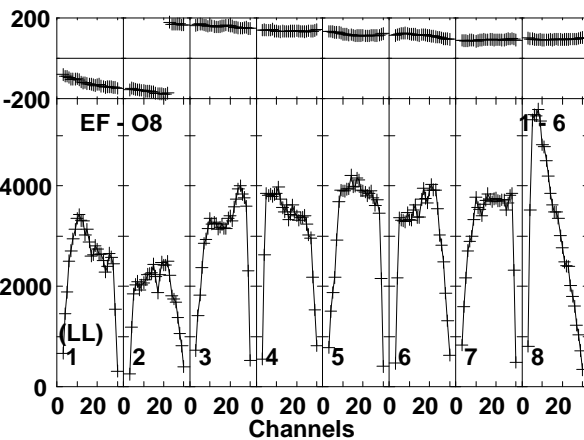
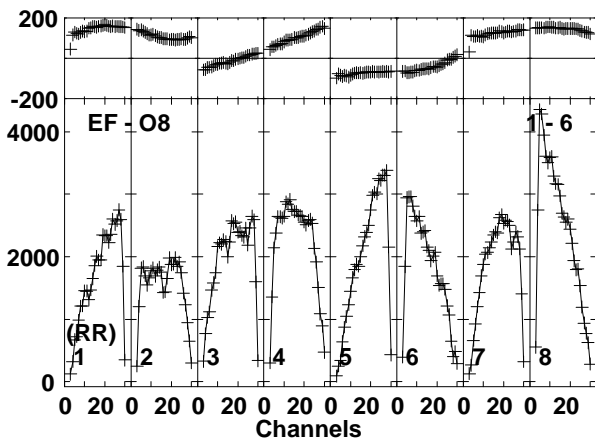
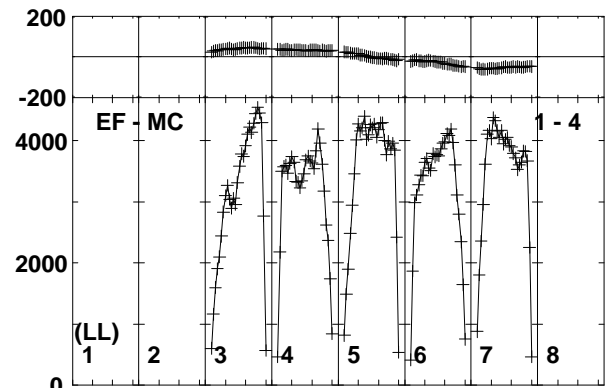
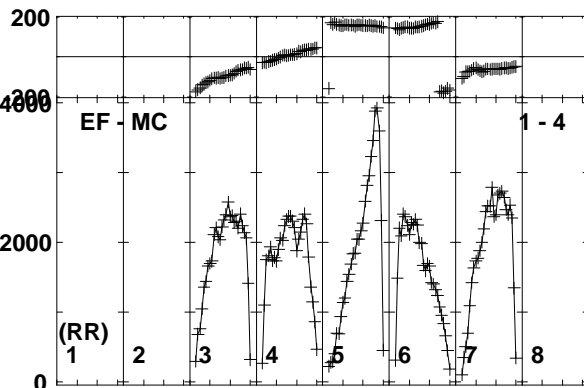
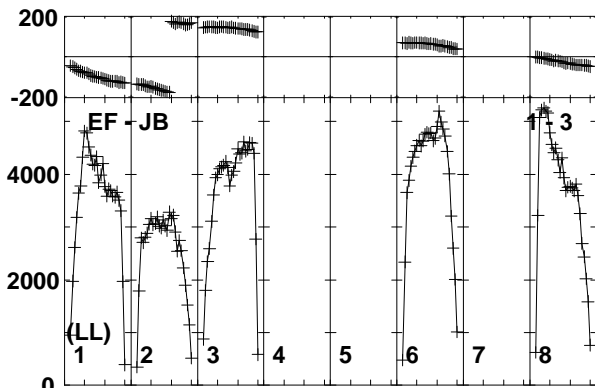
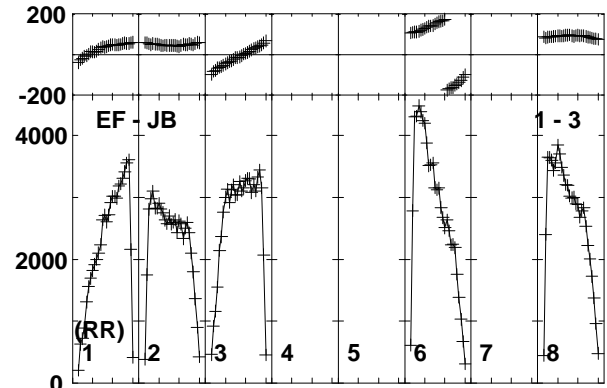
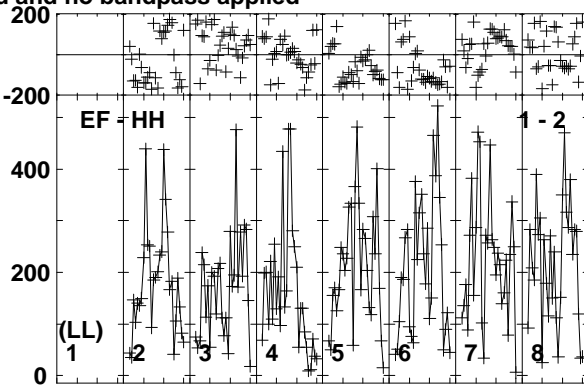
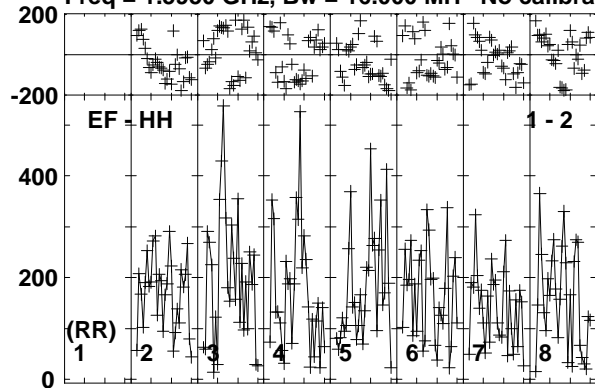

Lower frame: Micro Ampl Jy Top frame: Phas deg  
Vector averaged cross-power spectrum Baseline: EF (01) - HH (02)  
Timerange: 01/03:36:32 to 01/03:37:48

Plot file version 260 created 26-JUN-2015 10:51:28

J2025+3343 ET031A.UVDATA.1

Freq = 1.5950 GHz, Bw = 16.000 MH No calibration applied and no bandpass applied

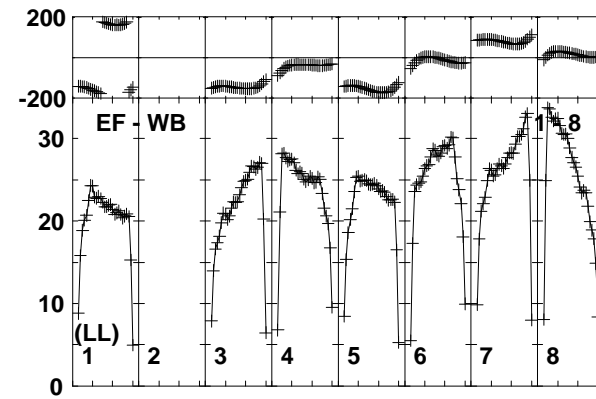
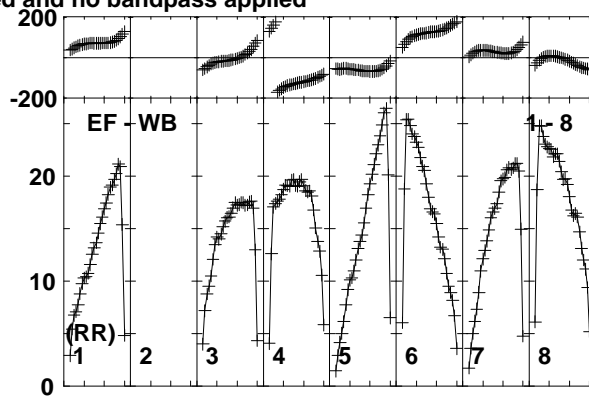
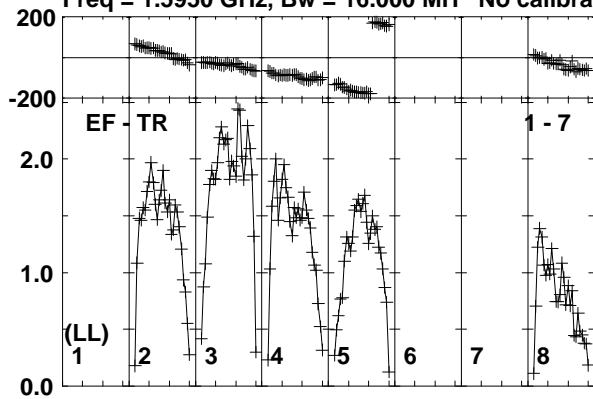

Lower frame: Milli Ampl Jy Top frame: Phas deg  
Vector averaged cross-power spectrum Baseline: EF (01) - TR (07)  
Timerange: 01/03:36:32 to 01/03:37:48

Plot file version 261 created 26-JUN-2015 10:51:28

V404CYG ET031A.UVDATA.1

Freq = 1.5950 GHz, Bw = 16.000 MH No calibration applied and no bandpass applied

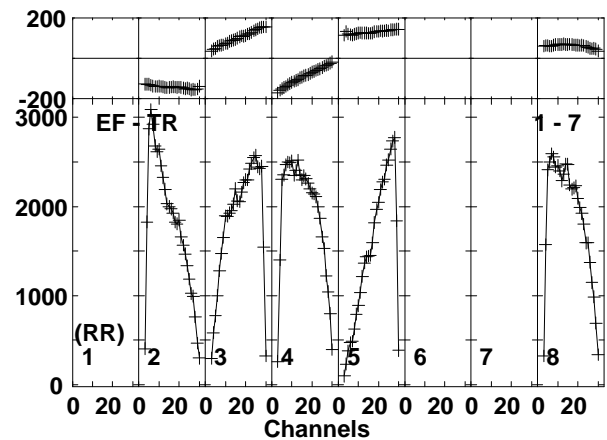
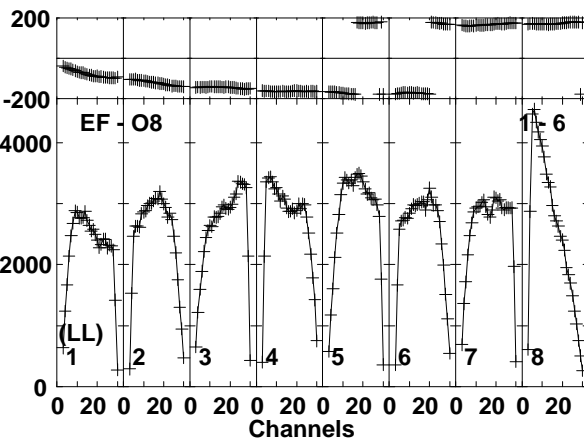
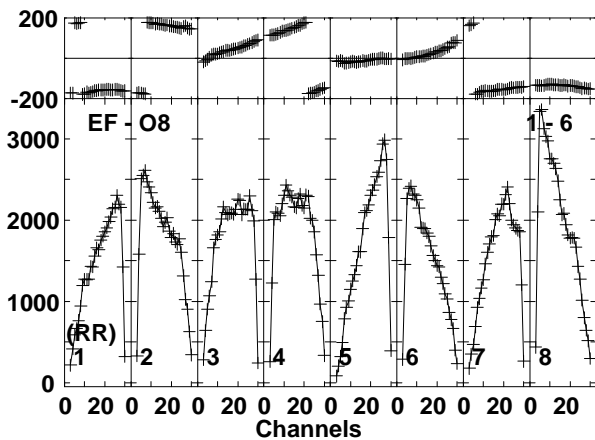
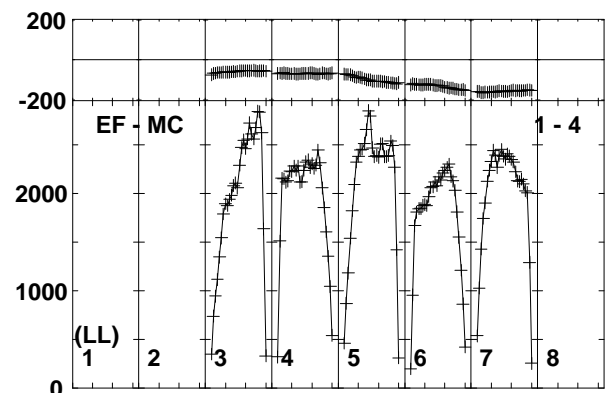
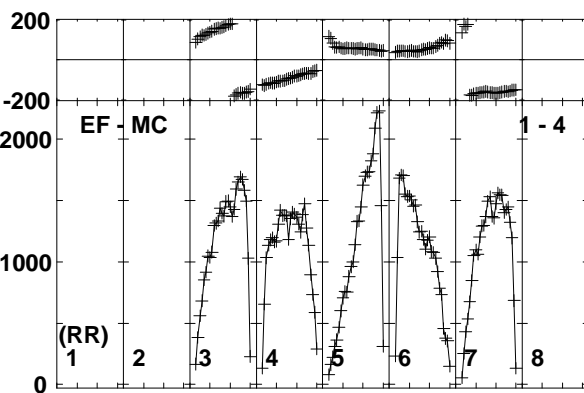
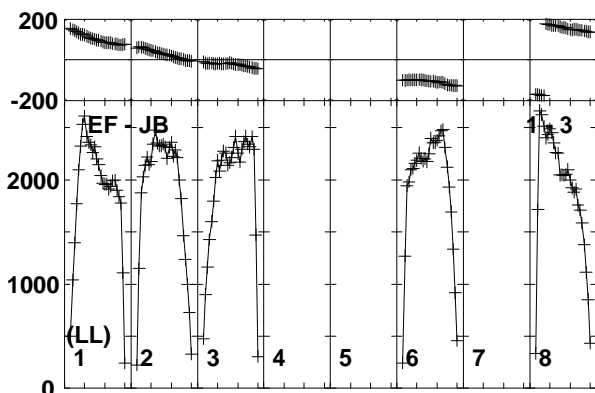
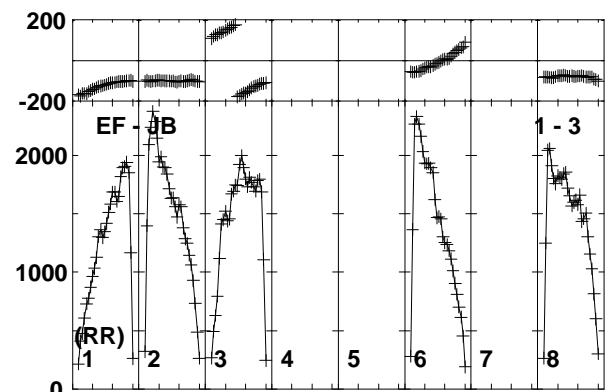
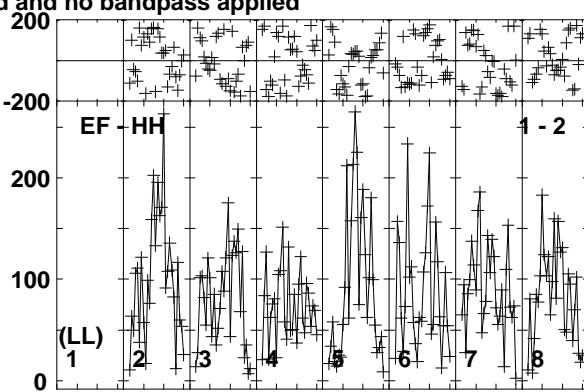
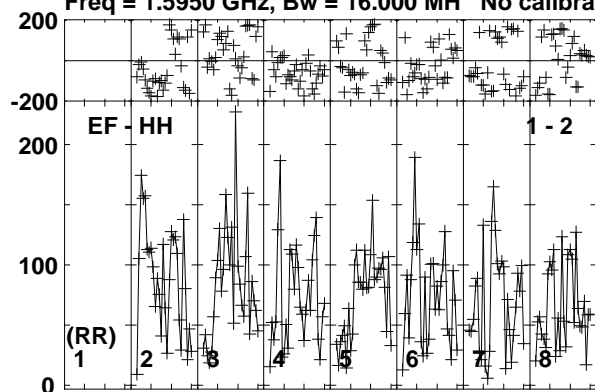

Lower frame: Micro Ampl Jy Top frame: Phas deg  
Vector averaged cross-power spectrum Baseline: EF (01) - HH (02)  
Timerange: 01/03:37:52 to 01/03:41:18

Plot file version 262 created 26-JUN-2015 10:51:28

V404CYG ET031A.UVDATA.1

Freq = 1.5950 GHz, Bw = 16.000 MH No calibration applied and no bandpass applied

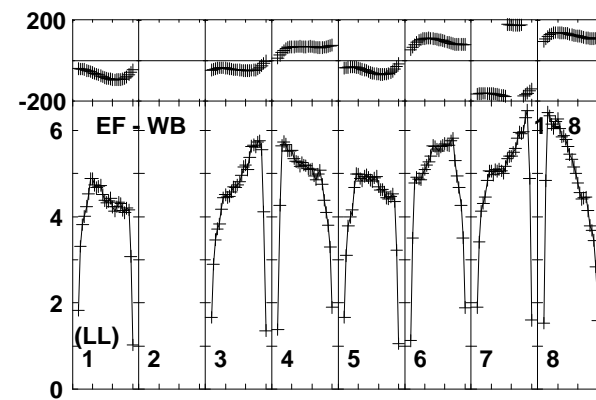
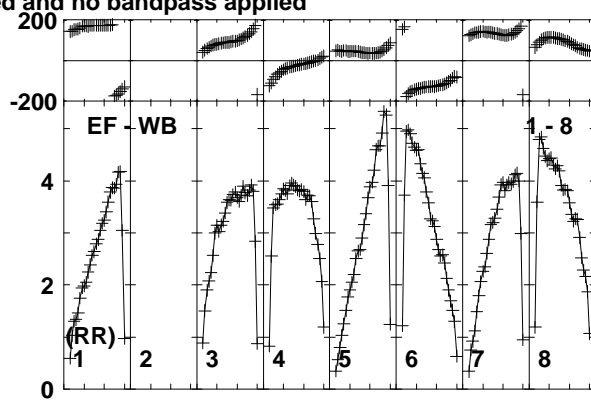
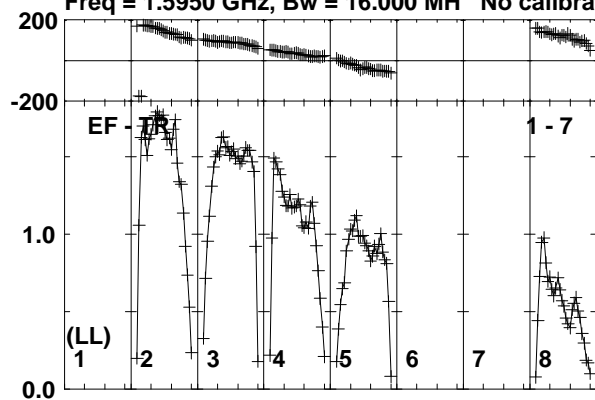

Lower frame: Milli Ampl Jy Top frame: Phas deg  
Vector averaged cross-power spectrum Baseline: EF (01) - TR (07)  
Timerange: 01/03:37:52 to 01/03:41:18

Plot file version 263 created 26-JUN-2015 10:51:28

J2025+3343 ET031A.UVDATA.1

Freq = 1.5950 GHz, Bw = 16.000 MH No calibration applied and no bandpass applied

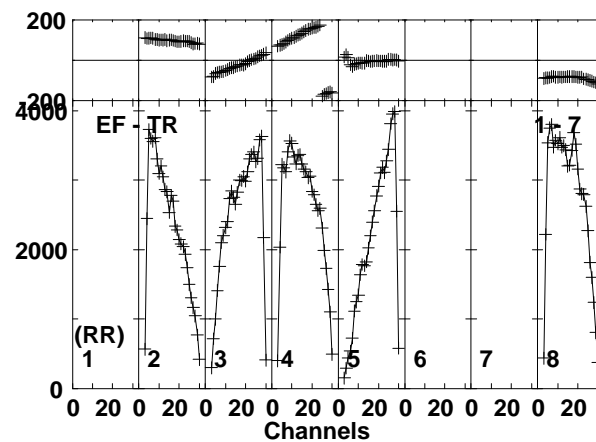
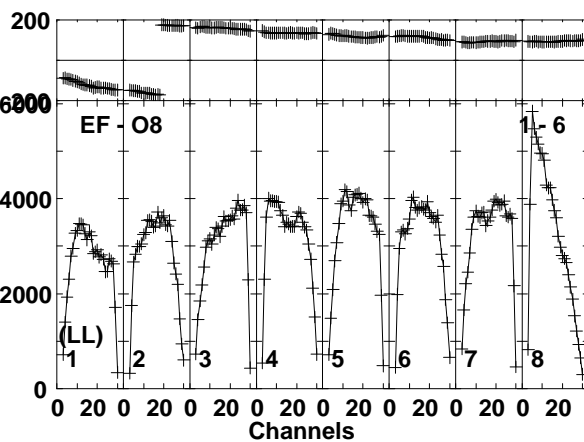
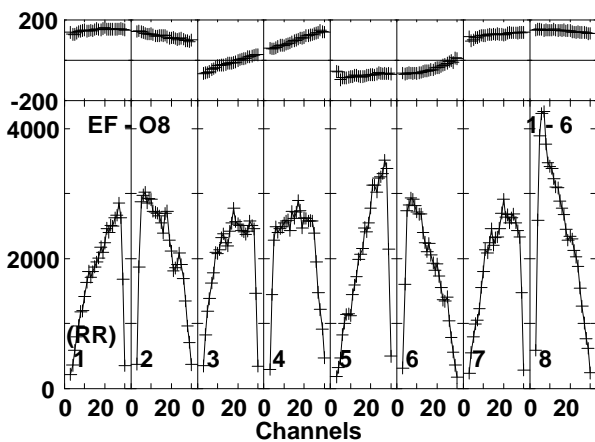
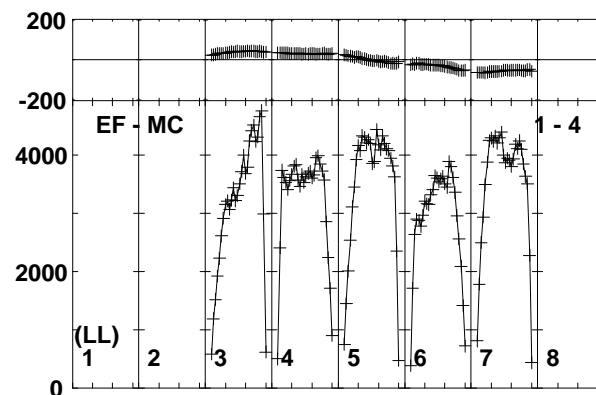
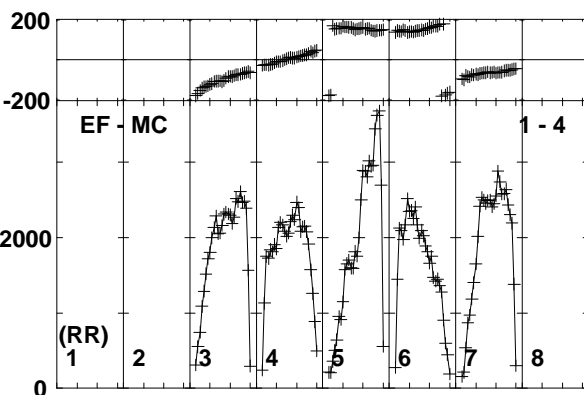
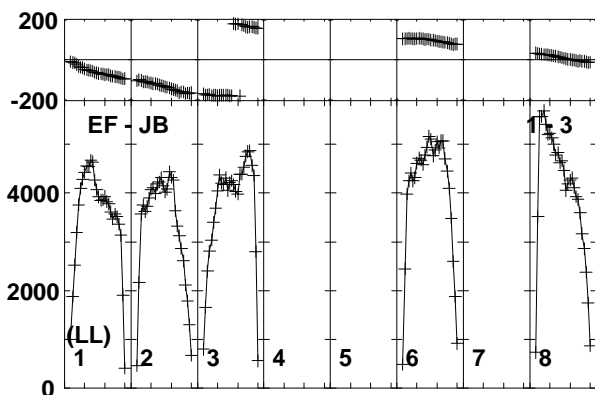
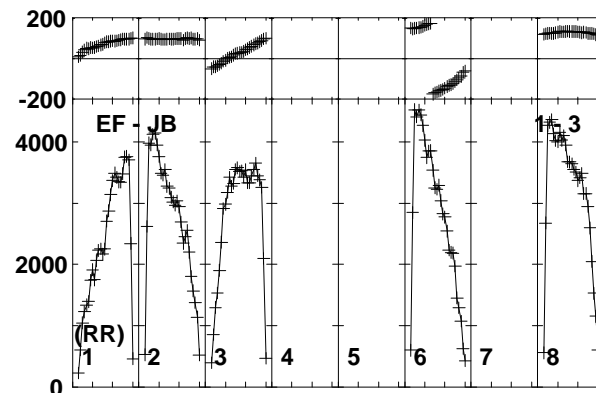
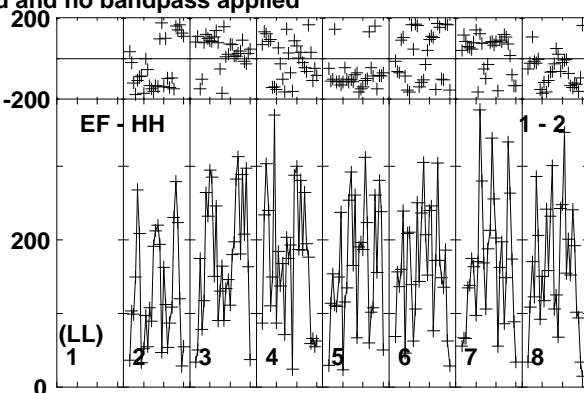
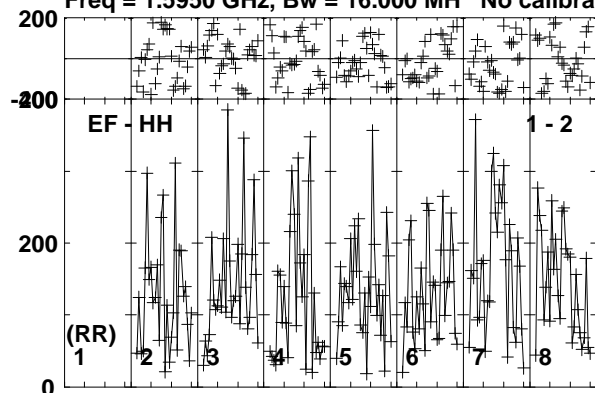

Lower frame: Micro Ampl Jy Top frame: Phas deg  
Vector averaged cross-power spectrum Baseline: EF (01) - HH (02)  
Timerange: 01/03:42:02 to 01/03:42:58

Plot file version 264 created 26-JUN-2015 10:51:29

J2025+3343 ET031A.UVDATA.1

Freq = 1.5950 GHz, Bw = 16.000 MH No calibration applied and no bandpass applied

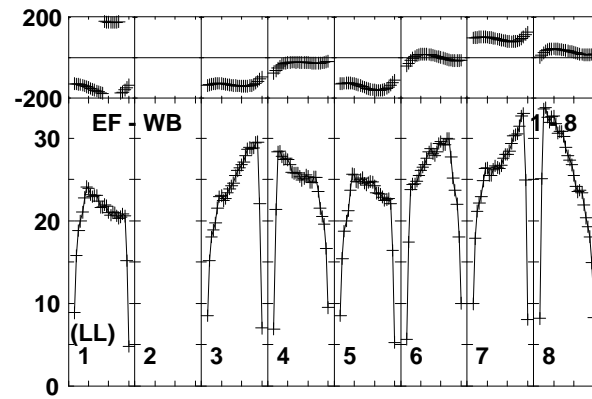
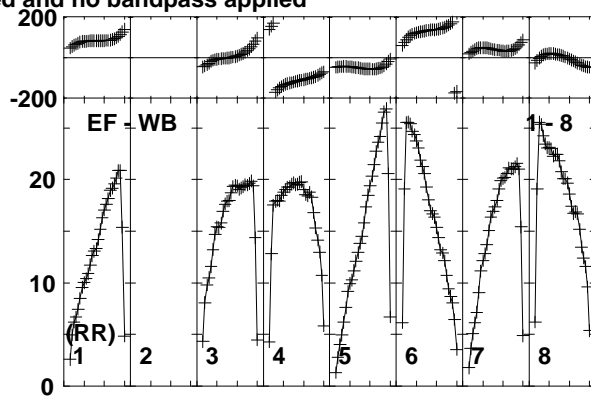
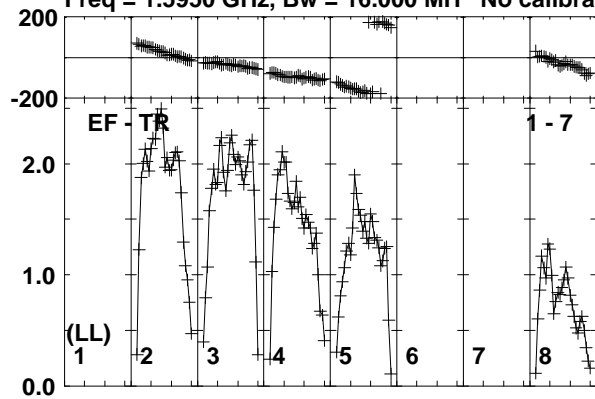

Lower frame: Milli Ampl Jy Top frame: Phas deg  
Vector averaged cross-power spectrum Baseline: EF (01) - TR (07)  
Timerange: 01/03:42:02 to 01/03:42:58



Plot file version 265 created 26-JUN-2015 10:51:29

3C454.3 ET031A.UVDATA.1

Freq = 1.5950 GHz, Bw = 16.000 MH No calibration applied and no bandpass applied

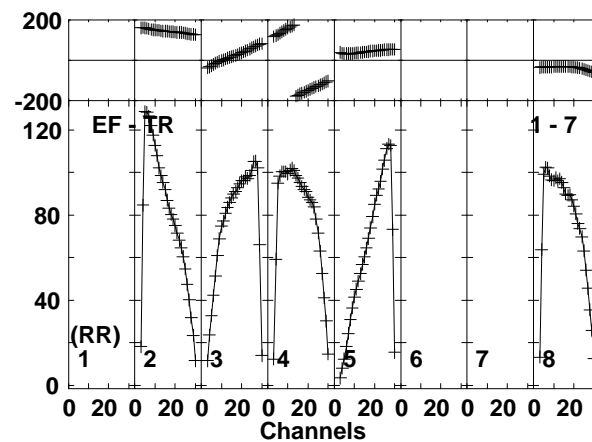
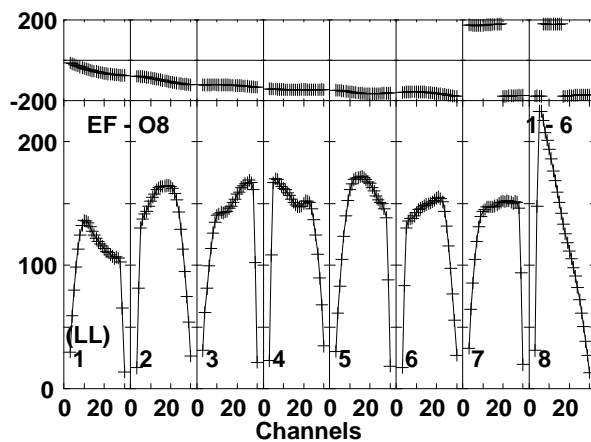
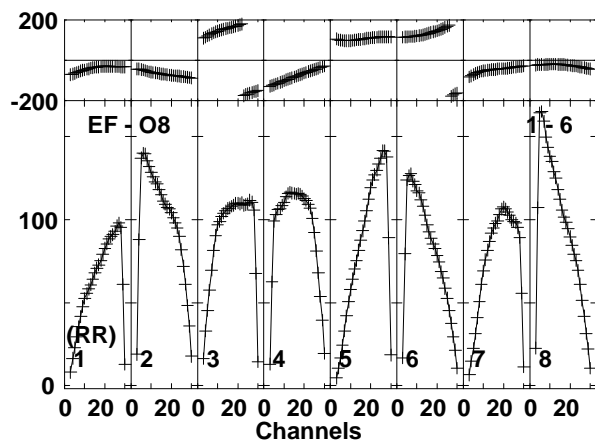
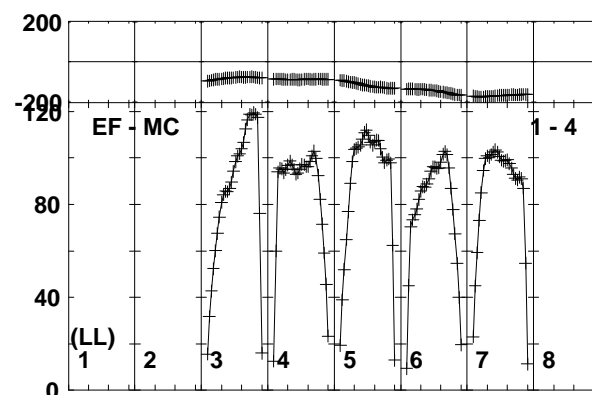
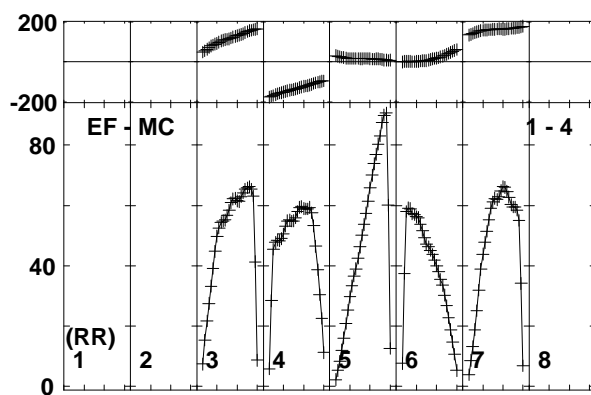
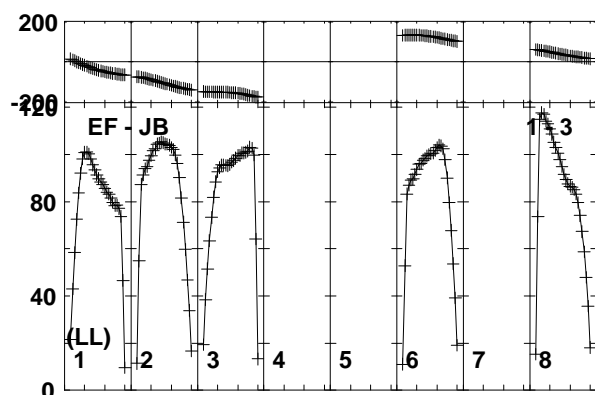
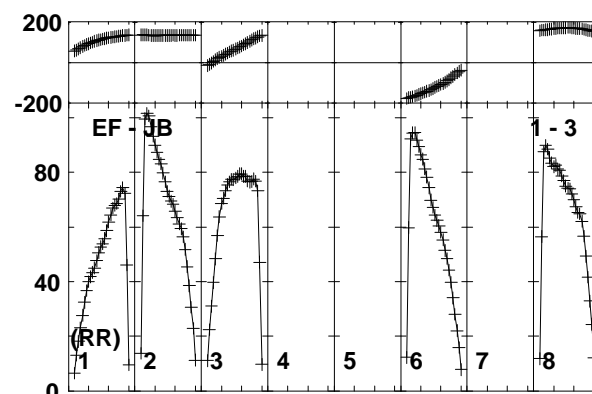
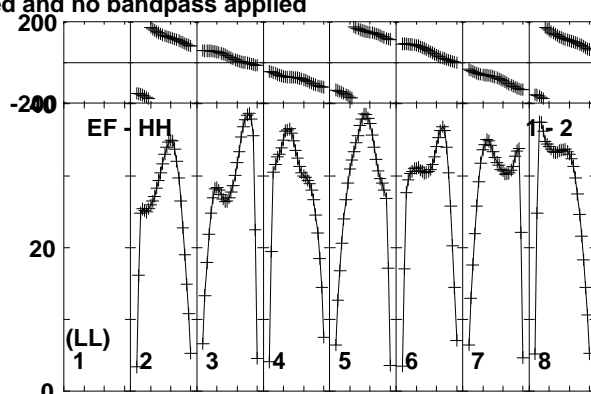
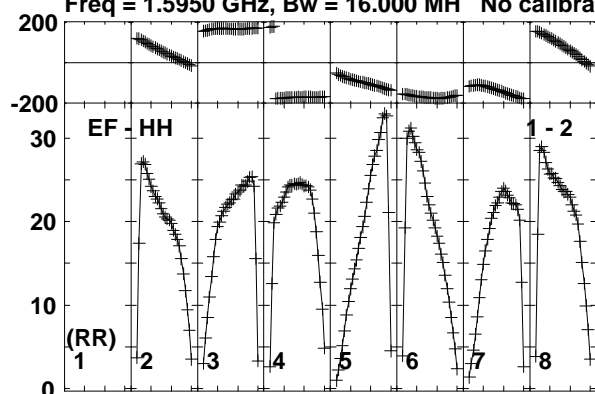

Lower frame: Milli Ampl Jy Top frame: Phas deg  
Vector averaged cross-power spectrum Baseline: EF (01) - HH (02)  
Timerange: 01/03:47:02 to 01/03:49:58

Plot file version 266 created 26-JUN-2015 10:51:29

3C454.3 ET031A.UVDATA.1

Freq = 1.5950 GHz, Bw = 16.000 MH No calibration applied and no bandpass applied

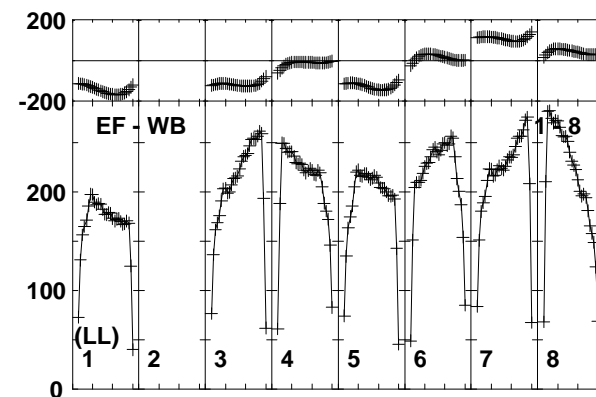
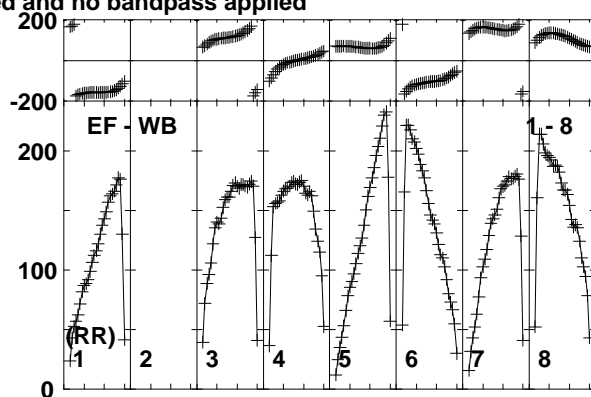
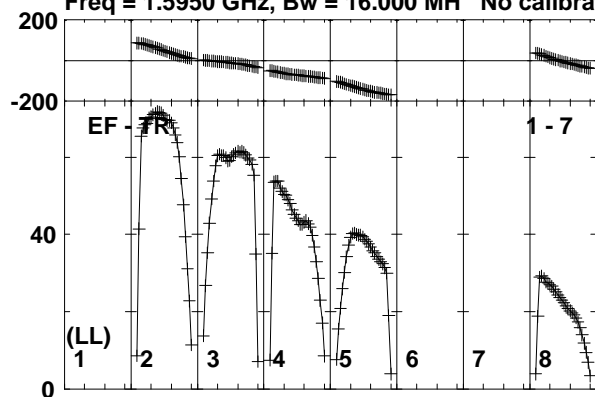

Lower frame: Milli Ampl Jy Top frame: Phas deg  
Vector averaged cross-power spectrum Baseline: EF (01) - TR (07)  
Timerange: 01/03:47:02 to 01/03:49:58

Plot file version 267 created 26-JUN-2015 10:51:29

J2025+3343 ET031A.UVDATA.1

Freq = 1.5950 GHz, Bw = 16.000 MH No calibration applied and no bandpass applied

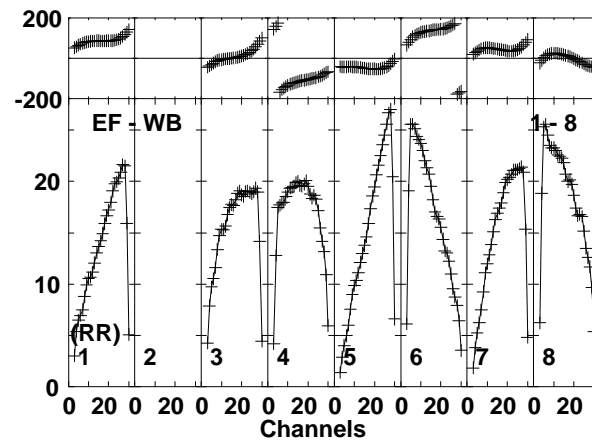
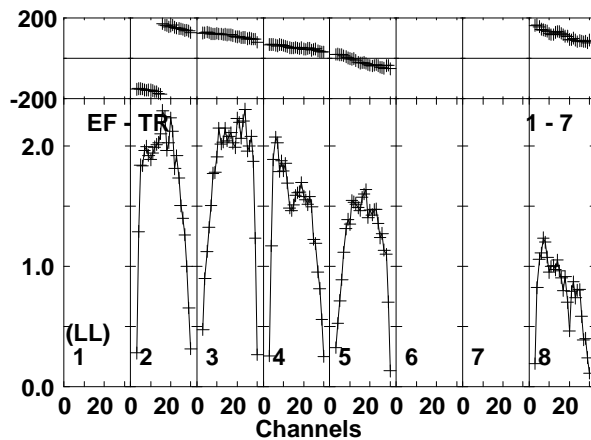
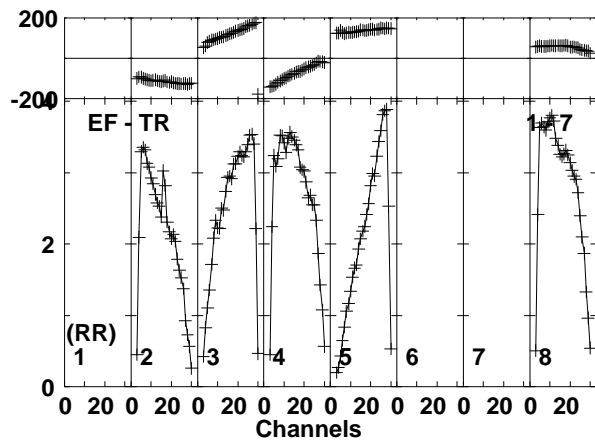
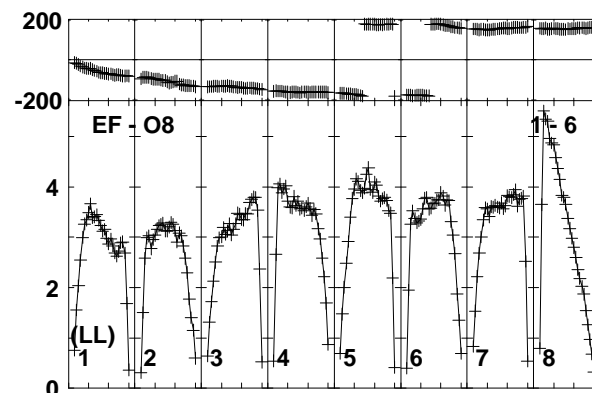
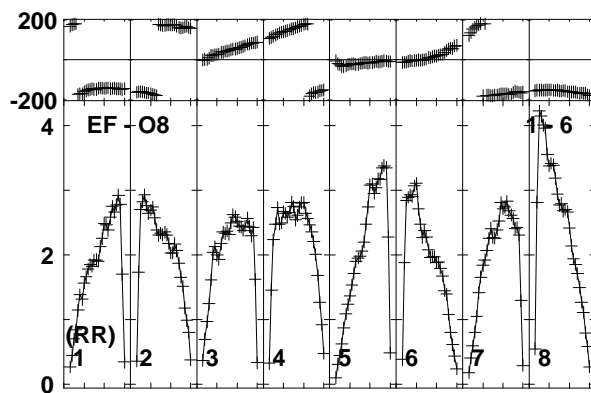
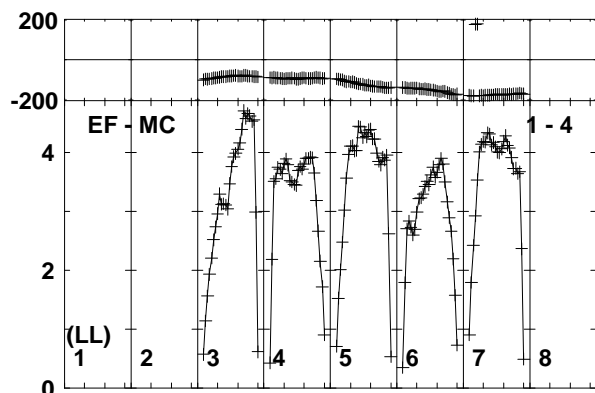
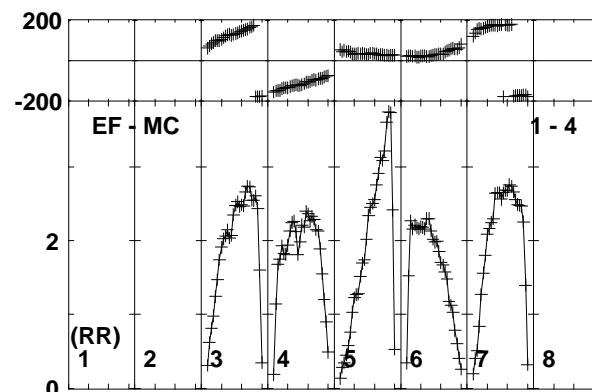
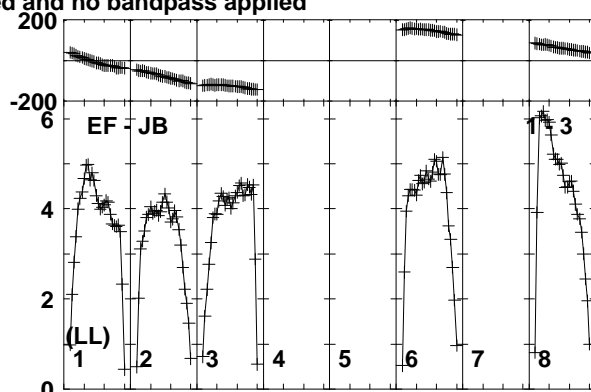
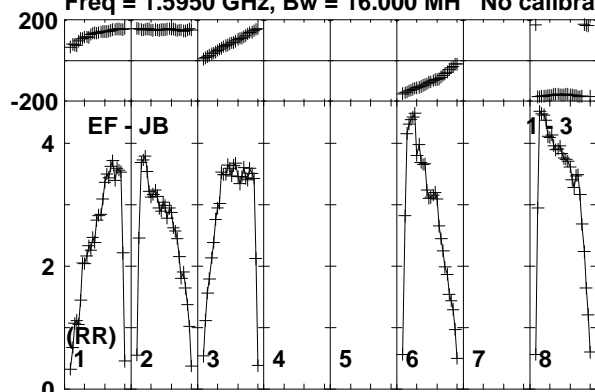

Lower frame: Milli Ampl Jy Top frame: Phas deg  
Vector averaged cross-power spectrum Baseline: EF (01) - JB (03)  
Timerange: 01/03:52:02 to 01/03:54:58

Plot file version 268 created 26-JUN-2015 10:51:29

J2025+3343 ET031A.UVDATA.1

Freq = 1.5950 GHz, Bw = 16.000 MH No calibration applied and no bandpass applied

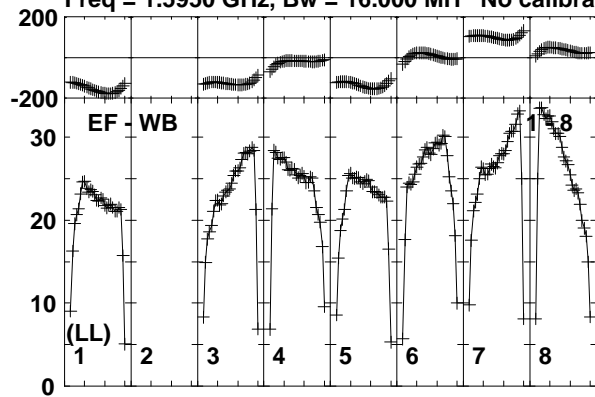

Lower frame: Milli Ampl Jy Top frame: Phas deg  
Vector averaged cross-power spectrum Baseline: EF (01) - WB (08)  
Timerange: 01/03:52:02 to 01/03:54:58

Plot file version 269 created 26-JUN-2015 10:51:29

V404CYG ET031A.UVDATA.1

Freq = 1.5950 GHz, Bw = 16.000 MH No calibration applied and no bandpass applied

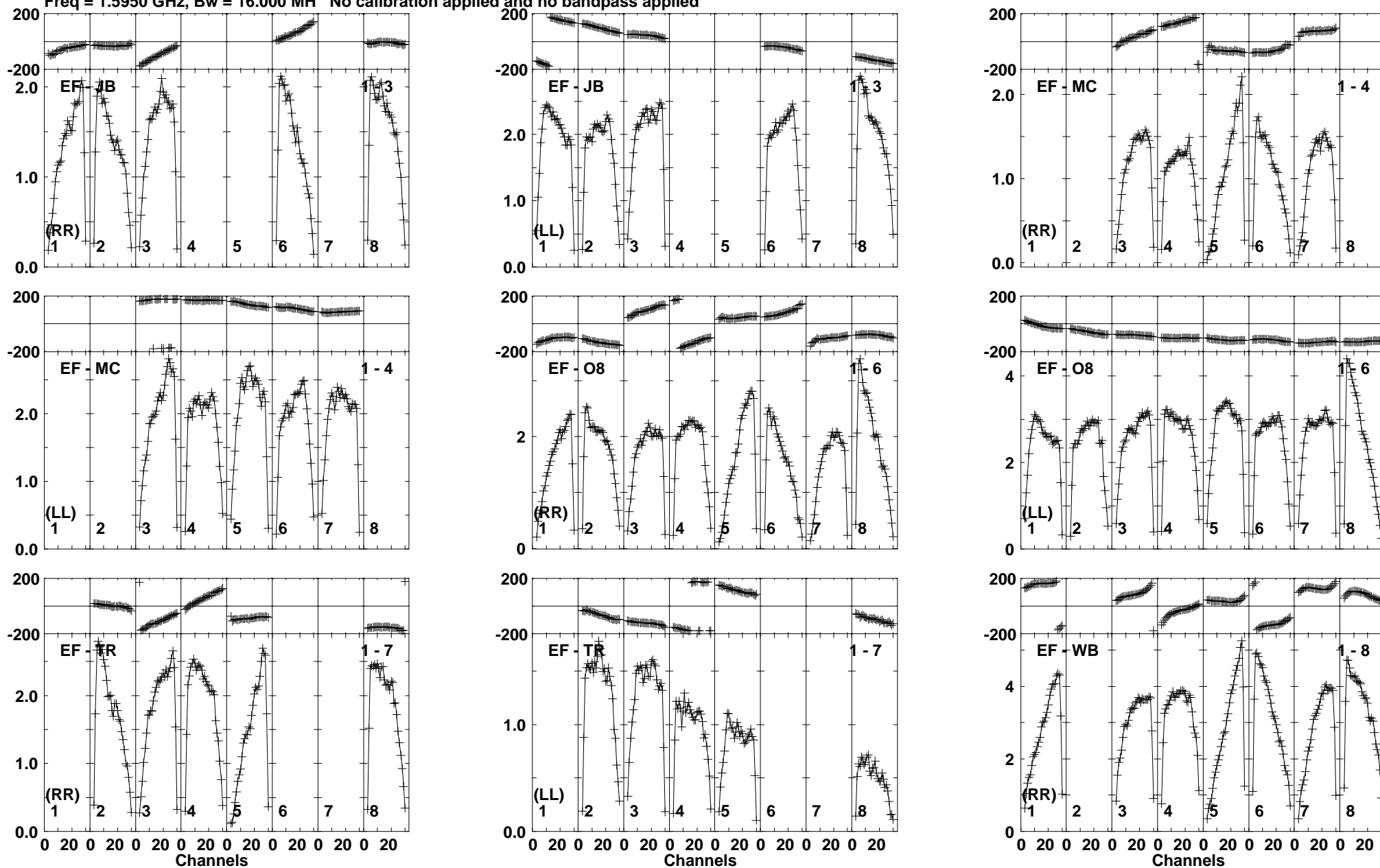

Lower frame: Milli Ampl Jy Top frame: Phas deg  
Vector averaged cross-power spectrum Baseline: EF (01) - JB (03)  
Timerange: 01/03:55:02 to 01/03:58:28

Plot file version 270 created 26-JUN-2015 10:51:29

V404CYG ET031A.UVDATA.1

Freq = 1.5950 GHz, Bw = 16.000 MH No calibration applied and no bandpass applied

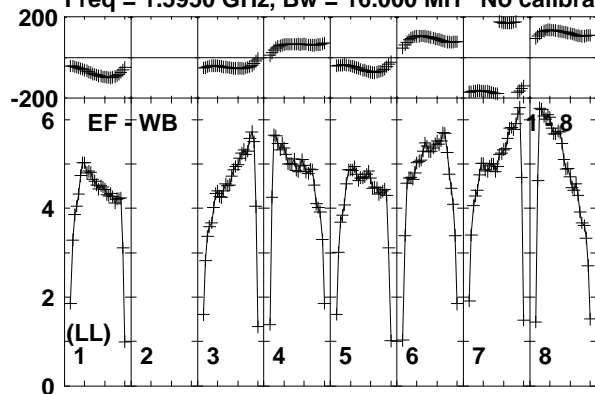

Lower frame: Milli Ampl Jy Top frame: Phas deg  
Vector averaged cross-power spectrum Baseline: EF (01) - WB (08)  
Timerange: 01/03:55:02 to 01/03:58:28

Plot file version 271 created 26-JUN-2015 10:51:29

J2025+3343 ET031A.UVDATA.1

Freq = 1.5950 GHz, Bw = 16.000 MH No calibration applied and no bandpass applied

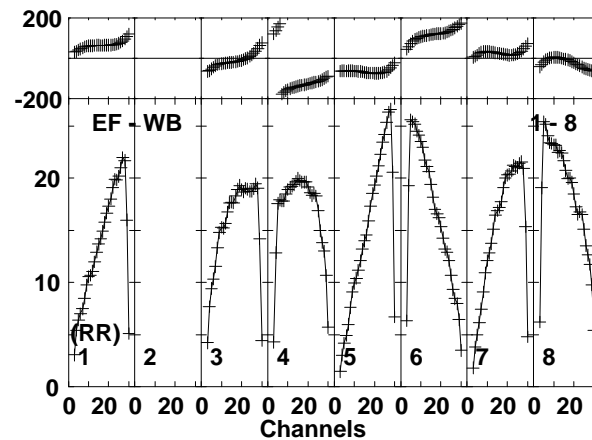
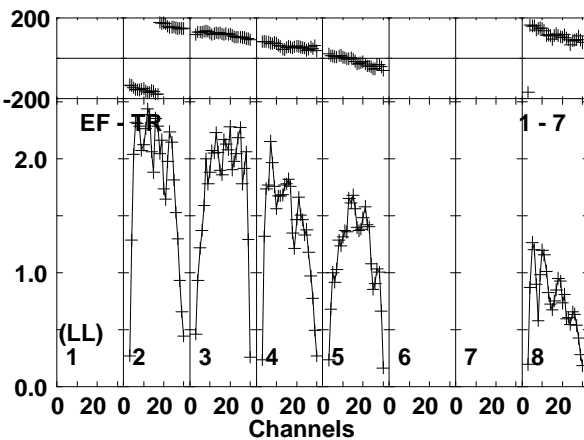
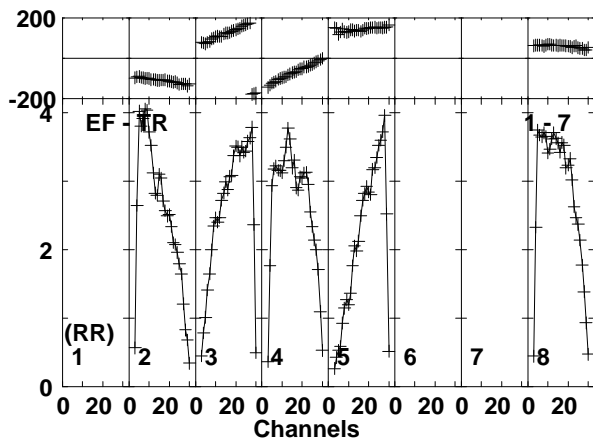
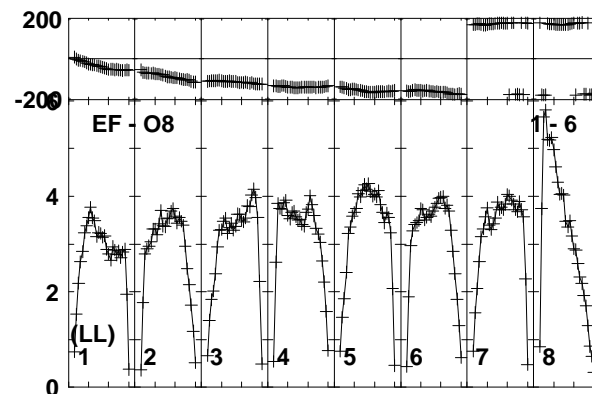
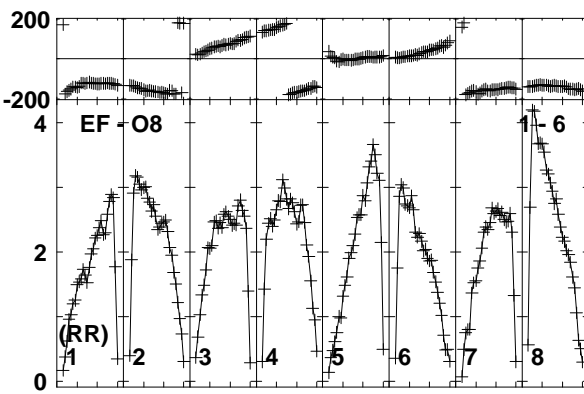
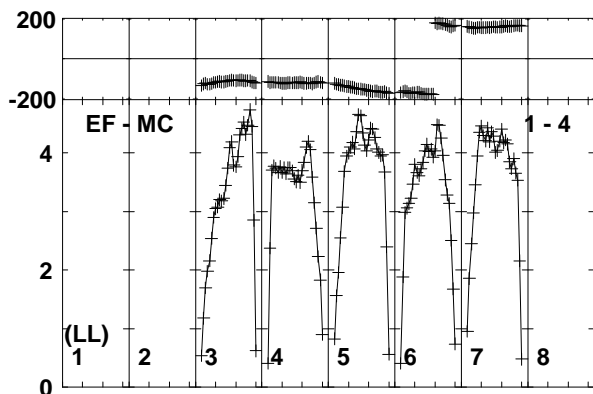
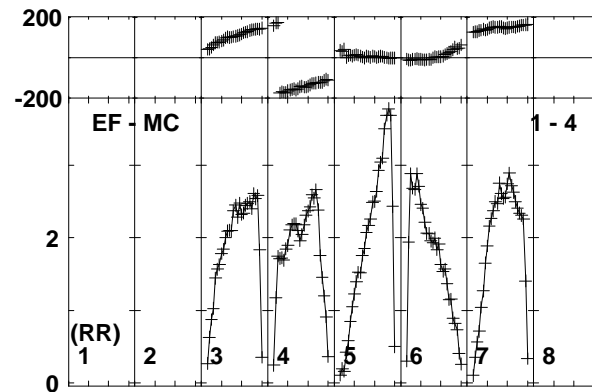
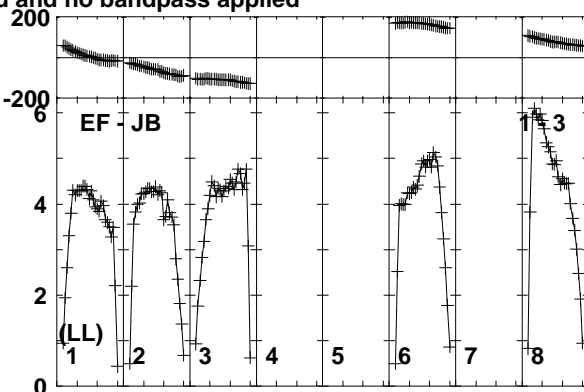
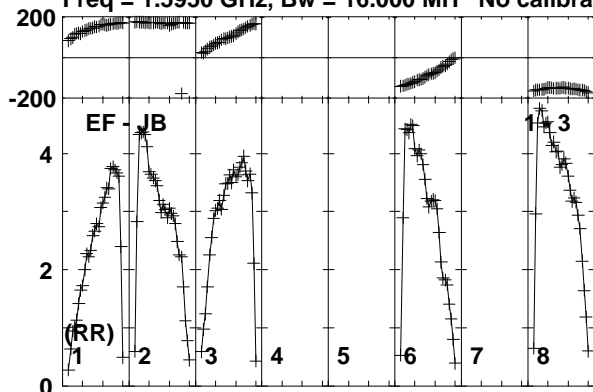

Lower frame: Milli Ampl Jy Top frame: Phas deg  
Vector averaged cross-power spectrum Baseline: EF (01) - JB (03)  
Timerange: 01/03:58:32 to 01/03:59:48

Plot file version 272 created 26-JUN-2015 10:51:29

J2025+3343 ET031A.UVDATA.1

Freq = 1.5950 GHz, Bw = 16.000 MH No calibration applied and no bandpass applied

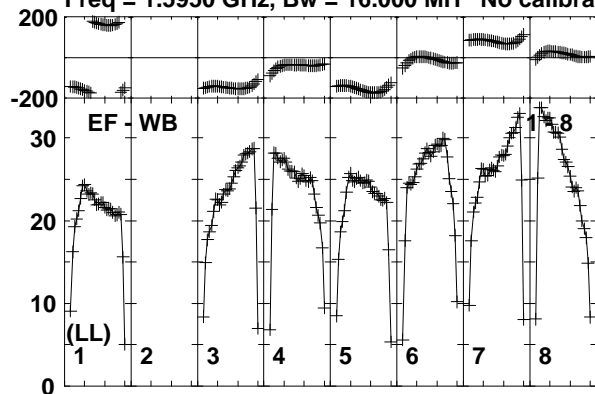

Lower frame: Milli Ampl Jy Top frame: Phas deg  
Vector averaged cross-power spectrum Baseline: EF (01) - WB (08)  
Timerange: 01/03:58:32 to 01/03:59:48



Plot file version 273 created 26-JUN-2015 10:51:29

V404CYG ET031A.UVDATA.1

Freq = 1.5950 GHz, Bw = 16.000 MH No calibration applied and no bandpass applied

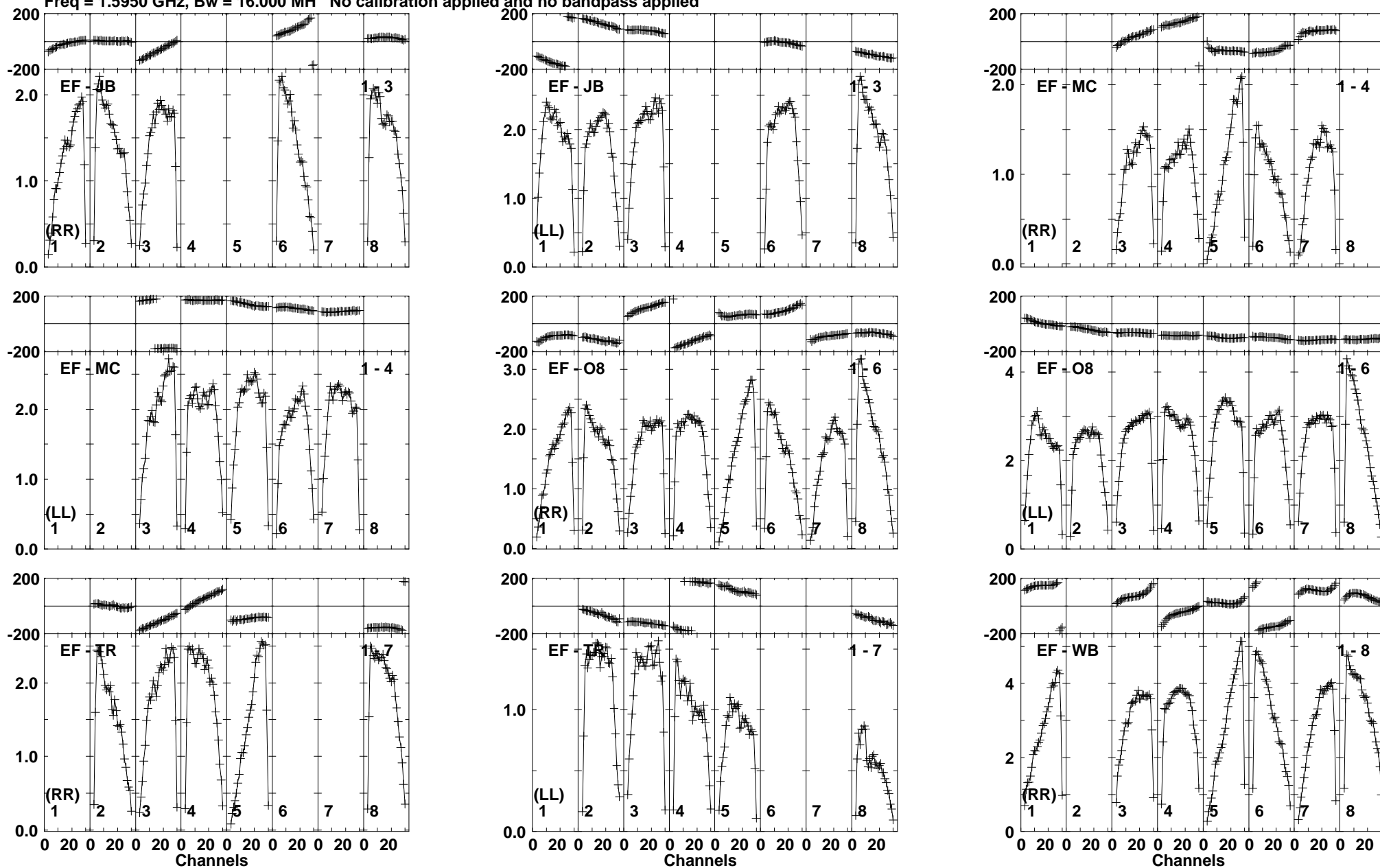

Lower frame: Milli Ampl Jy Top frame: Phas deg  
Vector averaged cross-power spectrum Baseline: EF (01) - JB (03)  
Timerange: 01/03:59:52 to 01/04:03:18

Plot file version 274 created 26-JUN-2015 10:51:29  
V404CYG ET031A.UVDATA.1  
Freq = 1.5950 GHz, Bw = 16.000 MH No calibration applied and no bandpass applied

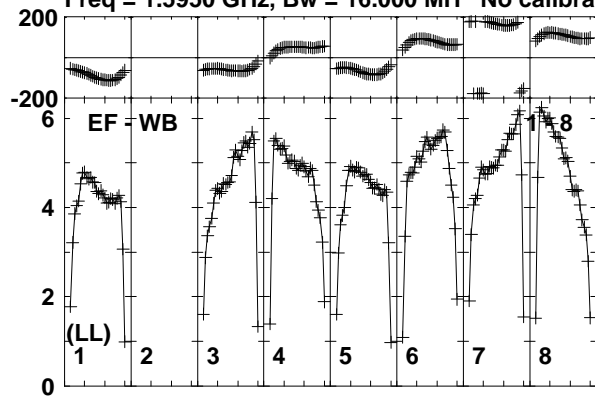

Lower frame: Milli Ampl Jy Top frame: Phas deg  
Vector averaged cross-power spectrum Baseline: EF (01) - WB (08)  
Timerange: 01/03:59:52 to 01/04:03:18

Plot file version 275 created 26-JUN-2015 10:51:29

J2025+3343 ET031A.UVDATA.1

Freq = 1.5950 GHz, Bw = 16.000 MH No calibration applied and no bandpass applied

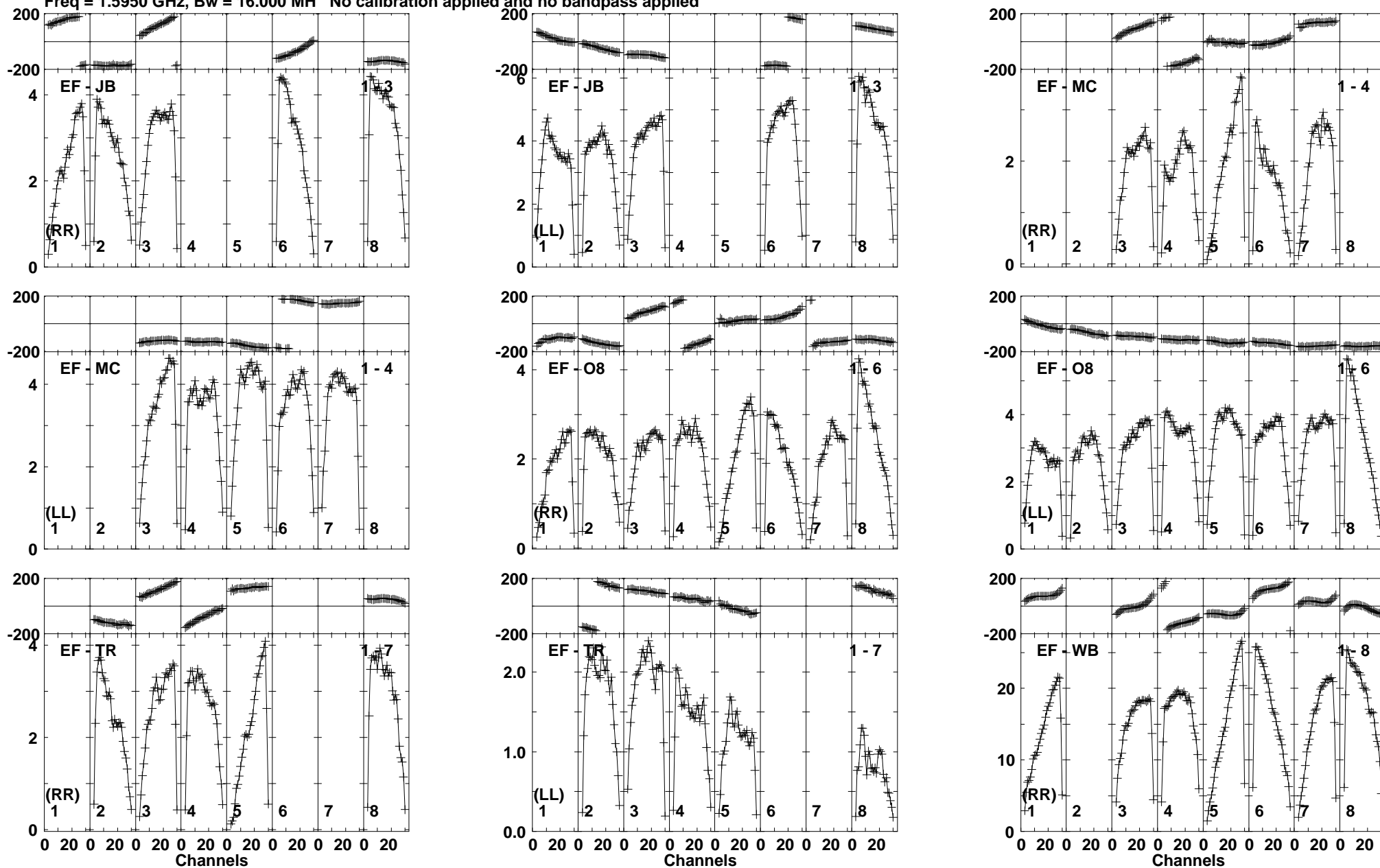

Lower frame: Milli Ampl Jy Top frame: Phas deg  
Vector averaged cross-power spectrum Baseline: EF (01) - JB (03)  
Timerange: 01/04:04:02 to 01/04:04:58

Plot file version 276 created 26-JUN-2015 10:51:29

J2025+3343 ET031A.UVDATA.1

Freq = 1.5950 GHz, Bw = 16.000 MH No calibration applied and no bandpass applied

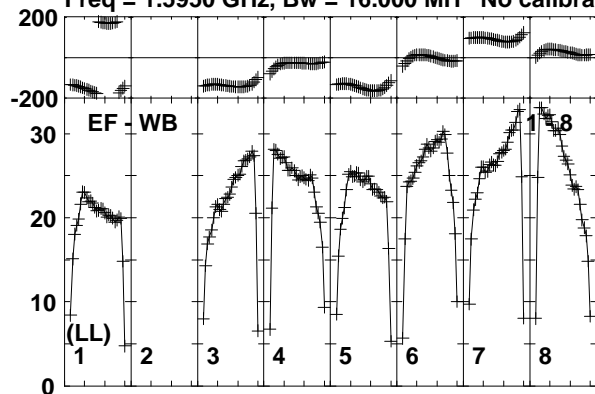

Lower frame: Milli Ampl Jy Top frame: Phas deg  
Vector averaged cross-power spectrum Baseline: EF (01) - WB (08)  
Timerange: 01/04:04:02 to 01/04:04:58

Plot file version 277 created 26-JUN-2015 10:51:29

V404CYG ET031A.UVDATA.1

Freq = 1.5950 GHz, Bw = 16.000 MH No calibration applied and no bandpass applied

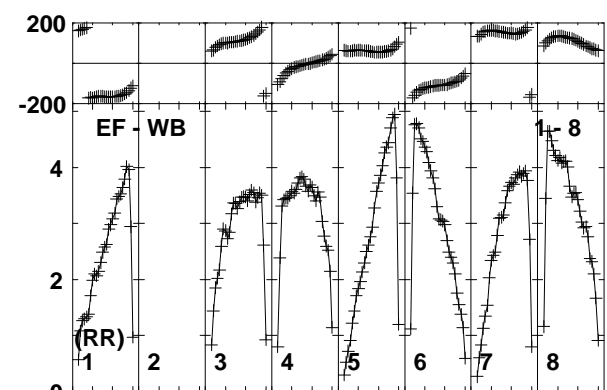
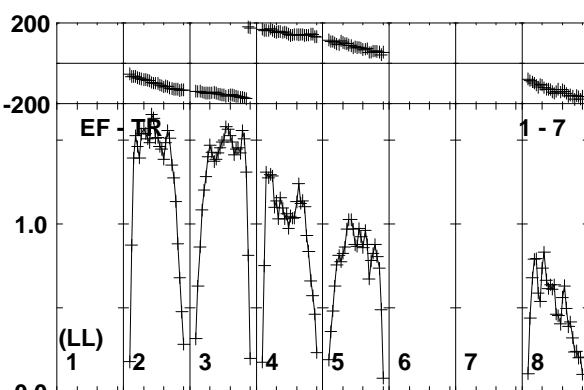
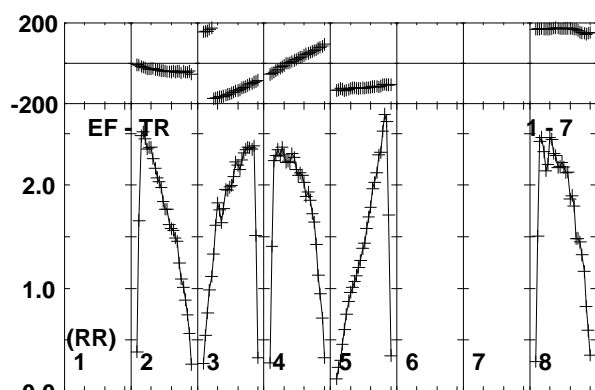
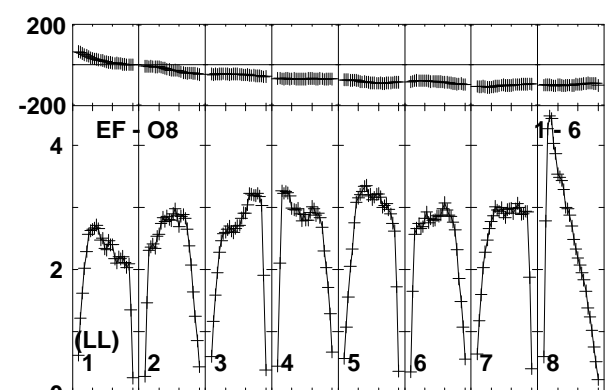
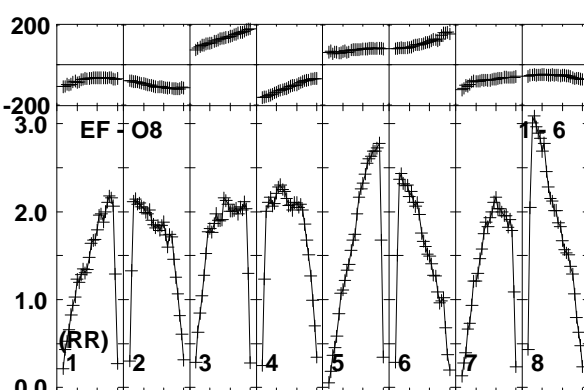
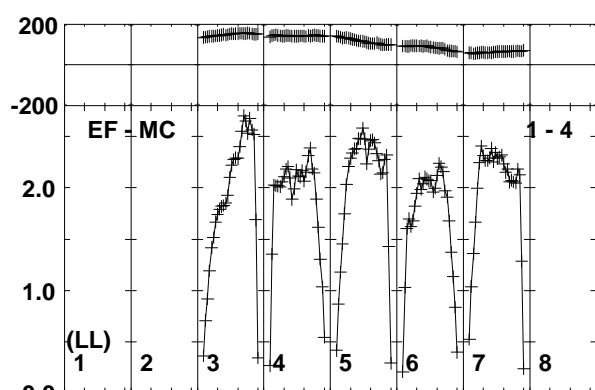
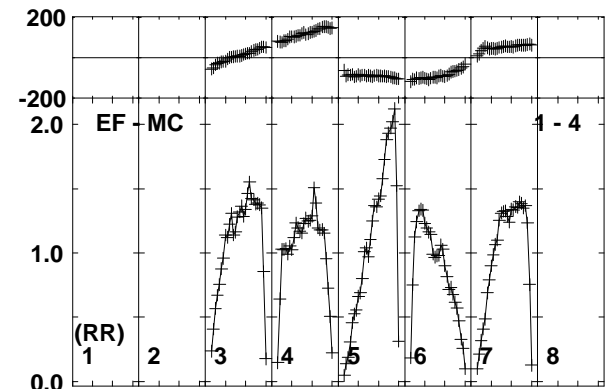
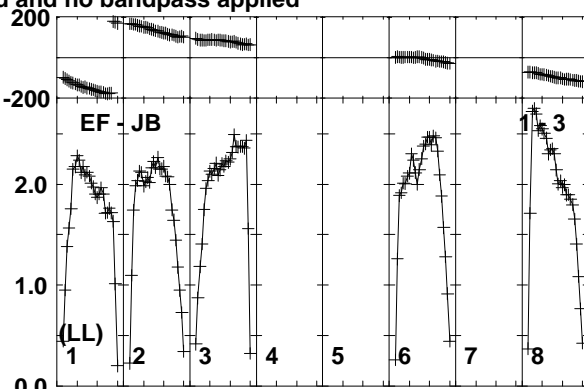
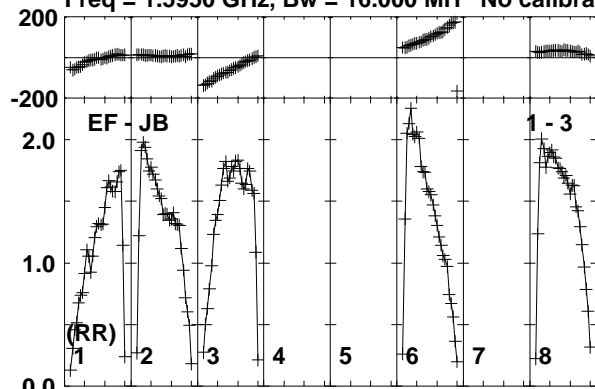

Lower frame: Milli Ampl Jy Top frame: Phas deg  
Vector averaged cross-power spectrum Baseline: EF (01) - JB (03)  
Timerange: 01/04:05:02 to 01/04:08:28

Plot file version 278 created 26-JUN-2015 10:51:29

V404CYG ET031A.UVDATA.1

Freq = 1.5950 GHz, Bw = 16.000 MH No calibration applied and no bandpass applied

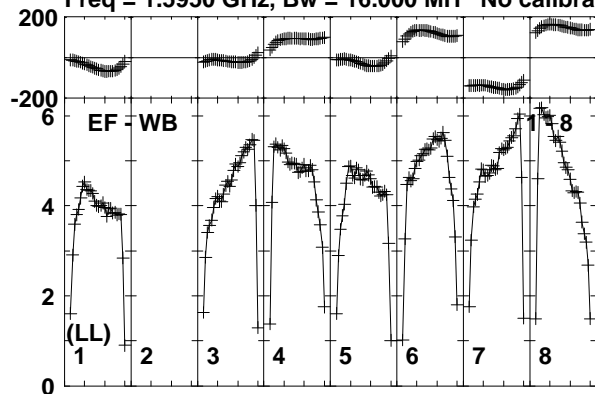

Lower frame: Milli Ampl Jy Top frame: Phas deg  
Vector averaged cross-power spectrum Baseline: EF (01) - WB (08)  
Timerange: 01/04:05:02 to 01/04:08:28

Plot file version 279 created 26-JUN-2015 10:51:29

J2025+3343 ET031A.UVDATA.1

Freq = 1.5950 GHz, Bw = 16.000 MH No calibration applied and no bandpass applied

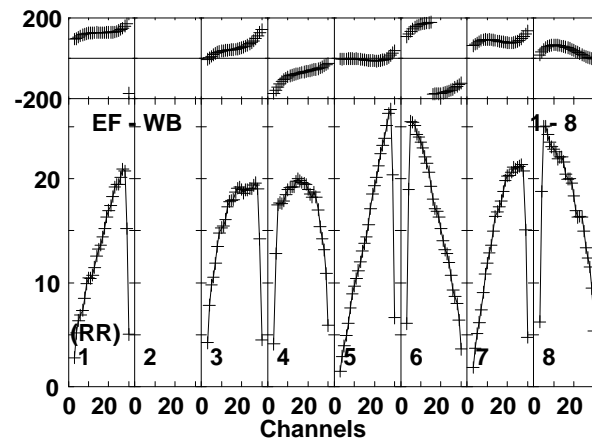
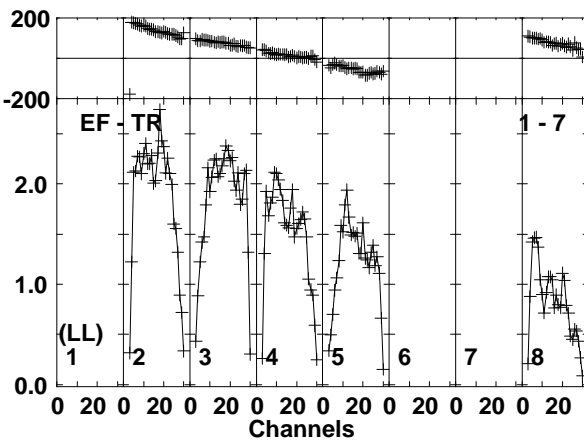
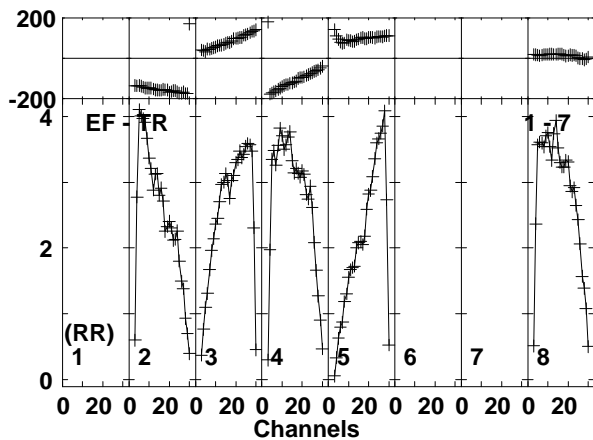
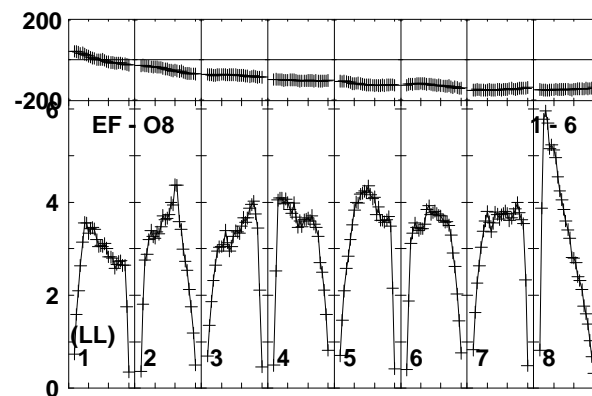
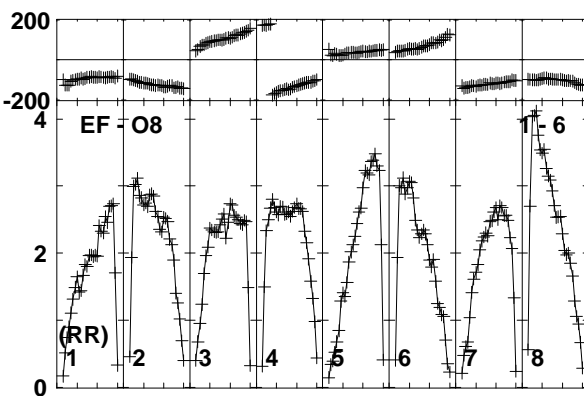
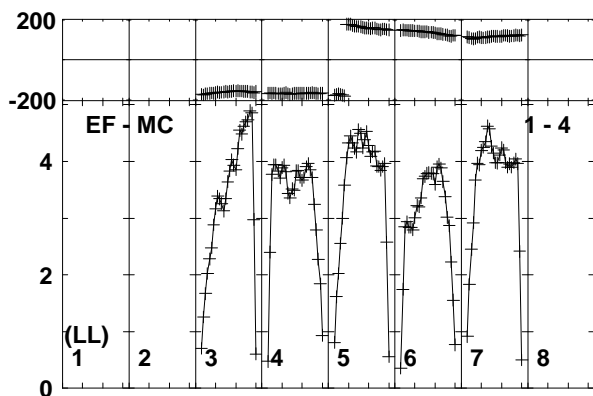
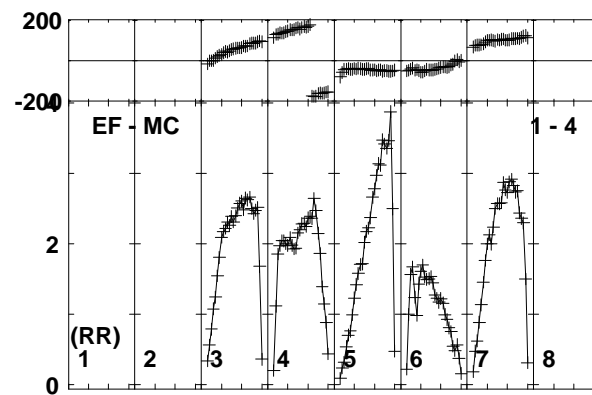
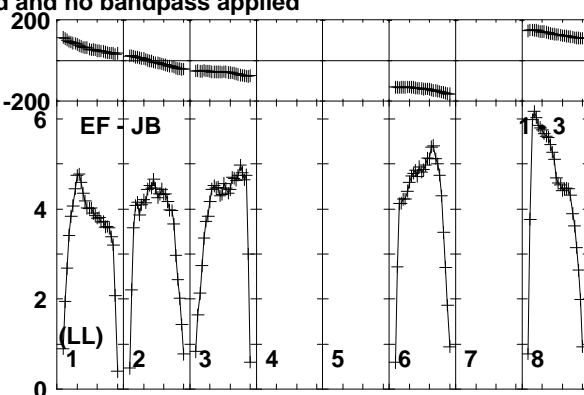
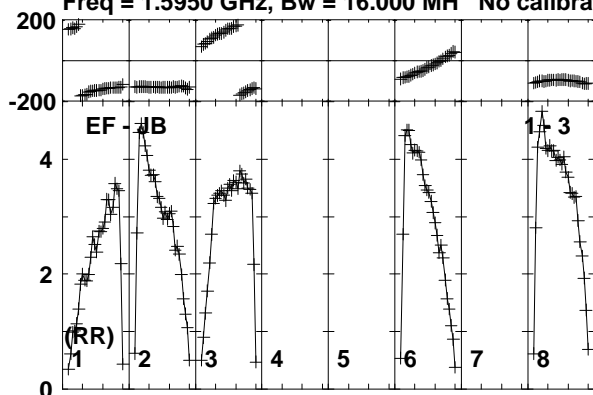

Lower frame: Milli Ampl Jy Top frame: Phas deg  
Vector averaged cross-power spectrum Baseline: EF (01) - JB (03)  
Timerange: 01/04:08:32 to 01/04:09:48

Plot file version 280 created 26-JUN-2015 10:51:29

J2025+3343 ET031A.UVDATA.1

Freq = 1.5950 GHz, Bw = 16.000 MH No calibration applied and no bandpass applied

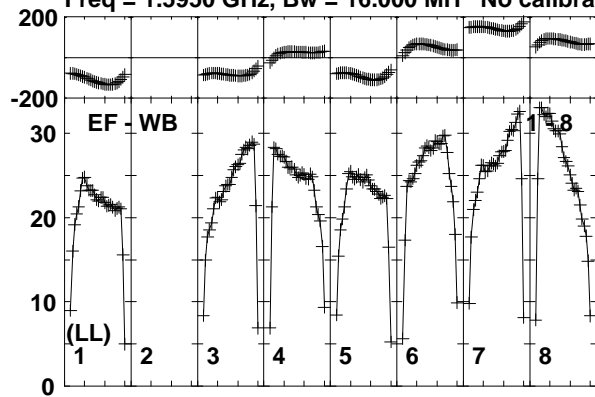

Lower frame: Milli Ampl Jy Top frame: Phas deg  
Vector averaged cross-power spectrum Baseline: EF (01) - WB (08)  
Timerange: 01/04:08:32 to 01/04:09:48



Plot file version 281 created 26-JUN-2015 10:51:29

V404CYG ET031A.UVDATA.1

Freq = 1.5950 GHz, Bw = 16.000 MH No calibration applied and no bandpass applied

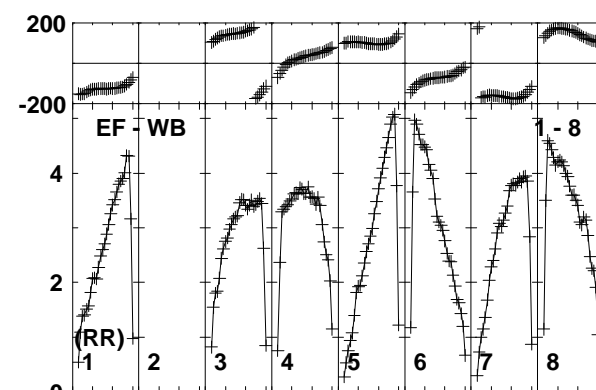
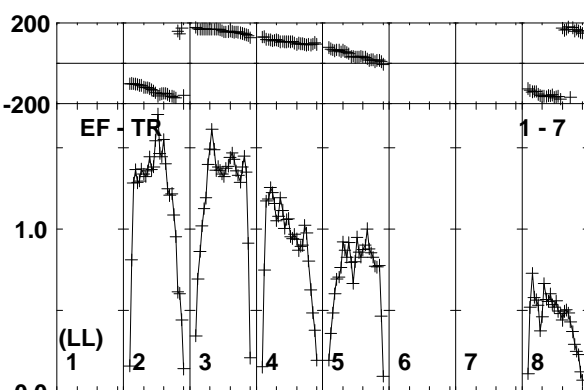
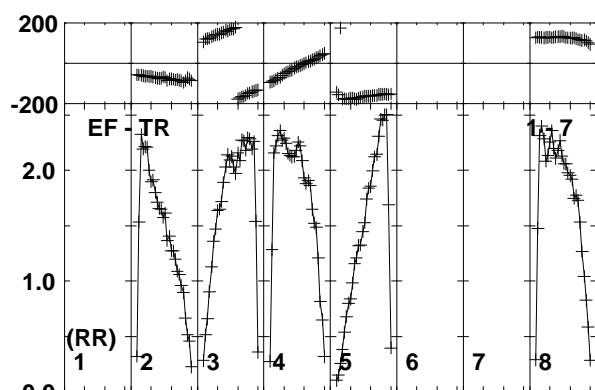
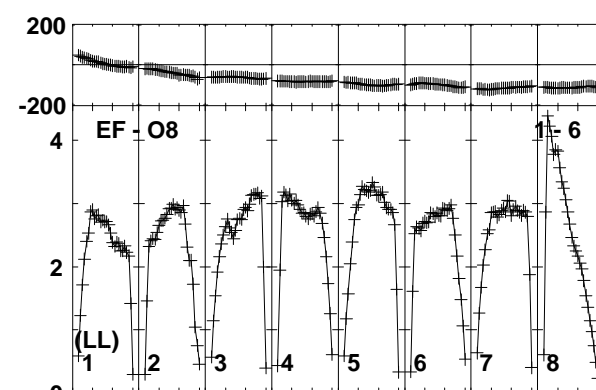
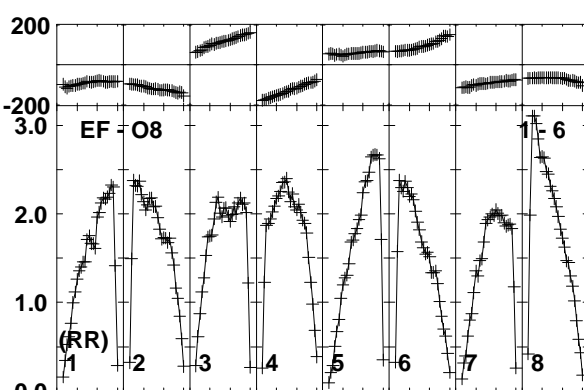
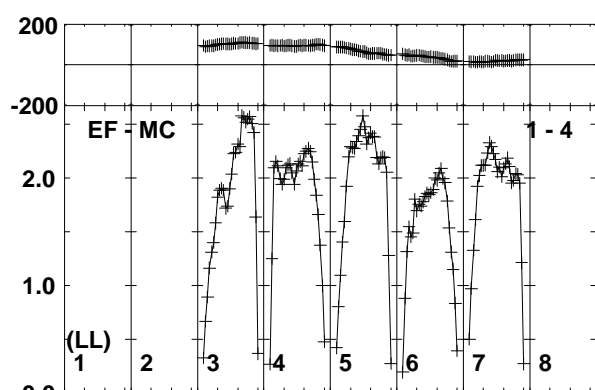
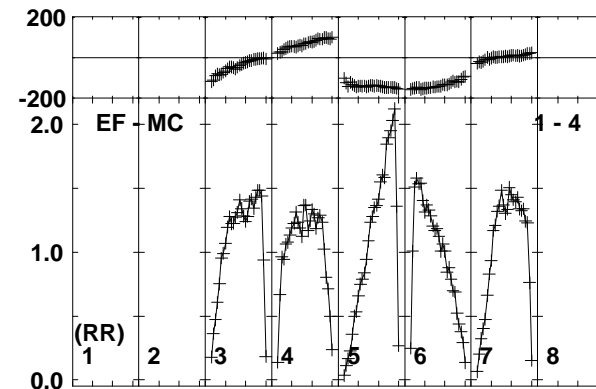
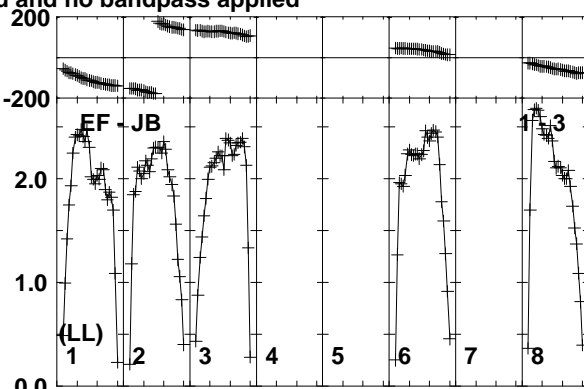
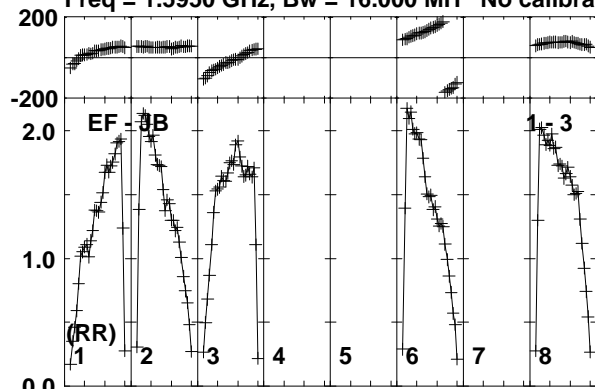

Lower frame: Milli Ampl Jy Top frame: Phas deg  
Vector averaged cross-power spectrum Baseline: EF (01) - JB (03)  
Timerange: 01/04:09:52 to 01/04:13:18

Plot file version 282 created 26-JUN-2015 10:51:29

V404CYG ET031A.UVDATA.1

Freq = 1.5950 GHz, Bw = 16.000 MH No calibration applied and no bandpass applied

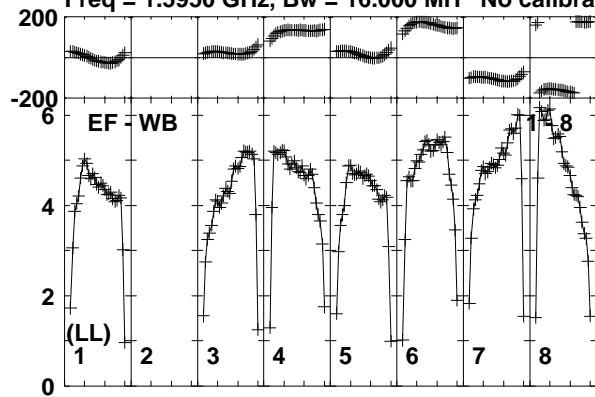

Lower frame: Milli Ampl Jy Top frame: Phas deg  
Vector averaged cross-power spectrum Baseline: EF (01) - WB (08)  
Timerange: 01/04:09:52 to 01/04:13:18

Plot file version 283 created 26-JUN-2015 10:51:29

J2025+3343 ET031A.UVDATA.1

Freq = 1.5950 GHz, Bw = 16.000 MH No calibration applied and no bandpass applied

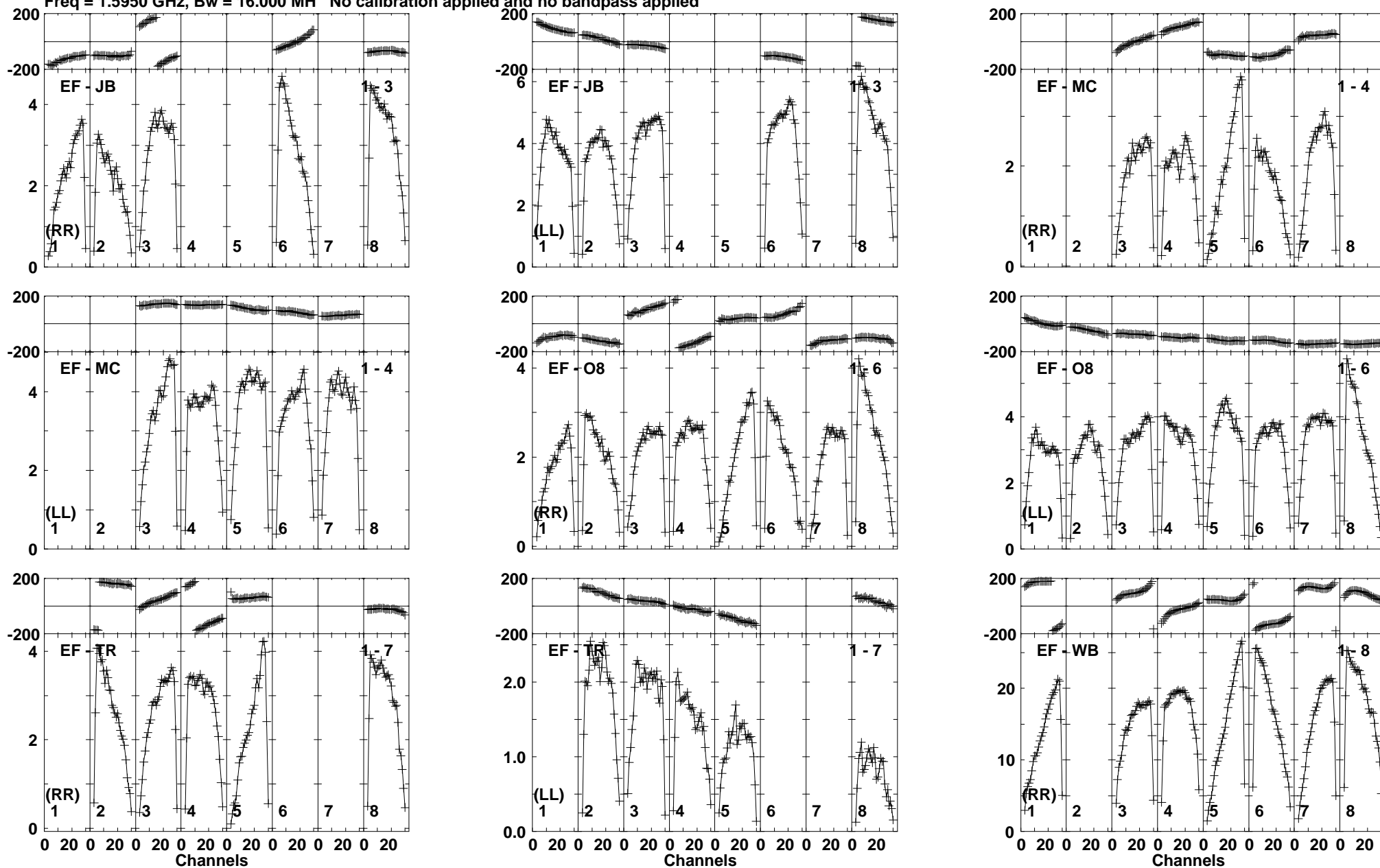

Lower frame: Milli Ampl Jy Top frame: Phas deg  
Vector averaged cross-power spectrum Baseline: EF (01) - JB (03)  
Timerange: 01/04:14:02 to 01/04:14:58

Plot file version 284 created 26-JUN-2015 10:51:29  
J2025+3343 ET031A.UVDATA.1  
Freq = 1.5950 GHz, Bw = 16.000 MH No calibration applied and no bandpass applied

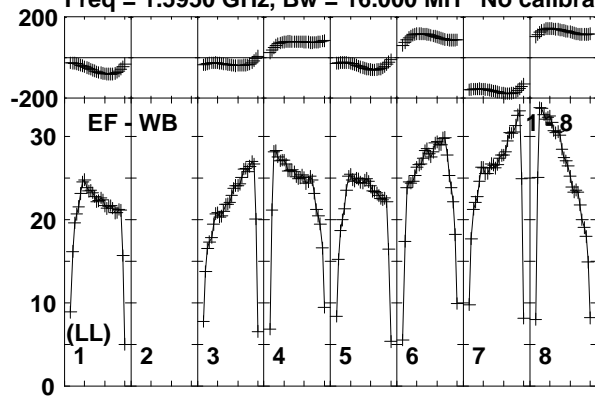

Lower frame: Milli Ampl Jy Top frame: Phas deg  
Vector averaged cross-power spectrum Baseline: EF (01) - WB (08)  
Timerange: 01/04:14:02 to 01/04:14:58

Plot file version 285 created 26-JUN-2015 10:51:29

V404CYG ET031A.UVDATA.1

Freq = 1.5950 GHz, Bw = 16.000 MH No calibration applied and no bandpass applied

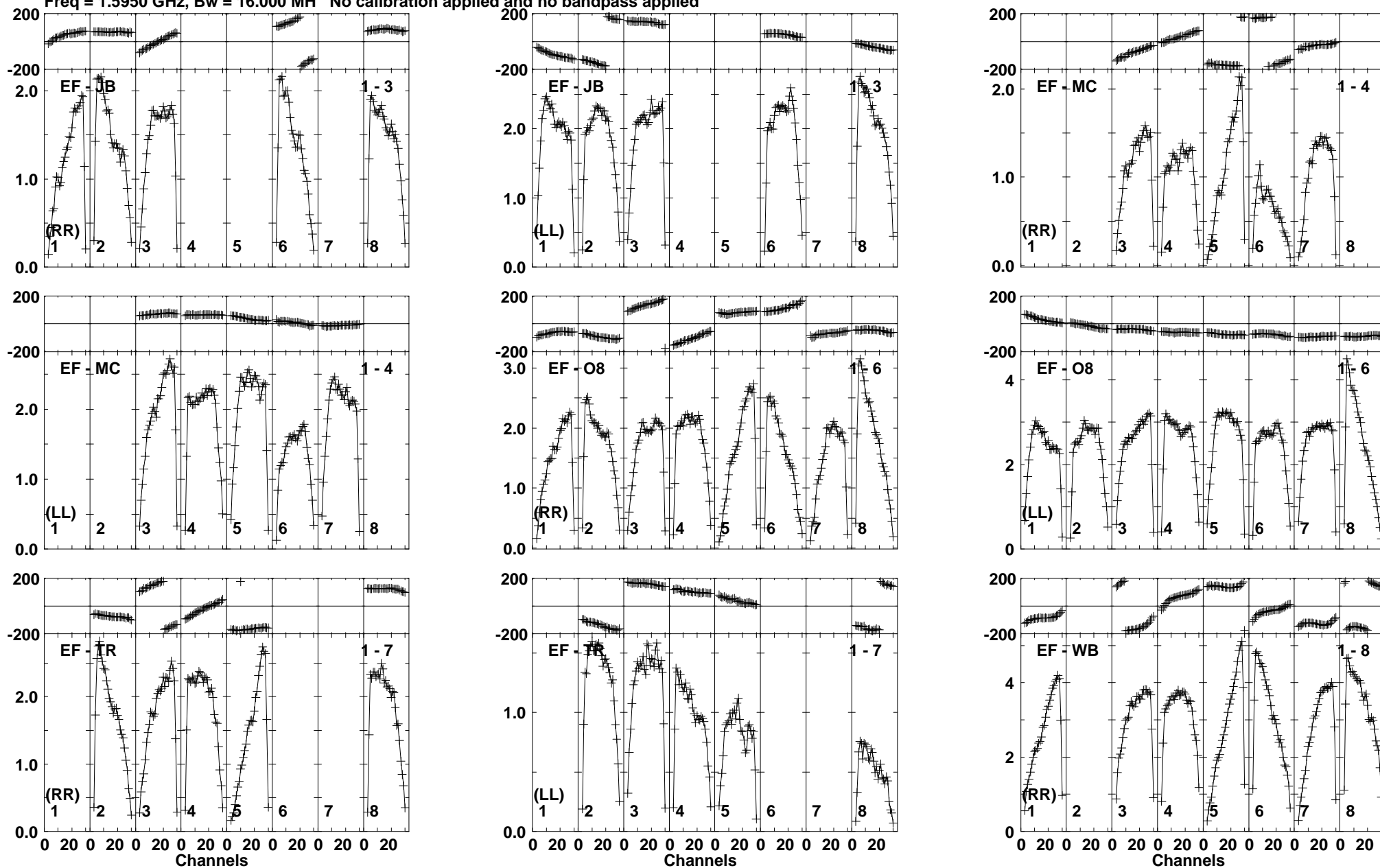

Lower frame: Milli Ampl Jy Top frame: Phas deg  
Vector averaged cross-power spectrum Baseline: EF (01) - JB (03)  
Timerange: 01/04:15:02 to 01/04:18:28

Plot file version 286 created 26-JUN-2015 10:51:30  
V404CYG ET031A.UVDATA.1  
Freq = 1.5950 GHz, Bw = 16.000 MH No calibration applied and no bandpass applied

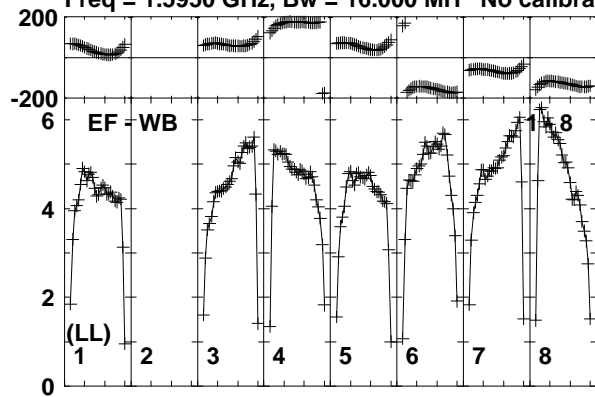

Lower frame: Milli Ampl Jy Top frame: Phas deg  
Vector averaged cross-power spectrum Baseline: EF (01) - WB (08)  
Timerange: 01/04:15:02 to 01/04:18:28

Plot file version 287 created 26-JUN-2015 10:51:30

J2025+3343 ET031A.UVDATA.1

Freq = 1.5950 GHz, Bw = 16.000 MH No calibration applied and no bandpass applied

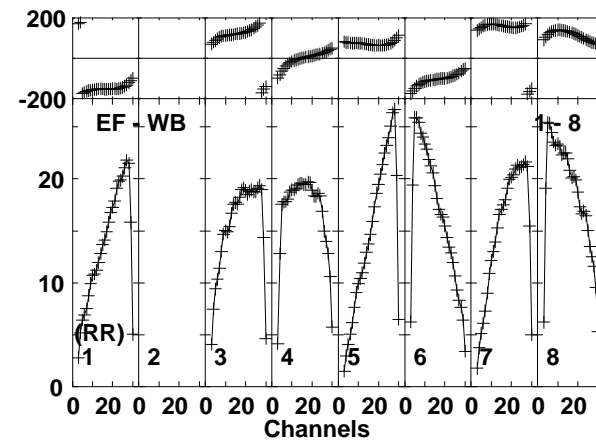
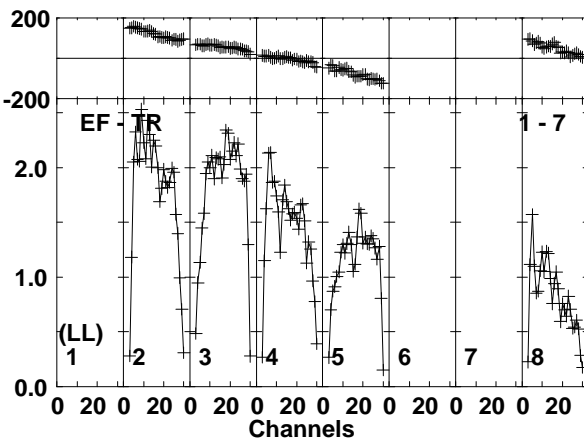
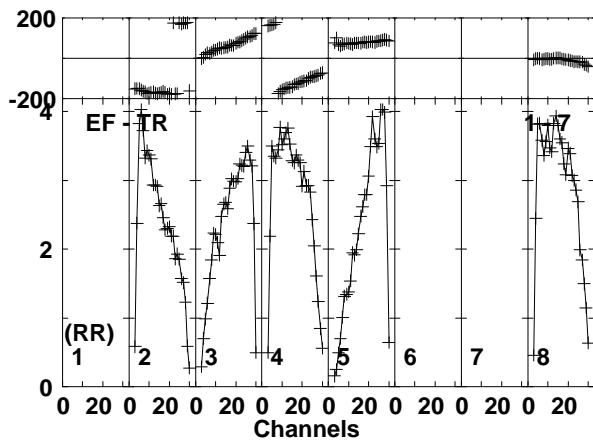
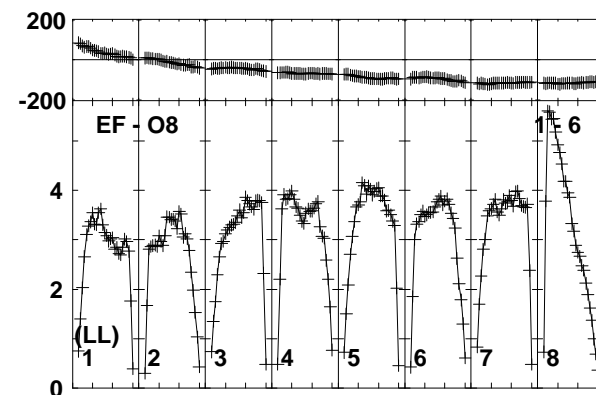
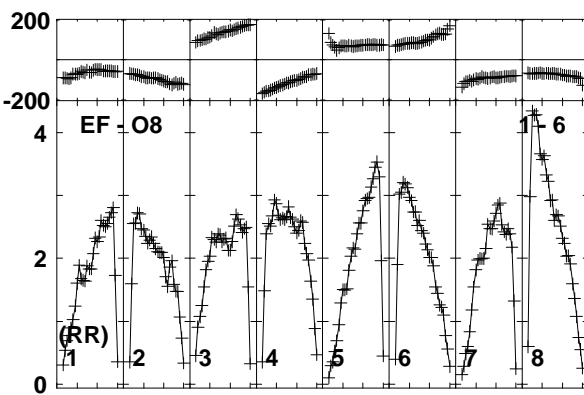
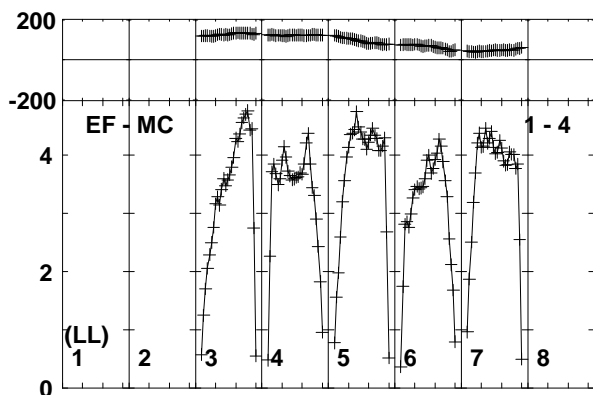
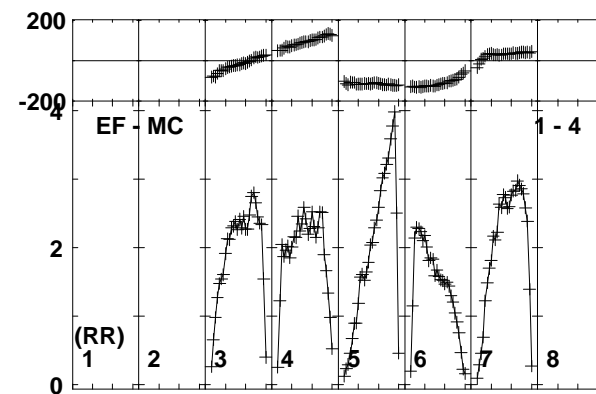
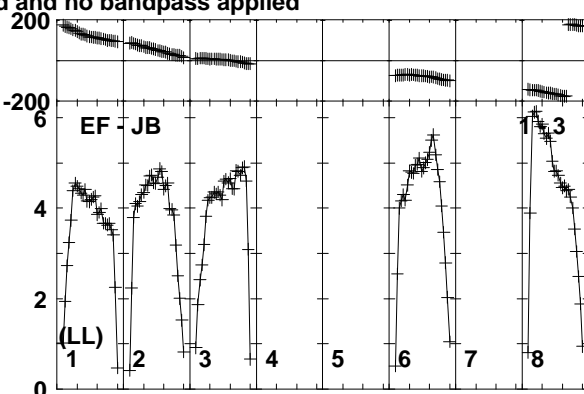
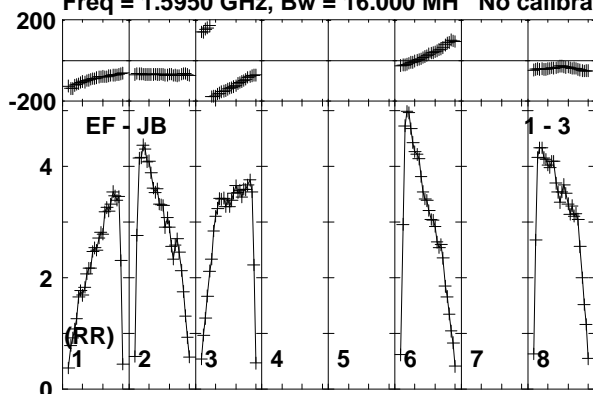

Lower frame: Milli Ampl Jy Top frame: Phas deg  
Vector averaged cross-power spectrum Baseline: EF (01) - JB (03)  
Timerange: 01/04:18:32 to 01/04:19:48

Plot file version 288 created 26-JUN-2015 10:51:30  
J2025+3343 ET031A.UVDATA.1  
Freq = 1.5950 GHz, Bw = 16.000 MH No calibration applied and no bandpass applied

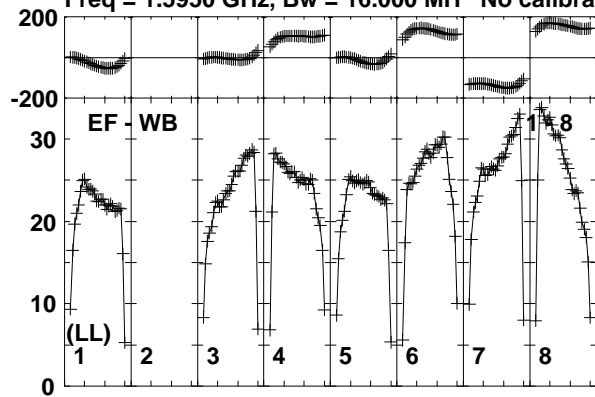

Lower frame: Milli Ampl Jy Top frame: Phas deg  
Vector averaged cross-power spectrum Baseline: EF (01) - WB (08)  
Timerange: 01/04:18:32 to 01/04:19:48



Plot file version 289 created 26-JUN-2015 10:51:30

V404CYG ET031A.UVDATA.1

Freq = 1.5950 GHz, Bw = 16.000 MH No calibration applied and no bandpass applied

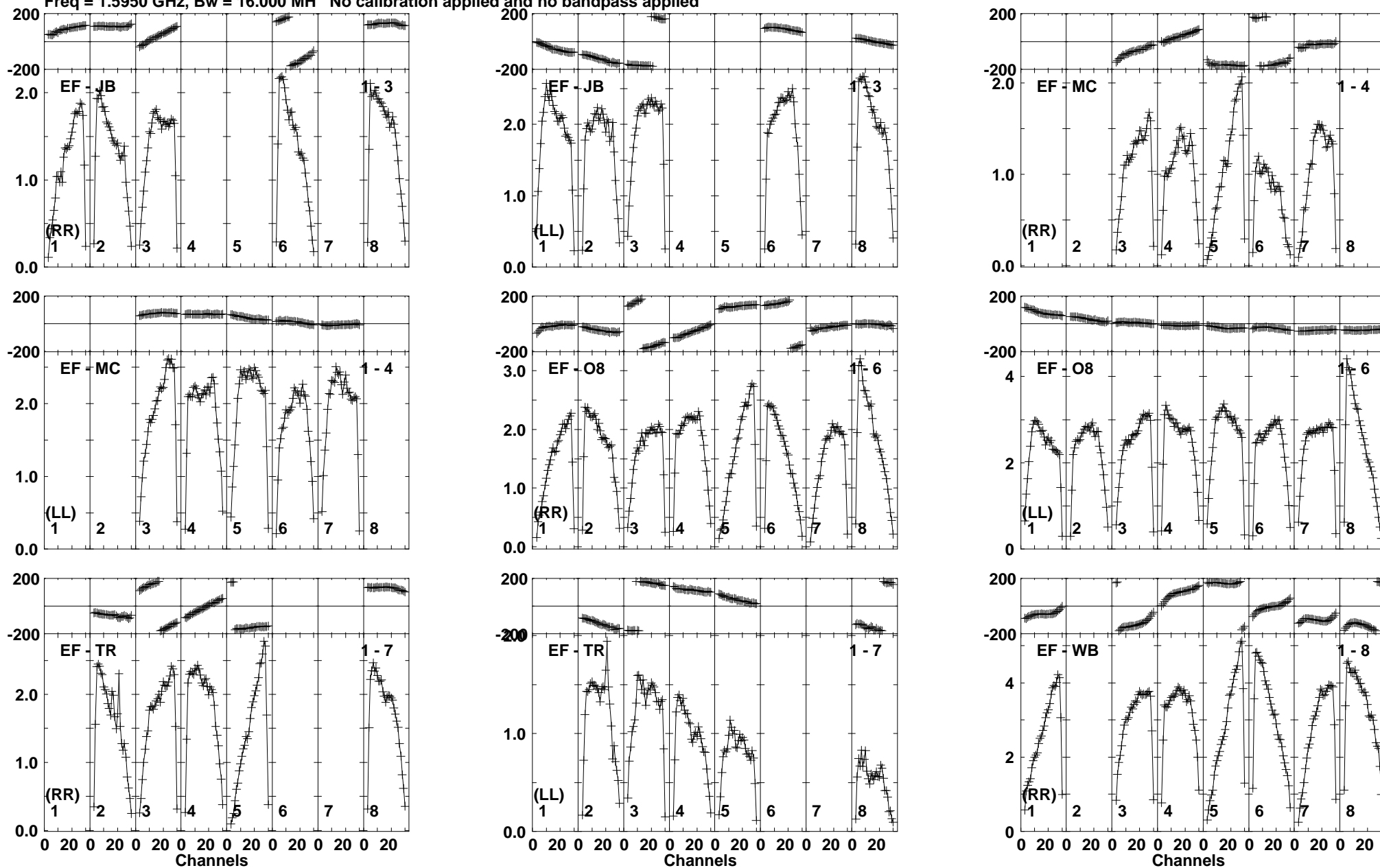

Lower frame: Milli Ampl Jy Top frame: Phas deg  
Vector averaged cross-power spectrum Baseline: EF (01) - JB (03)  
Timerange: 01/04:19:52 to 01/04:23:18

Plot file version 290 created 26-JUN-2015 10:51:30  
V404CYG ET031A.UVDATA.1  
Freq = 1.5950 GHz, Bw = 16.000 MH No calibration applied and no bandpass applied

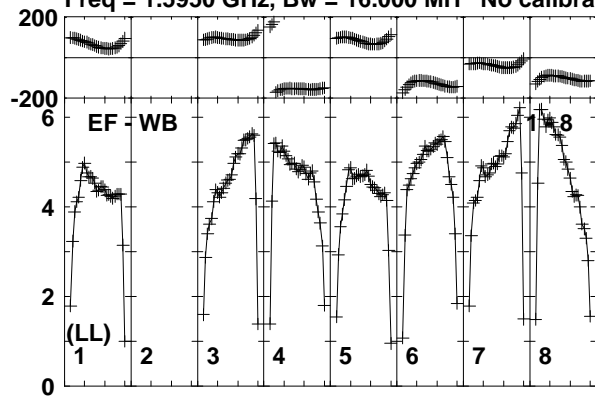

Lower frame: Milli Ampl Jy Top frame: Phas deg  
Vector averaged cross-power spectrum Baseline: EF (01) - WB (08)  
Timerange: 01/04:19:52 to 01/04:23:18

Plot file version 291 created 26-JUN-2015 10:51:30

J2025+3343 ET031A.UVDATA.1

Freq = 1.5950 GHz, Bw = 16.000 MH No calibration applied and no bandpass applied

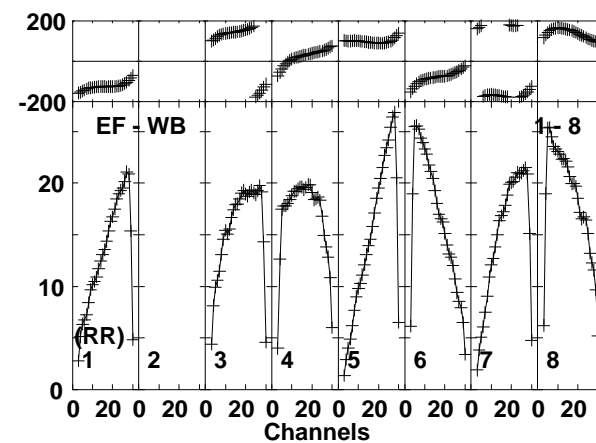
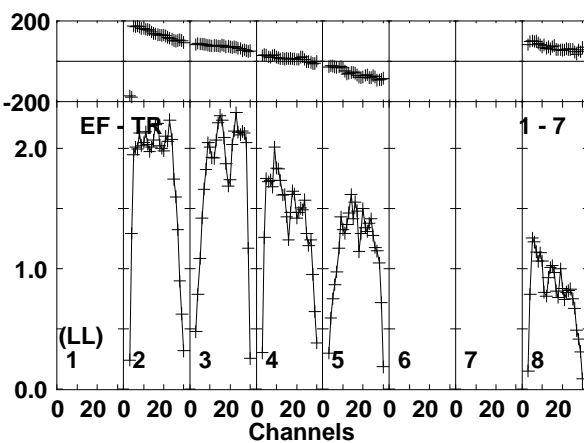
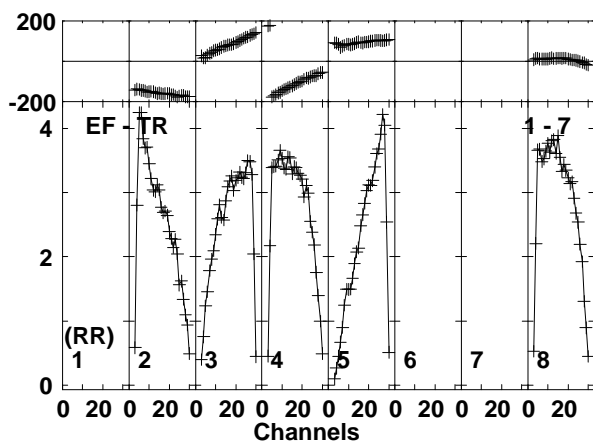
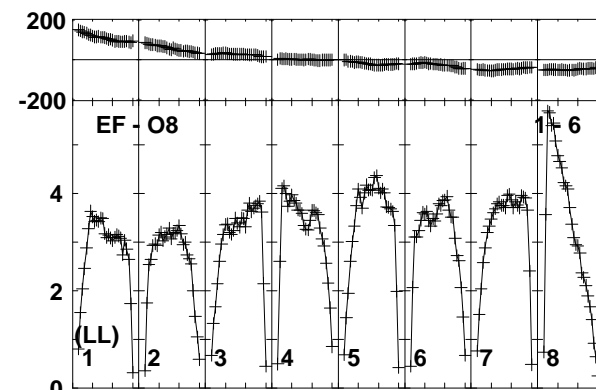
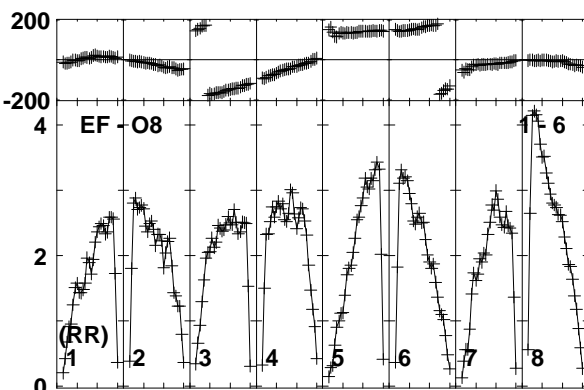
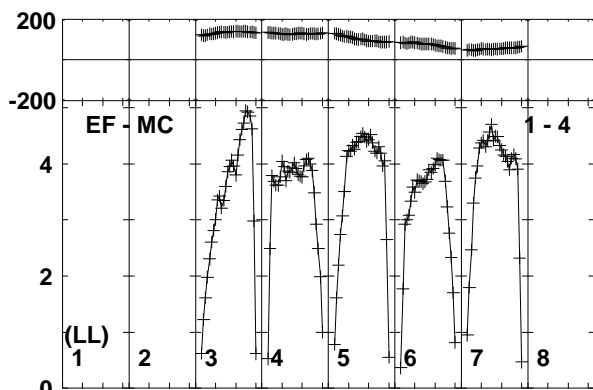
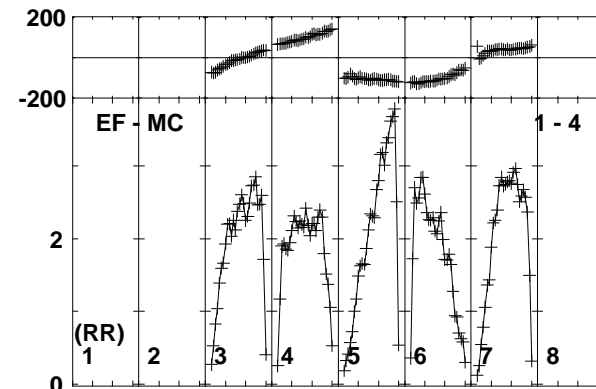
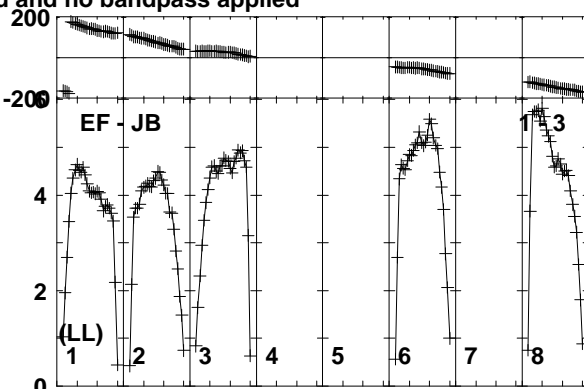
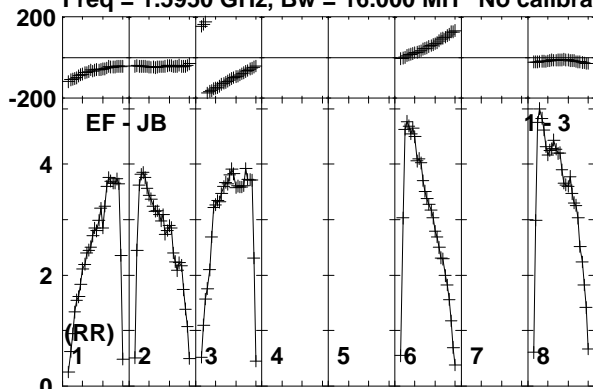

Lower frame: Milli Ampl Jy Top frame: Phas deg  
Vector averaged cross-power spectrum Baseline: EF (01) - JB (03)  
Timerange: 01/04:24:02 to 01/04:24:58

Plot file version 292 created 26-JUN-2015 10:51:30  
J2025+3343 ET031A.UVDATA.1  
Freq = 1.5950 GHz, Bw = 16.000 MH No calibration applied and no bandpass applied

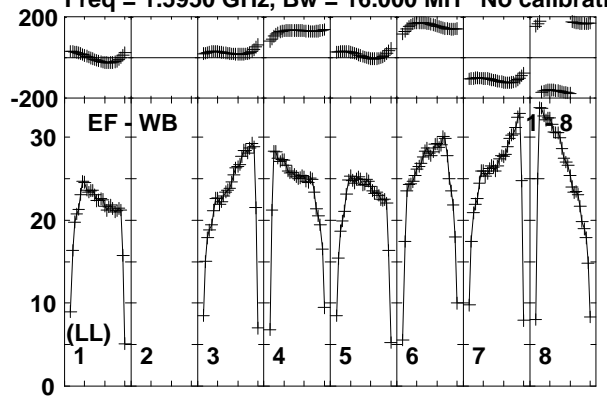

Lower frame: Milli Ampl Jy Top frame: Phas deg  
Vector averaged cross-power spectrum Baseline: EF (01) - WB (08)  
Timerange: 01/04:24:02 to 01/04:24:58

Plot file version 293 created 26-JUN-2015 10:51:30

V404CYG ET031A.UVDATA.1

Freq = 1.5950 GHz, Bw = 16.000 MH No calibration applied and no bandpass applied

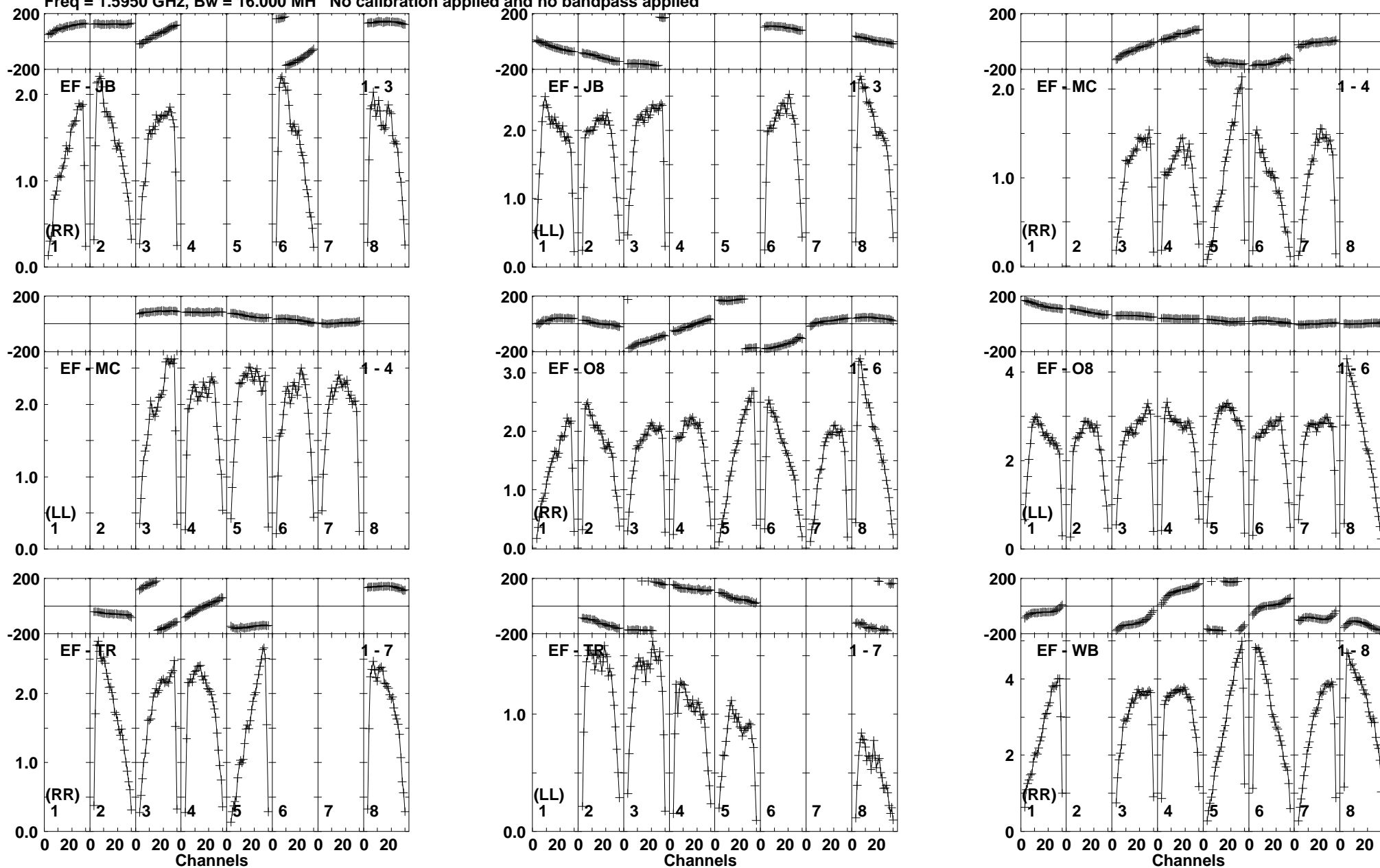

Lower frame: Milli Ampl Jy Top frame: Phas deg  
Vector averaged cross-power spectrum Baseline: EF (01) - JB (03)  
Timerange: 01/04:25:02 to 01/04:28:28

Plot file version 294 created 26-JUN-2015 10:51:30

V404CYG ET031A.UVDATA.1

Freq = 1.5950 GHz, Bw = 16.000 MH No calibration applied and no bandpass applied

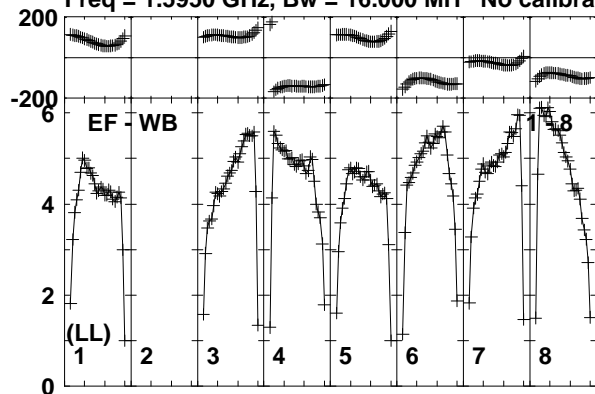

Lower frame: Milli Ampl Jy Top frame: Phas deg  
Vector averaged cross-power spectrum Baseline: EF (01) - WB (08)  
Timerange: 01/04:25:02 to 01/04:28:28

Plot file version 295 created 26-JUN-2015 10:51:30

J2025+3343 ET031A.UVDATA.1

Freq = 1.5950 GHz, Bw = 16.000 MH No calibration applied and no bandpass applied

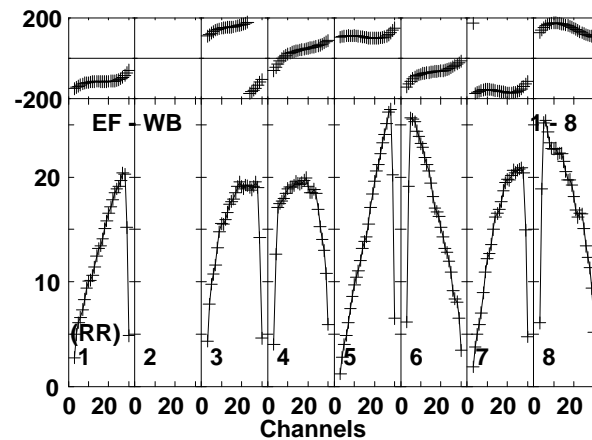
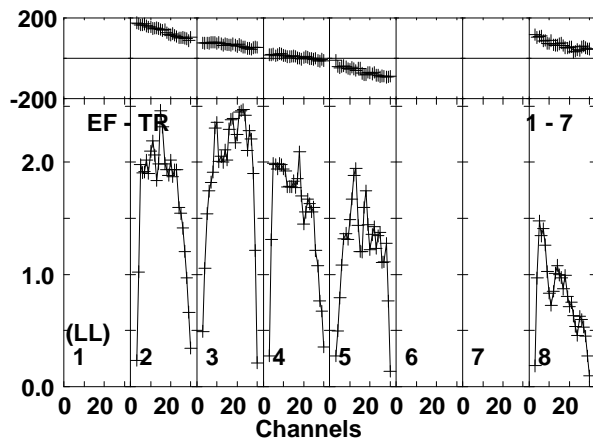
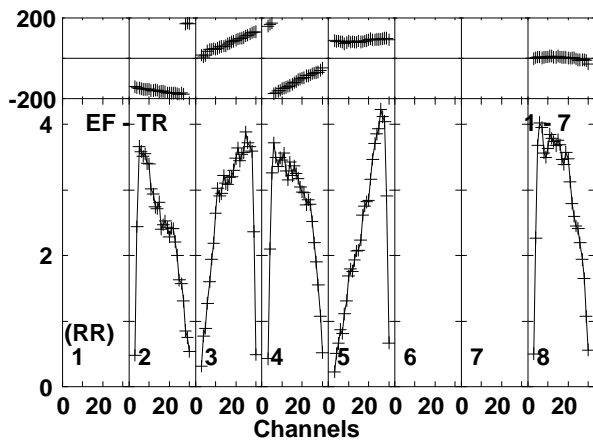
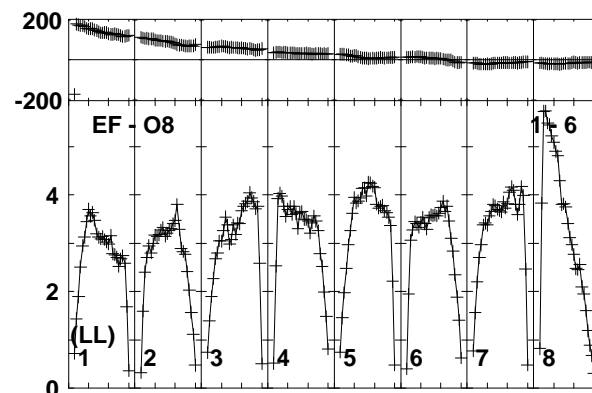
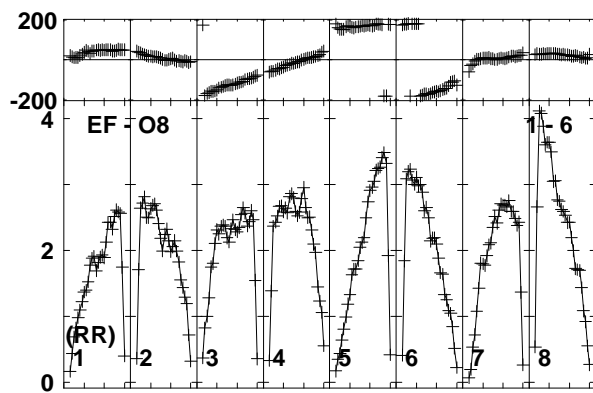
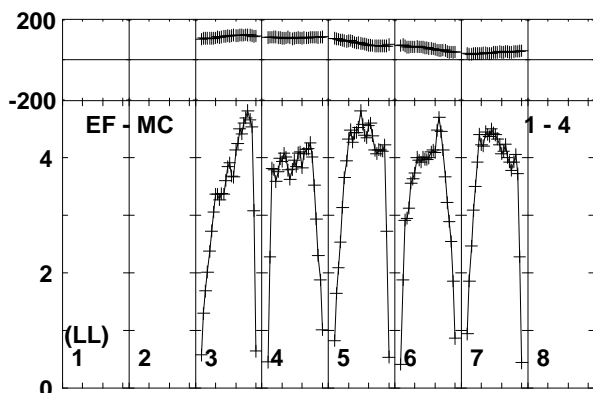
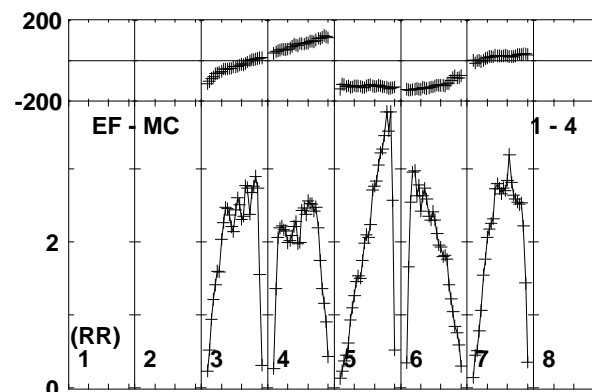
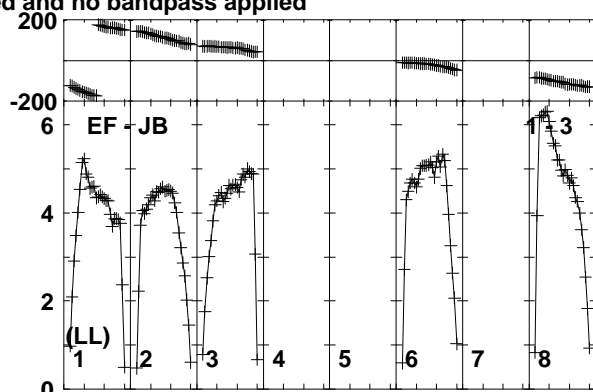
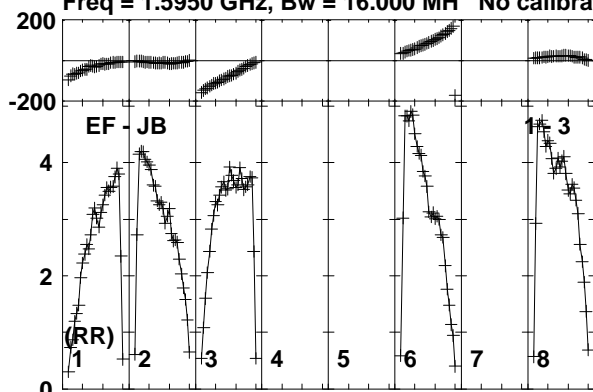

Lower frame: Milli Ampl Jy Top frame: Phas deg  
Vector averaged cross-power spectrum Baseline: EF (01) - JB (03)  
Timerange: 01/04:28:32 to 01/04:29:48

Plot file version 296 created 26-JUN-2015 10:51:30  
J2025+3343 ET031A.UVDATA.1  
Freq = 1.5950 GHz, Bw = 16.000 MH No calibration applied and no bandpass applied

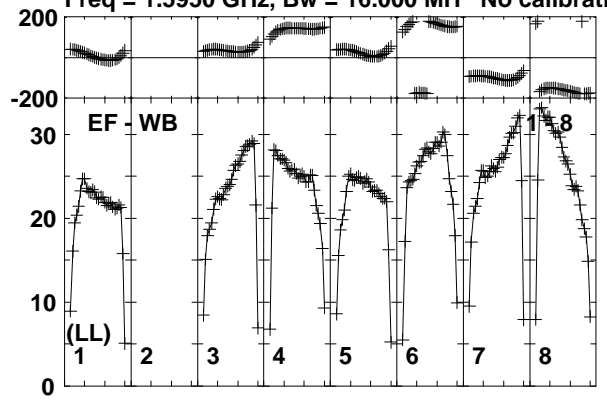

Lower frame: Milli Ampl Jy Top frame: Phas deg  
Vector averaged cross-power spectrum Baseline: EF (01) - WB (08)  
Timerange: 01/04:28:32 to 01/04:29:48



Plot file version 297 created 26-JUN-2015 10:51:30

V404CYG ET031A.UVDATA.1

Freq = 1.5950 GHz, Bw = 16.000 MH No calibration applied and no bandpass applied

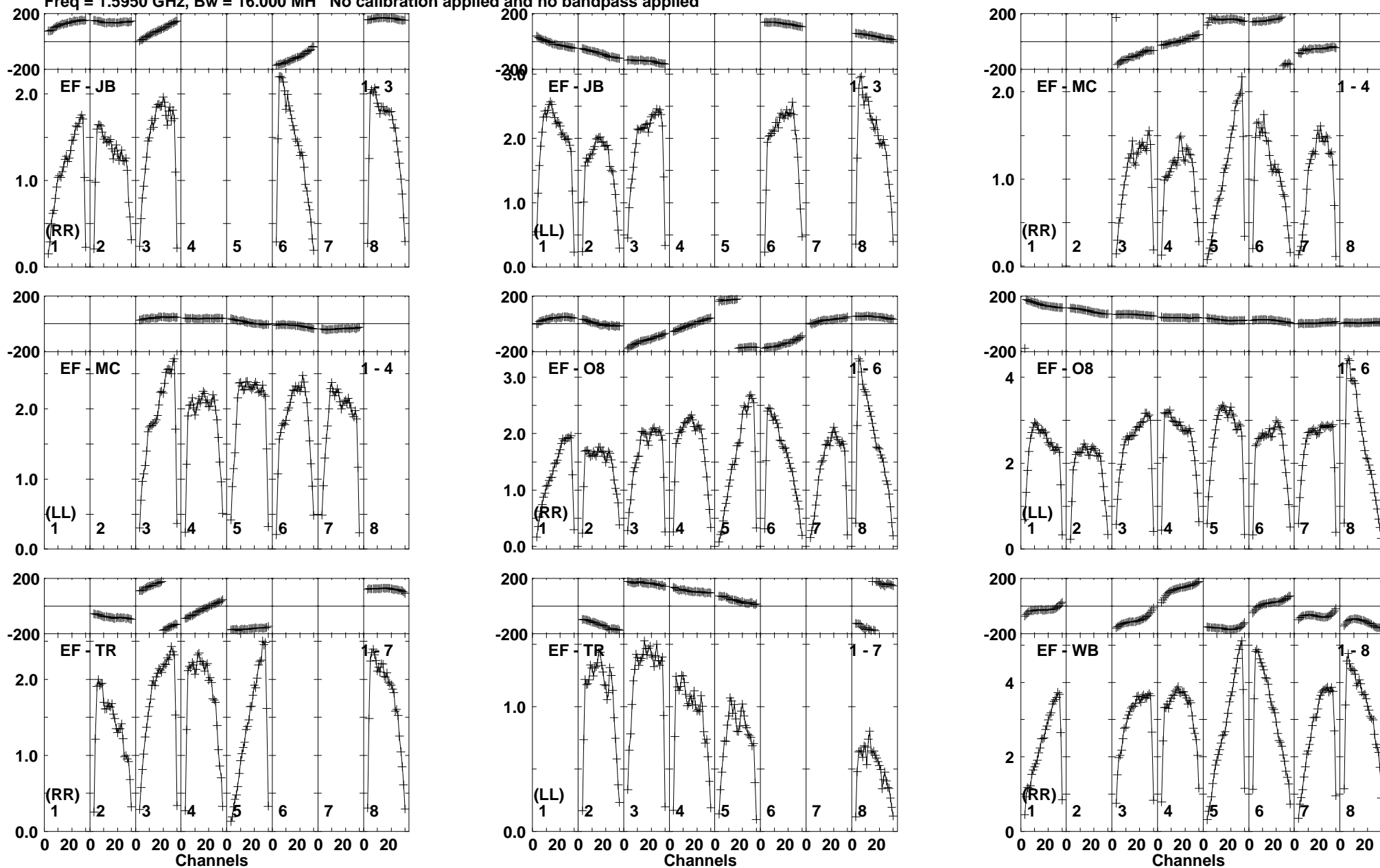

Lower frame: Milli Ampl Jy Top frame: Phas deg  
Vector averaged cross-power spectrum Baseline: EF (01) - JB (03)  
Timerange: 01/04:29:52 to 01/04:33:18

Plot file version 298 created 26-JUN-2015 10:51:30

V404CYG ET031A.UVDATA.1

Freq = 1.5950 GHz, Bw = 16.000 MH No calibration applied and no bandpass applied

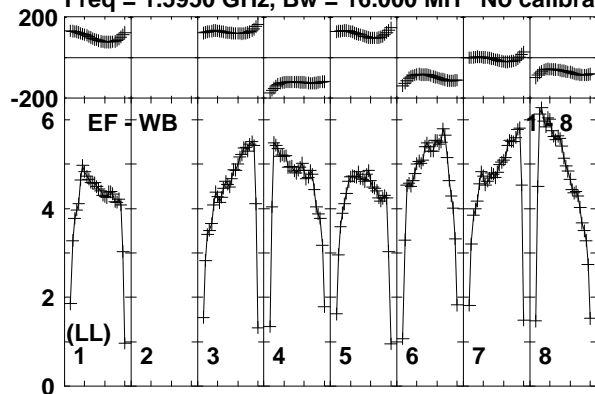

Lower frame: Milli Ampl Jy Top frame: Phas deg  
Vector averaged cross-power spectrum Baseline: EF (01) - WB (08)  
Timerange: 01/04:29:52 to 01/04:33:18

Plot file version 299 created 26-JUN-2015 10:51:30

J2025+3343 ET031A.UVDATA.1

Freq = 1.5950 GHz, Bw = 16.000 MH No calibration applied and no bandpass applied

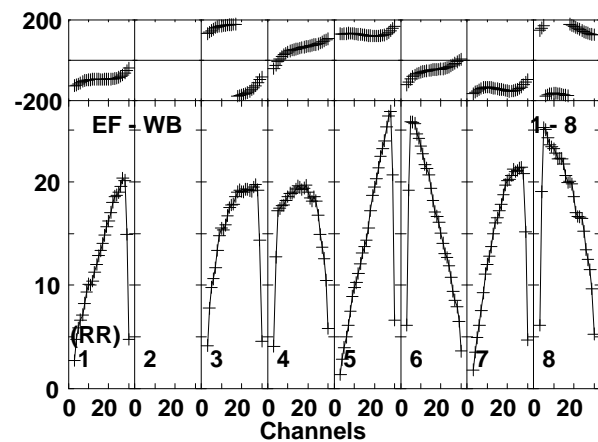
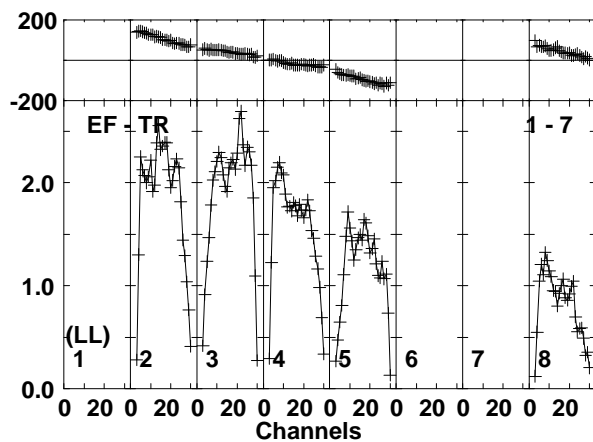
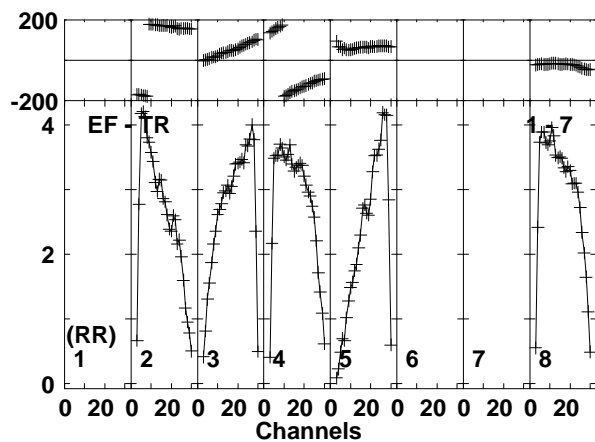
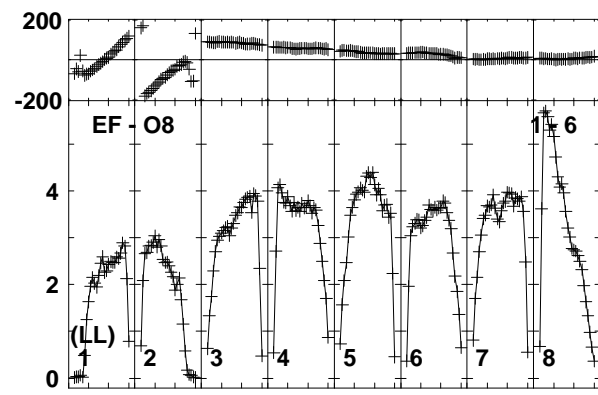
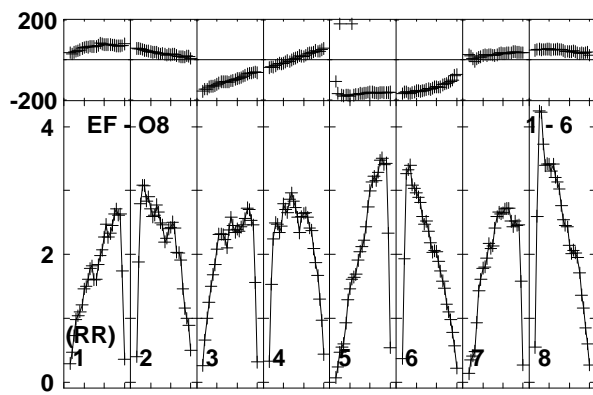
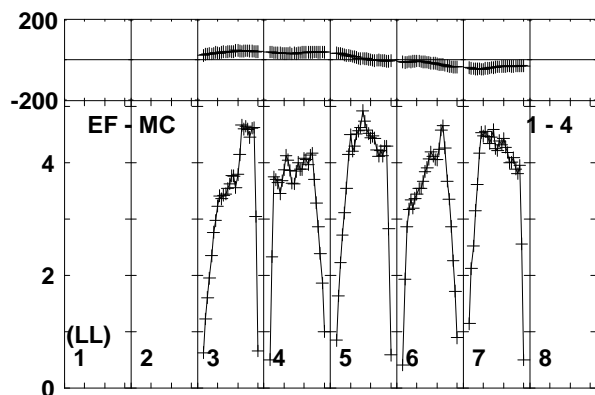
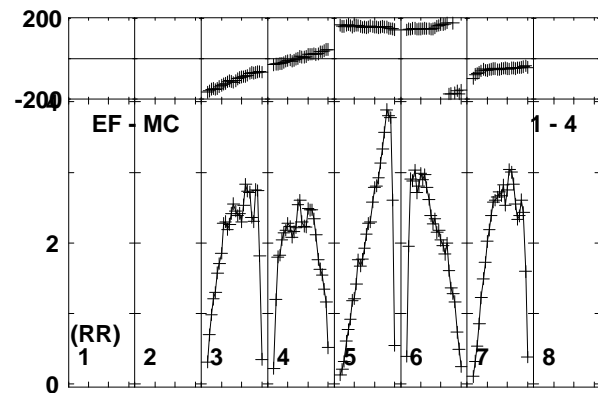
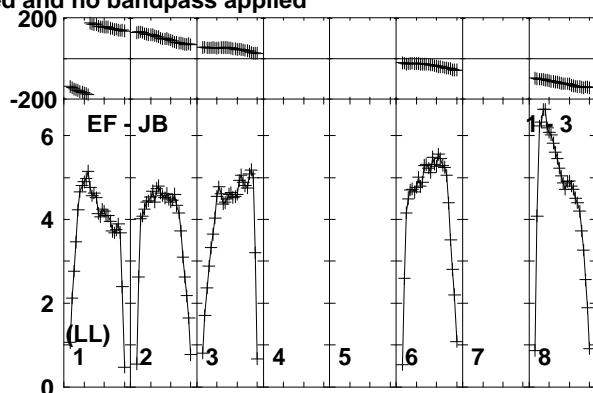
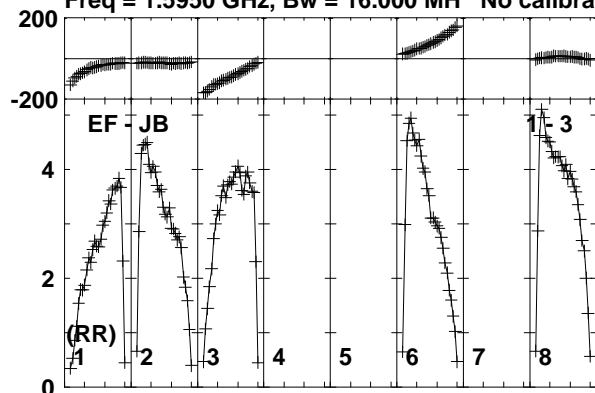

Lower frame: Milli Ampl Jy Top frame: Phas deg  
Vector averaged cross-power spectrum Baseline: EF (01) - JB (03)  
Timerange: 01/04:34:02 to 01/04:34:58

Plot file version 300 created 26-JUN-2015 10:51:30  
J2025+3343 ET031A.UVDATA.1  
Freq = 1.5950 GHz, Bw = 16.000 MH No calibration applied and no bandpass applied

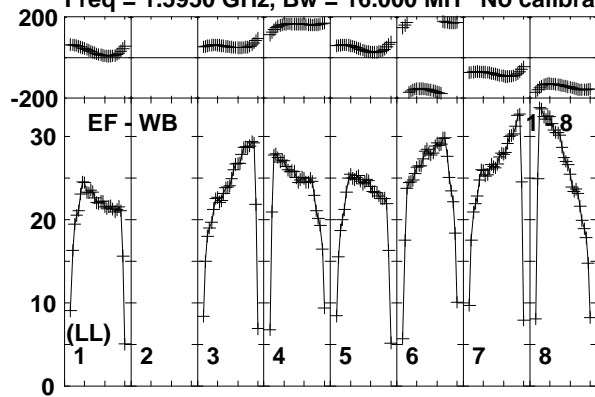

Lower frame: Milli Ampl Jy Top frame: Phas deg  
Vector averaged cross-power spectrum Baseline: EF (01) - WB (08)  
Timerange: 01/04:34:02 to 01/04:34:58

Plot file version 301 created 26-JUN-2015 10:51:30

V404CYG ET031A.UVDATA.1

Freq = 1.5950 GHz, Bw = 16.000 MH No calibration applied and no bandpass applied

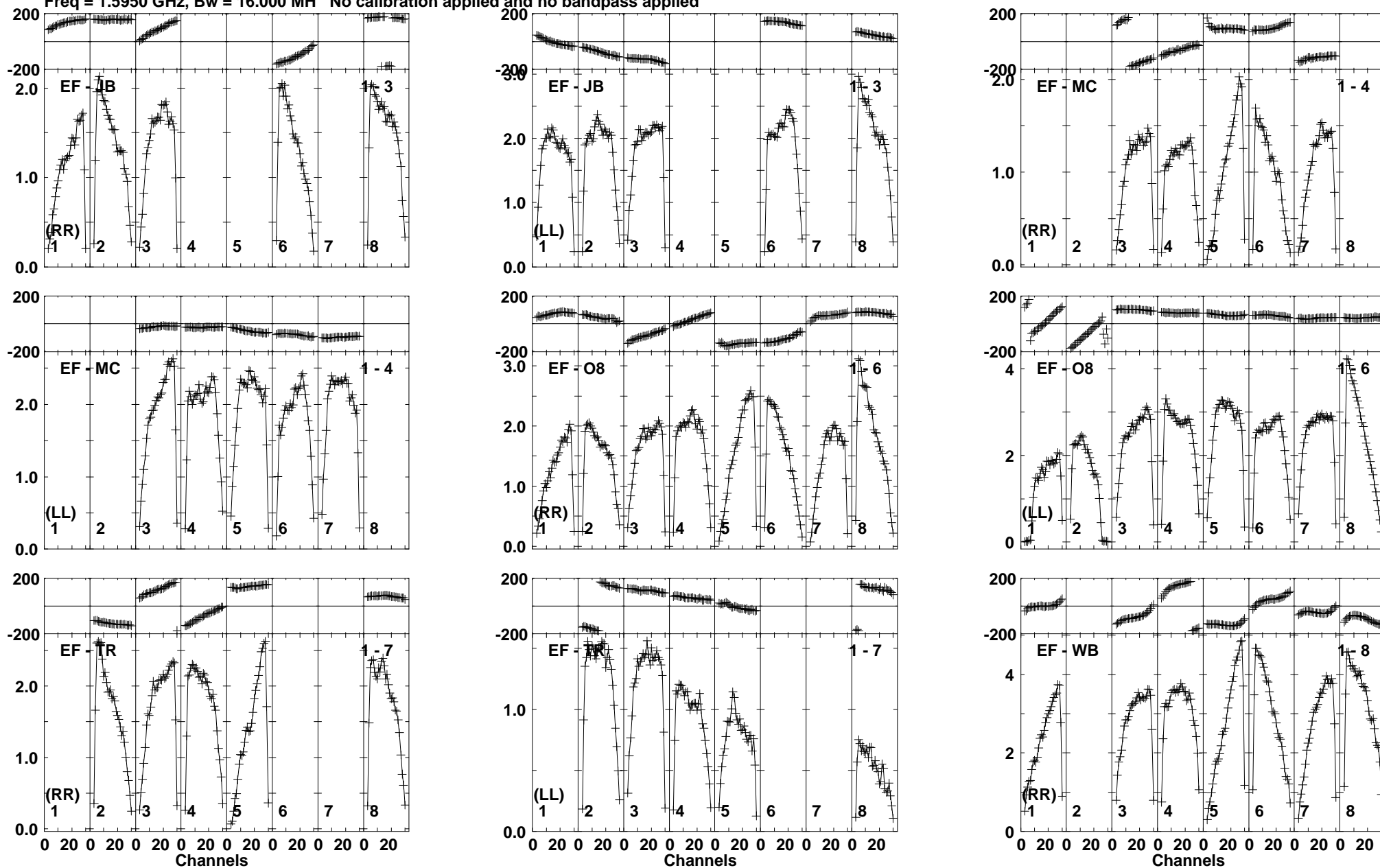

Lower frame: Milli Ampl Jy Top frame: Phas deg  
Vector averaged cross-power spectrum Baseline: EF (01) - JB (03)  
Timerange: 01/04:35:02 to 01/04:38:28

Plot file version 302 created 26-JUN-2015 10:51:30  
V404CYG ET031A.UVDATA.1  
Freq = 1.5950 GHz, Bw = 16.000 MH No calibration applied and no bandpass applied

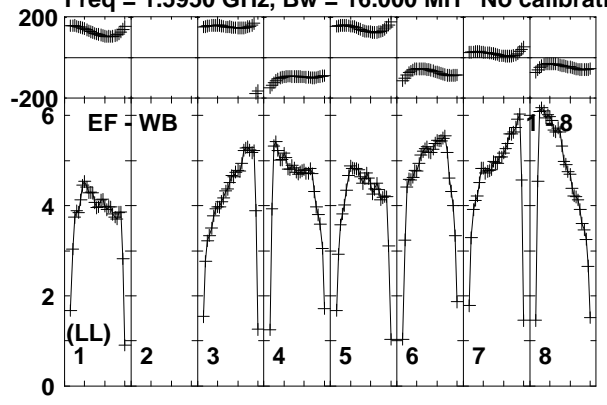

Lower frame: Milli Ampl Jy Top frame: Phas deg  
Vector averaged cross-power spectrum Baseline: EF (01) - WB (08)  
Timerange: 01/04:35:02 to 01/04:38:28

Plot file version 303 created 26-JUN-2015 10:51:30

J2025+3343 ET031A.UVDATA.1

Freq = 1.5950 GHz, Bw = 16.000 MH No calibration applied and no bandpass applied

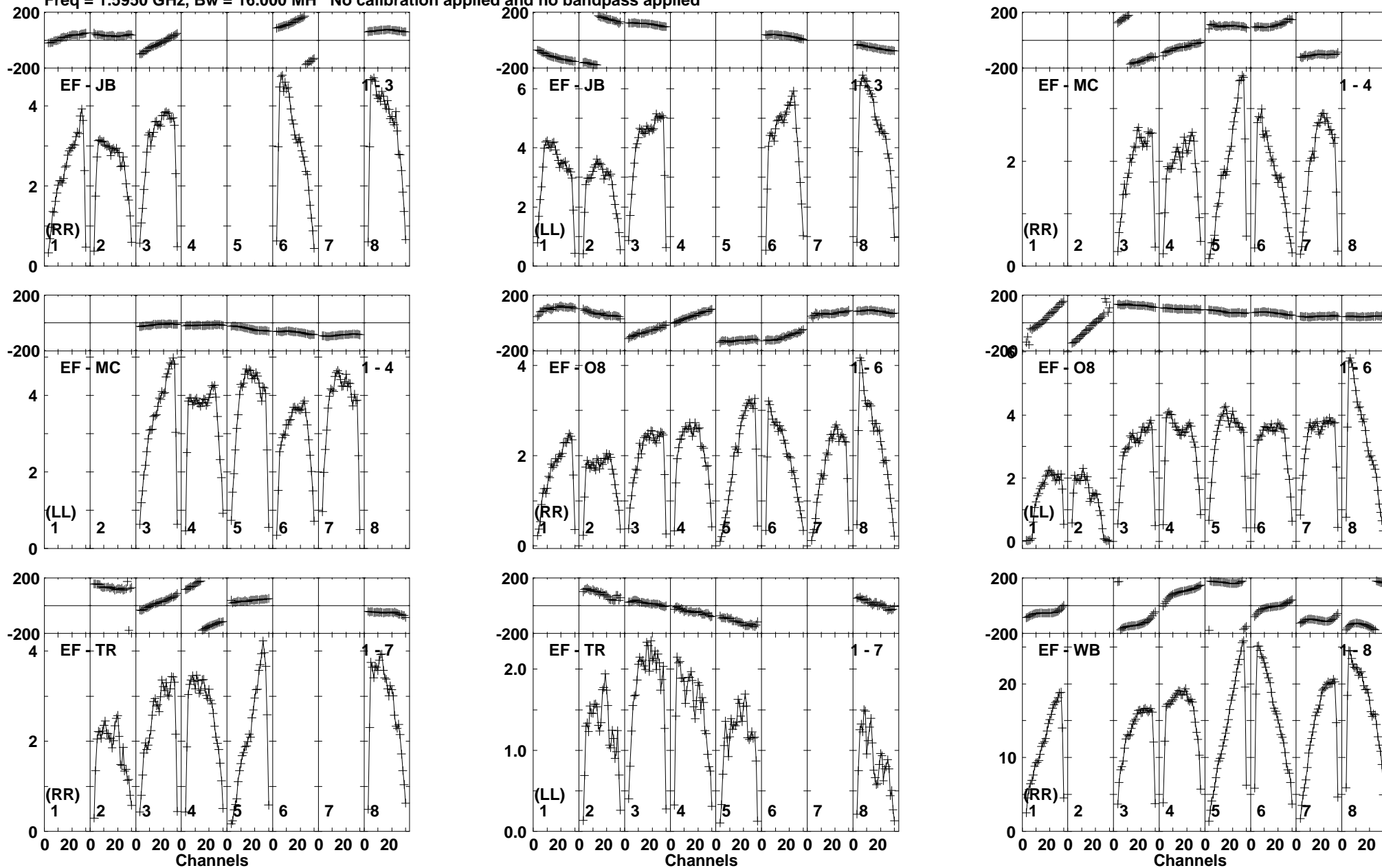

Lower frame: Milli Ampl Jy Top frame: Phas deg  
Vector averaged cross-power spectrum Baseline: EF (01) - JB (03)  
Timerange: 01/04:38:32 to 01/04:39:48

Plot file version 304 created 26-JUN-2015 10:51:30

J2025+3343 ET031A.UVDATA.1

Freq = 1.5950 GHz, Bw = 16.000 MH No calibration applied and no bandpass applied

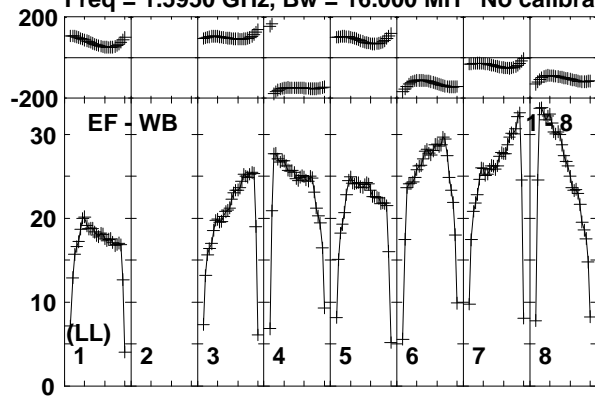

Lower frame: Milli Ampl Jy Top frame: Phas deg  
Vector averaged cross-power spectrum Baseline: EF (01) - WB (08)  
Timerange: 01/04:38:32 to 01/04:39:48



Plot file version 305 created 26-JUN-2015 10:51:30

V404CYG ET031A.UVDATA.1

Freq = 1.5950 GHz, Bw = 16.000 MH No calibration applied and no bandpass applied

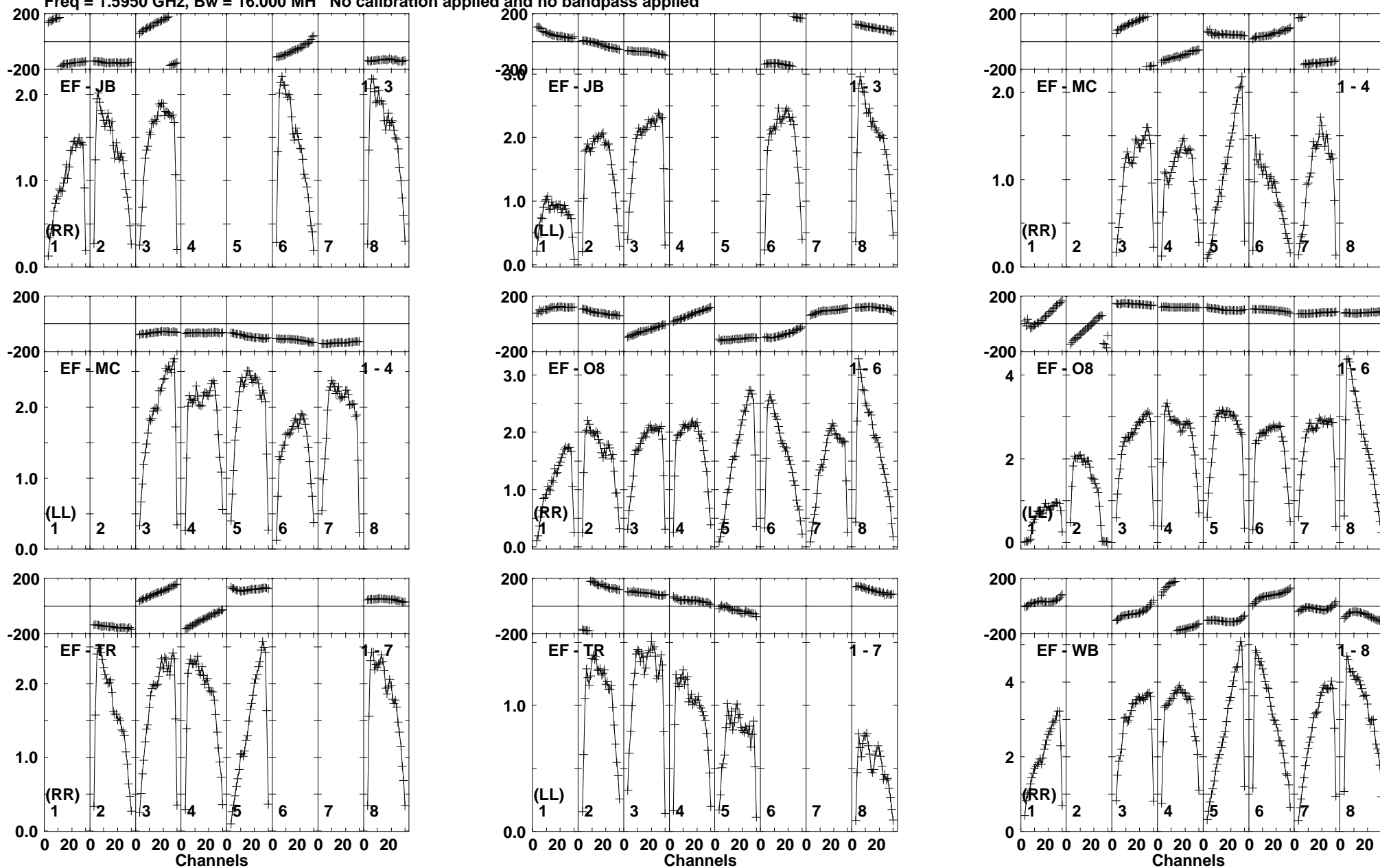

Lower frame: Milli Amply Jy Top frame: Phas deg  
Vector averaged cross-power spectrum Baseline: EF (01) - JB (03)  
Timerange: 01/04:39:52 to 01/04:43:18

Plot file version 306 created 26-JUN-2015 10:51:30

V404CYG ET031A.UVDATA.1

Freq = 1.5950 GHz, Bw = 16.000 MH No calibration applied and no bandpass applied

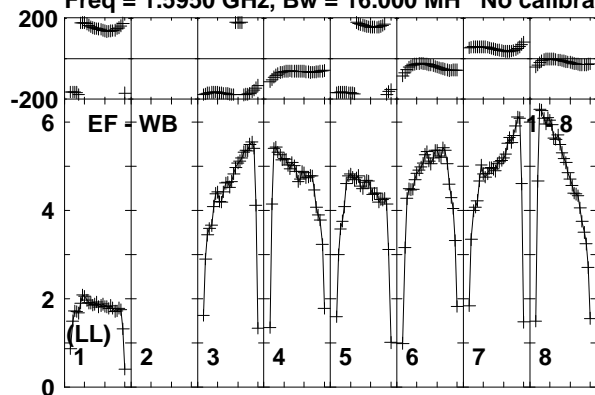

Lower frame: Milli Ampl Jy Top frame: Phas deg

Vector averaged cross-power spectrum Baseline: EF (01) - WB (08)

Timerange: 01/04:39:52 to 01/04:43:18

Plot file version 307 created 26-JUN-2015 10:51:30  
 J2025+3343 ET031A.UVDATA.1  
 Freq = 1.5950 GHz, Bw = 16.000 MH No calibration applied and no bandpass applied

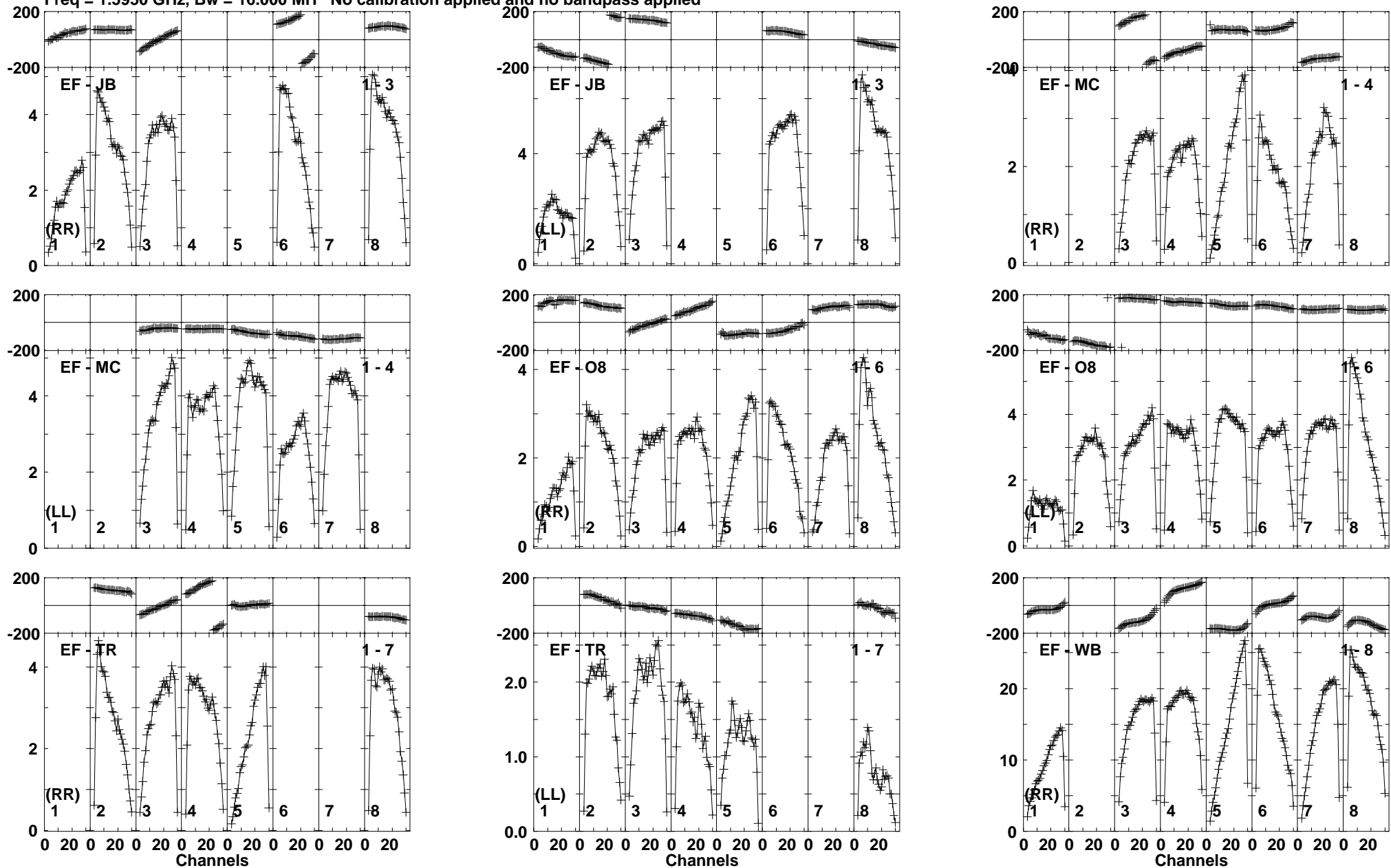

Lower frame: Milli Ampl Jy Top frame: Phas deg  
 Vector averaged cross-power spectrum Baseline: EF (01) - JB (03)  
 Timerange: 01/04:44:02 to 01/04:44:58

Plot file version 308 created 26-JUN-2015 10:51:30

J2025+3343 ET031A.UVDATA.1

Freq = 1.5950 GHz, Bw = 16.000 MH No calibration applied and no bandpass applied

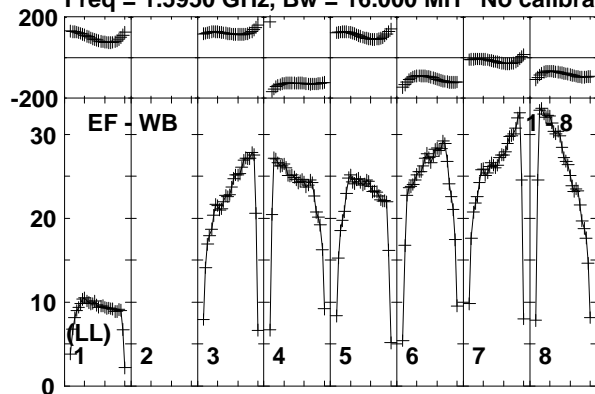

Lower frame: Milli Ampl Jy Top frame: Phas deg  
Vector averaged cross-power spectrum Baseline: EF (01) - WB (08)  
Timerange: 01/04:44:02 to 01/04:44:58

Plot file version 309 created 26-JUN-2015 10:51:30

V404CYG ET031A.UVDATA.1

Freq = 1.5950 GHz, Bw = 16.000 MH No calibration applied and no bandpass applied

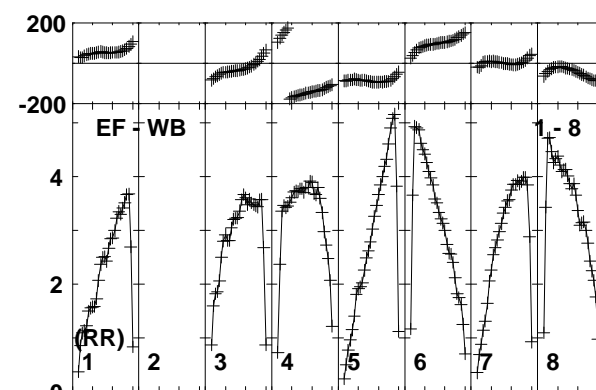
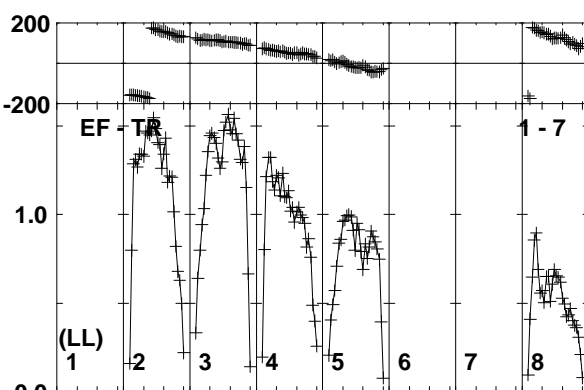
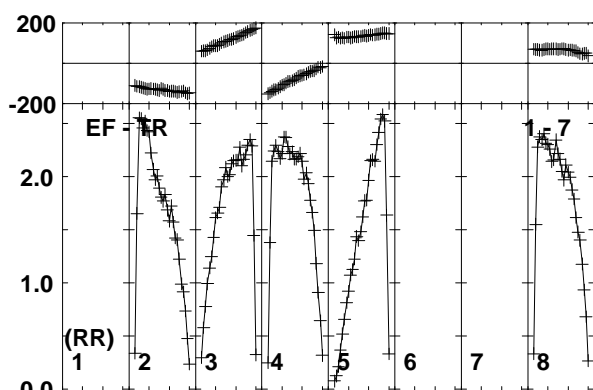
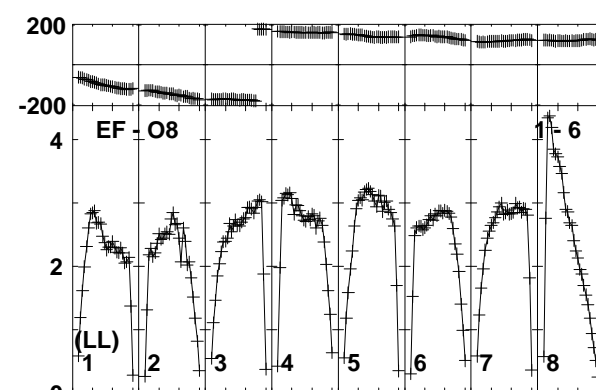
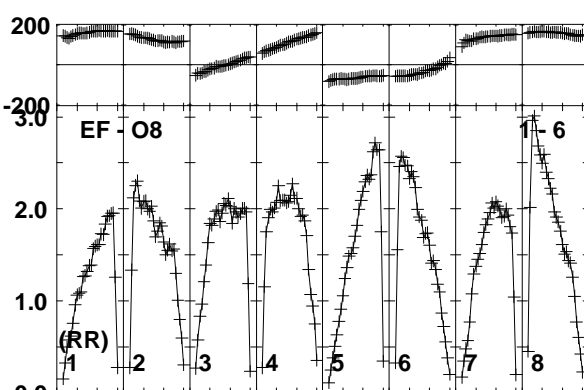
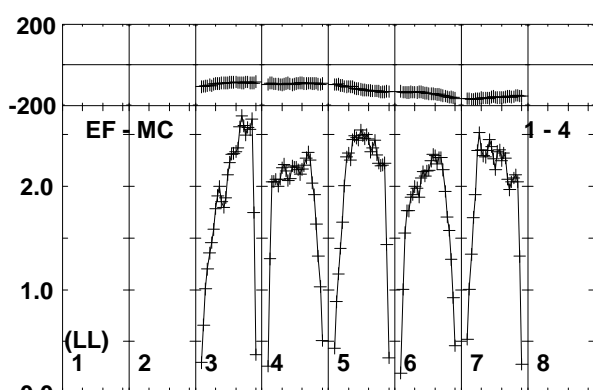
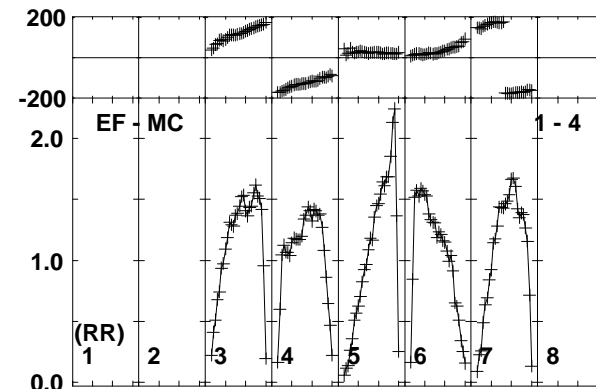
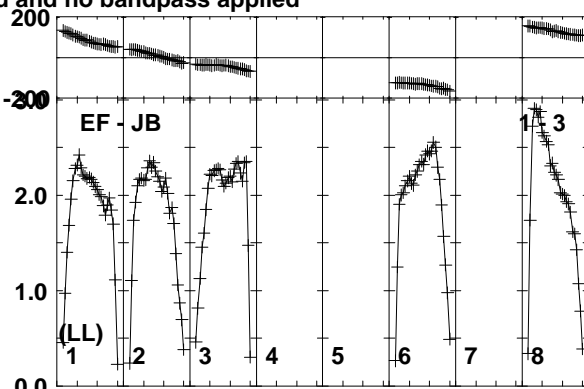
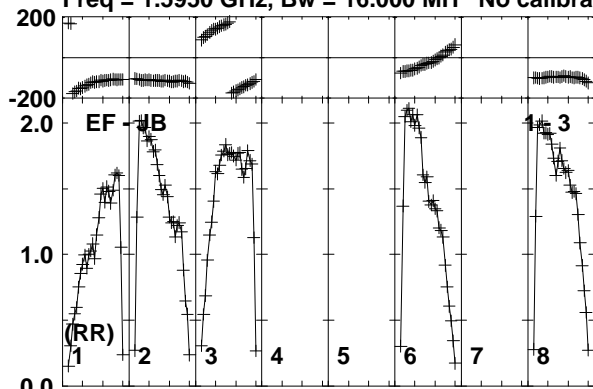

Lower frame: Milli Ampl Jy Top frame: Phas deg  
Vector averaged cross-power spectrum Baseline: EF (01) - JB (03)  
Timerange: 01/04:45:02 to 01/04:48:28

Plot file version 310 created 26-JUN-2015 10:51:30  
V404CYG ET031A.UVDATA.1  
Freq = 1.5950 GHz, Bw = 16.000 MH No calibration applied and no bandpass applied

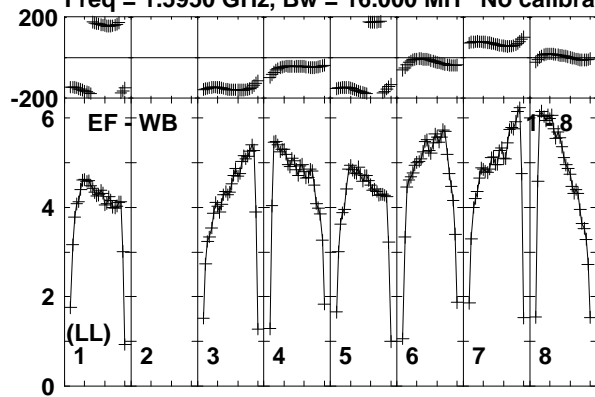

Lower frame: Milli Ampl Jy Top frame: Phas deg  
Vector averaged cross-power spectrum Baseline: EF (01) - WB (08)  
Timerange: 01/04:45:02 to 01/04:48:28

Plot file version 311 created 26-JUN-2015 10:51:30  
 J2025+3343 ET031A.UVDATA.1  
 Freq = 1.5950 GHz, Bw = 16.000 MH No calibration applied and no bandpass applied

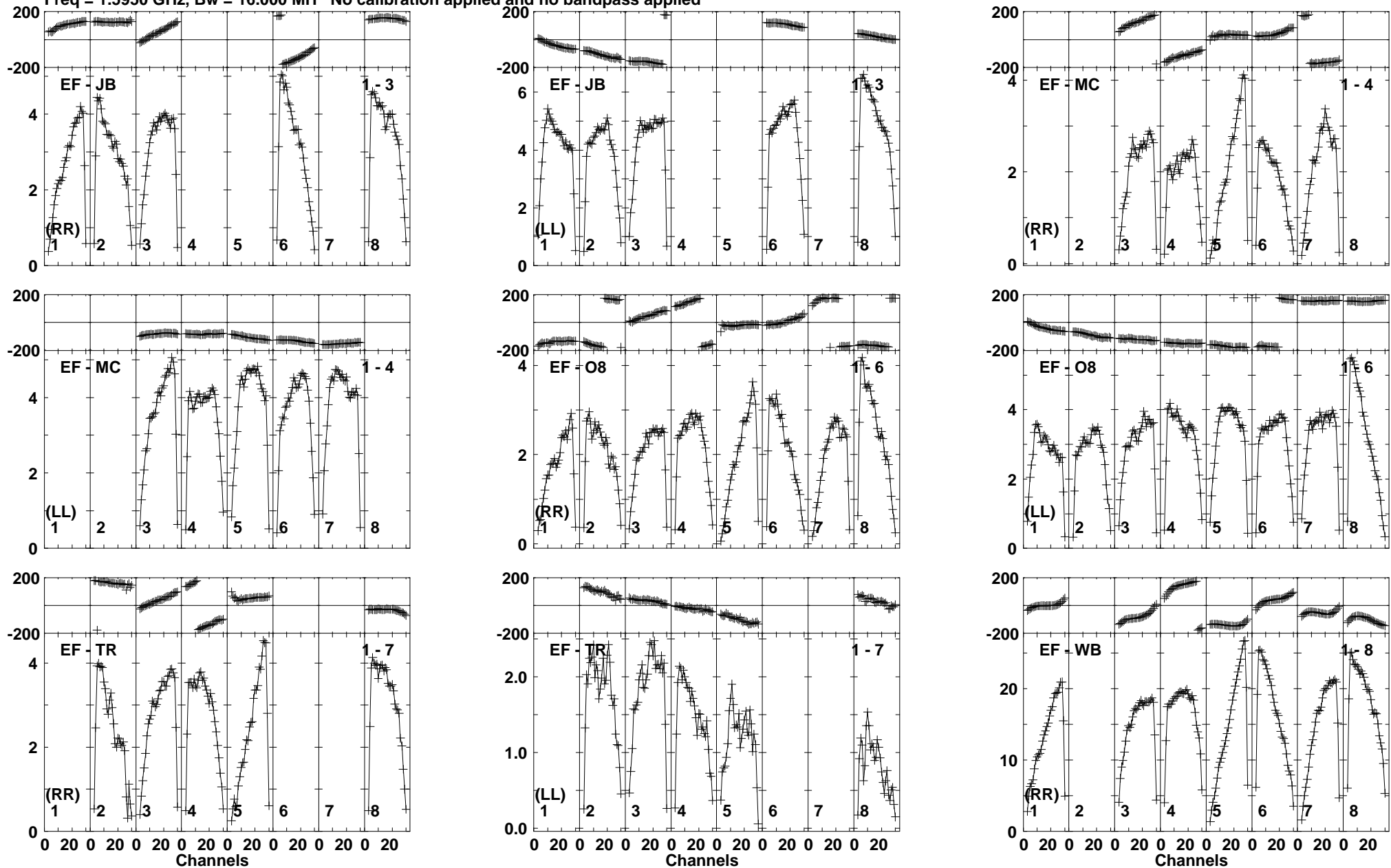

Lower frame: Milli Ampl Jy Top frame: Phas deg  
 Vector averaged cross-power spectrum Baseline: EF (01) - JB (03)  
 Timerange: 01/04:48:32 to 01/04:49:48

Plot file version 312 created 26-JUN-2015 10:51:31

J2025+3343 ET031A.UVDATA.1

Freq = 1.5950 GHz, Bw = 16.000 MH No calibration applied and no bandpass applied

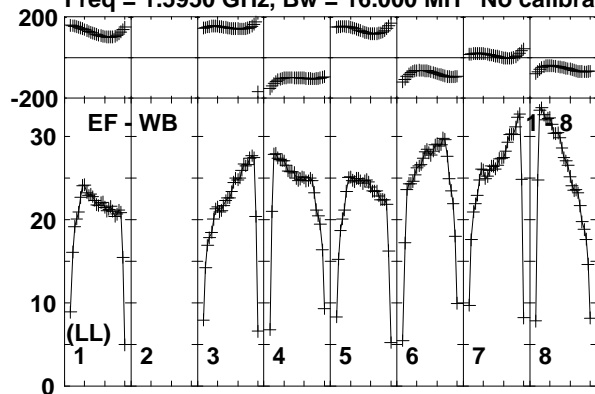

Lower frame: Milli Ampl Jy Top frame: Phas deg  
Vector averaged cross-power spectrum Baseline: EF (01) - WB (08)  
Timerange: 01/04:48:32 to 01/04:49:48



Plot file version 313 created 26-JUN-2015 10:51:31

V404CYG ET031A.UVDATA.1

Freq = 1.5950 GHz, Bw = 16.000 MH No calibration applied and no bandpass applied

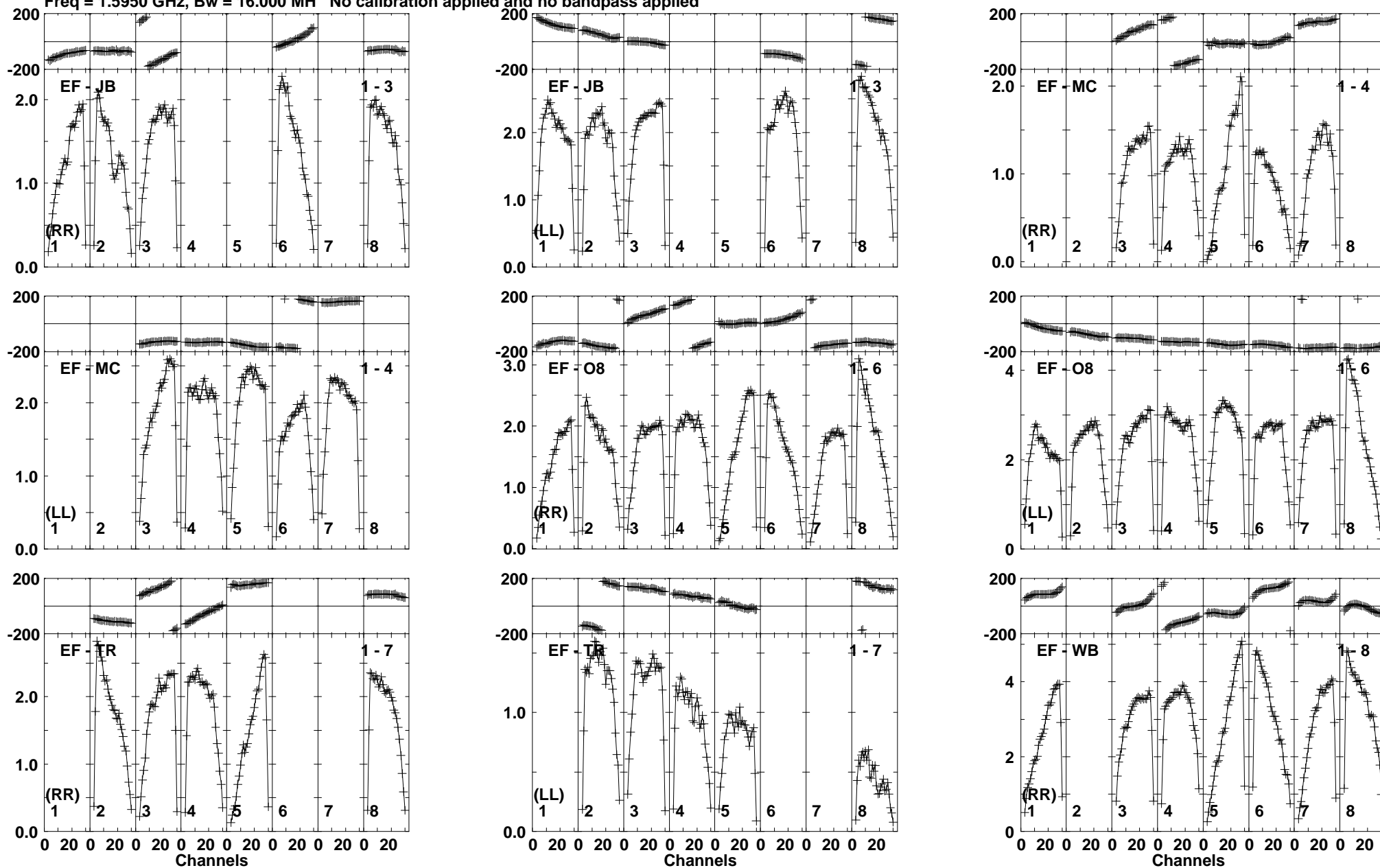

Lower frame: Milli Ampl Jy Top frame: Phas deg  
Vector averaged cross-power spectrum Baseline: EF (01) - JB (03)  
Timerange: 01/04:49:52 to 01/04:53:18

Plot file version 314 created 26-JUN-2015 10:51:31  
V404CYG ET031A.UVDATA.1  
Freq = 1.5950 GHz, Bw = 16.000 MH No calibration applied and no bandpass applied

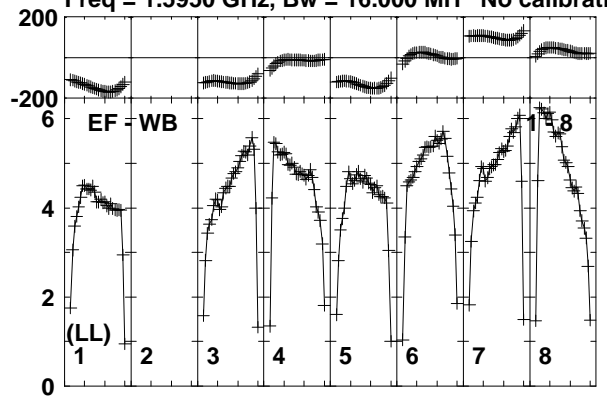

Lower frame: Milli Ampl Jy Top frame: Phas deg  
Vector averaged cross-power spectrum Baseline: EF (01) - WB (08)  
Timerange: 01/04:49:52 to 01/04:53:18

Plot file version 315 created 26-JUN-2015 10:51:31  
 J2025+3343 ET031A.UVDATA.1  
 Freq = 1.5950 GHz, Bw = 16.000 MH No calibration applied and no bandpass applied

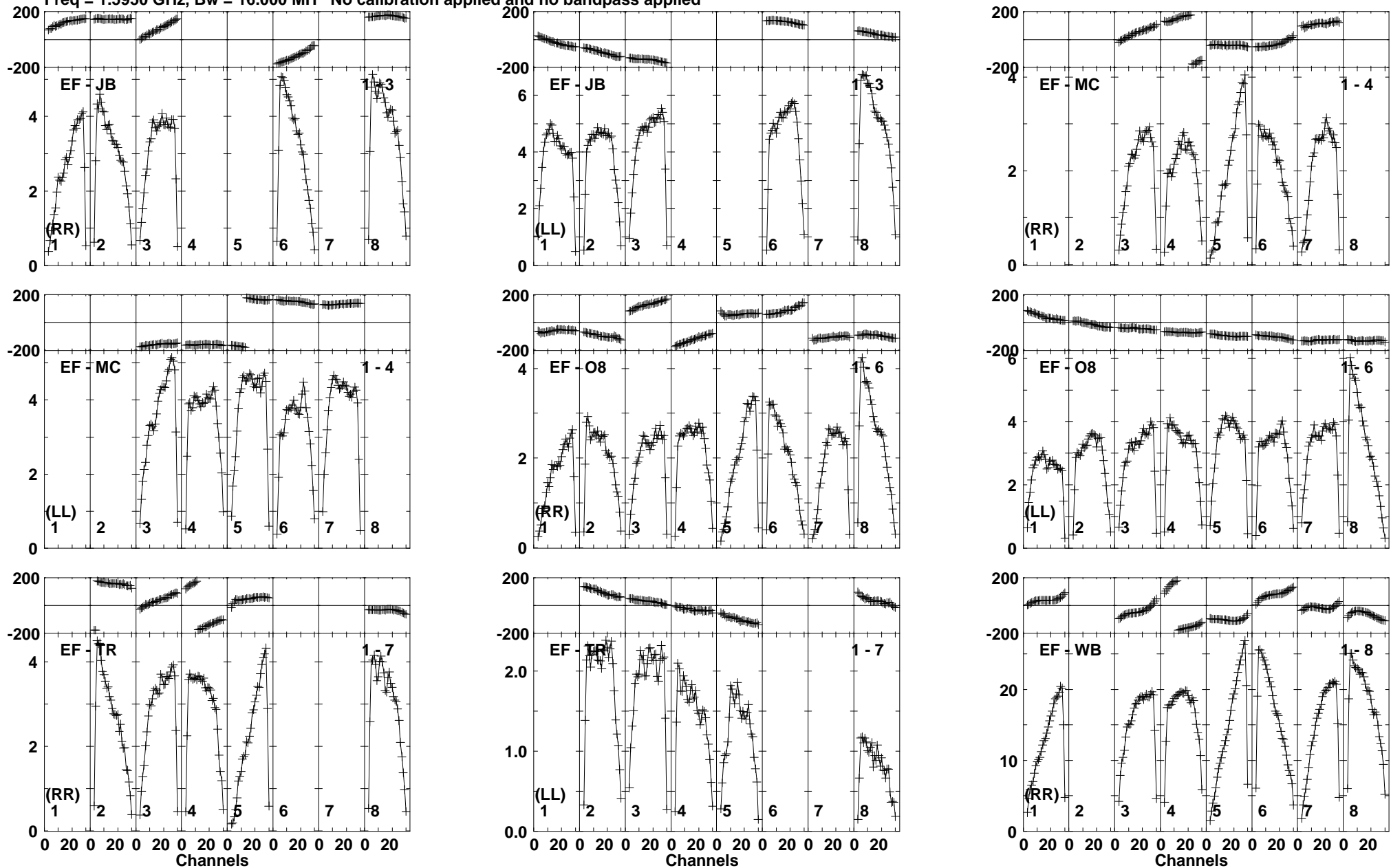

Lower frame: Milli Ampl Jy Top frame: Phas deg  
 Vector averaged cross-power spectrum Baseline: EF (01) - JB (03)  
 Timerange: 01/04:54:02 to 01/04:54:58

Plot file version 316 created 26-JUN-2015 10:51:31

J2025+3343 ET031A.UVDATA.1

Freq = 1.5950 GHz, Bw = 16.000 MH No calibration applied and no bandpass applied

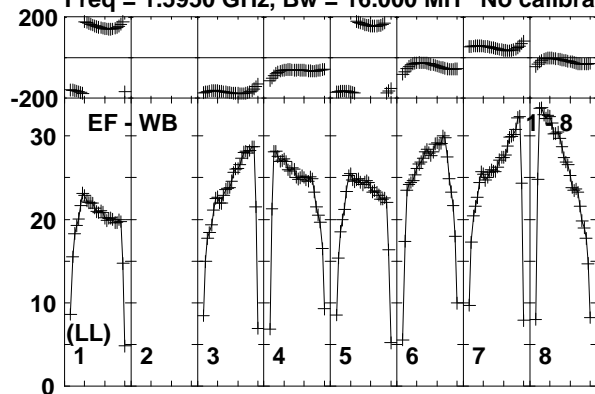

Lower frame: Milli Ampl Jy Top frame: Phas deg  
Vector averaged cross-power spectrum Baseline: EF (01) - WB (08)  
Timerange: 01/04:54:02 to 01/04:54:58

Plot file version 317 created 26-JUN-2015 10:51:31

V404CYG ET031A.UVDATA.1

Freq = 1.5950 GHz, Bw = 16.000 MH No calibration applied and no bandpass applied

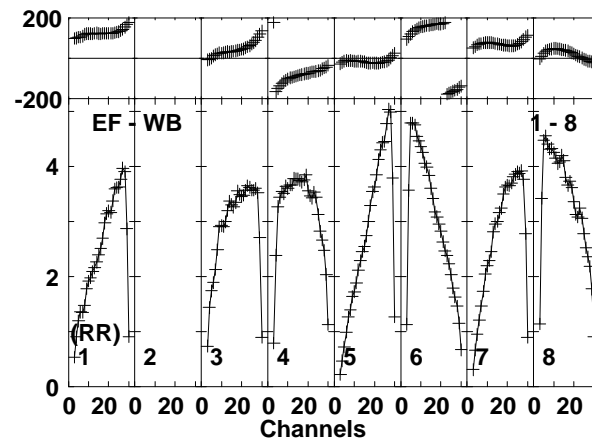
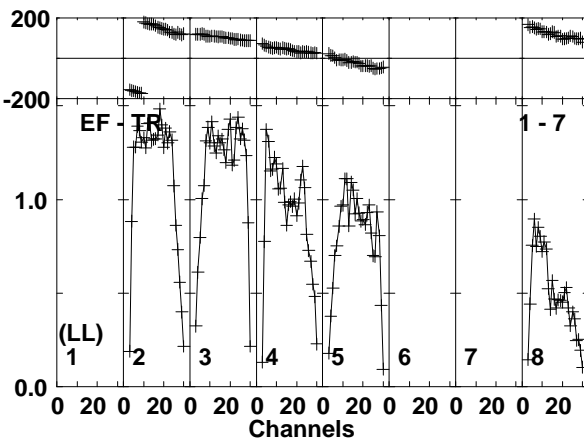
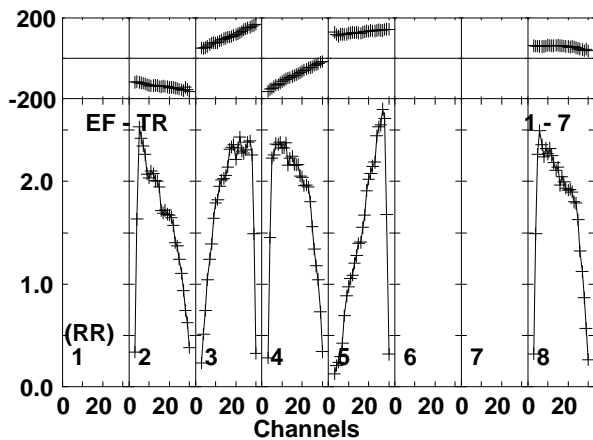
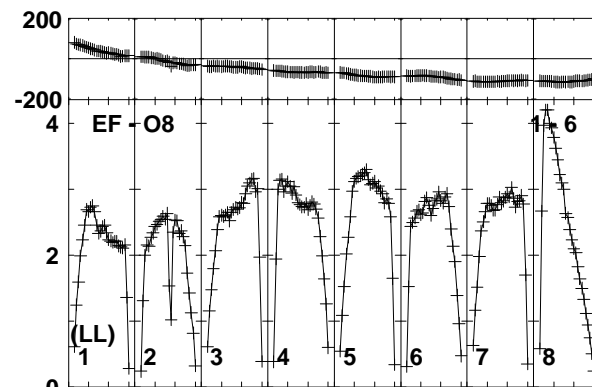
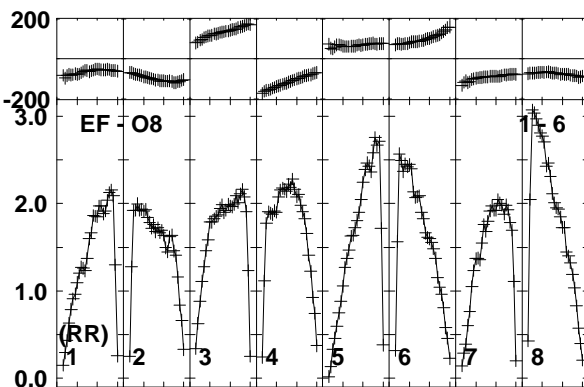
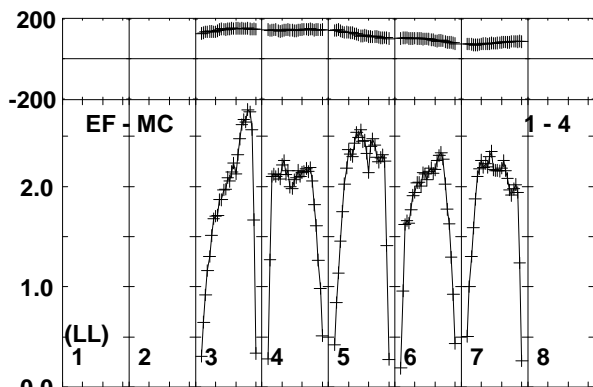
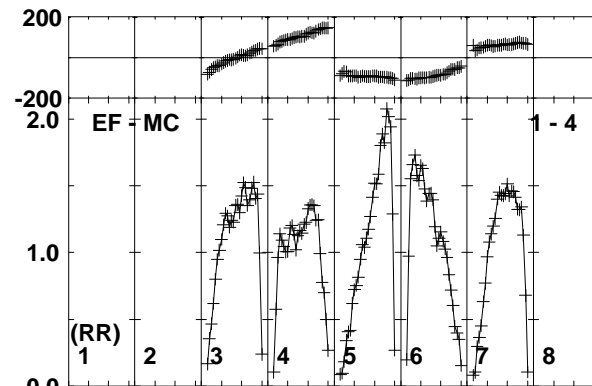
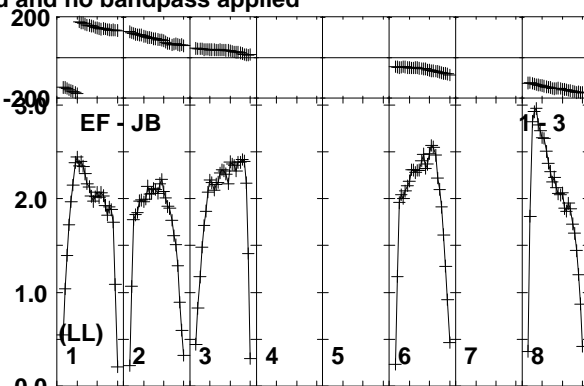
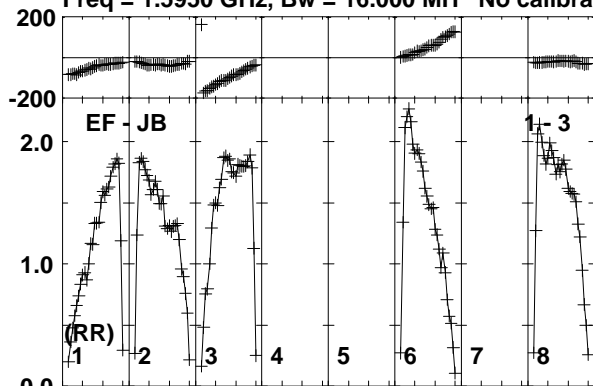

Lower frame: Milli Ampl Jy Top frame: Phas deg  
Vector averaged cross-power spectrum Baseline: EF (01) - JB (03)  
Timerange: 01/04:55:02 to 01/04:58:28

Plot file version 318 created 26-JUN-2015 10:51:31

V404CYG ET031A.UVDATA.1

Freq = 1.5950 GHz, Bw = 16.000 MH No calibration applied and no bandpass applied

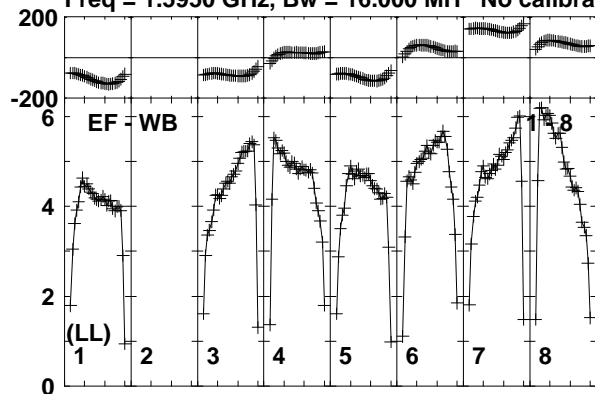

Lower frame: Milli Ampl Jy Top frame: Phas deg

Vector averaged cross-power spectrum Baseline: EF (01) - WB (08)

Timerange: 01/04:55:02 to 01/04:58:28

Plot file version 319 created 26-JUN-2015 10:51:31

J2025+3343 ET031A.UVDATA.1

Freq = 1.5950 GHz, Bw = 16.000 MH No calibration applied and no bandpass applied

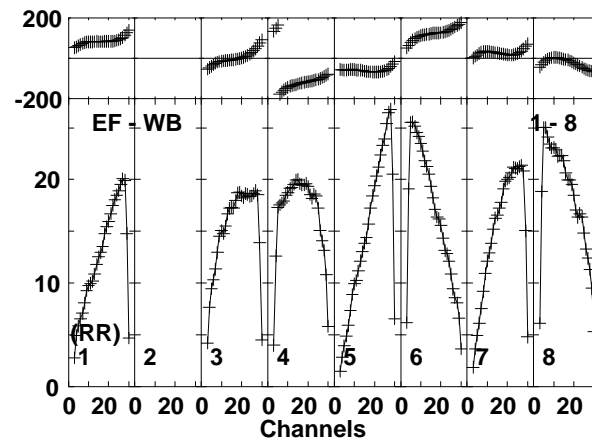
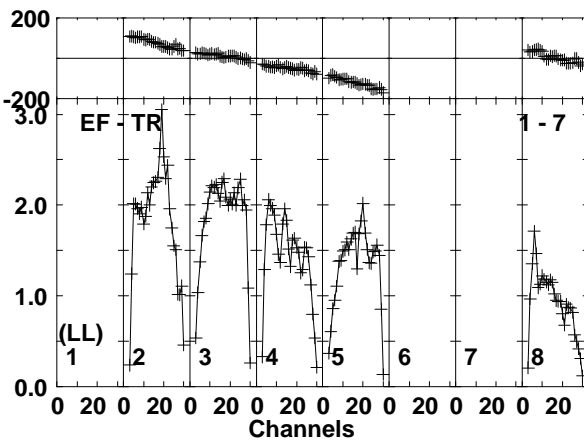
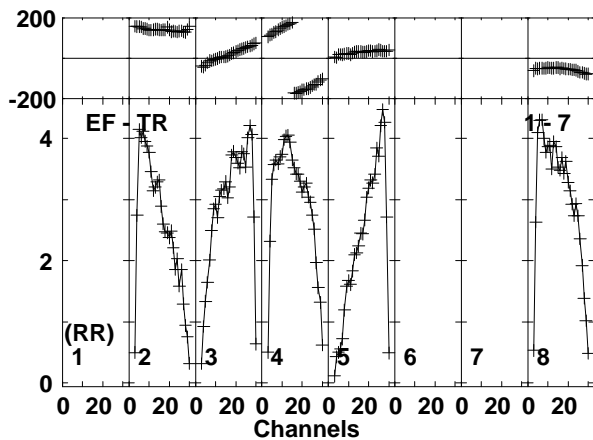
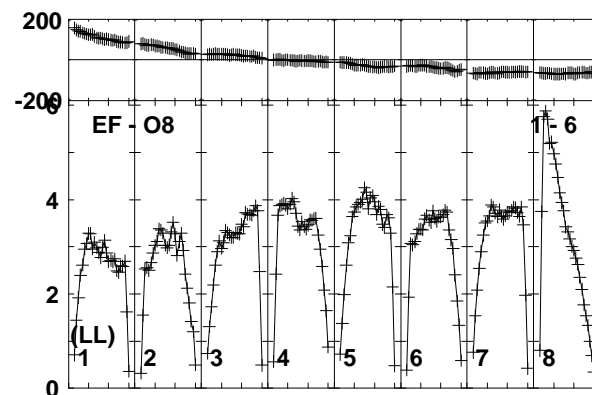
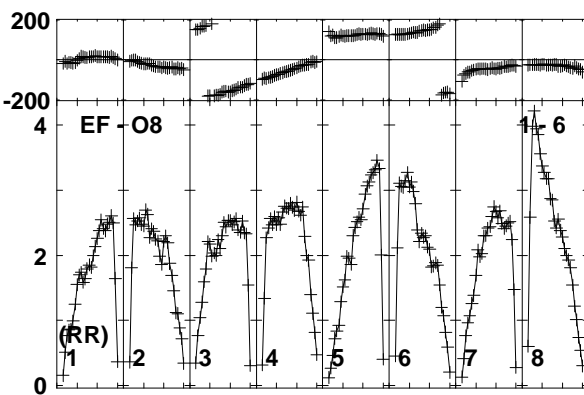
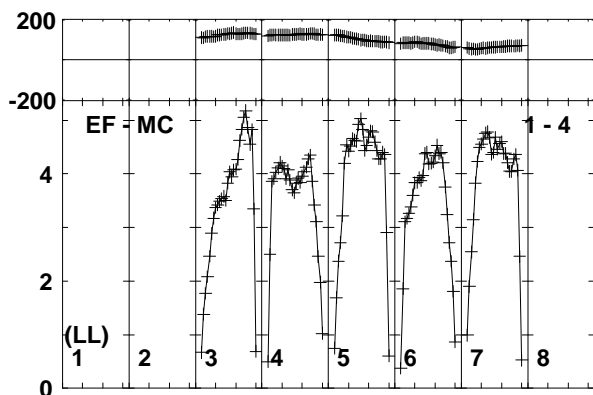
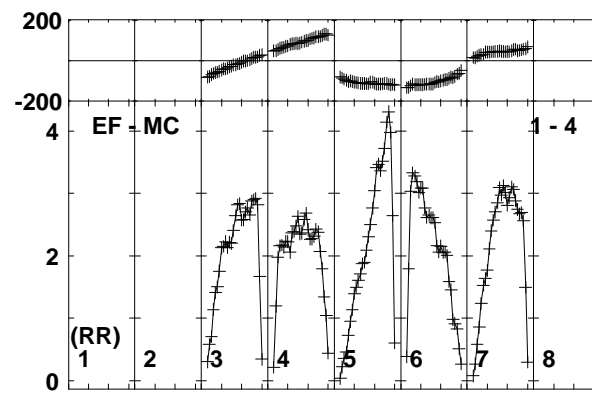
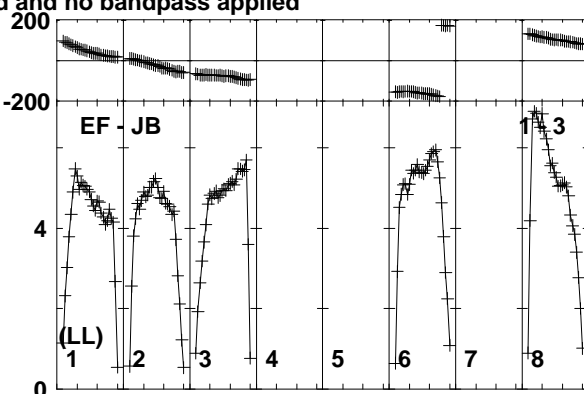
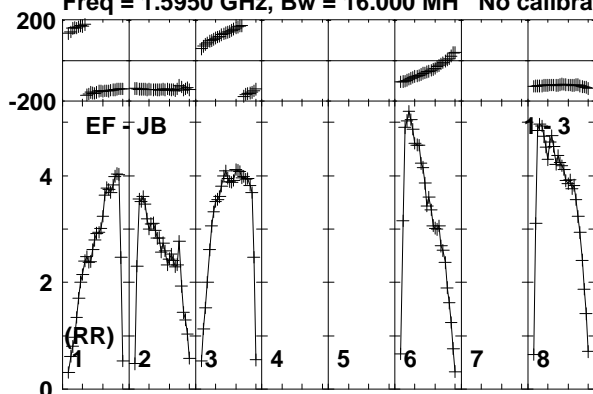

Lower frame: Milli Ampl Jy Top frame: Phas deg  
Vector averaged cross-power spectrum Baseline: EF (01) - JB (03)  
Timerange: 01/04:58:32 to 01/04:59:48

Plot file version 320 created 26-JUN-2015 10:51:31

J2025+3343 ET031A.UVDATA.1

Freq = 1.5950 GHz, Bw = 16.000 MH No calibration applied and no bandpass applied

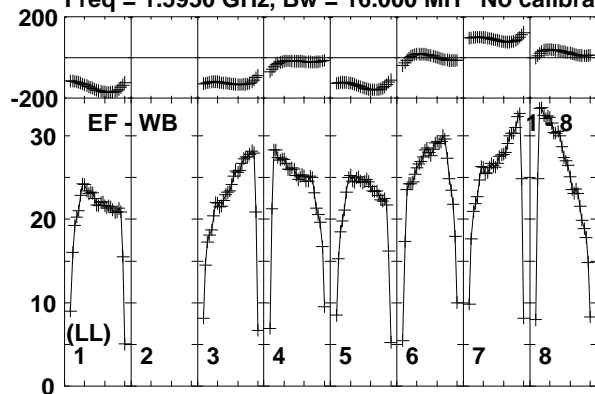

Lower frame: Milli Ampl Jy Top frame: Phas deg  
Vector averaged cross-power spectrum Baseline: EF (01) - WB (08)  
Timerange: 01/04:58:32 to 01/04:59:48



Plot file version 321 created 26-JUN-2015 10:51:31

V404CYG ET031A.UVDATA.1

Freq = 1.5950 GHz, Bw = 16.000 MH No calibration applied and no bandpass applied

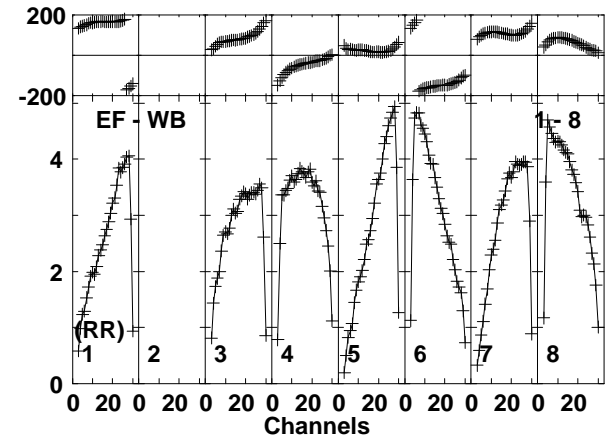
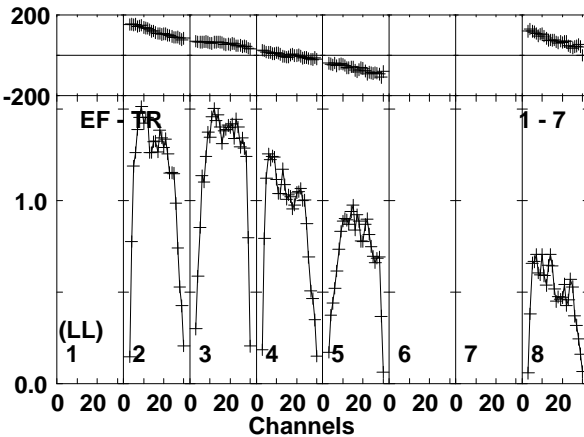
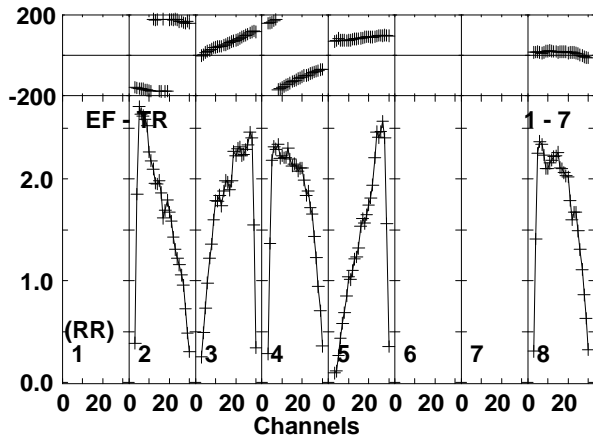
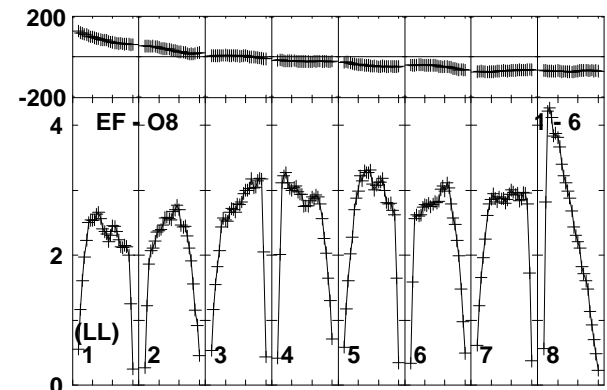
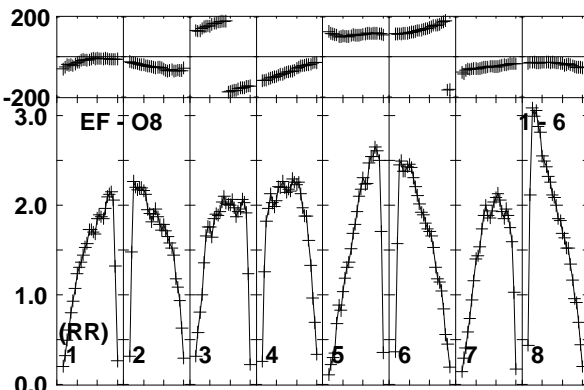
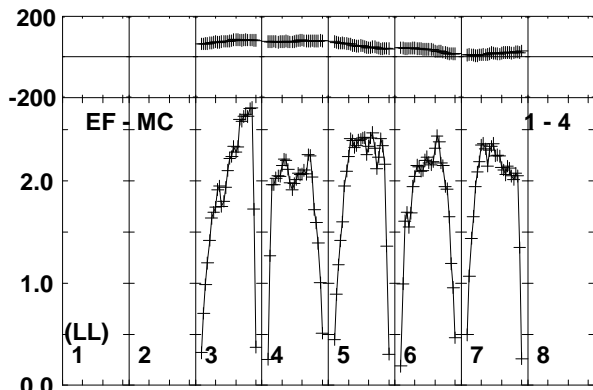
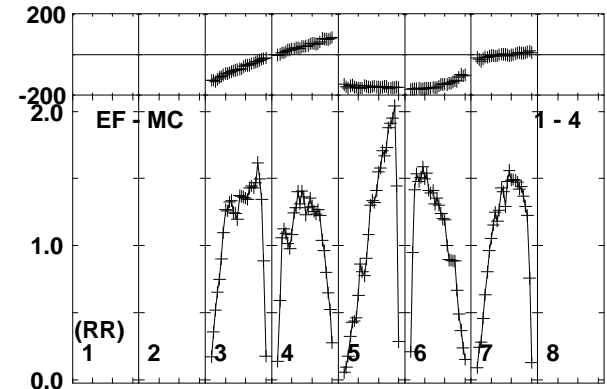
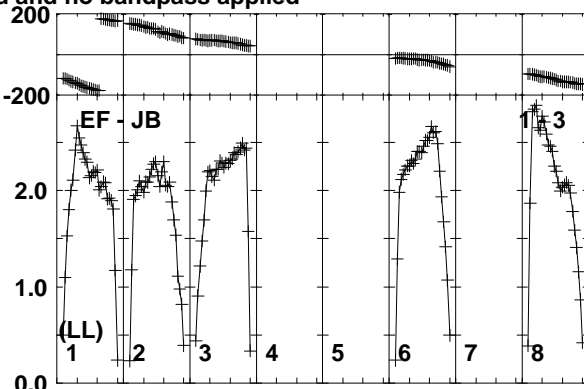
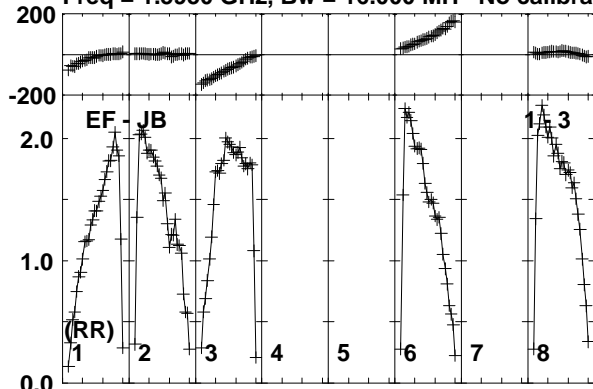

Lower frame: Milli Ampl Jy Top frame: Phas deg  
Vector averaged cross-power spectrum Baseline: EF (01) - JB (03)  
Timerange: 01/04:59:52 to 01/05:03:18

Plot file version 322 created 26-JUN-2015 10:51:31

V404CYG ET031A.UVDATA.1

Freq = 1.5950 GHz, Bw = 16.000 MH No calibration applied and no bandpass applied

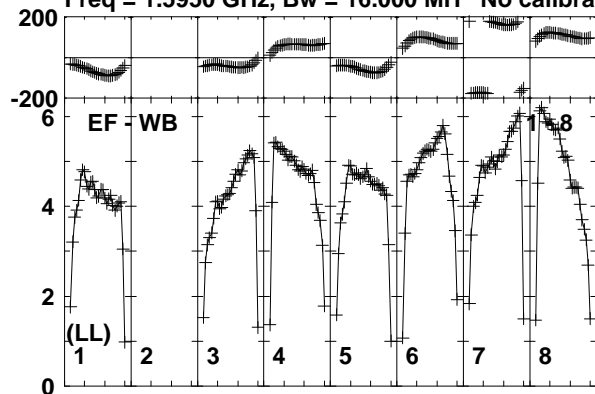

Lower frame: Milli Ampl Jy Top frame: Phas deg

Vector averaged cross-power spectrum Baseline: EF (01) - WB (08)

Timerange: 01/04:59:52 to 01/05:03:18

Plot file version 323 created 26-JUN-2015 10:51:31

J2025+3343 ET031A.UVDATA.1

Freq = 1.5950 GHz, Bw = 16.000 MH No calibration applied and no bandpass applied

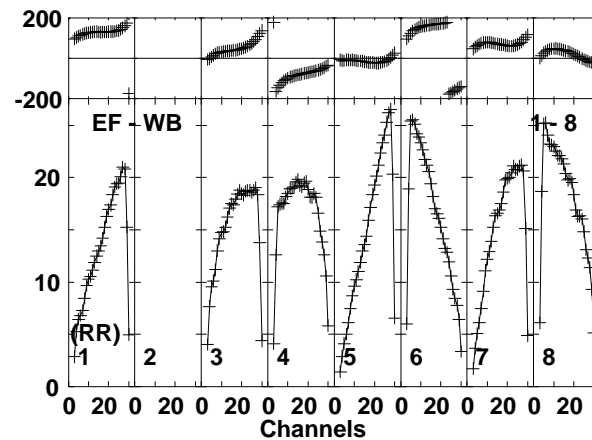
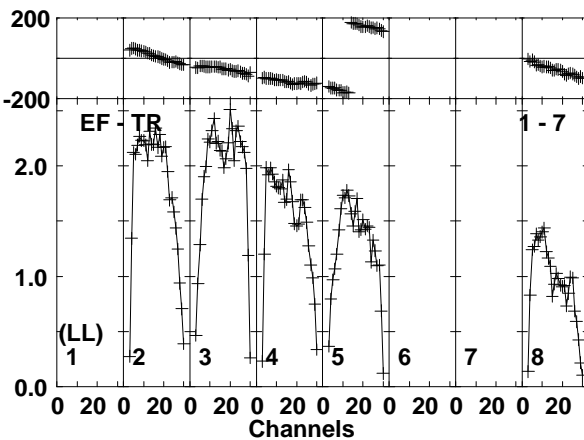
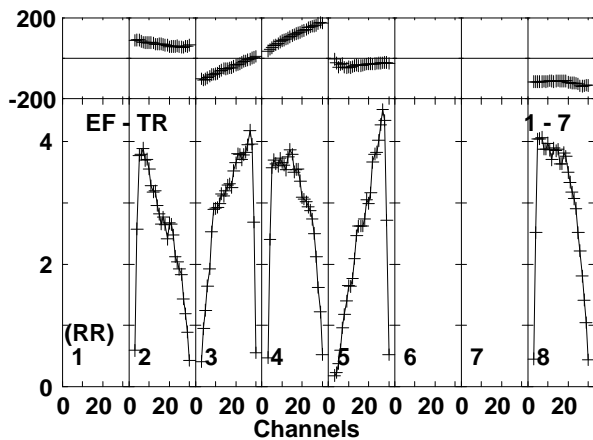
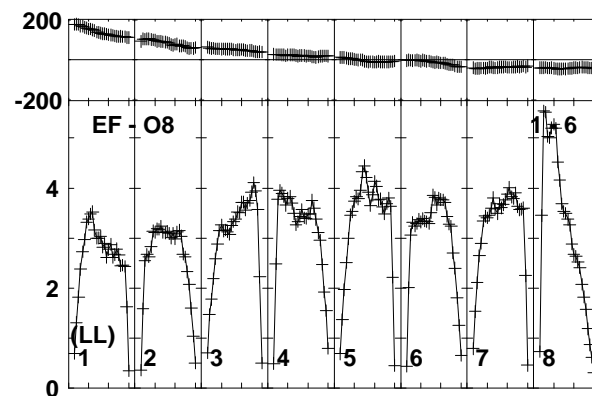
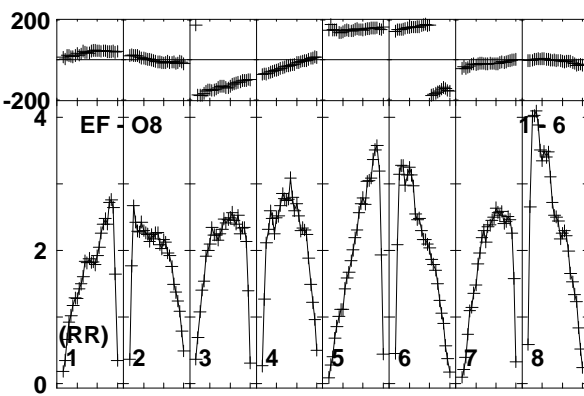
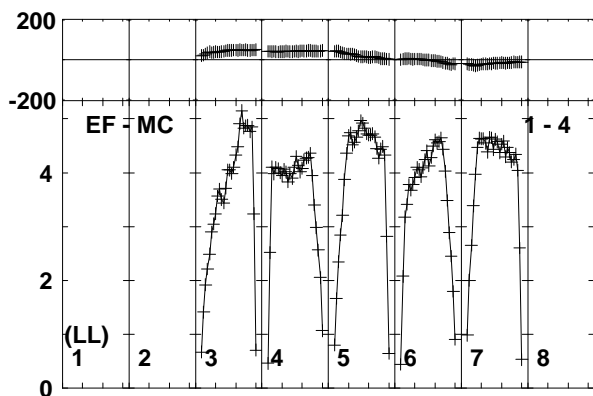
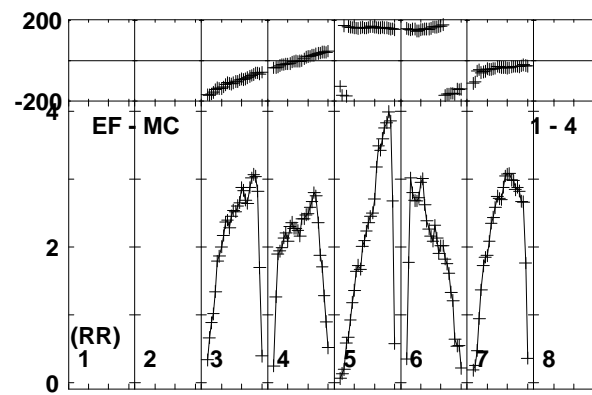
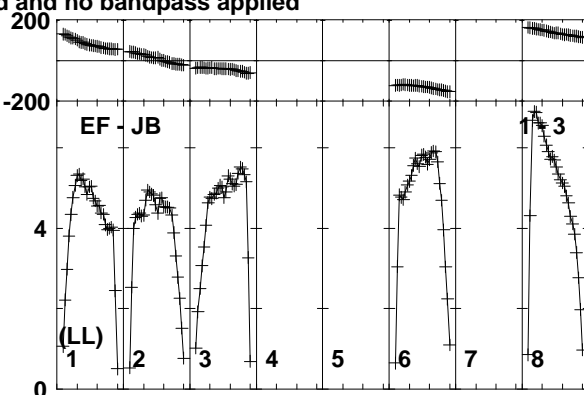
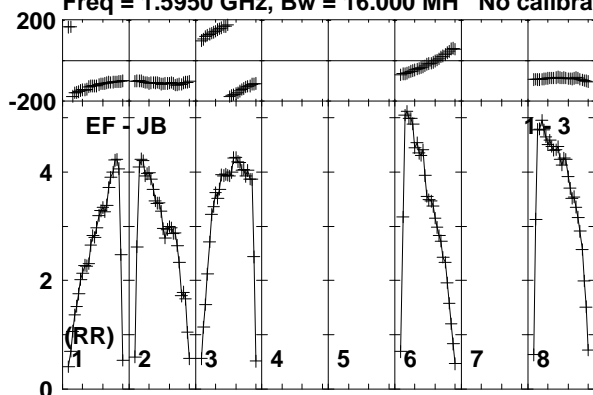

Lower frame: Milli Ampl Jy Top frame: Phas deg  
Vector averaged cross-power spectrum Baseline: EF (01) - JB (03)  
Timerange: 01/05:04:02 to 01/05:04:58

Plot file version 324 created 26-JUN-2015 10:51:31  
J2025+3343 ET031A.UVDATA.1  
Freq = 1.5950 GHz, Bw = 16.000 MH No calibration applied and no bandpass applied

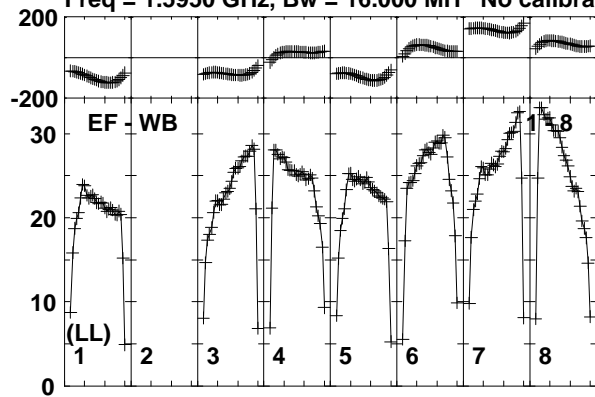

Lower frame: Milli Ampl Jy Top frame: Phas deg  
Vector averaged cross-power spectrum Baseline: EF (01) - WB (08)  
Timerange: 01/05:04:02 to 01/05:04:58

Plot file version 325 created 26-JUN-2015 10:51:31

V404CYG ET031A.UVDATA.1

Freq = 1.5950 GHz, Bw = 16.000 MH No calibration applied and no bandpass applied

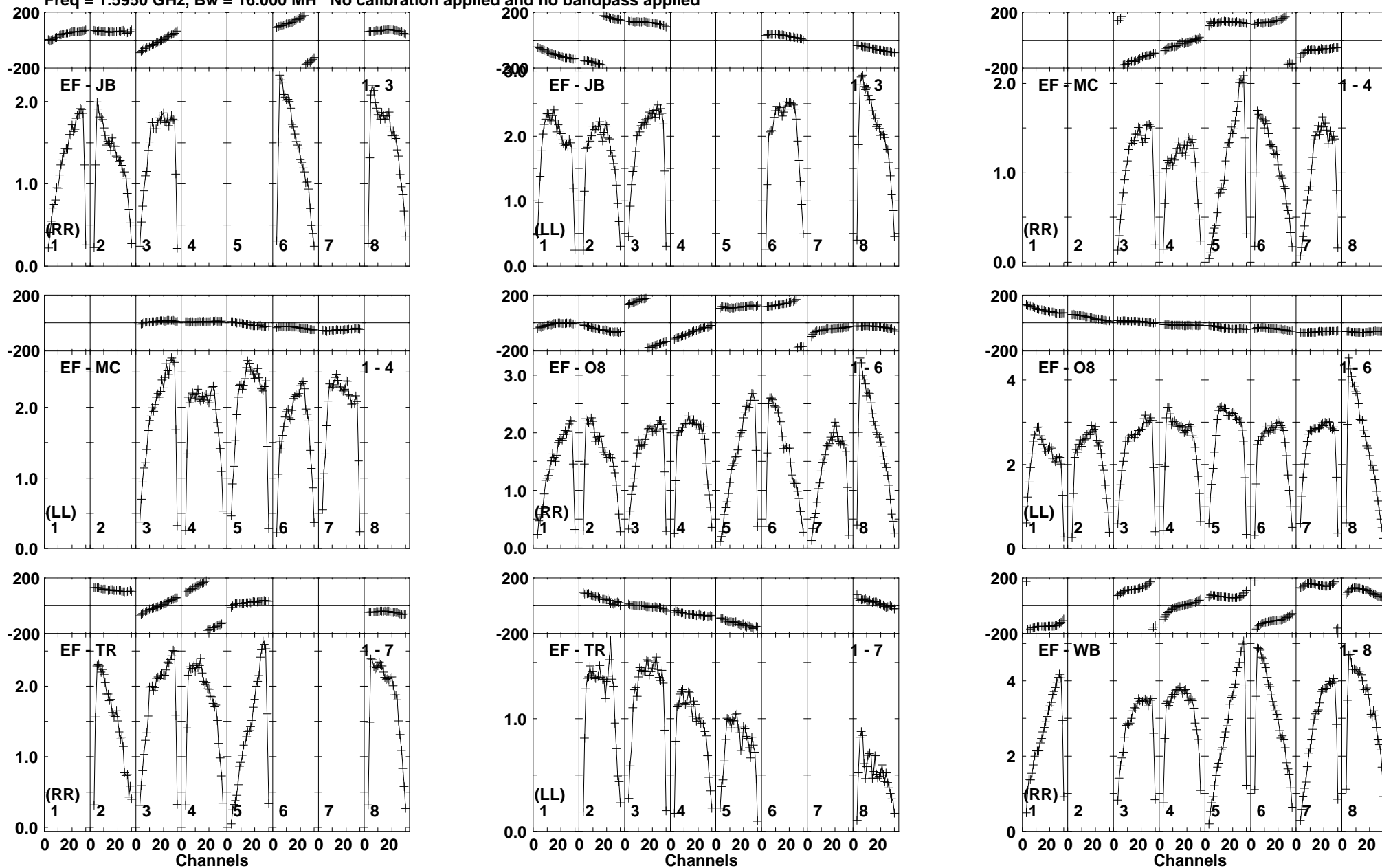

Lower frame: Milli Ampl Jy Top frame: Phas deg  
Vector averaged cross-power spectrum Baseline: EF (01) - JB (03)  
Timerange: 01/05:05:02 to 01/05:08:28

Plot file version 326 created 26-JUN-2015 10:51:31

V404CYG ET031A.UVDATA.1

Freq = 1.5950 GHz, Bw = 16.000 MH No calibration applied and no bandpass applied

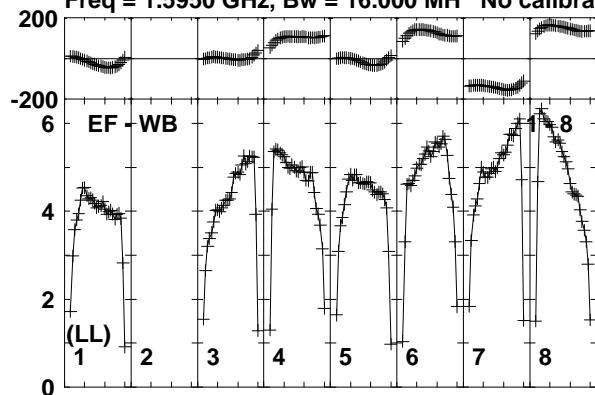

Lower frame: Milli Ampl Jy Top frame: Phas deg

Vector averaged cross-power spectrum Baseline: EF (01) - WB (08)

Timerange: 01/05:05:02 to 01/05:08:28

Plot file version 327 created 26-JUN-2015 10:51:31  
 J2025+3343 ET031A.UVDATA.1  
 Freq = 1.5950 GHz, Bw = 16.000 MH No calibration applied and no bandpass applied

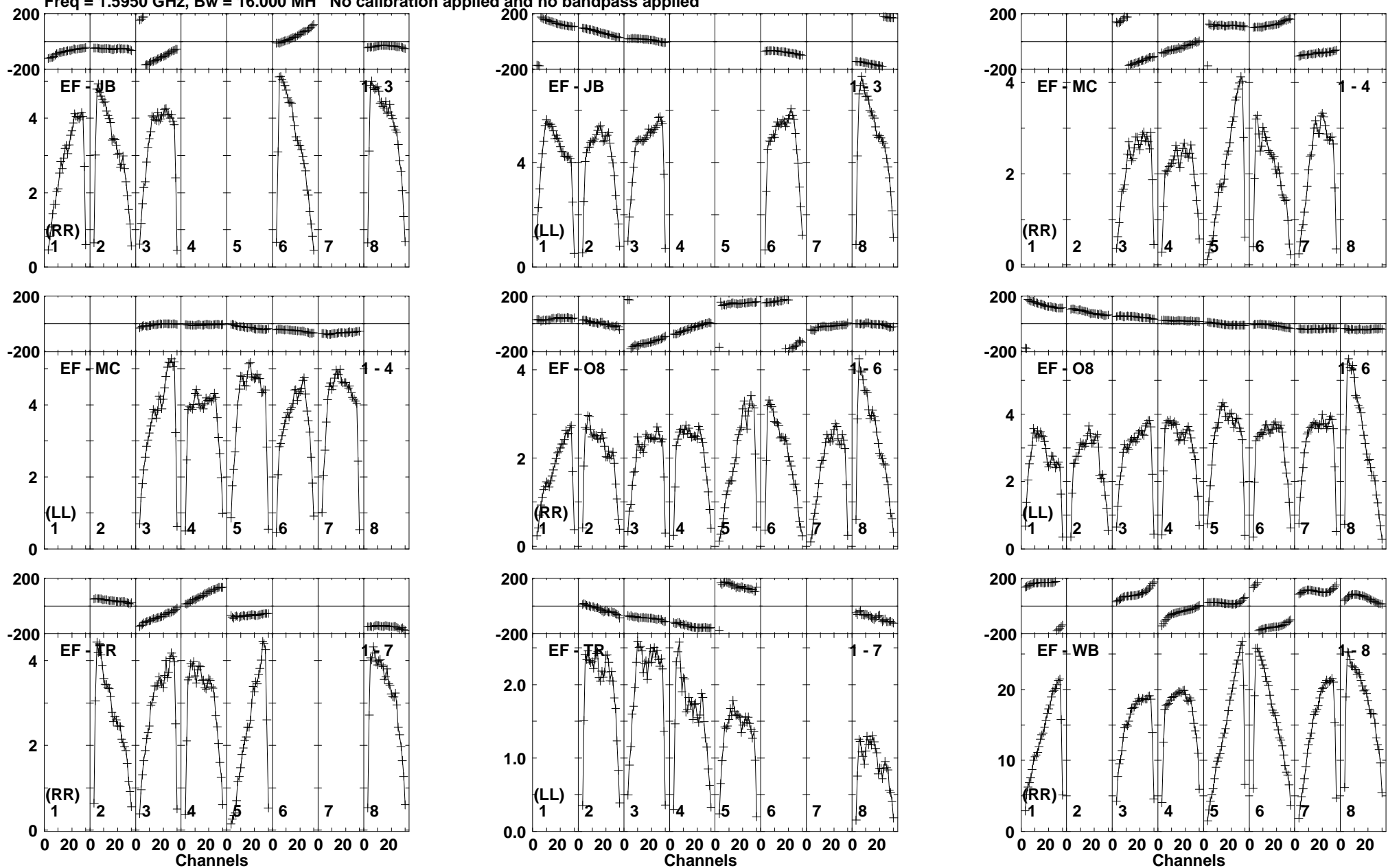

Lower frame: Milli Ampl Jy Top frame: Phas deg  
 Vector averaged cross-power spectrum Baseline: EF (01) - JB (03)  
 Timerange: 01/05:08:32 to 01/05:09:48

Plot file version 328 created 26-JUN-2015 10:51:31  
J2025+3343 ET031A.UVDATA.1  
Freq = 1.5950 GHz, Bw = 16.000 MH No calibration applied and no bandpass applied

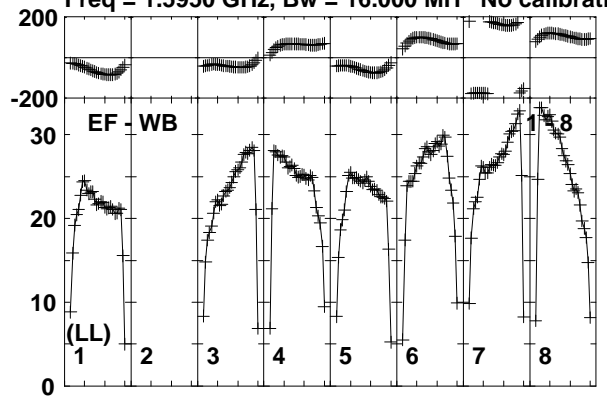

Lower frame: Milli Ampl Jy Top frame: Phas deg  
Vector averaged cross-power spectrum Baseline: EF (01) - WB (08)  
Timerange: 01/05:08:32 to 01/05:09:48



Plot file version 329 created 26-JUN-2015 10:51:31

V404CYG ET031A.UVDATA.1

Freq = 1.5950 GHz, Bw = 16.000 MH No calibration applied and no bandpass applied

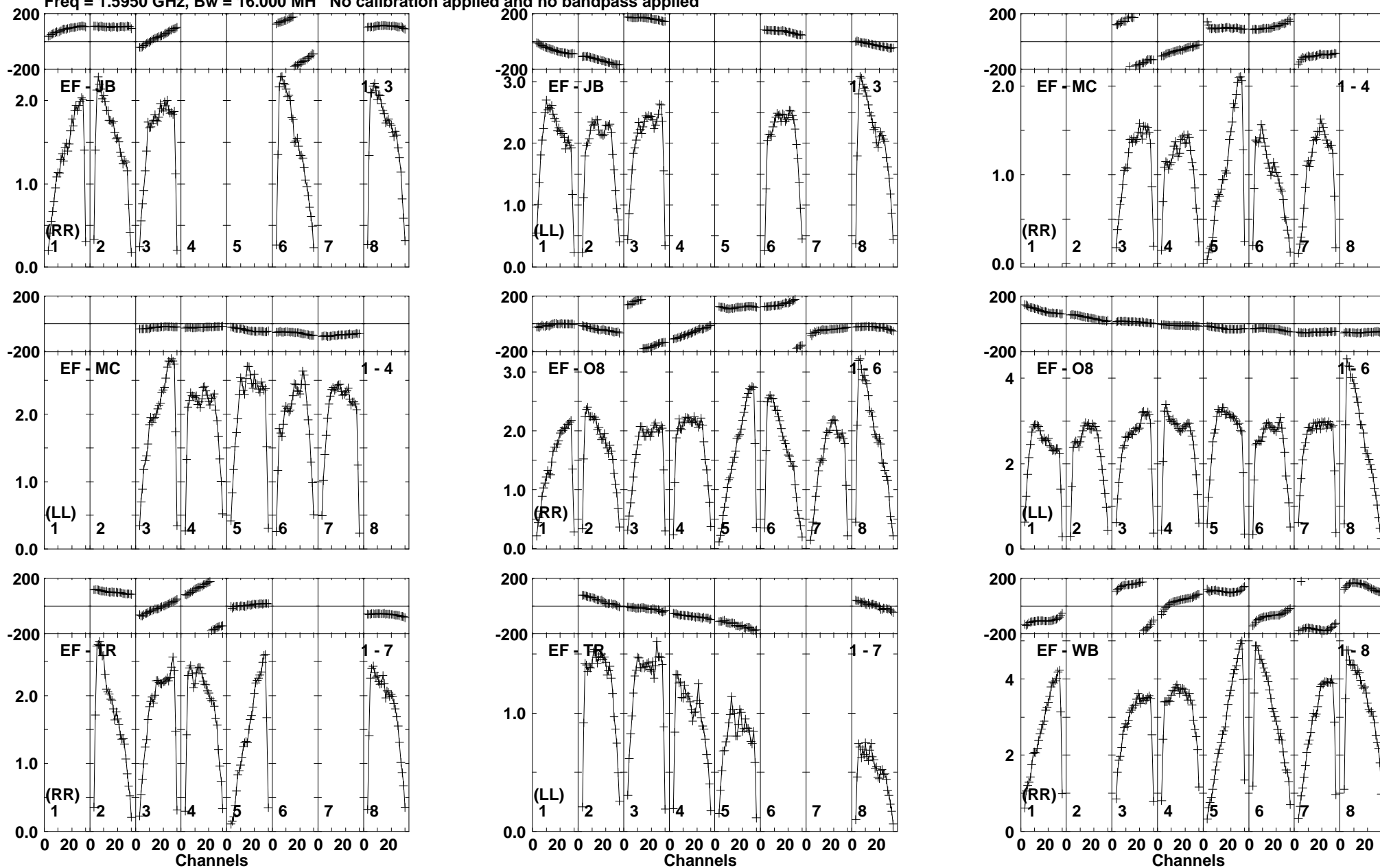

Lower frame: Milli Ampl Jy Top frame: Phas deg  
Vector averaged cross-power spectrum Baseline: EF (01) - JB (03)  
Timerange: 01/05:09:52 to 01/05:13:18

Plot file version 330 created 26-JUN-2015 10:51:31

V404CYG ET031A.UVDATA.1

Freq = 1.5950 GHz, Bw = 16.000 MH No calibration applied and no bandpass applied

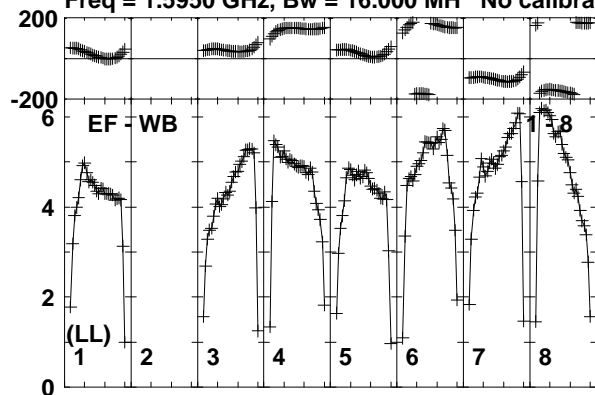

Lower frame: Milli Ampl Jy Top frame: Phas deg  
Vector averaged cross-power spectrum Baseline: EF (01) - WB (08)  
Timerange: 01/05:09:52 to 01/05:13:18

Plot file version 331 created 26-JUN-2015 10:51:31  
 J2025+3343 ET031A.UVDATA.1  
 Freq = 1.5950 GHz, Bw = 16.000 MH No calibration applied and no bandpass applied

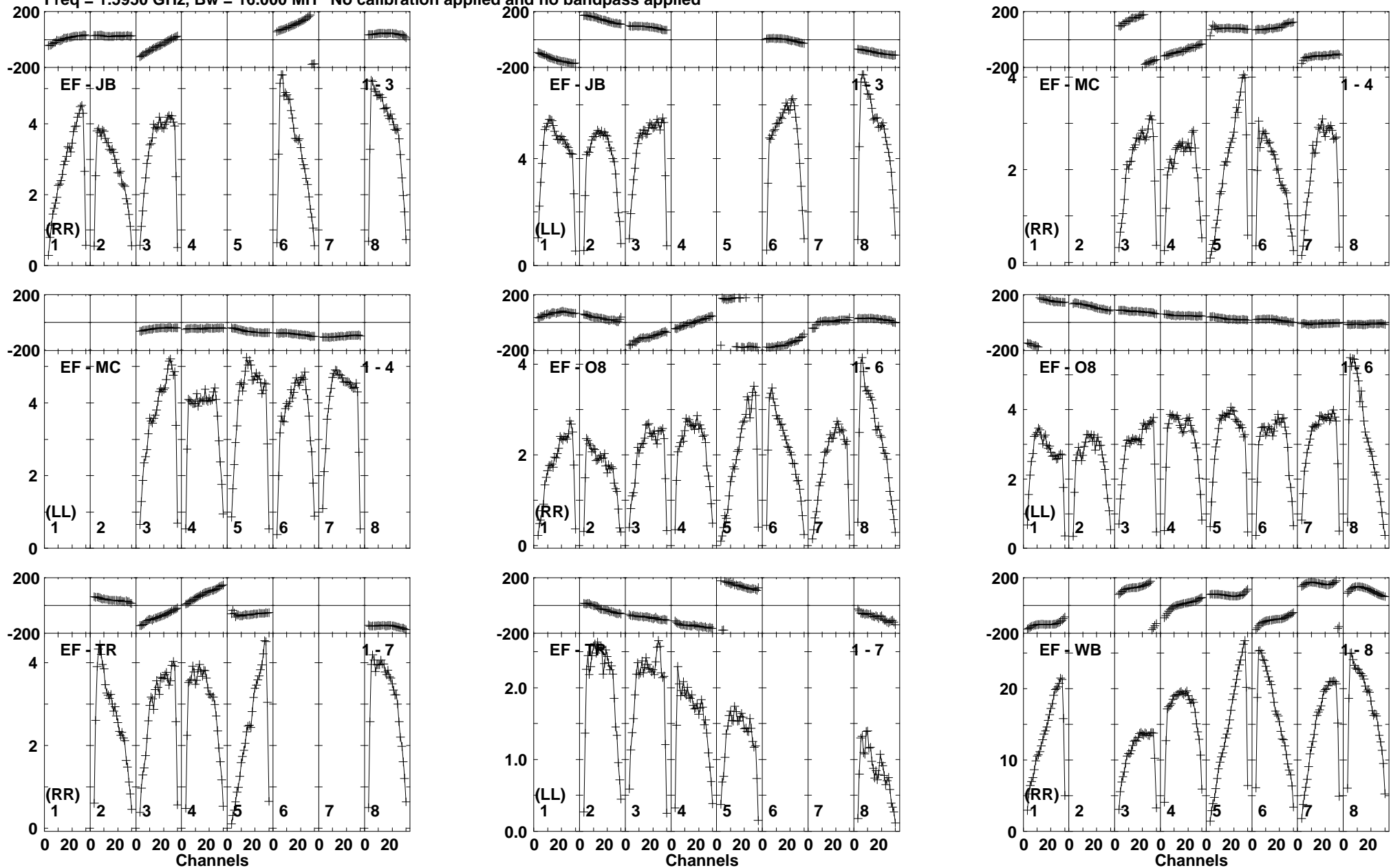

Lower frame: Milli Ampl Jy Top frame: Phas deg  
 Vector averaged cross-power spectrum Baseline: EF (01) - JB (03)  
 Timerange: 01/05:14:02 to 01/05:14:58

Plot file version 332 created 26-JUN-2015 10:51:31

J2025+3343 ET031A.UVDATA.1

Freq = 1.5950 GHz, Bw = 16.000 MH No calibration applied and no bandpass applied

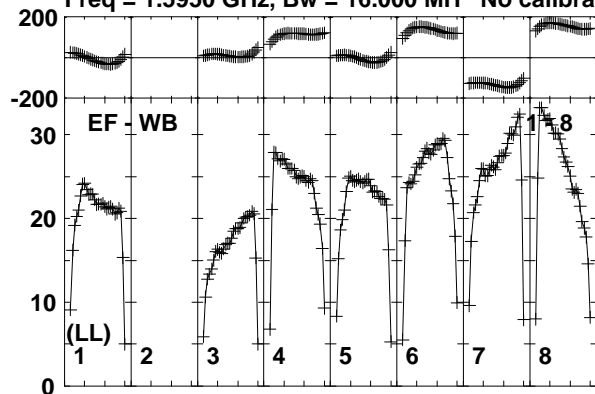

Lower frame: Milli Ampl Jy Top frame: Phas deg  
Vector averaged cross-power spectrum Baseline: EF (01) - WB (08)  
Timerange: 01/05:14:02 to 01/05:14:58

Plot file version 333 created 26-JUN-2015 10:51:31

V404CYG ET031A.UVDATA.1

Freq = 1.5950 GHz, Bw = 16.000 MH No calibration applied and no bandpass applied

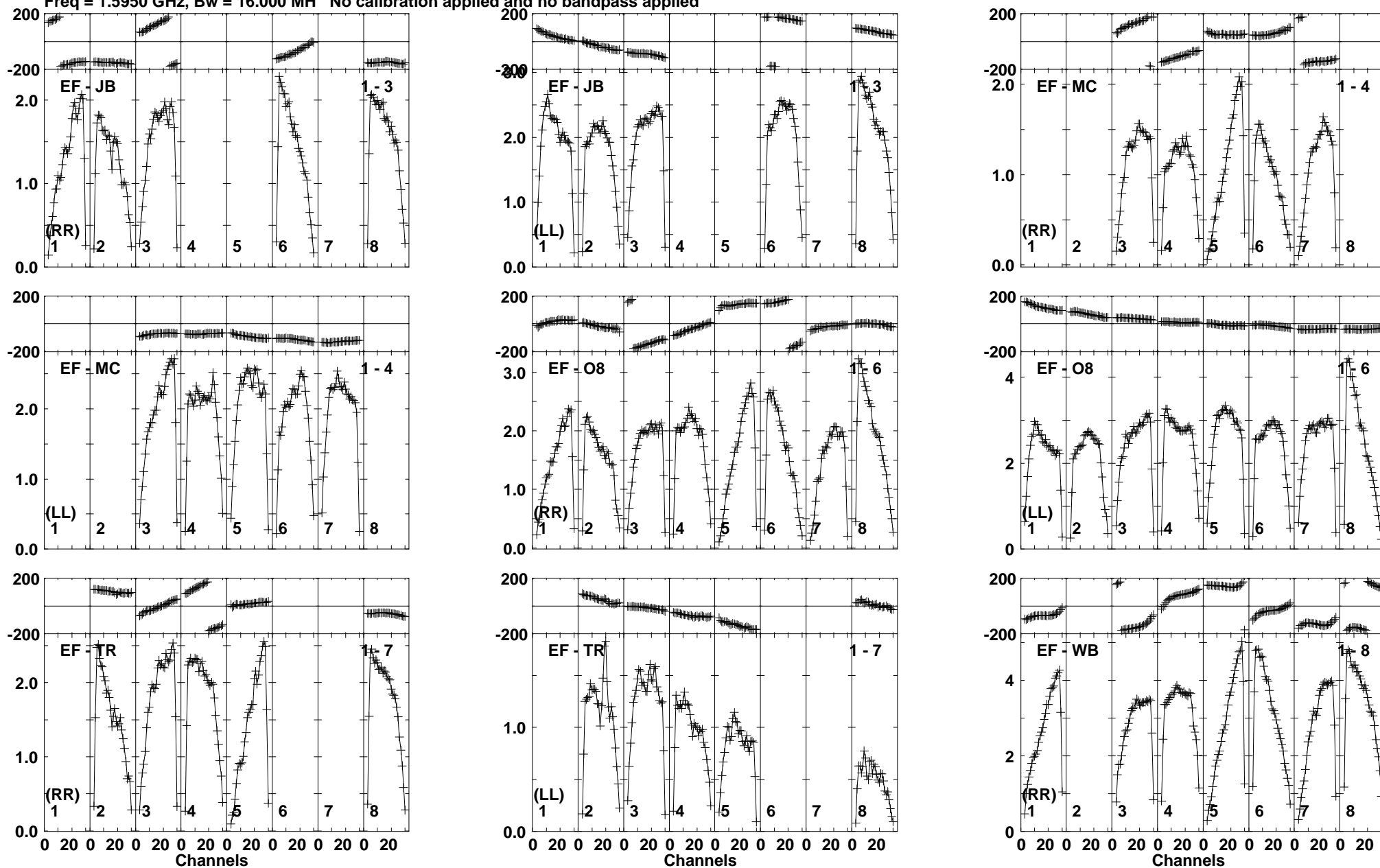

Lower frame: Milli Ampl Jy Top frame: Phas deg  
Vector averaged cross-power spectrum Baseline: EF (01) - JB (03)  
Timerange: 01/05:15:02 to 01/05:18:28

Plot file version 334 created 26-JUN-2015 10:51:31

V404CYG ET031A.UVDATA.1

Freq = 1.5950 GHz, Bw = 16.000 MH No calibration applied and no bandpass applied

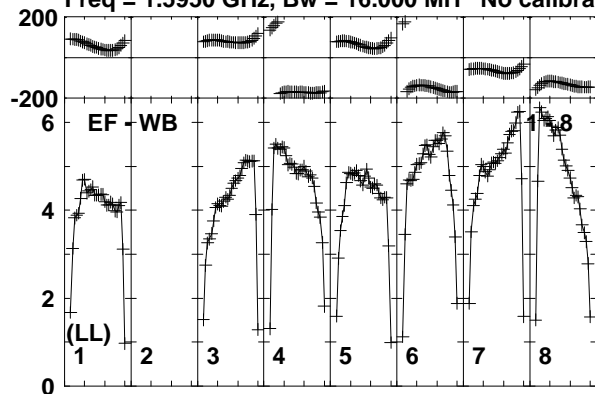

Lower frame: Milli Ampl Jy Top frame: Phas deg  
Vector averaged cross-power spectrum Baseline: EF (01) - WB (08)  
Timerange: 01/05:15:02 to 01/05:18:28

Plot file version 335 created 26-JUN-2015 10:51:31  
 J2025+3343 ET031A.UVDATA.1  
 Freq = 1.5950 GHz, Bw = 16.000 MH No calibration applied and no bandpass applied

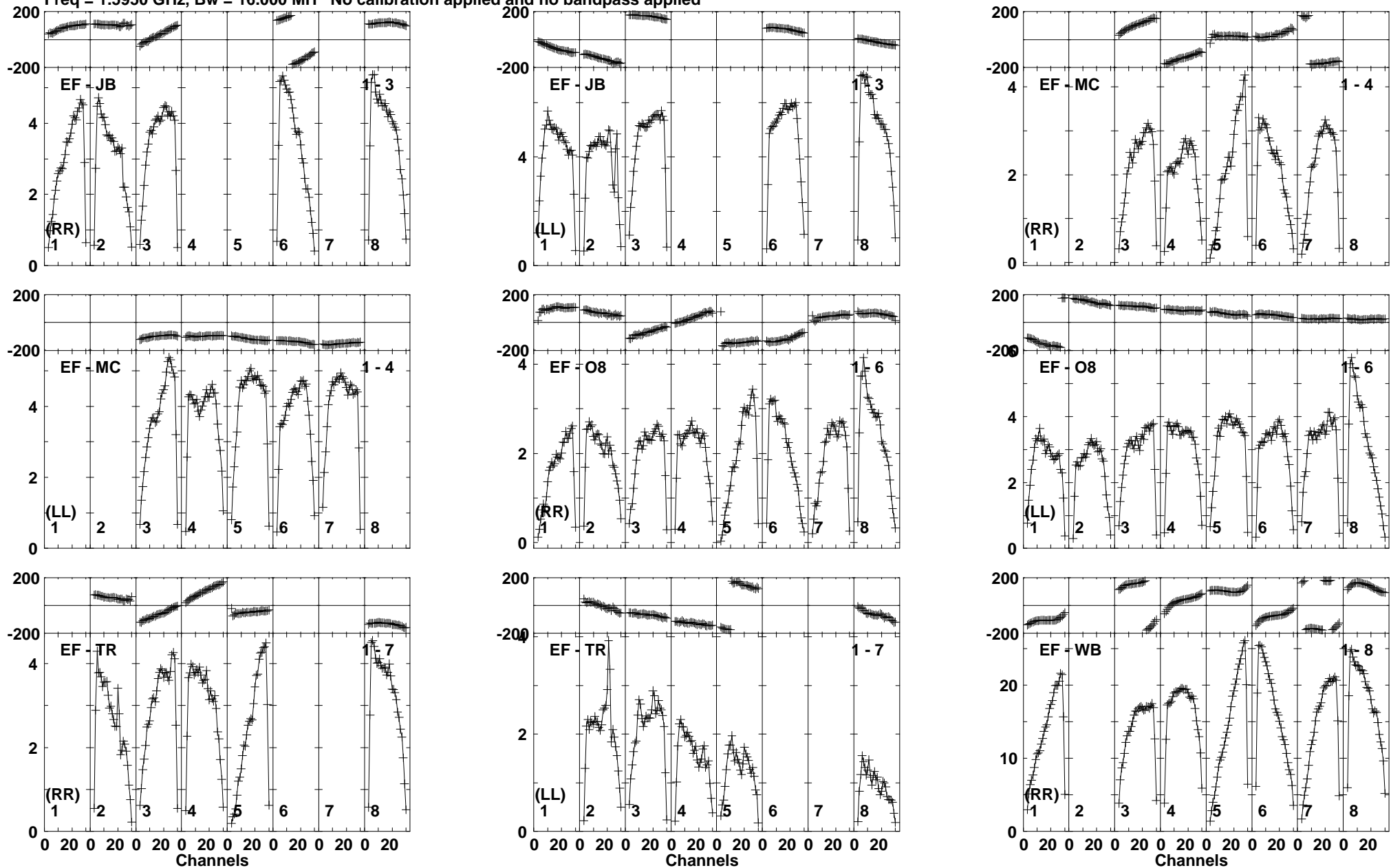

Lower frame: Milli Ampl Jy Top frame: Phas deg  
 Vector averaged cross-power spectrum Baseline: EF (01) - JB (03)  
 Timerange: 01/05:18:32 to 01/05:19:48

Plot file version 336 created 26-JUN-2015 10:51:31  
J2025+3343 ET031A.UVDATA.1  
Freq = 1.5950 GHz, Bw = 16.000 MH No calibration applied and no bandpass applied

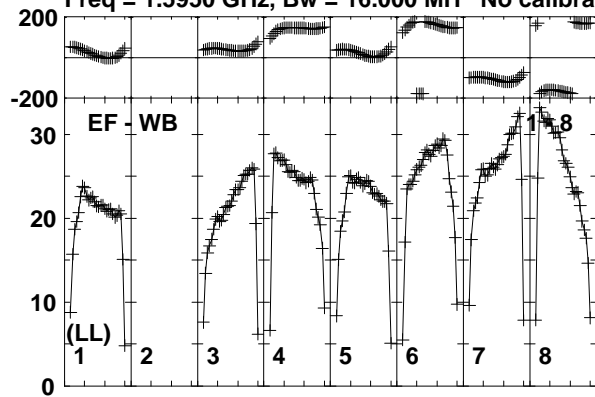

Lower frame: Milli Ampl Jy Top frame: Phas deg  
Vector averaged cross-power spectrum Baseline: EF (01) - WB (08)  
Timerange: 01/05:18:32 to 01/05:19:48



Plot file version 337 created 26-JUN-2015 10:51:31

V404CYG ET031A.UVDATA.1

Freq = 1.5950 GHz, Bw = 16.000 MH No calibration applied and no bandpass applied

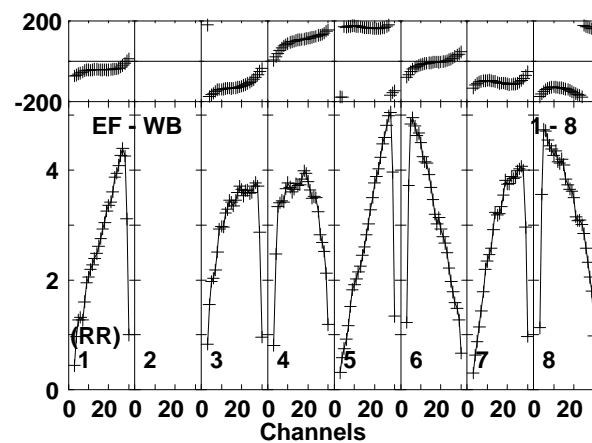
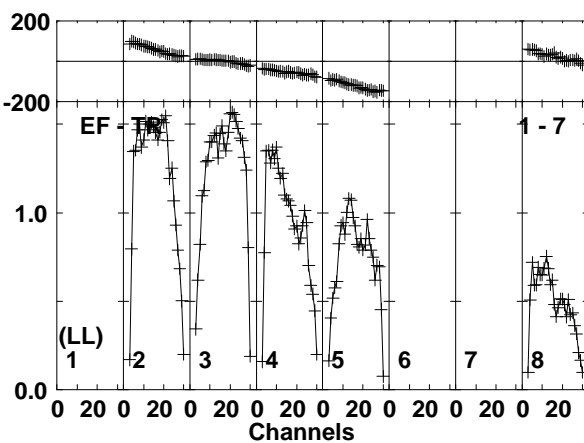
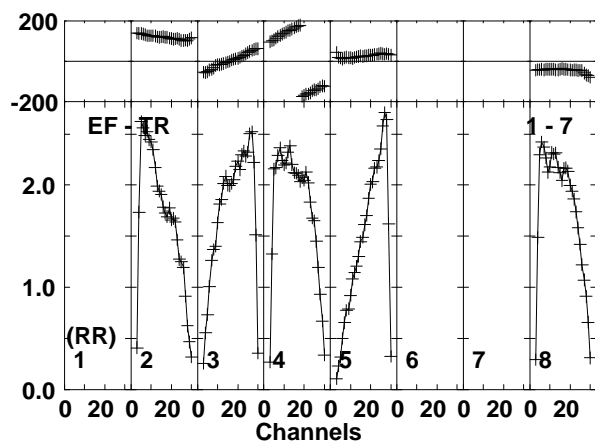
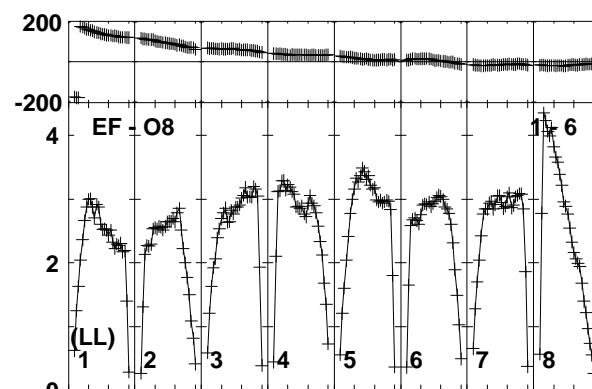
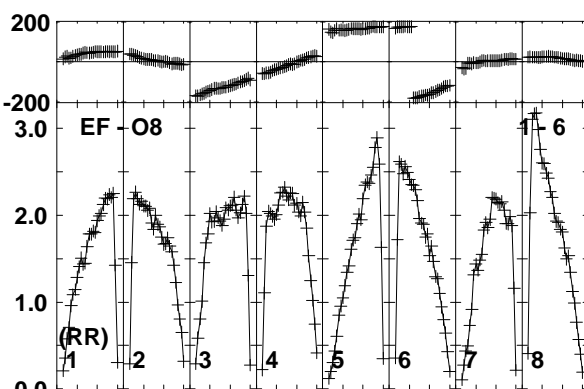
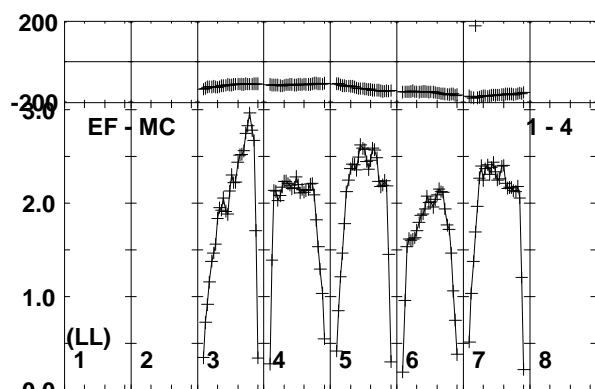
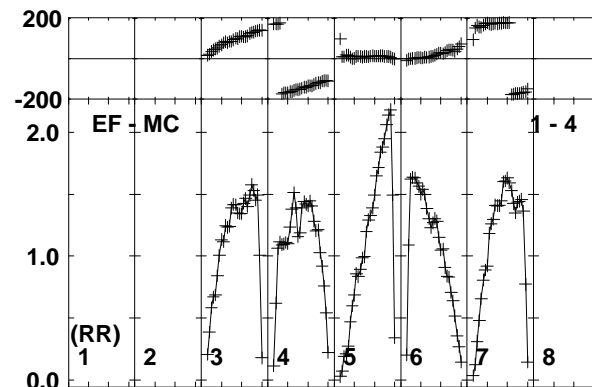
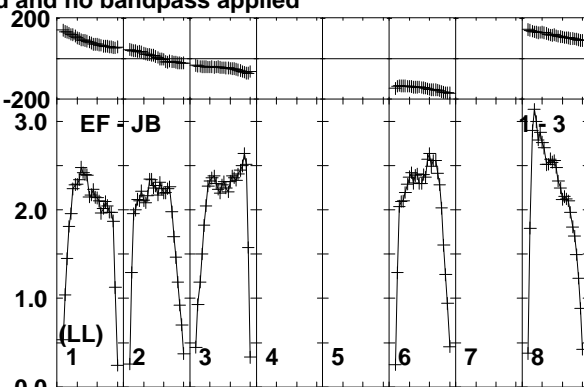
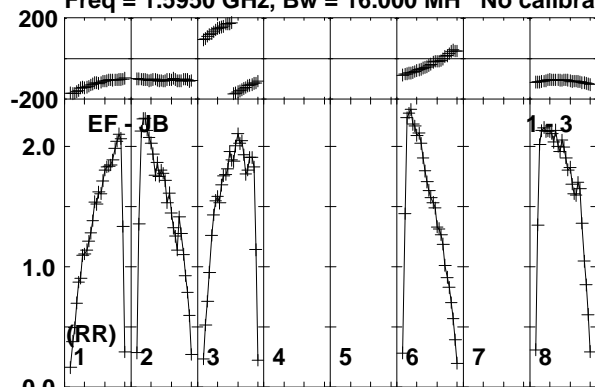

Lower frame: Milli Ampl Jy Top frame: Phas deg  
Vector averaged cross-power spectrum Baseline: EF (01) - JB (03)  
Timerange: 01/05:19:52 to 01/05:23:18

Plot file version 338 created 26-JUN-2015 10:51:31

V404CYG ET031A.UVDATA.1

Freq = 1.5950 GHz, Bw = 16.000 MH No calibration applied and no bandpass applied

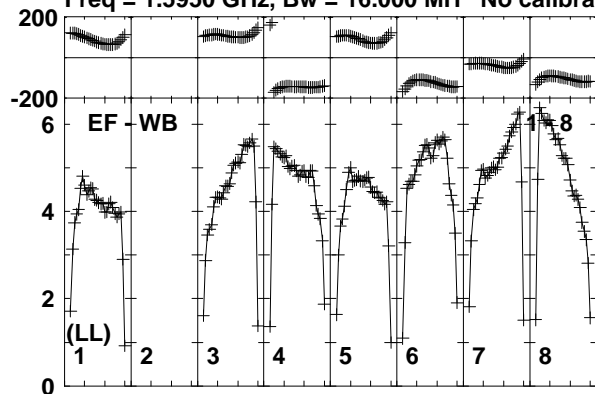

Lower frame: Milli Ampl Jy Top frame: Phas deg  
Vector averaged cross-power spectrum Baseline: EF (01) - WB (08)  
Timerange: 01/05:19:52 to 01/05:23:18

Plot file version 339 created 26-JUN-2015 10:51:31

J2025+3343 ET031A.UVDATA.1

Freq = 1.5950 GHz, Bw = 16.000 MH No calibration applied and no bandpass applied

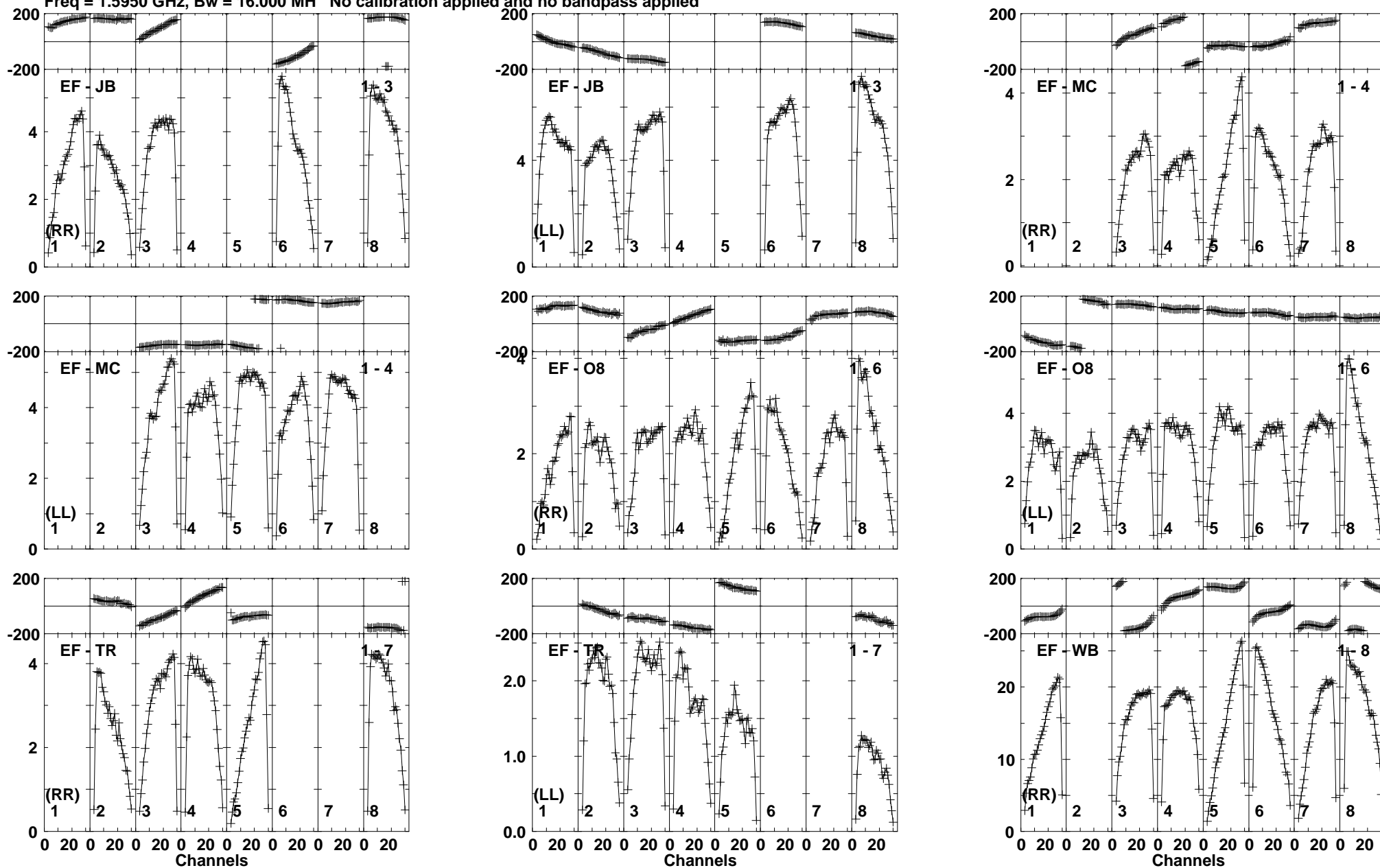

Lower frame: Milli Ampl Jy Top frame: Phas deg  
Vector averaged cross-power spectrum Baseline: EF (01) - JB (03)  
Timerange: 01/05:24:02 to 01/05:24:58

Plot file version 340 created 26-JUN-2015 10:51:32  
J2025+3343 ET031A.UVDATA.1  
Freq = 1.5950 GHz, Bw = 16.000 MH No calibration applied and no bandpass applied

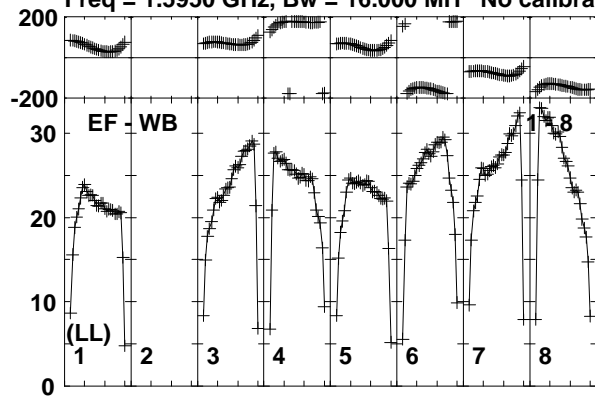

Lower frame: Milli Ampl Jy Top frame: Phas deg  
Vector averaged cross-power spectrum Baseline: EF (01) - WB (08)  
Timerange: 01/05:24:02 to 01/05:24:58

Plot file version 341 created 26-JUN-2015 10:51:32

V404CYG ET031A.UVDATA.1

Freq = 1.5950 GHz, Bw = 16.000 MH No calibration applied and no bandpass applied

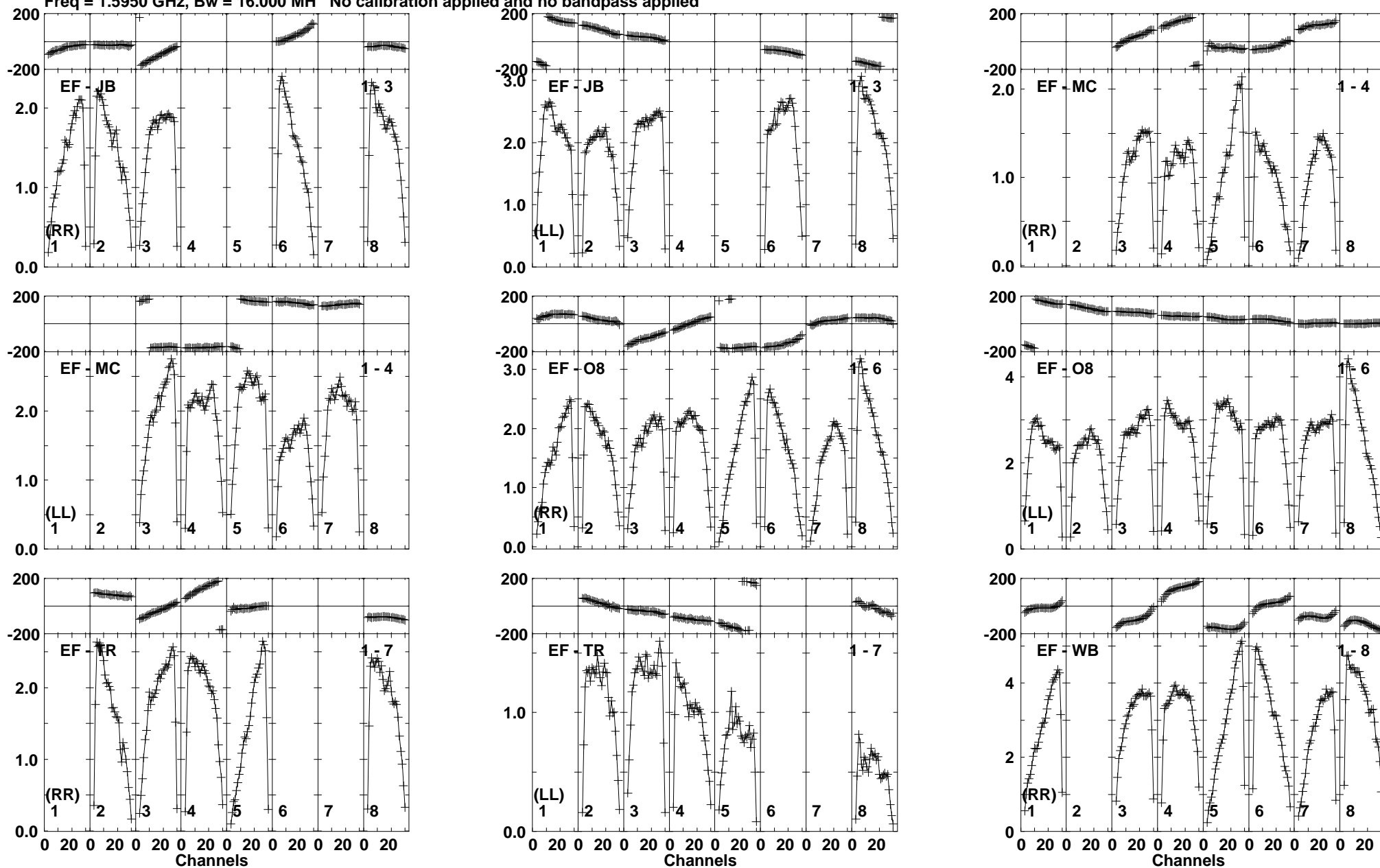

Lower frame: Milli Ampl Jy Top frame: Phas deg  
Vector averaged cross-power spectrum Baseline: EF (01) - JB (03)  
Timerange: 01/05:25:02 to 01/05:28:28

Plot file version 342 created 26-JUN-2015 10:51:32

V404CYG ET031A.UVDATA.1

Freq = 1.5950 GHz, Bw = 16.000 MH No calibration applied and no bandpass applied

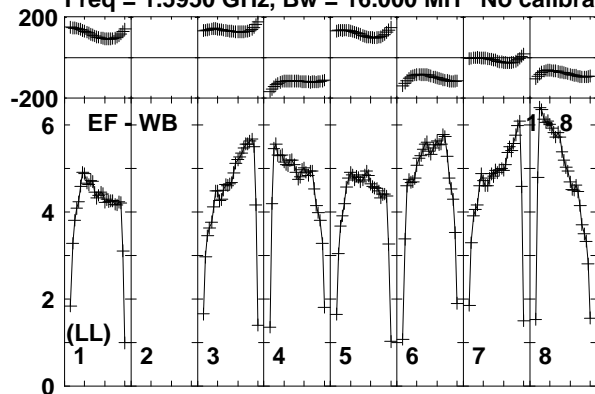

Lower frame: Milli Ampl Jy Top frame: Phas deg  
Vector averaged cross-power spectrum Baseline: EF (01) - WB (08)  
Timerange: 01/05:25:02 to 01/05:28:28

Plot file version 343 created 26-JUN-2015 10:51:32

J2025+3343 ET031A.UVDATA.1

Freq = 1.5950 GHz, Bw = 16.000 MH No calibration applied and no bandpass applied

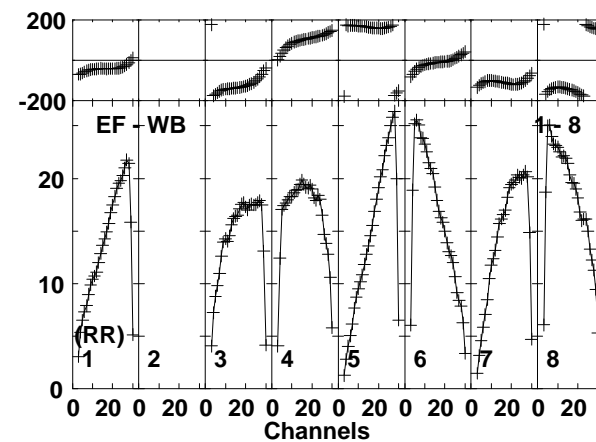
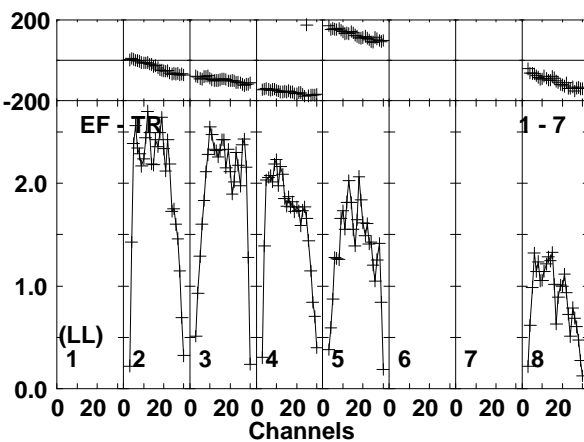
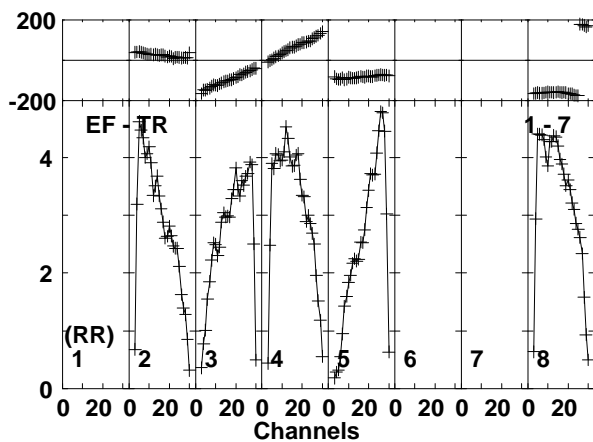
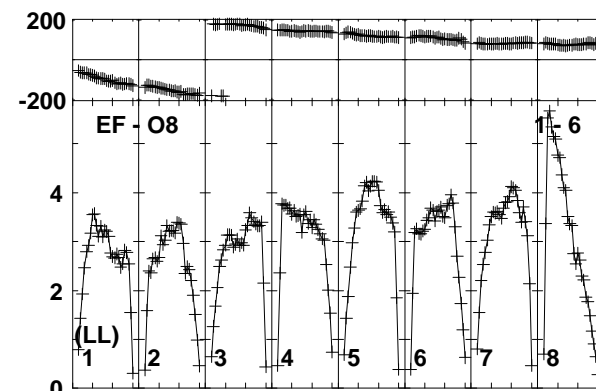
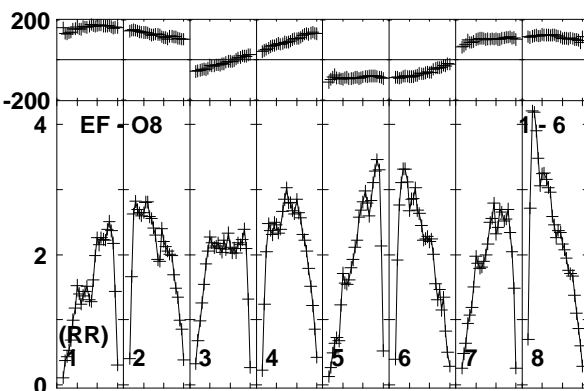
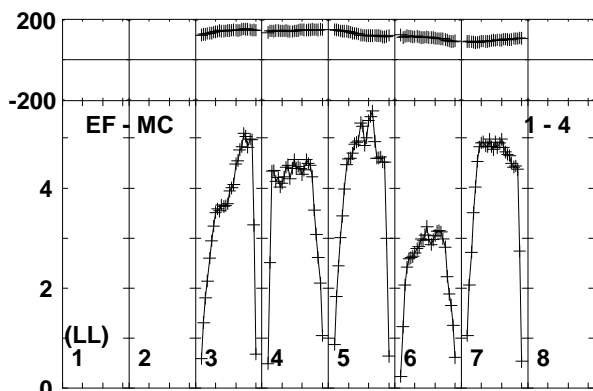
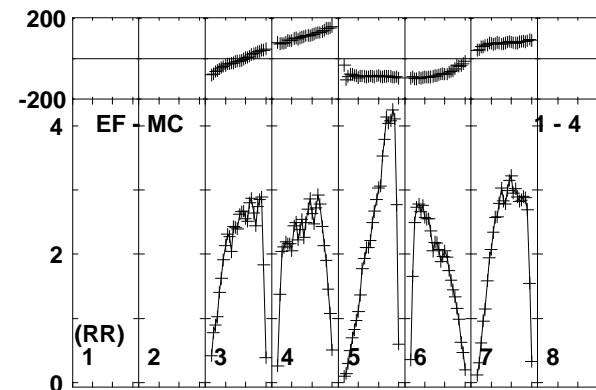
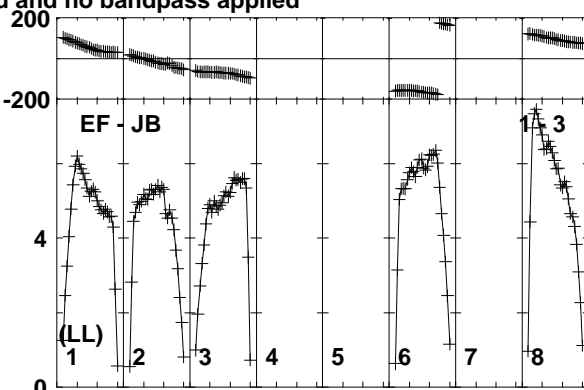
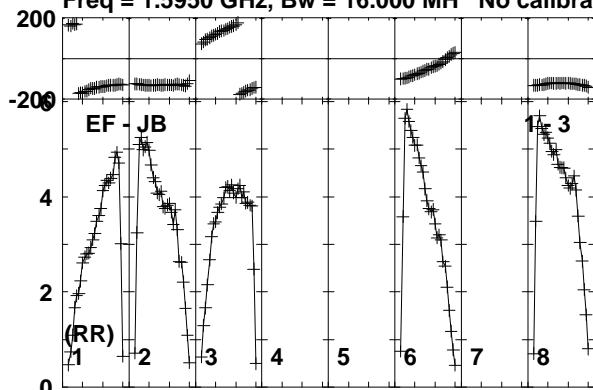

Lower frame: Milli Ampl Jy Top frame: Phas deg  
Vector averaged cross-power spectrum Baseline: EF (01) - JB (03)  
Timerange: 01/05:28:32 to 01/05:29:48

Plot file version 344 created 26-JUN-2015 10:51:32  
J2025+3343 ET031A.UVDATA.1  
Freq = 1.5950 GHz, Bw = 16.000 MH No calibration applied and no bandpass applied

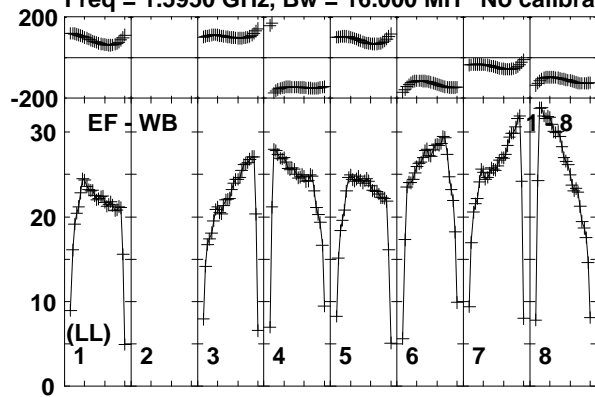

Lower frame: Milli Ampl Jy Top frame: Phas deg  
Vector averaged cross-power spectrum Baseline: EF (01) - WB (08)  
Timerange: 01/05:28:32 to 01/05:29:48



Plot file version 345 created 26-JUN-2015 10:51:32

V404CYG ET031A.UVDATA.1

Freq = 1.5950 GHz, Bw = 16.000 MH No calibration applied and no bandpass applied

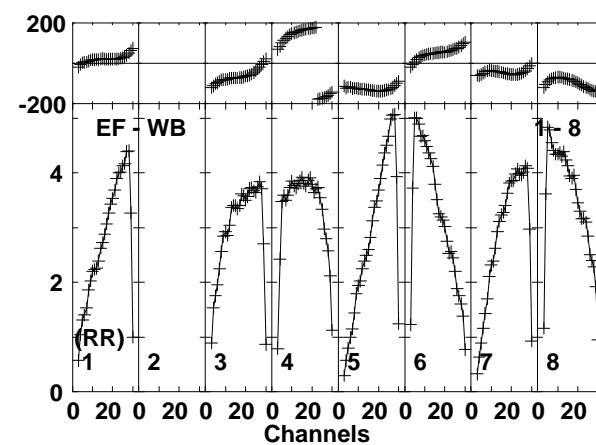
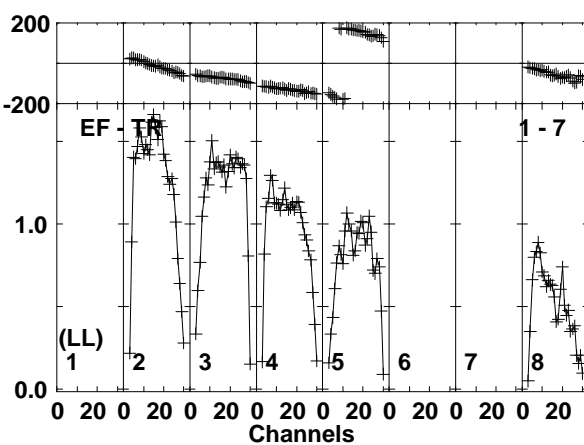
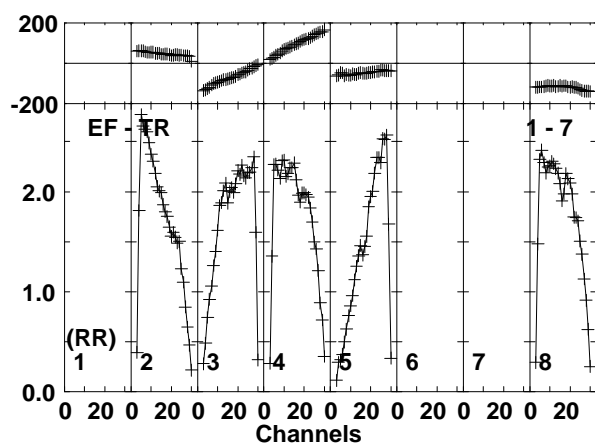
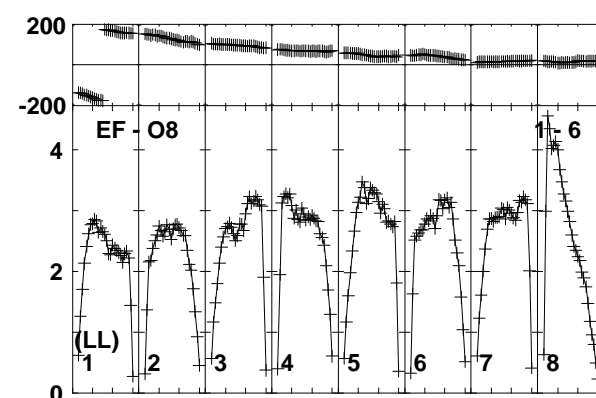
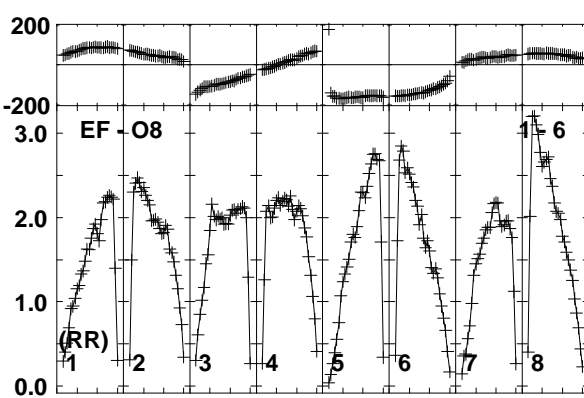
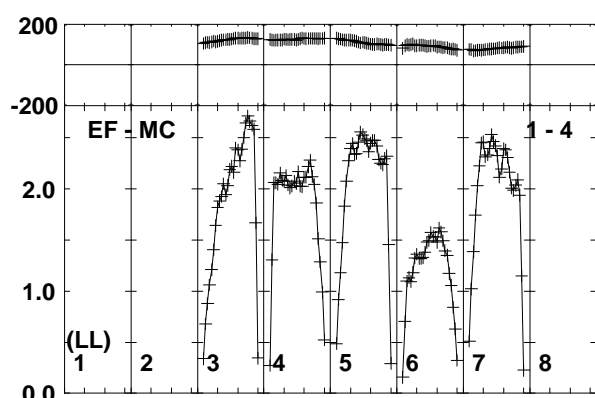
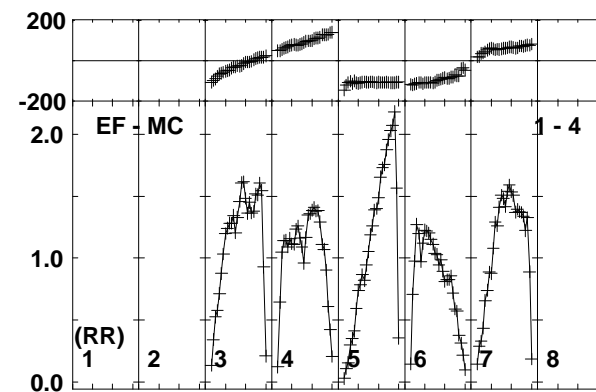
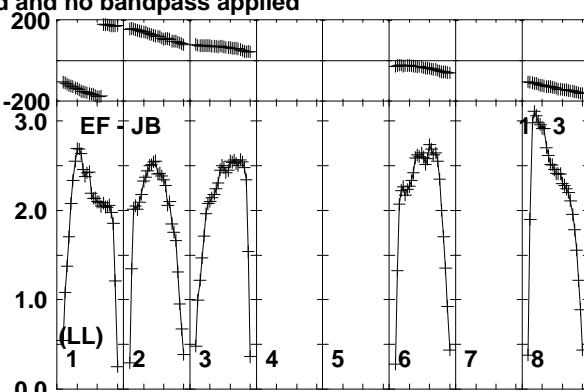
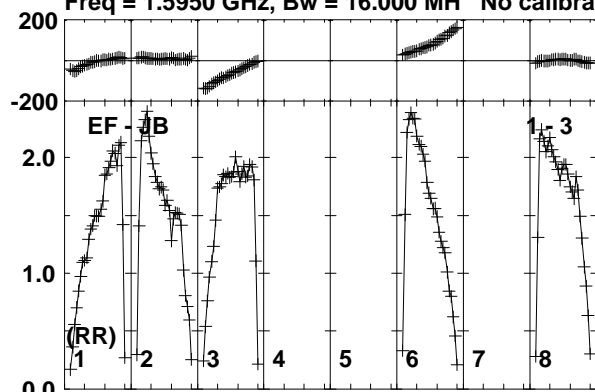

Lower frame: Milli Ampl Jy Top frame: Phas deg  
Vector averaged cross-power spectrum Baseline: EF (01) - JB (03)  
Timerange: 01/05:29:52 to 01/05:33:18

Plot file version 346 created 26-JUN-2015 10:51:32  
V404CYG ET031A.UVDATA.1  
Freq = 1.5950 GHz, Bw = 16.000 MH No calibration applied and no bandpass applied

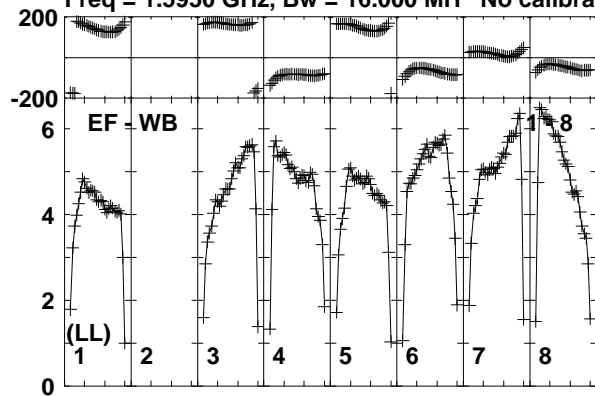

Lower frame: Milli Ampl Jy Top frame: Phas deg  
Vector averaged cross-power spectrum Baseline: EF (01) - WB (08)  
Timerange: 01/05:29:52 to 01/05:33:18

Plot file version 347 created 26-JUN-2015 10:51:32

J2025+3343 ET031A.UVDATA.1

Freq = 1.5950 GHz, Bw = 16.000 MH No calibration applied and no bandpass applied

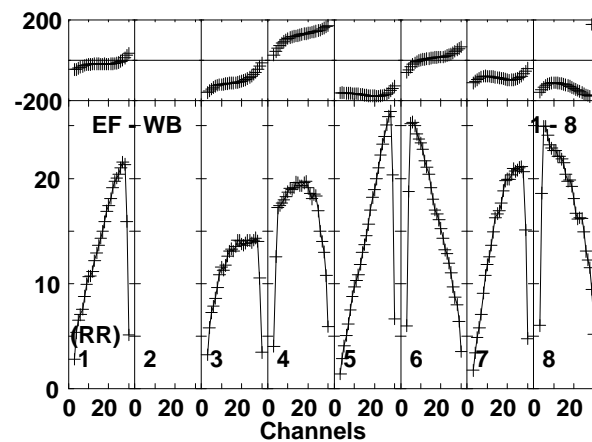
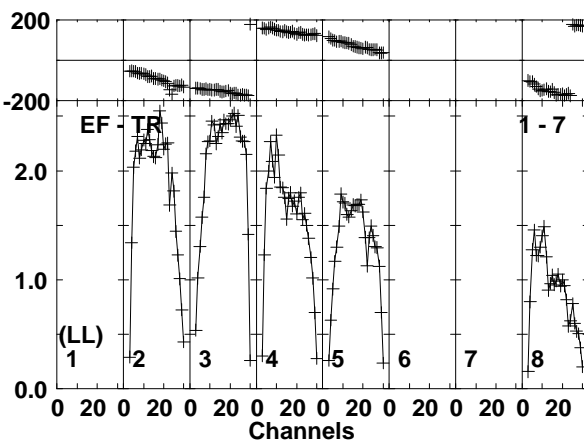
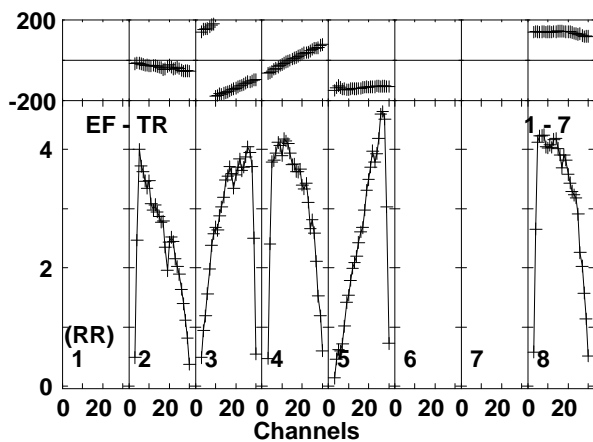
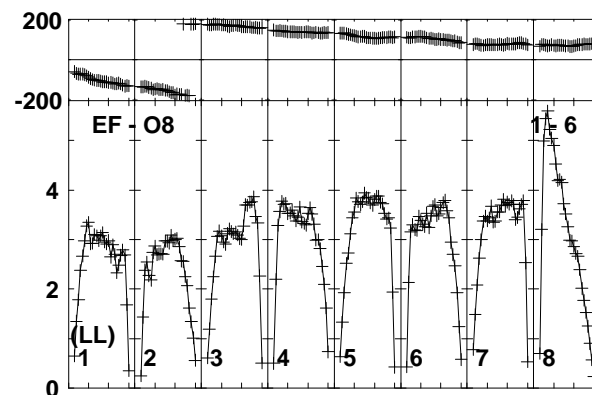
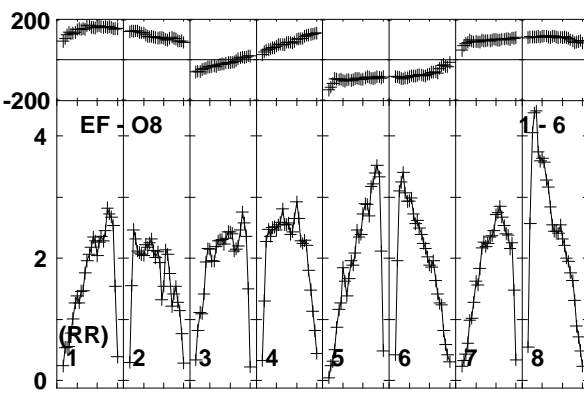
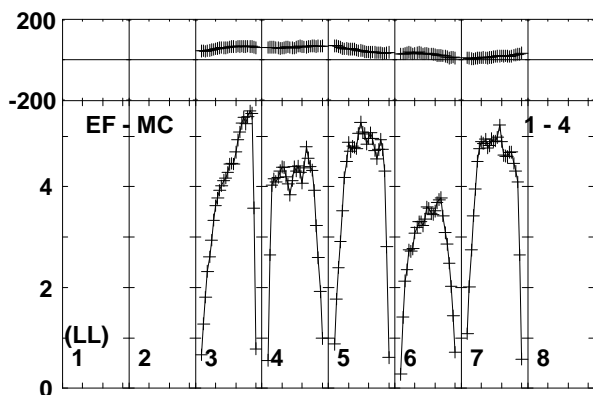
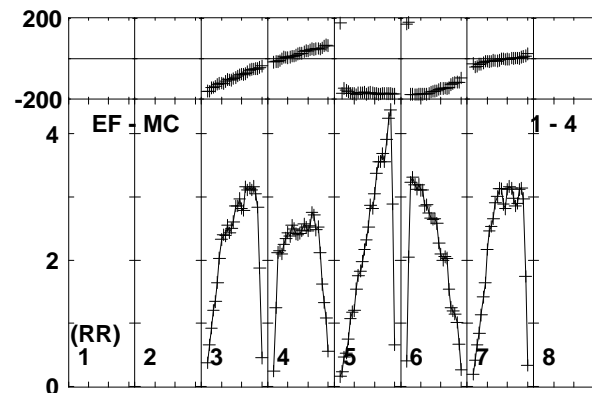
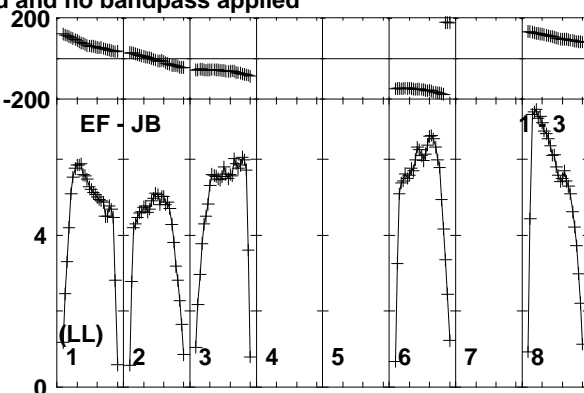
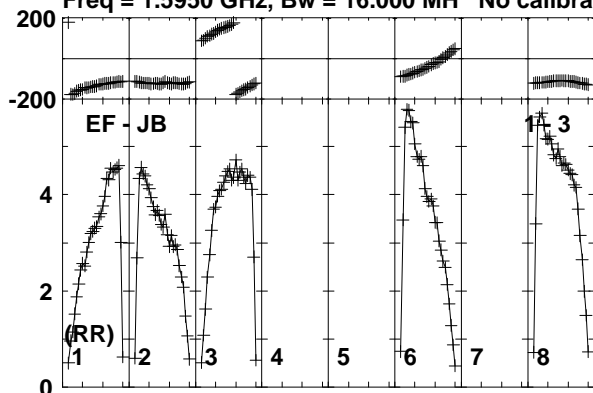

Lower frame: Milli Ampl Jy Top frame: Phas deg  
Vector averaged cross-power spectrum Baseline: EF (01) - JB (03)  
Timerange: 01/05:34:02 to 01/05:34:58

Plot file version 348 created 26-JUN-2015 10:51:32

J2025+3343 ET031A.UVDATA.1

Freq = 1.5950 GHz, Bw = 16.000 MH No calibration applied and no bandpass applied

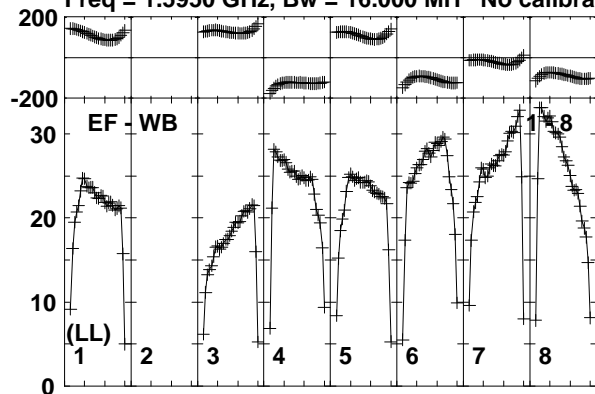

Lower frame: Milli Ampl Jy Top frame: Phas deg  
Vector averaged cross-power spectrum Baseline: EF (01) - WB (08)  
Timerange: 01/05:34:02 to 01/05:34:58

Plot file version 349 created 26-JUN-2015 10:51:32

V404CYG ET031A.UVDATA.1

Freq = 1.5950 GHz, Bw = 16.000 MH No calibration applied and no bandpass applied

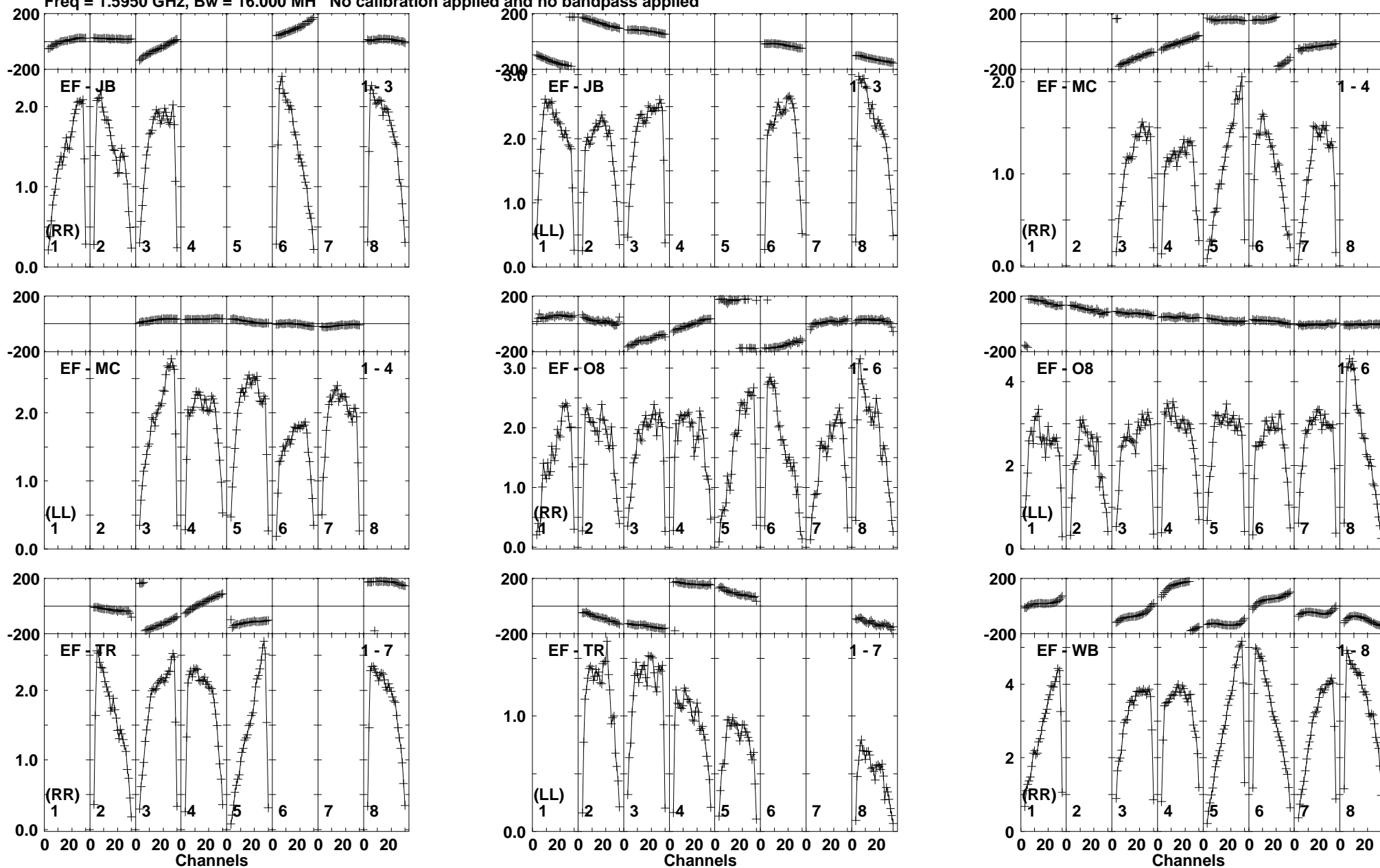

Lower frame: Milli Ampl Jy Top frame: Phas deg  
Vector averaged cross-power spectrum Baseline: EF (01) - JB (03)  
Timerange: 01/05:35:02 to 01/05:38:28

Plot file version 350 created 26-JUN-2015 10:51:32  
V404CYG ET031A.UVDATA.1  
Freq = 1.5950 GHz, Bw = 16.000 MH No calibration applied and no bandpass applied

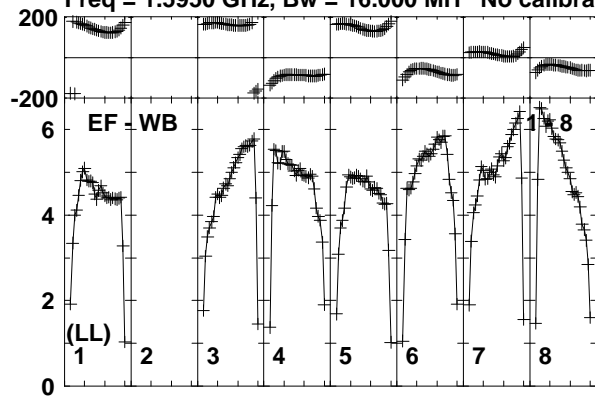

Lower frame: Milli Ampl Jy Top frame: Phas deg  
Vector averaged cross-power spectrum Baseline: EF (01) - WB (08)  
Timerange: 01/05:35:02 to 01/05:38:28

Plot file version 351 created 26-JUN-2015 10:51:32  
 J2025+3343 ET031A.UVDATA.1  
 Freq = 1.5950 GHz, Bw = 16.000 MH No calibration applied and no bandpass applied

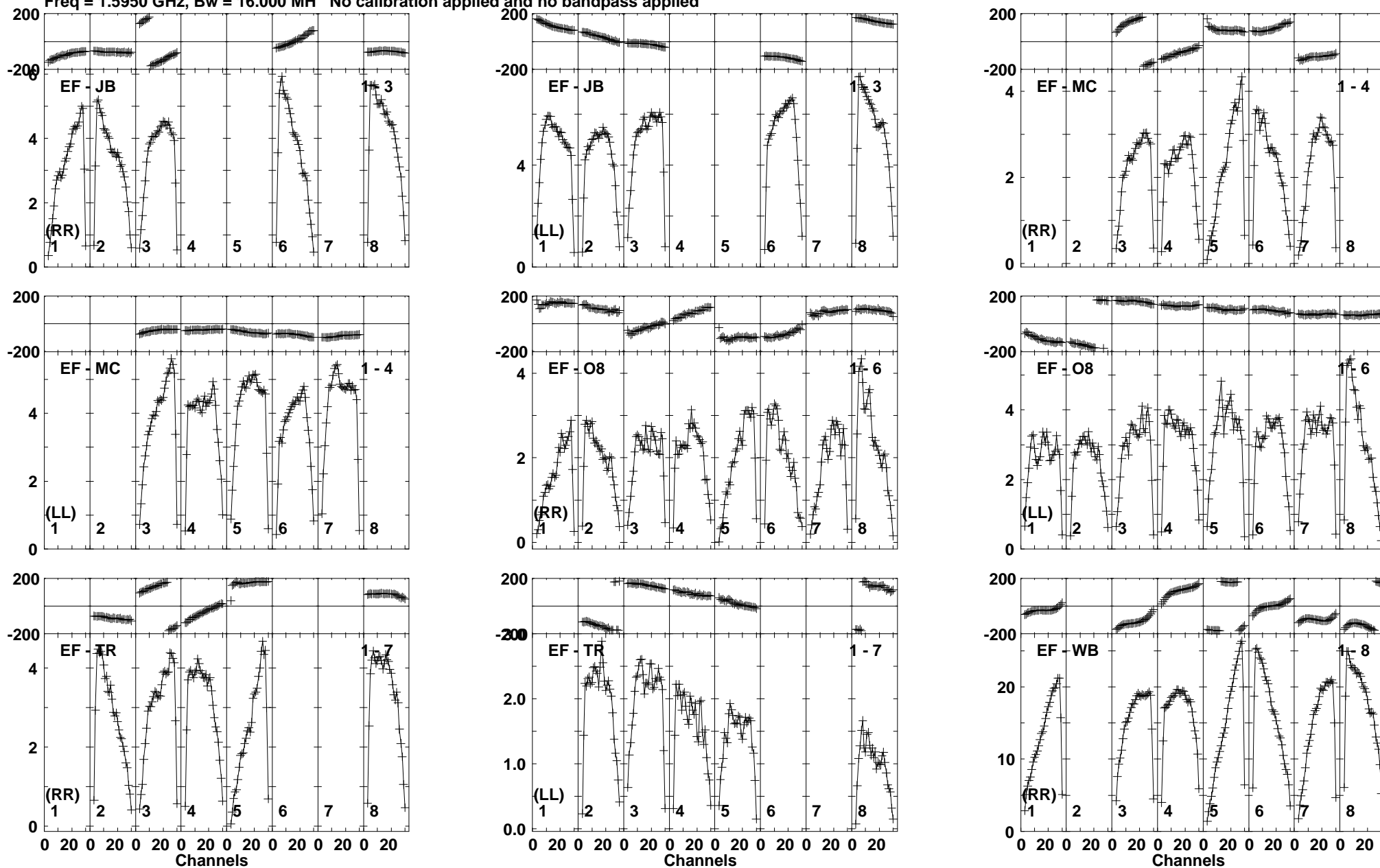

Lower frame: Milli Amp Jy Top frame: Phas deg  
 Vector averaged cross-power spectrum Baseline: EF (01) - JB (03)  
 Timerange: 01/05:38:32 to 01/05:39:48

Plot file version 352 created 26-JUN-2015 10:51:32

J2025+3343 ET031A.UVDATA.1

Freq = 1.5950 GHz, Bw = 16.000 MH No calibration applied and no bandpass applied

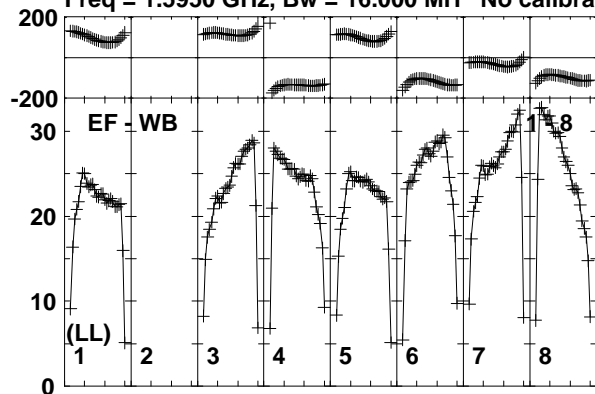

Lower frame: Milli Ampl Jy Top frame: Phas deg  
Vector averaged cross-power spectrum Baseline: EF (01) - WB (08)  
Timerange: 01/05:38:32 to 01/05:39:48



Plot file version 353 created 26-JUN-2015 10:51:32

V404CYG ET031A.UVDATA.1

Freq = 1.5950 GHz, Bw = 16.000 MH No calibration applied and no bandpass applied

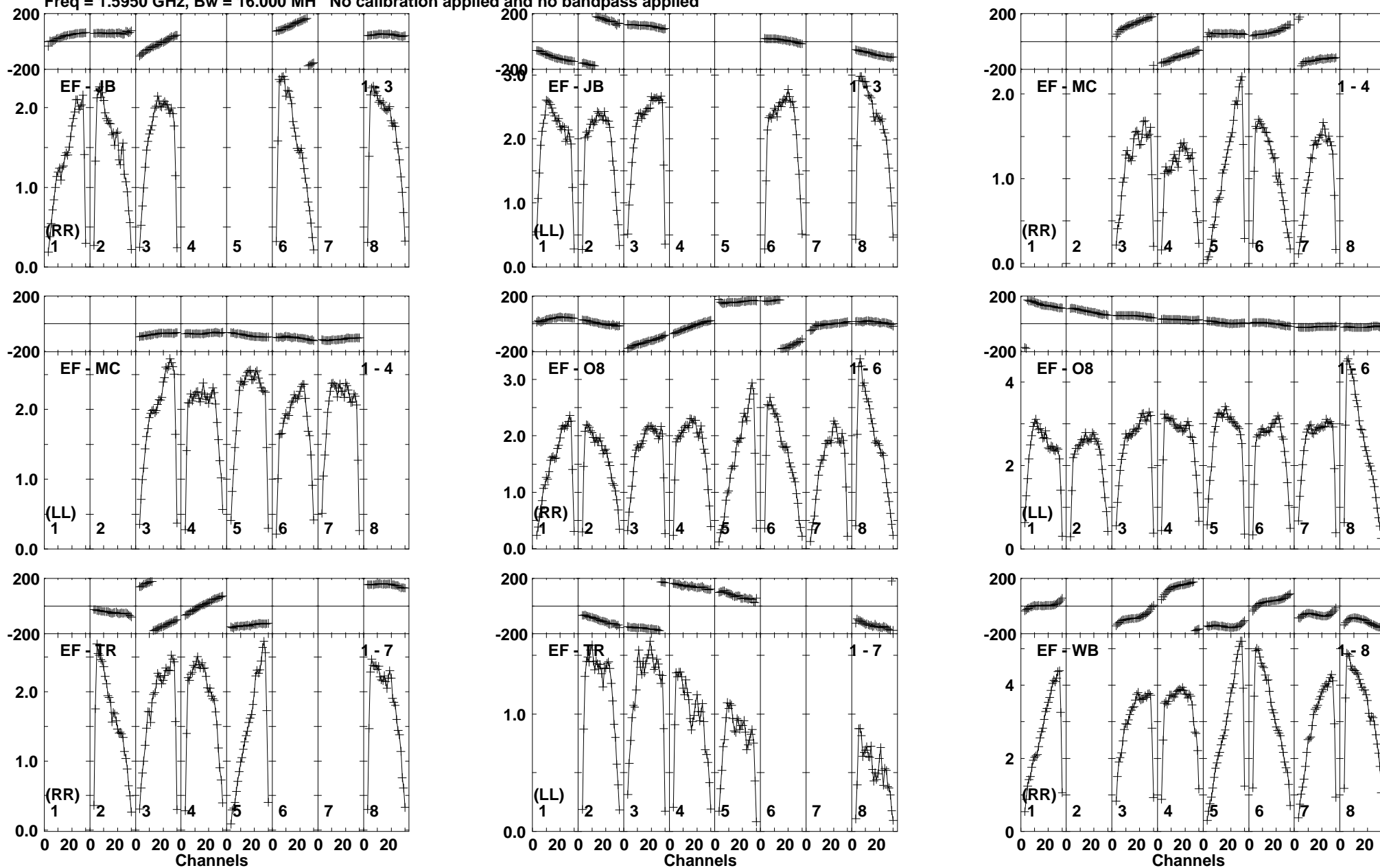

Lower frame: Milli Amply Jy Top frame: Phas deg  
Vector averaged cross-power spectrum Baseline: EF (01) - JB (03)  
Timerange: 01/05:39:52 to 01/05:43:18

Plot file version 354 created 26-JUN-2015 10:51:32

V404CYG ET031A.UVDATA.1

Freq = 1.5950 GHz, Bw = 16.000 MH No calibration applied and no bandpass applied

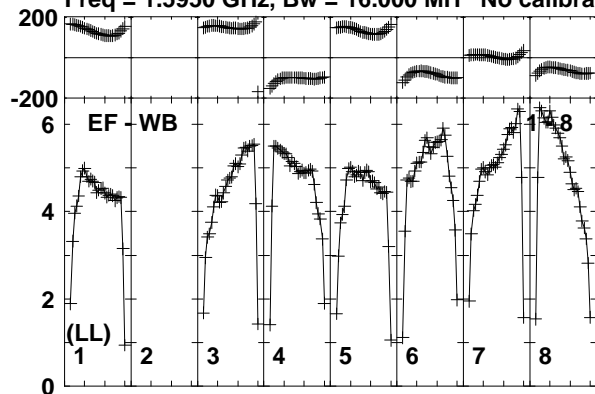

Lower frame: Milli Ampl Jy Top frame: Phas deg  
Vector averaged cross-power spectrum Baseline: EF (01) - WB (08)  
Timerange: 01/05:39:52 to 01/05:43:18

Plot file version 355 created 26-JUN-2015 10:51:32

J2025+3343 ET031A.UVDATA.1

Freq = 1.5950 GHz, Bw = 16.000 MH No calibration applied and no bandpass applied

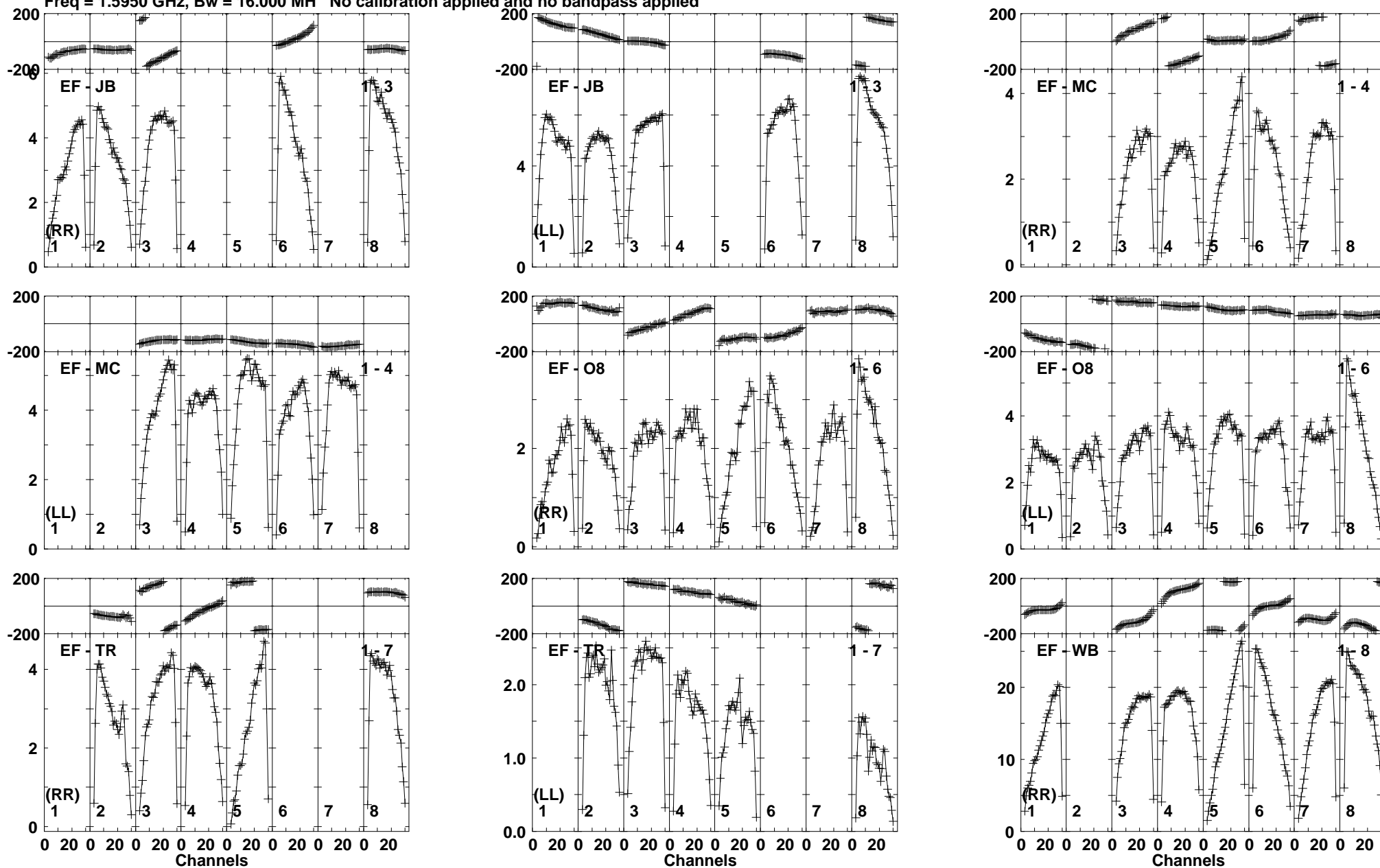

Lower frame: Milli Ampl Jy Top frame: Phas deg  
Vector averaged cross-power spectrum Baseline: EF (01) - JB (03)  
Timerange: 01/05:44:02 to 01/05:44:58

Plot file version 356 created 26-JUN-2015 10:51:32

J2025+3343 ET031A.UVDATA.1

Freq = 1.5950 GHz, Bw = 16.000 MH No calibration applied and no bandpass applied

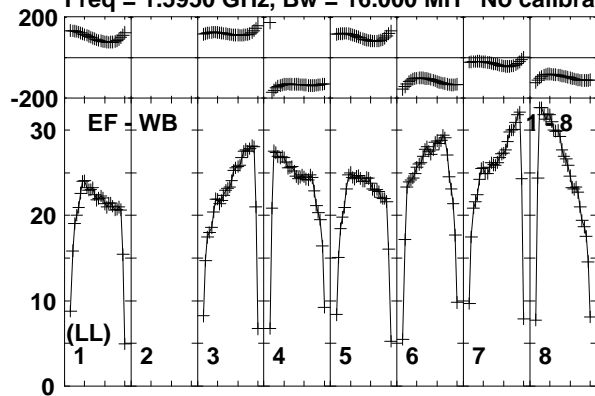

Lower frame: Milli Ampl Jy Top frame: Phas deg

Vector averaged cross-power spectrum Baseline: EF (01) - WB (08)

Timerange: 01/05:44:02 to 01/05:44:58

Plot file version 357 created 26-JUN-2015 10:51:32

V404CYG ET031A.UVDATA.1

Freq = 1.5950 GHz, Bw = 16.000 MH No calibration applied and no bandpass applied

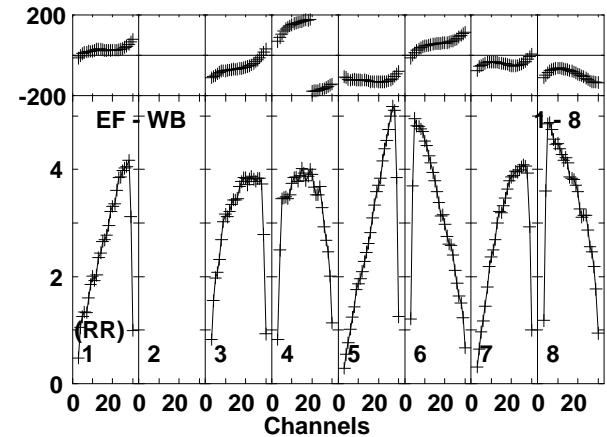
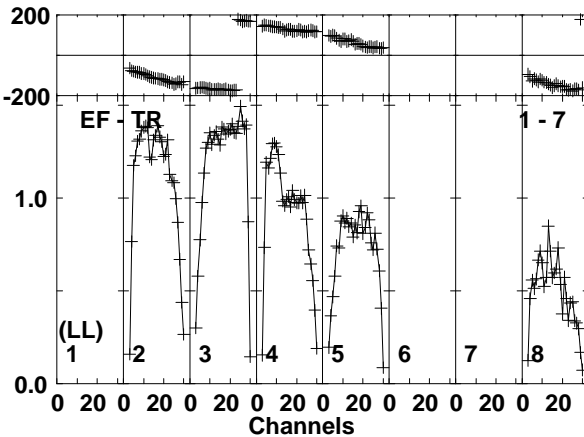
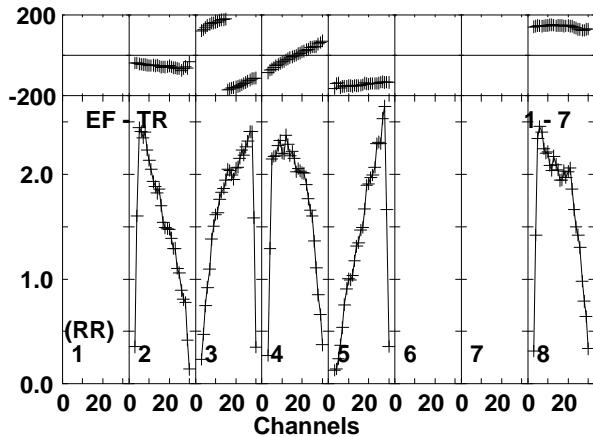
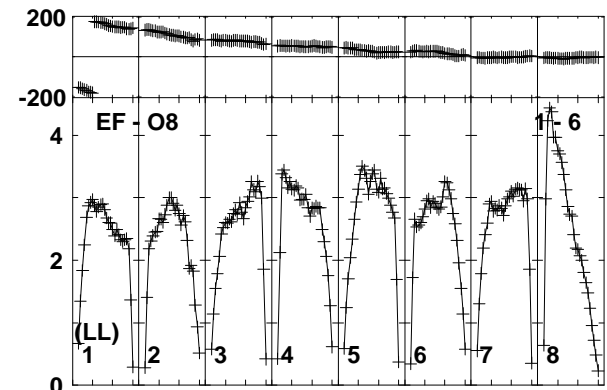
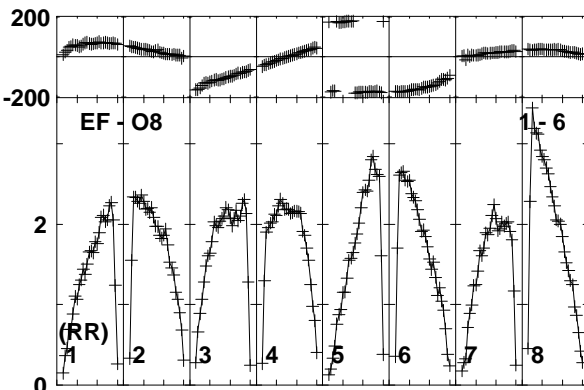
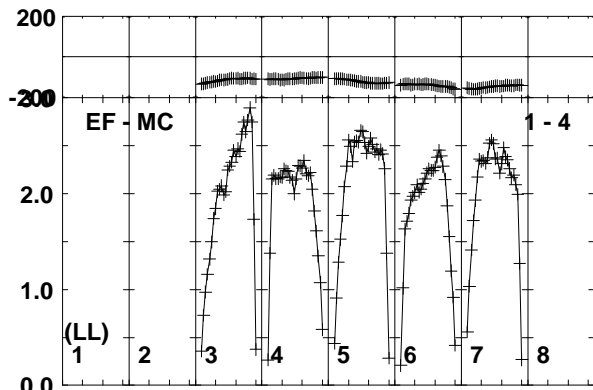
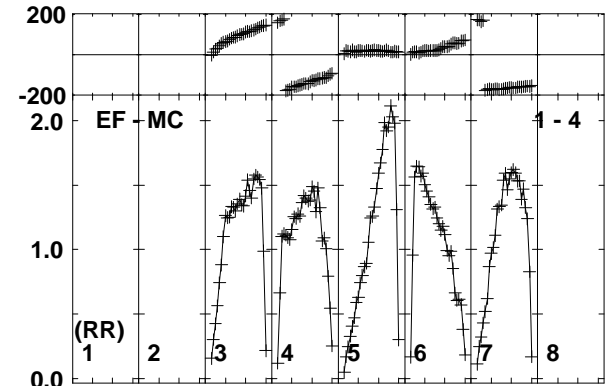
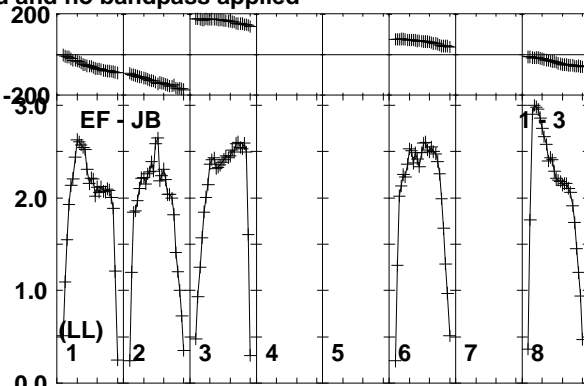
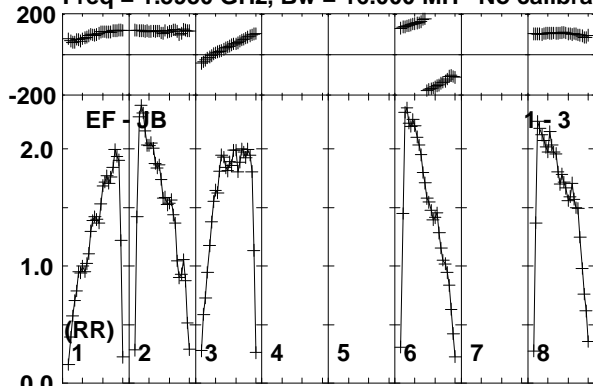

Lower frame: Milli Ampl Jy Top frame: Phas deg  
Vector averaged cross-power spectrum Baseline: EF (01) - JB (03)  
Timerange: 01/05:45:02 to 01/05:48:28

Plot file version 358 created 26-JUN-2015 10:51:32

V404CYG ET031A.UVDATA.1

Freq = 1.5950 GHz, Bw = 16.000 MH No calibration applied and no bandpass applied

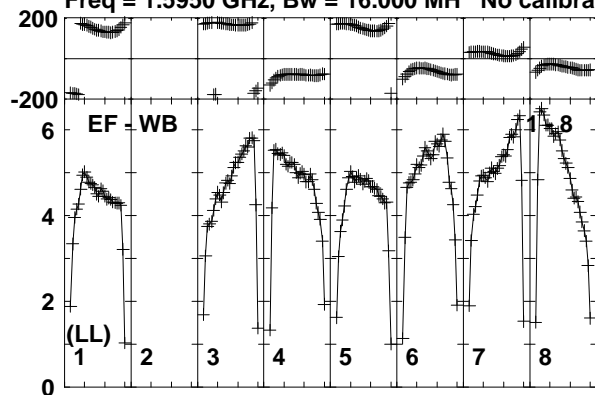

Lower frame: Milli Ampl Jy Top frame: Phas deg  
Vector averaged cross-power spectrum Baseline: EF (01) - WB (08)  
Timerange: 01/05:45:02 to 01/05:48:28

Plot file version 359 created 26-JUN-2015 10:51:32

J2025+3343 ET031A.UVDATA.1

Freq = 1.5950 GHz, Bw = 16.000 MH No calibration applied and no bandpass applied

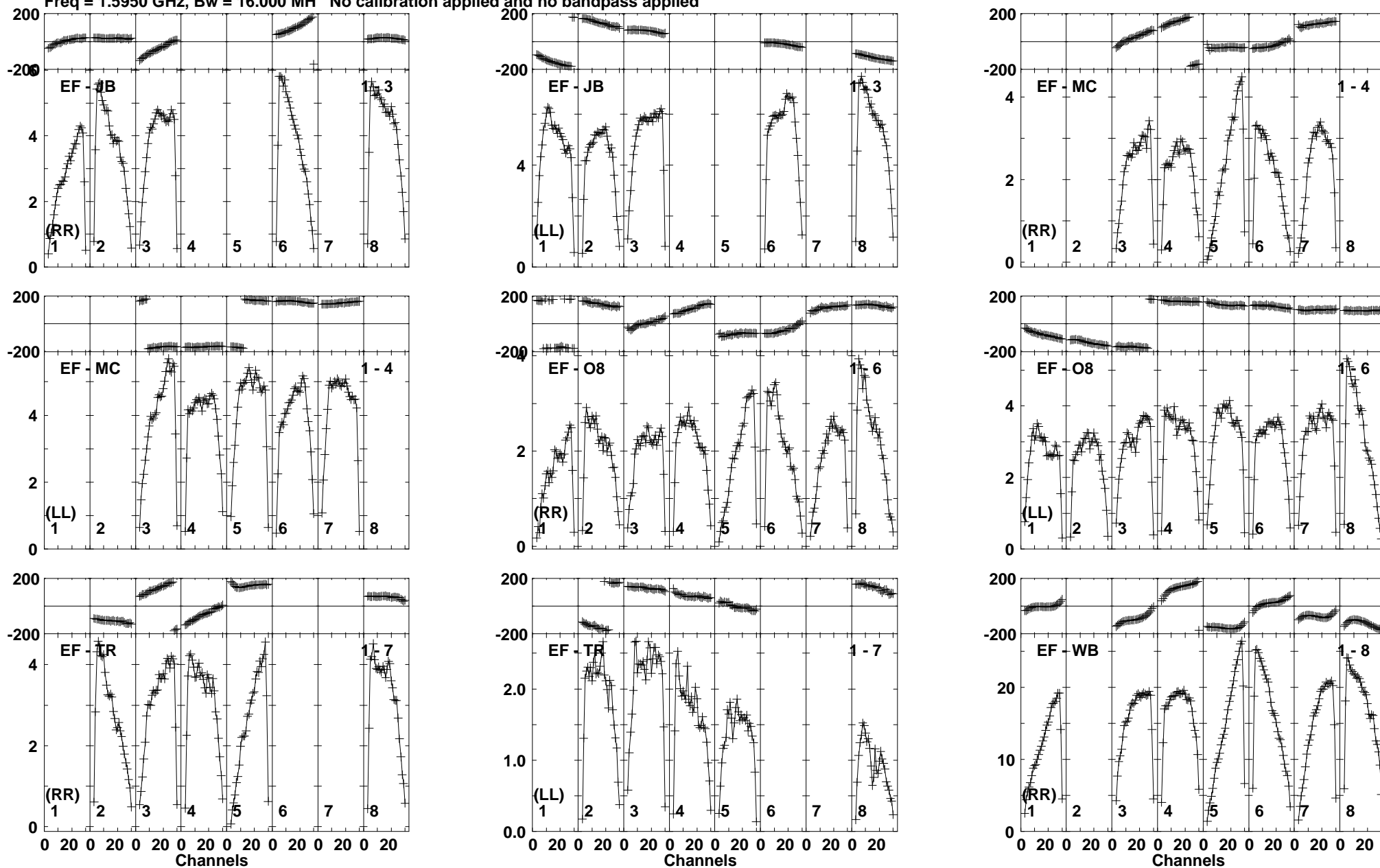

Lower frame: Milli Ampl Jy Top frame: Phas deg  
Vector averaged cross-power spectrum Baseline: EF (01) - JB (03)  
Timerange: 01/05:48:32 to 01/05:49:48

Plot file version 360 created 26-JUN-2015 10:51:32

J2025+3343 ET031A.UVDATA.1

Freq = 1.5950 GHz, Bw = 16.000 MH No calibration applied and no bandpass applied

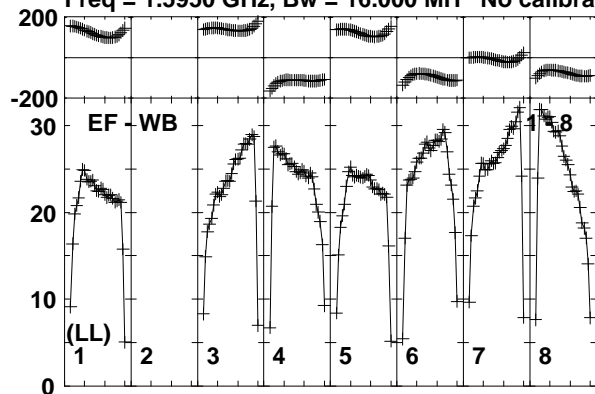

Lower frame: Milli Ampl Jy Top frame: Phas deg  
Vector averaged cross-power spectrum Baseline: EF (01) - WB (08)  
Timerange: 01/05:48:32 to 01/05:49:48



Plot file version 361 created 26-JUN-2015 10:51:32

V404CYG ET031A.UVDATA.1

Freq = 1.5950 GHz, Bw = 16.000 MH No calibration applied and no bandpass applied

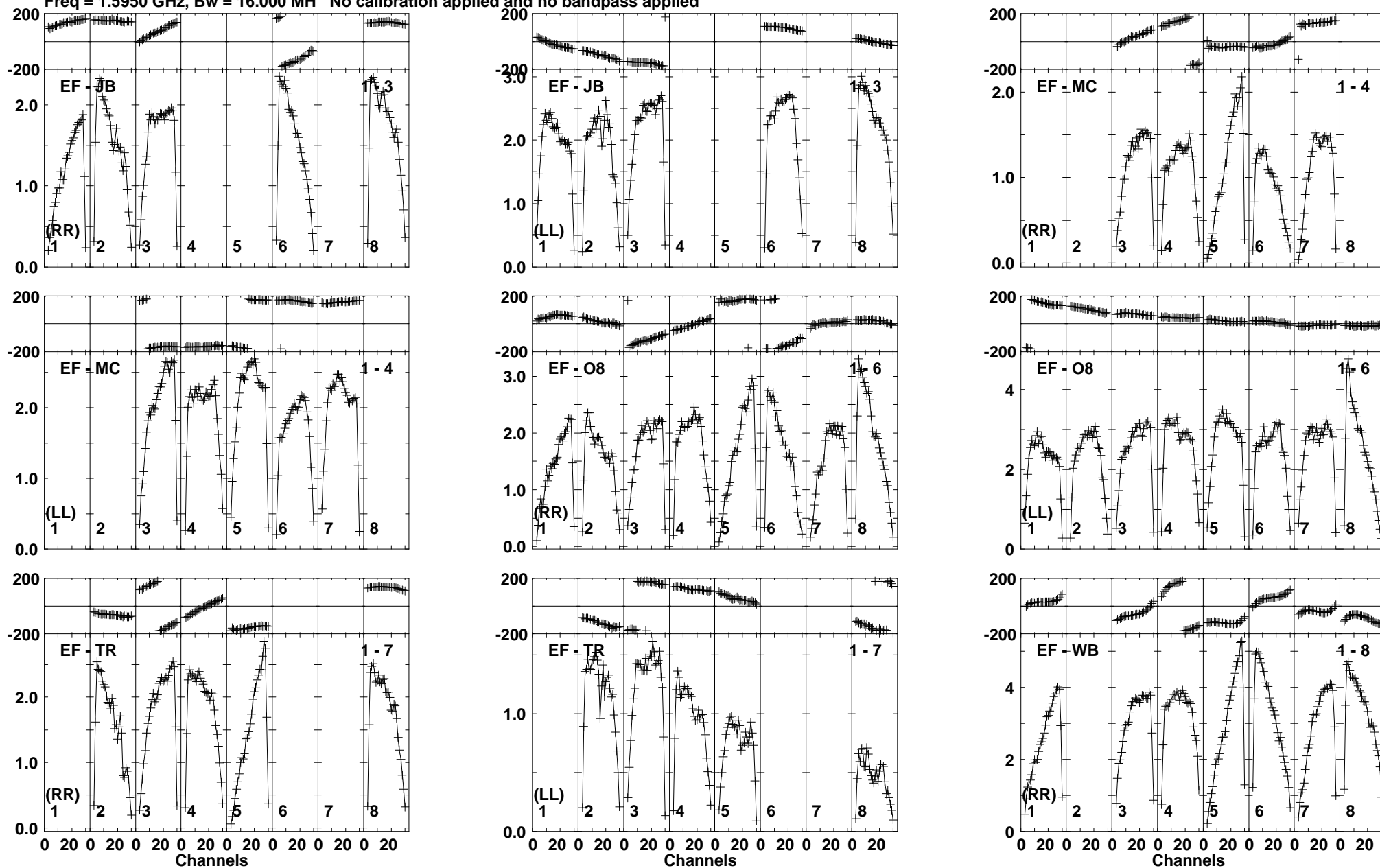

Lower frame: Milli Ampl Jy Top frame: Phas deg  
Vector averaged cross-power spectrum Baseline: EF (01) - JB (03)  
Timerange: 01/05:49:52 to 01/05:53:18

Plot file version 362 created 26-JUN-2015 10:51:32

V404CYG ET031A.UVDATA.1

Freq = 1.5950 GHz, Bw = 16.000 MH No calibration applied and no bandpass applied

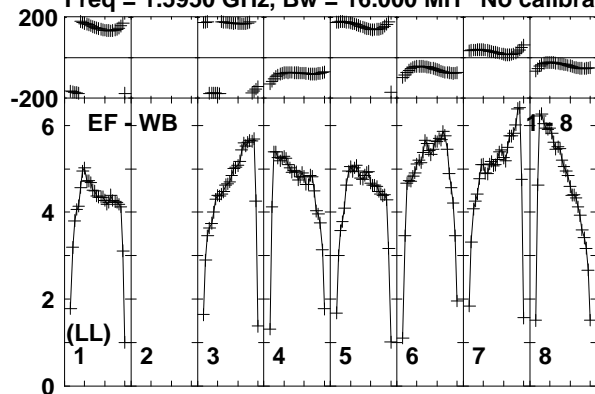

Lower frame: Milli Ampl Jy Top frame: Phas deg  
Vector averaged cross-power spectrum Baseline: EF (01) - WB (08)  
Timerange: 01/05:49:52 to 01/05:53:18

Plot file version 363 created 26-JUN-2015 10:51:32

J2025+3343 ET031A.UVDATA.1

Freq = 1.5950 GHz, Bw = 16.000 MH No calibration applied and no bandpass applied

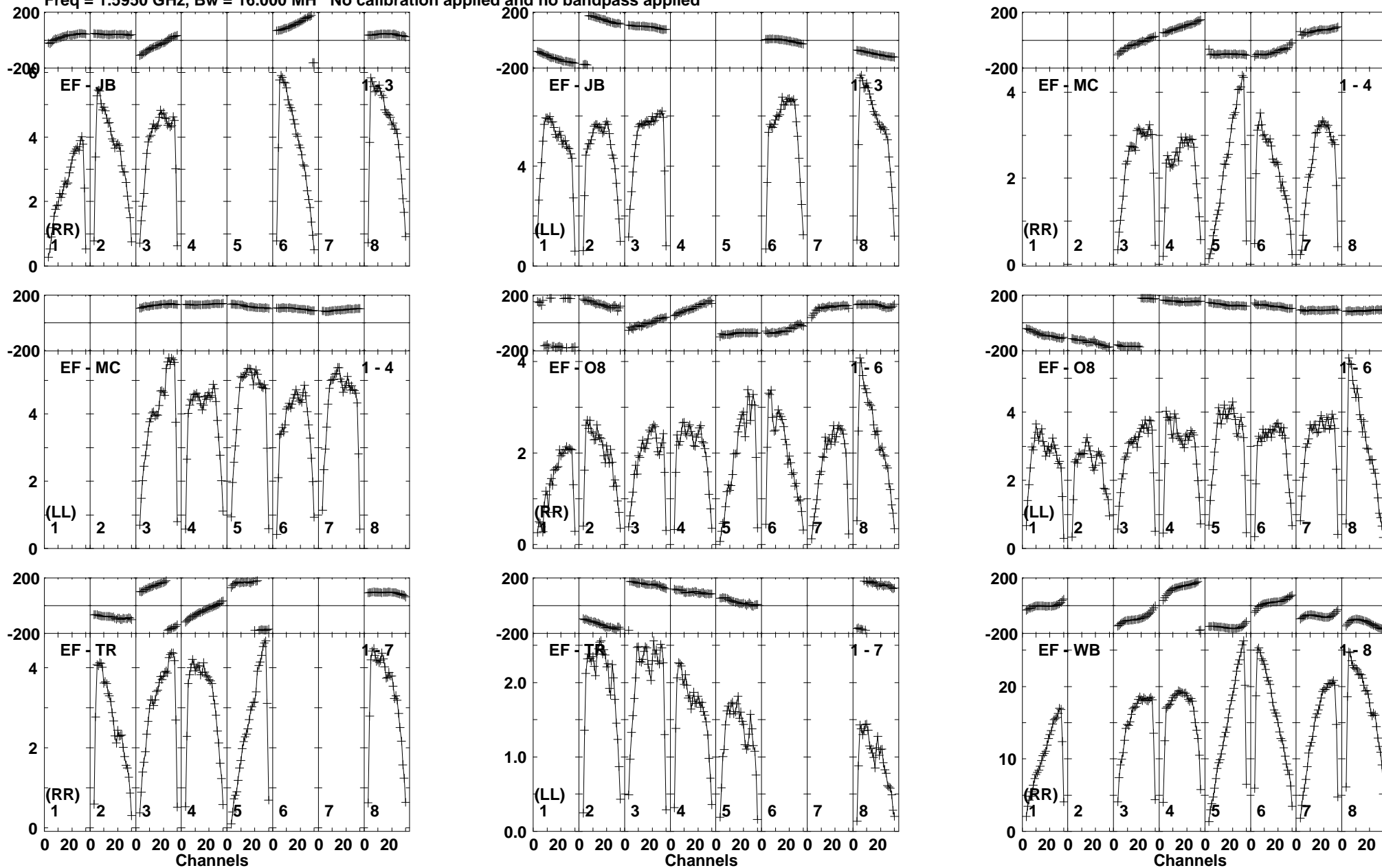

Lower frame: Milli Ampl Jy Top frame: Phas deg  
Vector averaged cross-power spectrum Baseline: EF (01) - JB (03)  
Timerange: 01/05:54:02 to 01/05:54:58

Plot file version 364 created 26-JUN-2015 10:51:32  
J2025+3343 ET031A.UVDATA.1  
Freq = 1.5950 GHz, Bw = 16.000 MH No calibration applied and no bandpass applied

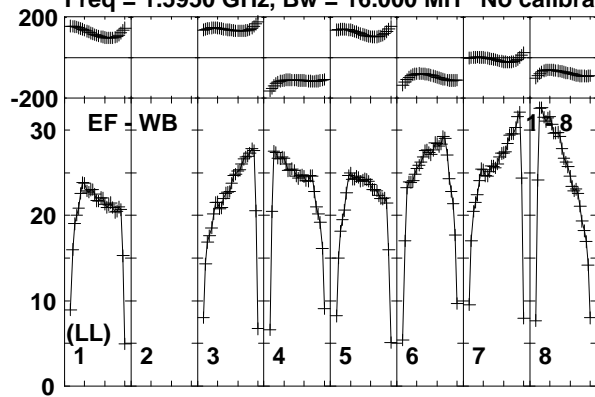

Lower frame: Milli Ampl Jy Top frame: Phas deg  
Vector averaged cross-power spectrum Baseline: EF (01) - WB (08)  
Timerange: 01/05:54:02 to 01/05:54:58

Plot file version 365 created 26-JUN-2015 10:51:32

V404CYG ET031A.UVDATA.1

Freq = 1.5950 GHz, Bw = 16.000 MH No calibration applied and no bandpass applied

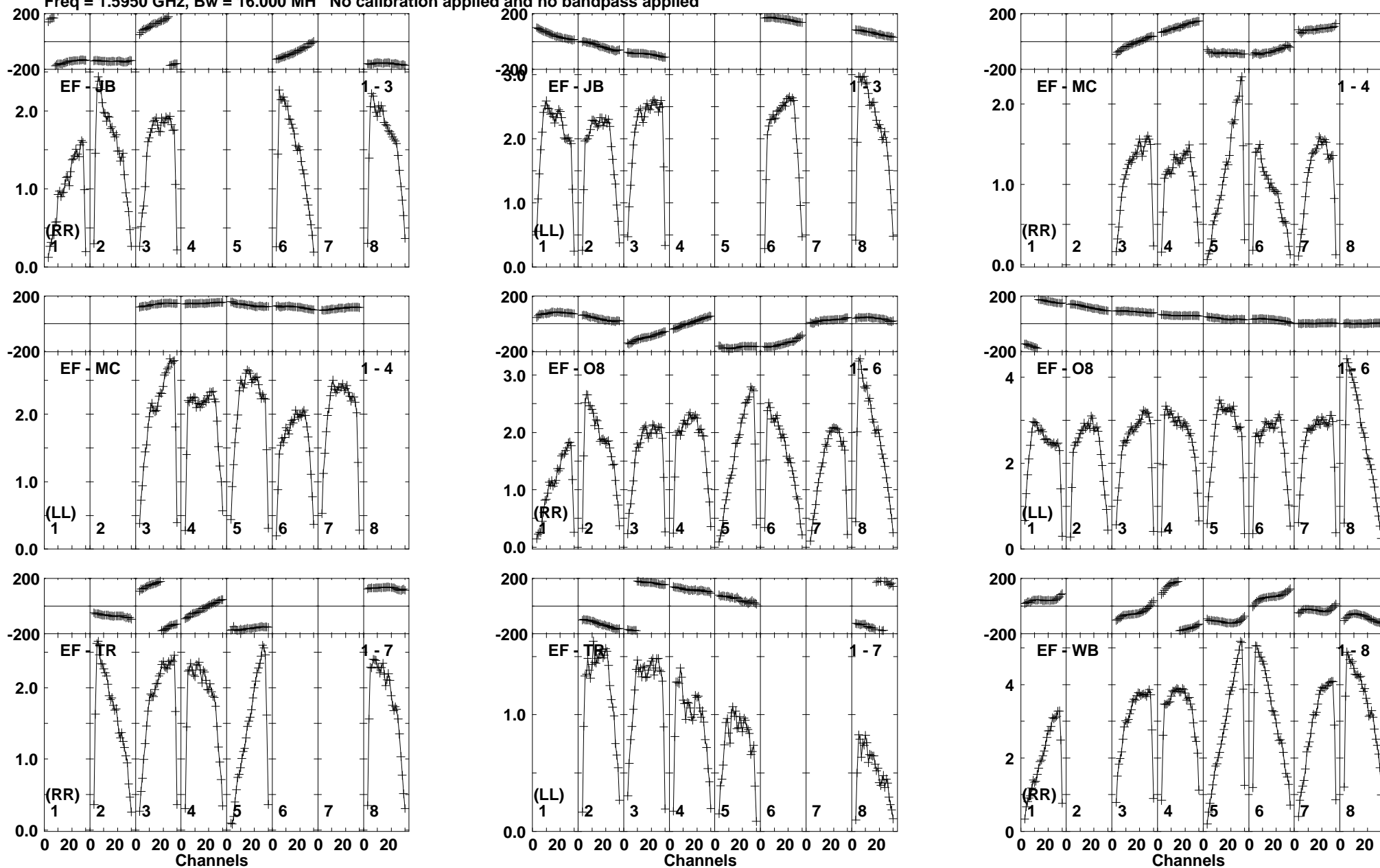

Lower frame: Milli Ampl Jy Top frame: Phas deg  
Vector averaged cross-power spectrum Baseline: EF (01) - JB (03)  
Timerange: 01/05:55:02 to 01/05:58:28

Plot file version 366 created 26-JUN-2015 10:51:32

V404CYG ET031A.UVDATA.1

Freq = 1.5950 GHz, Bw = 16.000 MH No calibration applied and no bandpass applied

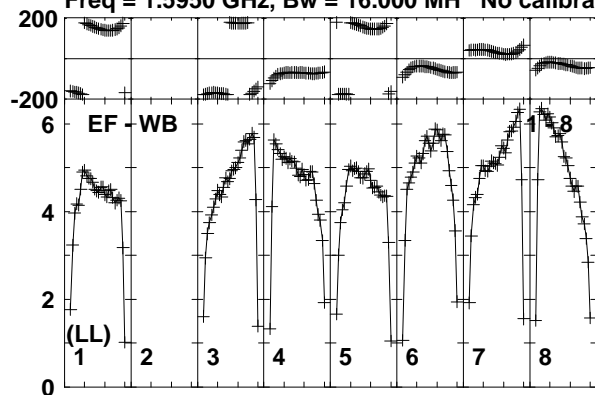

Lower frame: Milli Ampl Jy Top frame: Phas deg  
Vector averaged cross-power spectrum Baseline: EF (01) - WB (08)  
Timerange: 01/05:55:02 to 01/05:58:28

Plot file version 367 created 26-JUN-2015 10:51:33

J2025+3343 ET031A.UVDATA.1

Freq = 1.5950 GHz, Bw = 16.000 MH No calibration applied and no bandpass applied

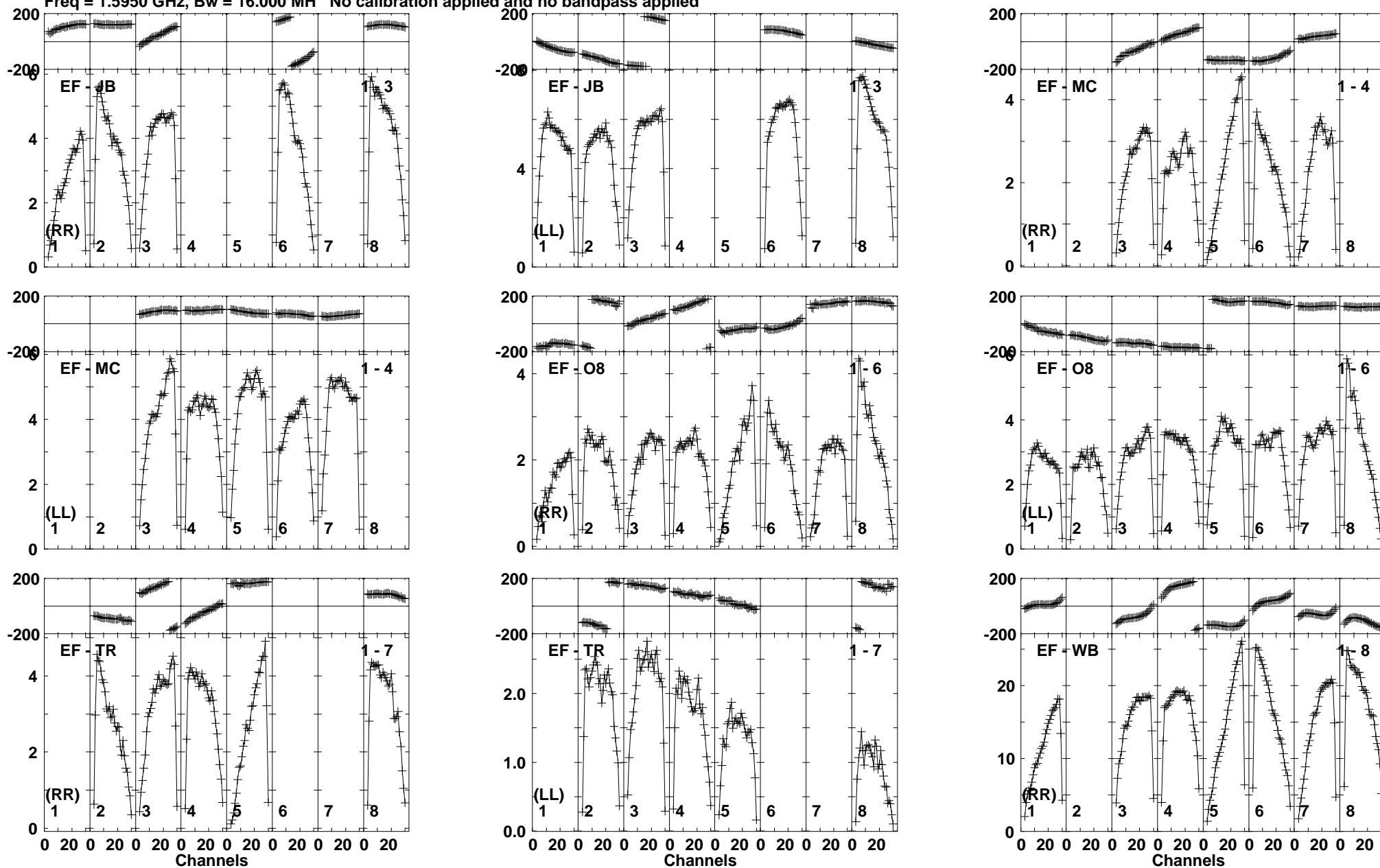

Lower frame: Milli Ampl Jy Top frame: Phas deg  
Vector averaged cross-power spectrum Baseline: EF (01) - JB (03)  
Timerange: 01/05:58:32 to 01/05:59:48

Plot file version 368 created 26-JUN-2015 10:51:33  
J2025+3343 ET031A.UVDATA.1  
Freq = 1.5950 GHz, Bw = 16.000 MH No calibration applied and no bandpass applied

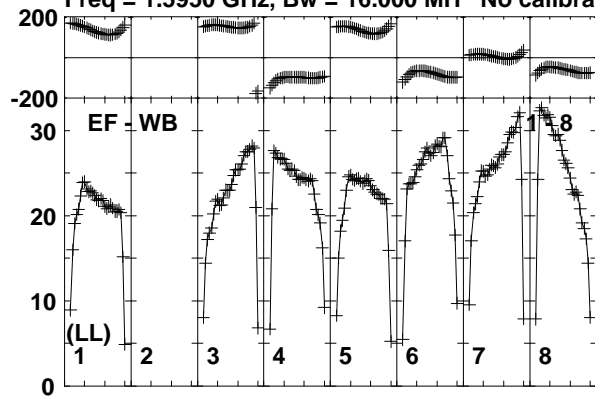

Lower frame: Milli Ampl Jy Top frame: Phas deg  
Vector averaged cross-power spectrum Baseline: EF (01) - WB (08)  
Timerange: 01/05:58:32 to 01/05:59:48



Plot file version 369 created 26-JUN-2015 10:51:33

V404CYG ET031A.UVDATA.1

Freq = 1.5950 GHz, Bw = 16.000 MH No calibration applied and no bandpass applied

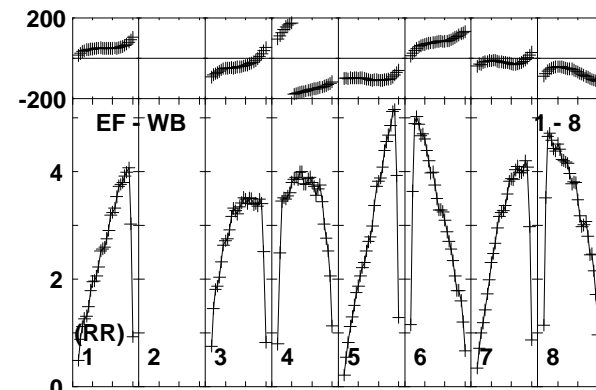
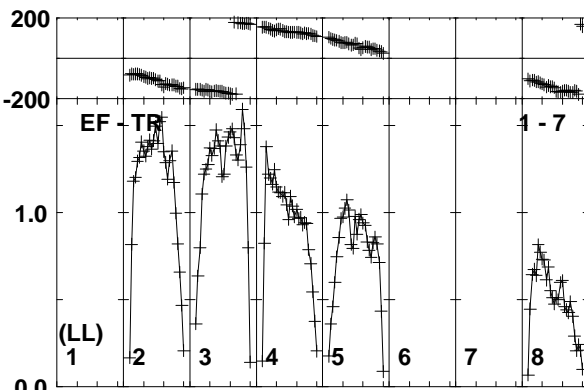
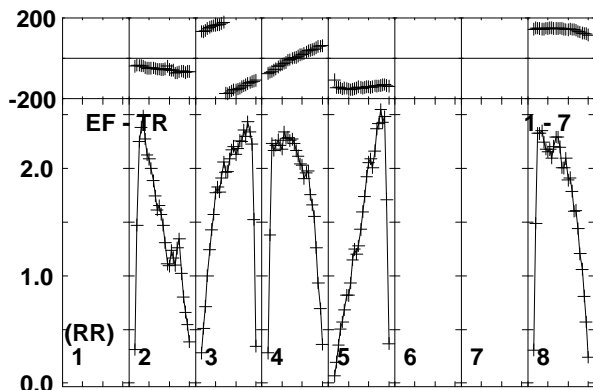
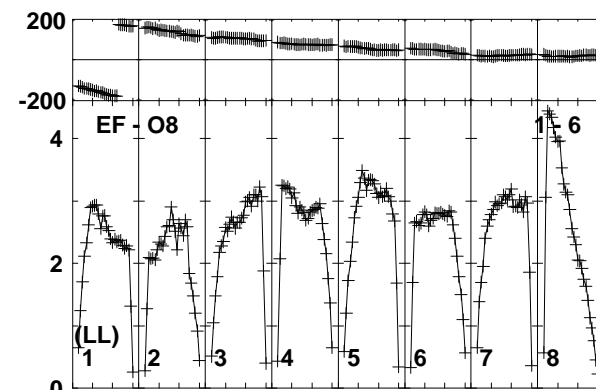
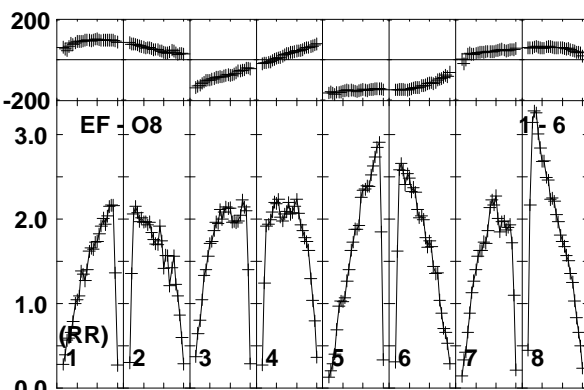
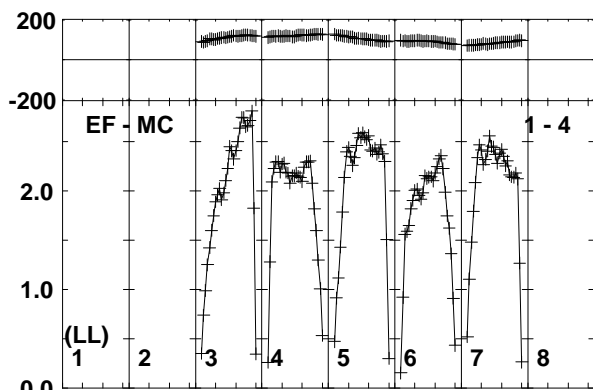
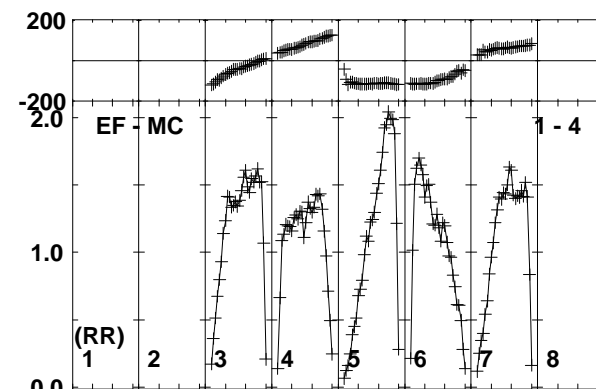
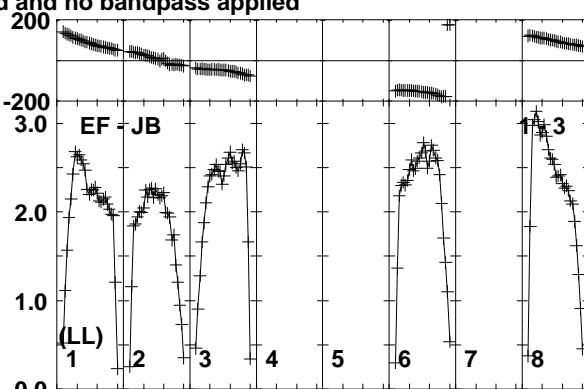
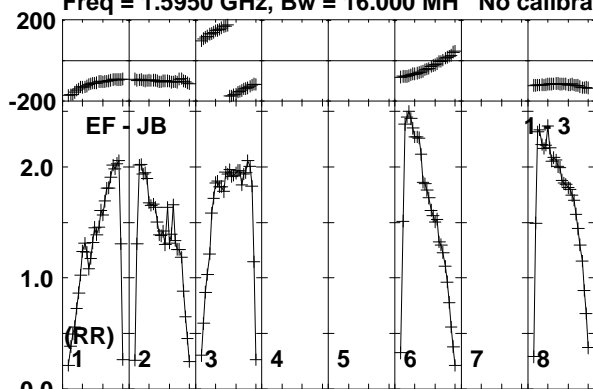

Lower frame: Milli Ampl Jy Top frame: Phas deg  
Vector averaged cross-power spectrum Baseline: EF (01) - JB (03)  
Timerange: 01/05:59:52 to 01/06:03:18

Plot file version 370 created 26-JUN-2015 10:51:33

V404CYG ET031A.UVDATA.1

Freq = 1.5950 GHz, Bw = 16.000 MH No calibration applied and no bandpass applied

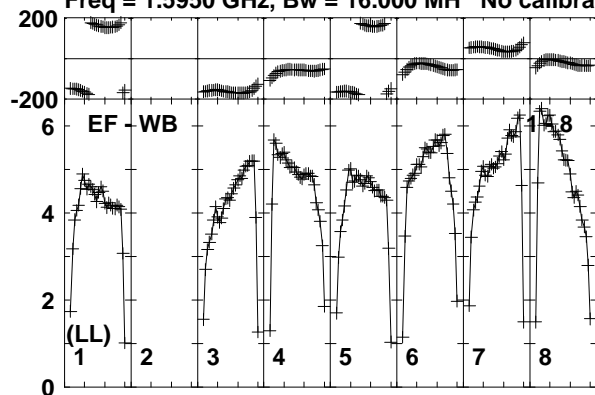

Lower frame: Milli Ampl Jy Top frame: Phas deg  
Vector averaged cross-power spectrum Baseline: EF (01) - WB (08)  
Timerange: 01/05:59:52 to 01/06:03:18

Plot file version 371 created 26-JUN-2015 10:51:33

J2025+3343 ET031A.UVDATA.1

Freq = 1.5950 GHz, Bw = 16.000 MH No calibration applied and no bandpass applied

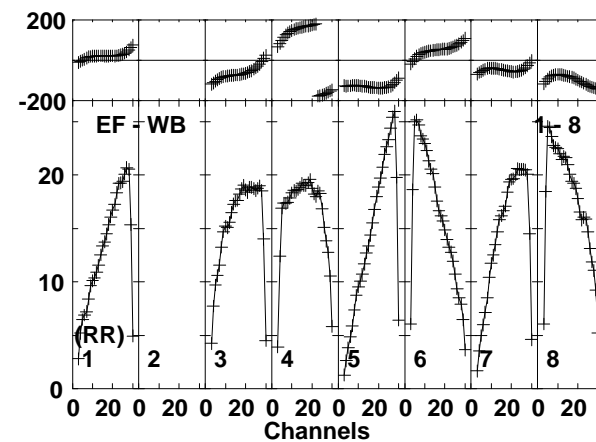
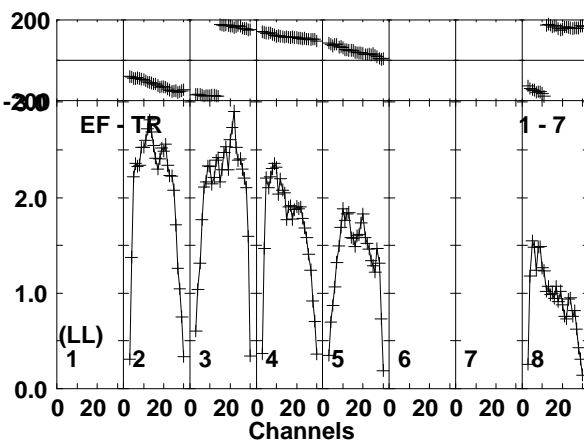
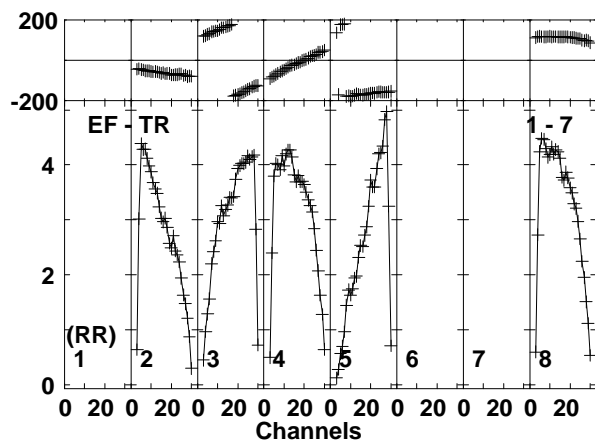
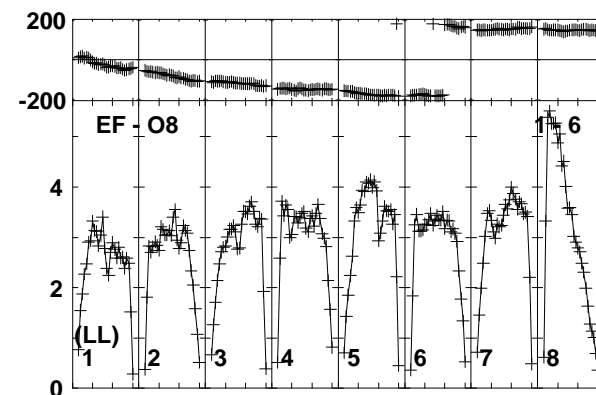
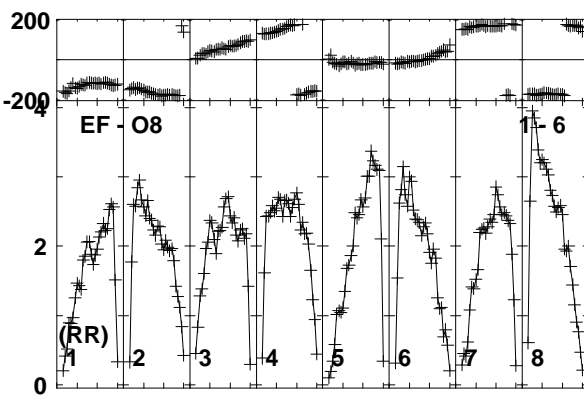
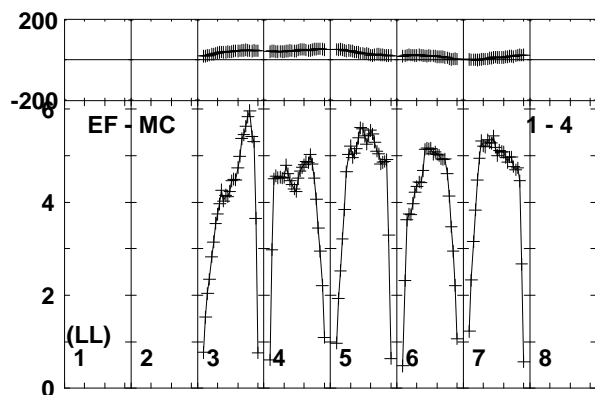
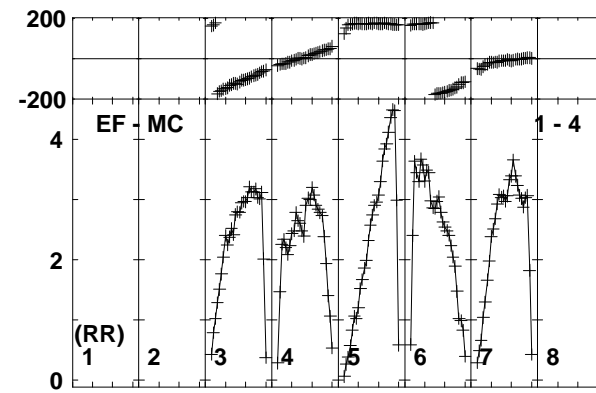
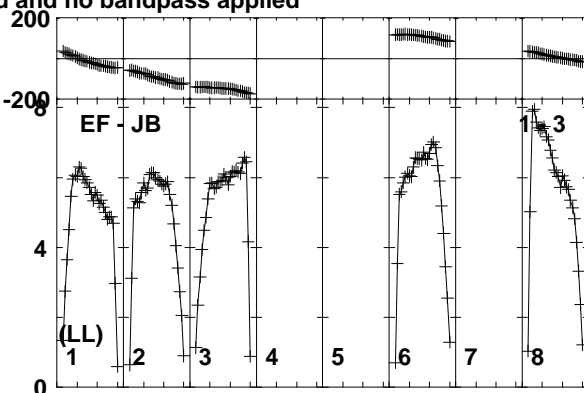
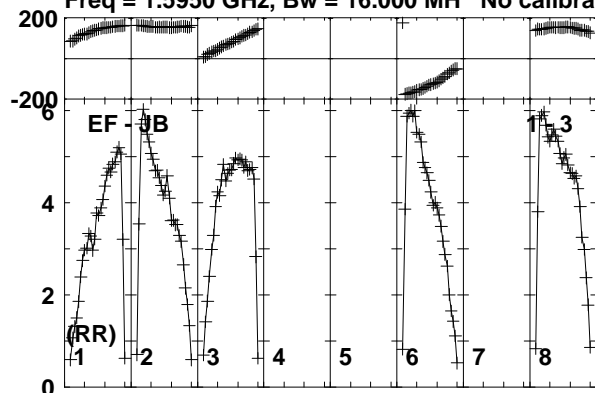

Lower frame: Milli Ampl Jy Top frame: Phas deg  
Vector averaged cross-power spectrum Baseline: EF (01) - JB (03)  
Timerange: 01/06:04:02 to 01/06:04:58

Plot file version 372 created 26-JUN-2015 10:51:33

J2025+3343 ET031A.UVDATA.1

Freq = 1.5950 GHz, Bw = 16.000 MH No calibration applied and no bandpass applied

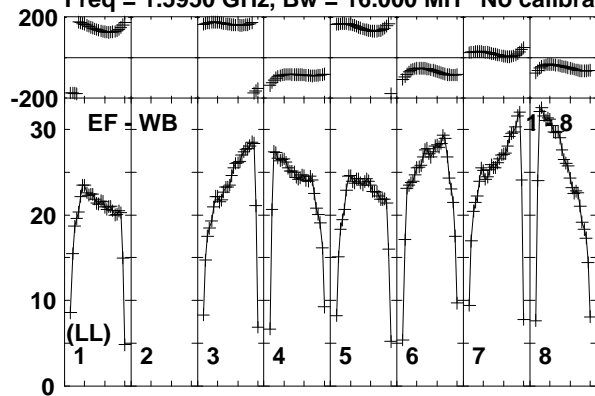

Lower frame: Milli Ampl Jy Top frame: Phas deg  
Vector averaged cross-power spectrum Baseline: EF (01) - WB (08)  
Timerange: 01/06:04:02 to 01/06:04:58

Plot file version 373 created 26-JUN-2015 10:51:33

V404CYG ET031A.UVDATA.1

Freq = 1.5950 GHz, Bw = 16.000 MH No calibration applied and no bandpass applied

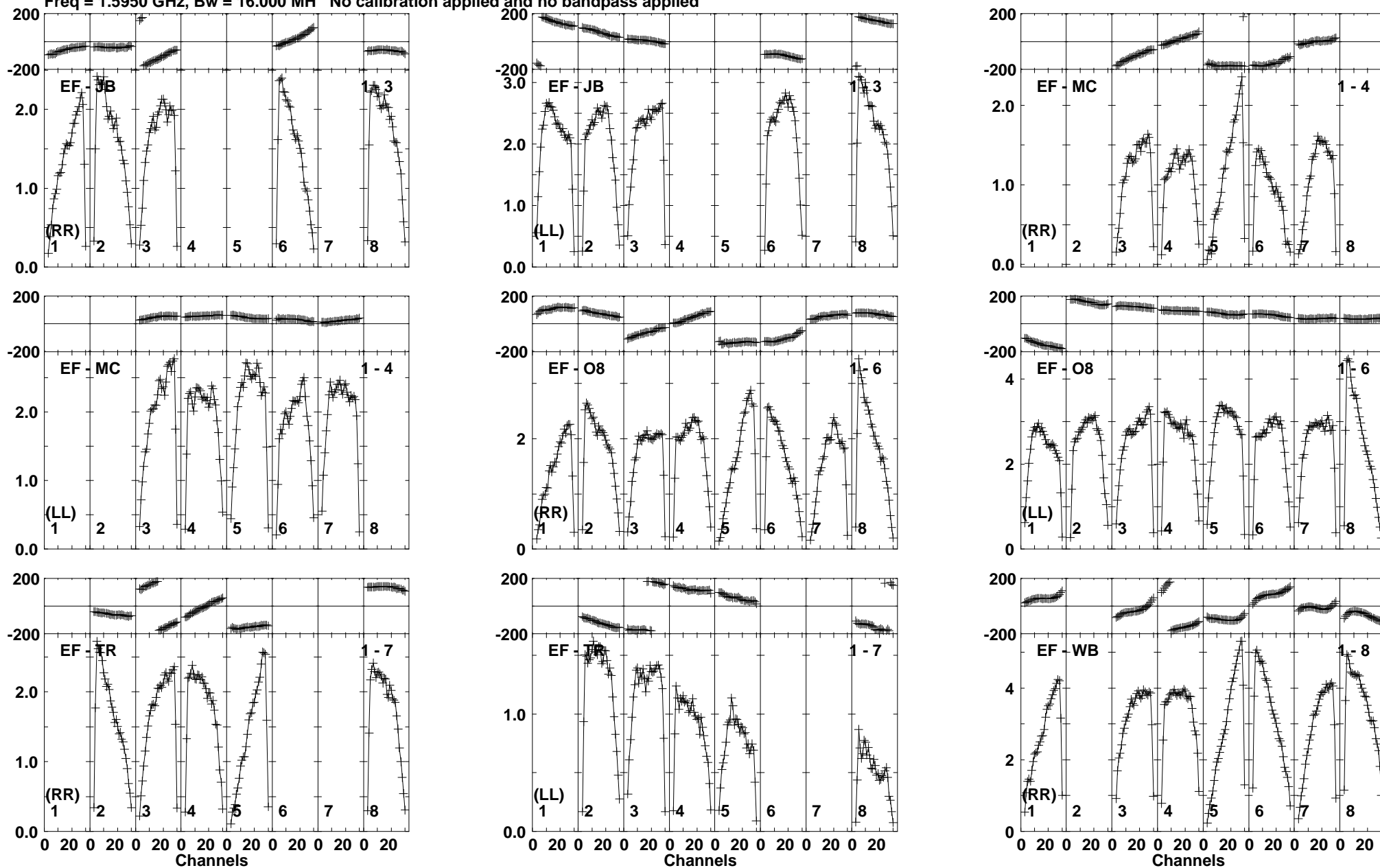

Lower frame: Milli Ampl Jy Top frame: Phas deg  
Vector averaged cross-power spectrum Baseline: EF (01) - JB (03)  
Timerange: 01/06:05:02 to 01/06:08:28

Plot file version 374 created 26-JUN-2015 10:51:33

V404CYG ET031A.UVDATA.1

Freq = 1.5950 GHz, Bw = 16.000 MH No calibration applied and no bandpass applied

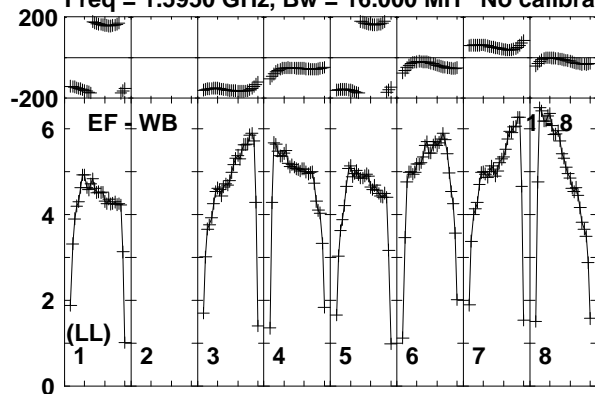

Lower frame: Milli Ampl Jy Top frame: Phas deg  
Vector averaged cross-power spectrum Baseline: EF (01) - WB (08)  
Timerange: 01/06:05:02 to 01/06:08:28

Plot file version 375 created 26-JUN-2015 10:51:33

J2025+3343 ET031A.UVDATA.1

Freq = 1.5950 GHz, Bw = 16.000 MH No calibration applied and no bandpass applied

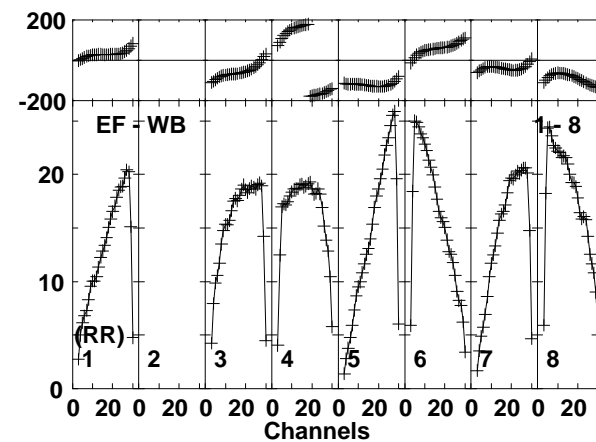
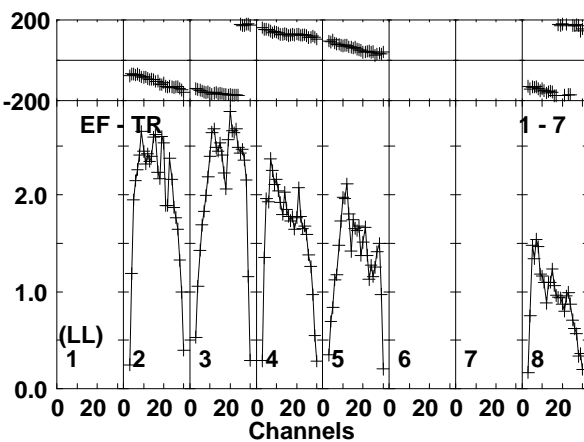
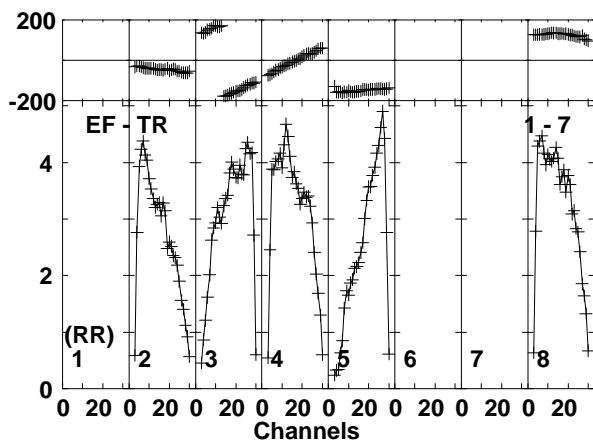
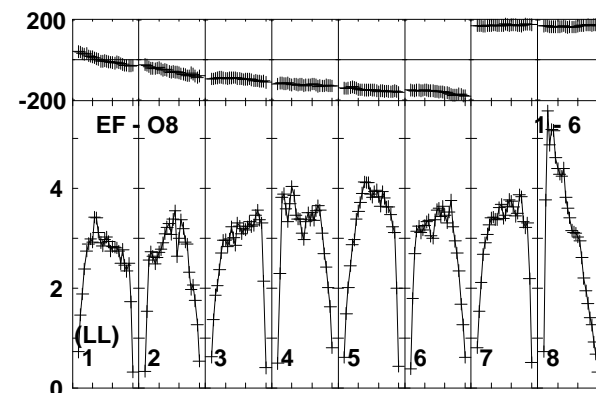
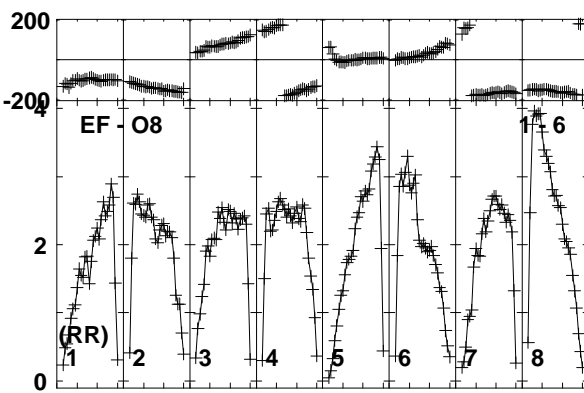
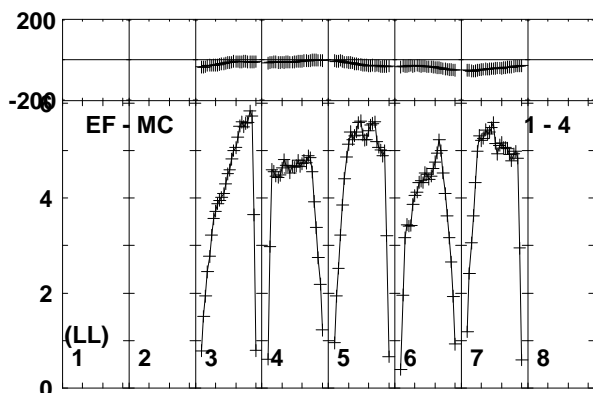
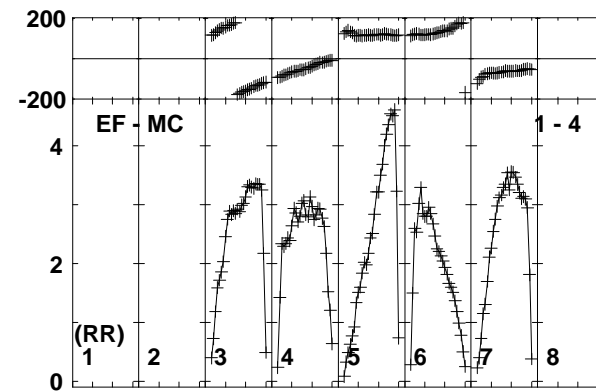
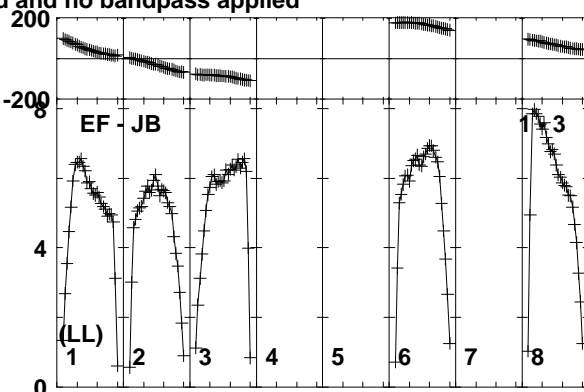
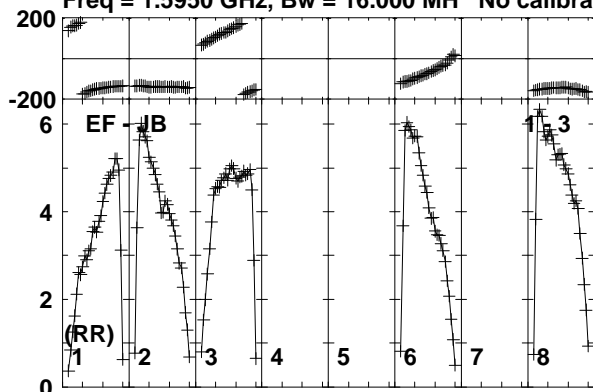

Lower frame: Milli Ampl Jy Top frame: Phas deg  
Vector averaged cross-power spectrum Baseline: EF (01) - JB (03)  
Timerange: 01/06:08:32 to 01/06:09:48

Plot file version 376 created 26-JUN-2015 10:51:33  
J2025+3343 ET031A.UVDATA.1  
Freq = 1.5950 GHz, Bw = 16.000 MH No calibration applied and no bandpass applied

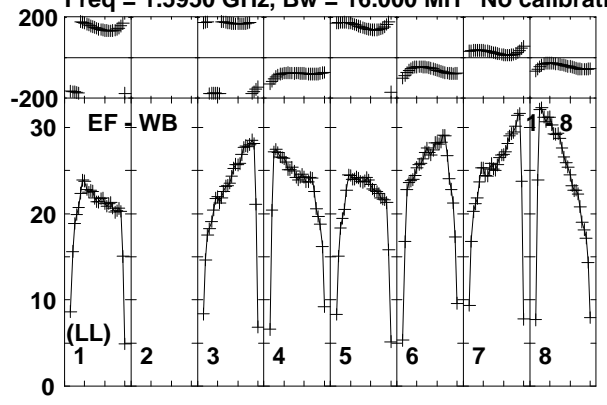

Lower frame: Milli Ampl Jy Top frame: Phas deg  
Vector averaged cross-power spectrum Baseline: EF (01) - WB (08)  
Timerange: 01/06:08:32 to 01/06:09:48



Plot file version 377 created 26-JUN-2015 10:51:33

V404CYG ET031A.UVDATA.1

Freq = 1.5950 GHz, Bw = 16.000 MH No calibration applied and no bandpass applied

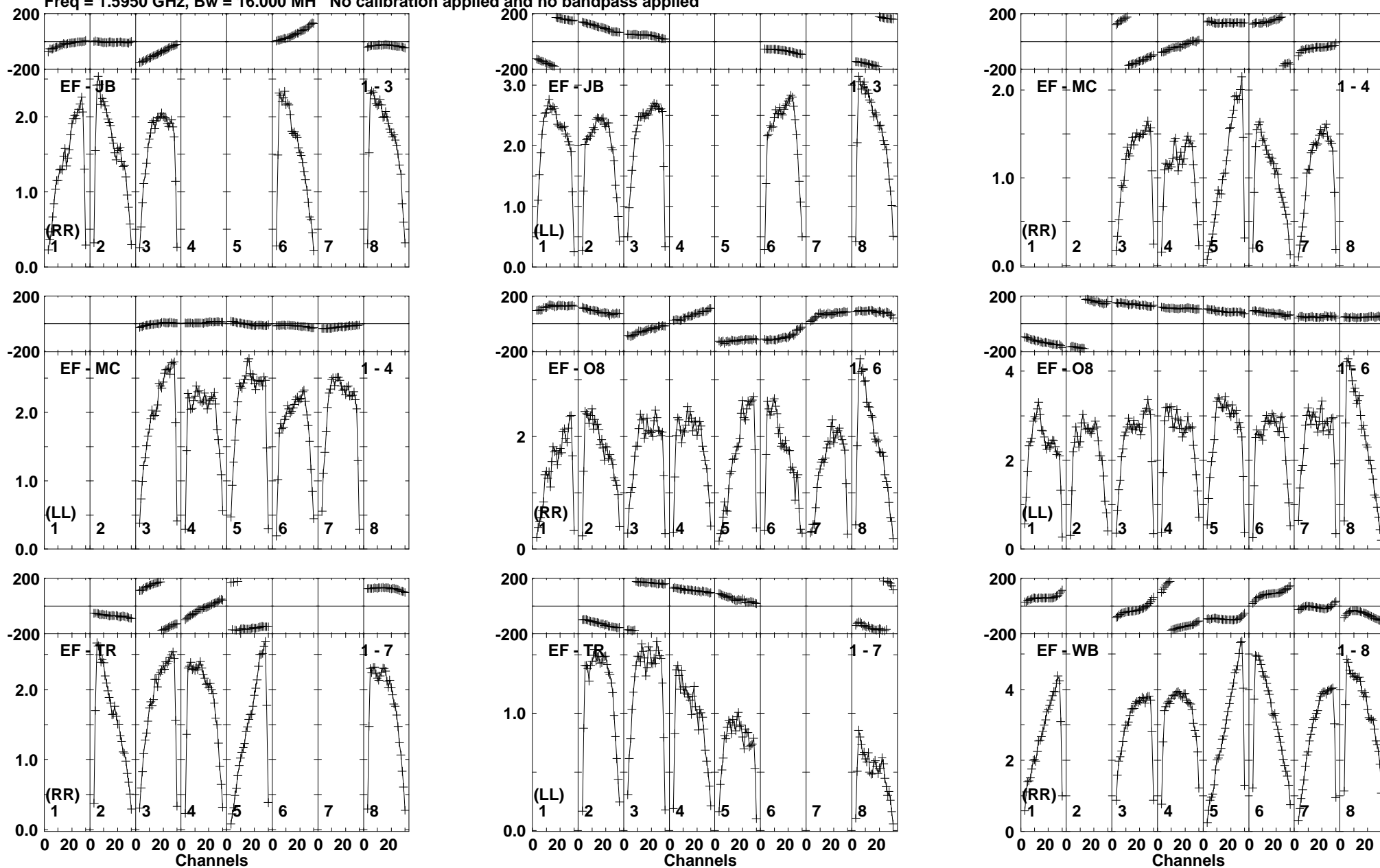

Lower frame: Milli Ampl Jy Top frame: Phas deg  
Vector averaged cross-power spectrum Baseline: EF (01) - JB (03)  
Timerange: 01/06:09:52 to 01/06:13:18

Plot file version 378 created 26-JUN-2015 10:51:33

V404CYG ET031A.UVDATA.1

Freq = 1.5950 GHz, Bw = 16.000 MH No calibration applied and no bandpass applied

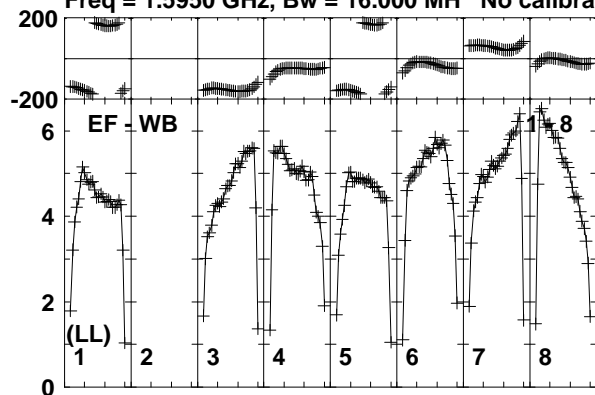

Lower frame: Milli Ampl Jy Top frame: Phas deg

Vector averaged cross-power spectrum Baseline: EF (01) - WB (08)

Timerange: 01/06:09:52 to 01/06:13:18

Plot file version 379 created 26-JUN-2015 10:51:33

J2025+3343 ET031A.UVDATA.1

Freq = 1.5950 GHz, Bw = 16.000 MH No calibration applied and no bandpass applied

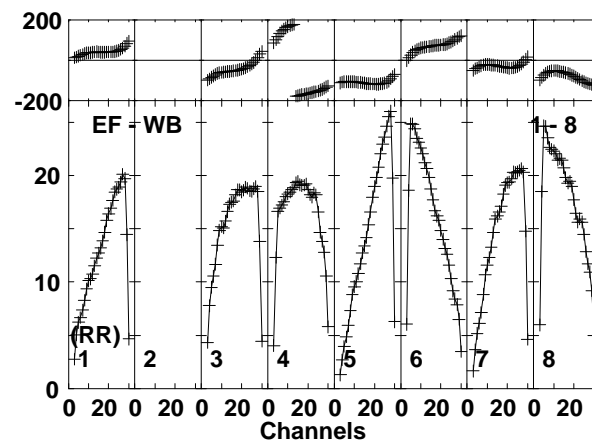
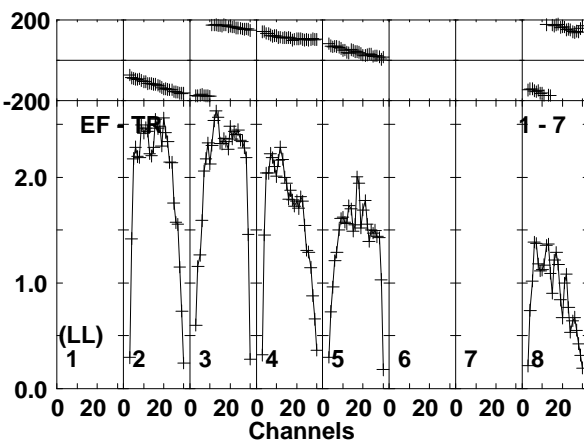
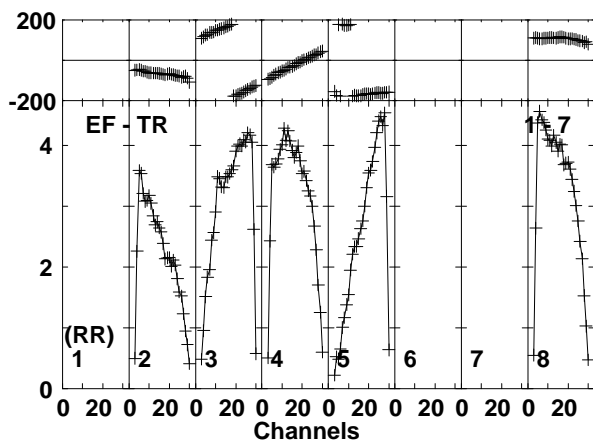
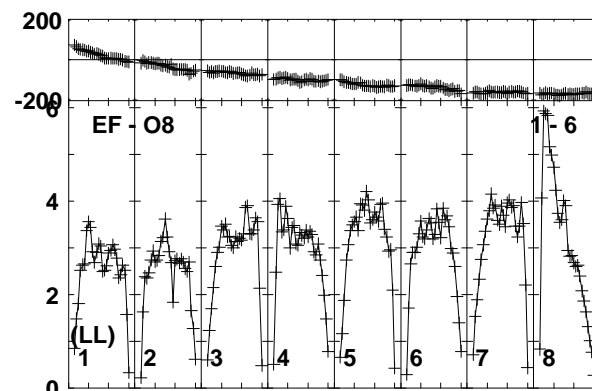
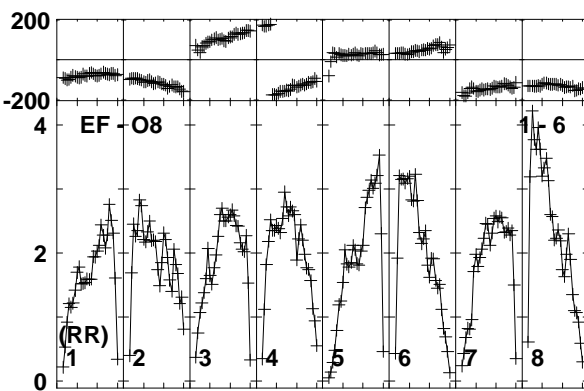
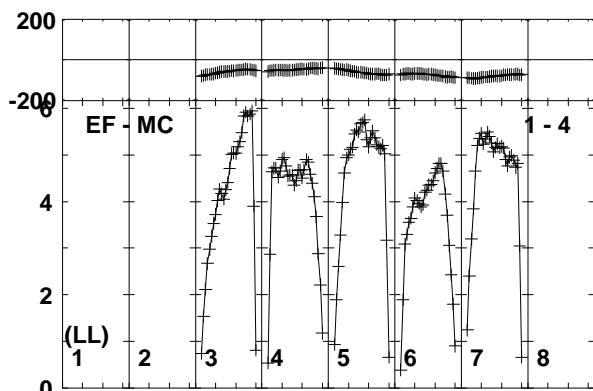
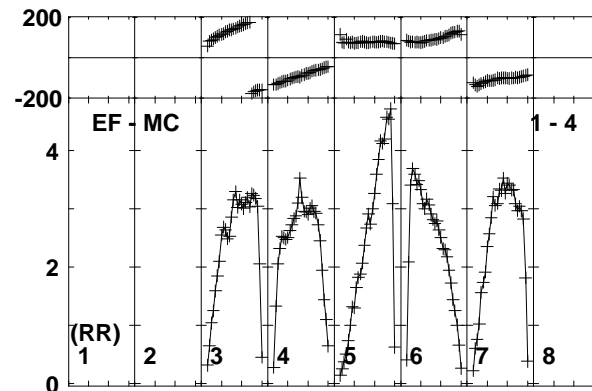
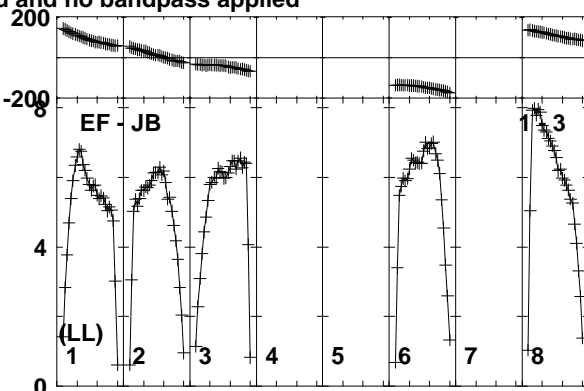
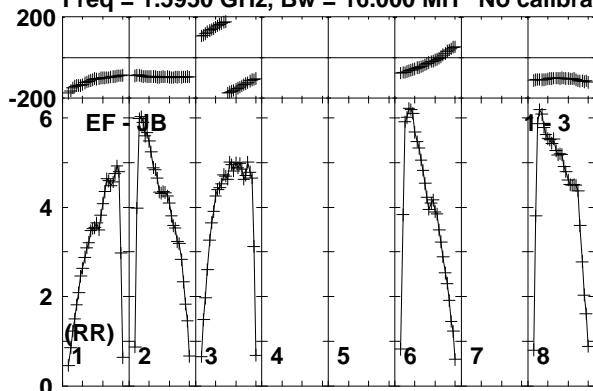

Lower frame: Milli Ampl Jy Top frame: Phas deg

Vector averaged cross-power spectrum Baseline: EF (01) - JB (03)

Timerange: 01/06:14:02 to 01/06:14:58

Plot file version 380 created 26-JUN-2015 10:51:33

J2025+3343 ET031A.UVDATA.1

Freq = 1.5950 GHz, Bw = 16.000 MH No calibration applied and no bandpass applied

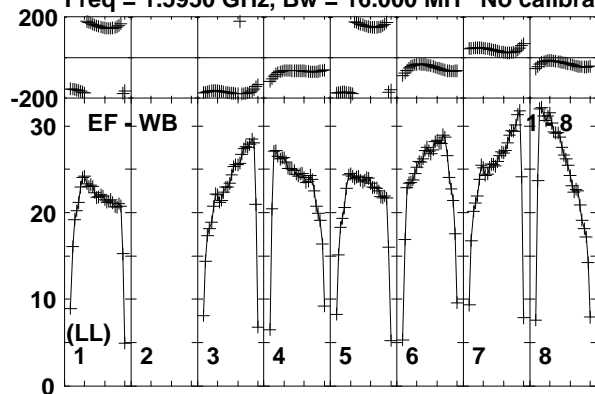

Lower frame: Milli Ampl Jy Top frame: Phas deg  
Vector averaged cross-power spectrum Baseline: EF (01) - WB (08)  
Timerange: 01/06:14:02 to 01/06:14:58

Plot file version 381 created 26-JUN-2015 10:51:33

V404CYG ET031A.UVDATA.1

Freq = 1.5950 GHz, Bw = 16.000 MH No calibration applied and no bandpass applied

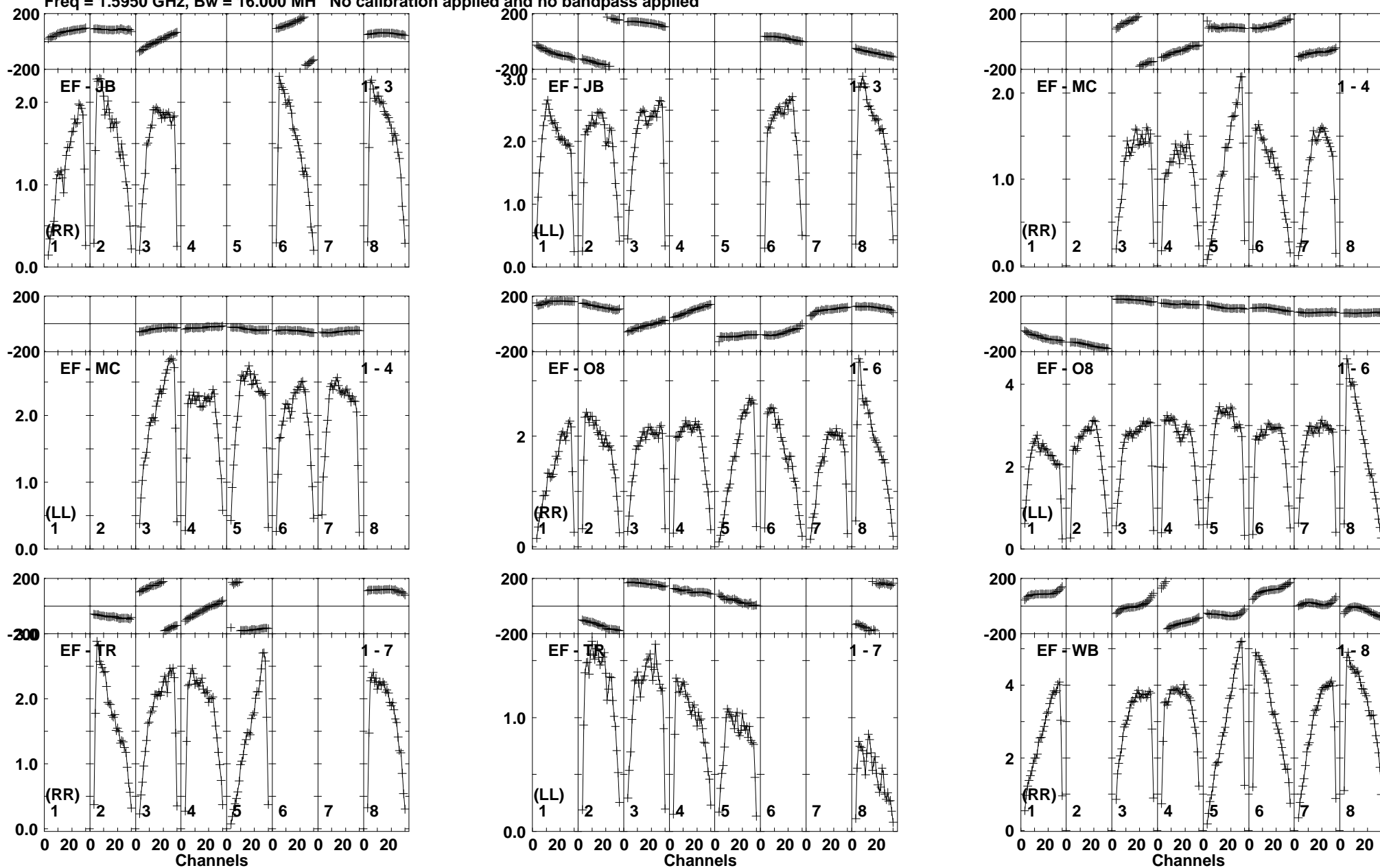

Lower frame: Milli Ampl Jy Top frame: Phas deg  
Vector averaged cross-power spectrum Baseline: EF (01) - JB (03)  
Timerange: 01/06:15:02 to 01/06:18:28

Plot file version 382 created 26-JUN-2015 10:51:33

V404CYG ET031A.UVDATA.1

Freq = 1.5950 GHz, Bw = 16.000 MH No calibration applied and no bandpass applied

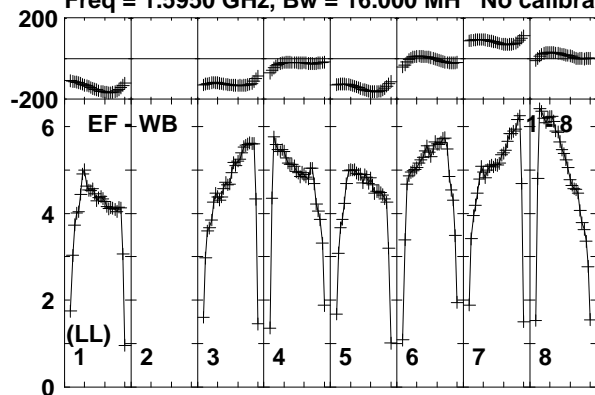

Lower frame: Milli Ampl Jy Top frame: Phas deg  
Vector averaged cross-power spectrum Baseline: EF (01) - WB (08)  
Timerange: 01/06:15:02 to 01/06:18:28

Plot file version 383 created 26-JUN-2015 10:51:33

J2025+3343 ET031A.UVDATA.1

Freq = 1.5950 GHz, Bw = 16.000 MH No calibration applied and no bandpass applied

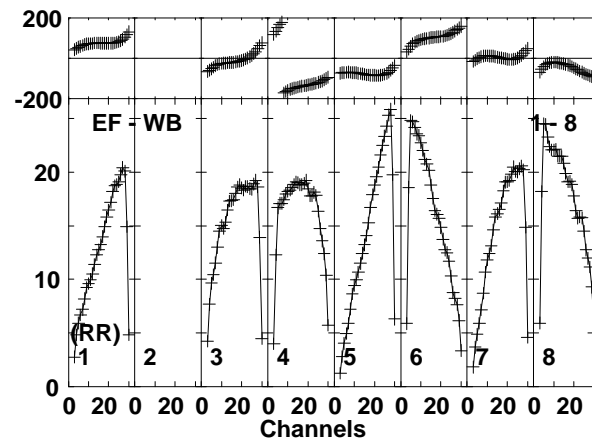
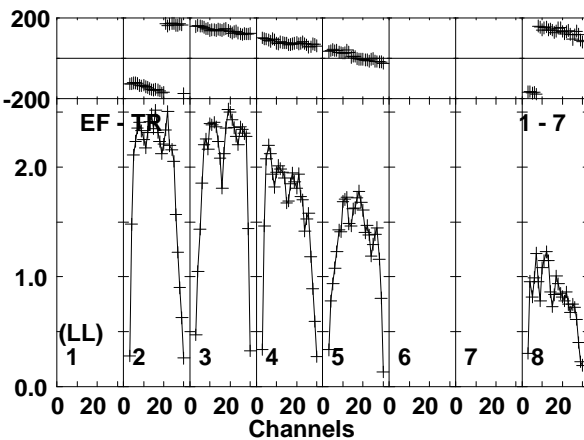
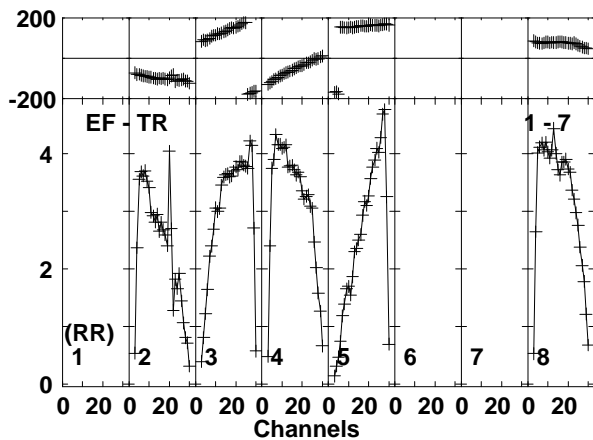
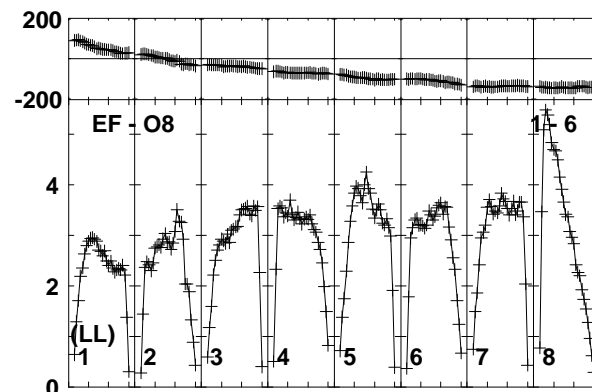
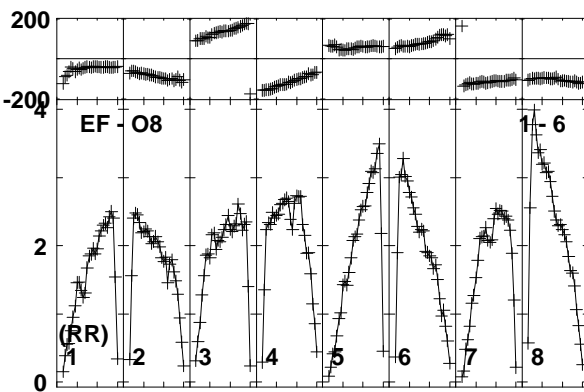
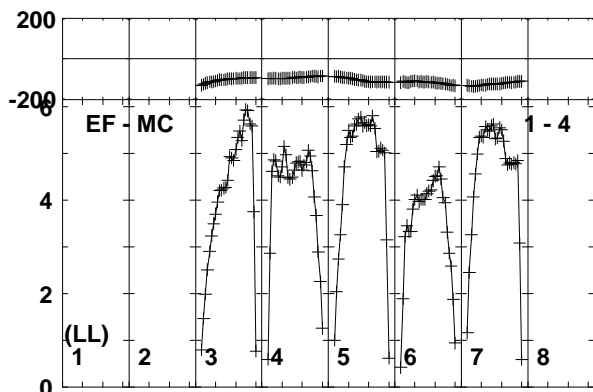
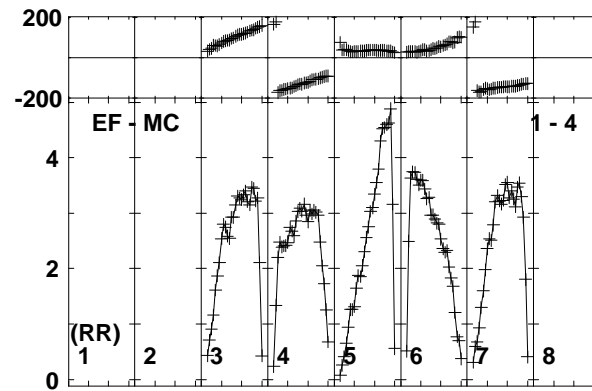
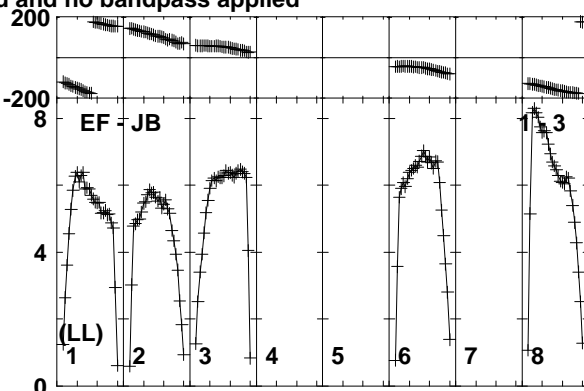
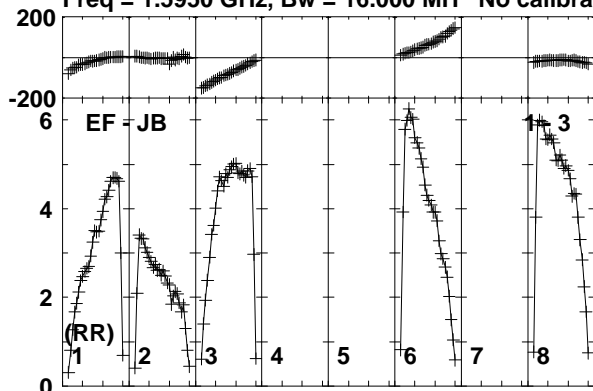

Lower frame: Milli Ampl Jy Top frame: Phas deg  
Vector averaged cross-power spectrum Baseline: EF (01) - JB (03)  
Timerange: 01/06:18:32 to 01/06:19:48

Plot file version 384 created 26-JUN-2015 10:51:33  
J2025+3343 ET031A.UVDATA.1  
Freq = 1.5950 GHz, Bw = 16.000 MH No calibration applied and no bandpass applied

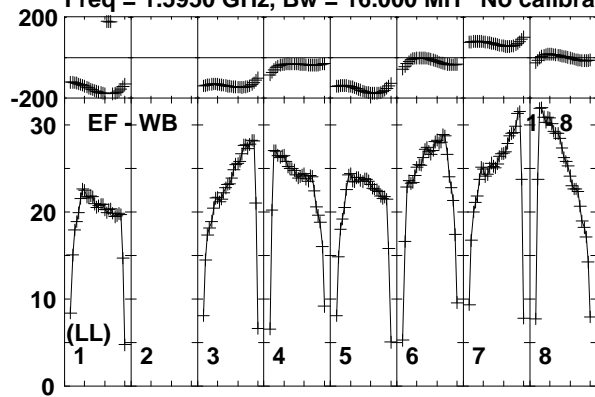

Lower frame: Milli Ampl Jy Top frame: Phas deg  
Vector averaged cross-power spectrum Baseline: EF (01) - WB (08)  
Timerange: 01/06:18:32 to 01/06:19:48



Plot file version 385 created 26-JUN-2015 10:51:33

V404CYG ET031A.UVDATA.1

Freq = 1.5950 GHz, Bw = 16.000 MH No calibration applied and no bandpass applied

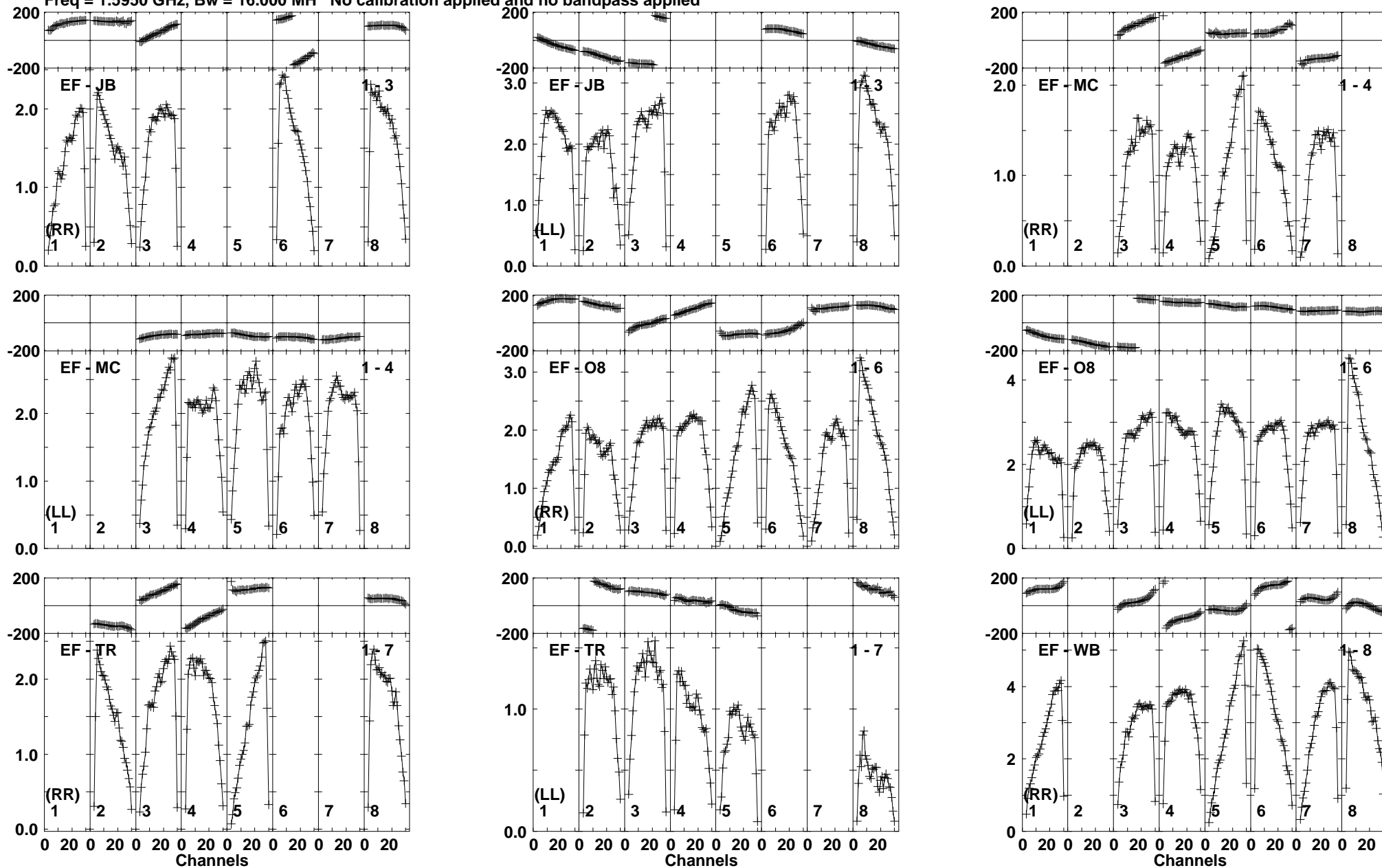

Lower frame: Milli Ampl Jy Top frame: Phas deg  
Vector averaged cross-power spectrum Baseline: EF (01) - JB (03)  
Timerange: 01/06:19:52 to 01/06:23:18

Plot file version 386 created 26-JUN-2015 10:51:33  
V404CYG ET031A.UVDATA.1  
Freq = 1.5950 GHz, Bw = 16.000 MH No calibration applied and no bandpass applied

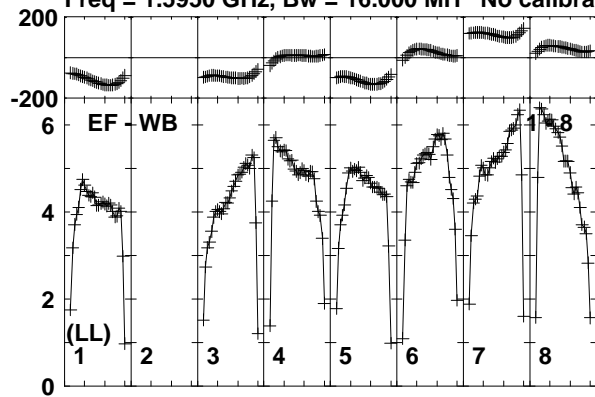

Lower frame: Milli Ampl Jy Top frame: Phas deg  
Vector averaged cross-power spectrum Baseline: EF (01) - WB (08)  
Timerange: 01/06:19:52 to 01/06:23:18

Plot file version 387 created 26-JUN-2015 10:51:33

J2025+3343 ET031A.UVDATA.1

Freq = 1.5950 GHz, Bw = 16.000 MH No calibration applied and no bandpass applied

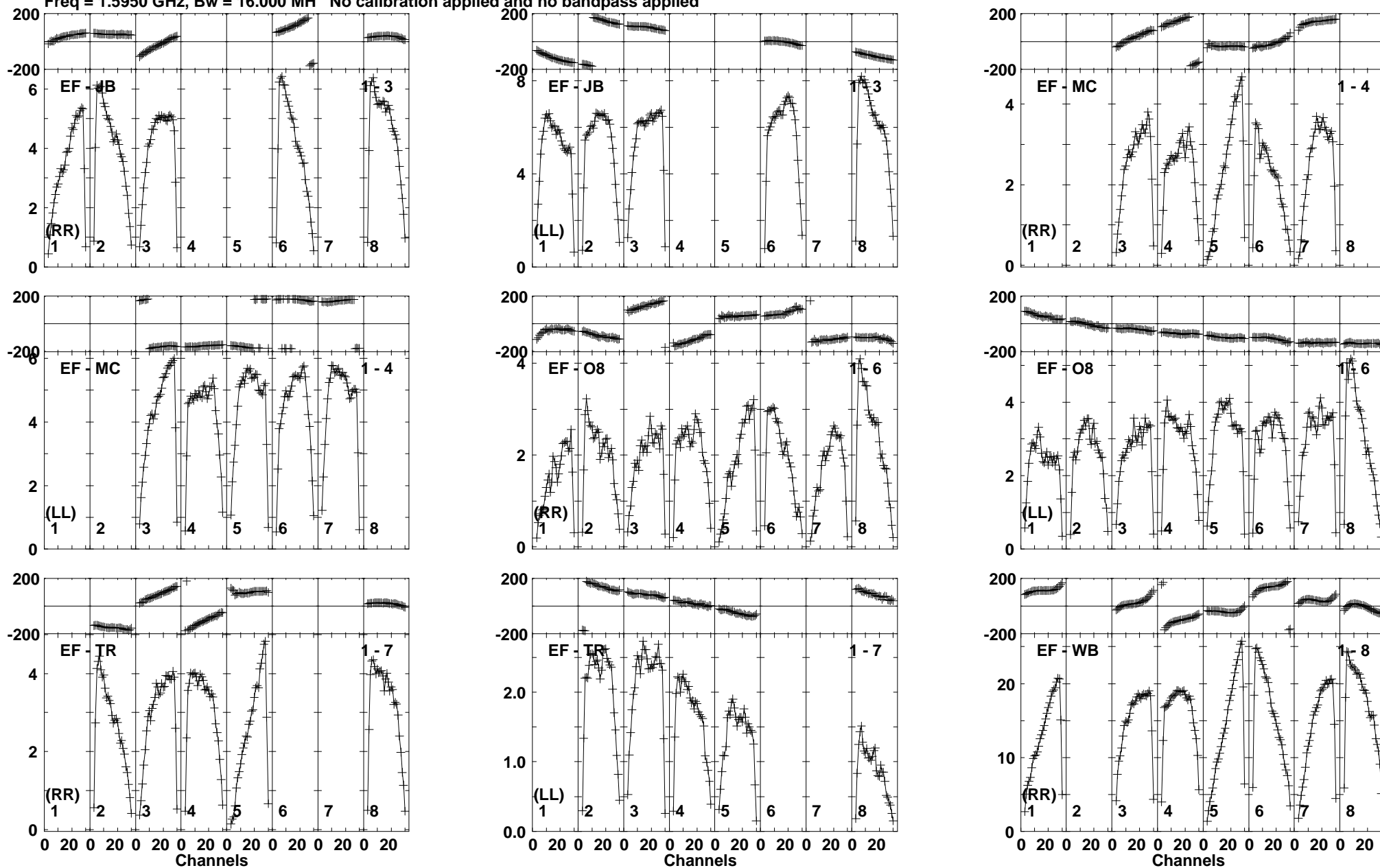

Lower frame: Milli Ampl Jy Top frame: Phas deg  
Vector averaged cross-power spectrum Baseline: EF (01) - JB (03)  
Timerange: 01/06:24:02 to 01/06:24:58

Plot file version 388 created 26-JUN-2015 10:51:33  
J2025+3343 ET031A.UVDATA.1  
Freq = 1.5950 GHz, Bw = 16.000 MH No calibration applied and no bandpass applied

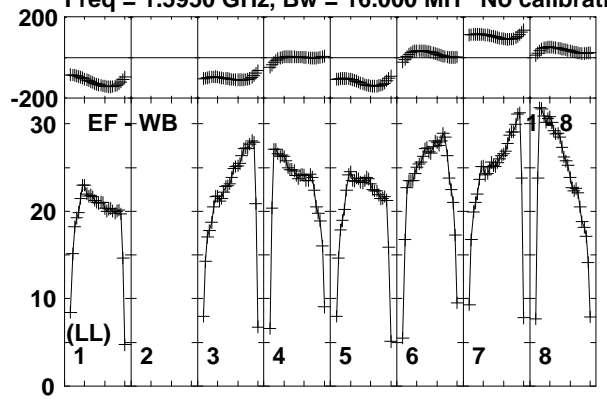

Lower frame: Milli Ampl Jy Top frame: Phas deg  
Vector averaged cross-power spectrum Baseline: EF (01) - WB (08)  
Timerange: 01/06:24:02 to 01/06:24:58

Plot file version 389 created 26-JUN-2015 10:51:33

V404CYG ET031A.UVDATA.1

Freq = 1.5950 GHz, Bw = 16.000 MH No calibration applied and no bandpass applied

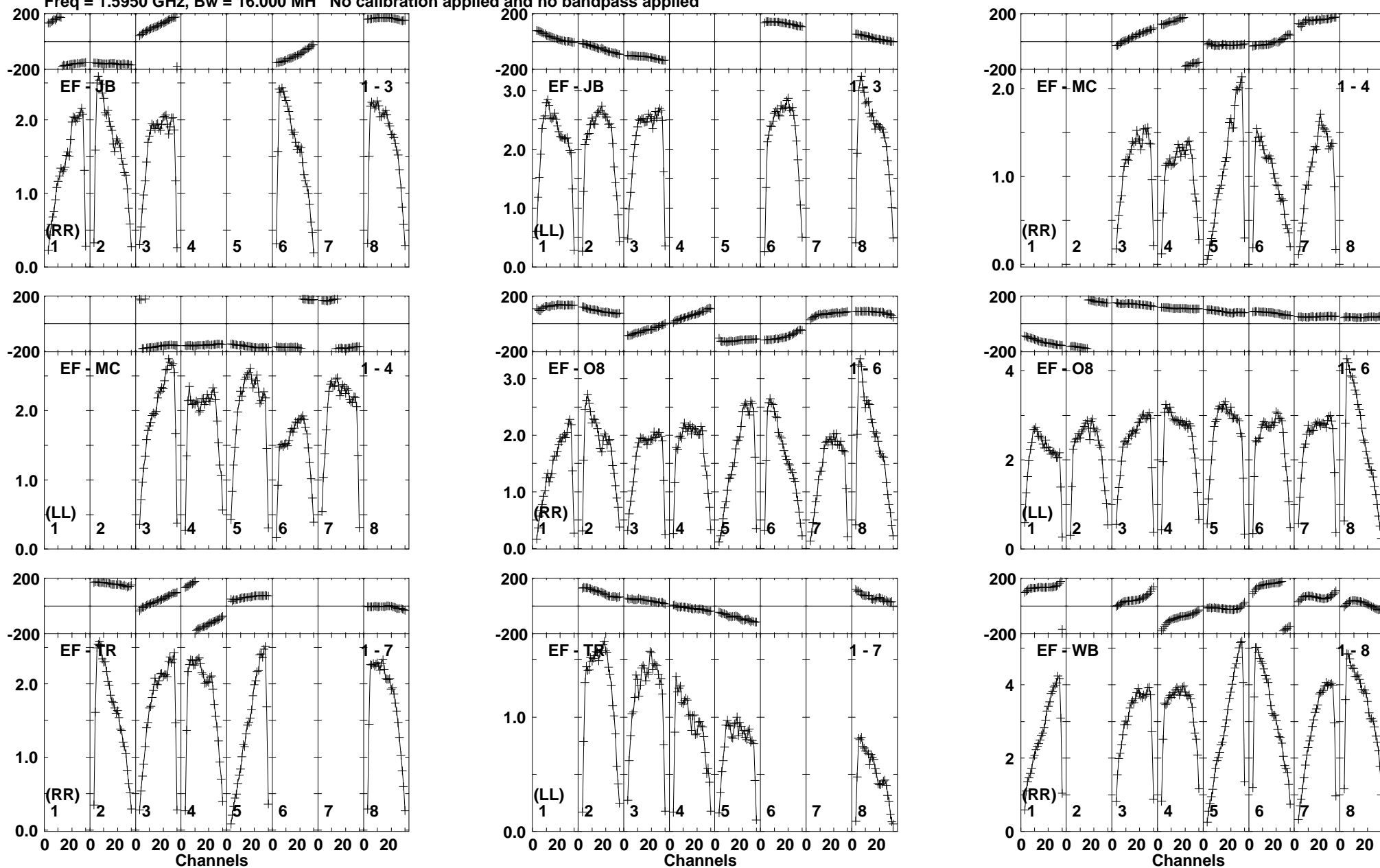

Lower frame: Milli Ampl Jy Top frame: Phas deg  
Vector averaged cross-power spectrum Baseline: EF (01) - JB (03)  
Timerange: 01/06:25:02 to 01/06:28:28

Plot file version 390 created 26-JUN-2015 10:51:33

V404CYG ET031A.UVDATA.1

Freq = 1.5950 GHz, Bw = 16.000 MH No calibration applied and no bandpass applied

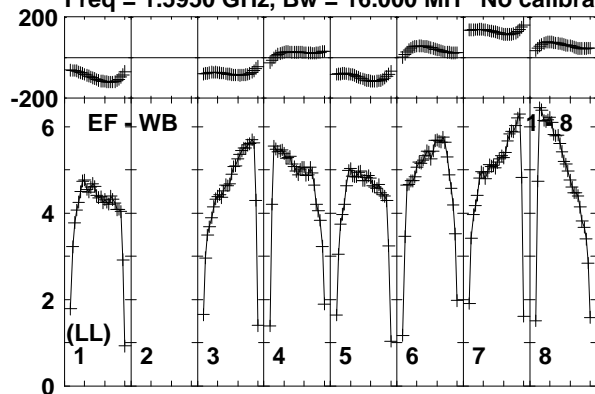

Lower frame: Milli Ampl Jy Top frame: Phas deg

Vector averaged cross-power spectrum Baseline: EF (01) - WB (08)

Timerange: 01/06:25:02 to 01/06:28:28

Plot file version 391 created 26-JUN-2015 10:51:33  
 J2025+3343 ET031A.UVDATA.1  
 Freq = 1.5950 GHz, Bw = 16.000 MH No calibration applied and no bandpass applied

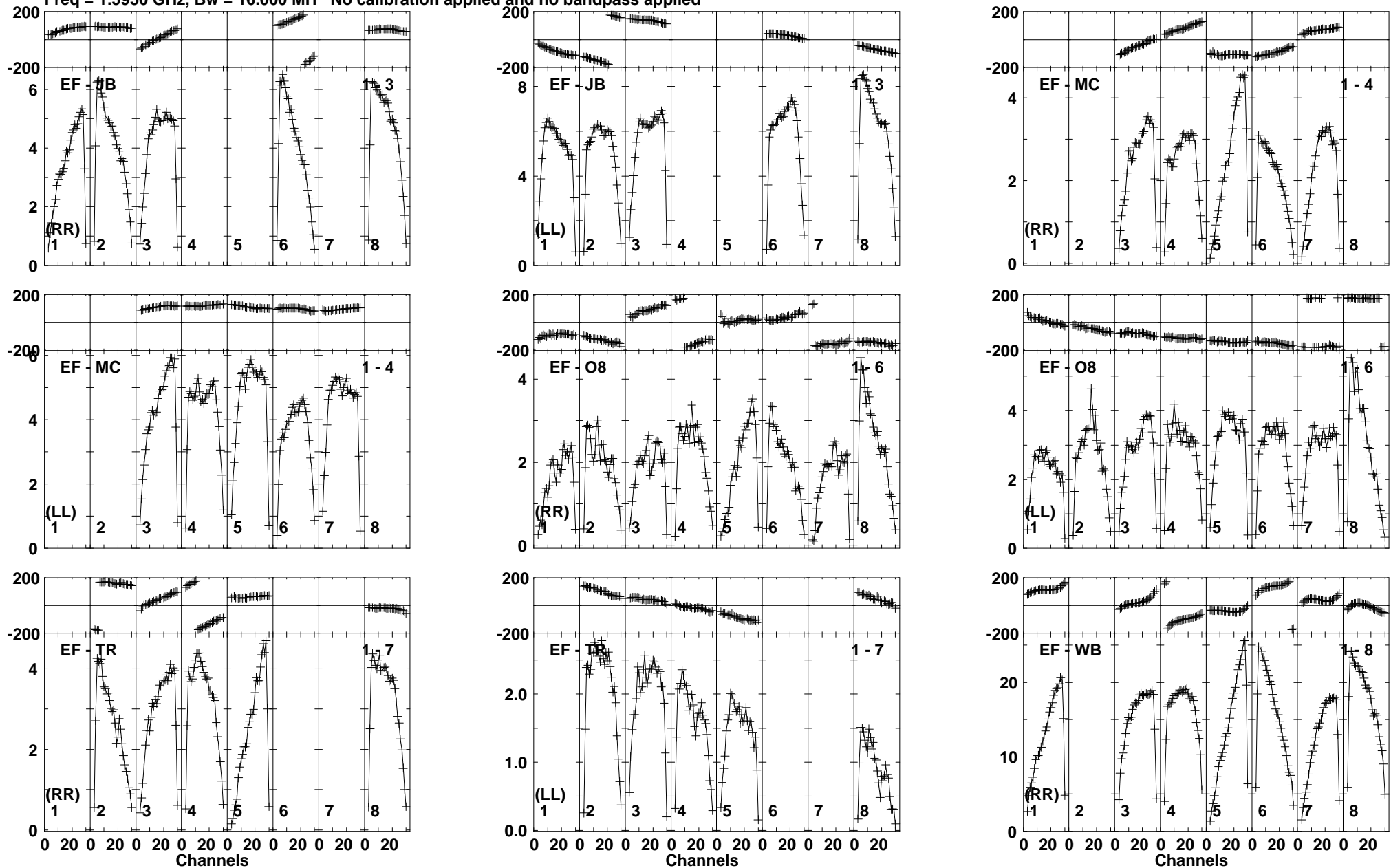

Lower frame: Milli Ampl Jy Top frame: Phas deg  
 Vector averaged cross-power spectrum Baseline: EF (01) - JB (03)  
 Timerange: 01/06:28:32 to 01/06:29:48

Plot file version 392 created 26-JUN-2015 10:51:33  
J2025+3343 ET031A.UVDATA.1  
Freq = 1.5950 GHz, Bw = 16.000 MH No calibration applied and no bandpass applied

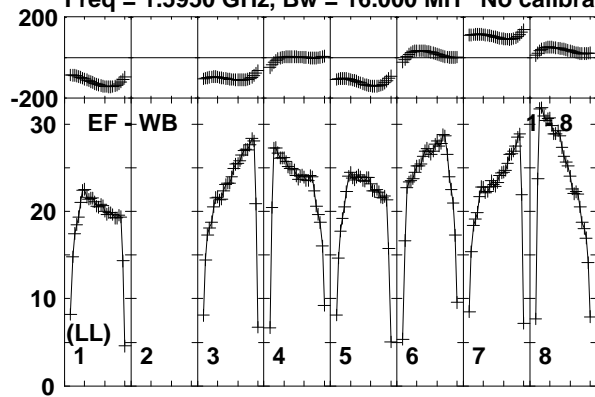

Lower frame: Milli Ampl Jy Top frame: Phas deg  
Vector averaged cross-power spectrum Baseline: EF (01) - WB (08)  
Timerange: 01/06:28:32 to 01/06:29:48



Plot file version 393 created 26-JUN-2015 10:51:33

V404CYG ET031A.UVDATA.1

Freq = 1.5950 GHz, Bw = 16.000 MH No calibration applied and no bandpass applied

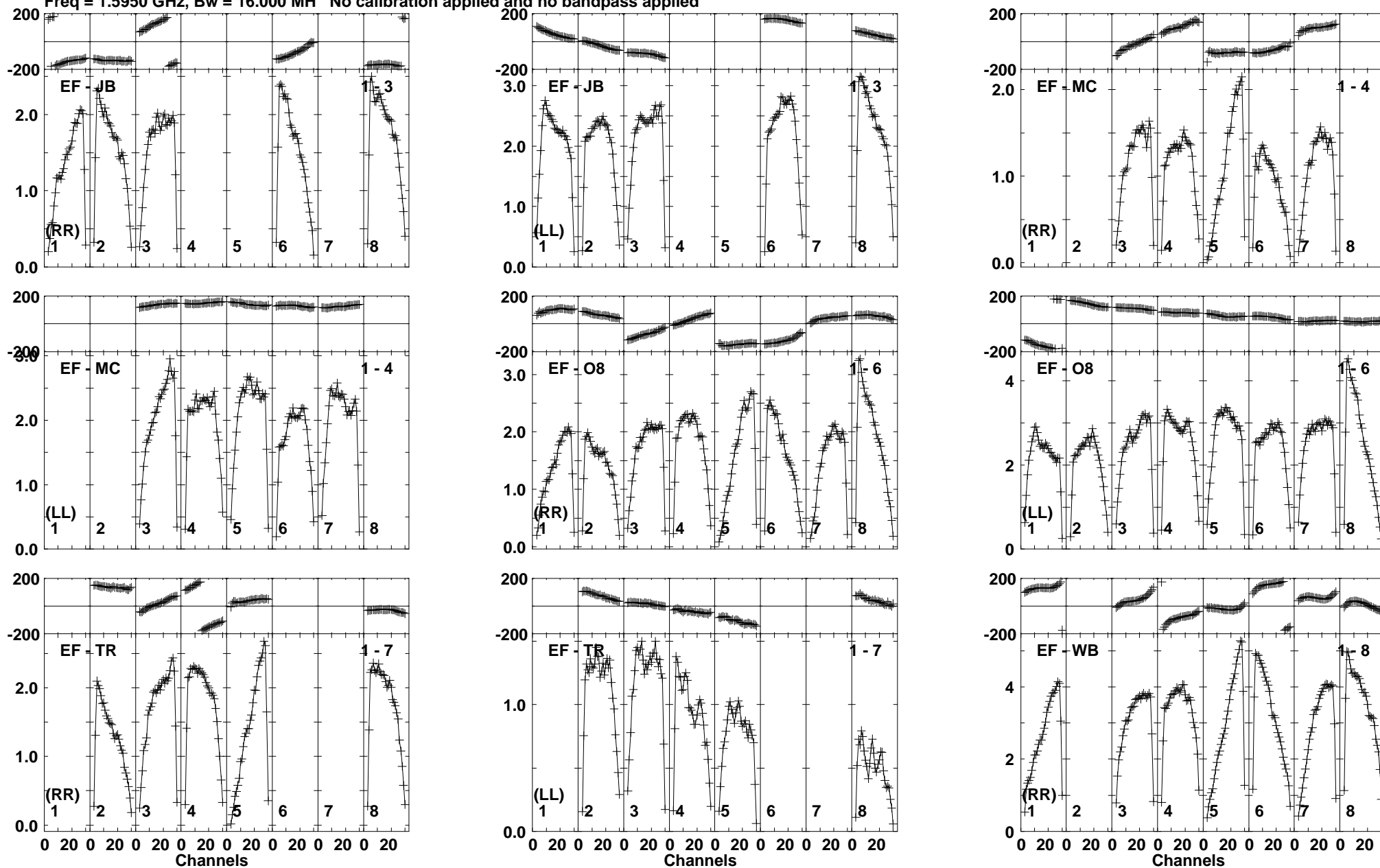

Lower frame: Milli Ampl Jy Top frame: Phas deg  
Vector averaged cross-power spectrum Baseline: EF (01) - JB (03)  
Timerange: 01/06:29:52 to 01/06:33:18

Plot file version 394 created 26-JUN-2015 10:51:34

V404CYG ET031A.UVDATA.1

Freq = 1.5950 GHz, Bw = 16.000 MH No calibration applied and no bandpass applied

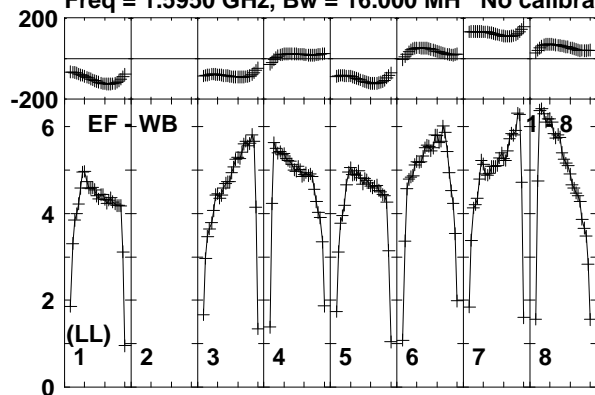

Lower frame: Milli Ampl Jy Top frame: Phas deg  
Vector averaged cross-power spectrum Baseline: EF (01) - WB (08)  
Timerange: 01/06:29:52 to 01/06:33:18

Plot file version 395 created 26-JUN-2015 10:51:34

J2025+3343 ET031A.UVDATA.1

Freq = 1.5950 GHz, Bw = 16.000 MH No calibration applied and no bandpass applied

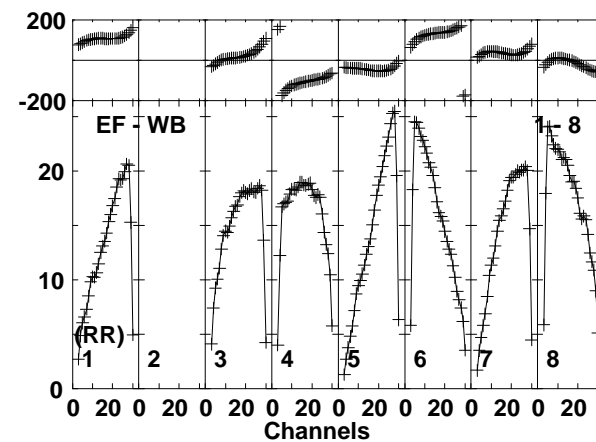
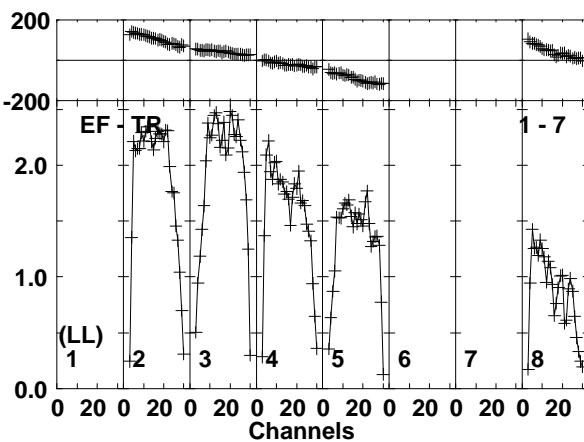
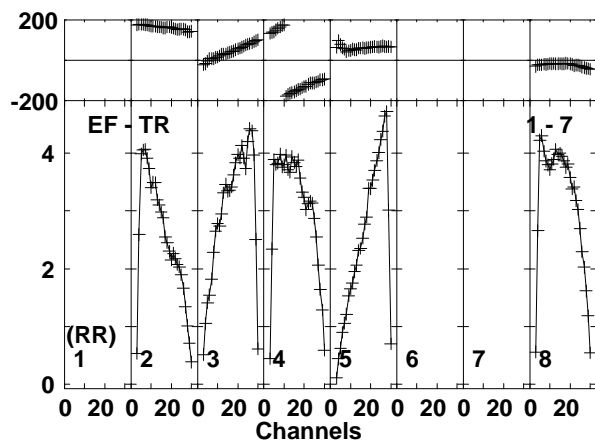
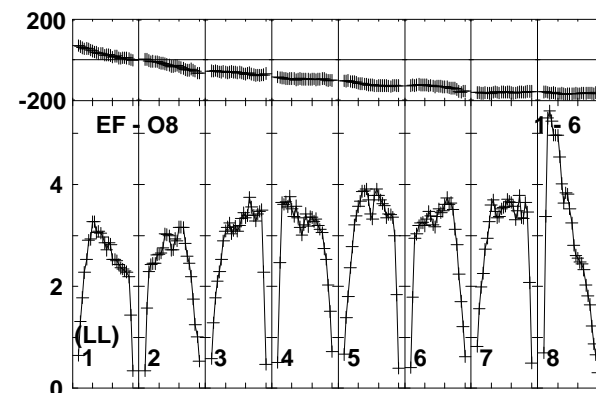
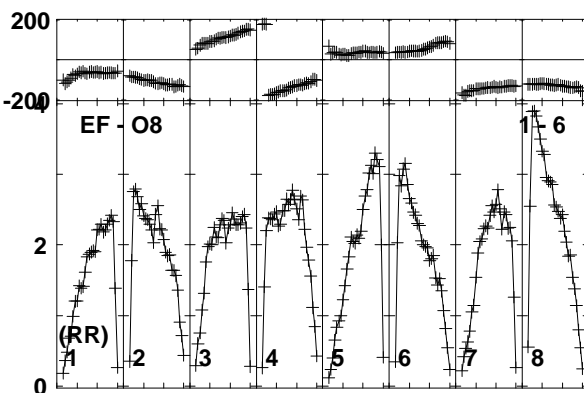
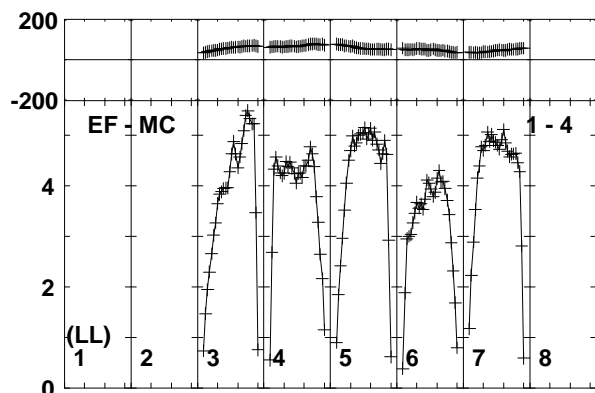
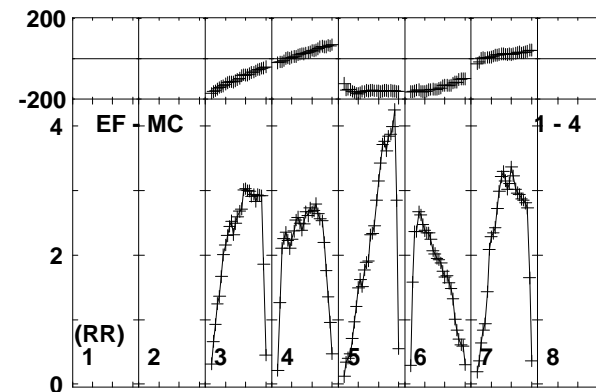
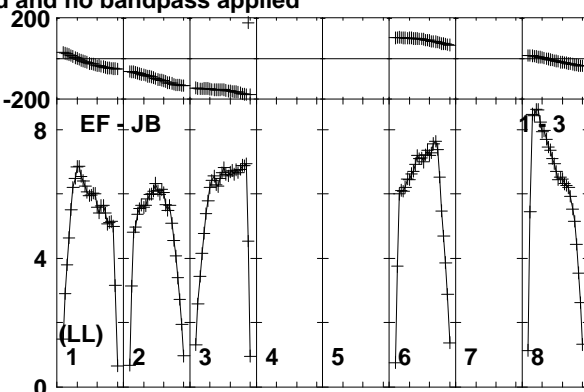
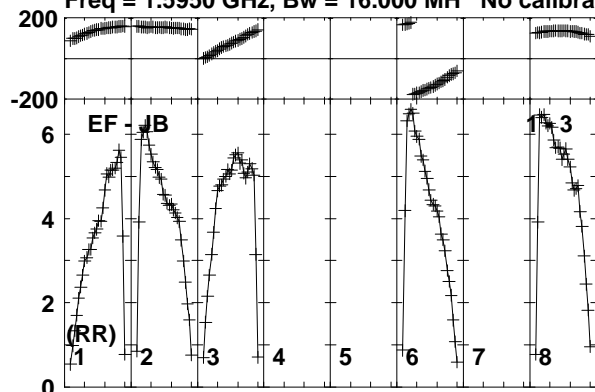

Lower frame: Milli Ampl Jy Top frame: Phas deg  
Vector averaged cross-power spectrum Baseline: EF (01) - JB (03)  
Timerange: 01/06:34:02 to 01/06:34:58

Plot file version 396 created 26-JUN-2015 10:51:34  
J2025+3343 ET031A.UVDATA.1  
Freq = 1.5950 GHz, Bw = 16.000 MH No calibration applied and no bandpass applied

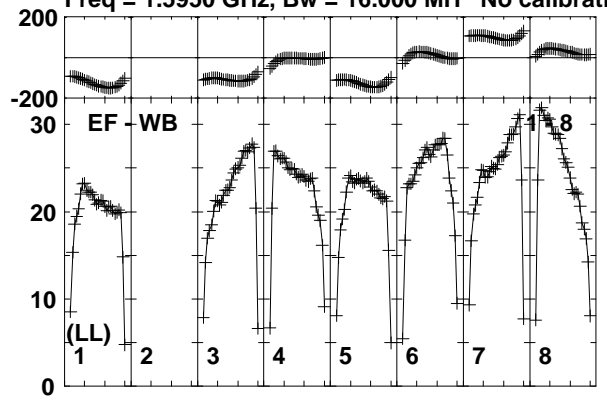

Lower frame: Milli Ampl Jy Top frame: Phas deg  
Vector averaged cross-power spectrum Baseline: EF (01) - WB (08)  
Timerange: 01/06:34:02 to 01/06:34:58

Plot file version 397 created 26-JUN-2015 10:51:34

V404CYG ET031A.UVDATA.1

Freq = 1.5950 GHz, Bw = 16.000 MH No calibration applied and no bandpass applied

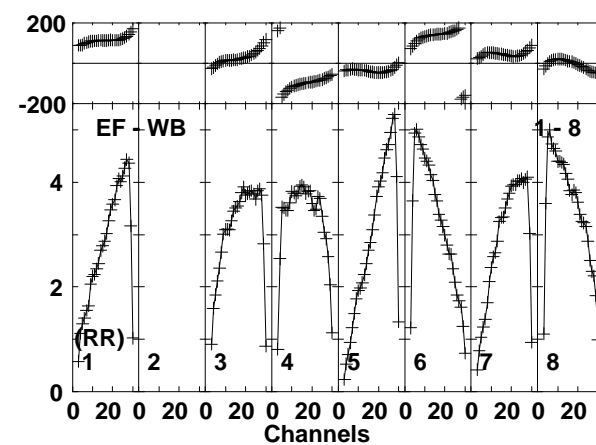
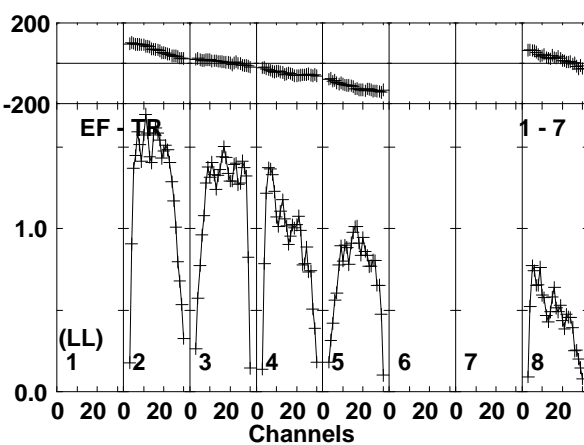
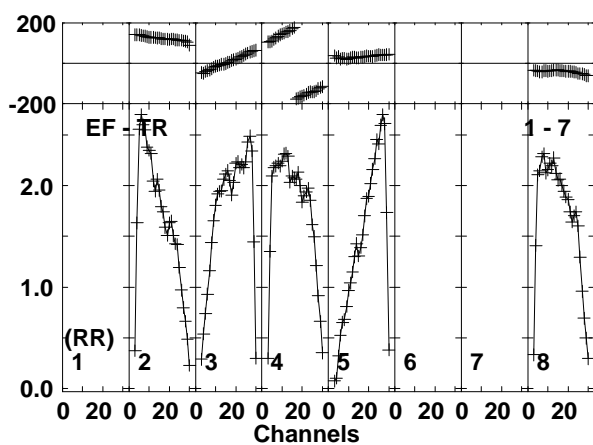
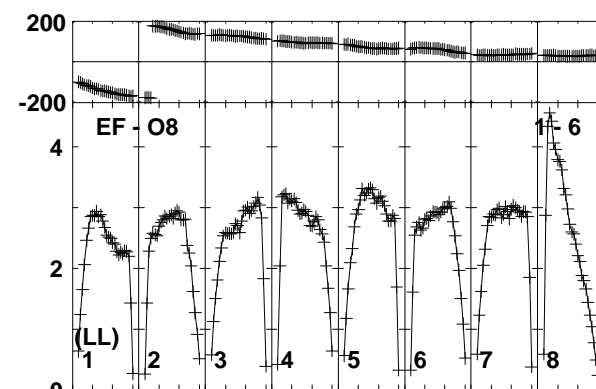
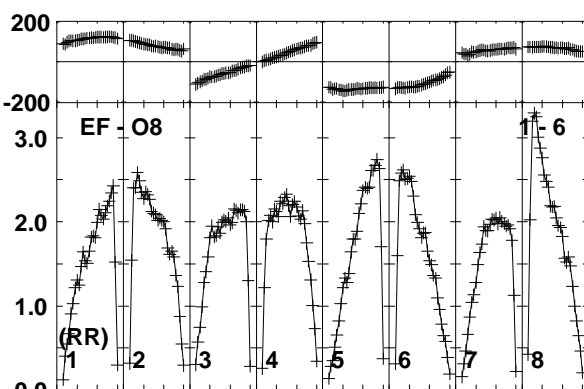
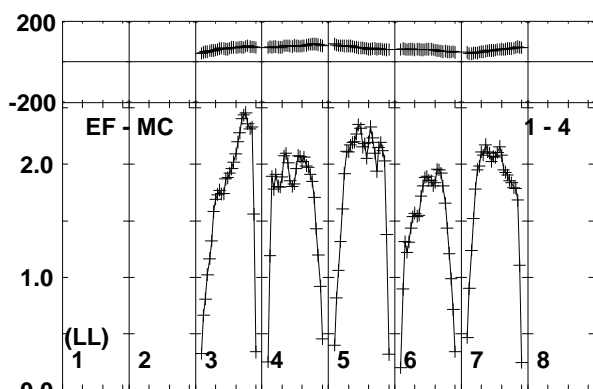
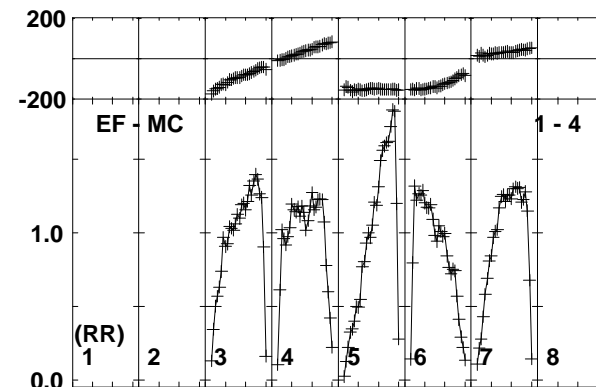
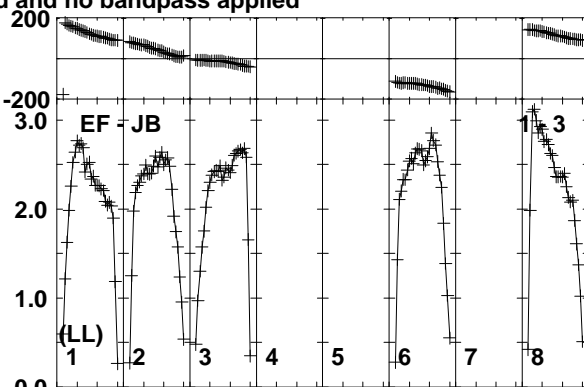
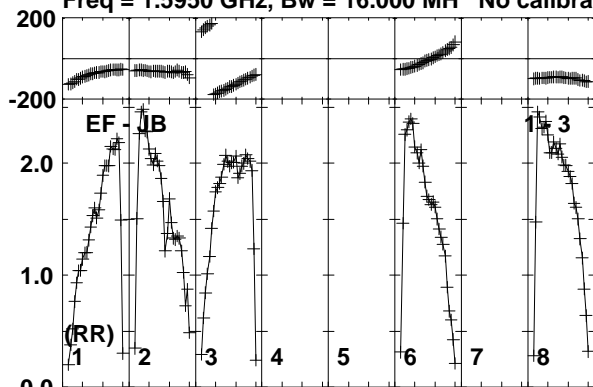

Lower frame: Milli Ampl Jy Top frame: Phas deg  
Vector averaged cross-power spectrum Baseline: EF (01) - JB (03)  
Timerange: 01/06:35:02 to 01/06:38:28

Plot file version 398 created 26-JUN-2015 10:51:34  
V404CYG ET031A.UVDATA.1  
Freq = 1.5950 GHz, Bw = 16.000 MH No calibration applied and no bandpass applied

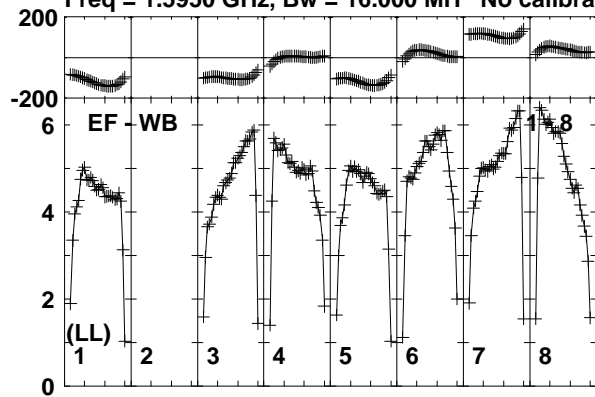

Lower frame: Milli Ampl Jy Top frame: Phas deg  
Vector averaged cross-power spectrum Baseline: EF (01) - WB (08)  
Timerange: 01/06:35:02 to 01/06:38:28

Plot file version 399 created 26-JUN-2015 10:51:34

J2025+3343 ET031A.UVDATA.1

Freq = 1.5950 GHz, Bw = 16.000 MH No calibration applied and no bandpass applied

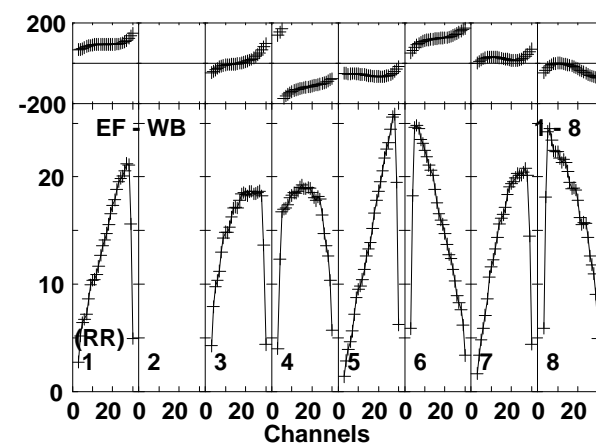
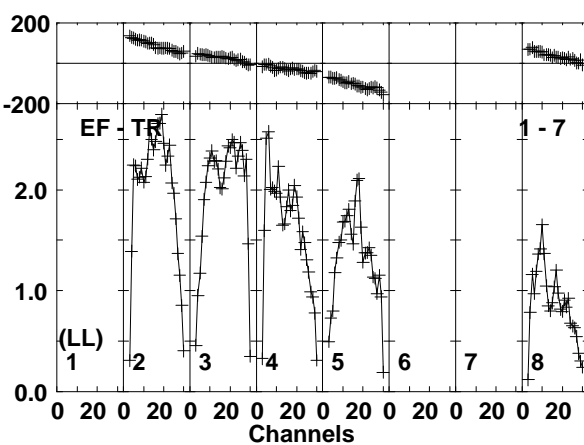
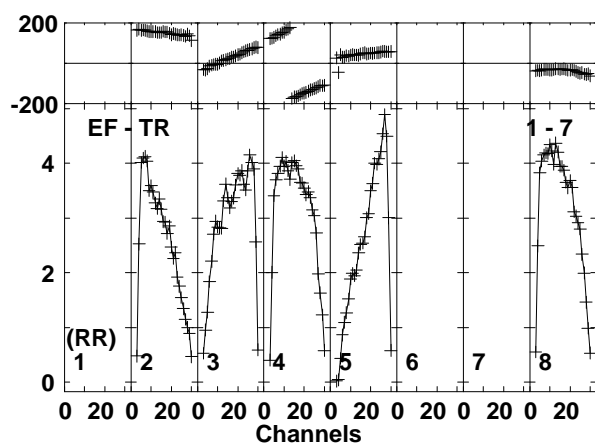
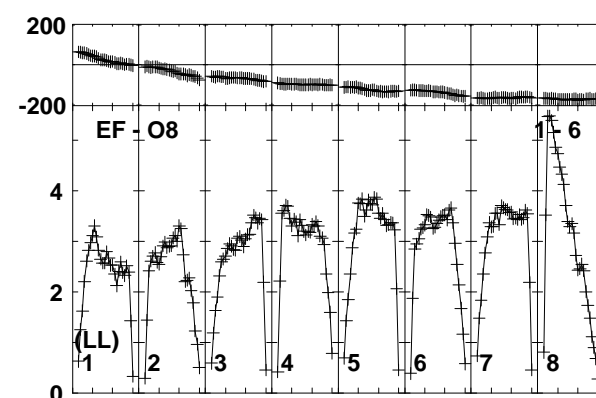
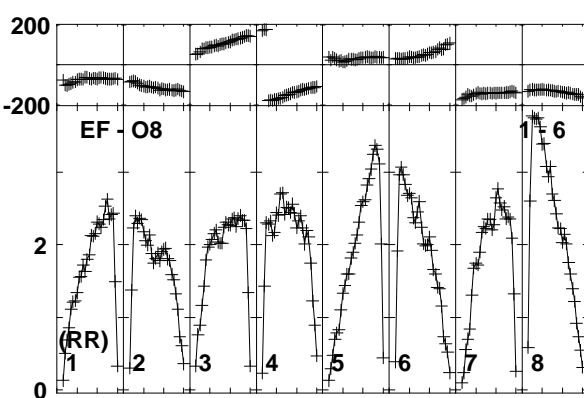
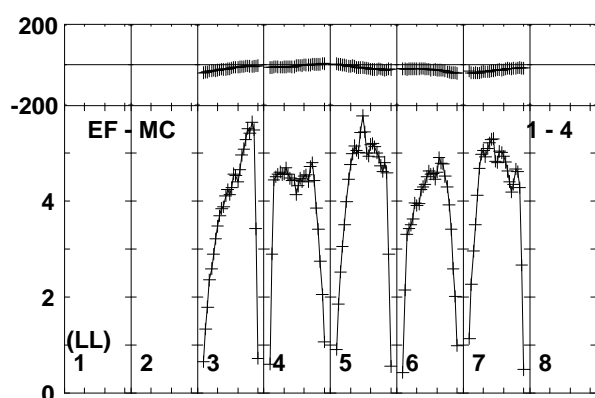
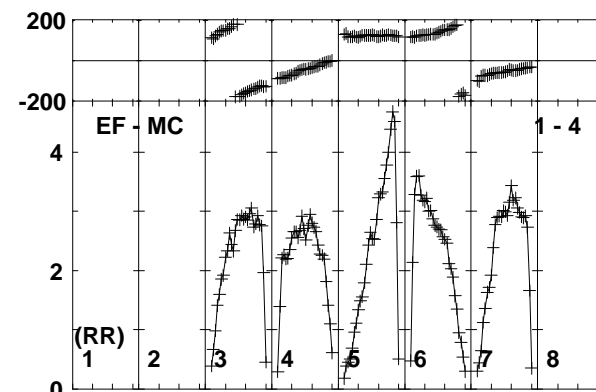
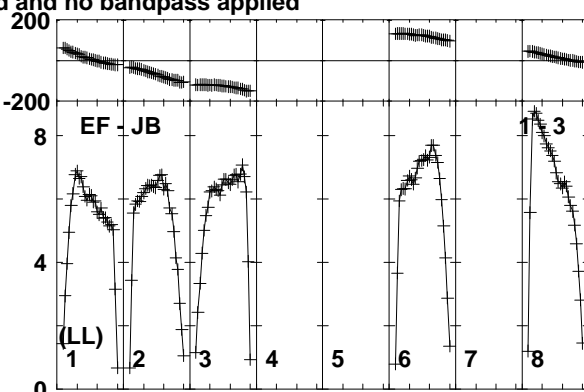
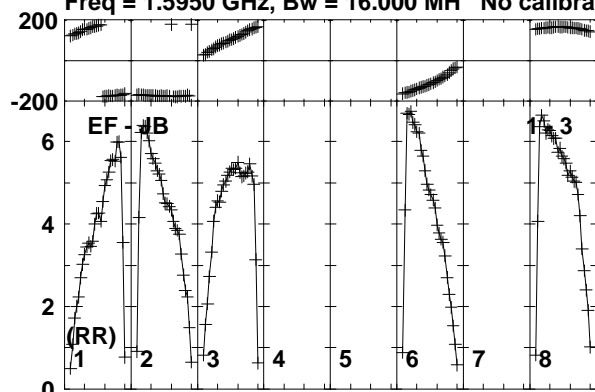

Lower frame: Milli Ampl Jy Top frame: Phas deg  
Vector averaged cross-power spectrum Baseline: EF (01) - JB (03)  
Timerange: 01/06:38:32 to 01/06:39:48

Plot file version 400 created 26-JUN-2015 10:51:34  
J2025+3343 ET031A.UVDATA.1  
Freq = 1.5950 GHz, Bw = 16.000 MH No calibration applied and no bandpass applied

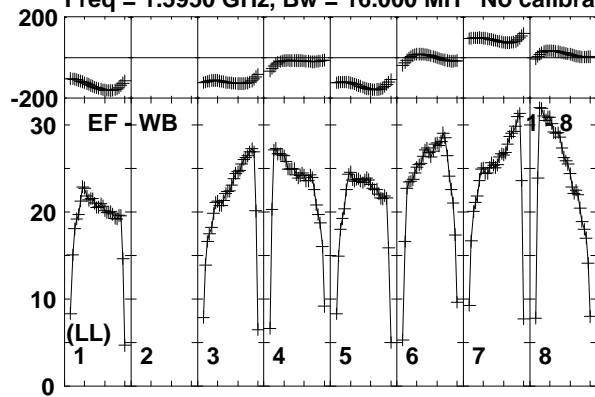

Lower frame: Milli Ampl Jy Top frame: Phas deg  
Vector averaged cross-power spectrum Baseline: EF (01) - WB (08)  
Timerange: 01/06:38:32 to 01/06:39:48



Plot file version 401 created 26-JUN-2015 10:51:34

V404CYG ET031A.UVDATA.1

Freq = 1.5950 GHz, Bw = 16.000 MH No calibration applied and no bandpass applied

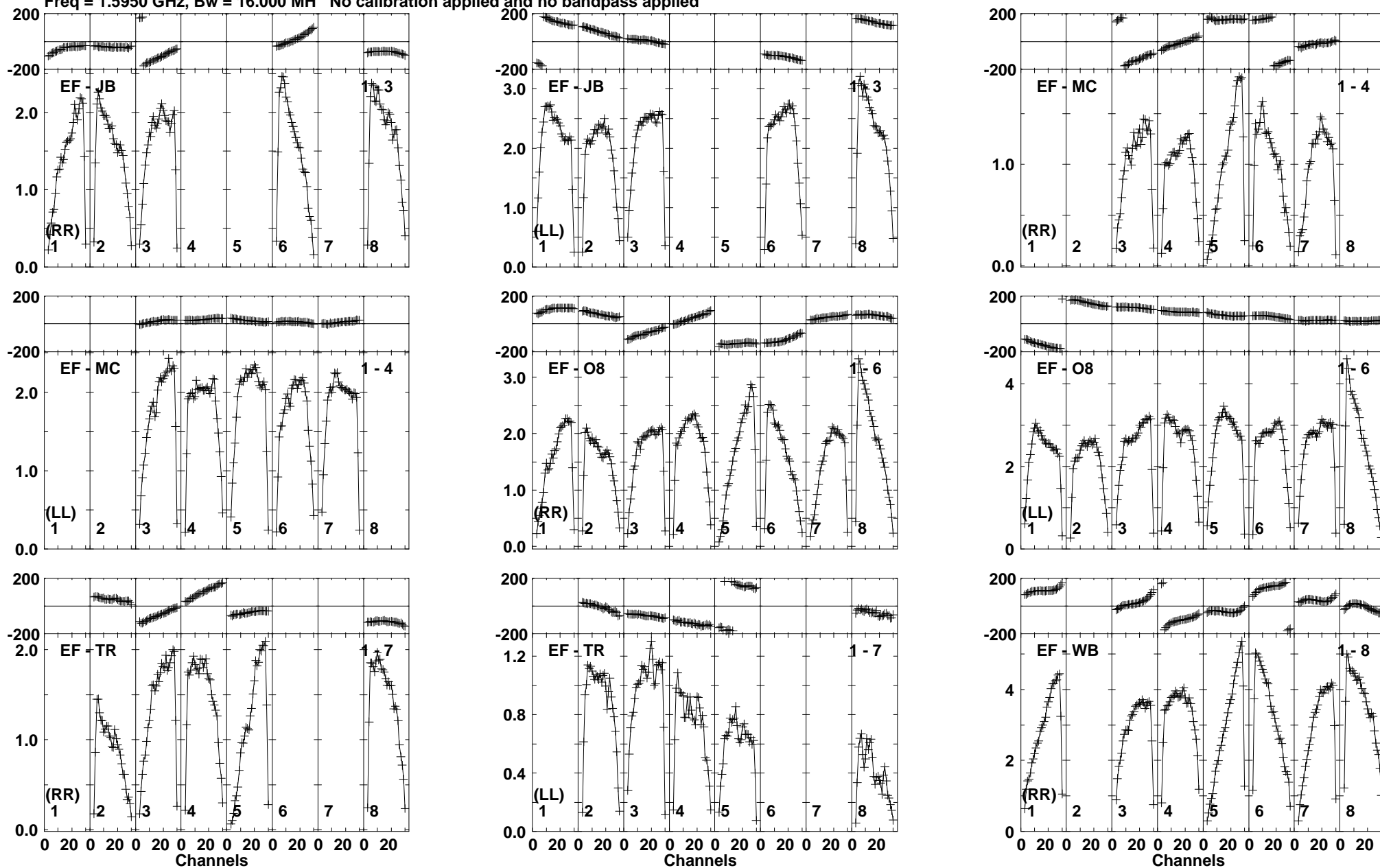

Lower frame: Milli Ampl Jy Top frame: Phas deg  
Vector averaged cross-power spectrum Baseline: EF (01) - JB (03)  
Timerange: 01/06:39:52 to 01/06:43:18

Plot file version 402 created 26-JUN-2015 10:51:34

V404CYG ET031A.UVDATA.1

Freq = 1.5950 GHz, Bw = 16.000 MH No calibration applied and no bandpass applied

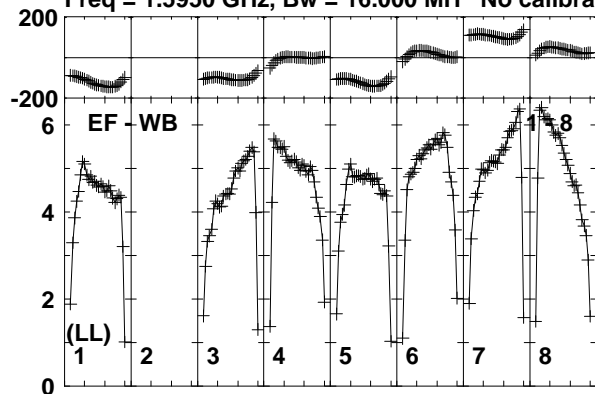

Lower frame: Milli Ampl Jy Top frame: Phas deg  
Vector averaged cross-power spectrum Baseline: EF (01) - WB (08)  
Timerange: 01/06:39:52 to 01/06:43:18

Plot file version 403 created 26-JUN-2015 10:51:34

J2025+3343 ET031A.UVDATA.1

Freq = 1.5950 GHz, Bw = 16.000 MH No calibration applied and no bandpass applied

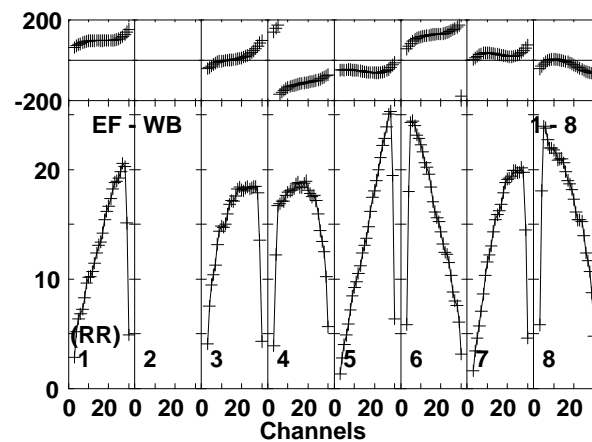
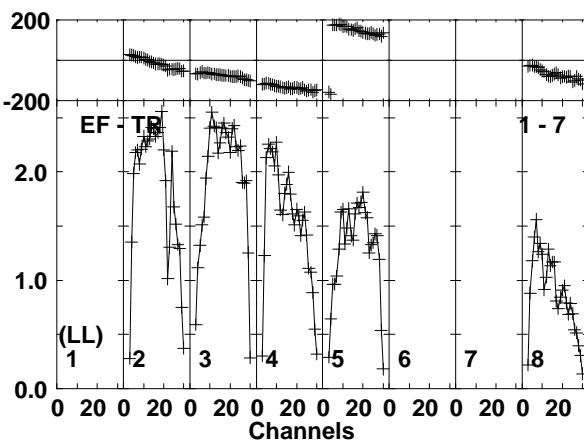
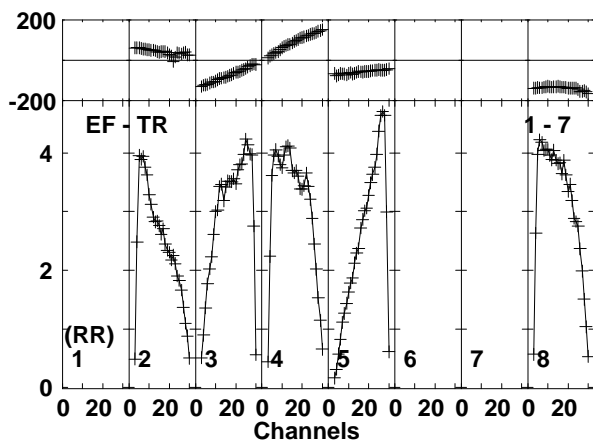
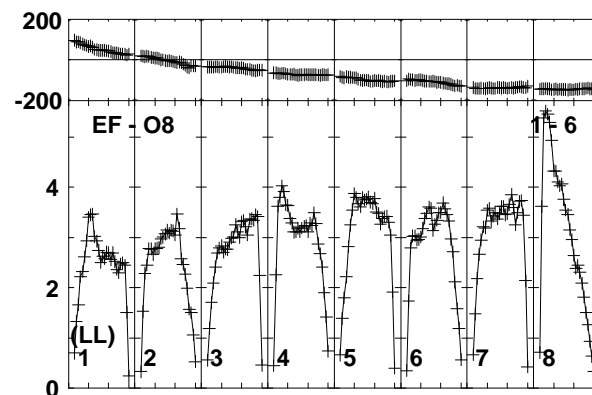
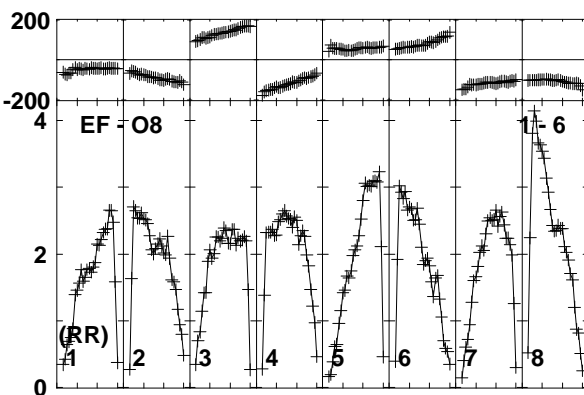
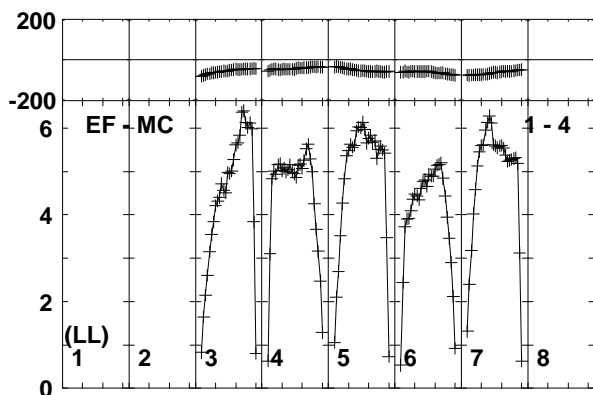
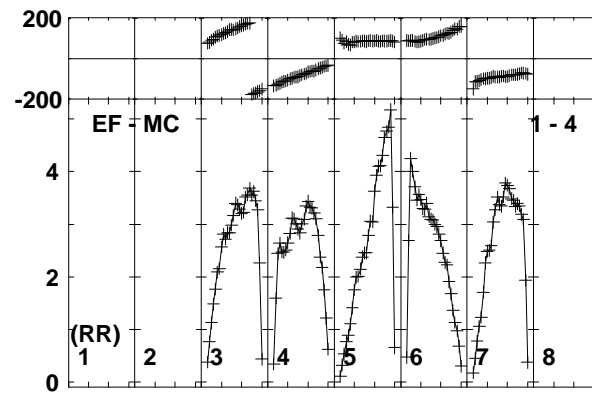
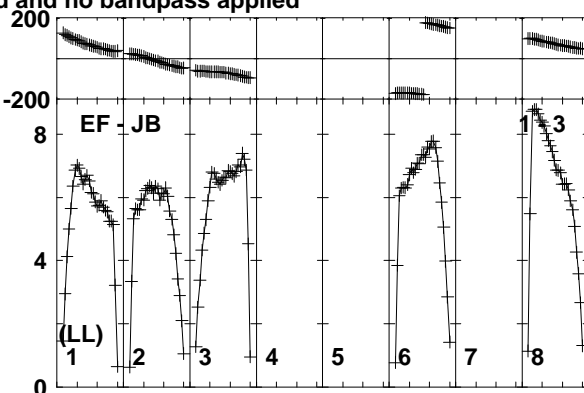
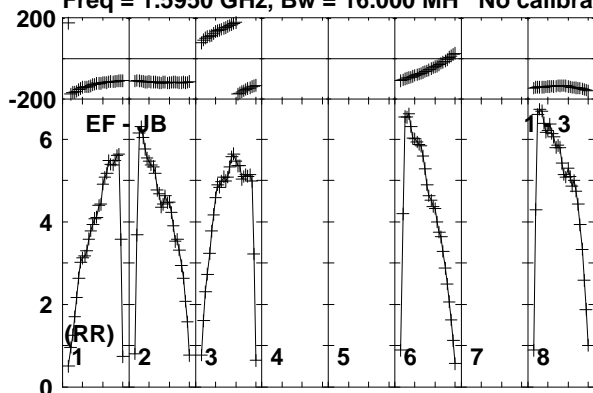

Lower frame: Milli Ampl Jy Top frame: Phas deg  
Vector averaged cross-power spectrum Baseline: EF (01) - JB (03)  
Timerange: 01/06:44:02 to 01/06:44:58

Plot file version 404 created 26-JUN-2015 10:51:34  
J2025+3343 ET031A.UVDATA.1  
Freq = 1.5950 GHz, Bw = 16.000 MH No calibration applied and no bandpass applied

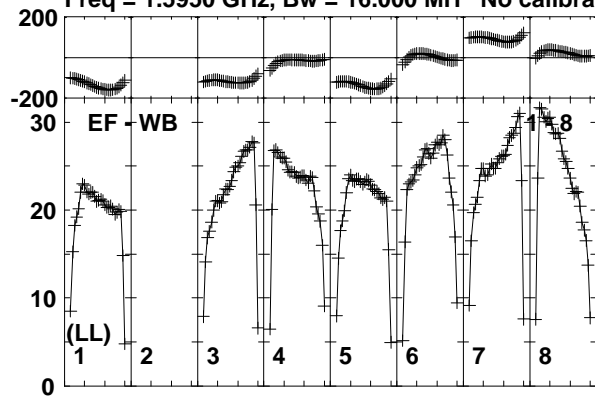

Lower frame: Milli Ampl Jy Top frame: Phas deg  
Vector averaged cross-power spectrum Baseline: EF (01) - WB (08)  
Timerange: 01/06:44:02 to 01/06:44:58

Plot file version 405 created 26-JUN-2015 10:51:34

V404CYG ET031A.UVDATA.1

Freq = 1.5950 GHz, Bw = 16.000 MH No calibration applied and no bandpass applied

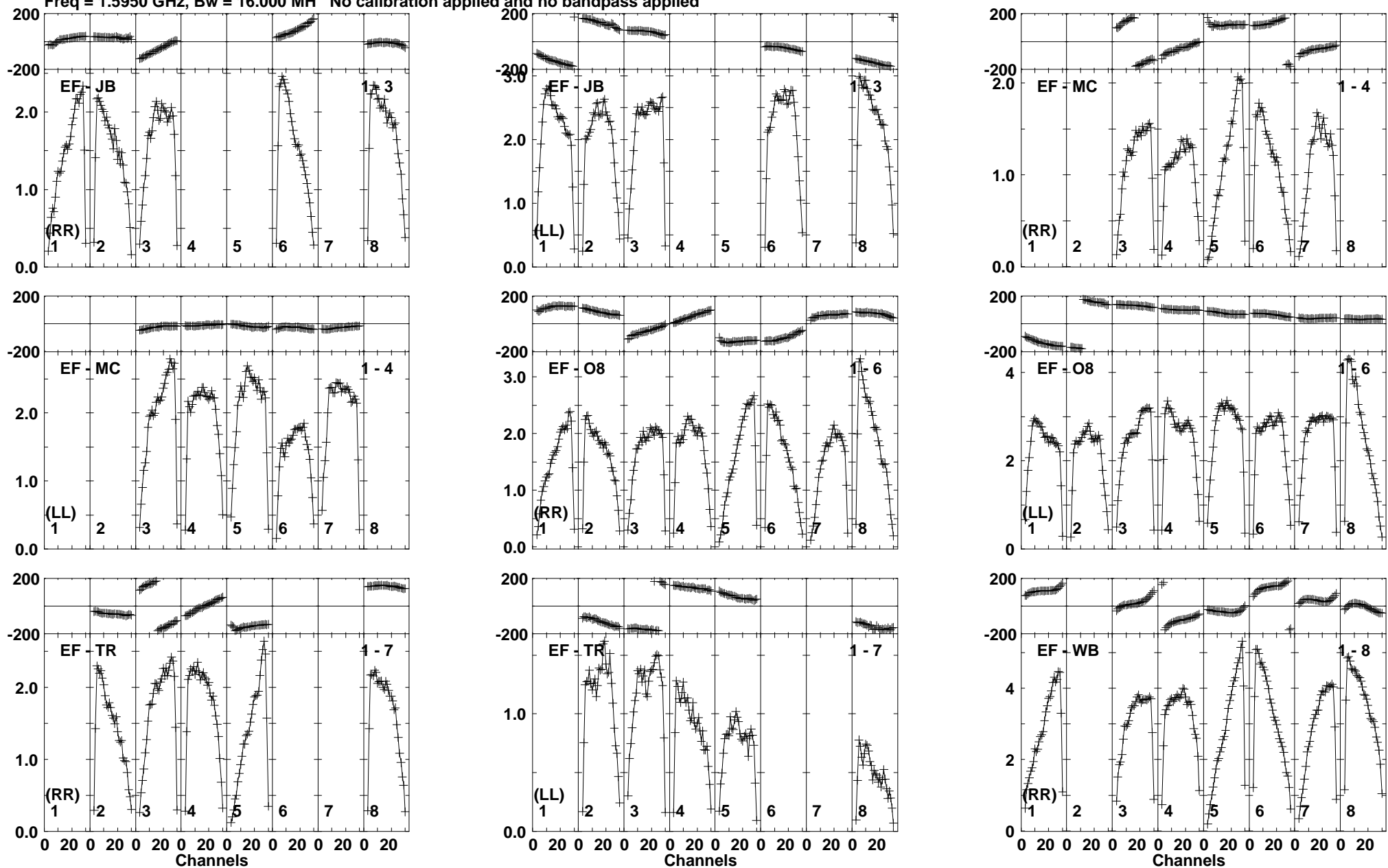

Lower frame: Milli Ampl Jy Top frame: Phas deg  
Vector averaged cross-power spectrum Baseline: EF (01) - JB (03)  
Timerange: 01/06:45:02 to 01/06:48:28

Plot file version 406 created 26-JUN-2015 10:51:34

V404CYG ET031A.UVDATA.1

Freq = 1.5950 GHz, Bw = 16.000 MH No calibration applied and no bandpass applied

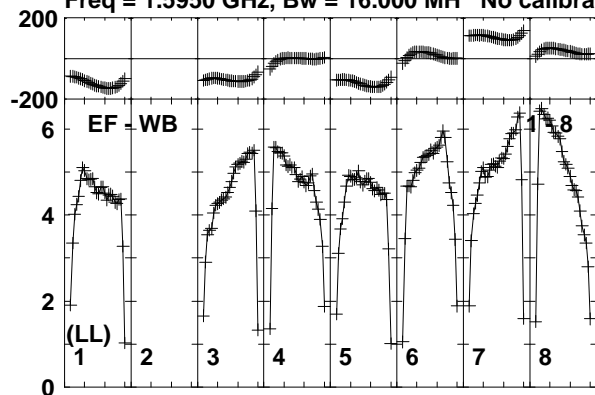

Lower frame: Milli Ampl Jy Top frame: Phas deg

Vector averaged cross-power spectrum Baseline: EF (01) - WB (08)

Timerange: 01/06:45:02 to 01/06:48:28

Plot file version 407 created 26-JUN-2015 10:51:34

J2025+3343 ET031A.UVDATA.1

Freq = 1.5950 GHz, Bw = 16.000 MH No calibration applied and no bandpass applied

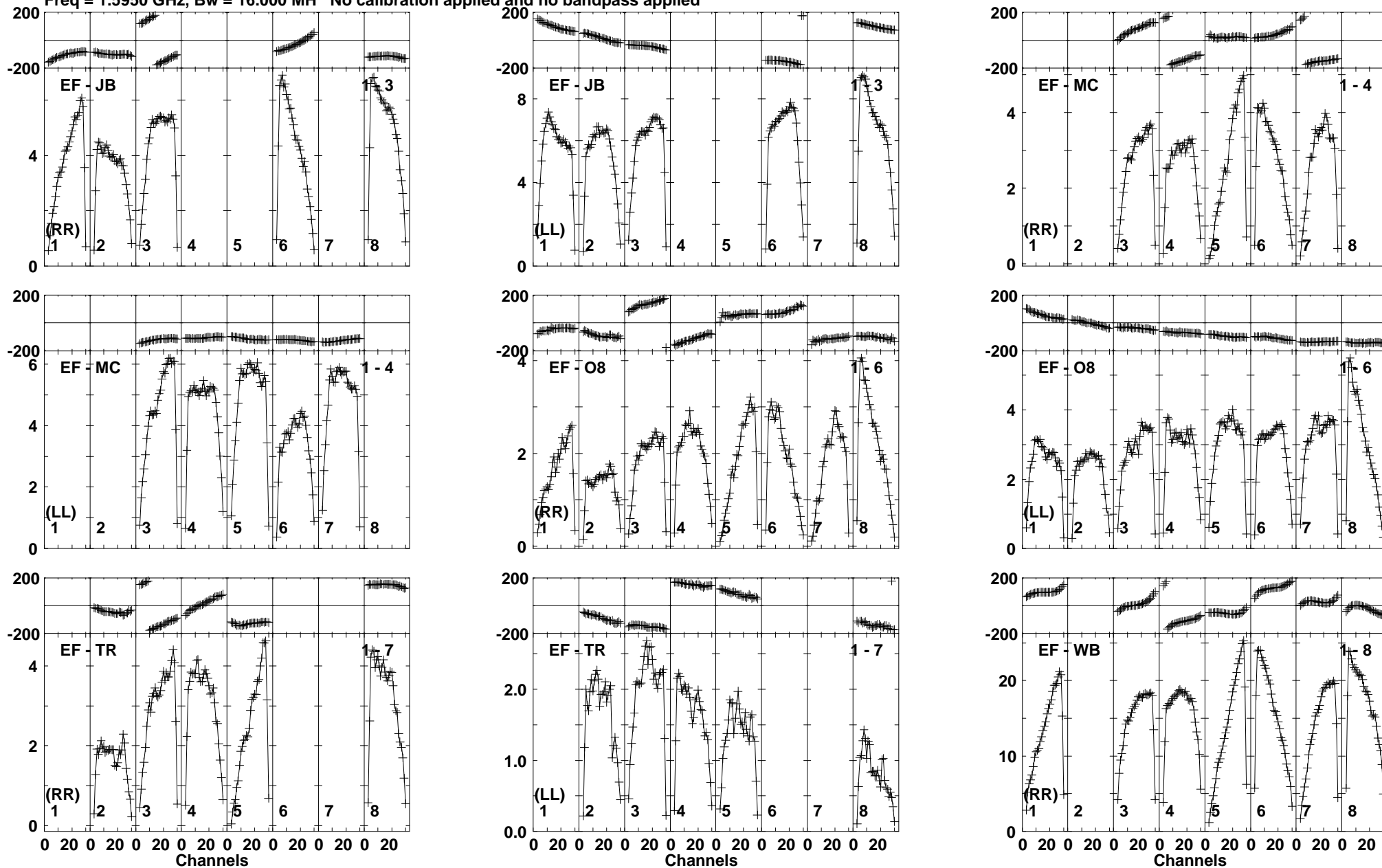

Lower frame: Milli Ampl Jy Top frame: Phas deg  
Vector averaged cross-power spectrum Baseline: EF (01) - JB (03)  
Timerange: 01/06:48:32 to 01/06:49:48

Plot file version 408 created 26-JUN-2015 10:51:34  
J2025+3343 ET031A.UVDATA.1  
Freq = 1.5950 GHz, Bw = 16.000 MH No calibration applied and no bandpass applied

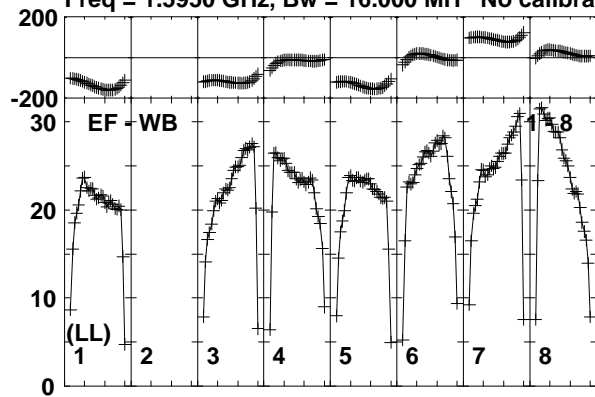

Lower frame: Milli Ampl Jy Top frame: Phas deg  
Vector averaged cross-power spectrum Baseline: EF (01) - WB (08)  
Timerange: 01/06:48:32 to 01/06:49:48



Plot file version 409 created 26-JUN-2015 10:51:34

V404CYG ET031A.UVDATA.1

Freq = 1.5950 GHz, Bw = 16.000 MH No calibration applied and no bandpass applied

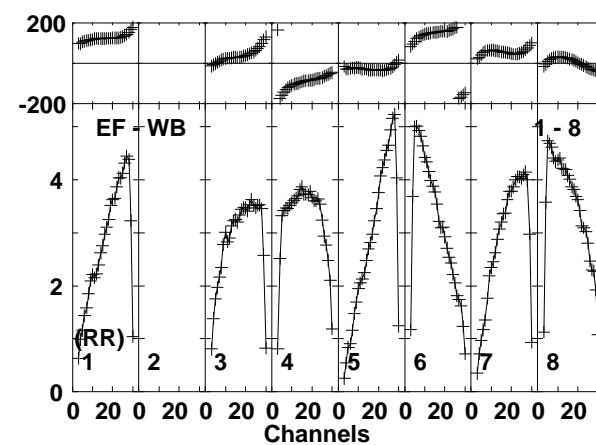
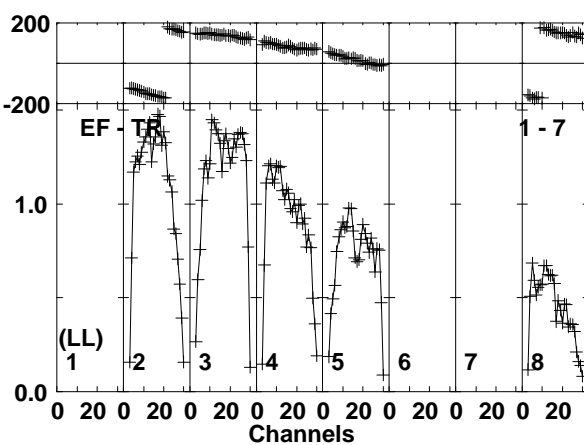
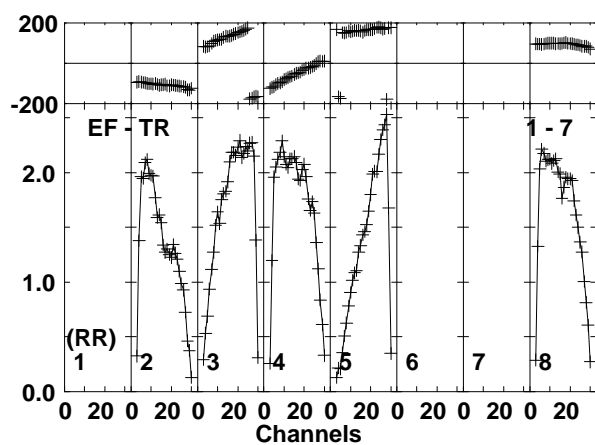
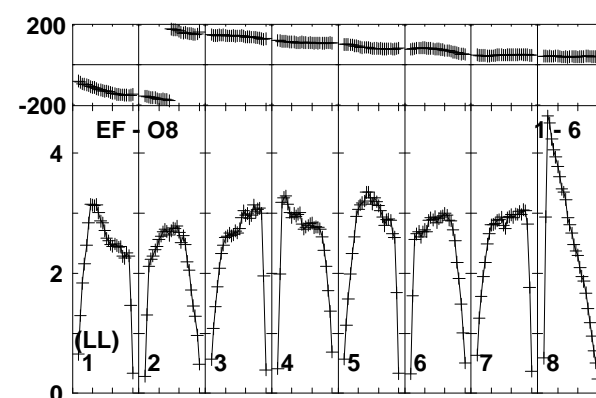
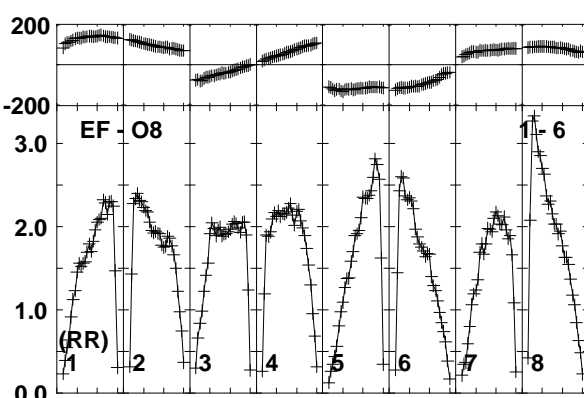
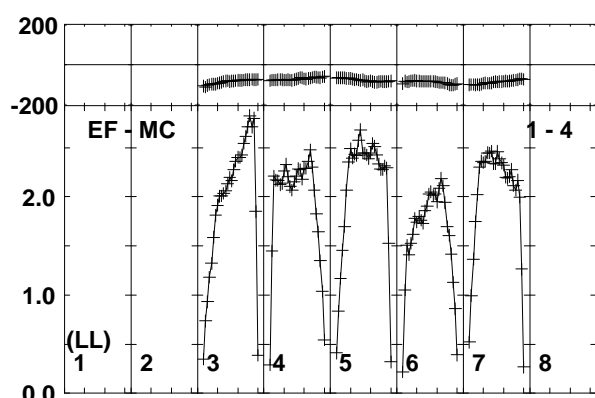
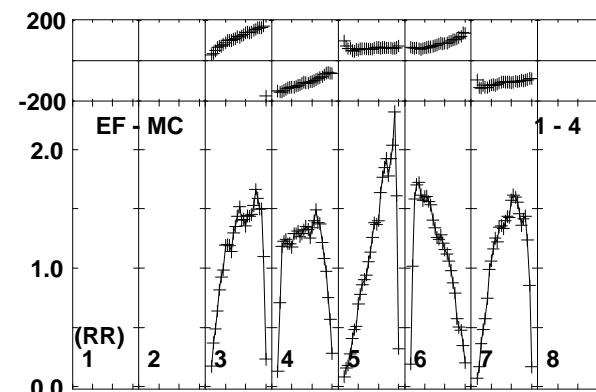
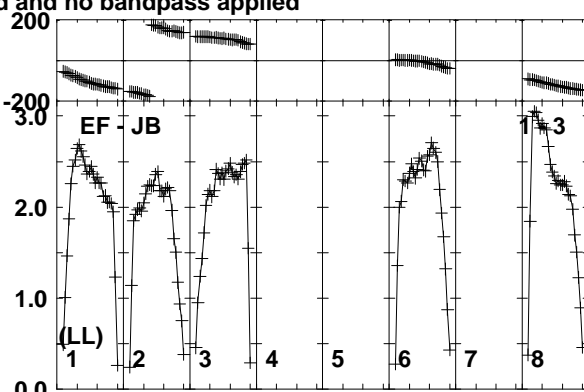
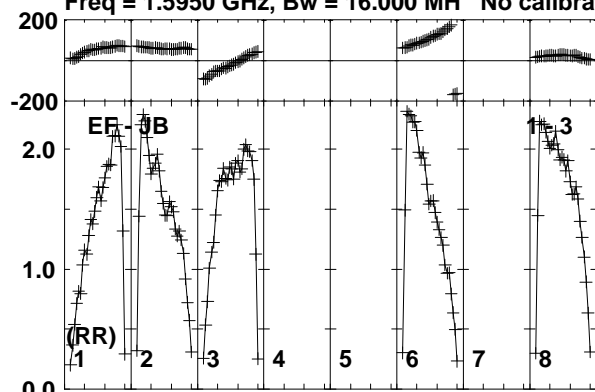

Lower frame: Milli Ampl Jy Top frame: Phas deg  
Vector averaged cross-power spectrum Baseline: EF (01) - JB (03)  
Timerange: 01/06:49:52 to 01/06:53:18

Plot file version 410 created 26-JUN-2015 10:51:34

V404CYG ET031A.UVDATA.1

Freq = 1.5950 GHz, Bw = 16.000 MH No calibration applied and no bandpass applied

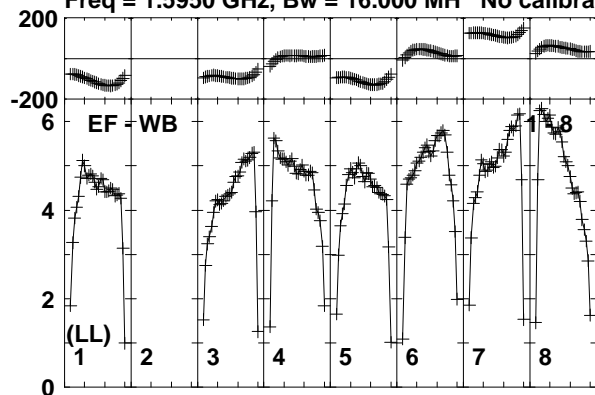

Lower frame: Milli Ampl Jy Top frame: Phas deg  
Vector averaged cross-power spectrum Baseline: EF (01) - WB (08)  
Timerange: 01/06:49:52 to 01/06:53:18

Plot file version 411 created 26-JUN-2015 10:51:34

J2025+3343 ET031A.UVDATA.1

Freq = 1.5950 GHz, Bw = 16.000 MH No calibration applied and no bandpass applied

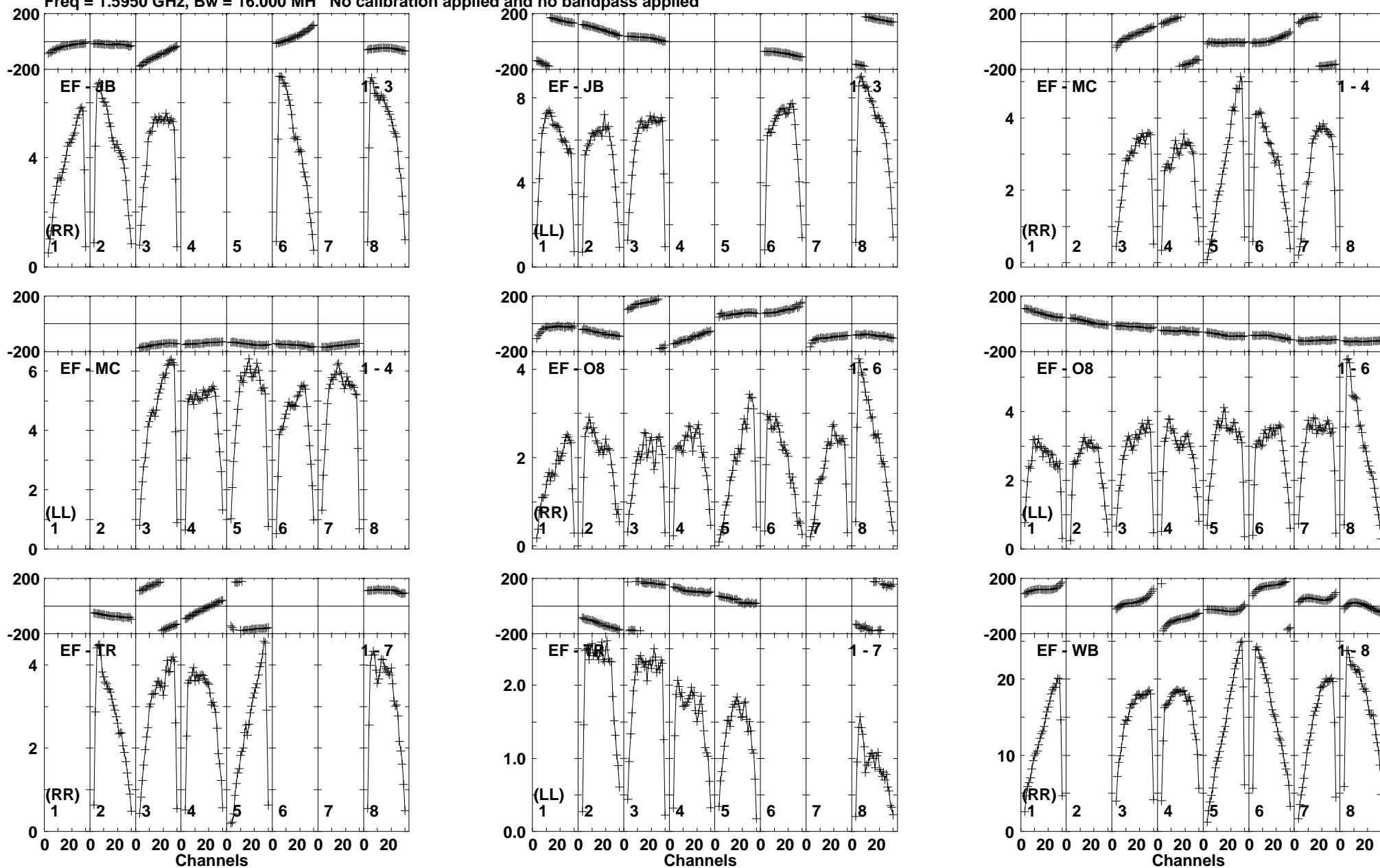

Lower frame: Milli Ampl Jy Top frame: Phas deg  
Vector averaged cross-power spectrum Baseline: EF (01) - JB (03)  
Timerange: 01/06:54:02 to 01/06:54:58

Plot file version 412 created 26-JUN-2015 10:51:34

J2025+3343 ET031A.UVDATA.1

Freq = 1.5950 GHz, Bw = 16.000 MH No calibration applied and no bandpass applied

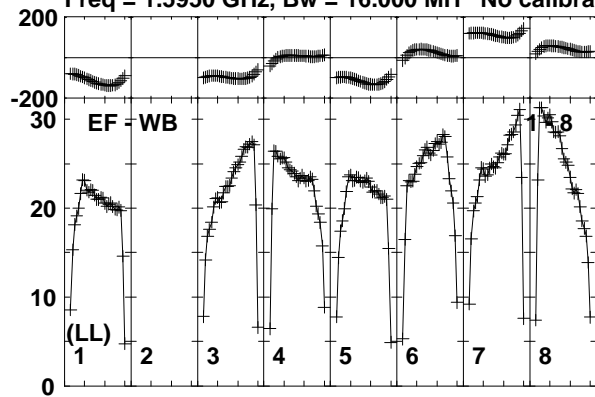

Lower frame: Milli Ampl Jy Top frame: Phas deg  
Vector averaged cross-power spectrum Baseline: EF (01) - WB (08)  
Timerange: 01/06:54:02 to 01/06:54:58

Plot file version 413 created 26-JUN-2015 10:51:34

V404CYG ET031A.UVDATA.1

Freq = 1.5950 GHz, Bw = 16.000 MH No calibration applied and no bandpass applied

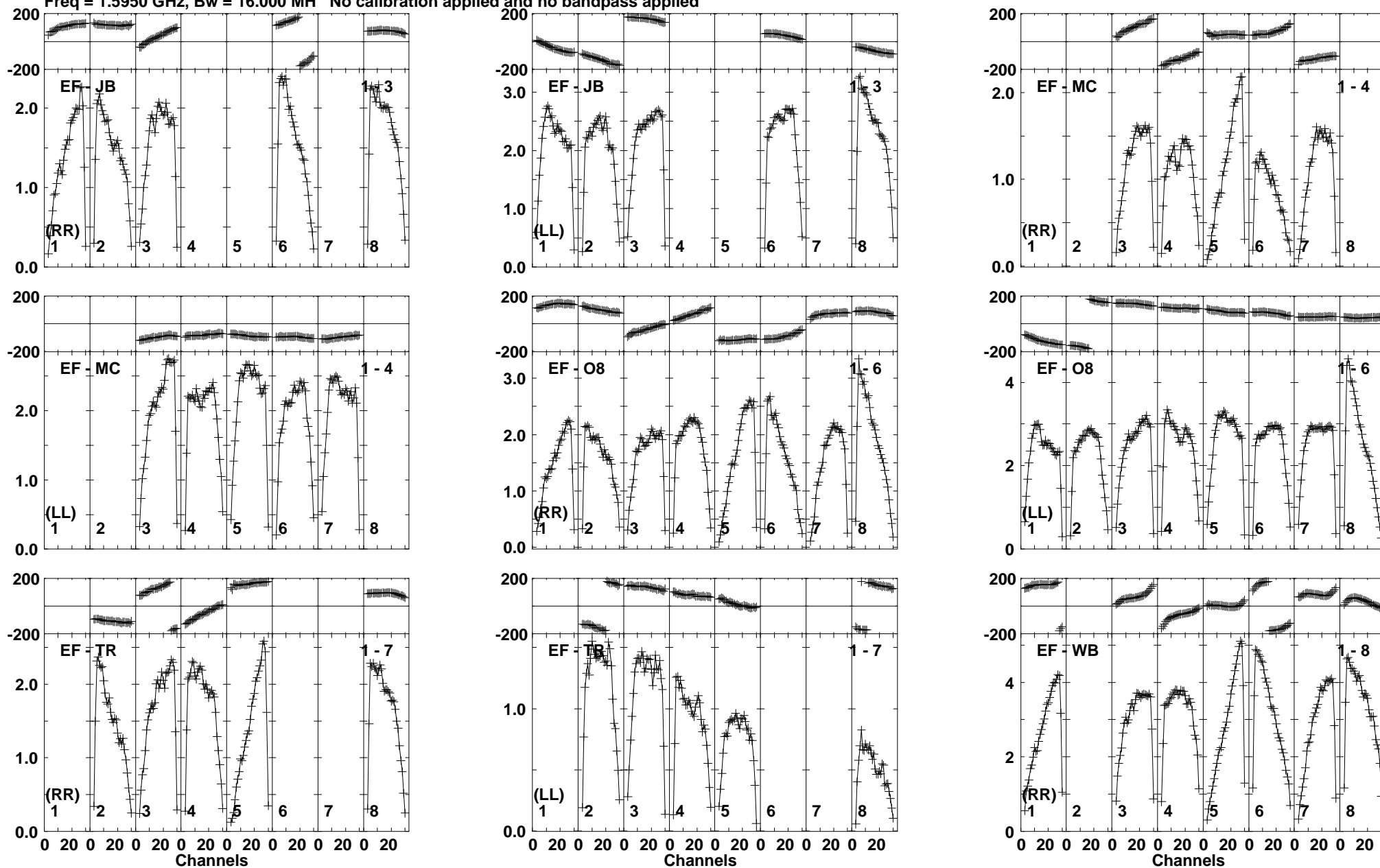

Lower frame: Milli Ampl Jy Top frame: Phas deg  
Vector averaged cross-power spectrum Baseline: EF (01) - JB (03)  
Timerange: 01/06:55:02 to 01/06:58:28

Plot file version 414 created 26-JUN-2015 10:51:34

V404CYG ET031A.UVDATA.1

Freq = 1.5950 GHz, Bw = 16.000 MH No calibration applied and no bandpass applied

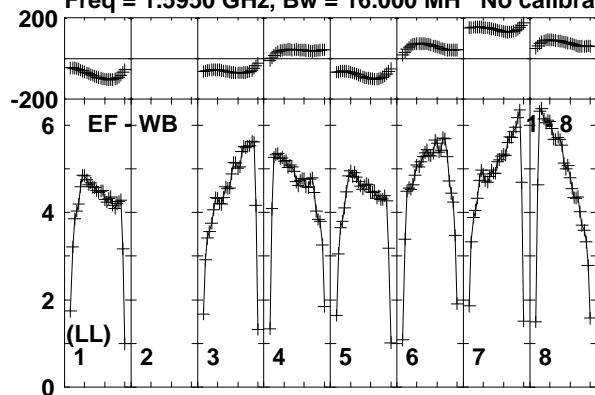

Lower frame: Milli Ampl Jy Top frame: Phas deg

Vector averaged cross-power spectrum Baseline: EF (01) - WB (08)

Timerange: 01/06:55:02 to 01/06:58:28

Plot file version 415 created 26-JUN-2015 10:51:34

J2025+3343 ET031A.UVDATA.1

Freq = 1.5950 GHz, Bw = 16.000 MH No calibration applied and no bandpass applied

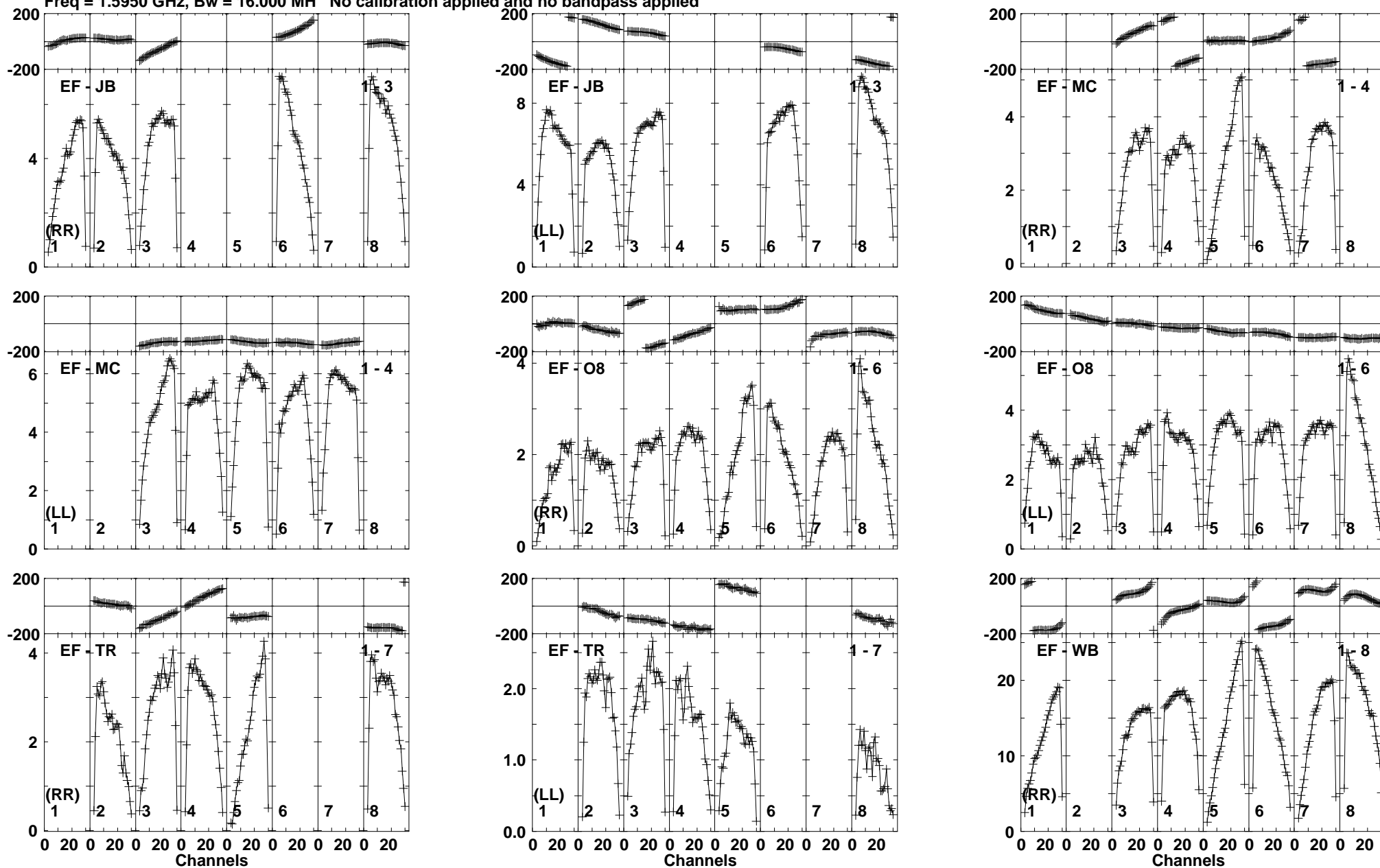

Lower frame: Milli Ampl Jy Top frame: Phas deg  
Vector averaged cross-power spectrum Baseline: EF (01) - JB (03)  
Timerange: 01/06:58:32 to 01/06:59:48

Plot file version 416 created 26-JUN-2015 10:51:34  
J2025+3343 ET031A.UVDATA.1  
Freq = 1.5950 GHz, Bw = 16.000 MH No calibration applied and no bandpass applied

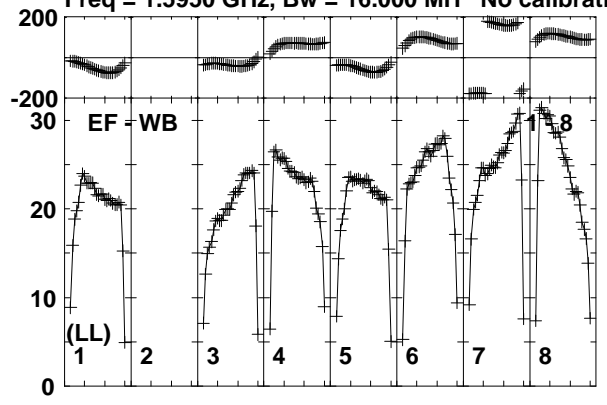

Lower frame: Milli Ampl Jy Top frame: Phas deg  
Vector averaged cross-power spectrum Baseline: EF (01) - WB (08)  
Timerange: 01/06:58:32 to 01/06:59:48



Plot file version 417 created 26-JUN-2015 10:51:34

V404CYG ET031A.UVDATA.1

Freq = 1.5950 GHz, Bw = 16.000 MH No calibration applied and no bandpass applied

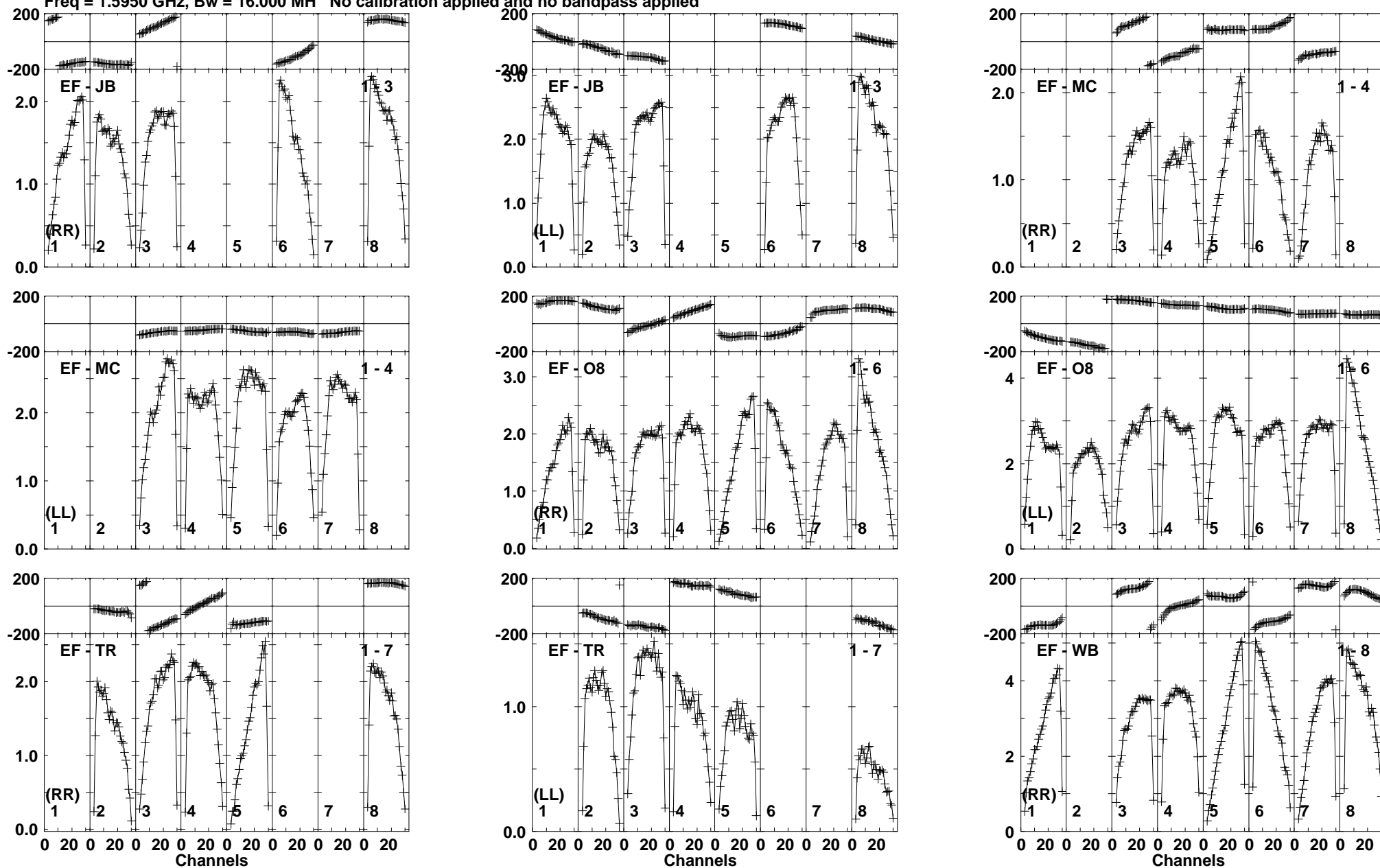

Lower frame: Milli Ampl Jy Top frame: Phas deg  
Vector averaged cross-power spectrum Baseline: EF (01) - JB (03)  
Timerange: 01/06:59:52 to 01/07:03:18

Plot file version 418 created 26-JUN-2015 10:51:35

V404CYG ET031A.UVDATA.1

Freq = 1.5950 GHz, Bw = 16.000 MH No calibration applied and no bandpass applied

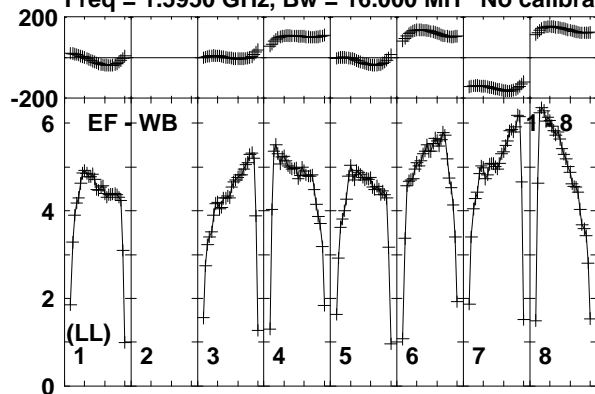

Lower frame: Milli Ampl Jy Top frame: Phas deg

Vector averaged cross-power spectrum Baseline: EF (01) - WB (08)

Timerange: 01/06:59:52 to 01/07:03:18

Plot file version 419 created 26-JUN-2015 10:51:35

J2025+3343 ET031A.UVDATA.1

Freq = 1.5950 GHz, Bw = 16.000 MH No calibration applied and no bandpass applied

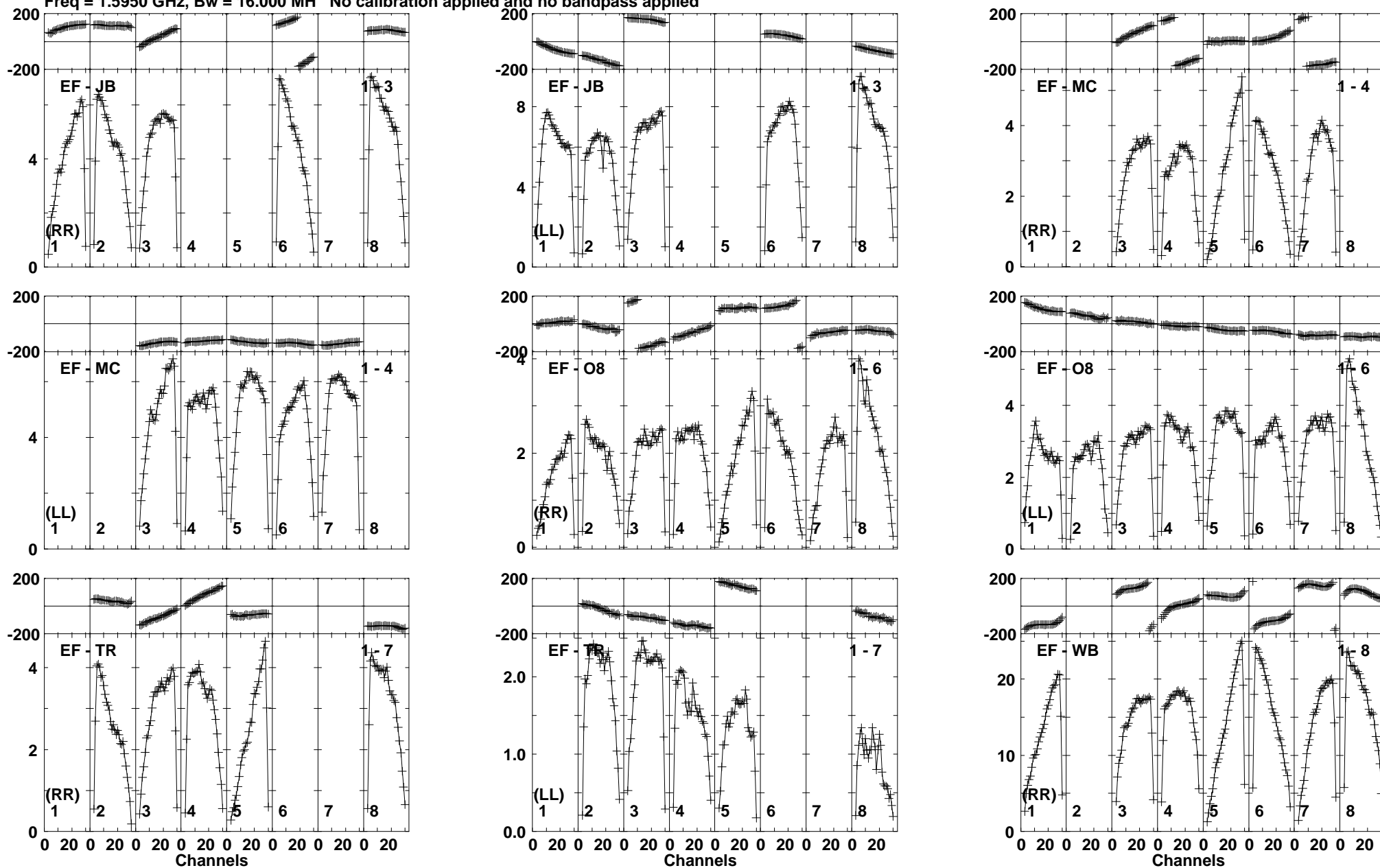

Lower frame: Milli Ampl Jy Top frame: Phas deg  
Vector averaged cross-power spectrum Baseline: EF (01) - JB (03)  
Timerange: 01/07:04:02 to 01/07:04:58

Plot file version 420 created 26-JUN-2015 10:51:35  
J2025+3343 ET031A.UVDATA.1  
Freq = 1.5950 GHz, Bw = 16.000 MH No calibration applied and no bandpass applied

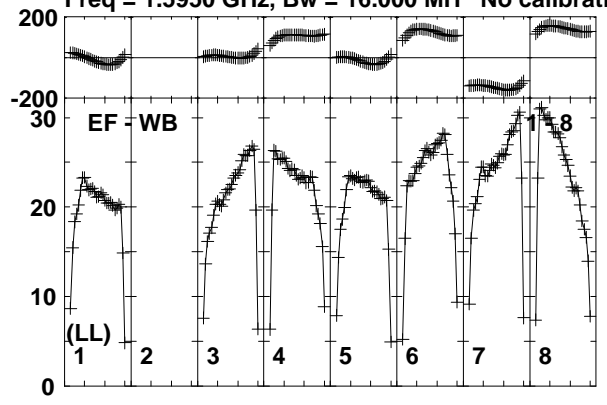

Lower frame: Milli Ampl Jy Top frame: Phas deg  
Vector averaged cross-power spectrum Baseline: EF (01) - WB (08)  
Timerange: 01/07:04:02 to 01/07:04:58

Plot file version 421 created 26-JUN-2015 10:51:35

V404CYG ET031A.UVDATA.1

Freq = 1.5950 GHz, Bw = 16.000 MH No calibration applied and no bandpass applied

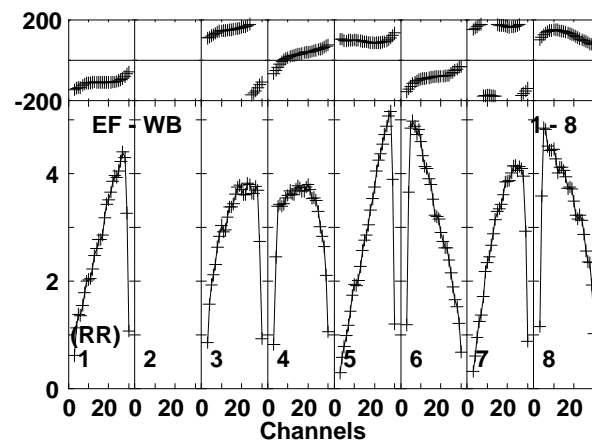
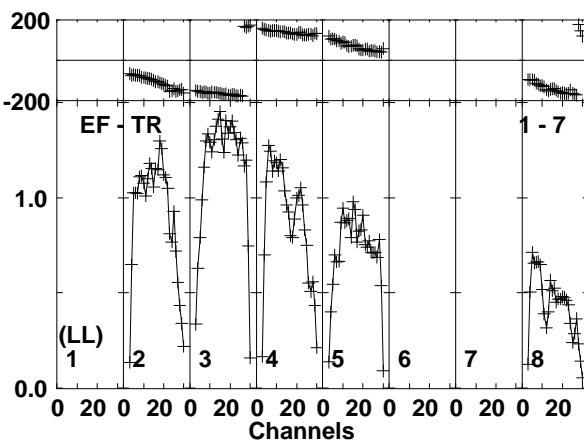
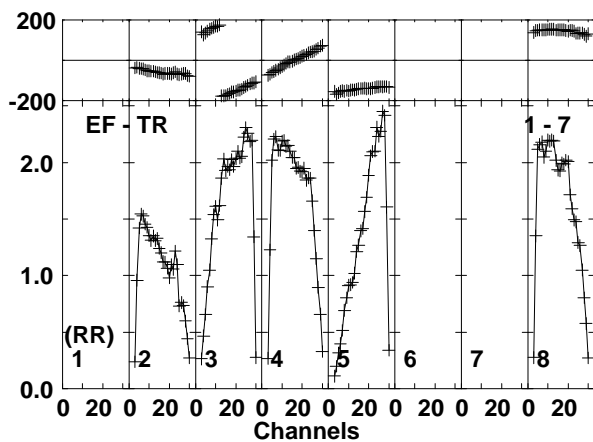
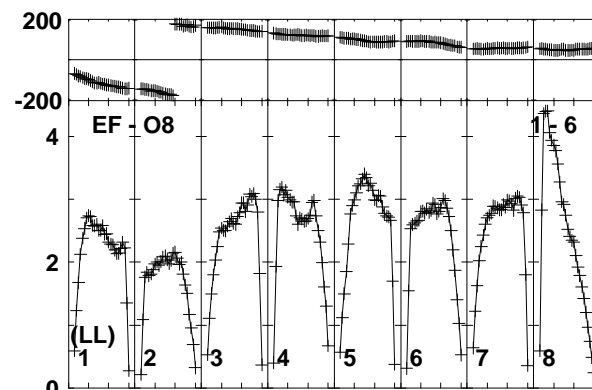
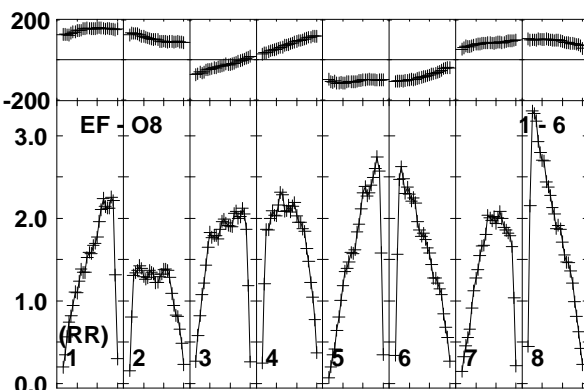
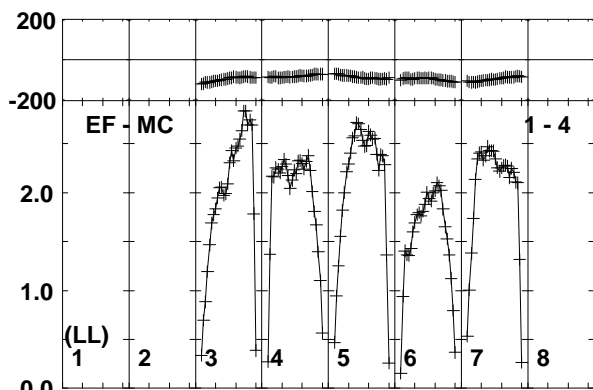
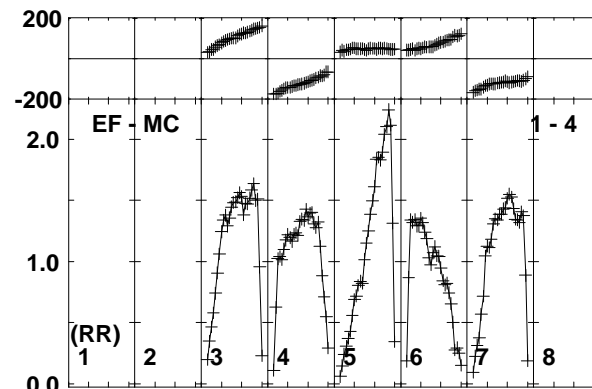
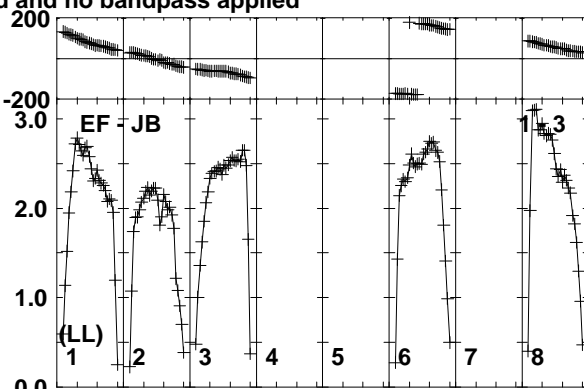
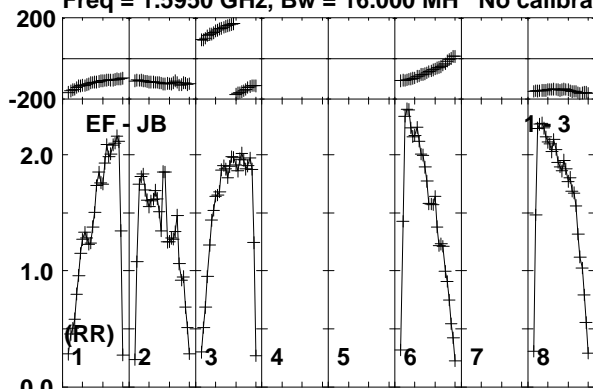

Lower frame: Milli Ampl Jy Top frame: Phas deg  
Vector averaged cross-power spectrum Baseline: EF (01) - JB (03)  
Timerange: 01/07:05:02 to 01/07:08:28

Plot file version 422 created 26-JUN-2015 10:51:35  
V404CYG ET031A.UVDATA.1  
Freq = 1.5950 GHz, Bw = 16.000 MH No calibration applied and no bandpass applied

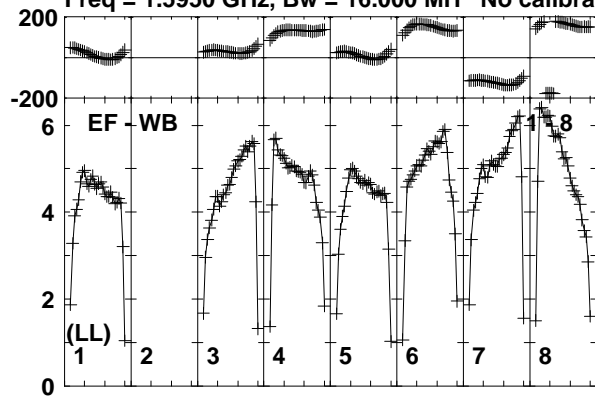

Lower frame: Milli Ampl Jy Top frame: Phas deg  
Vector averaged cross-power spectrum Baseline: EF (01) - WB (08)  
Timerange: 01/07:05:02 to 01/07:08:28

Plot file version 423 created 26-JUN-2015 10:51:35

J2025+3343 ET031A.UVDATA.1

Freq = 1.5950 GHz, Bw = 16.000 MH No calibration applied and no bandpass applied

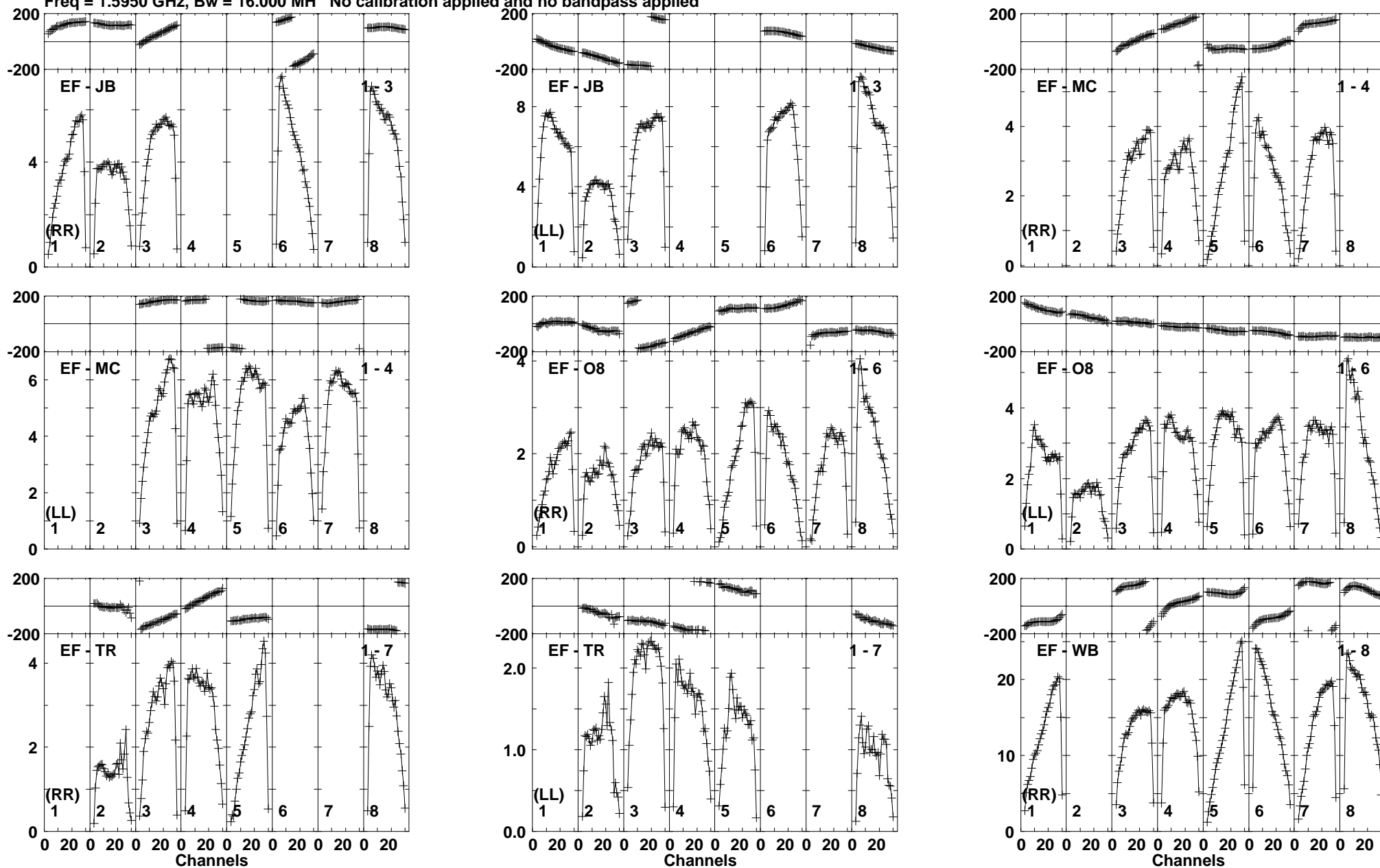

Lower frame: Milli Ampl Jy Top frame: Phas deg  
Vector averaged cross-power spectrum Baseline: EF (01) - JB (03)  
Timerange: 01/07:08:32 to 01/07:09:48

Plot file version 424 created 26-JUN-2015 10:51:35  
J2025+3343 ET031A.UVDATA.1  
Freq = 1.5950 GHz, Bw = 16.000 MH No calibration applied and no bandpass applied

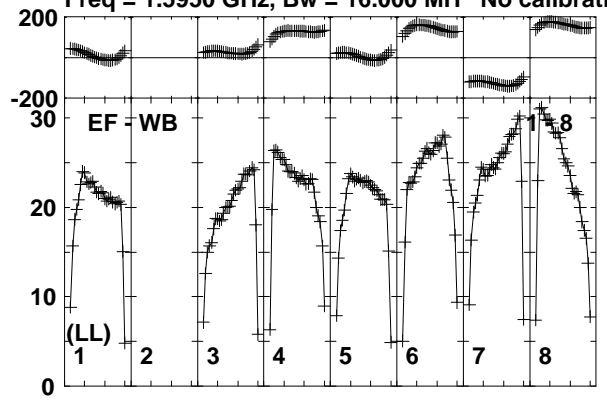

Lower frame: Milli Ampl Jy Top frame: Phas deg  
Vector averaged cross-power spectrum Baseline: EF (01) - WB (08)  
Timerange: 01/07:08:32 to 01/07:09:48



Plot file version 425 created 26-JUN-2015 10:51:35

V404CYG ET031A.UVDATA.1

Freq = 1.5950 GHz, Bw = 16.000 MH No calibration applied and no bandpass applied

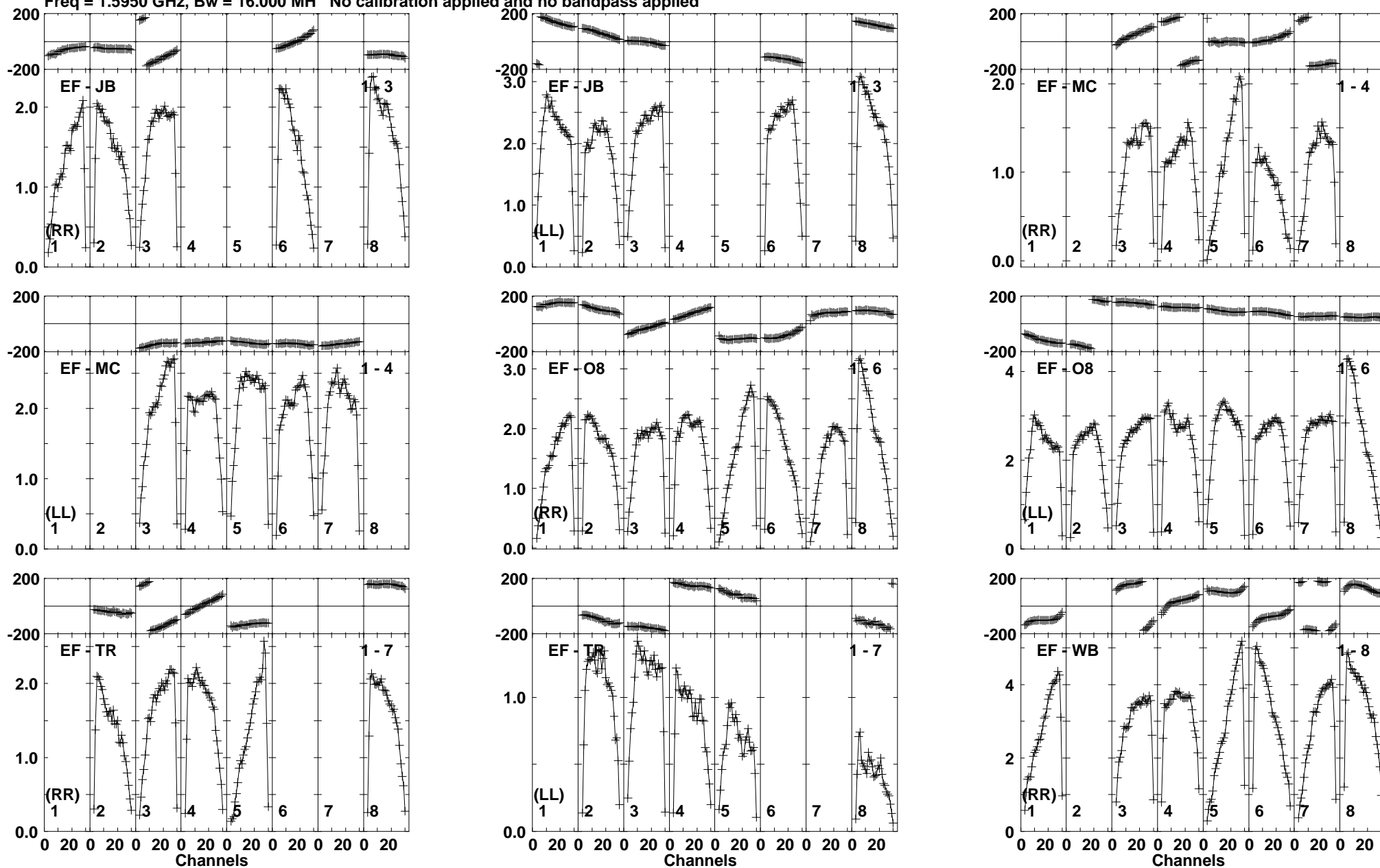

Lower frame: Milli Ampl Jy Top frame: Phas deg  
Vector averaged cross-power spectrum Baseline: EF (01) - JB (03)  
Timerange: 01/07:09:52 to 01/07:13:18

Plot file version 426 created 26-JUN-2015 10:51:35  
V404CYG ET031A.UVDATA.1  
Freq = 1.5950 GHz, Bw = 16.000 MH No calibration applied and no bandpass applied

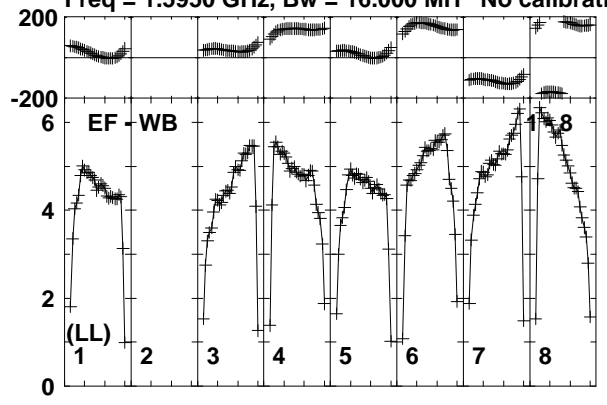

Lower frame: Milli Ampl Jy Top frame: Phas deg  
Vector averaged cross-power spectrum Baseline: EF (01) - WB (08)  
Timerange: 01/07:09:52 to 01/07:13:18

Plot file version 427 created 26-JUN-2015 10:51:35

J2025+3343 ET031A.UVDATA.1

Freq = 1.5950 GHz, Bw = 16.000 MH No calibration applied and no bandpass applied

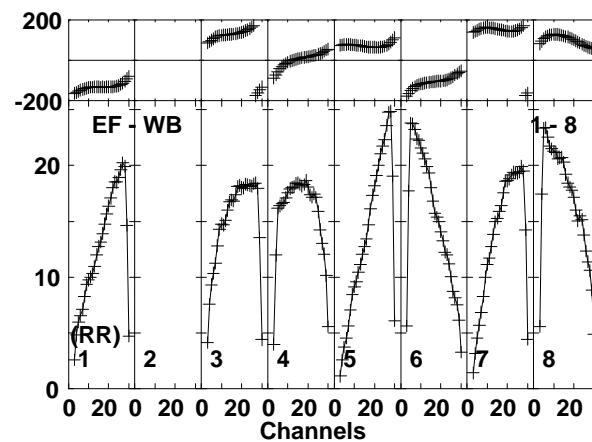
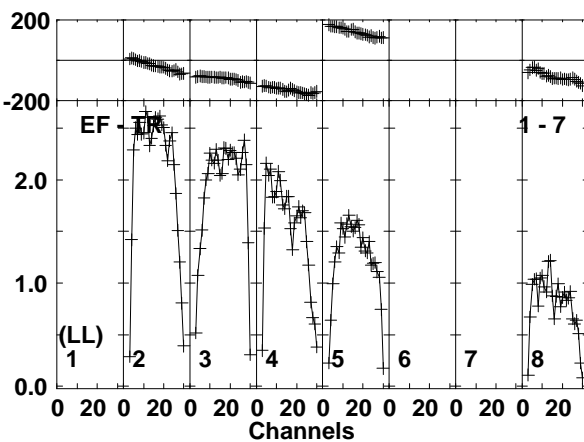
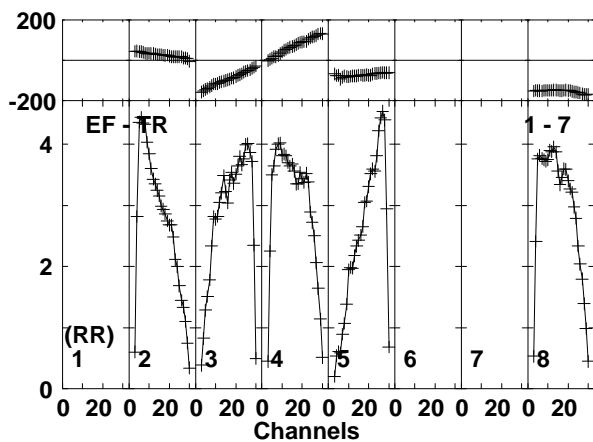
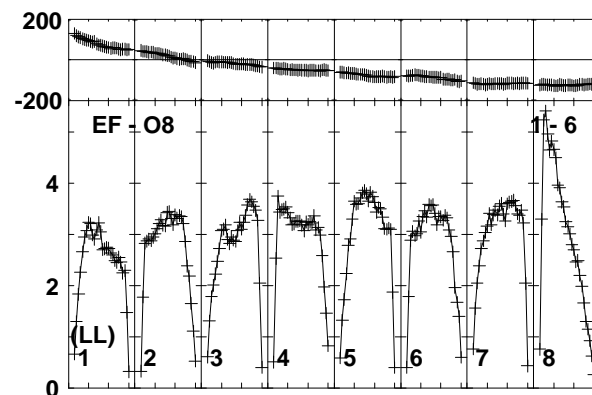
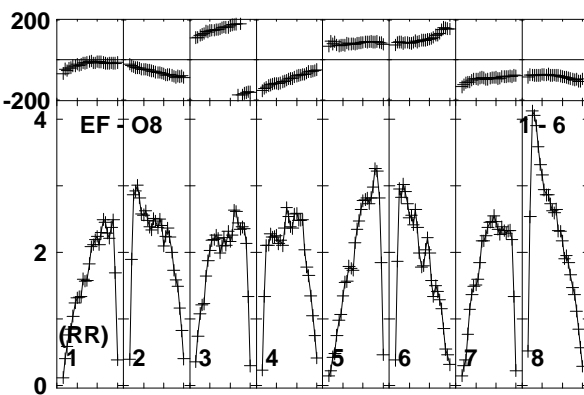
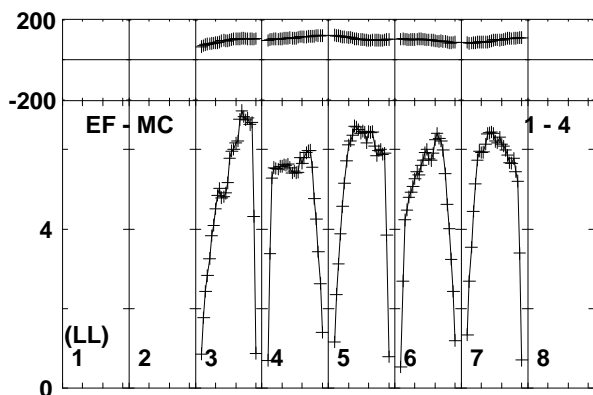
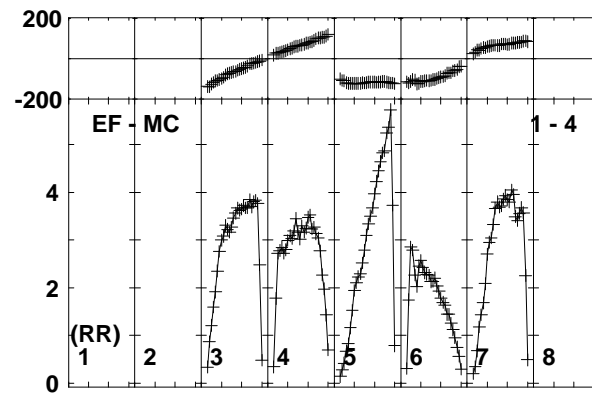
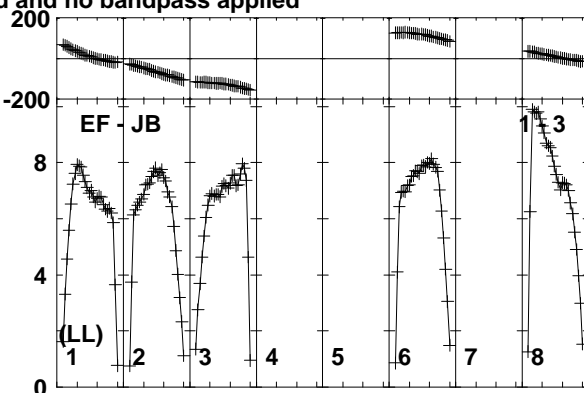
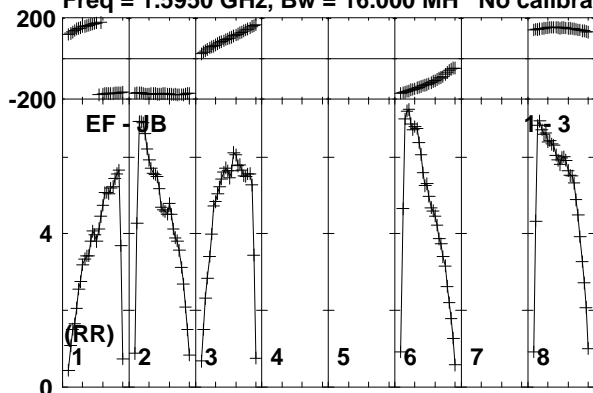

Lower frame: Milli Ampl Jy Top frame: Phas deg  
Vector averaged cross-power spectrum Baseline: EF (01) - JB (03)  
Timerange: 01/07:14:02 to 01/07:14:58

Plot file version 428 created 26-JUN-2015 10:51:35  
J2025+3343 ET031A.UVDATA.1  
Freq = 1.5950 GHz, Bw = 16.000 MH No calibration applied and no bandpass applied

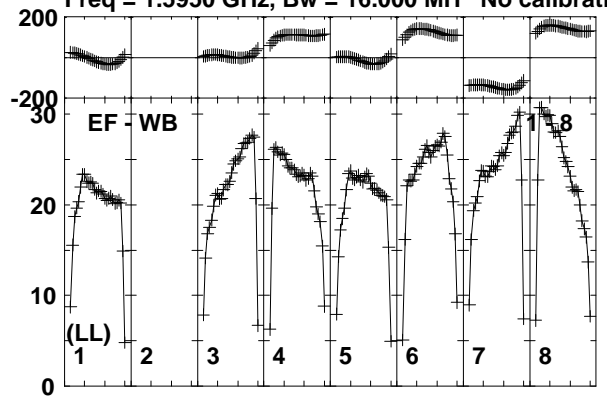

Lower frame: Milli Ampl Jy Top frame: Phas deg  
Vector averaged cross-power spectrum Baseline: EF (01) - WB (08)  
Timerange: 01/07:14:02 to 01/07:14:58

Plot file version 429 created 26-JUN-2015 10:51:35

V404CYG ET031A.UVDATA.1

Freq = 1.5950 GHz, Bw = 16.000 MH No calibration applied and no bandpass applied

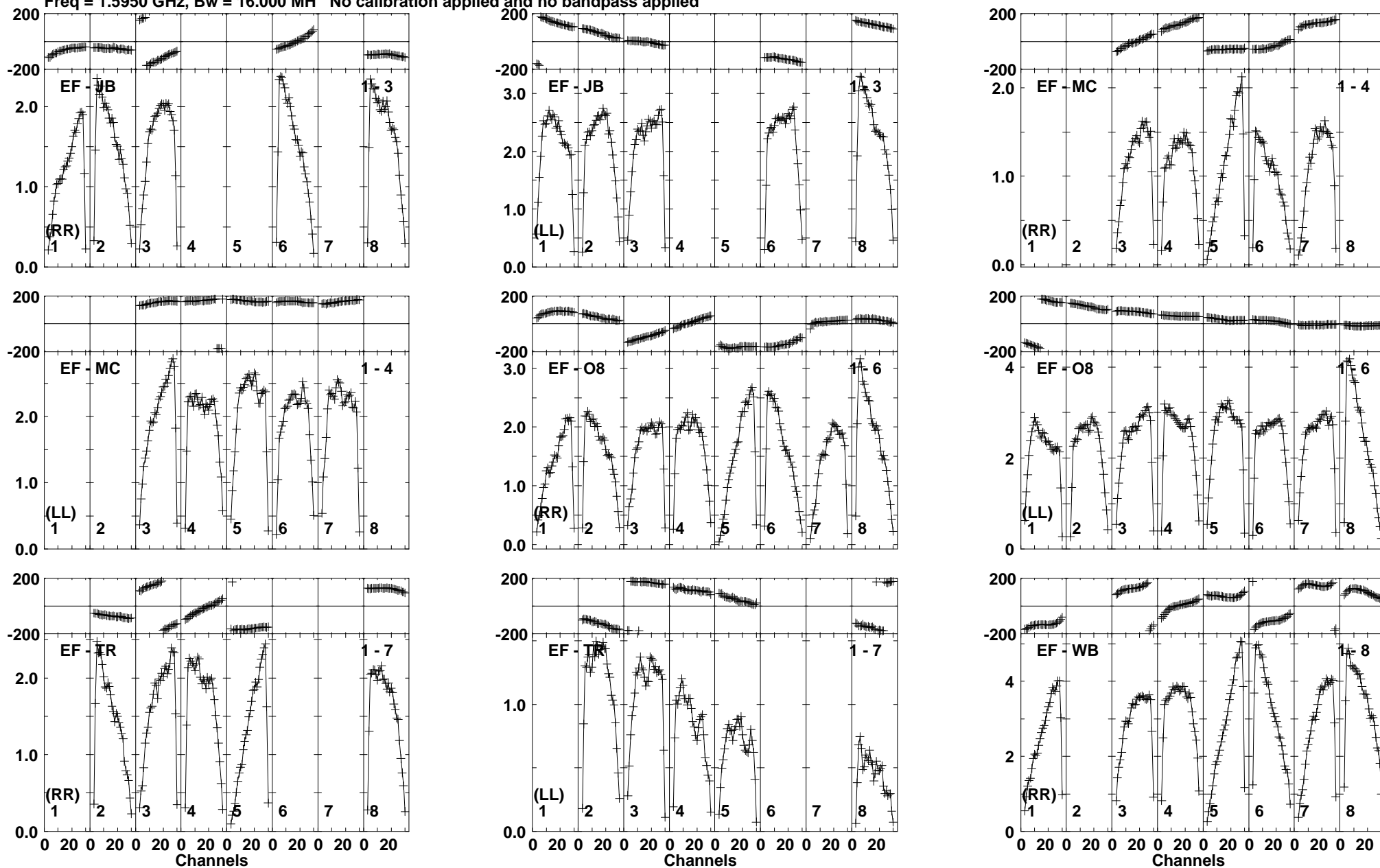

Lower frame: Milli Ampl Jy Top frame: Phas deg  
Vector averaged cross-power spectrum Baseline: EF (01) - JB (03)  
Timerange: 01/07:15:02 to 01/07:18:28

Plot file version 430 created 26-JUN-2015 10:51:35  
V404CYG ET031A.UVDATA.1  
Freq = 1.5950 GHz, Bw = 16.000 MH No calibration applied and no bandpass applied

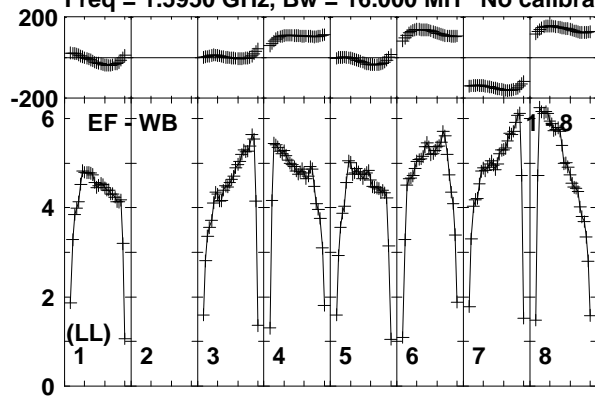

Lower frame: Milli Ampl Jy Top frame: Phas deg  
Vector averaged cross-power spectrum Baseline: EF (01) - WB (08)  
Timerange: 01/07:15:02 to 01/07:18:28

Plot file version 431 created 26-JUN-2015 10:51:35

J2025+3343 ET031A.UVDATA.1

Freq = 1.5950 GHz, Bw = 16.000 MH No calibration applied and no bandpass applied

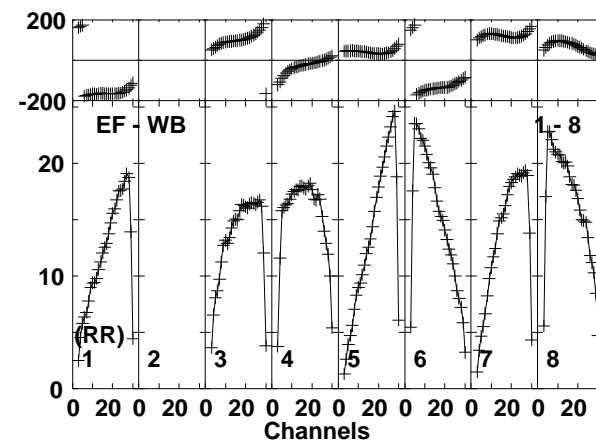
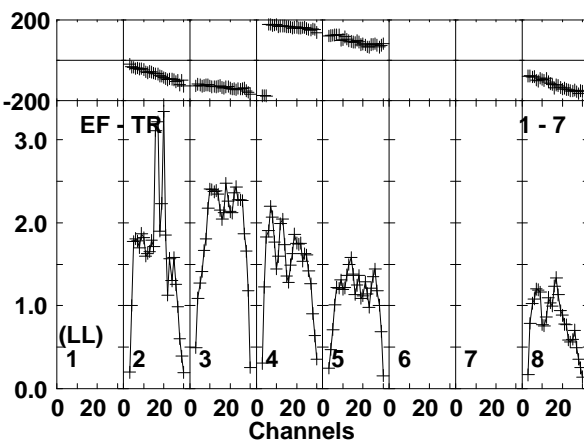
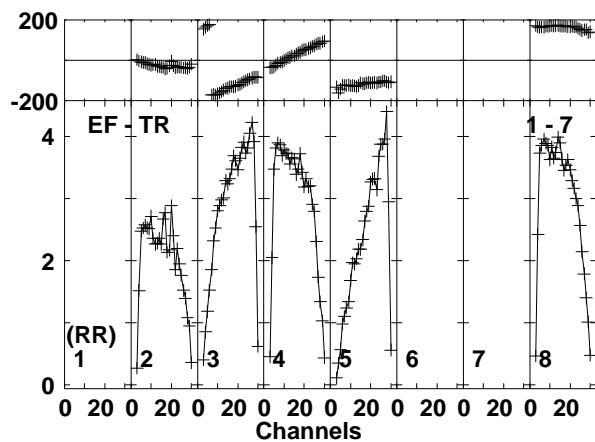
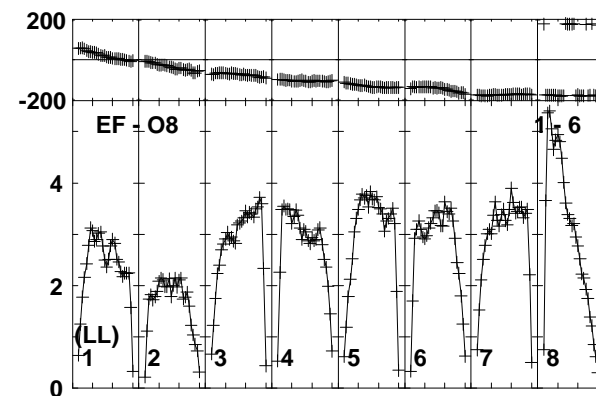
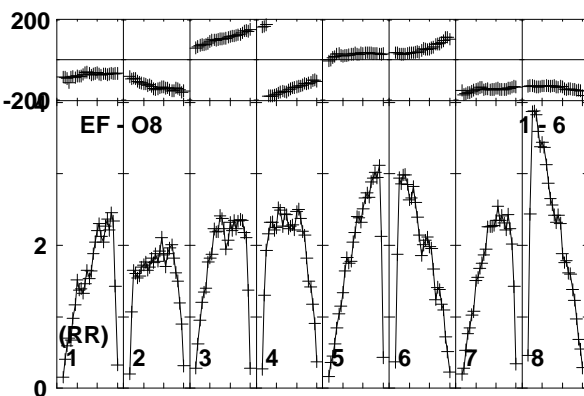
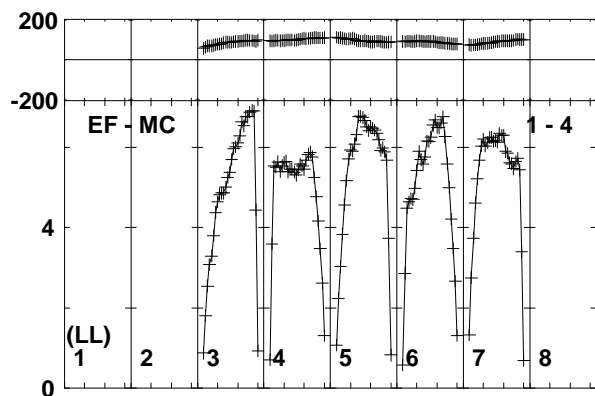
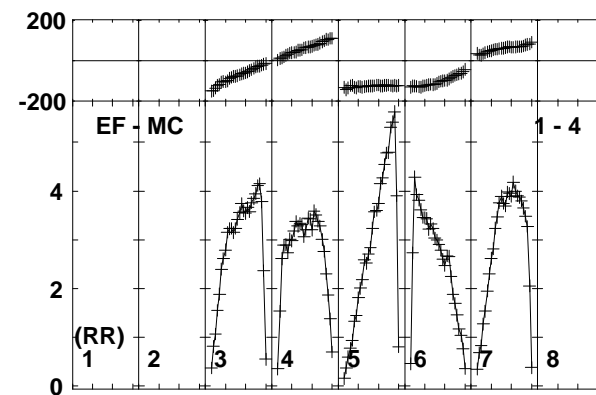
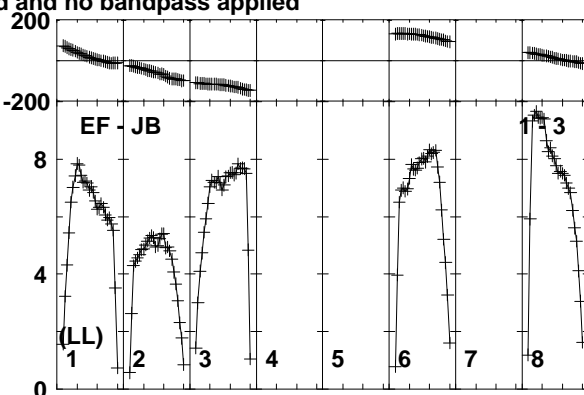
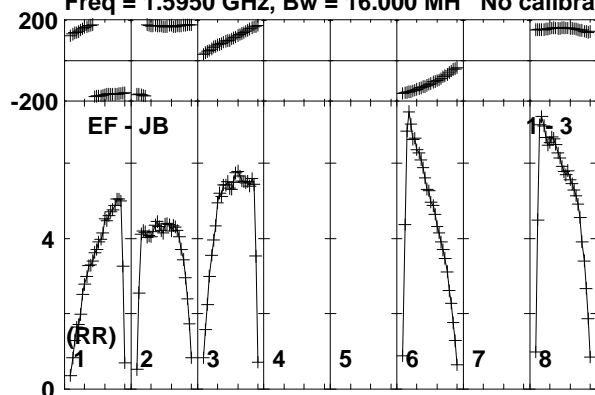

Lower frame: Milli Ampl Jy Top frame: Phas deg  
Vector averaged cross-power spectrum Baseline: EF (01) - JB (03)  
Timerange: 01/07:18:32 to 01/07:19:48

Plot file version 432 created 26-JUN-2015 10:51:35  
J2025+3343 ET031A.UVDATA.1  
Freq = 1.5950 GHz, Bw = 16.000 MH No calibration applied and no bandpass applied

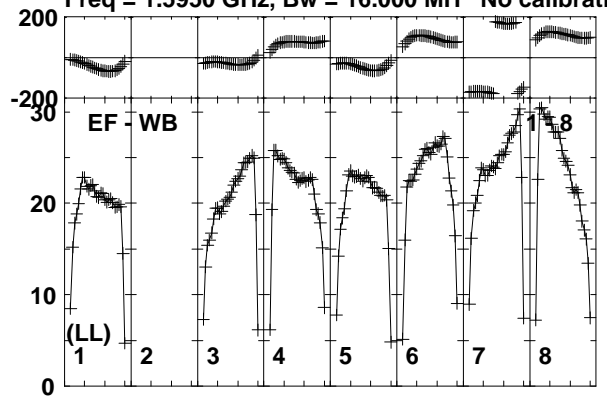

Lower frame: Milli Ampl Jy Top frame: Phas deg  
Vector averaged cross-power spectrum Baseline: EF (01) - WB (08)  
Timerange: 01/07:18:32 to 01/07:19:48



Plot file version 433 created 26-JUN-2015 10:51:35

V404CYG ET031A.UVDATA.1

Freq = 1.5950 GHz, Bw = 16.000 MH No calibration applied and no bandpass applied

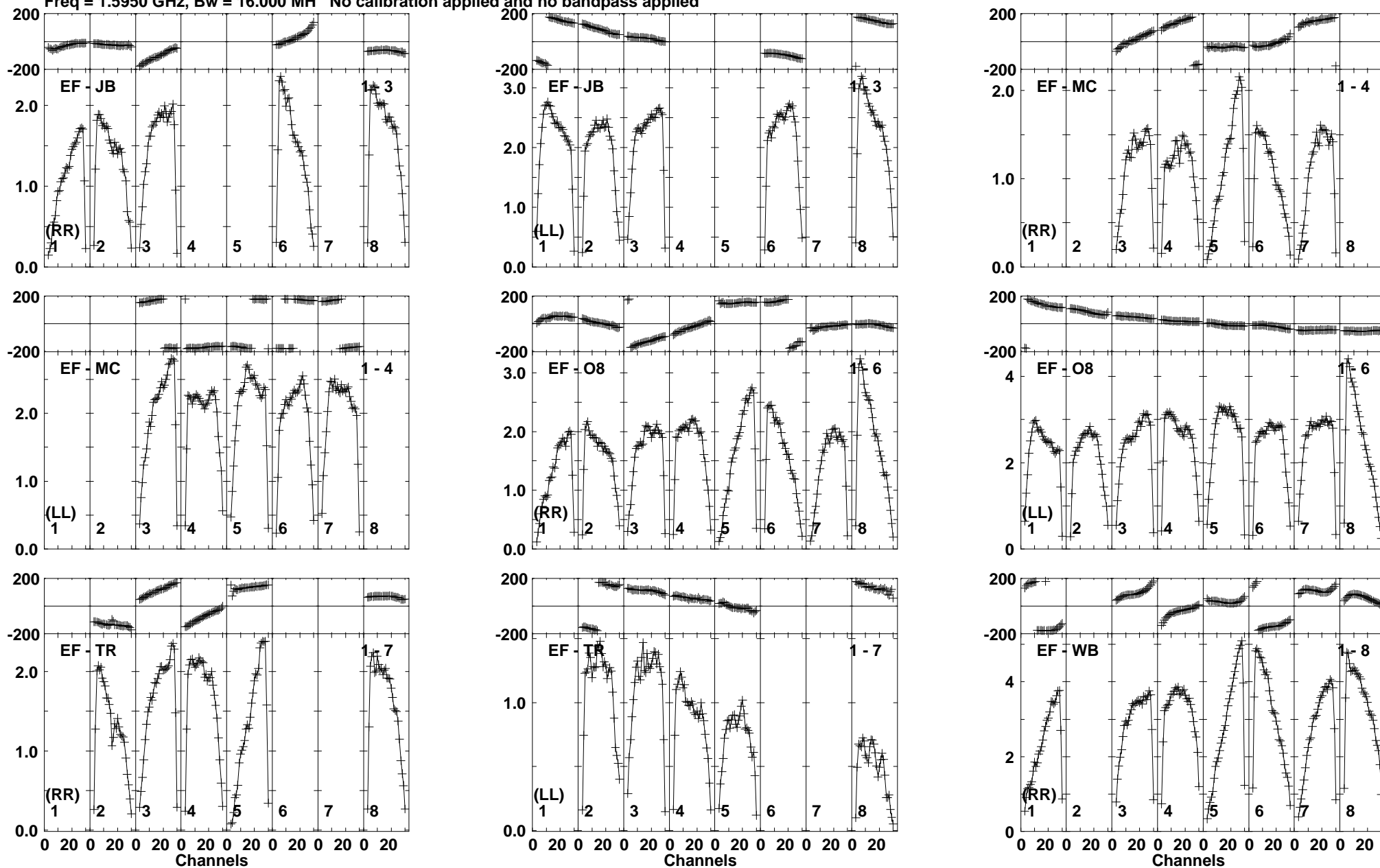

Lower frame: Milli Amply Jy Top frame: Phas deg  
Vector averaged cross-power spectrum Baseline: EF (01) - JB (03)  
Timerange: 01/07:19:52 to 01/07:23:18

Plot file version 434 created 26-JUN-2015 10:51:35  
V404CYG ET031A.UVDATA.1  
Freq = 1.5950 GHz, Bw = 16.000 MH No calibration applied and no bandpass applied

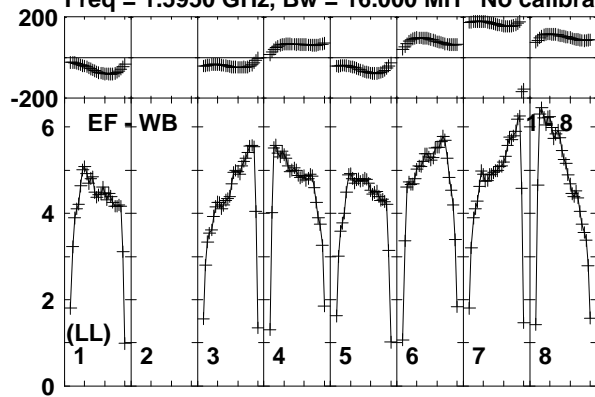

Lower frame: Milli Ampl Jy Top frame: Phas deg  
Vector averaged cross-power spectrum Baseline: EF (01) - WB (08)  
Timerange: 01/07:19:52 to 01/07:23:18

Plot file version 435 created 26-JUN-2015 10:51:35

J2025+3343 ET031A.UVDATA.1

Freq = 1.5950 GHz, Bw = 16.000 MH No calibration applied and no bandpass applied

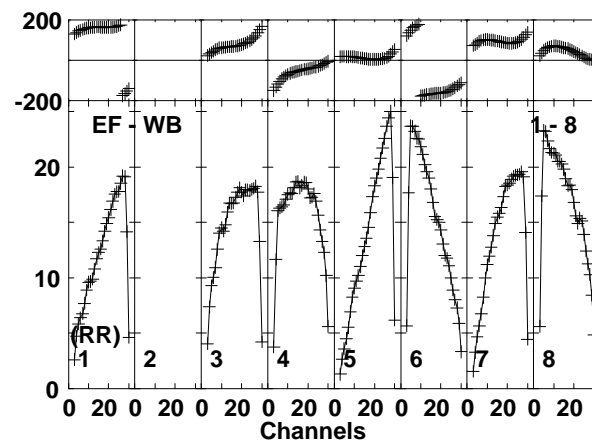
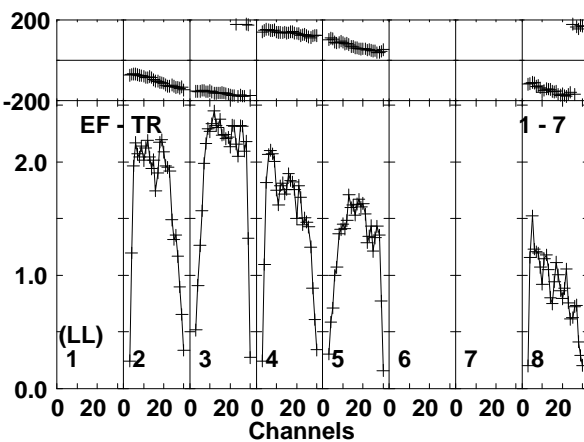
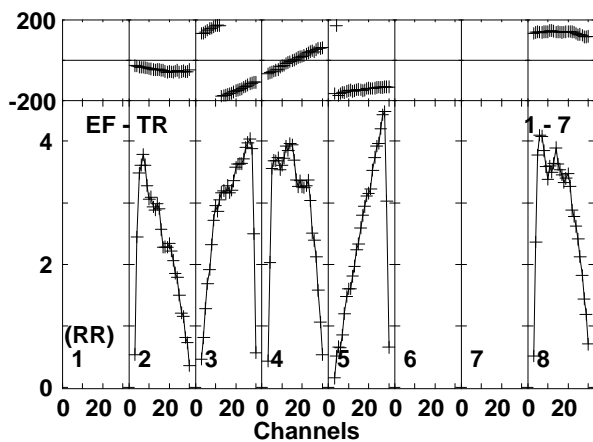
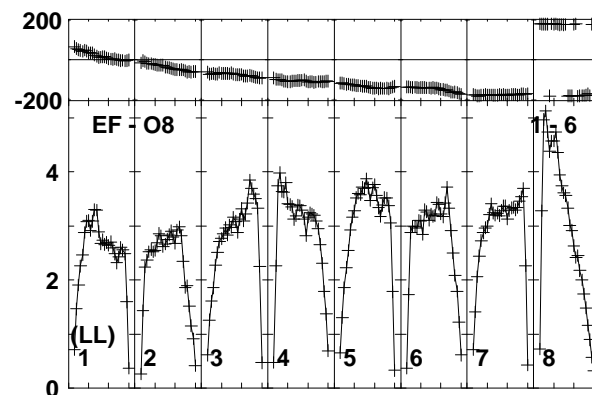
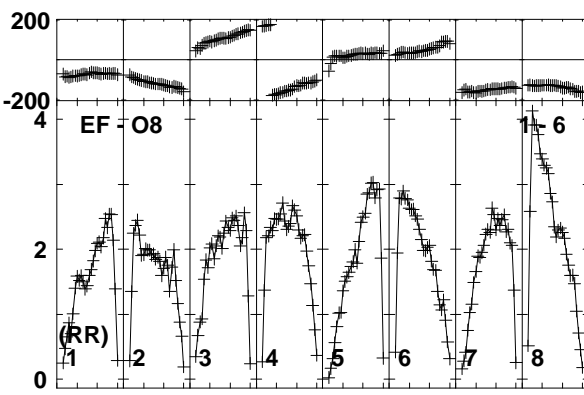
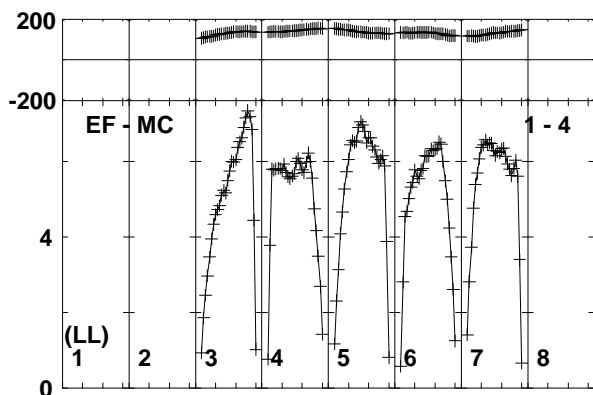
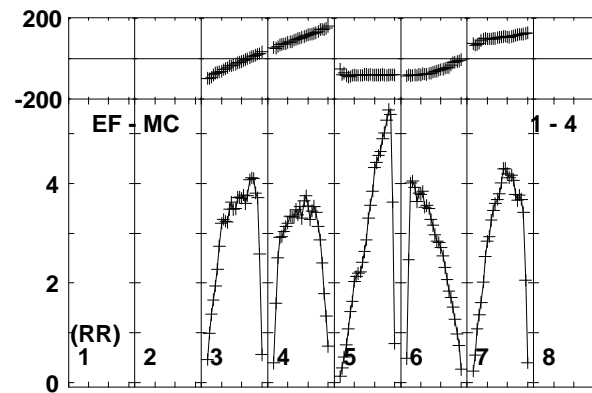
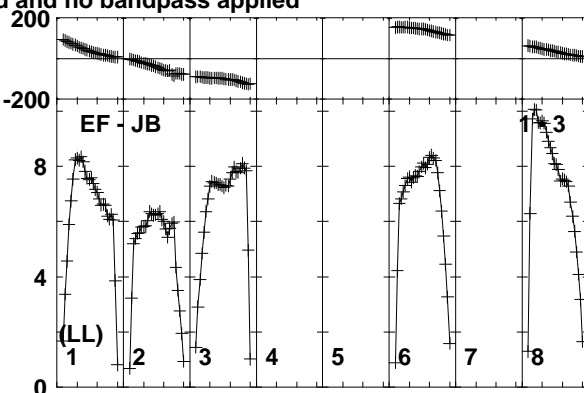
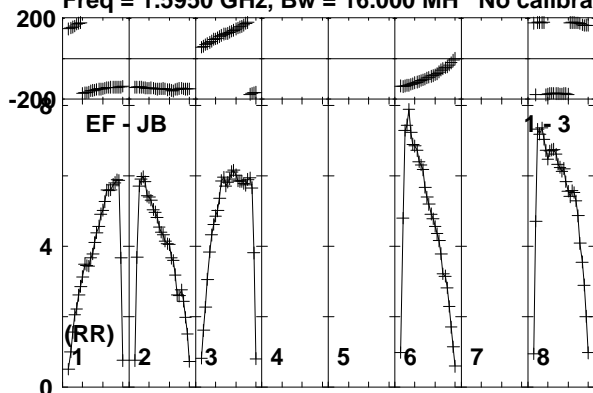

Lower frame: Milli Ampl Jy Top frame: Phas deg  
Vector averaged cross-power spectrum Baseline: EF (01) - JB (03)  
Timerange: 01/07:24:02 to 01/07:24:58

Plot file version 436 created 26-JUN-2015 10:51:35

J2025+3343 ET031A.UVDATA.1

Freq = 1.5950 GHz, Bw = 16.000 MH No calibration applied and no bandpass applied

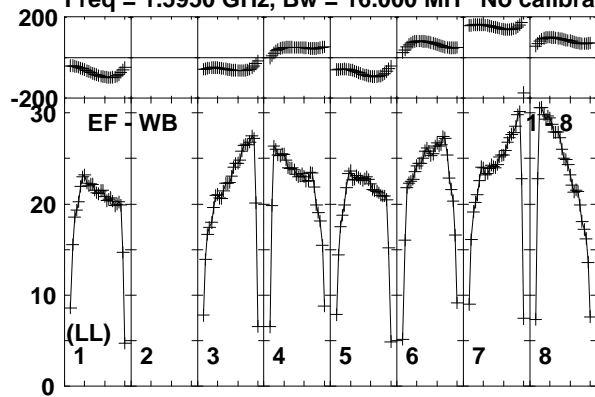

Lower frame: Milli Ampl Jy Top frame: Phas deg  
Vector averaged cross-power spectrum Baseline: EF (01) - WB (08)  
Timerange: 01/07:24:02 to 01/07:24:58

Plot file version 437 created 26-JUN-2015 10:51:35

V404CYG ET031A.UVDATA.1

Freq = 1.5950 GHz, Bw = 16.000 MH No calibration applied and no bandpass applied

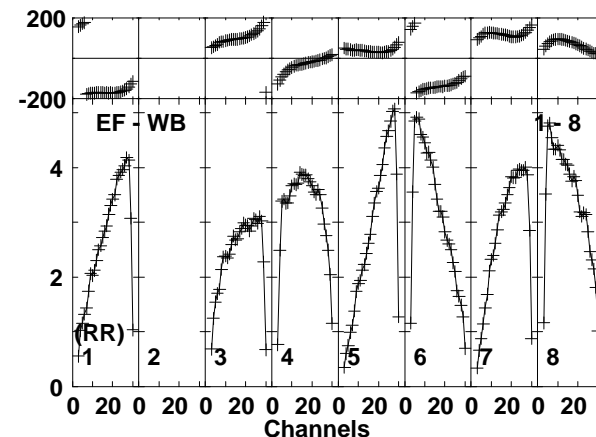
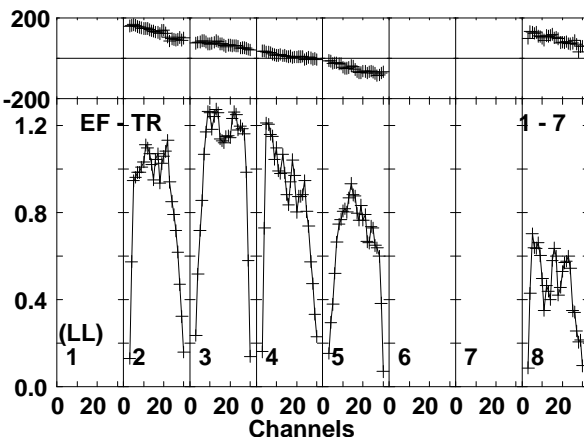
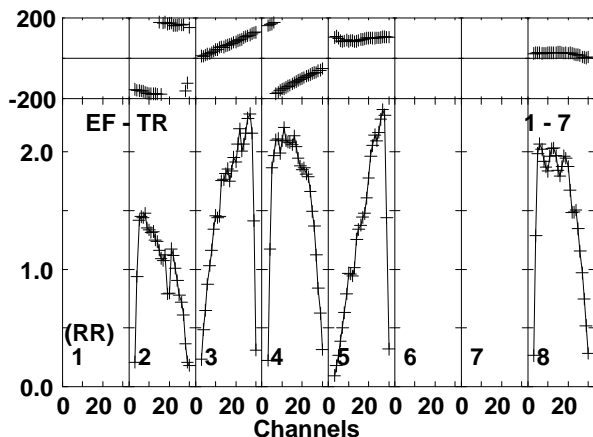
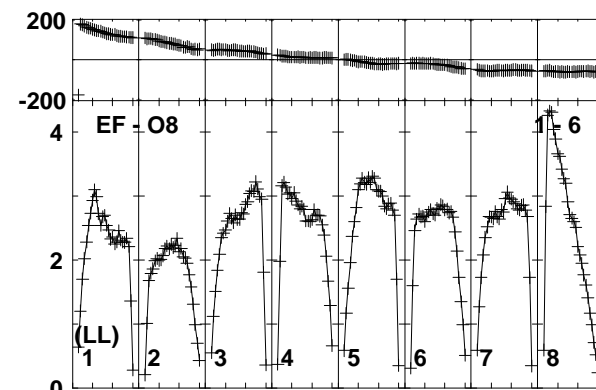
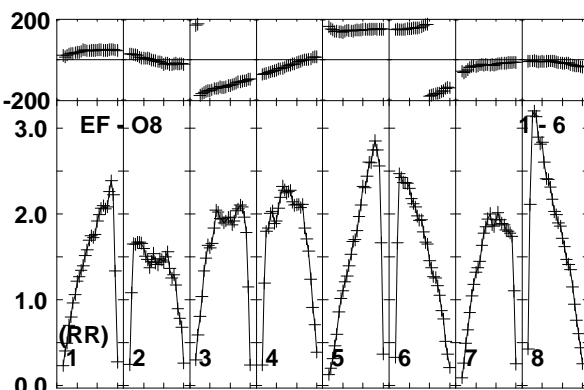
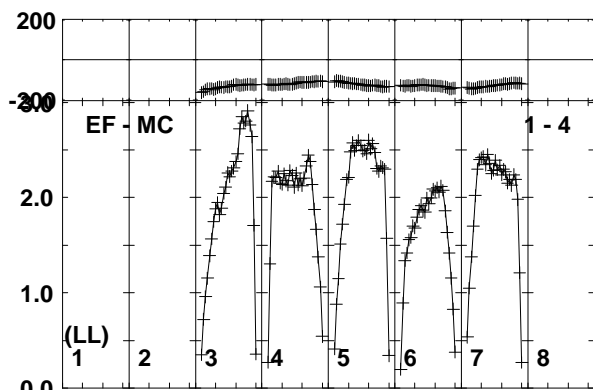
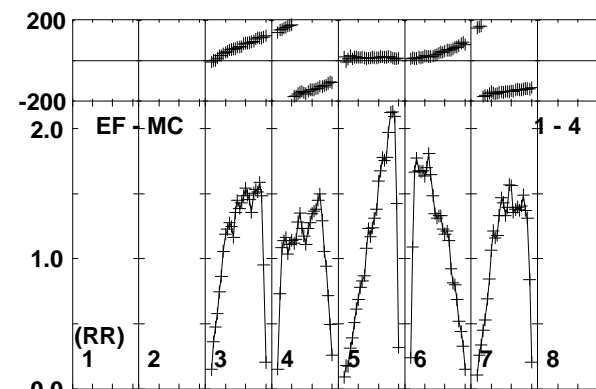
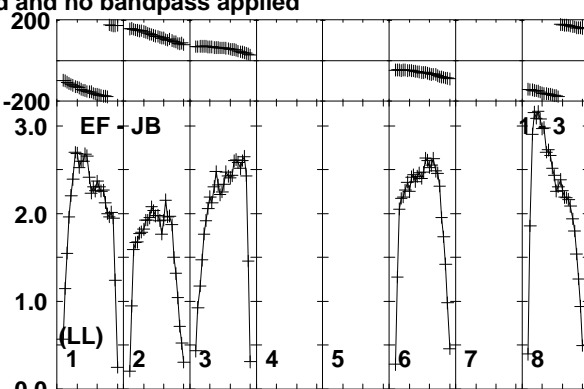
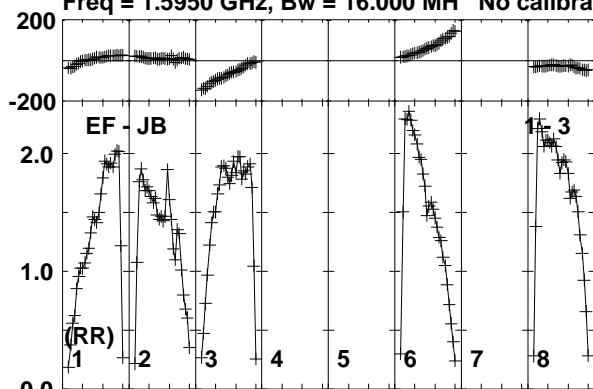

Lower frame: Milli Ampl Jy Top frame: Phas deg  
Vector averaged cross-power spectrum Baseline: EF (01) - JB (03)  
Timerange: 01/07:25:02 to 01/07:28:28

Plot file version 438 created 26-JUN-2015 10:51:35  
V404CYG ET031A.UVDATA.1  
Freq = 1.5950 GHz, Bw = 16.000 MH No calibration applied and no bandpass applied

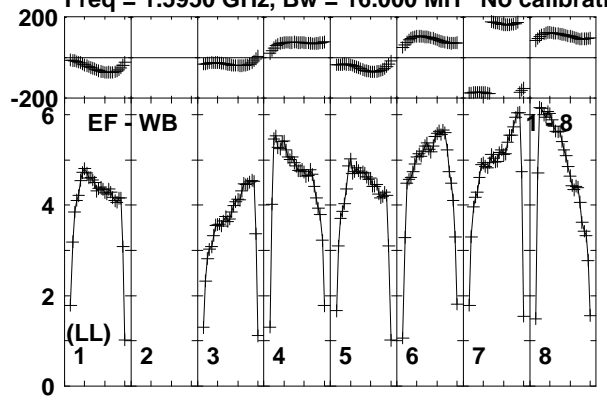

Lower frame: Milli Ampl Jy Top frame: Phas deg  
Vector averaged cross-power spectrum Baseline: EF (01) - WB (08)  
Timerange: 01/07:25:02 to 01/07:28:28

Plot file version 439 created 26-JUN-2015 10:51:35

J2025+3343 ET031A.UVDATA.1

Freq = 1.5950 GHz, Bw = 16.000 MH No calibration applied and no bandpass applied

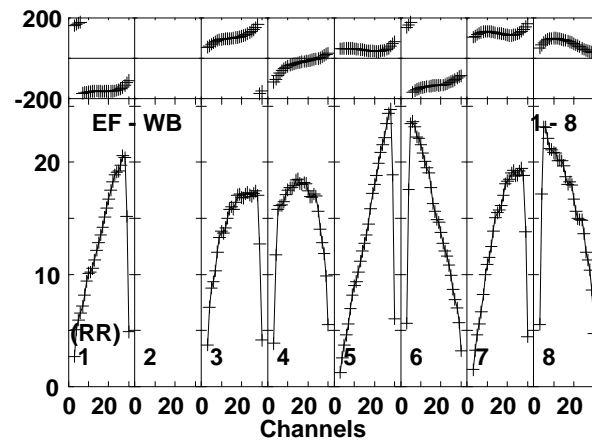
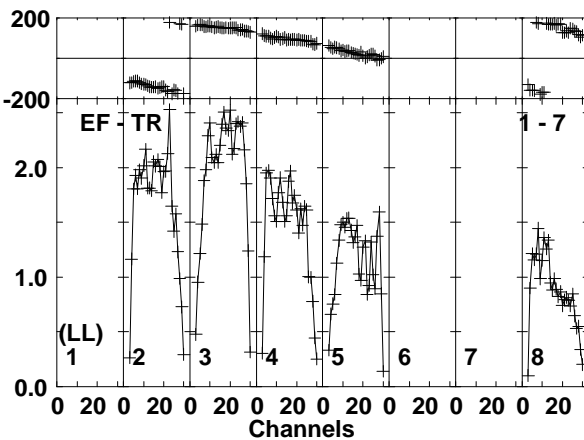
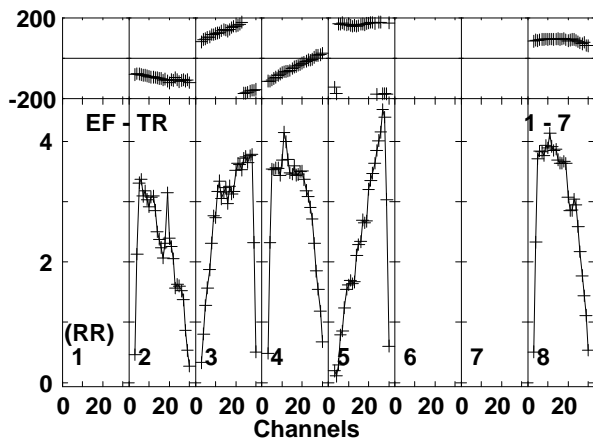
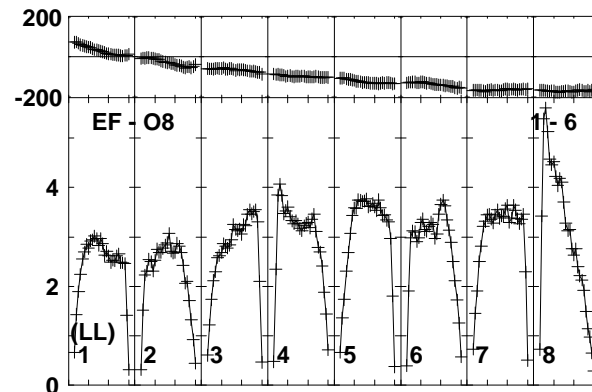
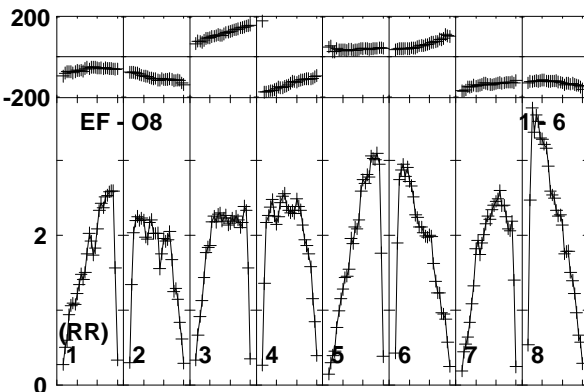
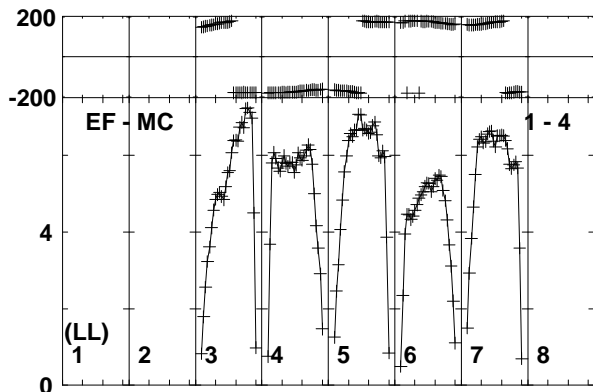
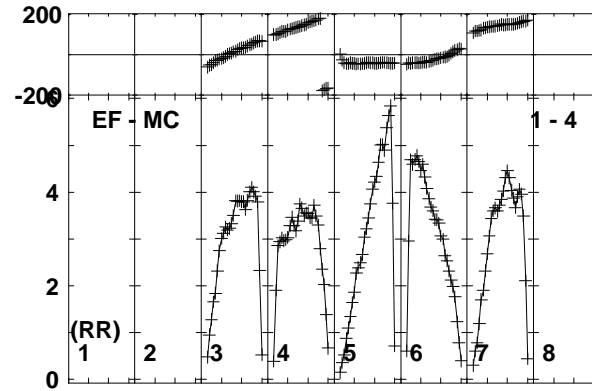
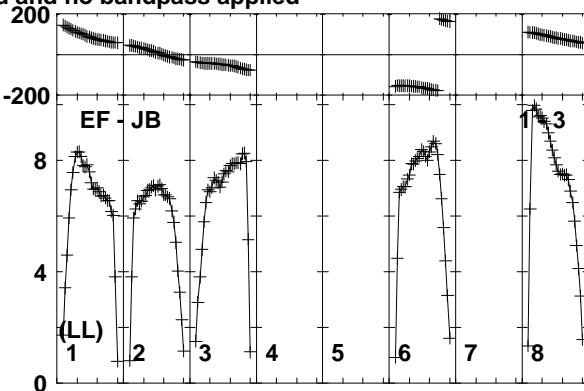
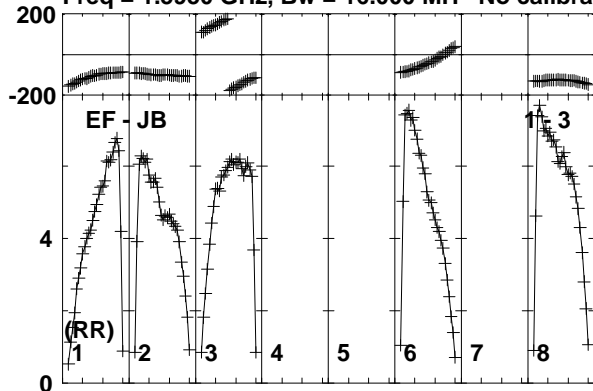

Lower frame: Milli Ampl Jy Top frame: Phas deg  
Vector averaged cross-power spectrum Baseline: EF (01) - JB (03)  
Timerange: 01/07:28:32 to 01/07:29:48

Plot file version 440 created 26-JUN-2015 10:51:35  
J2025+3343 ET031A.UVDATA.1  
Freq = 1.5950 GHz, Bw = 16.000 MH No calibration applied and no bandpass applied

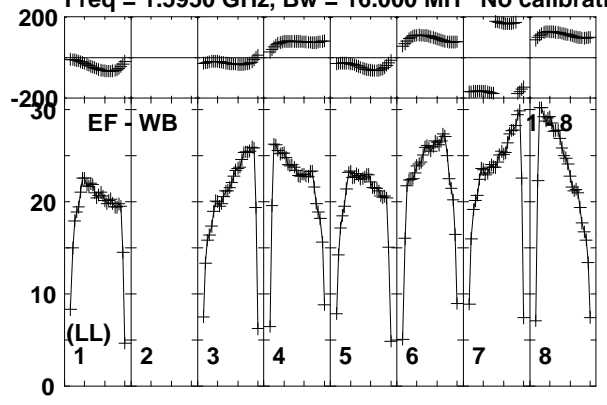

Lower frame: Milli Ampl Jy Top frame: Phas deg  
Vector averaged cross-power spectrum Baseline: EF (01) - WB (08)  
Timerange: 01/07:28:32 to 01/07:29:48



Plot file version 441 created 26-JUN-2015 10:51:35

V404CYG ET031A.UVDATA.1

Freq = 1.5950 GHz, Bw = 16.000 MH No calibration applied and no bandpass applied

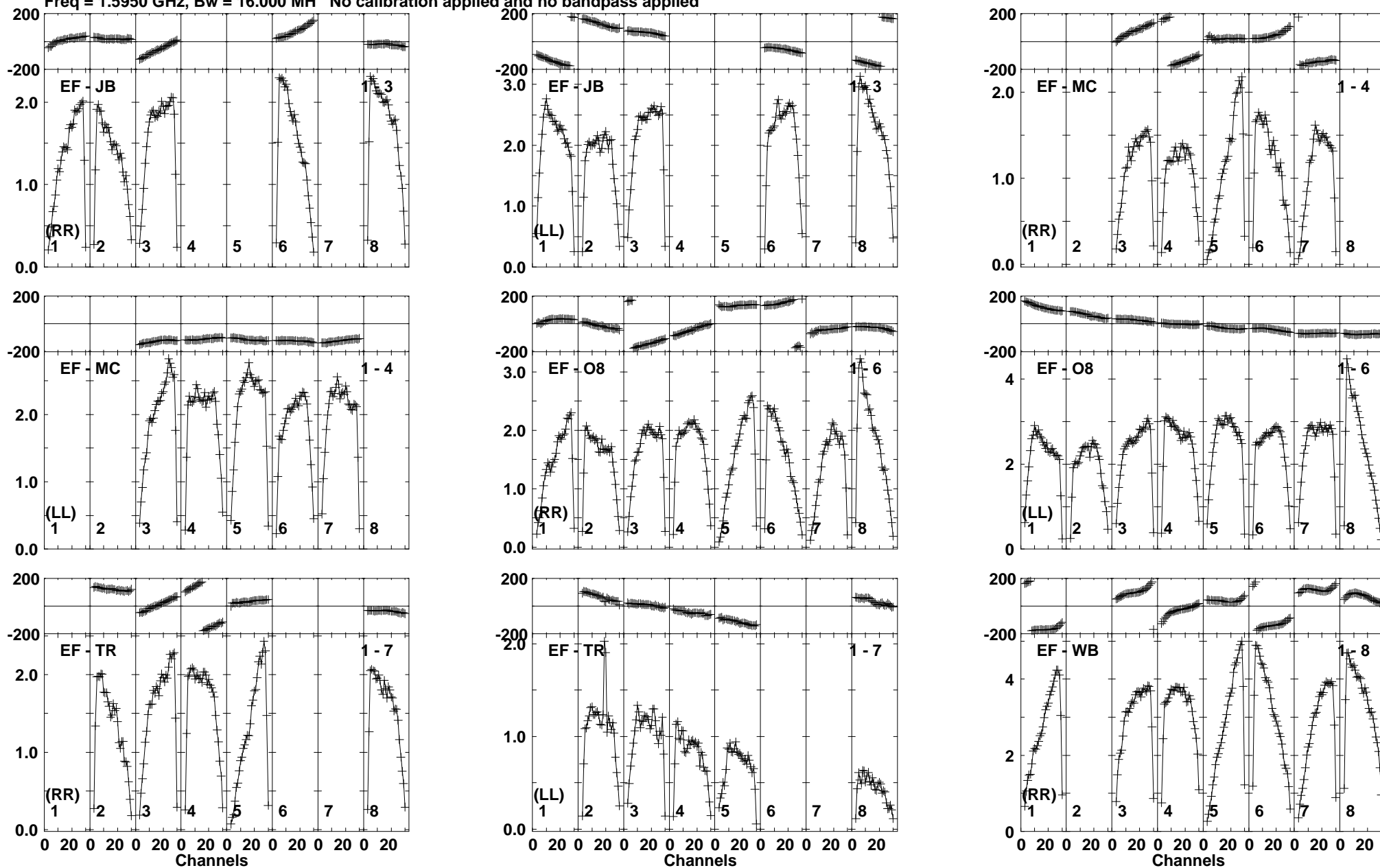

Lower frame: Milli Ampl Jy Top frame: Phas deg  
Vector averaged cross-power spectrum Baseline: EF (01) - JB (03)  
Timerange: 01/07:29:52 to 01/07:33:18

Plot file version 442 created 26-JUN-2015 10:51:36

V404CYG ET031A.UVDATA.1

Freq = 1.5950 GHz, Bw = 16.000 MH No calibration applied and no bandpass applied

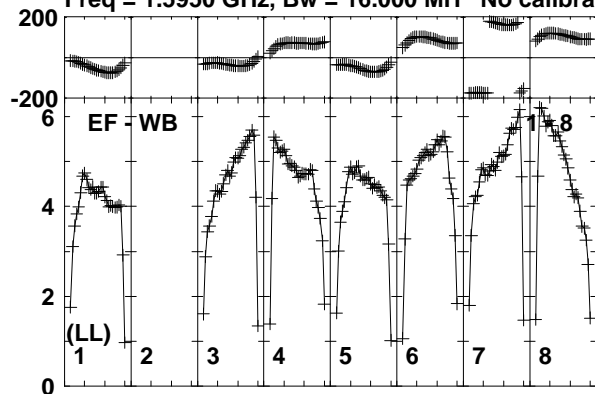

Lower frame: Milli Ampl Jy Top frame: Phas deg

Vector averaged cross-power spectrum Baseline: EF (01) - WB (08)

Timerange: 01/07:29:52 to 01/07:33:18

Plot file version 443 created 26-JUN-2015 10:51:36

J2025+3343 ET031A.UVDATA.1

Freq = 1.5950 GHz, Bw = 16.000 MH No calibration applied and no bandpass applied

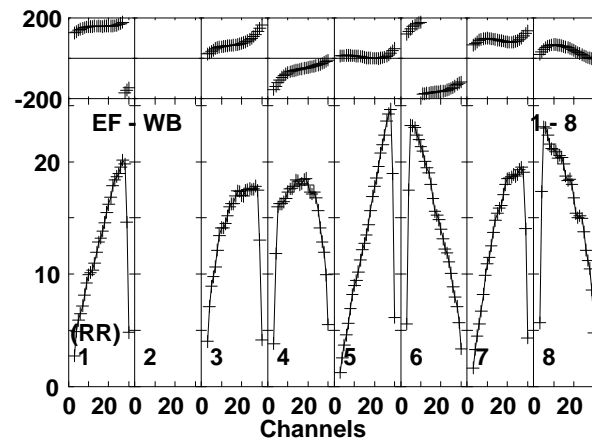
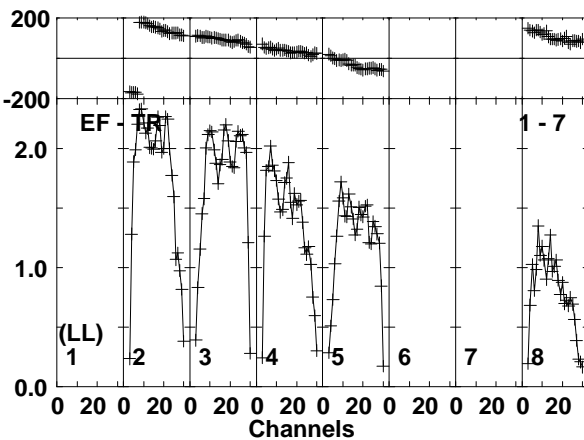
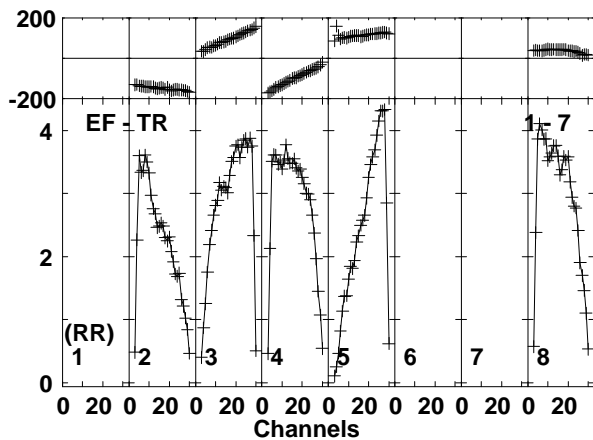
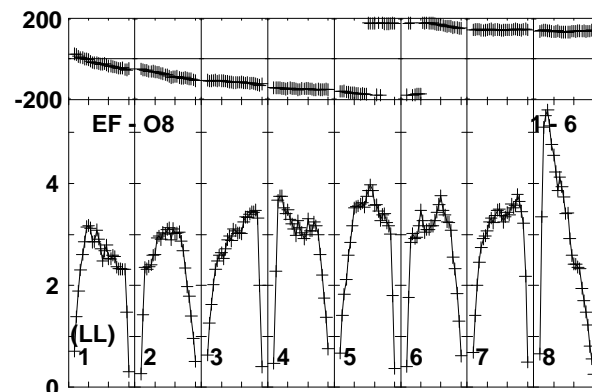
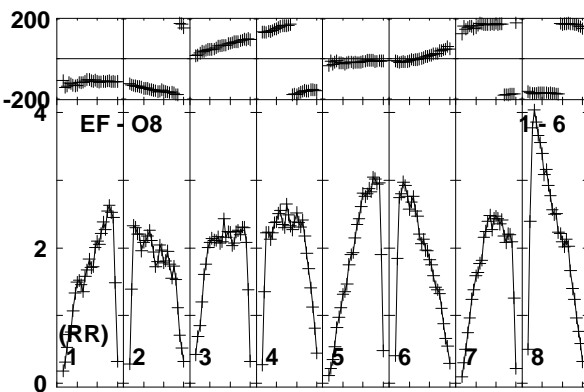
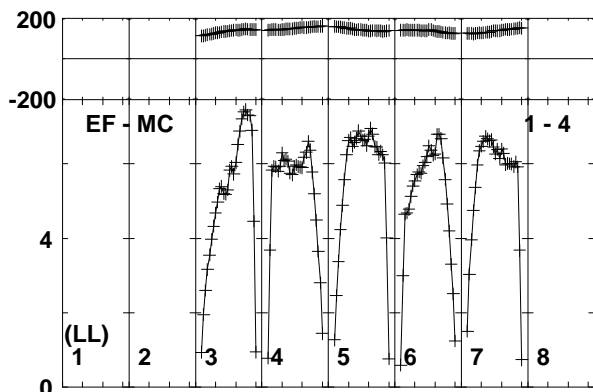
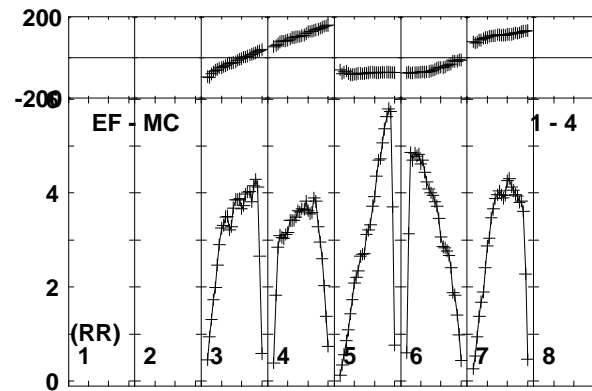
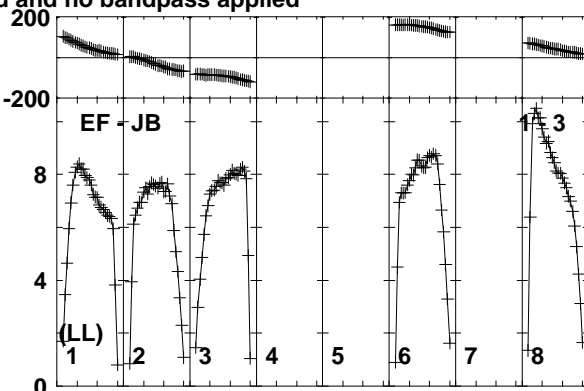
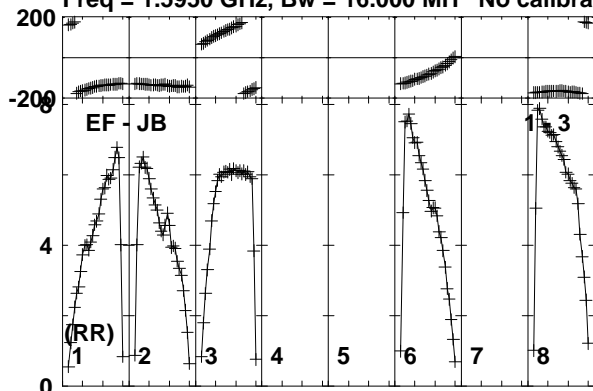

Lower frame: Milli Ampl Jy Top frame: Phas deg  
Vector averaged cross-power spectrum Baseline: EF (01) - JB (03)  
Timerange: 01/07:34:02 to 01/07:34:58

Plot file version 444 created 26-JUN-2015 10:51:36  
J2025+3343 ET031A.UVDATA.1  
Freq = 1.5950 GHz, Bw = 16.000 MH No calibration applied and no bandpass applied

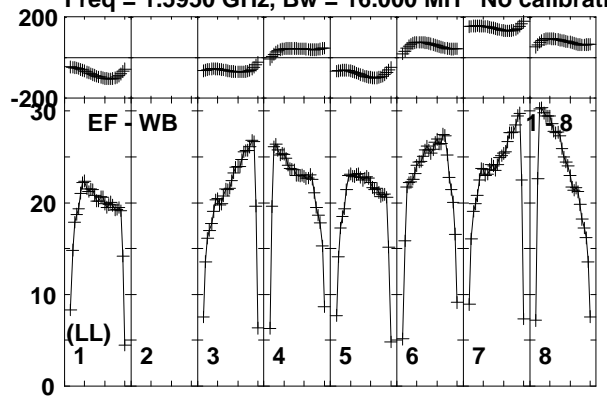

Lower frame: Milli Ampl Jy Top frame: Phas deg  
Vector averaged cross-power spectrum Baseline: EF (01) - WB (08)  
Timerange: 01/07:34:02 to 01/07:34:58

Plot file version 445 created 26-JUN-2015 10:51:36

V404CYG ET031A.UVDATA.1

Freq = 1.5950 GHz, Bw = 16.000 MH No calibration applied and no bandpass applied

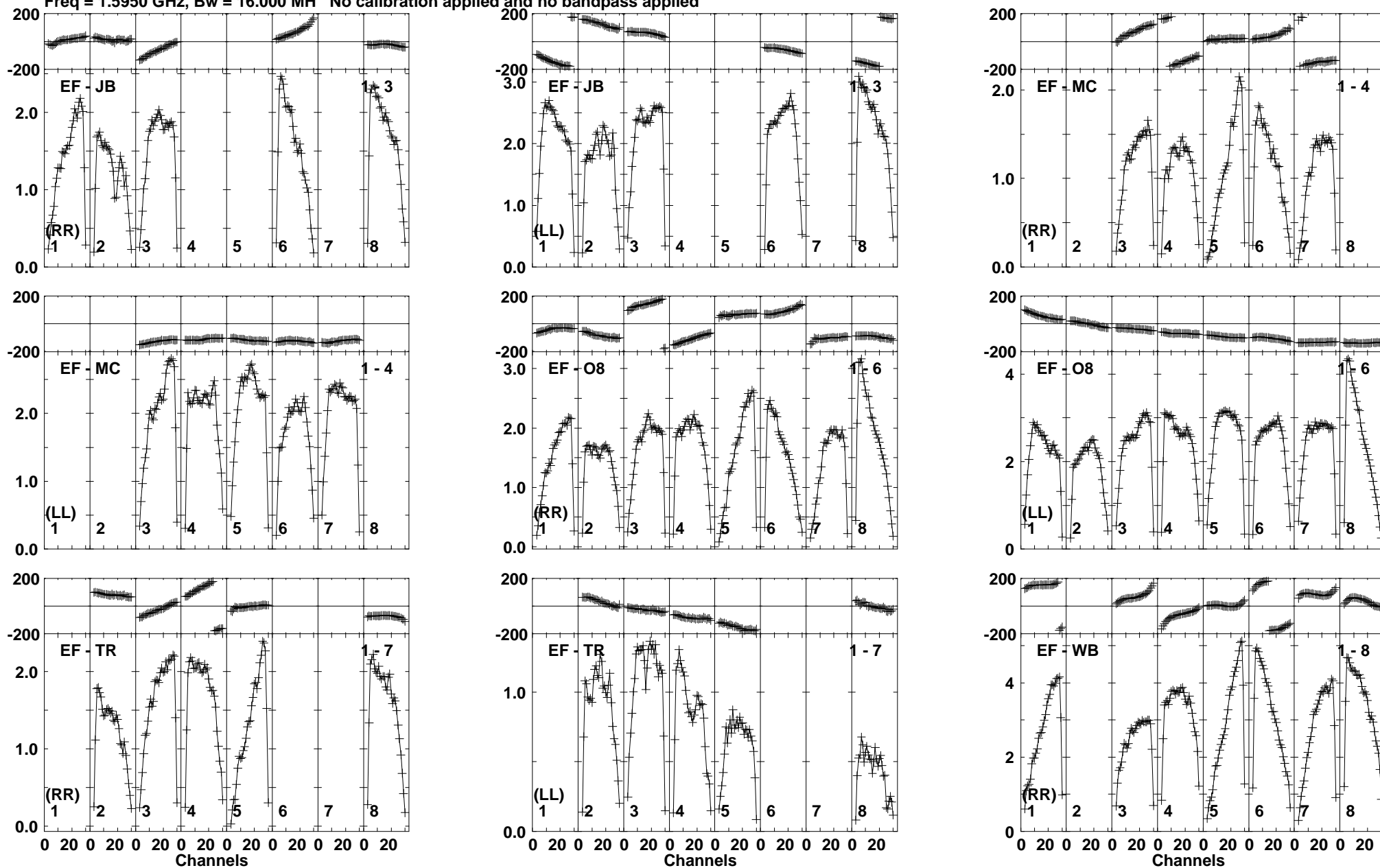

Lower frame: Milli Ampl Jy Top frame: Phas deg  
Vector averaged cross-power spectrum Baseline: EF (01) - JB (03)  
Timerange: 01/07:35:02 to 01/07:38:28

Plot file version 446 created 26-JUN-2015 10:51:36

V404CYG ET031A.UVDATA.1

Freq = 1.5950 GHz, Bw = 16.000 MH No calibration applied and no bandpass applied

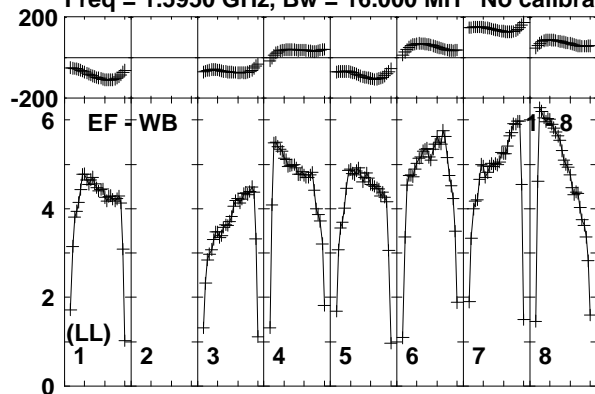

Lower frame: Milli Ampl Jy Top frame: Phas deg

Vector averaged cross-power spectrum Baseline: EF (01) - WB (08)

Timerange: 01/07:35:02 to 01/07:38:28

Plot file version 447 created 26-JUN-2015 10:51:36

J2025+3343 ET031A.UVDATA.1

Freq = 1.5950 GHz, Bw = 16.000 MH No calibration applied and no bandpass applied

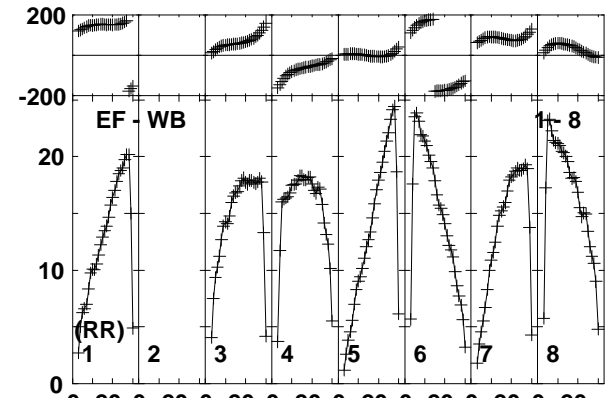
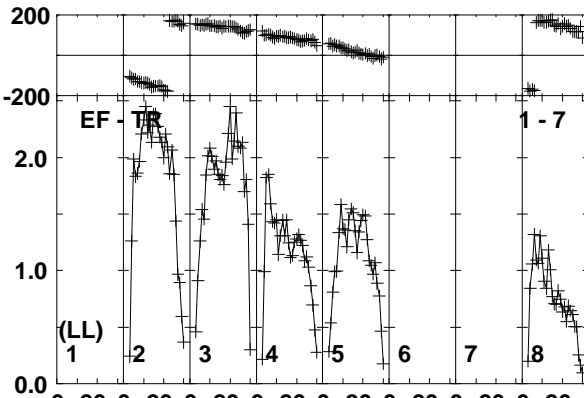
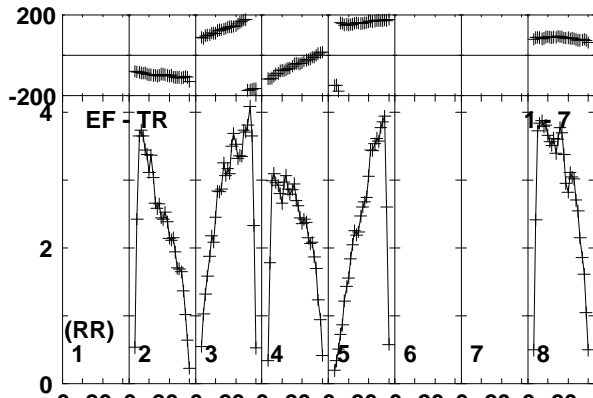
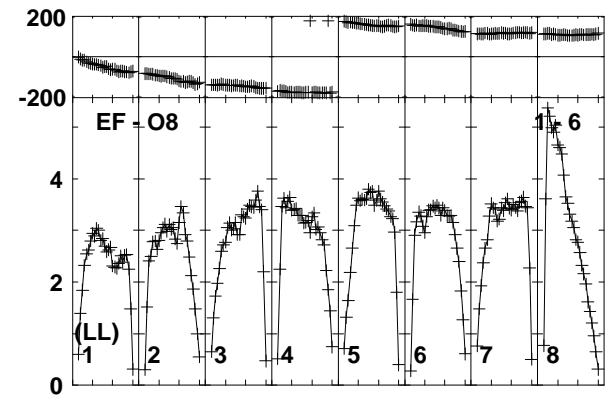
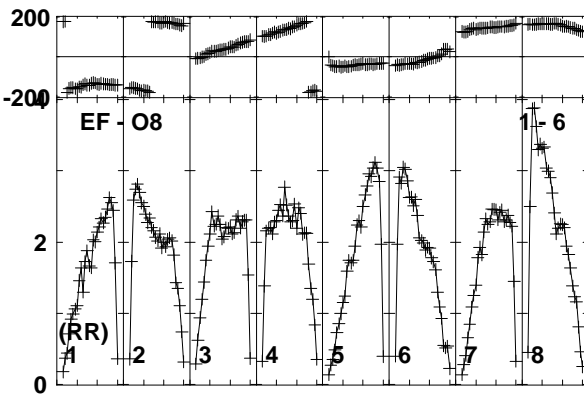
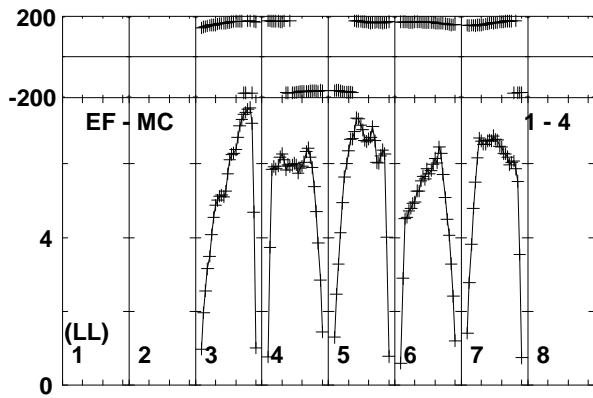
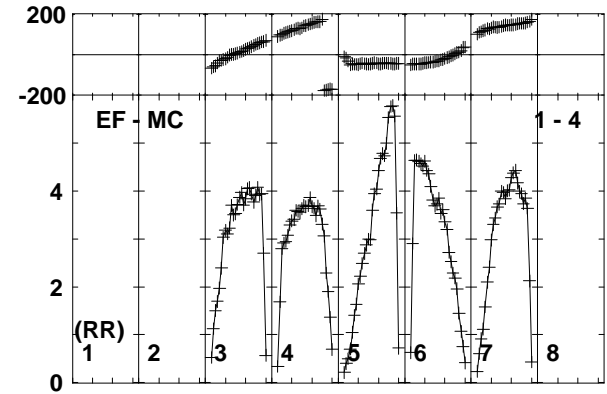
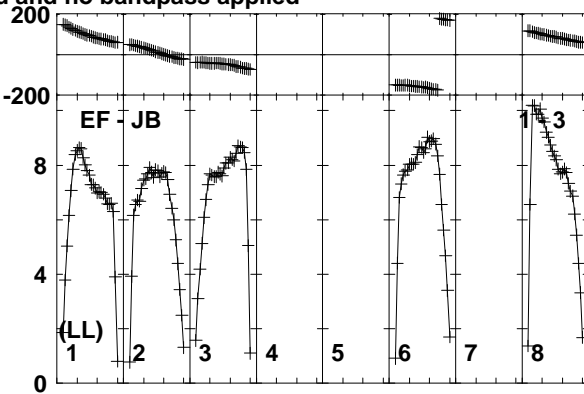
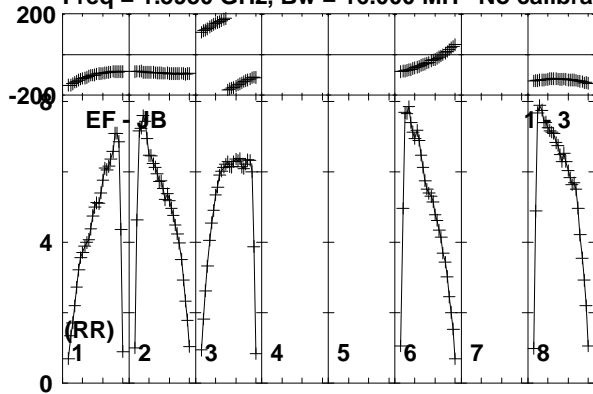

Lower frame: Milli Ampl Jy Top frame: Phas deg  
Vector averaged cross-power spectrum Baseline: EF (01) - JB (03)  
Timerange: 01/07:38:32 to 01/07:39:48

Plot file version 448 created 26-JUN-2015 10:51:36

J2025+3343 ET031A.UVDATA.1

Freq = 1.5950 GHz, Bw = 16.000 MH No calibration applied and no bandpass applied

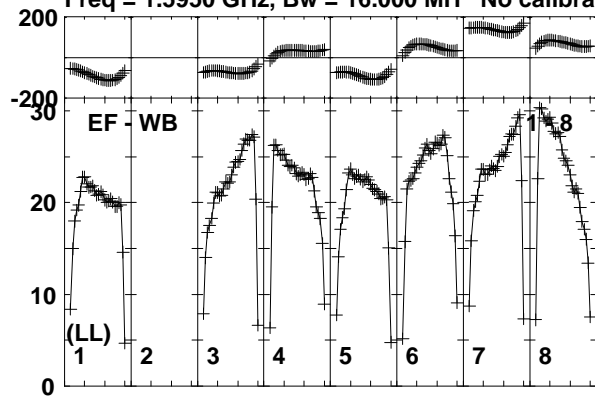

Lower frame: Milli Ampl Jy Top frame: Phas deg  
Vector averaged cross-power spectrum Baseline: EF (01) - WB (08)  
Timerange: 01/07:38:32 to 01/07:39:48



Plot file version 449 created 26-JUN-2015 10:51:36

V404CYG ET031A.UVDATA.1

Freq = 1.5950 GHz, Bw = 16.000 MH No calibration applied and no bandpass applied

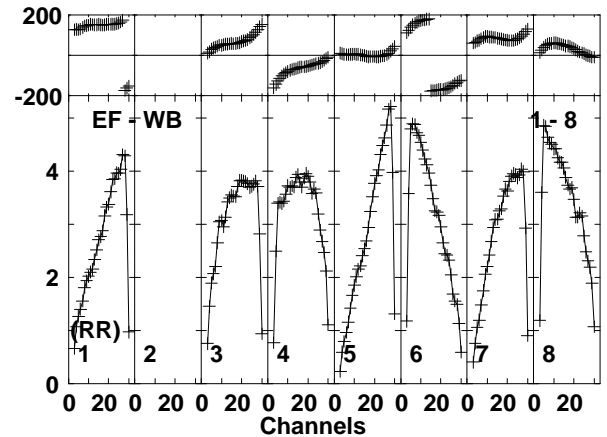
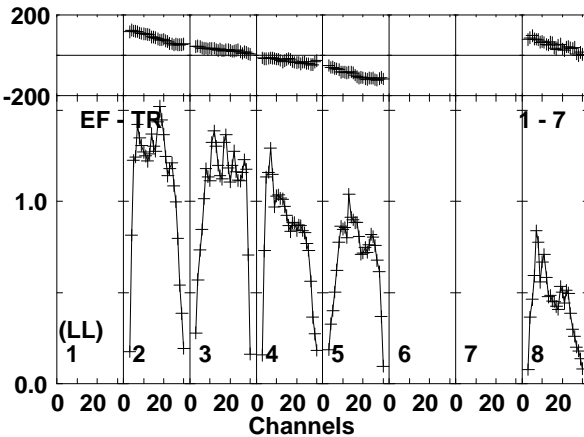
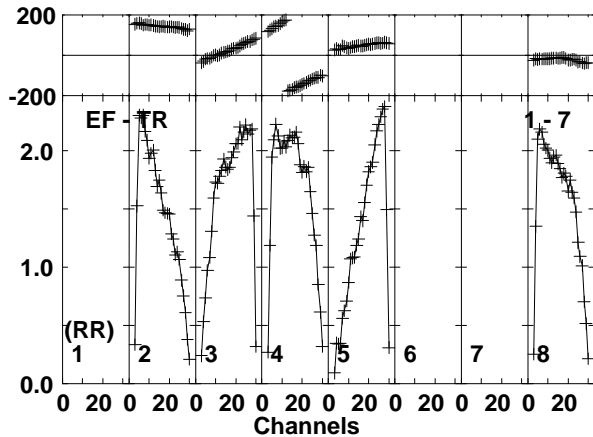
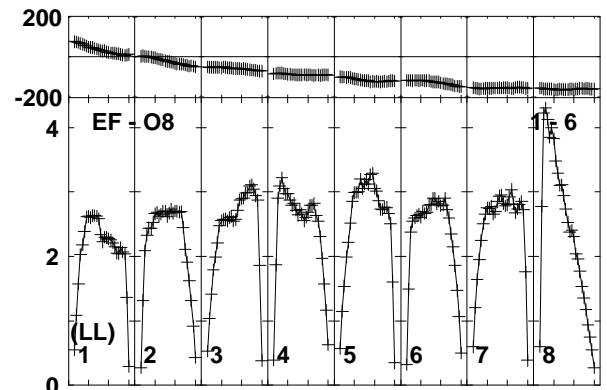
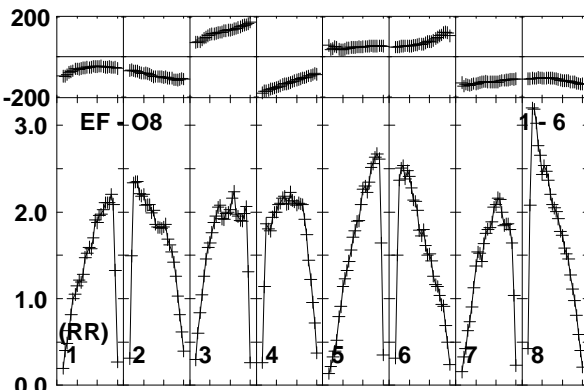
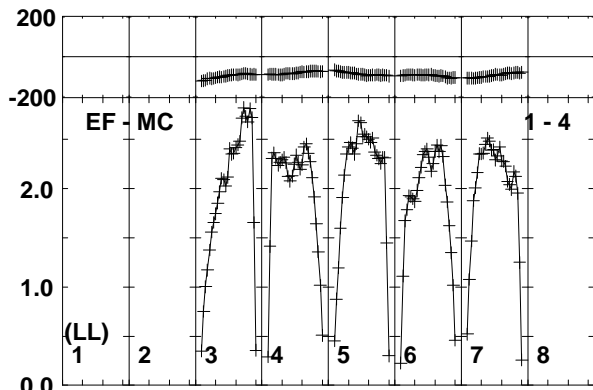
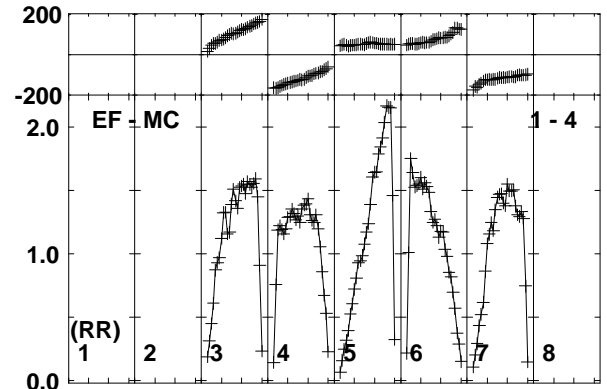
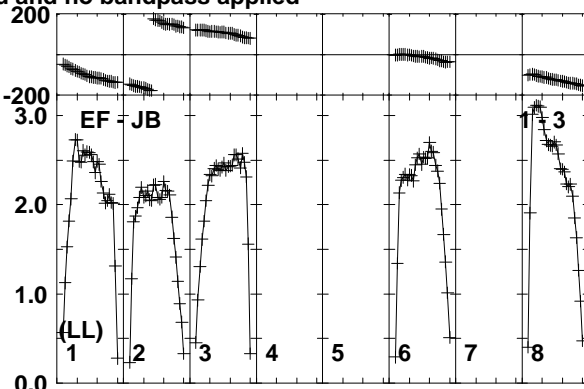
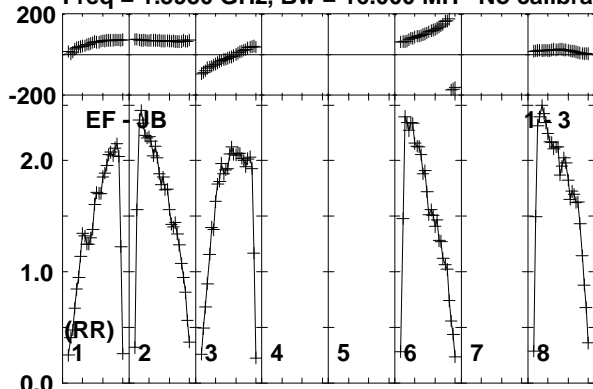

Lower frame: Milli Ampl Jy Top frame: Phas deg  
Vector averaged cross-power spectrum Baseline: EF (01) - JB (03)  
Timerange: 01/07:39:52 to 01/07:43:18

Plot file version 450 created 26-JUN-2015 10:51:36

V404CYG ET031A.UVDATA.1

Freq = 1.5950 GHz, Bw = 16.000 MH No calibration applied and no bandpass applied

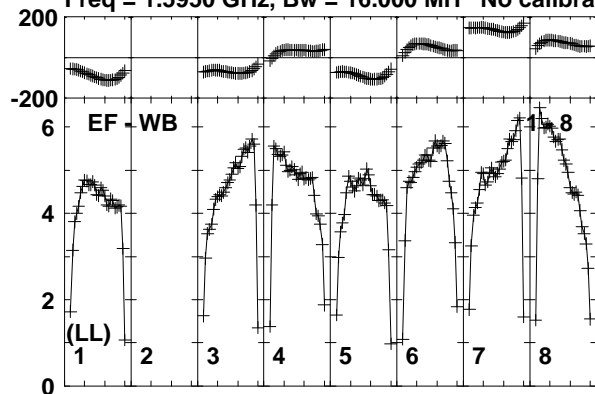

Lower frame: Milli Ampl Jy Top frame: Phas deg  
Vector averaged cross-power spectrum Baseline: EF (01) - WB (08)  
Timerange: 01/07:39:52 to 01/07:43:18

Plot file version 451 created 26-JUN-2015 10:51:36

V404CYG ET031A.UVDATA.1

Freq = 1.5950 GHz, Bw = 16.000 MH No calibration applied and no bandpass applied

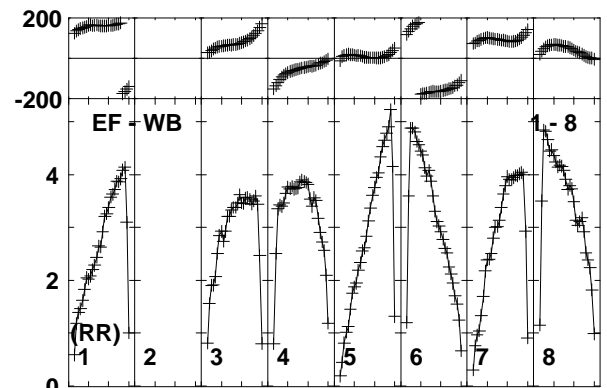
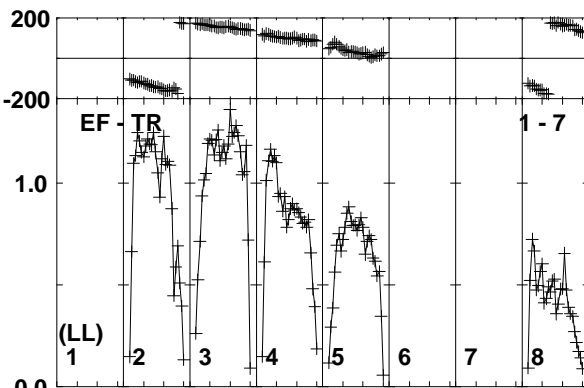
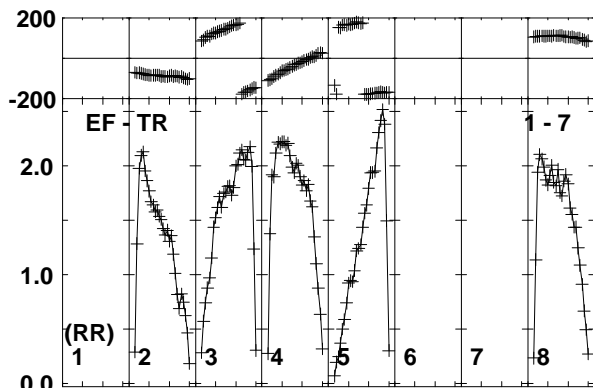
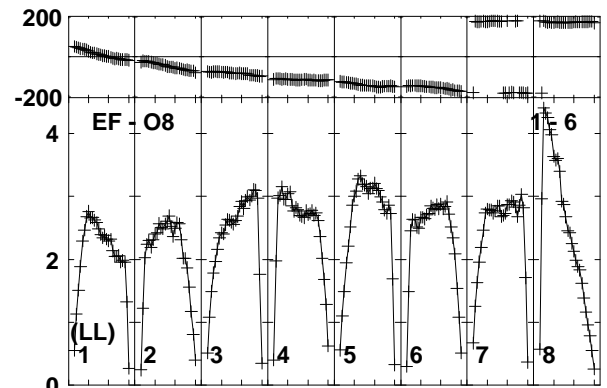
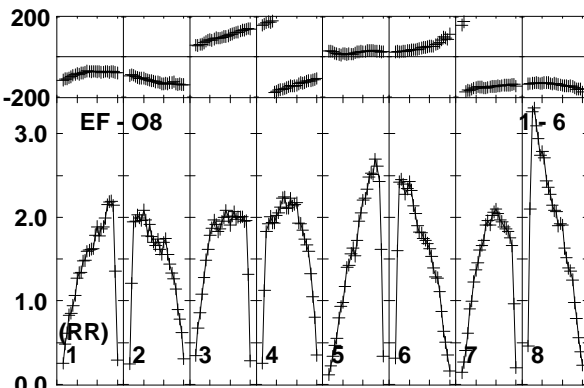
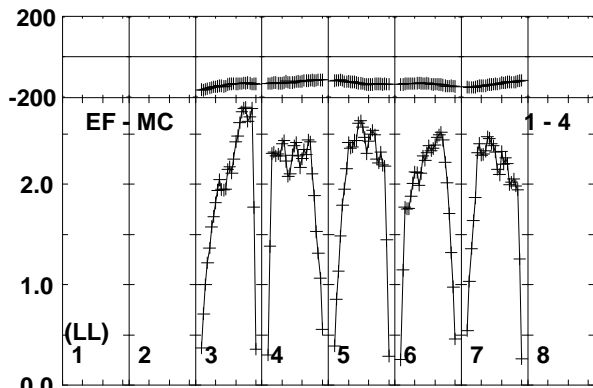
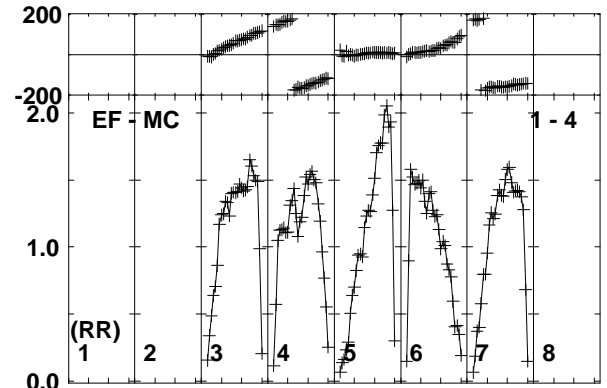
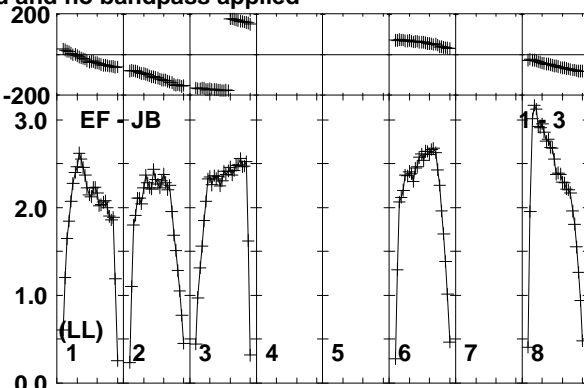
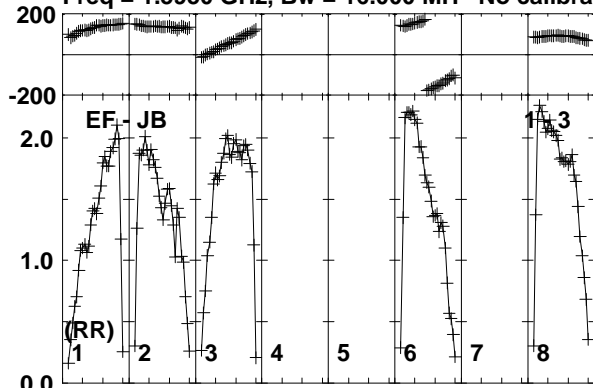

Lower frame: Milli Ampl Jy Top frame: Phas deg  
Vector averaged cross-power spectrum Baseline: EF (01) - JB (03)  
Timerange: 01/07:45:02 to 01/07:48:28

Plot file version 452 created 26-JUN-2015 10:51:36

V404CYG ET031A.UVDATA.1

Freq = 1.5950 GHz, Bw = 16.000 MH No calibration applied and no bandpass applied

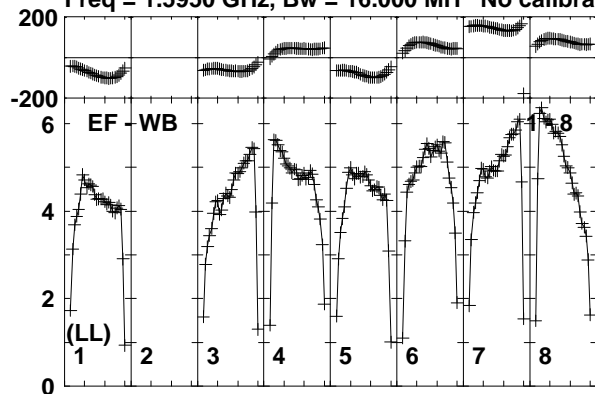

Lower frame: Milli Ampl Jy Top frame: Phas deg  
Vector averaged cross-power spectrum Baseline: EF (01) - WB (08)  
Timerange: 01/07:45:02 to 01/07:48:28

Plot file version 453 created 26-JUN-2015 10:51:36

J2025+3343 ET031A.UVDATA.1

Freq = 1.5950 GHz, Bw = 16.000 MH No calibration applied and no bandpass applied

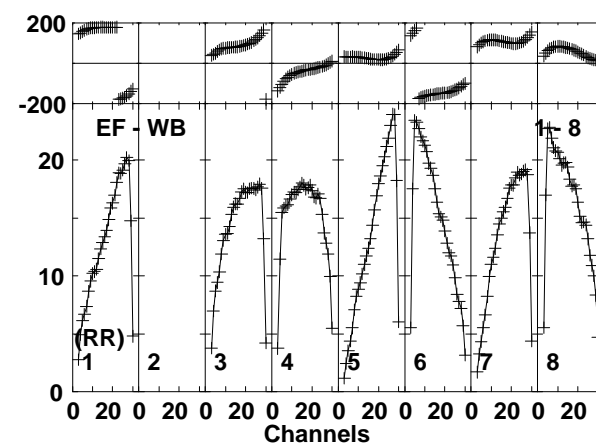
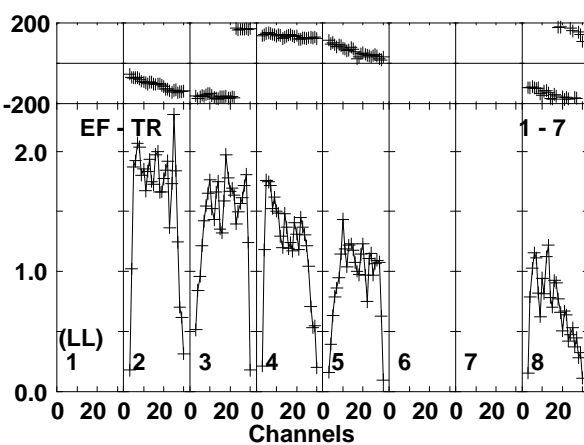
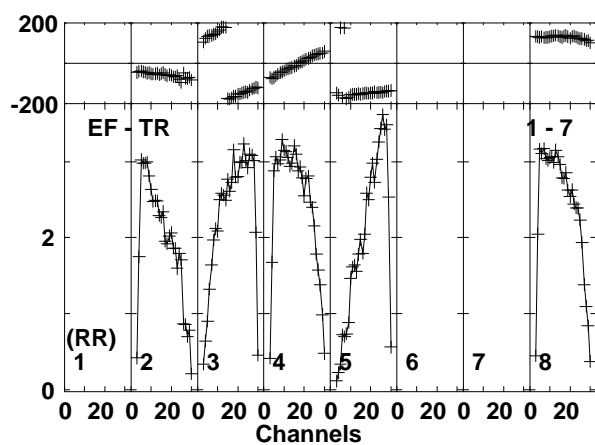
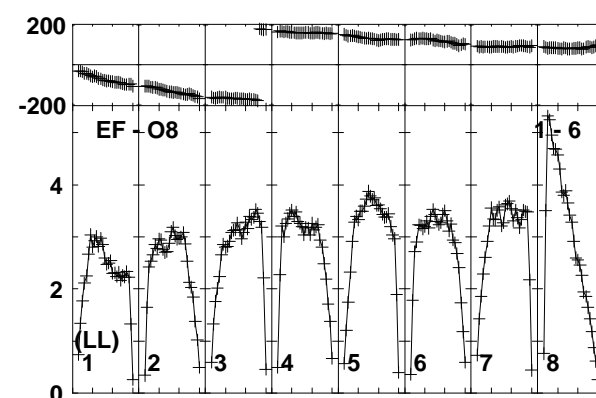
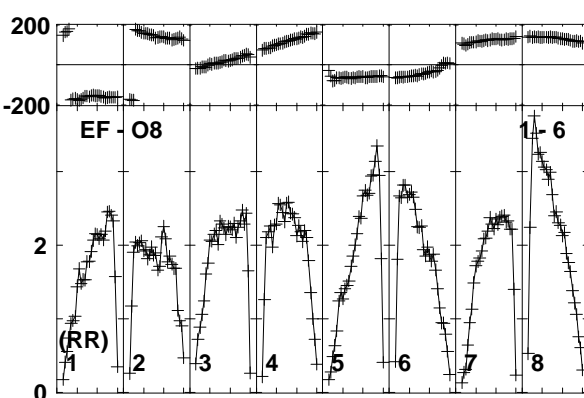
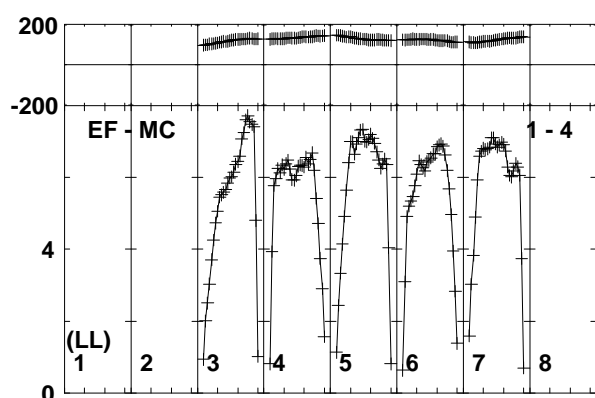
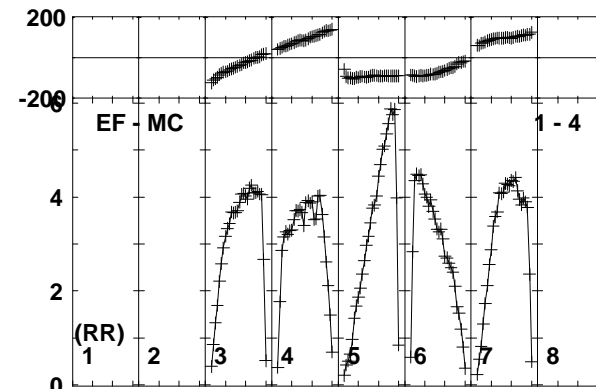
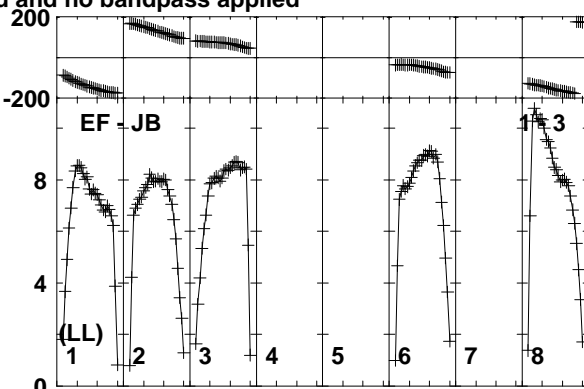
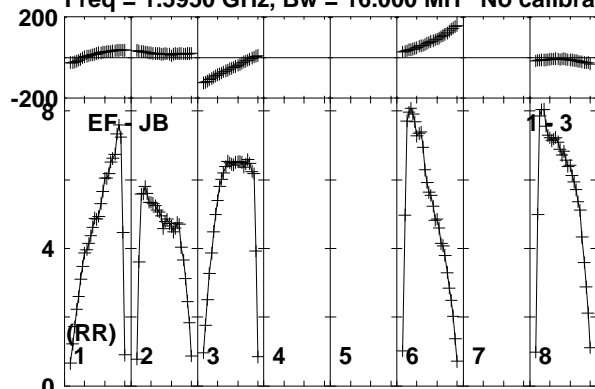

Lower frame: Milli Ampl Jy Top frame: Phas deg  
Vector averaged cross-power spectrum Baseline: EF (01) - JB (03)  
Timerange: 01/07:48:32 to 01/07:49:48

Plot file version 454 created 26-JUN-2015 10:51:36  
J2025+3343 ET031A.UVDATA.1  
Freq = 1.5950 GHz, Bw = 16.000 MH No calibration applied and no bandpass applied

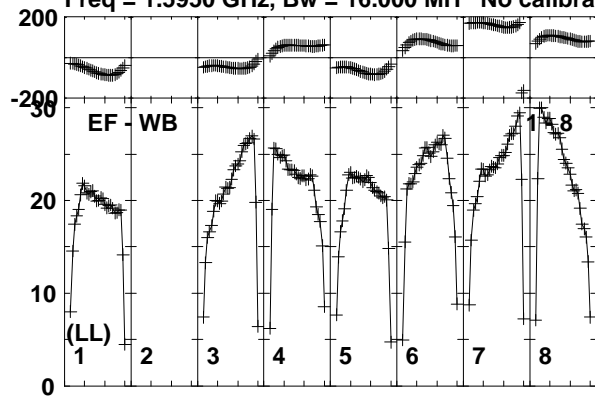

Lower frame: Milli Ampl Jy Top frame: Phas deg  
Vector averaged cross-power spectrum Baseline: EF (01) - WB (08)  
Timerange: 01/07:48:32 to 01/07:49:48

Plot file version 455 created 26-JUN-2015 10:51:36

V404CYG ET031A.UVDATA.1

Freq = 1.5950 GHz, Bw = 16.000 MH No calibration applied and no bandpass applied

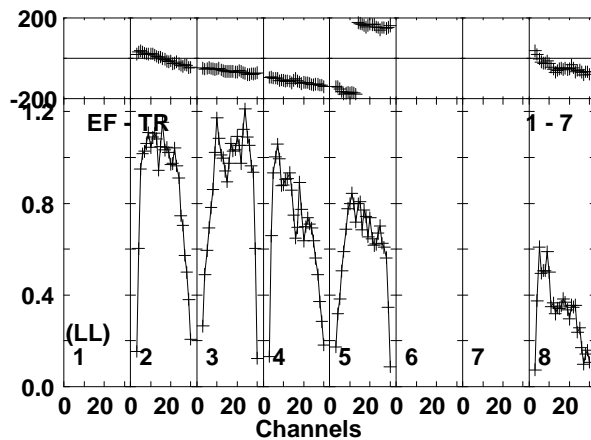
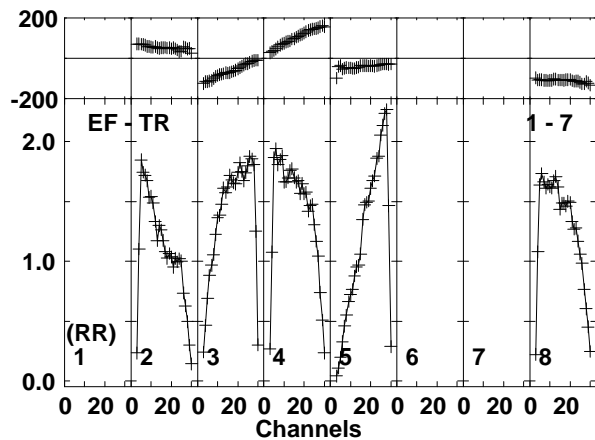
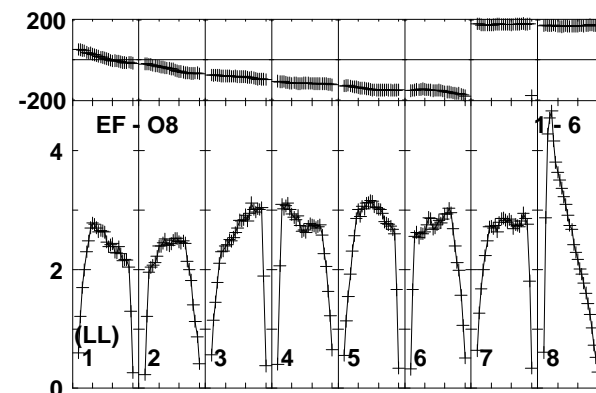
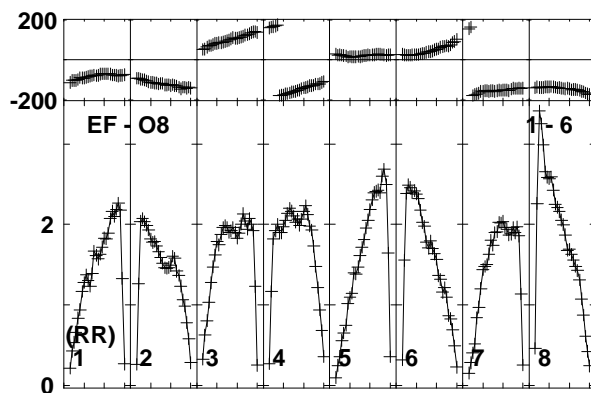
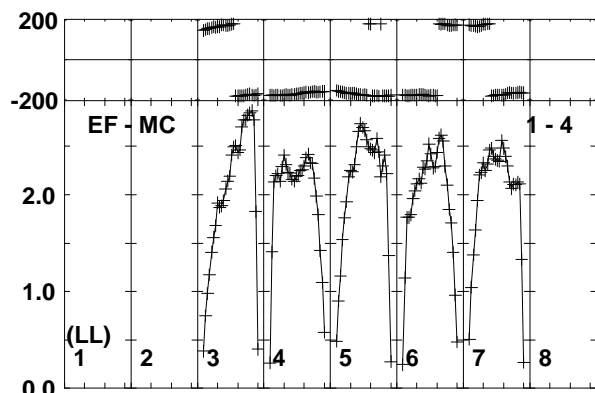
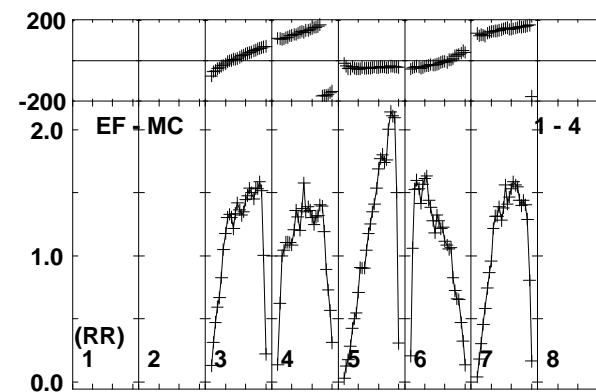
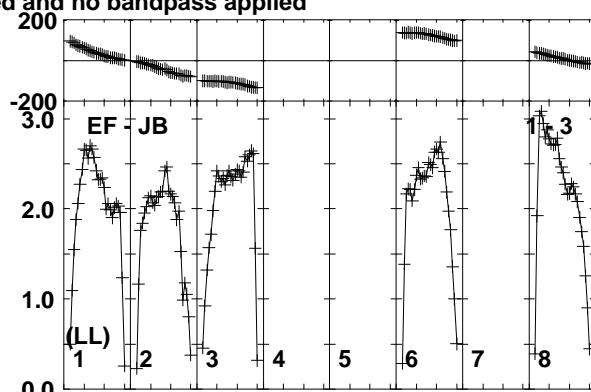
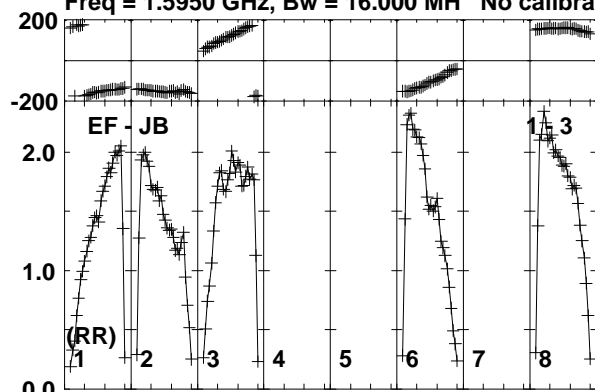

Lower frame: Milli Ampl Jy Top frame: Phas deg  
Vector averaged cross-power spectrum Baseline: EF (01) - JB (03)  
Timerange: 01/07:49:52 to 01/07:53:18

Plot file version 456 created 26-JUN-2015 10:51:36

J2025+3343 ET031A.UVDATA.1

Freq = 1.5950 GHz, Bw = 16.000 MH No calibration applied and no bandpass applied

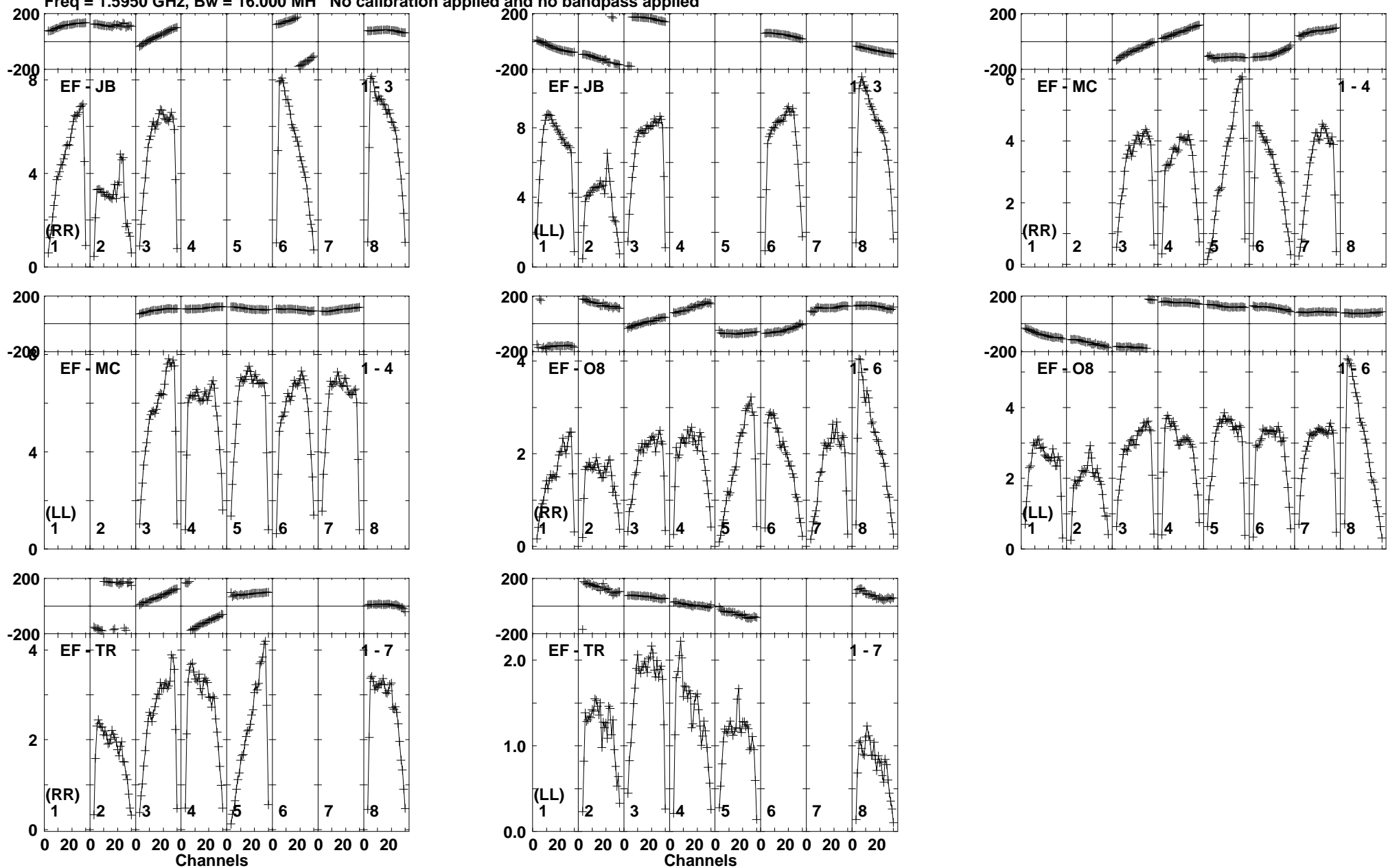

Lower frame: Milli Ampl Jy Top frame: Phas deg  
Vector averaged cross-power spectrum Baseline: EF (01) - JB (03)  
Timerange: 01/07:54:02 to 01/07:54:58



Plot file version 457 created 26-JUN-2015 10:51:36

V404CYG ET031A.UVDATA.1

Freq = 1.5950 GHz, Bw = 16.000 MH No calibration applied and no bandpass applied

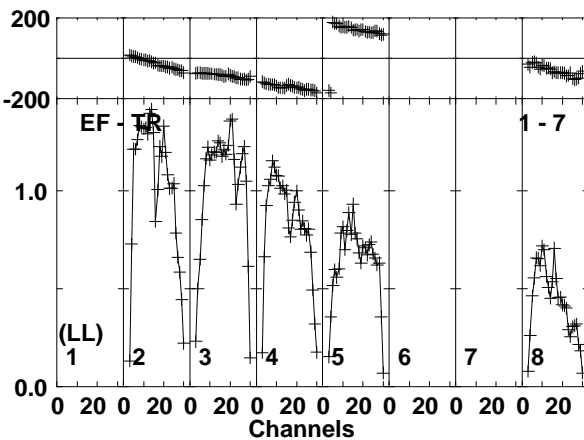
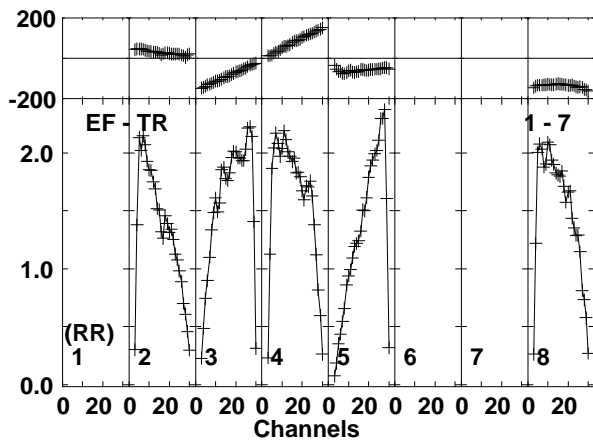
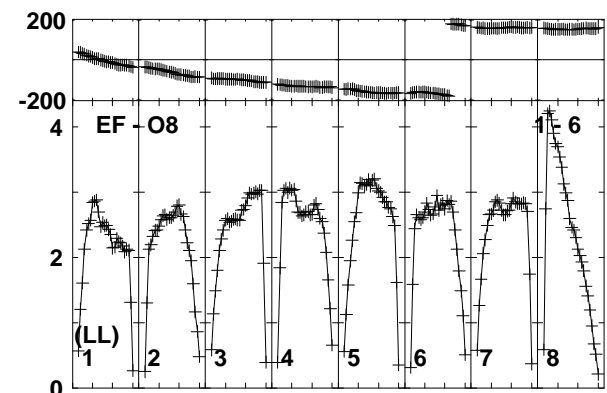
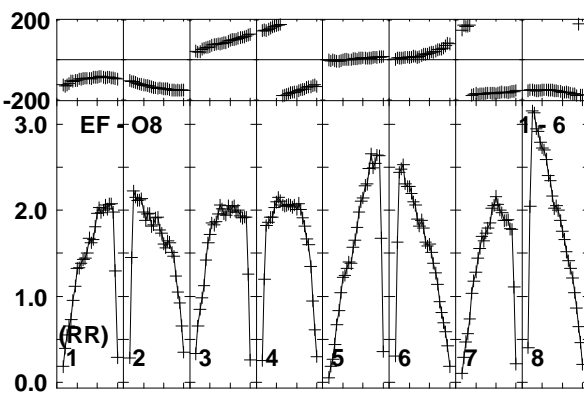
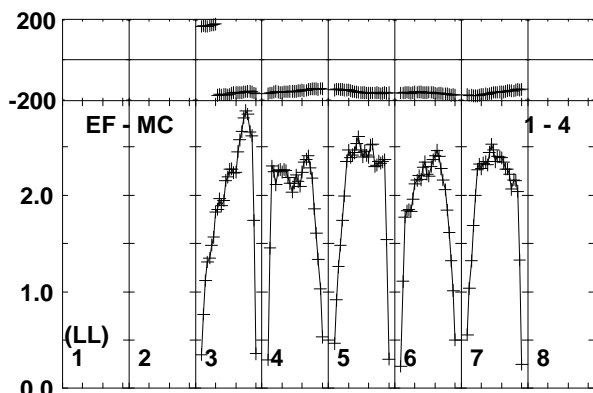
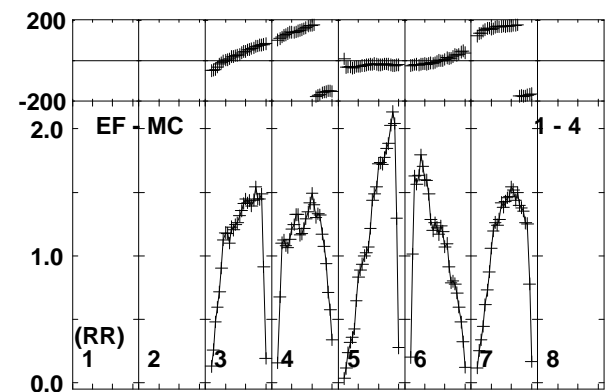
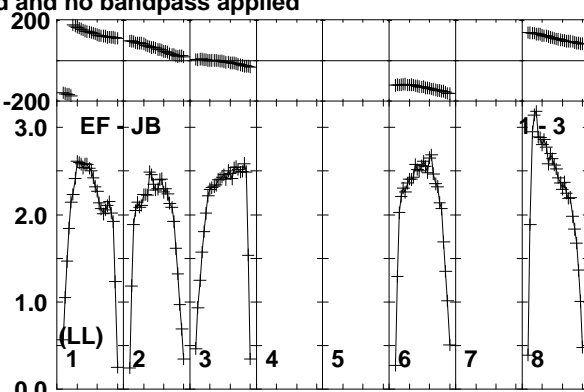
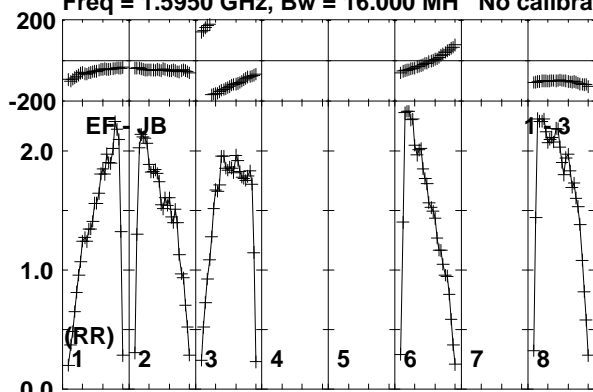

Lower frame: Milli Ampl Jy Top frame: Phas deg  
Vector averaged cross-power spectrum Baseline: EF (01) - JB (03)  
Timerange: 01/07:55:02 to 01/07:58:28

Plot file version 458 created 26-JUN-2015 10:51:36

J2025+3343 ET031A.UVDATA.1

Freq = 1.5950 GHz, Bw = 16.000 MH No calibration applied and no bandpass applied

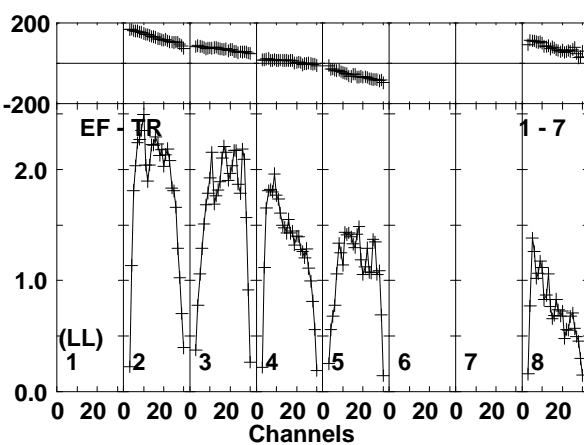
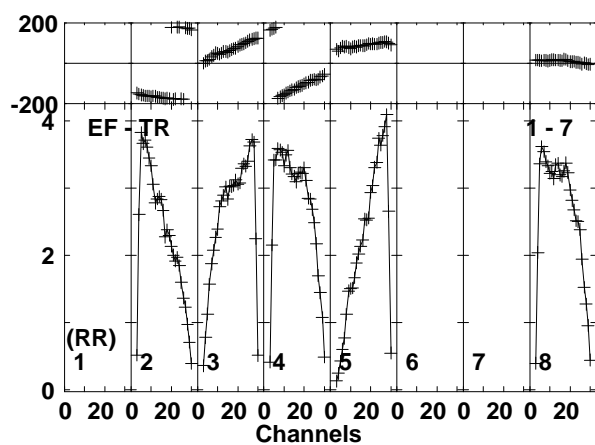
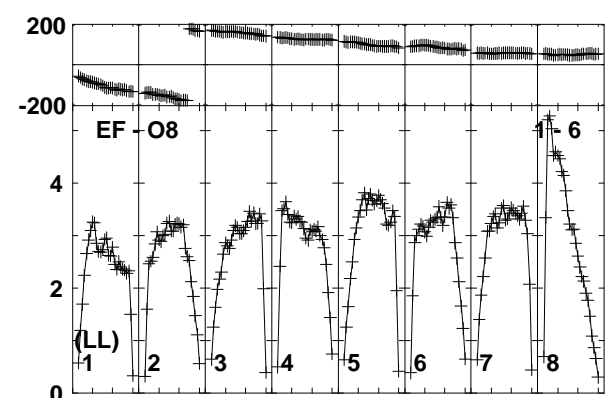
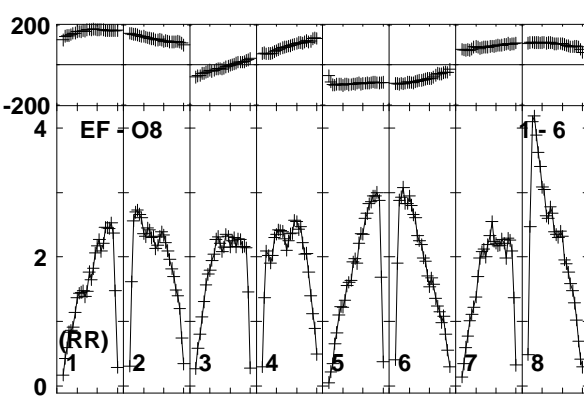
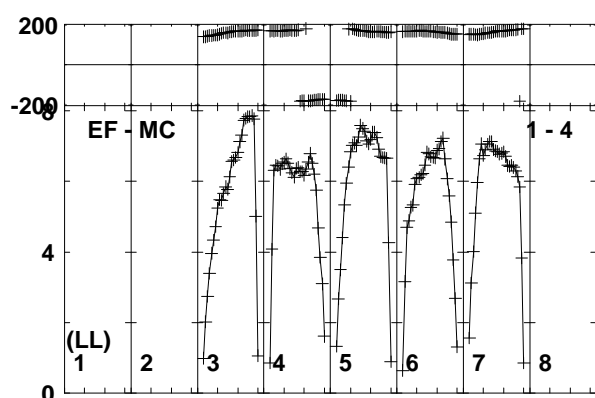
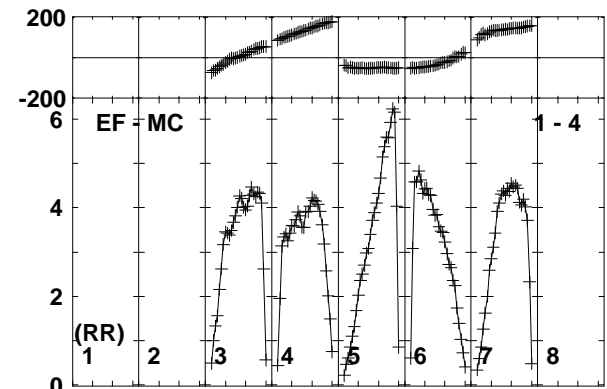
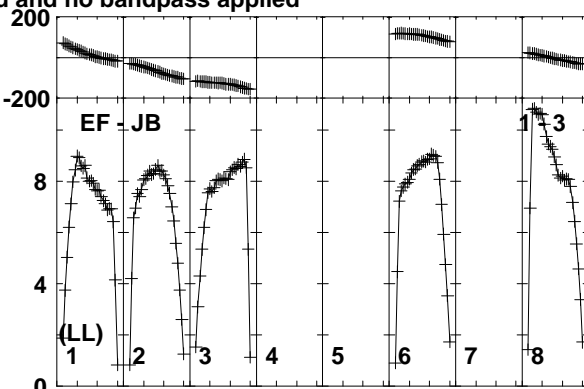
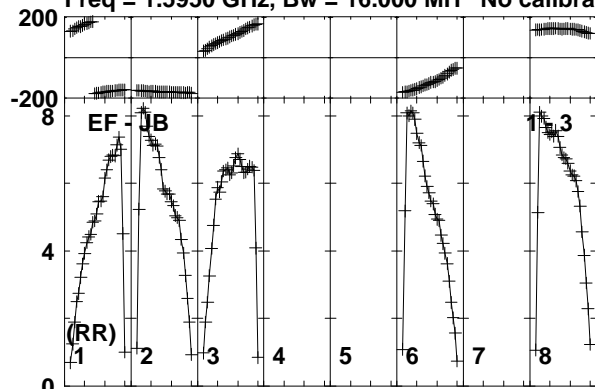

Lower frame: Milli Ampl Jy Top frame: Phas deg  
Vector averaged cross-power spectrum Baseline: EF (01) - JB (03)  
Timerange: 01/07:58:32 to 01/07:59:58