

Plot file version 1 created 24-OCT-2012 20:58:14

J1825-0737 EY017B.UVDATA.1

Freq = 4.9270 GHz, Bw = 16.000 MH No calibration applied and no bandpass applied

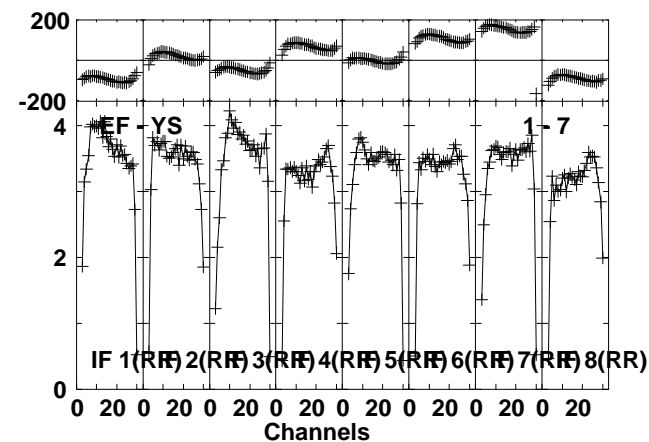
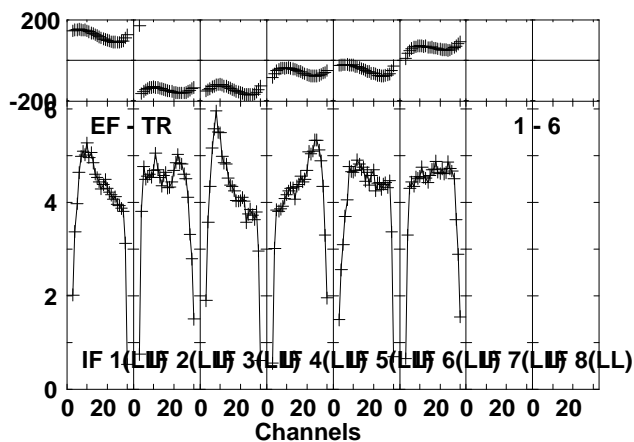
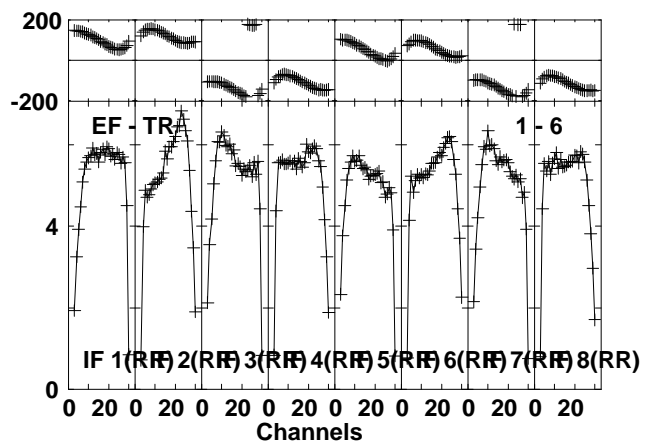
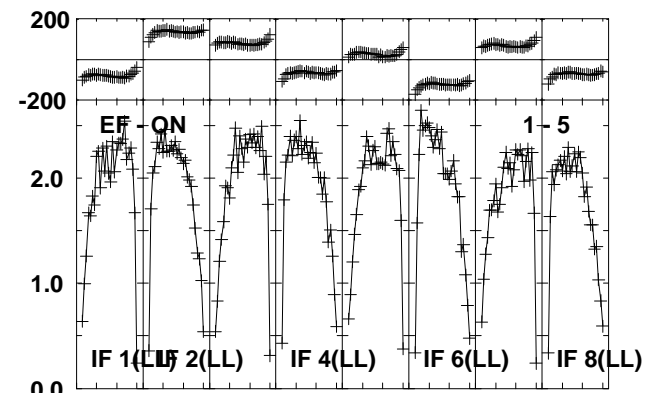
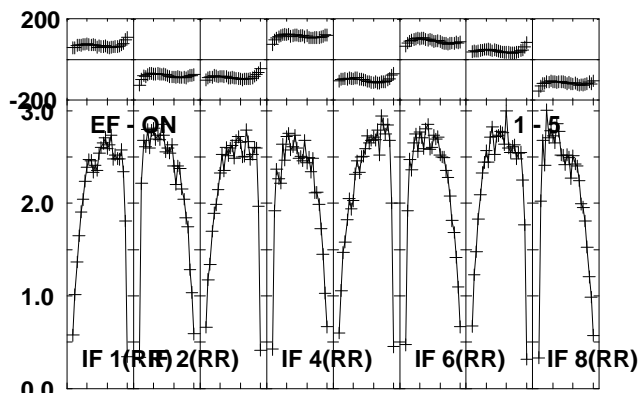
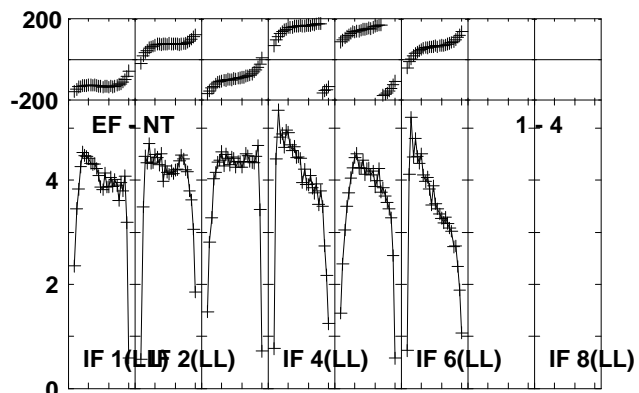
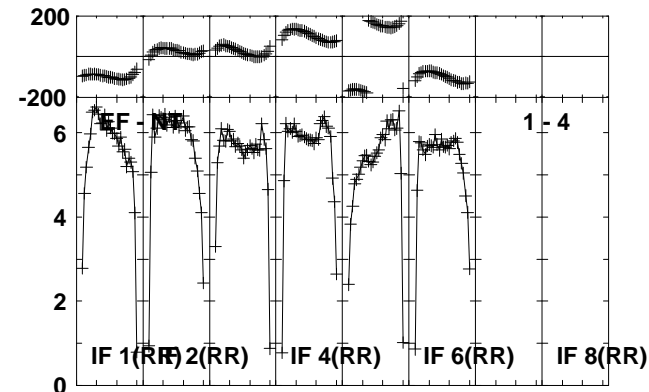
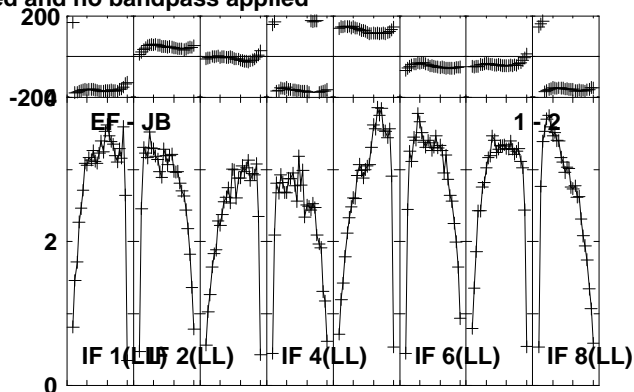
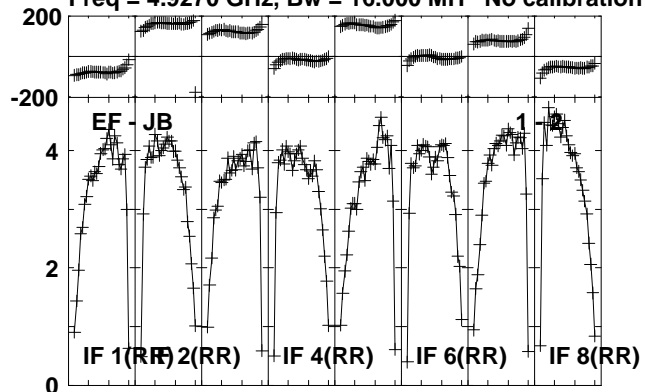

Lower frame: Milli Ampl Jy Top frame: Phas deg  
Vector averaged cross-power spectrum Several baselines displayed  
Timerange: 00/15:09:52 to 00/15:14:54

Plot file version 2 created 24-OCT-2012 20:58:15  
J1825-0737 EY017B.UVDATA.1

Freq = 4.9270 GHz, Bw = 16.000 MH No calibration applied and no bandpass applied

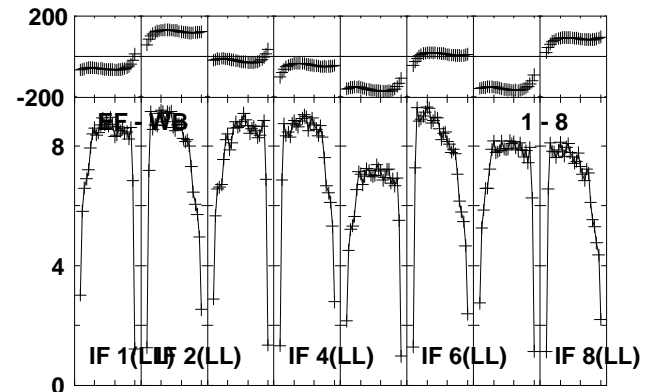
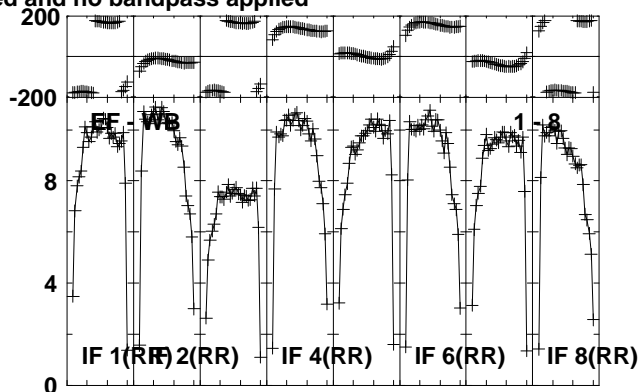
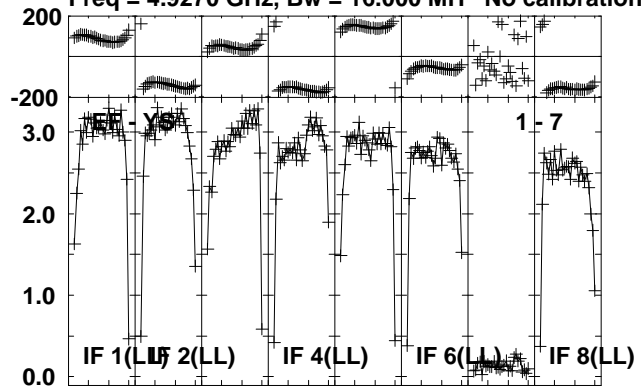

Lower frame: Milli Ampl Jy Top frame: Phas deg  
Vector averaged cross-power spectrum Several baselines displayed  
Timerange: 00/15:09:52 to 00/15:14:54

Plot file version 3 created 24-OCT-2012 20:58:16

G23.6-0.03 EY017B.UVDATA.1

Freq = 4.9270 GHz, Bw = 16.000 MH No calibration applied and no bandpass applied

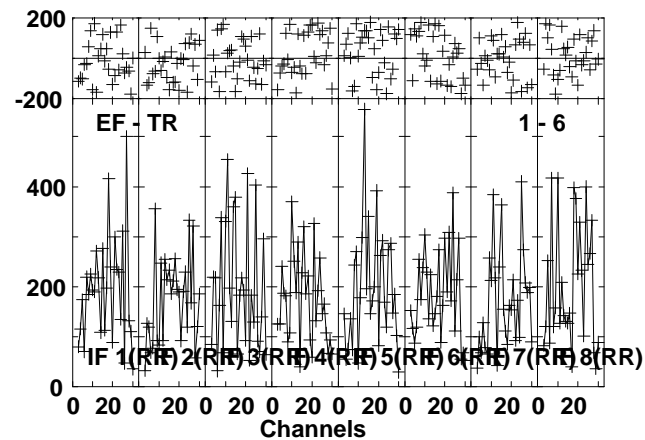
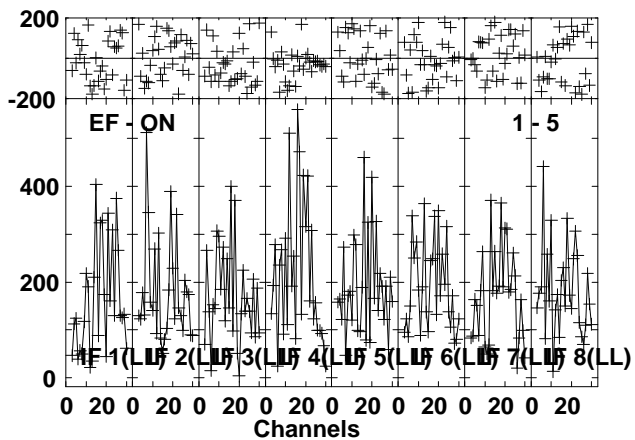
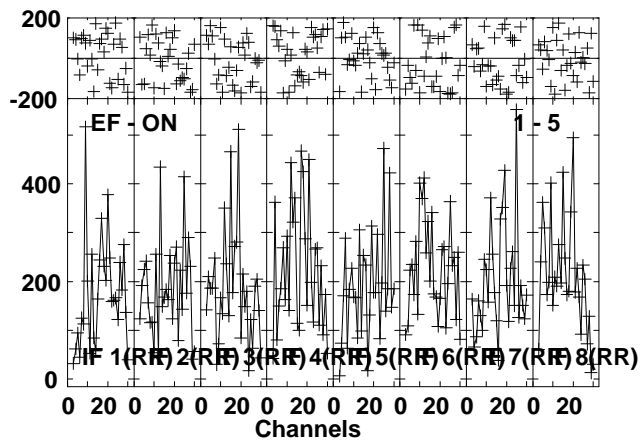
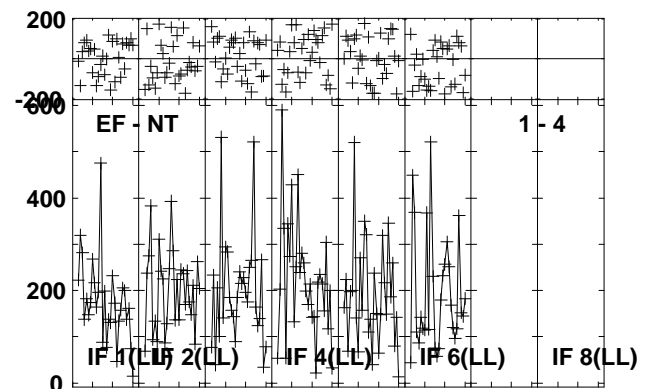
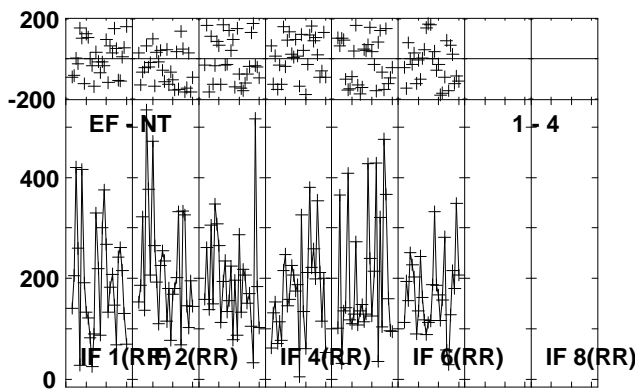
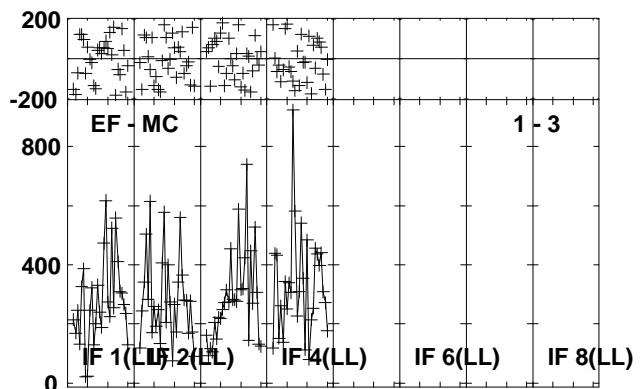
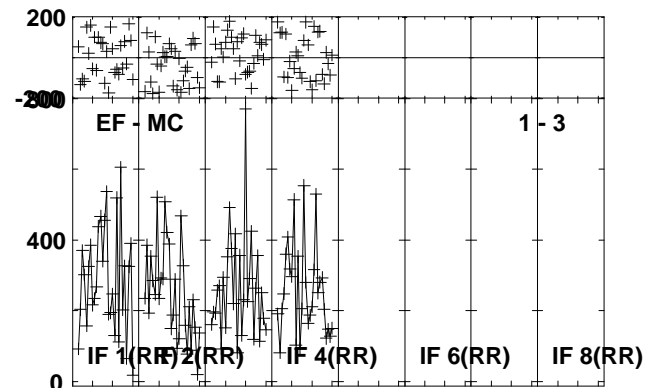
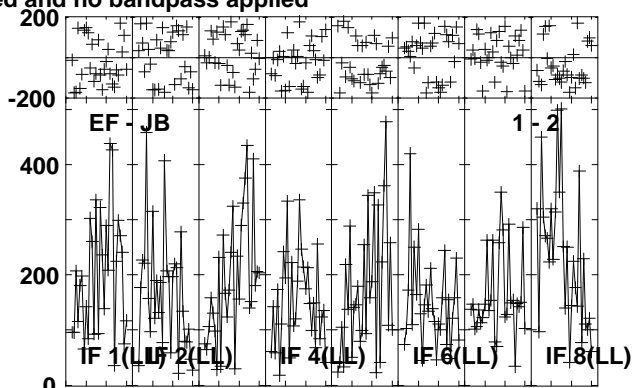
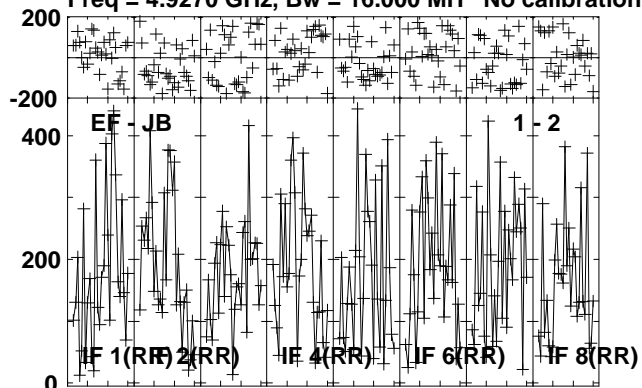

Lower frame: Micro Ampl Jy Top frame: Phas deg  
Vector averaged cross-power spectrum Several baselines displayed  
Timerange: 00/15:14:58 to 00/15:17:24

Plot file version 4 created 24-OCT-2012 20:58:16

G23.6-0.03 EY017B.UVDATA.1

Freq = 4.9270 GHz, Bw = 16.000 MH No calibration applied and no bandpass applied

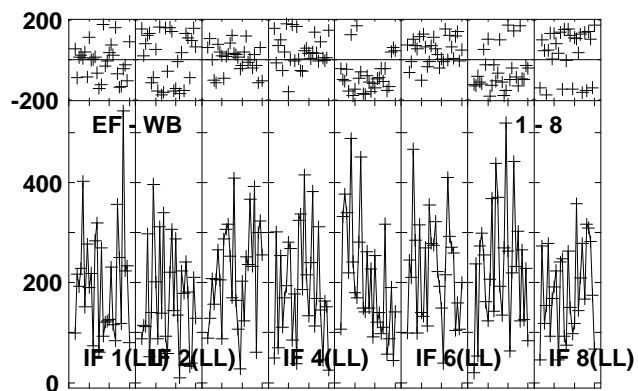
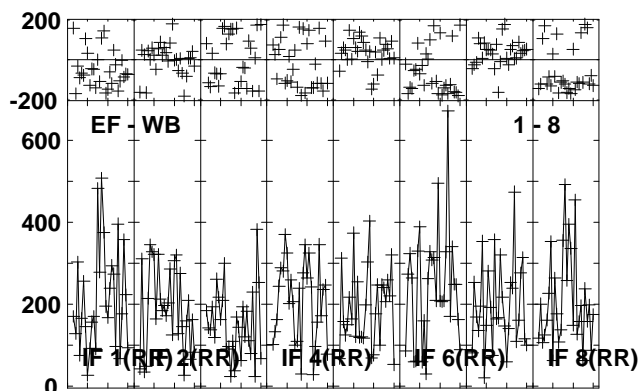
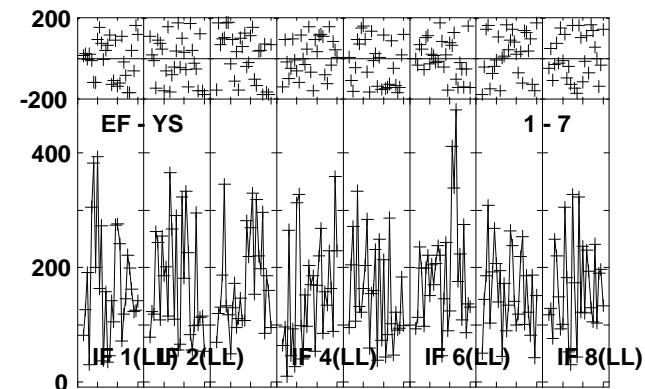
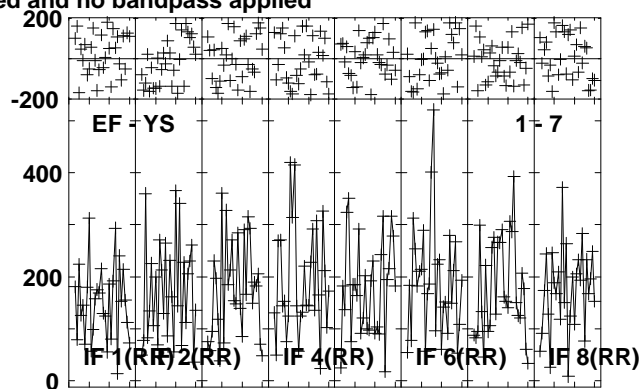
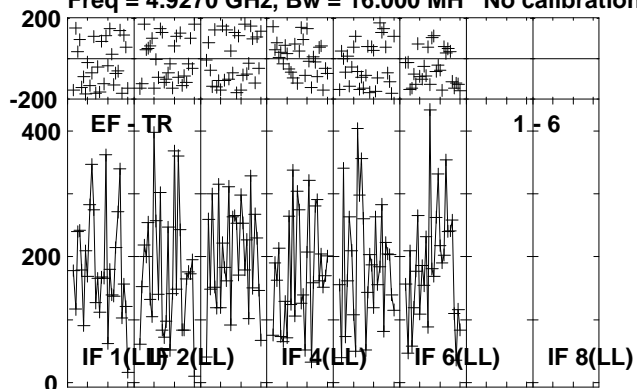

Lower frame: Micro Ampl Jy Top frame: Phas deg  
Vector averaged cross-power spectrum Several baselines displayed  
Timerange: 00/15:14:58 to 00/15:17:24



Plot file version 5 created 24-OCT-2012 20:58:17

J1825-0737 EY017B.UVDATA.1

Freq = 4.9270 GHz, Bw = 16.000 MH No calibration applied and no bandpass applied

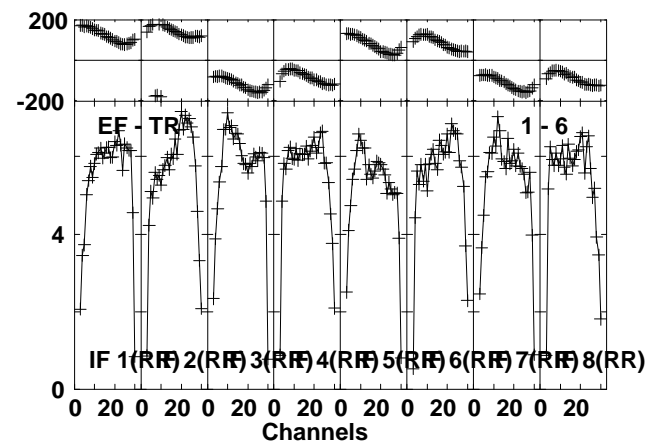
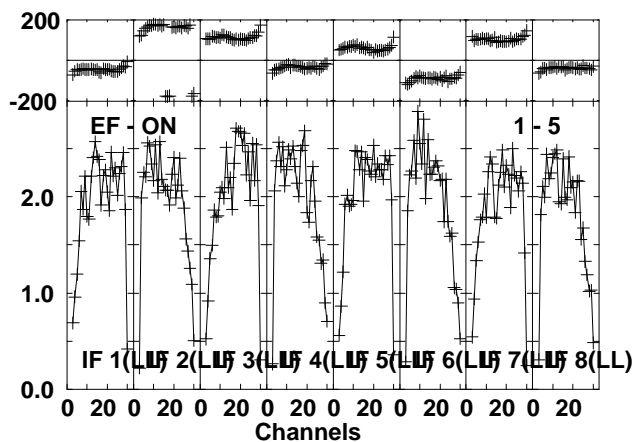
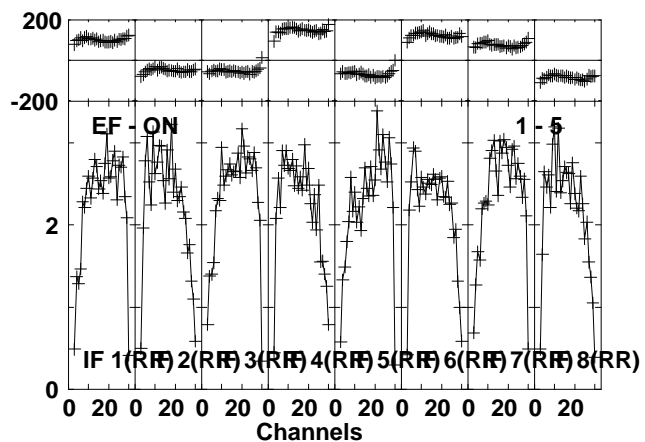
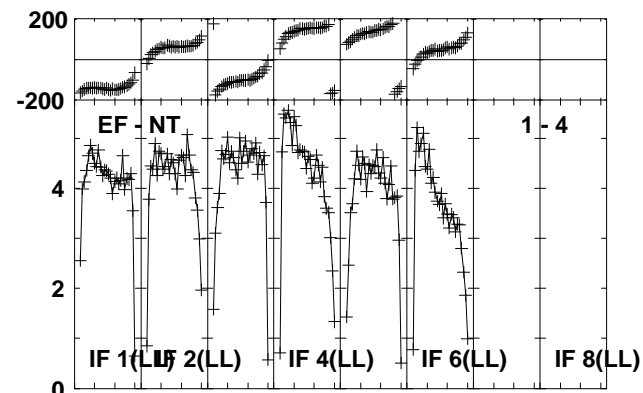
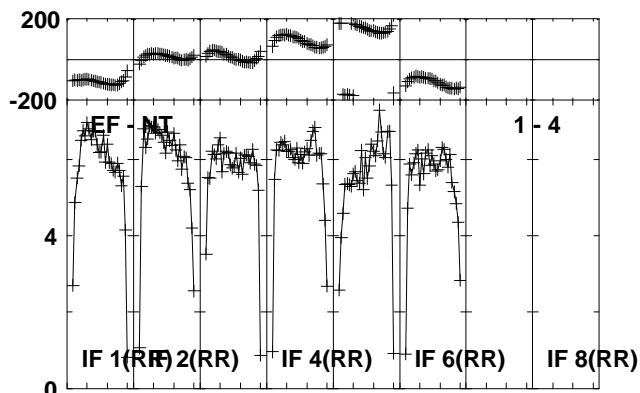
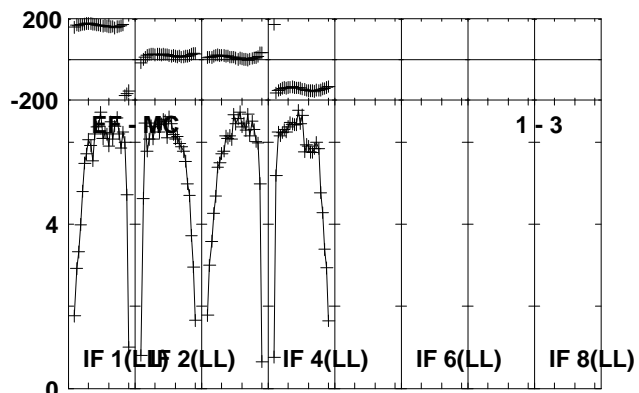
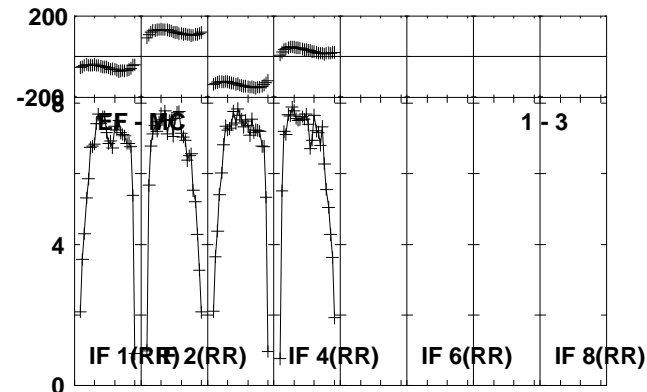
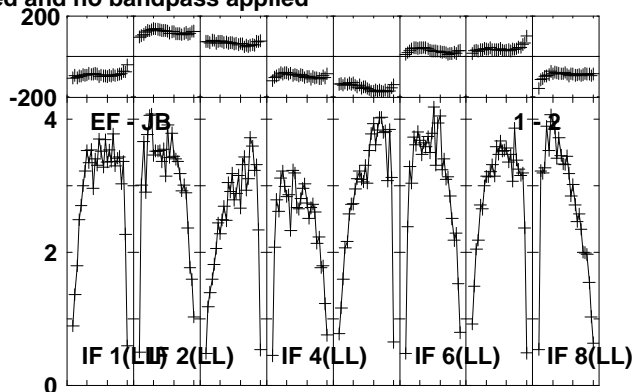
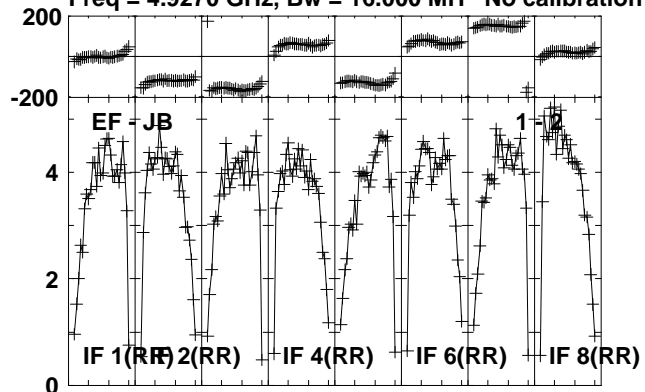

Lower frame: Milli Ampl Jy Top frame: Phas deg  
Vector averaged cross-power spectrum Several baselines displayed  
Timerange: 00/15:17:28 to 00/15:18:54

Plot file version 6 created 24-OCT-2012 20:58:17  
J1825-0737 EY017B.UVDATA.1

Freq = 4.9270 GHz, Bw = 16.000 MH No calibration applied and no bandpass applied

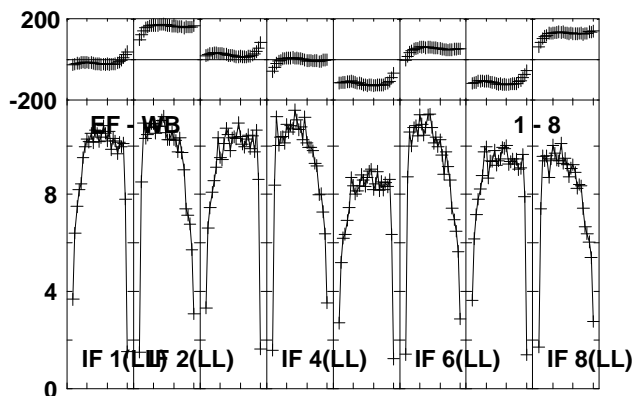
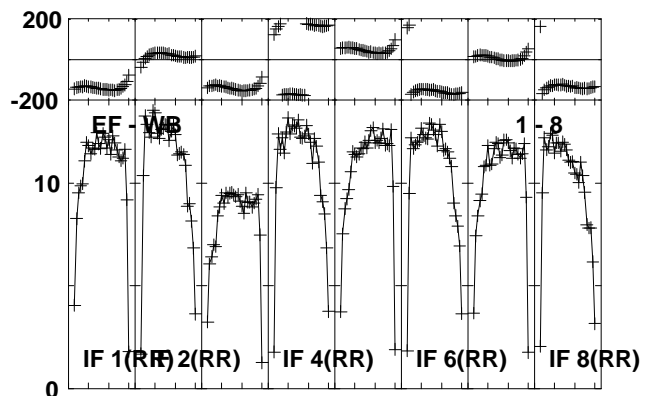
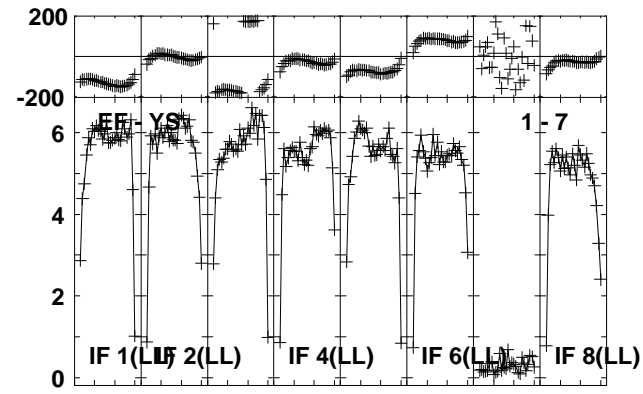
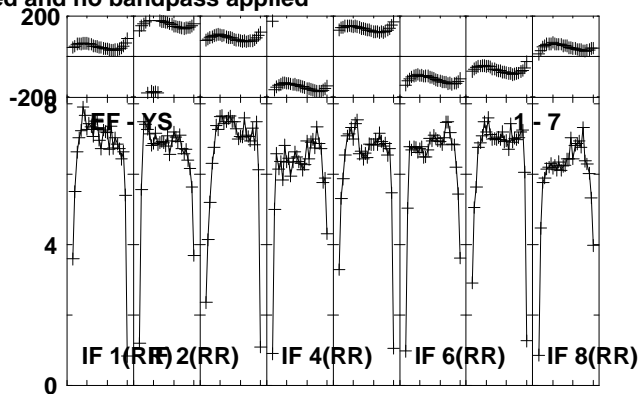
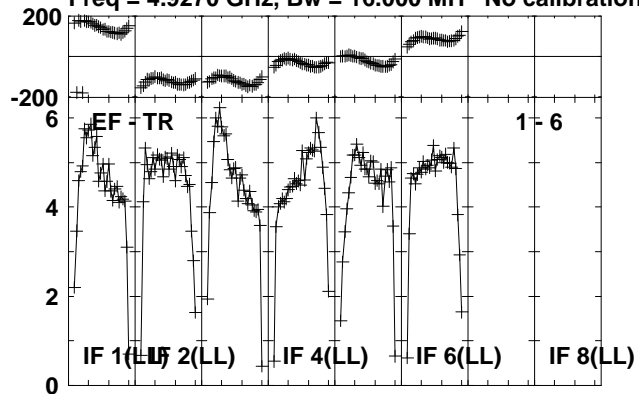

Lower frame: Milli Ampl Jy Top frame: Phas deg  
Vector averaged cross-power spectrum Several baselines displayed  
Timerange: 00/15:17:28 to 00/15:18:54

Plot file version 7 created 24-OCT-2012 20:58:18  
 G23.6-0.03 EY017B.UVDATA.1

Freq = 4.9270 GHz, Bw = 16.000 MH No calibration applied and no bandpass applied

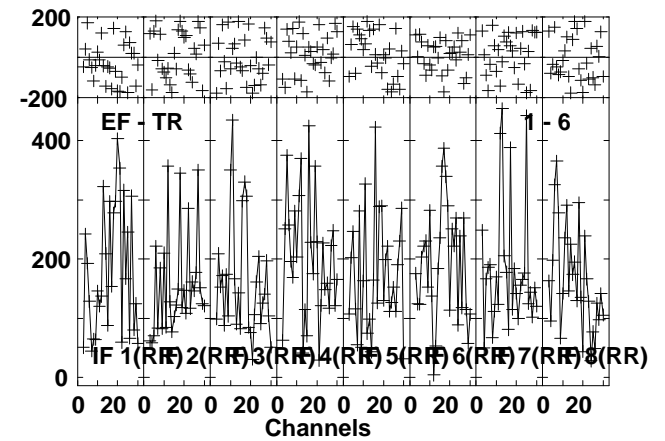
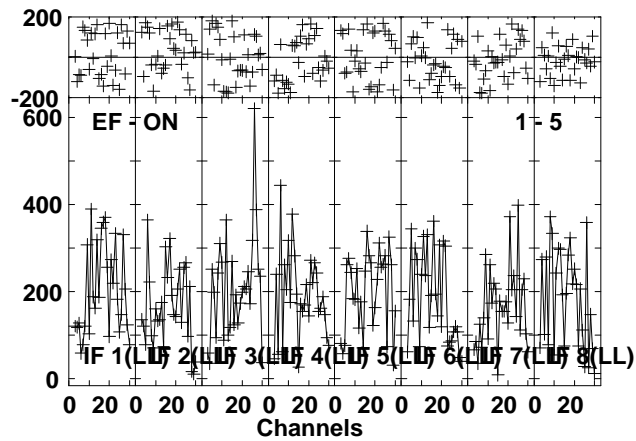
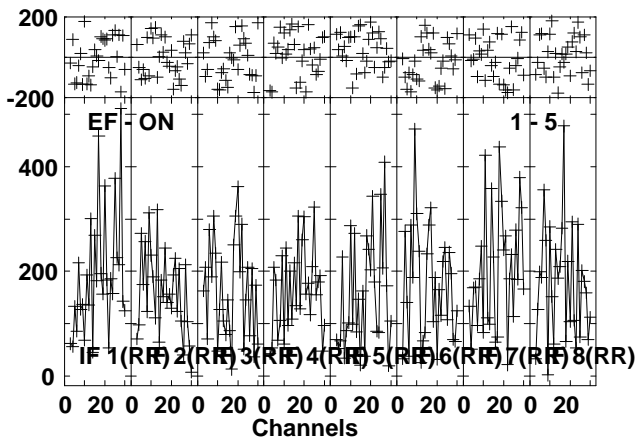
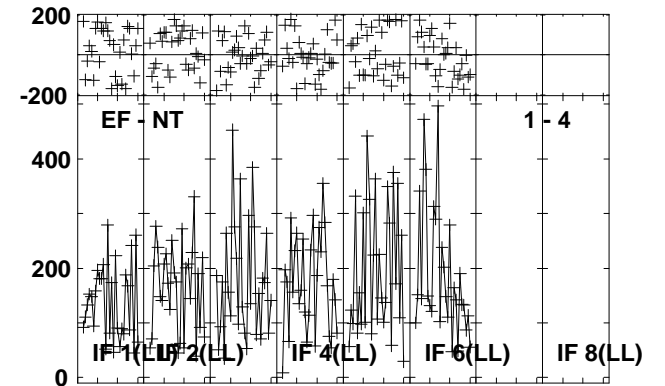
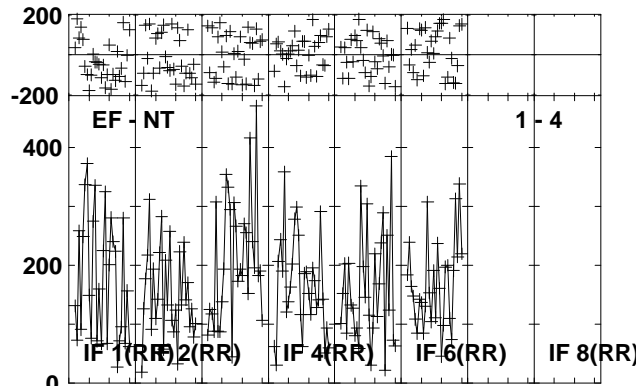
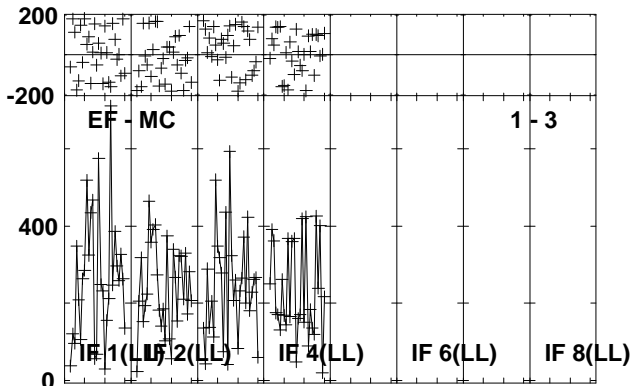
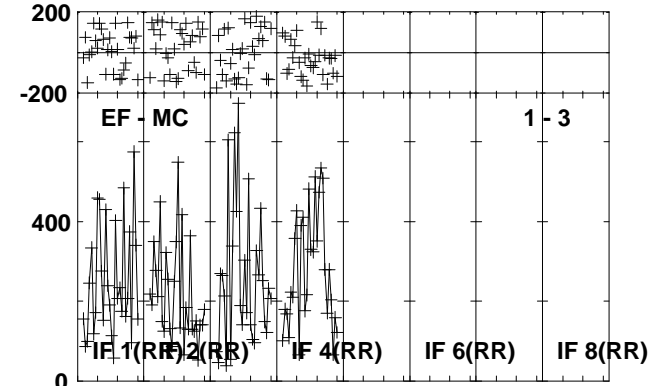
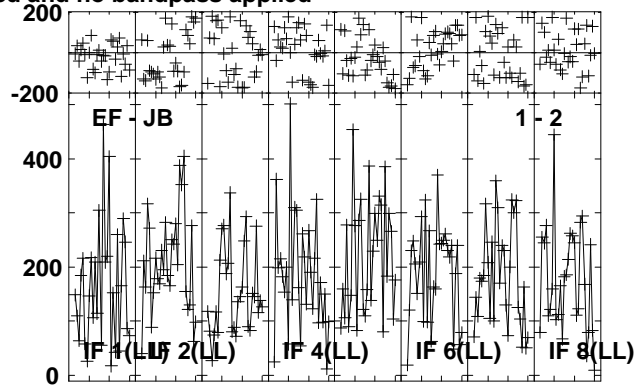
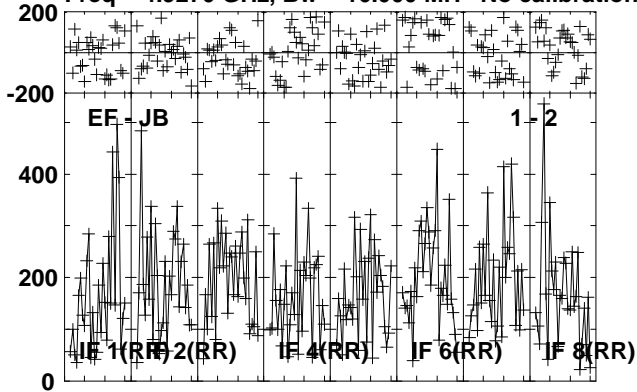

Lower frame: Micro Ampl Jy Top frame: Phas deg  
 Vector averaged cross-power spectrum Several baselines displayed  
 Timerange: 00/15:18:58 to 00/15:21:24

Plot file version 8 created 24-OCT-2012 20:58:18

G23.6-0.03 EY017B.UVDATA.1

Freq = 4.9270 GHz, Bw = 16.000 MH No calibration applied and no bandpass applied

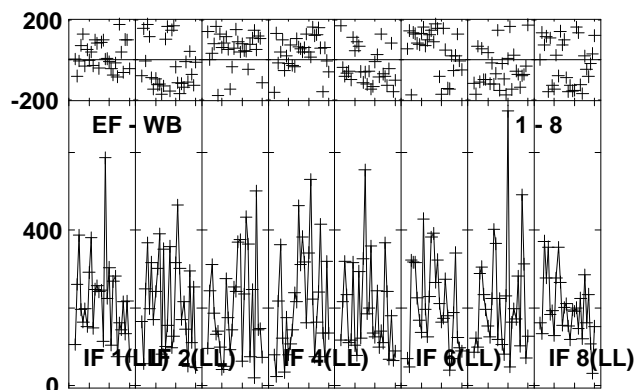
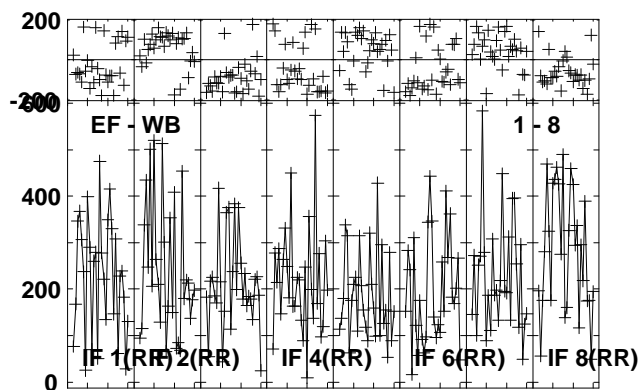
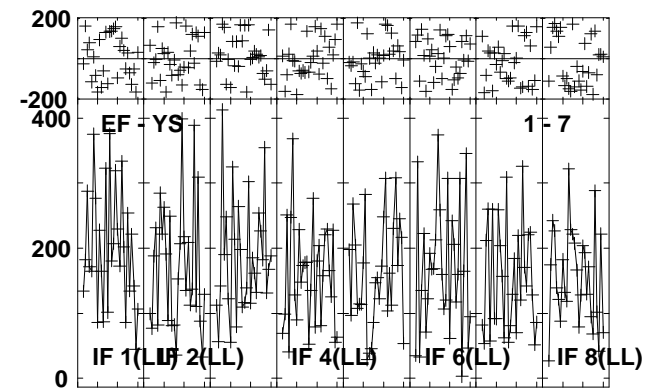
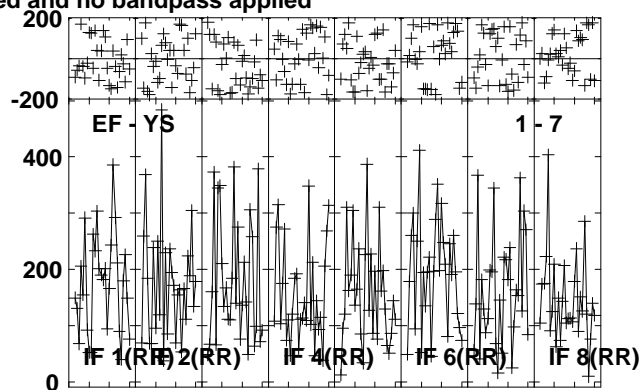
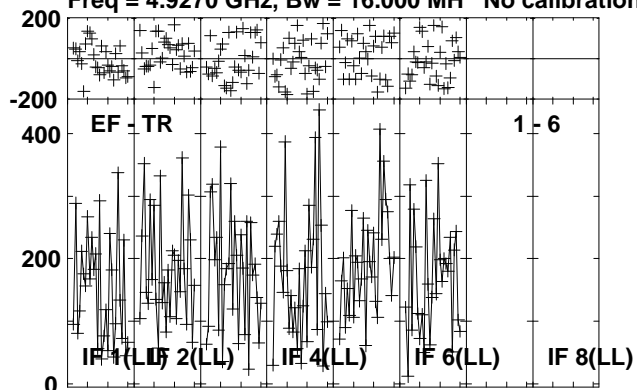

Lower frame: Micro Ampl Jy Top frame: Phas deg  
Vector averaged cross-power spectrum Several baselines displayed  
Timerange: 00/15:18:58 to 00/15:21:24

Plot file version 9 created 24-OCT-2012 20:58:19

J1825-0737 EY017B.UVDATA.1

Freq = 4.9270 GHz, Bw = 16.000 MH No calibration applied and no bandpass applied

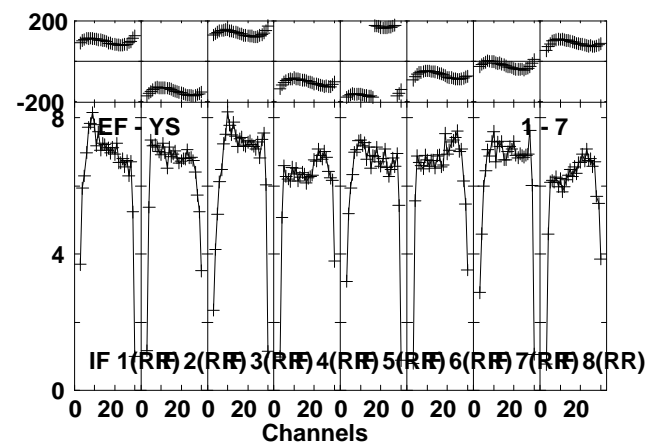
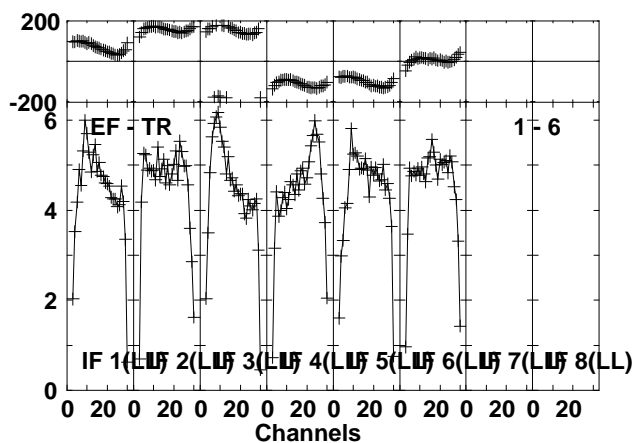
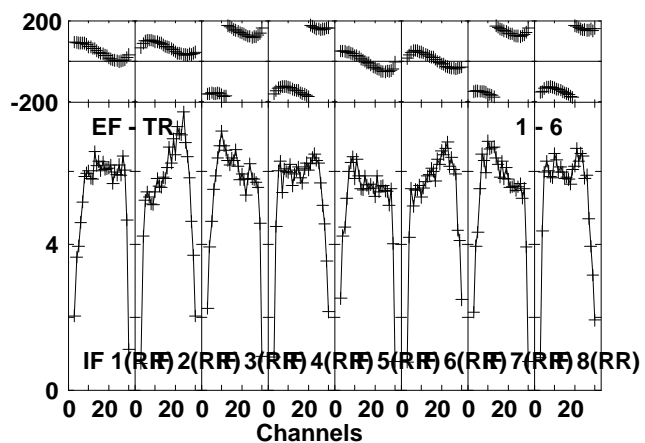
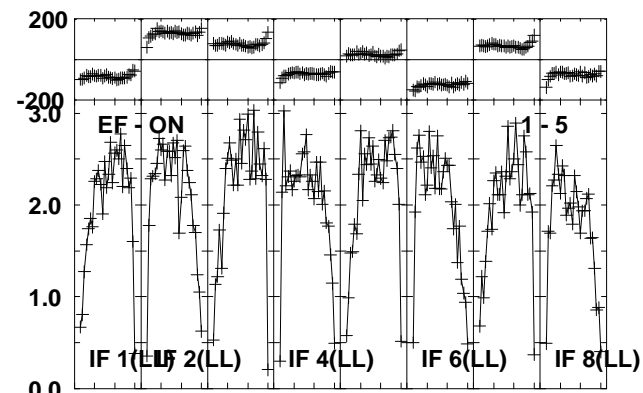
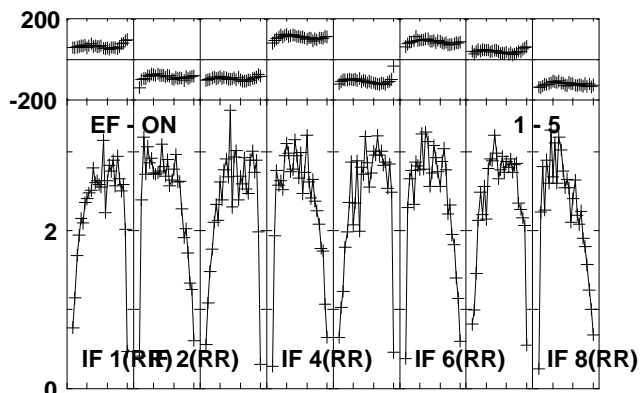
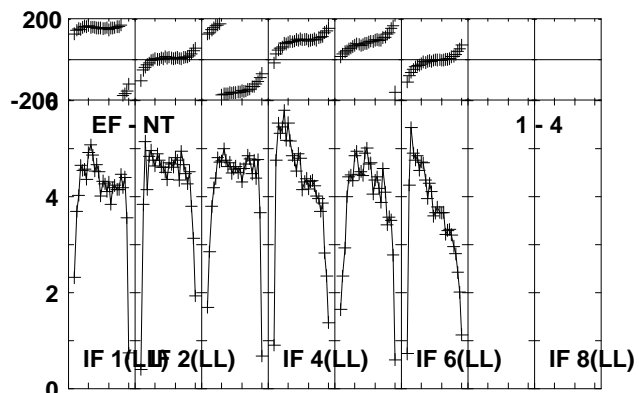
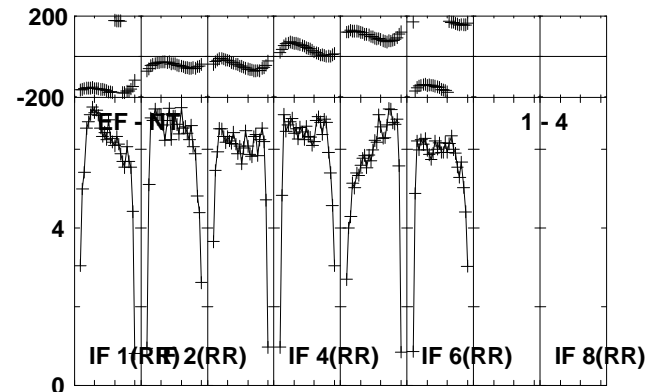
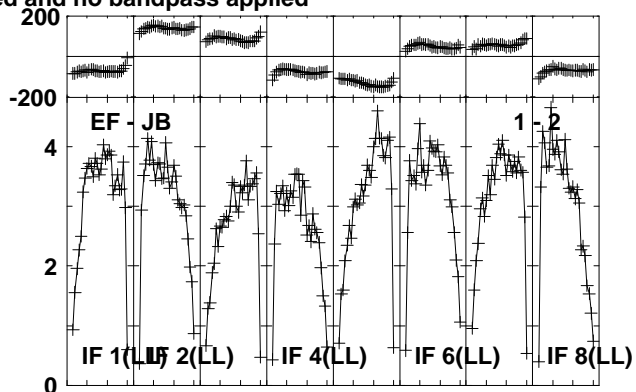
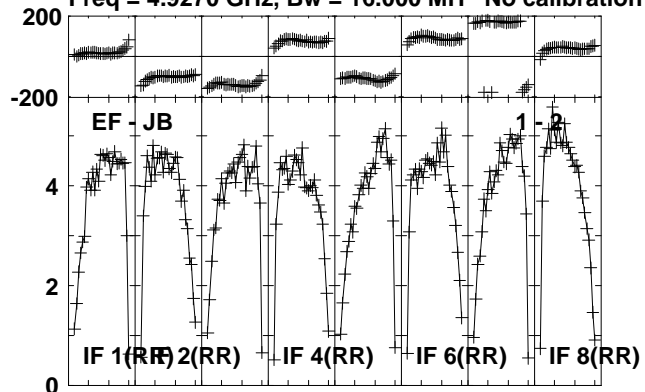

Lower frame: Milli Ampl Jy Top frame: Phas deg  
Vector averaged cross-power spectrum Several baselines displayed  
Timerange: 00/15:21:34 to 00/15:22:54

Plot file version 10 created 24-OCT-2012 20:58:19

J1825-0737 EY017B.UVDATA.1

Freq = 4.9270 GHz, Bw = 16.000 MH No calibration applied and no bandpass applied

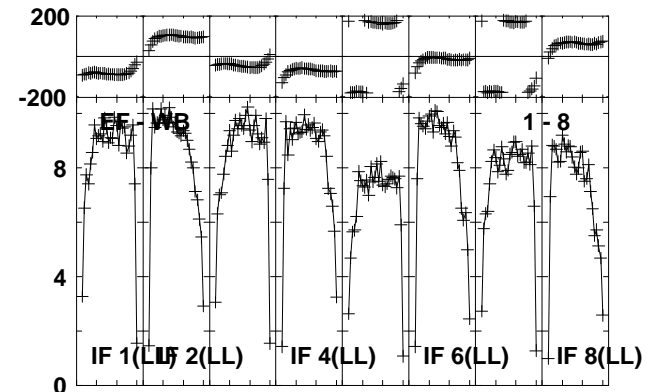
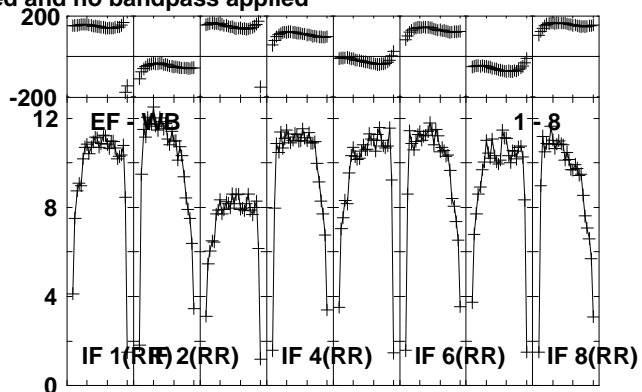
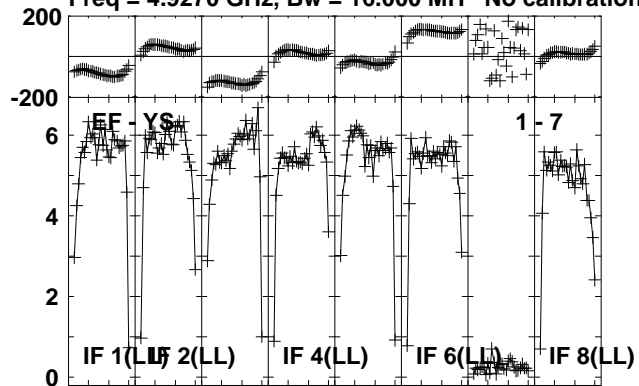

Lower frame: Milli Ampl Jy Top frame: Phas deg  
Vector averaged cross-power spectrum Several baselines displayed  
Timerange: 00/15:21:34 to 00/15:22:54

Plot file version 11 created 24-OCT-2012 20:58:19

G23.6-0.03 EY017B.UVDATA.1

Freq = 4.9270 GHz, Bw = 16.000 MH No calibration applied and no bandpass applied

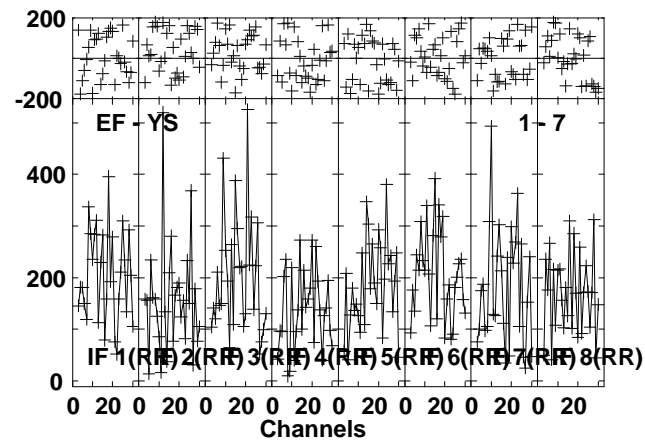
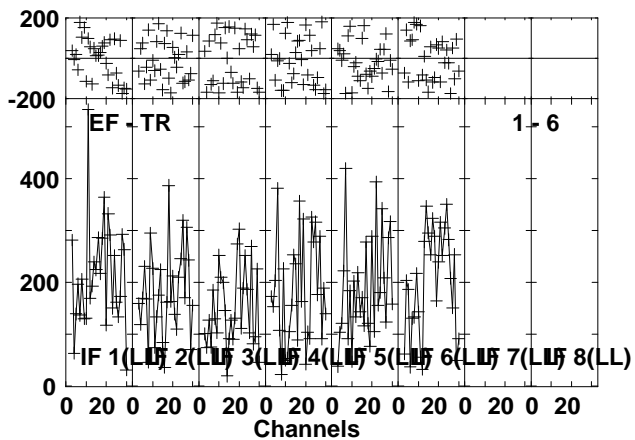
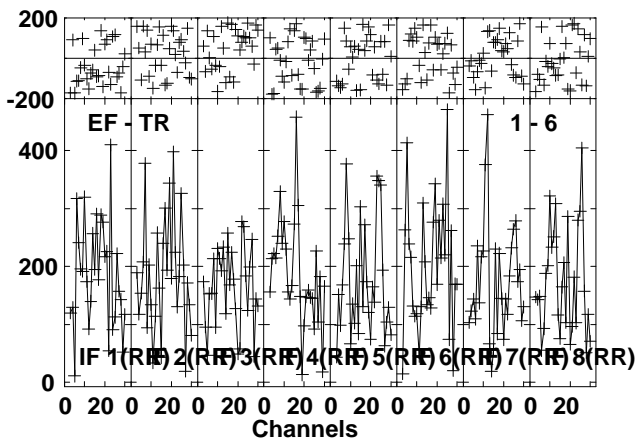
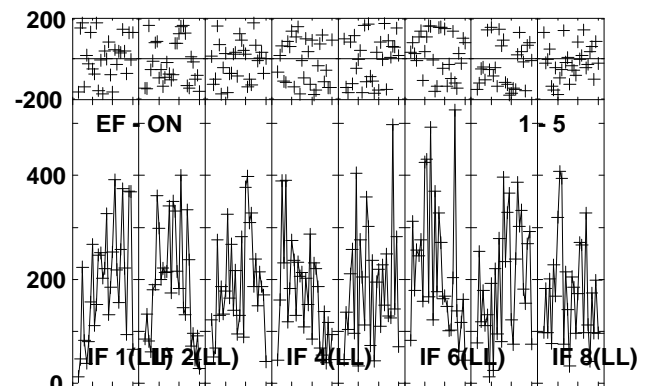
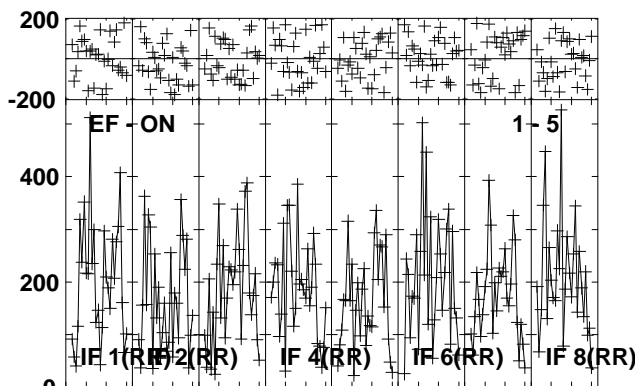
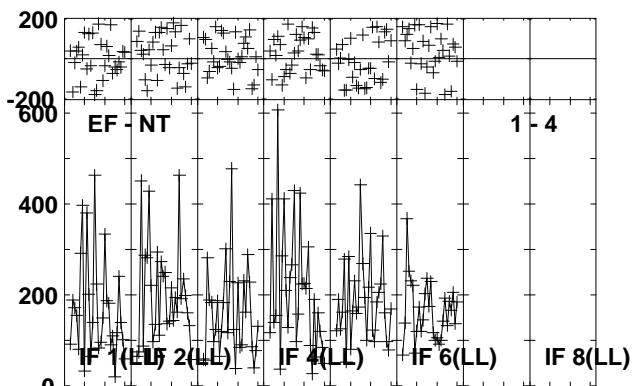
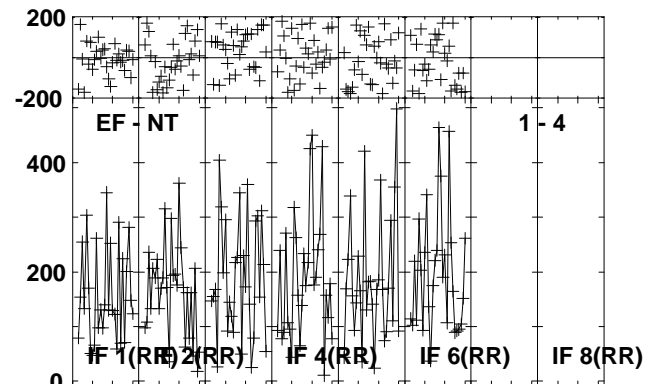
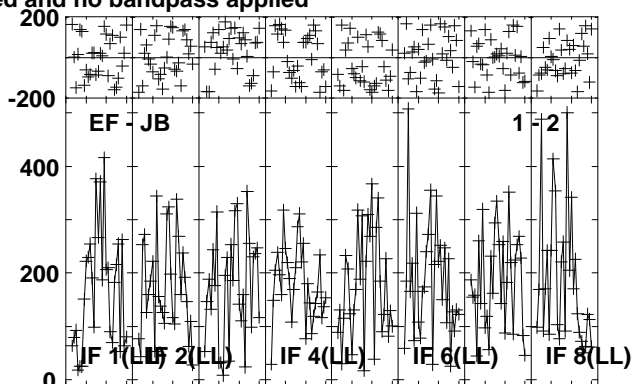
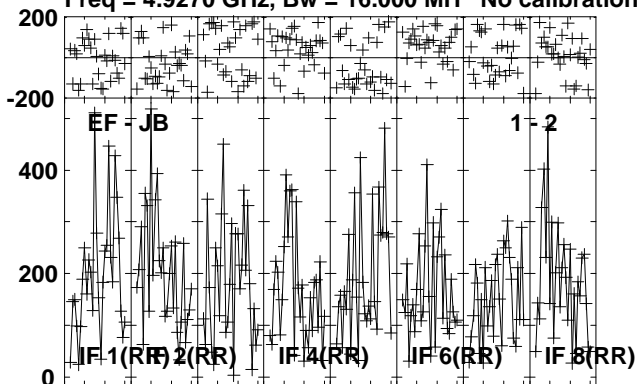

Lower frame: Micro Ampl Jy Top frame: Phas deg  
Vector averaged cross-power spectrum Several baselines displayed  
Timerange: 00/15:22:58 to 00/15:25:24

Plot file version 12 created 24-OCT-2012 20:58:20

G23.6-0.03 EY017B.UVDATA.1

Freq = 4.9270 GHz, Bw = 16.000 MH No calibration applied and no bandpass applied

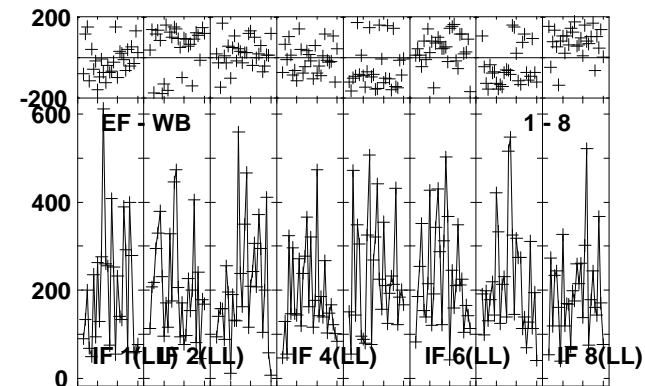
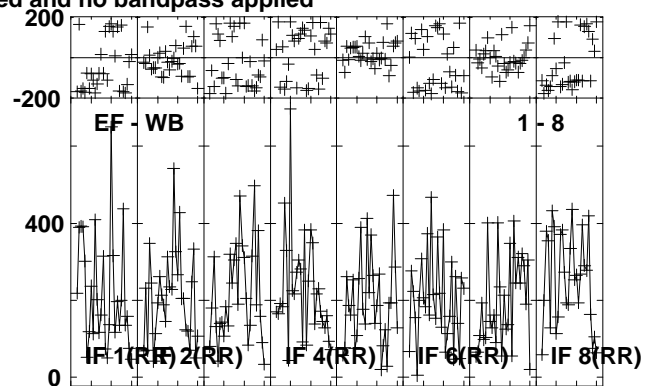
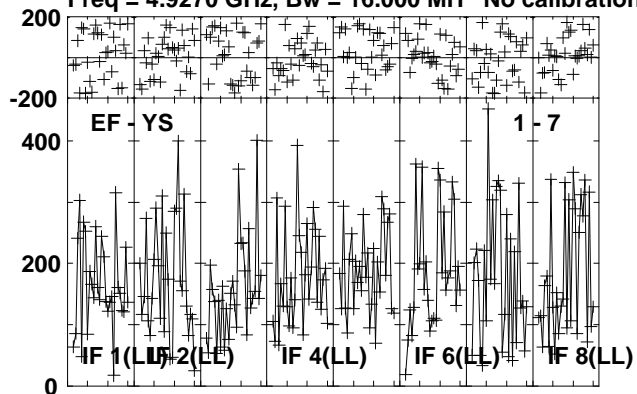

Lower frame: Micro Ampl Jy Top frame: Phas deg  
Vector averaged cross-power spectrum Several baselines displayed  
Timerange: 00/15:22:58 to 00/15:25:24



Plot file version 13 created 24-OCT-2012 20:58:20

J1825-0737 EY017B.UVDATA.1

Freq = 4.9270 GHz, Bw = 16.000 MH No calibration applied and no bandpass applied

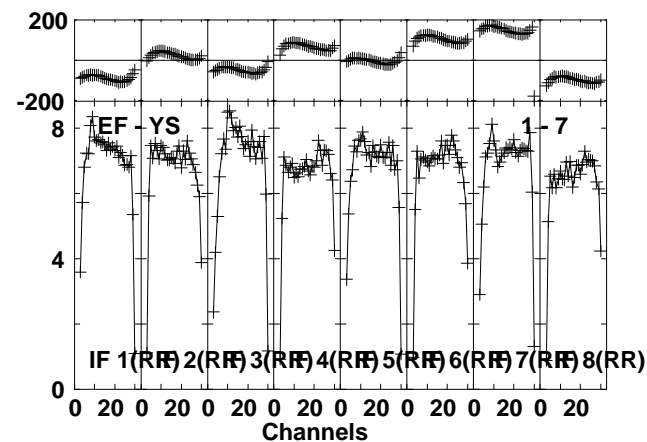
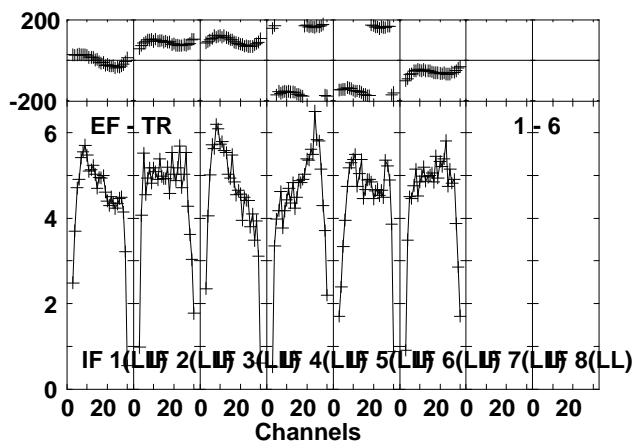
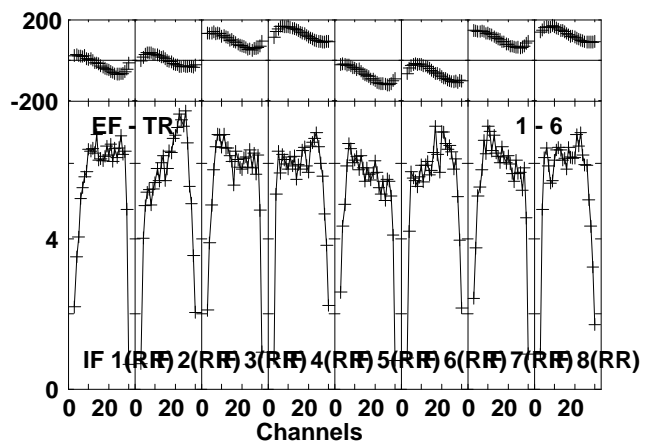
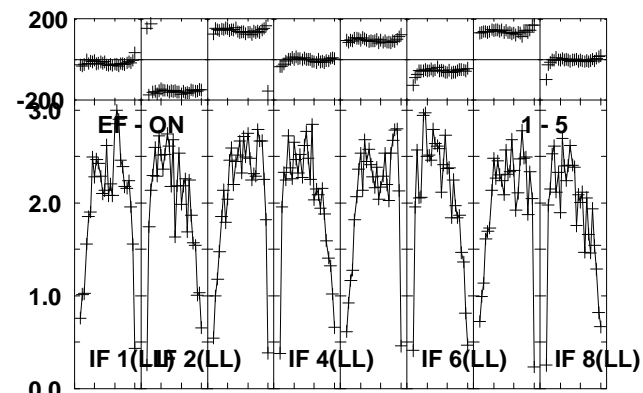
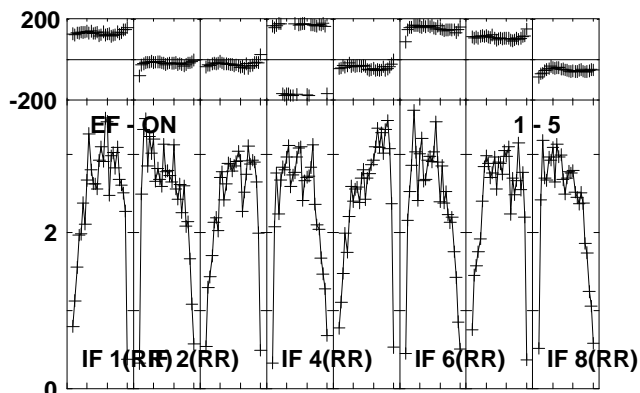
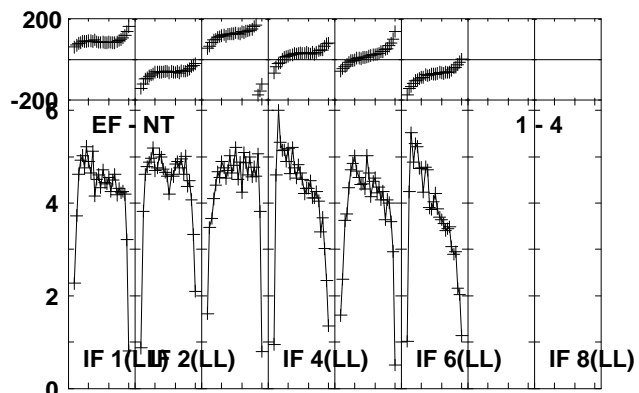
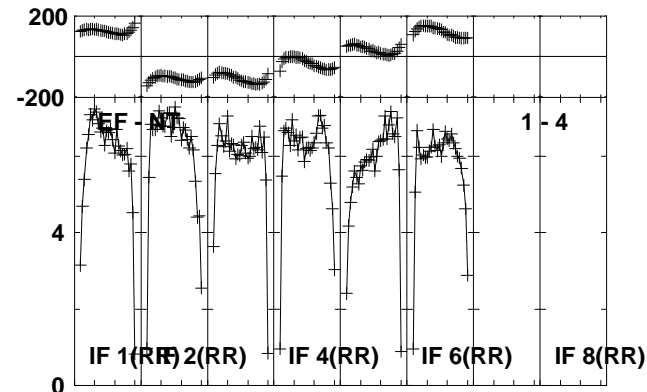
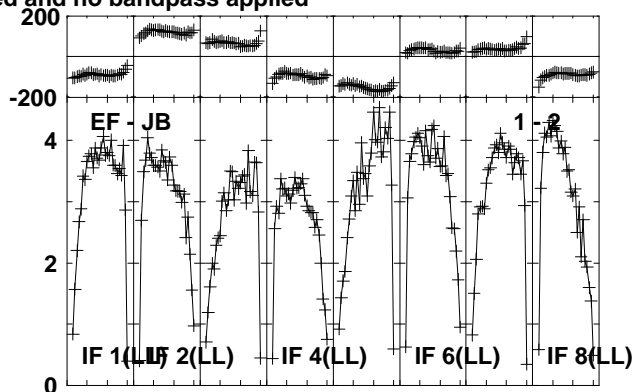
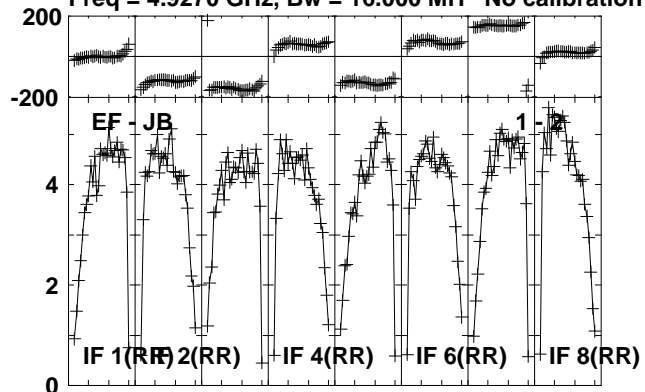

Lower frame: Milli Ampl Jy Top frame: Phas deg  
Vector averaged cross-power spectrum Several baselines displayed  
Timerange: 00/15:25:28 to 00/15:26:54

Plot file version 14 created 24-OCT-2012 20:58:21

J1825-0737 EY017B.UVDATA.1

Freq = 4.9270 GHz, Bw = 16.000 MH No calibration applied and no bandpass applied

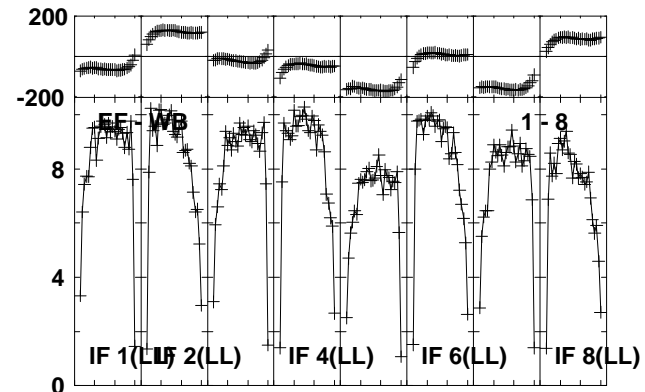
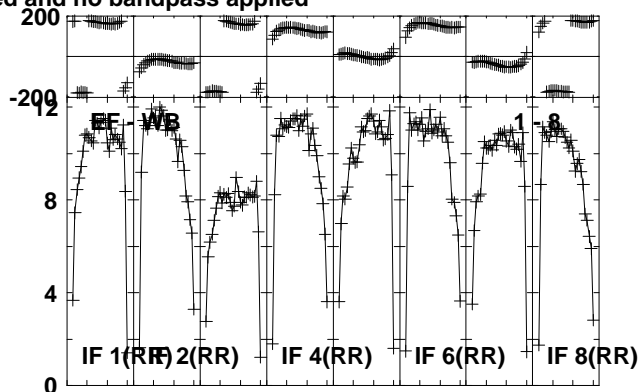
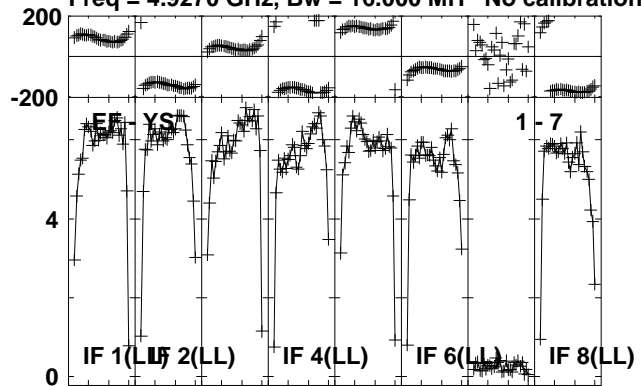

Lower frame: Milli Ampl Jy Top frame: Phas deg  
Vector averaged cross-power spectrum Several baselines displayed  
Timerange: 00/15:25:28 to 00/15:26:54

Plot file version 15 created 24-OCT-2012 20:58:21

J1831-0756 EY017B.UVDATA.1

Freq = 4.9270 GHz, Bw = 16.000 MH No calibration applied and no bandpass applied

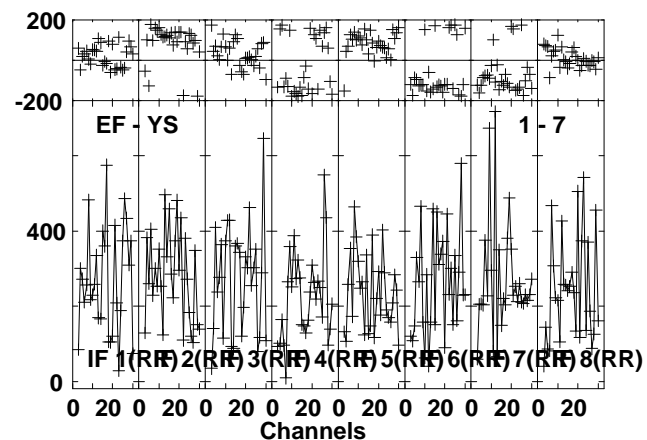
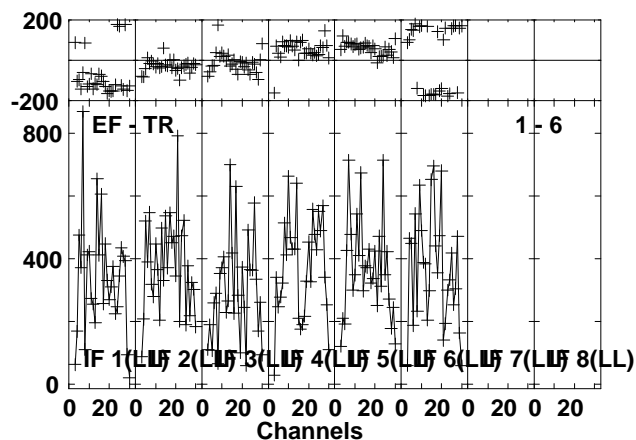
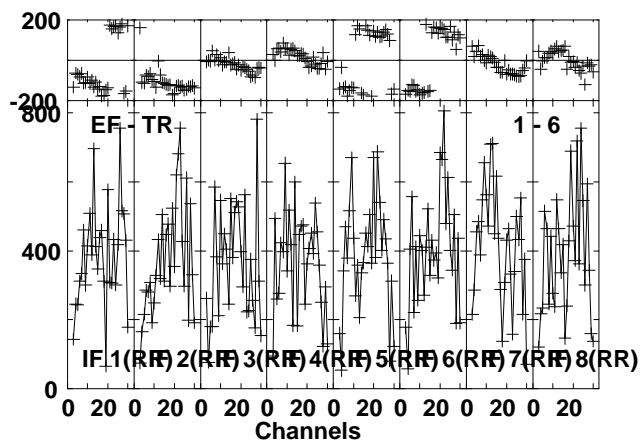
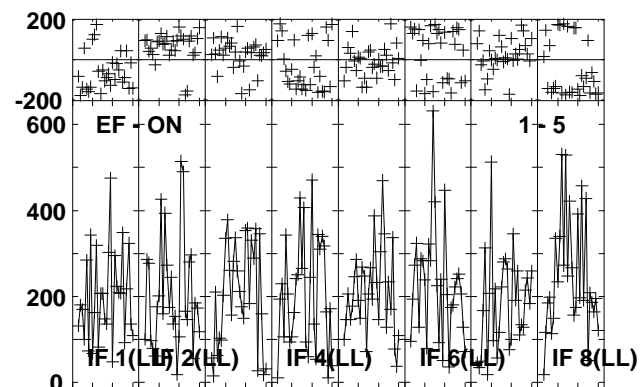
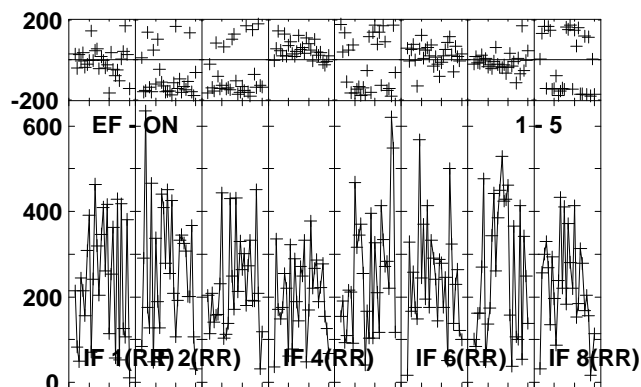
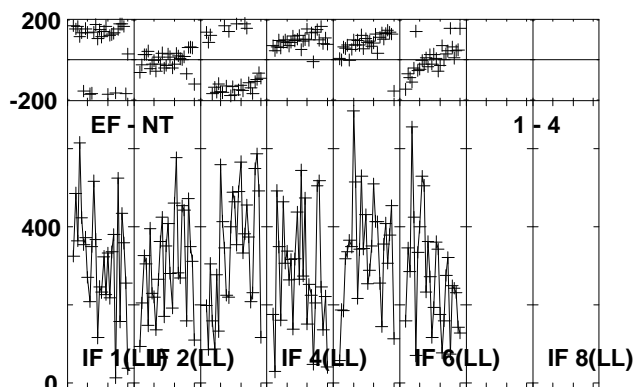
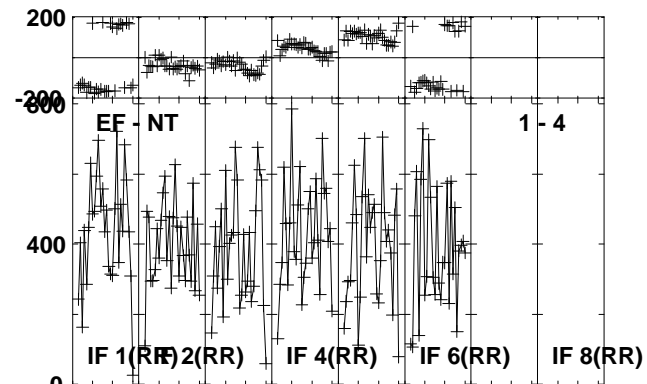
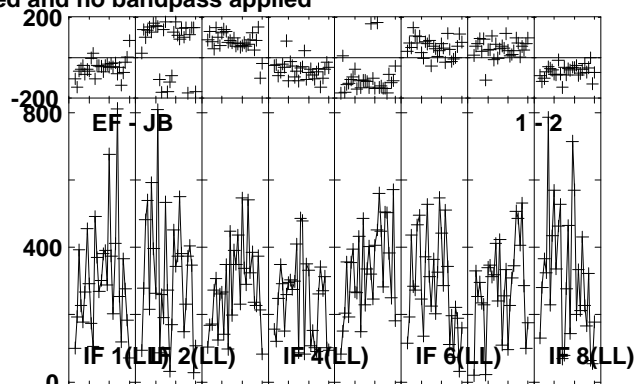
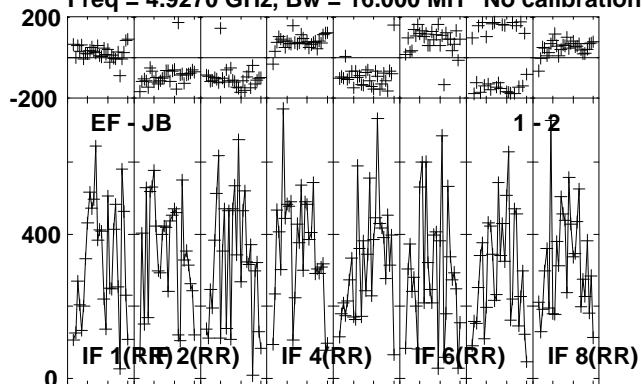

Lower frame: Micro Ampl Jy Top frame: Phas deg  
Vector averaged cross-power spectrum Several baselines displayed  
Timerange: 00/15:27:28 to 00/15:29:28

Plot file version 16 created 24-OCT-2012 20:58:21

J1831-0756 EY017B.UVDATA.1

Freq = 4.9270 GHz, Bw = 16.000 MH No calibration applied and no bandpass applied

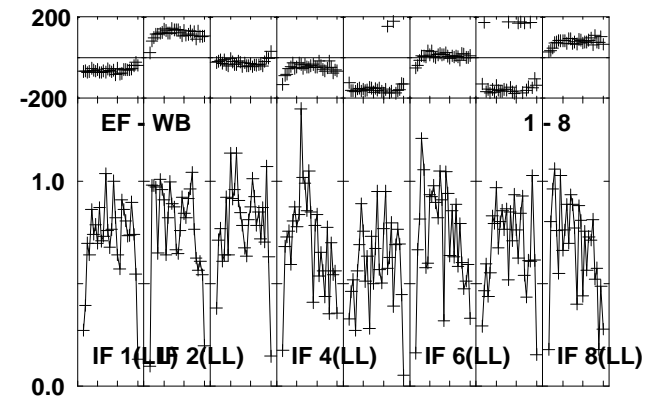
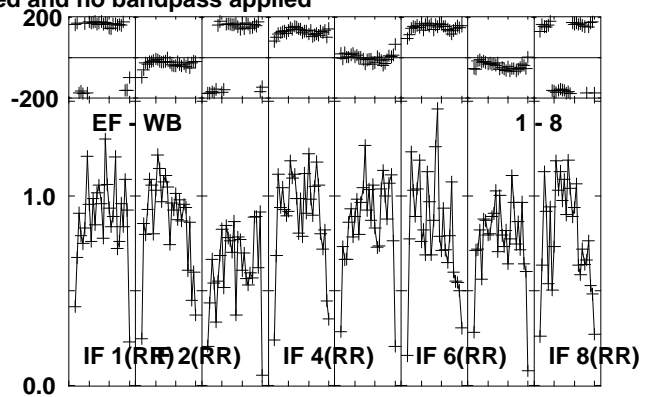
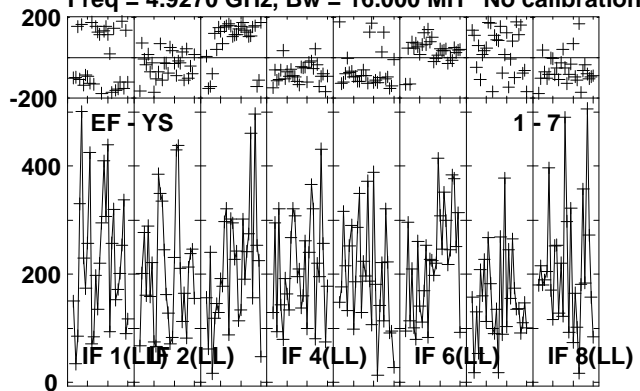

Lower frame: Micro Ampl Jy Top frame: Phas deg  
Vector averaged cross-power spectrum Several baselines displayed  
Timerange: 00/15:27:28 to 00/15:29:28

Plot file version 17 created 24-OCT-2012 20:58:22

J1825-0737 EY017B.UVDATA.1

Freq = 4.9270 GHz, Bw = 16.000 MH No calibration applied and no bandpass applied

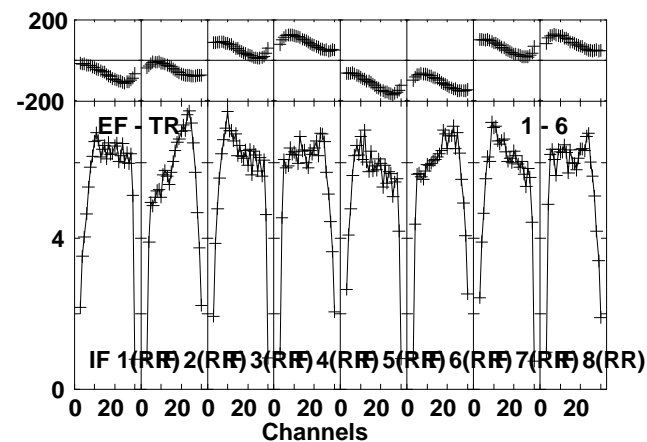
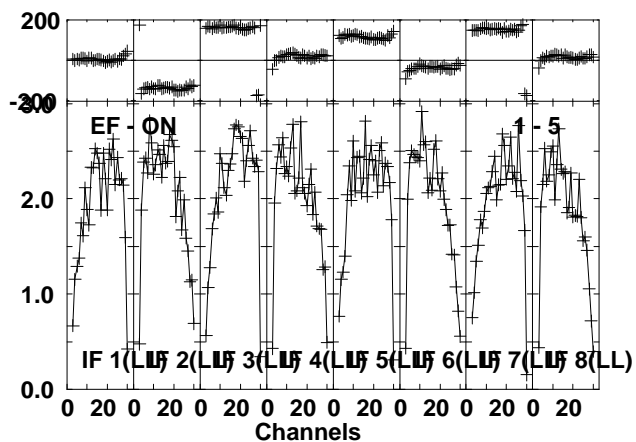
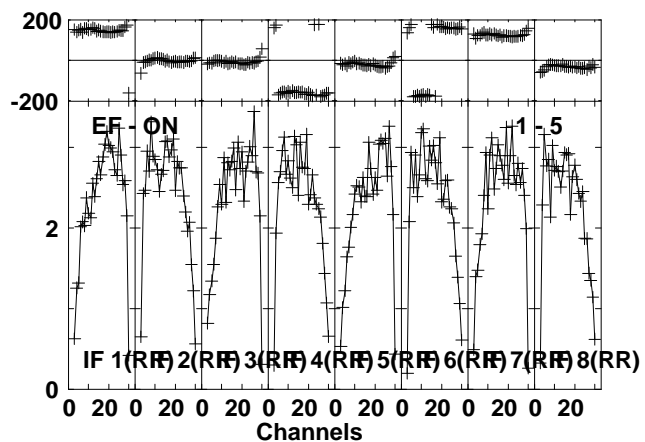
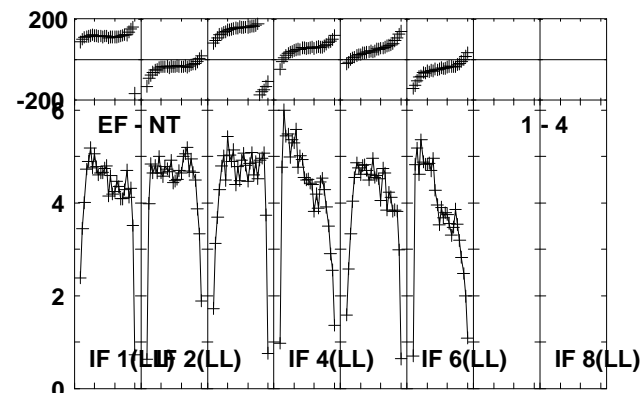
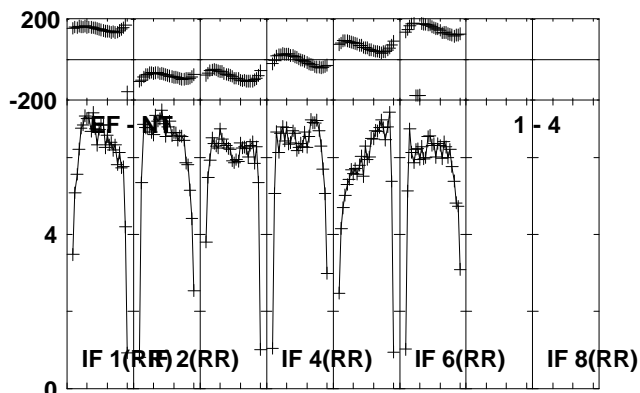
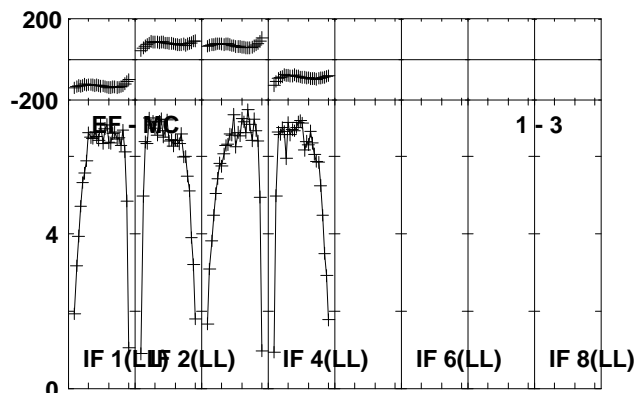
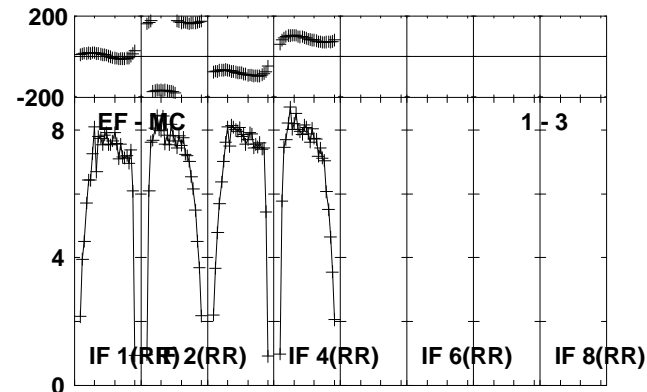
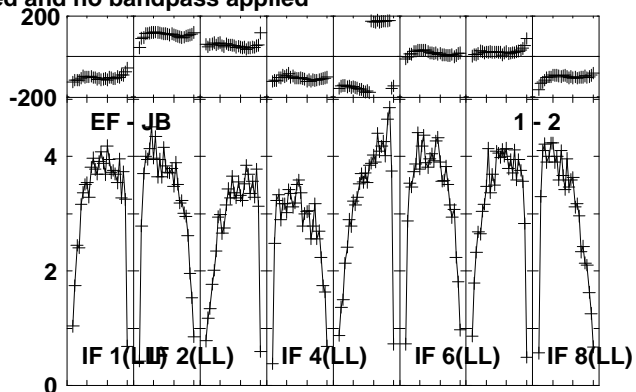
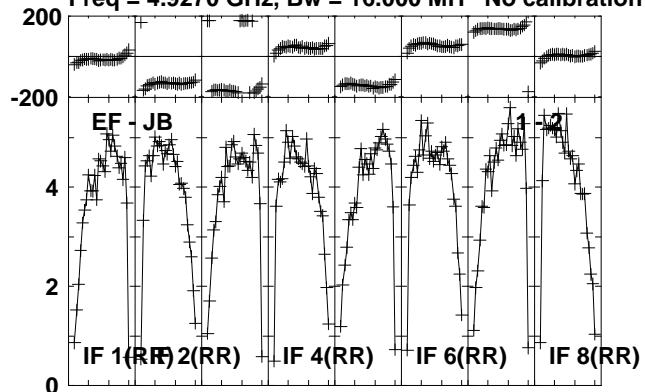

Lower frame: Milli Ampl Jy Top frame: Phas deg  
Vector averaged cross-power spectrum Several baselines displayed  
Timerange: 00/15:29:32 to 00/15:30:58

Plot file version 18 created 24-OCT-2012 20:58:22

J1825-0737 EY017B.UVDATA.1

Freq = 4.9270 GHz, Bw = 16.000 MH No calibration applied and no bandpass applied

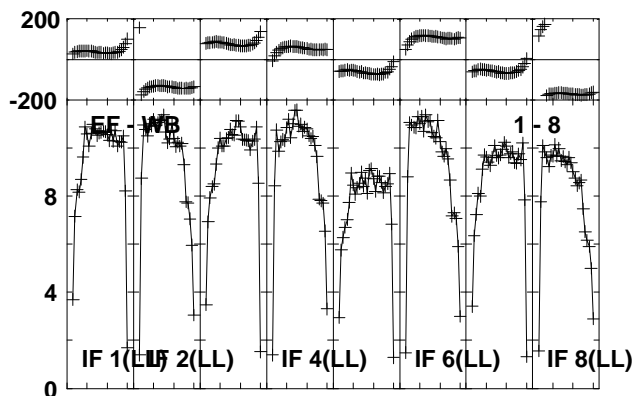
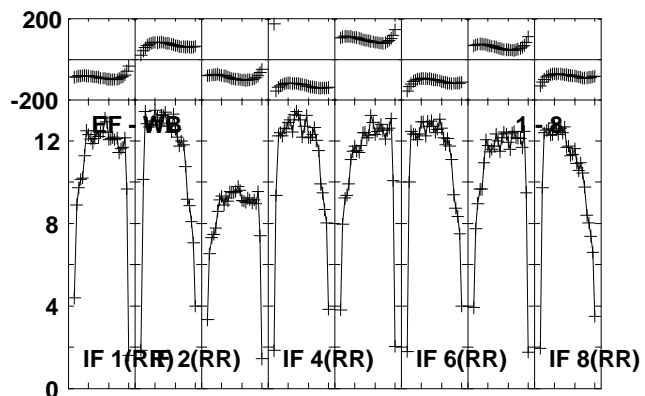
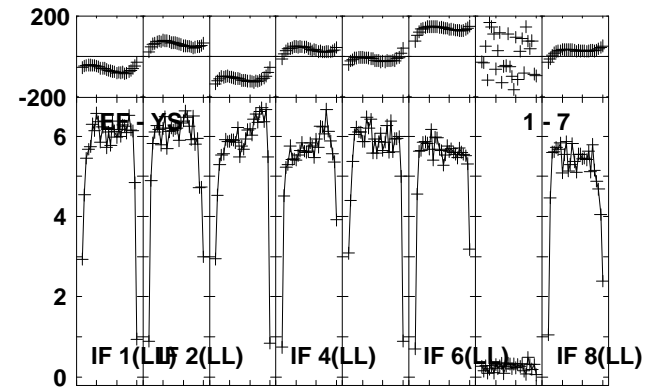
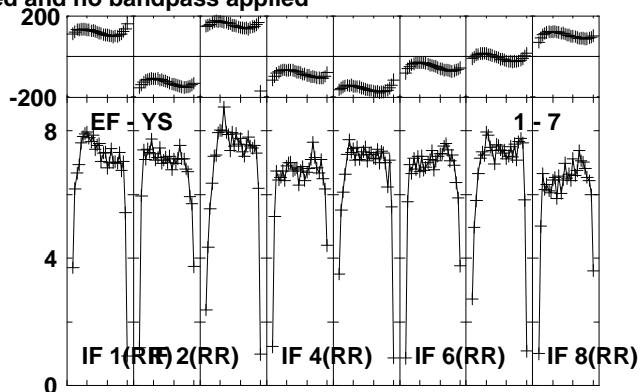
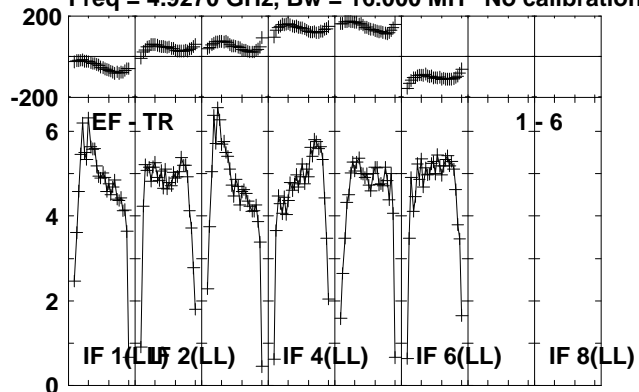

Lower frame: Milli Ampl Jy Top frame: Phas deg  
Vector averaged cross-power spectrum Several baselines displayed  
Timerange: 00/15:29:32 to 00/15:30:58



Plot file version 20 created 24-OCT-2012 20:58:23

G23.6-0.03 EY017B.UVDATA.1

Freq = 4.9270 GHz, Bw = 16.000 MH No calibration applied and no bandpass applied

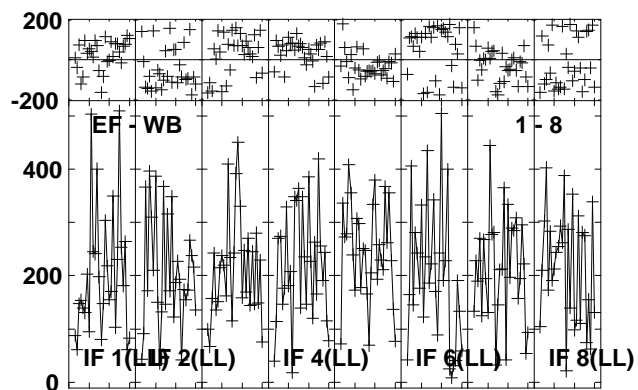
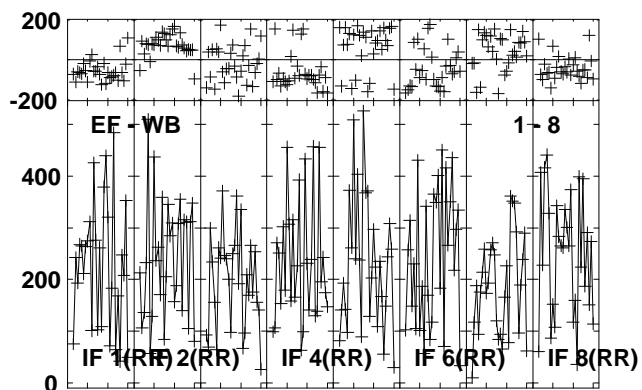
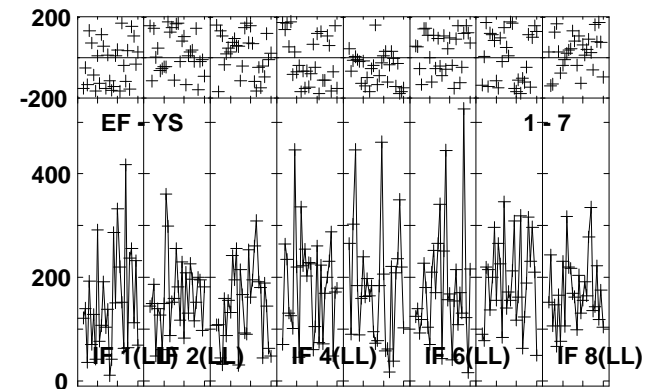
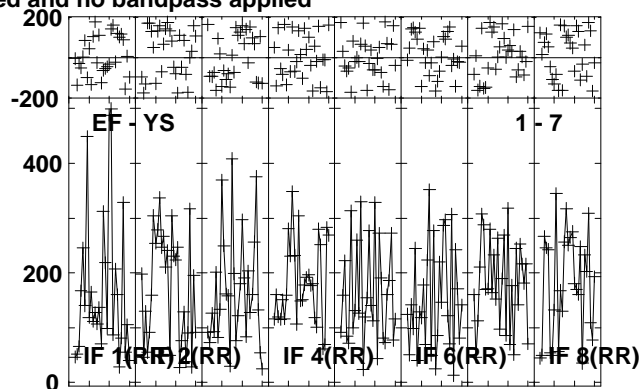
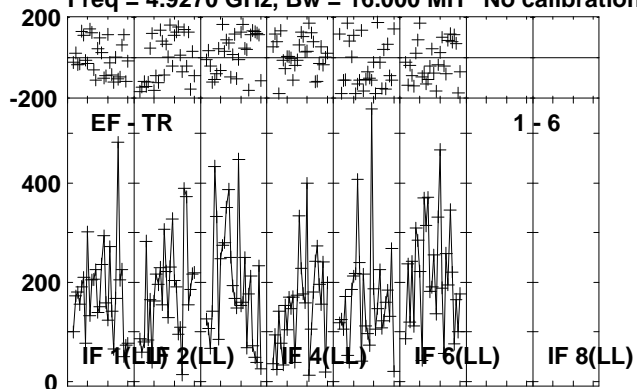

Lower frame: Micro Ampl Jy Top frame: Phas deg  
Vector averaged cross-power spectrum Several baselines displayed  
Timerange: 00/15:31:02 to 00/15:33:28



Plot file version 21 created 24-OCT-2012 20:58:24

J1825-0737 EY017B.UVDATA.1

Freq = 4.9270 GHz, Bw = 16.000 MH No calibration applied and no bandpass applied

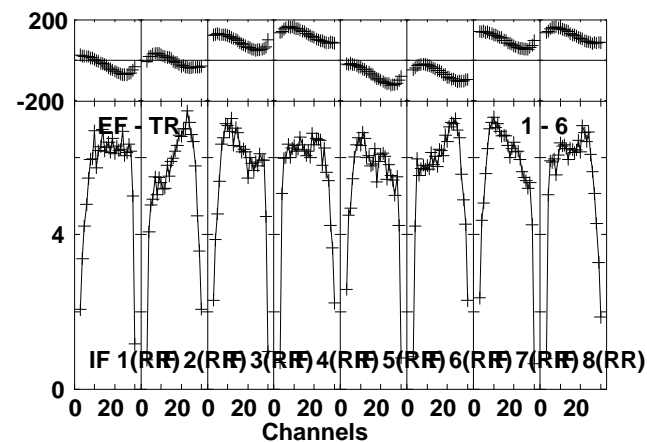
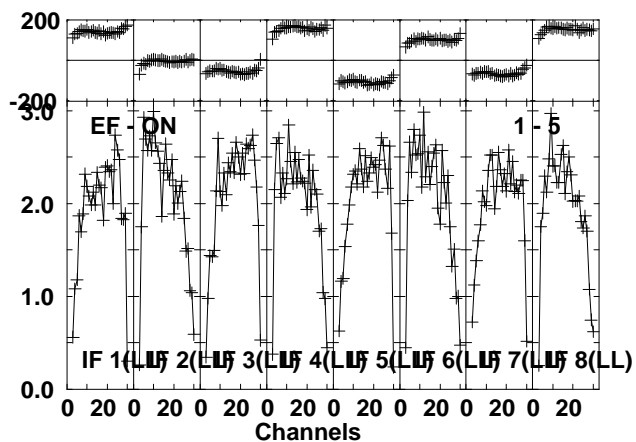
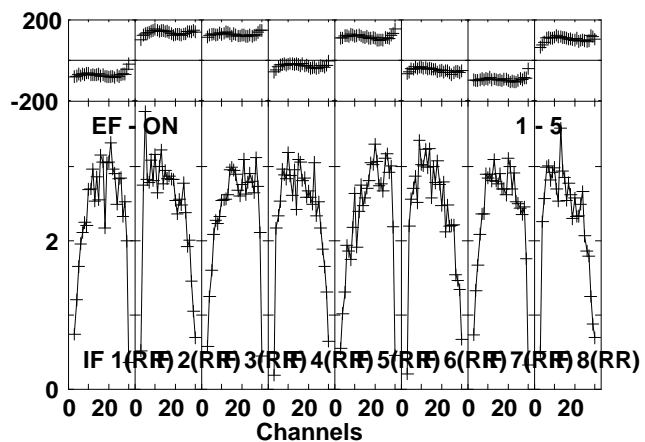
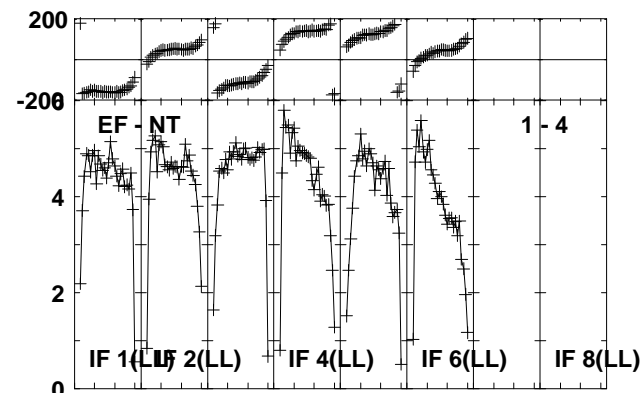
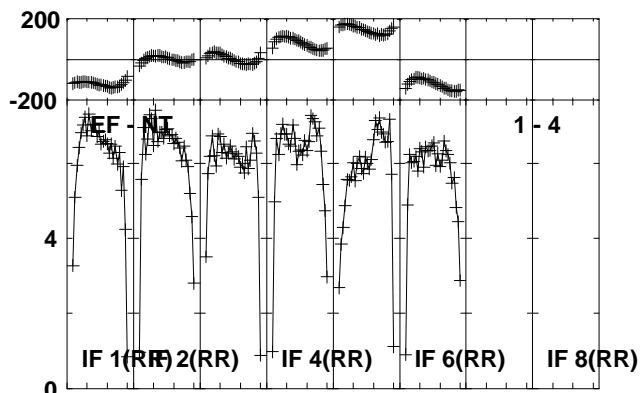
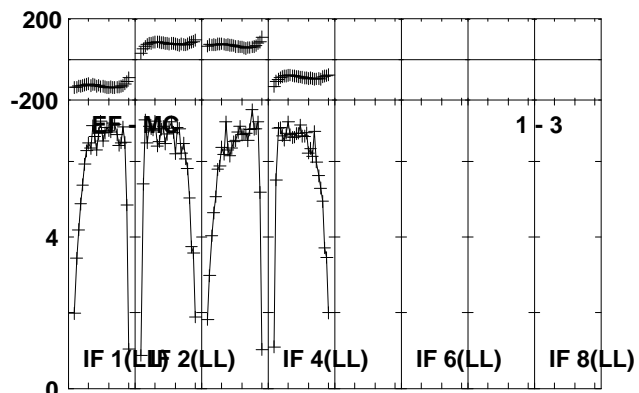
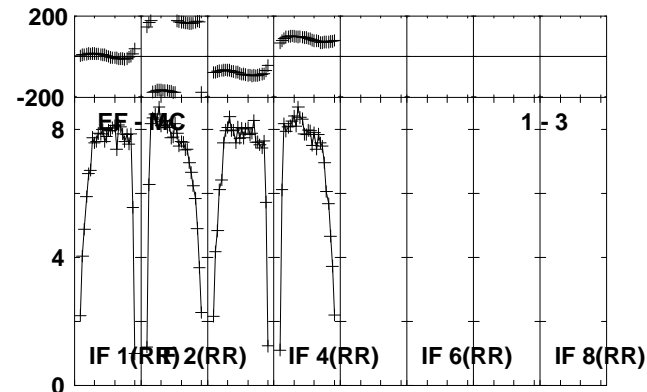
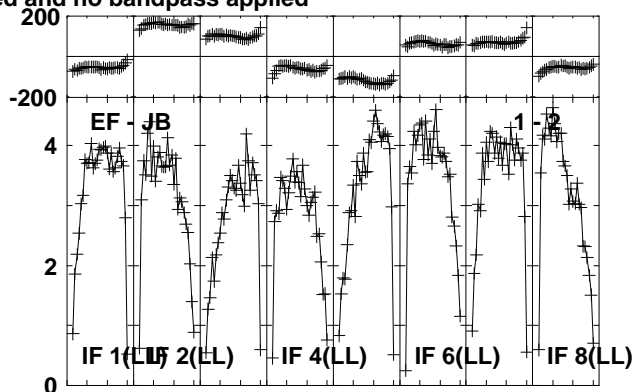
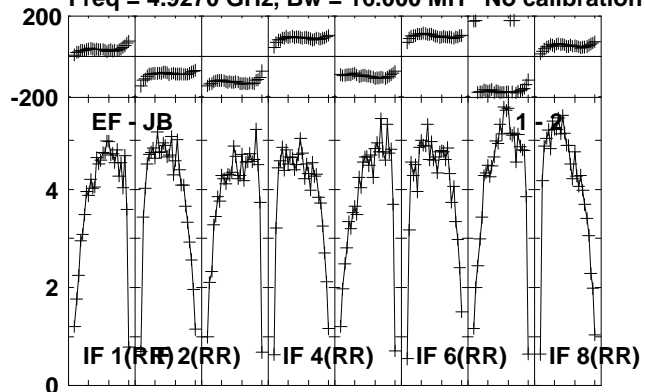

Lower frame: Milli Ampl Jy Top frame: Phas deg  
Vector averaged cross-power spectrum Several baselines displayed  
Timerange: 00/15:33:32 to 00/15:34:58

Plot file version 22 created 24-OCT-2012 20:58:25

J1825-0737 EY017B.UVDATA.1

Freq = 4.9270 GHz, Bw = 16.000 MH No calibration applied and no bandpass applied

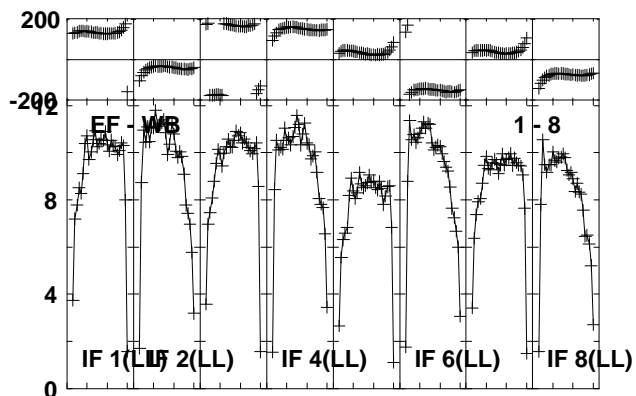
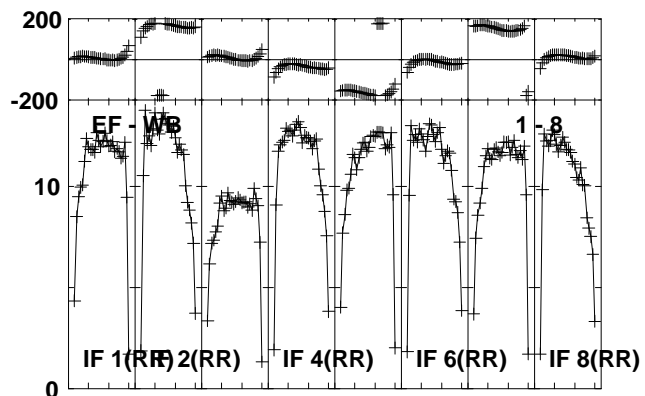
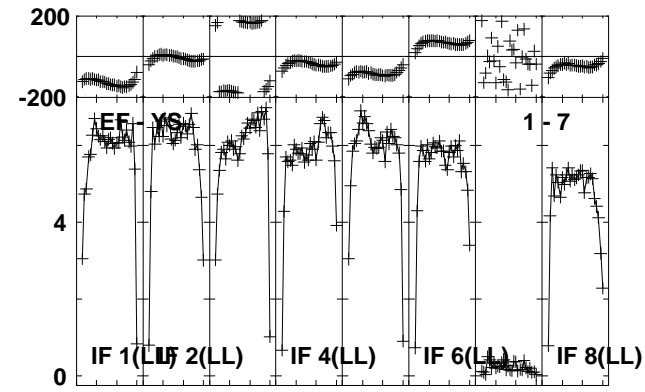
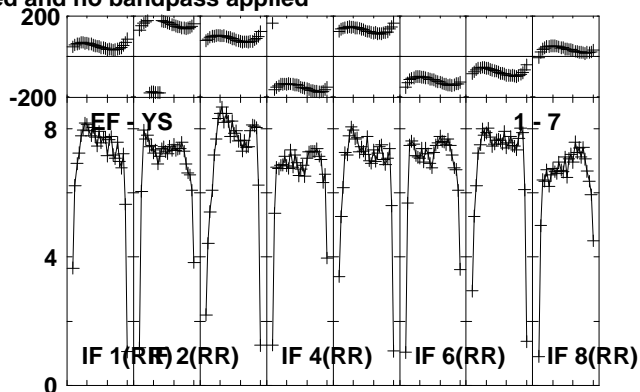
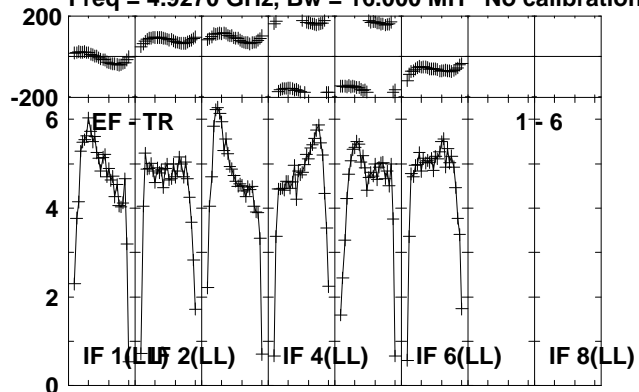

Lower frame: Milli Ampl Jy Top frame: Phas deg  
Vector averaged cross-power spectrum Several baselines displayed  
Timerange: 00/15:33:32 to 00/15:34:58

Plot file version 23 created 24-OCT-2012 20:58:25

G23.6-0.03 EY017B.UVDATA.1

Freq = 4.9270 GHz, Bw = 16.000 MH No calibration applied and no bandpass applied

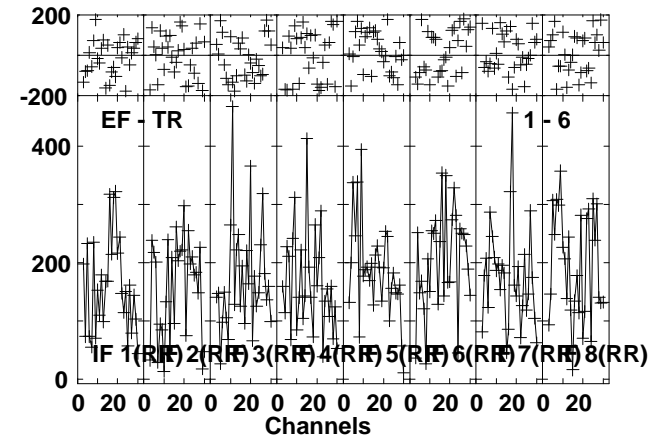
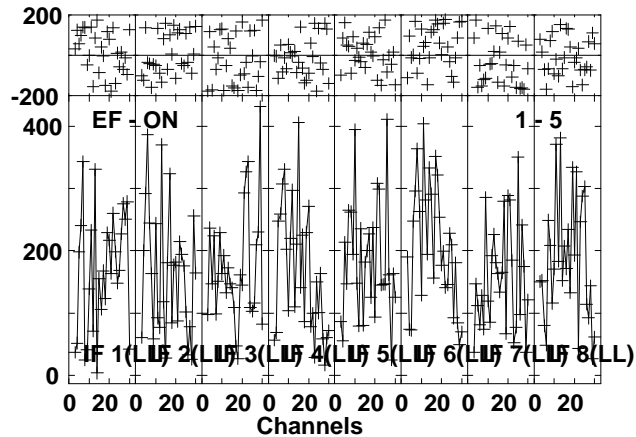
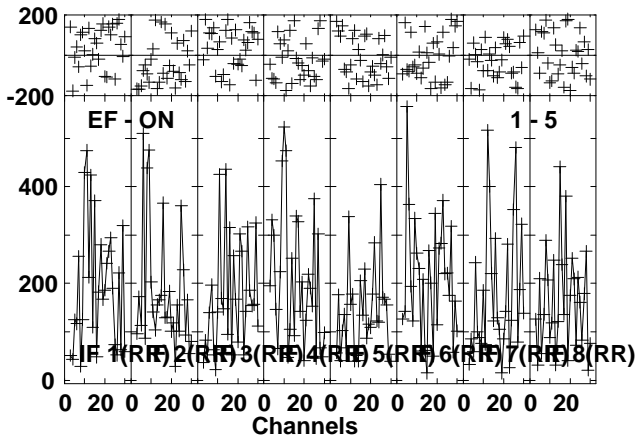
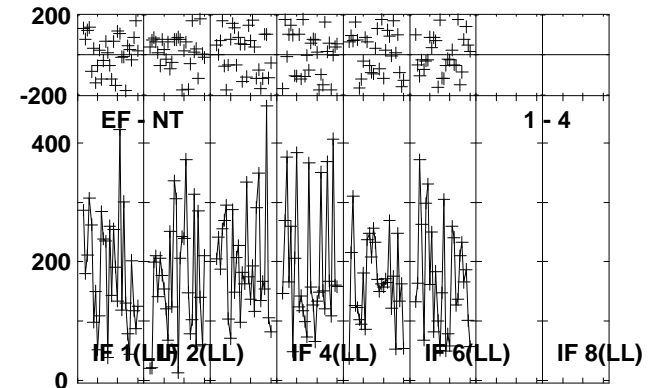
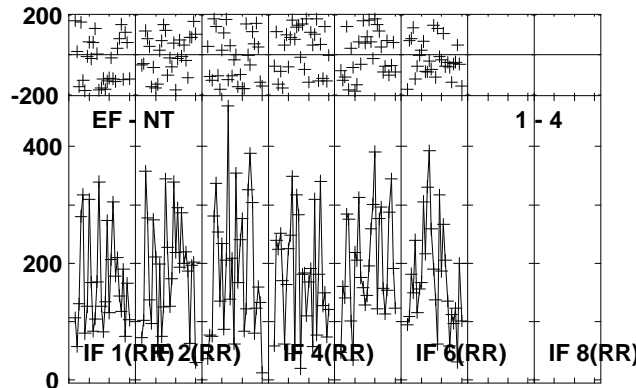
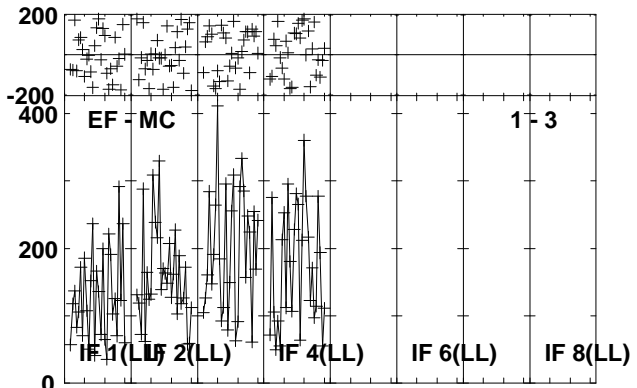
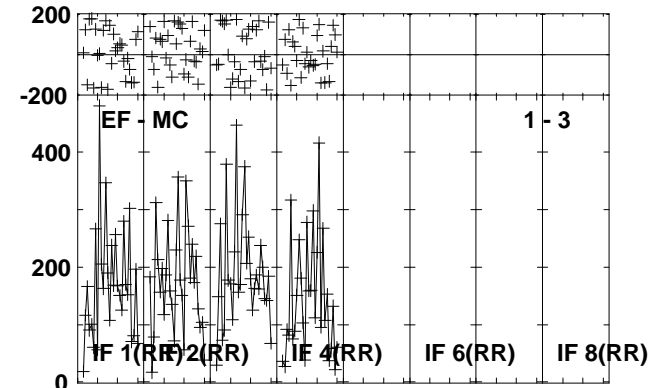
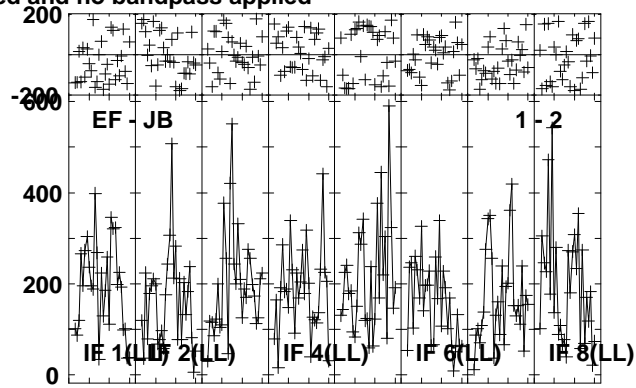
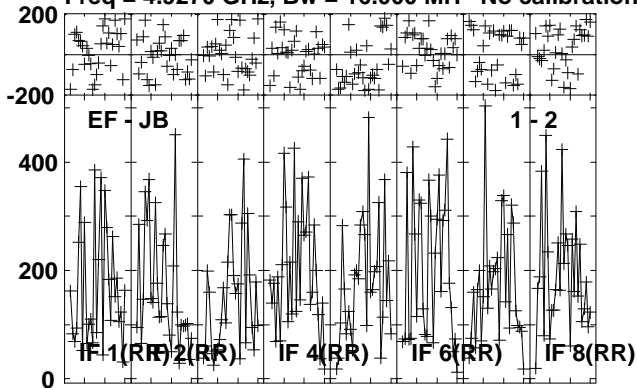

Lower frame: Micro Ampl Jy Top frame: Phas deg  
Vector averaged cross-power spectrum Several baselines displayed  
Timerange: 00/15:35:02 to 00/15:37:28

Plot file version 24 created 24-OCT-2012 20:58:26

G23.6-0.03 EY017B.UVDATA.1

Freq = 4.9270 GHz, Bw = 16.000 MH No calibration applied and no bandpass applied

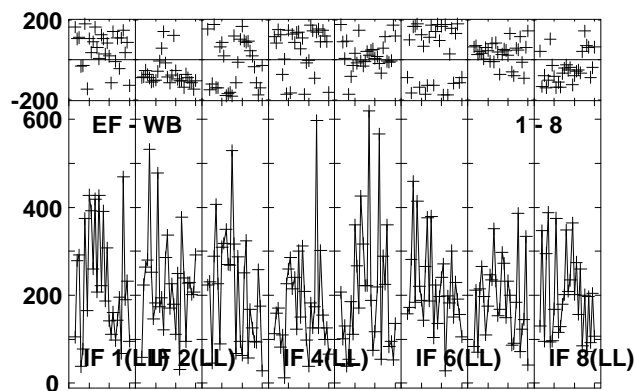
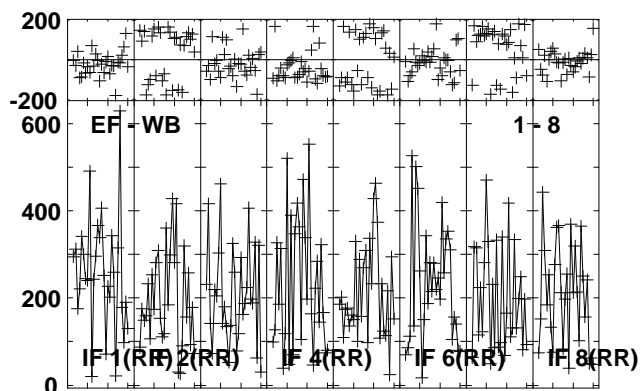
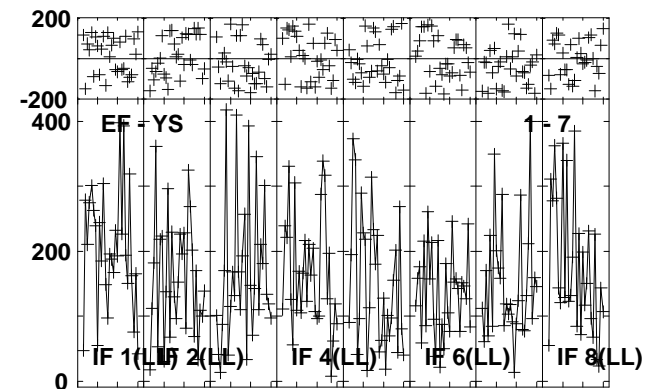
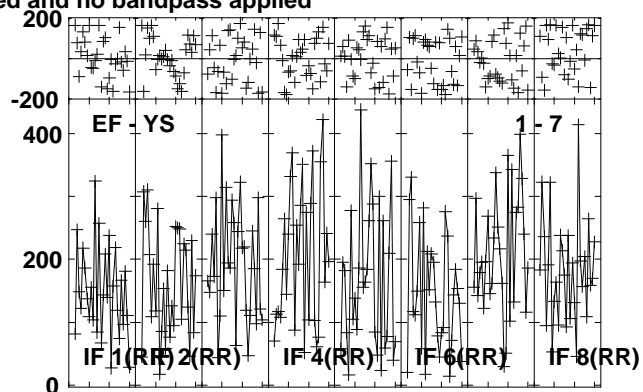
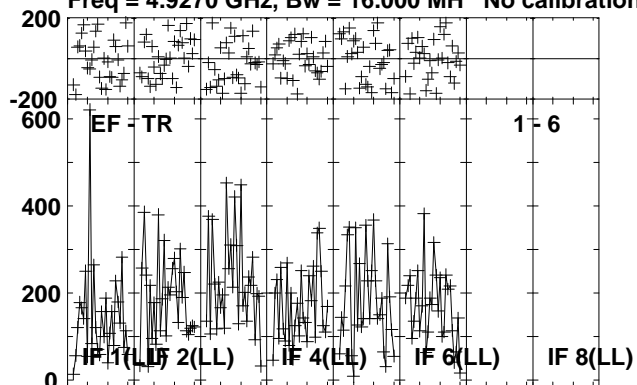

Lower frame: Micro Ampl Jy Top frame: Phas deg  
Vector averaged cross-power spectrum Several baselines displayed  
Timerange: 00/15:35:02 to 00/15:37:28

Plot file version 25 created 24-OCT-2012 20:58:26

J1825-0737 EY017B.UVDATA.1

Freq = 4.9270 GHz, Bw = 16.000 MH No calibration applied and no bandpass applied

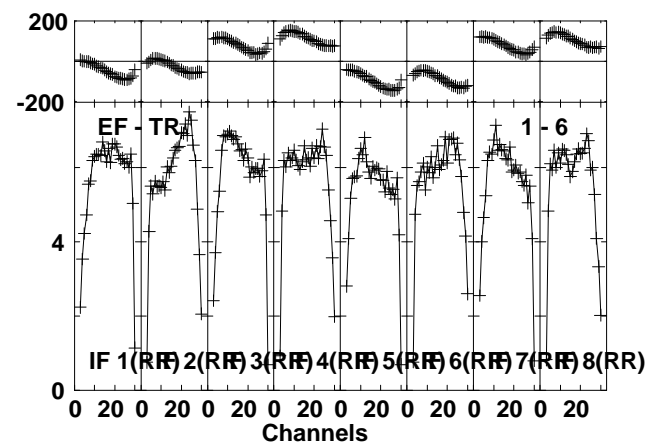
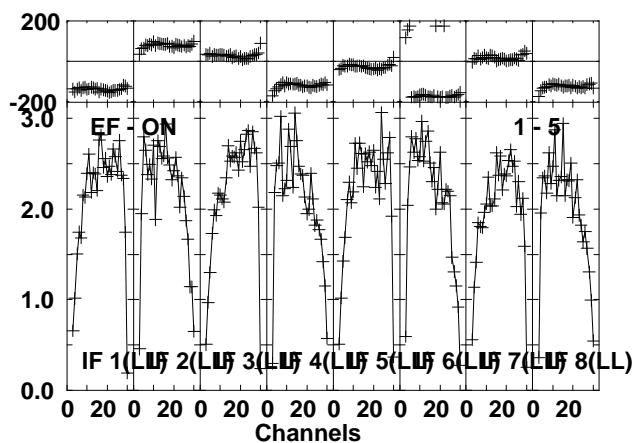
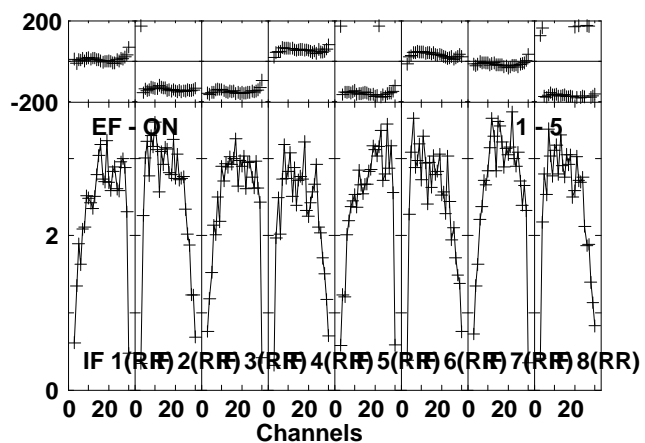
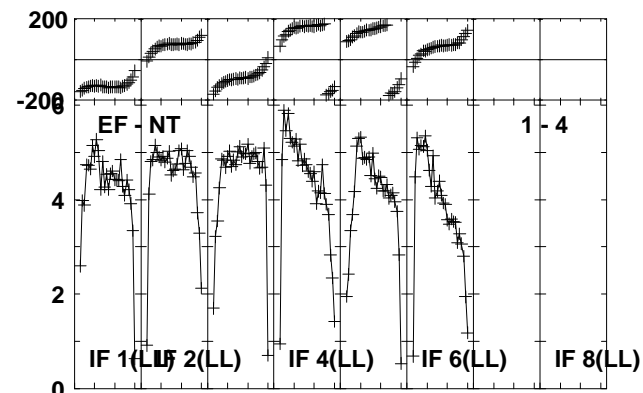
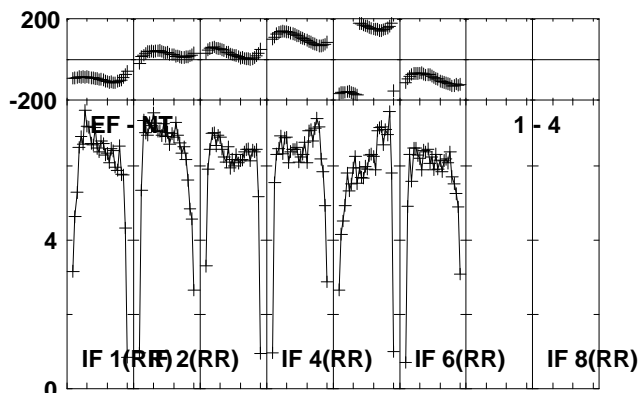
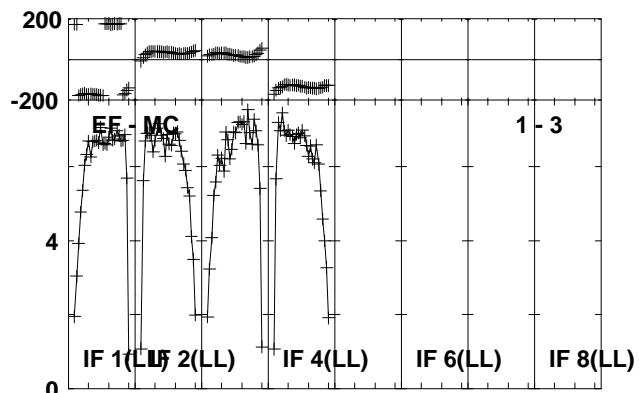
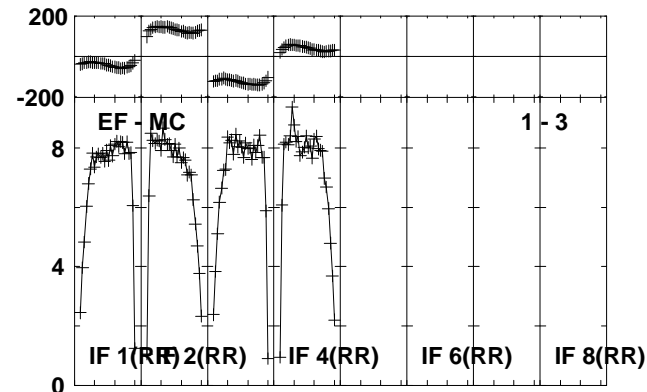
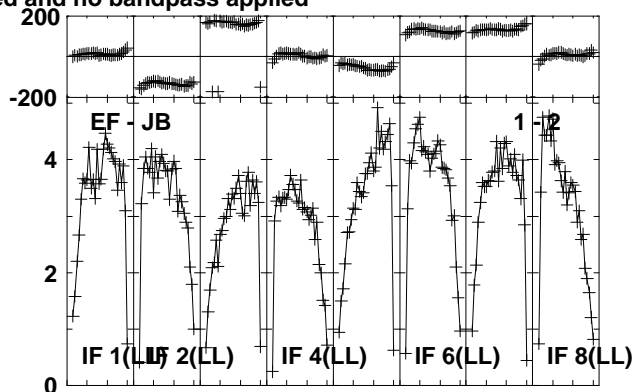
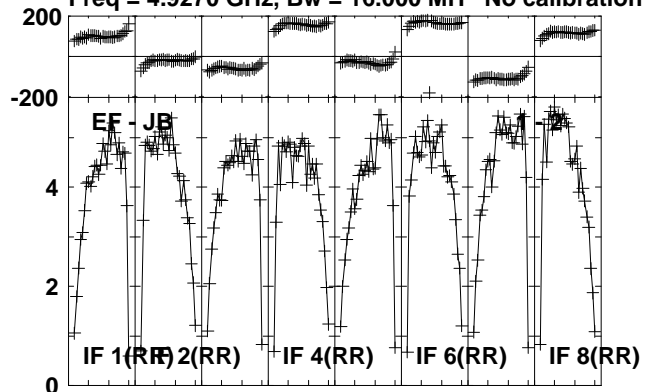

Lower frame: Milli Ampl Jy Top frame: Phas deg  
Vector averaged cross-power spectrum Several baselines displayed  
Timerange: 00/15:37:32 to 00/15:38:58

Plot file version 26 created 24-OCT-2012 20:58:27

J1825-0737 EY017B.UVDATA.1

Freq = 4.9270 GHz, Bw = 16.000 MH No calibration applied and no bandpass applied

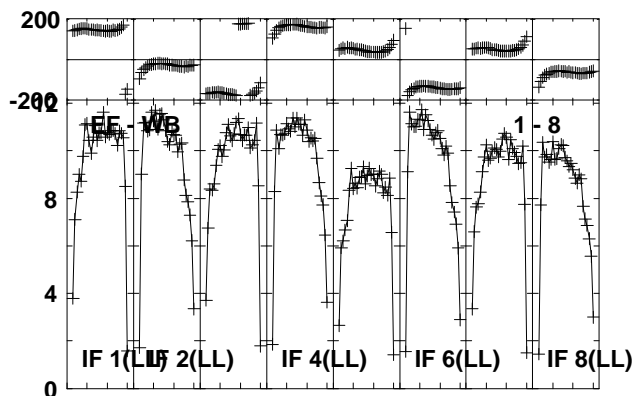
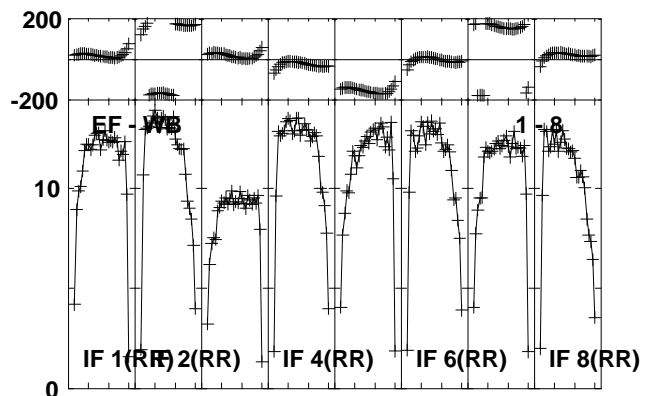
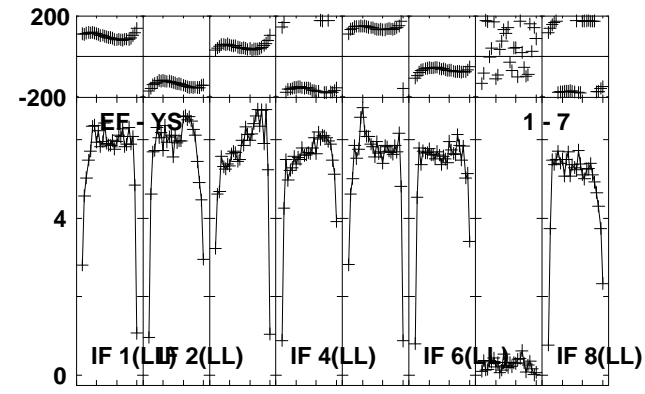
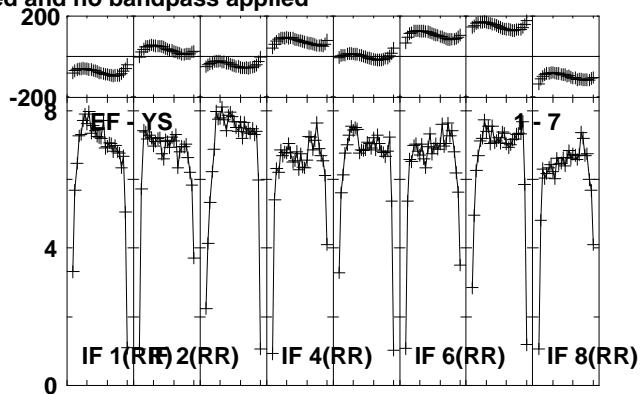
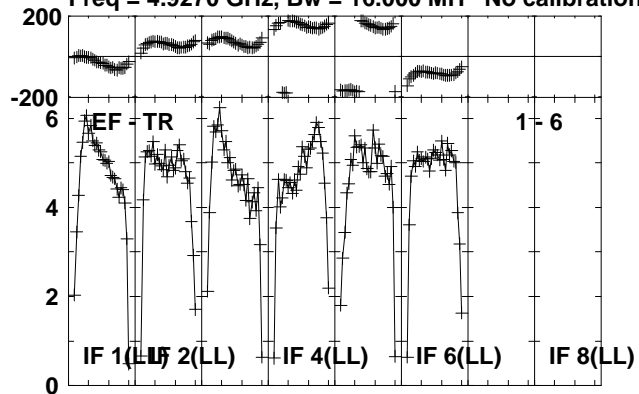

Lower frame: Milli Ampl Jy Top frame: Phas deg  
Vector averaged cross-power spectrum Several baselines displayed  
Timerange: 00/15:37:32 to 00/15:38:58

Plot file version 27 created 24-OCT-2012 20:58:27

G23.6-0.03 EY017B.UVDATA.1

Freq = 4.9270 GHz, Bw = 16.000 MH No calibration applied and no bandpass applied

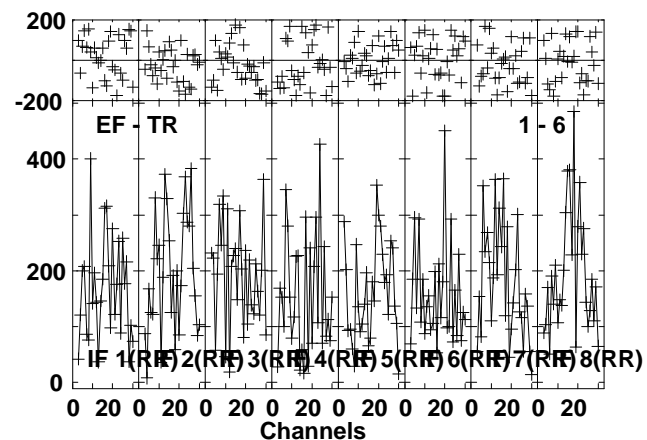
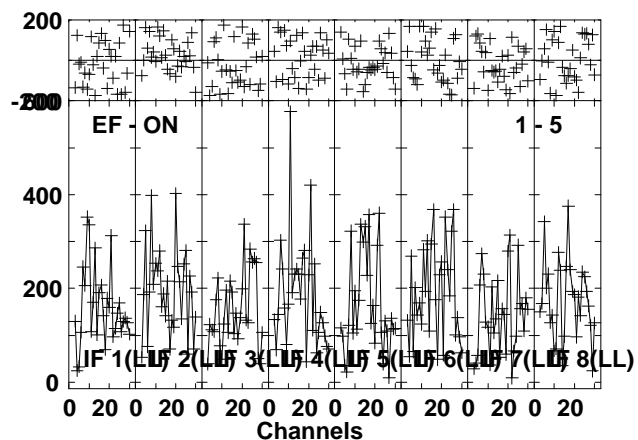
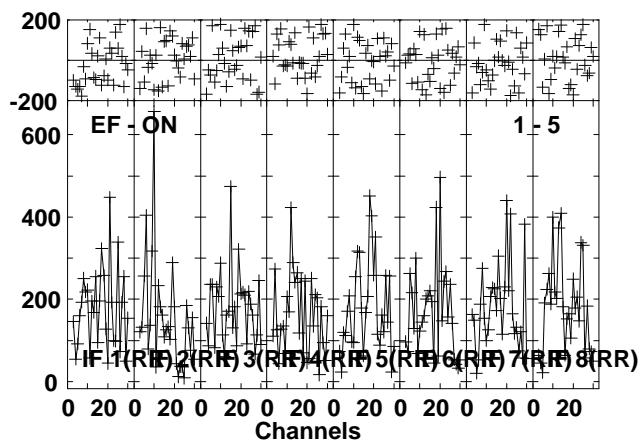
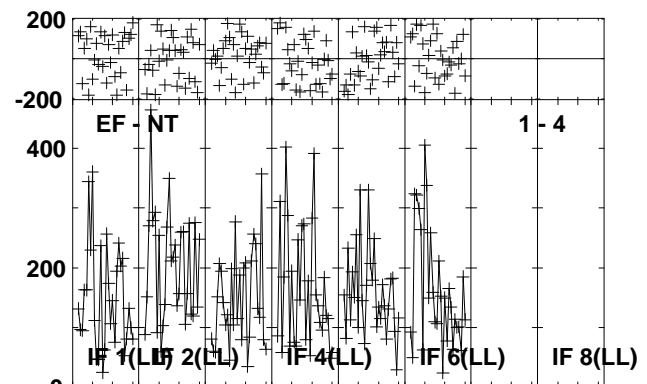
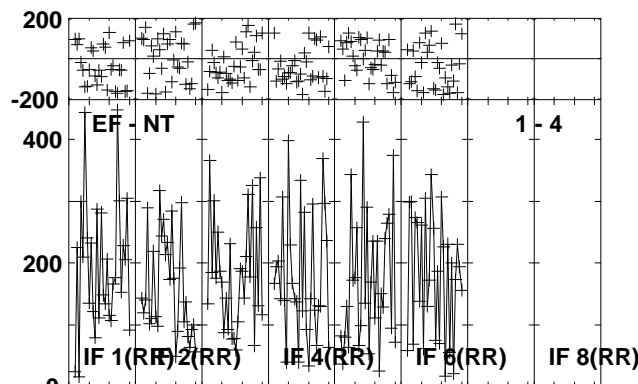
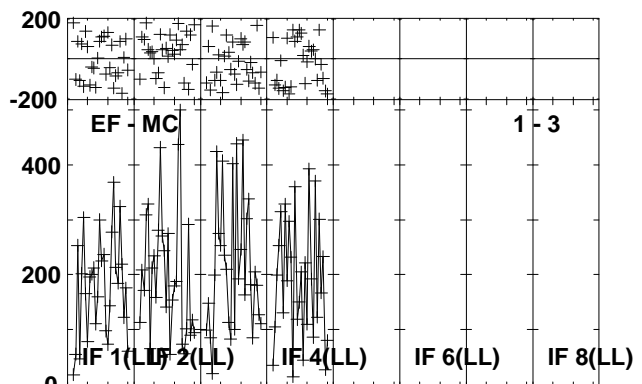
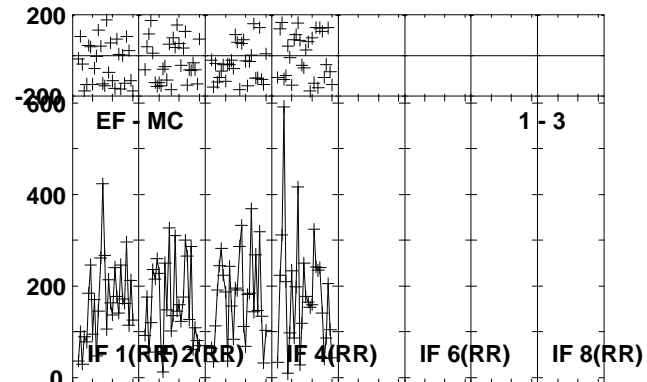
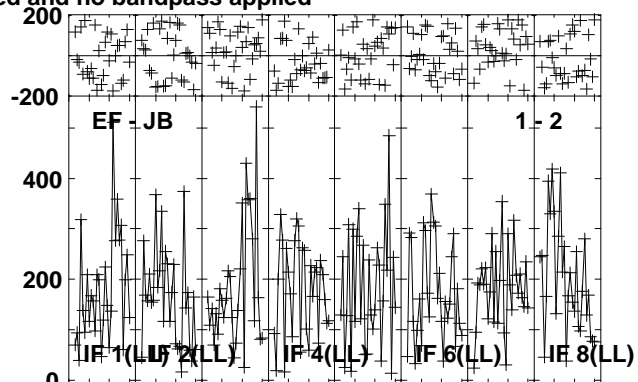
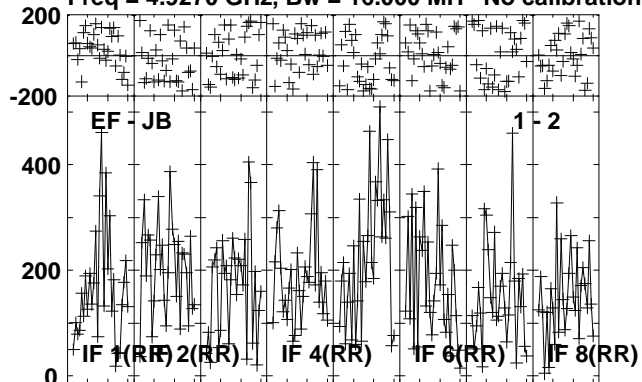

Lower frame: Micro Ampl Jy Top frame: Phas deg  
Vector averaged cross-power spectrum Several baselines displayed  
Timerange: 00/15:39:02 to 00/15:41:28

Plot file version 28 created 24-OCT-2012 20:58:28

G23.6-0.03 EY017B.UVDATA.1

Freq = 4.9270 GHz, Bw = 16.000 MH No calibration applied and no bandpass applied

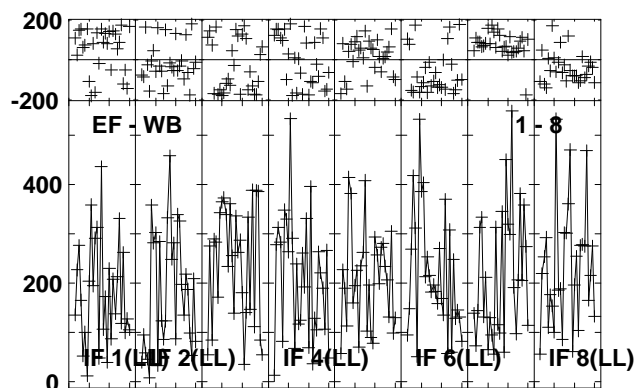
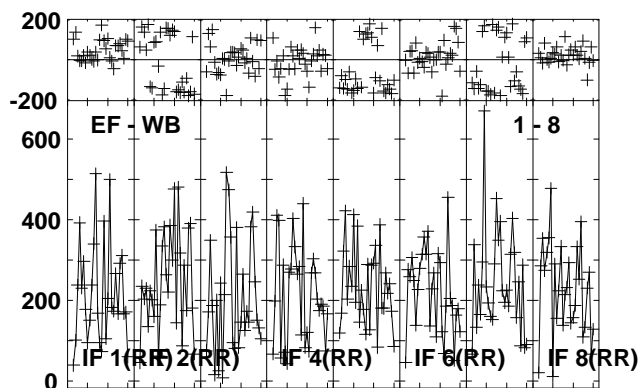
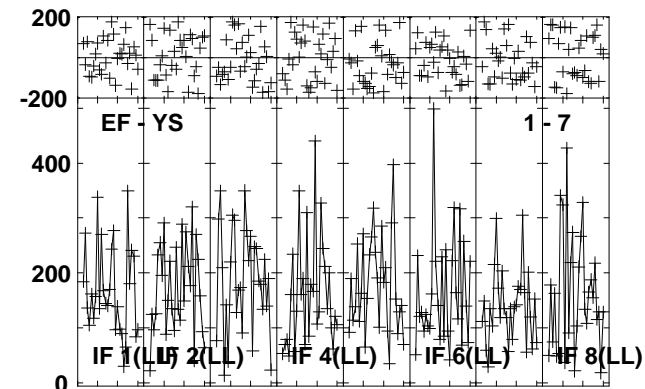
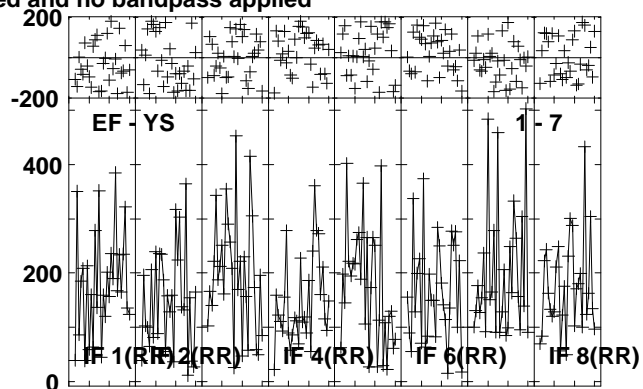
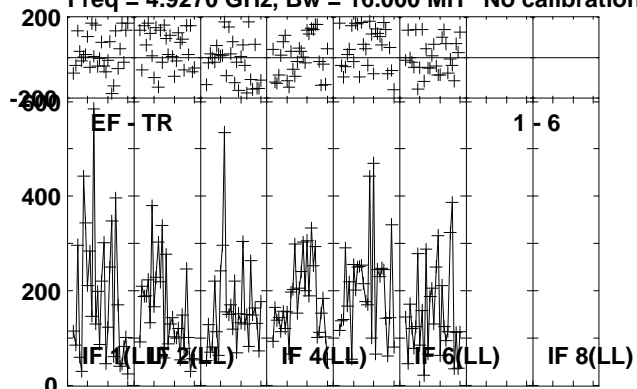

Lower frame: Micro Ampl Jy Top frame: Phas deg  
Vector averaged cross-power spectrum Several baselines displayed  
Timerange: 00/15:39:02 to 00/15:41:28



Plot file version 29 created 24-OCT-2012 20:58:29

J1825-0737 EY017B.UVDATA.1

Freq = 4.9270 GHz, Bw = 16.000 MH No calibration applied and no bandpass applied

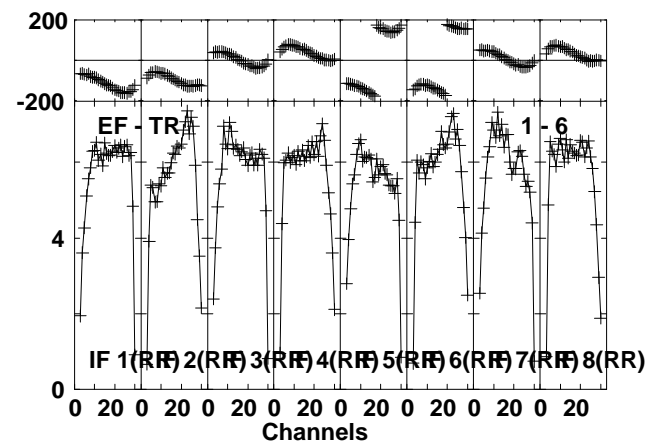
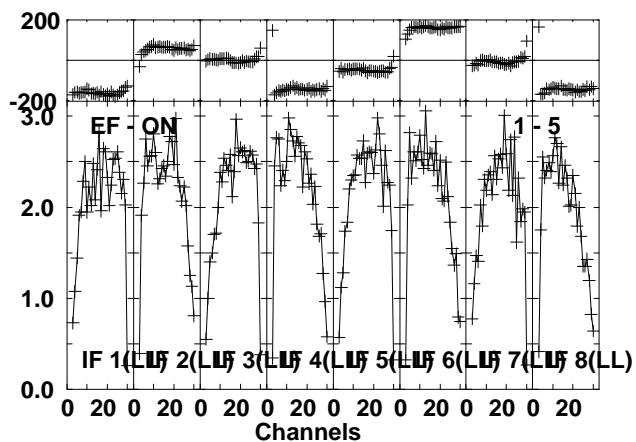
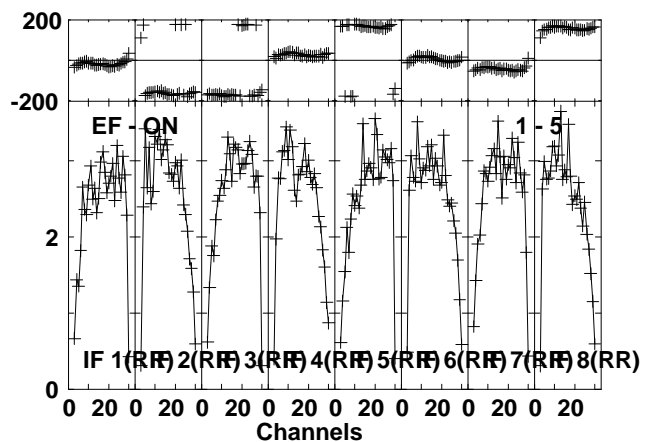
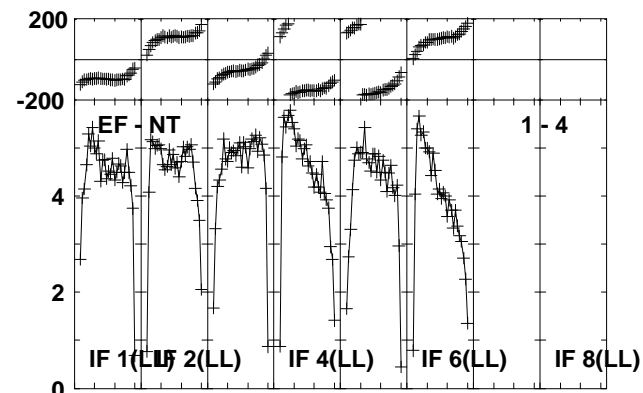
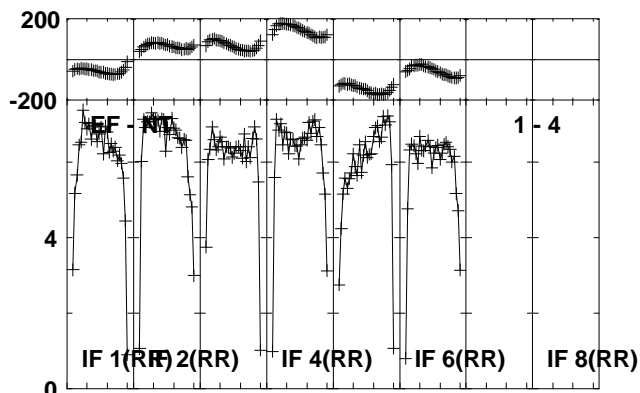
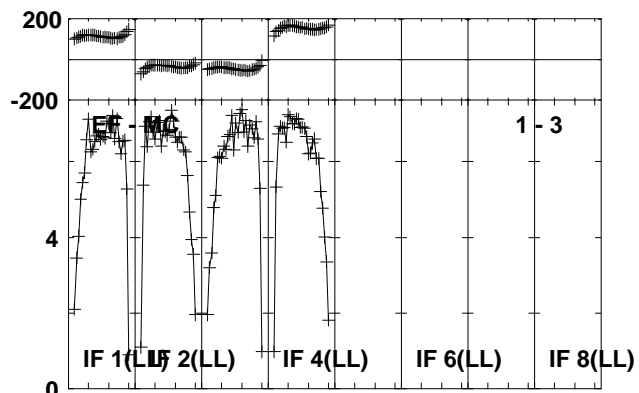
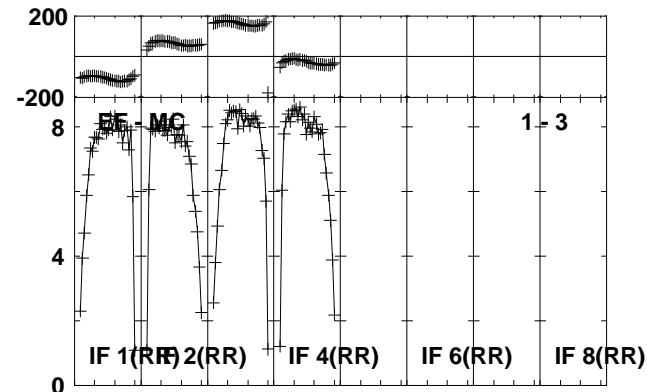
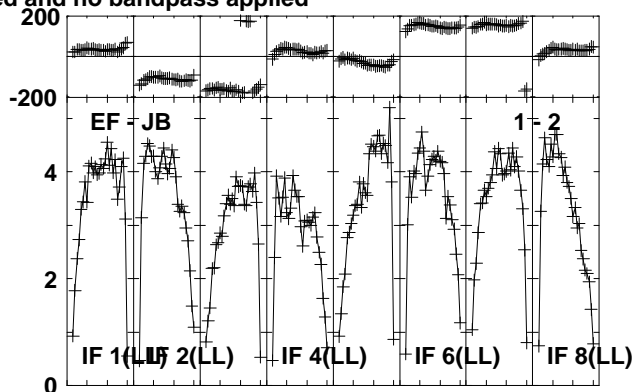
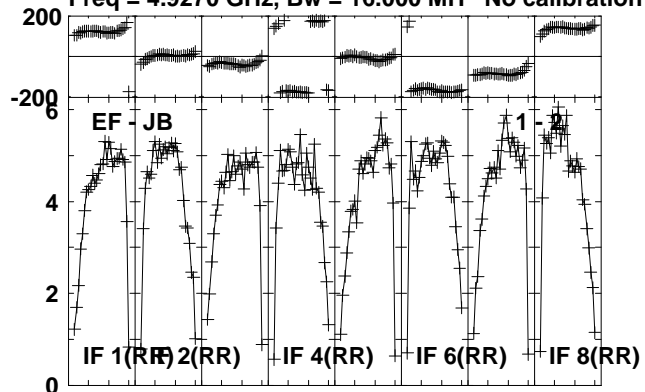

Lower frame: Milli Ampl Jy Top frame: Phas deg  
Vector averaged cross-power spectrum Several baselines displayed  
Timerange: 00/15:41:32 to 00/15:42:58

Plot file version 30 created 24-OCT-2012 20:58:29

J1825-0737 EY017B.UVDATA.1

Freq = 4.9270 GHz, Bw = 16.000 MH No calibration applied and no bandpass applied

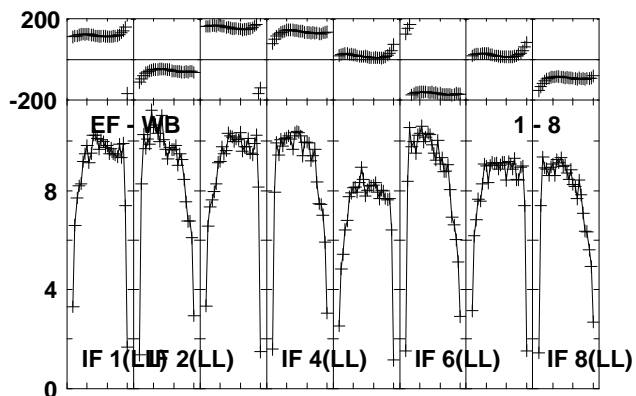
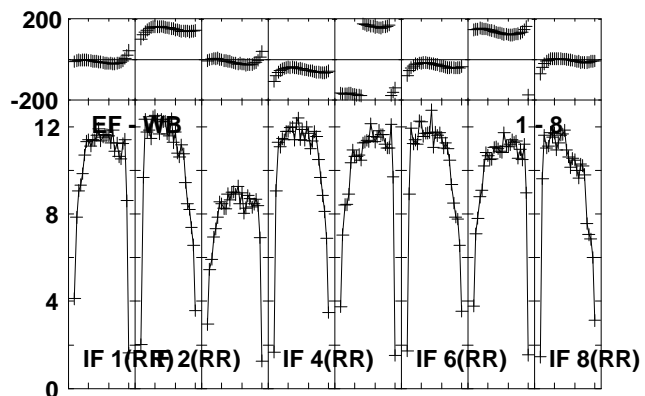
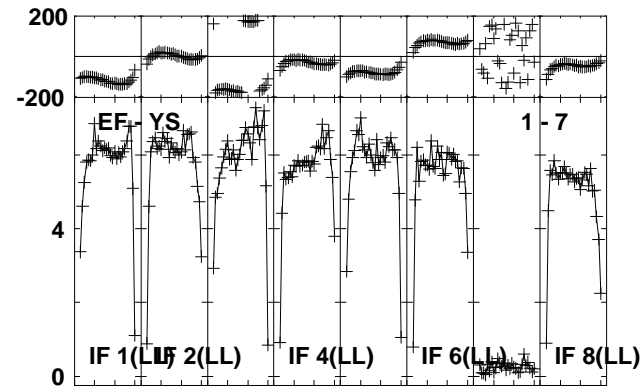
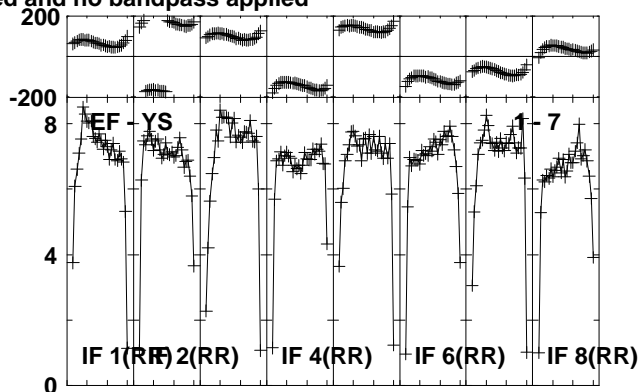
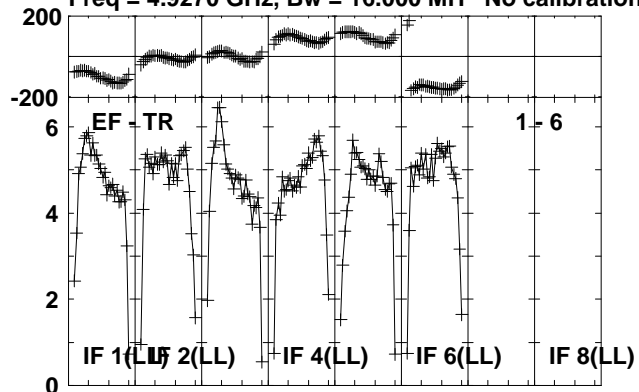

Lower frame: Milli Ampl Jy Top frame: Phas deg  
Vector averaged cross-power spectrum Several baselines displayed  
Timerange: 00/15:41:32 to 00/15:42:58

Plot file version 31 created 24-OCT-2012 20:58:30

J1831-0756 EY017B.UVDATA.1

Freq = 4.9270 GHz, Bw = 16.000 MH No calibration applied and no bandpass applied

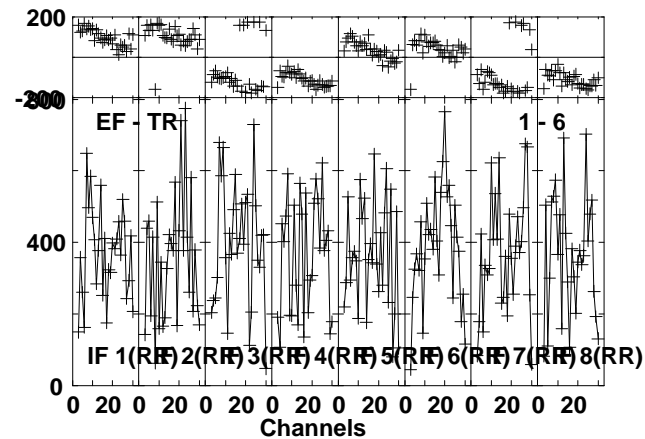
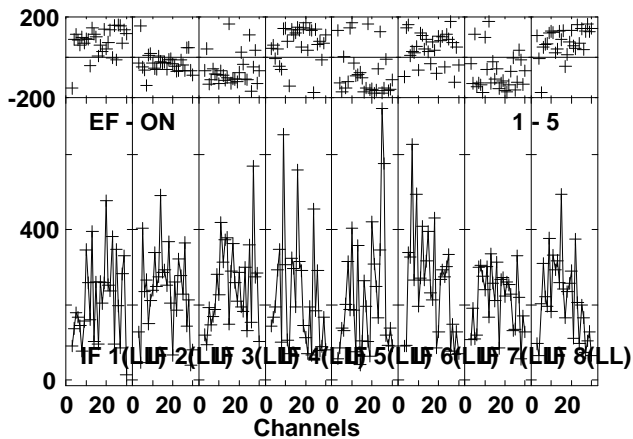
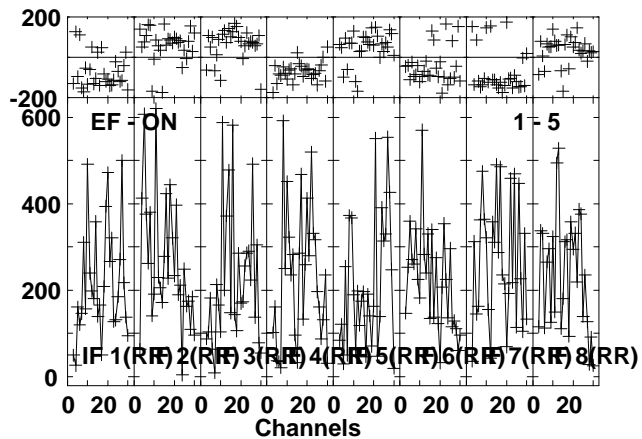
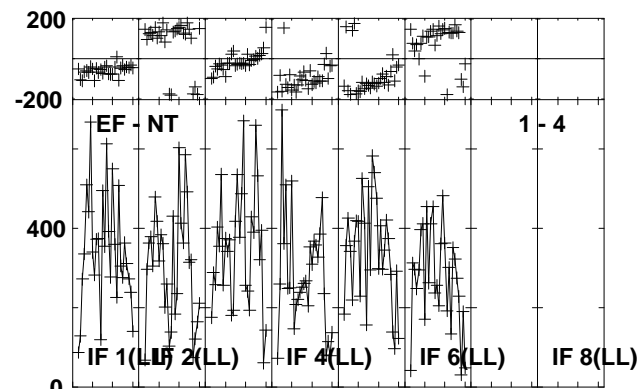
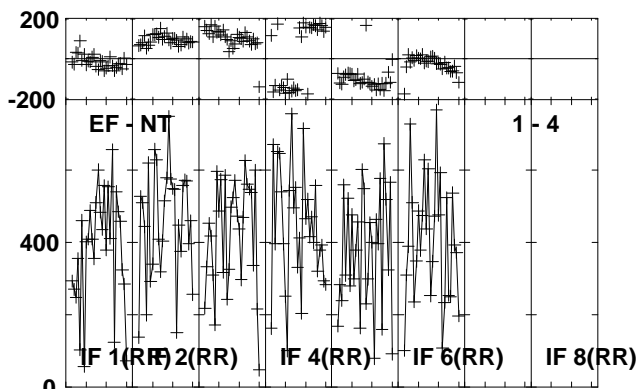
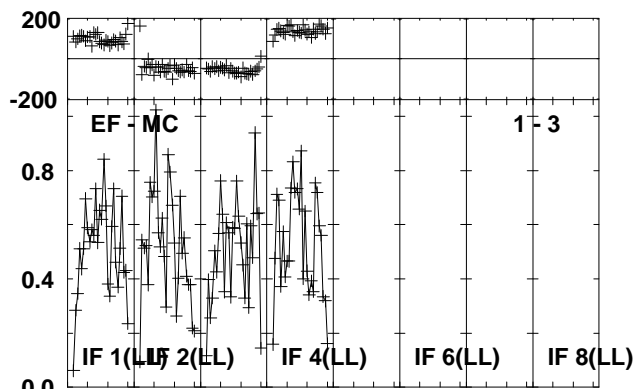
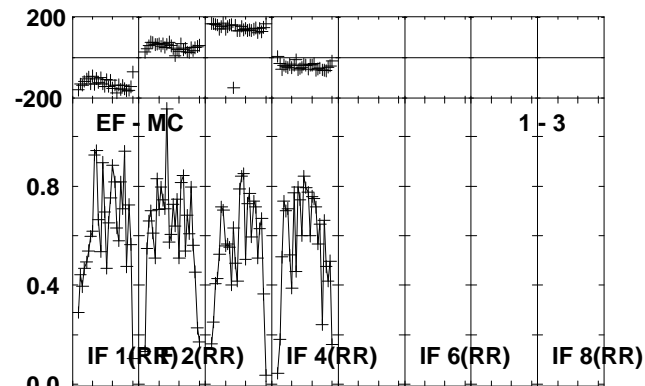
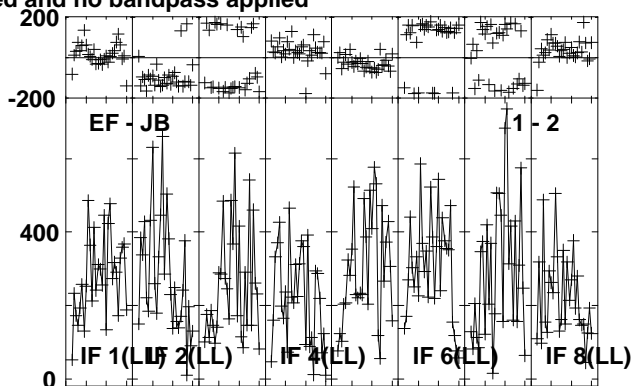
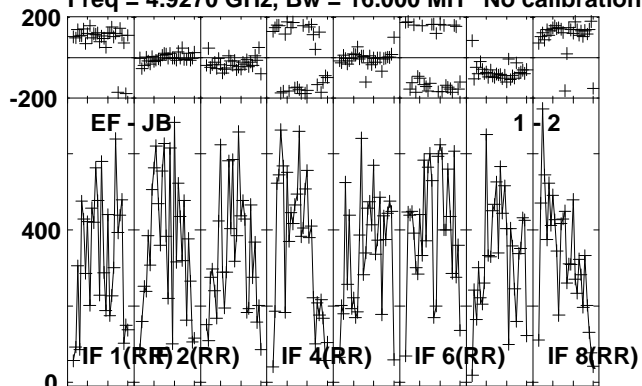

Lower frame: Micro Ampl Jy Top frame: Phas deg  
Vector averaged cross-power spectrum Several baselines displayed  
Timerange: 00/15:43:32 to 00/15:45:34

Plot file version 32 created 24-OCT-2012 20:58:30

J1831-0756 EY017B.UVDATA.1

Freq = 4.9270 GHz, Bw = 16.000 MH No calibration applied and no bandpass applied

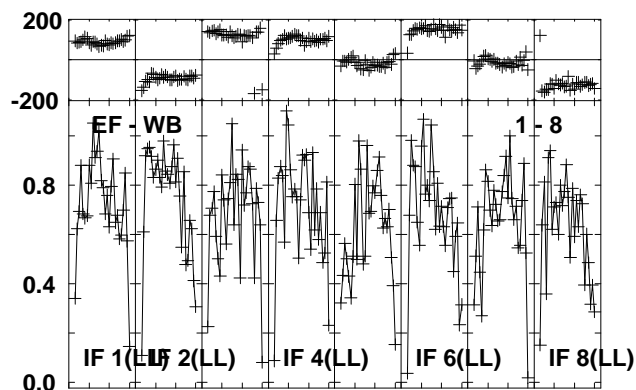
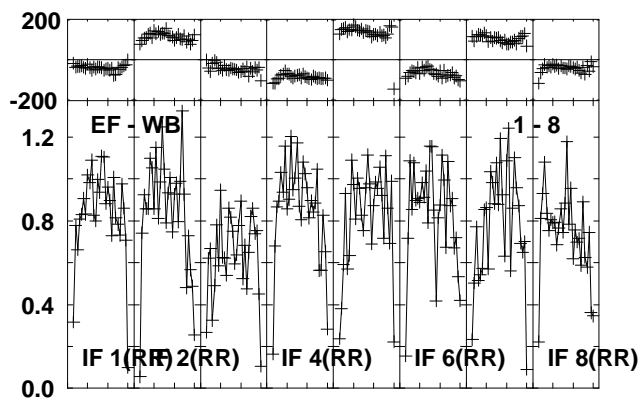
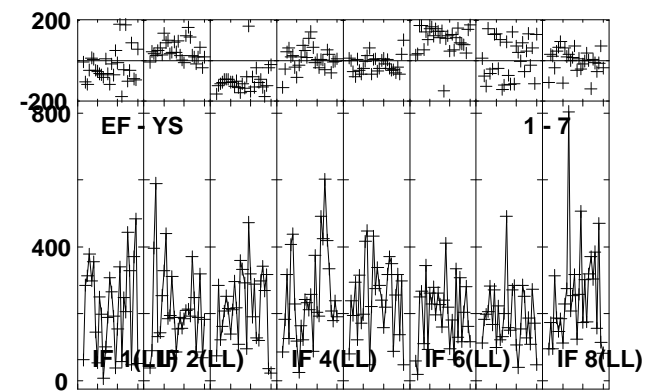
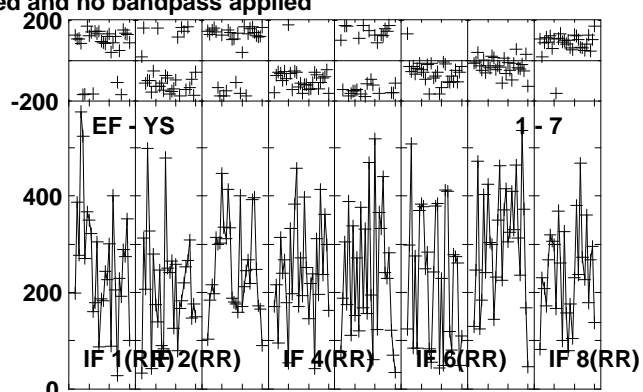
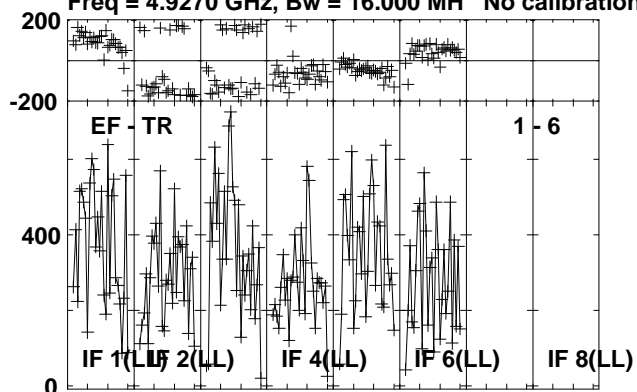

Lower frame: Micro Ampl Jy Top frame: Phas deg  
Vector averaged cross-power spectrum Several baselines displayed  
Timerange: 00/15:43:32 to 00/15:45:34

Plot file version 33 created 24-OCT-2012 20:58:31

J1825-0737 EY017B.UVDATA.1

Freq = 4.9270 GHz, Bw = 16.000 MH No calibration applied and no bandpass applied

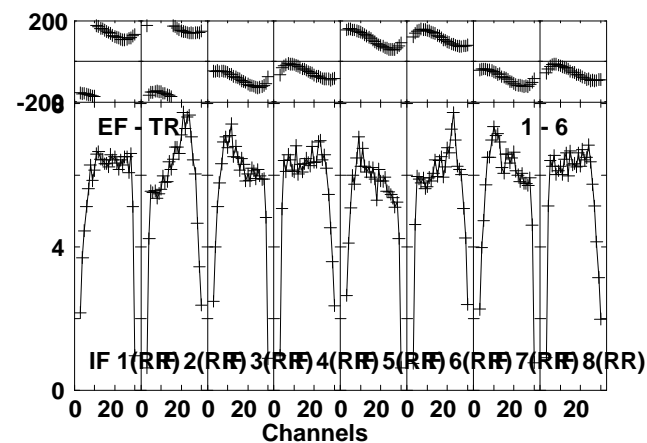
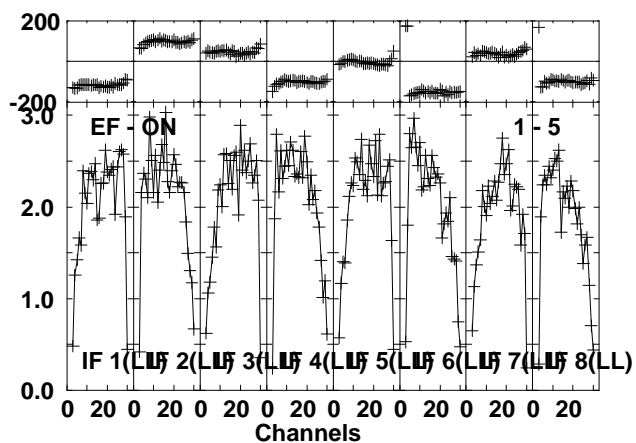
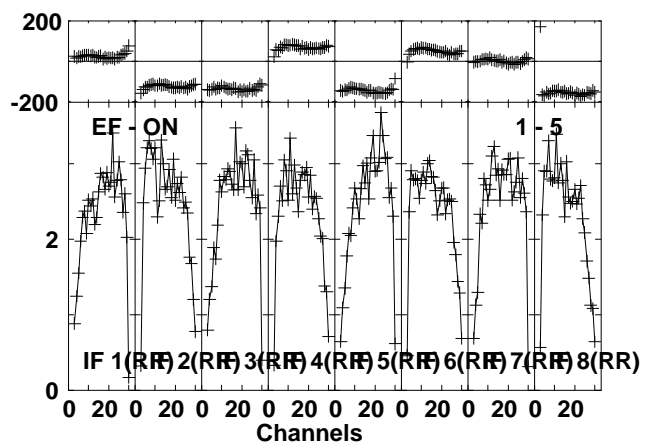
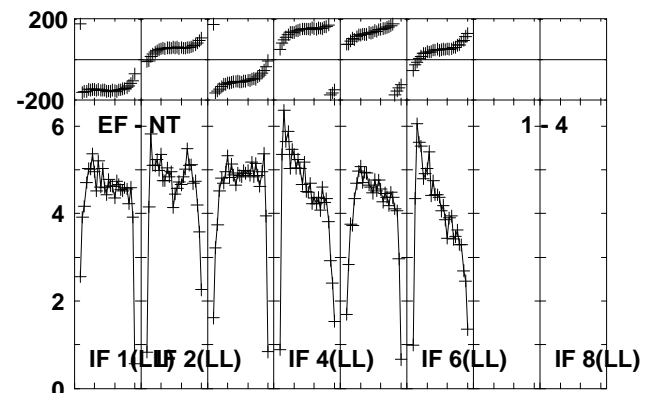
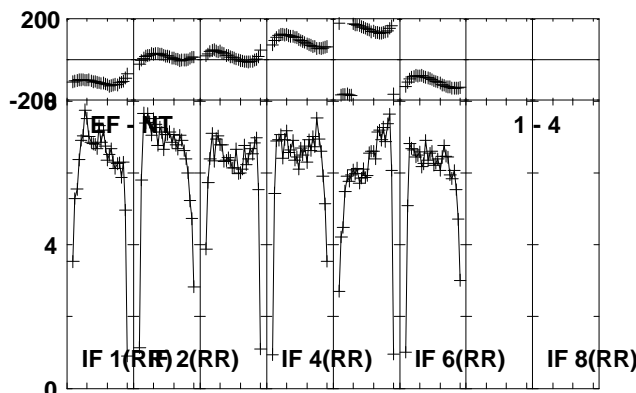
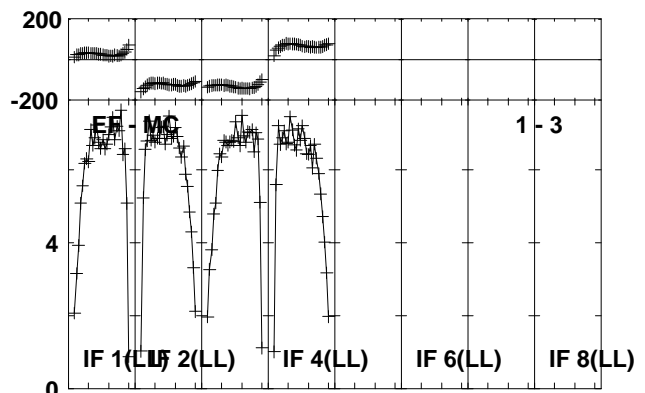
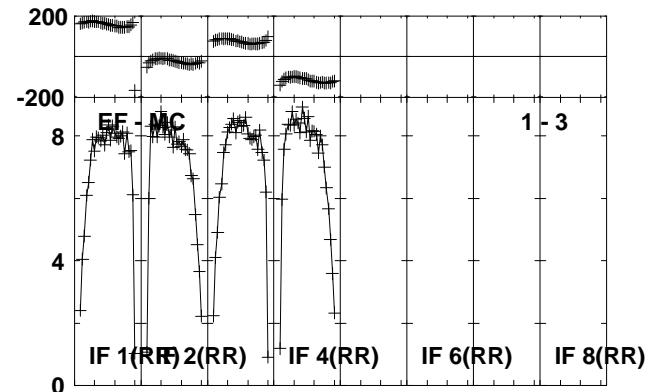
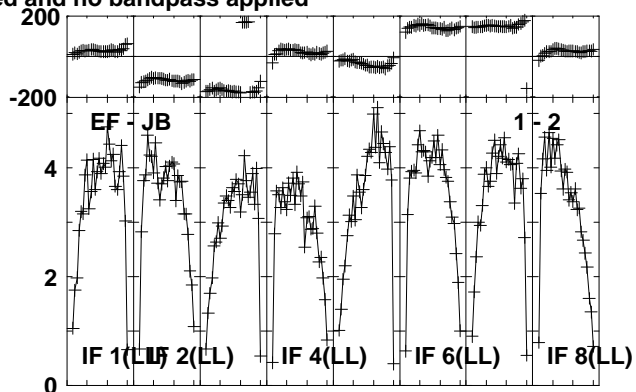
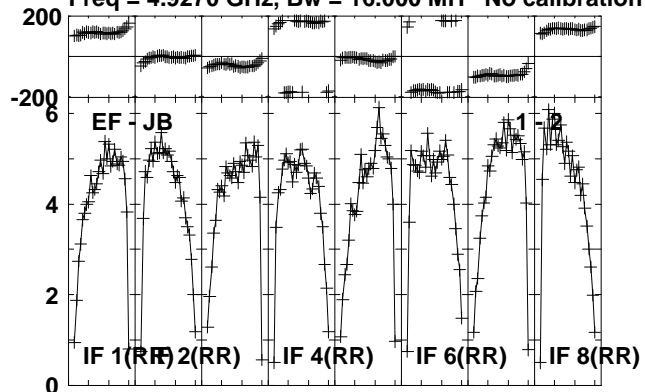

Lower frame: Milli Ampl Jy Top frame: Phas deg  
Vector averaged cross-power spectrum Several baselines displayed  
Timerange: 00/15:45:38 to 00/15:47:04

Plot file version 34 created 24-OCT-2012 20:58:31

J1825-0737 EY017B.UVDATA.1

Freq = 4.9270 GHz, Bw = 16.000 MH No calibration applied and no bandpass applied

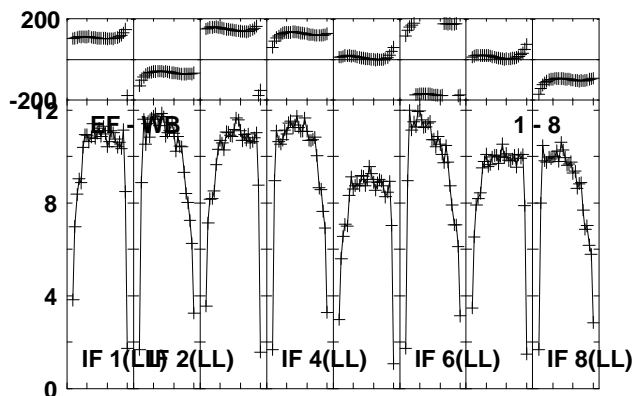
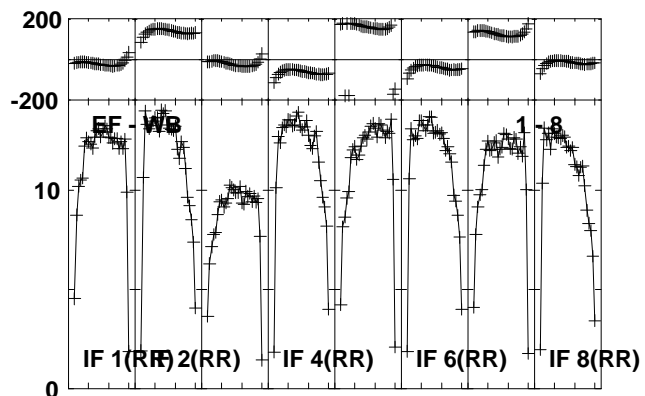
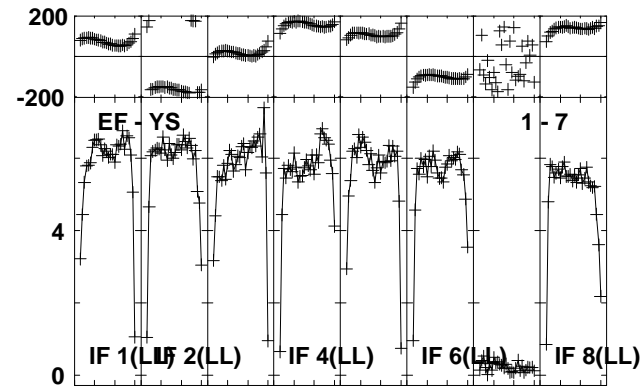
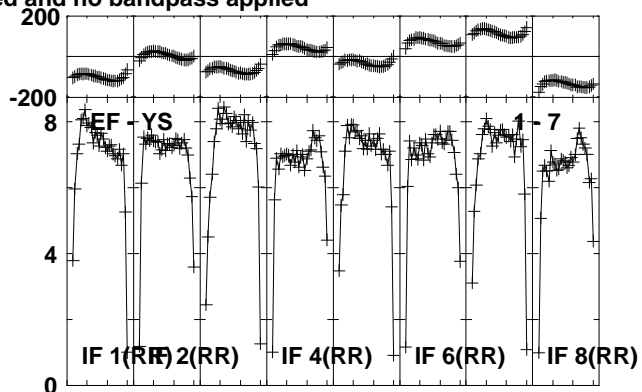
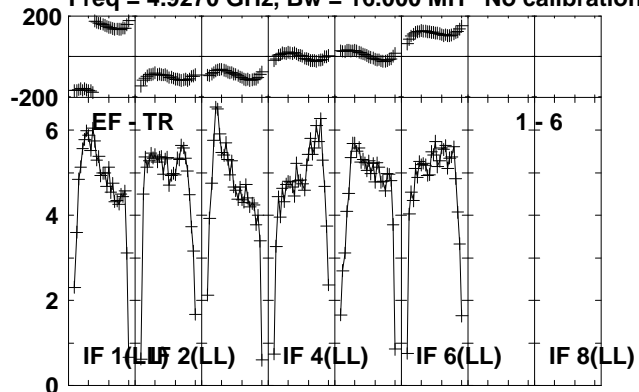

Lower frame: Milli Amp Jy Top frame: Phas deg  
Vector averaged cross-power spectrum Several baselines displayed  
Timerange: 00/15:45:38 to 00/15:47:04

Plot file version 35 created 24-OCT-2012 20:58:32

G23.6-0.03 EY017B.UVDATA.1

Freq = 4.9270 GHz, Bw = 16.000 MH No calibration applied and no bandpass applied

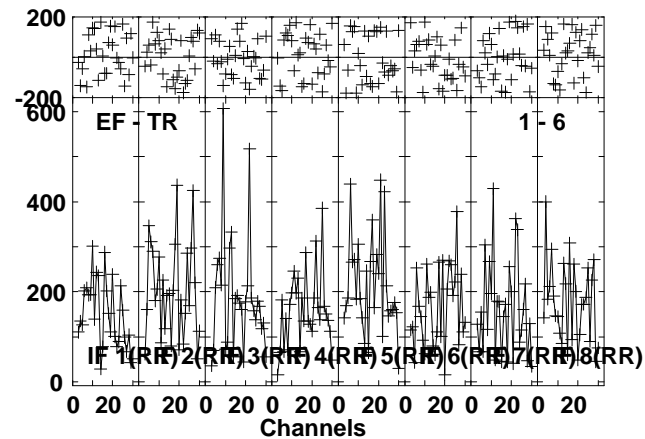
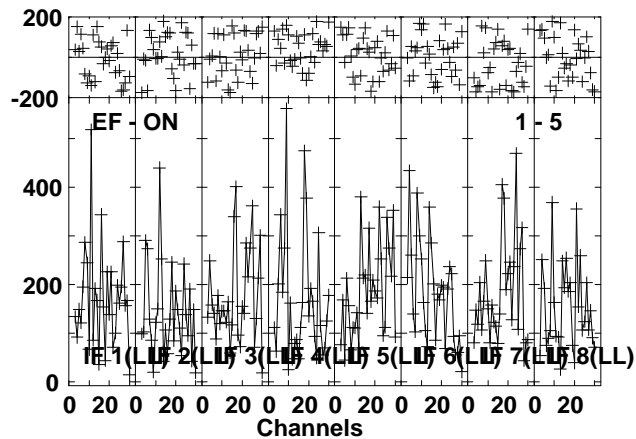
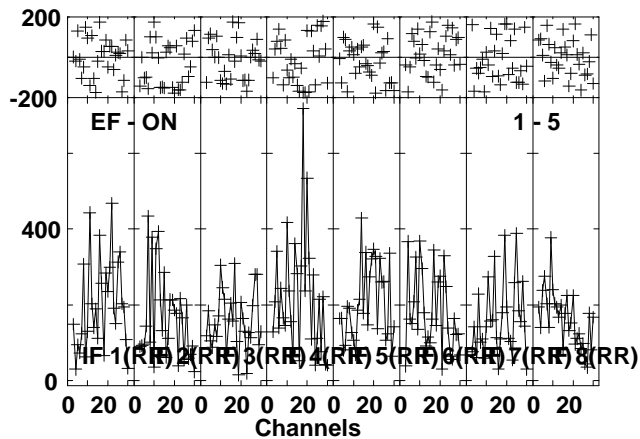
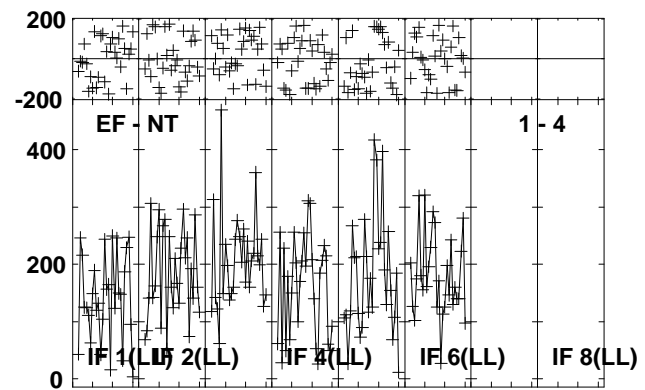
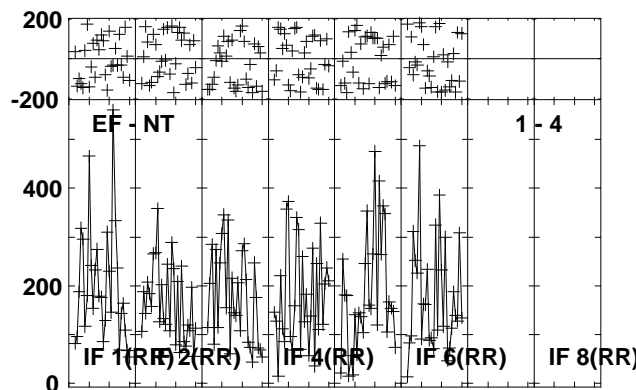
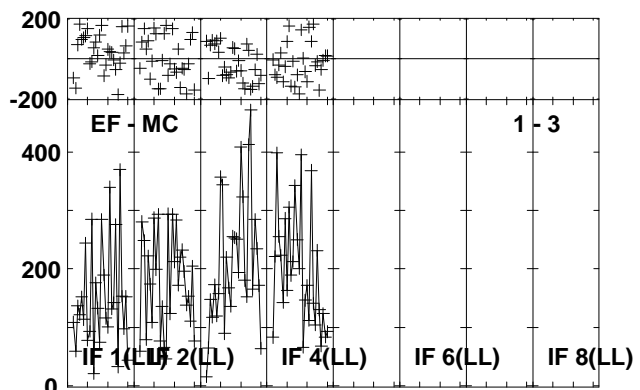
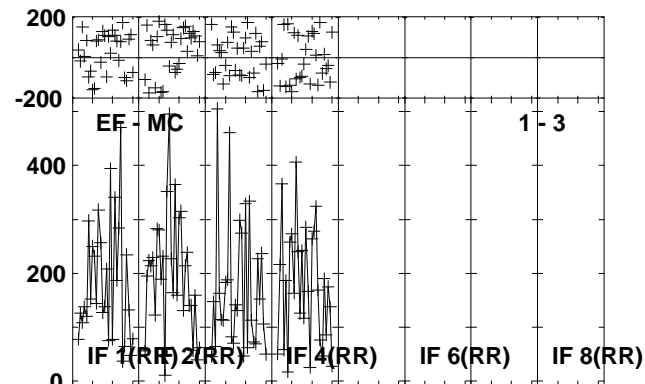
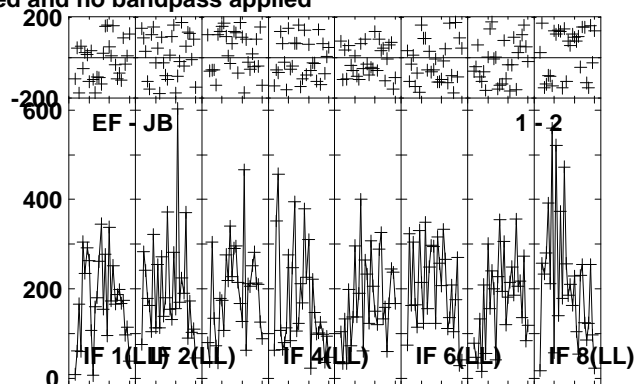
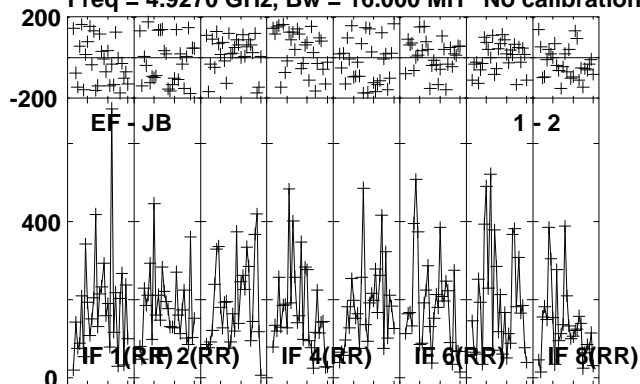

Lower frame: Micro Ampl Jy Top frame: Phas deg  
Vector averaged cross-power spectrum Several baselines displayed  
Timerange: 00/15:47:08 to 00/15:49:34

Plot file version 36 created 24-OCT-2012 20:58:32

G23.6-0.03 EY017B.UVDATA.1

Freq = 4.9270 GHz, Bw = 16.000 MH No calibration applied and no bandpass applied

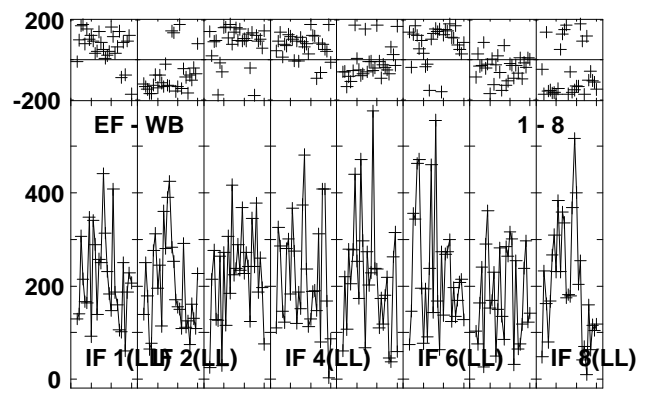
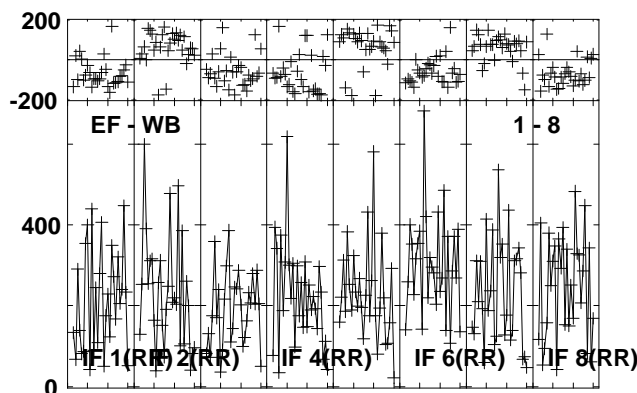
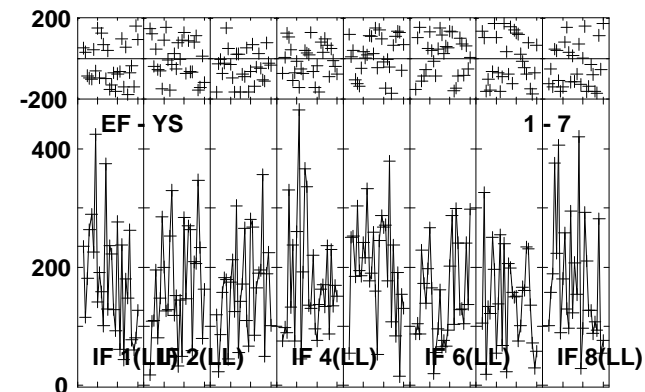
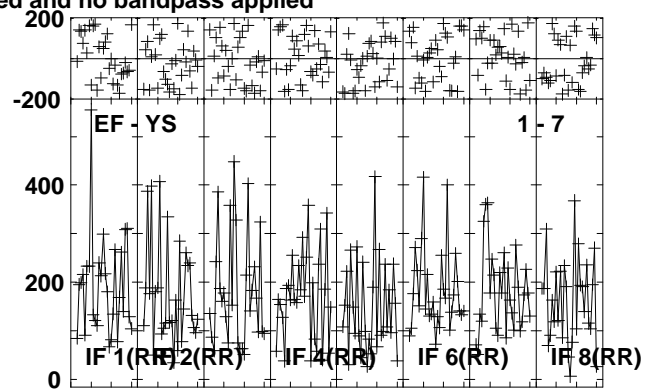
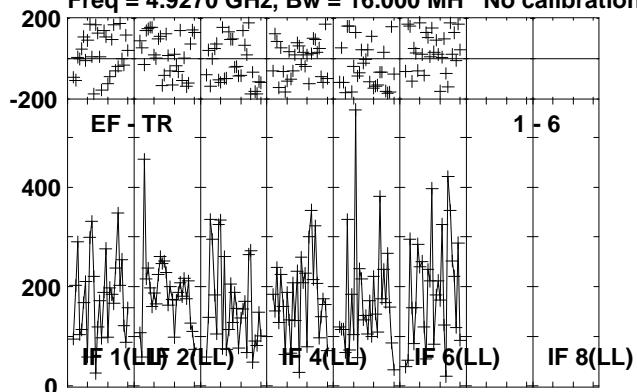

Lower frame: Micro Ampl Jy Top frame: Phas deg  
Vector averaged cross-power spectrum Several baselines displayed  
Timerange: 00/15:47:08 to 00/15:49:34



Plot file version 37 created 24-OCT-2012 20:58:33

J1825-0737 EY017B.UVDATA.1

Freq = 4.9270 GHz, Bw = 16.000 MH No calibration applied and no bandpass applied

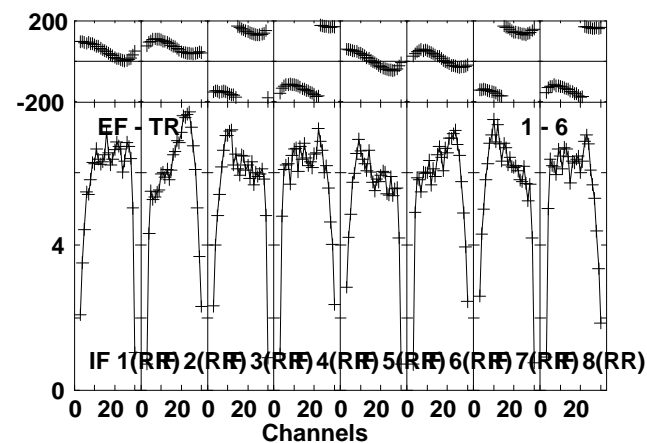
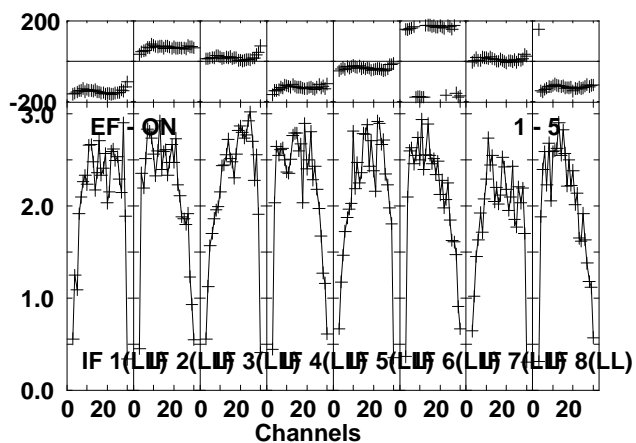
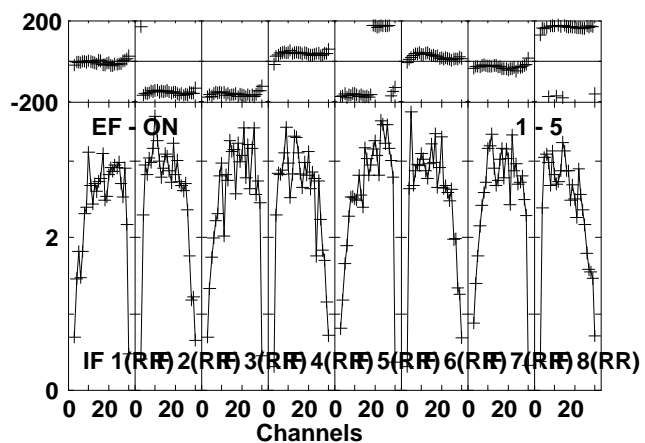
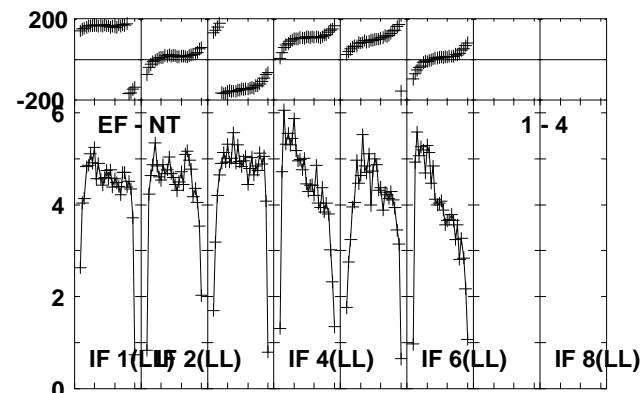
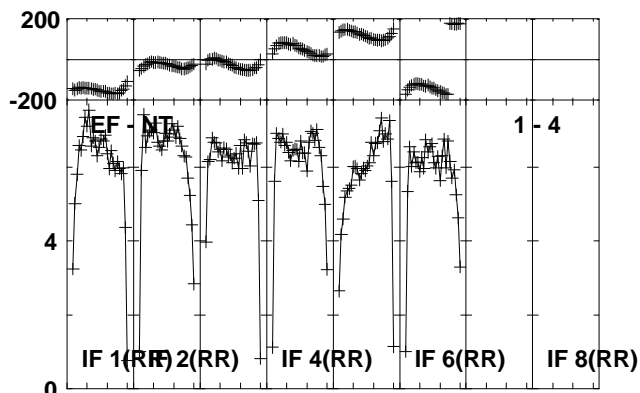
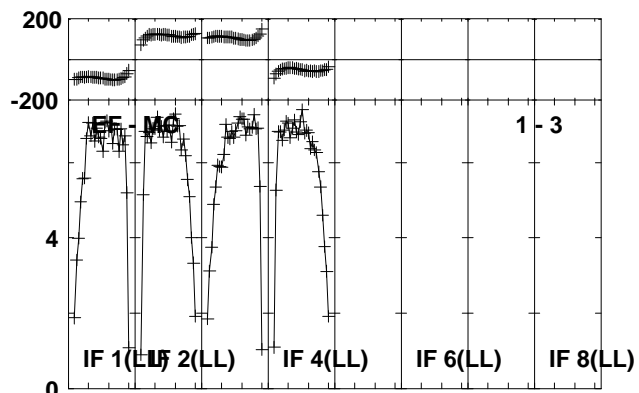
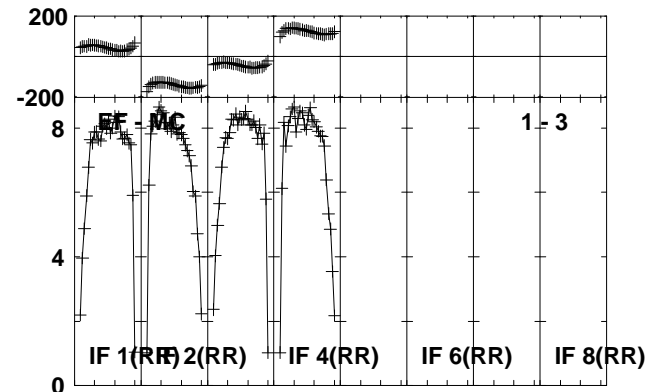
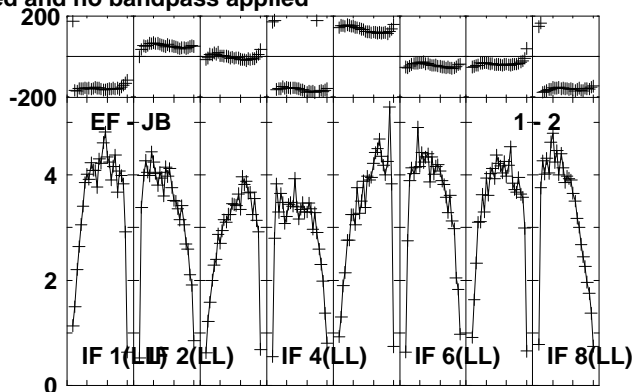
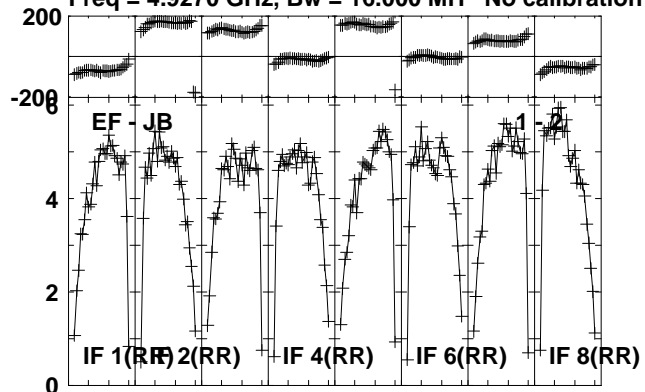

Lower frame: Milli Ampl Jy Top frame: Phas deg  
Vector averaged cross-power spectrum Several baselines displayed  
Timerange: 00/15:49:38 to 00/15:51:04

Plot file version 38 created 24-OCT-2012 20:58:33

J1825-0737 EY017B.UVDATA.1

Freq = 4.9270 GHz, Bw = 16.000 MH No calibration applied and no bandpass applied

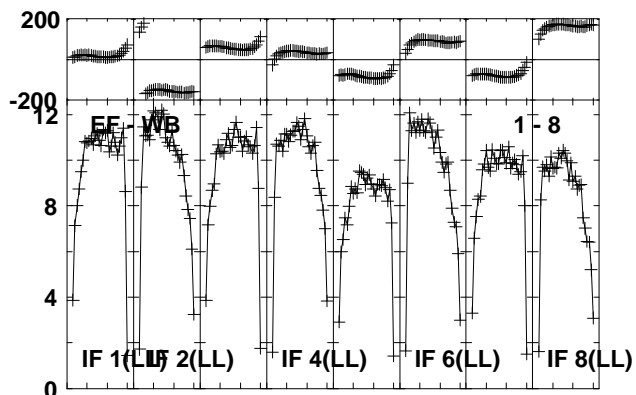
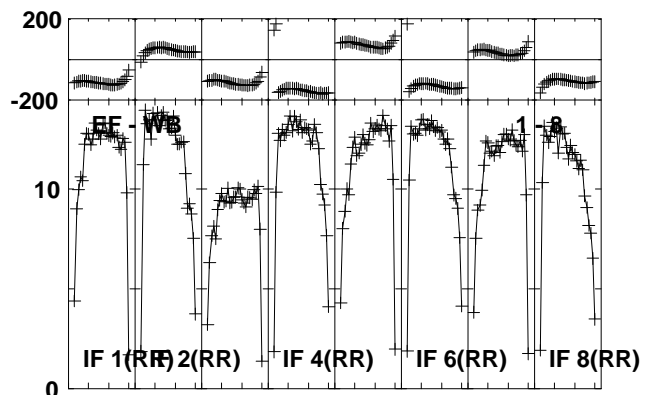
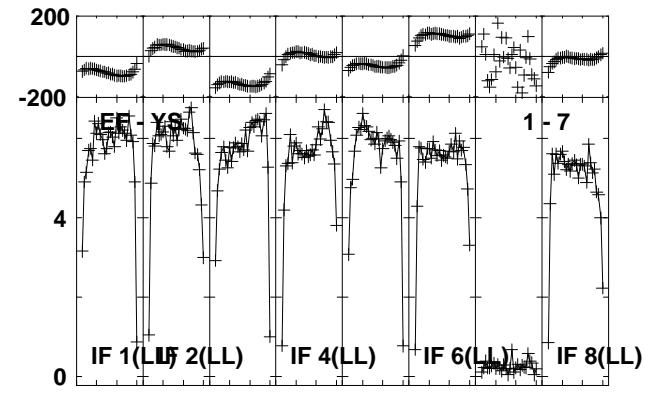
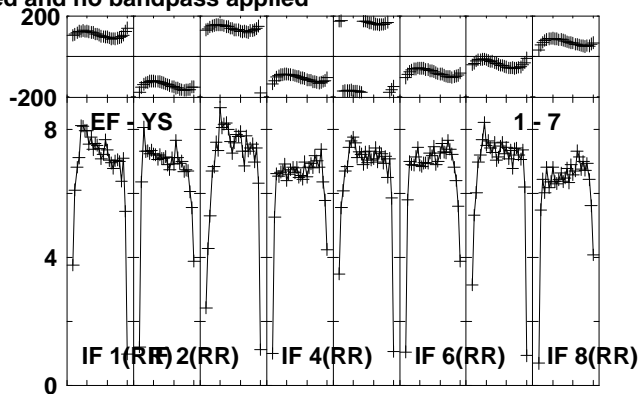
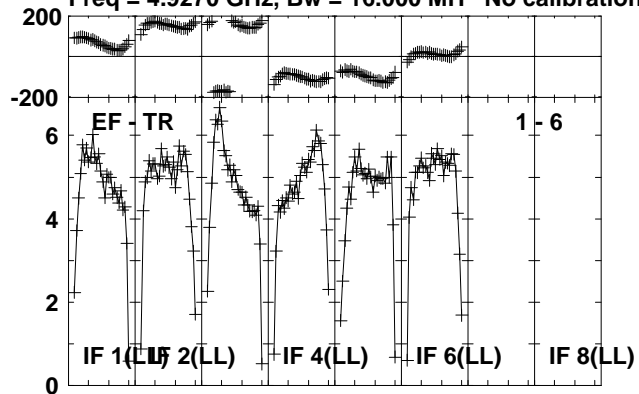

Lower frame: Milli Ampl Jy Top frame: Phas deg  
Vector averaged cross-power spectrum Several baselines displayed  
Timerange: 00/15:49:38 to 00/15:51:04

Plot file version 39 created 24-OCT-2012 20:58:34

G23.6-0.03 EY017B.UVDATA.1

Freq = 4.9270 GHz, Bw = 16.000 MH No calibration applied and no bandpass applied

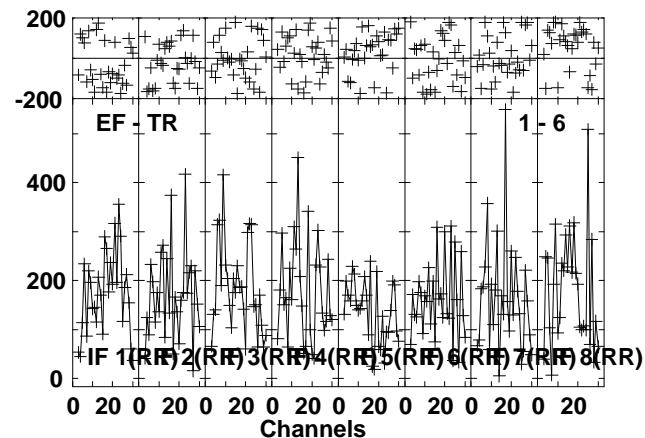
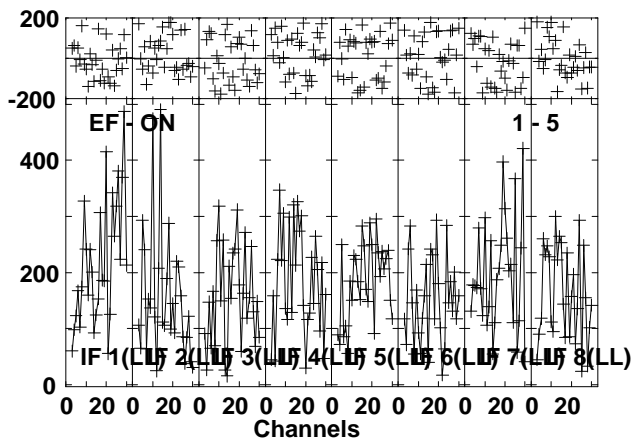
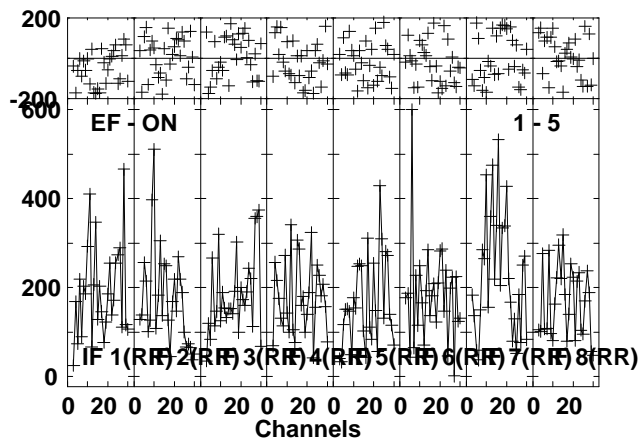
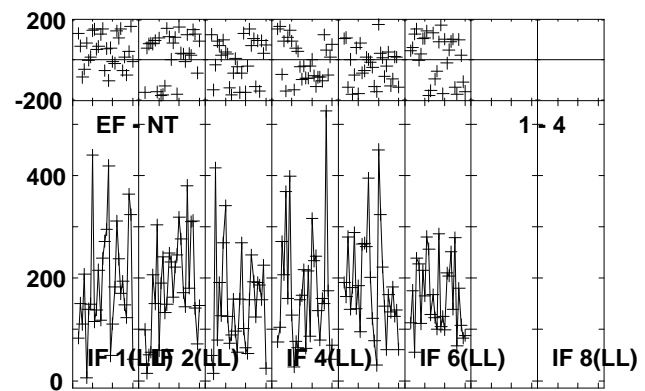
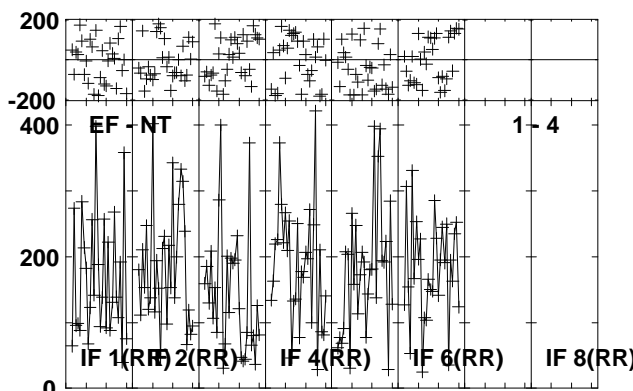
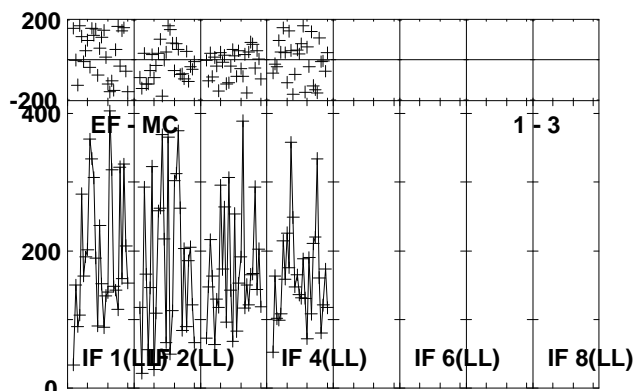
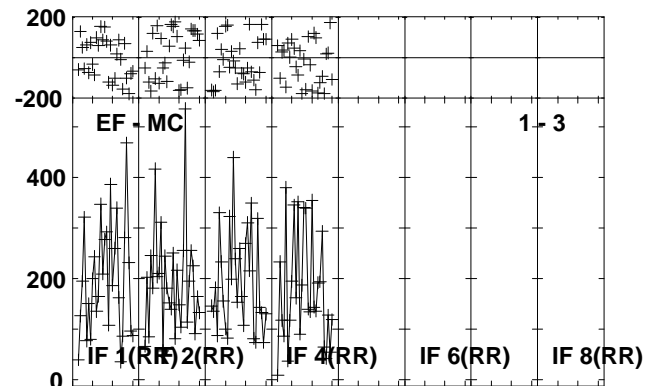
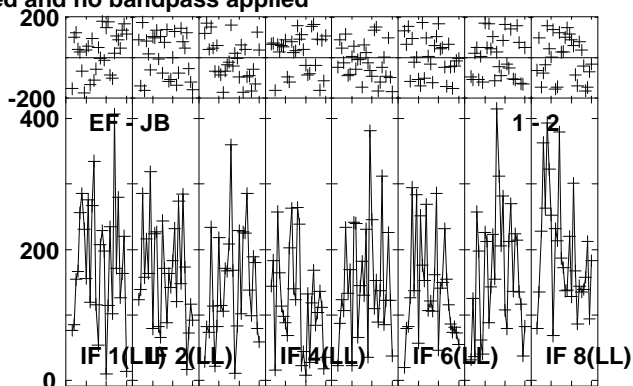
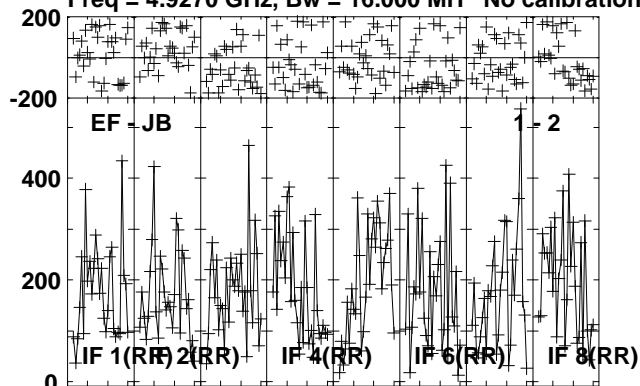

Lower frame: Micro Ampl Jy Top frame: Phas deg  
 Vector averaged cross-power spectrum Several baselines displayed  
 Timerange: 00/15:51:08 to 00/15:53:34

Plot file version 40 created 24-OCT-2012 20:58:35

G23.6-0.03 EY017B.UVDATA.1

Freq = 4.9270 GHz, Bw = 16.000 MH No calibration applied and no bandpass applied

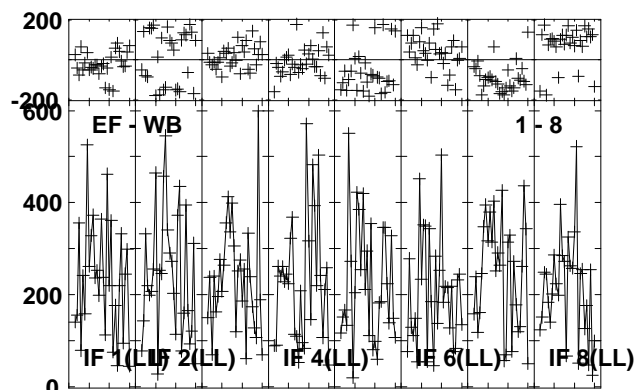
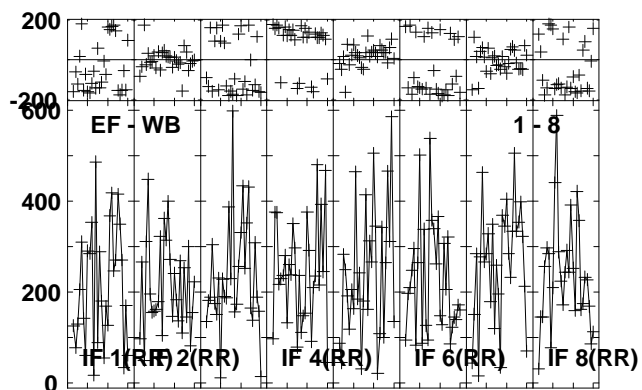
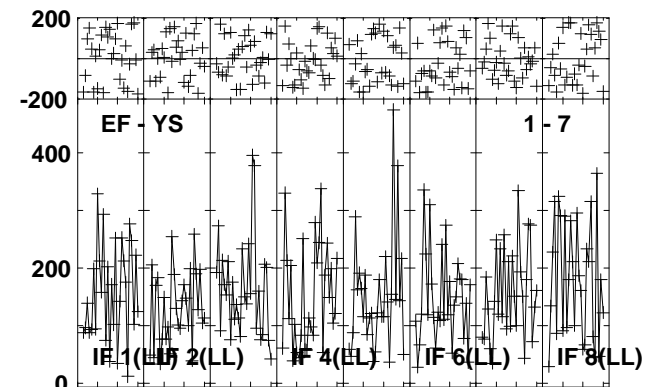
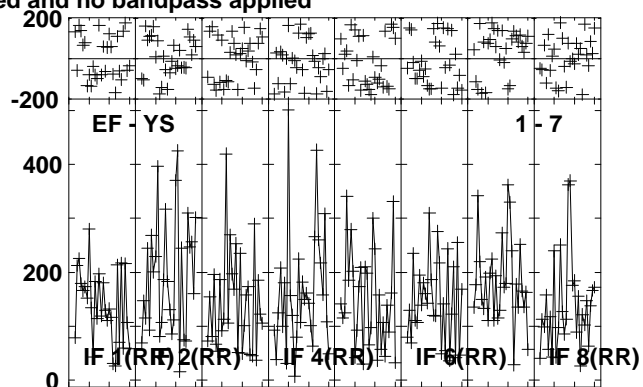
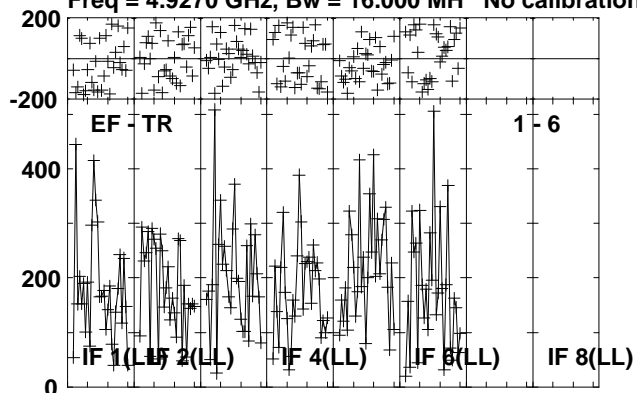

Lower frame: Micro Ampl Jy Top frame: Phas deg  
Vector averaged cross-power spectrum Several baselines displayed  
Timerange: 00/15:51:08 to 00/15:53:34

Plot file version 41 created 24-OCT-2012 20:58:35

J1825-0737 EY017B.UVDATA.1

Freq = 4.9270 GHz, Bw = 16.000 MH No calibration applied and no bandpass applied

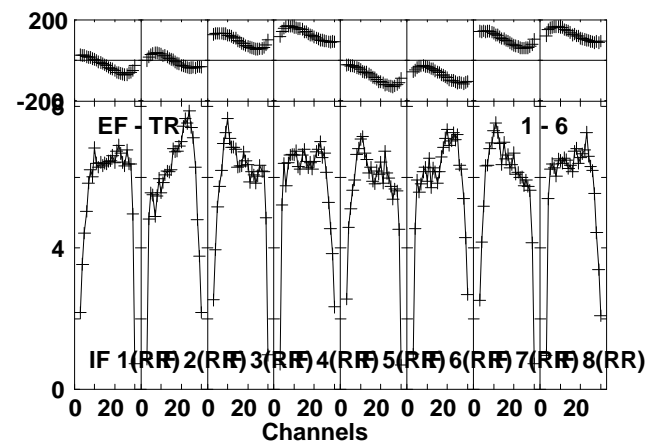
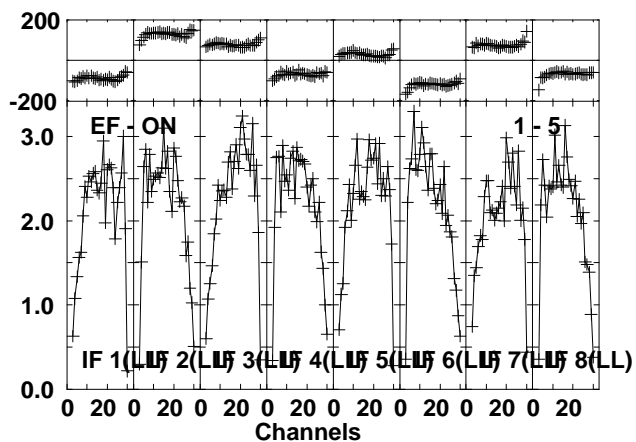
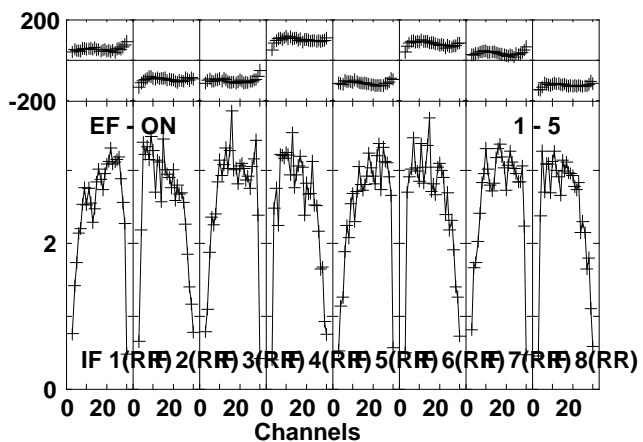
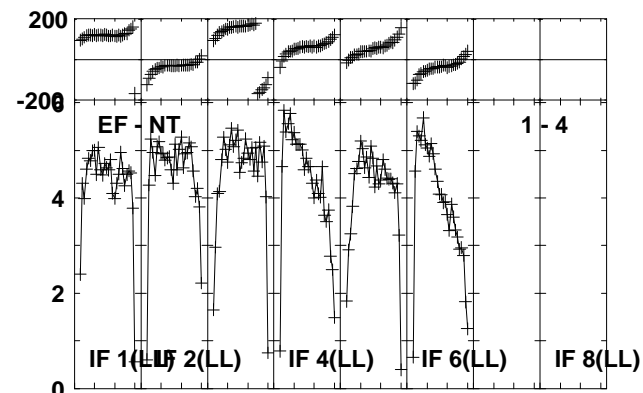
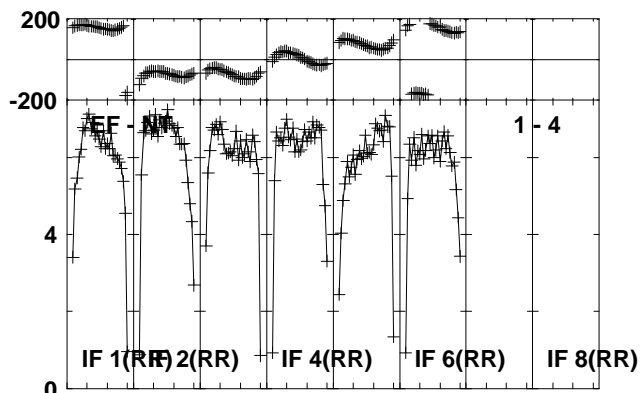
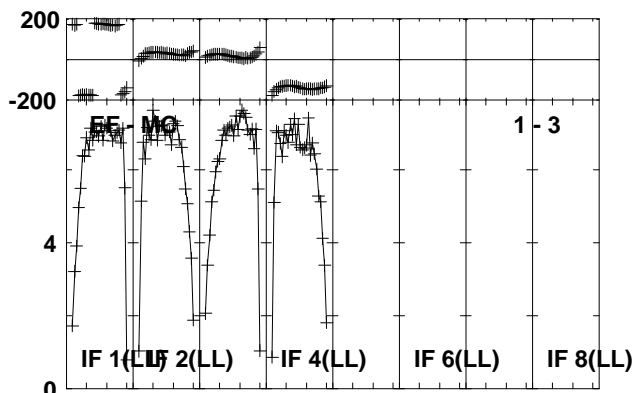
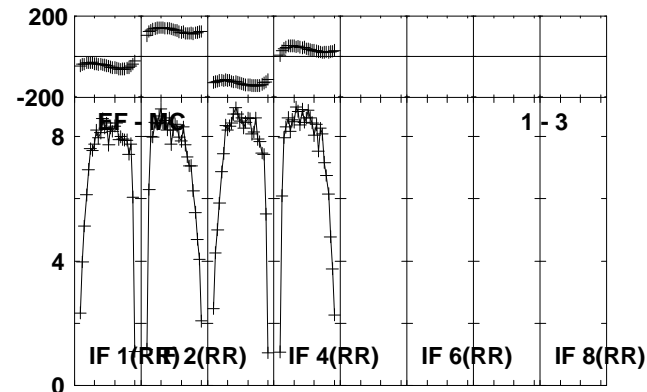
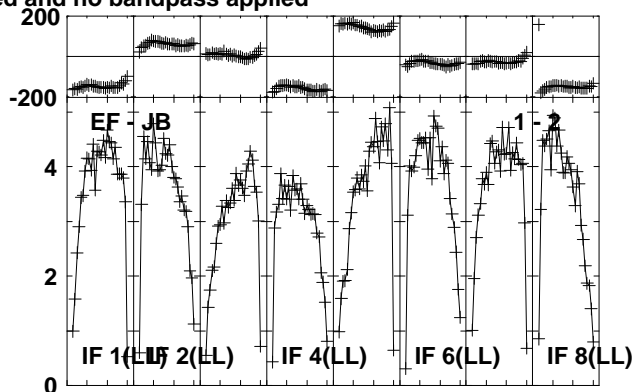
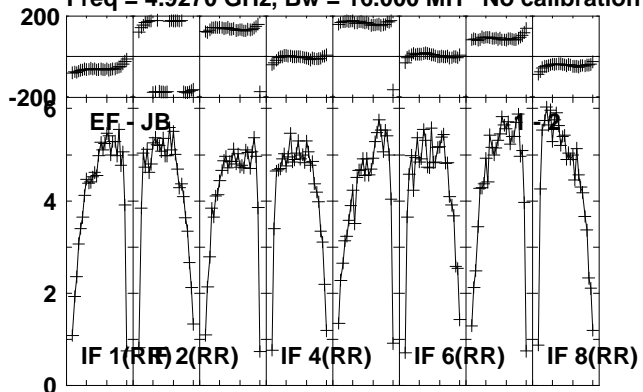

Lower frame: Milli Ampl Jy Top frame: Phas deg  
Vector averaged cross-power spectrum Several baselines displayed  
Timerange: 00/15:53:38 to 00/15:55:04

Plot file version 42 created 24-OCT-2012 20:58:36

J1825-0737 EY017B.UVDATA.1

Freq = 4.9270 GHz, Bw = 16.000 MH No calibration applied and no bandpass applied

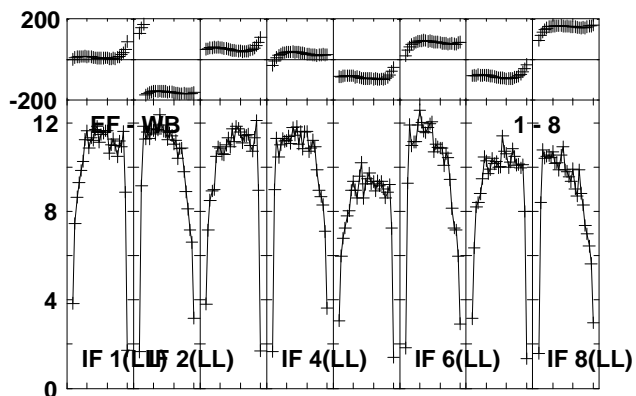
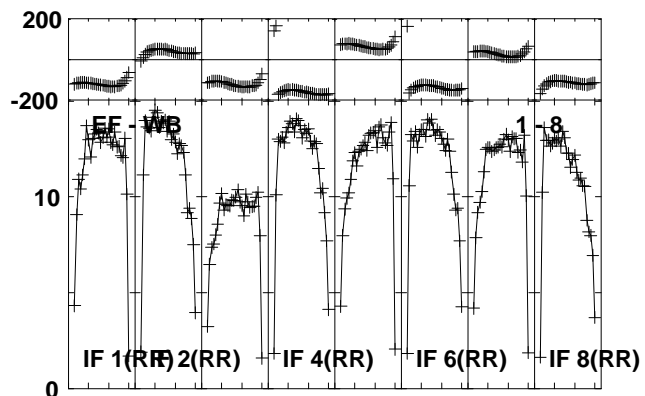
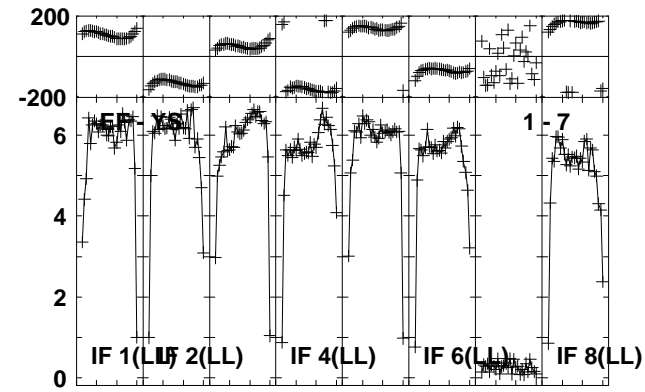
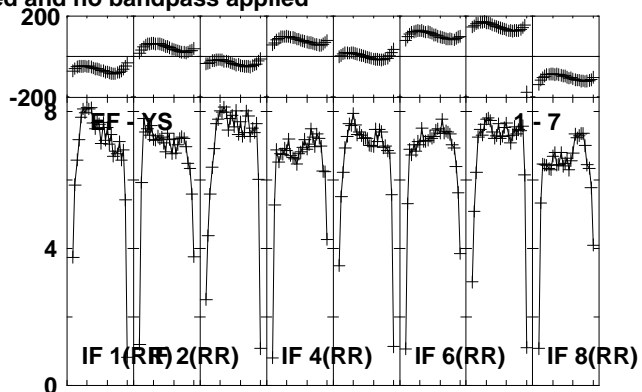
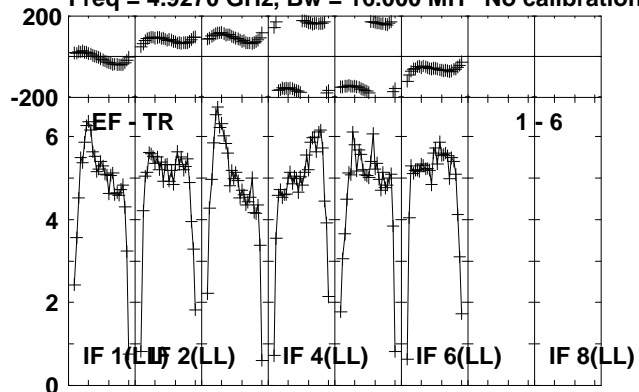

Lower frame: Milli Ampl Jy Top frame: Phas deg  
Vector averaged cross-power spectrum Several baselines displayed  
Timerange: 00/15:53:38 to 00/15:55:04

Plot file version 43 created 24-OCT-2012 20:58:36

G23.6-0.03 EY017B.UVDATA.1

Freq = 4.9270 GHz, Bw = 16.000 MH No calibration applied and no bandpass applied

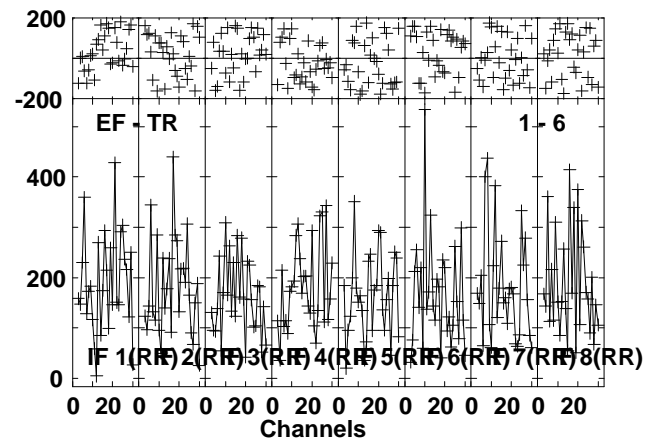
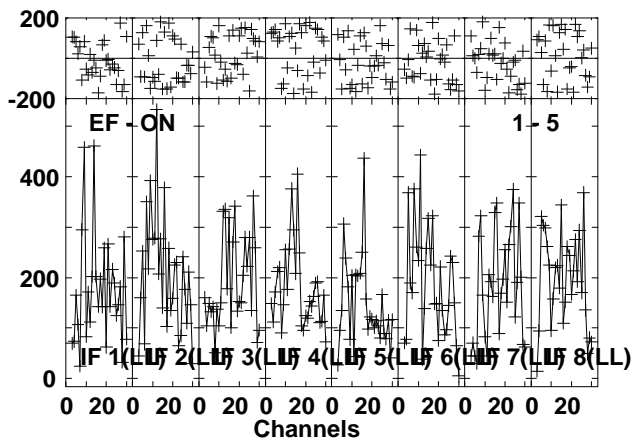
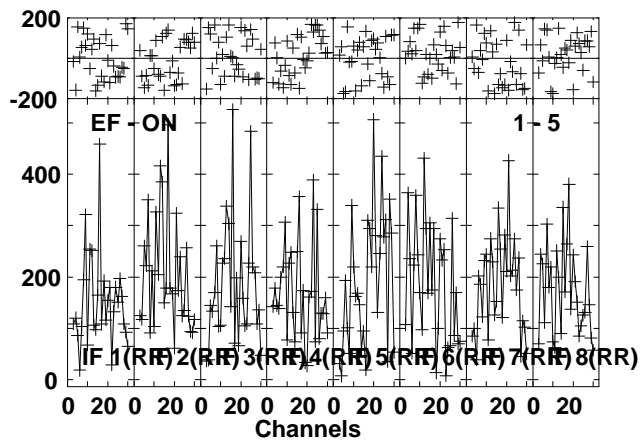
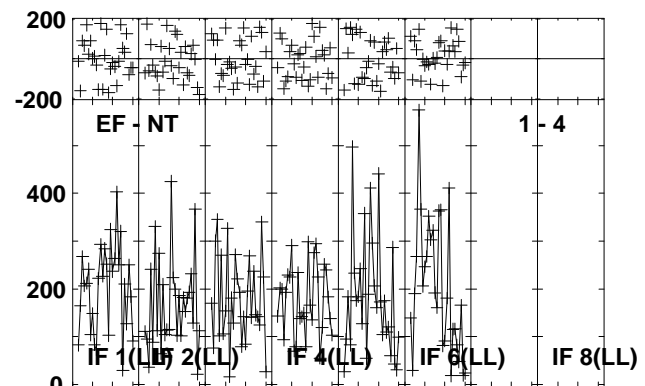
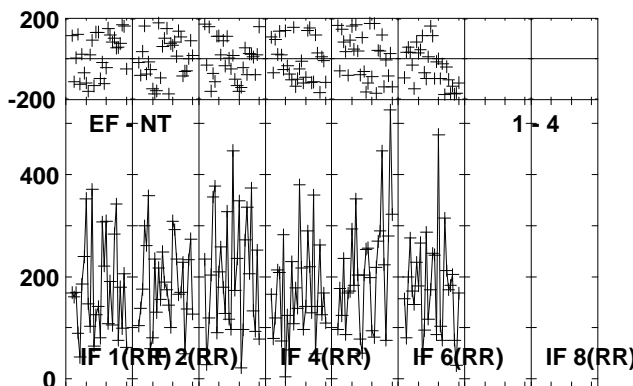
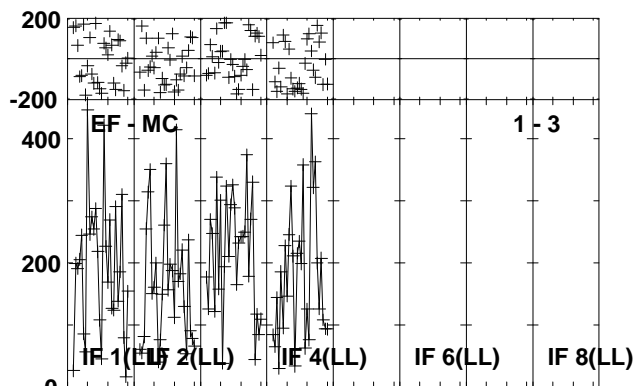
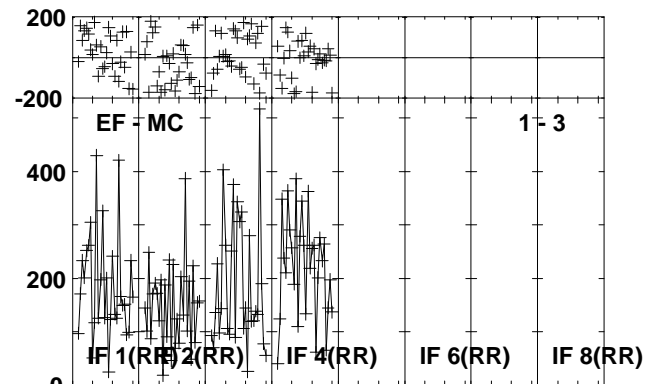
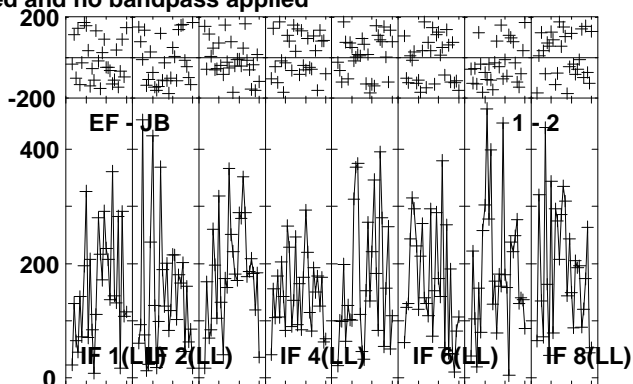
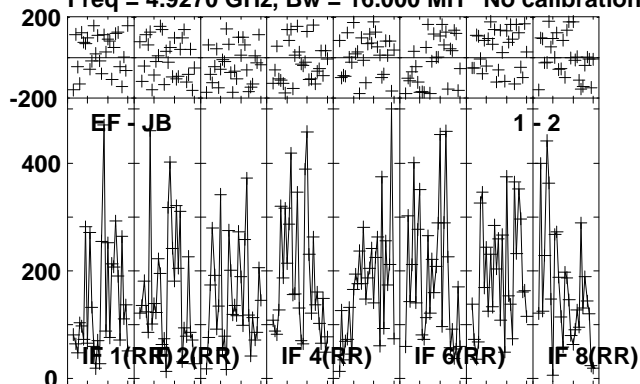

Lower frame: Micro Ampl Jy Top frame: Phas deg  
Vector averaged cross-power spectrum Several baselines displayed  
Timerange: 00/15:55:08 to 00/15:57:34

Plot file version 44 created 24-OCT-2012 20:58:37

G23.6-0.03 EY017B.UVDATA.1

Freq = 4.9270 GHz, Bw = 16.000 MH No calibration applied and no bandpass applied

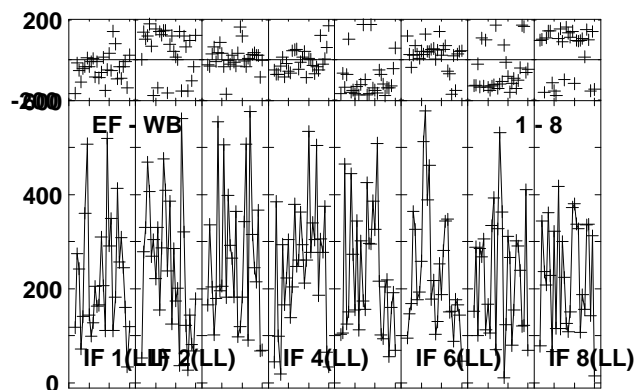
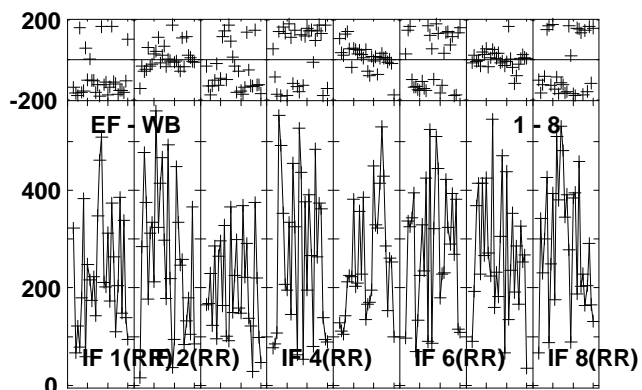
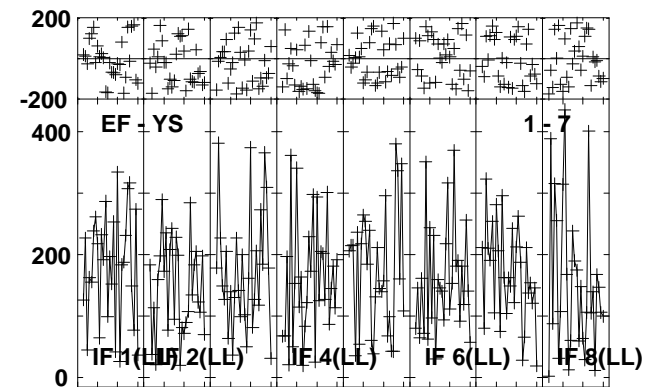
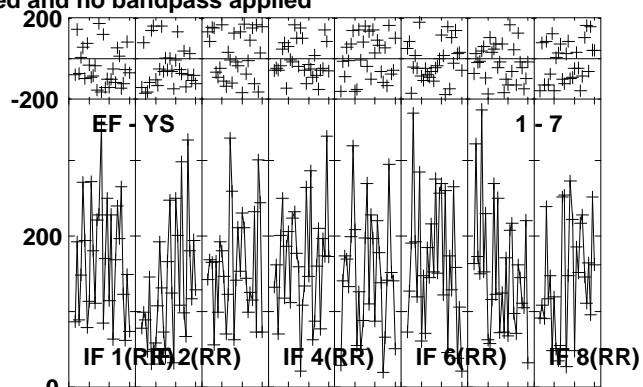
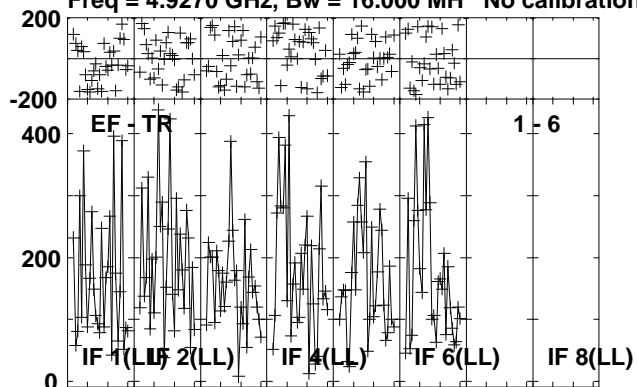

Lower frame: Micro Ampl Jy Top frame: Phas deg  
Vector averaged cross-power spectrum Several baselines displayed  
Timerange: 00:15:55:08 to 00:15:57:34



Plot file version 45 created 24-OCT-2012 20:58:38

J1825-0737 EY017B.UVDATA.1

Freq = 4.9270 GHz, Bw = 16.000 MH No calibration applied and no bandpass applied

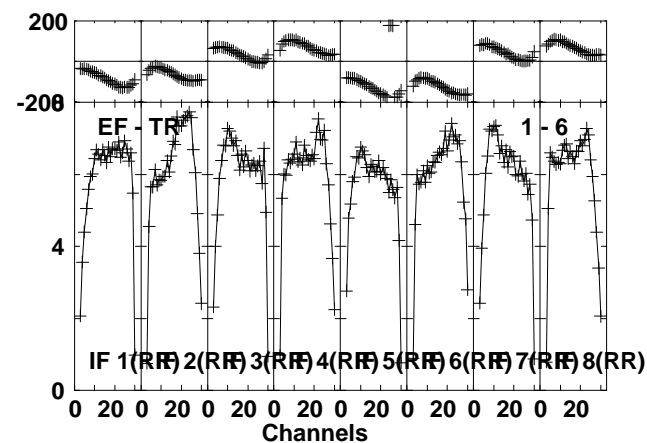
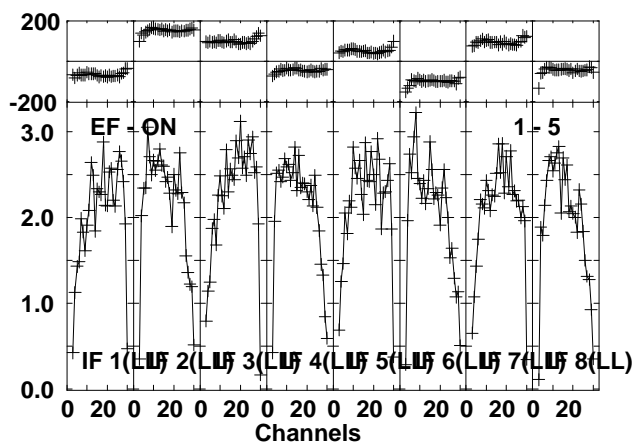
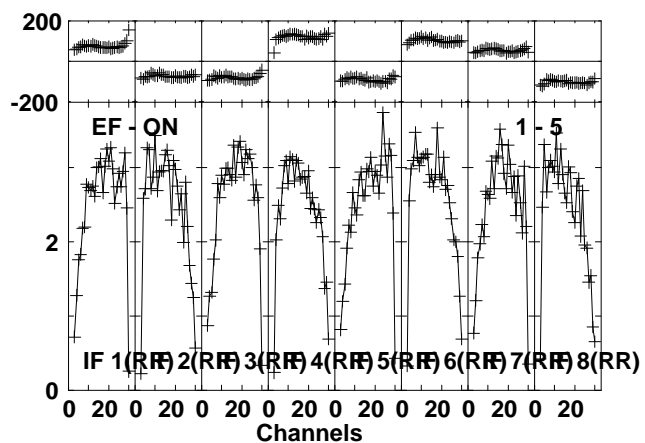
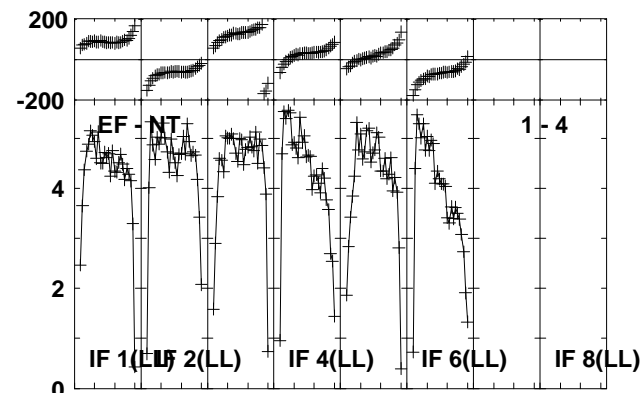
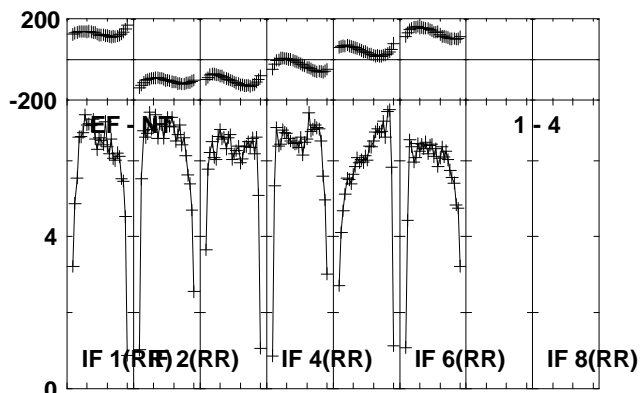
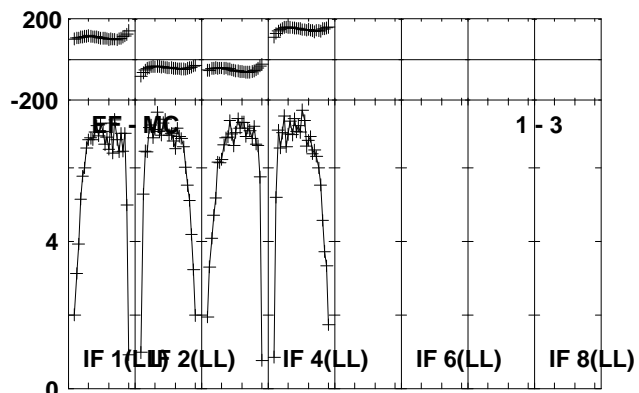
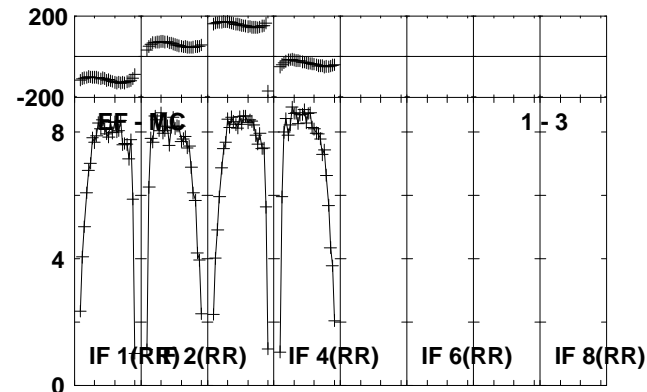
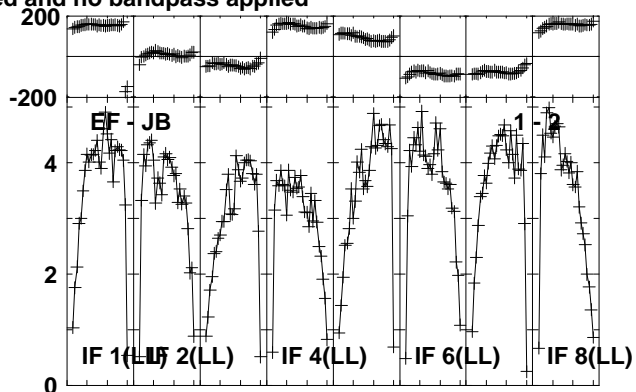
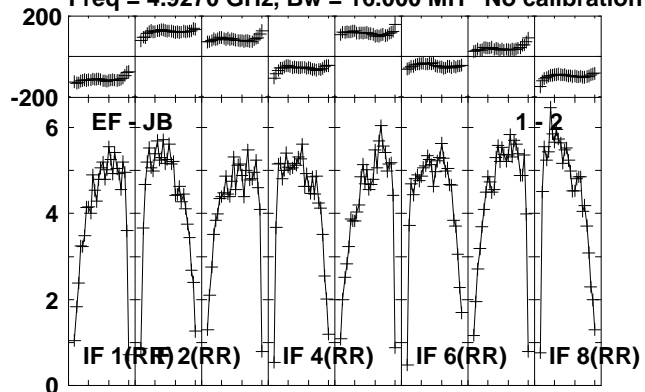

Lower frame: Milli Ampl Jy Top frame: Phas deg  
Vector averaged cross-power spectrum Several baselines displayed  
Timerange: 00/15:57:38 to 00/15:59:04

Plot file version 46 created 24-OCT-2012 20:58:38

J1825-0737 EY017B.UVDATA.1

Freq = 4.9270 GHz, Bw = 16.000 MH No calibration applied and no bandpass applied

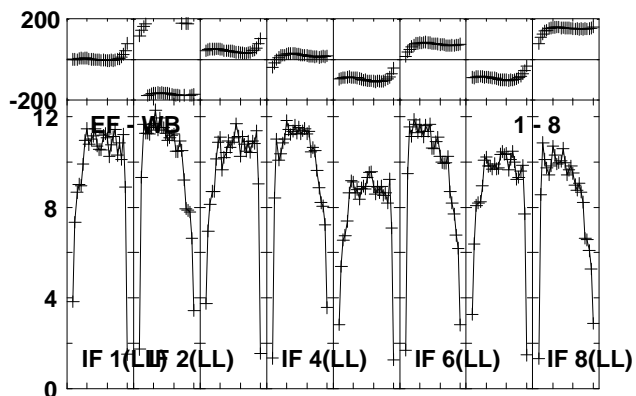
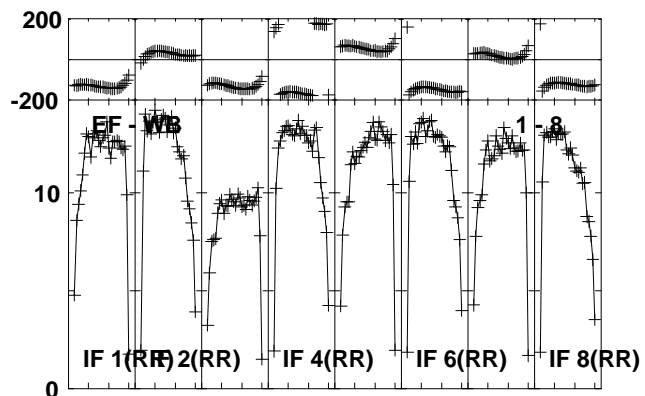
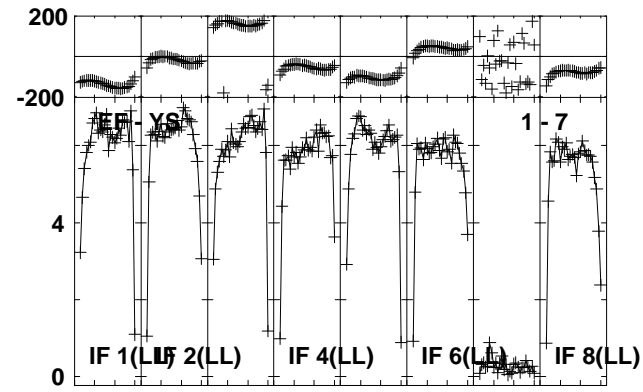
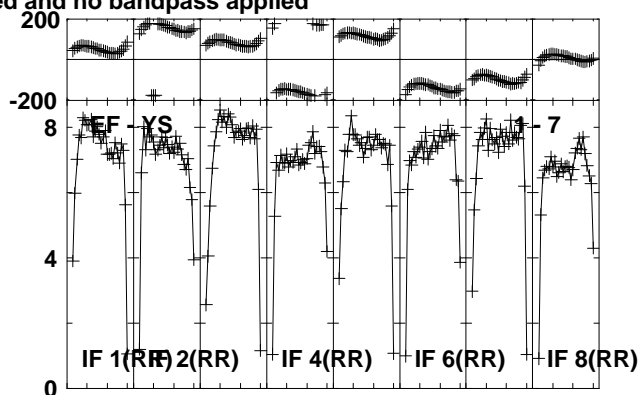
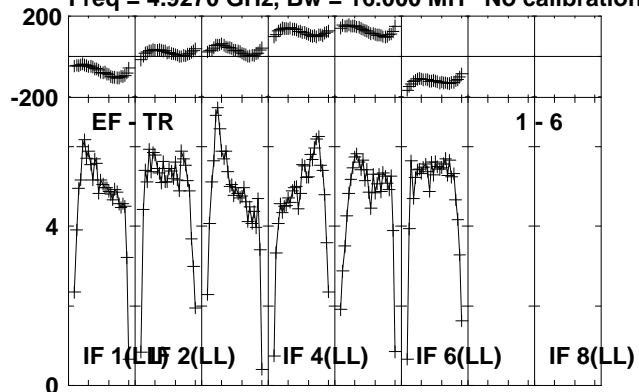

Lower frame: Milli Ampl Jy Top frame: Phas deg  
Vector averaged cross-power spectrum Several baselines displayed  
Timerange: 00/15:57:38 to 00/15:59:04



Plot file version 48 created 24-OCT-2012 20:58:39

J1831-0756 EY017B.UVDATA.1

Freq = 4.9270 GHz, Bw = 16.000 MH No calibration applied and no bandpass applied

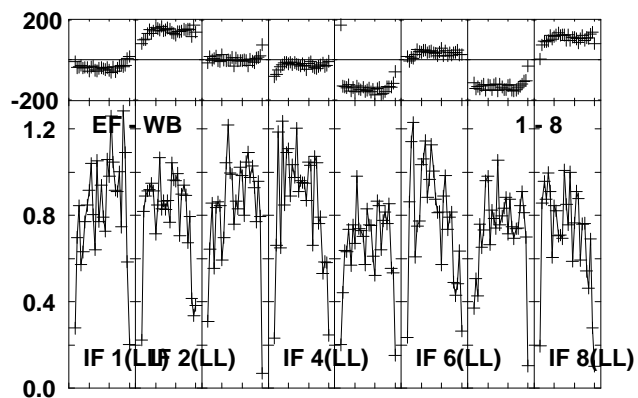
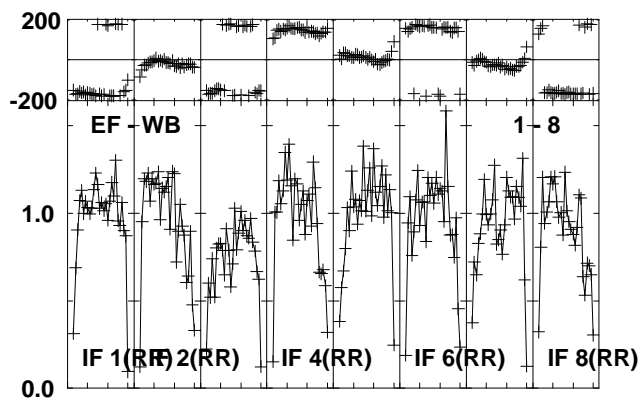
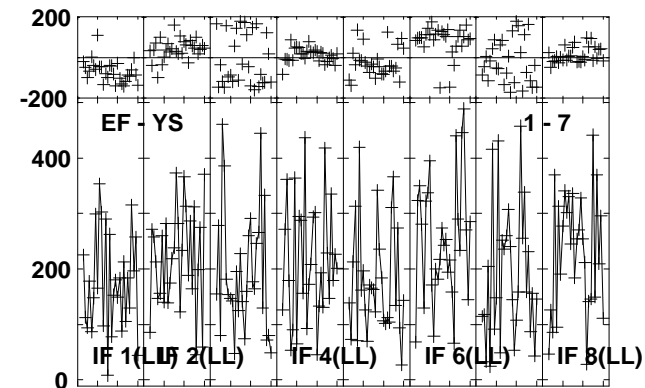
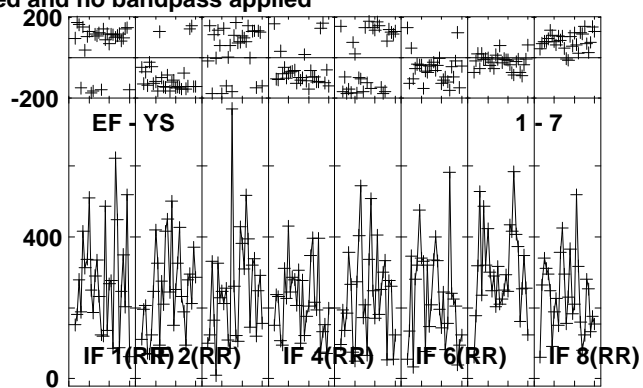
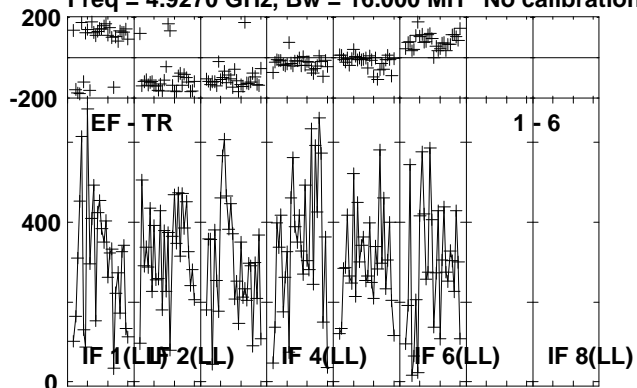

Lower frame: Micro Ampl Jy Top frame: Phas deg  
Vector averaged cross-power spectrum Several baselines displayed  
Timerange: 00/15:59:38 to 00/16:01:38

Plot file version 49 created 24-OCT-2012 20:58:40

J1825-0737 EY017B.UVDATA.1

Freq = 4.9270 GHz, Bw = 16.000 MH No calibration applied and no bandpass applied

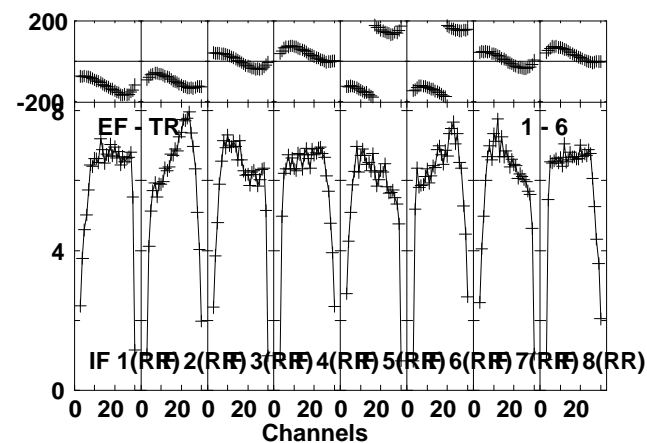
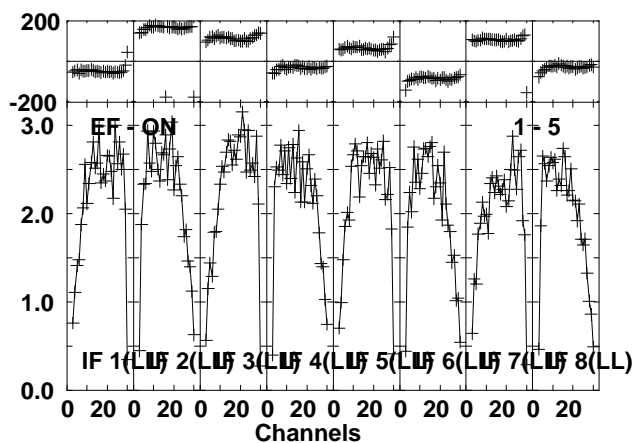
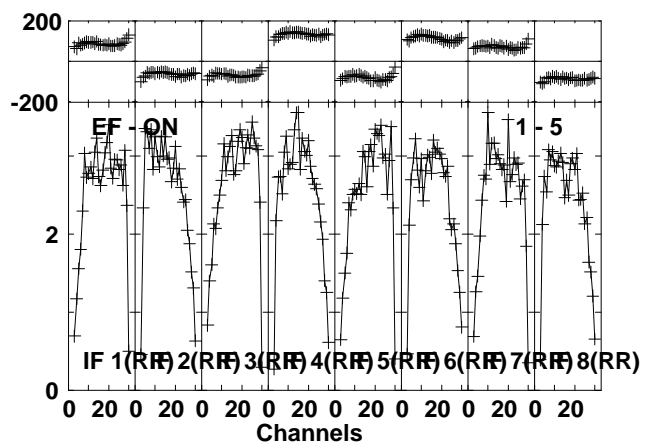
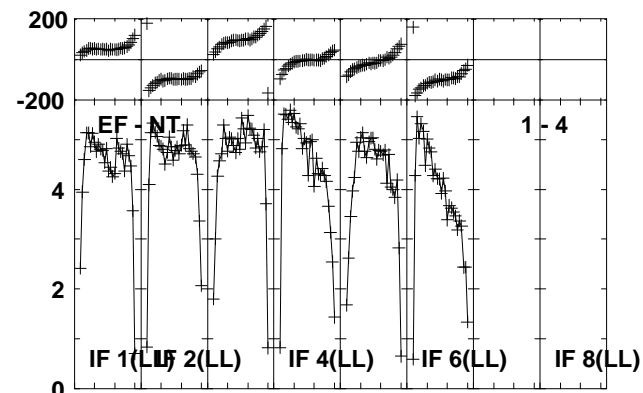
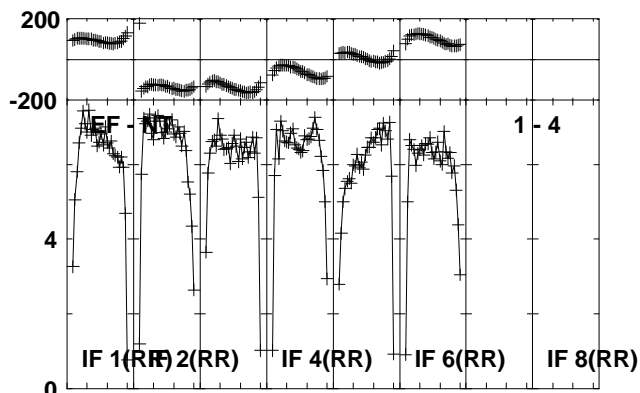
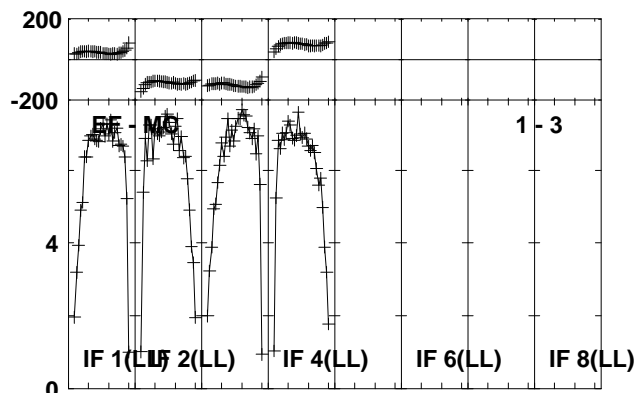
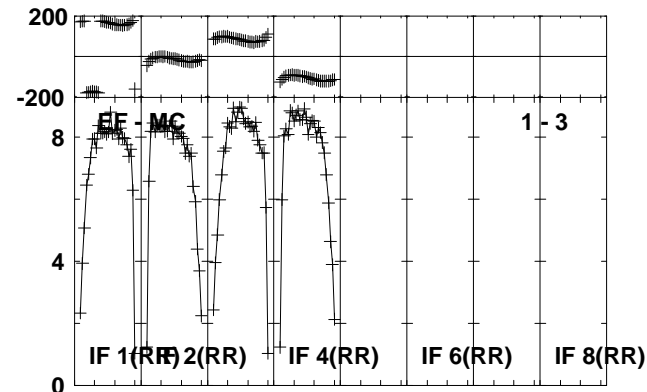
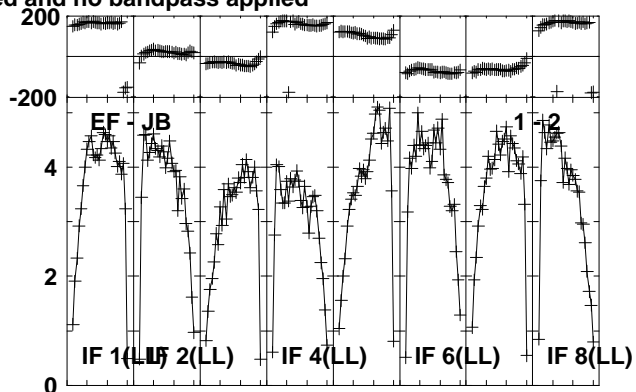
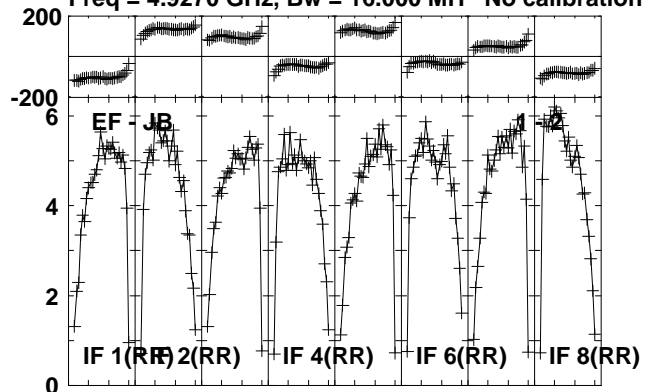

Lower frame: Milli Ampl Jy Top frame: Phas deg  
Vector averaged cross-power spectrum Several baselines displayed  
Timerange: 00/16:01:42 to 00/16:03:08

Plot file version 50 created 24-OCT-2012 20:58:40

J1825-0737 EY017B.UVDATA.1

Freq = 4.9270 GHz, Bw = 16.000 MH No calibration applied and no bandpass applied

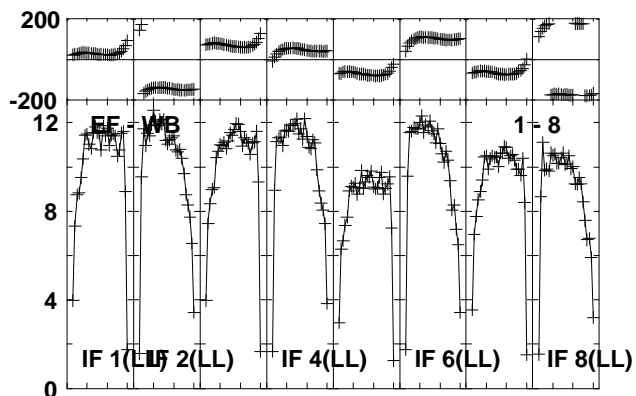
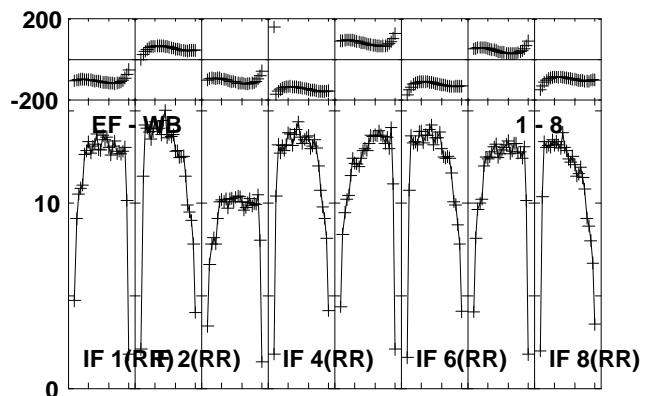
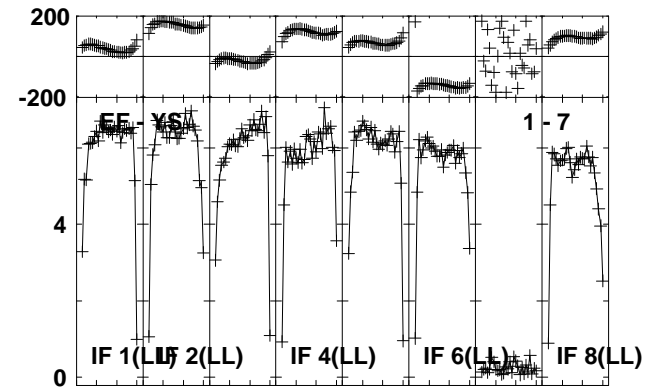
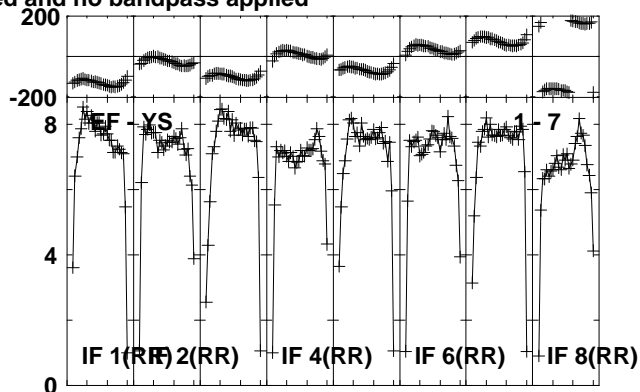
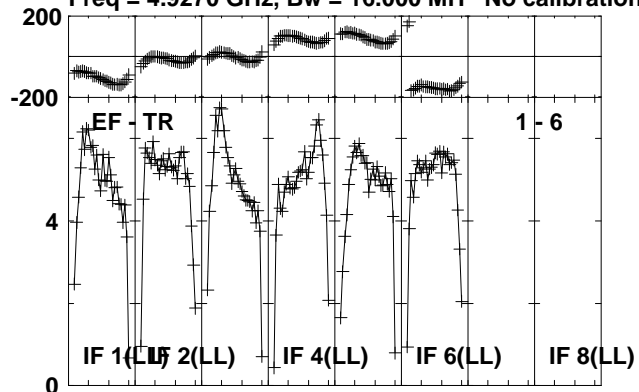

Lower frame: Milli Ampl Jy Top frame: Phas deg  
Vector averaged cross-power spectrum Several baselines displayed  
Timerange: 00/16:01:42 to 00/16:03:08

Plot file version 51 created 24-OCT-2012 20:58:41

G23.6-0.03 EY017B.UVDATA.1

Freq = 4.9270 GHz, Bw = 16.000 MH No calibration applied and no bandpass applied

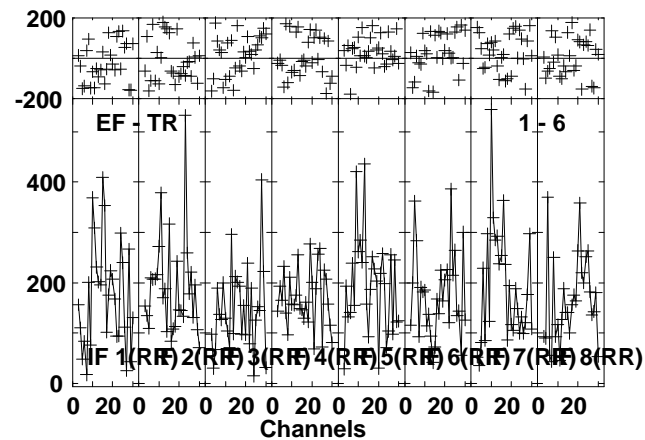
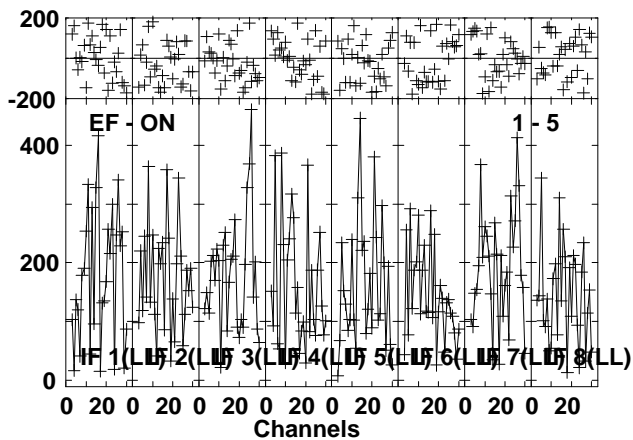
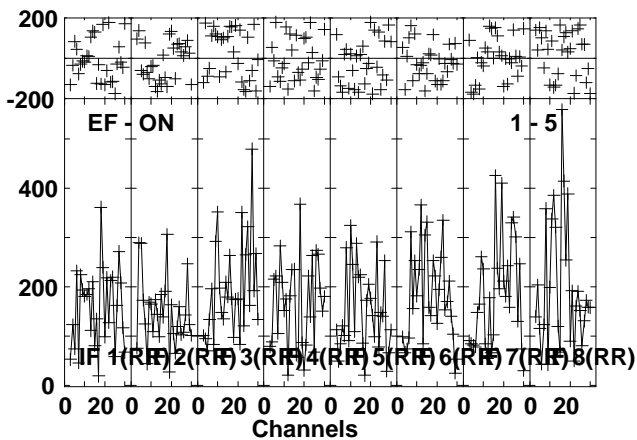
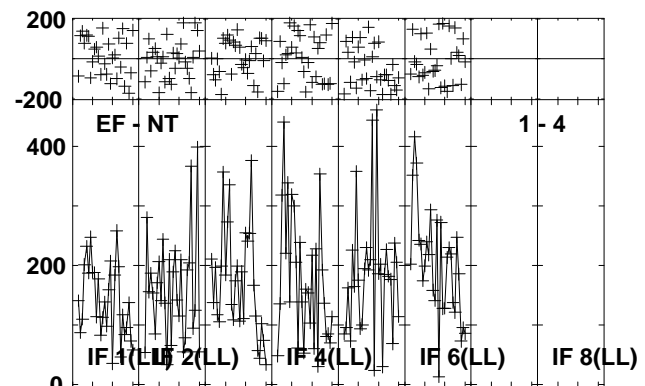
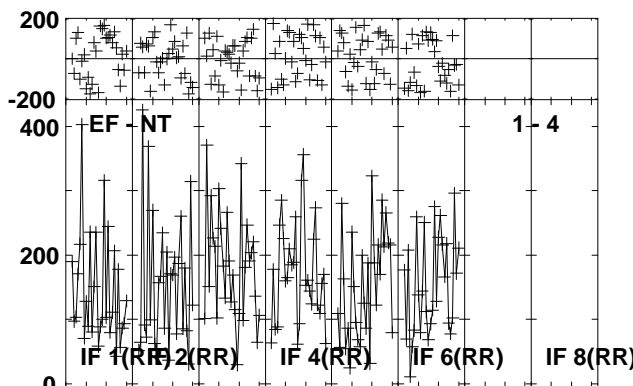
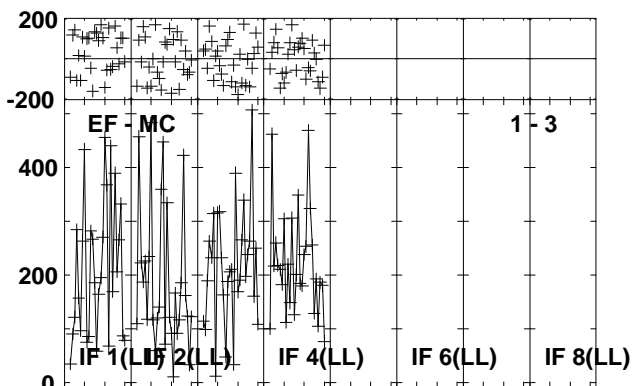
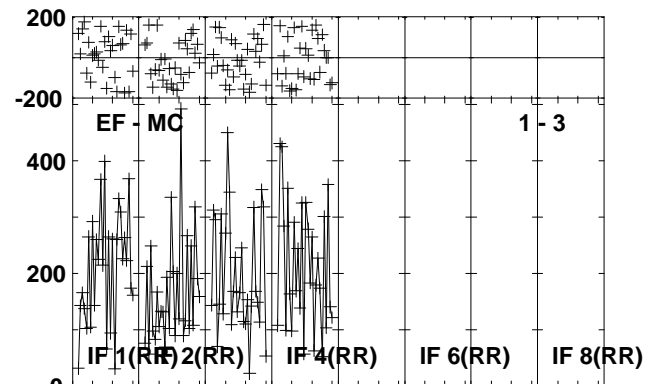
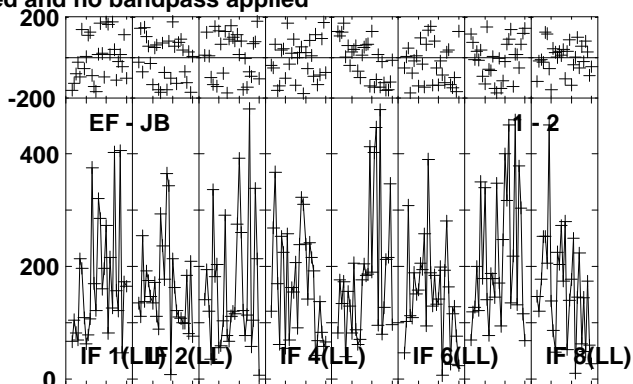
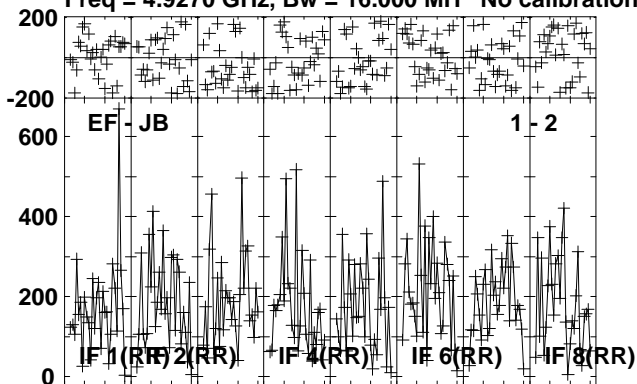

Lower frame: Micro Ampl Jy Top frame: Phas deg  
Vector averaged cross-power spectrum Several baselines displayed  
Timerange: 00/16:03:12 to 00/16:05:38

Plot file version 52 created 24-OCT-2012 20:58:41

G23.6-0.03 EY017B.UVDATA.1

Freq = 4.9270 GHz, Bw = 16.000 MH No calibration applied and no bandpass applied

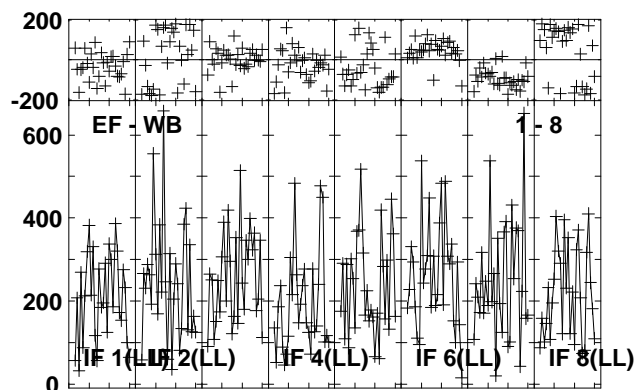
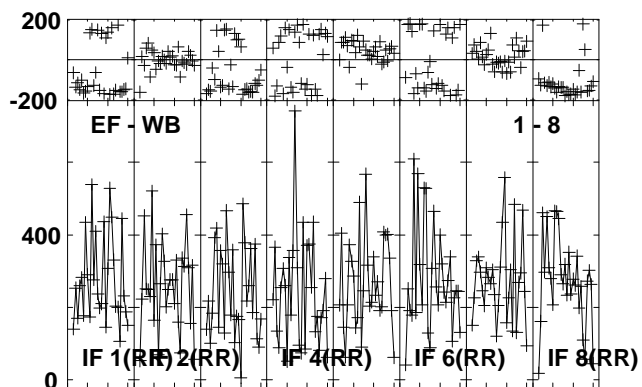
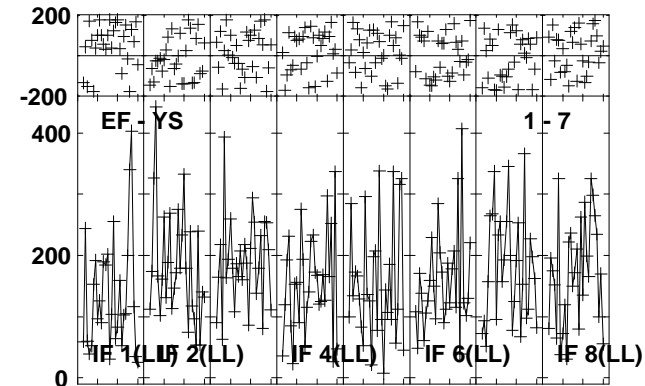
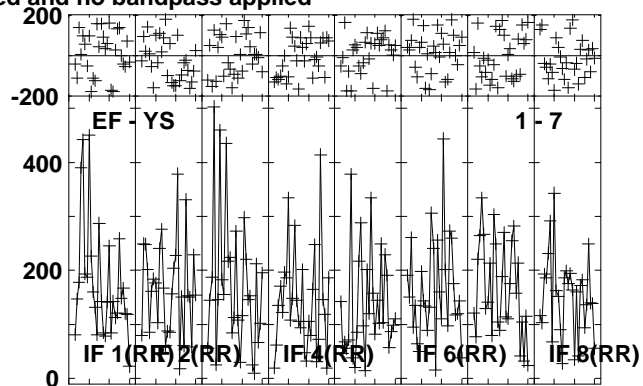
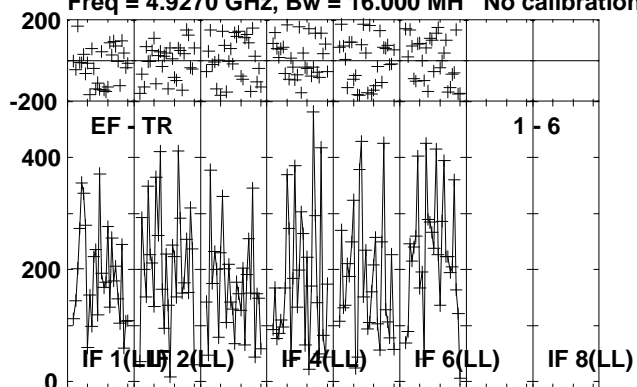

Lower frame: Micro Ampl Jy Top frame: Phas deg  
Vector averaged cross-power spectrum Several baselines displayed  
Timerange: 00/16:03:12 to 00/16:05:38



Plot file version 53 created 24-OCT-2012 20:58:42

J1825-0737 EY017B.UVDATA.1

Freq = 4.9270 GHz, Bw = 16.000 MH No calibration applied and no bandpass applied

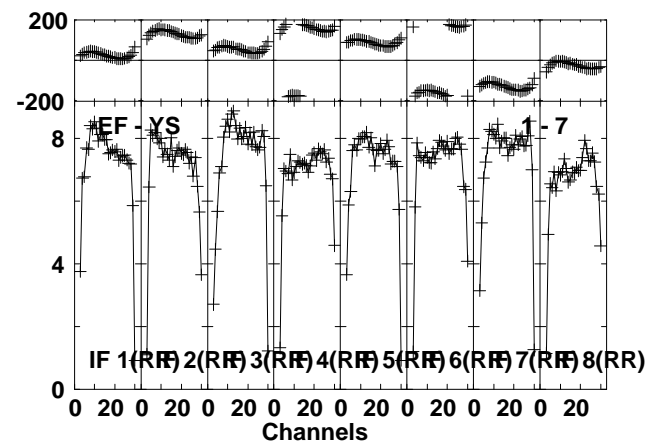
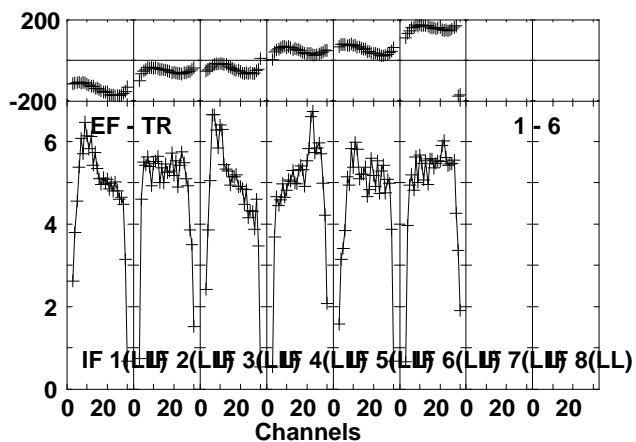
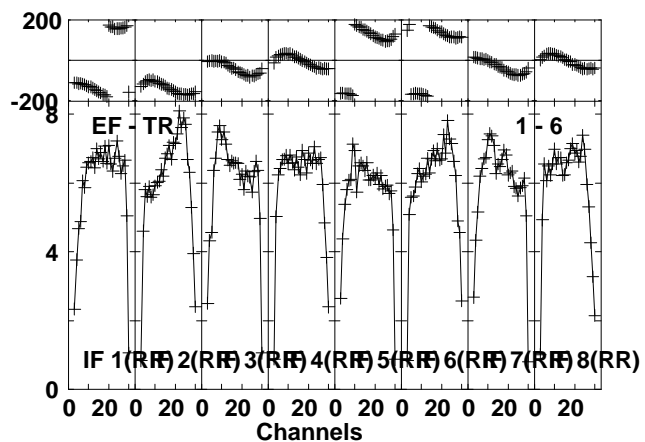
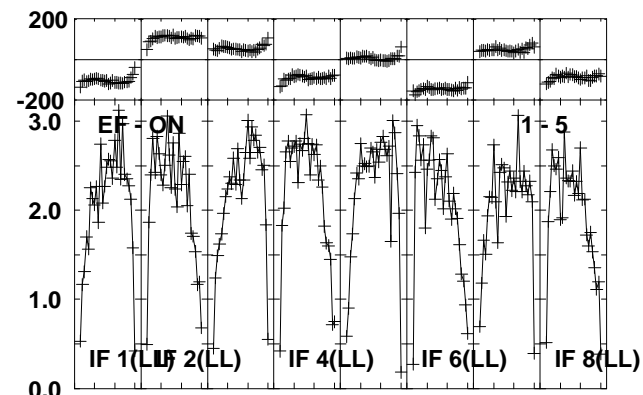
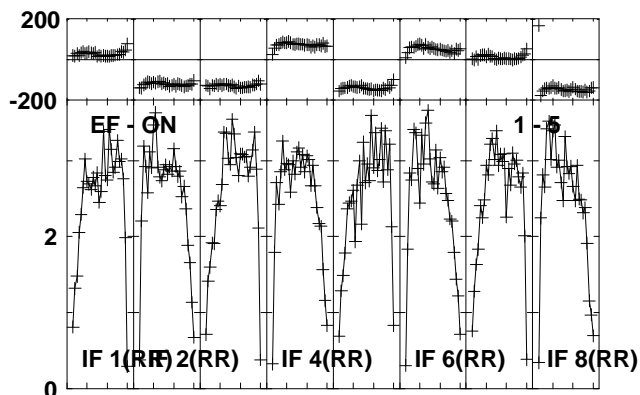
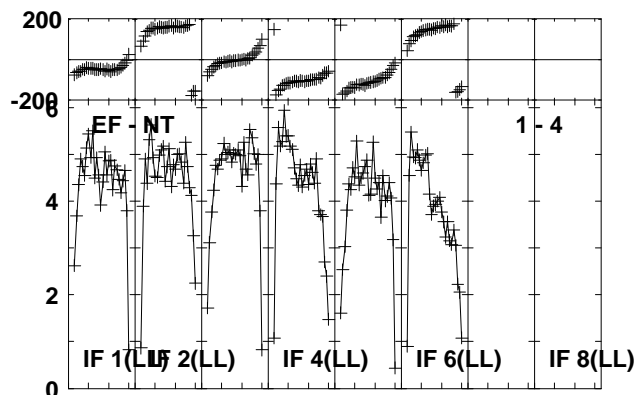
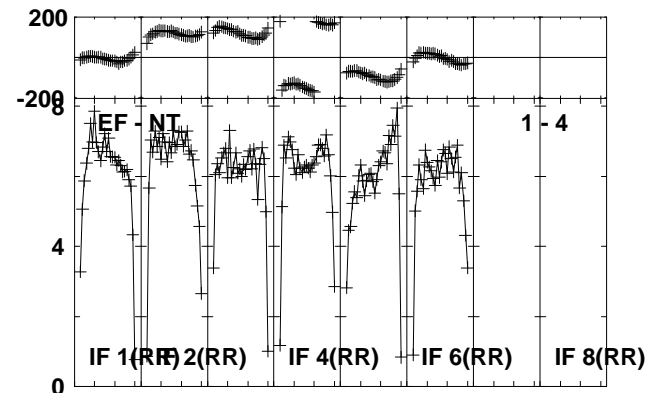
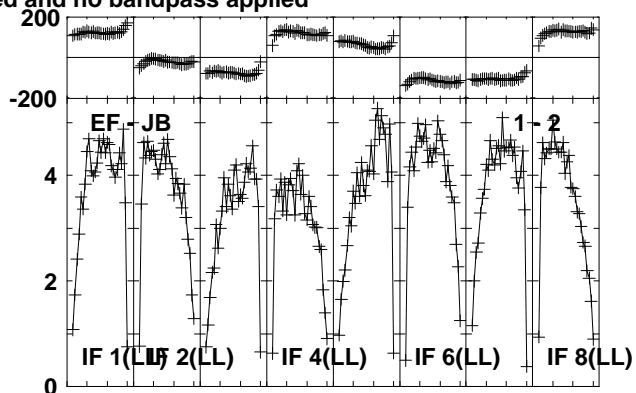
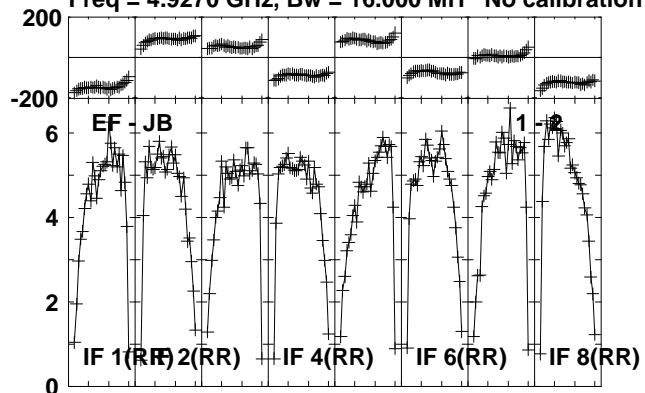

Lower frame: Milli Ampl Jy Top frame: Phas deg  
Vector averaged cross-power spectrum Several baselines displayed  
Timerange: 00/16:05:42 to 00/16:07:08

Plot file version 54 created 24-OCT-2012 20:58:42

J1825-0737 EY017B.UVDATA.1

Freq = 4.9270 GHz, Bw = 16.000 MH No calibration applied and no bandpass applied

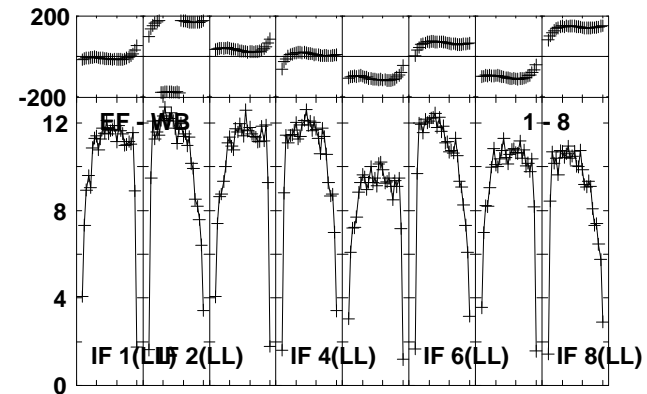
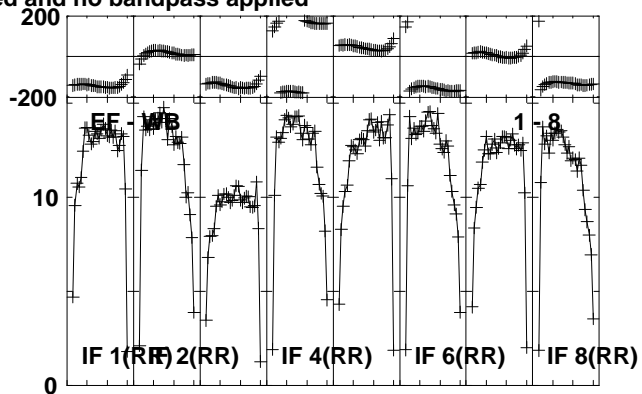
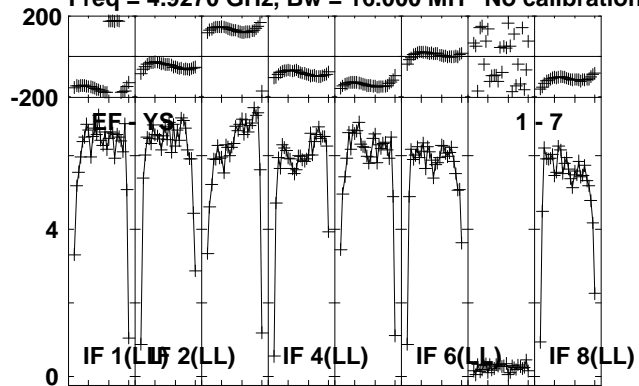

Lower frame: Milli Ampl Jy Top frame: Phas deg  
Vector averaged cross-power spectrum Several baselines displayed  
Timerange: 00/16:05:42 to 00/16:07:08

Plot file version 55 created 24-OCT-2012 20:58:42

G23.6-0.03 EY017B.UVDATA.1

Freq = 4.9270 GHz, Bw = 16.000 MH No calibration applied and no bandpass applied

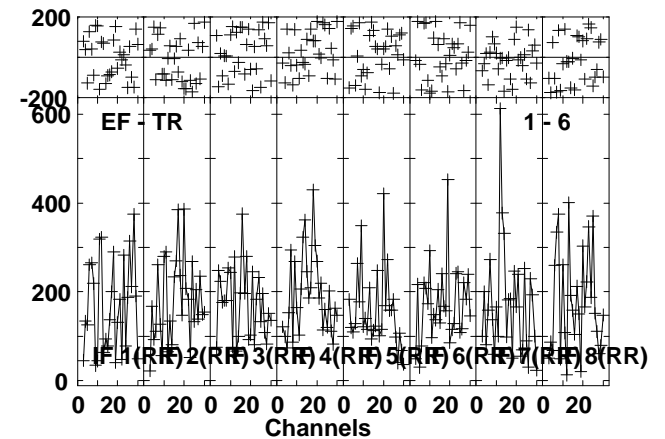
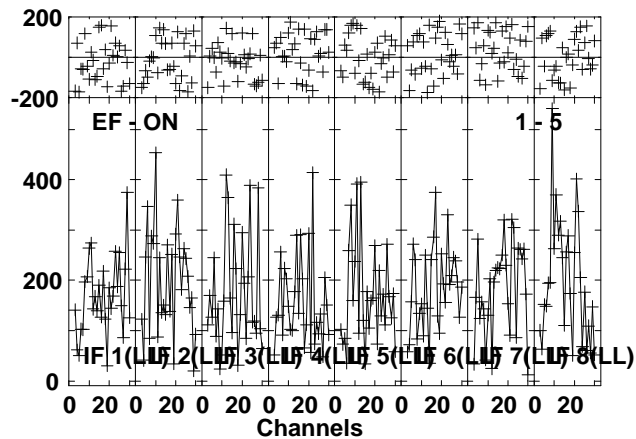
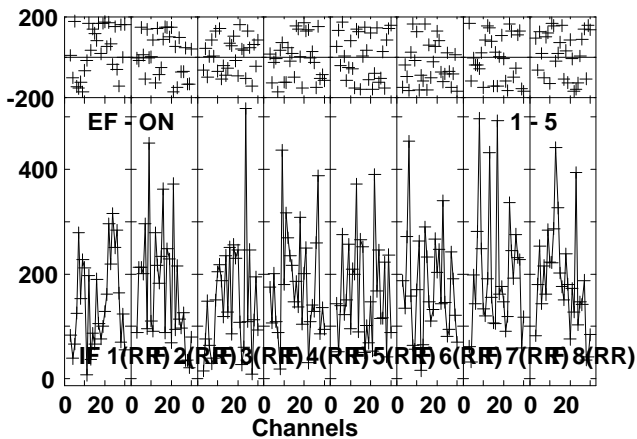
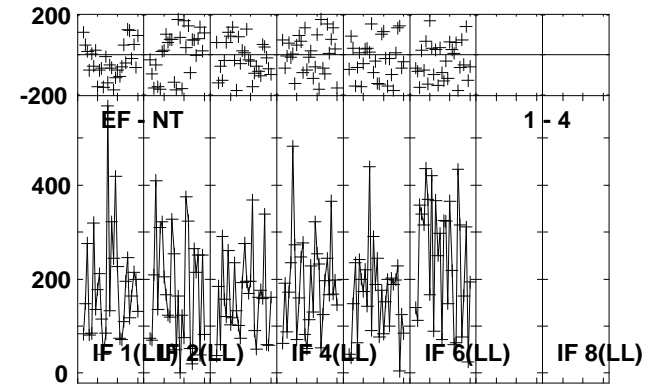
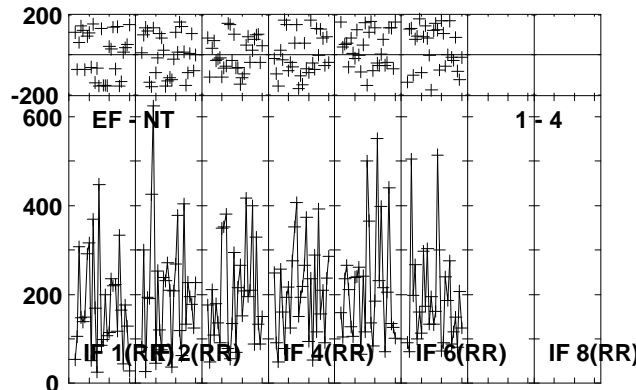
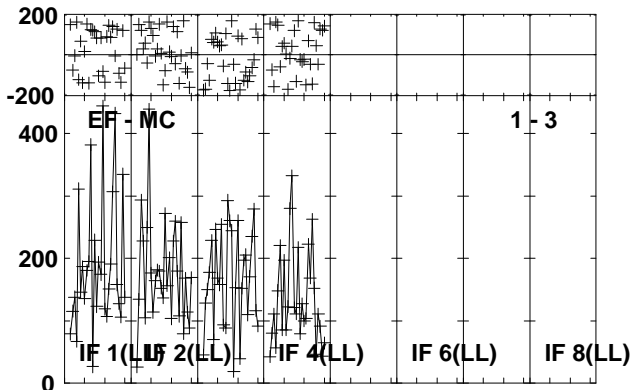
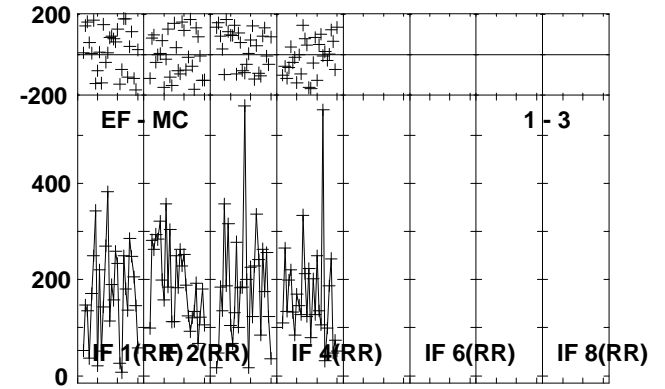
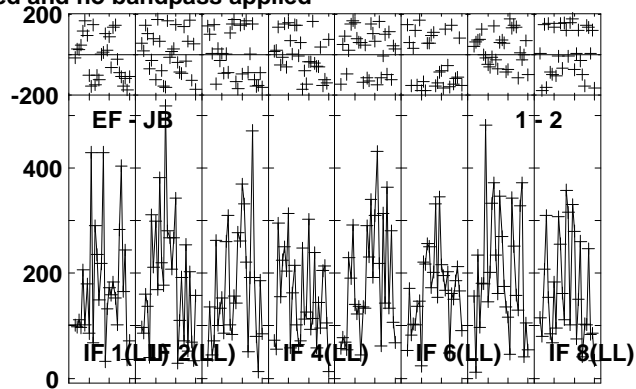
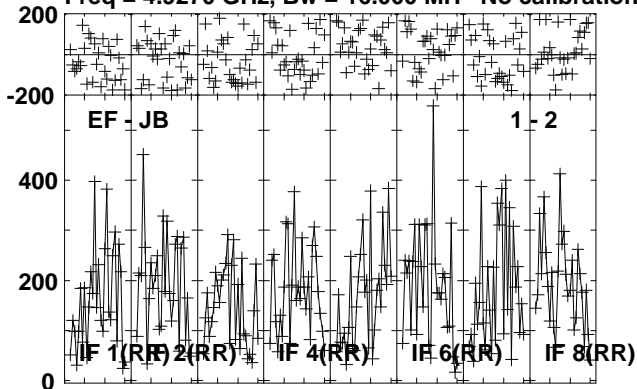

Lower frame: Micro Ampl Jy Top frame: Phas deg  
Vector averaged cross-power spectrum Several baselines displayed  
Timerange: 00/16:07:12 to 00/16:09:38

Plot file version 56 created 24-OCT-2012 20:58:43

G23.6-0.03 EY017B.UVDATA.1

Freq = 4.9270 GHz, Bw = 16.000 MH No calibration applied and no bandpass applied

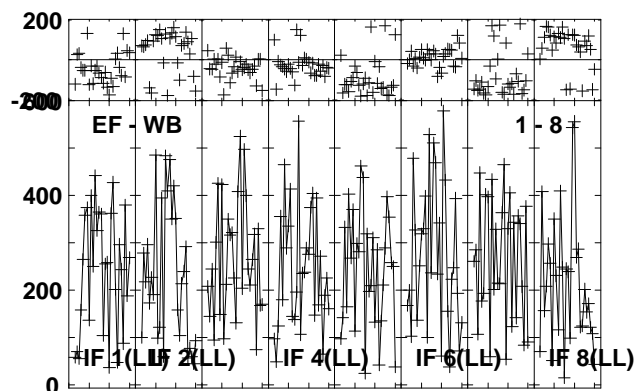
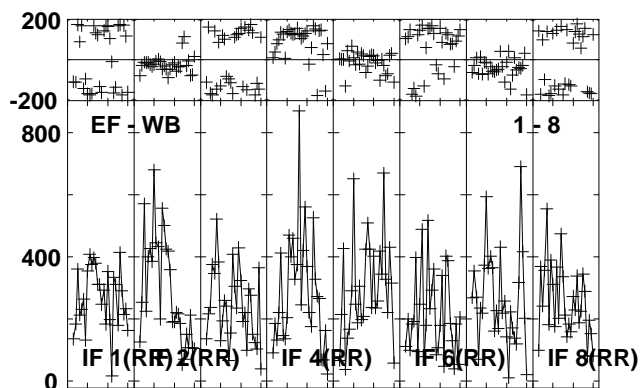
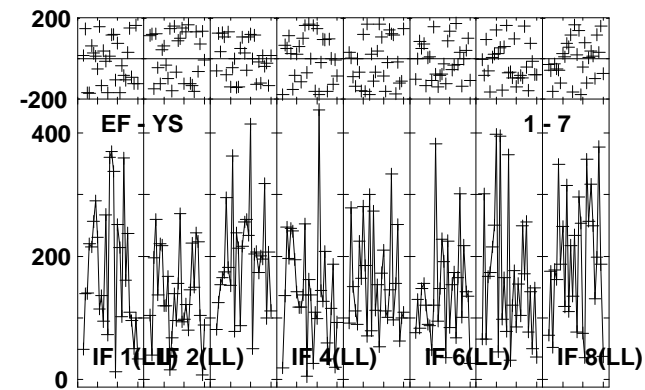
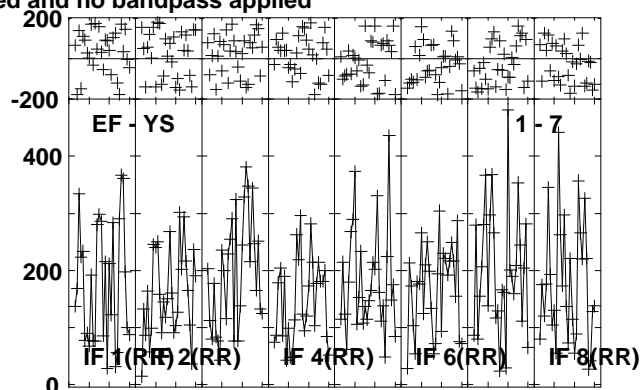
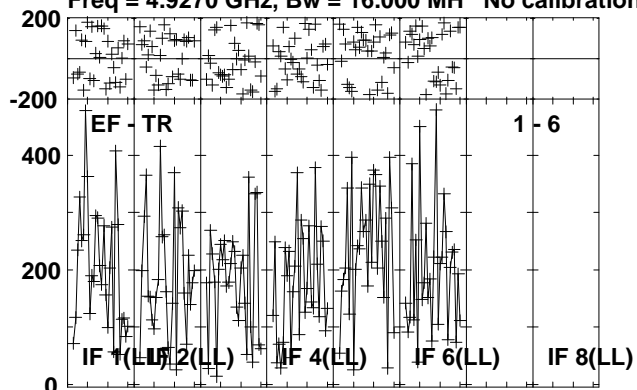

Lower frame: Micro Ampl Jy Top frame: Phas deg  
Vector averaged cross-power spectrum Several baselines displayed  
Timerange: 00/16:07:12 to 00/16:09:38

Plot file version 57 created 24-OCT-2012 20:58:44

J1825-0737 EY017B.UVDATA.1

Freq = 4.9270 GHz, Bw = 16.000 MH No calibration applied and no bandpass applied

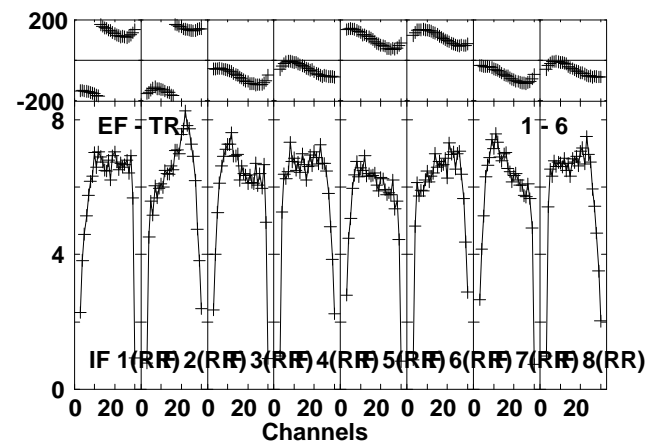
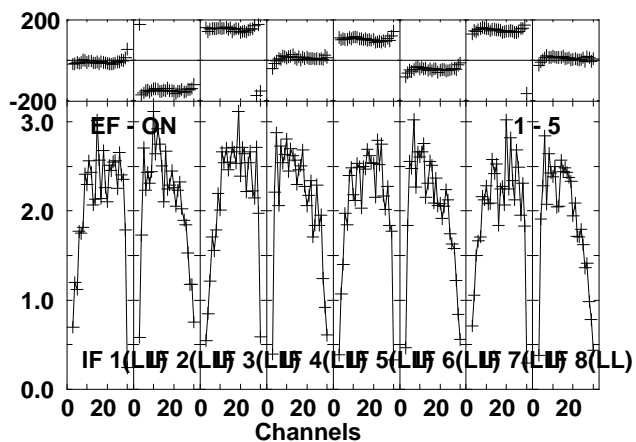
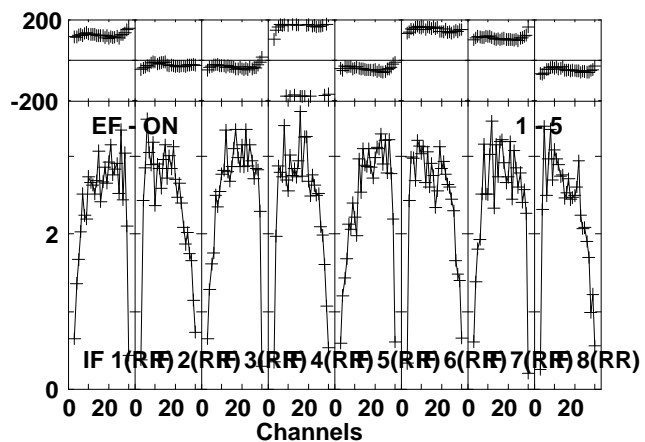
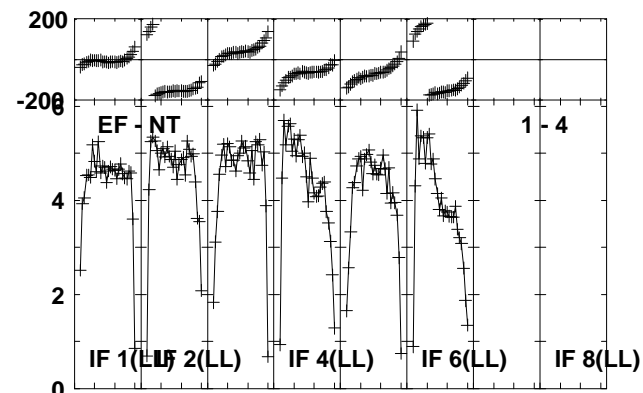
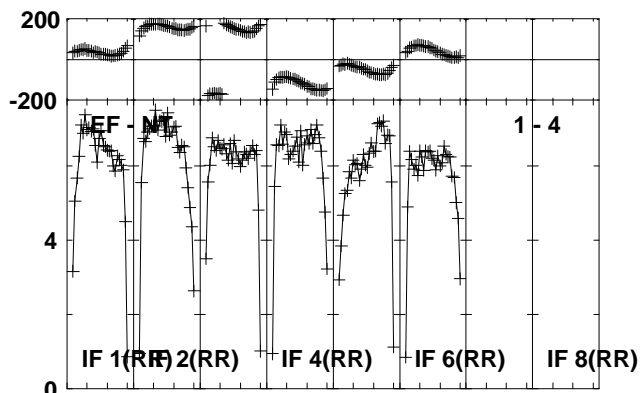
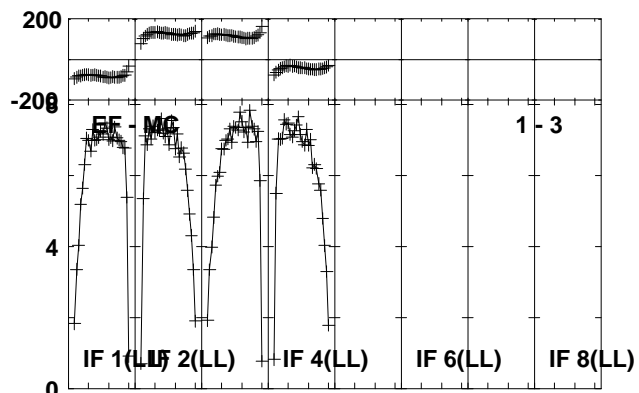
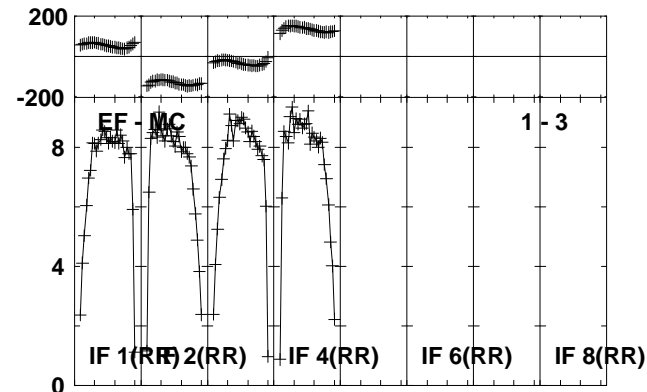
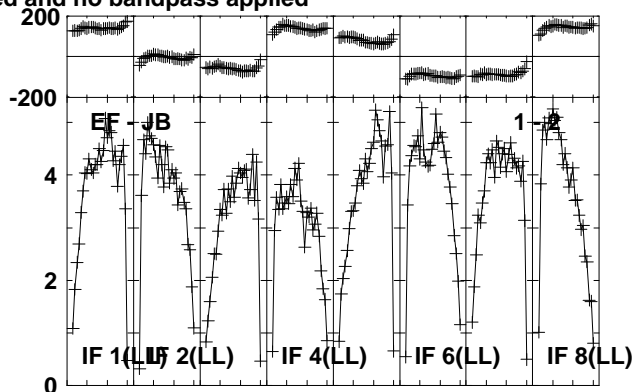
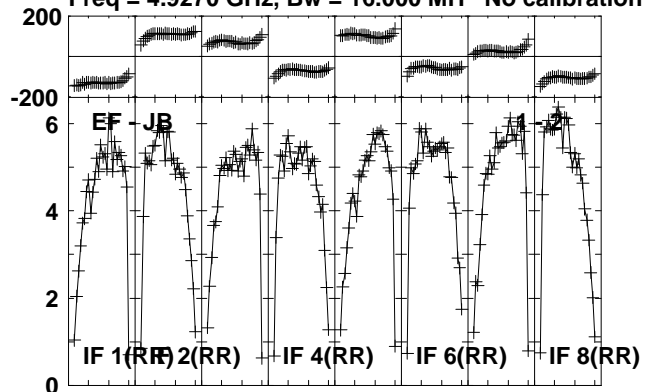

Lower frame: Milli Ampl Jy Top frame: Phas deg  
Vector averaged cross-power spectrum Several baselines displayed  
Timerange: 00/16:09:42 to 00/16:11:08

Plot file version 58 created 24-OCT-2012 20:58:44

J1825-0737 EY017B.UVDATA.1

Freq = 4.9270 GHz, Bw = 16.000 MH No calibration applied and no bandpass applied

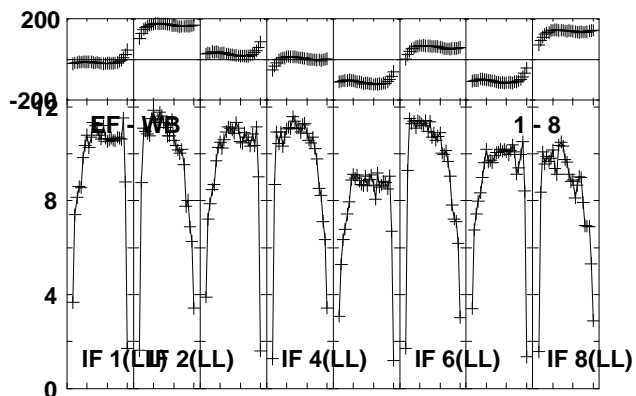
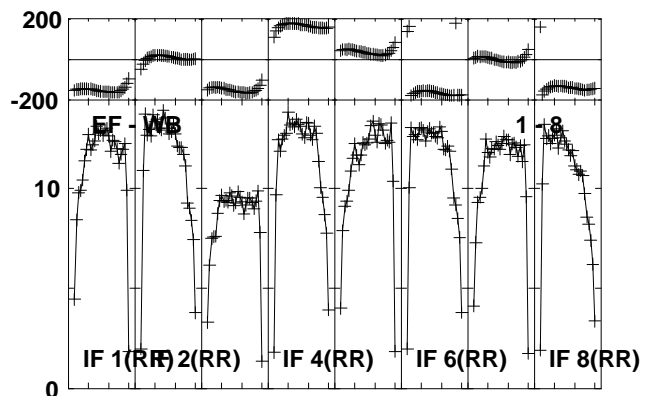
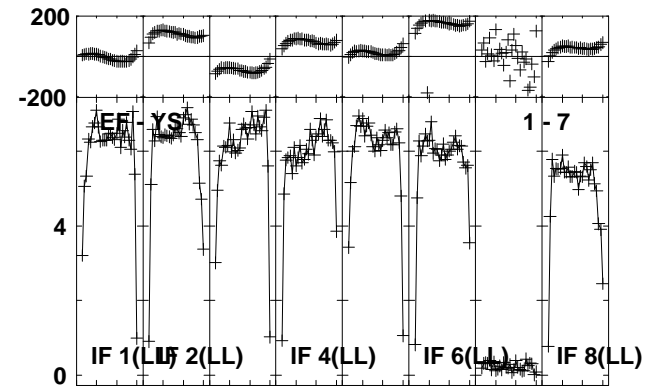
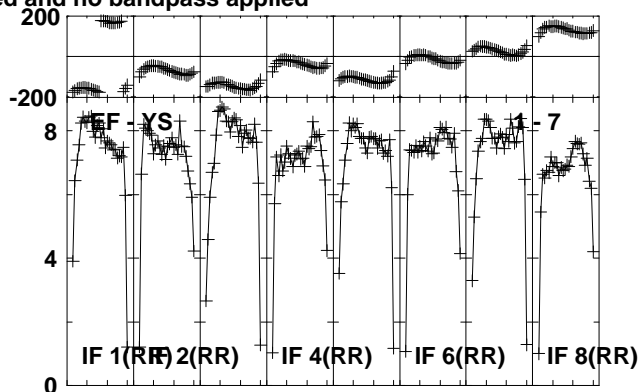
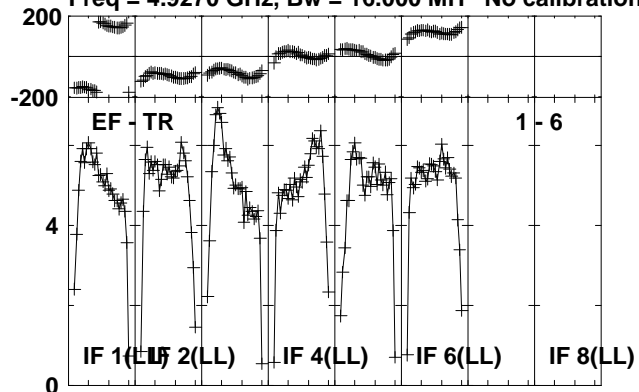

Lower frame: Milli Ampl Jy Top frame: Phas deg  
Vector averaged cross-power spectrum Several baselines displayed  
Timerange: 00/16:09:42 to 00/16:11:08

Plot file version 59 created 24-OCT-2012 20:58:45

G23.6-0.03 EY017B.UVDATA.1

Freq = 4.9270 GHz, Bw = 16.000 MH No calibration applied and no bandpass applied

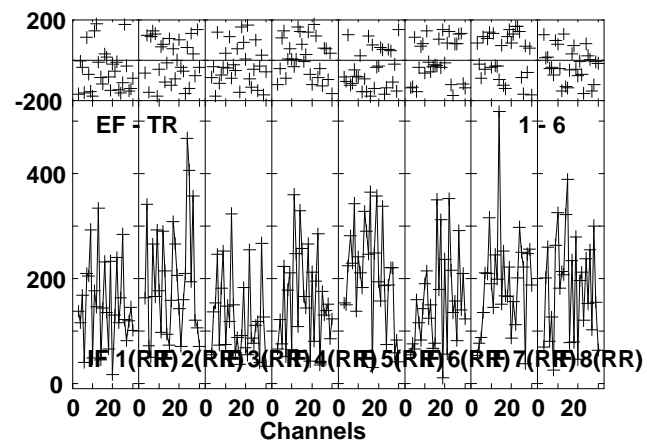
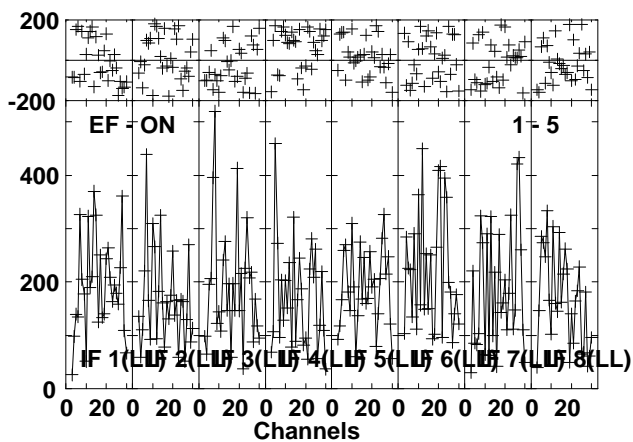
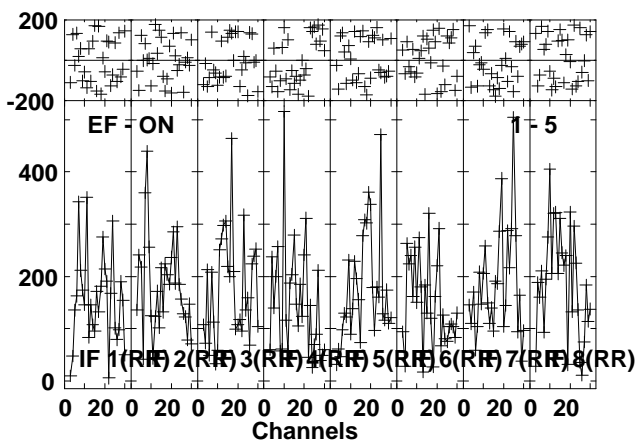
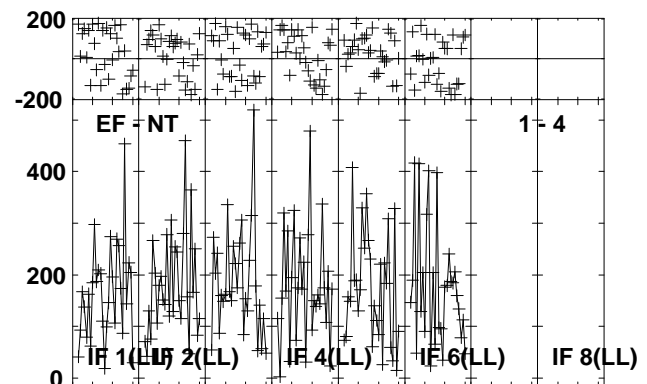
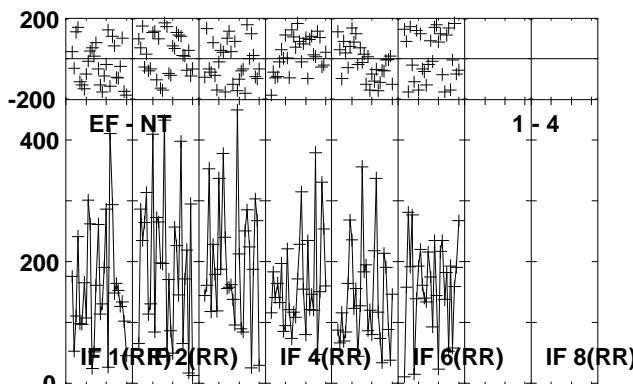
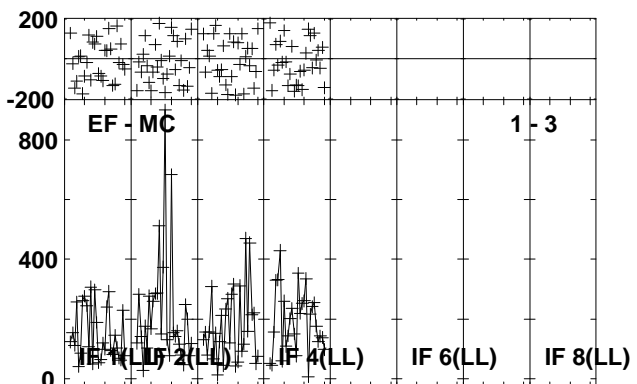
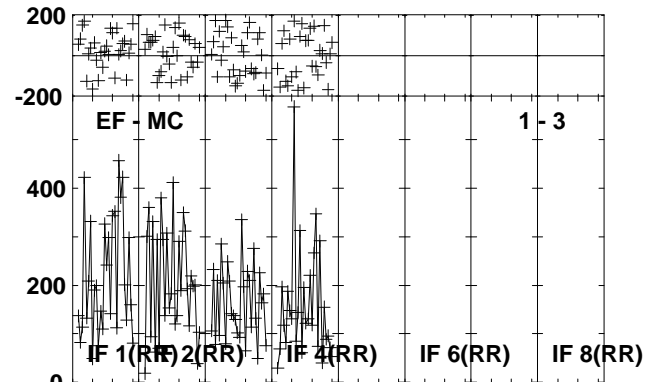
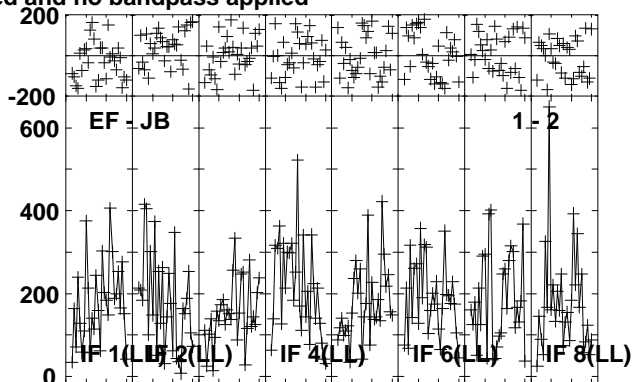
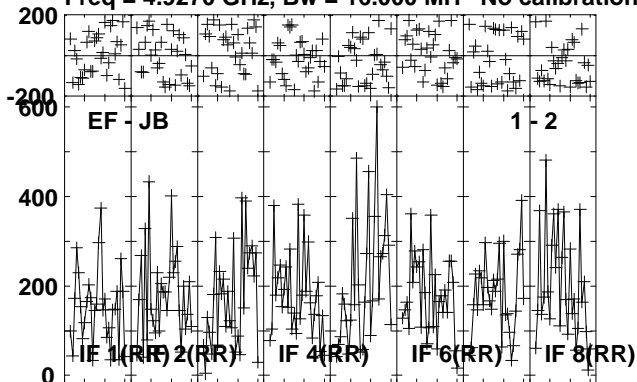

Lower frame: Micro Ampl Jy Top frame: Phas deg  
Vector averaged cross-power spectrum Several baselines displayed  
Timerange: 00/16:11:12 to 00/16:13:38

Plot file version 60 created 24-OCT-2012 20:58:45

G23.6-0.03 EY017B.UVDATA.1

Freq = 4.9270 GHz, Bw = 16.000 MH No calibration applied and no bandpass applied

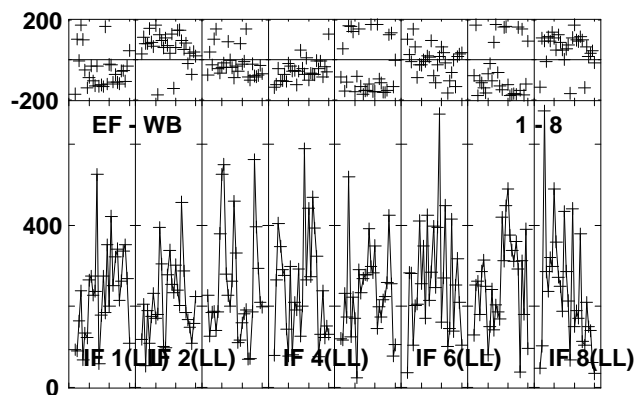
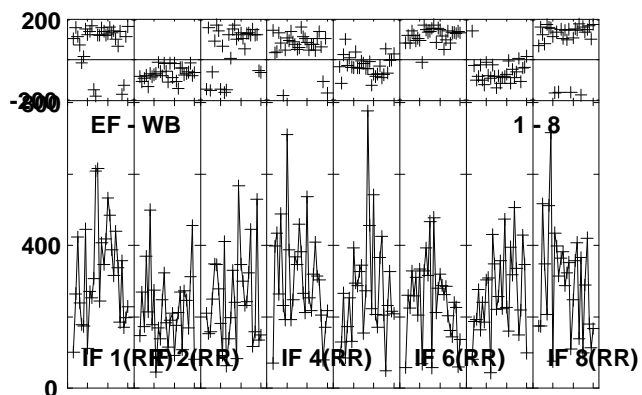
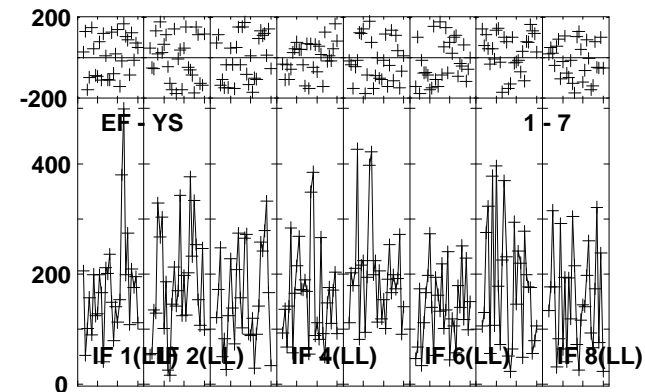
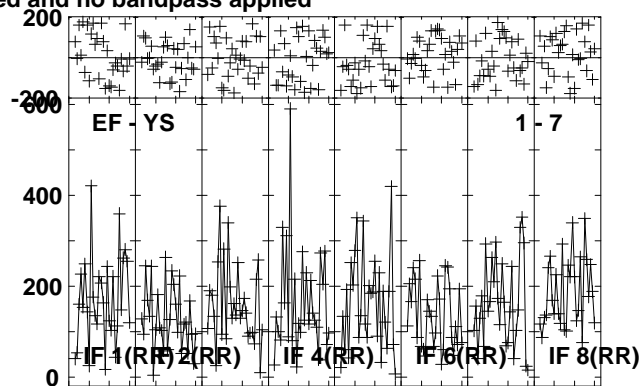
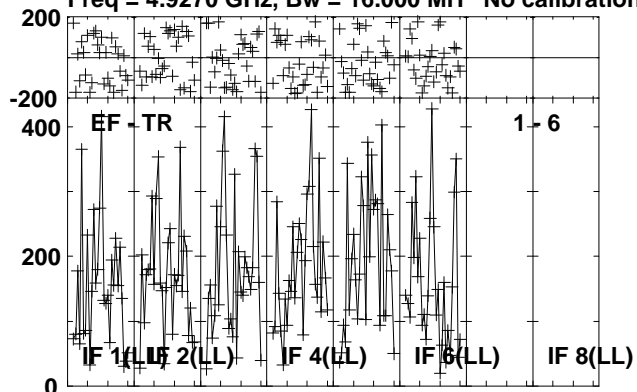

Lower frame: Micro Ampl Jy Top frame: Phas deg  
Vector averaged cross-power spectrum Several baselines displayed  
Timerange: 00/16:11:12 to 00/16:13:38



Plot file version 61 created 24-OCT-2012 20:58:46

J1825-0737 EY017B.UVDATA.1

Freq = 4.9270 GHz, Bw = 16.000 MH No calibration applied and no bandpass applied

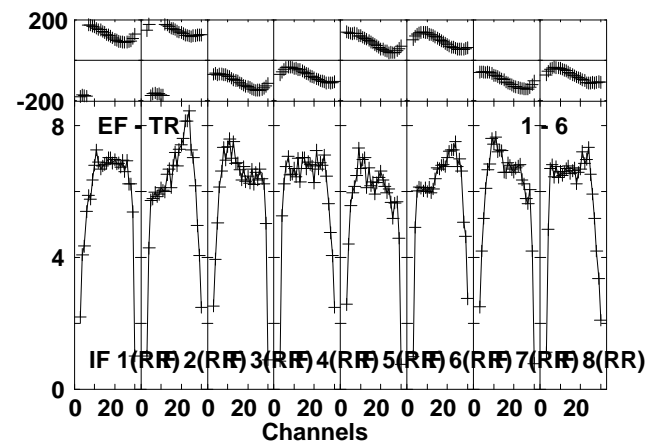
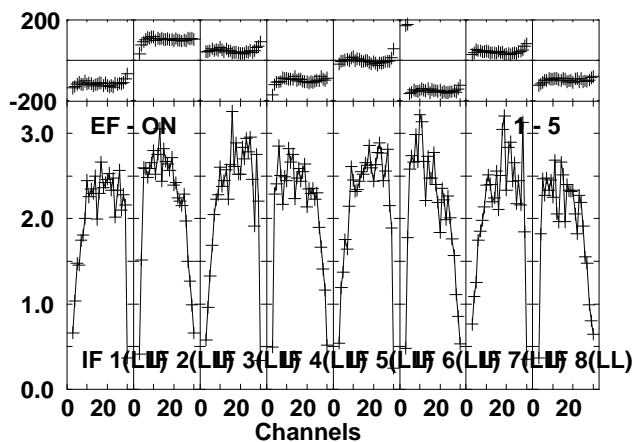
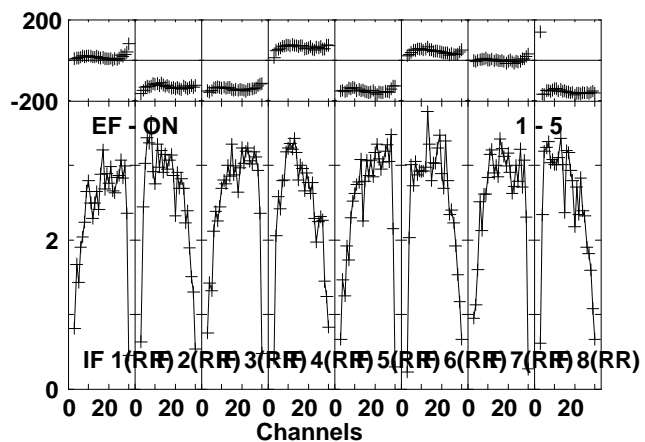
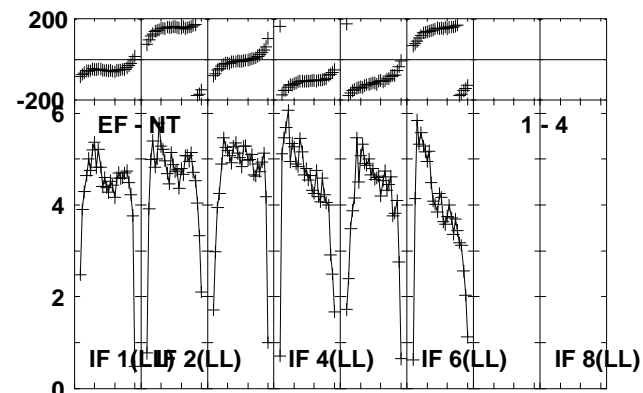
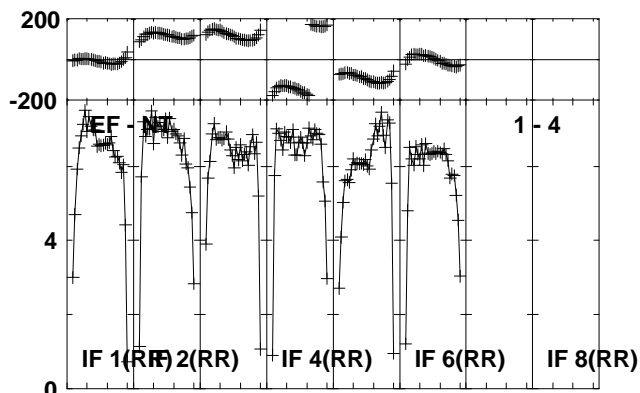
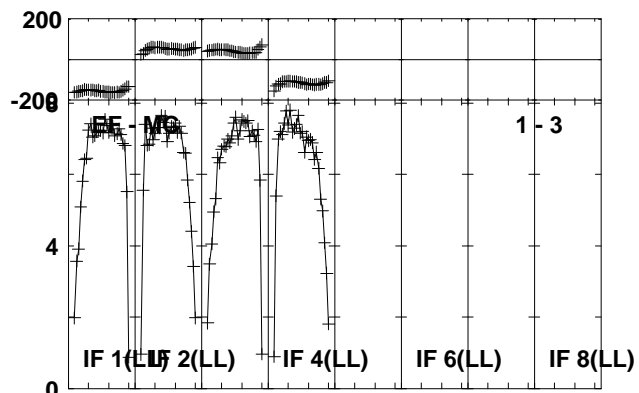
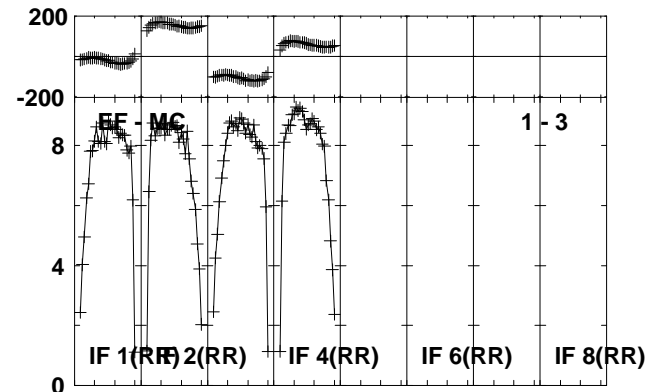
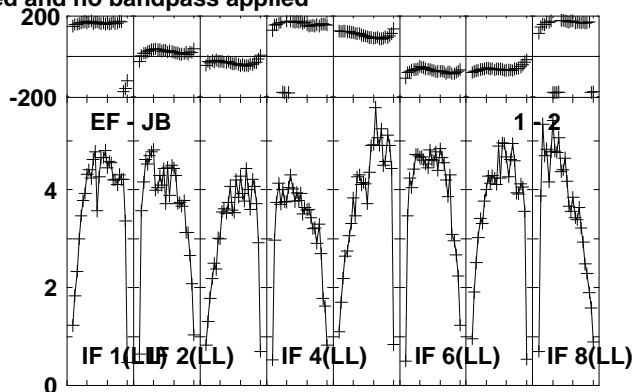
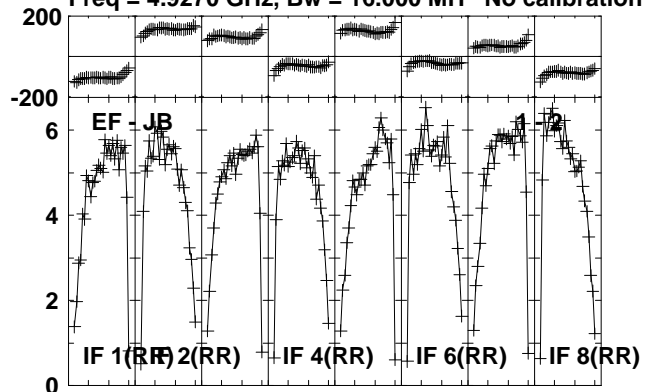

Lower frame: Milli Ampl Jy Top frame: Phas deg  
Vector averaged cross-power spectrum Several baselines displayed  
Timerange: 00/16:13:42 to 00/16:15:08

Plot file version 62 created 24-OCT-2012 20:58:46

J1825-0737 EY017B.UVDATA.1

Freq = 4.9270 GHz, Bw = 16.000 MH No calibration applied and no bandpass applied

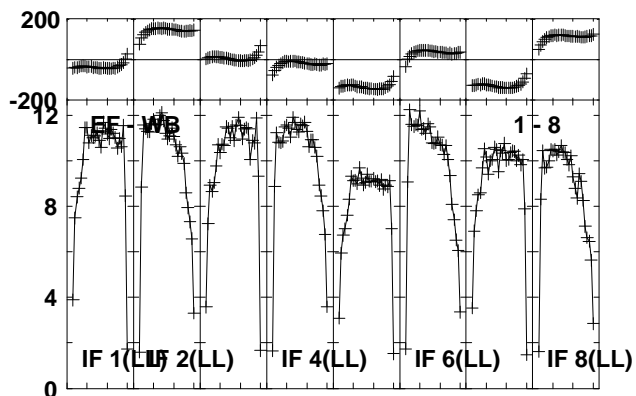
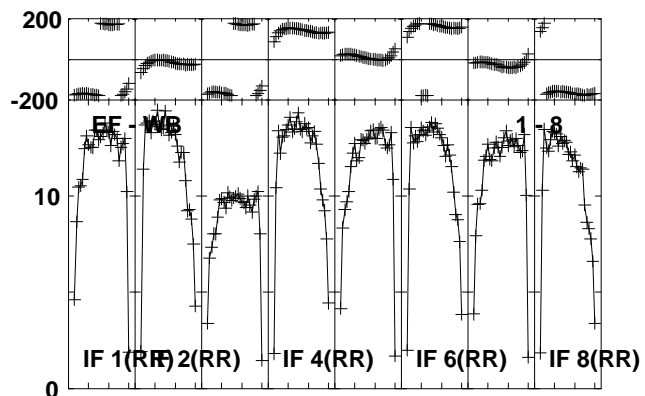
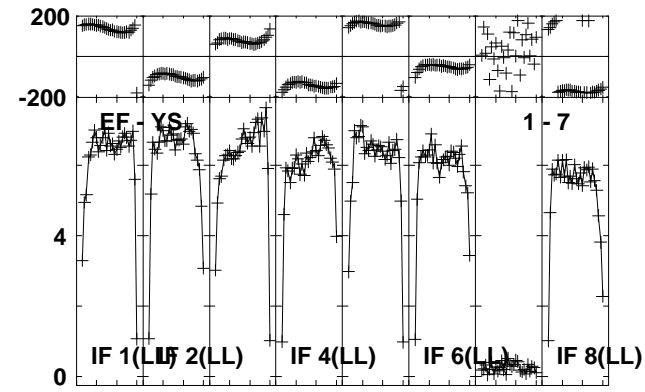
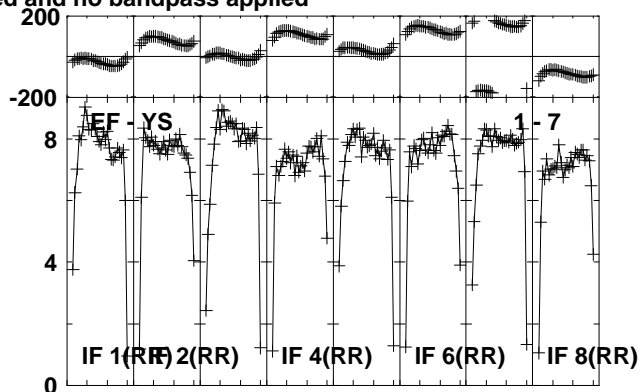
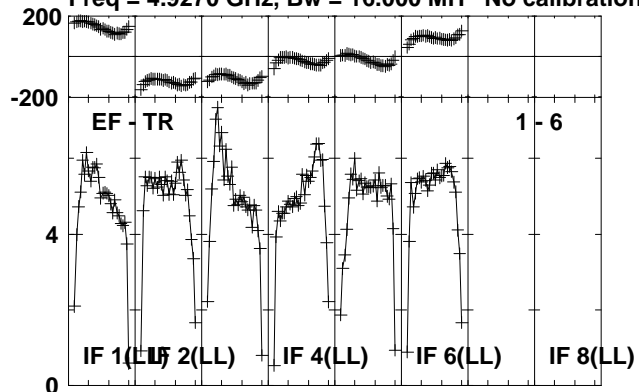

Lower frame: Milli Ampl Jy Top frame: Phas deg  
Vector averaged cross-power spectrum Several baselines displayed  
Timerange: 00/16:13:42 to 00/16:15:08

Plot file version 63 created 24-OCT-2012 20:58:47

J1831-0756 EY017B.UVDATA.1

Freq = 4.9270 GHz, Bw = 16.000 MH No calibration applied and no bandpass applied

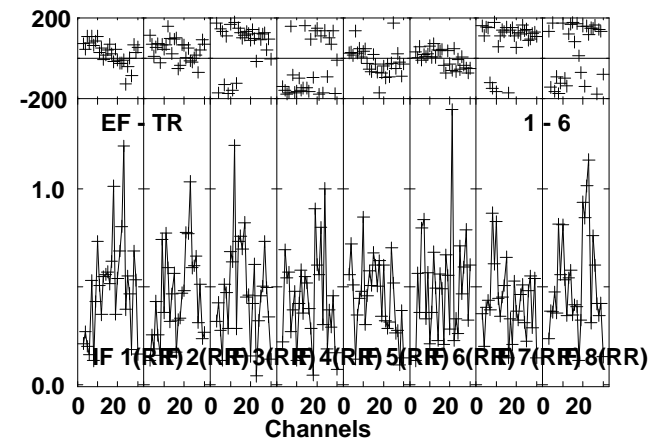
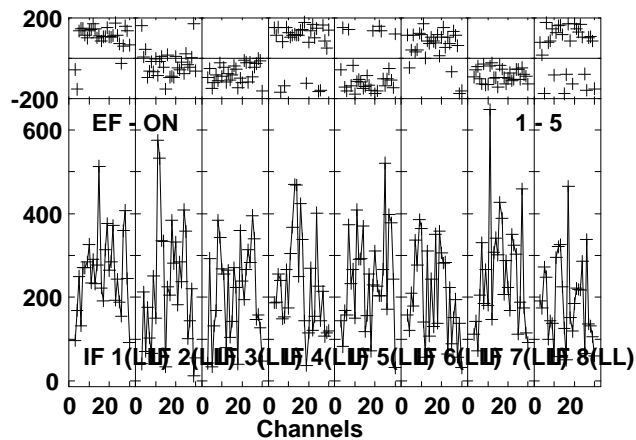
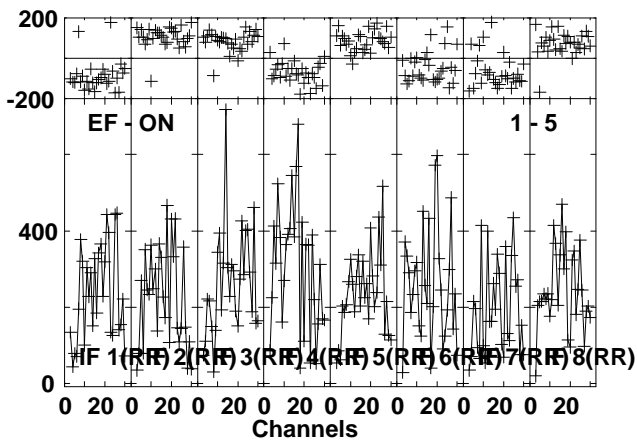
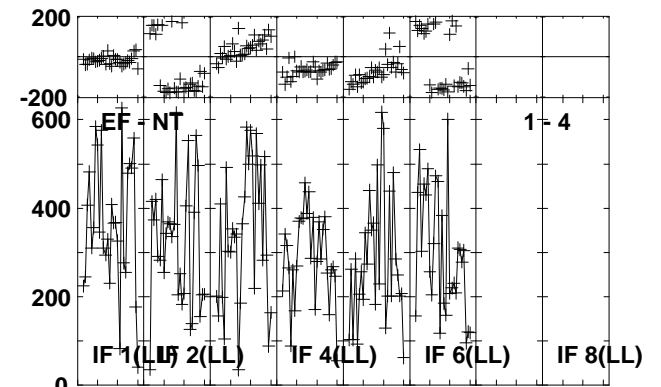
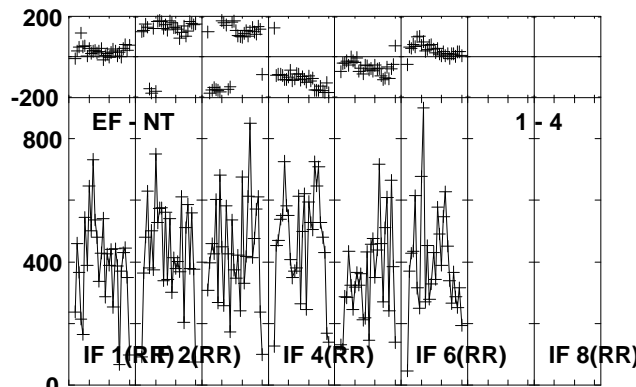
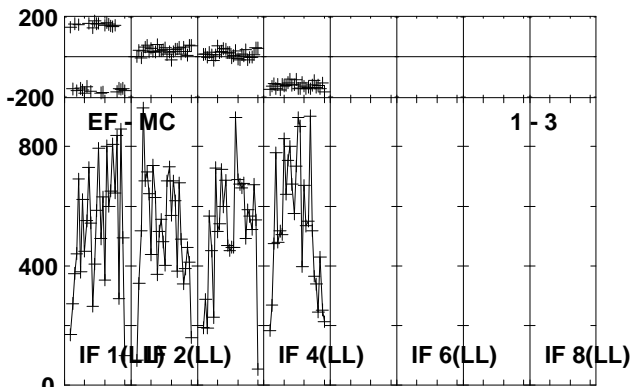
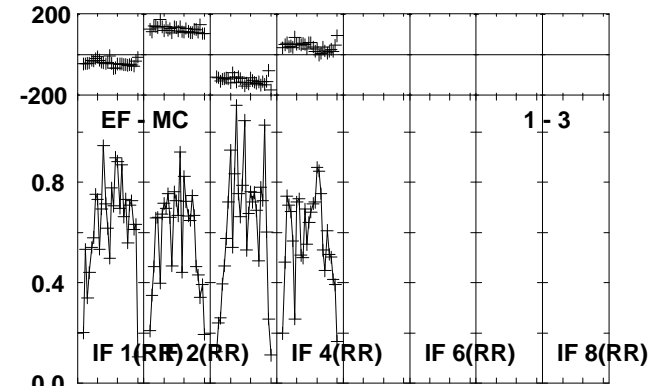
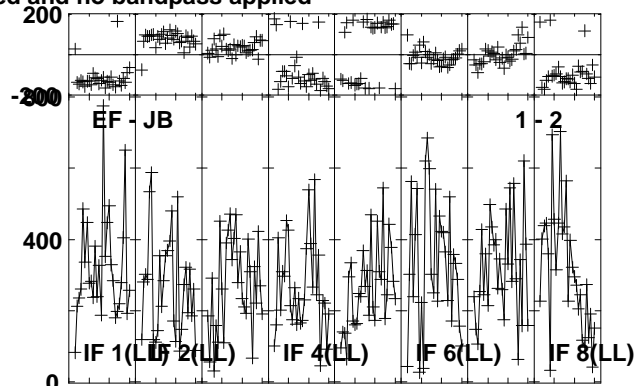
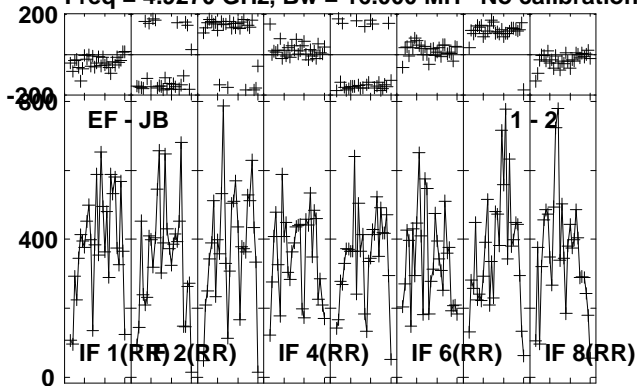

Lower frame: Micro Ampl Jy Top frame: Phas deg  
Vector averaged cross-power spectrum Several baselines displayed  
Timerange: 00/16:15:42 to 00/16:17:44

Plot file version 64 created 24-OCT-2012 20:58:47

J1831-0756 EY017B.UVDATA.1

Freq = 4.9270 GHz, Bw = 16.000 MH No calibration applied and no bandpass applied

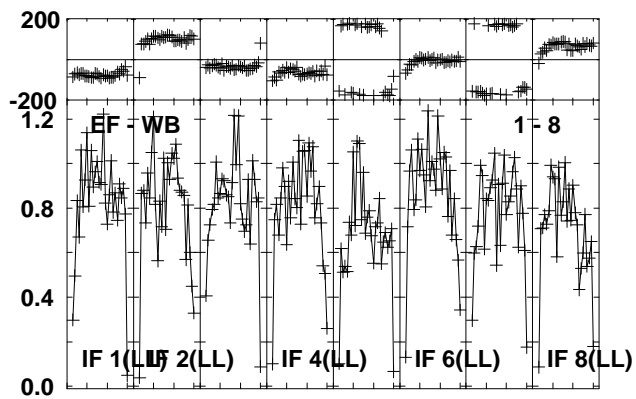
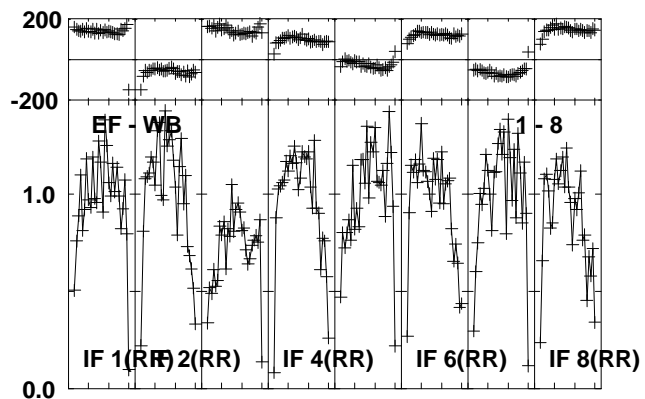
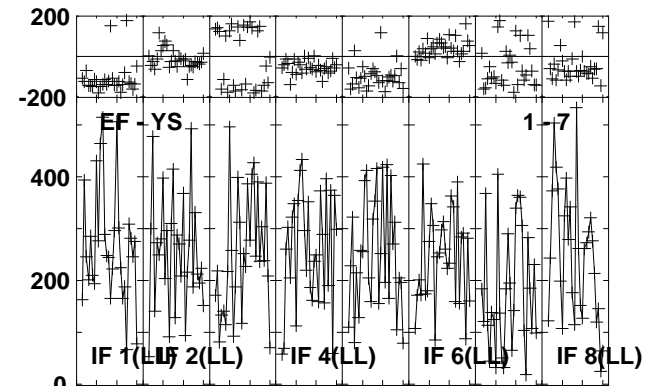
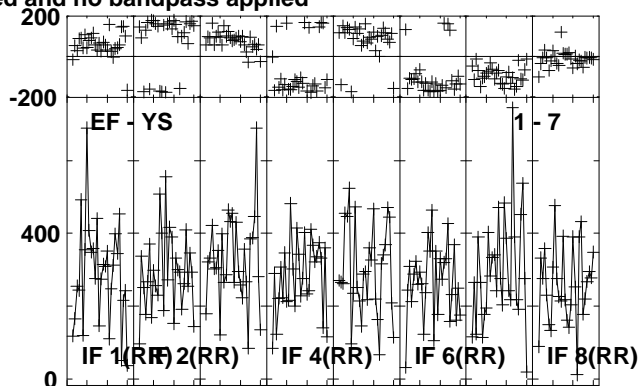
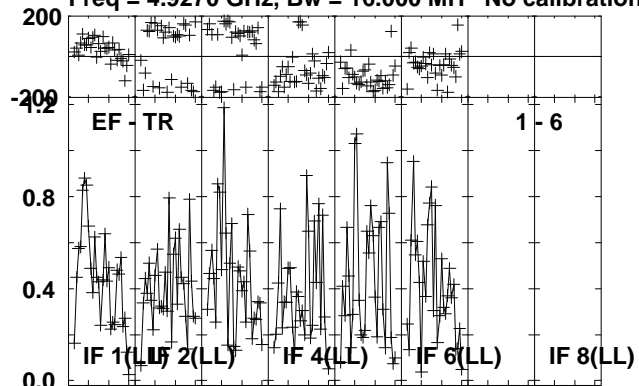

Lower frame: Milli Ampl Jy Top frame: Phas deg  
Vector averaged cross-power spectrum Several baselines displayed  
Timerange: 00/16:15:42 to 00/16:17:44

Plot file version 65 created 24-OCT-2012 20:58:48

J1825-0737 EY017B.UVDATA.1

Freq = 4.9270 GHz, Bw = 16.000 MH No calibration applied and no bandpass applied

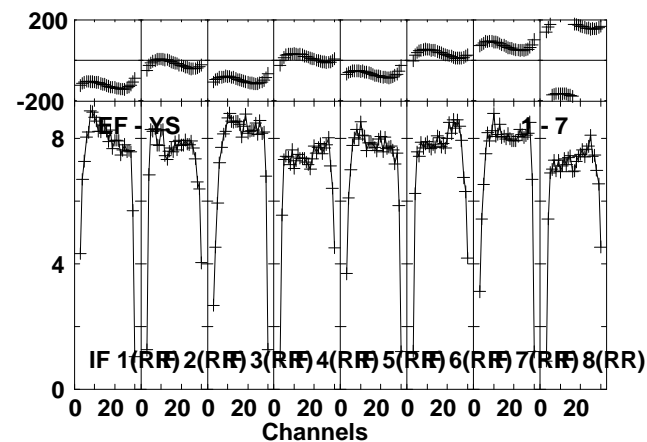
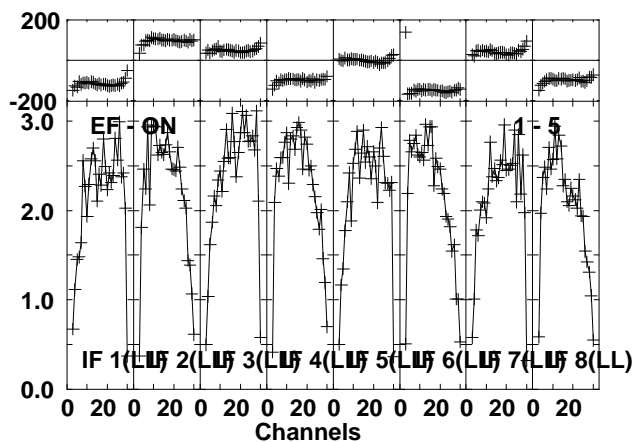
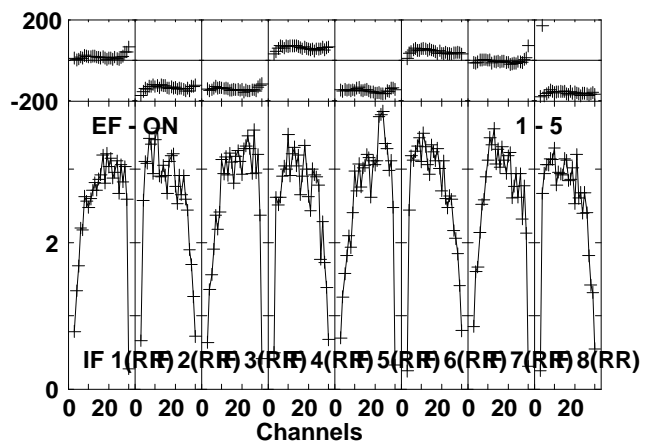
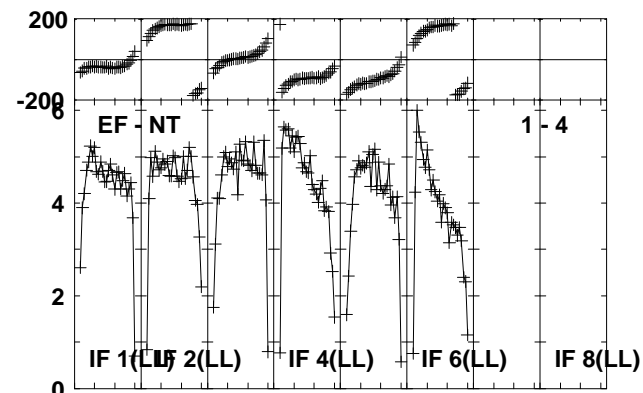
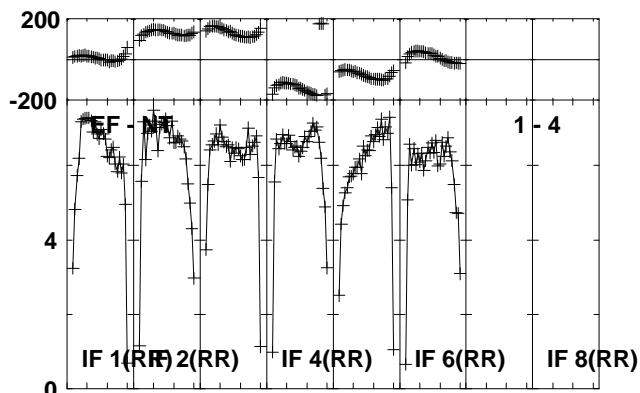
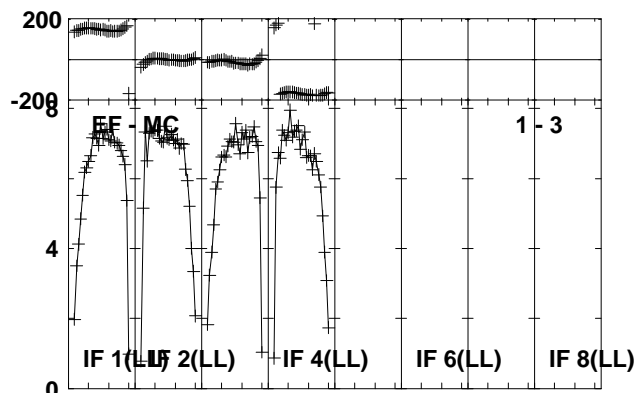
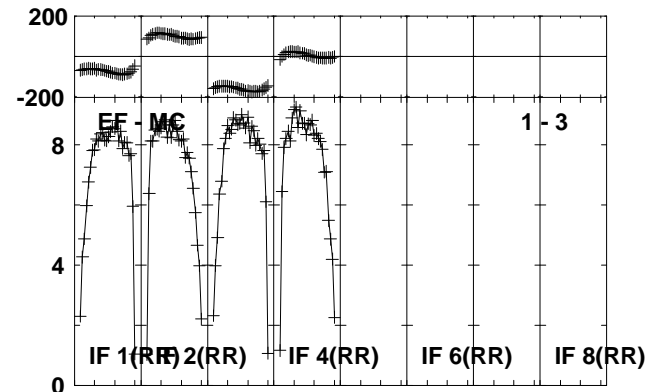
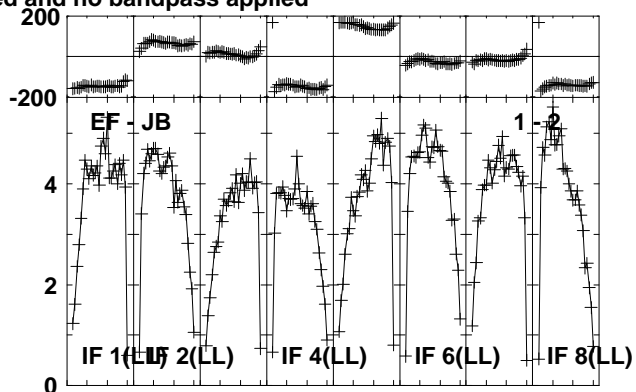
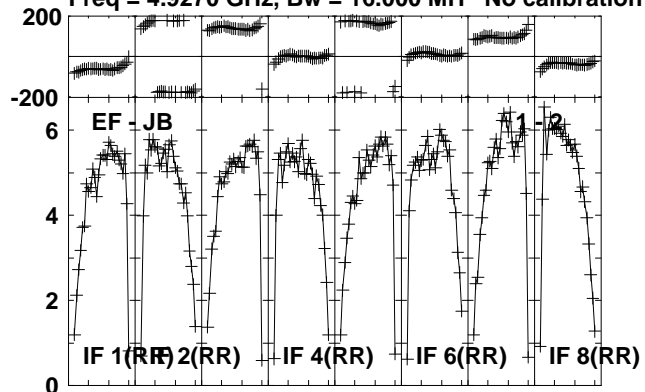

Lower frame: Milli Ampl Jy Top frame: Phas deg  
Vector averaged cross-power spectrum Several baselines displayed  
Timerange: 00/16:17:48 to 00/16:19:14

Plot file version 66 created 24-OCT-2012 20:58:48

J1825-0737 EY017B.UVDATA.1

Freq = 4.9270 GHz, Bw = 16.000 MH No calibration applied and no bandpass applied

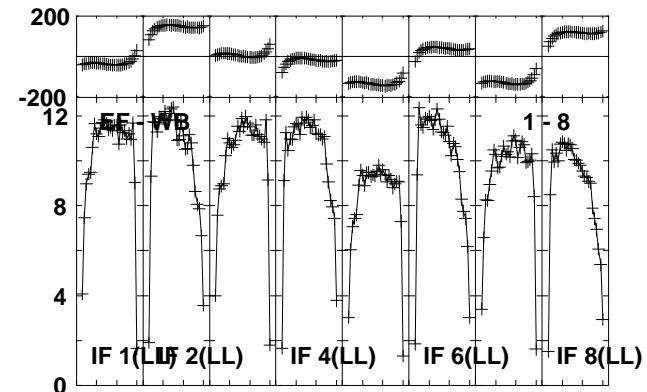
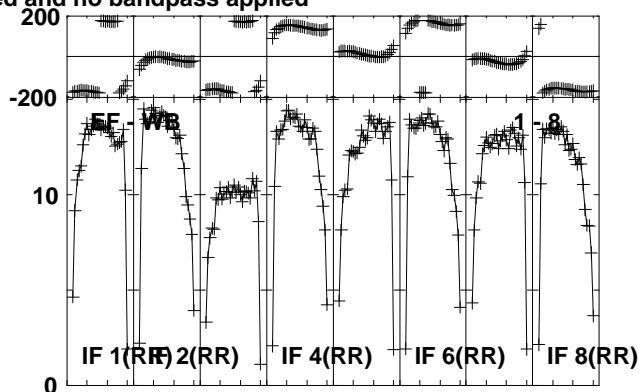
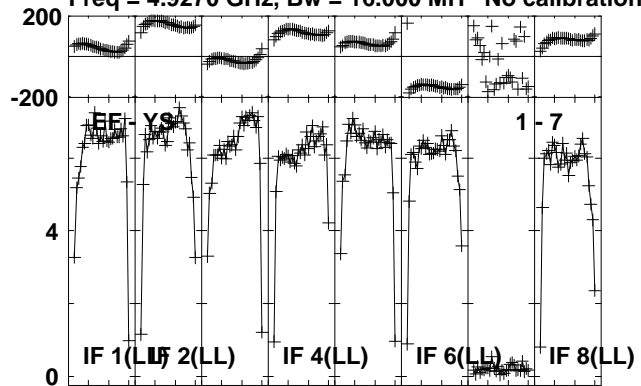

Lower frame: Milli Ampl Jy Top frame: Phas deg  
Vector averaged cross-power spectrum Several baselines displayed  
Timerange: 00/16:17:48 to 00/16:19:14



Plot file version 68 created 24-OCT-2012 20:58:49

G23.6-0.03 EY017B.UVDATA.1

Freq = 4.9270 GHz, Bw = 16.000 MH No calibration applied and no bandpass applied

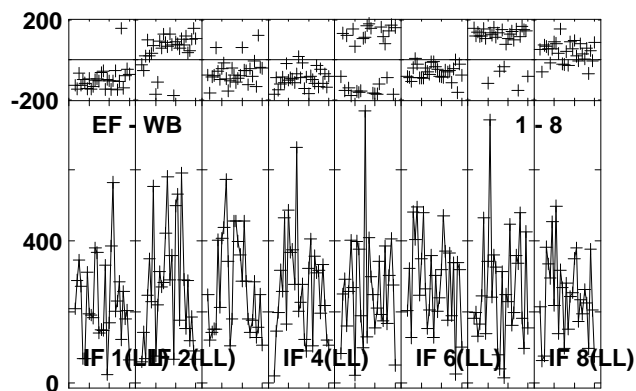
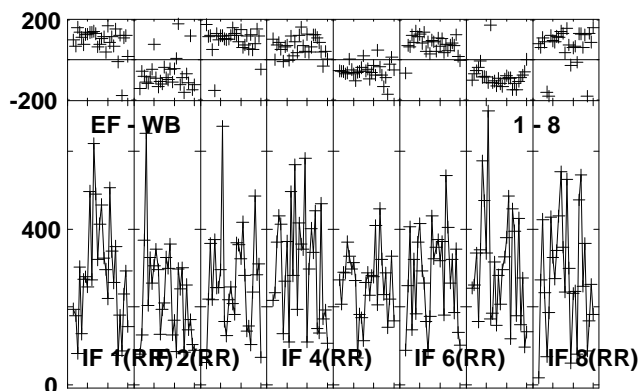
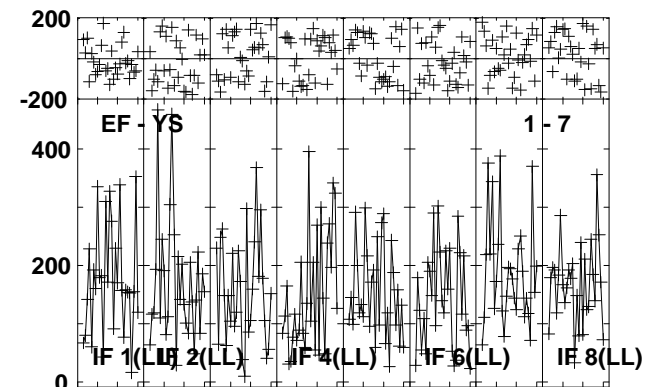
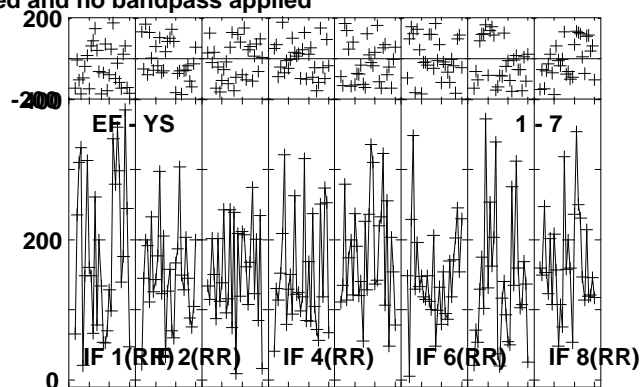
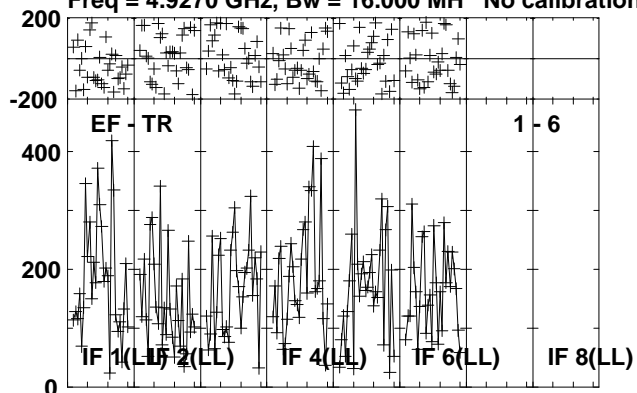

Lower frame: Micro Ampl Jy Top frame: Phas deg  
Vector averaged cross-power spectrum Several baselines displayed  
Timerange: 00/16:19:18 to 00/16:21:44



Plot file version 69 created 24-OCT-2012 20:58:50

J1825-0737 EY017B.UVDATA.1

Freq = 4.9270 GHz, Bw = 16.000 MH No calibration applied and no bandpass applied

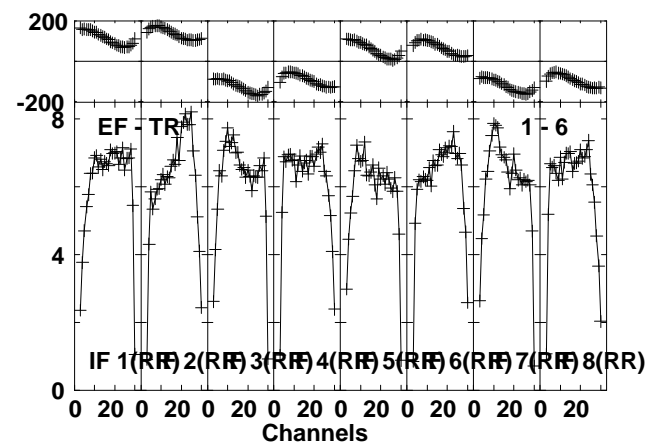
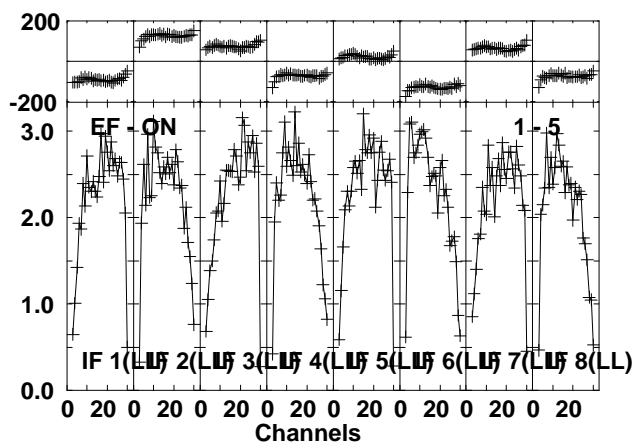
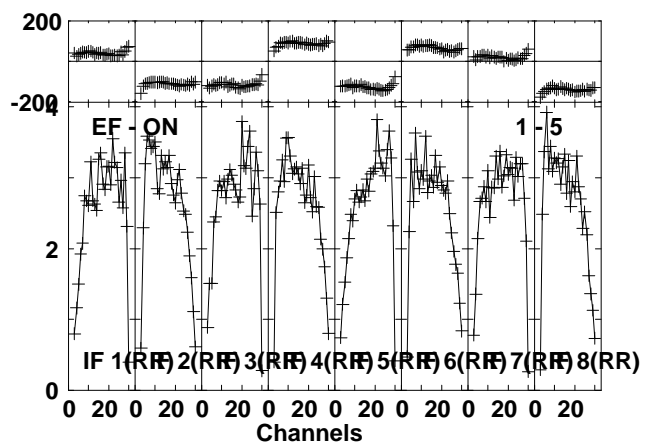
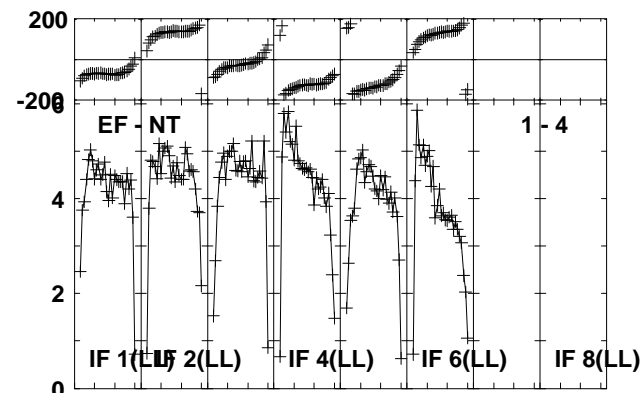
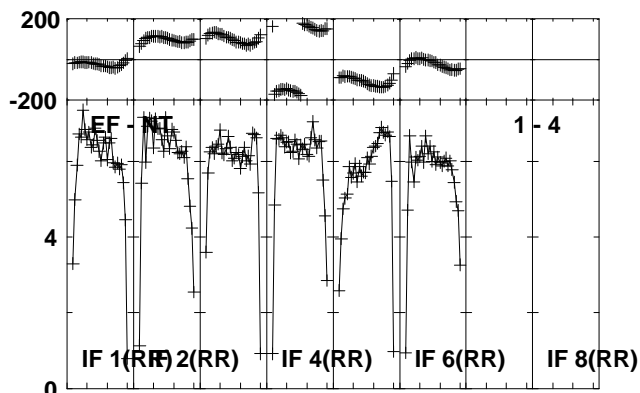
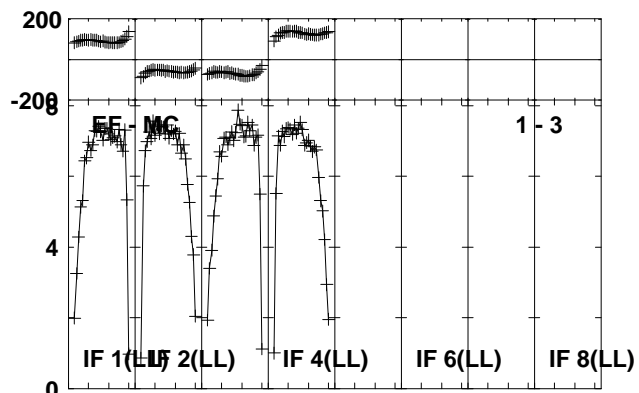
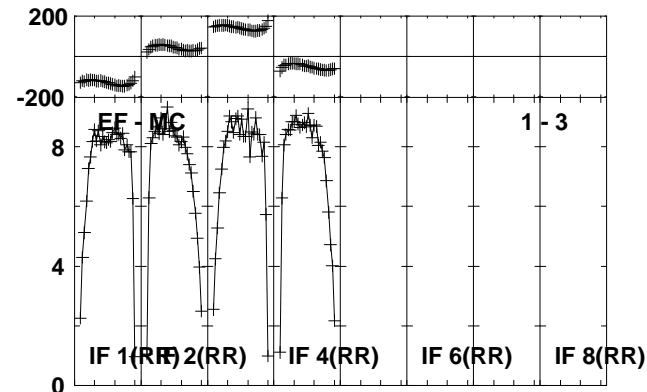
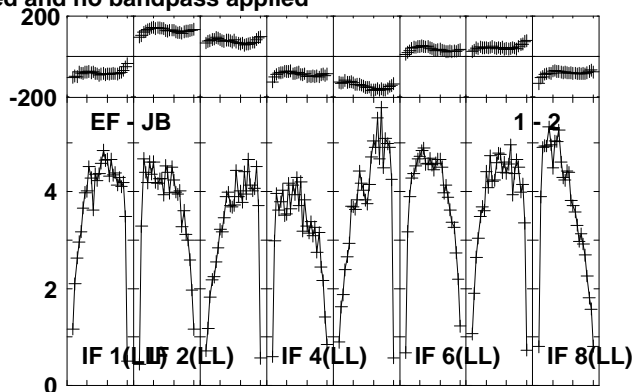
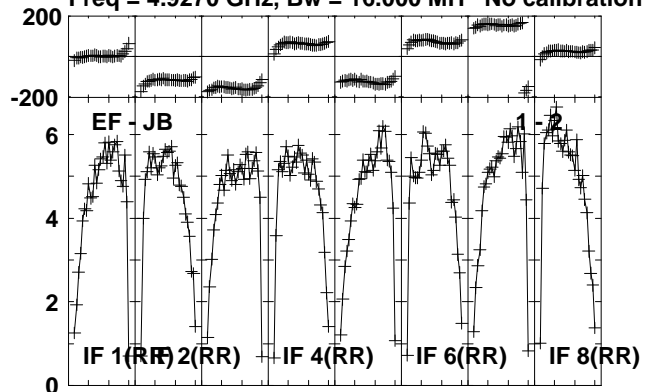

Lower frame: Milli Ampl Jy Top frame: Phas deg  
Vector averaged cross-power spectrum Several baselines displayed  
Timerange: 00/16:21:48 to 00/16:23:14

Plot file version 70 created 24-OCT-2012 20:58:50

J1825-0737 EY017B.UVDATA.1

Freq = 4.9270 GHz, Bw = 16.000 MH No calibration applied and no bandpass applied

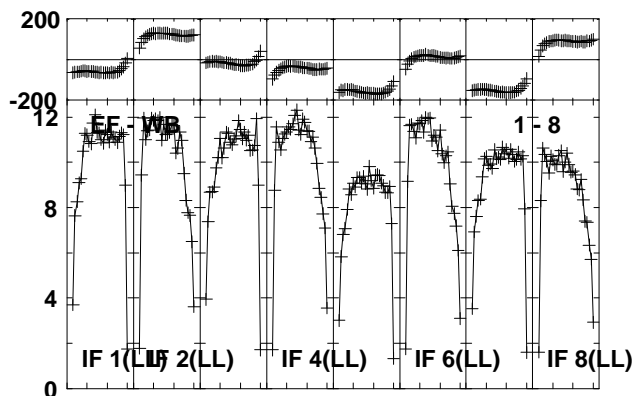
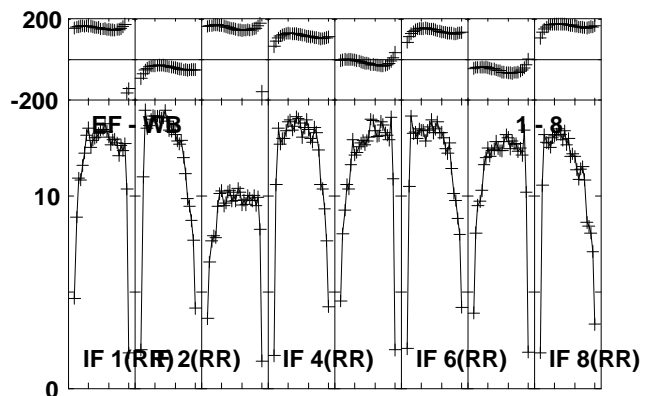
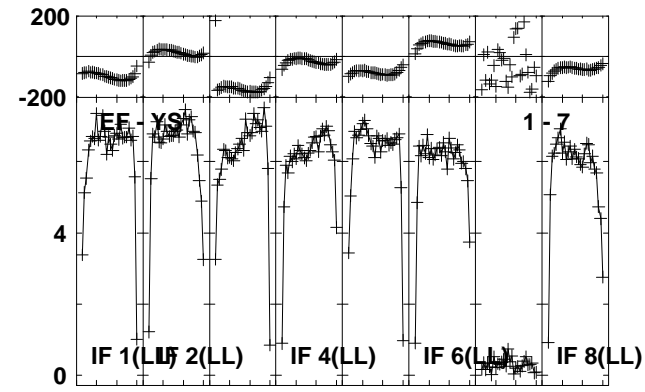
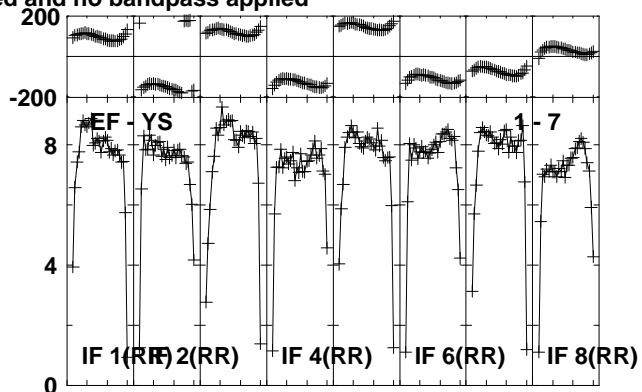
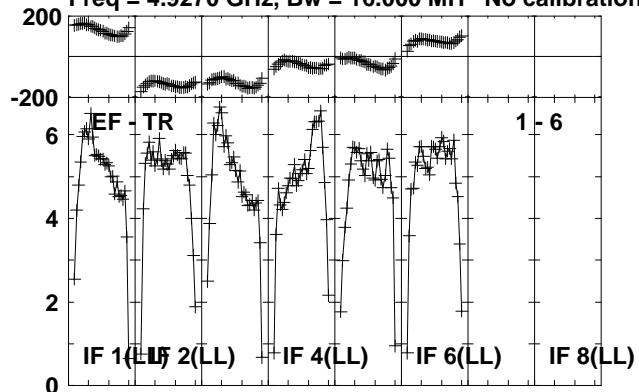

Lower frame: Milli Ampl Jy Top frame: Phas deg  
Vector averaged cross-power spectrum Several baselines displayed  
Timerange: 00/16:21:48 to 00/16:23:14

Plot file version 71 created 24-OCT-2012 20:58:50

G23.6-0.03 EY017B.UVDATA.1

Freq = 4.9270 GHz, Bw = 16.000 MH No calibration applied and no bandpass applied

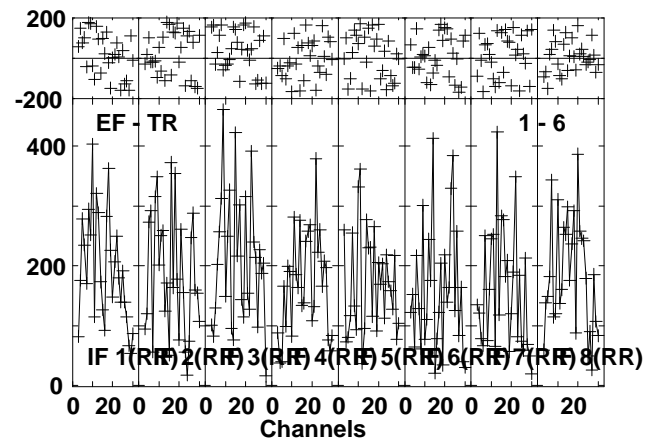
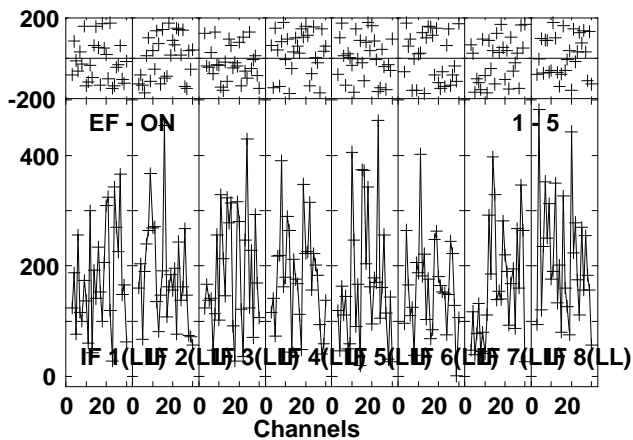
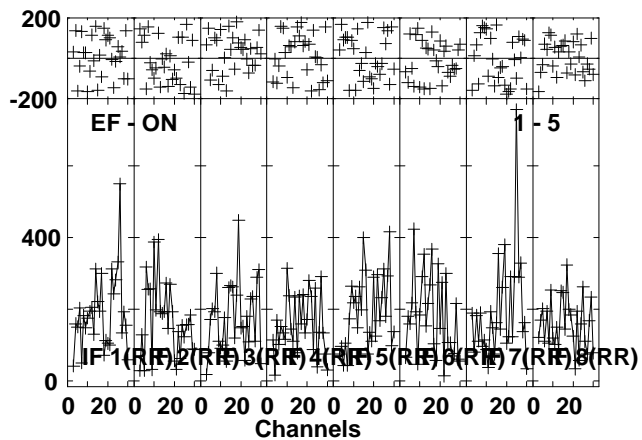
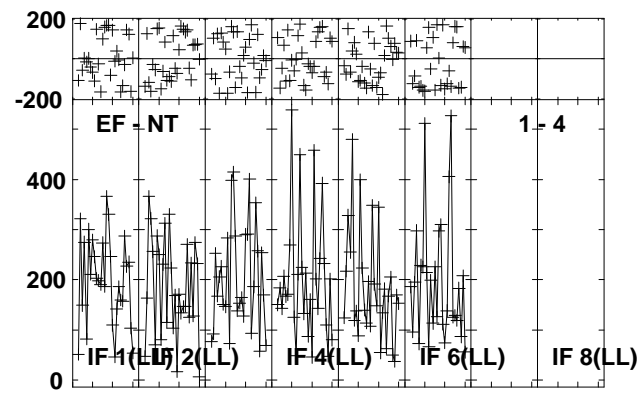
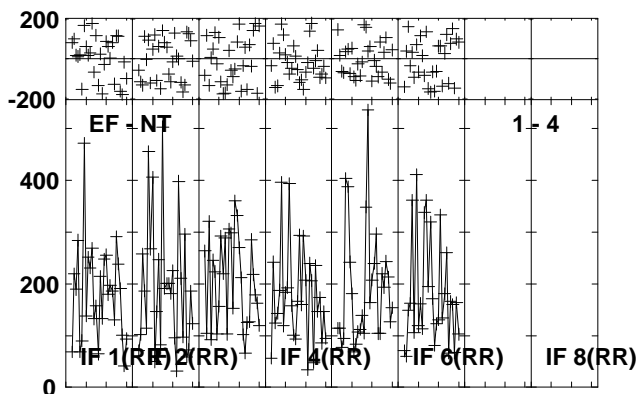
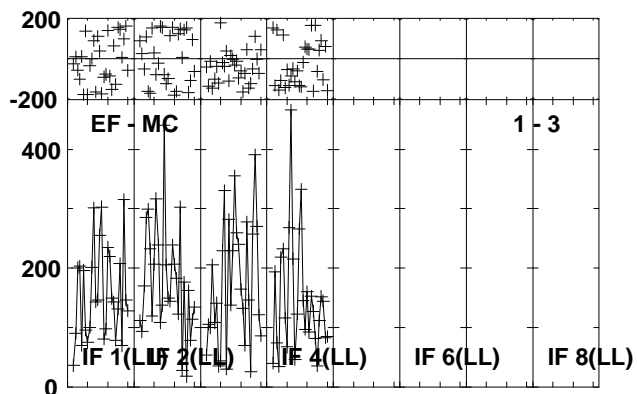
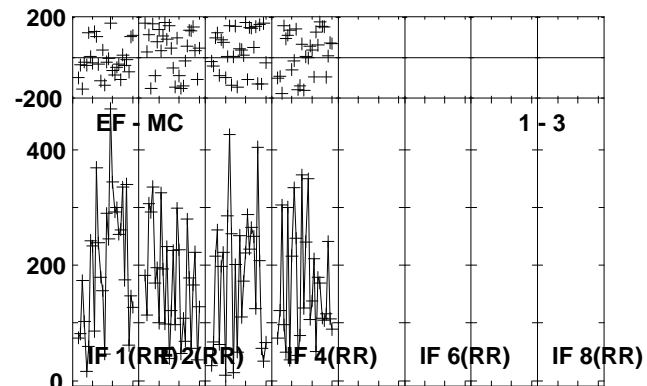
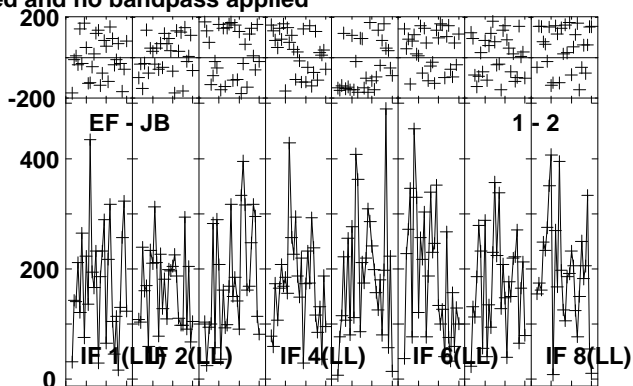
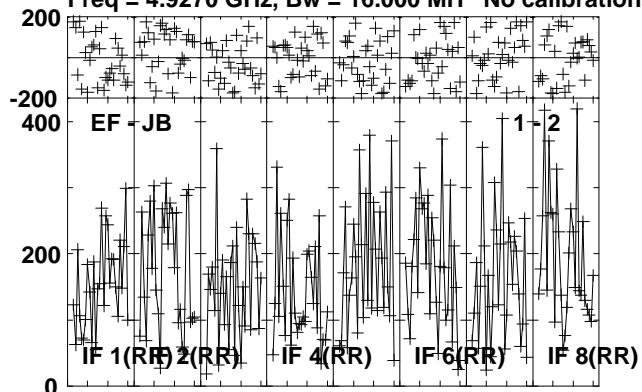

Lower frame: Micro Ampl Jy Top frame: Phas deg  
Vector averaged cross-power spectrum Several baselines displayed  
Timerange: 00/16:23:18 to 00/16:25:44

Plot file version 72 created 24-OCT-2012 20:58:51

G23.6-0.03 EY017B.UVDATA.1

Freq = 4.9270 GHz, Bw = 16.000 MH No calibration applied and no bandpass applied

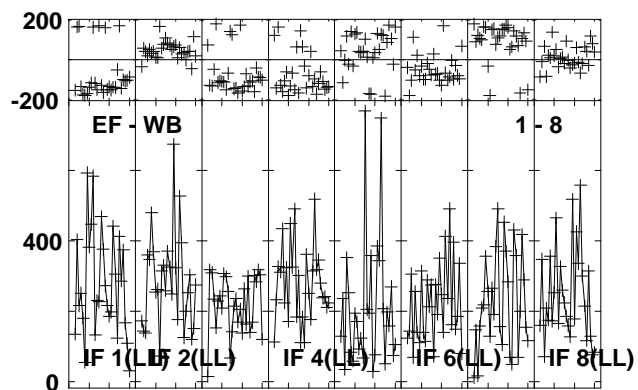
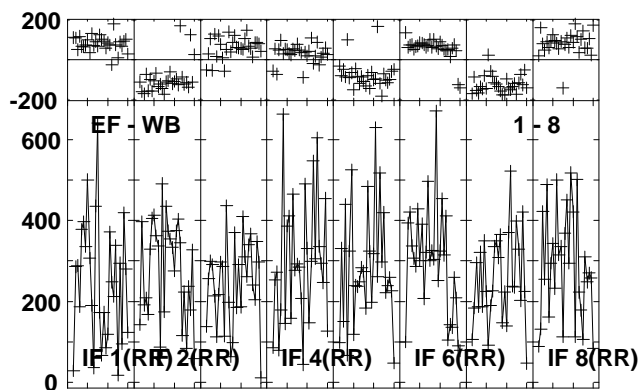
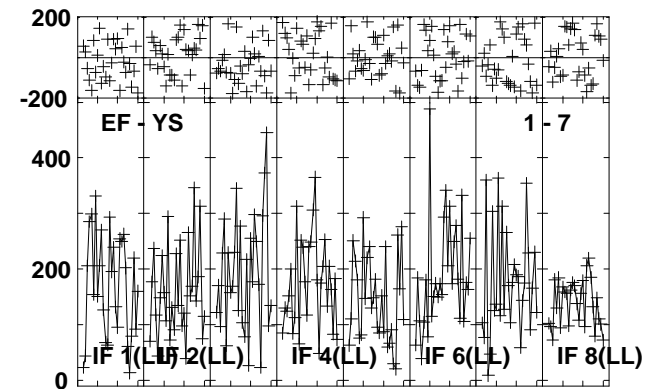
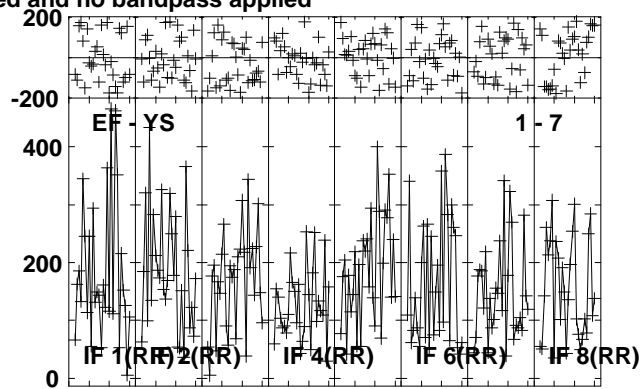
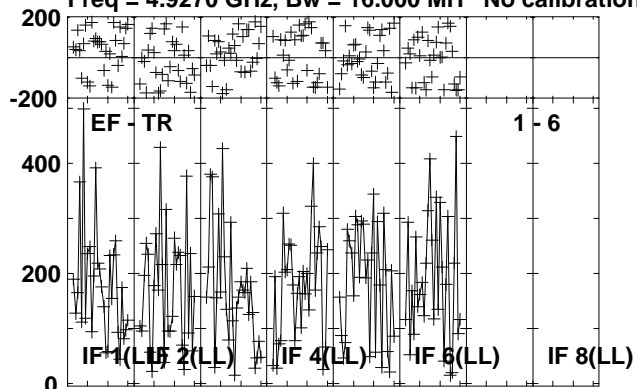

Lower frame: Micro Ampl Jy Top frame: Phas deg  
Vector averaged cross-power spectrum Several baselines displayed  
Timerange: 00/16:23:18 to 00/16:25:44

Plot file version 73 created 24-OCT-2012 20:58:52

J1825-0737 EY017B.UVDATA.1

Freq = 4.9270 GHz, Bw = 16.000 MH No calibration applied and no bandpass applied

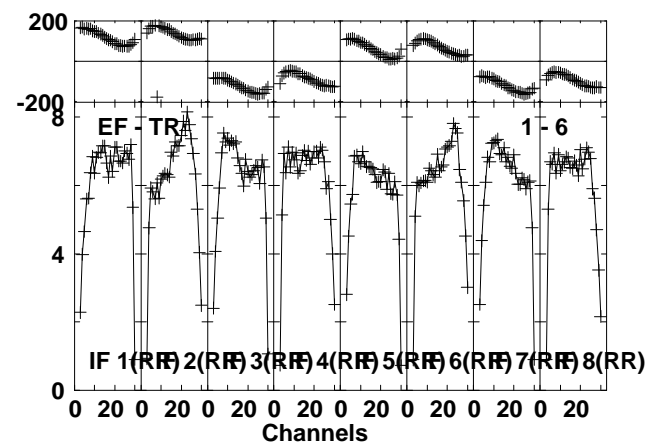
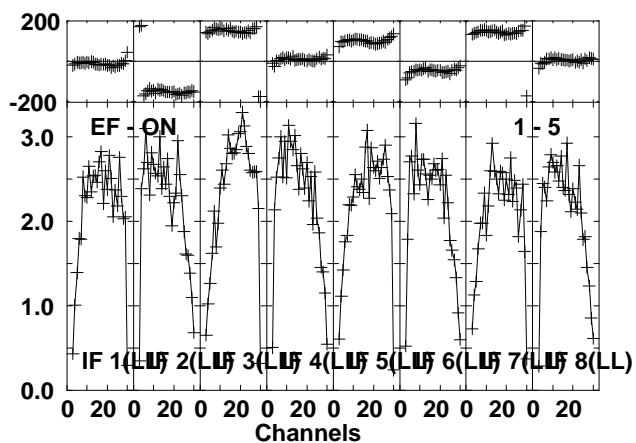
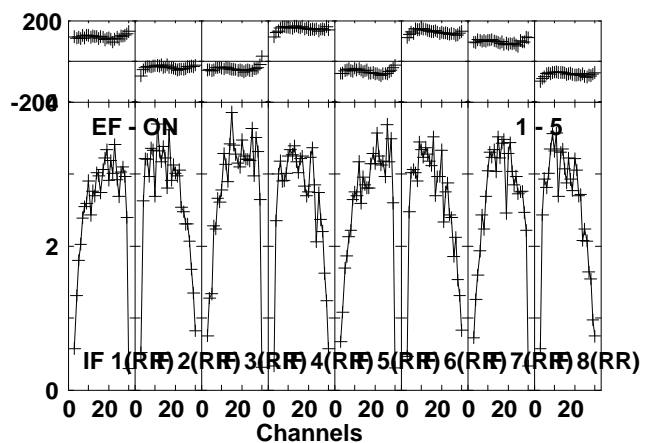
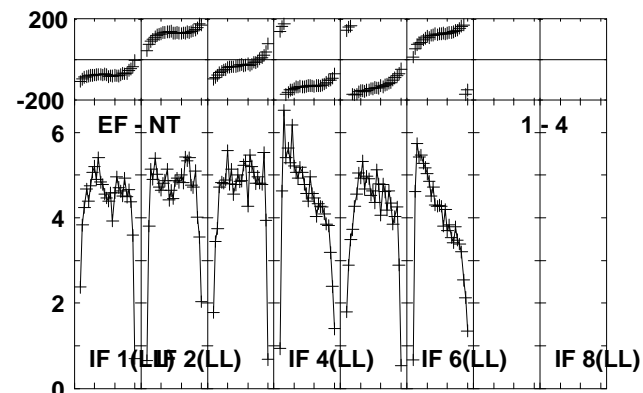
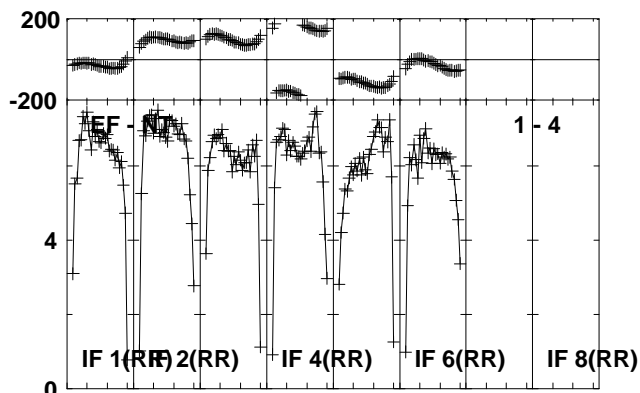
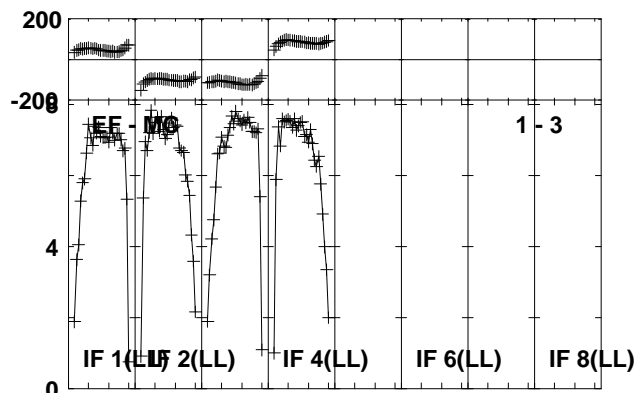
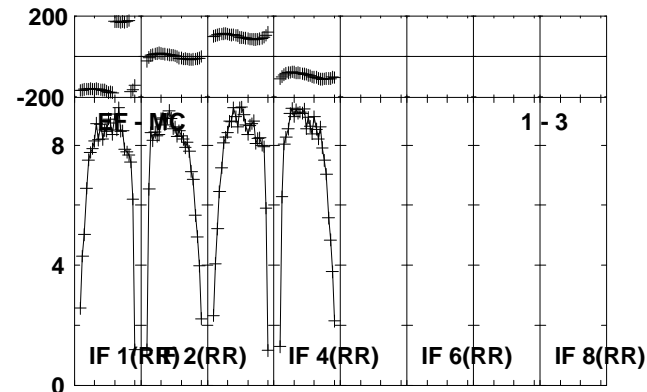
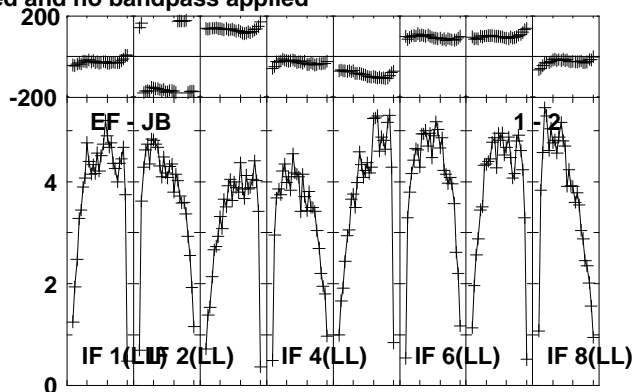
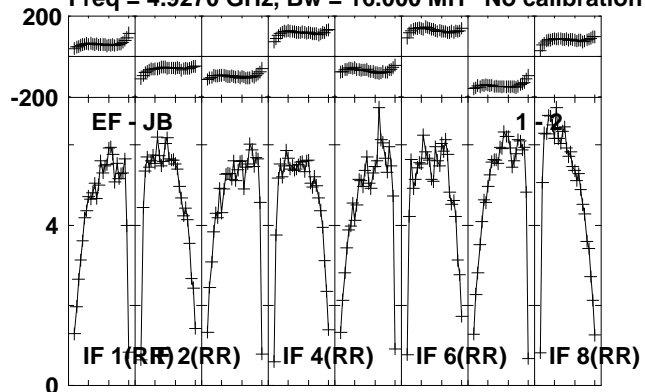

Lower frame: Milli Ampl Jy Top frame: Phas deg  
Vector averaged cross-power spectrum Several baselines displayed  
Timerange: 00/16:25:48 to 00/16:27:14

Plot file version 74 created 24-OCT-2012 20:58:52

J1825-0737 EY017B.UVDATA.1

Freq = 4.9270 GHz, Bw = 16.000 MH No calibration applied and no bandpass applied

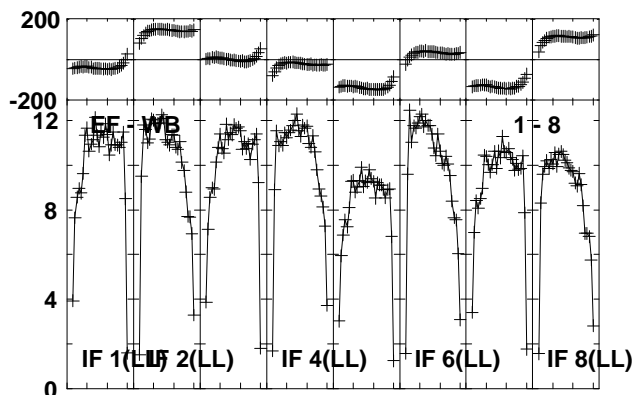
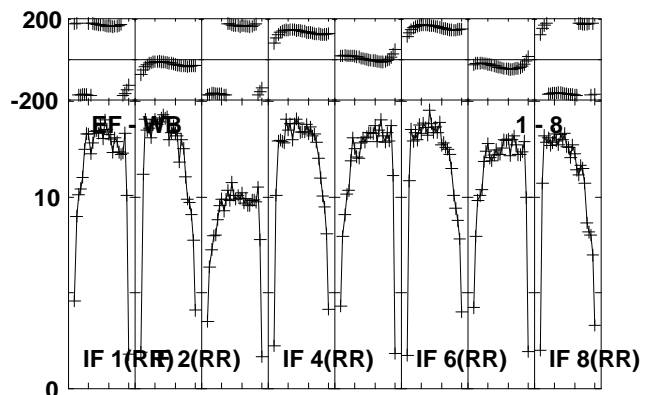
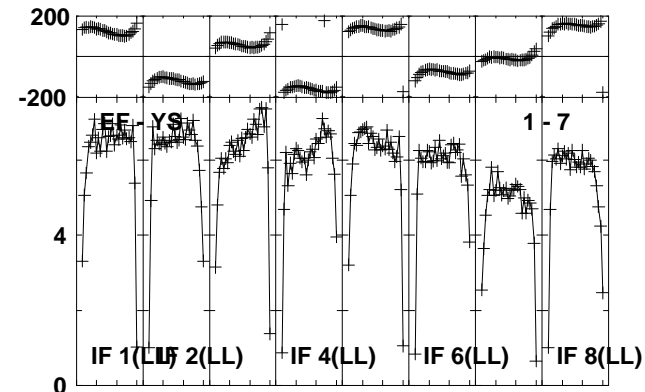
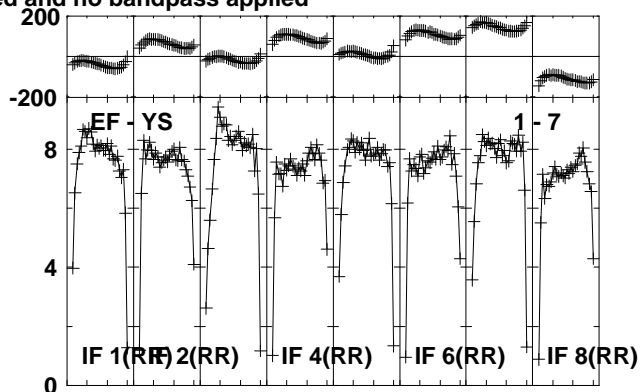
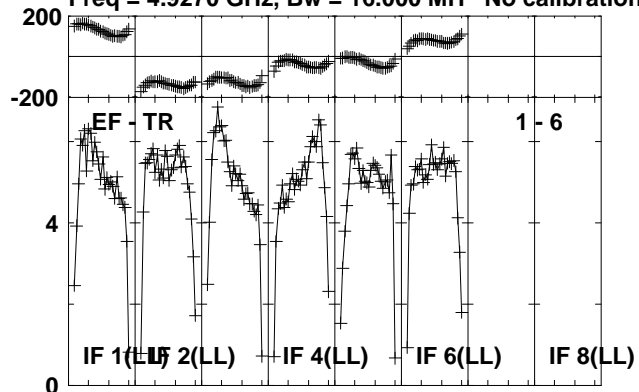

Lower frame: Milli Ampl Jy Top frame: Phas deg  
Vector averaged cross-power spectrum Several baselines displayed  
Timerange: 00/16:25:48 to 00/16:27:14

Plot file version 75 created 24-OCT-2012 20:58:53

G23.6-0.03 EY017B.UVDATA.1

Freq = 4.9270 GHz, Bw = 16.000 MH No calibration applied and no bandpass applied

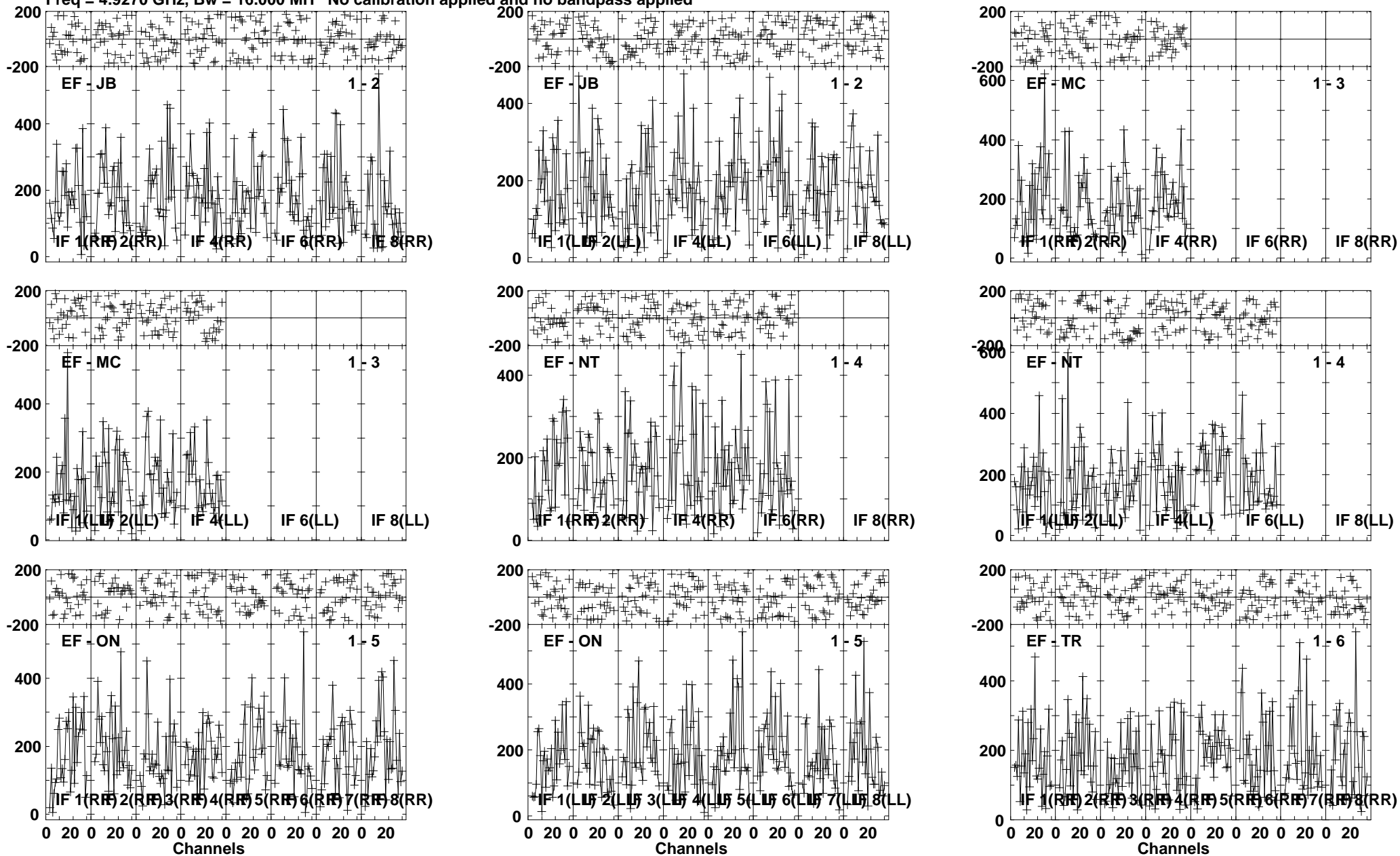

Lower frame: Micro Ampl Jy Top frame: Phas deg  
Vector averaged cross-power spectrum Several baselines displayed  
Timerange: 00/16:27:18 to 00/16:29:44

Plot file version 76 created 24-OCT-2012 20:58:53

G23.6-0.03 EY017B.UVDATA.1

Freq = 4.9270 GHz, Bw = 16.000 MH No calibration applied and no bandpass applied

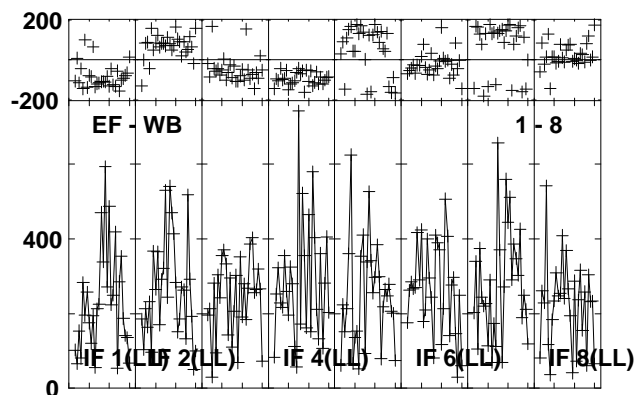
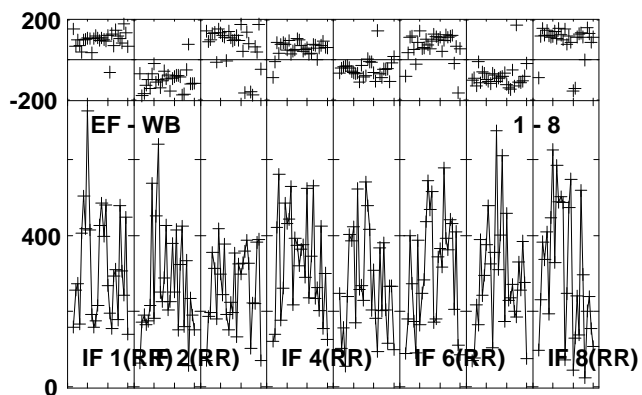
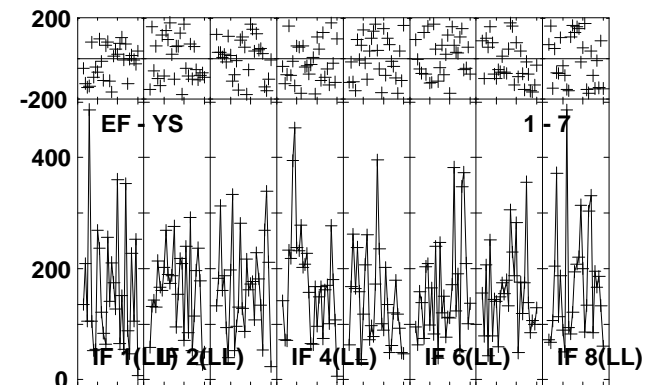
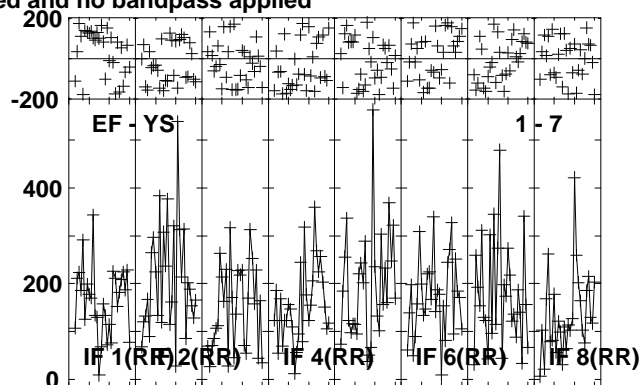
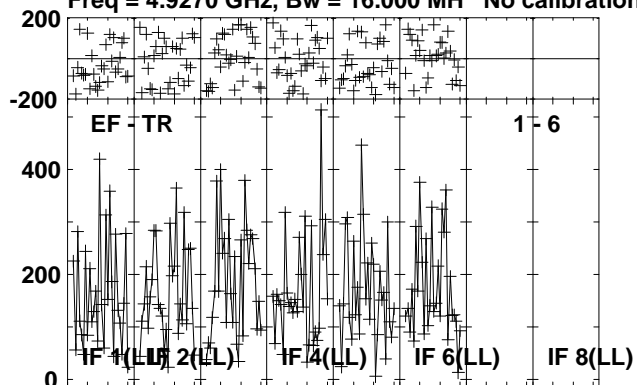

Lower frame: Micro Ampl Jy Top frame: Phas deg  
Vector averaged cross-power spectrum Several baselines displayed  
Timerange: 00/16:27:18 to 00/16:29:44





Plot file version 78 created 24-OCT-2012 20:58:54

J1825-0737 EY017B.UVDATA.1

Freq = 4.9270 GHz, Bw = 16.000 MH No calibration applied and no bandpass applied

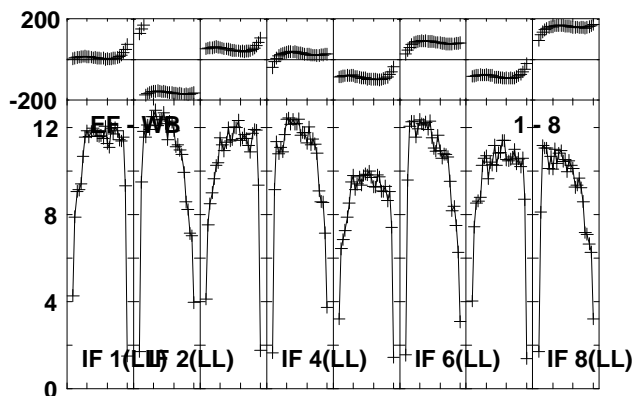
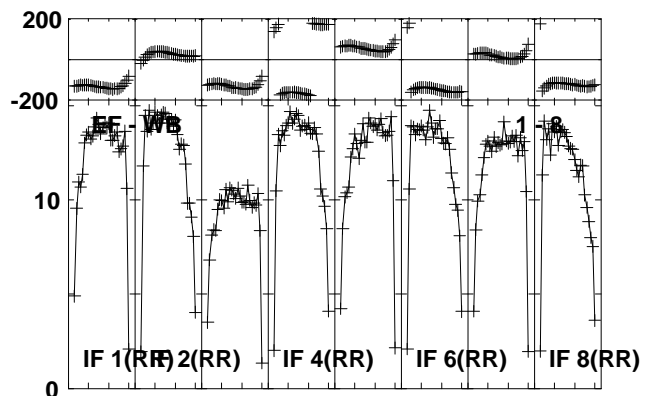
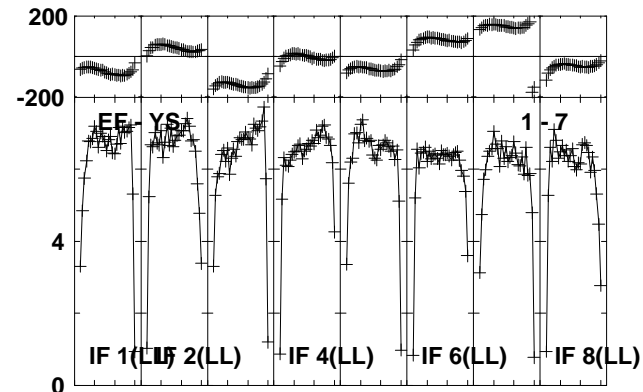
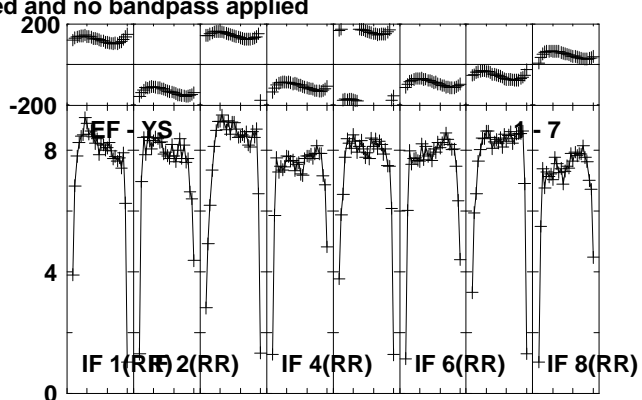
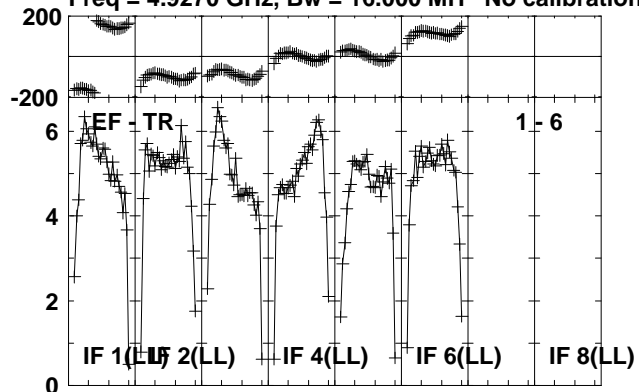

Lower frame: Milli Ampl Jy Top frame: Phas deg  
Vector averaged cross-power spectrum Several baselines displayed  
Timerange: 00/16:29:48 to 00/16:31:14

Plot file version 79 created 24-OCT-2012 20:58:55

J1831-0756 EY017B.UVDATA.1

Freq = 4.9270 GHz, Bw = 16.000 MH No calibration applied and no bandpass applied

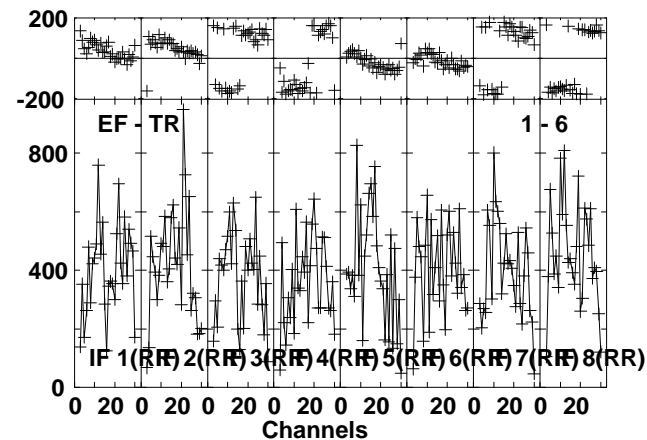
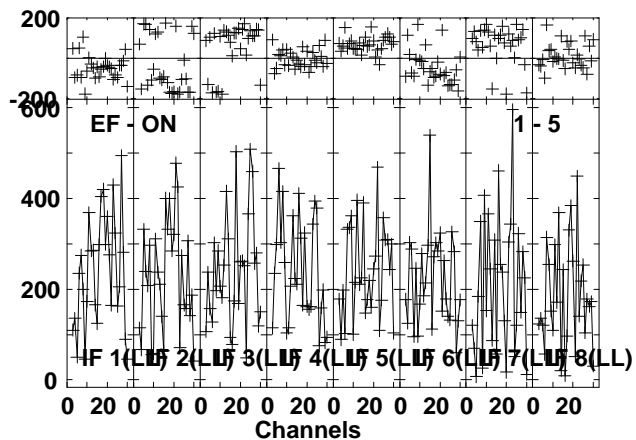
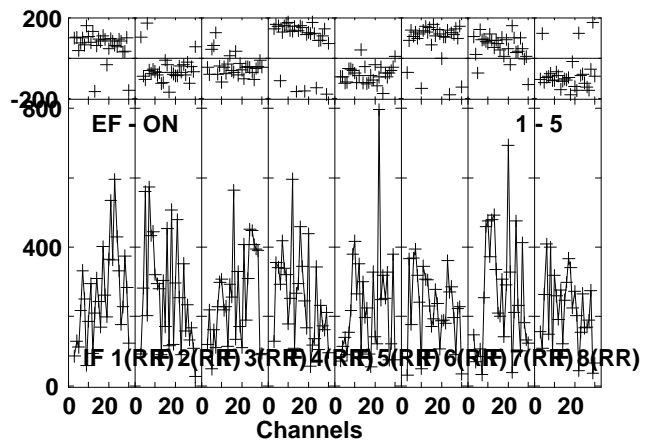
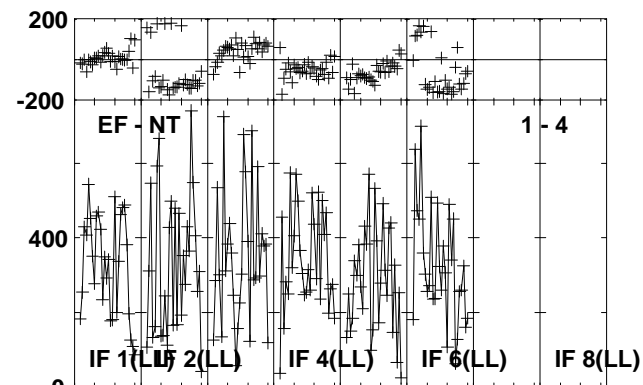
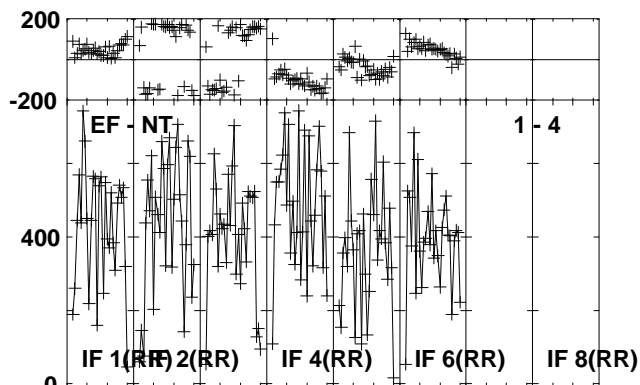
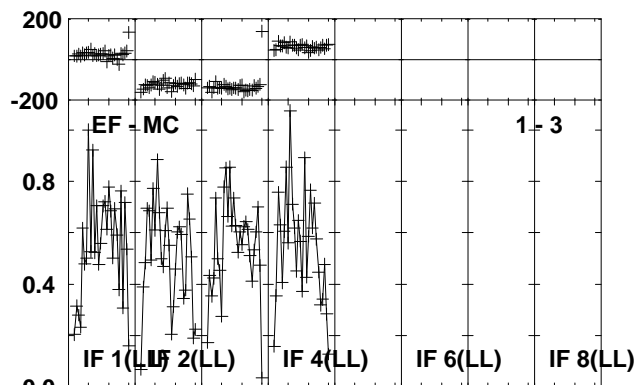
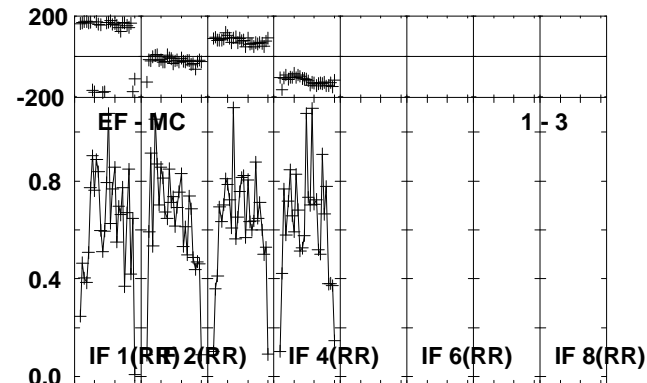
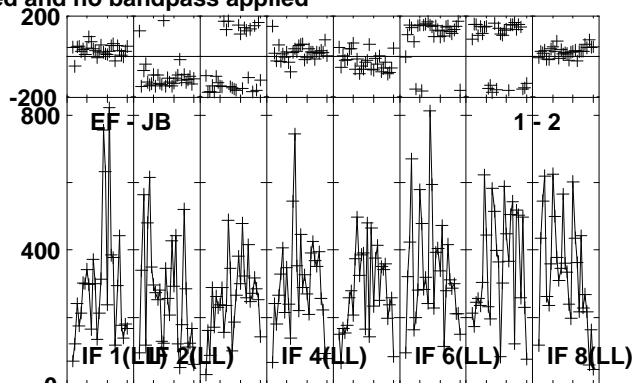
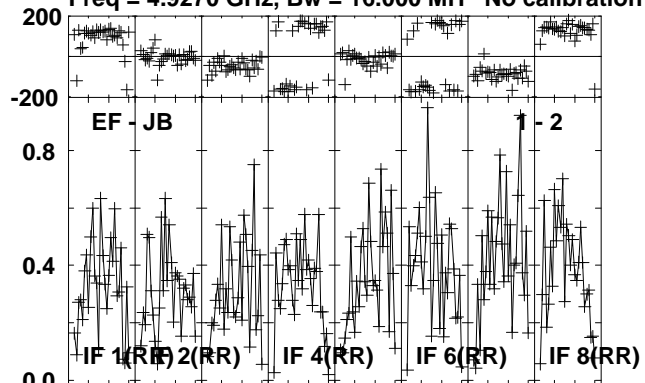

Lower frame: Milli Ampl Jy Top frame: Phas deg  
Vector averaged cross-power spectrum Several baselines displayed  
Timerange: 00/16:31:48 to 00/16:33:48

Plot file version 80 created 24-OCT-2012 20:58:55

J1831-0756 EY017B.UVDATA.1

Freq = 4.9270 GHz, Bw = 16.000 MH No calibration applied and no bandpass applied

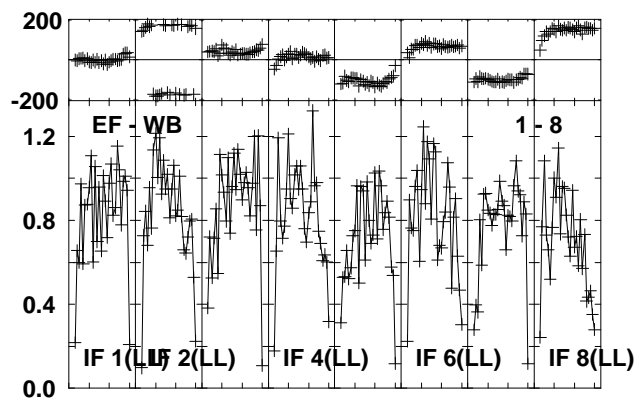
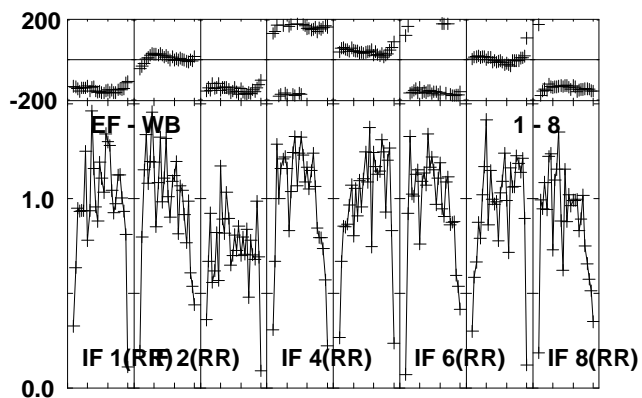
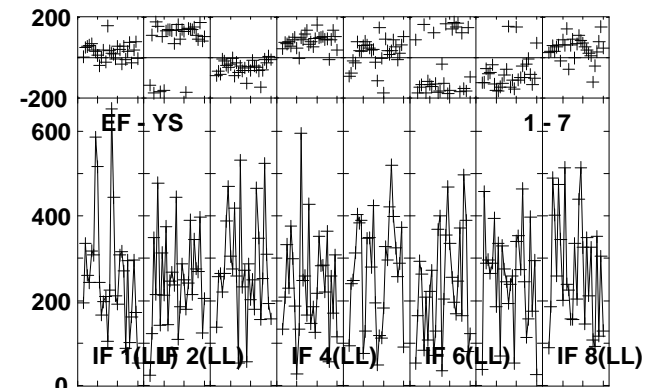
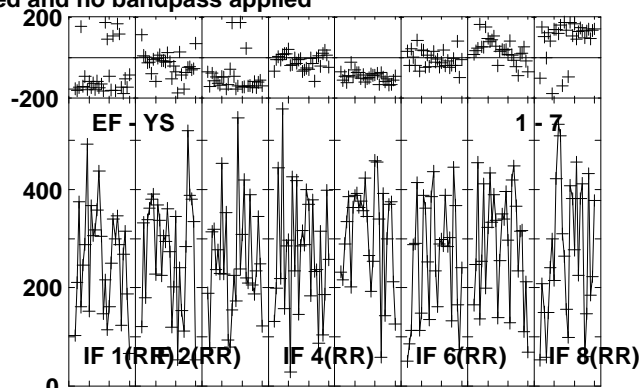
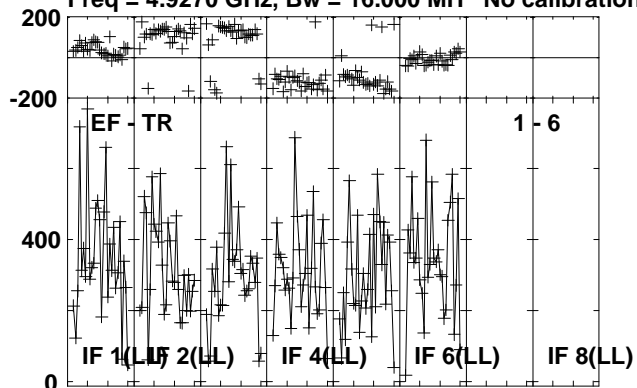

Lower frame: Micro Ampl Jy Top frame: Phas deg  
Vector averaged cross-power spectrum Several baselines displayed  
Timerange: 00/16:31:48 to 00/16:33:48



Plot file version 82 created 24-OCT-2012 20:58:56

J1825-0737 EY017B.UVDATA.1

Freq = 4.9270 GHz, Bw = 16.000 MH No calibration applied and no bandpass applied

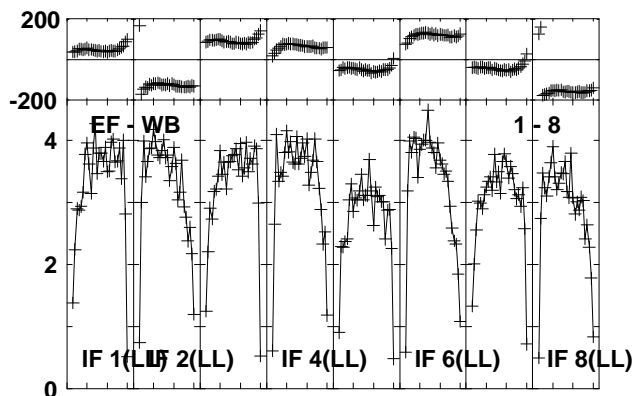
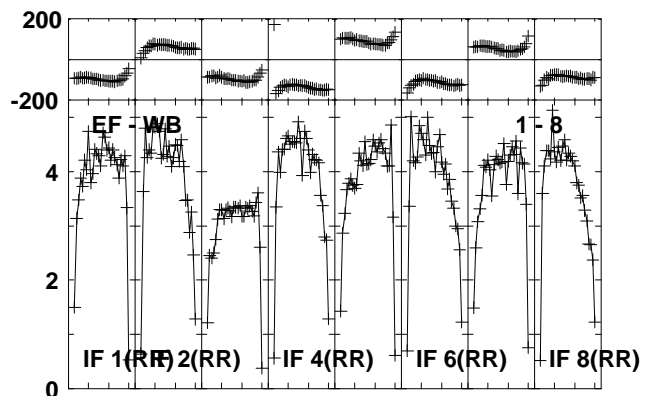
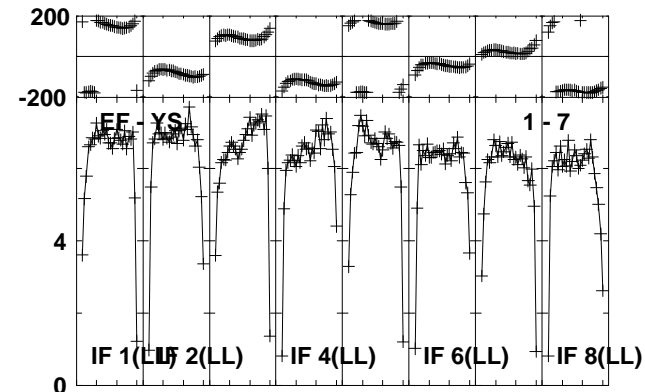
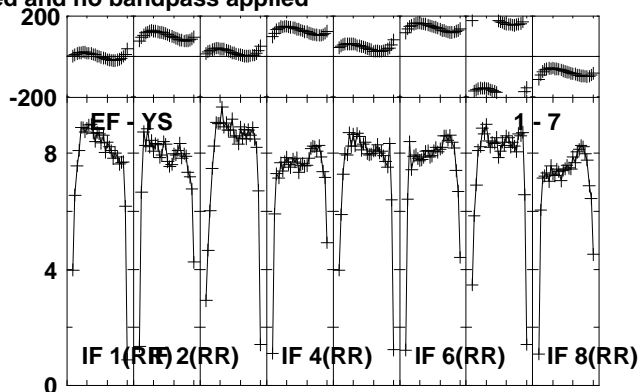
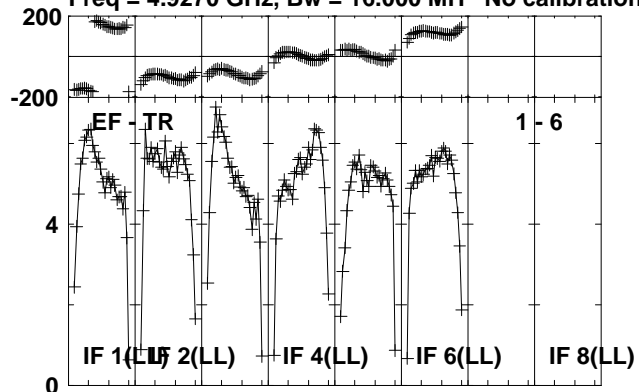

Lower frame: Milli Ampl Jy Top frame: Phas deg  
Vector averaged cross-power spectrum Several baselines displayed  
Timerange: 00/16:33:52 to 00/16:35:18

Plot file version 83 created 24-OCT-2012 20:58:57

G23.6-0.03 EY017B.UVDATA.1

Freq = 4.9270 GHz, Bw = 16.000 MH No calibration applied and no bandpass applied

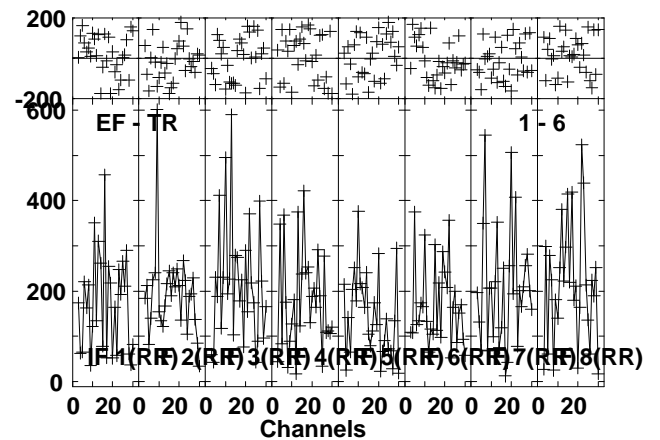
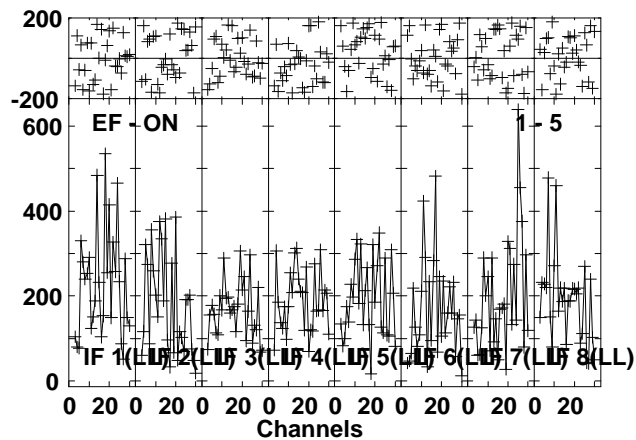
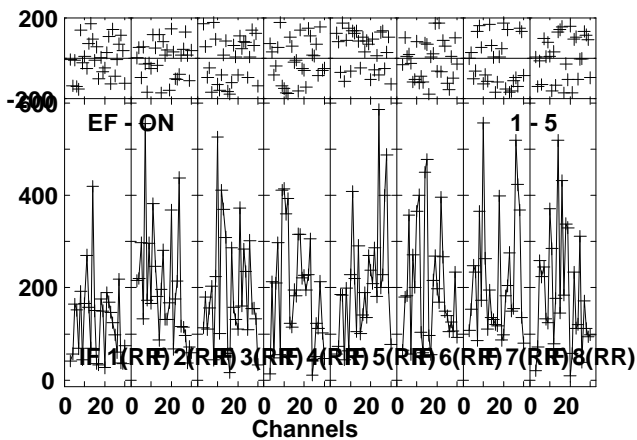
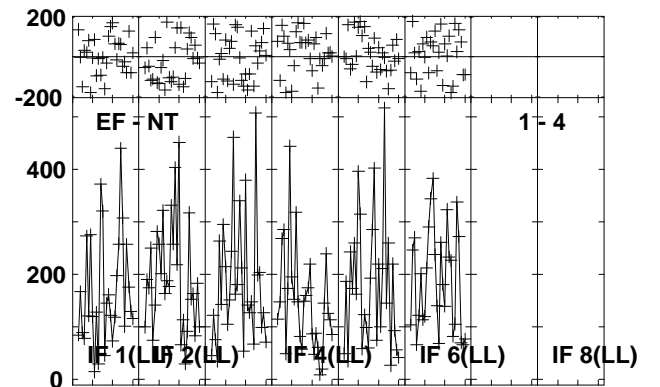
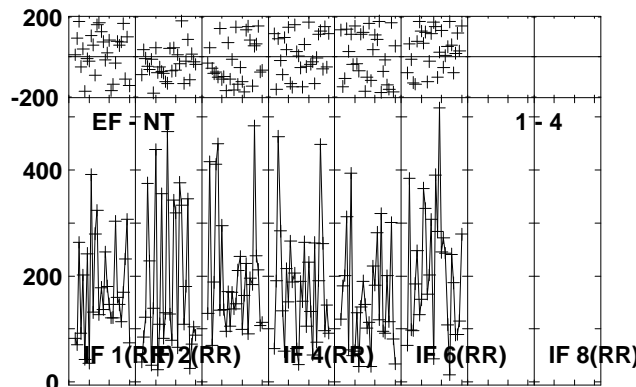
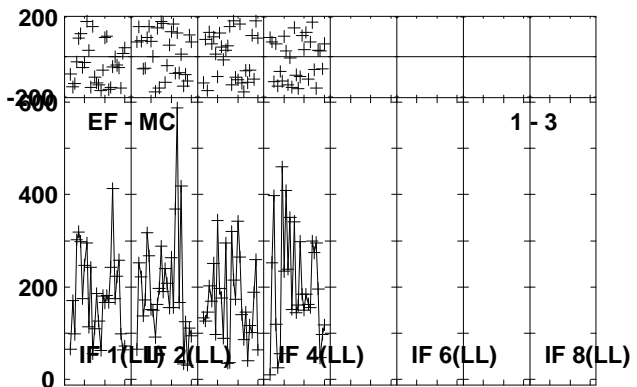
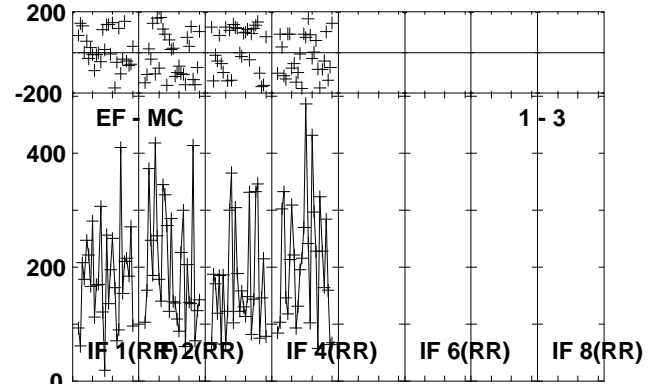
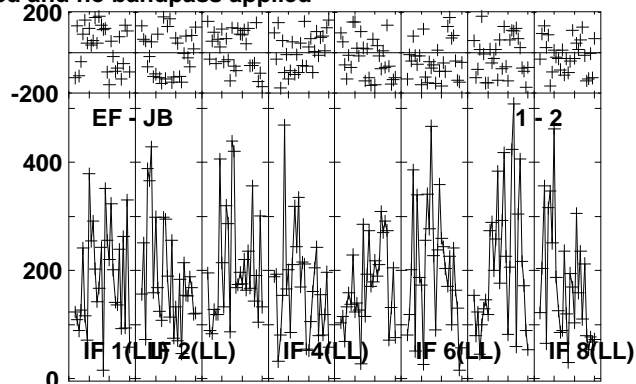
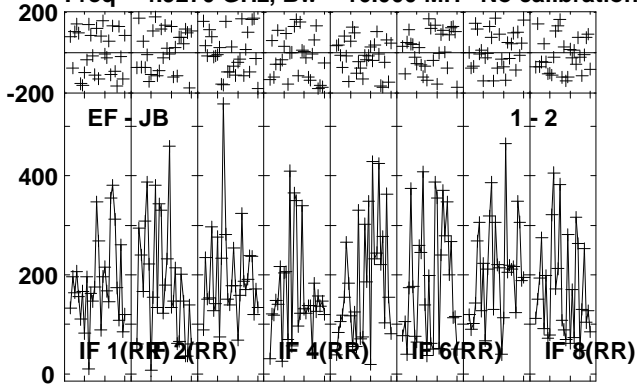

Lower frame: Micro Ampl Jy Top frame: Phas deg  
Vector averaged cross-power spectrum Several baselines displayed  
Timerange: 00/16:35:22 to 00/16:37:48

Plot file version 84 created 24-OCT-2012 20:58:57

G23.6-0.03 EY017B.UVDATA.1

Freq = 4.9270 GHz, Bw = 16.000 MH No calibration applied and no bandpass applied

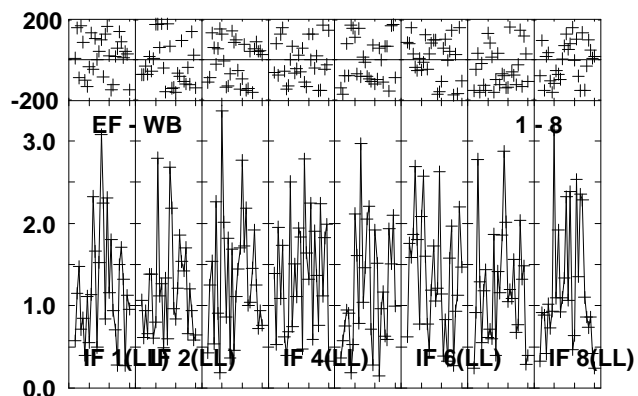
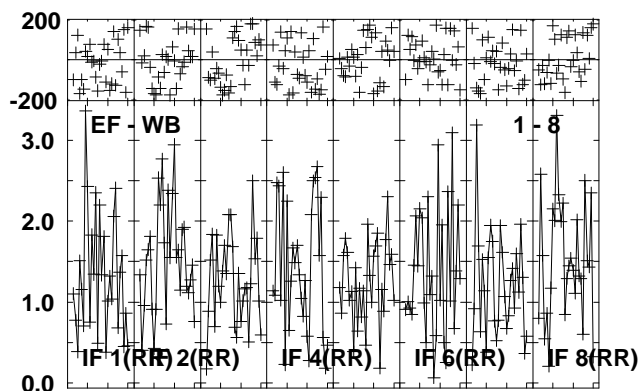
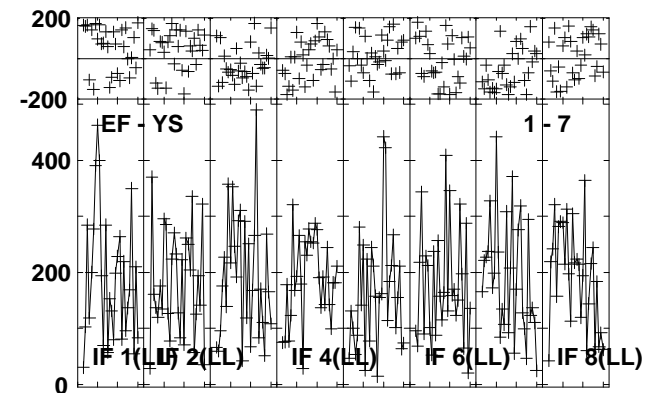
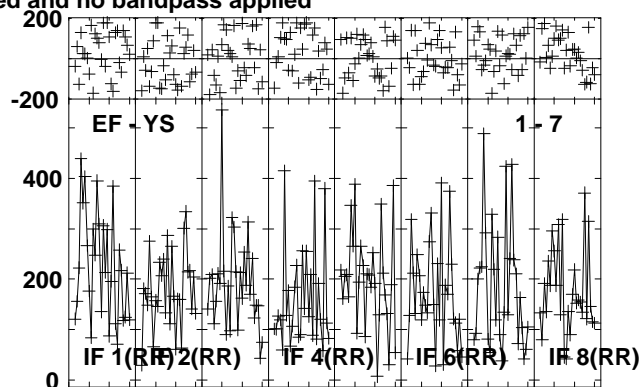
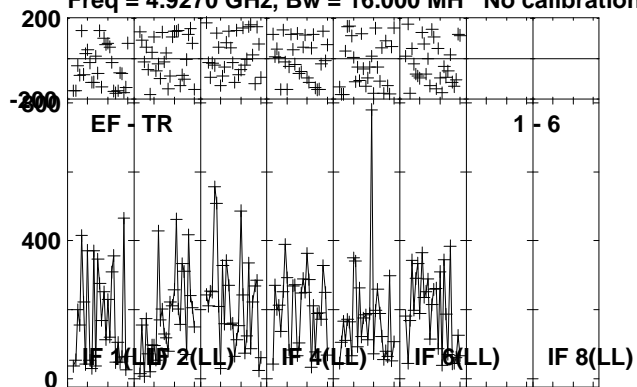

Lower frame: Micro Ampl Jy Top frame: Phas deg  
Vector averaged cross-power spectrum Several baselines displayed  
Timerange: 00/16:35:22 to 00/16:37:48





Plot file version 86 created 24-OCT-2012 20:58:58

J1825-0737 EY017B.UVDATA.1

Freq = 4.9270 GHz, Bw = 16.000 MH No calibration applied and no bandpass applied

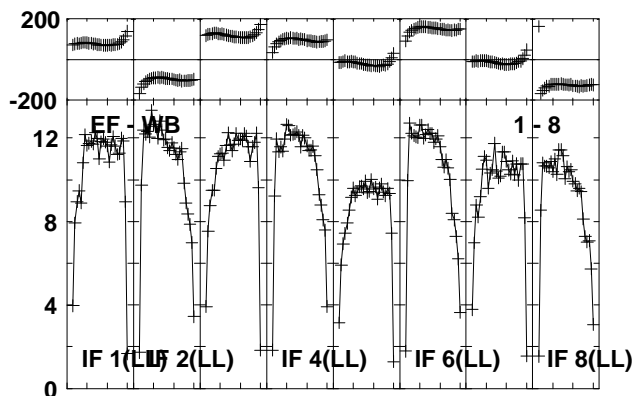
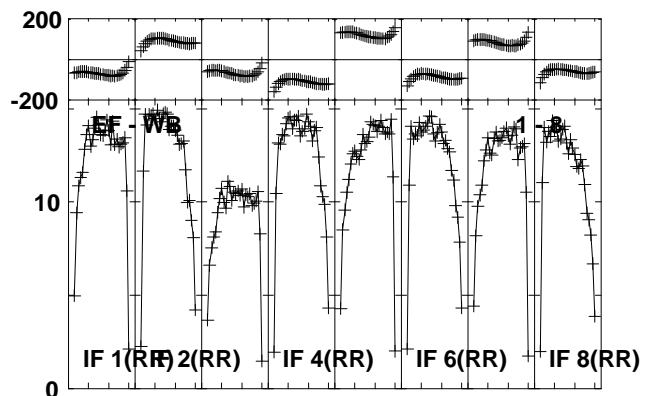
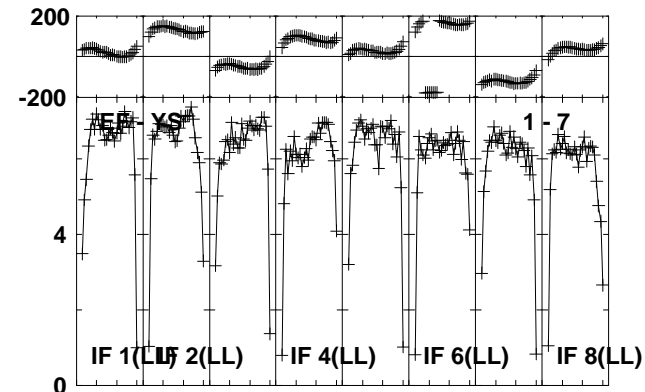
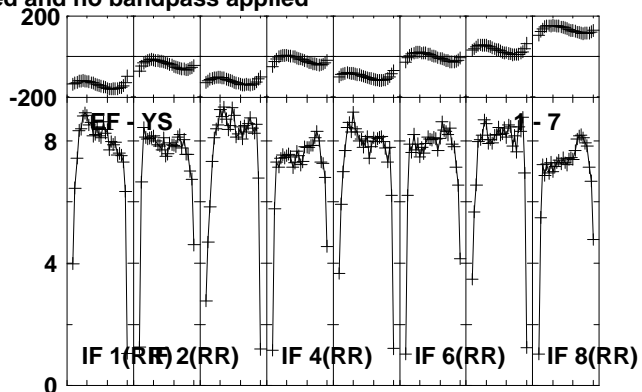
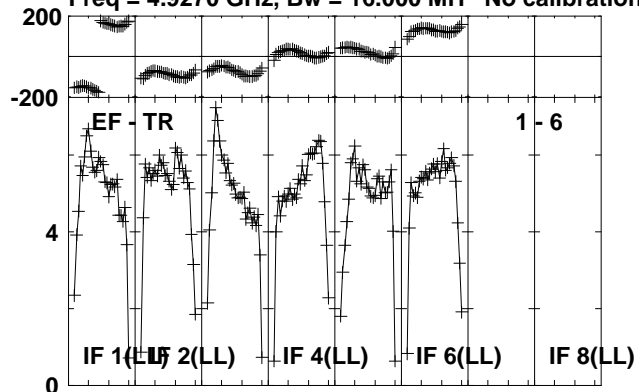

Lower frame: Milli Ampl Jy Top frame: Phas deg  
Vector averaged cross-power spectrum Several baselines displayed  
Timerange: 00/16:37:52 to 00/16:39:18

Plot file version 87 created 24-OCT-2012 20:58:59

G23.6-0.03 EY017B.UVDATA.1

Freq = 4.9270 GHz, Bw = 16.000 MH No calibration applied and no bandpass applied

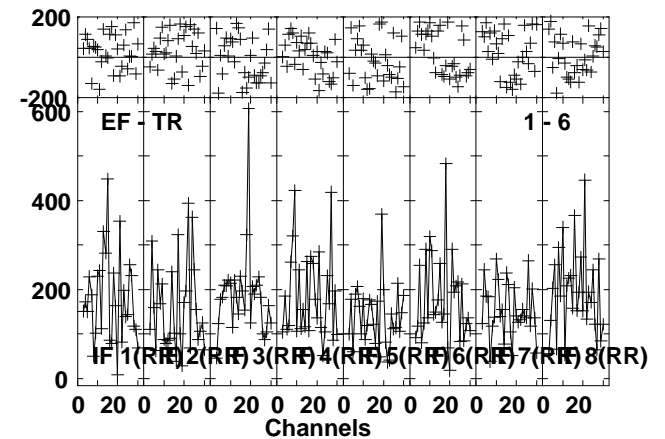
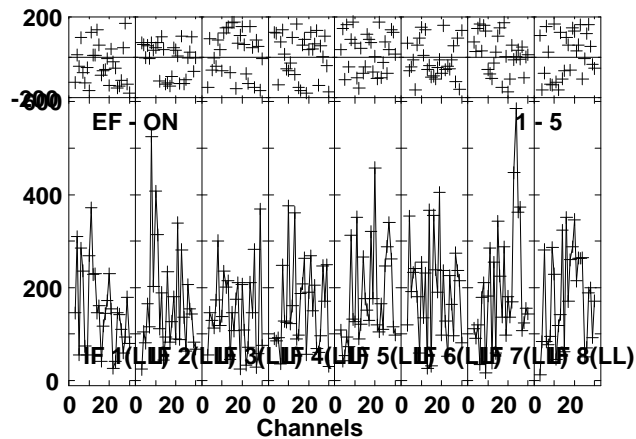
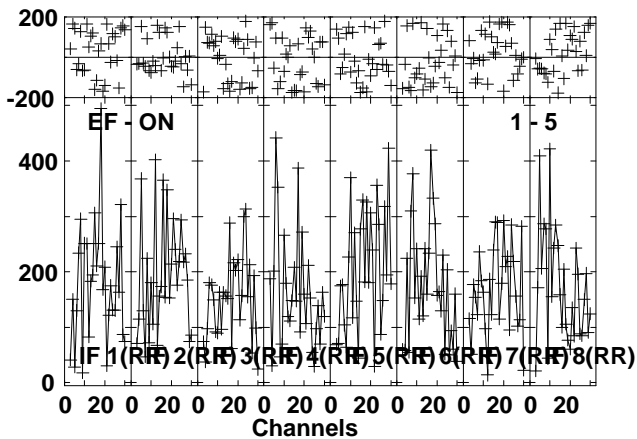
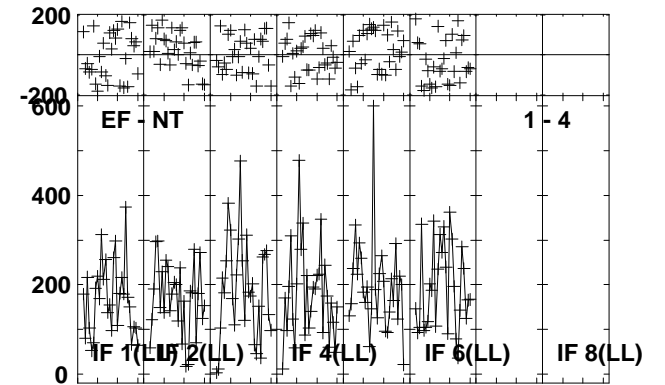
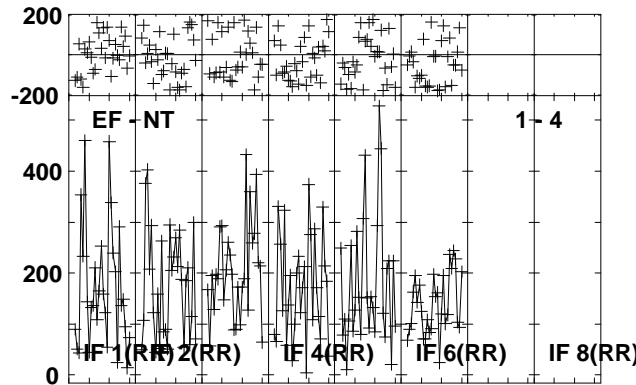
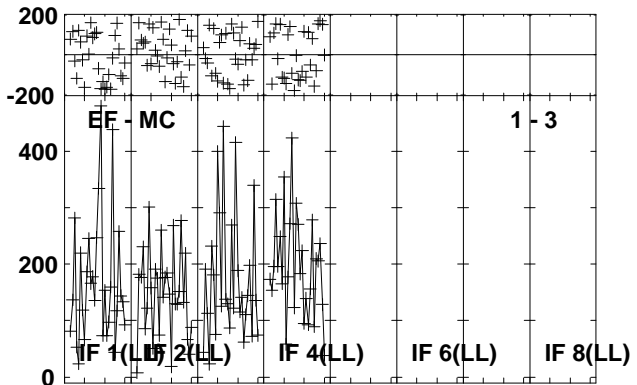
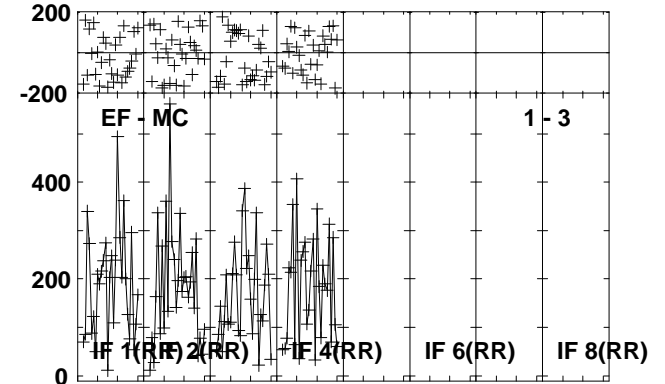
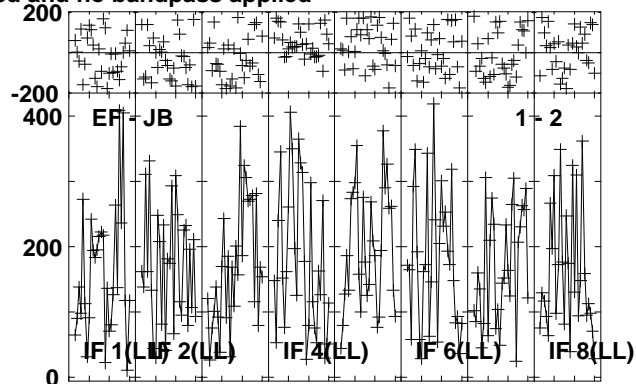
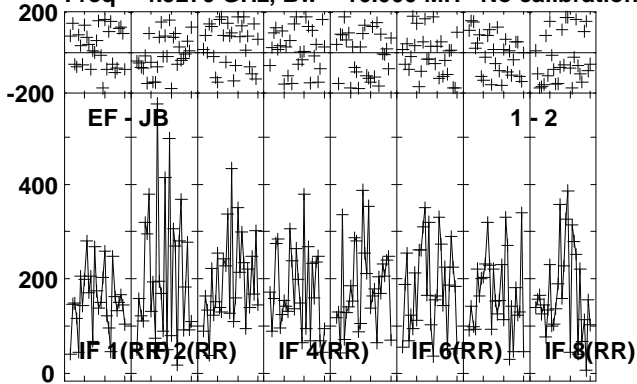

Lower frame: Micro Ampl Jy Top frame: Phas deg  
Vector averaged cross-power spectrum Several baselines displayed  
Timerange: 00/16:39:22 to 00/16:41:48

Plot file version 88 created 24-OCT-2012 20:58:59

G23.6-0.03 EY017B.UVDATA.1

Freq = 4.9270 GHz, Bw = 16.000 MH No calibration applied and no bandpass applied

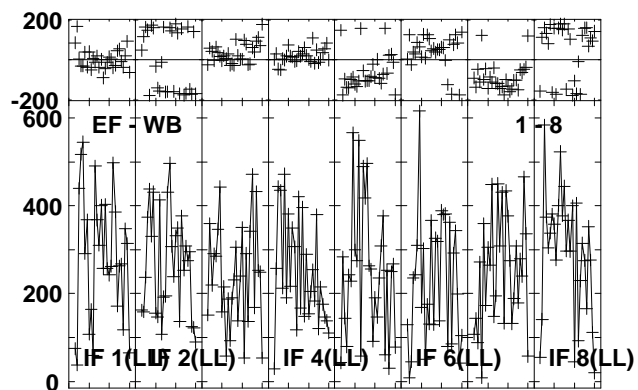
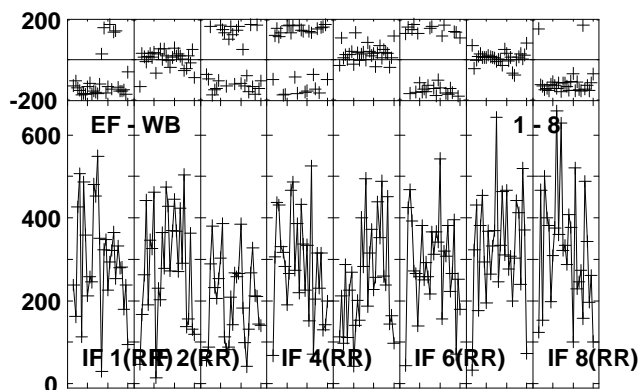
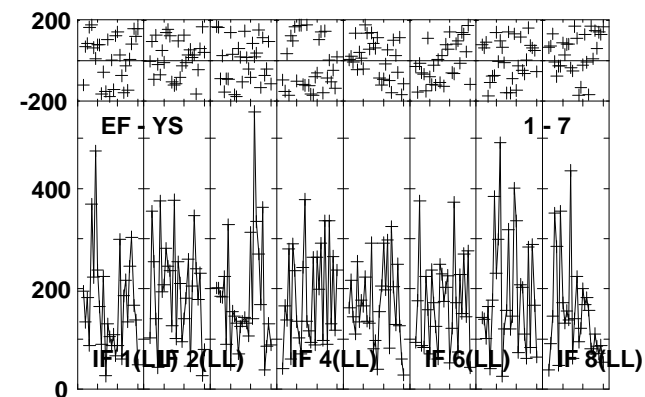
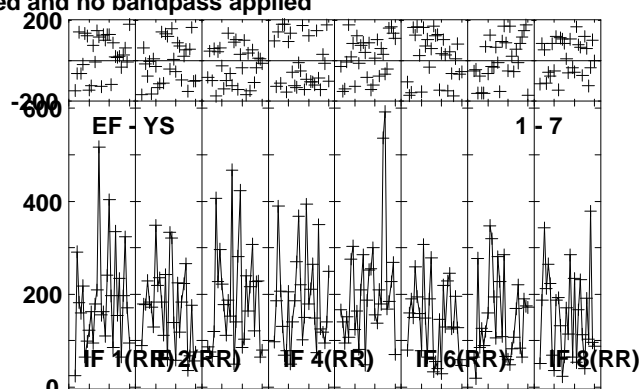
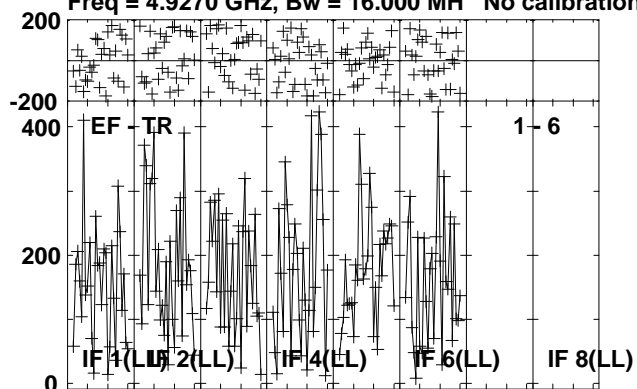

Lower frame: Micro Ampl Jy Top frame: Phas deg  
Vector averaged cross-power spectrum Several baselines displayed  
Timerange: 00/16:39:22 to 00/16:41:48

Plot file version 89 created 24-OCT-2012 20:59:00

J1825-0737 EY017B.UVDATA.1

Freq = 4.9270 GHz, Bw = 16.000 MH No calibration applied and no bandpass applied

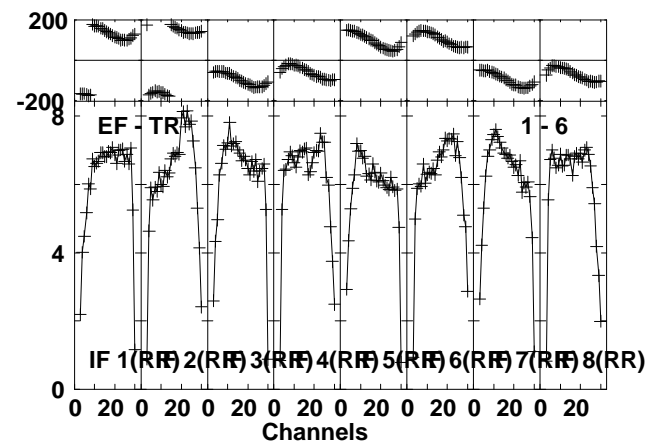
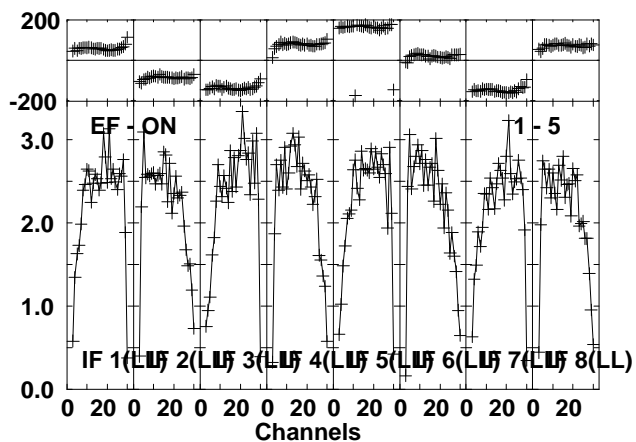
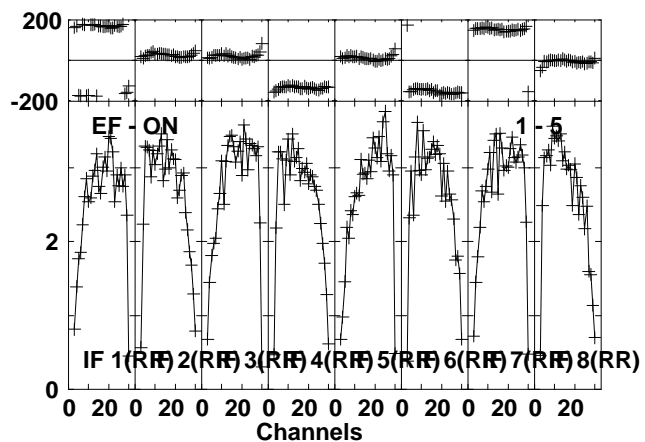
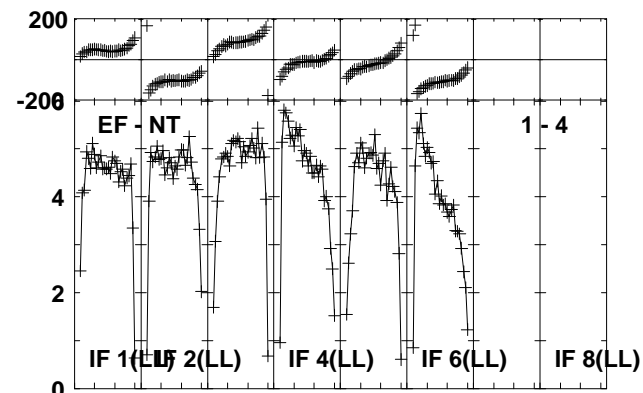
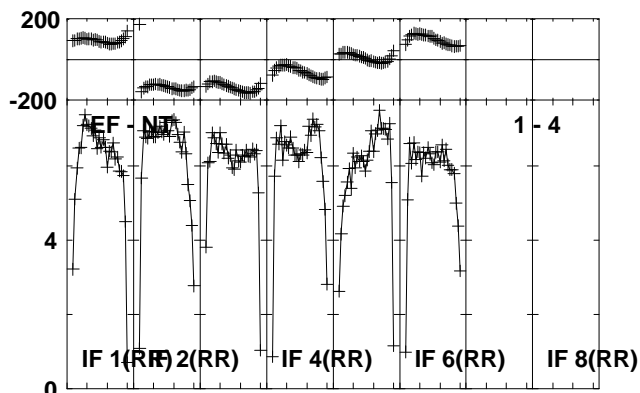
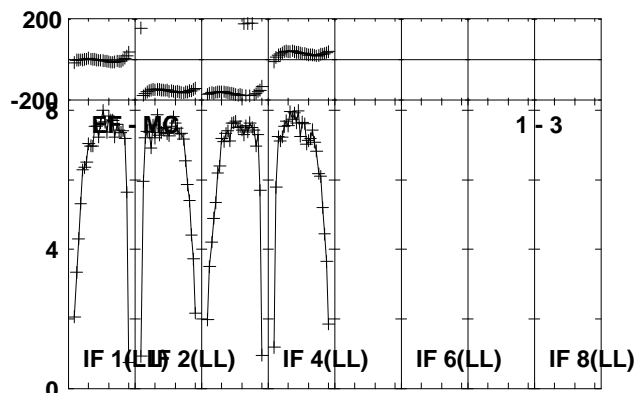
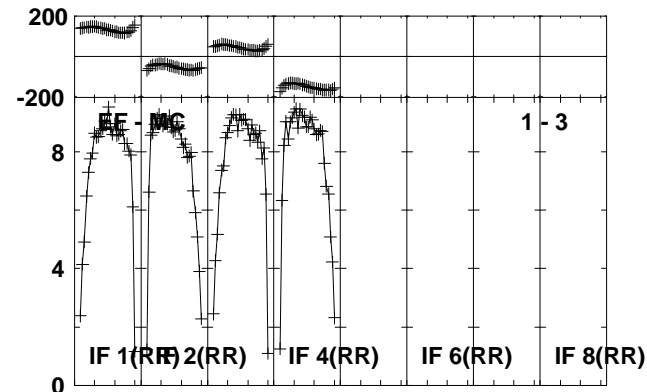
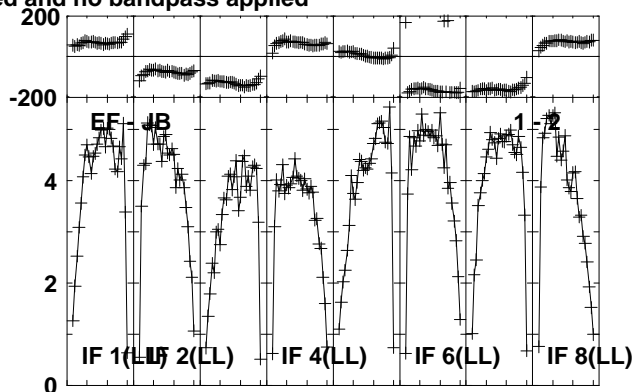
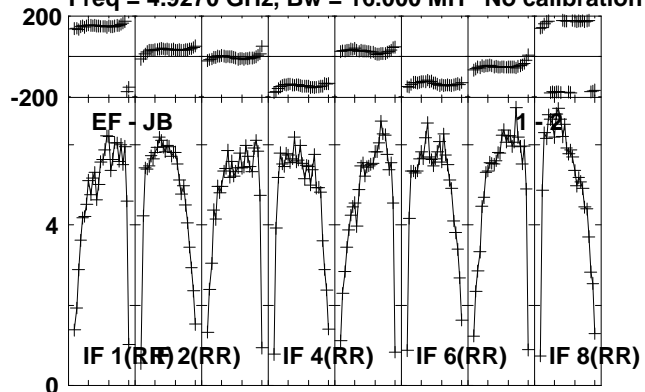

Lower frame: Milli Ampl Jy Top frame: Phas deg  
Vector averaged cross-power spectrum Several baselines displayed  
Timerange: 00/16:41:52 to 00/16:43:18

Plot file version 90 created 24-OCT-2012 20:59:00

J1825-0737 EY017B.UVDATA.1

Freq = 4.9270 GHz, Bw = 16.000 MH No calibration applied and no bandpass applied

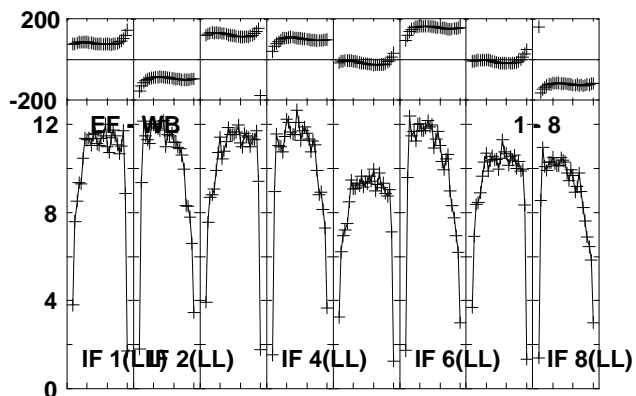
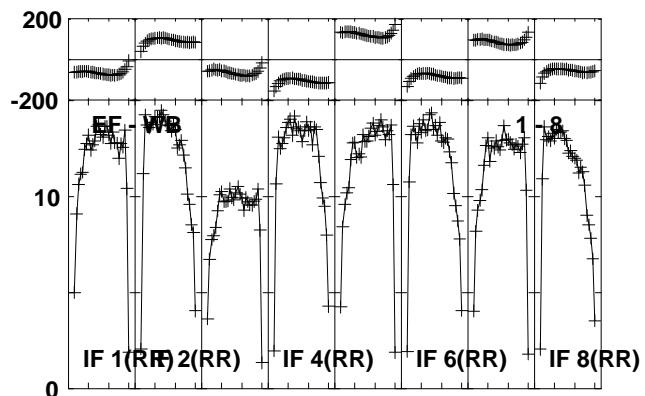
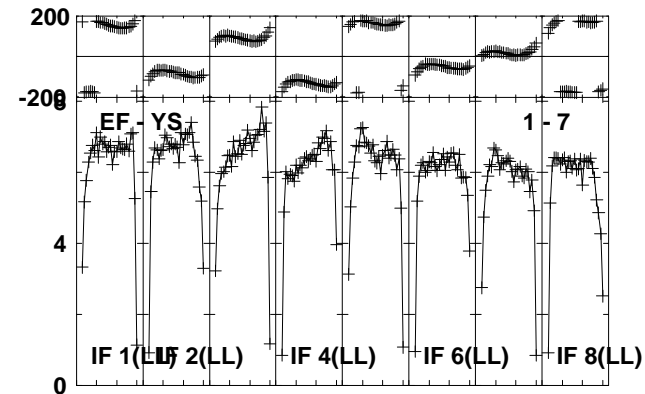
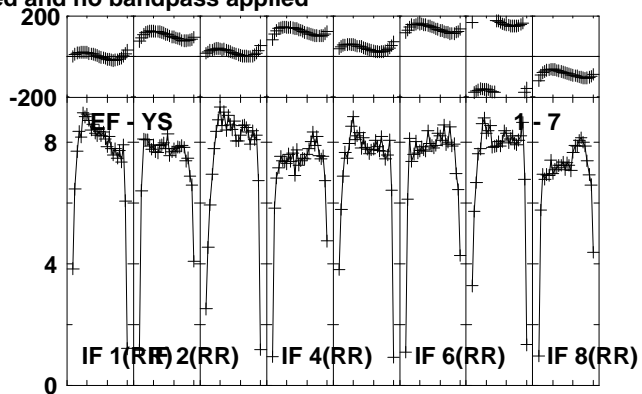
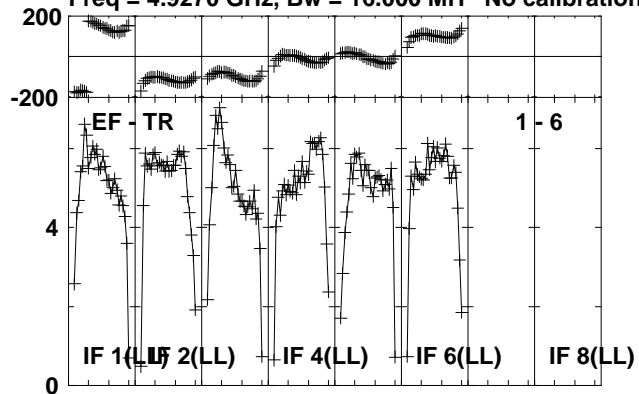

Lower frame: Milli Ampl Jy Top frame: Phas deg  
Vector averaged cross-power spectrum Several baselines displayed  
Timerange: 00/16:41:52 to 00/16:43:18

Plot file version 91 created 24-OCT-2012 20:59:01

G23.6-0.03 EY017B.UVDATA.1

Freq = 4.9270 GHz, Bw = 16.000 MH No calibration applied and no bandpass applied

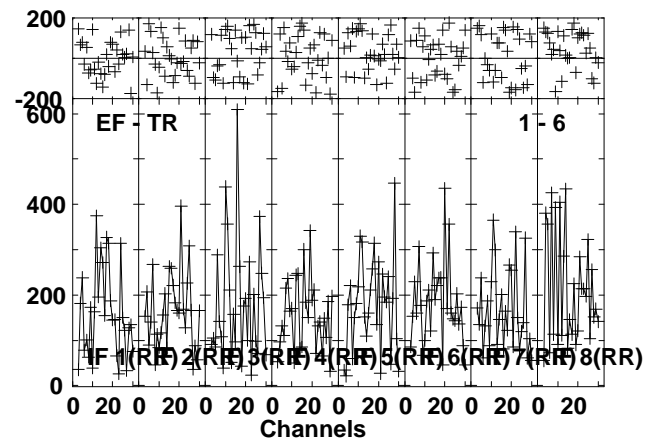
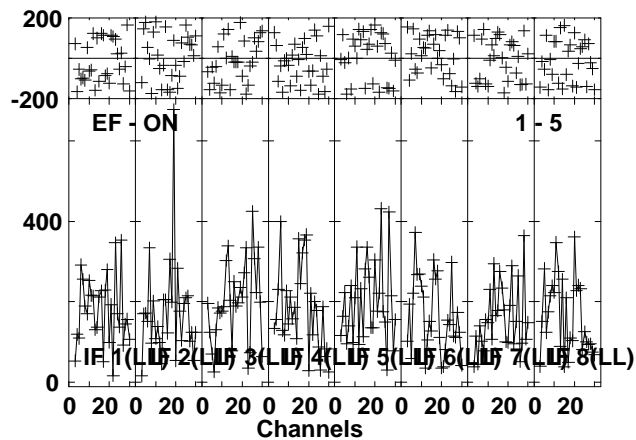
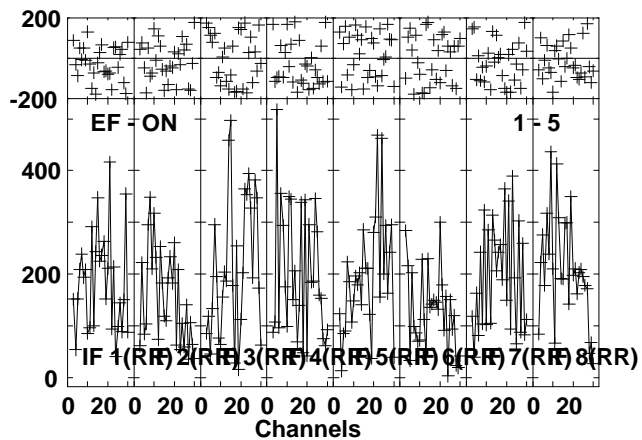
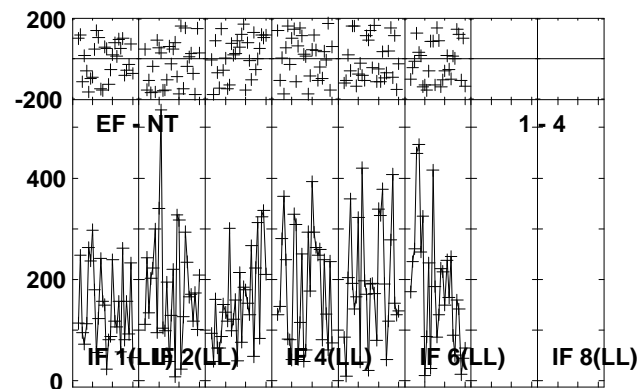
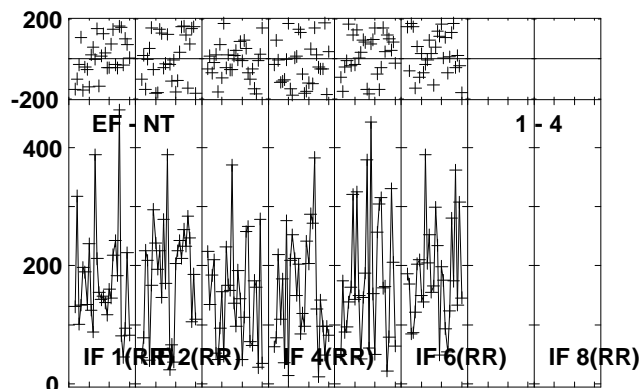
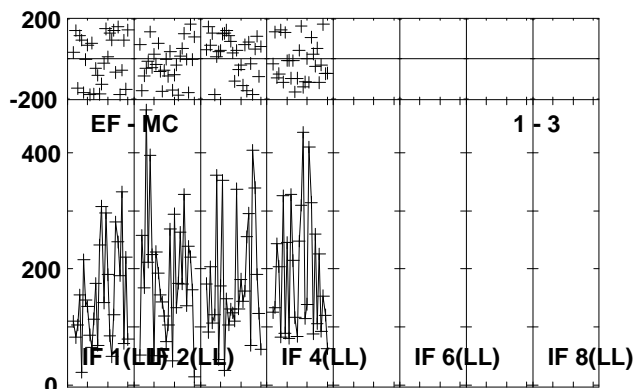
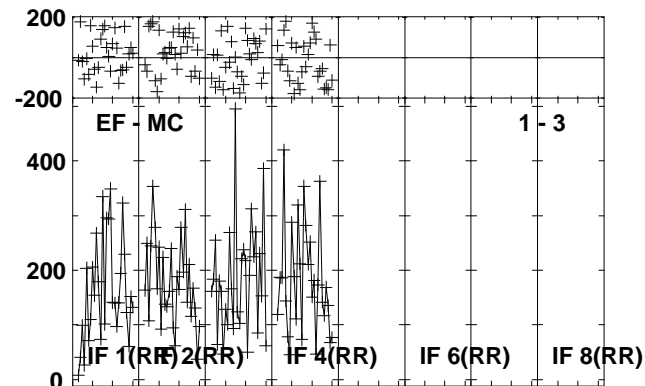
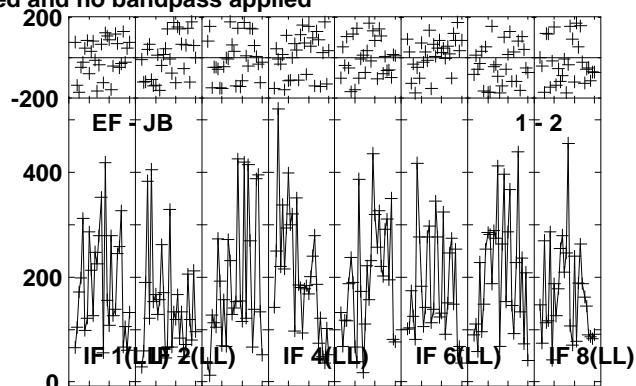
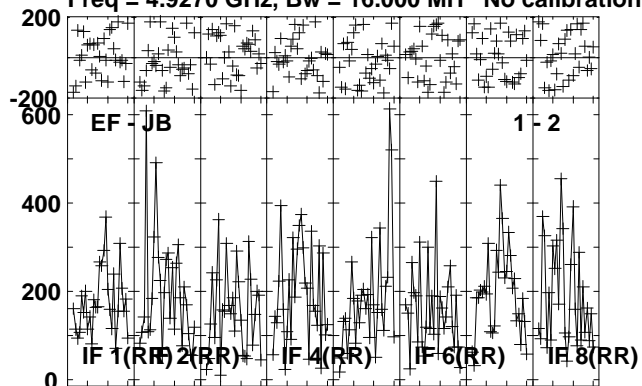

Lower frame: Micro Ampl Jy Top frame: Phas deg  
Vector averaged cross-power spectrum Several baselines displayed  
Timerange: 00/16:43:22 to 00/16:45:48

Plot file version 92 created 24-OCT-2012 20:59:02

G23.6-0.03 EY017B.UVDATA.1

Freq = 4.9270 GHz, Bw = 16.000 MH No calibration applied and no bandpass applied

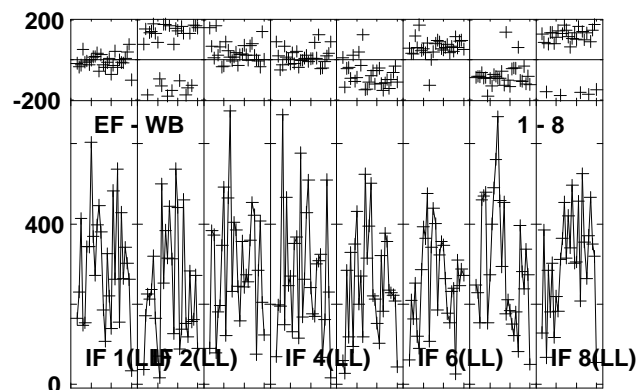
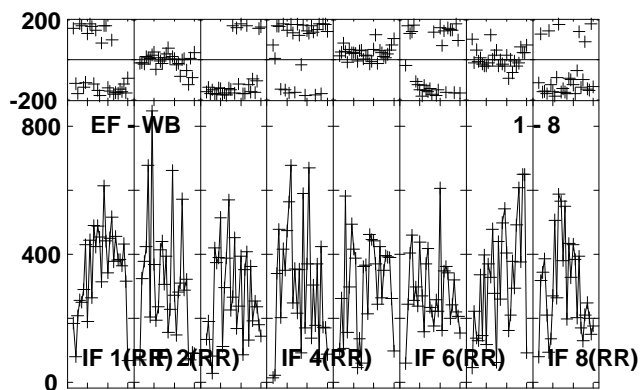
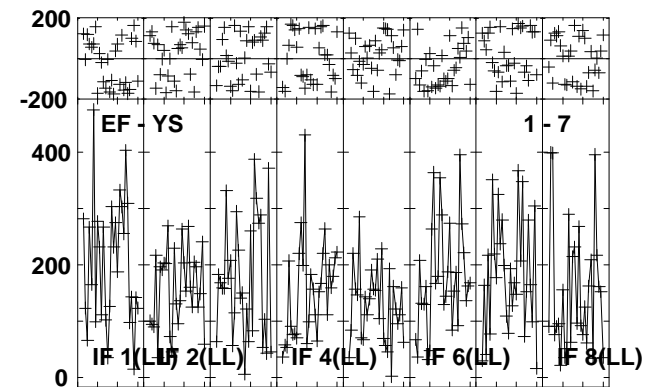
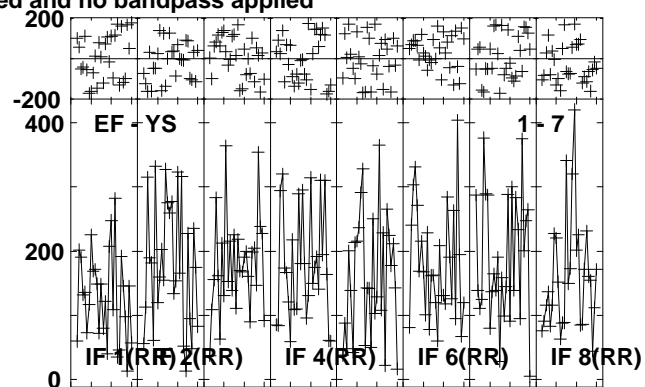
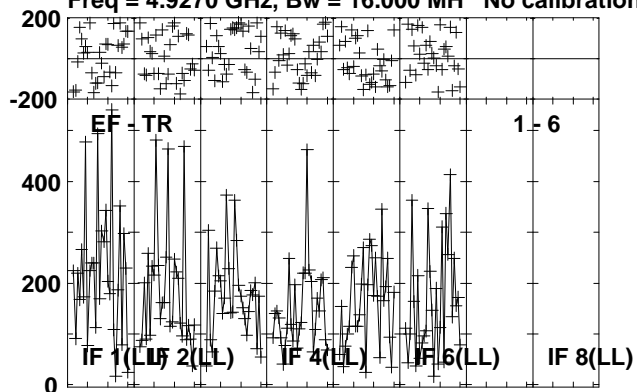

Lower frame: Micro Ampl Jy Top frame: Phas deg  
Vector averaged cross-power spectrum Several baselines displayed  
Timerange: 00/16:43:22 to 00/16:45:48



Plot file version 93 created 24-OCT-2012 20:59:02

J1825-0737 EY017B.UVDATA.1

Freq = 4.9270 GHz, Bw = 16.000 MH No calibration applied and no bandpass applied

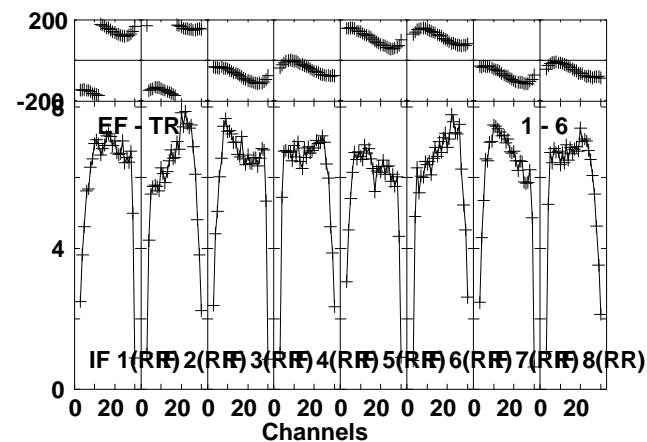
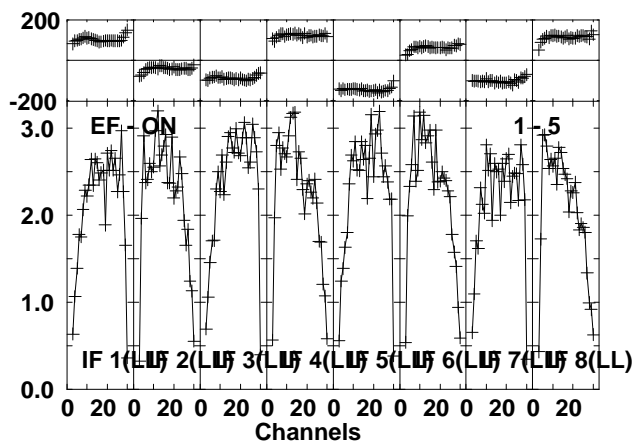
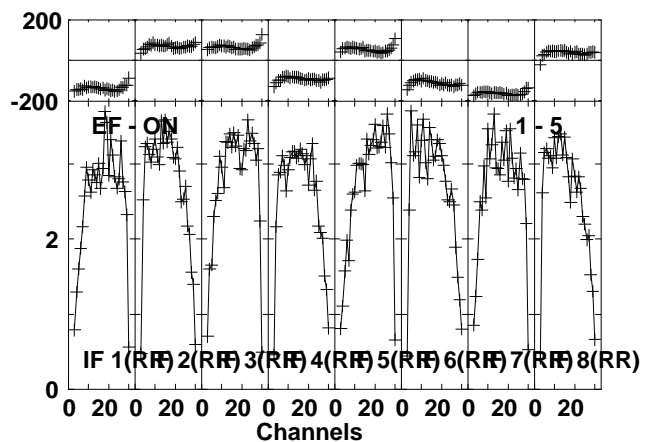
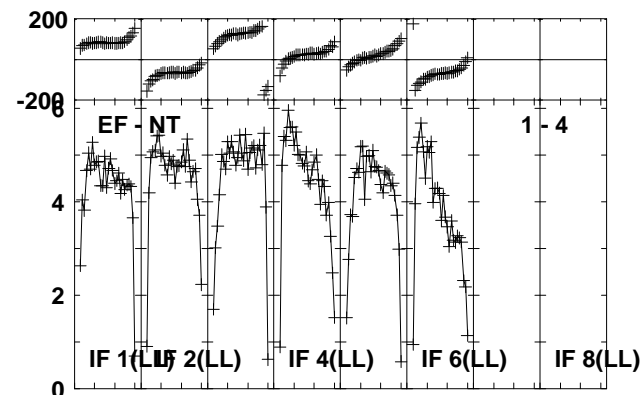
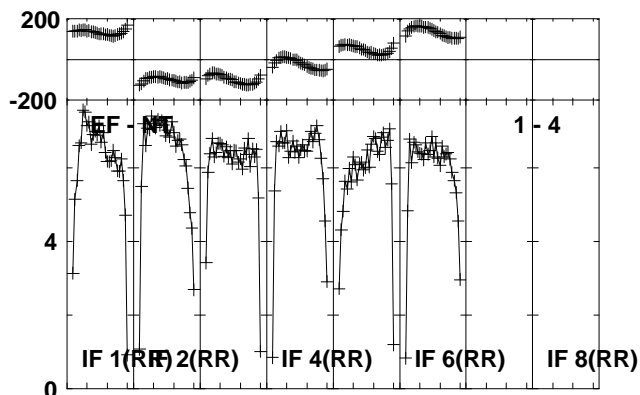
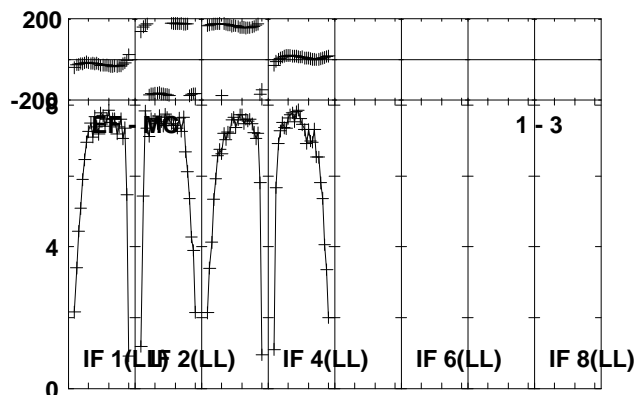
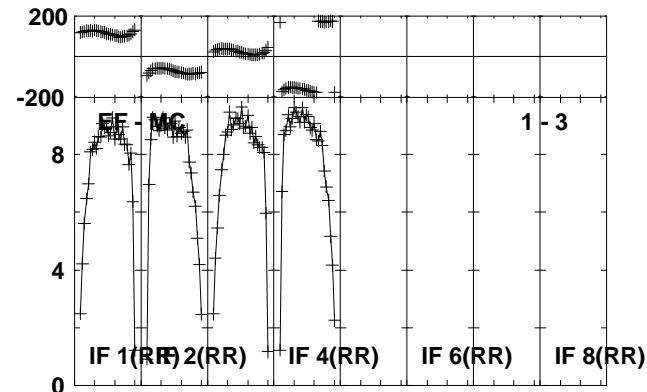
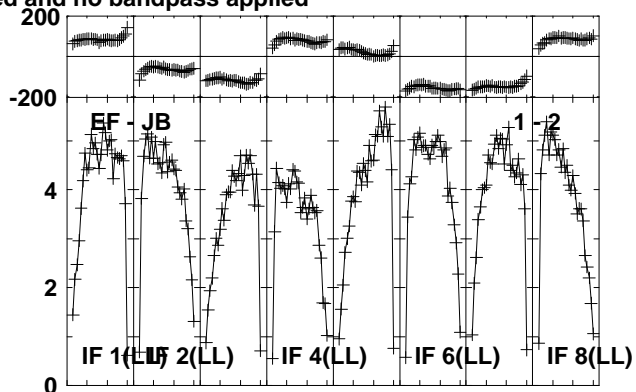
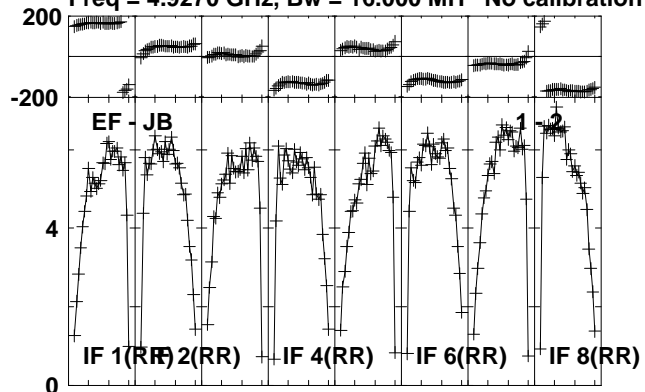

Lower frame: Milli Ampl Jy Top frame: Phas deg  
Vector averaged cross-power spectrum Several baselines displayed  
Timerange: 00/16:45:52 to 00/16:47:18

Plot file version 94 created 24-OCT-2012 20:59:03

J1825-0737 EY017B.UVDATA.1

Freq = 4.9270 GHz, Bw = 16.000 MH No calibration applied and no bandpass applied

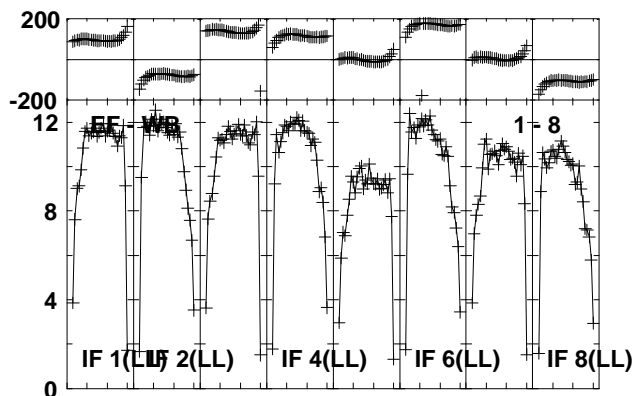
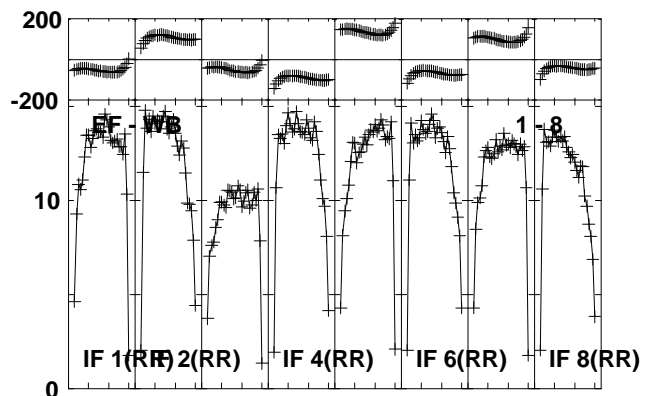
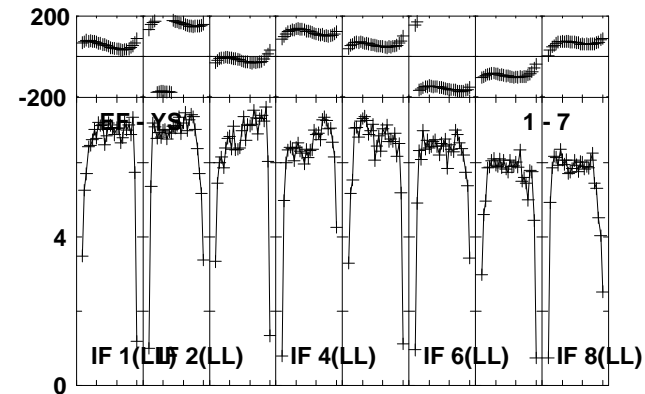
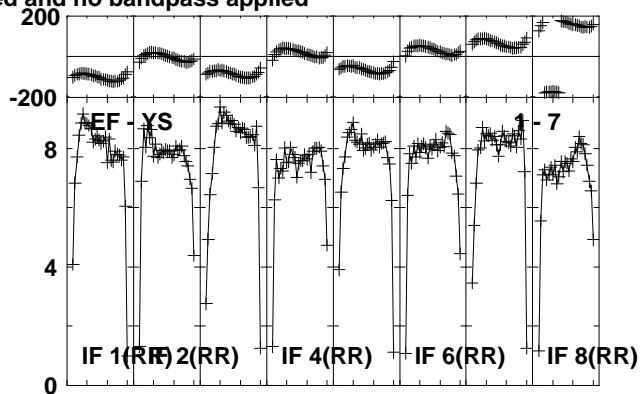
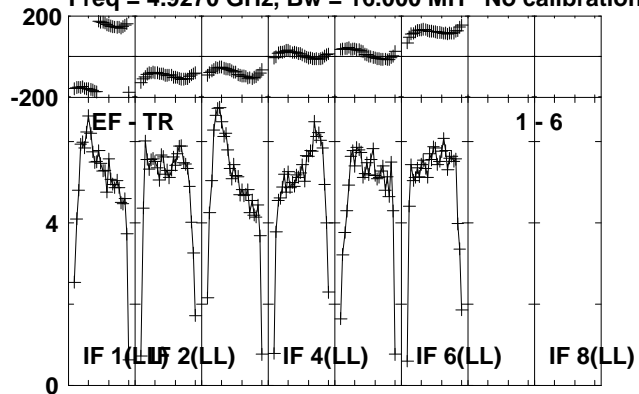

Lower frame: Milli Ampl Jy Top frame: Phas deg  
Vector averaged cross-power spectrum Several baselines displayed  
Timerange: 00/16:45:52 to 00/16:47:18

Plot file version 95 created 24-OCT-2012 20:59:03

J1831-0756 EY017B.UVDATA.1

Freq = 4.9270 GHz, Bw = 16.000 MH No calibration applied and no bandpass applied

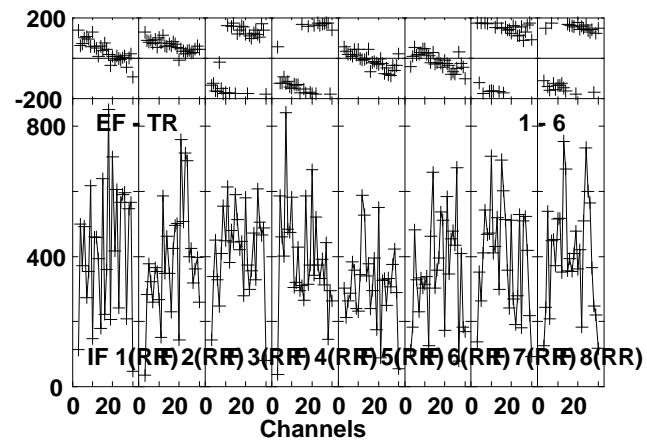
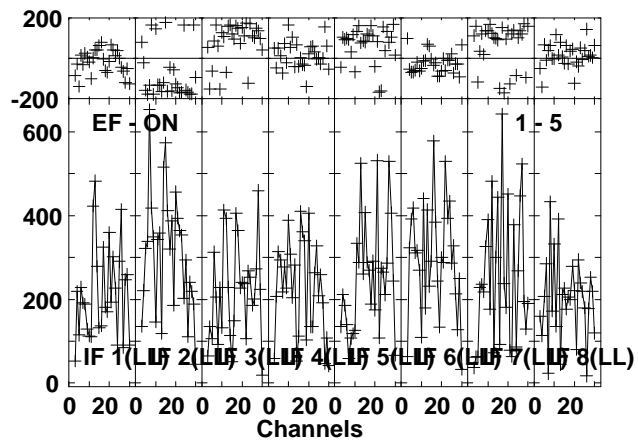
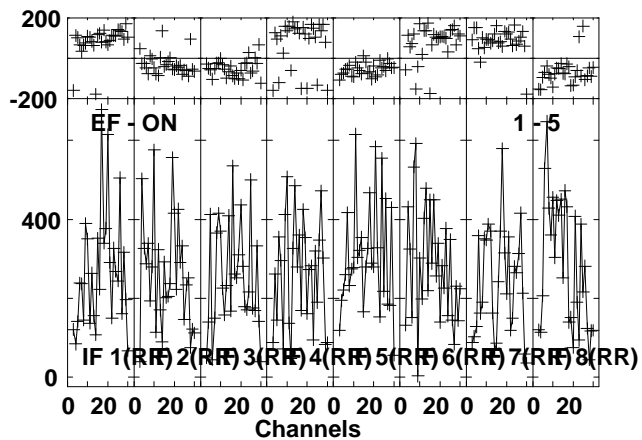
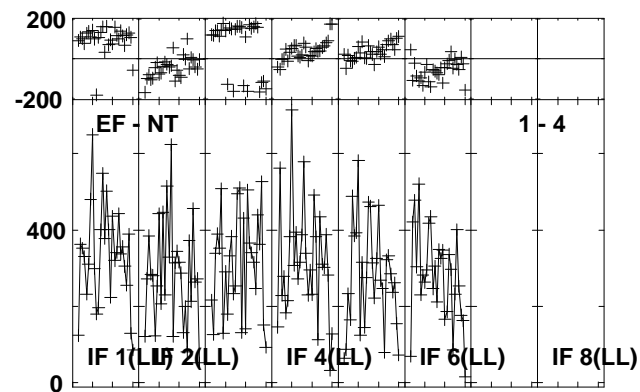
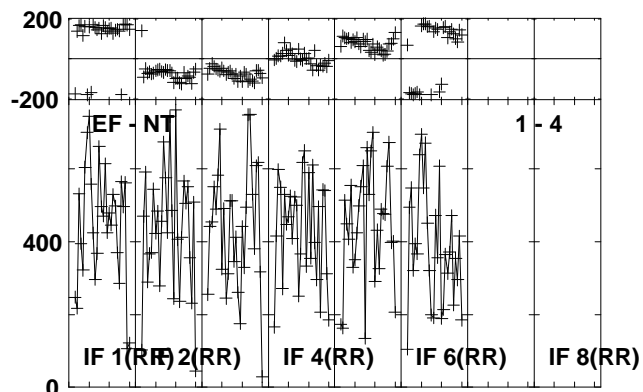
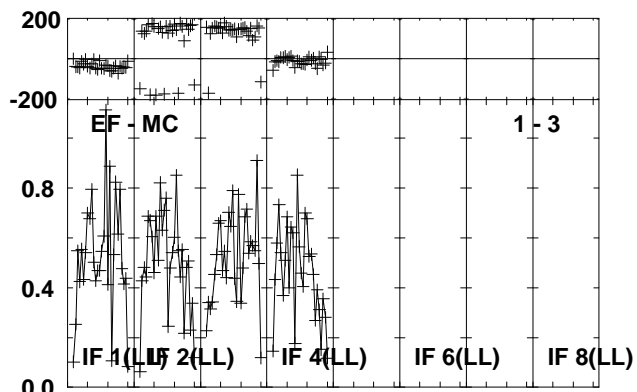
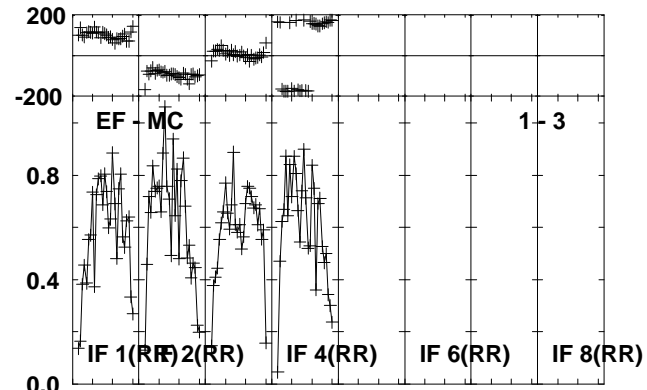
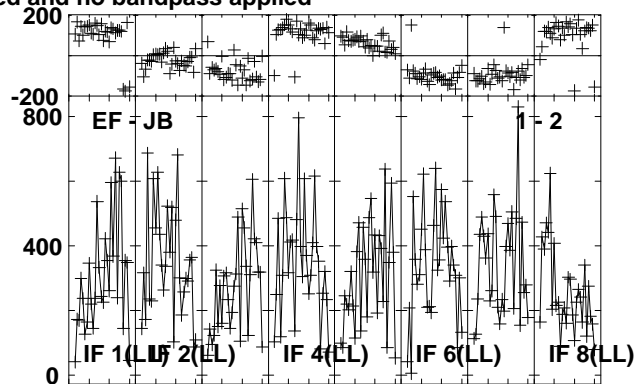
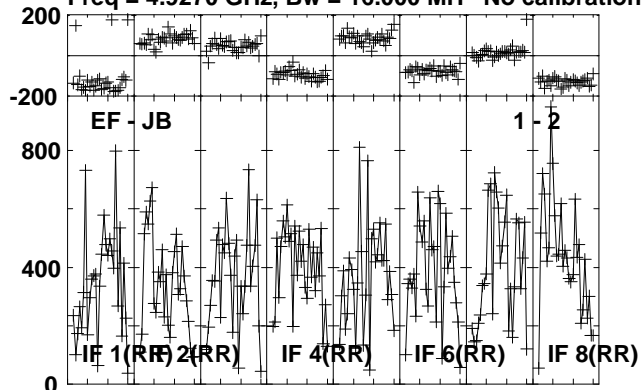

Lower frame: Micro Ampl Jy Top frame: Phas deg  
Vector averaged cross-power spectrum Several baselines displayed  
Timerange: 00/16:47:52 to 00/16:49:54

Plot file version 96 created 24-OCT-2012 20:59:04

J1831-0756 EY017B.UVDATA.1

Freq = 4.9270 GHz, Bw = 16.000 MH No calibration applied and no bandpass applied

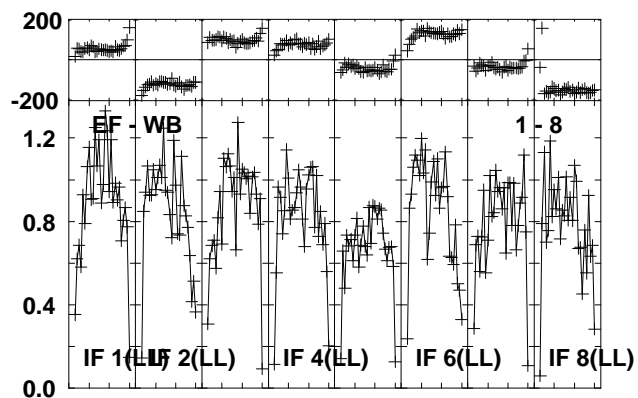
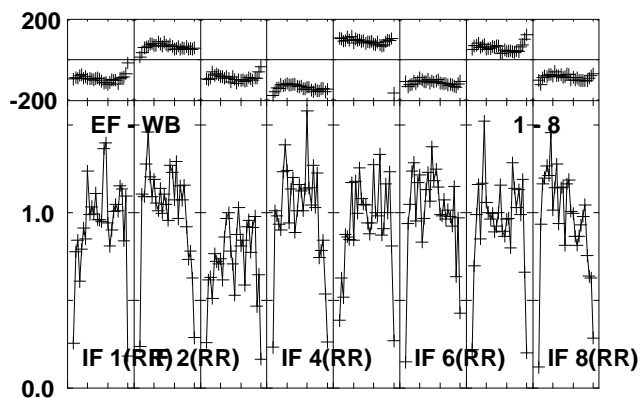
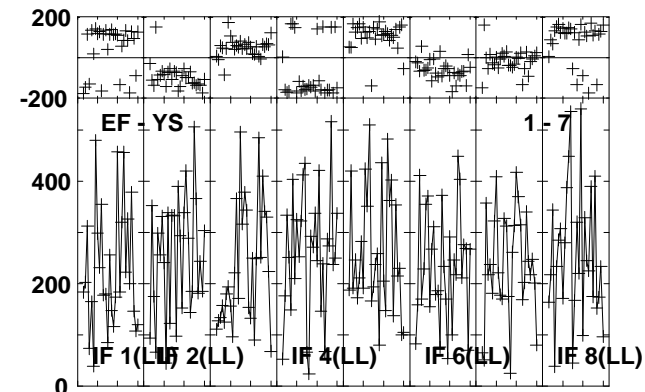
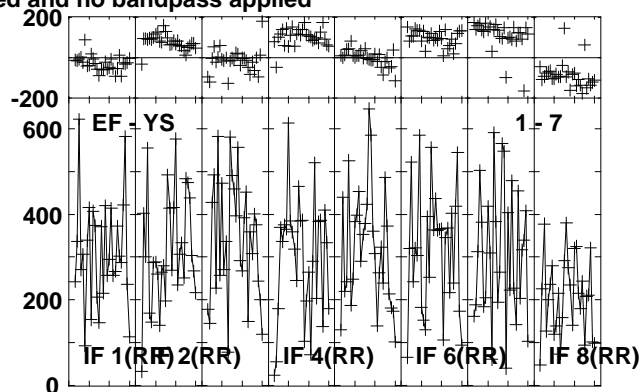
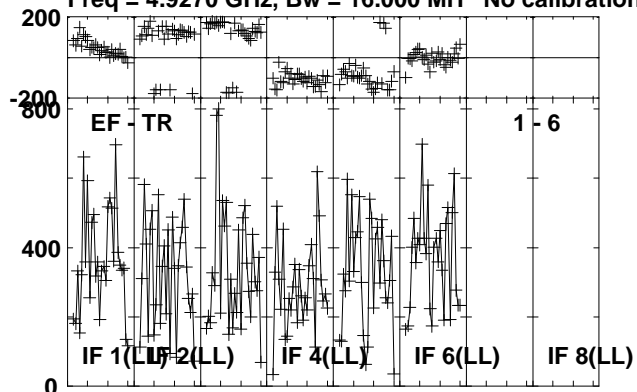

Lower frame: Micro Ampl Jy Top frame: Phas deg  
Vector averaged cross-power spectrum Several baselines displayed  
Timerange: 00/16:47:52 to 00/16:49:54

Plot file version 97 created 24-OCT-2012 20:59:04

J1825-0737 EY017B.UVDATA.1

Freq = 4.9270 GHz, Bw = 16.000 MH No calibration applied and no bandpass applied

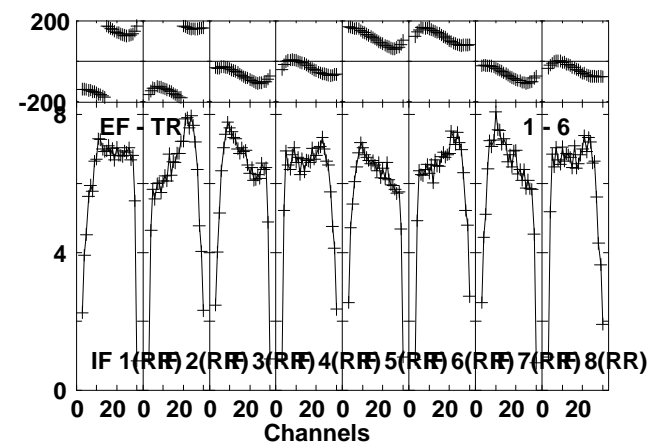
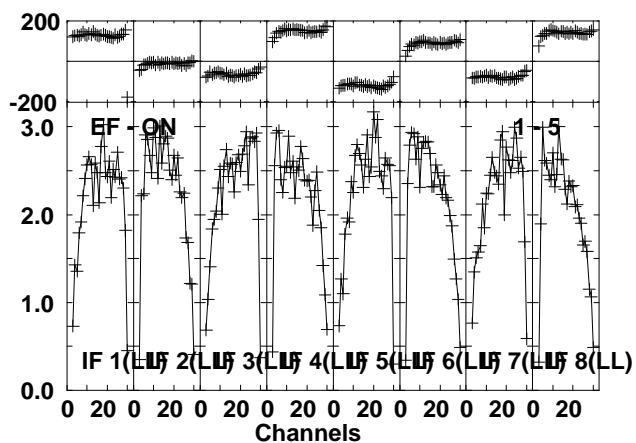
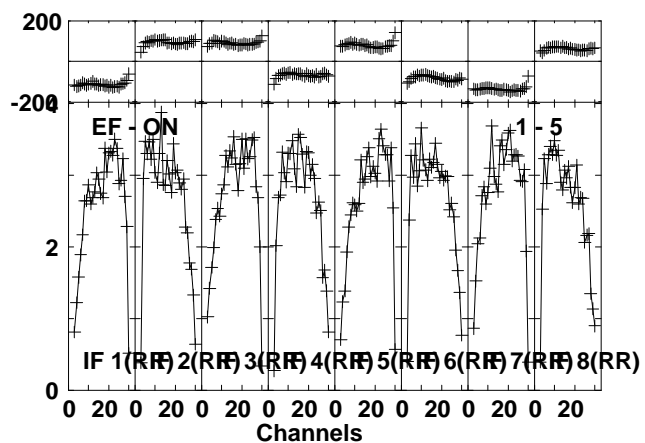
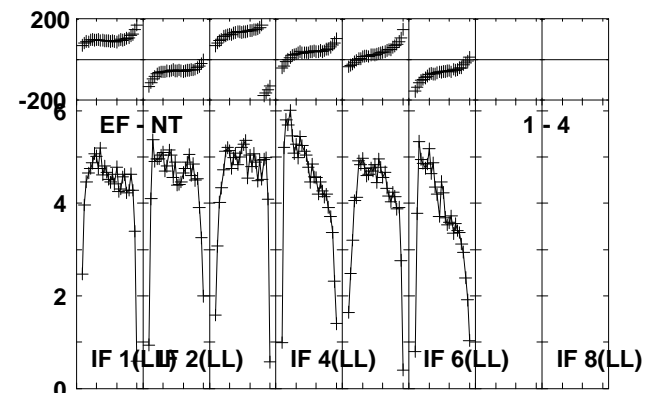
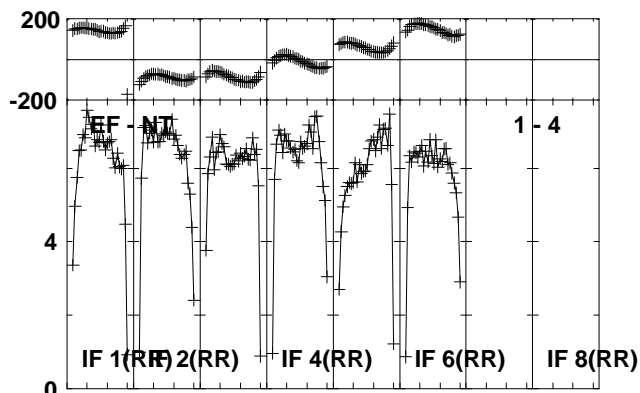
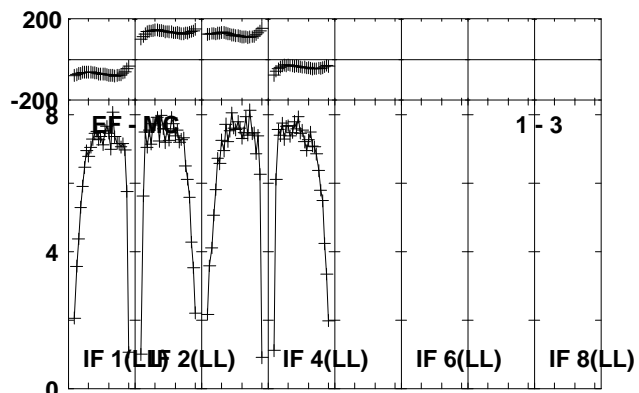
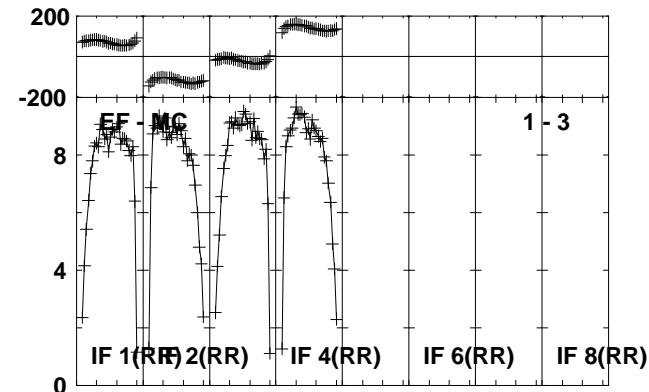
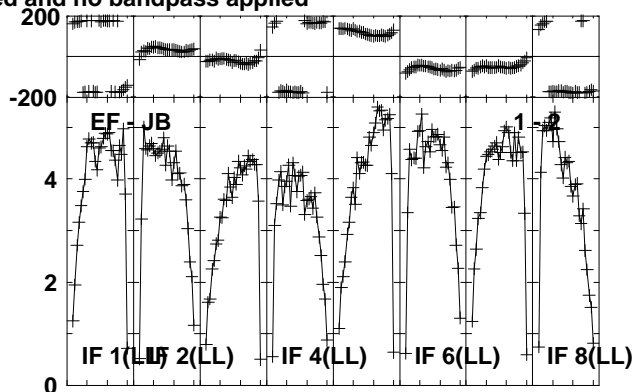
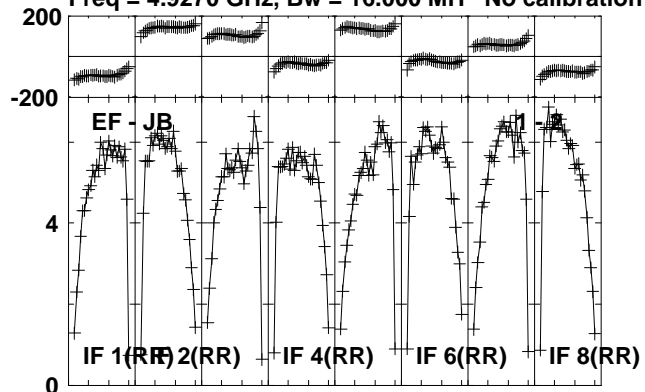

Lower frame: Milli Ampl Jy Top frame: Phas deg  
Vector averaged cross-power spectrum Several baselines displayed  
Timerange: 00/16:49:58 to 00/16:51:24

Plot file version 98 created 24-OCT-2012 20:59:05

J1825-0737 EY017B.UVDATA.1

Freq = 4.9270 GHz, Bw = 16.000 MH No calibration applied and no bandpass applied

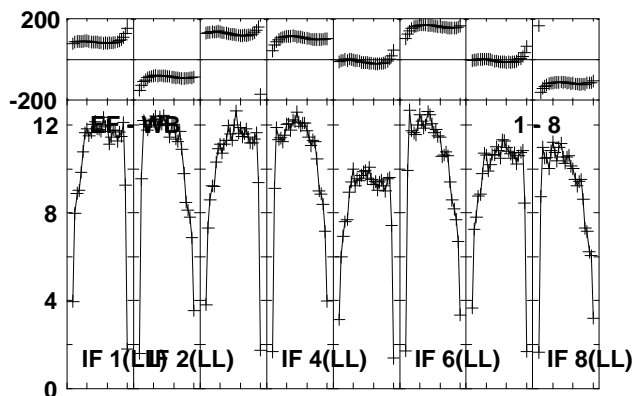
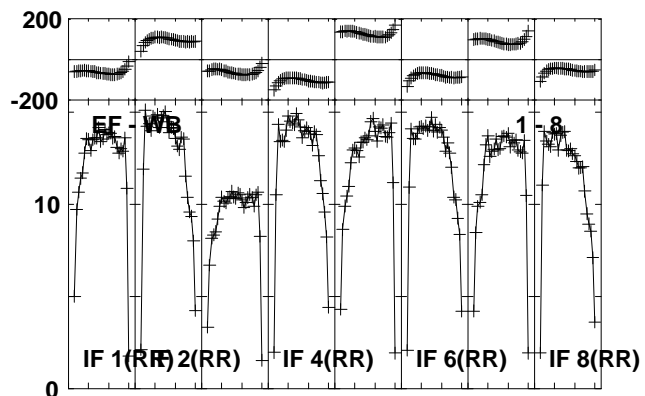
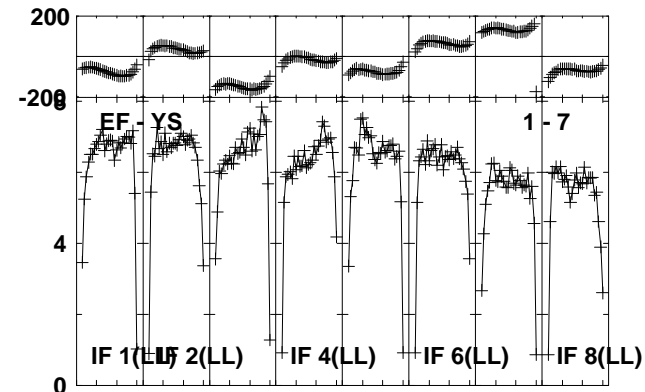
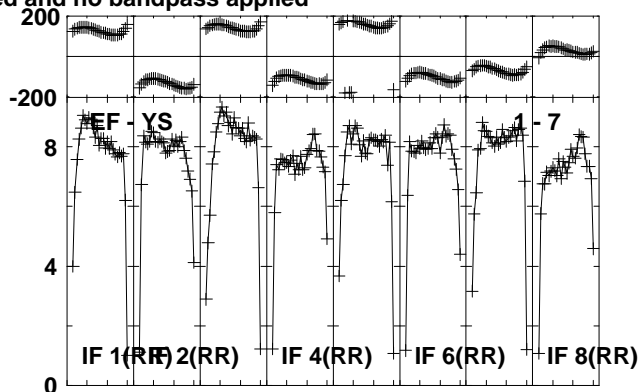
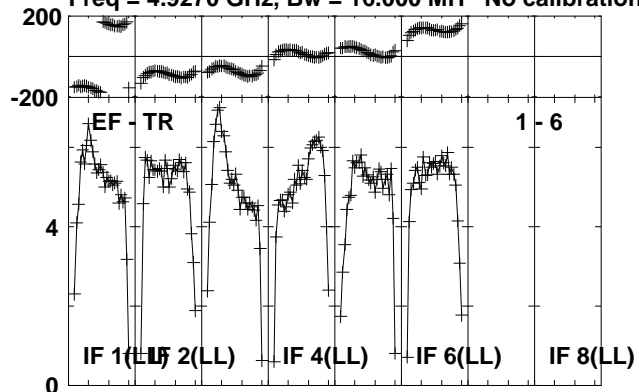

Lower frame: Milli Ampl Jy Top frame: Phas deg  
Vector averaged cross-power spectrum Several baselines displayed  
Timerange: 00/16:49:58 to 00/16:51:24

Plot file version 99 created 24-OCT-2012 20:59:05

G23.6-0.03 EY017B.UVDATA.1

Freq = 4.9270 GHz, Bw = 16.000 MH No calibration applied and no bandpass applied

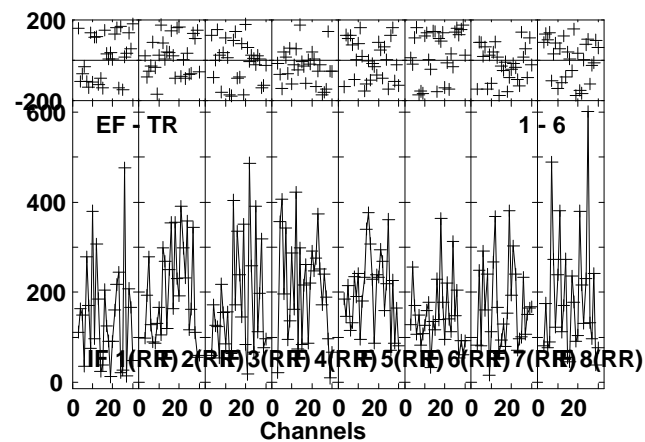
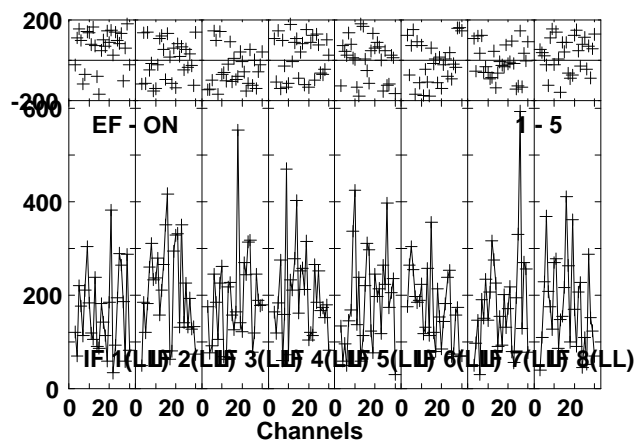
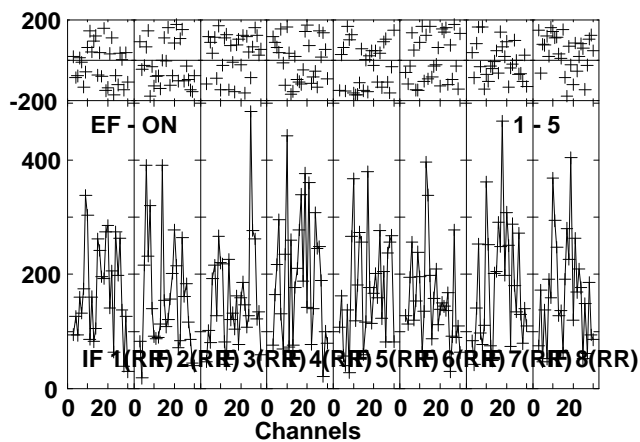
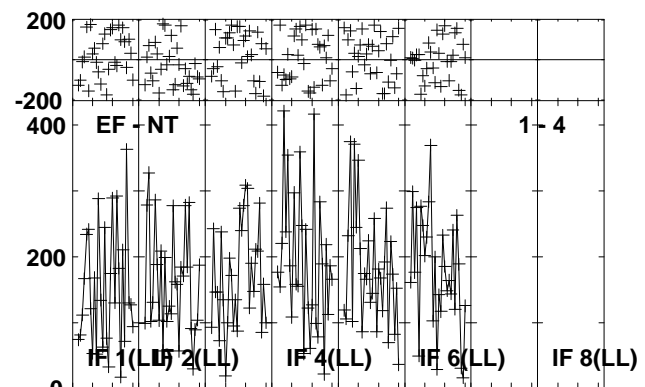
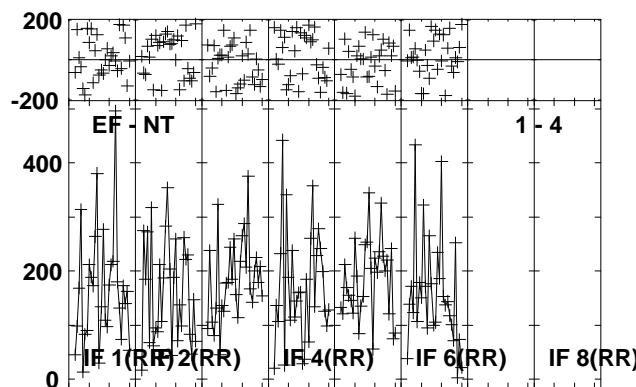
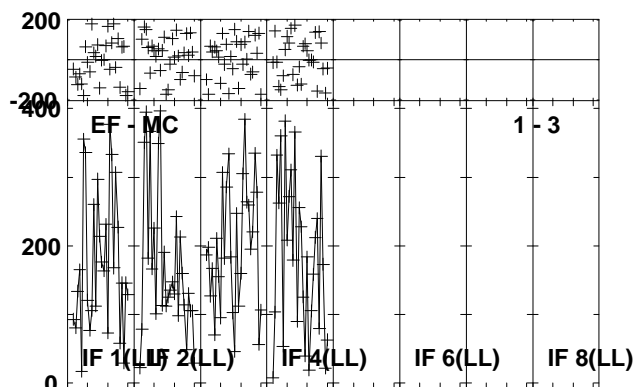
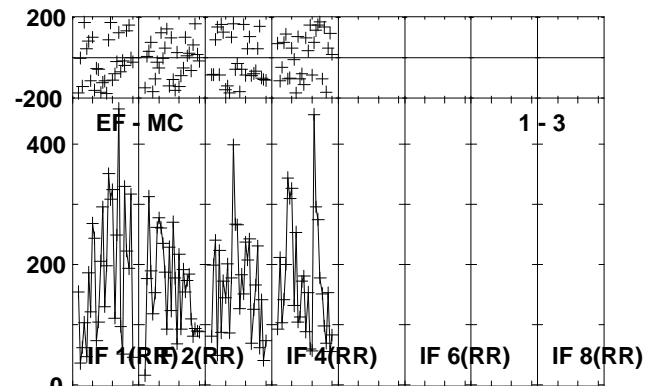
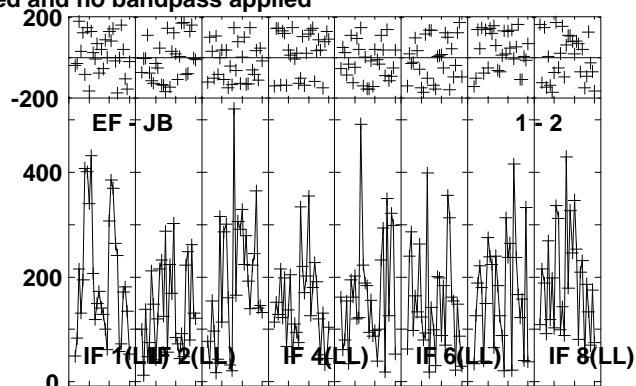
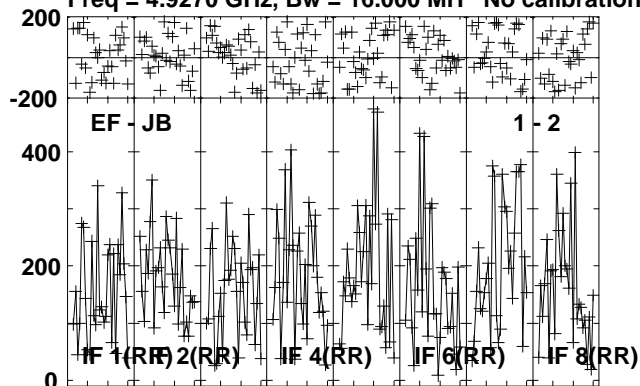

Lower frame: Micro Ampl Jy Top frame: Phas deg  
Vector averaged cross-power spectrum Several baselines displayed  
Timerange: 00/16:51:28 to 00/16:53:54

Plot file version 100 created 24-OCT-2012 20:59:06

G23.6-0.03 EY017B.UVDATA.1

Freq = 4.9270 GHz, Bw = 16.000 MH No calibration applied and no bandpass applied

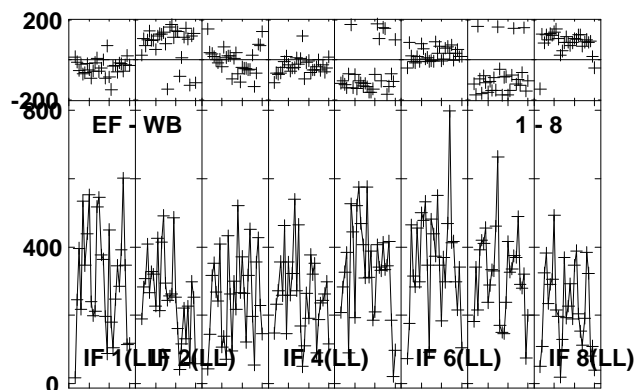
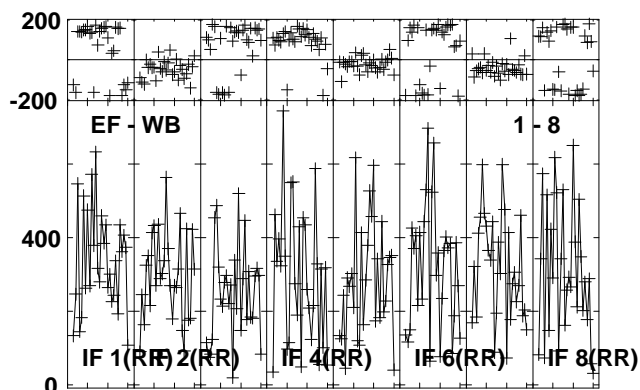
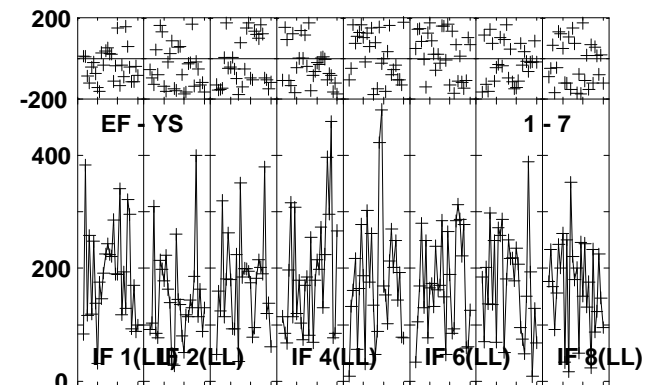
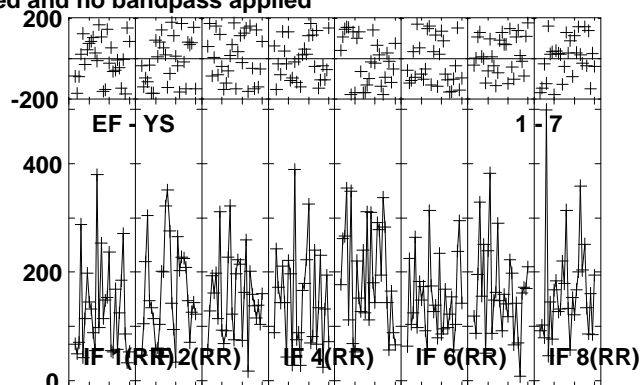
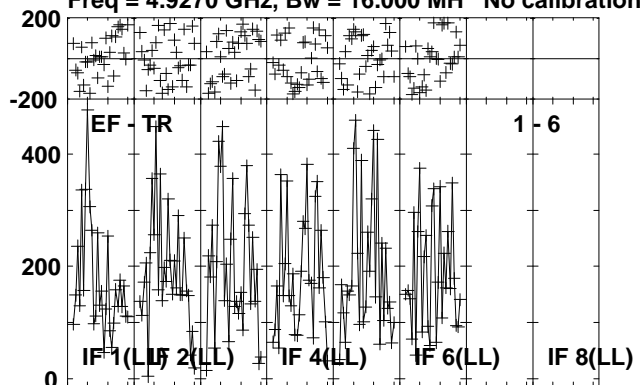

Lower frame: Micro Ampl Jy Top frame: Phas deg  
Vector averaged cross-power spectrum Several baselines displayed  
Timerange: 00/16:51:28 to 00/16:53:54



Plot file version 101 created 24-OCT-2012 20:59:06

J1825-0737 EY017B.UVDATA.1

Freq = 4.9270 GHz, Bw = 16.000 MH No calibration applied and no bandpass applied

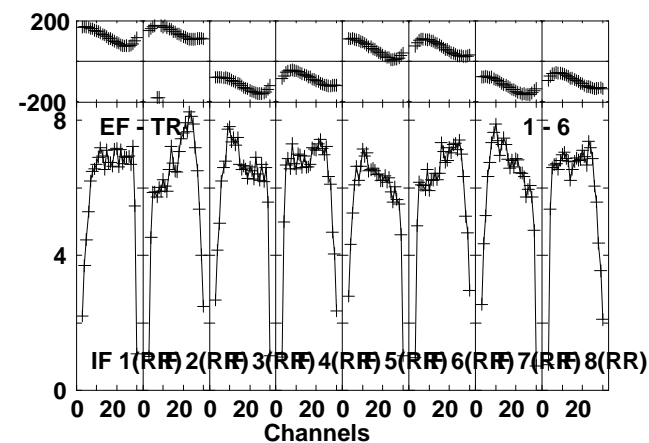
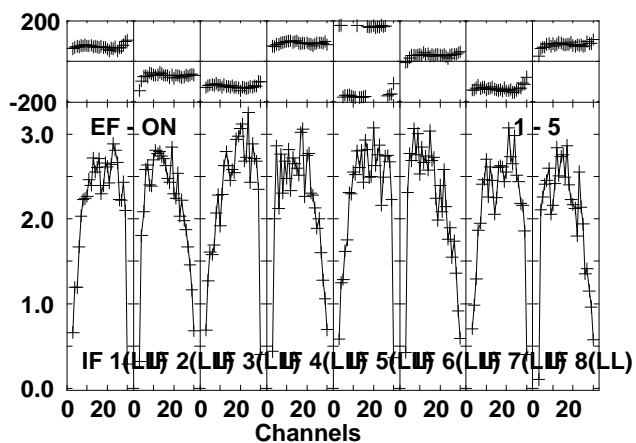
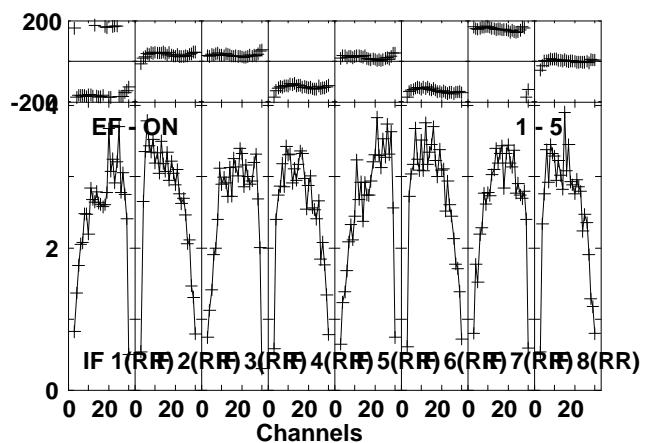
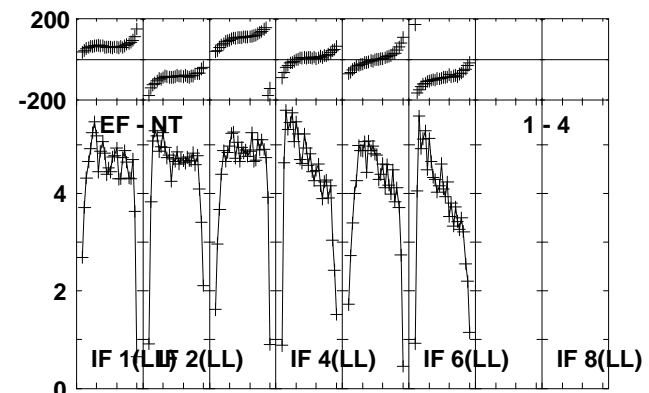
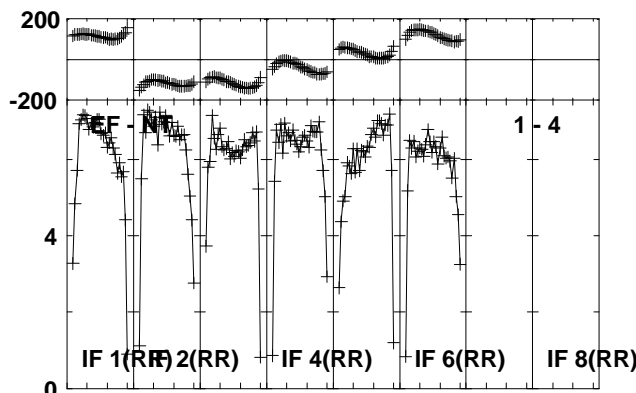
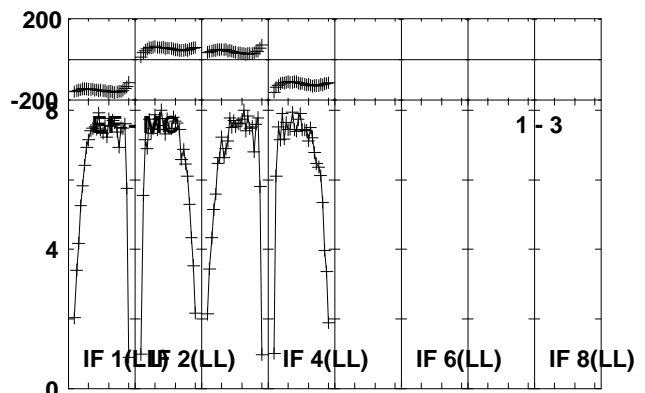
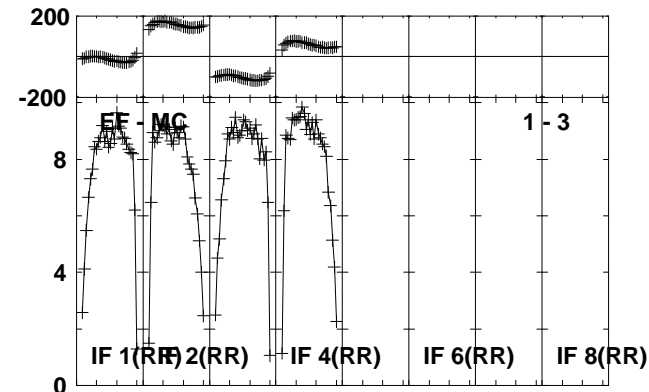
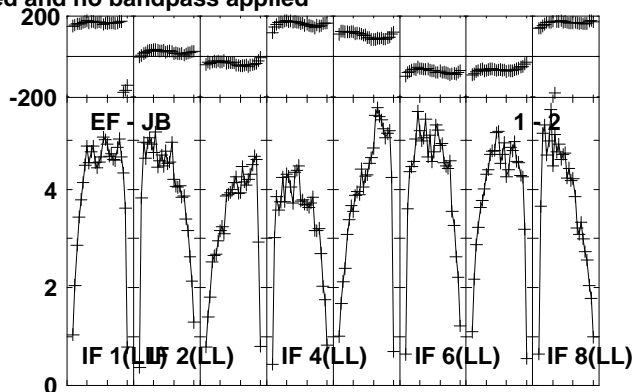
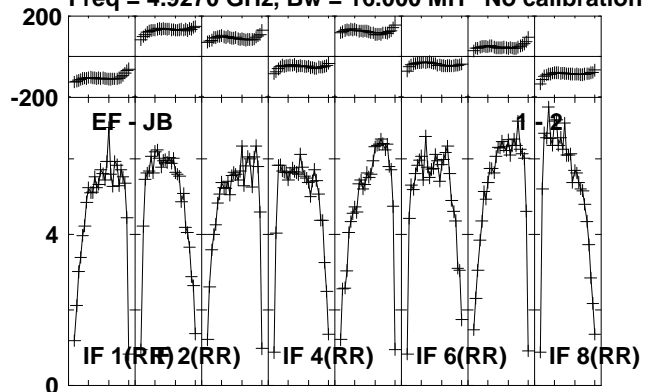

Lower frame: Milli Ampl Jy Top frame: Phas deg  
Vector averaged cross-power spectrum Several baselines displayed  
Timerange: 00/16:53:58 to 00/16:55:24

Plot file version 102 created 24-OCT-2012 20:59:07

J1825-0737 EY017B.UVDATA.1

Freq = 4.9270 GHz, Bw = 16.000 MH No calibration applied and no bandpass applied

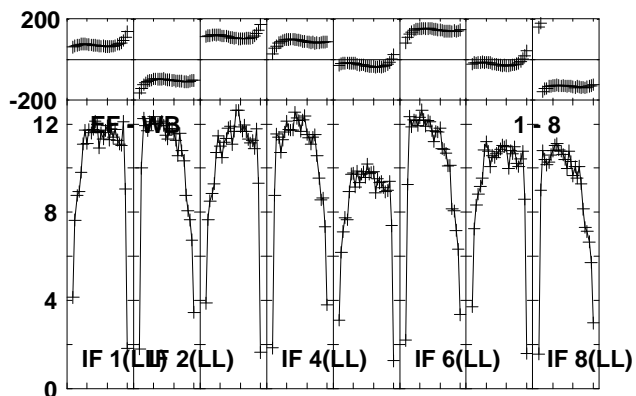
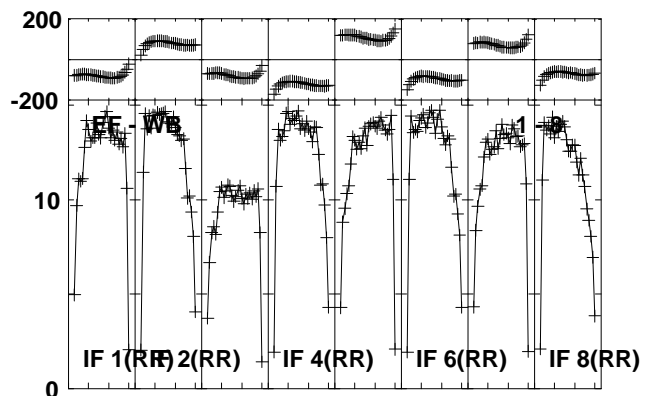
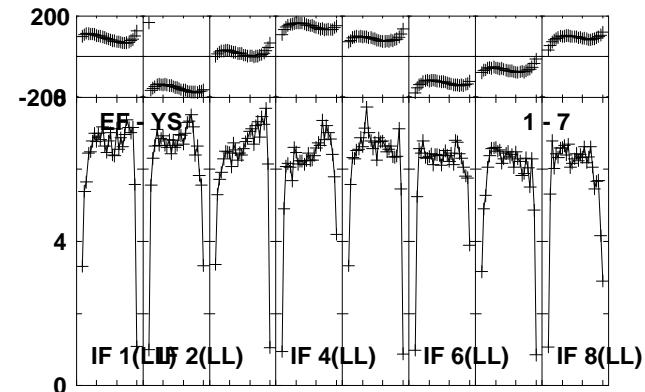
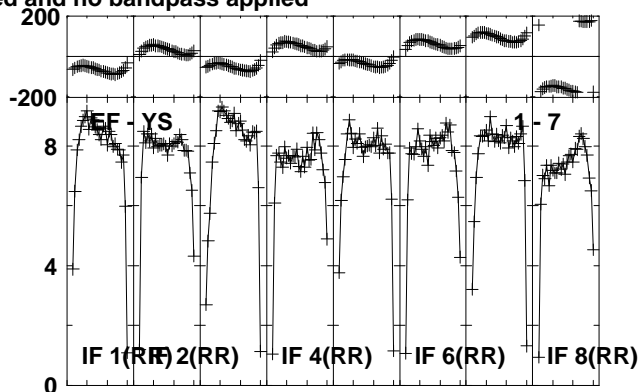
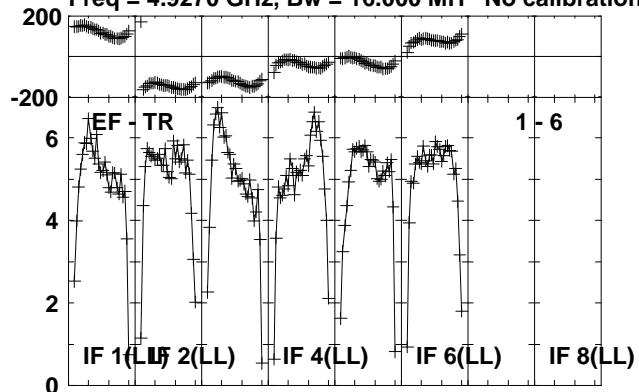

Lower frame: Milli Ampl Jy Top frame: Phas deg  
Vector averaged cross-power spectrum Several baselines displayed  
Timerange: 00/16:53:58 to 00/16:55:24

Plot file version 103 created 24-OCT-2012 20:59:07  
 G23.6-0.03 EY017B.UVDATA.1

Freq = 4.9270 GHz, Bw = 16.000 MH No calibration applied and no bandpass applied

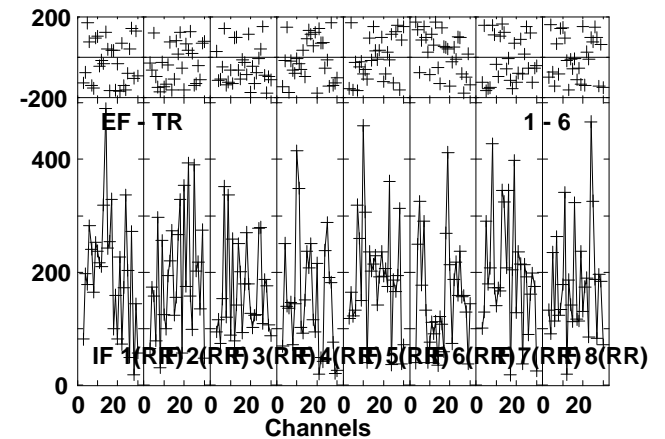
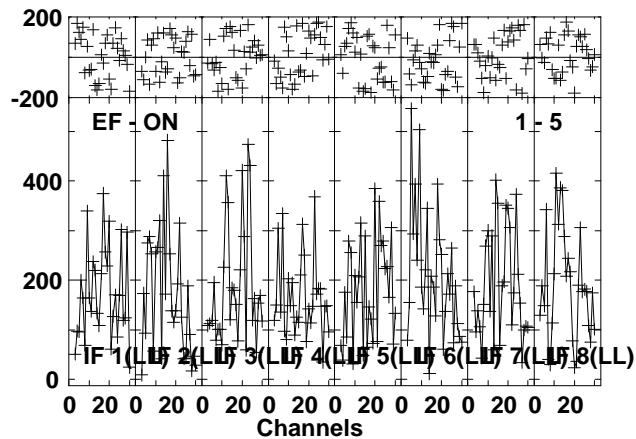
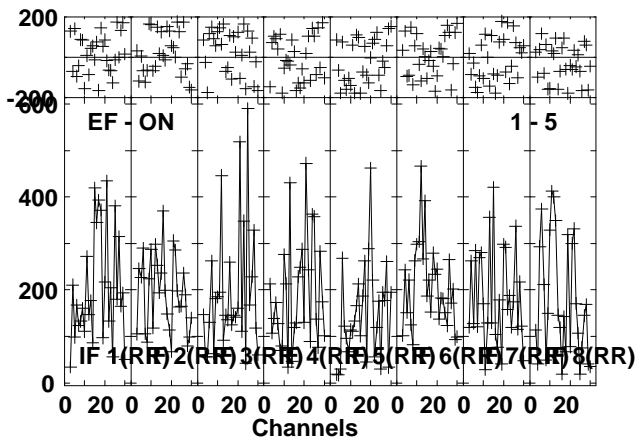
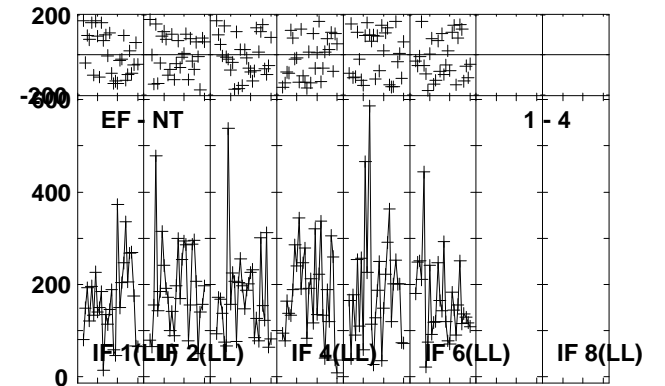
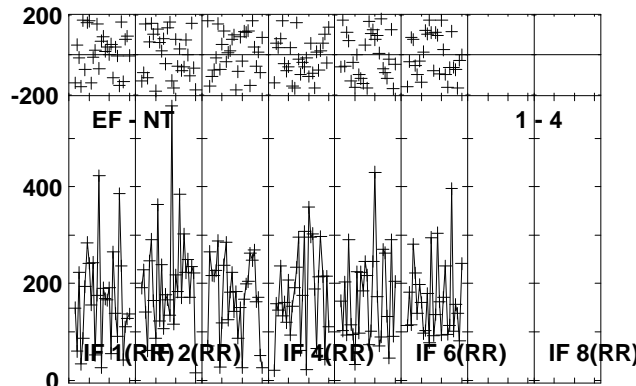
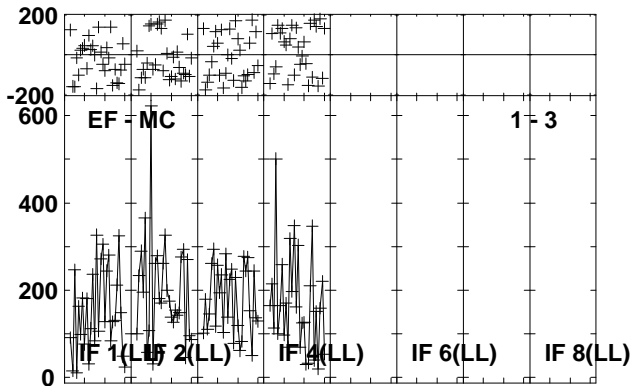
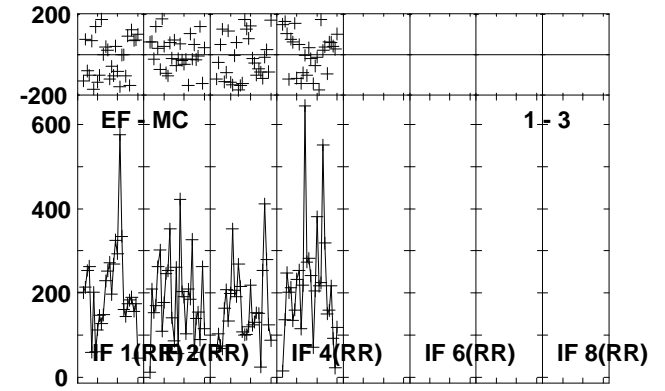
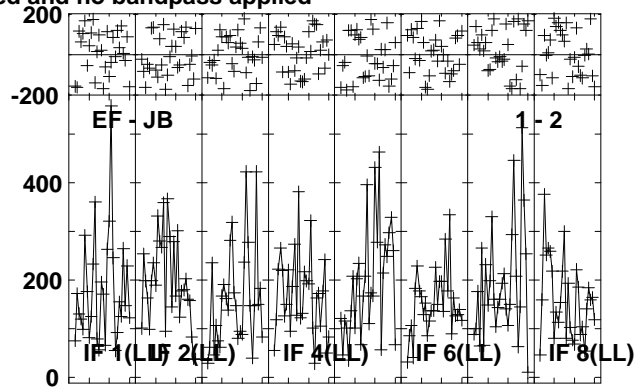
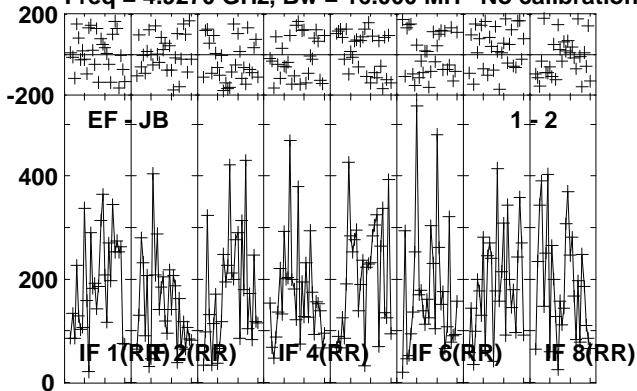

Lower frame: Micro Ampl Jy Top frame: Phas deg  
 Vector averaged cross-power spectrum Several baselines displayed  
 Timerange: 00/16:55:28 to 00/16:57:54

Plot file version 104 created 24-OCT-2012 20:59:08

G23.6-0.03 EY017B.UVDATA.1

Freq = 4.9270 GHz, Bw = 16.000 MH No calibration applied and no bandpass applied

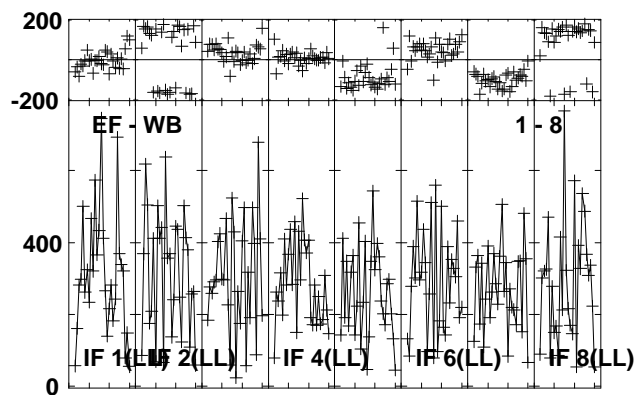
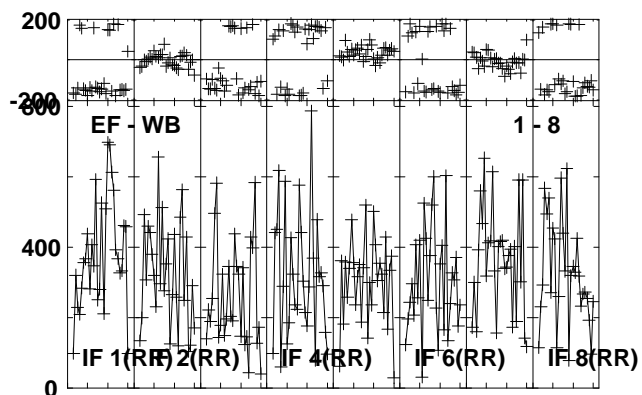
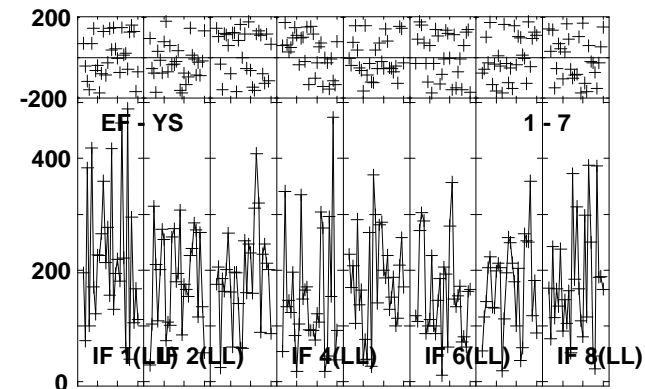
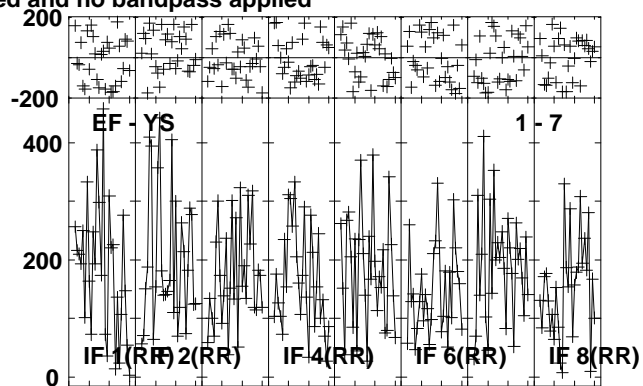
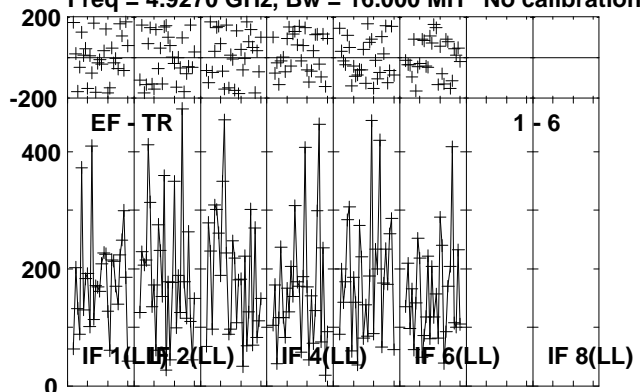

Lower frame: Micro Ampl Jy Top frame: Phas deg  
Vector averaged cross-power spectrum Several baselines displayed  
Timerange: 00/16:55:28 to 00/16:57:54

Plot file version 105 created 24-OCT-2012 20:59:09

J1825-0737 EY017B.UVDATA.1

Freq = 4.9270 GHz, Bw = 16.000 MH No calibration applied and no bandpass applied

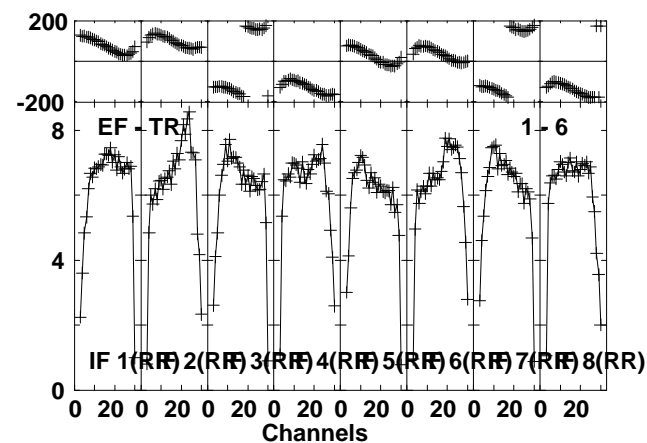
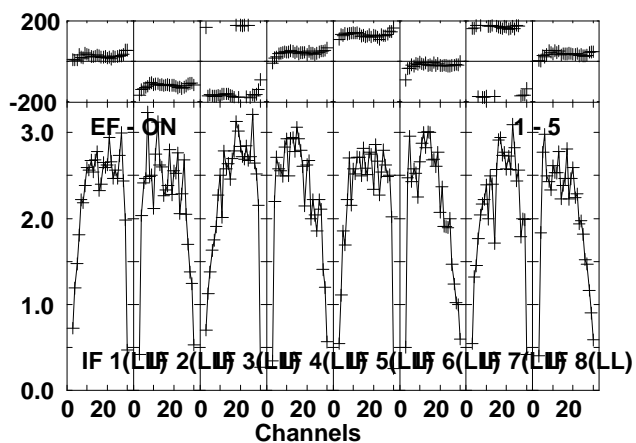
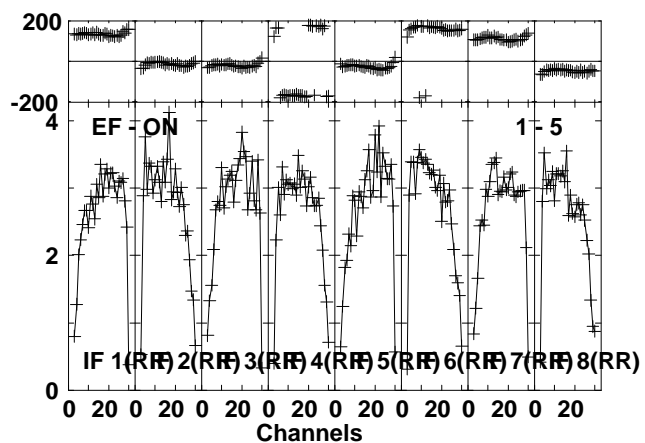
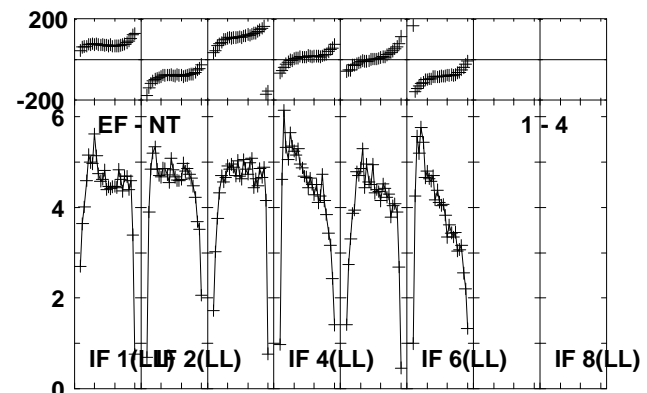
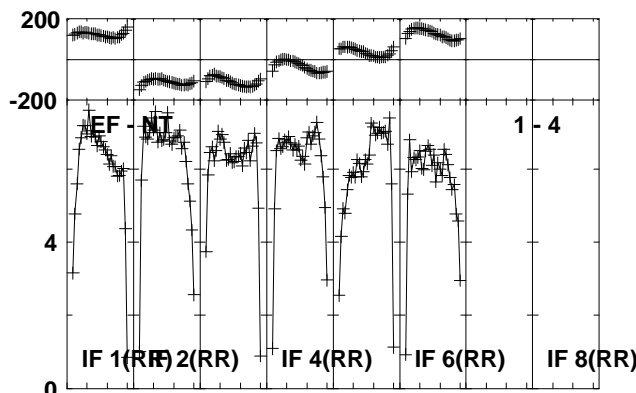
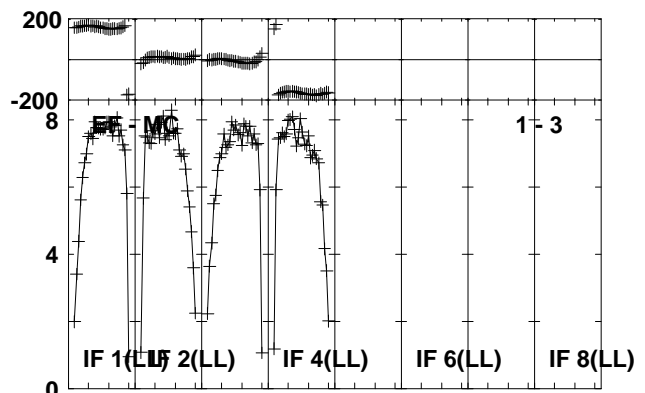
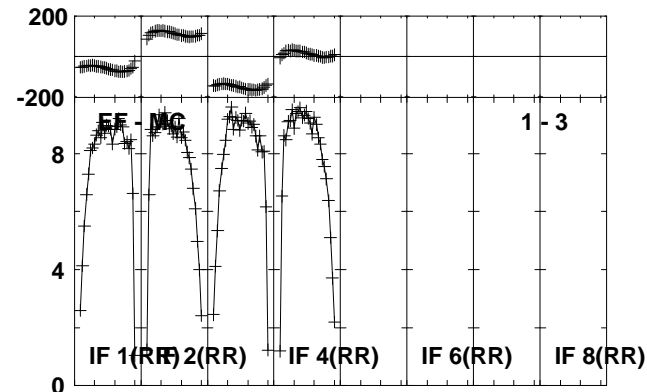
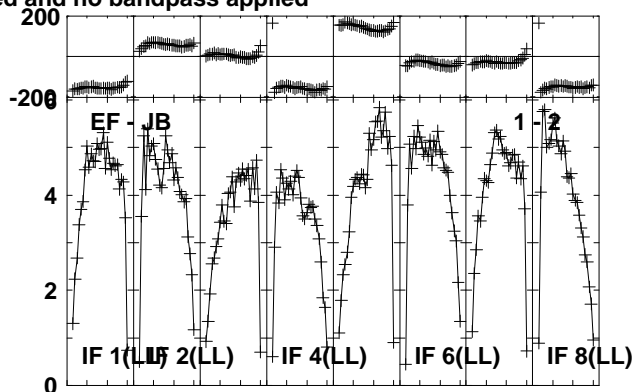
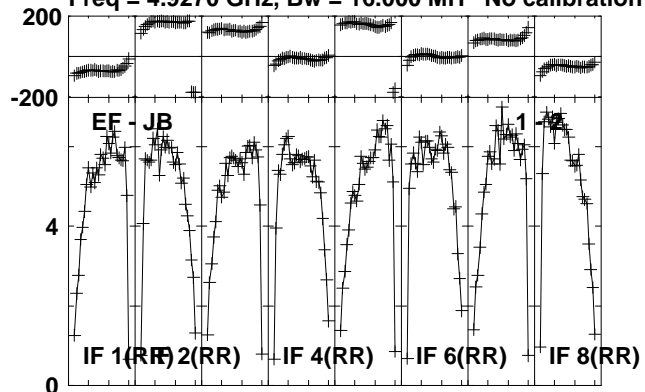

Lower frame: Milli Ampl Jy Top frame: Phas deg  
Vector averaged cross-power spectrum Several baselines displayed  
Timerange: 00/16:57:58 to 00/16:59:24

Plot file version 106 created 24-OCT-2012 20:59:09

J1825-0737 EY017B.UVDATA.1

Freq = 4.9270 GHz, Bw = 16.000 MH No calibration applied and no bandpass applied

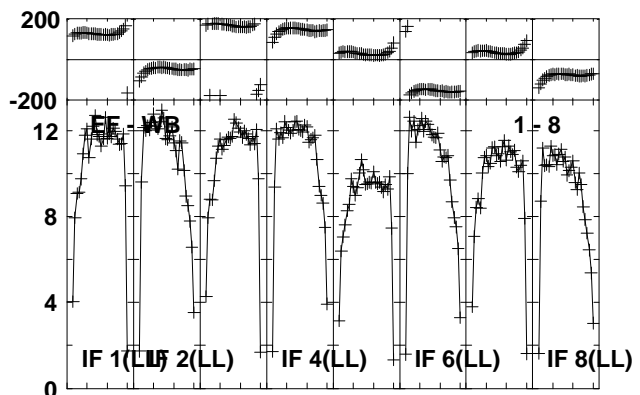
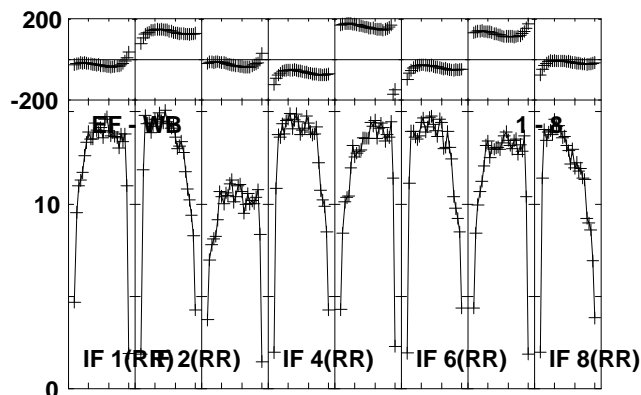
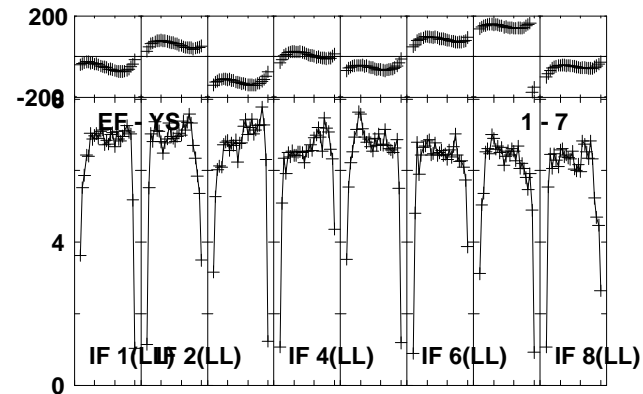
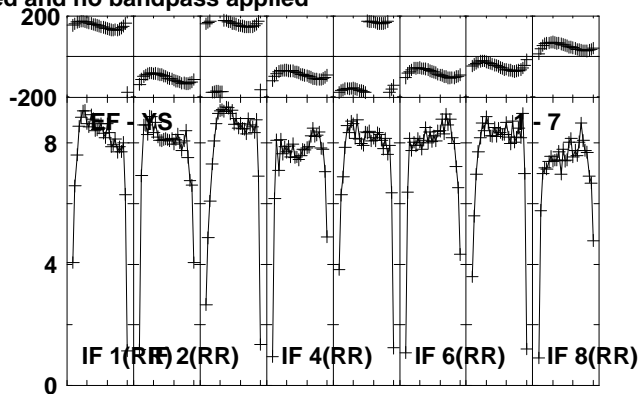
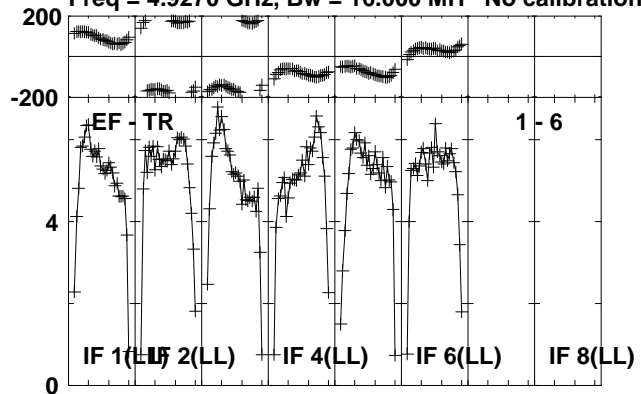

Lower frame: Milli Ampl Jy Top frame: Phas deg  
Vector averaged cross-power spectrum Several baselines displayed  
Timerange: 00/16:57:58 to 00/16:59:24

Plot file version 107 created 24-OCT-2012 20:59:10  
 G23.6-0.03 EY017B.UVDATA.1

Freq = 4.9270 GHz, Bw = 16.000 MH No calibration applied and no bandpass applied

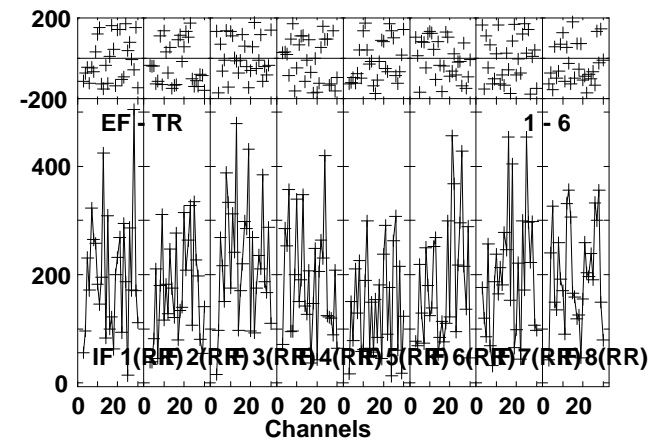
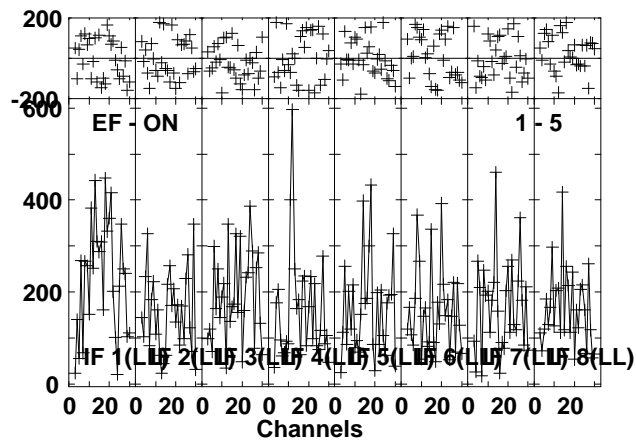
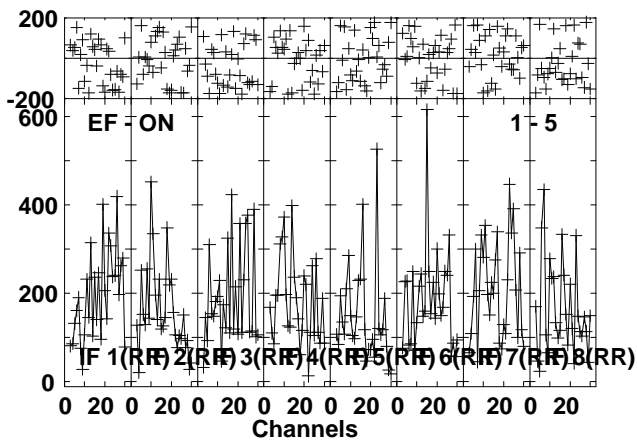
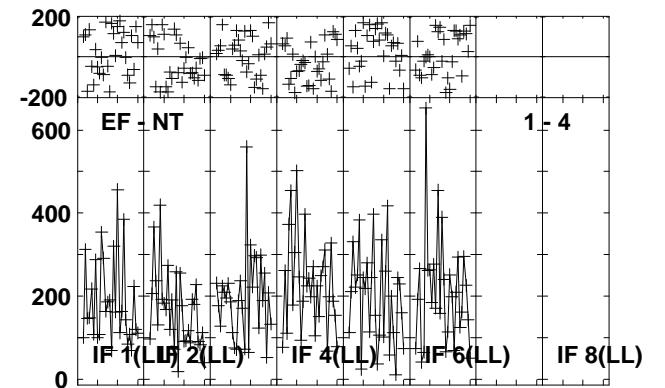
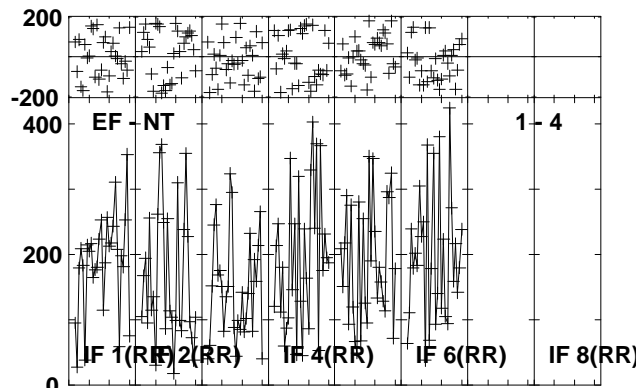
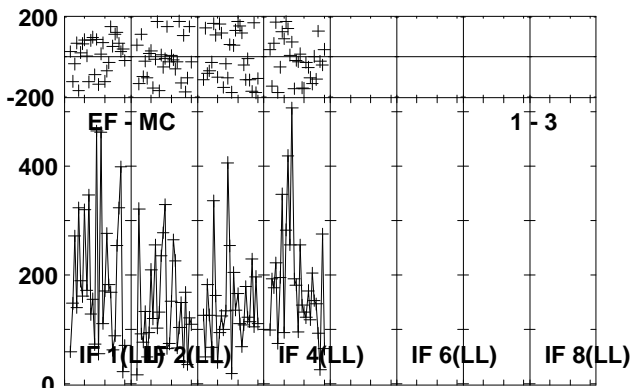
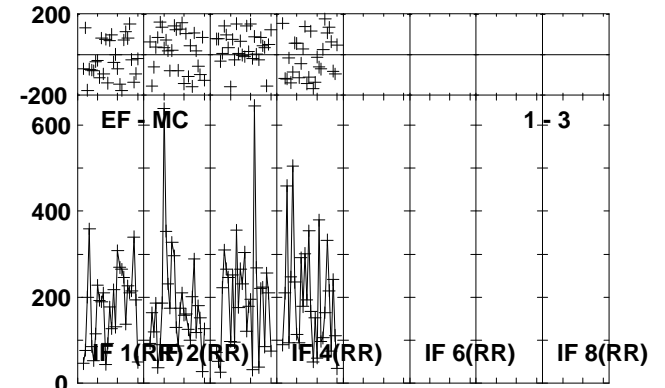
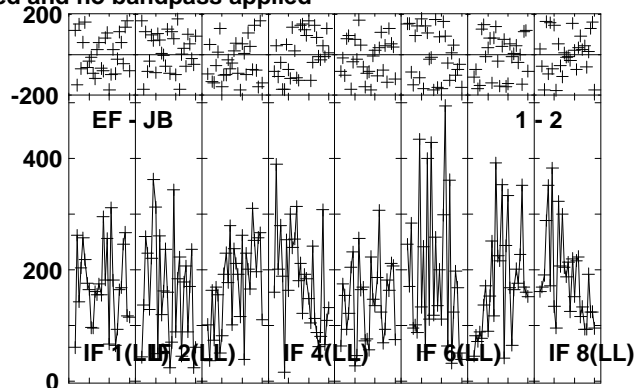
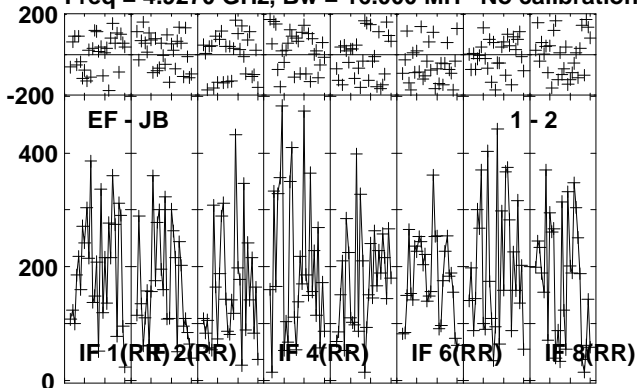

Lower frame: Micro Ampl Jy Top frame: Phas deg  
 Vector averaged cross-power spectrum Several baselines displayed  
 Timerange: 00/16:59:28 to 00/17:01:54

Plot file version 108 created 24-OCT-2012 20:59:10

G23.6-0.03 EY017B.UVDATA.1

Freq = 4.9270 GHz, Bw = 16.000 MH No calibration applied and no bandpass applied

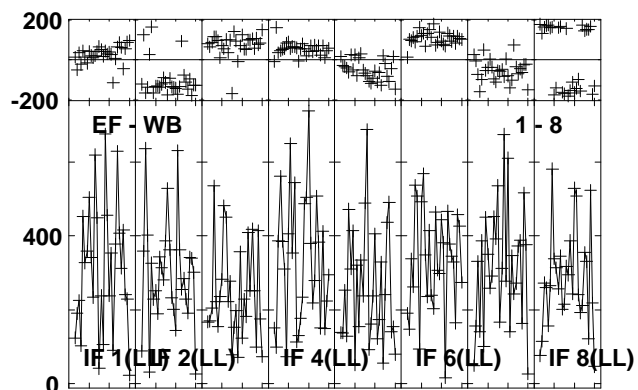
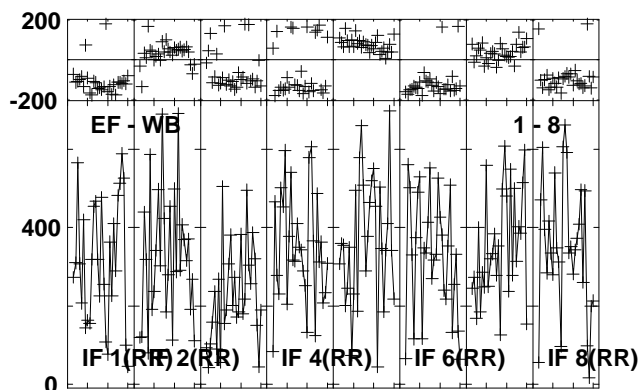
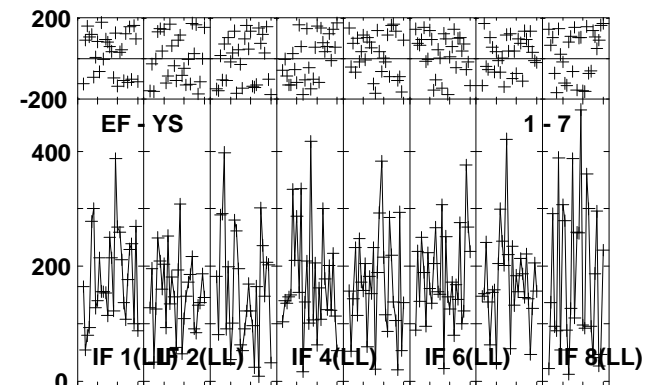
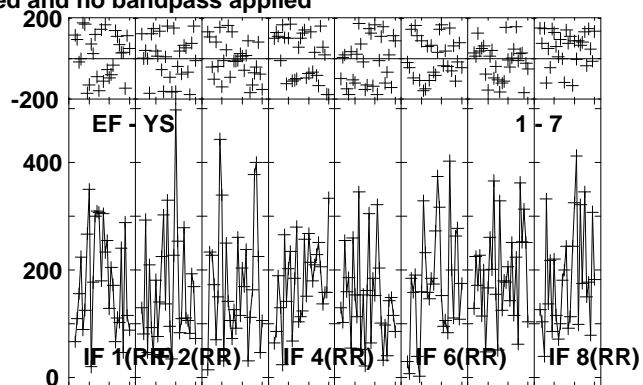
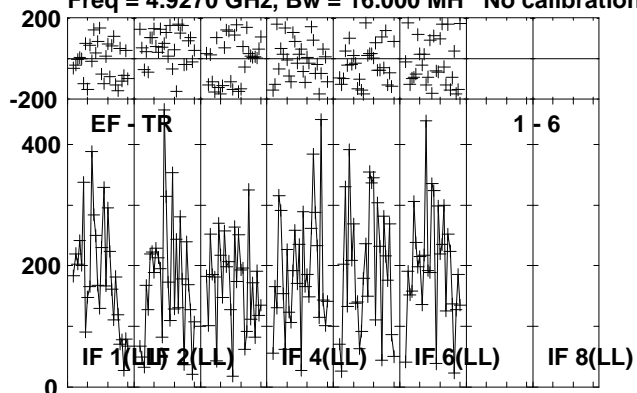

Lower frame: Micro Ampl Jy Top frame: Phas deg  
Vector averaged cross-power spectrum Several baselines displayed  
Timerange: 00/16:59:28 to 00/17:01:54



Plot file version 109 created 24-OCT-2012 20:59:11

J1825-0737 EY017B.UVDATA.1

Freq = 4.9270 GHz, Bw = 16.000 MH No calibration applied and no bandpass applied

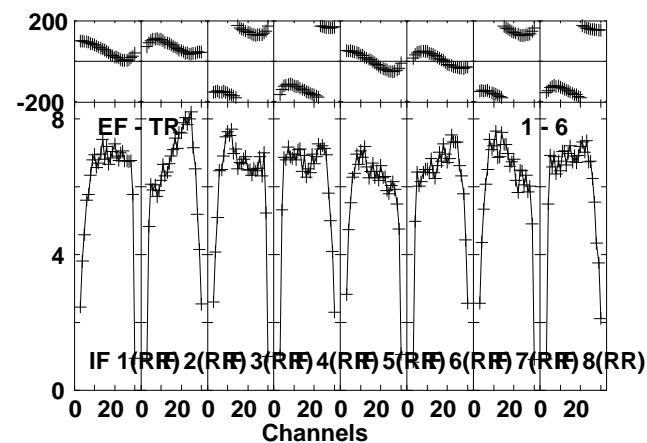
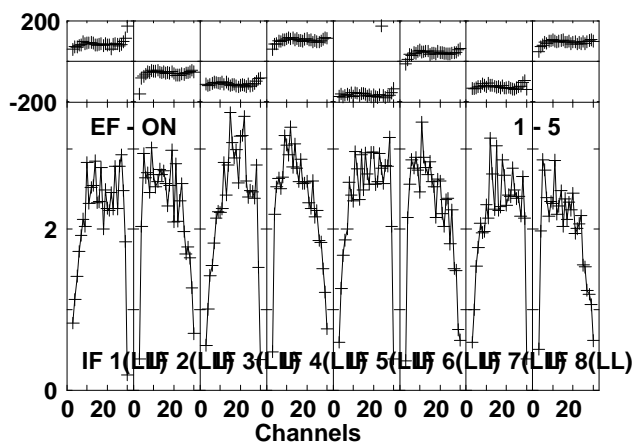
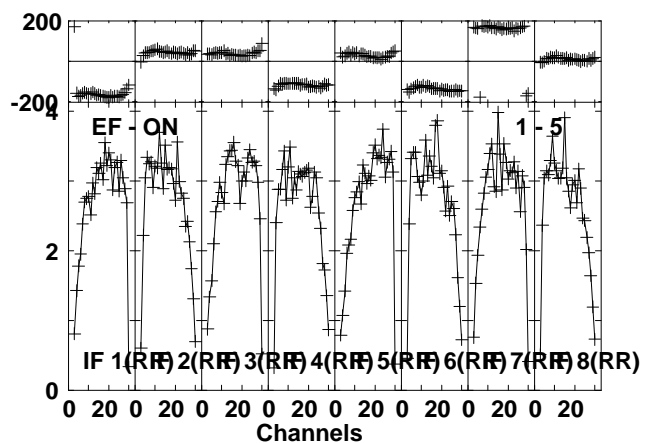
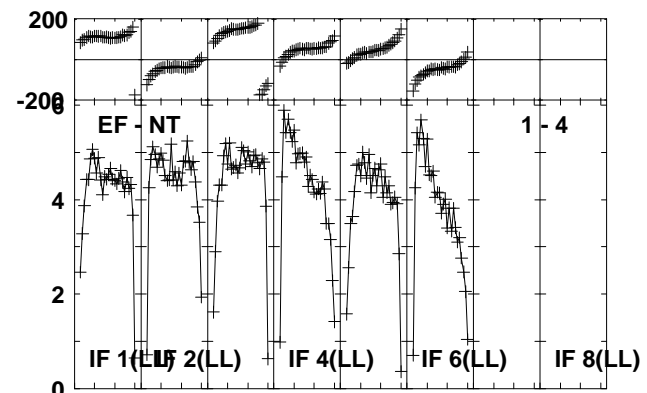
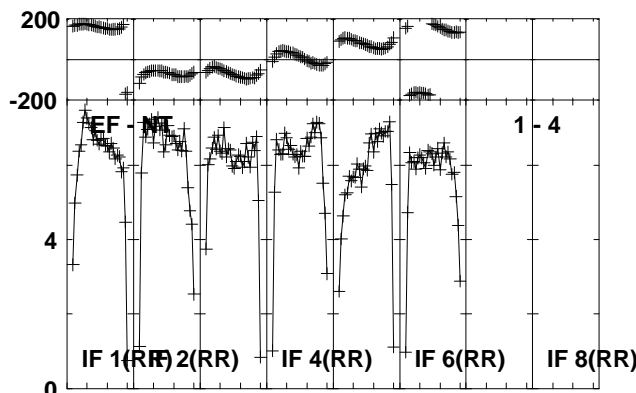
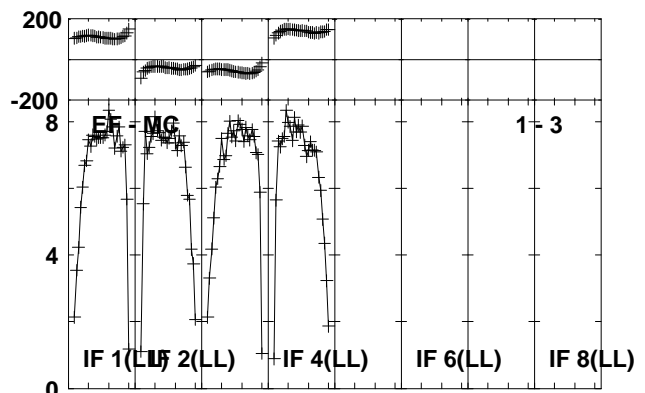
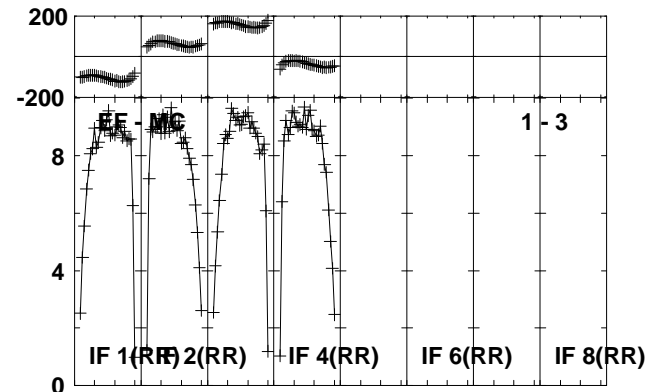
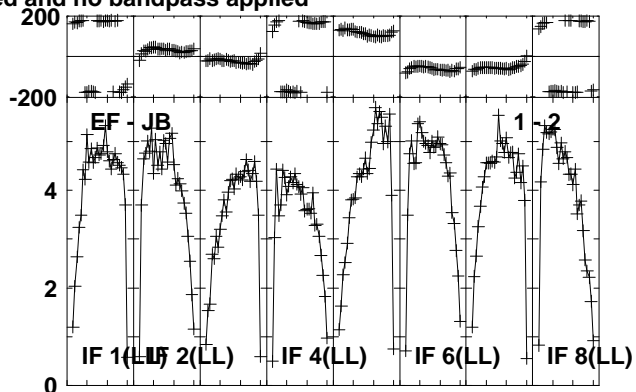
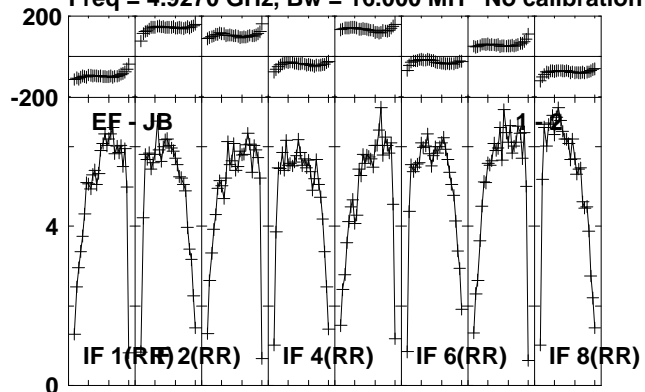

Lower frame: Milli Ampl Jy Top frame: Phas deg  
Vector averaged cross-power spectrum Several baselines displayed  
Timerange: 00/17:01:58 to 00/17:03:24

Plot file version 110 created 24-OCT-2012 20:59:11

J1825-0737 EY017B.UVDATA.1

Freq = 4.9270 GHz, Bw = 16.000 MH No calibration applied and no bandpass applied

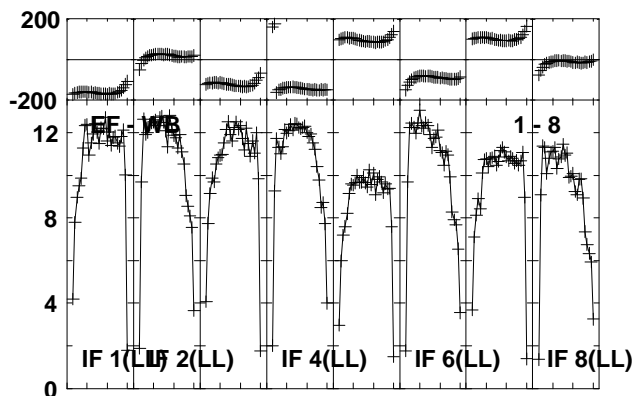
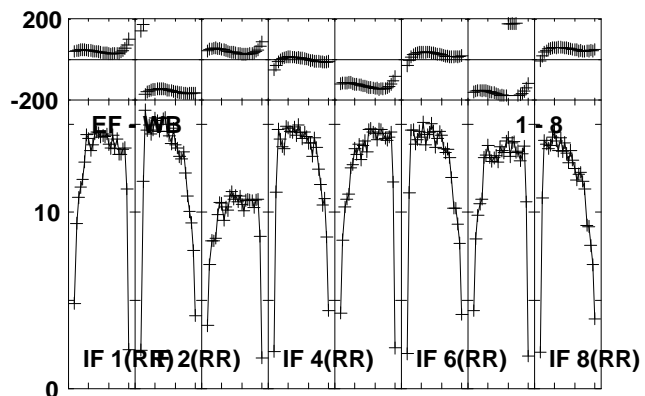
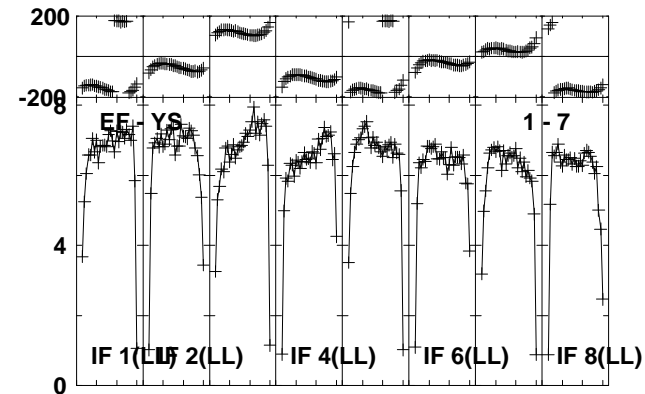
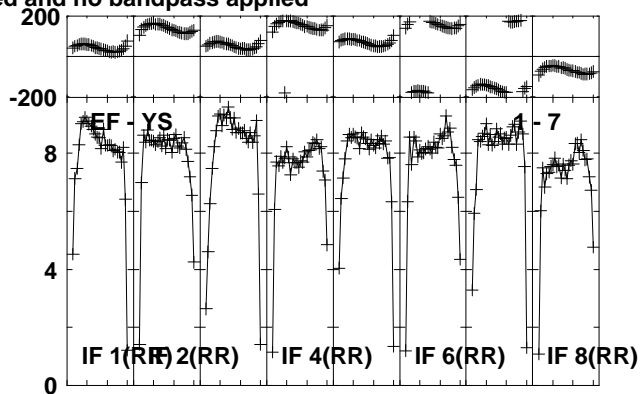
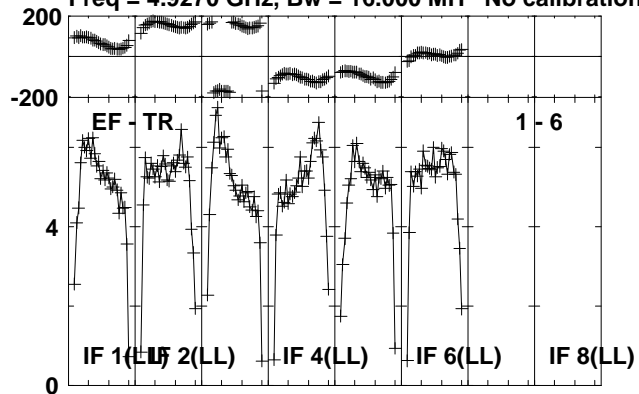

Lower frame: Milli Ampl Jy Top frame: Phas deg  
Vector averaged cross-power spectrum Several baselines displayed  
Timerange: 00/17:01:58 to 00/17:03:24

Plot file version 111 created 24-OCT-2012 20:59:12  
 J1831-0756 EY017B.UVDATA.1

Freq = 4.9270 GHz, Bw = 16.000 MH No calibration applied and no bandpass applied

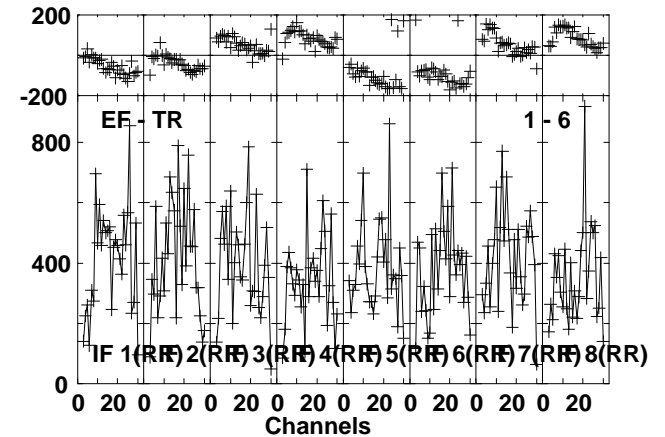
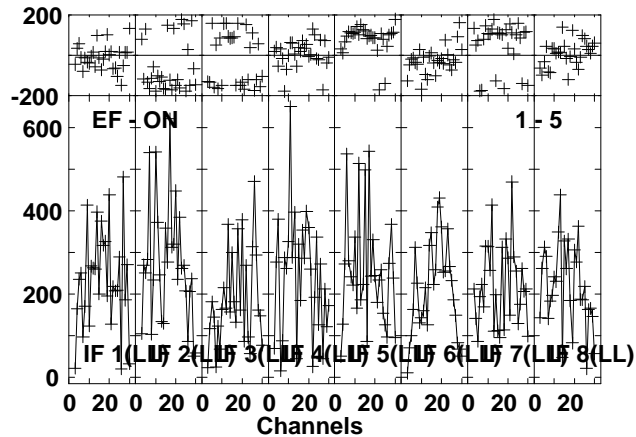
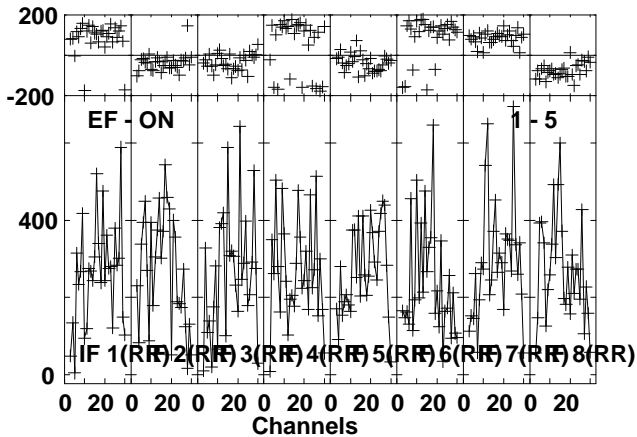
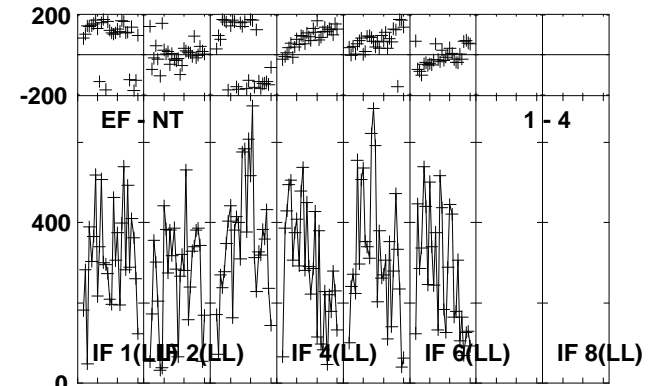
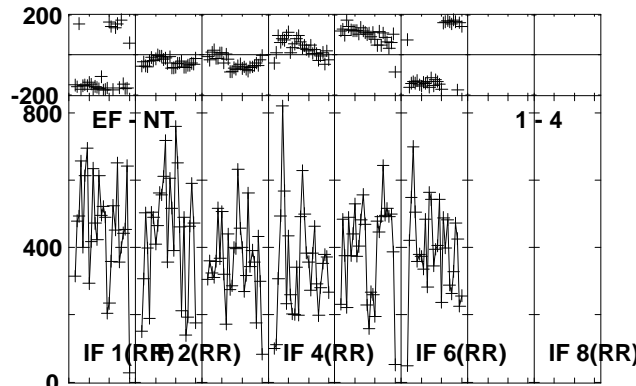
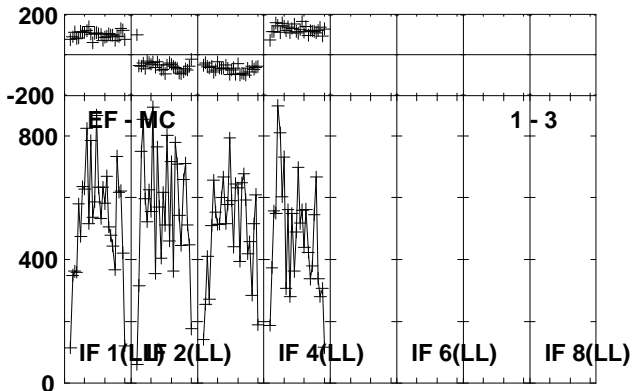
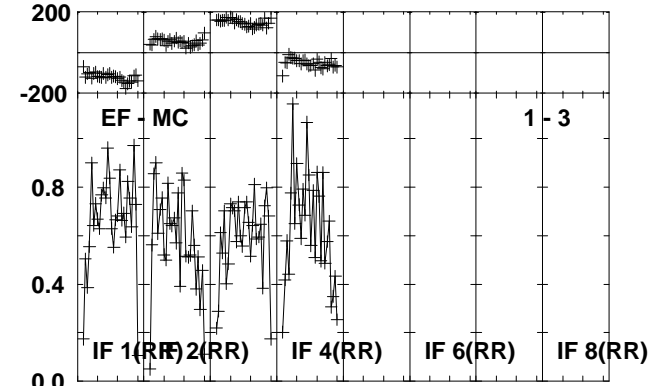
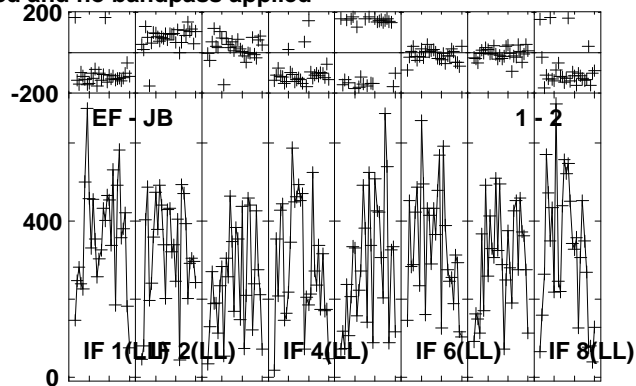
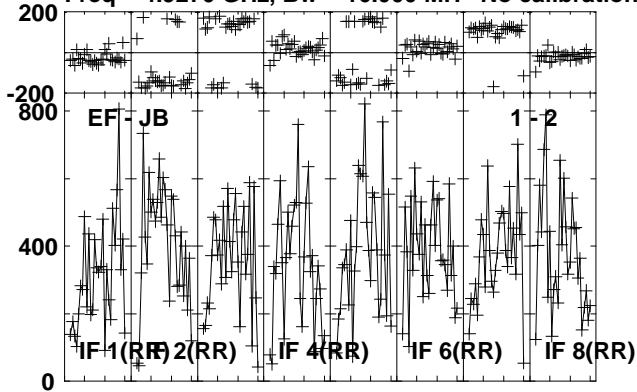

Lower frame: Micro Ampl Jy Top frame: Phas deg  
 Vector averaged cross-power spectrum Several baselines displayed  
 Timerange: 00/17:03:58 to 00/17:05:58

Plot file version 112 created 24-OCT-2012 20:59:12

J1831-0756 EY017B.UVDATA.1

Freq = 4.9270 GHz, Bw = 16.000 MH No calibration applied and no bandpass applied

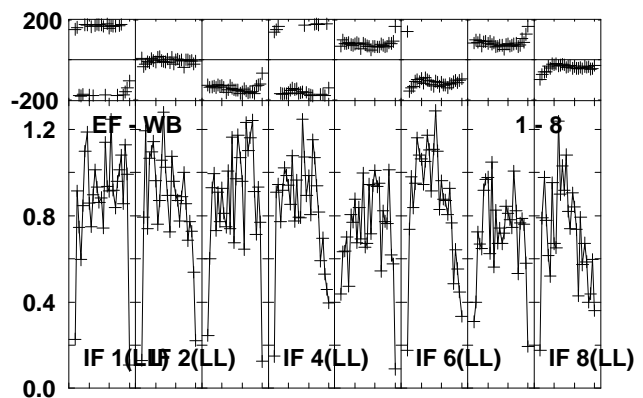
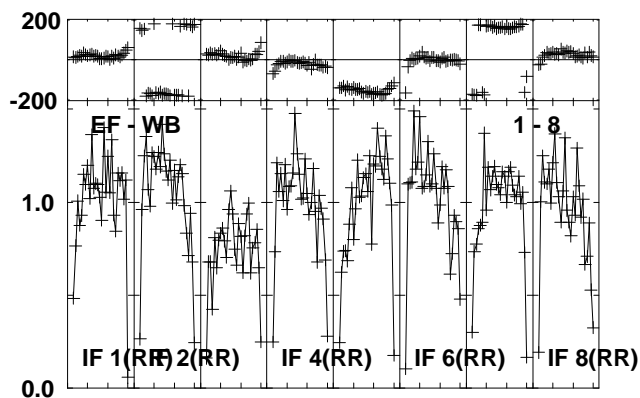
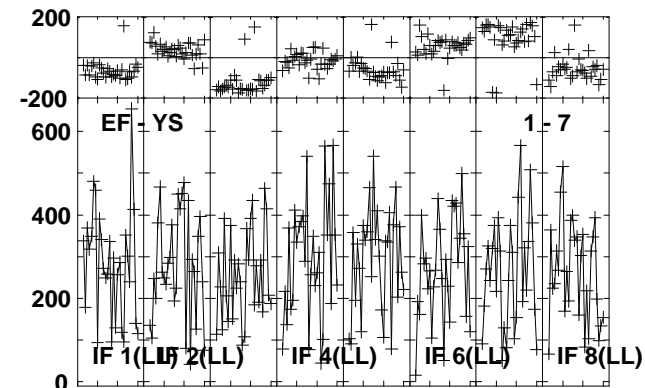
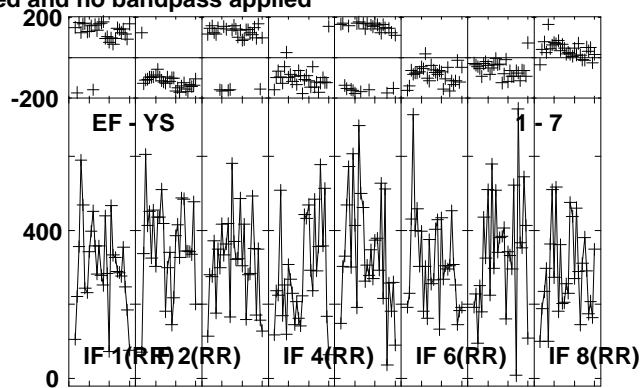
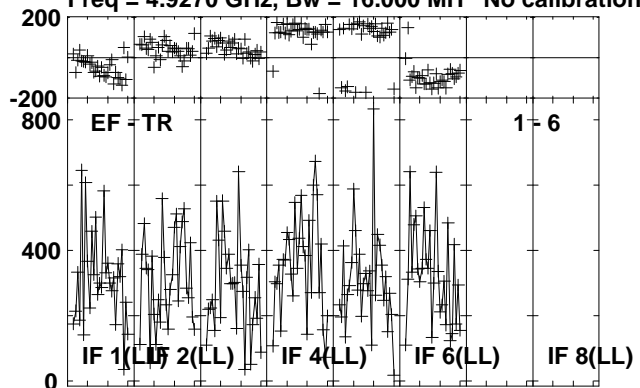

Lower frame: Micro Ampl Jy Top frame: Phas deg  
Vector averaged cross-power spectrum Several baselines displayed  
Timerange: 00/17:03:58 to 00/17:05:58

Plot file version 113 created 24-OCT-2012 20:59:13

J1825-0737 EY017B.UVDATA.1

Freq = 4.9270 GHz, Bw = 16.000 MH No calibration applied and no bandpass applied

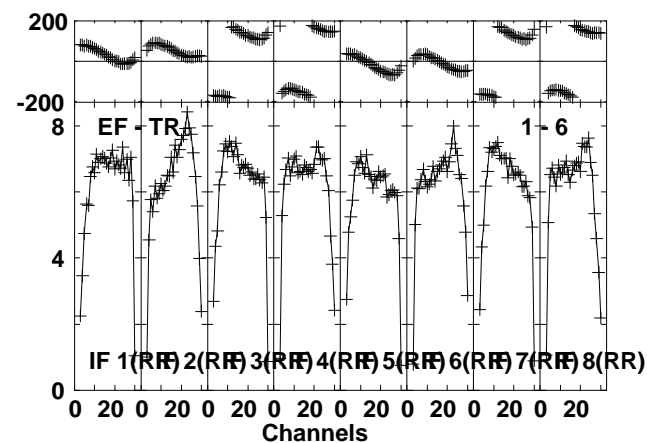
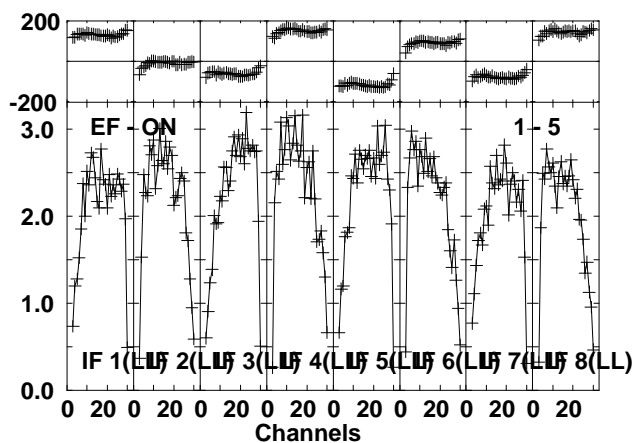
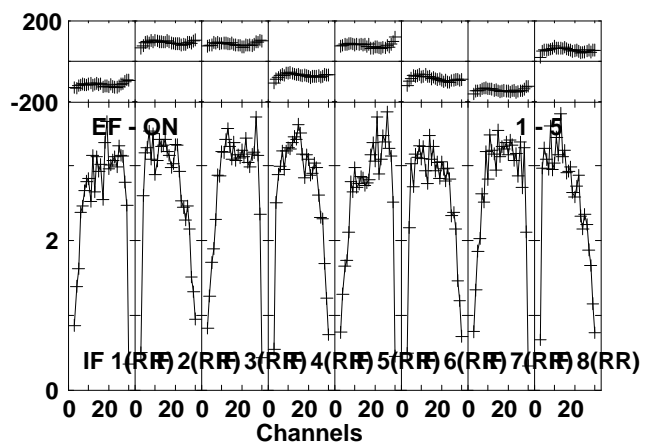
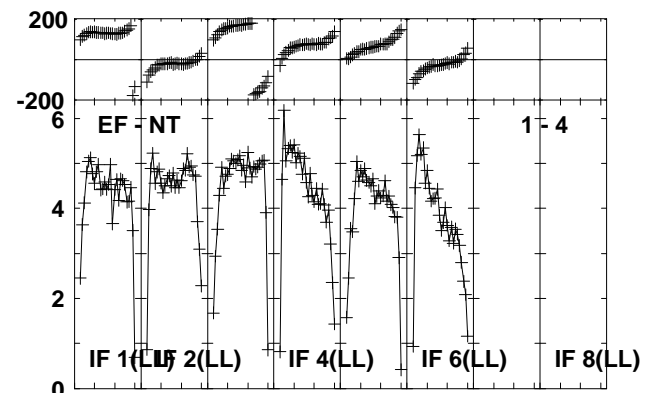
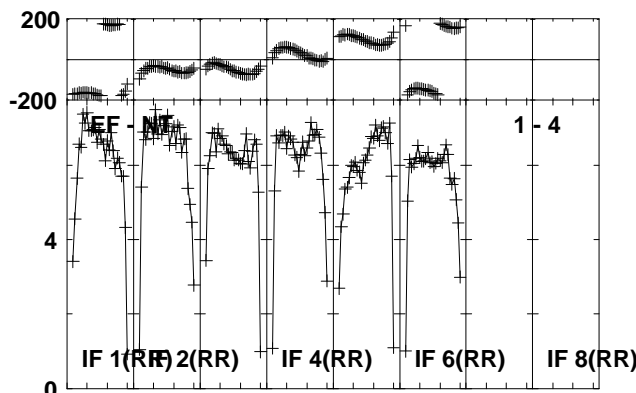
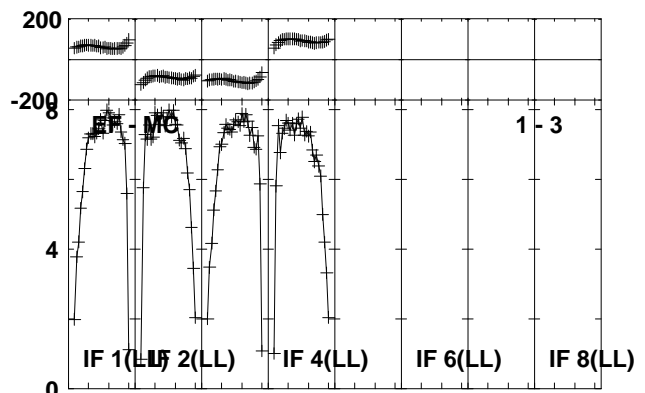
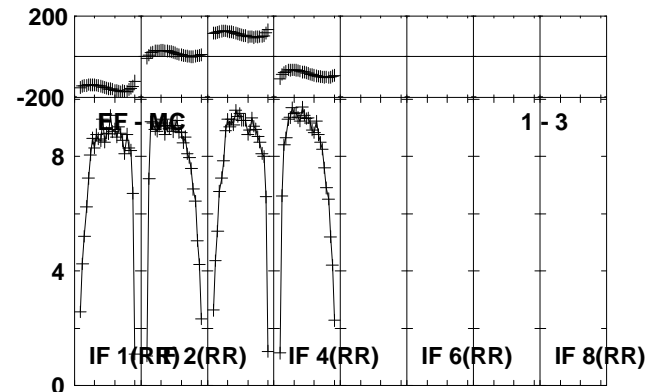
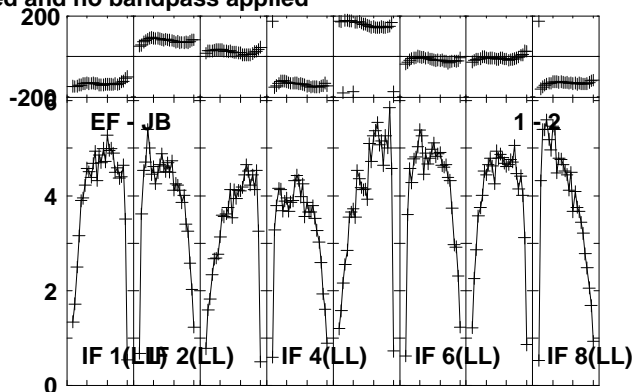
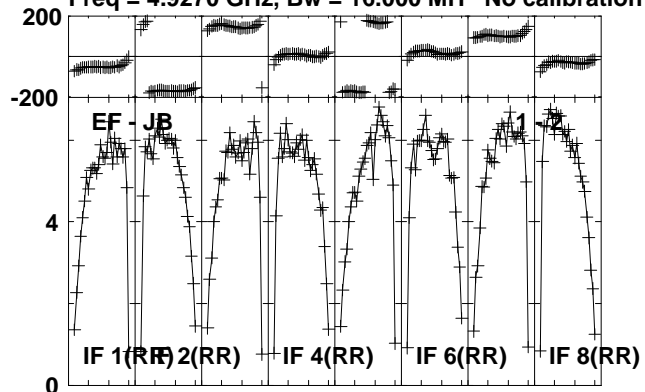

Lower frame: Milli Ampl Jy Top frame: Phas deg  
Vector averaged cross-power spectrum Several baselines displayed  
Timerange: 00/17:06:02 to 00/17:07:28

Plot file version 114 created 24-OCT-2012 20:59:13  
J1825-0737 EY017B.UVDATA.1

Freq = 4.9270 GHz, Bw = 16.000 MH No calibration applied and no bandpass applied

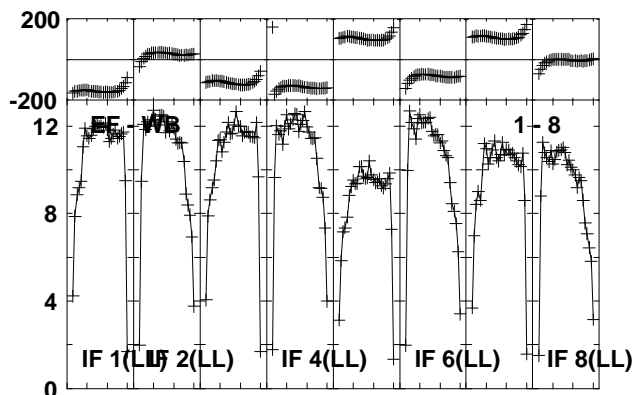
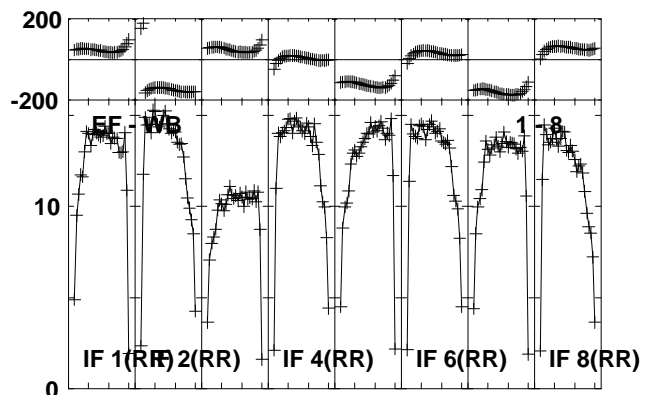
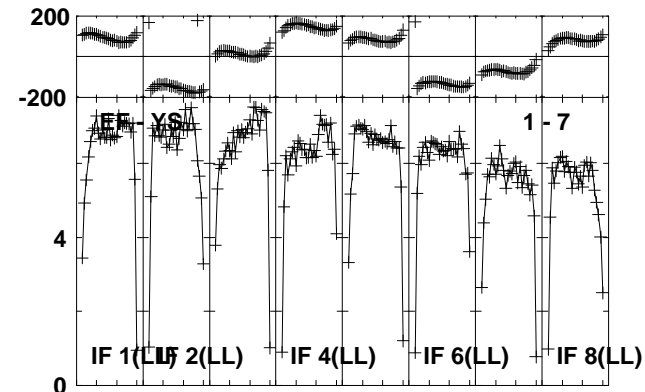
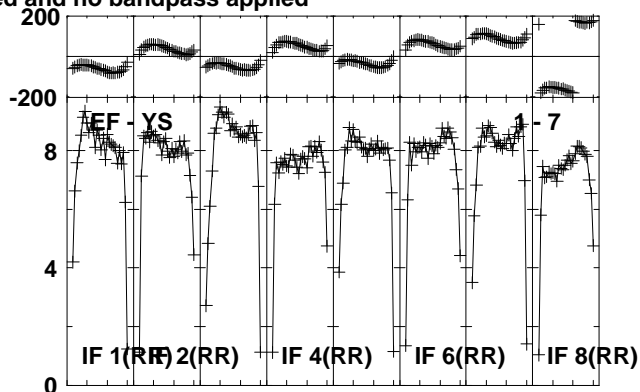
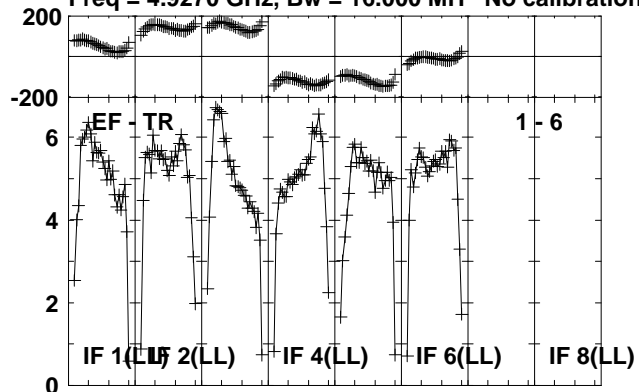

Lower frame: Milli Ampl Jy Top frame: Phas deg  
Vector averaged cross-power spectrum Several baselines displayed  
Timerange: 00/17:06:02 to 00/17:07:28

Plot file version 115 created 24-OCT-2012 20:59:14

G23.6-0.03 EY017B.UVDATA.1

Freq = 4.9270 GHz, Bw = 16.000 MH No calibration applied and no bandpass applied

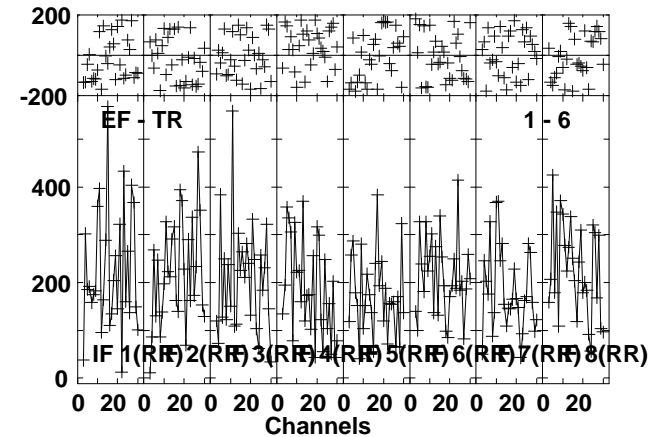
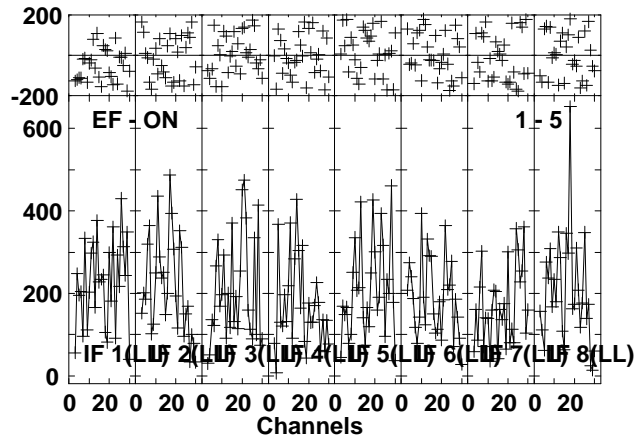
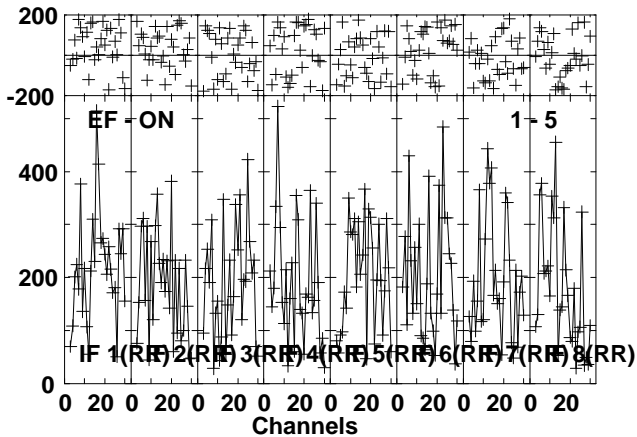
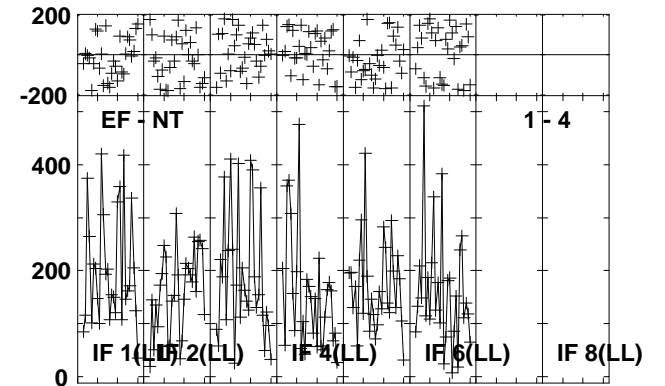
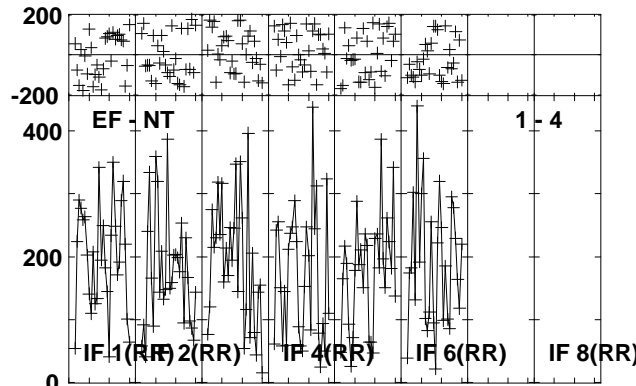
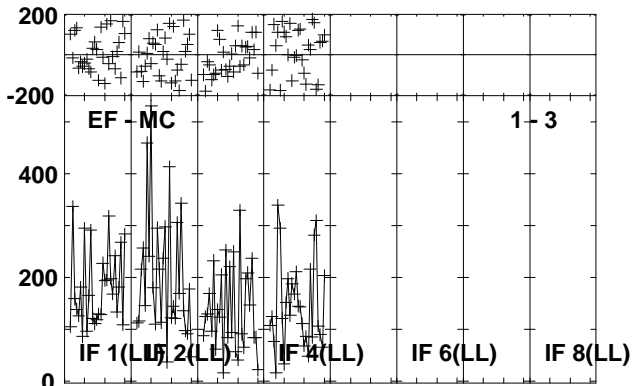
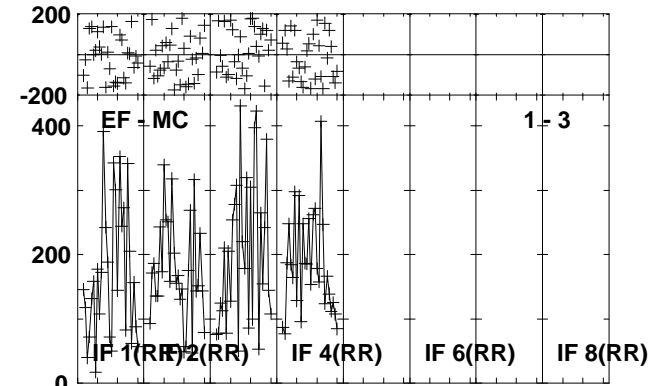
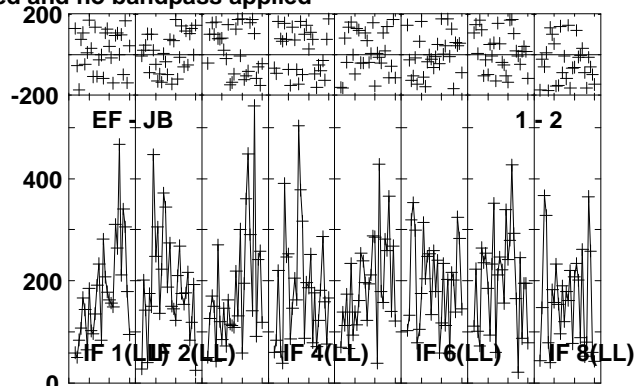
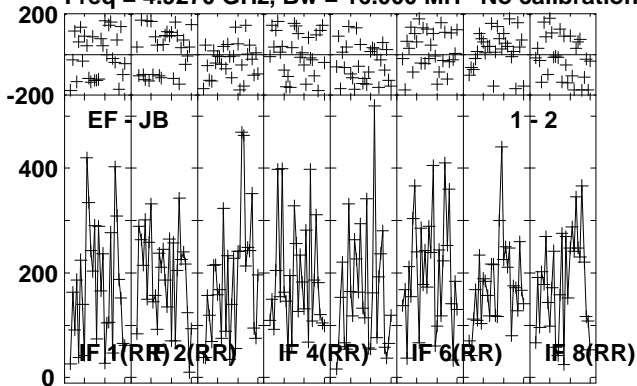

Lower frame: Micro Ampl Jy Top frame: Phas deg  
Vector averaged cross-power spectrum Several baselines displayed  
Timerange: 00/17:07:32 to 00/17:09:58

Plot file version 116 created 24-OCT-2012 20:59:15

G23.6-0.03 EY017B.UVDATA.1

Freq = 4.9270 GHz, Bw = 16.000 MH No calibration applied and no bandpass applied

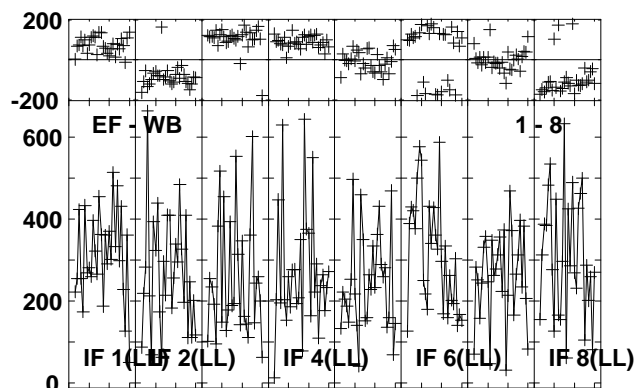
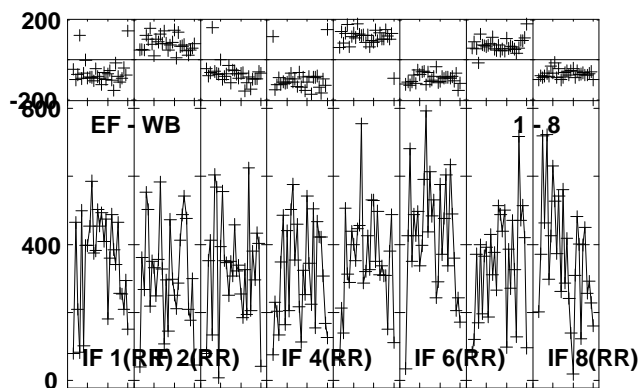
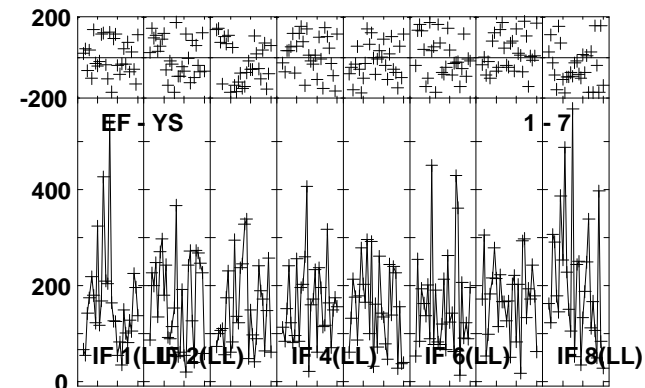
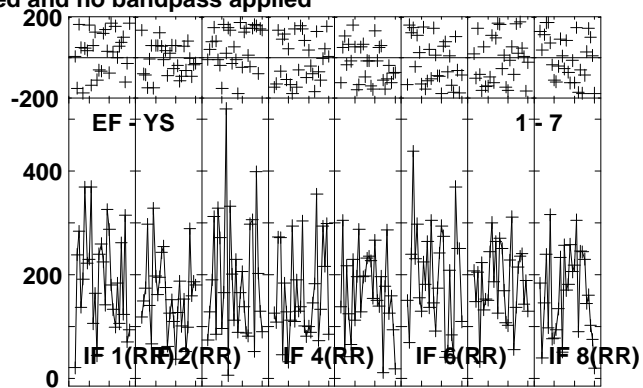
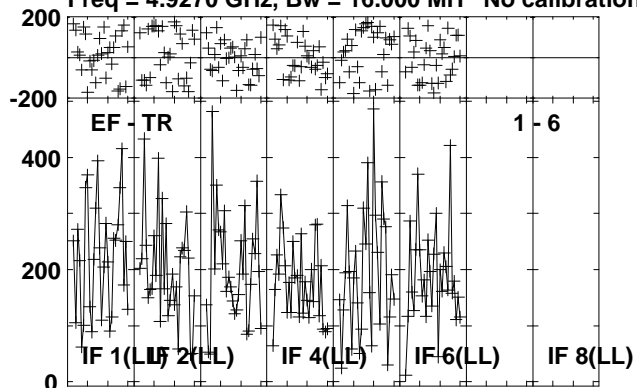

Lower frame: Micro Ampl Jy Top frame: Phas deg  
Vector averaged cross-power spectrum Several baselines displayed  
Timerange: 00/17:07:32 to 00/17:09:58



Plot file version 117 created 24-OCT-2012 20:59:15

J1825-0737 EY017B.UVDATA.1

Freq = 4.9270 GHz, Bw = 16.000 MH No calibration applied and no bandpass applied

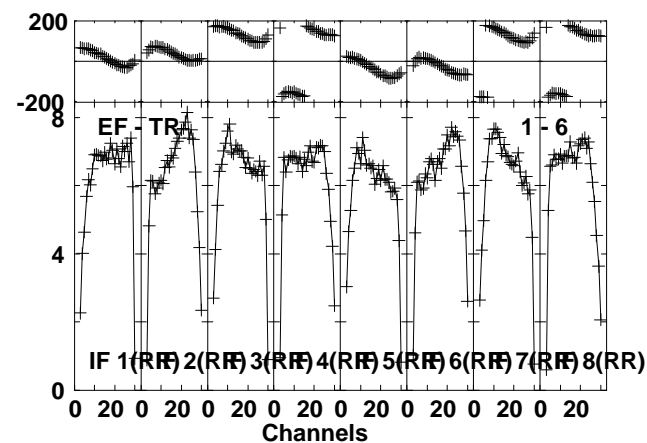
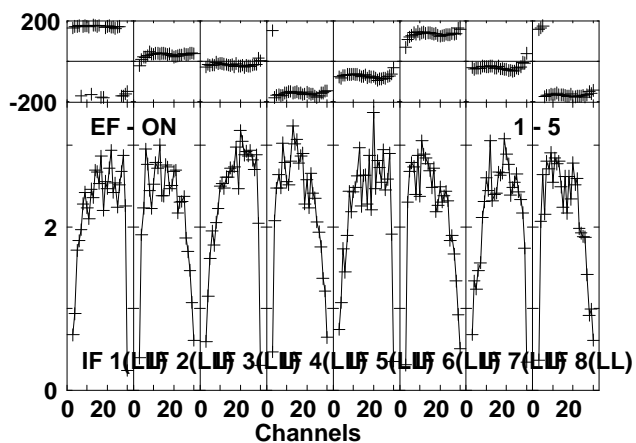
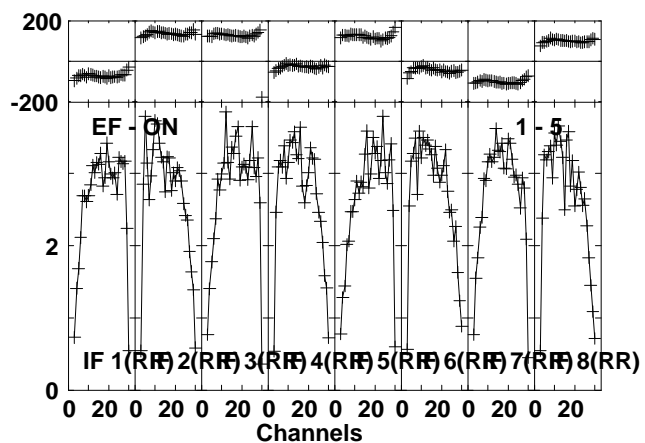
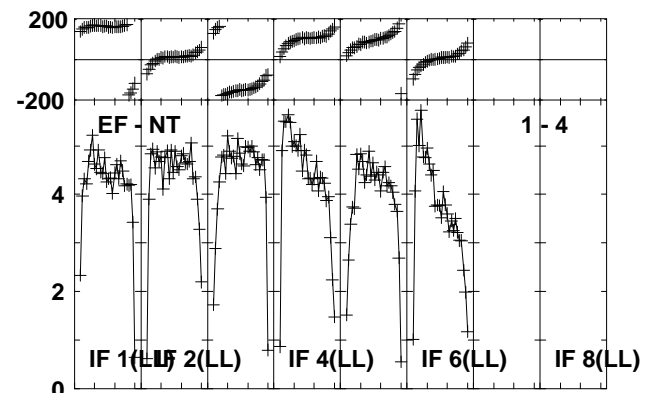
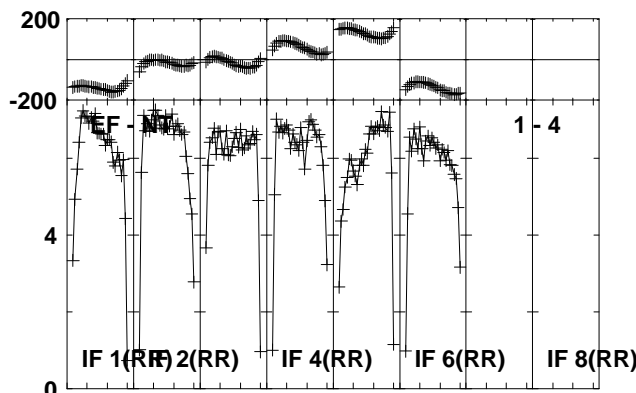
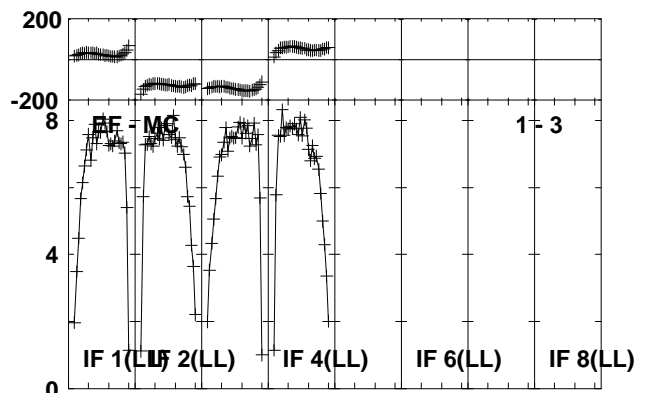
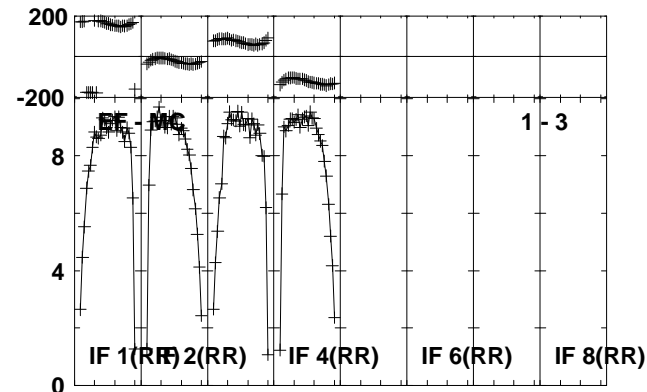
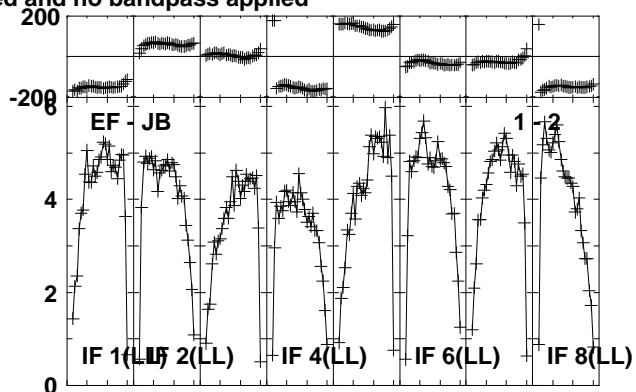
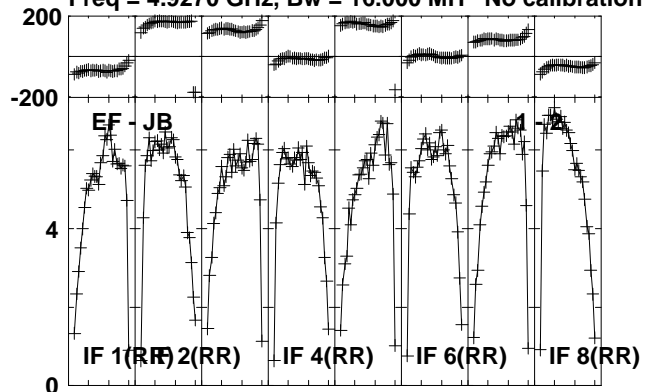

Lower frame: Milli Ampl Jy Top frame: Phas deg  
Vector averaged cross-power spectrum Several baselines displayed  
Timerange: 00/17:10:02 to 00/17:11:28

Plot file version 118 created 24-OCT-2012 20:59:16

J1825-0737 EY017B.UVDATA.1

Freq = 4.9270 GHz, Bw = 16.000 MH No calibration applied and no bandpass applied

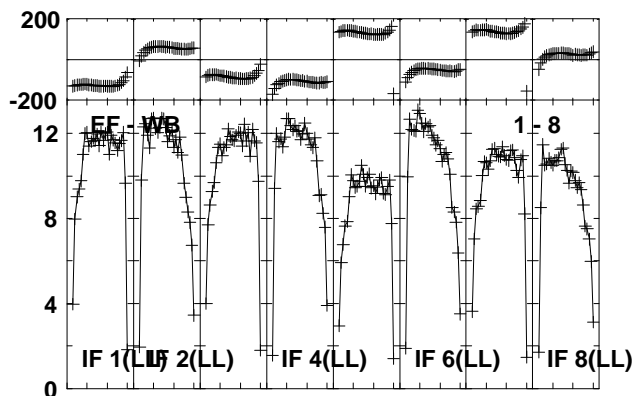
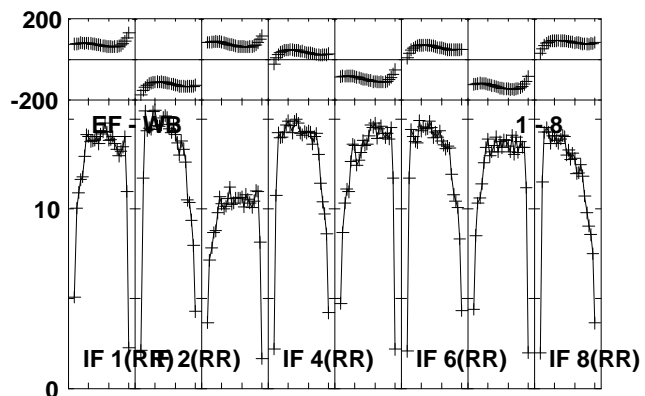
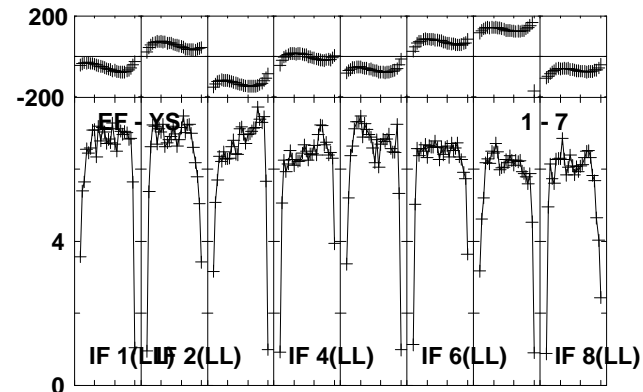
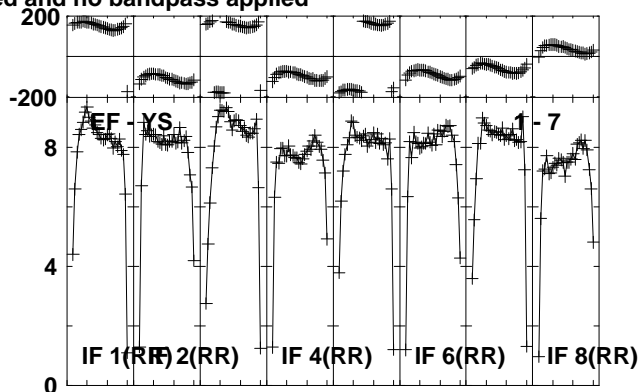
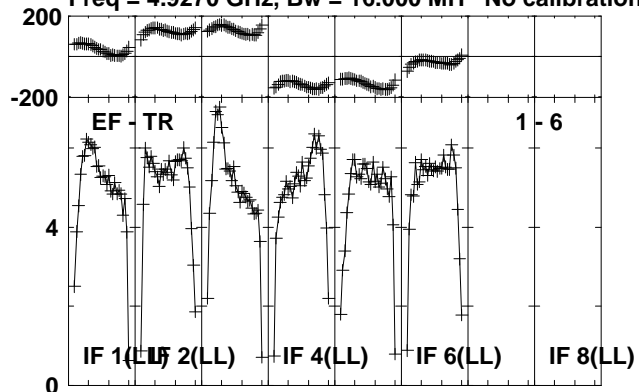

Lower frame: Milli Ampl Jy Top frame: Phas deg  
Vector averaged cross-power spectrum Several baselines displayed  
Timerange: 00/17:10:02 to 00/17:11:28

Plot file version 119 created 24-OCT-2012 20:59:16

G23.6-0.03 EY017B.UVDATA.1

Freq = 4.9270 GHz, Bw = 16.000 MH No calibration applied and no bandpass applied

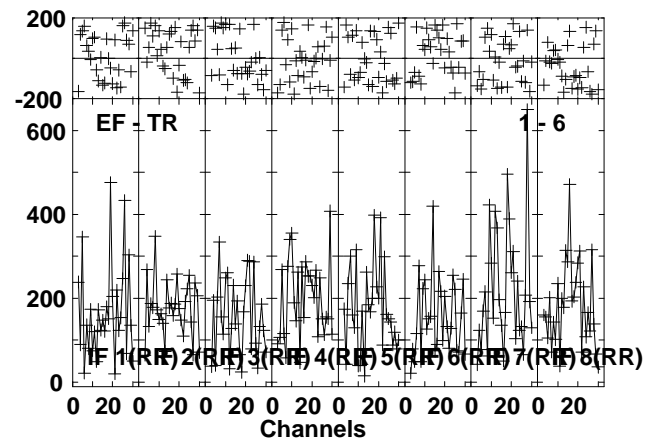
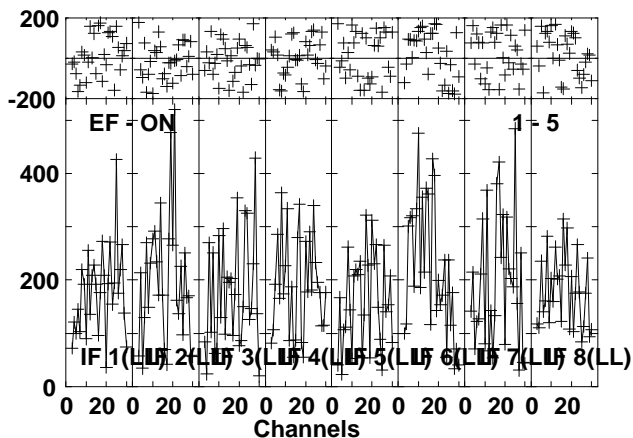
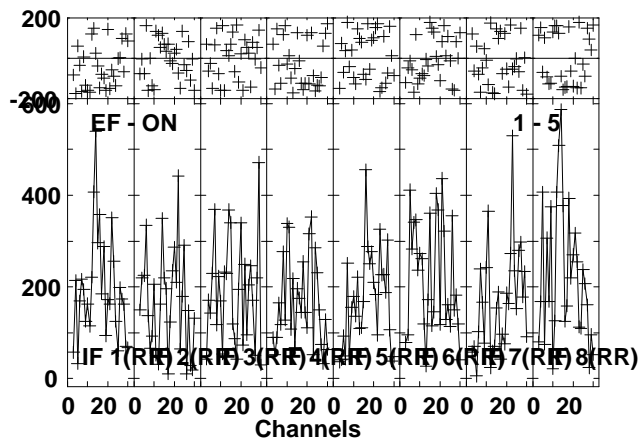
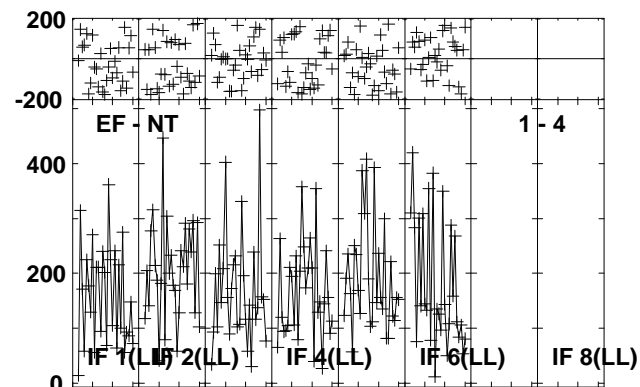
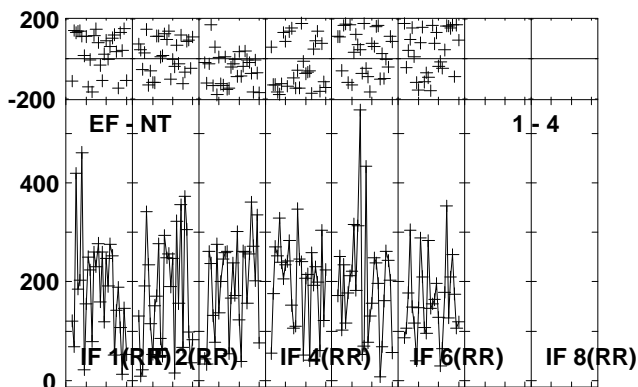
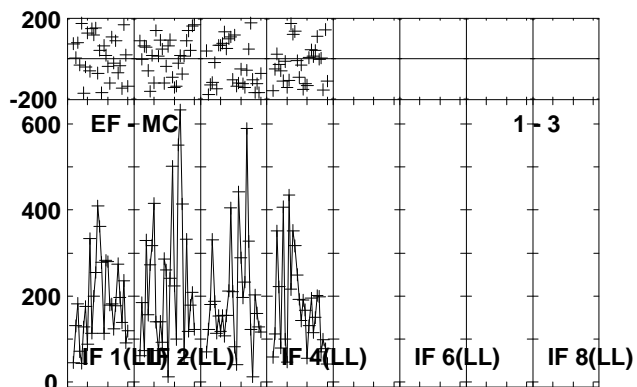
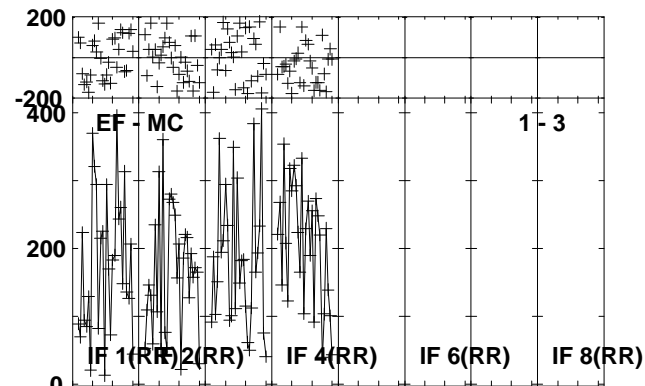
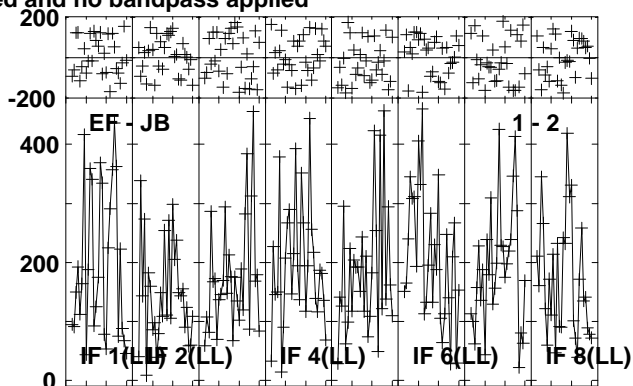
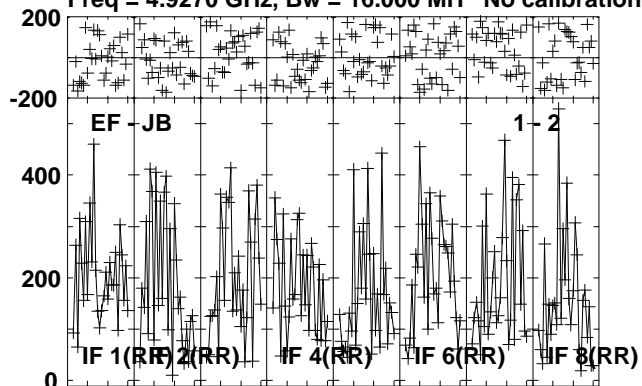

Lower frame: Micro Ampl Jy Top frame: Phas deg  
Vector averaged cross-power spectrum Several baselines displayed  
Timerange: 00/17:11:32 to 00/17:13:58

Plot file version 120 created 24-OCT-2012 20:59:17

G23.6-0.03 EY017B.UVDATA.1

Freq = 4.9270 GHz, Bw = 16.000 MH No calibration applied and no bandpass applied

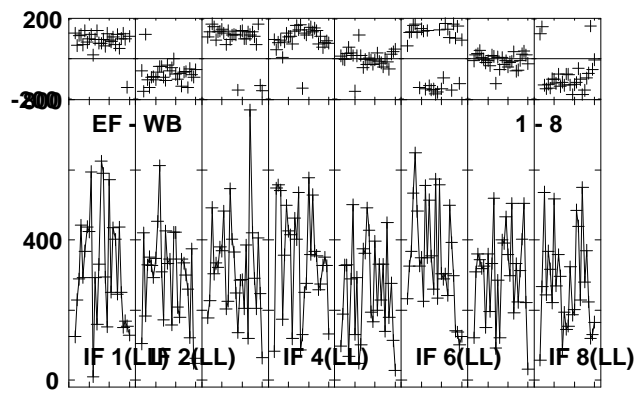
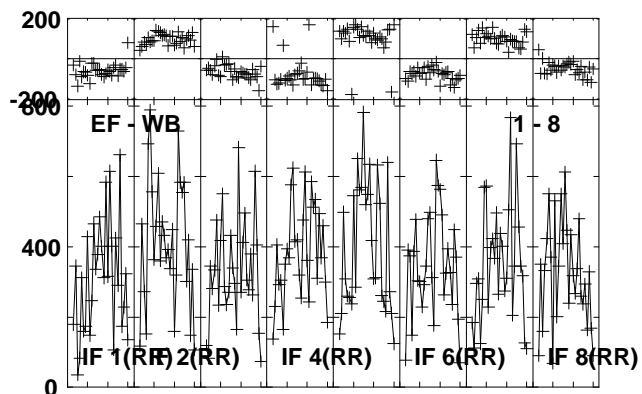
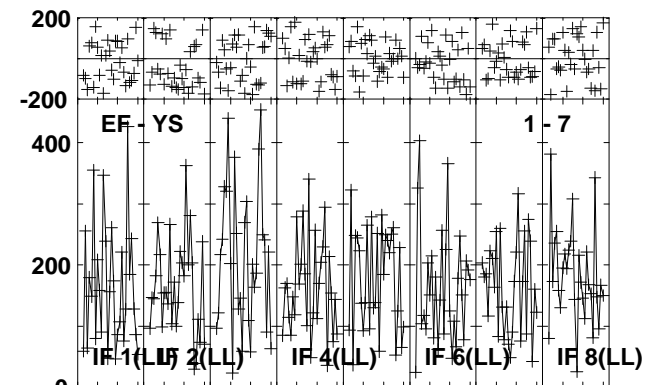
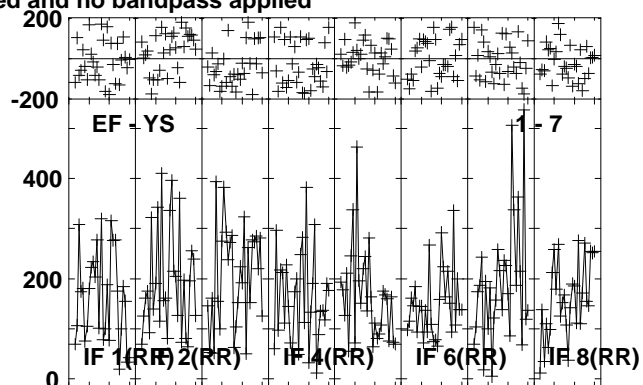
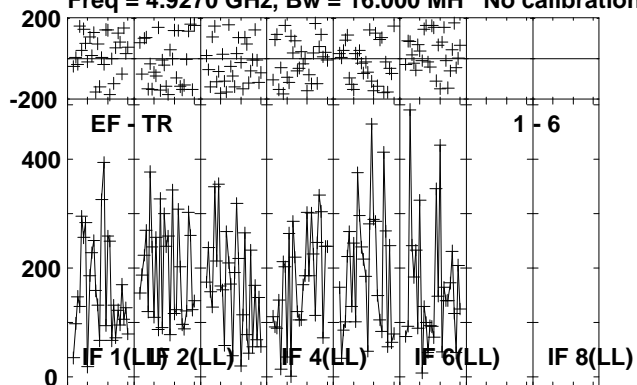

Lower frame: Micro Ampl Jy Top frame: Phas deg  
Vector averaged cross-power spectrum Several baselines displayed  
Timerange: 00/17:11:32 to 00/17:13:58

Plot file version 121 created 24-OCT-2012 20:59:17

J1825-0737 EY017B.UVDATA.1

Freq = 4.9270 GHz, Bw = 16.000 MH No calibration applied and no bandpass applied

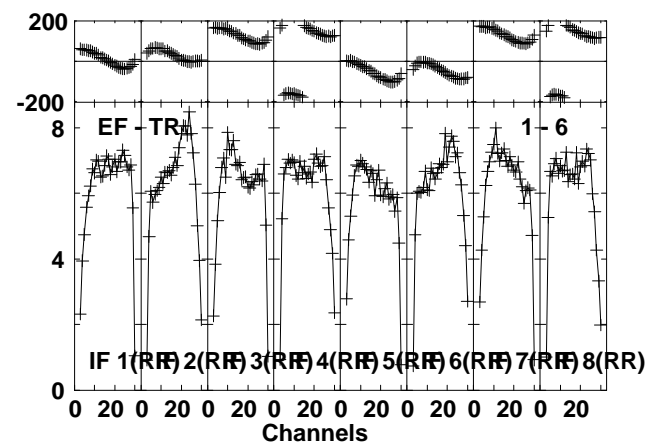
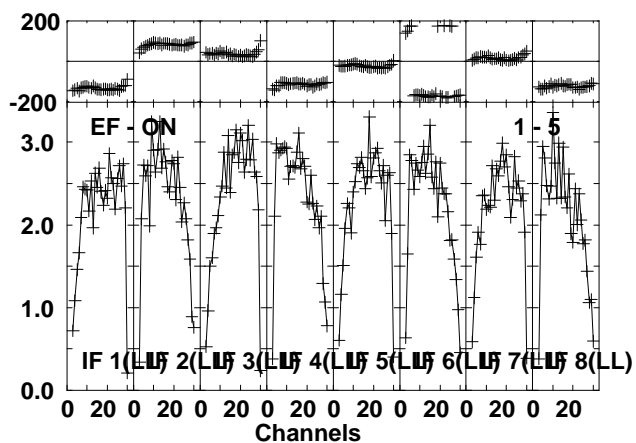
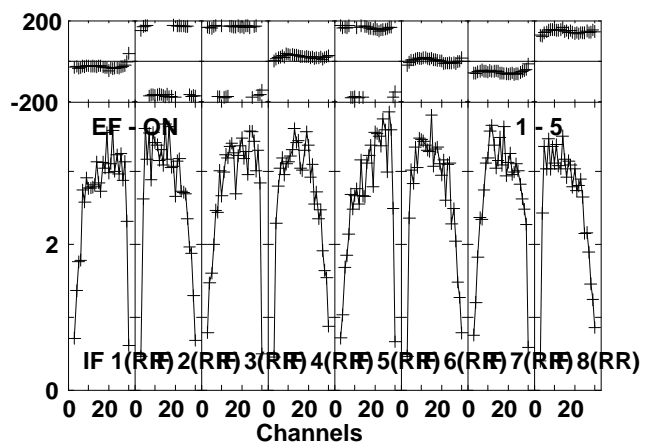
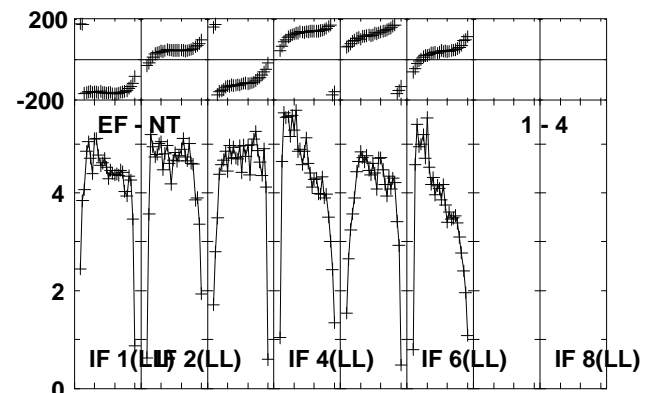
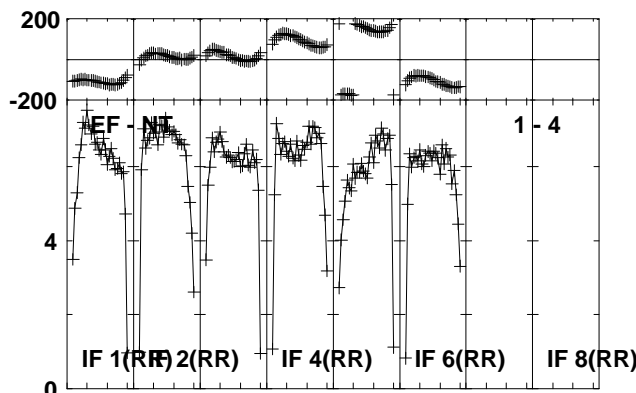
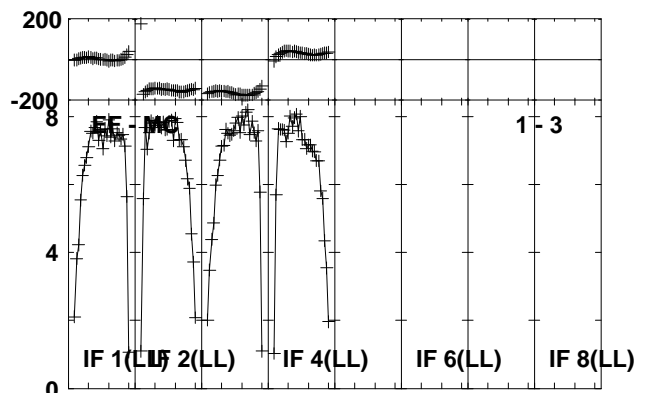
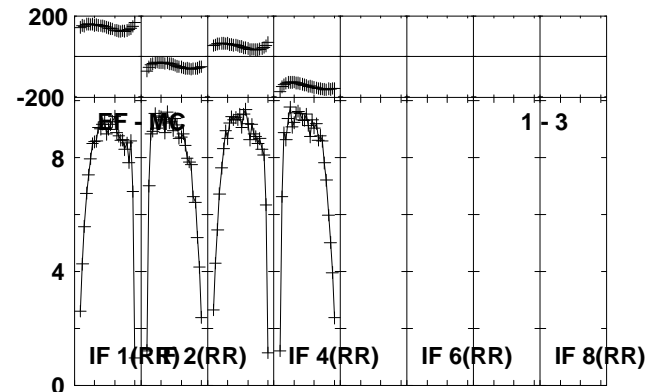
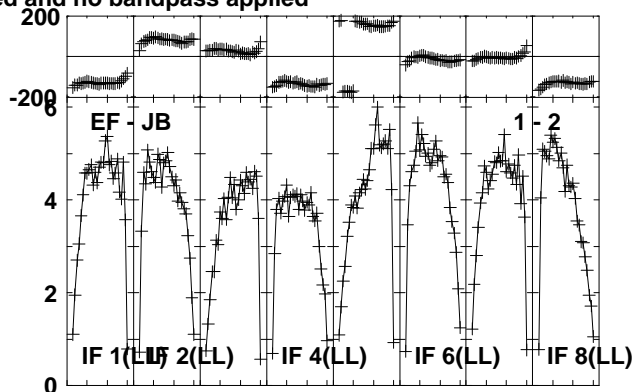
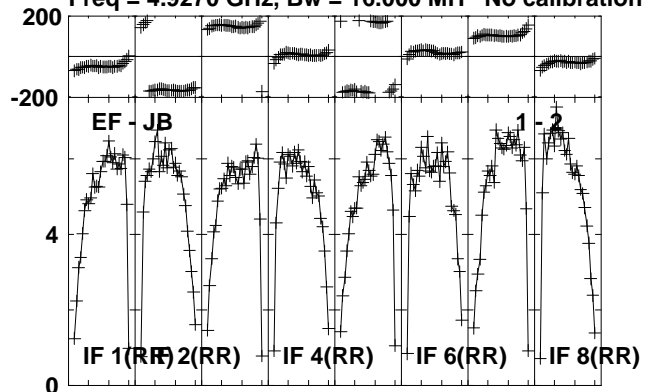

Lower frame: Milli Ampl Jy Top frame: Phas deg  
Vector averaged cross-power spectrum Several baselines displayed  
Timerange: 00/17:14:02 to 00/17:15:28

Plot file version 122 created 24-OCT-2012 20:59:18

J1825-0737 EY017B.UVDATA.1

Freq = 4.9270 GHz, Bw = 16.000 MH No calibration applied and no bandpass applied

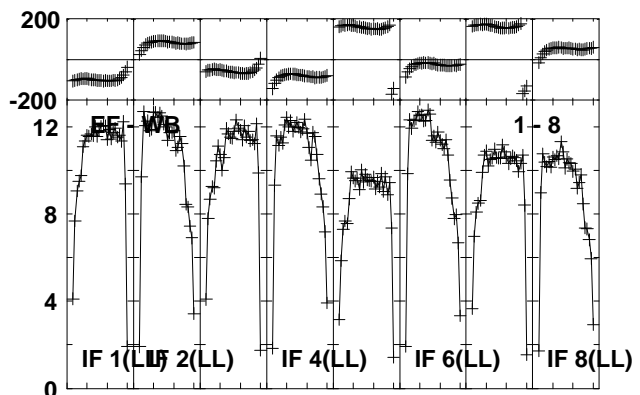
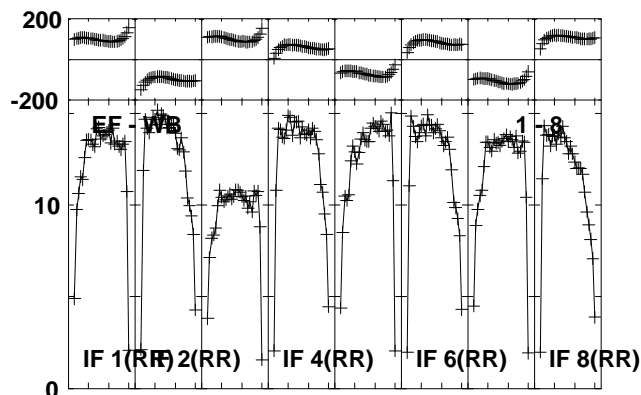
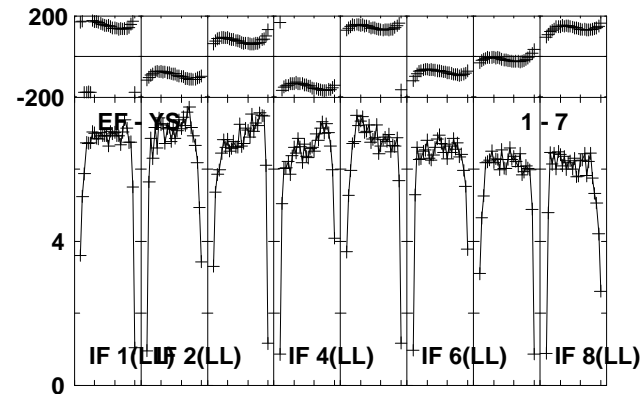
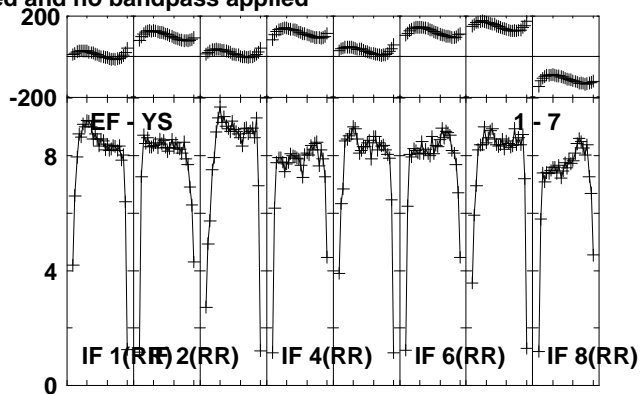
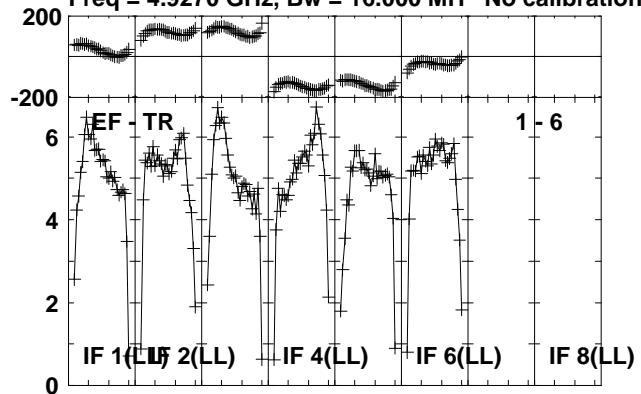

Lower frame: Milli Ampl Jy Top frame: Phas deg  
Vector averaged cross-power spectrum Several baselines displayed  
Timerange: 00/17:14:02 to 00/17:15:28

Plot file version 123 created 24-OCT-2012 20:59:18

G23.6-0.03 EY017B.UVDATA.1

Freq = 4.9270 GHz, Bw = 16.000 MH No calibration applied and no bandpass applied

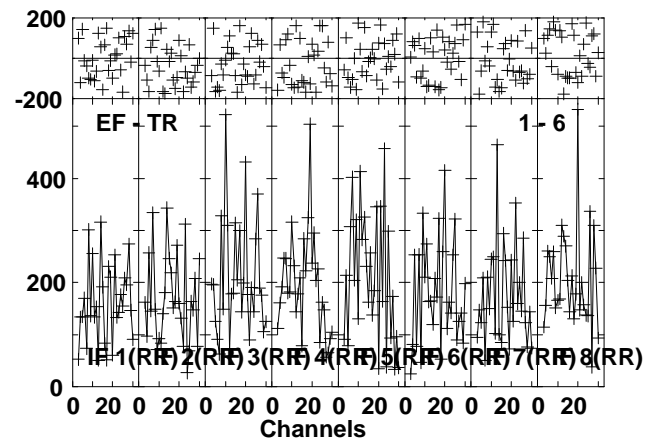
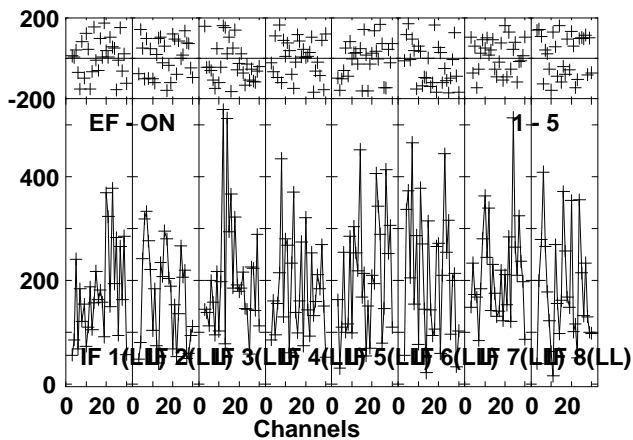
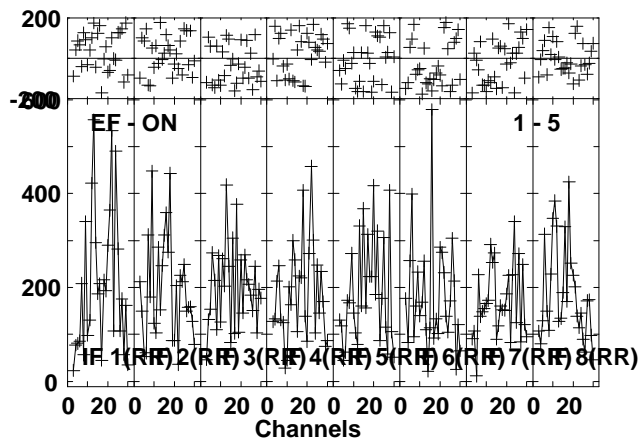
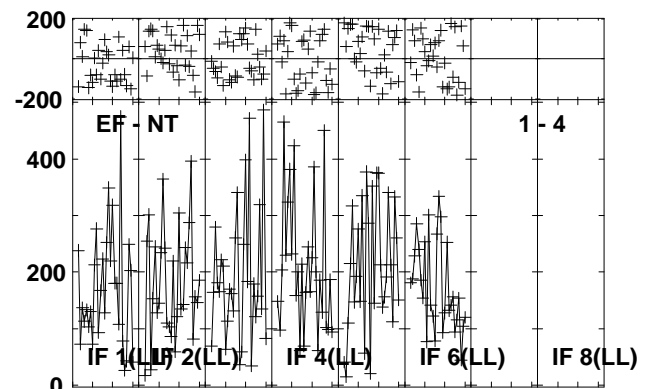
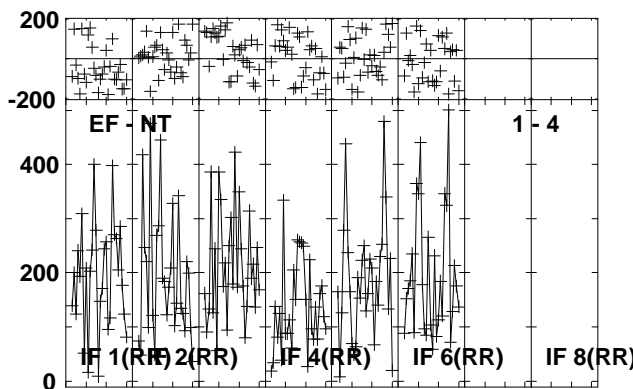
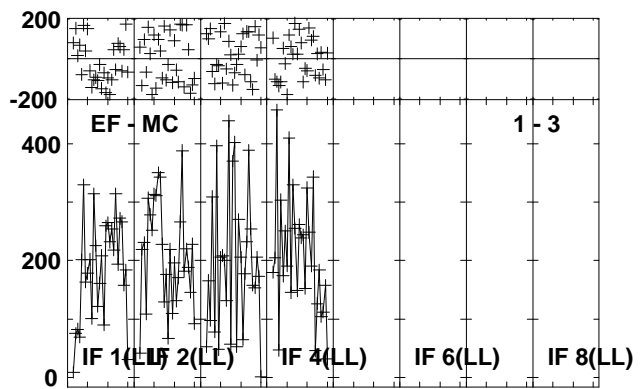
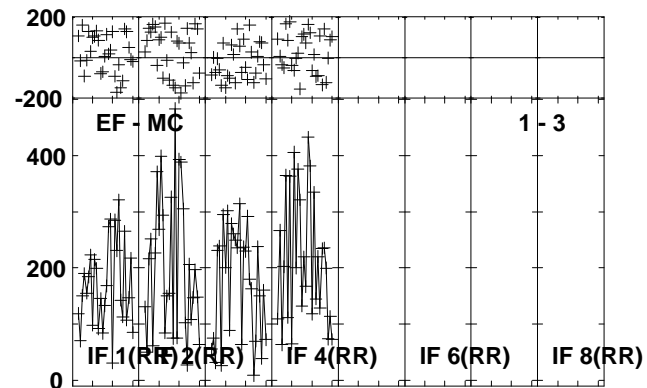
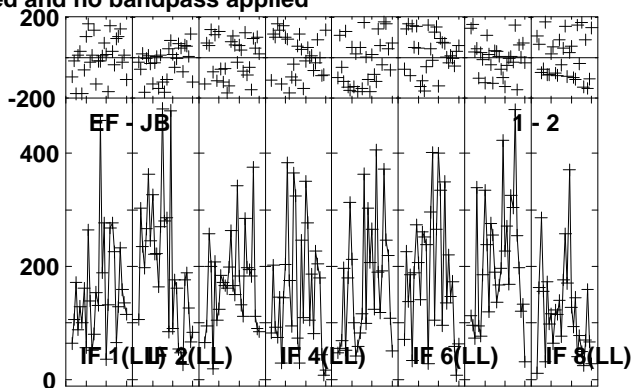
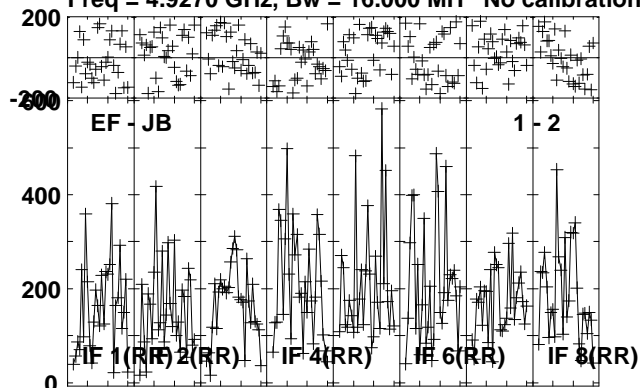

Lower frame: Micro Ampl Jy Top frame: Phas deg  
Vector averaged cross-power spectrum Several baselines displayed  
Timerange: 00/17:15:32 to 00/17:17:58

Plot file version 124 created 24-OCT-2012 20:59:19

G23.6-0.03 EY017B.UVDATA.1

Freq = 4.9270 GHz, Bw = 16.000 MH No calibration applied and no bandpass applied

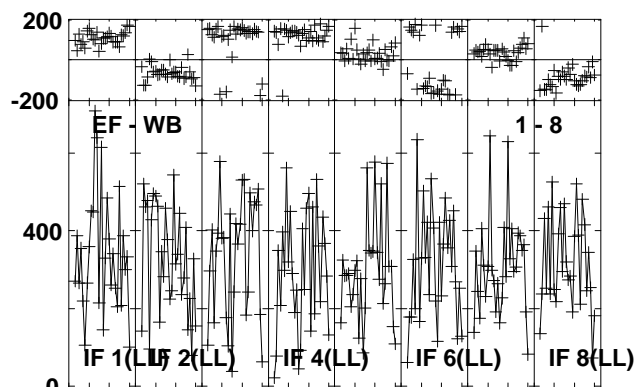
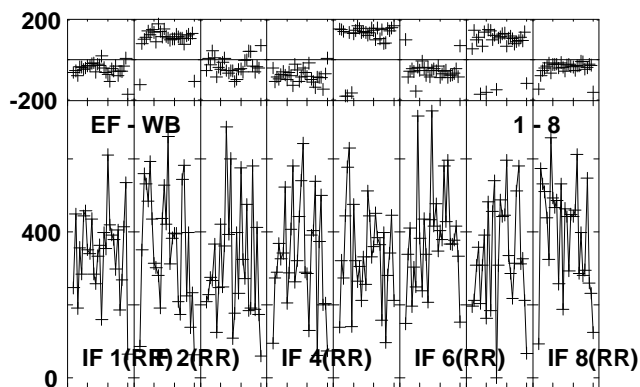
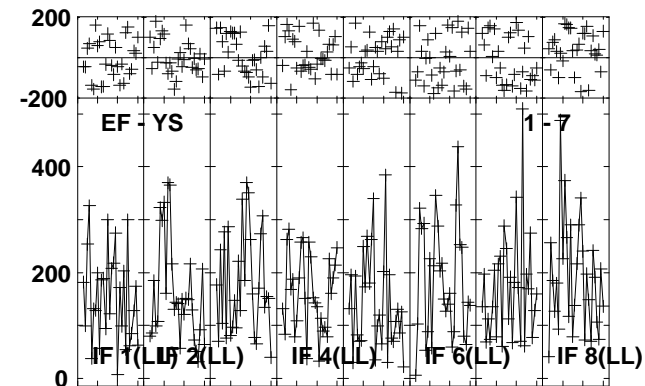
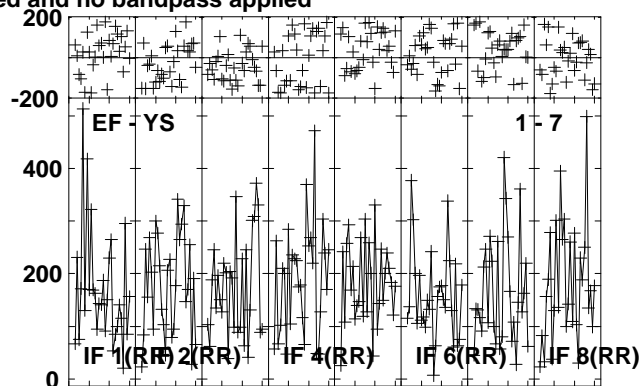
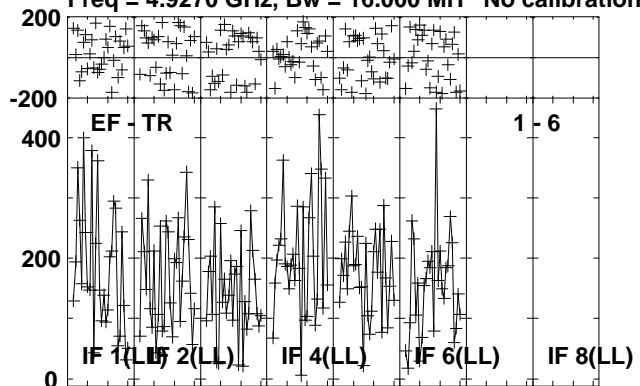

Lower frame: Micro Ampl Jy Top frame: Phas deg  
Vector averaged cross-power spectrum Several baselines displayed  
Timerange: 00/17:15:32 to 00/17:17:58



Plot file version 125 created 24-OCT-2012 20:59:19

J1825-0737 EY017B.UVDATA.1

Freq = 4.9270 GHz, Bw = 16.000 MH No calibration applied and no bandpass applied

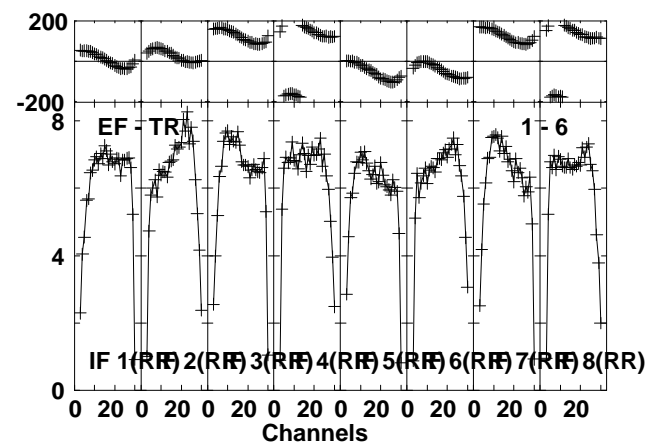
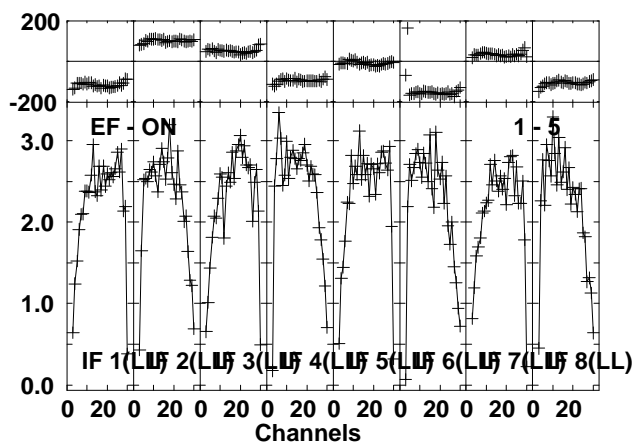
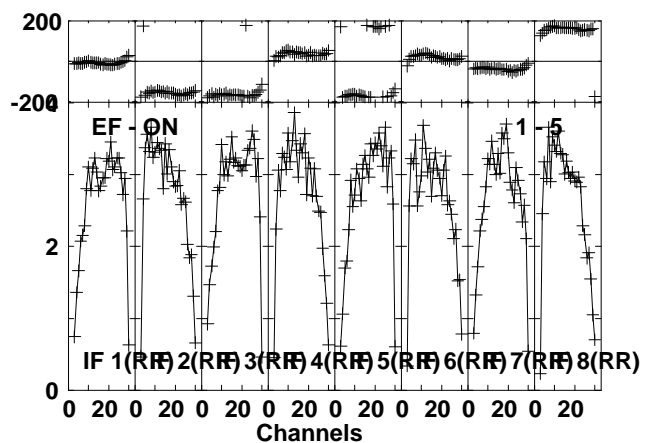
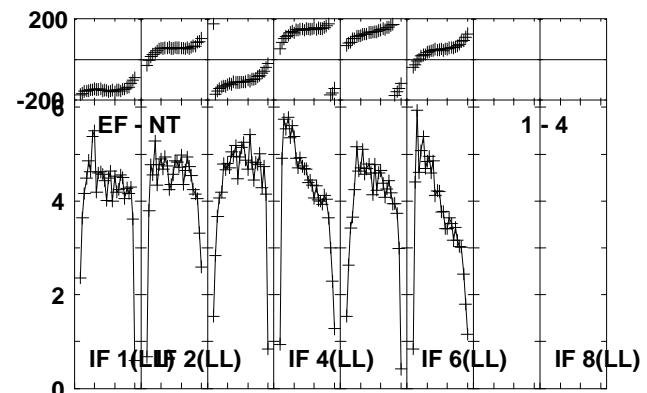
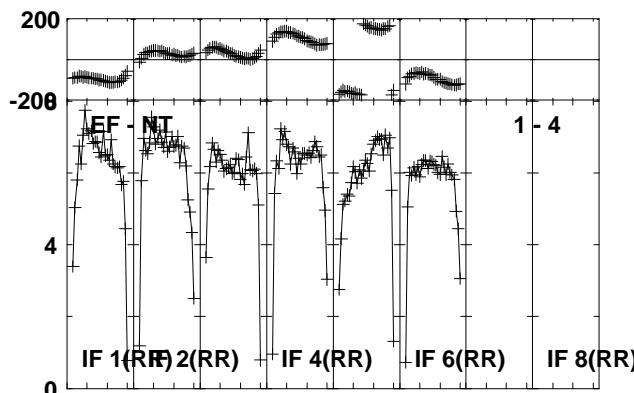
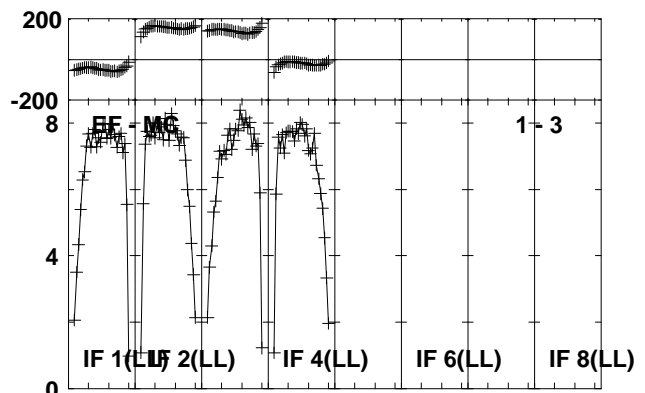
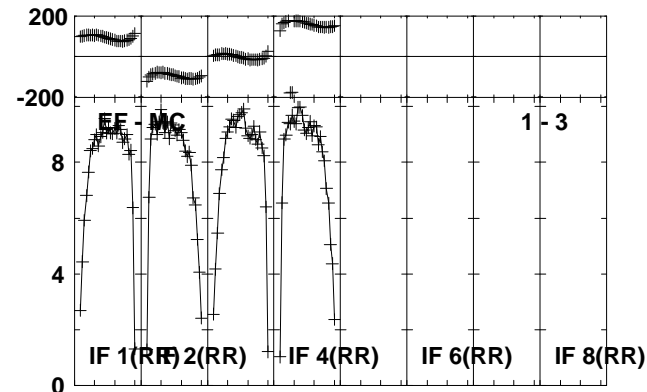
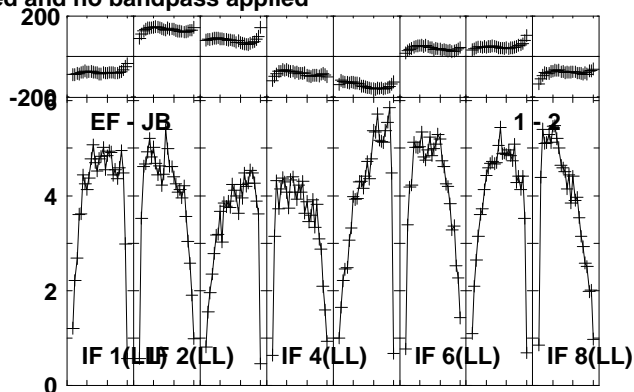
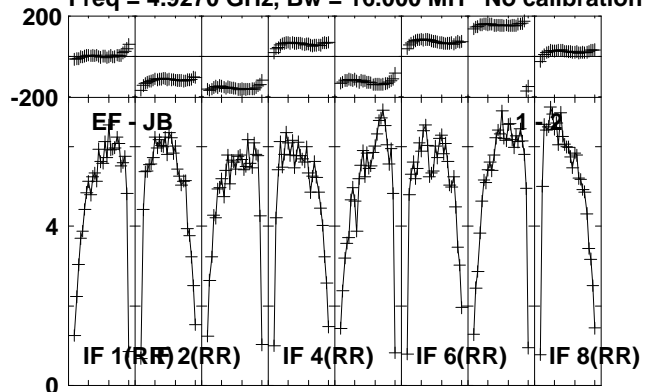

Lower frame: Milli Ampl Jy Top frame: Phas deg  
Vector averaged cross-power spectrum Several baselines displayed  
Timerange: 00/17:18:02 to 00/17:19:28

Plot file version 126 created 24-OCT-2012 20:59:20

J1825-0737 EY017B.UVDATA.1

Freq = 4.9270 GHz, Bw = 16.000 MH No calibration applied and no bandpass applied

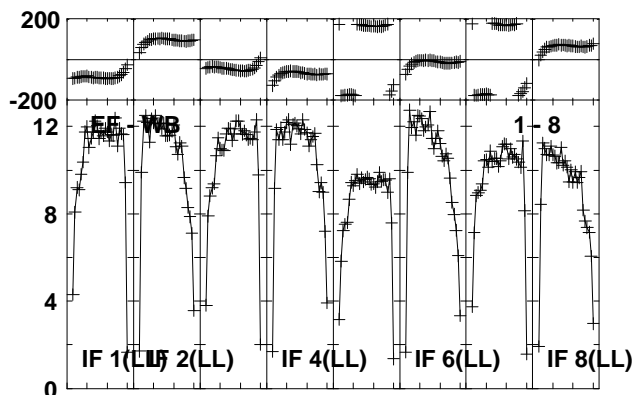
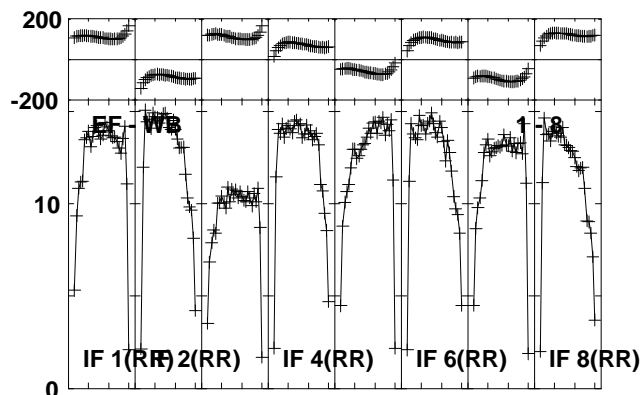
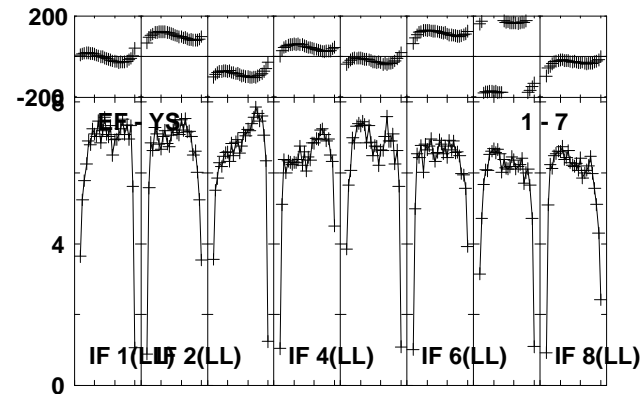
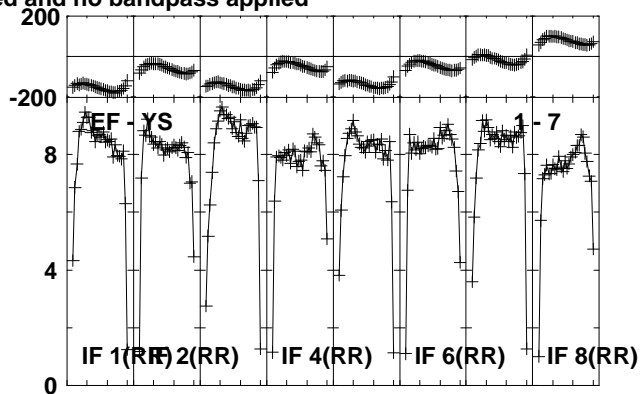
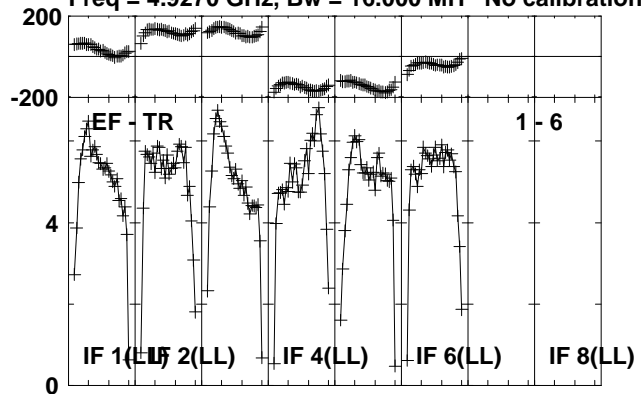

Lower frame: Milli Ampl Jy Top frame: Phas deg  
Vector averaged cross-power spectrum Several baselines displayed  
Timerange: 00/17:18:02 to 00/17:19:28

Plot file version 127 created 24-OCT-2012 20:59:20

J1831-0756 EY017B.UVDATA.1

Freq = 4.9270 GHz, Bw = 16.000 MH No calibration applied and no bandpass applied

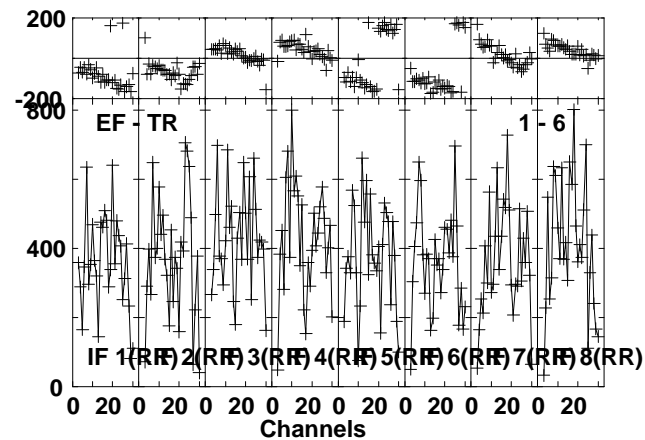
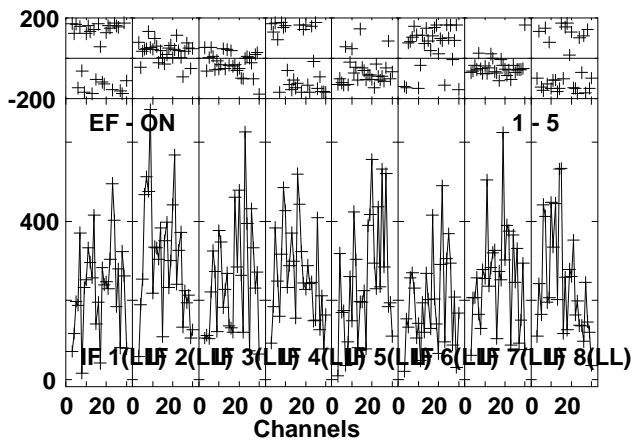
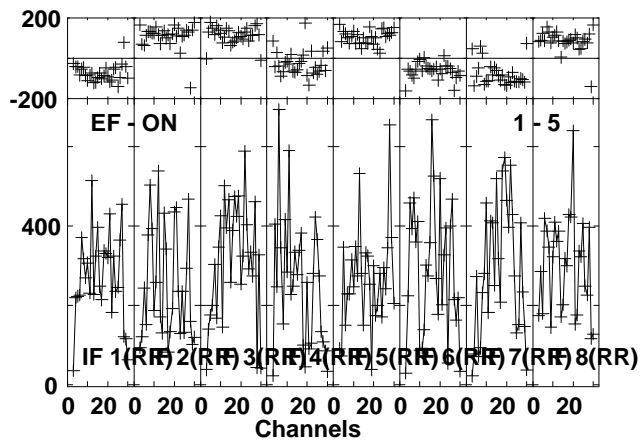
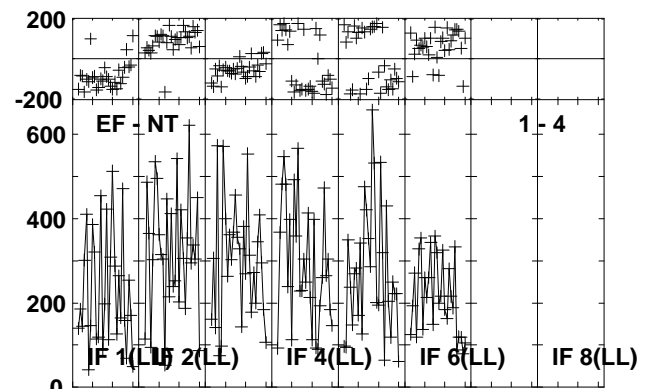
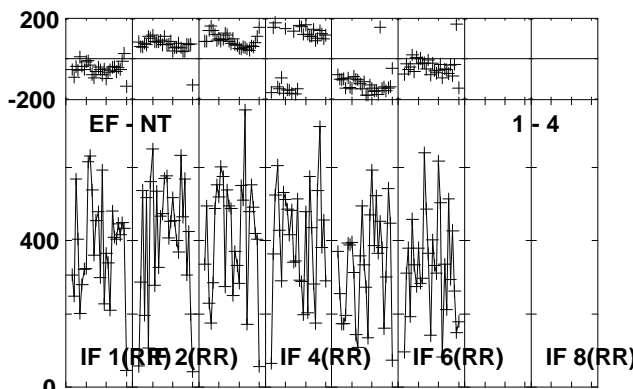
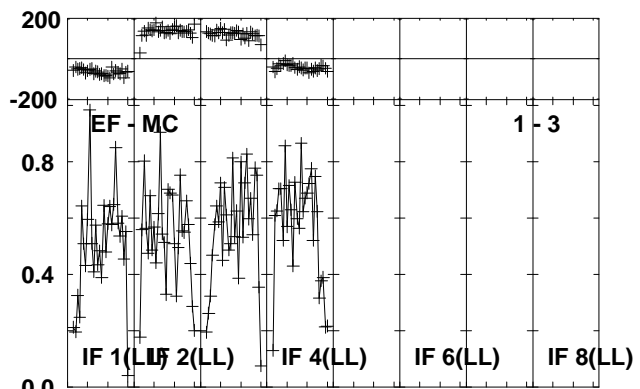
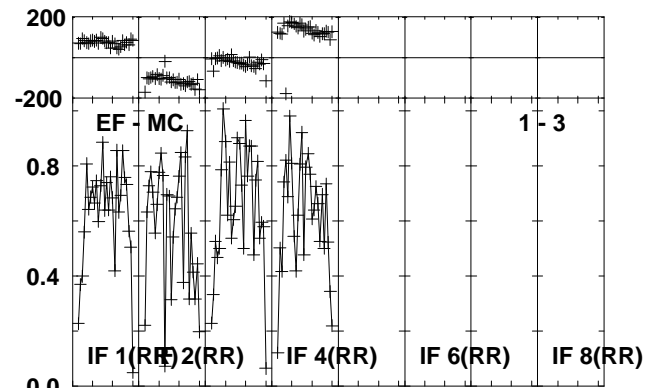
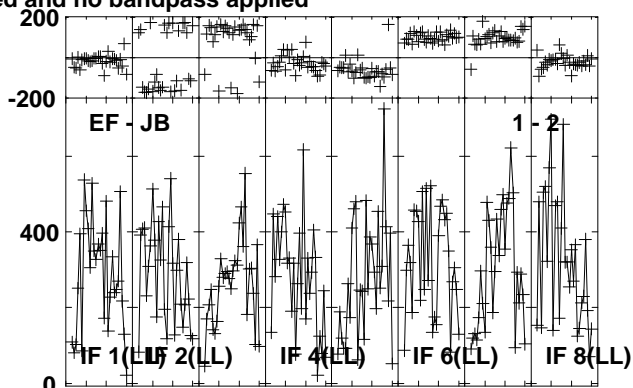
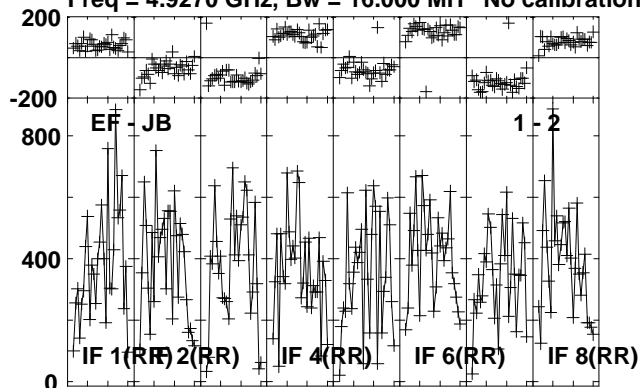

Lower frame: Micro Ampl Jy Top frame: Phas deg  
Vector averaged cross-power spectrum Several baselines displayed  
Timerange: 00/17:20:02 to 00/17:22:04

Plot file version 128 created 24-OCT-2012 20:59:21

J1831-0756 EY017B.UVDATA.1

Freq = 4.9270 GHz, Bw = 16.000 MH No calibration applied and no bandpass applied

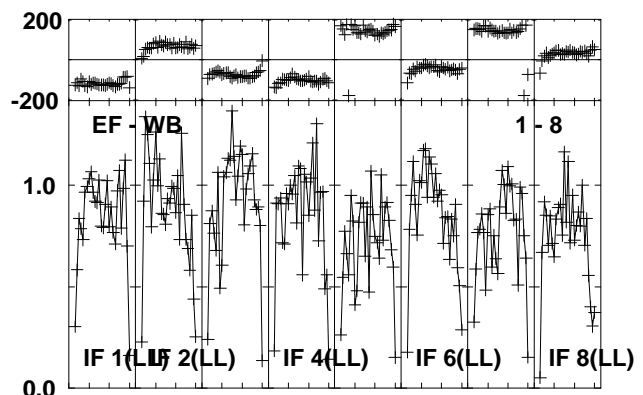
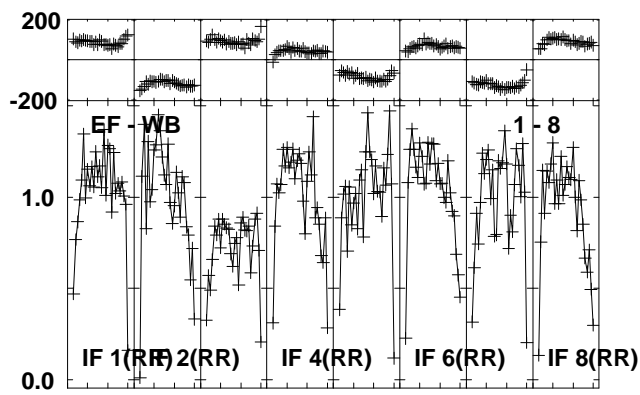
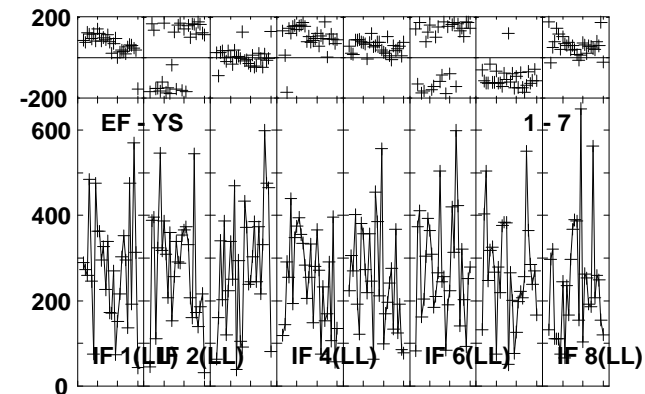
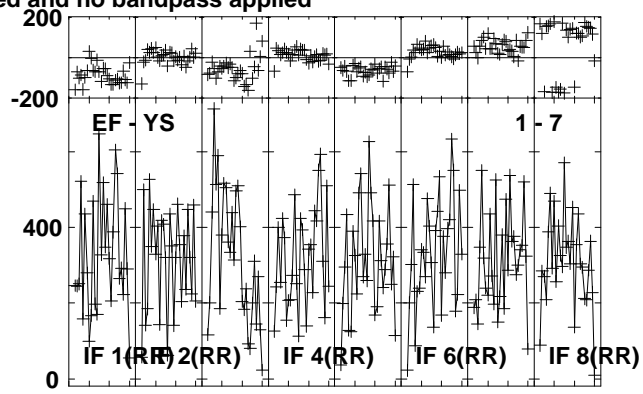
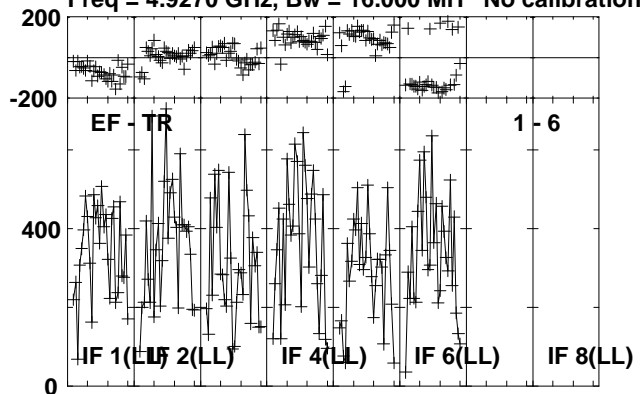

Lower frame: Micro Ampl Jy Top frame: Phas deg  
Vector averaged cross-power spectrum Several baselines displayed  
Timerange: 00/17:20:02 to 00/17:22:04

Plot file version 129 created 24-OCT-2012 20:59:21

J1825-0737 EY017B.UVDATA.1

Freq = 4.9270 GHz, Bw = 16.000 MH No calibration applied and no bandpass applied

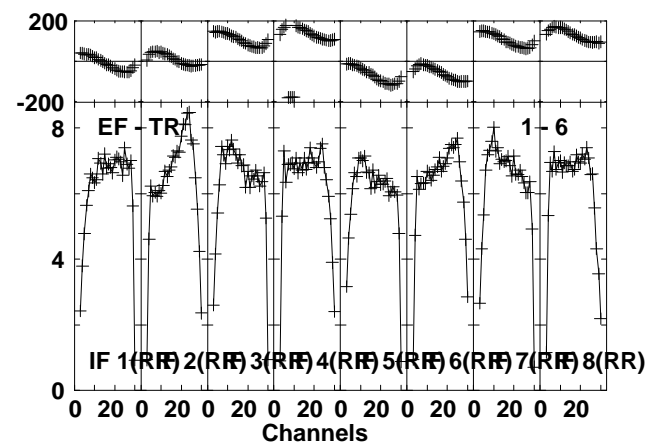
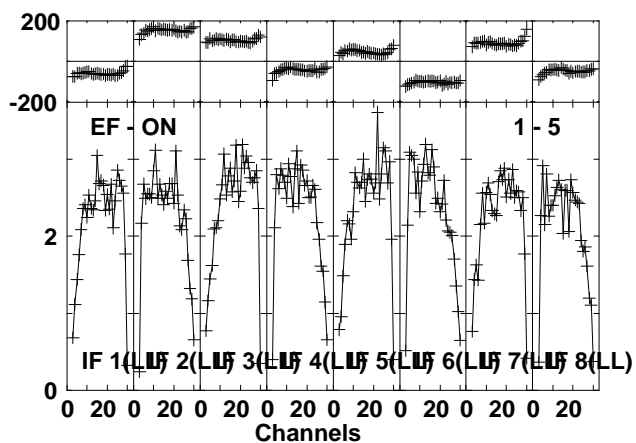
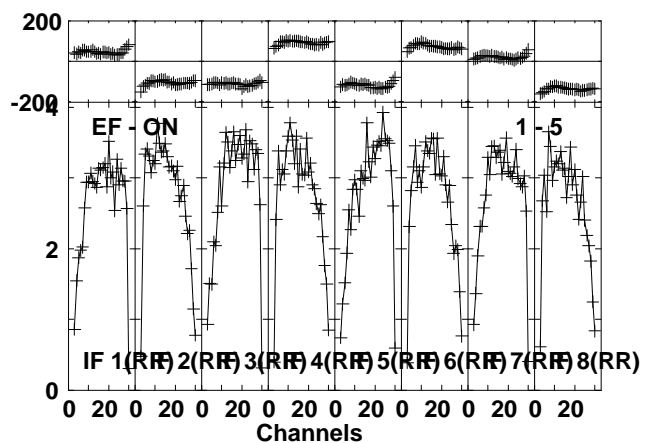
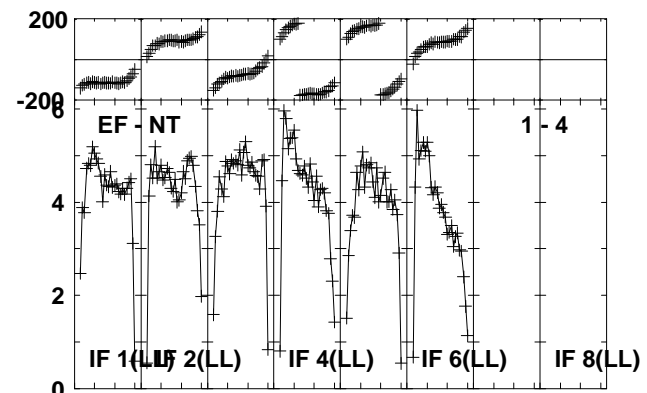
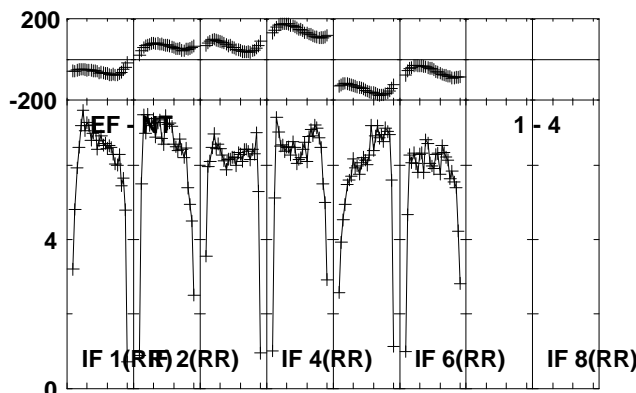
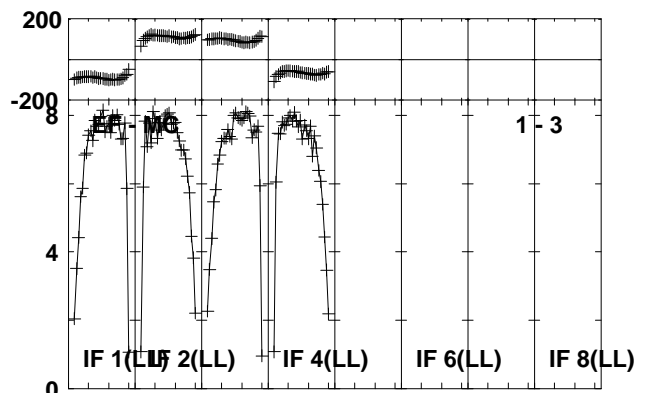
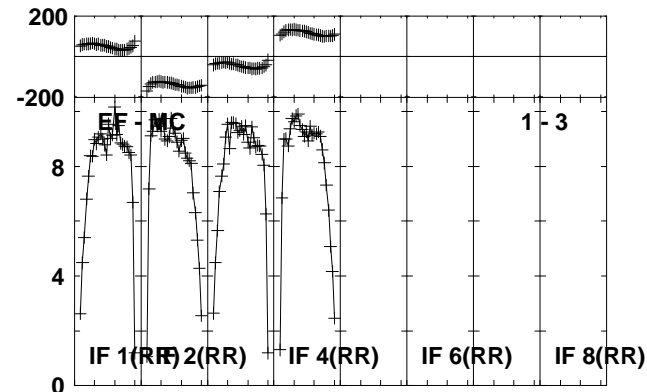
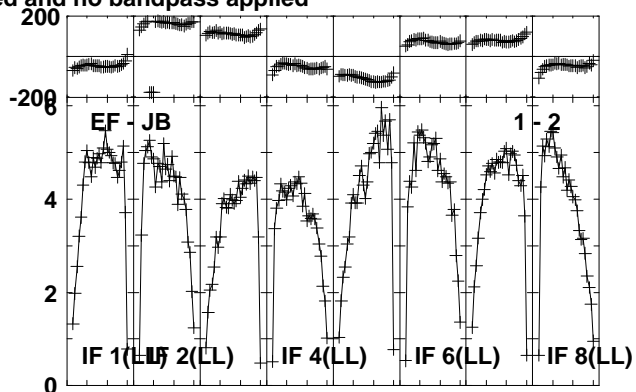
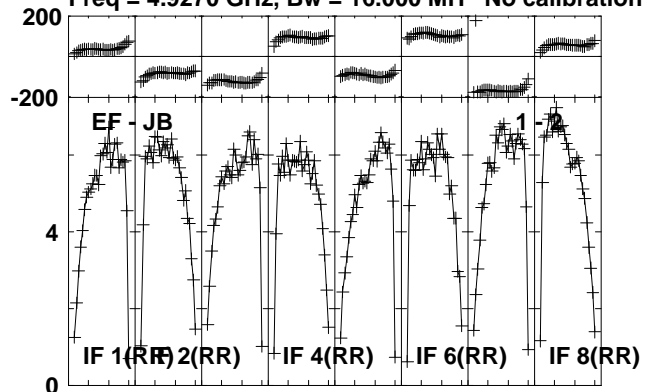

Lower frame: Milli Ampl Jy Top frame: Phas deg  
Vector averaged cross-power spectrum Several baselines displayed  
Timerange: 00/17:22:08 to 00/17:23:34

Plot file version 130 created 24-OCT-2012 20:59:22

J1825-0737 EY017B.UVDATA.1

Freq = 4.9270 GHz, Bw = 16.000 MH No calibration applied and no bandpass applied

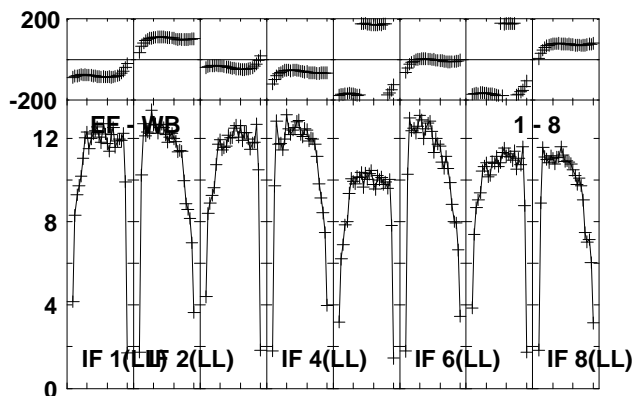
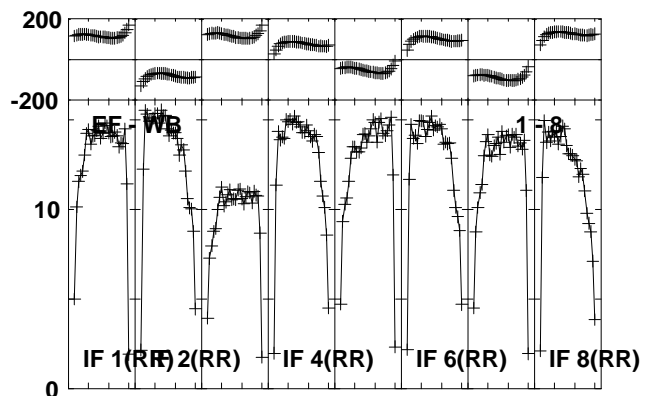
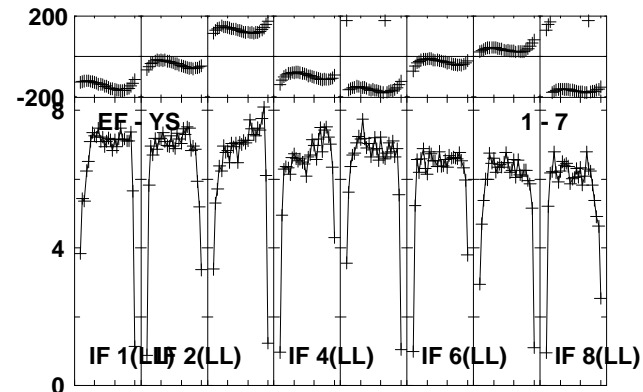
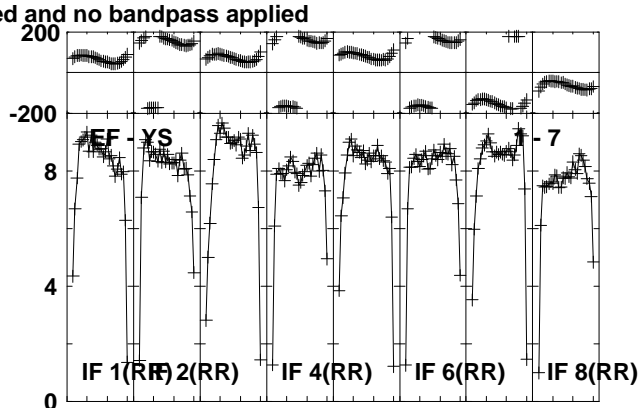
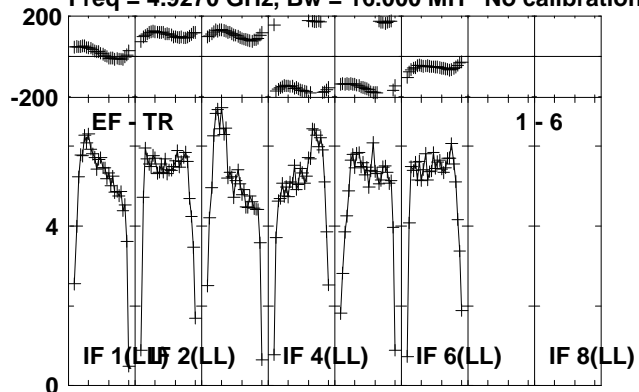

Lower frame: Milli Ampl Jy Top frame: Phas deg  
Vector averaged cross-power spectrum Several baselines displayed  
Timerange: 00/17:22:08 to 00/17:23:34

Plot file version 131 created 24-OCT-2012 20:59:22

G23.6-0.03 EY017B.UVDATA.1

Freq = 4.9270 GHz, Bw = 16.000 MH No calibration applied and no bandpass applied

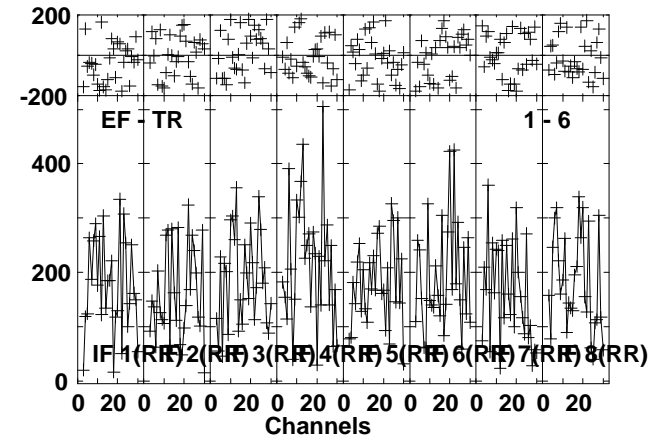
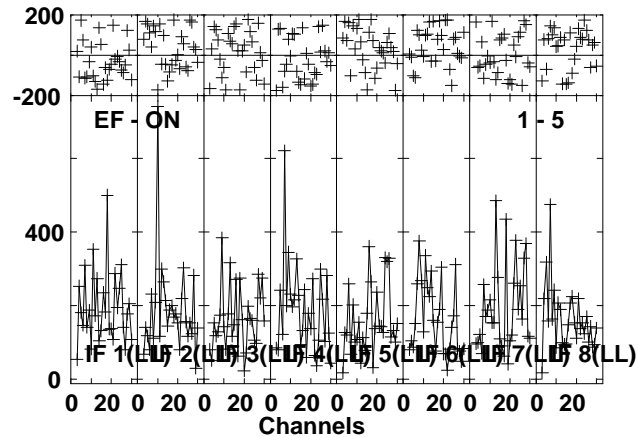
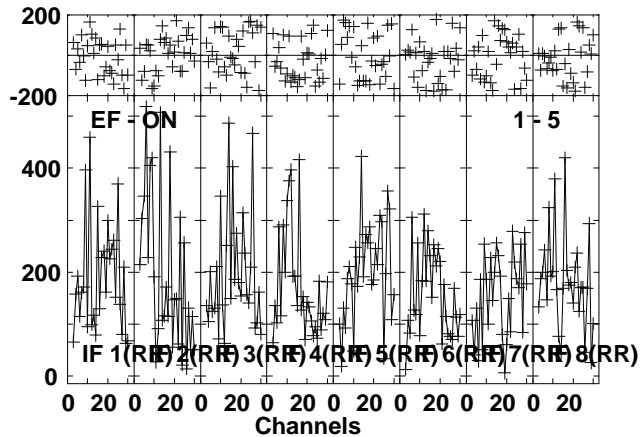
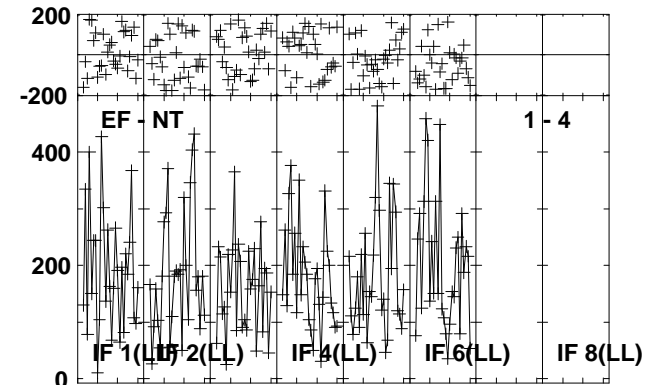
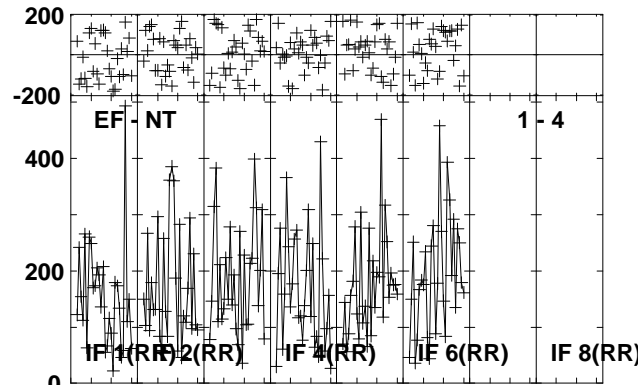
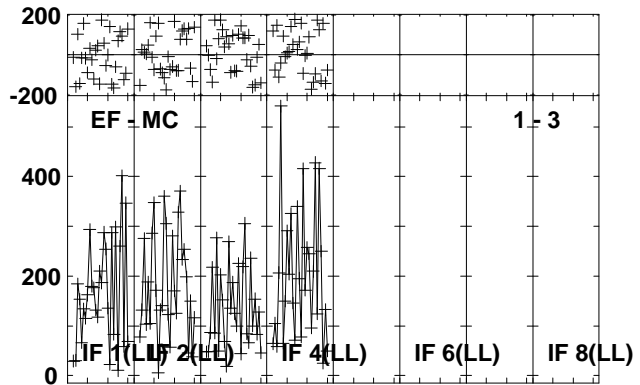
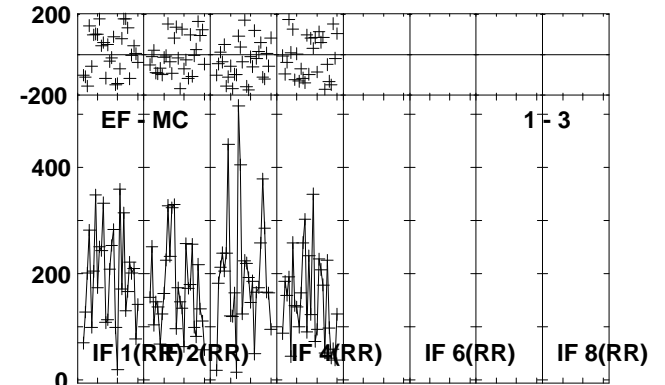
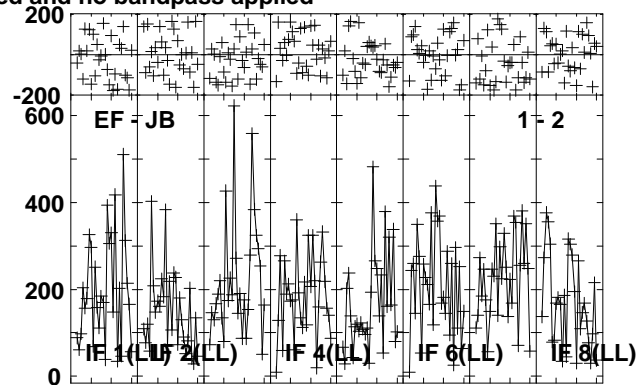
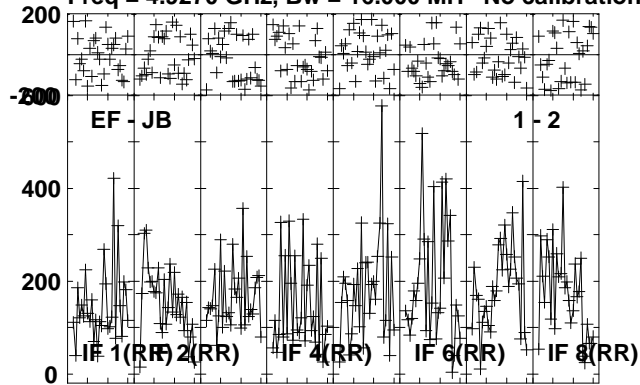

Lower frame: Micro Ampl Jy Top frame: Phas deg  
Vector averaged cross-power spectrum Several baselines displayed  
Timerange: 00/17:23:38 to 00/17:26:04

Plot file version 132 created 24-OCT-2012 20:59:23

G23.6-0.03 EY017B.UVDATA.1

Freq = 4.9270 GHz, Bw = 16.000 MH No calibration applied and no bandpass applied

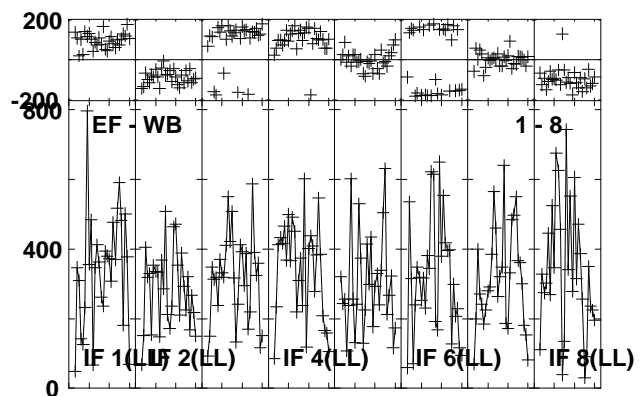
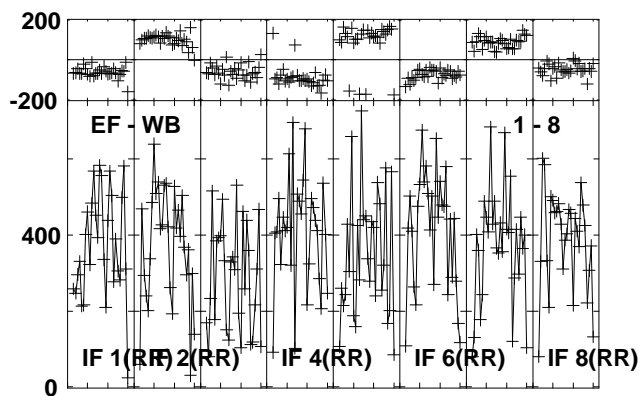
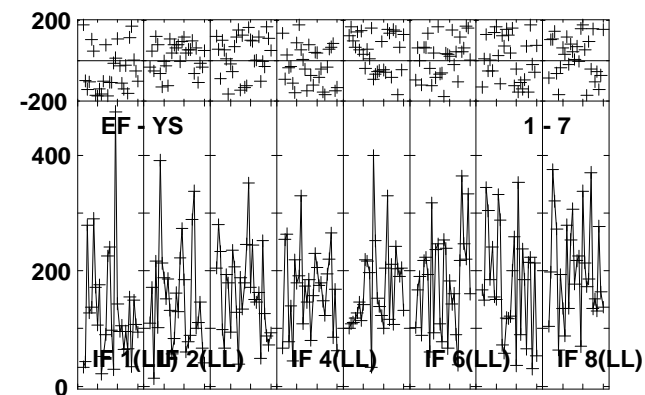
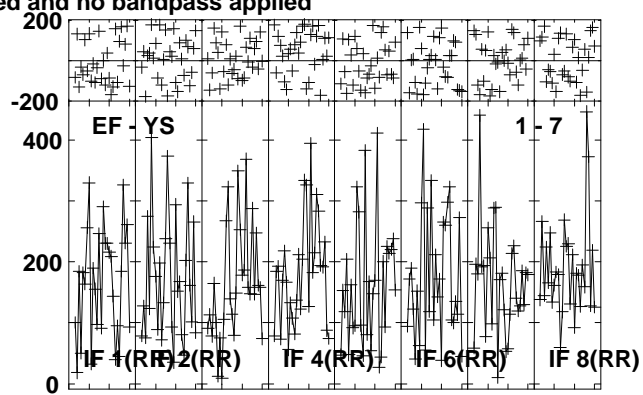
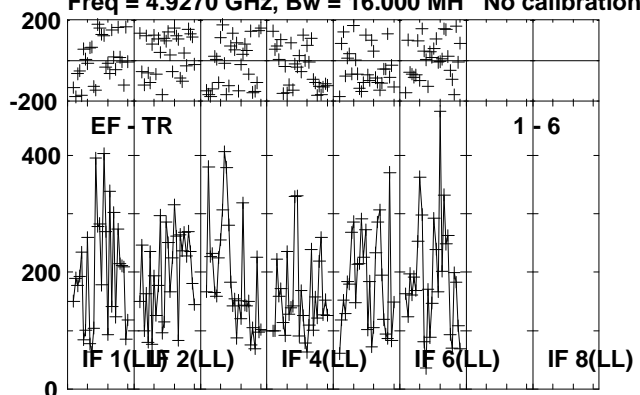

Lower frame: Micro Ampl Jy Top frame: Phas deg  
Vector averaged cross-power spectrum Several baselines displayed  
Timerange: 00/17:23:38 to 00/17:26:04



Plot file version 133 created 24-OCT-2012 20:59:24

J1825-0737 EY017B.UVDATA.1

Freq = 4.9270 GHz, Bw = 16.000 MH No calibration applied and no bandpass applied

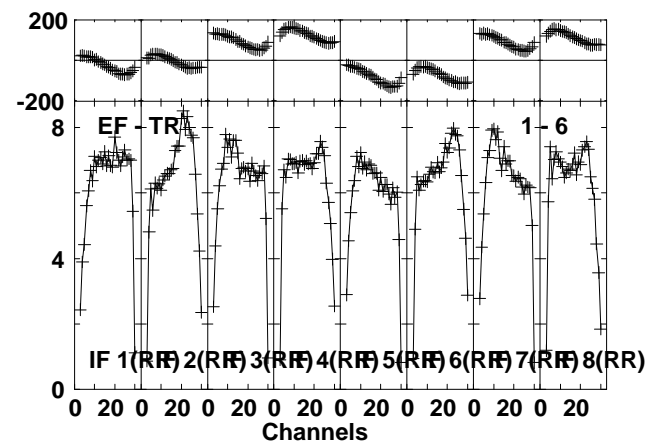
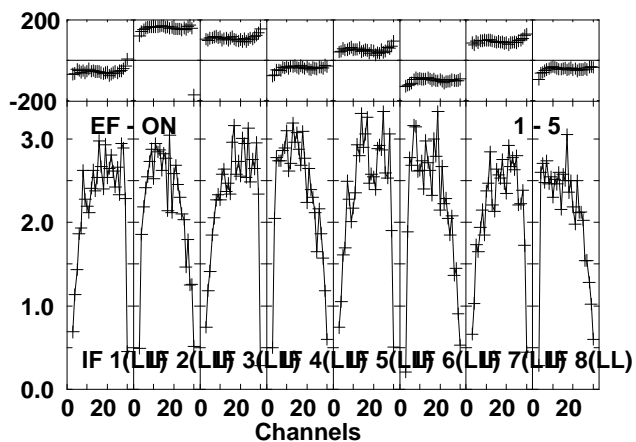
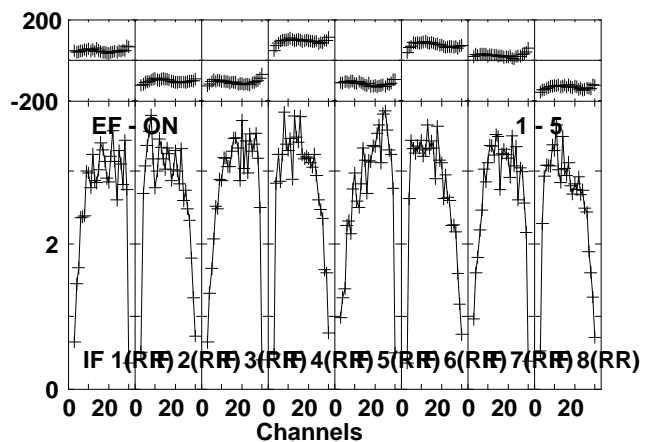
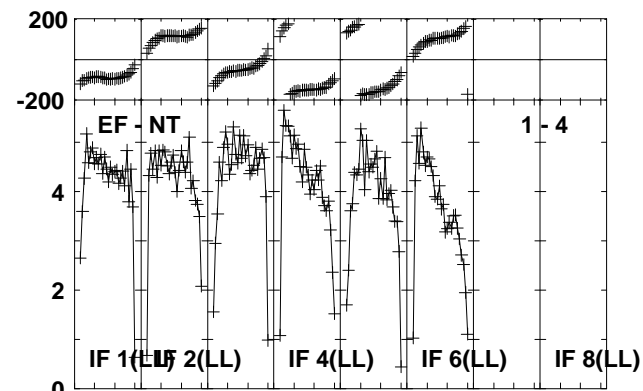
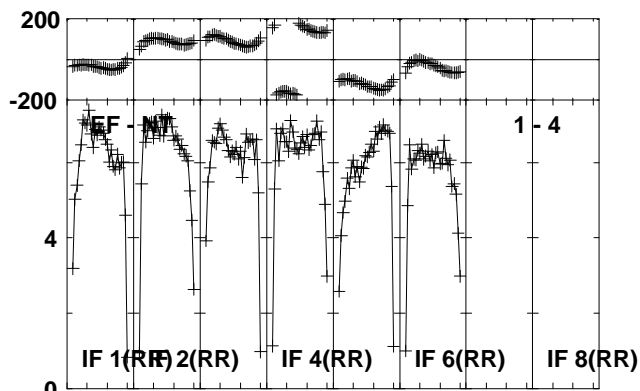
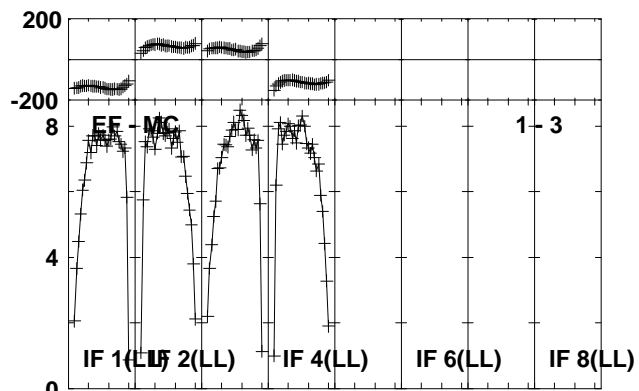
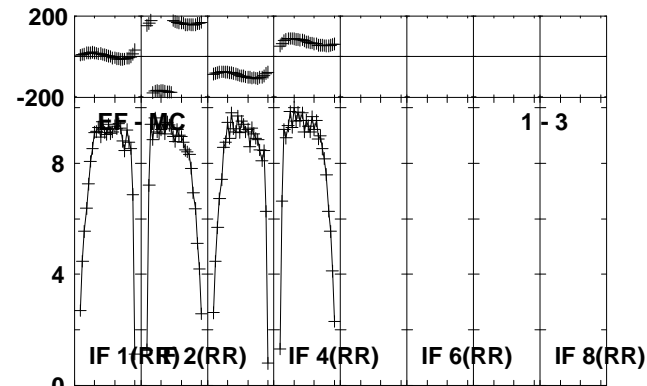
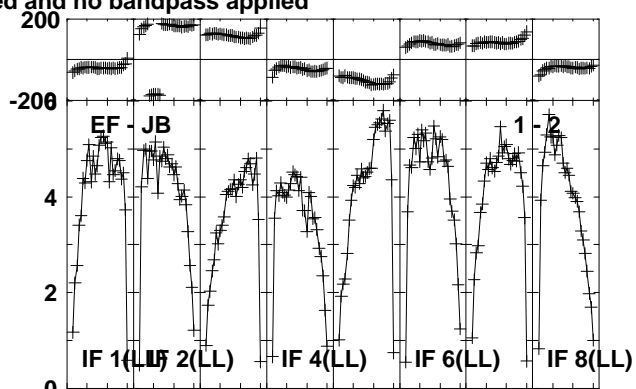
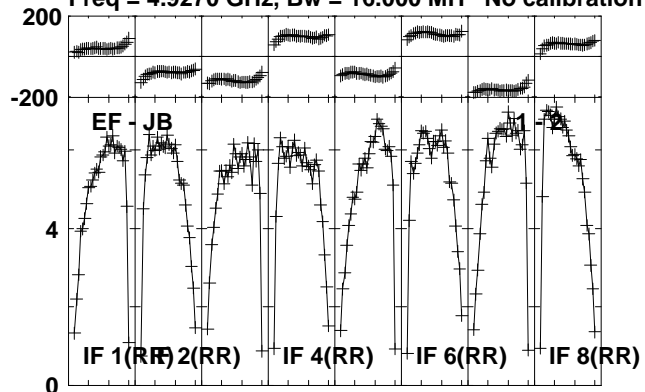

Lower frame: Milli Ampl Jy Top frame: Phas deg  
Vector averaged cross-power spectrum Several baselines displayed  
Timerange: 00/17:26:08 to 00/17:27:34

Plot file version 134 created 24-OCT-2012 20:59:24

J1825-0737 EY017B.UVDATA.1

Freq = 4.9270 GHz, Bw = 16.000 MH No calibration applied and no bandpass applied

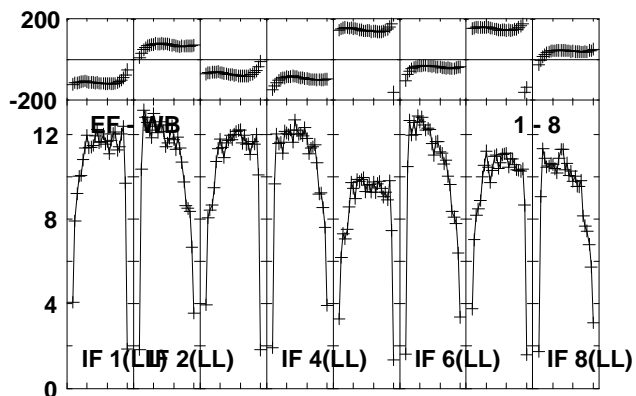
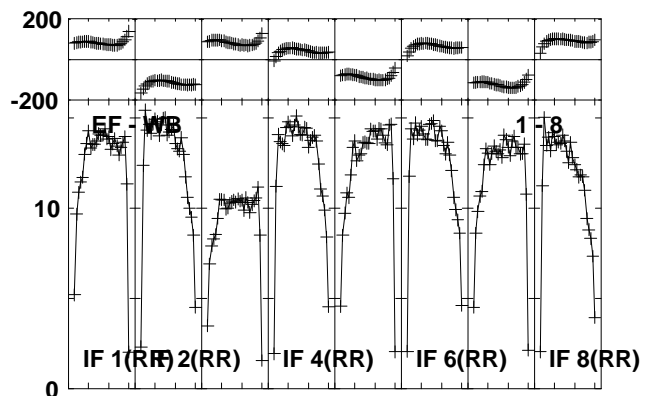
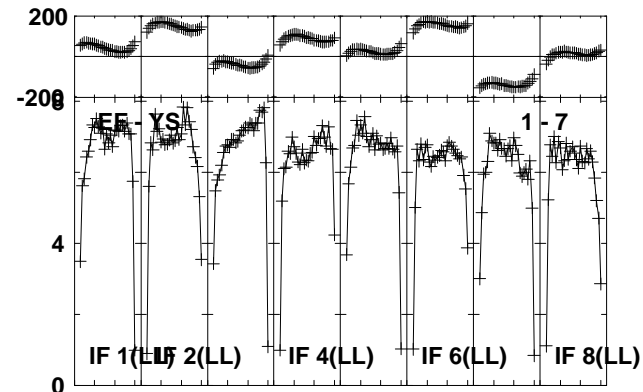
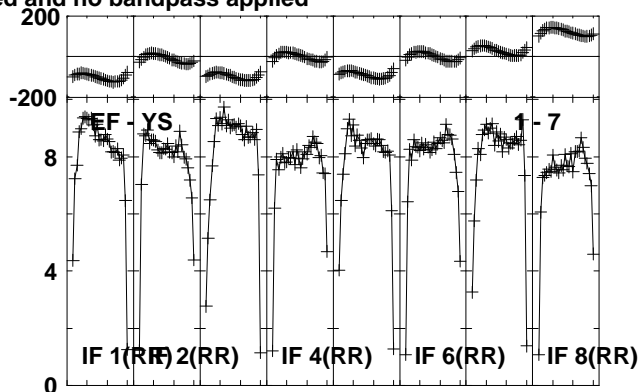
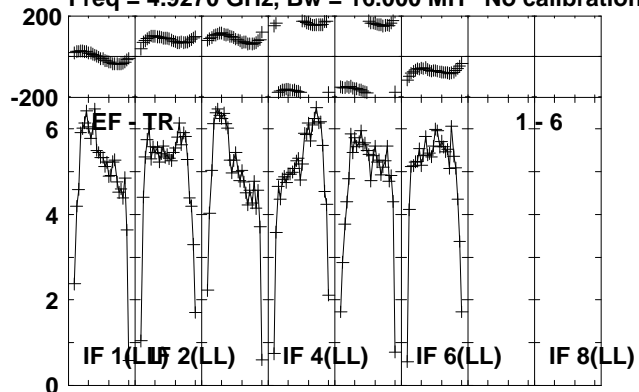

Lower frame: Milli Ampl Jy Top frame: Phas deg  
Vector averaged cross-power spectrum Several baselines displayed  
Timerange: 00/17:26:08 to 00/17:27:34

Plot file version 135 created 24-OCT-2012 20:59:25

G23.6-0.03 EY017B.UVDATA.1

Freq = 4.9270 GHz, Bw = 16.000 MH No calibration applied and no bandpass applied

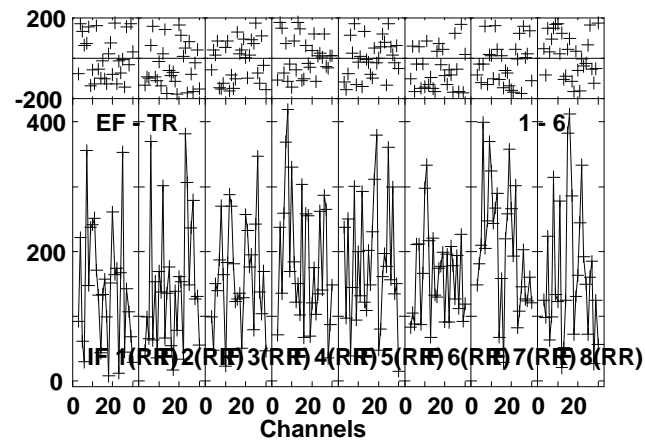
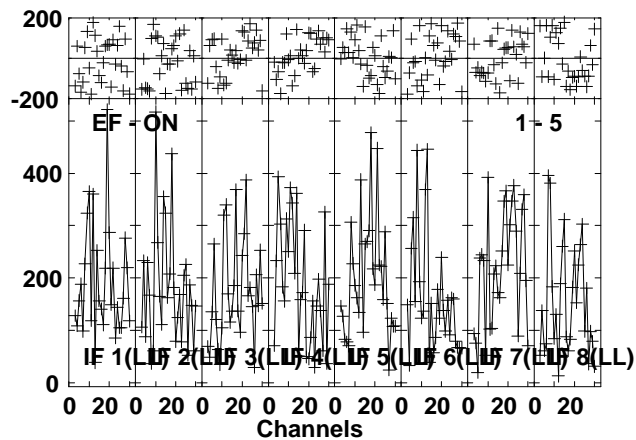
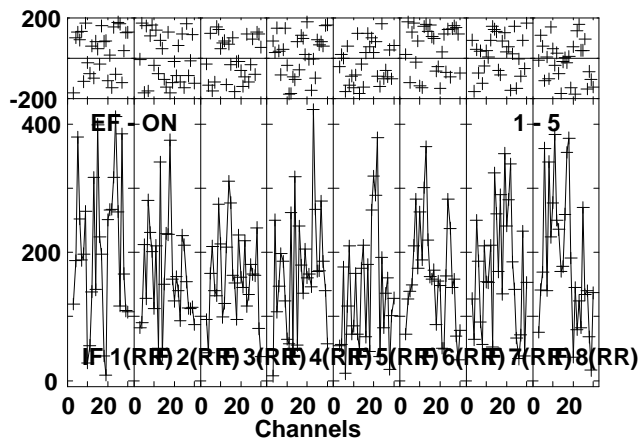
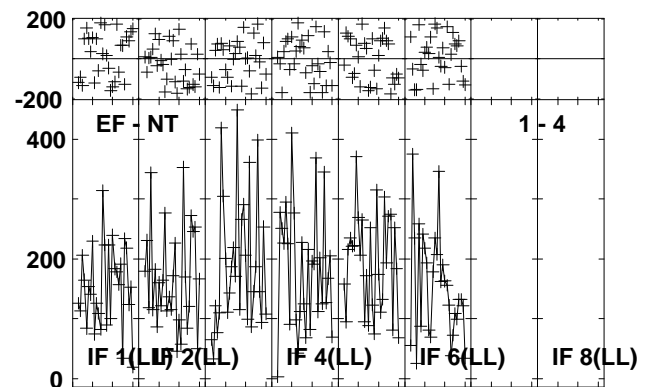
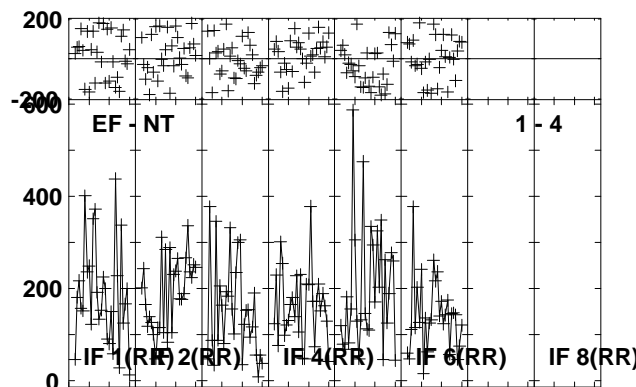
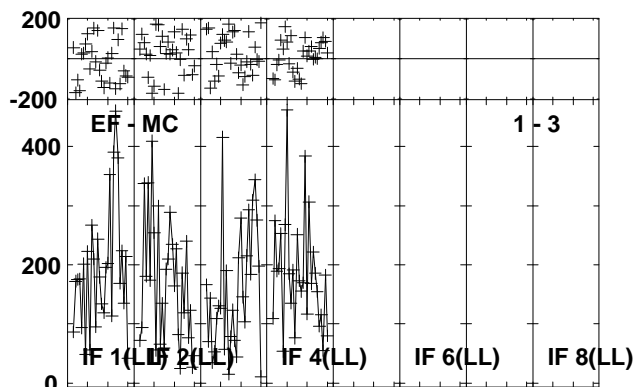
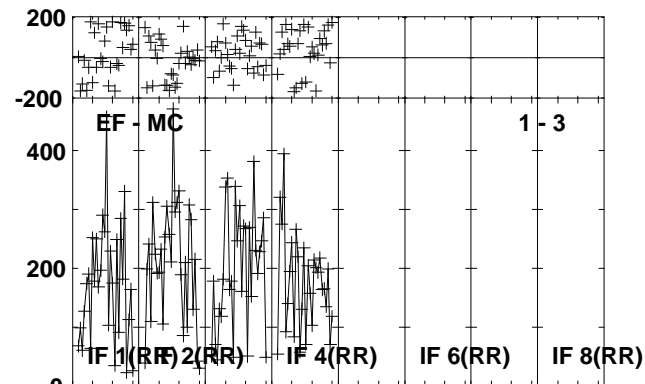
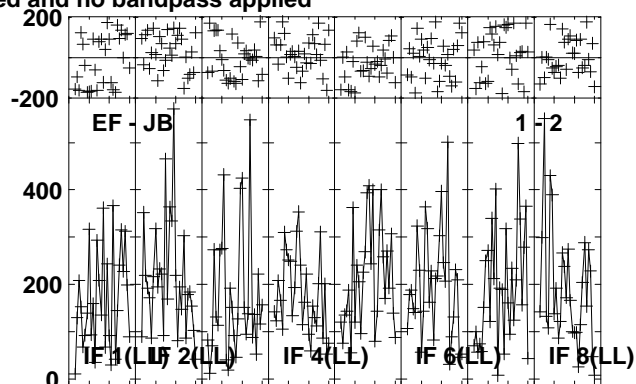
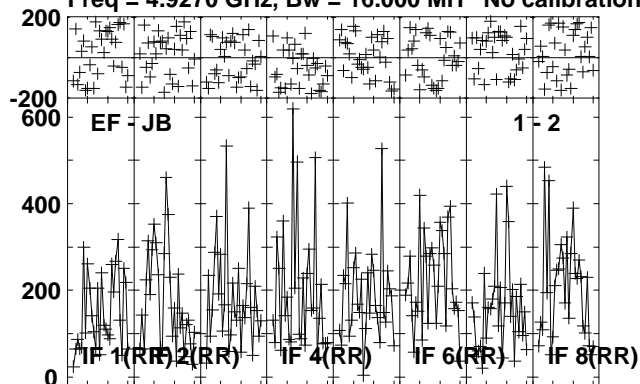

Lower frame: Micro Ampl Jy Top frame: Phas deg  
Vector averaged cross-power spectrum Several baselines displayed  
Timerange: 00/17:27:38 to 00/17:30:04

Plot file version 136 created 24-OCT-2012 20:59:25

G23.6-0.03 EY017B.UVDATA.1

Freq = 4.9270 GHz, Bw = 16.000 MH No calibration applied and no bandpass applied

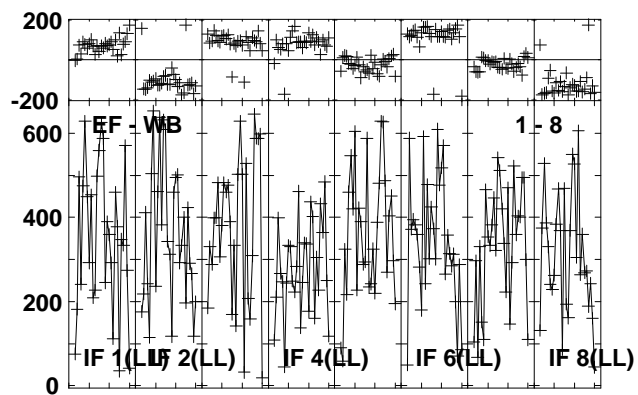
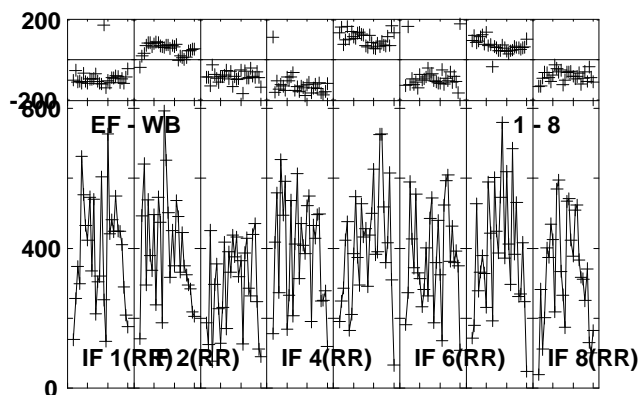
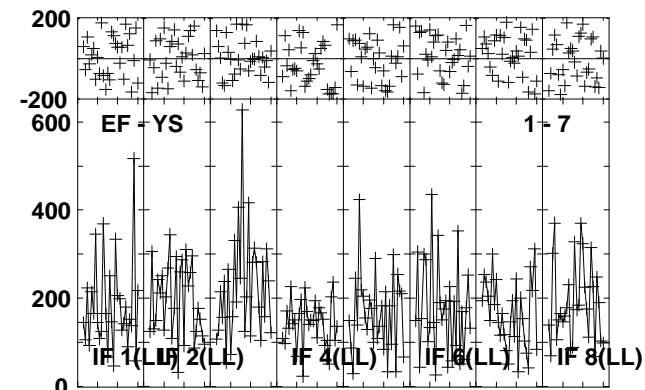
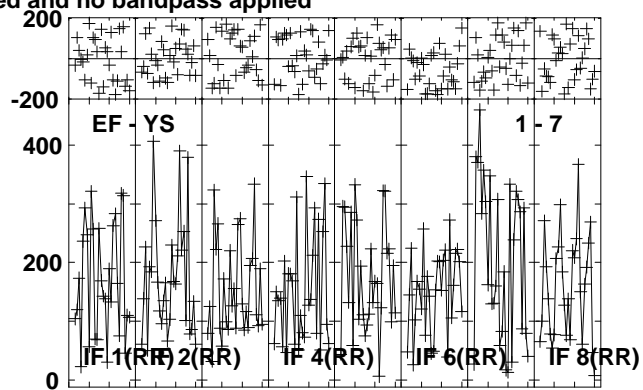
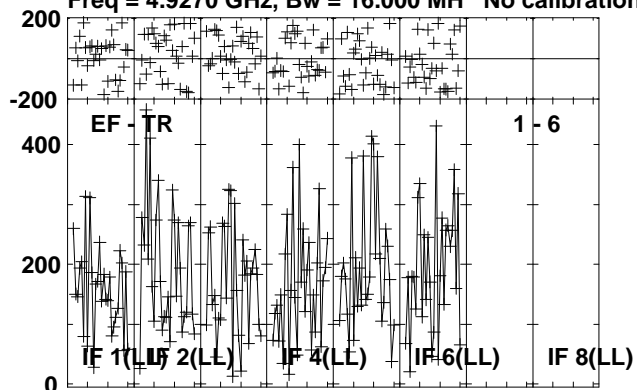

Lower frame: Micro Ampl Jy Top frame: Phas deg  
Vector averaged cross-power spectrum Several baselines displayed  
Timerange: 00/17:27:38 to 00/17:30:04

Plot file version 137 created 24-OCT-2012 20:59:26

J1825-0737 EY017B.UVDATA.1

Freq = 4.9270 GHz, Bw = 16.000 MH No calibration applied and no bandpass applied

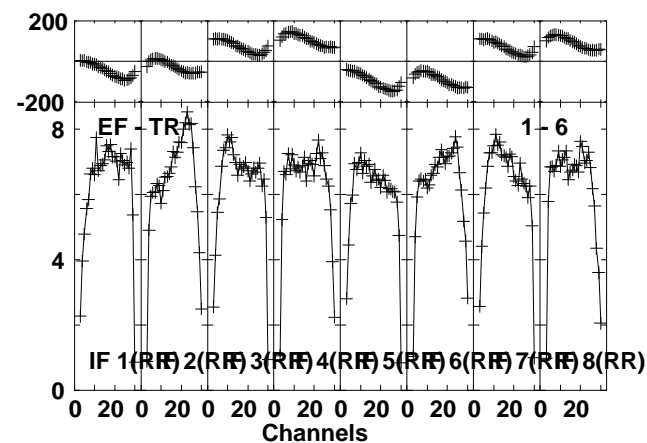
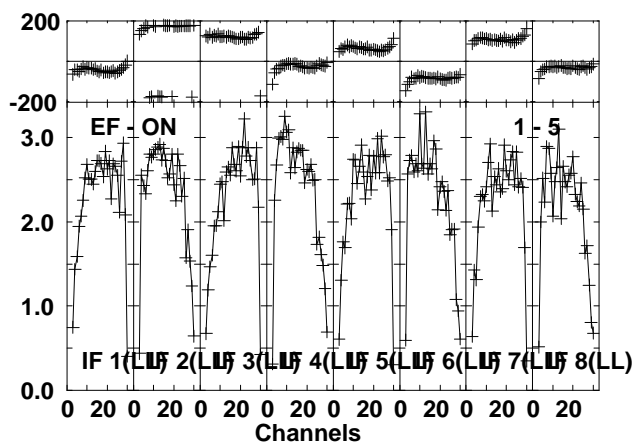
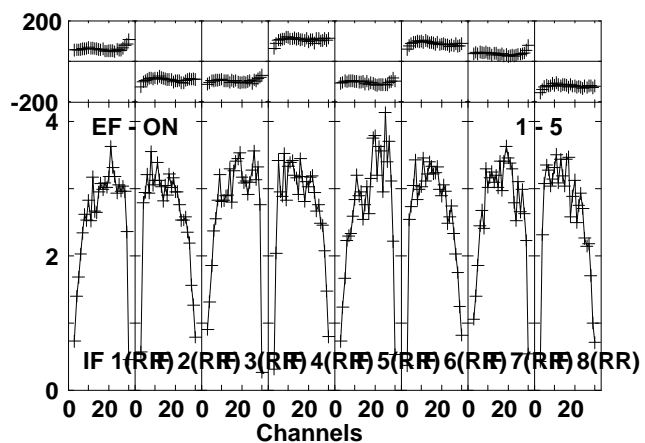
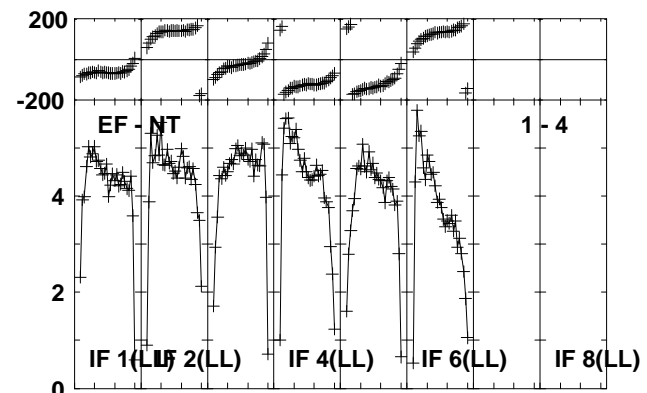
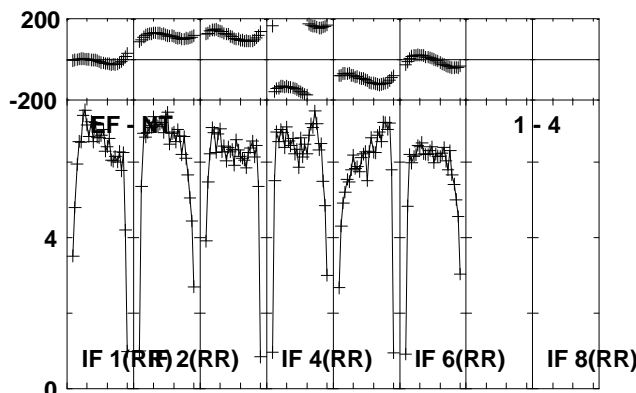
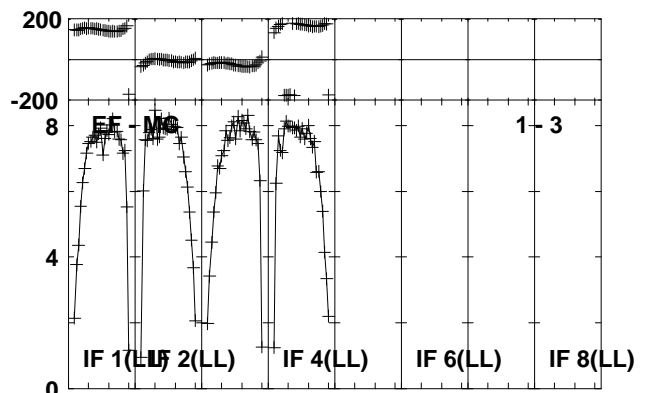
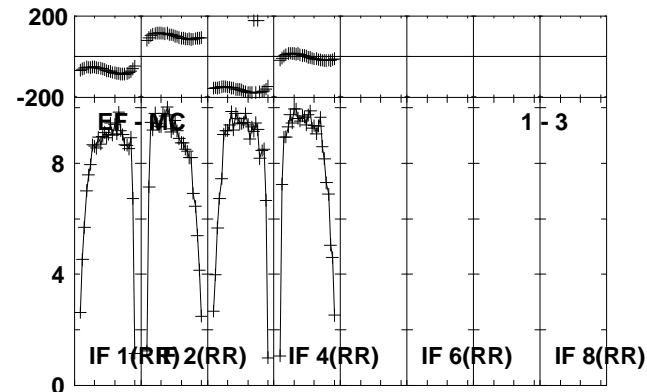
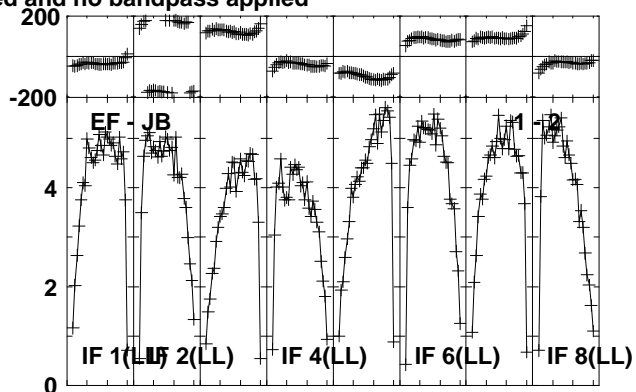
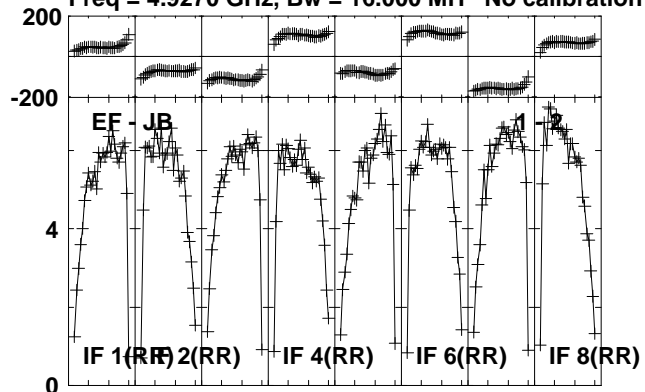

Lower frame: Milli Ampl Jy Top frame: Phas deg  
Vector averaged cross-power spectrum Several baselines displayed  
Timerange: 00/17:30:08 to 00/17:31:34

Plot file version 138 created 24-OCT-2012 20:59:26

J1825-0737 EY017B.UVDATA.1

Freq = 4.9270 GHz, Bw = 16.000 MH No calibration applied and no bandpass applied

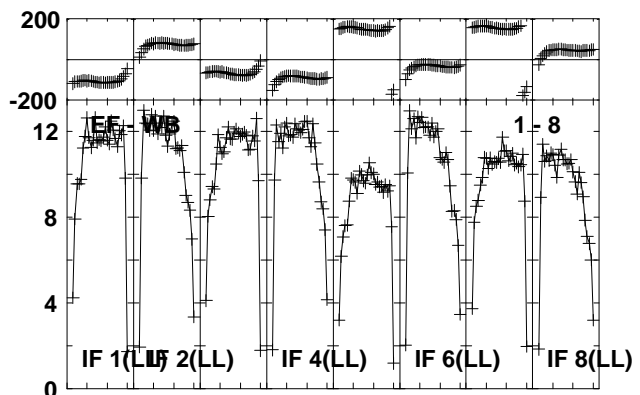
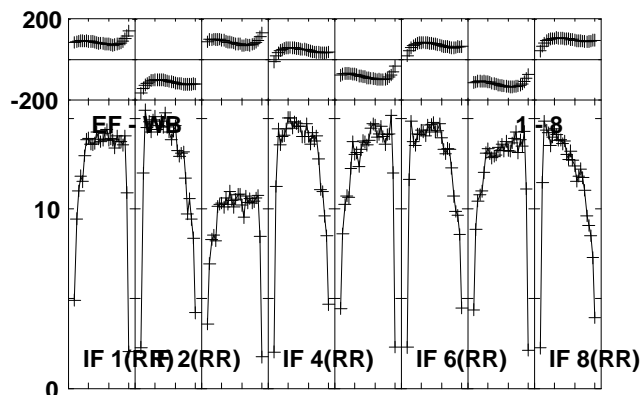
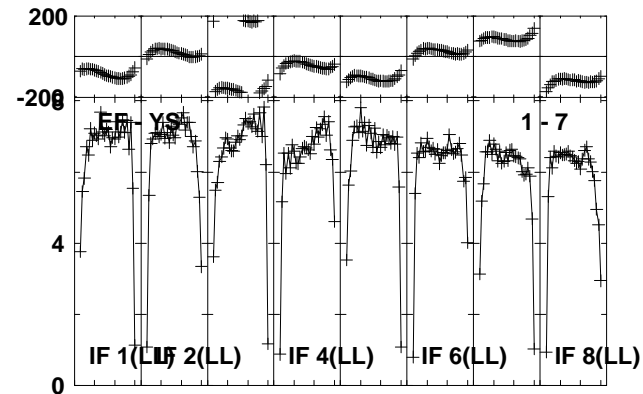
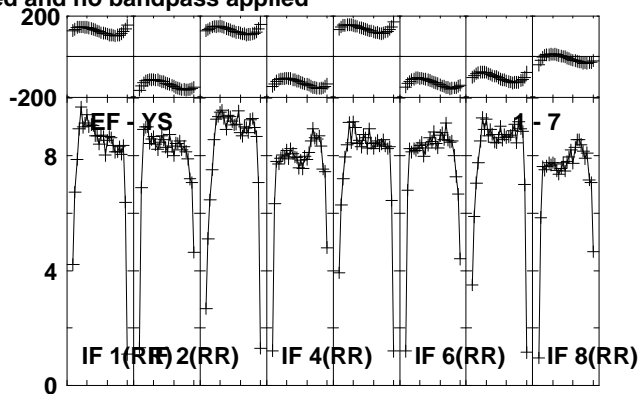
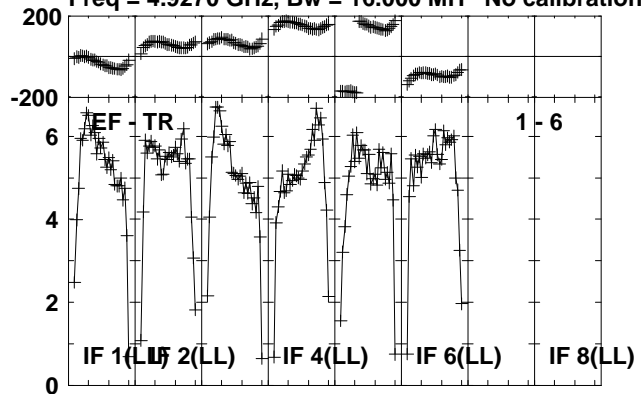

Lower frame: Milli Ampl Jy Top frame: Phas deg  
Vector averaged cross-power spectrum Several baselines displayed  
Timerange: 00/17:30:08 to 00/17:31:34

Plot file version 139 created 24-OCT-2012 20:59:27

G23.6-0.03 EY017B.UVDATA.1

Freq = 4.9270 GHz, Bw = 16.000 MH No calibration applied and no bandpass applied

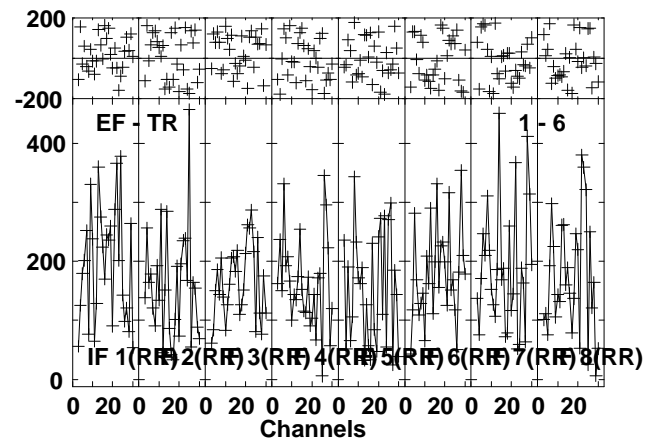
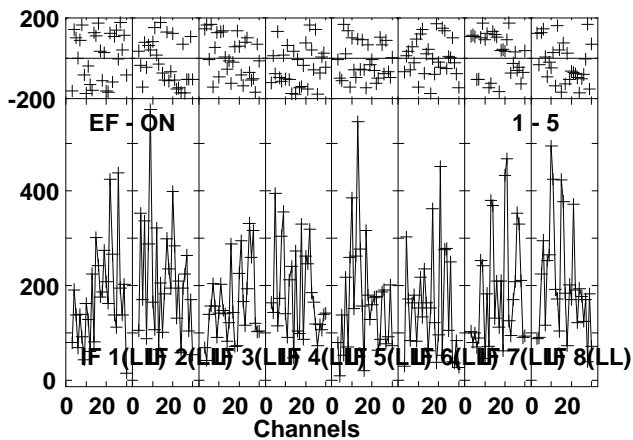
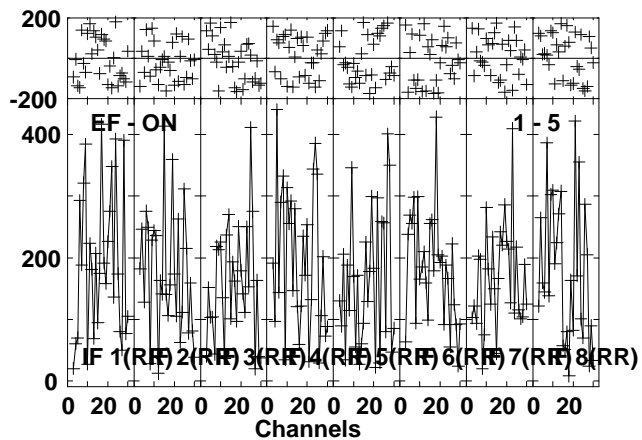
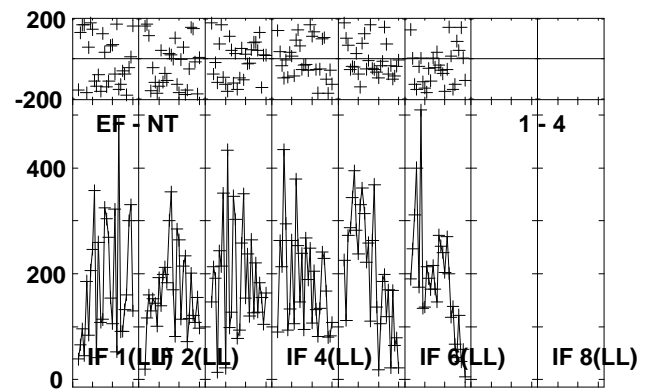
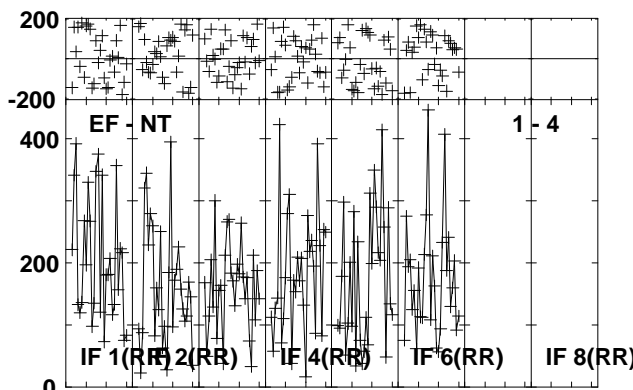
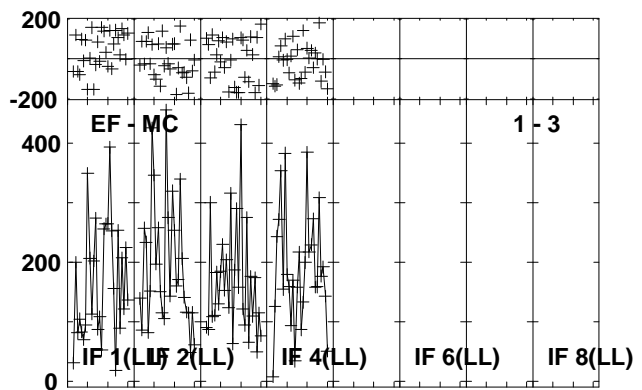
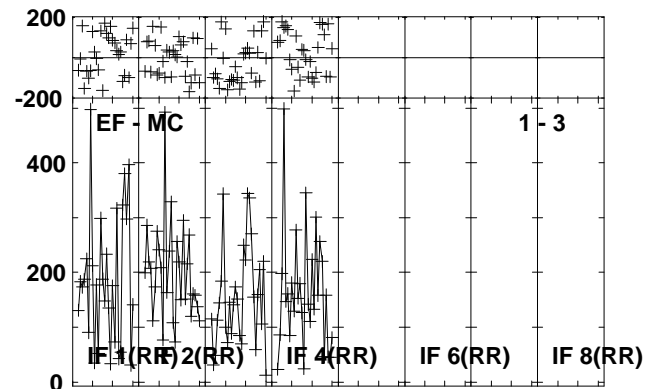
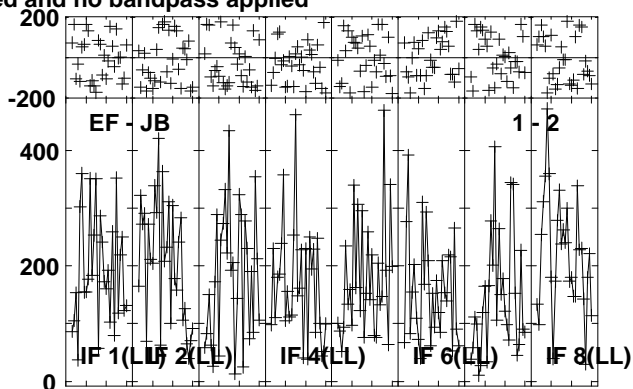
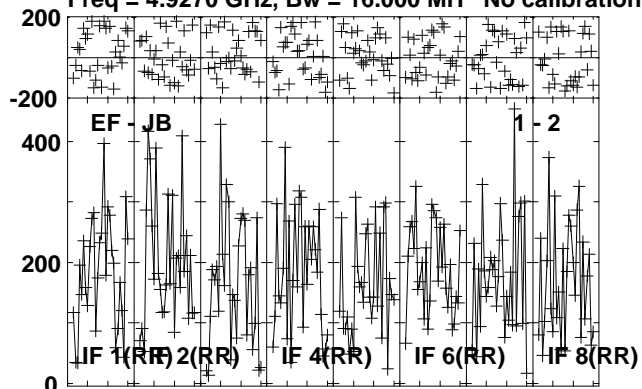

Lower frame: Micro Ampl Jy Top frame: Phas deg  
Vector averaged cross-power spectrum Several baselines displayed  
Timerange: 00/17:31:38 to 00/17:34:04

Plot file version 140 created 24-OCT-2012 20:59:27

G23.6-0.03 EY017B.UVDATA.1

Freq = 4.9270 GHz, Bw = 16.000 MH No calibration applied and no bandpass applied

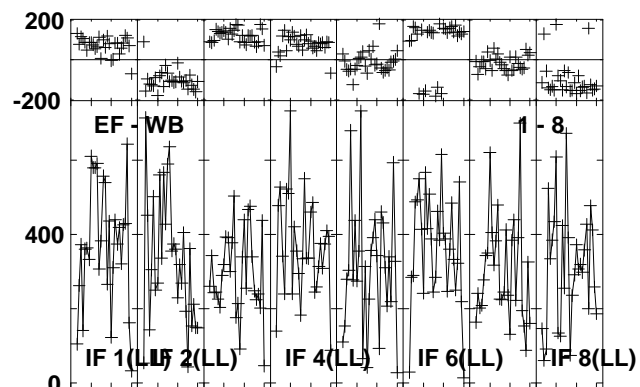
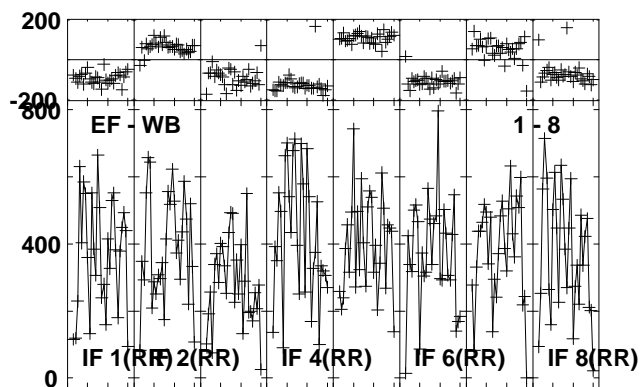
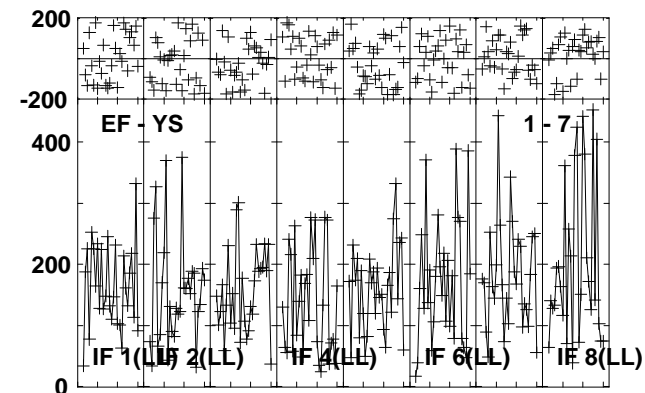
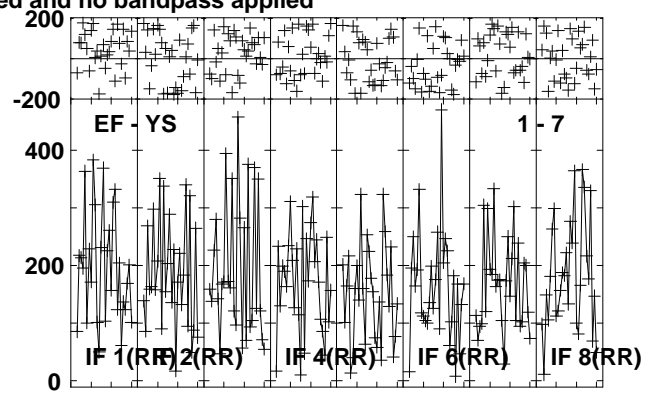
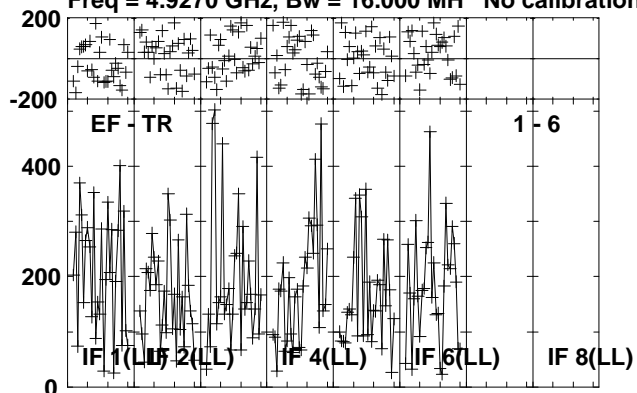

Lower frame: Micro Ampl Jy Top frame: Phas deg  
Vector averaged cross-power spectrum Several baselines displayed  
Timerange: 00/17:31:38 to 00/17:34:04



Plot file version 141 created 24-OCT-2012 20:59:28

J1825-0737 EY017B.UVDATA.1

Freq = 4.9270 GHz, Bw = 16.000 MH No calibration applied and no bandpass applied

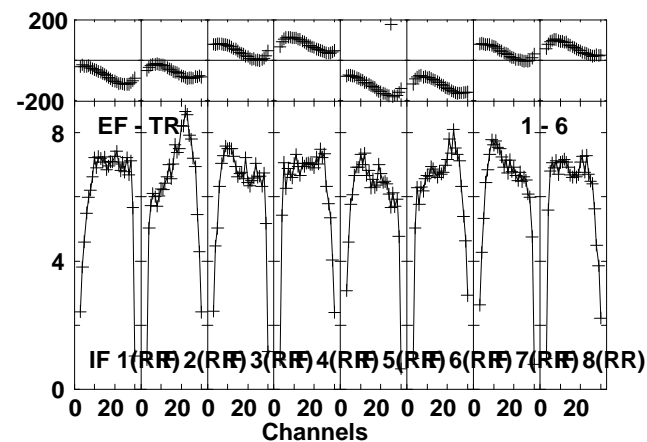
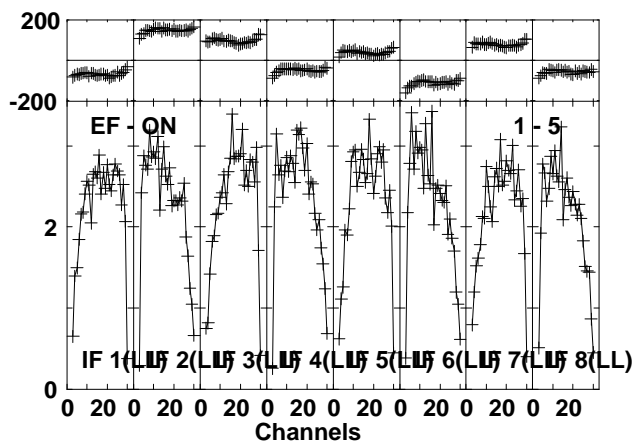
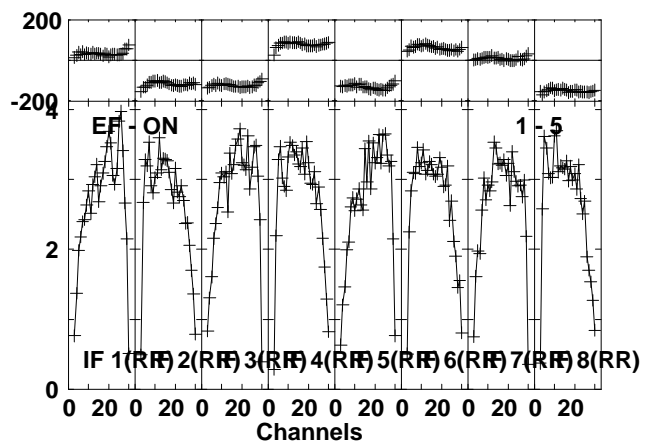
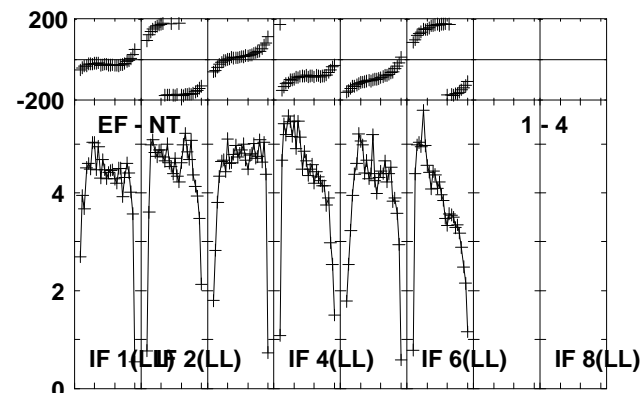
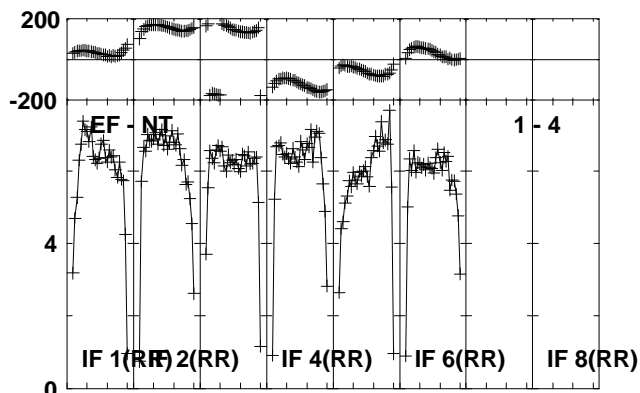
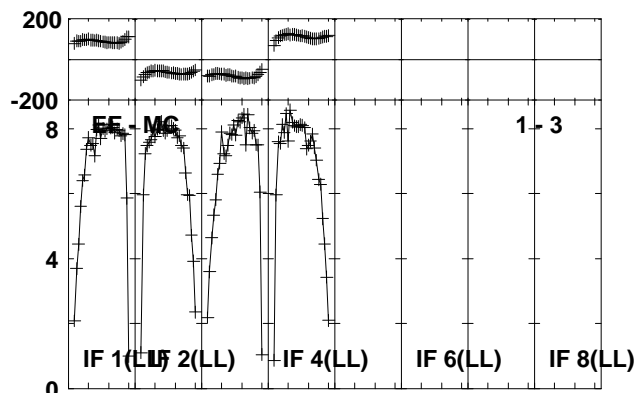
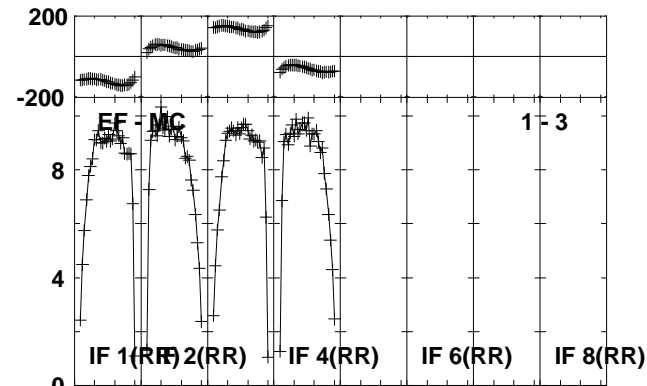
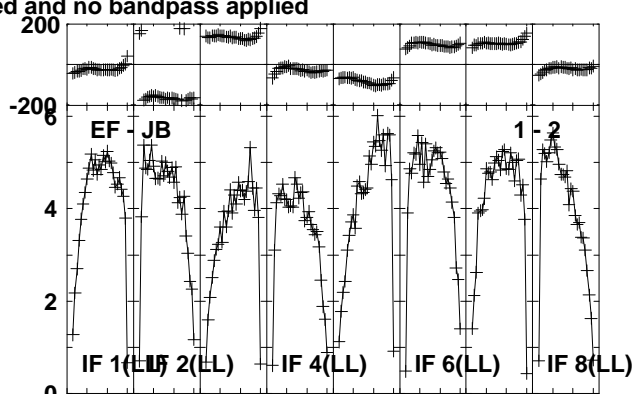
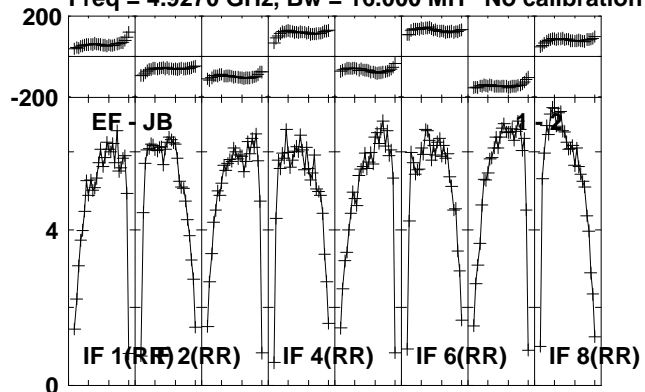

Lower frame: Milli Ampl Jy Top frame: Phas deg  
Vector averaged cross-power spectrum Several baselines displayed  
Timerange: 00/17:34:08 to 00/17:35:34

Plot file version 142 created 24-OCT-2012 20:59:28

J1825-0737 EY017B.UVDATA.1

Freq = 4.9270 GHz, Bw = 16.000 MH No calibration applied and no bandpass applied

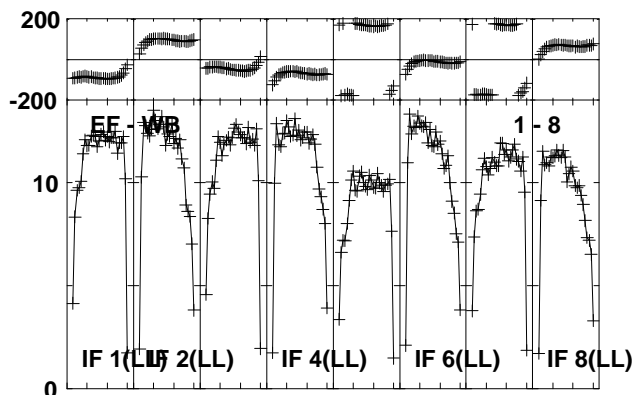
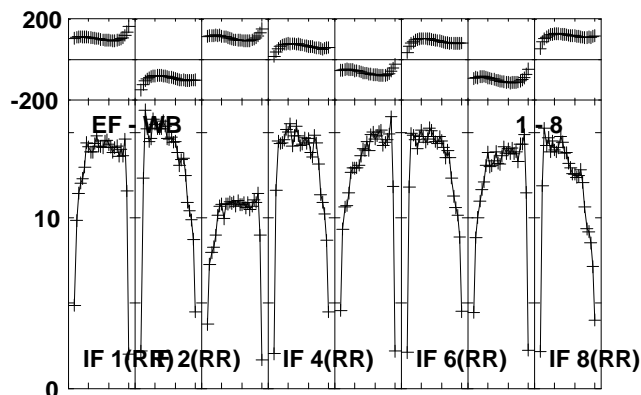
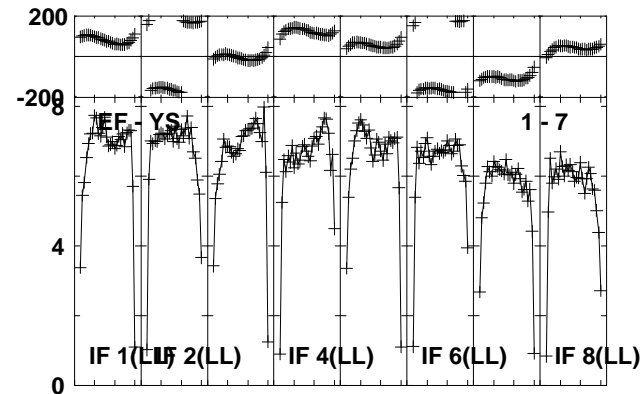
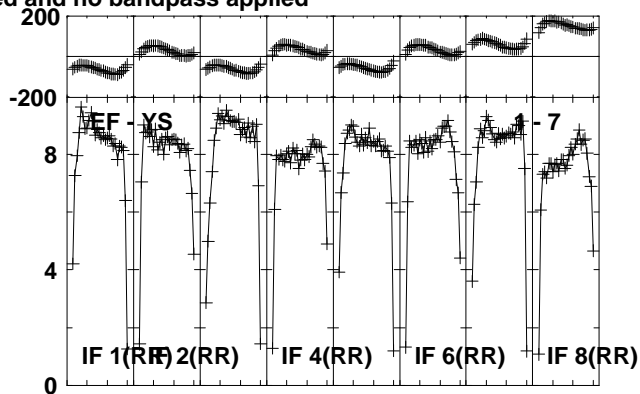
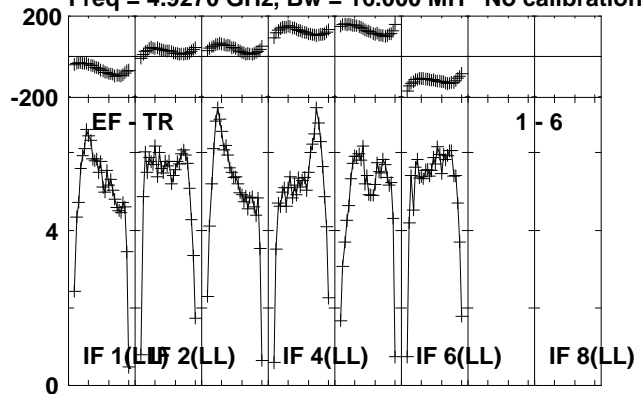

Lower frame: Milli Ampl Jy Top frame: Phas deg  
Vector averaged cross-power spectrum Several baselines displayed  
Timerange: 00/17:34:08 to 00/17:35:34

Plot file version 143 created 24-OCT-2012 20:59:29  
 J1831-0756 EY017B.UVDATA.1

Freq = 4.9270 GHz, Bw = 16.000 MH No calibration applied and no bandpass applied

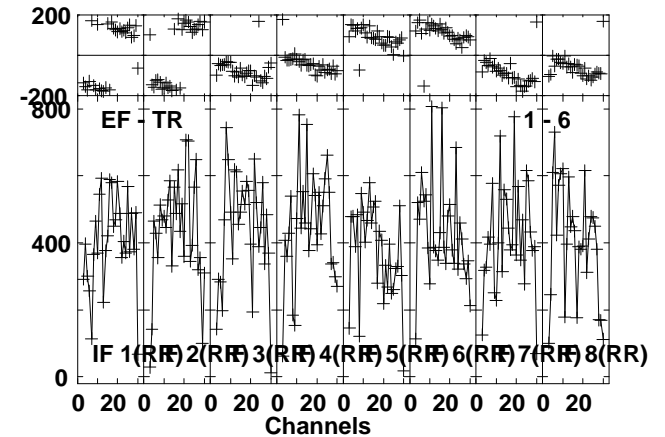
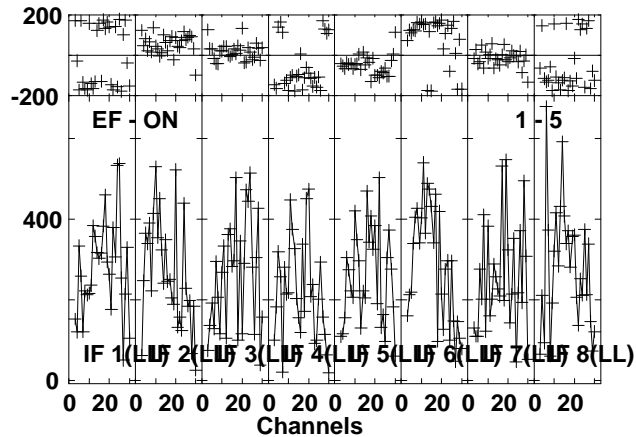
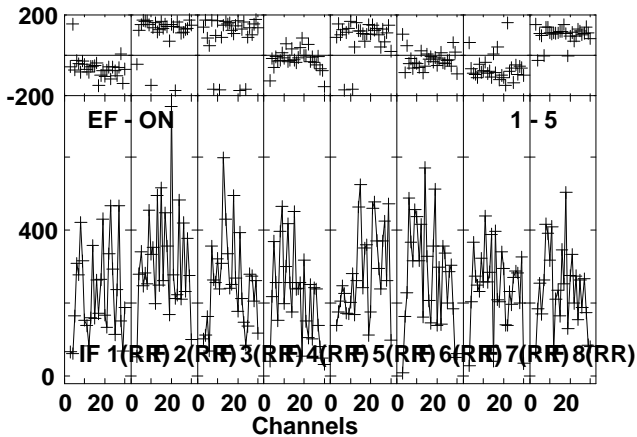
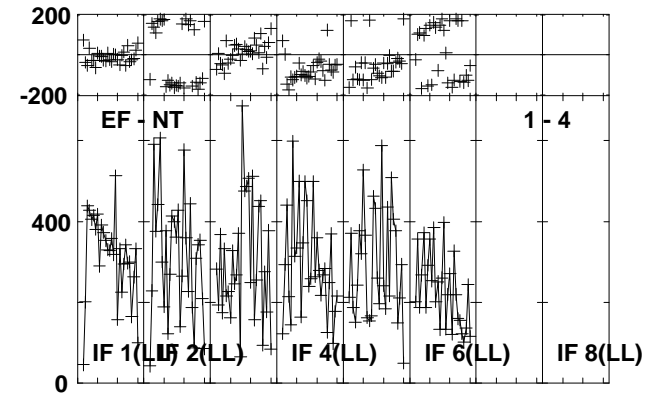
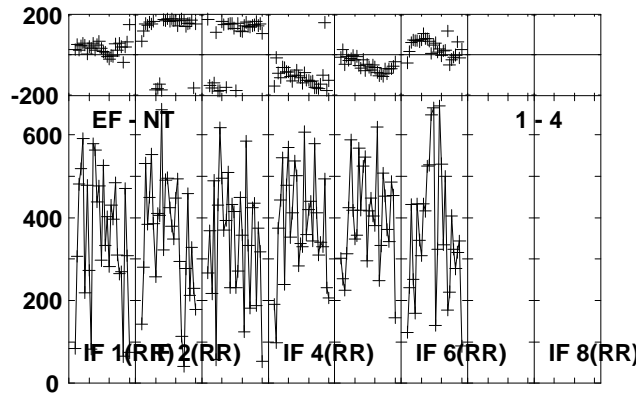
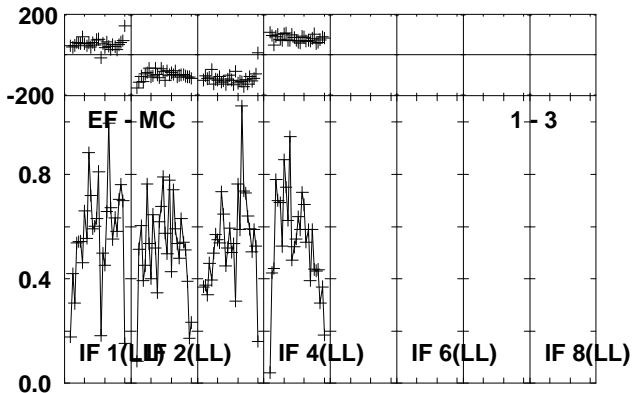
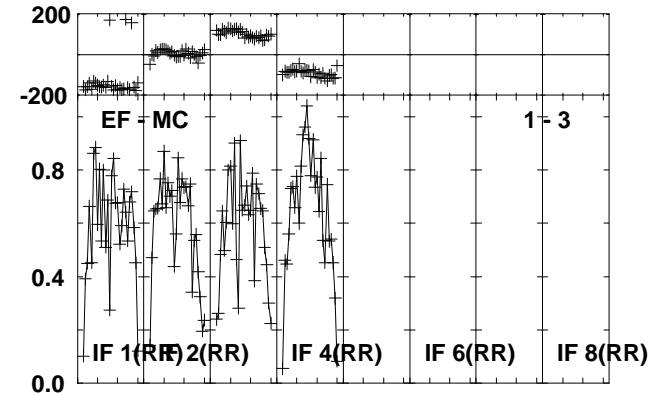
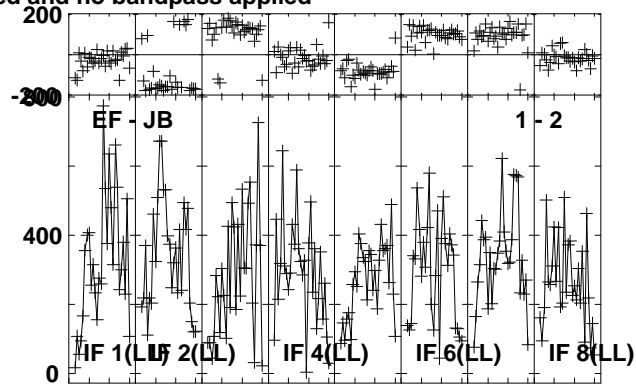
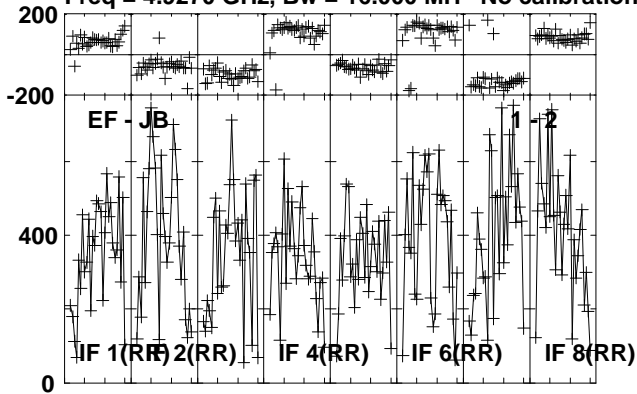

Lower frame: Micro Ampl Jy Top frame: Phas deg  
 Vector averaged cross-power spectrum Several baselines displayed  
 Timerange: 00/17:36:08 to 00/17:38:08

Plot file version 144 created 24-OCT-2012 20:59:30

J1831-0756 EY017B.UVDATA.1

Freq = 4.9270 GHz, Bw = 16.000 MH No calibration applied and no bandpass applied

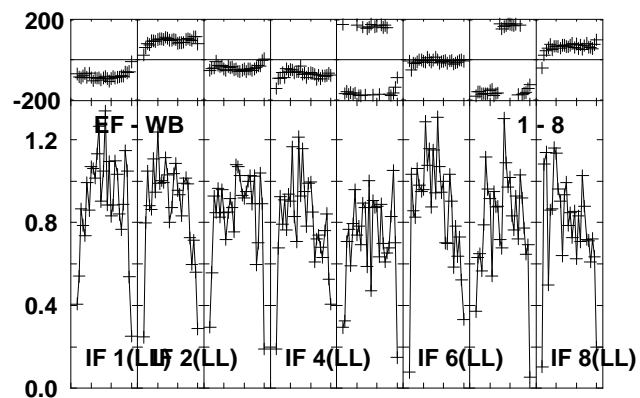
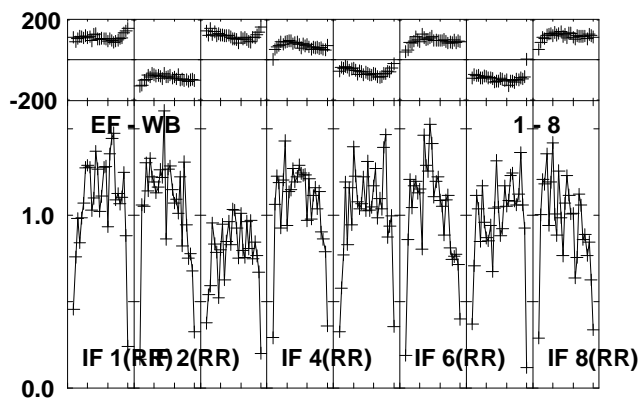
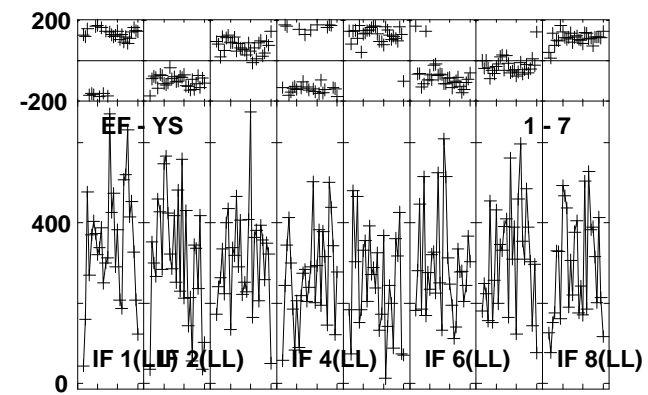
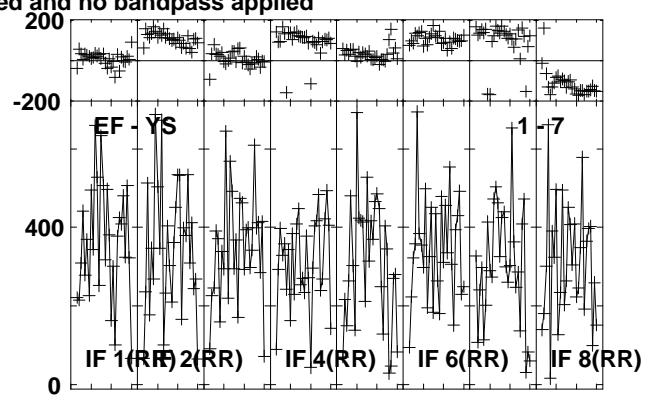
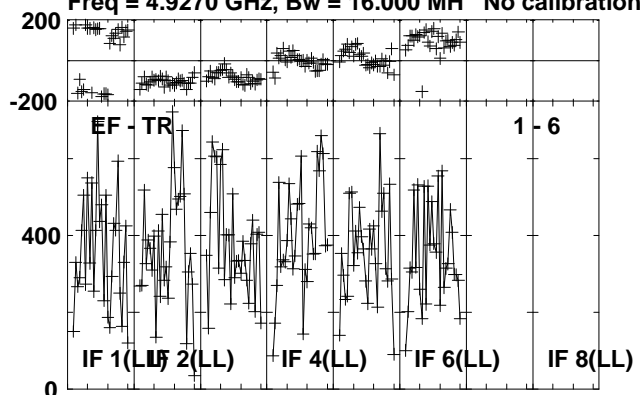

Lower frame: Micro Ampl Jy Top frame: Phas deg  
Vector averaged cross-power spectrum Several baselines displayed  
Timerange: 00/17:36:08 to 00/17:38:08

Plot file version 145 created 24-OCT-2012 20:59:30

J1825-0737 EY017B.UVDATA.1

Freq = 4.9270 GHz, Bw = 16.000 MH No calibration applied and no bandpass applied

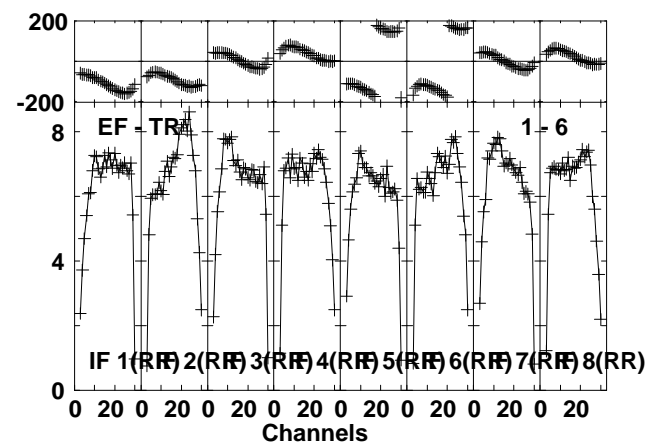
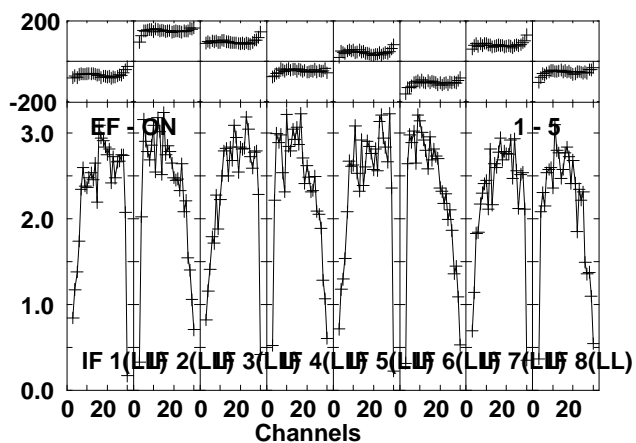
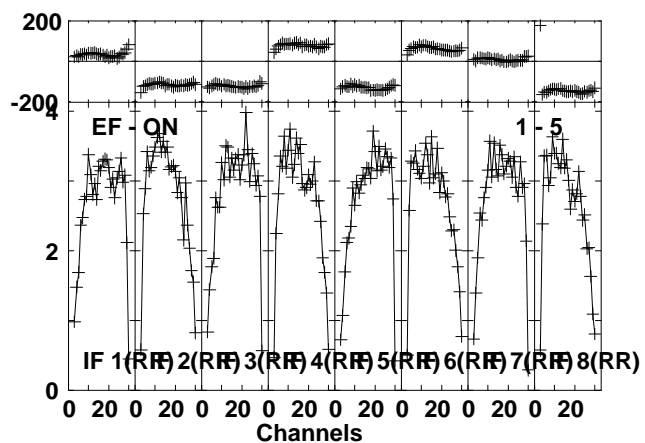
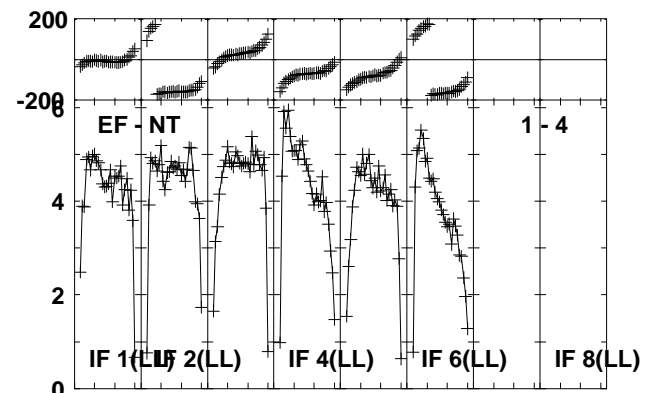
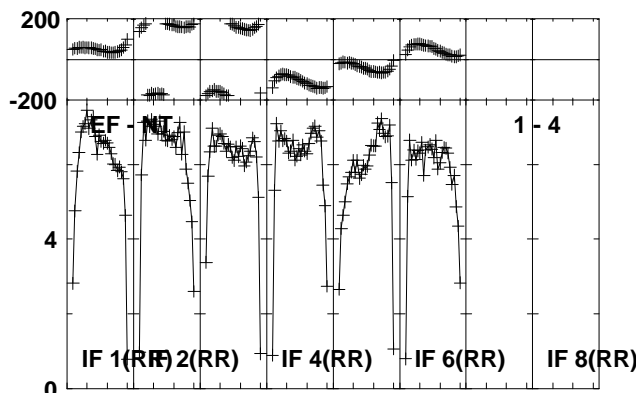
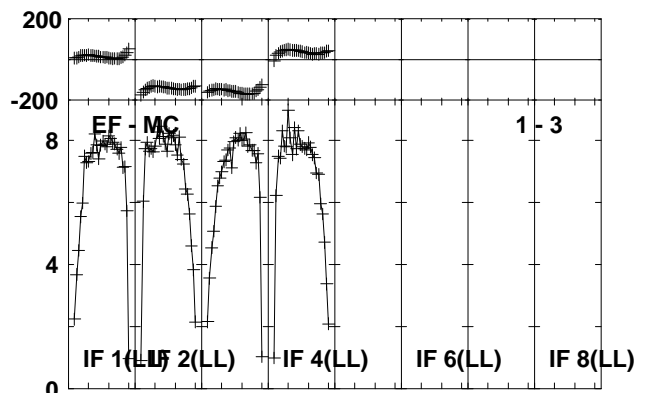
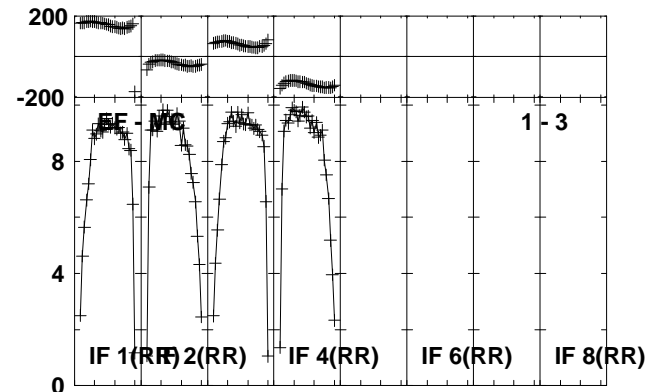
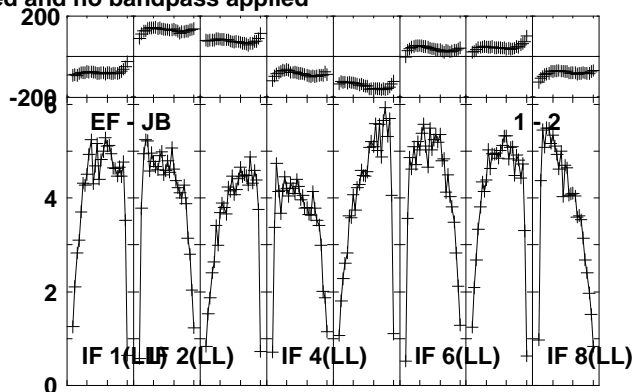
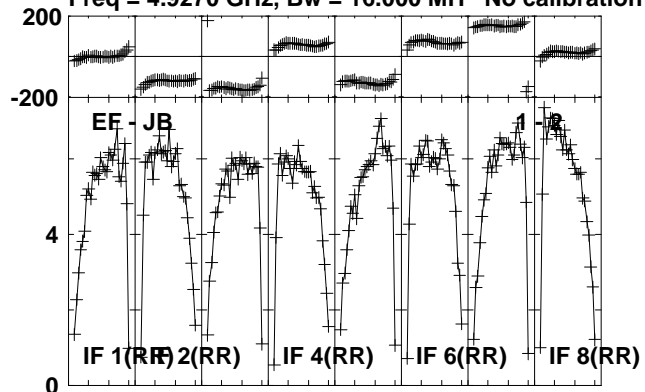

Lower frame: Milli Ampl Jy Top frame: Phas deg  
Vector averaged cross-power spectrum Several baselines displayed  
Timerange: 00/17:38:12 to 00/17:39:38

Plot file version 146 created 24-OCT-2012 20:59:31  
J1825-0737 EY017B.UVDATA.1

Freq = 4.9270 GHz, Bw = 16.000 MH No calibration applied and no bandpass applied

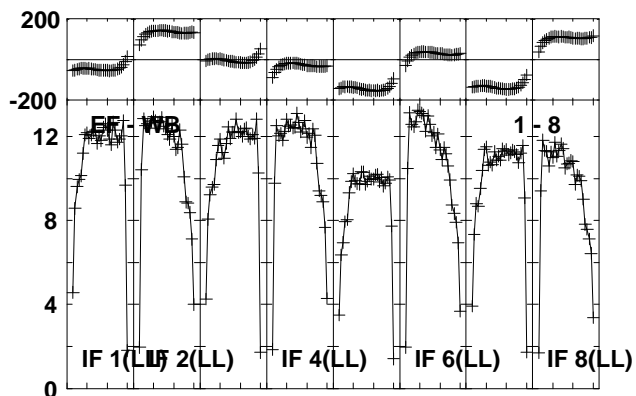
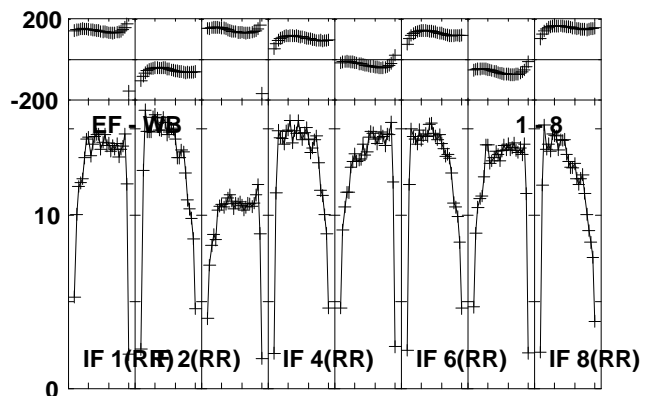
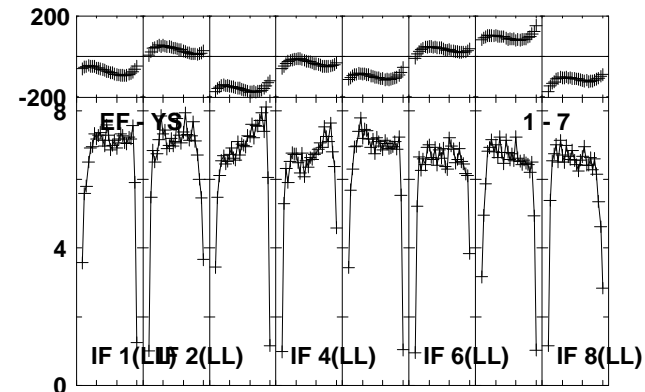
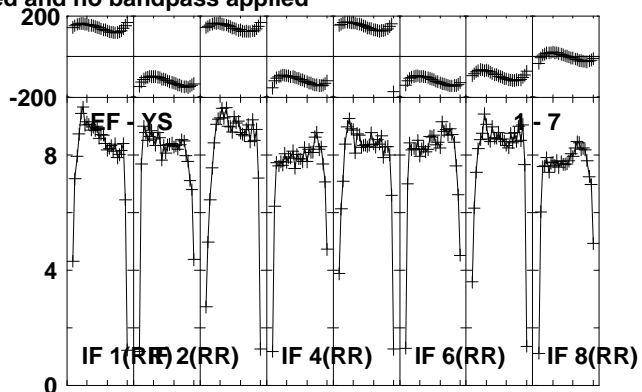
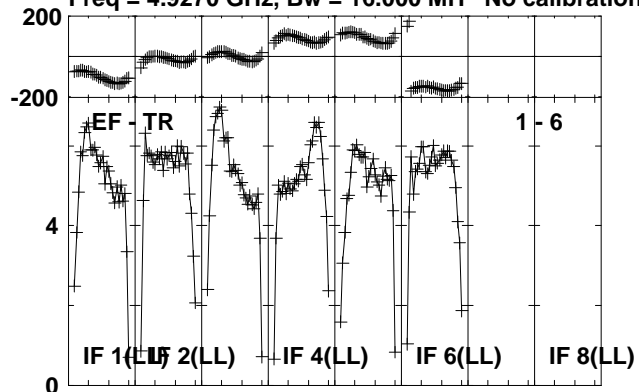

Lower frame: Milli Ampl Jy Top frame: Phas deg  
Vector averaged cross-power spectrum Several baselines displayed  
Timerange: 00/17:38:12 to 00/17:39:38

Plot file version 147 created 24-OCT-2012 20:59:31

G23.6-0.03 EY017B.UVDATA.1

Freq = 4.9270 GHz, Bw = 16.000 MH No calibration applied and no bandpass applied

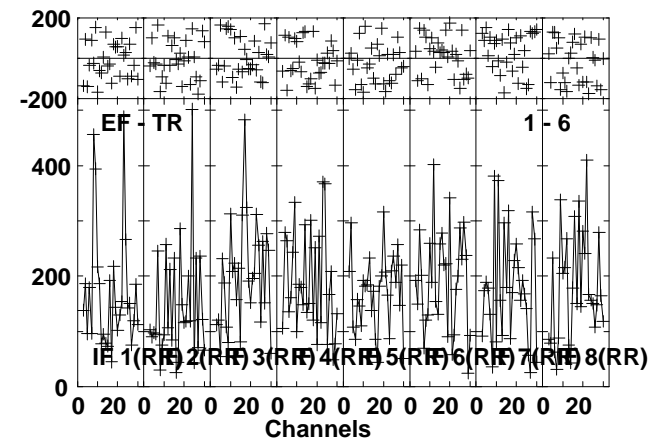
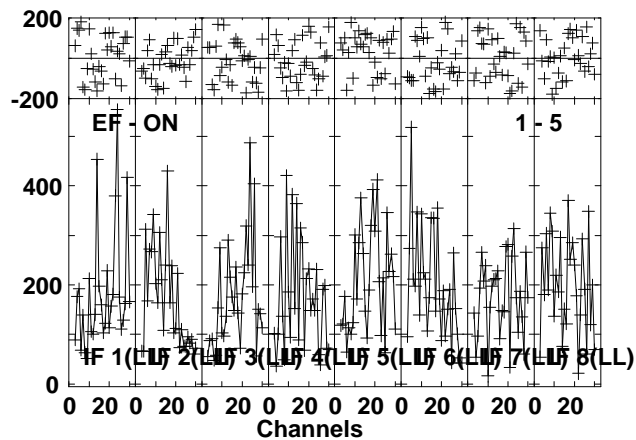
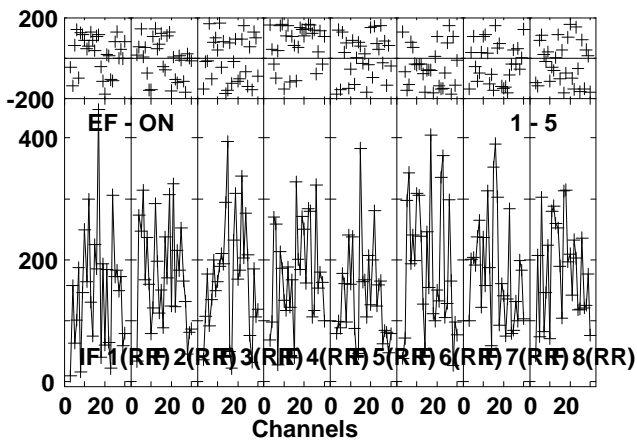
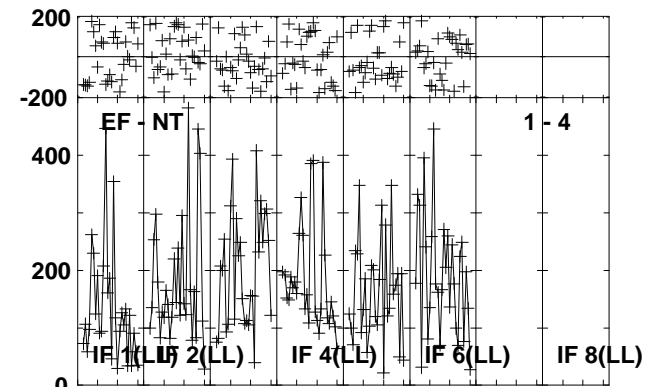
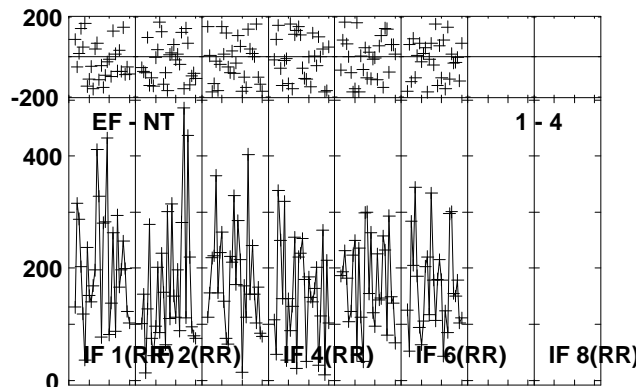
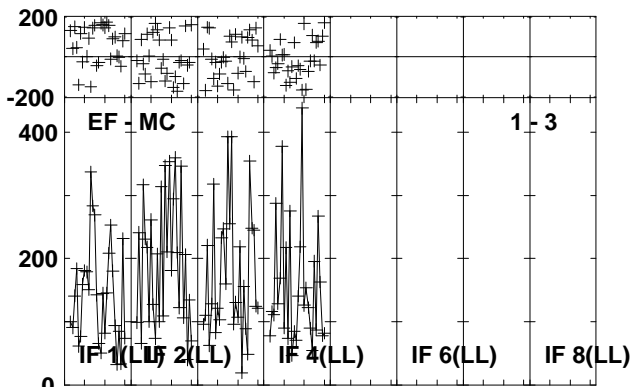
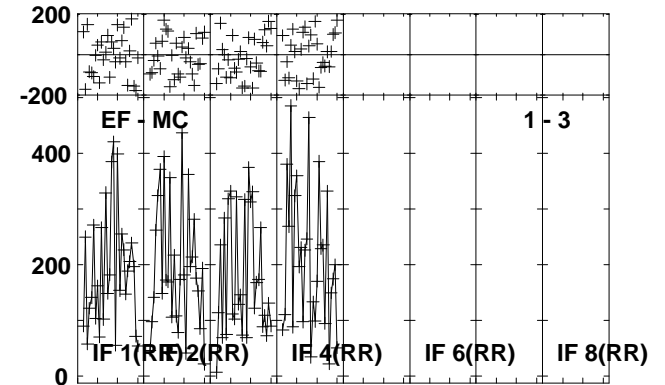
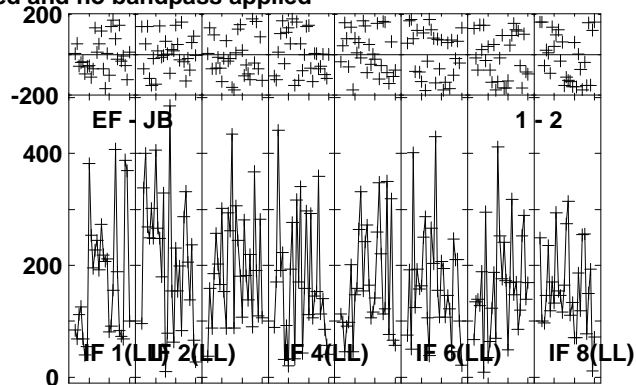
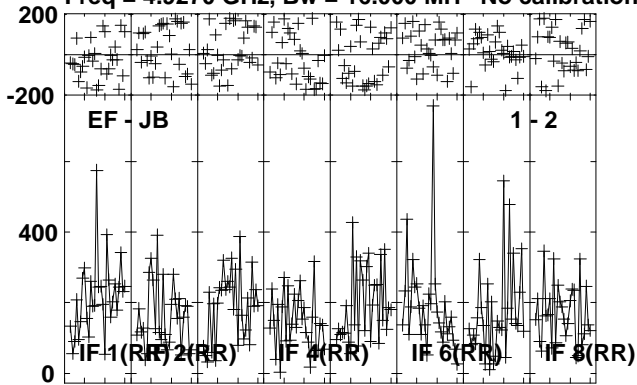

Lower frame: Micro Ampl Jy Top frame: Phas deg  
Vector averaged cross-power spectrum Several baselines displayed  
Timerange: 00/17:39:42 to 00/17:42:08

Plot file version 148 created 24-OCT-2012 20:59:32

G23.6-0.03 EY017B.UVDATA.1

Freq = 4.9270 GHz, Bw = 16.000 MH No calibration applied and no bandpass applied

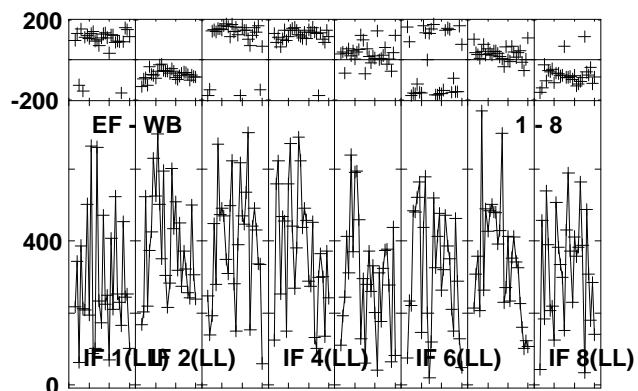
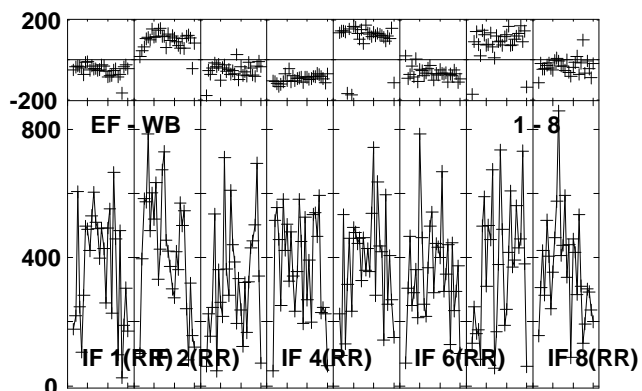
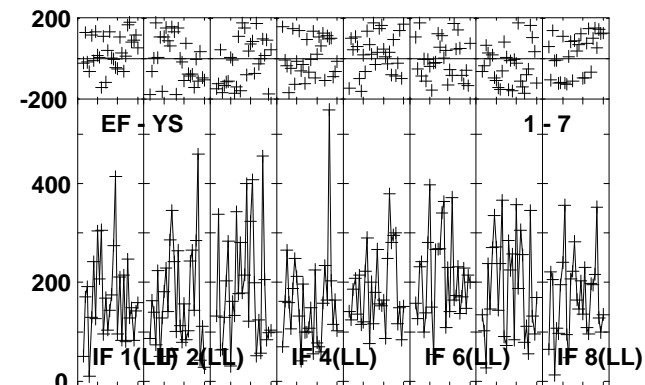
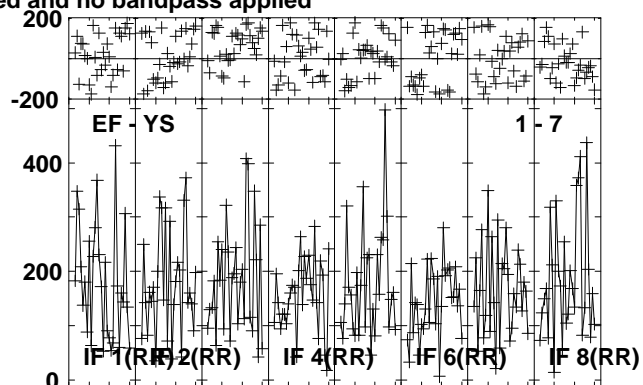
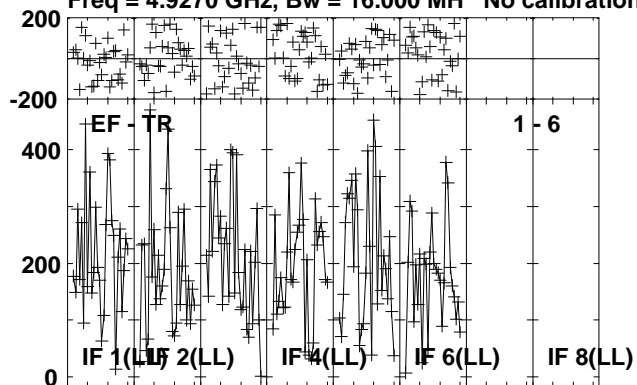

Lower frame: Micro Ampl Jy Top frame: Phas deg  
Vector averaged cross-power spectrum Several baselines displayed  
Timerange: 00:17:39:42 to 00:17:42:08





Plot file version 150 created 24-OCT-2012 20:59:33

J1825-0737 EY017B.UVDATA.1

Freq = 4.9270 GHz, Bw = 16.000 MH No calibration applied and no bandpass applied

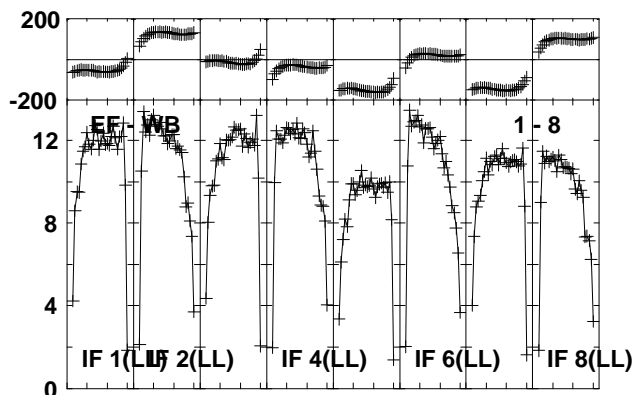
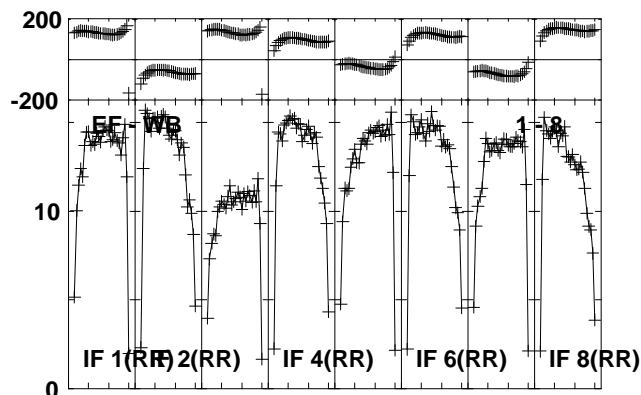
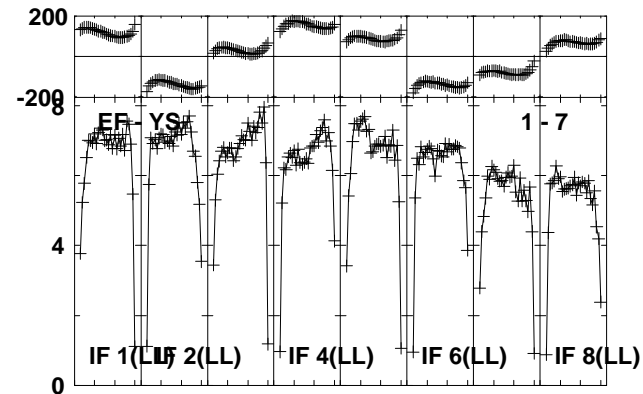
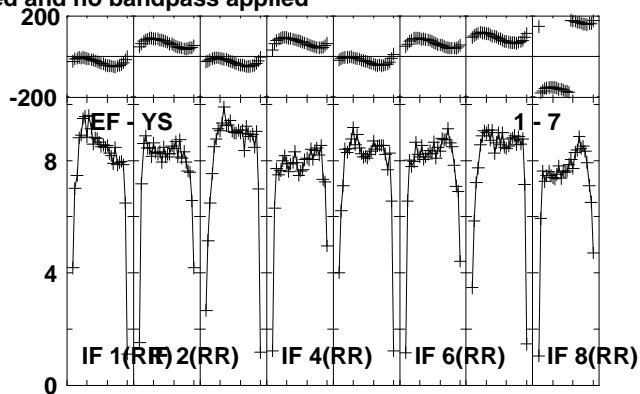
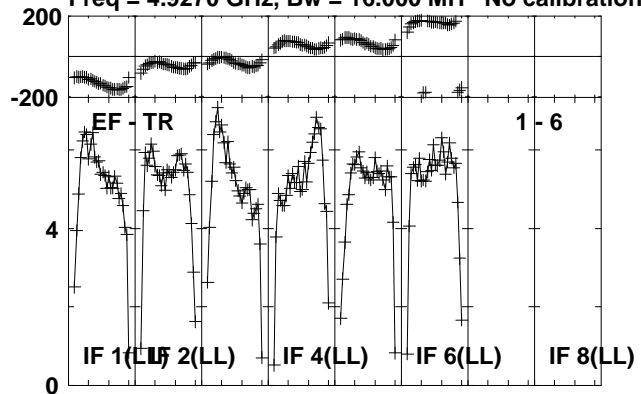

Lower frame: Milli Ampl Jy Top frame: Phas deg  
Vector averaged cross-power spectrum Several baselines displayed  
Timerange: 00/17:42:12 to 00/17:43:38

Plot file version 151 created 24-OCT-2012 20:59:33  
 G23.6-0.03 EY017B.UVDATA.1

Freq = 4.9270 GHz, Bw = 16.000 MH No calibration applied and no bandpass applied

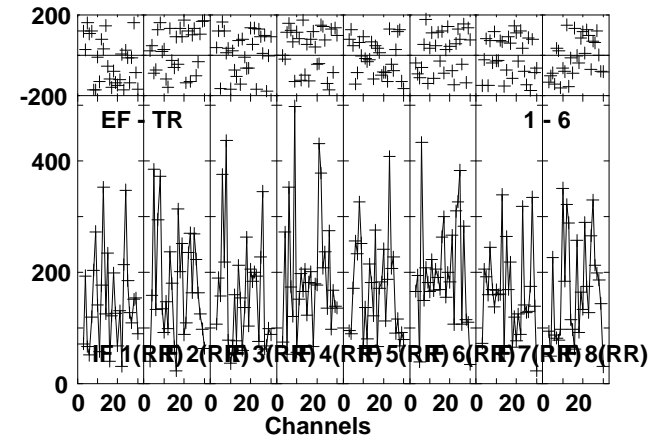
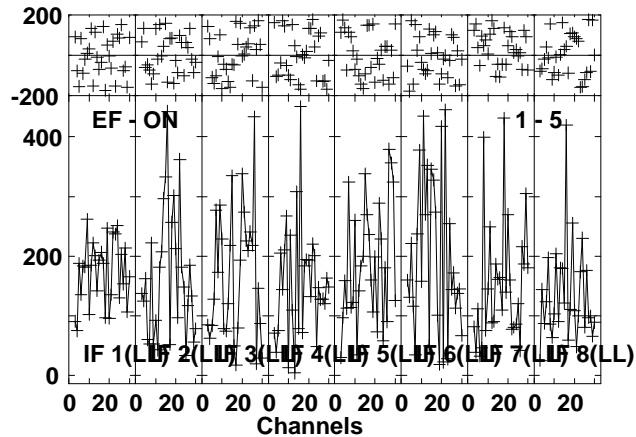
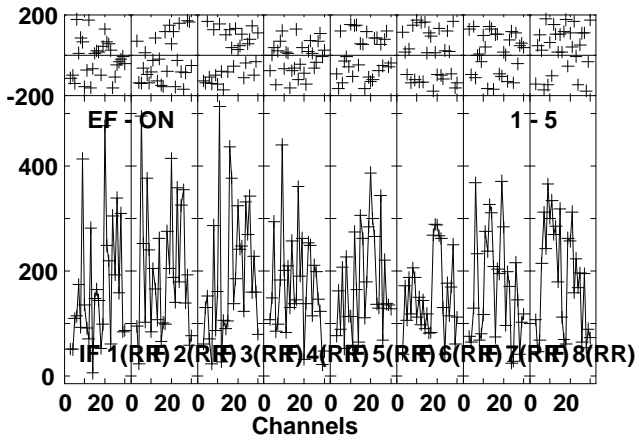
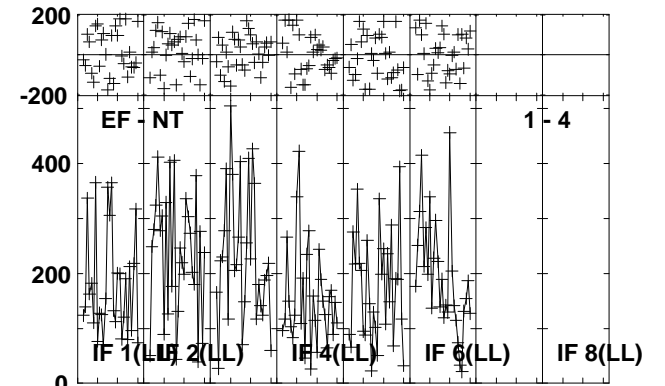
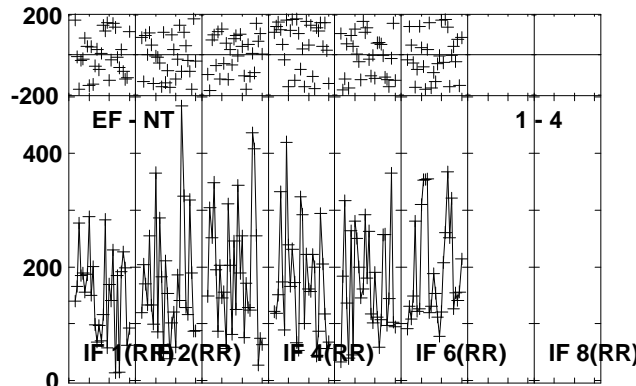
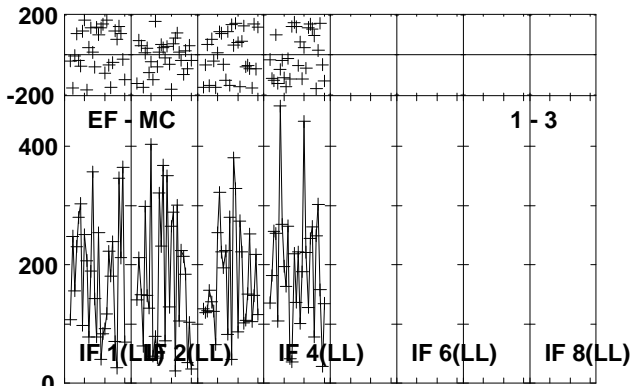
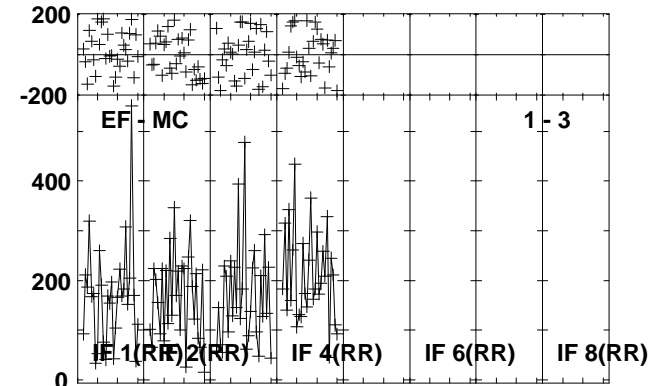
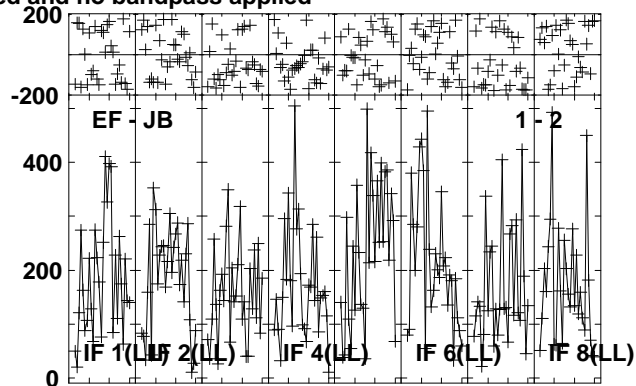
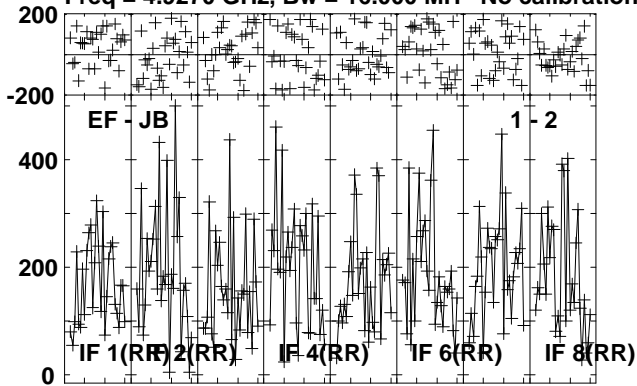

Lower frame: Micro Ampl Jy Top frame: Phas deg  
 Vector averaged cross-power spectrum Several baselines displayed  
 Timerange: 00:17:43:42 to 00:17:46:08

Plot file version 152 created 24-OCT-2012 20:59:34

G23.6-0.03 EY017B.UVDATA.1

Freq = 4.9270 GHz, Bw = 16.000 MH No calibration applied and no bandpass applied

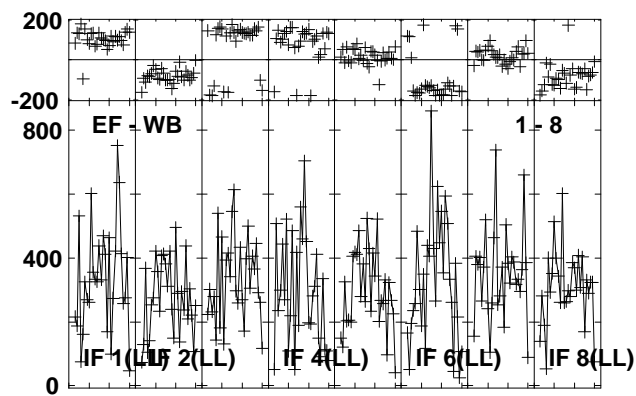
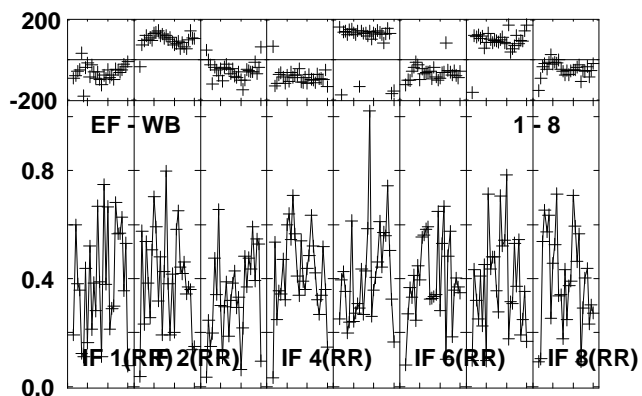
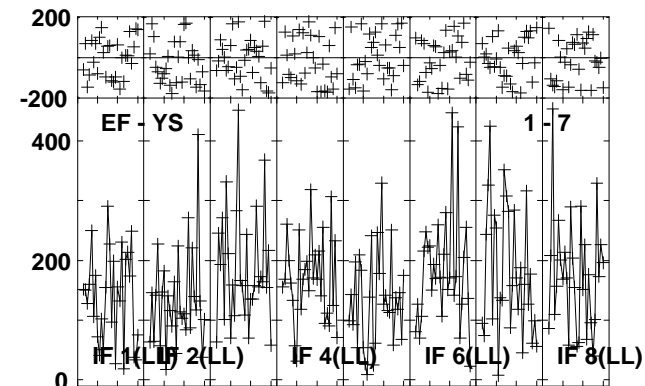
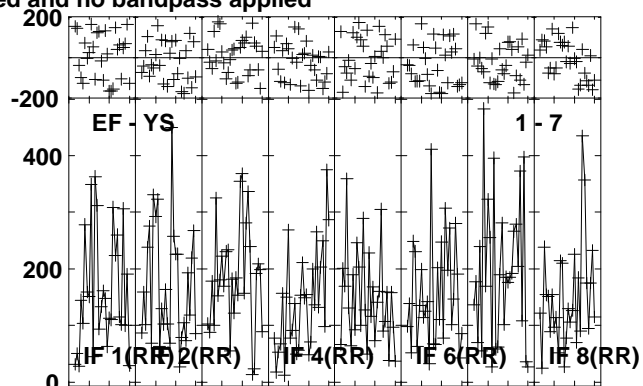
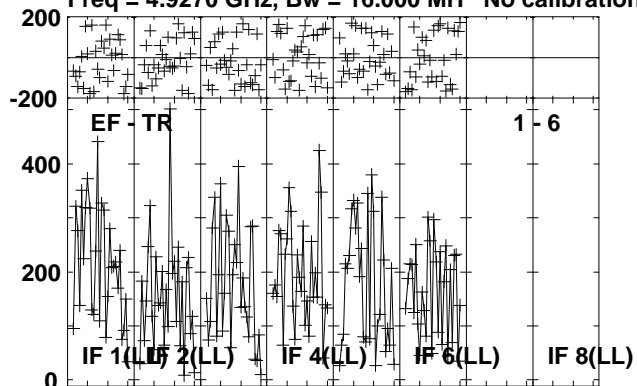

Lower frame: Micro Ampl Jy Top frame: Phas deg  
Vector averaged cross-power spectrum Several baselines displayed  
Timerange: 00/17:43:42 to 00/17:46:08

Plot file version 153 created 24-OCT-2012 20:59:35

J1825-0737 EY017B.UVDATA.1

Freq = 4.9270 GHz, Bw = 16.000 MH No calibration applied and no bandpass applied

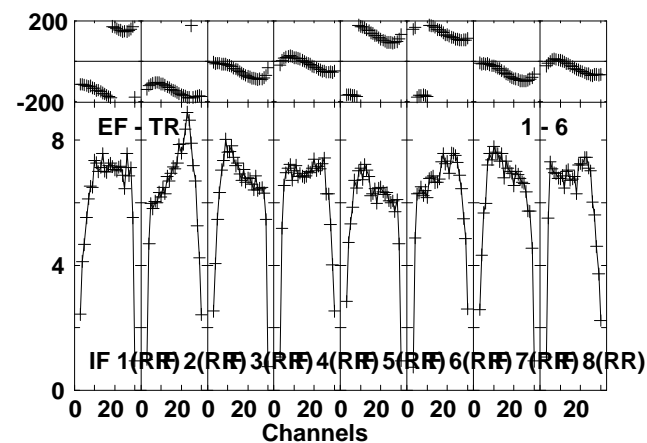
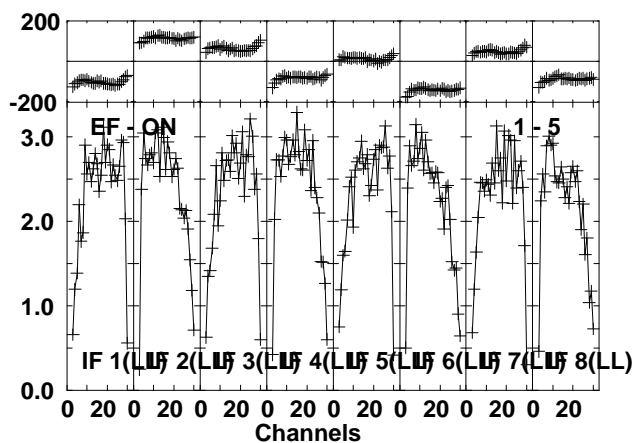
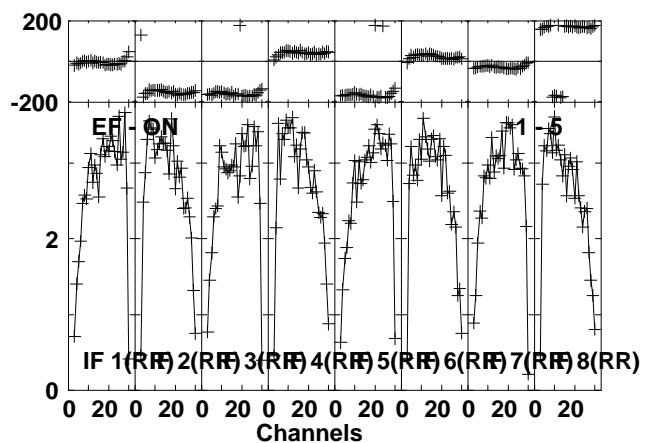
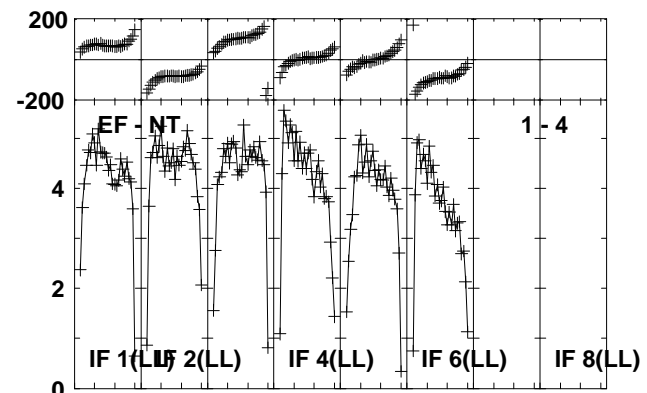
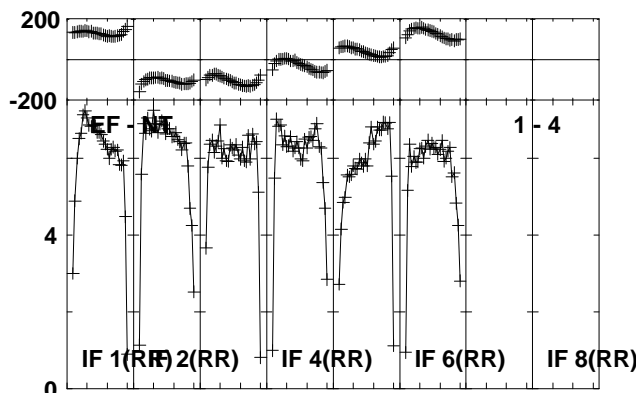
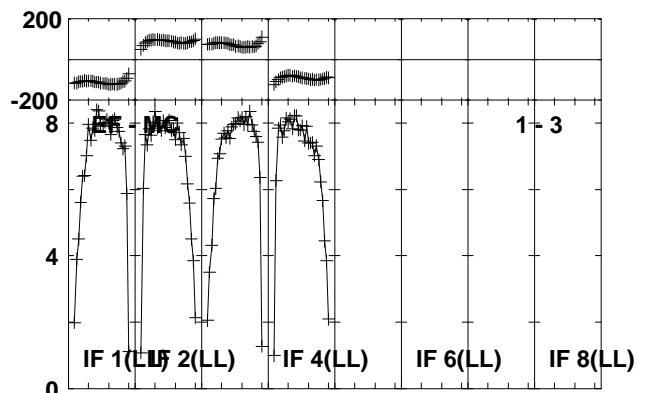
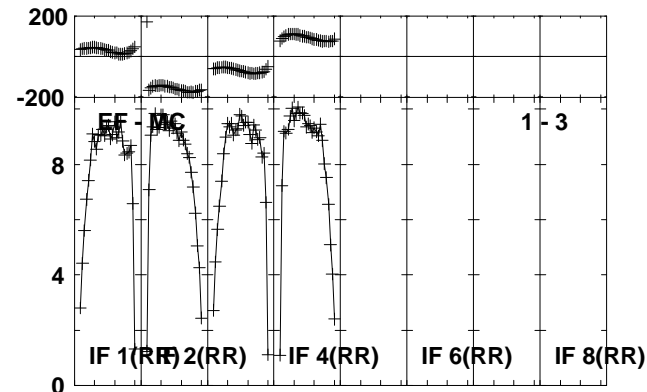
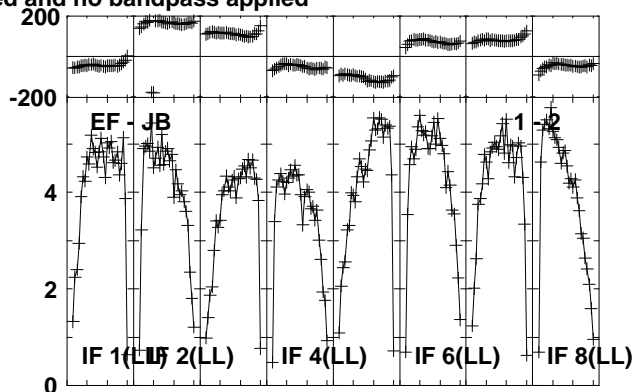
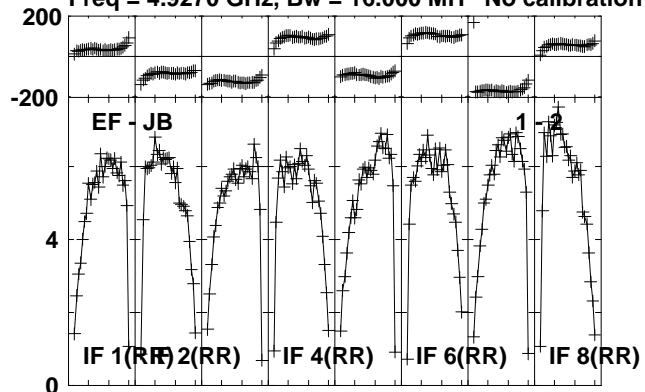

Lower frame: Milli Ampl Jy Top frame: Phas deg  
Vector averaged cross-power spectrum Several baselines displayed  
Timerange: 00/17:46:12 to 00/17:47:38

Plot file version 154 created 24-OCT-2012 20:59:35

J1825-0737 EY017B.UVDATA.1

Freq = 4.9270 GHz, Bw = 16.000 MH No calibration applied and no bandpass applied

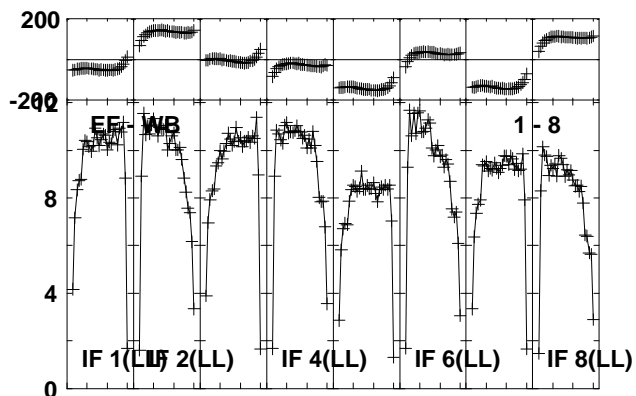
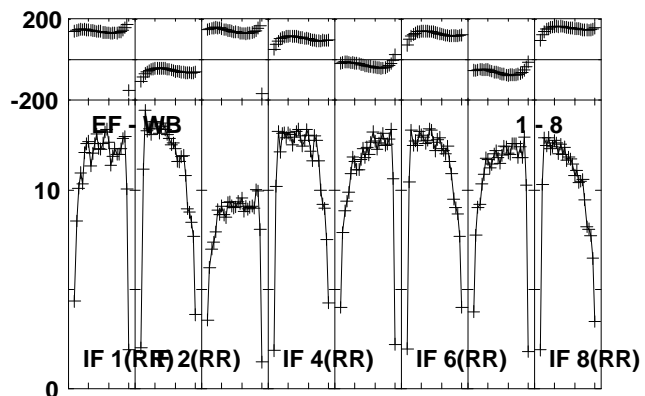
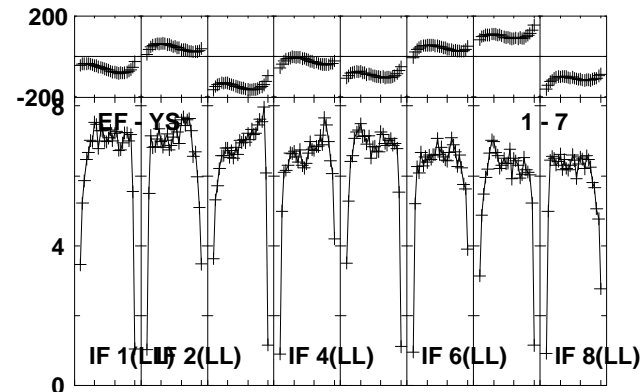
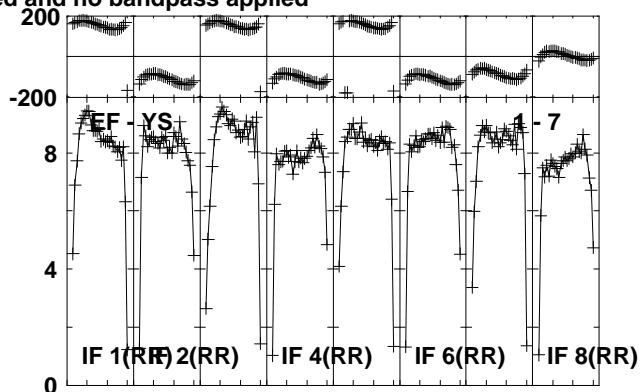
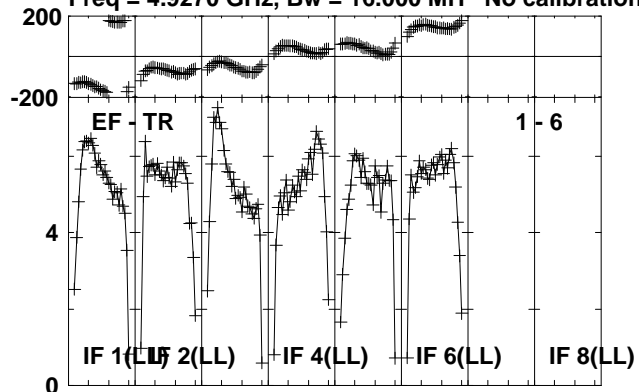

Lower frame: Milli Ampl Jy Top frame: Phas deg  
Vector averaged cross-power spectrum Several baselines displayed  
Timerange: 00/17:46:12 to 00/17:47:38

Plot file version 155 created 24-OCT-2012 20:59:36  
 G23.6-0.03 EY017B.UVDATA.1

Freq = 4.9270 GHz, Bw = 16.000 MH No calibration applied and no bandpass applied

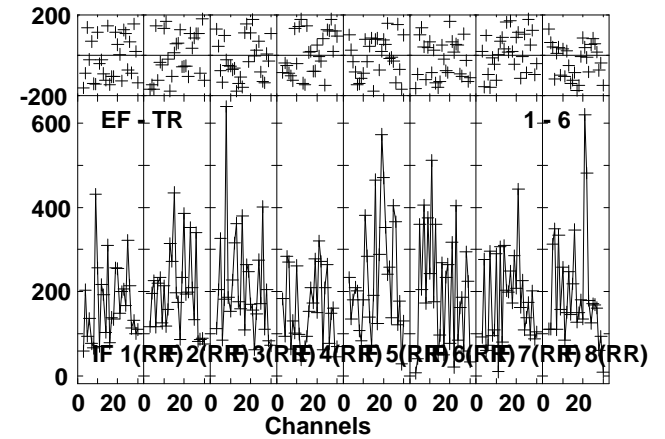
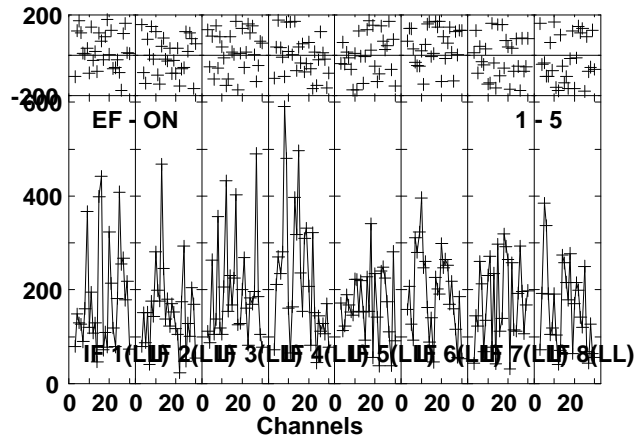
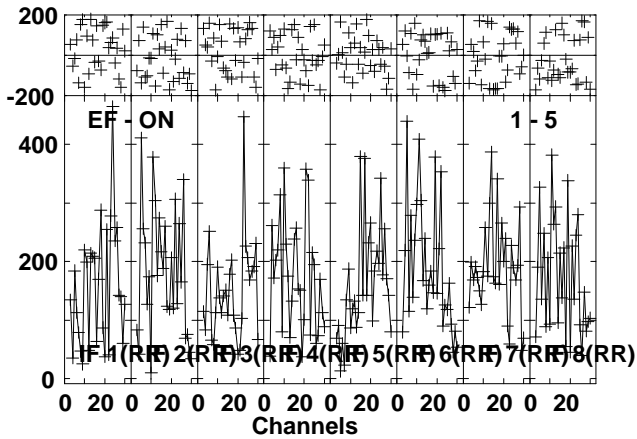
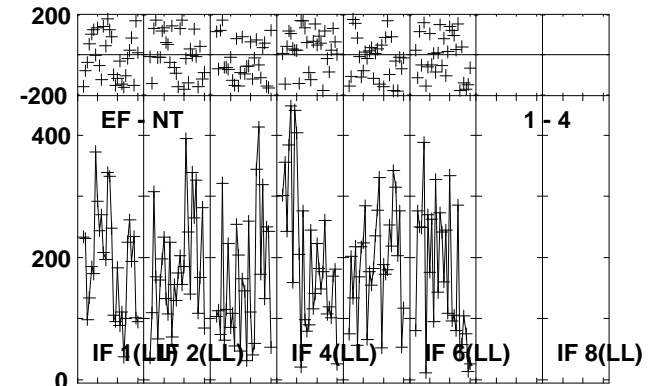
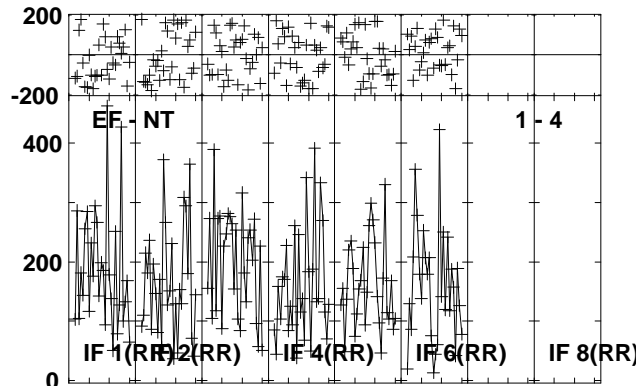
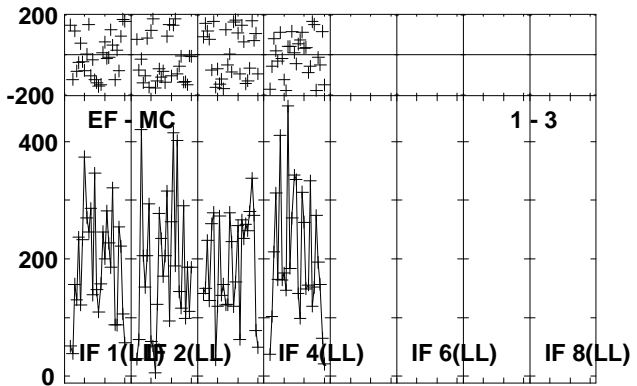
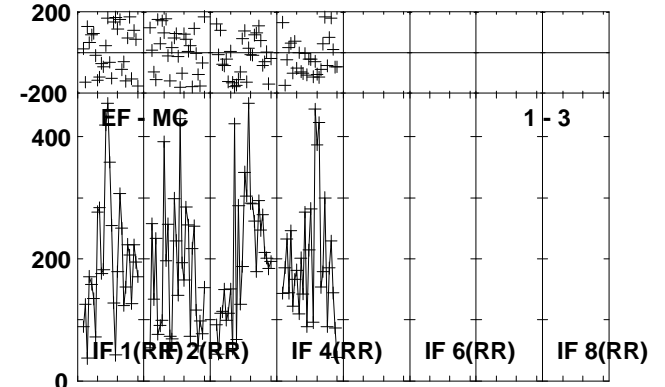
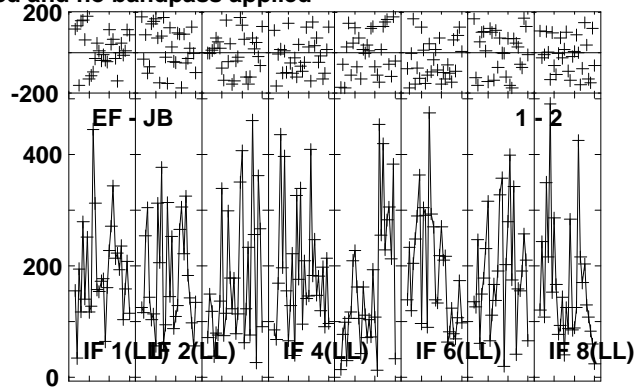
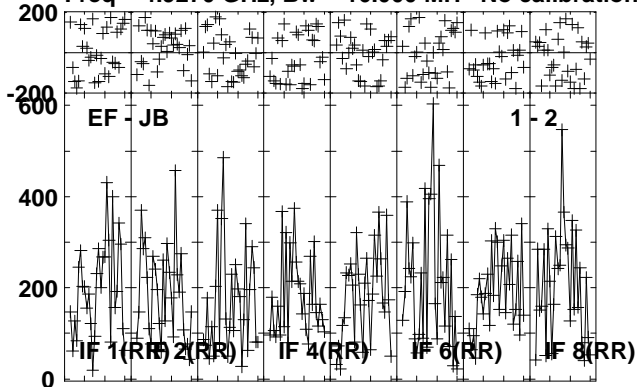

Lower frame: Micro Ampl Jy Top frame: Phas deg  
 Vector averaged cross-power spectrum Several baselines displayed  
 Timerange: 00/17:47:42 to 00/17:50:08

Plot file version 156 created 24-OCT-2012 20:59:36

G23.6-0.03 EY017B.UVDATA.1

Freq = 4.9270 GHz, Bw = 16.000 MH No calibration applied and no bandpass applied

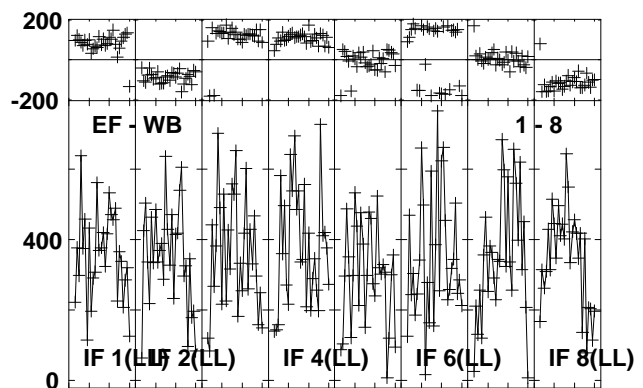
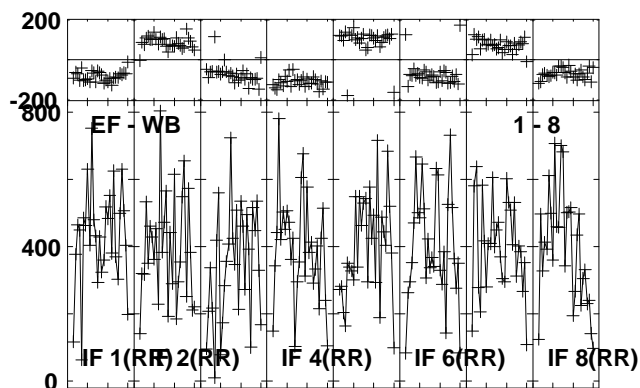
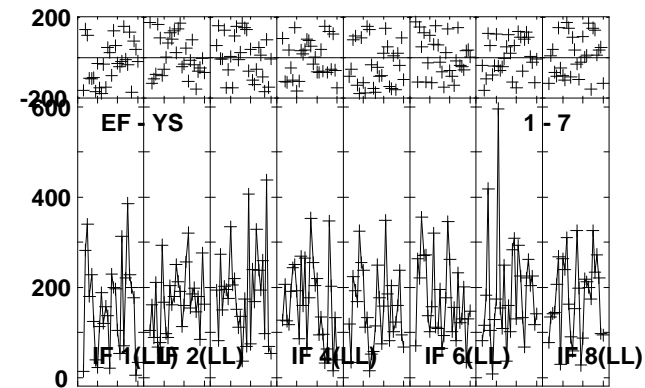
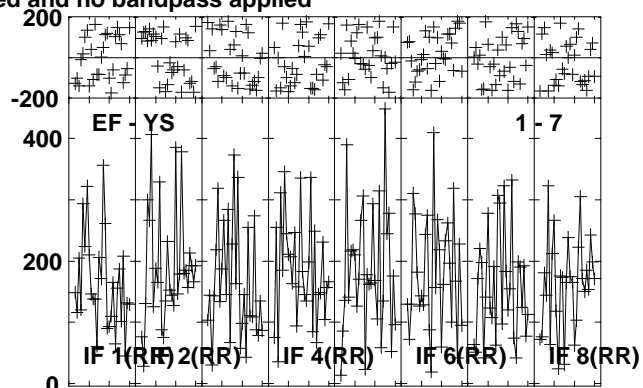
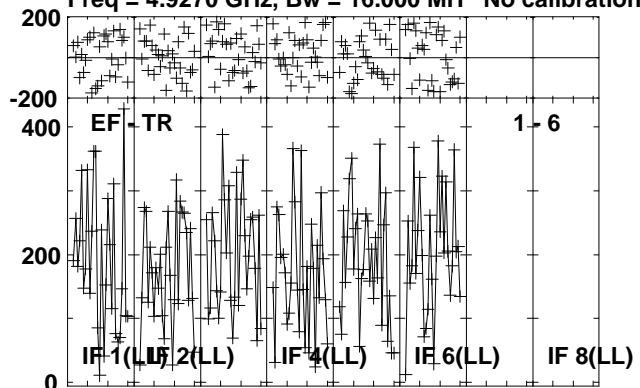

Lower frame: Micro Ampl Jy Top frame: Phas deg  
Vector averaged cross-power spectrum Several baselines displayed  
Timerange: 00/17:47:42 to 00/17:50:08



Plot file version 157 created 24-OCT-2012 20:59:37

J1825-0737 EY017B.UVDATA.1

Freq = 4.9270 GHz, Bw = 16.000 MH No calibration applied and no bandpass applied

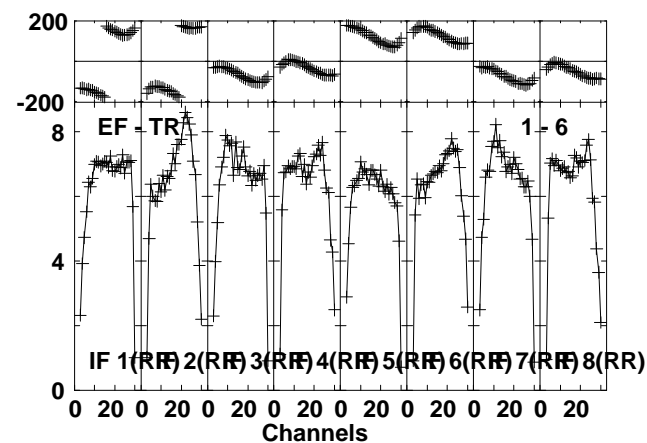
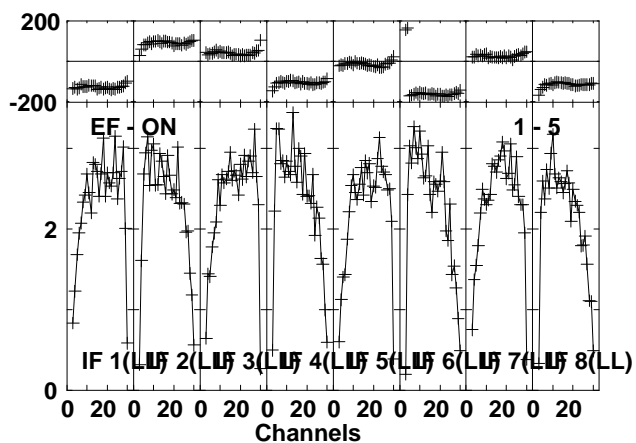
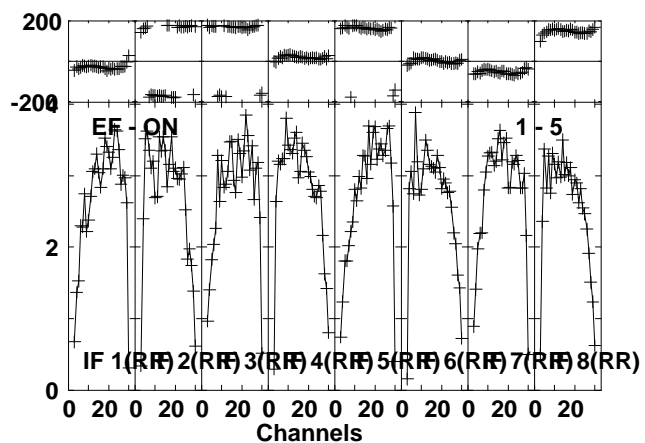
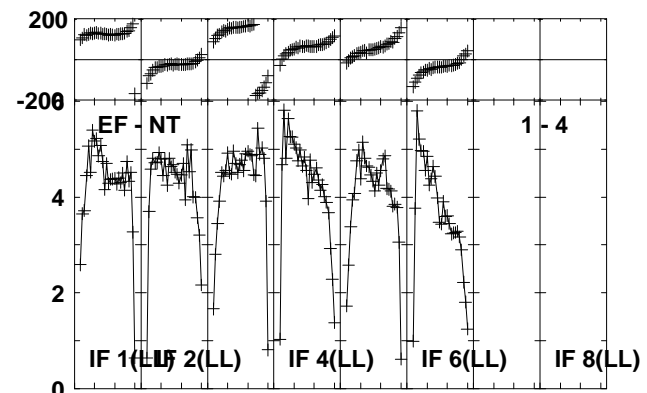
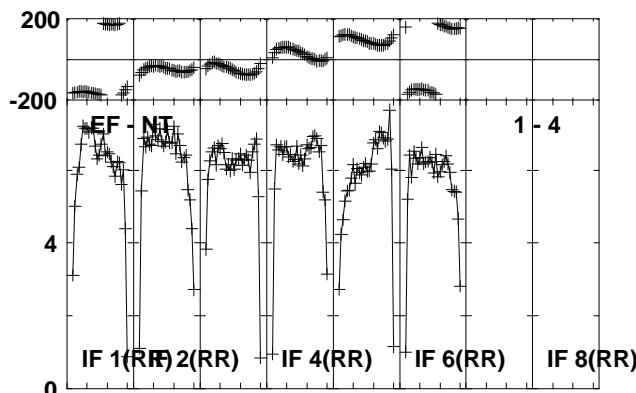
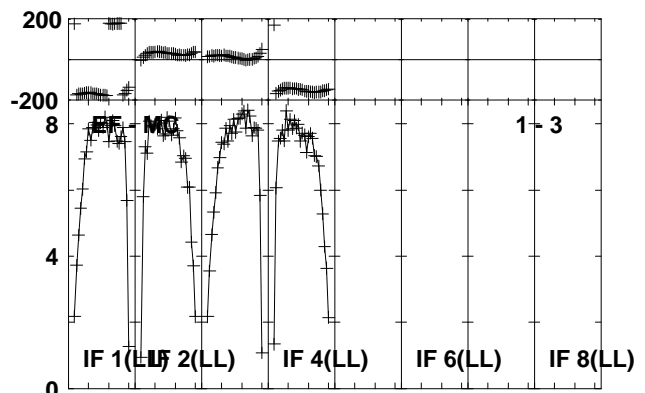
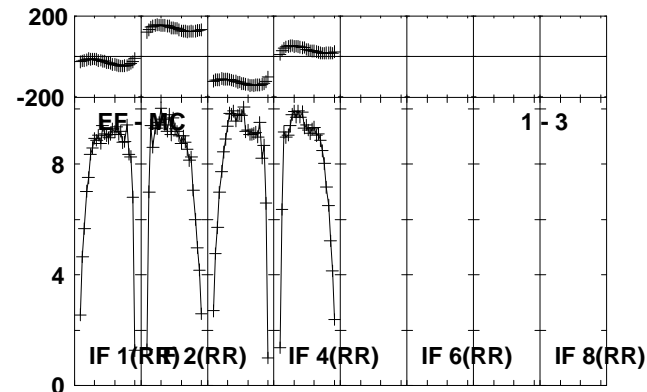
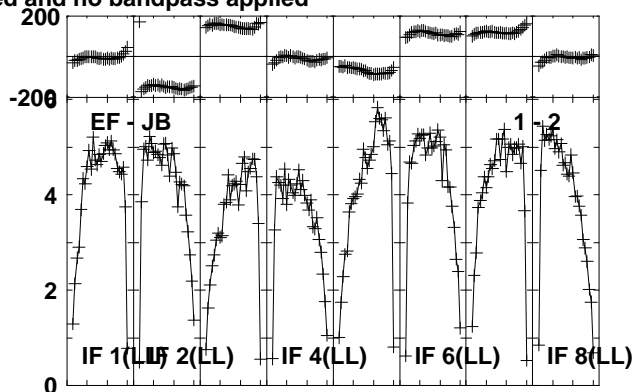
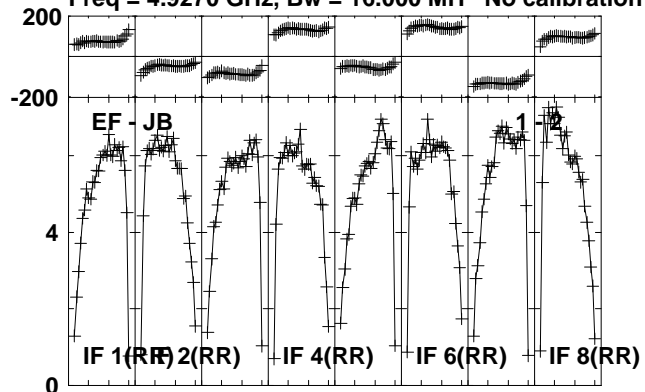

Lower frame: Milli Ampl Jy Top frame: Phas deg  
Vector averaged cross-power spectrum Several baselines displayed  
Timerange: 00/17:50:12 to 00/17:51:38

Plot file version 158 created 24-OCT-2012 20:59:37

J1825-0737 EY017B.UVDATA.1

Freq = 4.9270 GHz, Bw = 16.000 MH No calibration applied and no bandpass applied

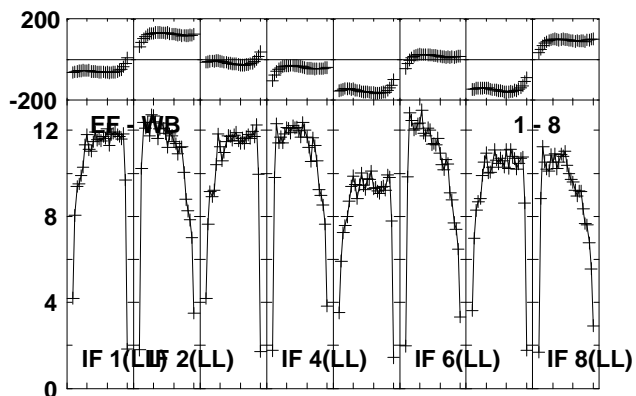
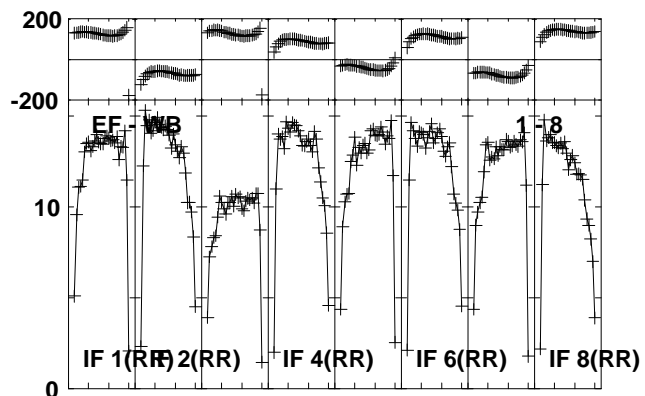
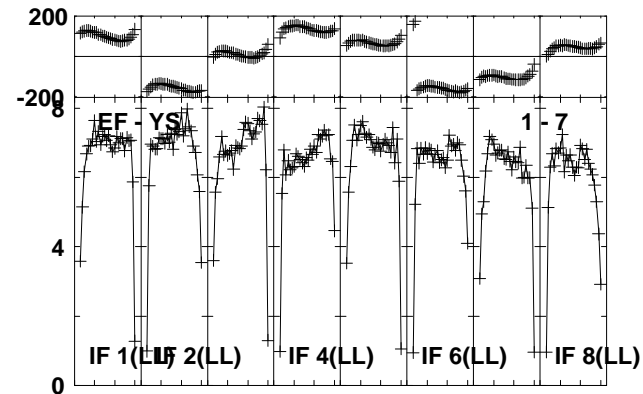
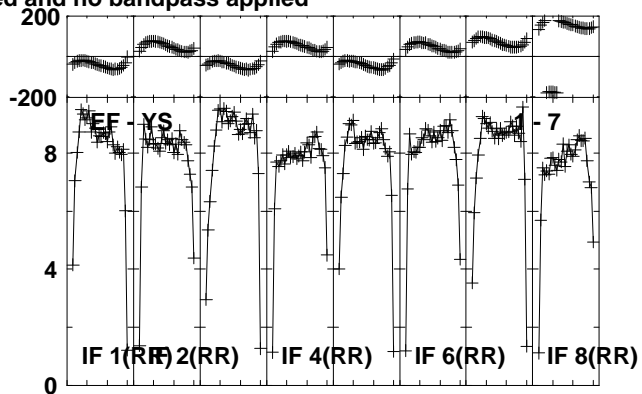
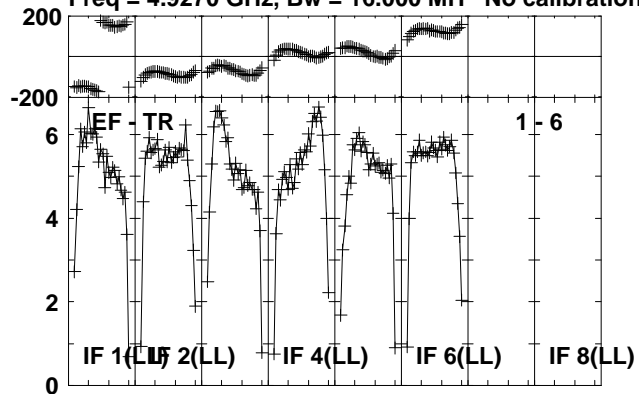

Lower frame: Milli Ampl Jy Top frame: Phas deg  
Vector averaged cross-power spectrum Several baselines displayed  
Timerange: 00/17:50:12 to 00/17:51:38

Plot file version 159 created 24-OCT-2012 20:59:38

J1831-0756 EY017B.UVDATA.1

Freq = 4.9270 GHz, Bw = 16.000 MH No calibration applied and no bandpass applied

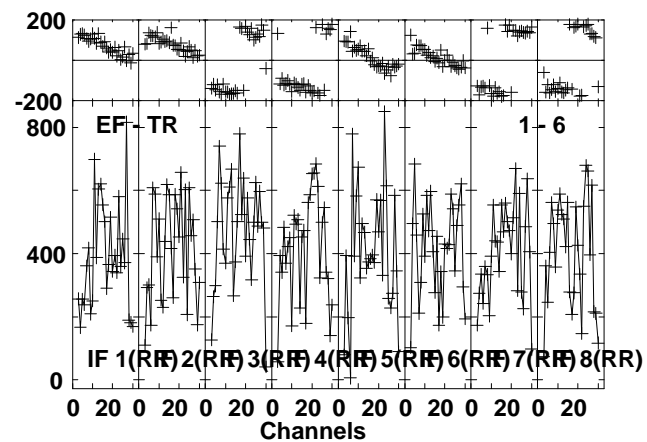
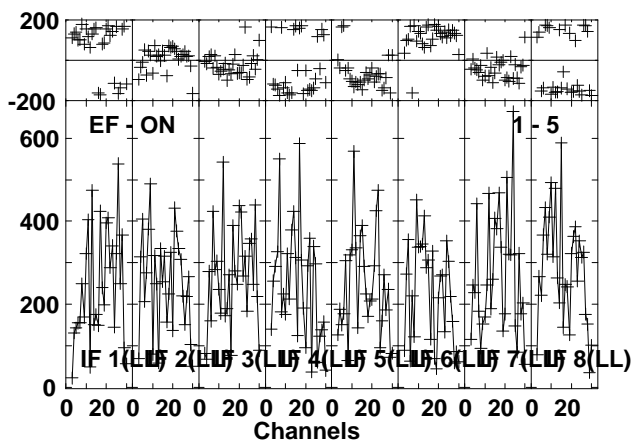
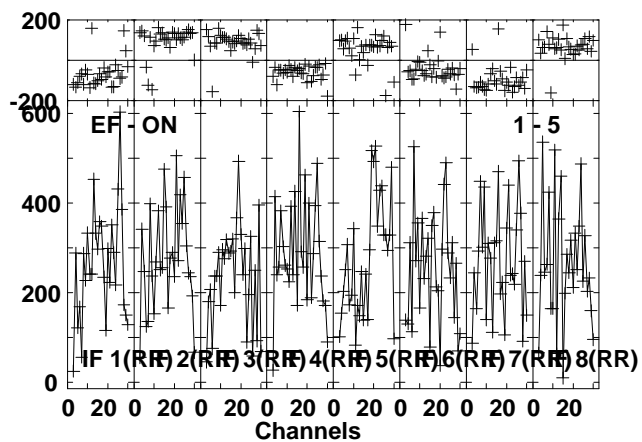
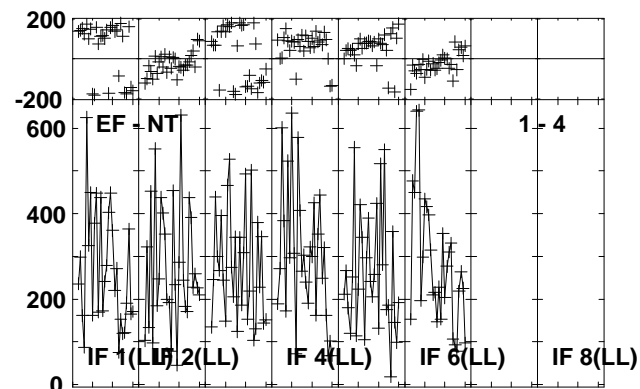
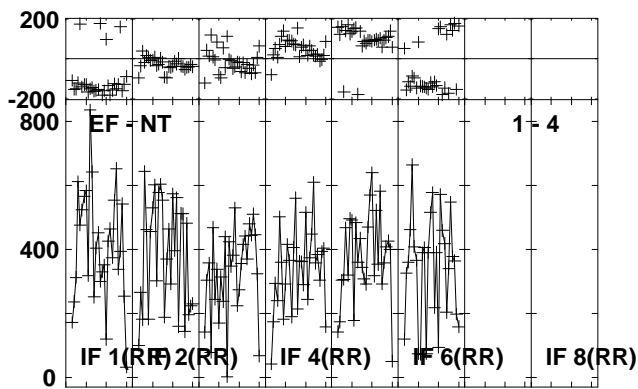
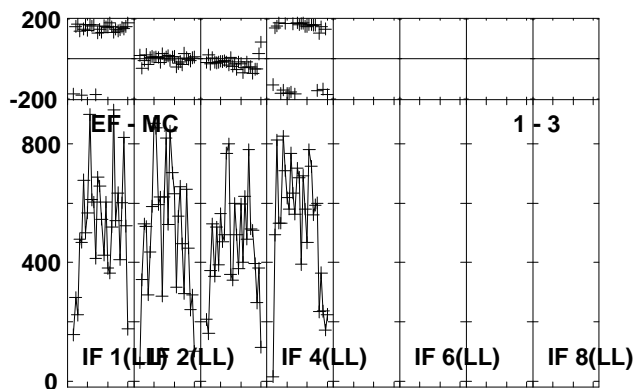
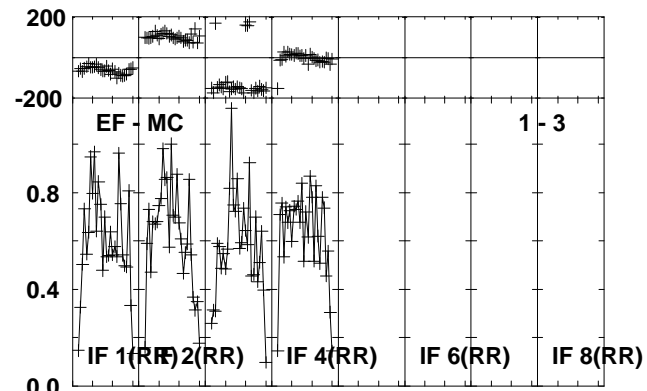
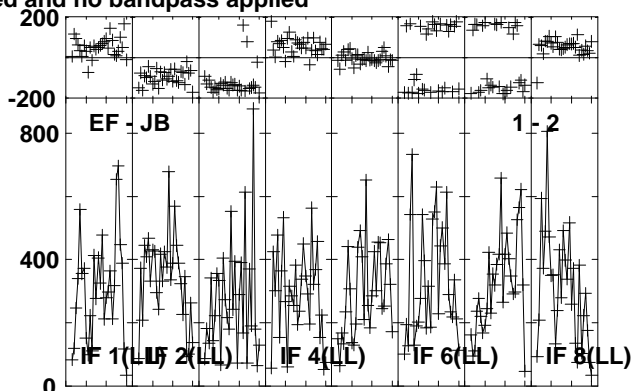
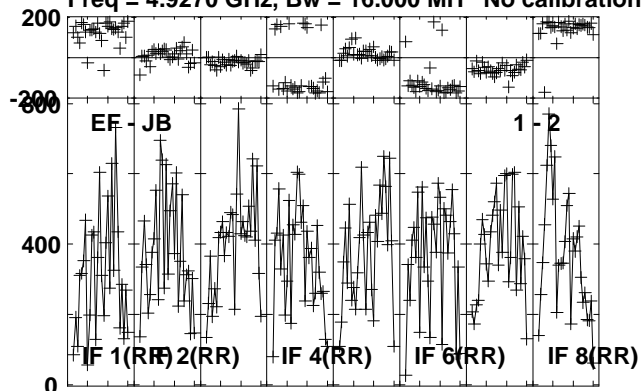

Lower frame: Micro Ampl Jy Top frame: Phas deg  
Vector averaged cross-power spectrum Several baselines displayed  
Timerange: 00/17:52:12 to 00/17:54:14

Plot file version 160 created 24-OCT-2012 20:59:38

J1831-0756 EY017B.UVDATA.1

Freq = 4.9270 GHz, Bw = 16.000 MH No calibration applied and no bandpass applied

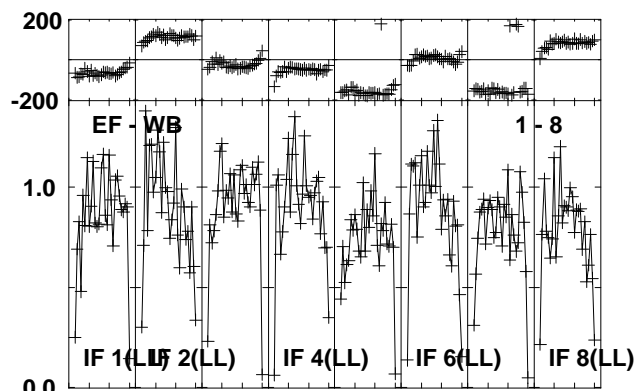
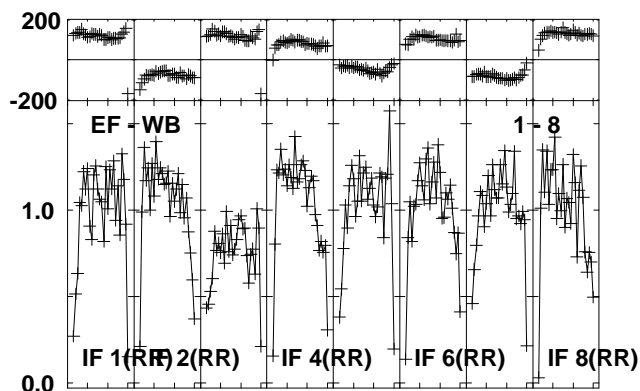
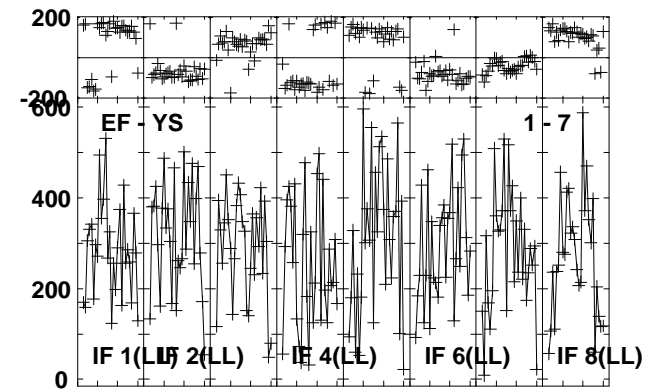
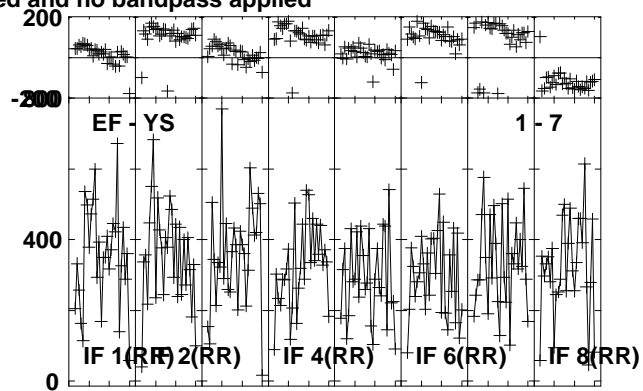
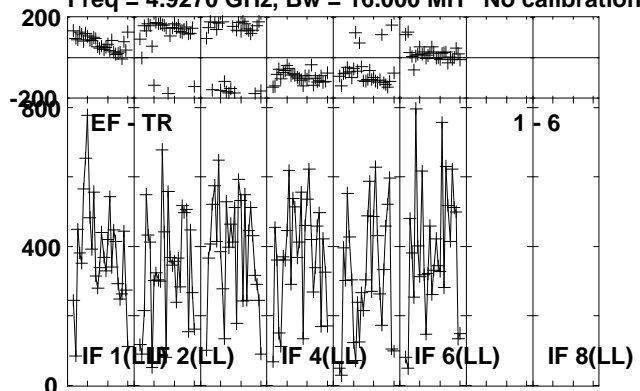

Lower frame: Micro Ampl Jy Top frame: Phas deg  
Vector averaged cross-power spectrum Several baselines displayed  
Timerange: 00/17:52:12 to 00/17:54:14

Plot file version 161 created 24-OCT-2012 20:59:39

J1825-0737 EY017B.UVDATA.1

Freq = 4.9270 GHz, Bw = 16.000 MH No calibration applied and no bandpass applied

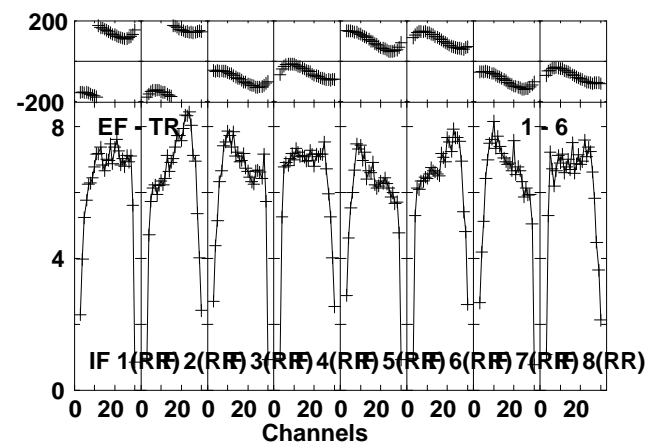
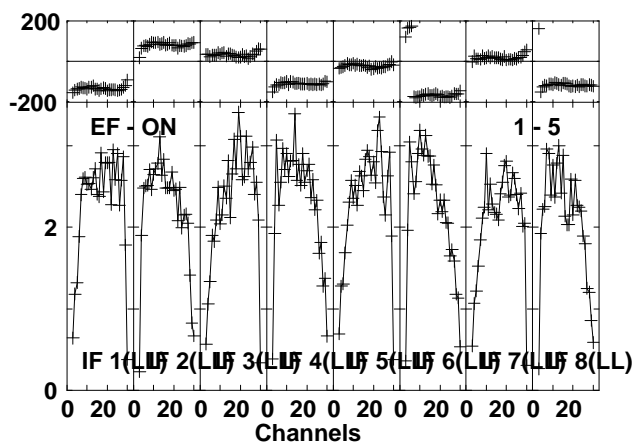
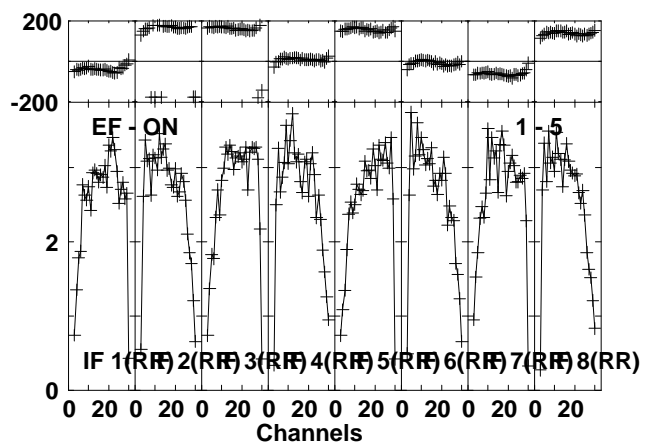
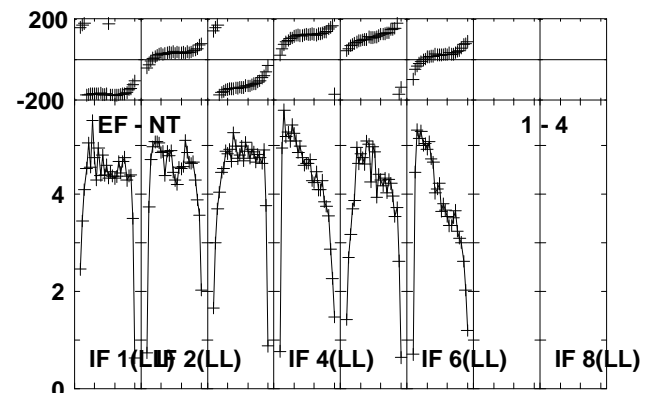
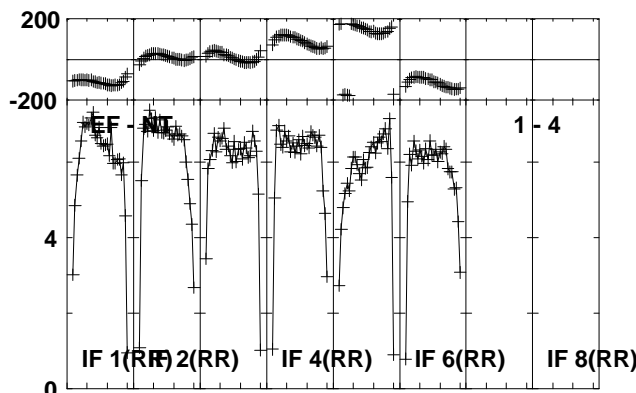
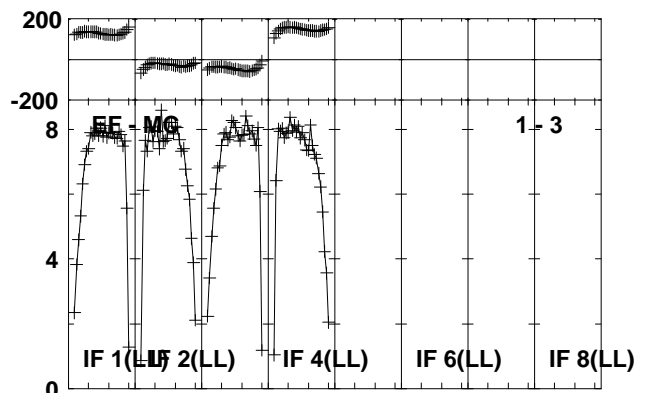
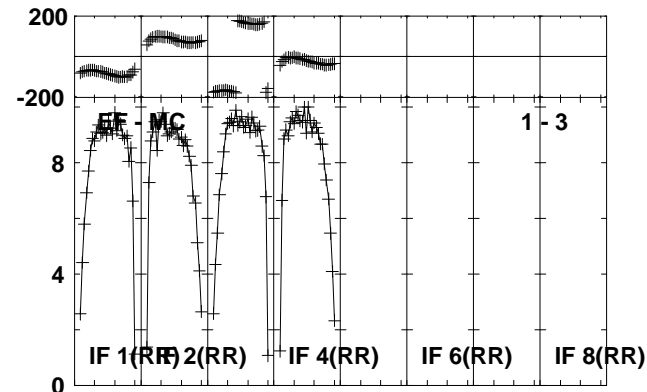
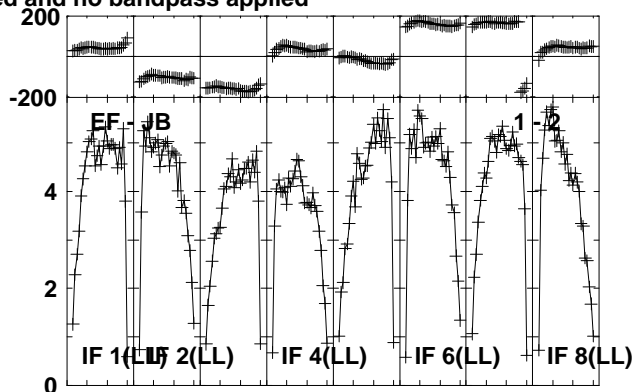
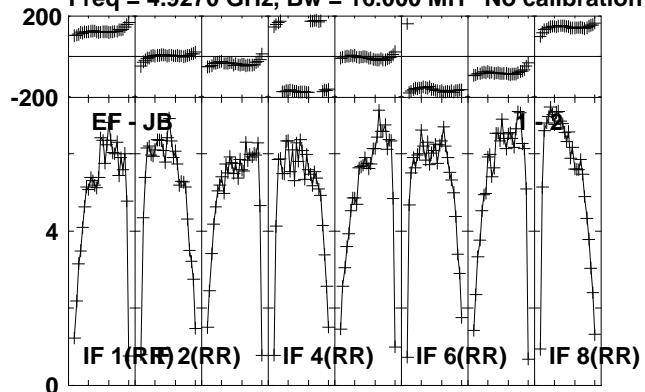

Lower frame: Milli Ampl Jy Top frame: Phas deg  
Vector averaged cross-power spectrum Several baselines displayed  
Timerange: 00/17:54:18 to 00/17:55:44

Plot file version 162 created 24-OCT-2012 20:59:40

J1825-0737 EY017B.UVDATA.1

Freq = 4.9270 GHz, Bw = 16.000 MH No calibration applied and no bandpass applied

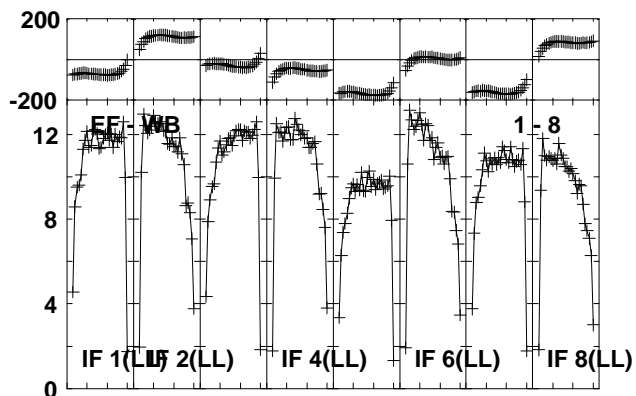
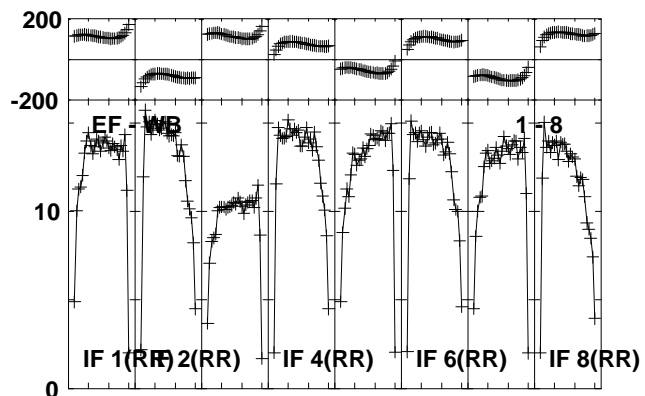
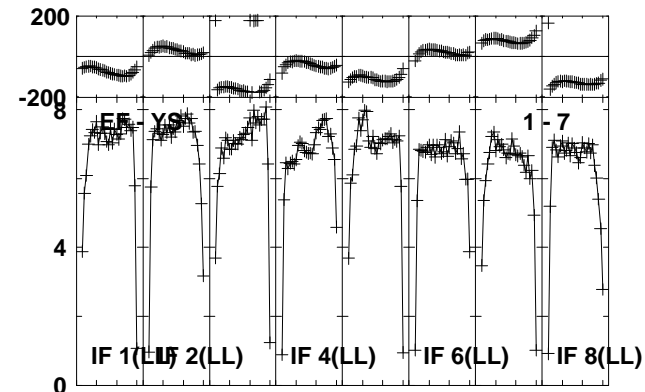
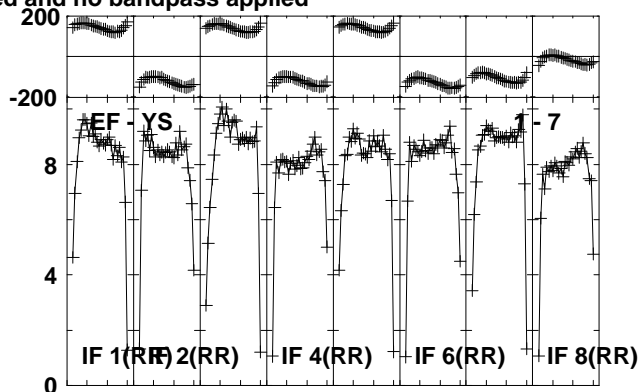
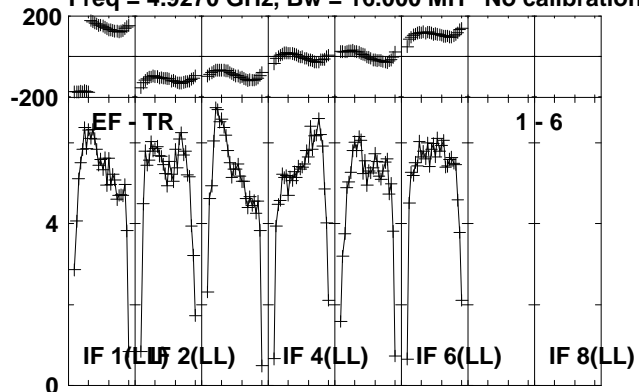

Lower frame: Milli Ampl Jy Top frame: Phas deg  
Vector averaged cross-power spectrum Several baselines displayed  
Timerange: 00/17:54:18 to 00/17:55:44

Plot file version 163 created 24-OCT-2012 20:59:40  
 G23.6-0.03 EY017B.UVDATA.1

Freq = 4.9270 GHz, Bw = 16.000 MH No calibration applied and no bandpass applied

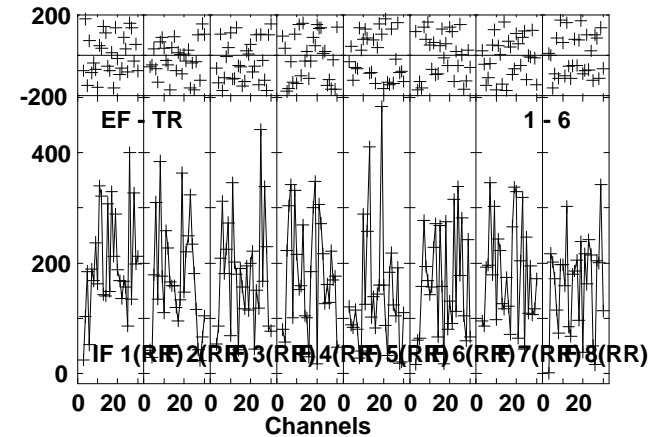
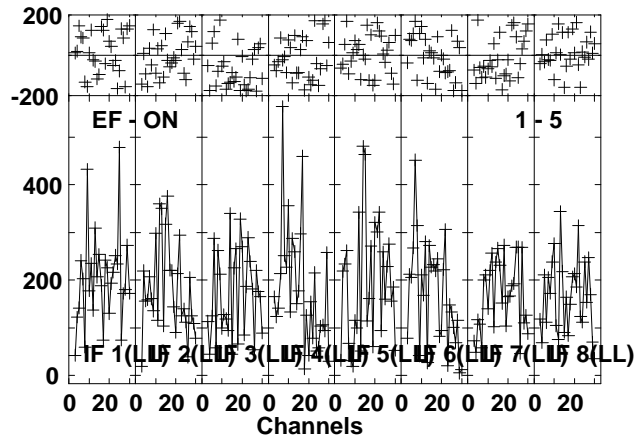
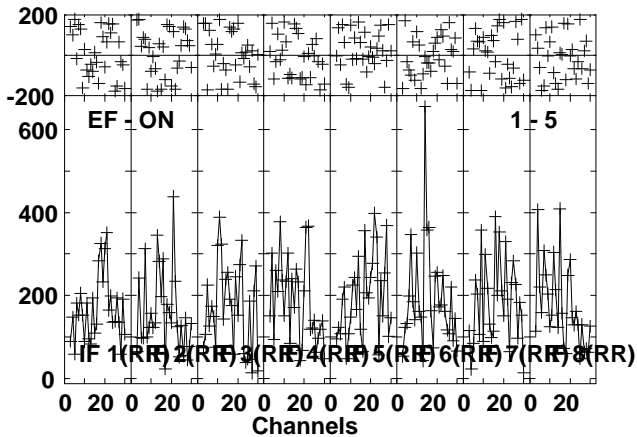
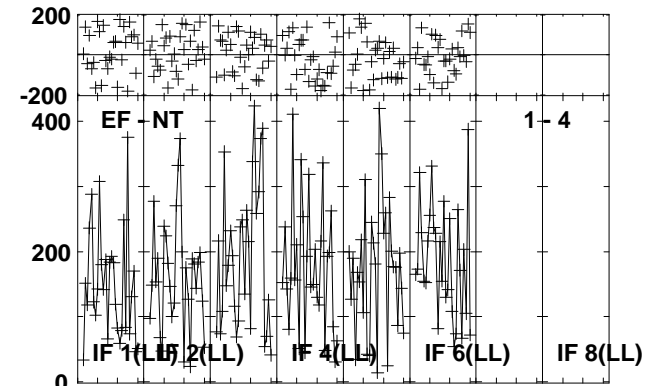
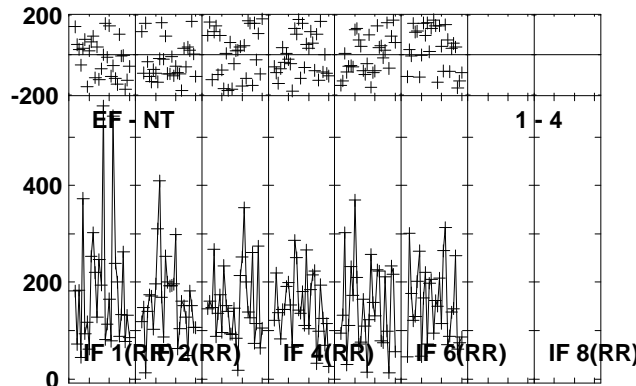
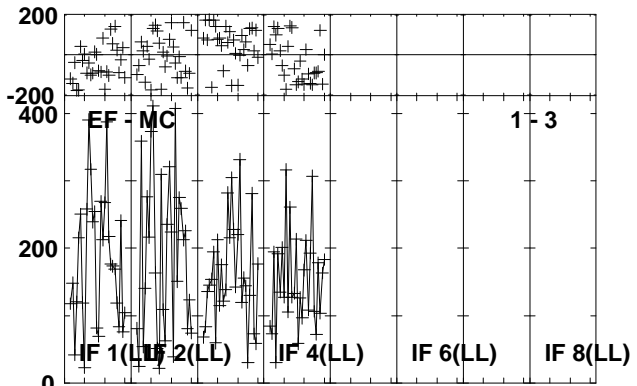
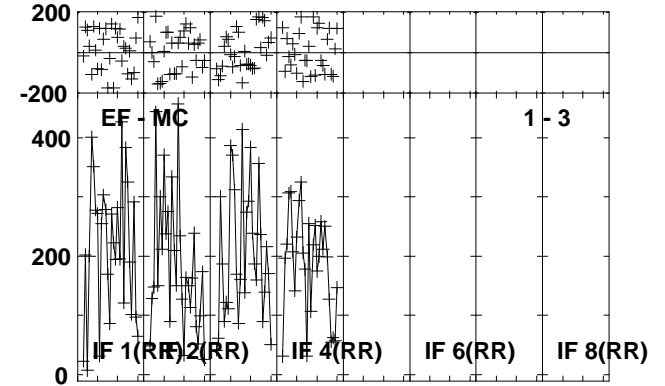
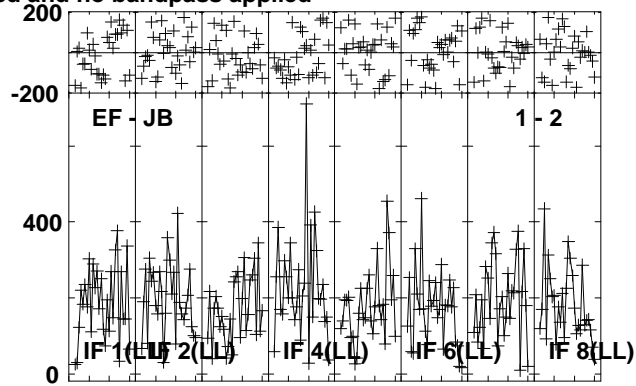
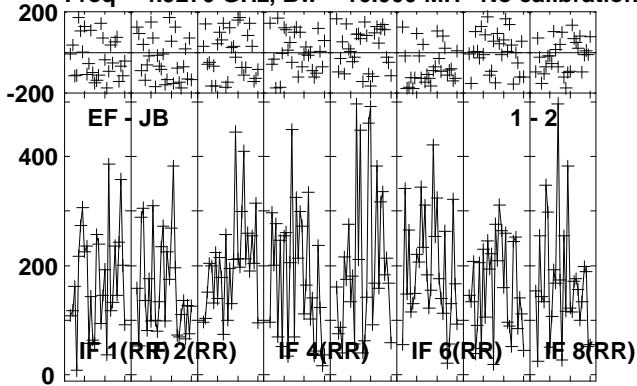

Lower frame: Micro Ampl Jy Top frame: Phas deg  
 Vector averaged cross-power spectrum Several baselines displayed  
 Timerange: 00/17:55:48 to 00/17:58:14

Plot file version 164 created 24-OCT-2012 20:59:41

G23.6-0.03 EY017B.UVDATA.1

Freq = 4.9270 GHz, Bw = 16.000 MH No calibration applied and no bandpass applied

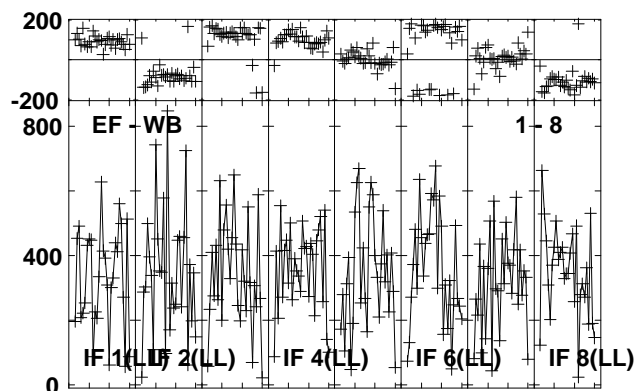
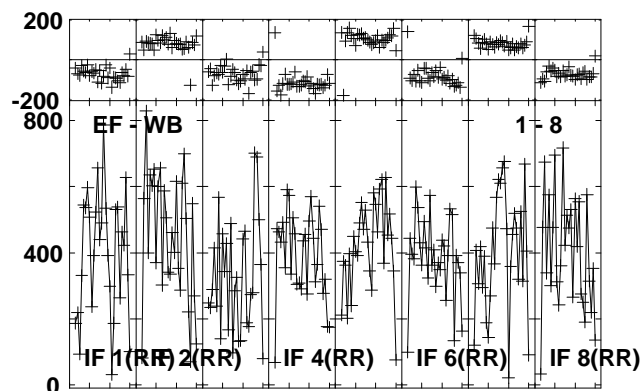
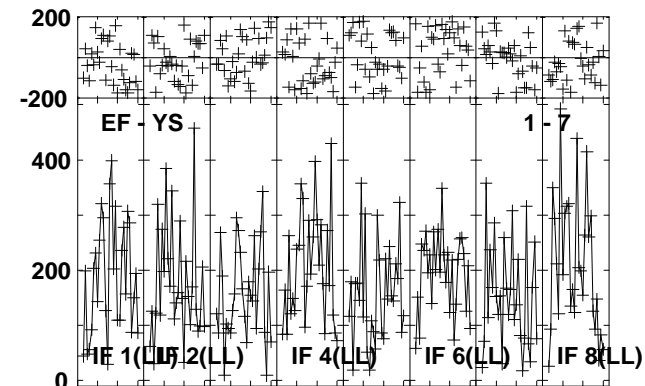
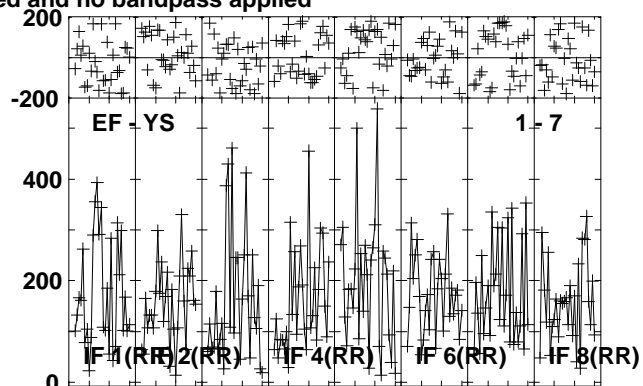
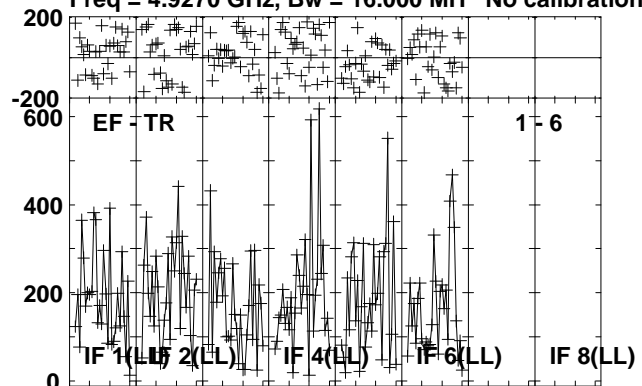

Lower frame: Micro Ampl Jy Top frame: Phas deg  
Vector averaged cross-power spectrum Several baselines displayed  
Timerange: 00/17:55:48 to 00/17:58:14



Plot file version 165 created 24-OCT-2012 20:59:41

J1825-0737 EY017B.UVDATA.1

Freq = 4.9270 GHz, Bw = 16.000 MH No calibration applied and no bandpass applied

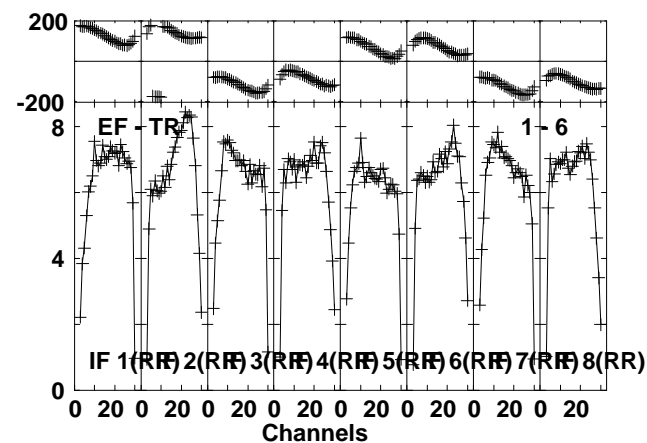
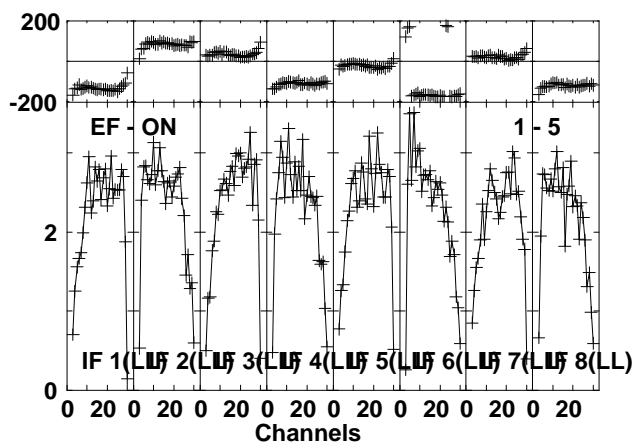
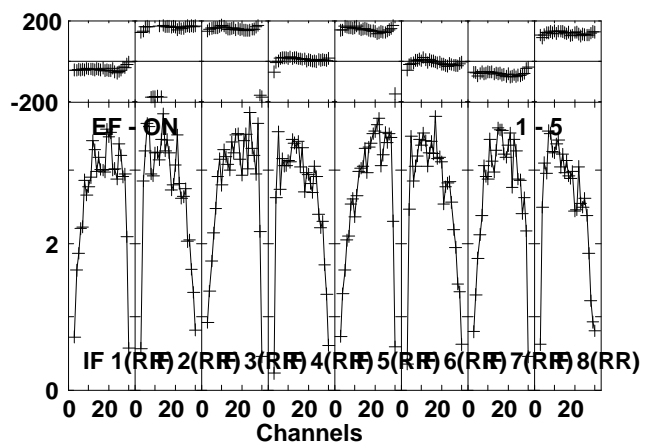
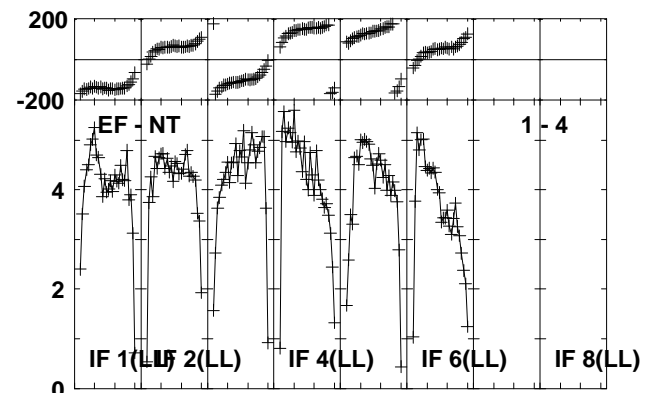
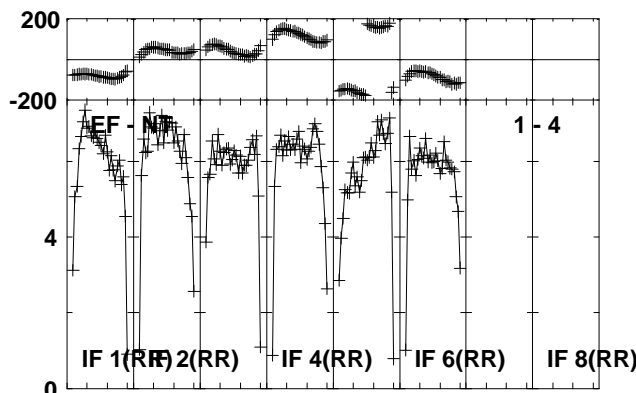
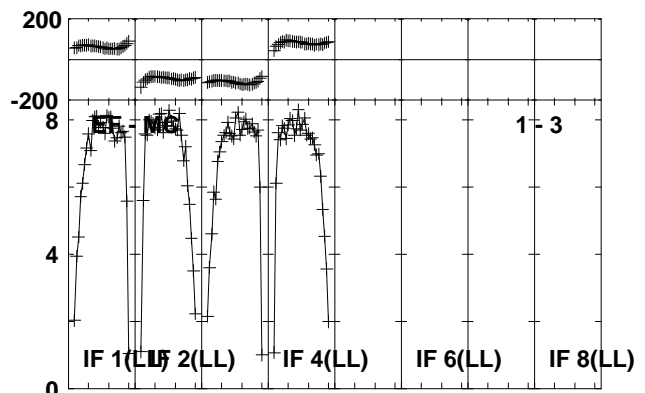
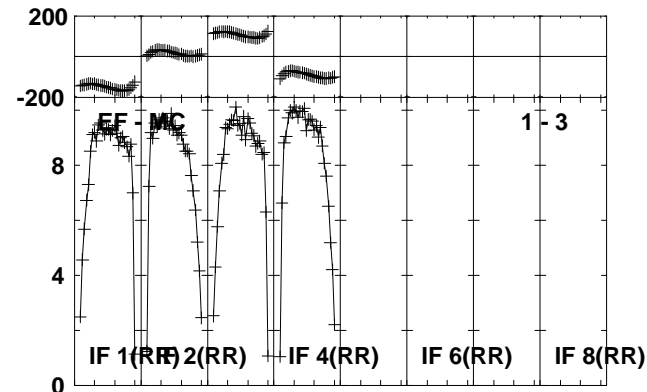
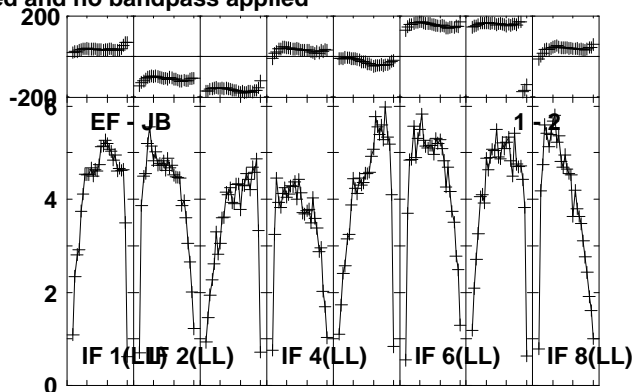
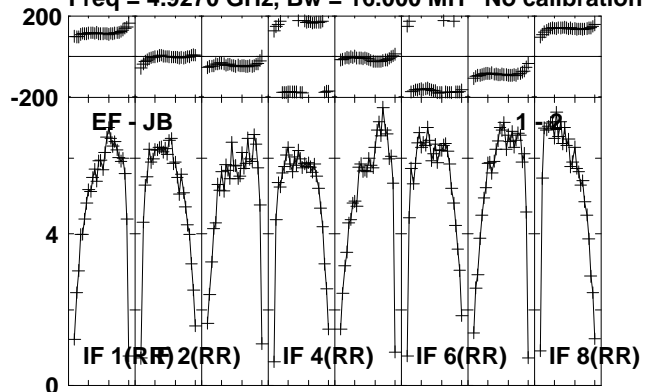

Lower frame: Milli Ampl Jy Top frame: Phas deg  
Vector averaged cross-power spectrum Several baselines displayed  
Timerange: 00/17:58:18 to 00/17:59:44

Plot file version 166 created 24-OCT-2012 20:59:42

J1825-0737 EY017B.UVDATA.1

Freq = 4.9270 GHz, Bw = 16.000 MH No calibration applied and no bandpass applied

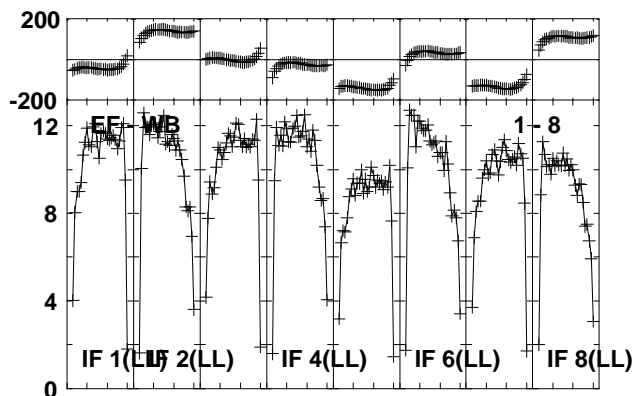
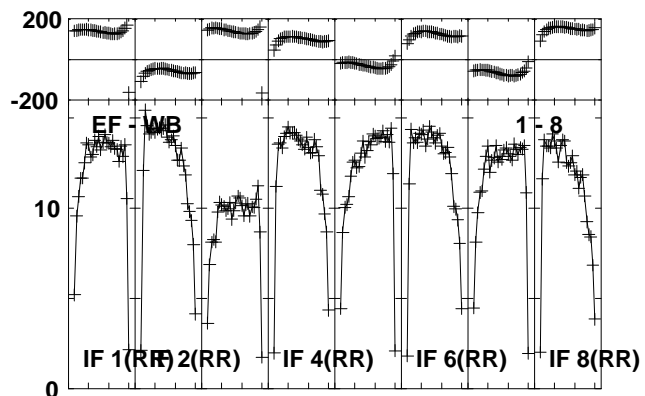
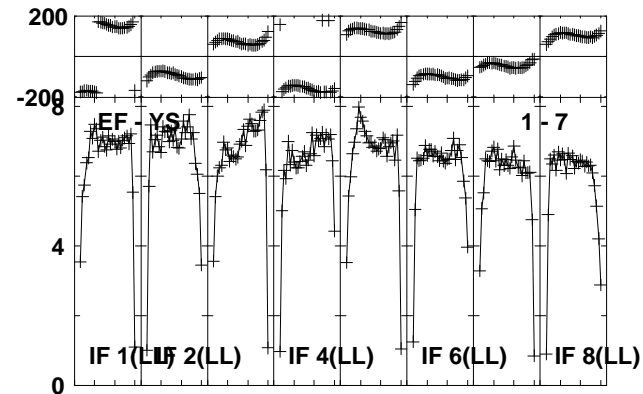
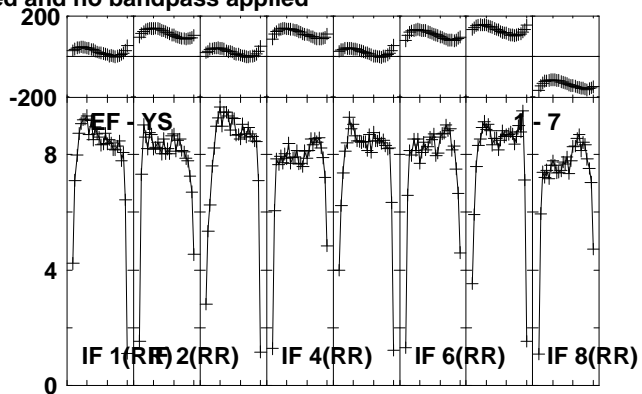
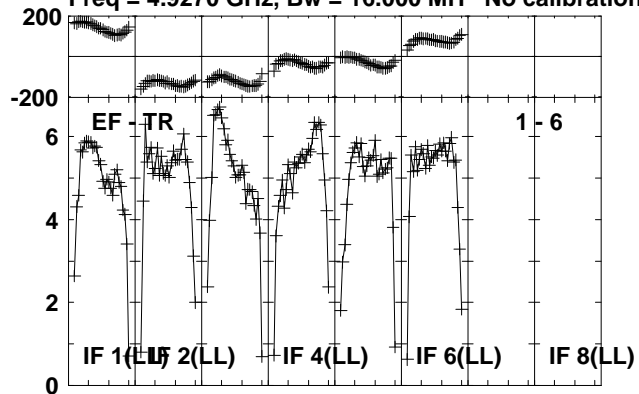

Lower frame: Milli Ampl Jy Top frame: Phas deg  
Vector averaged cross-power spectrum Several baselines displayed  
Timerange: 00/17:58:18 to 00/17:59:44

Plot file version 167 created 24-OCT-2012 20:59:42

G23.6-0.03 EY017B.UVDATA.1

Freq = 4.9270 GHz, Bw = 16.000 MH No calibration applied and no bandpass applied

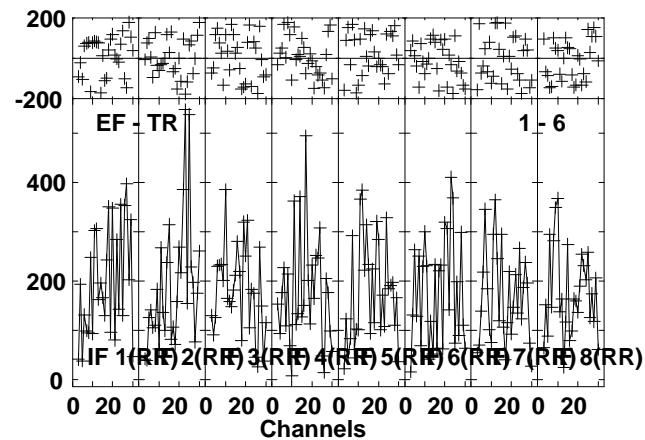
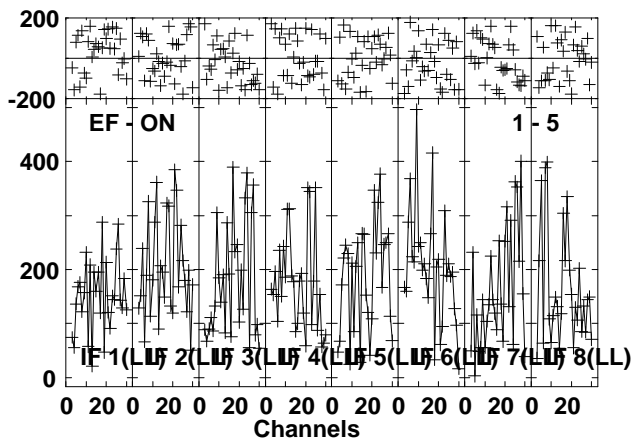
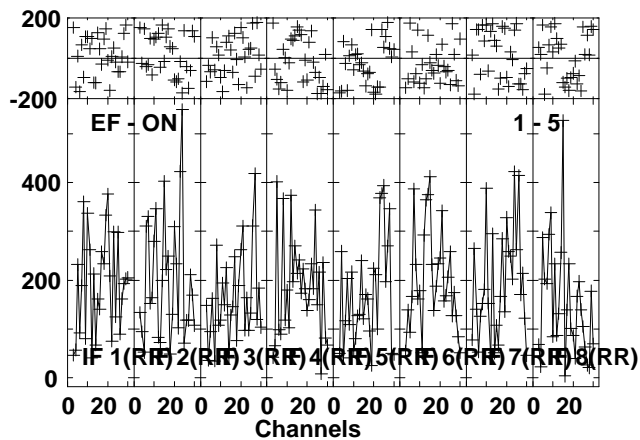
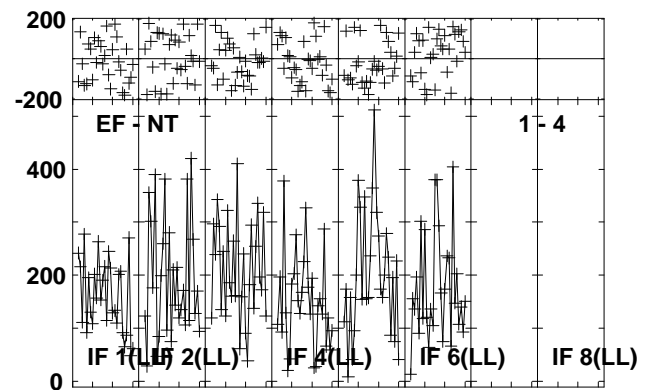
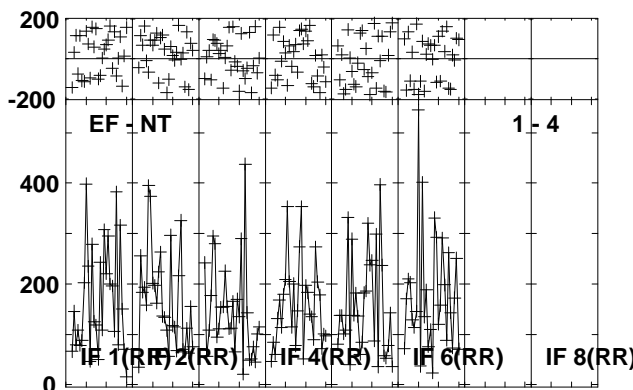
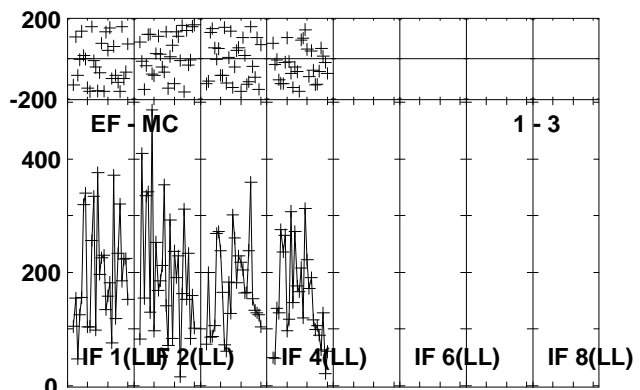
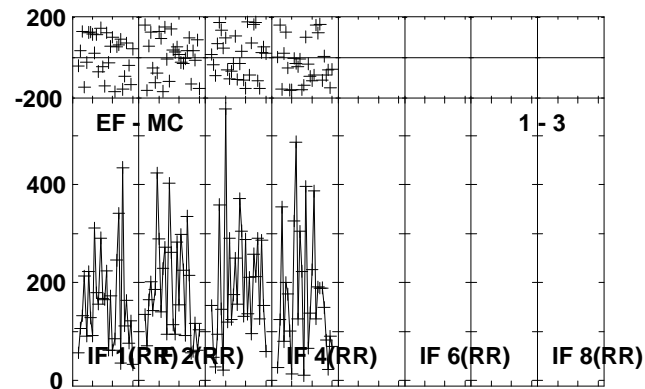
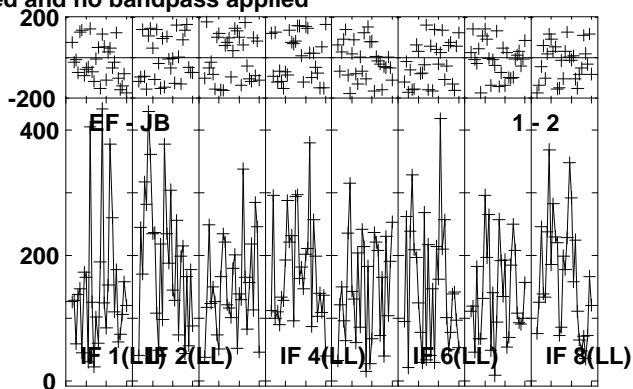
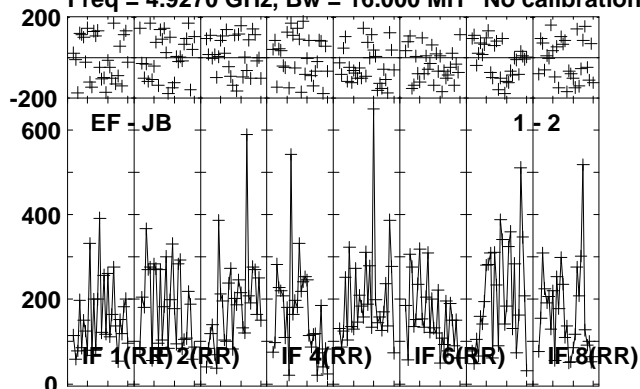

Lower frame: Micro Ampl Jy Top frame: Phas deg  
Vector averaged cross-power spectrum Several baselines displayed  
Timerange: 00/17:59:48 to 00/18:02:14

Plot file version 168 created 24-OCT-2012 20:59:43

G23.6-0.03 EY017B.UVDATA.1

Freq = 4.9270 GHz, Bw = 16.000 MH No calibration applied and no bandpass applied

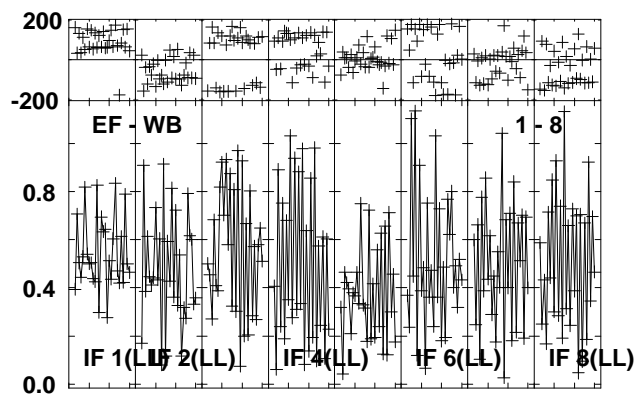
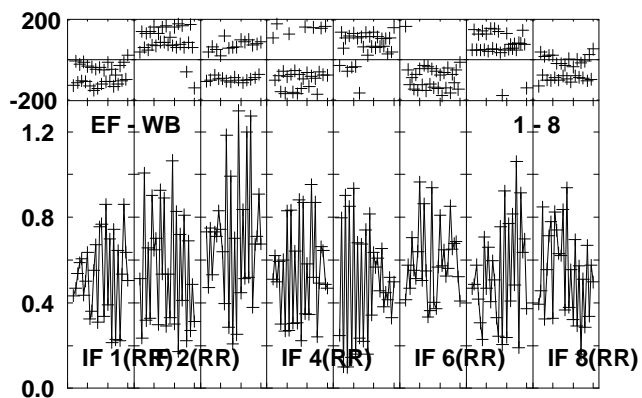
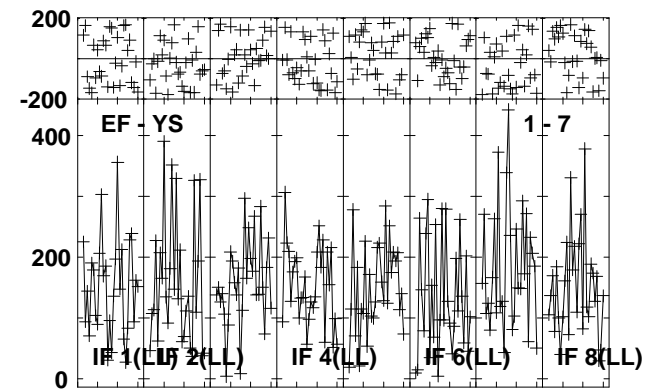
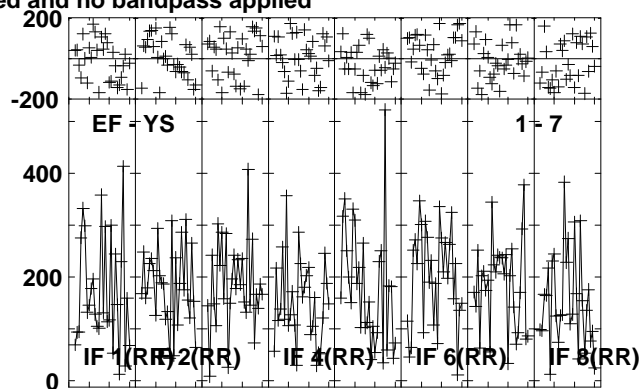
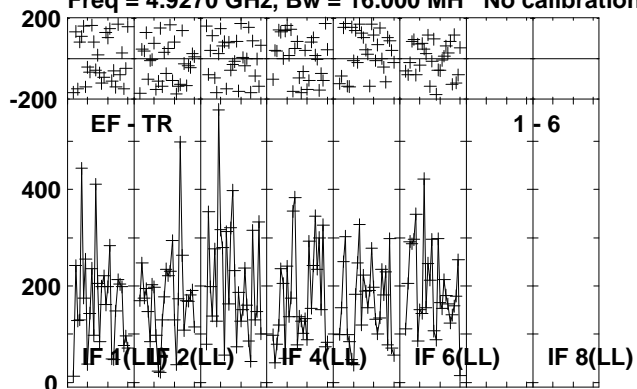

Lower frame: Micro Ampl Jy Top frame: Phas deg  
Vector averaged cross-power spectrum Several baselines displayed  
Timerange: 00:17:59:48 to 00:18:02:14

Plot file version 169 created 24-OCT-2012 20:59:43

J1825-0737 EY017B.UVDATA.1

Freq = 4.9270 GHz, Bw = 16.000 MH No calibration applied and no bandpass applied

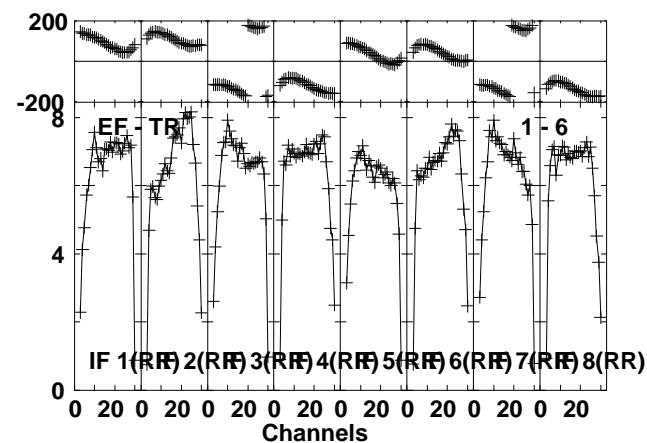
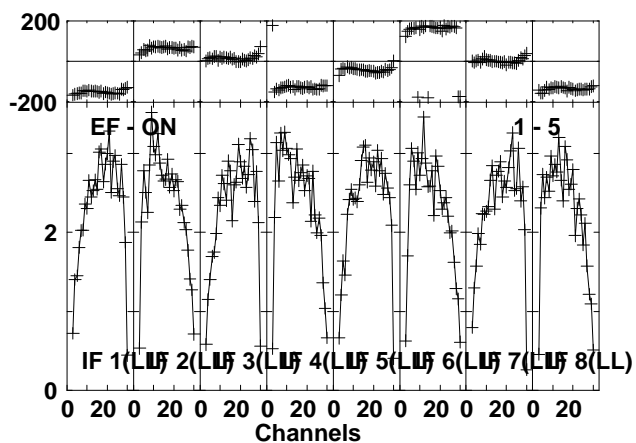
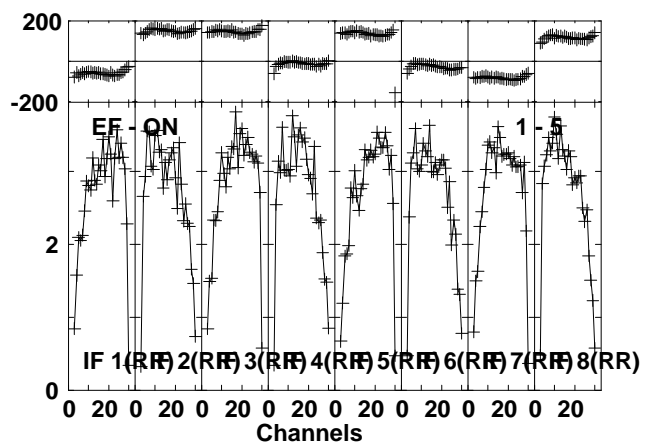
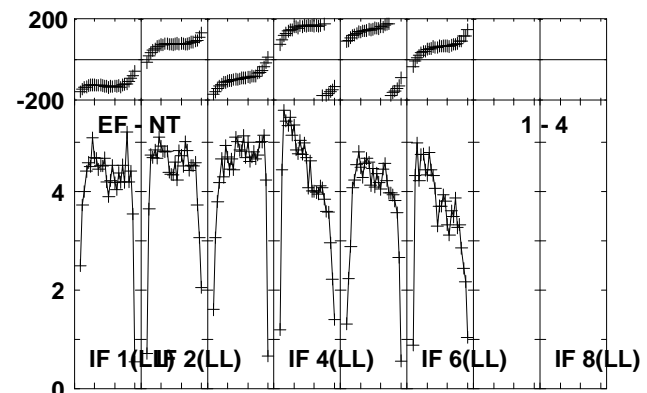
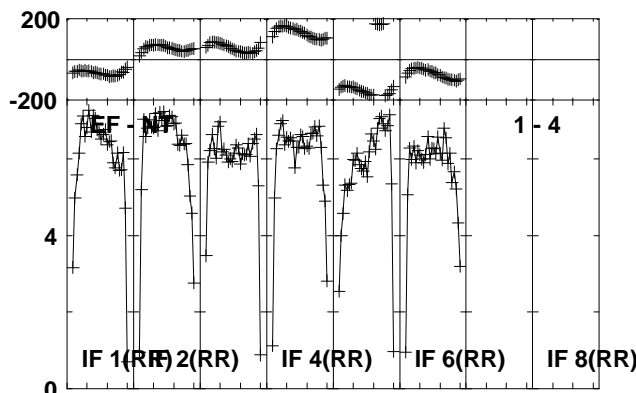
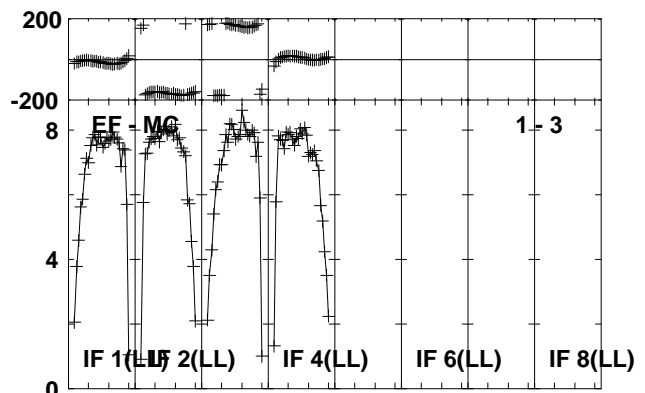
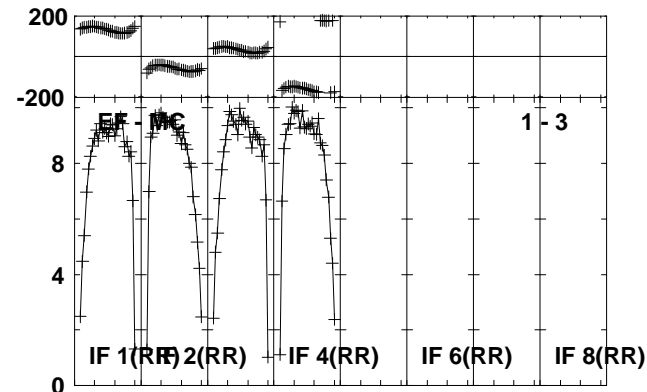
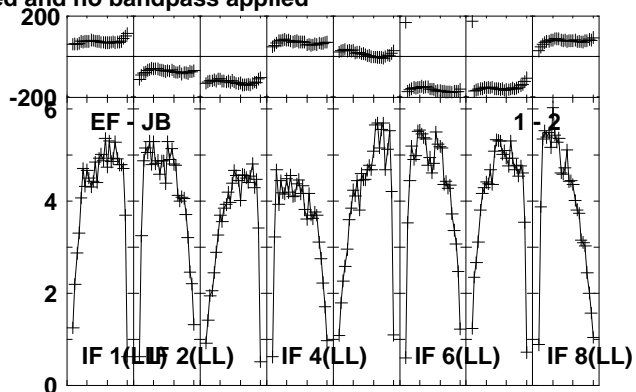
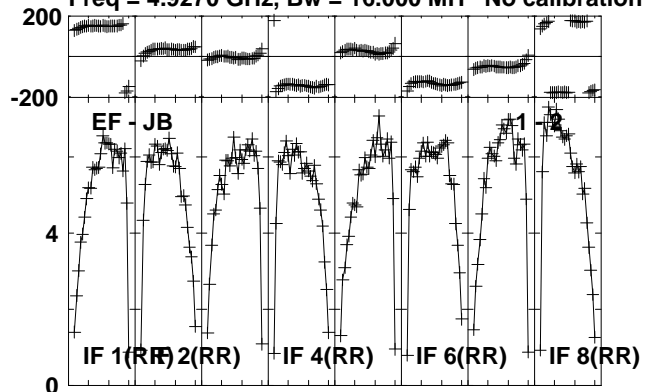

Lower frame: Milli Ampl Jy Top frame: Phas deg  
Vector averaged cross-power spectrum Several baselines displayed  
Timerange: 00/18:02:18 to 00/18:03:44

Plot file version 170 created 24-OCT-2012 20:59:44

J1825-0737 EY017B.UVDATA.1

Freq = 4.9270 GHz, Bw = 16.000 MH No calibration applied and no bandpass applied

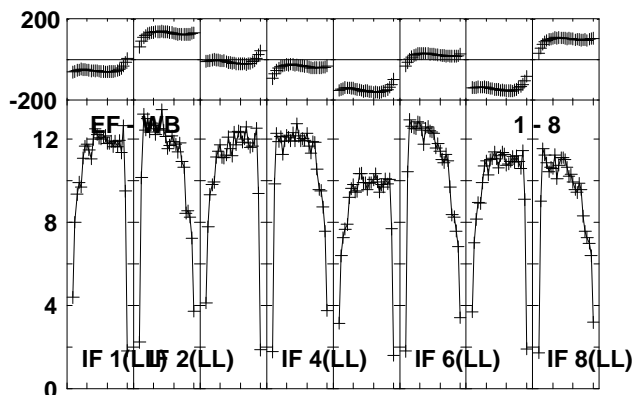
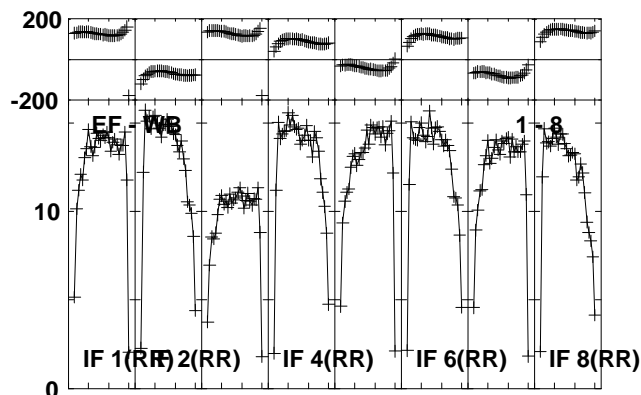
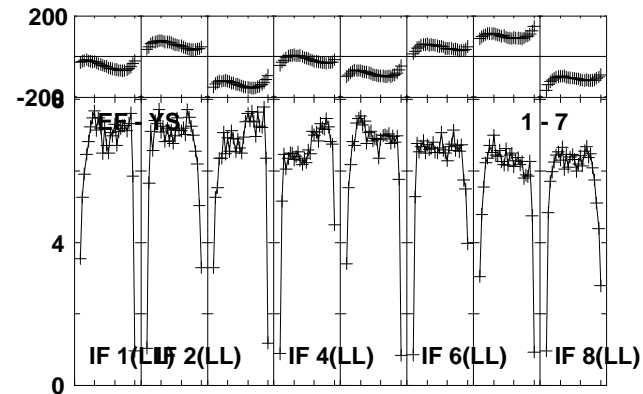
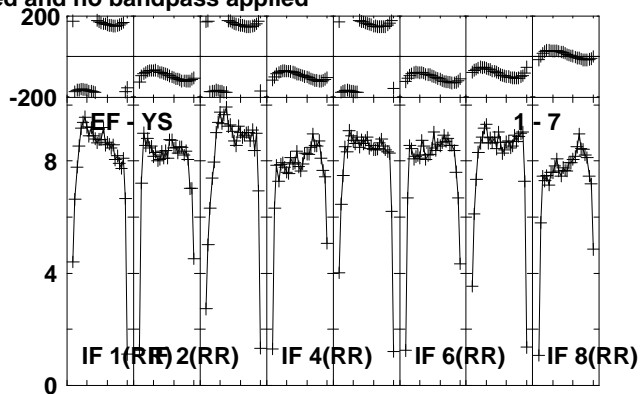
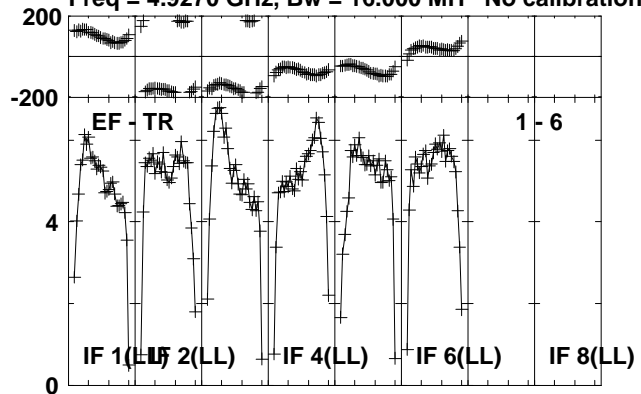

Lower frame: Milli Ampl Jy Top frame: Phas deg  
Vector averaged cross-power spectrum Several baselines displayed  
Timerange: 00/18:02:18 to 00/18:03:44

Plot file version 171 created 24-OCT-2012 20:59:44  
 G23.6-0.03 EY017B.UVDATA.1

Freq = 4.9270 GHz, Bw = 16.000 MH No calibration applied and no bandpass applied

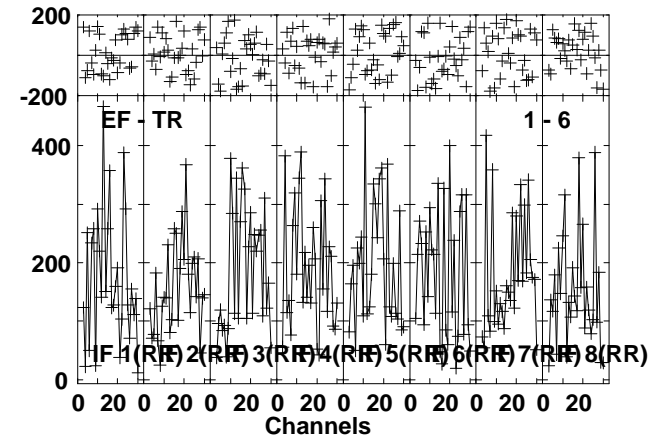
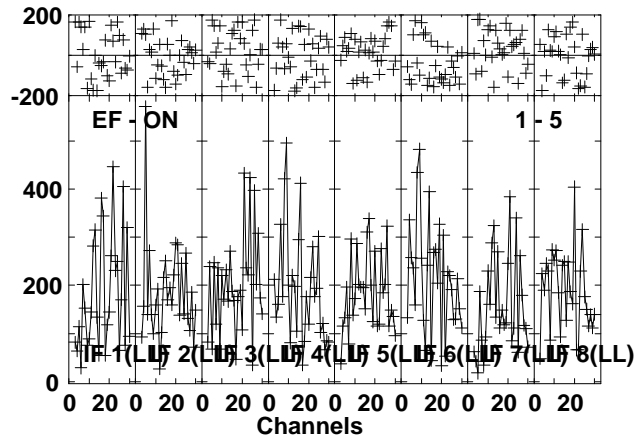
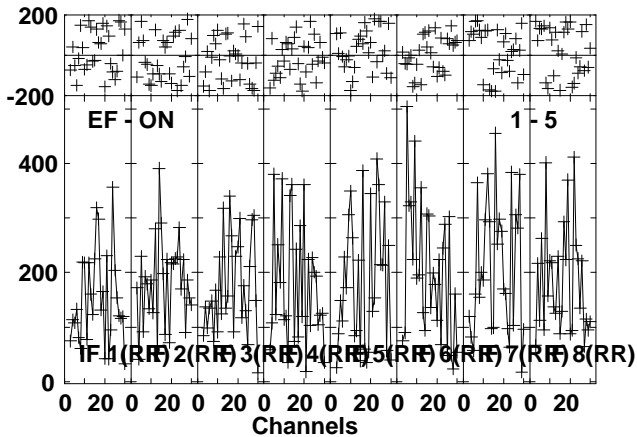
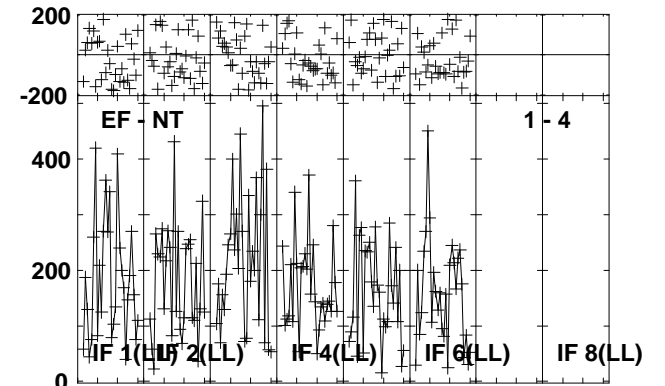
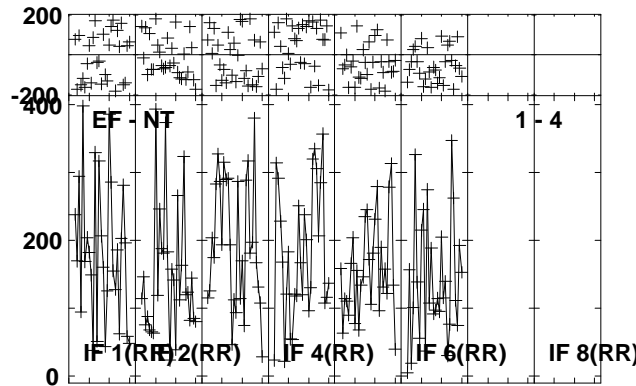
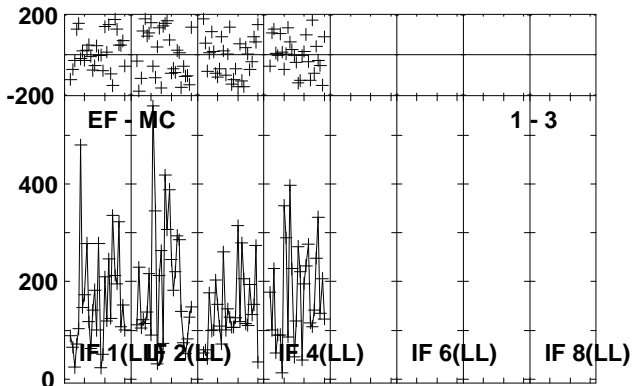
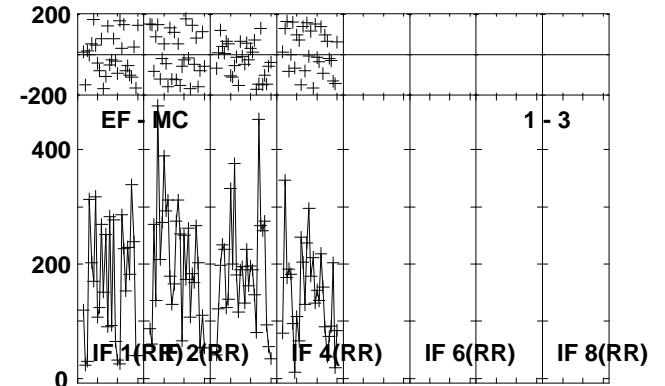
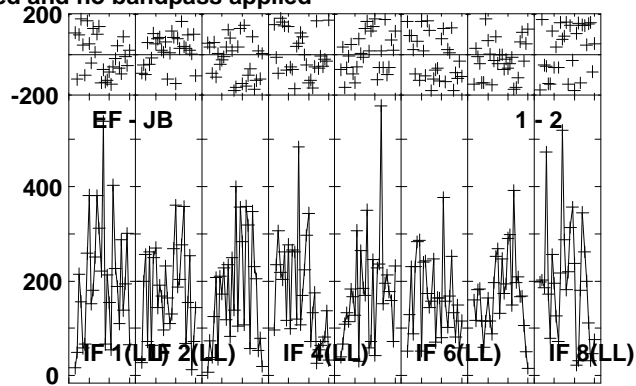
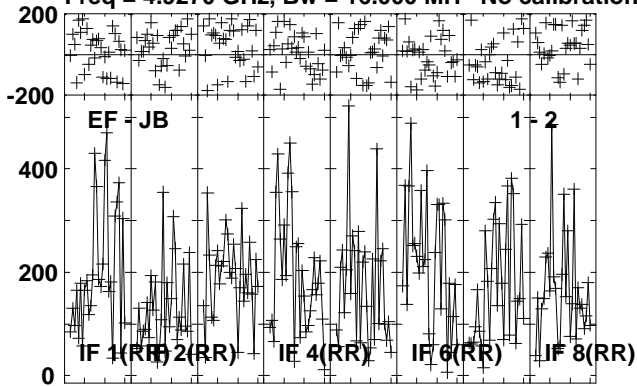

Lower frame: Micro Ampl Jy Top frame: Phas deg  
 Vector averaged cross-power spectrum Several baselines displayed  
 Timerange: 00:18:03:48 to 00:18:06:14

Plot file version 172 created 24-OCT-2012 20:59:45

G23.6-0.03 EY017B.UVDATA.1

Freq = 4.9270 GHz, Bw = 16.000 MH No calibration applied and no bandpass applied

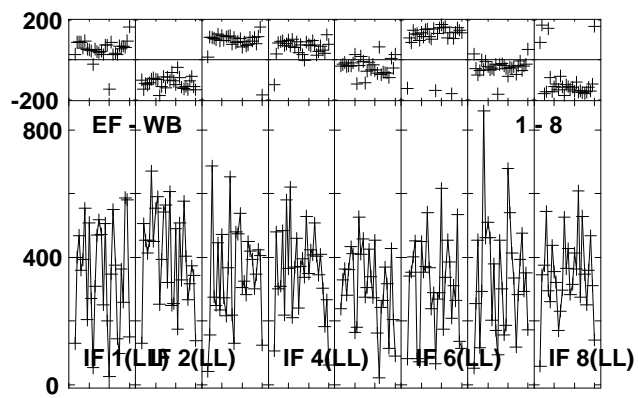
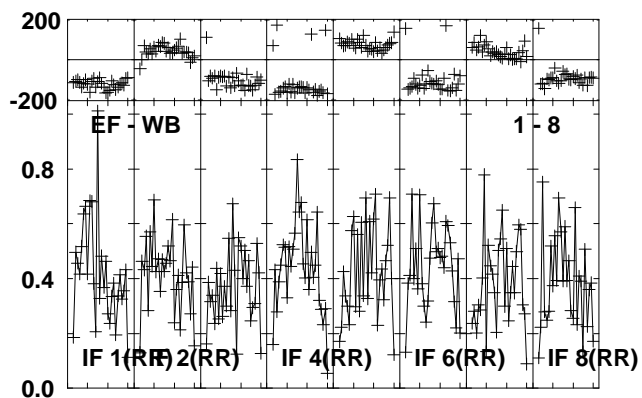
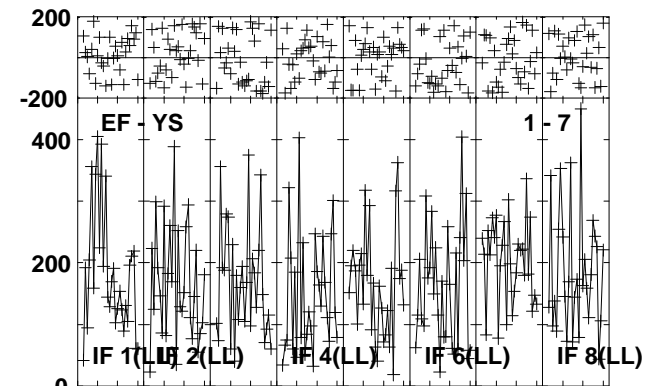
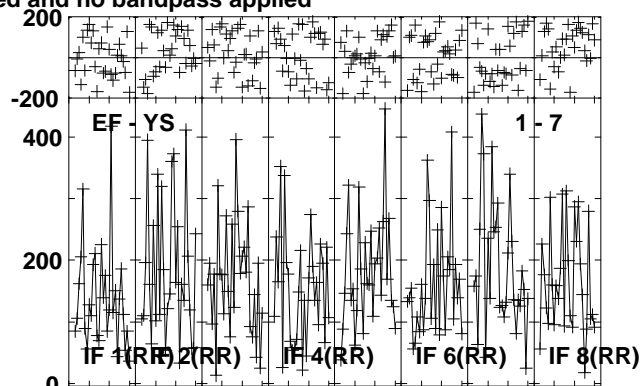
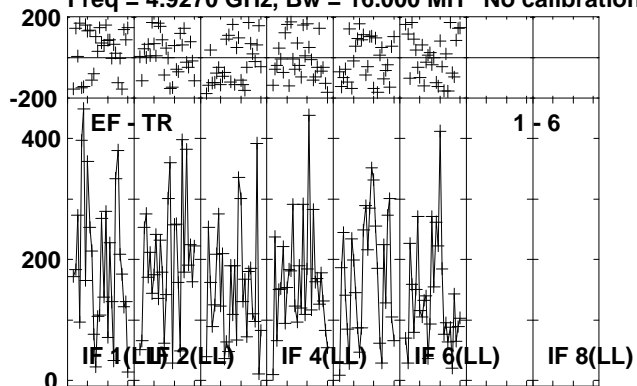

Lower frame: Micro Ampl Jy Top frame: Phas deg  
Vector averaged cross-power spectrum Several baselines displayed  
Timerange: 00:18:03:48 to 00:18:06:14



Plot file version 173 created 24-OCT-2012 20:59:46

J1825-0737 EY017B.UVDATA.1

Freq = 4.9270 GHz, Bw = 16.000 MH No calibration applied and no bandpass applied

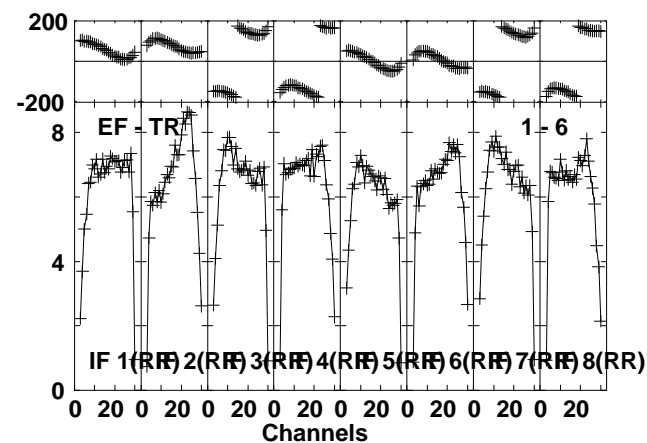
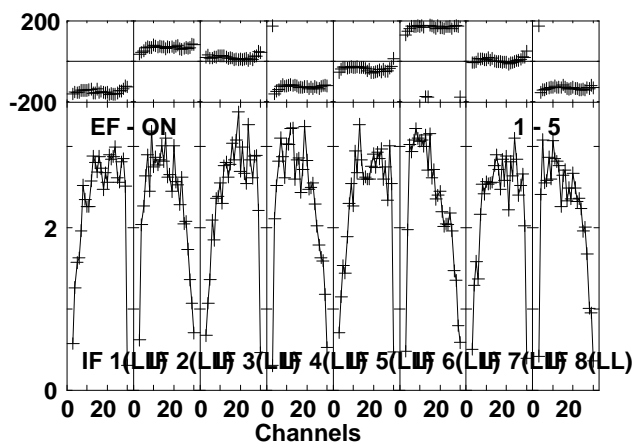
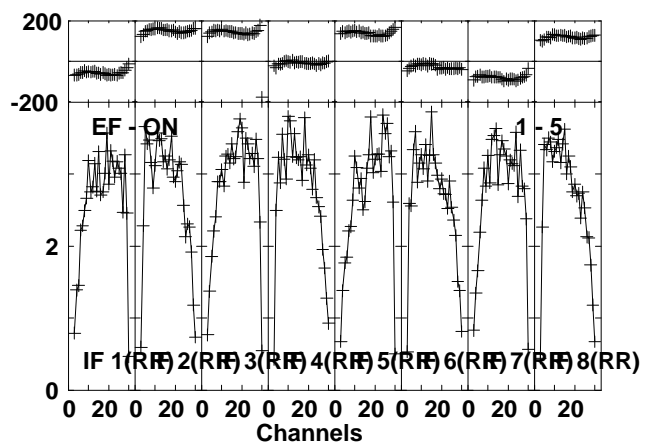
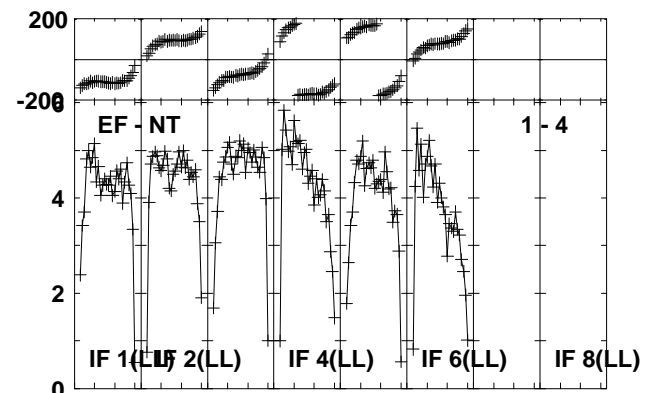
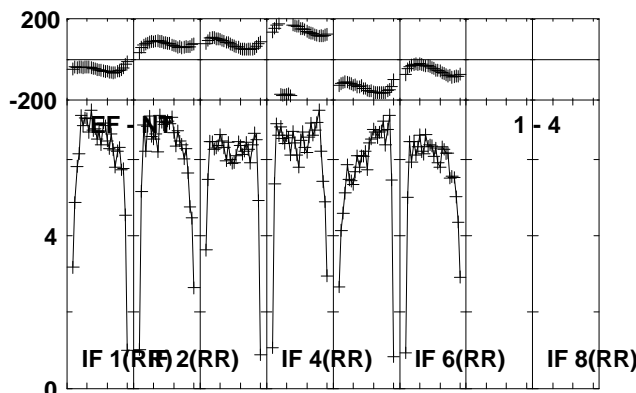
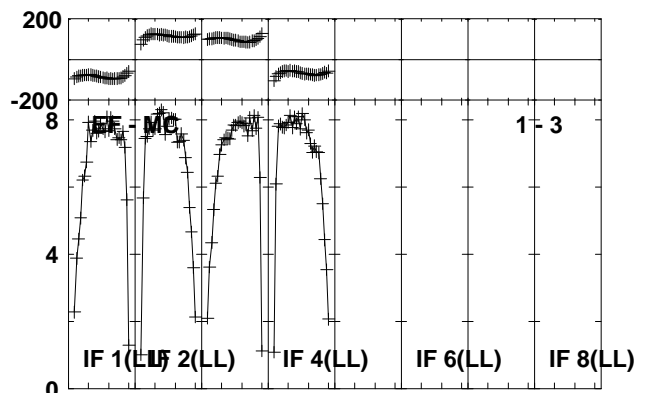
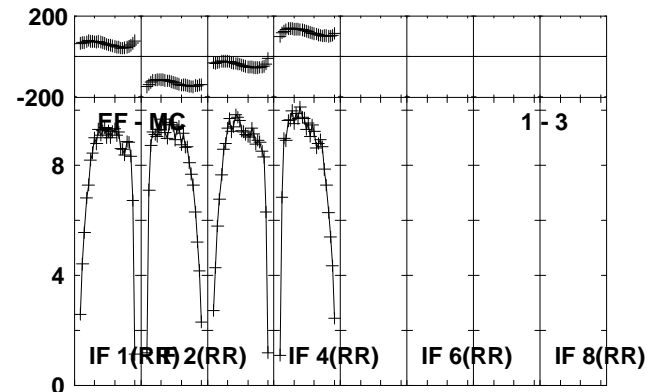
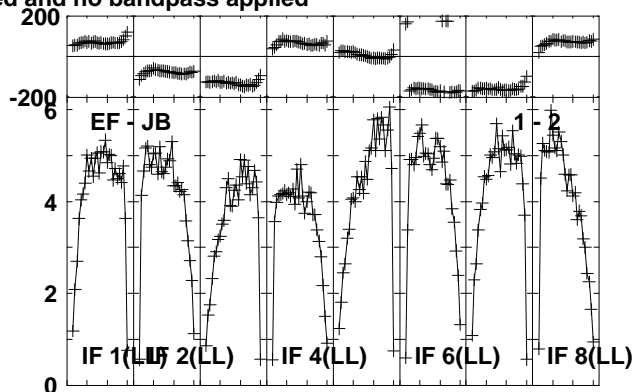
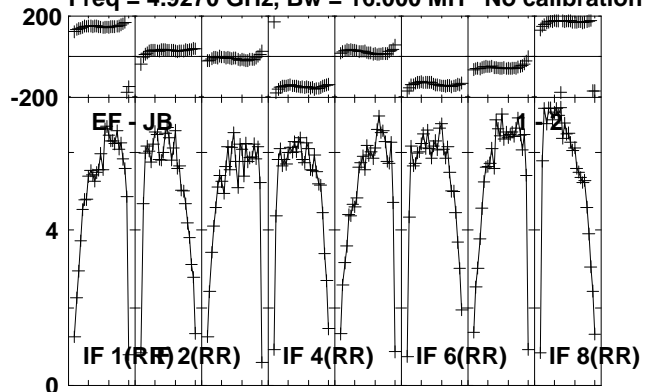

Lower frame: Milli Ampl Jy Top frame: Phas deg  
Vector averaged cross-power spectrum Several baselines displayed  
Timerange: 00/18:06:18 to 00/18:07:44

Plot file version 174 created 24-OCT-2012 20:59:46

J1825-0737 EY017B.UVDATA.1

Freq = 4.9270 GHz, Bw = 16.000 MH No calibration applied and no bandpass applied

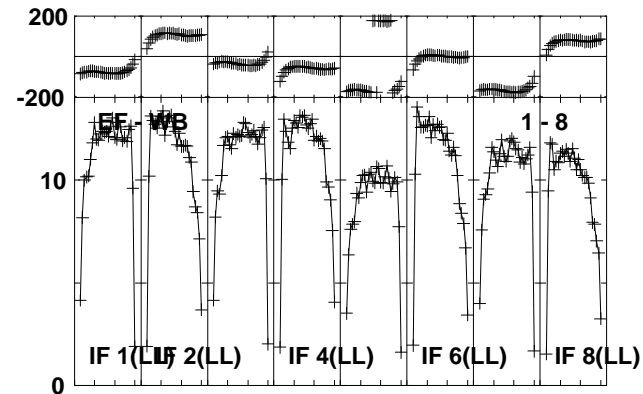
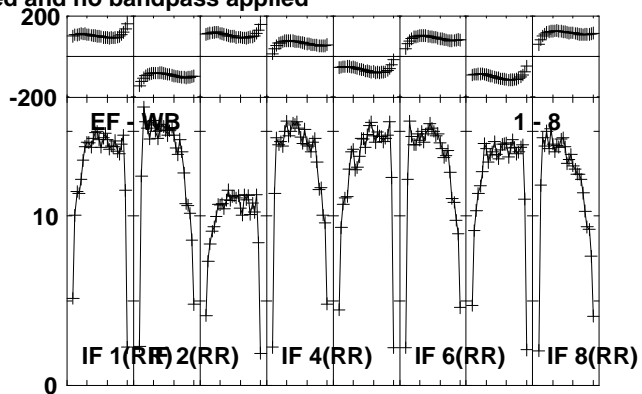
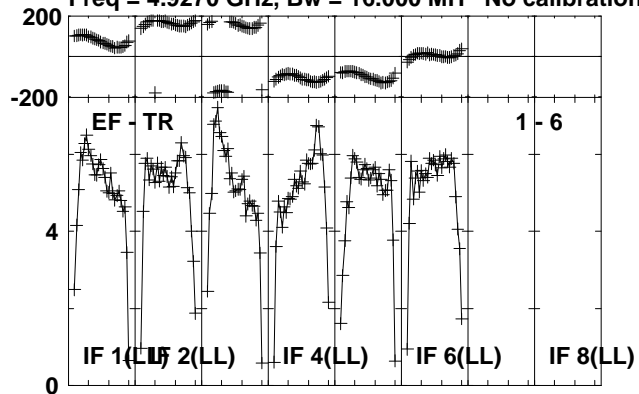

Lower frame: Milli Ampl Jy Top frame: Phas deg  
Vector averaged cross-power spectrum Several baselines displayed  
Timerange: 00/18:06:18 to 00/18:07:44

Plot file version 175 created 24-OCT-2012 20:59:46  
 J1831-0756 EY017B.UVDATA.1

Freq = 4.9270 GHz, Bw = 16.000 MH No calibration applied and no bandpass applied

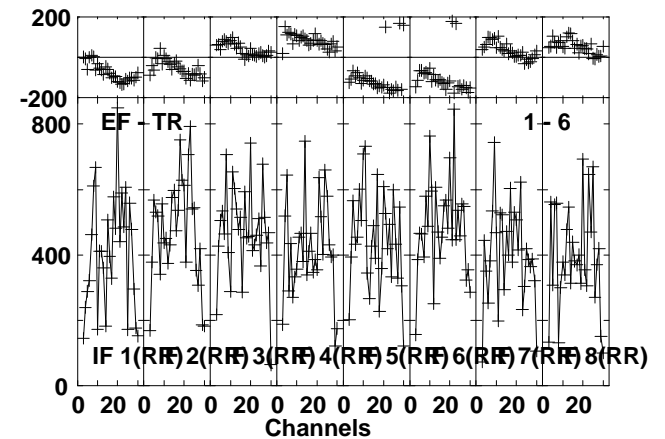
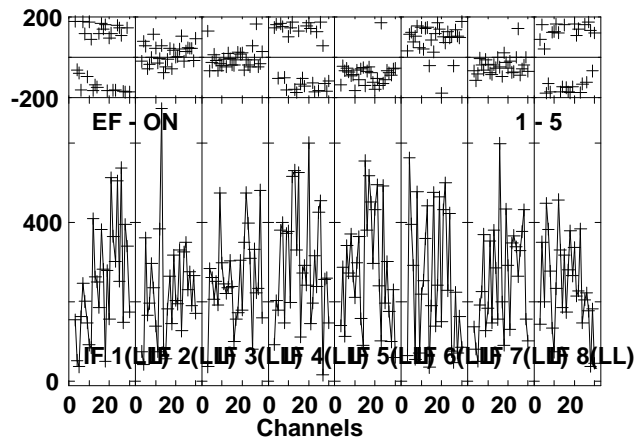
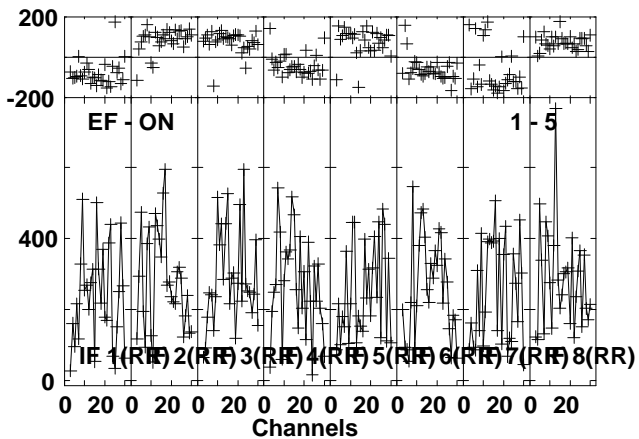
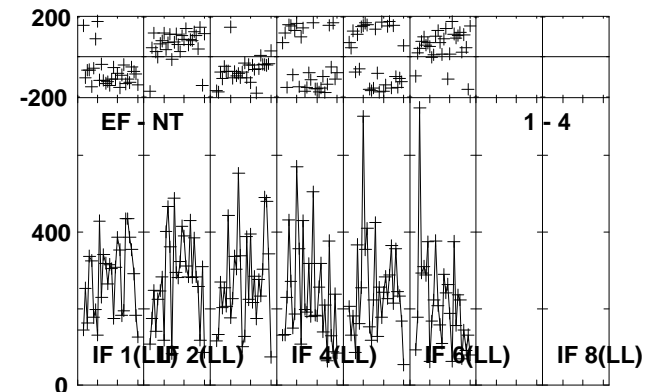
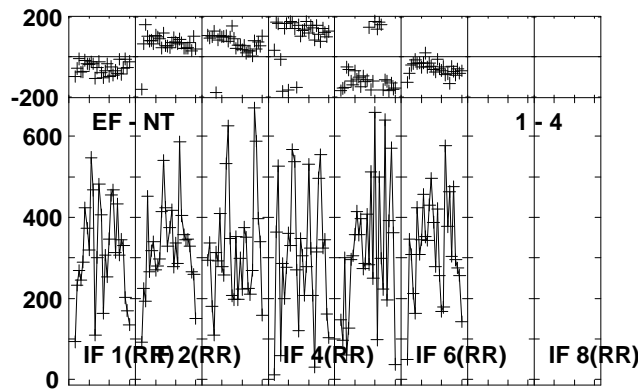
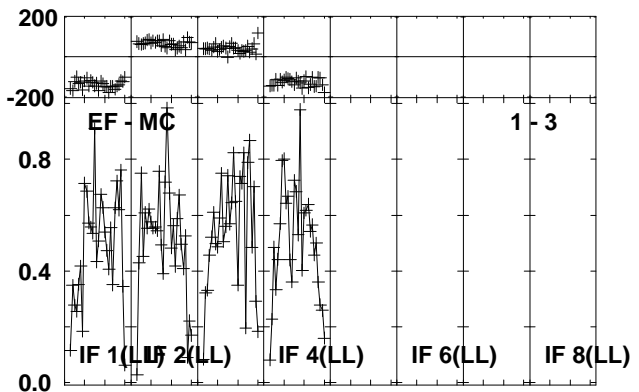
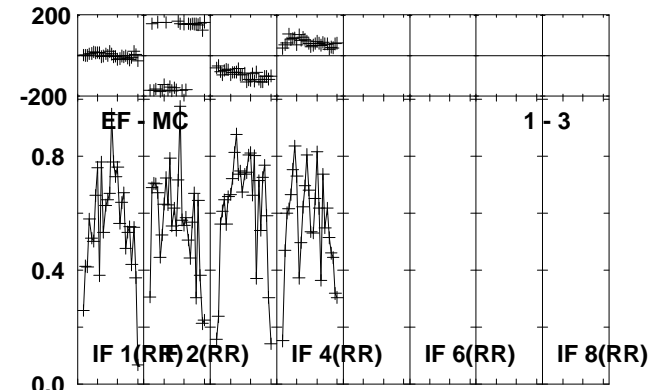
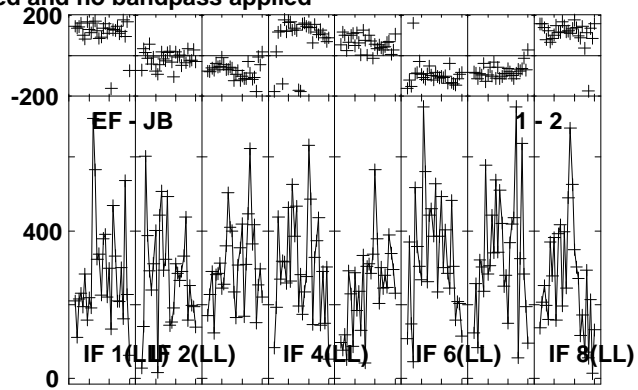
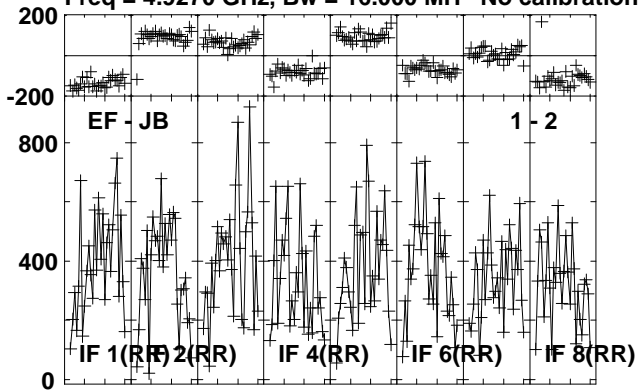

Lower frame: Micro Ampl Jy Top frame: Phas deg  
 Vector averaged cross-power spectrum Several baselines displayed  
 Timerange: 00/18:08:18 to 00/18:10:18

Plot file version 176 created 24-OCT-2012 20:59:47

J1831-0756 EY017B.UVDATA.1

Freq = 4.9270 GHz, Bw = 16.000 MH No calibration applied and no bandpass applied

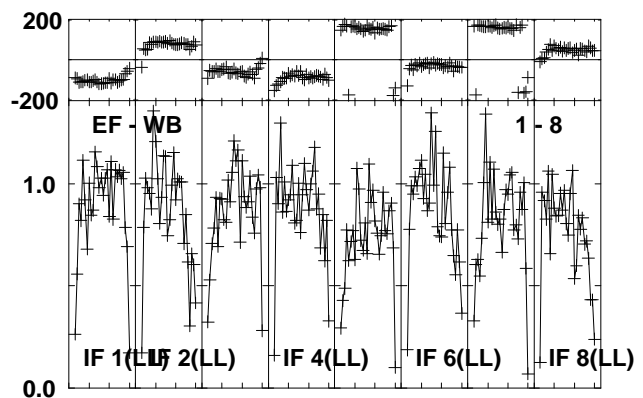
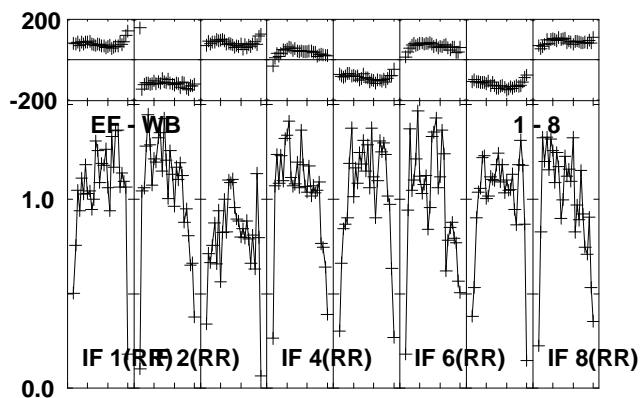
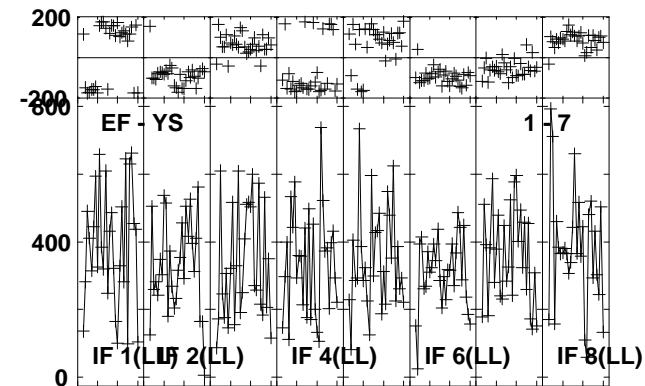
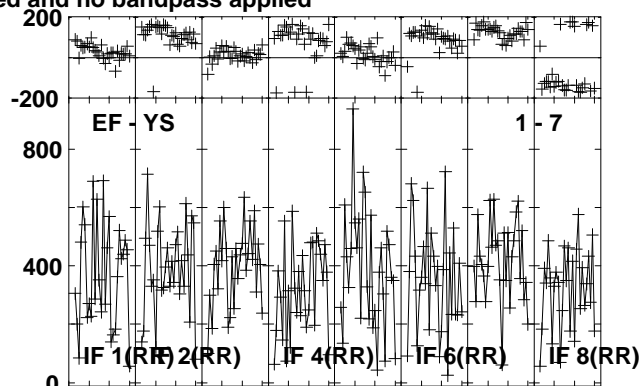
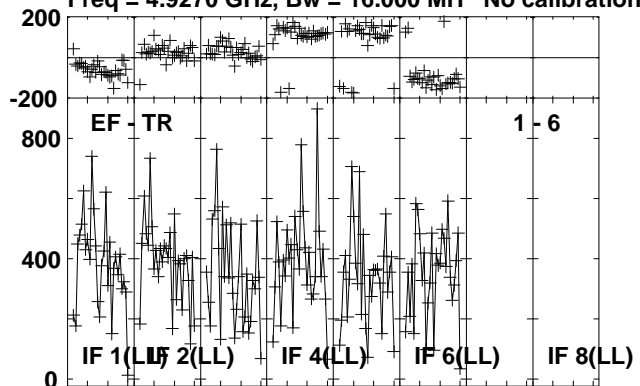

Lower frame: Micro Ampl Jy Top frame: Phas deg  
Vector averaged cross-power spectrum Several baselines displayed  
Timerange: 00:18:08:18 to 00:18:10:18

Plot file version 177 created 24-OCT-2012 20:59:47

J1825-0737 EY017B.UVDATA.1

Freq = 4.9270 GHz, Bw = 16.000 MH No calibration applied and no bandpass applied

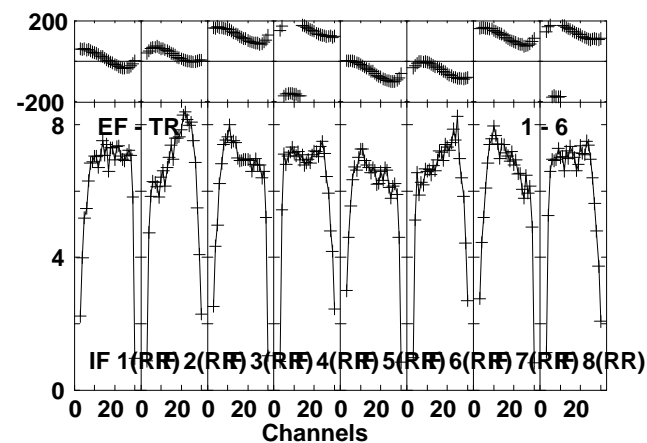
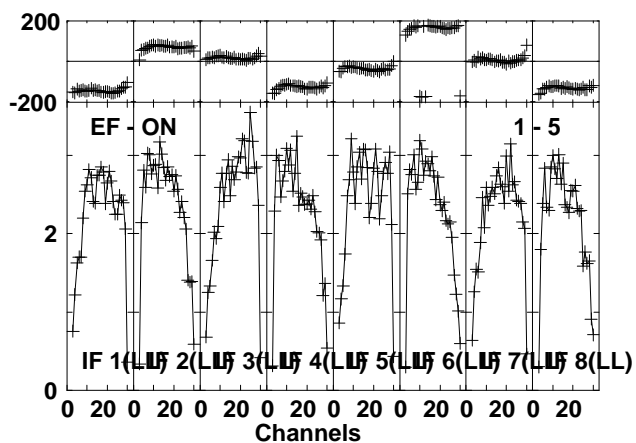
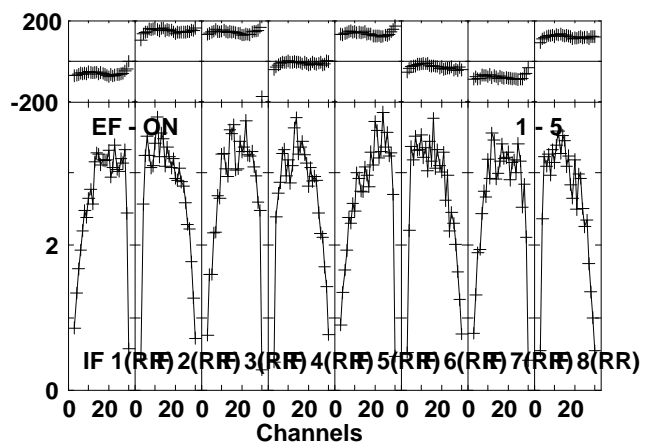
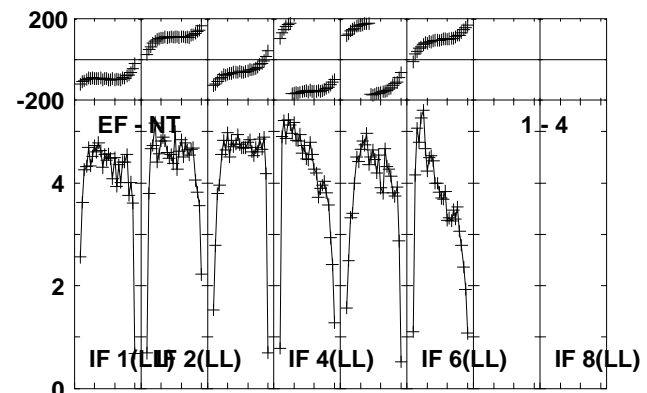
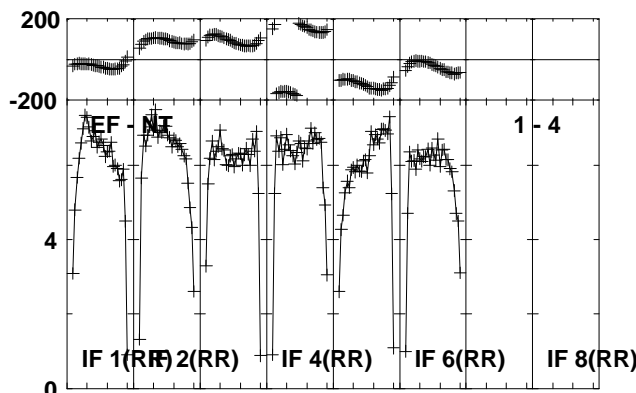
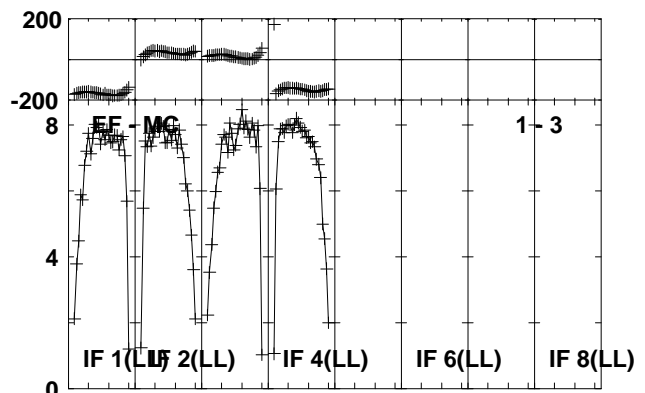
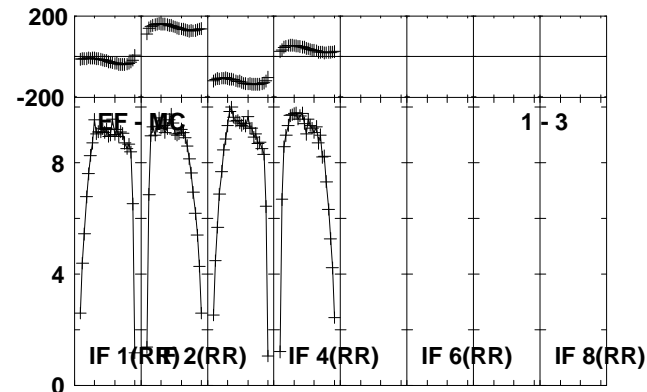
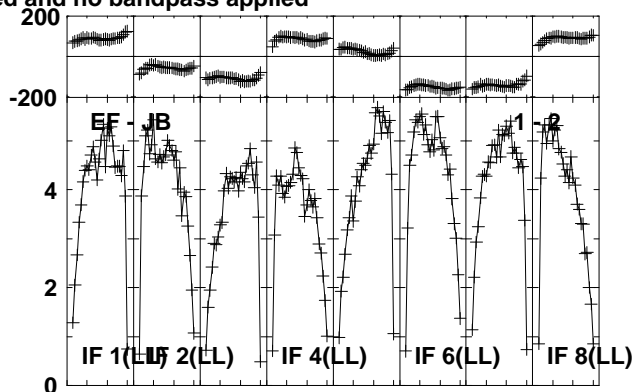
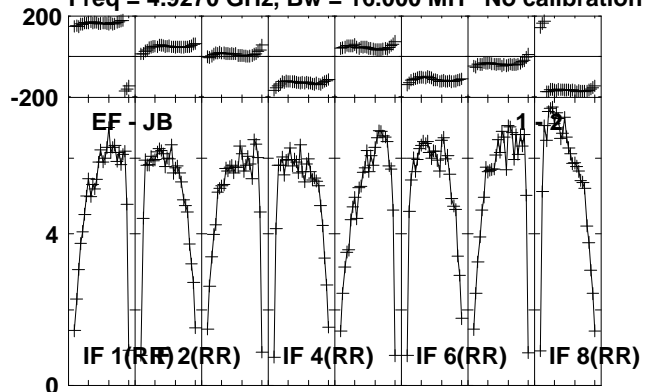

Lower frame: Milli Ampl Jy Top frame: Phas deg  
Vector averaged cross-power spectrum Several baselines displayed  
Timerange: 00/18:10:22 to 00/18:11:48

Plot file version 178 created 24-OCT-2012 20:59:48

J1825-0737 EY017B.UVDATA.1

Freq = 4.9270 GHz, Bw = 16.000 MH No calibration applied and no bandpass applied

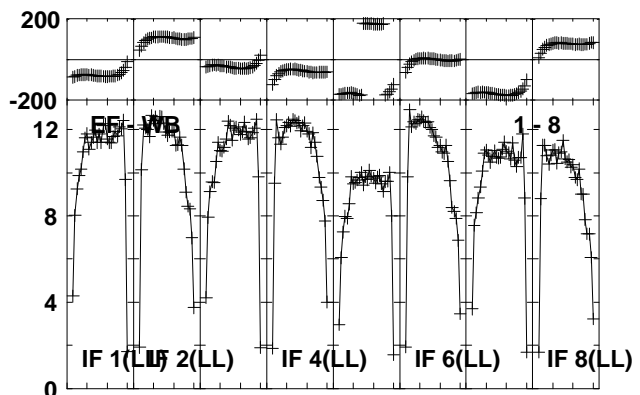
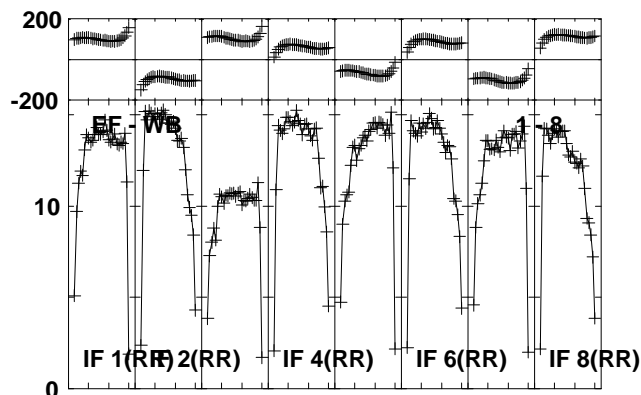
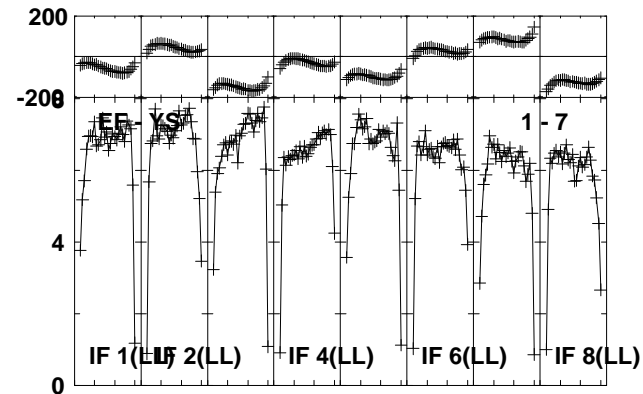
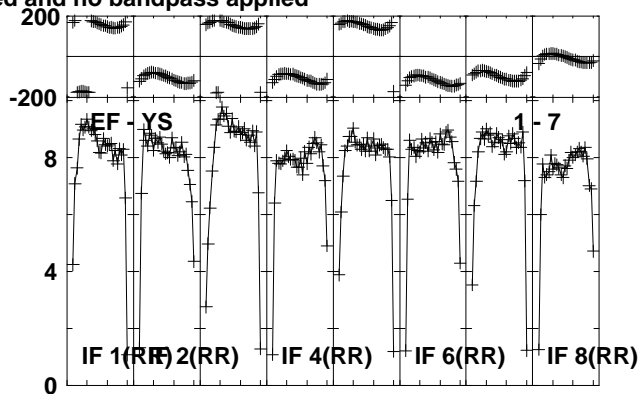
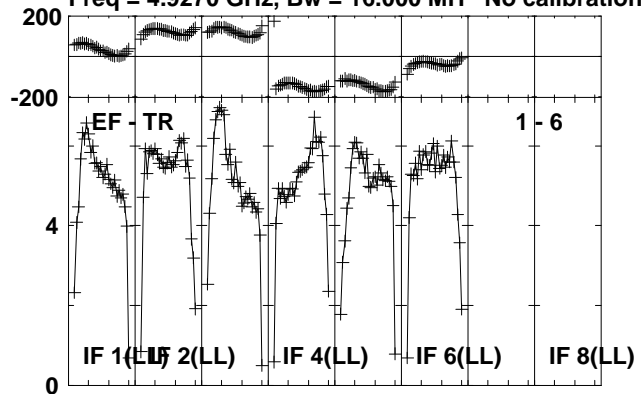

Lower frame: Milli Ampl Jy Top frame: Phas deg  
Vector averaged cross-power spectrum Several baselines displayed  
Timerange: 00:18:10:22 to 00:18:11:48

Plot file version 179 created 24-OCT-2012 20:59:48

G23.6-0.03 EY017B.UVDATA.1

Freq = 4.9270 GHz, Bw = 16.000 MH No calibration applied and no bandpass applied

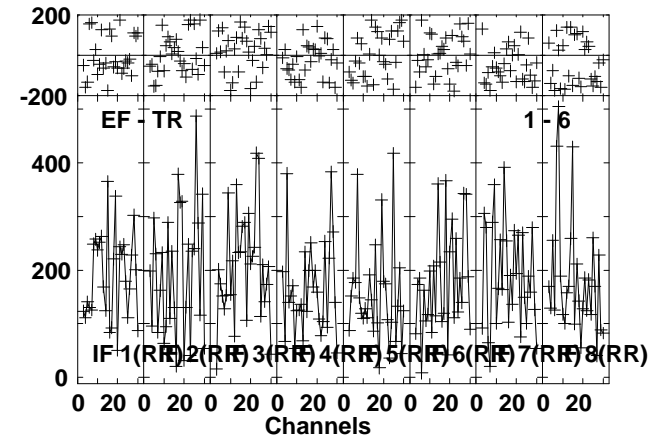
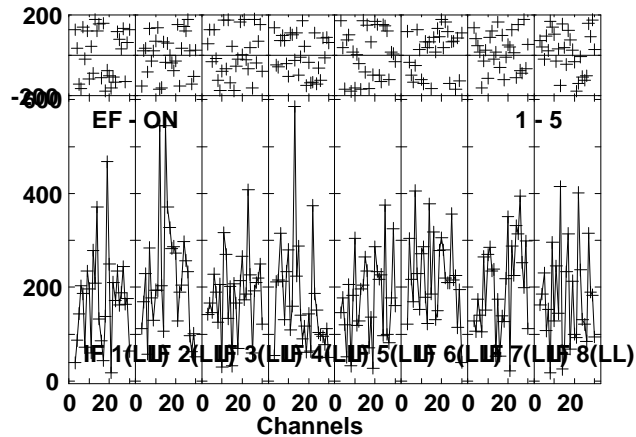
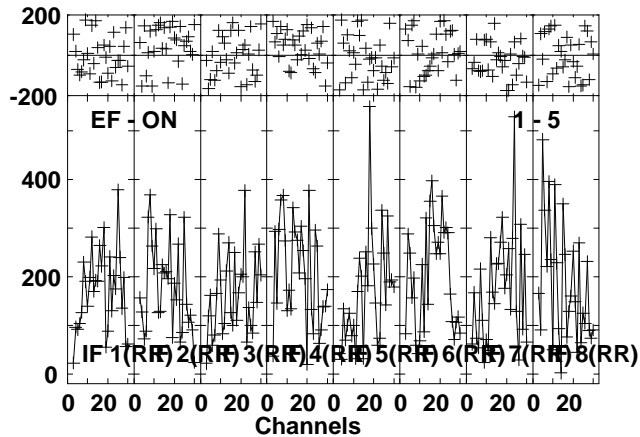
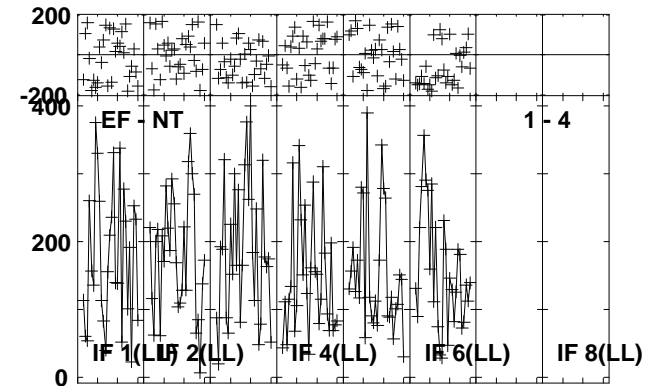
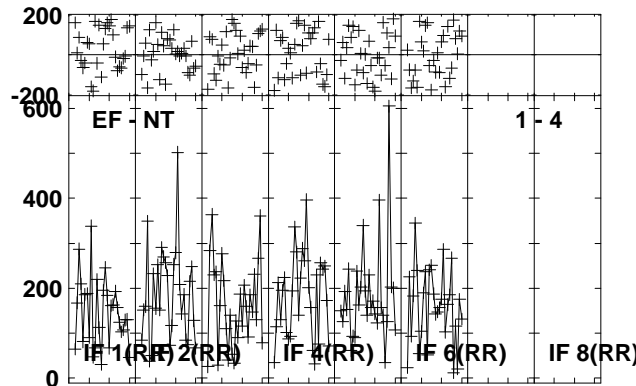
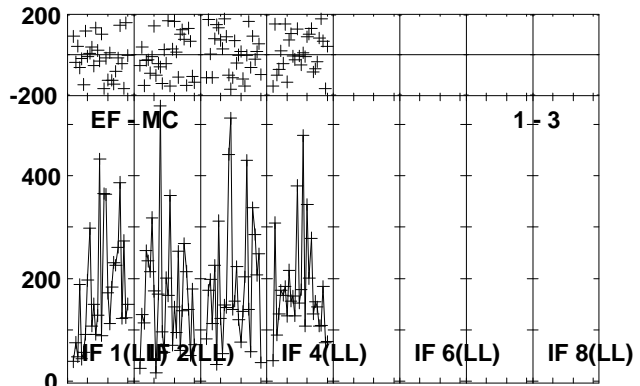
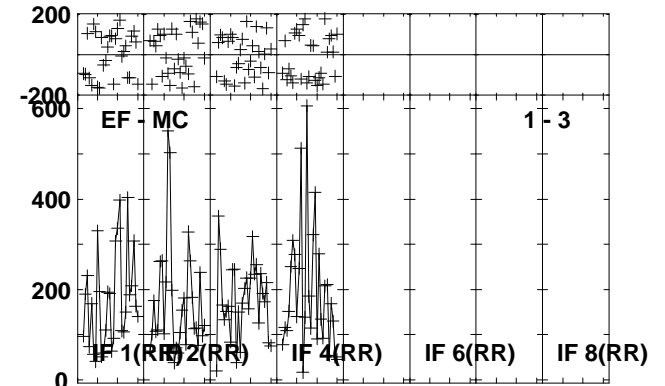
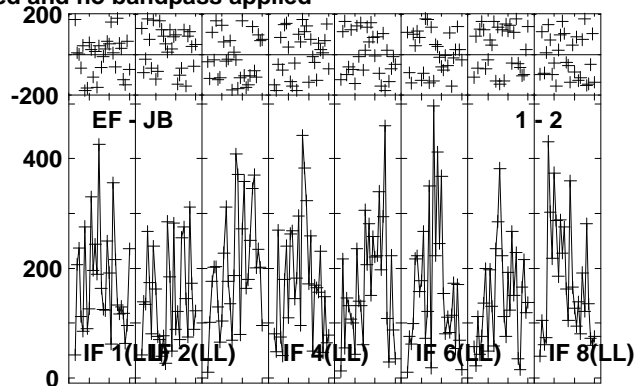
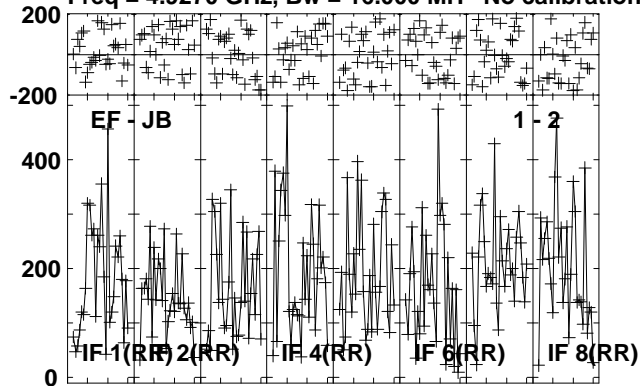

Lower frame: Micro Ampl Jy Top frame: Phas deg  
Vector averaged cross-power spectrum Several baselines displayed  
Timerange: 00/18:11:52 to 00/18:14:18

Plot file version 180 created 24-OCT-2012 20:59:49

G23.6-0.03 EY017B.UVDATA.1

Freq = 4.9270 GHz, Bw = 16.000 MH No calibration applied and no bandpass applied

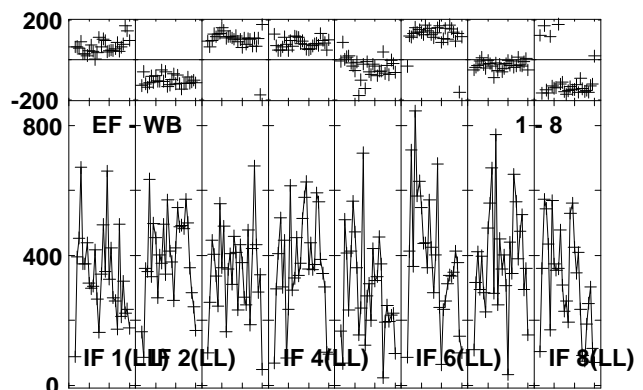
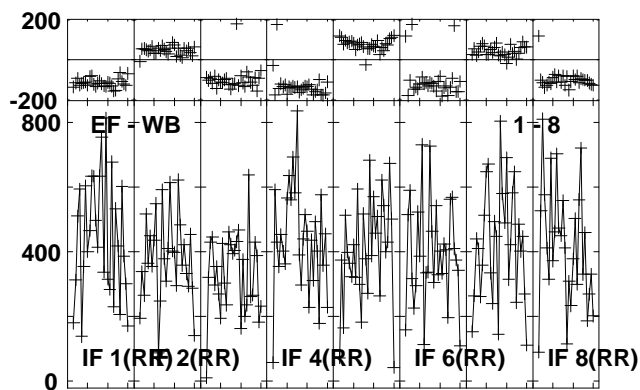
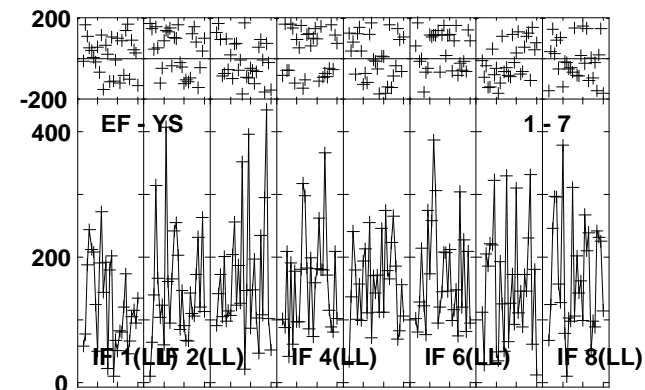
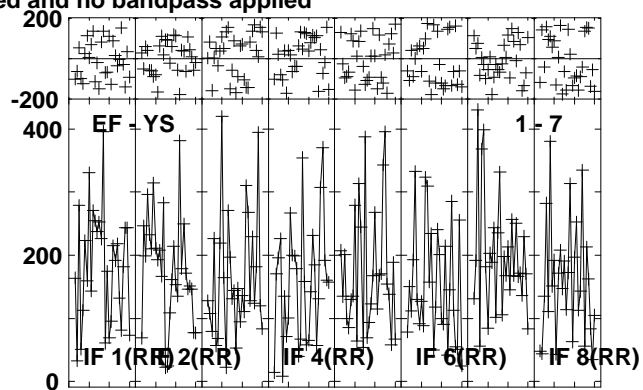
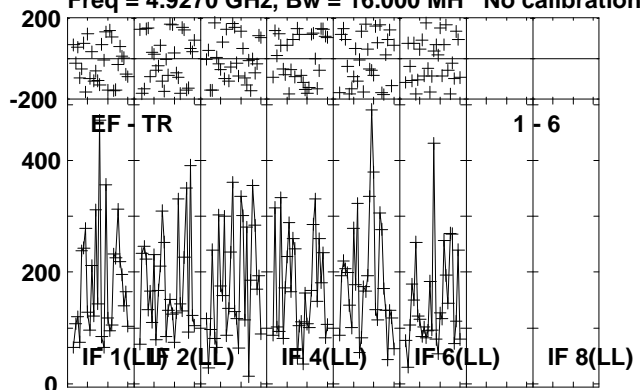

Lower frame: Micro Ampl Jy Top frame: Phas deg  
Vector averaged cross-power spectrum Several baselines displayed  
Timerange: 00/18:11:52 to 00/18:14:18





Plot file version 182 created 24-OCT-2012 20:59:50

J1825-0737 EY017B.UVDATA.1

Freq = 4.9270 GHz, Bw = 16.000 MH No calibration applied and no bandpass applied

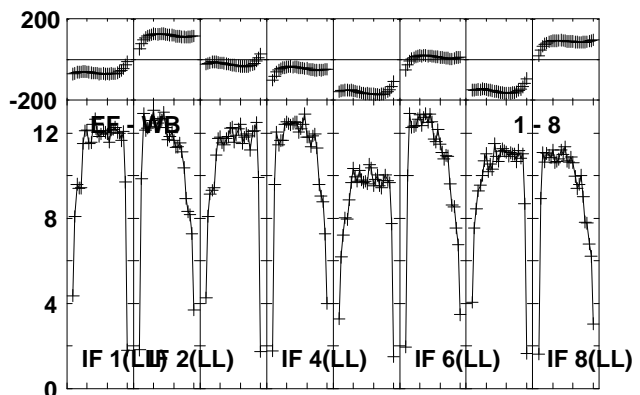
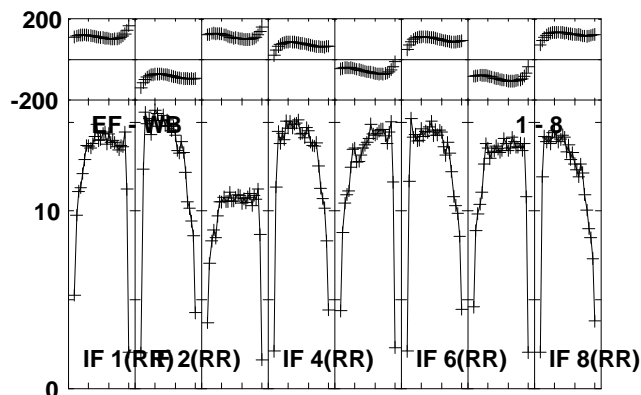
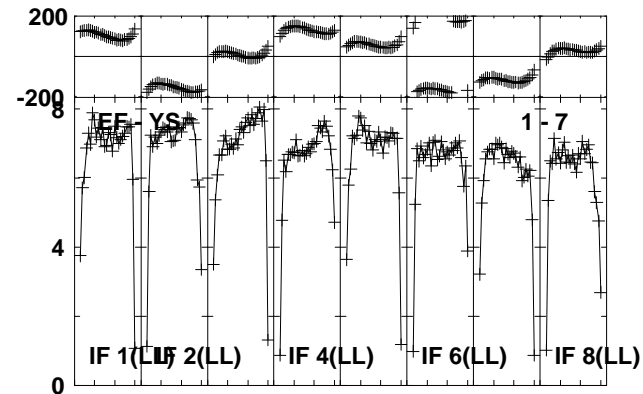
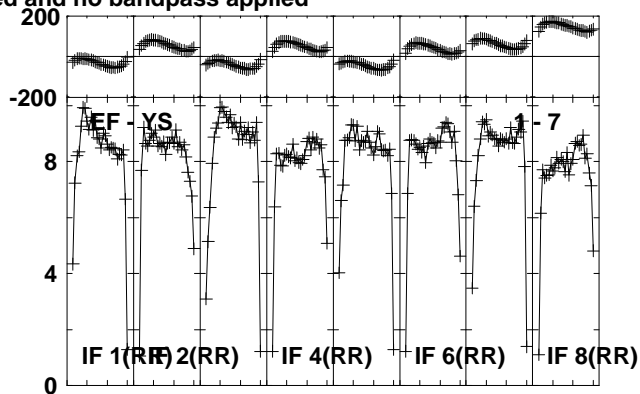
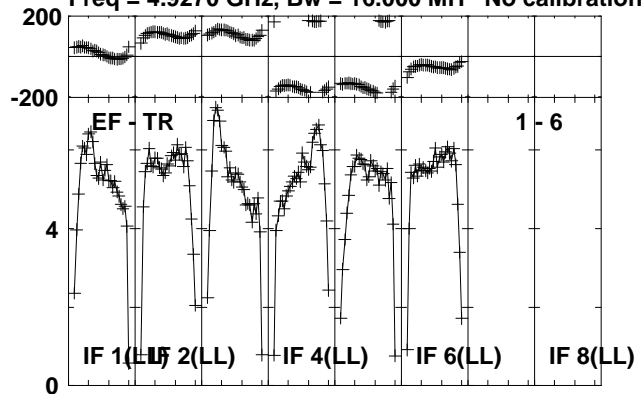

Lower frame: Milli Ampl Jy Top frame: Phas deg  
Vector averaged cross-power spectrum Several baselines displayed  
Timerange: 00/18:14:22 to 00/18:15:48



Plot file version 184 created 24-OCT-2012 20:59:51

G23.6-0.03 EY017B.UVDATA.1

Freq = 4.9270 GHz, Bw = 16.000 MH No calibration applied and no bandpass applied

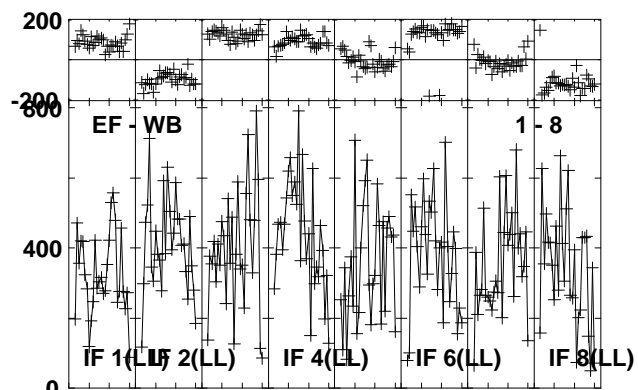
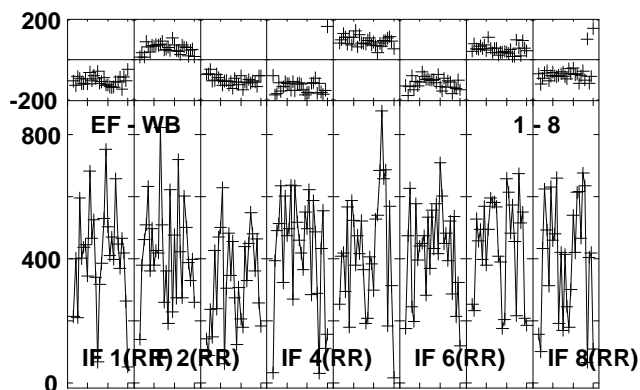
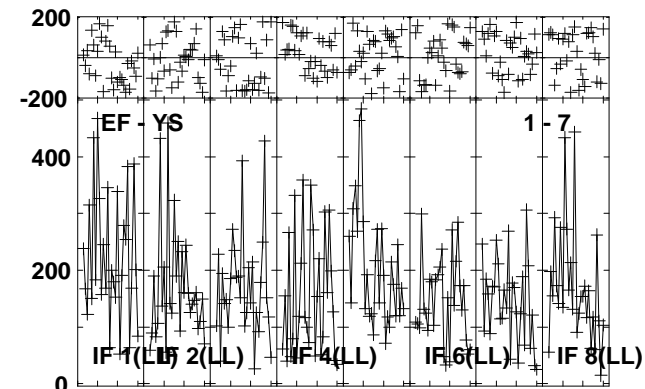
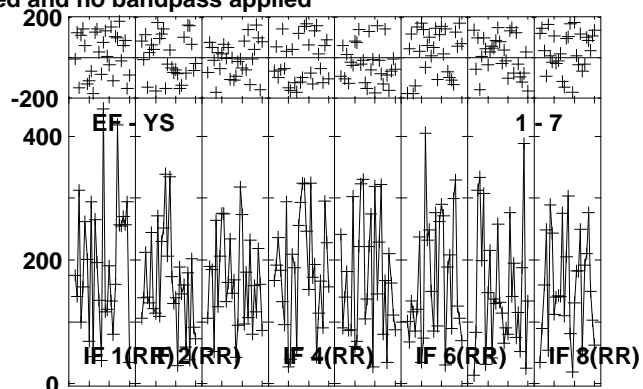
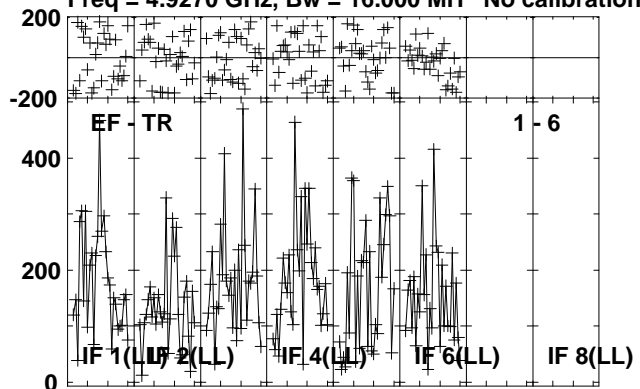

Lower frame: Micro Ampl Jy Top frame: Phas deg  
Vector averaged cross-power spectrum Several baselines displayed  
Timerange: 00:18:15:52 to 00:18:18:18

Plot file version 185 created 24-OCT-2012 20:59:51

J1825-0737 EY017B.UVDATA.1

Freq = 4.9270 GHz, Bw = 16.000 MH No calibration applied and no bandpass applied

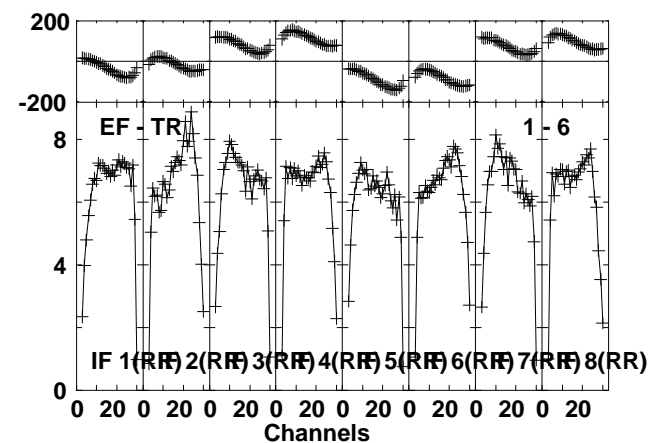
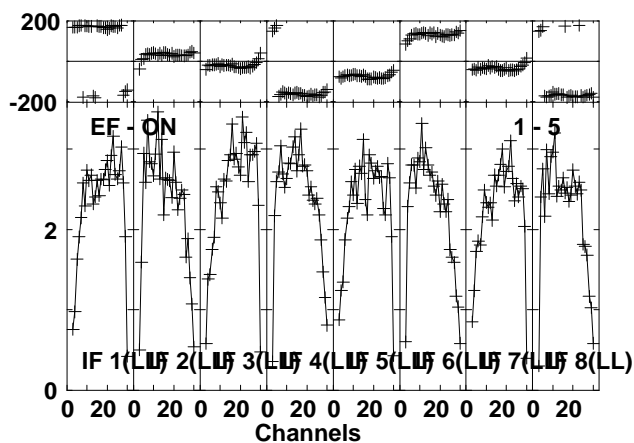
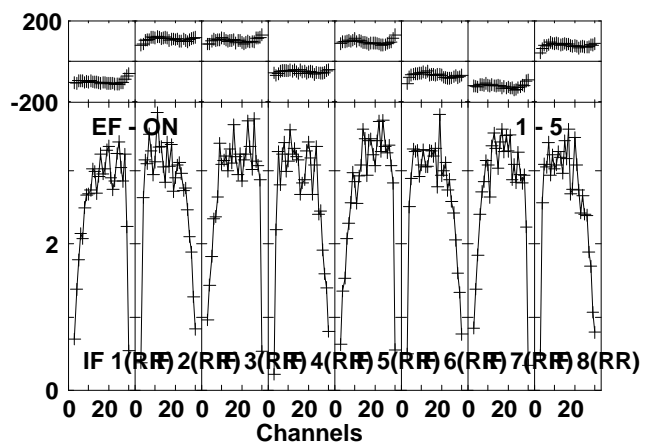
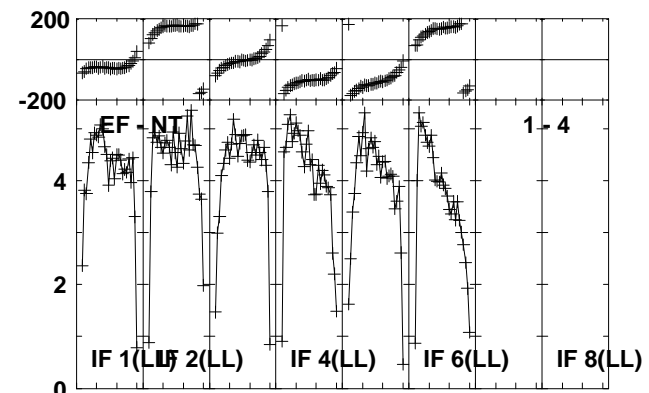
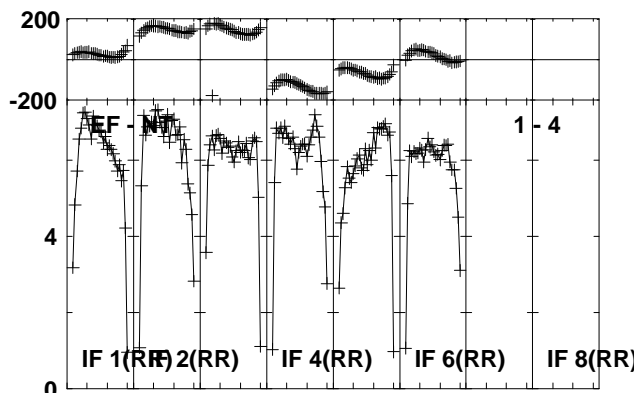
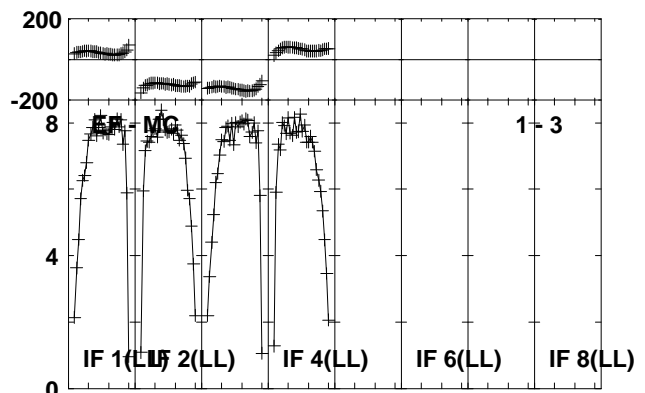
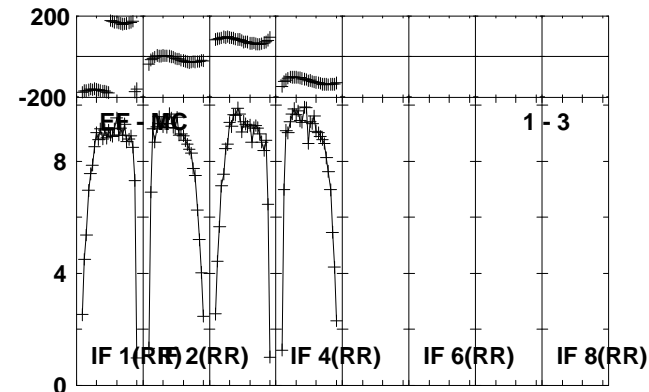
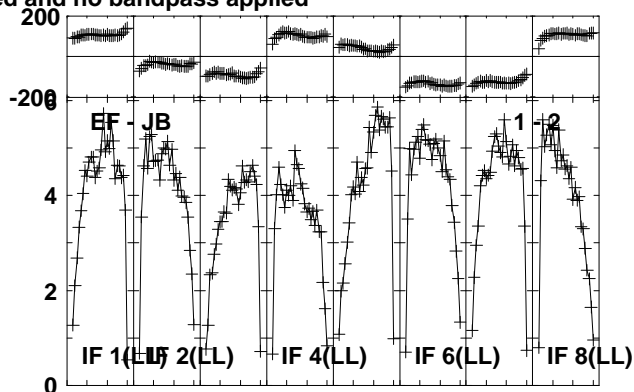
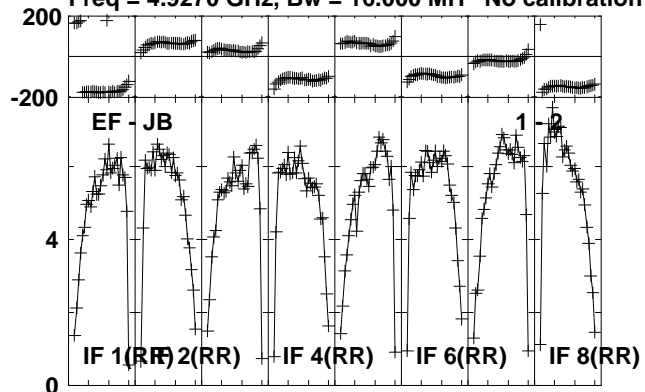

Lower frame: Milli Ampl Jy Top frame: Phas deg  
Vector averaged cross-power spectrum Several baselines displayed  
Timerange: 00/18:18:22 to 00/18:19:48

Plot file version 186 created 24-OCT-2012 20:59:52

J1825-0737 EY017B.UVDATA.1

Freq = 4.9270 GHz, Bw = 16.000 MH No calibration applied and no bandpass applied

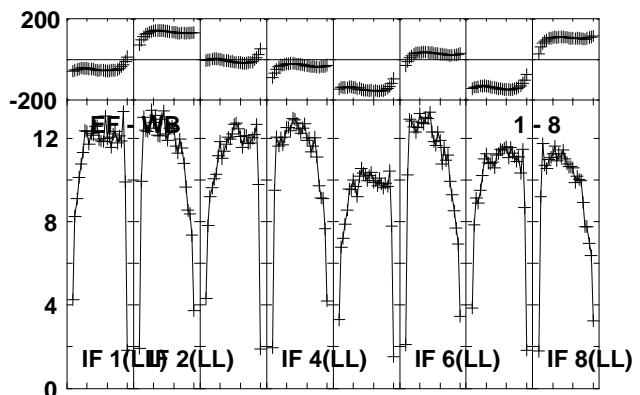
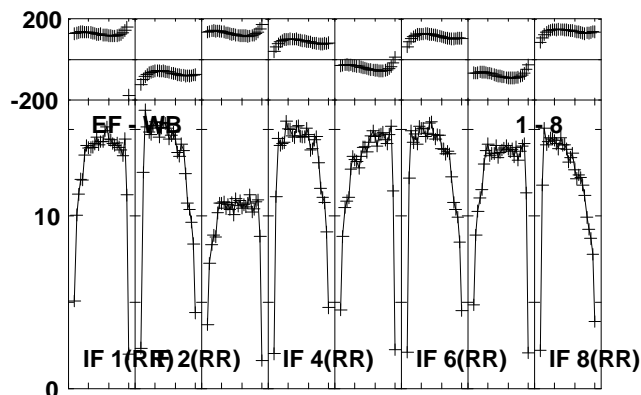
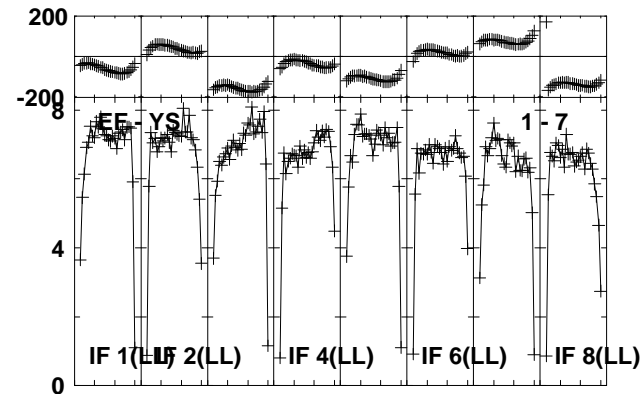
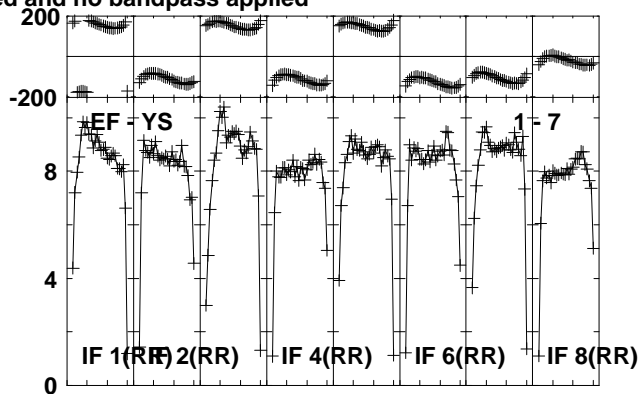
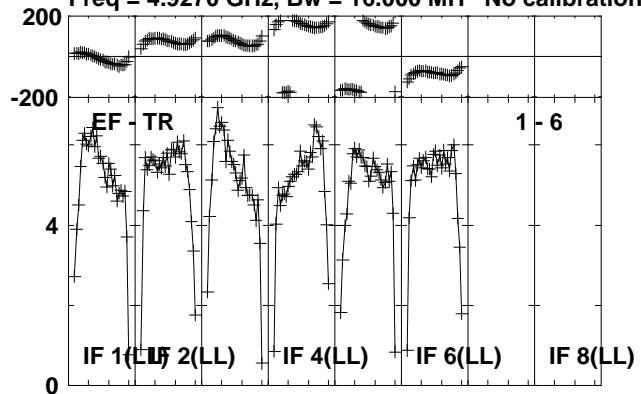

Lower frame: Milli Ampl Jy Top frame: Phas deg  
Vector averaged cross-power spectrum Several baselines displayed  
Timerange: 00/18:18:22 to 00/18:19:48

Plot file version 187 created 24-OCT-2012 20:59:52

G23.6-0.03 EY017B.UVDATA.1

Freq = 4.9270 GHz, Bw = 16.000 MH No calibration applied and no bandpass applied

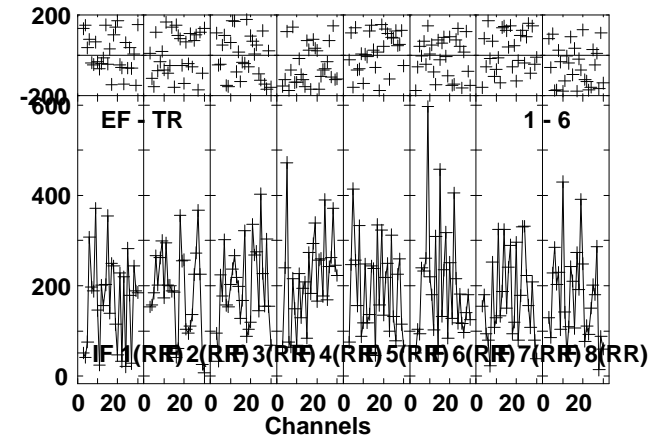
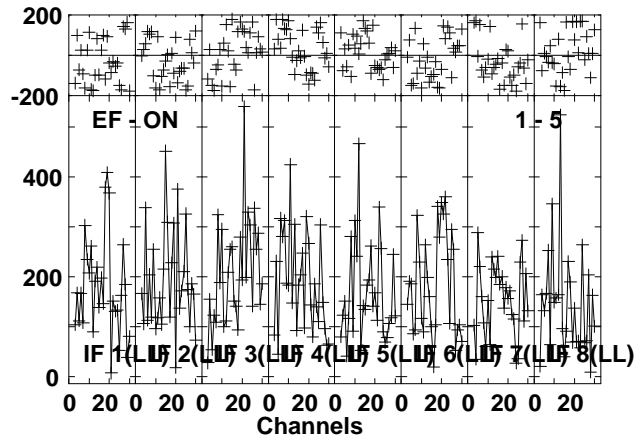
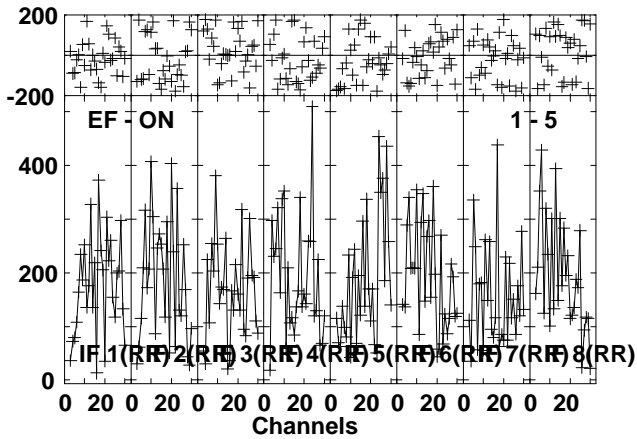
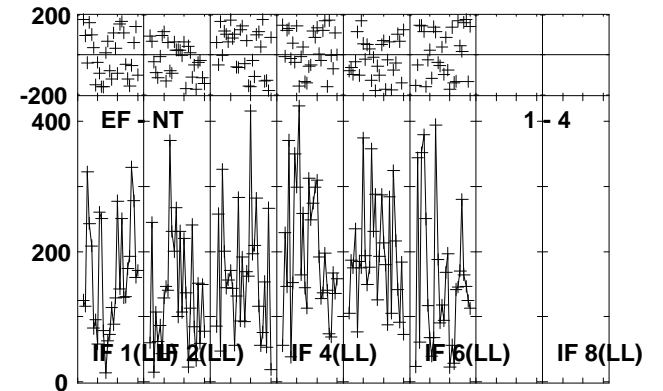
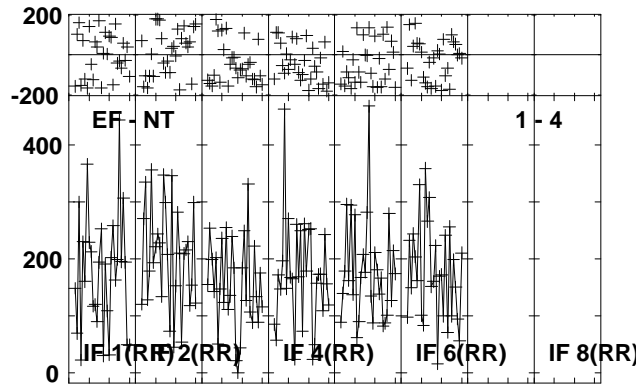
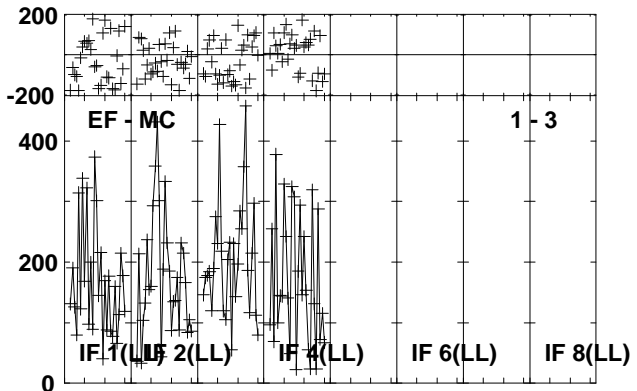
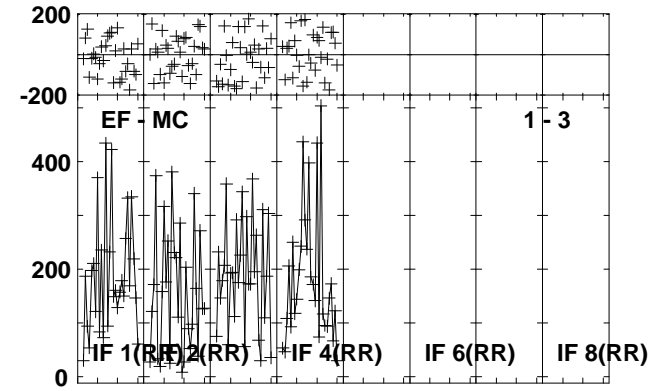
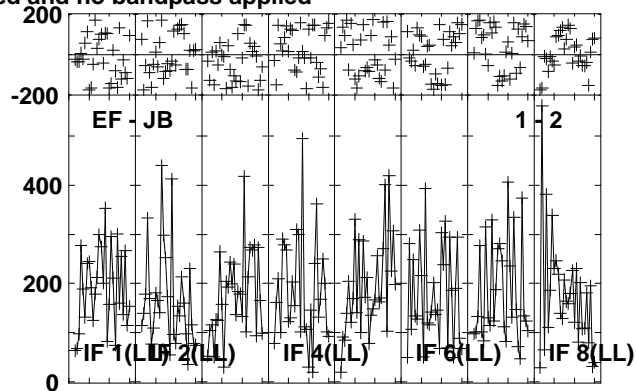
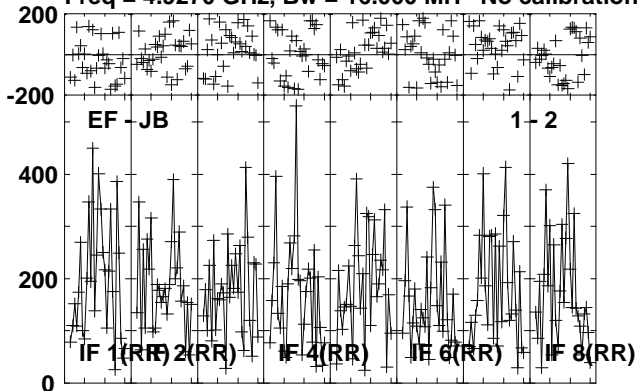

Lower frame: Micro Ampl Jy Top frame: Phas deg  
Vector averaged cross-power spectrum Several baselines displayed  
Timerange: 00/18:19:52 to 00/18:22:18

Plot file version 188 created 24-OCT-2012 20:59:53

G23.6-0.03 EY017B.UVDATA.1

Freq = 4.9270 GHz, Bw = 16.000 MH No calibration applied and no bandpass applied

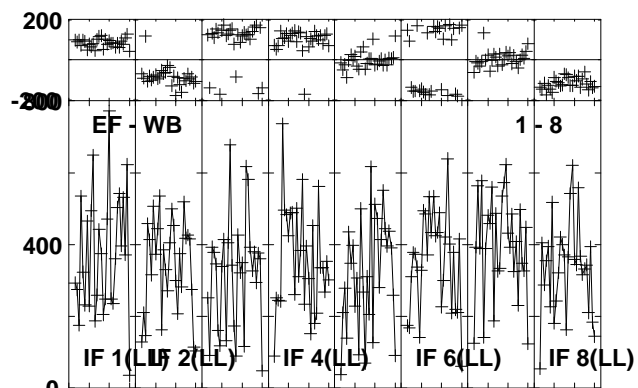
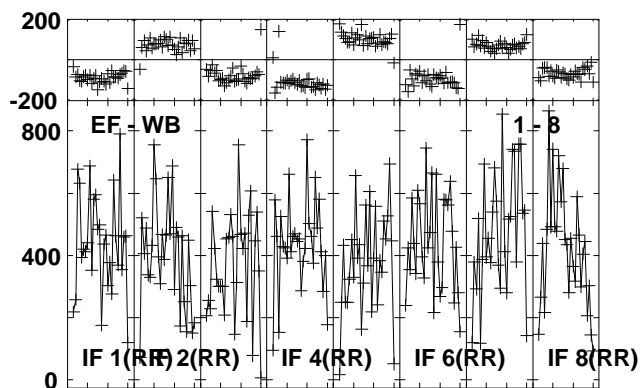
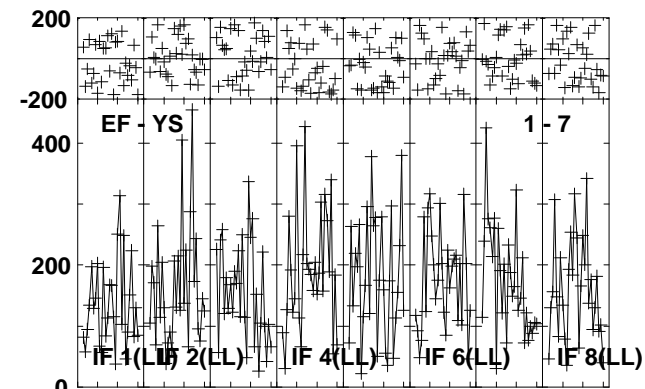
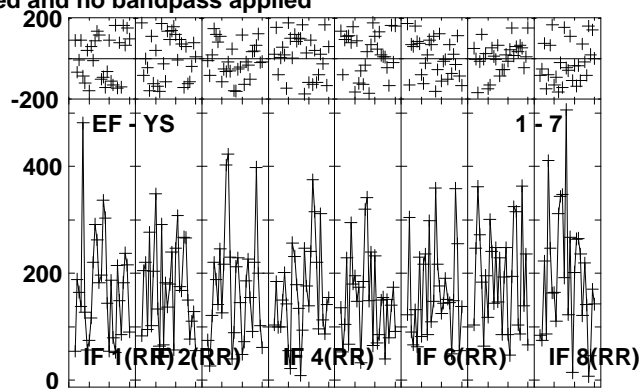
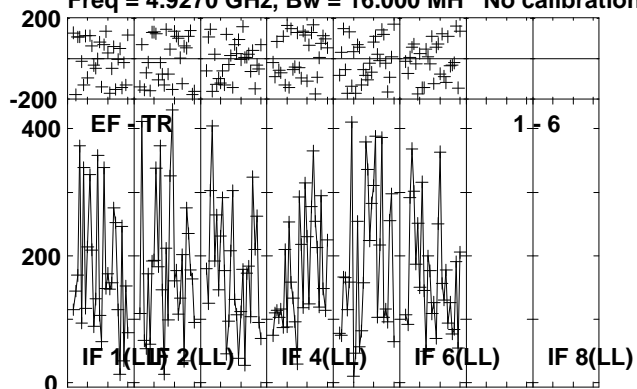

Lower frame: Micro Ampl Jy Top frame: Phas deg  
Vector averaged cross-power spectrum Several baselines displayed  
Timerange: 00/18:19:52 to 00/18:22:18



Plot file version 189 created 24-OCT-2012 20:59:54

J1825-0737 EY017B.UVDATA.1

Freq = 4.9270 GHz, Bw = 16.000 MH No calibration applied and no bandpass applied

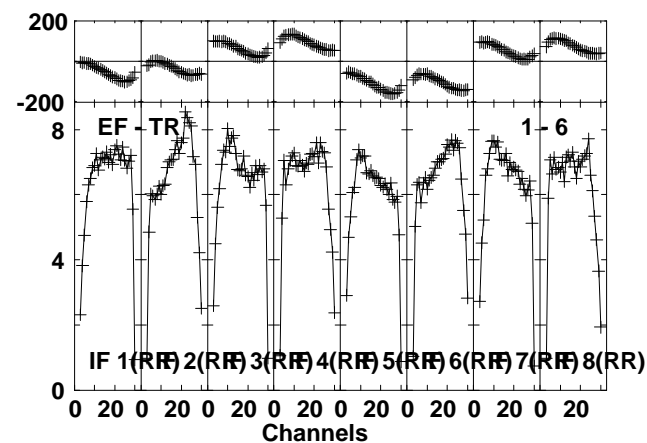
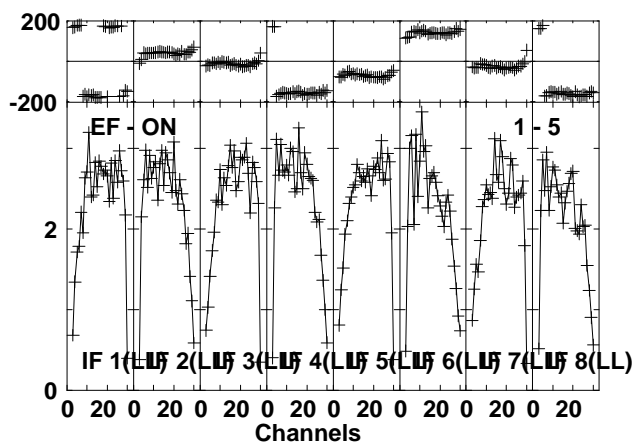
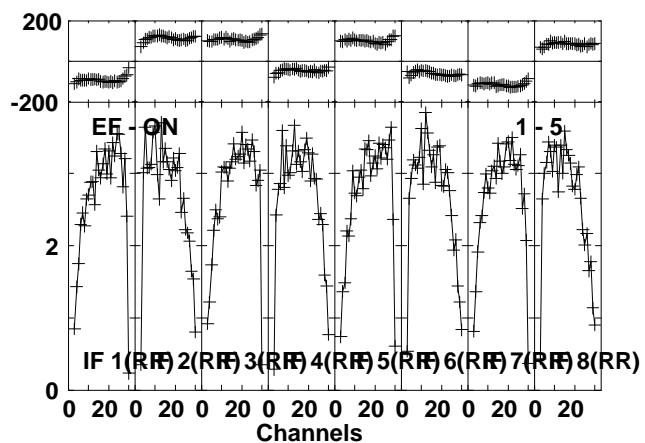
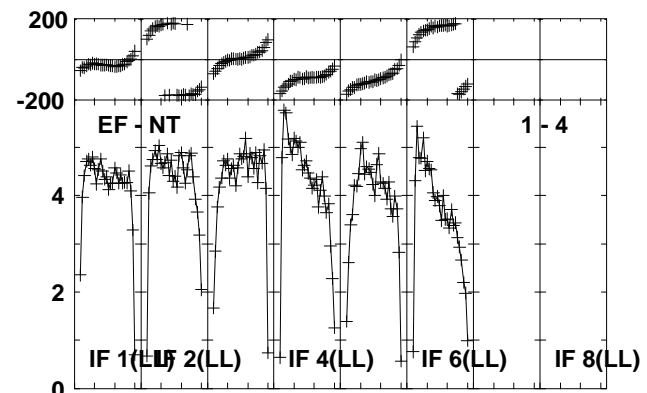
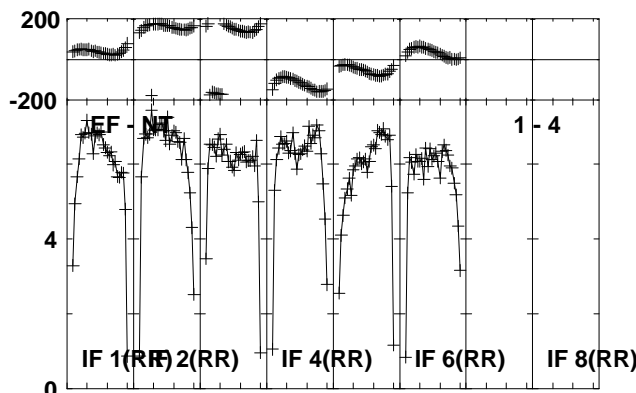
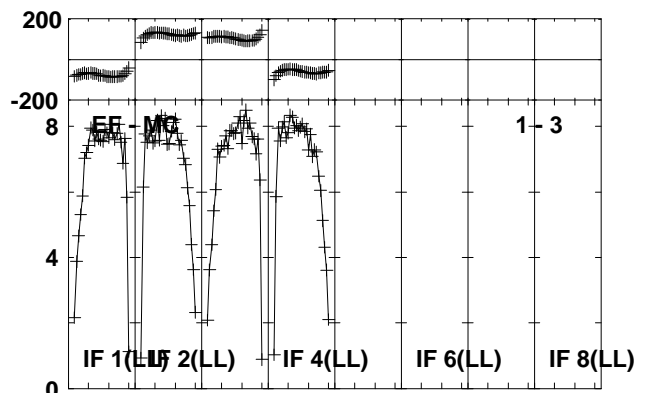
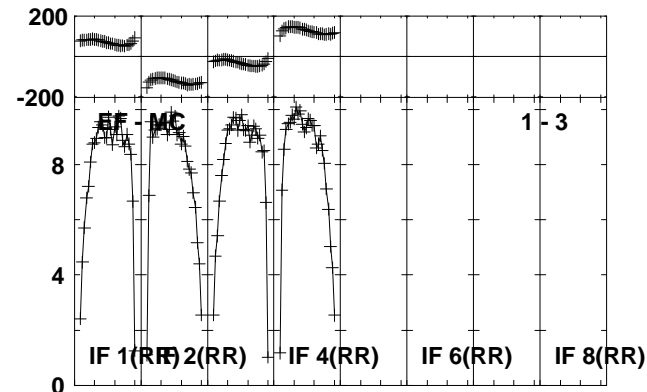
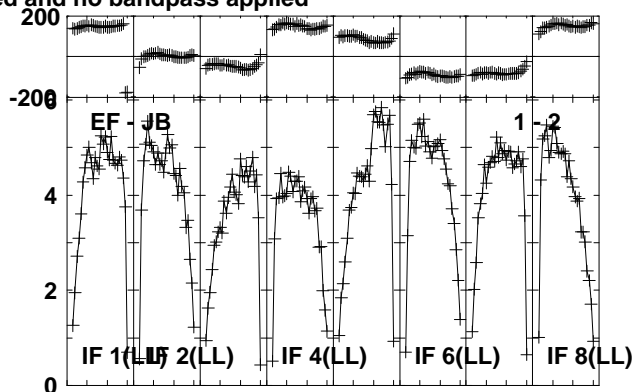
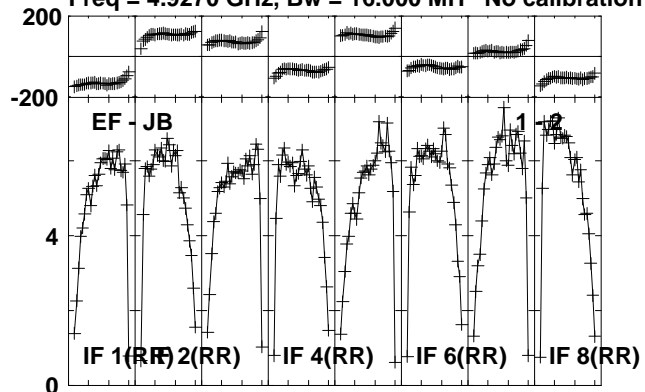

Lower frame: Milli Ampl Jy Top frame: Phas deg  
Vector averaged cross-power spectrum Several baselines displayed  
Timerange: 00/18:22:22 to 00/18:23:48

Plot file version 190 created 24-OCT-2012 20:59:54

J1825-0737 EY017B.UVDATA.1

Freq = 4.9270 GHz, Bw = 16.000 MH No calibration applied and no bandpass applied

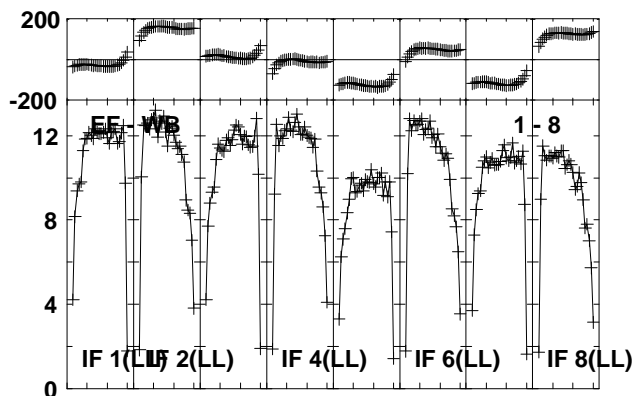
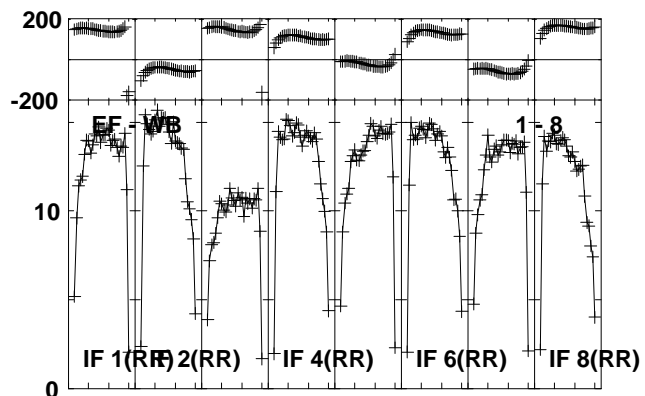
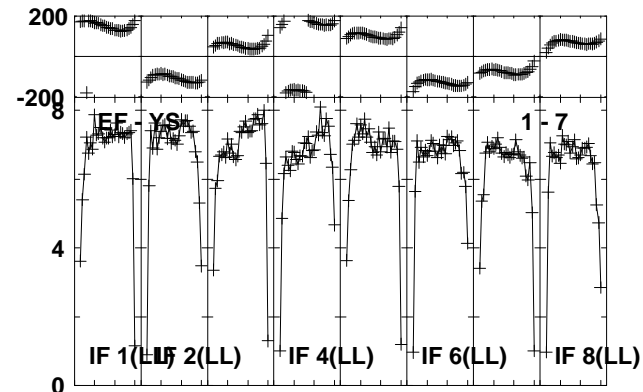
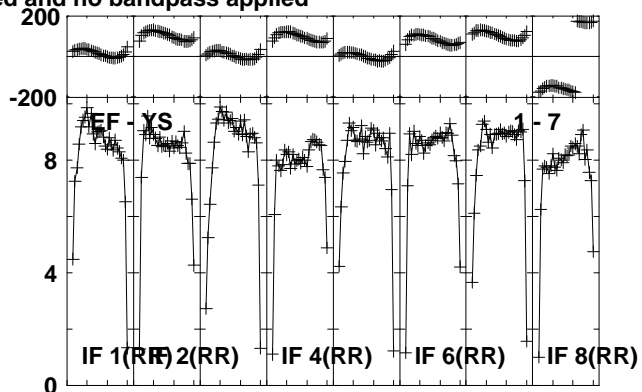
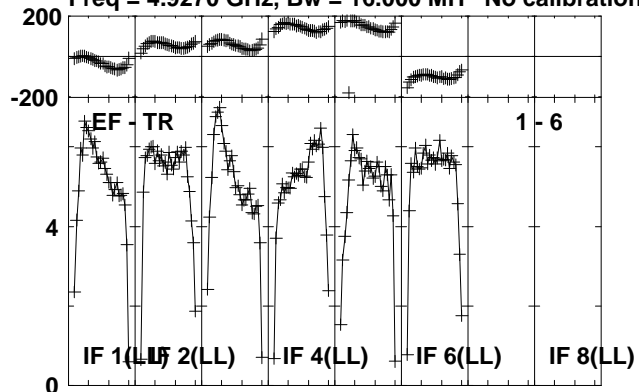

Lower frame: Milli Ampl Jy Top frame: Phas deg  
Vector averaged cross-power spectrum Several baselines displayed  
Timerange: 00/18:22:22 to 00/18:23:48

Plot file version 191 created 24-OCT-2012 20:59:55  
 J1831-0756 EY017B.UVDATA.1

Freq = 4.9270 GHz, Bw = 16.000 MH No calibration applied and no bandpass applied

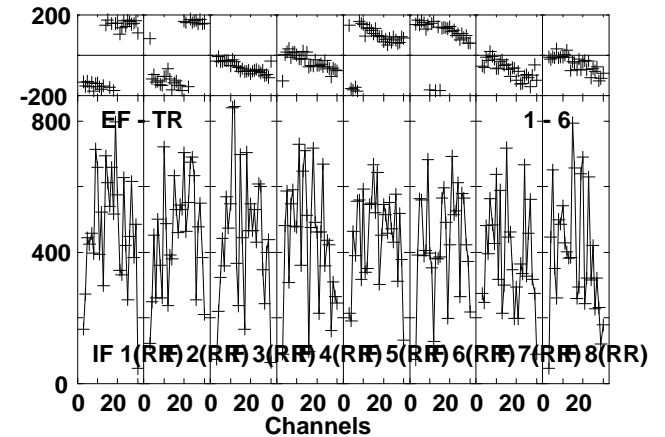
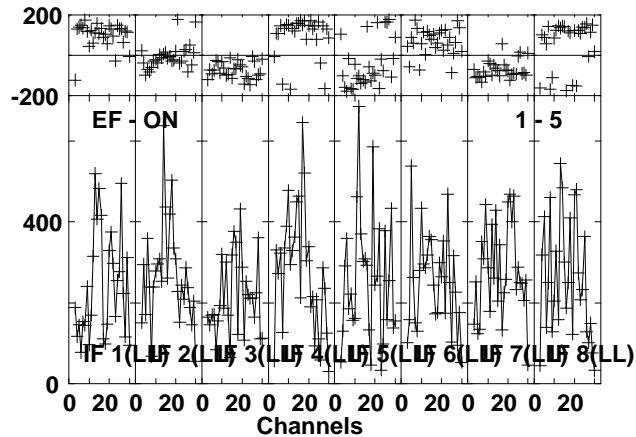
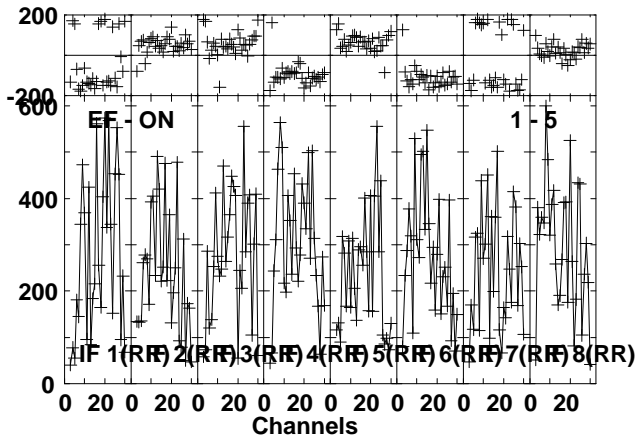
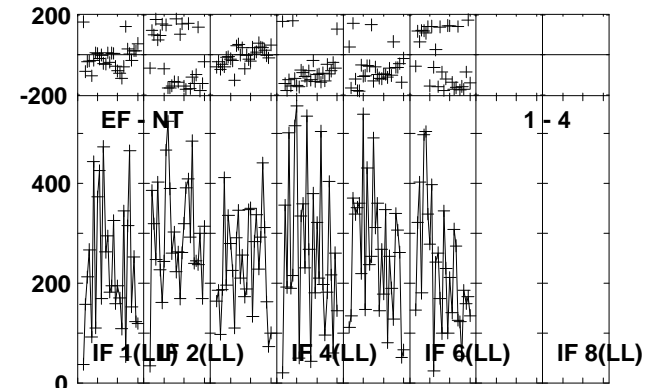
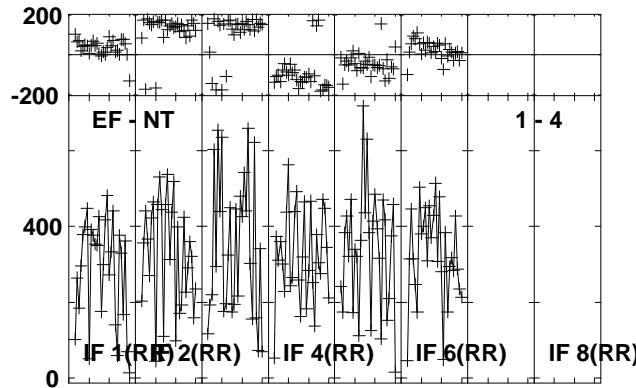
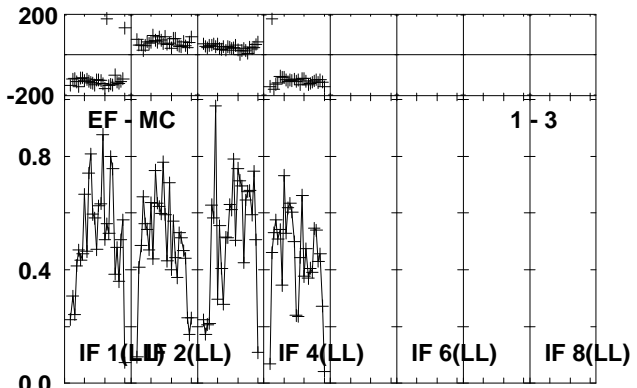
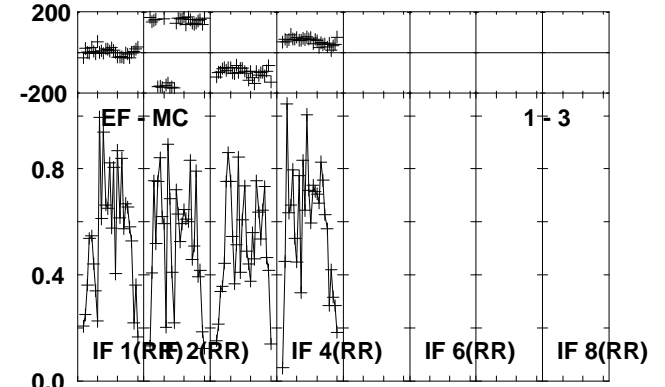
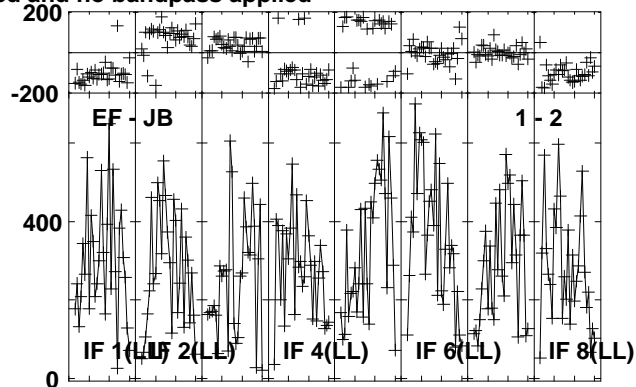
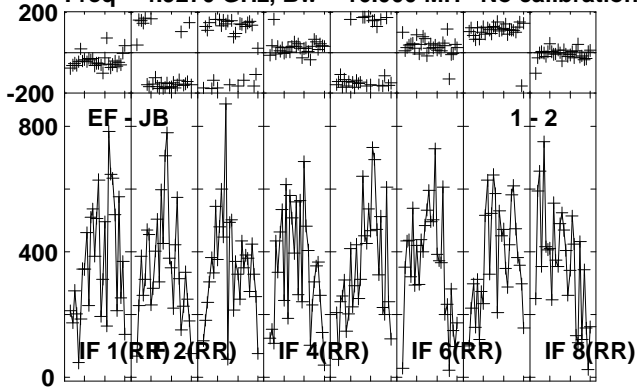

Lower frame: Micro Ampl Jy Top frame: Phas deg  
 Vector averaged cross-power spectrum Several baselines displayed  
 Timerange: 00/18:24:22 to 00/18:26:24

Plot file version 192 created 24-OCT-2012 20:59:55

J1831-0756 EY017B.UVDATA.1

Freq = 4.9270 GHz, Bw = 16.000 MH No calibration applied and no bandpass applied

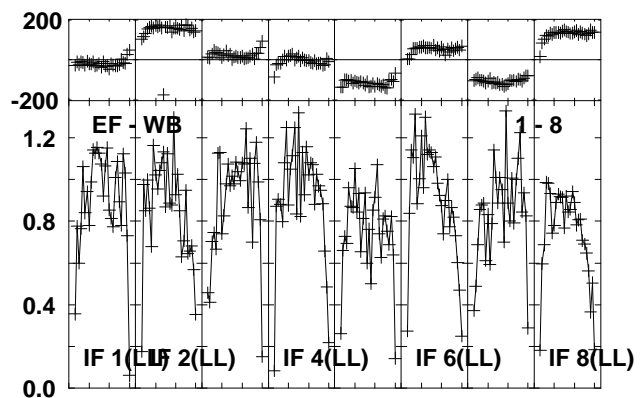
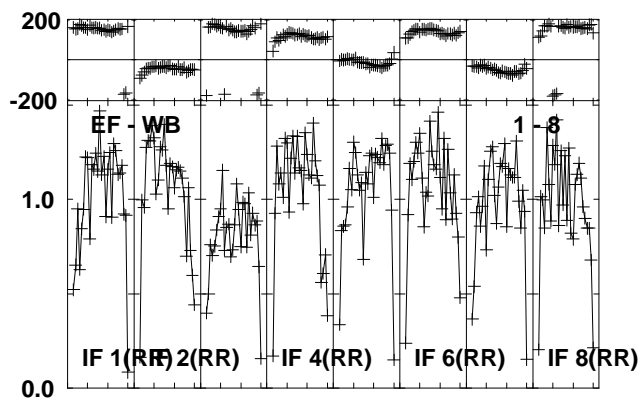
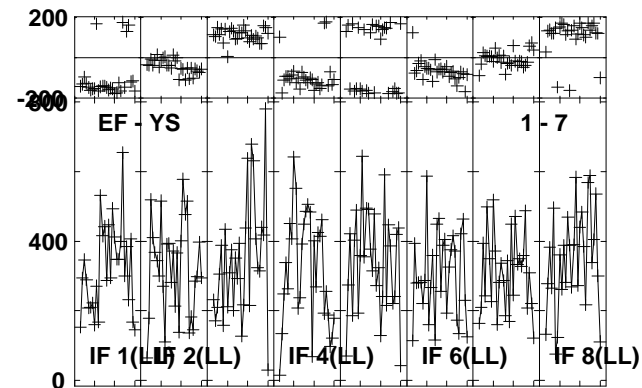
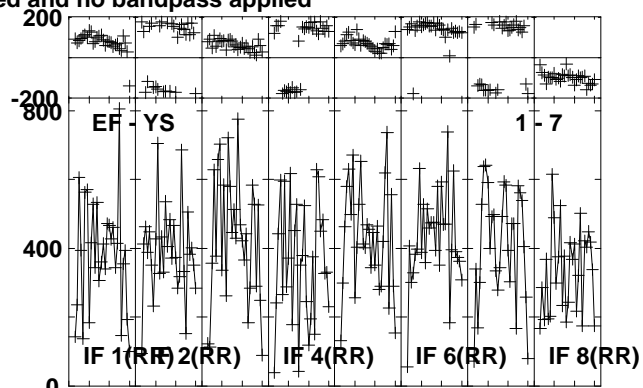
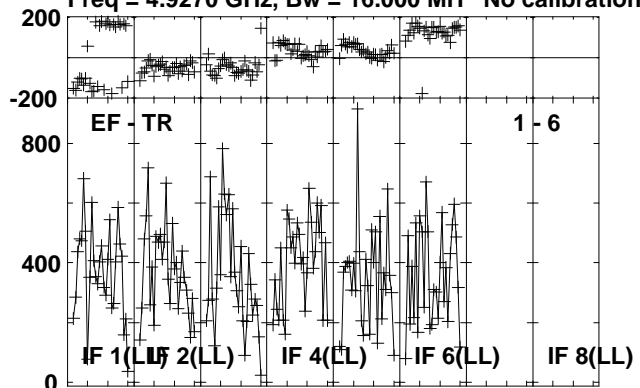

Lower frame: Micro Ampl Jy Top frame: Phas deg  
Vector averaged cross-power spectrum Several baselines displayed  
Timerange: 00:18:24:22 to 00:18:26:24

Plot file version 193 created 24-OCT-2012 20:59:56

J1825-0737 EY017B.UVDATA.1

Freq = 4.9270 GHz, Bw = 16.000 MH No calibration applied and no bandpass applied

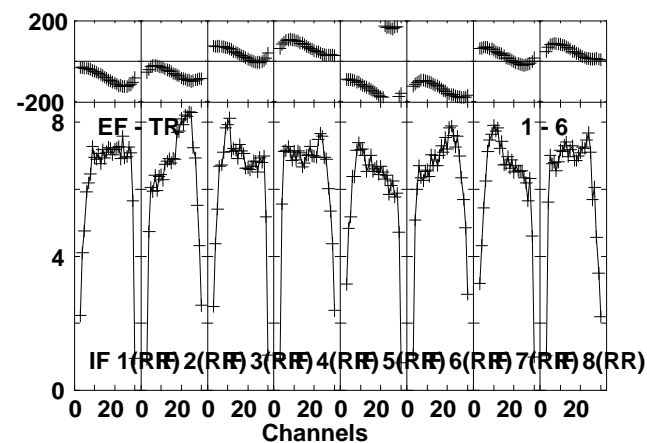
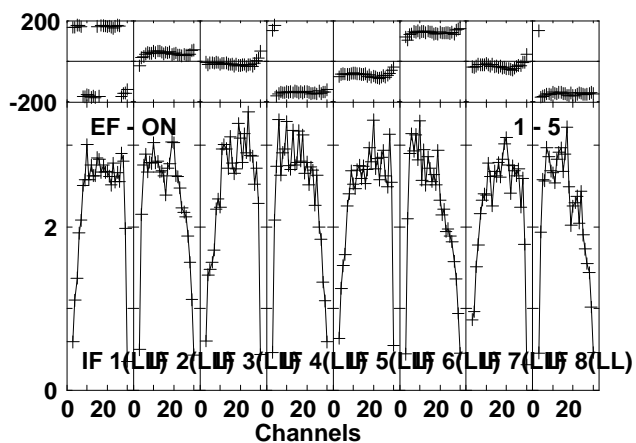
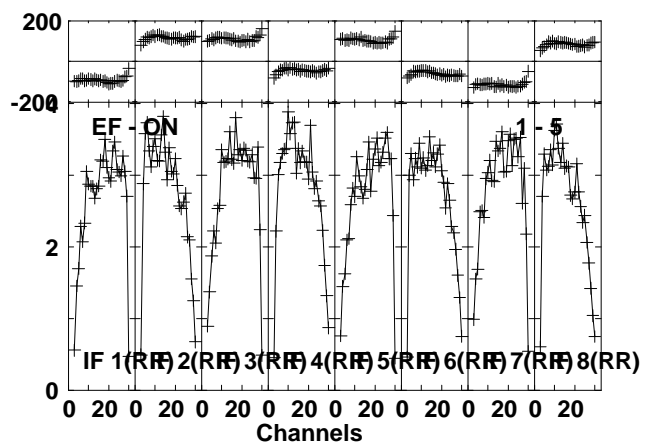
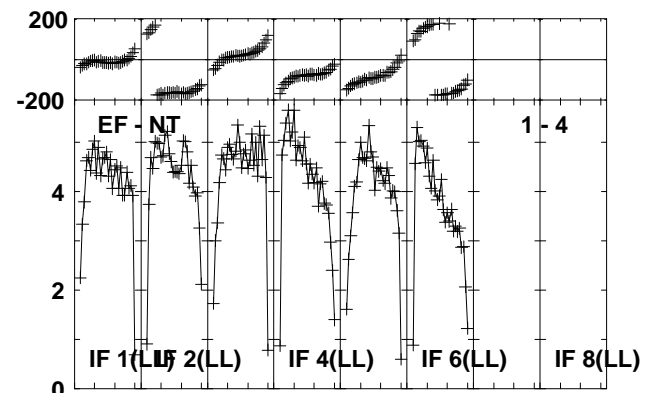
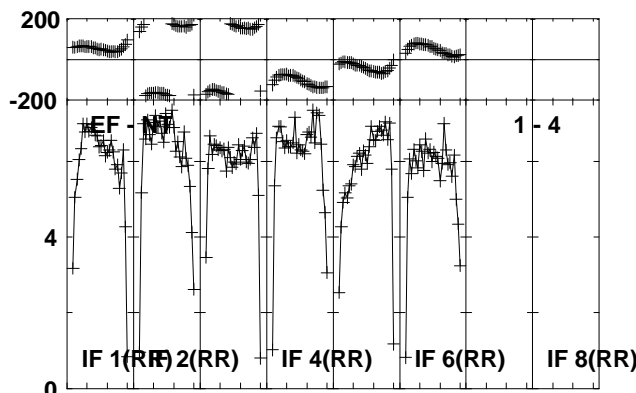
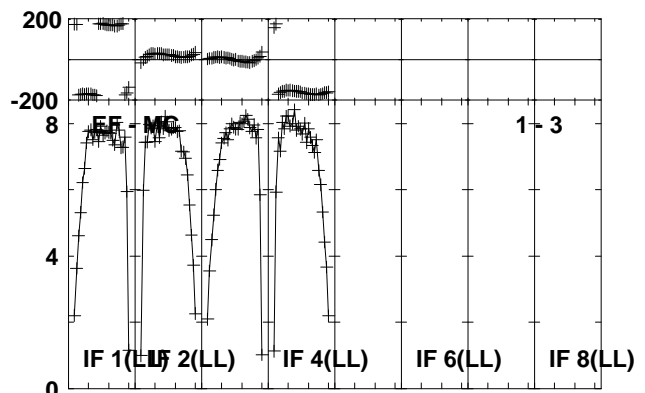
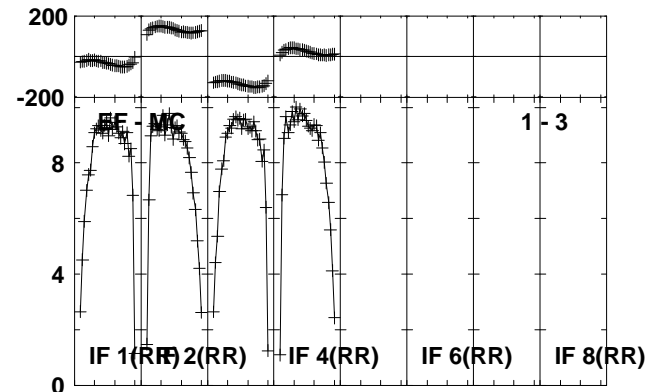
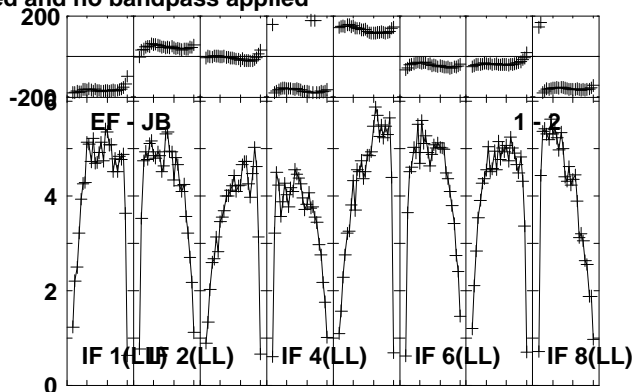
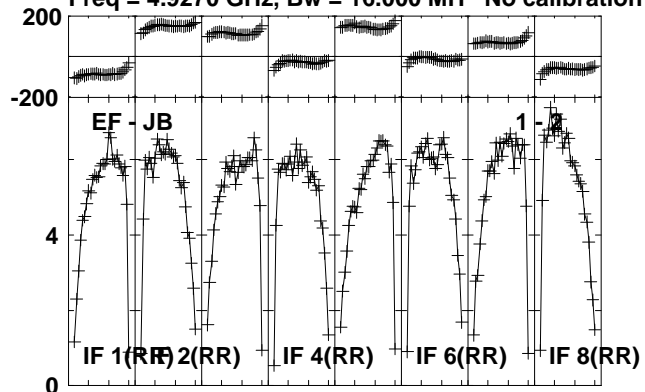

Lower frame: Milli Ampl Jy Top frame: Phas deg  
Vector averaged cross-power spectrum Several baselines displayed  
Timerange: 00/18:26:28 to 00/18:27:54

Plot file version 194 created 24-OCT-2012 20:59:56

J1825-0737 EY017B.UVDATA.1

Freq = 4.9270 GHz, Bw = 16.000 MH No calibration applied and no bandpass applied

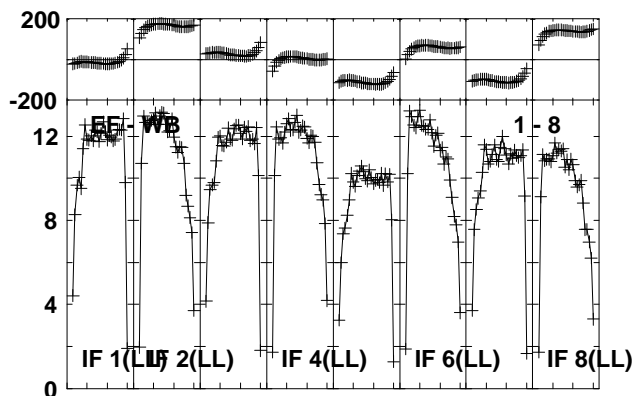
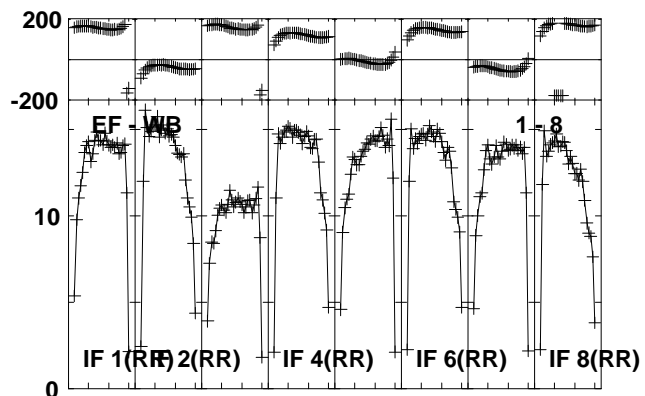
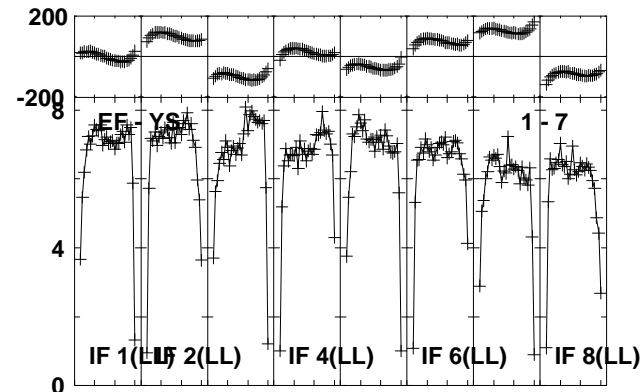
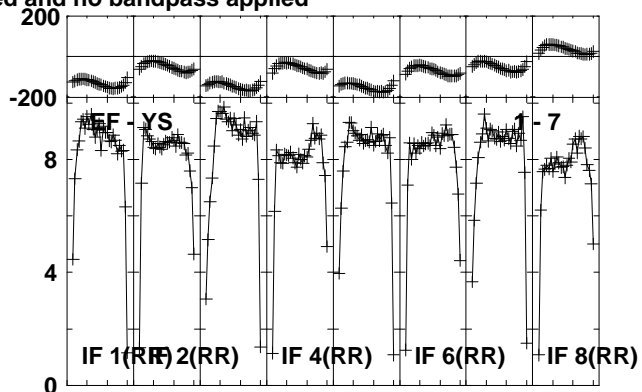
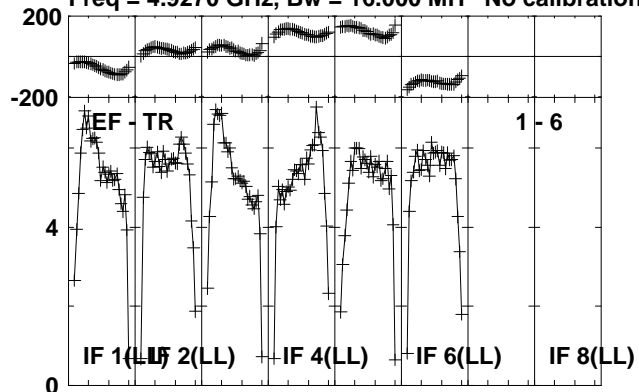

Lower frame: Milli Ampl Jy Top frame: Phas deg  
Vector averaged cross-power spectrum Several baselines displayed  
Timerange: 00/18:26:28 to 00/18:27:54

Plot file version 195 created 24-OCT-2012 20:59:57

G23.6-0.03 EY017B.UVDATA.1

Freq = 4.9270 GHz, Bw = 16.000 MH No calibration applied and no bandpass applied

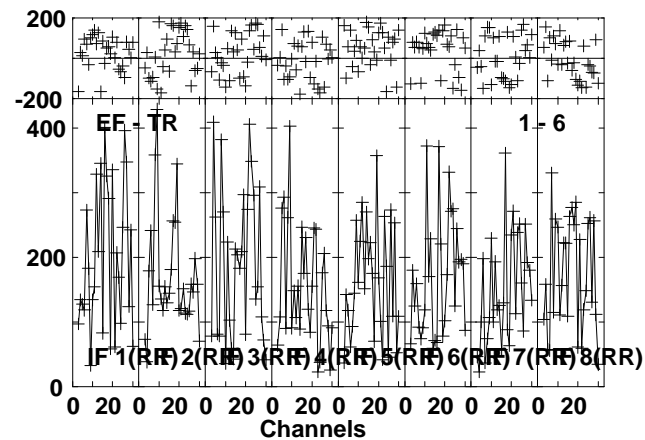
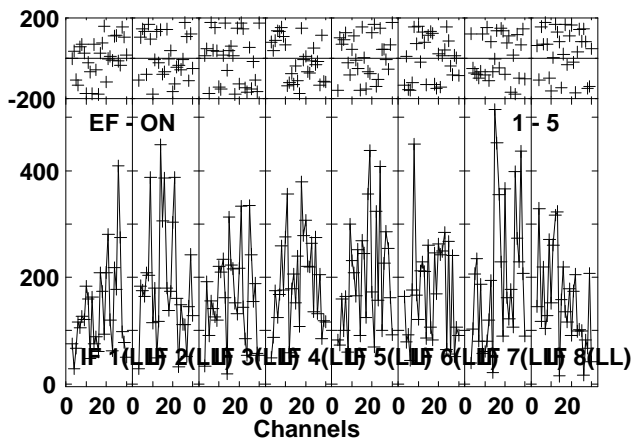
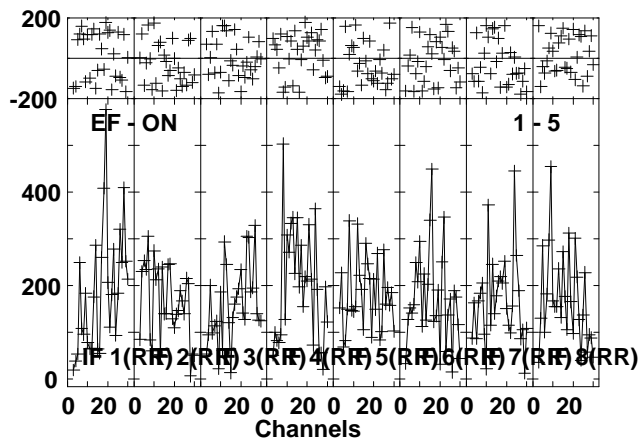
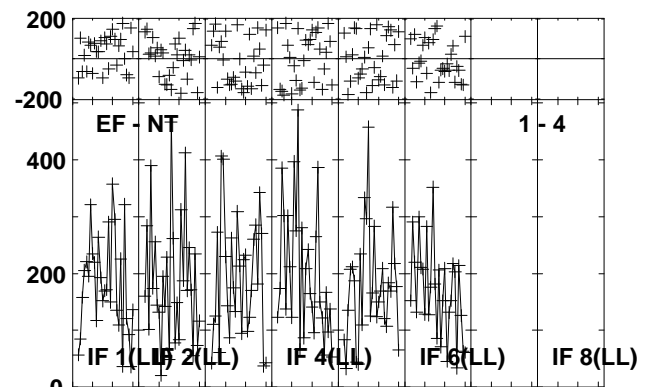
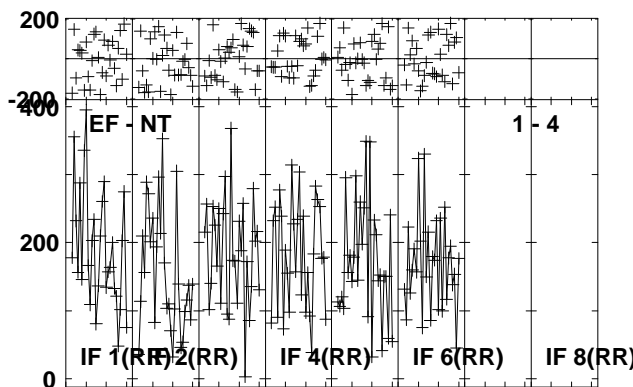
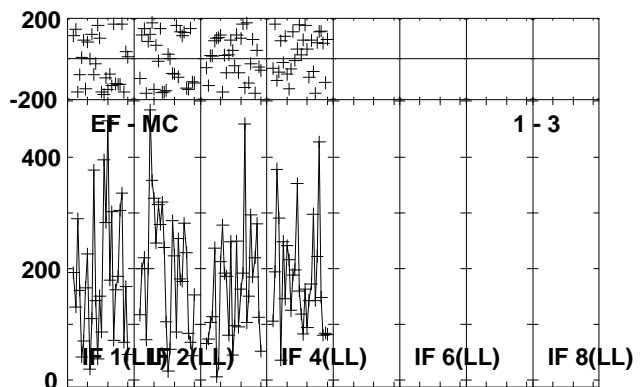
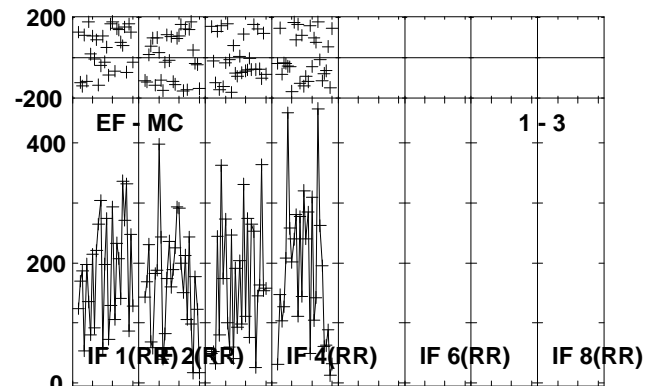
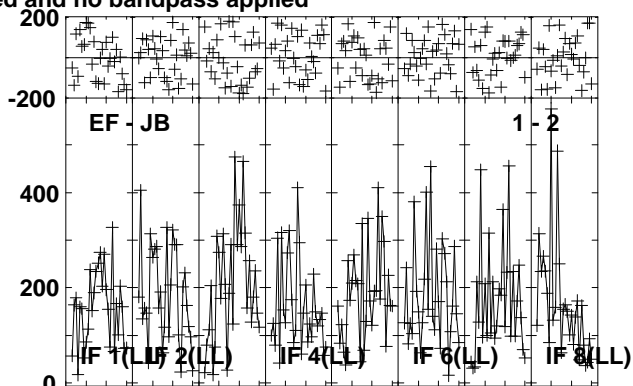
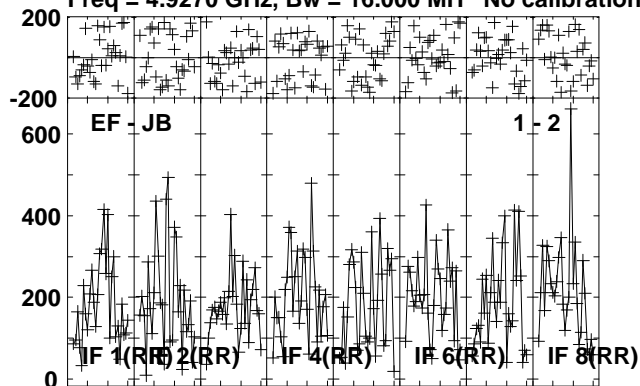

Lower frame: Micro Ampl Jy Top frame: Phas deg  
Vector averaged cross-power spectrum Several baselines displayed  
Timerange: 00/18:27:58 to 00/18:30:24

Plot file version 196 created 24-OCT-2012 20:59:57

G23.6-0.03 EY017B.UVDATA.1

Freq = 4.9270 GHz, Bw = 16.000 MH No calibration applied and no bandpass applied

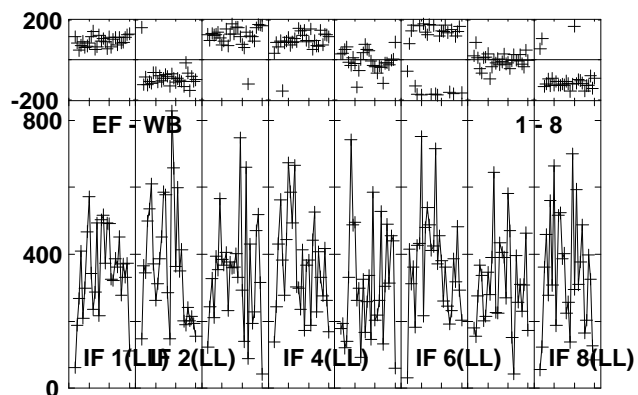
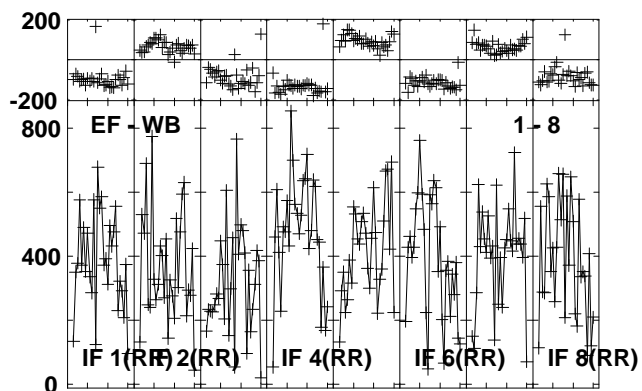
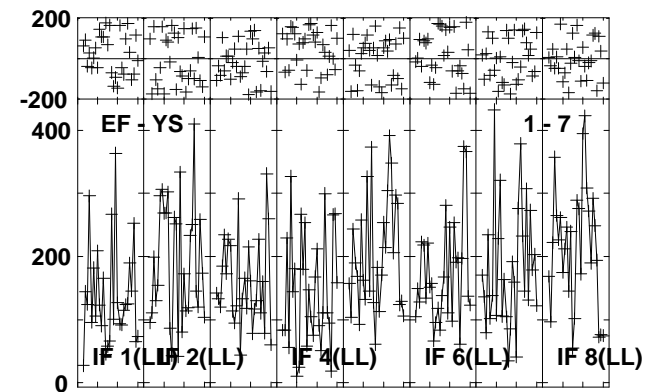
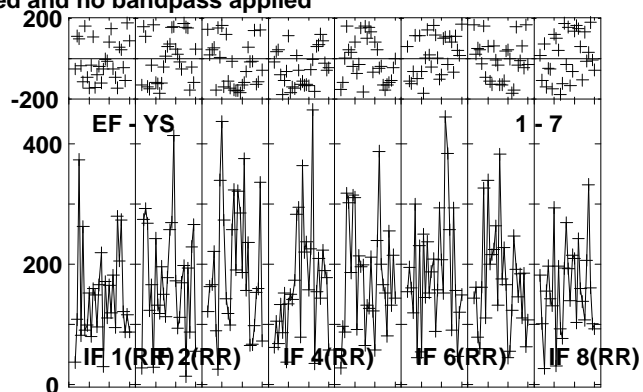
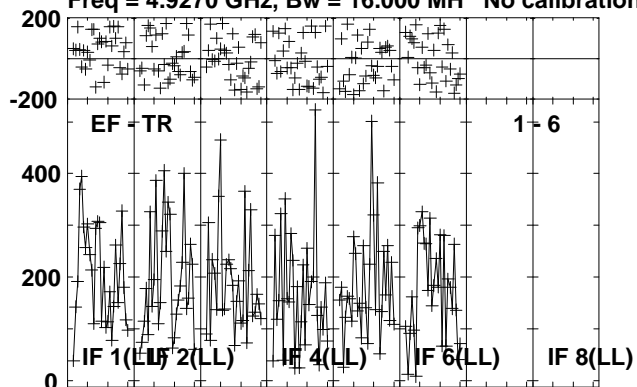

Lower frame: Micro Ampl Jy Top frame: Phas deg  
Vector averaged cross-power spectrum Several baselines displayed  
Timerange: 00/18:27:58 to 00/18:30:24





Plot file version 198 created 24-OCT-2012 20:59:58

J1825-0737 EY017B.UVDATA.1

Freq = 4.9270 GHz, Bw = 16.000 MH No calibration applied and no bandpass applied

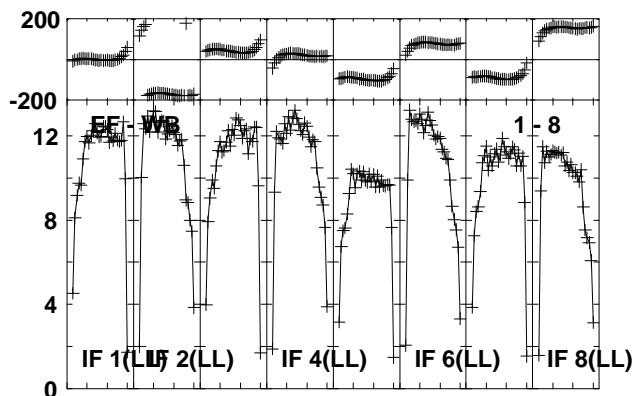
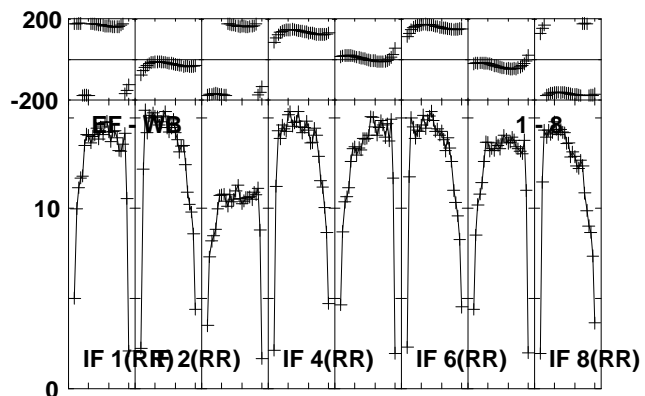
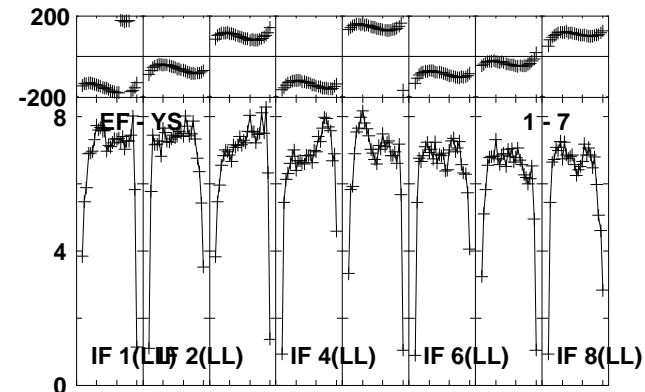
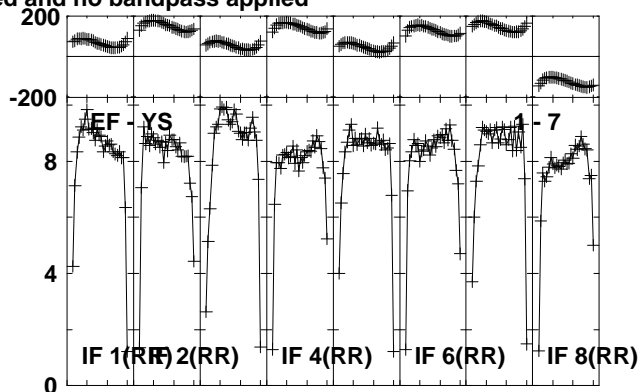
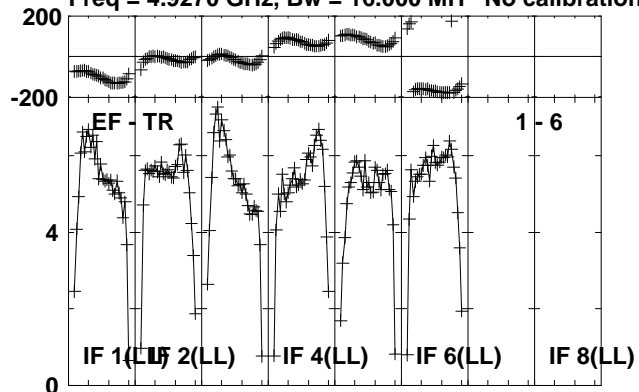

Lower frame: Milli Ampl Jy Top frame: Phas deg  
Vector averaged cross-power spectrum Several baselines displayed  
Timerange: 00/18:30:28 to 00/18:31:54

Plot file version 199 created 24-OCT-2012 20:59:59  
 G23.6-0.03 EY017B.UVDATA.1

Freq = 4.9270 GHz, Bw = 16.000 MH No calibration applied and no bandpass applied

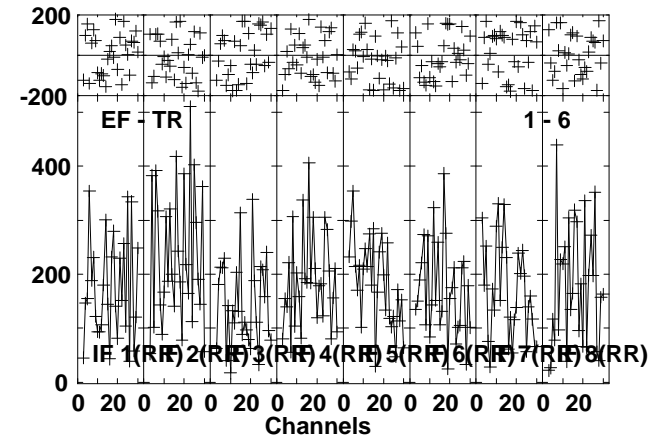
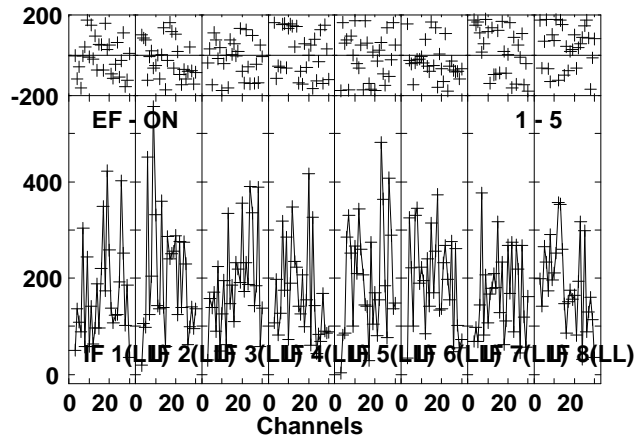
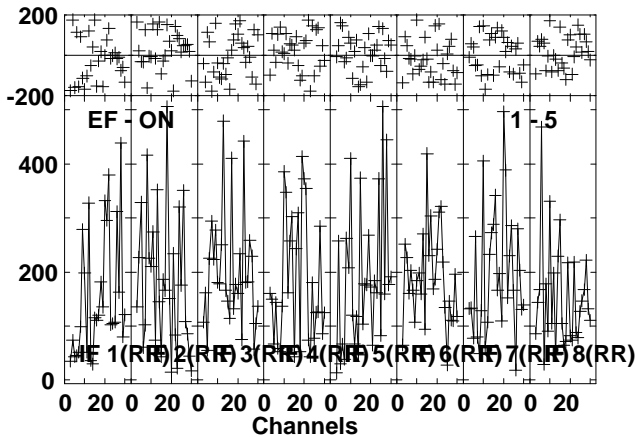
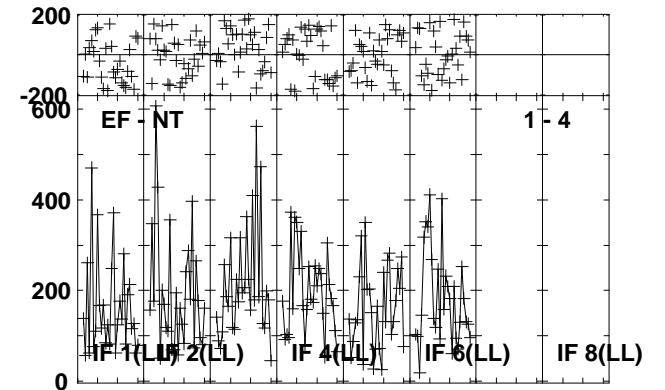
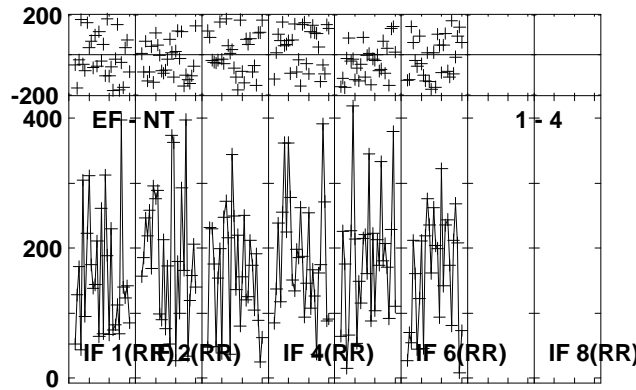
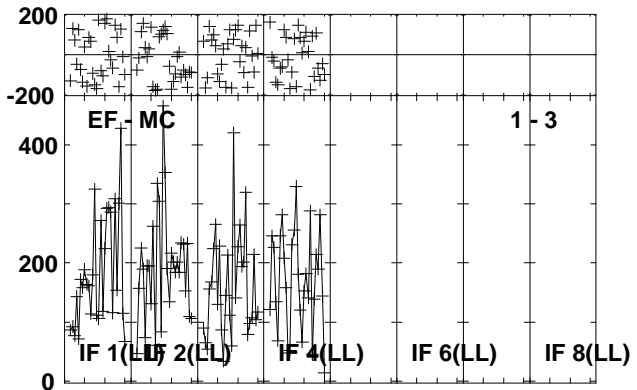
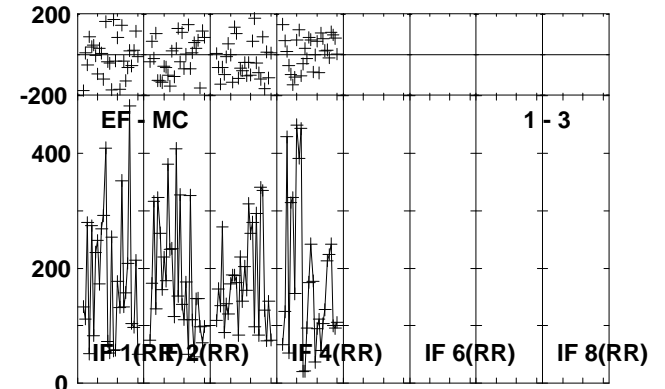
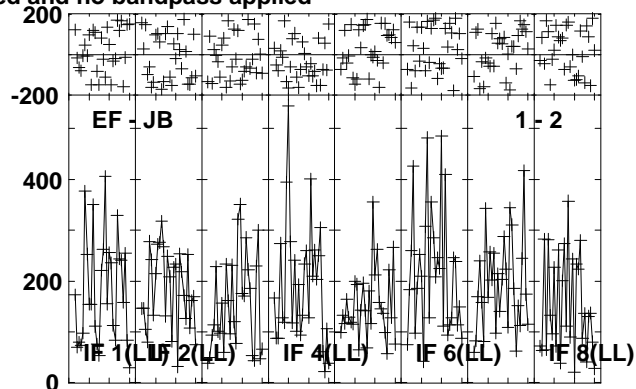
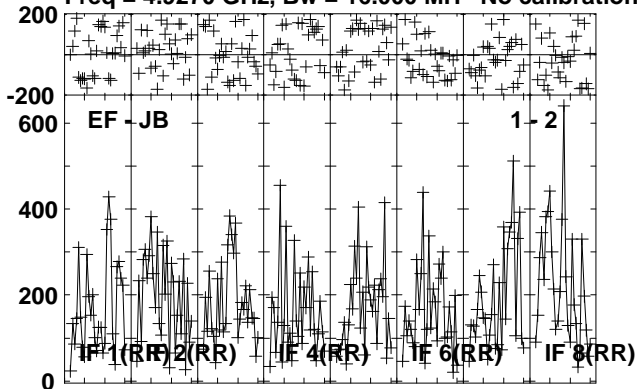

Lower frame: Micro Ampl Jy Top frame: Phas deg  
 Vector averaged cross-power spectrum Several baselines displayed  
 Timerange: 00/18:31:58 to 00/18:34:24

Plot file version 200 created 24-OCT-2012 21:00:00

G23.6-0.03 EY017B.UVDATA.1

Freq = 4.9270 GHz, Bw = 16.000 MH No calibration applied and no bandpass applied

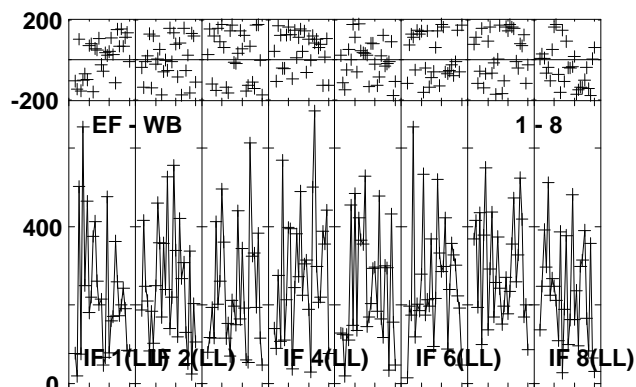
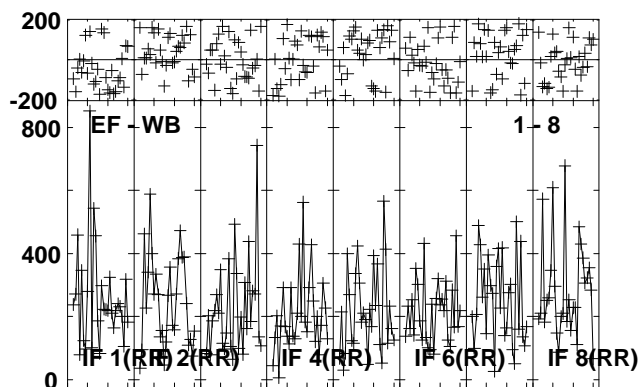
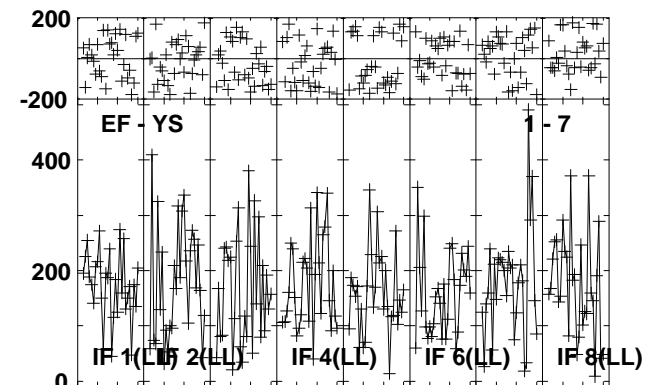
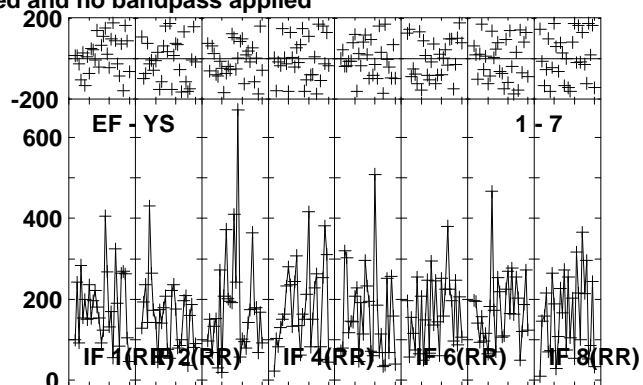
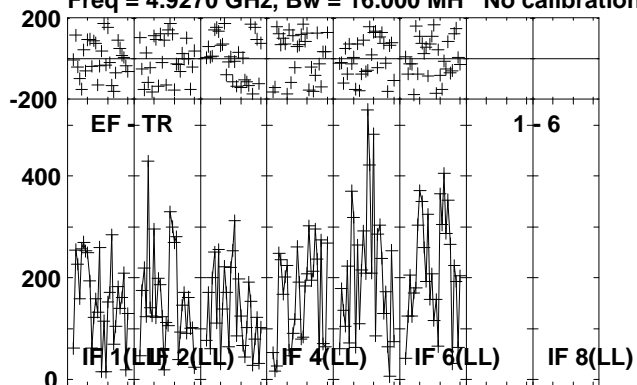

Lower frame: Micro Ampl Jy Top frame: Phas deg  
Vector averaged cross-power spectrum Several baselines displayed  
Timerange: 00:18:31:58 to 00:18:34:24



Plot file version 202 created 24-OCT-2012 21:00:01

J1825-0737 EY017B.UVDATA.1

Freq = 4.9270 GHz, Bw = 16.000 MH No calibration applied and no bandpass applied

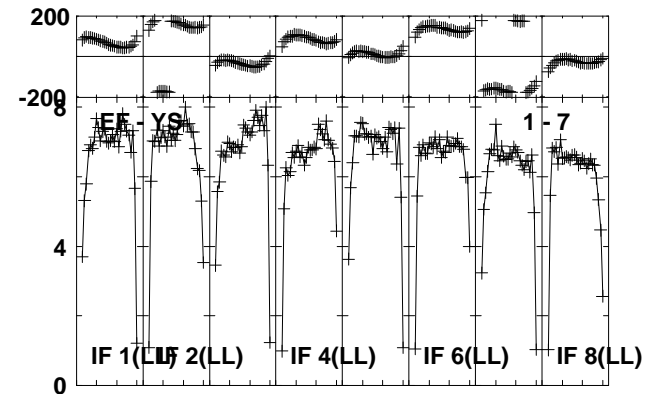
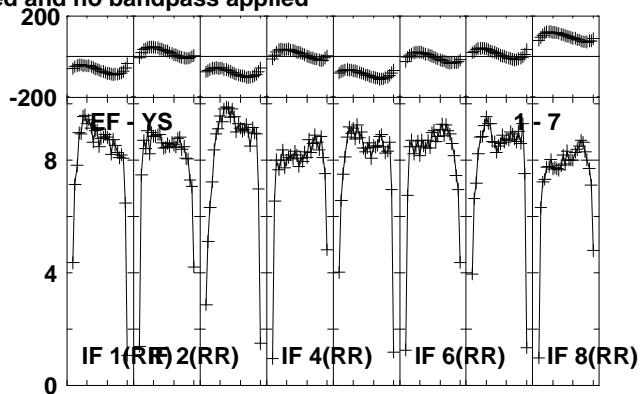
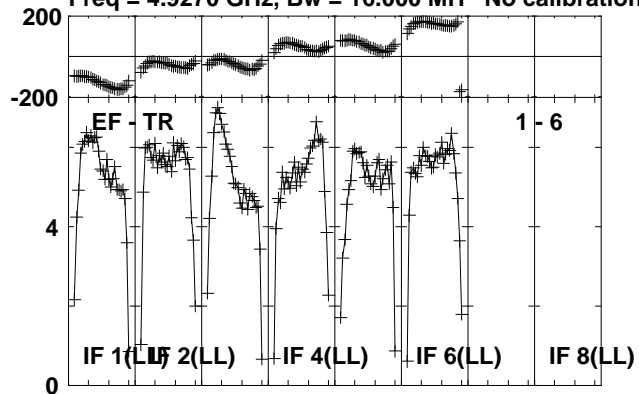

Lower frame: Milli Ampl Jy Top frame: Phas deg  
Vector averaged cross-power spectrum Several baselines displayed  
Timerange: 00/18:34:28 to 00/18:35:54

Plot file version 203 created 24-OCT-2012 21:00:01

G23.6-0.03 EY017B.UVDATA.1

Freq = 4.9270 GHz, Bw = 16.000 MH No calibration applied and no bandpass applied

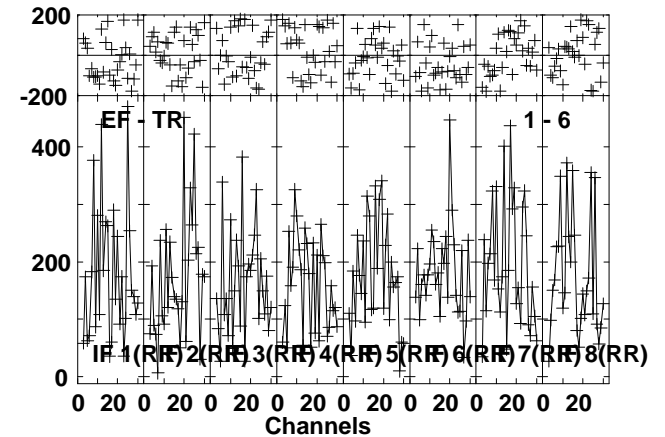
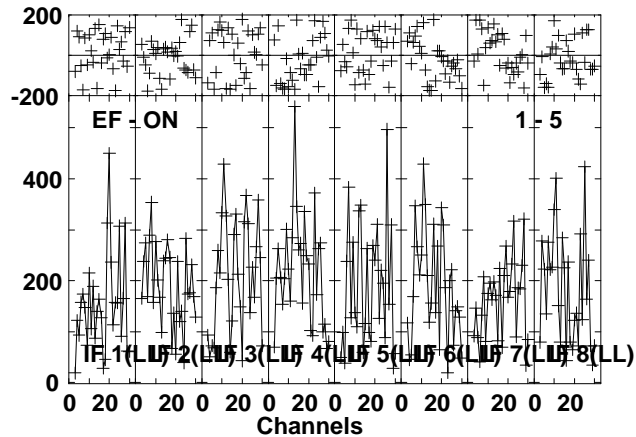
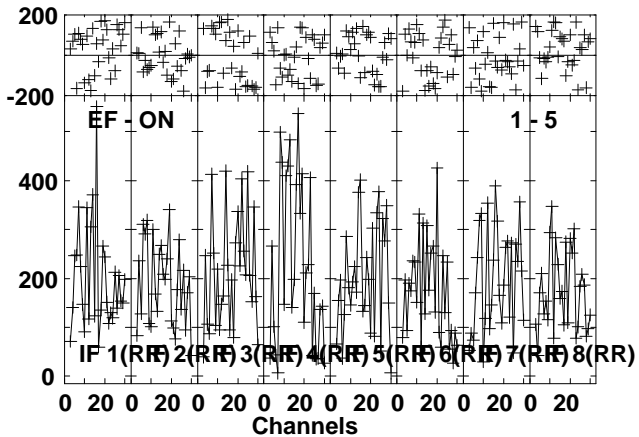
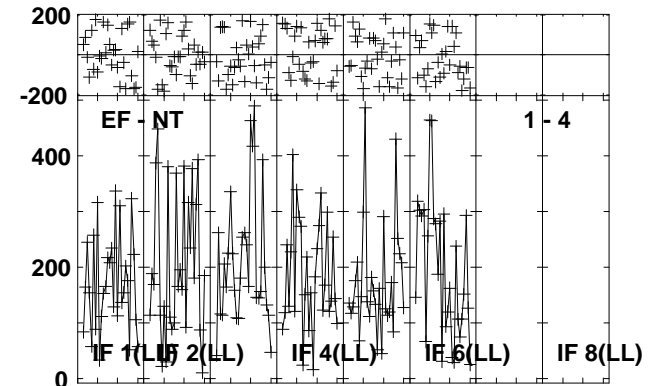
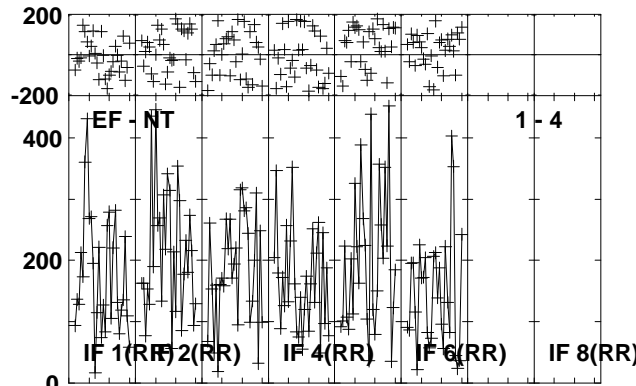
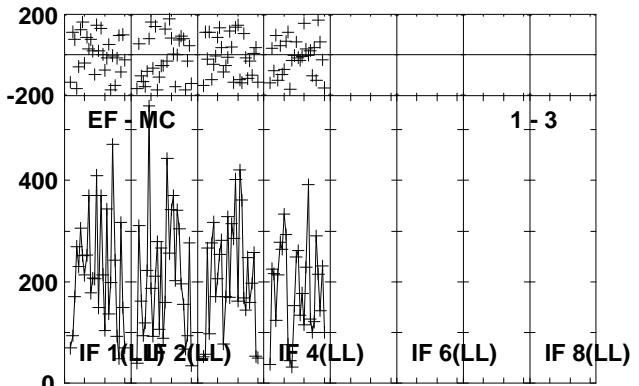
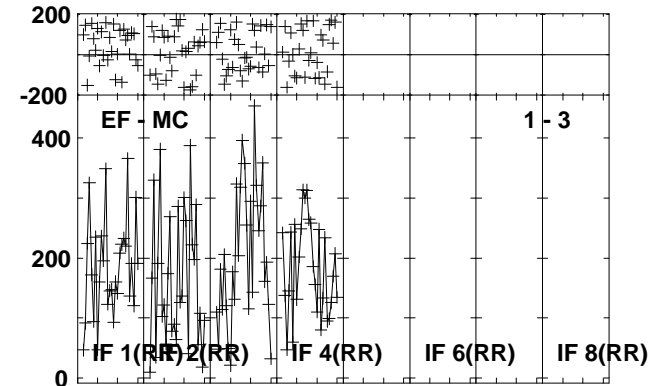
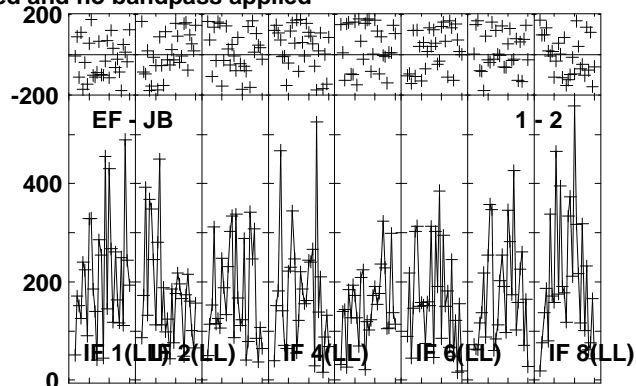
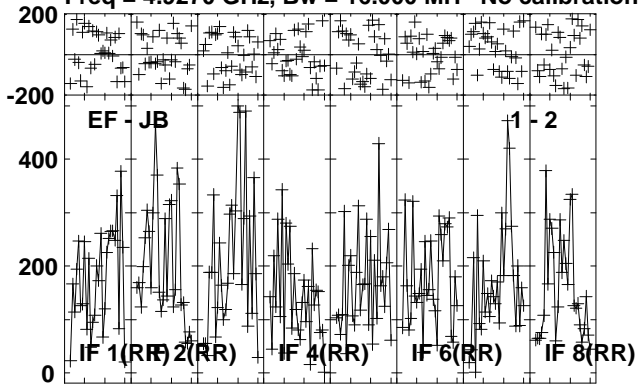

Lower frame: Micro Ampl Jy Top frame: Phas deg  
Vector averaged cross-power spectrum Several baselines displayed  
Timerange: 00/18:35:58 to 00/18:38:24

Plot file version 204 created 24-OCT-2012 21:00:01

G23.6-0.03 EY017B.UVDATA.1

Freq = 4.9270 GHz, Bw = 16.000 MH No calibration applied and no bandpass applied

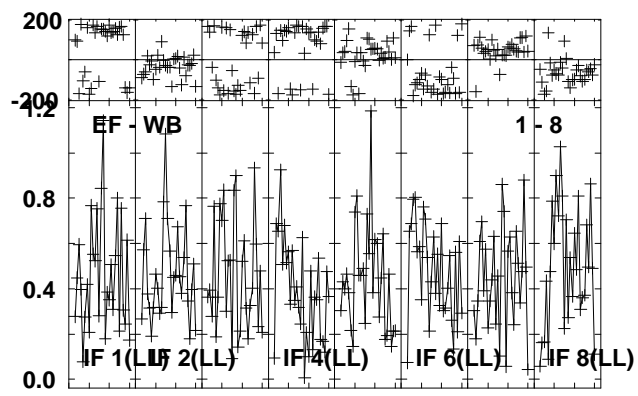
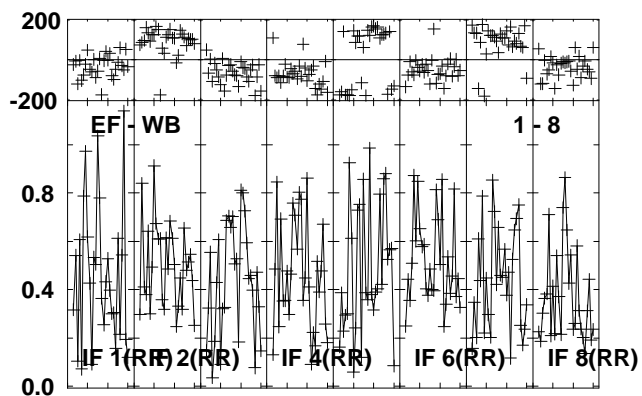
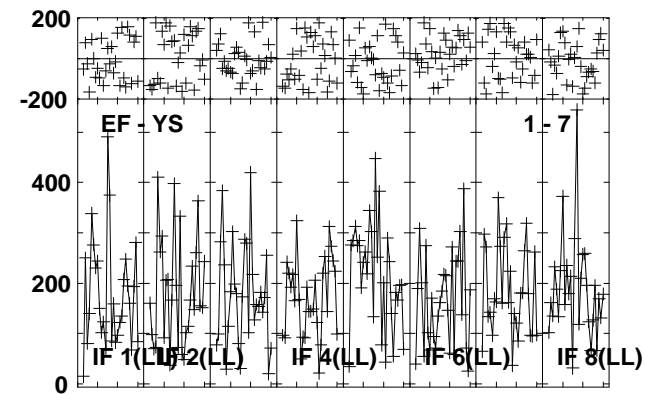
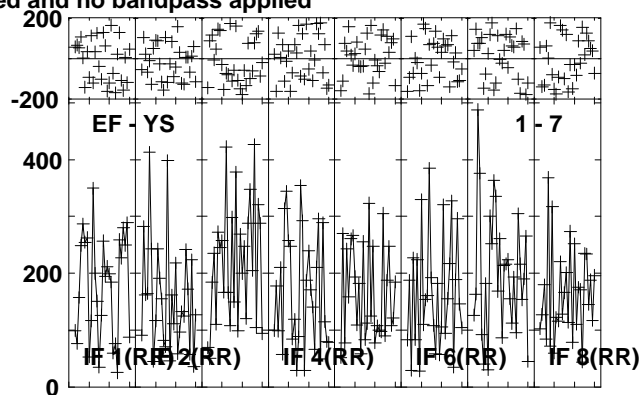
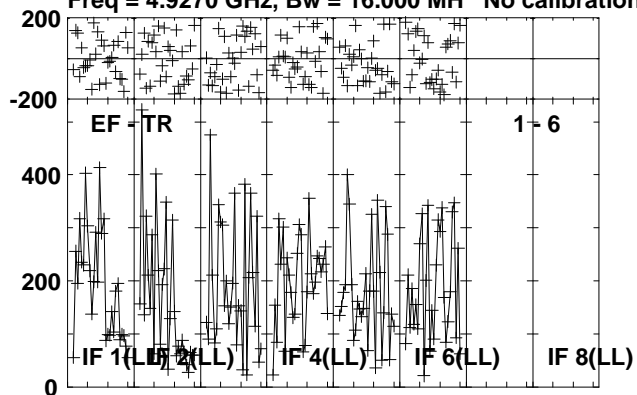

Lower frame: Micro Ampl Jy Top frame: Phas deg  
Vector averaged cross-power spectrum Several baselines displayed  
Timerange: 00:18:35:58 to 00:18:38:24





Plot file version 206 created 24-OCT-2012 21:00:02

J1825-0737 EY017B.UVDATA.1

Freq = 4.9270 GHz, Bw = 16.000 MH No calibration applied and no bandpass applied

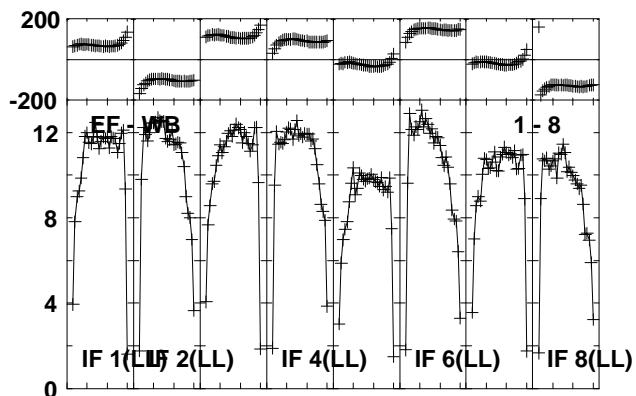
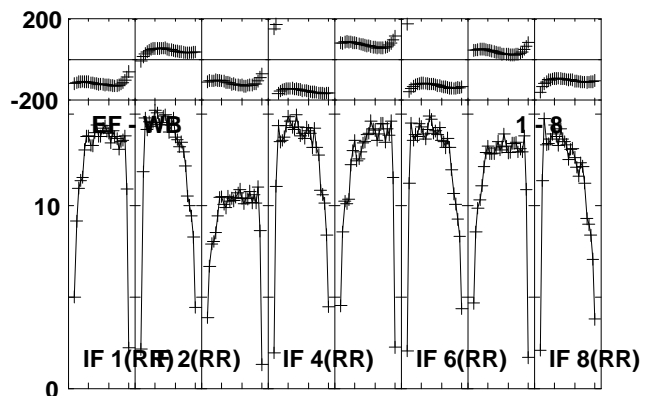
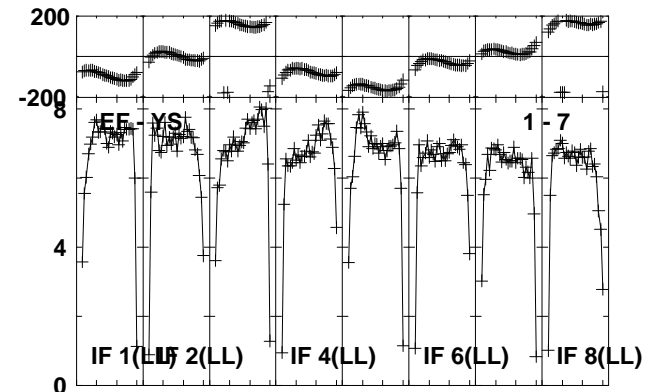
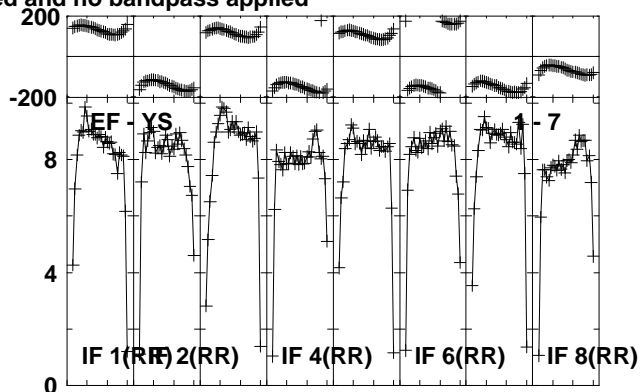
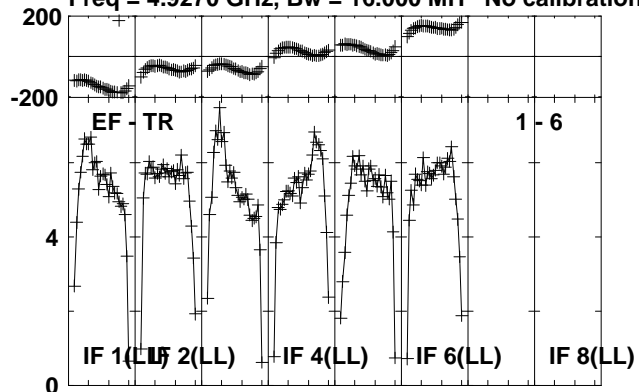

Lower frame: Milli Ampl Jy Top frame: Phas deg  
Vector averaged cross-power spectrum Several baselines displayed  
Timerange: 00/18:38:28 to 00/18:39:54

Plot file version 207 created 24-OCT-2012 21:00:03

J1831-0756 EY017B.UVDATA.1

Freq = 4.9270 GHz, Bw = 16.000 MH No calibration applied and no bandpass applied

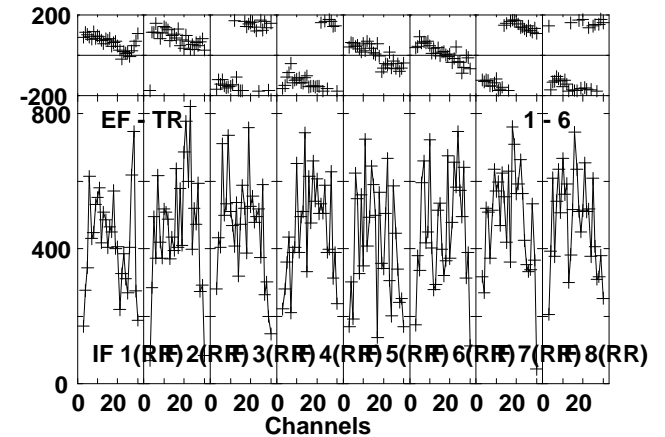
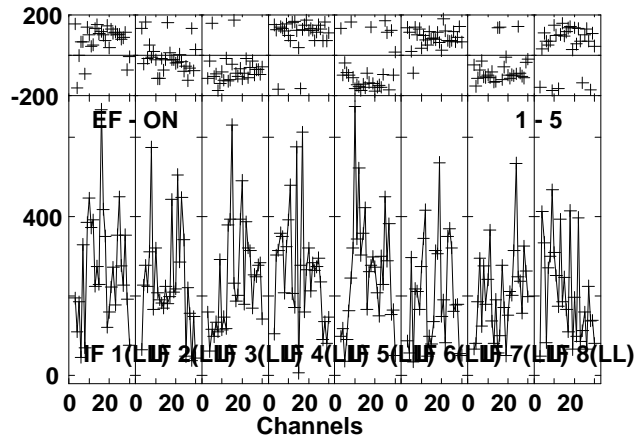
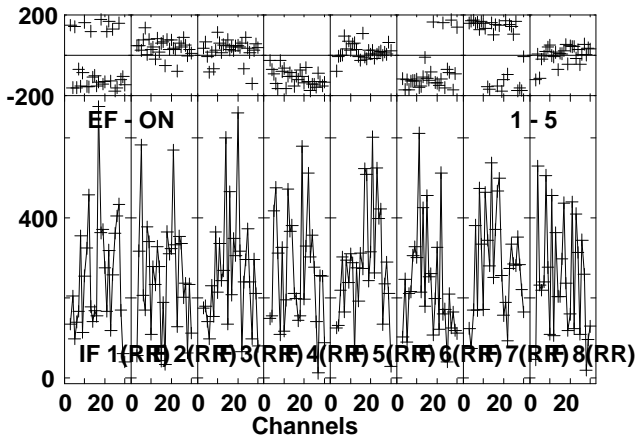
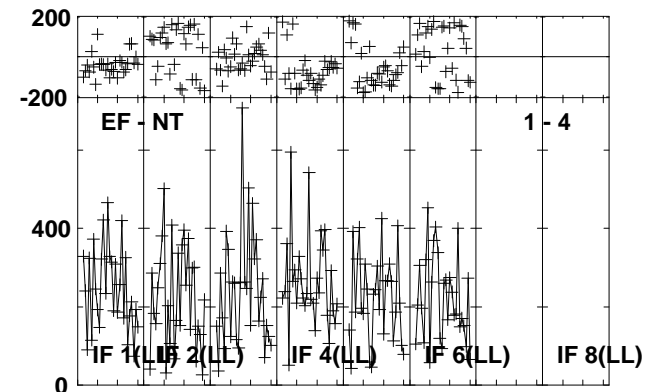
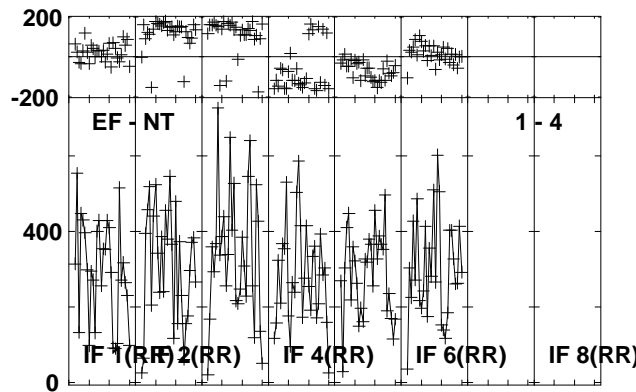
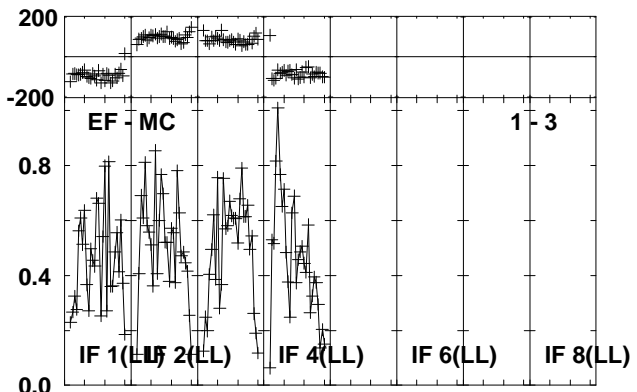
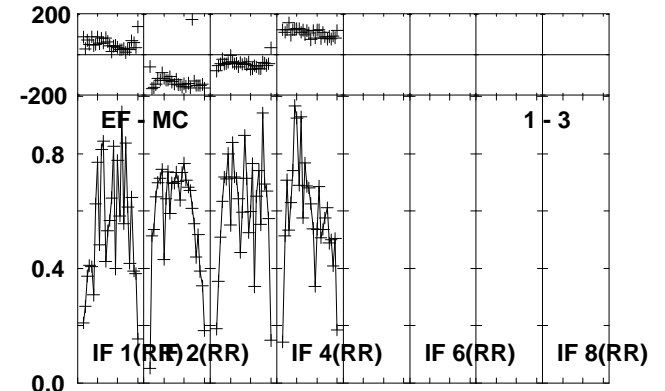
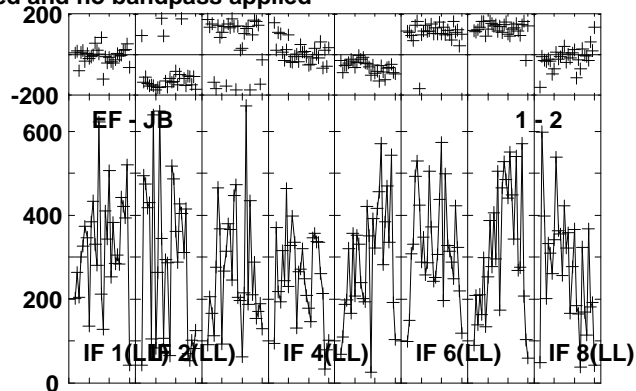
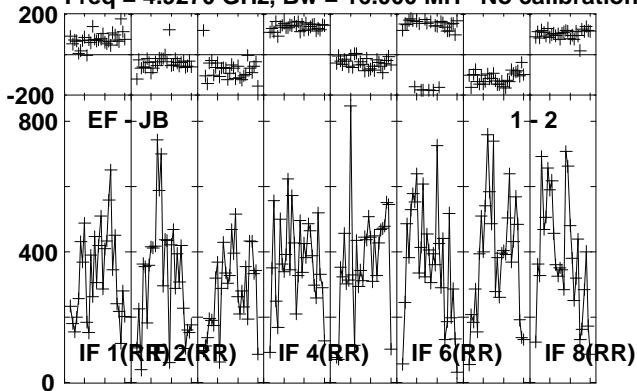

Lower frame: Micro Ampl Jy Top frame: Phas deg  
Vector averaged cross-power spectrum Several baselines displayed  
Timerange: 00/18:40:28 to 00/18:42:28

Plot file version 208 created 24-OCT-2012 21:00:03

J1831-0756 EY017B.UVDATA.1

Freq = 4.9270 GHz, Bw = 16.000 MH No calibration applied and no bandpass applied

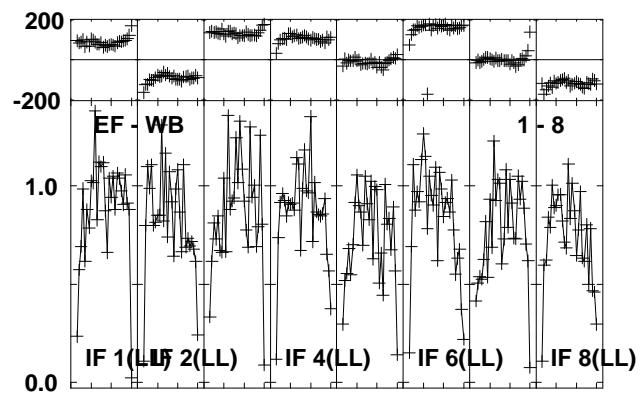
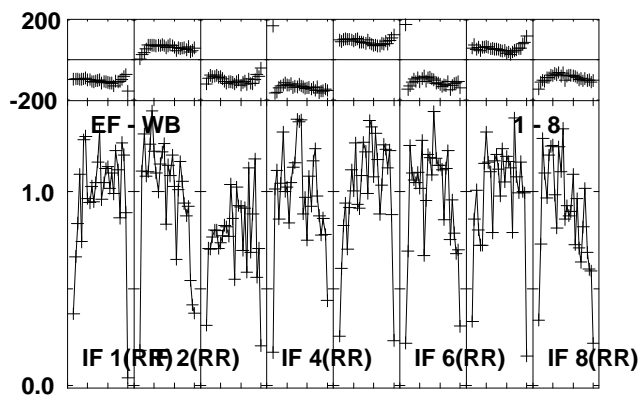
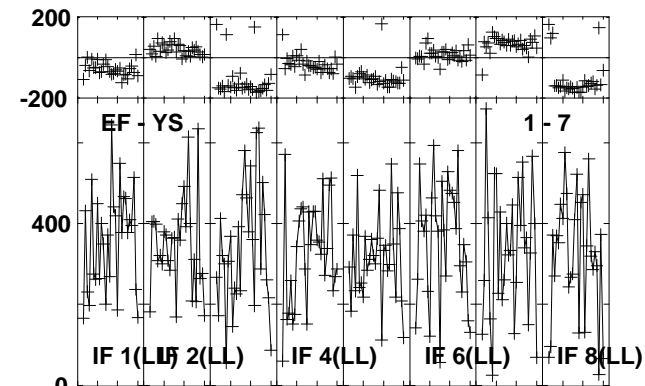
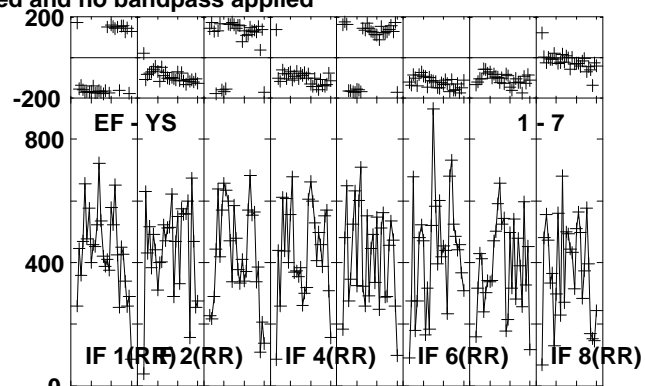
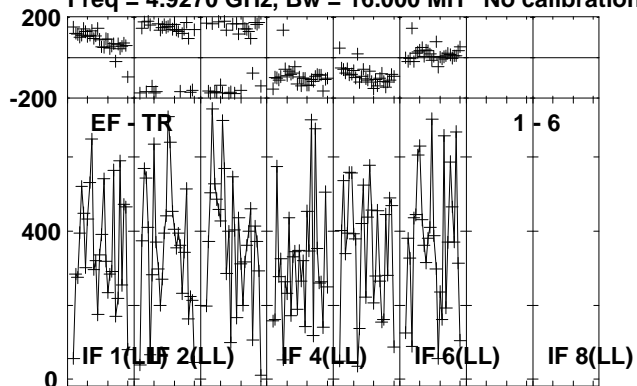

Lower frame: Micro Ampl Jy Top frame: Phas deg  
Vector averaged cross-power spectrum Several baselines displayed  
Timerange: 00:18:40:28 to 00:18:42:28

Plot file version 209 created 24-OCT-2012 21:00:04

J1825-0737 EY017B.UVDATA.1

Freq = 4.9270 GHz, Bw = 16.000 MH No calibration applied and no bandpass applied

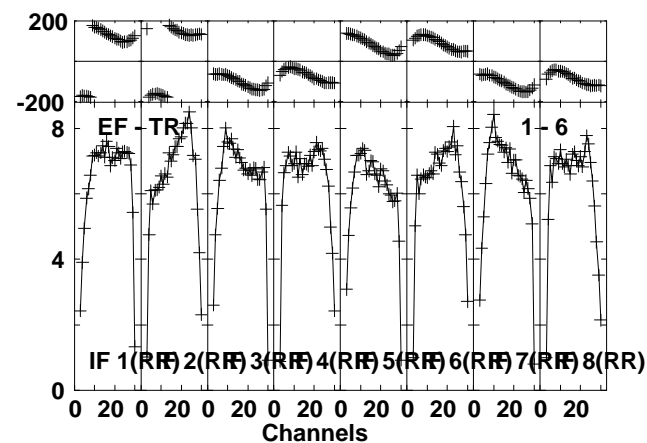
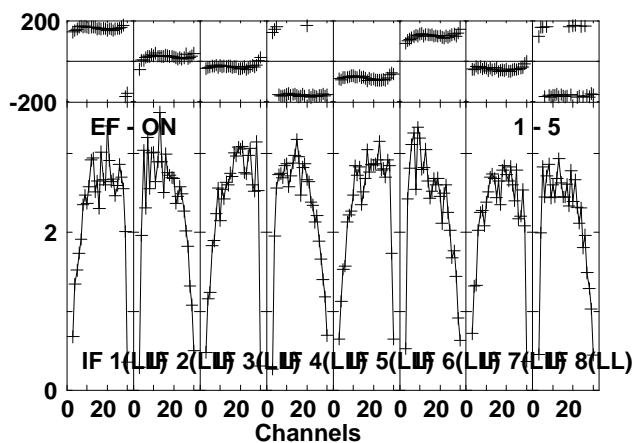
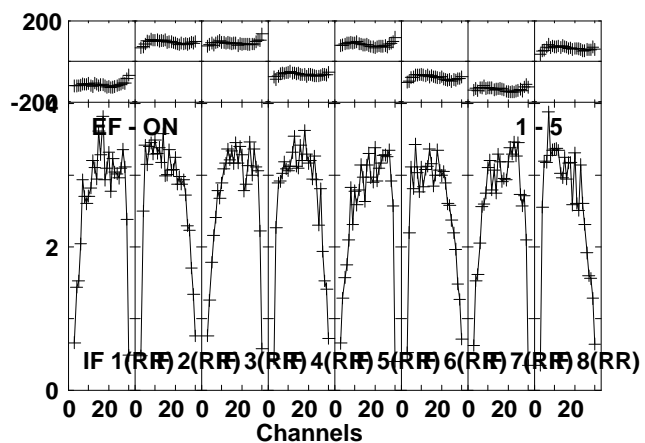
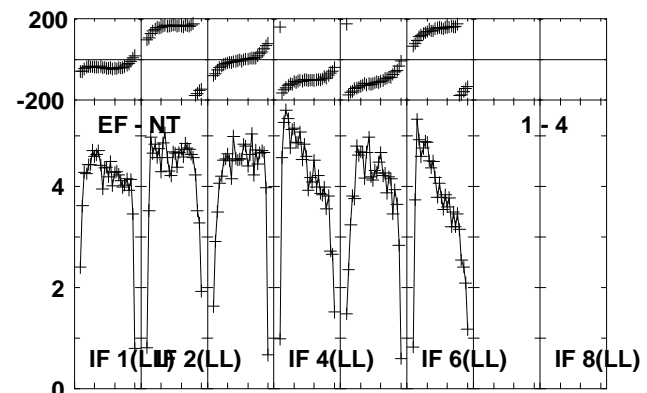
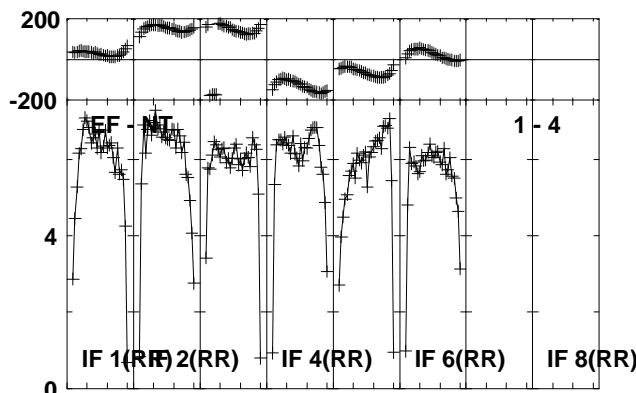
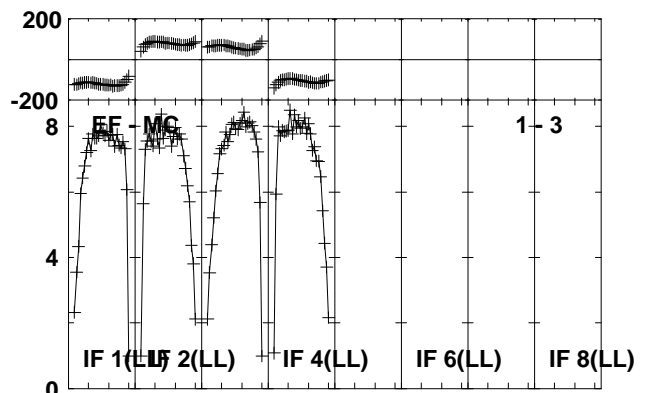
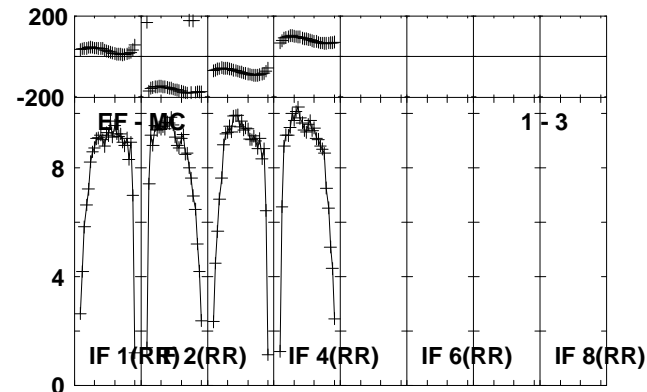
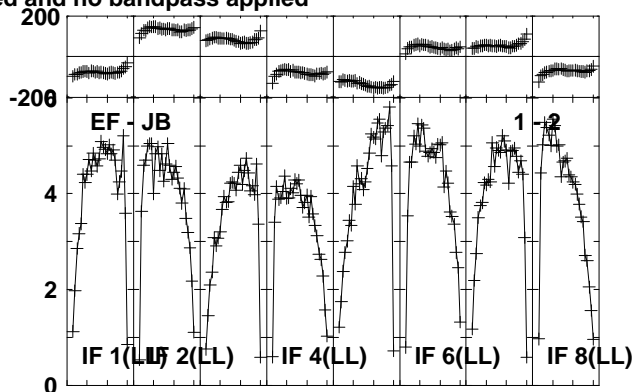
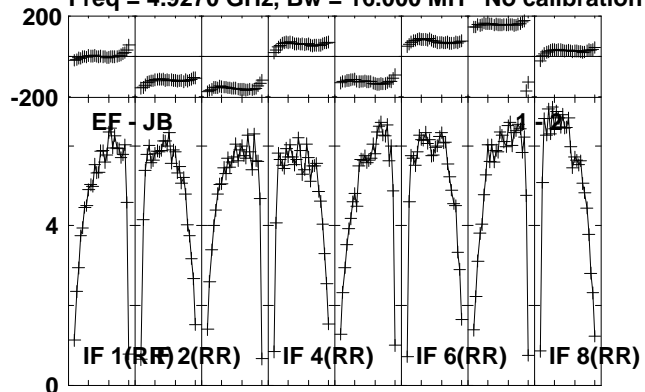

Lower frame: Milli Ampl Jy Top frame: Phas deg  
Vector averaged cross-power spectrum Several baselines displayed  
Timerange: 00/18:42:32 to 00/18:43:58

Plot file version 210 created 24-OCT-2012 21:00:04

J1825-0737 EY017B.UVDATA.1

Freq = 4.9270 GHz, Bw = 16.000 MH No calibration applied and no bandpass applied

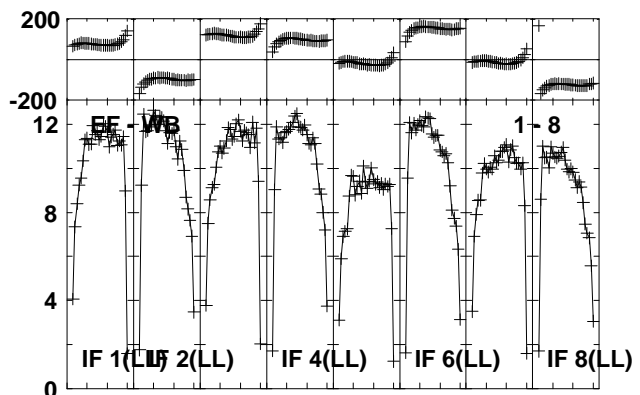
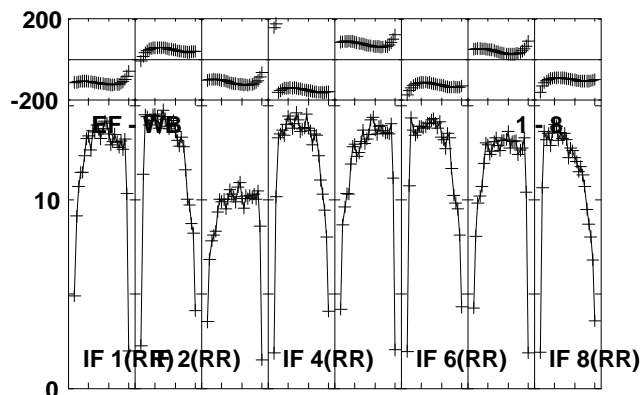
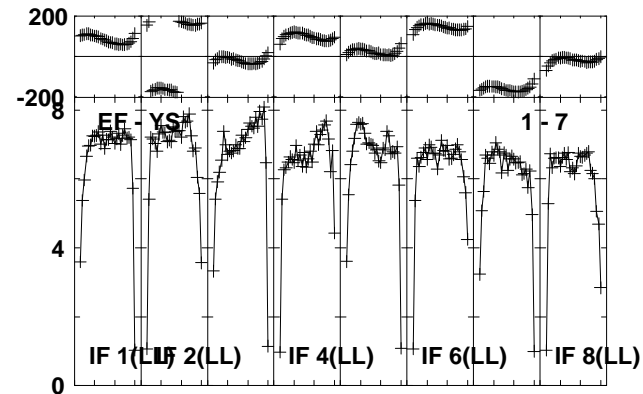
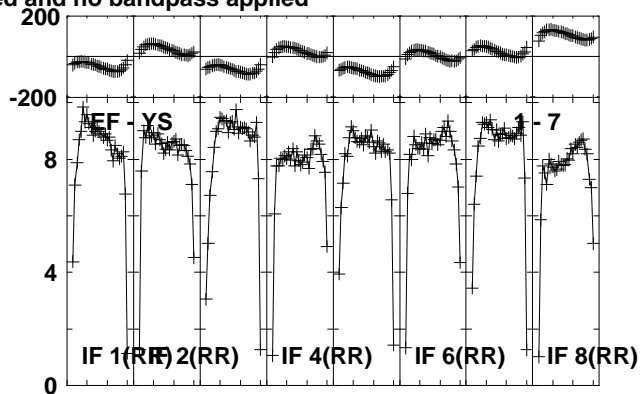
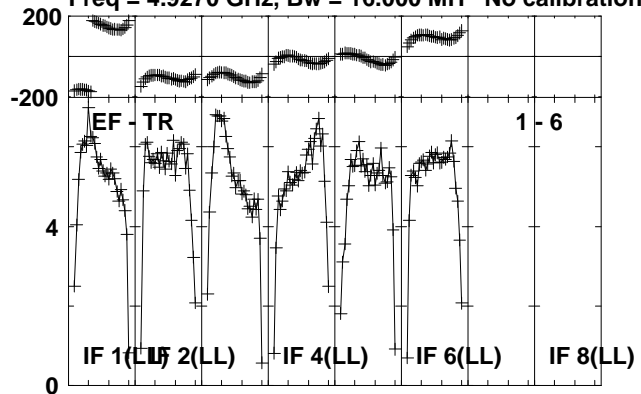

Lower frame: Milli Ampl Jy Top frame: Phas deg  
Vector averaged cross-power spectrum Several baselines displayed  
Timerange: 00/18:42:32 to 00/18:43:58

Plot file version 211 created 24-OCT-2012 21:00:05

G23.6-0.03 EY017B.UVDATA.1

Freq = 4.9270 GHz, Bw = 16.000 MH No calibration applied and no bandpass applied

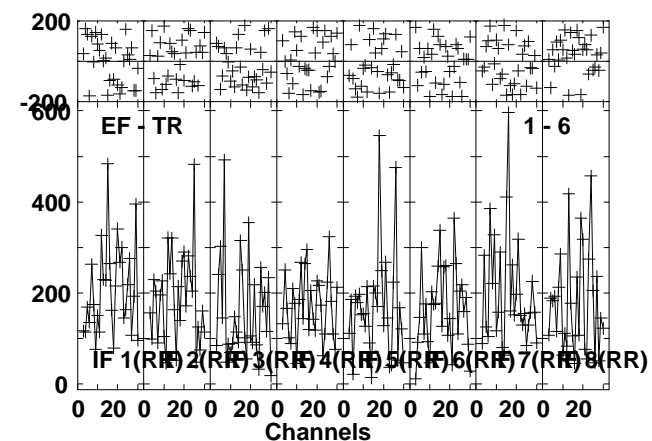
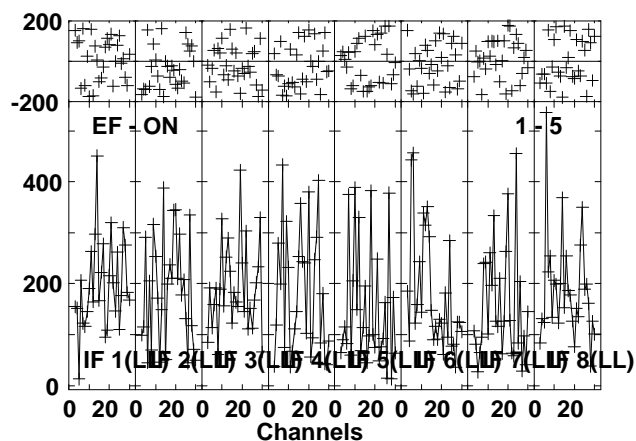
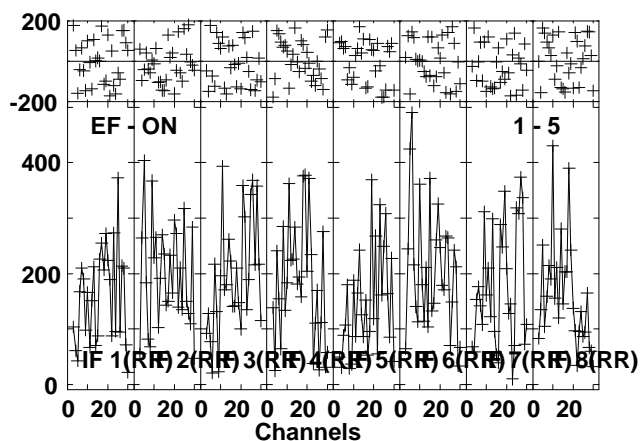
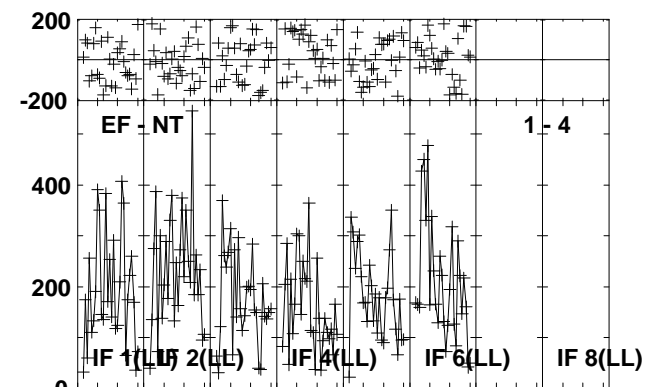
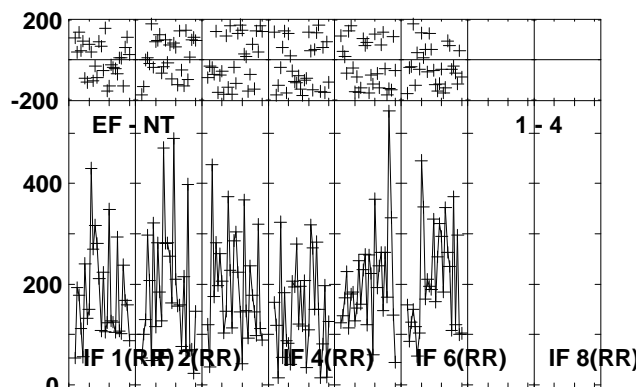
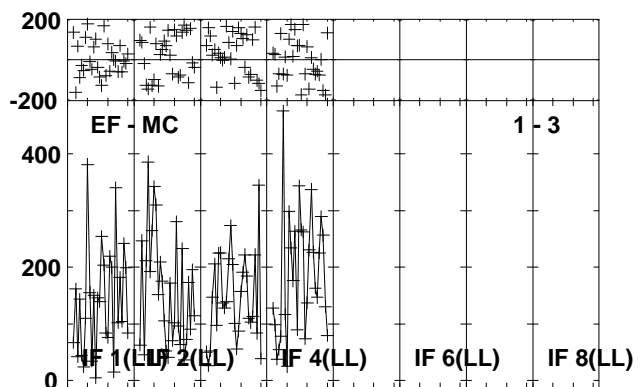
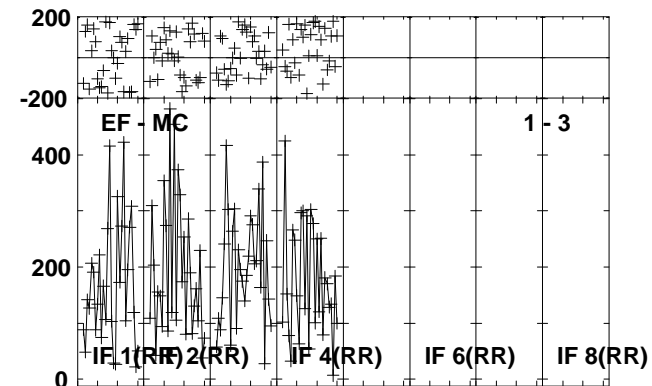
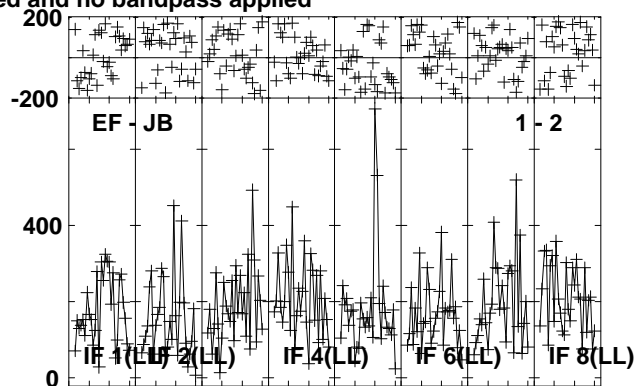
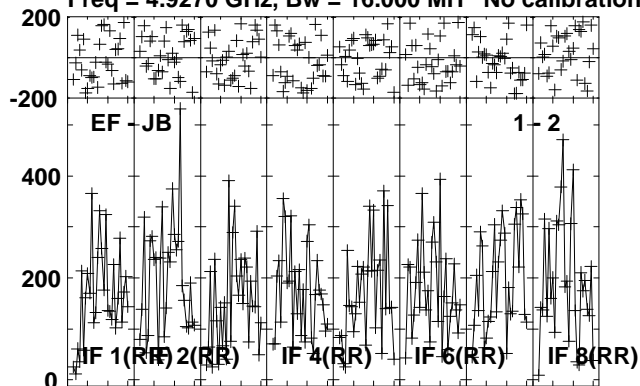

Lower frame: Micro Ampl Jy Top frame: Phas deg  
 Vector averaged cross-power spectrum Several baselines displayed  
 Timerange: 00/18:44:02 to 00/18:46:28

Plot file version 212 created 24-OCT-2012 21:00:06

G23.6-0.03 EY017B.UVDATA.1

Freq = 4.9270 GHz, Bw = 16.000 MH No calibration applied and no bandpass applied

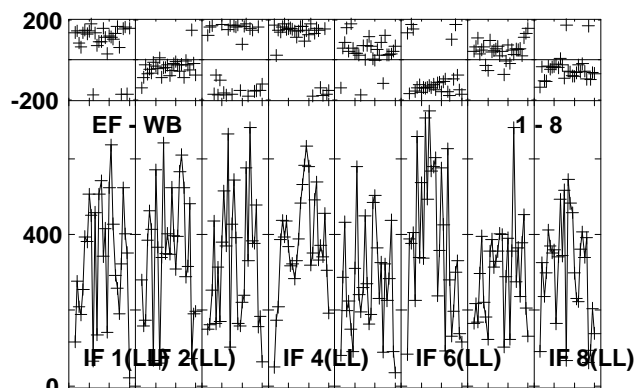
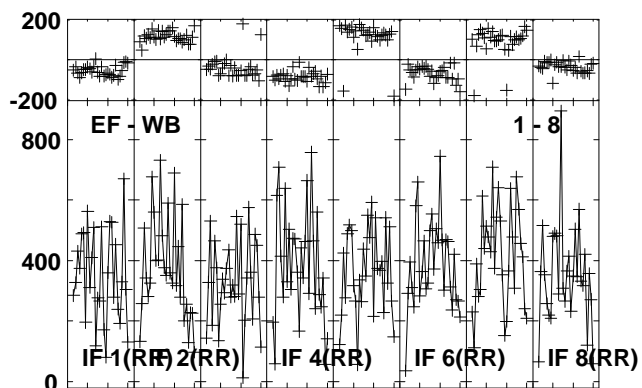
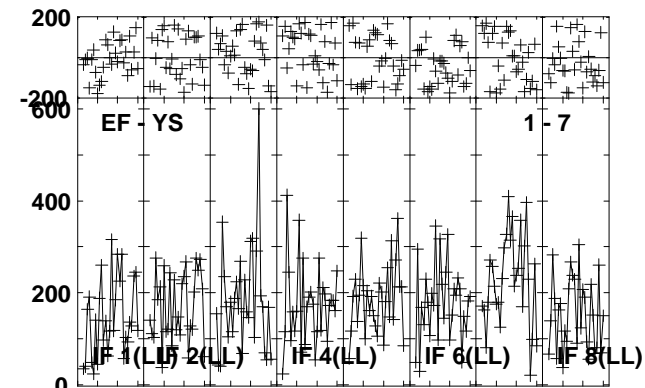
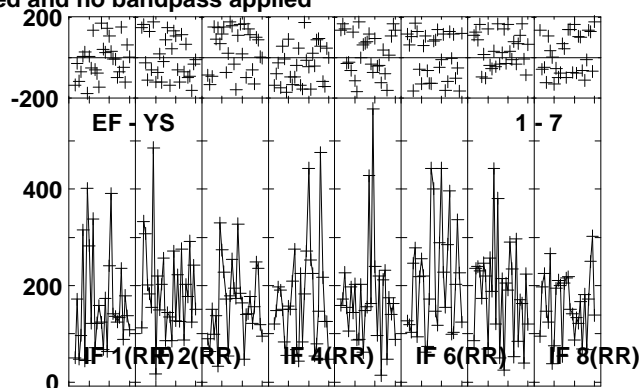
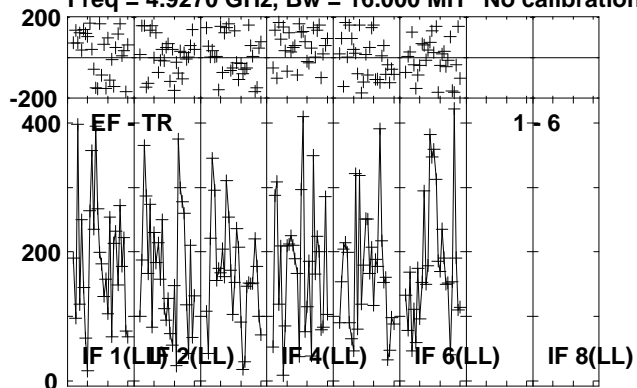

Lower frame: Micro Ampl Jy Top frame: Phas deg  
Vector averaged cross-power spectrum Several baselines displayed  
Timerange: 00/18:44:02 to 00/18:46:28



Plot file version 213 created 24-OCT-2012 21:00:06

J1825-0737 EY017B.UVDATA.1

Freq = 4.9270 GHz, Bw = 16.000 MH No calibration applied and no bandpass applied

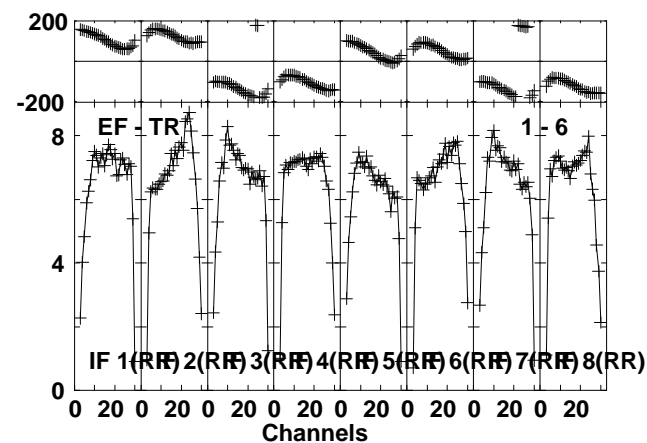
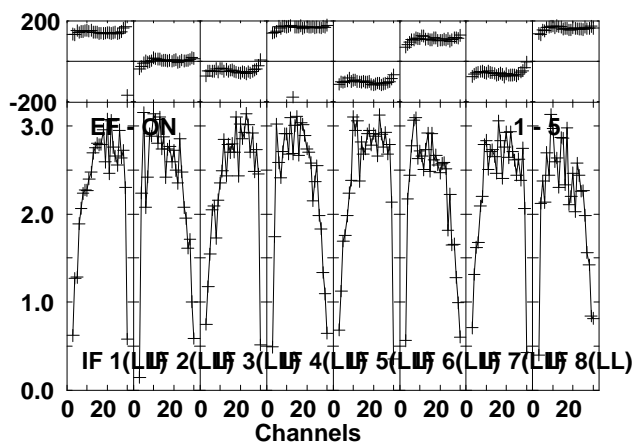
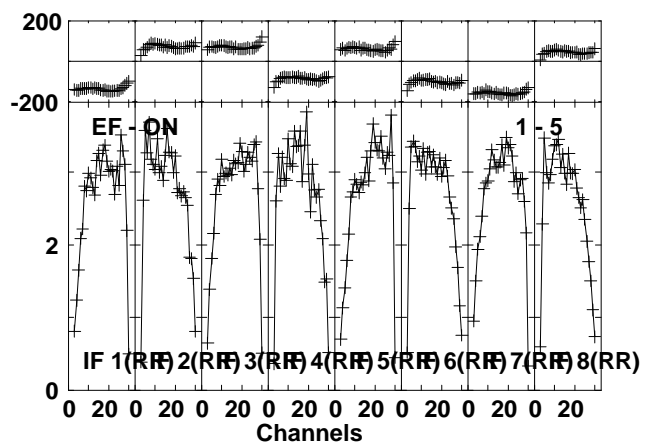
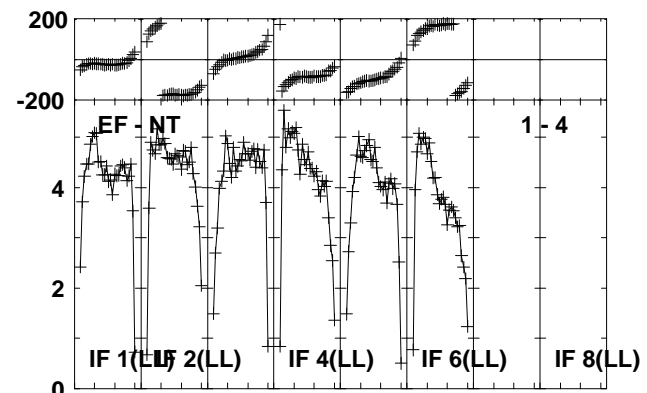
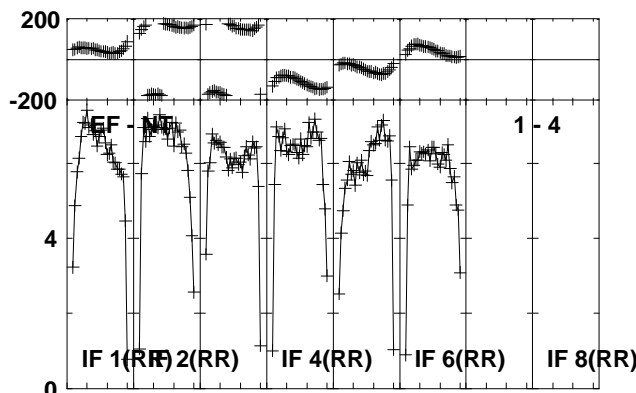
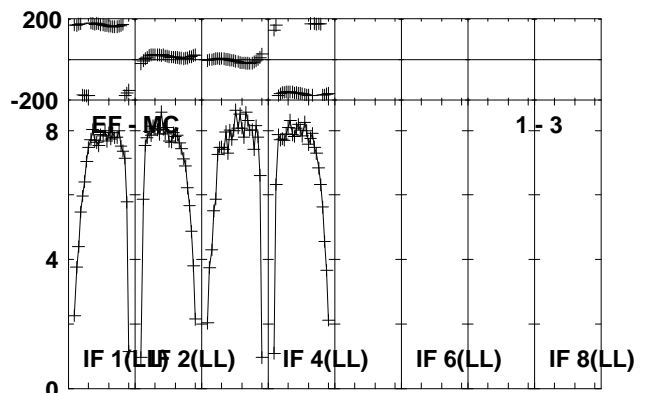
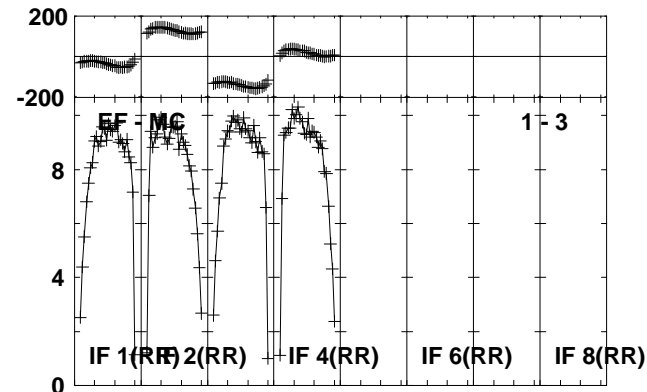
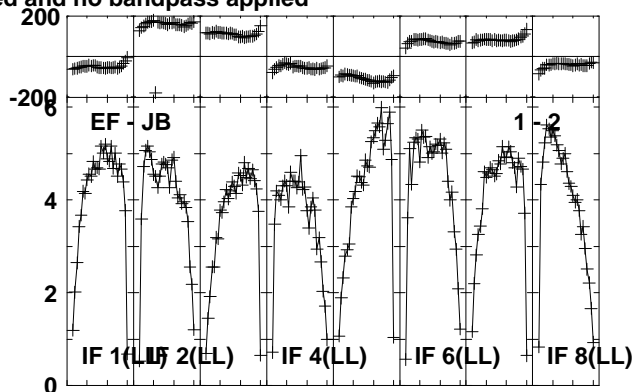
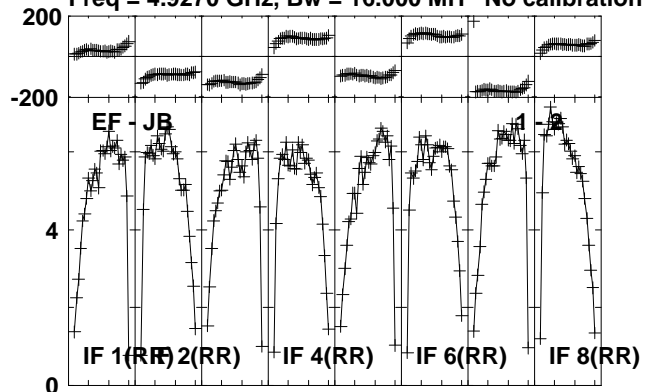

Lower frame: Milli Ampl Jy Top frame: Phas deg  
Vector averaged cross-power spectrum Several baselines displayed  
Timerange: 00/18:46:32 to 00/18:47:58

Plot file version 214 created 24-OCT-2012 21:00:07  
J1825-0737 EY017B.UVDATA.1

Freq = 4.9270 GHz, Bw = 16.000 MH No calibration applied and no bandpass applied

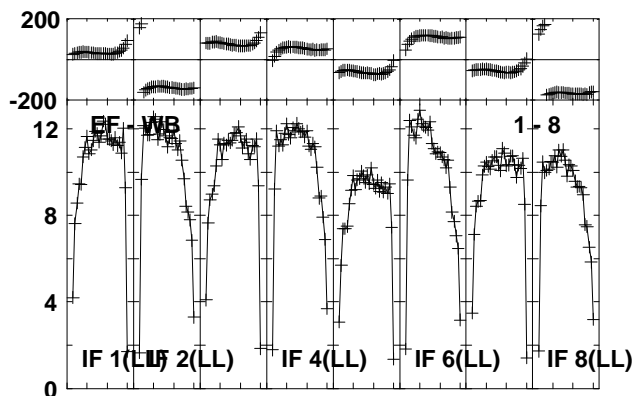
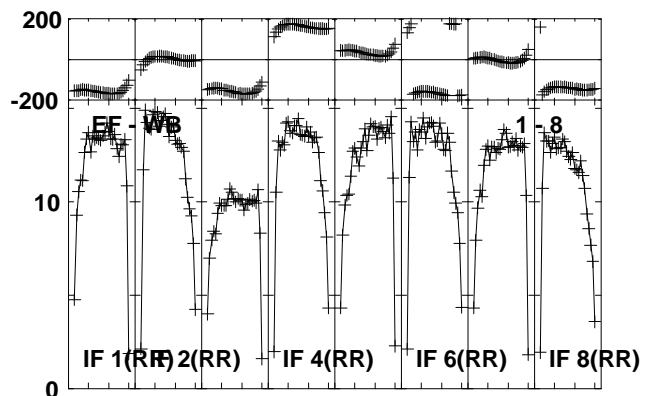
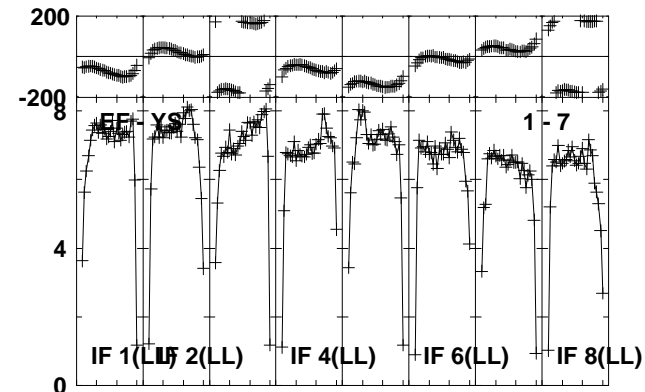
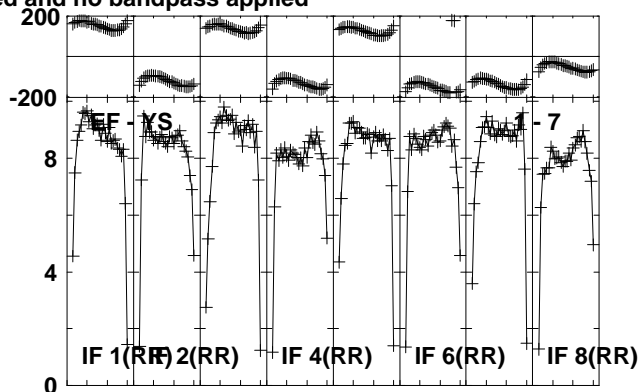
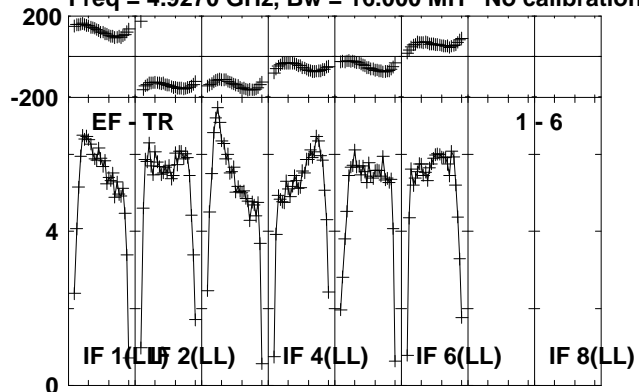

Lower frame: Milli Ampl Jy Top frame: Phas deg  
Vector averaged cross-power spectrum Several baselines displayed  
Timerange: 00/18:46:32 to 00/18:47:58

Plot file version 215 created 24-OCT-2012 21:00:07

G23.6-0.03 EY017B.UVDATA.1

Freq = 4.9270 GHz, Bw = 16.000 MH No calibration applied and no bandpass applied

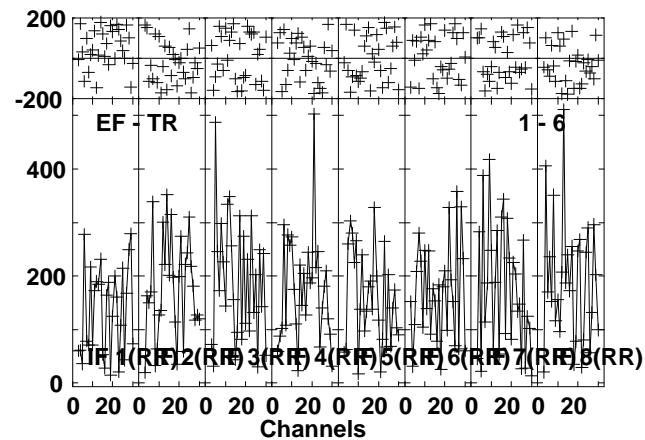
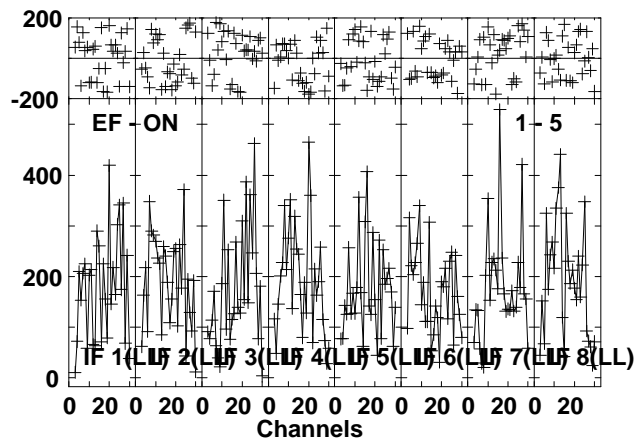
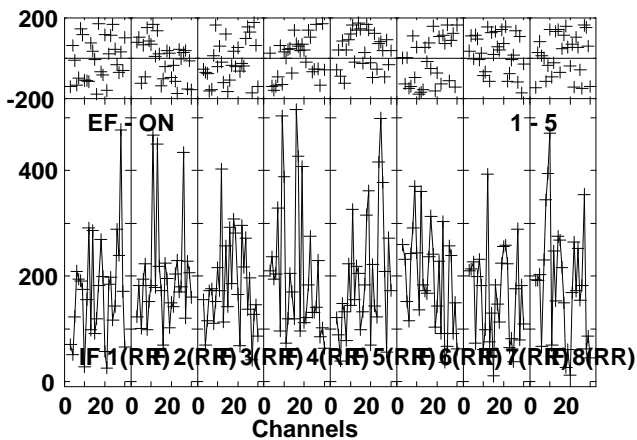
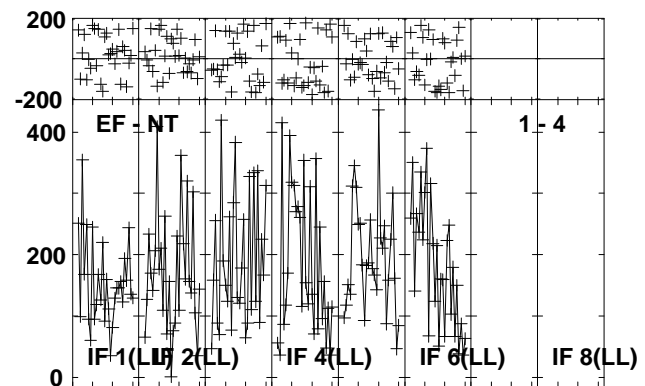
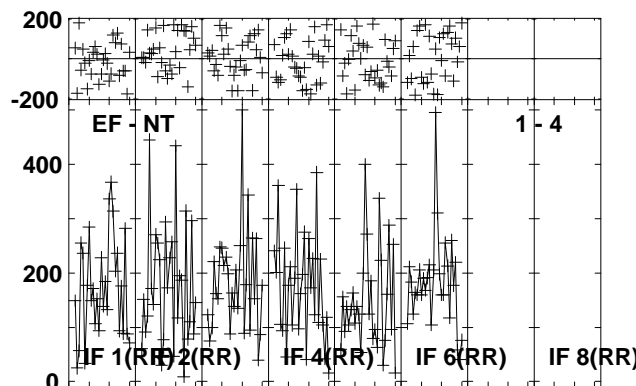
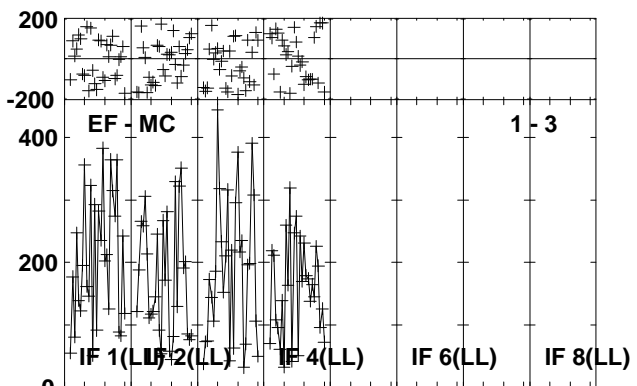
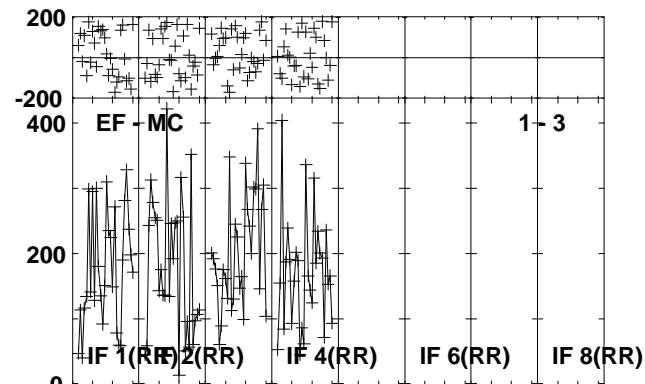
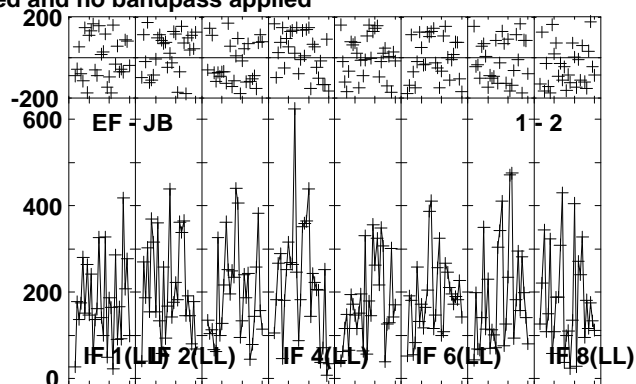
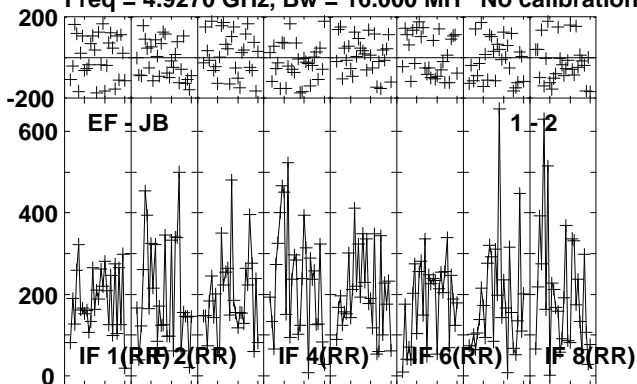

Lower frame: Micro Ampl Jy Top frame: Phas deg  
Vector averaged cross-power spectrum Several baselines displayed  
Timerange: 00/18:48:02 to 00/18:50:28

Plot file version 216 created 24-OCT-2012 21:00:08

G23.6-0.03 EY017B.UVDATA.1

Freq = 4.9270 GHz, Bw = 16.000 MH No calibration applied and no bandpass applied

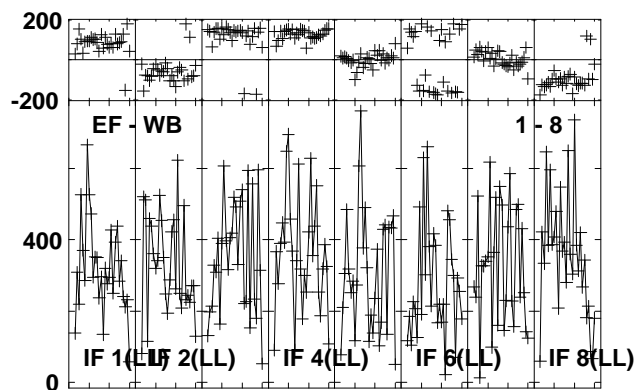
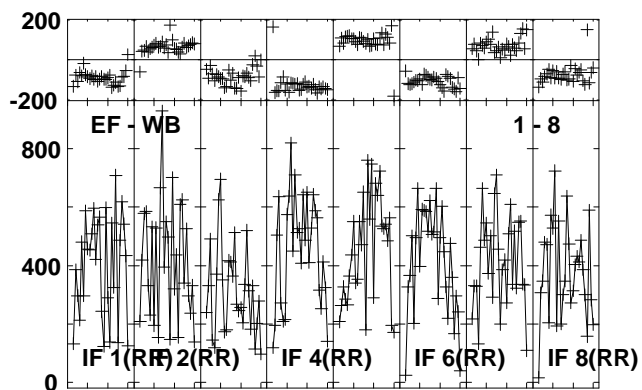
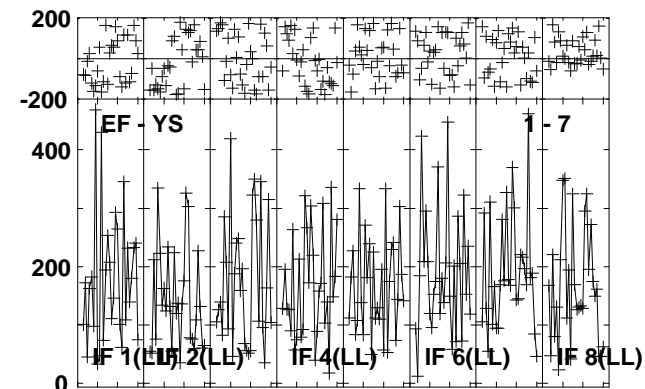
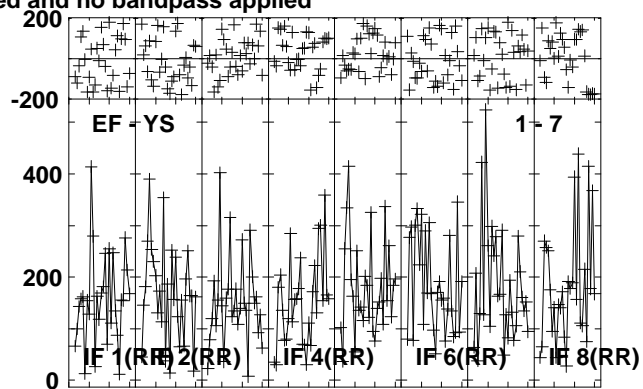
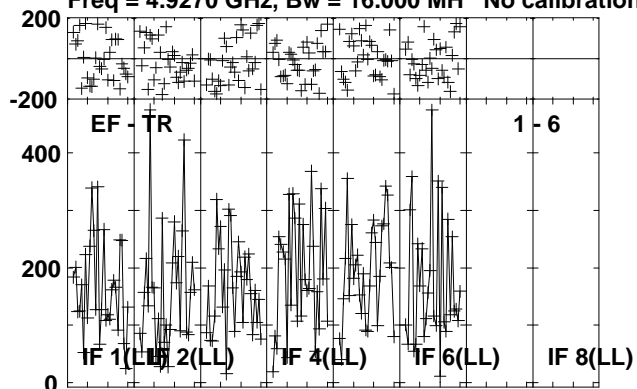

Lower frame: Micro Ampl Jy Top frame: Phas deg  
Vector averaged cross-power spectrum Several baselines displayed  
Timerange: 00/18:48:02 to 00/18:50:28

Plot file version 217 created 24-OCT-2012 21:00:08

J1825-0737 EY017B.UVDATA.1

Freq = 4.9270 GHz, Bw = 16.000 MH No calibration applied and no bandpass applied

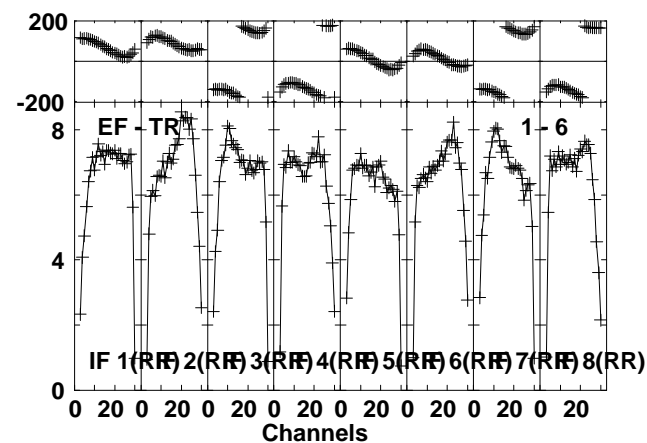
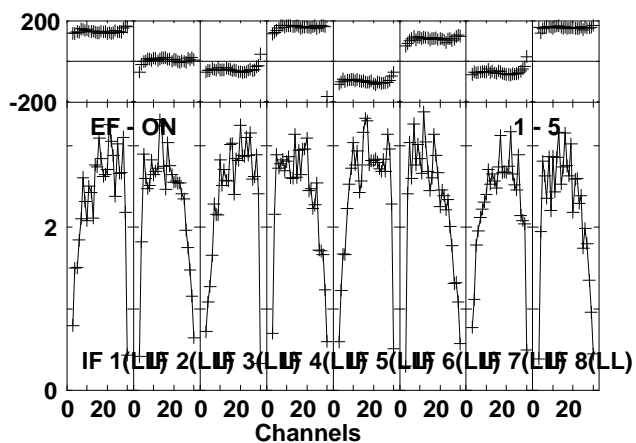
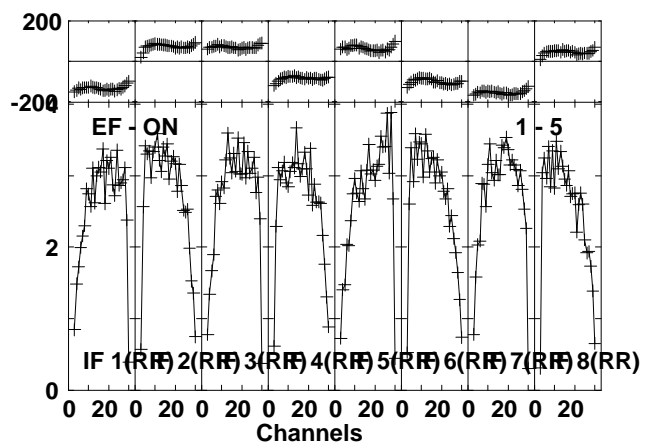
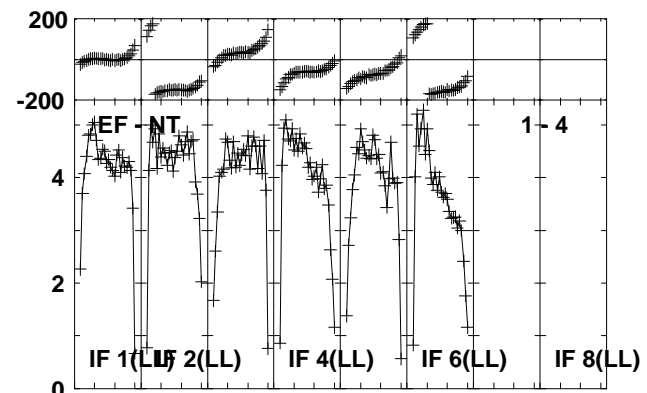
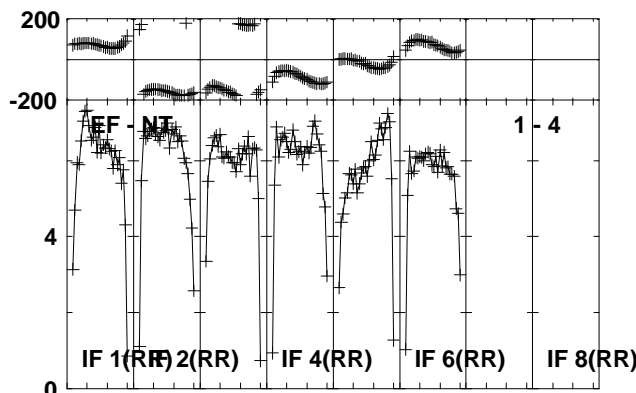
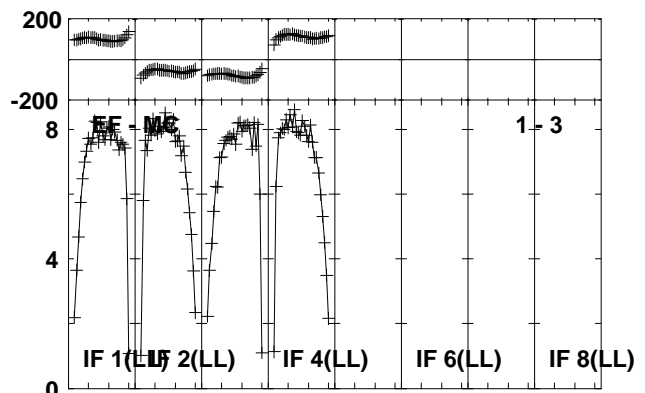
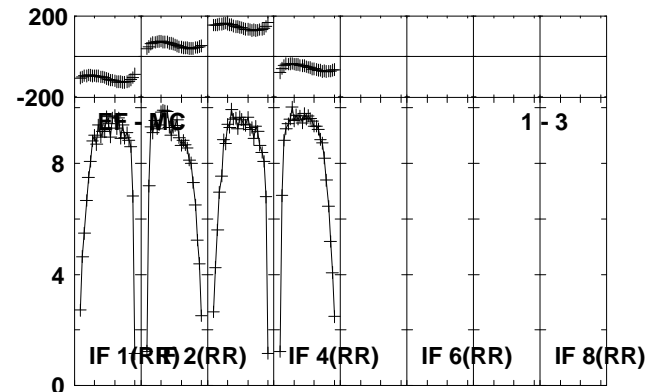
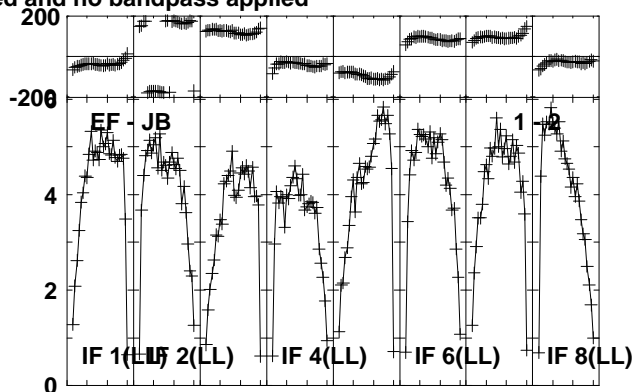
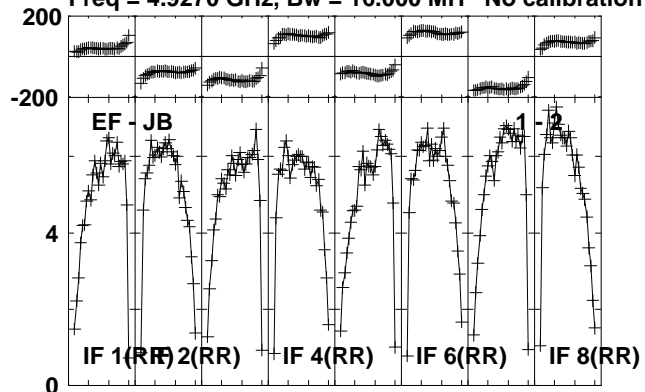

Lower frame: Milli Ampl Jy Top frame: Phas deg  
Vector averaged cross-power spectrum Several baselines displayed  
Timerange: 00/18:50:32 to 00/18:51:58

Plot file version 218 created 24-OCT-2012 21:00:09

J1825-0737 EY017B.UVDATA.1

Freq = 4.9270 GHz, Bw = 16.000 MH No calibration applied and no bandpass applied

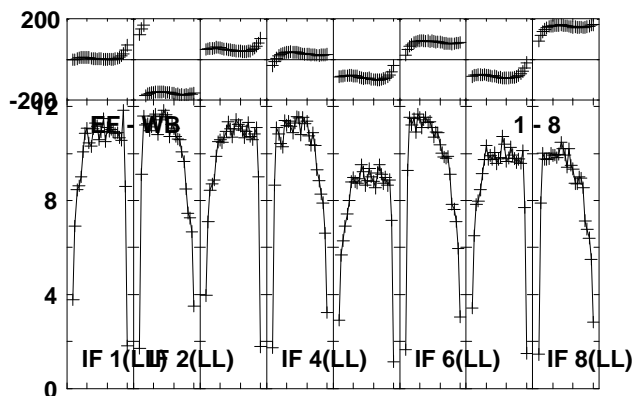
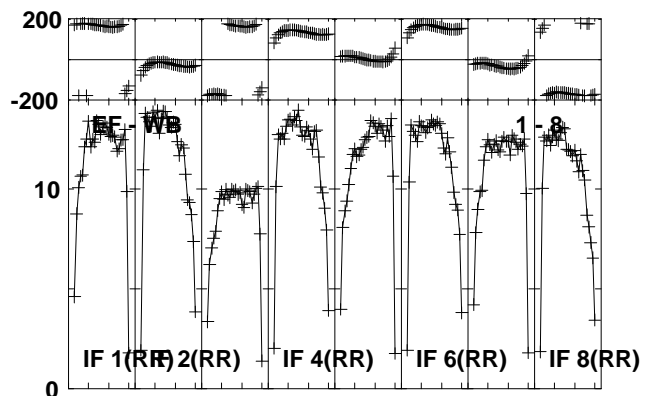
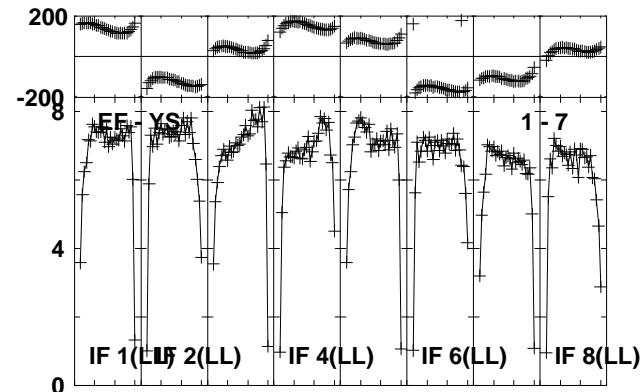
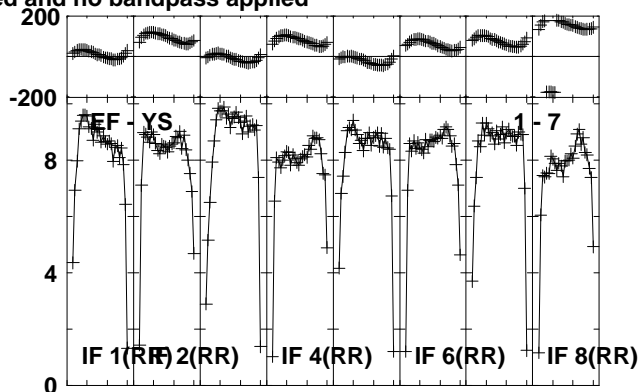
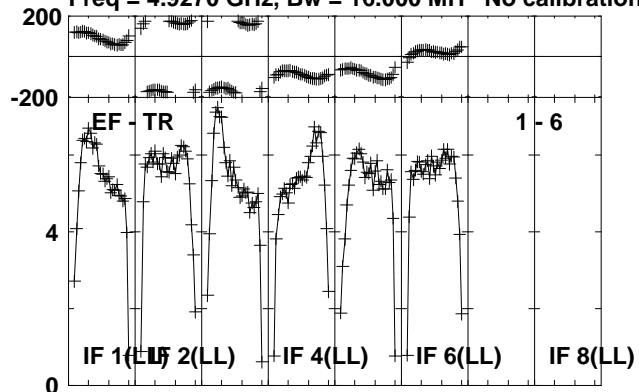

Lower frame: Milli Ampl Jy Top frame: Phas deg  
Vector averaged cross-power spectrum Several baselines displayed  
Timerange: 00/18:50:32 to 00/18:51:58

Plot file version 219 created 24-OCT-2012 21:00:09

G23.6-0.03 EY017B.UVDATA.1

Freq = 4.9270 GHz, Bw = 16.000 MH No calibration applied and no bandpass applied

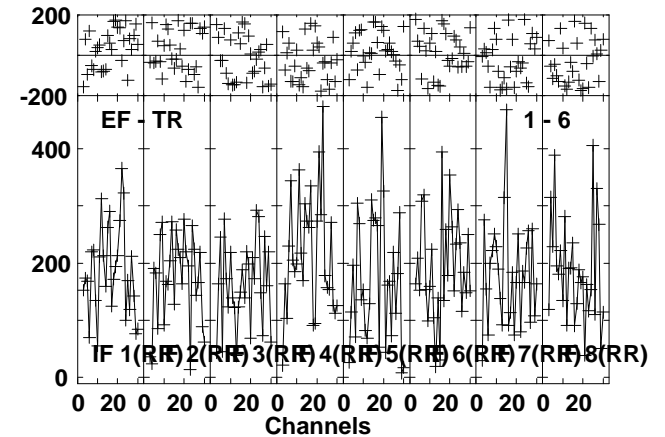
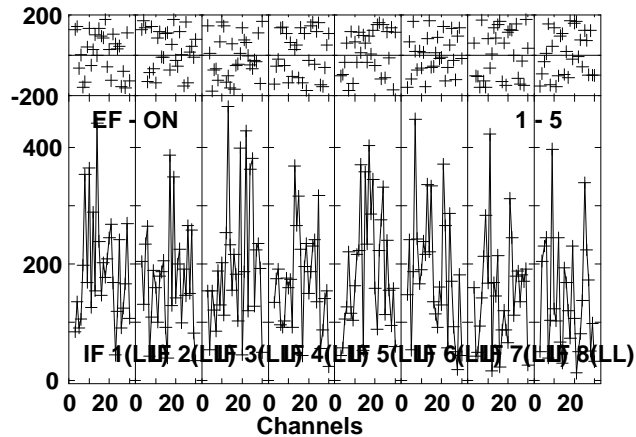
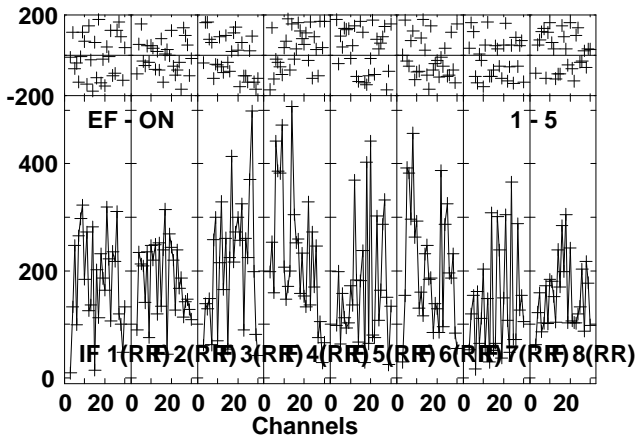
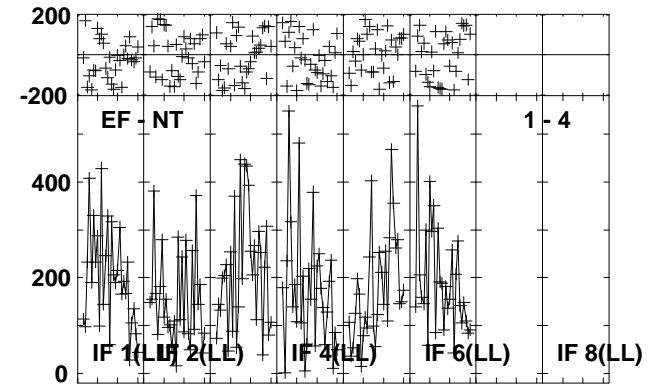
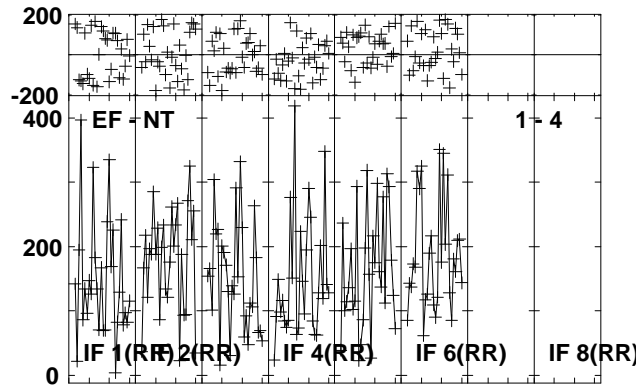
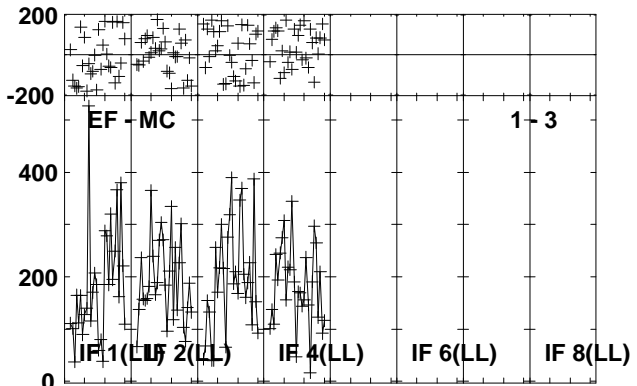
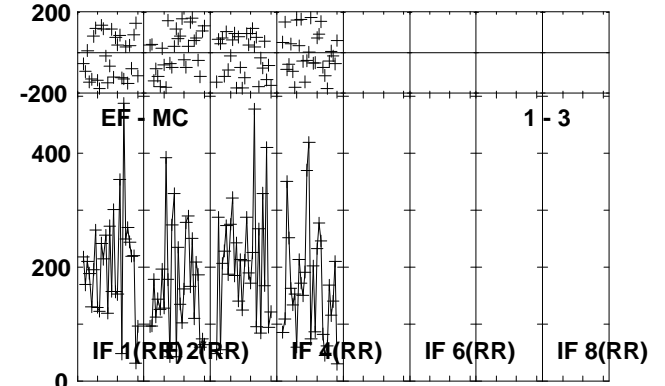
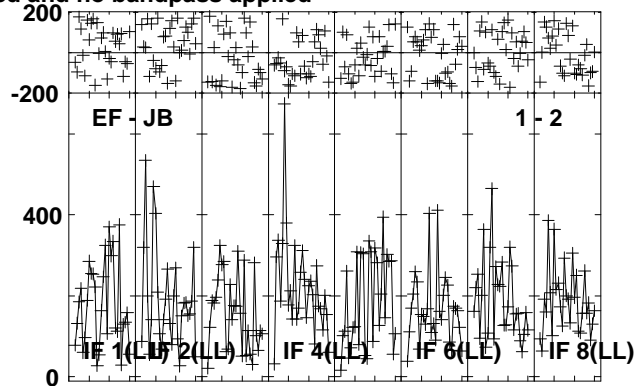
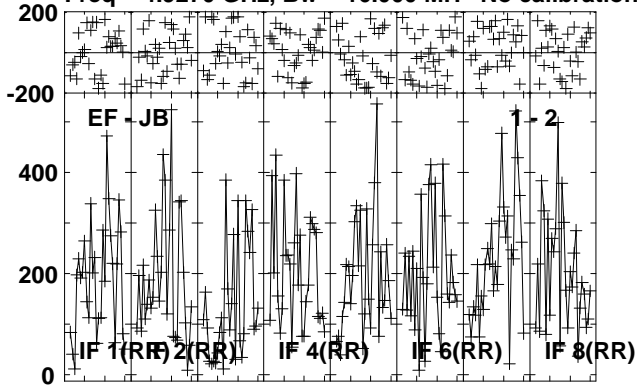

Lower frame: Micro Ampl Jy Top frame: Phas deg  
Vector averaged cross-power spectrum Several baselines displayed  
Timerange: 00/18:52:02 to 00/18:54:28

Plot file version 220 created 24-OCT-2012 21:00:10

G23.6-0.03 EY017B.UVDATA.1

Freq = 4.9270 GHz, Bw = 16.000 MH No calibration applied and no bandpass applied

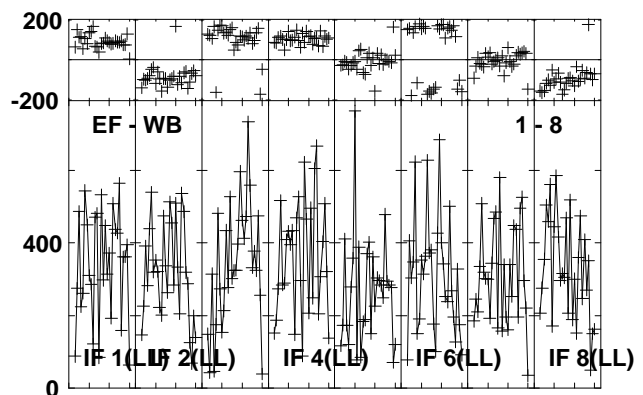
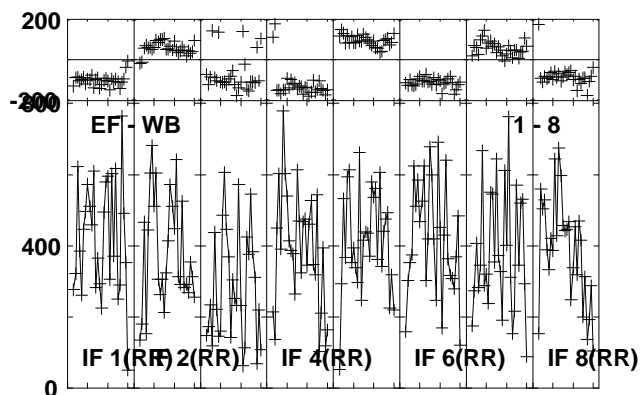
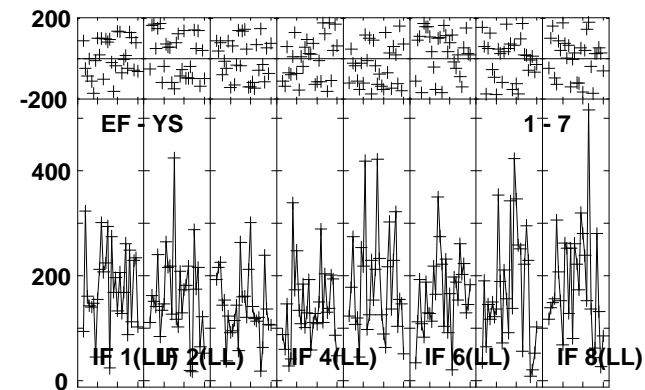
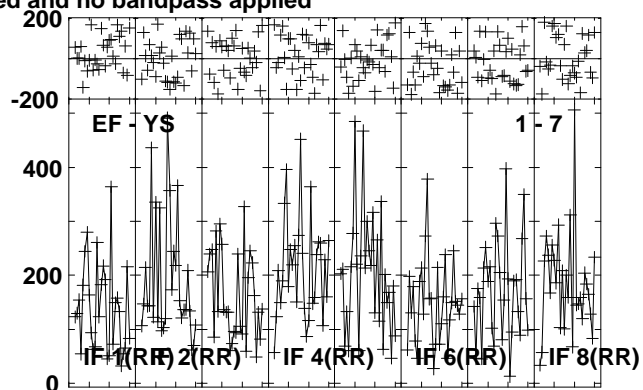
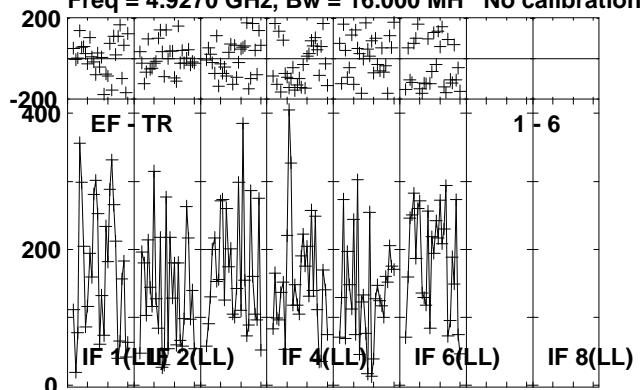

Lower frame: Micro Ampl Jy Top frame: Phas deg  
Vector averaged cross-power spectrum Several baselines displayed  
Timerange: 00/18:52:02 to 00/18:54:28



Plot file version 221 created 24-OCT-2012 21:00:11

J1825-0737 EY017B.UVDATA.1

Freq = 4.9270 GHz, Bw = 16.000 MH No calibration applied and no bandpass applied

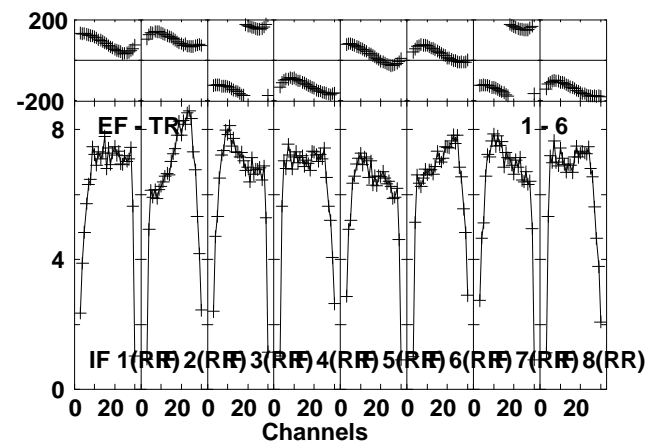
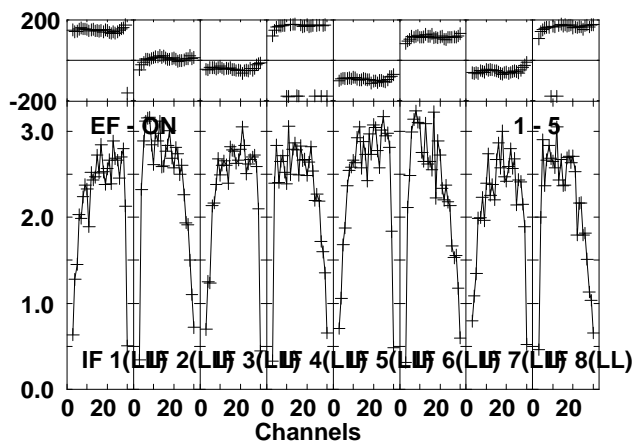
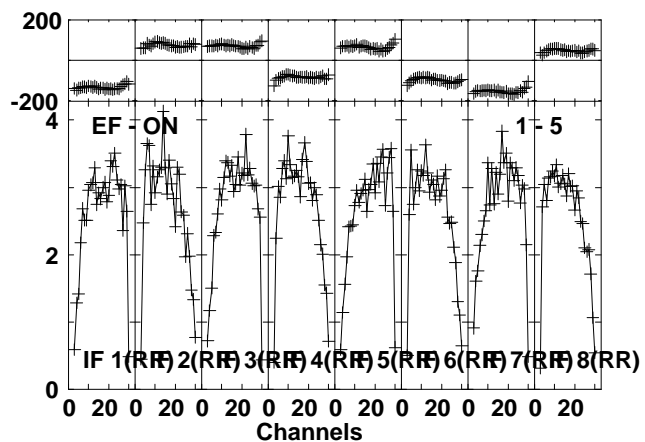
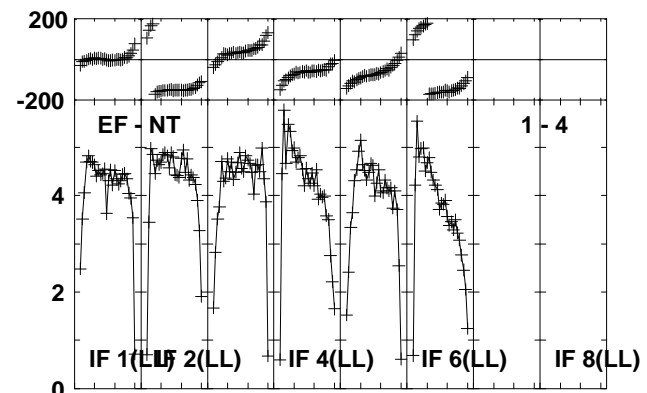
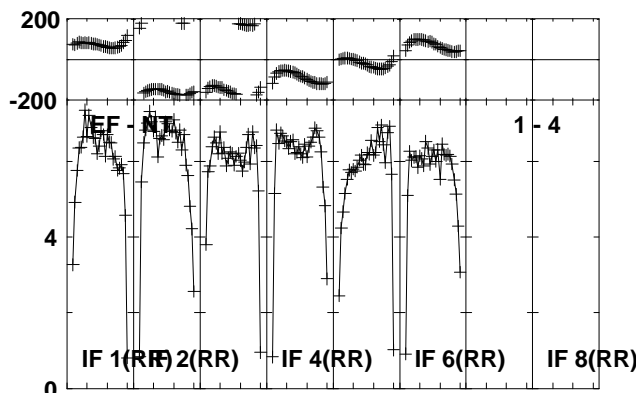
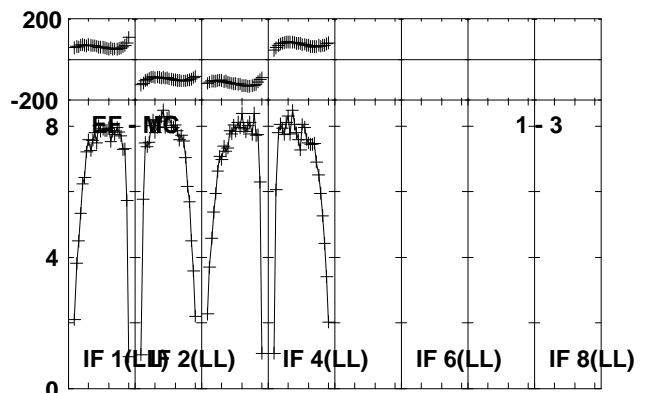
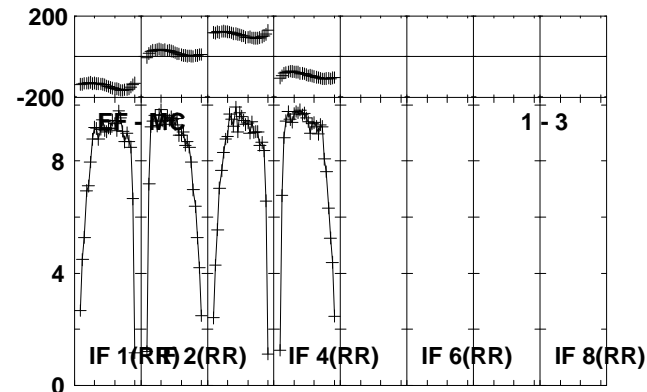
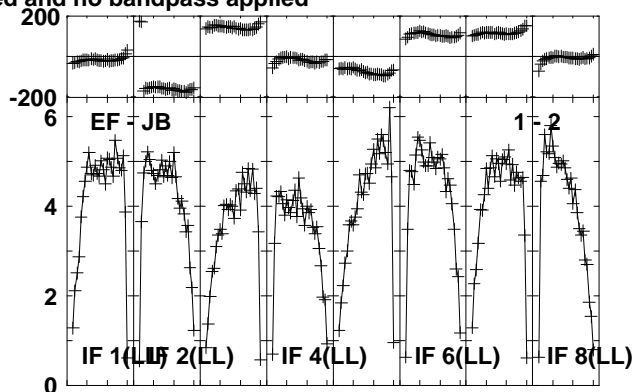
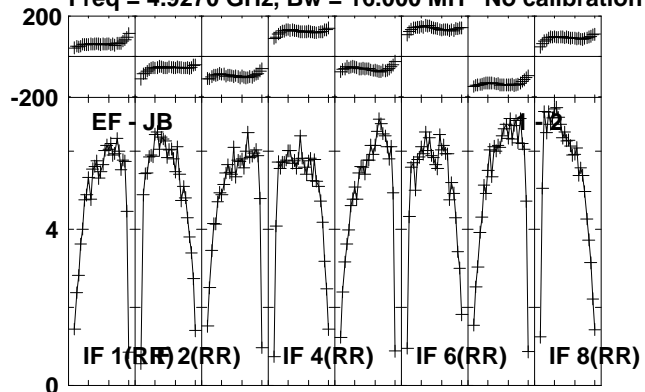

Lower frame: Milli Ampl Jy Top frame: Phas deg  
Vector averaged cross-power spectrum Several baselines displayed  
Timerange: 00/18:54:32 to 00/18:55:58

Plot file version 222 created 24-OCT-2012 21:00:11  
J1825-0737 EY017B.UVDATA.1

Freq = 4.9270 GHz, Bw = 16.000 MH No calibration applied and no bandpass applied

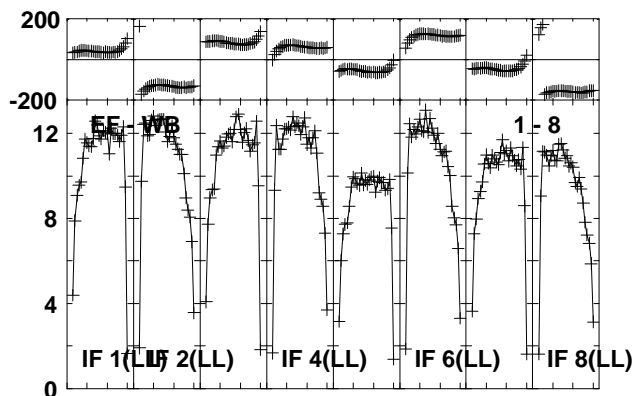
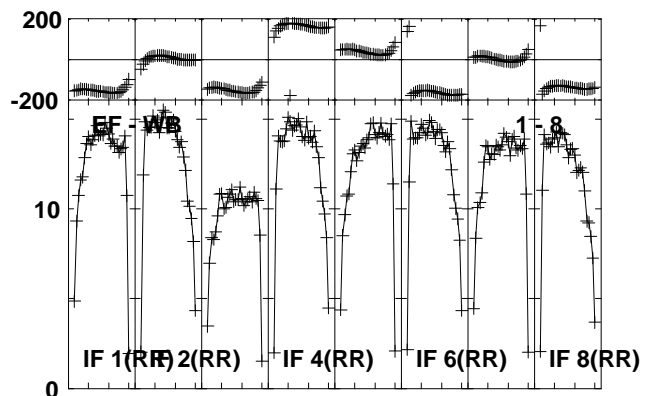
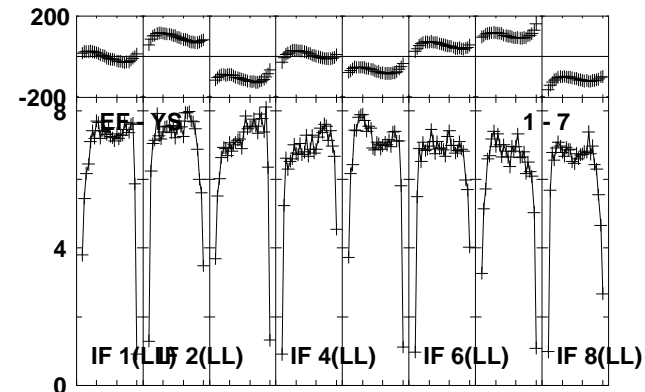
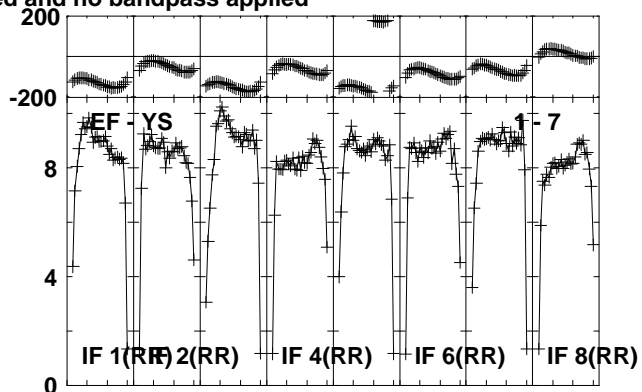
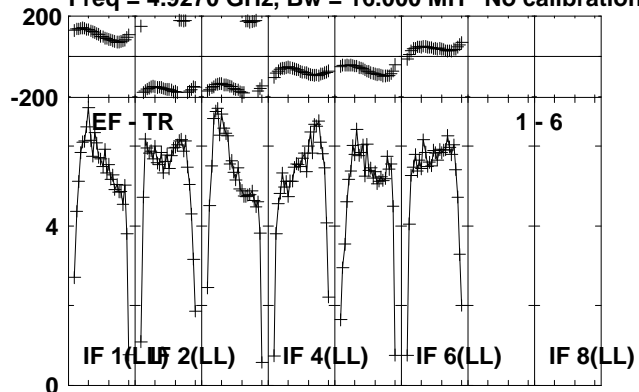

Lower frame: Milli Ampl Jy Top frame: Phas deg  
Vector averaged cross-power spectrum Several baselines displayed  
Timerange: 00/18:54:32 to 00/18:55:58

Plot file version 223 created 24-OCT-2012 21:00:12

J1831-0756 EY017B.UVDATA.1

Freq = 4.9270 GHz, Bw = 16.000 MH No calibration applied and no bandpass applied

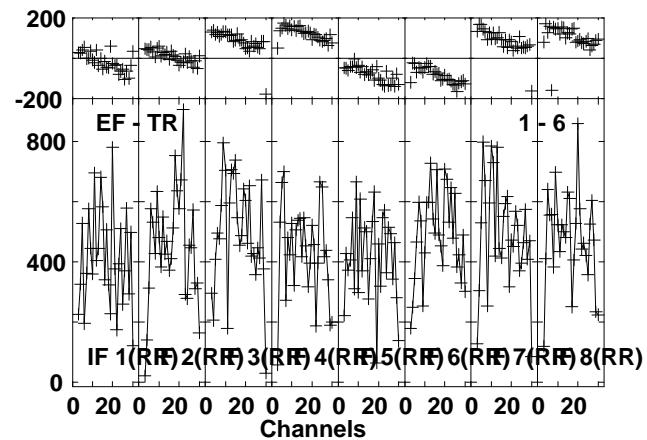
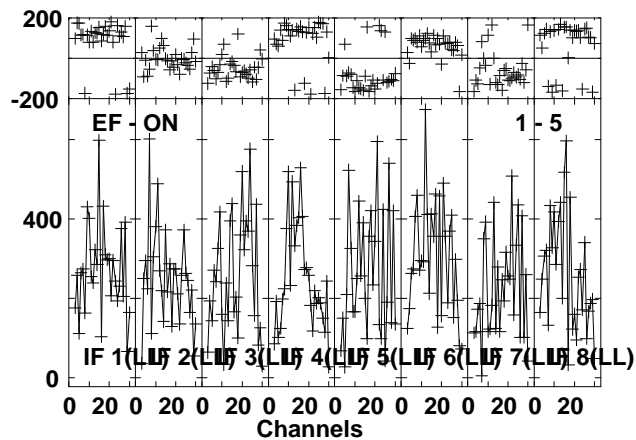
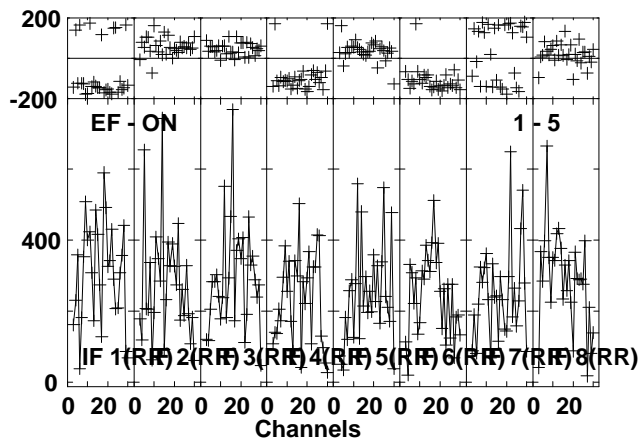
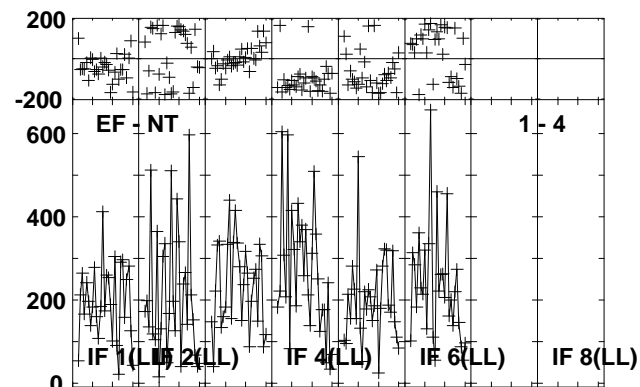
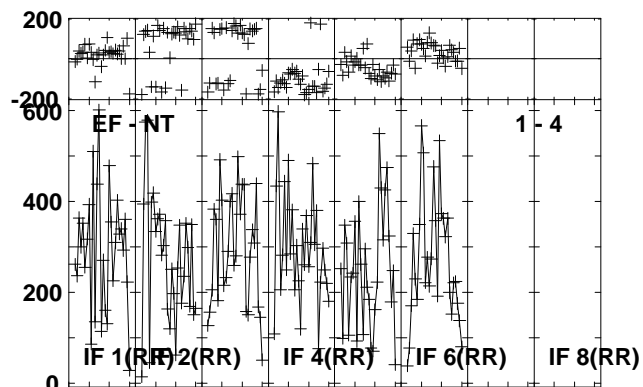
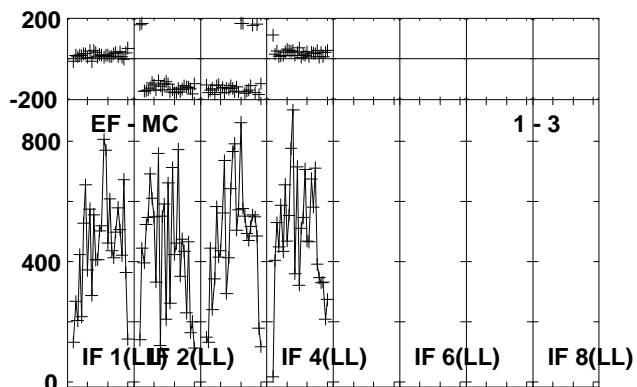
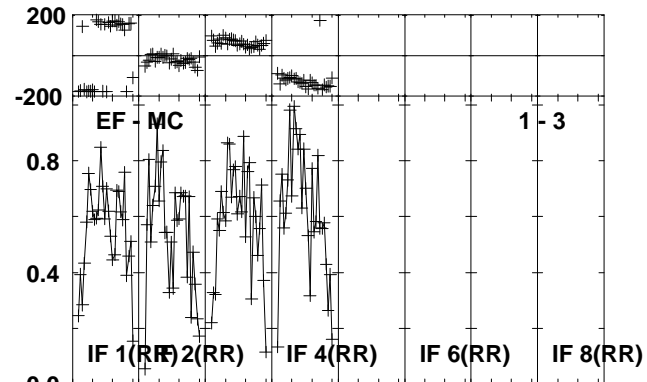
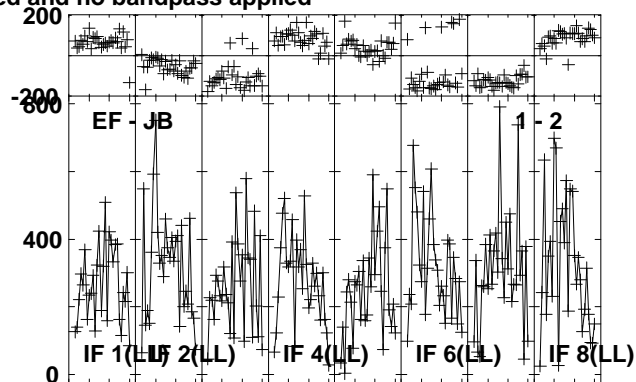
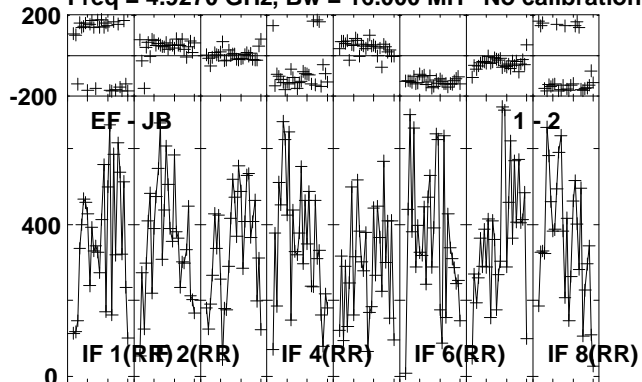

Lower frame: Micro Ampl Jy Top frame: Phas deg  
Vector averaged cross-power spectrum Several baselines displayed  
Timerange: 00/18:56:32 to 00/18:58:34

Plot file version 224 created 24-OCT-2012 21:00:12

J1831-0756 EY017B.UVDATA.1

Freq = 4.9270 GHz, Bw = 16.000 MH No calibration applied and no bandpass applied

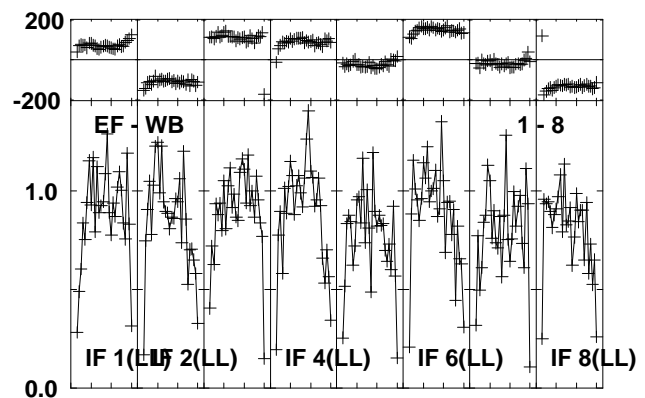
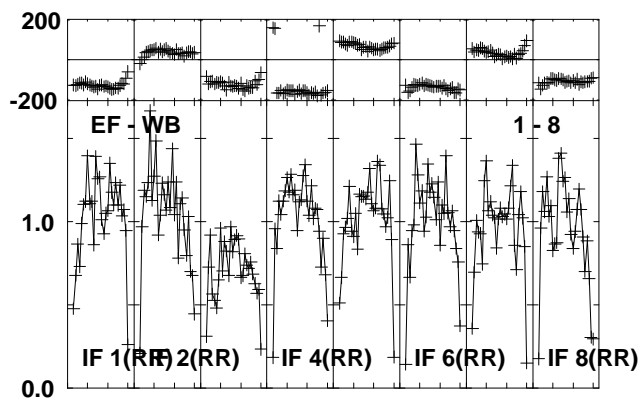
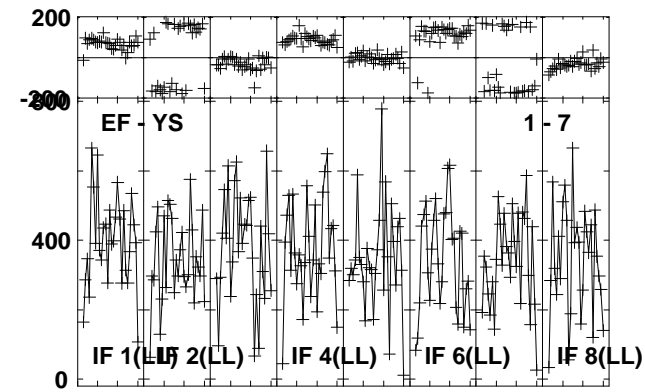
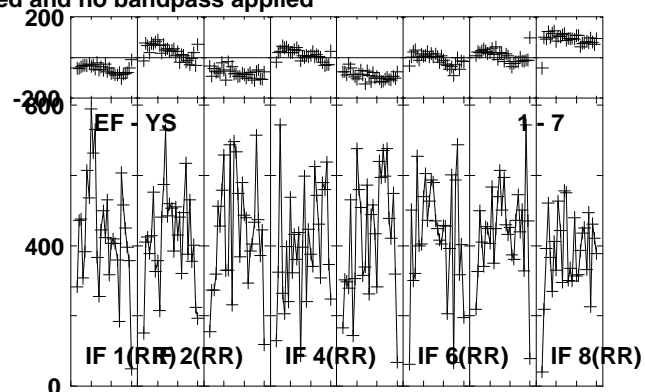
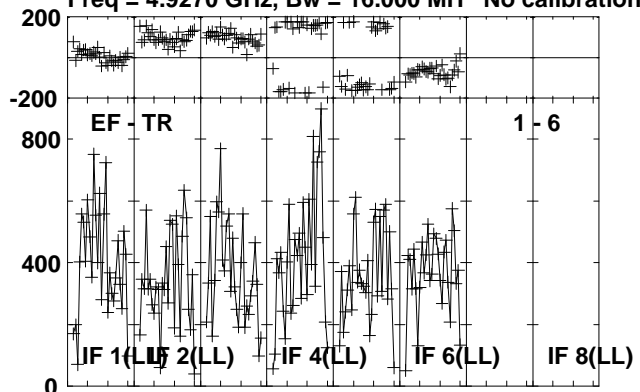

Lower frame: Micro Ampl Jy Top frame: Phas deg  
Vector averaged cross-power spectrum Several baselines displayed  
Timerange: 00/18:56:32 to 00/18:58:34

Plot file version 225 created 24-OCT-2012 21:00:13

J1825-0737 EY017B.UVDATA.1

Freq = 4.9270 GHz, Bw = 16.000 MH No calibration applied and no bandpass applied

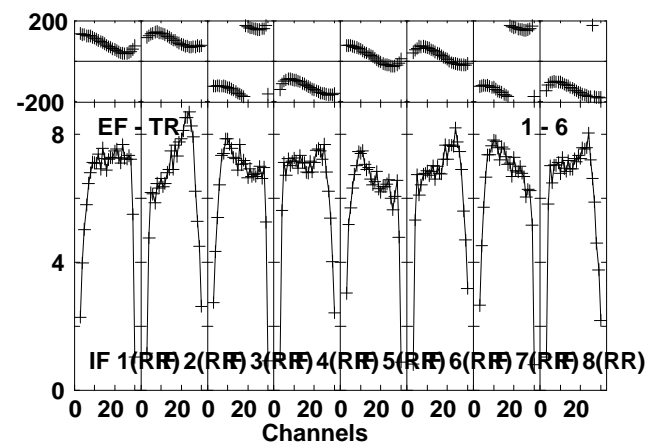
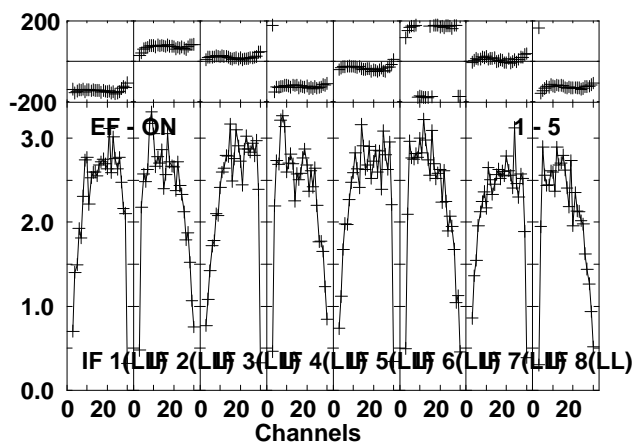
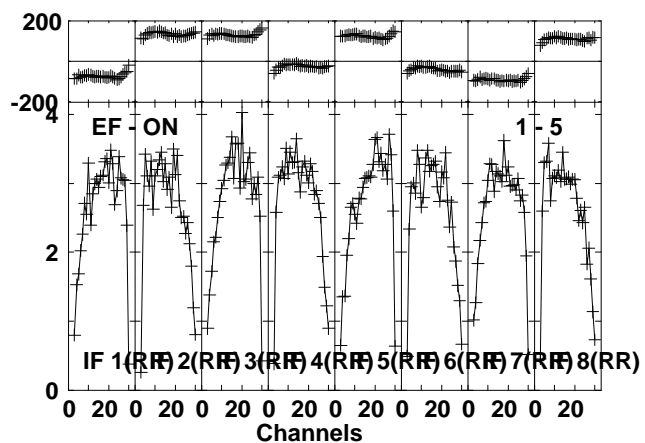
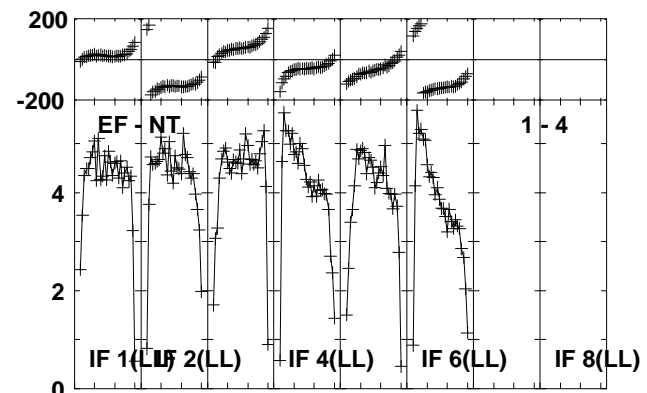
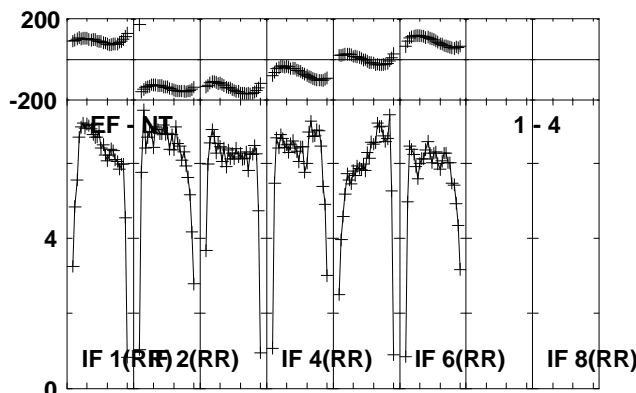
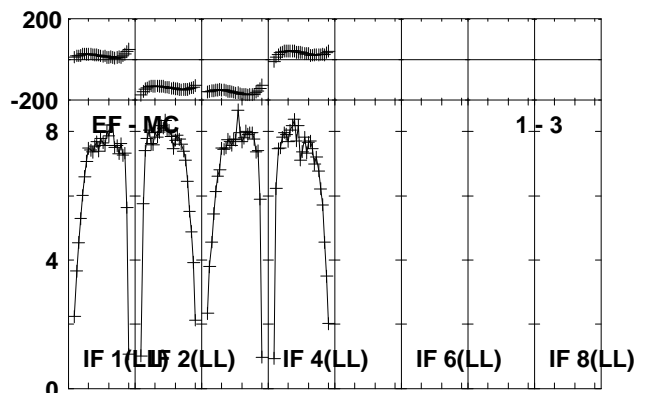
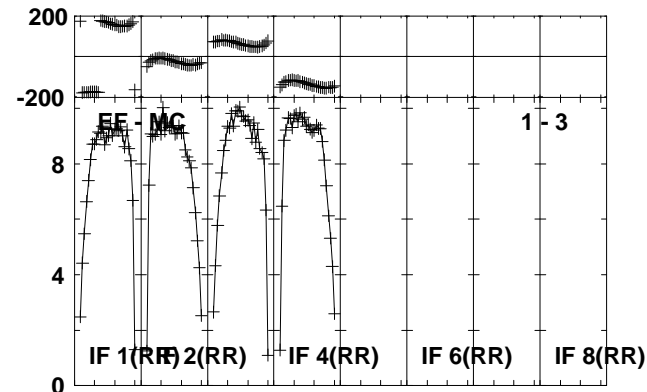
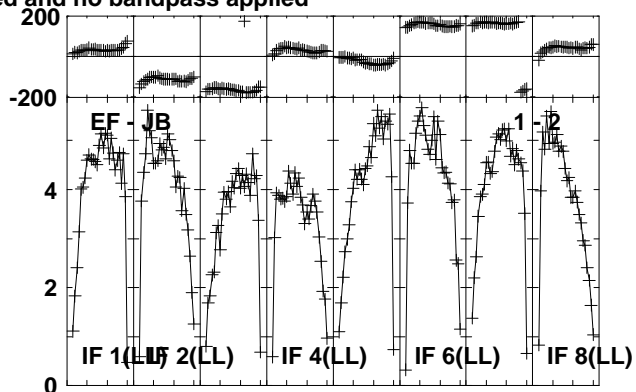
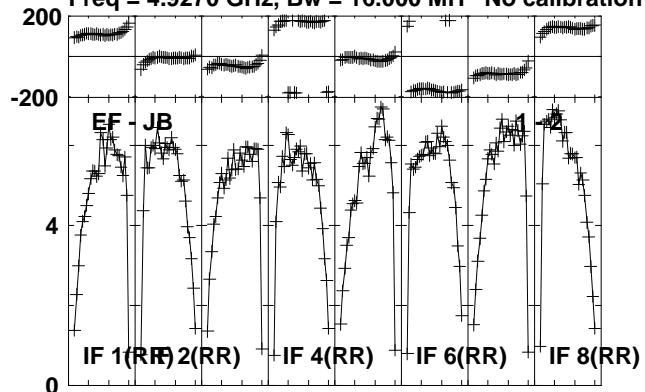

Lower frame: Milli Ampl Jy Top frame: Phas deg  
Vector averaged cross-power spectrum Several baselines displayed  
Timerange: 00/18:58:38 to 00/19:00:04

Plot file version 226 created 24-OCT-2012 21:00:13

J1825-0737 EY017B.UVDATA.1

Freq = 4.9270 GHz, Bw = 16.000 MH No calibration applied and no bandpass applied

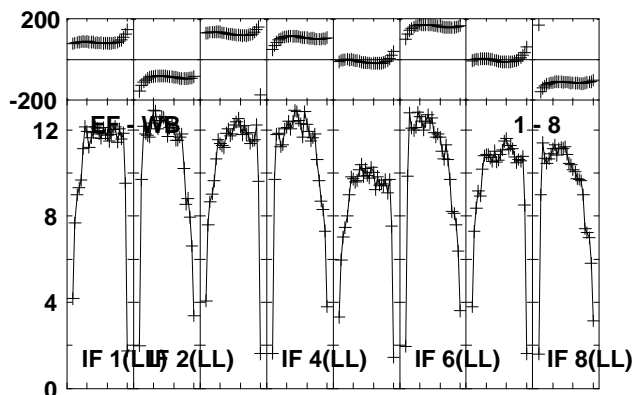
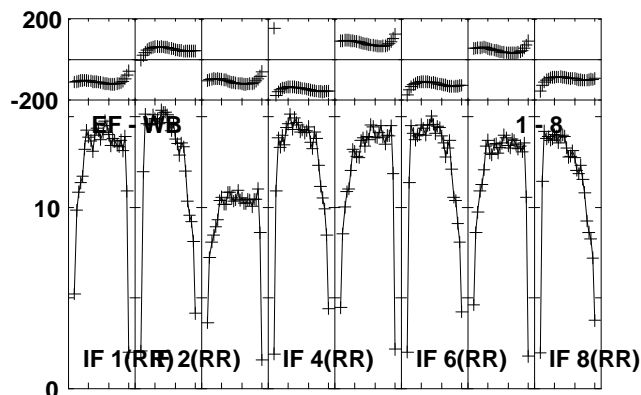
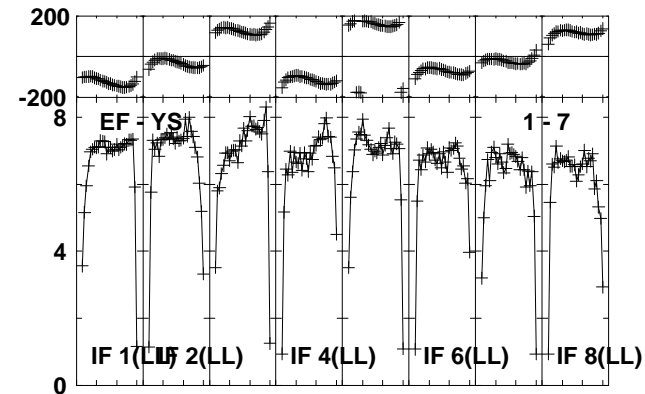
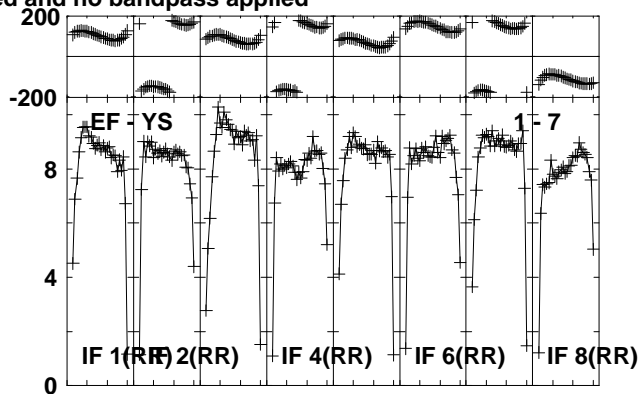
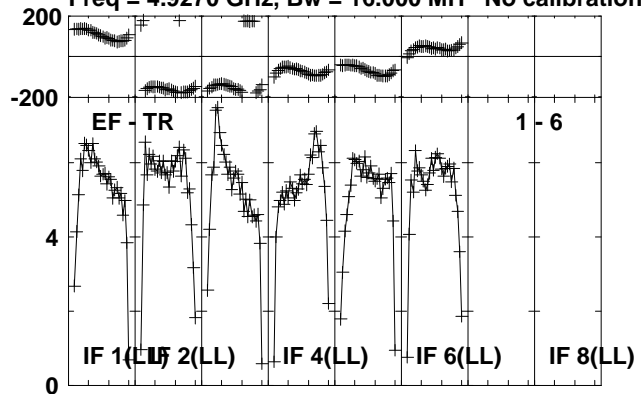

Lower frame: Milli Ampl Jy Top frame: Phas deg  
Vector averaged cross-power spectrum Several baselines displayed  
Timerange: 00/18:58:38 to 00/19:00:04

Plot file version 227 created 24-OCT-2012 21:00:14

G23.6-0.03 EY017B.UVDATA.1

Freq = 4.9270 GHz, Bw = 16.000 MH No calibration applied and no bandpass applied

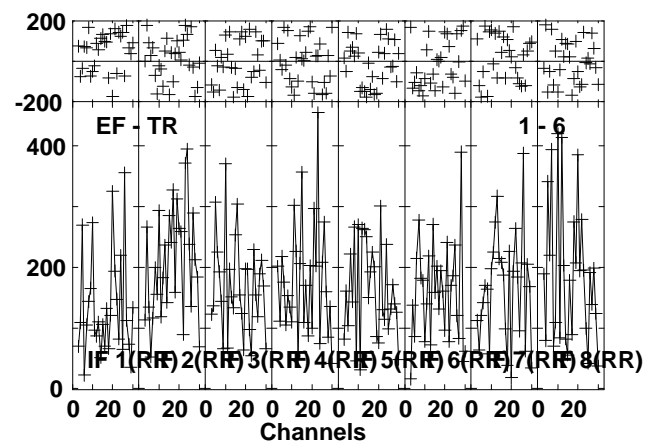
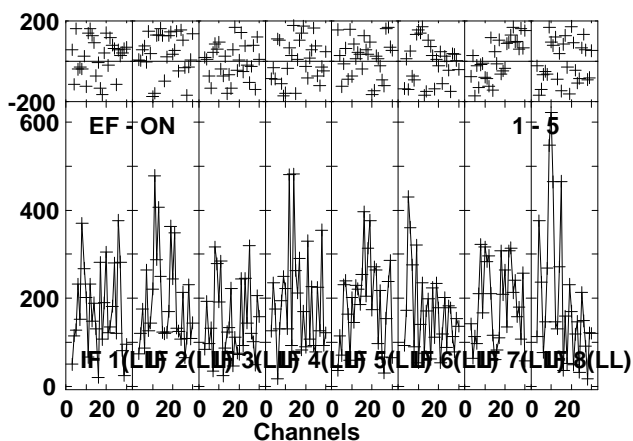
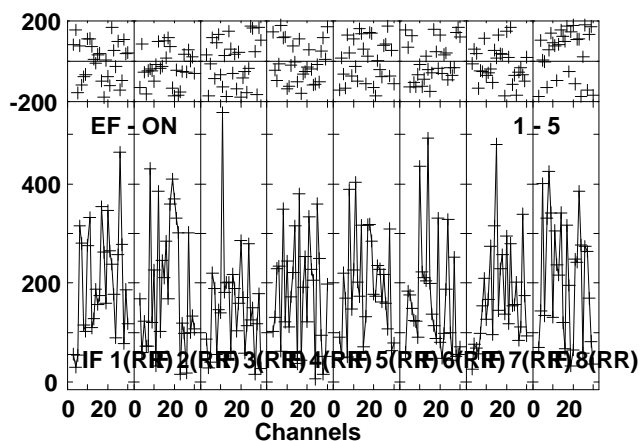
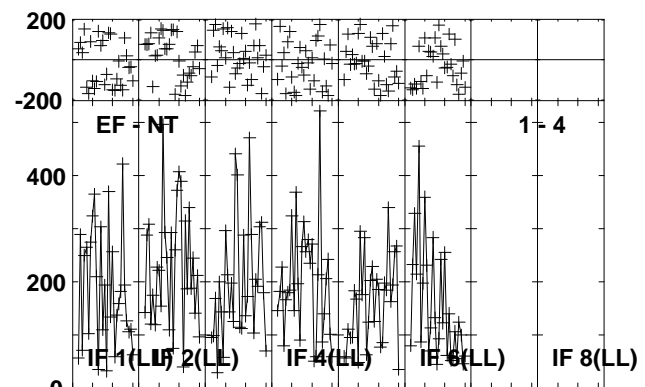
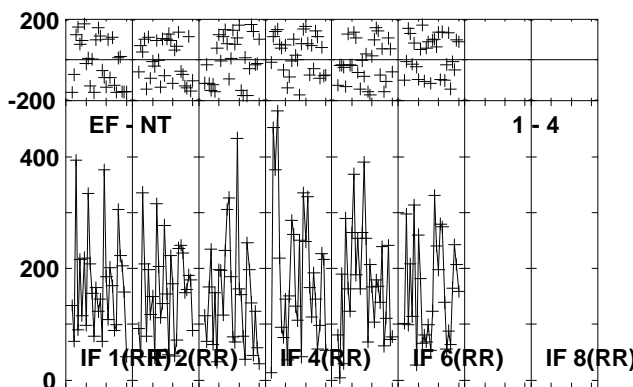
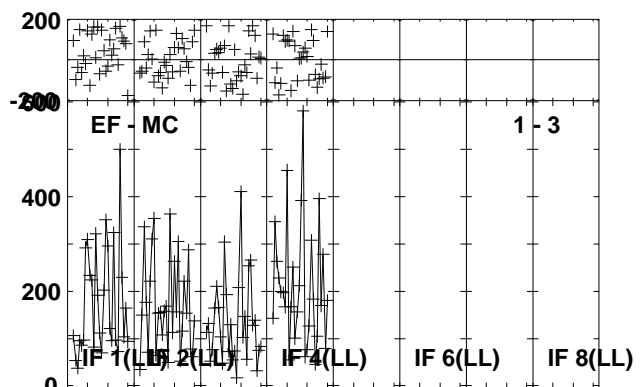
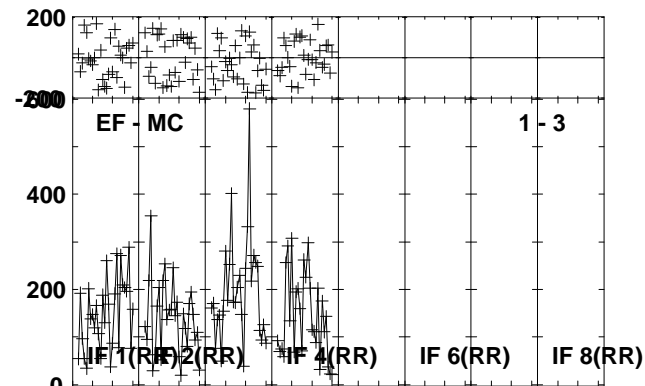
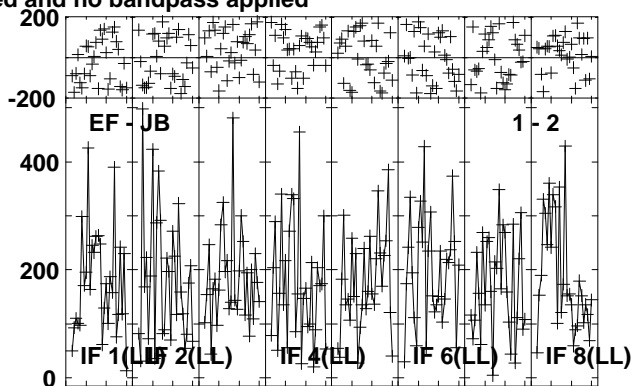
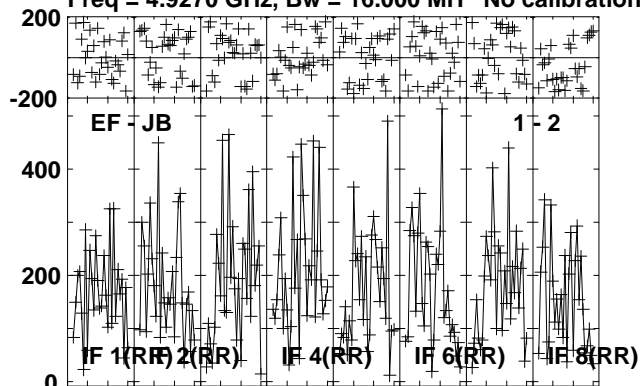

Lower frame: Micro Ampl Jy Top frame: Phas deg  
Vector averaged cross-power spectrum Several baselines displayed  
Timerange: 00/19:00:08 to 00/19:02:34

Plot file version 228 created 24-OCT-2012 21:00:14

G23.6-0.03 EY017B.UVDATA.1

Freq = 4.9270 GHz, Bw = 16.000 MH No calibration applied and no bandpass applied

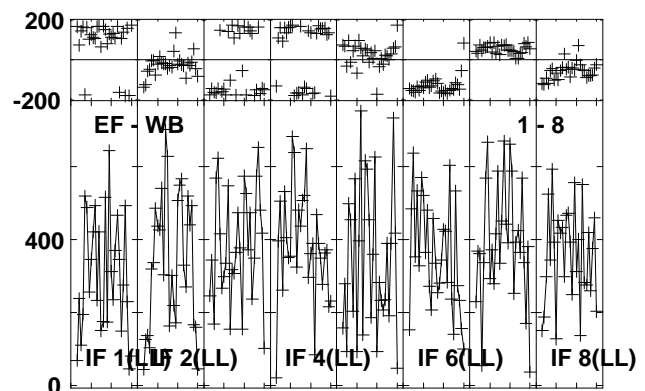
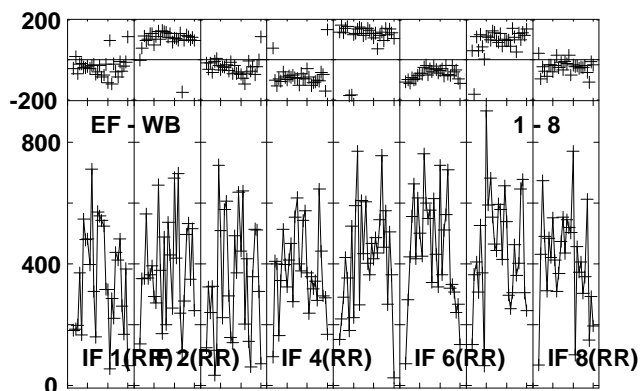
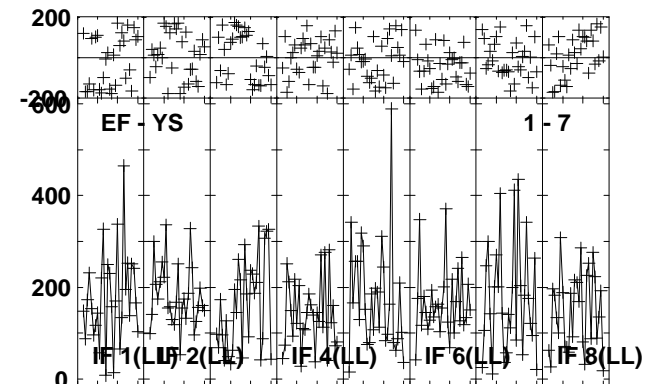
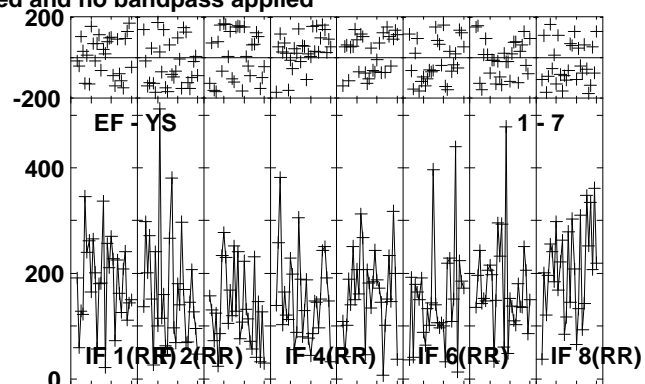
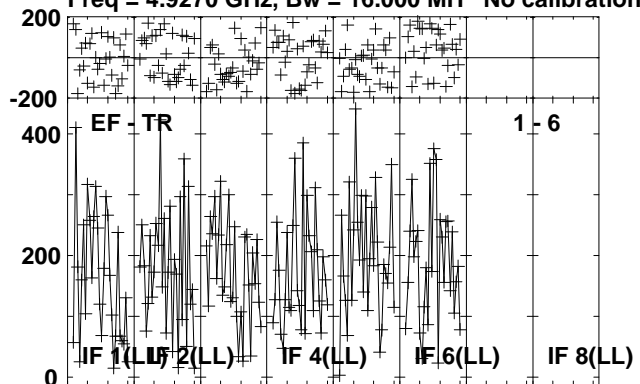

Lower frame: Micro Ampl Jy Top frame: Phas deg  
Vector averaged cross-power spectrum Several baselines displayed  
Timerange: 00/19:00:08 to 00/19:02:34



Plot file version 229 created 24-OCT-2012 21:00:15

J1825-0737 EY017B.UVDATA.1

Freq = 4.9270 GHz, Bw = 16.000 MH No calibration applied and no bandpass applied

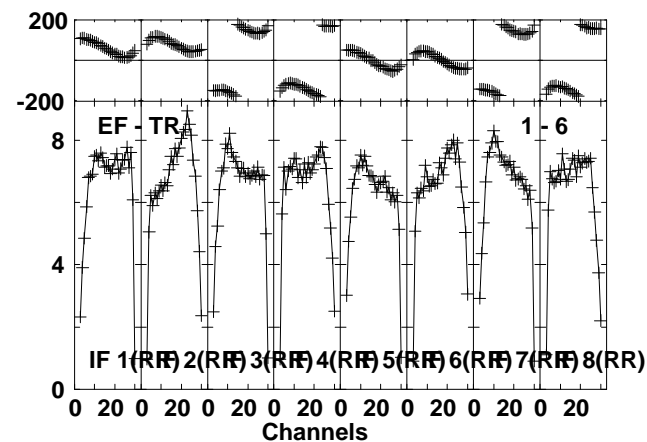
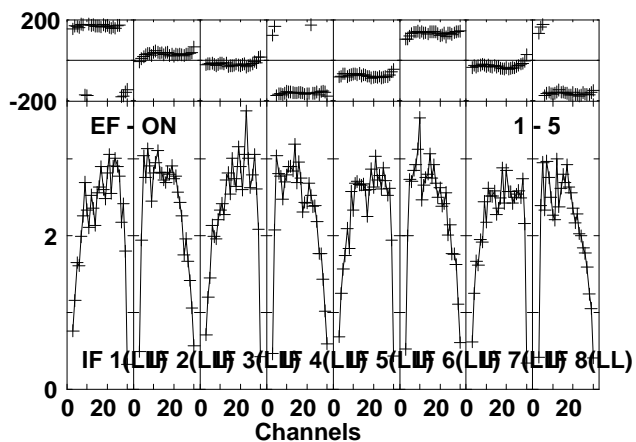
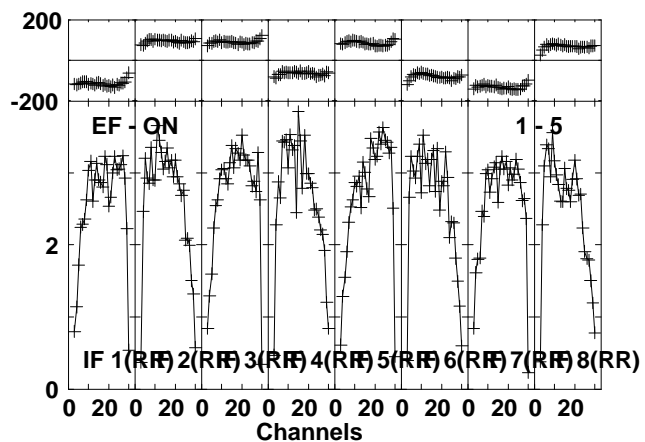
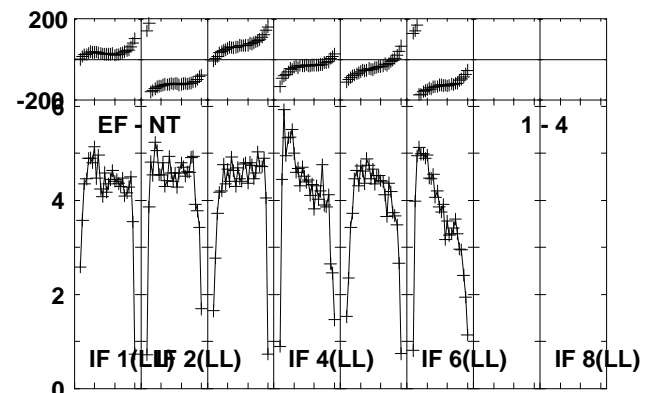
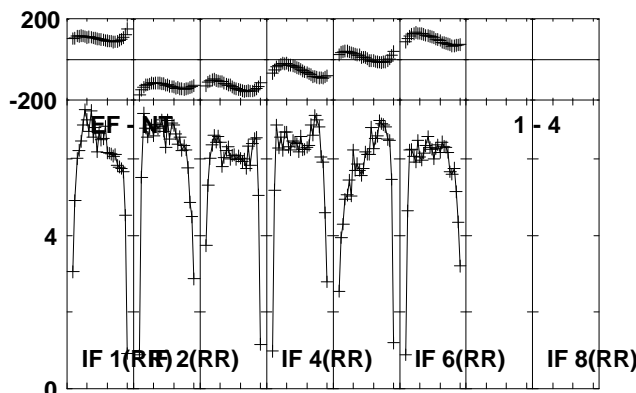
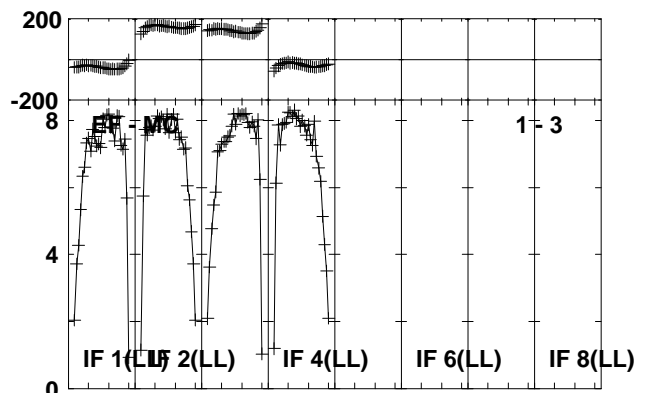
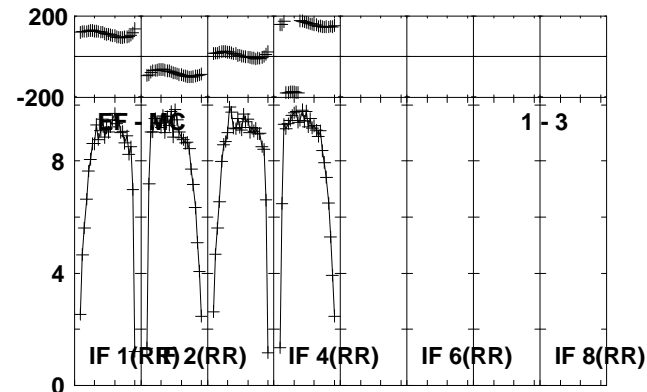
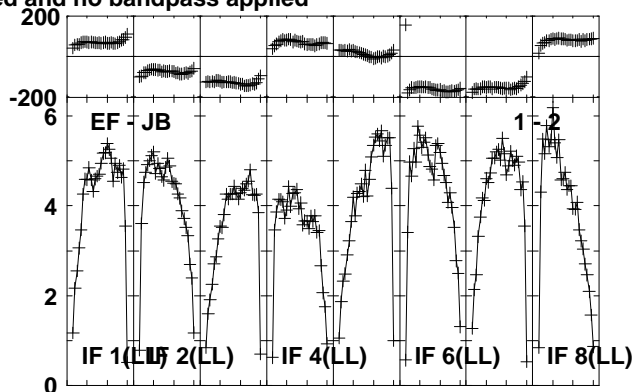
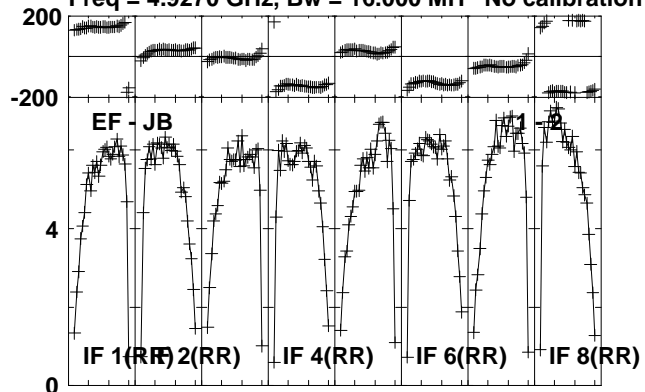

Lower frame: Milli Ampl Jy Top frame: Phas deg  
Vector averaged cross-power spectrum Several baselines displayed  
Timerange: 00/19:02:38 to 00/19:04:04

Plot file version 230 created 24-OCT-2012 21:00:15

J1825-0737 EY017B.UVDATA.1

Freq = 4.9270 GHz, Bw = 16.000 MH No calibration applied and no bandpass applied

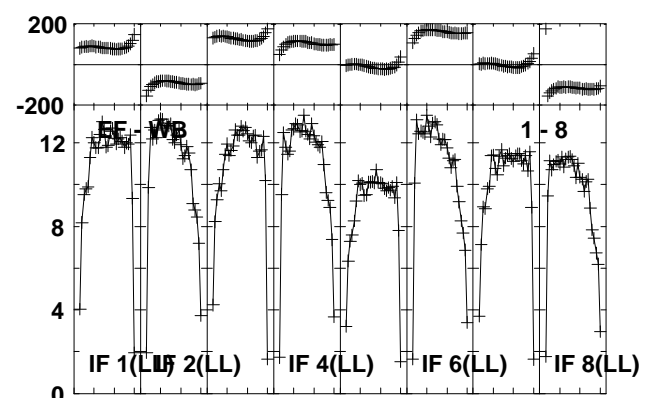
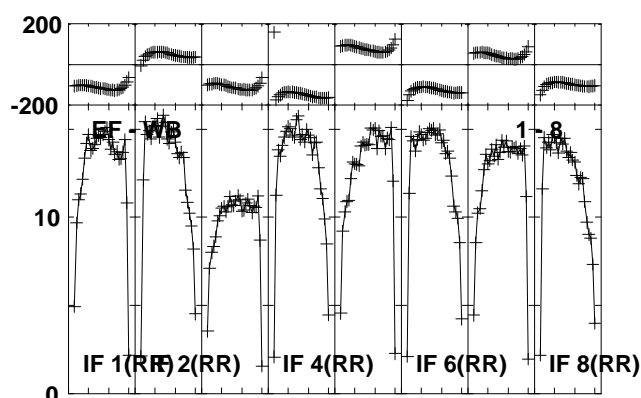
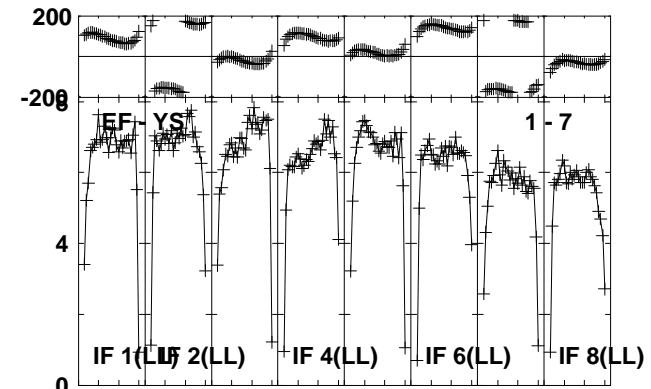
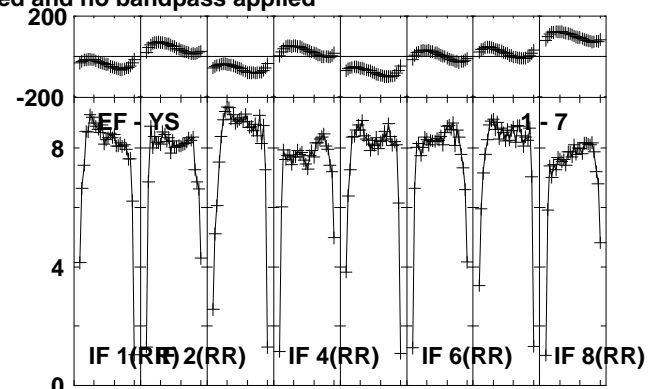
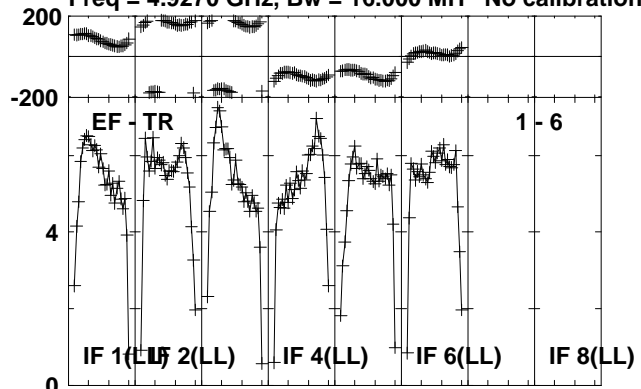

Lower frame: Milli Ampl Jy Top frame: Phas deg  
Vector averaged cross-power spectrum Several baselines displayed  
Timerange: 00/19:02:38 to 00/19:04:04

Plot file version 231 created 24-OCT-2012 21:00:16

G23.6-0.03 EY017B.UVDATA.1

Freq = 4.9270 GHz, Bw = 16.000 MH No calibration applied and no bandpass applied

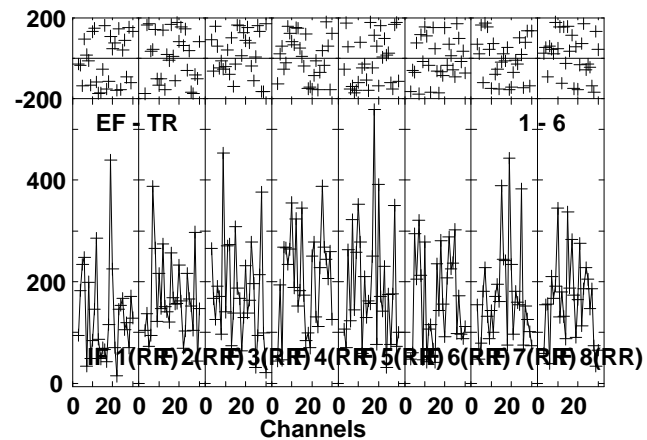
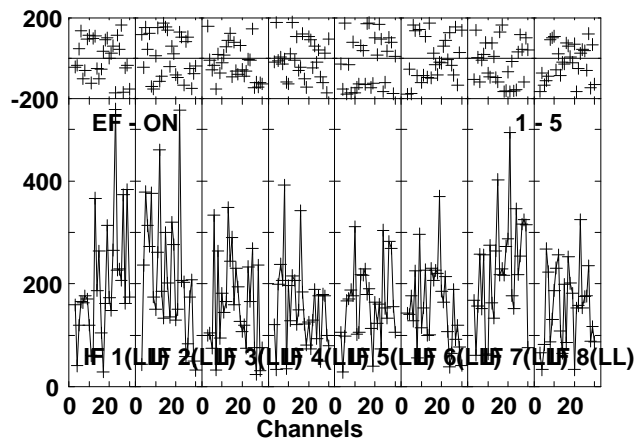
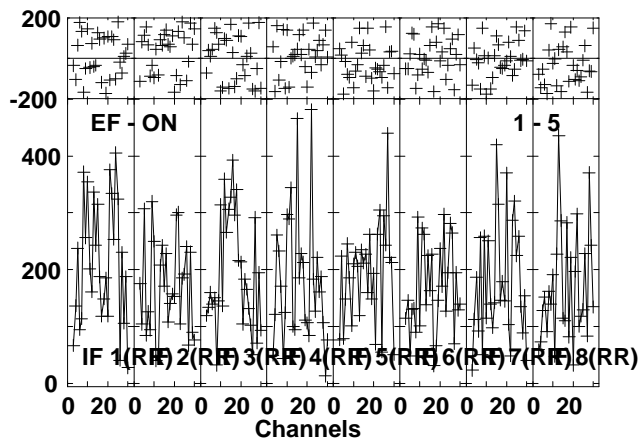
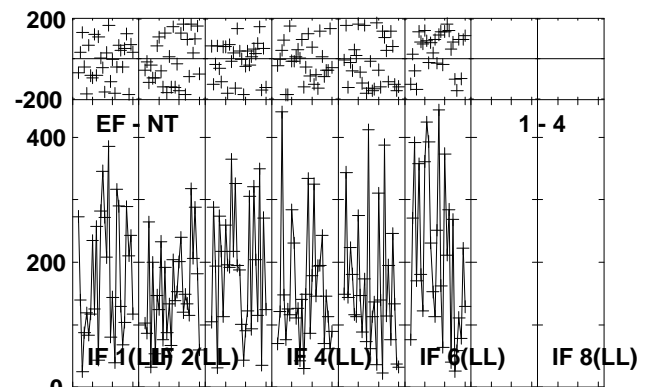
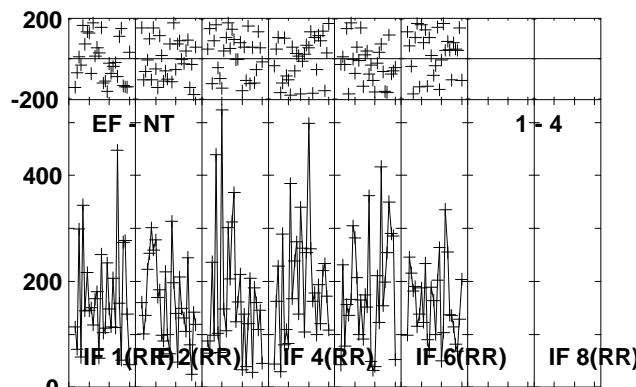
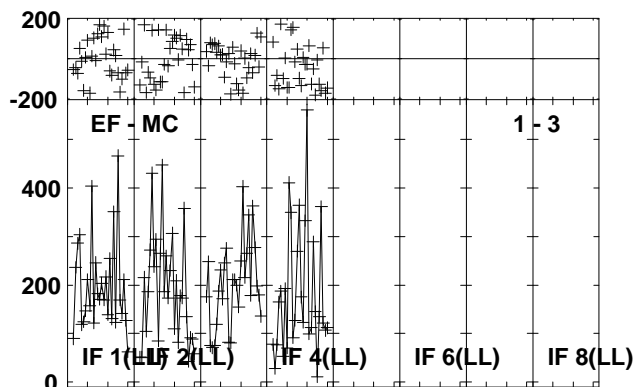
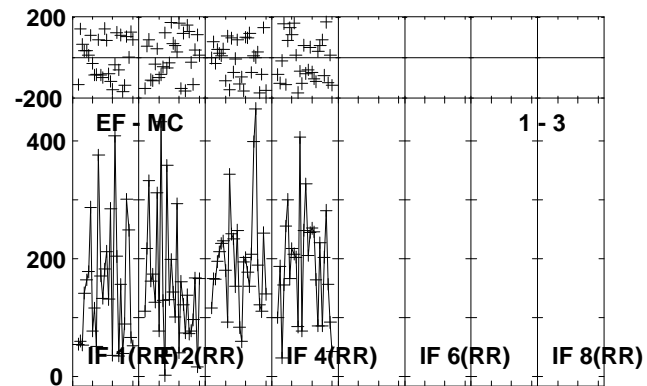
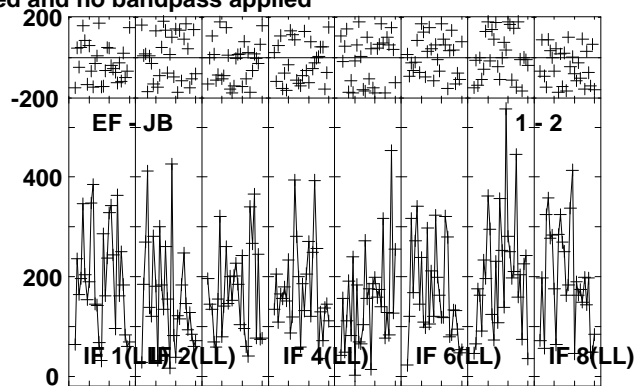
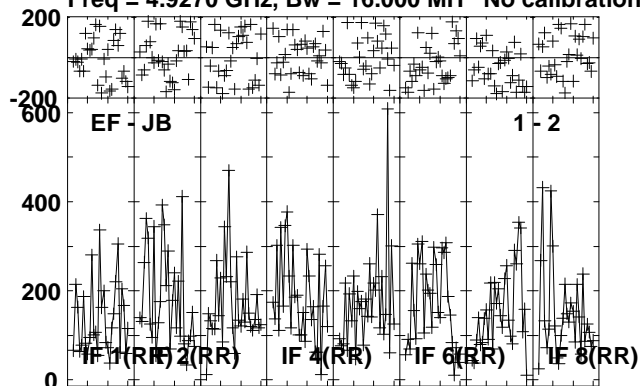

Lower frame: Micro Ampl Jy Top frame: Phas deg  
Vector averaged cross-power spectrum Several baselines displayed  
Timerange: 00/19:04:08 to 00/19:06:34

Plot file version 232 created 24-OCT-2012 21:00:17

G23.6-0.03 EY017B.UVDATA.1

Freq = 4.9270 GHz, Bw = 16.000 MH No calibration applied and no bandpass applied

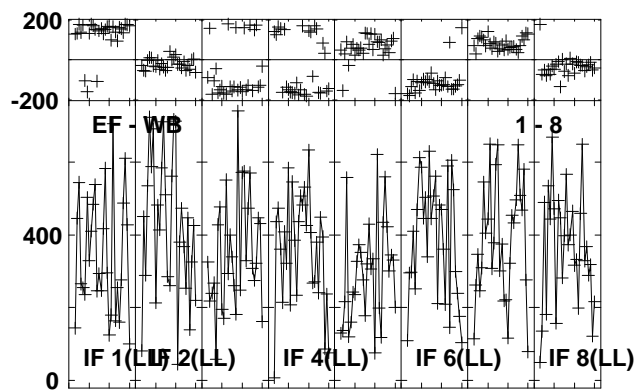
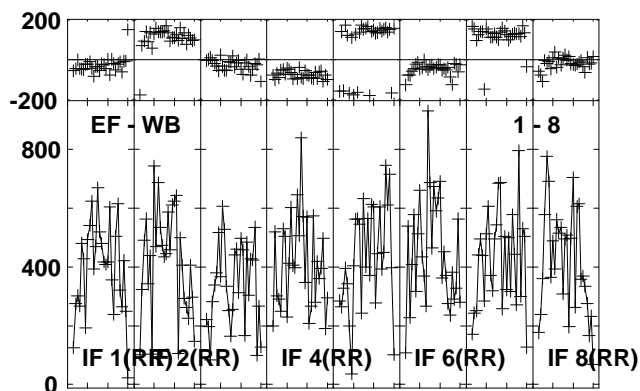
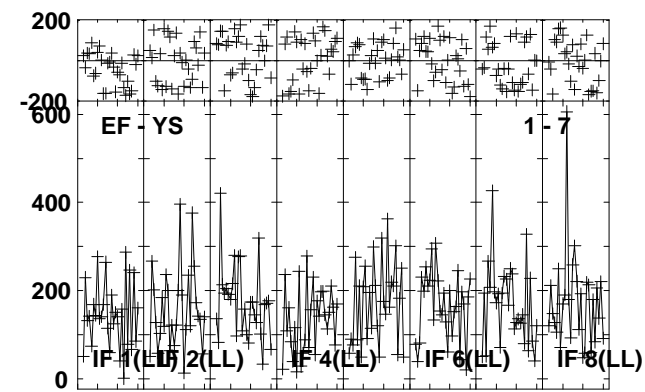
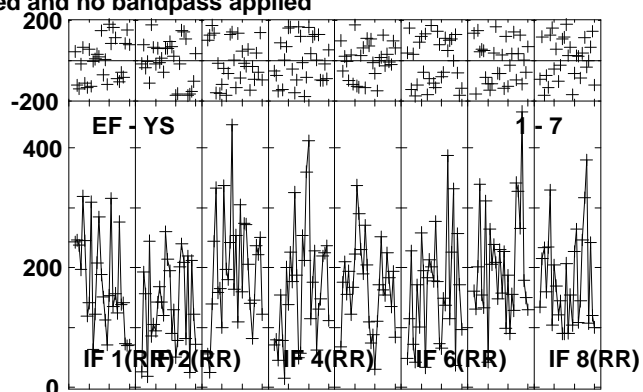
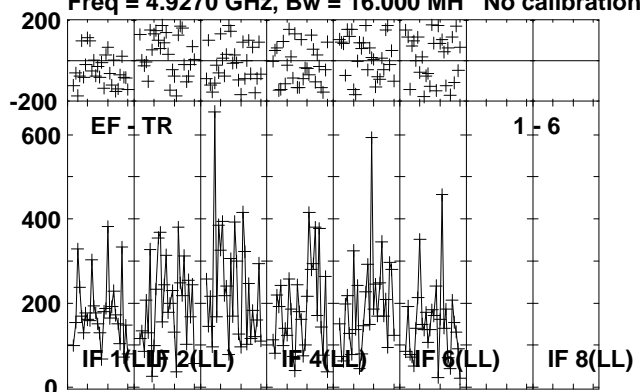

Lower frame: Micro Ampl Jy Top frame: Phas deg  
Vector averaged cross-power spectrum Several baselines displayed  
Timerange: 00/19:04:08 to 00/19:06:34

Plot file version 233 created 24-OCT-2012 21:00:17

J1825-0737 EY017B.UVDATA.1

Freq = 4.9270 GHz, Bw = 16.000 MH No calibration applied and no bandpass applied

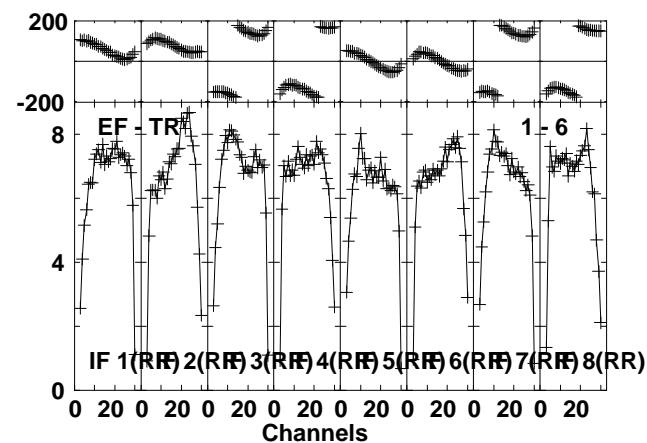
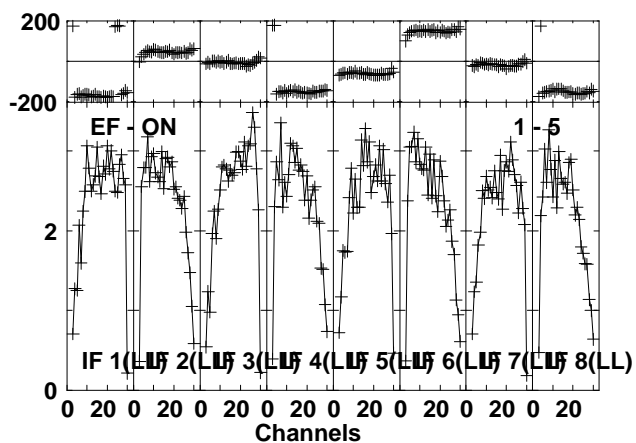
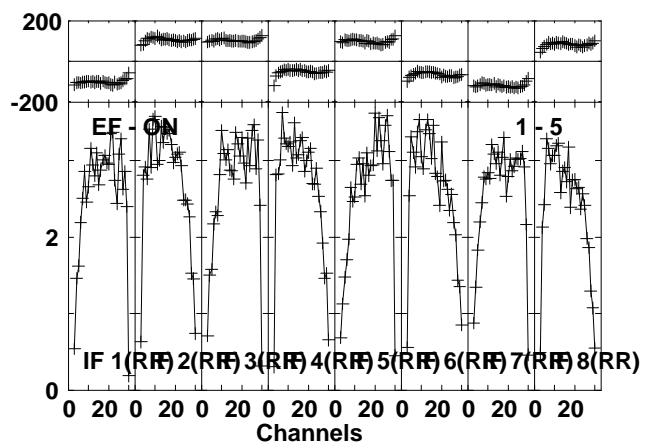
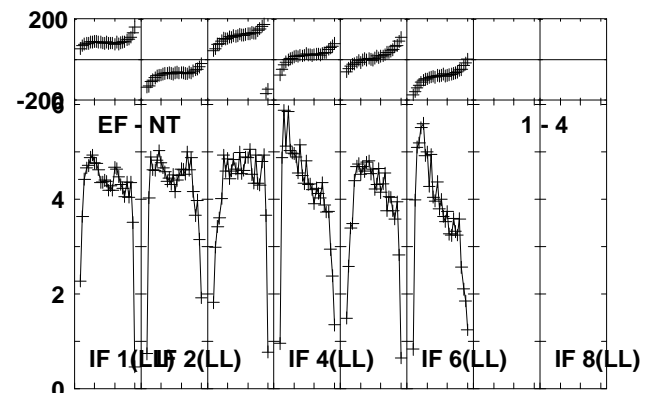
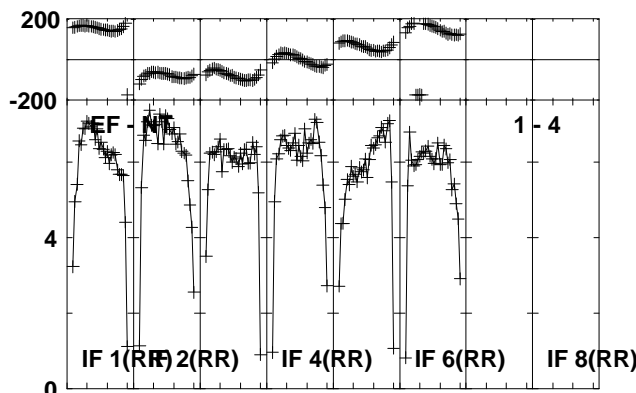
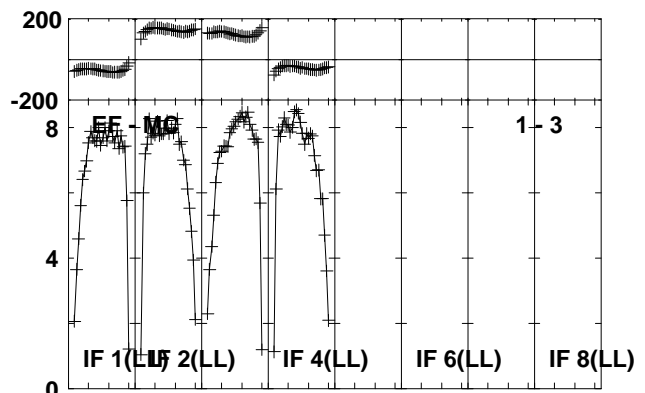
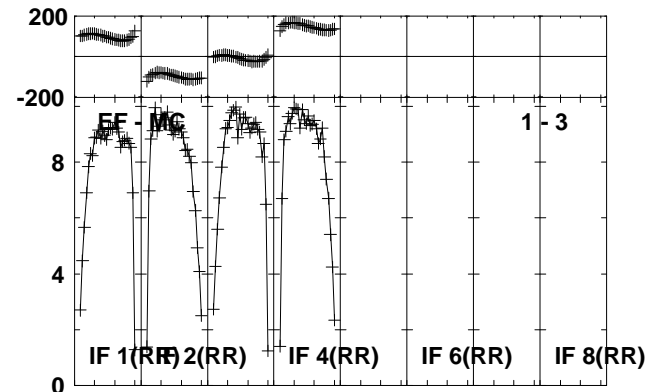
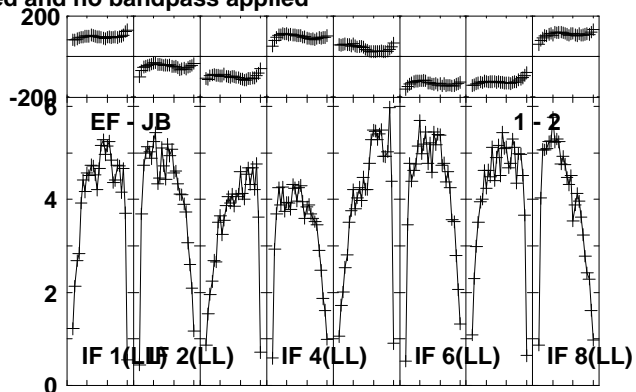
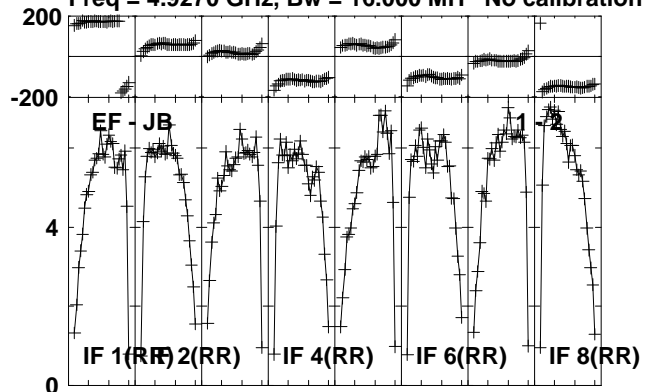

Lower frame: Milli Ampl Jy Top frame: Phas deg  
Vector averaged cross-power spectrum Several baselines displayed  
Timerange: 00/19:06:38 to 00/19:08:04

Plot file version 234 created 24-OCT-2012 21:00:18

J1825-0737 EY017B.UVDATA.1

Freq = 4.9270 GHz, Bw = 16.000 MH No calibration applied and no bandpass applied

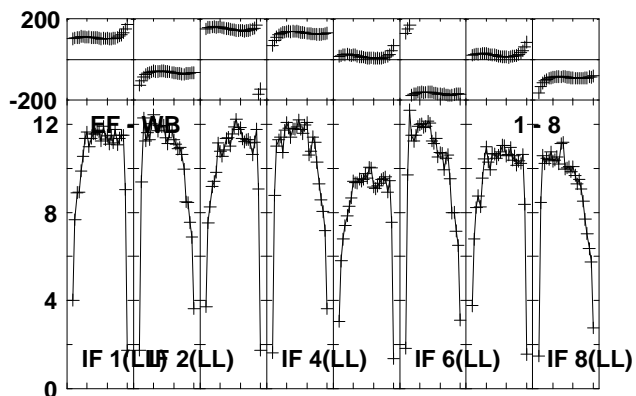
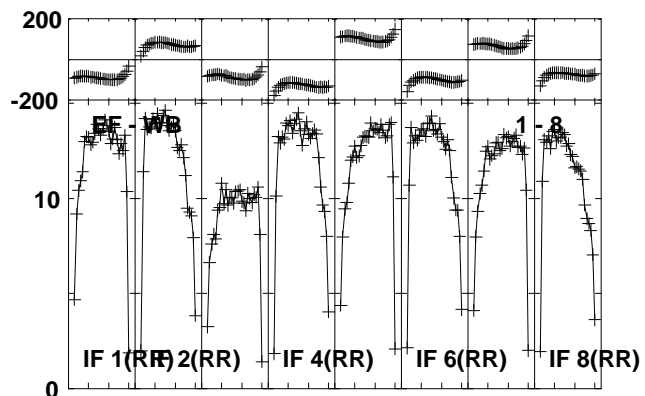
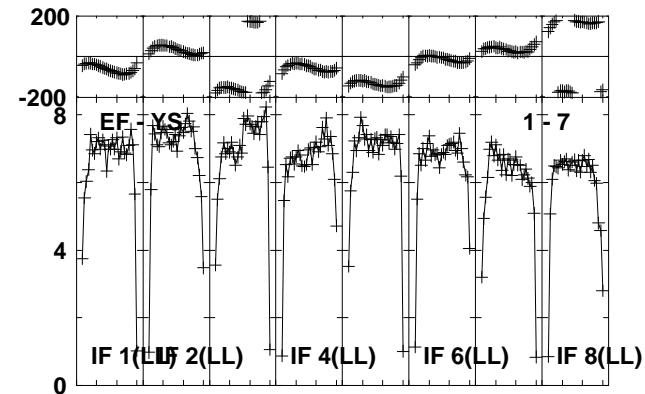
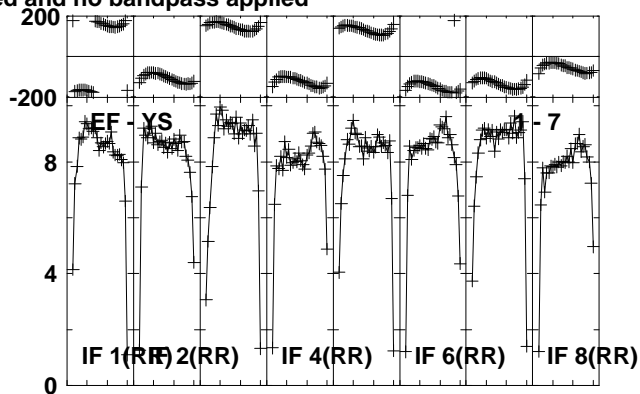
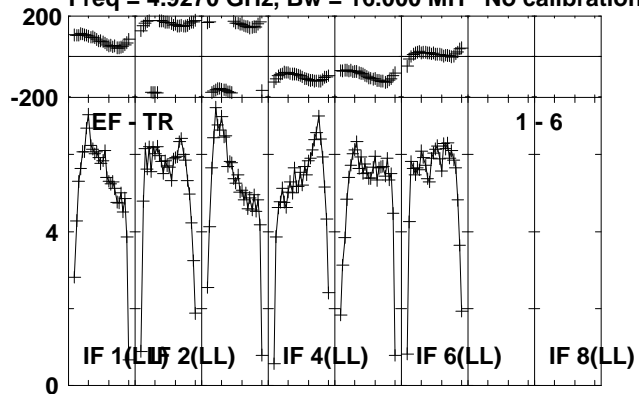

Lower frame: Milli Ampl Jy Top frame: Phas deg  
Vector averaged cross-power spectrum Several baselines displayed  
Timerange: 00/19:06:38 to 00/19:08:04

Plot file version 235 created 24-OCT-2012 21:00:18

G23.6-0.03 EY017B.UVDATA.1

Freq = 4.9270 GHz, Bw = 16.000 MH No calibration applied and no bandpass applied

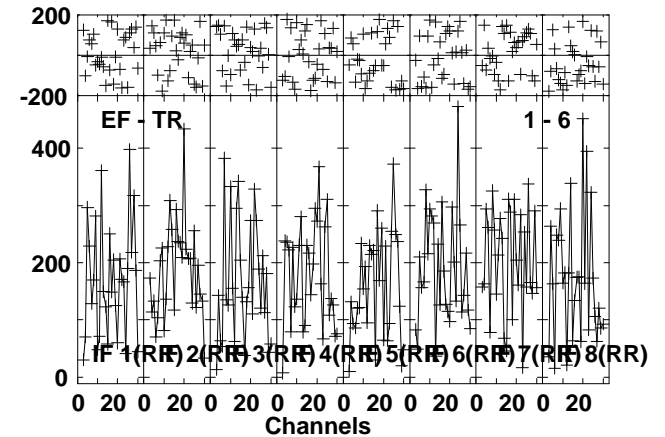
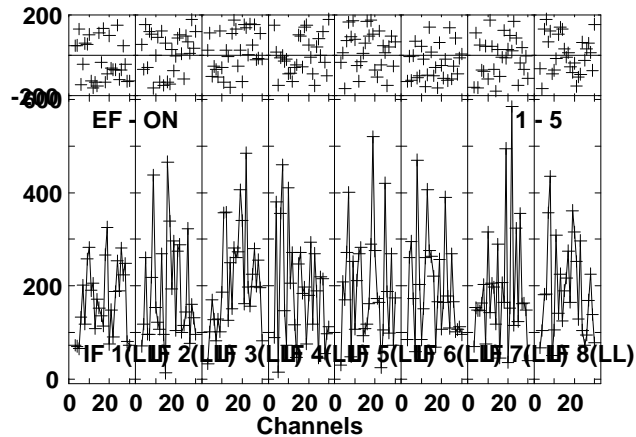
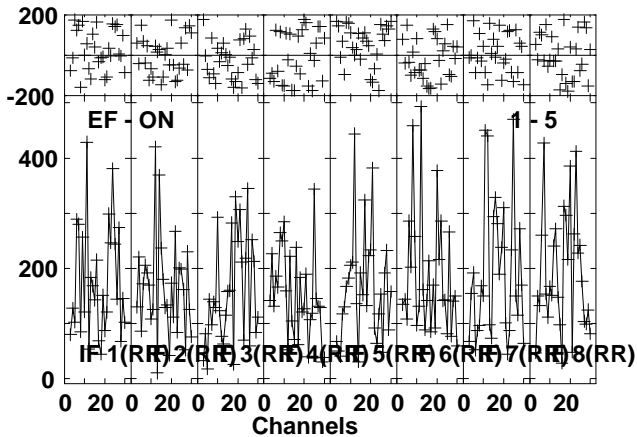
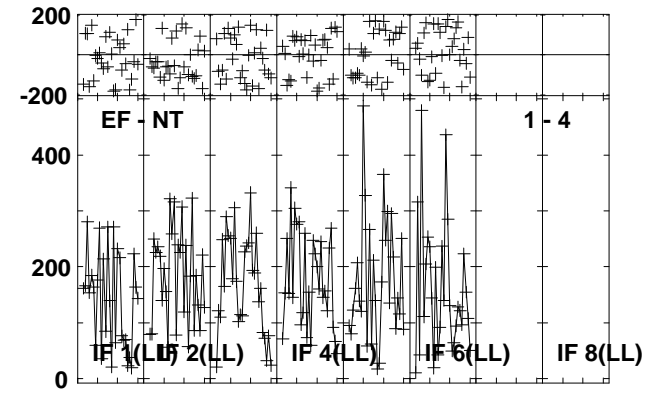
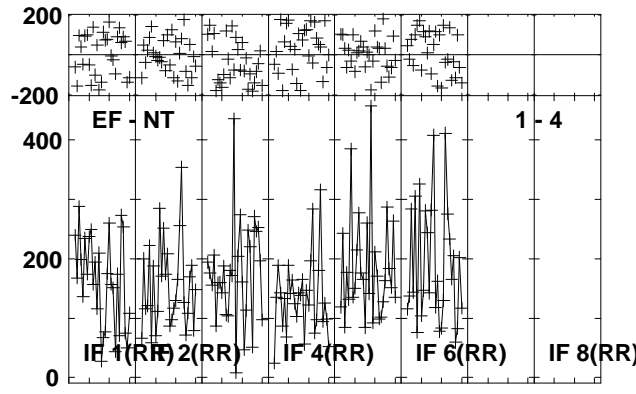
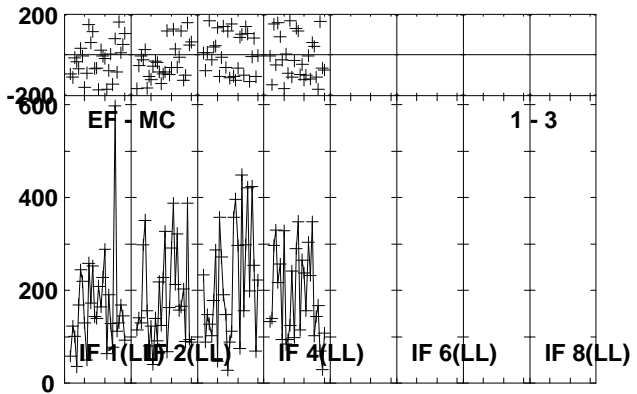
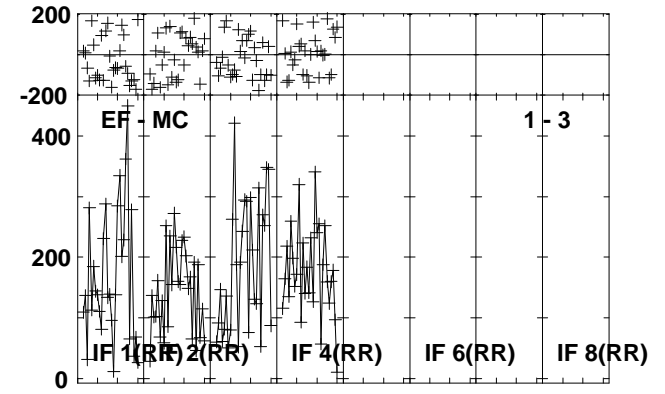
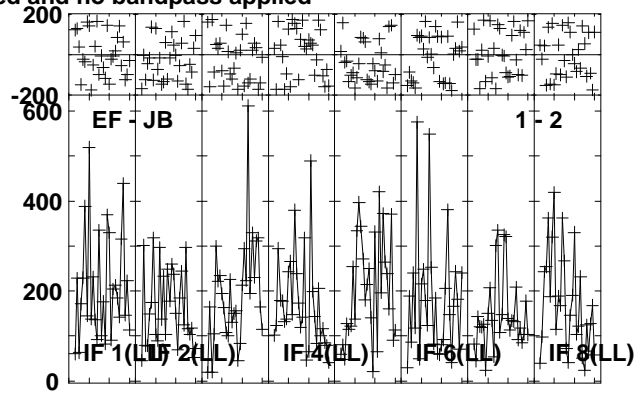
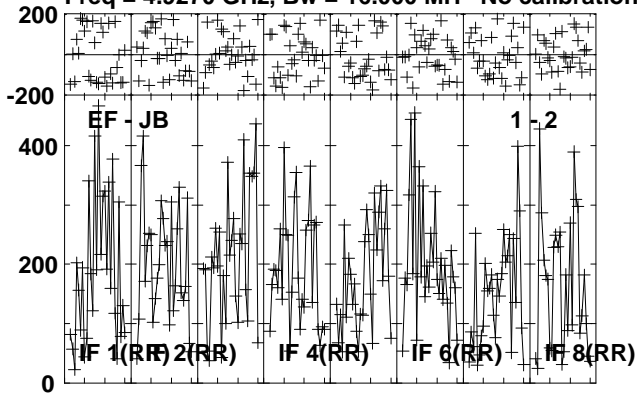

Lower frame: Micro Ampl Jy Top frame: Phas deg  
Vector averaged cross-power spectrum Several baselines displayed  
Timerange: 00/19:08:08 to 00/19:10:34

Plot file version 236 created 24-OCT-2012 21:00:19

G23.6-0.03 EY017B.UVDATA.1

Freq = 4.9270 GHz, Bw = 16.000 MH No calibration applied and no bandpass applied

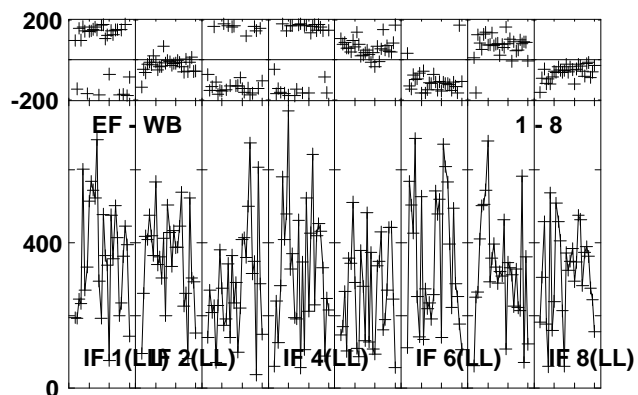
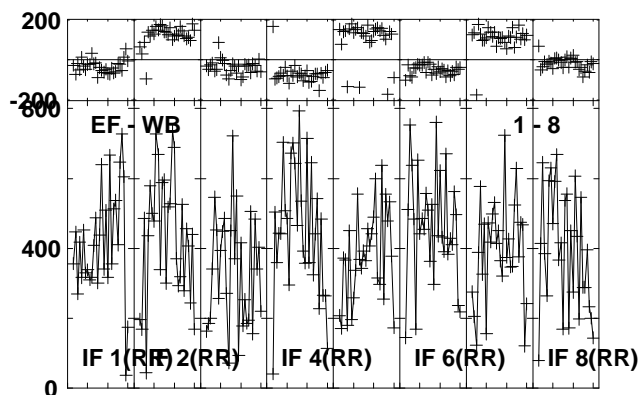
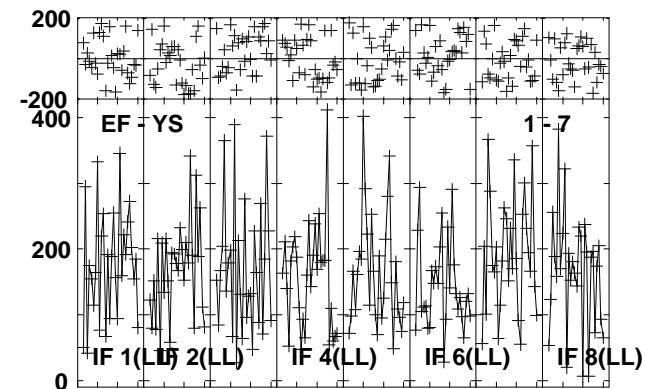
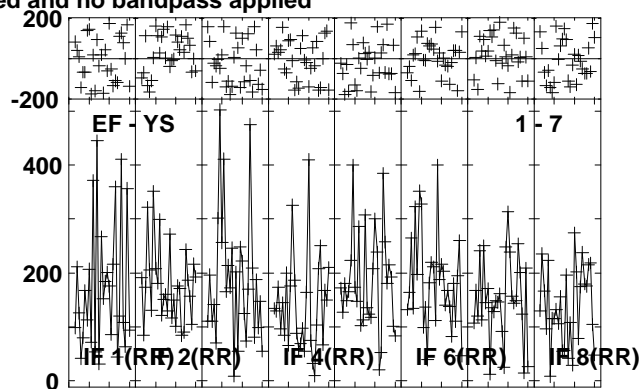
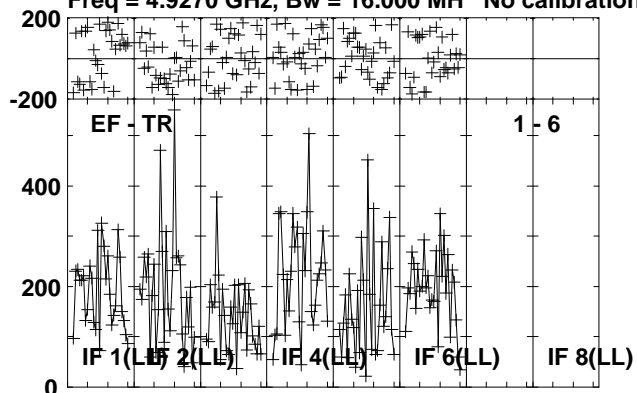

Lower frame: Micro Ampl Jy Top frame: Phas deg  
Vector averaged cross-power spectrum Several baselines displayed  
Timerange: 00:19:08:08 to 00:19:10:34



Plot file version 237 created 24-OCT-2012 21:00:20

J1825-0737 EY017B.UVDATA.1

Freq = 4.9270 GHz, Bw = 16.000 MH No calibration applied and no bandpass applied

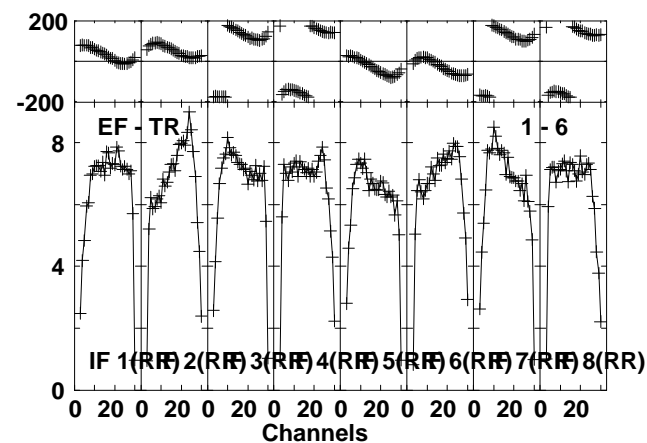
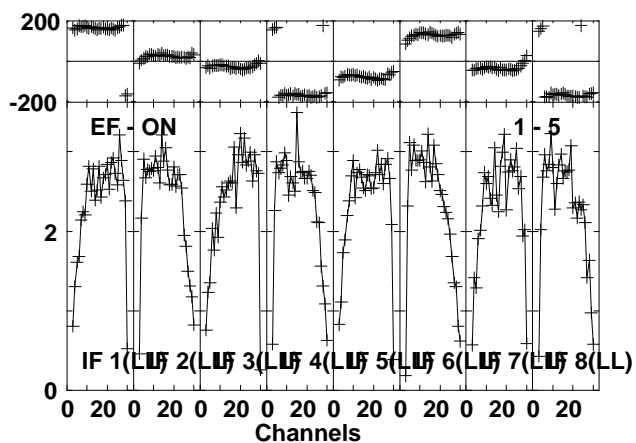
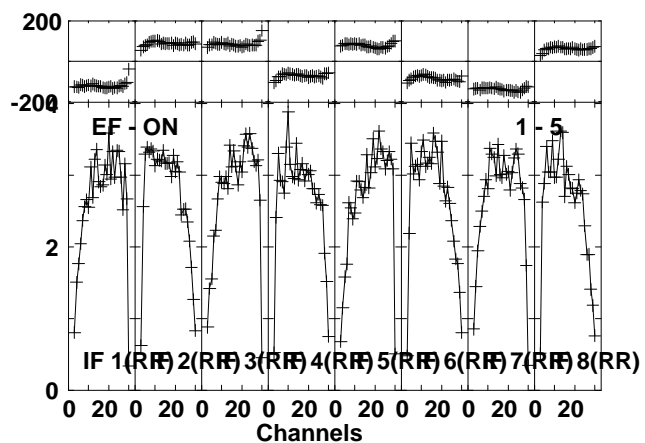
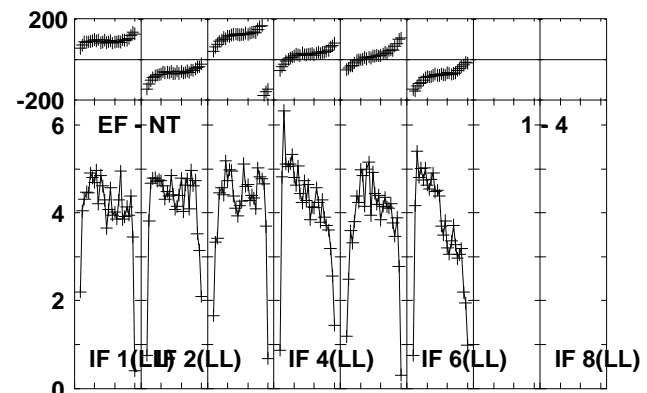
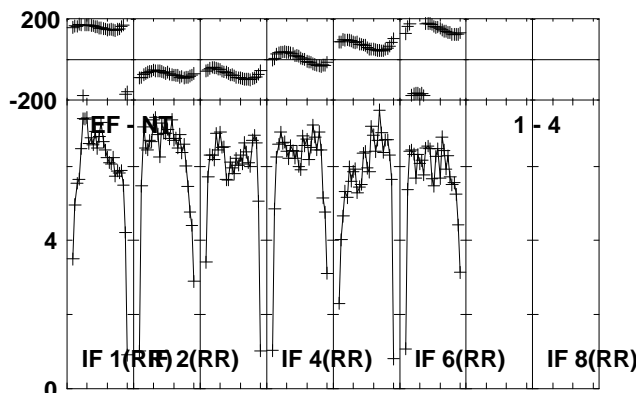
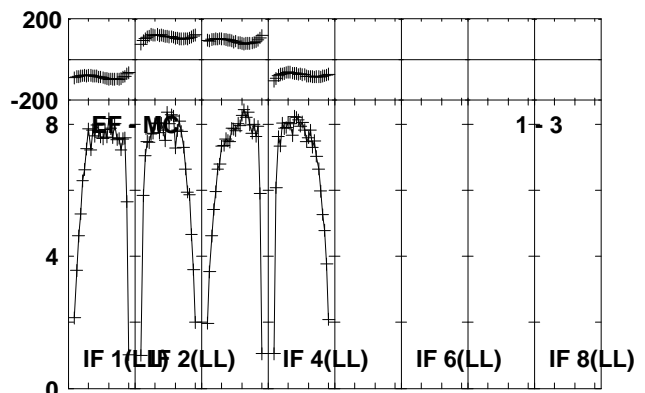
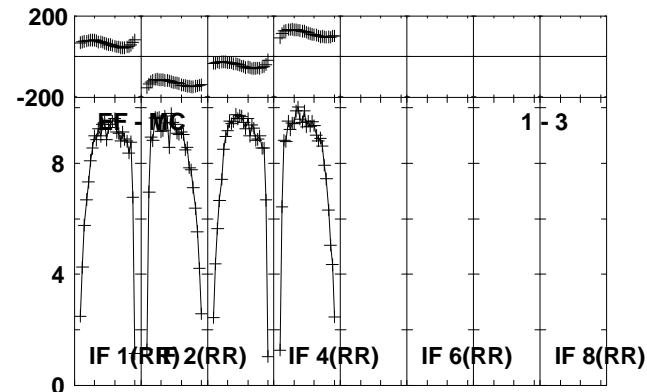
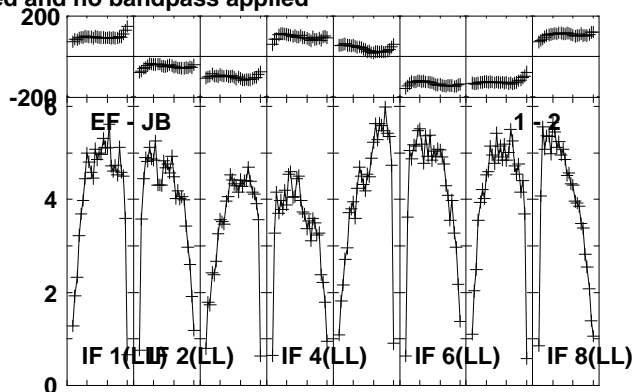
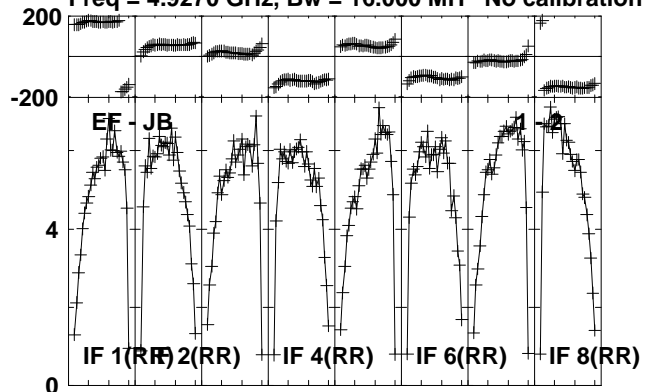

Lower frame: Milli Ampl Jy Top frame: Phas deg  
Vector averaged cross-power spectrum Several baselines displayed  
Timerange: 00/19:10:38 to 00/19:12:04

Plot file version 238 created 24-OCT-2012 21:00:20

J1825-0737 EY017B.UVDATA.1

Freq = 4.9270 GHz, Bw = 16.000 MH No calibration applied and no bandpass applied

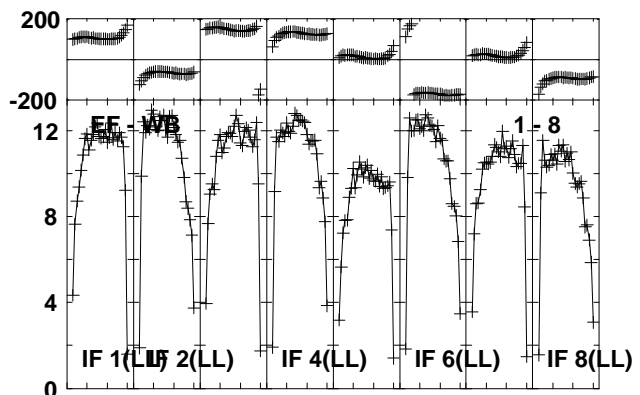
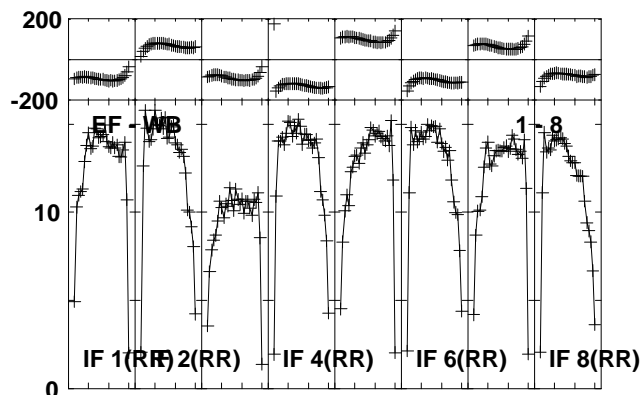
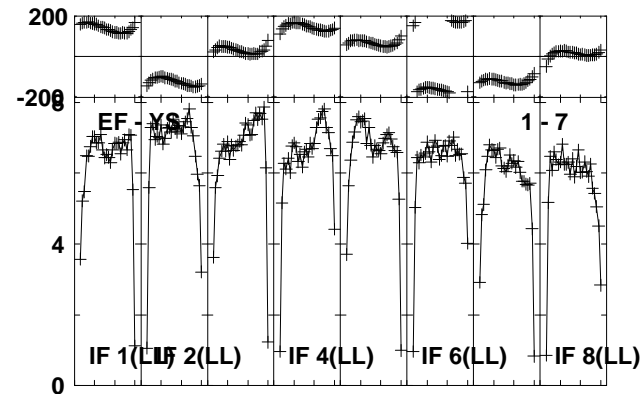
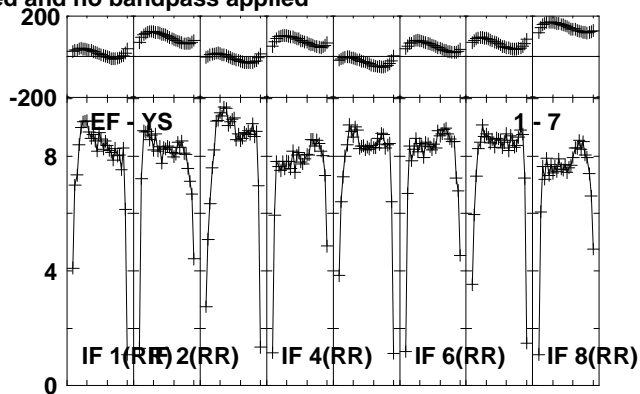
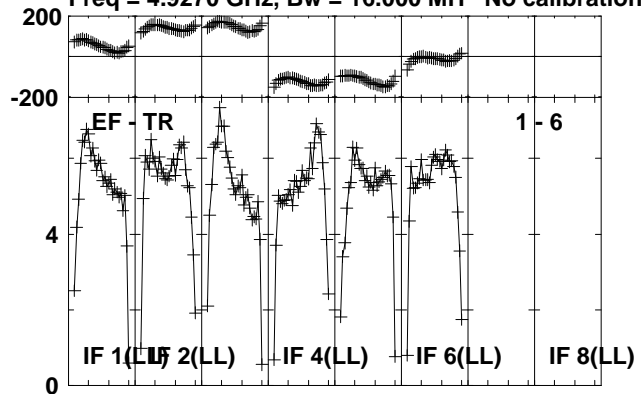

Lower frame: Milli Ampl Jy Top frame: Phas deg  
Vector averaged cross-power spectrum Several baselines displayed  
Timerange: 00/19:10:38 to 00/19:12:04

Plot file version 239 created 24-OCT-2012 21:00:20  
 J1831-0756 EY017B.UVDATA.1

Freq = 4.9270 GHz, Bw = 16.000 MH No calibration applied and no bandpass applied

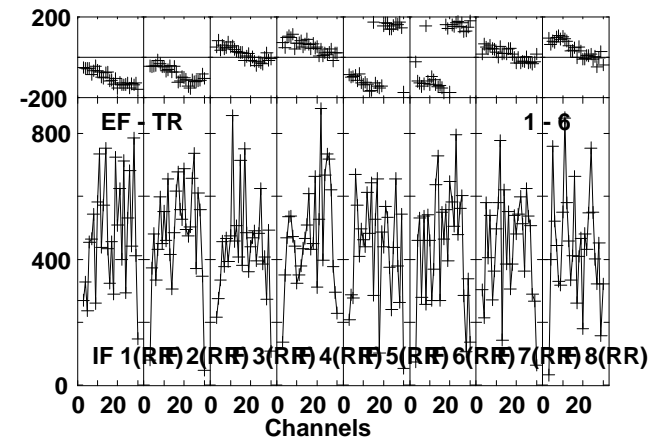
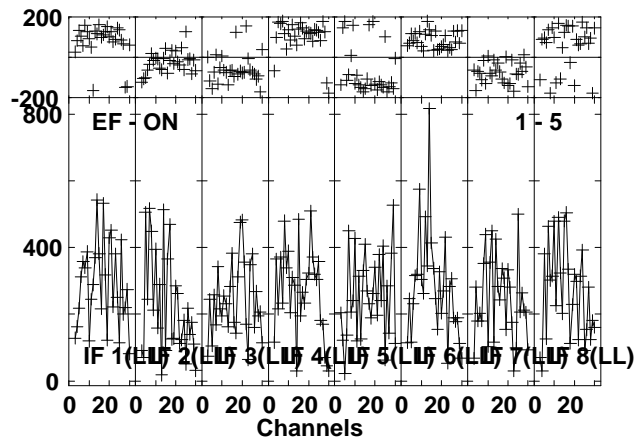
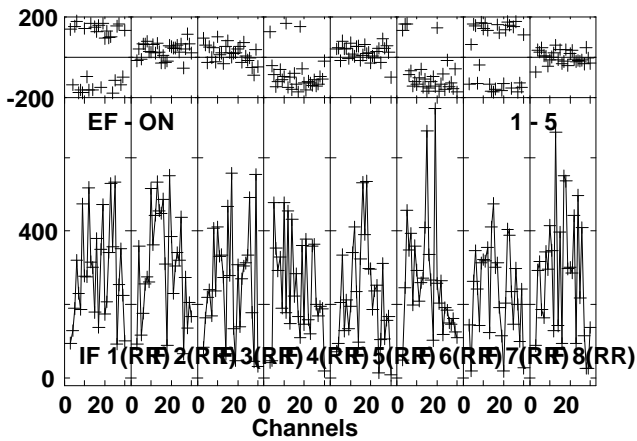
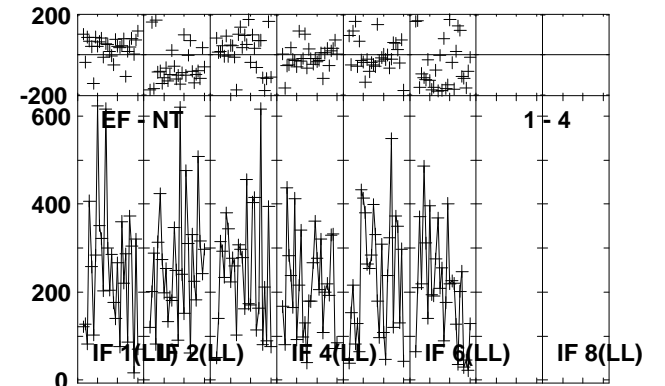
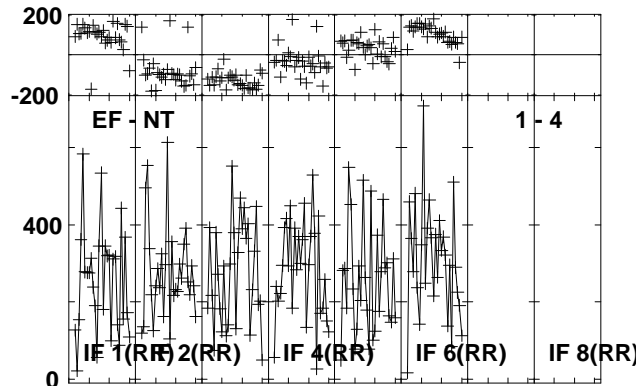
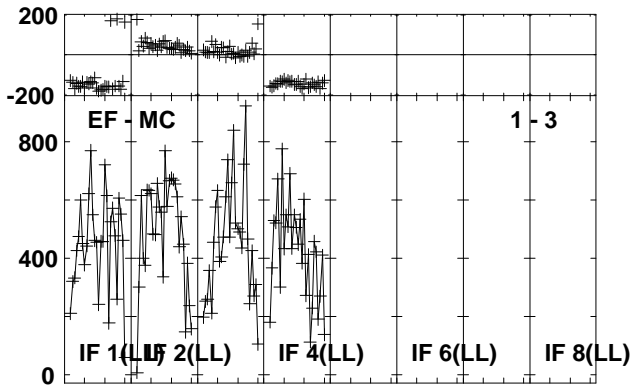
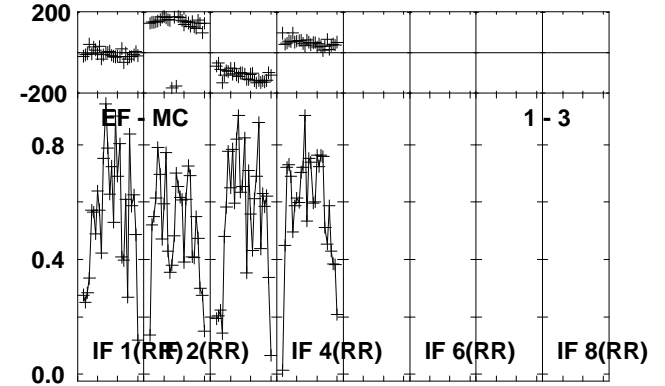
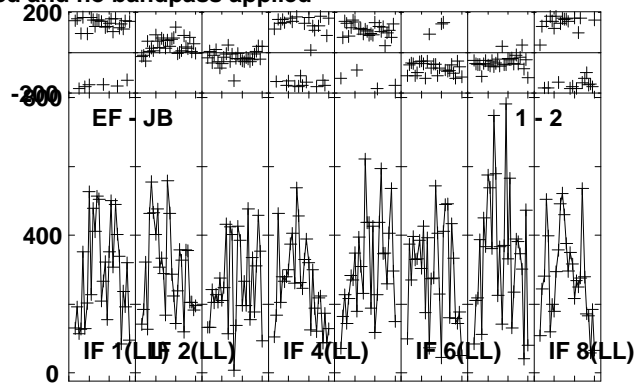
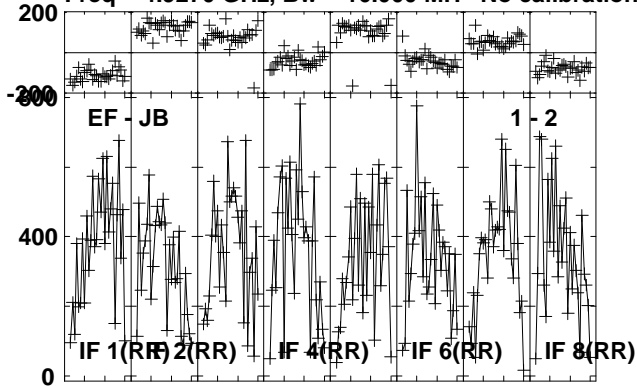

Lower frame: Micro Ampl Jy Top frame: Phas deg  
 Vector averaged cross-power spectrum Several baselines displayed  
 Timerange: 00/19:12:38 to 00/19:14:38

Plot file version 240 created 24-OCT-2012 21:00:21

J1831-0756 EY017B.UVDATA.1

Freq = 4.9270 GHz, Bw = 16.000 MH No calibration applied and no bandpass applied

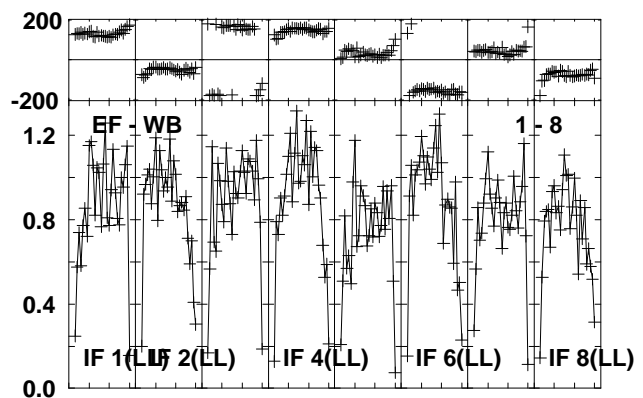
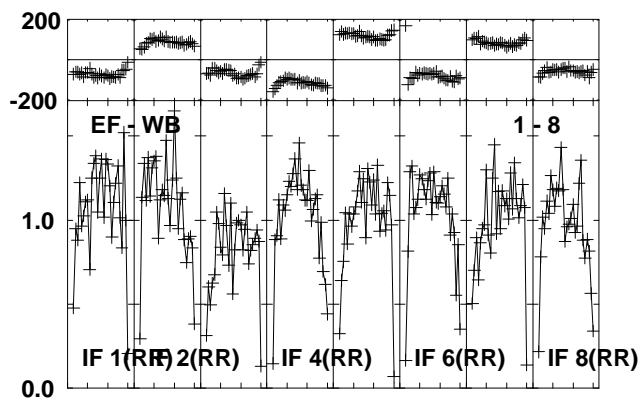
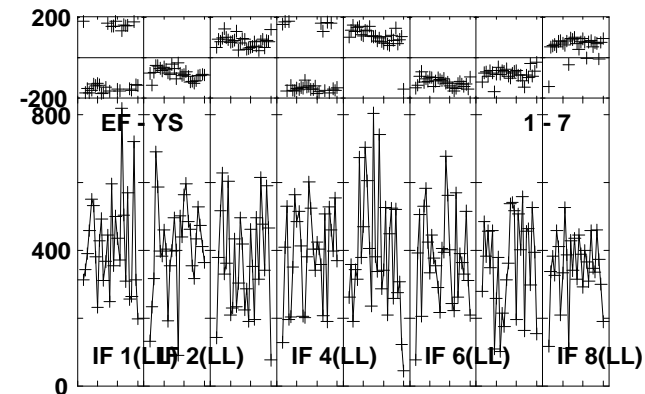
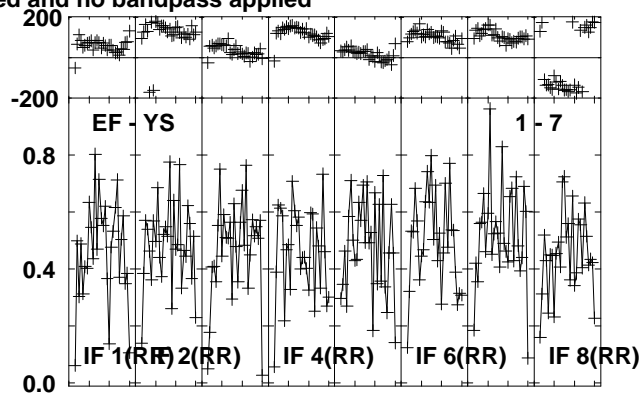
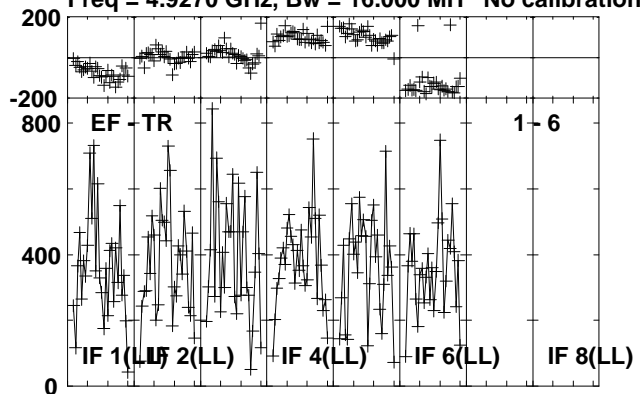

Lower frame: Micro Ampl Jy Top frame: Phas deg  
Vector averaged cross-power spectrum Several baselines displayed  
Timerange: 00/19:12:38 to 00/19:14:38



Plot file version 242 created 24-OCT-2012 21:00:22

J1825-0737 EY017B.UVDATA.1

Freq = 4.9270 GHz, Bw = 16.000 MH No calibration applied and no bandpass applied

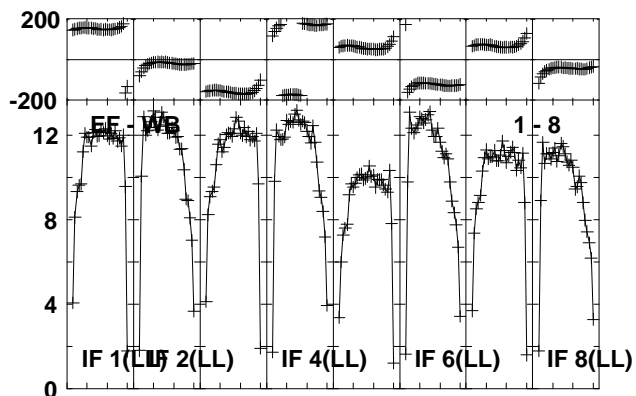
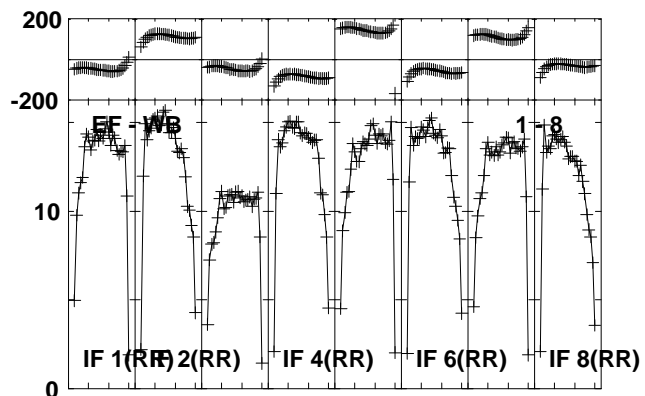
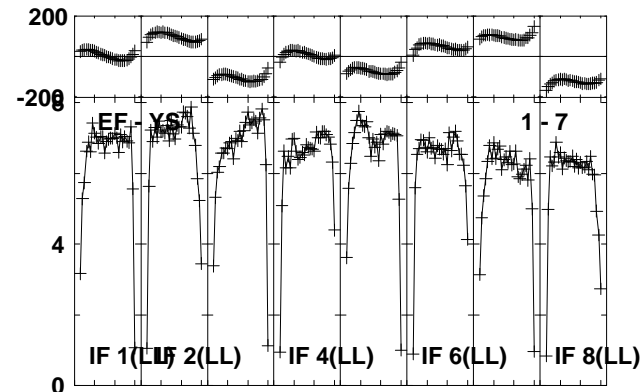
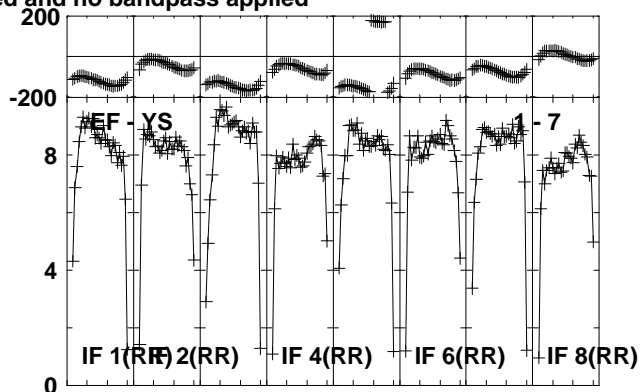
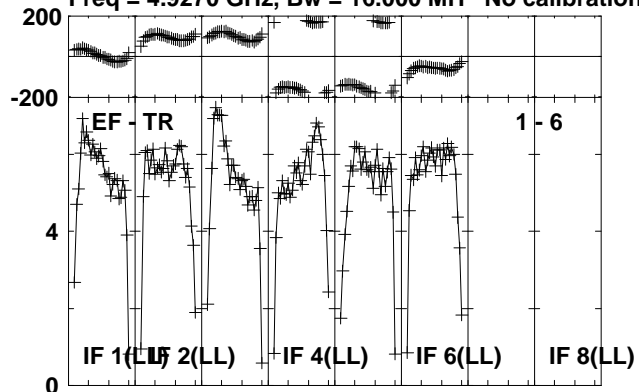

Lower frame: Milli Ampl Jy Top frame: Phas deg  
Vector averaged cross-power spectrum Several baselines displayed  
Timerange: 00/19:14:42 to 00/19:16:08

Plot file version 243 created 24-OCT-2012 21:00:22

G23.6-0.03 EY017B.UVDATA.1

Freq = 4.9270 GHz, Bw = 16.000 MH No calibration applied and no bandpass applied

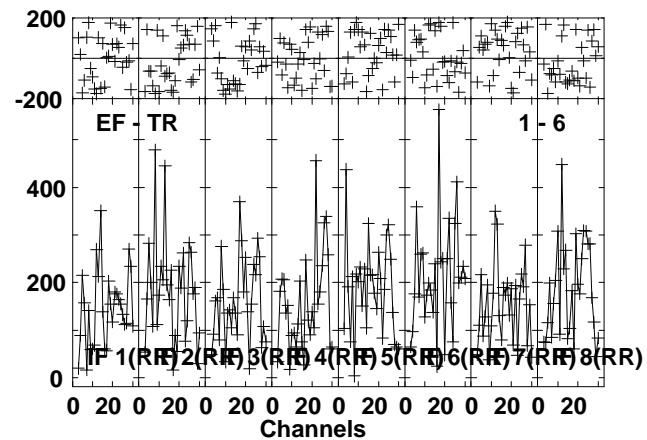
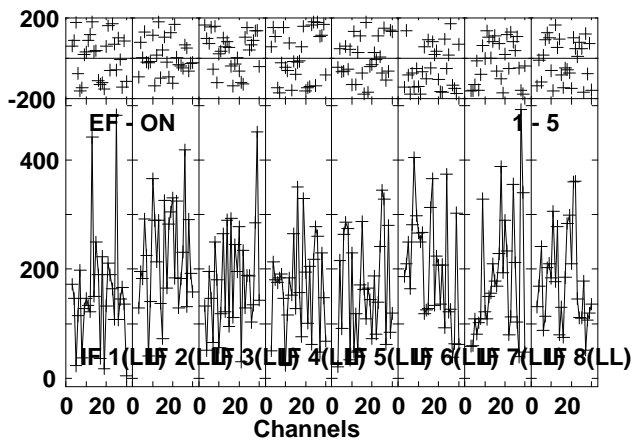
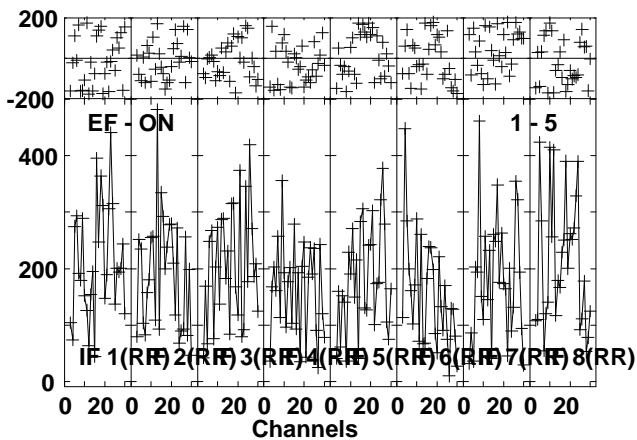
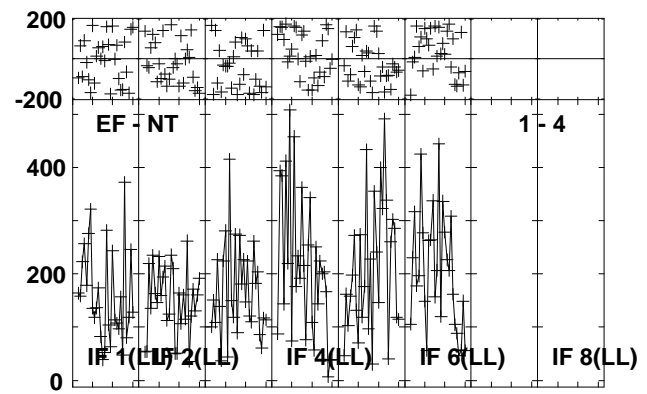
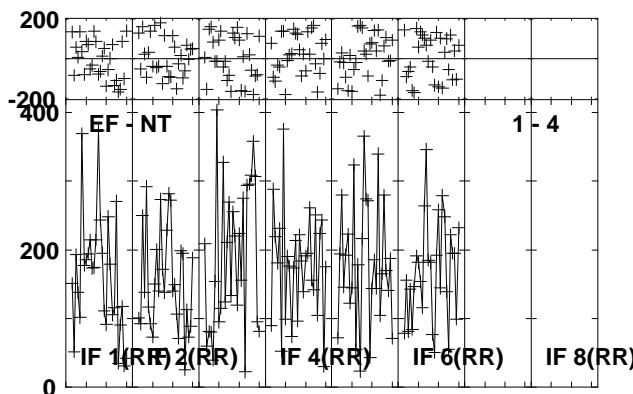
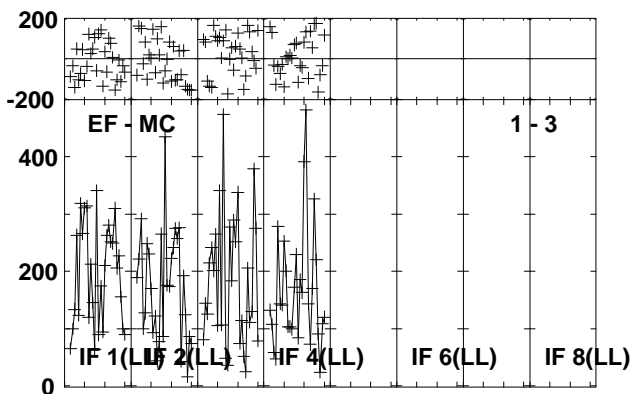
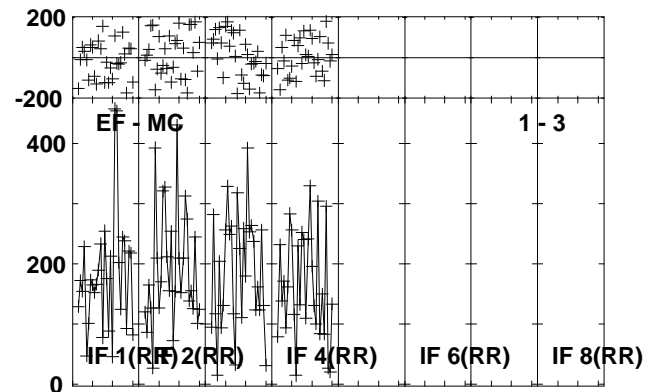
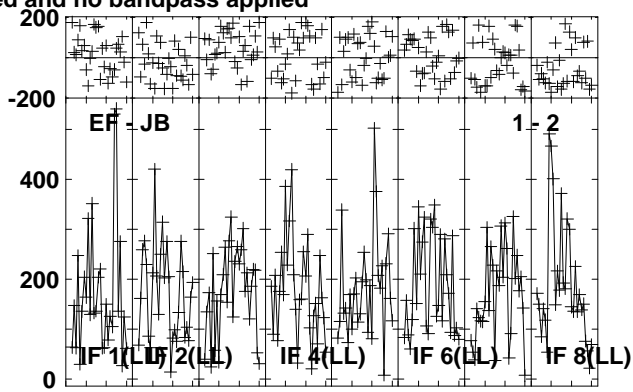
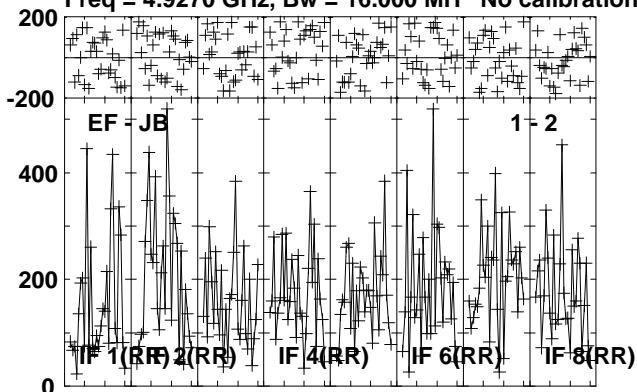

Lower frame: Micro Ampl Jy Top frame: Phas deg  
Vector averaged cross-power spectrum Several baselines displayed  
Timerange: 00/19:16:12 to 00/19:18:38

Plot file version 244 created 24-OCT-2012 21:00:23

G23.6-0.03 EY017B.UVDATA.1

Freq = 4.9270 GHz, Bw = 16.000 MH No calibration applied and no bandpass applied

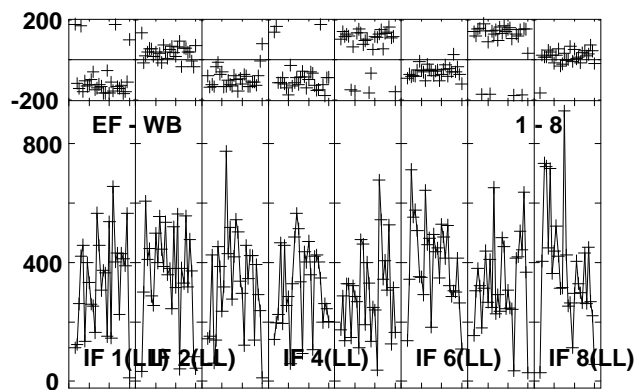
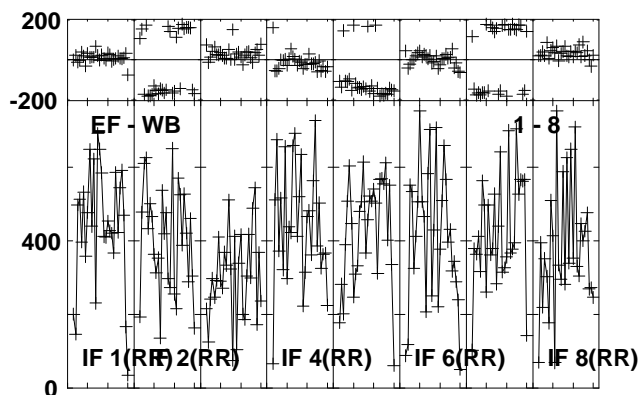
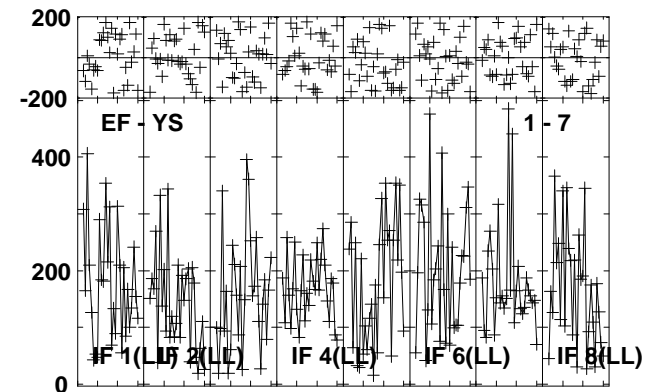
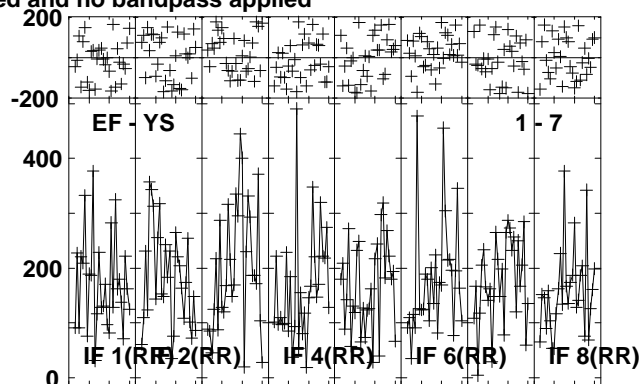
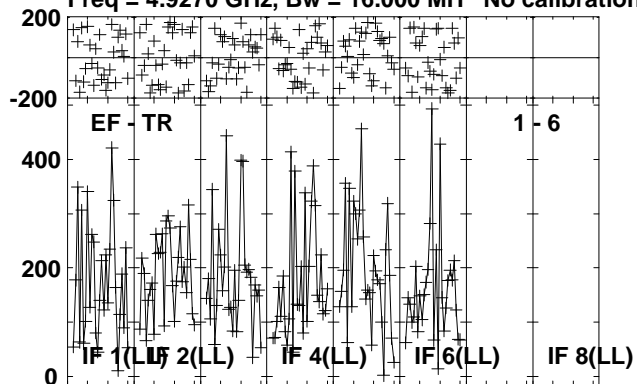

Lower frame: Micro Ampl Jy Top frame: Phas deg  
Vector averaged cross-power spectrum Several baselines displayed  
Timerange: 00/19:16:12 to 00/19:18:38



Plot file version 245 created 24-OCT-2012 21:00:24

J1825-0737 EY017B.UVDATA.1

Freq = 4.9270 GHz, Bw = 16.000 MH No calibration applied and no bandpass applied

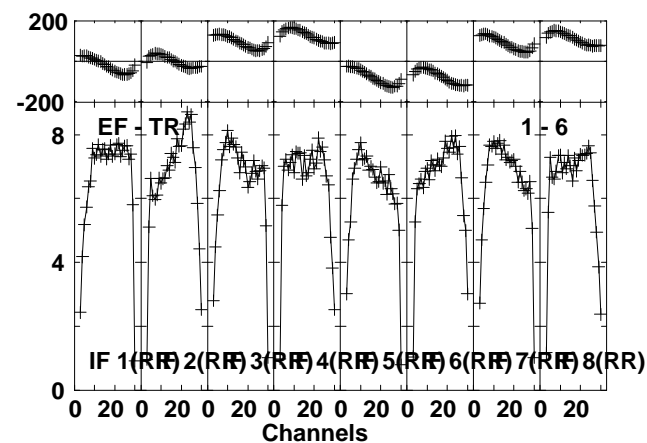
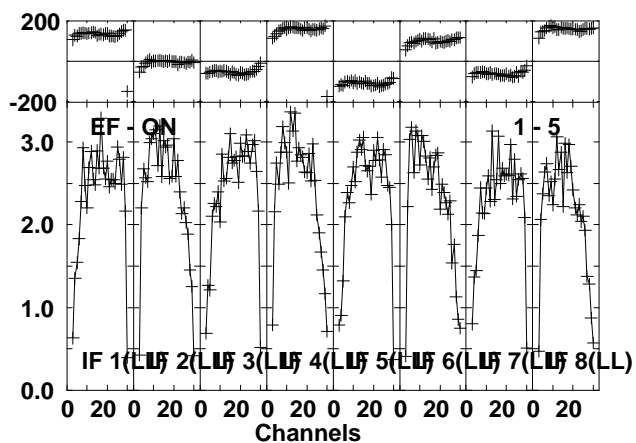
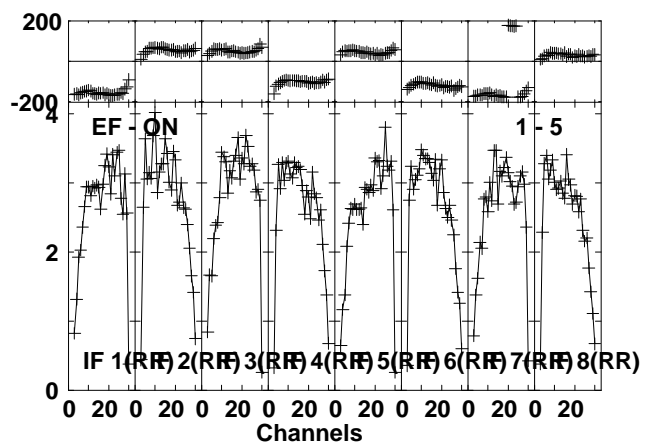
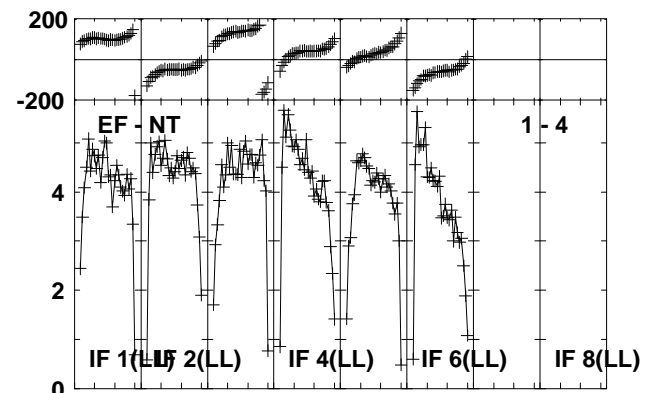
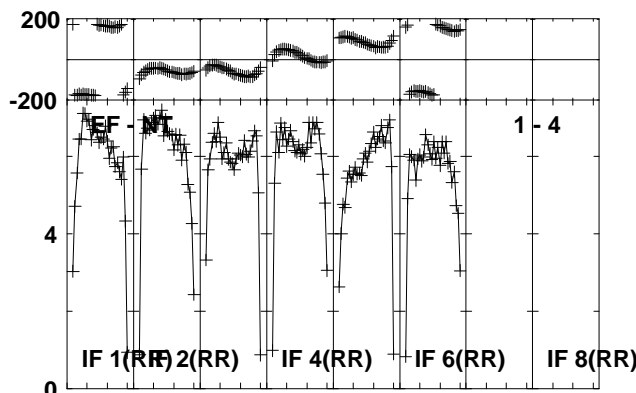
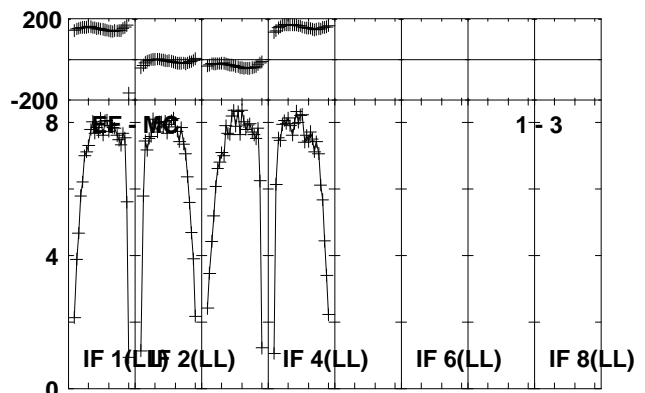
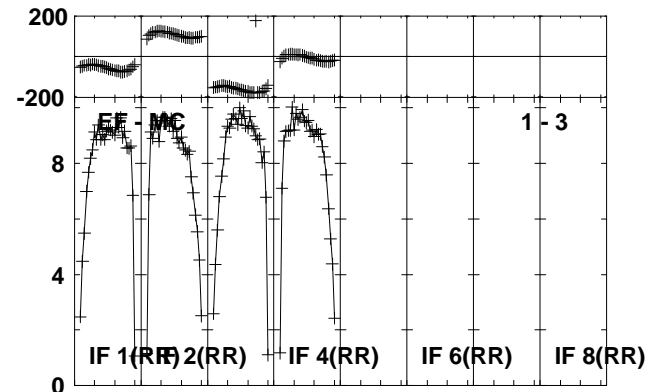
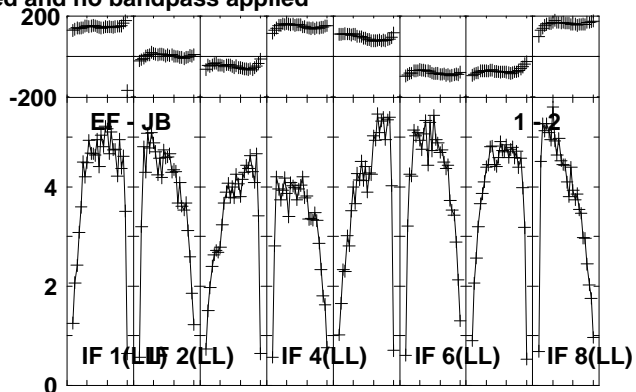
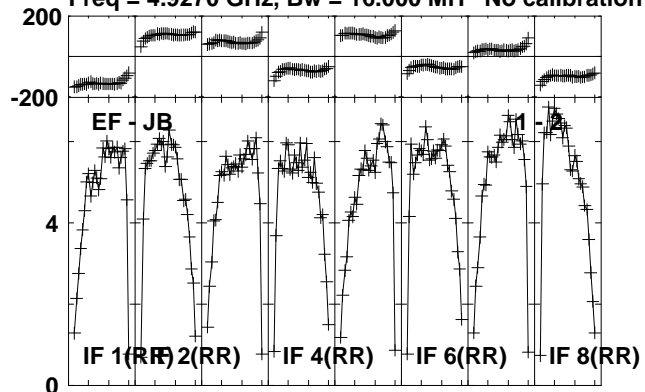

Lower frame: Milli Ampl Jy Top frame: Phas deg  
Vector averaged cross-power spectrum Several baselines displayed  
Timerange: 00/19:18:42 to 00/19:20:08

Plot file version 246 created 24-OCT-2012 21:00:24

J1825-0737 EY017B.UVDATA.1

Freq = 4.9270 GHz, Bw = 16.000 MH No calibration applied and no bandpass applied

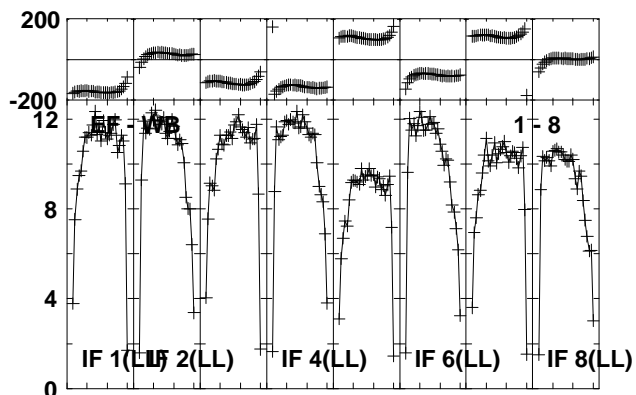
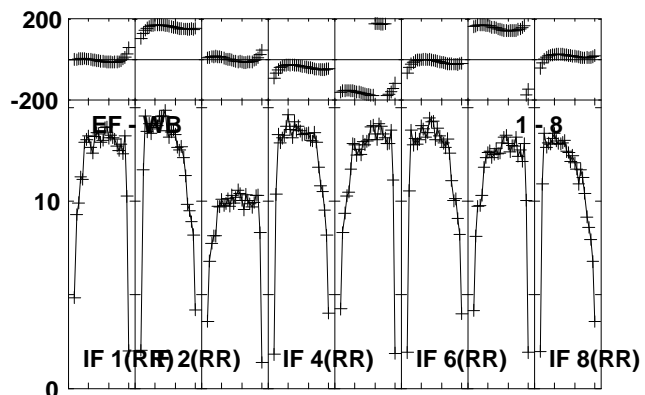
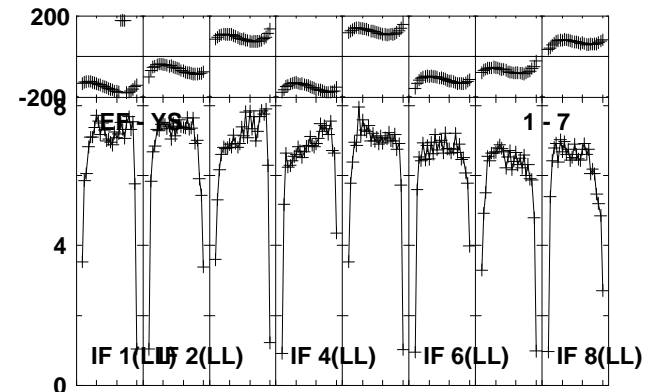
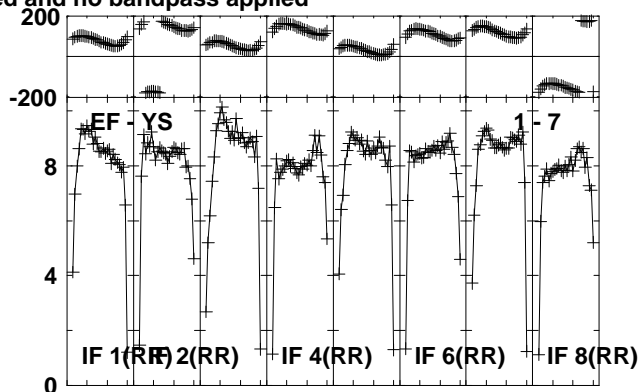
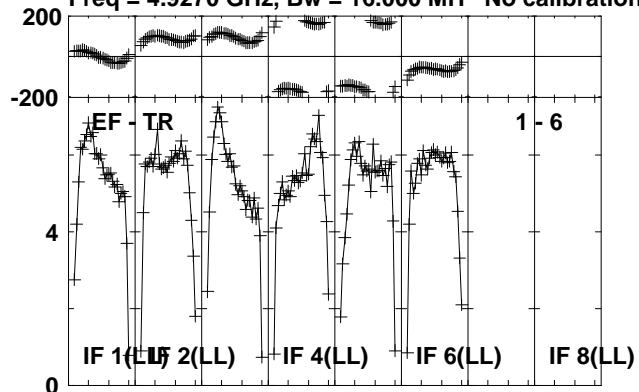

Lower frame: Milli Ampl Jy Top frame: Phas deg  
Vector averaged cross-power spectrum Several baselines displayed  
Timerange: 00/19:18:42 to 00/19:20:08

Plot file version 247 created 24-OCT-2012 21:00:24  
 G23.6-0.03 EY017B.UVDATA.1

Freq = 4.9270 GHz, Bw = 16.000 MH No calibration applied and no bandpass applied

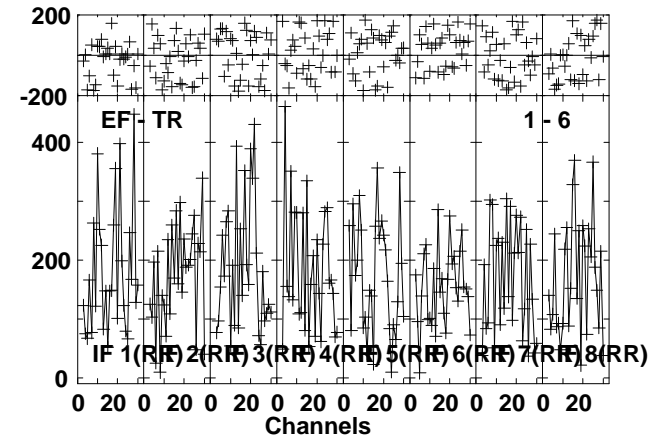
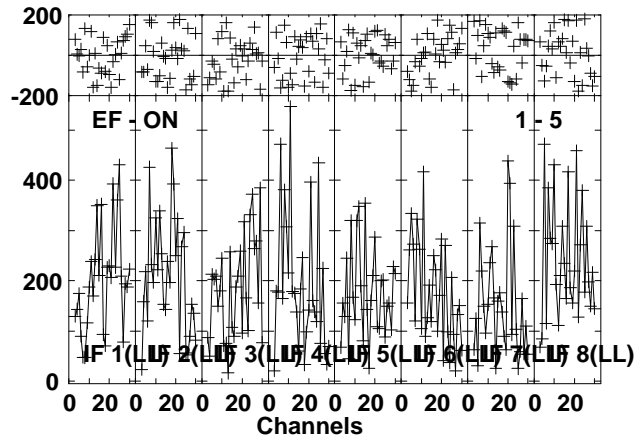
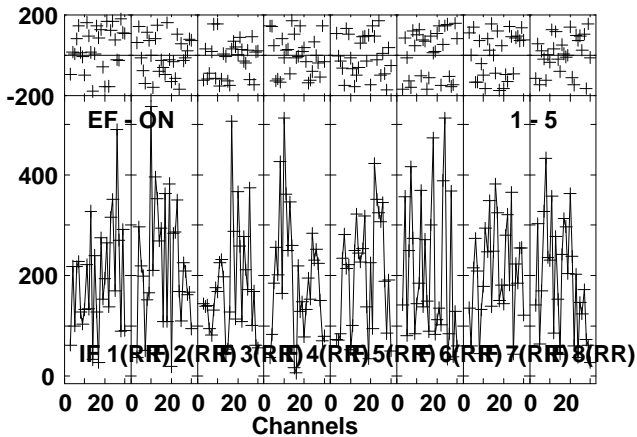
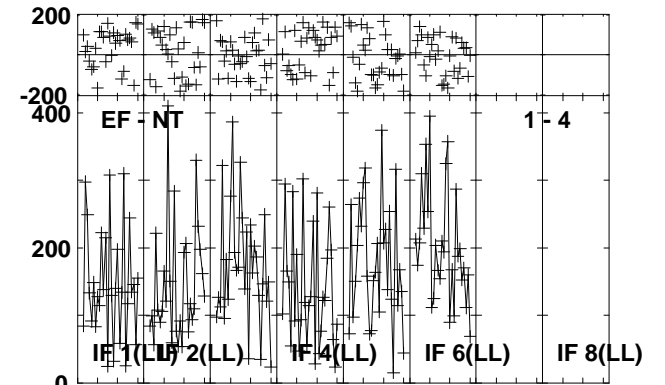
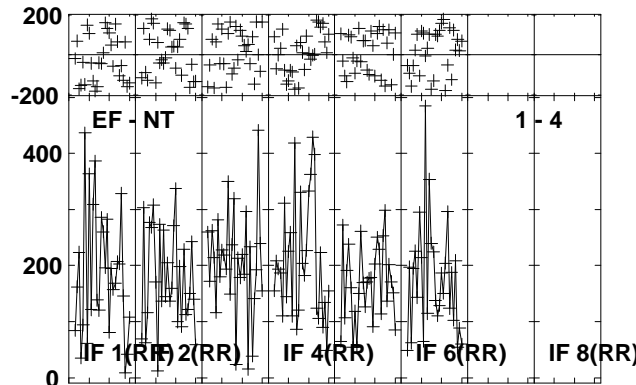
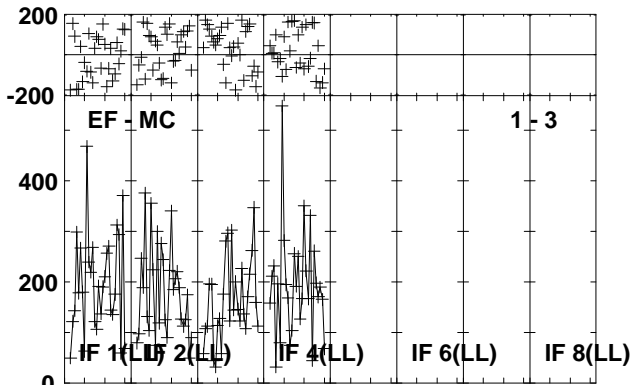
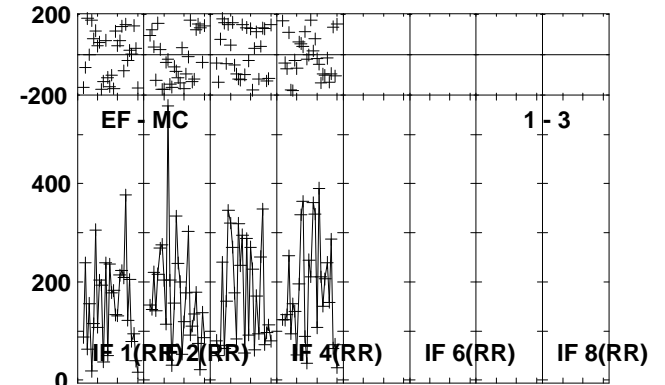
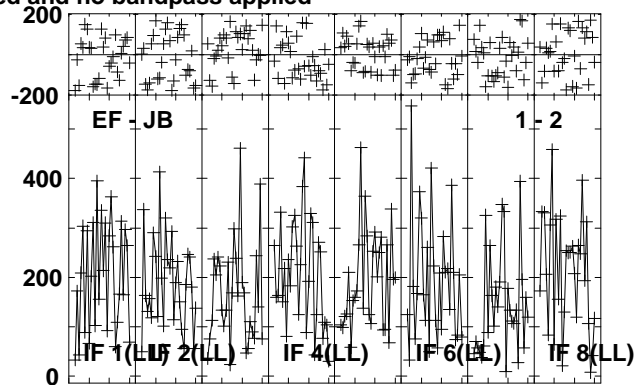
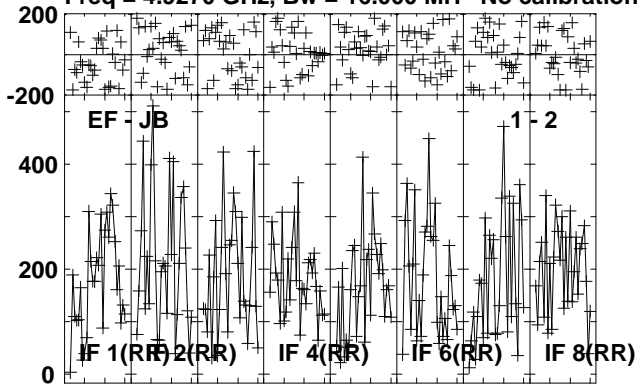

Lower frame: Micro Ampl Jy Top frame: Phas deg  
 Vector averaged cross-power spectrum Several baselines displayed  
 Timerange: 00/19:20:12 to 00/19:22:38

Plot file version 248 created 24-OCT-2012 21:00:25

G23.6-0.03 EY017B.UVDATA.1

Freq = 4.9270 GHz, Bw = 16.000 MH No calibration applied and no bandpass applied

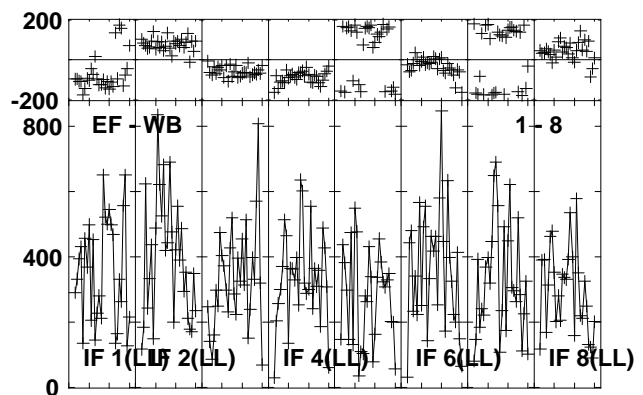
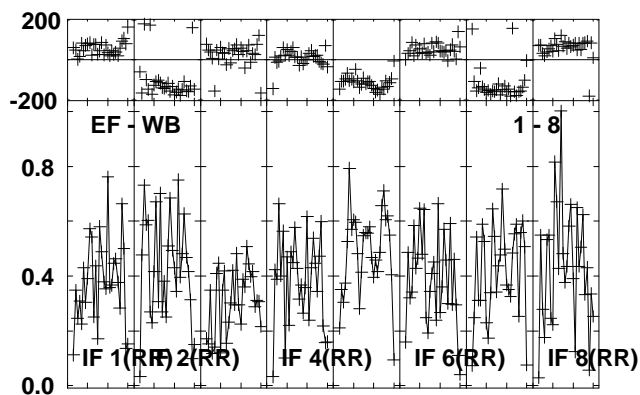
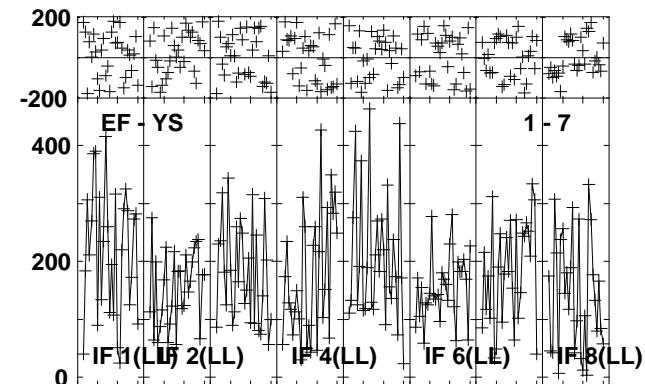
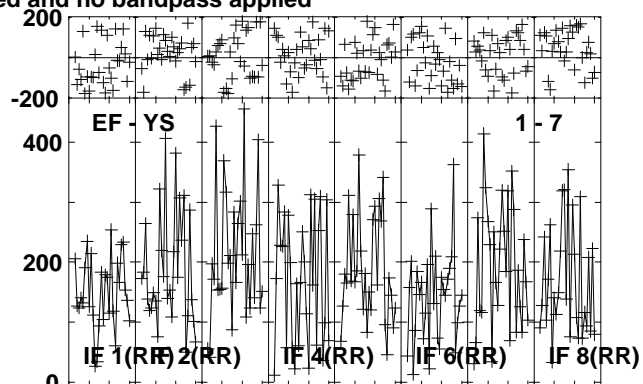
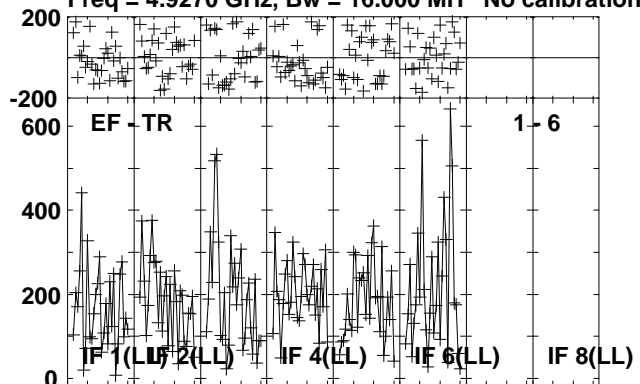

Lower frame: Micro Ampl Jy Top frame: Phas deg  
Vector averaged cross-power spectrum Several baselines displayed  
Timerange: 00/19:20:12 to 00/19:22:38

Plot file version 249 created 24-OCT-2012 21:00:26

J1825-0737 EY017B.UVDATA.1

Freq = 4.9270 GHz, Bw = 16.000 MH No calibration applied and no bandpass applied

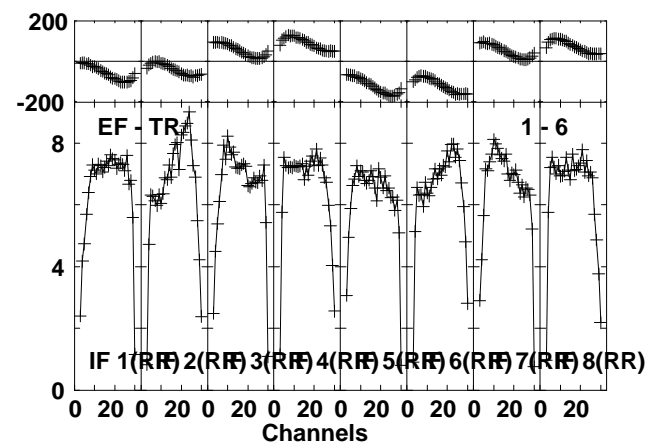
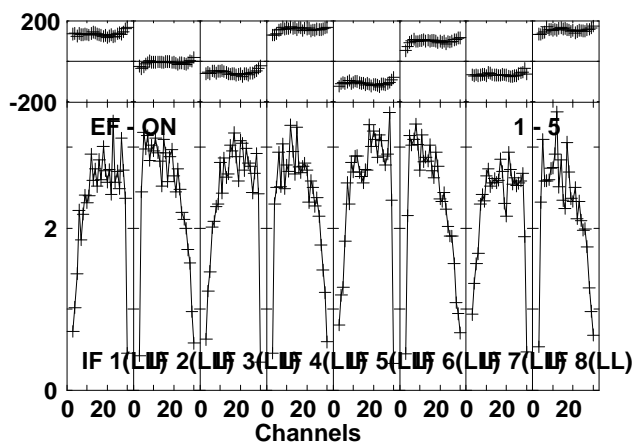
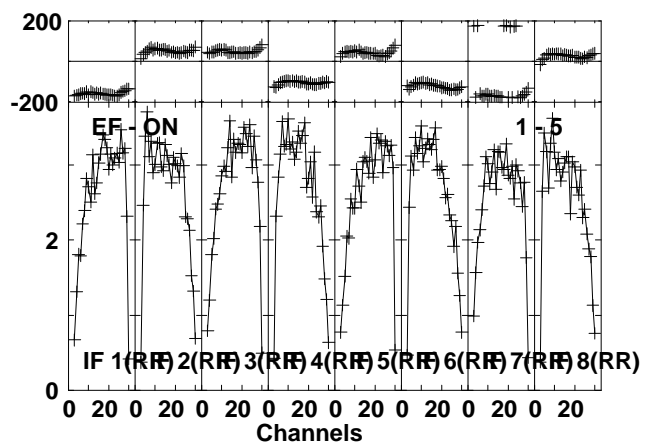
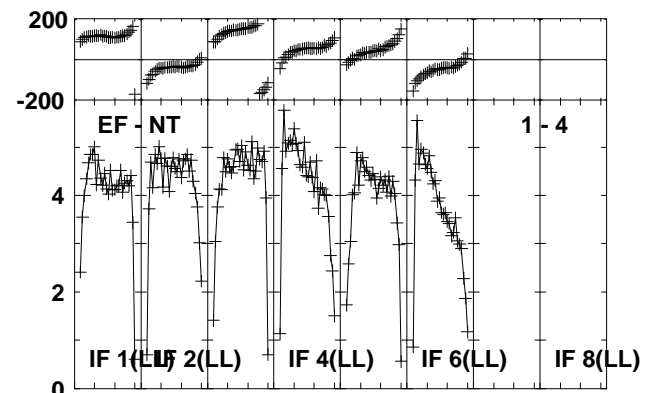
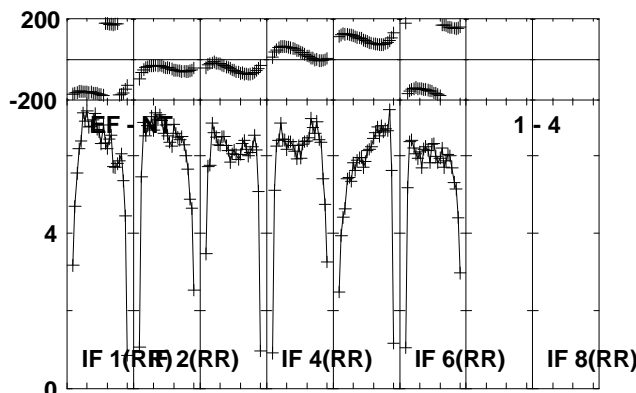
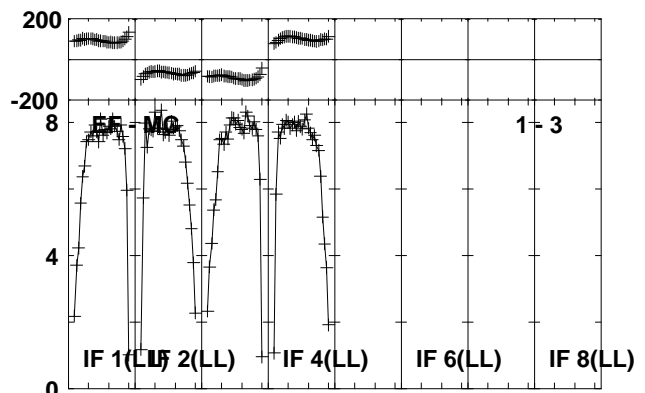
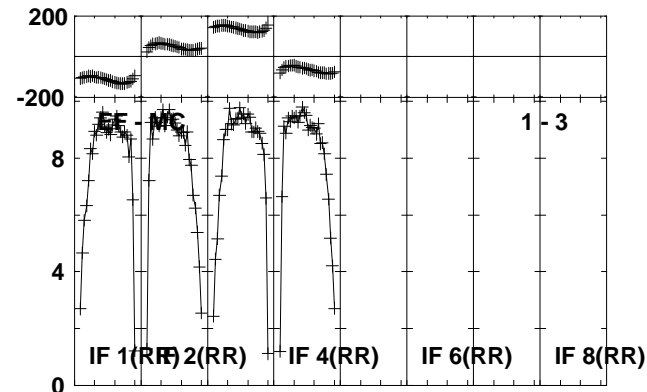
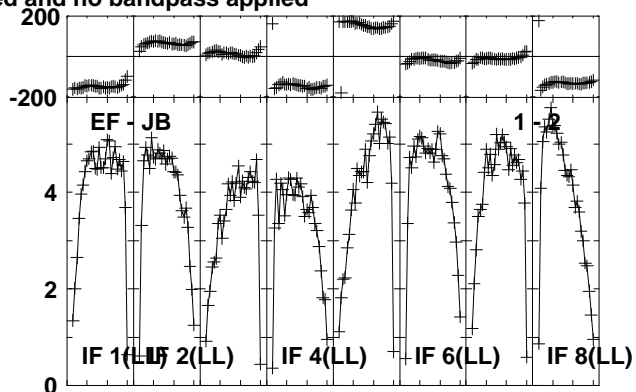
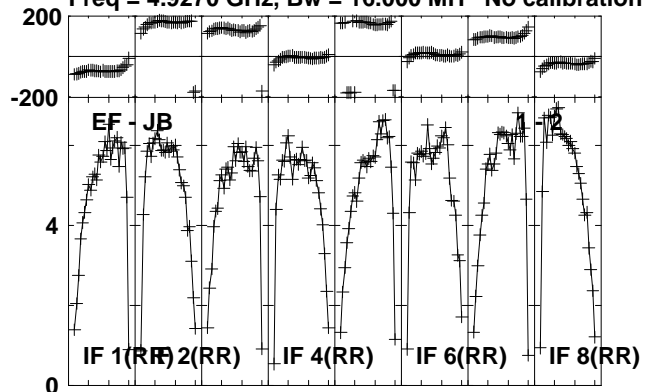

Lower frame: Milli Ampl Jy Top frame: Phas deg  
Vector averaged cross-power spectrum Several baselines displayed  
Timerange: 00/19:22:42 to 00/19:24:08

Plot file version 250 created 24-OCT-2012 21:00:26

J1825-0737 EY017B.UVDATA.1

Freq = 4.9270 GHz, Bw = 16.000 MH No calibration applied and no bandpass applied

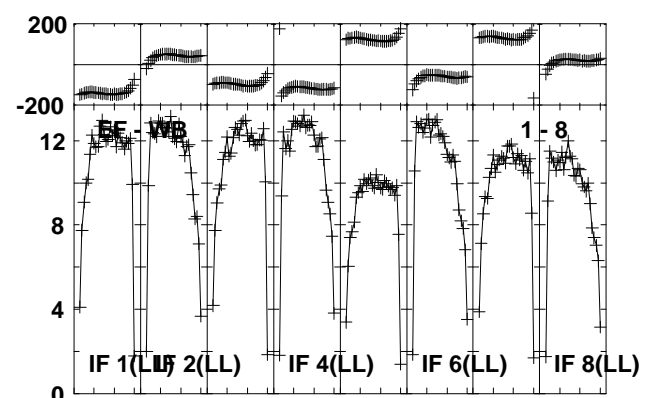
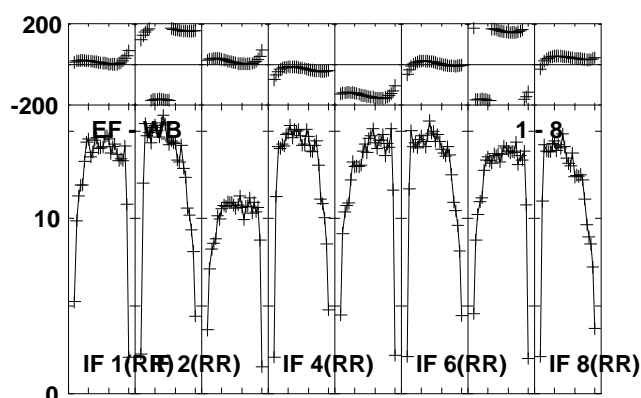
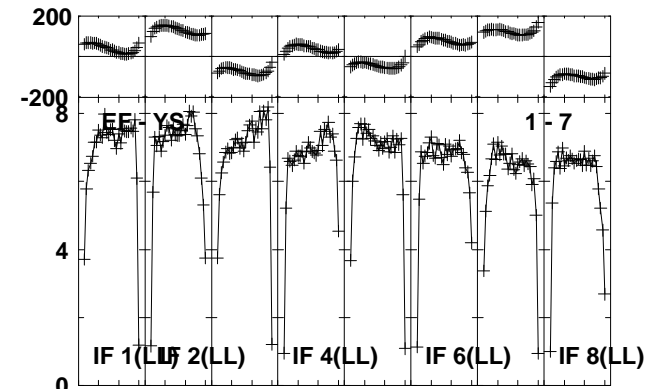
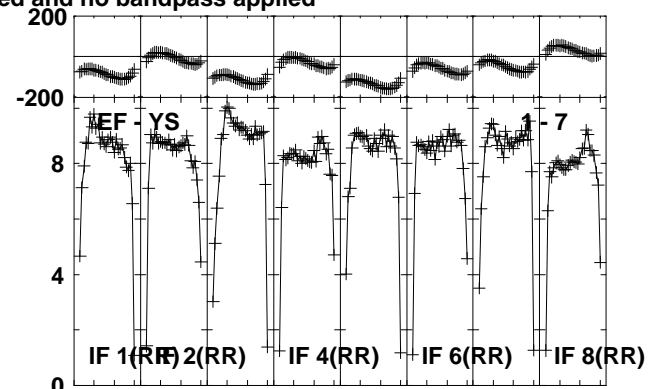
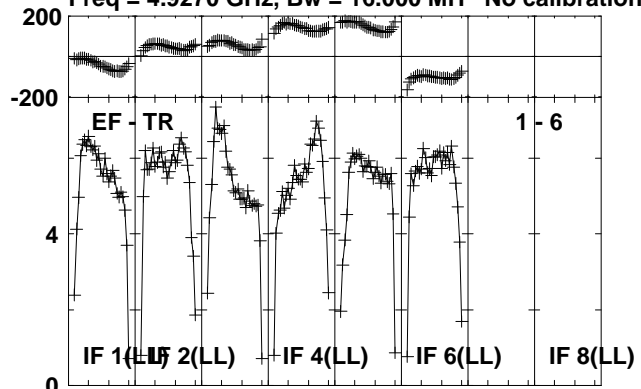

Lower frame: Milli Ampl Jy Top frame: Phas deg  
Vector averaged cross-power spectrum Several baselines displayed  
Timerange: 00/19:22:42 to 00/19:24:08

Plot file version 251 created 24-OCT-2012 21:00:27

G23.6-0.03 EY017B.UVDATA.1

Freq = 4.9270 GHz, Bw = 16.000 MH No calibration applied and no bandpass applied

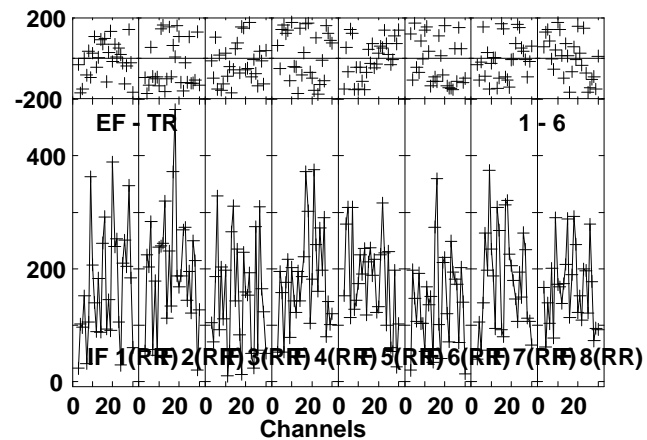
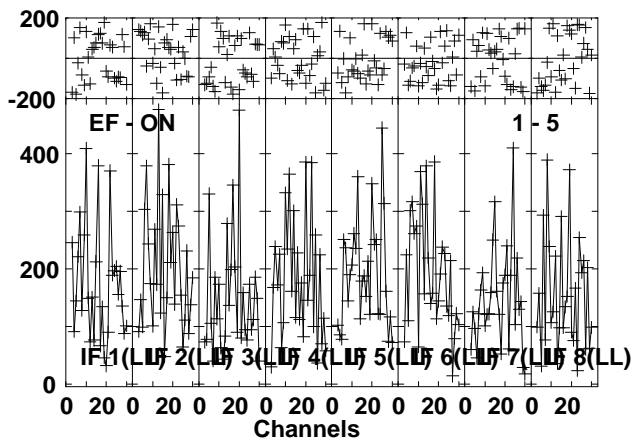
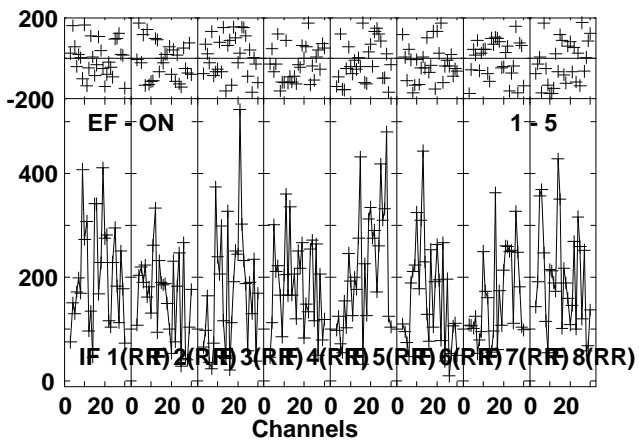
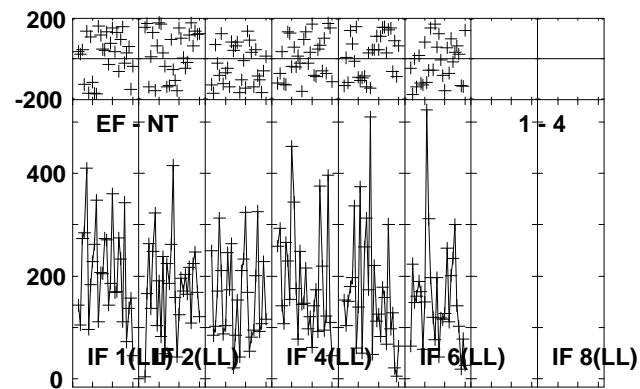
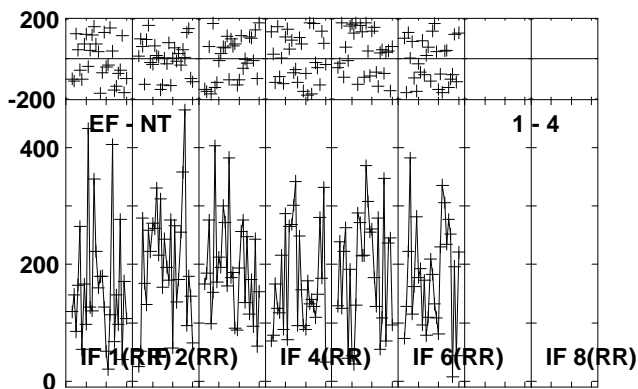
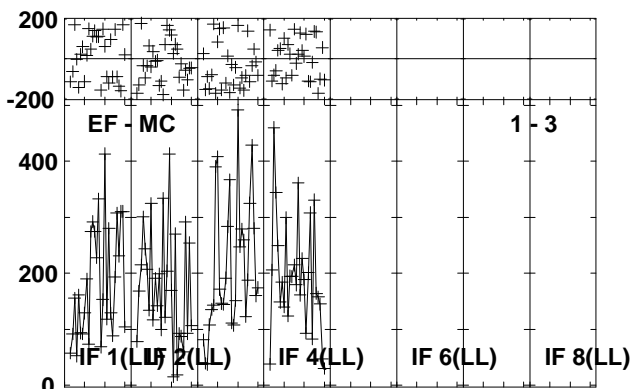
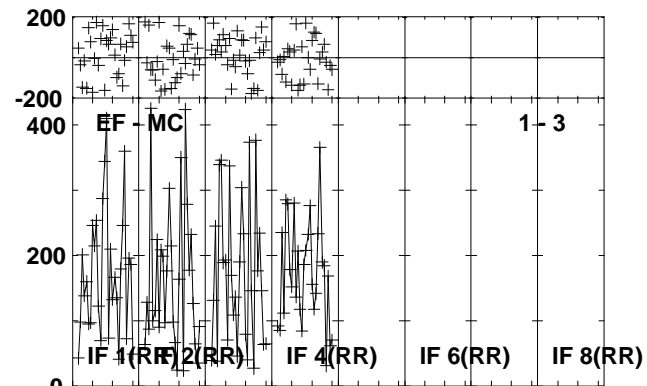
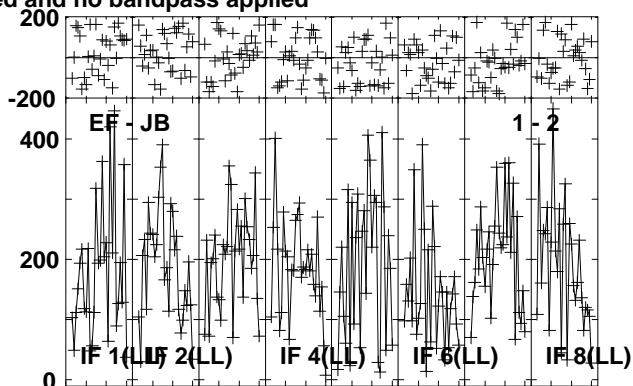
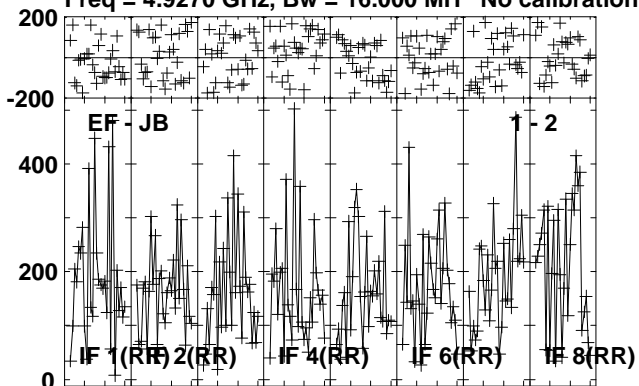

Lower frame: Micro Ampl Jy Top frame: Phas deg  
Vector averaged cross-power spectrum Several baselines displayed  
Timerange: 00/19:24:12 to 00/19:26:38

Plot file version 252 created 24-OCT-2012 21:00:27

G23.6-0.03 EY017B.UVDATA.1

Freq = 4.9270 GHz, Bw = 16.000 MH No calibration applied and no bandpass applied

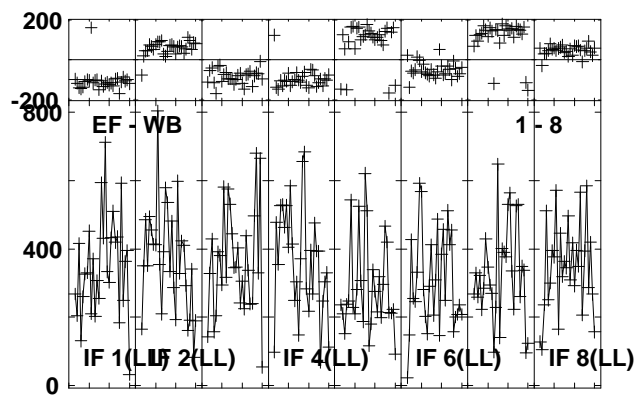
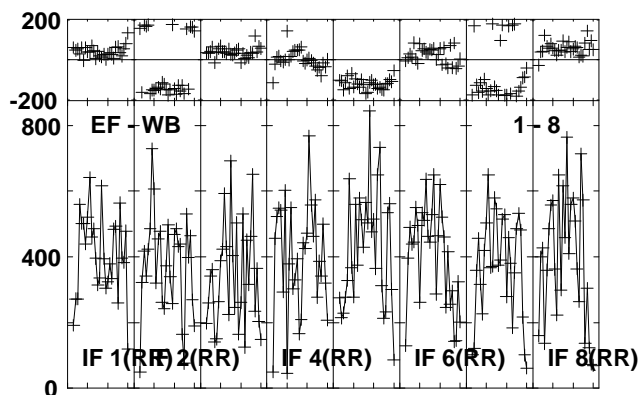
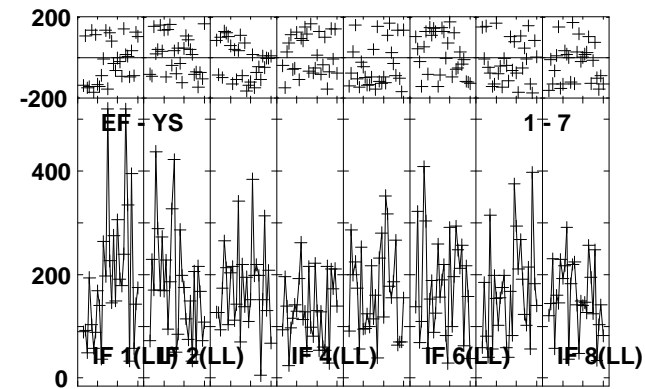
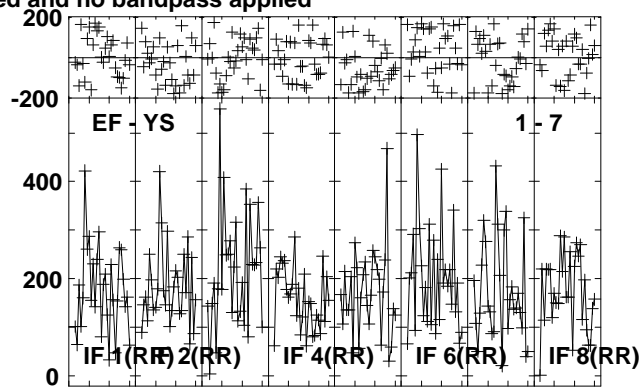
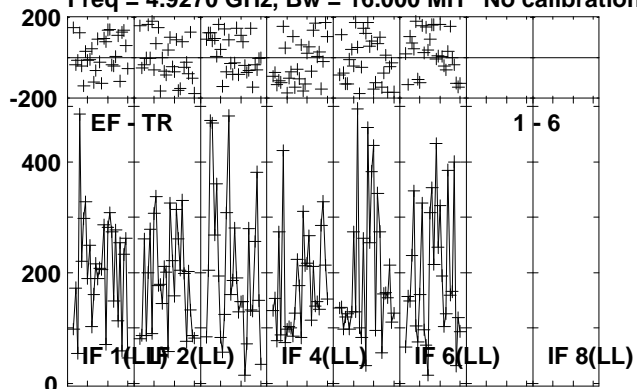

Lower frame: Micro Ampl Jy Top frame: Phas deg  
Vector averaged cross-power spectrum Several baselines displayed  
Timerange: 00/19:24:12 to 00/19:26:38





Plot file version 254 created 24-OCT-2012 21:00:28

J1825-0737 EY017B.UVDATA.1

Freq = 4.9270 GHz, Bw = 16.000 MH No calibration applied and no bandpass applied

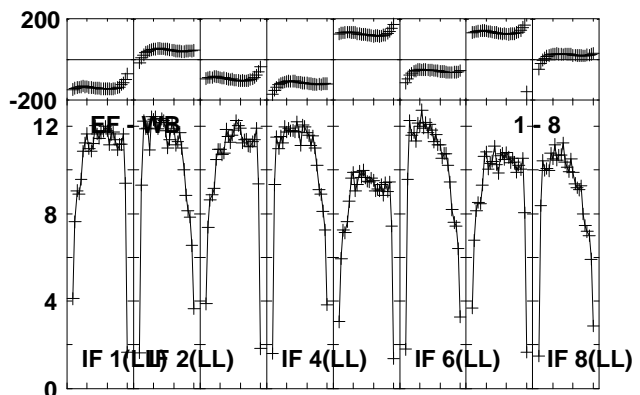
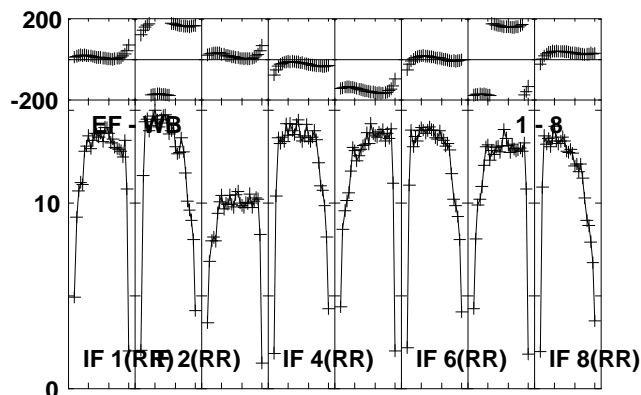
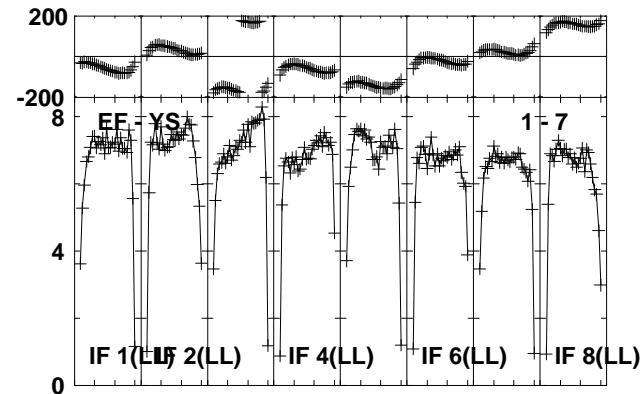
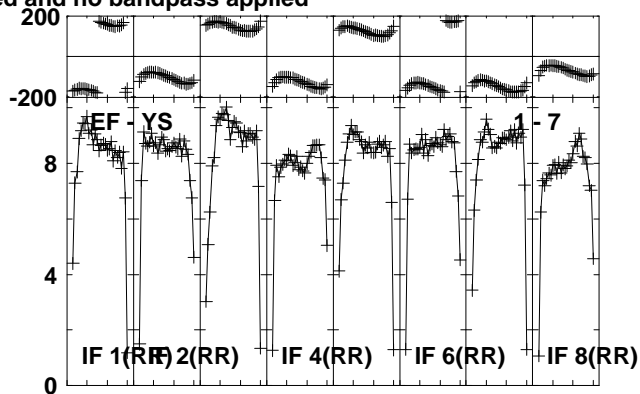
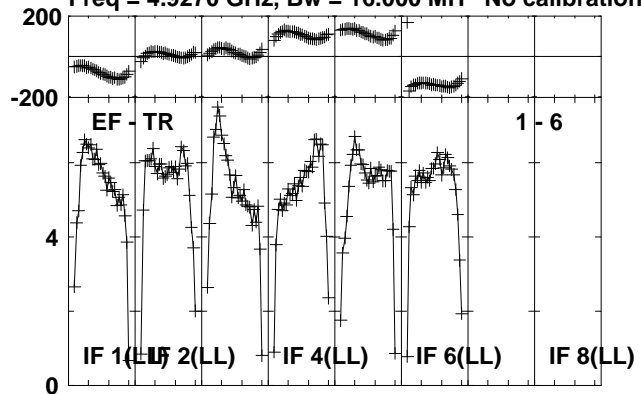

Lower frame: Milli Ampl Jy Top frame: Phas deg  
Vector averaged cross-power spectrum Several baselines displayed  
Timerange: 00/19:26:42 to 00/19:28:08

Plot file version 255 created 24-OCT-2012 21:00:29

J1831-0756 EY017B.UVDATA.1

Freq = 4.9270 GHz, Bw = 16.000 MH No calibration applied and no bandpass applied

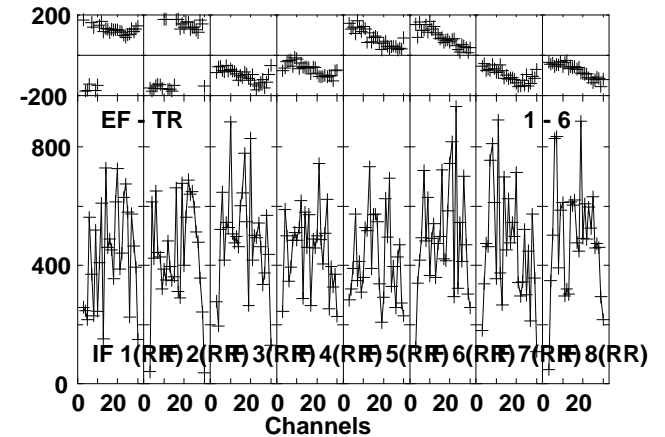
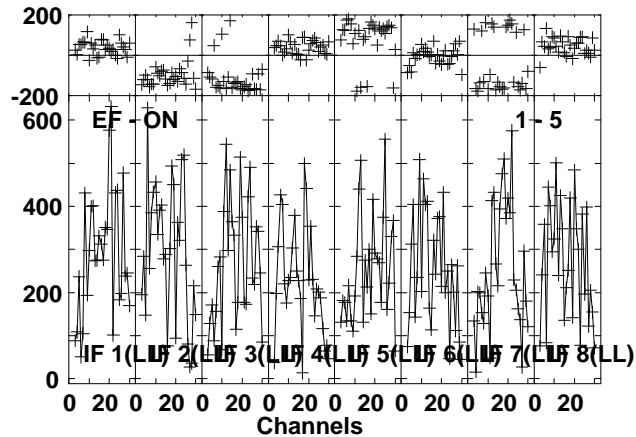
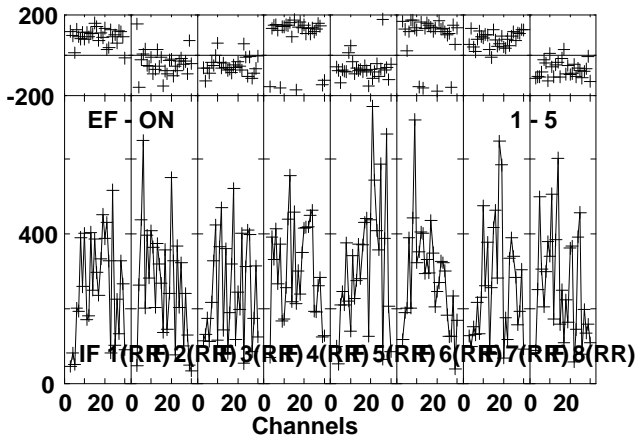
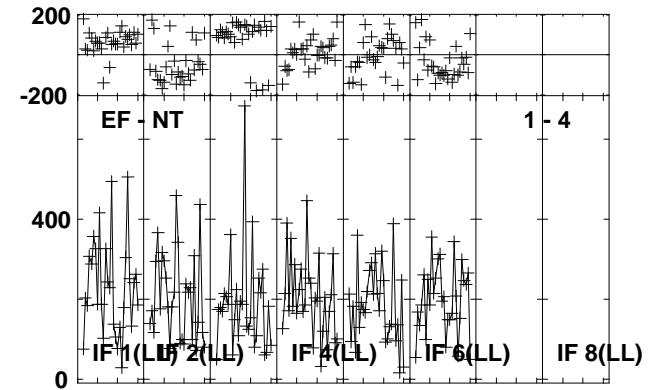
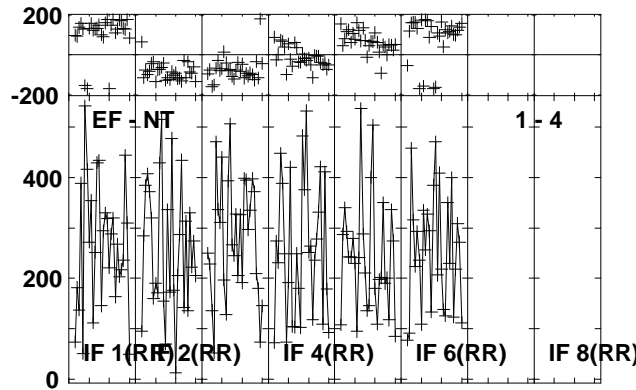
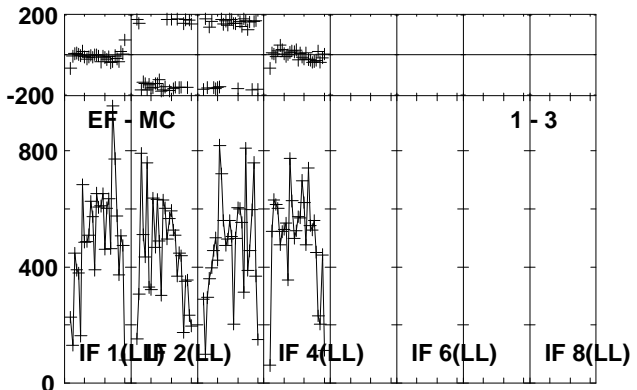
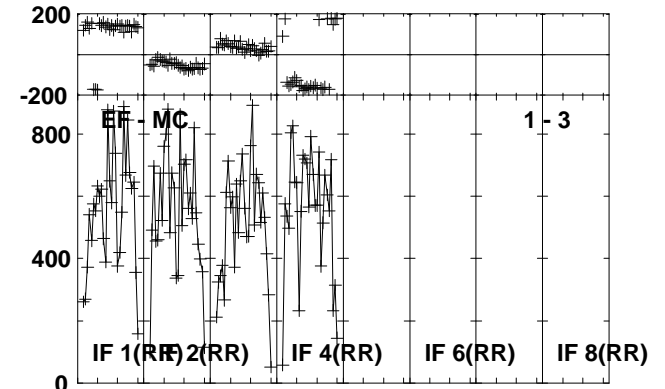
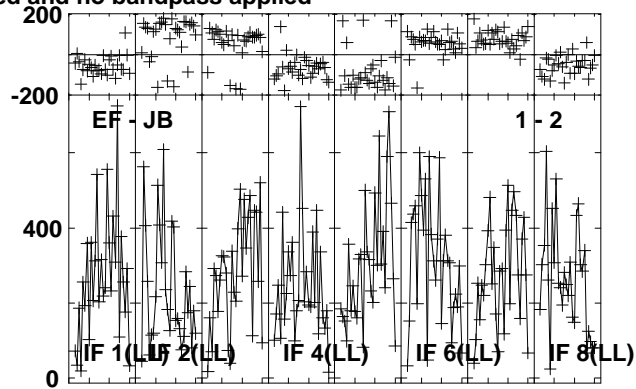
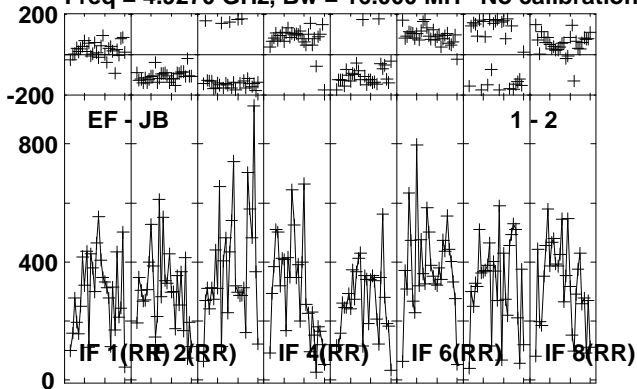

Lower frame: Micro Ampl Jy Top frame: Phas deg  
Vector averaged cross-power spectrum Several baselines displayed  
Timerange: 00:19:28:42 to 00:19:30:44

Plot file version 256 created 24-OCT-2012 21:00:29

J1831-0756 EY017B.UVDATA.1

Freq = 4.9270 GHz, Bw = 16.000 MH No calibration applied and no bandpass applied

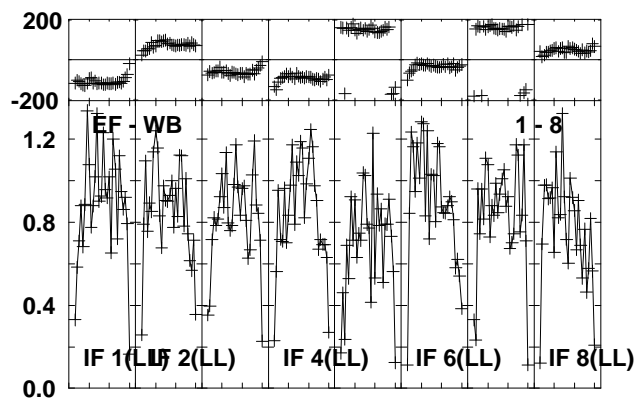
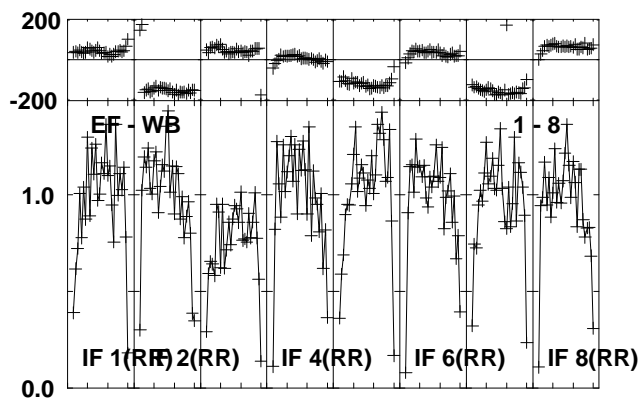
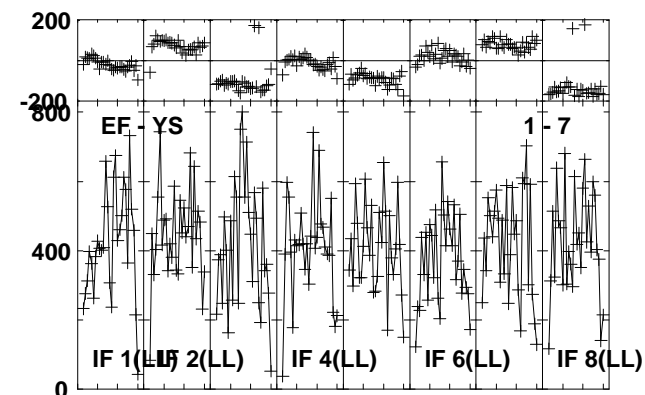
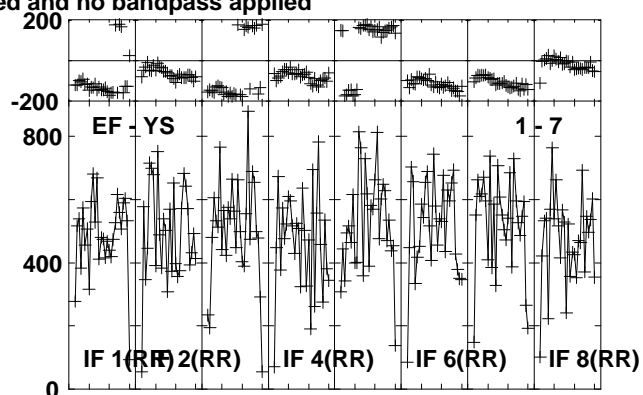
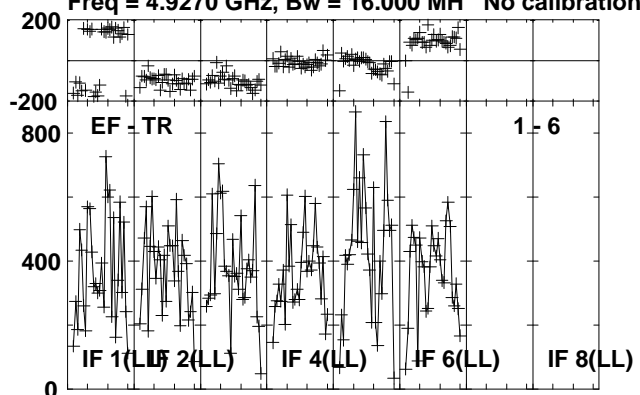

Lower frame: Micro Ampl Jy Top frame: Phas deg  
Vector averaged cross-power spectrum Several baselines displayed  
Timerange: 00/19:28:42 to 00/19:30:44

Plot file version 257 created 24-OCT-2012 21:00:30

J1825-0737 EY017B.UVDATA.1

Freq = 4.9270 GHz, Bw = 16.000 MH No calibration applied and no bandpass applied

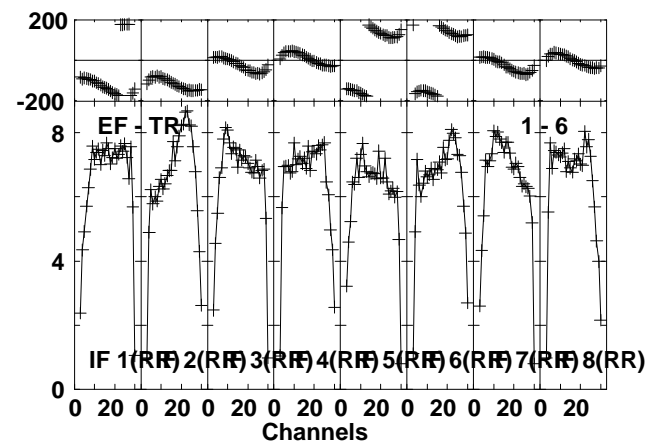
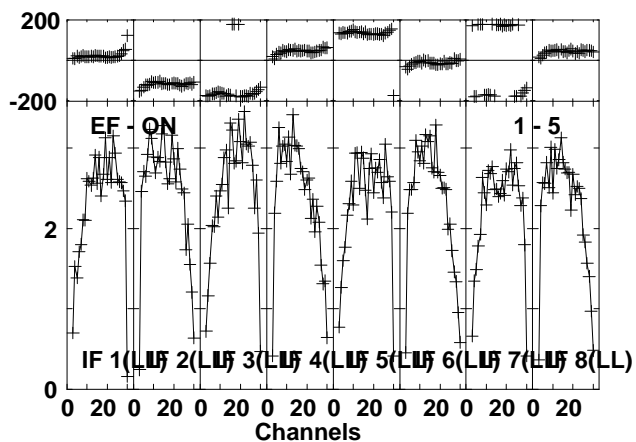
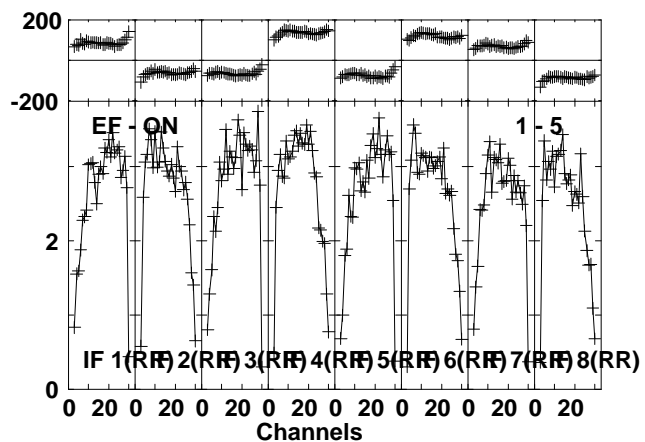
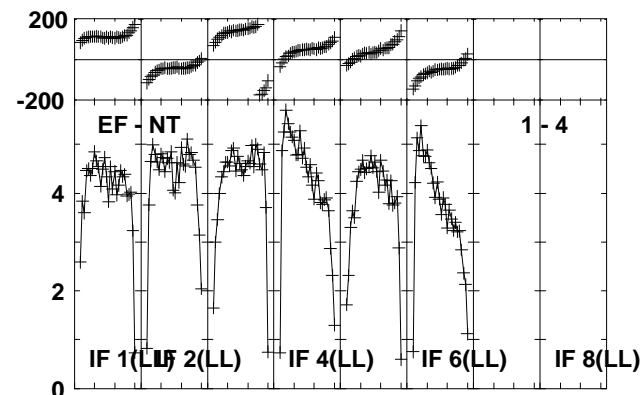
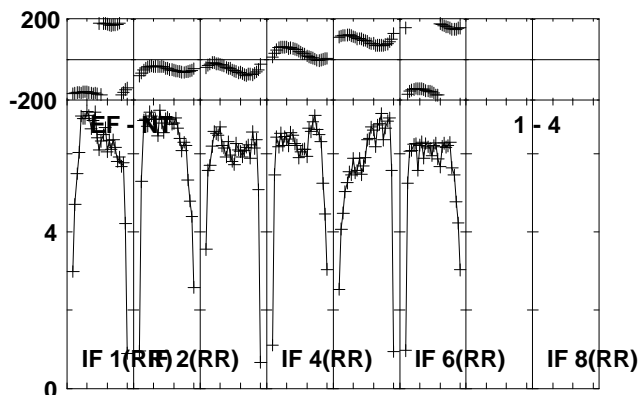
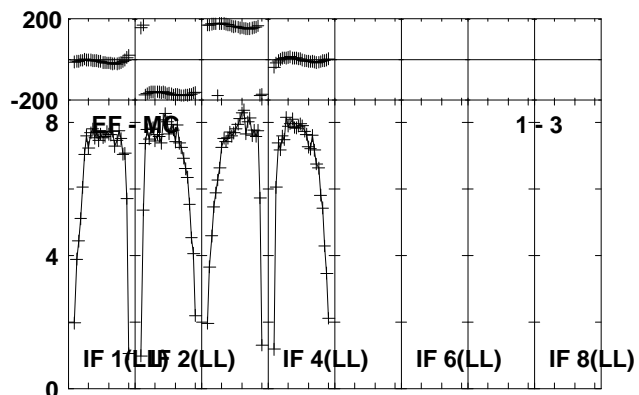
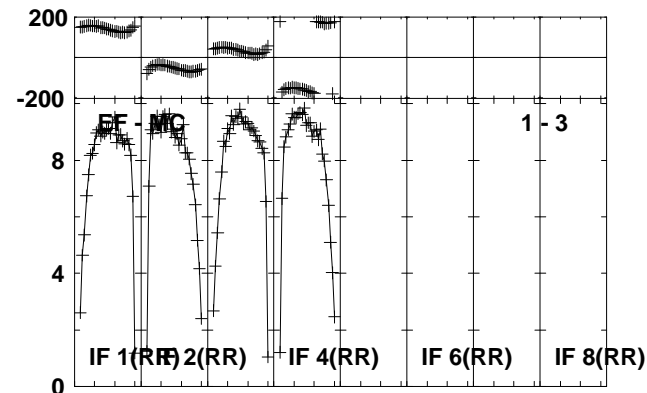
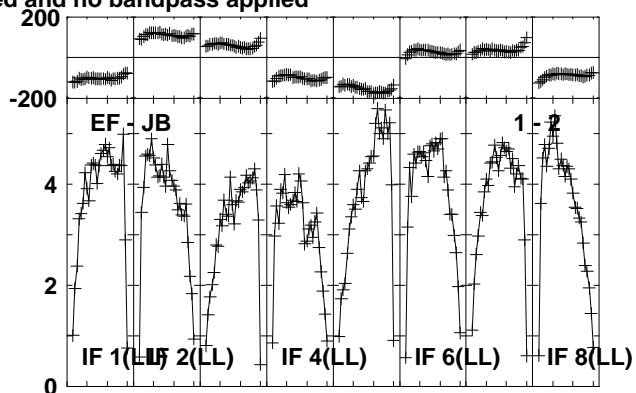
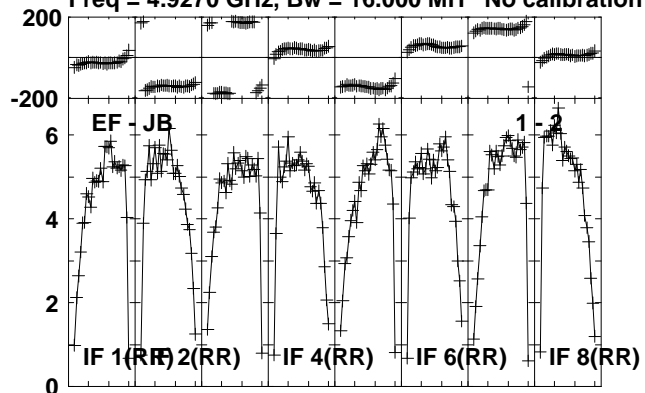

Lower frame: Milli Ampl Jy Top frame: Phas deg  
Vector averaged cross-power spectrum Several baselines displayed  
Timerange: 00/19:30:48 to 00/19:32:14

Plot file version 258 created 24-OCT-2012 21:00:31

J1825-0737 EY017B.UVDATA.1

Freq = 4.9270 GHz, Bw = 16.000 MH No calibration applied and no bandpass applied

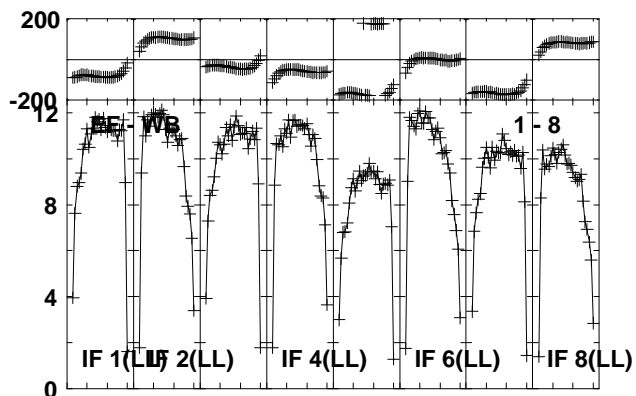
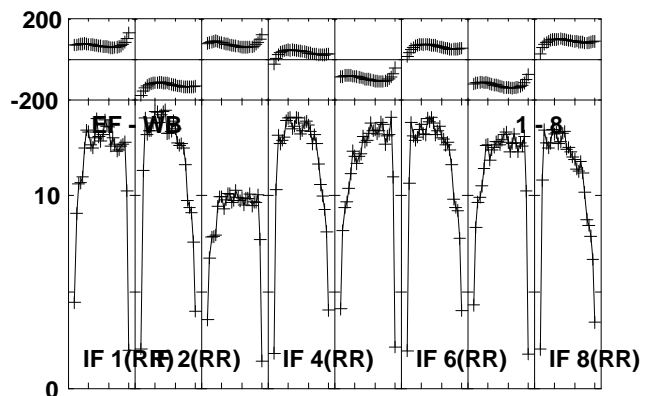
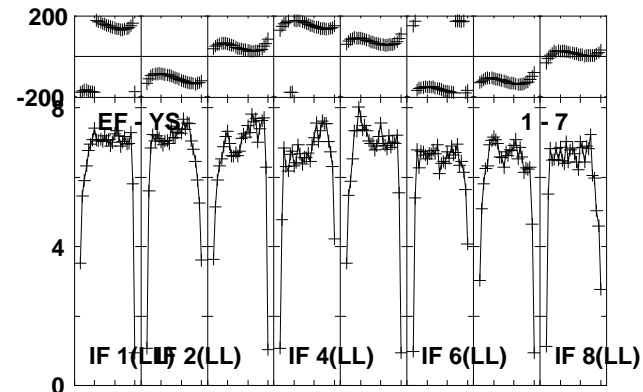
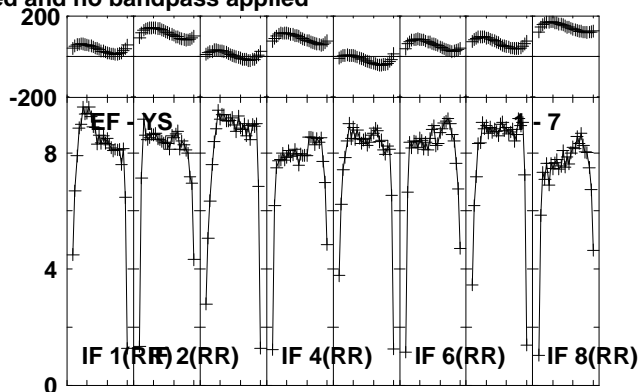
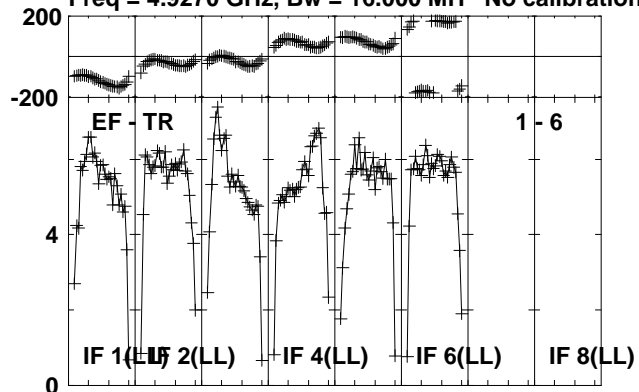

Lower frame: Milli Ampl Jy Top frame: Phas deg  
Vector averaged cross-power spectrum Several baselines displayed  
Timerange: 00/19:30:48 to 00/19:32:14

Plot file version 259 created 24-OCT-2012 21:00:31

G23.6-0.03 EY017B.UVDATA.1

Freq = 4.9270 GHz, Bw = 16.000 MH No calibration applied and no bandpass applied

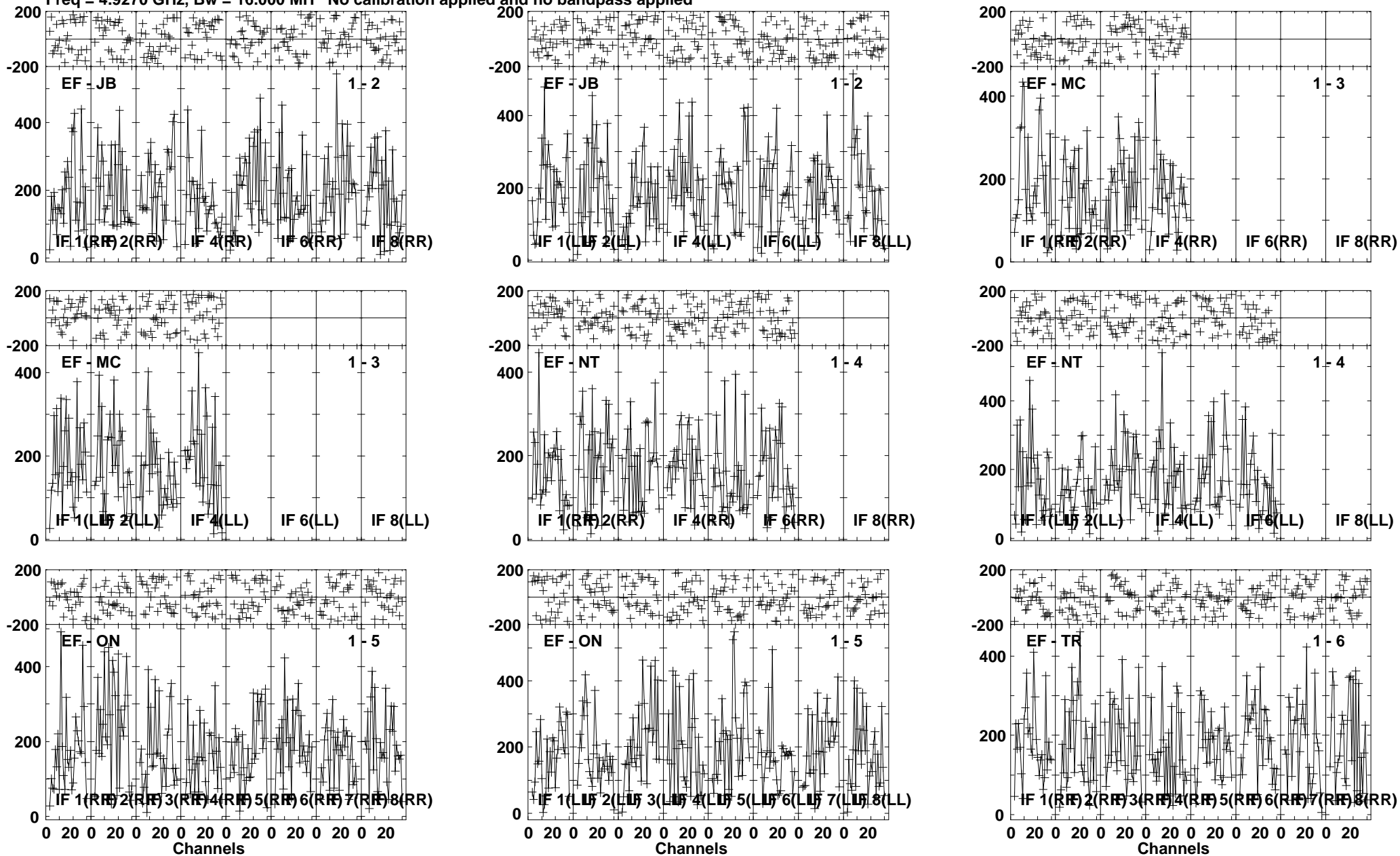

Lower frame: Micro Ampl Jy Top frame: Phas deg  
Vector averaged cross-power spectrum Several baselines displayed  
Timerange: 00/19:32:18 to 00/19:34:44

Plot file version 260 created 24-OCT-2012 21:00:32

G23.6-0.03 EY017B.UVDATA.1

Freq = 4.9270 GHz, Bw = 16.000 MH No calibration applied and no bandpass applied

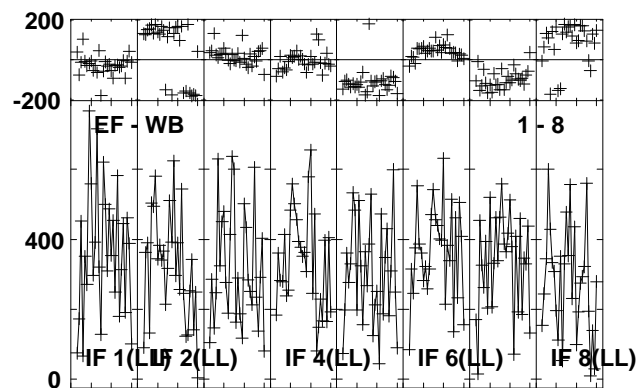
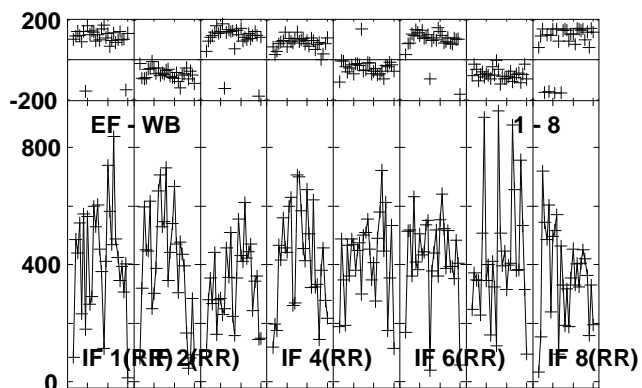
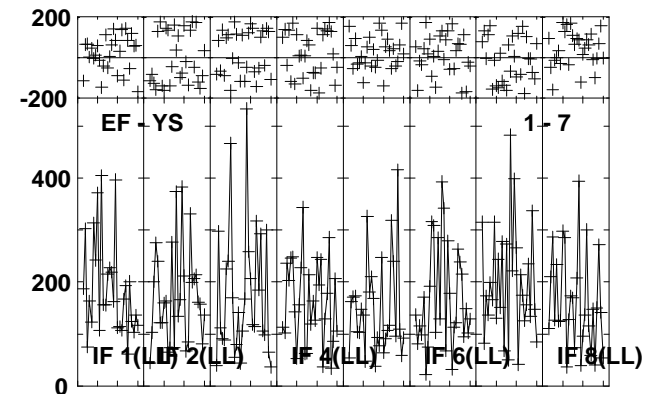
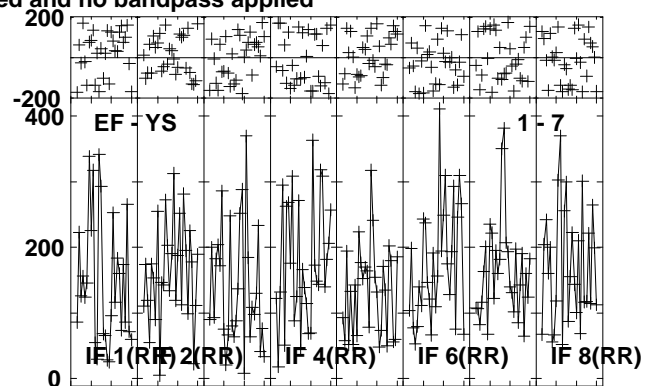
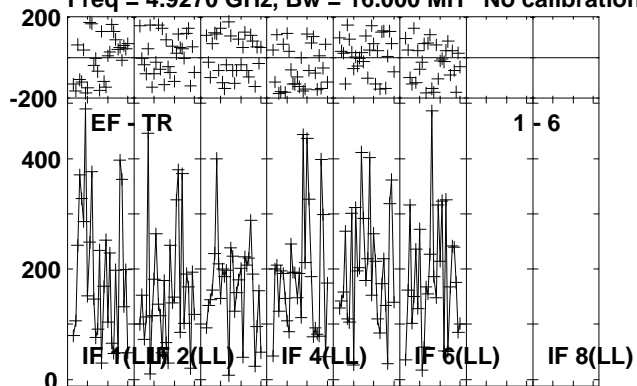

Lower frame: Micro Ampl Jy Top frame: Phas deg  
Vector averaged cross-power spectrum Several baselines displayed  
Timerange: 00/19:32:18 to 00/19:34:44



Plot file version 261 created 24-OCT-2012 21:00:32

J1825-0737 EY017B.UVDATA.1

Freq = 4.9270 GHz, Bw = 16.000 MH No calibration applied and no bandpass applied

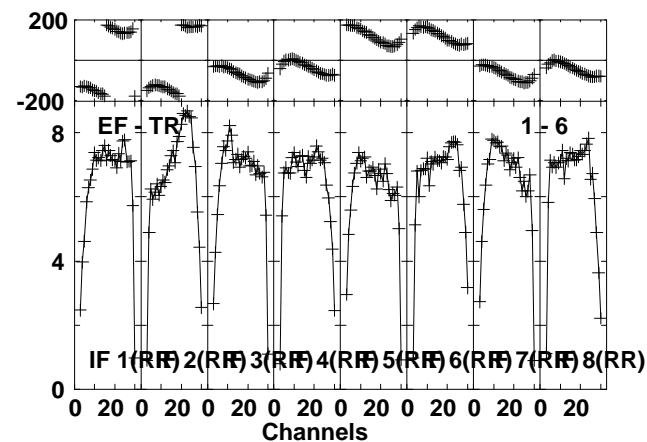
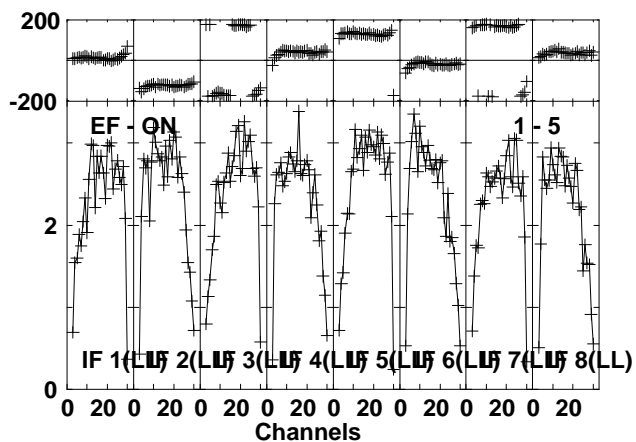
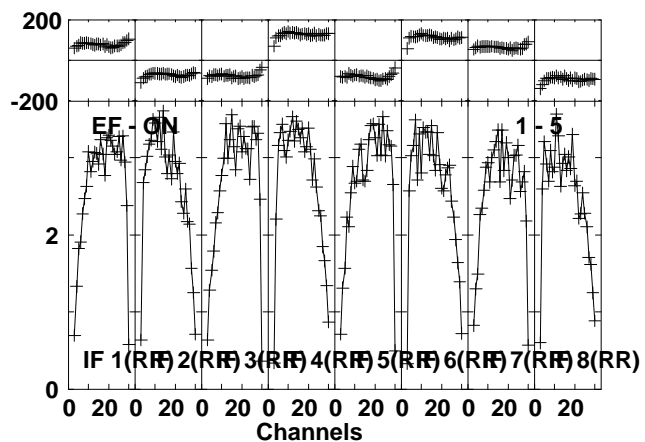
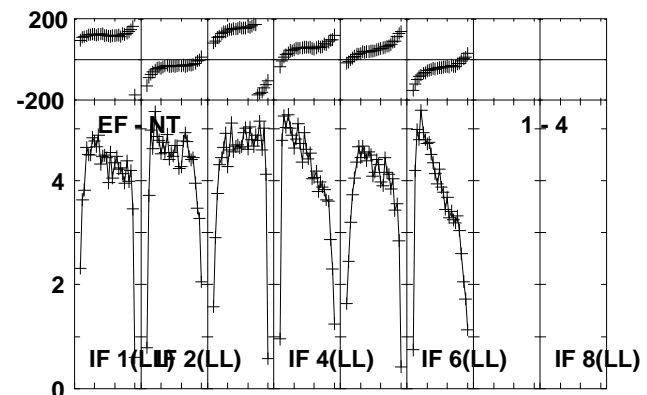
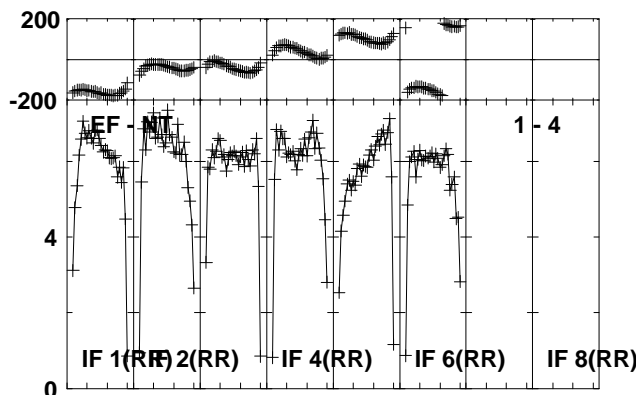
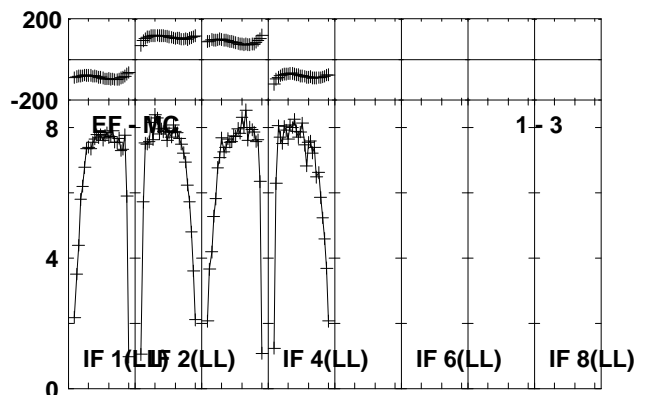
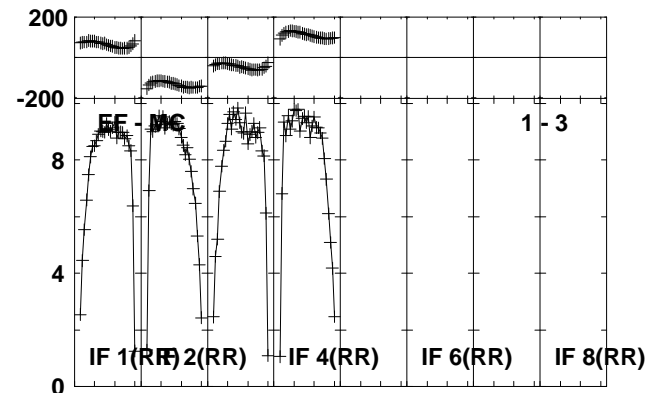
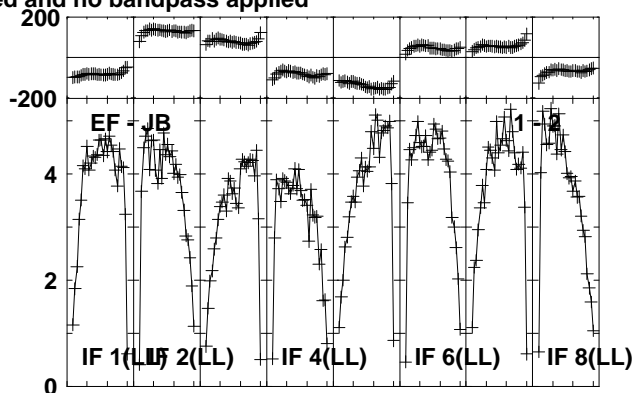
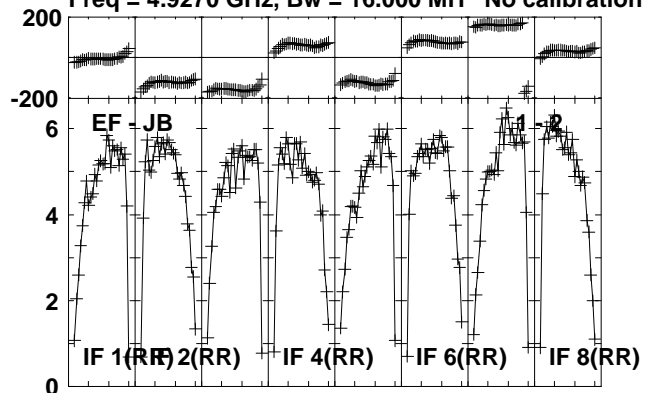

Lower frame: Milli Ampl Jy Top frame: Phas deg  
Vector averaged cross-power spectrum Several baselines displayed  
Timerange: 00/19:34:48 to 00/19:36:14

Plot file version 262 created 24-OCT-2012 21:00:33

J1825-0737 EY017B.UVDATA.1

Freq = 4.9270 GHz, Bw = 16.000 MH No calibration applied and no bandpass applied

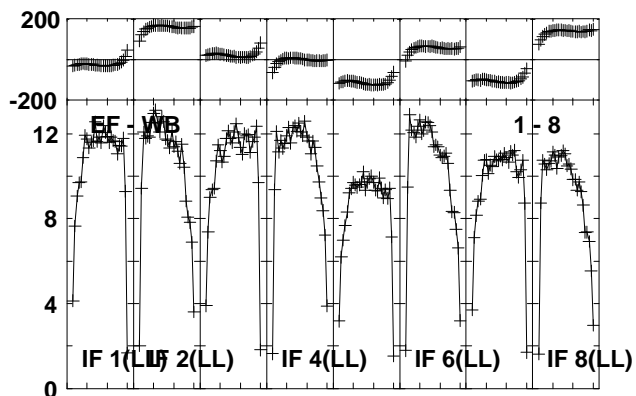
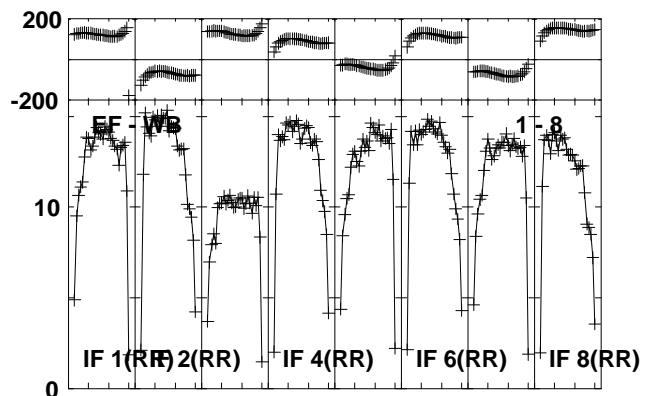
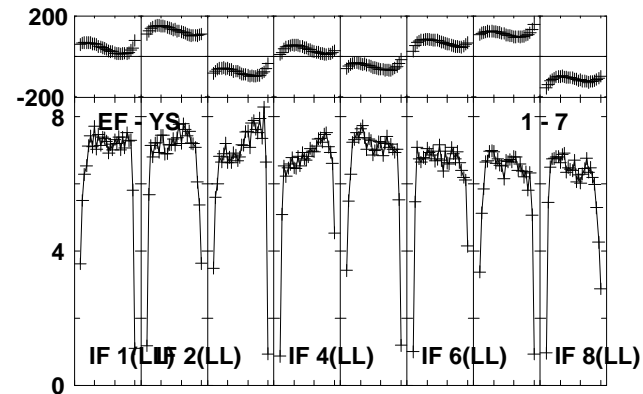
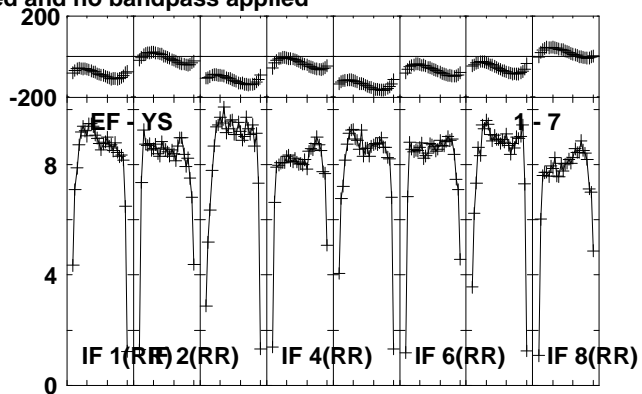
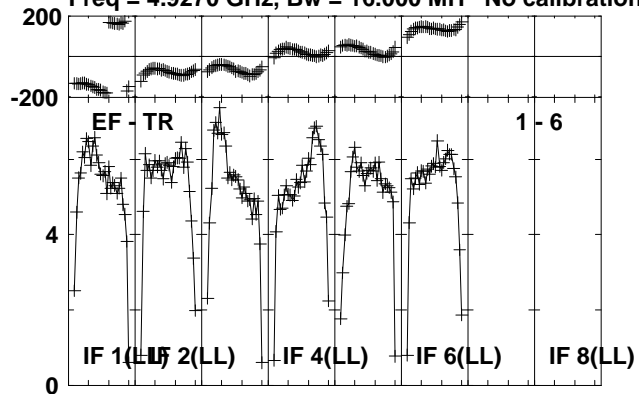

Lower frame: Milli Ampl Jy Top frame: Phas deg  
Vector averaged cross-power spectrum Several baselines displayed  
Timerange: 00/19:34:48 to 00/19:36:14

Plot file version 263 created 24-OCT-2012 21:00:33

G23.6-0.03 EY017B.UVDATA.1

Freq = 4.9270 GHz, Bw = 16.000 MH No calibration applied and no bandpass applied

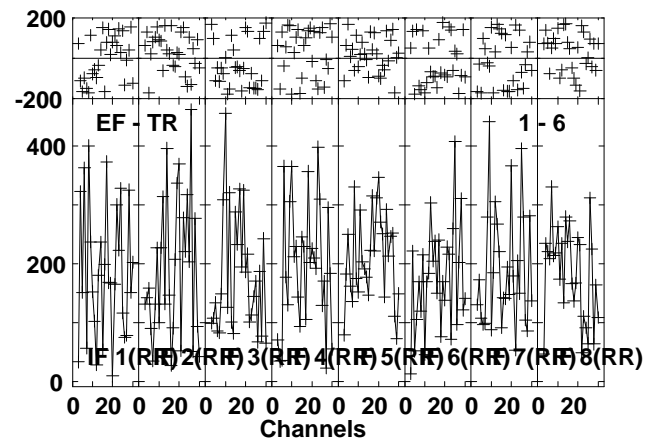
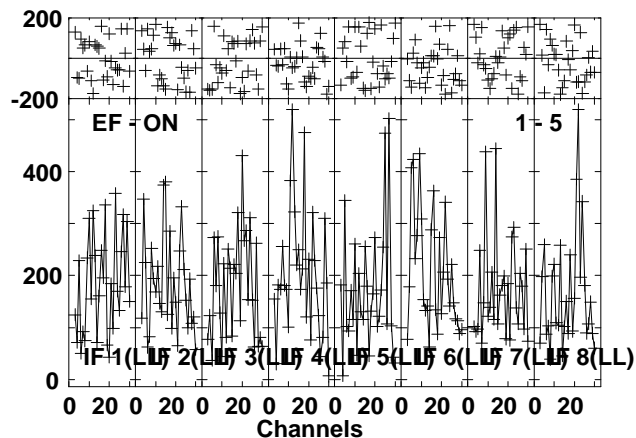
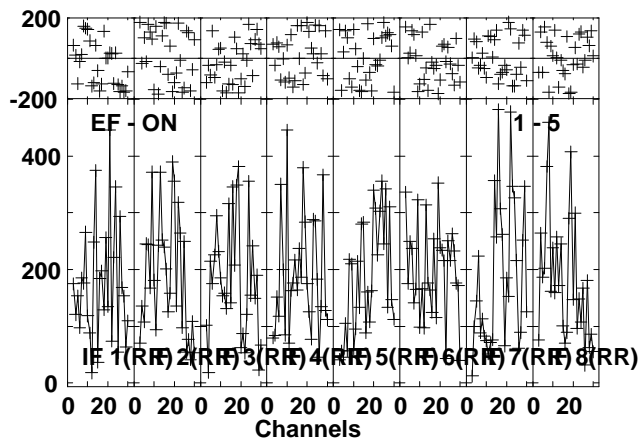
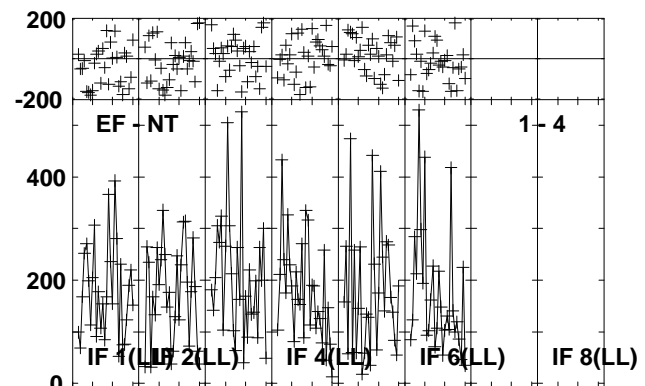
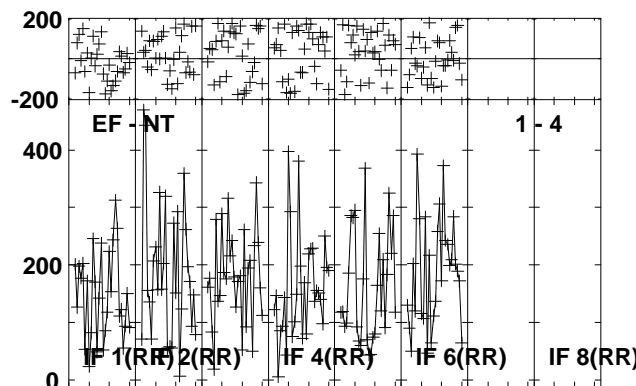
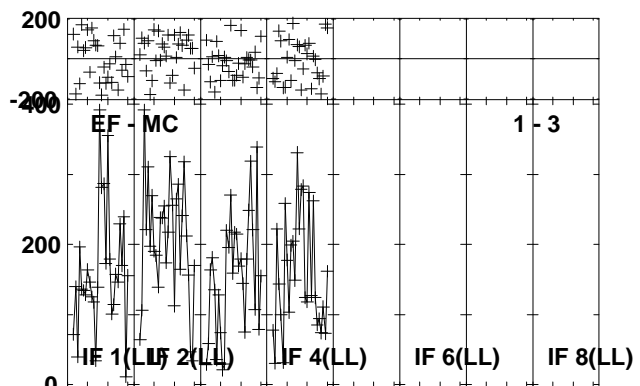
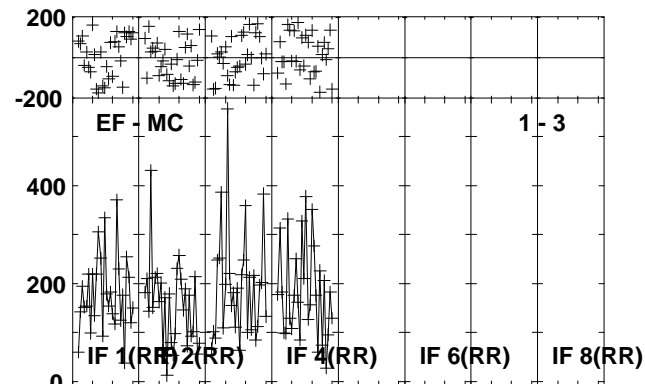
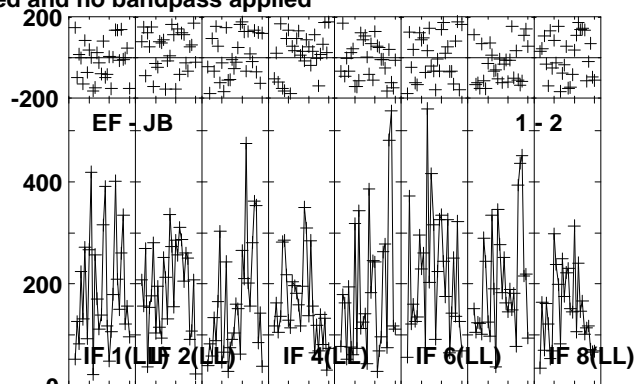
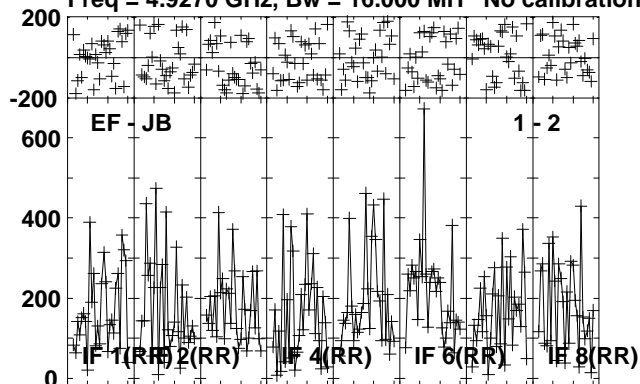

Lower frame: Micro Ampl Jy Top frame: Phas deg  
Vector averaged cross-power spectrum Several baselines displayed  
Timerange: 00:19:36:18 to 00:19:38:44

Plot file version 264 created 24-OCT-2012 21:00:34  
G23.6-0.03 EY017B.UVDATA.1

Freq = 4.9270 GHz, Bw = 16.000 MH No calibration applied and no bandpass applied

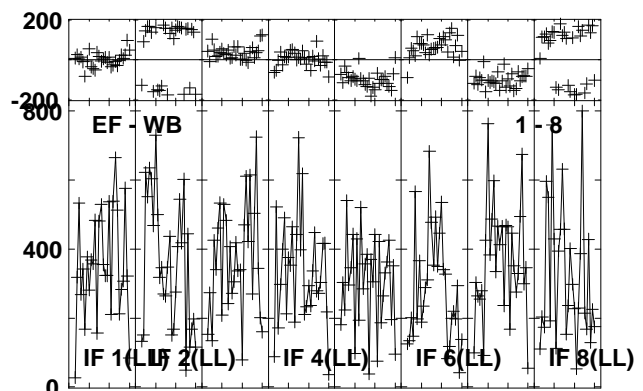
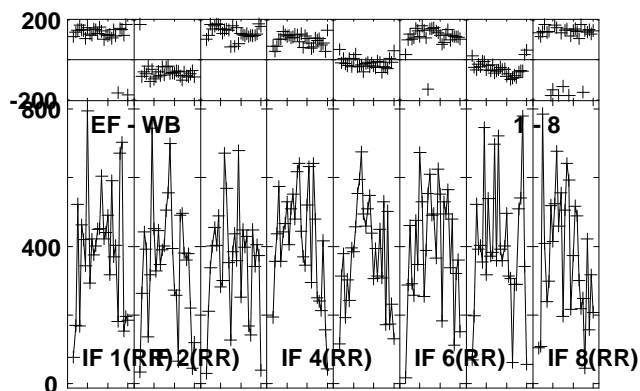
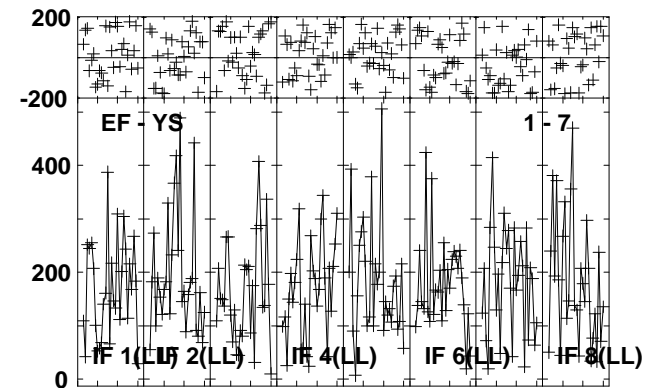
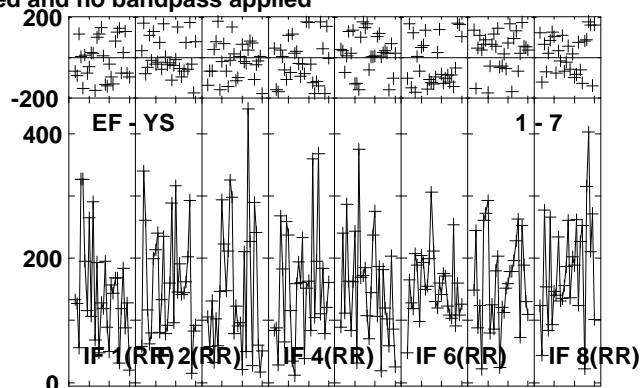
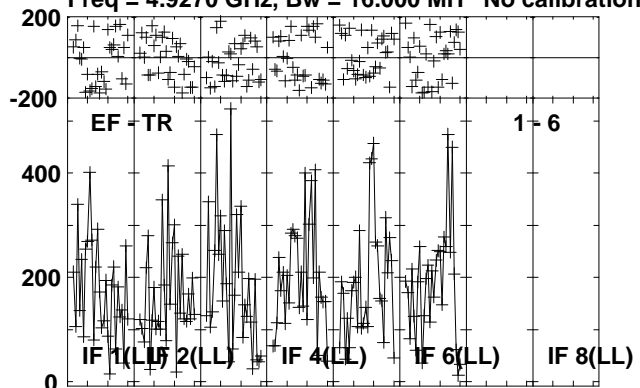

Lower frame: Micro Ampl Jy Top frame: Phas deg  
Vector averaged cross-power spectrum Several baselines displayed  
Timerange: 00:19:36:18 to 00:19:38:44

Plot file version 265 created 24-OCT-2012 21:00:35

J1825-0737 EY017B.UVDATA.1

Freq = 4.9270 GHz, Bw = 16.000 MH No calibration applied and no bandpass applied

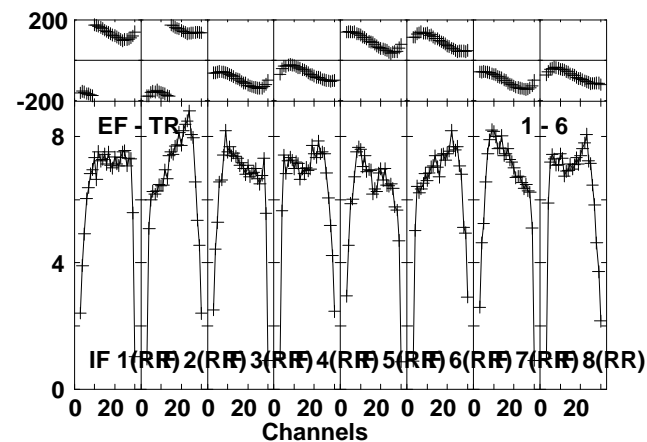
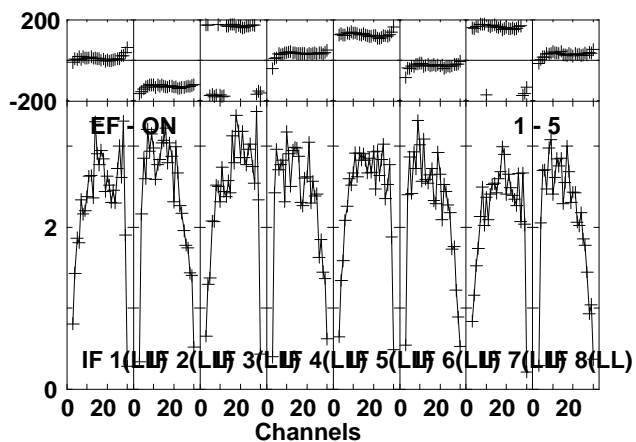
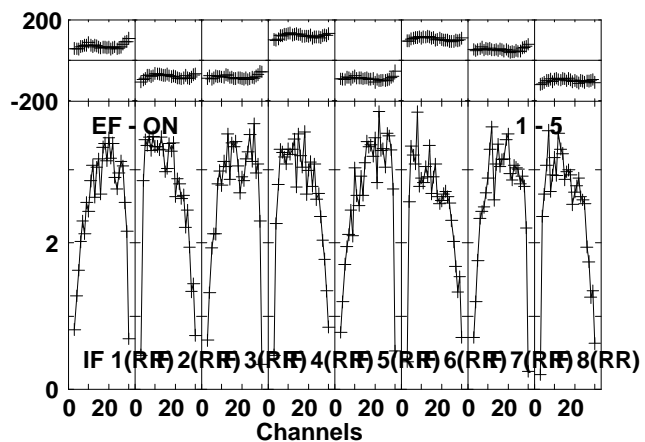
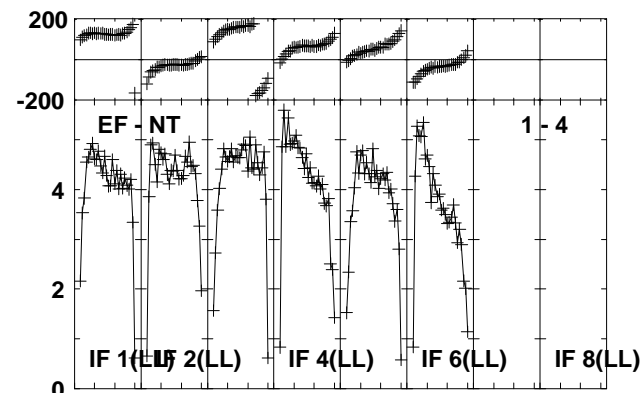
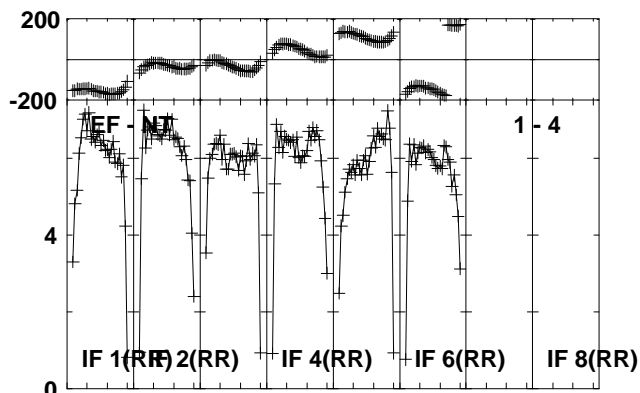
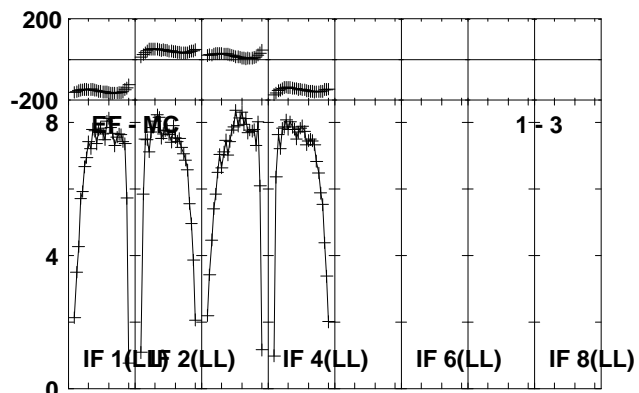
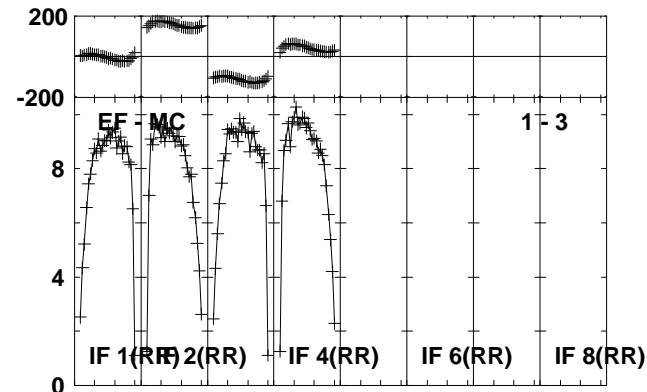
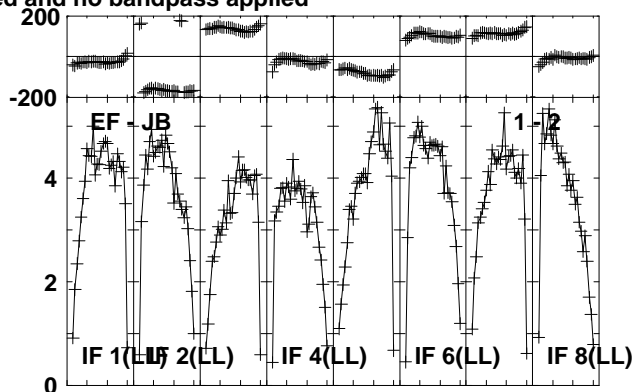
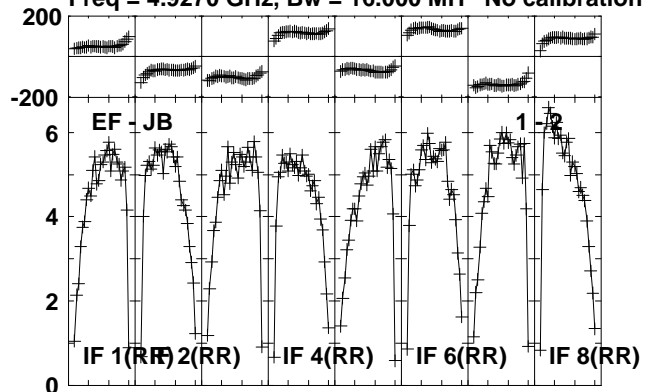

Lower frame: Milli Ampl Jy Top frame: Phas deg  
Vector averaged cross-power spectrum Several baselines displayed  
Timerange: 00/19:38:48 to 00/19:40:14

Plot file version 266 created 24-OCT-2012 21:00:35

J1825-0737 EY017B.UVDATA.1

Freq = 4.9270 GHz, Bw = 16.000 MH No calibration applied and no bandpass applied

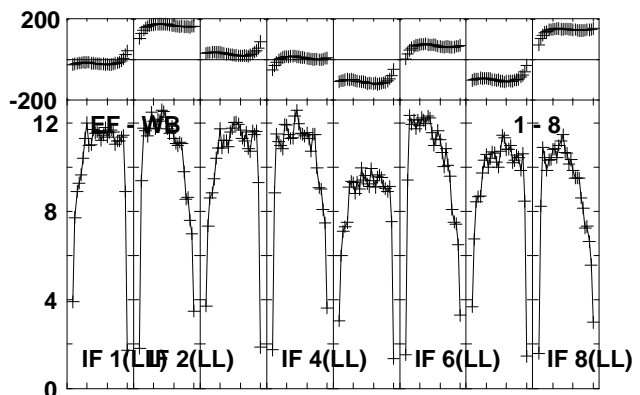
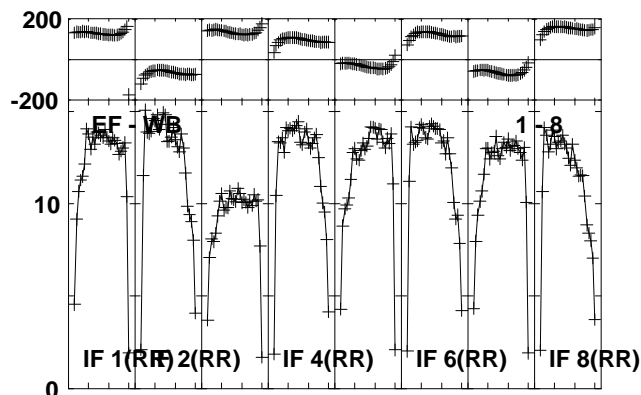
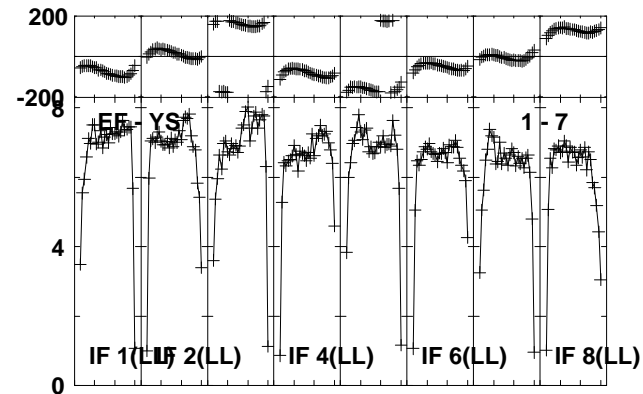
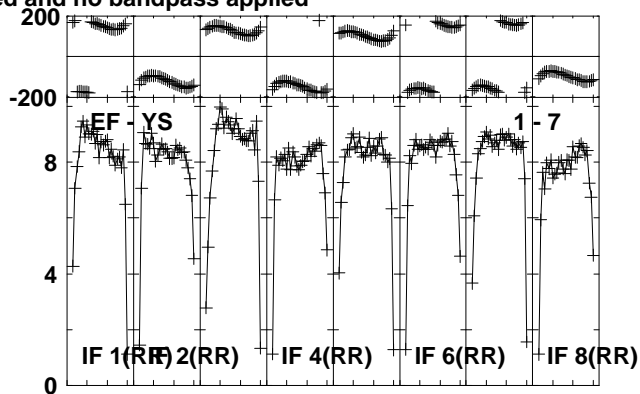
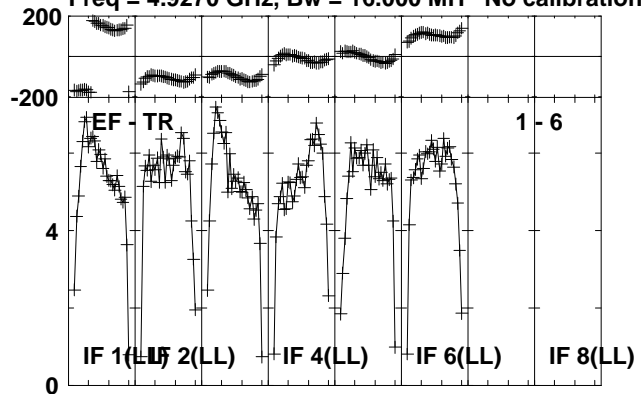

Lower frame: Milli Ampl Jy Top frame: Phas deg  
Vector averaged cross-power spectrum Several baselines displayed  
Timerange: 00/19:38:48 to 00/19:40:14

Plot file version 267 created 24-OCT-2012 21:00:36

G23.6-0.03 EY017B.UVDATA.1

Freq = 4.9270 GHz, Bw = 16.000 MH No calibration applied and no bandpass applied

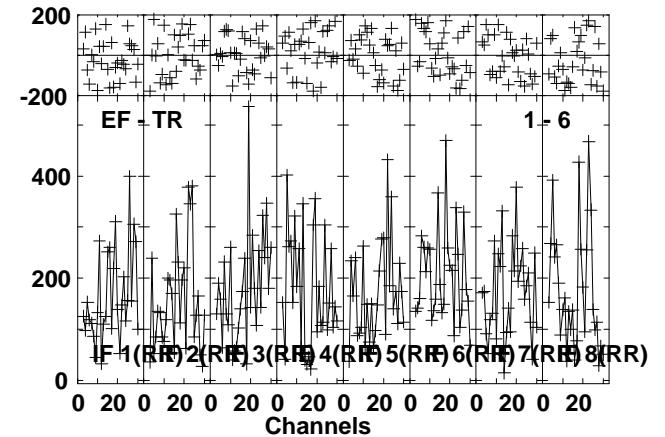
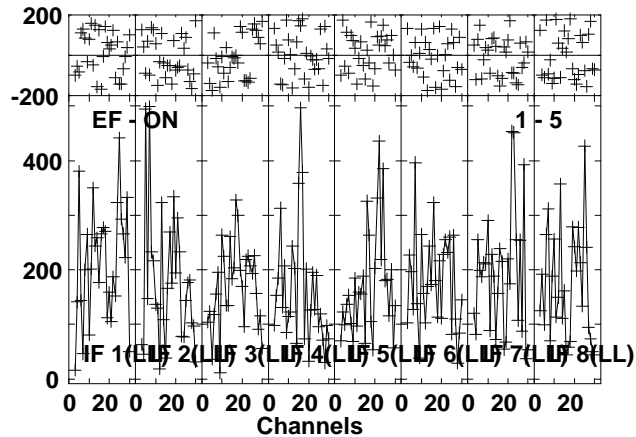
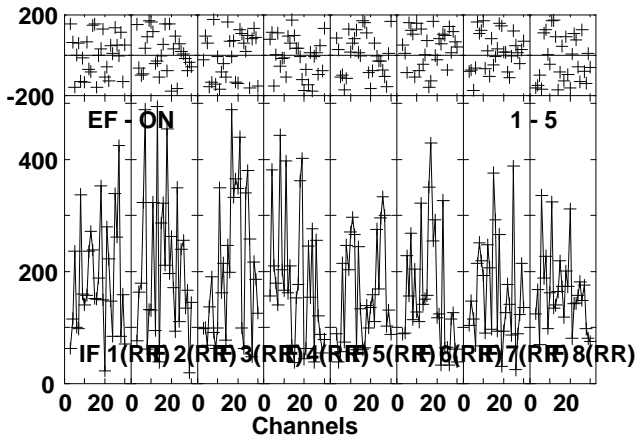
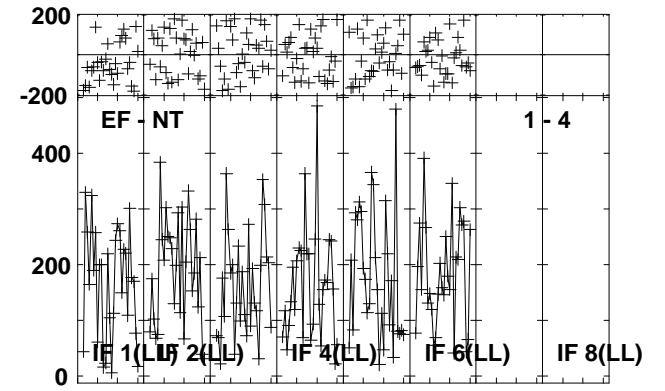
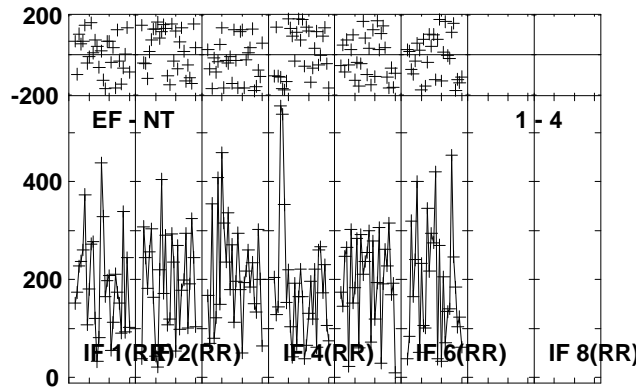
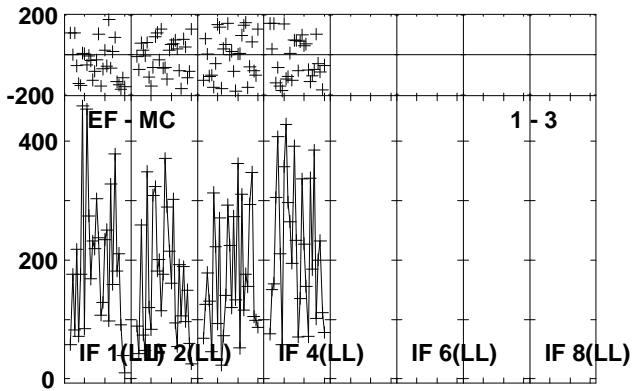
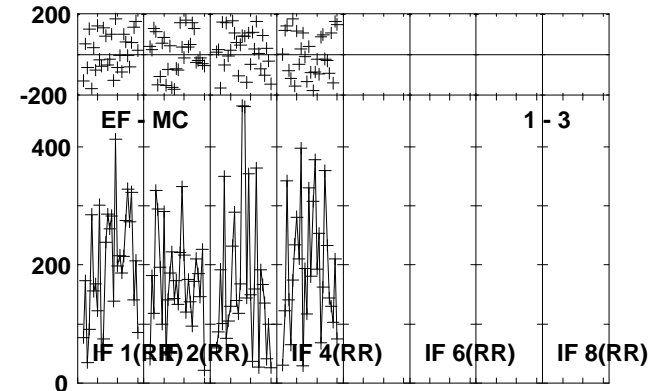
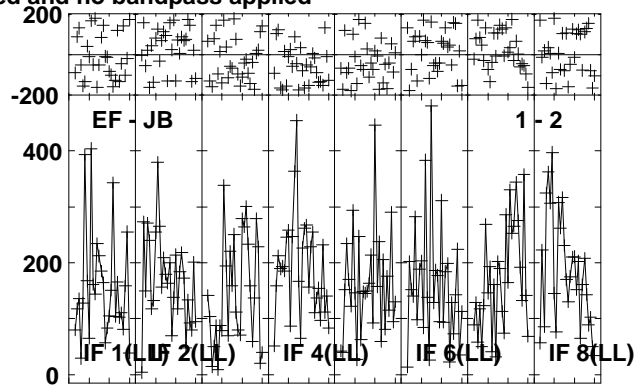
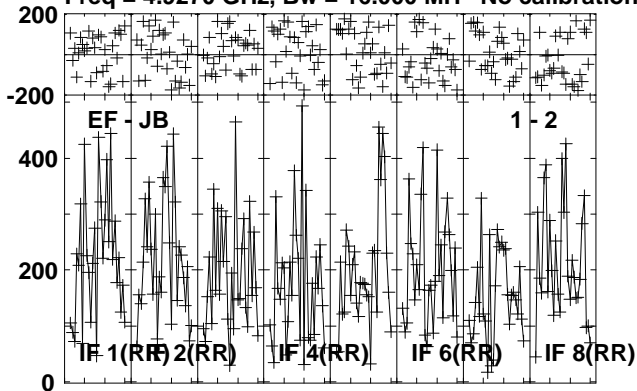

Lower frame: Micro Ampl Jy Top frame: Phas deg  
Vector averaged cross-power spectrum Several baselines displayed  
Timerange: 00/19:40:18 to 00/19:42:44

Plot file version 268 created 24-OCT-2012 21:00:36

G23.6-0.03 EY017B.UVDATA.1

Freq = 4.9270 GHz, Bw = 16.000 MH No calibration applied and no bandpass applied

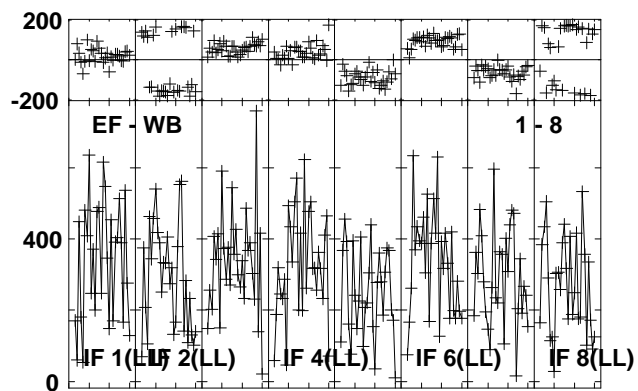
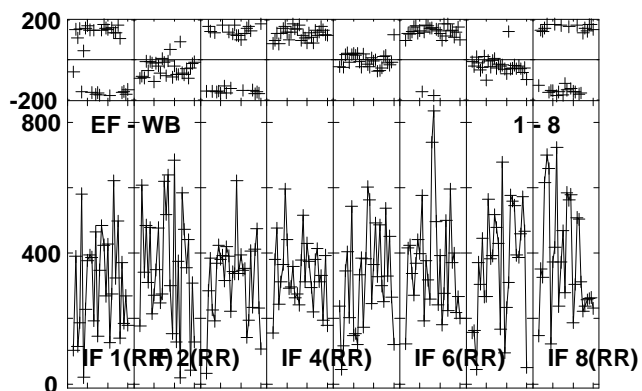
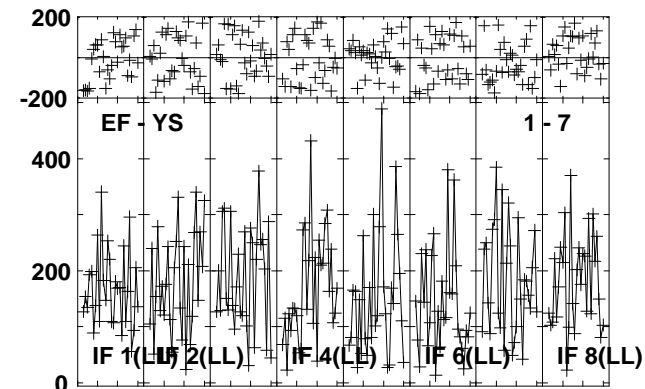
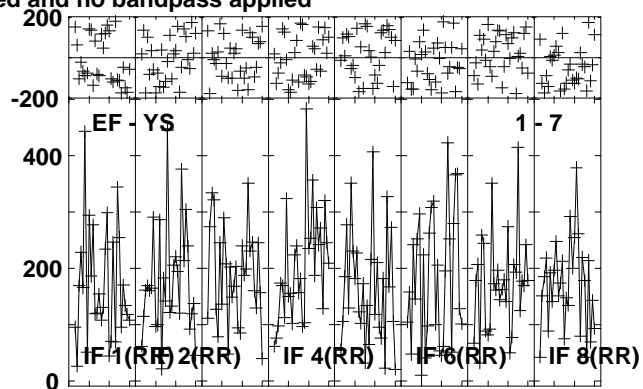
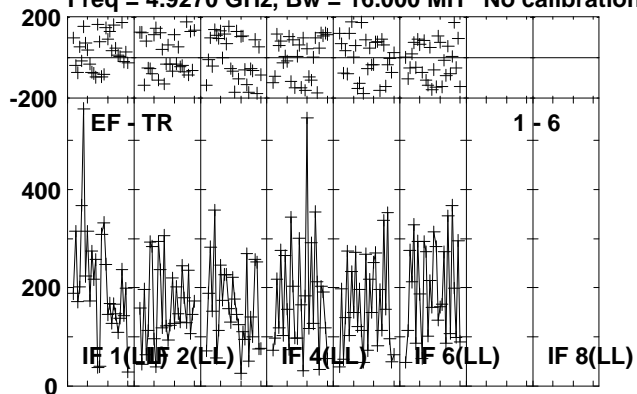

Lower frame: Micro Ampl Jy Top frame: Phas deg  
Vector averaged cross-power spectrum Several baselines displayed  
Timerange: 00/19:40:18 to 00/19:42:44



Plot file version 269 created 24-OCT-2012 21:00:37

J1825-0737 EY017B.UVDATA.1

Freq = 4.9270 GHz, Bw = 16.000 MH No calibration applied and no bandpass applied

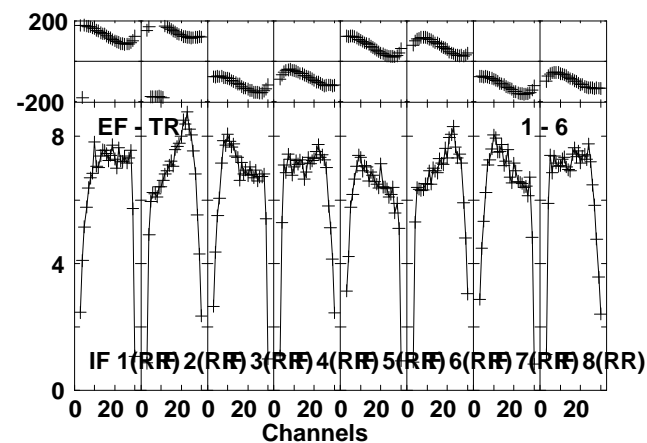
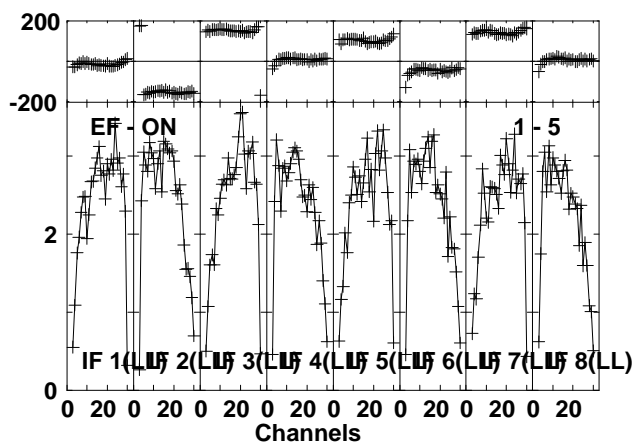
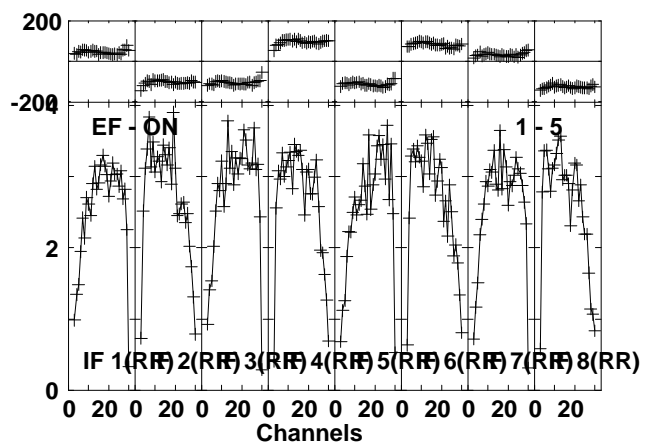
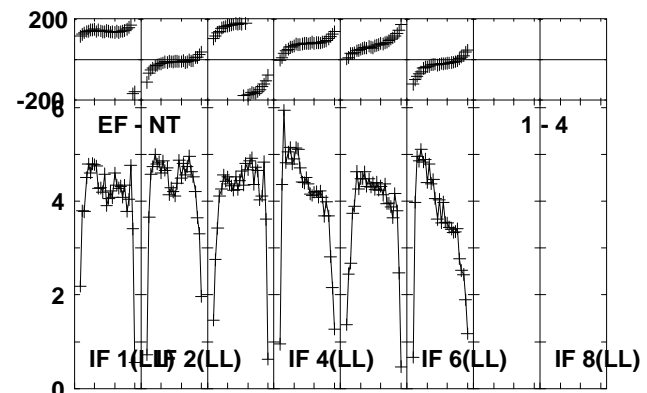
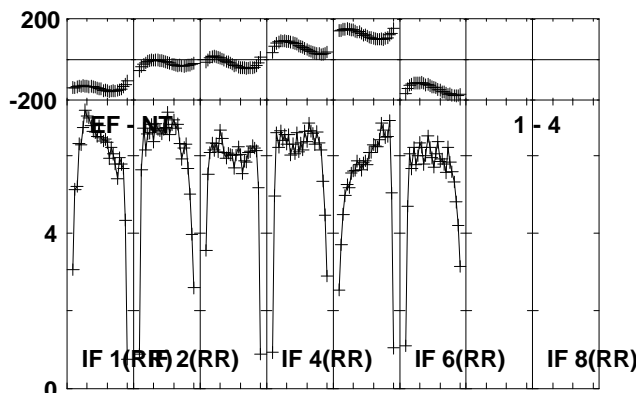
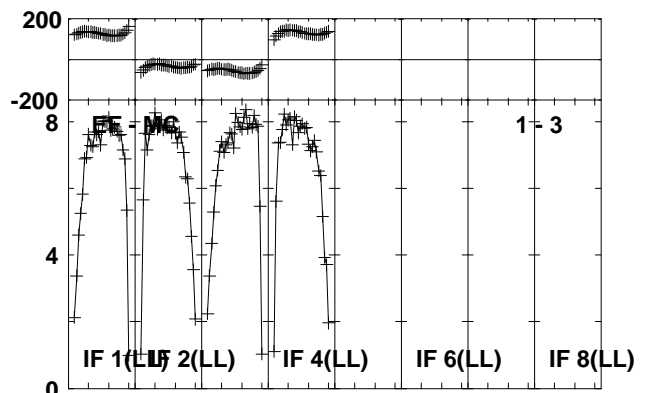
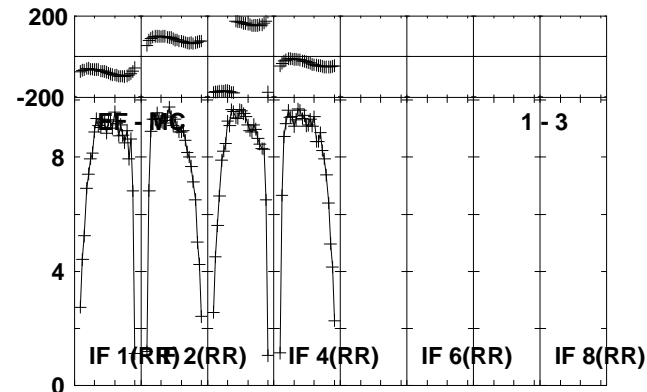
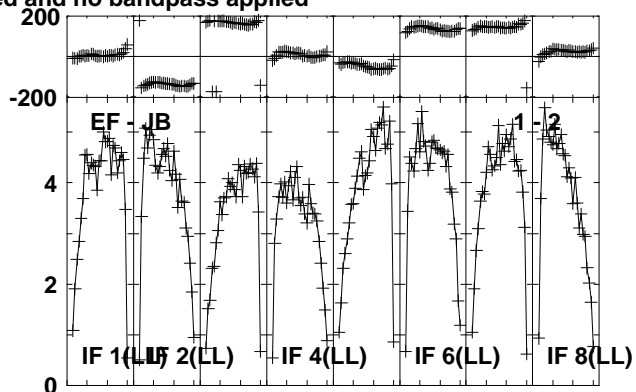
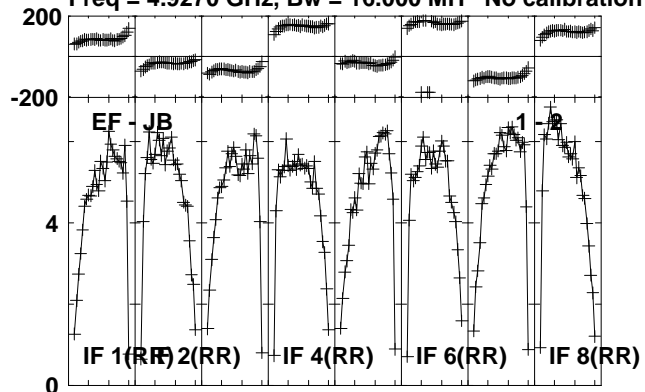

Lower frame: Milli Ampl Jy Top frame: Phas deg  
Vector averaged cross-power spectrum Several baselines displayed  
Timerange: 00/19:42:48 to 00/19:44:14

Plot file version 270 created 24-OCT-2012 21:00:37

J1825-0737 EY017B.UVDATA.1

Freq = 4.9270 GHz, Bw = 16.000 MH No calibration applied and no bandpass applied

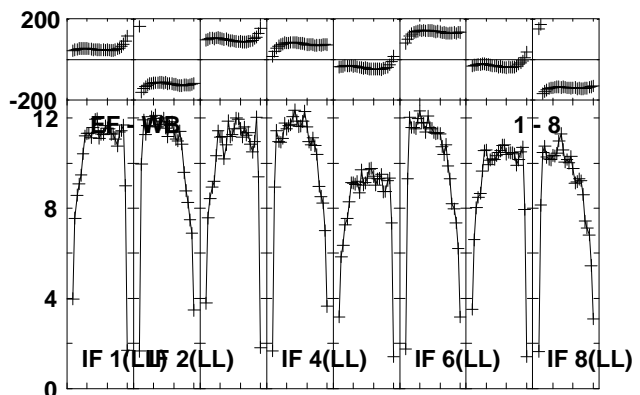
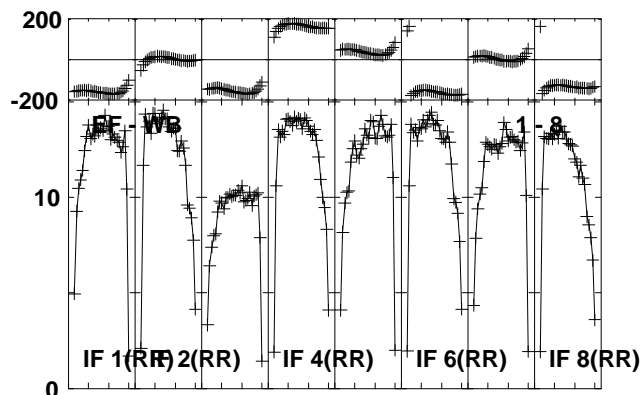
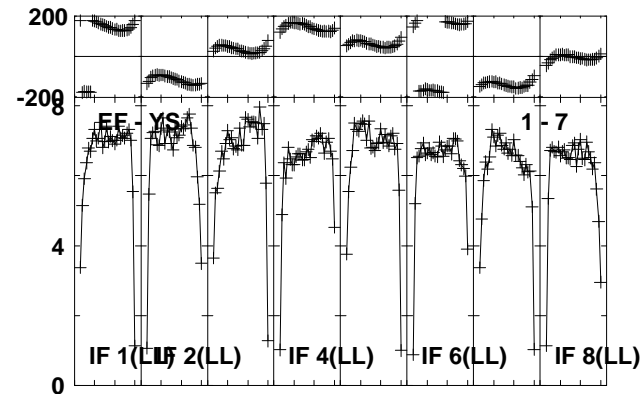
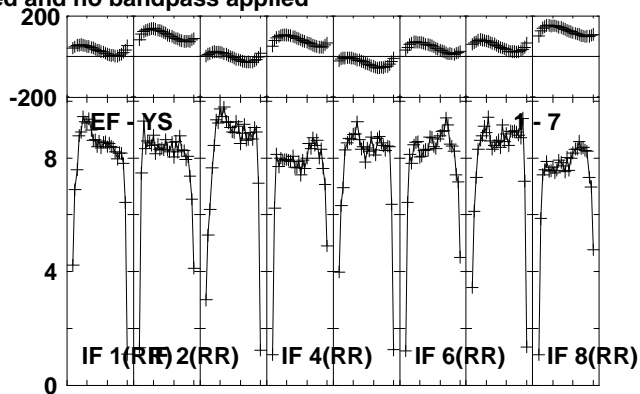
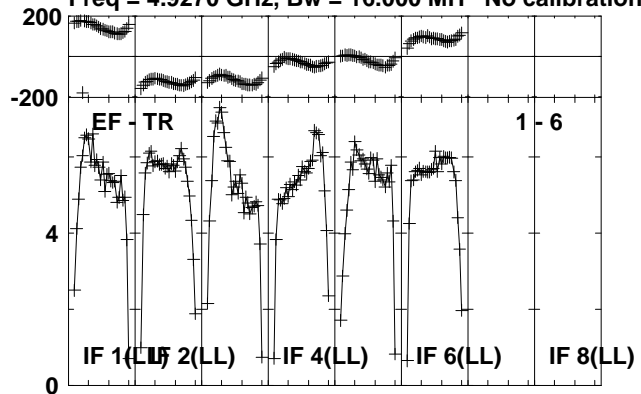

Lower frame: Milli Ampl Jy Top frame: Phas deg  
Vector averaged cross-power spectrum Several baselines displayed  
Timerange: 00/19:42:48 to 00/19:44:14

Plot file version 271 created 24-OCT-2012 21:00:38

J1831-0756 EY017B.UVDATA.1

Freq = 4.9270 GHz, Bw = 16.000 MH No calibration applied and no bandpass applied

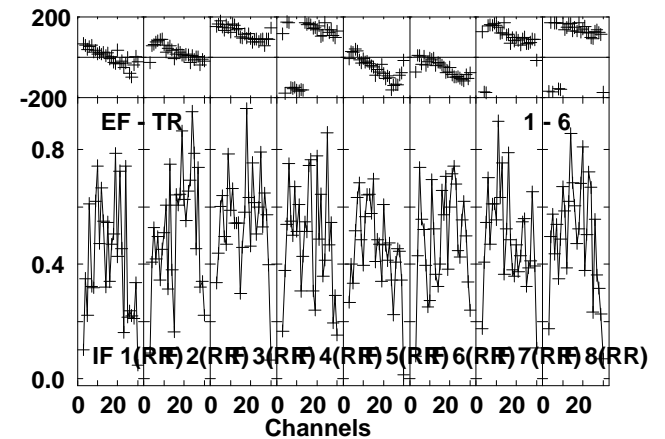
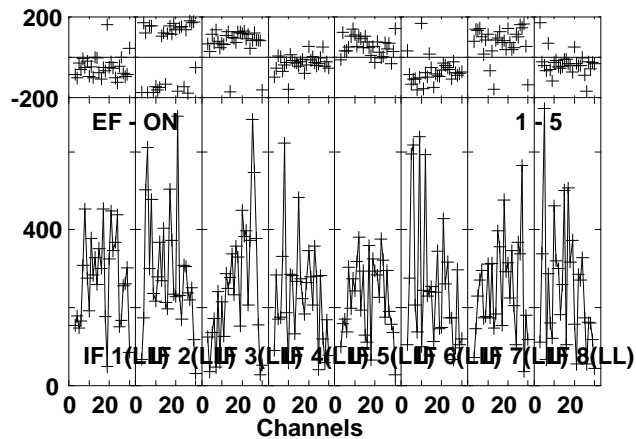
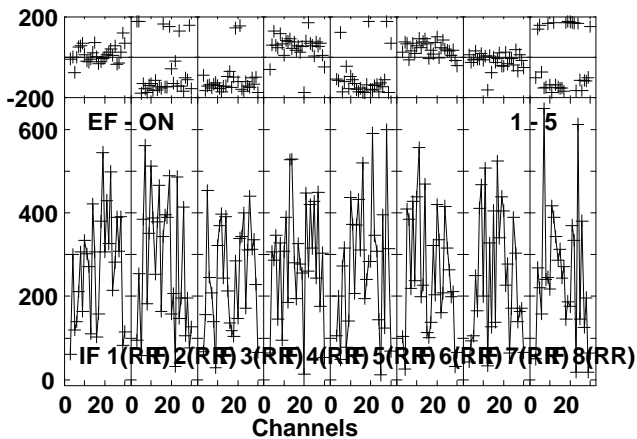
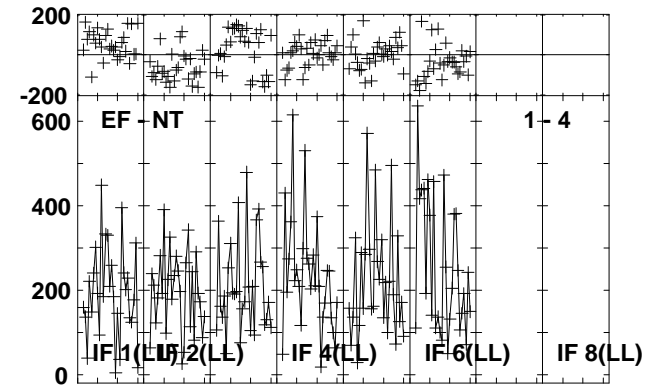
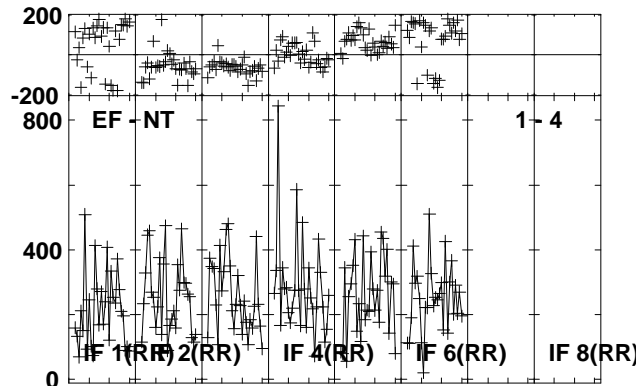
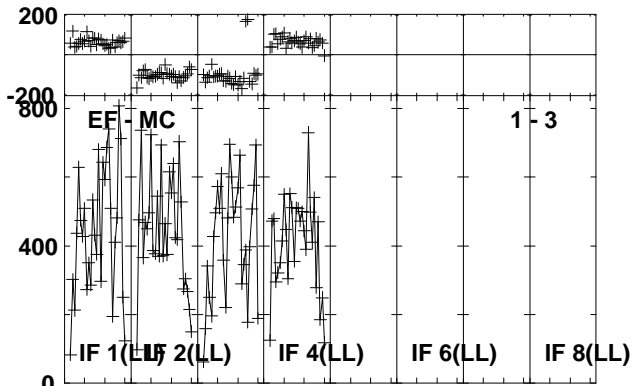
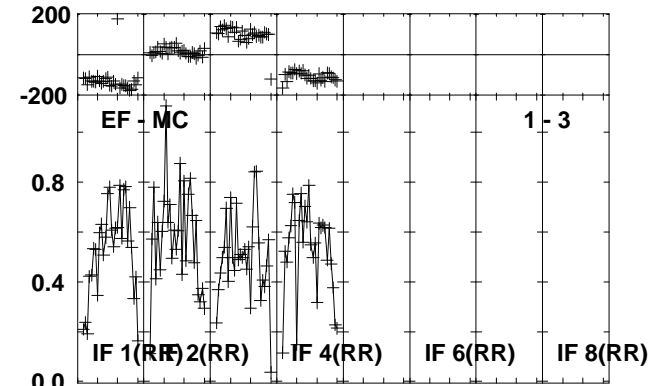
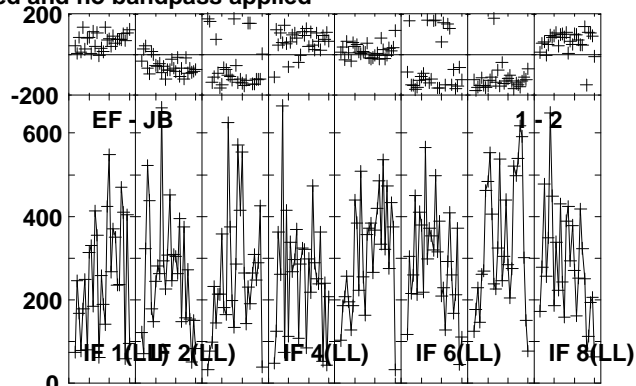
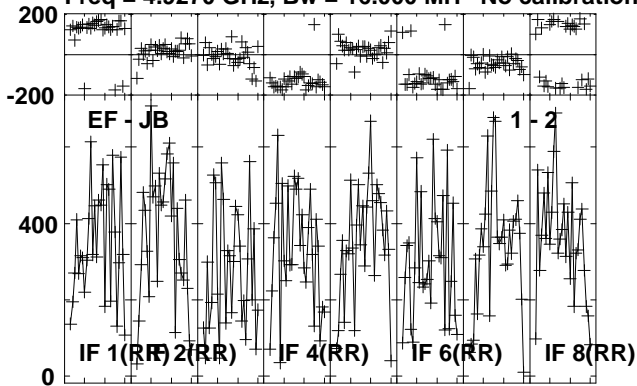

Lower frame: Micro Ampl Jy Top frame: Phas deg  
Vector averaged cross-power spectrum Several baselines displayed  
Timerange: 00:19:44:48 to 00:19:46:48

Plot file version 272 created 24-OCT-2012 21:00:38

J1831-0756 EY017B.UVDATA.1

Freq = 4.9270 GHz, Bw = 16.000 MH No calibration applied and no bandpass applied

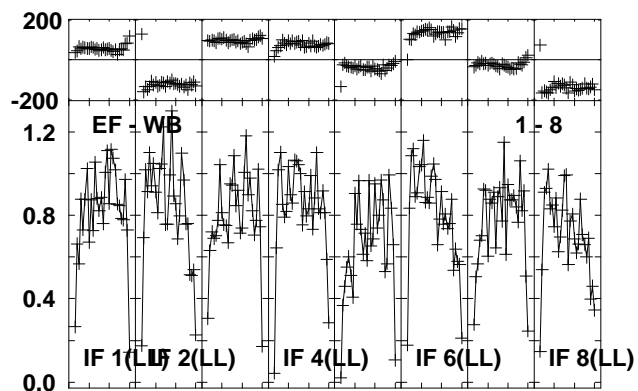
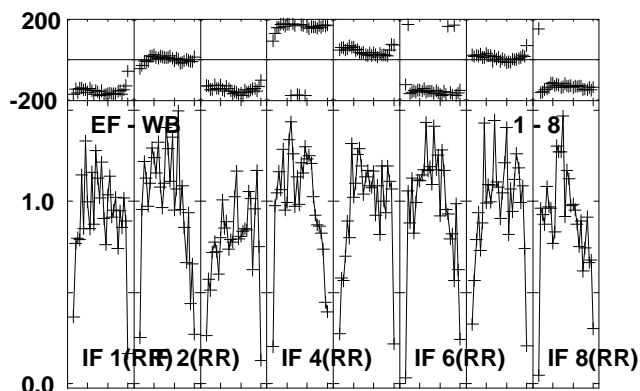
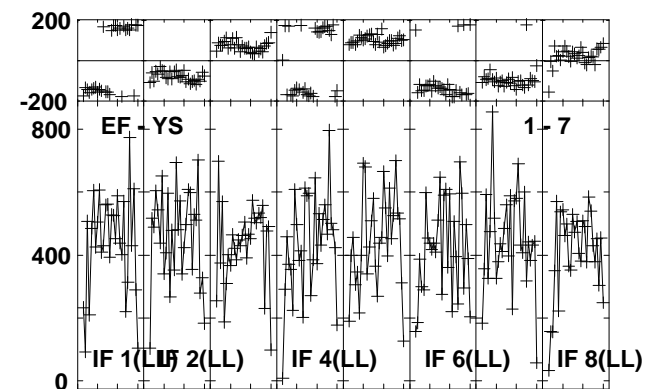
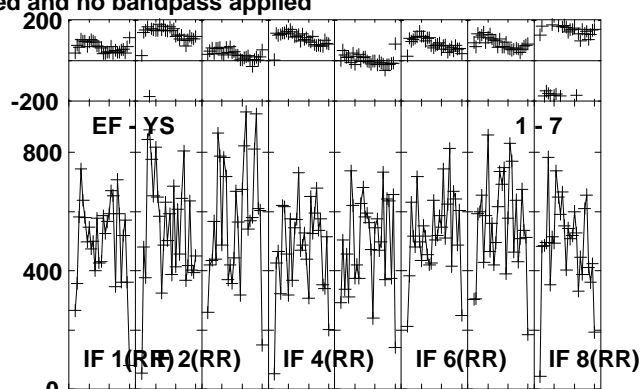
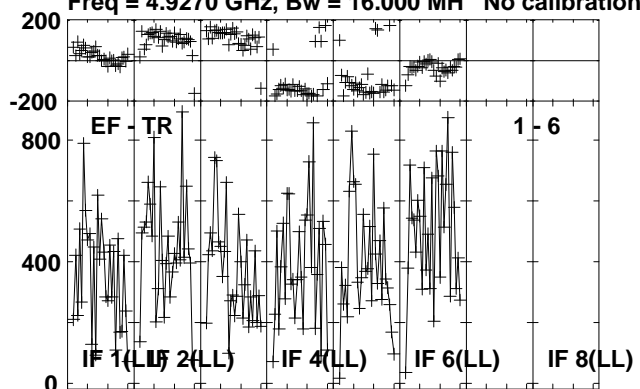

Lower frame: Micro Ampl Jy Top frame: Phas deg  
Vector averaged cross-power spectrum Several baselines displayed  
Timerange: 00/19:44:48 to 00/19:46:48

Plot file version 273 created 24-OCT-2012 21:00:39

J1825-0737 EY017B.UVDATA.1

Freq = 4.9270 GHz, Bw = 16.000 MH No calibration applied and no bandpass applied

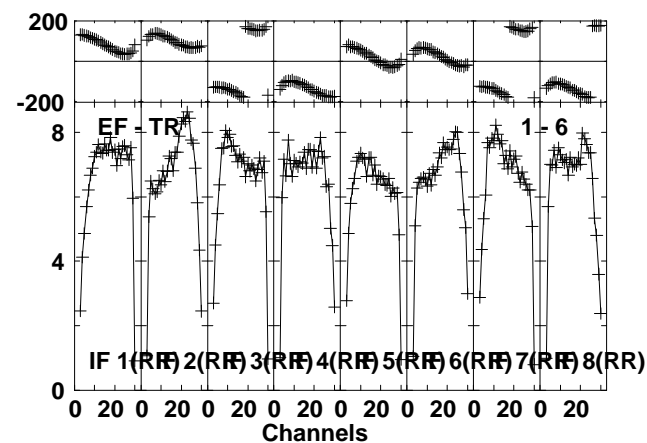
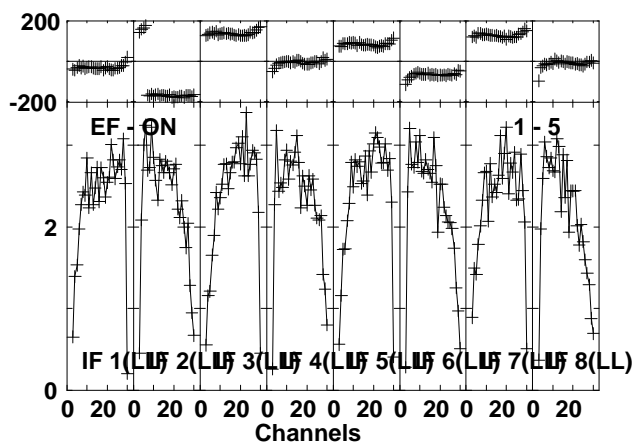
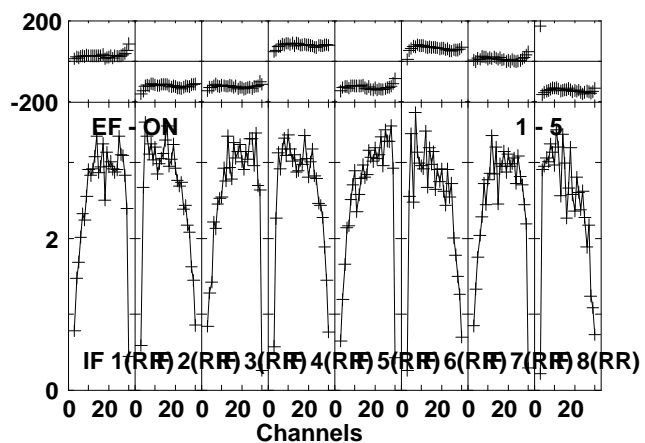
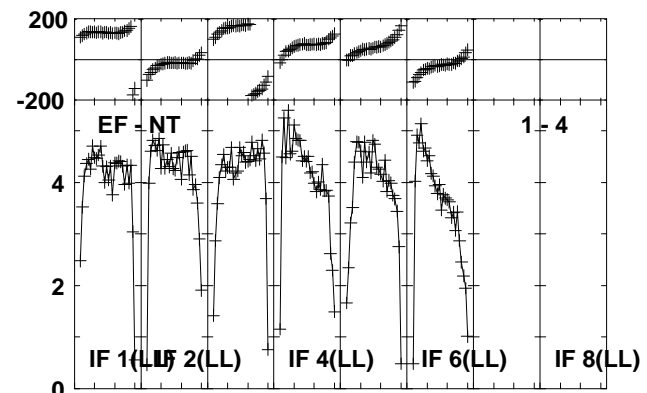
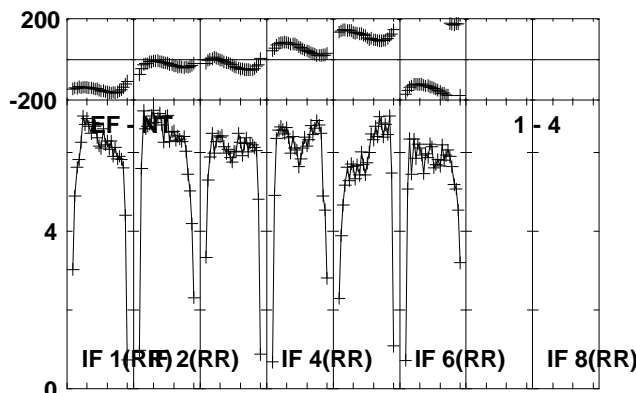
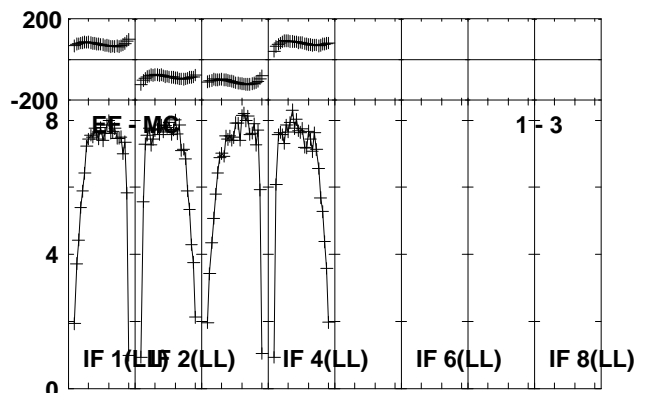
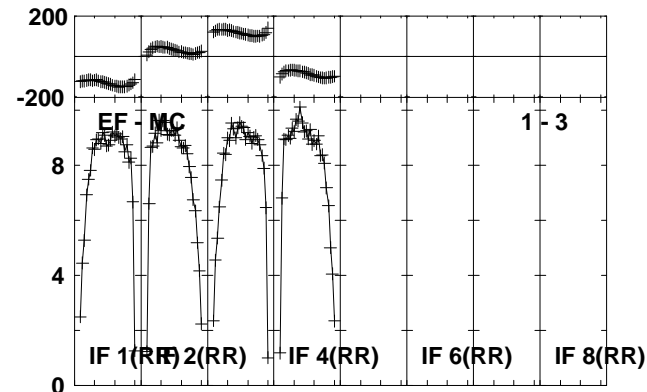
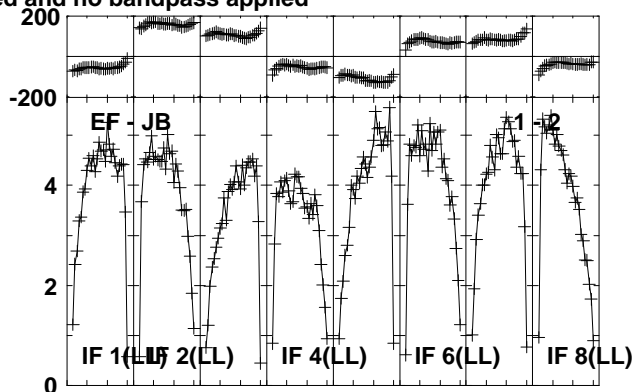
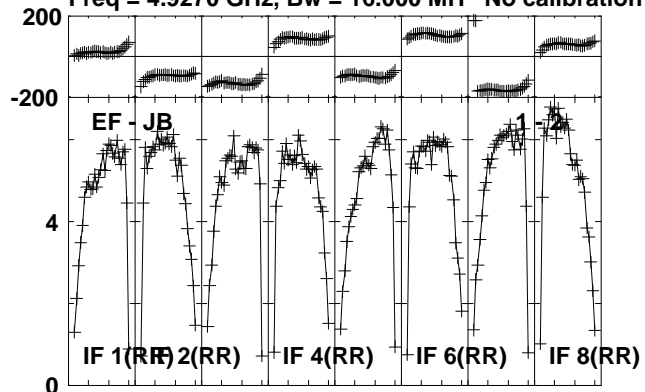

Lower frame: Milli Ampl Jy Top frame: Phas deg  
Vector averaged cross-power spectrum Several baselines displayed  
Timerange: 00/19:46:52 to 00/19:48:18

Plot file version 274 created 24-OCT-2012 21:00:39

J1825-0737 EY017B.UVDATA.1

Freq = 4.9270 GHz, Bw = 16.000 MH No calibration applied and no bandpass applied

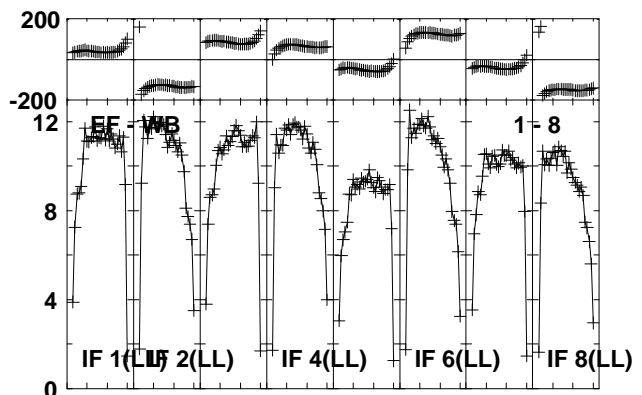
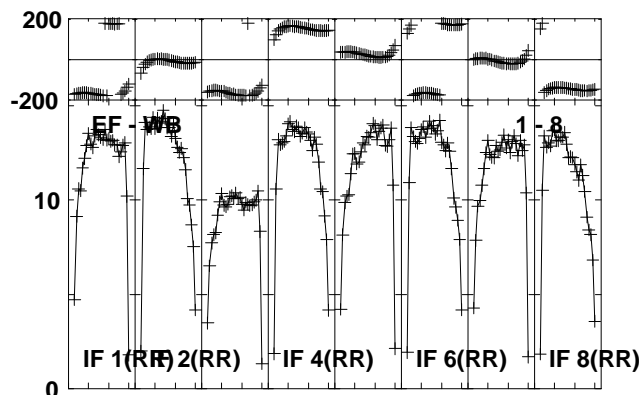
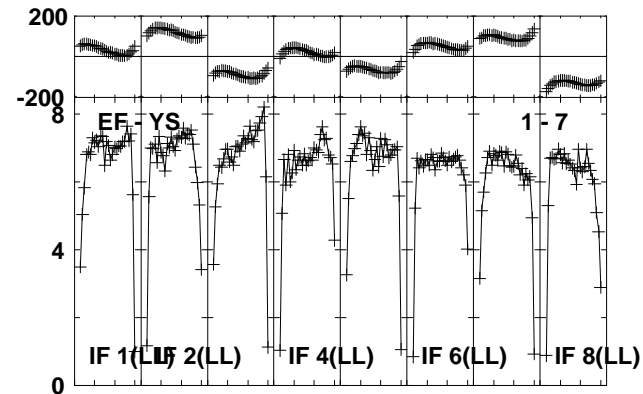
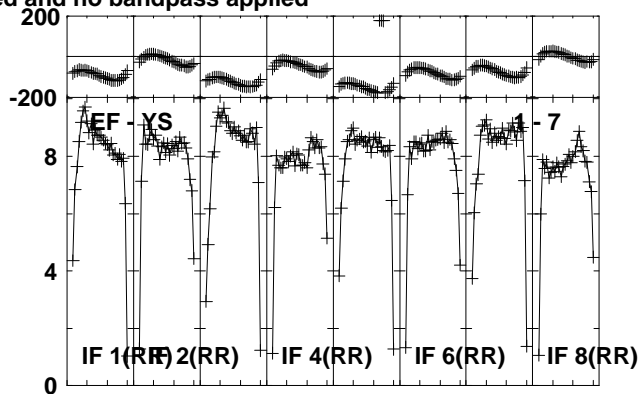
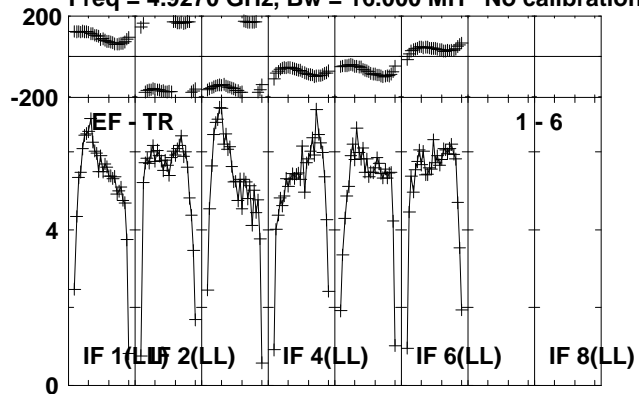

Lower frame: Milli Ampl Jy Top frame: Phas deg  
Vector averaged cross-power spectrum Several baselines displayed  
Timerange: 00/19:46:52 to 00/19:48:18

Plot file version 275 created 24-OCT-2012 21:00:40  
 G23.6-0.03 EY017B.UVDATA.1

Freq = 4.9270 GHz, Bw = 16.000 MH No calibration applied and no bandpass applied

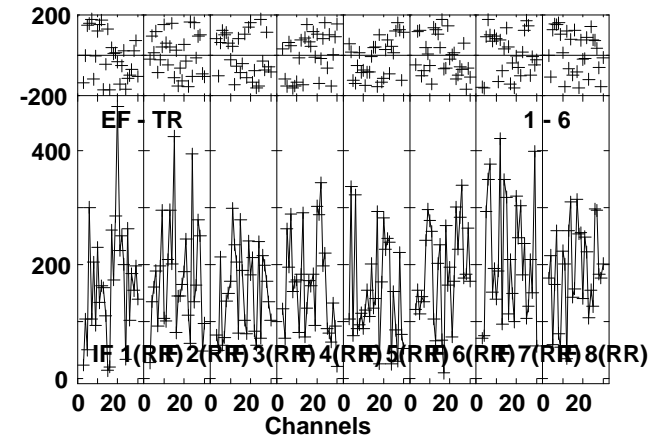
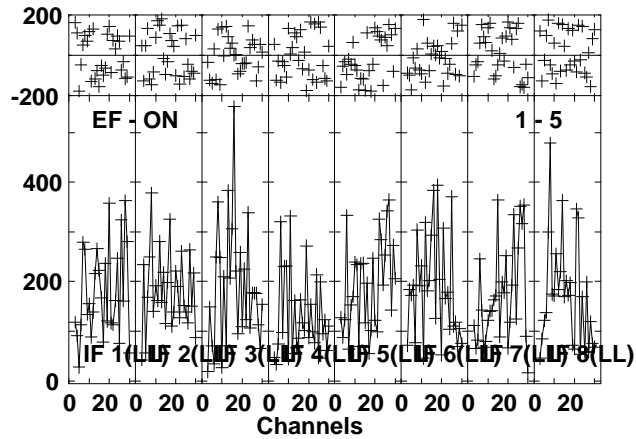
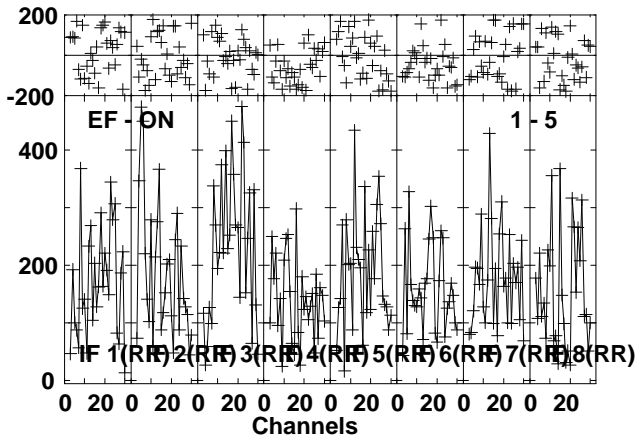
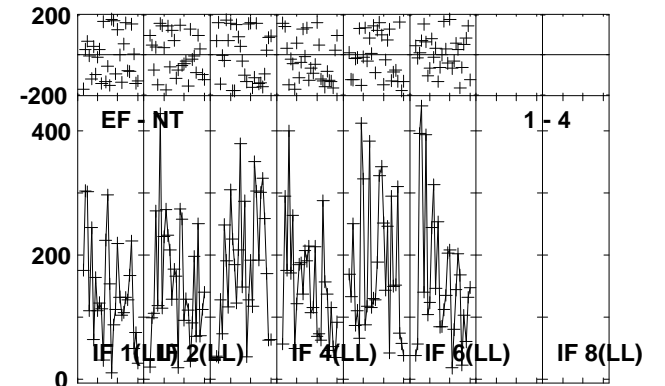
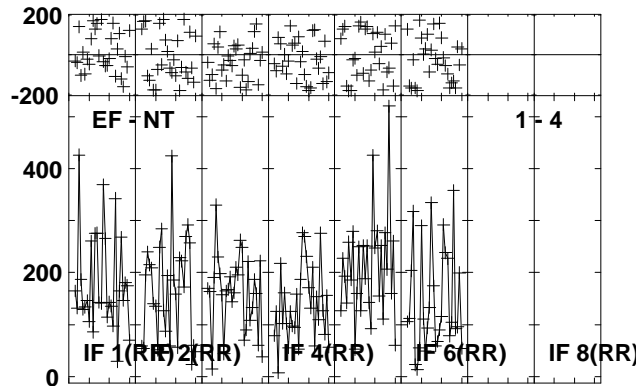
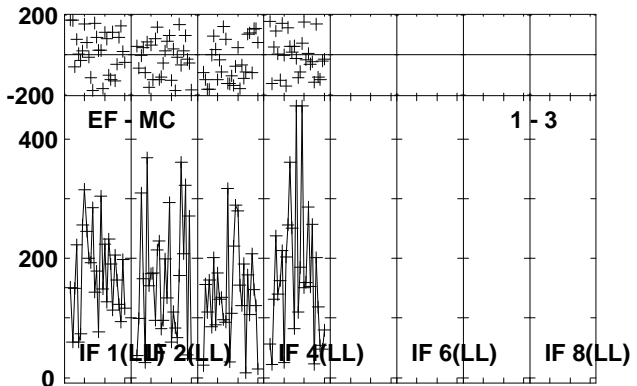
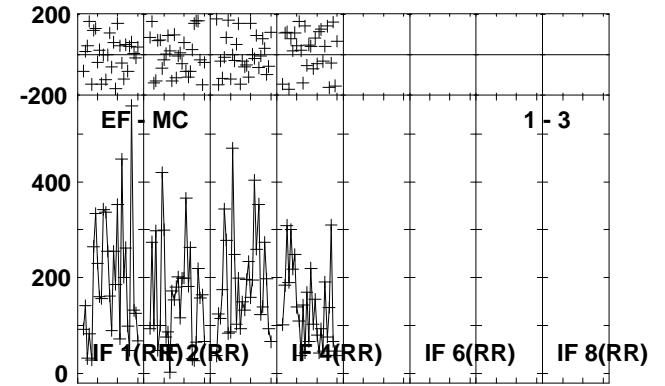
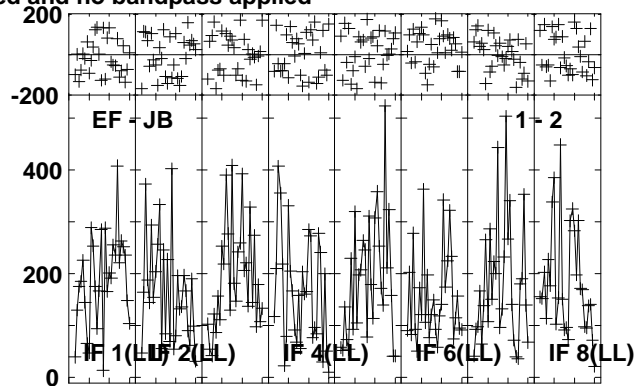
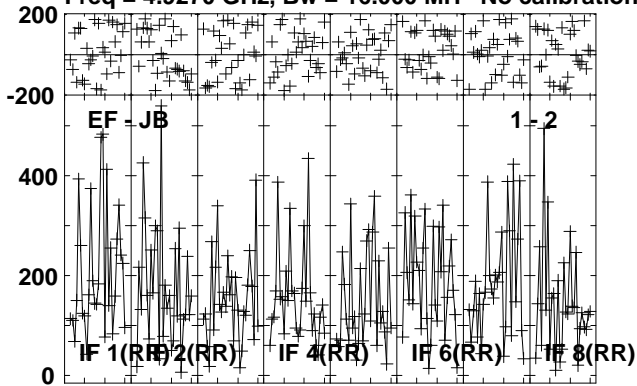

Lower frame: Micro Ampl Jy Top frame: Phas deg  
 Vector averaged cross-power spectrum Several baselines displayed  
 Timerange: 00/19:48:22 to 00/19:50:48

Plot file version 276 created 24-OCT-2012 21:00:41

G23.6-0.03 EY017B.UVDATA.1

Freq = 4.9270 GHz, Bw = 16.000 MH No calibration applied and no bandpass applied

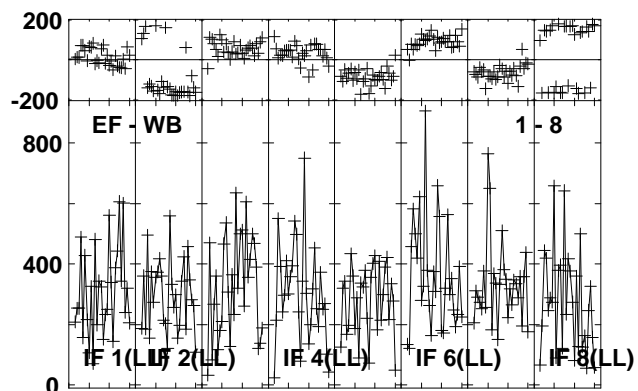
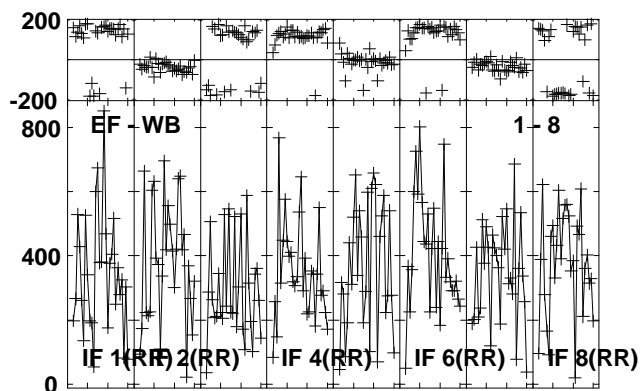
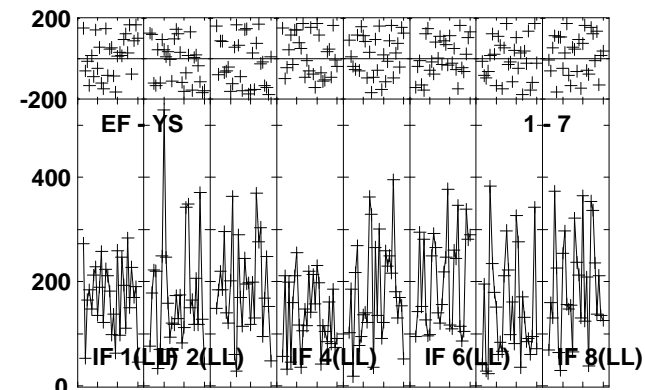
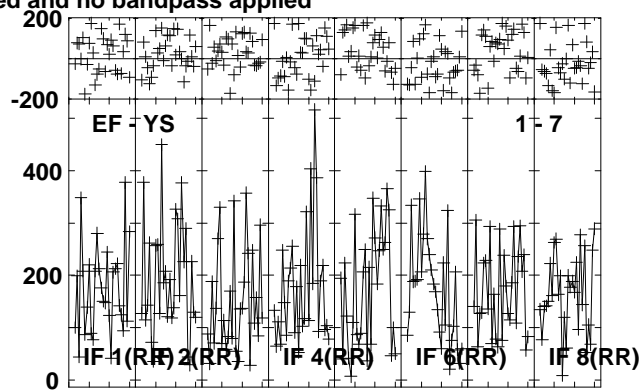
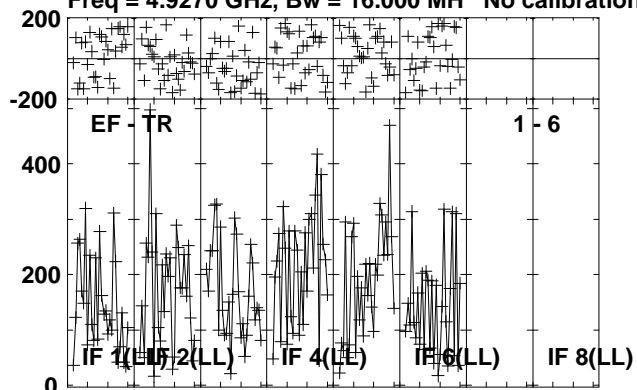

Lower frame: Micro Ampl Jy Top frame: Phas deg  
Vector averaged cross-power spectrum Several baselines displayed  
Timerange: 00:19:48:22 to 00:19:50:48



Plot file version 277 created 24-OCT-2012 21:00:41

J1825-0737 EY017B.UVDATA.1

Freq = 4.9270 GHz, Bw = 16.000 MH No calibration applied and no bandpass applied

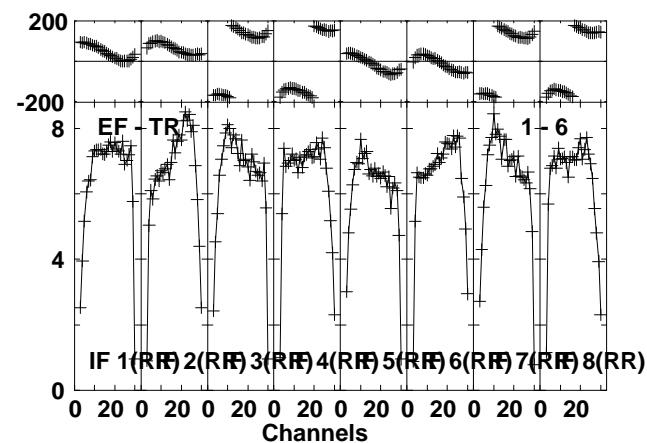
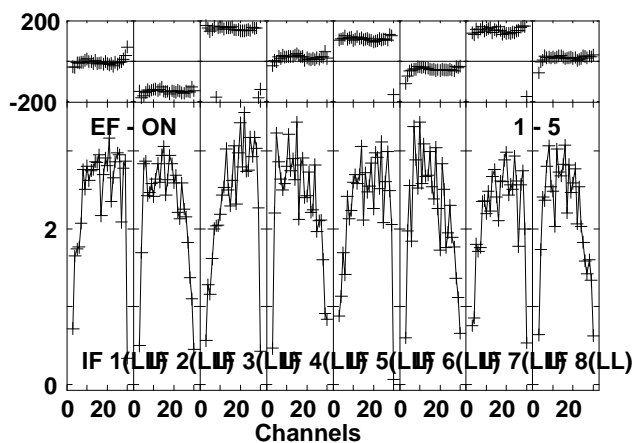
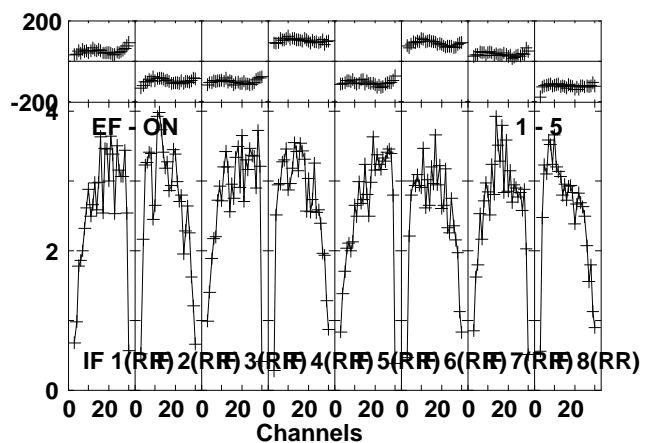
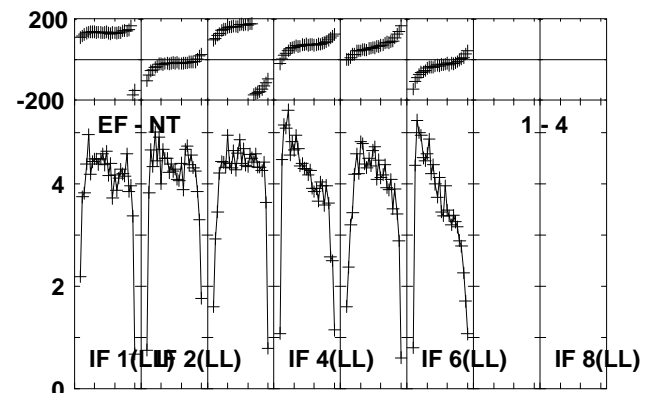
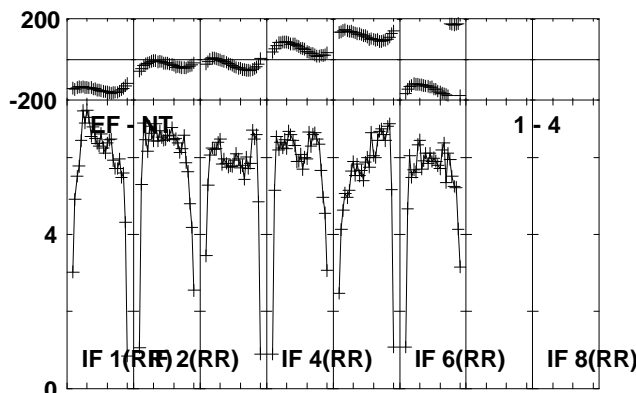
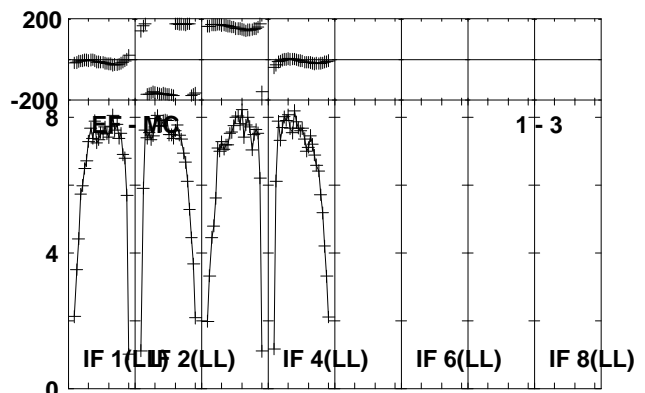
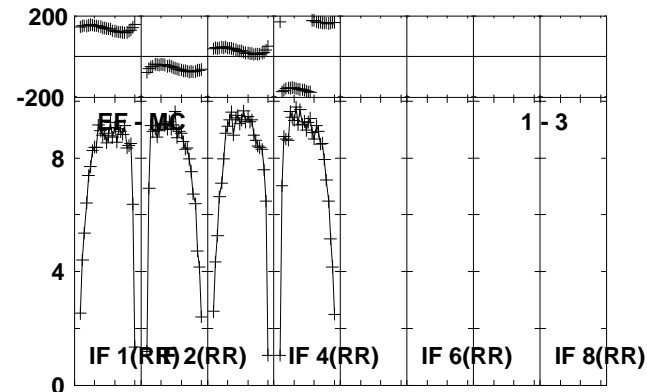
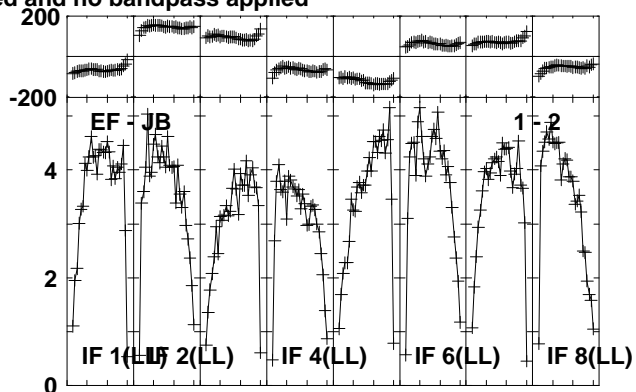
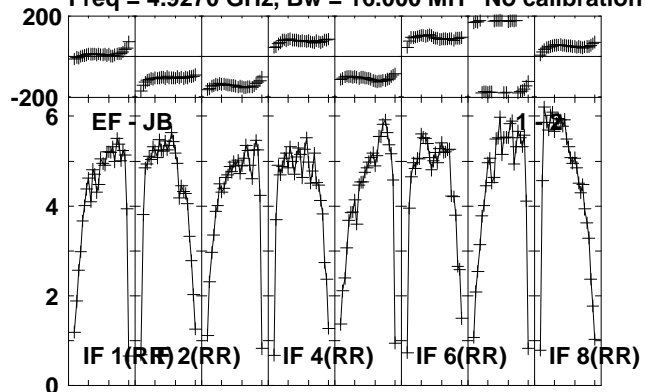

Lower frame: Milli Ampl Jy Top frame: Phas deg  
Vector averaged cross-power spectrum Several baselines displayed  
Timerange: 00/19:50:52 to 00/19:52:18

Plot file version 278 created 24-OCT-2012 21:00:42

J1825-0737 EY017B.UVDATA.1

Freq = 4.9270 GHz, Bw = 16.000 MH No calibration applied and no bandpass applied

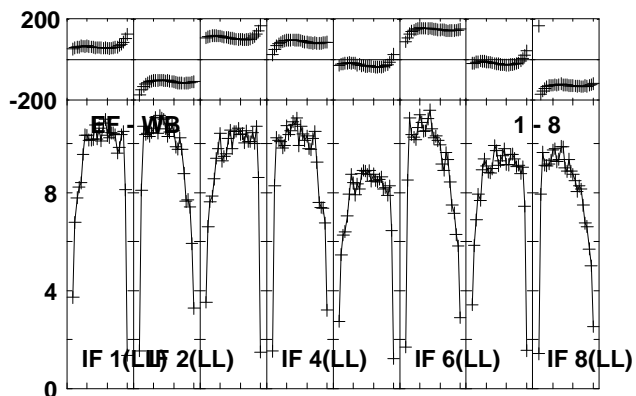
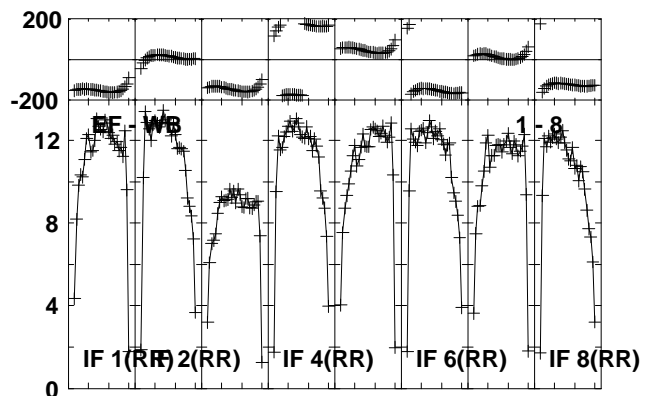
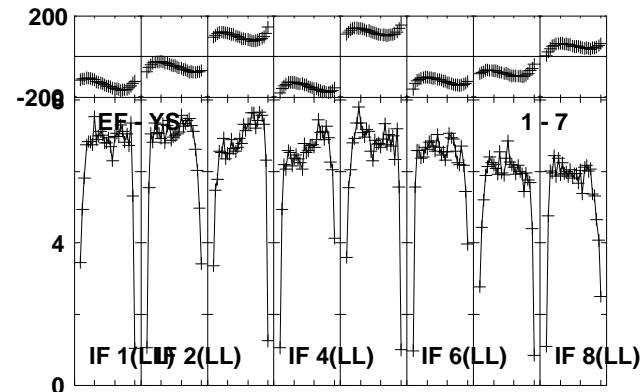
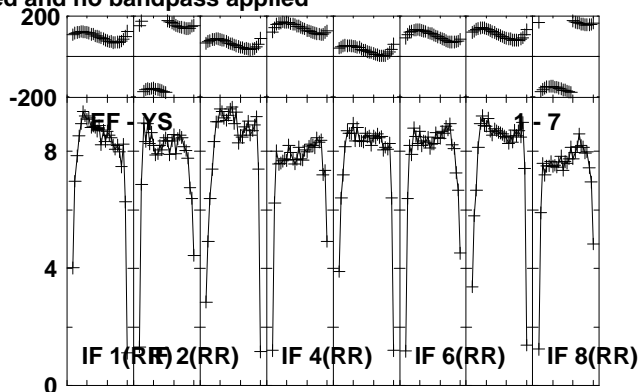
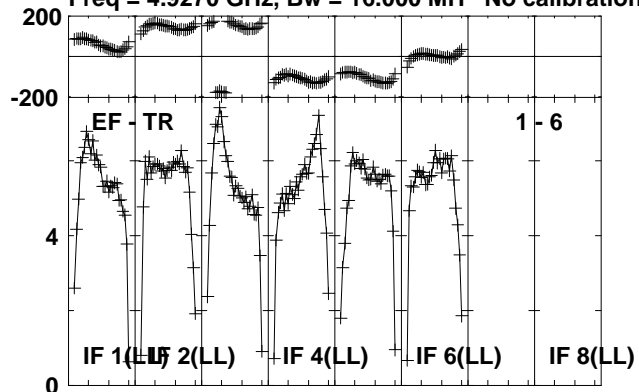

Lower frame: Milli Ampl Jy Top frame: Phas deg  
Vector averaged cross-power spectrum Several baselines displayed  
Timerange: 00/19:50:52 to 00/19:52:18

Plot file version 279 created 24-OCT-2012 21:00:42

G23.6-0.03 EY017B.UVDATA.1

Freq = 4.9270 GHz, Bw = 16.000 MH No calibration applied and no bandpass applied

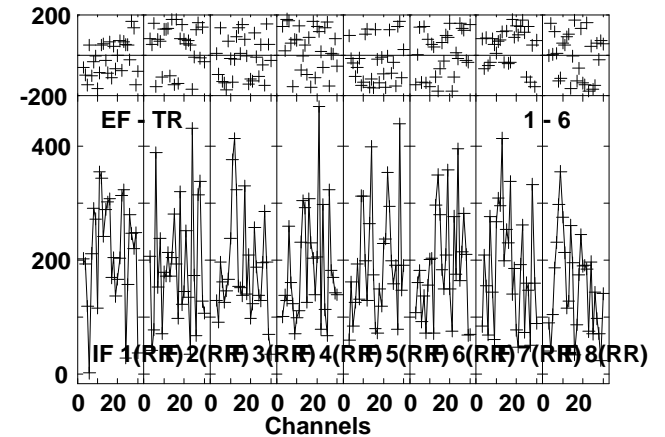
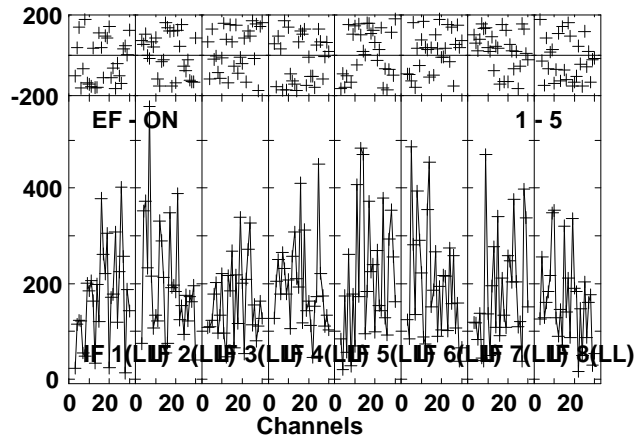
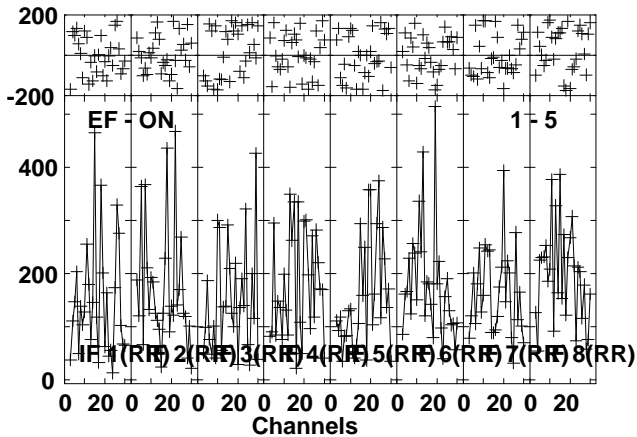
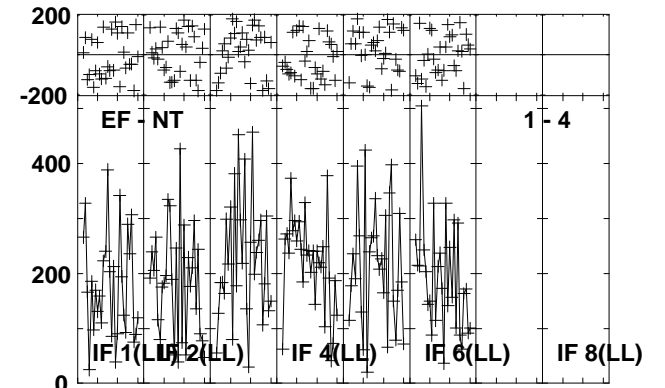
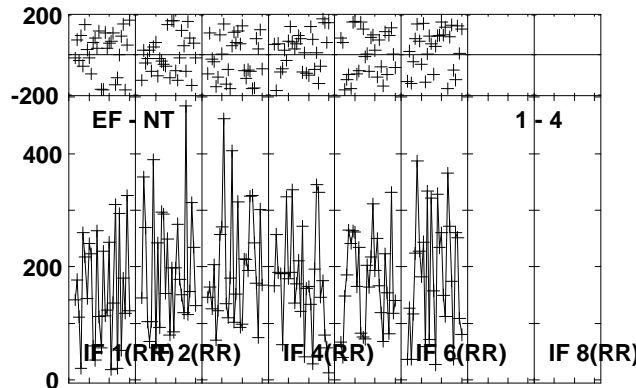
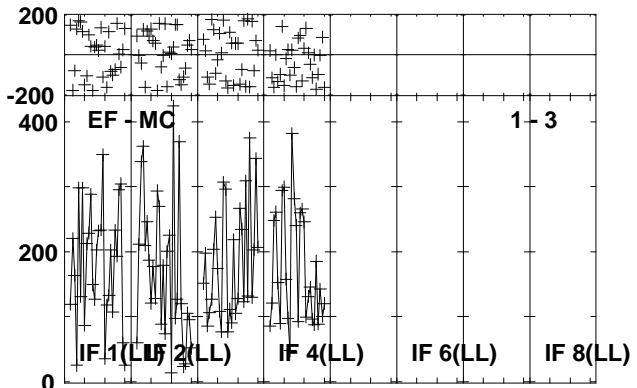
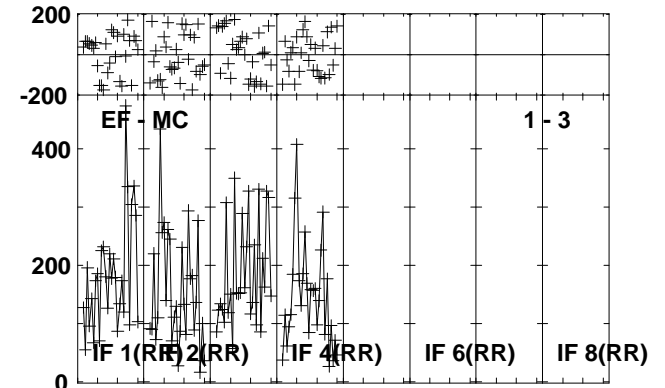
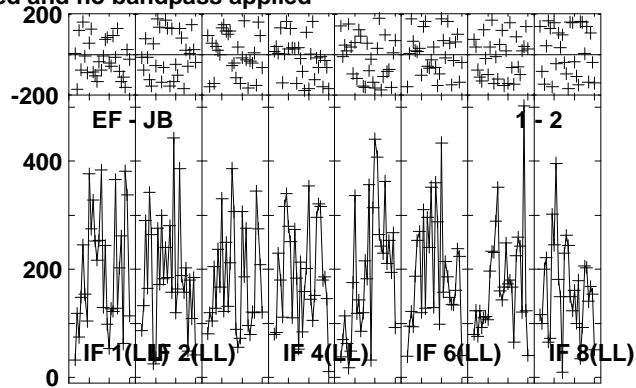
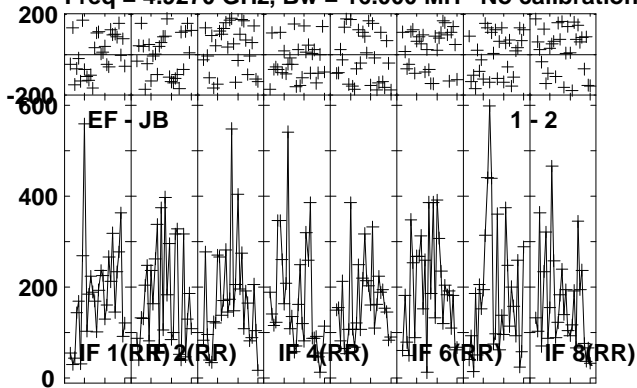

Lower frame: Micro Ampl Jy Top frame: Phas deg  
Vector averaged cross-power spectrum Several baselines displayed  
Timerange: 00:19:52:22 to 00:19:54:48

Plot file version 280 created 24-OCT-2012 21:00:43

G23.6-0.03 EY017B.UVDATA.1

Freq = 4.9270 GHz, Bw = 16.000 MH No calibration applied and no bandpass applied

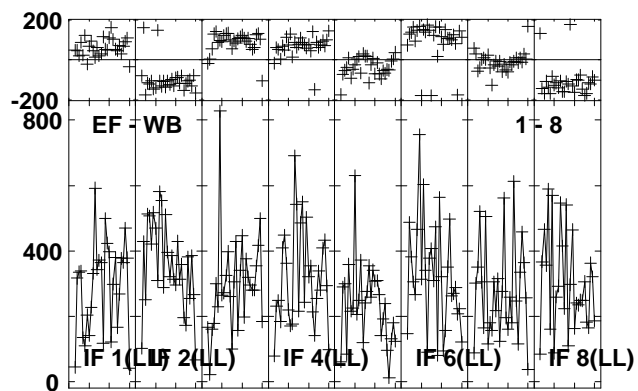
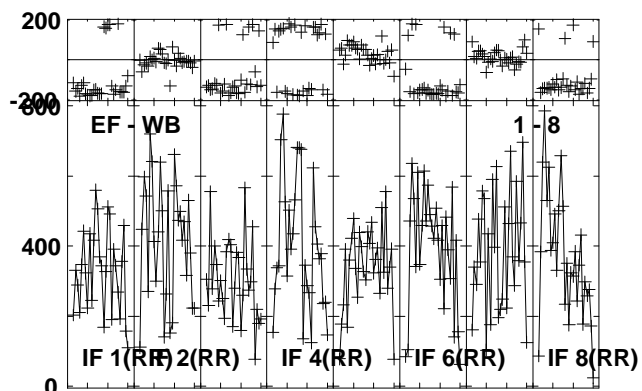
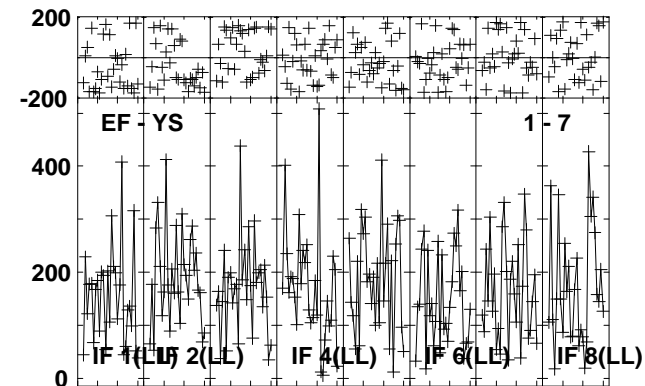
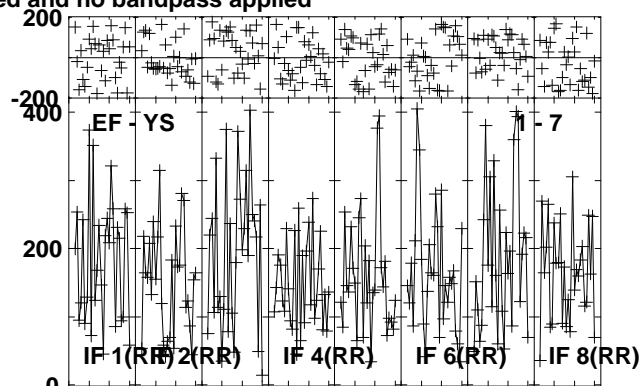
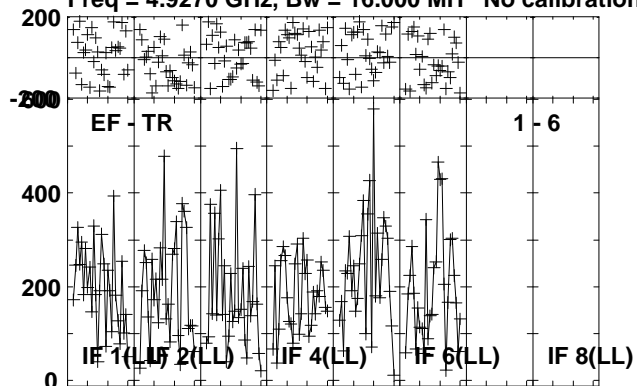

Lower frame: Micro Ampl Jy Top frame: Phas deg  
Vector averaged cross-power spectrum Several baselines displayed  
Timerange: 00:19:52:22 to 00:19:54:48

Plot file version 281 created 24-OCT-2012 21:00:43

J1825-0737 EY017B.UVDATA.1

Freq = 4.9270 GHz, Bw = 16.000 MH No calibration applied and no bandpass applied

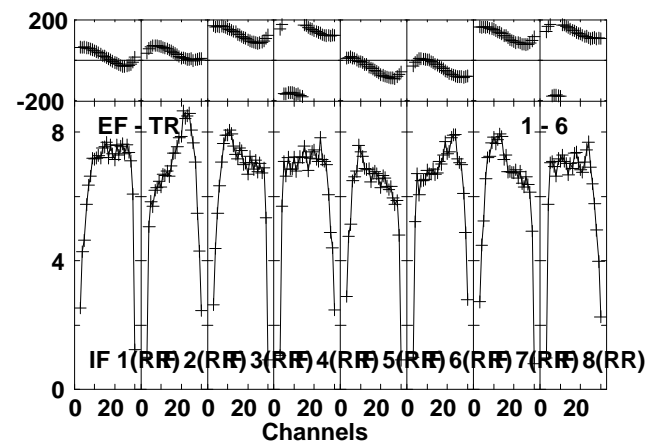
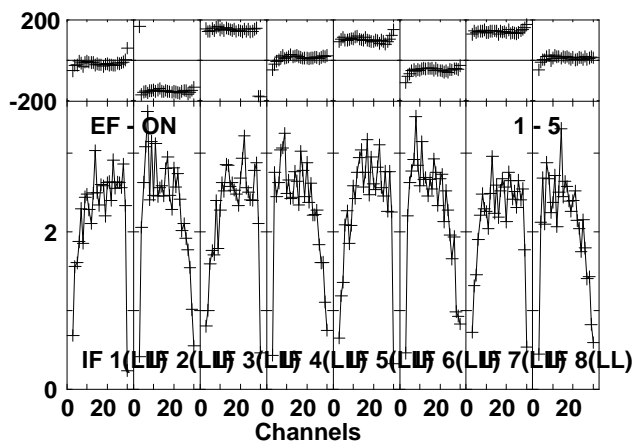
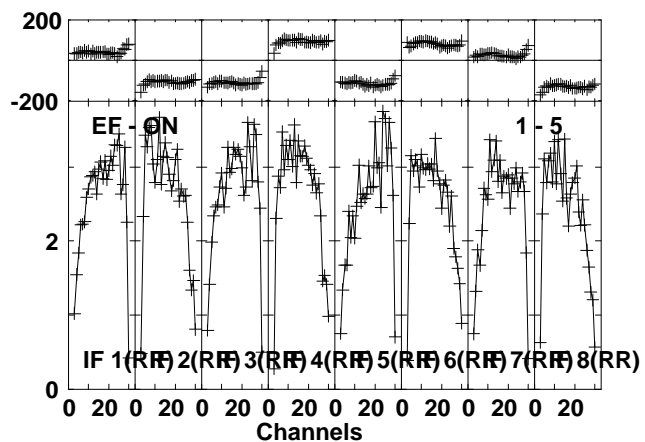
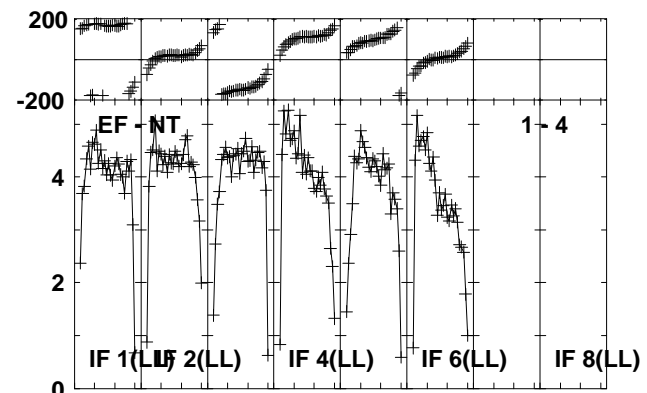
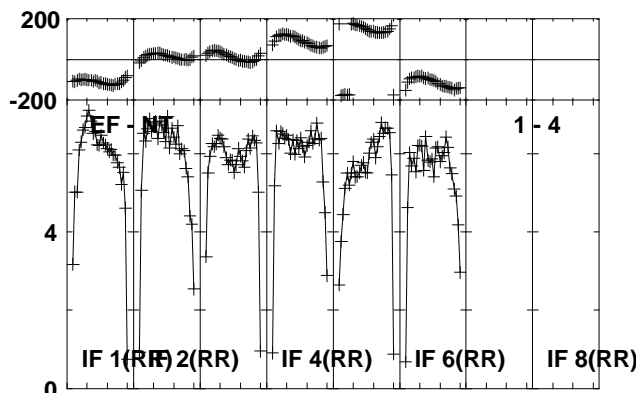
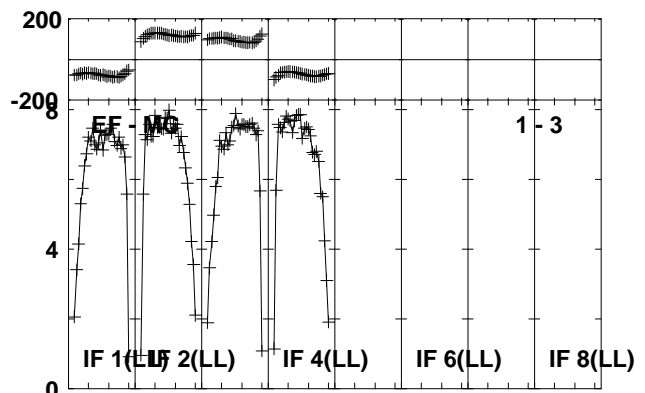
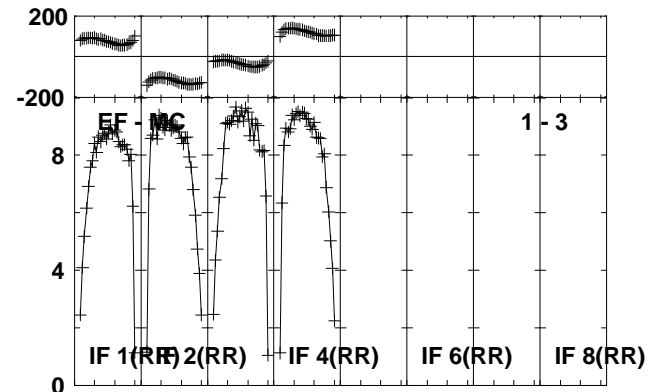
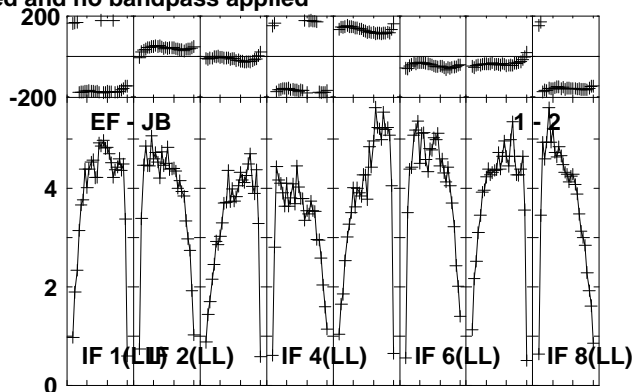
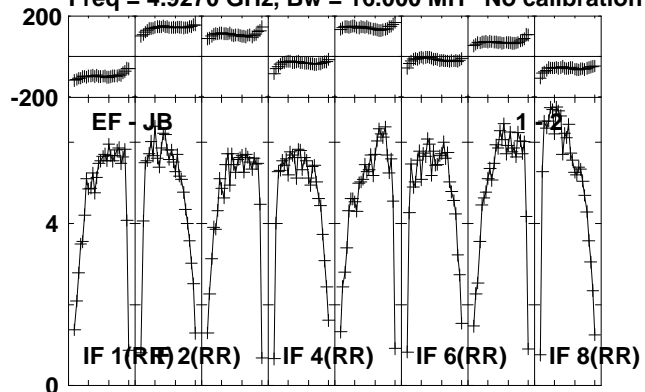

Lower frame: Milli Ampl Jy Top frame: Phas deg  
Vector averaged cross-power spectrum Several baselines displayed  
Timerange: 00/19:54:52 to 00/19:56:18

Plot file version 282 created 24-OCT-2012 21:00:44

J1825-0737 EY017B.UVDATA.1

Freq = 4.9270 GHz, Bw = 16.000 MH No calibration applied and no bandpass applied

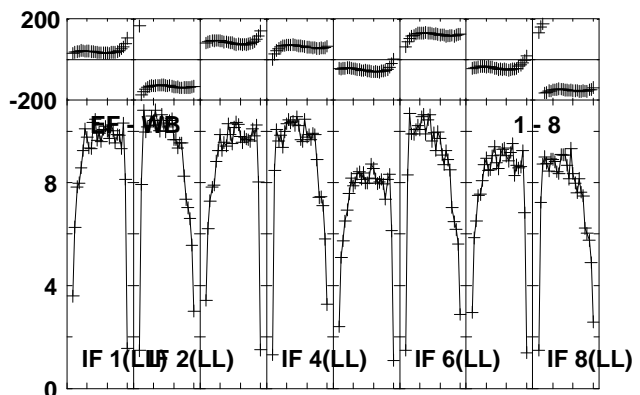
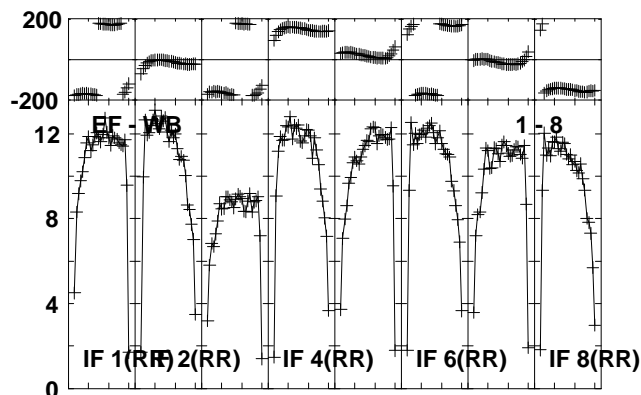
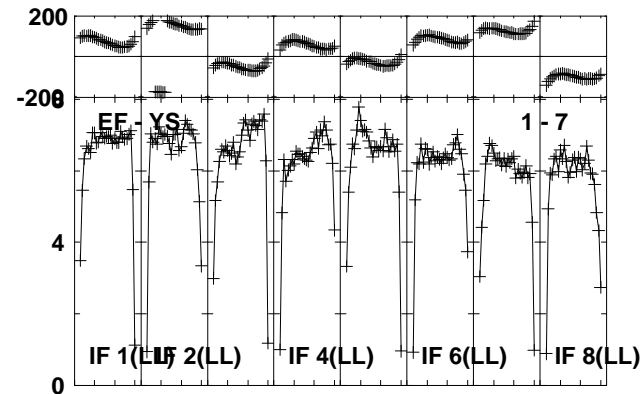
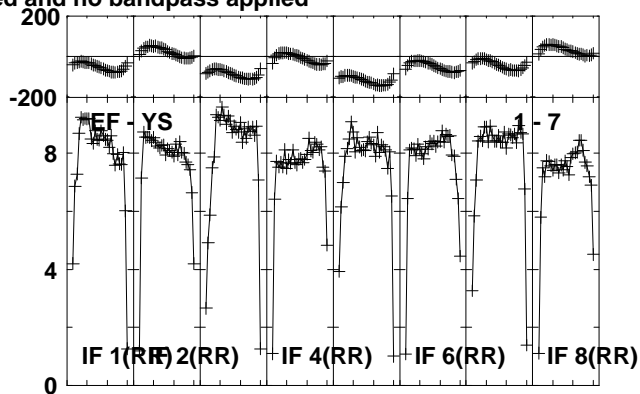
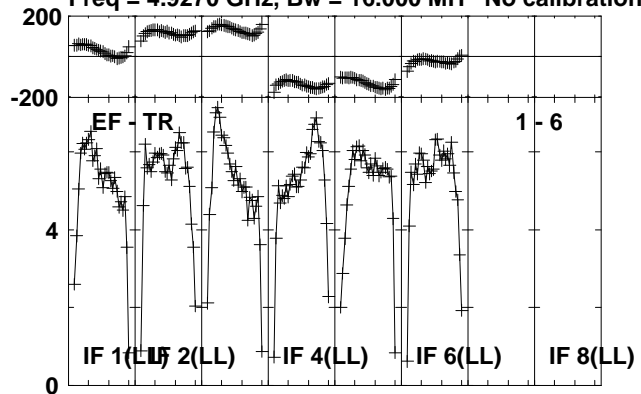

Lower frame: Milli Ampl Jy Top frame: Phas deg  
Vector averaged cross-power spectrum Several baselines displayed  
Timerange: 00/19:54:52 to 00/19:56:18

Plot file version 283 created 24-OCT-2012 21:00:44  
 G23.6-0.03 EY017B.UVDATA.1

Freq = 4.9270 GHz, Bw = 16.000 MH No calibration applied and no bandpass applied

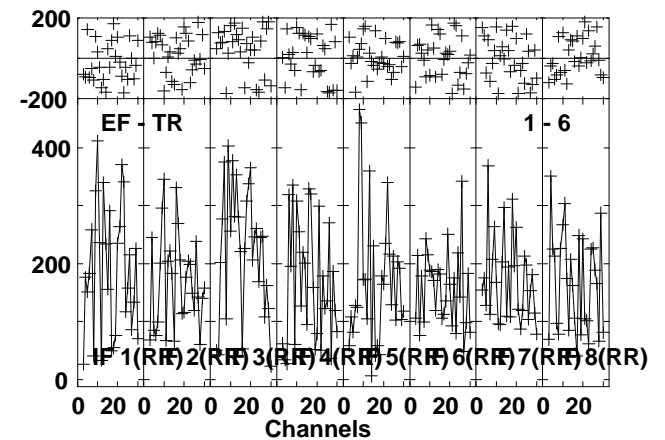
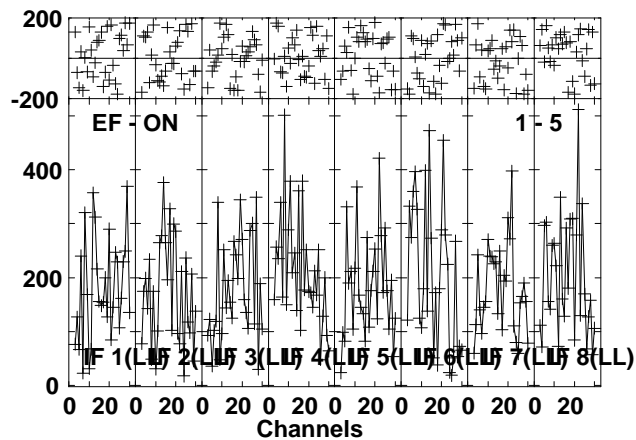
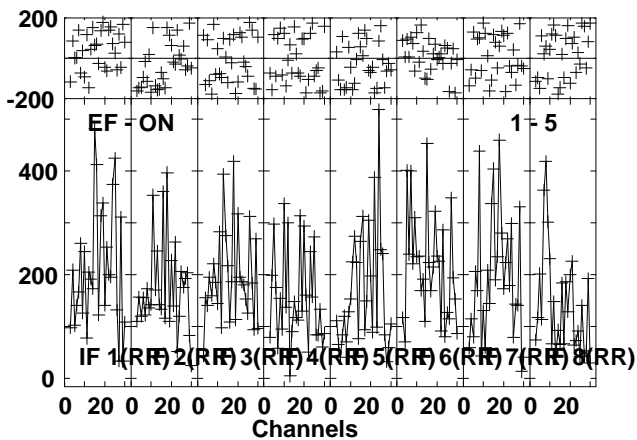
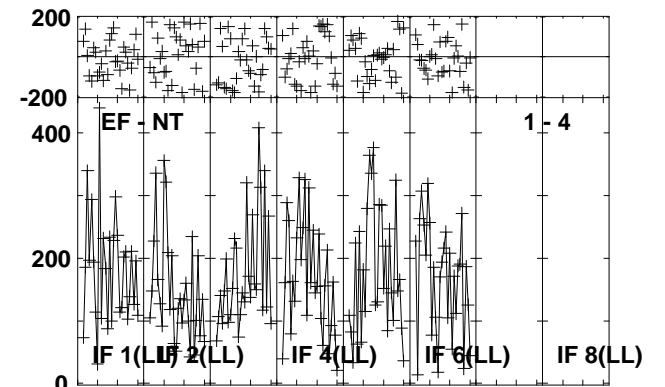
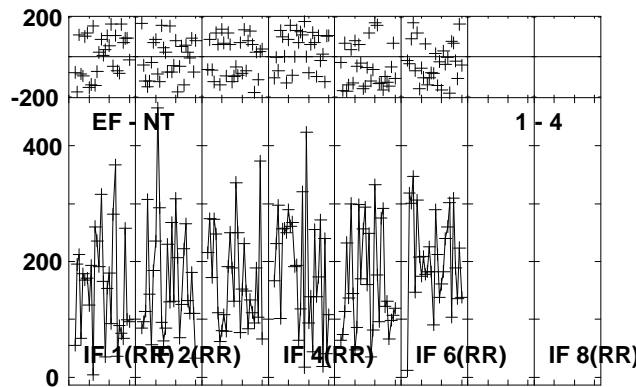
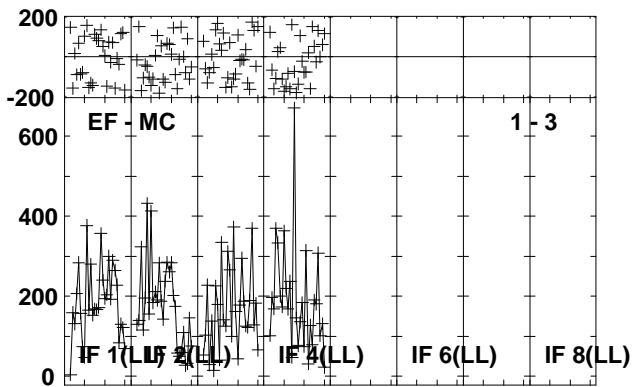
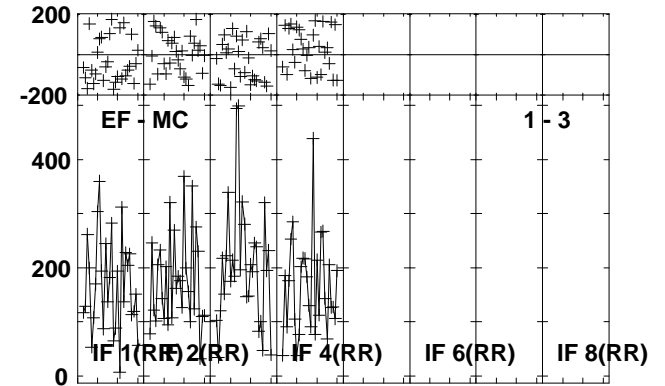
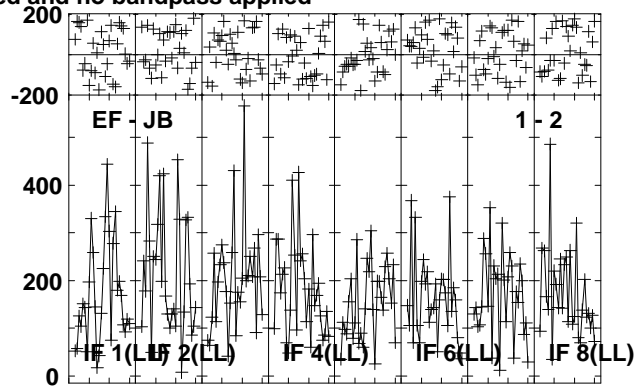
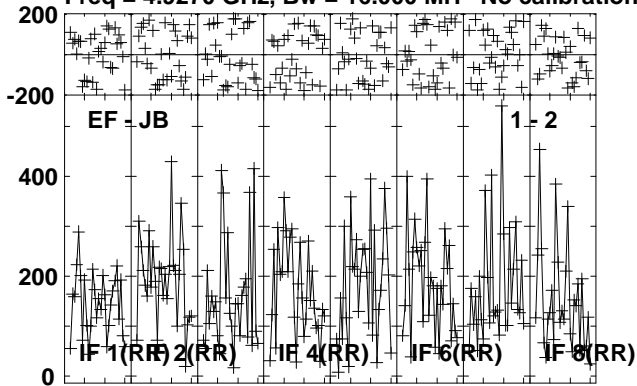

Lower frame: Micro Ampl Jy Top frame: Phas deg  
 Vector averaged cross-power spectrum Several baselines displayed  
 Timerange: 00/19:56:22 to 00/19:58:48

Plot file version 284 created 24-OCT-2012 21:00:45

G23.6-0.03 EY017B.UVDATA.1

Freq = 4.9270 GHz, Bw = 16.000 MH No calibration applied and no bandpass applied

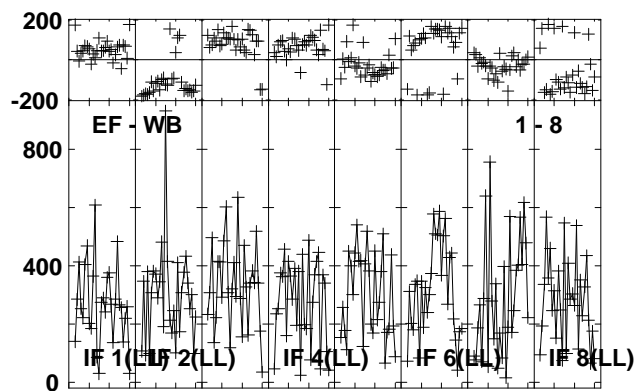
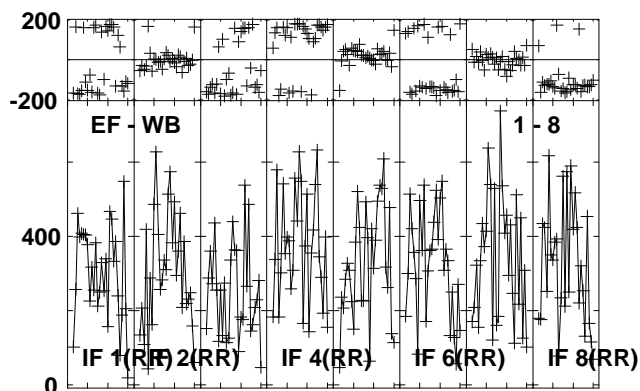
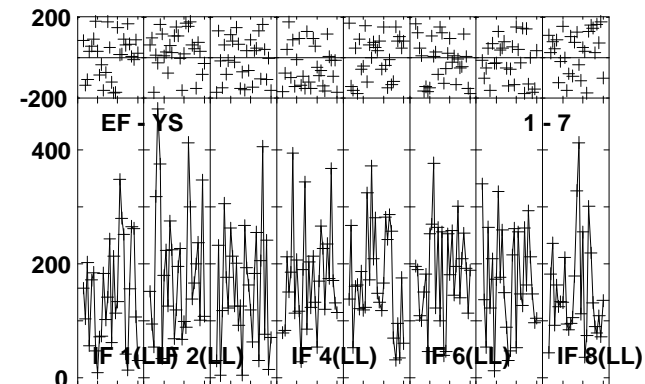
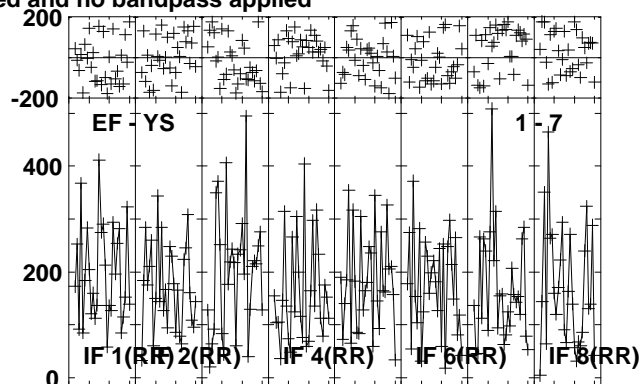
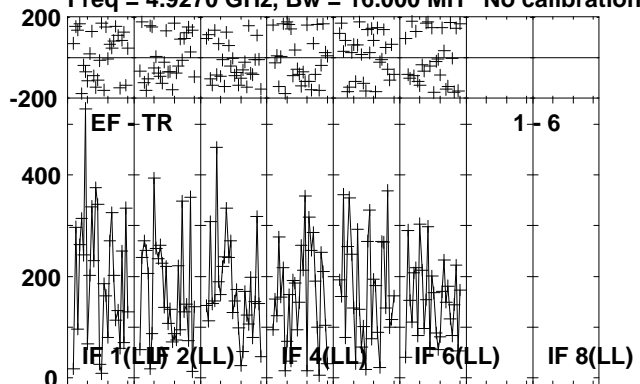

Lower frame: Micro Ampl Jy Top frame: Phas deg  
Vector averaged cross-power spectrum Several baselines displayed  
Timerange: 00:19:56:22 to 00:19:58:48



Plot file version 285 created 24-OCT-2012 21:00:46

J1825-0737 EY017B.UVDATA.1

Freq = 4.9270 GHz, Bw = 16.000 MH No calibration applied and no bandpass applied

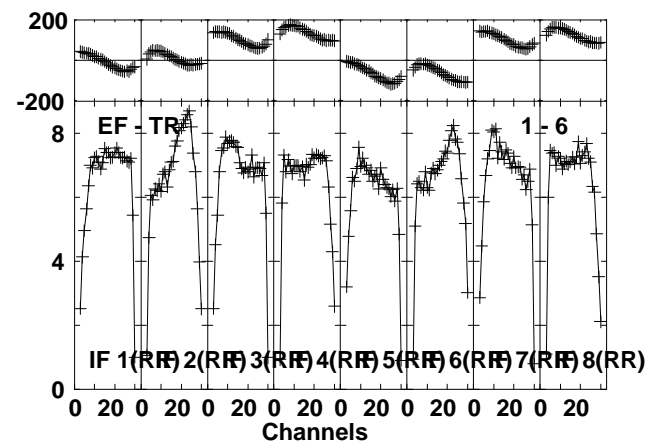
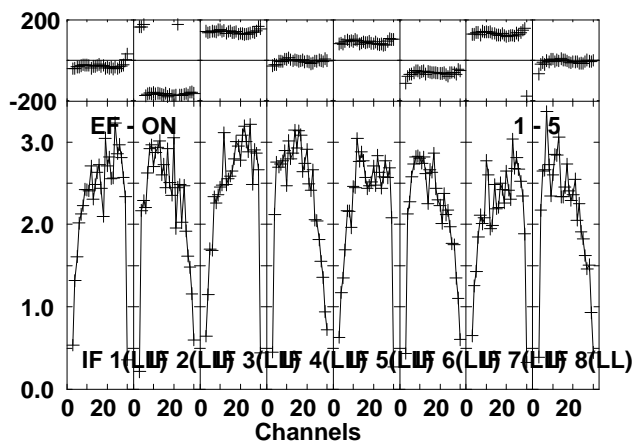
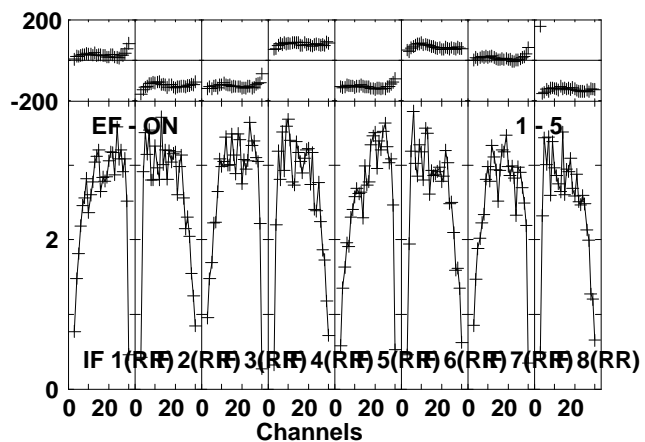
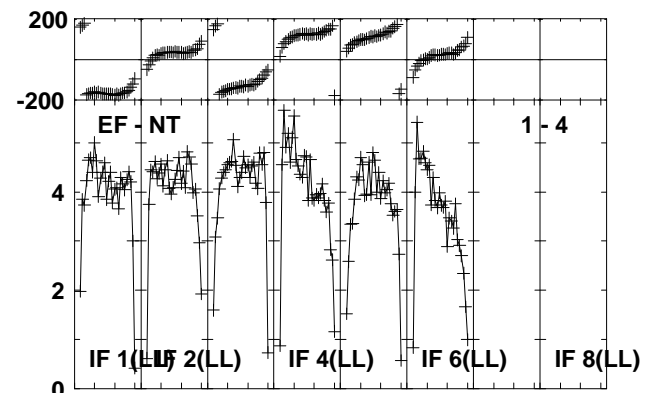
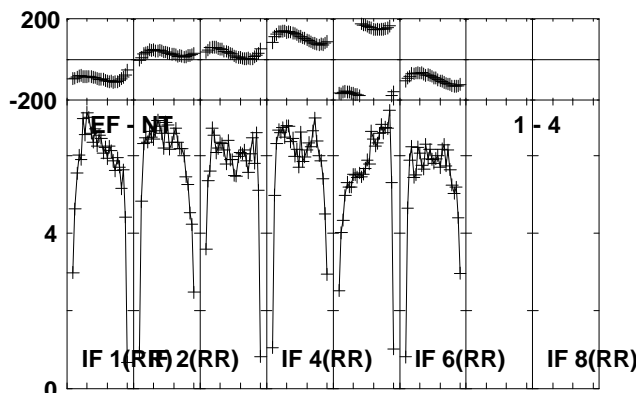
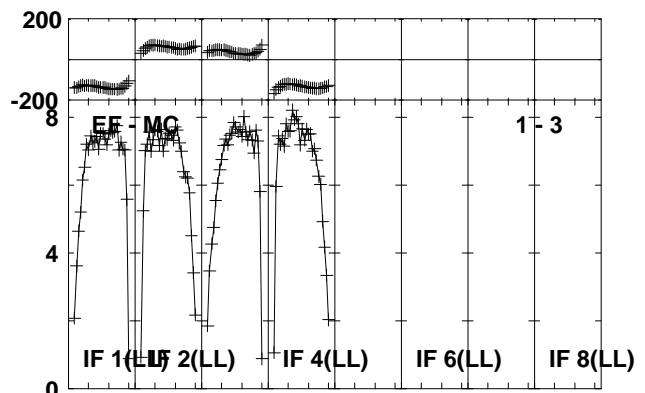
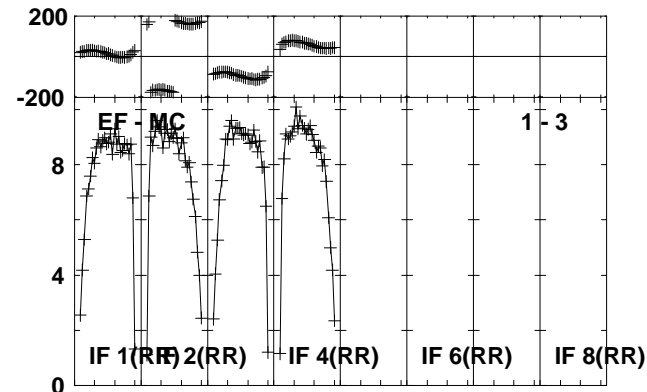
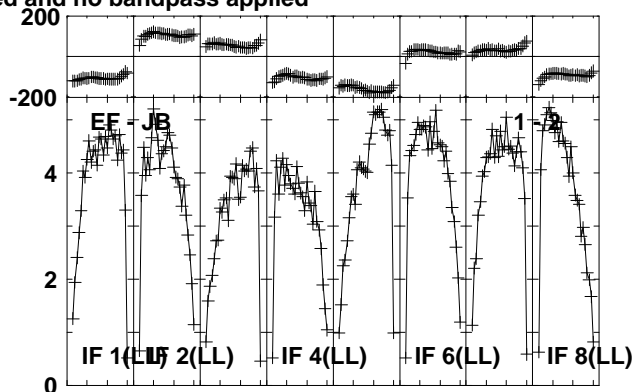
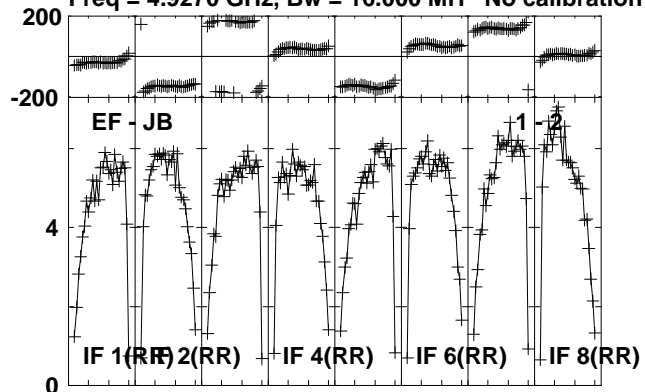

Lower frame: Milli Ampl Jy Top frame: Phas deg  
Vector averaged cross-power spectrum Several baselines displayed  
Timerange: 00/19:58:52 to 00/20:00:18

Plot file version 286 created 24-OCT-2012 21:00:46

J1825-0737 EY017B.UVDATA.1

Freq = 4.9270 GHz, Bw = 16.000 MH No calibration applied and no bandpass applied

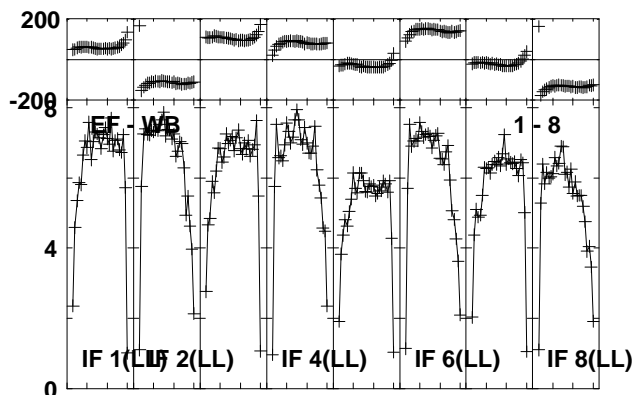
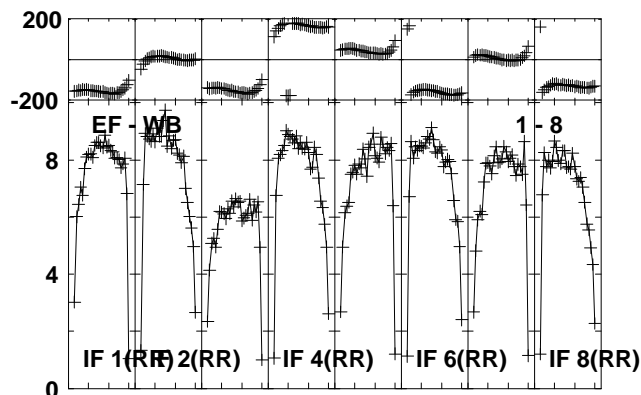
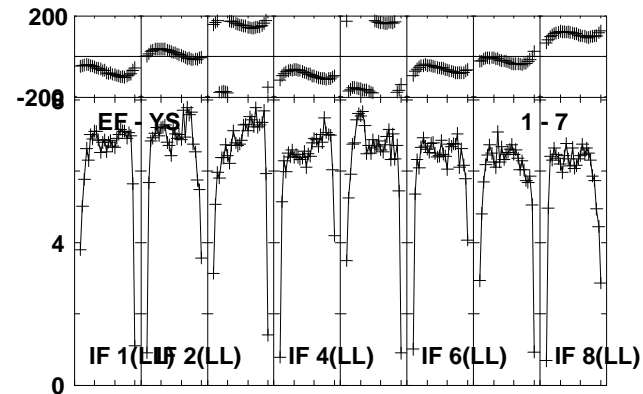
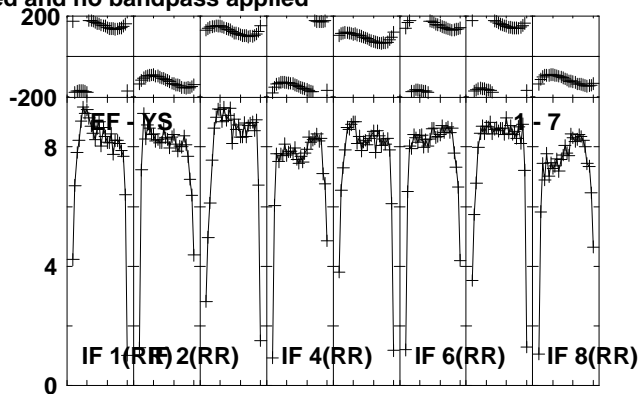
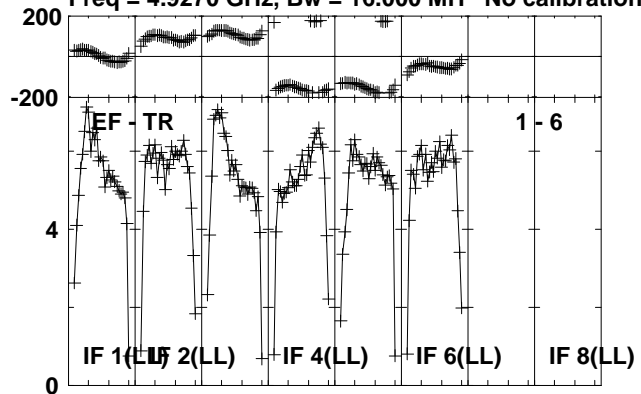

Lower frame: Milli Ampl Jy Top frame: Phas deg  
Vector averaged cross-power spectrum Several baselines displayed  
Timerange: 00/19:58:52 to 00/20:00:18

Plot file version 287 created 24-OCT-2012 21:00:47

J1831-0756 EY017B.UVDATA.1

Freq = 4.9270 GHz, Bw = 16.000 MH No calibration applied and no bandpass applied

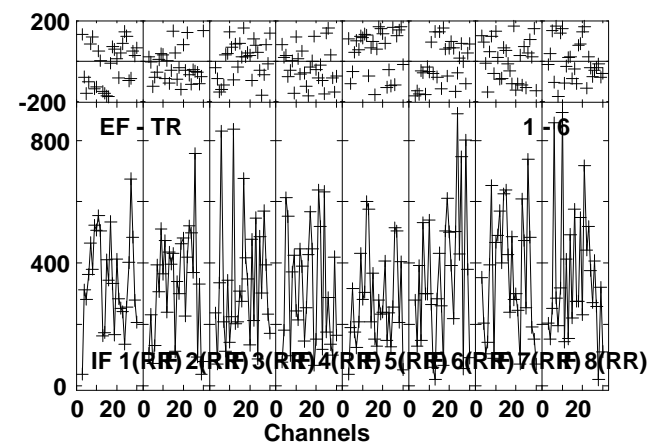
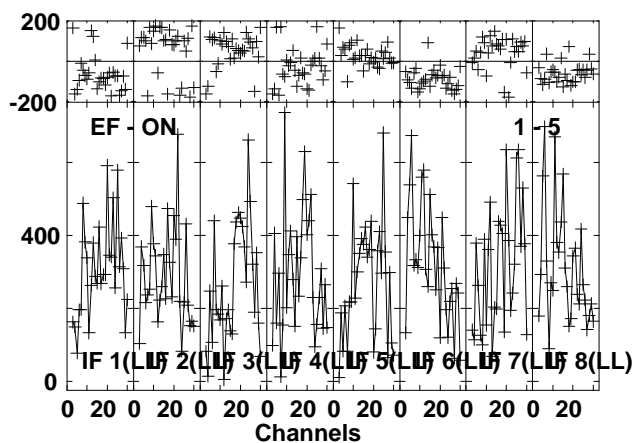
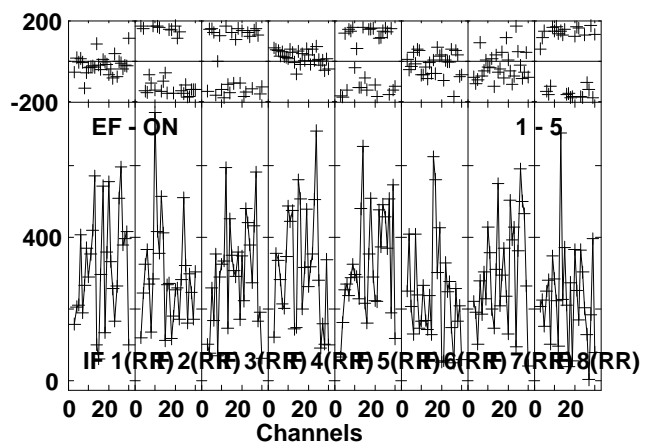
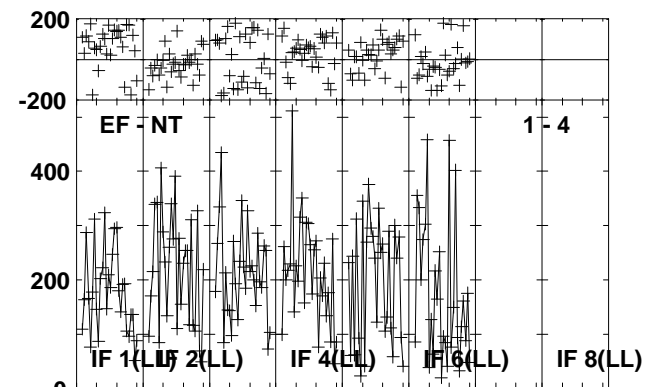
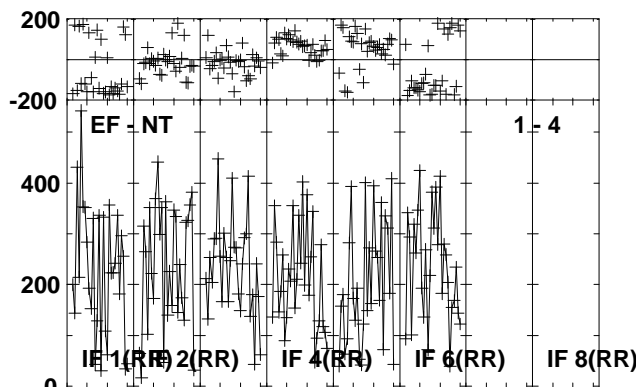
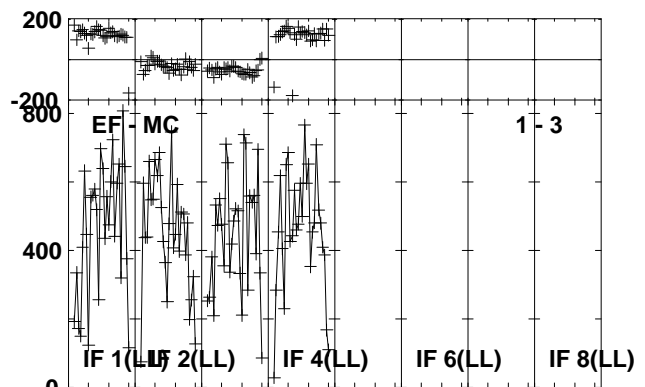
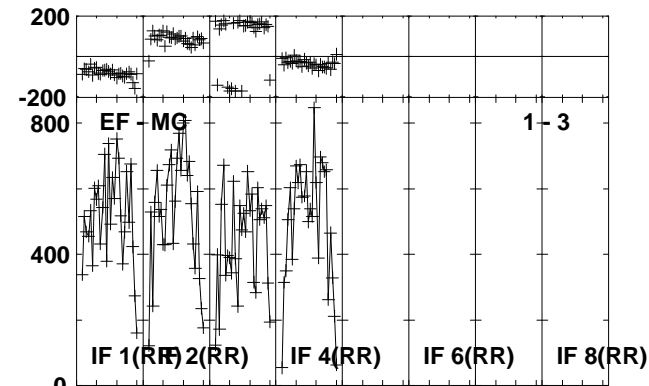
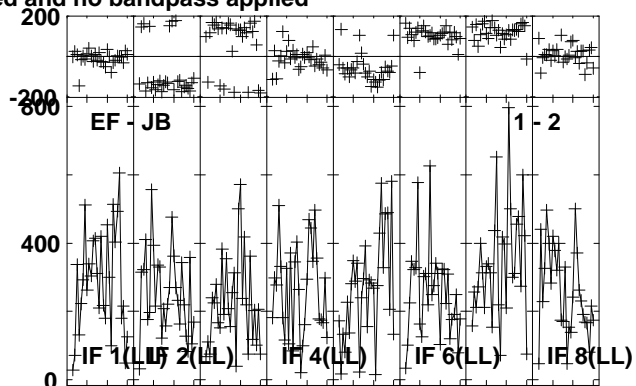
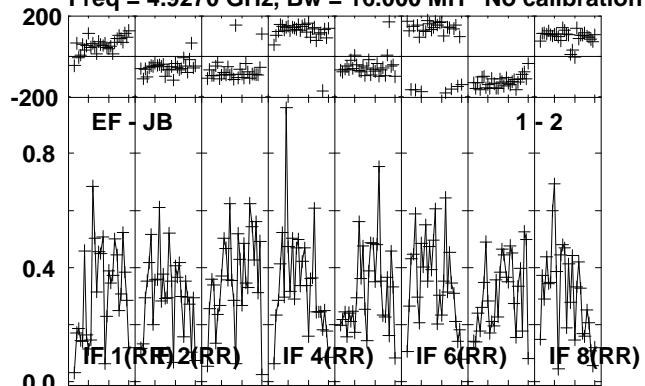

Lower frame: Milli Ampl Jy Top frame: Phas deg  
Vector averaged cross-power spectrum Several baselines displayed  
Timerange: 00/20:00:52 to 00/20:02:54

Plot file version 288 created 24-OCT-2012 21:00:47

J1831-0756 EY017B.UVDATA.1

Freq = 4.9270 GHz, Bw = 16.000 MH No calibration applied and no bandpass applied

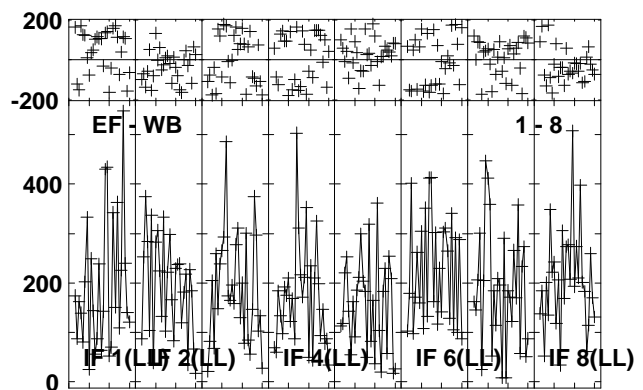
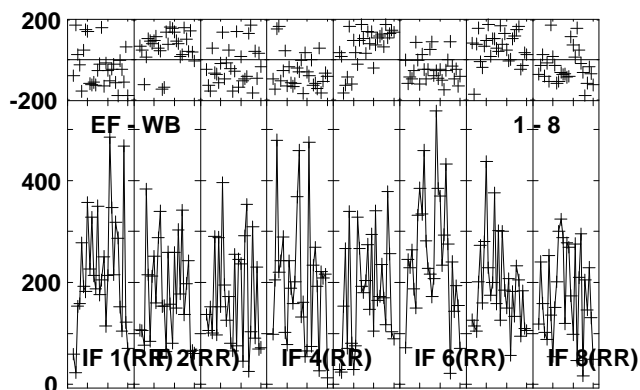
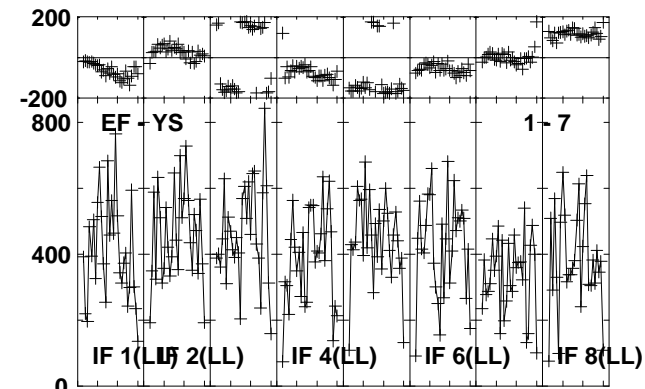
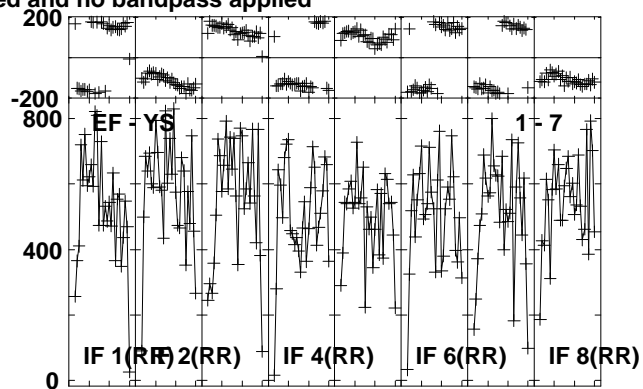
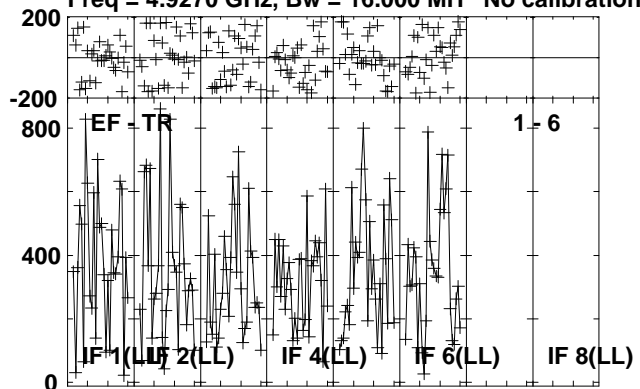

Lower frame: Micro Ampl Jy Top frame: Phas deg  
Vector averaged cross-power spectrum Several baselines displayed  
Timerange: 00/20:00:52 to 00/20:02:54

Plot file version 289 created 24-OCT-2012 21:00:47

J1825-0737 EY017B.UVDATA.1

Freq = 4.9270 GHz, Bw = 16.000 MH No calibration applied and no bandpass applied

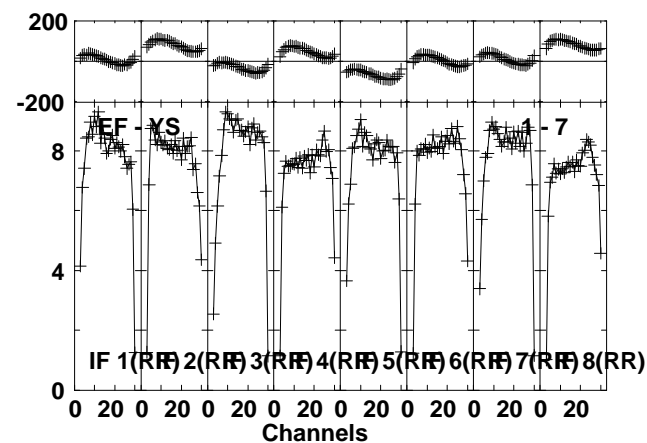
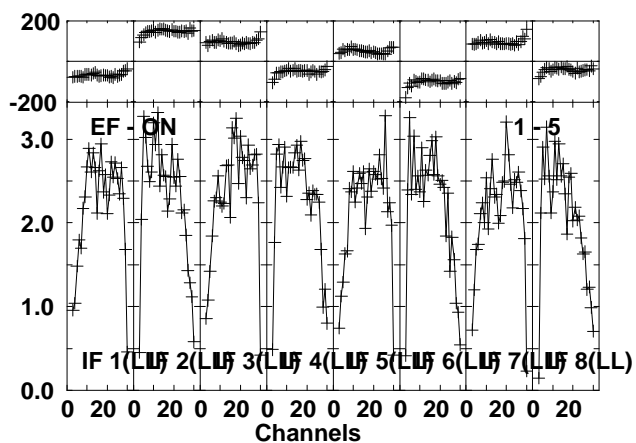
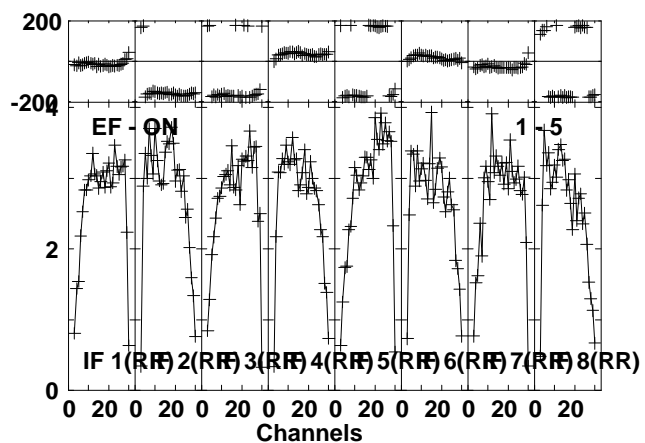
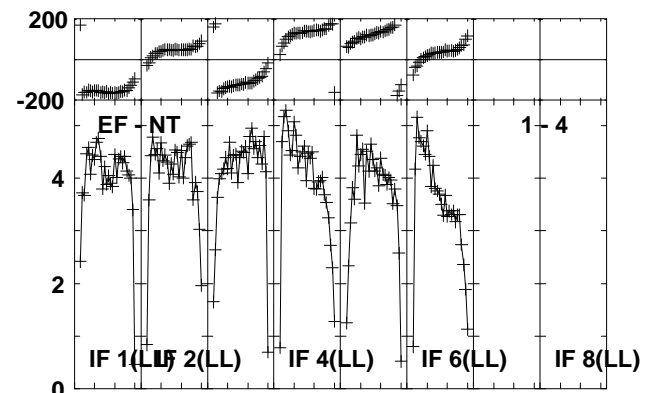
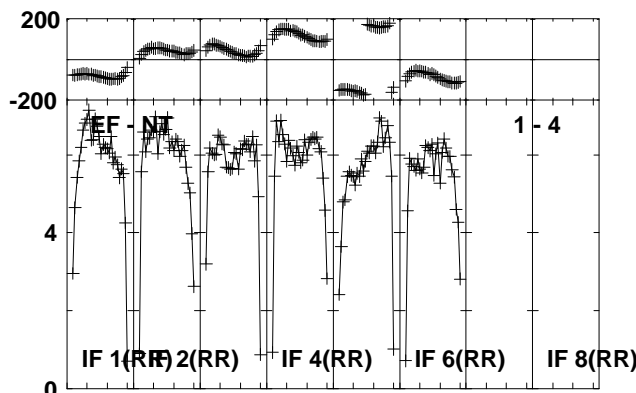
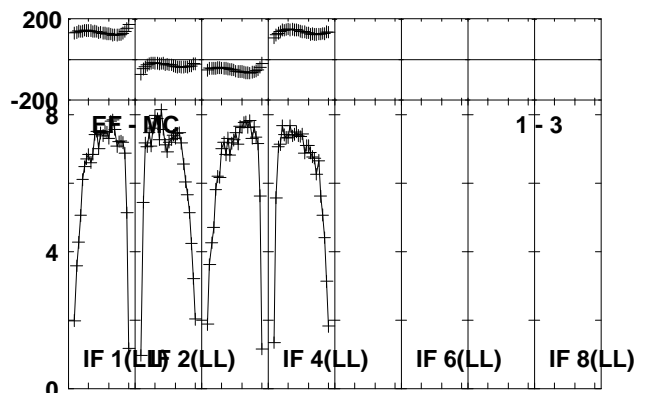
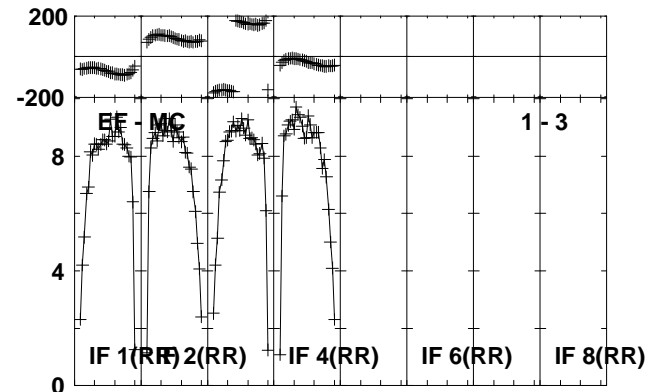
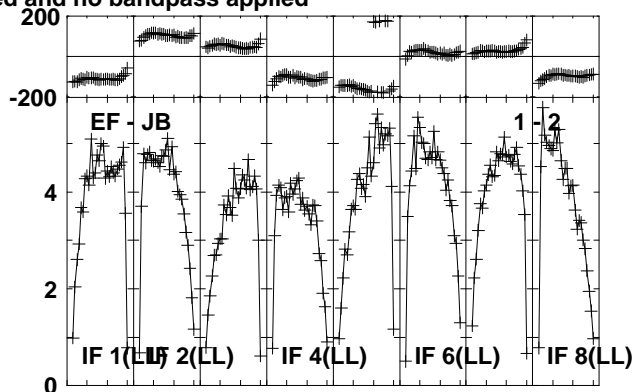
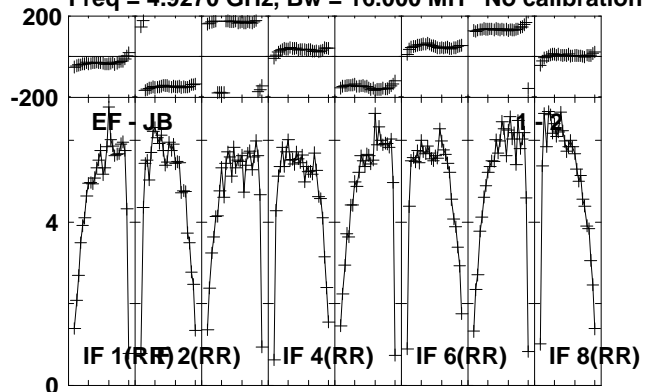

Lower frame: Milli Ampl Jy Top frame: Phas deg  
Vector averaged cross-power spectrum Several baselines displayed  
Timerange: 00/20:02:58 to 00/20:04:24

Plot file version 290 created 24-OCT-2012 21:00:48

J1825-0737 EY017B.UVDATA.1

Freq = 4.9270 GHz, Bw = 16.000 MH No calibration applied and no bandpass applied

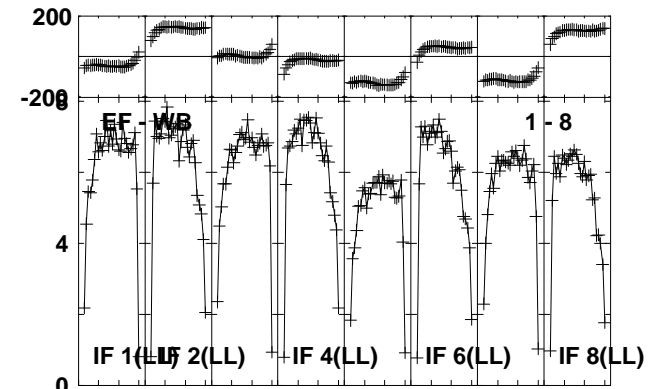
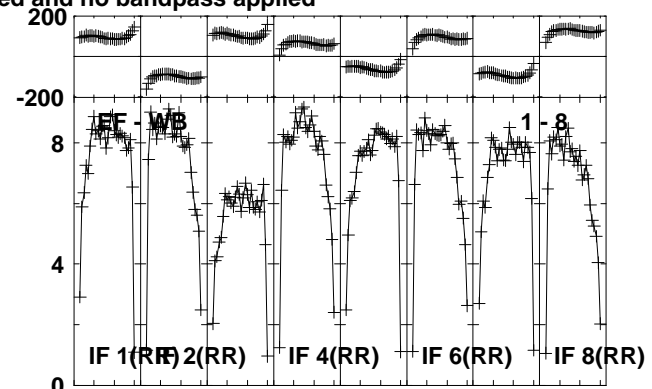
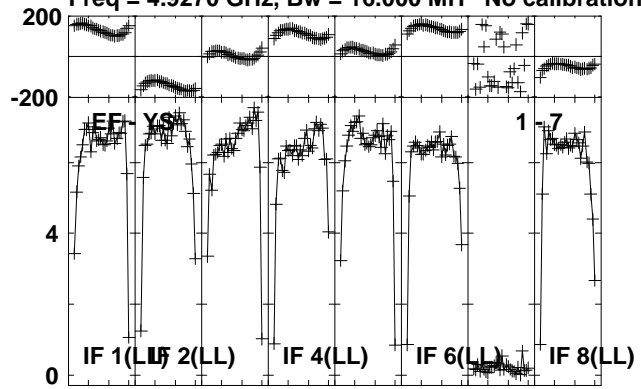

Lower frame: Milli Ampl Jy Top frame: Phas deg  
Vector averaged cross-power spectrum Several baselines displayed  
Timerange: 00/20:02:58 to 00/20:04:24

Plot file version 291 created 24-OCT-2012 21:00:48  
 G23.6-0.03 EY017B.UVDATA.1

Freq = 4.9270 GHz, Bw = 16.000 MH No calibration applied and no bandpass applied

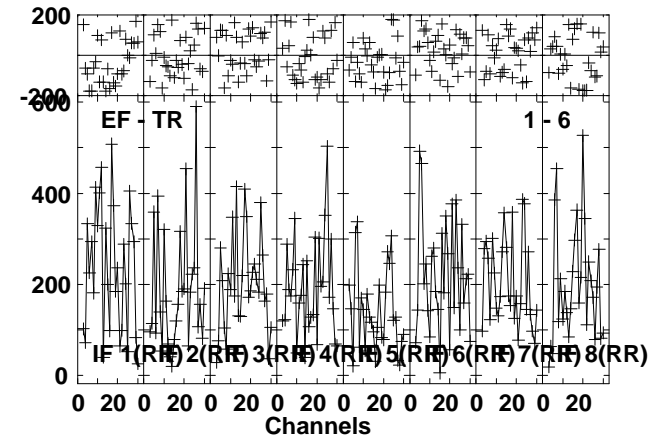
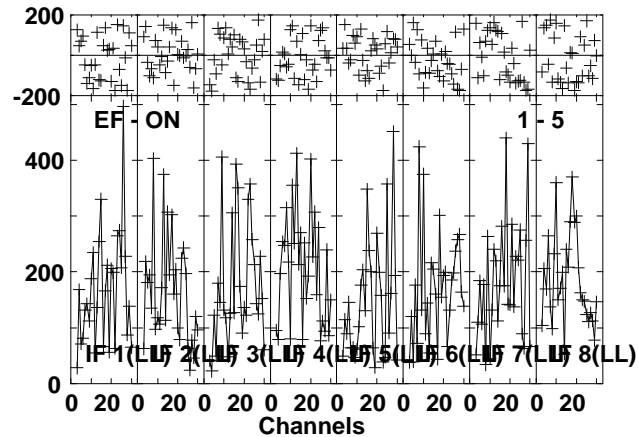
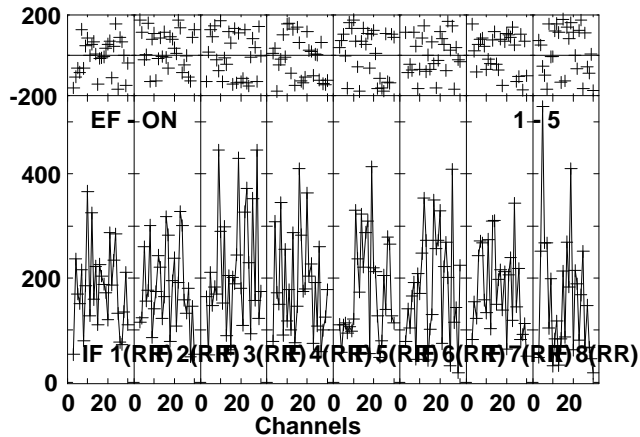
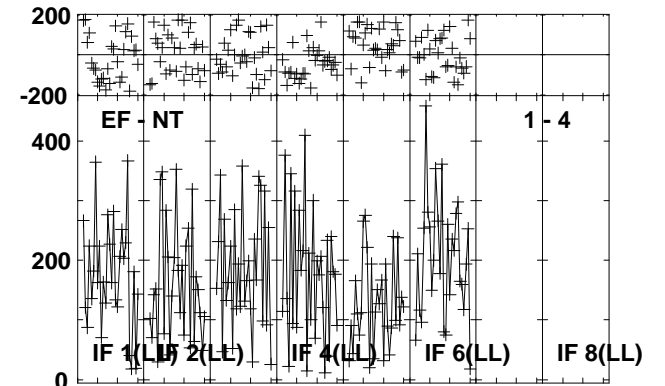
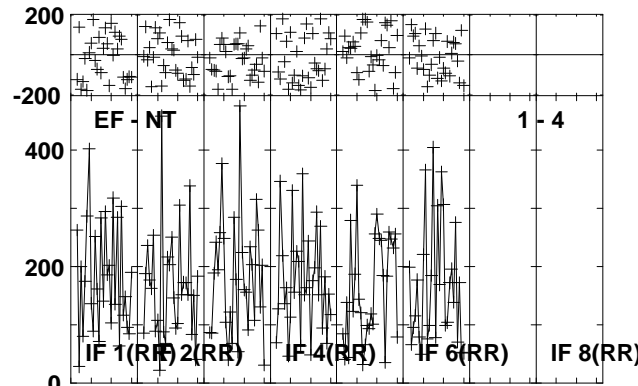
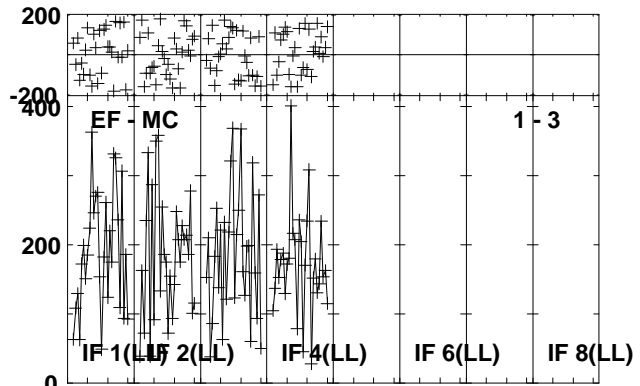
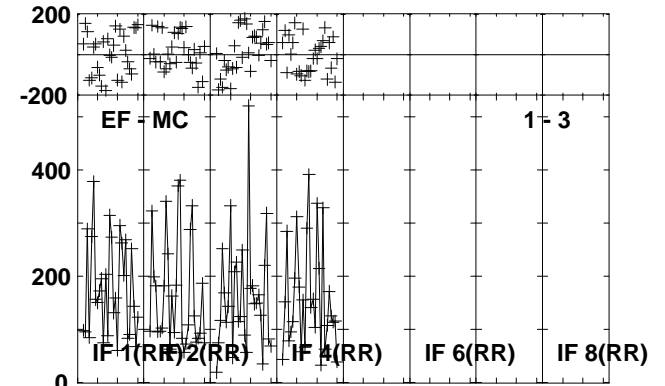
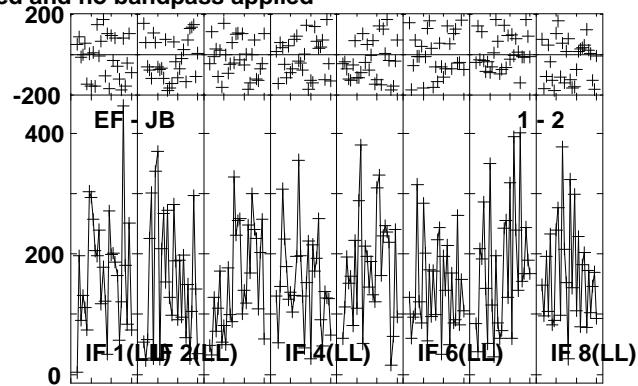
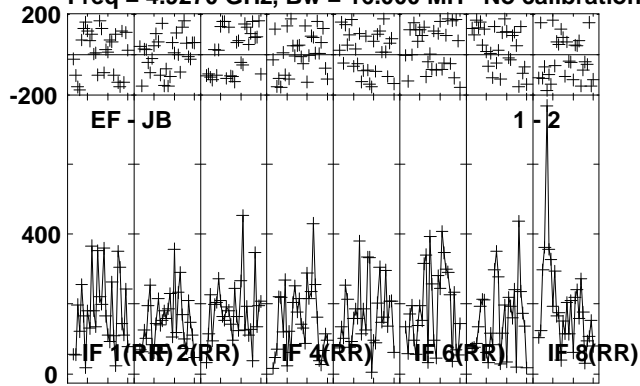

Lower frame: Micro Ampl Jy Top frame: Phas deg  
 Vector averaged cross-power spectrum Several baselines displayed  
 Timerange: 00/20:04:28 to 00/20:06:54

Plot file version 292 created 24-OCT-2012 21:00:49

G23.6-0.03 EY017B.UVDATA.1

Freq = 4.9270 GHz, Bw = 16.000 MH No calibration applied and no bandpass applied

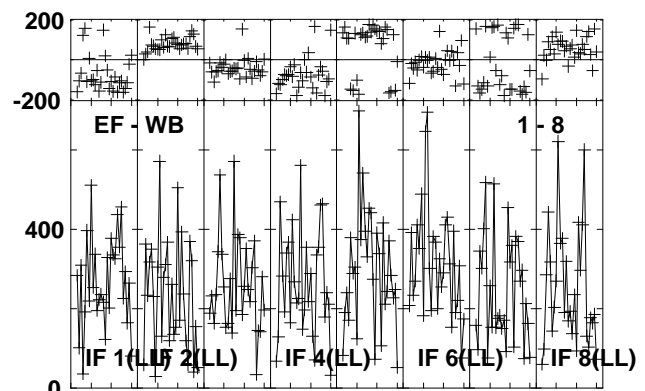
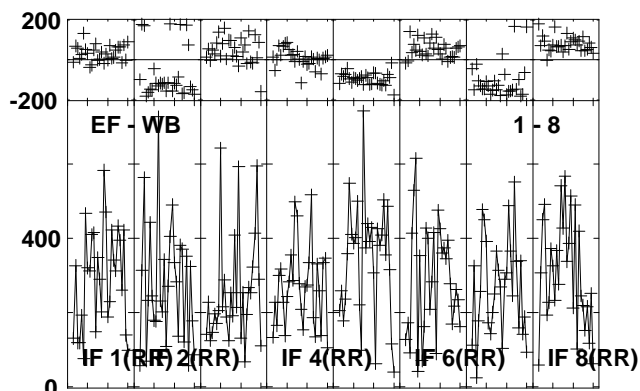
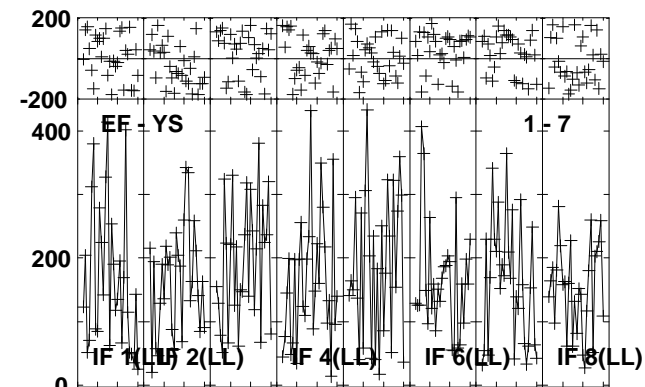
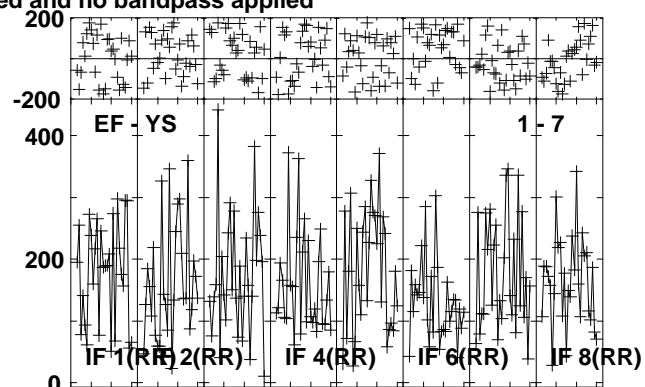
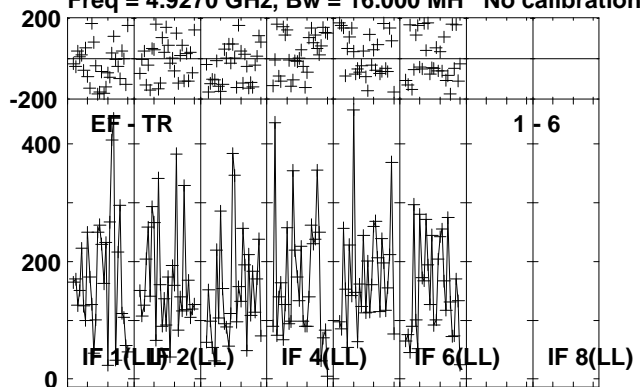

Lower frame: Micro Ampl Jy Top frame: Phas deg  
Vector averaged cross-power spectrum Several baselines displayed  
Timerange: 00/20:04:28 to 00/20:06:54



Plot file version 293 created 24-OCT-2012 21:00:49

J1825-0737 EY017B.UVDATA.1

Freq = 4.9270 GHz, Bw = 16.000 MH No calibration applied and no bandpass applied

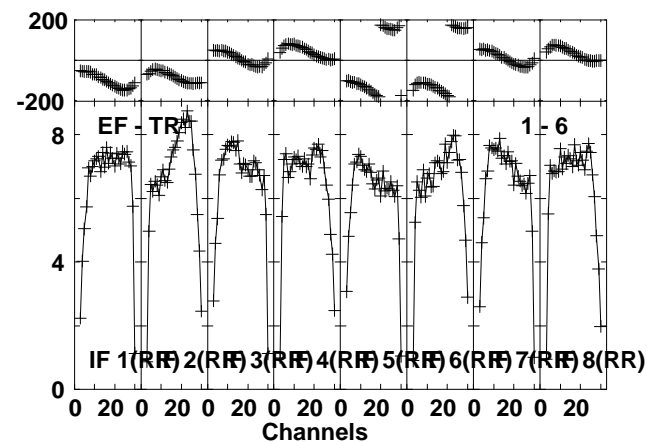
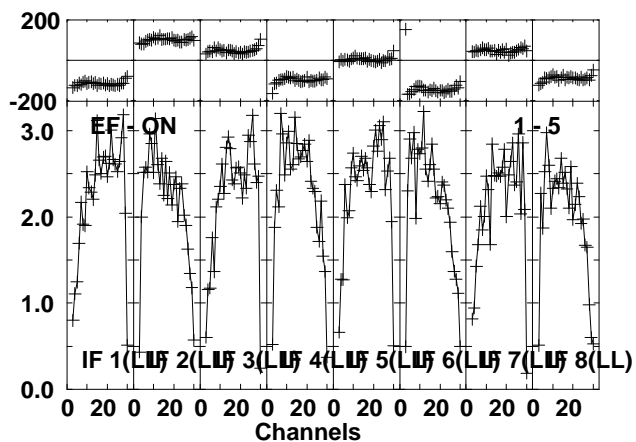
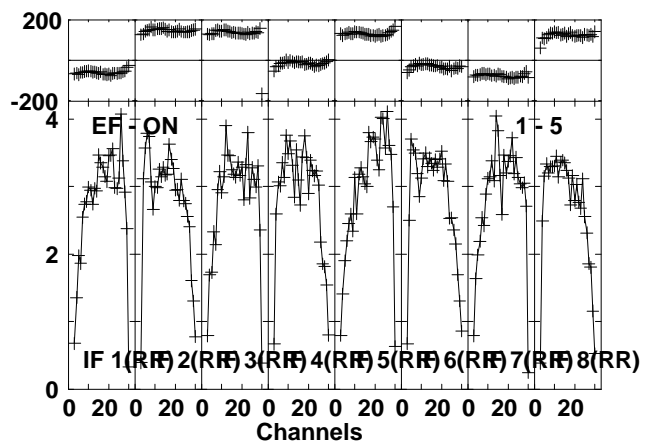
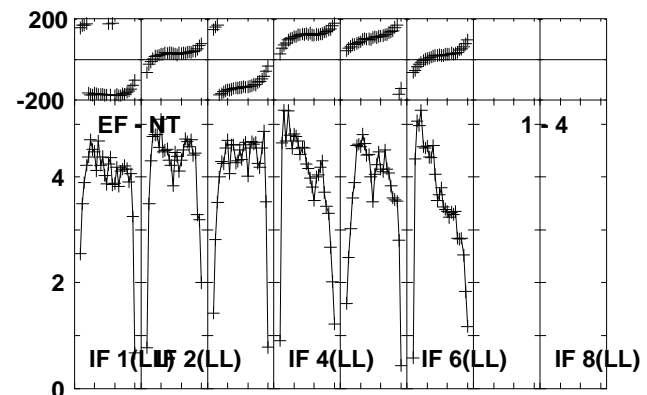
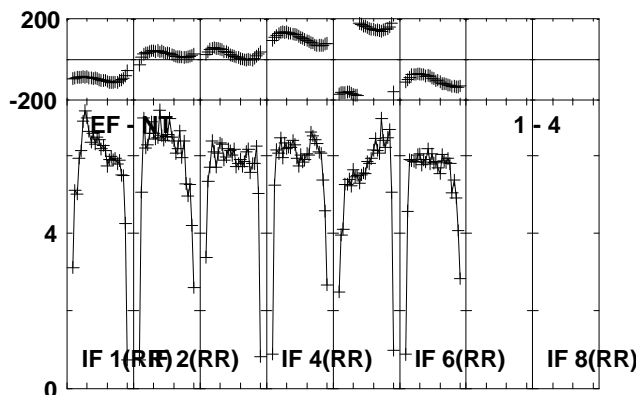
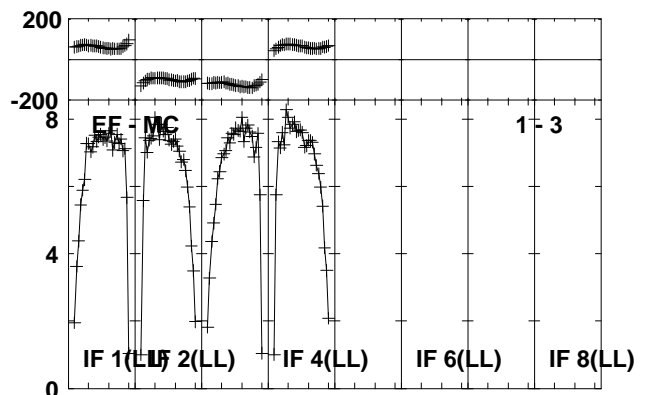
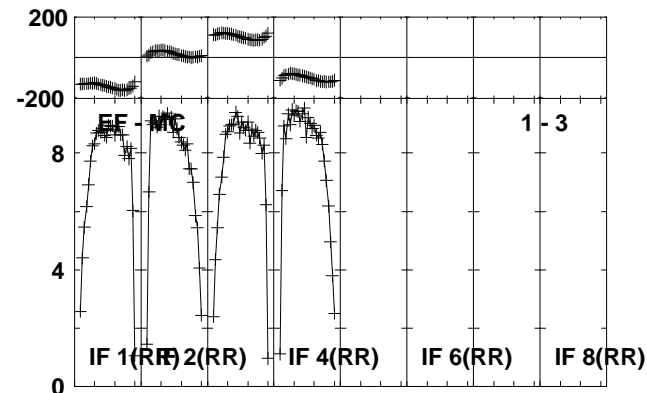
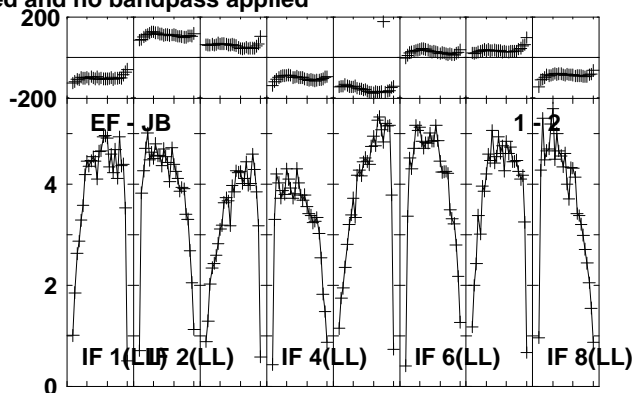
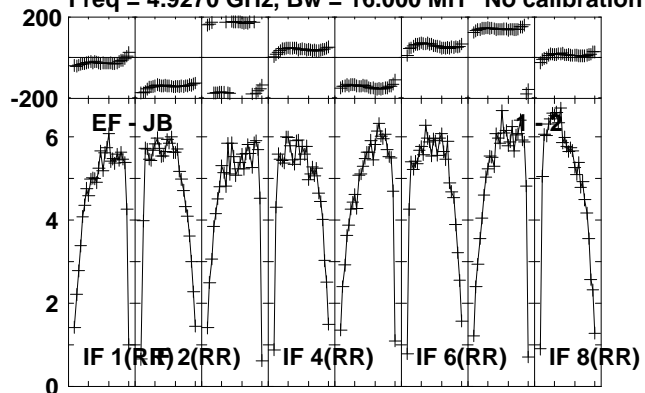

Lower frame: Milli Ampl Jy Top frame: Phas deg  
Vector averaged cross-power spectrum Several baselines displayed  
Timerange: 00/20:06:58 to 00/20:08:24

Plot file version 294 created 24-OCT-2012 21:00:50

J1825-0737 EY017B.UVDATA.1

Freq = 4.9270 GHz, Bw = 16.000 MH No calibration applied and no bandpass applied

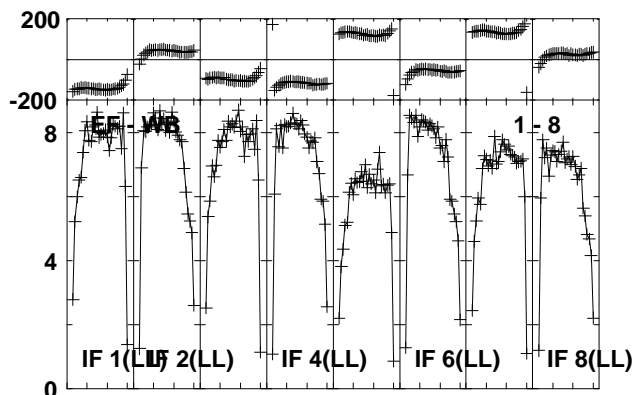
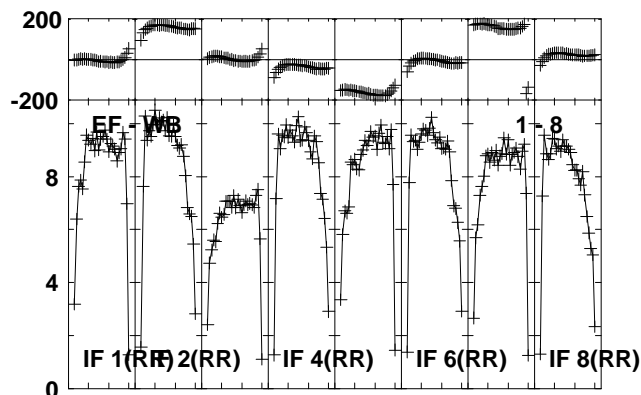
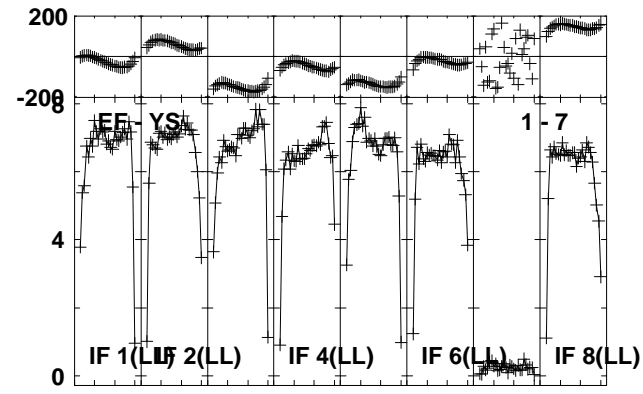
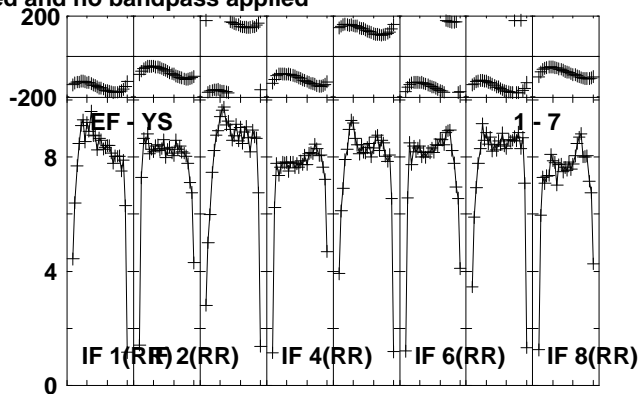
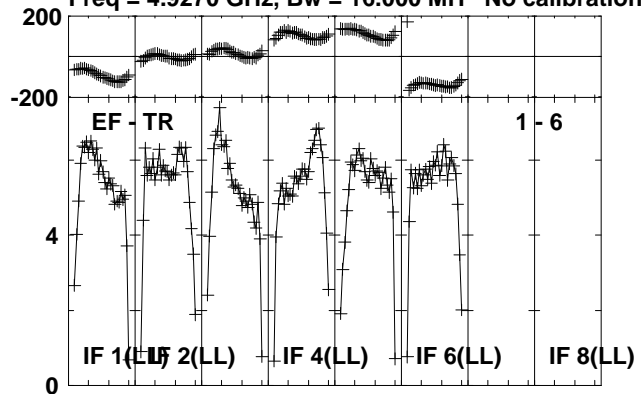

Lower frame: Milli Ampl Jy Top frame: Phas deg  
Vector averaged cross-power spectrum Several baselines displayed  
Timerange: 00/20:06:58 to 00/20:08:24

Plot file version 295 created 24-OCT-2012 21:00:50

G23.6-0.03 EY017B.UVDATA.1

Freq = 4.9270 GHz, Bw = 16.000 MH No calibration applied and no bandpass applied

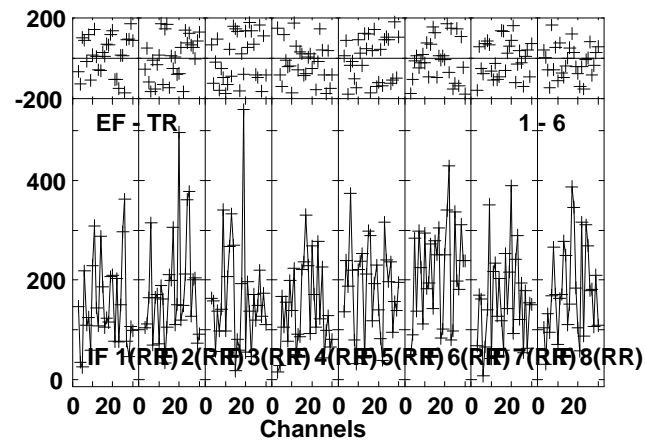
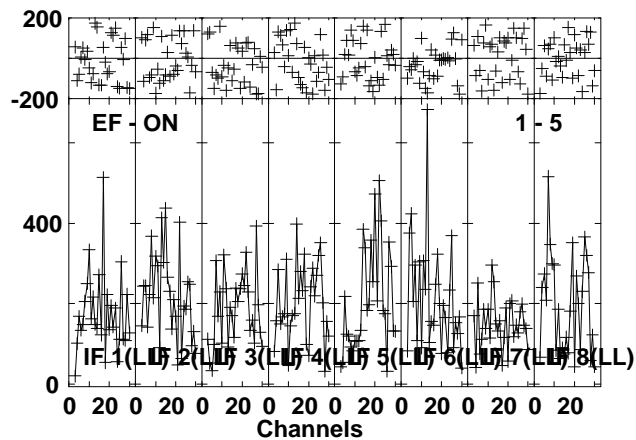
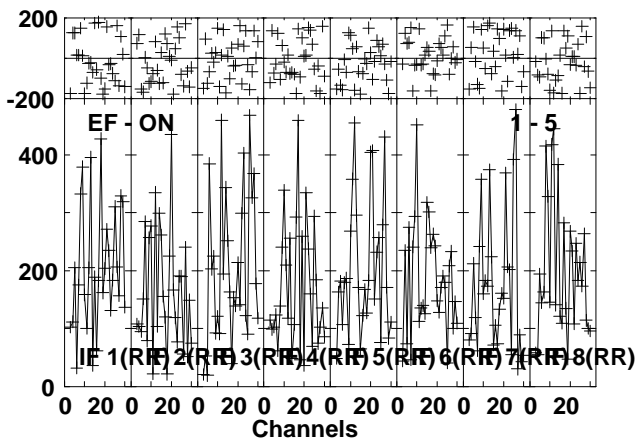
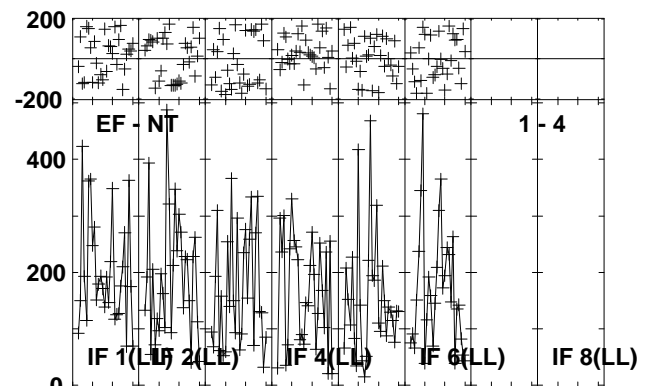
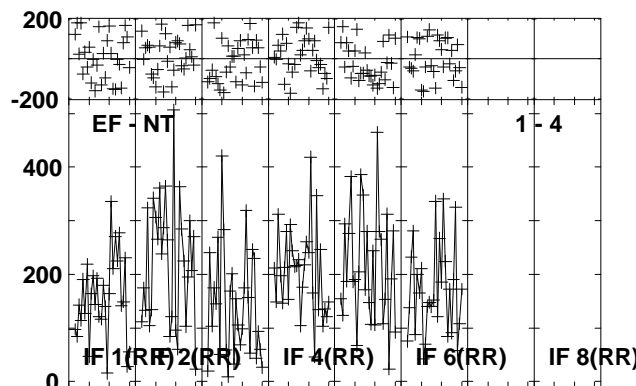
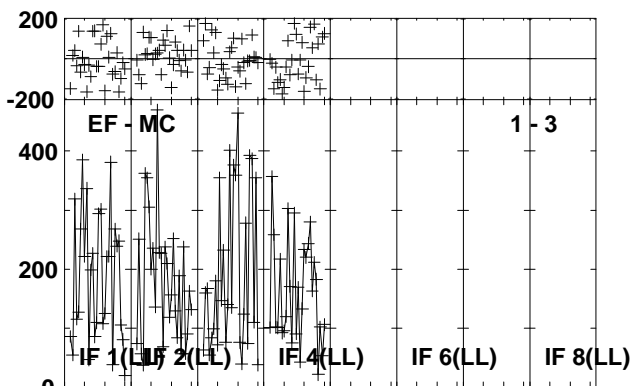
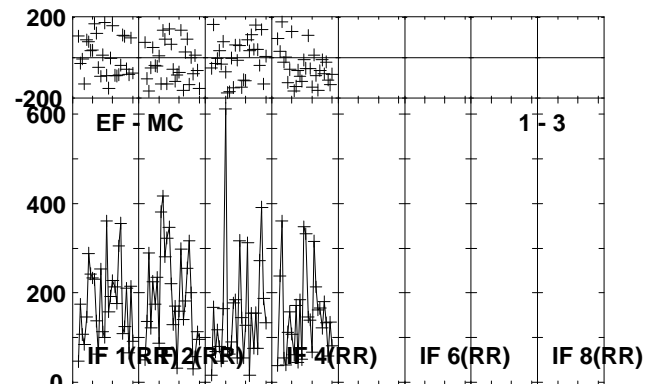
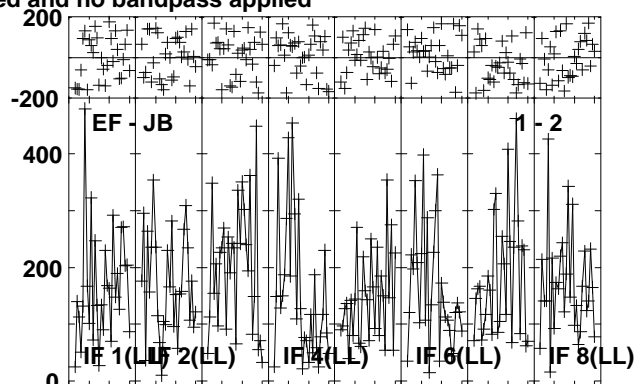
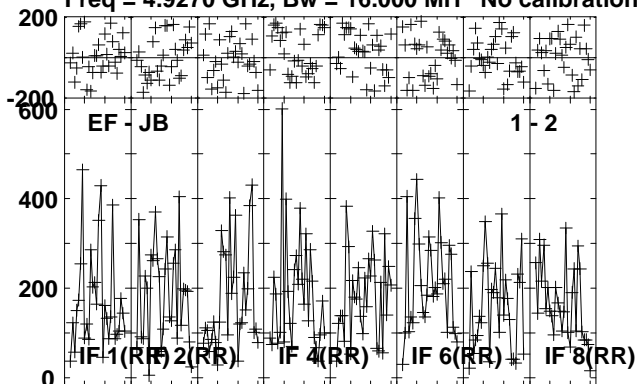

Lower frame: Micro Ampl Jy Top frame: Phas deg  
Vector averaged cross-power spectrum Several baselines displayed  
Timerange: 00/20:08:28 to 00/20:10:54

Plot file version 296 created 24-OCT-2012 21:00:51

G23.6-0.03 EY017B.UVDATA.1

Freq = 4.9270 GHz, Bw = 16.000 MH No calibration applied and no bandpass applied

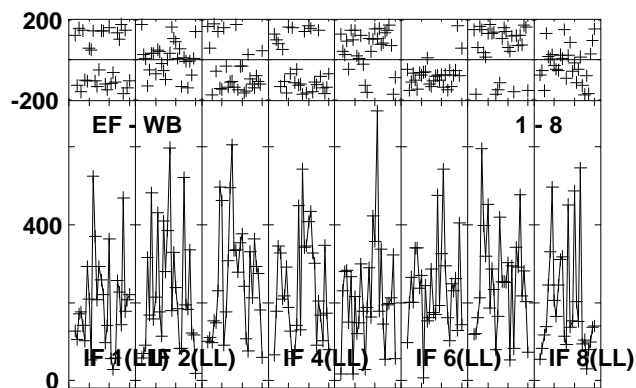
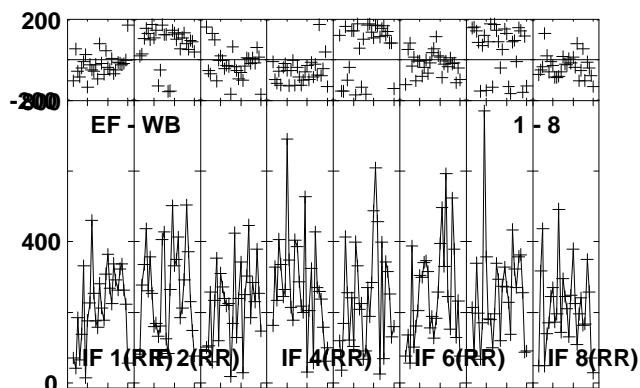
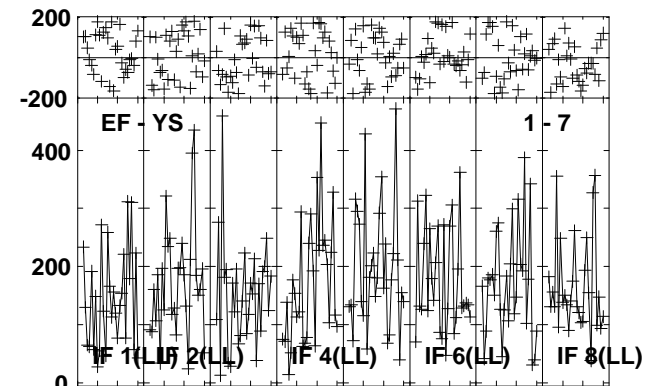
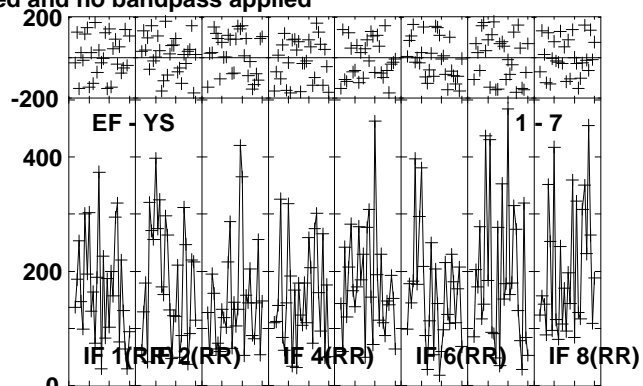
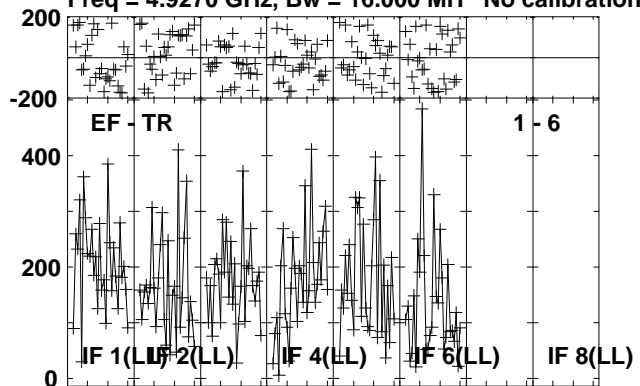

Lower frame: Micro Ampl Jy Top frame: Phas deg  
Vector averaged cross-power spectrum Several baselines displayed  
Timerange: 00/20:08:28 to 00/20:10:54

Plot file version 297 created 24-OCT-2012 21:00:51

J1825-0737 EY017B.UVDATA.1

Freq = 4.9270 GHz, Bw = 16.000 MH No calibration applied and no bandpass applied

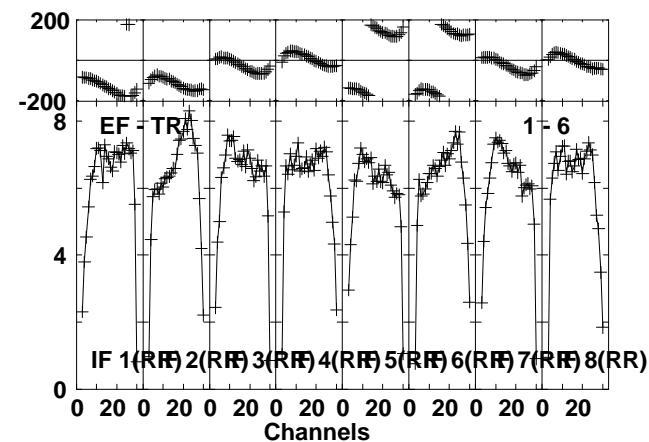
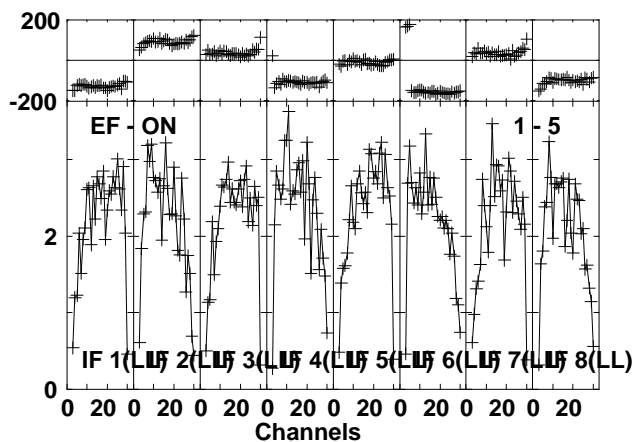
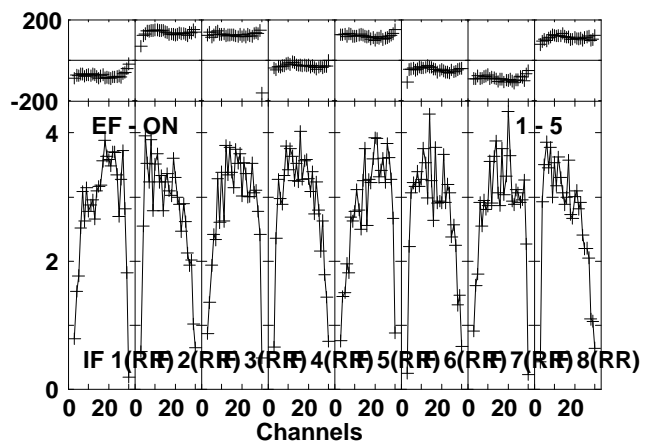
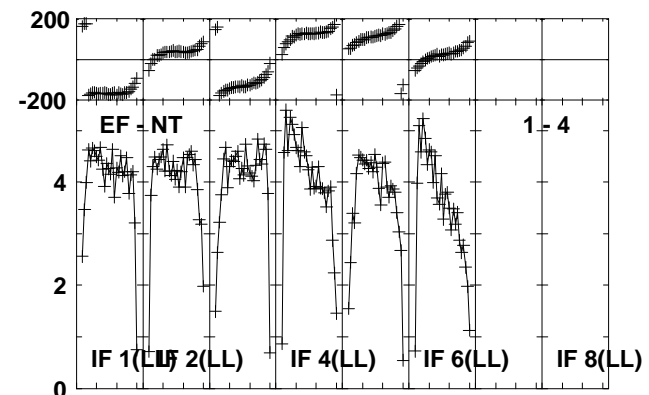
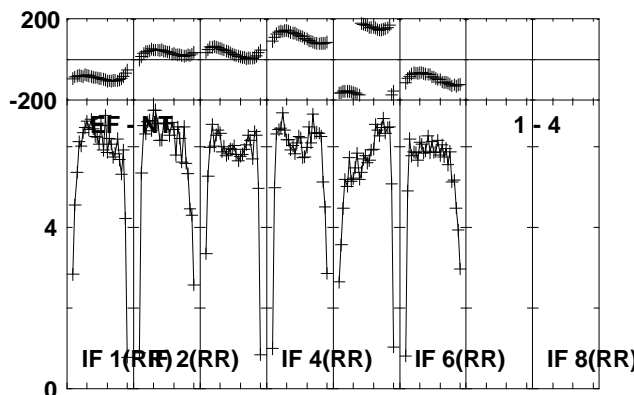
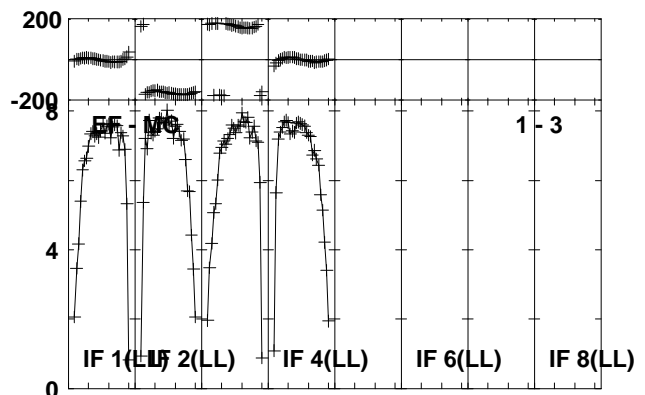
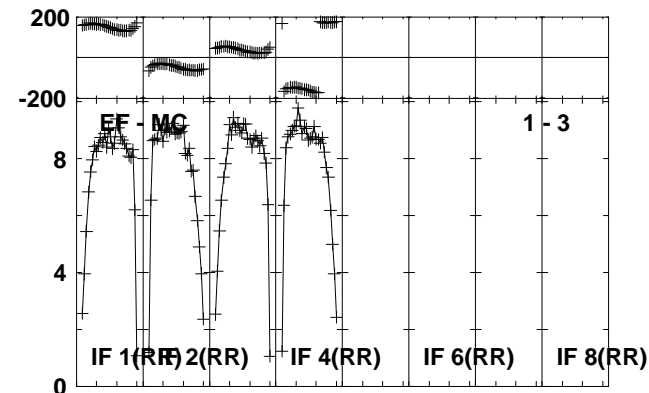
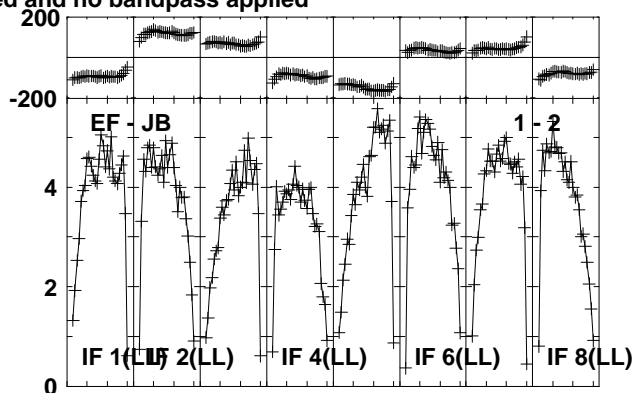
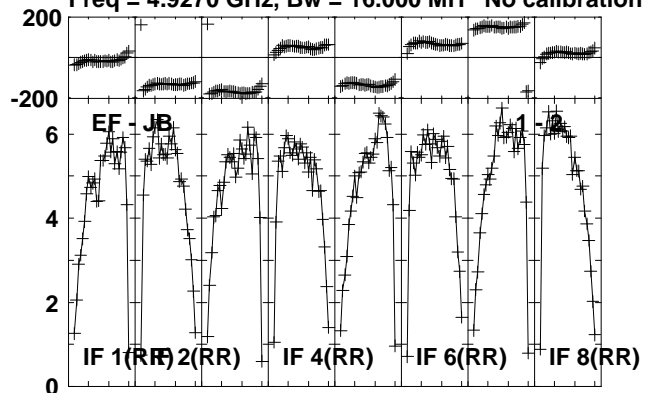

Lower frame: Milli Ampl Jy Top frame: Phas deg  
Vector averaged cross-power spectrum Several baselines displayed  
Timerange: 00/20:10:58 to 00/20:12:24

Plot file version 298 created 24-OCT-2012 21:00:52

J1825-0737 EY017B.UVDATA.1

Freq = 4.9270 GHz, Bw = 16.000 MH No calibration applied and no bandpass applied

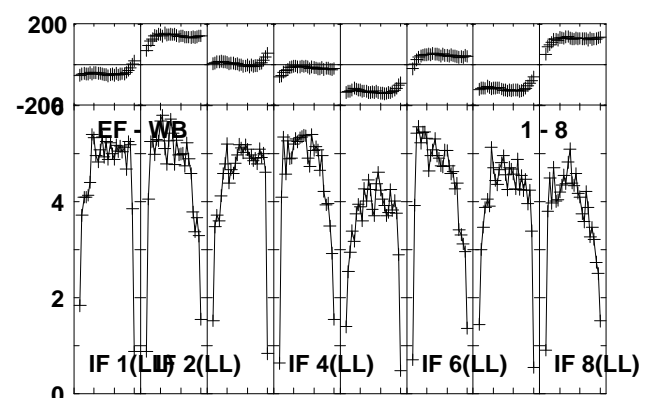
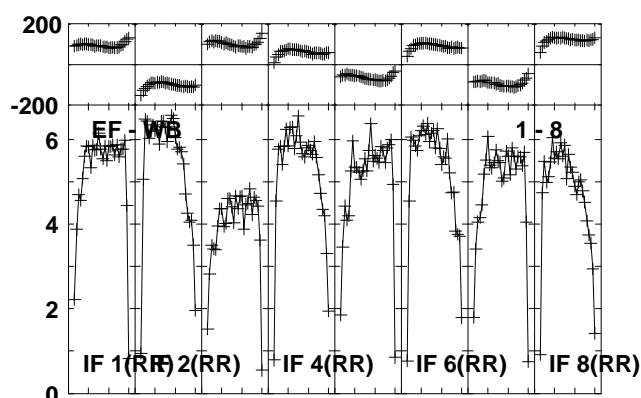
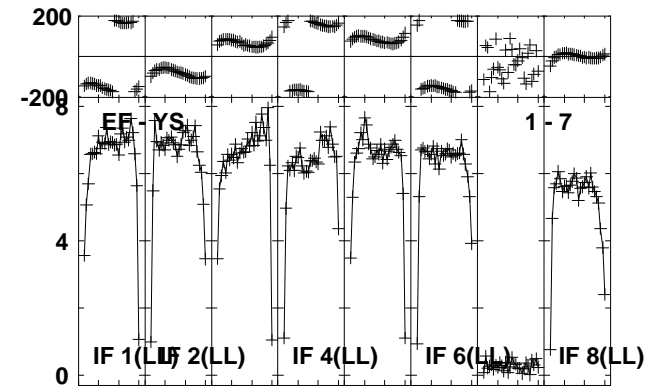
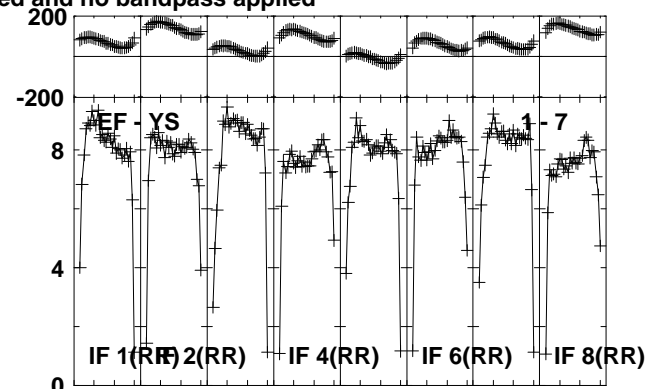
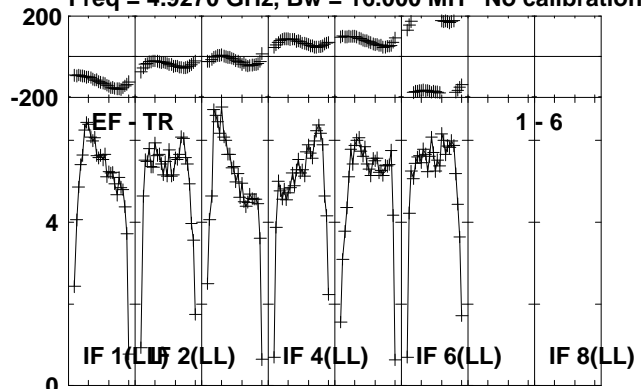

Lower frame: Milli Ampl Jy Top frame: Phas deg  
Vector averaged cross-power spectrum Several baselines displayed  
Timerange: 00/20:10:58 to 00/20:12:24

Plot file version 299 created 24-OCT-2012 21:00:52

G23.6-0.03 EY017B.UVDATA.1

Freq = 4.9270 GHz, Bw = 16.000 MH No calibration applied and no bandpass applied

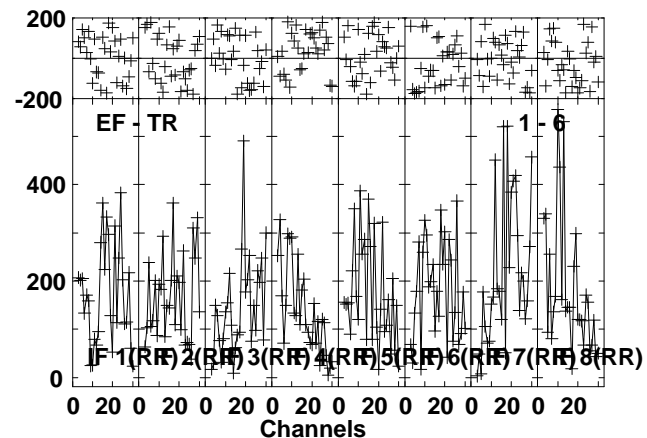
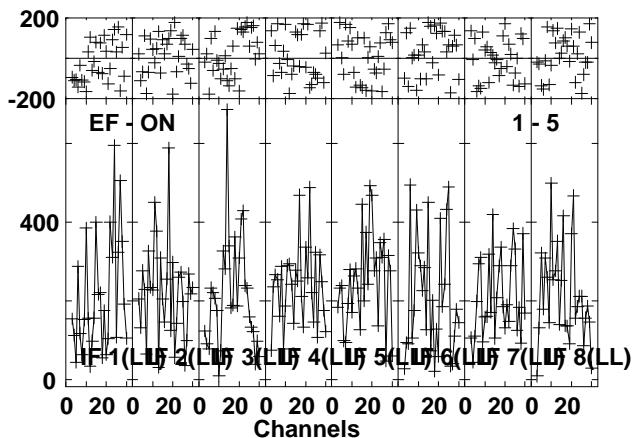
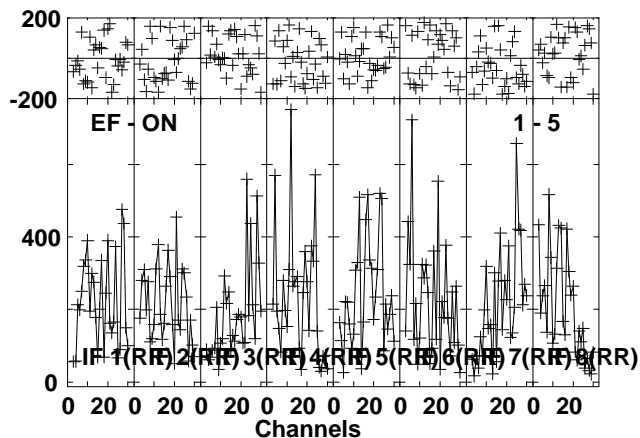
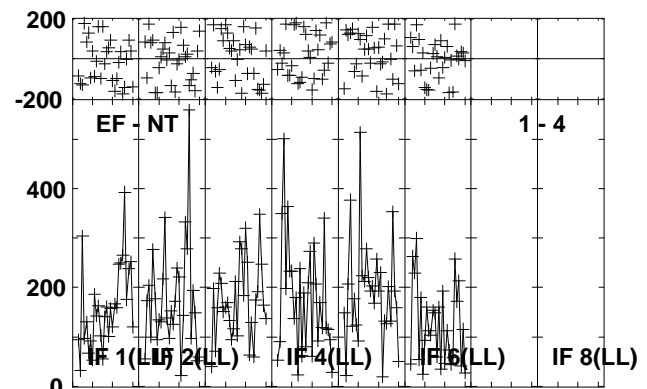
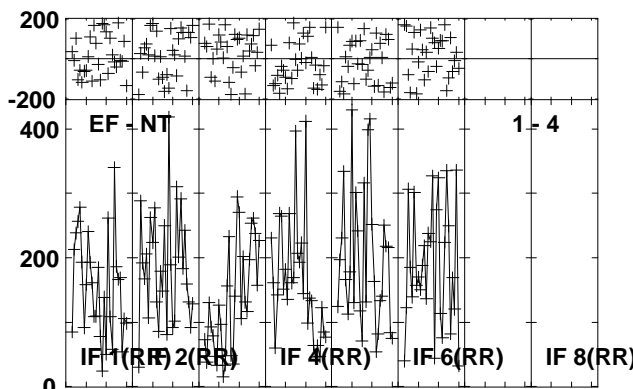
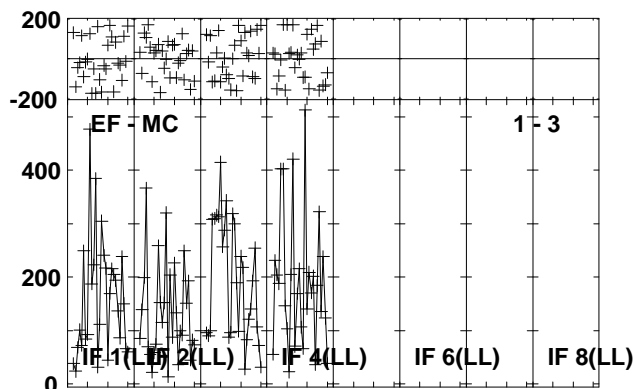
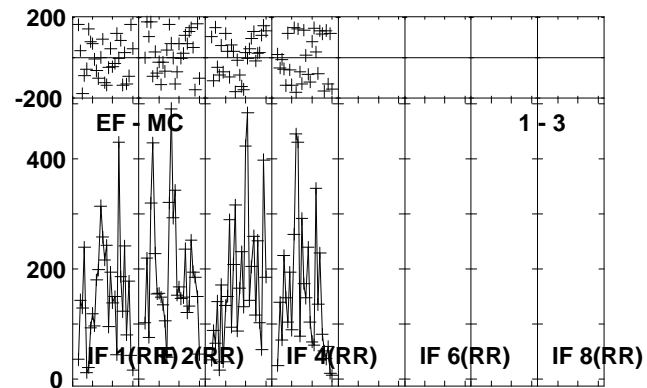
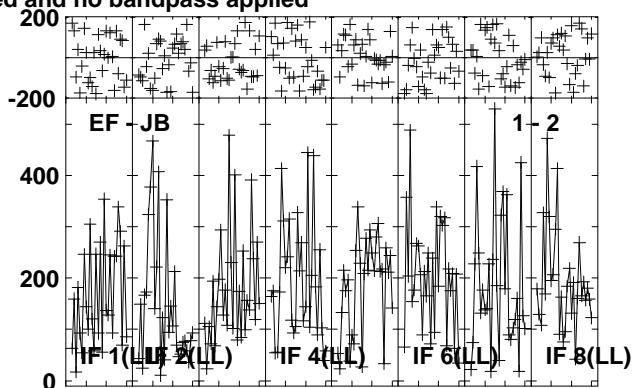
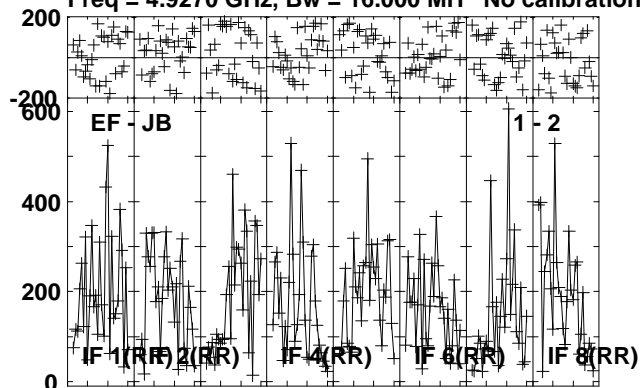

Lower frame: Micro Ampl Jy Top frame: Phas deg  
Vector averaged cross-power spectrum Several baselines displayed  
Timerange: 00/20:12:28 to 00/20:14:54

Plot file version 300 created 24-OCT-2012 21:00:53

G23.6-0.03 EY017B.UVDATA.1

Freq = 4.9270 GHz, Bw = 16.000 MH No calibration applied and no bandpass applied

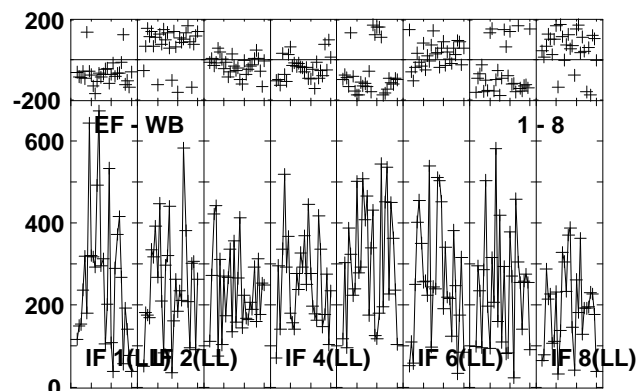
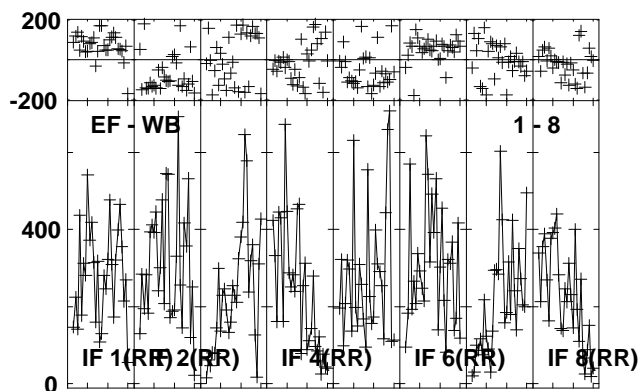
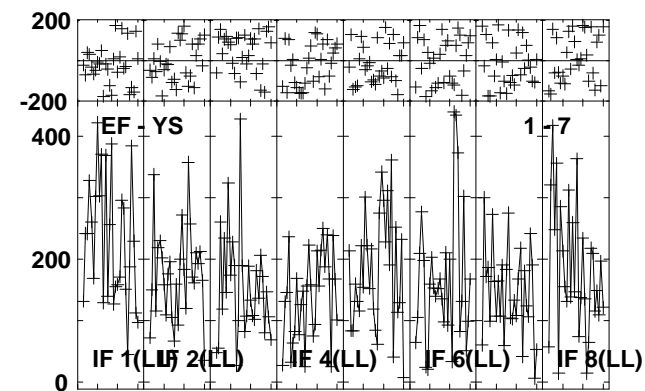
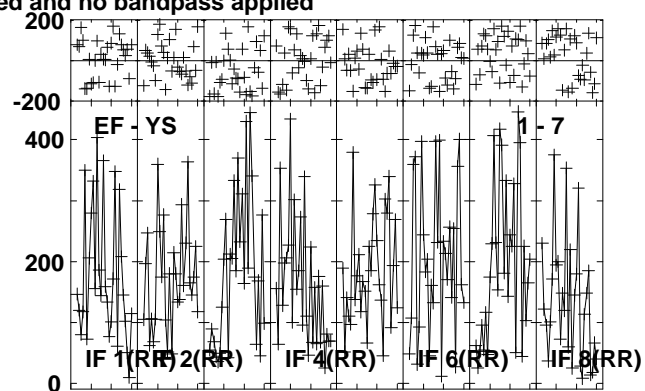
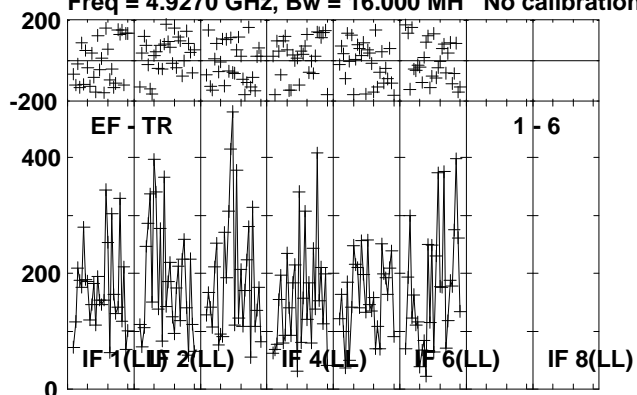

Lower frame: Micro Ampl Jy Top frame: Phas deg  
Vector averaged cross-power spectrum Several baselines displayed  
Timerange: 00/20:12:28 to 00/20:14:54



Plot file version 301 created 24-OCT-2012 21:00:54

J1825-0737 EY017B.UVDATA.1

Freq = 4.9270 GHz, Bw = 16.000 MH No calibration applied and no bandpass applied

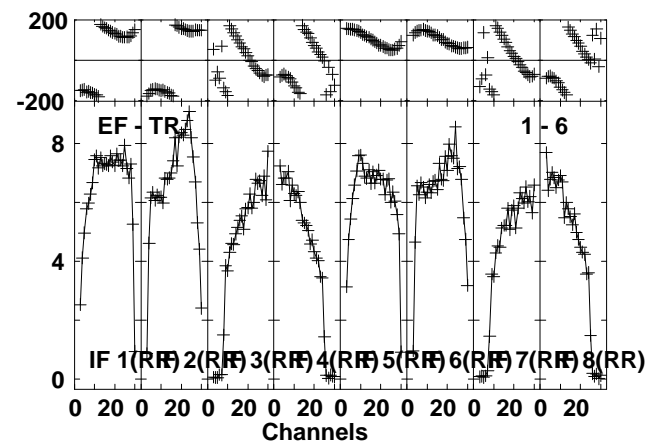
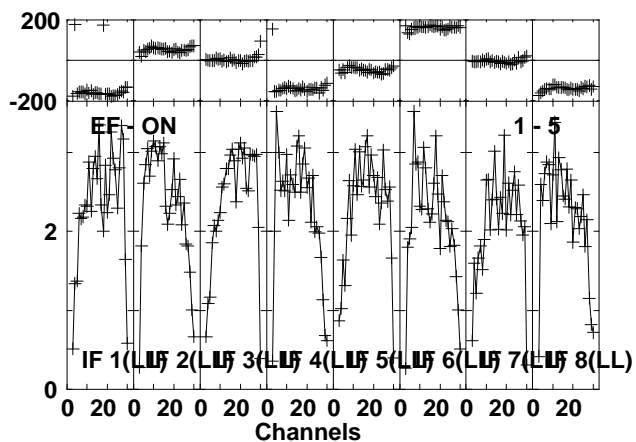
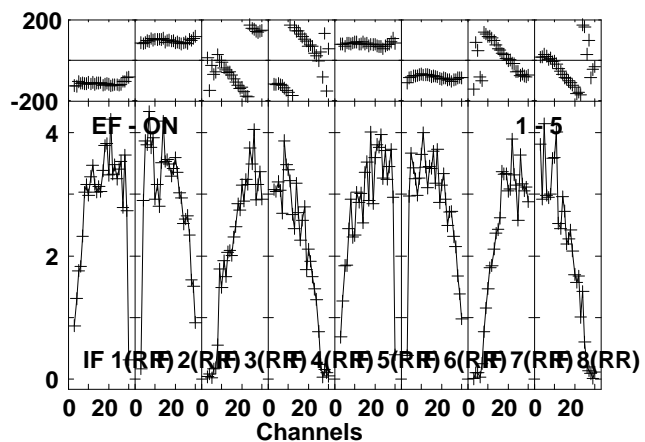
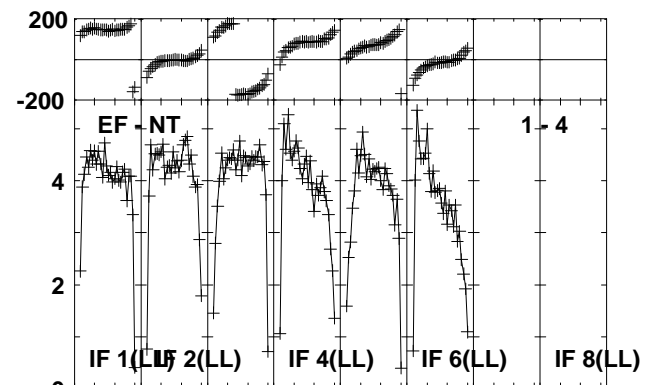
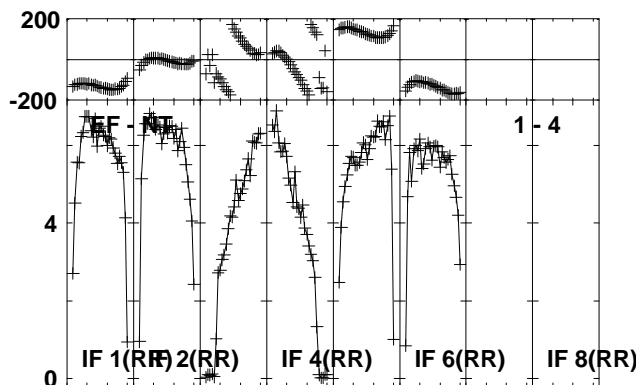
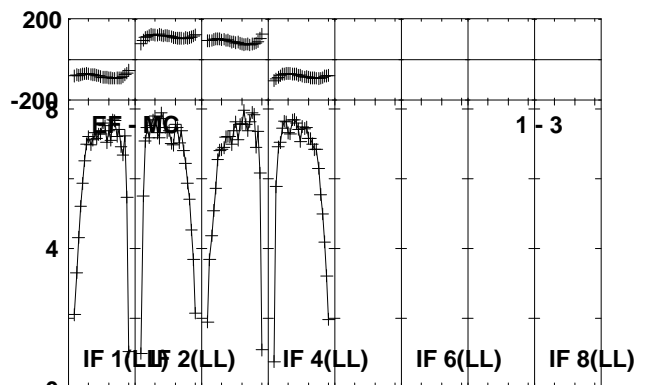
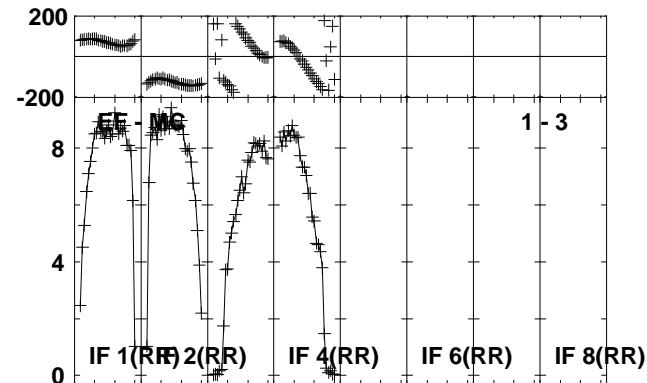
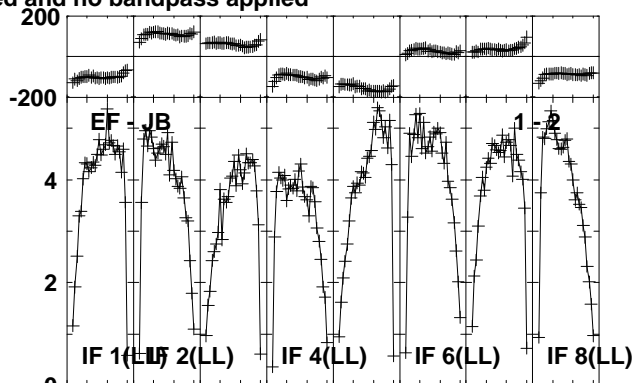
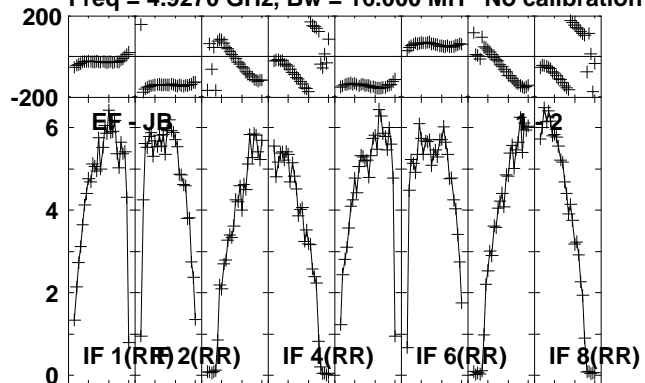

Lower frame: Milli Ampl Jy Top frame: Phas deg  
Vector averaged cross-power spectrum Several baselines displayed  
Timerange: 00/20:14:58 to 00/20:16:24

Plot file version 302 created 24-OCT-2012 21:00:54

J1825-0737 EY017B.UVDATA.1

Freq = 4.9270 GHz, Bw = 16.000 MH No calibration applied and no bandpass applied

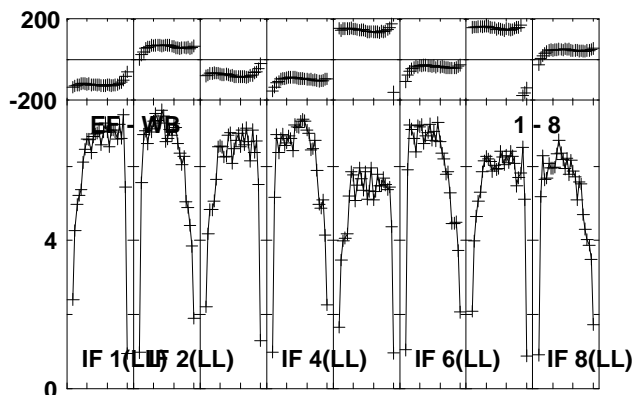
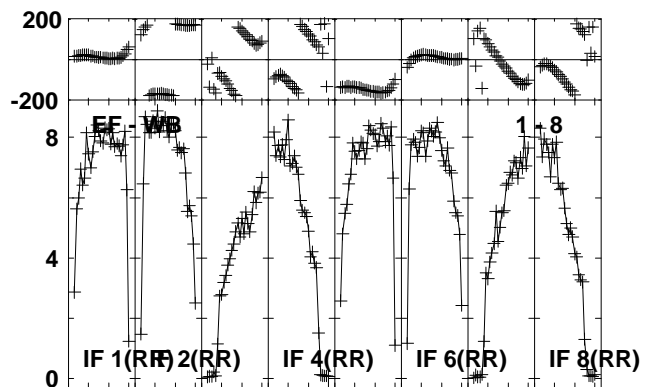
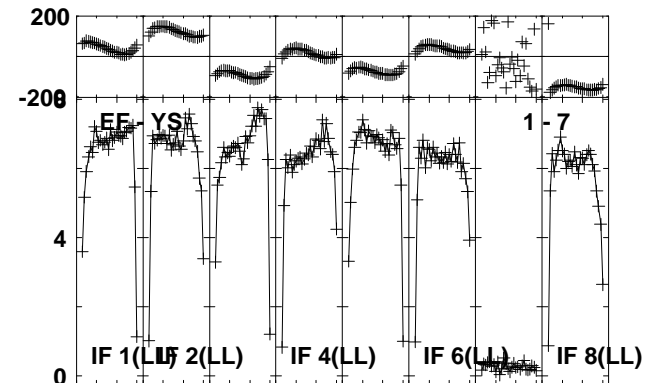
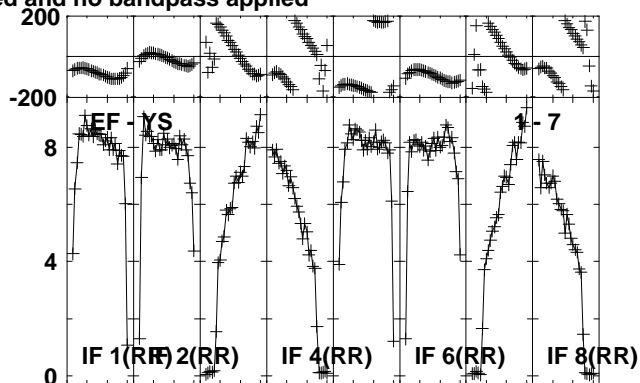
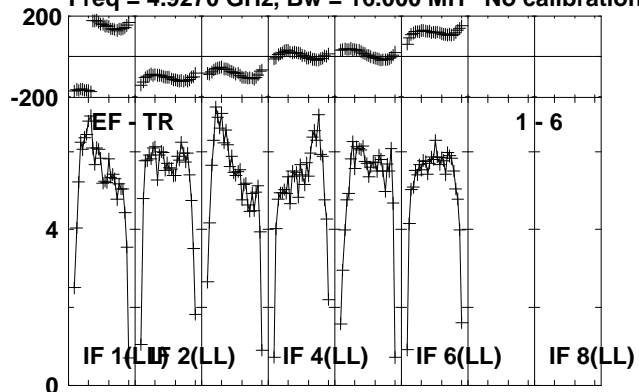

Lower frame: Milli Ampl Jy Top frame: Phas deg  
Vector averaged cross-power spectrum Several baselines displayed  
Timerange: 00/20:14:58 to 00/20:16:24

Plot file version 303 created 24-OCT-2012 21:00:54  
 J1831-0756 EY017B.UVDATA.1

Freq = 4.9270 GHz, Bw = 16.000 MH No calibration applied and no bandpass applied

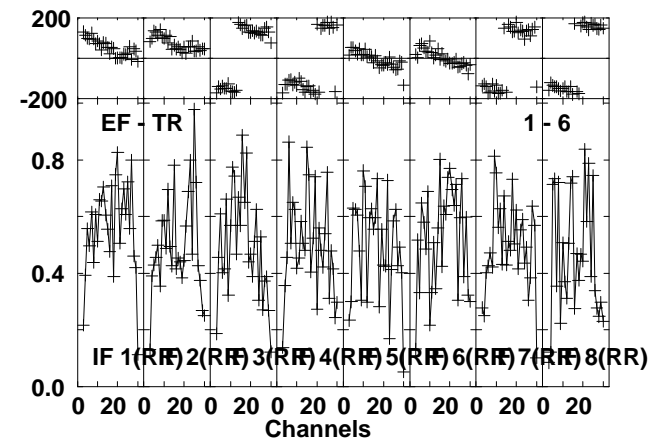
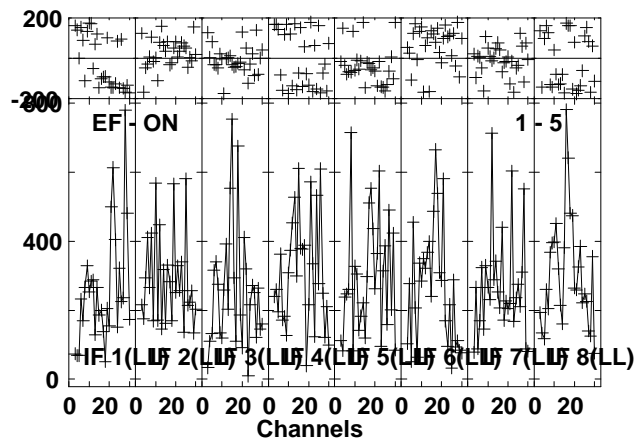
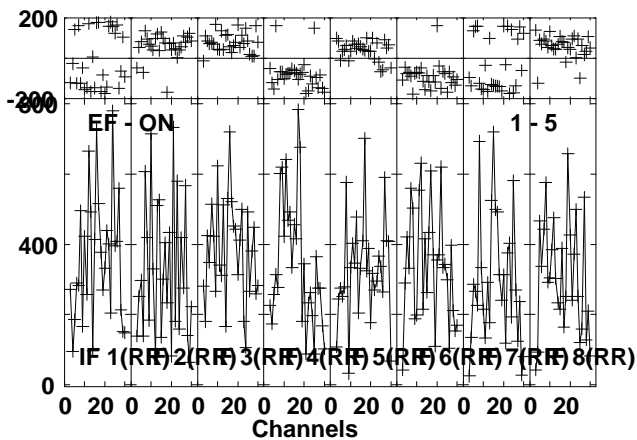
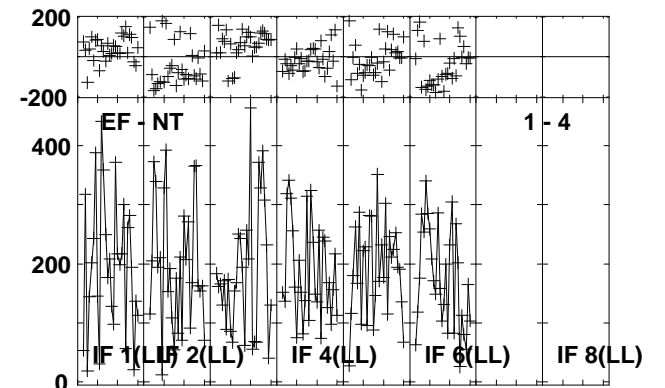
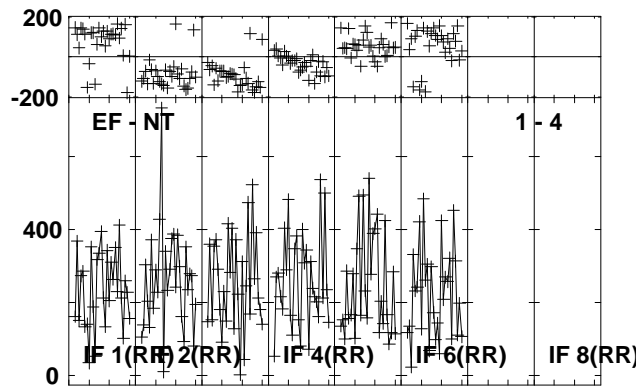
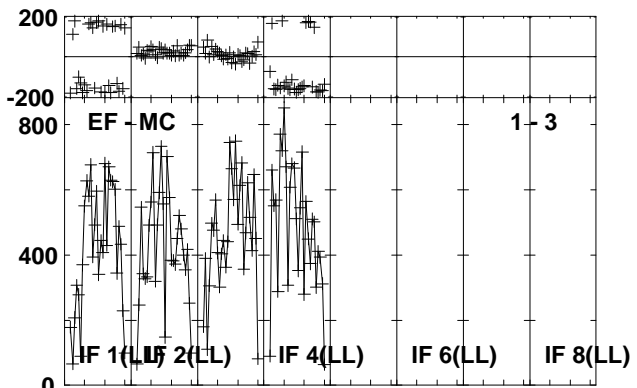
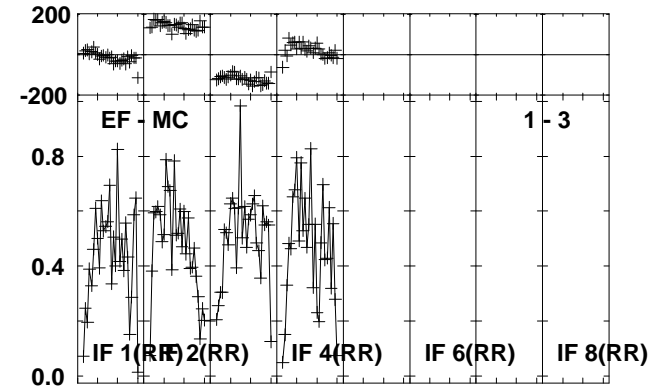
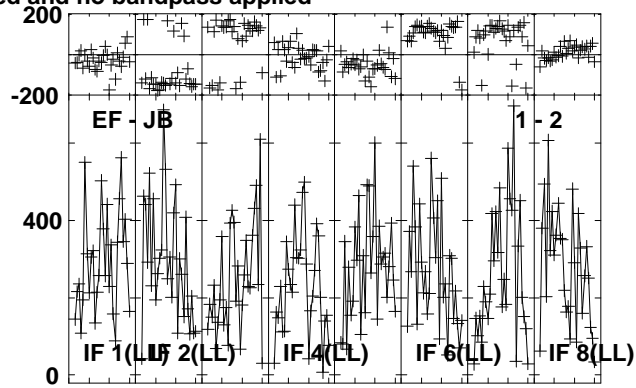
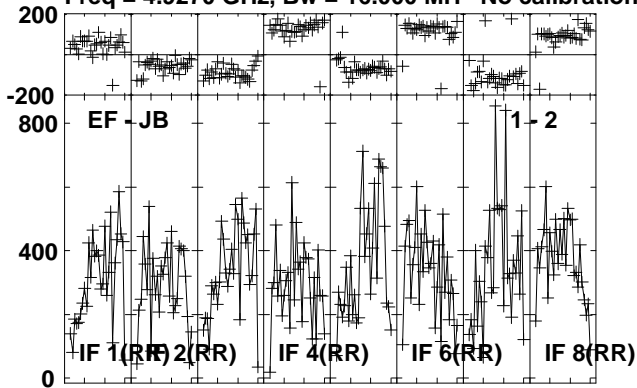

Lower frame: Micro Ampl Jy Top frame: Phas deg  
 Vector averaged cross-power spectrum Several baselines displayed  
 Timerange: 00/20:16:58 to 00/20:18:58

Plot file version 304 created 24-OCT-2012 21:00:55

J1831-0756 EY017B.UVDATA.1

Freq = 4.9270 GHz, Bw = 16.000 MH No calibration applied and no bandpass applied

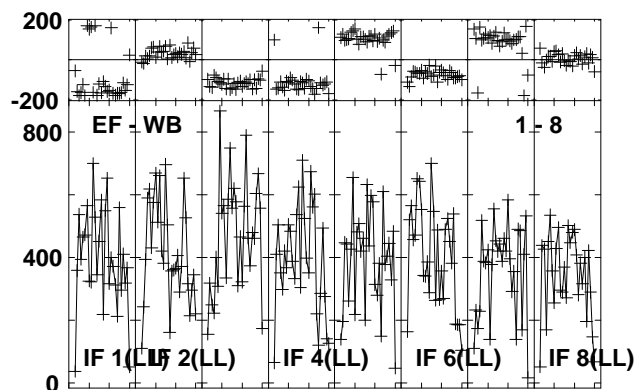
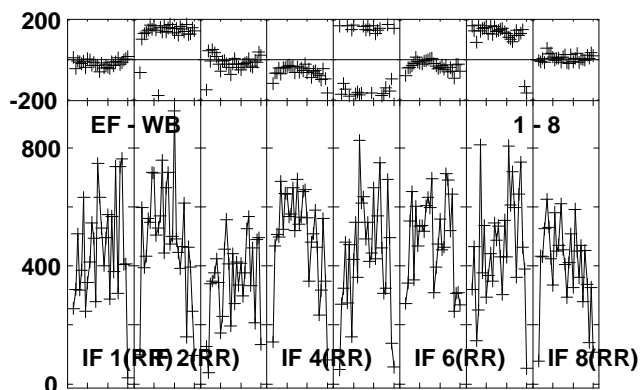
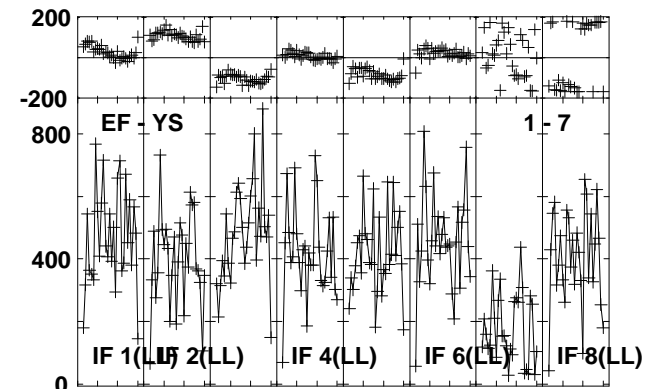
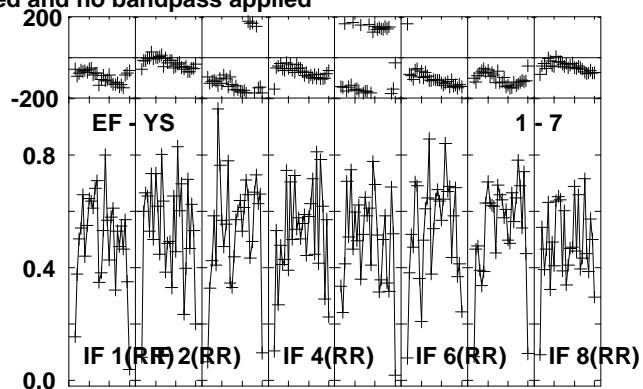
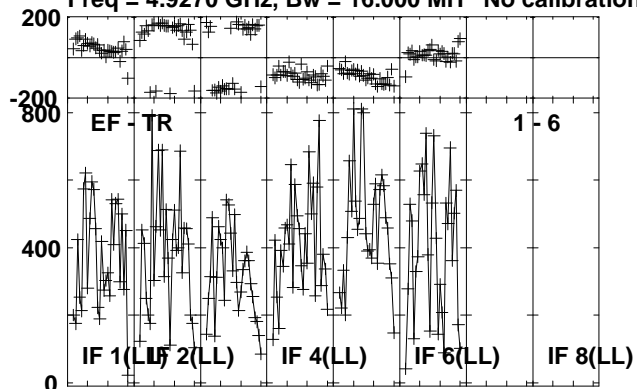

Lower frame: Micro Ampl Jy Top frame: Phas deg  
Vector averaged cross-power spectrum Several baselines displayed  
Timerange: 00/20:16:58 to 00/20:18:58

Plot file version 305 created 24-OCT-2012 21:00:56

J1825-0737 EY017B.UVDATA.1

Freq = 4.9270 GHz, Bw = 16.000 MH No calibration applied and no bandpass applied

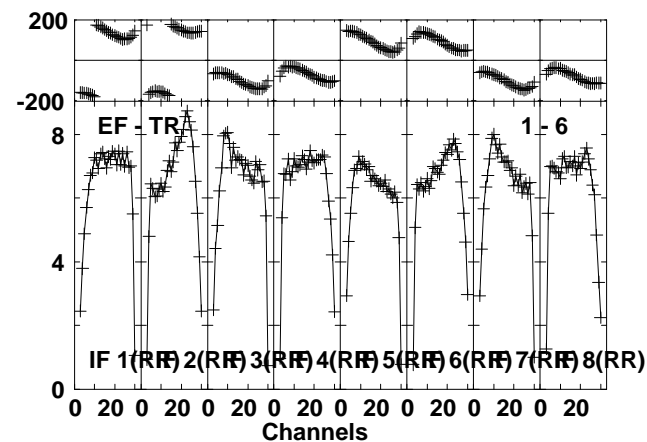
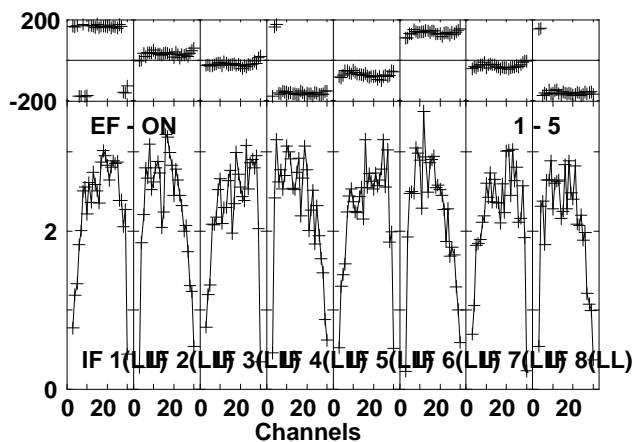
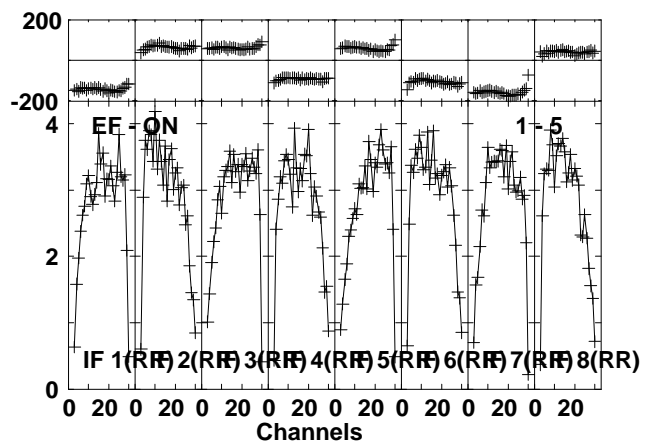
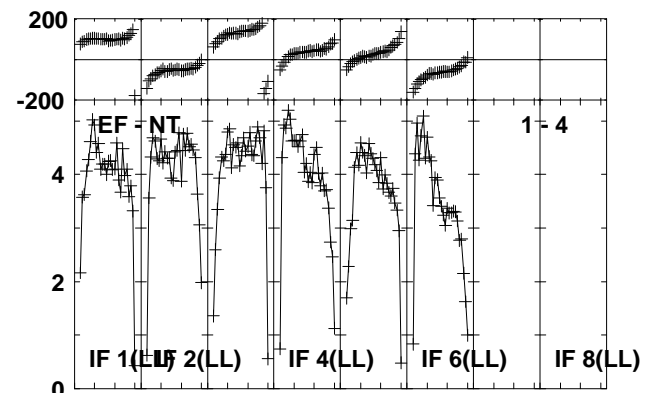
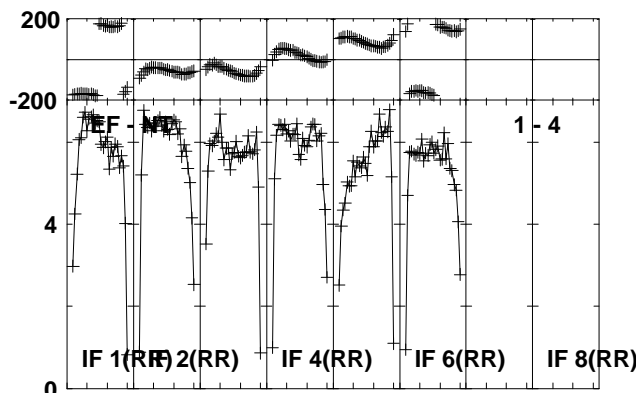
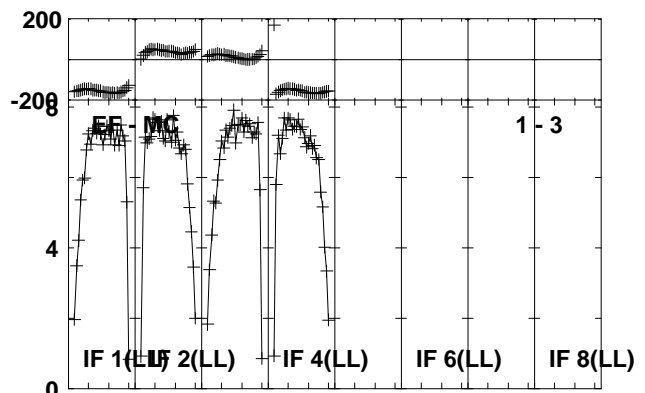
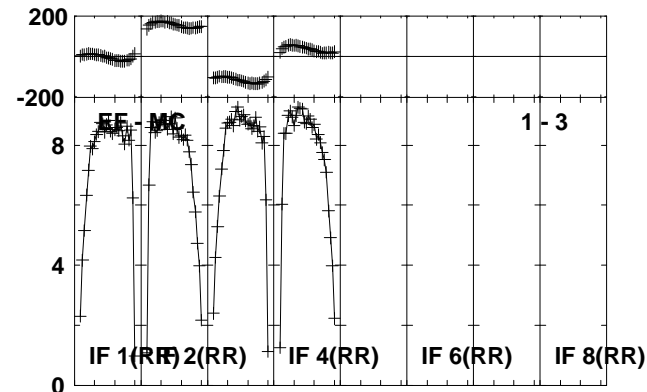
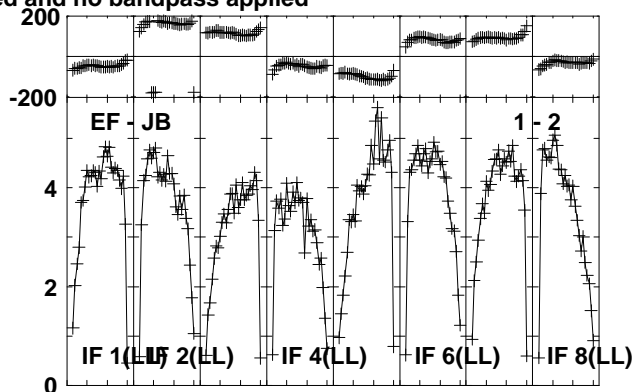
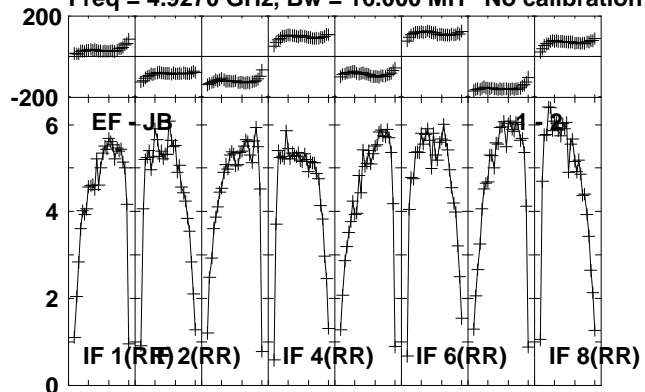

Lower frame: Milli Ampl Jy Top frame: Phas deg  
Vector averaged cross-power spectrum Several baselines displayed  
Timerange: 00/20:19:02 to 00/20:20:28

Plot file version 306 created 24-OCT-2012 21:00:56

J1825-0737 EY017B.UVDATA.1

Freq = 4.9270 GHz, Bw = 16.000 MH No calibration applied and no bandpass applied

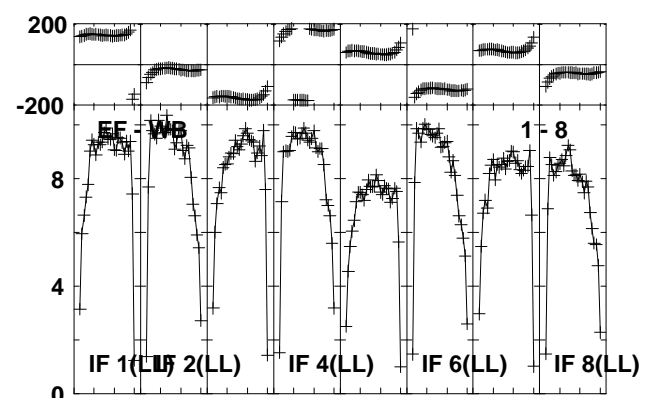
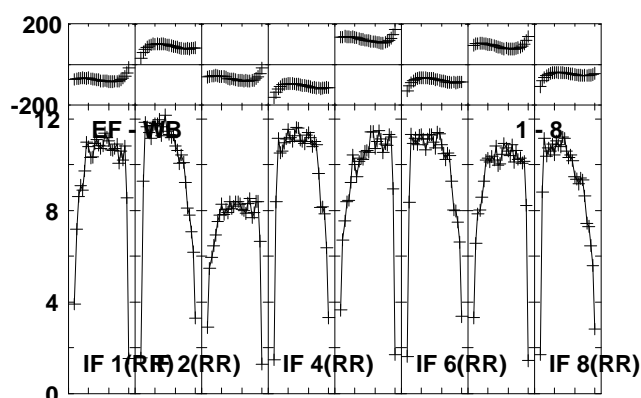
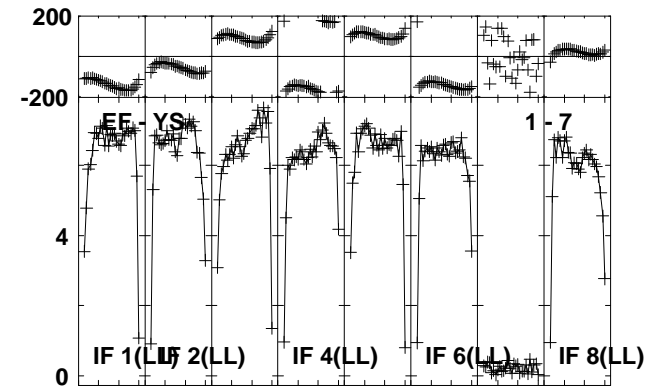
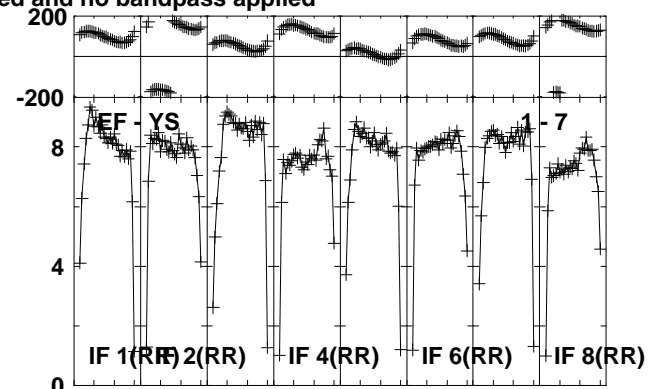
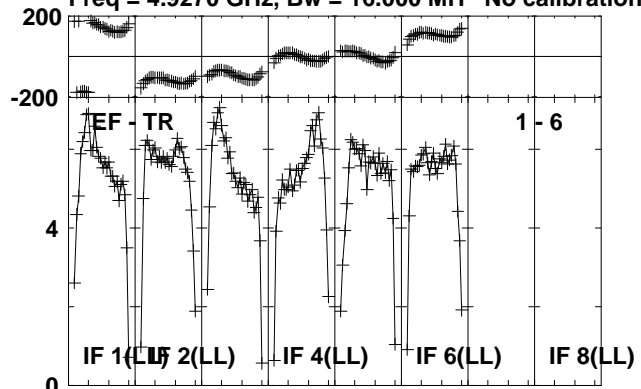

Lower frame: Milli Ampl Jy Top frame: Phas deg  
Vector averaged cross-power spectrum Several baselines displayed  
Timerange: 00/20:19:02 to 00/20:20:28

Plot file version 307 created 24-OCT-2012 21:00:57

G23.6-0.03 EY017B.UVDATA.1

Freq = 4.9270 GHz, Bw = 16.000 MH No calibration applied and no bandpass applied

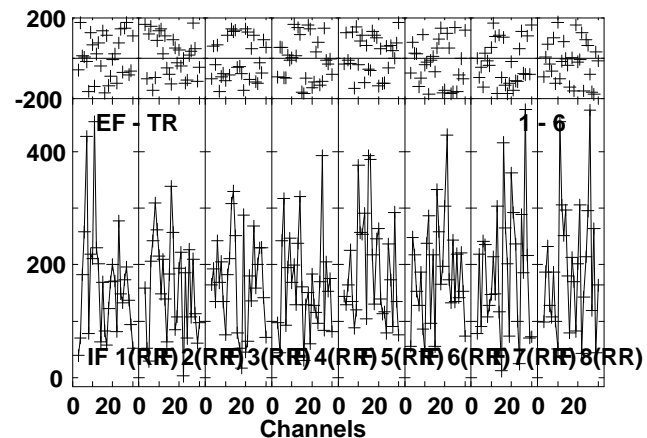
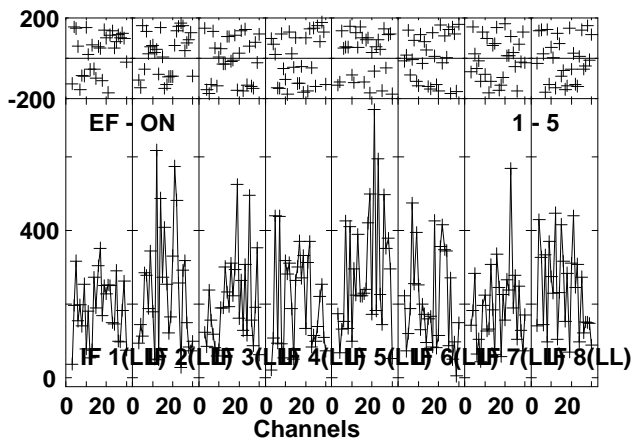
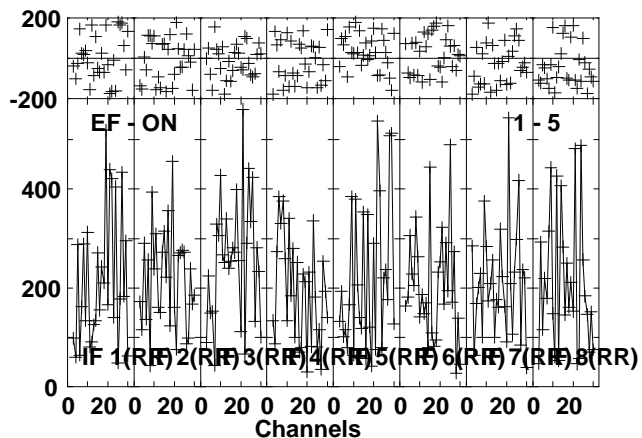
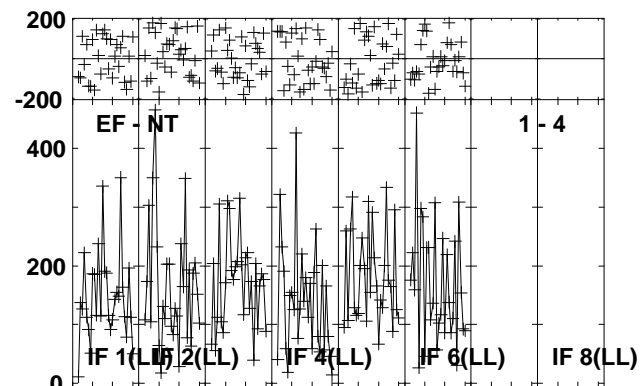
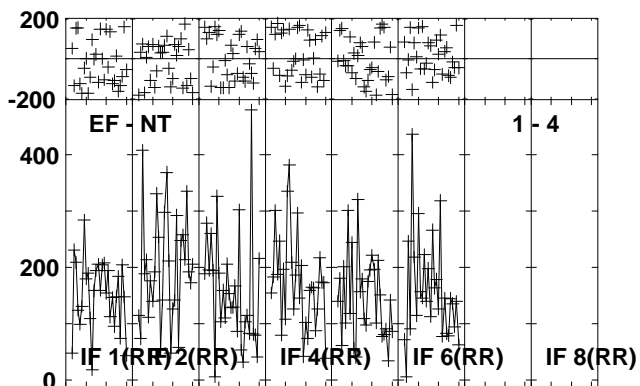
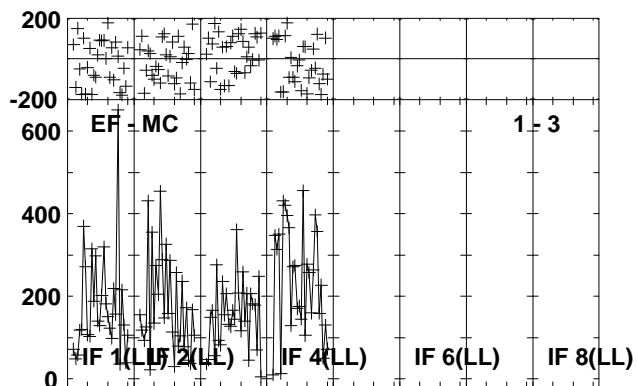
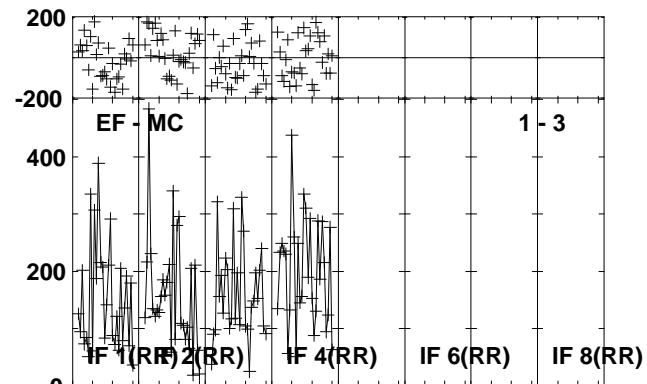
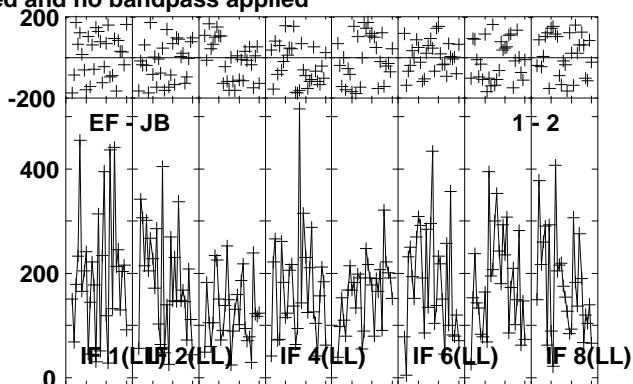
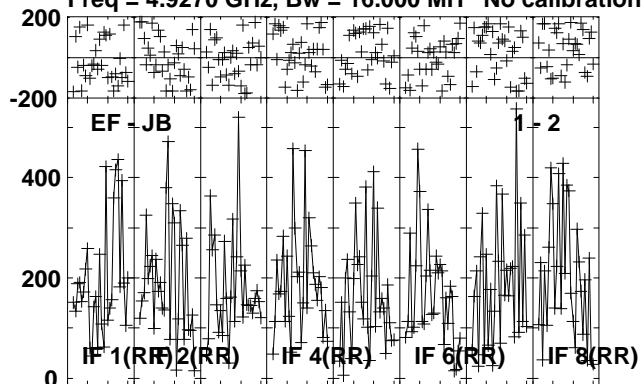

Lower frame: Micro Ampl Jy Top frame: Phas deg  
Vector averaged cross-power spectrum Several baselines displayed  
Timerange: 00/20:20:32 to 00/20:22:58

Plot file version 308 created 24-OCT-2012 21:00:57

G23.6-0.03 EY017B.UVDATA.1

Freq = 4.9270 GHz, Bw = 16.000 MH No calibration applied and no bandpass applied

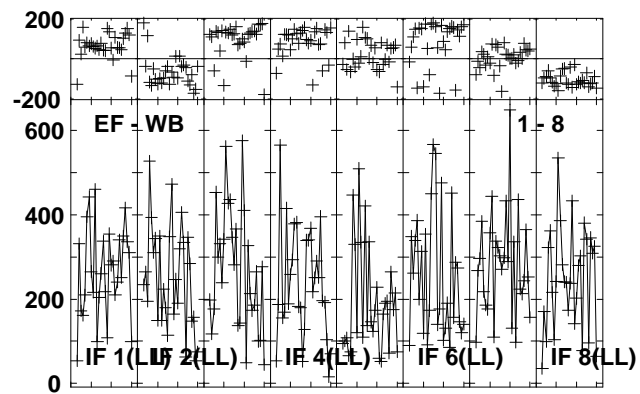
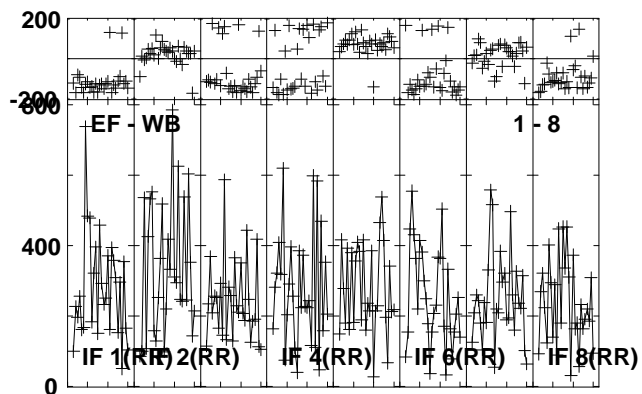
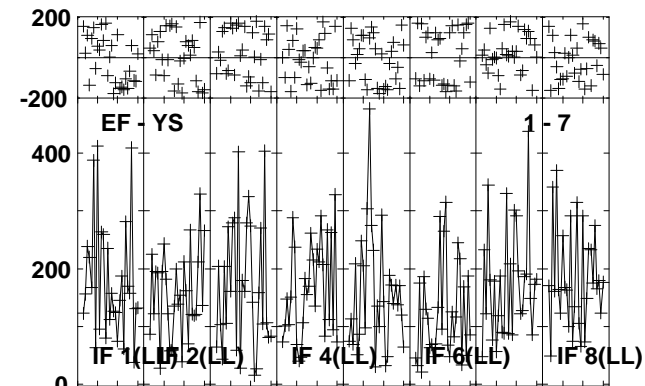
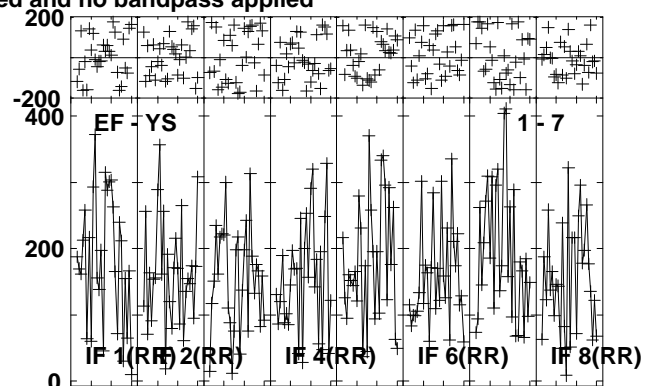
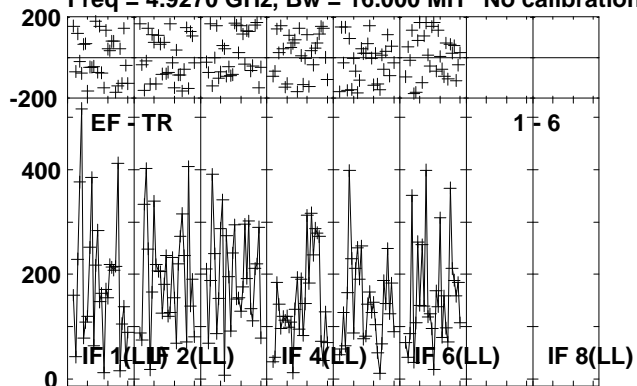

Lower frame: Micro Ampl Jy Top frame: Phas deg  
Vector averaged cross-power spectrum Several baselines displayed  
Timerange: 00/20:20:32 to 00/20:22:58



Plot file version 309 created 24-OCT-2012 21:00:58

J1825-0737 EY017B.UVDATA.1

Freq = 4.9270 GHz, Bw = 16.000 MH No calibration applied and no bandpass applied

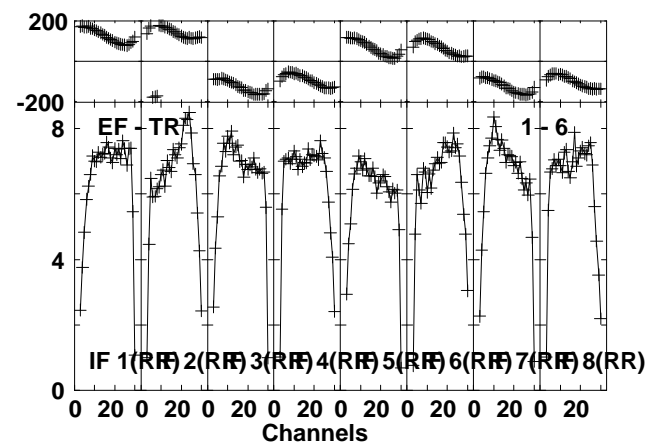
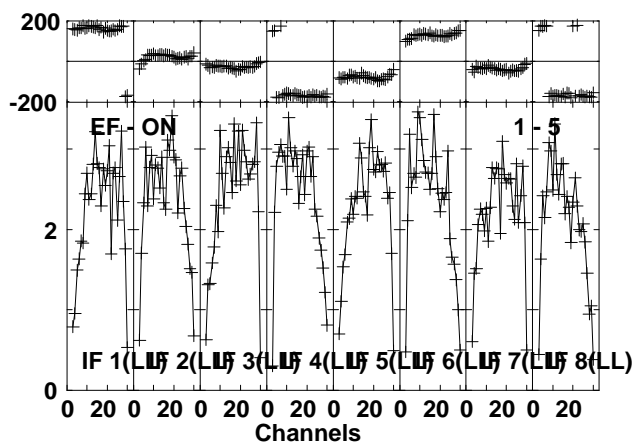
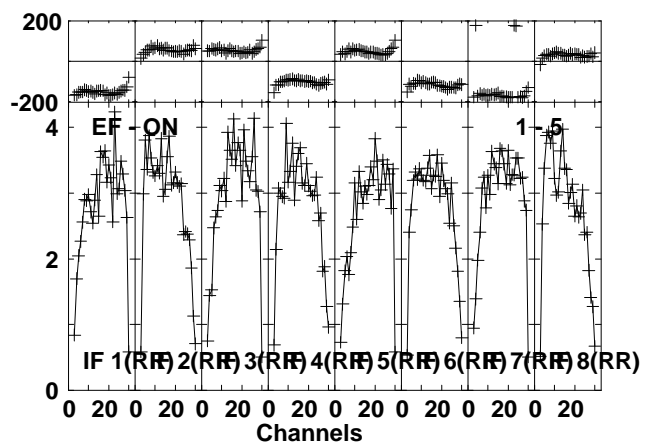
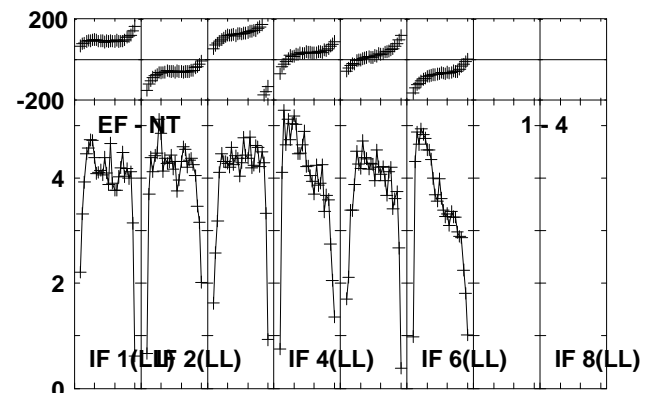
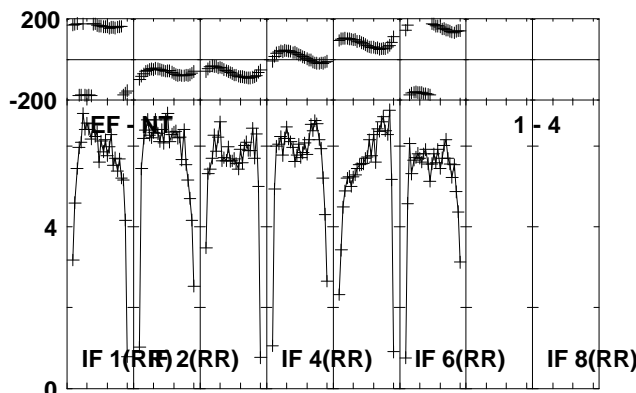
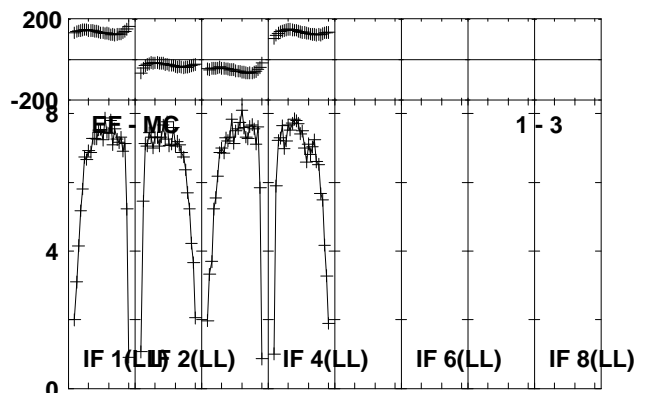
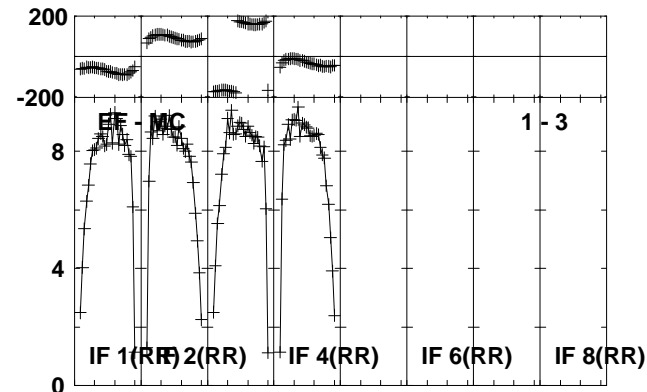
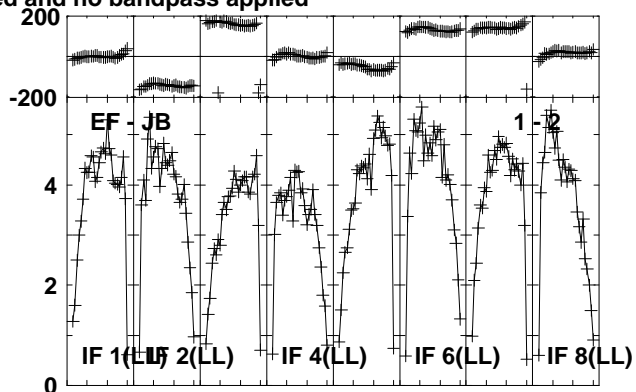
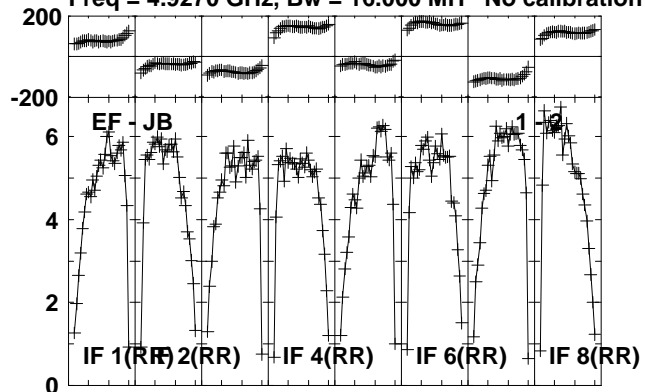

Lower frame: Milli Ampl Jy Top frame: Phas deg  
Vector averaged cross-power spectrum Several baselines displayed  
Timerange: 00/20:23:02 to 00/20:24:28

Plot file version 310 created 24-OCT-2012 21:00:58

J1825-0737 EY017B.UVDATA.1

Freq = 4.9270 GHz, Bw = 16.000 MH No calibration applied and no bandpass applied

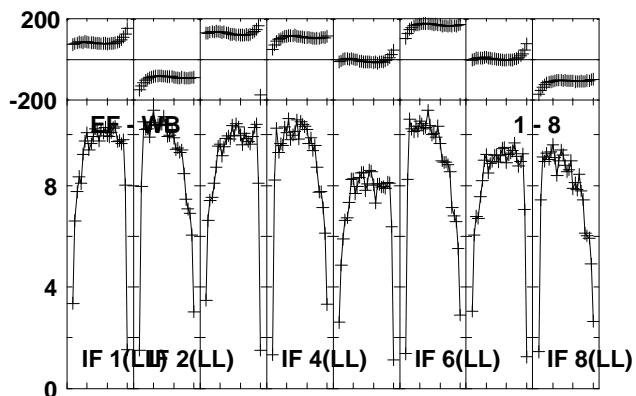
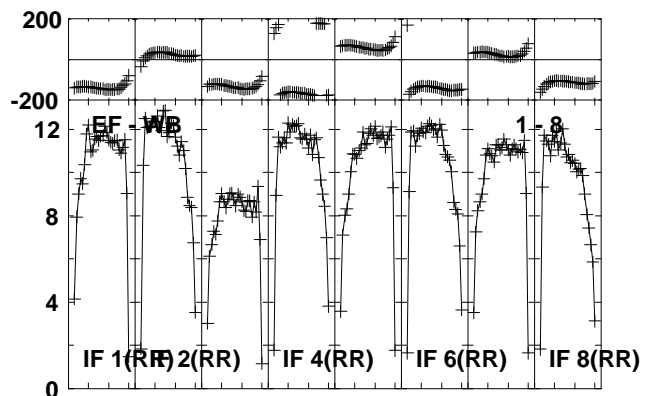
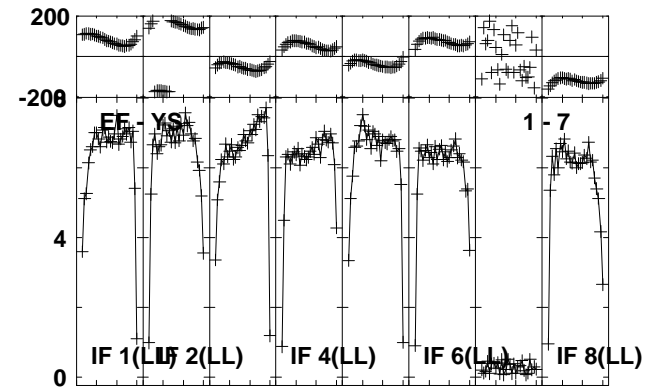
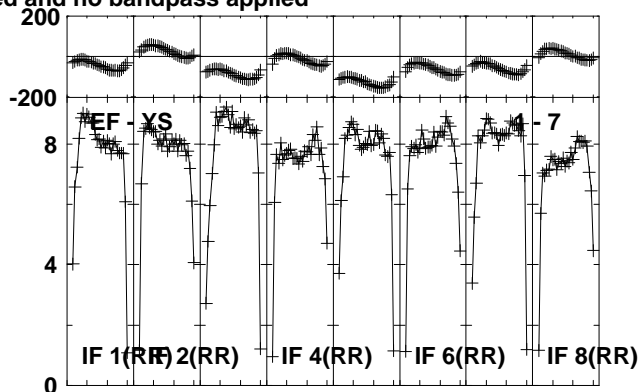
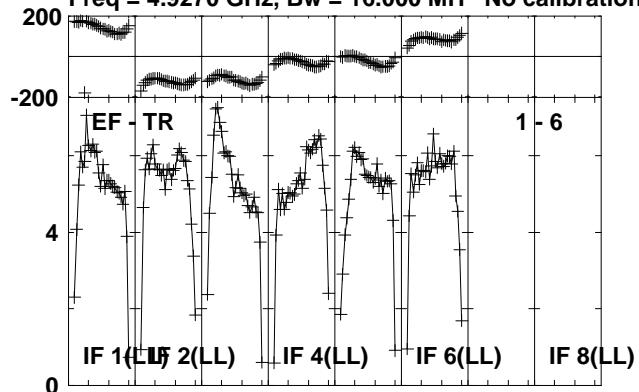

Lower frame: Milli Ampl Jy Top frame: Phas deg  
Vector averaged cross-power spectrum Several baselines displayed  
Timerange: 00/20:23:02 to 00/20:24:28

Plot file version 311 created 24-OCT-2012 21:00:59

G23.6-0.03 EY017B.UVDATA.1

Freq = 4.9270 GHz, Bw = 16.000 MH No calibration applied and no bandpass applied

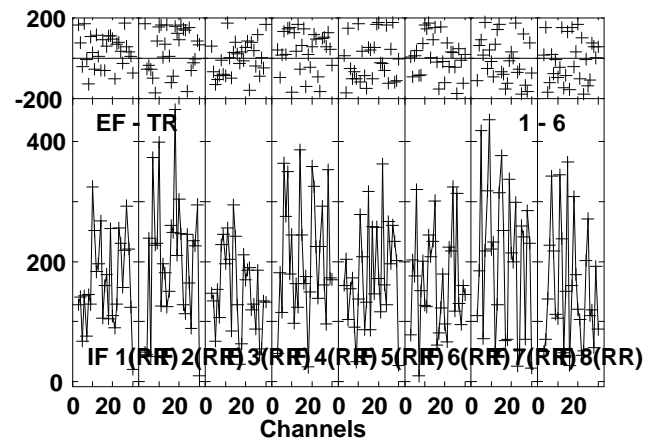
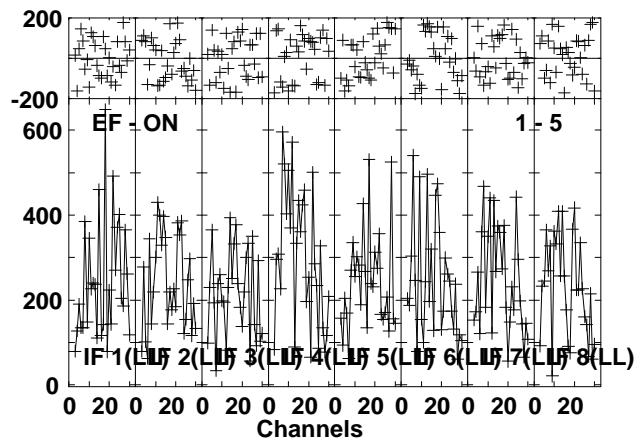
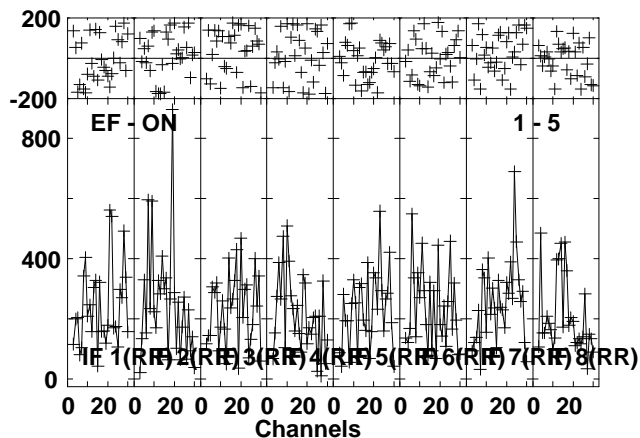
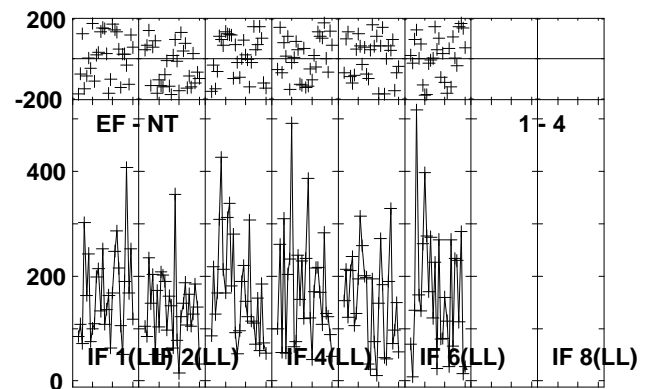
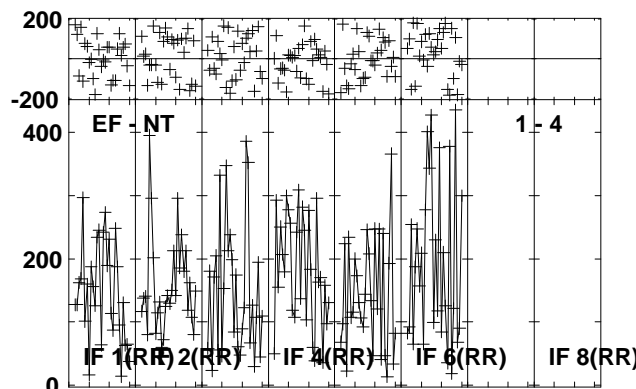
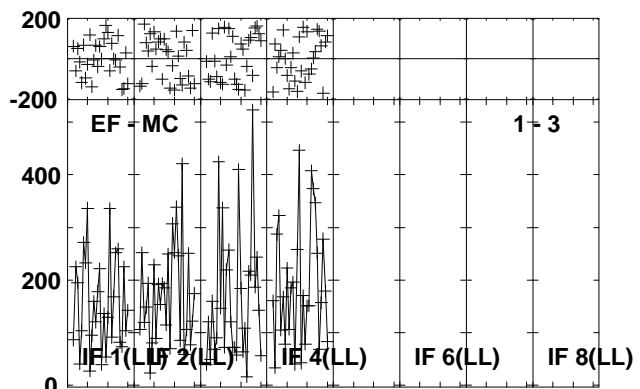
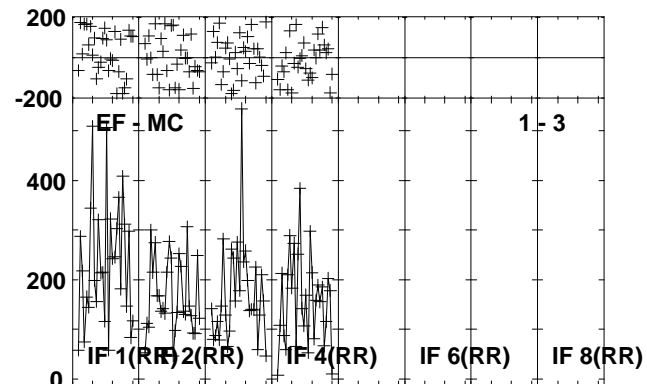
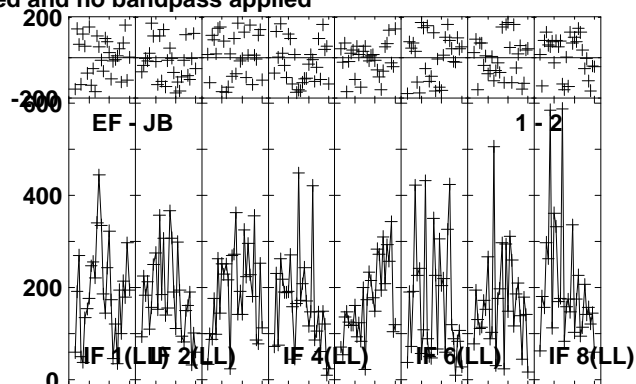
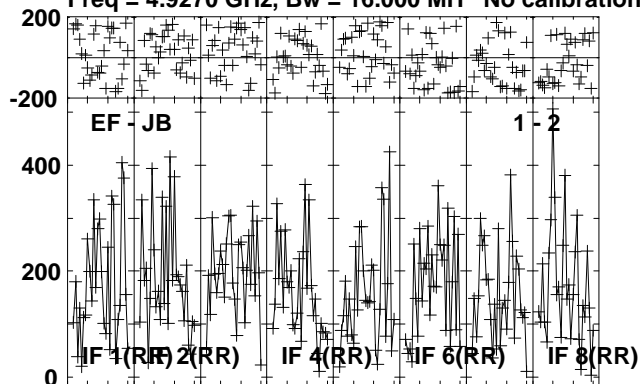

Lower frame: Micro Ampl Jy Top frame: Phas deg  
Vector averaged cross-power spectrum Several baselines displayed  
Timerange: 00/20:24:32 to 00/20:26:58

Plot file version 312 created 24-OCT-2012 21:01:00

G23.6-0.03 EY017B.UVDATA.1

Freq = 4.9270 GHz, Bw = 16.000 MH No calibration applied and no bandpass applied

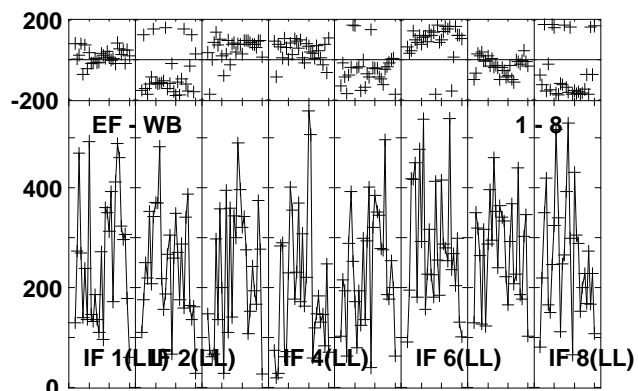
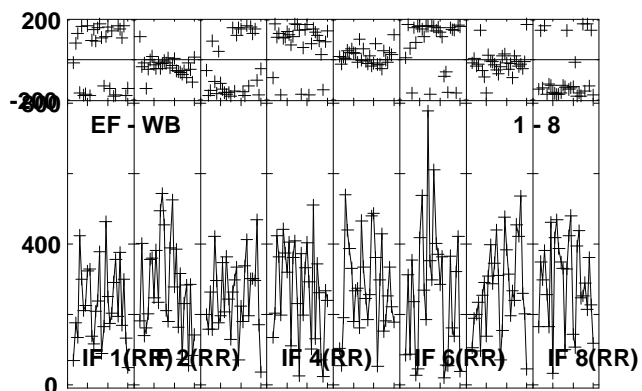
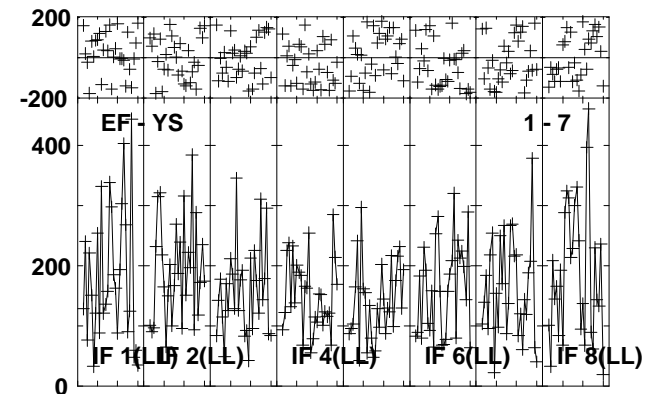
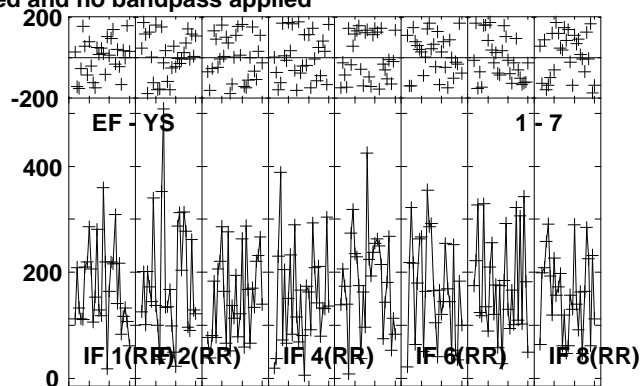
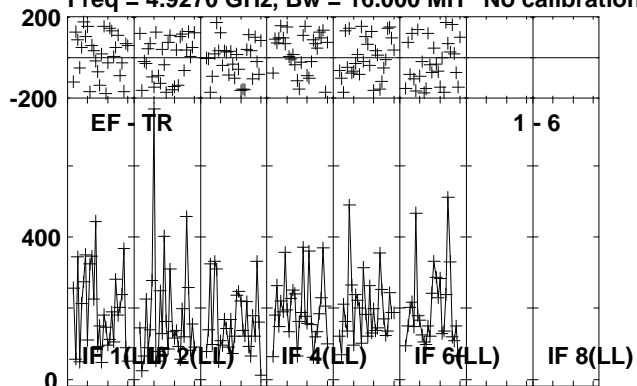

Lower frame: Micro Ampl Jy Top frame: Phas deg  
Vector averaged cross-power spectrum Several baselines displayed  
Timerange: 00/20:24:32 to 00/20:26:58

Plot file version 313 created 24-OCT-2012 21:01:00

J1825-0737 EY017B.UVDATA.1

Freq = 4.9270 GHz, Bw = 16.000 MH No calibration applied and no bandpass applied

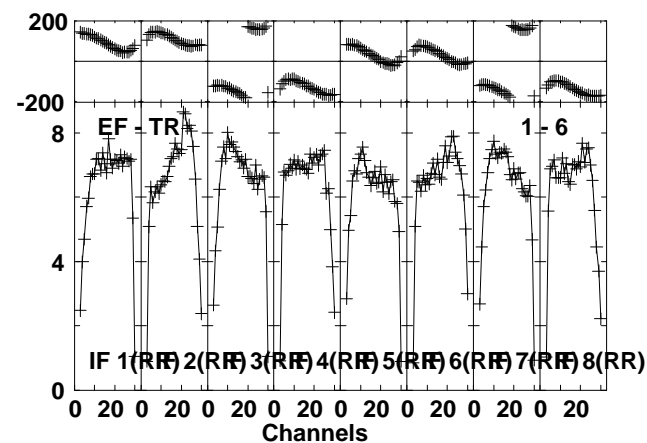
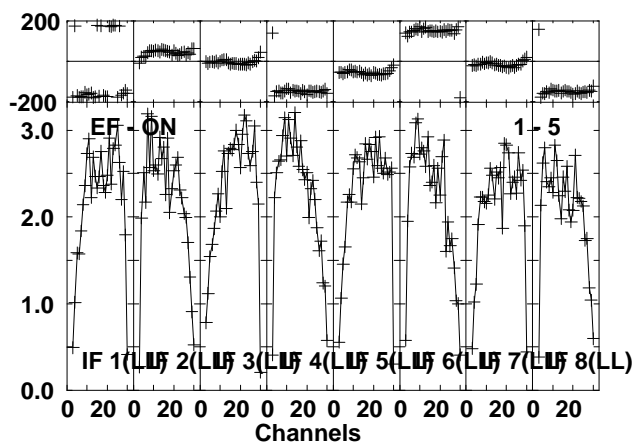
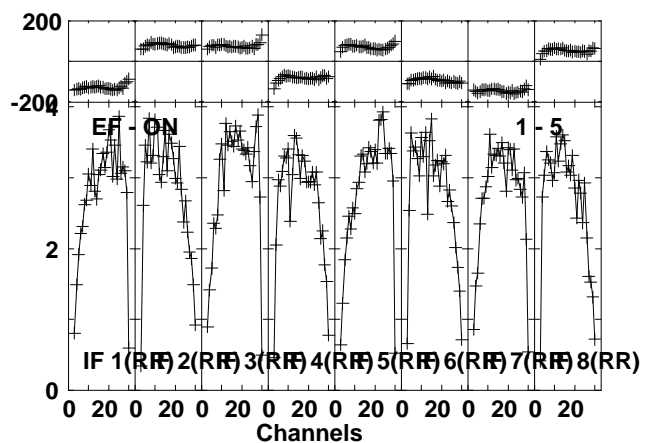
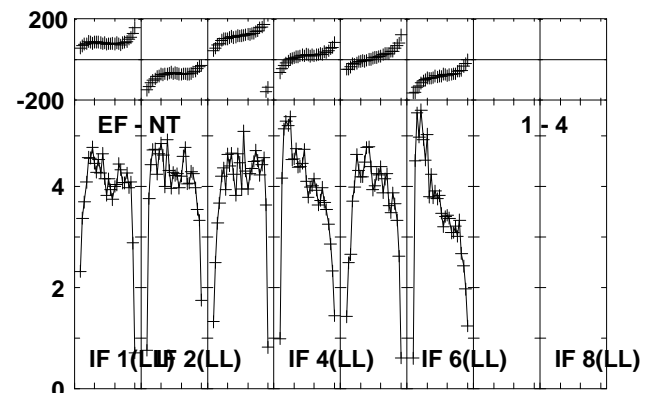
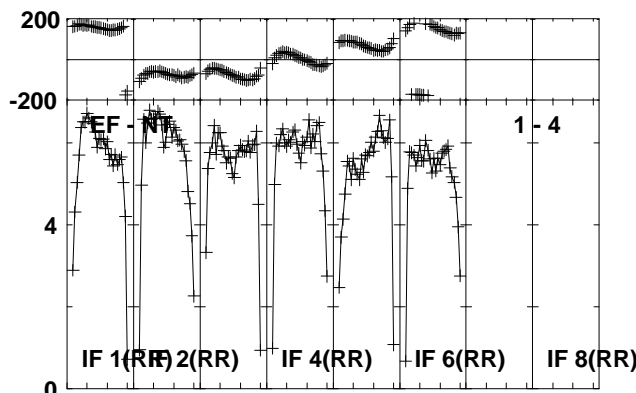
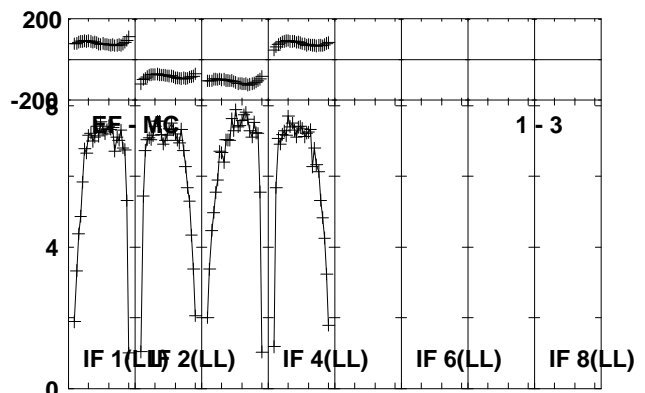
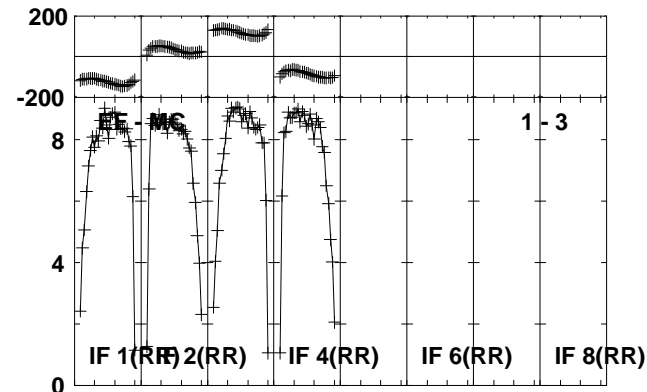
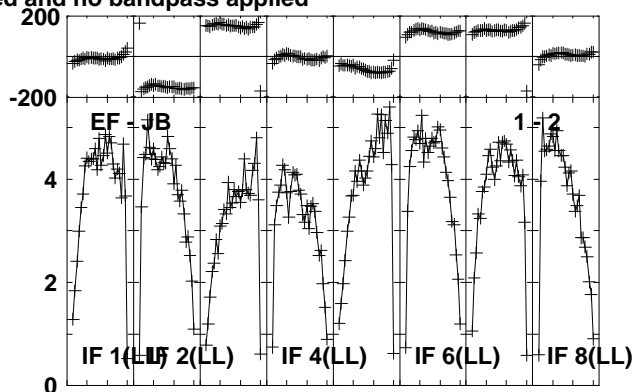
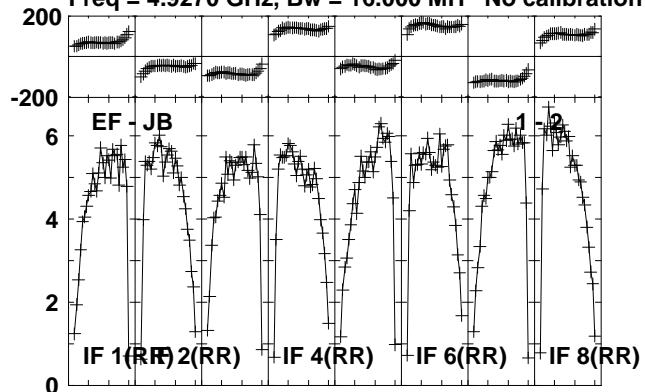

Lower frame: Milli Ampl Jy Top frame: Phas deg  
Vector averaged cross-power spectrum Several baselines displayed  
Timerange: 00/20:27:02 to 00/20:28:28

Plot file version 314 created 24-OCT-2012 21:01:01  
J1825-0737 EY017B.UVDATA.1

Freq = 4.9270 GHz, Bw = 16.000 MH No calibration applied and no bandpass applied

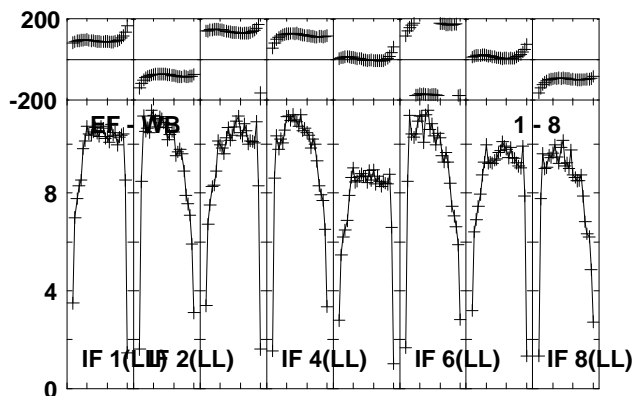
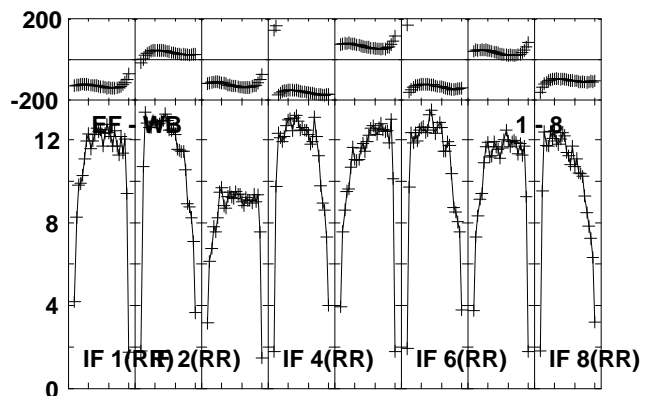
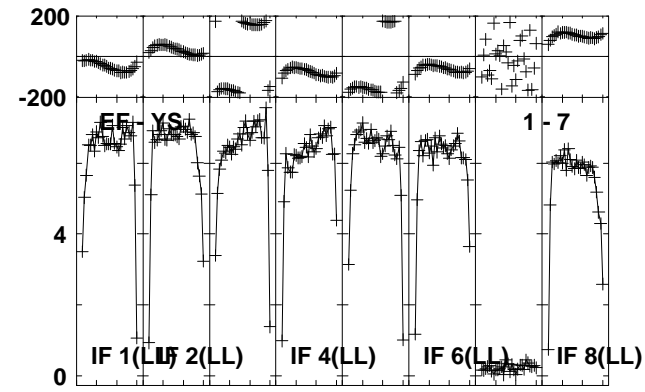
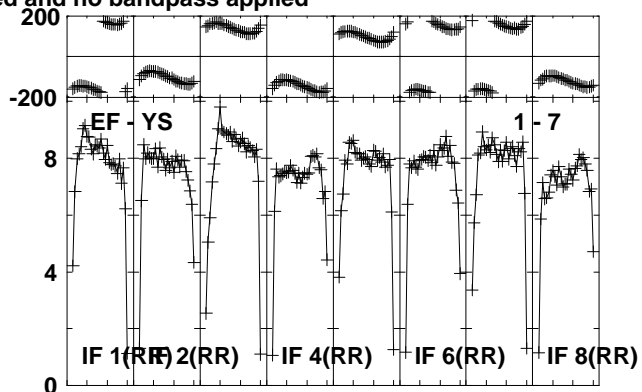
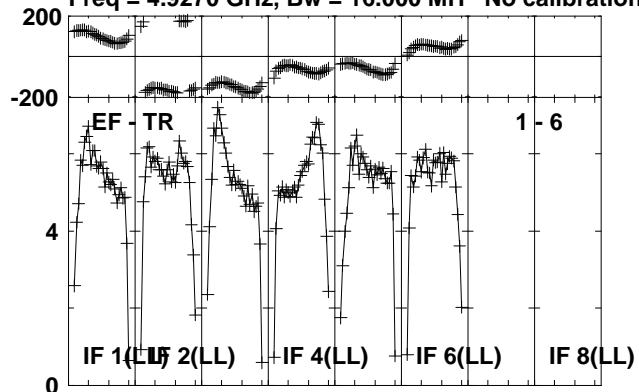

Lower frame: Milli Ampl Jy Top frame: Phas deg  
Vector averaged cross-power spectrum Several baselines displayed  
Timerange: 00/20:27:02 to 00/20:28:28

Plot file version 315 created 24-OCT-2012 21:01:01  
 G23.6-0.03 EY017B.UVDATA.1

Freq = 4.9270 GHz, Bw = 16.000 MH No calibration applied and no bandpass applied

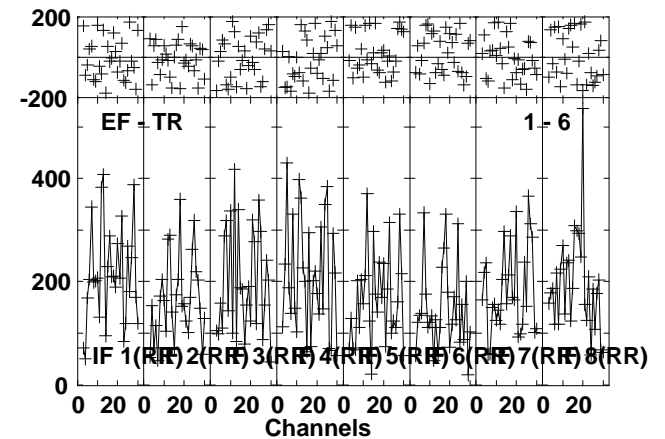
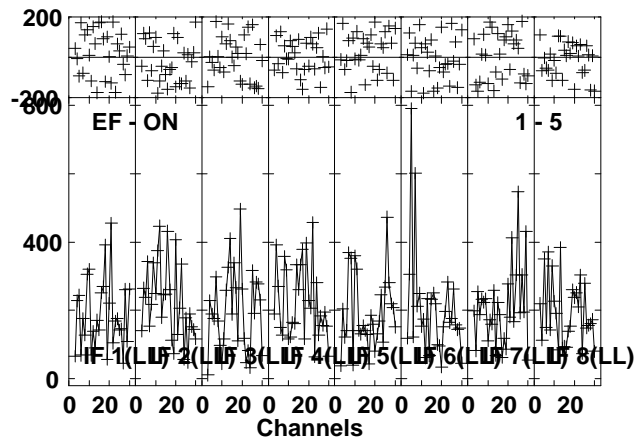
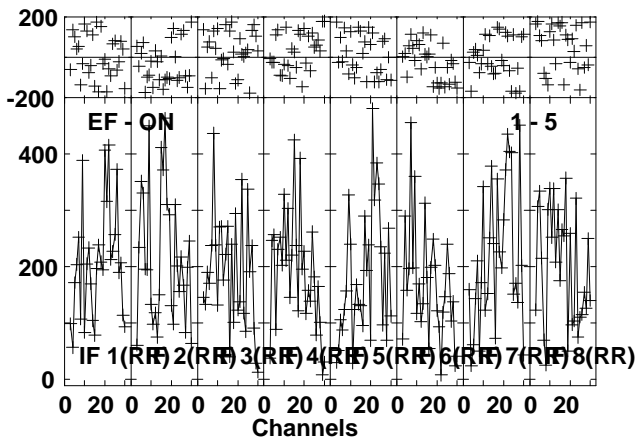
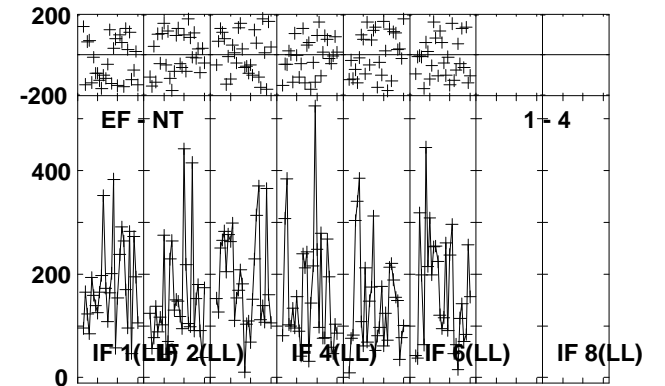
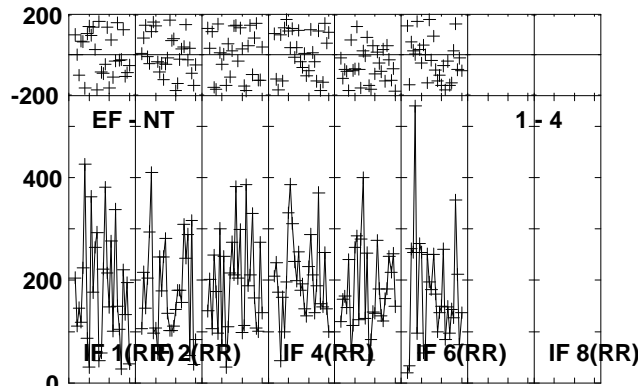
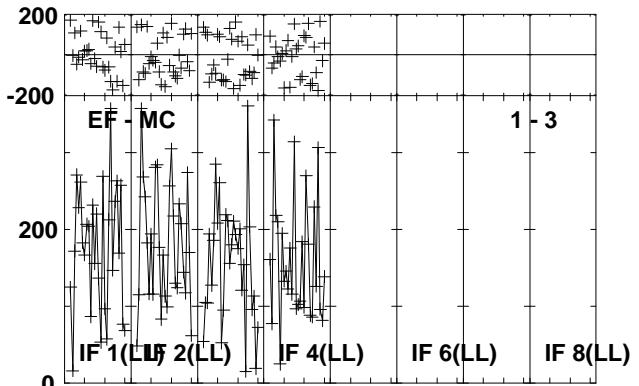
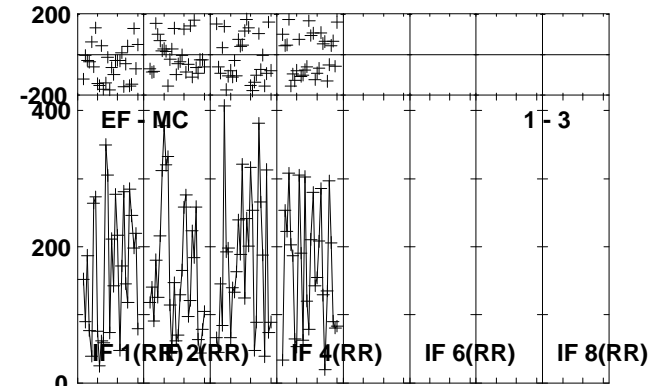
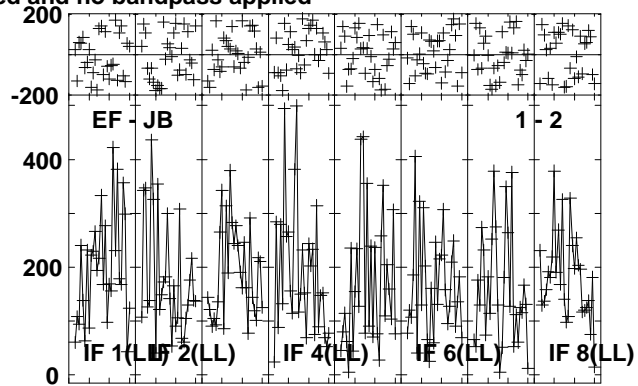
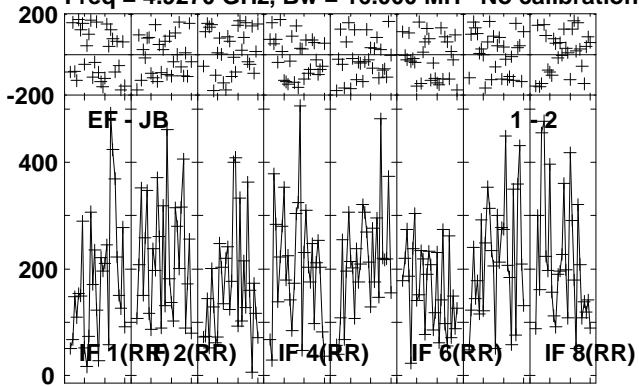

Lower frame: Micro Ampl Jy Top frame: Phas deg  
 Vector averaged cross-power spectrum Several baselines displayed  
 Timerange: 00/20:28:32 to 00/20:30:58

Plot file version 316 created 24-OCT-2012 21:01:02

G23.6-0.03 EY017B.UVDATA.1

Freq = 4.9270 GHz, Bw = 16.000 MH No calibration applied and no bandpass applied

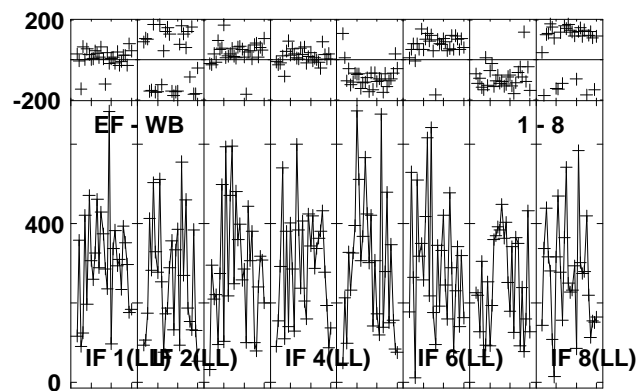
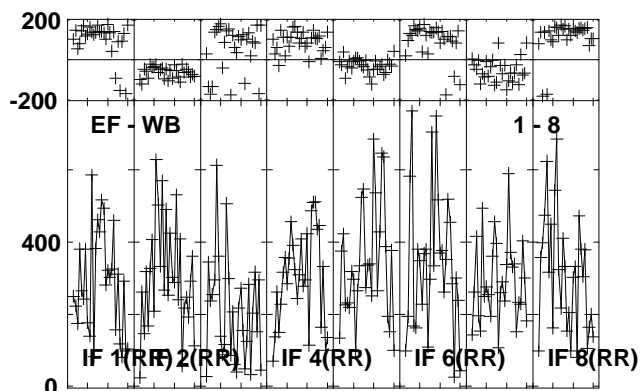
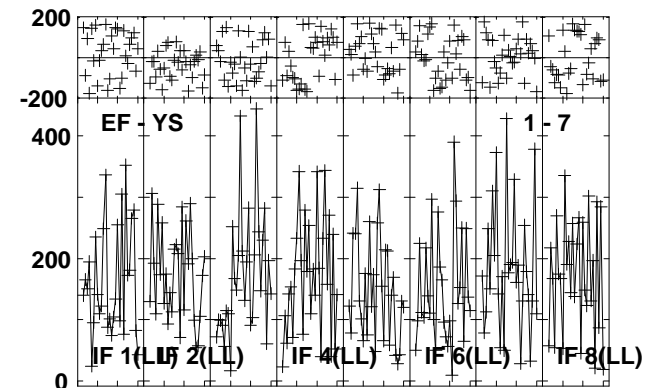
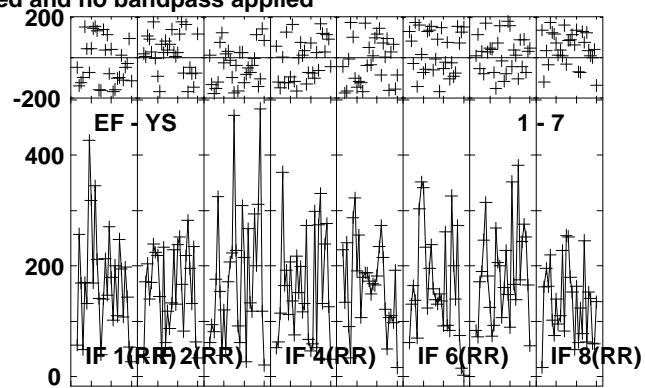
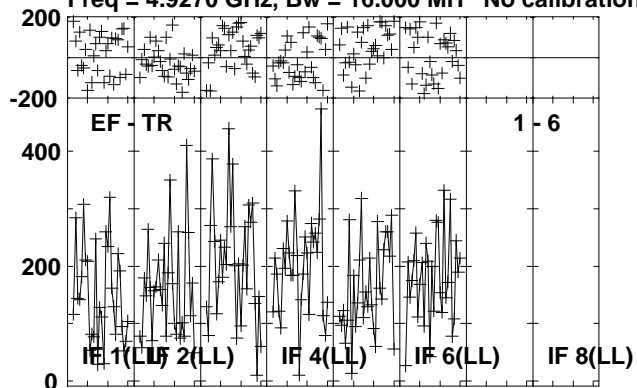

Lower frame: Micro Ampl Jy Top frame: Phas deg  
Vector averaged cross-power spectrum Several baselines displayed  
Timerange: 00/20:28:32 to 00/20:30:58



Plot file version 317 created 24-OCT-2012 21:01:02

J1825-0737 EY017B.UVDATA.1

Freq = 4.9270 GHz, Bw = 16.000 MH No calibration applied and no bandpass applied

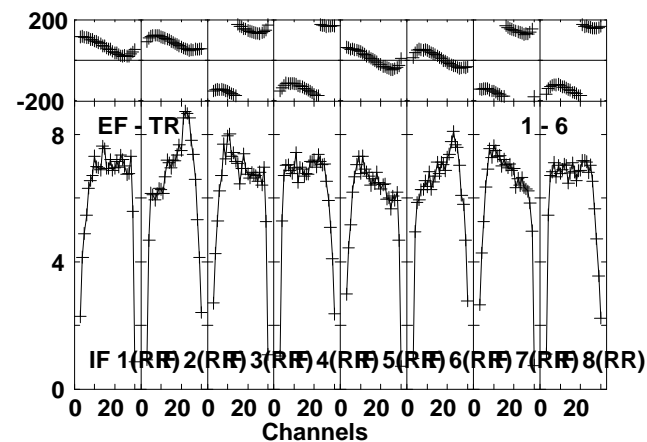
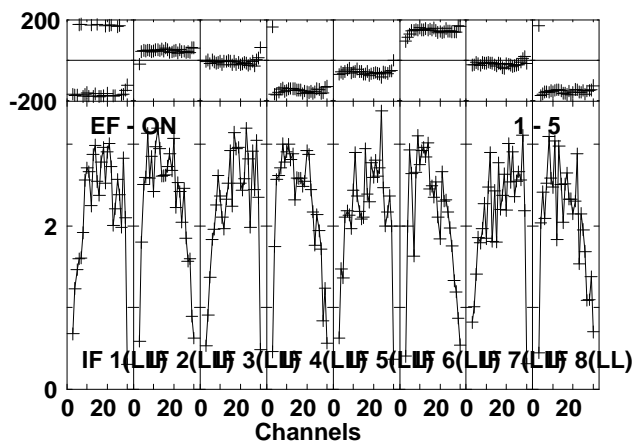
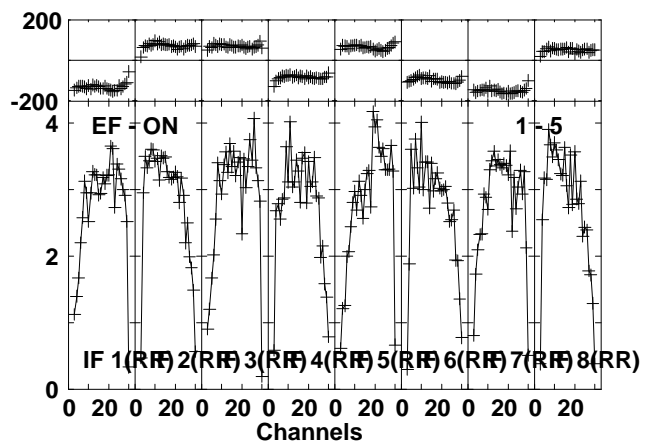
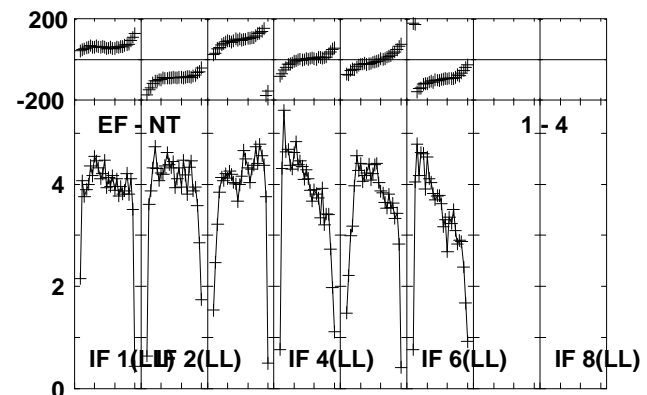
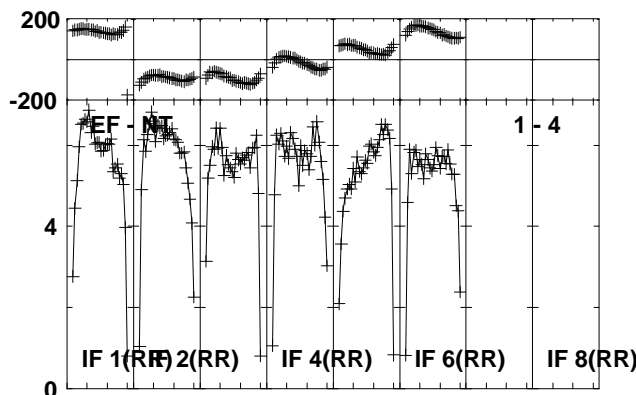
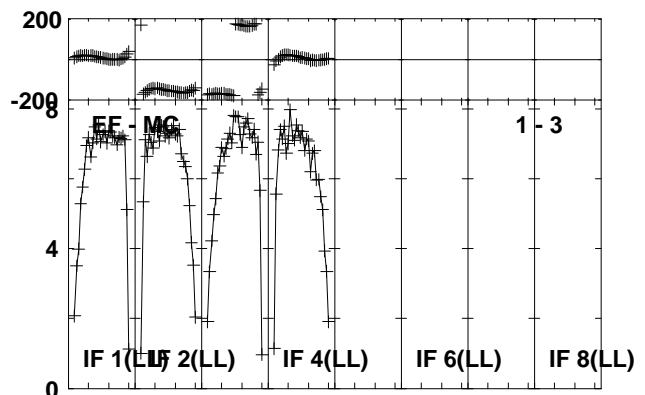
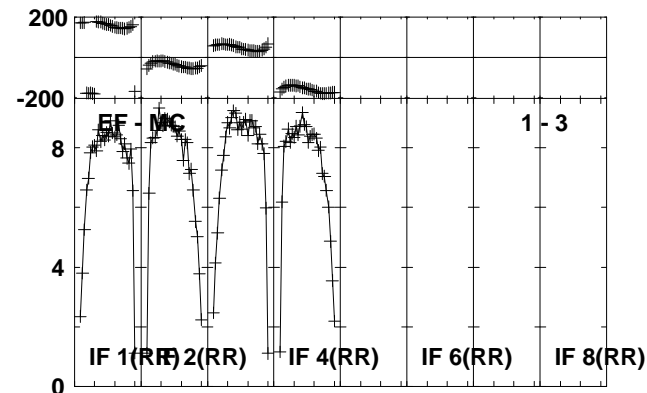
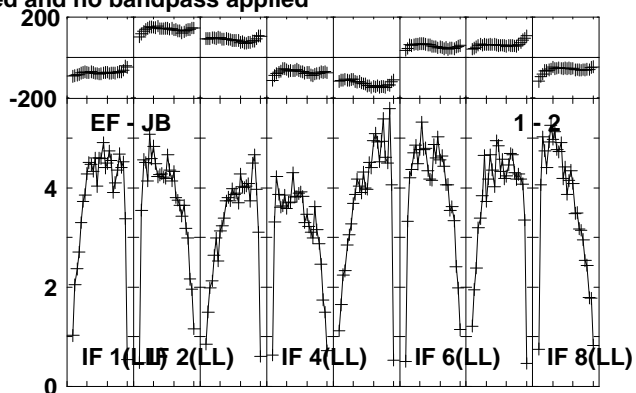
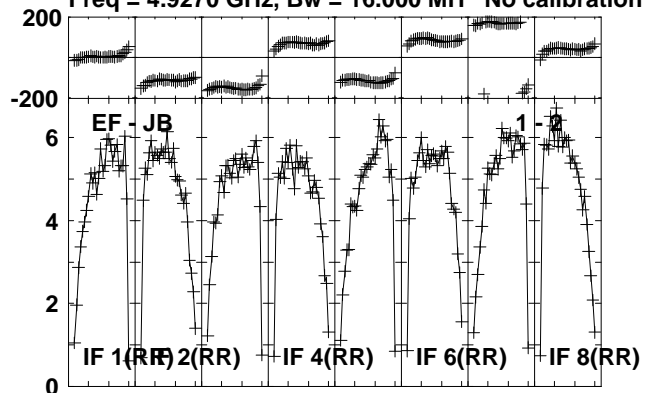

Lower frame: Milli Ampl Jy Top frame: Phas deg  
Vector averaged cross-power spectrum Several baselines displayed  
Timerange: 00/20:31:02 to 00/20:32:28

Plot file version 318 created 24-OCT-2012 21:01:03

J1825-0737 EY017B.UVDATA.1

Freq = 4.9270 GHz, Bw = 16.000 MH No calibration applied and no bandpass applied

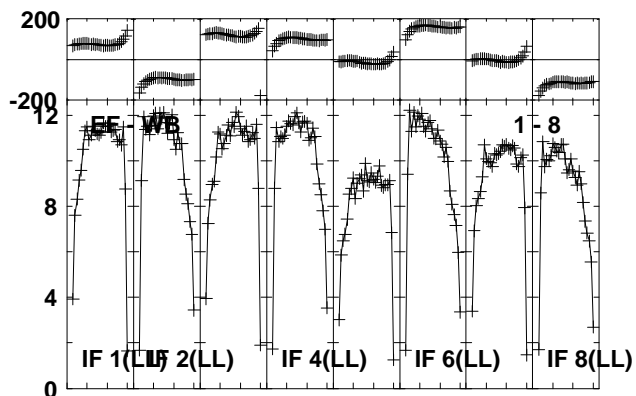
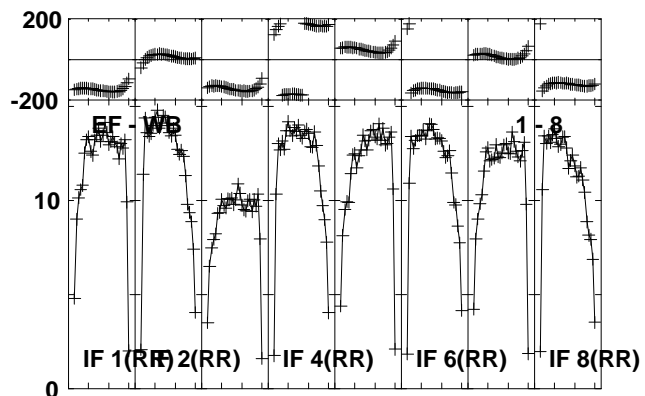
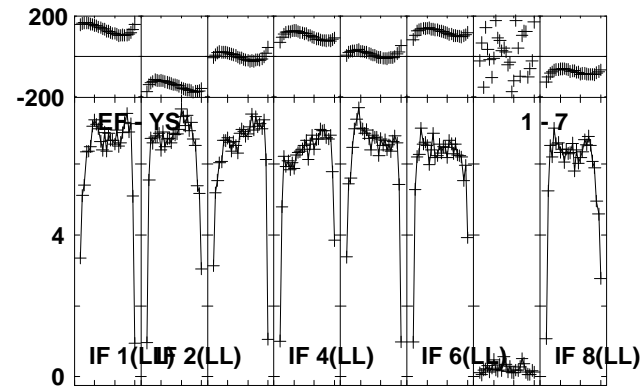
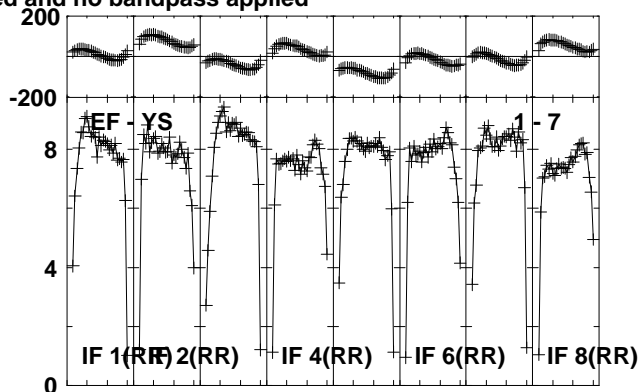
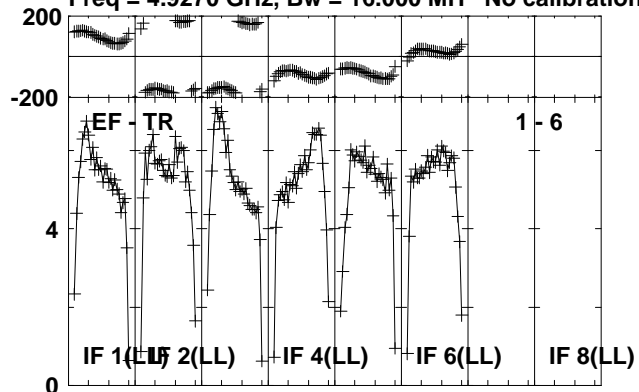

Lower frame: Milli Ampl Jy Top frame: Phas deg  
Vector averaged cross-power spectrum Several baselines displayed  
Timerange: 00/20:31:02 to 00/20:32:28

Plot file version 319 created 24-OCT-2012 21:01:03  
 J1831-0756 EY017B.UVDATA.1

Freq = 4.9270 GHz, Bw = 16.000 MH No calibration applied and no bandpass applied

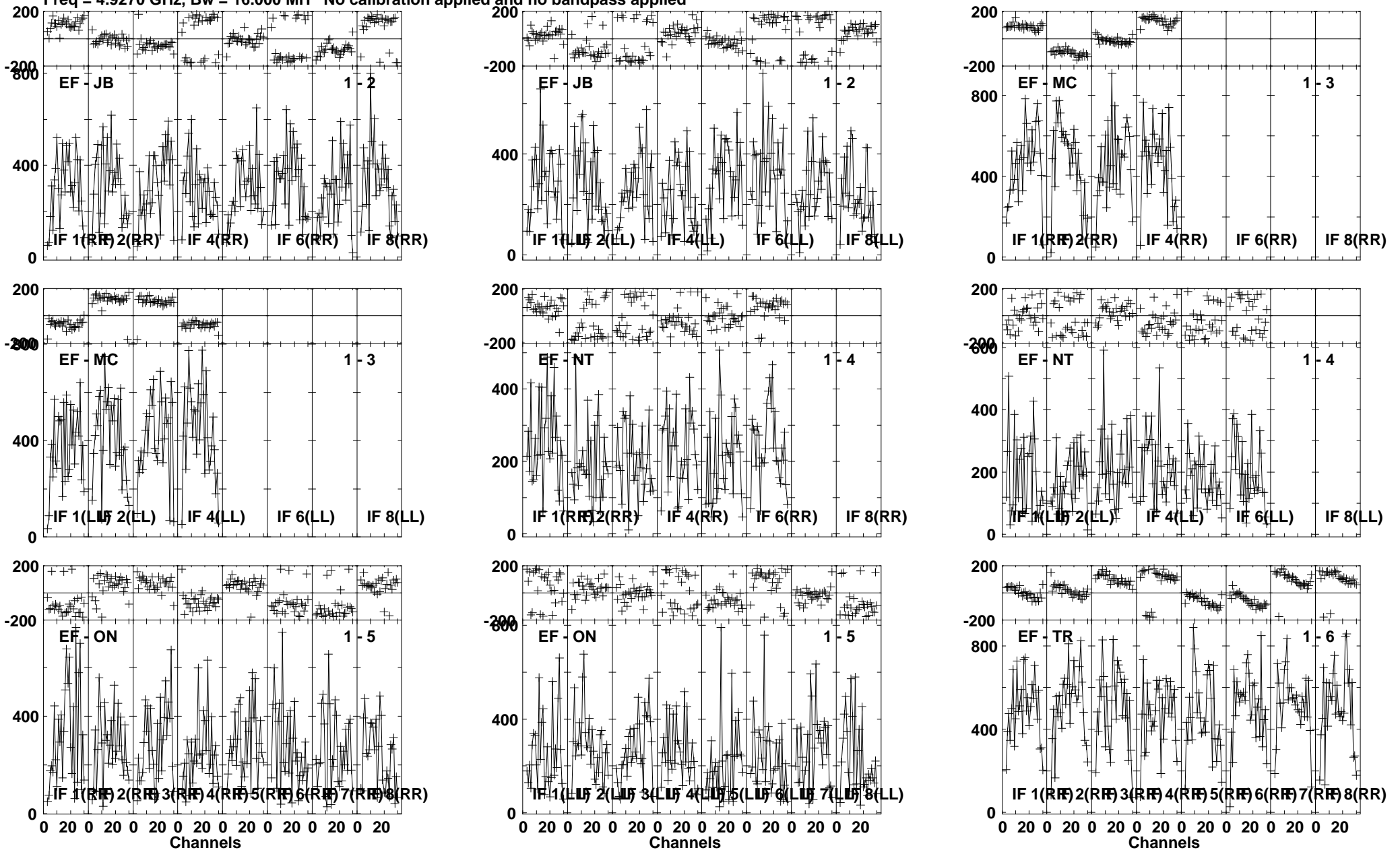

Lower frame: Micro Ampl Jy Top frame: Phas deg  
 Vector averaged cross-power spectrum Several baselines displayed  
 Timerange: 00/20:33:02 to 00/20:35:04

Plot file version 320 created 24-OCT-2012 21:01:04

J1831-0756 EY017B.UVDATA.1

Freq = 4.9270 GHz, Bw = 16.000 MH No calibration applied and no bandpass applied

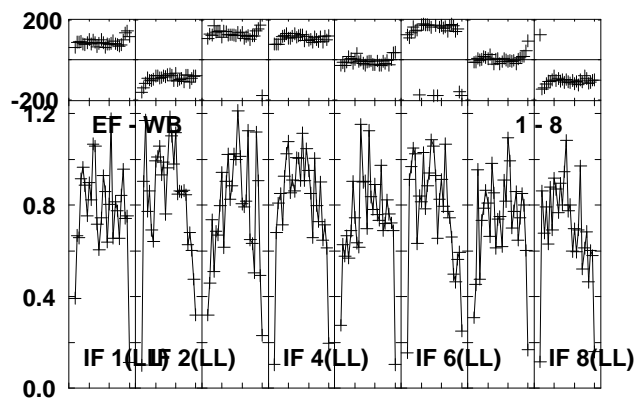
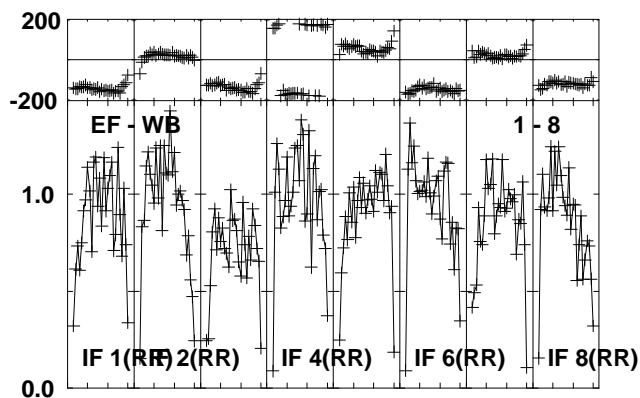
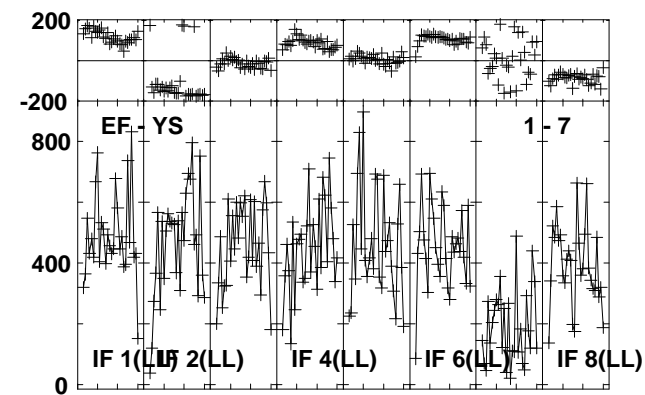
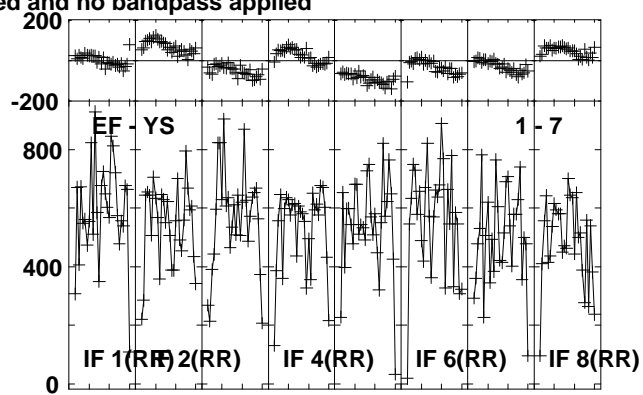
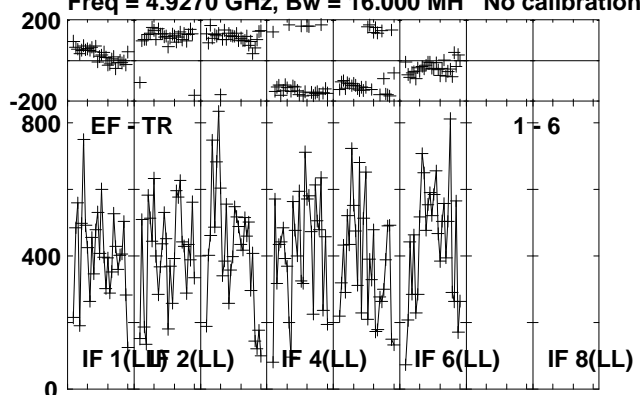

Lower frame: Micro Ampl Jy Top frame: Phas deg  
Vector averaged cross-power spectrum Several baselines displayed  
Timerange: 00/20:33:02 to 00/20:35:04

Plot file version 321 created 24-OCT-2012 21:01:04

J1825-0737 EY017B.UVDATA.1

Freq = 4.9270 GHz, Bw = 16.000 MH No calibration applied and no bandpass applied

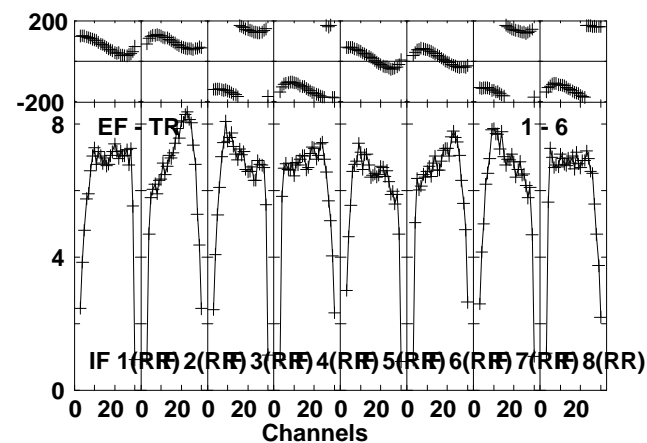
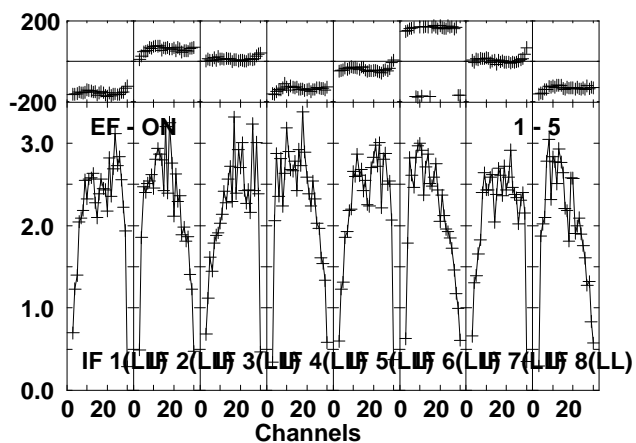
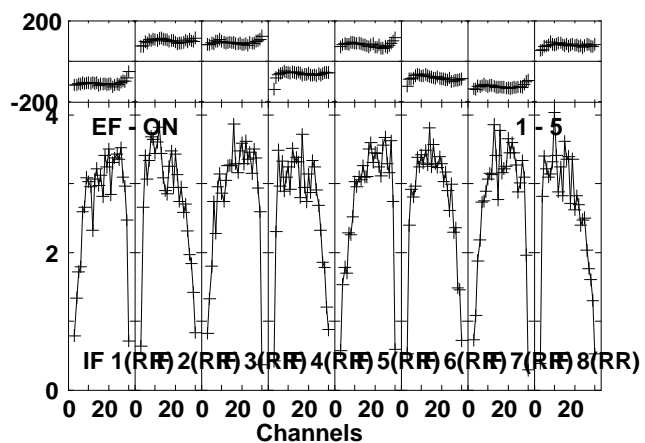
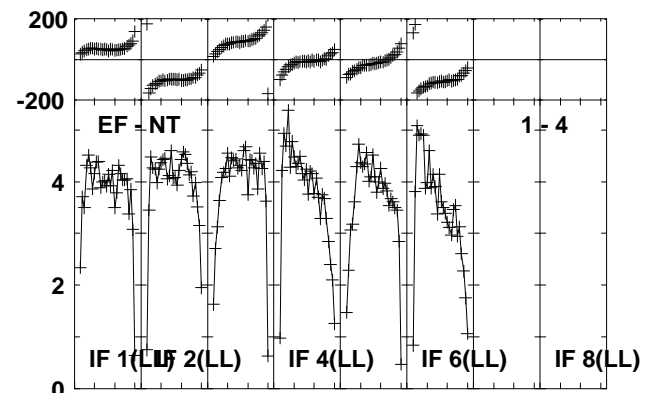
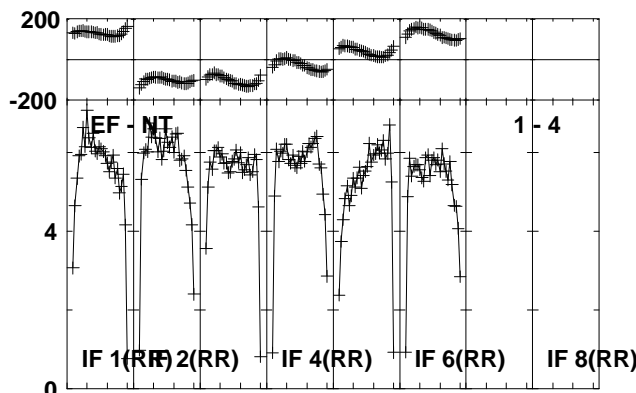
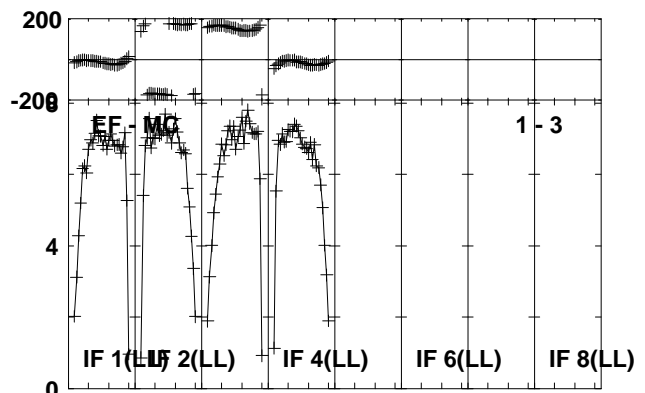
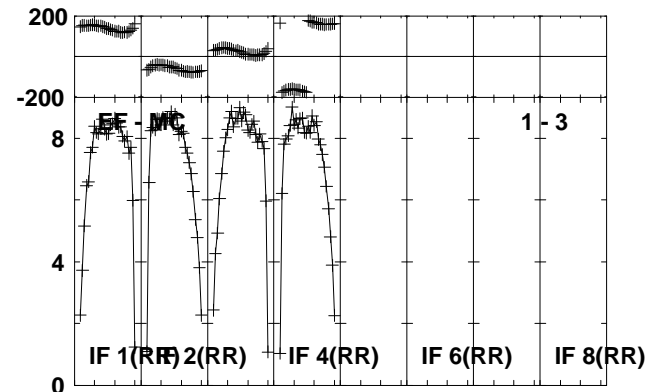
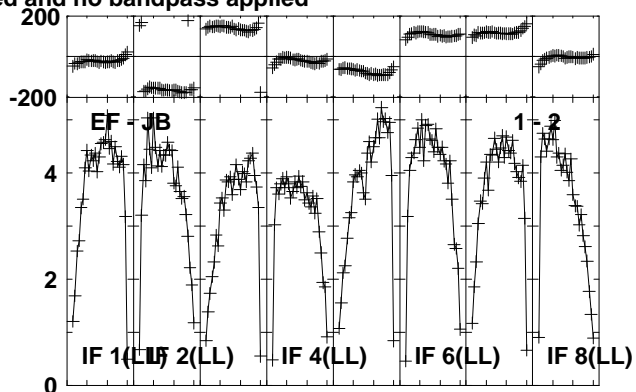
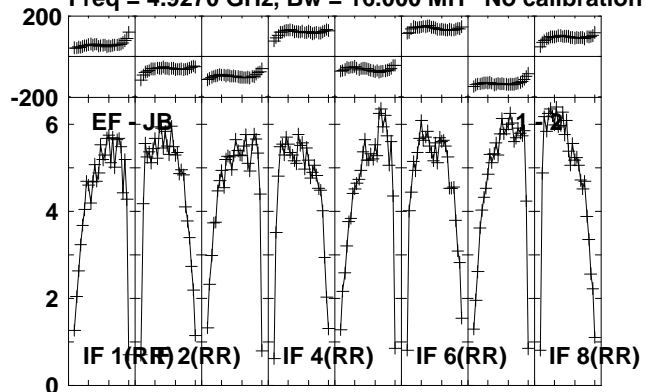

Lower frame: Milli Ampl Jy Top frame: Phas deg  
Vector averaged cross-power spectrum Several baselines displayed  
Timerange: 00/20:35:08 to 00/20:36:34

Plot file version 322 created 24-OCT-2012 21:01:05

J1825-0737 EY017B.UVDATA.1

Freq = 4.9270 GHz, Bw = 16.000 MH No calibration applied and no bandpass applied

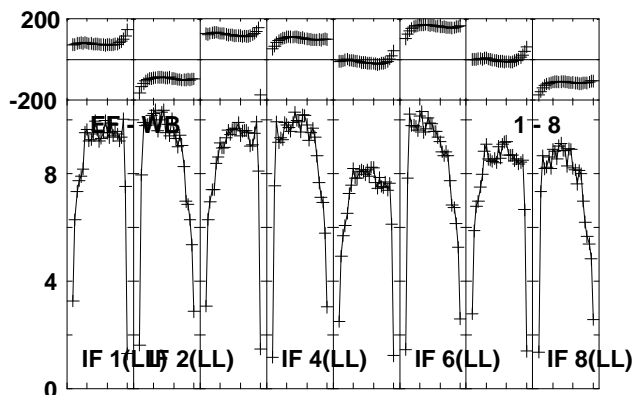
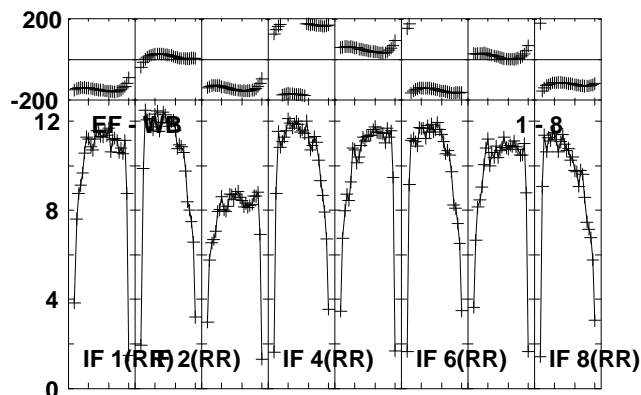
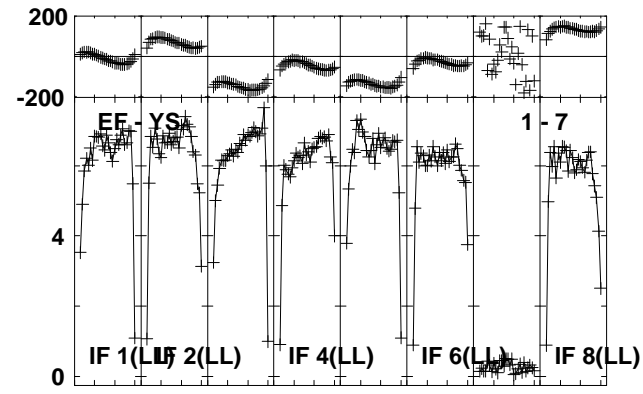
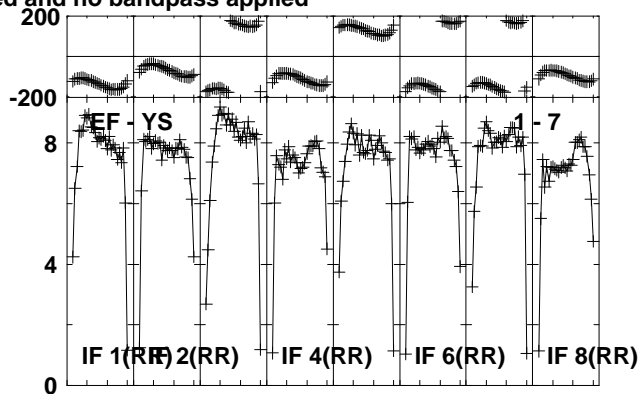
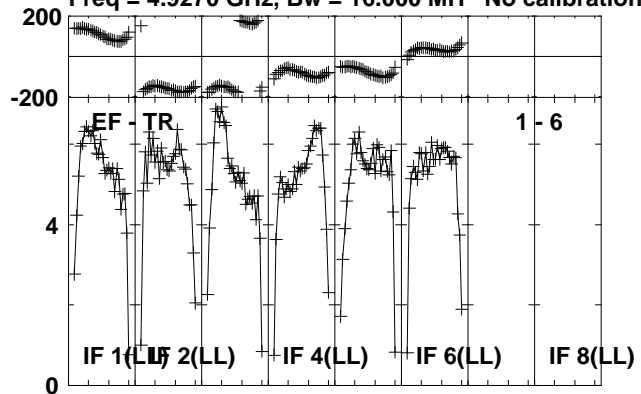

Lower frame: Milli Ampl Jy Top frame: Phas deg  
Vector averaged cross-power spectrum Several baselines displayed  
Timerange: 00/20:35:08 to 00/20:36:34

Plot file version 323 created 24-OCT-2012 21:01:05  
 G23.6-0.03 EY017B.UVDATA.1

Freq = 4.9270 GHz, Bw = 16.000 MH No calibration applied and no bandpass applied

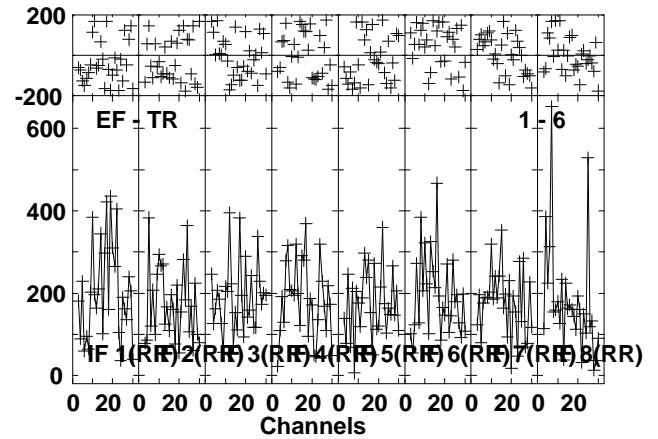
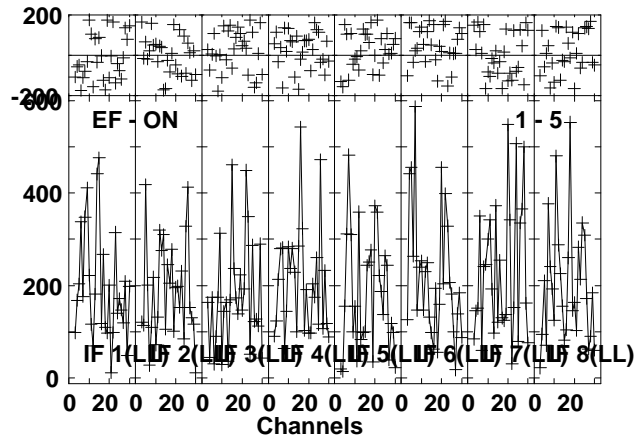
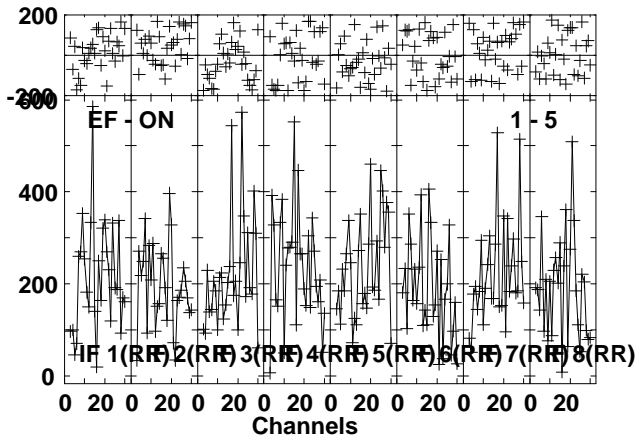
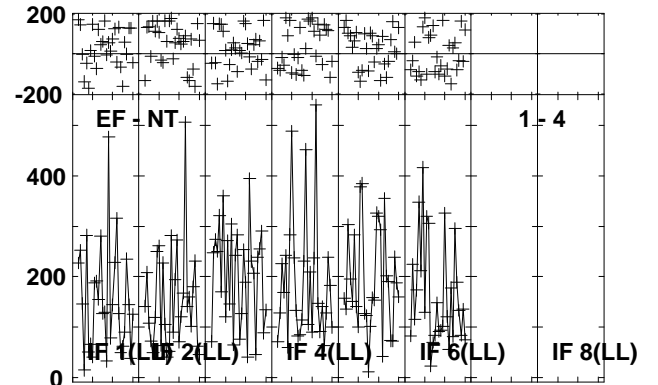
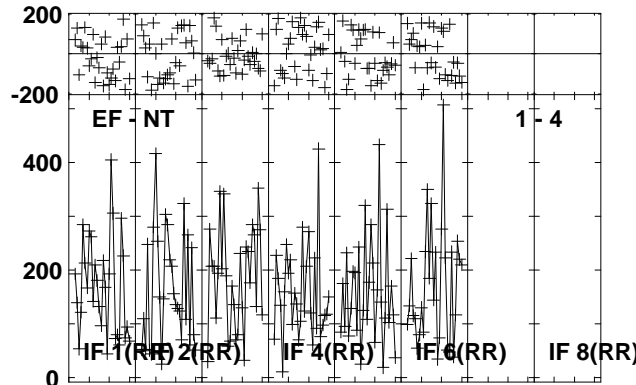
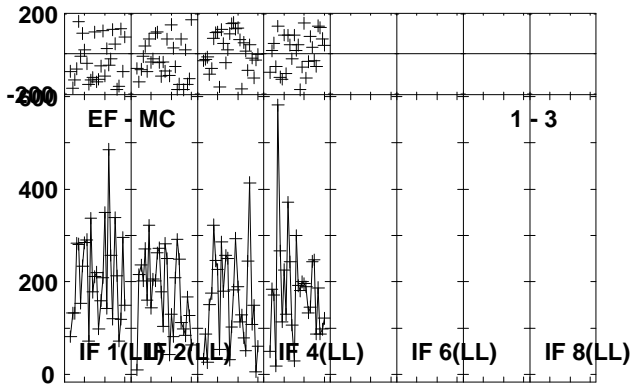
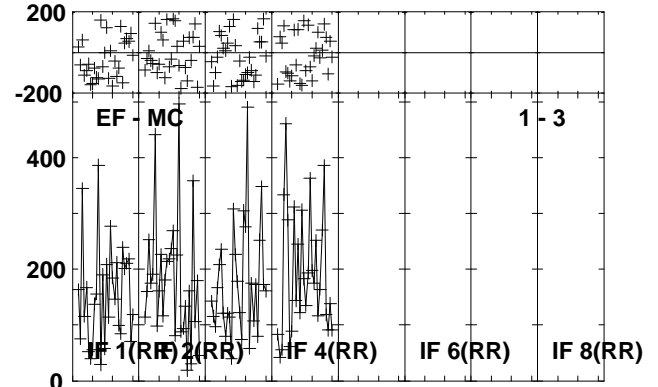
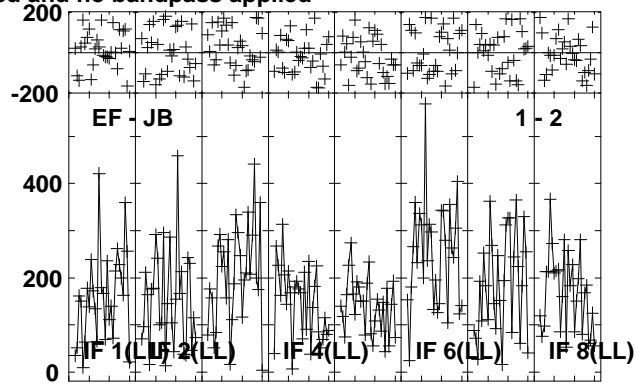
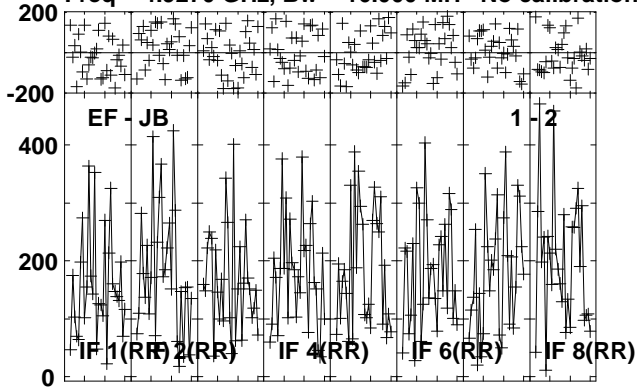

Lower frame: Micro Ampl Jy Top frame: Phas deg  
 Vector averaged cross-power spectrum Several baselines displayed  
 Timerange: 00/20:36:38 to 00/20:39:04

Plot file version 324 created 24-OCT-2012 21:01:06

G23.6-0.03 EY017B.UVDATA.1

Freq = 4.9270 GHz, Bw = 16.000 MH No calibration applied and no bandpass applied

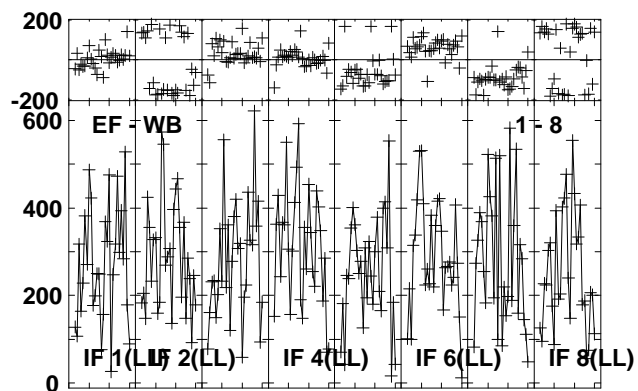
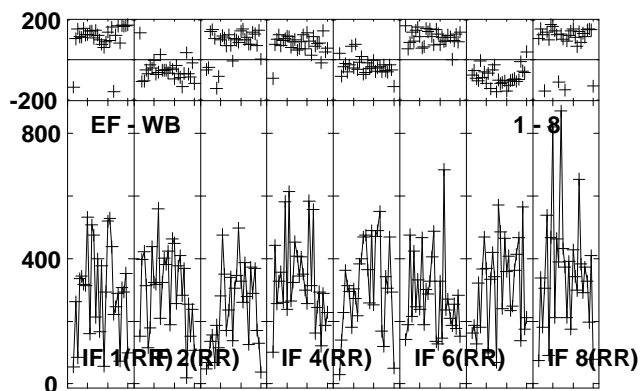
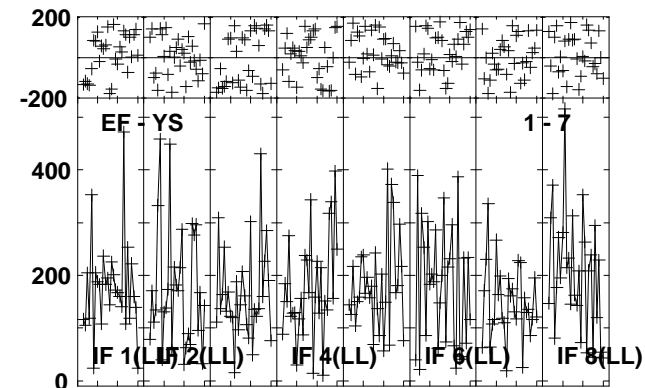
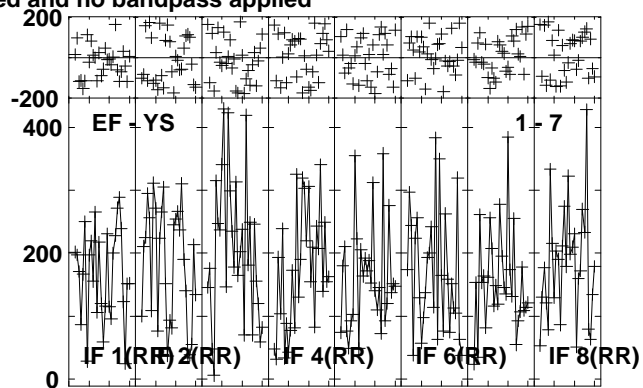
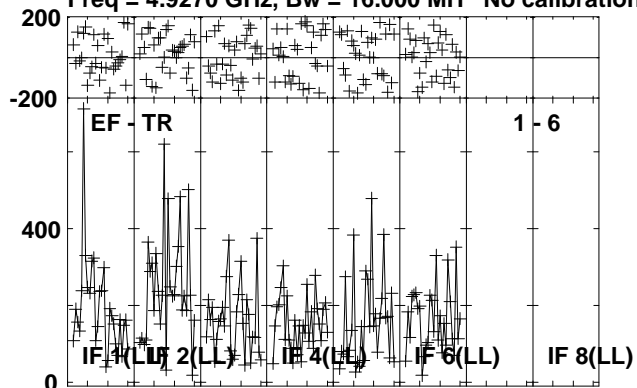

Lower frame: Micro Ampl Jy Top frame: Phas deg  
Vector averaged cross-power spectrum Several baselines displayed  
Timerange: 00/20:36:38 to 00/20:39:04



Plot file version 325 created 24-OCT-2012 21:01:06

J1825-0737 EY017B.UVDATA.1

Freq = 4.9270 GHz, Bw = 16.000 MH No calibration applied and no bandpass applied

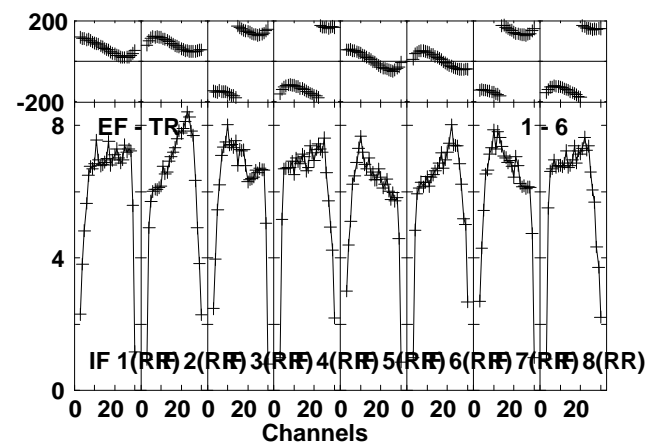
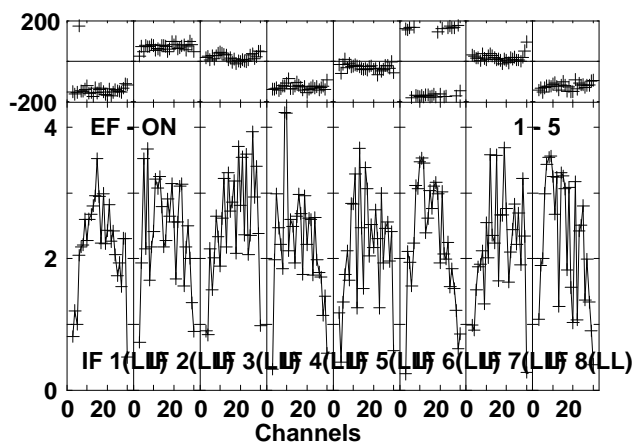
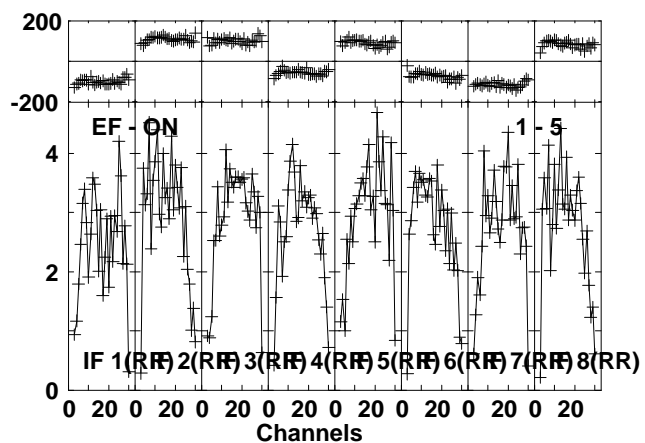
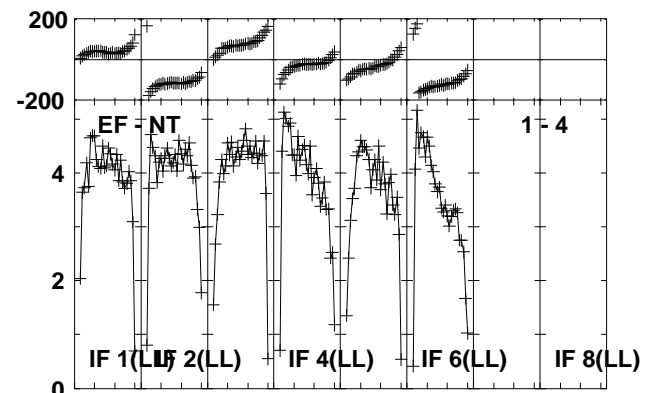
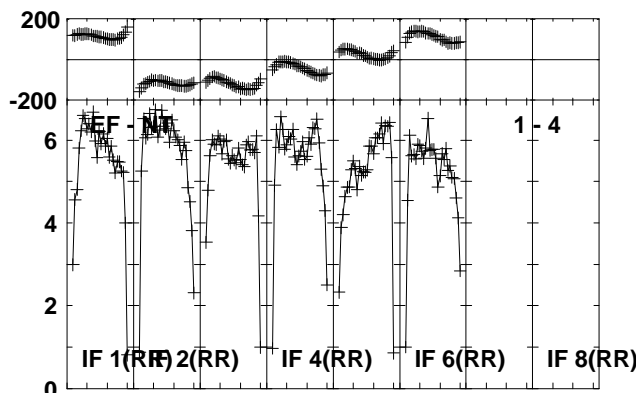
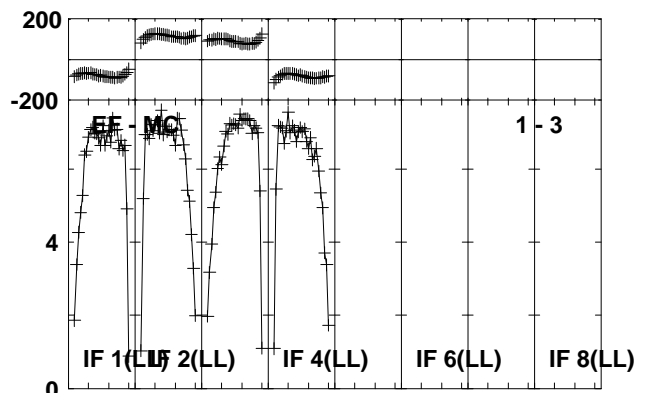
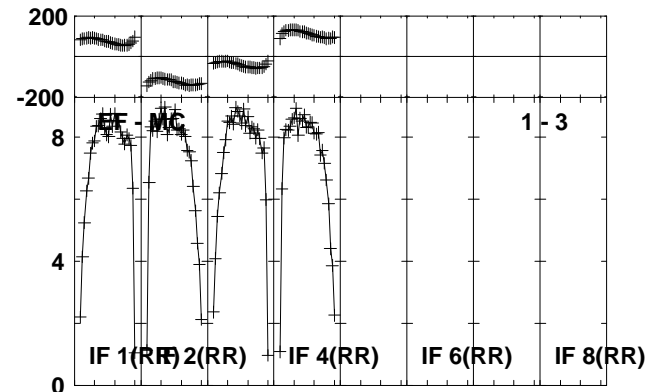
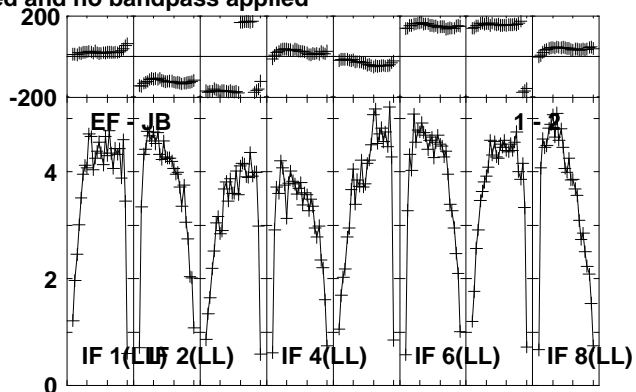
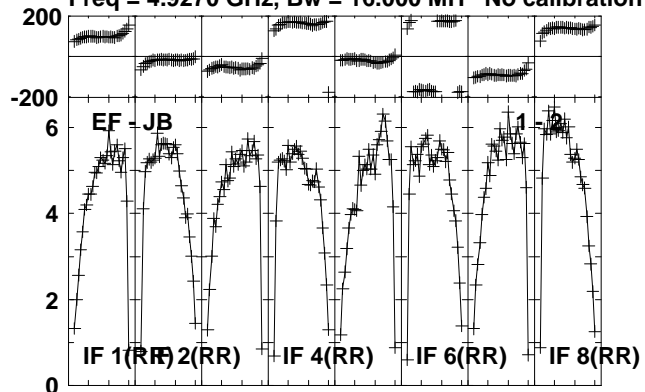

Lower frame: Milli Ampl Jy Top frame: Phas deg  
Vector averaged cross-power spectrum Several baselines displayed  
Timerange: 00/20:39:08 to 00/20:40:34

Plot file version 326 created 24-OCT-2012 21:01:07

J1825-0737 EY017B.UVDATA.1

Freq = 4.9270 GHz, Bw = 16.000 MH No calibration applied and no bandpass applied

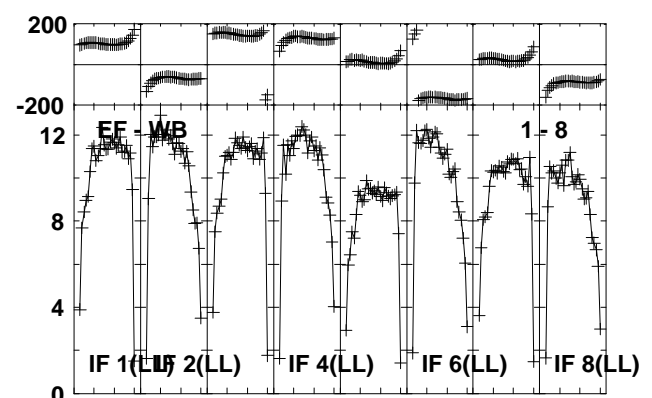
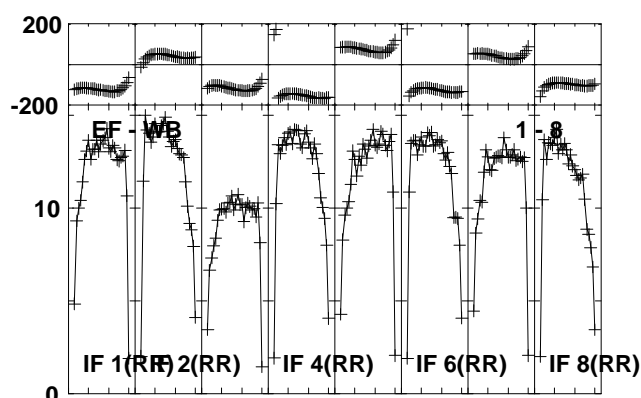
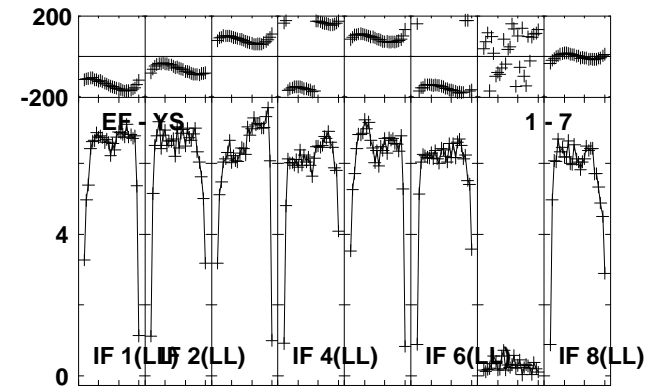
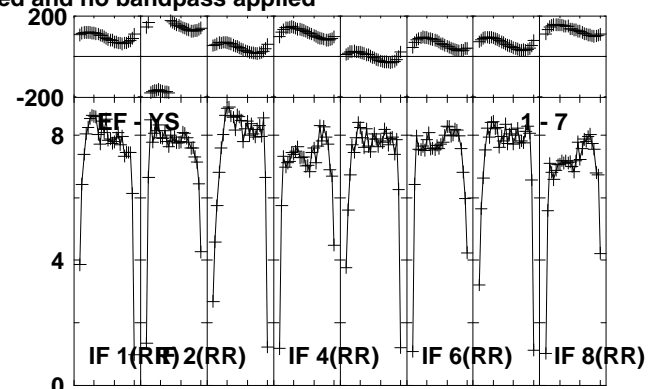
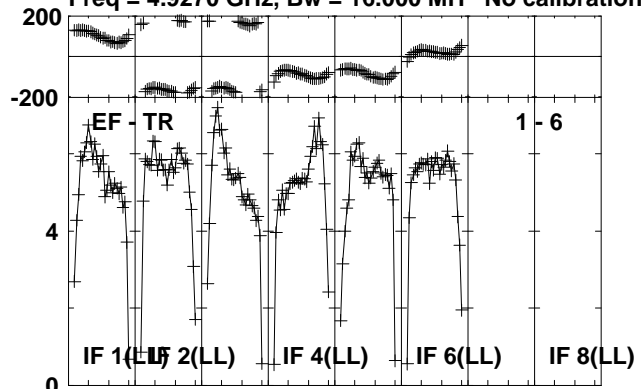

Lower frame: Milli Ampl Jy Top frame: Phas deg  
Vector averaged cross-power spectrum Several baselines displayed  
Timerange: 00/20:39:08 to 00/20:40:34

Plot file version 327 created 24-OCT-2012 21:01:07

G23.6-0.03 EY017B.UVDATA.1

Freq = 4.9270 GHz, Bw = 16.000 MH No calibration applied and no bandpass applied

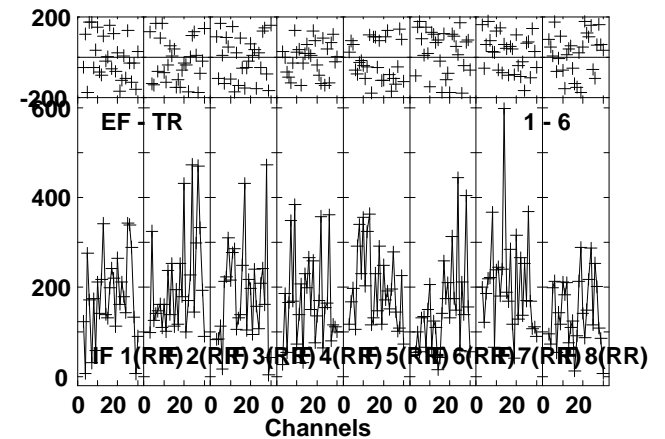
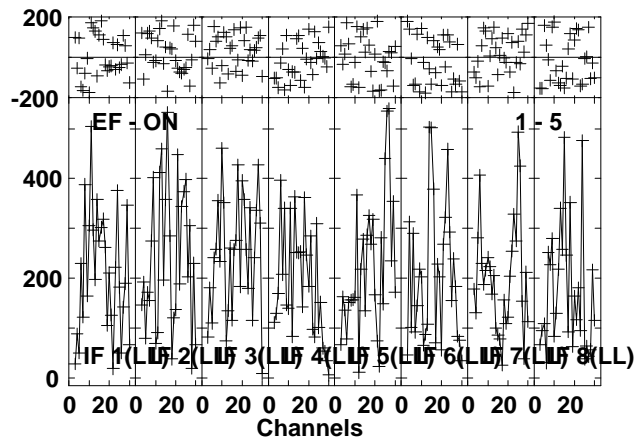
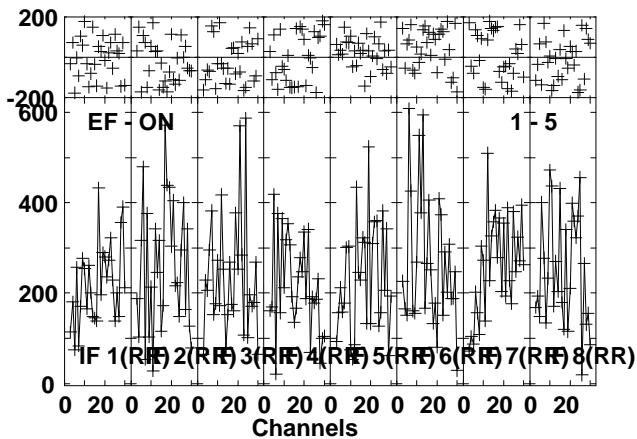
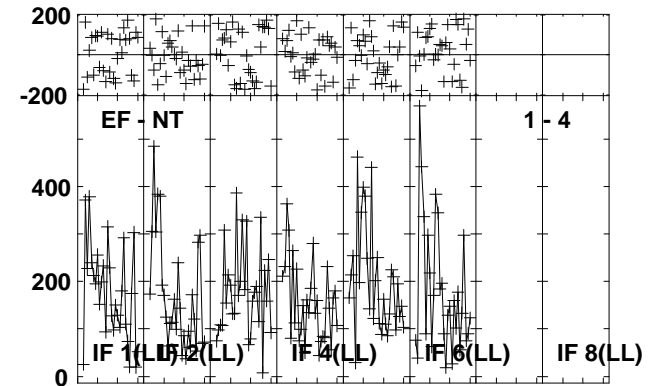
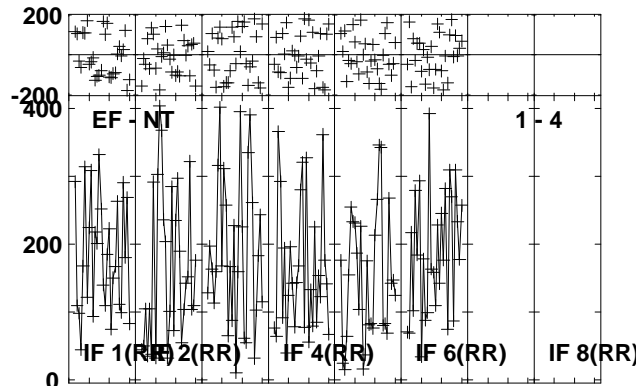
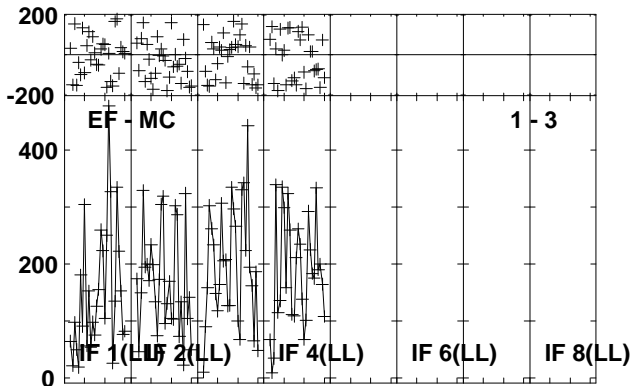
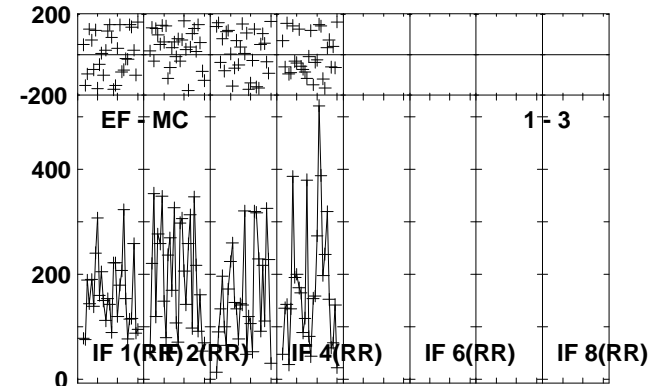
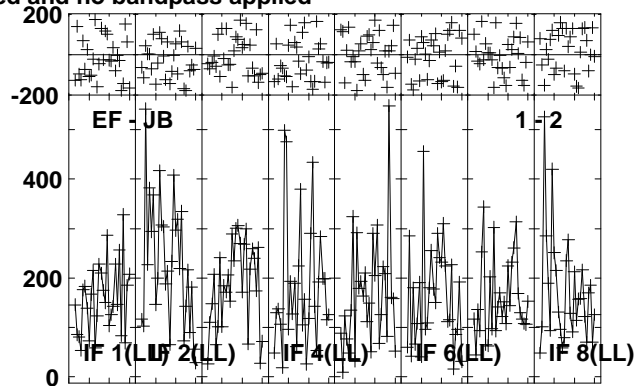
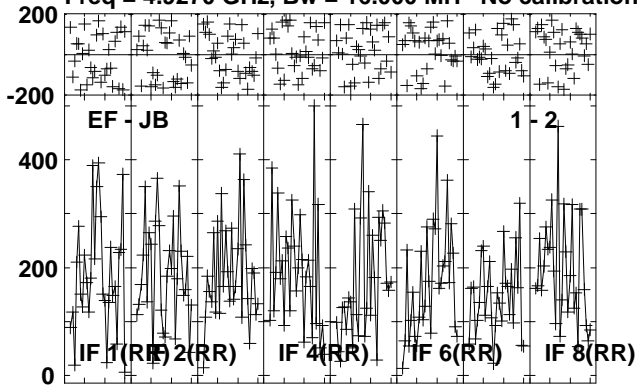

Lower frame: Micro Ampl Jy Top frame: Phas deg  
Vector averaged cross-power spectrum Several baselines displayed  
Timerange: 00/20:40:38 to 00/20:43:04

Plot file version 328 created 24-OCT-2012 21:01:08

G23.6-0.03 EY017B.UVDATA.1

Freq = 4.9270 GHz, Bw = 16.000 MH No calibration applied and no bandpass applied

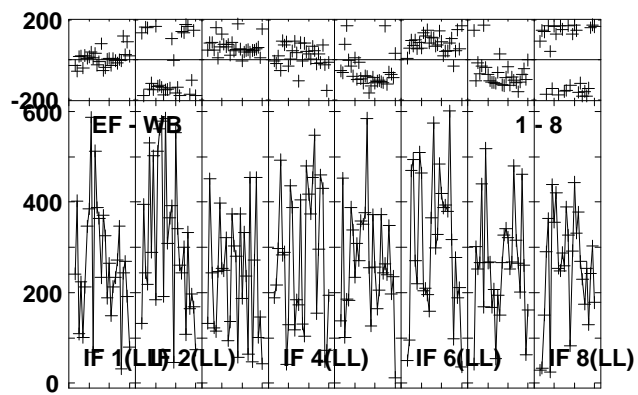
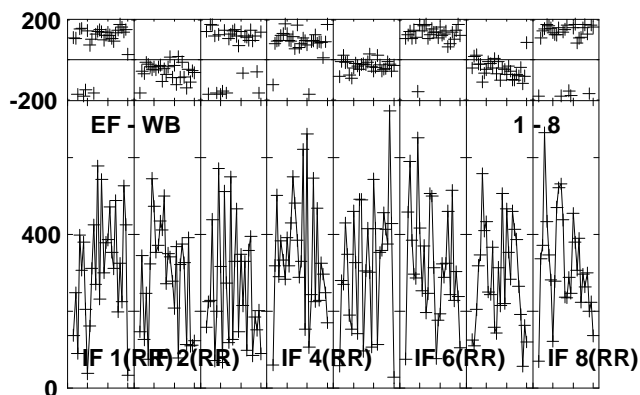
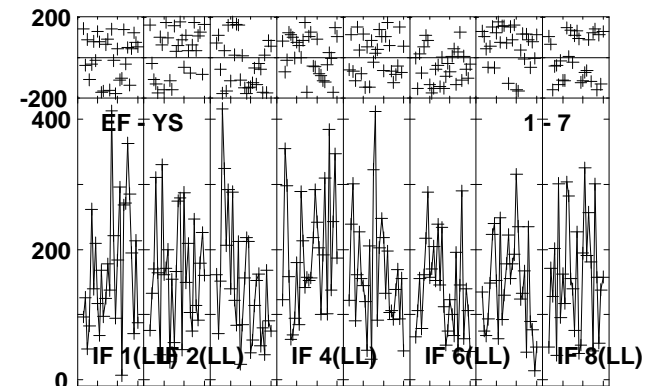
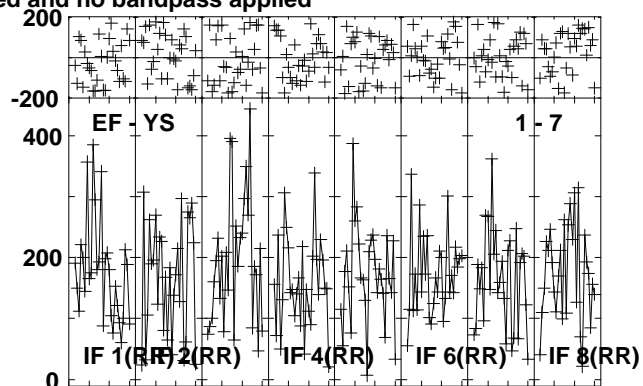
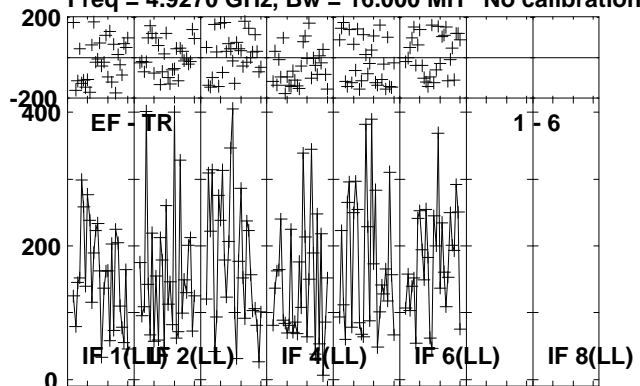

Lower frame: Micro Ampl Jy Top frame: Phas deg  
Vector averaged cross-power spectrum Several baselines displayed  
Timerange: 00/20:40:38 to 00/20:43:04

Plot file version 329 created 24-OCT-2012 21:01:09

J1825-0737 EY017B.UVDATA.1

Freq = 4.9270 GHz, Bw = 16.000 MH No calibration applied and no bandpass applied

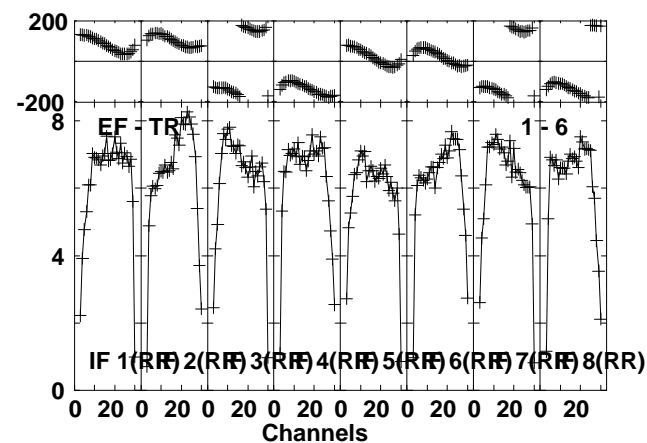
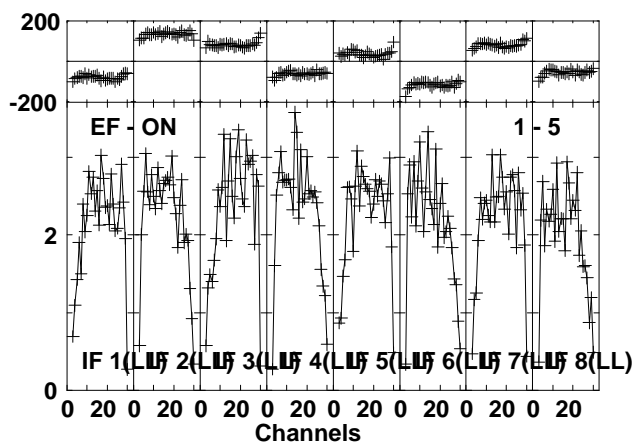
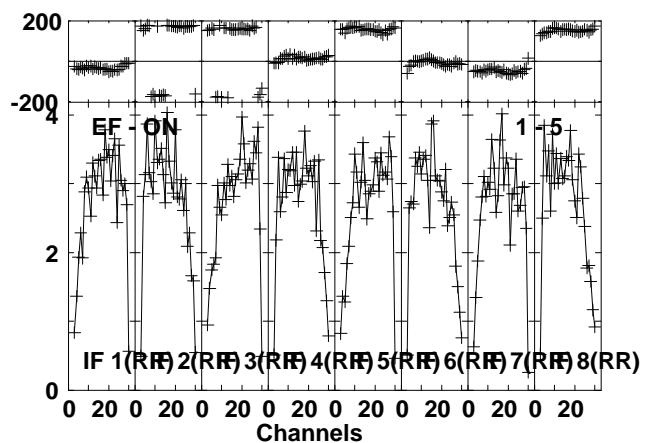
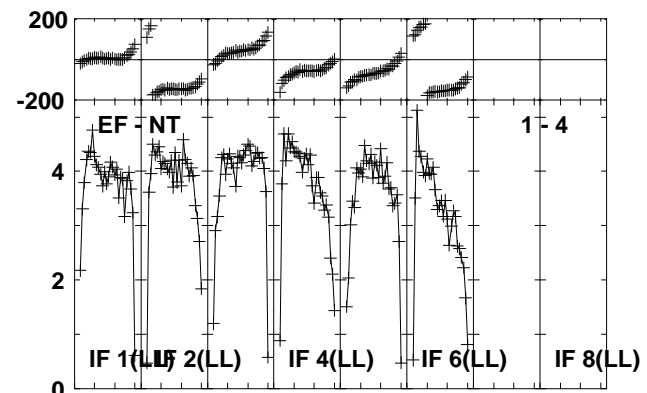
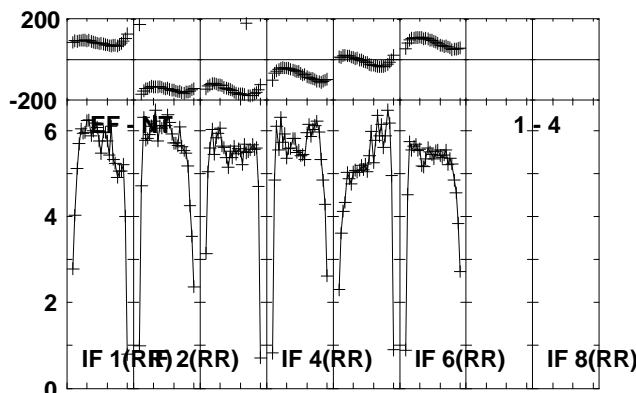
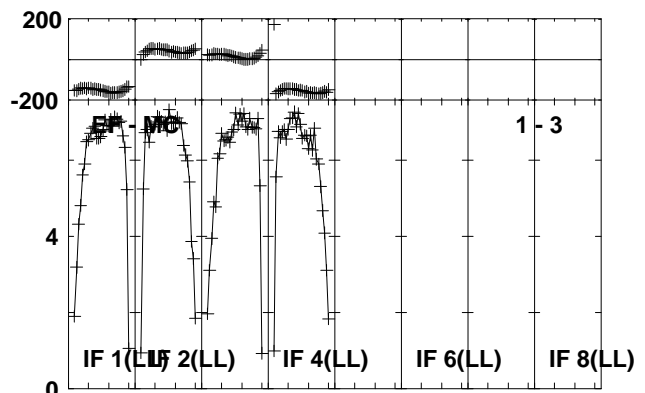
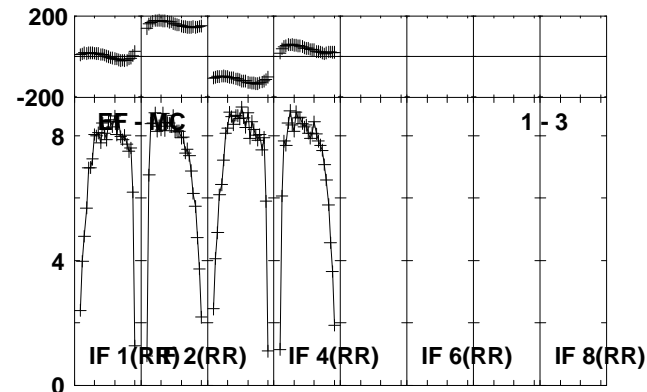
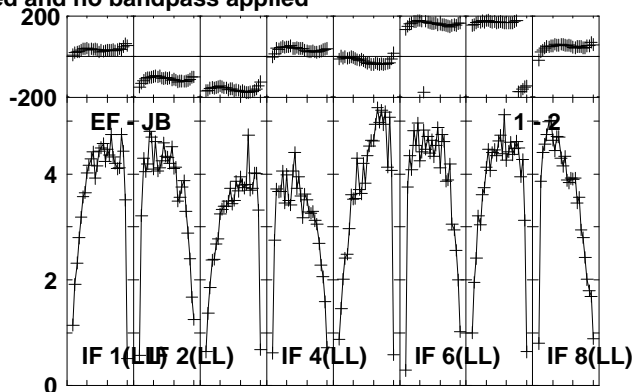
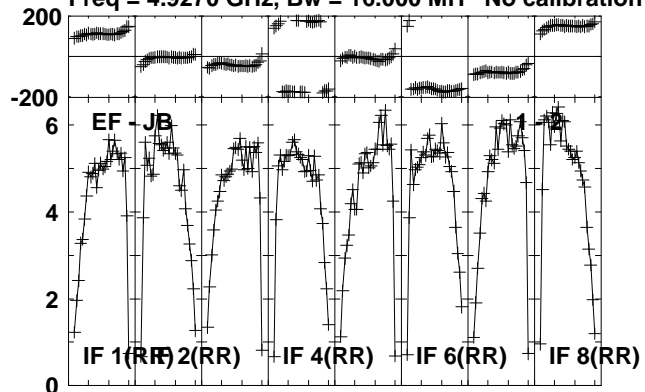

Lower frame: Milli Ampl Jy Top frame: Phas deg  
Vector averaged cross-power spectrum Several baselines displayed  
Timerange: 00/20:43:08 to 00/20:44:34

Plot file version 330 created 24-OCT-2012 21:01:09

J1825-0737 EY017B.UVDATA.1

Freq = 4.9270 GHz, Bw = 16.000 MH No calibration applied and no bandpass applied

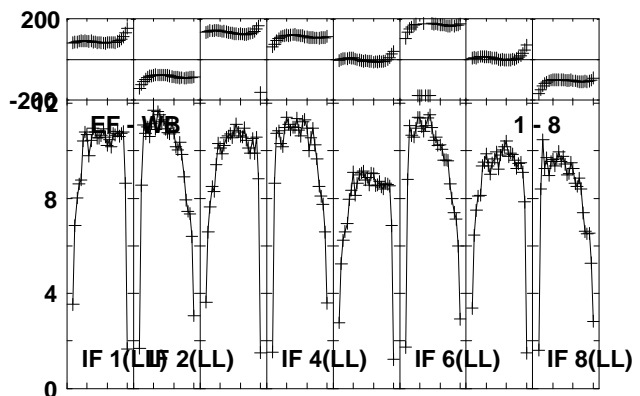
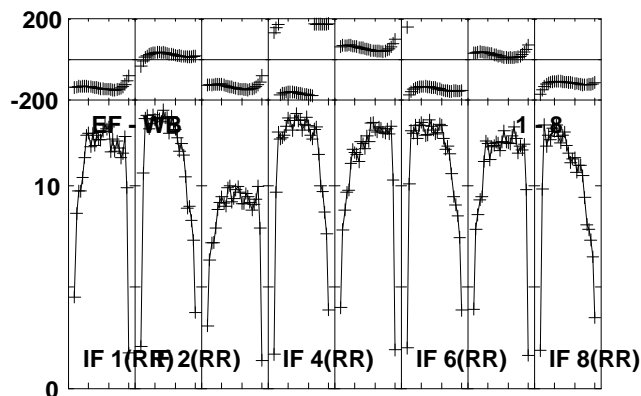
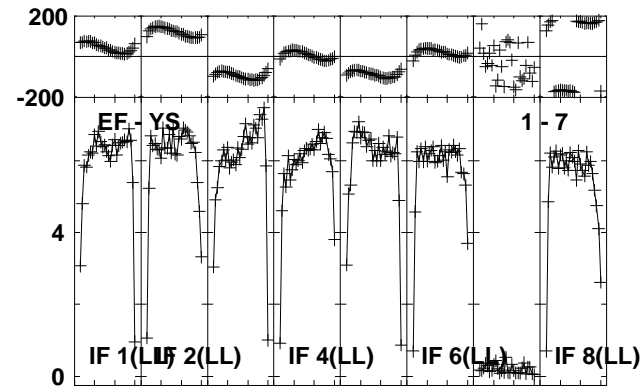
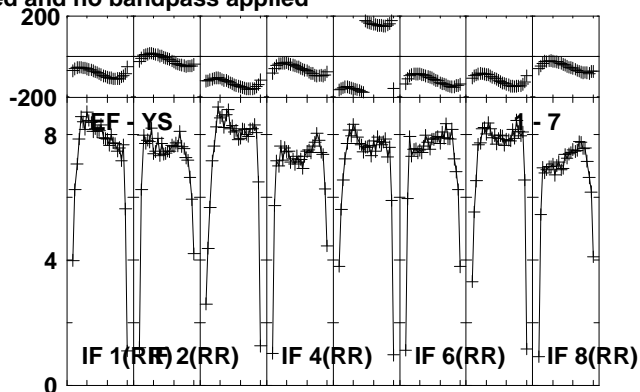
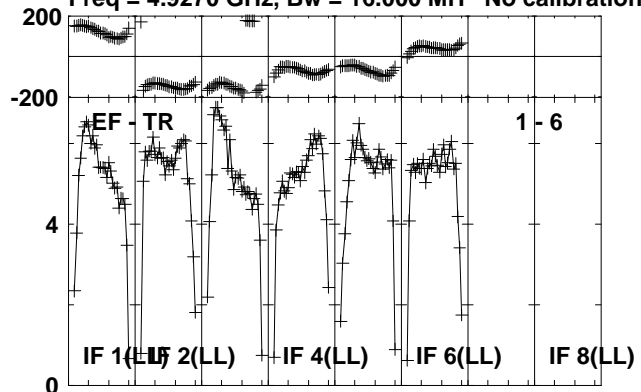

Lower frame: Milli Ampl Jy Top frame: Phas deg  
Vector averaged cross-power spectrum Several baselines displayed  
Timerange: 00/20:43:08 to 00/20:44:34

Plot file version 331 created 24-OCT-2012 21:01:10  
 G23.6-0.03 EY017B.UVDATA.1

Freq = 4.9270 GHz, Bw = 16.000 MH No calibration applied and no bandpass applied

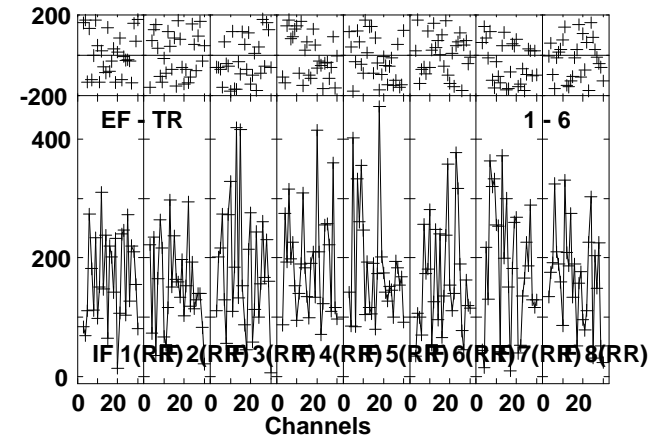
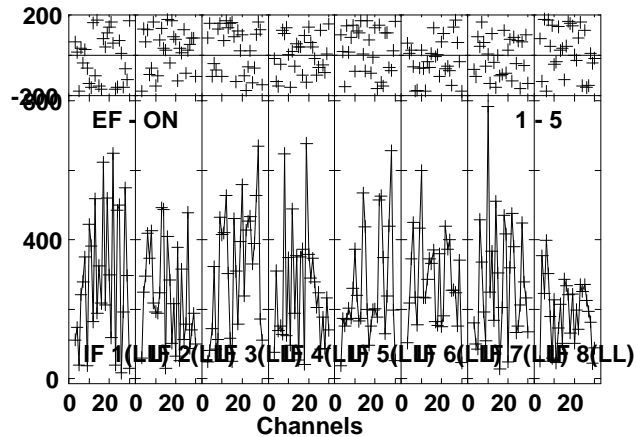
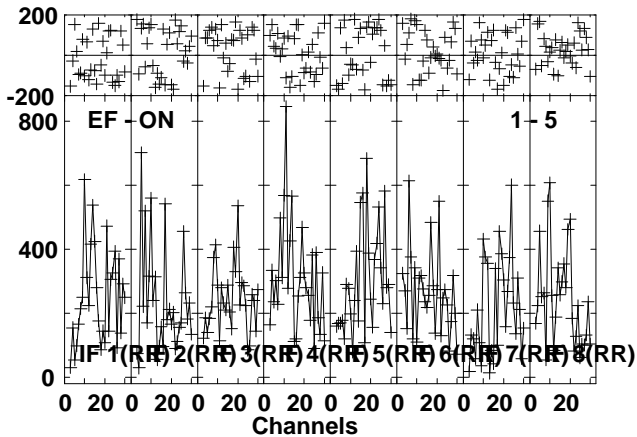
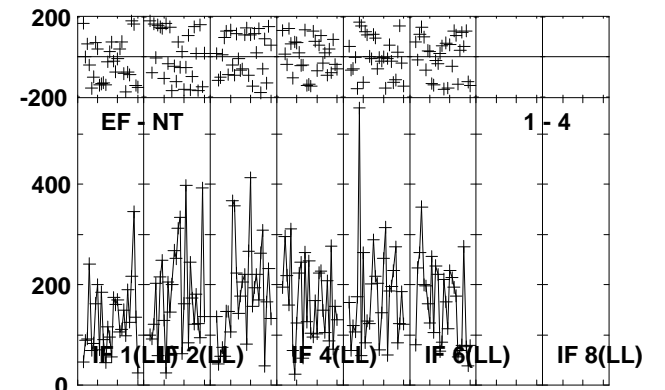
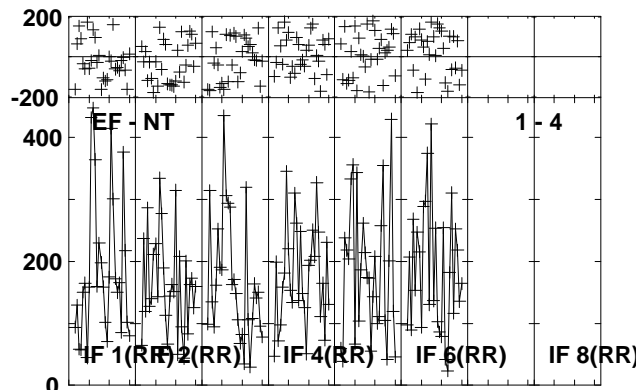
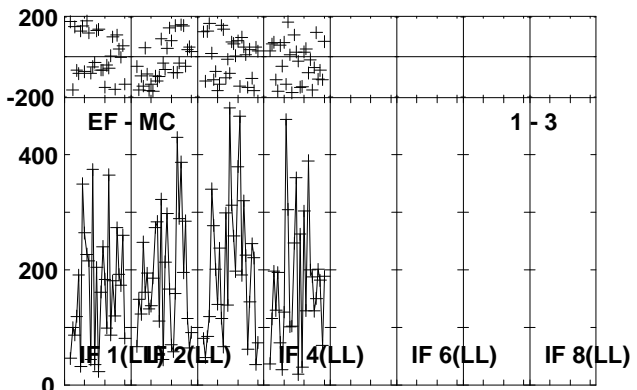
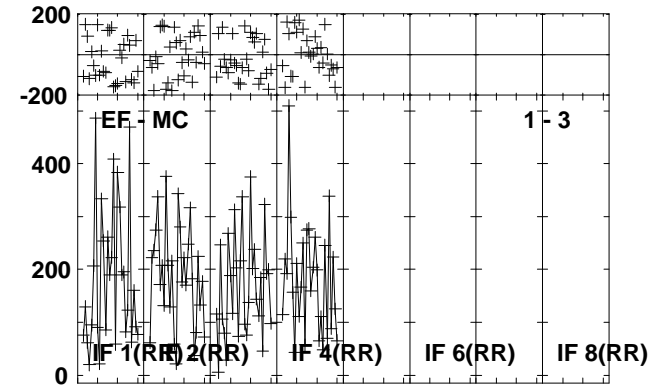
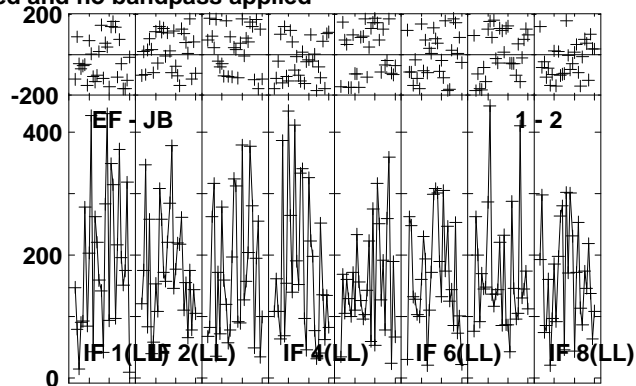
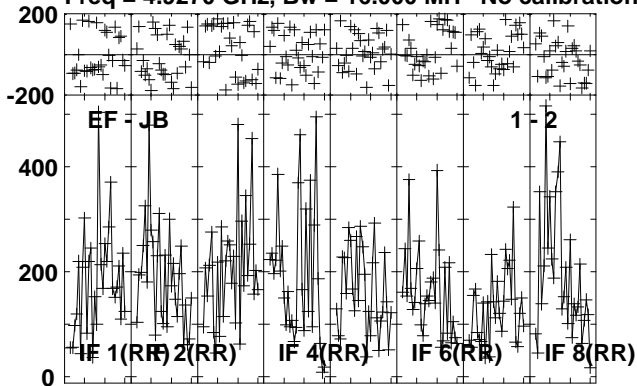

Lower frame: Micro Ampl Jy Top frame: Phas deg  
 Vector averaged cross-power spectrum Several baselines displayed  
 Timerange: 00/20:44:38 to 00/20:47:04

Plot file version 332 created 24-OCT-2012 21:01:11

G23.6-0.03 EY017B.UVDATA.1

Freq = 4.9270 GHz, Bw = 16.000 MH No calibration applied and no bandpass applied

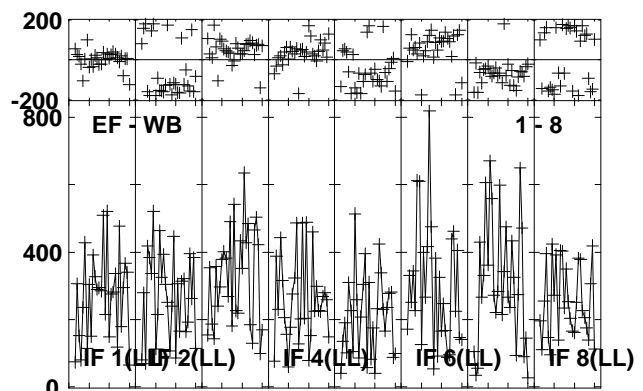
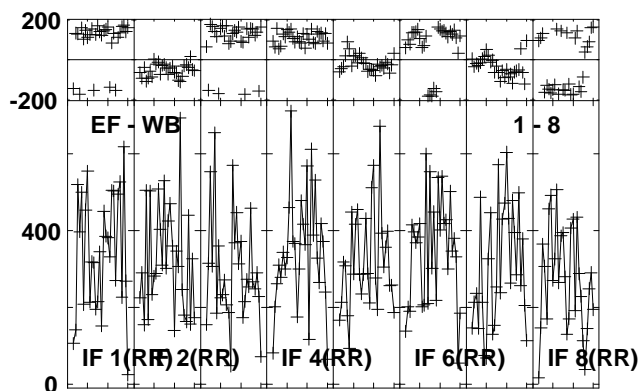
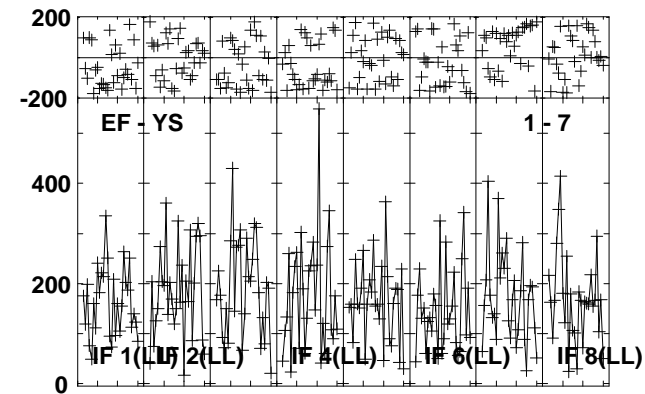
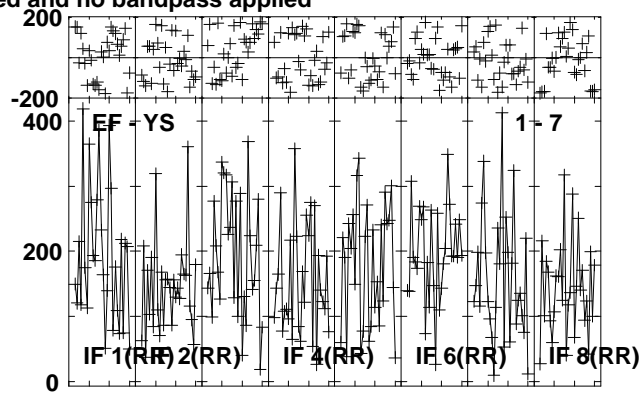
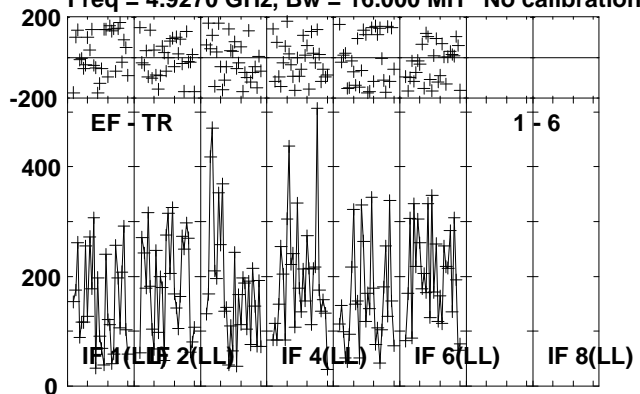

Lower frame: Micro Ampl Jy Top frame: Phas deg  
Vector averaged cross-power spectrum Several baselines displayed  
Timerange: 00/20:44:38 to 00/20:47:04



Plot file version 333 created 24-OCT-2012 21:01:11

J1825-0737 EY017B.UVDATA.1

Freq = 4.9270 GHz, Bw = 16.000 MH No calibration applied and no bandpass applied

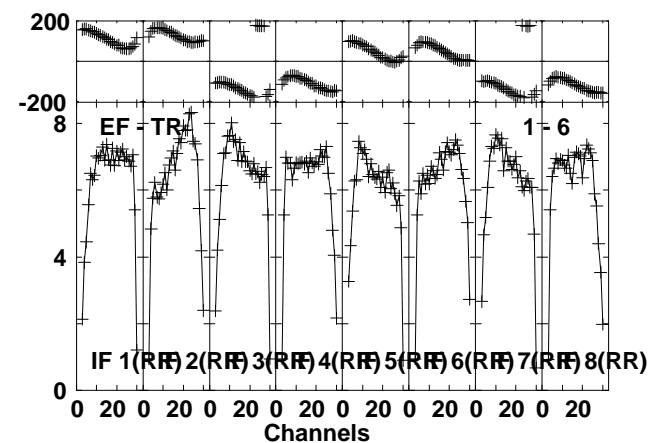
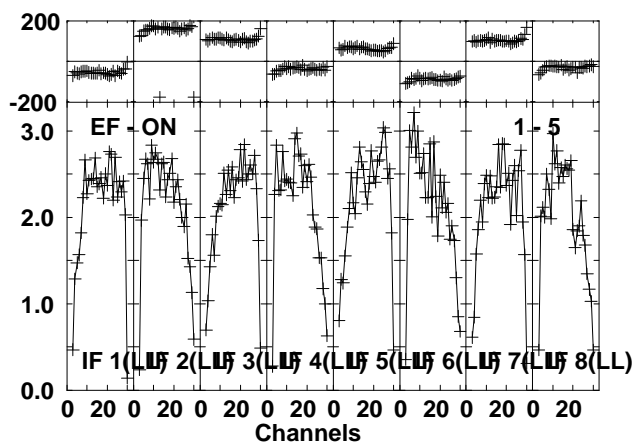
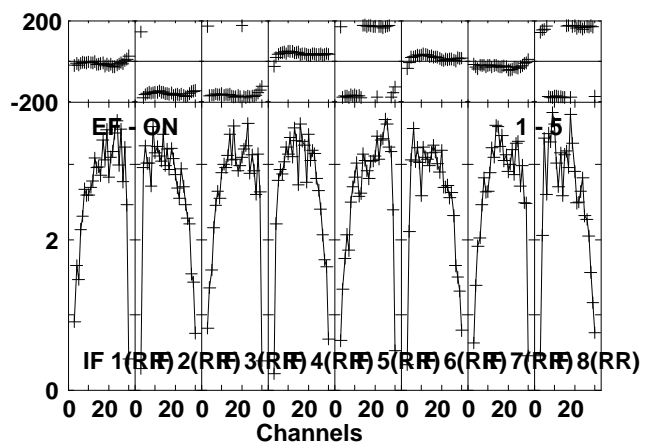
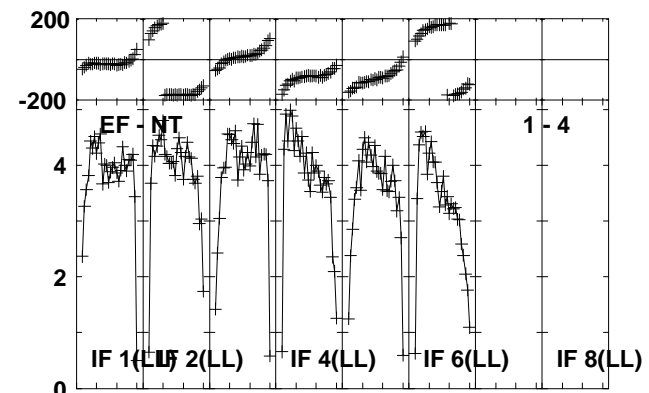
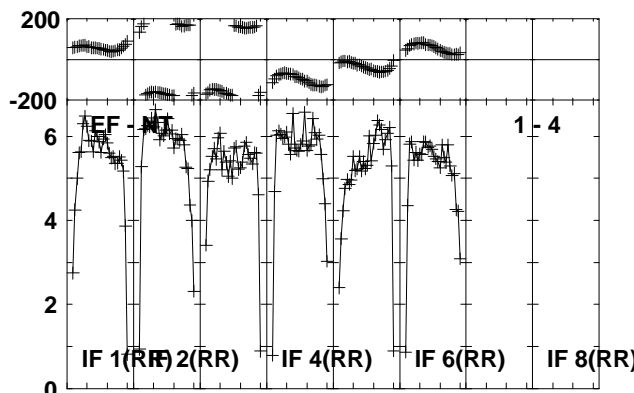
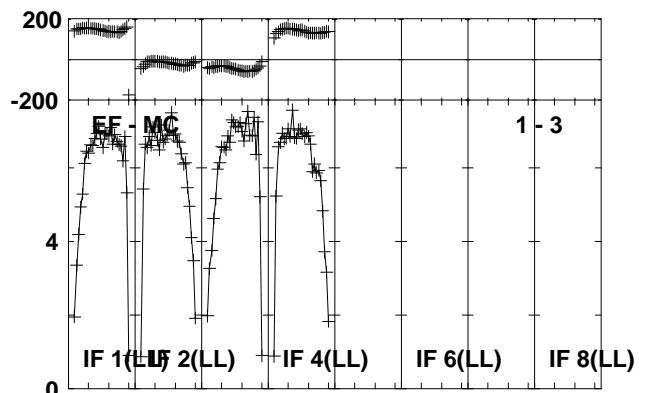
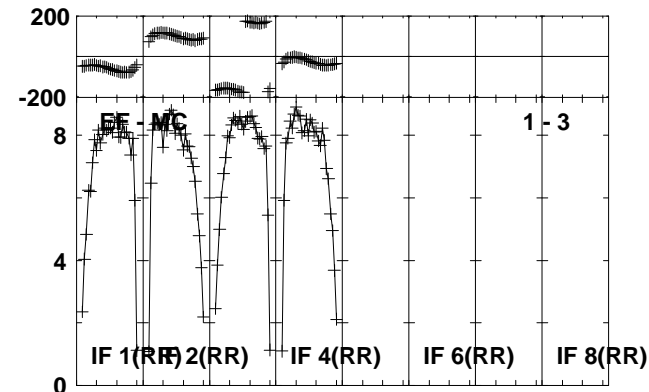
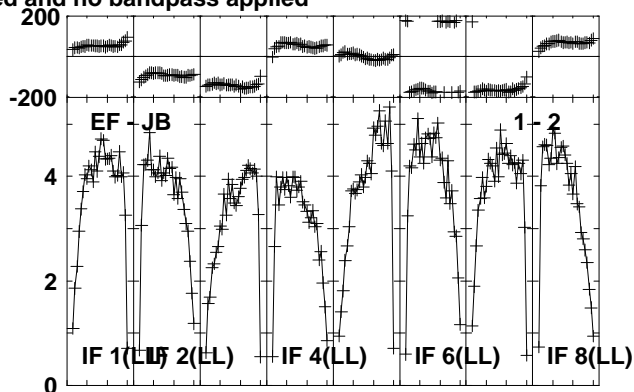
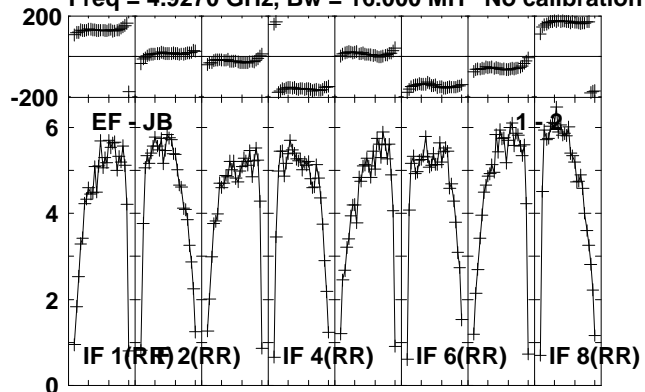

Lower frame: Milli Ampl Jy Top frame: Phas deg  
Vector averaged cross-power spectrum Several baselines displayed  
Timerange: 00/20:47:08 to 00/20:48:34

Plot file version 334 created 24-OCT-2012 21:01:12

J1825-0737 EY017B.UVDATA.1

Freq = 4.9270 GHz, Bw = 16.000 MH No calibration applied and no bandpass applied

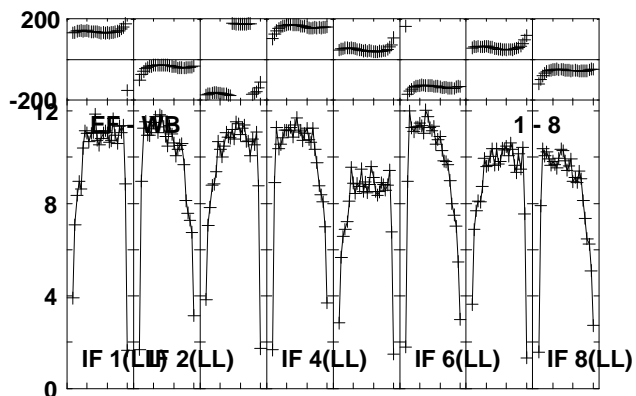
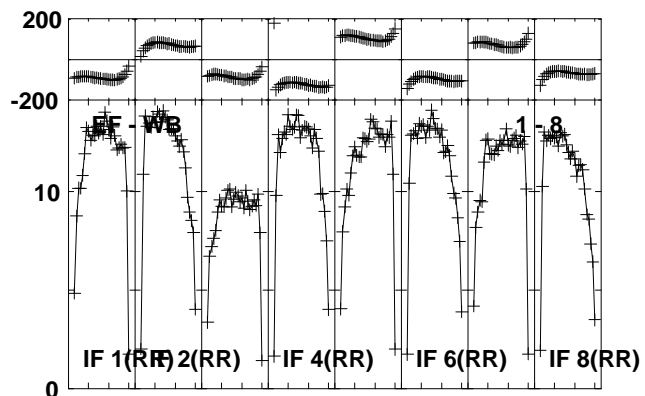
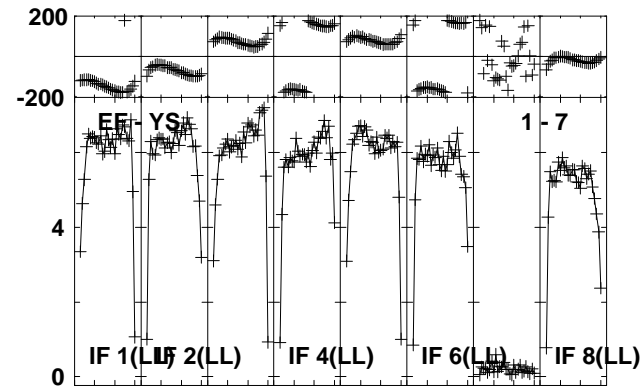
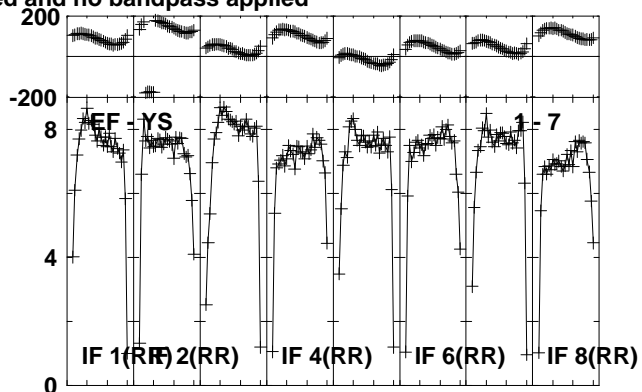
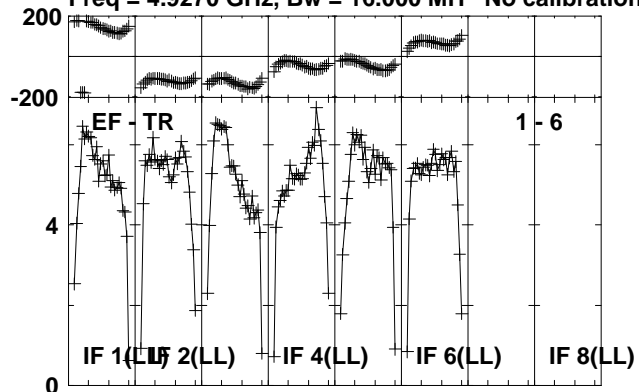

Lower frame: Milli Ampl Jy Top frame: Phas deg  
Vector averaged cross-power spectrum Several baselines displayed  
Timerange: 00/20:47:08 to 00/20:48:34

Plot file version 335 created 24-OCT-2012 21:01:12  
 J1831-0756 EY017B.UVDATA.1

Freq = 4.9270 GHz, Bw = 16.000 MH No calibration applied and no bandpass applied

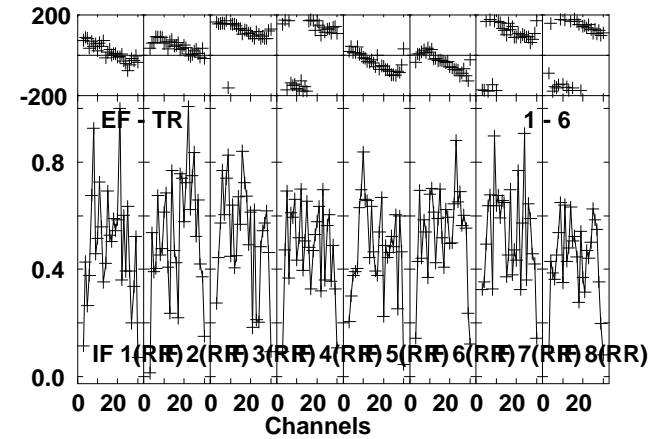
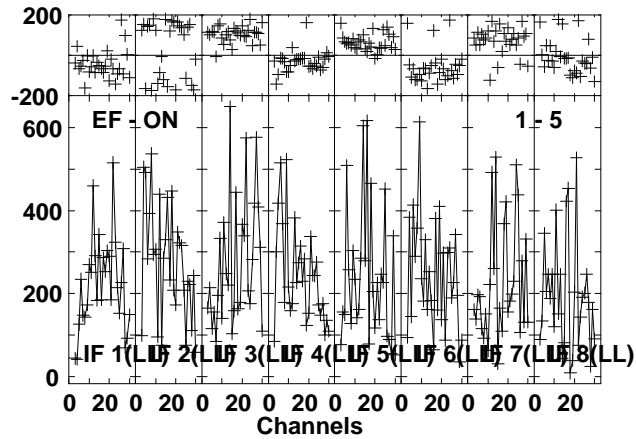
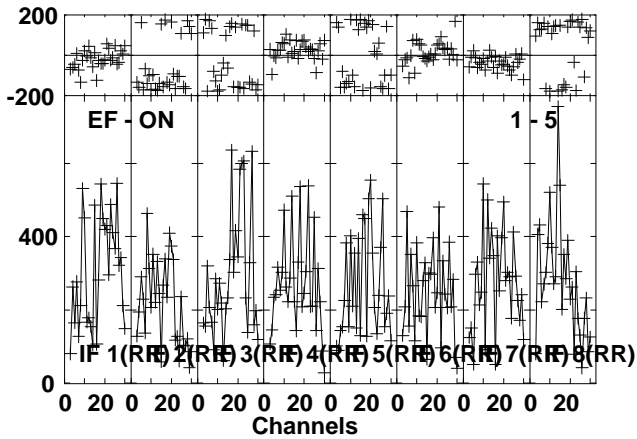
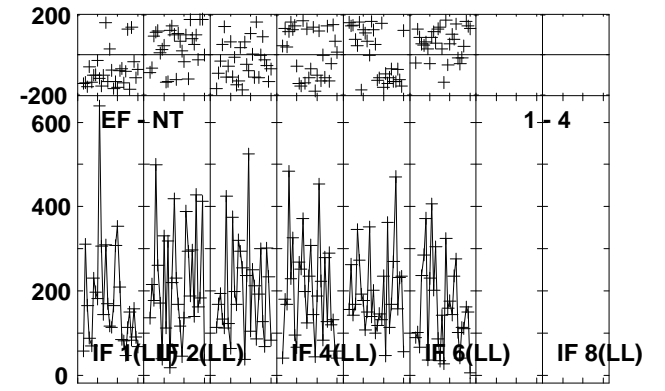
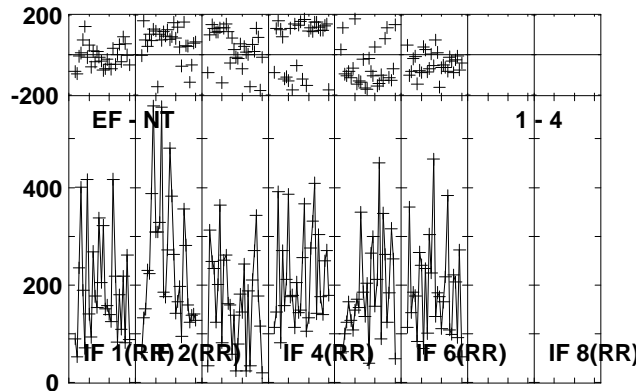
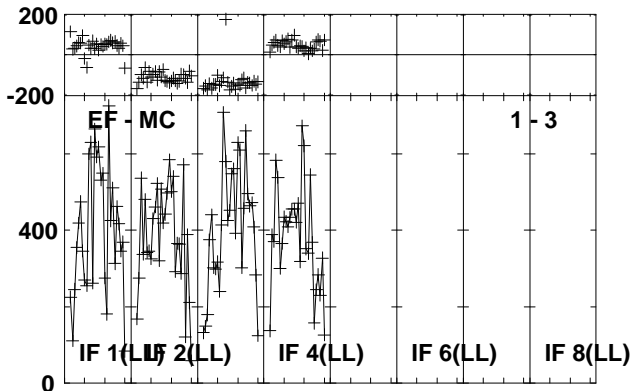
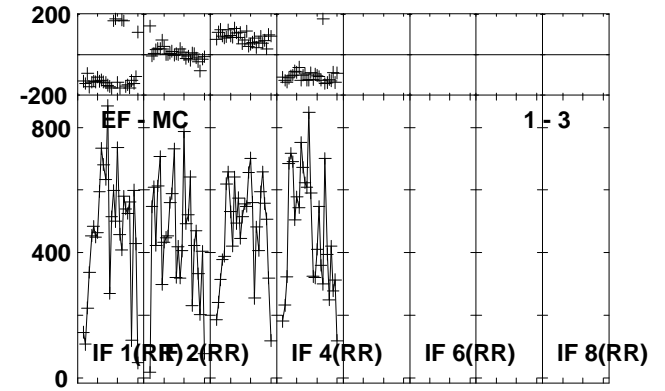
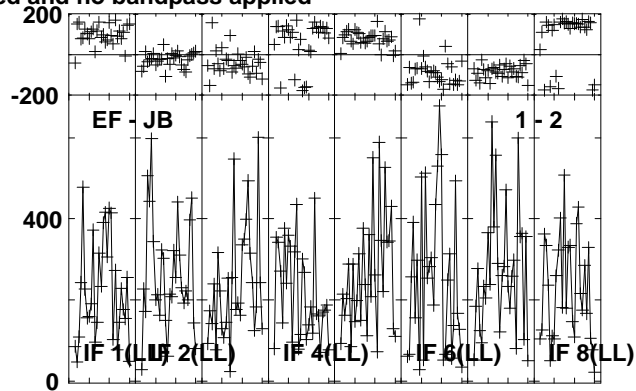
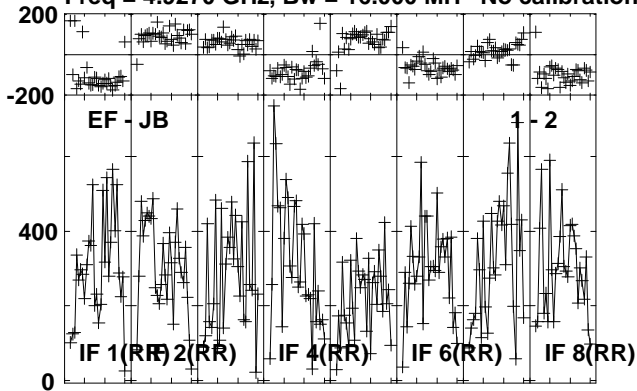

Lower frame: Micro Ampl Jy Top frame: Phas deg  
 Vector averaged cross-power spectrum Several baselines displayed  
 Timerange: 00/20:49:08 to 00/20:51:08

Plot file version 336 created 24-OCT-2012 21:01:13

J1831-0756 EY017B.UVDATA.1

Freq = 4.9270 GHz, Bw = 16.000 MH No calibration applied and no bandpass applied

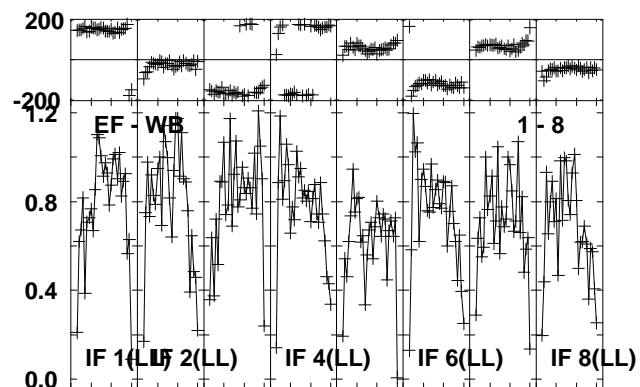
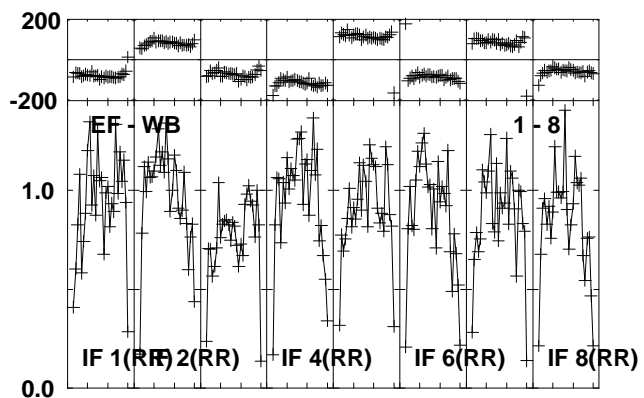
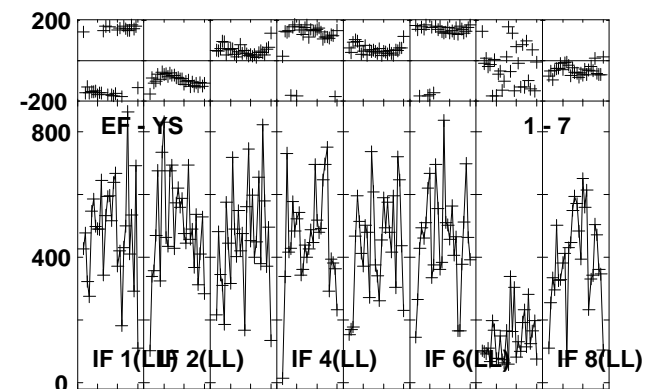
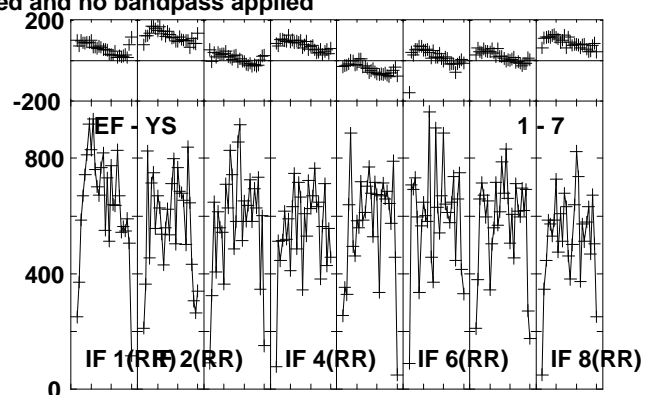
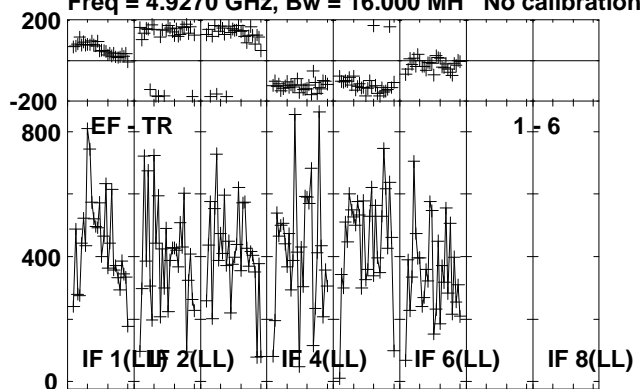

Lower frame: Micro Ampl Jy Top frame: Phas deg  
Vector averaged cross-power spectrum Several baselines displayed  
Timerange: 00/20:49:08 to 00/20:51:08

Plot file version 337 created 24-OCT-2012 21:01:13

J1825-0737 EY017B.UVDATA.1

Freq = 4.9270 GHz, Bw = 16.000 MH No calibration applied and no bandpass applied

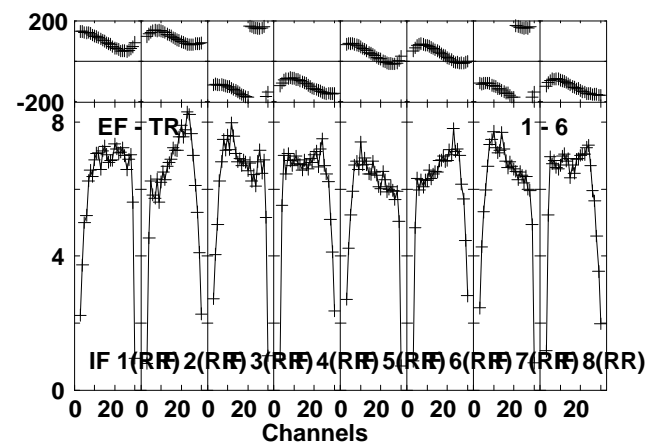
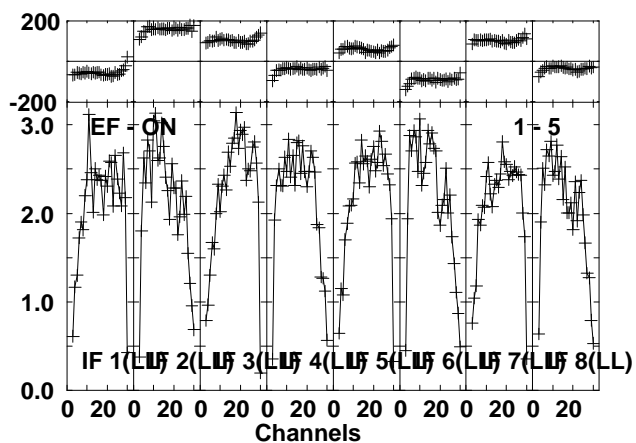
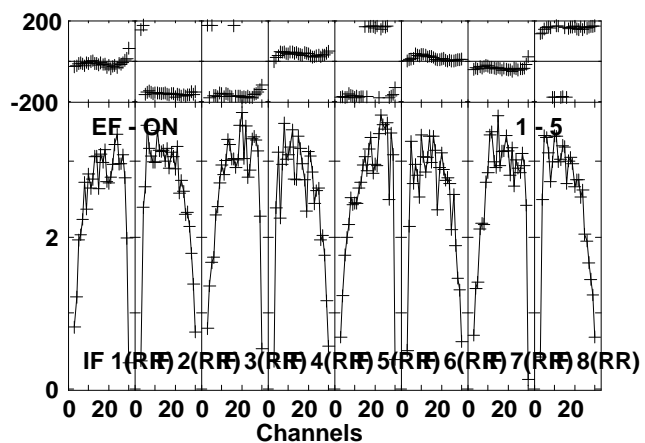
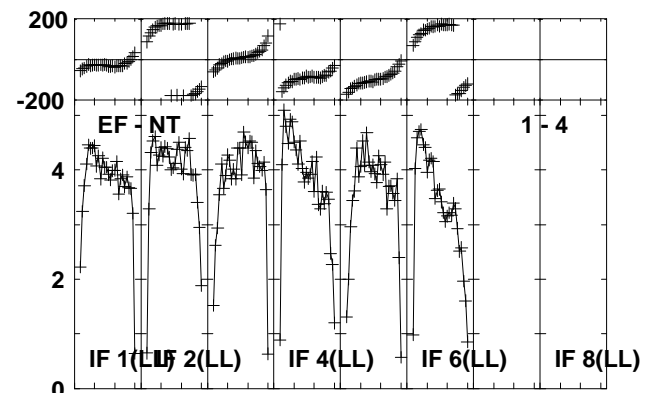
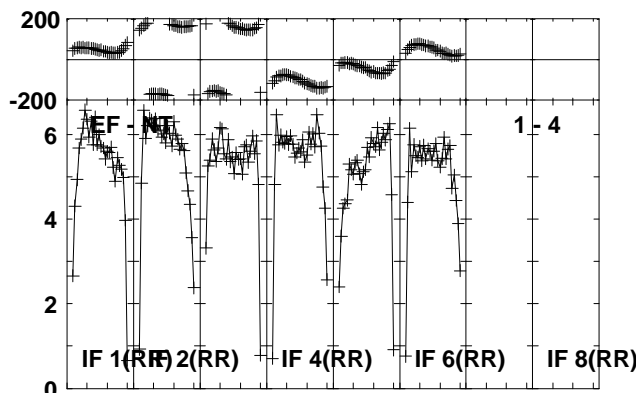
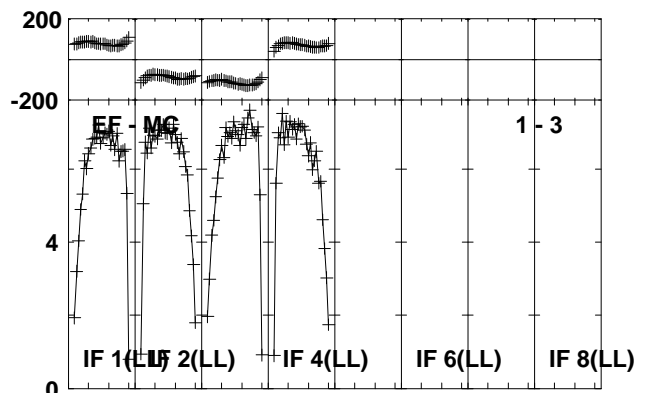
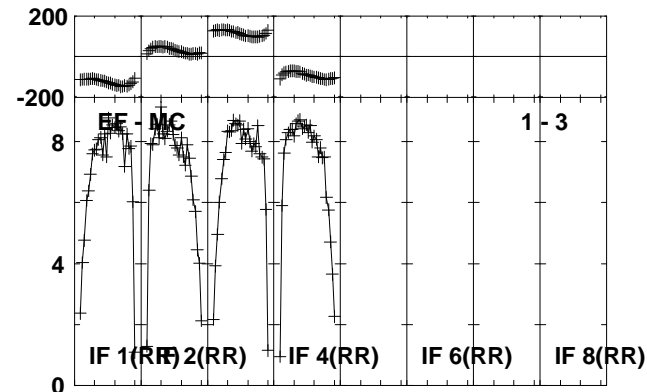
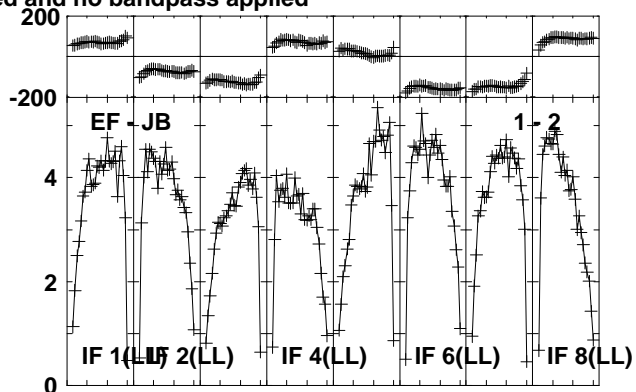
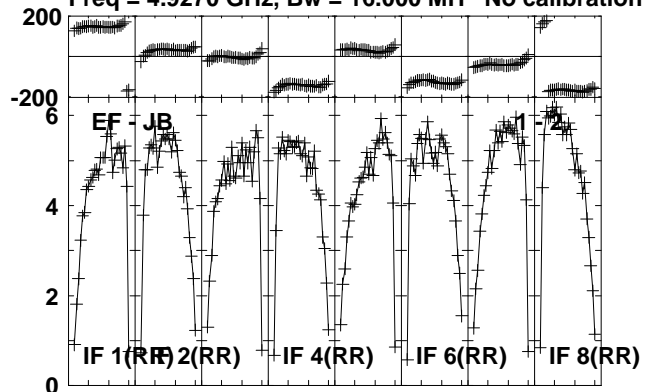

Lower frame: Milli Ampl Jy Top frame: Phas deg  
Vector averaged cross-power spectrum Several baselines displayed  
Timerange: 00/20:51:12 to 00/20:52:38

Plot file version 338 created 24-OCT-2012 21:01:14

J1825-0737 EY017B.UVDATA.1

Freq = 4.9270 GHz, Bw = 16.000 MH No calibration applied and no bandpass applied

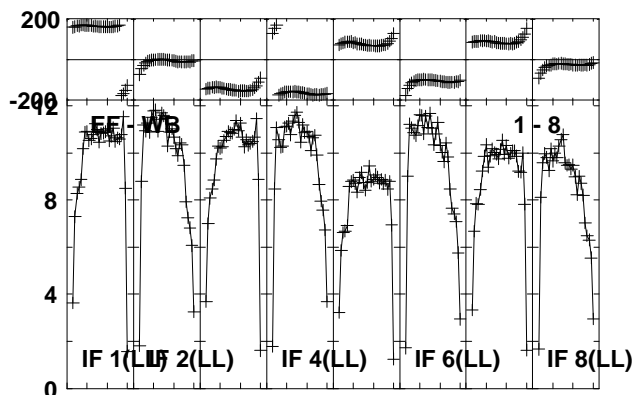
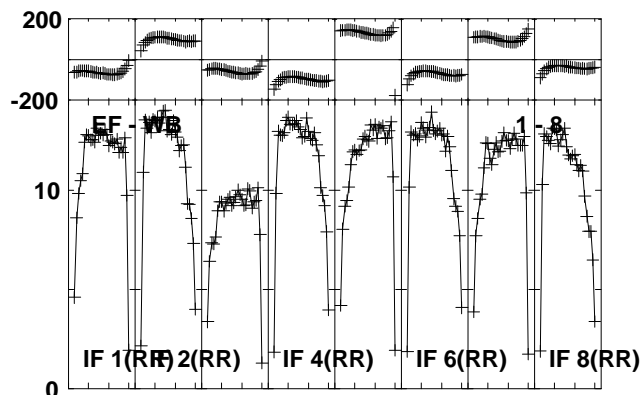
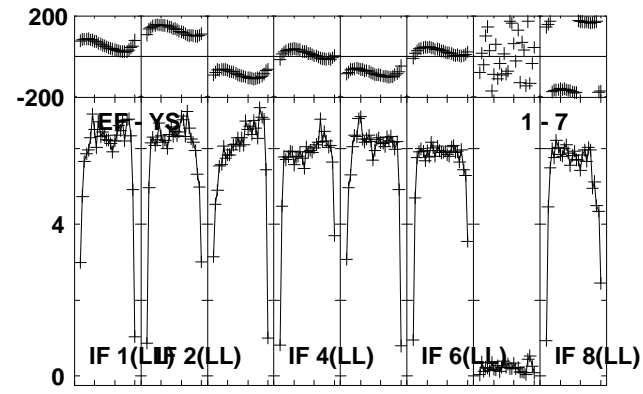
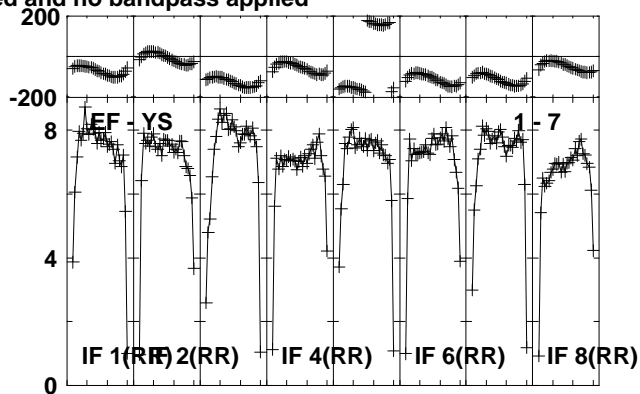
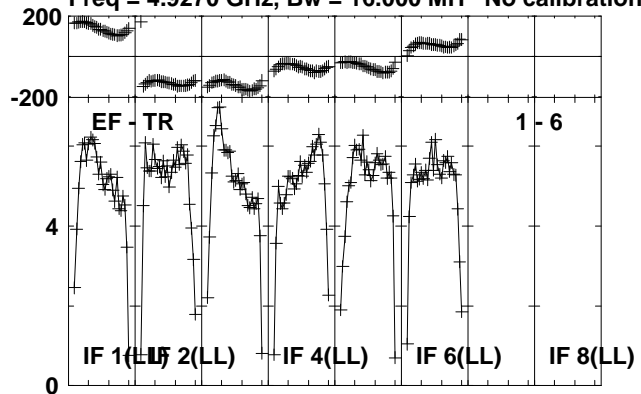

Lower frame: Milli Ampl Jy Top frame: Phas deg  
Vector averaged cross-power spectrum Several baselines displayed  
Timerange: 00/20:51:12 to 00/20:52:38

Plot file version 339 created 24-OCT-2012 21:01:14

G23.6-0.03 EY017B.UVDATA.1

Freq = 4.9270 GHz, Bw = 16.000 MH No calibration applied and no bandpass applied

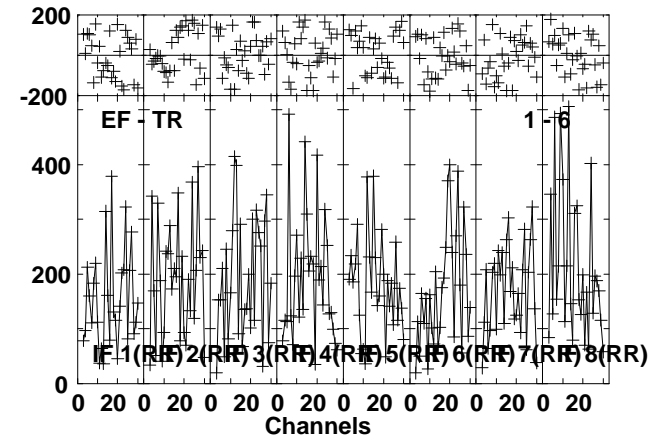
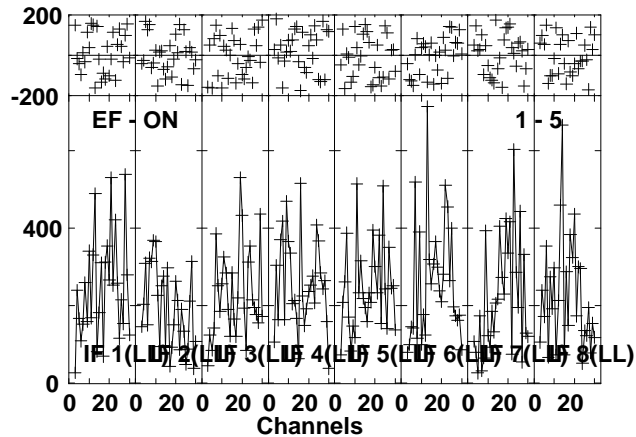
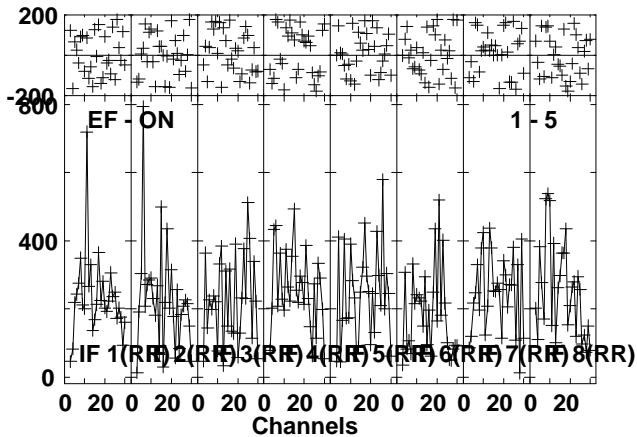
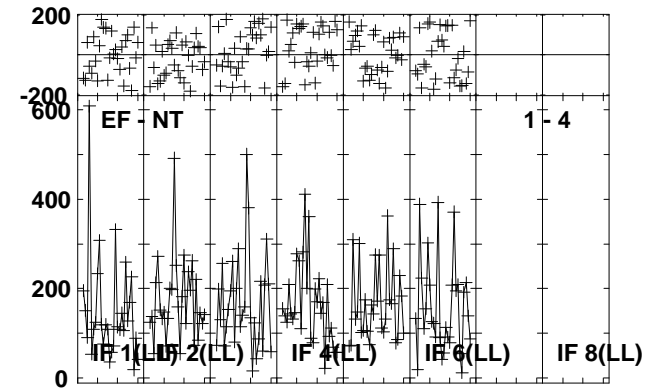
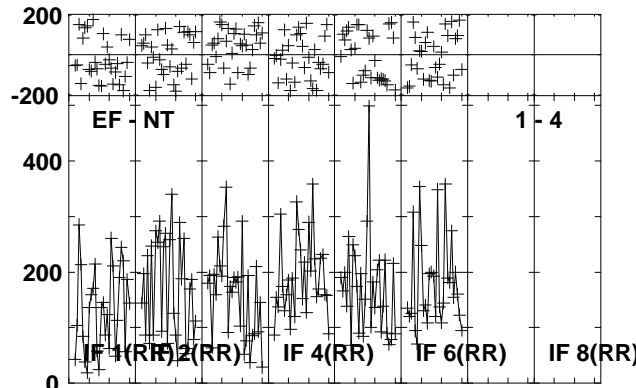
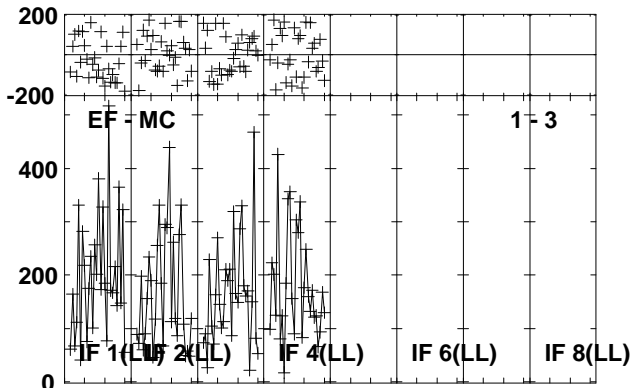
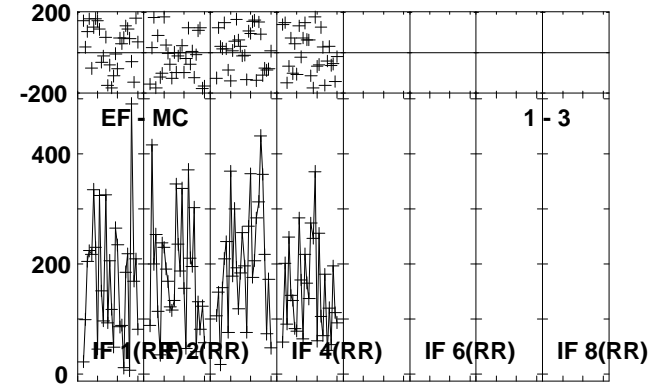
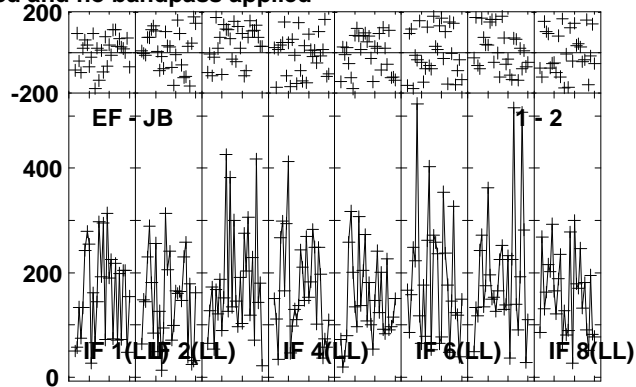
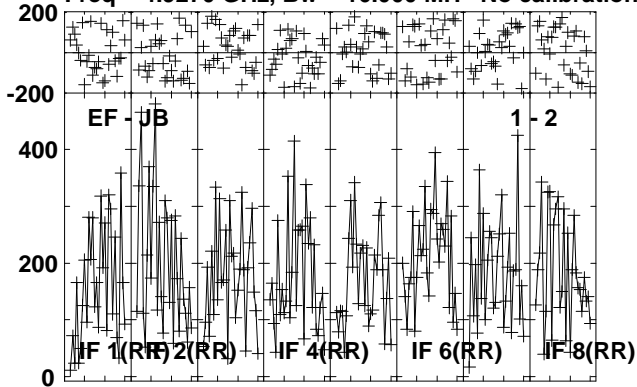

Lower frame: Micro Ampl Jy Top frame: Phas deg  
Vector averaged cross-power spectrum Several baselines displayed  
Timerange: 00/20:52:42 to 00/20:55:08

Plot file version 340 created 24-OCT-2012 21:01:15

G23.6-0.03 EY017B.UVDATA.1

Freq = 4.9270 GHz, Bw = 16.000 MH No calibration applied and no bandpass applied

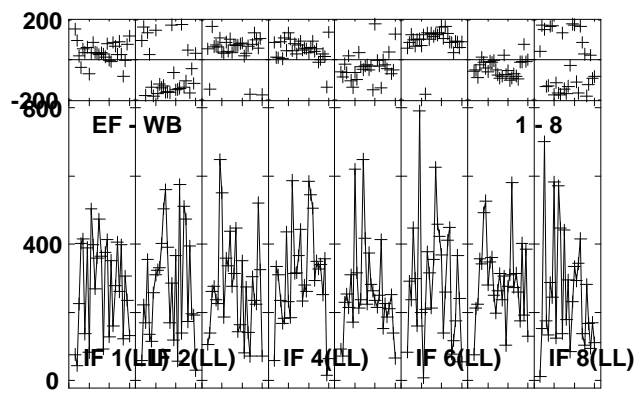
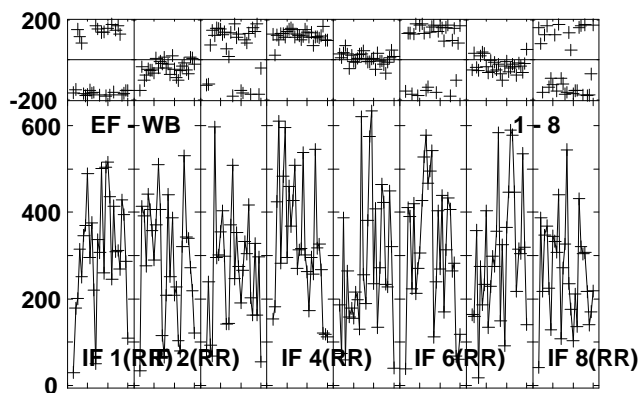
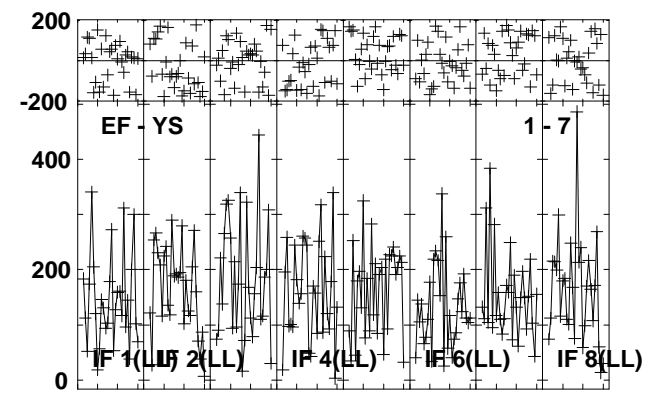
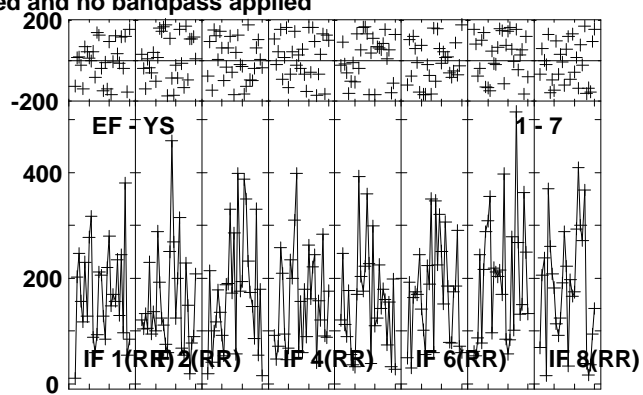
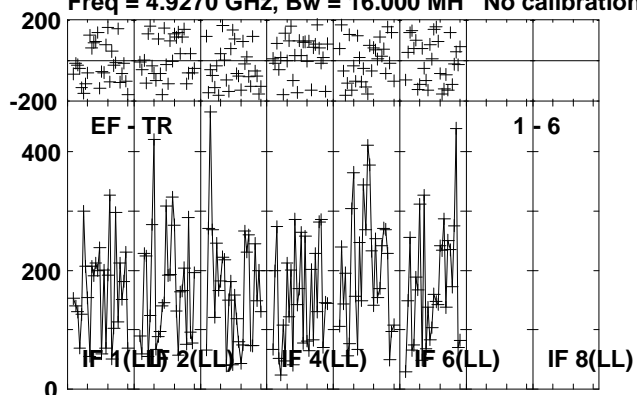

Lower frame: Micro Ampl Jy Top frame: Phas deg  
Vector averaged cross-power spectrum Several baselines displayed  
Timerange: 00/20:52:42 to 00/20:55:08



Plot file version 341 created 24-OCT-2012 21:01:15

J1825-0737 EY017B.UVDATA.1

Freq = 4.9270 GHz, Bw = 16.000 MH No calibration applied and no bandpass applied

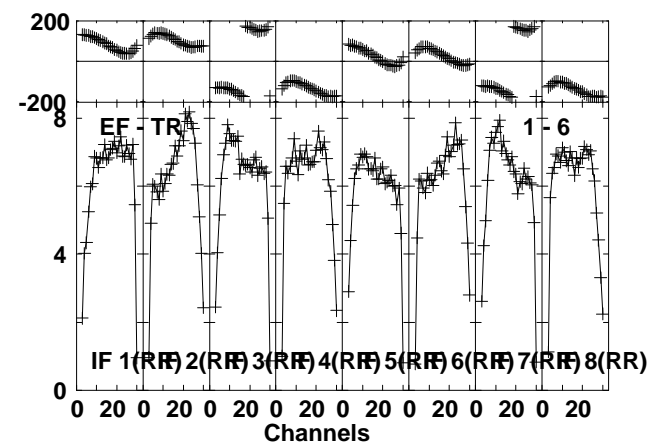
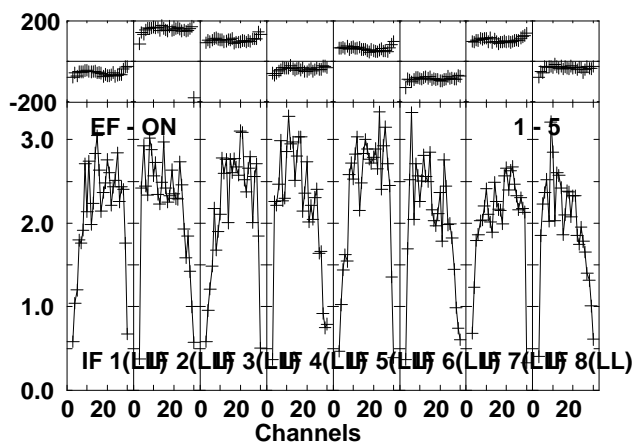
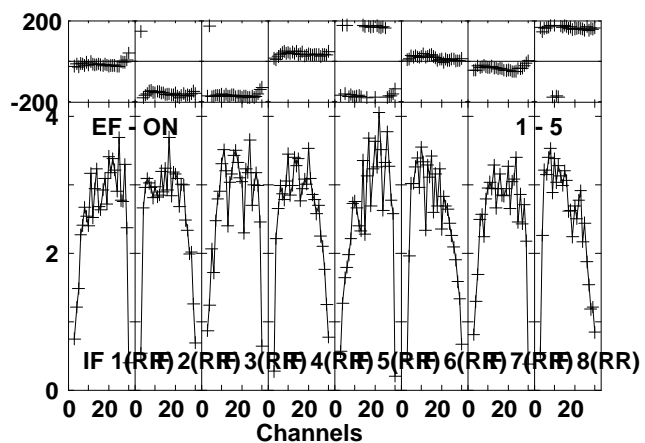
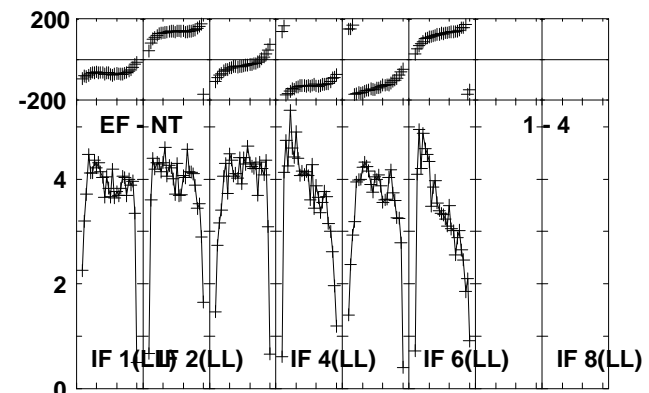
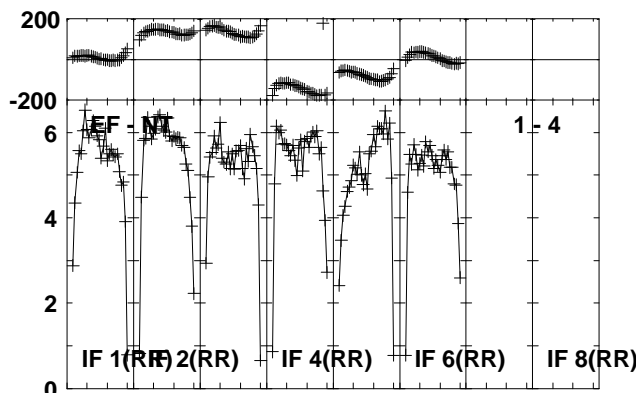
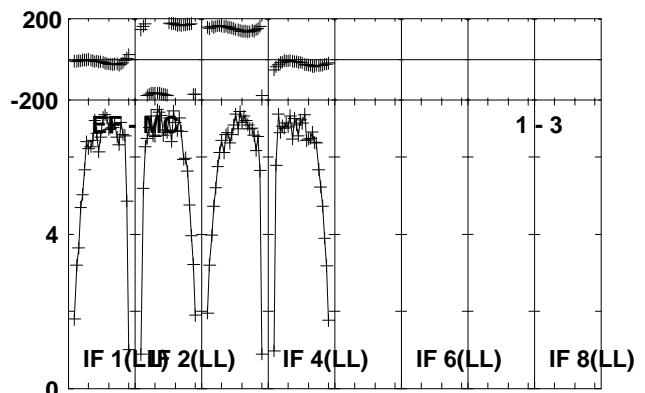
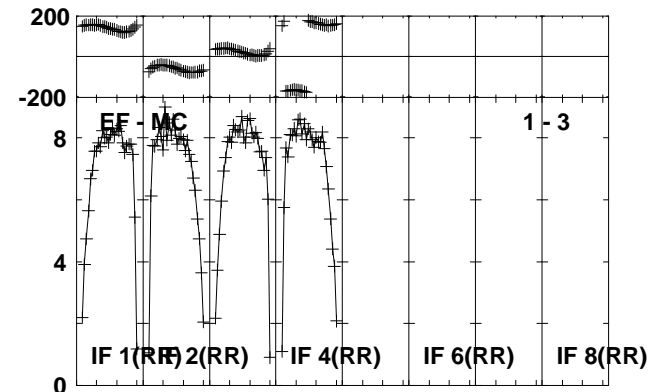
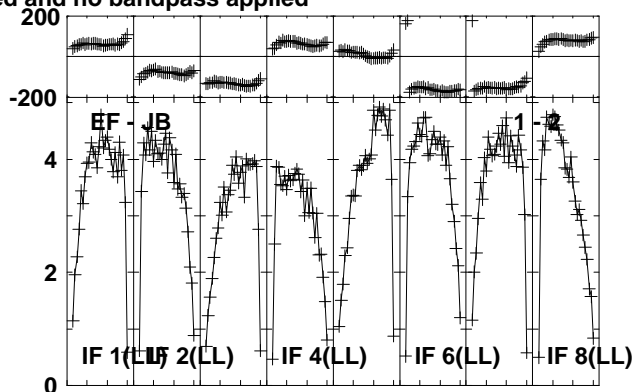
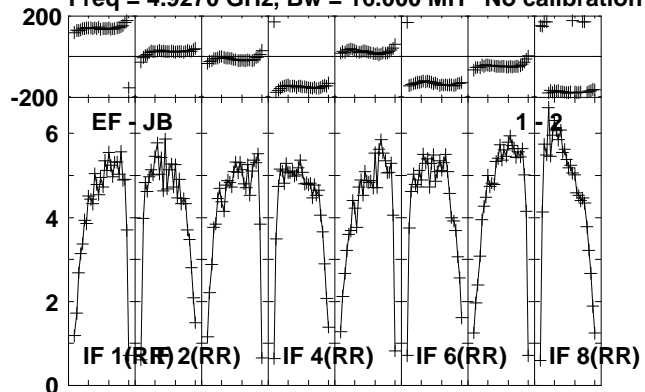

Lower frame: Milli Ampl Jy Top frame: Phas deg  
Vector averaged cross-power spectrum Several baselines displayed  
Timerange: 00/20:55:12 to 00/20:56:38

Plot file version 342 created 24-OCT-2012 21:01:16

J1825-0737 EY017B.UVDATA.1

Freq = 4.9270 GHz, Bw = 16.000 MH No calibration applied and no bandpass applied

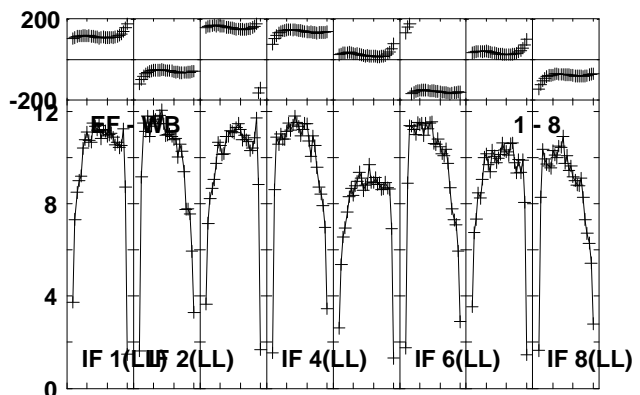
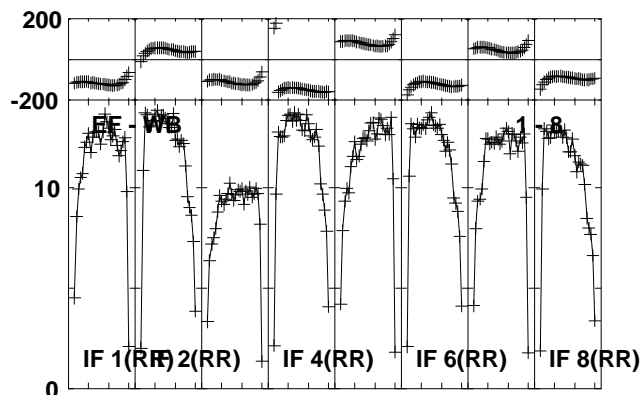
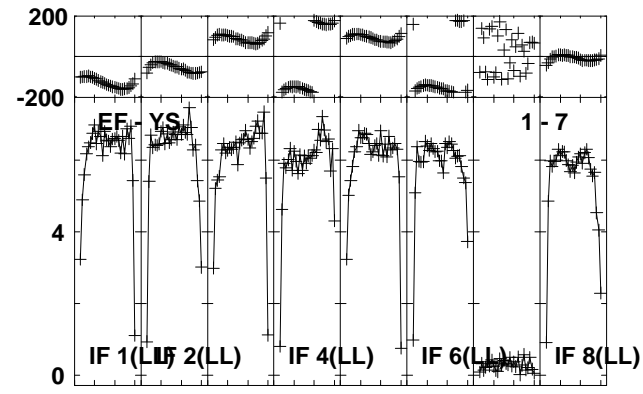
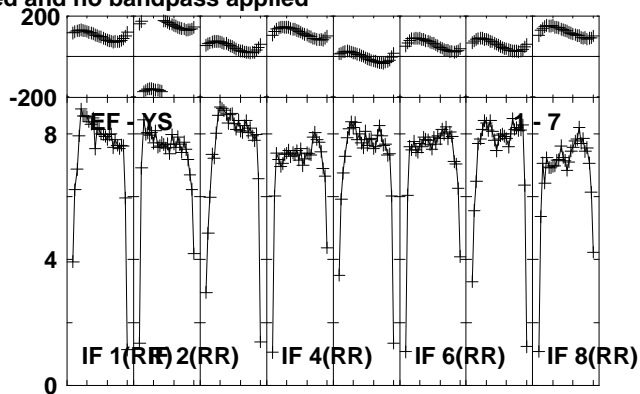
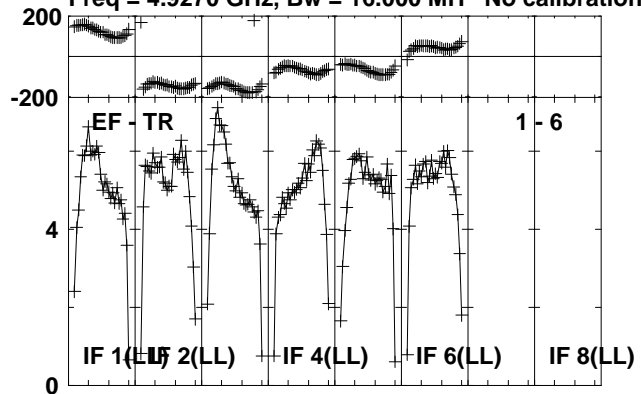

Lower frame: Milli Ampl Jy Top frame: Phas deg  
Vector averaged cross-power spectrum Several baselines displayed  
Timerange: 00/20:55:12 to 00/20:56:38

Plot file version 343 created 24-OCT-2012 21:01:16  
 G23.6-0.03 EY017B.UVDATA.1

Freq = 4.9270 GHz, Bw = 16.000 MH No calibration applied and no bandpass applied

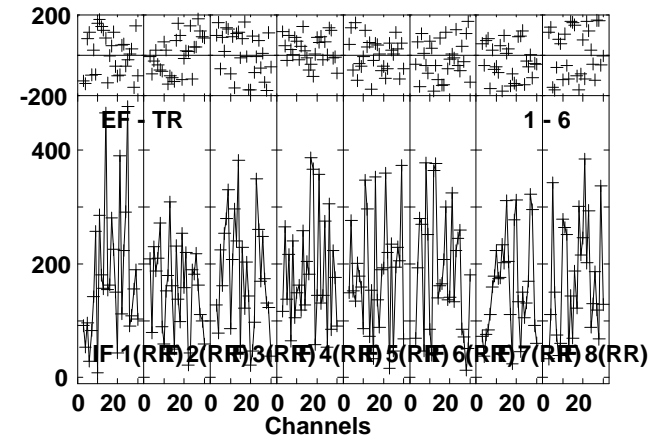
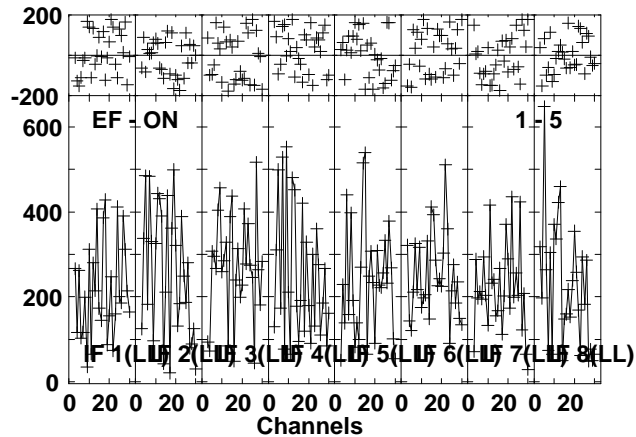
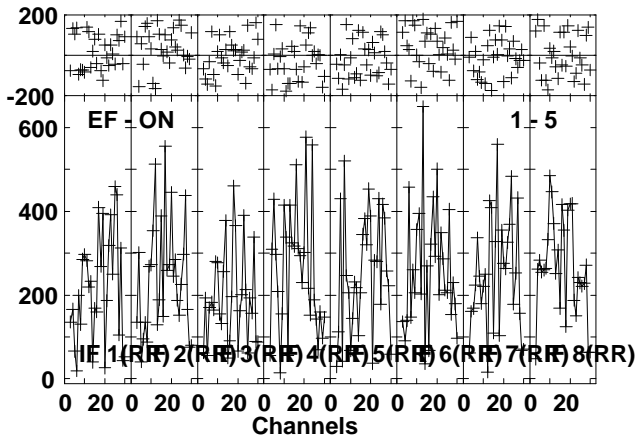
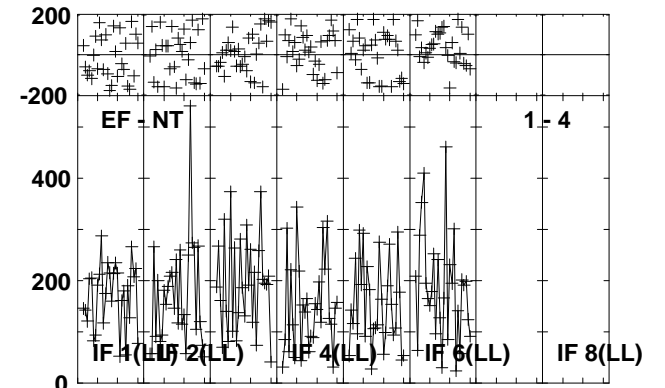
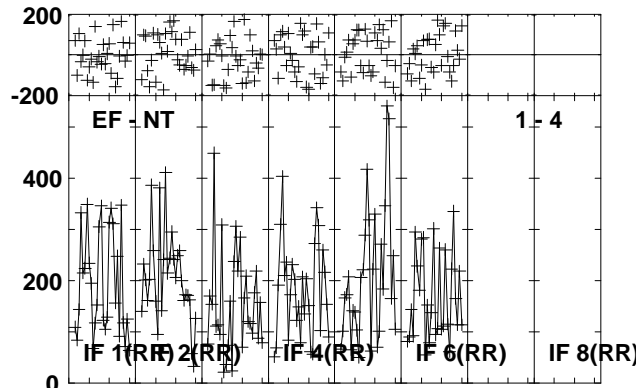
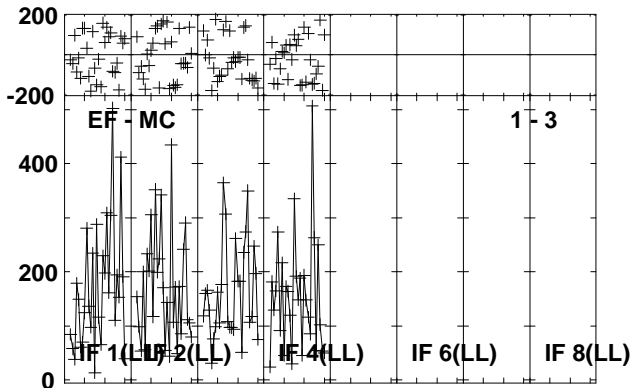
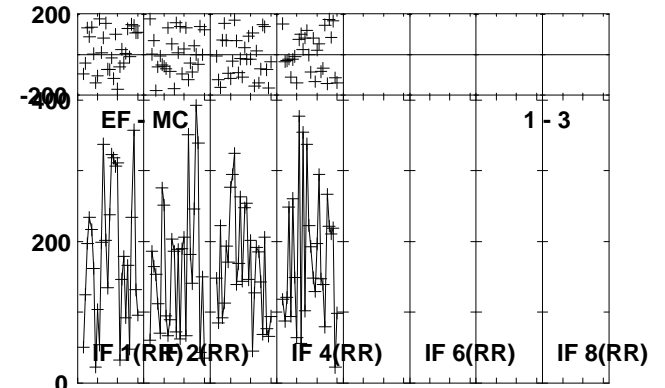
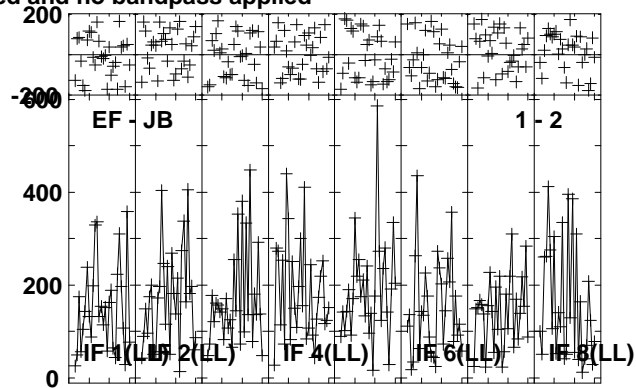
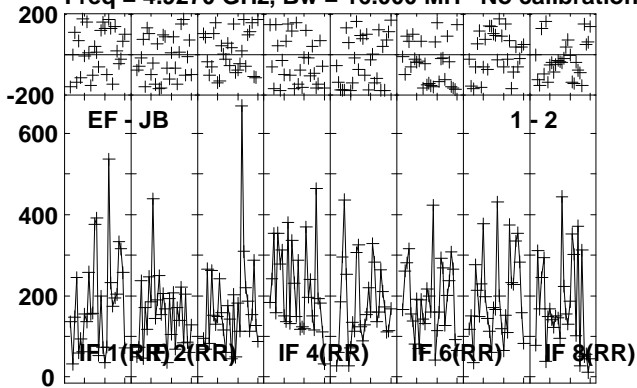

Lower frame: Micro Ampl Jy Top frame: Phas deg  
 Vector averaged cross-power spectrum Several baselines displayed  
 Timerange: 00/20:56:42 to 00/20:59:08

Plot file version 344 created 24-OCT-2012 21:01:17

G23.6-0.03 EY017B.UVDATA.1

Freq = 4.9270 GHz, Bw = 16.000 MH No calibration applied and no bandpass applied

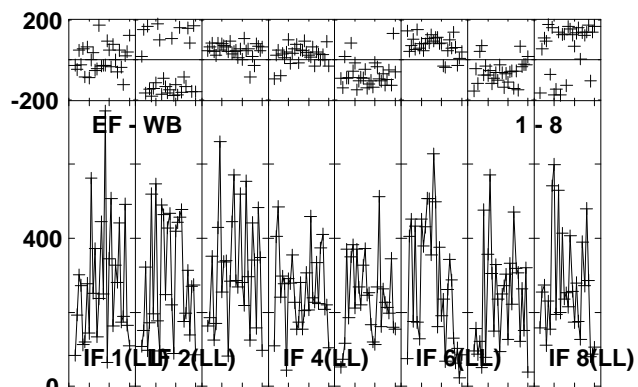
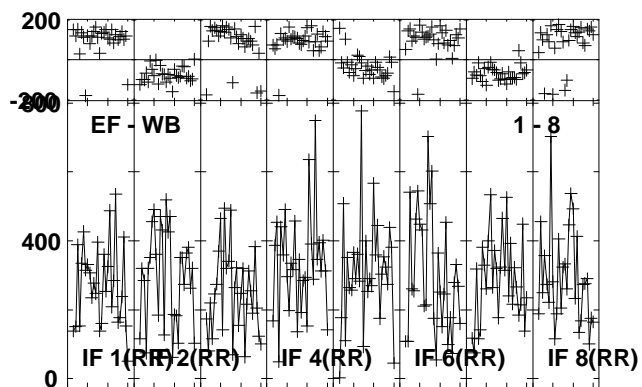
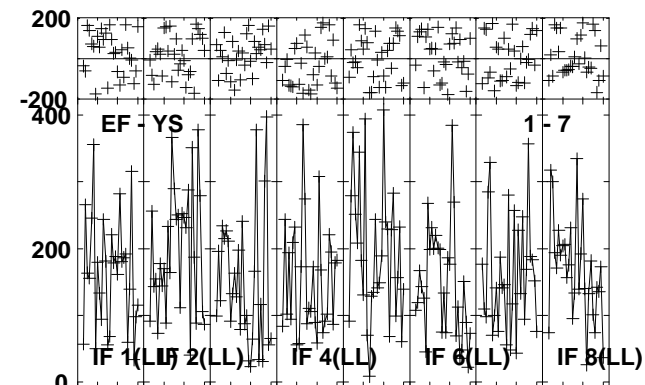
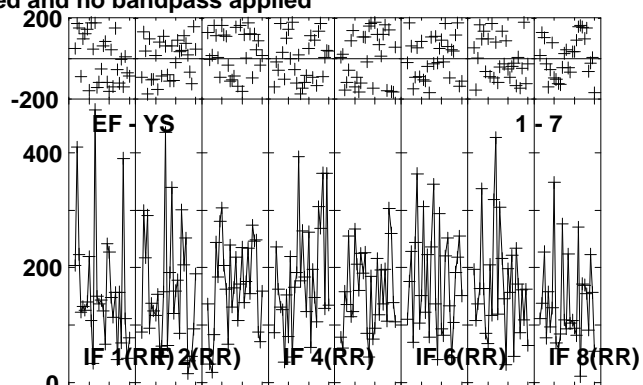
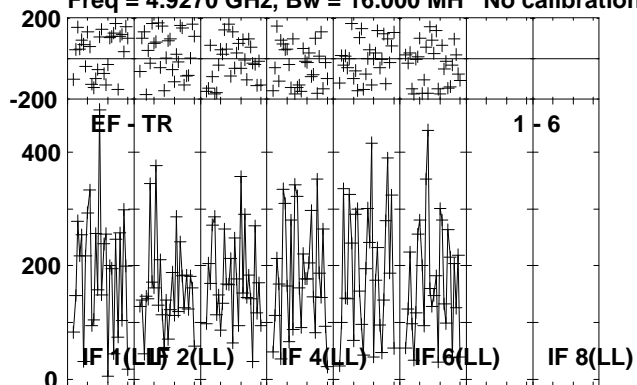

Lower frame: Micro Ampl Jy Top frame: Phas deg  
Vector averaged cross-power spectrum Several baselines displayed  
Timerange: 00/20:56:42 to 00/20:59:08

Plot file version 345 created 24-OCT-2012 21:01:18

J1825-0737 EY017B.UVDATA.1

Freq = 4.9270 GHz, Bw = 16.000 MH No calibration applied and no bandpass applied

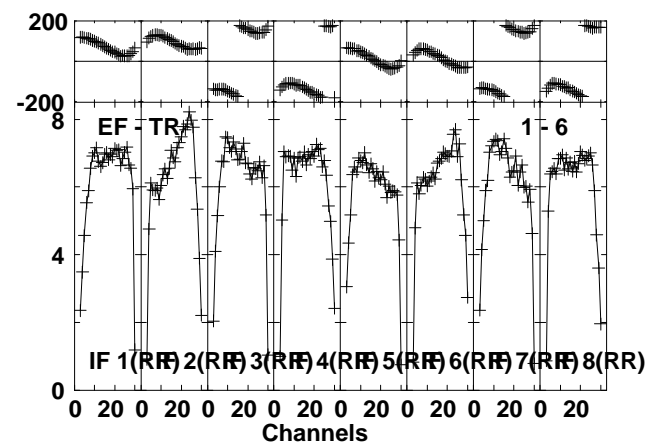
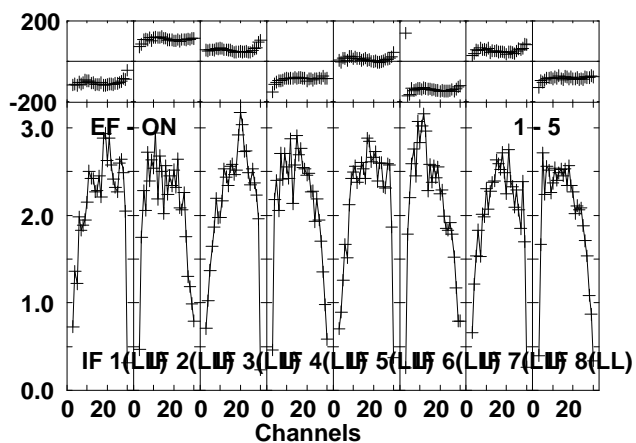
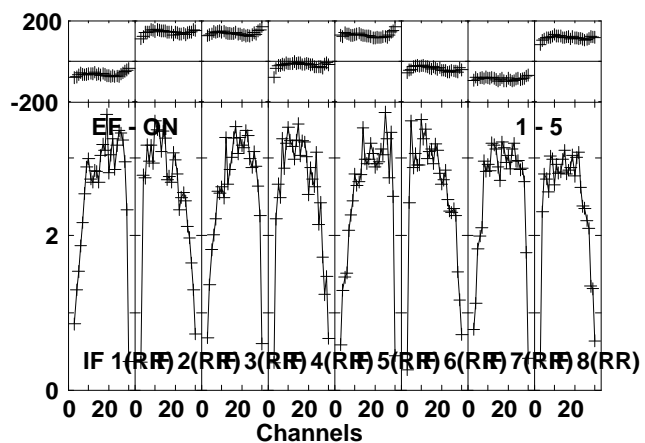
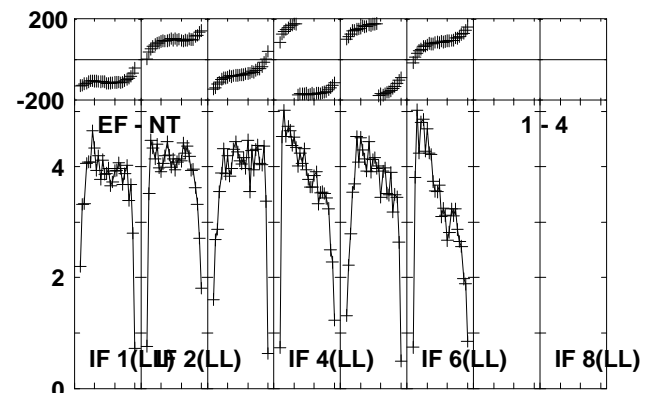
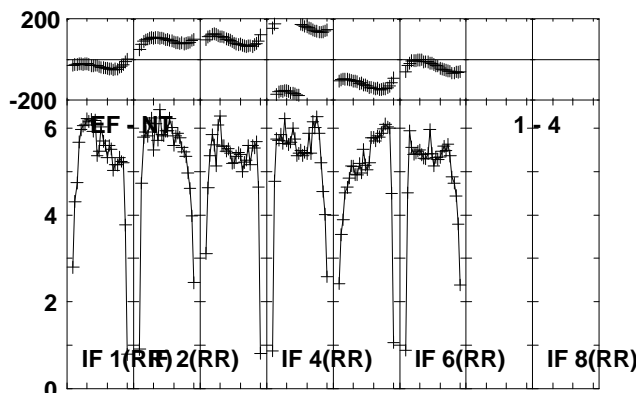
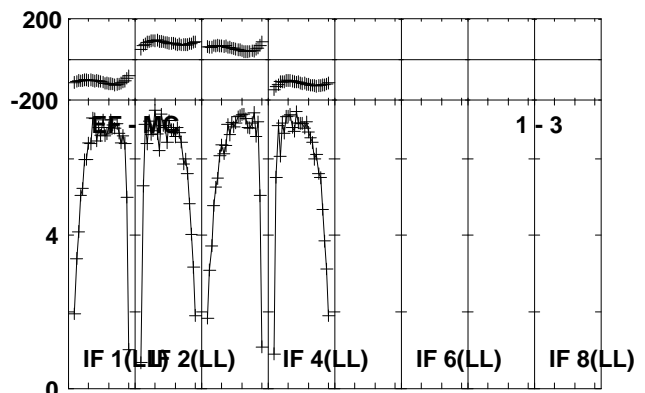
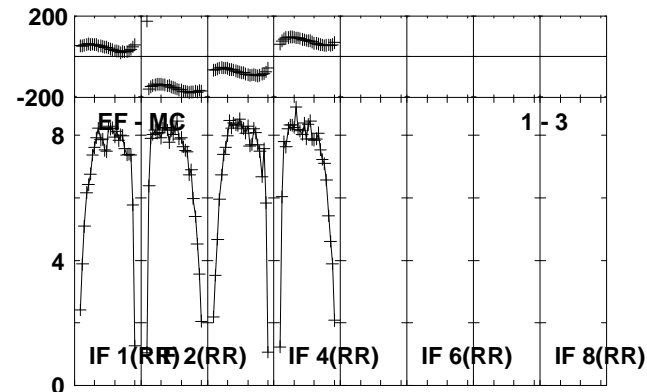
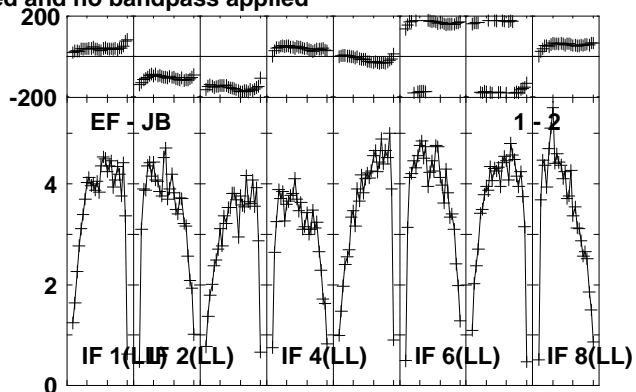
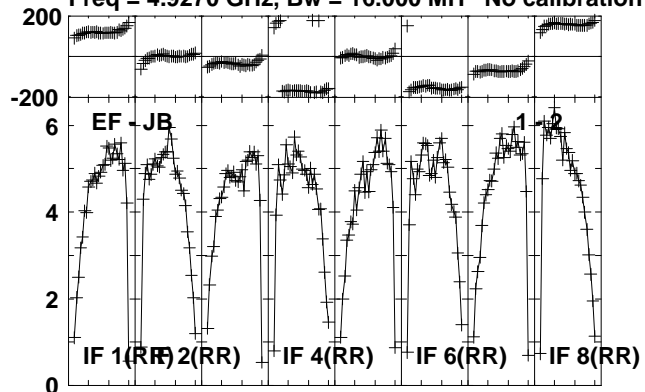

Lower frame: Milli Ampl Jy Top frame: Phas deg  
Vector averaged cross-power spectrum Several baselines displayed  
Timerange: 00/20:59:12 to 00/21:00:38

Plot file version 346 created 24-OCT-2012 21:01:18

J1825-0737 EY017B.UVDATA.1

Freq = 4.9270 GHz, Bw = 16.000 MH No calibration applied and no bandpass applied

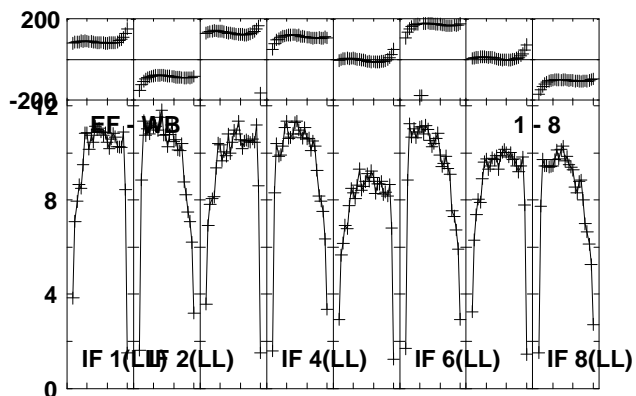
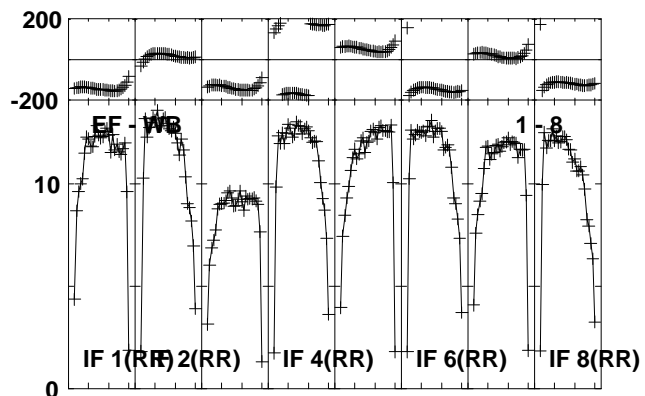
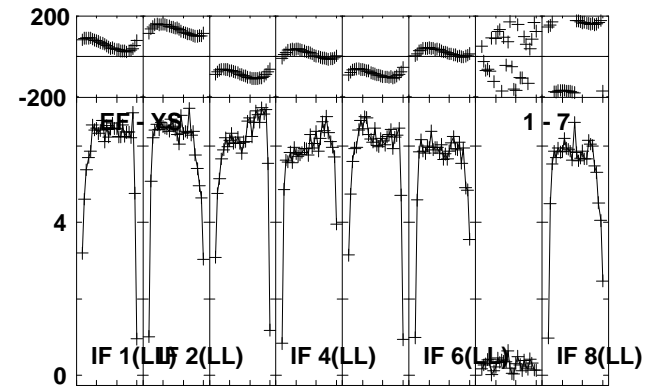
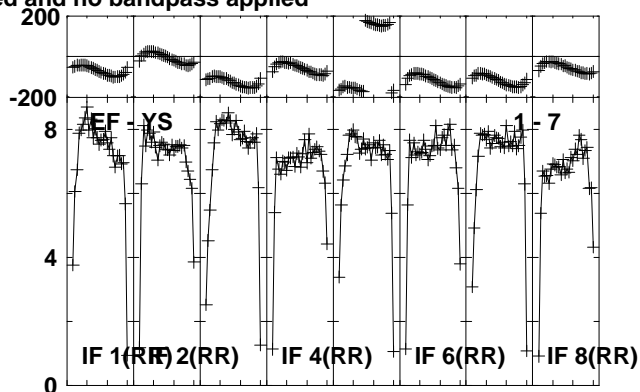
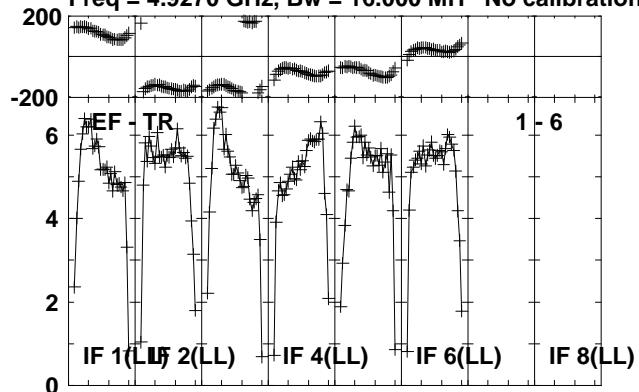

Lower frame: Milli Ampl Jy Top frame: Phas deg  
Vector averaged cross-power spectrum Several baselines displayed  
Timerange: 00/20:59:12 to 00/21:00:38

Plot file version 347 created 24-OCT-2012 21:01:19

G23.6-0.03 EY017B.UVDATA.1

Freq = 4.9270 GHz, Bw = 16.000 MH No calibration applied and no bandpass applied

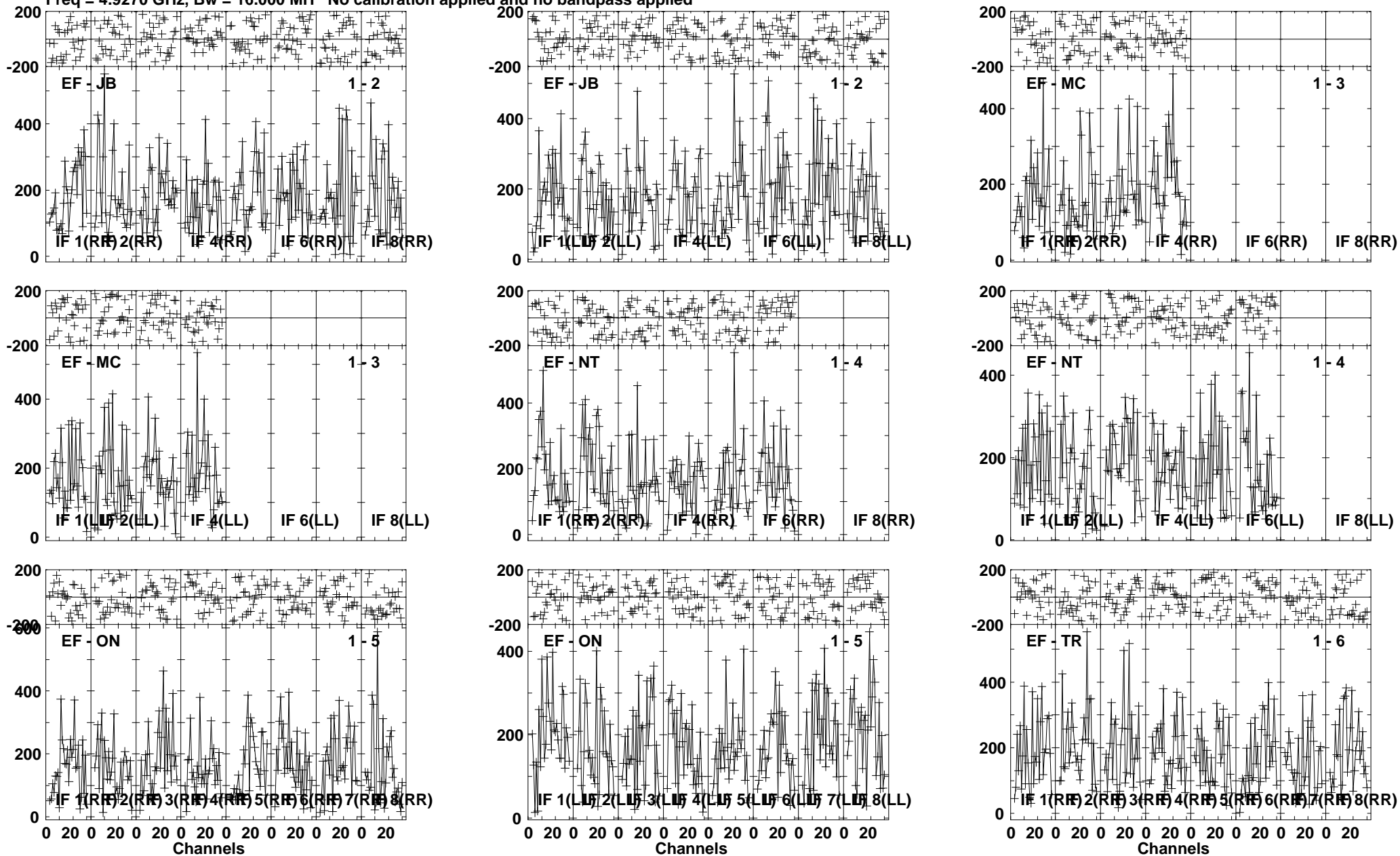

Lower frame: Micro Ampl Jy Top frame: Phas deg  
Vector averaged cross-power spectrum Several baselines displayed  
Timerange: 00/21:00:42 to 00/21:03:08

Plot file version 348 created 24-OCT-2012 21:01:19

G23.6-0.03 EY017B.UVDATA.1

Freq = 4.9270 GHz, Bw = 16.000 MH No calibration applied and no bandpass applied

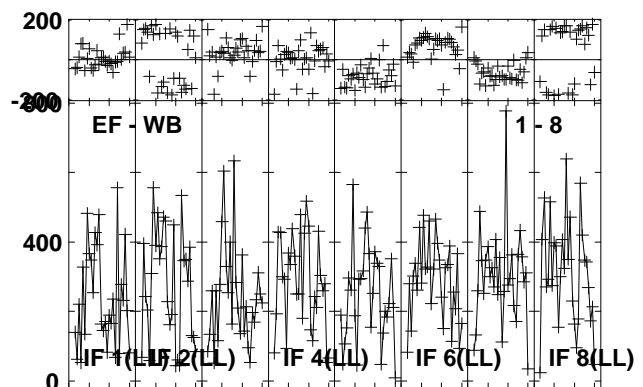
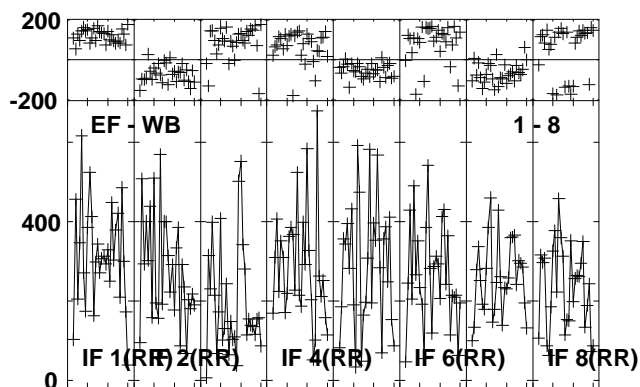
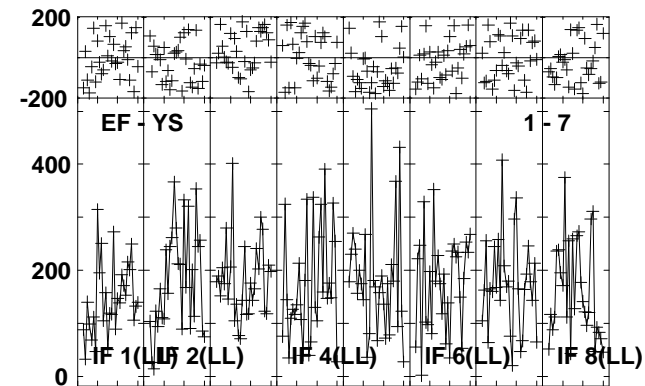
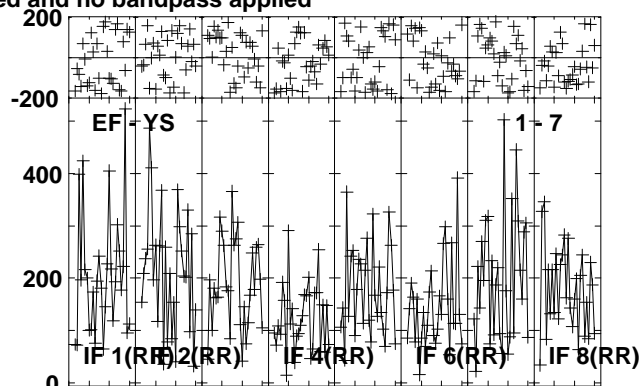
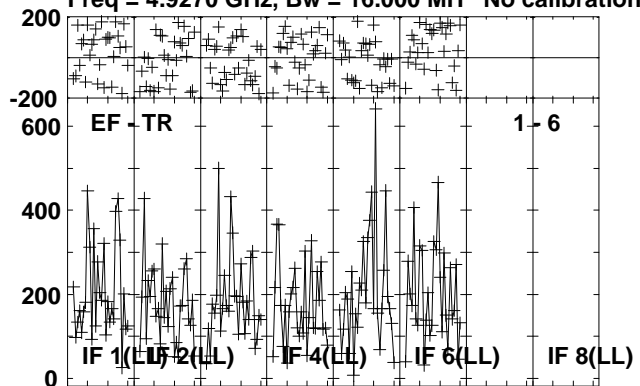

Lower frame: Micro Ampl Jy Top frame: Phas deg  
Vector averaged cross-power spectrum Several baselines displayed  
Timerange: 00/21:00:42 to 00/21:03:08



Plot file version 349 created 24-OCT-2012 21:01:20

J1825-0737 EY017B.UVDATA.1

Freq = 4.9270 GHz, Bw = 16.000 MH No calibration applied and no bandpass applied

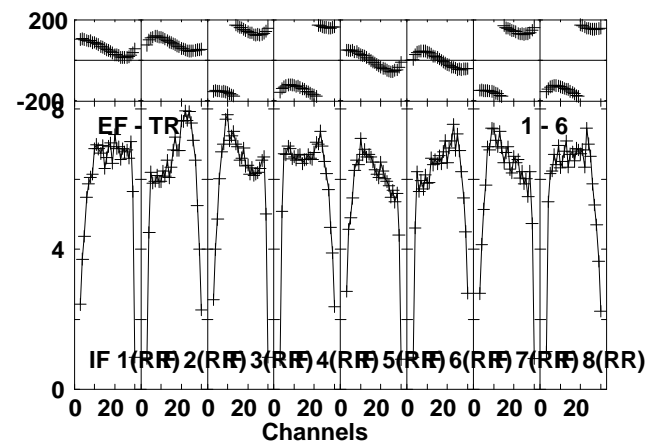
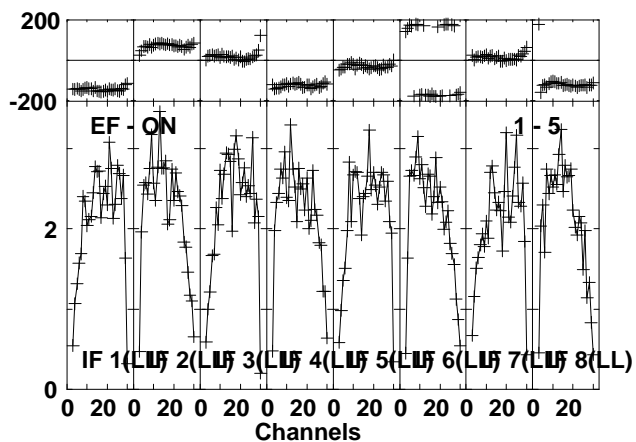
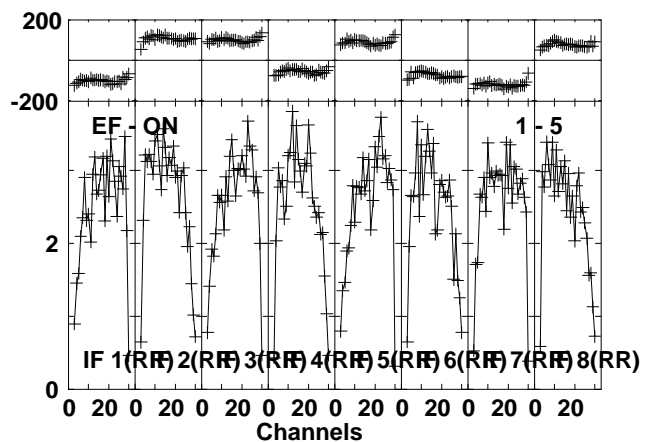
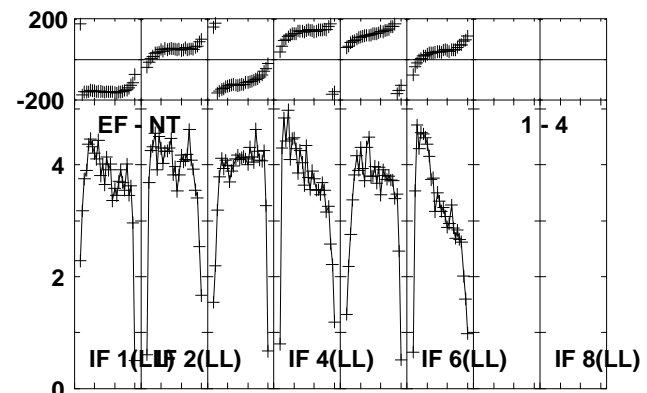
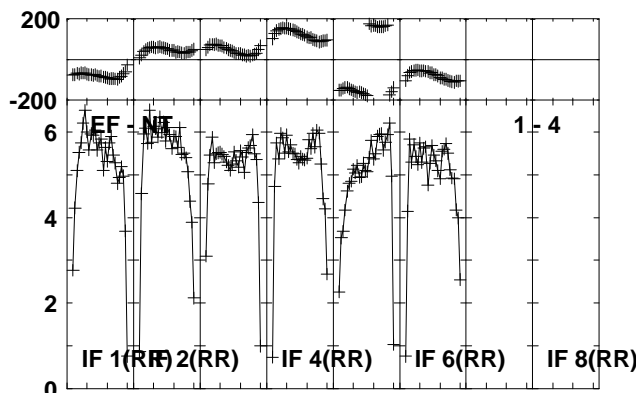
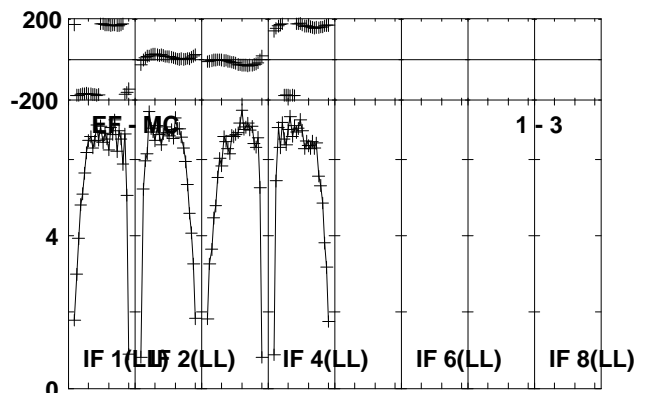
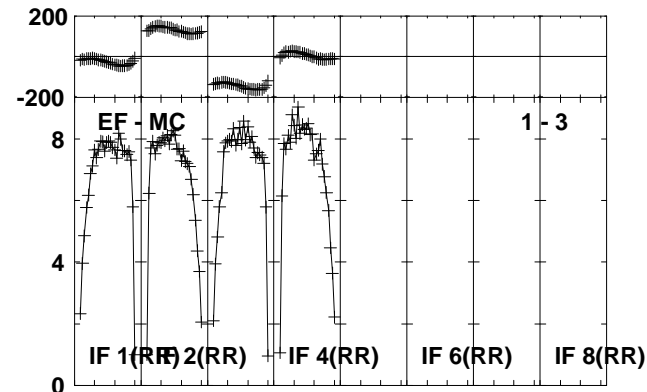
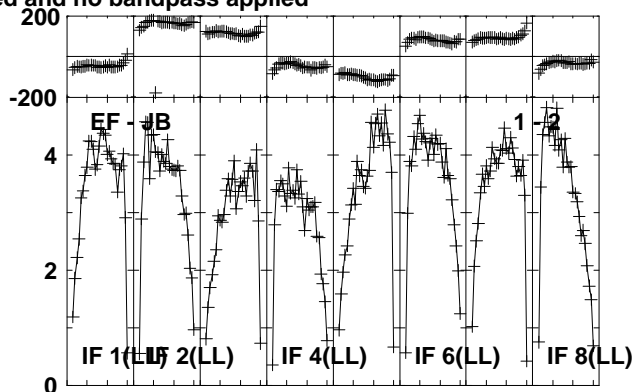
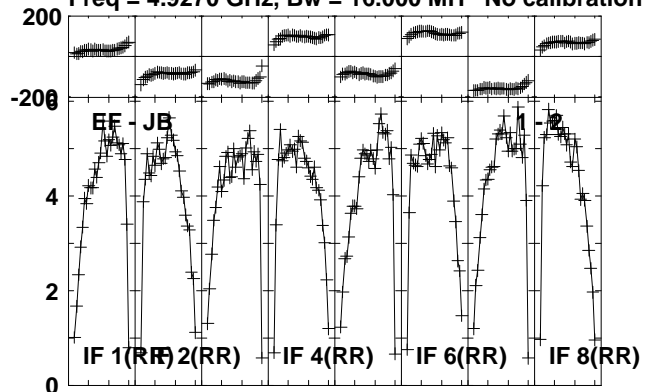

Lower frame: Milli Ampl Jy Top frame: Phas deg  
Vector averaged cross-power spectrum Several baselines displayed  
Timerange: 00/21:03:12 to 00/21:04:38

Plot file version 350 created 24-OCT-2012 21:01:20

J1825-0737 EY017B.UVDATA.1

Freq = 4.9270 GHz, Bw = 16.000 MH No calibration applied and no bandpass applied

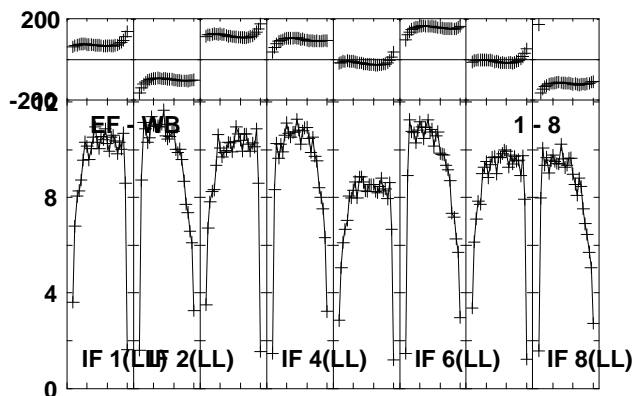
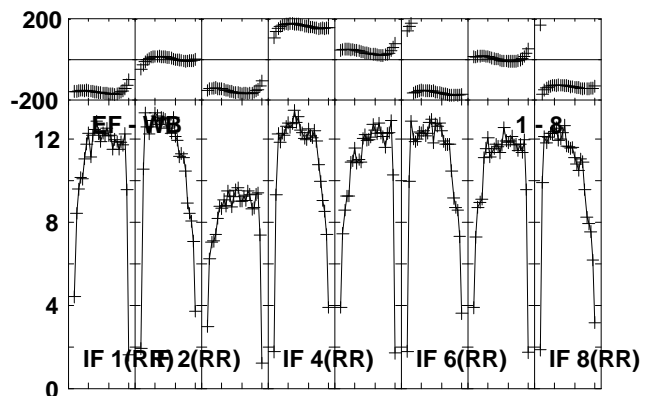
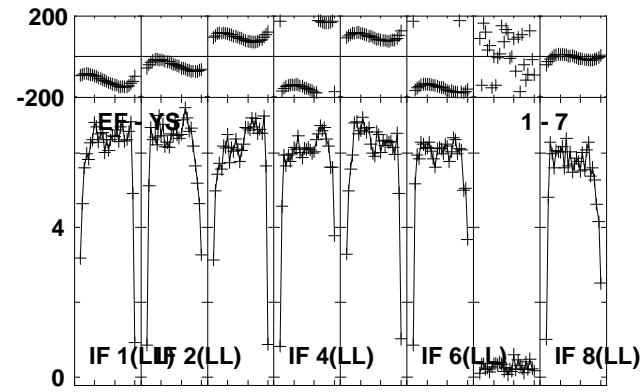
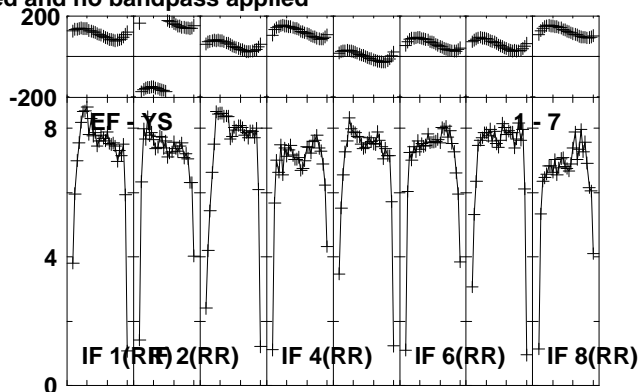
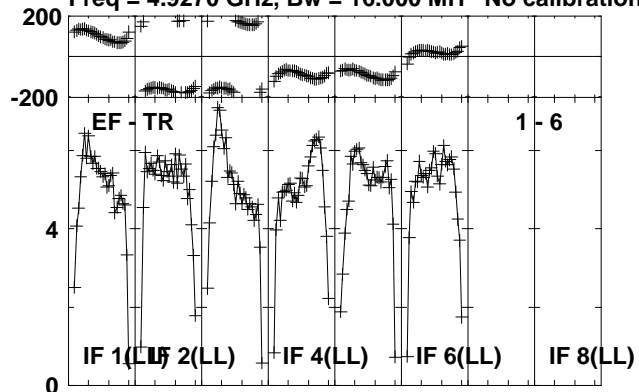

Lower frame: Milli Ampl Jy Top frame: Phas deg  
Vector averaged cross-power spectrum Several baselines displayed  
Timerange: 00/21:03:12 to 00/21:04:38

Plot file version 351 created 24-OCT-2012 21:01:21  
 J1831-0756 EY017B.UVDATA.1

Freq = 4.9270 GHz, Bw = 16.000 MH No calibration applied and no bandpass applied

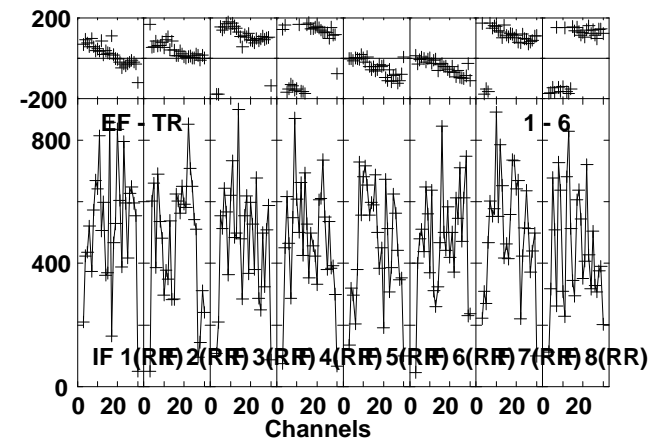
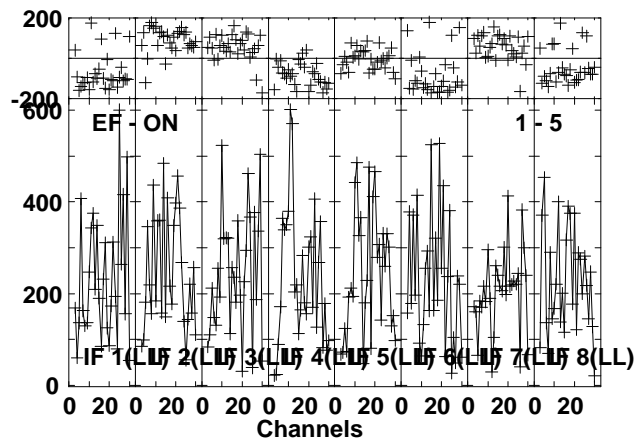
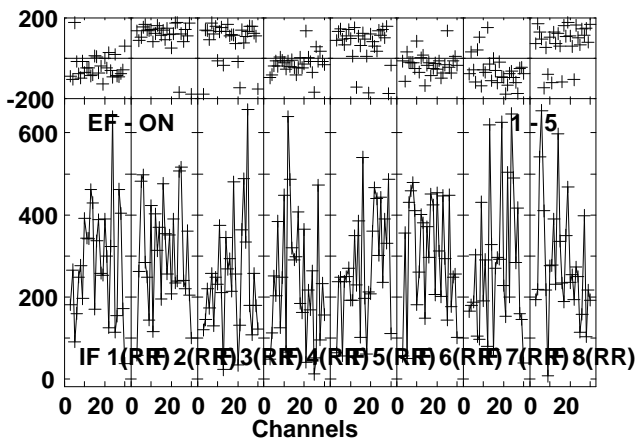
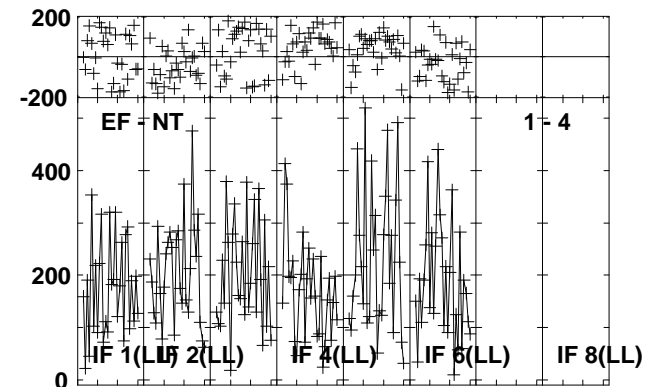
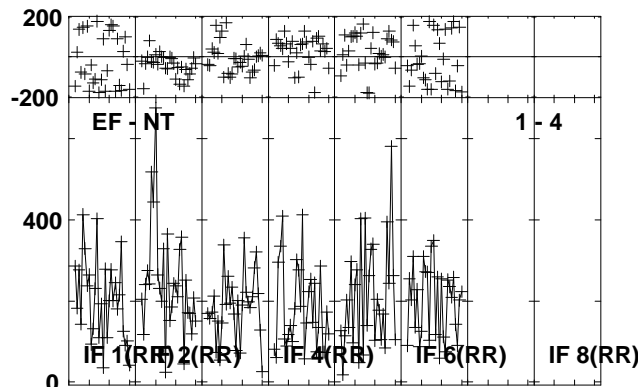
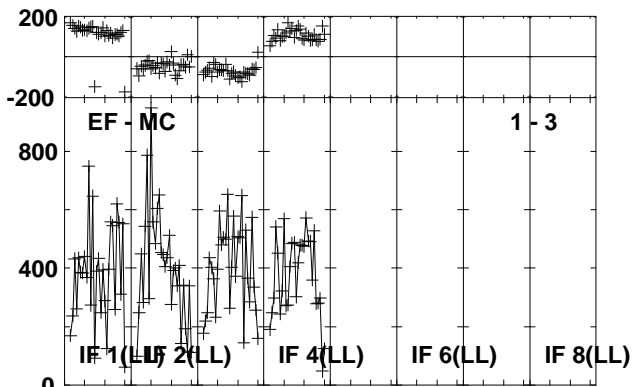
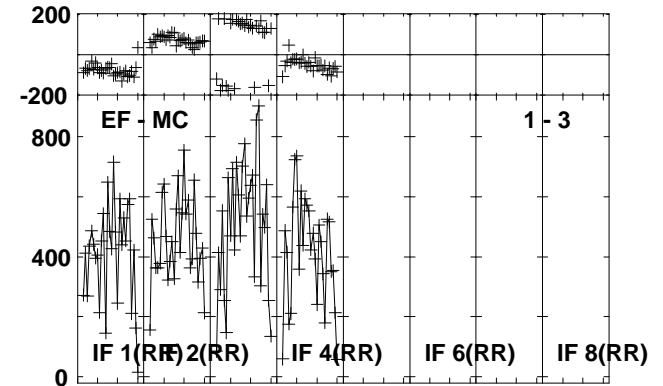
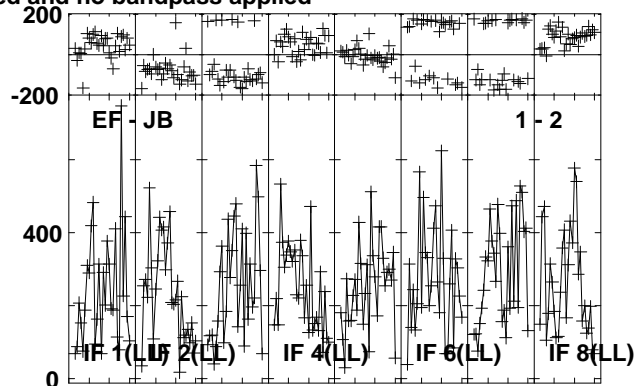
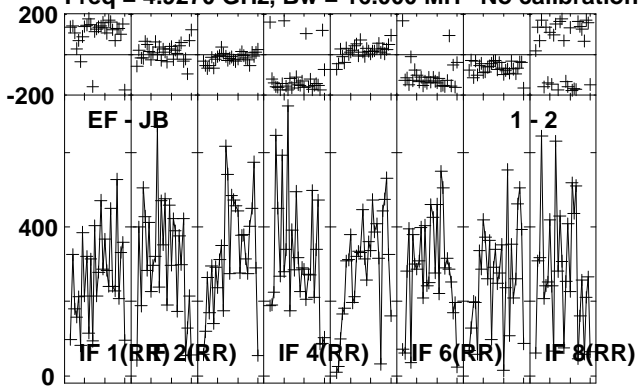

Lower frame: Micro Ampl Jy Top frame: Phas deg  
 Vector averaged cross-power spectrum Several baselines displayed  
 Timerange: 00/21:05:12 to 00/21:07:14

Plot file version 352 created 24-OCT-2012 21:01:22

J1831-0756 EY017B.UVDATA.1

Freq = 4.9270 GHz, Bw = 16.000 MH No calibration applied and no bandpass applied

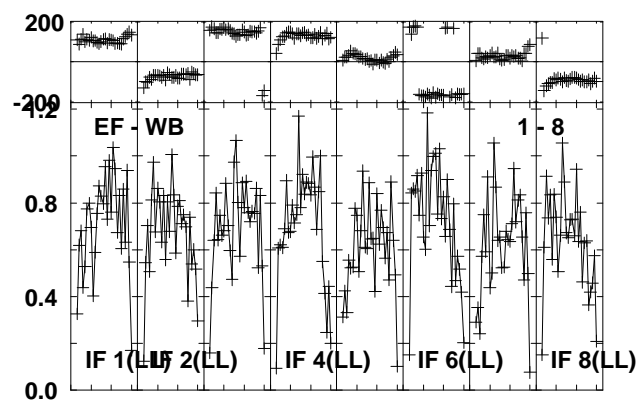
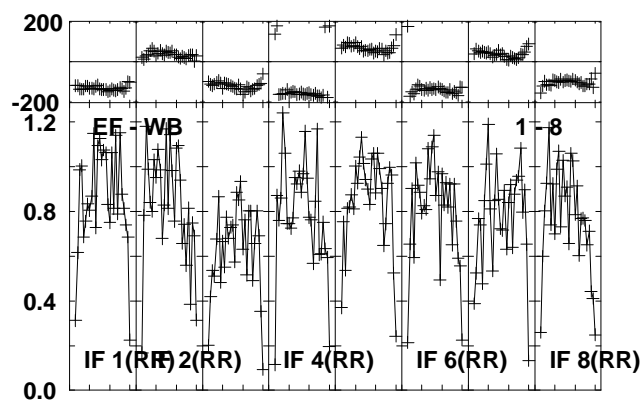
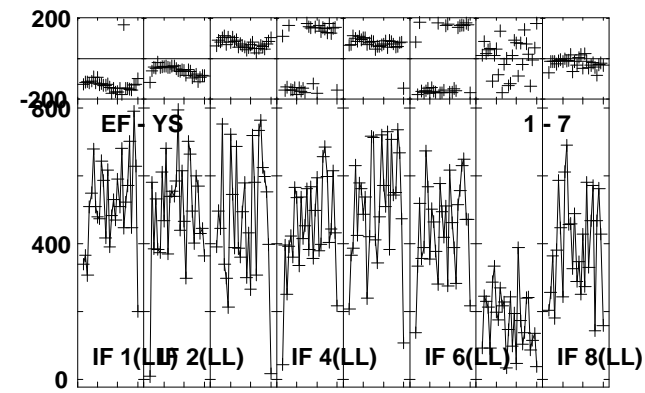
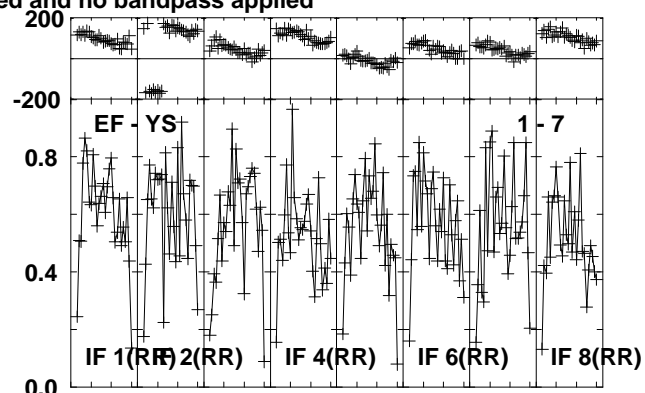
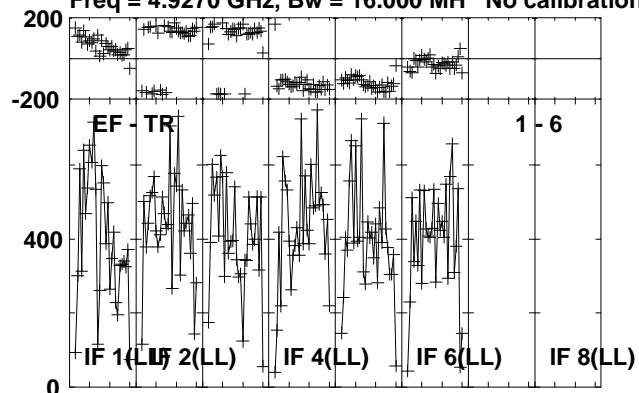

Lower frame: Micro Ampl Jy Top frame: Phas deg  
Vector averaged cross-power spectrum Several baselines displayed  
Timerange: 00/21:05:12 to 00/21:07:14

Plot file version 353 created 24-OCT-2012 21:01:22

J1825-0737 EY017B.UVDATA.1

Freq = 4.9270 GHz, Bw = 16.000 MH No calibration applied and no bandpass applied

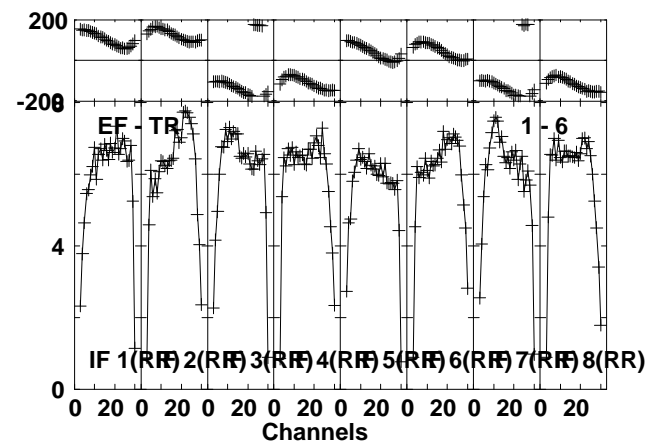
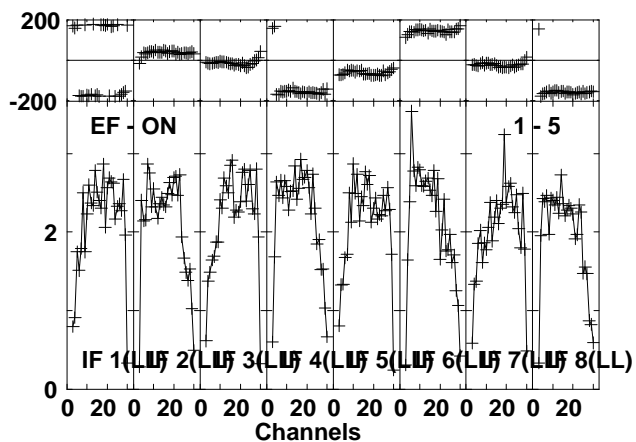
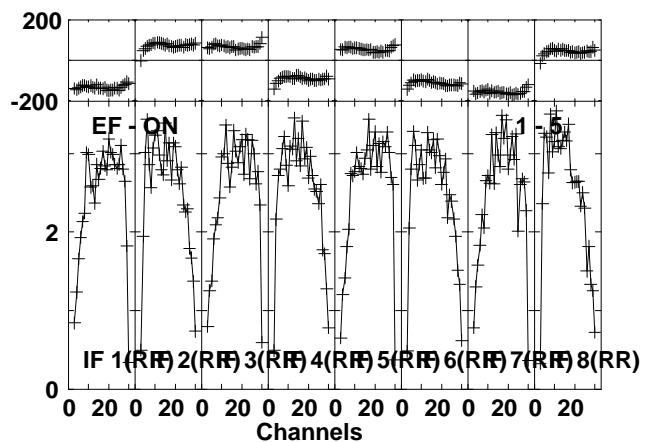
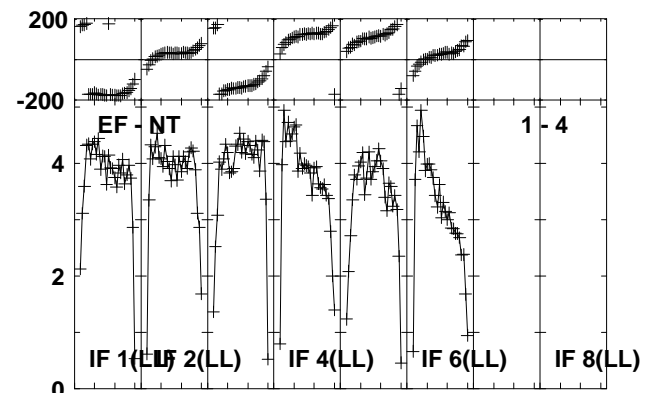
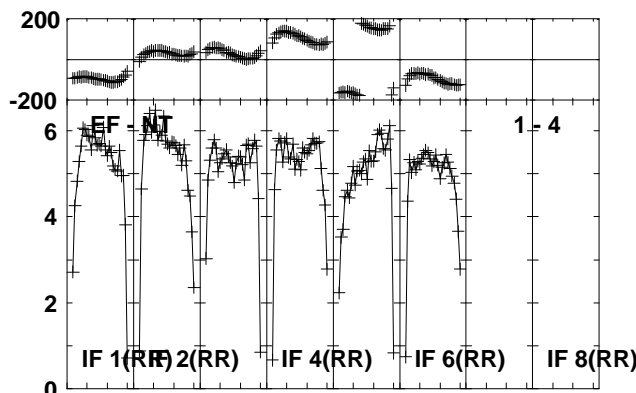
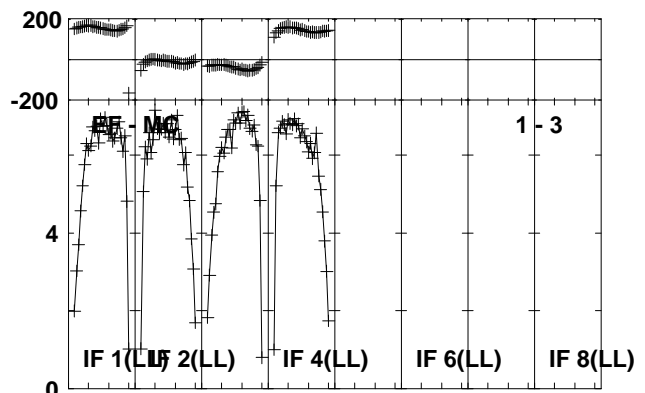
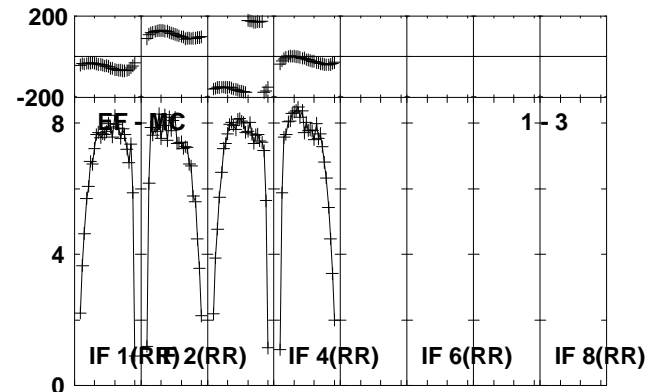
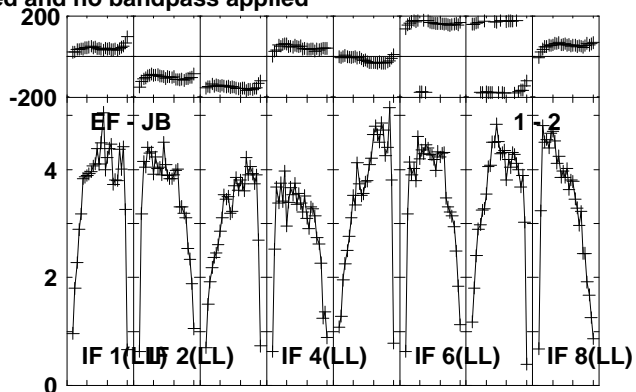
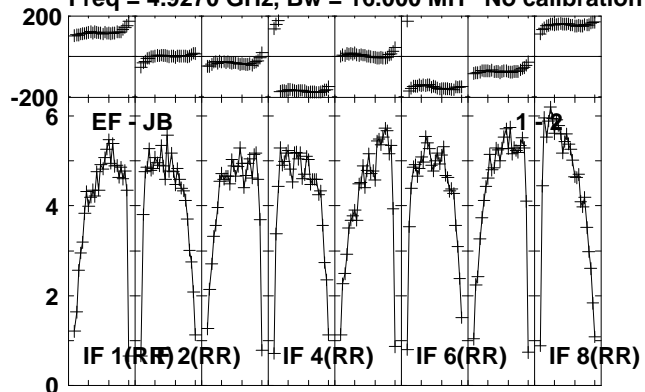

Lower frame: Milli Ampl Jy Top frame: Phas deg  
Vector averaged cross-power spectrum Several baselines displayed  
Timerange: 00/21:07:18 to 00/21:08:44

Plot file version 354 created 24-OCT-2012 21:01:22

J1825-0737 EY017B.UVDATA.1

Freq = 4.9270 GHz, Bw = 16.000 MH No calibration applied and no bandpass applied

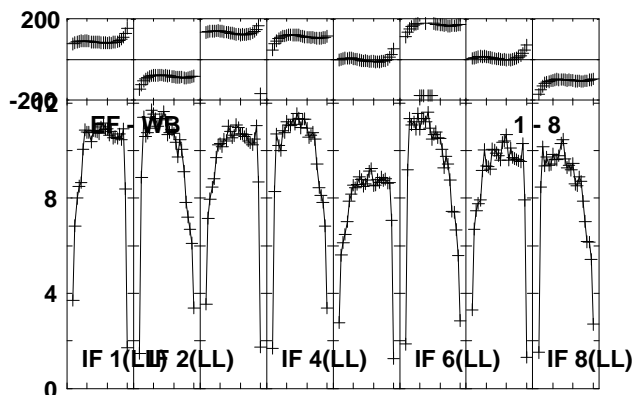
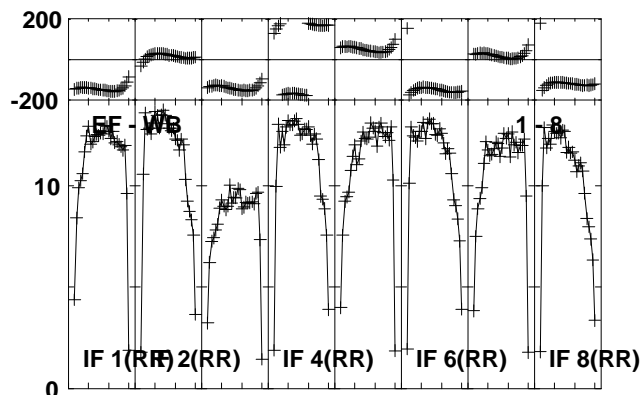
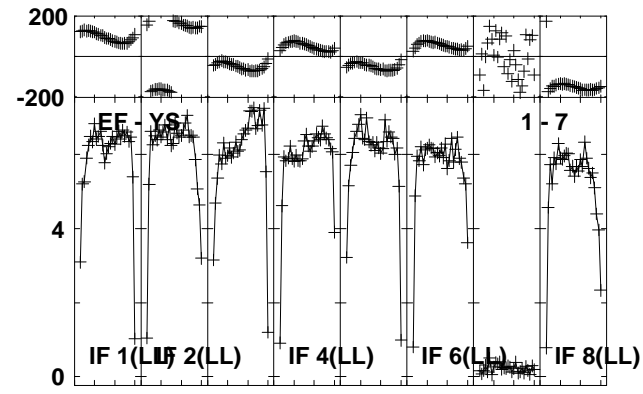
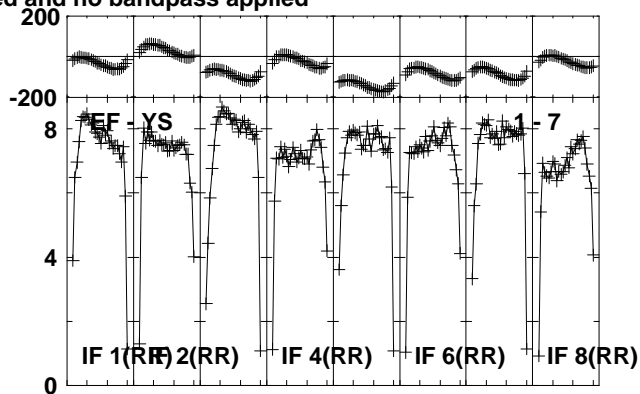
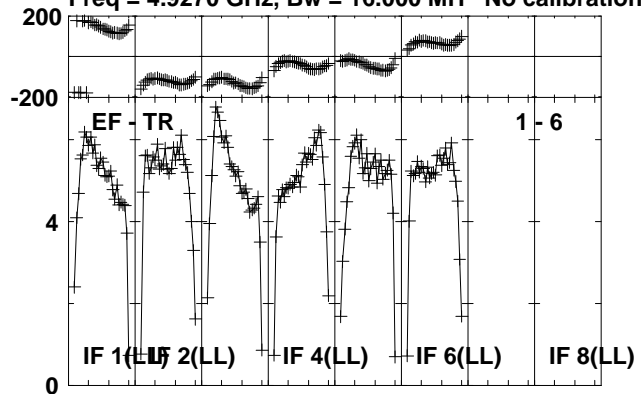

Lower frame: Milli Ampl Jy Top frame: Phas deg  
Vector averaged cross-power spectrum Several baselines displayed  
Timerange: 00/21:07:18 to 00/21:08:44

Plot file version 355 created 24-OCT-2012 21:01:23

G23.6-0.03 EY017B.UVDATA.1

Freq = 4.9270 GHz, Bw = 16.000 MH No calibration applied and no bandpass applied

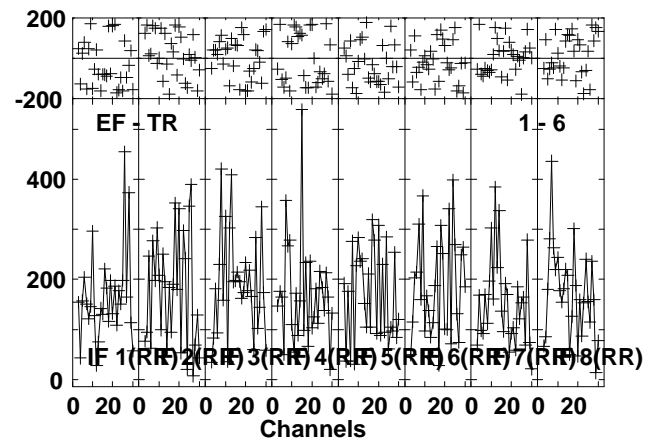
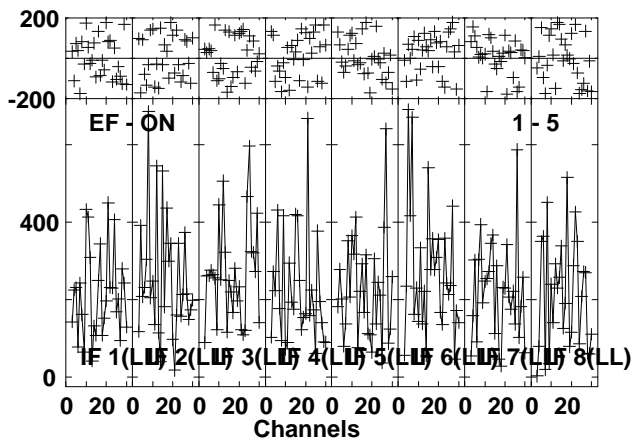
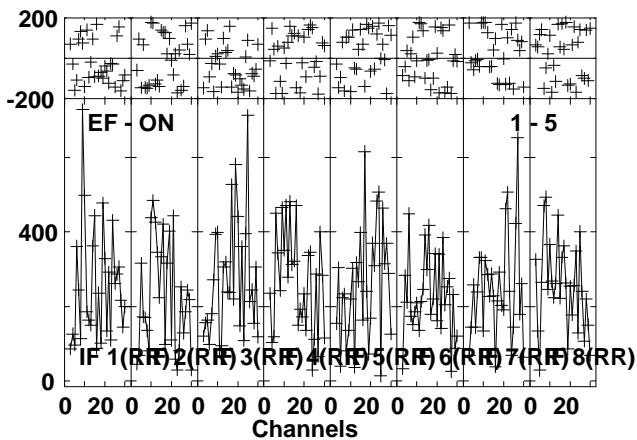
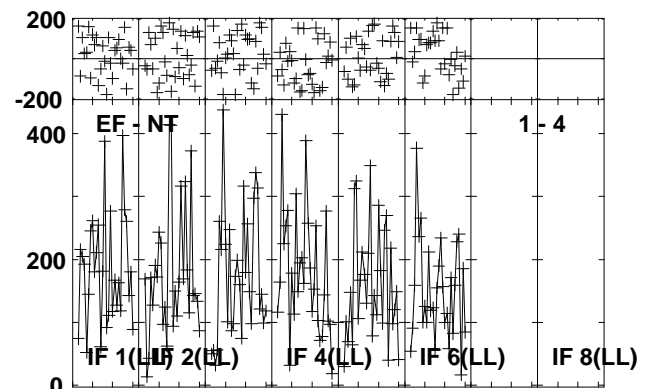
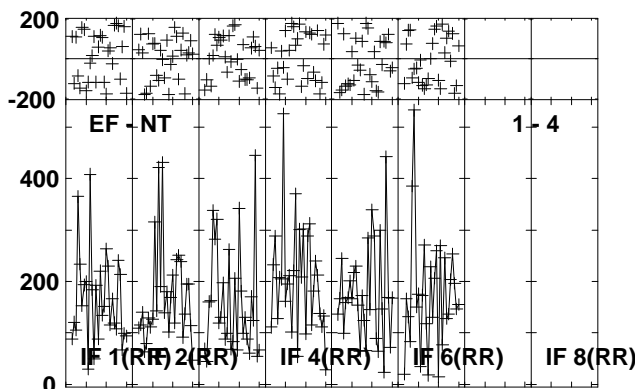
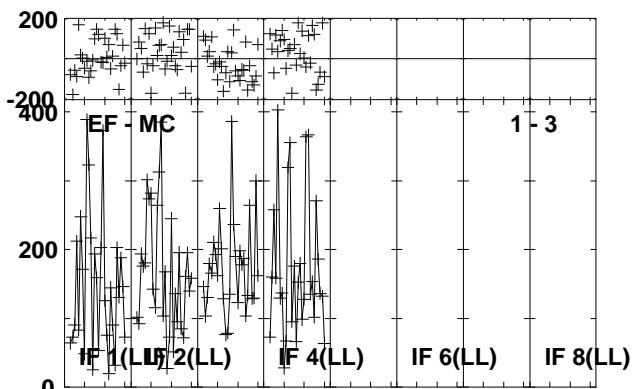
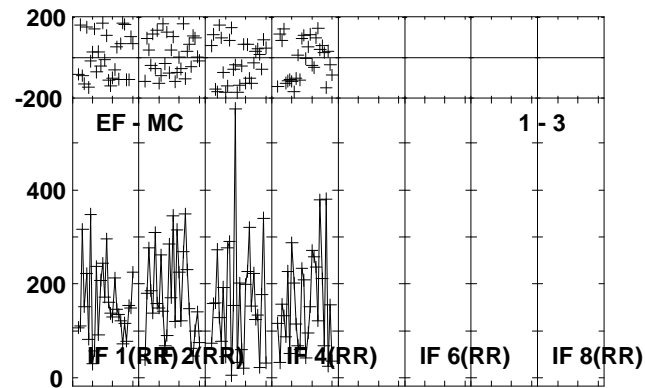
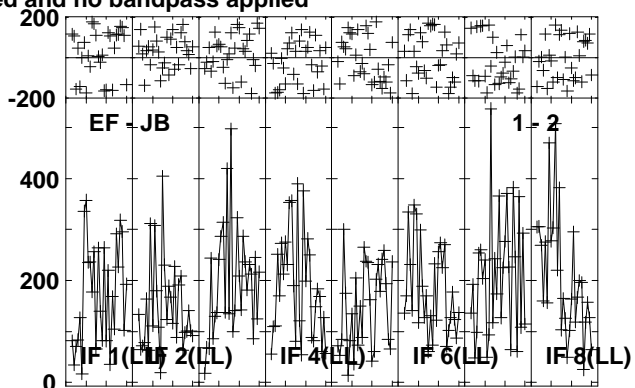
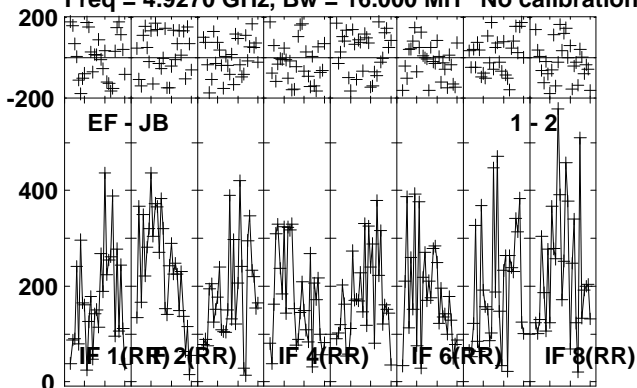

Lower frame: Micro Ampl Jy Top frame: Phas deg  
Vector averaged cross-power spectrum Several baselines displayed  
Timerange: 00/21:08:48 to 00/21:11:14

Plot file version 356 created 24-OCT-2012 21:01:24

G23.6-0.03 EY017B.UVDATA.1

Freq = 4.9270 GHz, Bw = 16.000 MH No calibration applied and no bandpass applied

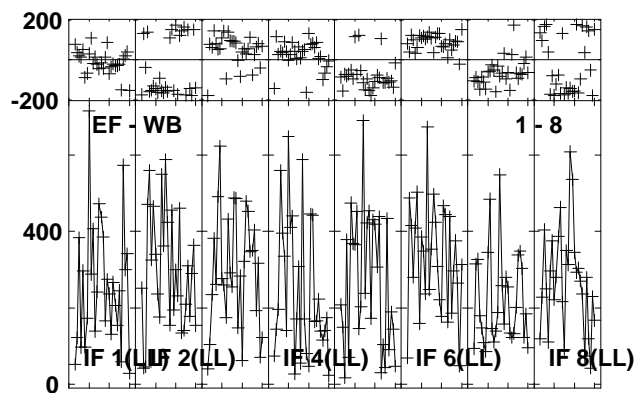
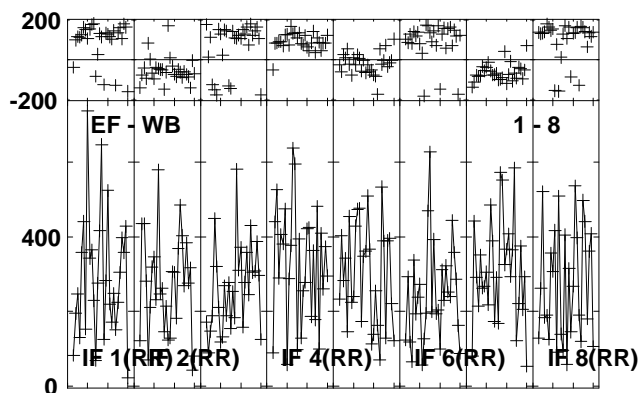
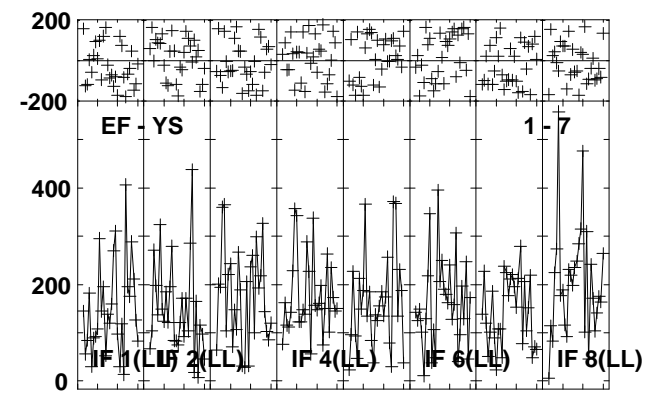
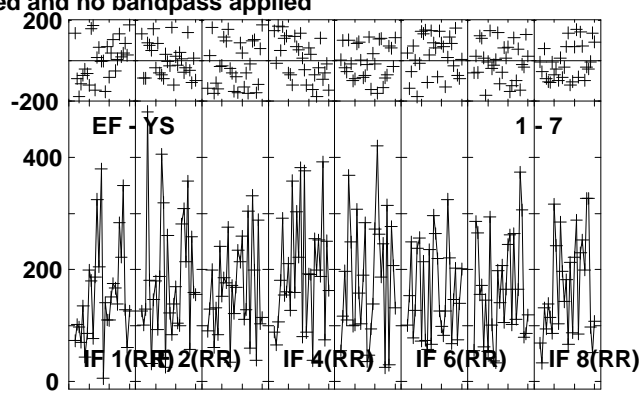
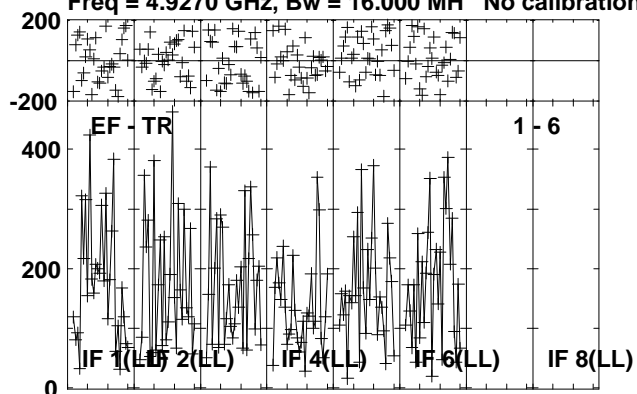

Lower frame: Micro Ampl Jy Top frame: Phas deg  
Vector averaged cross-power spectrum Several baselines displayed  
Timerange: 00/21:08:48 to 00/21:11:14



Plot file version 357 created 24-OCT-2012 21:01:24

J1825-0737 EY017B.UVDATA.1

Freq = 4.9270 GHz, Bw = 16.000 MH No calibration applied and no bandpass applied

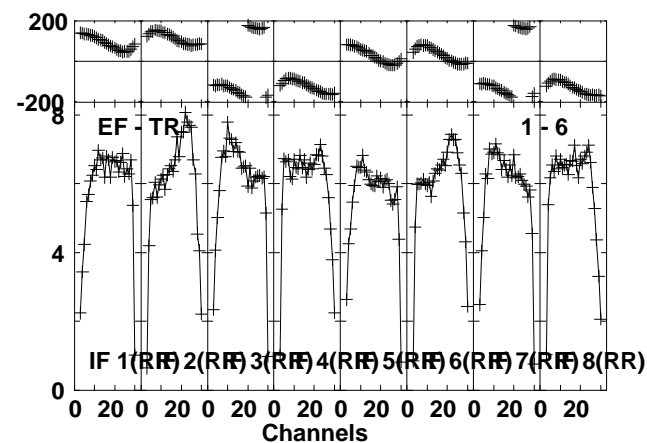
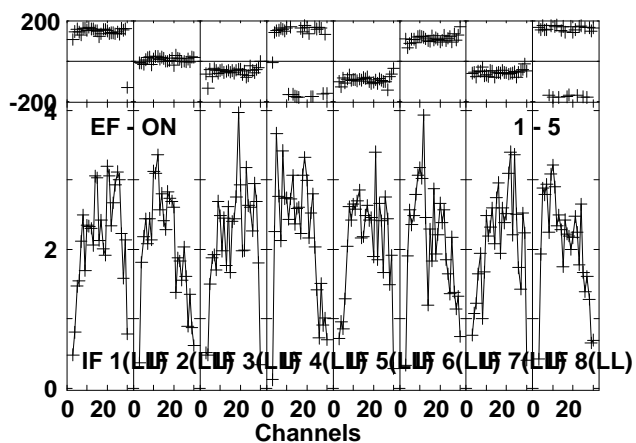
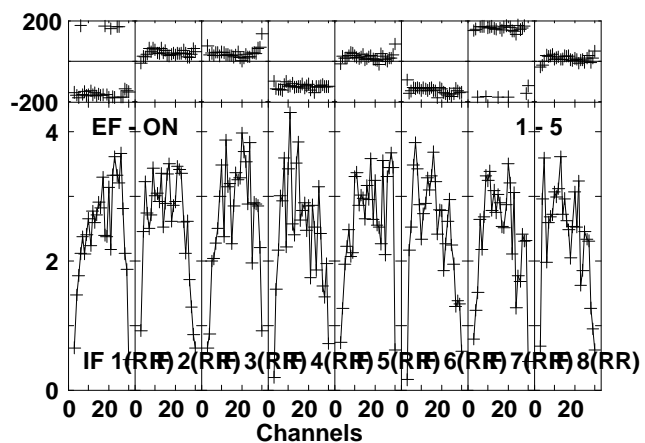
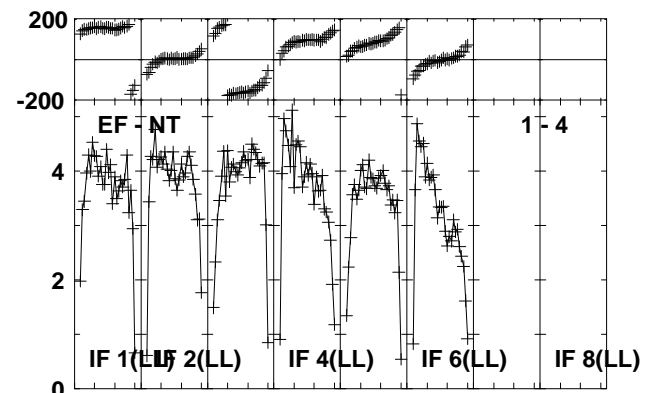
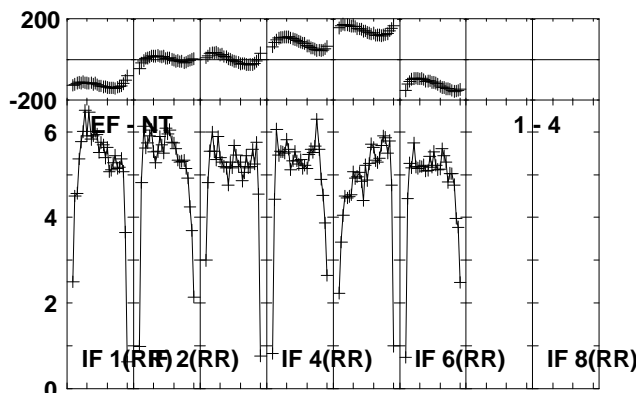
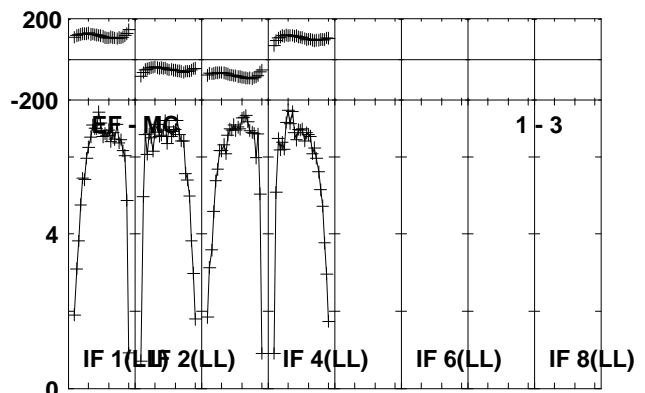
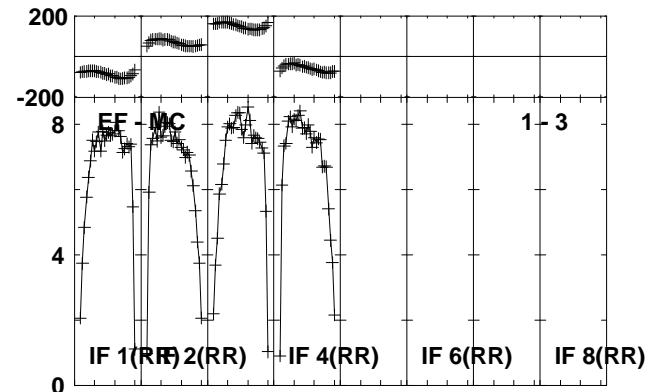
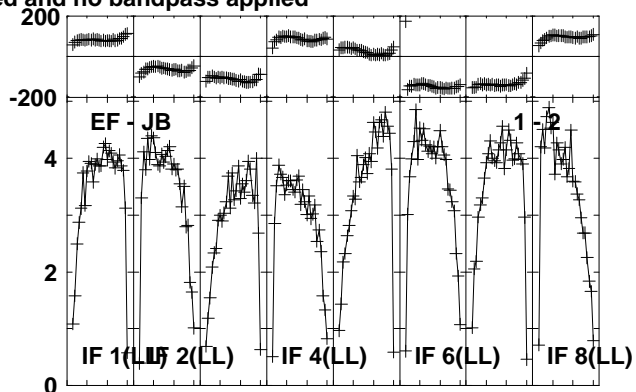
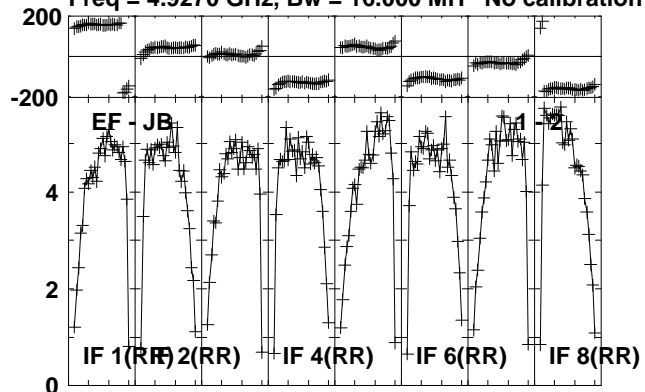

Lower frame: Milli Ampl Jy Top frame: Phas deg  
Vector averaged cross-power spectrum Several baselines displayed  
Timerange: 00/21:11:18 to 00/21:12:44

Plot file version 358 created 24-OCT-2012 21:01:25

J1825-0737 EY017B.UVDATA.1

Freq = 4.9270 GHz, Bw = 16.000 MH No calibration applied and no bandpass applied

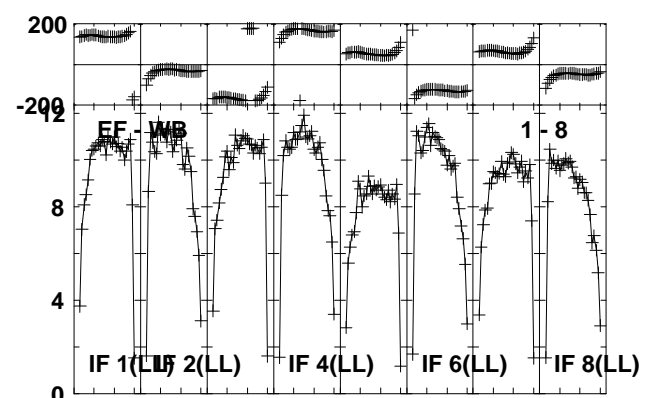
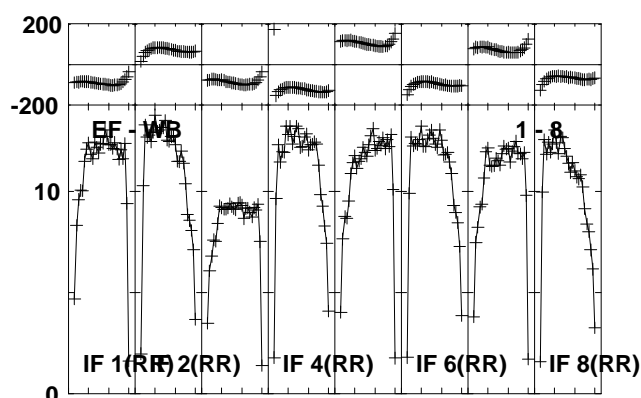
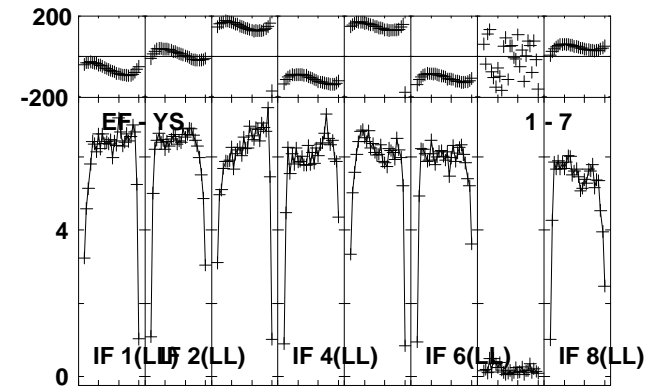
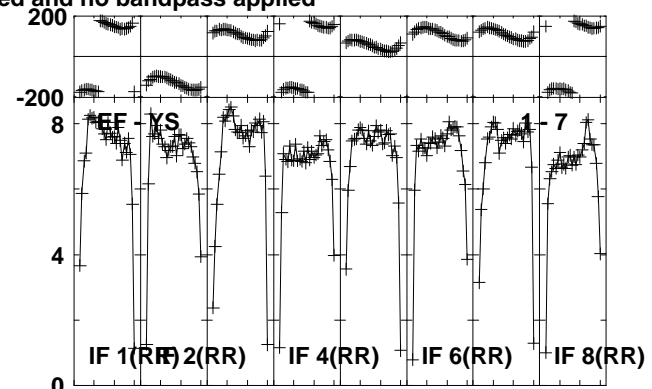
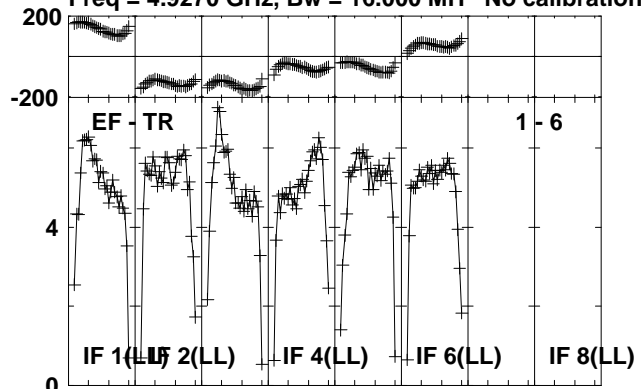

Lower frame: Milli Ampl Jy Top frame: Phas deg  
Vector averaged cross-power spectrum Several baselines displayed  
Timerange: 00/21:11:18 to 00/21:12:44

Plot file version 359 created 24-OCT-2012 21:01:25

G23.6-0.03 EY017B.UVDATA.1

Freq = 4.9270 GHz, Bw = 16.000 MH No calibration applied and no bandpass applied

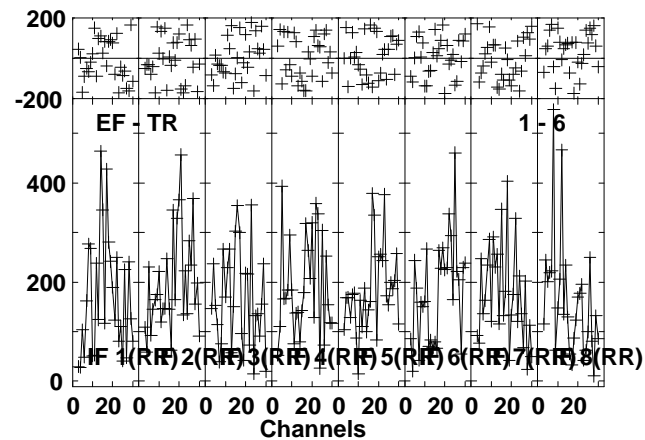
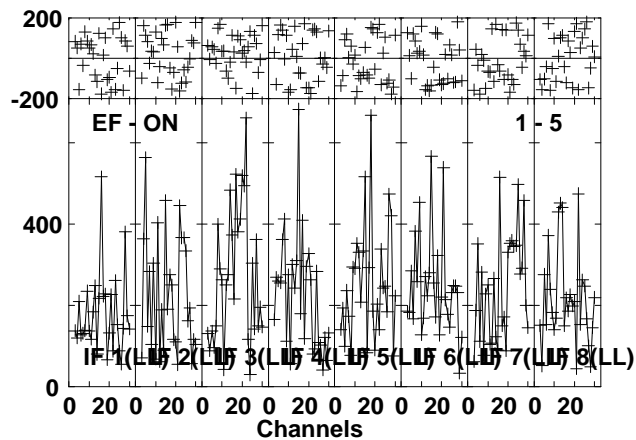
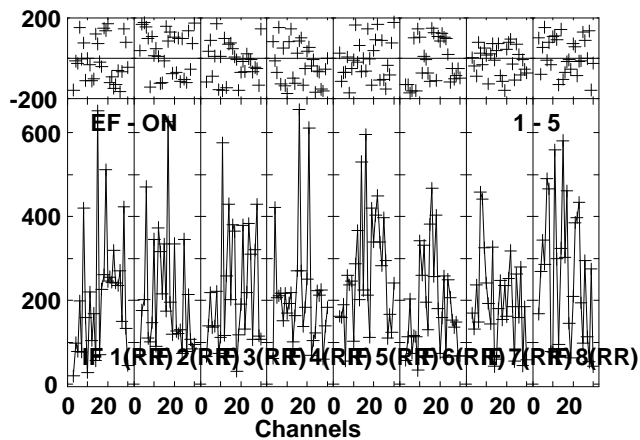
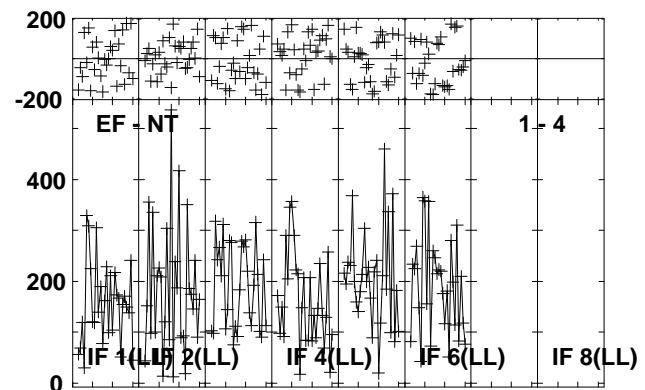
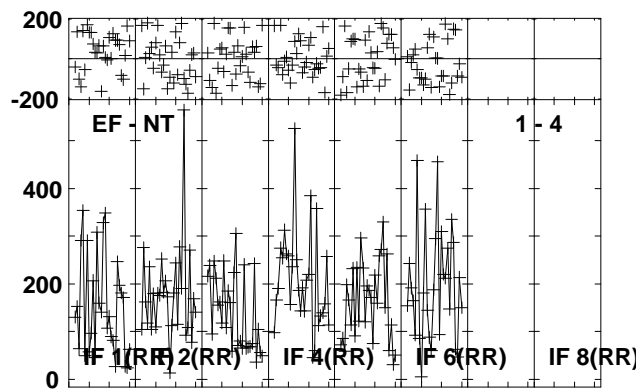
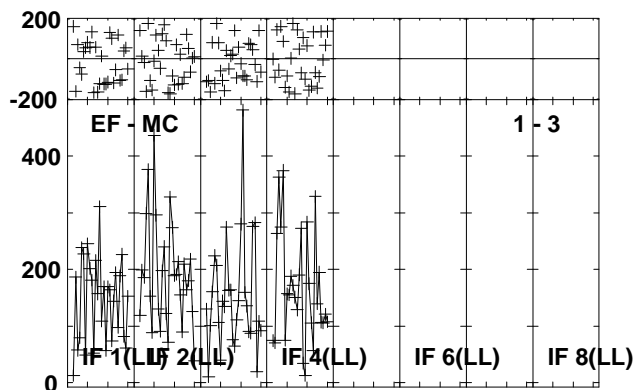
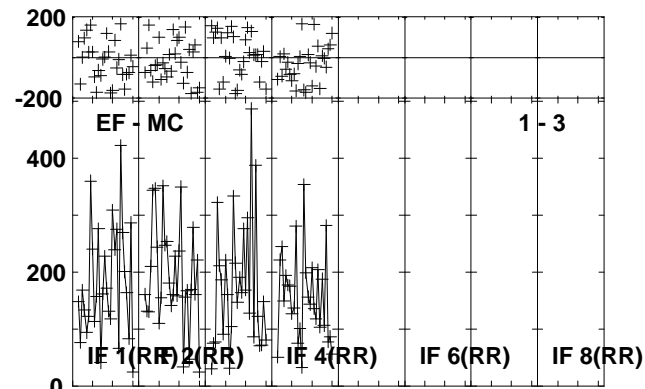
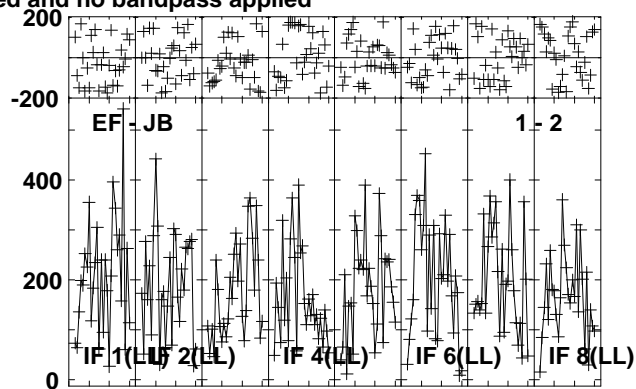
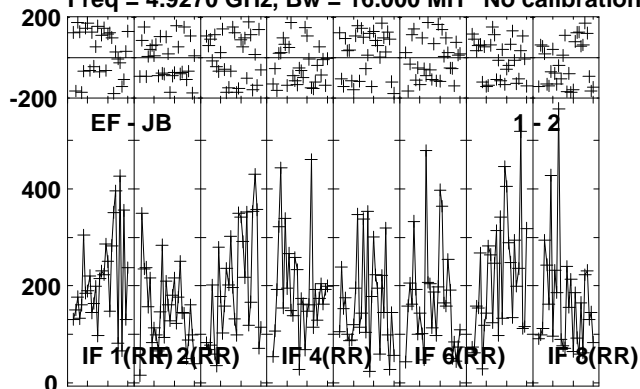

Lower frame: Micro Ampl Jy Top frame: Phas deg  
Vector averaged cross-power spectrum Several baselines displayed  
Timerange: 00/21:12:48 to 00/21:15:14

Plot file version 360 created 24-OCT-2012 21:01:26

G23.6-0.03 EY017B.UVDATA.1

Freq = 4.9270 GHz, Bw = 16.000 MH No calibration applied and no bandpass applied

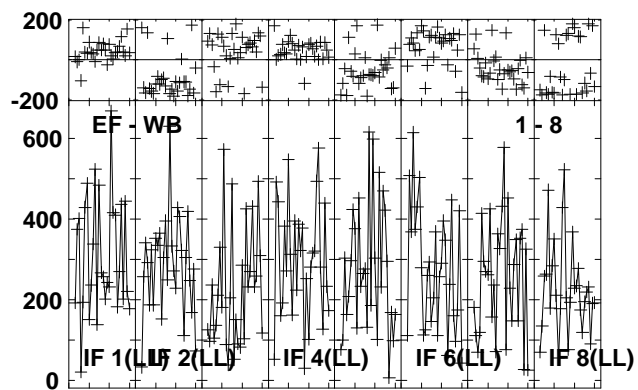
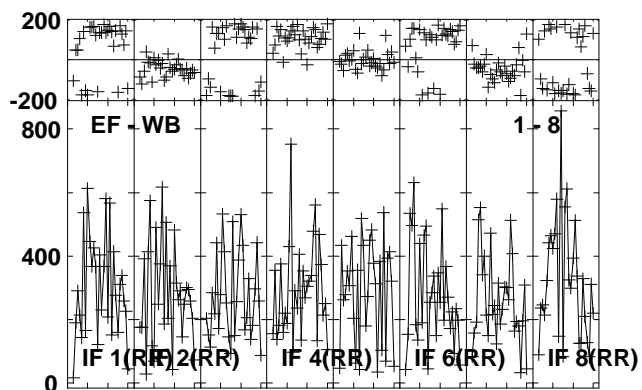
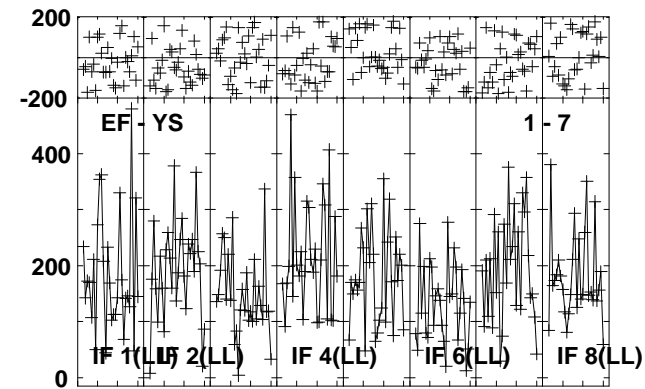
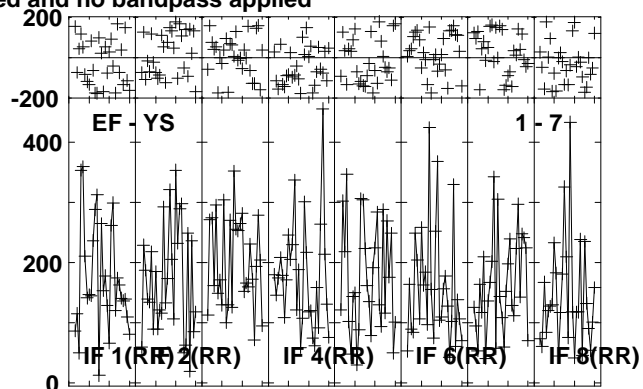
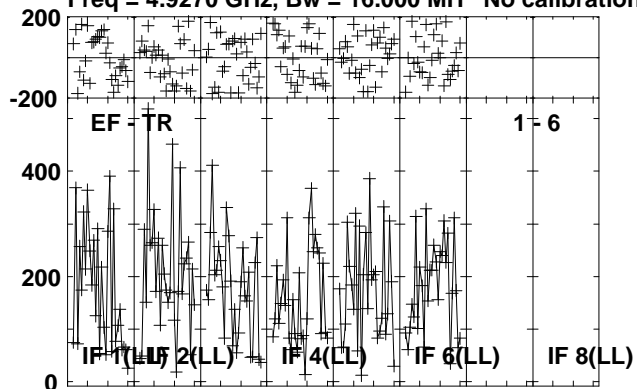

Lower frame: Micro Ampl Jy Top frame: Phas deg  
Vector averaged cross-power spectrum Several baselines displayed  
Timerange: 00/21:12:48 to 00/21:15:14

Plot file version 361 created 24-OCT-2012 21:01:27

J1825-0737 EY017B.UVDATA.1

Freq = 4.9270 GHz, Bw = 16.000 MH No calibration applied and no bandpass applied

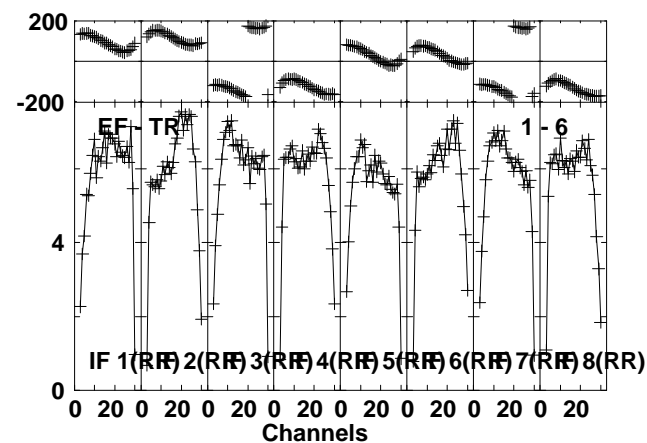
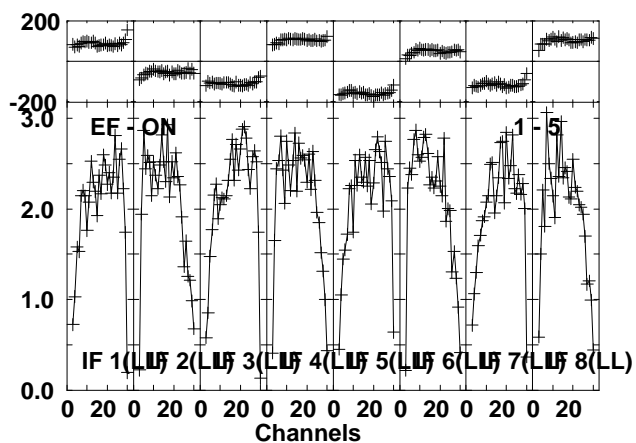
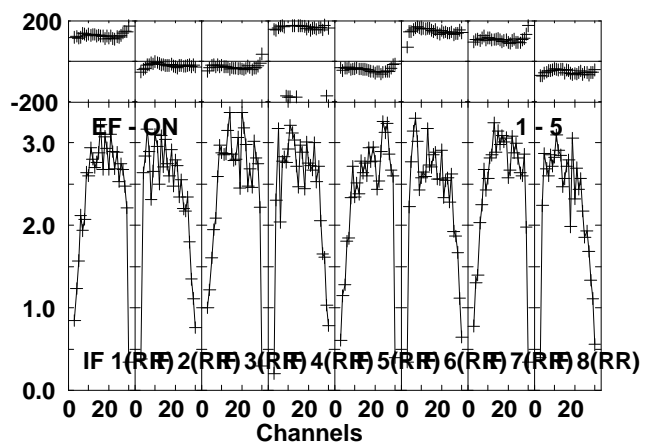
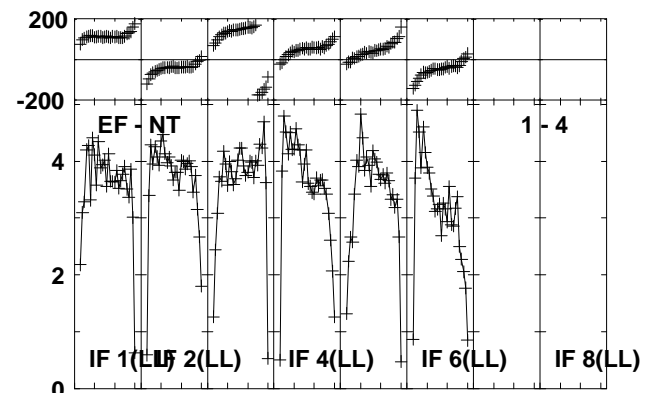
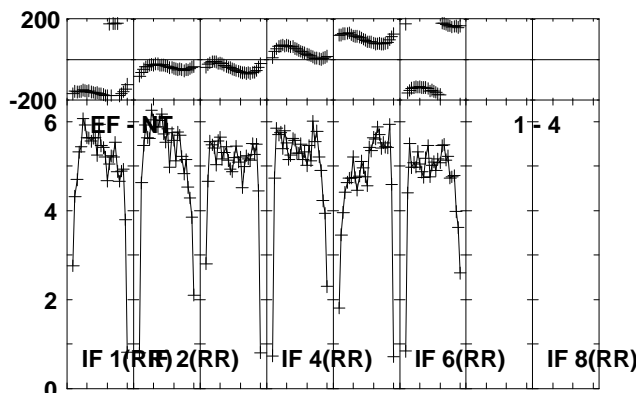
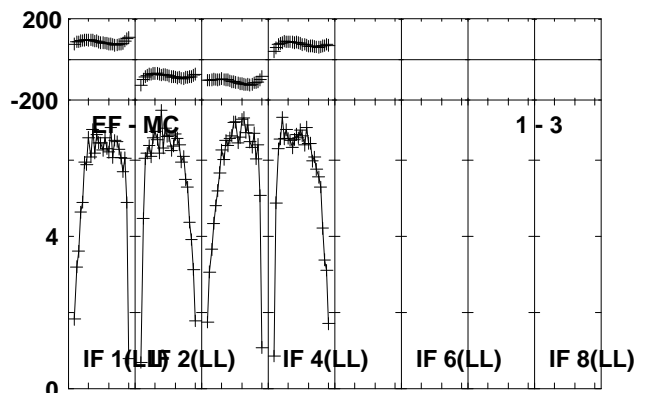
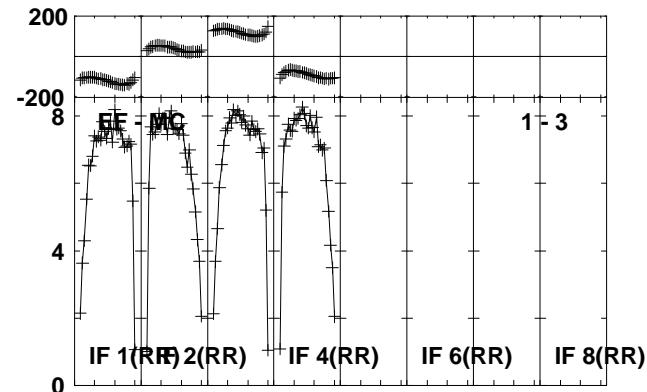
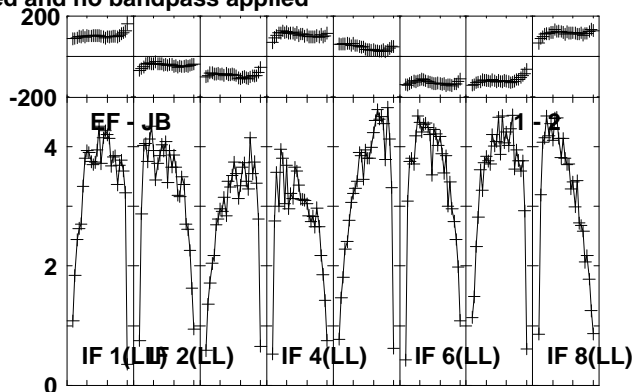
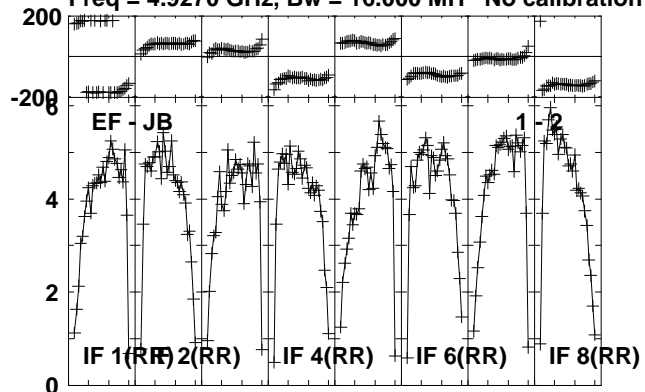

Lower frame: Milli Ampl Jy Top frame: Phas deg  
Vector averaged cross-power spectrum Several baselines displayed  
Timerange: 00/21:15:18 to 00/21:16:44

Plot file version 362 created 24-OCT-2012 21:01:27

J1825-0737 EY017B.UVDATA.1

Freq = 4.9270 GHz, Bw = 16.000 MH No calibration applied and no bandpass applied

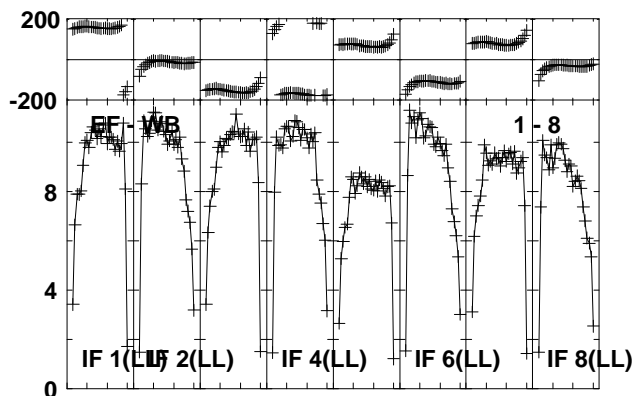
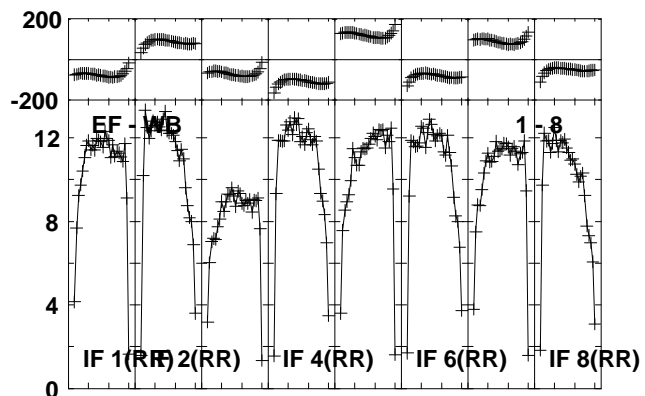
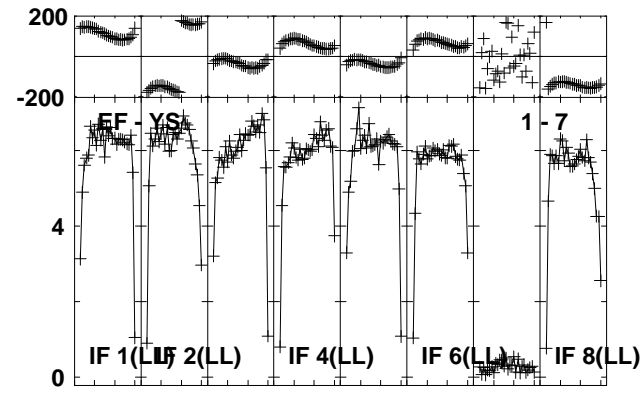
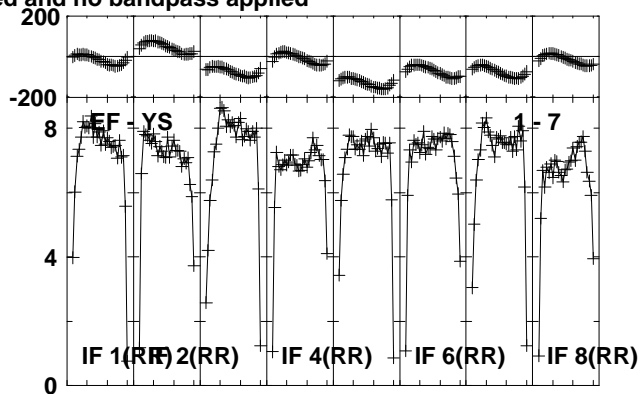
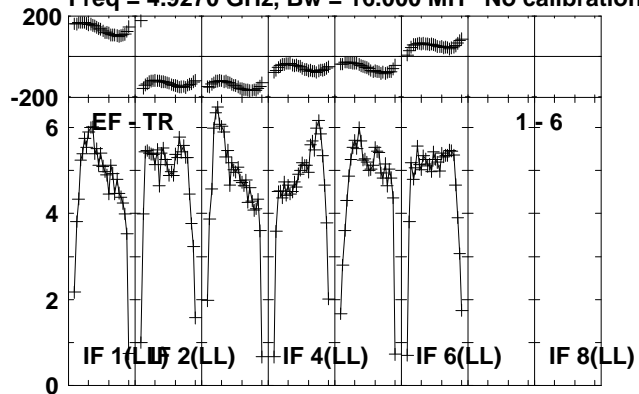

Lower frame: Milli Ampl Jy Top frame: Phas deg  
Vector averaged cross-power spectrum Several baselines displayed  
Timerange: 00/21:15:18 to 00/21:16:44

Plot file version 363 created 24-OCT-2012 21:01:27

G23.6-0.03 EY017B.UVDATA.1

Freq = 4.9270 GHz, Bw = 16.000 MH No calibration applied and no bandpass applied

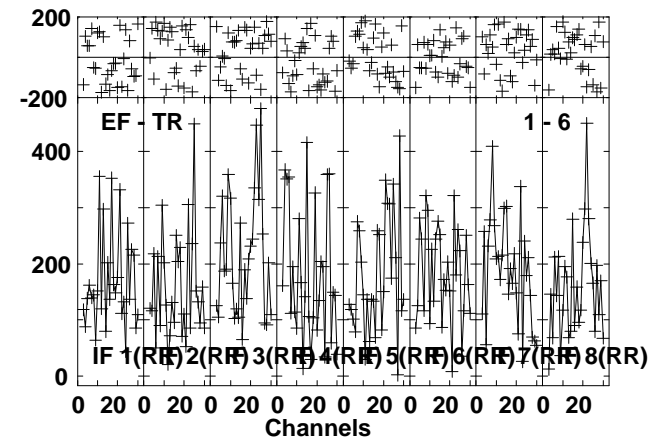
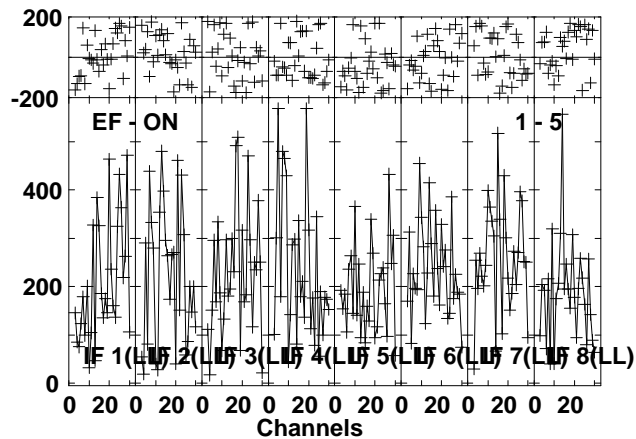
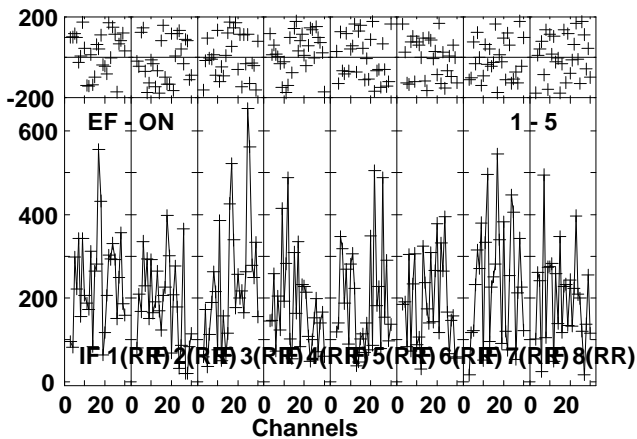
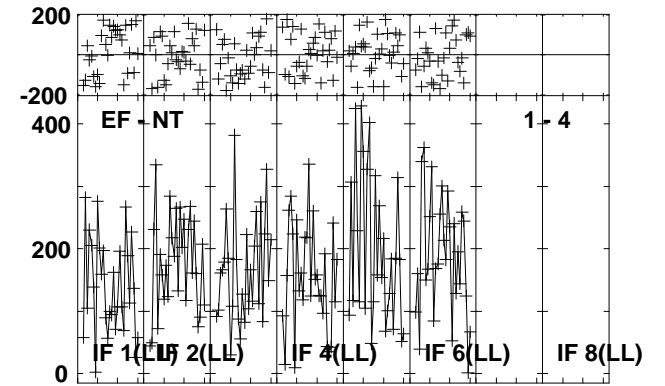
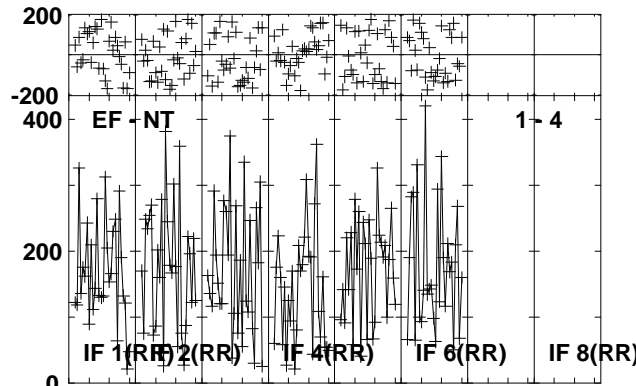
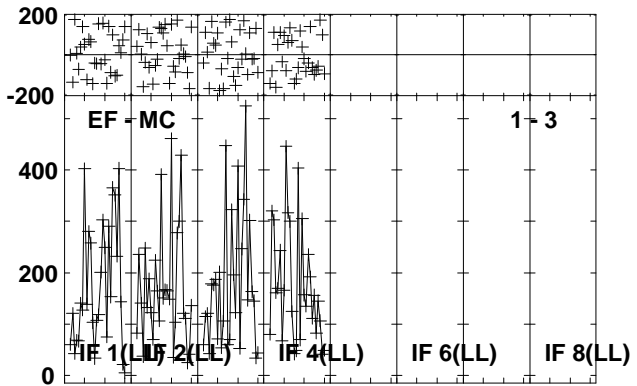
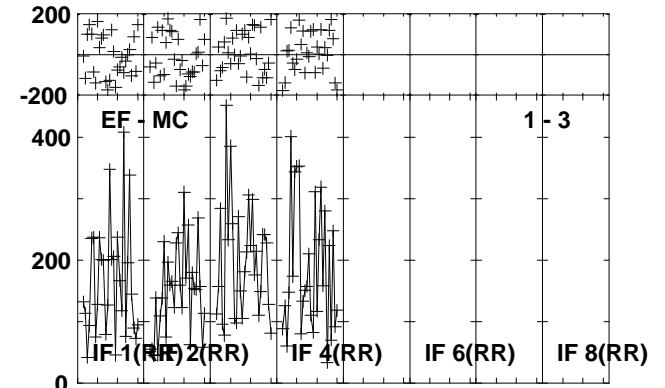
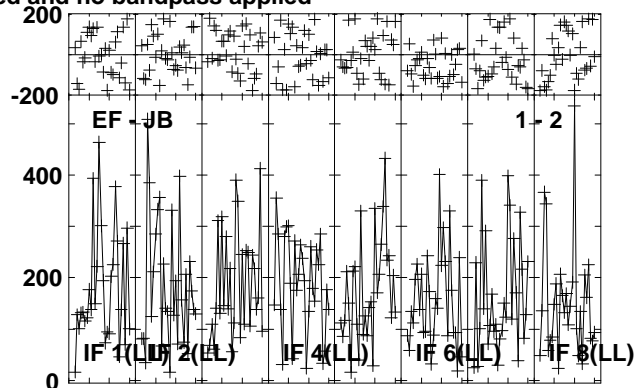
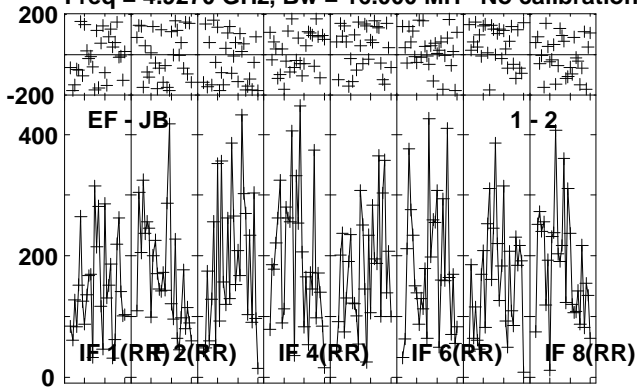

Lower frame: Micro Ampl Jy Top frame: Phas deg  
Vector averaged cross-power spectrum Several baselines displayed  
Timerange: 00/21:16:48 to 00/21:19:14

Plot file version 364 created 24-OCT-2012 21:01:28

G23.6-0.03 EY017B.UVDATA.1

Freq = 4.9270 GHz, Bw = 16.000 MH No calibration applied and no bandpass applied

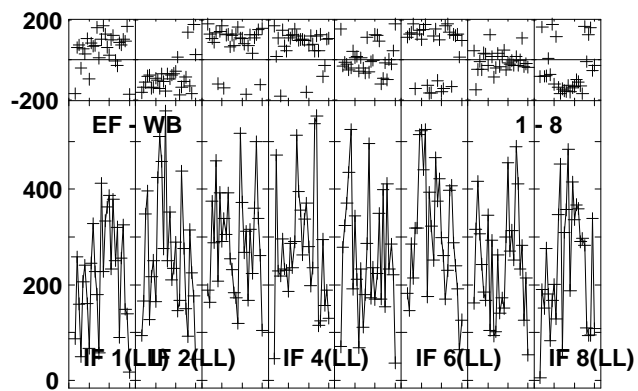
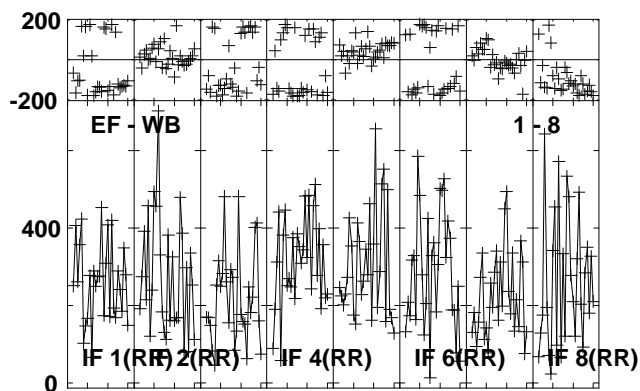
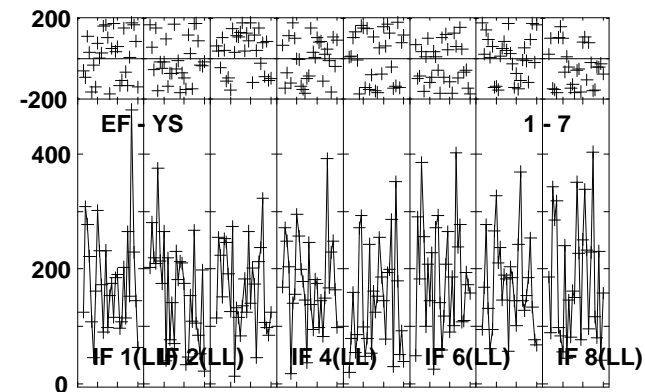
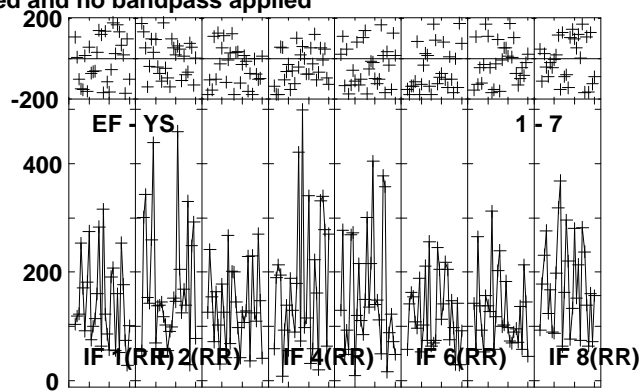
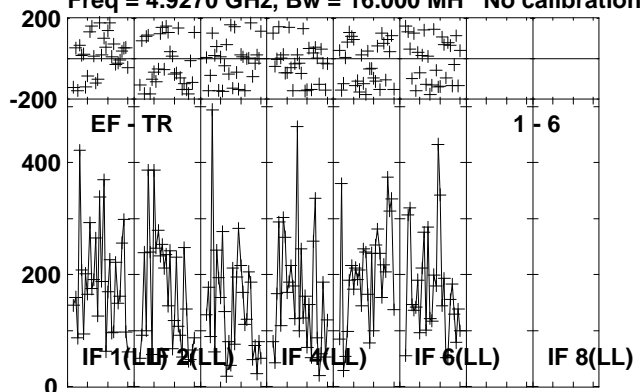

Lower frame: Micro Ampl Jy Top frame: Phas deg  
Vector averaged cross-power spectrum Several baselines displayed  
Timerange: 00/21:16:48 to 00/21:19:14



Plot file version 365 created 24-OCT-2012 21:01:29

J1825-0737 EY017B.UVDATA.1

Freq = 4.9270 GHz, Bw = 16.000 MH No calibration applied and no bandpass applied

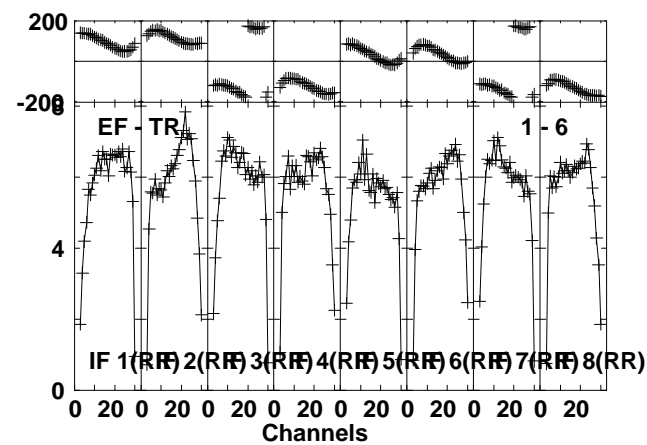
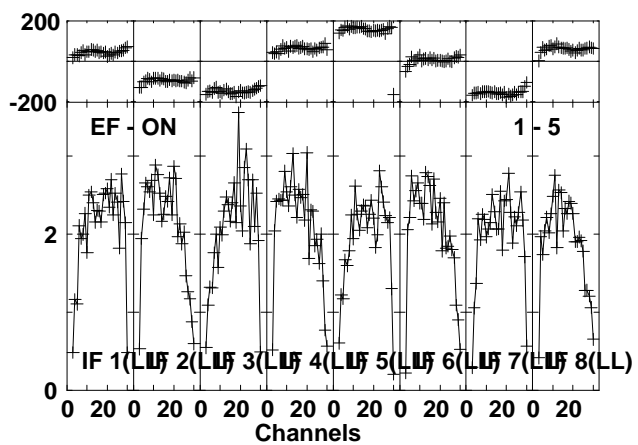
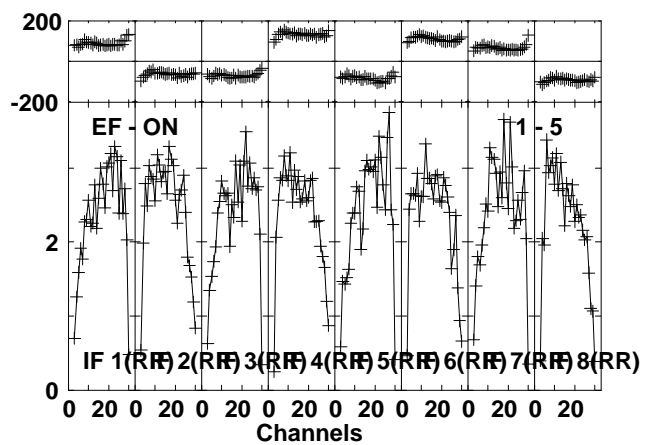
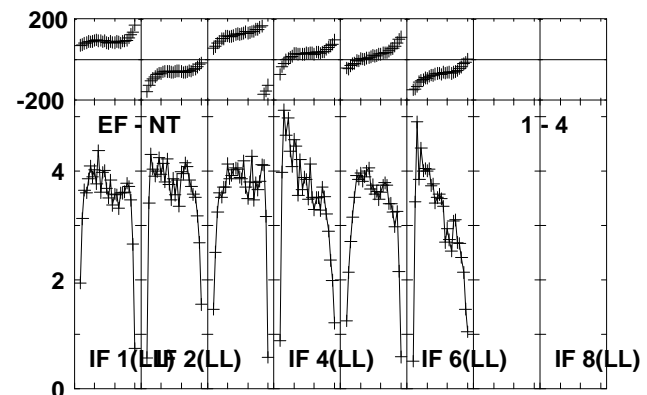
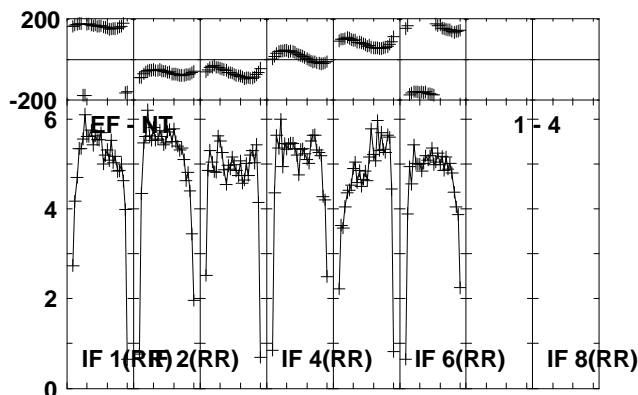
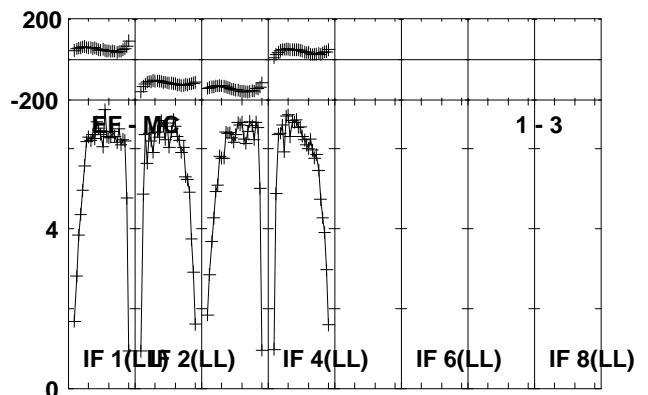
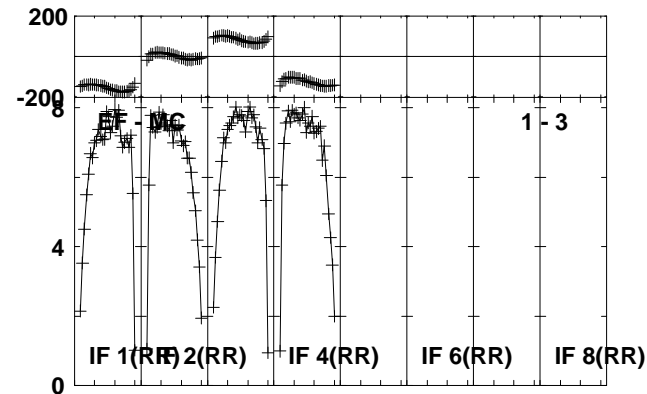
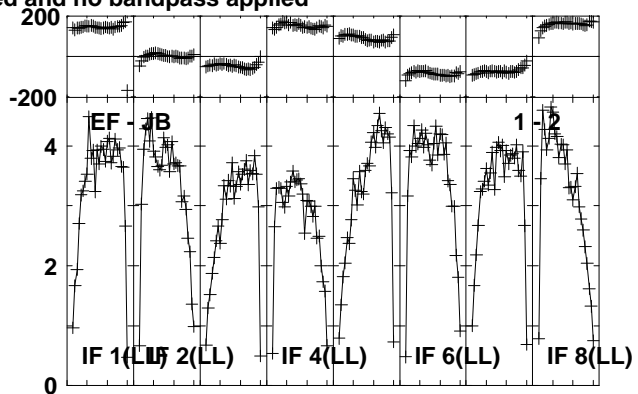
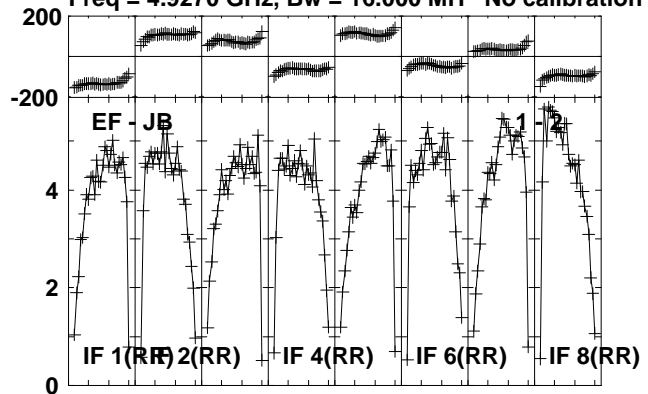

Lower frame: Milli Ampl Jy Top frame: Phas deg  
Vector averaged cross-power spectrum Several baselines displayed  
Timerange: 00/21:19:18 to 00/21:20:44

Plot file version 366 created 24-OCT-2012 21:01:29

J1825-0737 EY017B.UVDATA.1

Freq = 4.9270 GHz, Bw = 16.000 MH No calibration applied and no bandpass applied

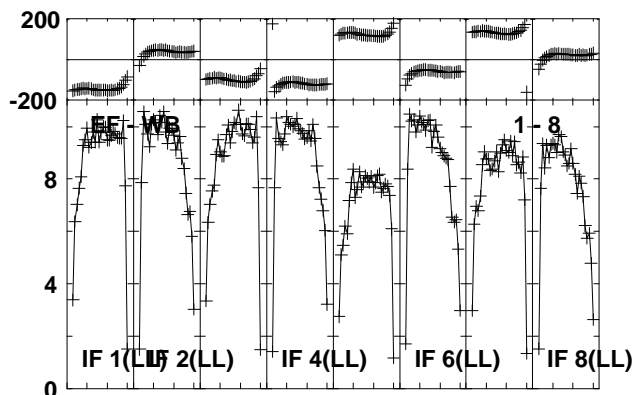
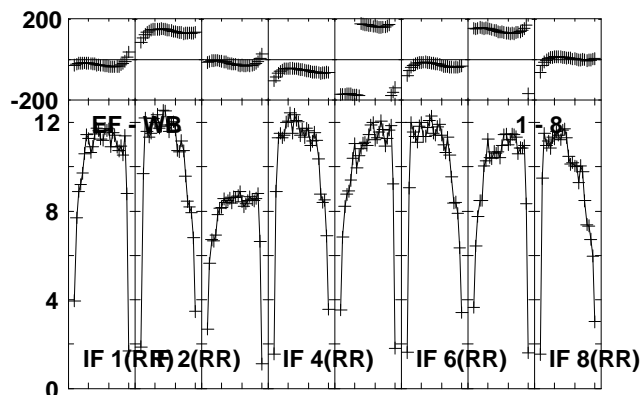
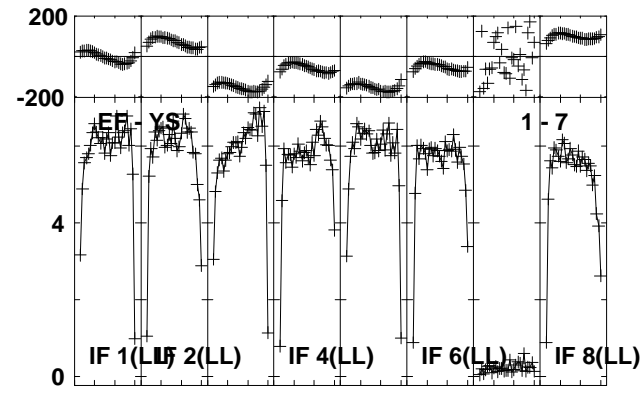
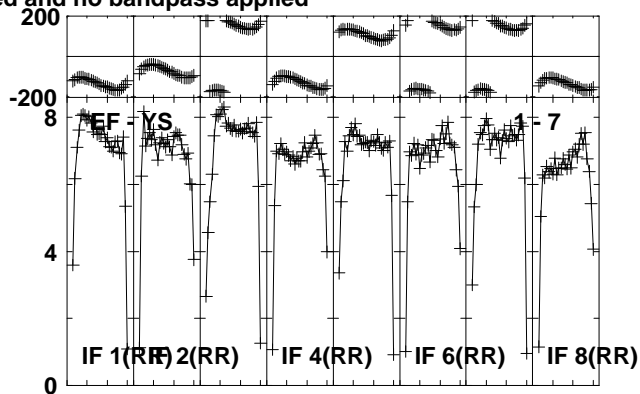
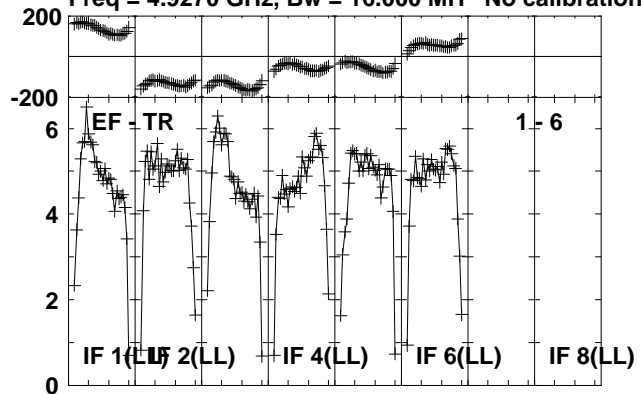

Lower frame: Milli Ampl Jy Top frame: Phas deg  
Vector averaged cross-power spectrum Several baselines displayed  
Timerange: 00/21:19:18 to 00/21:20:44

Plot file version 367 created 24-OCT-2012 21:01:30

J1831-0756 EY017B.UVDATA.1

Freq = 4.9270 GHz, Bw = 16.000 MH No calibration applied and no bandpass applied

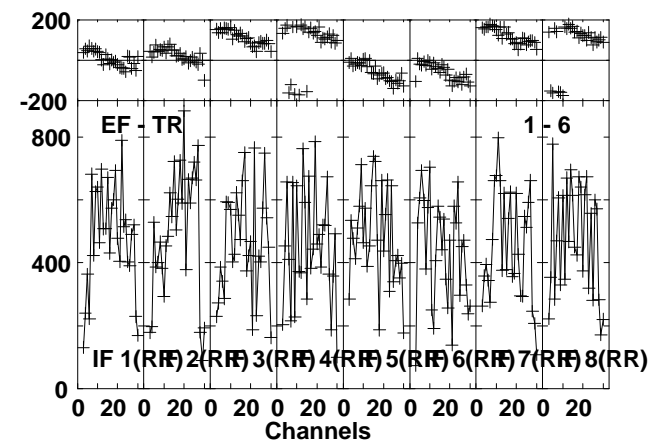
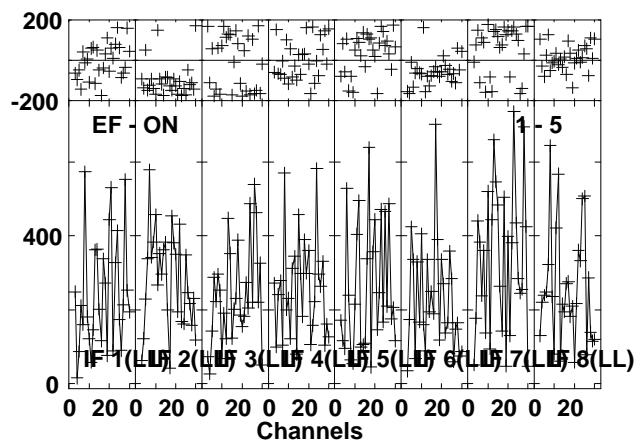
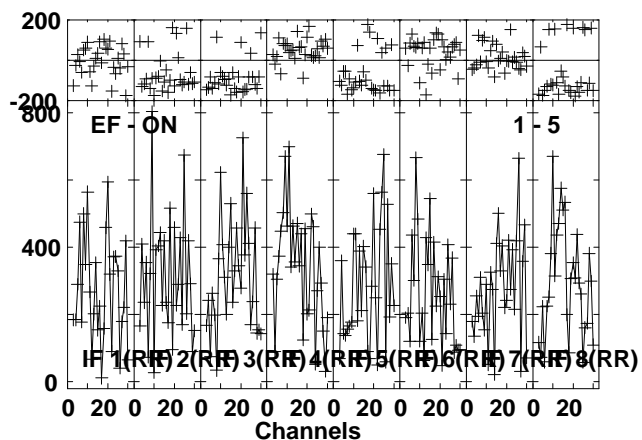
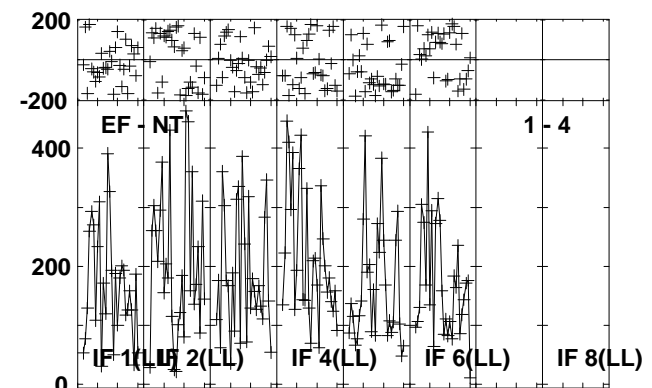
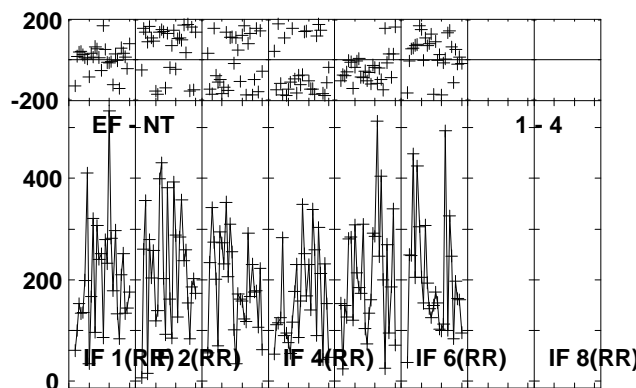
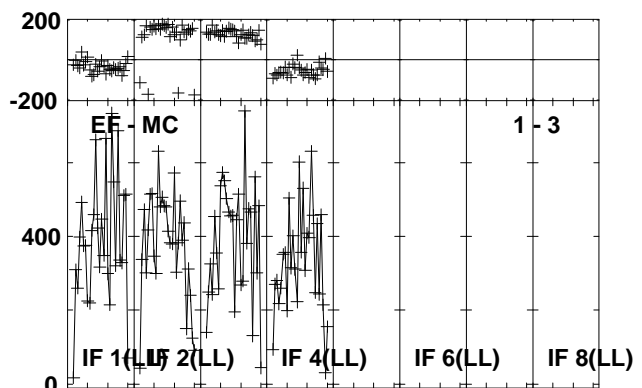
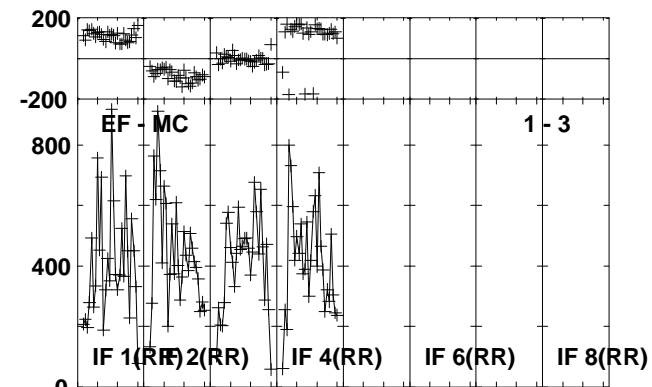
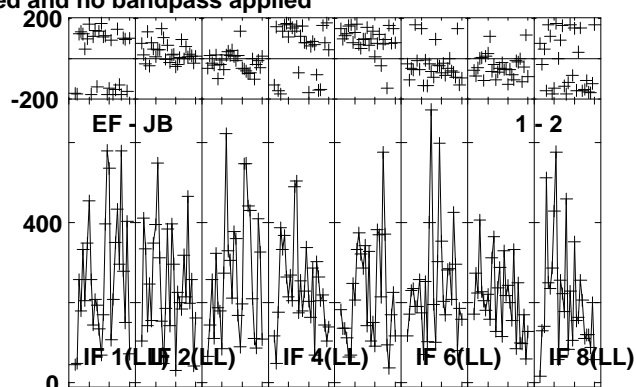
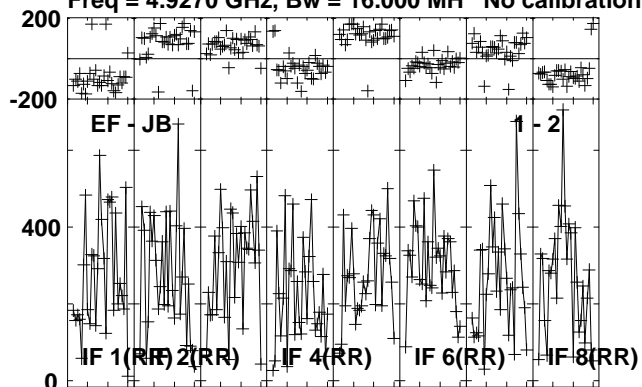

Lower frame: Micro Ampl Jy Top frame: Phas deg  
Vector averaged cross-power spectrum Several baselines displayed  
Timerange: 00/21:21:18 to 00/21:23:18

Plot file version 368 created 24-OCT-2012 21:01:30

J1831-0756 EY017B.UVDATA.1

Freq = 4.9270 GHz, Bw = 16.000 MH No calibration applied and no bandpass applied

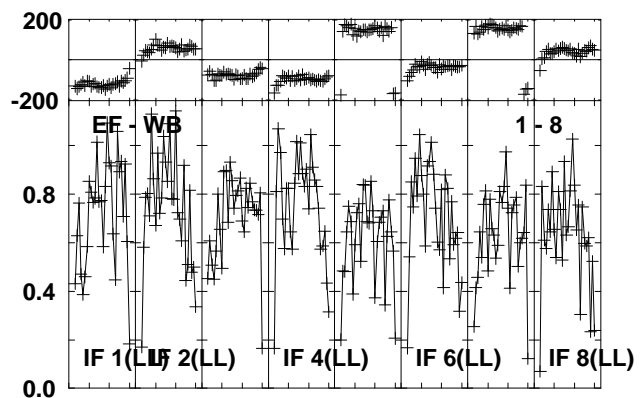
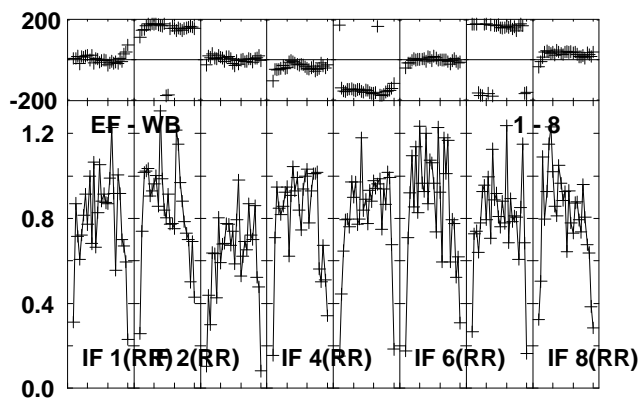
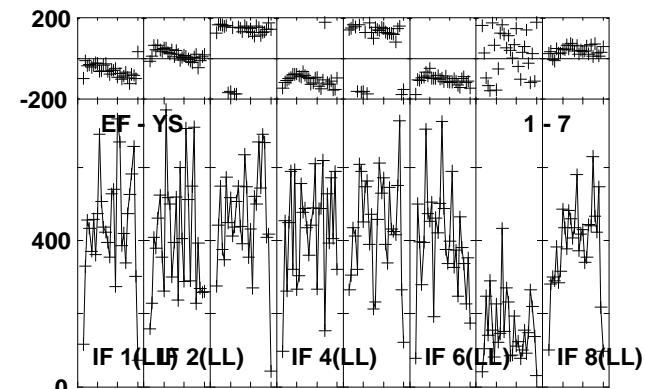
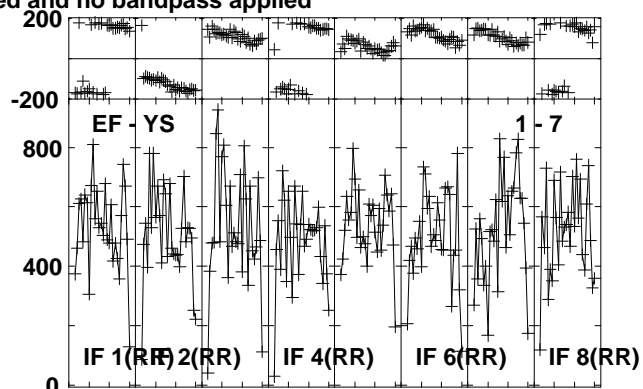
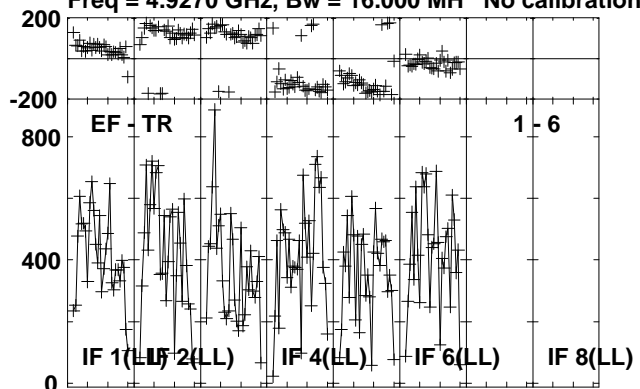

Lower frame: Micro Ampl Jy Top frame: Phas deg  
Vector averaged cross-power spectrum Several baselines displayed  
Timerange: 00/21:21:18 to 00/21:23:18

Plot file version 369 created 24-OCT-2012 21:01:31

J1825-0737 EY017B.UVDATA.1

Freq = 4.9270 GHz, Bw = 16.000 MH No calibration applied and no bandpass applied

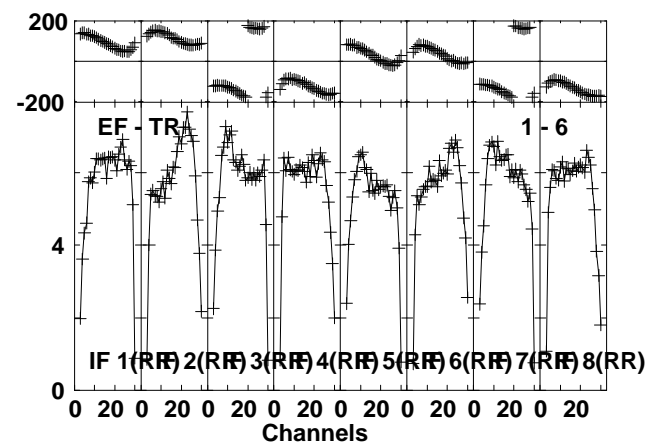
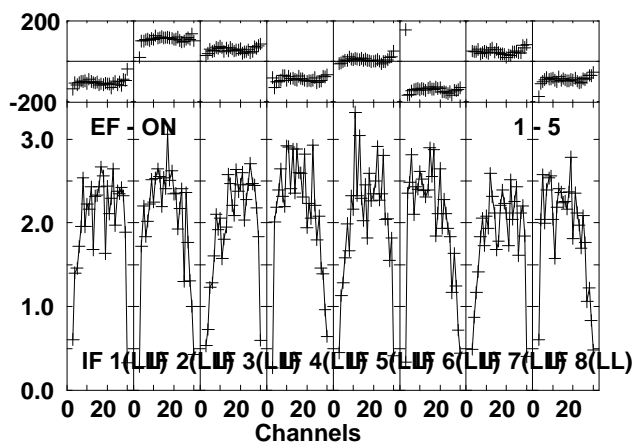
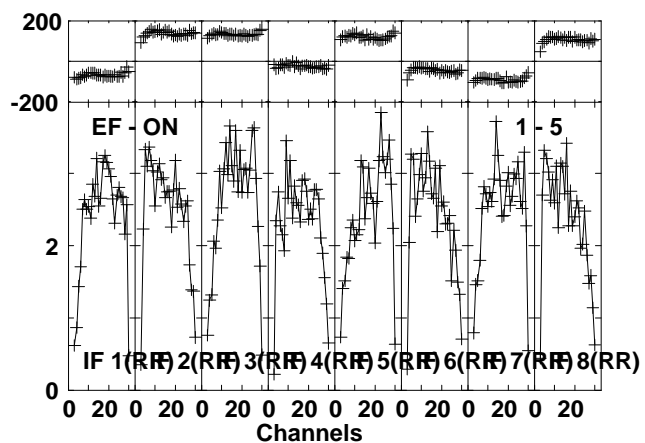
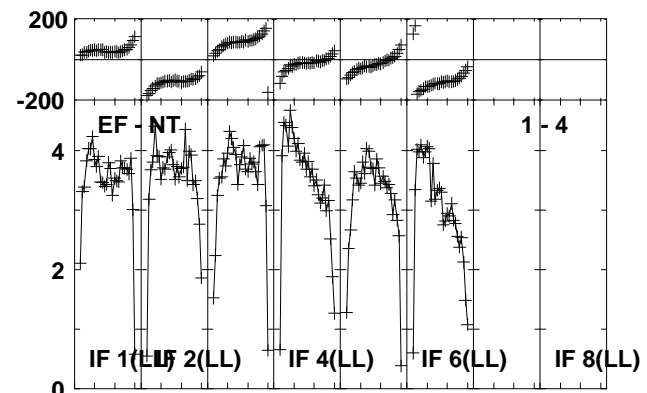
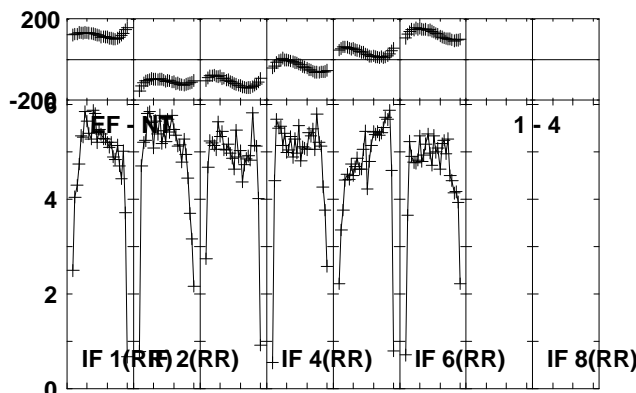
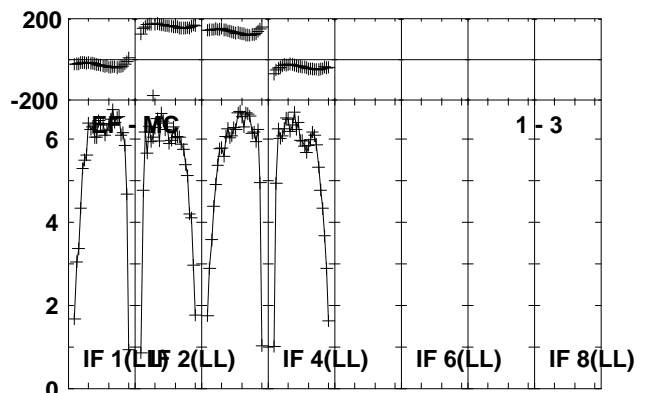
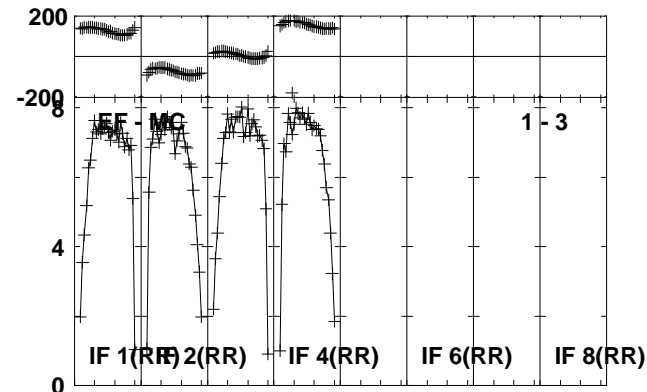
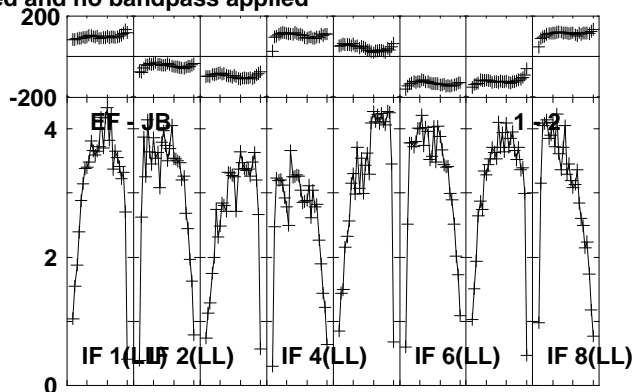
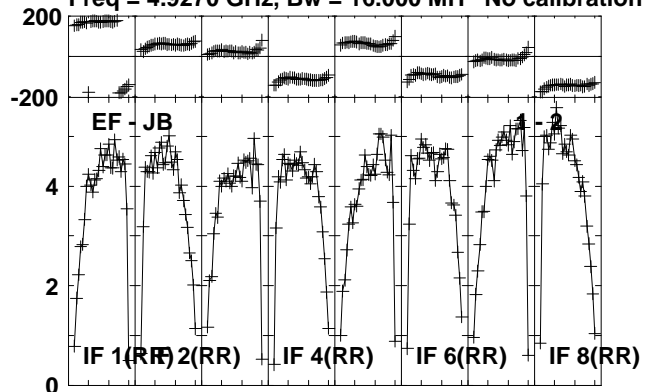

Lower frame: Milli Ampl Jy Top frame: Phas deg  
Vector averaged cross-power spectrum Several baselines displayed  
Timerange: 00/21:23:22 to 00/21:24:48

Plot file version 370 created 24-OCT-2012 21:01:31

J1825-0737 EY017B.UVDATA.1

Freq = 4.9270 GHz, Bw = 16.000 MH No calibration applied and no bandpass applied

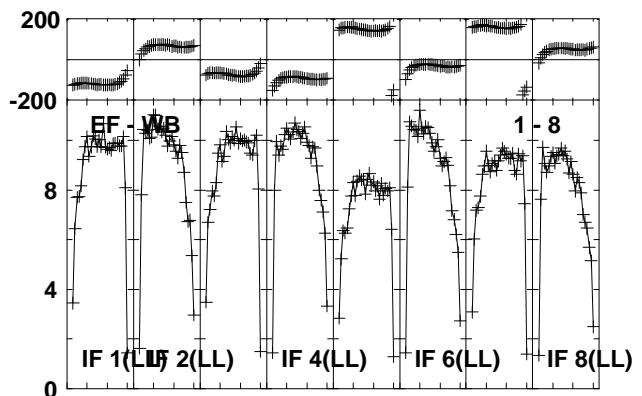
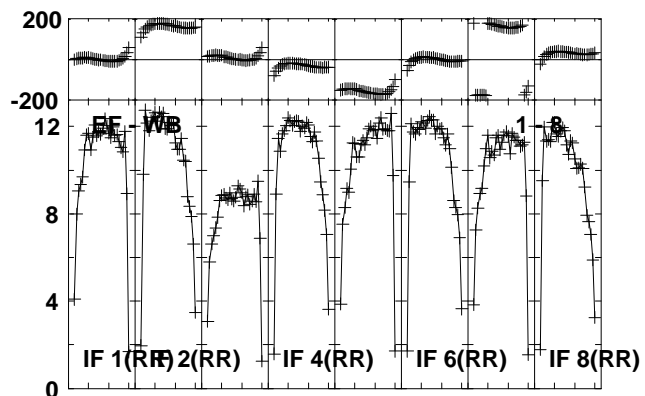
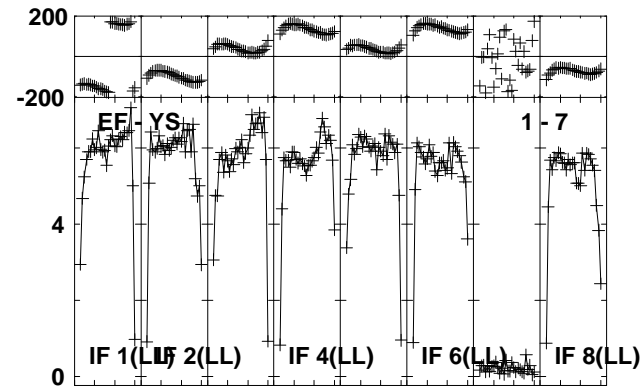
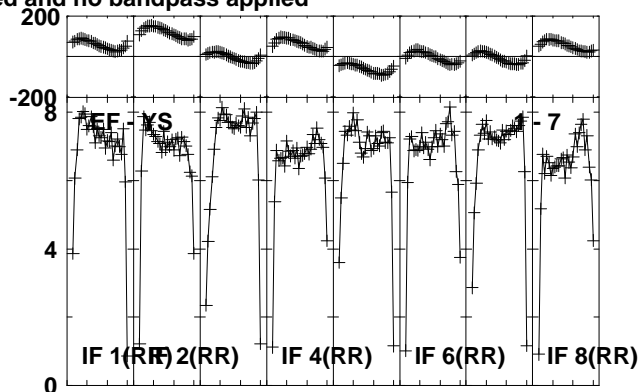
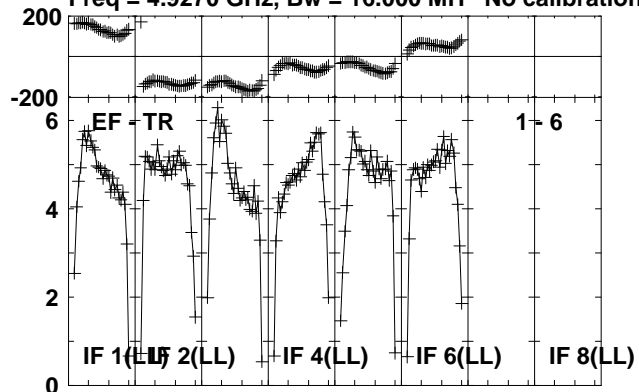

Lower frame: Milli Ampl Jy Top frame: Phas deg  
Vector averaged cross-power spectrum Several baselines displayed  
Timerange: 00/21:23:22 to 00/21:24:48

Plot file version 371 created 24-OCT-2012 21:01:32

G23.6-0.03 EY017B.UVDATA.1

Freq = 4.9270 GHz, Bw = 16.000 MH No calibration applied and no bandpass applied

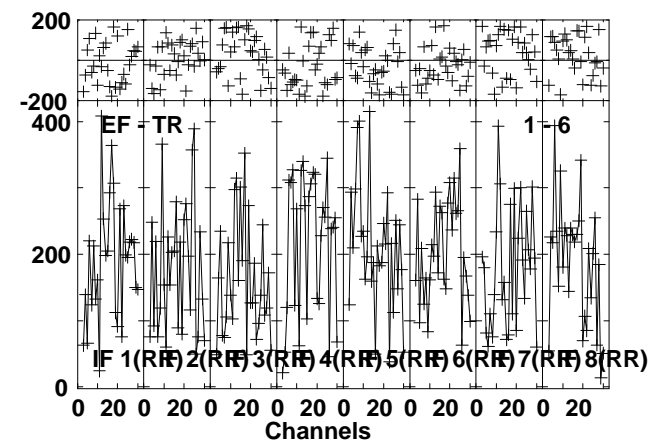
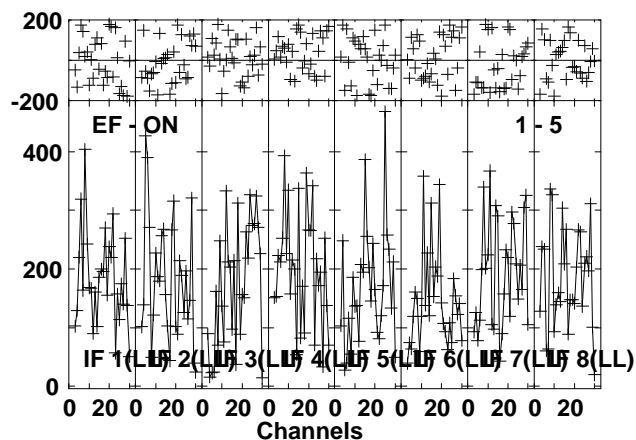
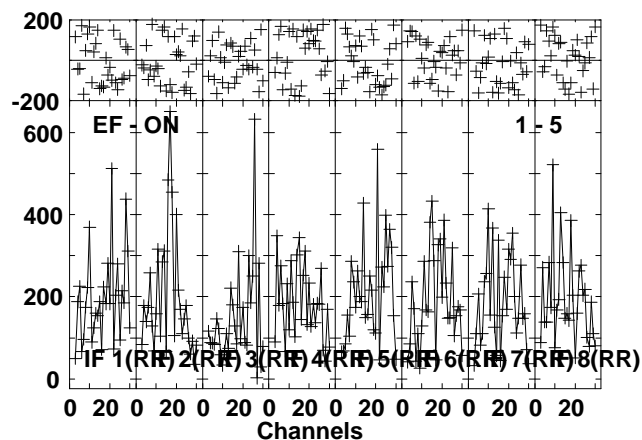
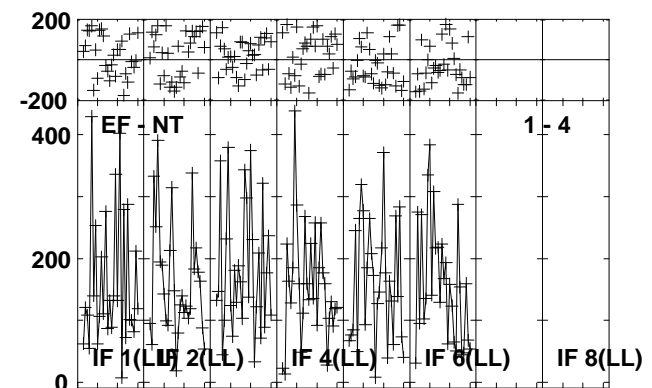
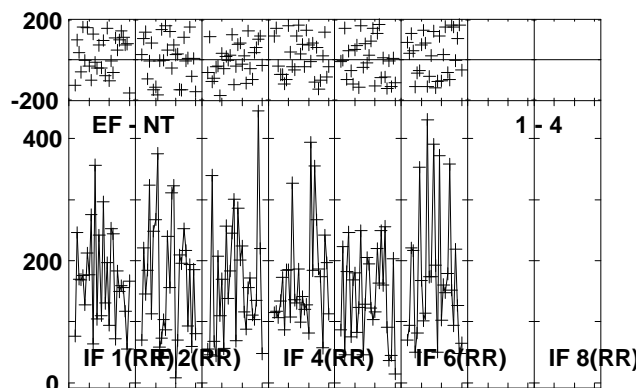
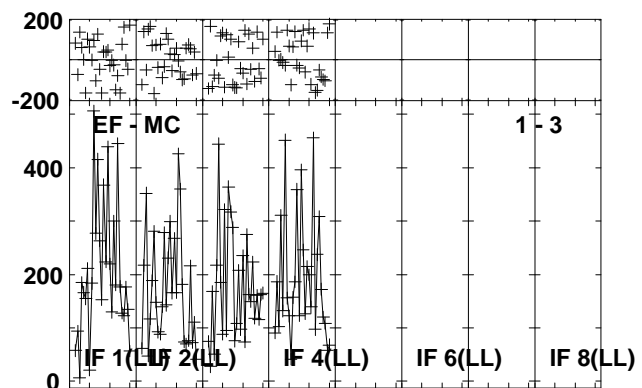
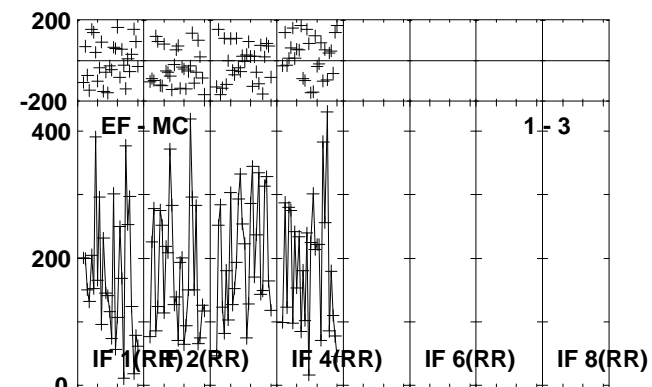
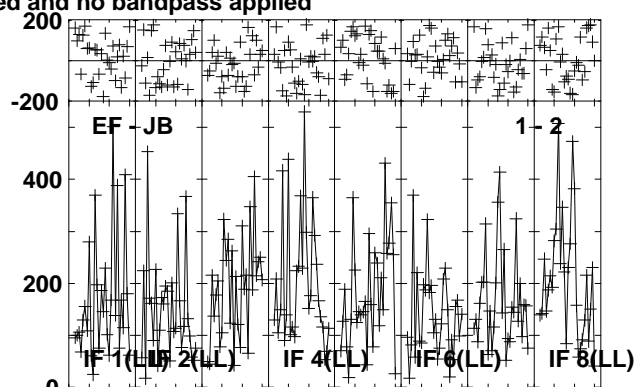
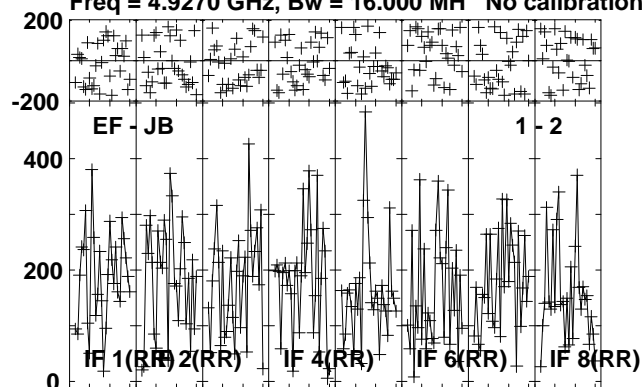

Lower frame: Micro Ampl Jy Top frame: Phas deg  
Vector averaged cross-power spectrum Several baselines displayed  
Timerange: 00/21:24:52 to 00/21:27:18

Plot file version 372 created 24-OCT-2012 21:01:32

G23.6-0.03 EY017B.UVDATA.1

Freq = 4.9270 GHz, Bw = 16.000 MH No calibration applied and no bandpass applied

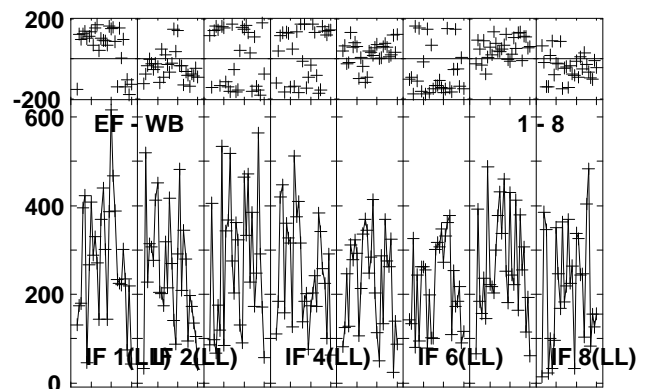
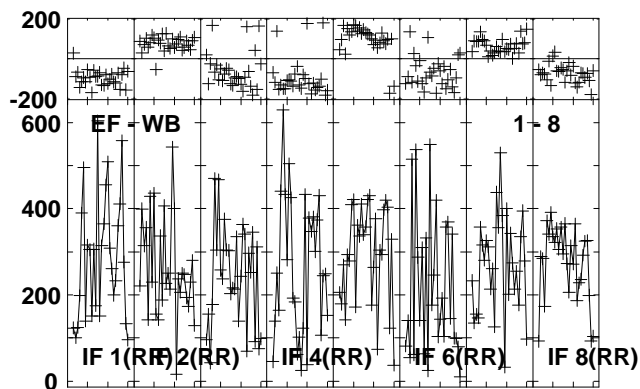
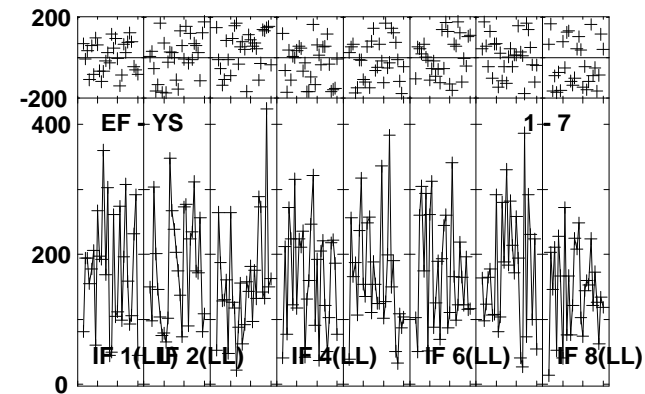
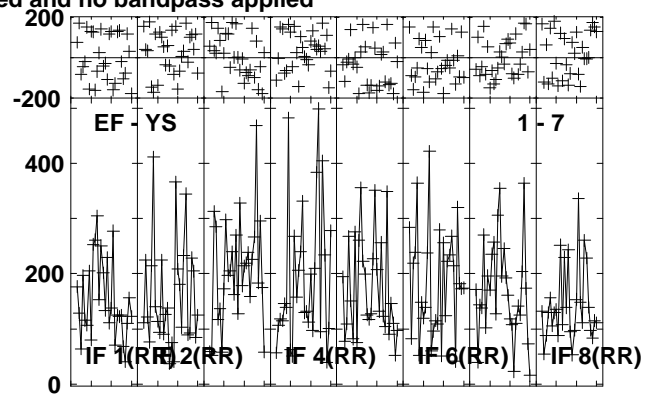
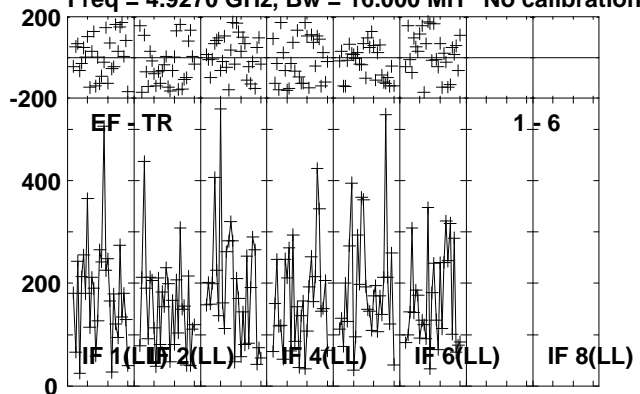

Lower frame: Micro Ampl Jy Top frame: Phas deg  
Vector averaged cross-power spectrum Several baselines displayed  
Timerange: 00/21:24:52 to 00/21:27:18



Plot file version 373 created 24-OCT-2012 21:01:33

J1825-0737 EY017B.UVDATA.1

Freq = 4.9270 GHz, Bw = 16.000 MH No calibration applied and no bandpass applied

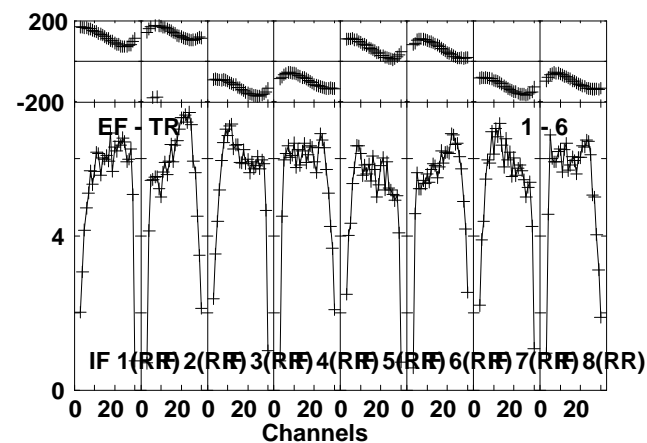
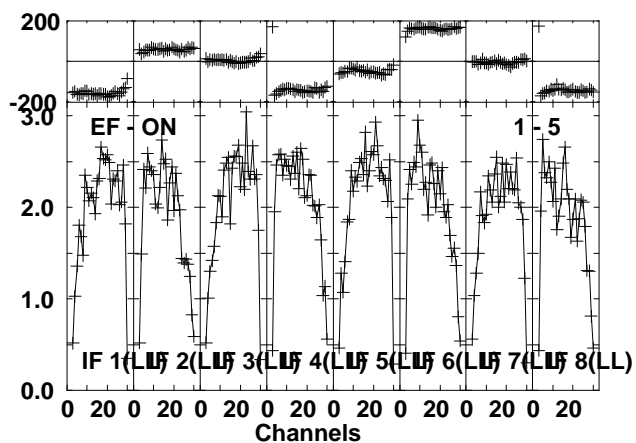
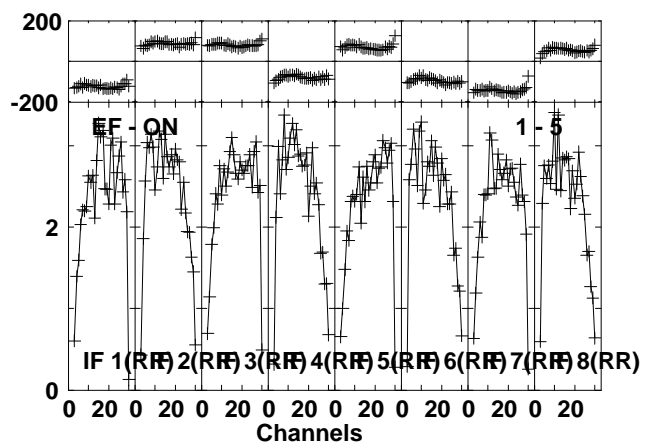
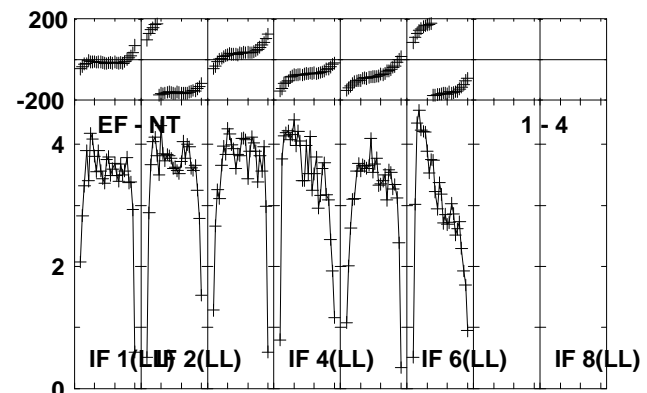
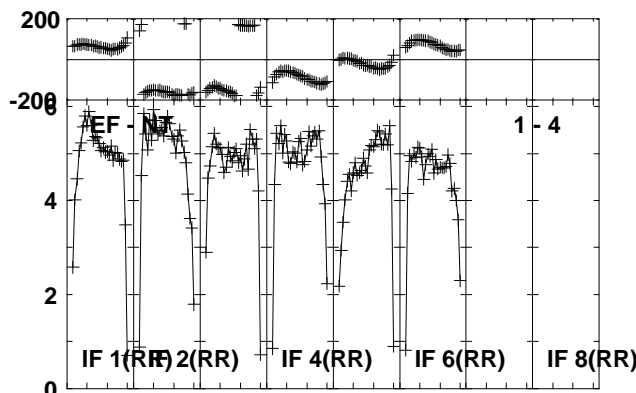
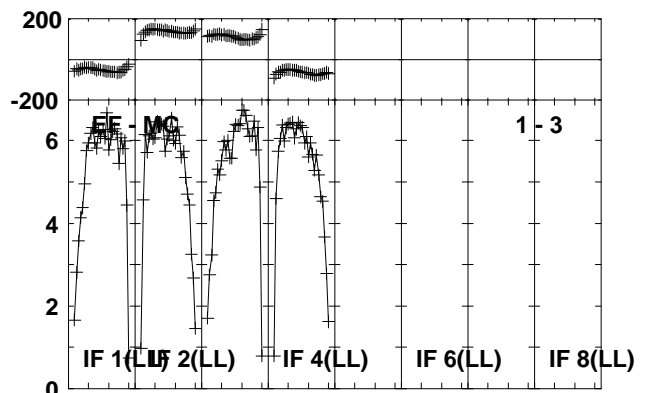
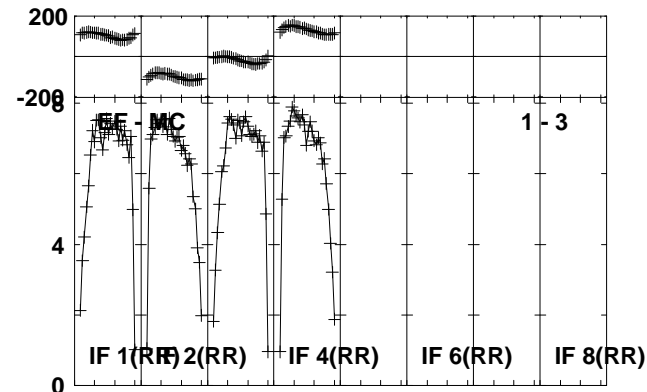
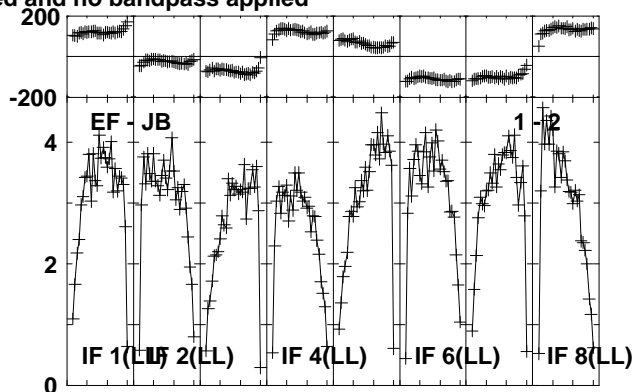
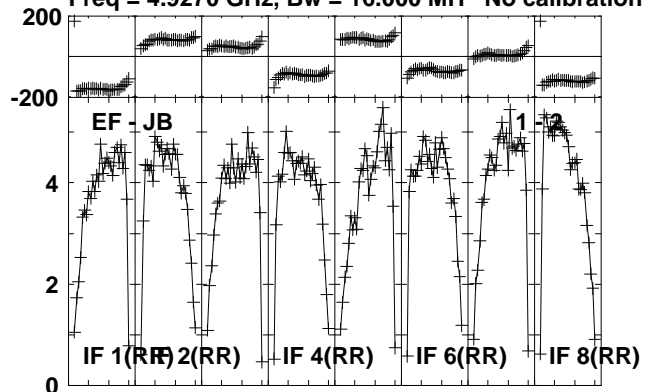

Lower frame: Milli Ampl Jy Top frame: Phas deg  
Vector averaged cross-power spectrum Several baselines displayed  
Timerange: 00/21:27:22 to 00/21:28:48

Plot file version 374 created 24-OCT-2012 21:01:33

J1825-0737 EY017B.UVDATA.1

Freq = 4.9270 GHz, Bw = 16.000 MH No calibration applied and no bandpass applied

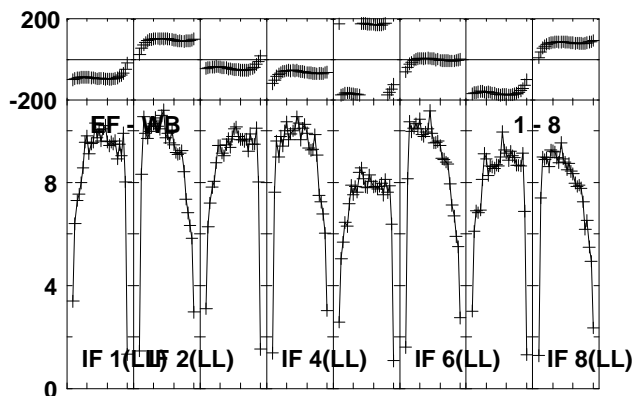
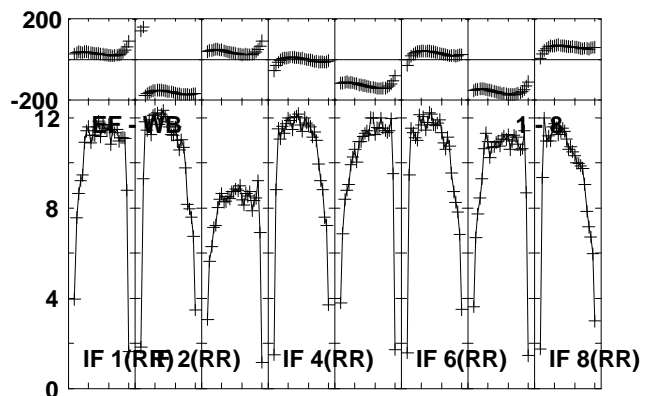
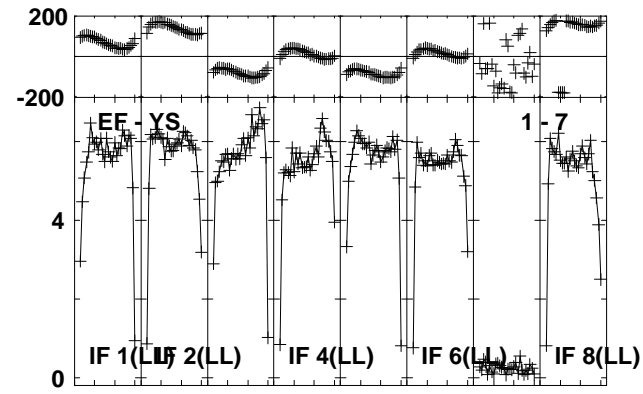
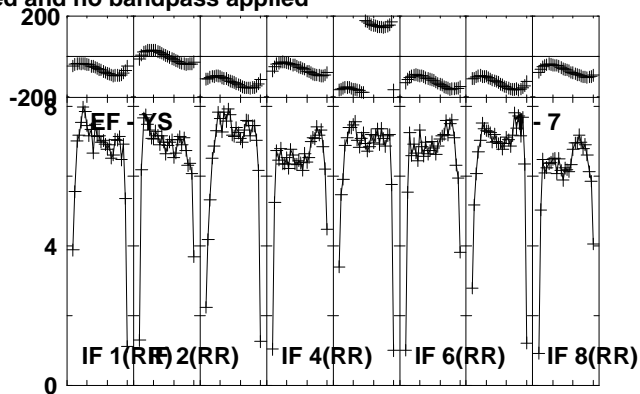
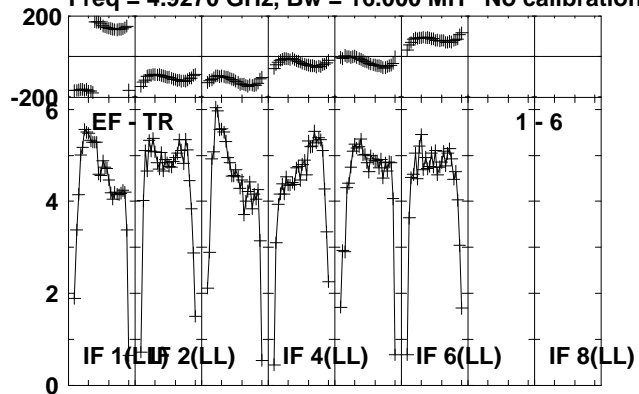

Lower frame: Milli Ampl Jy Top frame: Phas deg  
Vector averaged cross-power spectrum Several baselines displayed  
Timerange: 00/21:27:22 to 00/21:28:48

Plot file version 375 created 24-OCT-2012 21:01:34

G23.6-0.03 EY017B.UVDATA.1

Freq = 4.9270 GHz, Bw = 16.000 MH No calibration applied and no bandpass applied

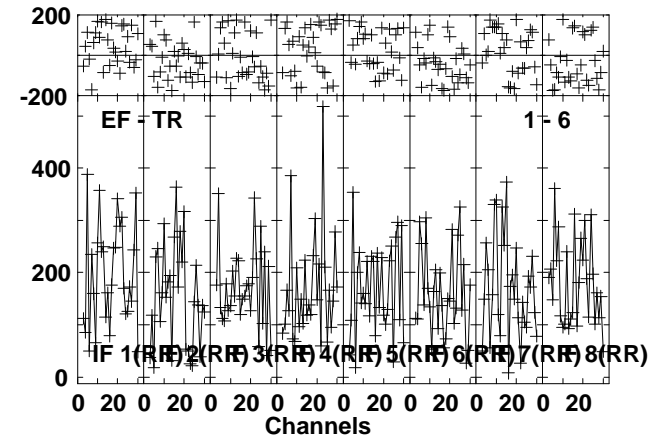
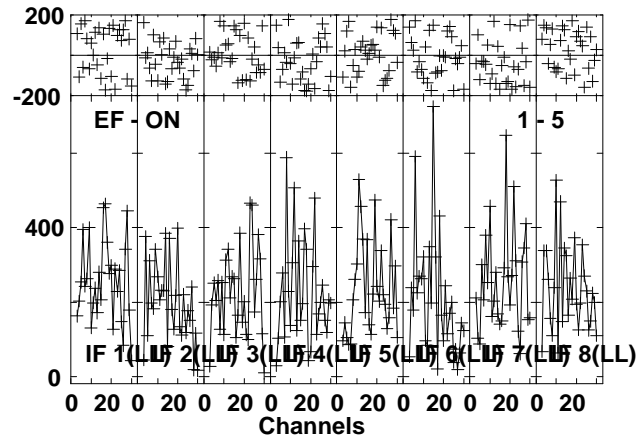
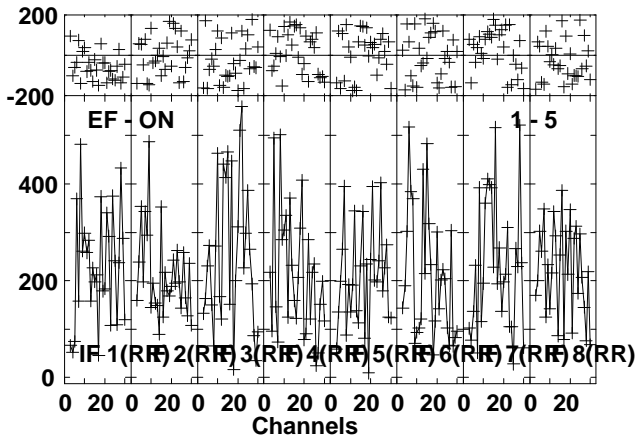
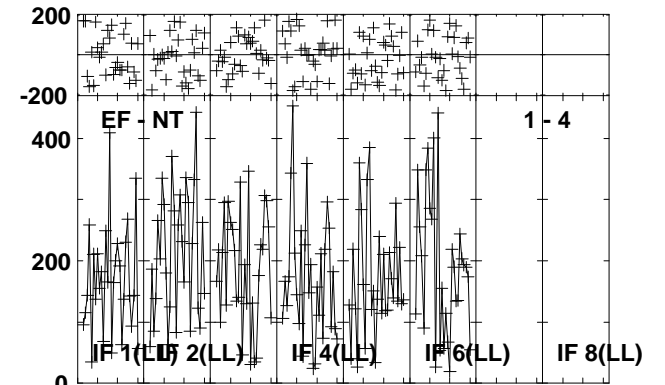
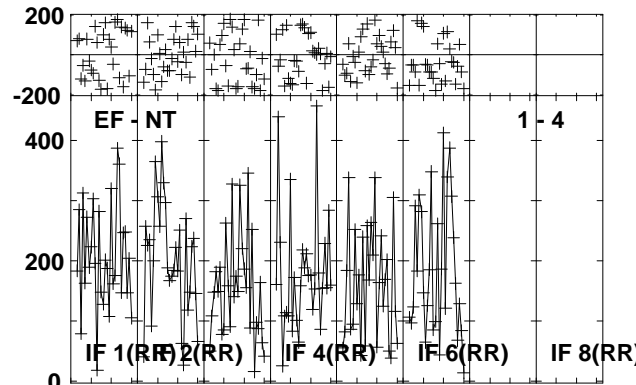
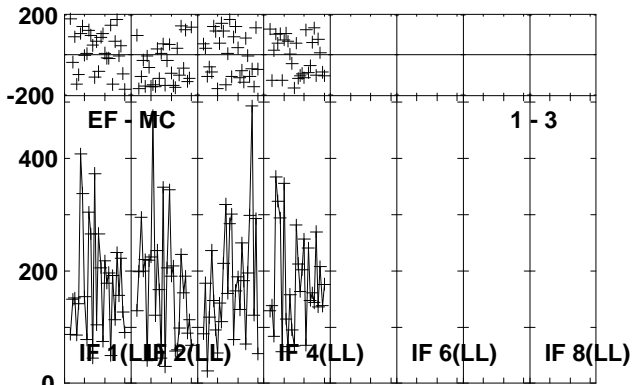
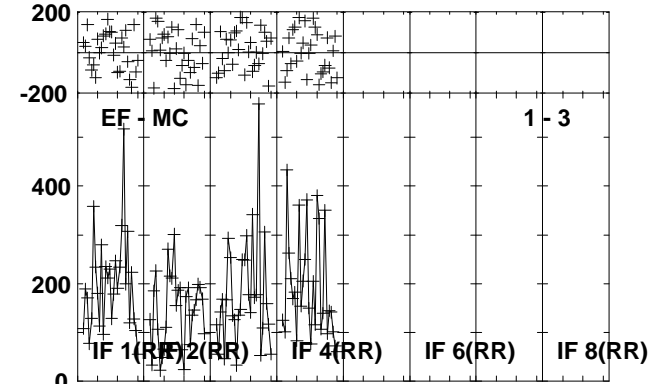
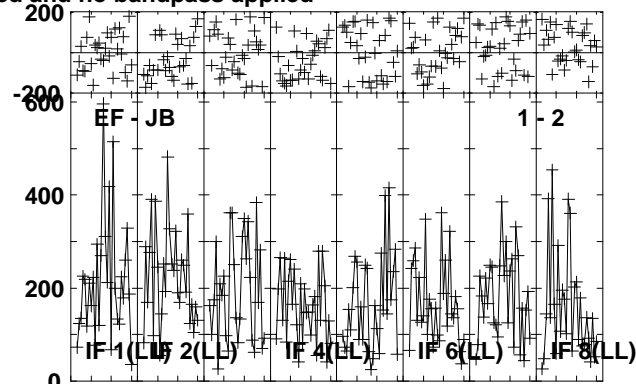
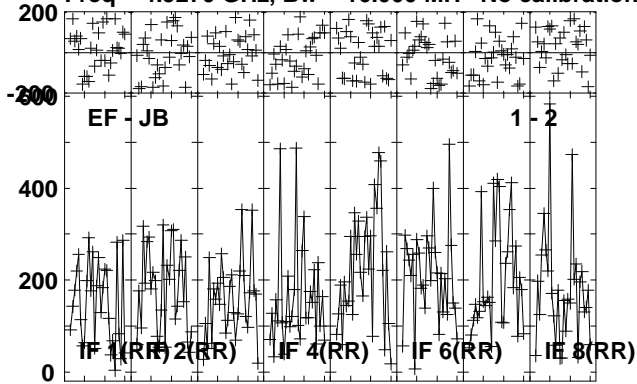

Lower frame: Micro Ampl Jy Top frame: Phas deg  
Vector averaged cross-power spectrum Several baselines displayed  
Timerange: 00/21:28:52 to 00/21:31:18

Plot file version 376 created 24-OCT-2012 21:01:35

G23.6-0.03 EY017B.UVDATA.1

Freq = 4.9270 GHz, Bw = 16.000 MH No calibration applied and no bandpass applied

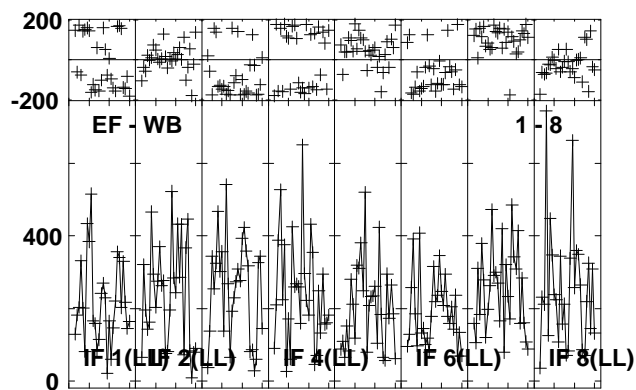
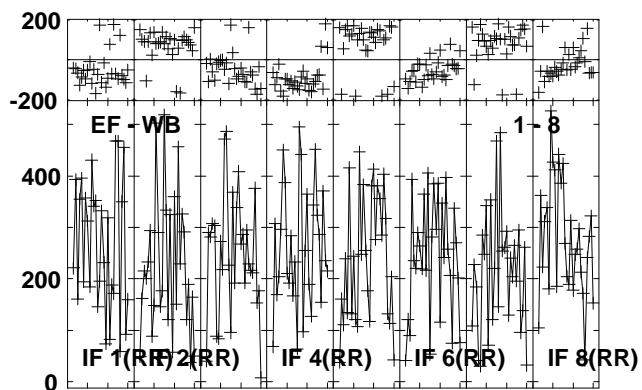
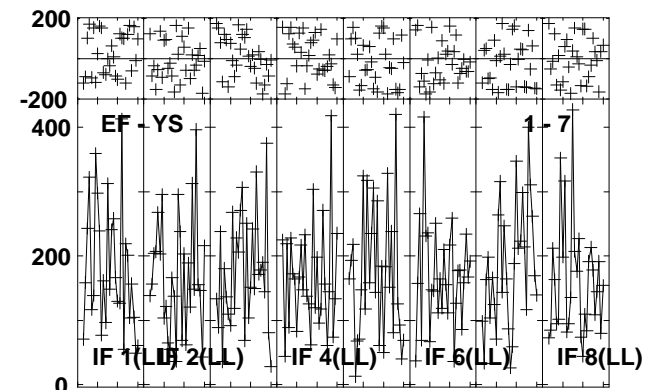
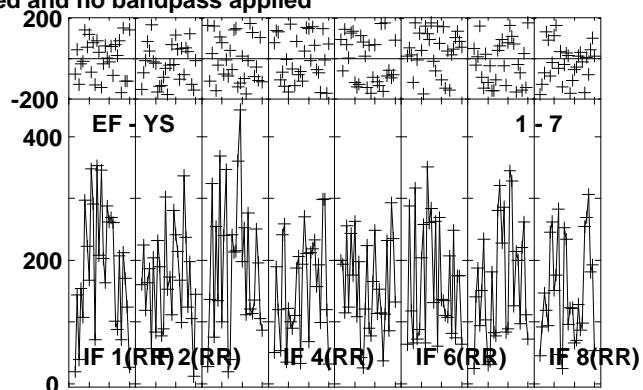
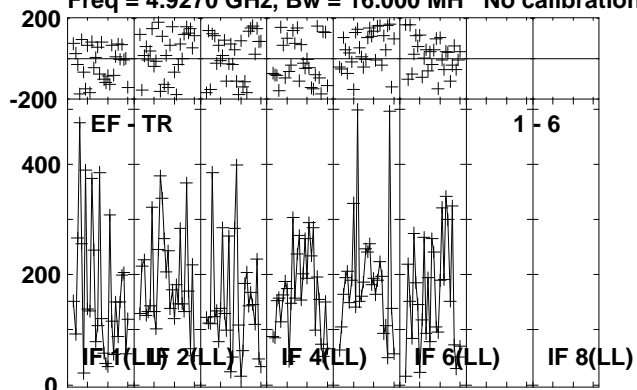

Lower frame: Micro Ampl Jy Top frame: Phas deg  
Vector averaged cross-power spectrum Several baselines displayed  
Timerange: 00/21:28:52 to 00/21:31:18

Plot file version 377 created 24-OCT-2012 21:01:35

J1825-0737 EY017B.UVDATA.1

Freq = 4.9270 GHz, Bw = 16.000 MH No calibration applied and no bandpass applied

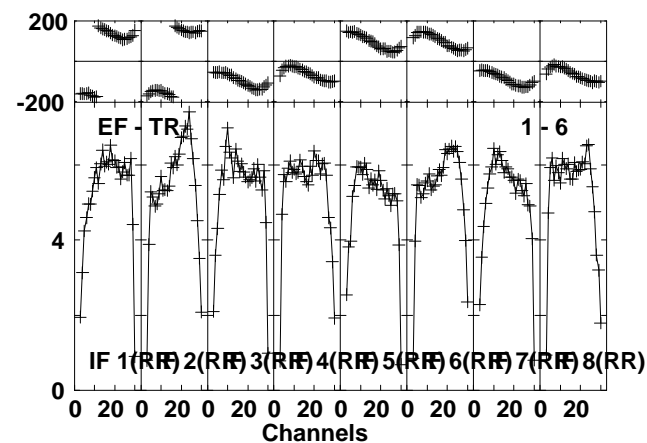
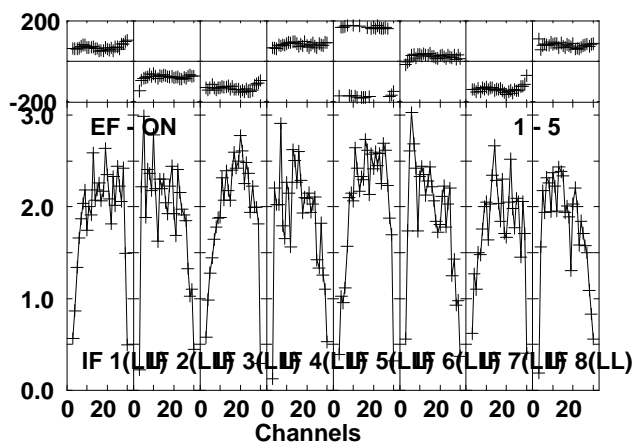
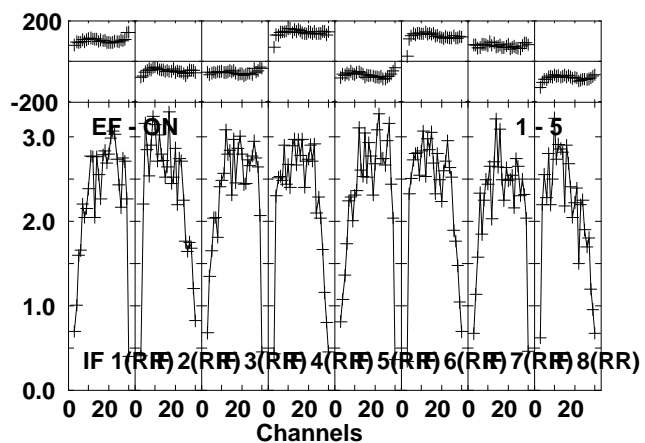
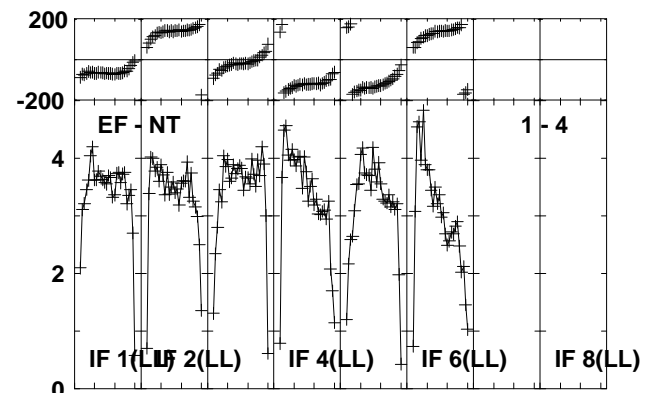
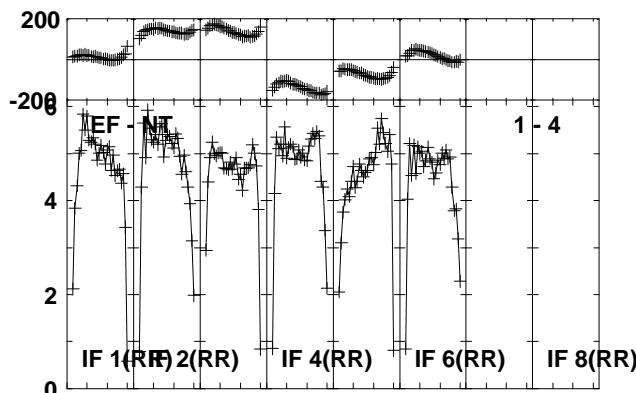
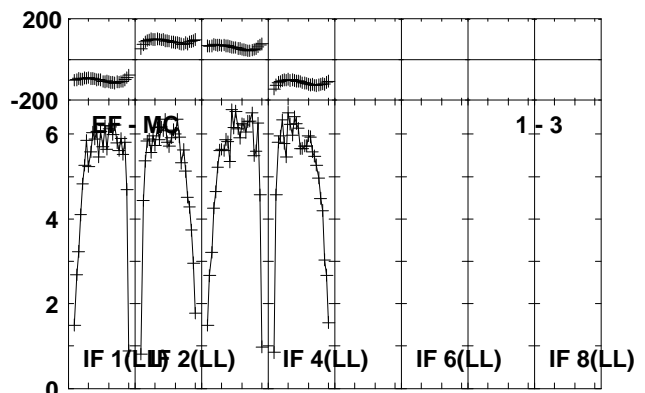
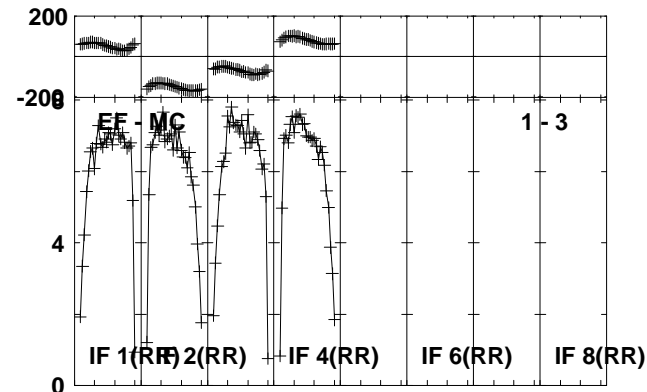
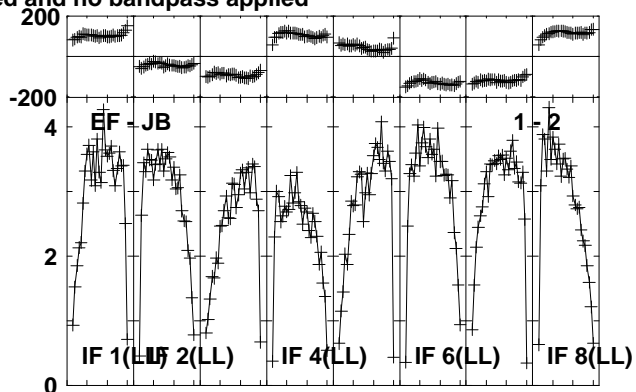
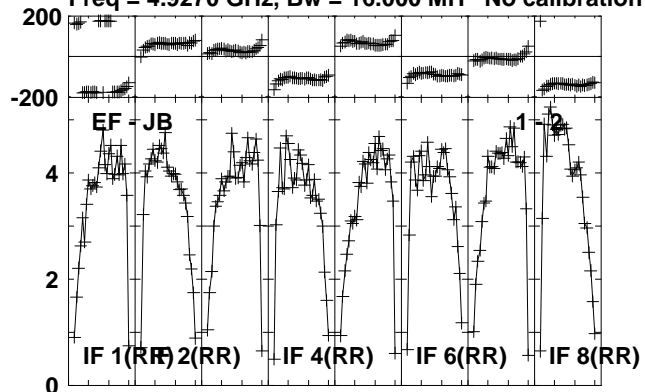

Lower frame: Milli Ampl Jy Top frame: Phas deg  
Vector averaged cross-power spectrum Several baselines displayed  
Timerange: 00/21:31:22 to 00/21:32:48

Plot file version 378 created 24-OCT-2012 21:01:36

J1825-0737 EY017B.UVDATA.1

Freq = 4.9270 GHz, Bw = 16.000 MH No calibration applied and no bandpass applied

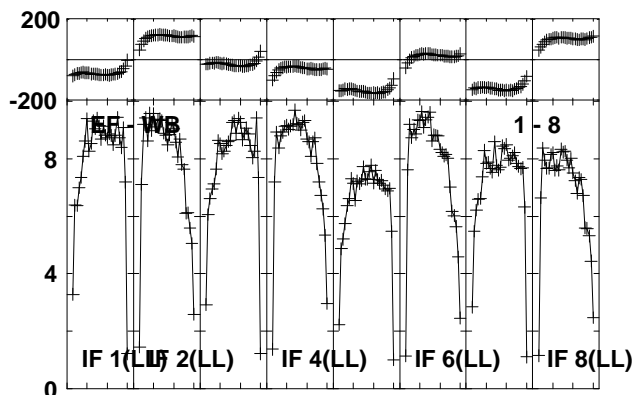
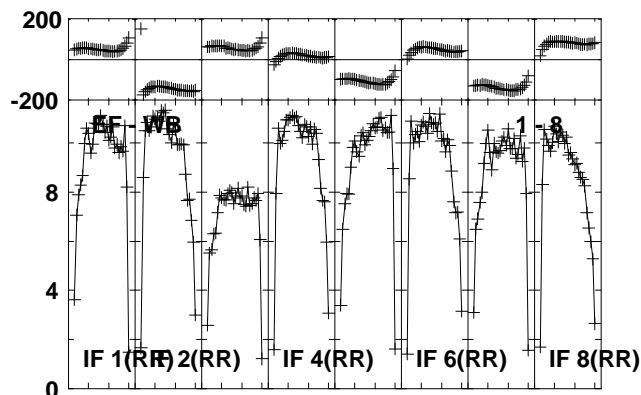
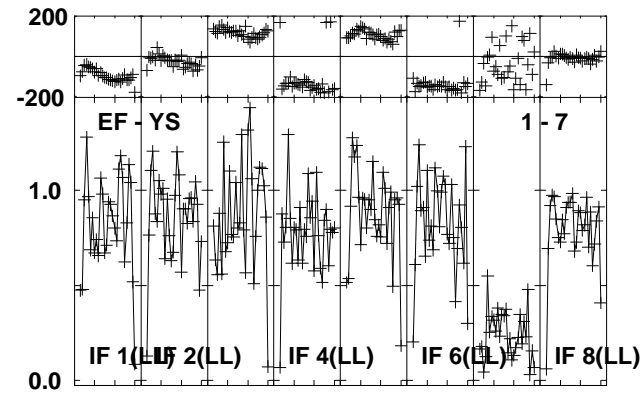
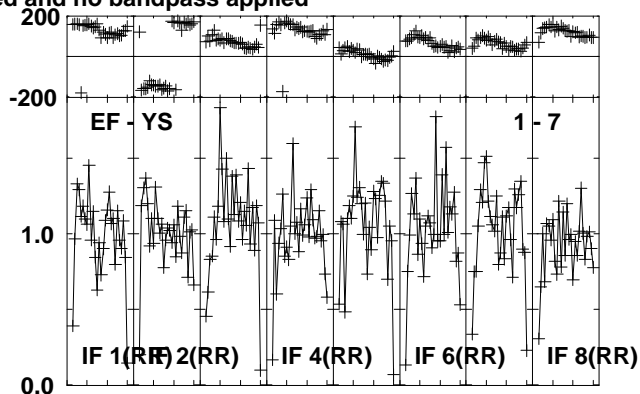
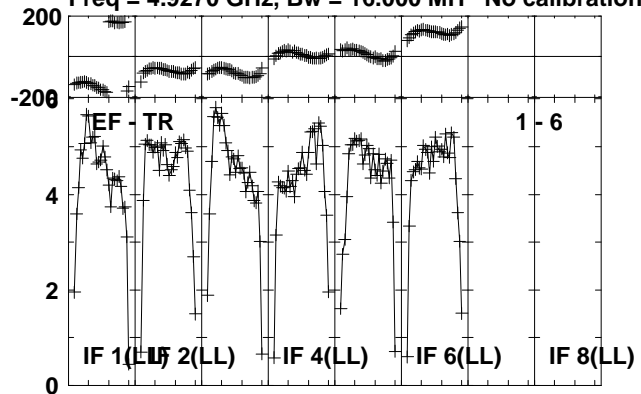

Lower frame: Milli Ampl Jy Top frame: Phas deg  
Vector averaged cross-power spectrum Several baselines displayed  
Timerange: 00/21:31:22 to 00/21:32:48

Plot file version 379 created 24-OCT-2012 21:01:36

G23.6-0.03 EY017B.UVDATA.1

Freq = 4.9270 GHz, Bw = 16.000 MH No calibration applied and no bandpass applied

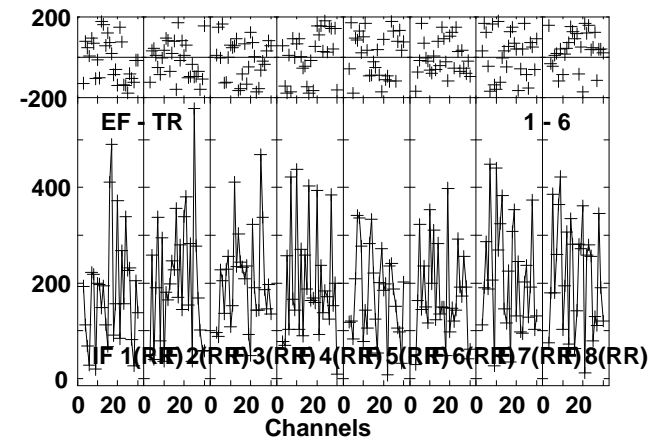
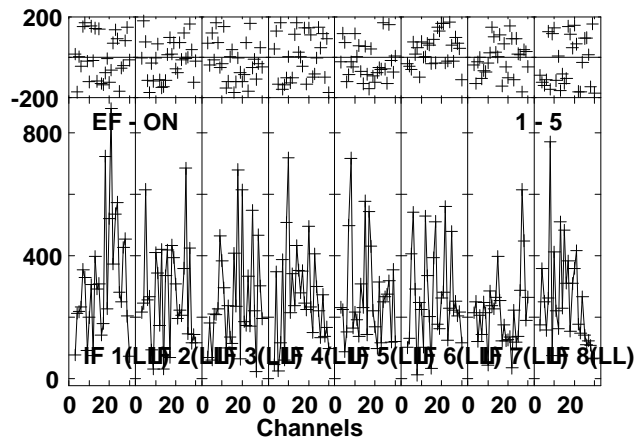
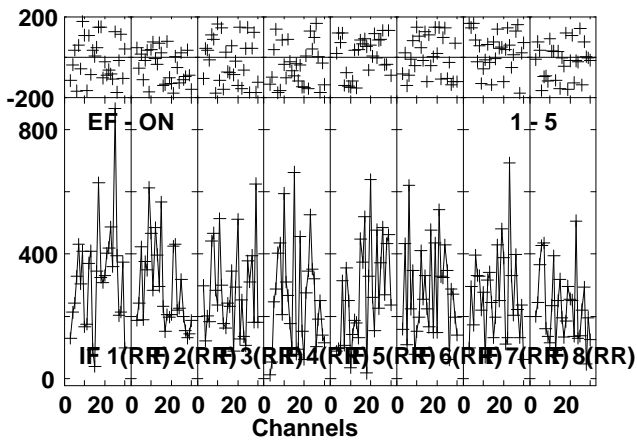
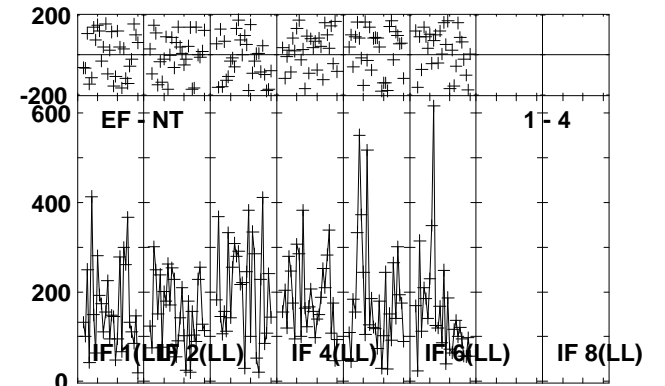
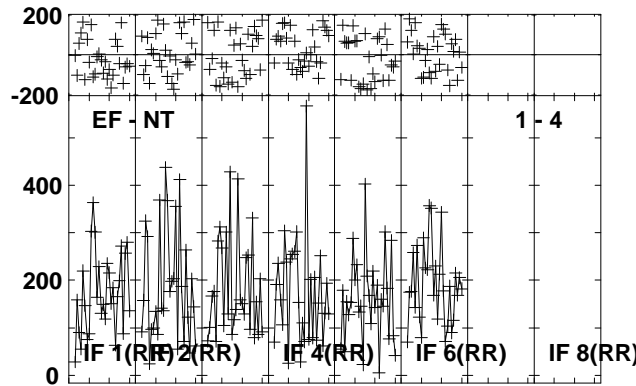
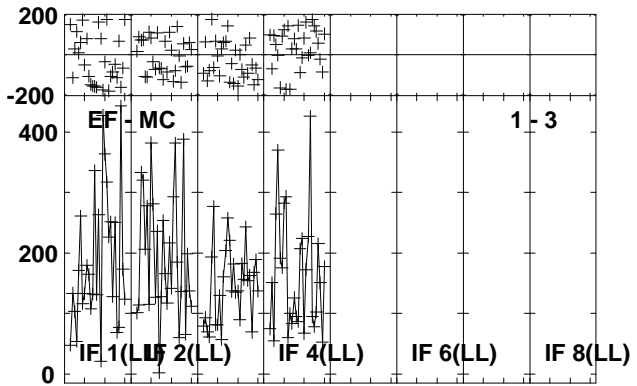
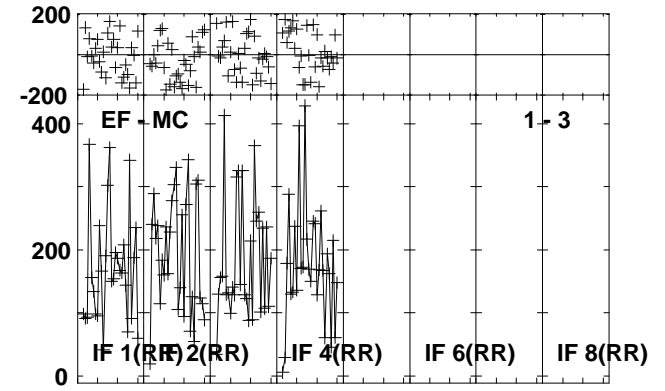
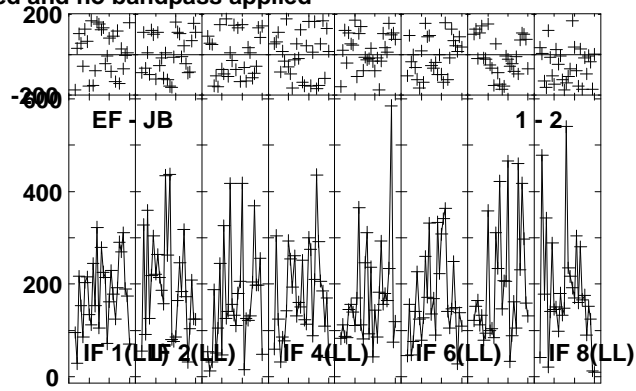
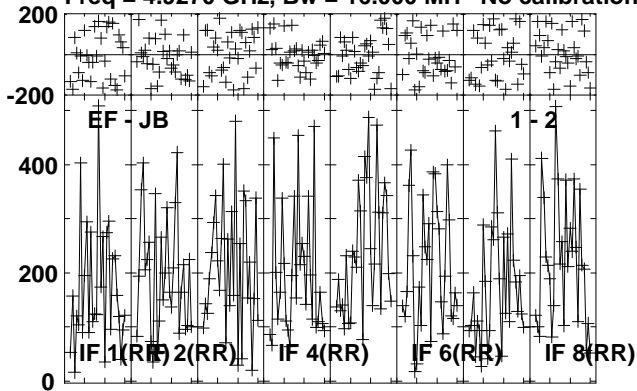

Lower frame: Micro Ampl Jy Top frame: Phas deg  
Vector averaged cross-power spectrum Several baselines displayed  
Timerange: 00/21:32:52 to 00/21:35:18

Plot file version 380 created 24-OCT-2012 21:01:37

G23.6-0.03 EY017B.UVDATA.1

Freq = 4.9270 GHz, Bw = 16.000 MH No calibration applied and no bandpass applied

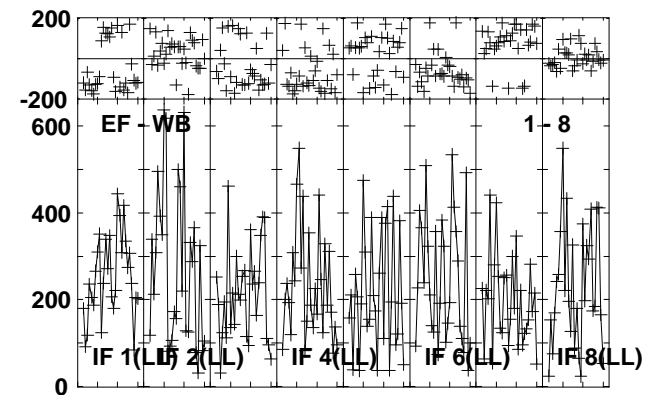
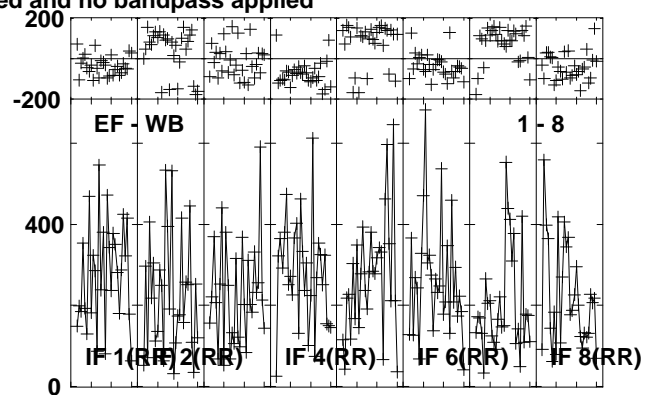
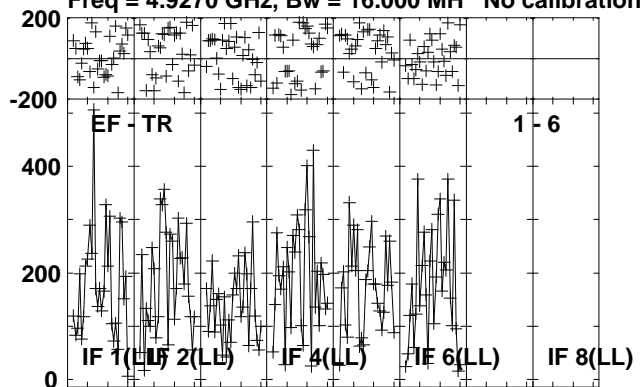

Lower frame: Micro Ampl Jy Top frame: Phas deg  
Vector averaged cross-power spectrum Several baselines displayed  
Timerange: 00/21:32:52 to 00/21:35:18



Plot file version 381 created 24-OCT-2012 21:01:37  
J1825-0737 EY017B.UVDATA.1

Freq = 4.9270 GHz, Bw = 16.000 MH No calibration applied and no bandpass applied

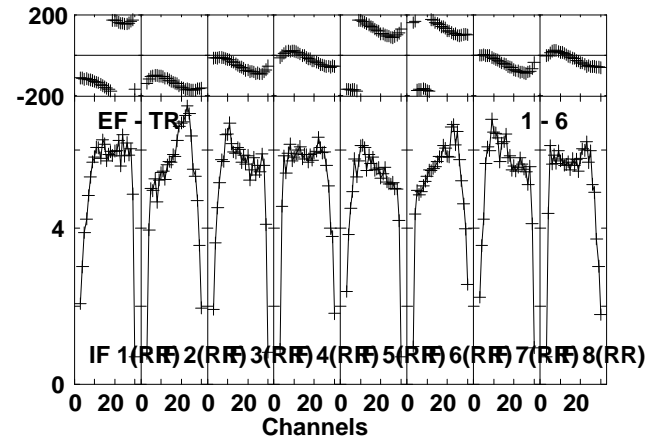
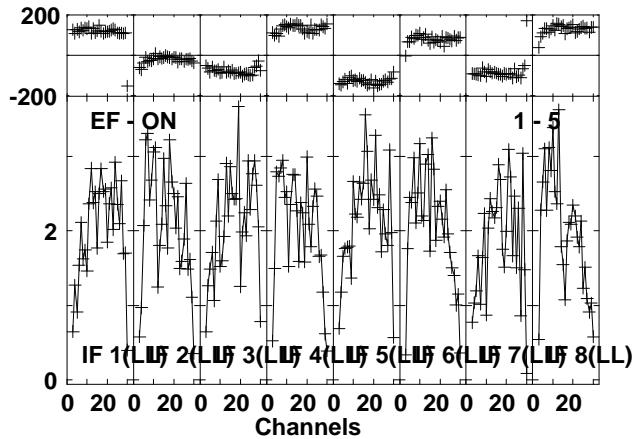
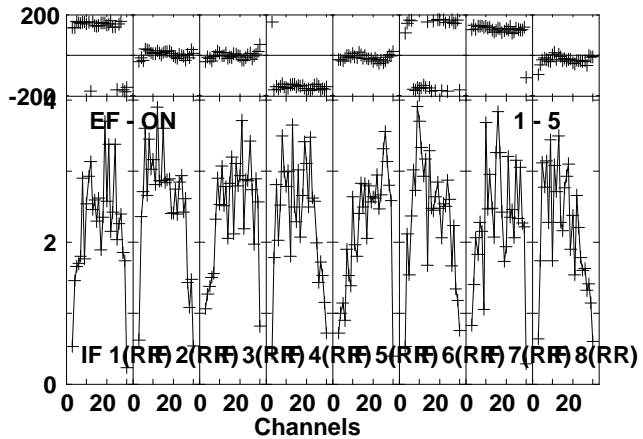
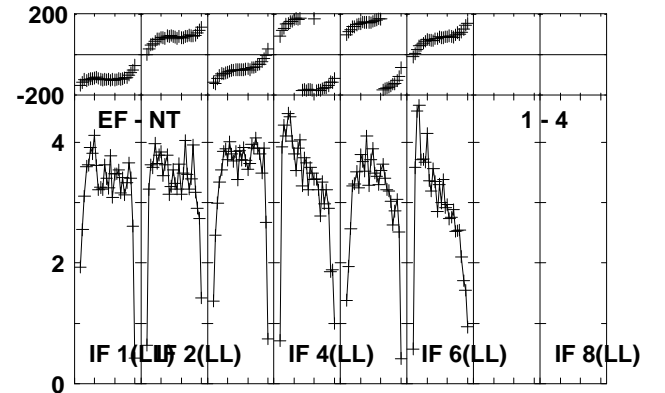
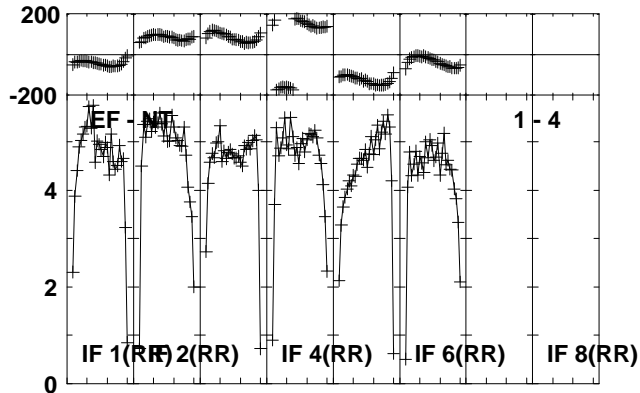
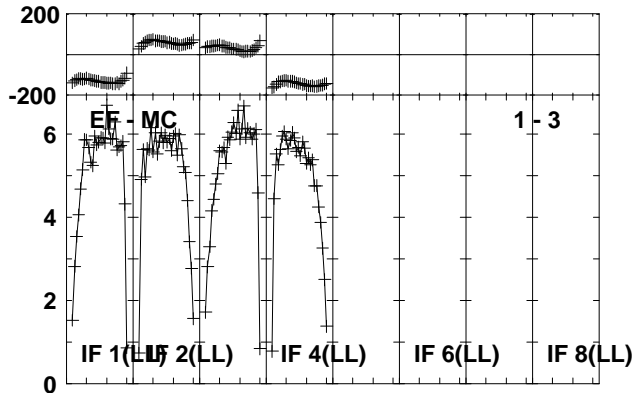
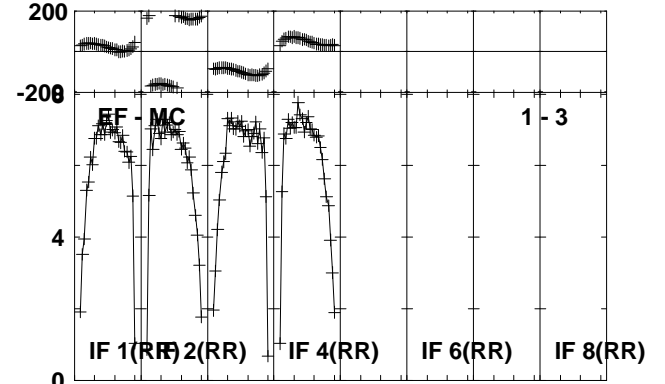
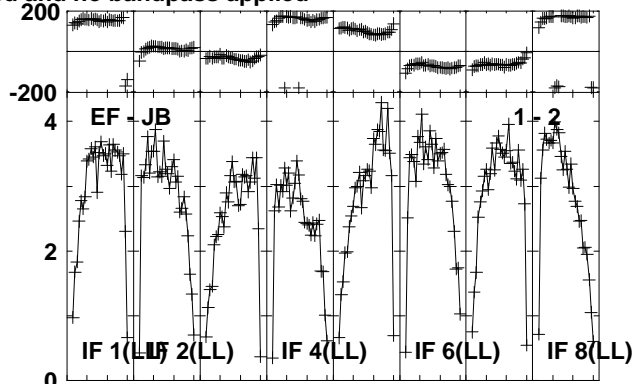
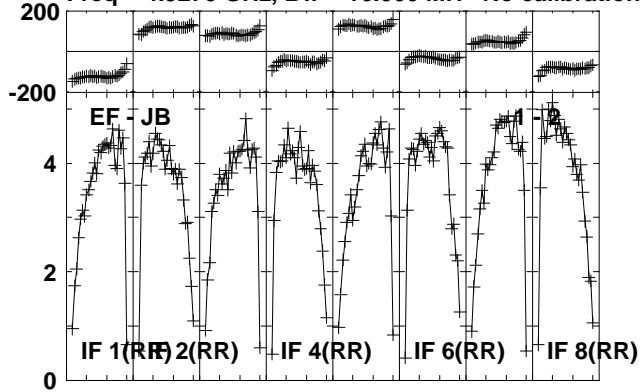

Lower frame: Milli Ampl Jy Top frame: Phas deg  
Vector averaged cross-power spectrum Several baselines displayed  
Timerange: 00/21:35:22 to 00/21:36:48

Plot file version 382 created 24-OCT-2012 21:01:38

J1825-0737 EY017B.UVDATA.1

Freq = 4.9270 GHz, Bw = 16.000 MH No calibration applied and no bandpass applied

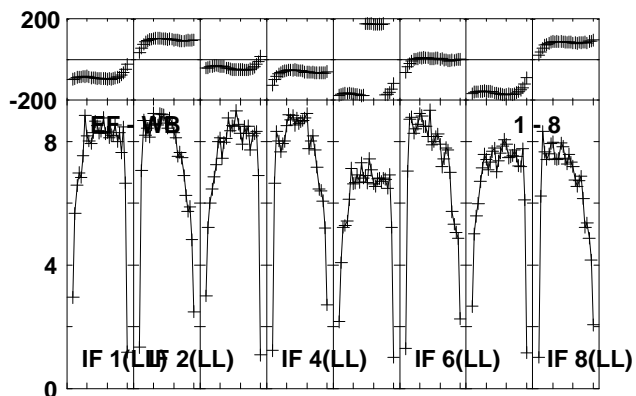
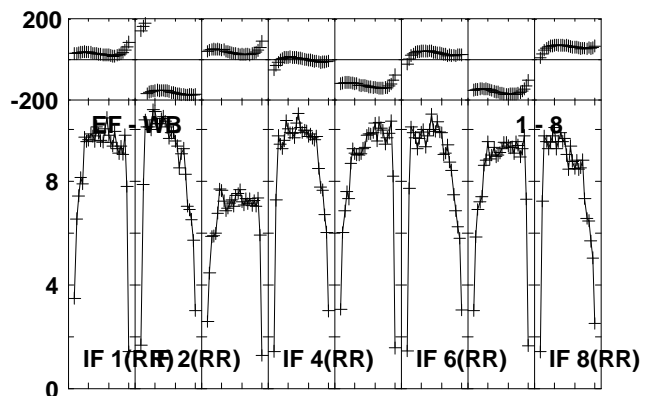
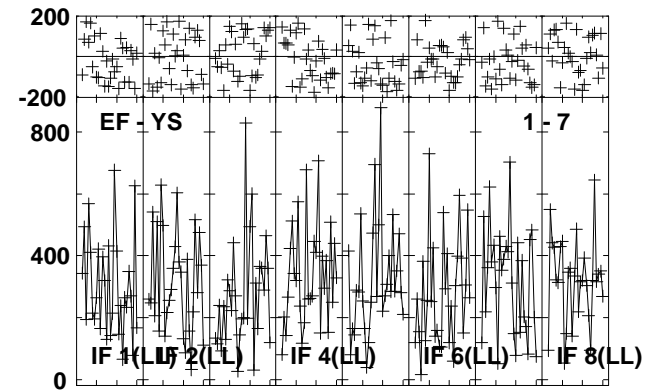
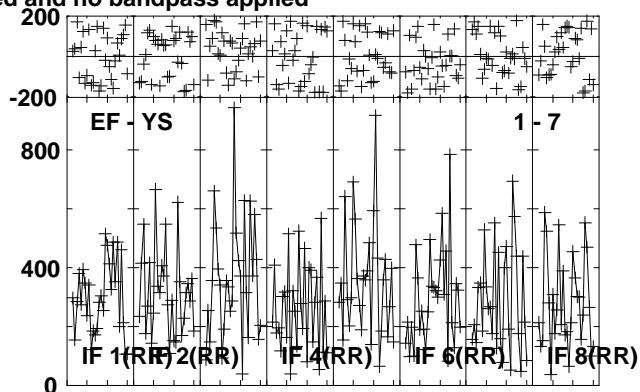
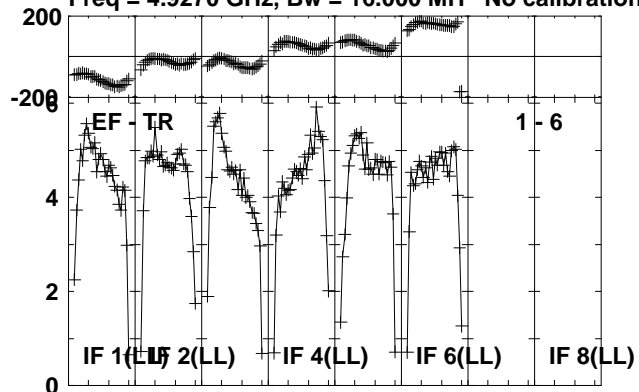

Lower frame: Milli Ampl Jy Top frame: Phas deg  
Vector averaged cross-power spectrum Several baselines displayed  
Timerange: 00/21:35:22 to 00/21:36:48

Plot file version 383 created 24-OCT-2012 21:01:38  
 J1831-0756 EY017B.UVDATA.1

Freq = 4.9270 GHz, Bw = 16.000 MH No calibration applied and no bandpass applied

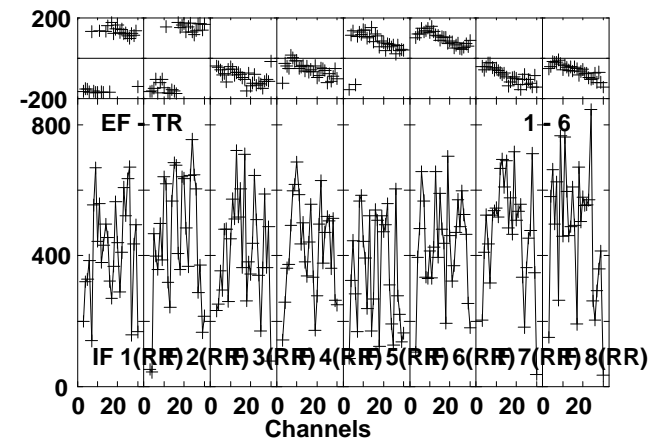
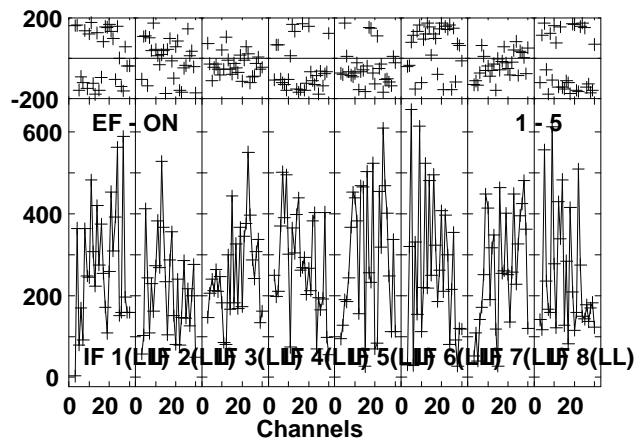
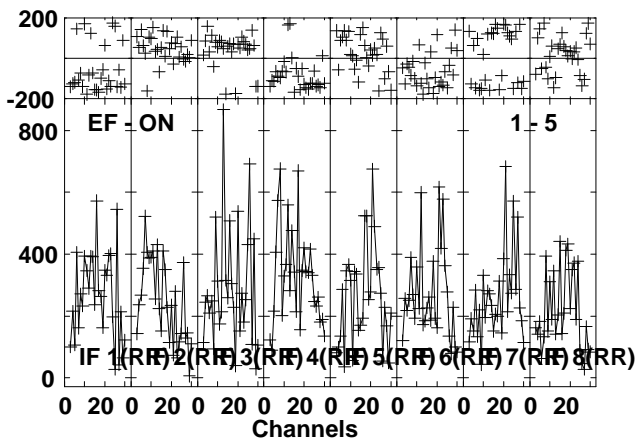
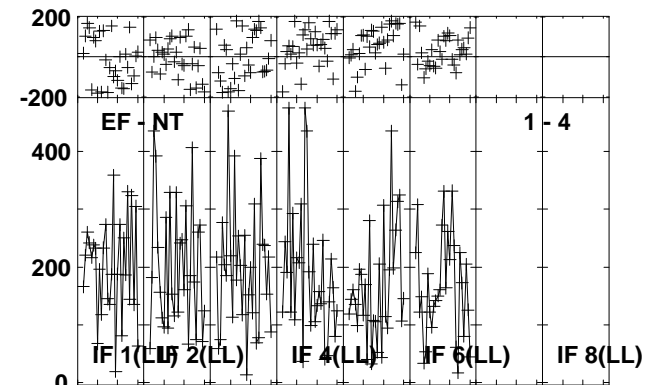
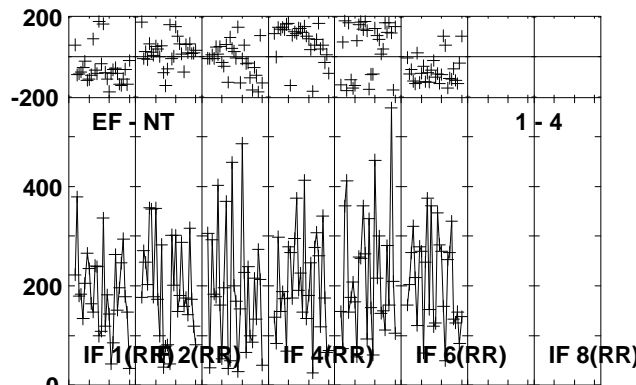
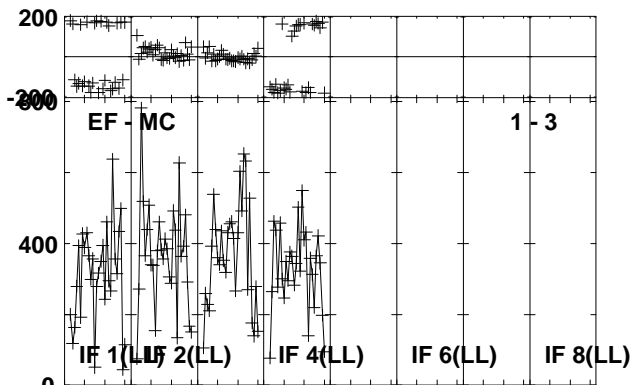
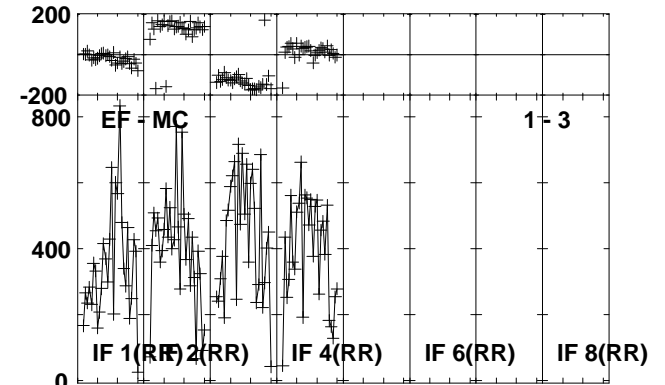
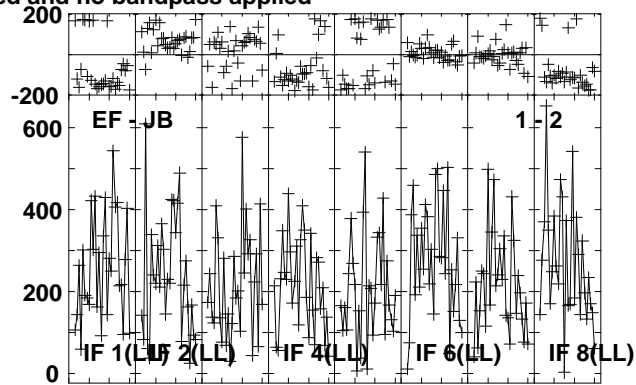
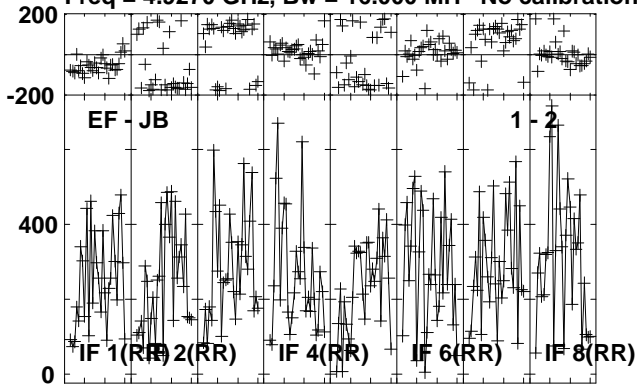

Lower frame: Micro Ampl Jy Top frame: Phas deg  
 Vector averaged cross-power spectrum Several baselines displayed  
 Timerange: 00/21:37:22 to 00/21:39:24

Plot file version 384 created 24-OCT-2012 21:01:39

J1831-0756 EY017B.UVDATA.1

Freq = 4.9270 GHz, Bw = 16.000 MH No calibration applied and no bandpass applied

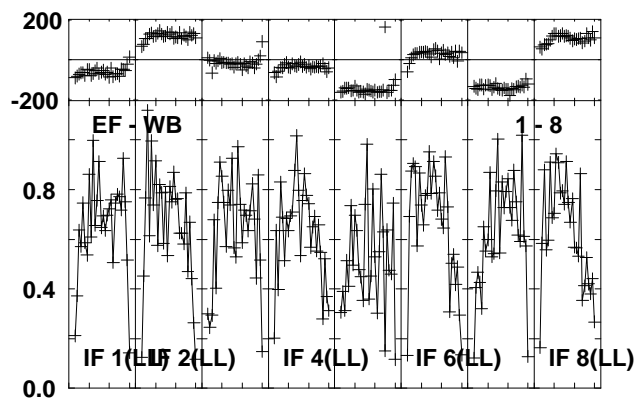
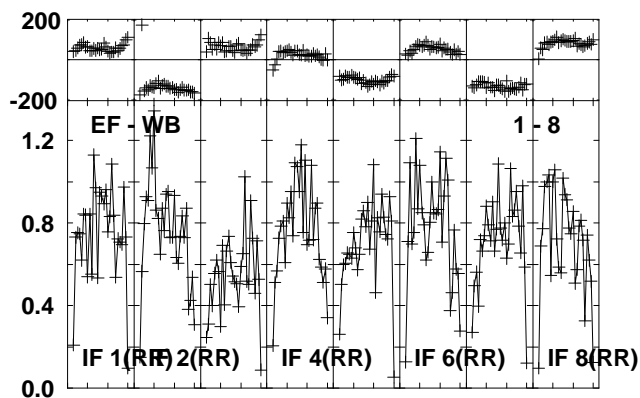
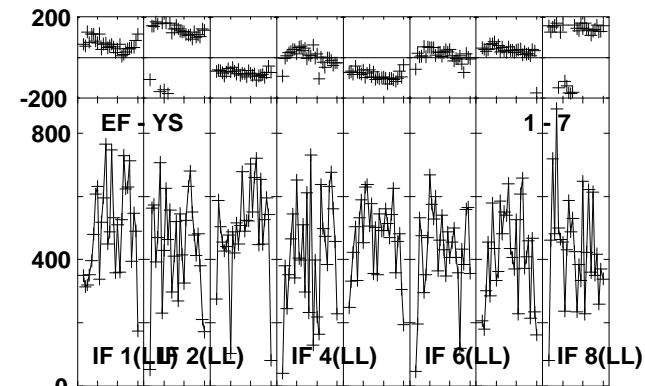
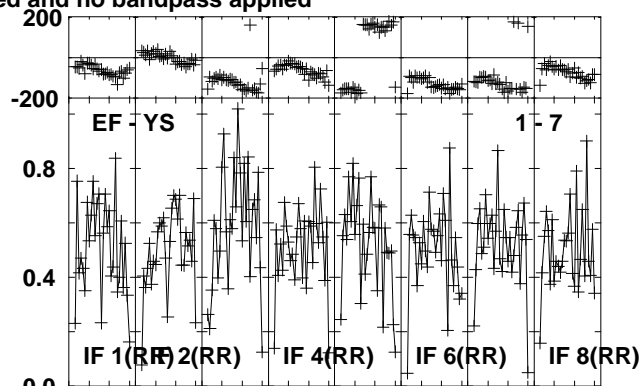
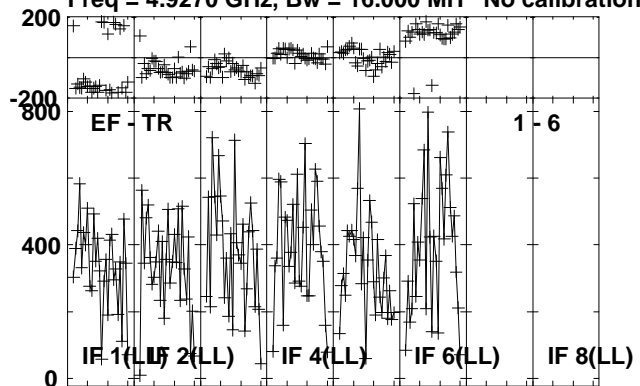

Lower frame: Micro Ampl Jy Top frame: Phas deg  
Vector averaged cross-power spectrum Several baselines displayed  
Timerange: 00/21:37:22 to 00/21:39:24

Plot file version 385 created 24-OCT-2012 21:01:39

J1825-0737 EY017B.UVDATA.1

Freq = 4.9270 GHz, Bw = 16.000 MH No calibration applied and no bandpass applied

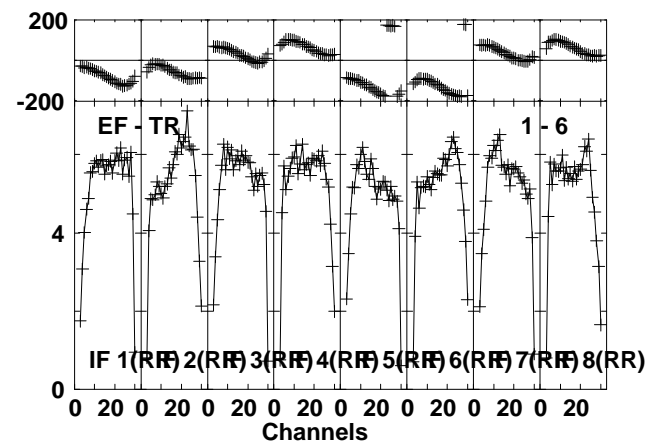
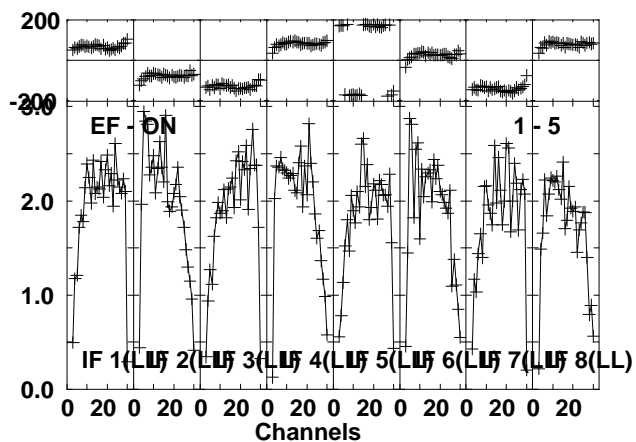
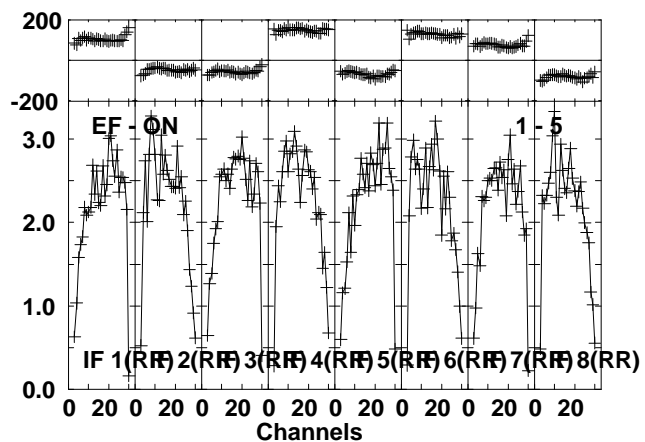
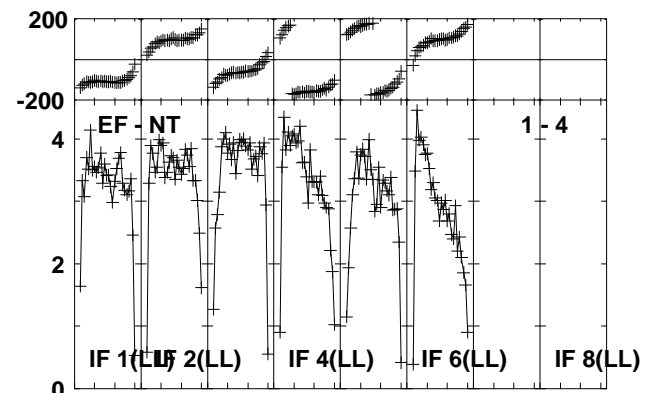
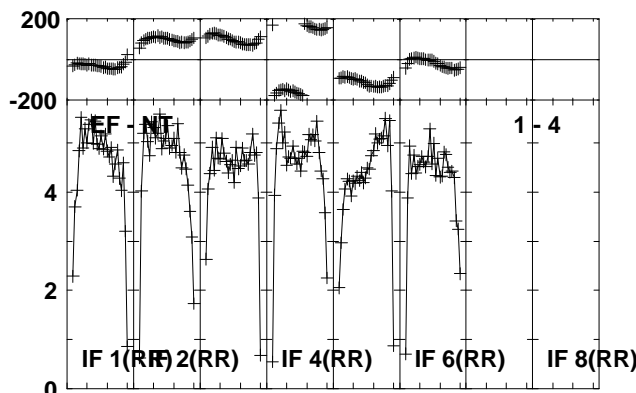
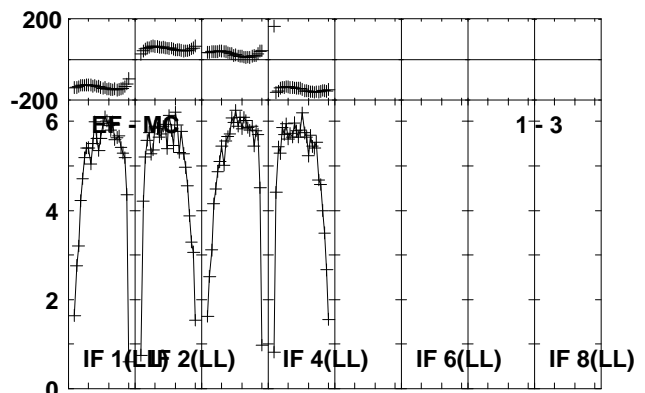
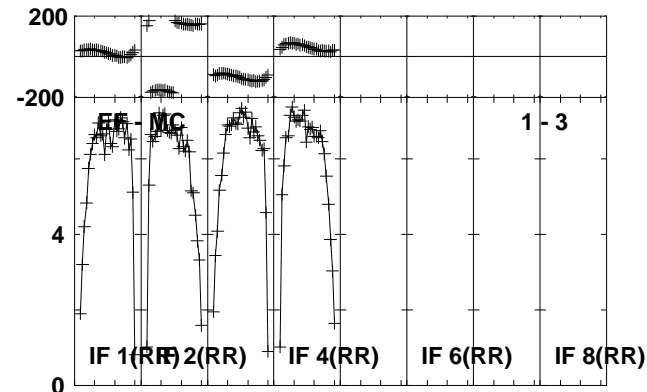
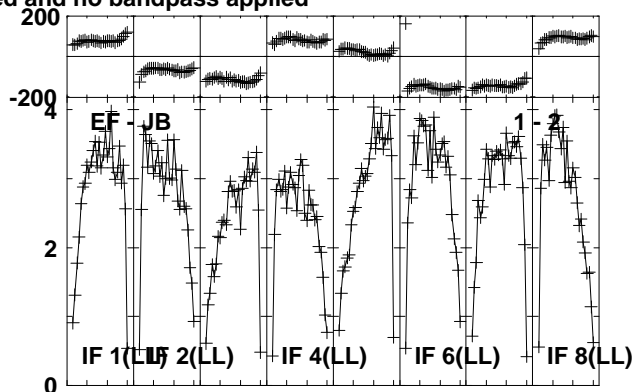
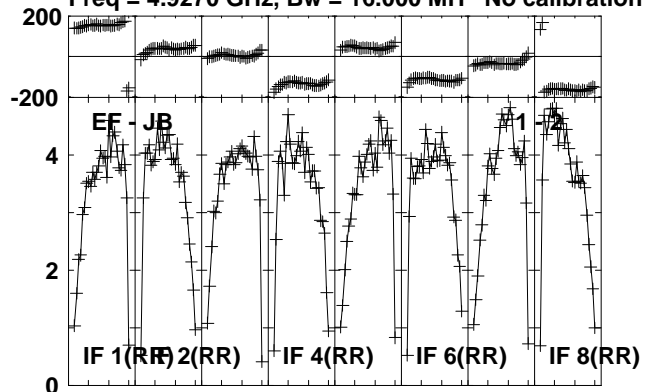

Lower frame: Milli Ampl Jy Top frame: Phas deg  
Vector averaged cross-power spectrum Several baselines displayed  
Timerange: 00/21:39:28 to 00/21:40:54

Plot file version 386 created 24-OCT-2012 21:01:40

J1825-0737 EY017B.UVDATA.1

Freq = 4.9270 GHz, Bw = 16.000 MH No calibration applied and no bandpass applied

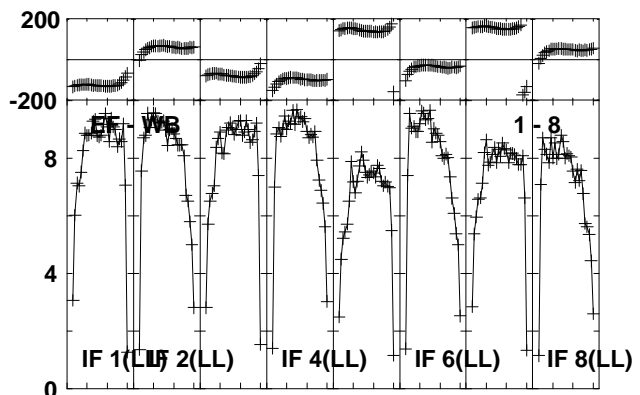
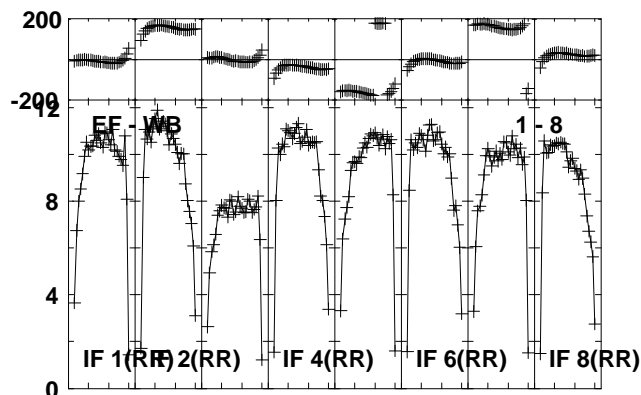
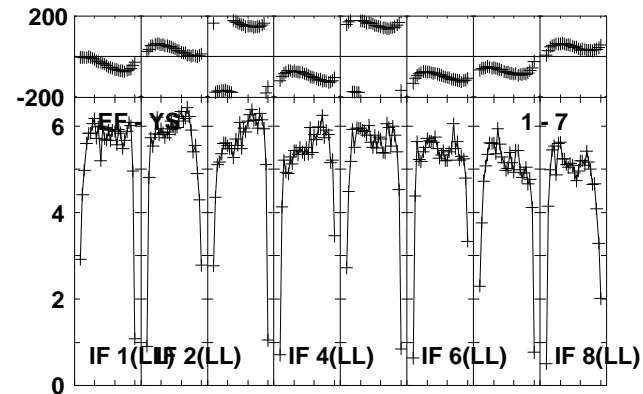
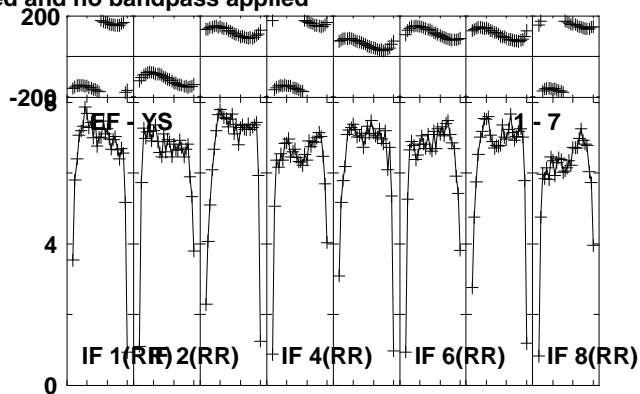
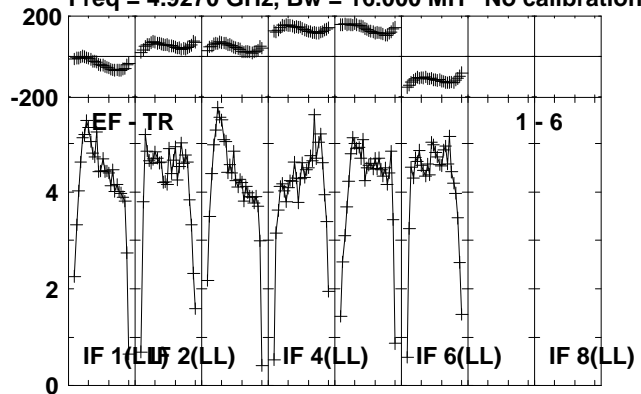

Lower frame: Milli Ampl Jy Top frame: Phas deg  
Vector averaged cross-power spectrum Several baselines displayed  
Timerange: 00/21:39:28 to 00/21:40:54

Plot file version 387 created 24-OCT-2012 21:01:40

3C454.3 EY017B.UVDATA.1

Freq = 4.9270 GHz, Bw = 16.000 MH No calibration applied and no bandpass applied

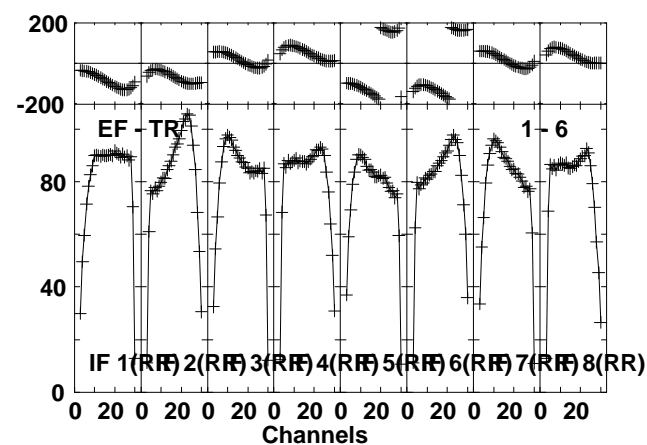
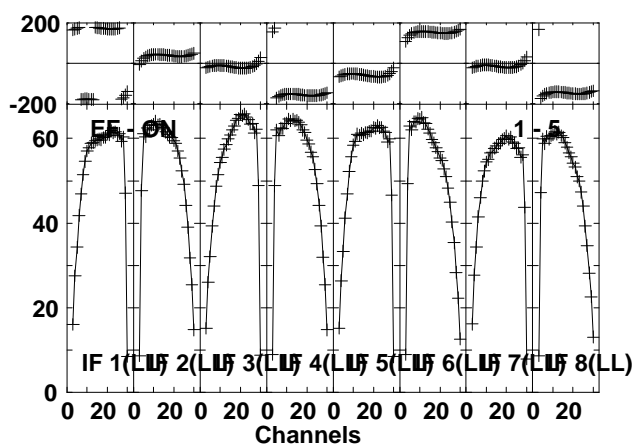
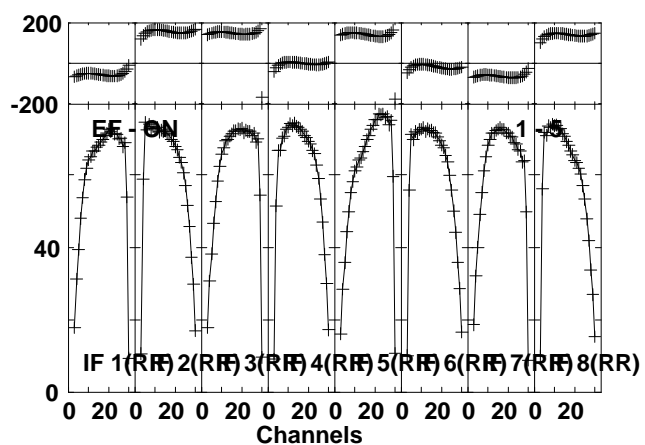
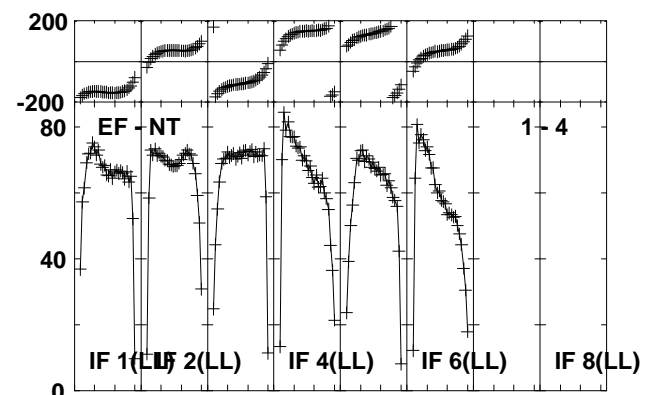
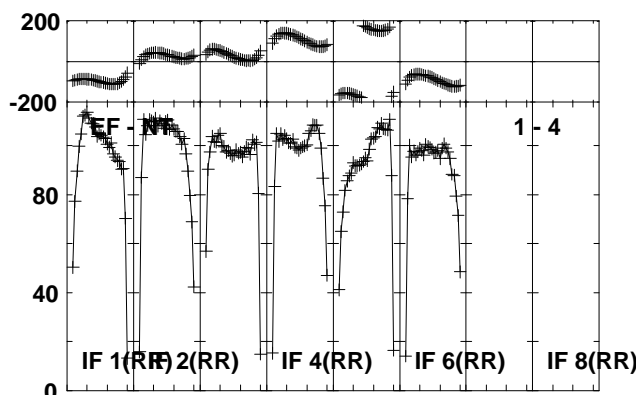
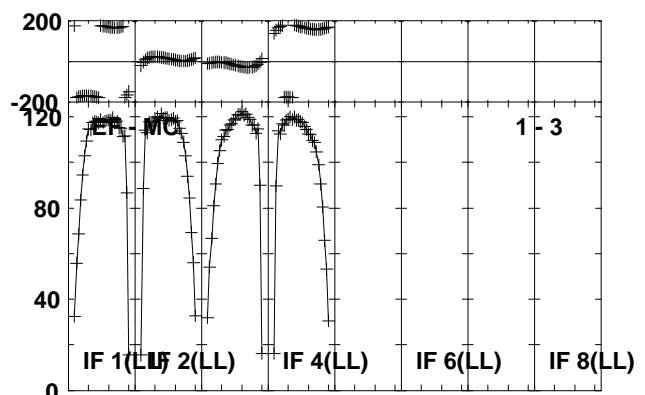
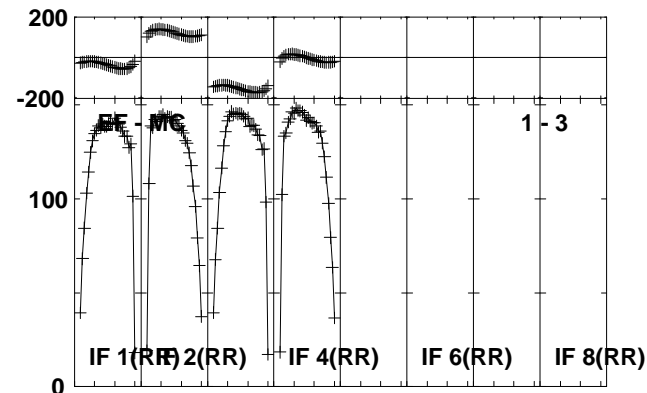
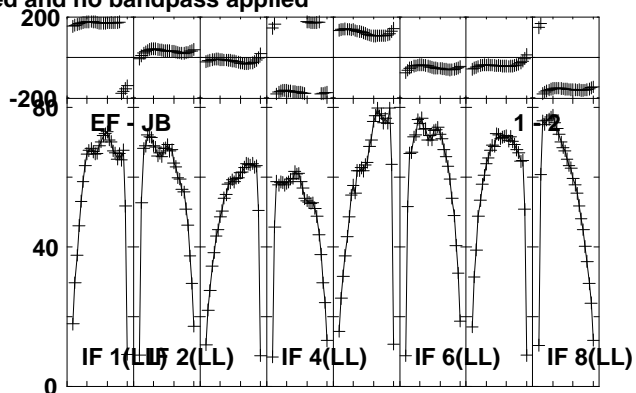
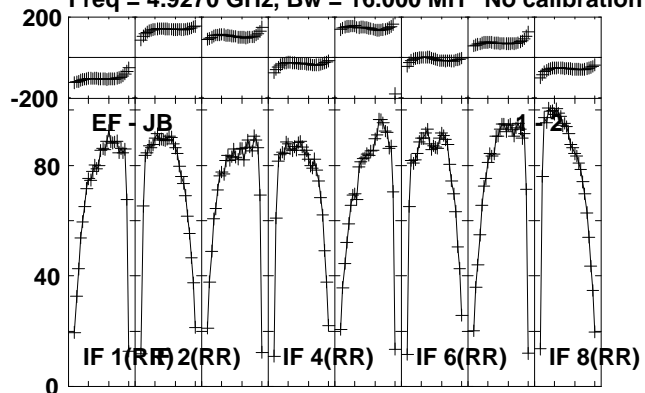

Lower frame: Milli Ampl Jy Top frame: Phas deg  
Vector averaged cross-power spectrum Several baselines displayed  
Timerange: 00/21:45:52 to 00/21:50:54

Plot file version 388 created 24-OCT-2012 21:01:42

3C454.3 EY017B.UVDATA.1

Freq = 4.9270 GHz, Bw = 16.000 MH No calibration applied and no bandpass applied

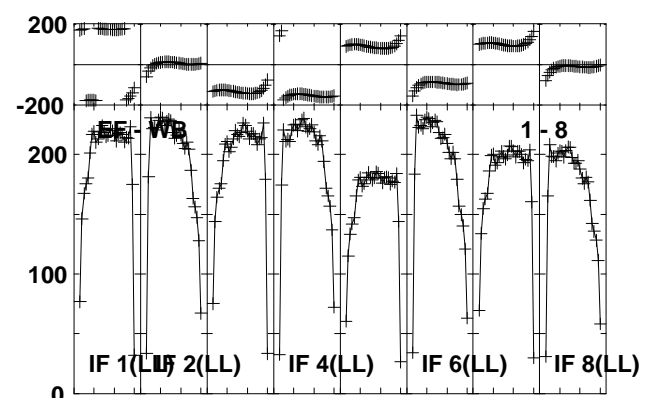
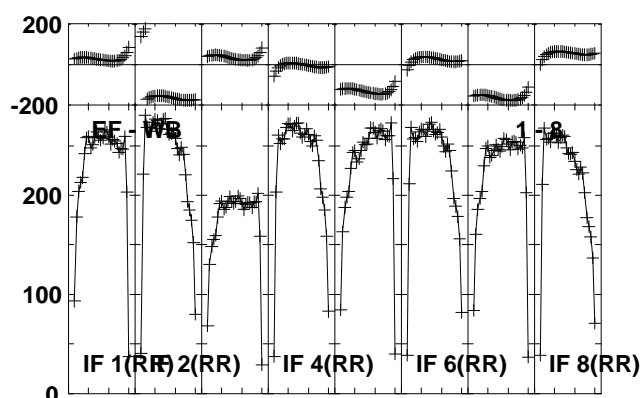
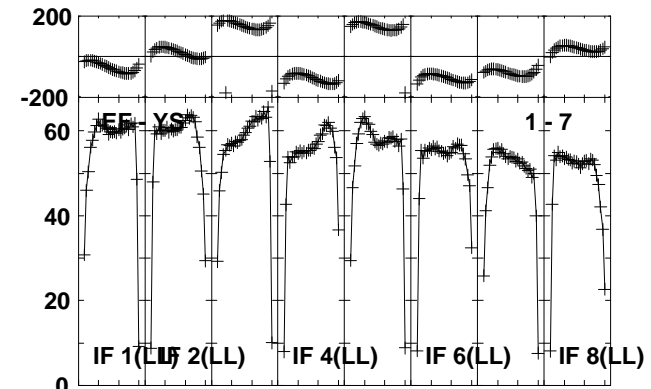
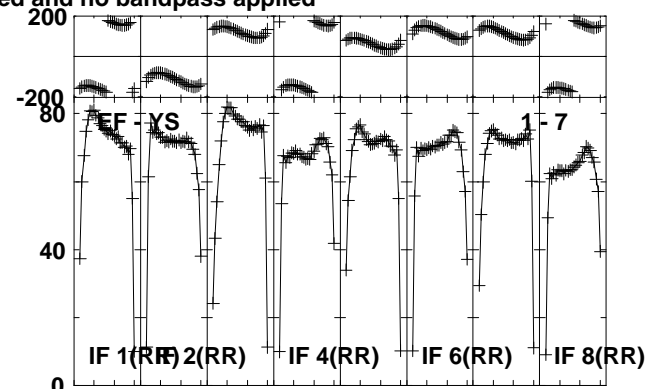
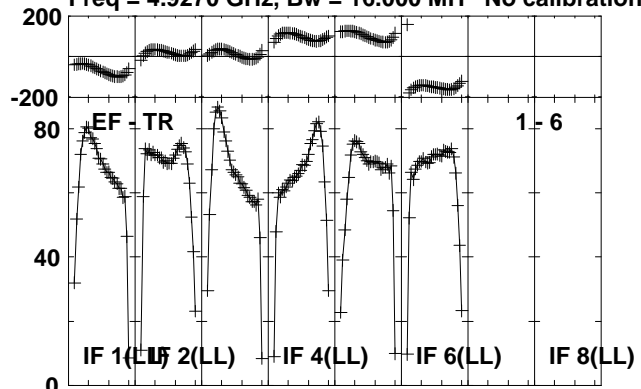

Lower frame: Milli Ampl Jy Top frame: Phas deg  
Vector averaged cross-power spectrum Several baselines displayed  
Timerange: 00/21:45:52 to 00/21:50:54



Plot file version 389 created 24-OCT-2012 21:01:43  
3C454.3 EY017B.UVDATA.1

Freq = 4.9270 GHz, Bw = 16.000 MH No calibration applied and no bandpass applied

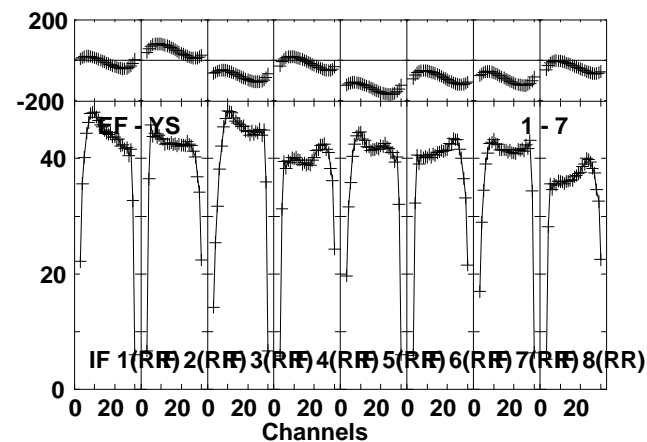
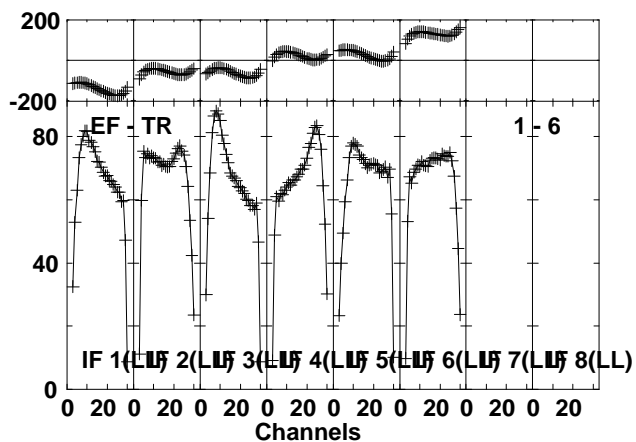
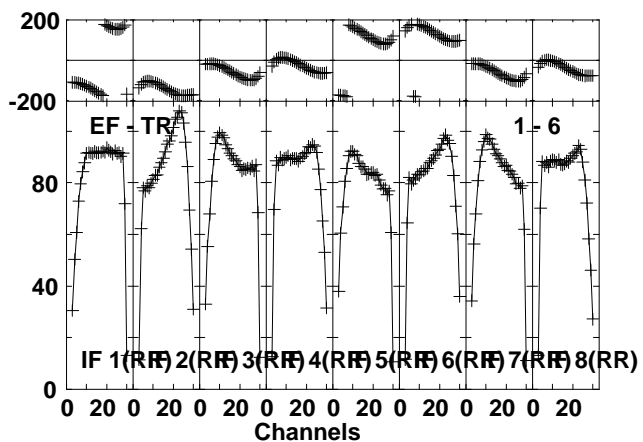
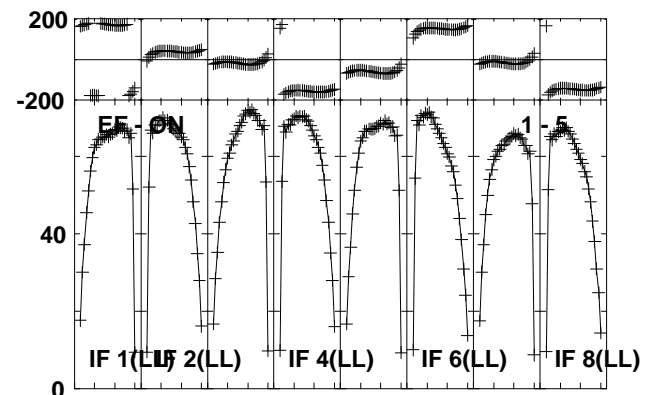
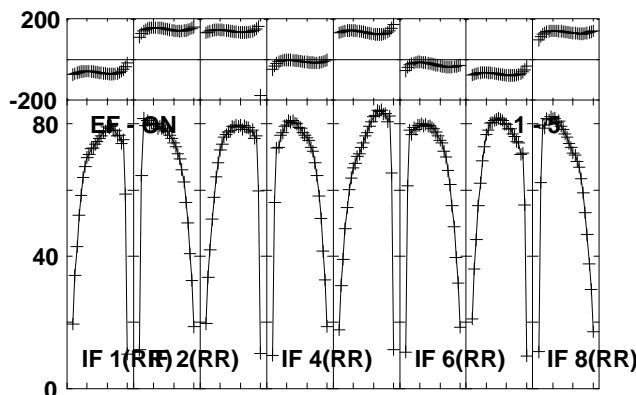
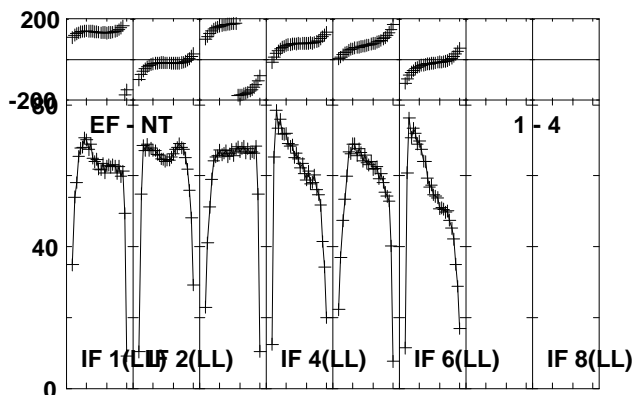
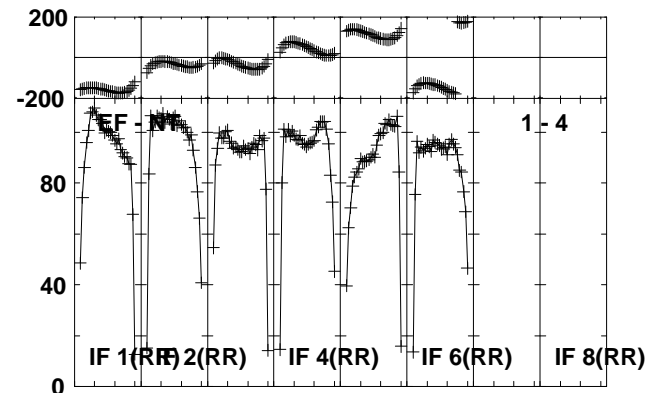
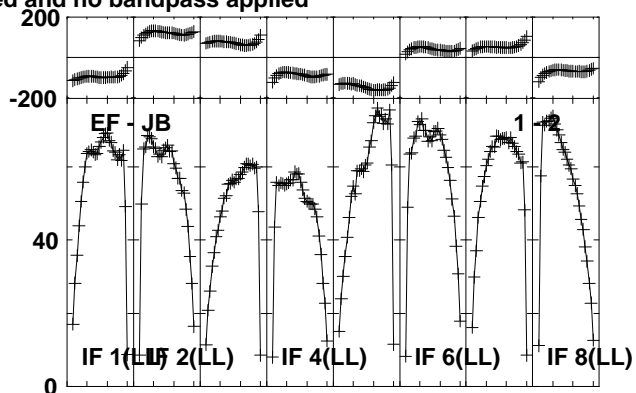
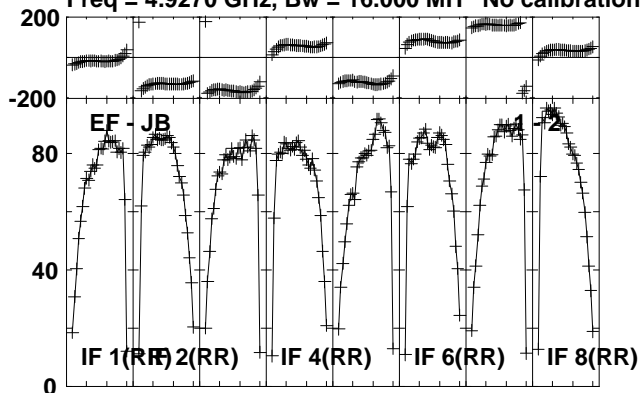

Lower frame: Milli Ampl Jy Top frame: Phas deg  
Vector averaged cross-power spectrum Several baselines displayed  
Timerange: 00/21:59:12 to 00/22:05:18

Plot file version 390 created 24-OCT-2012 21:01:45

3C454.3 EY017B.UVDATA.1

Freq = 4.9270 GHz, Bw = 16.000 MH No calibration applied and no bandpass applied

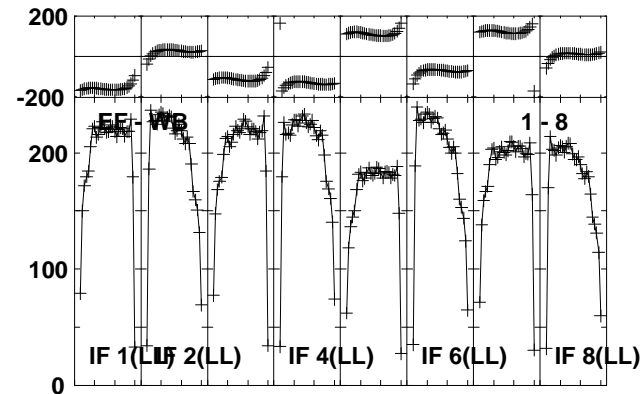
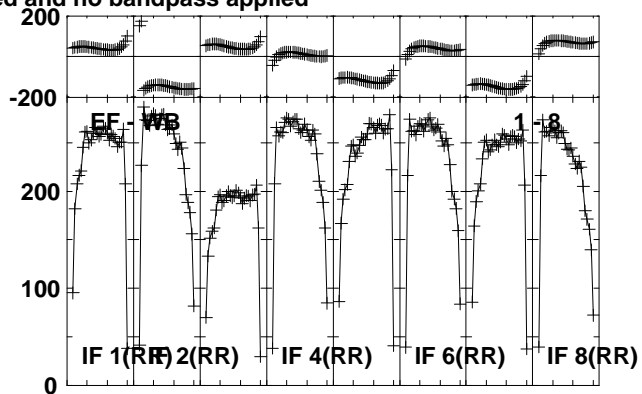
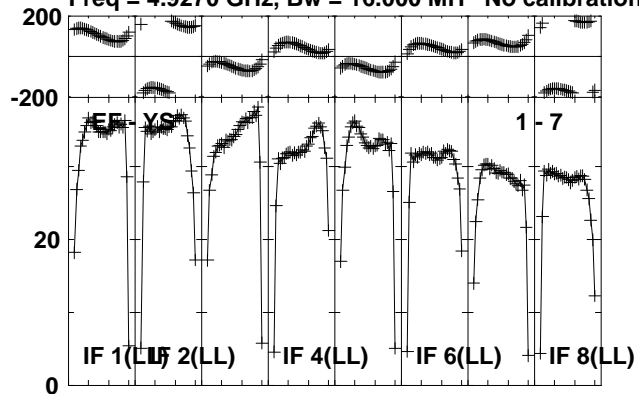

Lower frame: Milli Ampl Jy Top frame: Phas deg  
Vector averaged cross-power spectrum Several baselines displayed  
Timerange: 00/21:59:12 to 00/22:05:18