

Plot file version 1 created 04-NOV-2019 14:14:00
 3C454.3 EY034.UVDATA.1
 Freq = 1.5947 GHz, Bw = 16.000 MH No calibration applied and no bandpass applied

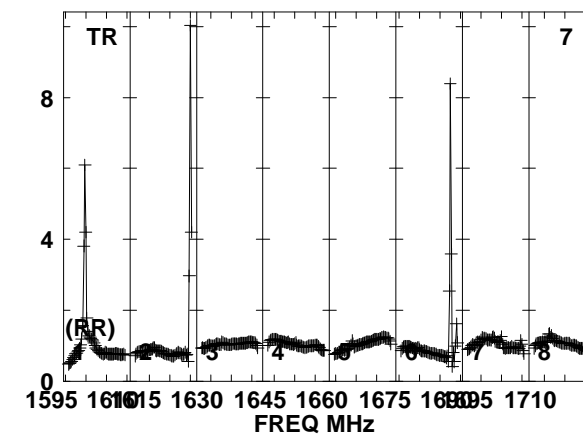
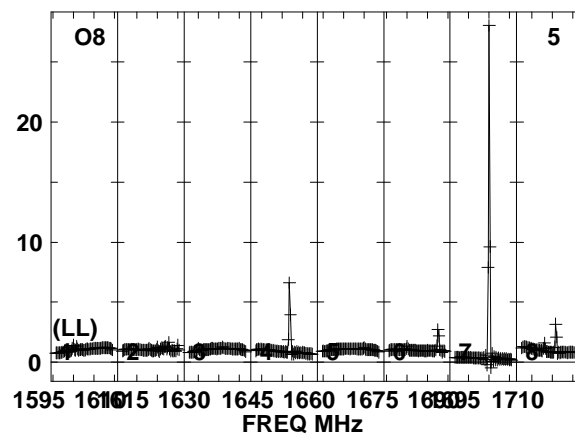
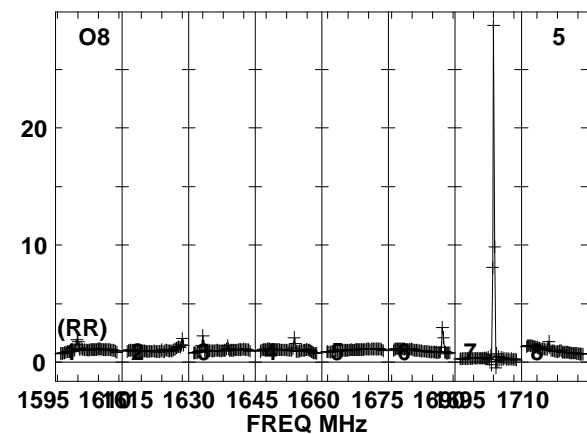
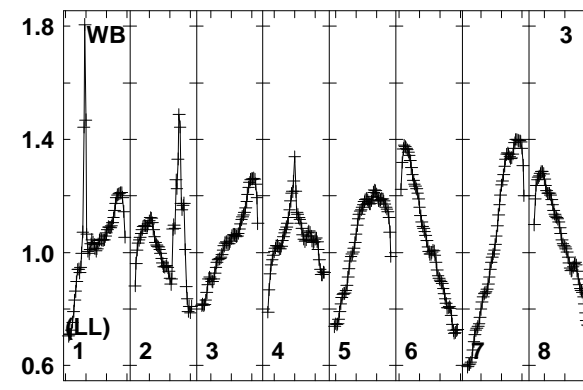
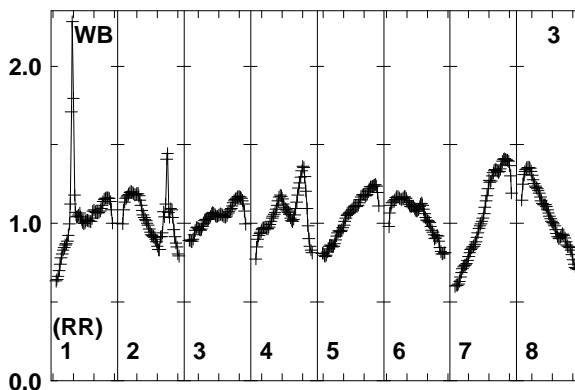
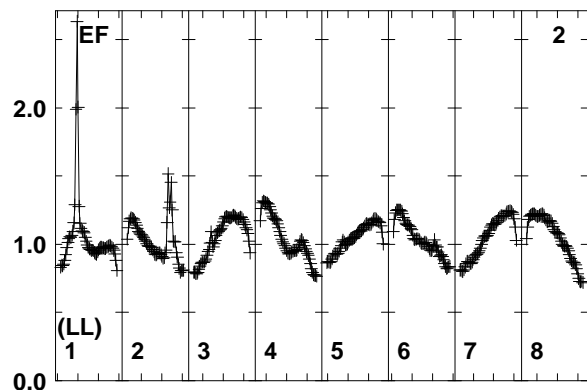
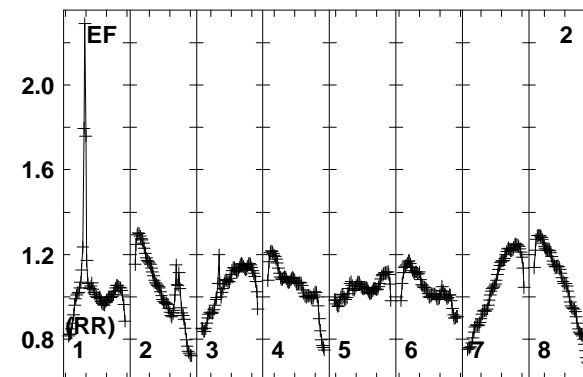
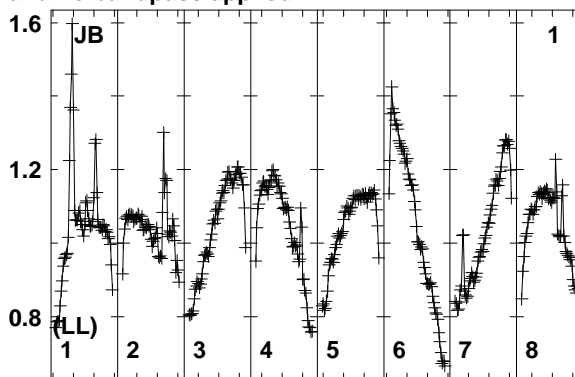
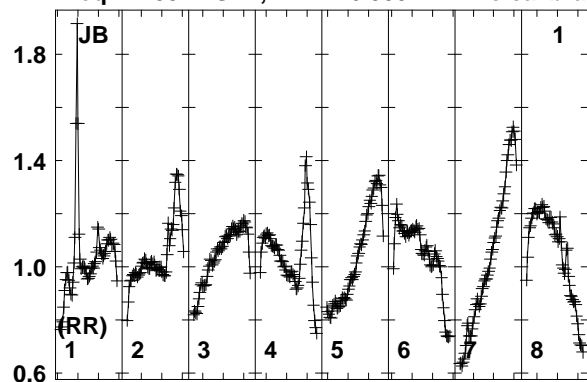

Lower frame: Real Jy
 Total-power spectrum Antenna: JB (01)
 Timerange: 00/03:00:01 to 00/03:03:29

Plot file version 2 created 04-NOV-2019 14:14:00

3C454.3 EY034.UVDATA.1

Freq = 1.5947 GHz, Bw = 16.000 MH No calibration applied and no bandpass applied

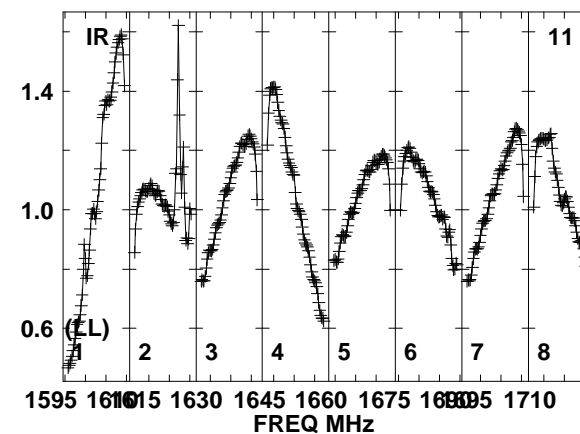
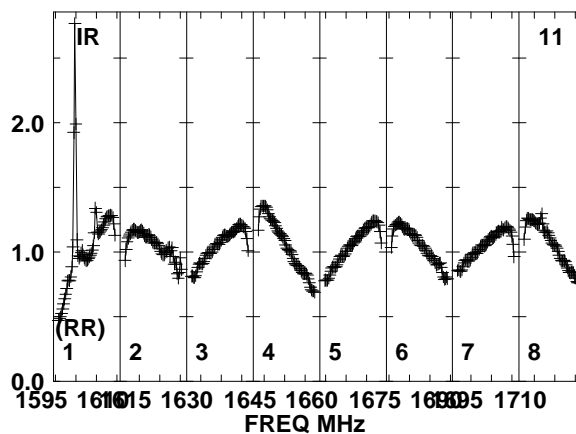
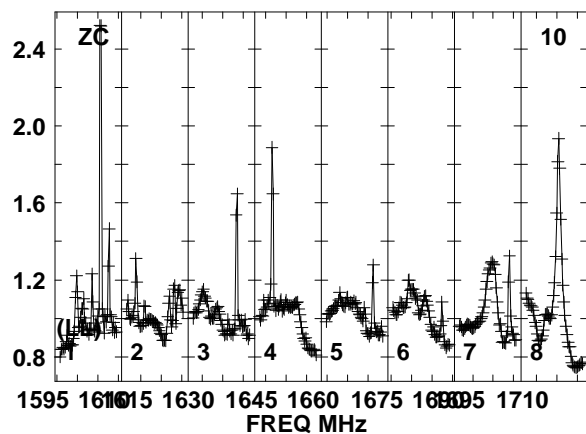
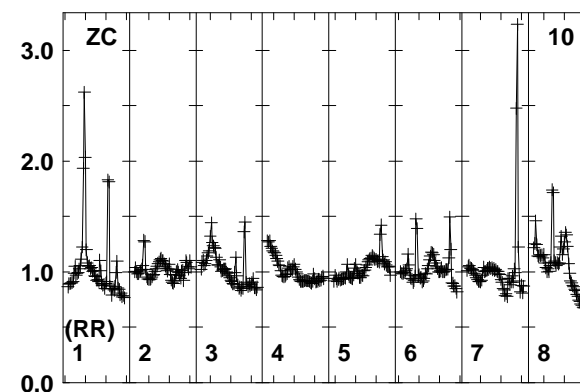
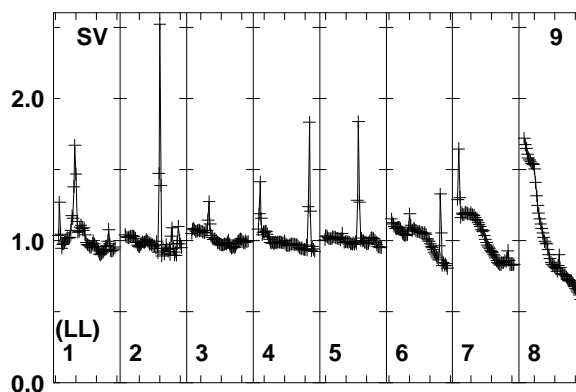
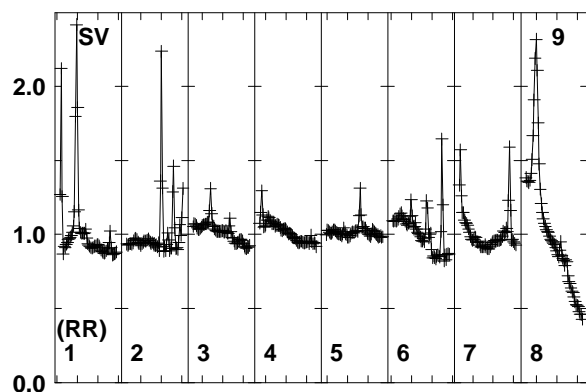
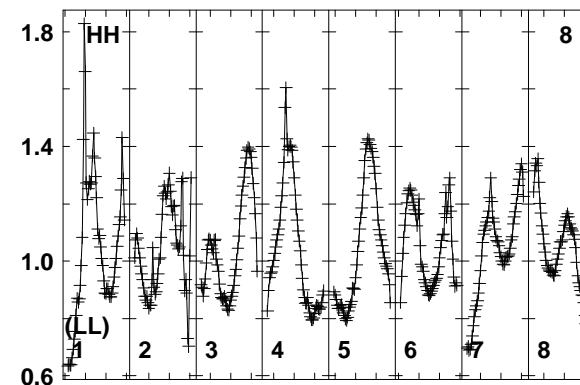
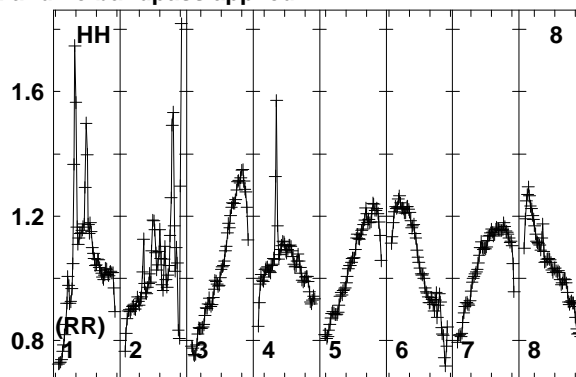
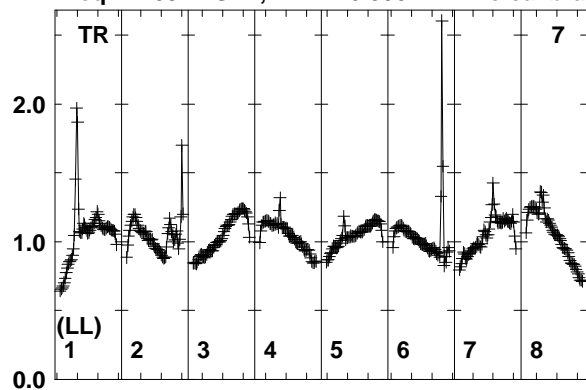

Lower frame: Real Jy
Total-power spectrum Antenna: TR (07)
Timerange: 00/03:00:01 to 00/03:03:29

Plot file version 3 created 04-NOV-2019 14:14:00

3C454.3 EY034.UVDATA.1

Freq = 1.5947 GHz, Bw = 16.000 MH No calibration applied and no bandpass applied

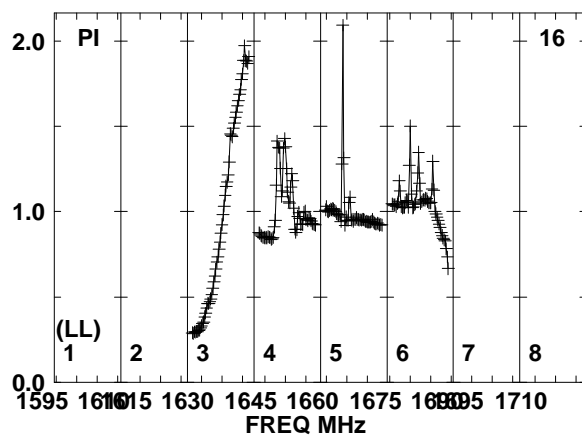
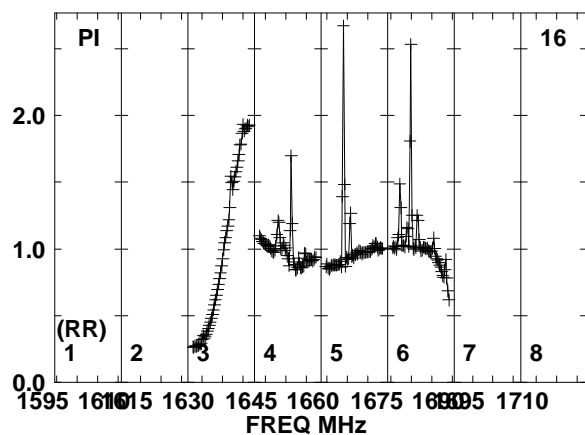
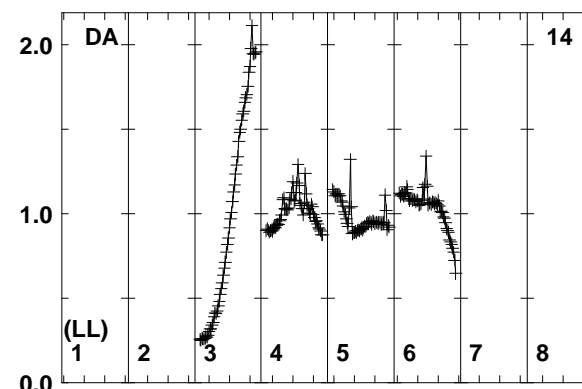
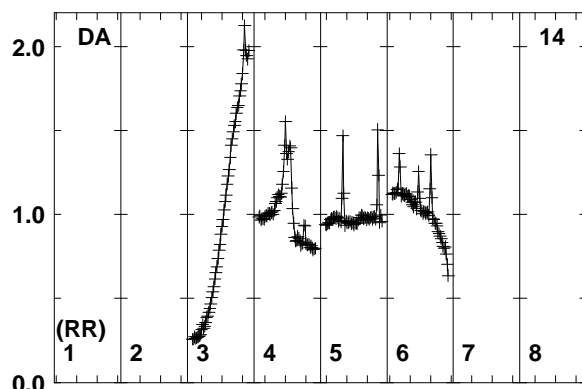
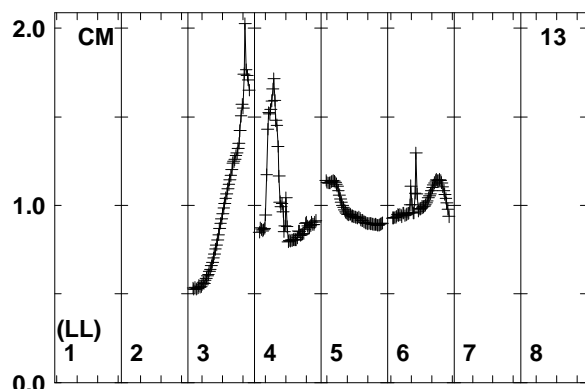
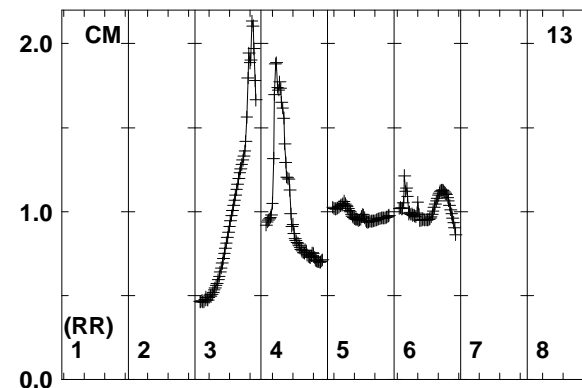
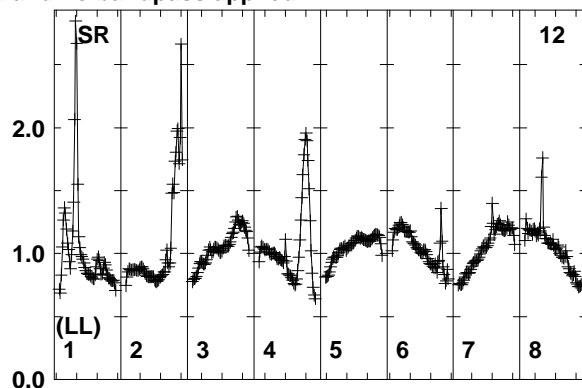
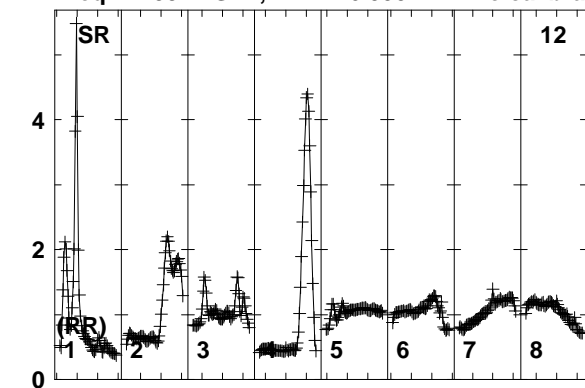

Lower frame: Real Jy
Total-power spectrum Antenna: SR (12)
Timerange: 00/03:00:01 to 00/03:03:29

Plot file version 4 created 04-NOV-2019 14:14:00

J2248-0541 EY034.UVDATA.1

Freq = 1.5947 GHz, Bw = 16.000 MH No calibration applied and no bandpass applied

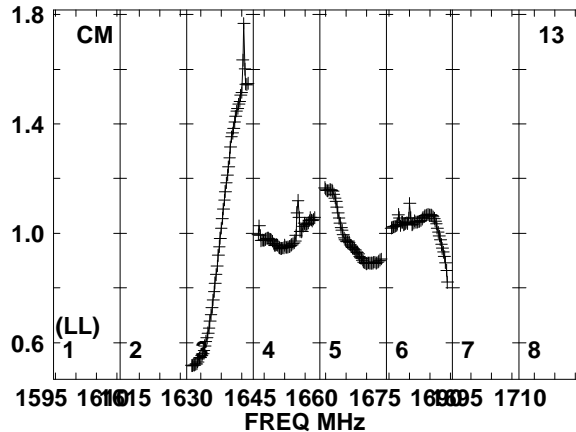
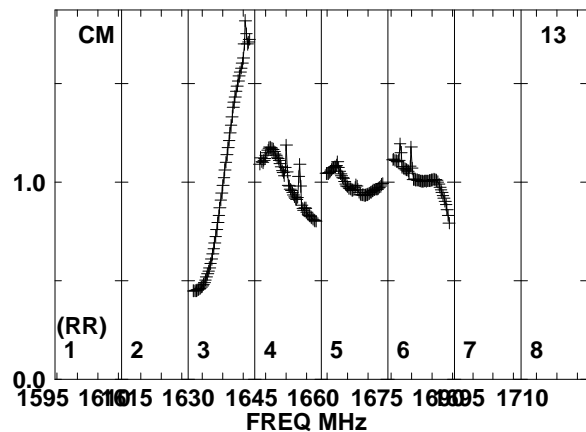
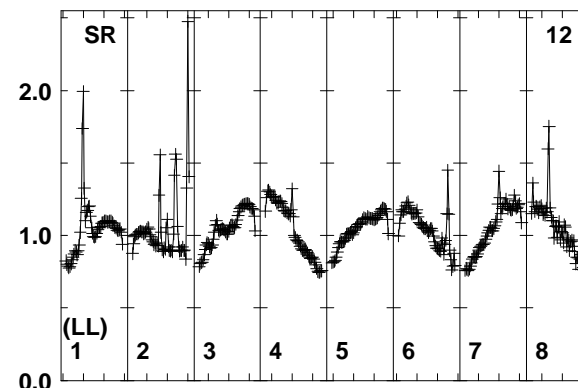
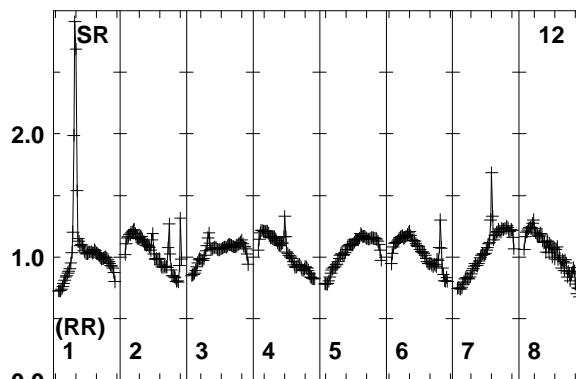
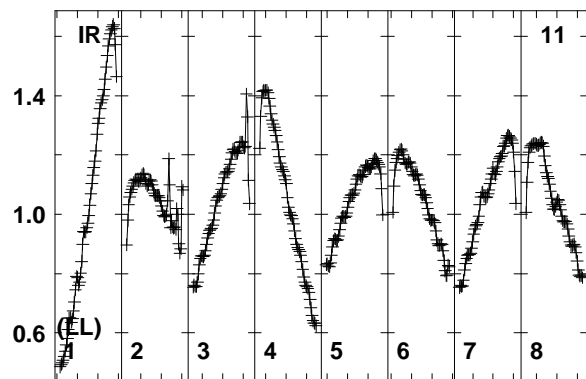
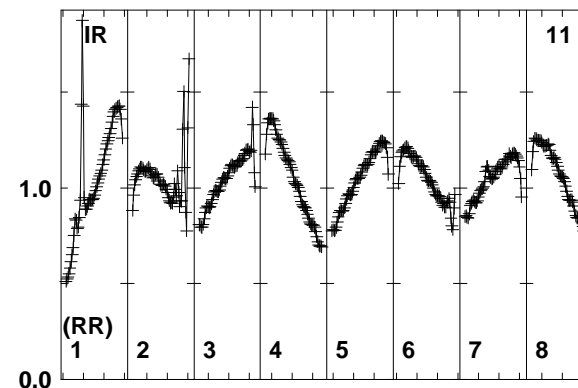
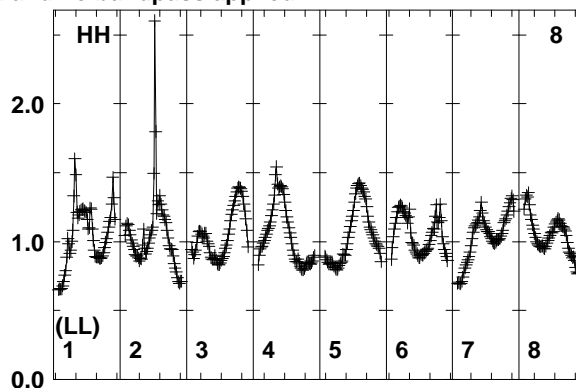
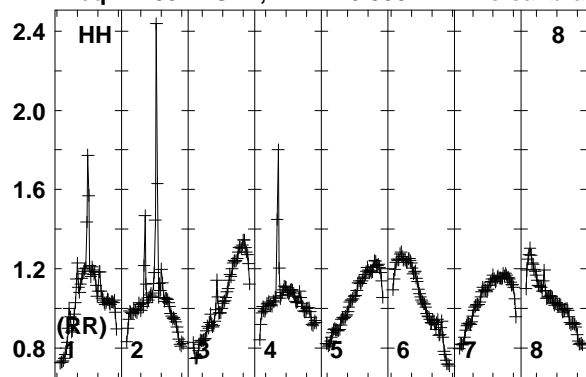

Lower frame: Real Jy
Total-power spectrum Antenna: HH (08)
Timerange: 00/03:04:16 to 00/03:04:44

Plot file version 5 created 04-NOV-2019 14:14:00

J2248-0541 EY034.UVDATA.1

Freq = 1.5947 GHz, Bw = 16.000 MH No calibration applied and no bandpass applied

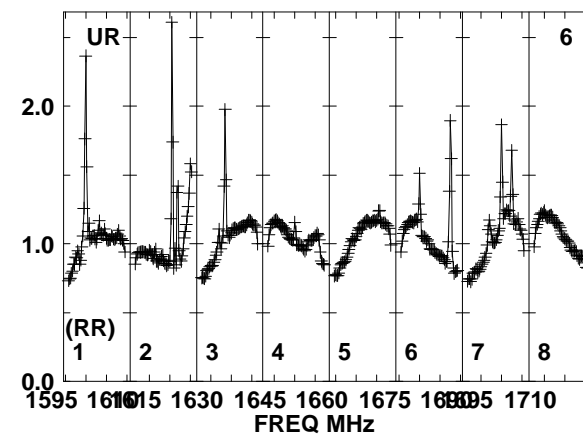
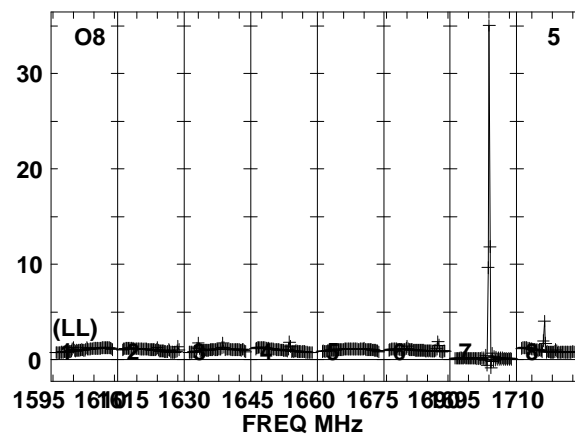
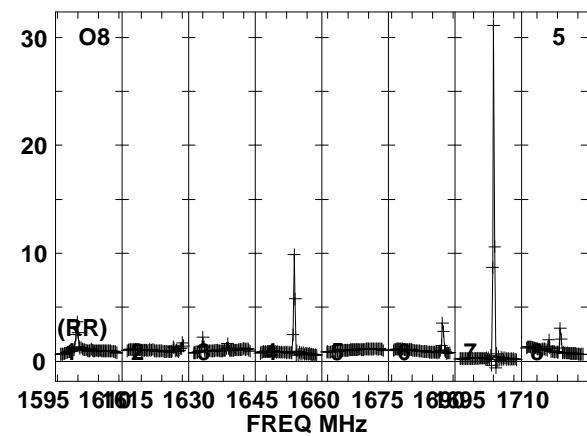
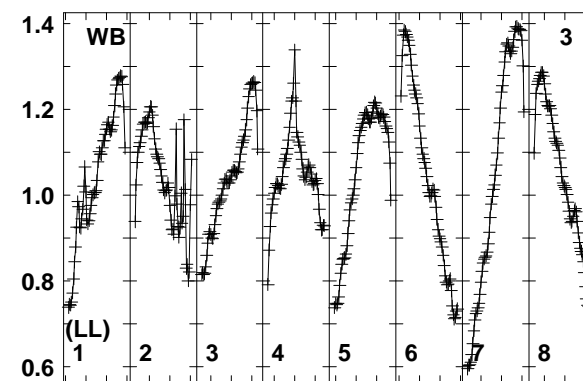
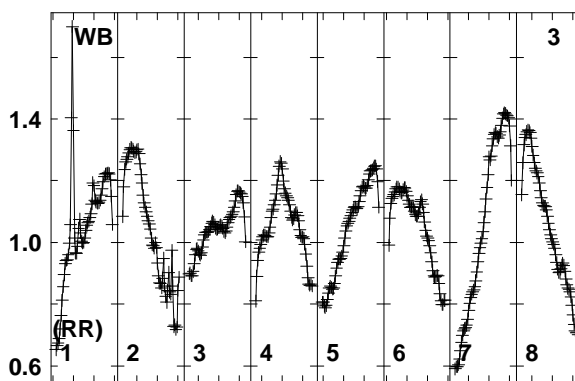
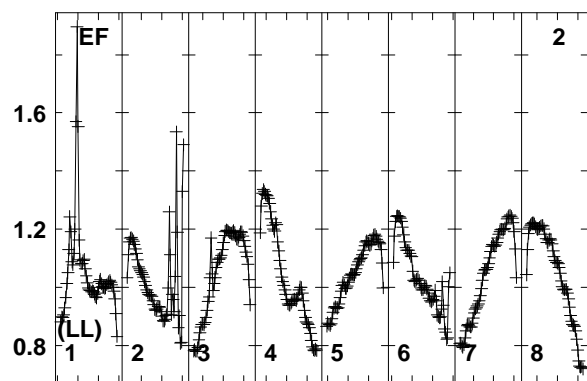
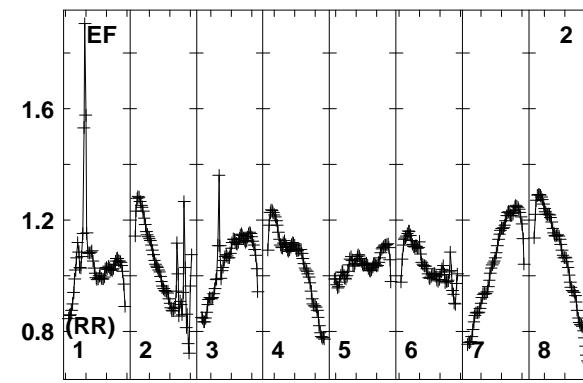
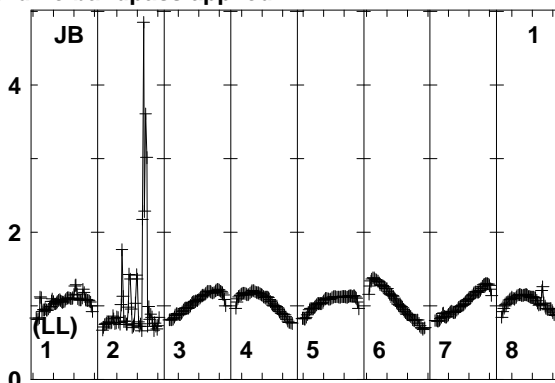
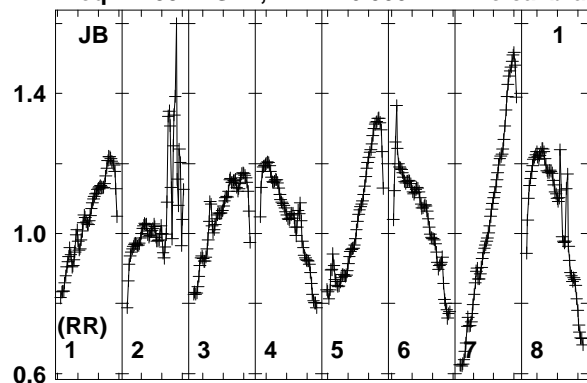

Lower frame: Real Jy
Total-power spectrum Antenna: JB (01)
Timerange: 00/03:05:31 to 00/03:06:29

Plot file version 6 created 04-NOV-2019 14:14:00

J2248-0541 EY034.UVDATA.1

Freq = 1.5947 GHz, Bw = 16.000 MH No calibration applied and no bandpass applied

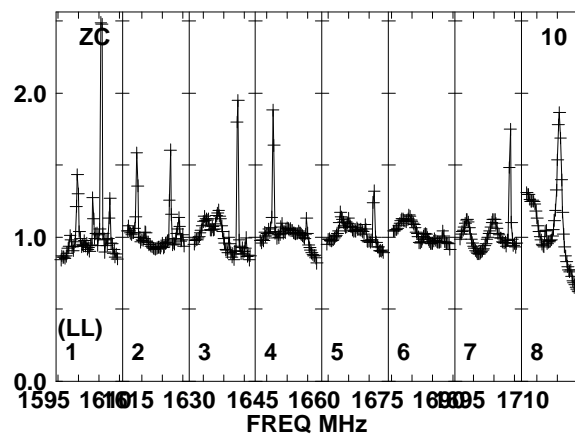
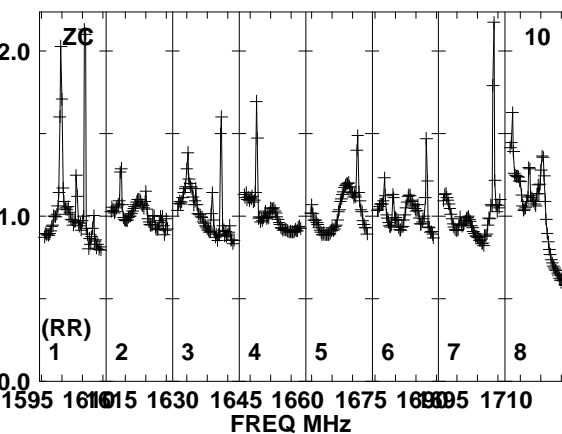
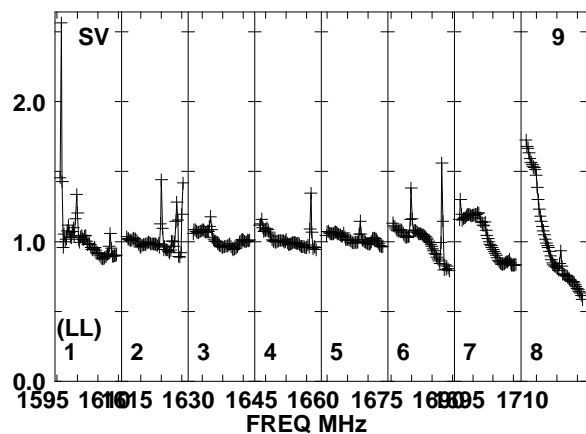
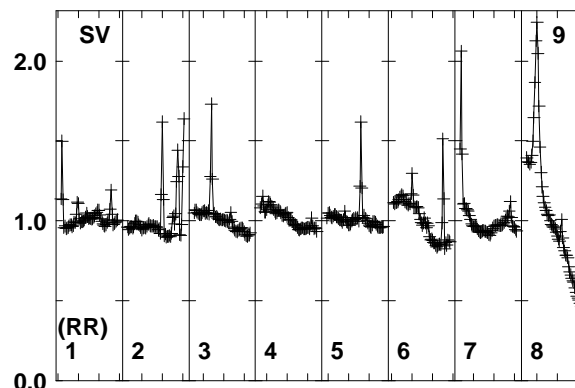
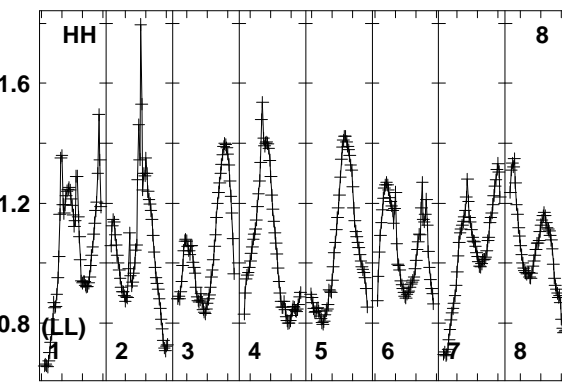
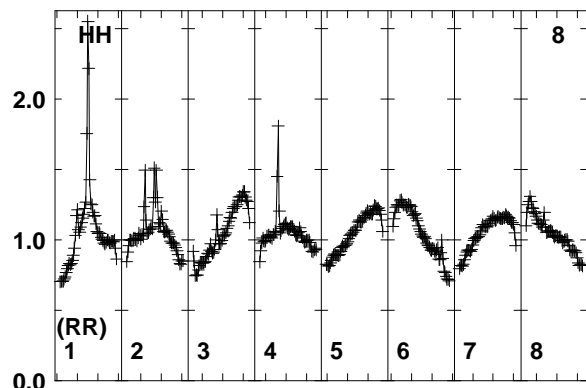
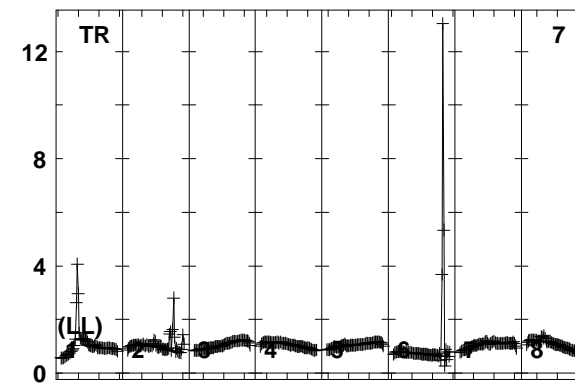
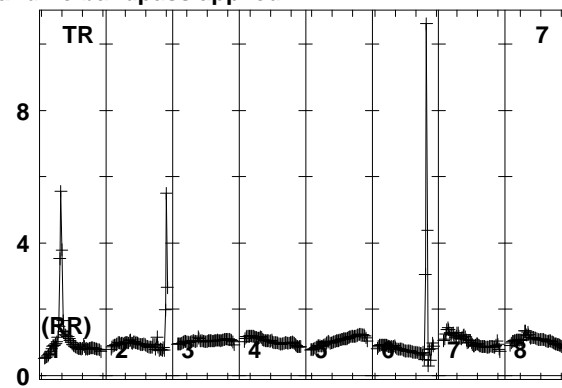
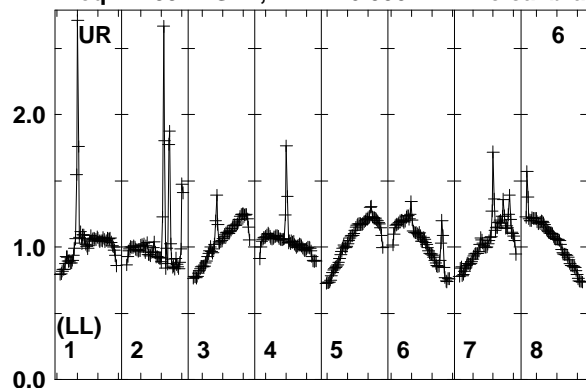

Lower frame: Real Jy
Total-power spectrum Antenna: UR (06)
Timerange: 00/03:05:31 to 00/03:06:29

Plot file version 7 created 04-NOV-2019 14:14:00

J2248-0541 EY034.UVDATA.1

Freq = 1.5947 GHz, Bw = 16.000 MH No calibration applied and no bandpass applied

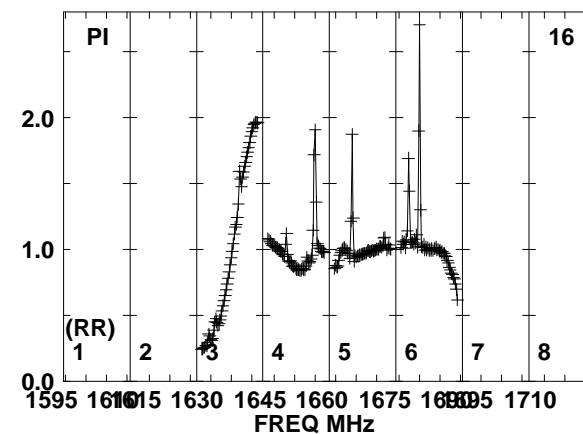
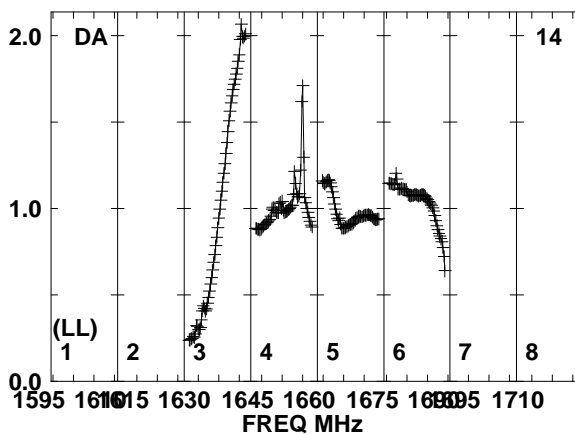
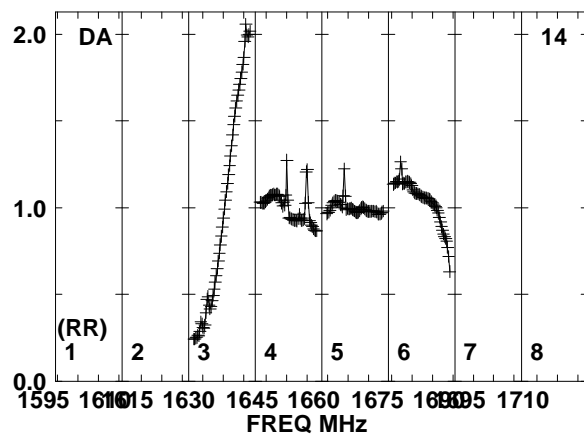
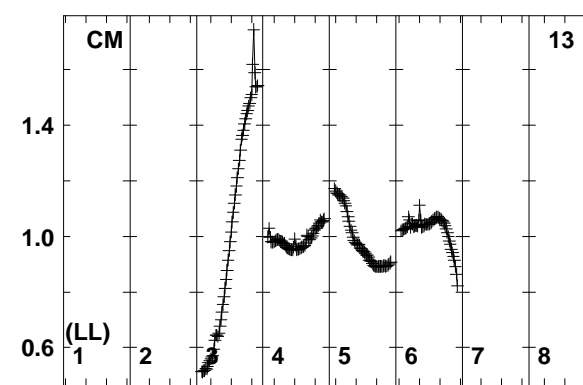
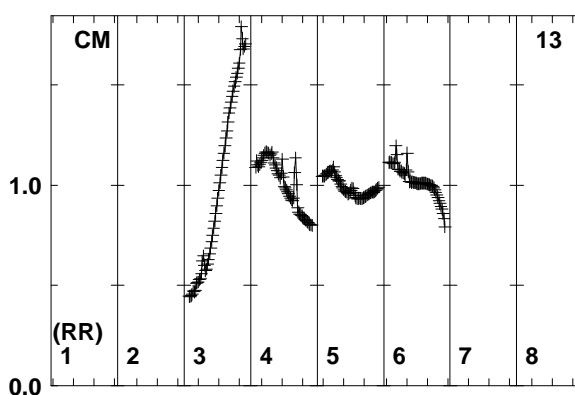
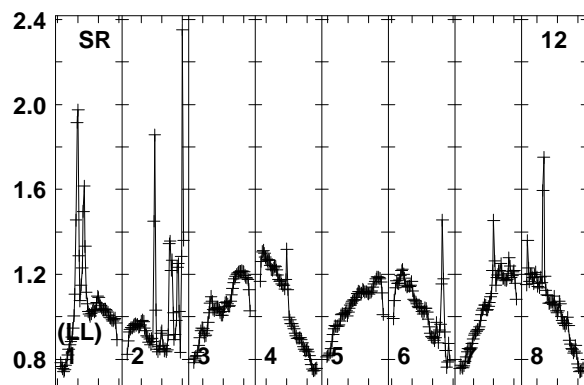
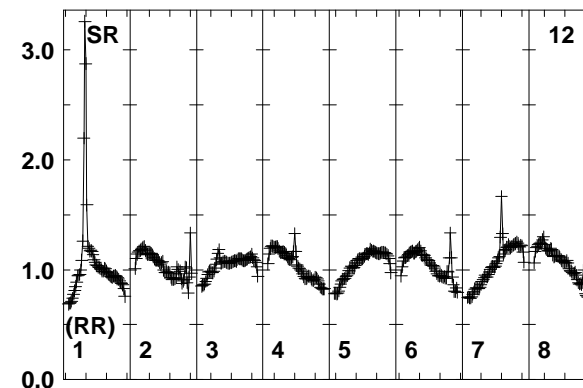
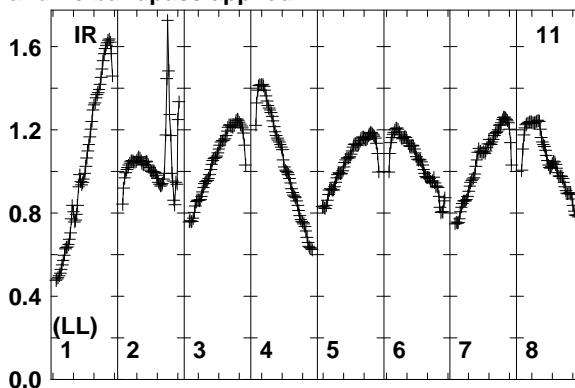
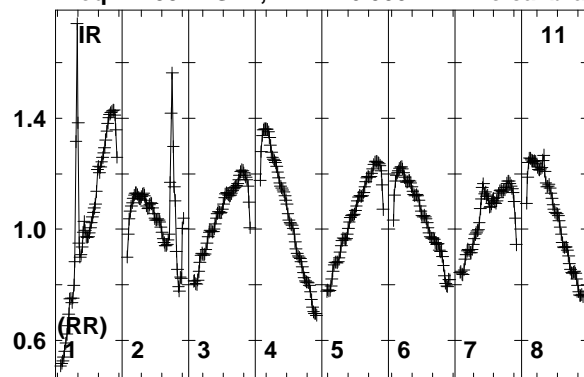

Lower frame: Real Jy
Total-power spectrum Antenna: IR (11)
Timerange: 00/03:05:31 to 00/03:06:29

Plot file version 8 created 04-NOV-2019 14:14:00
J2248-0541 EY034.UVDATA.1
Freq = 1.5947 GHz, Bw = 16.000 MH No calibration applied and no bandpass applied

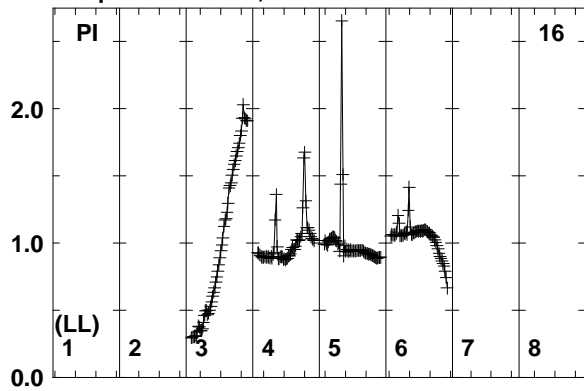

Lower frame: Real Jy
Total-power spectrum Antenna: PI (16)
Timerange: 00/03:05:31 to 00/03:06:29

Plot file version 9 created 04-NOV-2019 14:14:00

W2246-0526 EY034.UVDATA.1

Freq = 1.5947 GHz, Bw = 16.000 MH No calibration applied and no bandpass applied

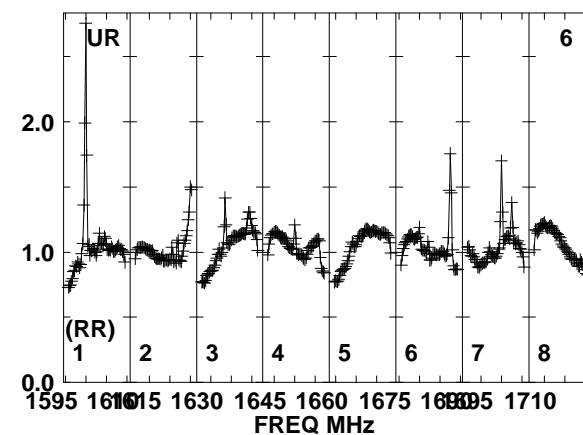
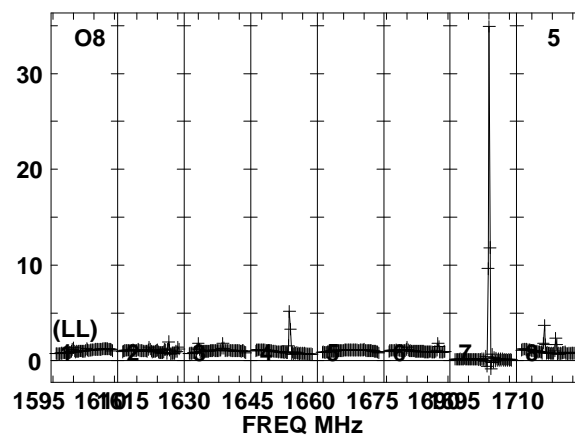
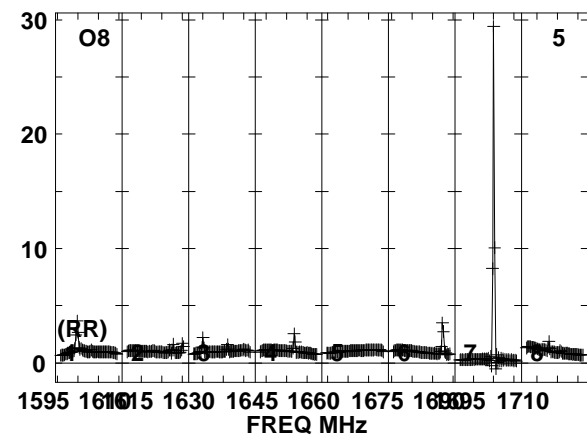
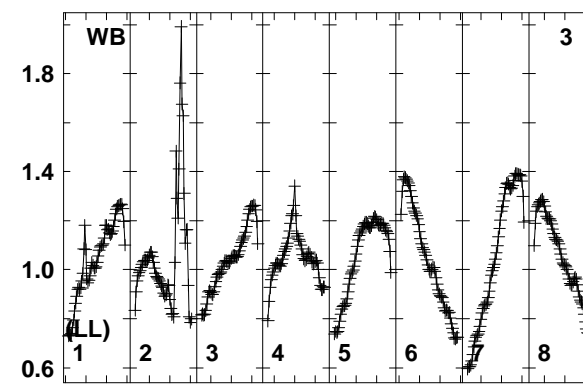
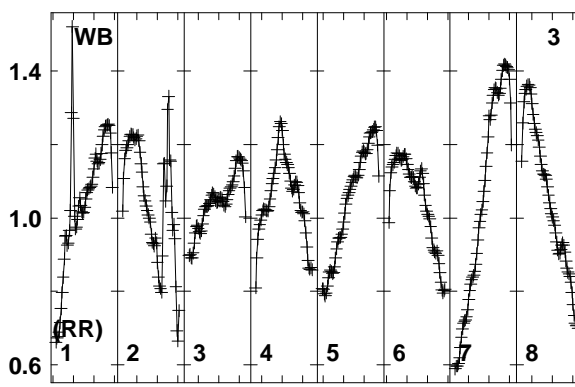
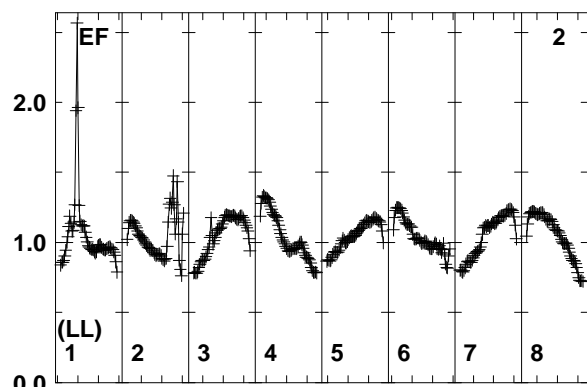
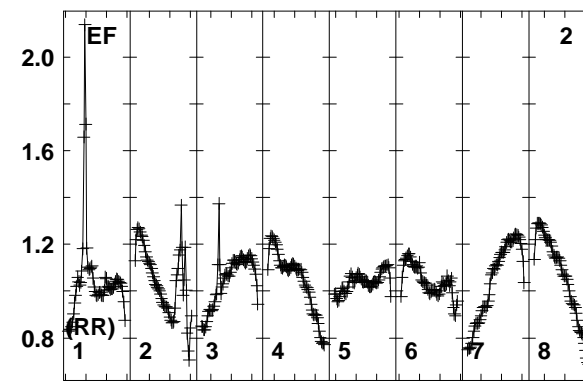
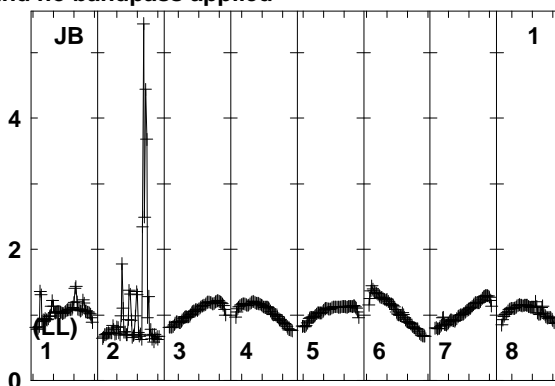
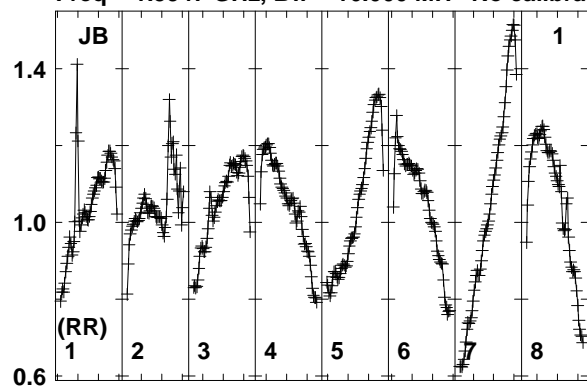

Lower frame: Real Jy
Total-power spectrum Antenna: JB (01)
Timerange: 00/03:06:31 to 00/03:08:59

Plot file version 10 created 04-NOV-2019 14:14:00

W2246-0526 EY034.UVDATA.1

Freq = 1.5947 GHz, Bw = 16.000 MH No calibration applied and no bandpass applied

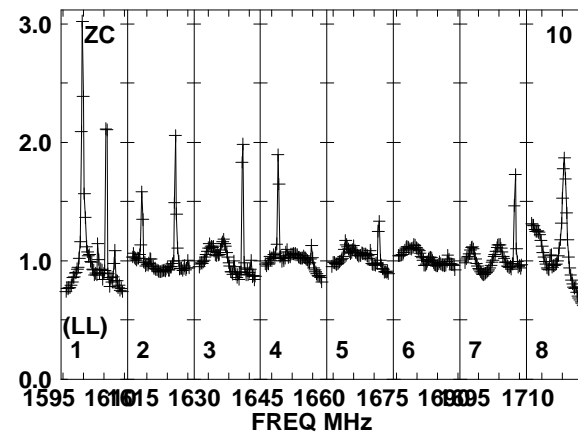
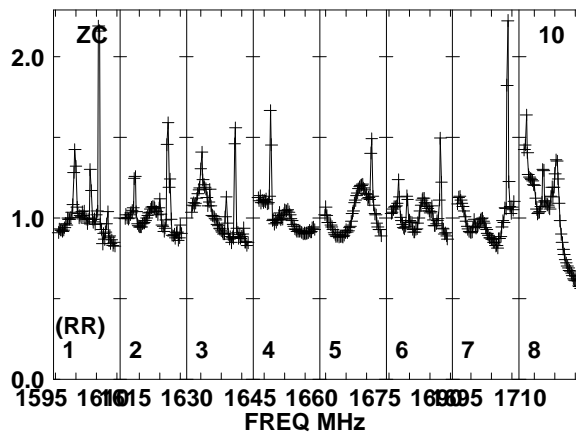
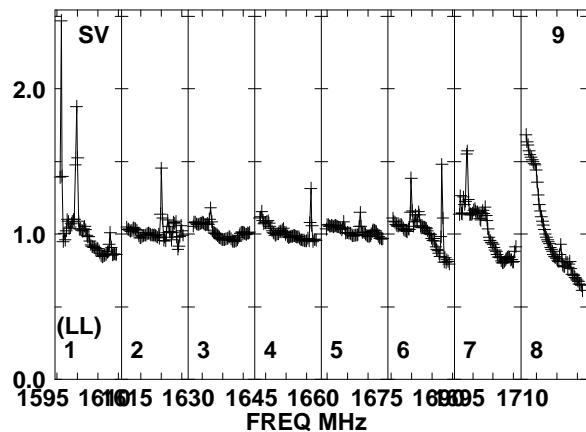
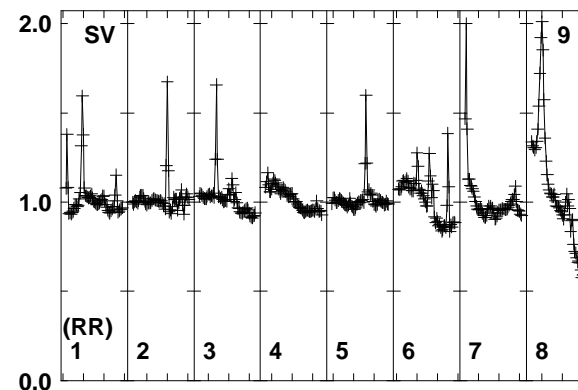
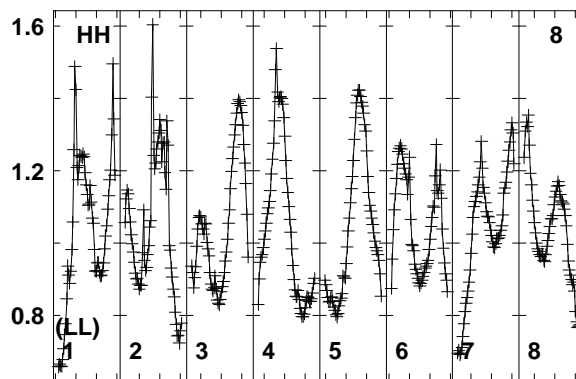
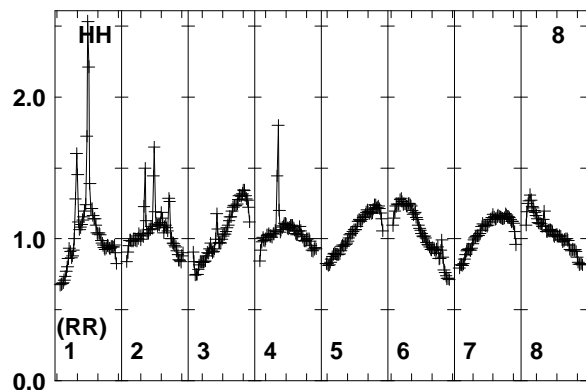
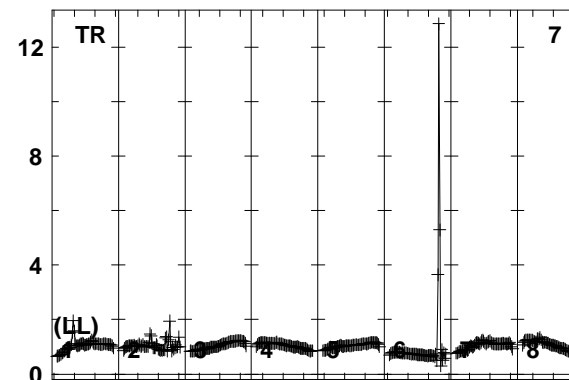
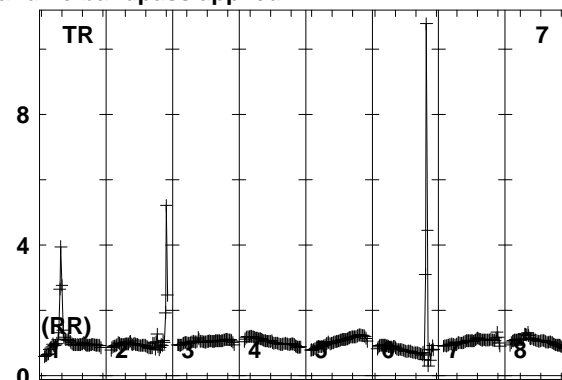
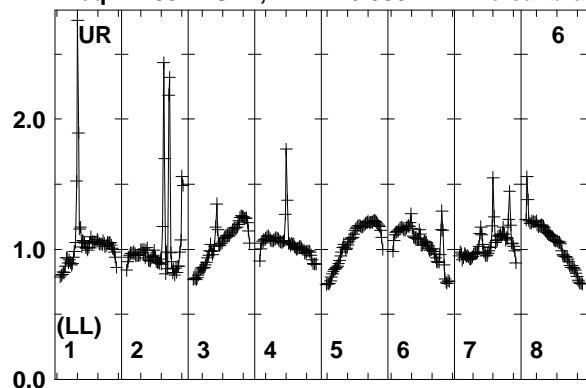

Lower frame: Real Jy
Total-power spectrum Antenna: UR (06)
Timerange: 00/03:06:31 to 00/03:08:59

Plot file version 11 created 04-NOV-2019 14:14:00

W2246-0526 EY034.UVDATA.1

Freq = 1.5947 GHz, Bw = 16.000 MH No calibration applied and no bandpass applied

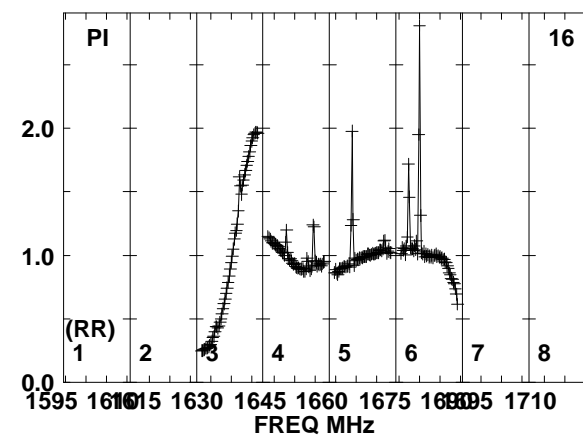
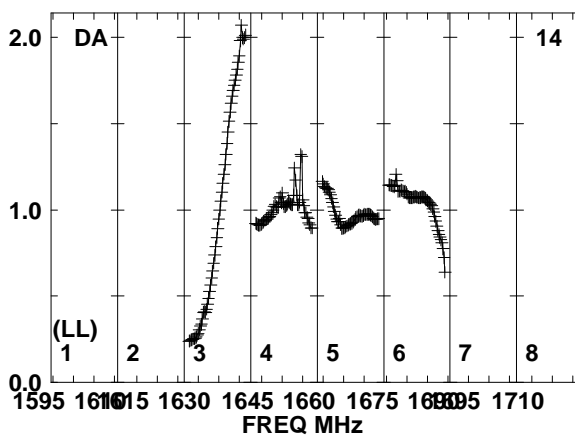
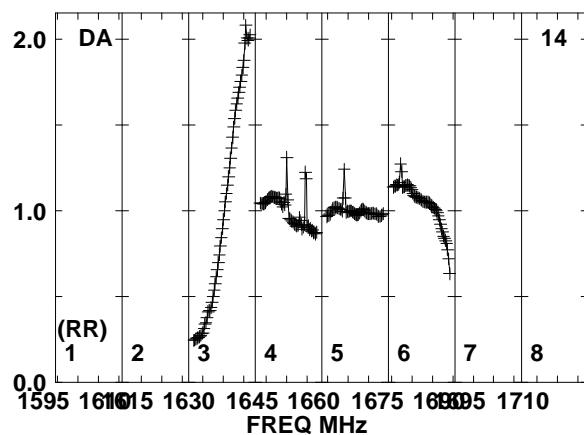
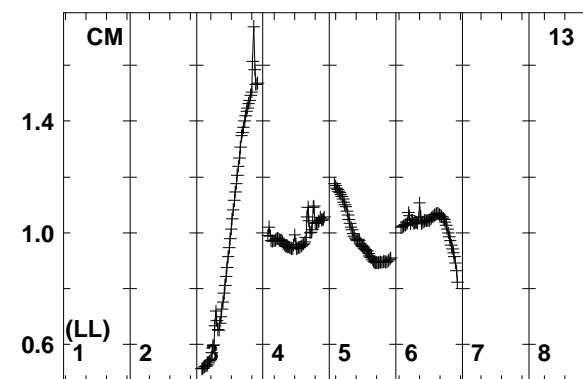
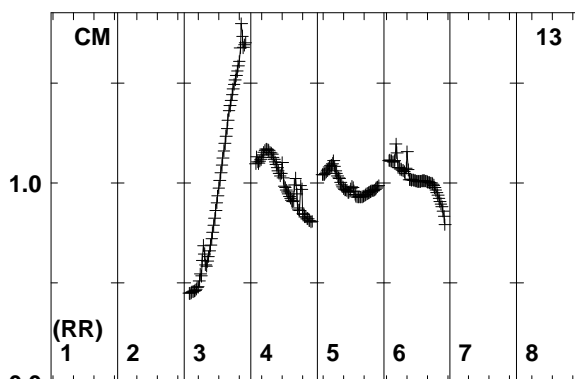
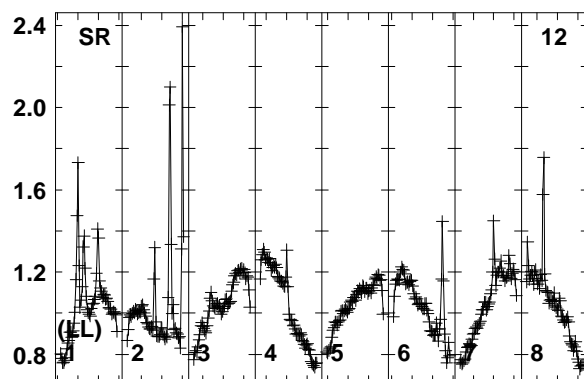
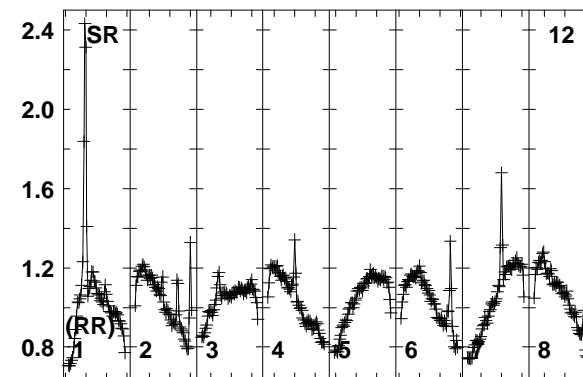
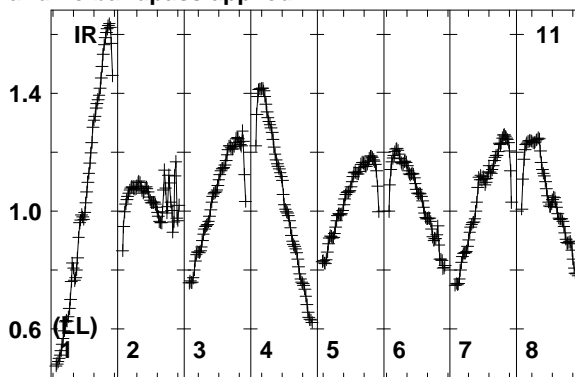
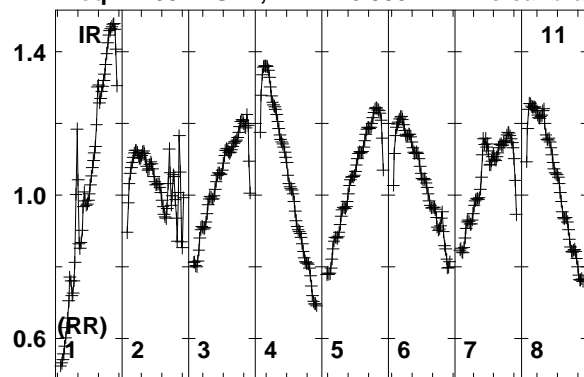

Lower frame: Real Jy
Total-power spectrum Antenna: IR (11)
Timerange: 00/03:06:31 to 00/03:08:59

Plot file version 12 created 04-NOV-2019 14:14:01
W2246-0526 EY034.UVDATA.1
Freq = 1.5947 GHz, Bw = 16.000 MH No calibration applied and no bandpass applied

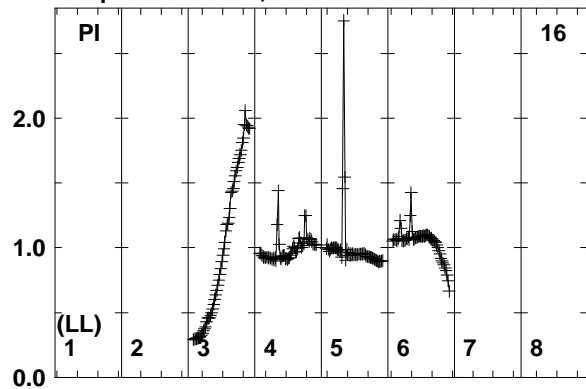

Lower frame: Real Jy
Total-power spectrum Antenna: PI (16)
Timerange: 00/03:06:31 to 00/03:08:59

Plot file version 13 created 04-NOV-2019 14:14:01

J2248-0541 EY034.UVDATA.1

Freq = 1.5947 GHz, Bw = 16.000 MH No calibration applied and no bandpass applied

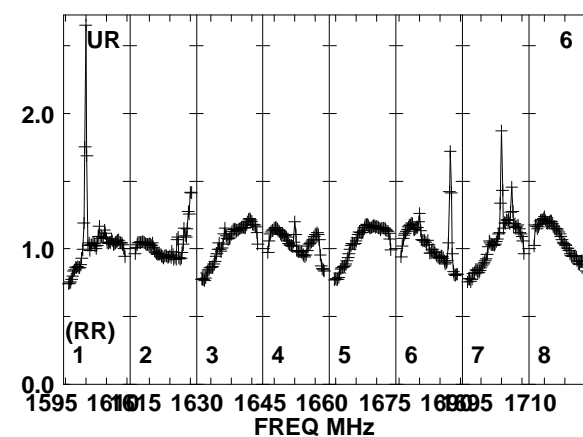
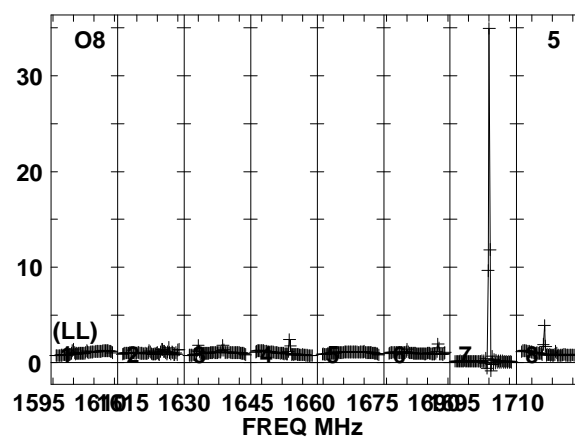
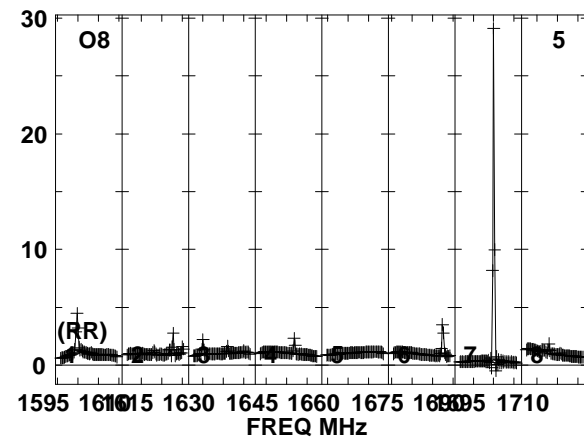
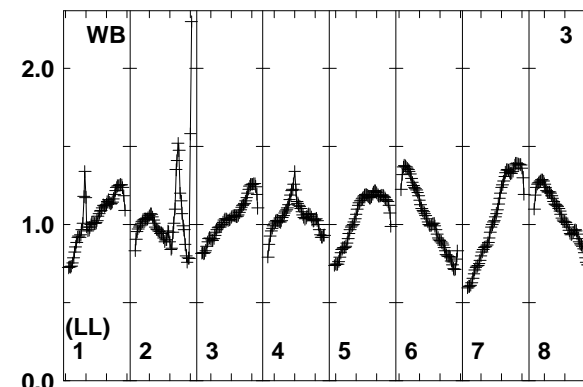
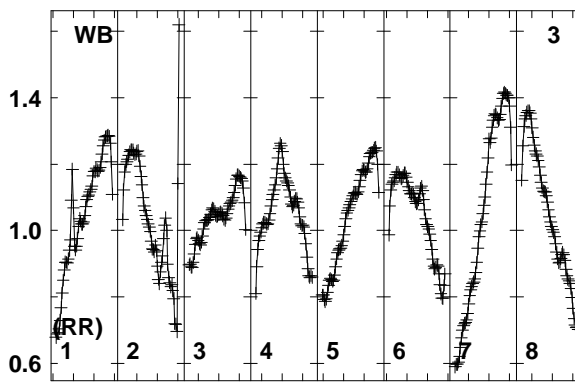
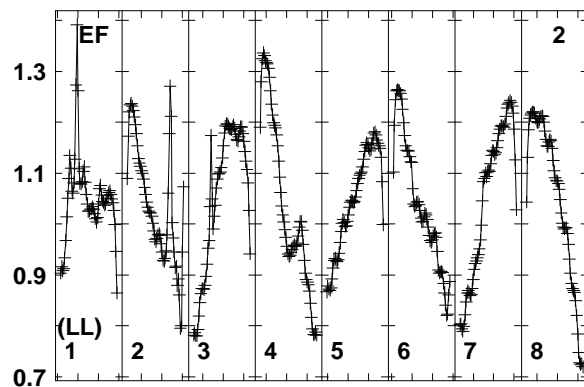
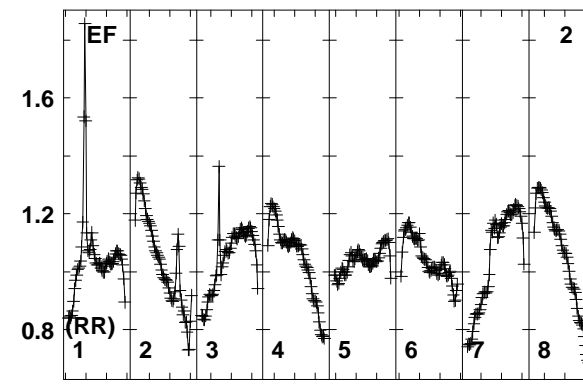
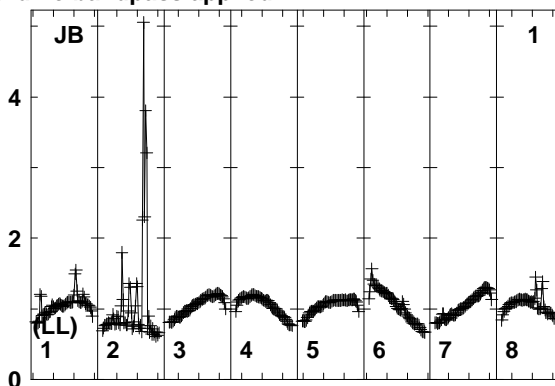
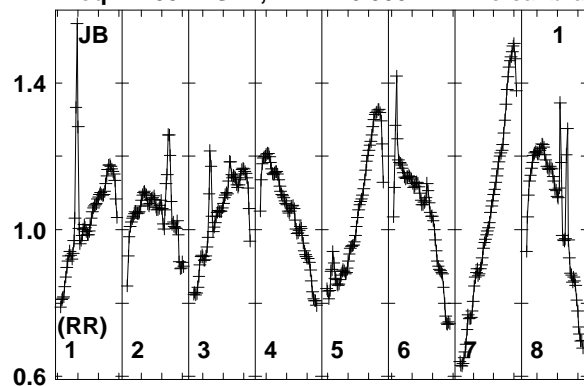

Lower frame: Real Jy
Total-power spectrum Antenna: JB (01)
Timerange: 00/03:09:16 to 00/03:10:14

Plot file version 14 created 04-NOV-2019 14:14:01

J2248-0541 EY034.UVDATA.1

Freq = 1.5947 GHz, Bw = 16.000 MH No calibration applied and no bandpass applied

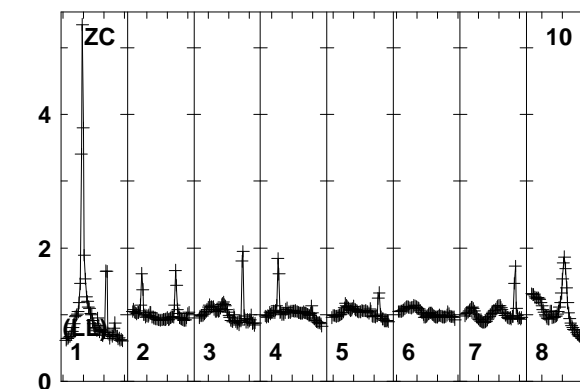
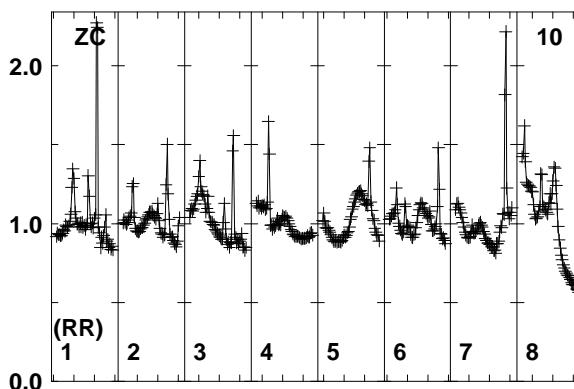
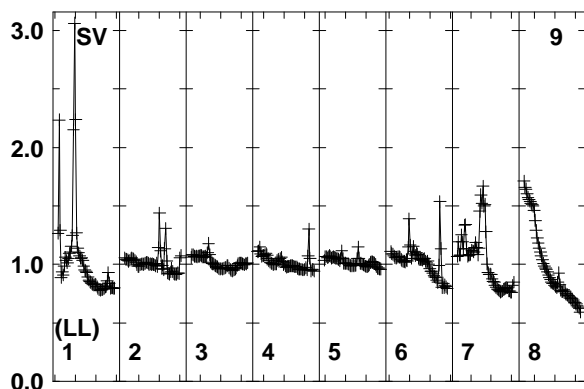
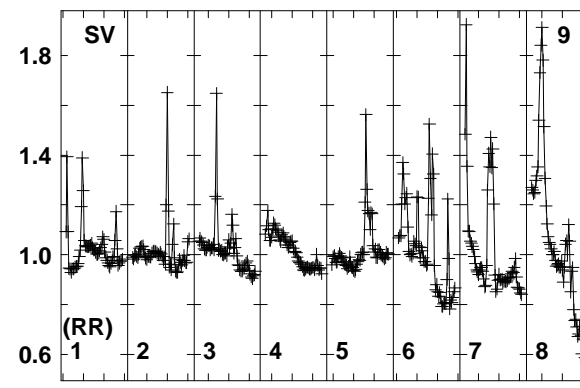
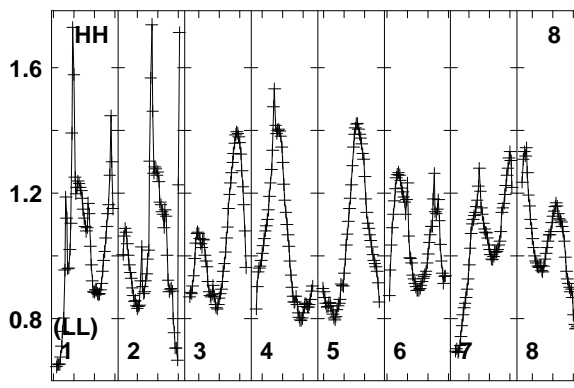
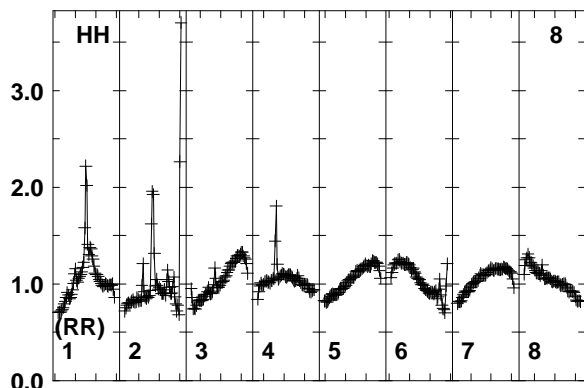
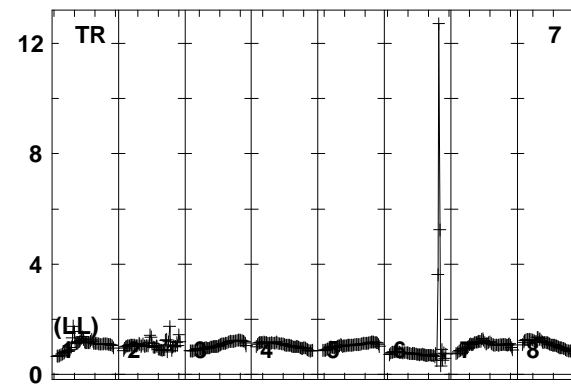
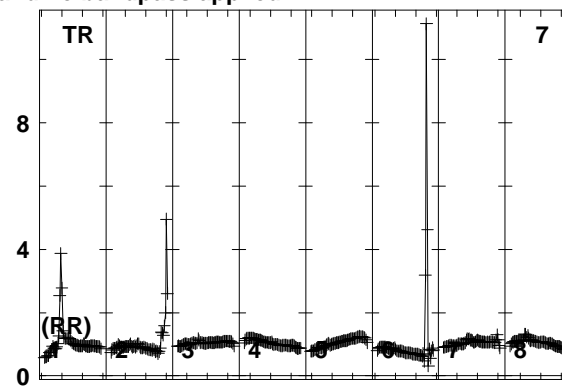
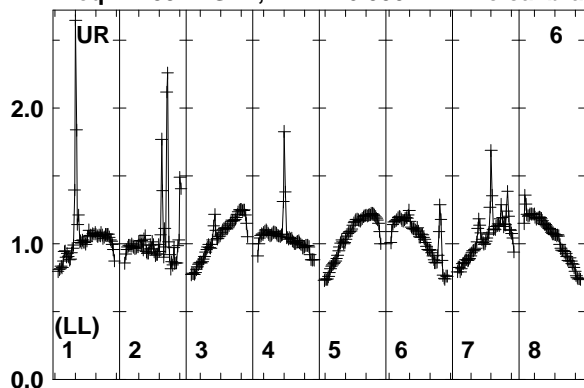

1595 1610 1615 1630 1645 1660 1675 1690 1710
FREQ MHz

1595 1610 1615 1630 1645 1660 1675 1690 1710
FREQ MHz

1595 1610 1615 1630 1645 1660 1675 1690 1710
FREQ MHz

Lower frame: Real Jy
Total-power spectrum Antenna: UR (06)
Timerange: 00/03:09:16 to 00/03:10:14

Plot file version 15 created 04-NOV-2019 14:14:01

J2248-0541 EY034.UVDATA.1

Freq = 1.5947 GHz, Bw = 16.000 MH No calibration applied and no bandpass applied

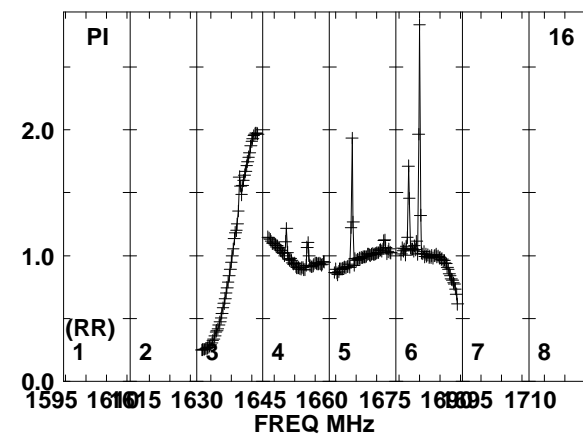
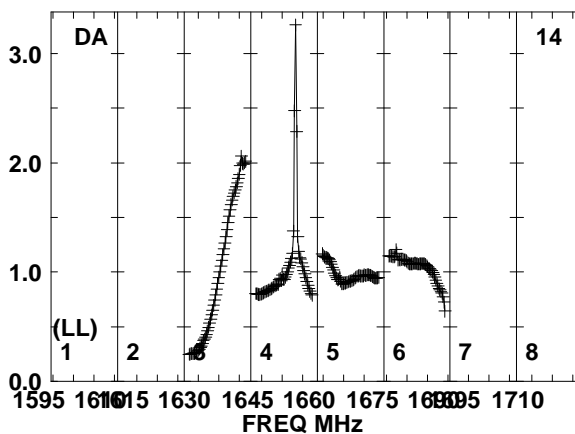
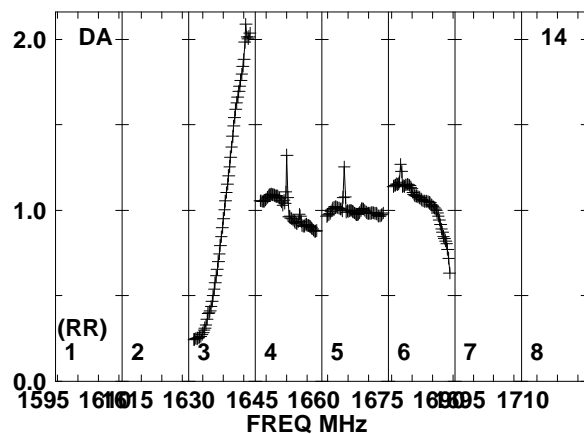
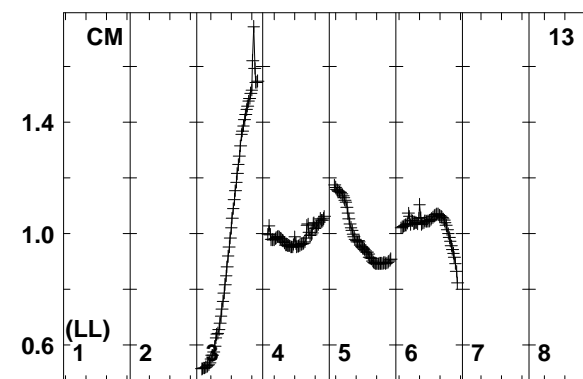
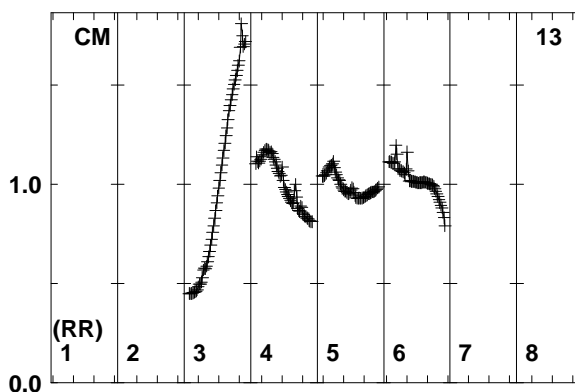
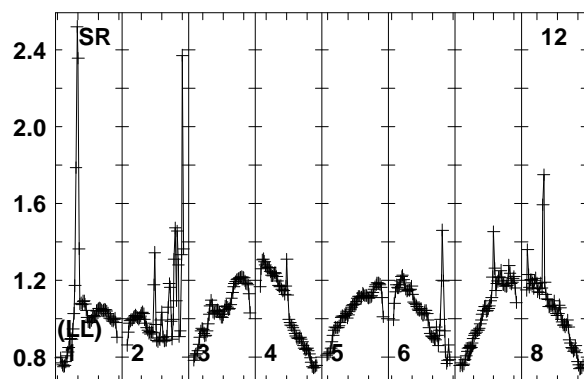
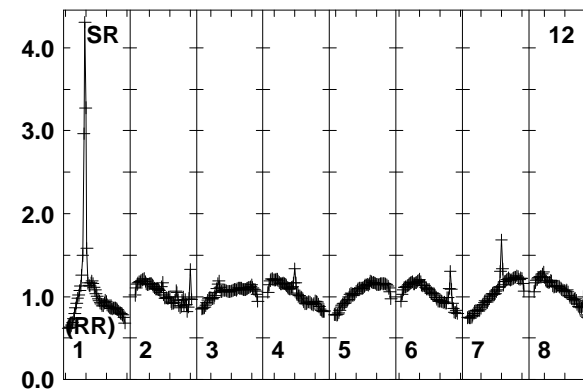
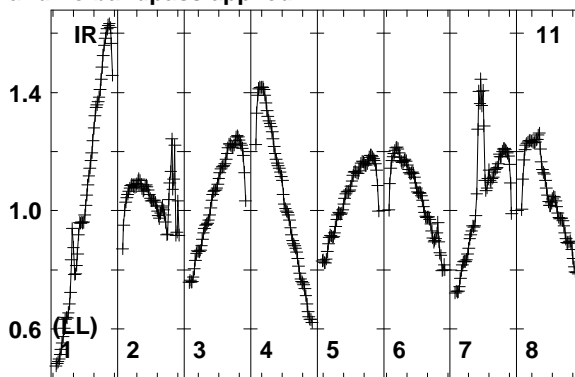
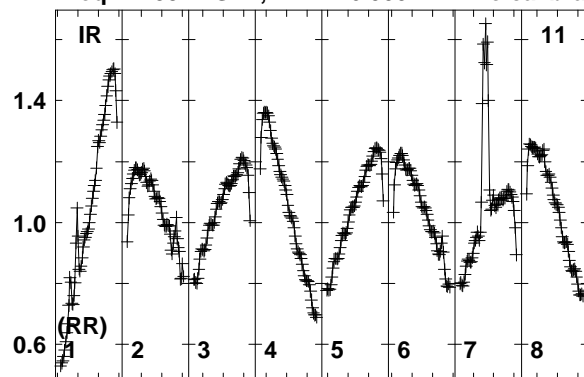

Lower frame: Real Jy
Total-power spectrum Antenna: IR (11)
Timerange: 00/03:09:16 to 00/03:10:14

Plot file version 16 created 04-NOV-2019 14:14:01
J2248-0541 EY034.UVDATA.1
Freq = 1.5947 GHz, Bw = 16.000 MH No calibration applied and no bandpass applied

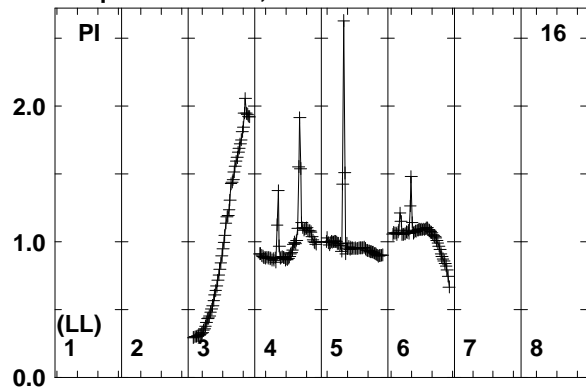

Lower frame: Real Jy
Total-power spectrum Antenna: PI (16)
Timerange: 00/03:09:16 to 00/03:10:14

Plot file version 17 created 04-NOV-2019 14:14:01

W2246-0526 EY034.UVDATA.1

Freq = 1.5947 GHz, Bw = 16.000 MH No calibration applied and no bandpass applied

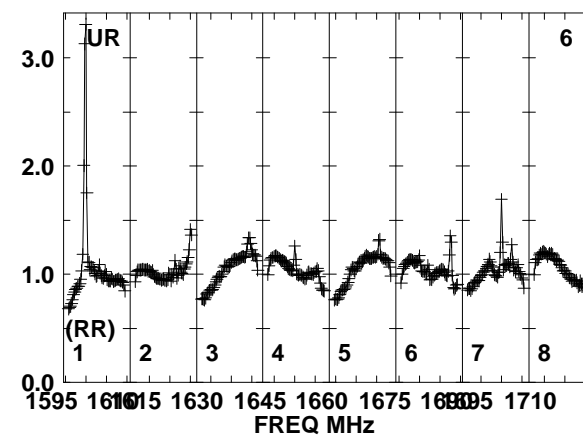
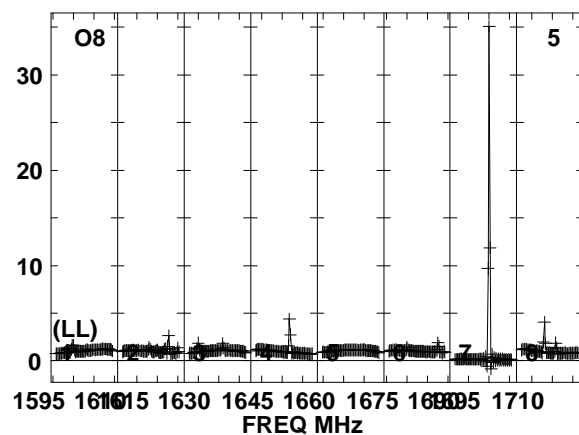
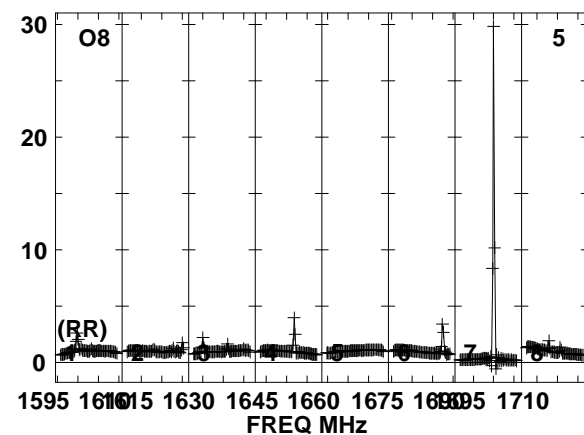
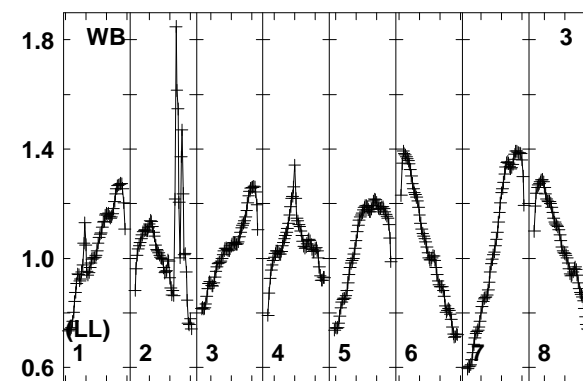
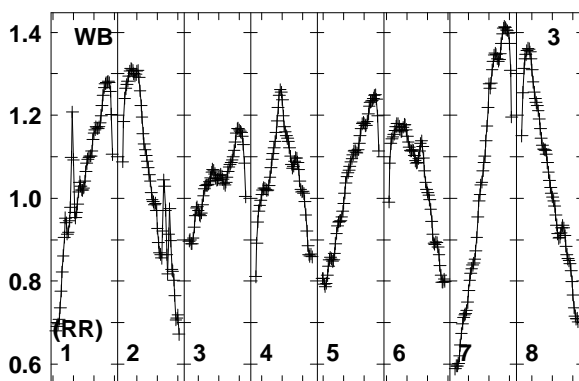
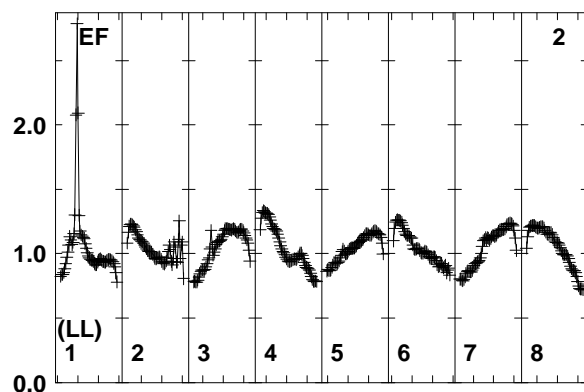
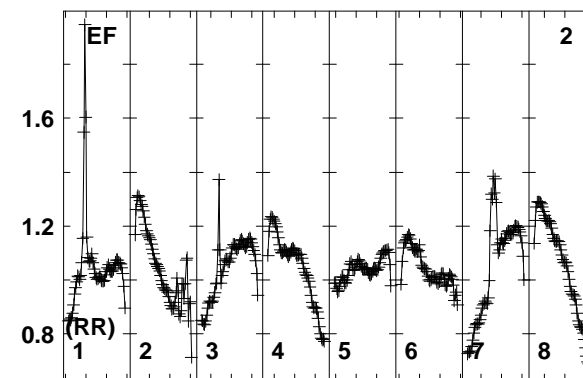
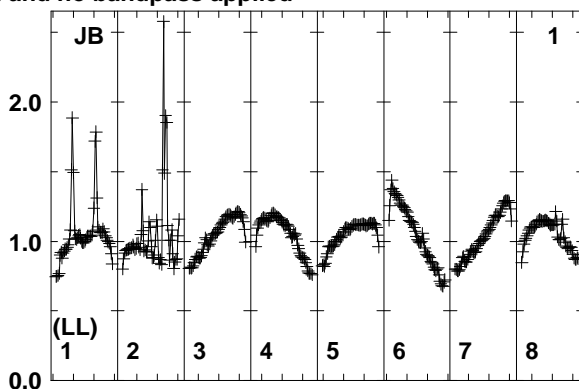
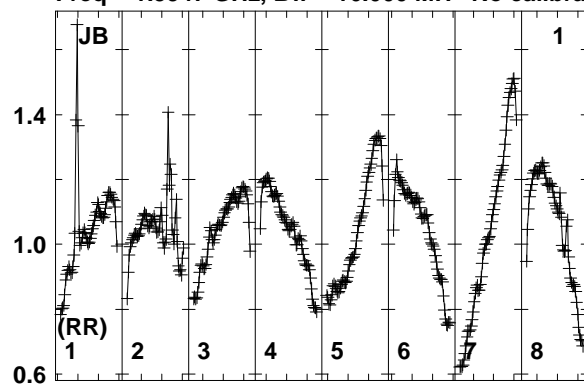

Lower frame: Real Jy
Total-power spectrum Antenna: JB (01)
Timerange: 00/03:10:16 to 00/03:12:54

Plot file version 18 created 04-NOV-2019 14:14:01

W2246-0526 EY034.UVDATA.1

Freq = 1.5947 GHz, Bw = 16.000 MH No calibration applied and no bandpass applied

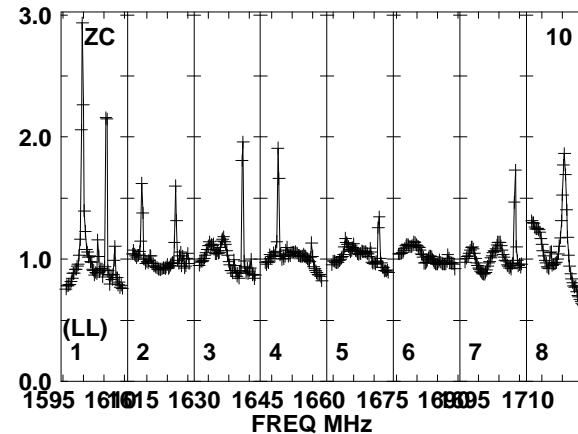
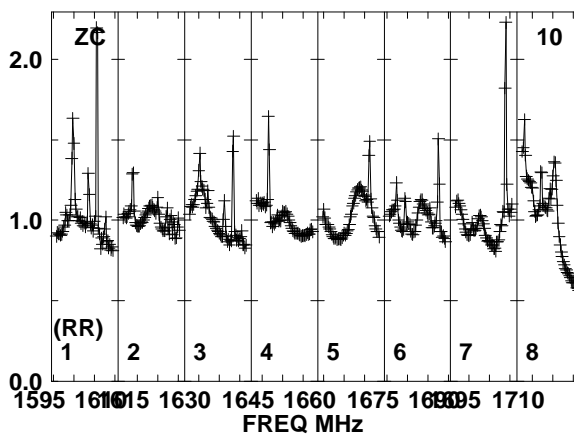
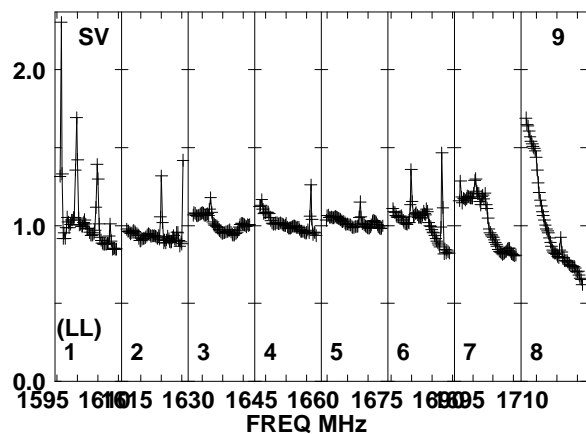
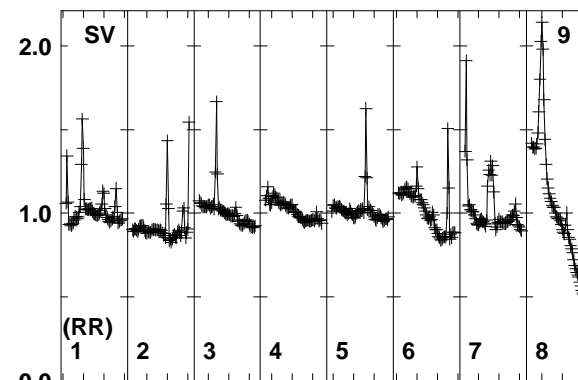
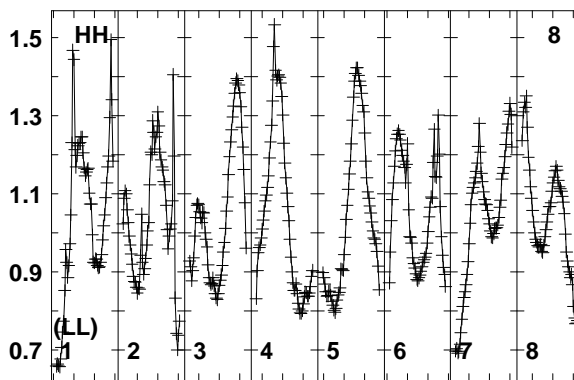
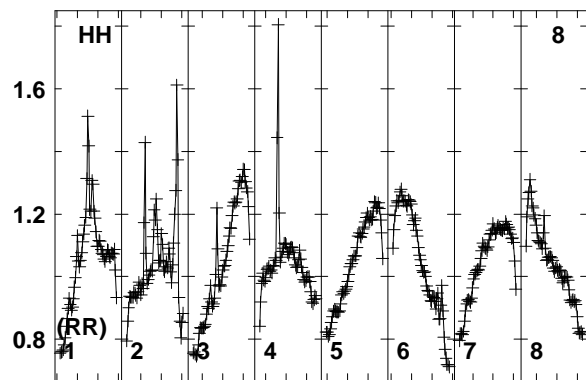
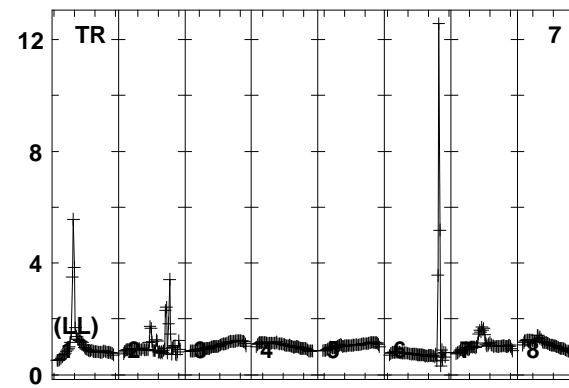
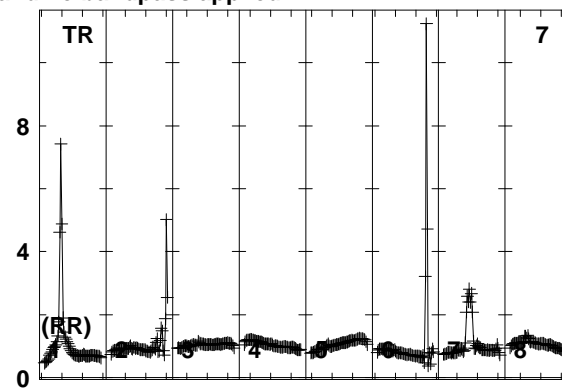
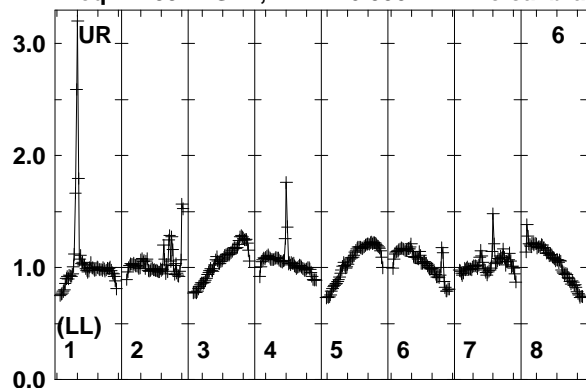

Lower frame: Real Jy
Total-power spectrum Antenna: UR (06)
Timerange: 00/03:10:16 to 00/03:12:54

Plot file version 19 created 04-NOV-2019 14:14:01

W2246-0526 EY034.UVDATA.1

Freq = 1.5947 GHz, Bw = 16.000 MH No calibration applied and no bandpass applied

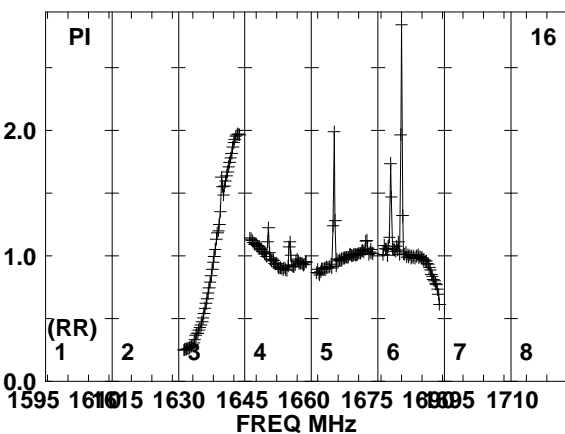
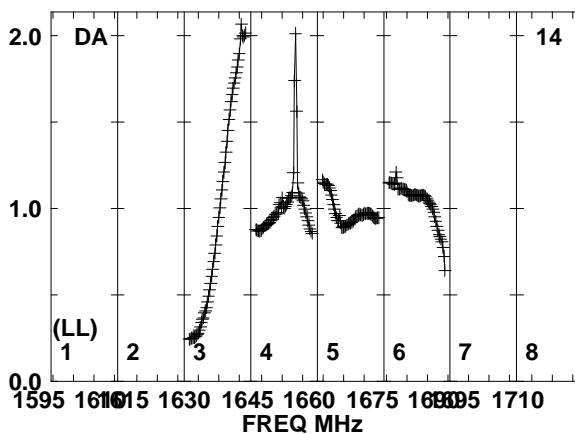
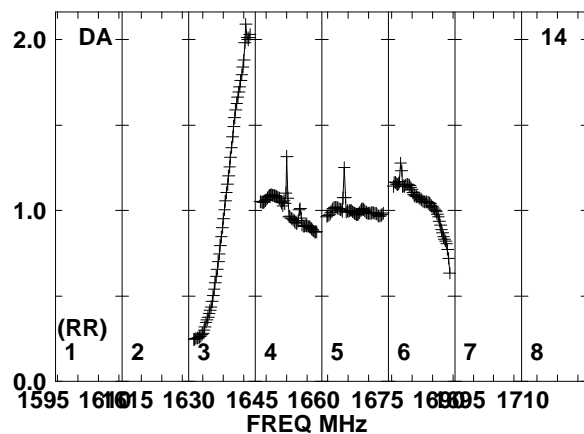
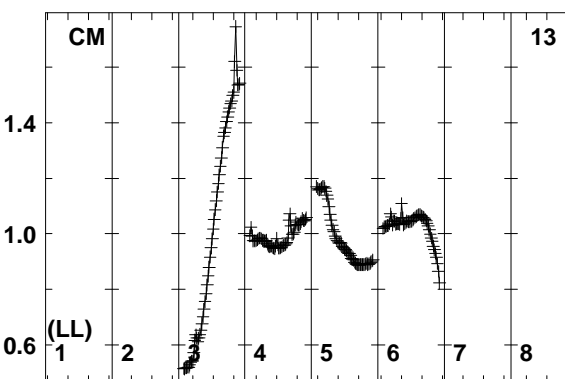
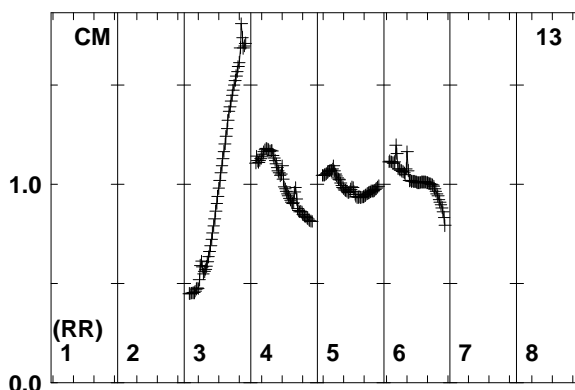
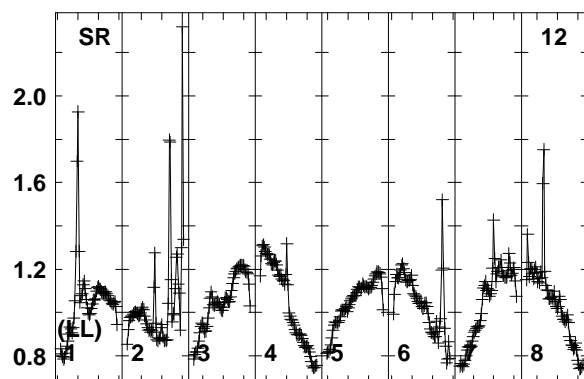
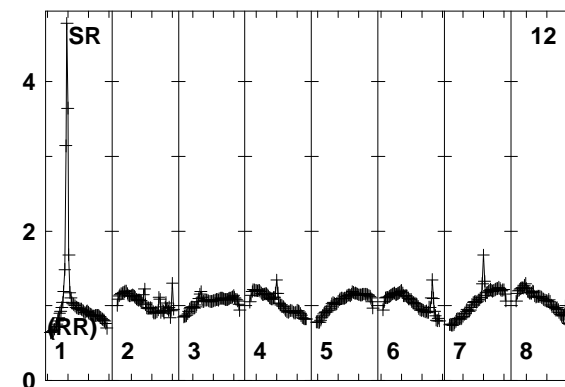
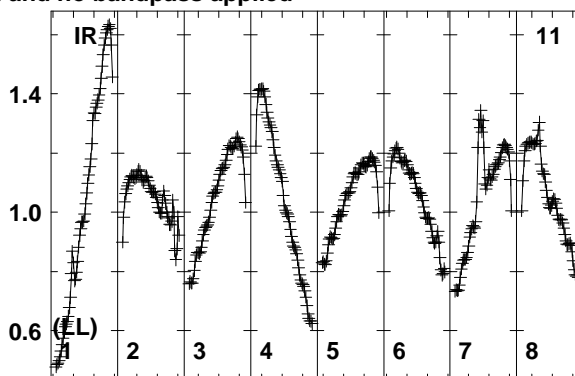
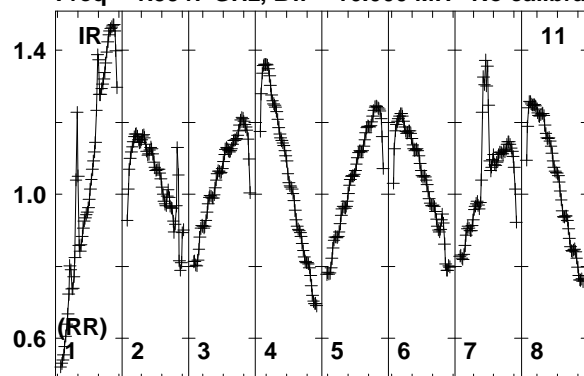

Lower frame: Real Jy
Total-power spectrum Antenna: IR (11)
Timerange: 00/03:10:16 to 00/03:12:54

Plot file version 20 created 04-NOV-2019 14:14:01
W2246-0526 EY034.UVDATA.1
Freq = 1.5947 GHz, Bw = 16.000 MH No calibration applied and no bandpass applied

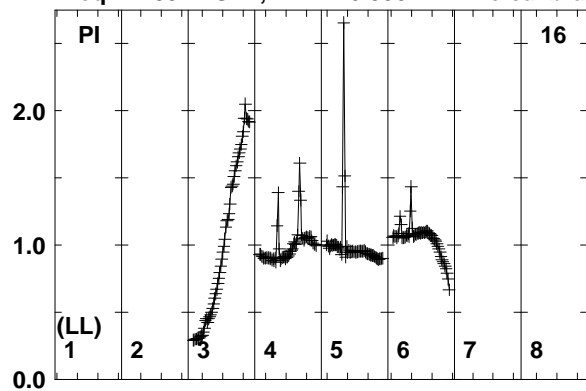

Lower frame: Real Jy
Total-power spectrum Antenna: PI (16)
Timerange: 00/03:10:16 to 00/03:12:54

Plot file version 21 created 04-NOV-2019 14:14:01

J2248-0541 EY034.UVDATA.1

Freq = 1.5947 GHz, Bw = 16.000 MH No calibration applied and no bandpass applied

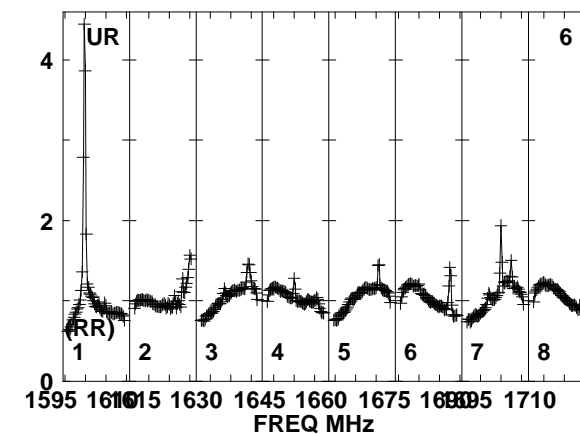
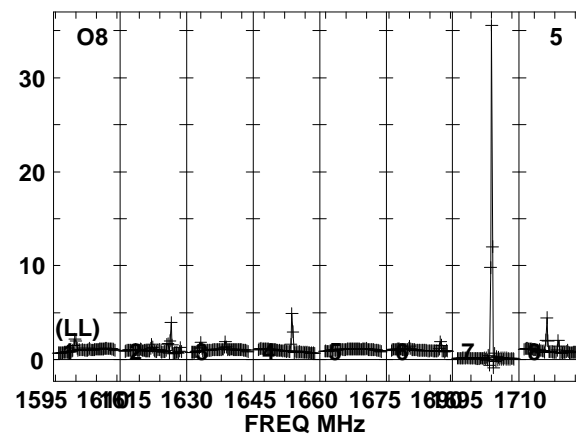
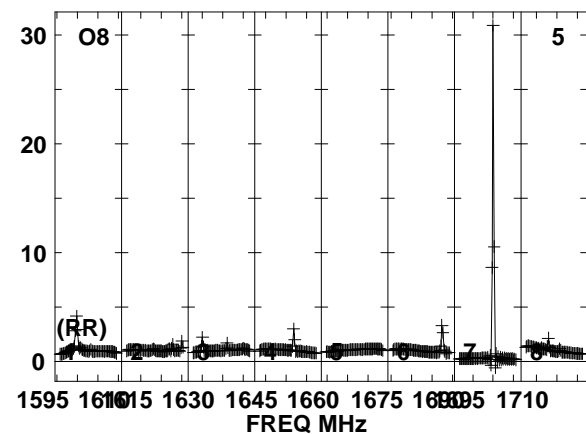
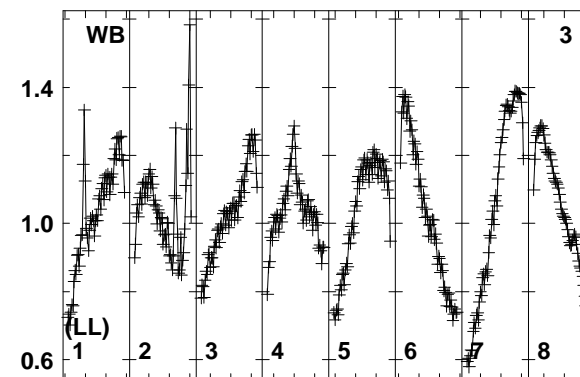
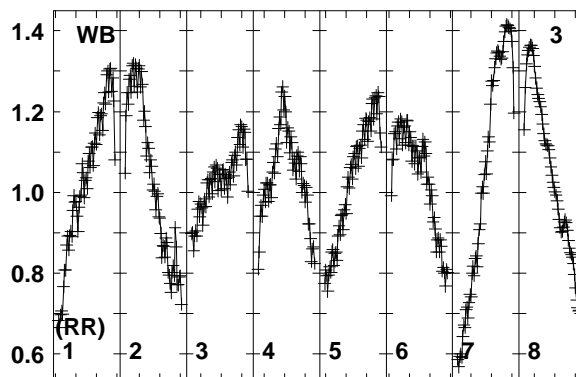
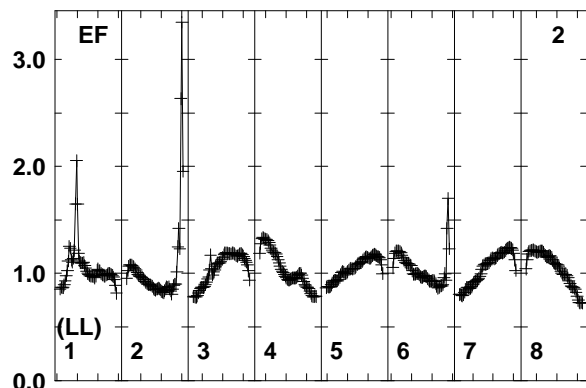
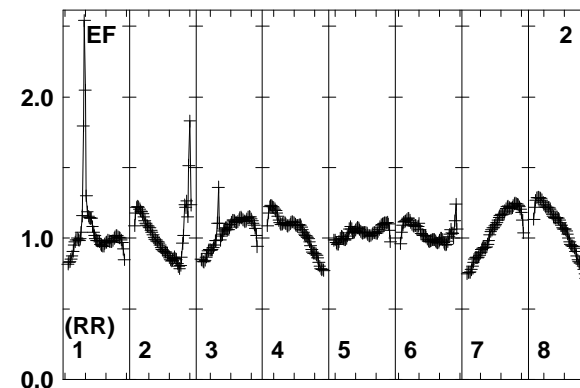
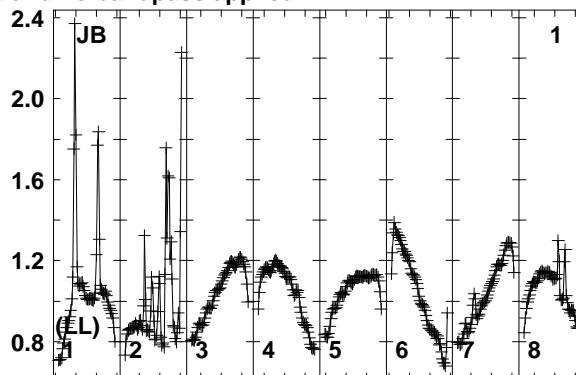
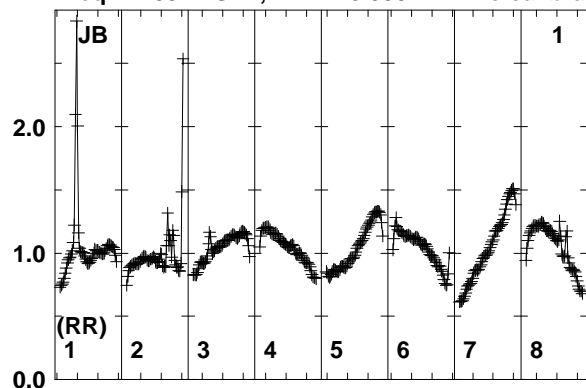

Lower frame: Real Jy
Total-power spectrum Antenna: JB (01)
Timerange: 00/03:13:11 to 00/03:14:09

Plot file version 22 created 04-NOV-2019 14:14:01

J2248-0541 EY034.UVDATA.1

Freq = 1.5947 GHz, Bw = 16.000 MH No calibration applied and no bandpass applied

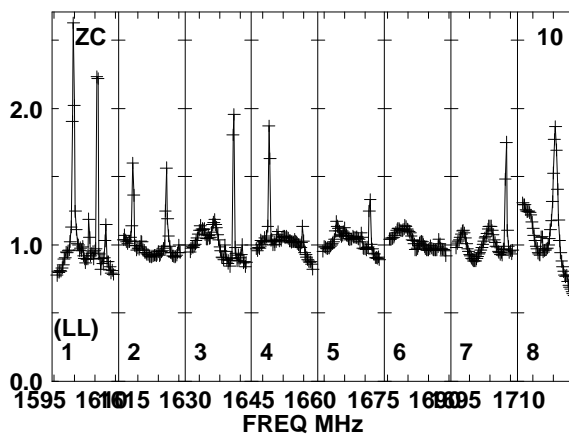
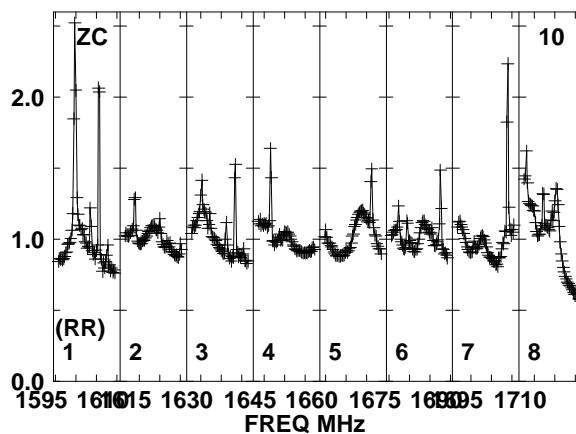
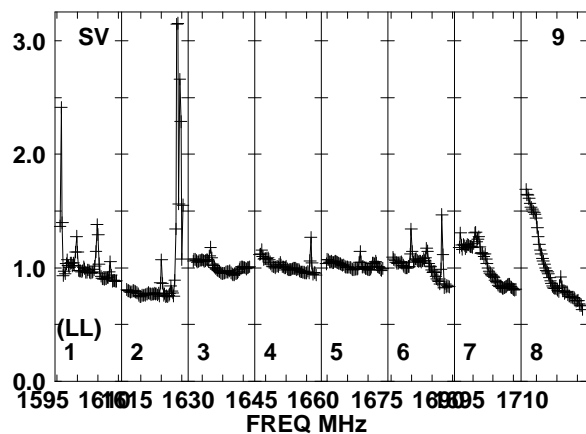
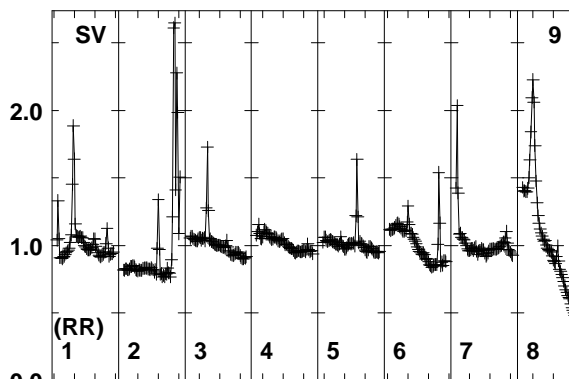
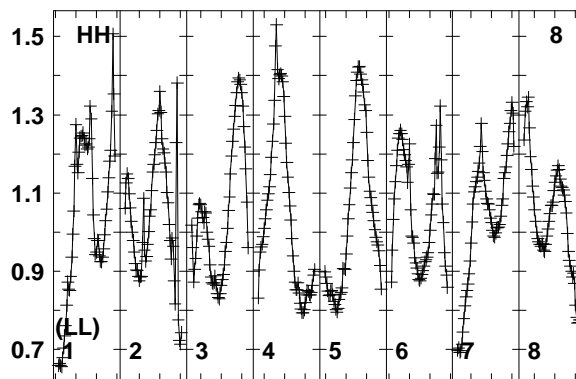
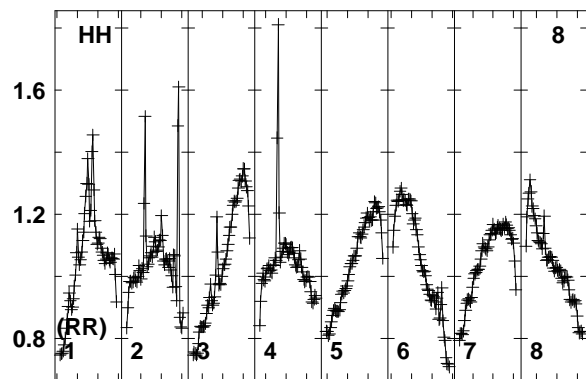
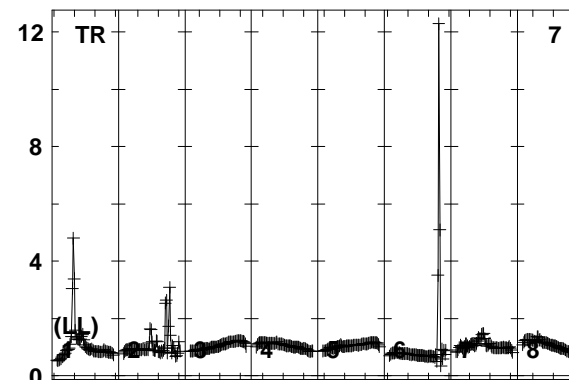
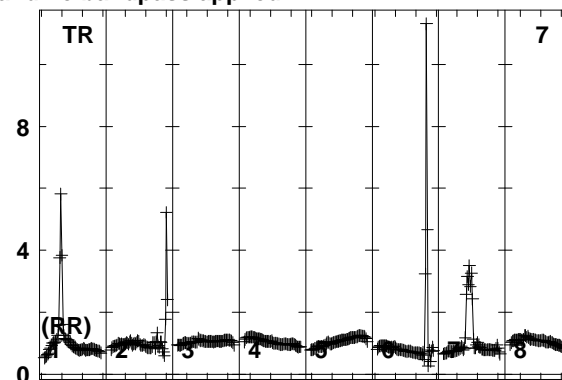
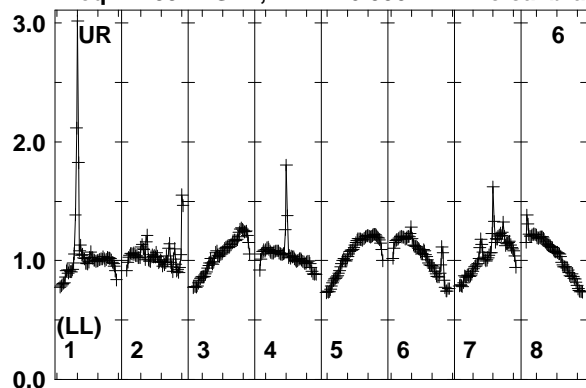

Lower frame: Real Jy
Total-power spectrum Antenna: UR (06)
Timerange: 00/03:13:11 to 00/03:14:09

Plot file version 23 created 04-NOV-2019 14:14:01

J2248-0541 EY034.UVDATA.1

Freq = 1.5947 GHz, Bw = 16.000 MH No calibration applied and no bandpass applied

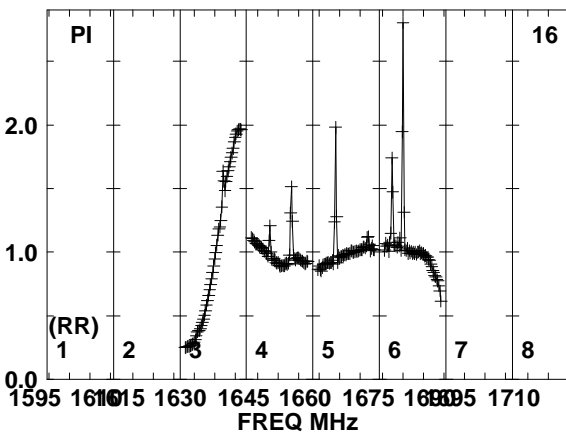
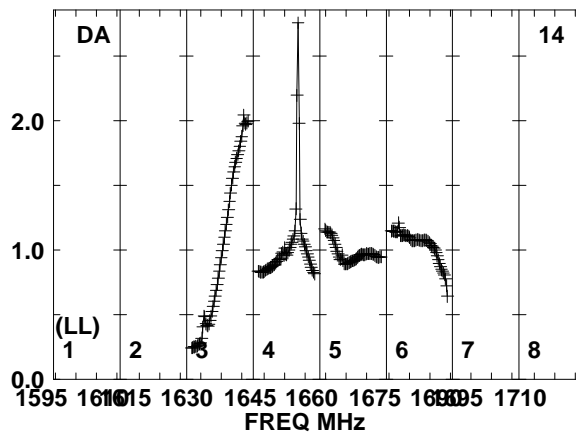
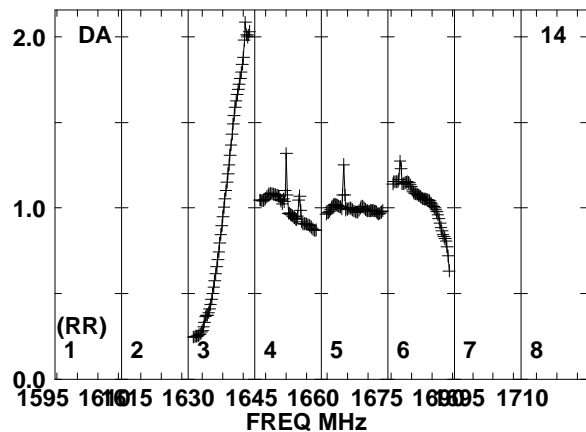
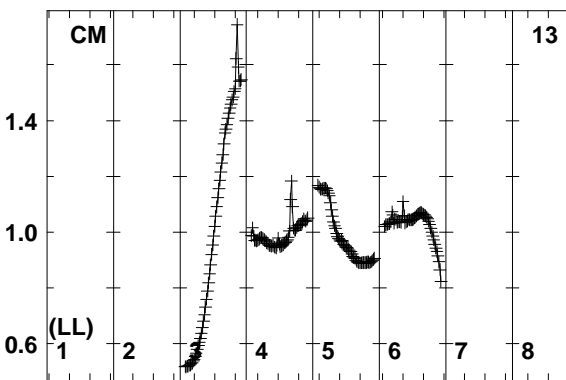
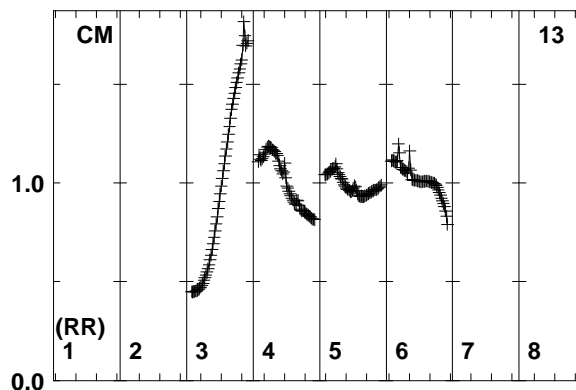
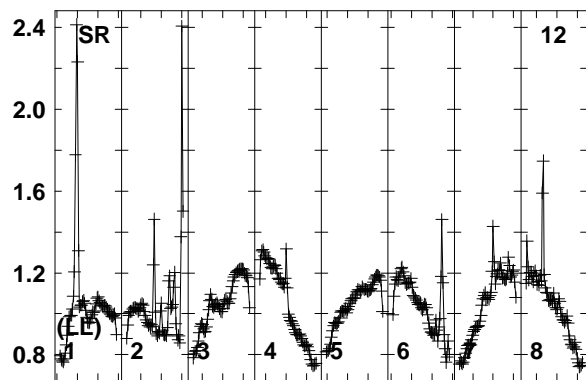
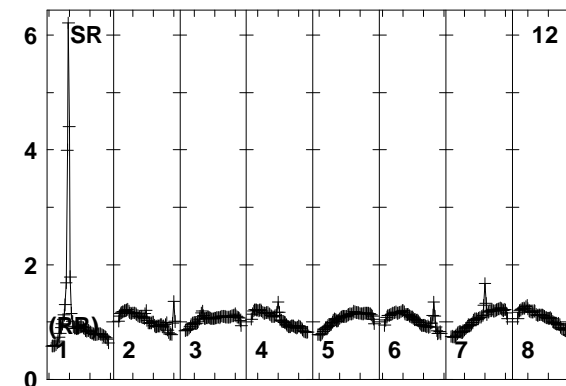
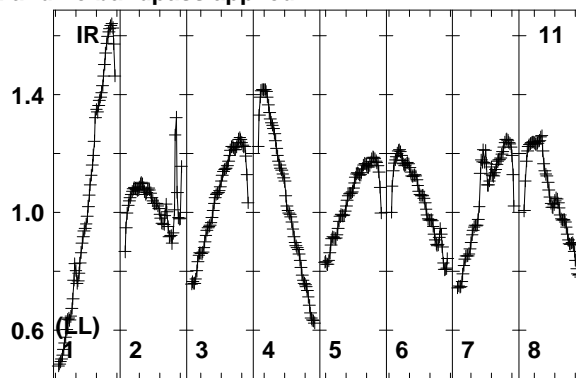
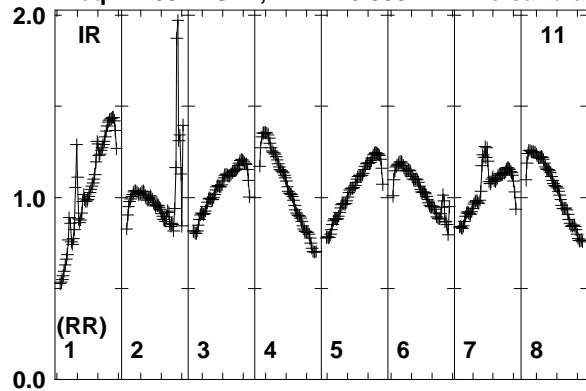

Lower frame: Real Jy
Total-power spectrum Antenna: IR (11)
Timerange: 00/03:13:11 to 00/03:14:09

Plot file version 24 created 04-NOV-2019 14:14:01
J2248-0541 EY034.UVDATA.1
Freq = 1.5947 GHz, Bw = 16.000 MH No calibration applied and no bandpass applied

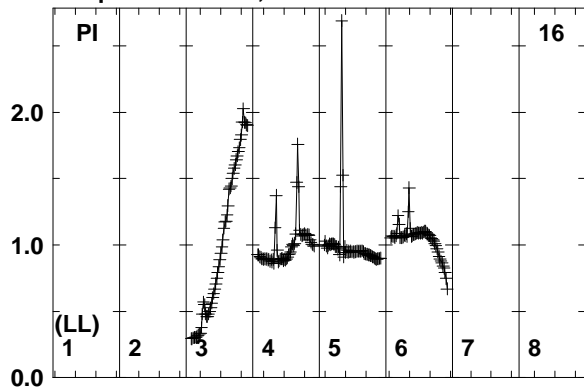

Lower frame: Real Jy
Total-power spectrum Antenna: PI (16)
Timerange: 00/03:13:11 to 00/03:14:09

Plot file version 25 created 04-NOV-2019 14:14:01

W2246-0526 EY034.UVDATA.1

Freq = 1.5947 GHz, Bw = 16.000 MH No calibration applied and no bandpass applied

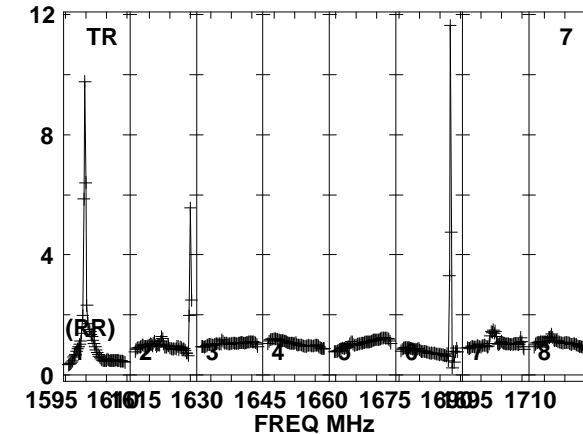
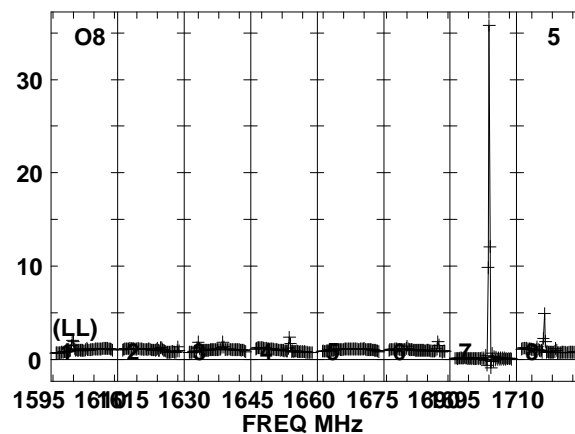
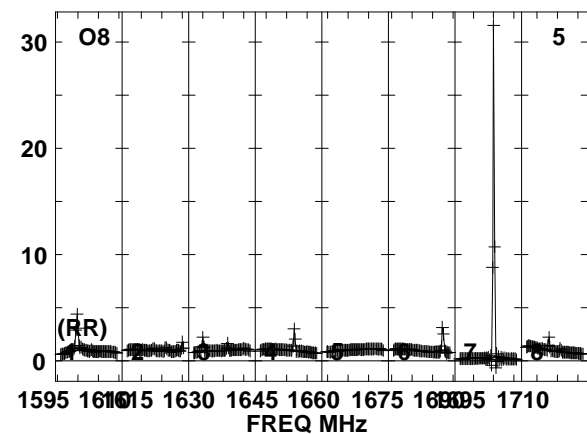
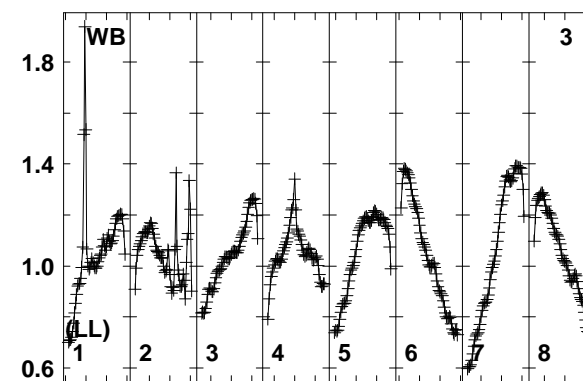
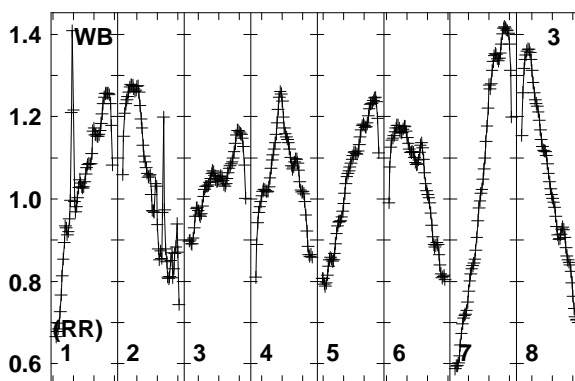
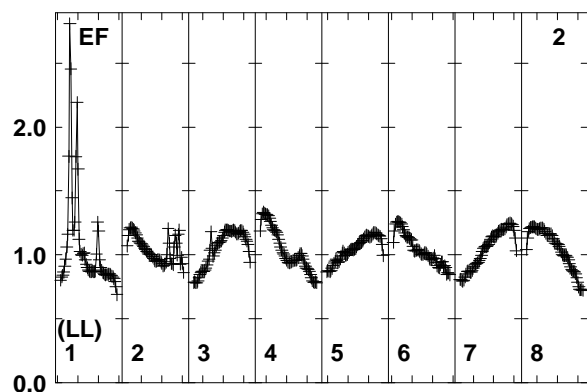
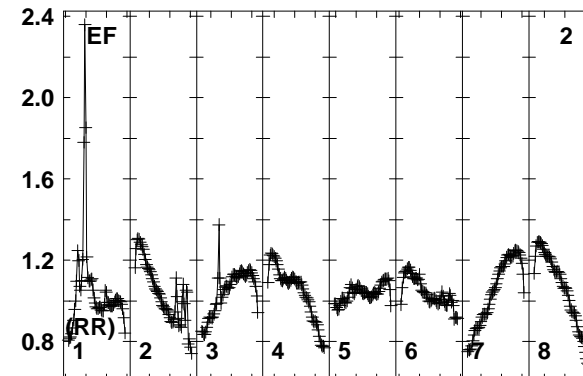
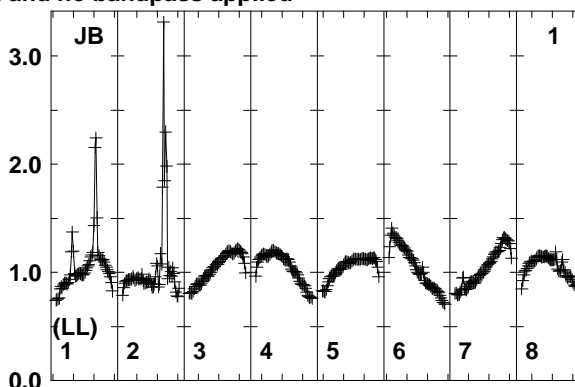
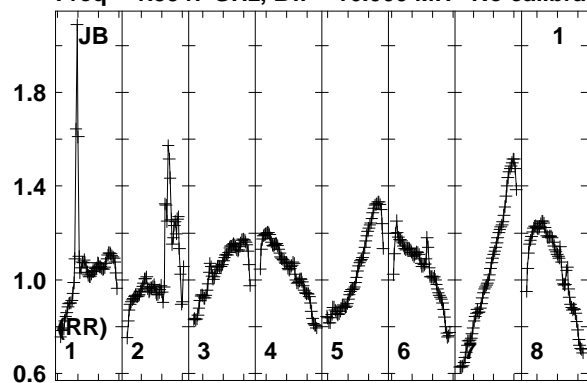

Lower frame: Real Jy
Total-power spectrum Antenna: JB (01)
Timerange: 00/03:14:11 to 00/03:16:49

Plot file version 26 created 04-NOV-2019 14:14:02

W2246-0526 EY034.UVDATA.1

Freq = 1.5947 GHz, Bw = 16.000 MH No calibration applied and no bandpass applied

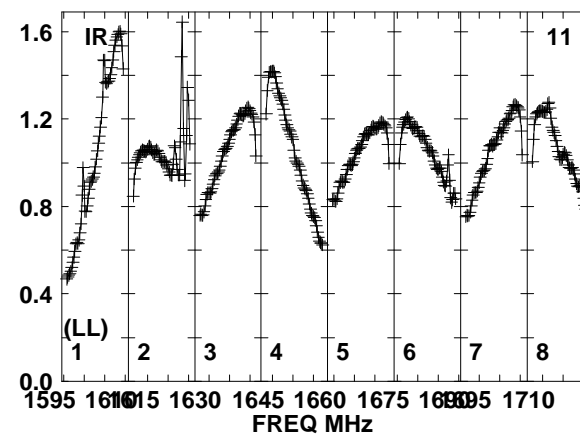
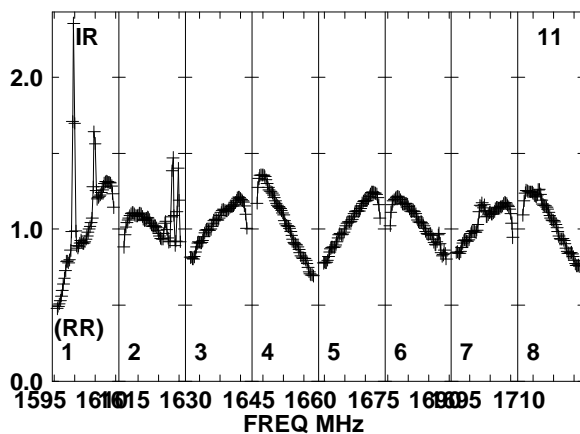
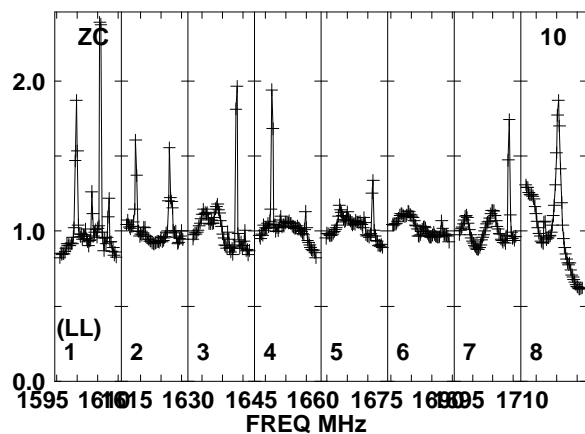
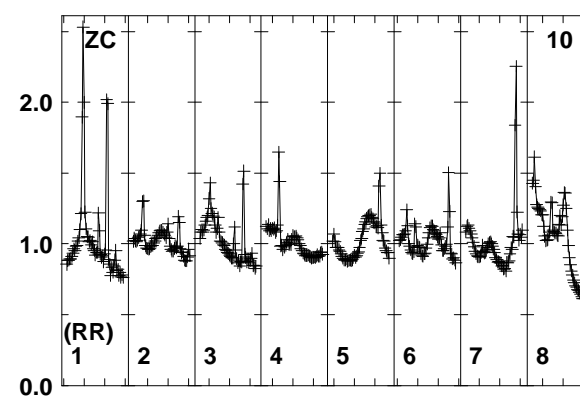
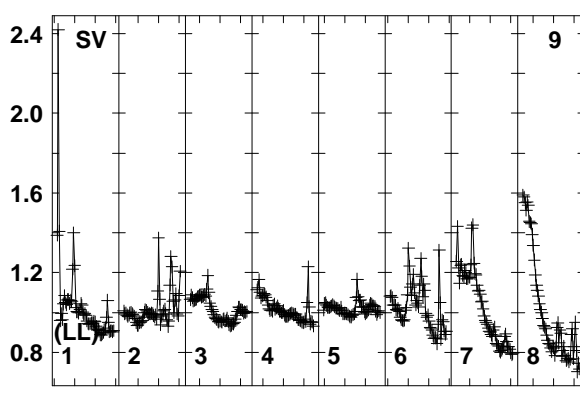
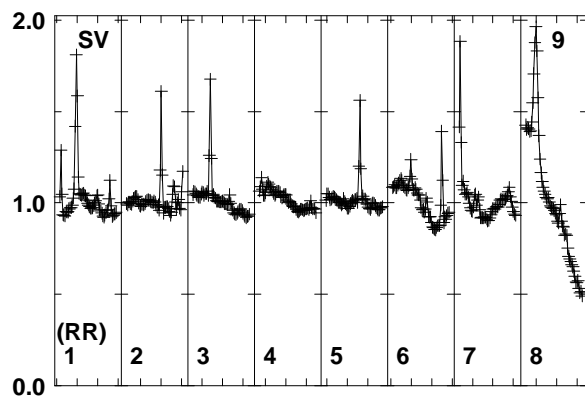
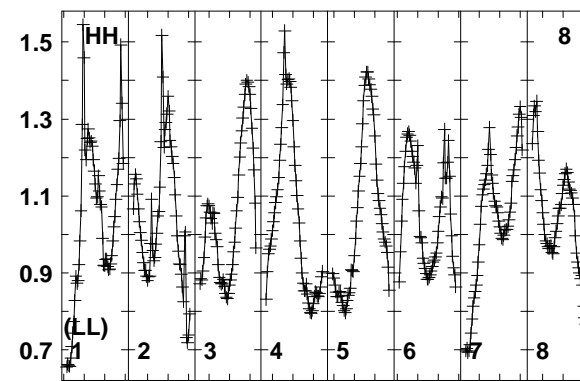
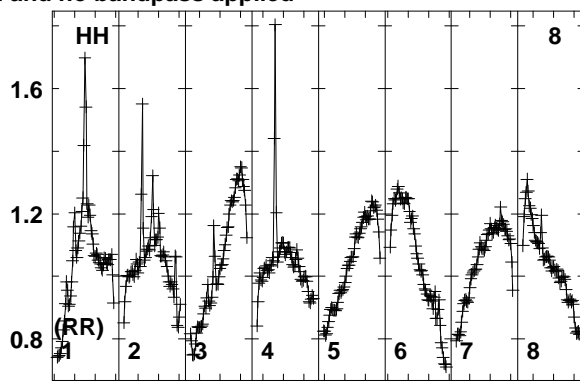
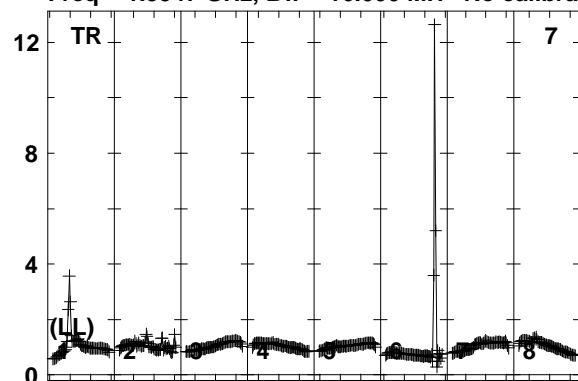

Lower frame: Real Jy
Total-power spectrum Antenna: TR (07)
Timerange: 00/03:14:11 to 00/03:16:49

Plot file version 27 created 04-NOV-2019 14:14:02

W2246-0526 EY034.UVDATA.1

Freq = 1.5947 GHz, Bw = 16.000 MH No calibration applied and no bandpass applied

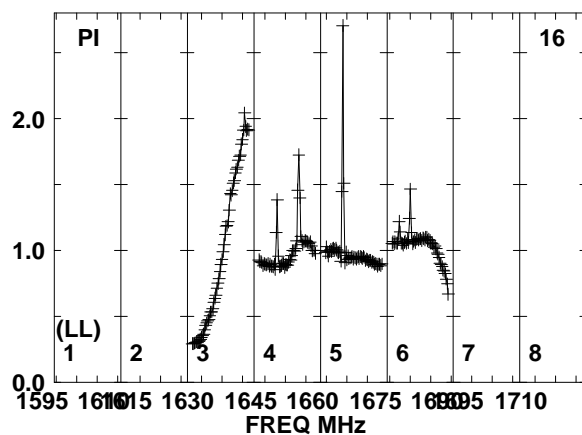
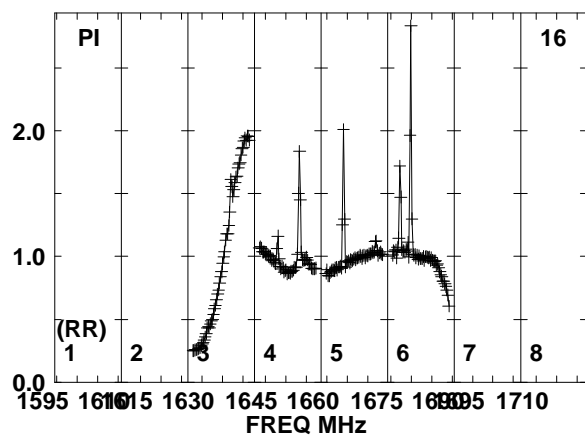
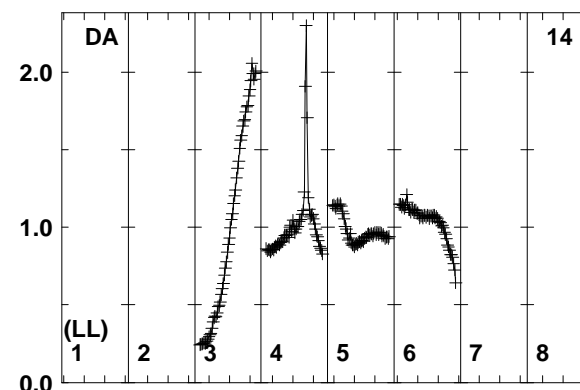
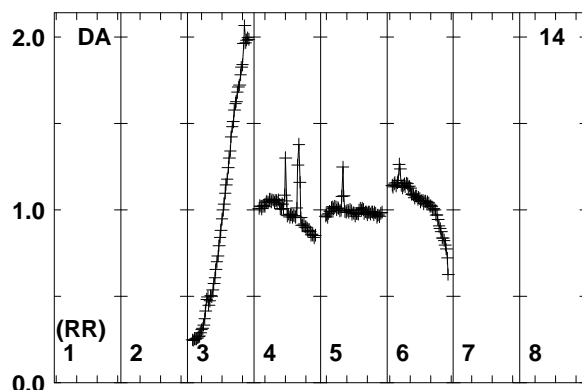
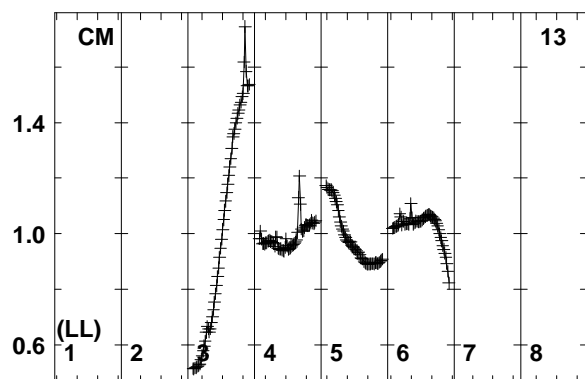
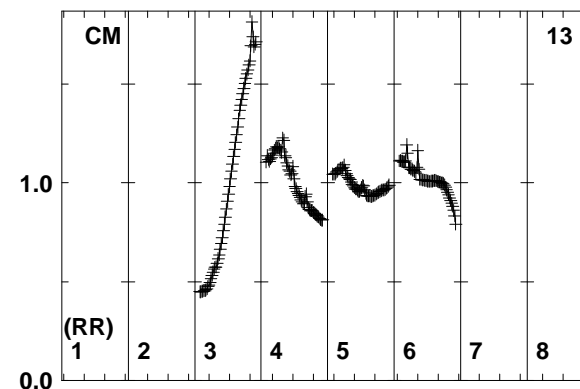
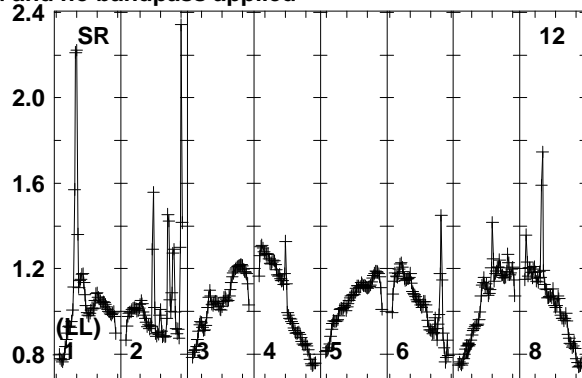
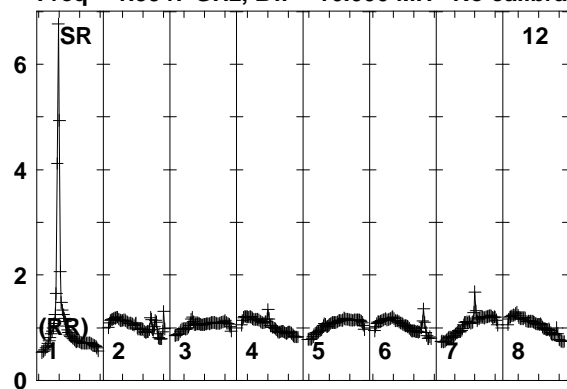

Lower frame: Real Jy
Total-power spectrum Antenna: SR (12)
Timerange: 00/03:14:11 to 00/03:16:49

Plot file version 28 created 04-NOV-2019 14:14:02

J2248-0541 EY034.UVDATA.1

Freq = 1.5947 GHz, Bw = 16.000 MH No calibration applied and no bandpass applied

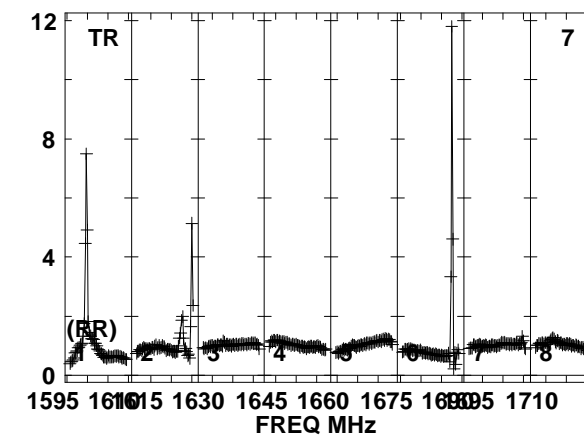
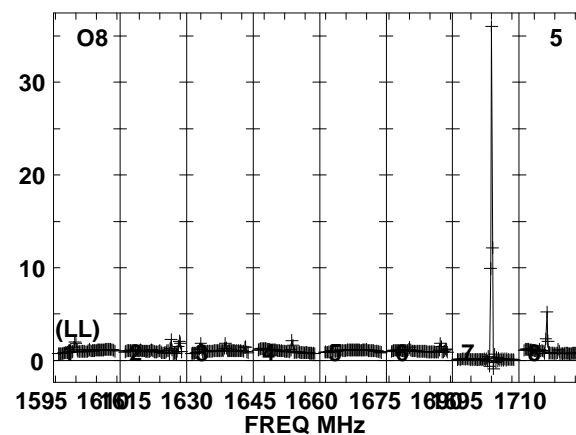
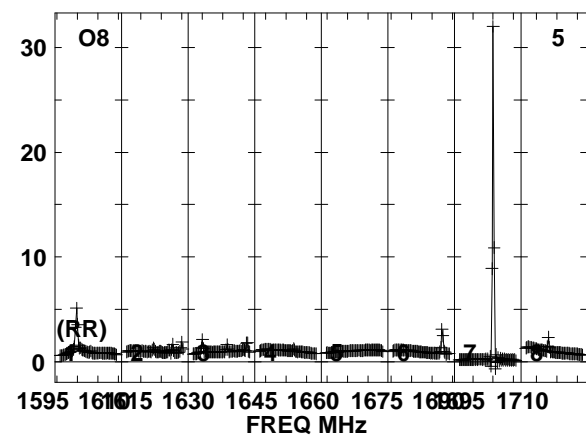
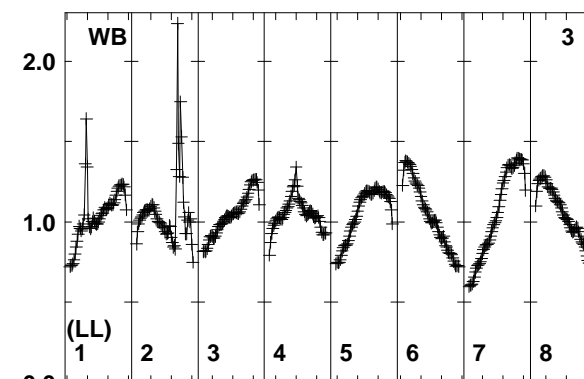
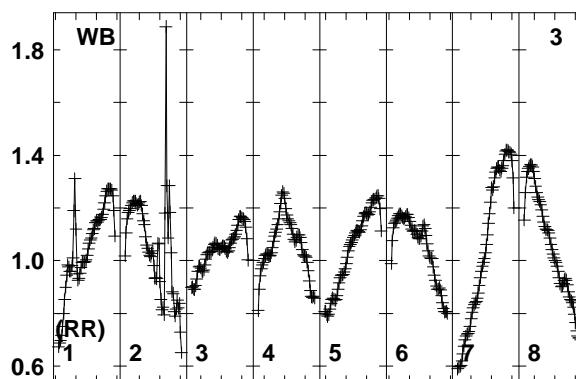
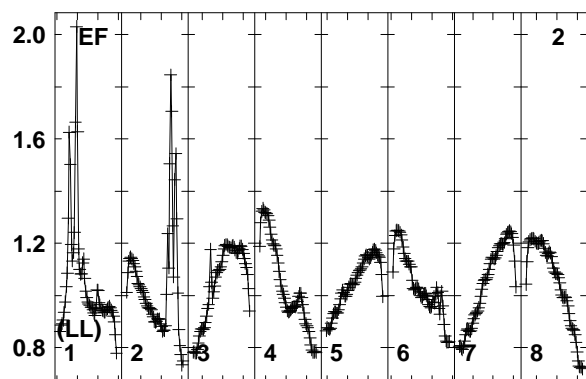
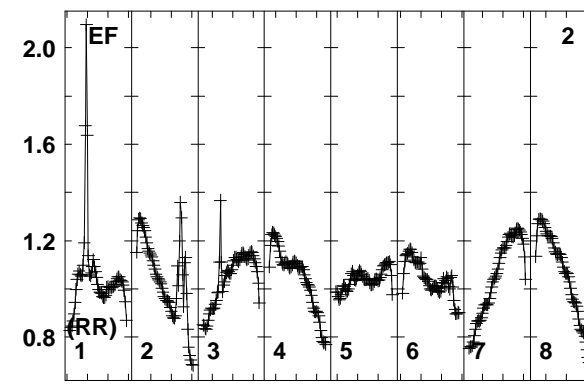
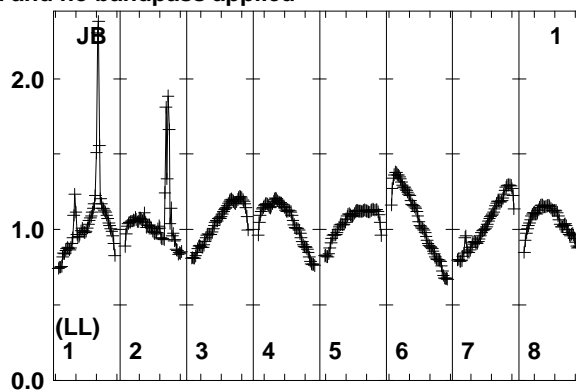
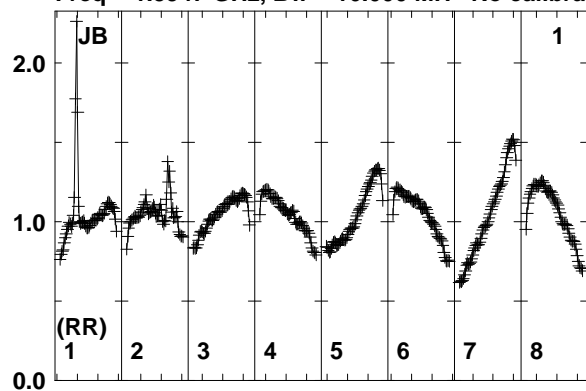

Lower frame: Real Jy
Total-power spectrum Antenna: JB (01)
Timerange: 00/03:17:06 to 00/03:18:04

Plot file version 29 created 04-NOV-2019 14:14:02

J2248-0541 EY034.UVDATA.1

Freq = 1.5947 GHz, Bw = 16.000 MH No calibration applied and no bandpass applied

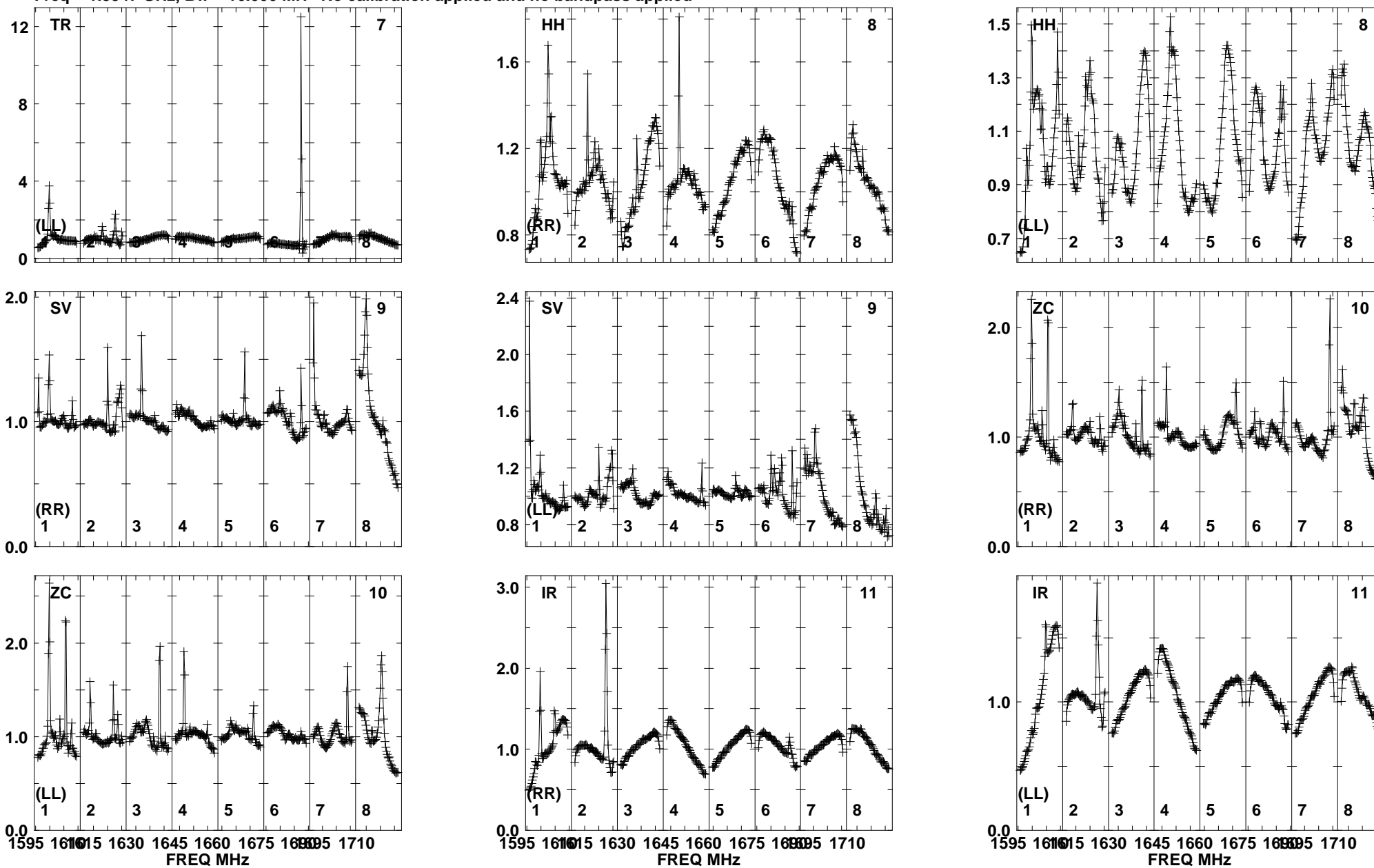

Lower frame: Real Jy
Total-power spectrum Antenna: TR (07)
Timerange: 00/03:17:06 to 00/03:18:04

Plot file version 30 created 04-NOV-2019 14:14:02

J2248-0541 EY034.UVDATA.1

Freq = 1.5947 GHz, Bw = 16.000 MH No calibration applied and no bandpass applied

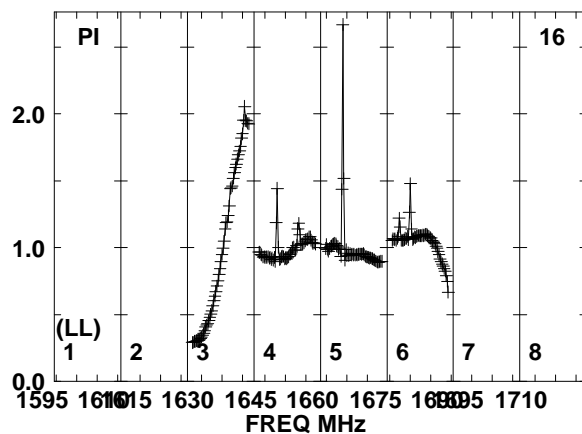
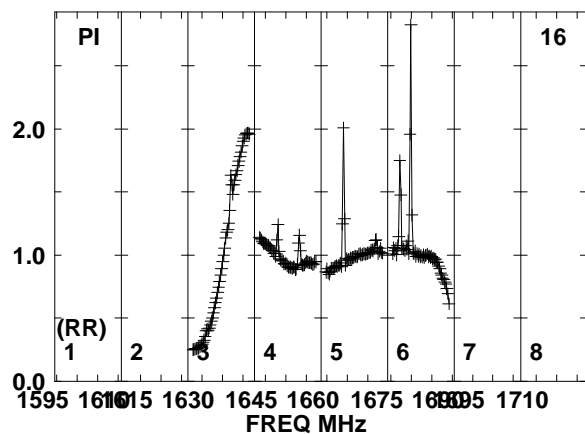
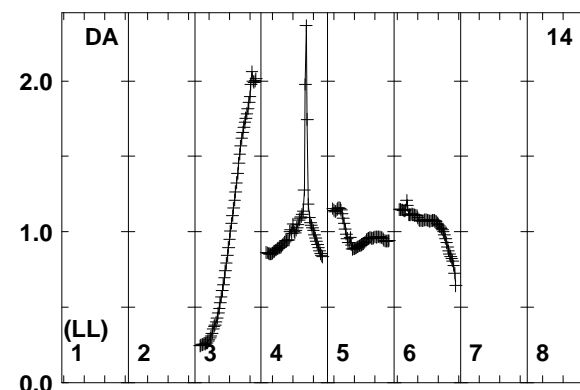
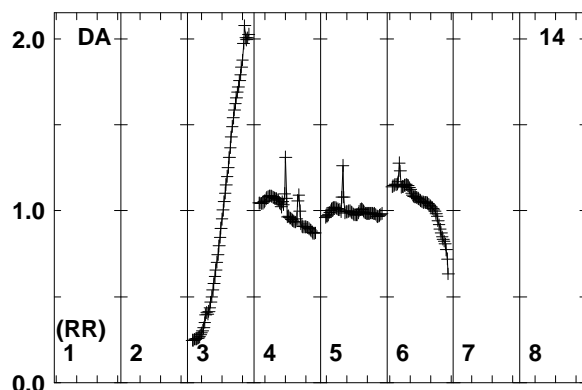
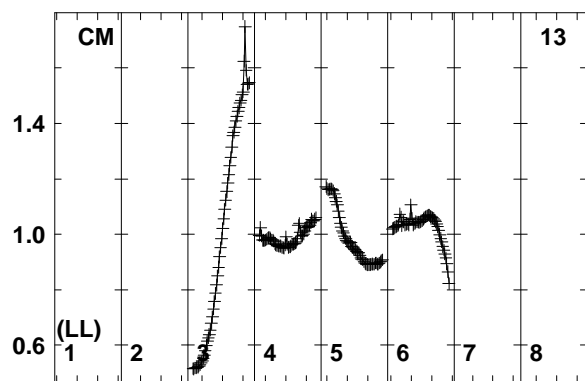
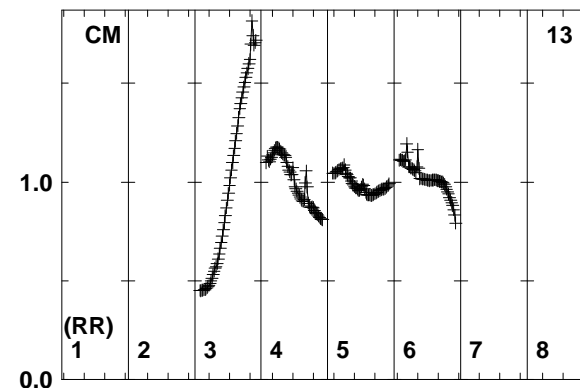
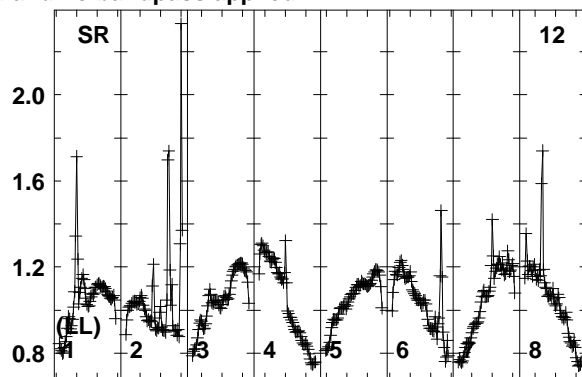
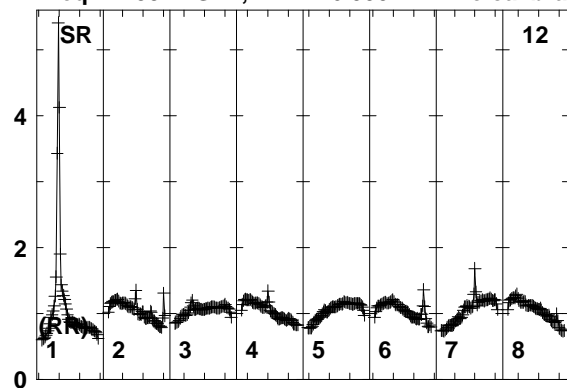

Lower frame: Real Jy
Total-power spectrum Antenna: SR (12)
Timerange: 00/03:17:06 to 00/03:18:04

Plot file version 31 created 04-NOV-2019 14:14:02

W2246-0526 EY034.UVDATA.1

Freq = 1.5947 GHz, Bw = 16.000 MH No calibration applied and no bandpass applied

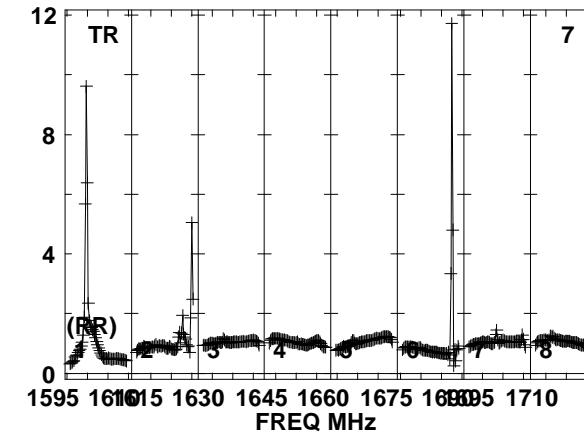
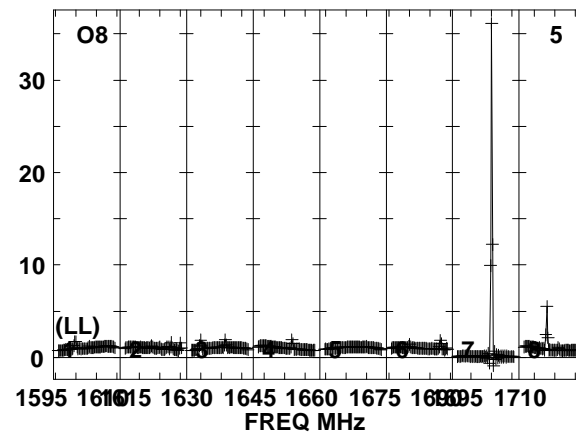
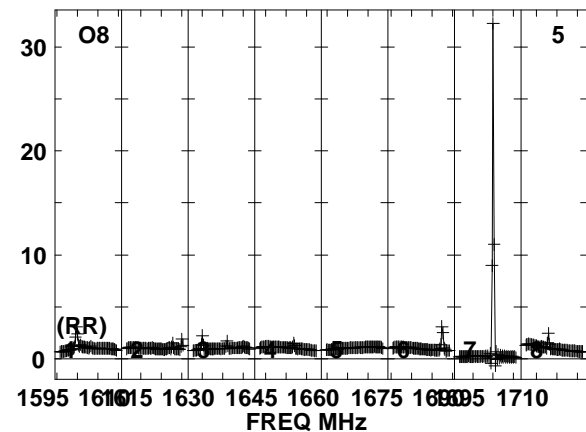
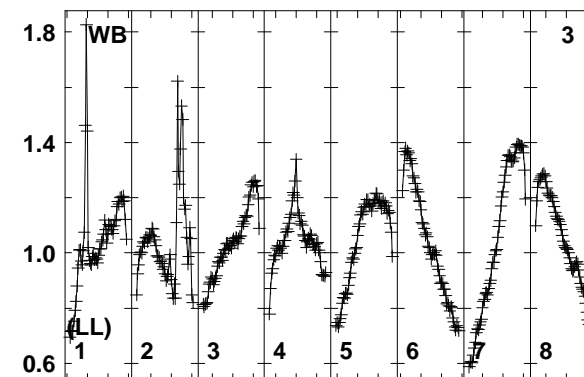
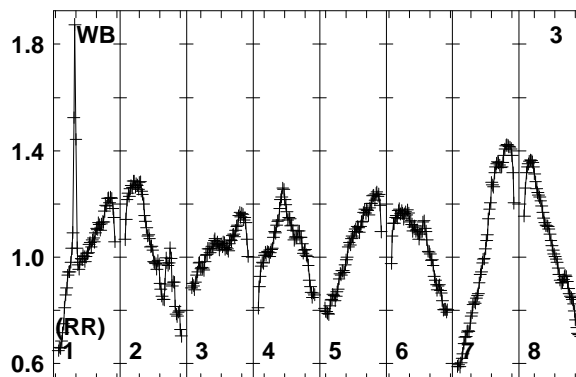
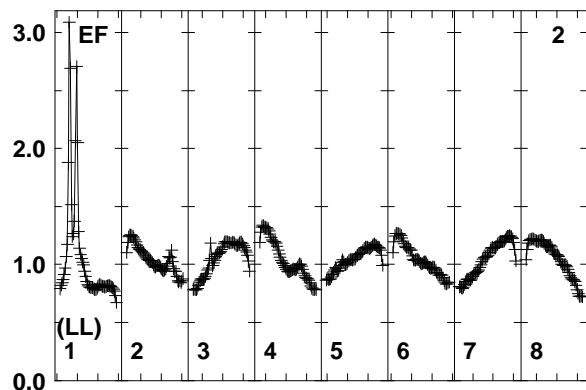
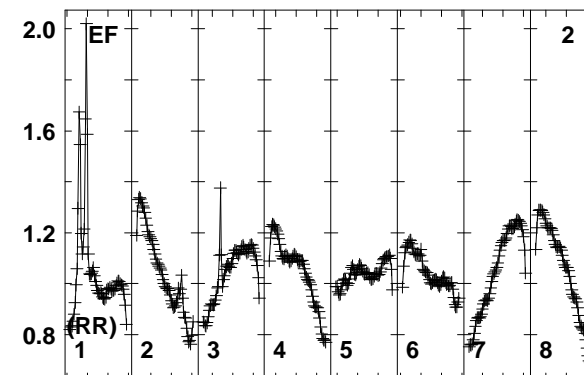
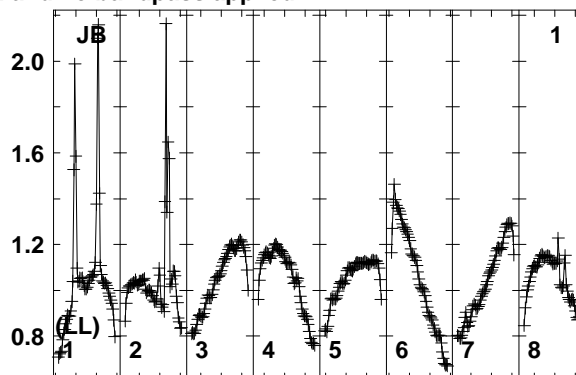
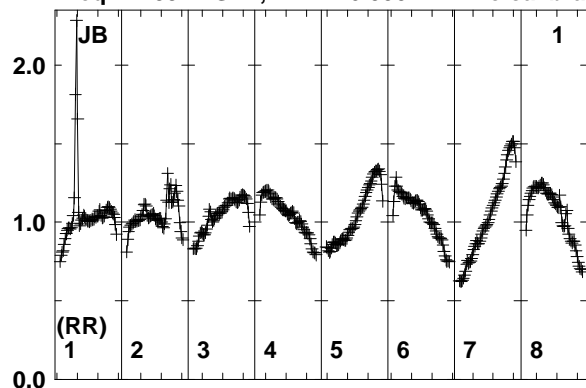

Lower frame: Real Jy
Total-power spectrum Antenna: JB (01)
Timerange: 00/03:18:06 to 00/03:20:44

Plot file version 32 created 04-NOV-2019 14:14:02

W2246-0526 EY034.UVDATA.1

Freq = 1.5947 GHz, Bw = 16.000 MH No calibration applied and no bandpass applied

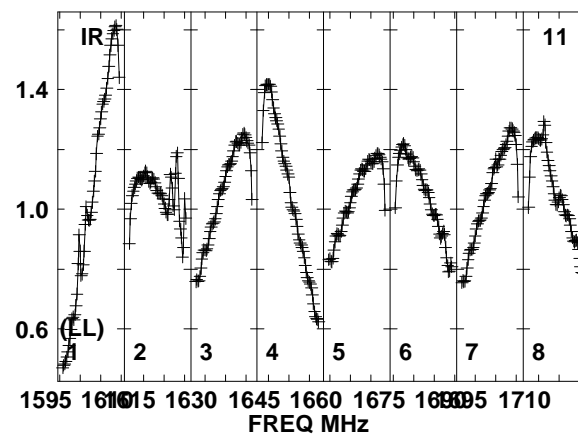
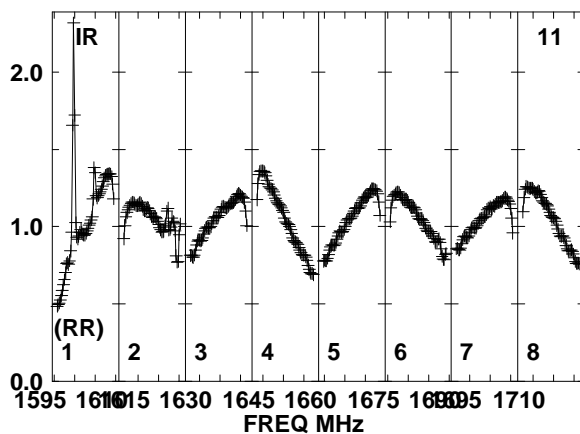
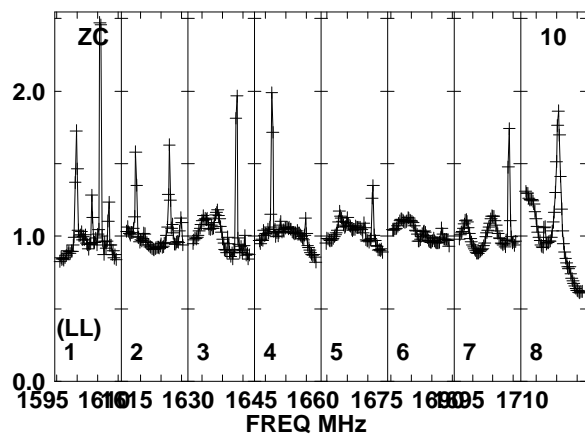
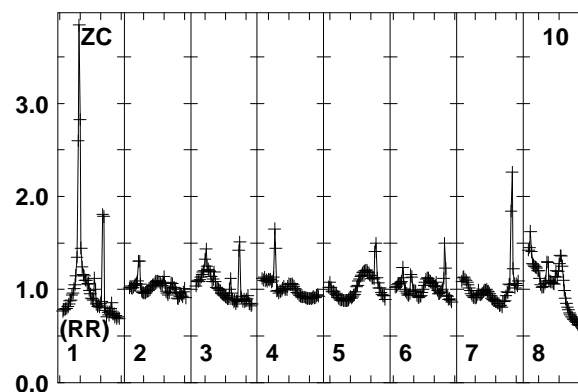
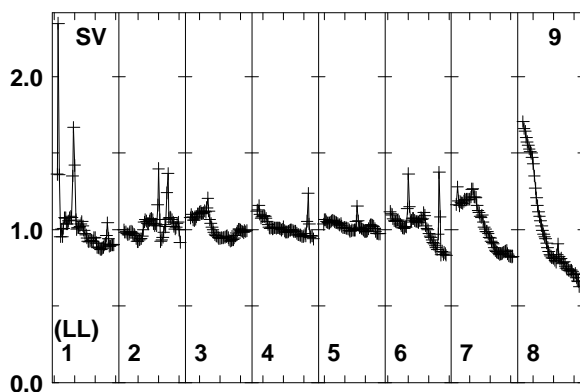
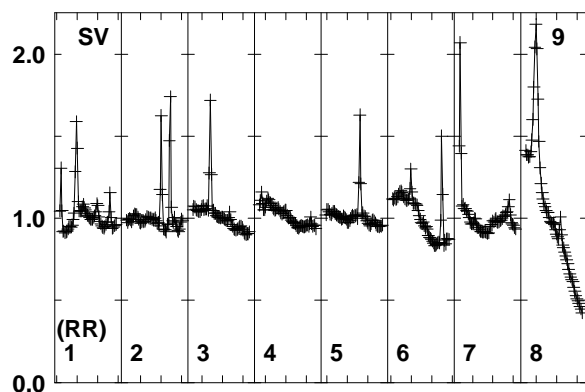
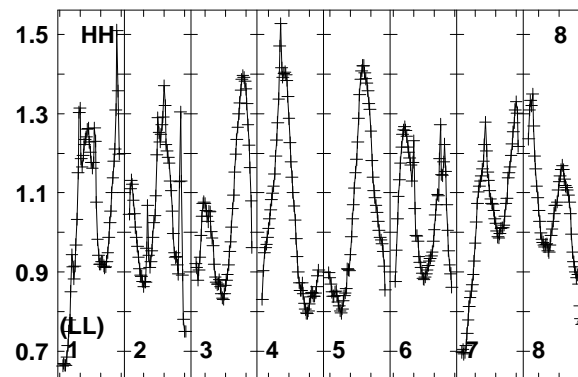
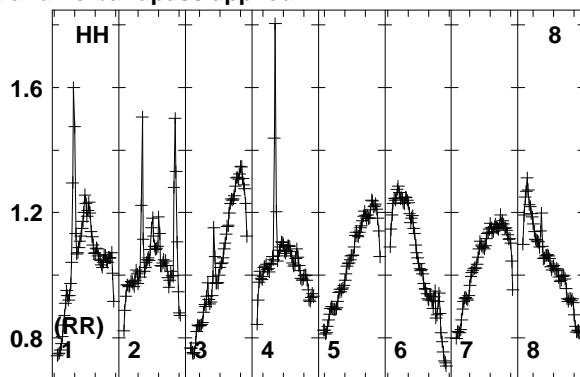
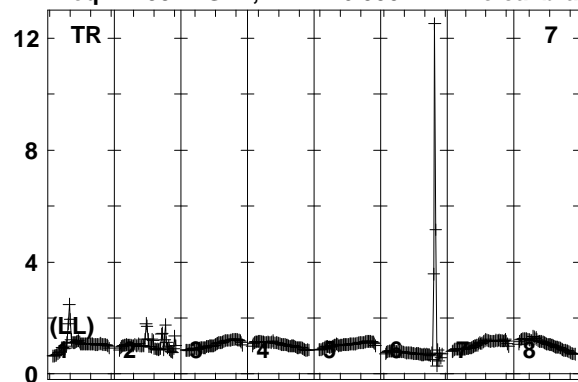

Lower frame: Real Jy
Total-power spectrum Antenna: TR (07)
Timerange: 00/03:18:06 to 00/03:20:44

Plot file version 33 created 04-NOV-2019 14:14:02

W2246-0526 EY034.UVDATA.1

Freq = 1.5947 GHz, Bw = 16.000 MH No calibration applied and no bandpass applied

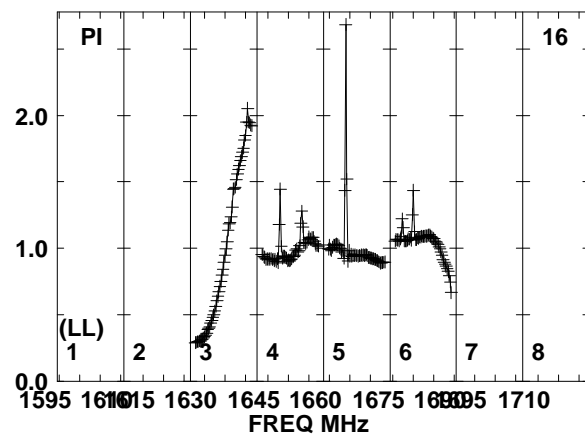
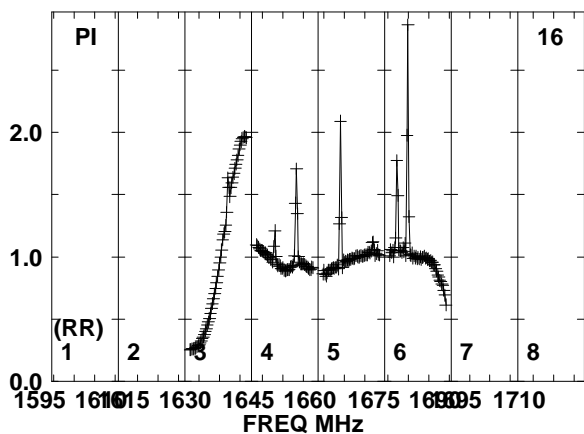
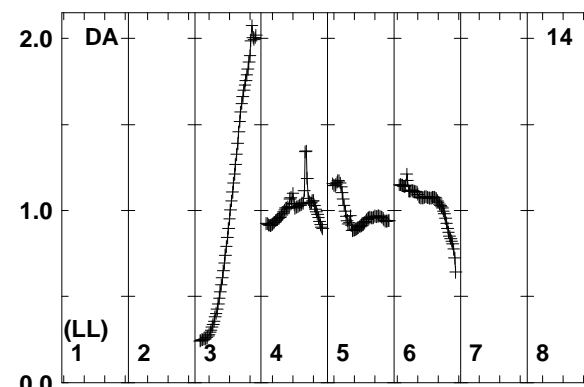
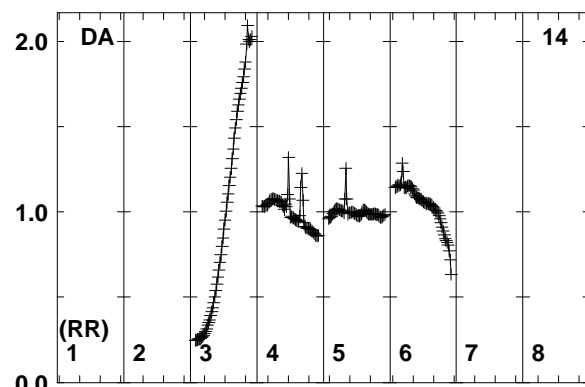
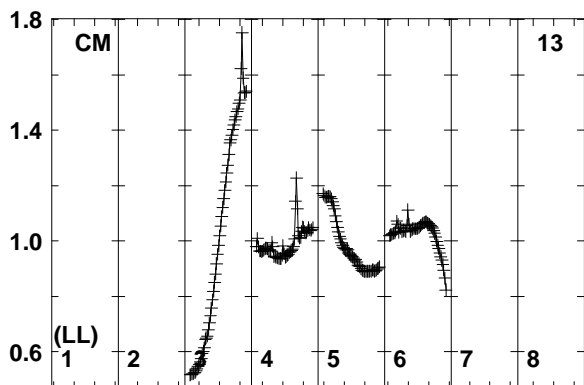
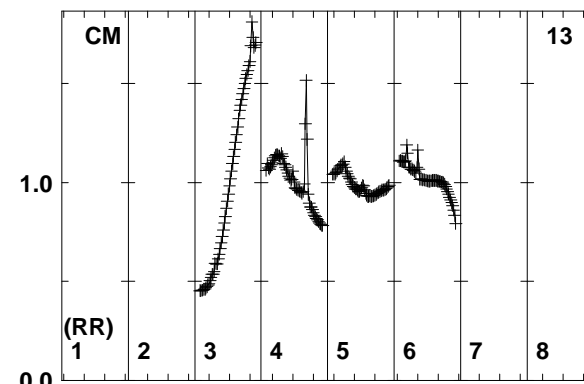
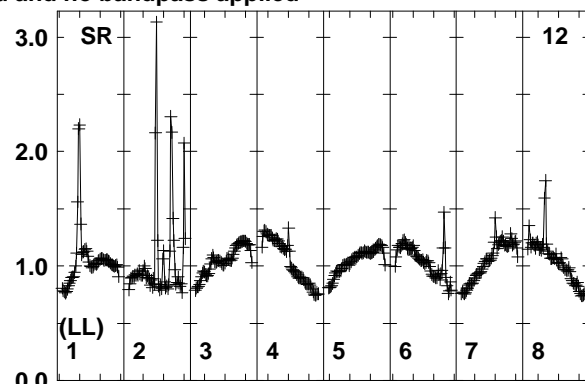
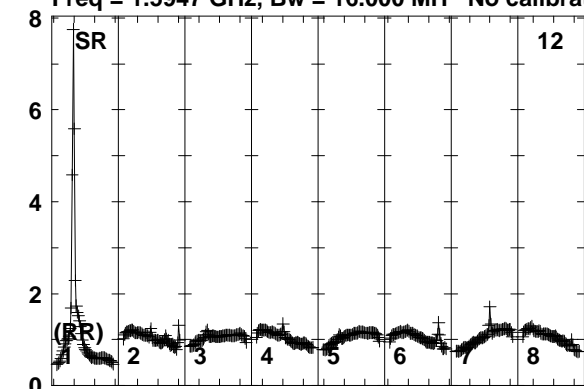

Lower frame: Real Jy
Total-power spectrum Antenna: SR (12)
Timerange: 00/03:18:06 to 00/03:20:44

Plot file version 34 created 04-NOV-2019 14:14:02

J2248-0541 EY034.UVDATA.1

Freq = 1.5947 GHz, Bw = 16.000 MH No calibration applied and no bandpass applied

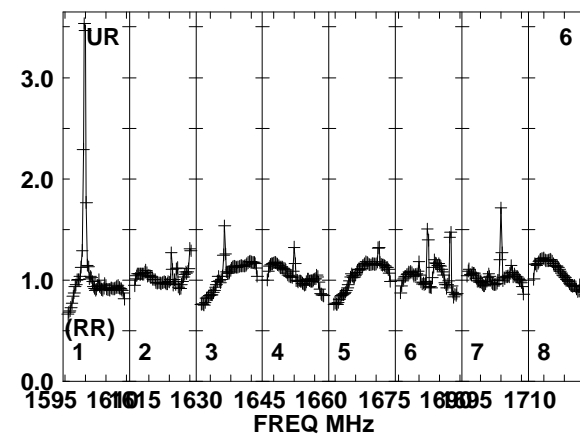
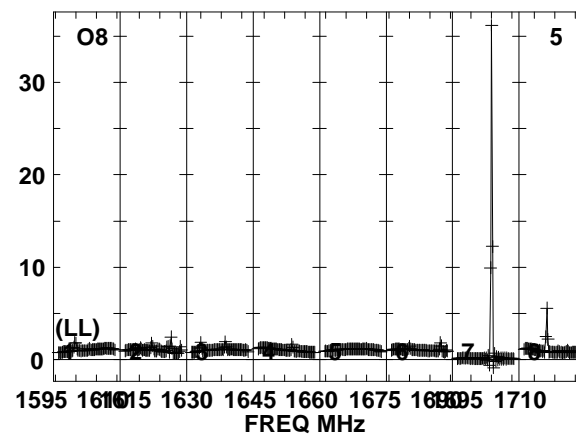
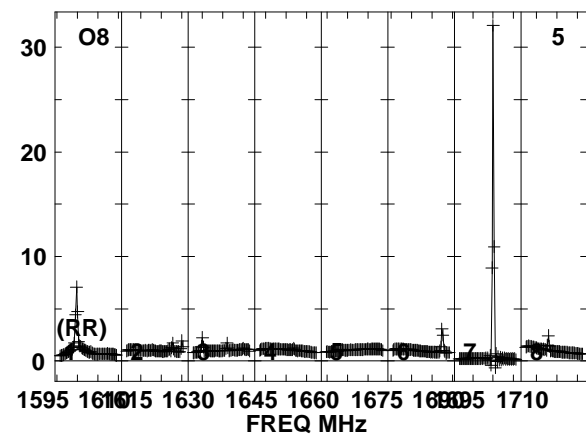
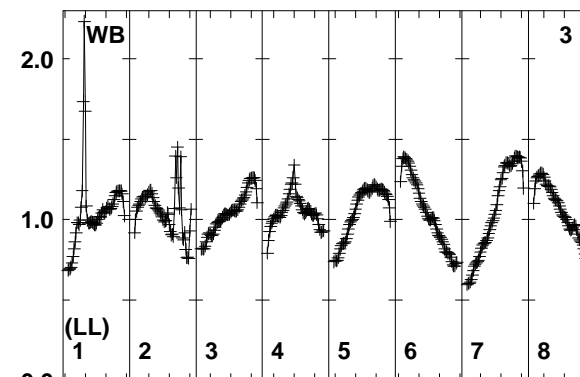
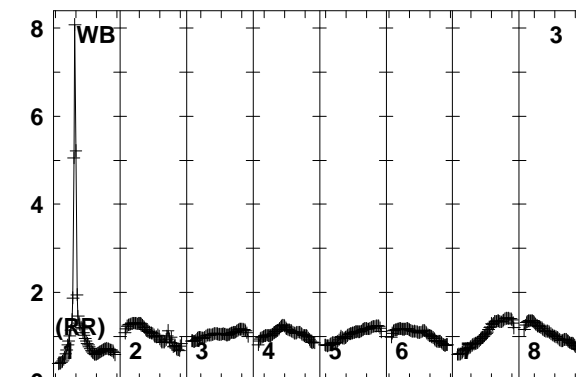
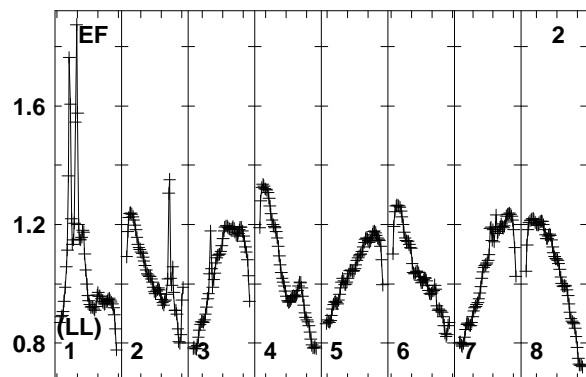
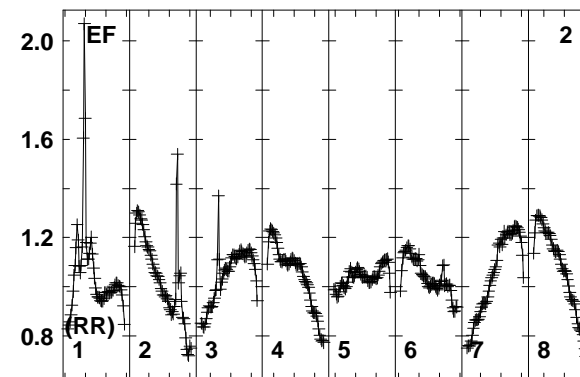
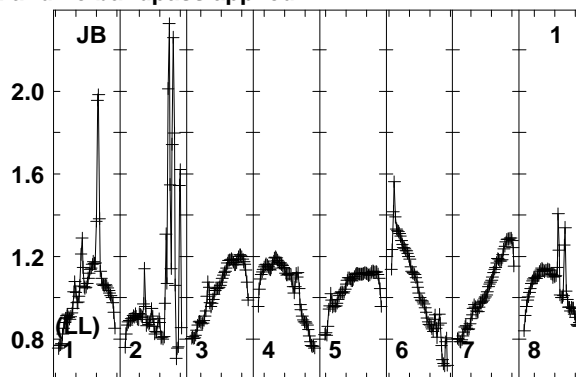
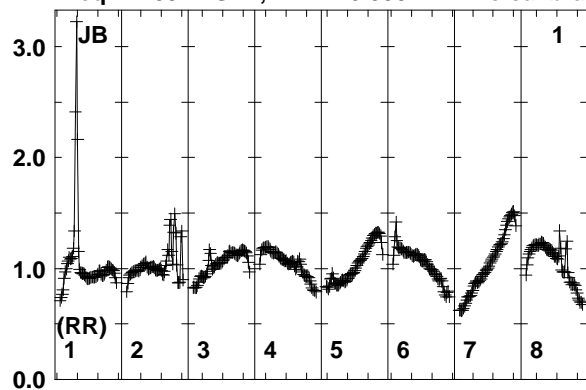

Lower frame: Real Jy
Total-power spectrum Antenna: JB (01)
Timerange: 00/03:21:21 to 00/03:22:19

Plot file version 35 created 04-NOV-2019 14:14:02

J2248-0541 EY034.UVDATA.1

Freq = 1.5947 GHz, Bw = 16.000 MH No calibration applied and no bandpass applied

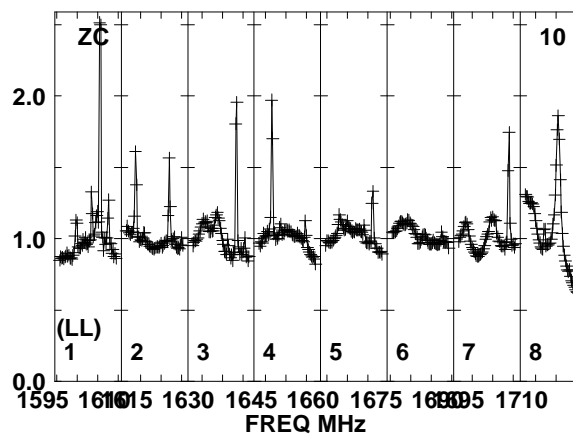
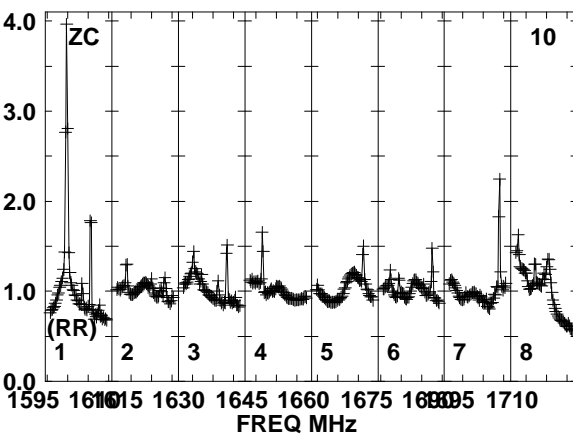
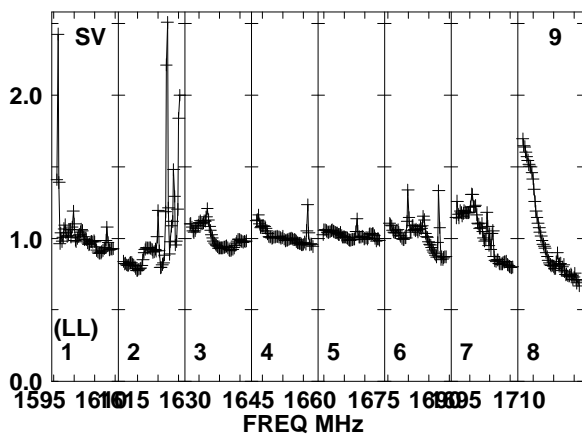
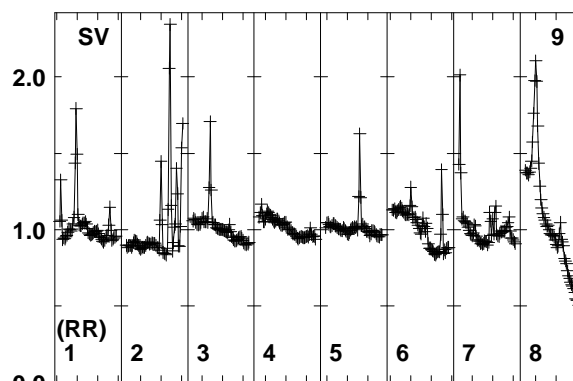
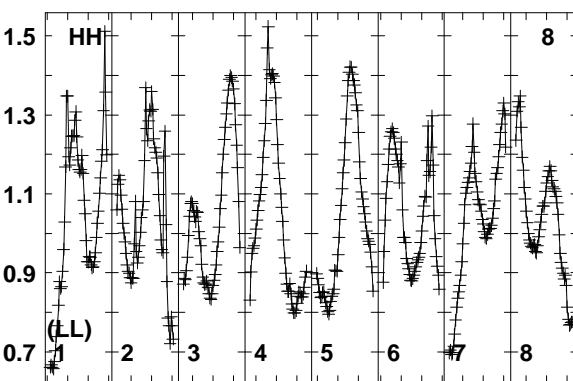
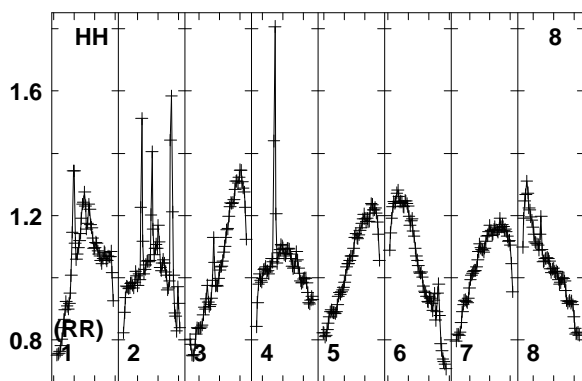
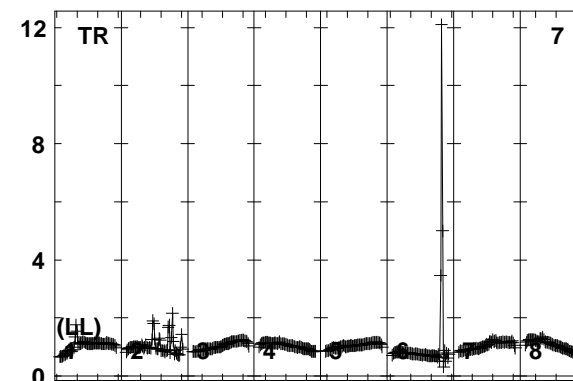
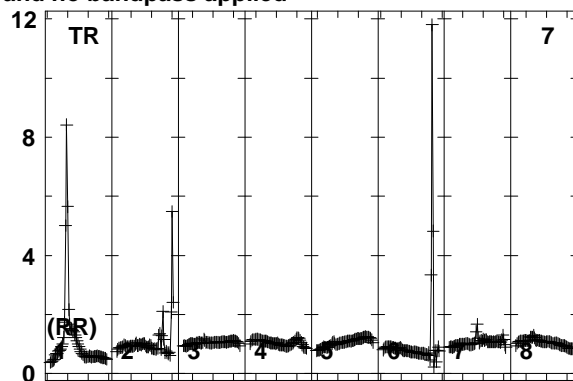
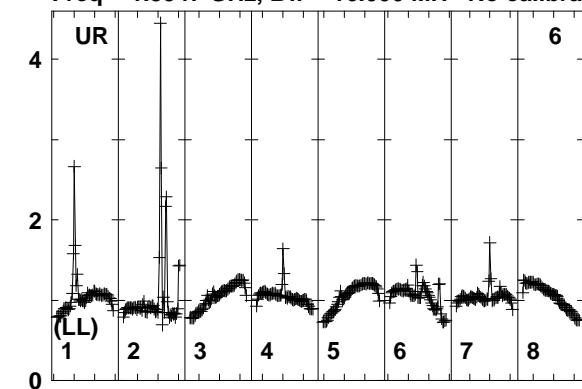

Lower frame: Real Jy
Total-power spectrum Antenna: UR (06)
Timerange: 00/03:21:21 to 00/03:22:19

Plot file version 36 created 04-NOV-2019 14:14:02

J2248-0541 EY034.UVDATA.1

Freq = 1.5947 GHz, Bw = 16.000 MH No calibration applied and no bandpass applied

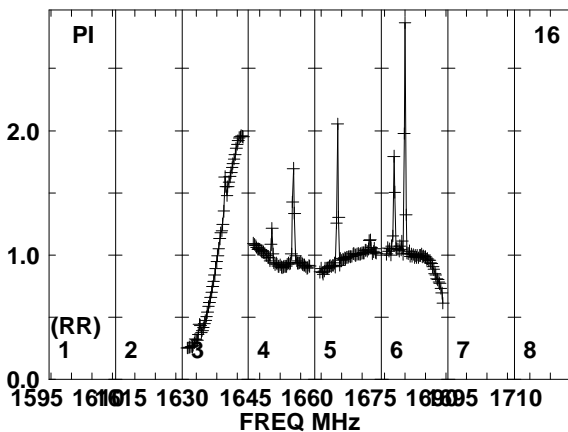
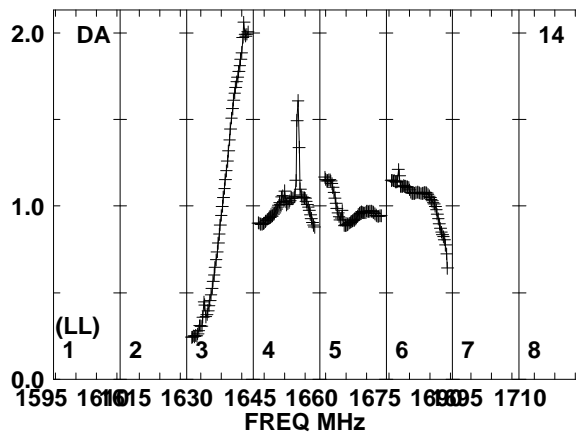
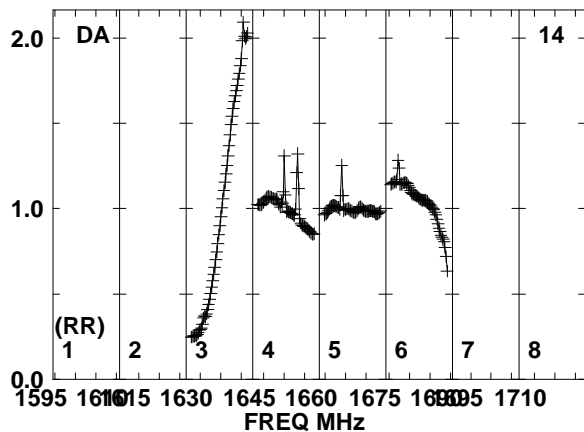
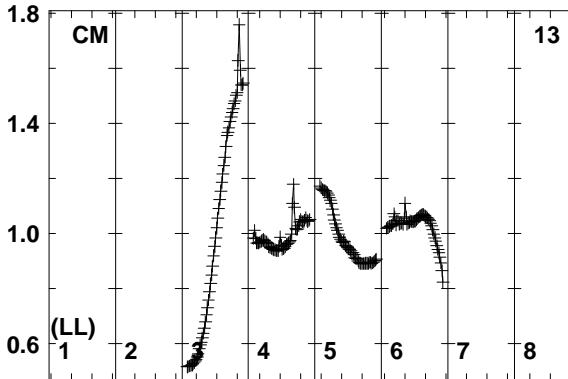
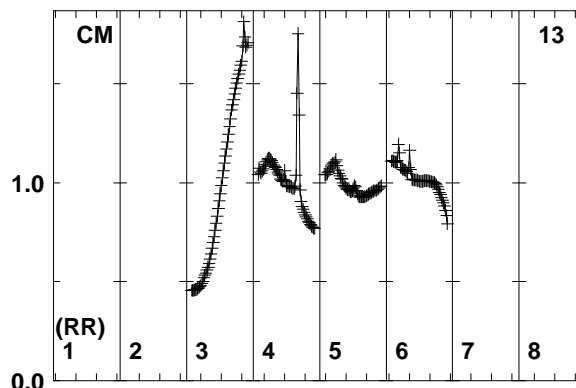
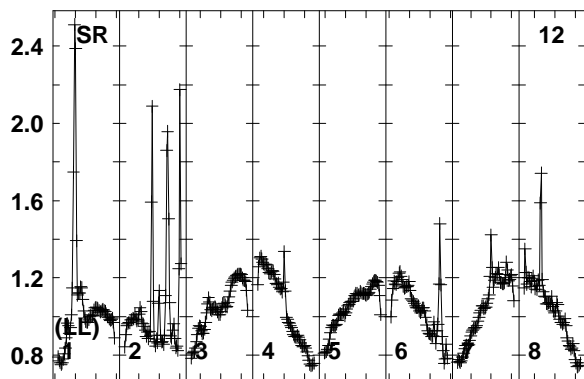
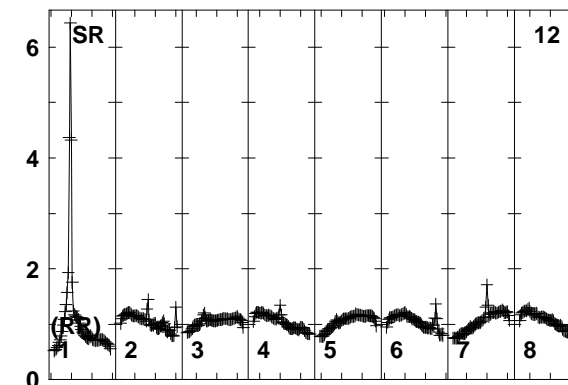
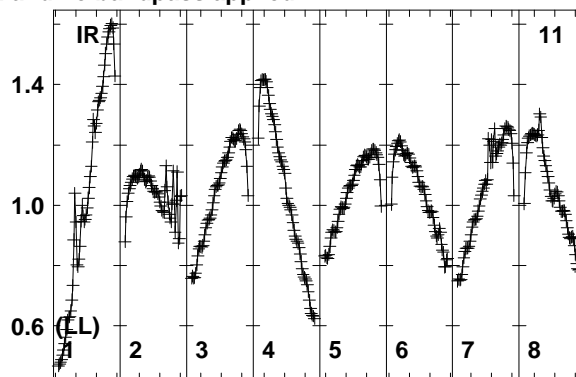
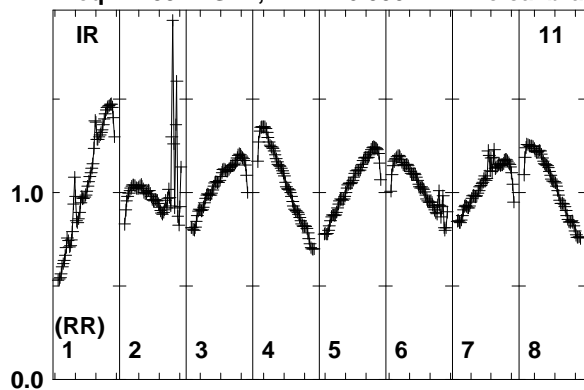

Lower frame: Real Jy
Total-power spectrum Antenna: IR (11)
Timerange: 00/03:21:21 to 00/03:22:19

Plot file version 37 created 04-NOV-2019 14:14:03
J2248-0541 EY034.UVDATA.1
Freq = 1.5947 GHz, Bw = 16.000 MH No calibration applied and no bandpass applied

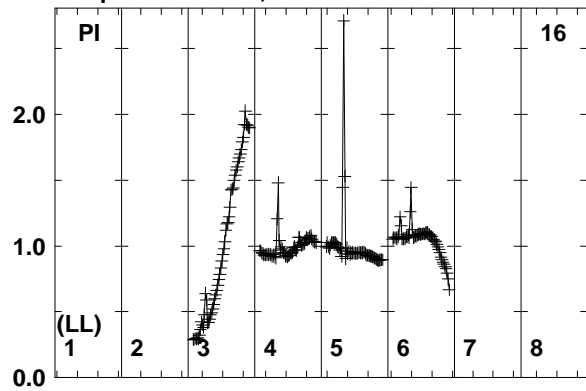

Lower frame: Real Jy
Total-power spectrum Antenna: PI (16)
Timerange: 00/03:21:21 to 00/03:22:19

Plot file version 38 created 04-NOV-2019 14:14:03

W2246-0526 EY034.UVDATA.1

Freq = 1.5947 GHz, Bw = 16.000 MH No calibration applied and no bandpass applied

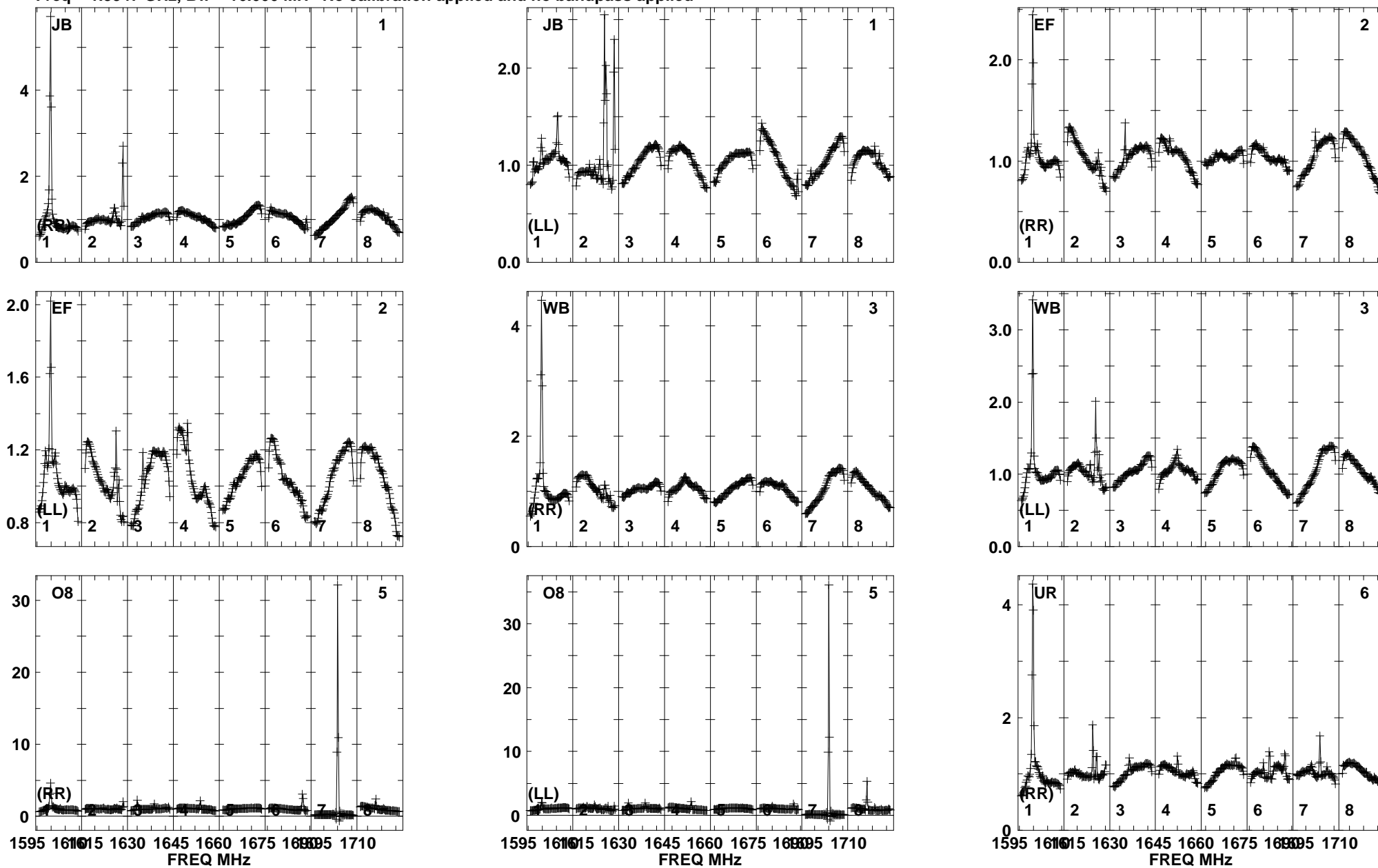

Lower frame: Real Jy
Total-power spectrum Antenna: JB (01)
Timerange: 00/03:22:21 to 00/03:24:59

Plot file version 39 created 04-NOV-2019 14:14:03

W2246-0526 EY034.UVDATA.1

Freq = 1.5947 GHz, Bw = 16.000 MH No calibration applied and no bandpass applied

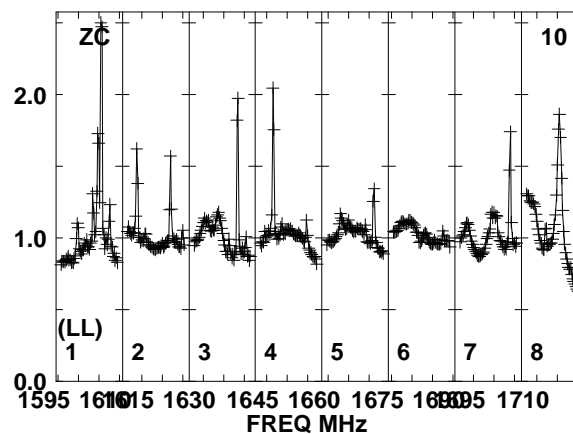
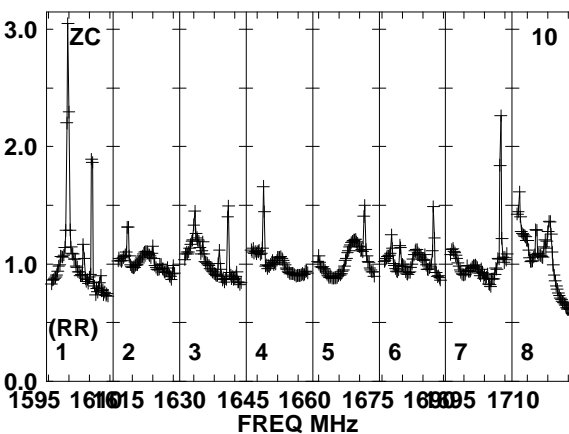
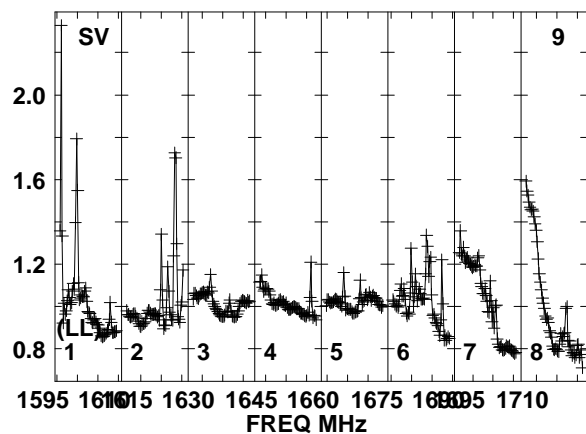
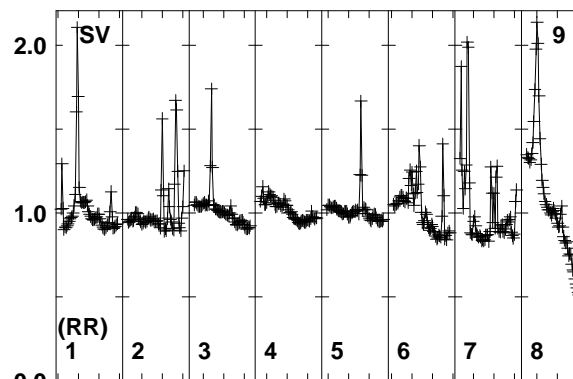
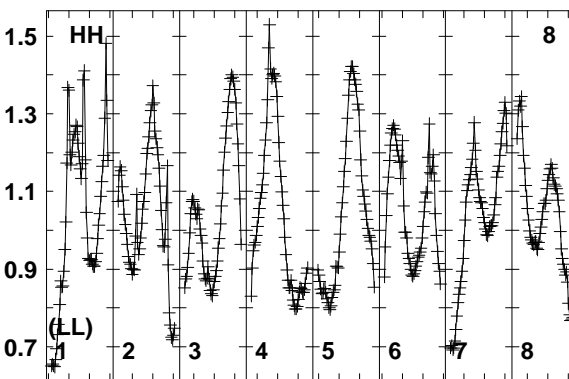
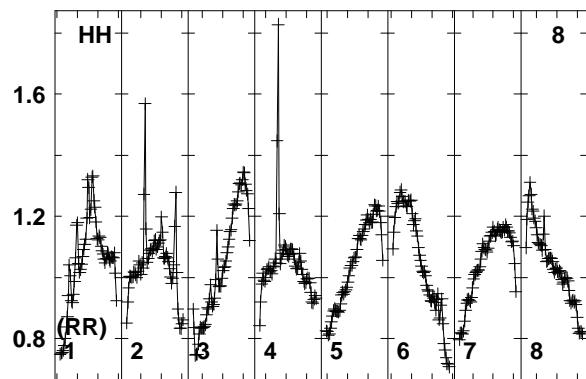
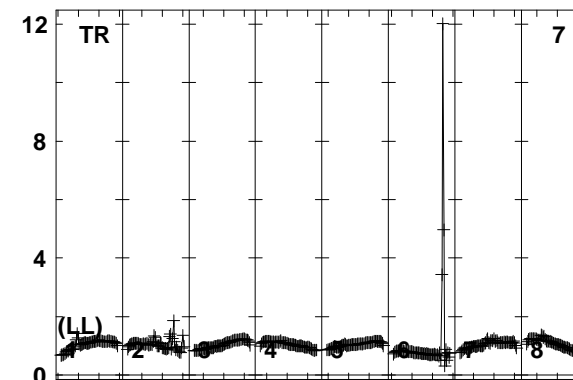
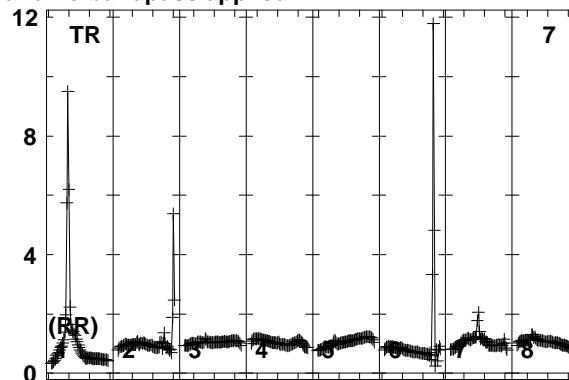
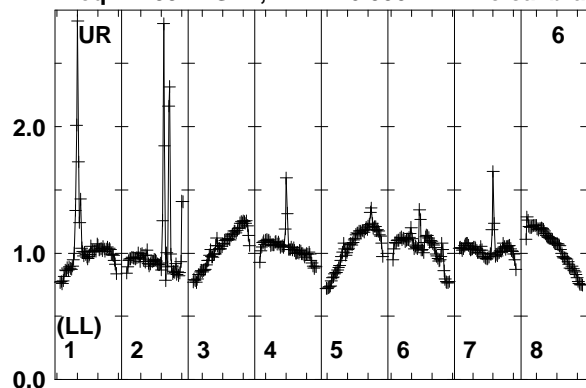

Lower frame: Real Jy
Total-power spectrum Antenna: UR (06)
Timerange: 00/03:22:21 to 00/03:24:59

Plot file version 40 created 04-NOV-2019 14:14:03

W2246-0526 EY034.UVDATA.1

Freq = 1.5947 GHz, Bw = 16.000 MH No calibration applied and no bandpass applied

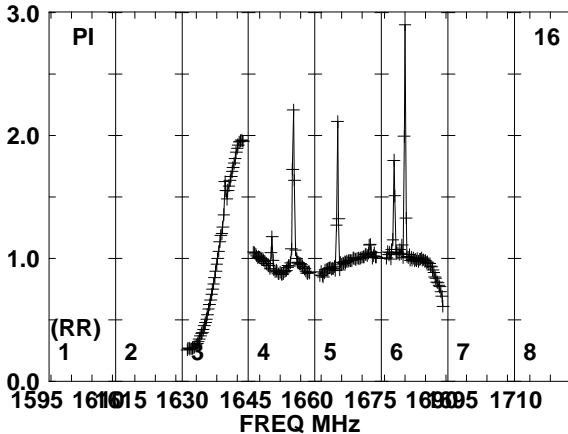
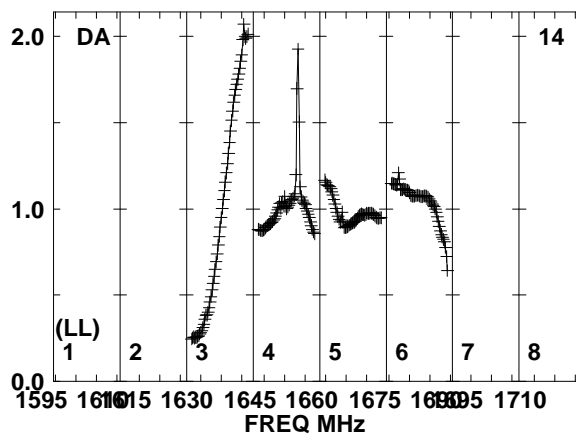
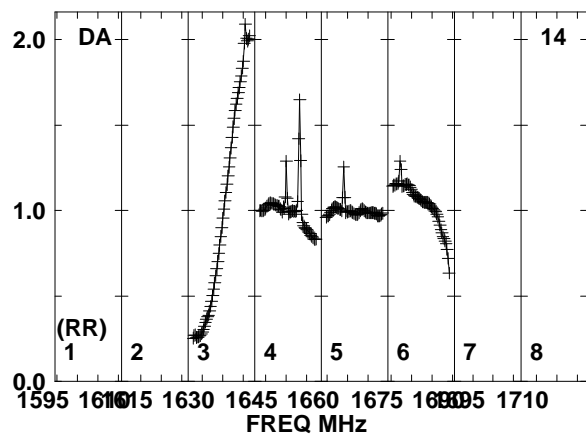
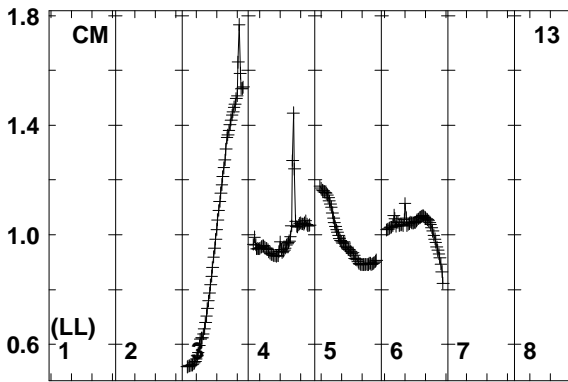
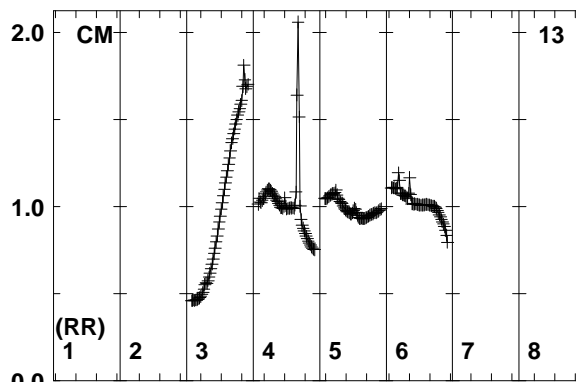
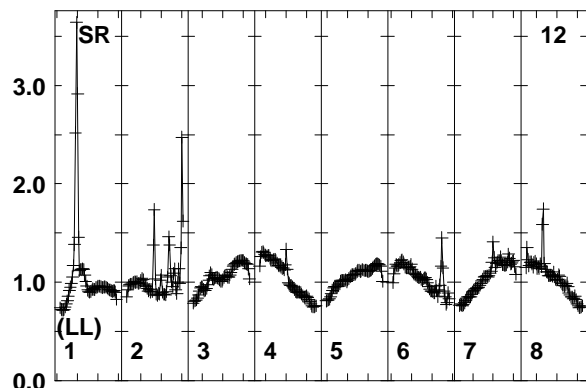
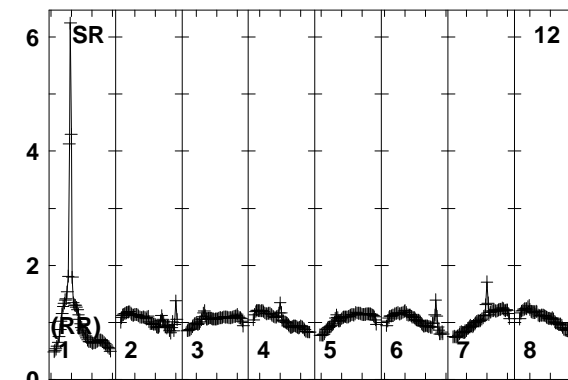
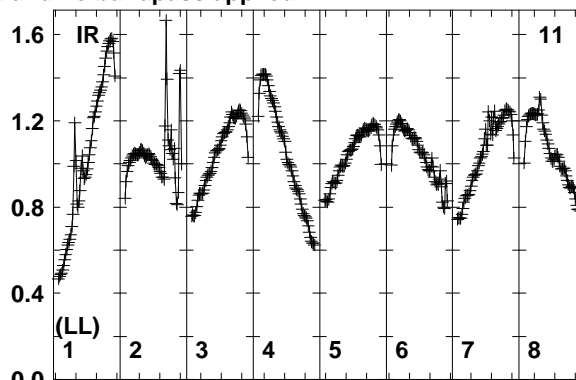
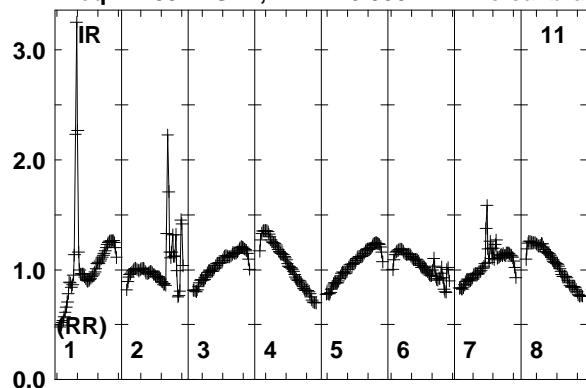

Lower frame: Real Jy
Total-power spectrum Antenna: IR (11)
Timerange: 00/03:22:21 to 00/03:24:59

Plot file version 41 created 04-NOV-2019 14:14:03
W2246-0526 EY034.UVDATA.1
Freq = 1.5947 GHz, Bw = 16.000 MH No calibration applied and no bandpass applied

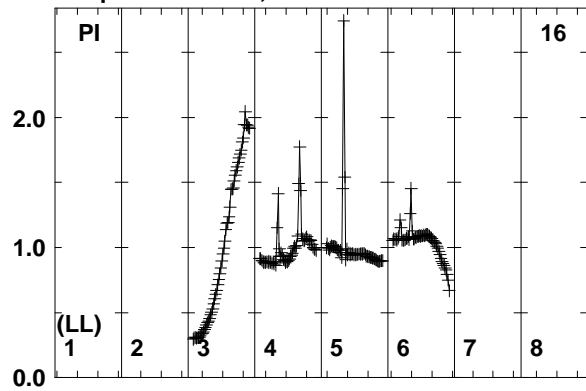

Lower frame: Real Jy
Total-power spectrum Antenna: PI (16)
Timerange: 00/03:22:21 to 00/03:24:59

Plot file version 42 created 04-NOV-2019 14:14:03

J2248-0541 EY034.UVDATA.1

Freq = 1.5947 GHz, Bw = 16.000 MH No calibration applied and no bandpass applied

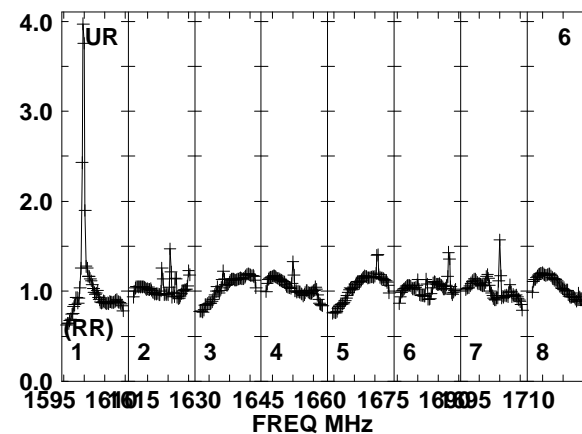
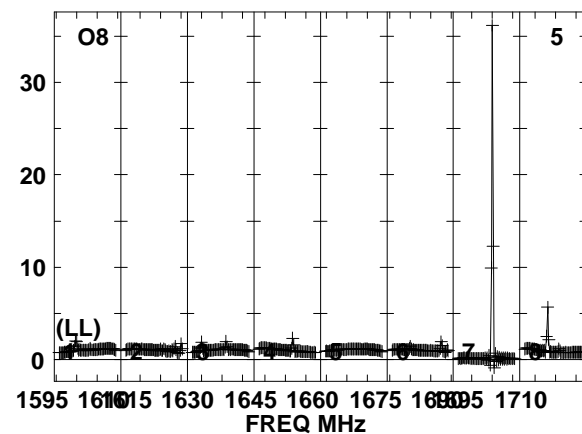
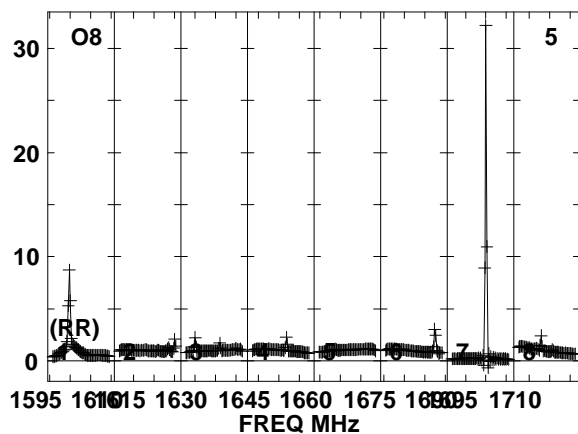
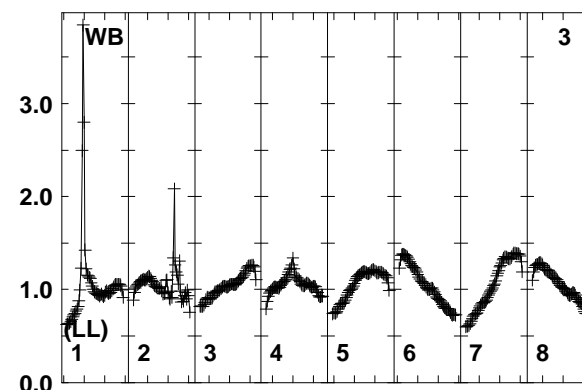
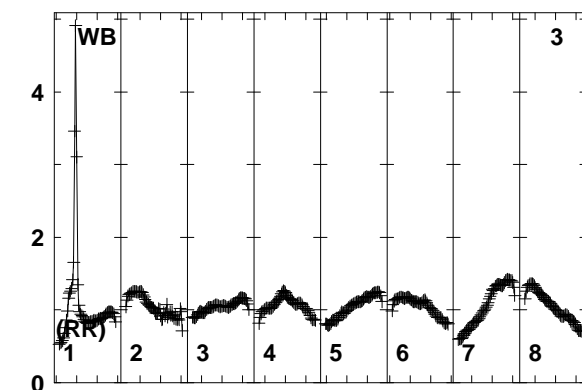
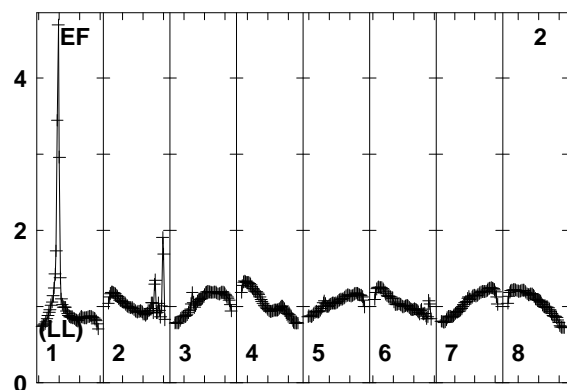
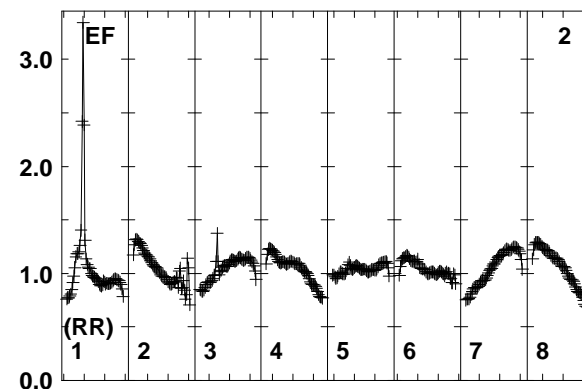
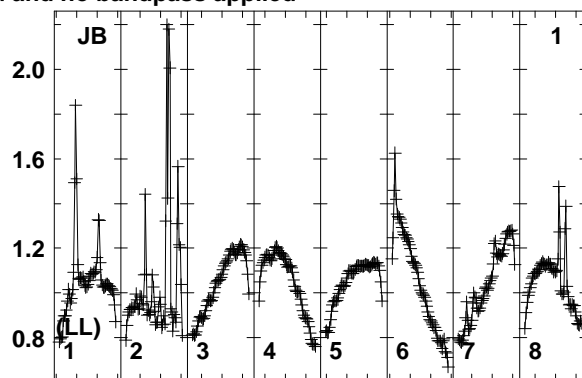
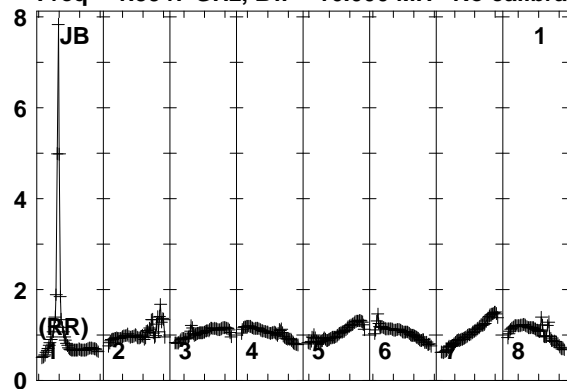

Lower frame: Real Jy
Total-power spectrum Antenna: JB (01)
Timerange: 00/03:25:16 to 00/03:26:14

Plot file version 43 created 04-NOV-2019 14:14:03

J2248-0541 EY034.UVDATA.1

Freq = 1.5947 GHz, Bw = 16.000 MH No calibration applied and no bandpass applied

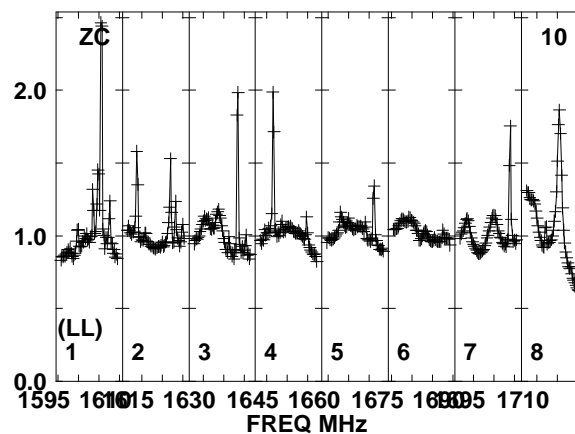
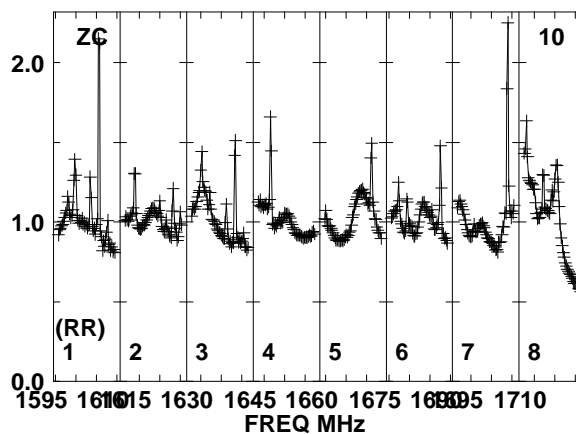
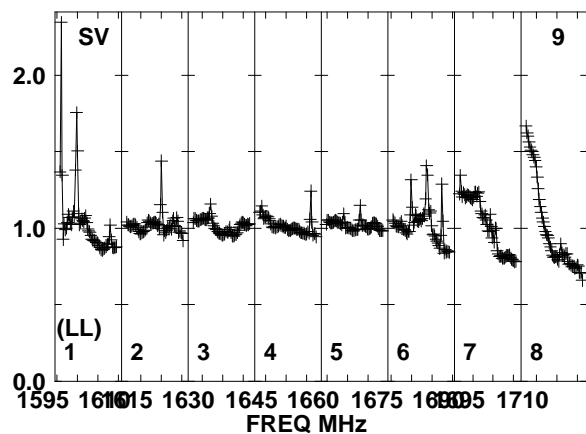
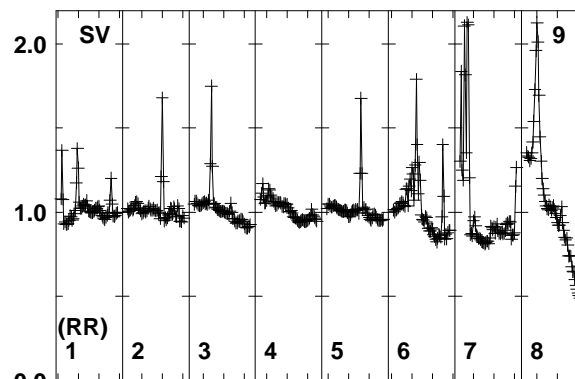
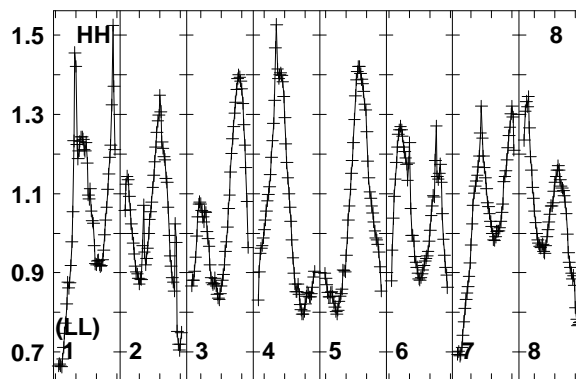
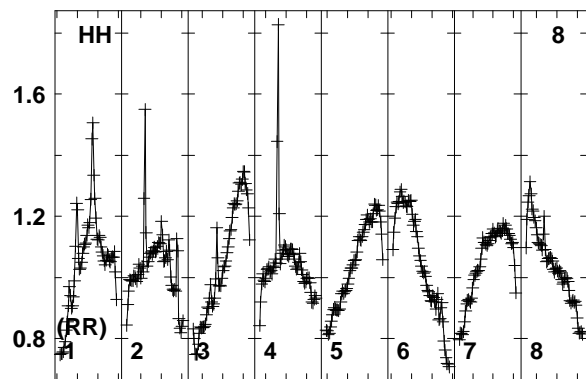
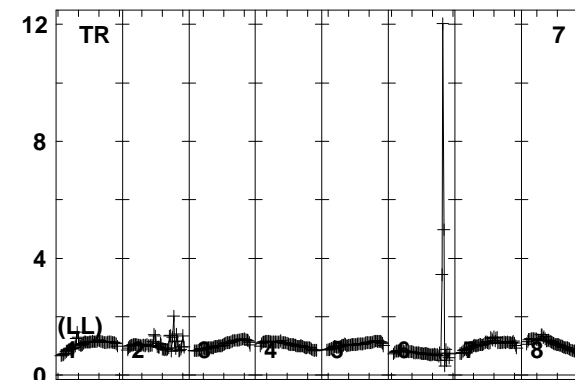
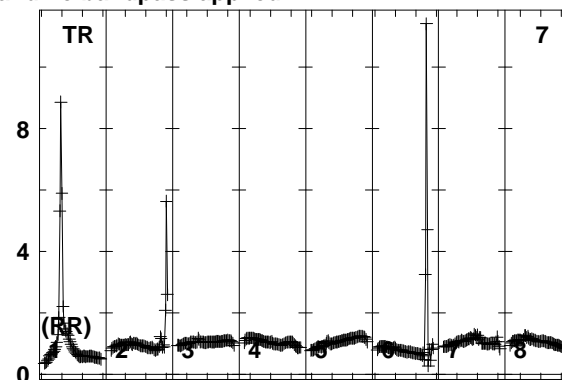
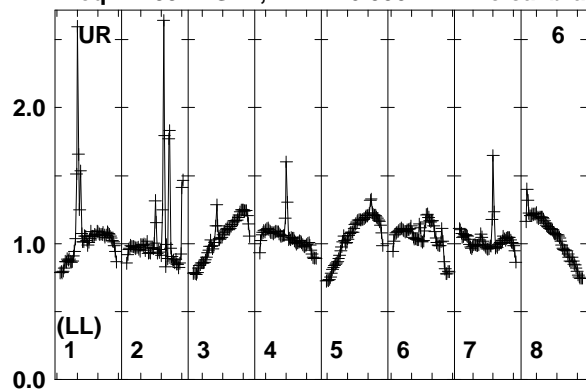

Lower frame: Real Jy
Total-power spectrum Antenna: UR (06)
Timerange: 00/03:25:16 to 00/03:26:14

Plot file version 44 created 04-NOV-2019 14:14:03

J2248-0541 EY034.UVDATA.1

Freq = 1.5947 GHz, Bw = 16.000 MH No calibration applied and no bandpass applied

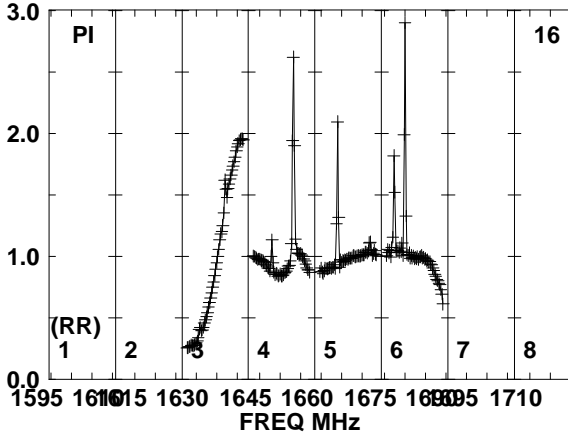
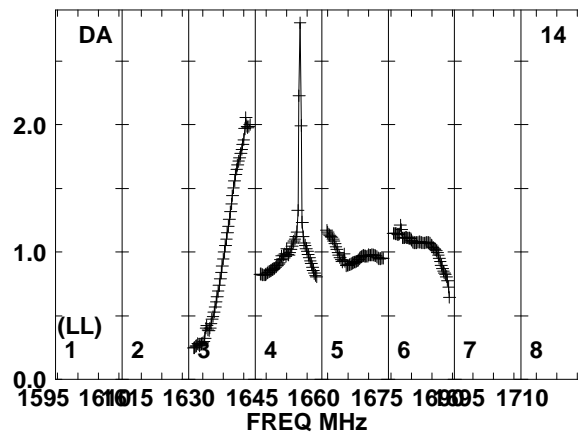
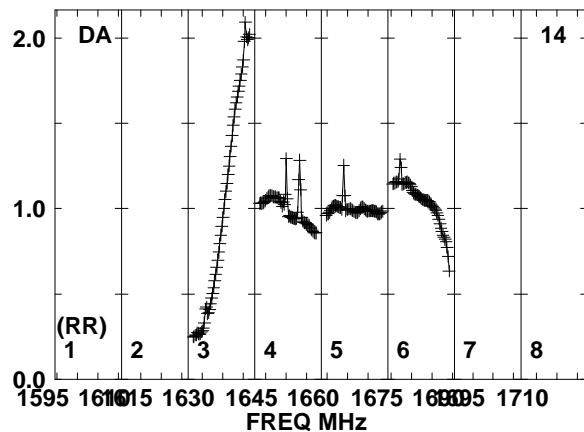
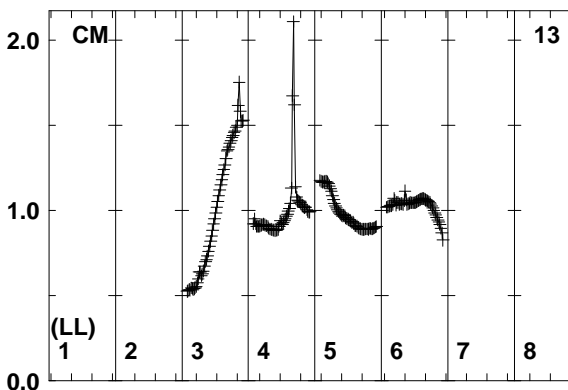
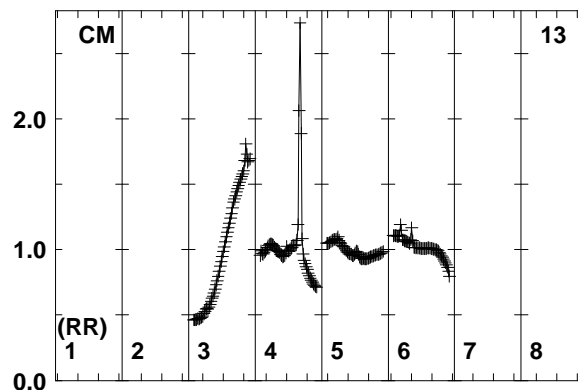
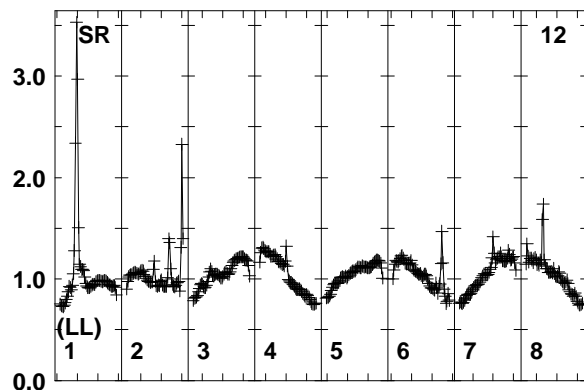
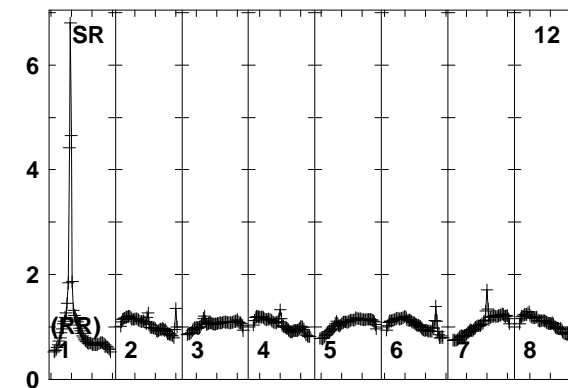
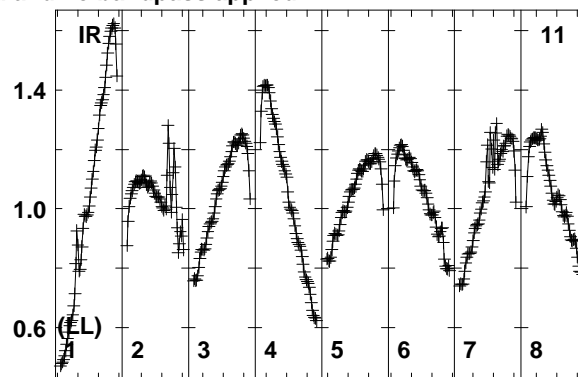
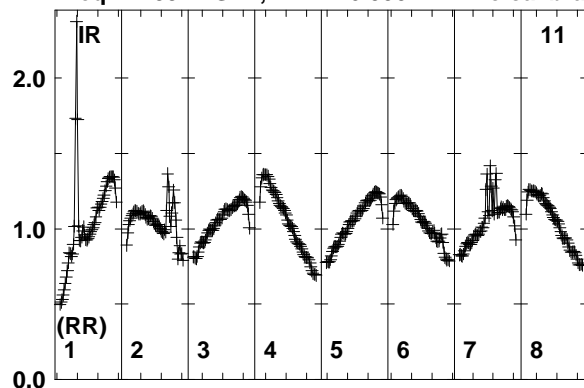

Lower frame: Real Jy
Total-power spectrum Antenna: IR (11)
Timerange: 00/03:25:16 to 00/03:26:14

Plot file version 45 created 04-NOV-2019 14:14:03
J2248-0541 EY034.UVDATA.1
Freq = 1.5947 GHz, Bw = 16.000 MH No calibration applied and no bandpass applied

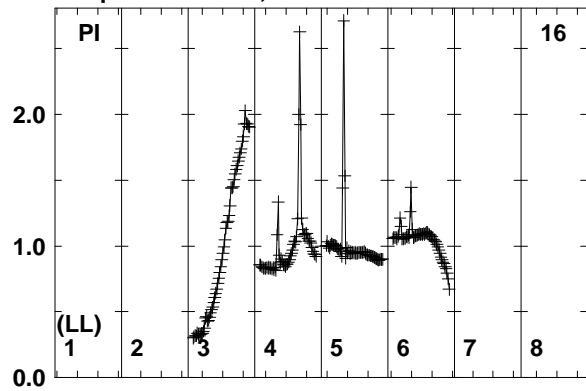

Lower frame: Real Jy
Total-power spectrum Antenna: PI (16)
Timerange: 00/03:25:16 to 00/03:26:14

Plot file version 46 created 04-NOV-2019 14:14:03

J2245-0755 EY034.UVDATA.1

Freq = 1.5947 GHz, Bw = 16.000 MH No calibration applied and no bandpass applied

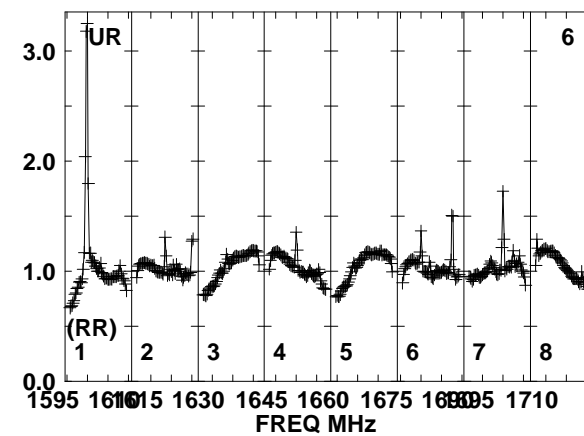
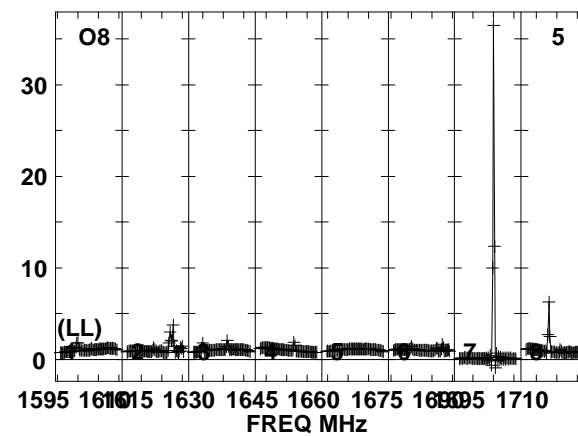
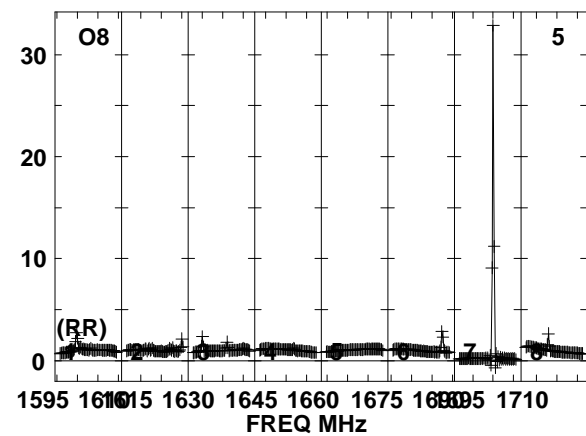
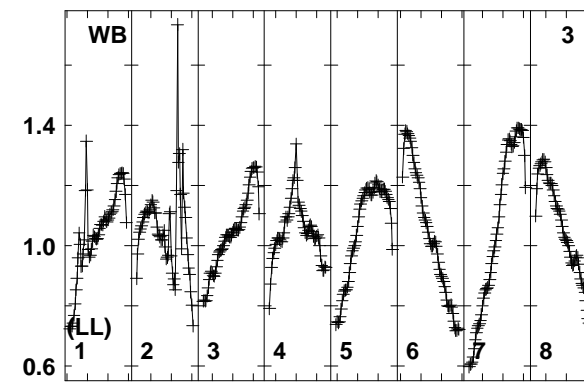
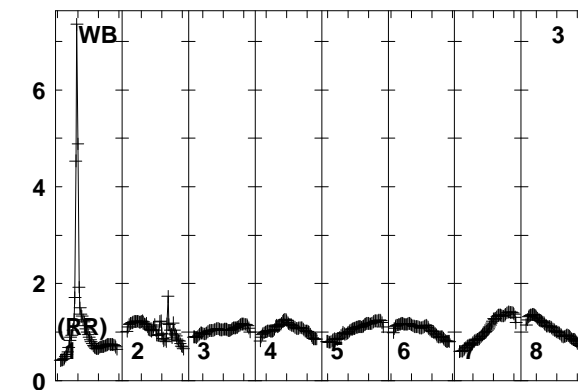
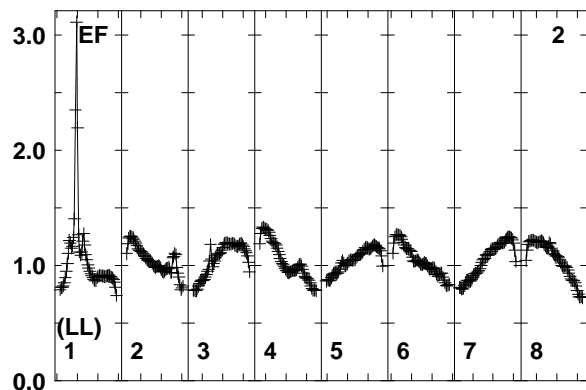
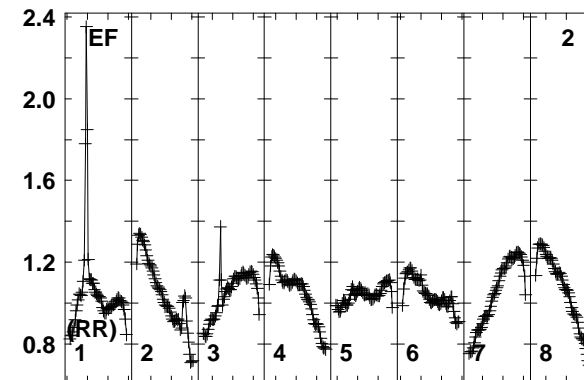
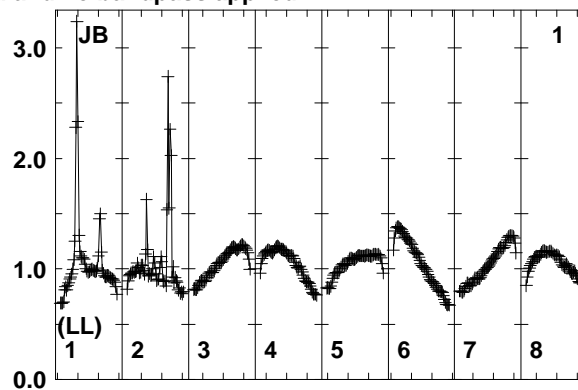
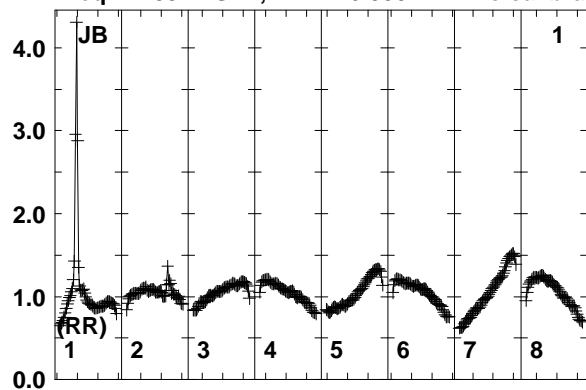

Lower frame: Real Jy
Total-power spectrum Antenna: JB (01)
Timerange: 00/03:26:31 to 00/03:27:29

Plot file version 47 created 04-NOV-2019 14:14:03

J2245-0755 EY034.UVDATA.1

Freq = 1.5947 GHz, Bw = 16.000 MH No calibration applied and no bandpass applied

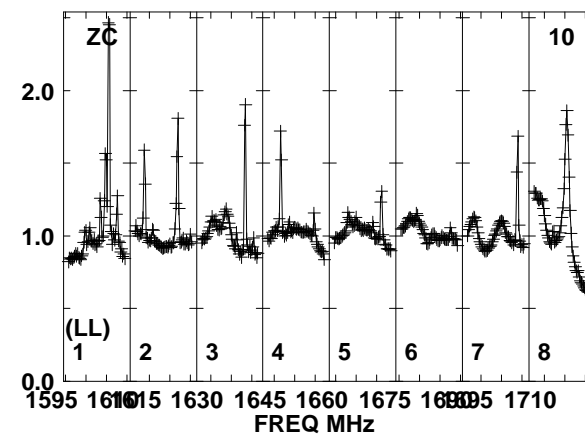
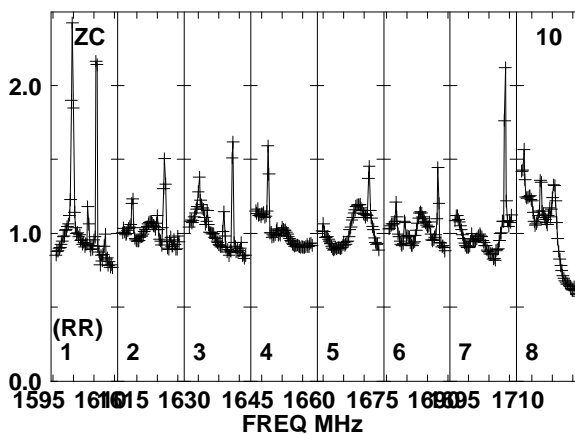
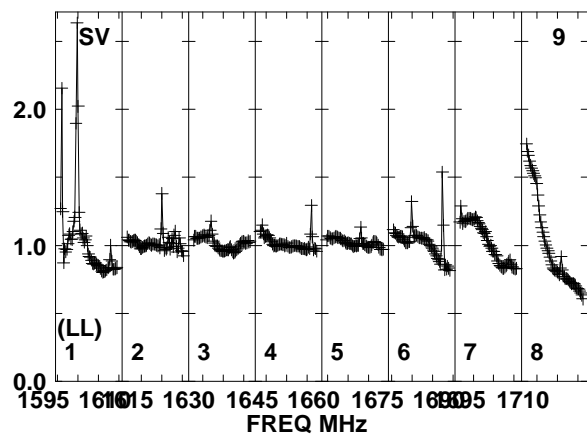
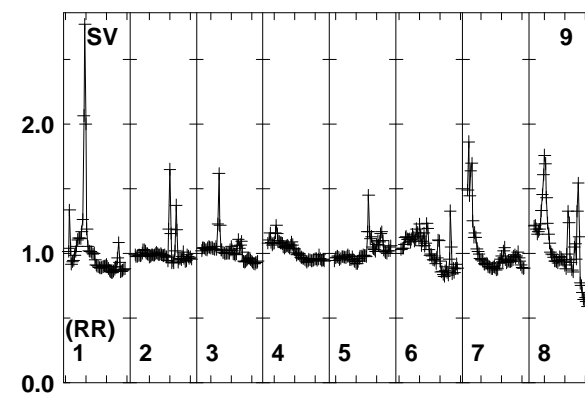
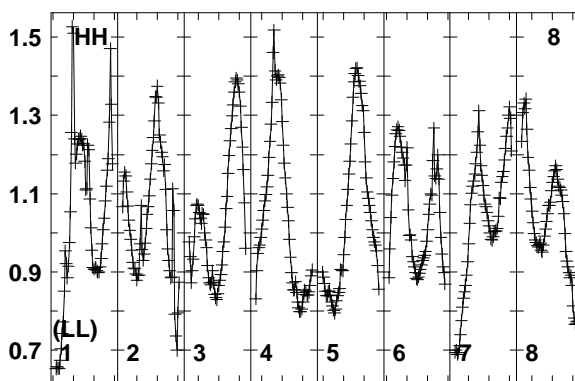
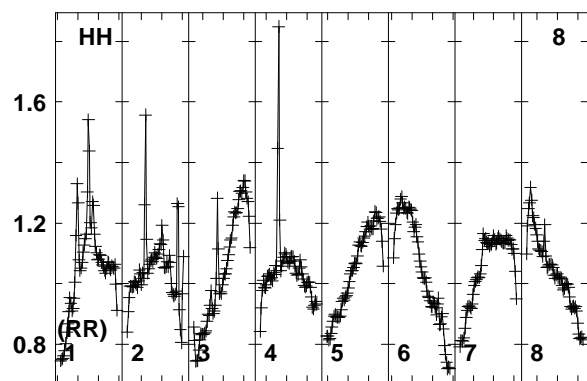
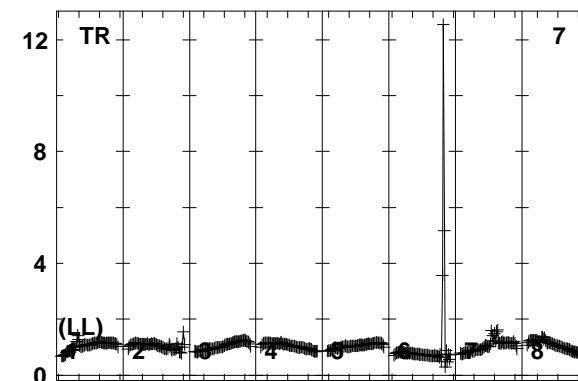
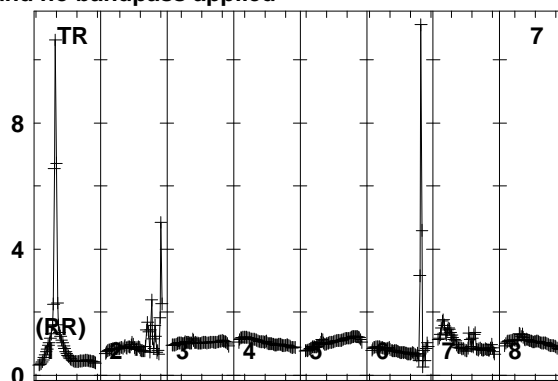
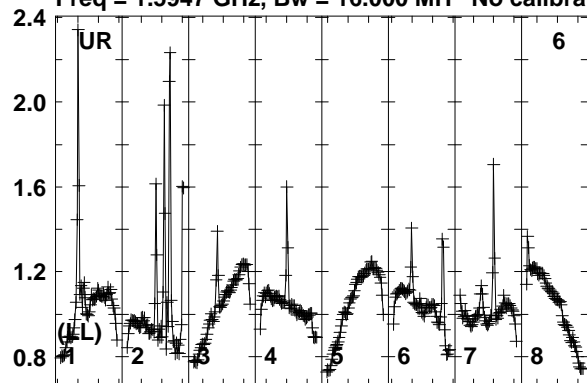

Lower frame: Real Jy
Total-power spectrum Antenna: UR (06)
Timerange: 00/03:26:31 to 00/03:27:29

Plot file version 48 created 04-NOV-2019 14:14:03

J2245-0755 EY034.UVDATA.1

Freq = 1.5947 GHz, Bw = 16.000 MH No calibration applied and no bandpass applied

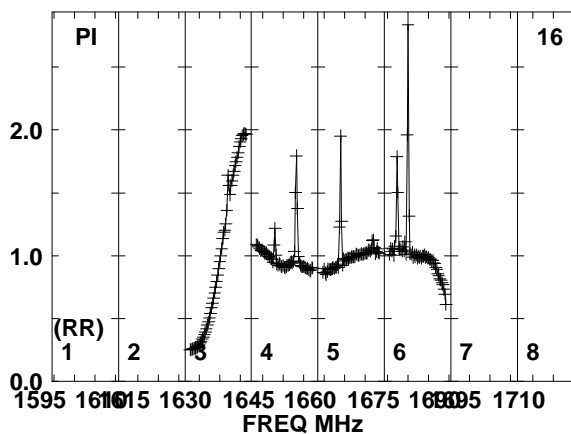
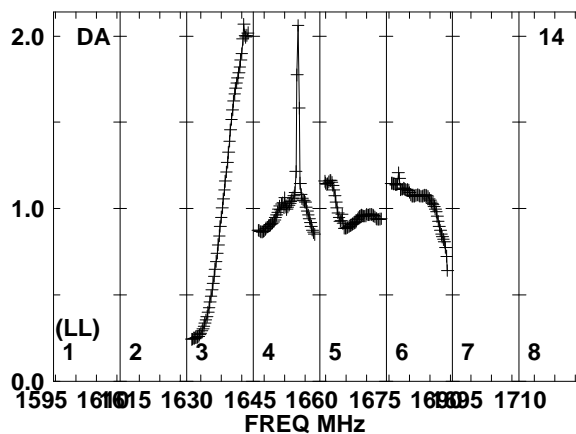
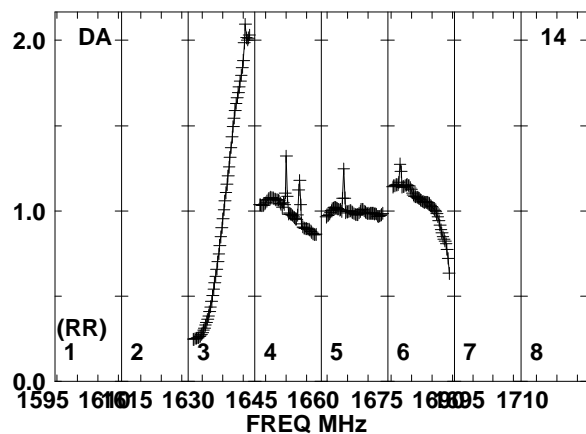
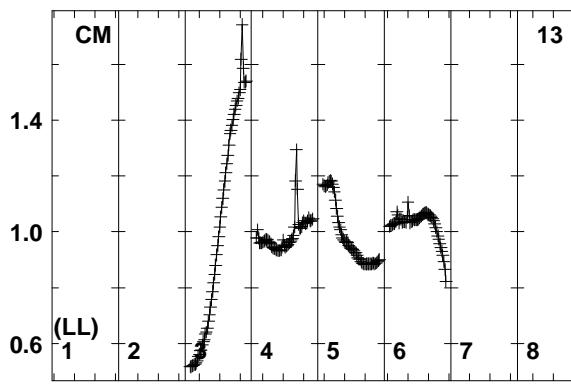
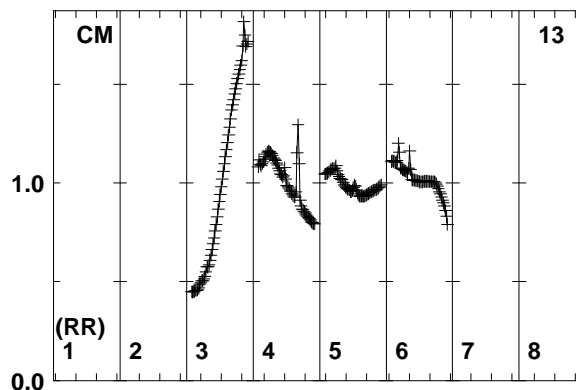
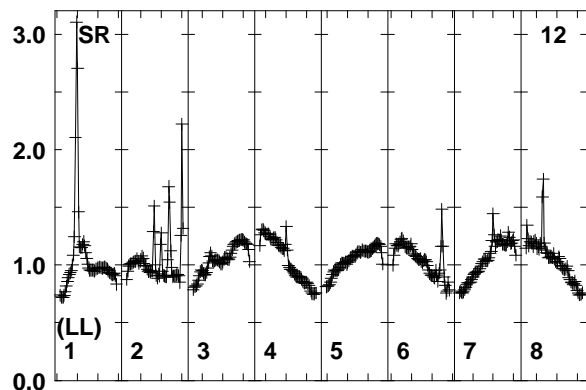
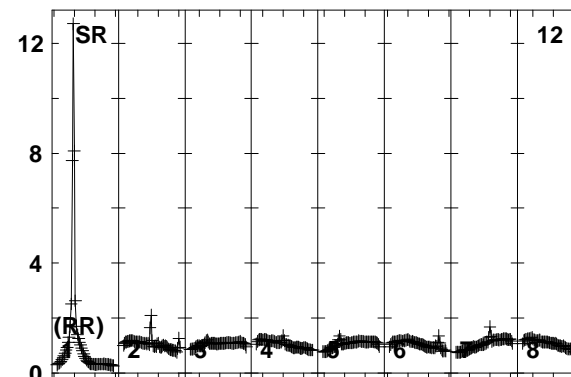
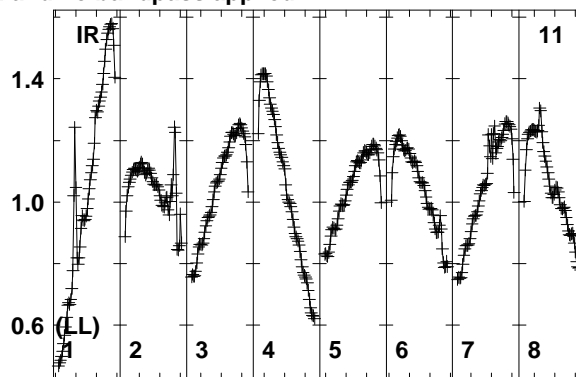
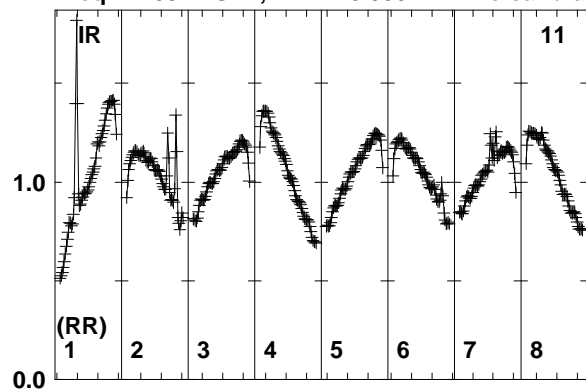

Lower frame: Real Jy
Total-power spectrum Antenna: IR (11)
Timerange: 00/03:26:31 to 00/03:27:29

Plot file version 49 created 04-NOV-2019 14:14:03
J2245-0755 EY034.UVDATA.1
Freq = 1.5947 GHz, Bw = 16.000 MH No calibration applied and no bandpass applied

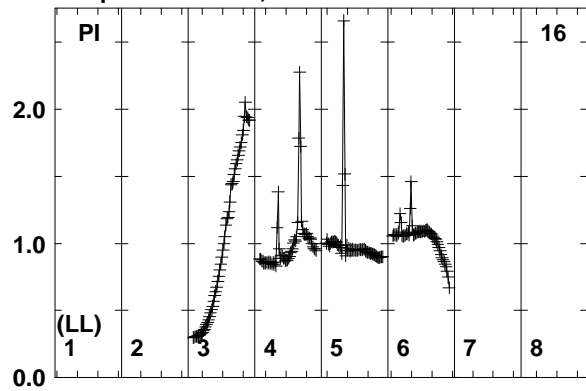

Lower frame: Real Jy
Total-power spectrum Antenna: PI (16)
Timerange: 00/03:26:31 to 00/03:27:29

Plot file version 50 created 04-NOV-2019 14:14:03

J2248-0541 EY034.UVDATA.1

Freq = 1.5947 GHz, Bw = 16.000 MH No calibration applied and no bandpass applied

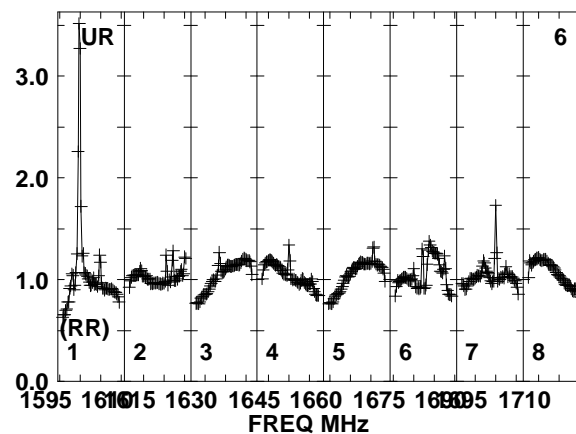
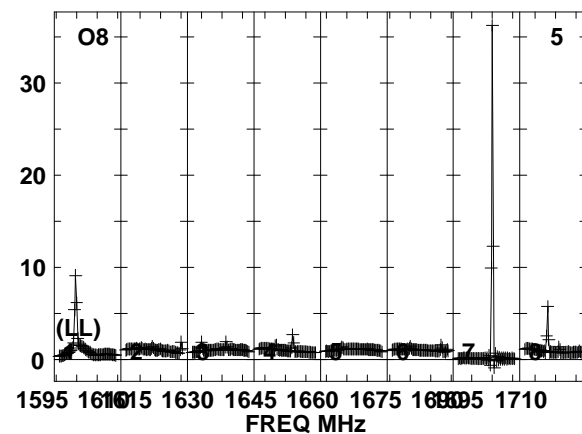
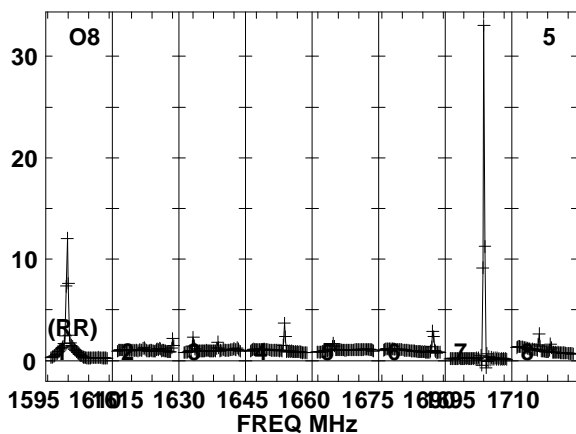
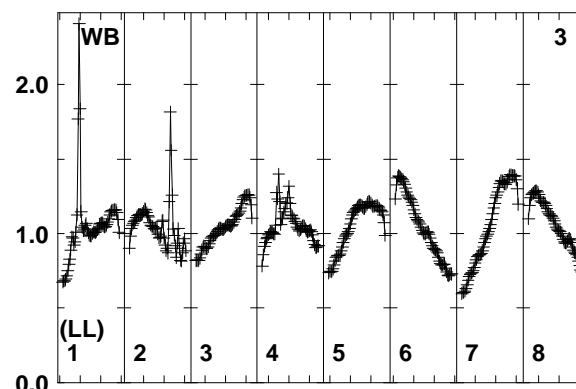
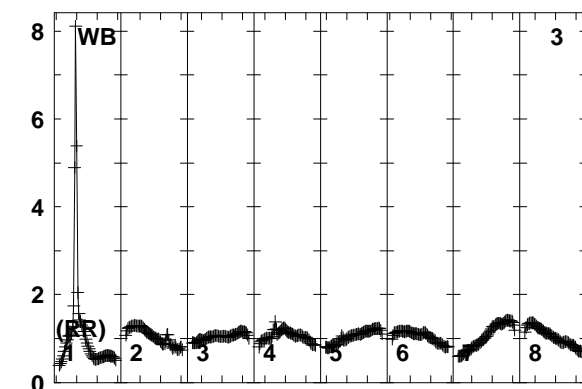
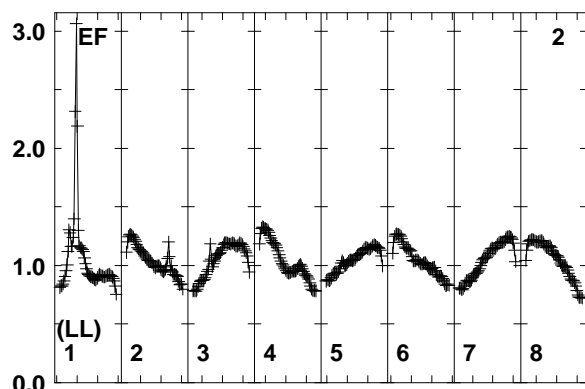
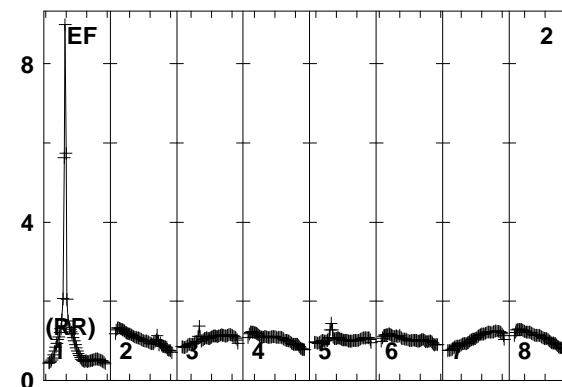
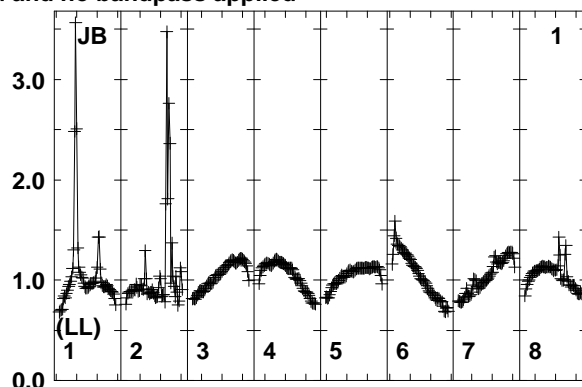
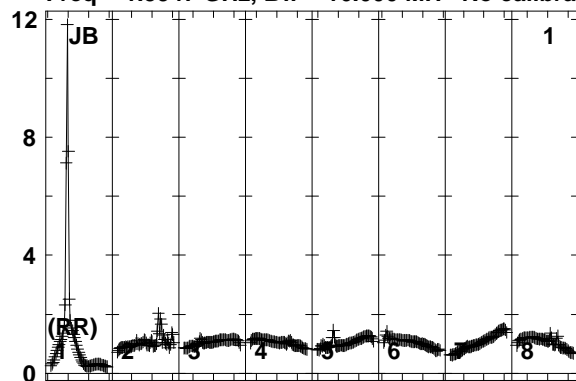

Lower frame: Real Jy
Total-power spectrum Antenna: JB (01)
Timerange: 00/03:28:16 to 00/03:29:14

Plot file version 51 created 04-NOV-2019 14:14:03

J2248-0541 EY034.UVDATA.1

Freq = 1.5947 GHz, Bw = 16.000 MH No calibration applied and no bandpass applied

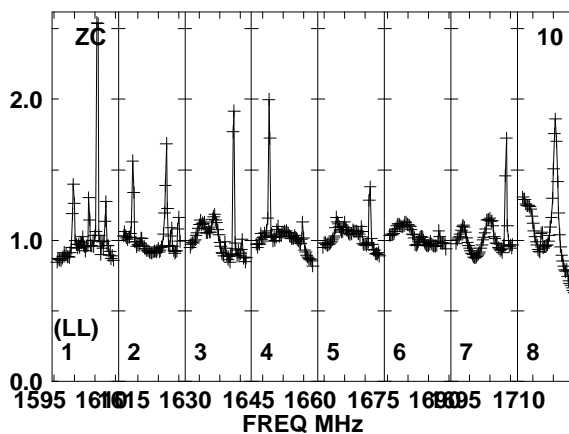
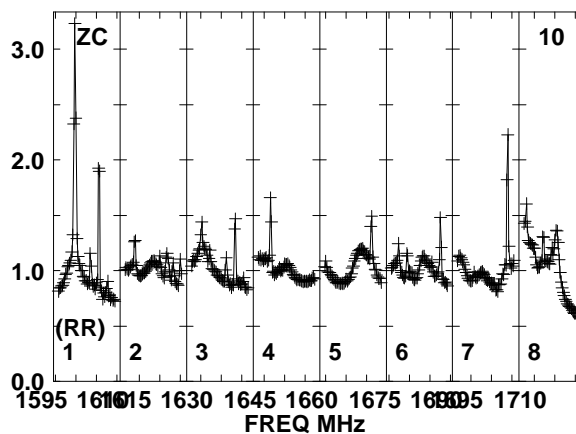
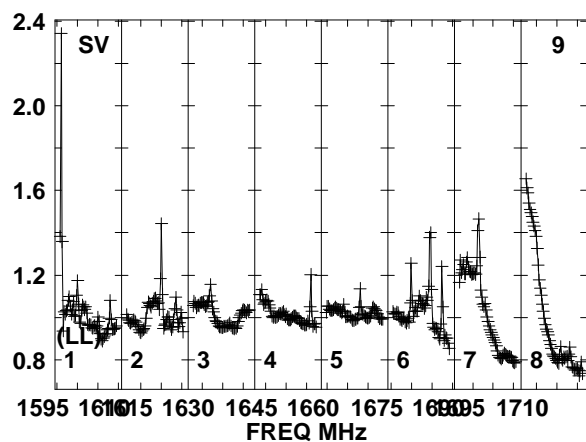
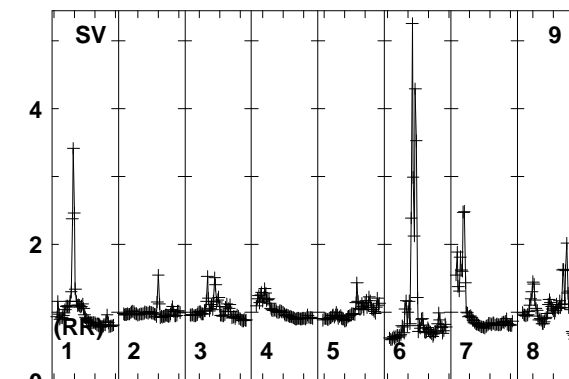
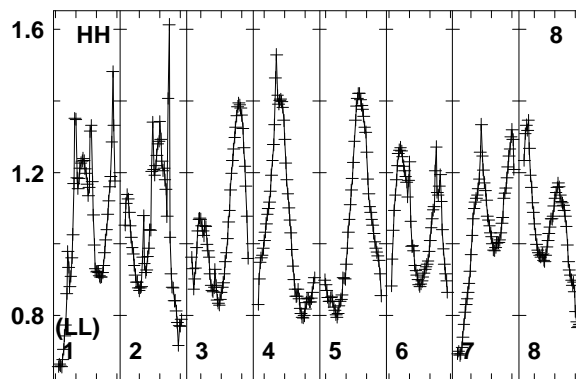
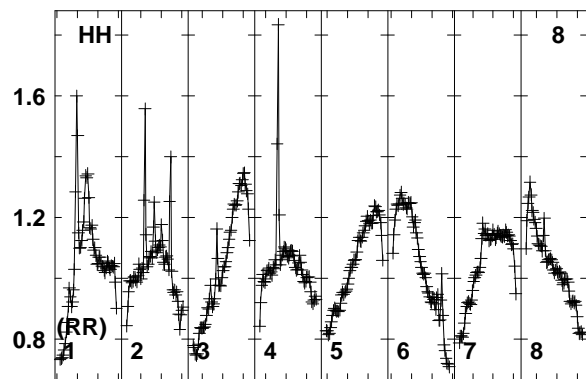
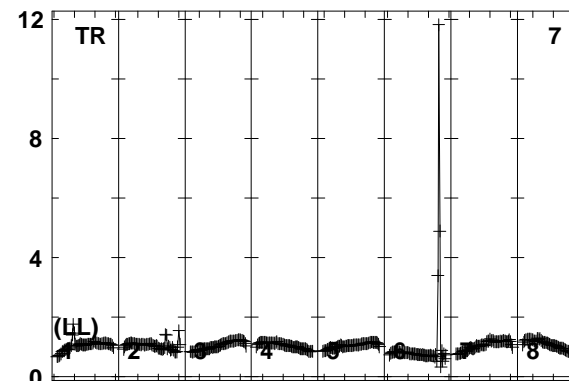
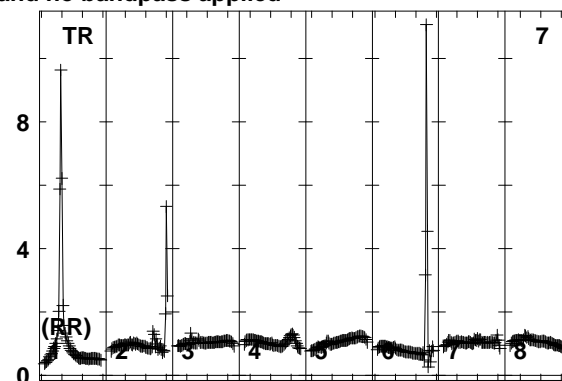
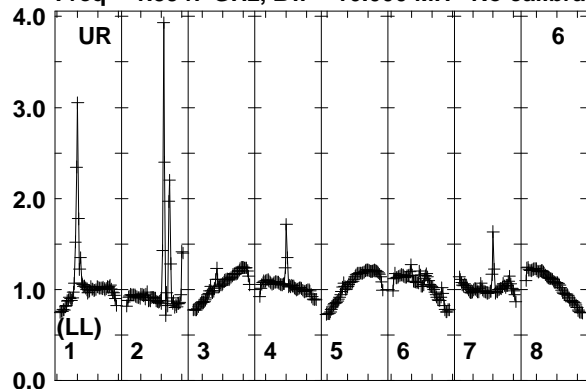

Lower frame: Real Jy
Total-power spectrum Antenna: UR (06)
Timerange: 00/03:28:16 to 00/03:29:14

Plot file version 52 created 04-NOV-2019 14:14:04

J2248-0541 EY034.UVDATA.1

Freq = 1.5947 GHz, Bw = 16.000 MH No calibration applied and no bandpass applied

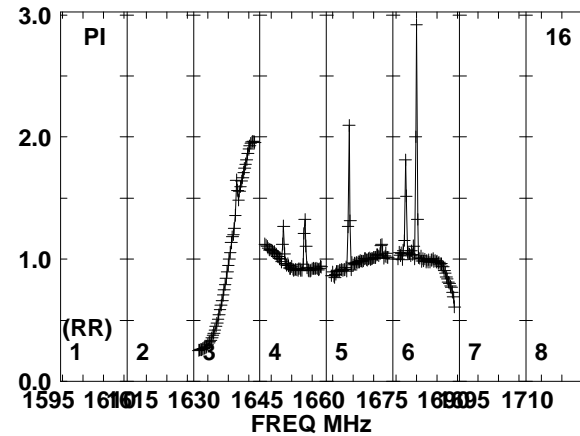
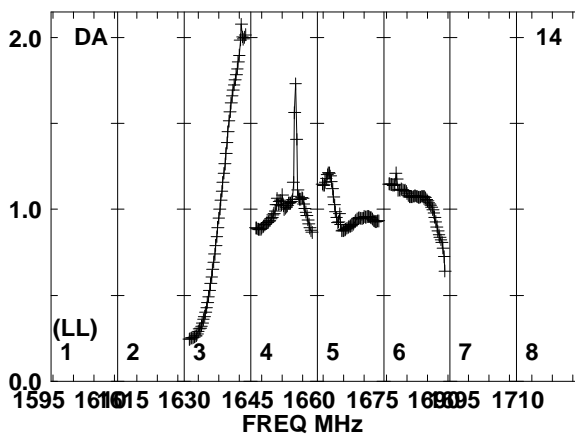
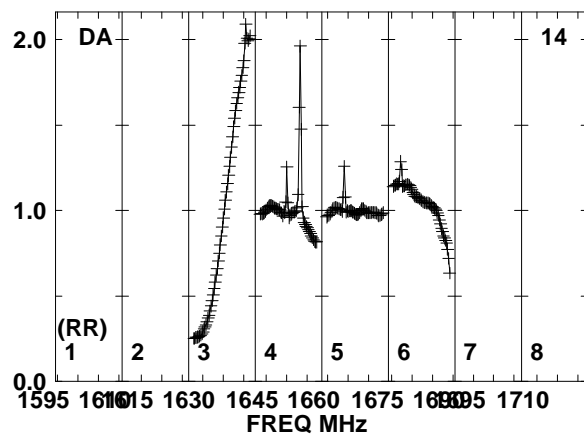
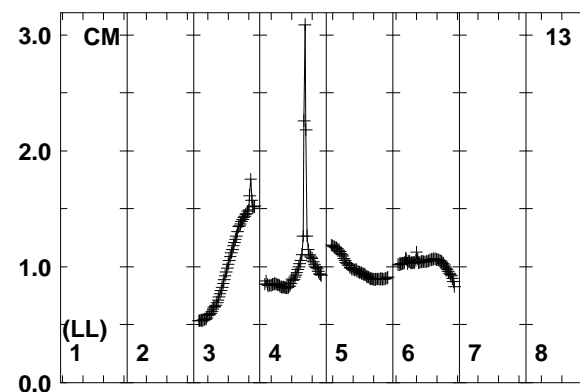
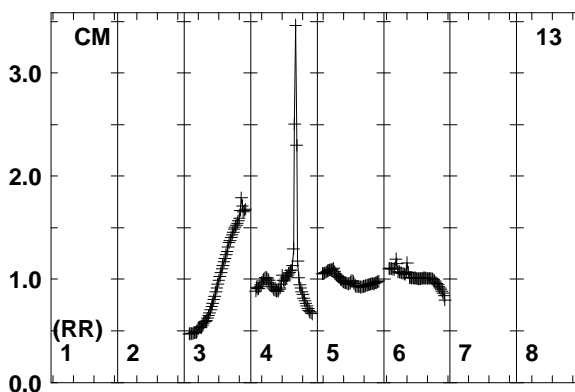
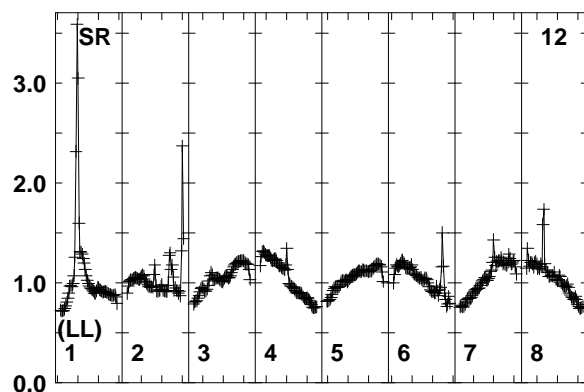
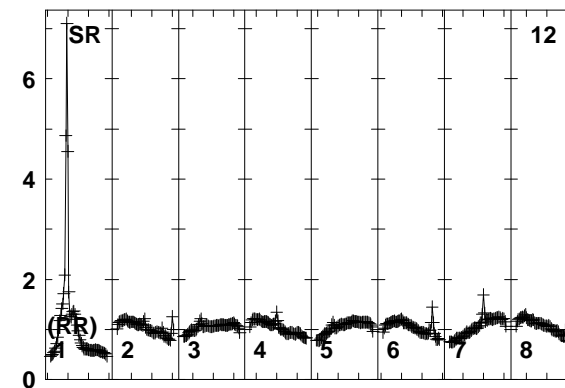
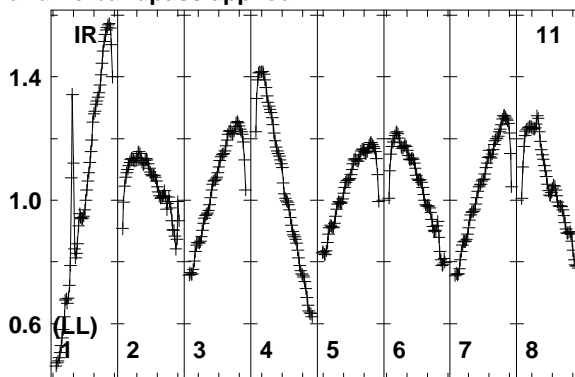
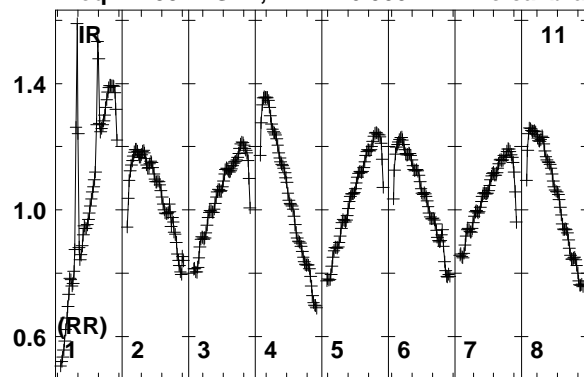

Lower frame: Real Jy
Total-power spectrum Antenna: IR (11)
Timerange: 00/03:28:16 to 00/03:29:14

Plot file version 53 created 04-NOV-2019 14:14:04
J2248-0541 EY034.UVDATA.1
Freq = 1.5947 GHz, Bw = 16.000 MH No calibration applied and no bandpass applied

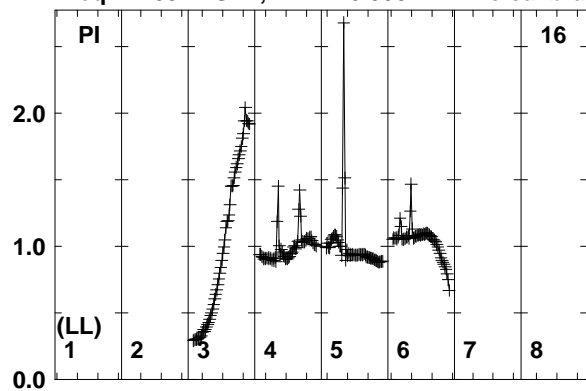

Lower frame: Real Jy
Total-power spectrum Antenna: PI (16)
Timerange: 00/03:28:16 to 00/03:29:14

Plot file version 54 created 04-NOV-2019 14:14:04

W2246-0526 EY034.UVDATA.1

Freq = 1.5947 GHz, Bw = 16.000 MH No calibration applied and no bandpass applied

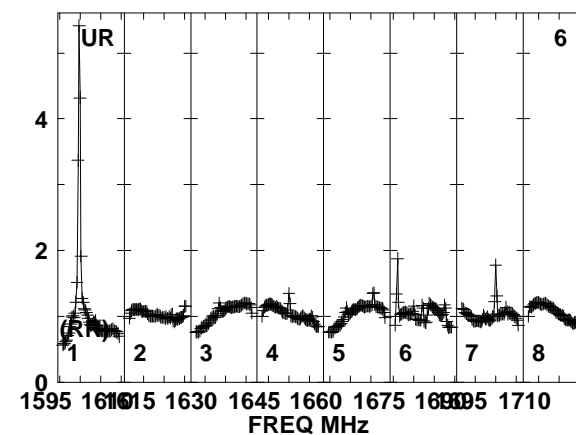
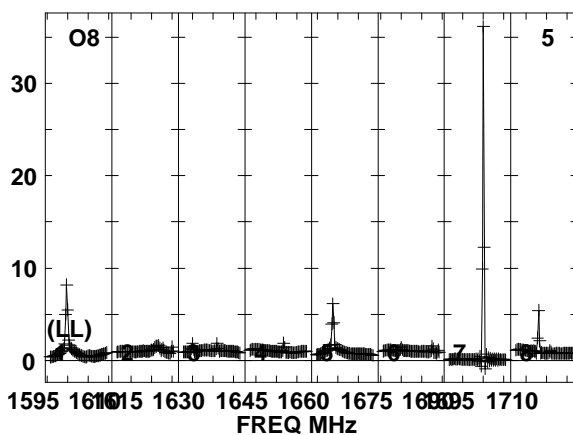
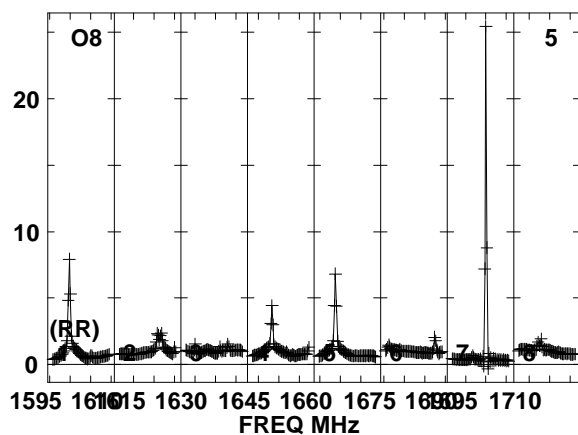
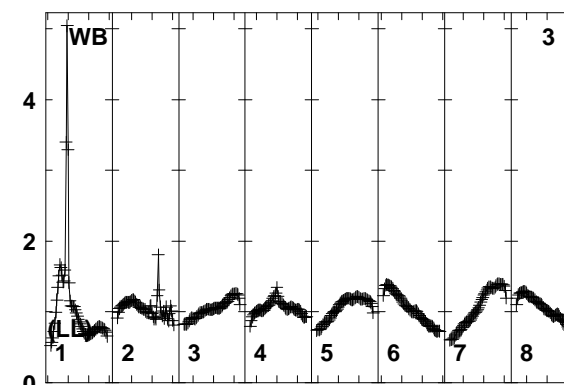
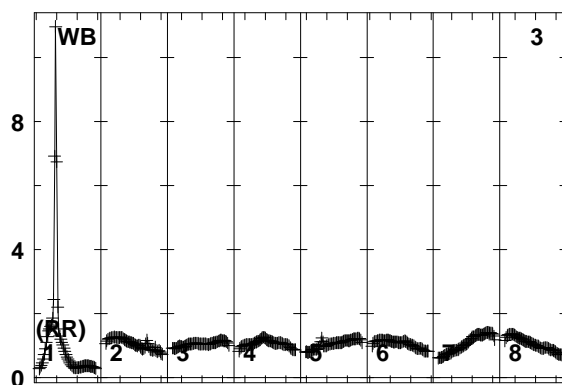
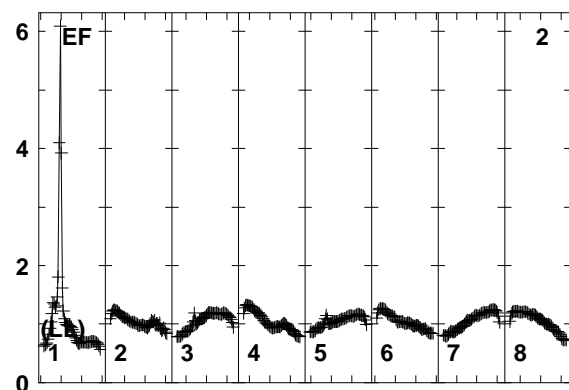
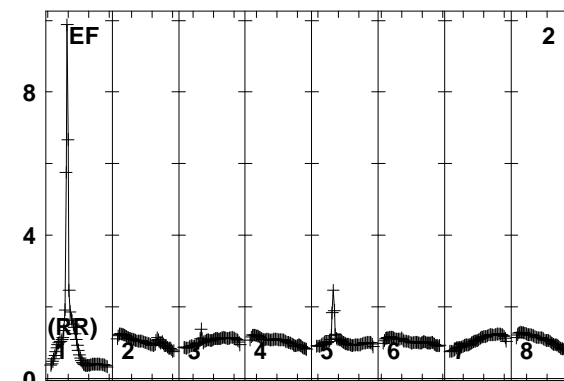
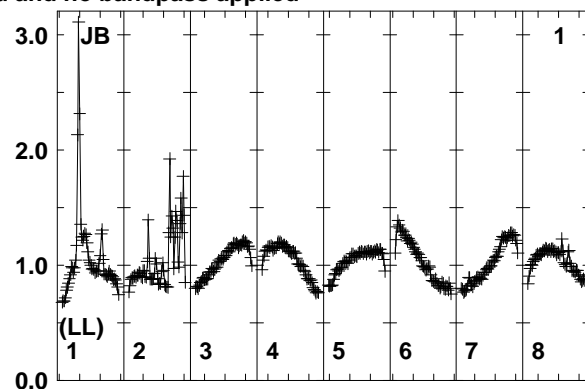
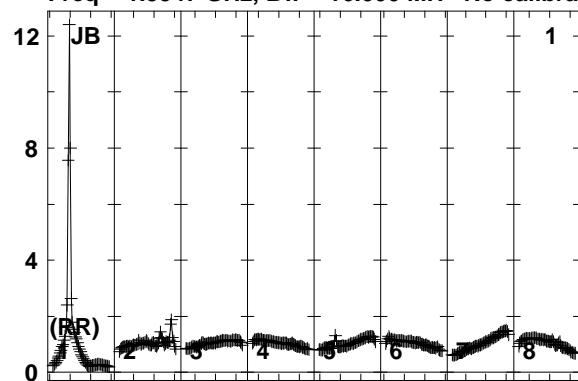

Lower frame: Real Jy
Total-power spectrum Antenna: JB (01)
Timerange: 00/03:29:16 to 00/03:31:44

Plot file version 55 created 04-NOV-2019 14:14:04

W2246-0526 EY034.UVDATA.1

Freq = 1.5947 GHz, Bw = 16.000 MH No calibration applied and no bandpass applied

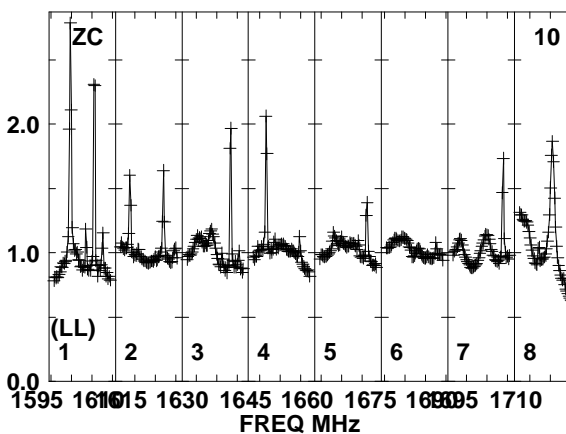
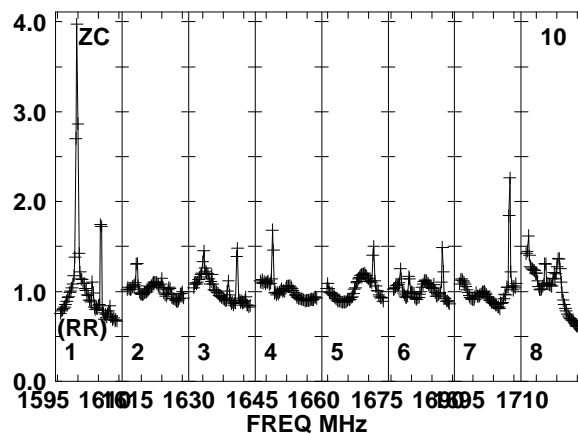
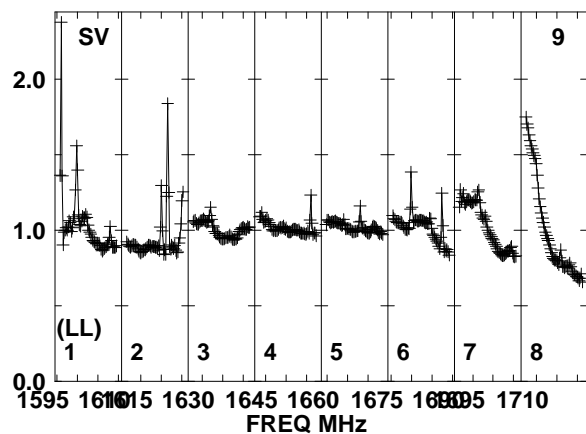
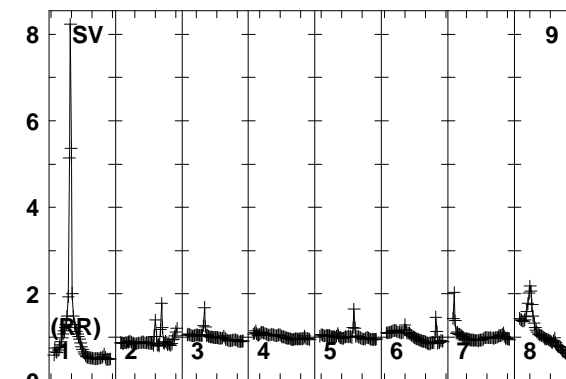
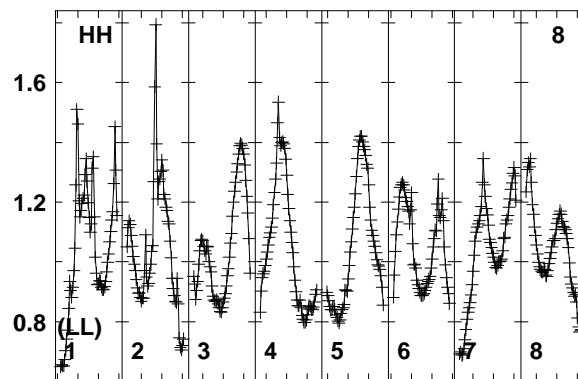
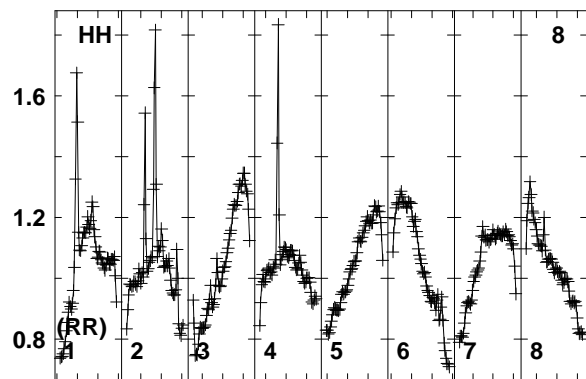
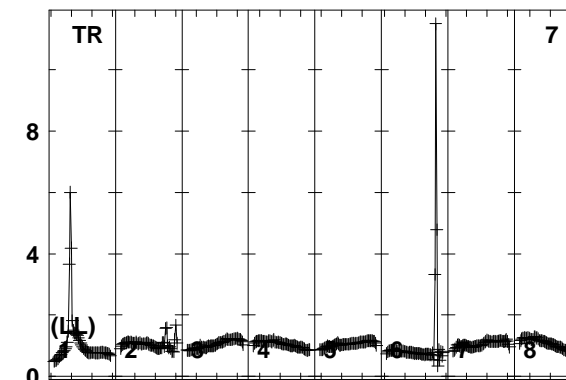
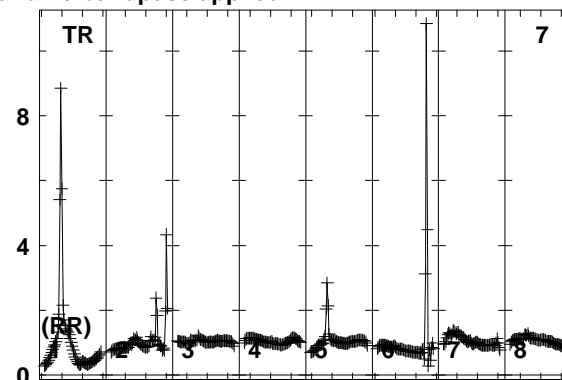
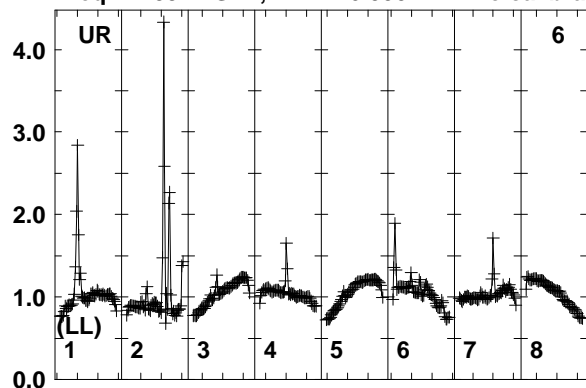

Lower frame: Real Jy
Total-power spectrum Antenna: UR (06)
Timerange: 00/03:29:16 to 00/03:31:44

Plot file version 56 created 04-NOV-2019 14:14:04

W2246-0526 EY034.UVDATA.1

Freq = 1.5947 GHz, Bw = 16.000 MH No calibration applied and no bandpass applied

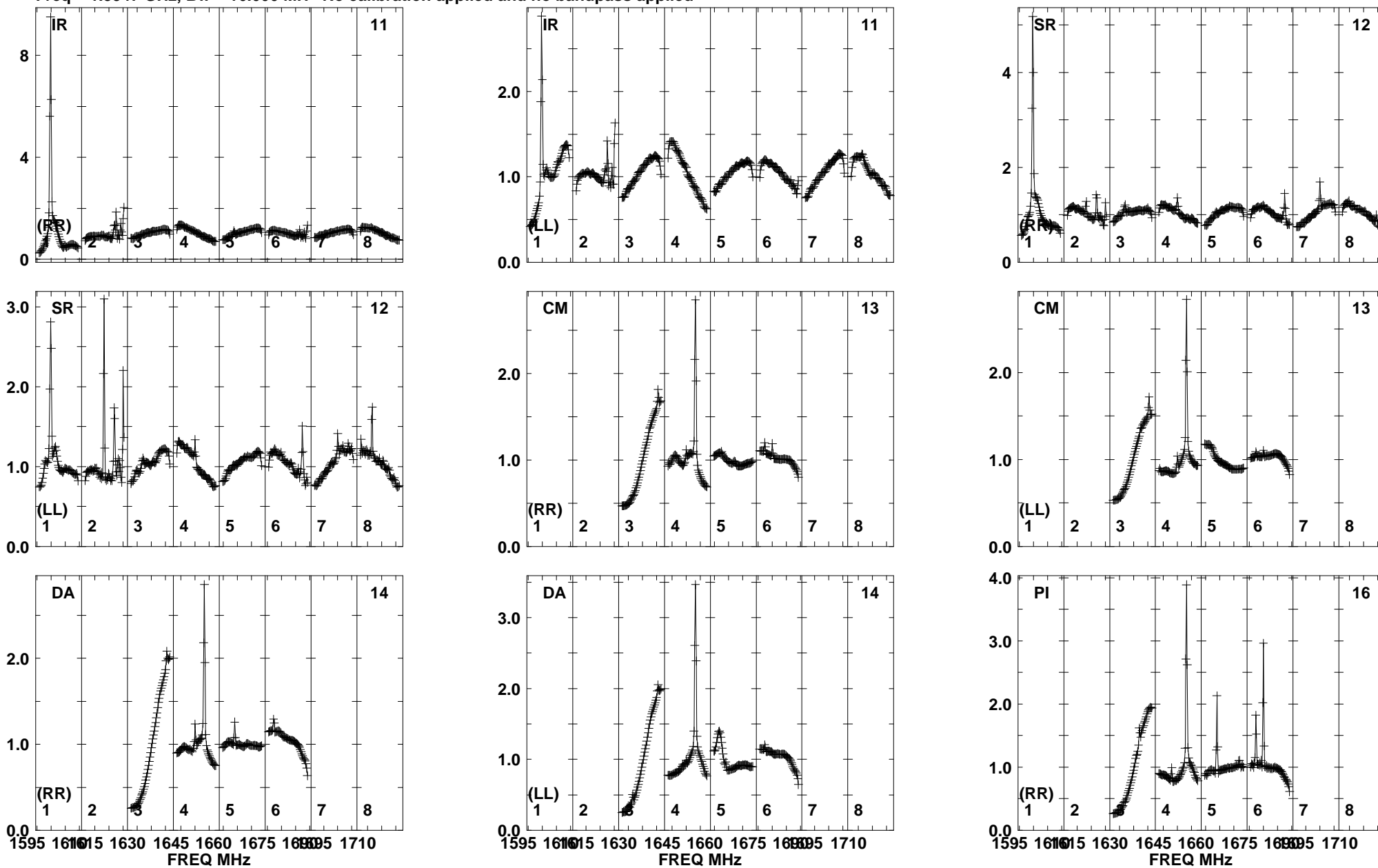

Lower frame: Real Jy
Total-power spectrum Antenna: IR (11)
Timerange: 00/03:29:16 to 00/03:31:44

Plot file version 57 created 04-NOV-2019 14:14:04
W2246-0526 EY034.UVDATA.1
Freq = 1.5947 GHz, Bw = 16.000 MH No calibration applied and no bandpass applied

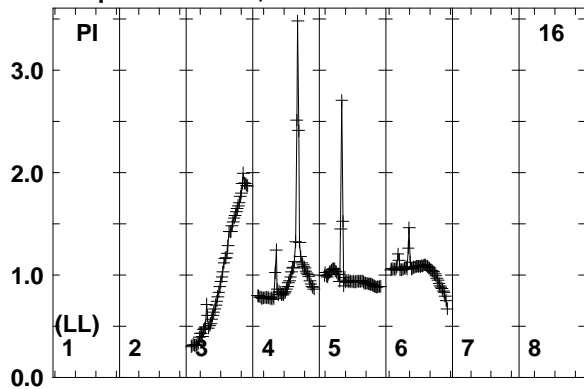

Lower frame: Real Jy
Total-power spectrum Antenna: PI (16)
Timerange: 00/03:29:16 to 00/03:31:44

Plot file version 58 created 04-NOV-2019 14:14:04

J2248-0541 EY034.UVDATA.1

Freq = 1.5947 GHz, Bw = 16.000 MH No calibration applied and no bandpass applied

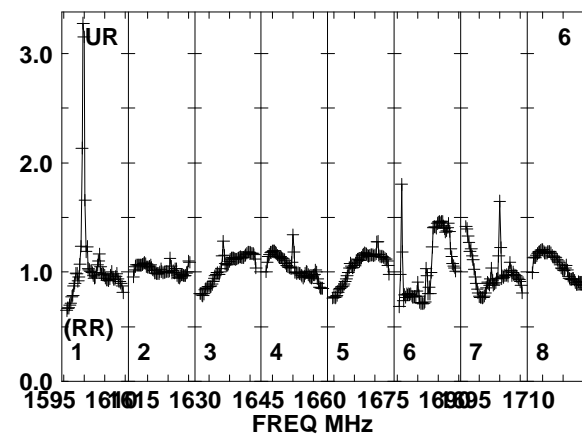
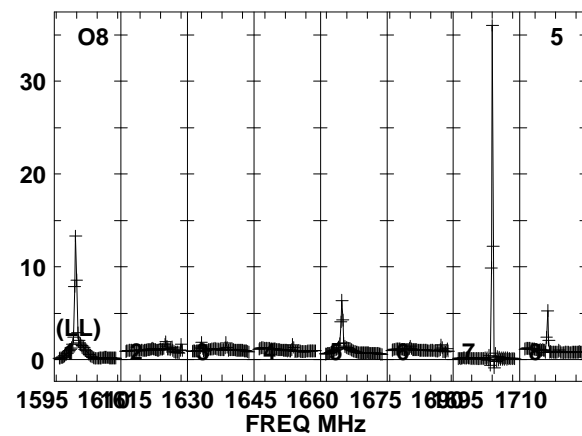
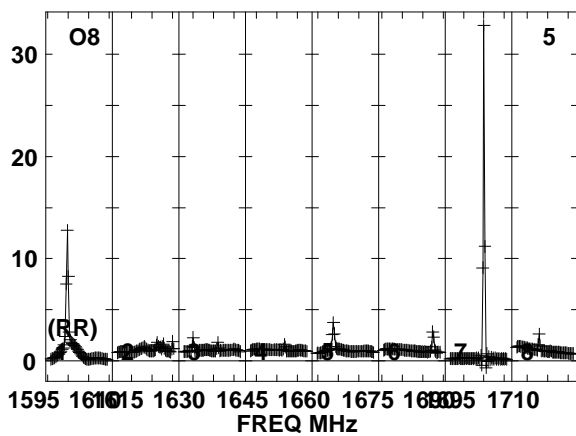
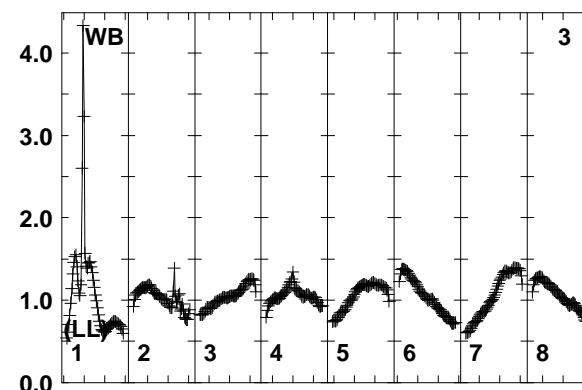
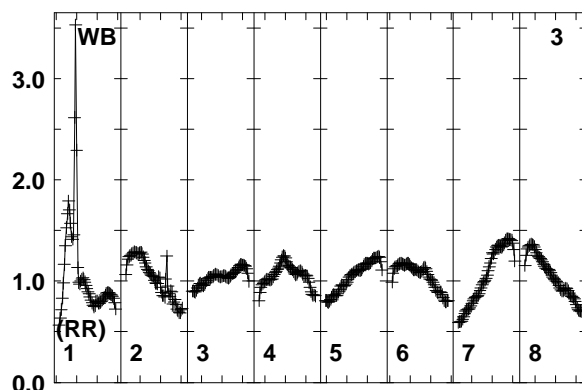
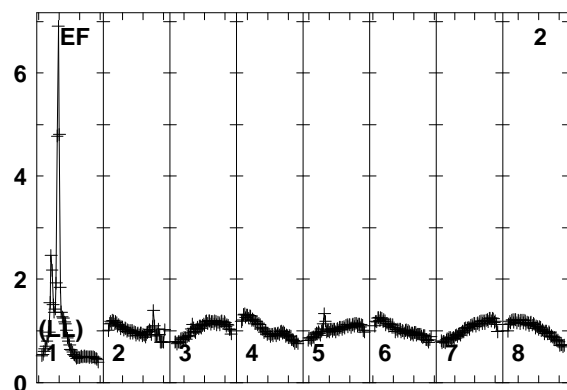
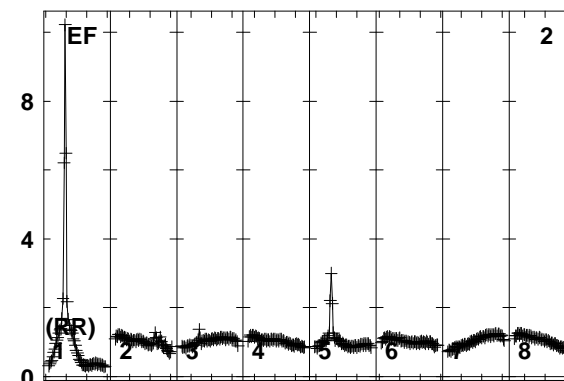
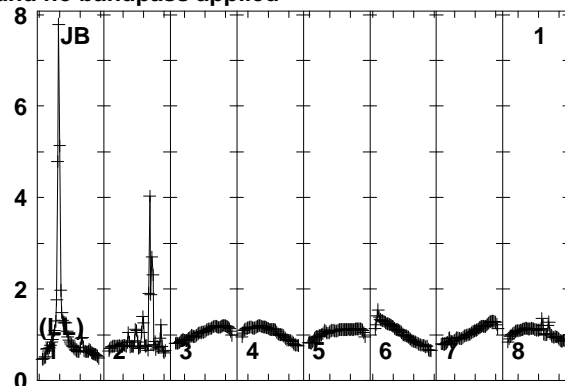
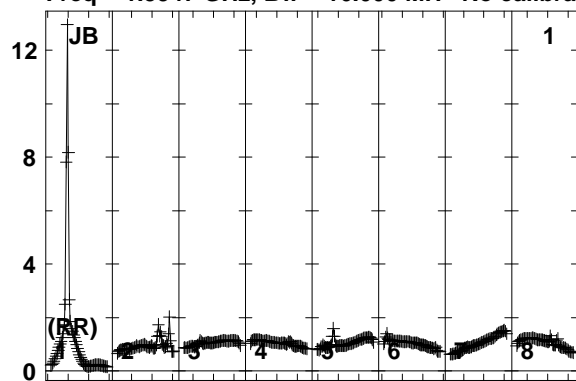

Lower frame: Real Jy
Total-power spectrum Antenna: JB (01)
Timerange: 00/03:32:01 to 00/03:32:59

Plot file version 59 created 04-NOV-2019 14:14:04

J2248-0541 EY034.UVDATA.1

Freq = 1.5947 GHz, Bw = 16.000 MH No calibration applied and no bandpass applied

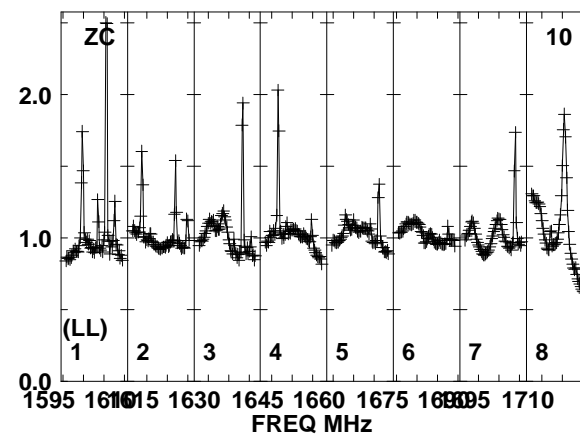
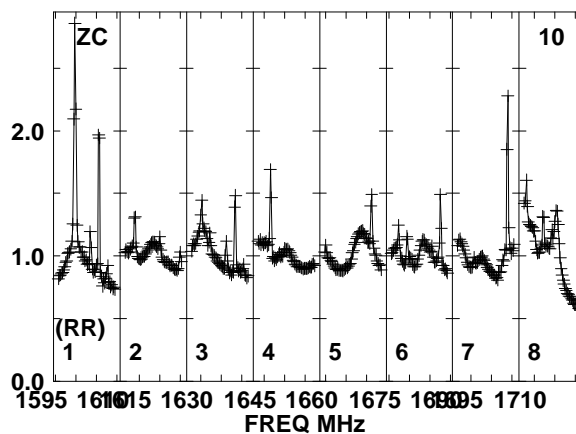
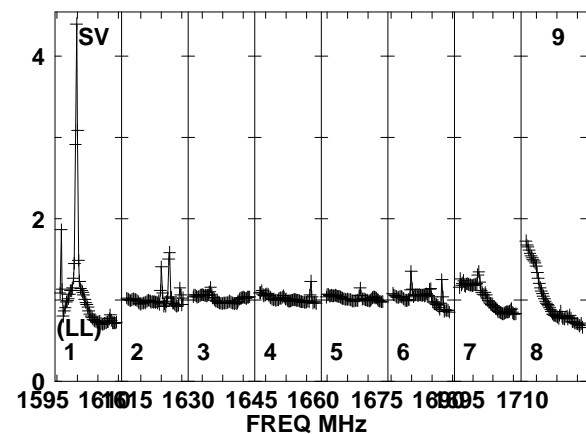
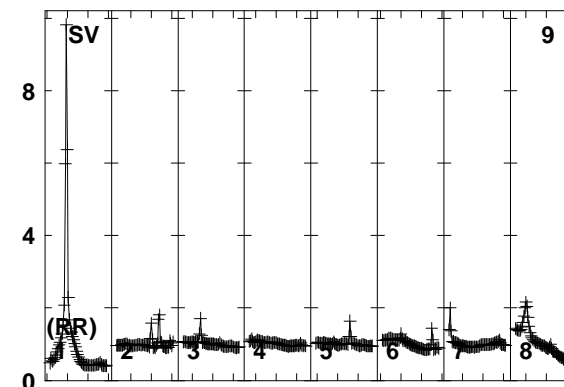
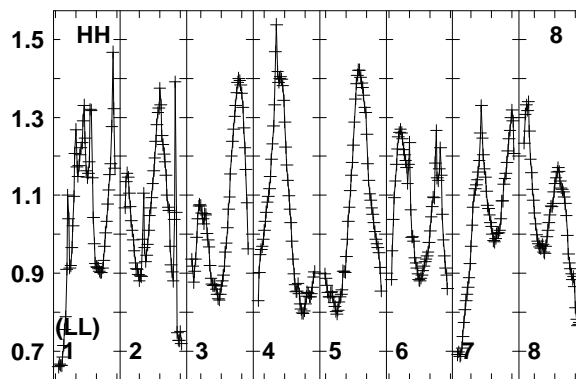
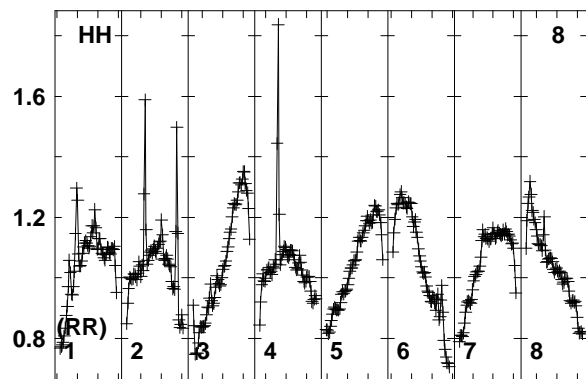
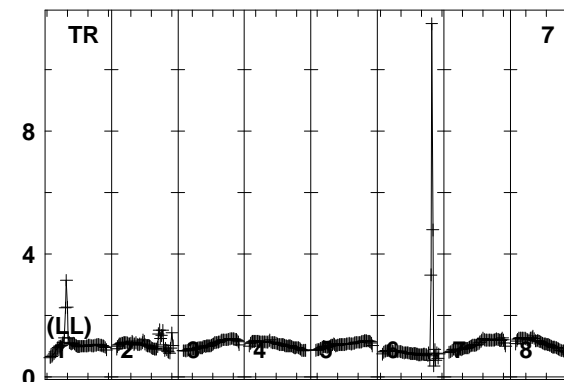
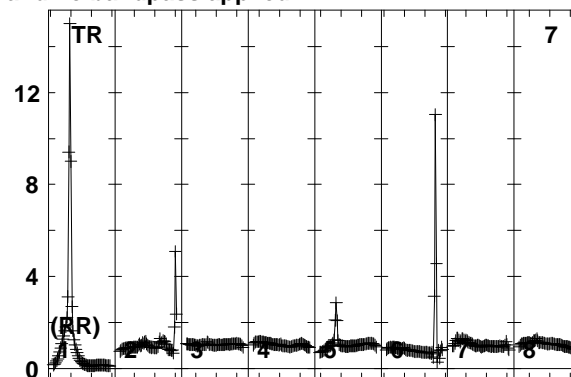
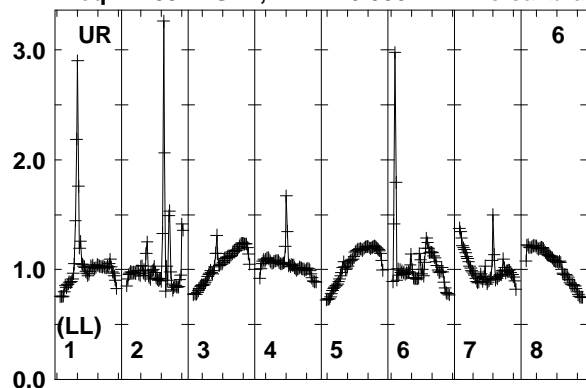

Lower frame: Real Jy
Total-power spectrum Antenna: UR (06)
Timerange: 00/03:32:01 to 00/03:32:59

Plot file version 60 created 04-NOV-2019 14:14:04

J2248-0541 EY034.UVDATA.1

Freq = 1.5947 GHz, Bw = 16.000 MH No calibration applied and no bandpass applied

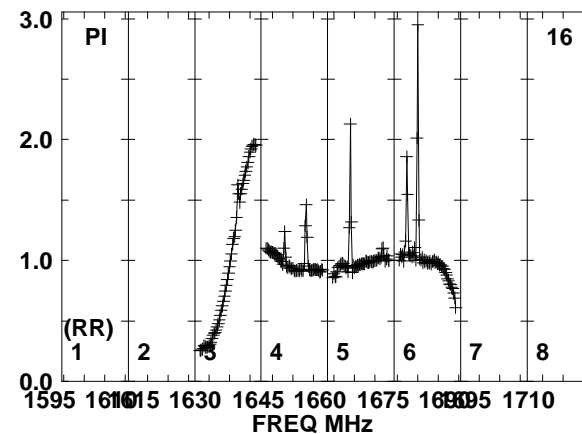
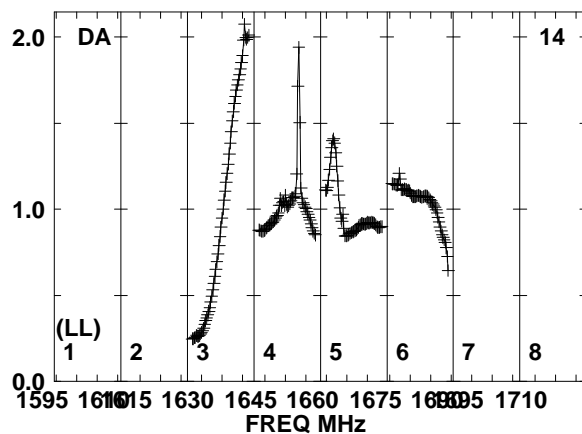
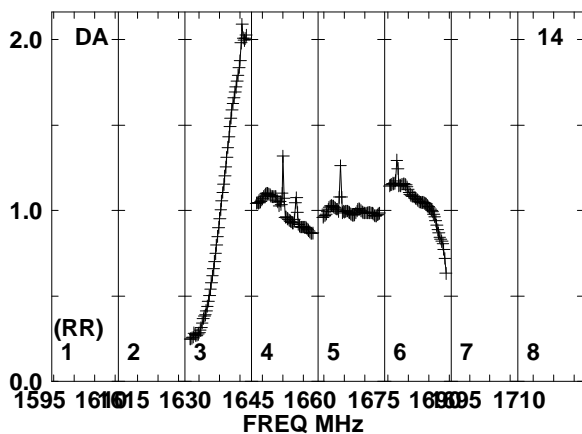
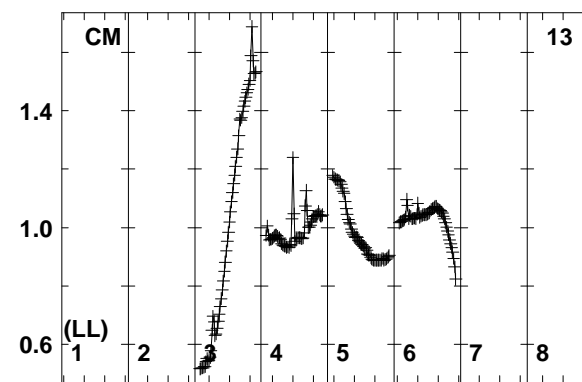
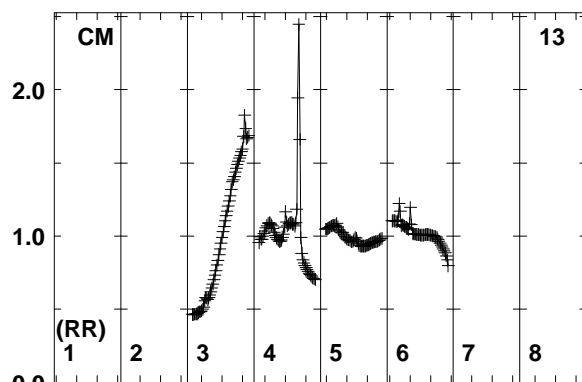
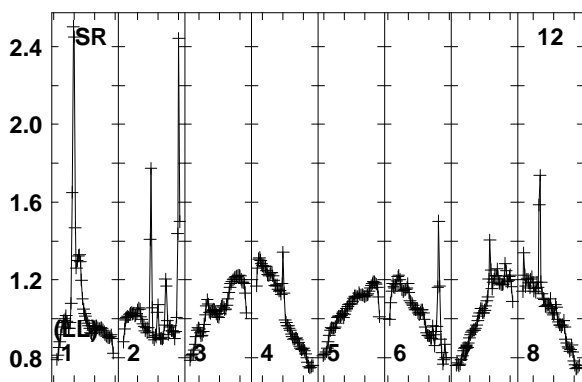
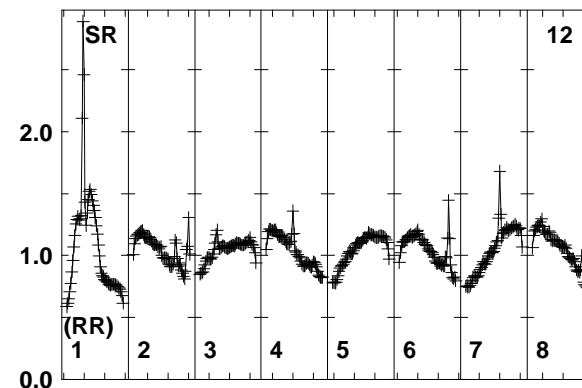
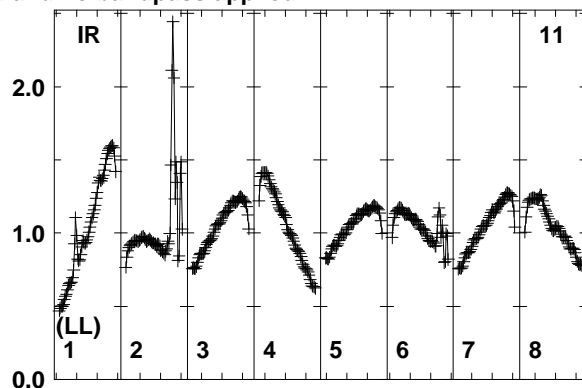
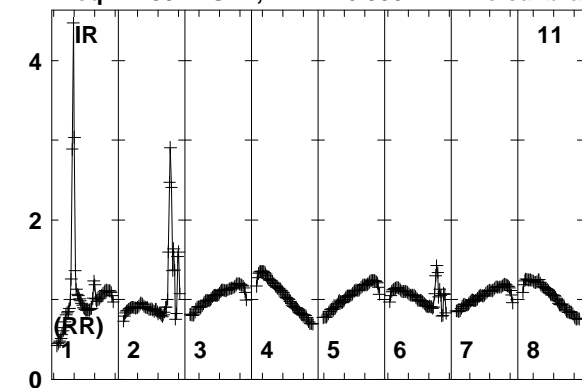

Lower frame: Real Jy
Total-power spectrum Antenna: IR (11)
Timerange: 00/03:32:01 to 00/03:32:59

Plot file version 61 created 04-NOV-2019 14:14:04
J2248-0541 EY034.UVDATA.1
Freq = 1.5947 GHz, Bw = 16.000 MH No calibration applied and no bandpass applied

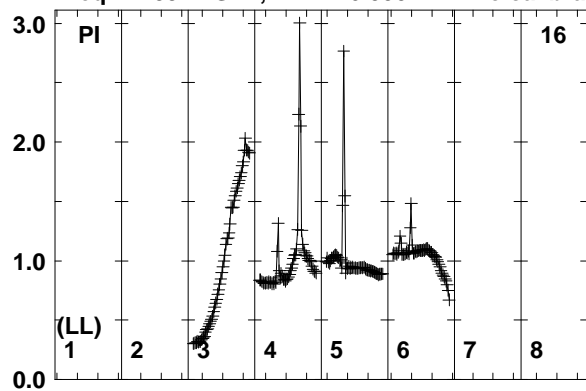

Lower frame: Real Jy
Total-power spectrum Antenna: PI (16)
Timerange: 00/03:32:01 to 00/03:32:59

Plot file version 62 created 04-NOV-2019 14:14:04

W2246-0526 EY034.UVDATA.1

Freq = 1.5947 GHz, Bw = 16.000 MH No calibration applied and no bandpass applied

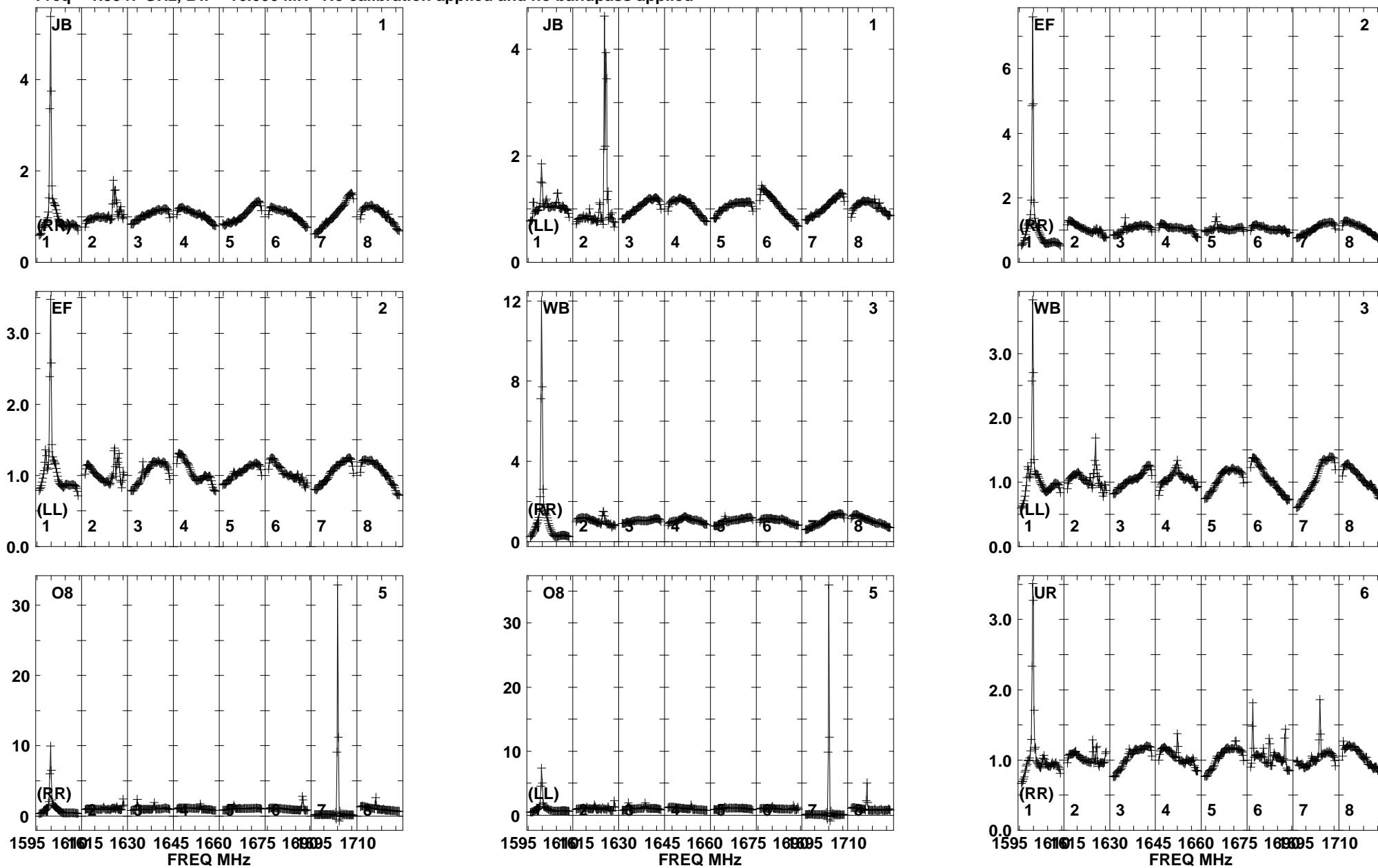

Lower frame: Real Jy
Total-power spectrum Antenna: JB (01)
Timerange: 00/03:33:01 to 00/03:35:39

Plot file version 63 created 04-NOV-2019 14:14:04

W2246-0526 EY034.UVDATA.1

Freq = 1.5947 GHz, Bw = 16.000 MH No calibration applied and no bandpass applied

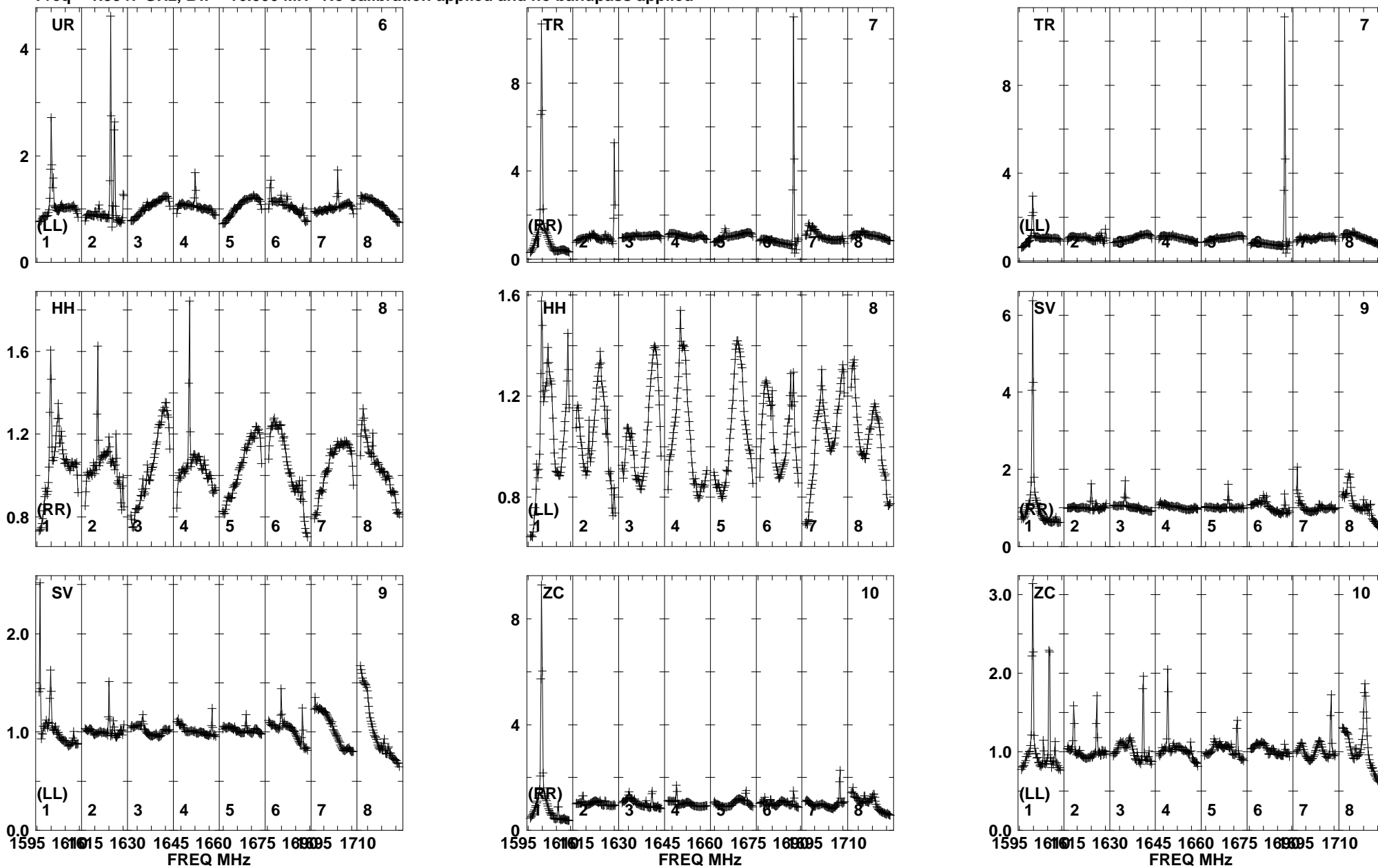

Lower frame: Real Jy
Total-power spectrum Antenna: UR (06)
Timerange: 00/03:33:01 to 00/03:35:39

Plot file version 64 created 04-NOV-2019 14:14:05

W2246-0526 EY034.UVDATA.1

Freq = 1.5947 GHz, Bw = 16.000 MH No calibration applied and no bandpass applied

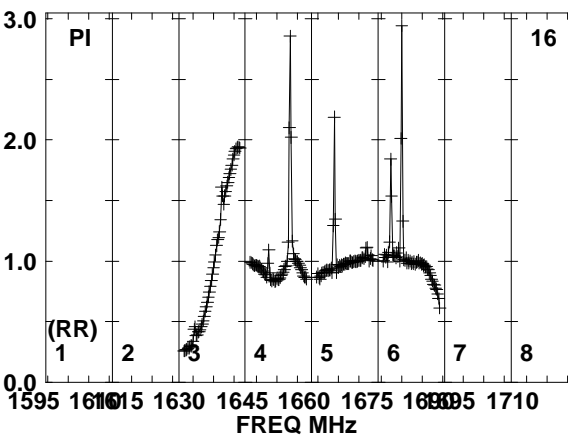
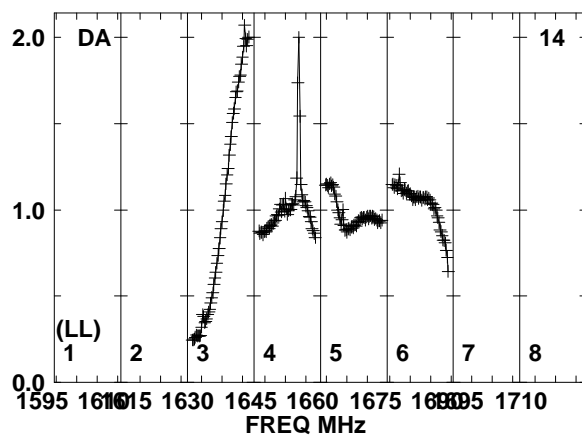
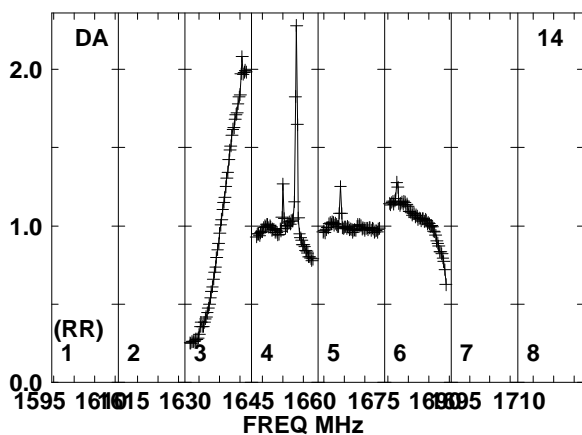
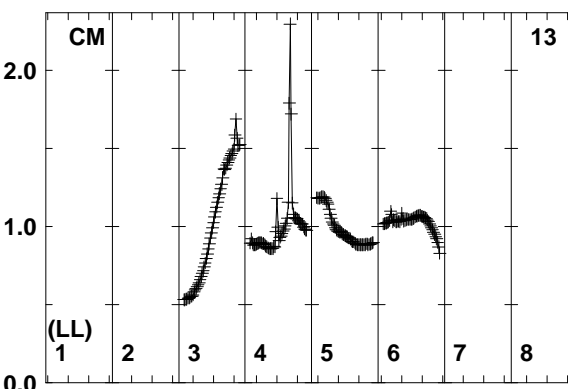
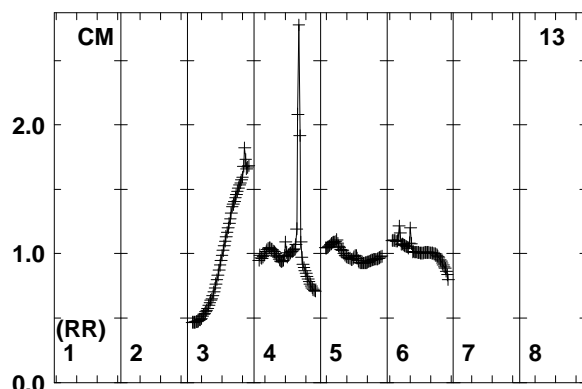
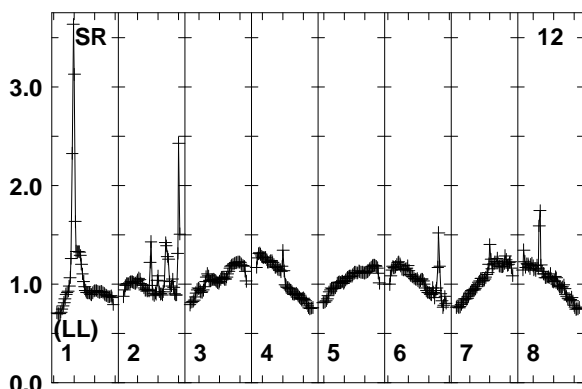
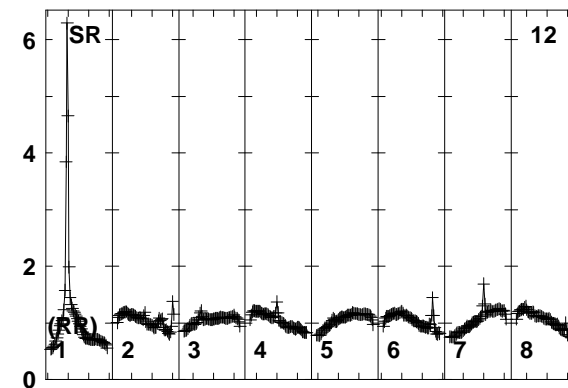
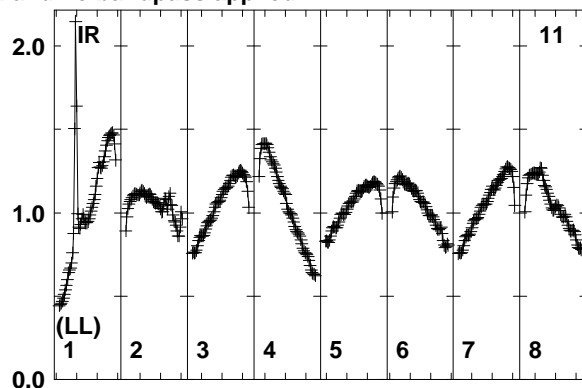
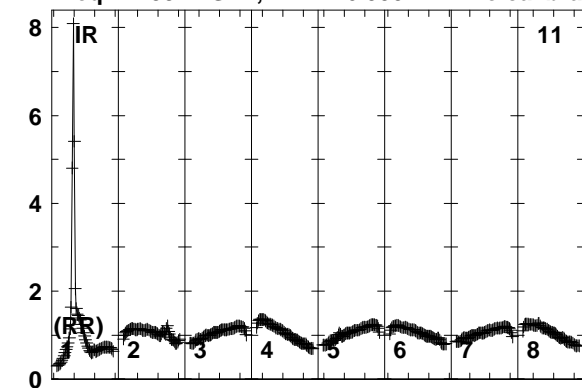

Lower frame: Real Jy
Total-power spectrum Antenna: IR (11)
Timerange: 00/03:33:01 to 00/03:35:39

Plot file version 65 created 04-NOV-2019 14:14:05
W2246-0526 EY034.UVDATA.1
Freq = 1.5947 GHz, Bw = 16.000 MH No calibration applied and no bandpass applied

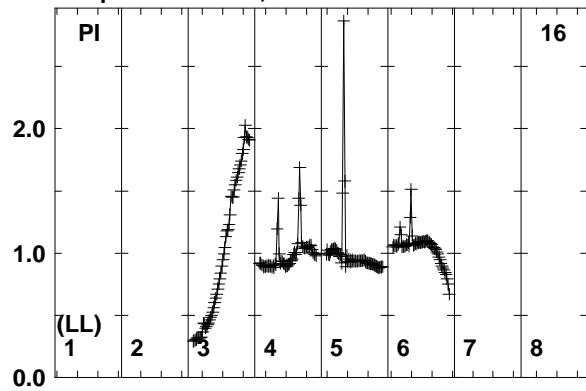

Lower frame: Real Jy
Total-power spectrum Antenna: PI (16)
Timerange: 00/03:33:01 to 00/03:35:39

Plot file version 66 created 04-NOV-2019 14:14:05

J2248-0541 EY034.UVDATA.1

Freq = 1.5947 GHz, Bw = 16.000 MH No calibration applied and no bandpass applied

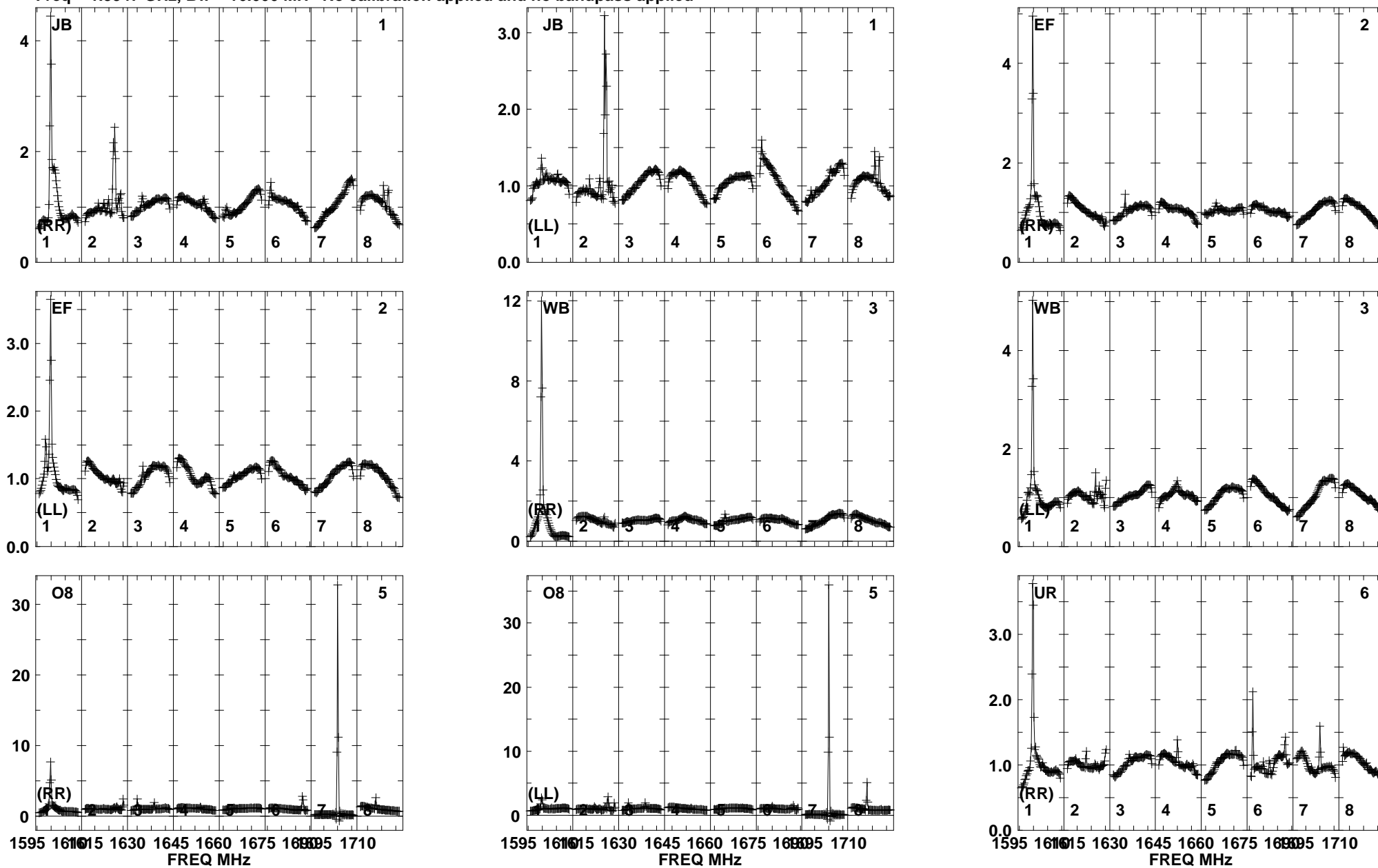

Lower frame: Real Jy
Total-power spectrum Antenna: JB (01)
Timerange: 00/03:35:56 to 00/03:36:54

Plot file version 67 created 04-NOV-2019 14:14:05

J2248-0541 EY034.UVDATA.1

Freq = 1.5947 GHz, Bw = 16.000 MH No calibration applied and no bandpass applied

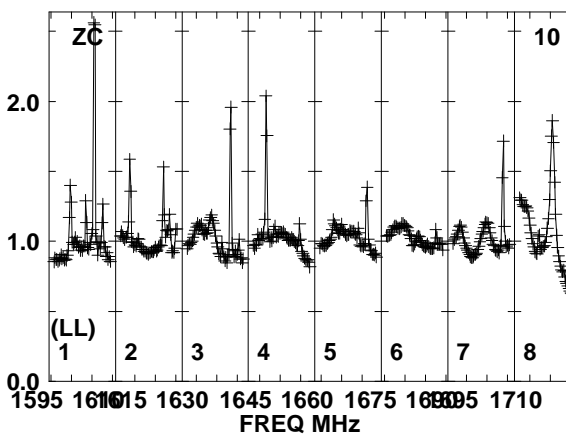
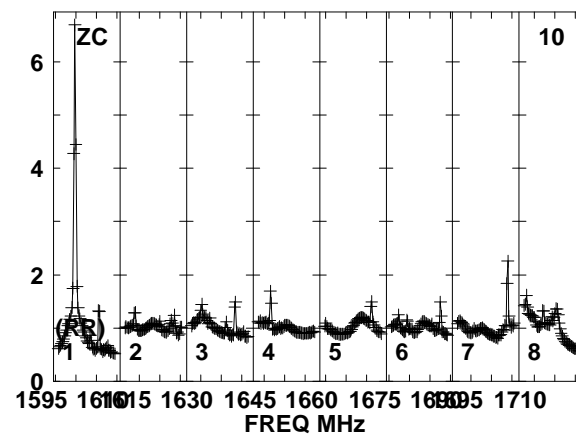
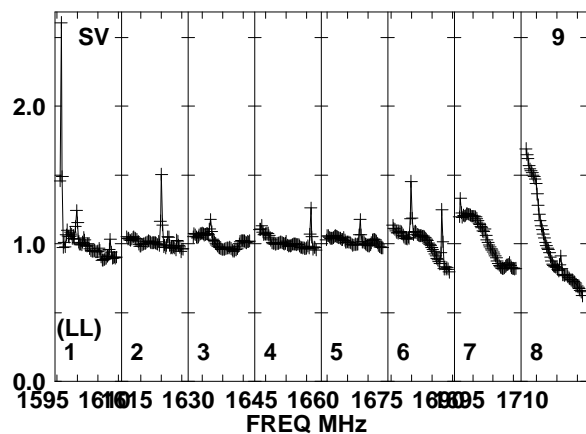
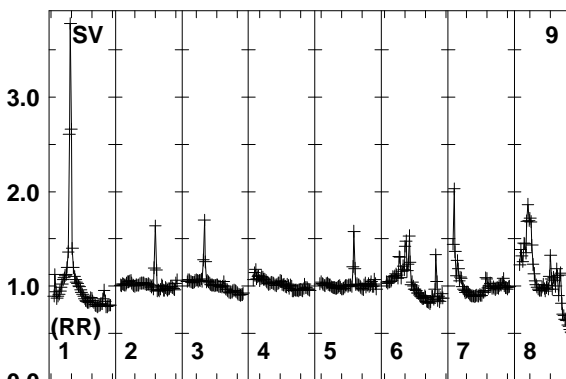
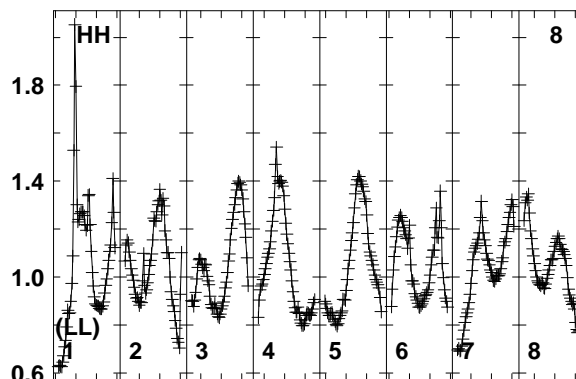
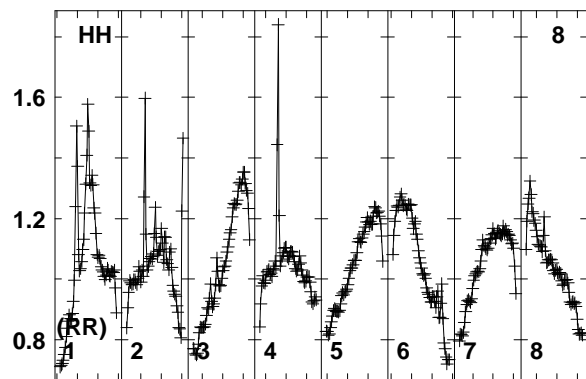
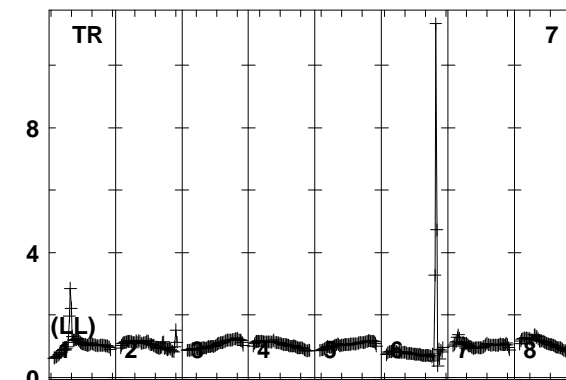
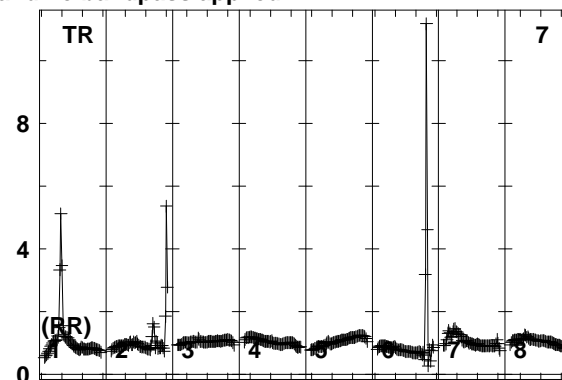
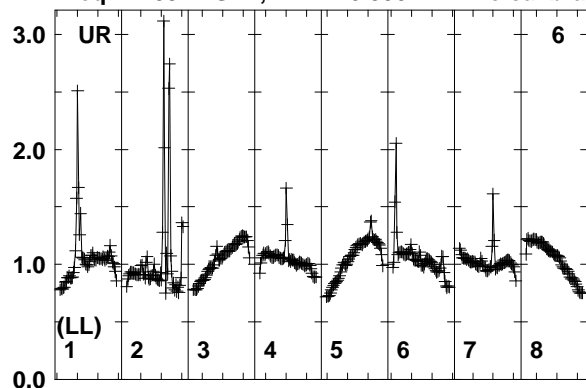

Lower frame: Real Jy
Total-power spectrum Antenna: UR (06)
Timerange: 00/03:35:56 to 00/03:36:54

Plot file version 68 created 04-NOV-2019 14:14:05

J2248-0541 EY034.UVDATA.1

Freq = 1.5947 GHz, Bw = 16.000 MH No calibration applied and no bandpass applied

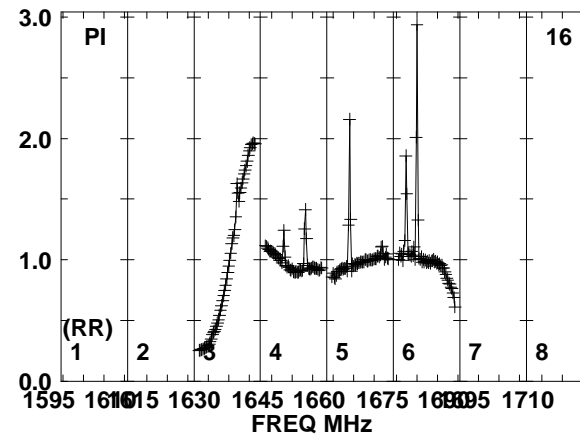
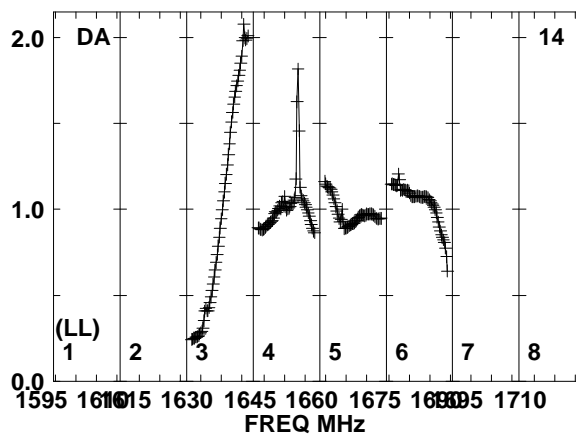
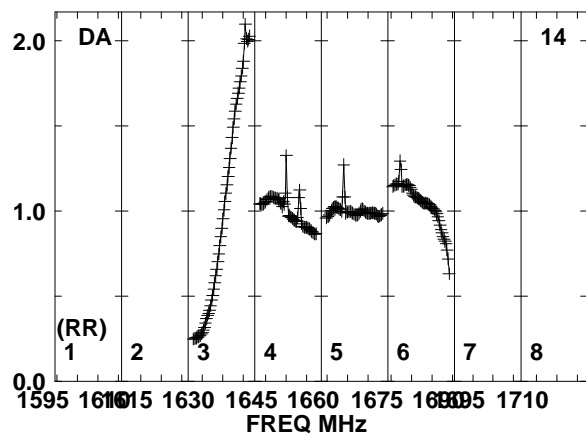
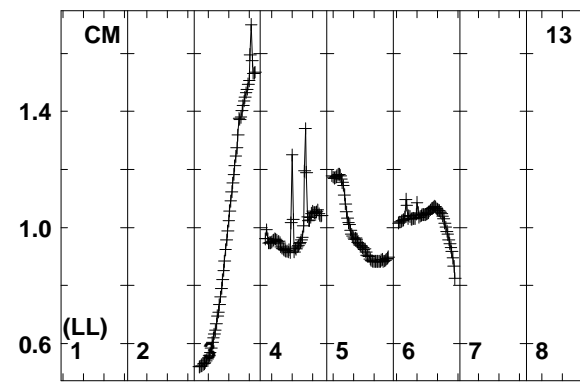
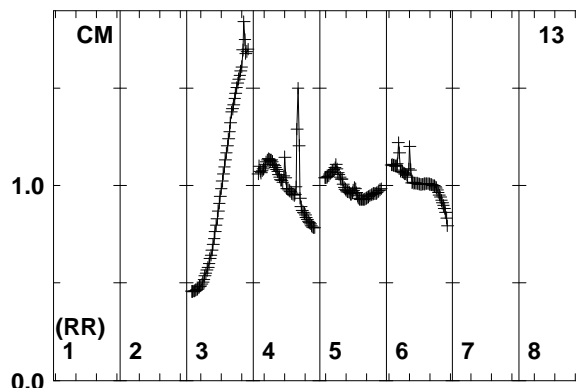
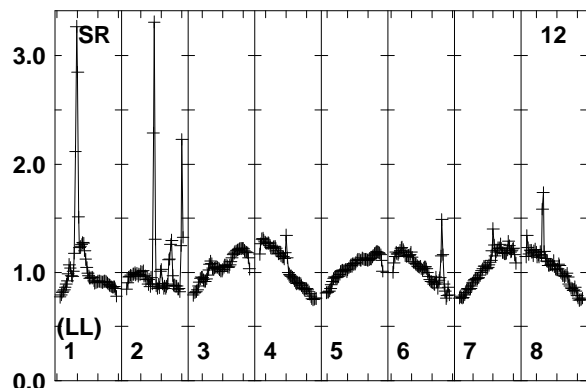
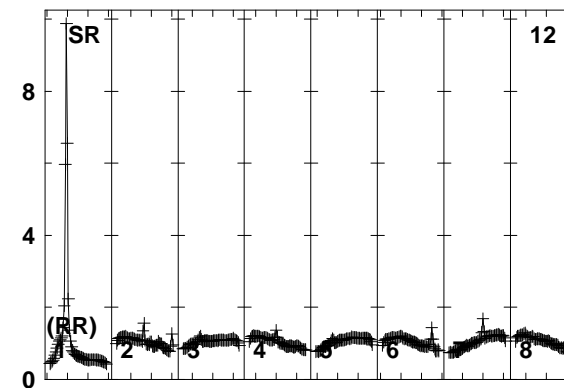
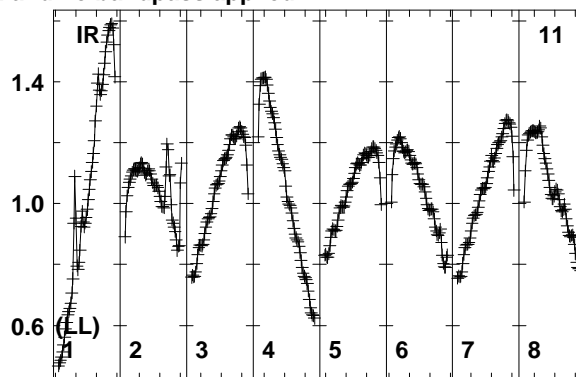
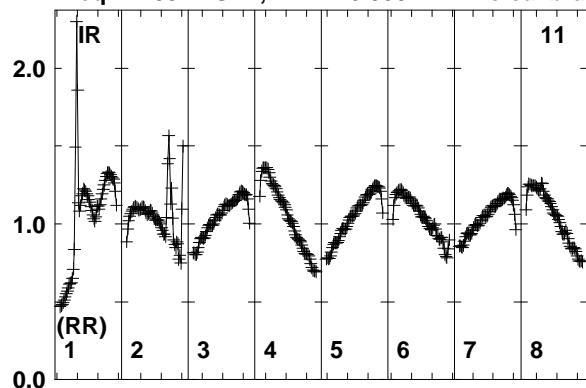

Lower frame: Real Jy
Total-power spectrum Antenna: IR (11)
Timerange: 00/03:35:56 to 00/03:36:54

Plot file version 69 created 04-NOV-2019 14:14:05
J2248-0541 EY034.UVDATA.1
Freq = 1.5947 GHz, Bw = 16.000 MH No calibration applied and no bandpass applied

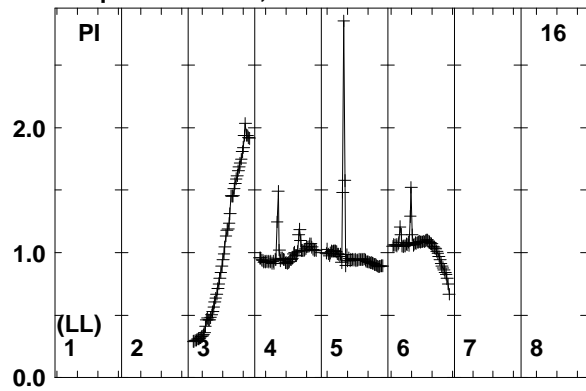

Lower frame: Real Jy
Total-power spectrum Antenna: PI (16)
Timerange: 00/03:35:56 to 00/03:36:54

Plot file version 70 created 04-NOV-2019 14:14:05
 W2246-0526 EY034.UVDATA.1
 Freq = 1.5947 GHz, Bw = 16.000 MH No calibration applied and no bandpass applied

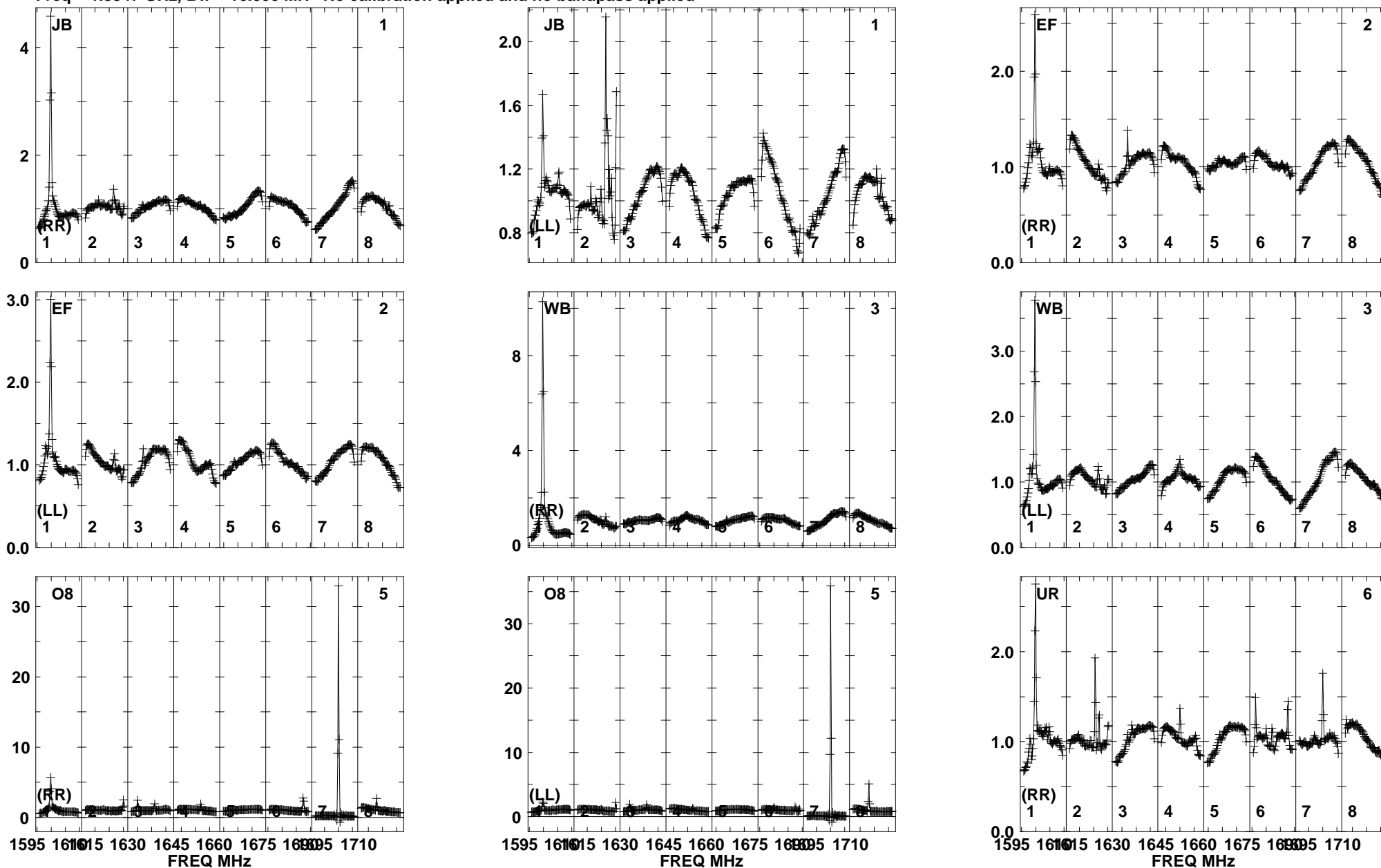

Lower frame: Real Jy
 Total-power spectrum Antenna: JB (01)
 Timerange: 00/03:36:56 to 00/03:39:34

Plot file version 71 created 04-NOV-2019 14:14:05

W2246-0526 EY034.UVDATA.1

Freq = 1.5947 GHz, Bw = 16.000 MH No calibration applied and no bandpass applied

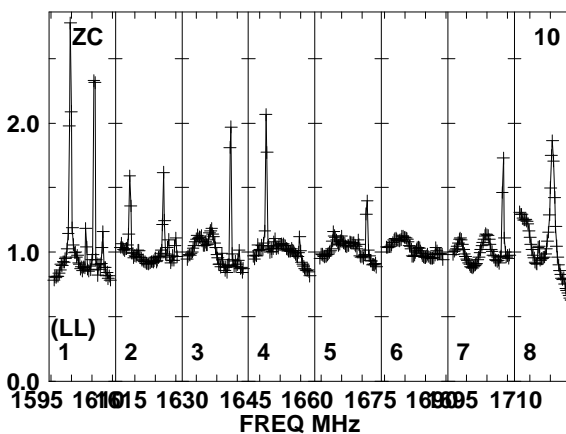
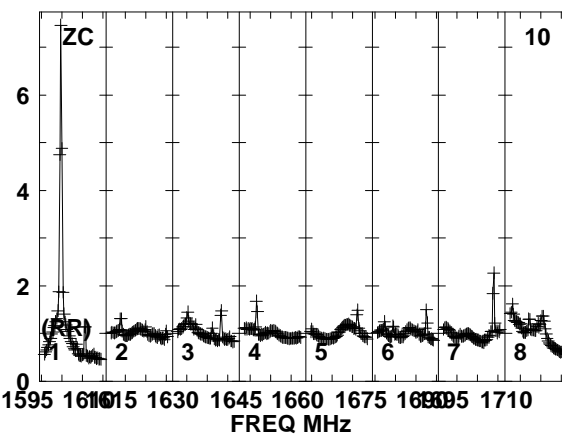
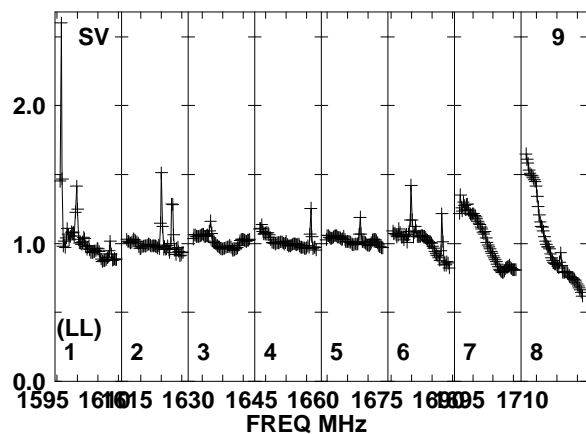
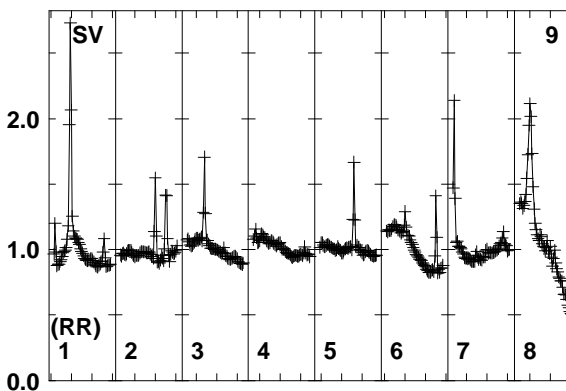
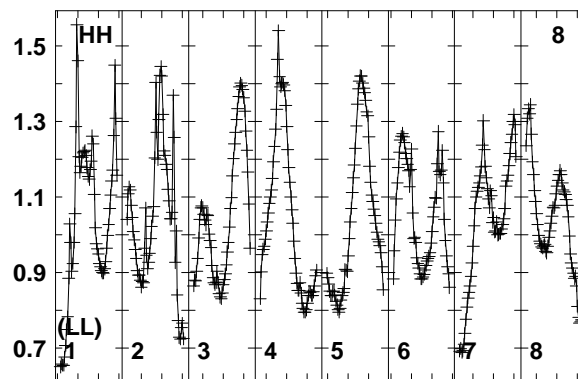
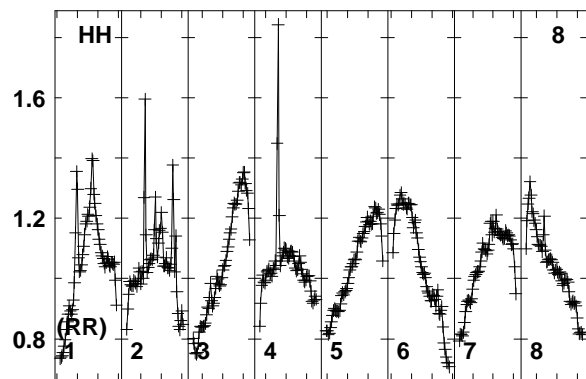
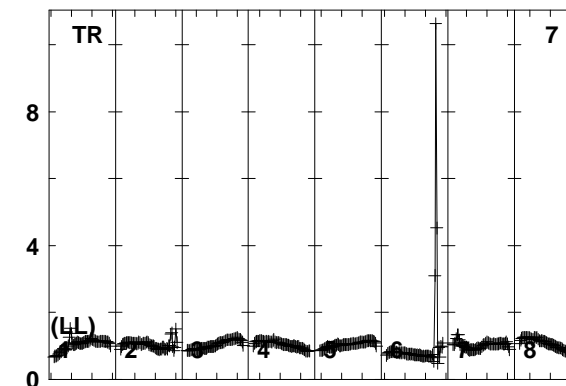
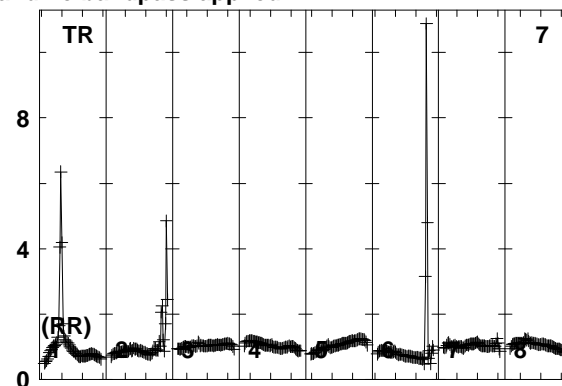
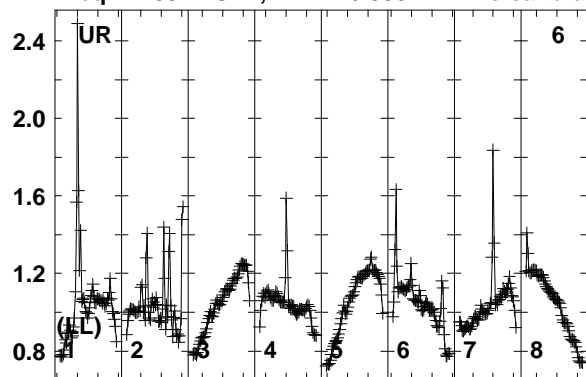

Lower frame: Real Jy
Total-power spectrum Antenna: UR (06)
Timerange: 00/03:36:56 to 00/03:39:34

Plot file version 72 created 04-NOV-2019 14:14:05

W2246-0526 EY034.UVDATA.1

Freq = 1.5947 GHz, Bw = 16.000 MH No calibration applied and no bandpass applied

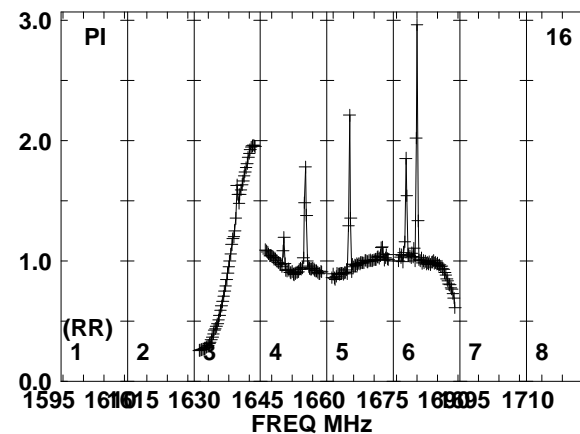
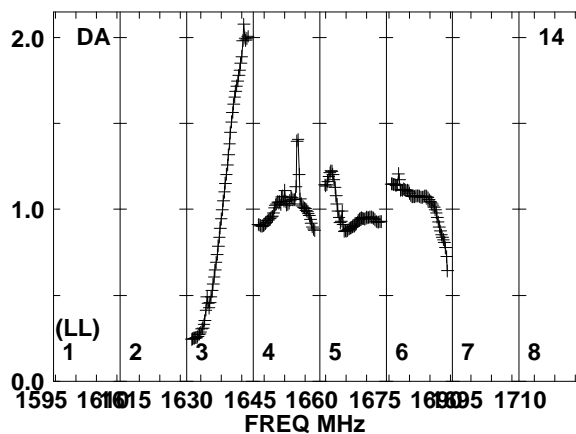
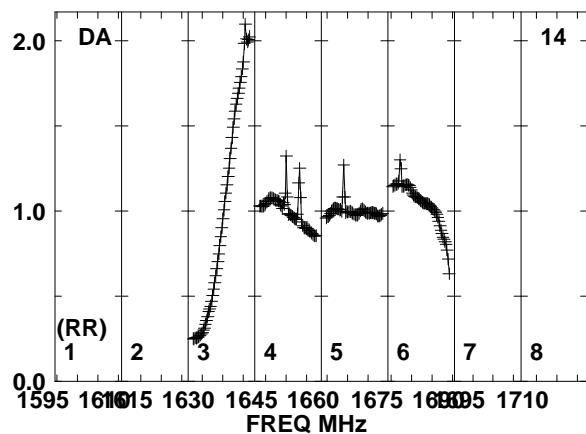
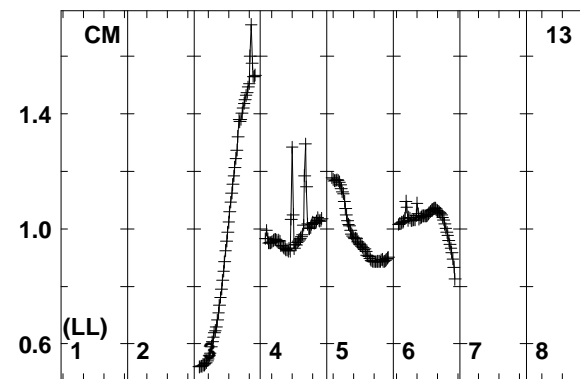
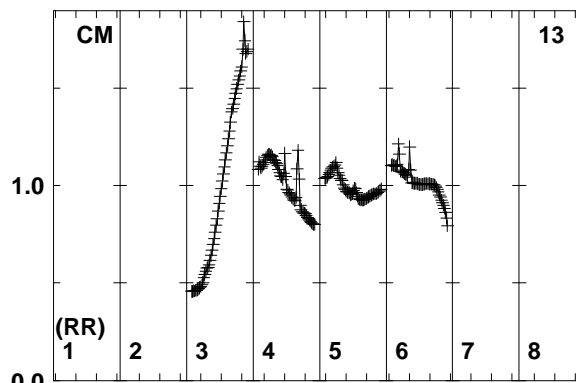
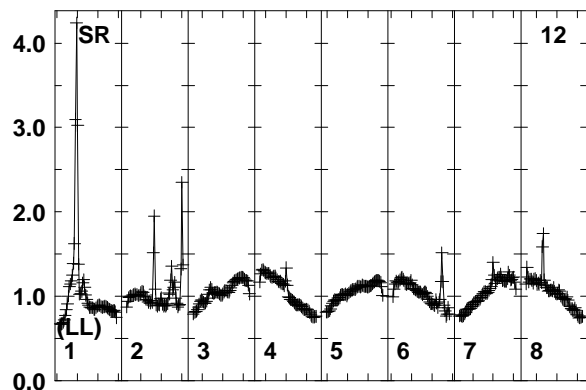
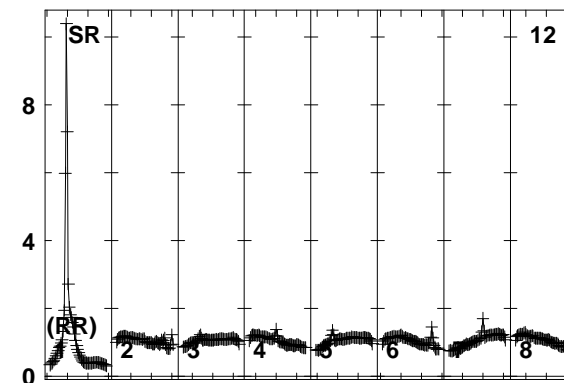
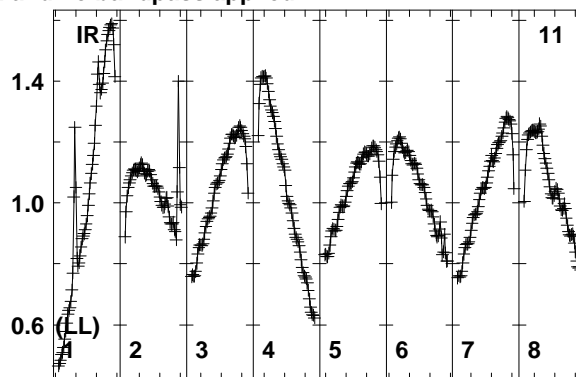
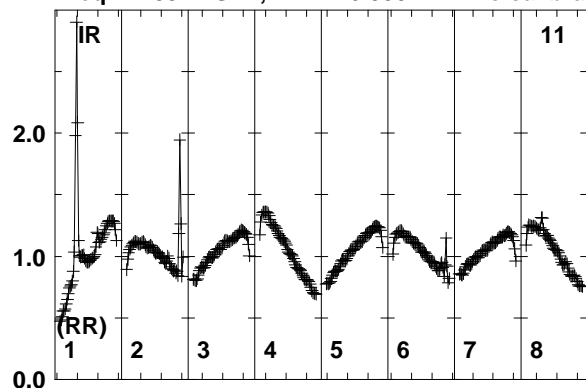

Lower frame: Real Jy
Total-power spectrum Antenna: IR (11)
Timerange: 00/03:36:56 to 00/03:39:34

Plot file version 73 created 04-NOV-2019 14:14:05
W2246-0526 EY034.UVDATA.1
Freq = 1.5947 GHz, Bw = 16.000 MH No calibration applied and no bandpass applied

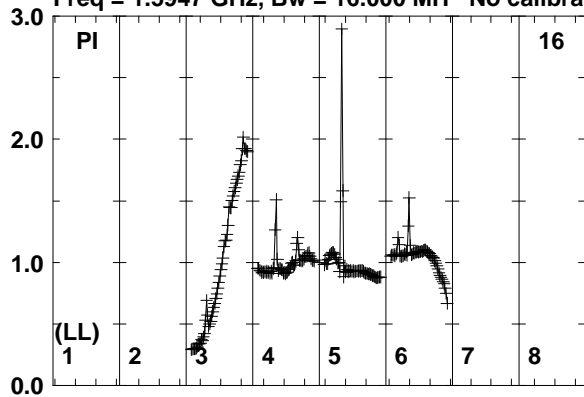

Lower frame: Real Jy
Total-power spectrum Antenna: PI (16)
Timerange: 00/03:36:56 to 00/03:39:34

Plot file version 74 created 04-NOV-2019 14:14:05

J2248-0541 EY034.UVDATA.1

Freq = 1.5947 GHz, Bw = 16.000 MH No calibration applied and no bandpass applied

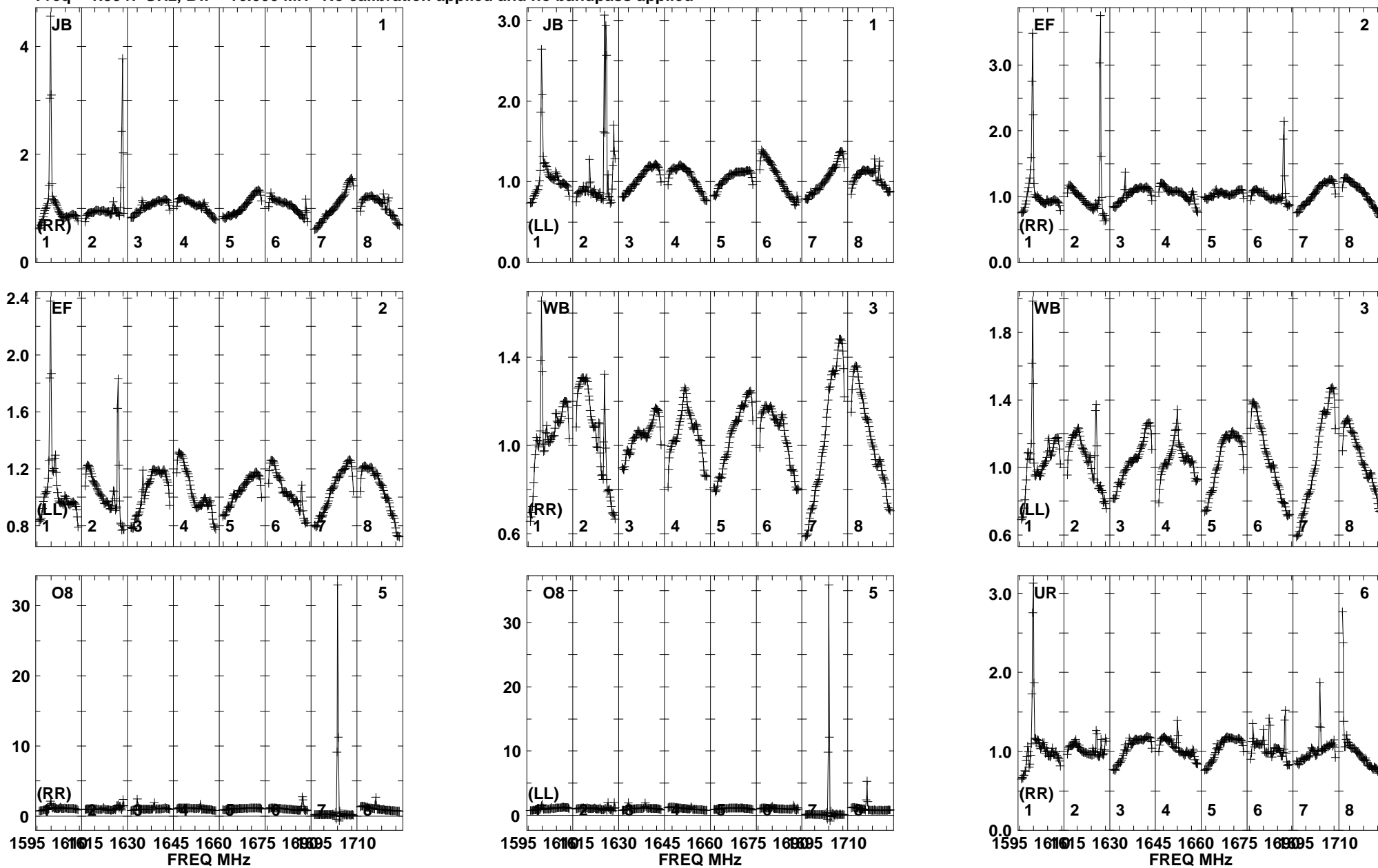

Lower frame: Real Jy
Total-power spectrum Antenna: JB (01)
Timerange: 00/03:39:51 to 00/03:40:49

Plot file version 75 created 04-NOV-2019 14:14:05

J2248-0541 EY034.UVDATA.1

Freq = 1.5947 GHz, Bw = 16.000 MH No calibration applied and no bandpass applied

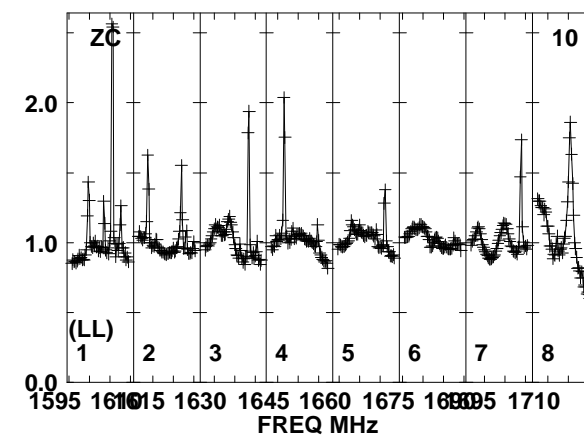
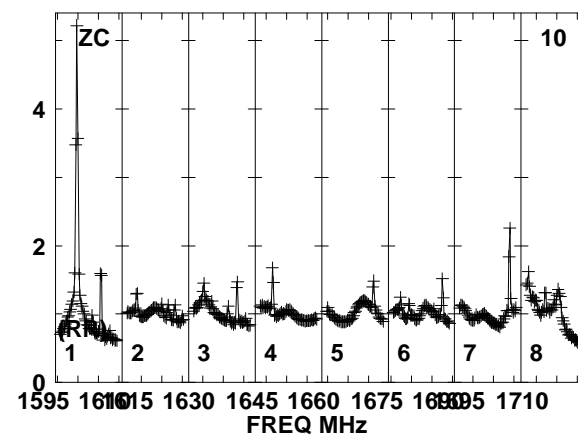
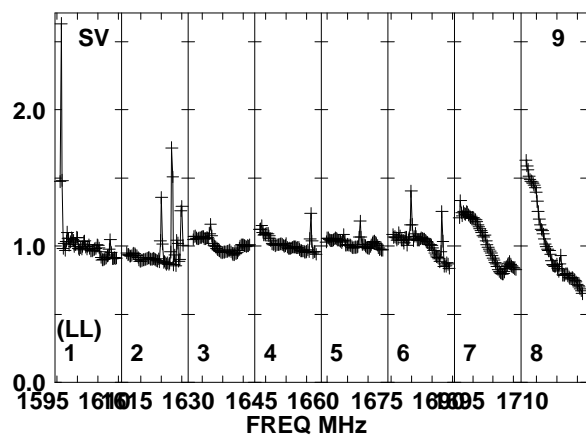
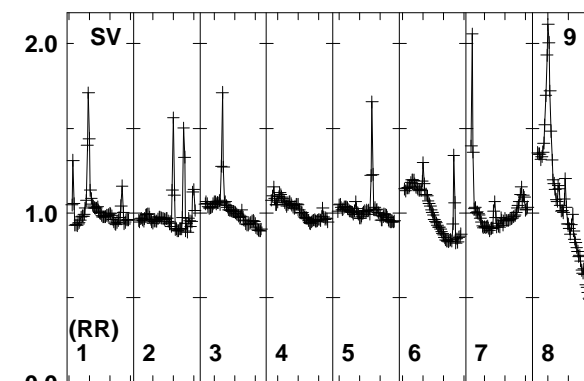
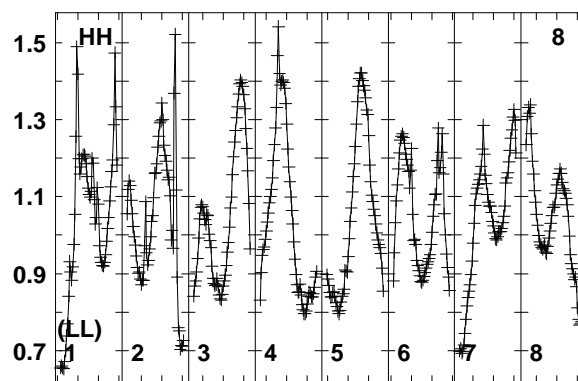
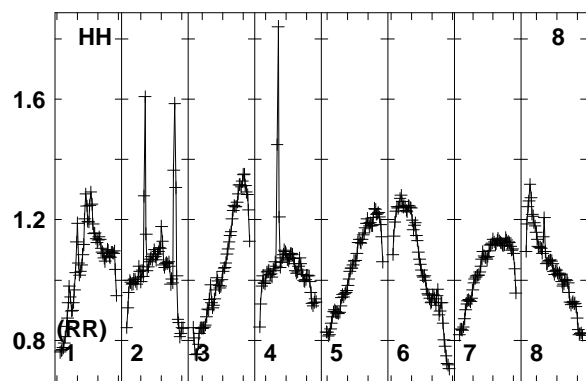
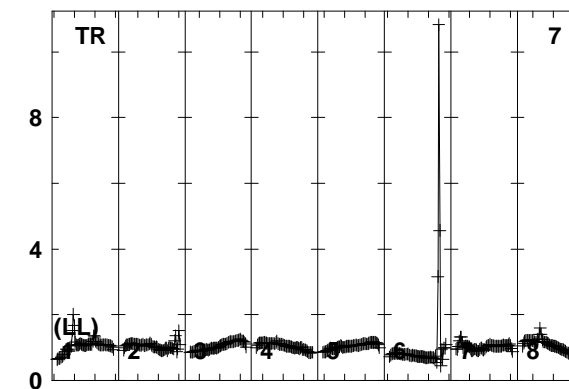
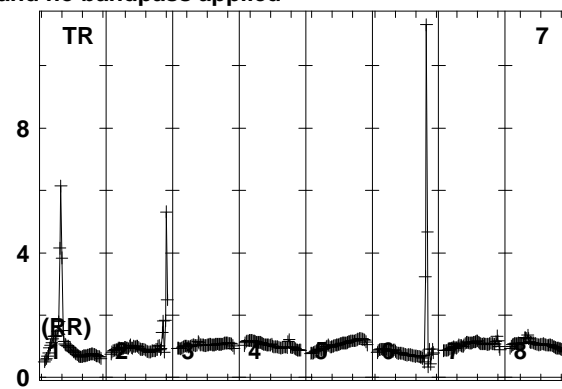
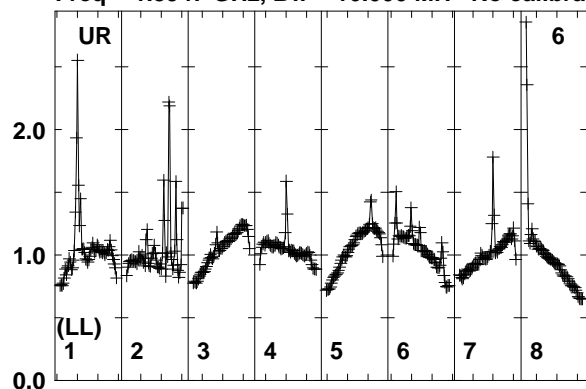

Lower frame: Real Jy
Total-power spectrum Antenna: UR (06)
Timerange: 00/03:39:51 to 00/03:40:49

Plot file version 76 created 04-NOV-2019 14:14:06

J2248-0541 EY034.UVDATA.1

Freq = 1.5947 GHz, Bw = 16.000 MH No calibration applied and no bandpass applied

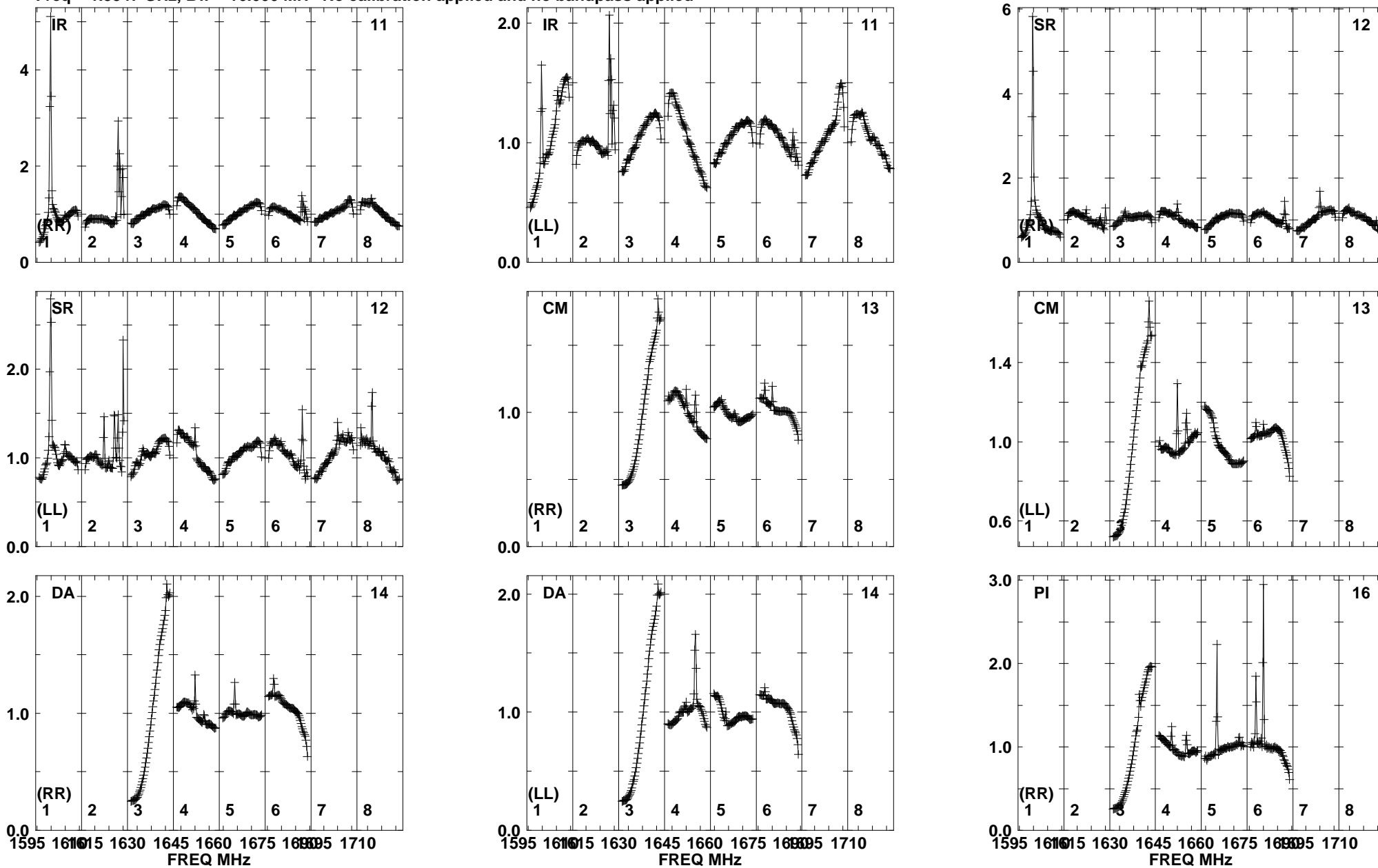

Lower frame: Real Jy
Total-power spectrum Antenna: IR (11)
Timerange: 00/03:39:51 to 00/03:40:49

Plot file version 77 created 04-NOV-2019 14:14:06
J2248-0541 EY034.UVDATA.1
Freq = 1.5947 GHz, Bw = 16.000 MH No calibration applied and no bandpass applied

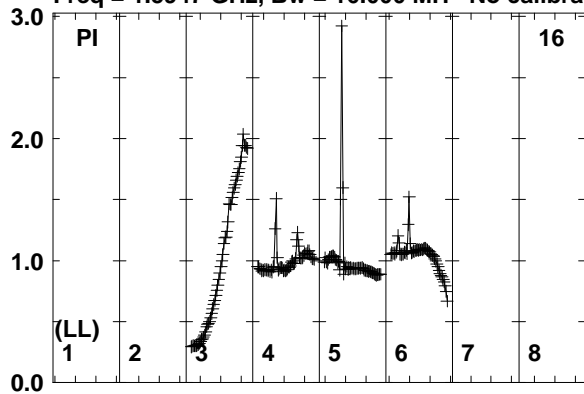

Lower frame: Real Jy
Total-power spectrum Antenna: PI (16)
Timerange: 00/03:39:51 to 00/03:40:49

Plot file version 78 created 04-NOV-2019 14:14:06
 W2246-0526 EY034.UVDATA.1
 Freq = 1.5947 GHz, Bw = 16.000 MH No calibration applied and no bandpass applied

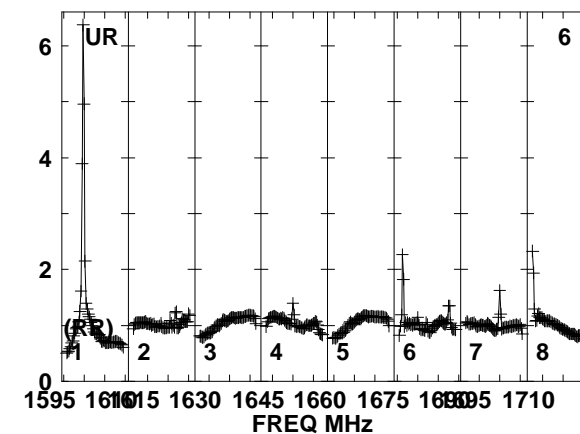
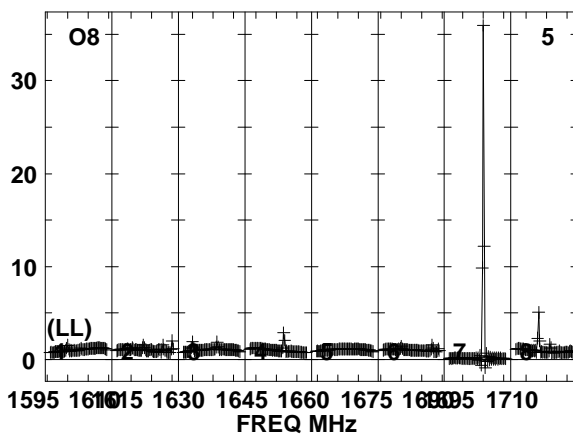
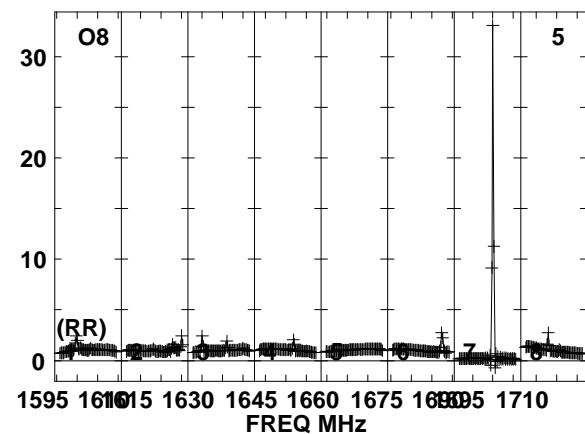
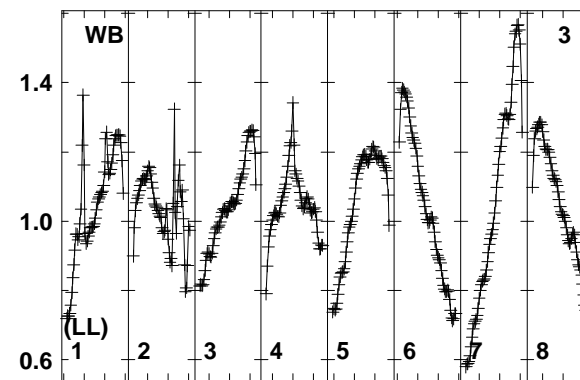
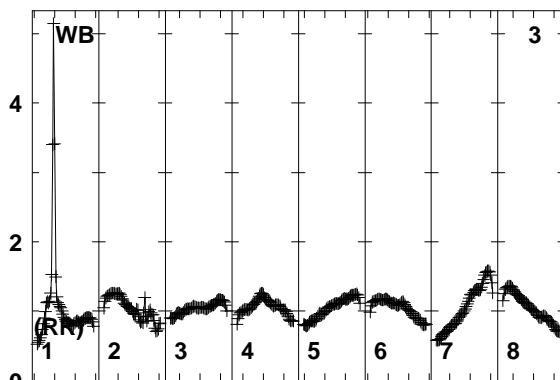
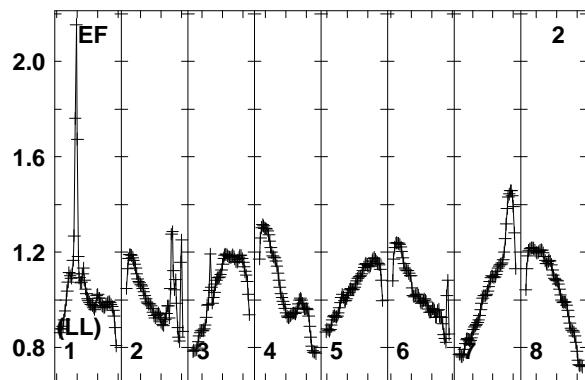
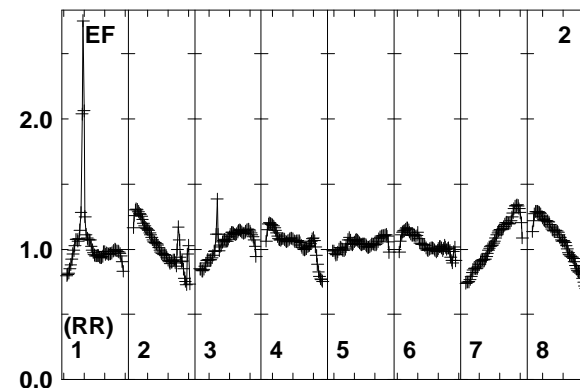
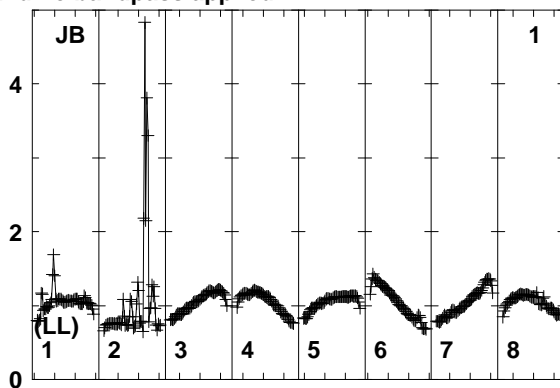
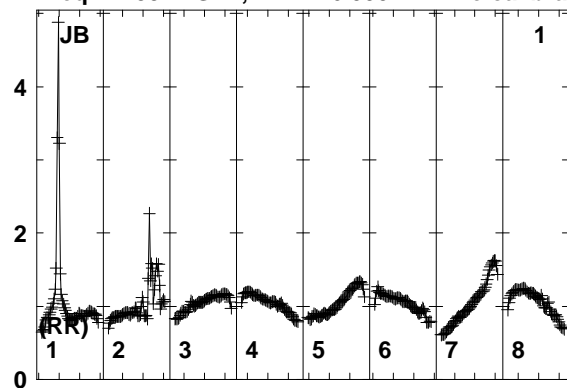

Lower frame: Real Jy
 Total-power spectrum Antenna: JB (01)
 Timerange: 00/03:40:51 to 00/03:43:29

Plot file version 79 created 04-NOV-2019 14:14:06

W2246-0526 EY034.UVDATA.1

Freq = 1.5947 GHz, Bw = 16.000 MH No calibration applied and no bandpass applied

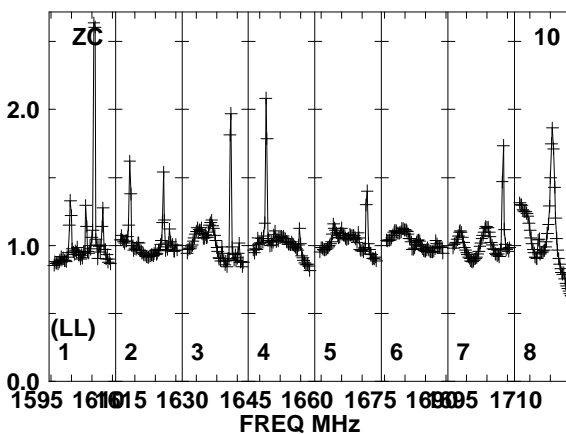
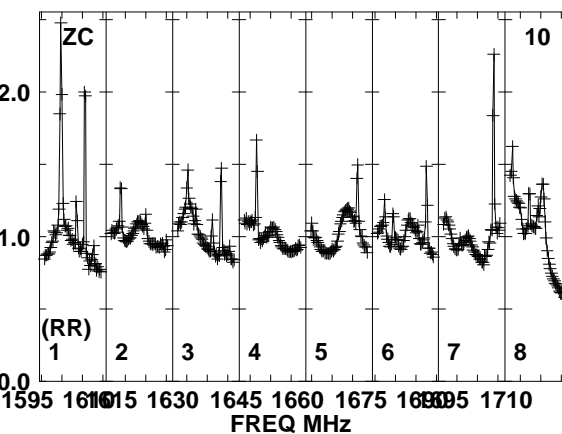
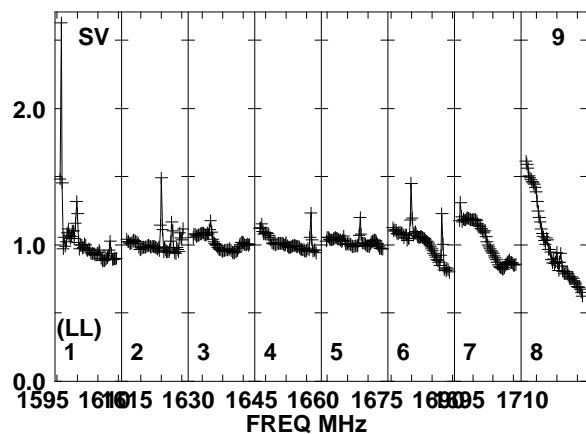
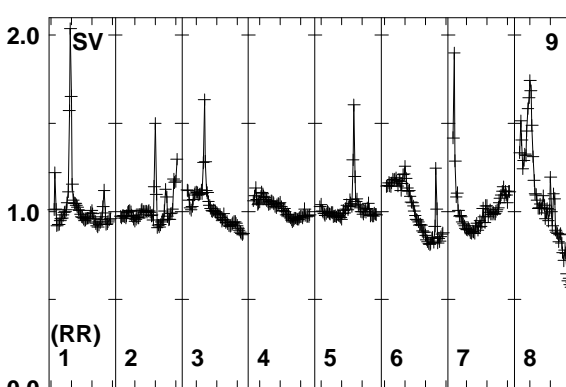
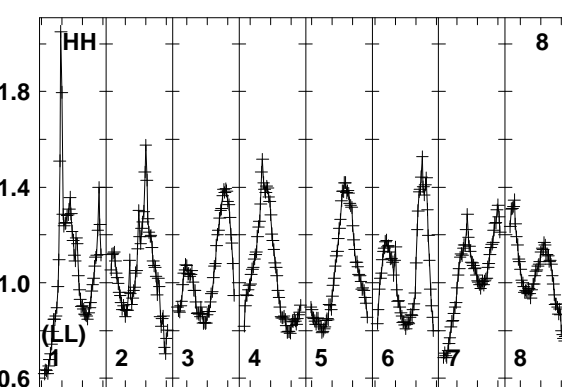
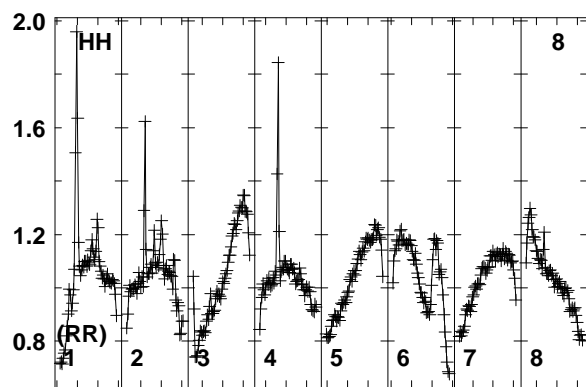
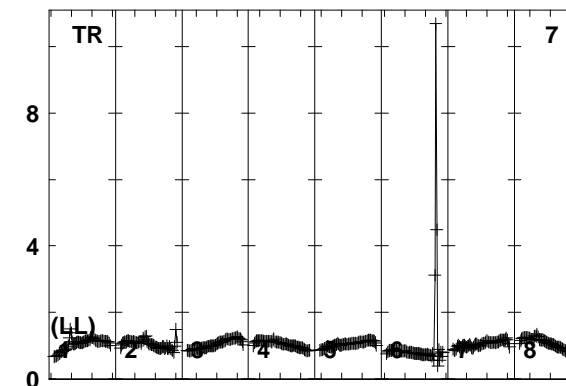
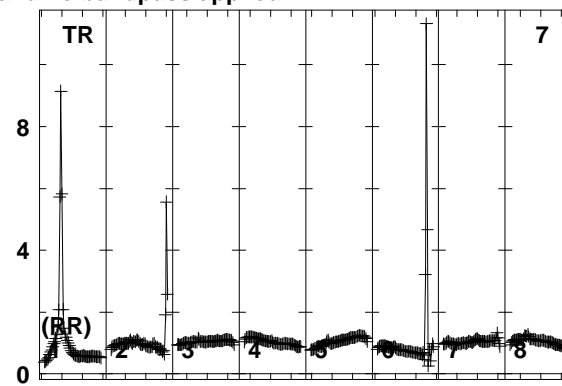
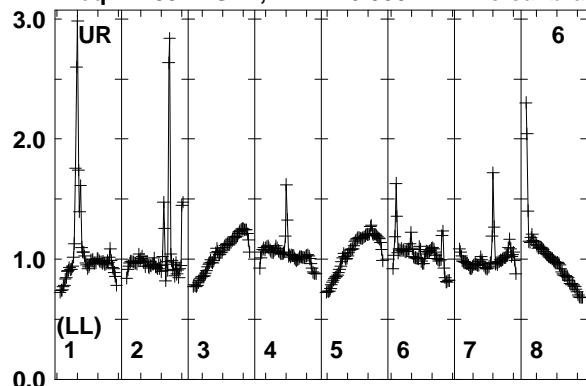

Lower frame: Real Jy
Total-power spectrum Antenna: UR (06)
Timerange: 00/03:40:51 to 00/03:43:29

Plot file version 80 created 04-NOV-2019 14:14:06

W2246-0526 EY034.UVDATA.1

Freq = 1.5947 GHz, Bw = 16.000 MH No calibration applied and no bandpass applied

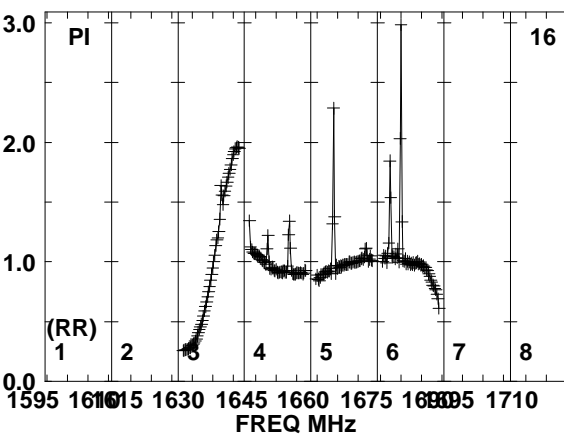
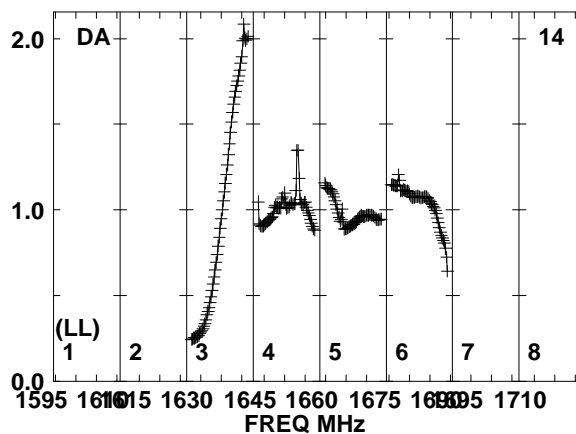
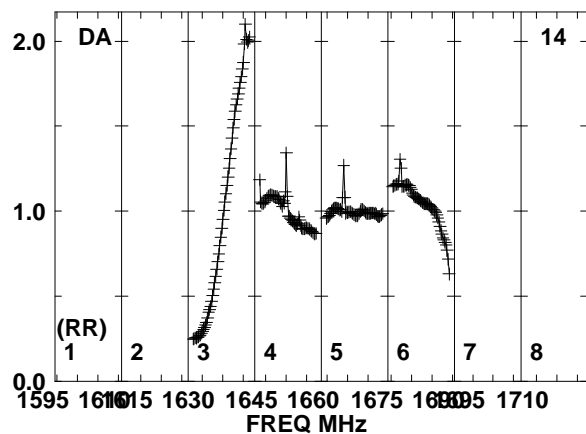
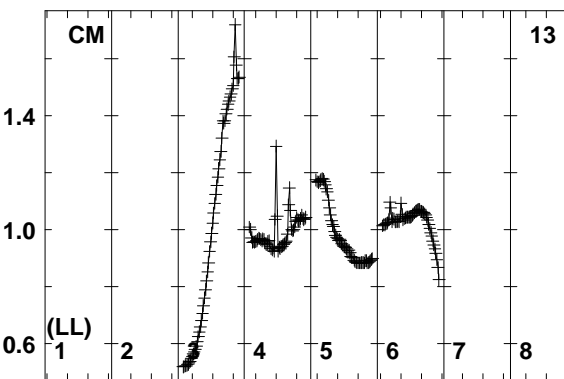
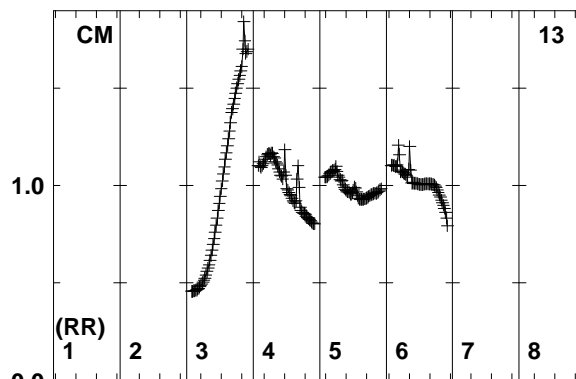
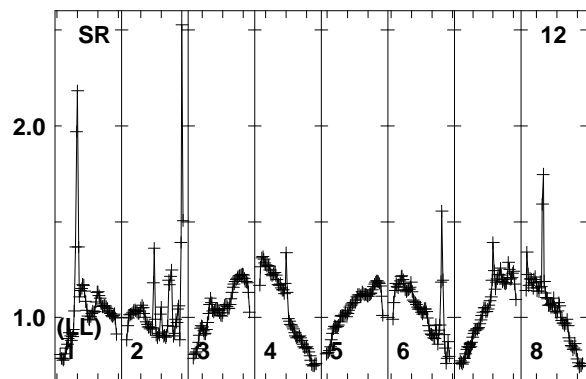
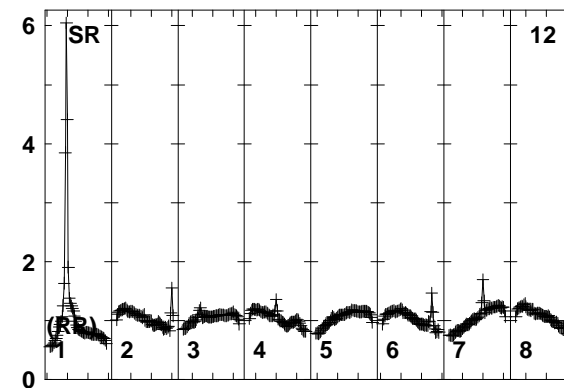
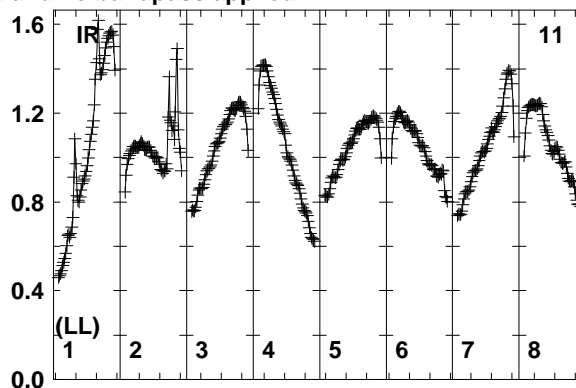
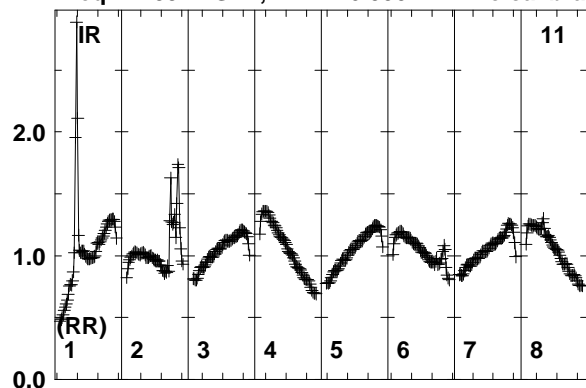

Lower frame: Real Jy
Total-power spectrum Antenna: IR (11)
Timerange: 00/03:40:51 to 00/03:43:29

Plot file version 81 created 04-NOV-2019 14:14:06
W2246-0526 EY034.UVDATA.1
Freq = 1.5947 GHz, Bw = 16.000 MH No calibration applied and no bandpass applied

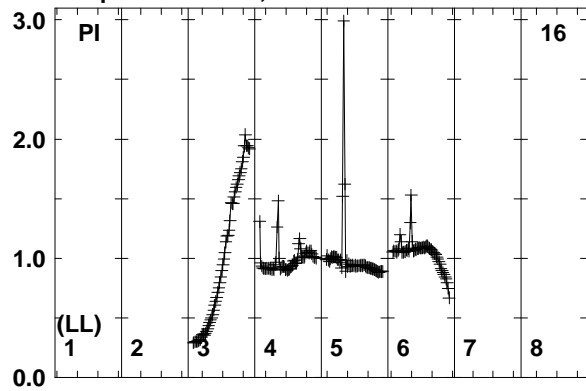

Lower frame: Real Jy
Total-power spectrum Antenna: PI (16)
Timerange: 00/03:40:51 to 00/03:43:29

Plot file version 82 created 04-NOV-2019 14:14:06

J2248-0541 EY034.UVDATA.1

Freq = 1.5947 GHz, Bw = 16.000 MH No calibration applied and no bandpass applied

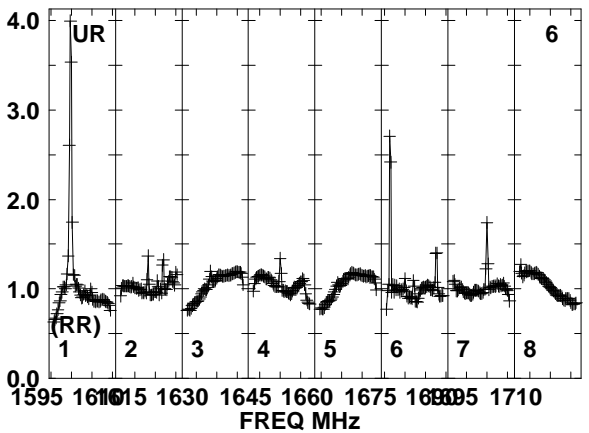
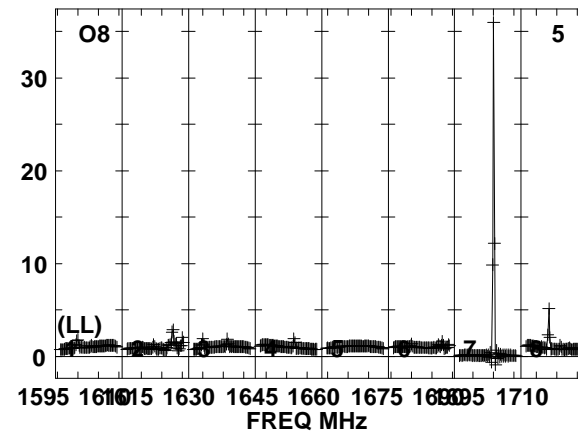
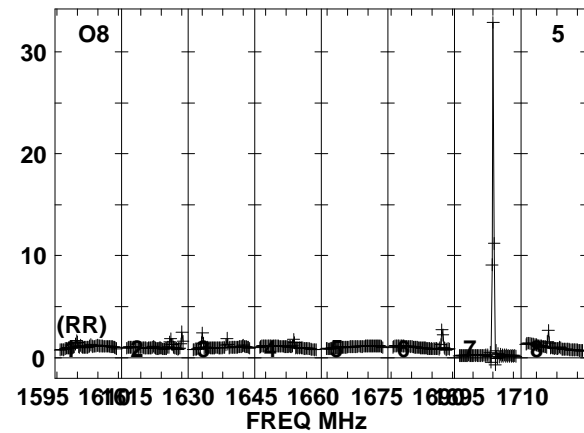
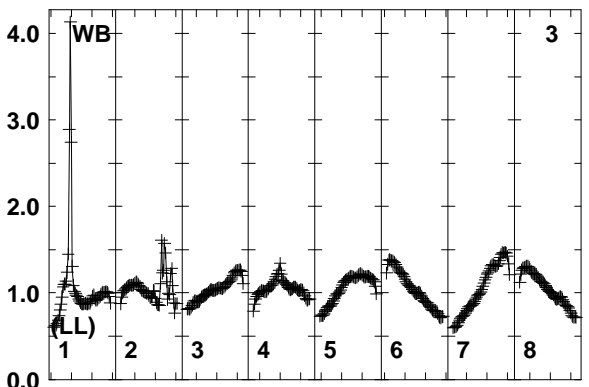
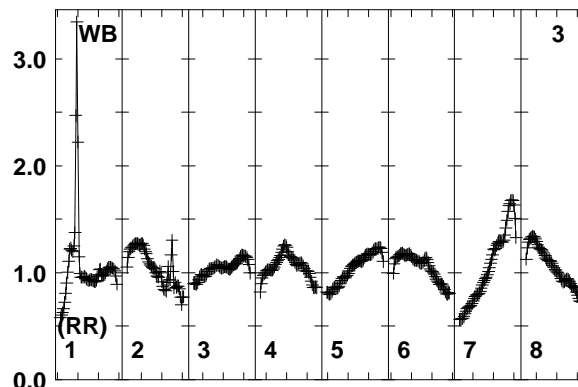
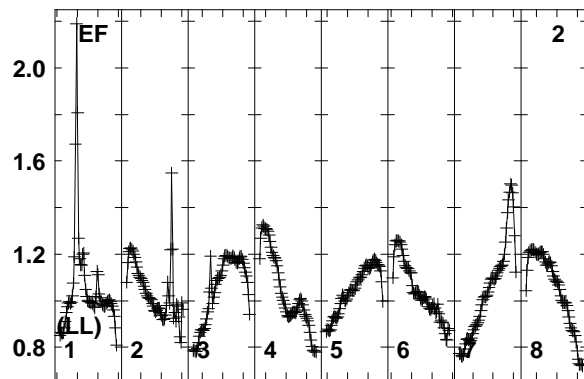
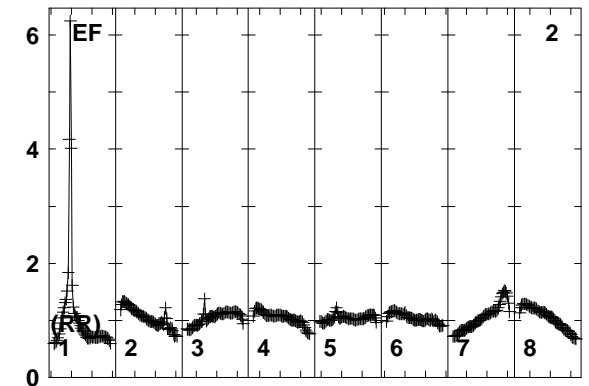
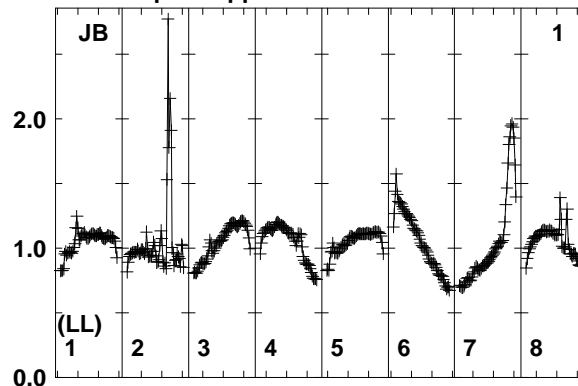
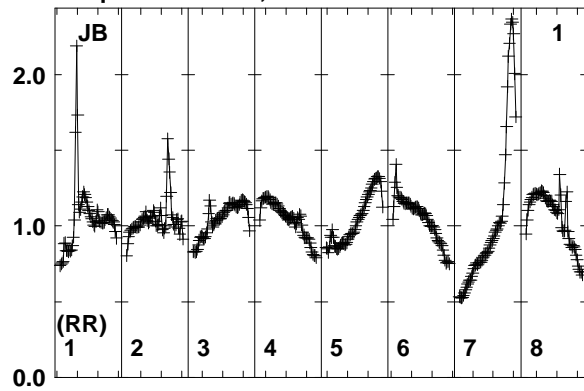

Lower frame: Real Jy
Total-power spectrum Antenna: JB (01)
Timerange: 00/03:44:06 to 00/03:45:04

Plot file version 83 created 04-NOV-2019 14:14:06

J2248-0541 EY034.UVDATA.1

Freq = 1.5947 GHz, Bw = 16.000 MH No calibration applied and no bandpass applied

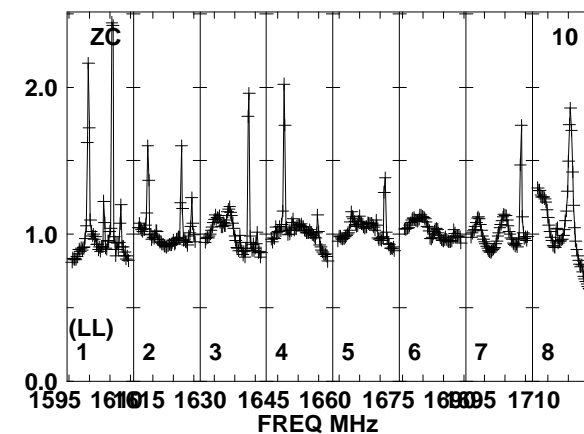
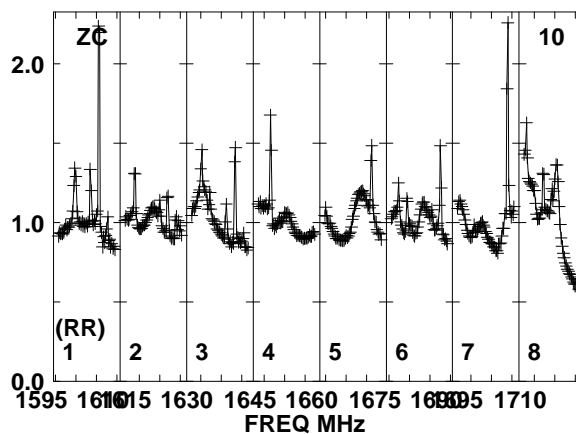
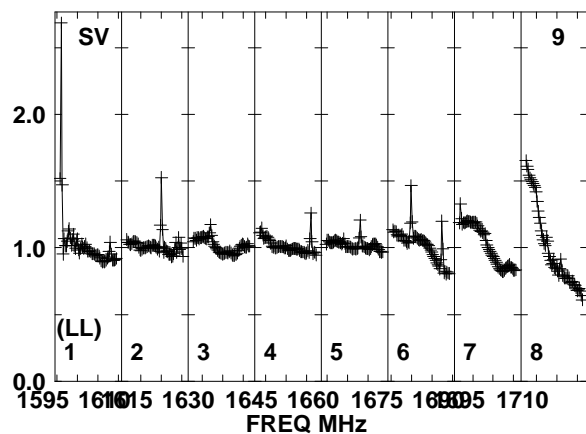
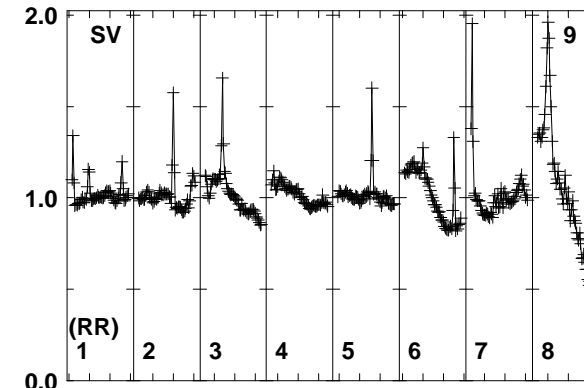
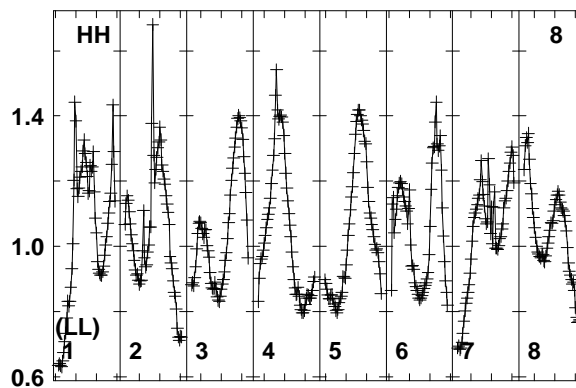
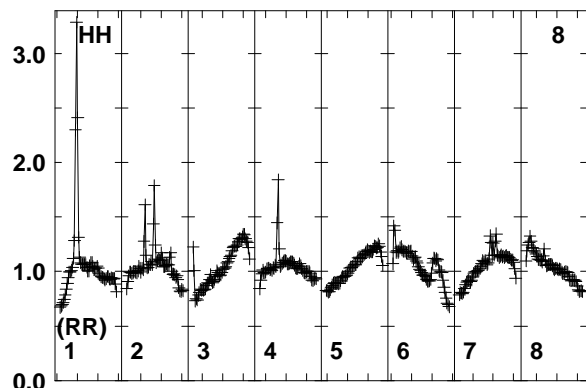
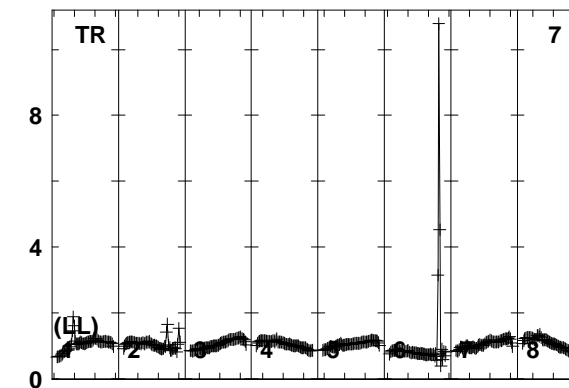
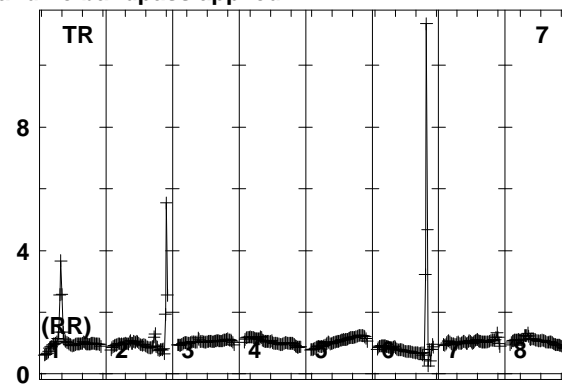
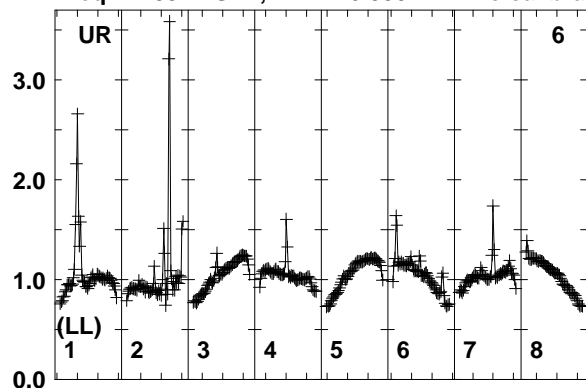

Lower frame: Real Jy
Total-power spectrum Antenna: UR (06)
Timerange: 00/03:44:06 to 00/03:45:04

Plot file version 84 created 04-NOV-2019 14:14:06

J2248-0541 EY034.UVDATA.1

Freq = 1.5947 GHz, Bw = 16.000 MH No calibration applied and no bandpass applied

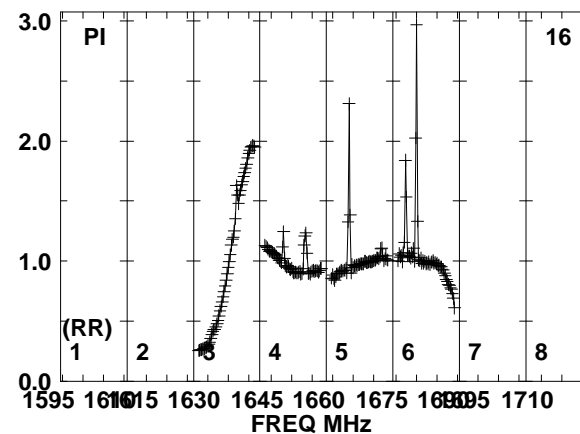
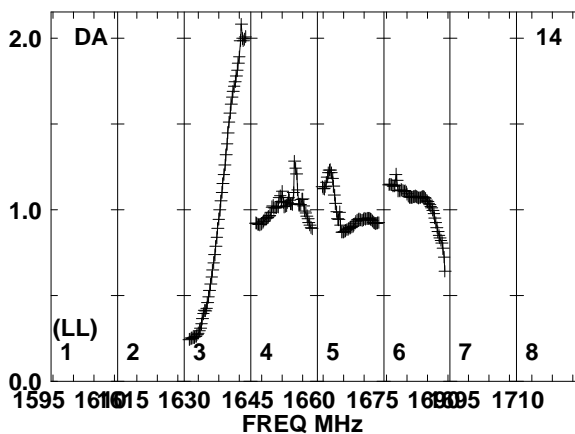
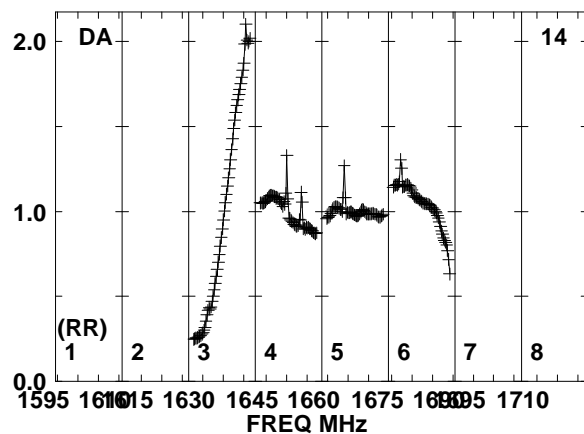
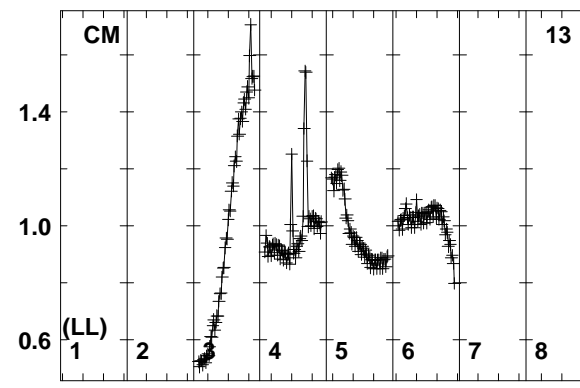
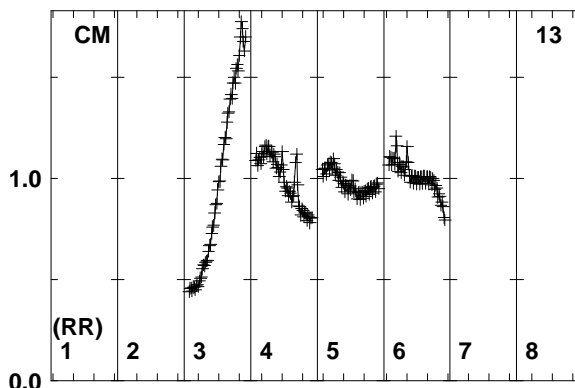
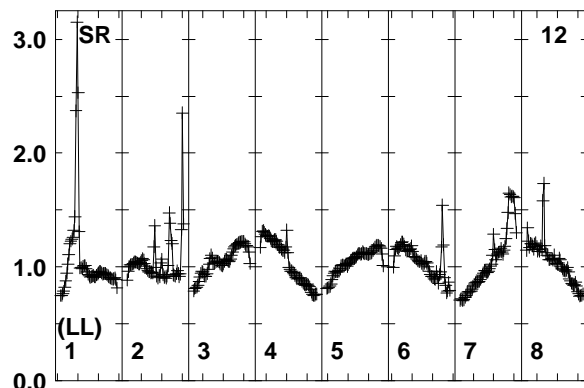
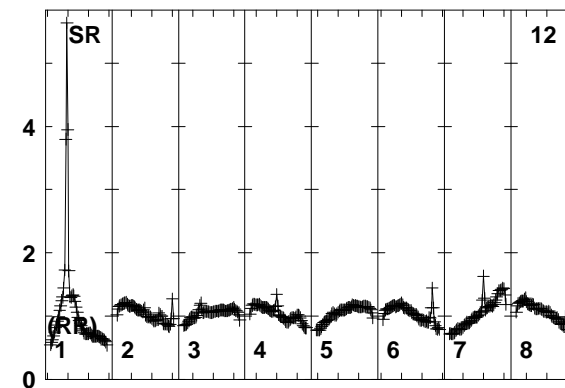
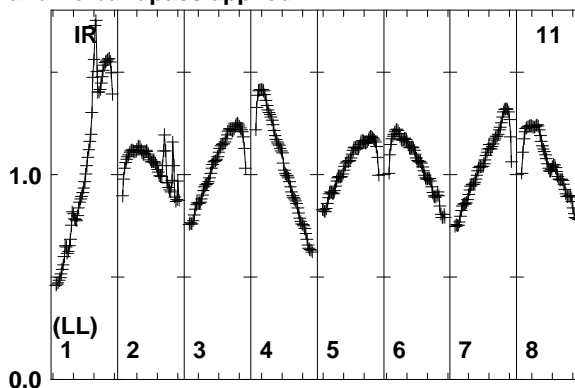
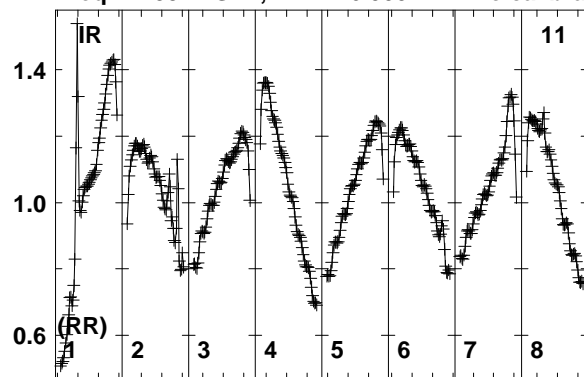

Lower frame: Real Jy
Total-power spectrum Antenna: IR (11)
Timerange: 00/03:44:06 to 00/03:45:04

Plot file version 85 created 04-NOV-2019 14:14:06
J2248-0541 EY034.UVDATA.1
Freq = 1.5947 GHz, Bw = 16.000 MH No calibration applied and no bandpass applied

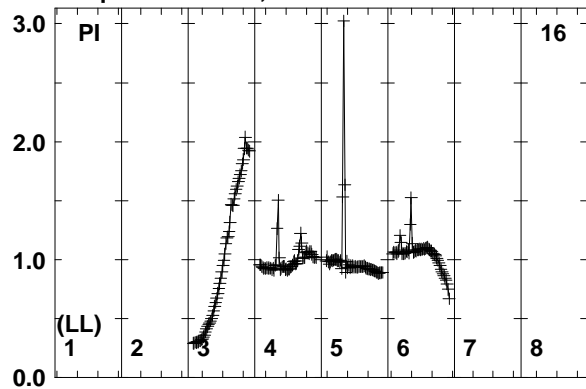

Lower frame: Real Jy
Total-power spectrum Antenna: PI (16)
Timerange: 00/03:44:06 to 00/03:45:04

Plot file version 86 created 04-NOV-2019 14:14:06

W2246-0526 EY034.UVDATA.1

Freq = 1.5947 GHz, Bw = 16.000 MH No calibration applied and no bandpass applied

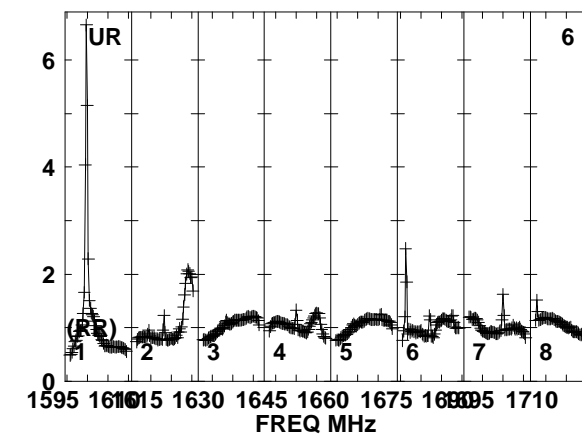
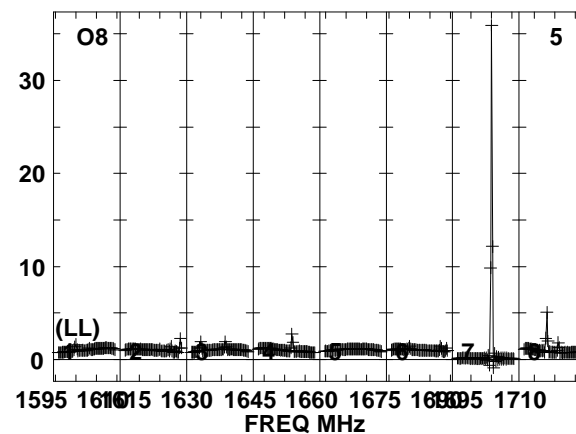
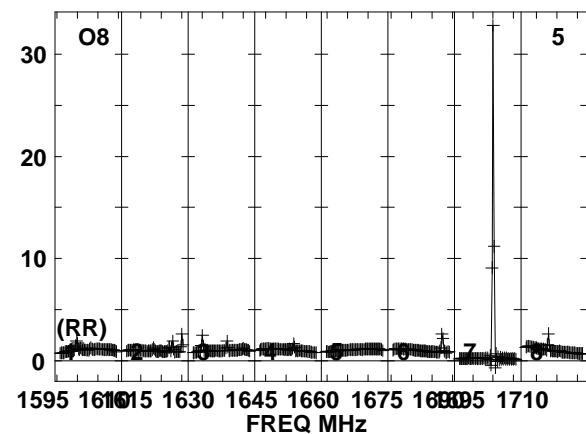
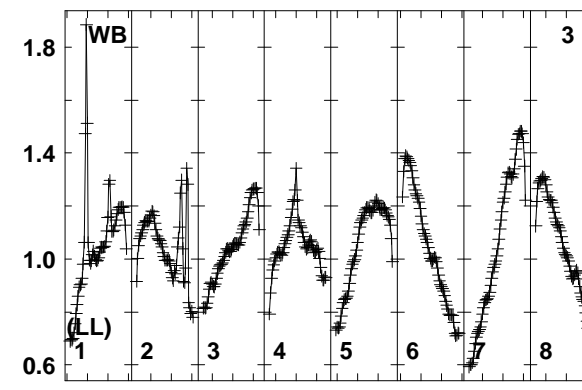
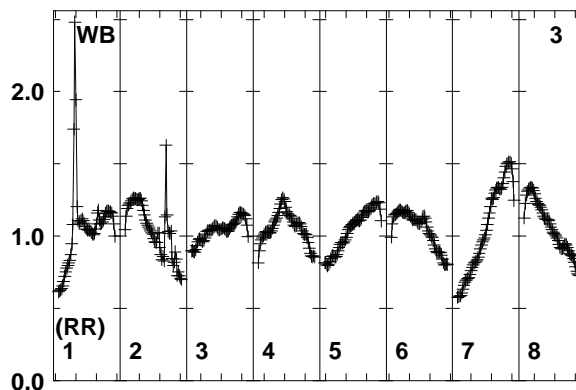
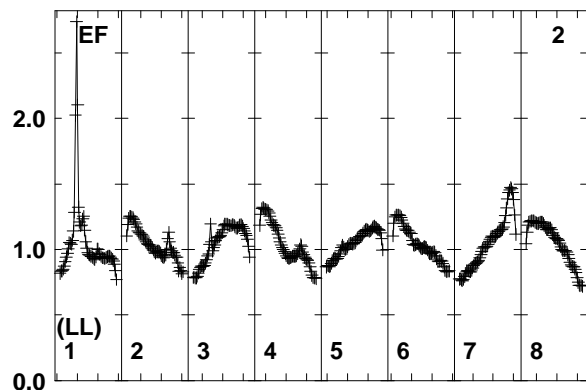
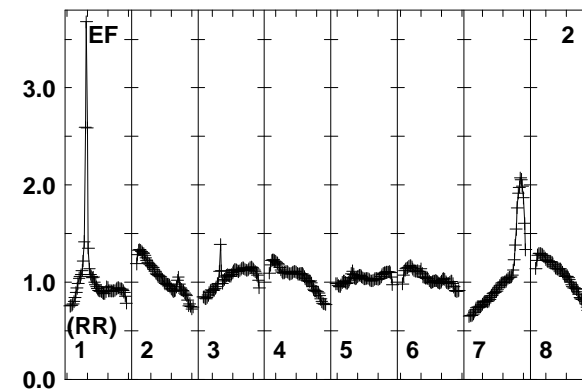
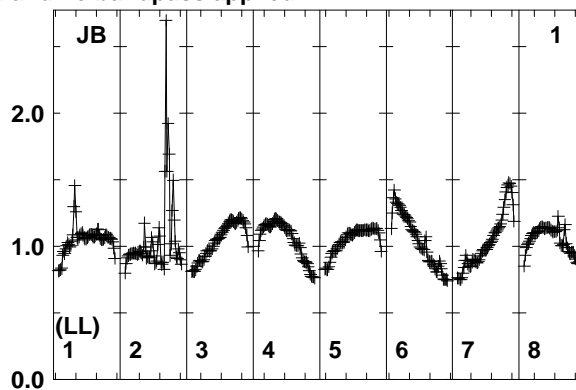
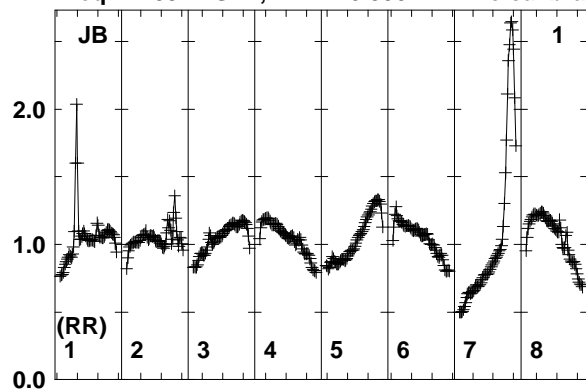

Lower frame: Real Jy
Total-power spectrum Antenna: JB (01)
Timerange: 00/03:45:06 to 00/03:47:44

Plot file version 87 created 04-NOV-2019 14:14:06

W2246-0526 EY034.UVDATA.1

Freq = 1.5947 GHz, Bw = 16.000 MH No calibration applied and no bandpass applied

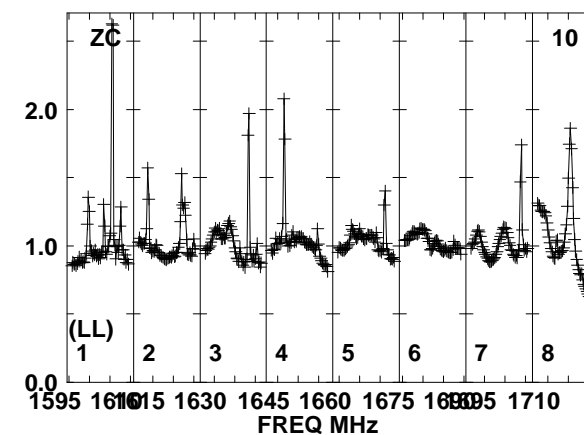
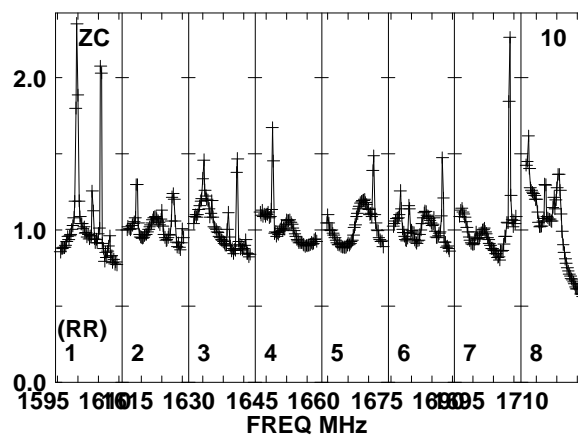
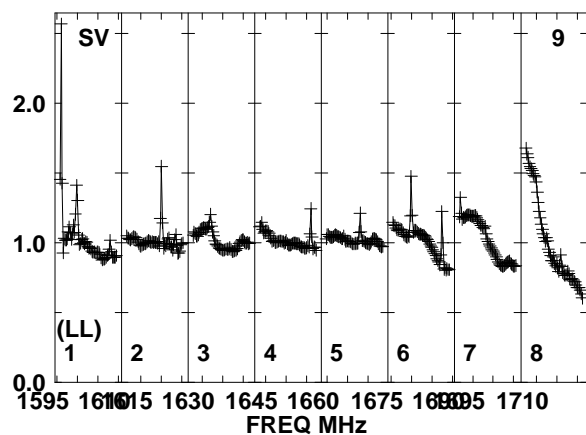
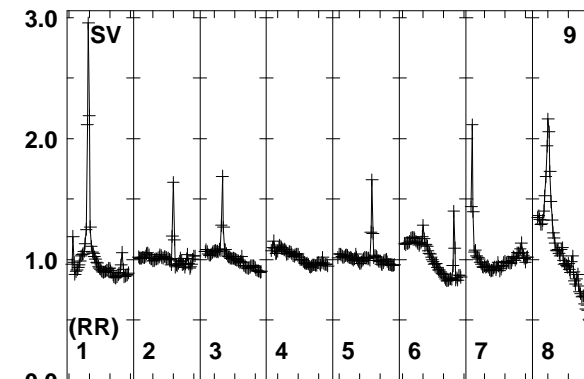
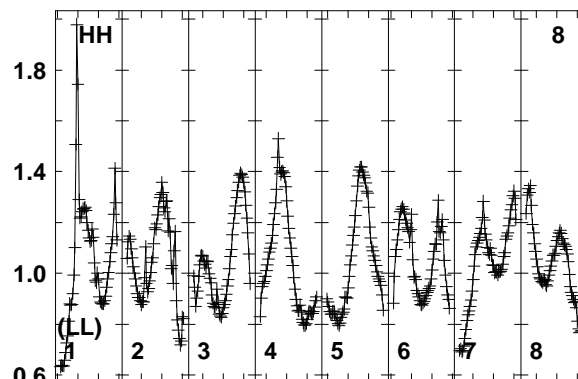
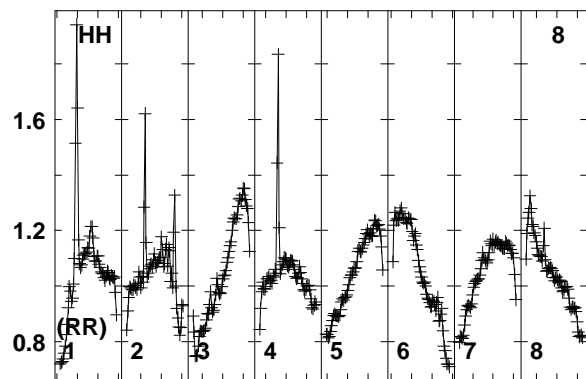
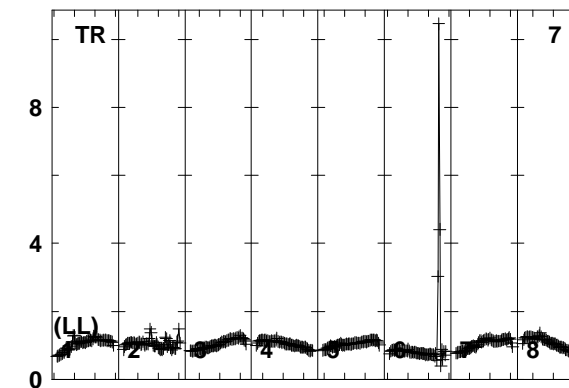
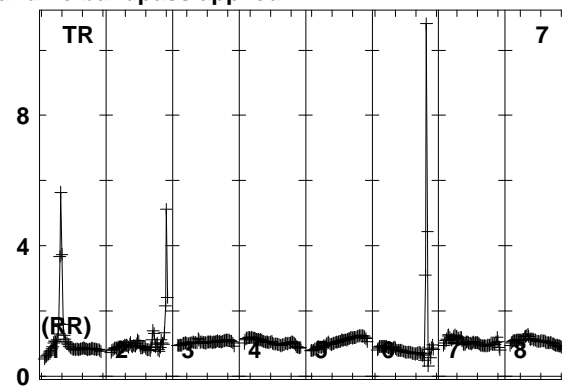
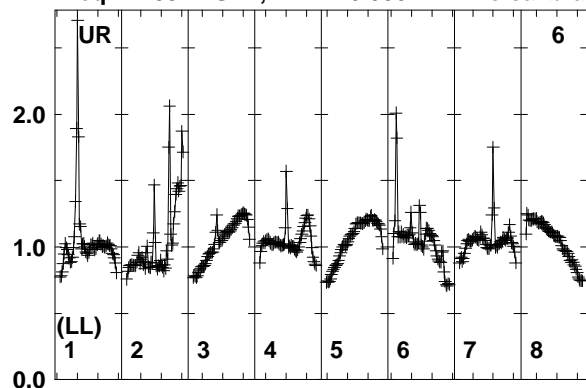

Lower frame: Real Jy
Total-power spectrum Antenna: UR (06)
Timerange: 00/03:45:06 to 00/03:47:44

Plot file version 88 created 04-NOV-2019 14:14:07

W2246-0526 EY034.UVDATA.1

Freq = 1.5947 GHz, Bw = 16.000 MH No calibration applied and no bandpass applied

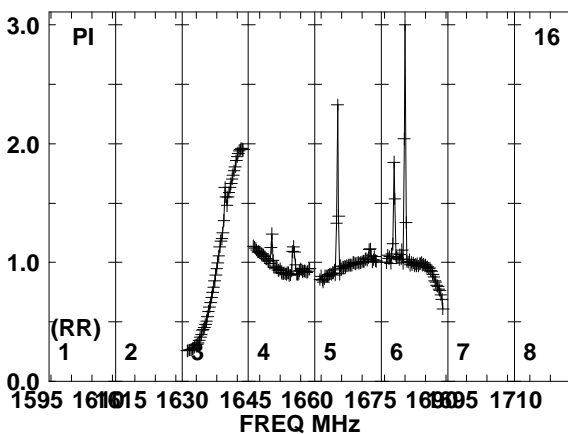
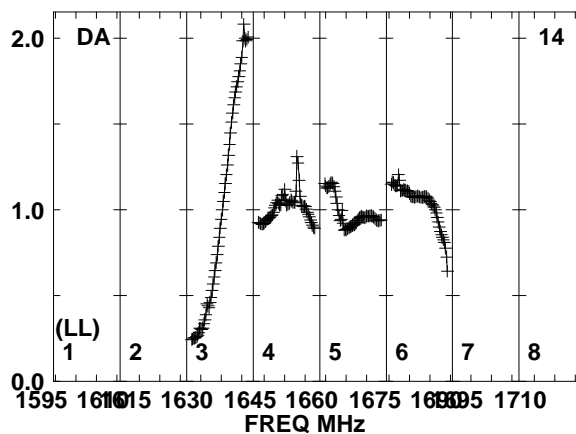
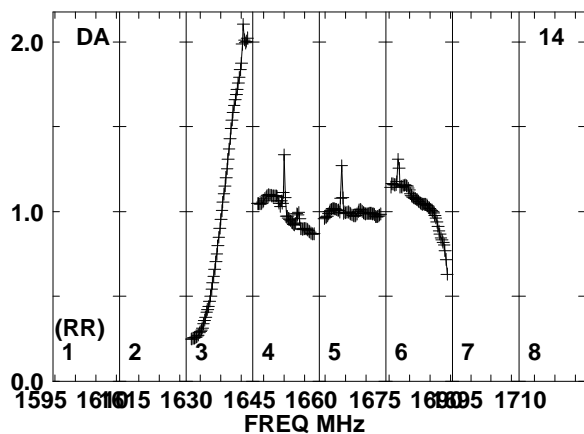
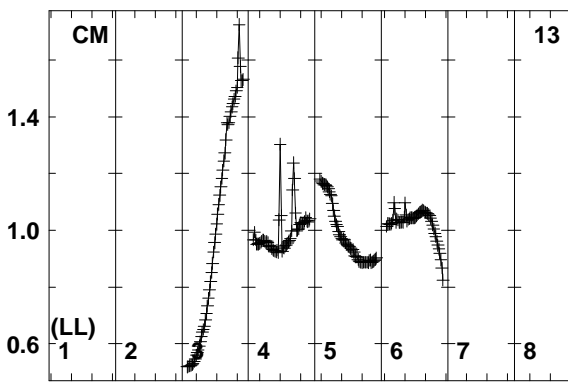
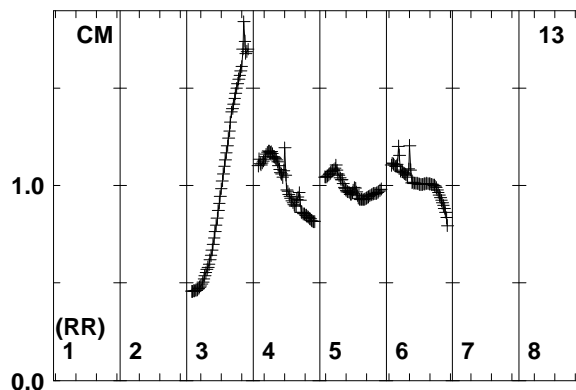
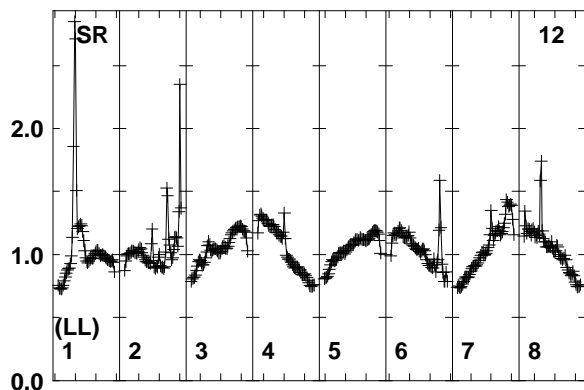
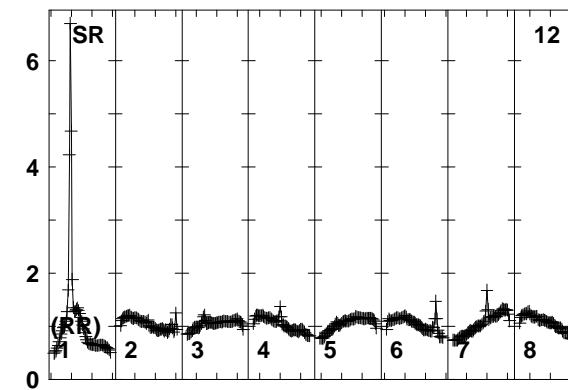
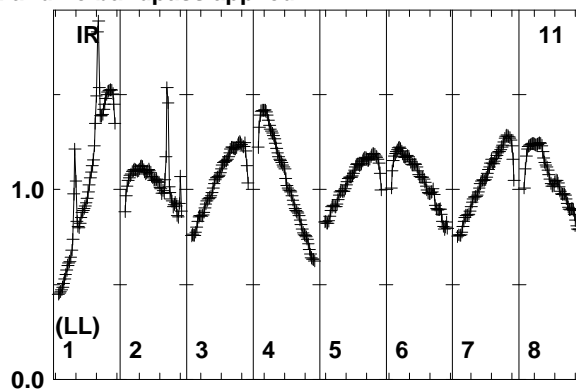
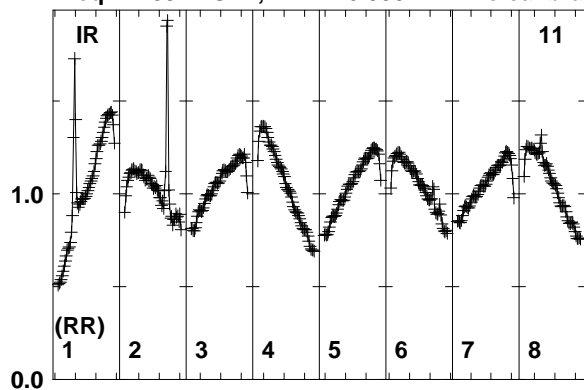

Lower frame: Real Jy
Total-power spectrum Antenna: IR (11)
Timerange: 00/03:45:06 to 00/03:47:44

Plot file version 89 created 04-NOV-2019 14:14:07
W2246-0526 EY034.UVDATA.1
Freq = 1.5947 GHz, Bw = 16.000 MH No calibration applied and no bandpass applied

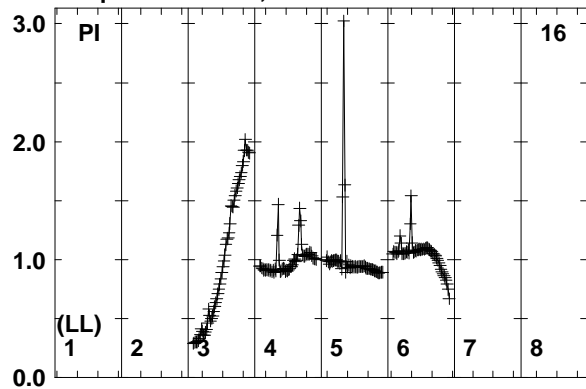

Lower frame: Real Jy
Total-power spectrum Antenna: PI (16)
Timerange: 00/03:45:06 to 00/03:47:44

Plot file version 90 created 04-NOV-2019 14:14:07

J2248-0541 EY034.UVDATA.1

Freq = 1.5947 GHz, Bw = 16.000 MH No calibration applied and no bandpass applied

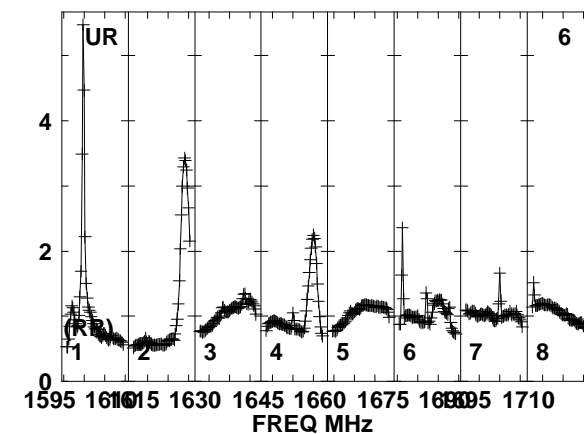
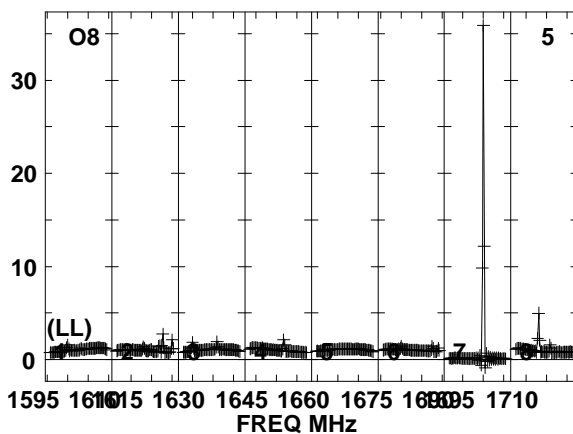
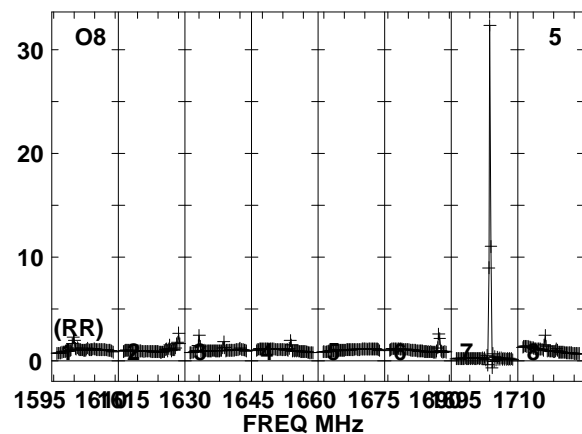
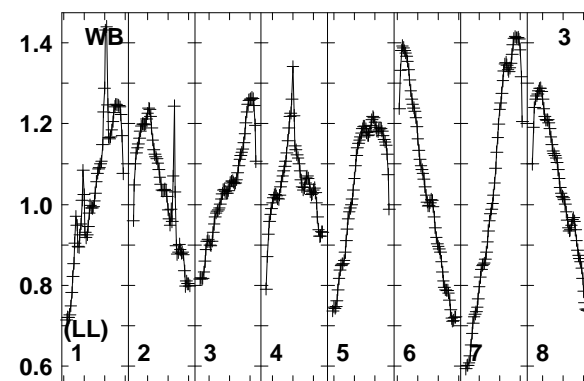
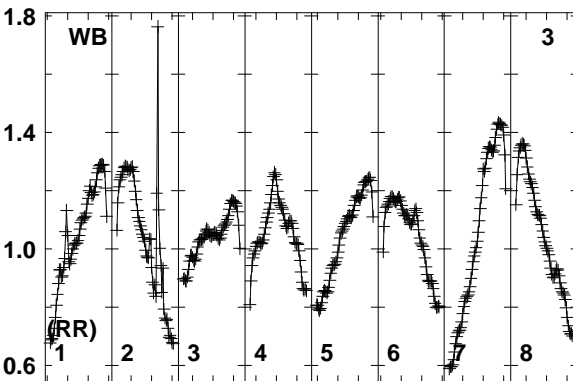
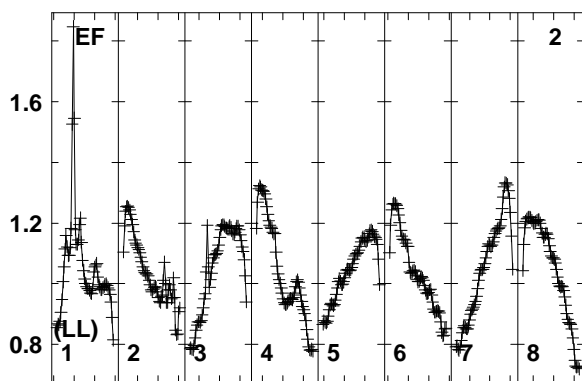
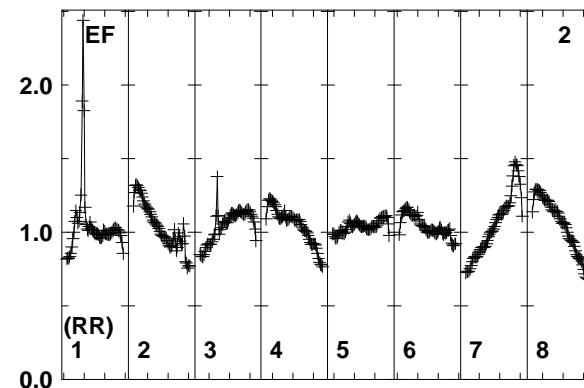
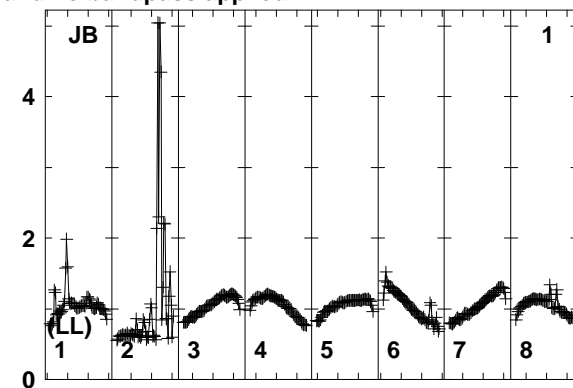
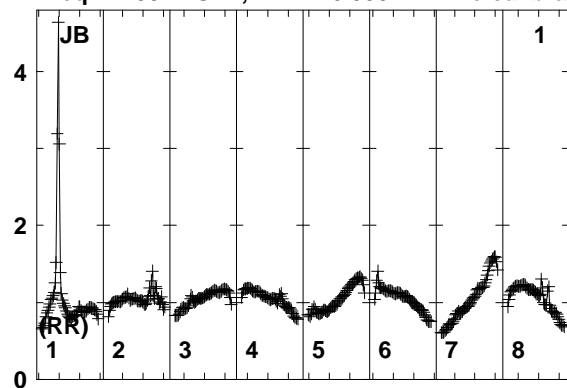

Lower frame: Real Jy
Total-power spectrum Antenna: JB (01)
Timerange: 00/03:48:01 to 00/03:48:59

Plot file version 91 created 04-NOV-2019 14:14:07

J2248-0541 EY034.UVDATA.1

Freq = 1.5947 GHz, Bw = 16.000 MH No calibration applied and no bandpass applied

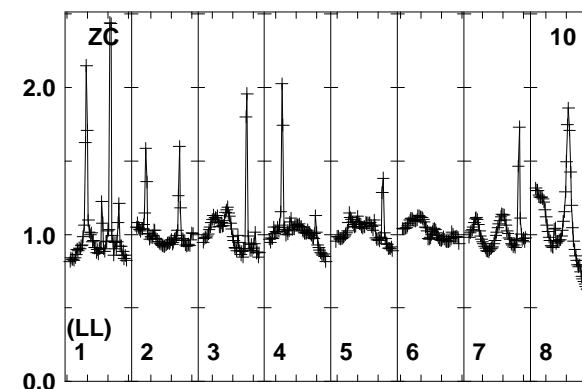
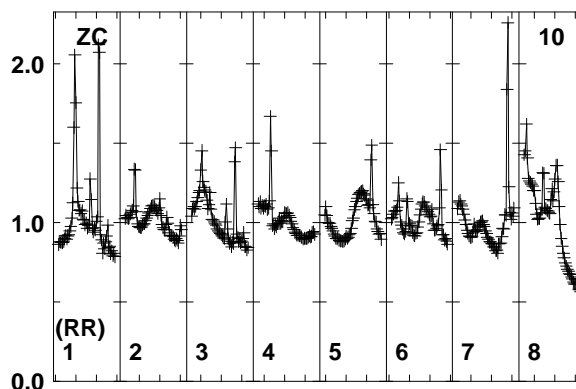
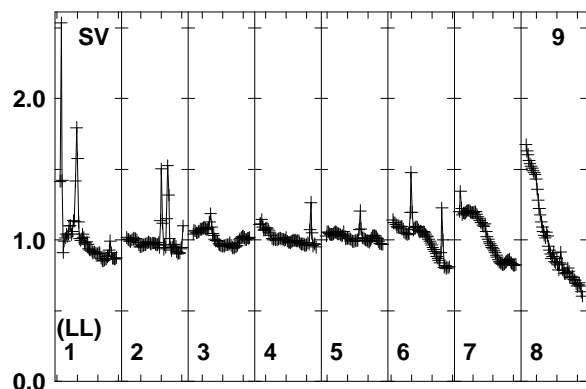
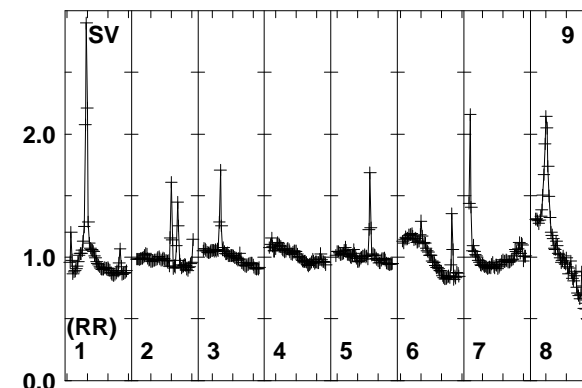
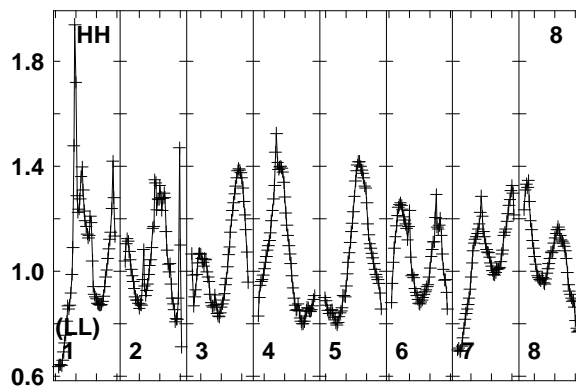
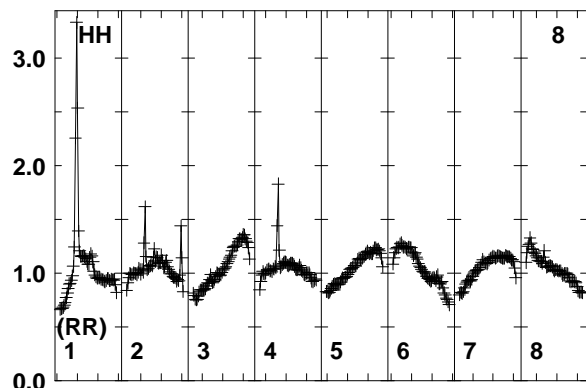
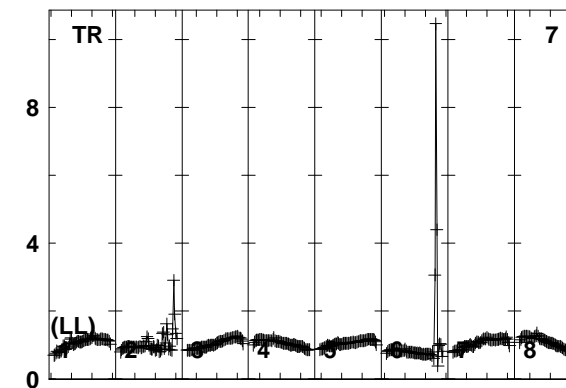
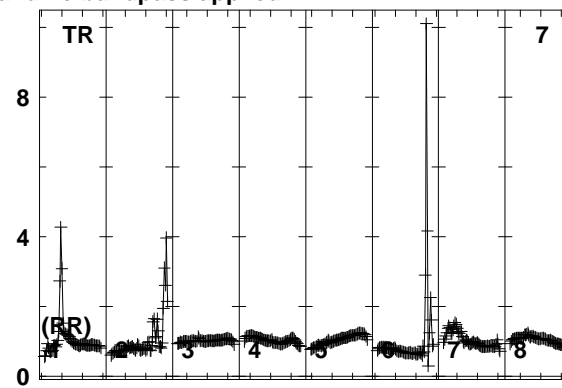
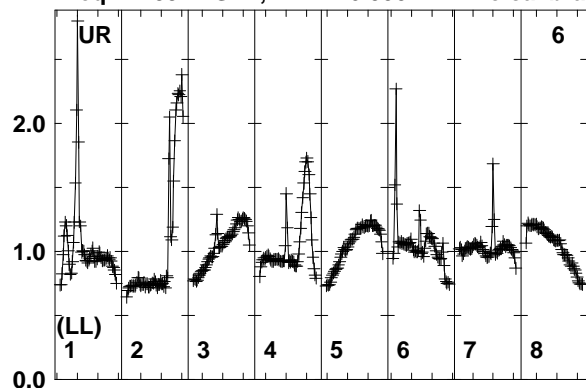

1595 1610 1630 1645 1660 1675 1690 1710
FREQ MHz
Lower frame: Real Jy
Total-power spectrum Antenna: UR (06)
Timerange: 00/03:48:01 to 00/03:48:59

Plot file version 92 created 04-NOV-2019 14:14:07

J2248-0541 EY034.UVDATA.1

Freq = 1.5947 GHz, Bw = 16.000 MH No calibration applied and no bandpass applied

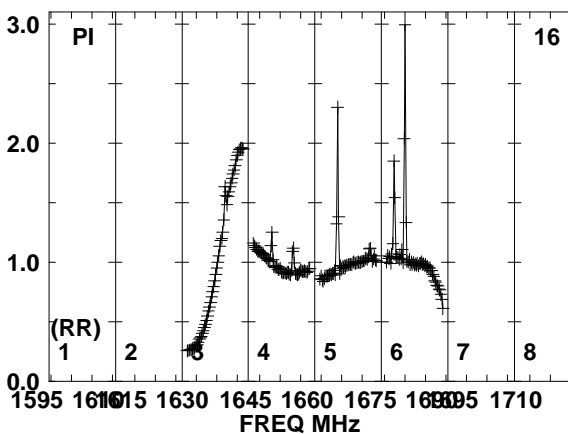
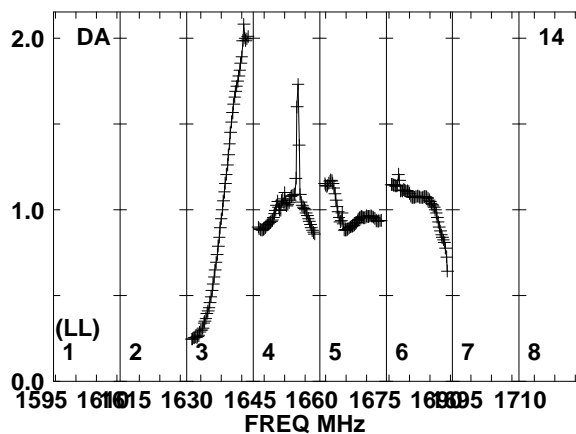
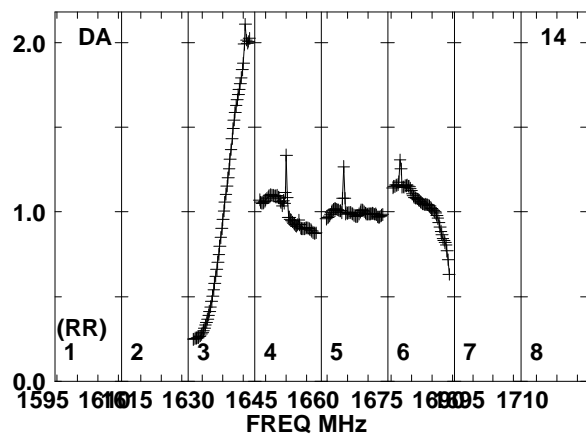
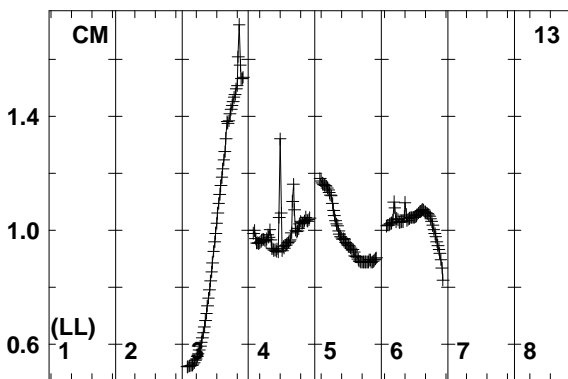
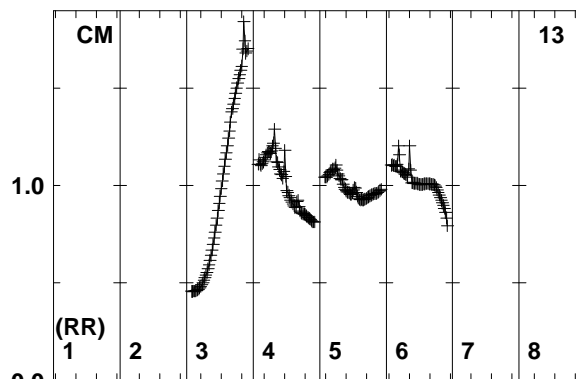
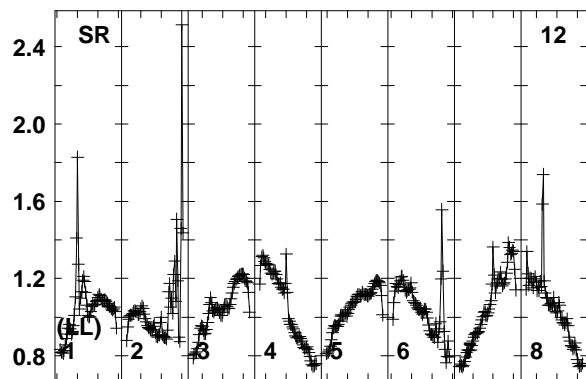
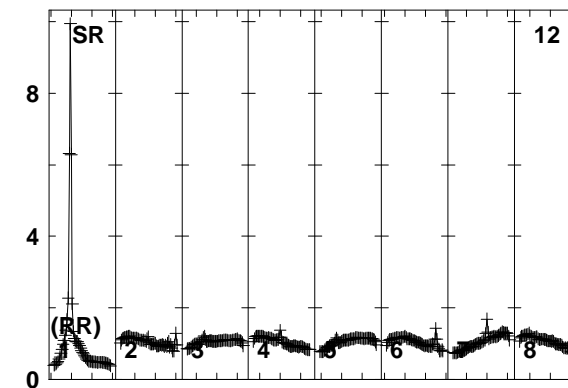
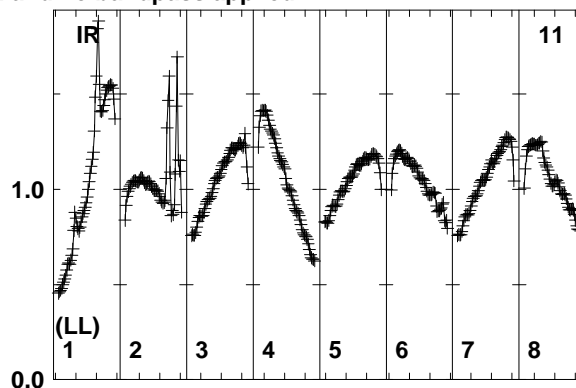
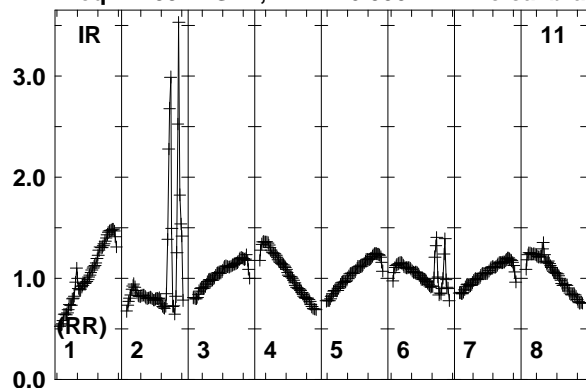

Lower frame: Real Jy
Total-power spectrum Antenna: IR (11)
Timerange: 00/03:48:01 to 00/03:48:59

Plot file version 93 created 04-NOV-2019 14:14:07
J2248-0541 EY034.UVDATA.1
Freq = 1.5947 GHz, Bw = 16.000 MH No calibration applied and no bandpass applied

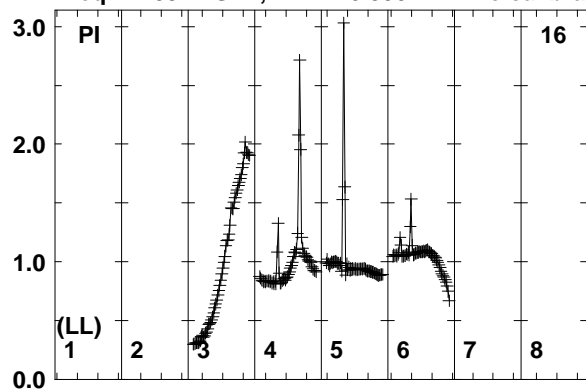

Lower frame: Real Jy
Total-power spectrum Antenna: PI (16)
Timerange: 00/03:48:01 to 00/03:48:59

Plot file version 94 created 04-NOV-2019 14:14:07

J2245-0755 EY034.UVDATA.1

Freq = 1.5947 GHz, Bw = 16.000 MH No calibration applied and no bandpass applied

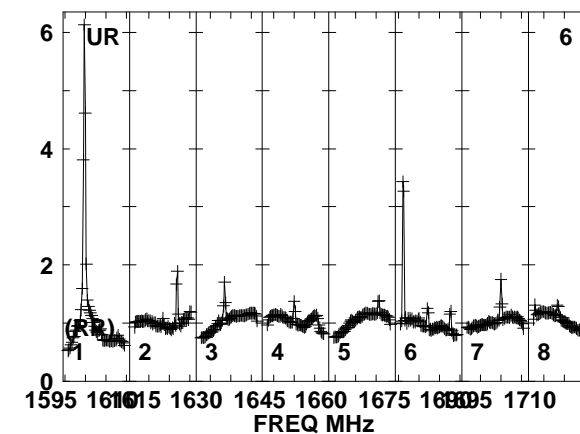
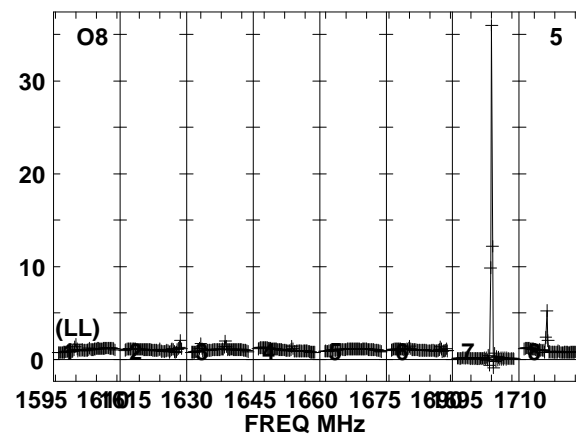
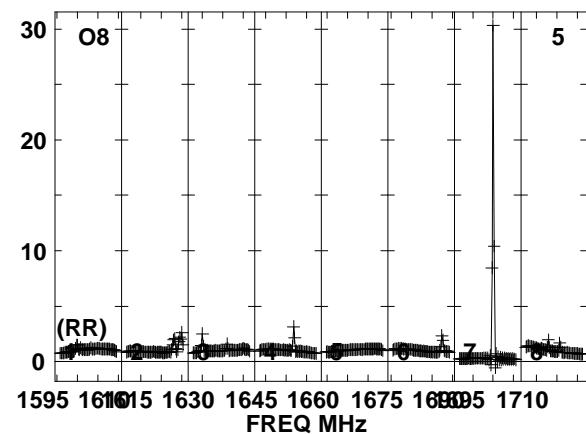
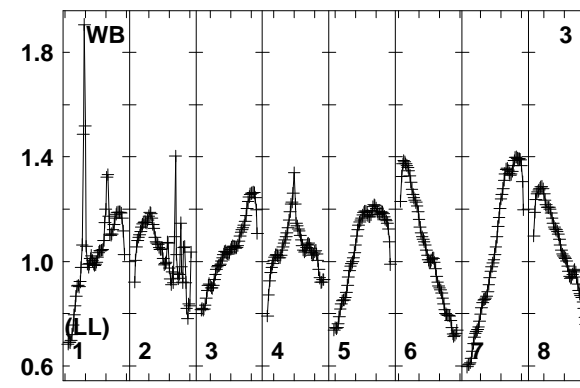
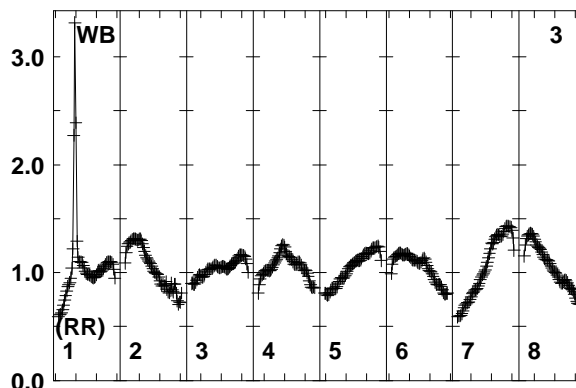
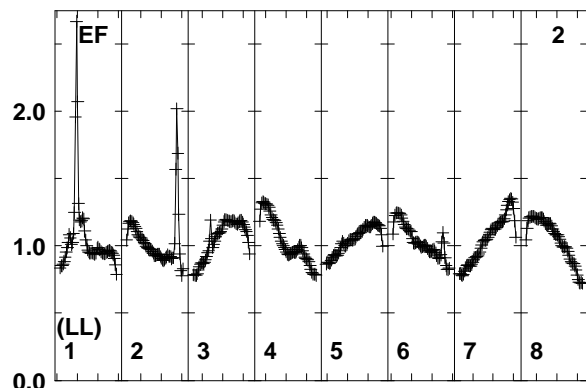
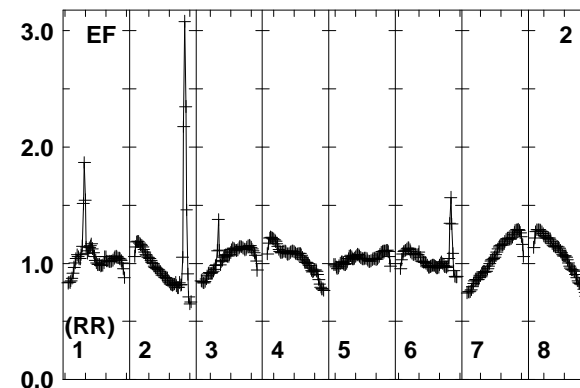
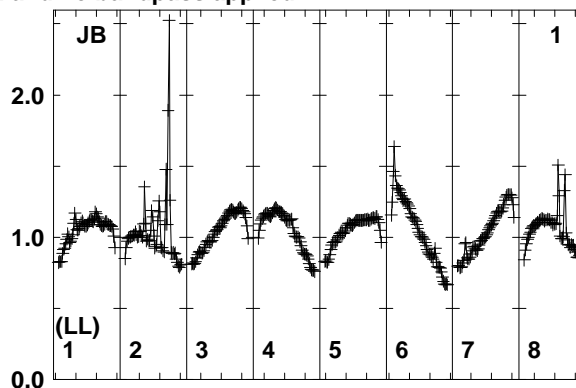
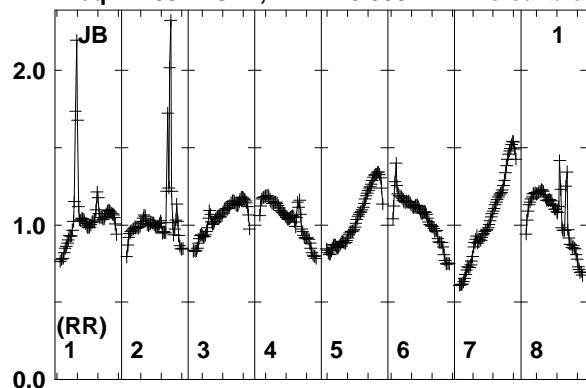

Lower frame: Real Jy
Total-power spectrum Antenna: JB (01)
Timerange: 00/03:49:16 to 00/03:50:14

Plot file version 95 created 04-NOV-2019 14:14:07

J2245-0755 EY034.UVDATA.1

Freq = 1.5947 GHz, Bw = 16.000 MH No calibration applied and no bandpass applied

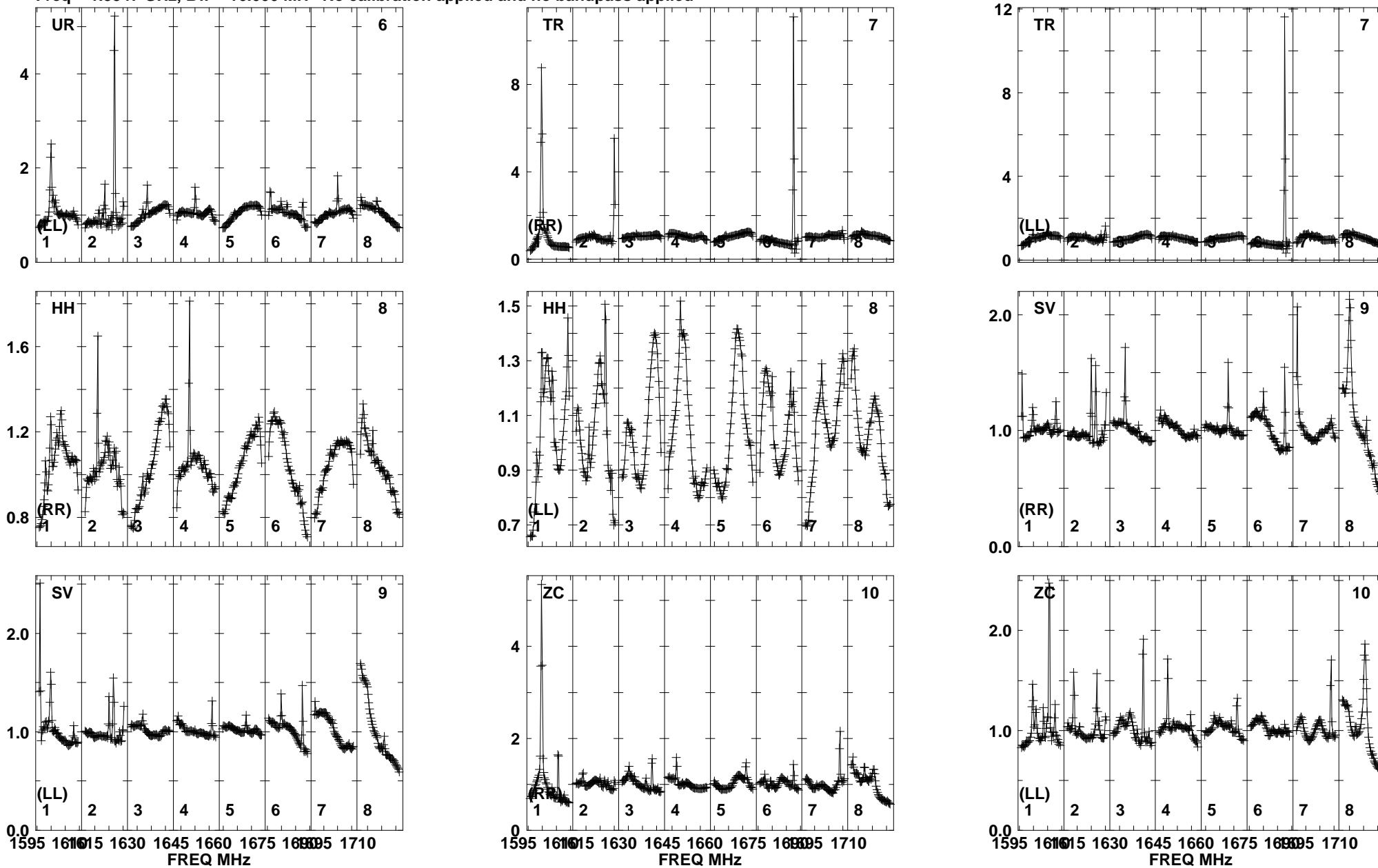

Lower frame: Real Jy
Total-power spectrum Antenna: UR (06)
Timerange: 00/03:49:16 to 00/03:50:14

Plot file version 96 created 04-NOV-2019 14:14:07

J2245-0755 EY034.UVDATA.1

Freq = 1.5947 GHz, Bw = 16.000 MH No calibration applied and no bandpass applied

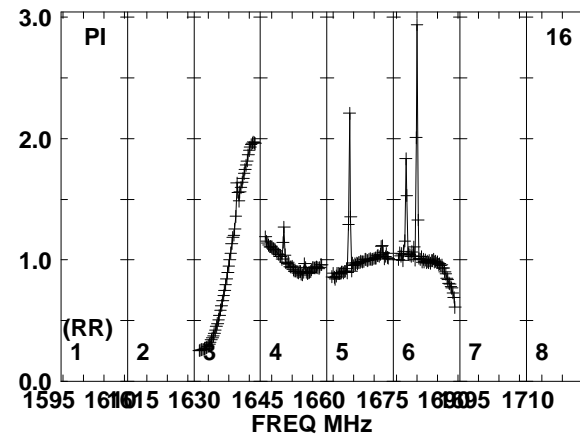
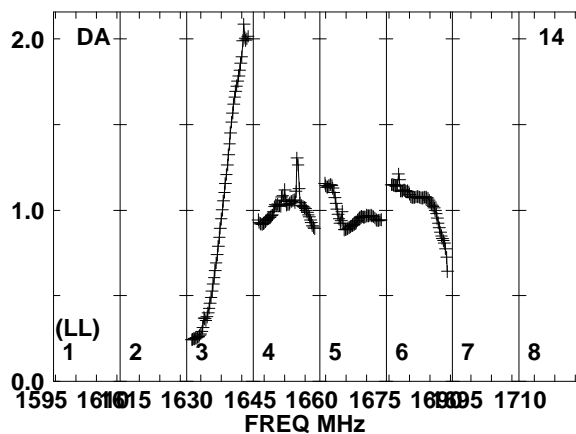
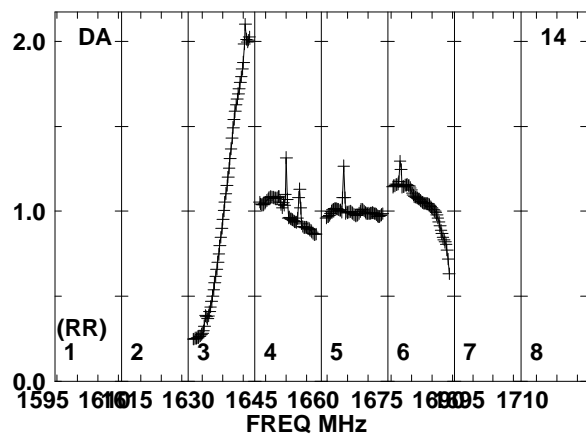
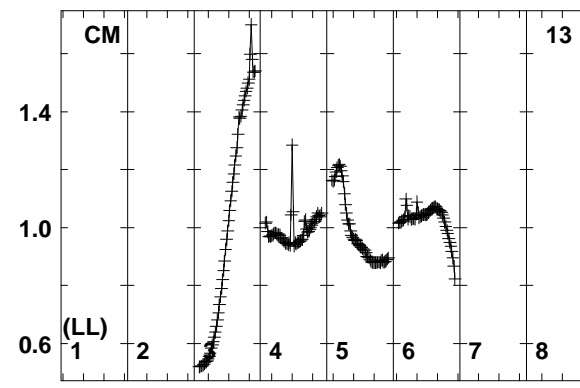
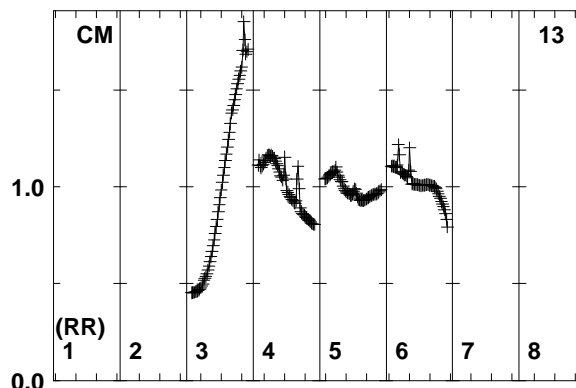
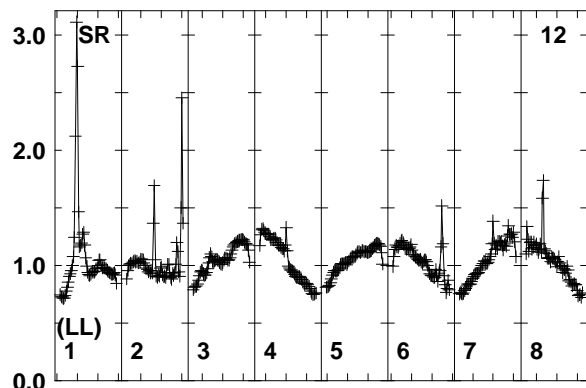
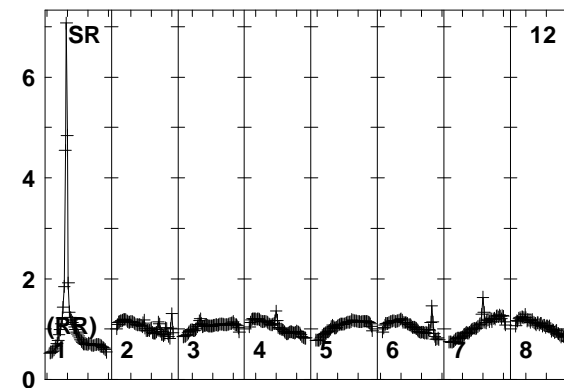
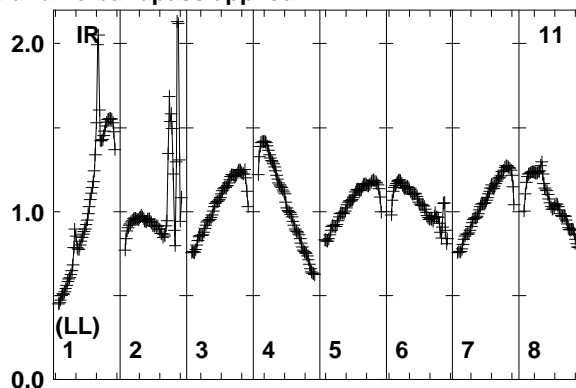
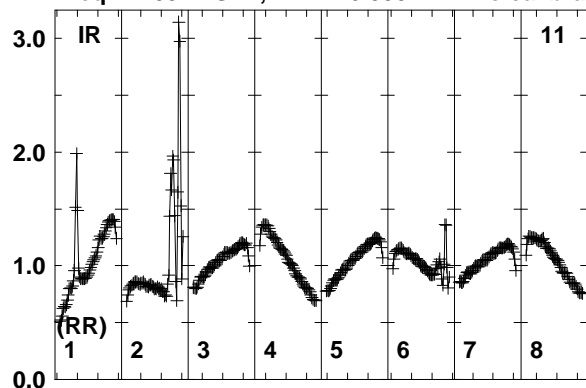

Lower frame: Real Jy
Total-power spectrum Antenna: IR (11)
Timerange: 00/03:49:16 to 00/03:50:14

Plot file version 97 created 04-NOV-2019 14:14:07
J2245-0755 EY034.UVDATA.1
Freq = 1.5947 GHz, Bw = 16.000 MH No calibration applied and no bandpass applied

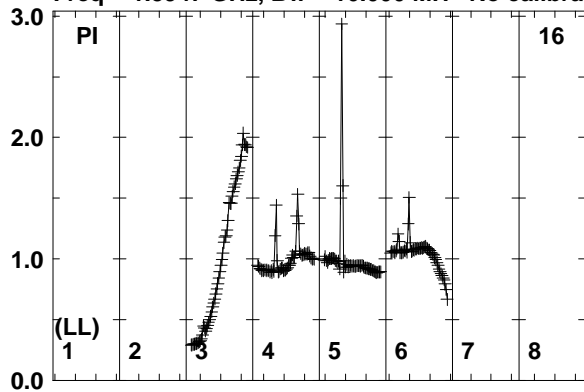

Lower frame: Real Jy
Total-power spectrum Antenna: PI (16)
Timerange: 00/03:49:16 to 00/03:50:14

Plot file version 98 created 04-NOV-2019 14:14:07

J2248-0541 EY034.UVDATA.1

Freq = 1.5947 GHz, Bw = 16.000 MH No calibration applied and no bandpass applied

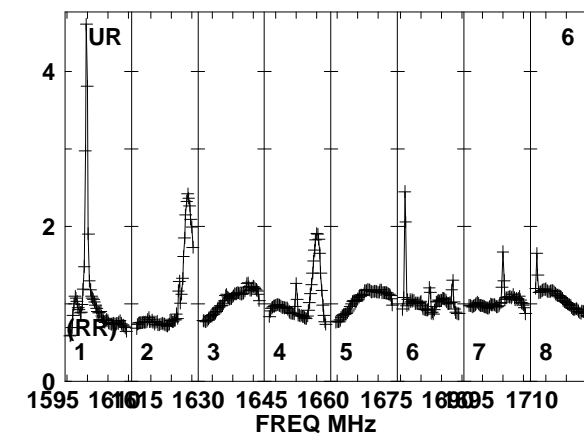
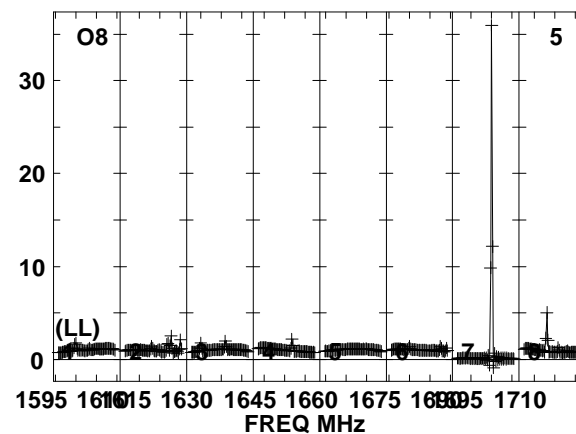
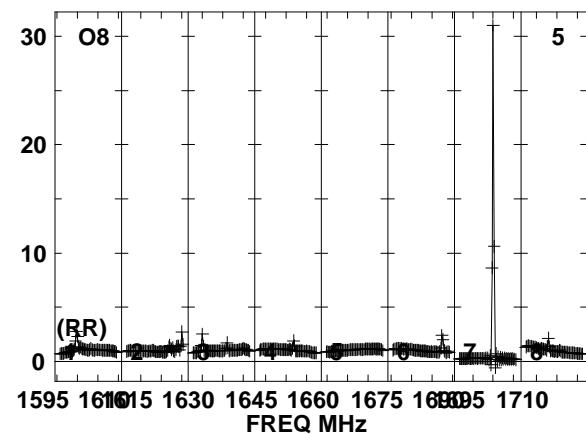
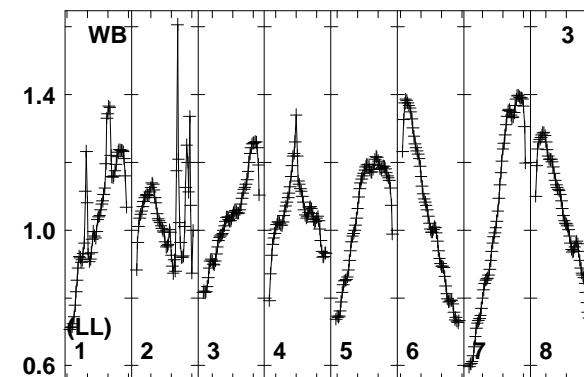
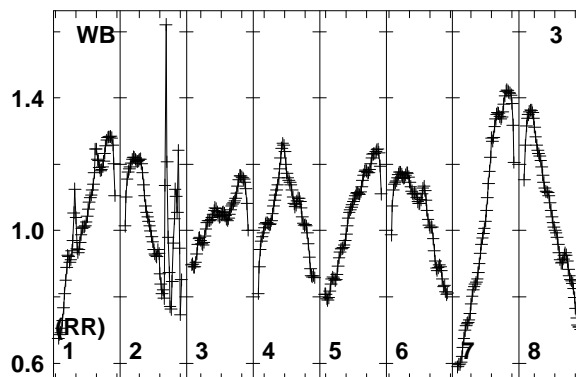
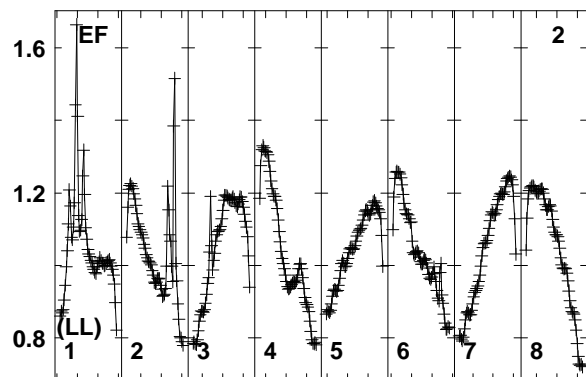
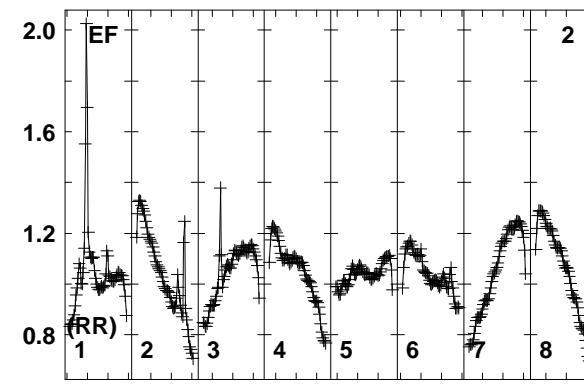
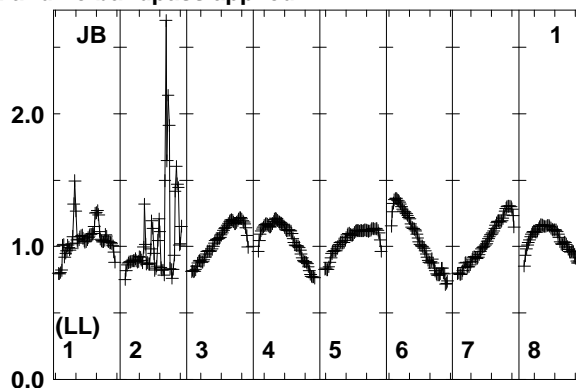
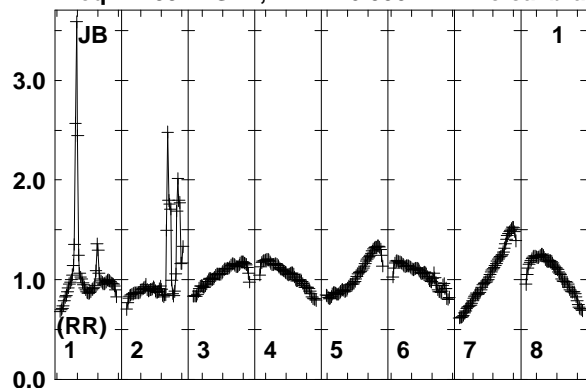

Lower frame: Real Jy
Total-power spectrum Antenna: JB (01)
Timerange: 00/03:51:01 to 00/03:51:59

Plot file version 99 created 04-NOV-2019 14:14:07

J2248-0541 EY034.UVDATA.1

Freq = 1.5947 GHz, Bw = 16.000 MH No calibration applied and no bandpass applied

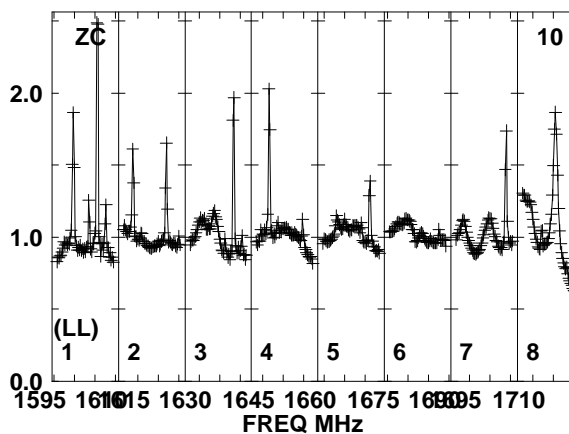
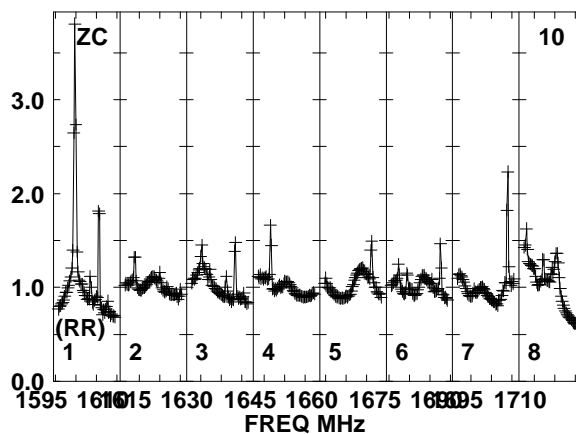
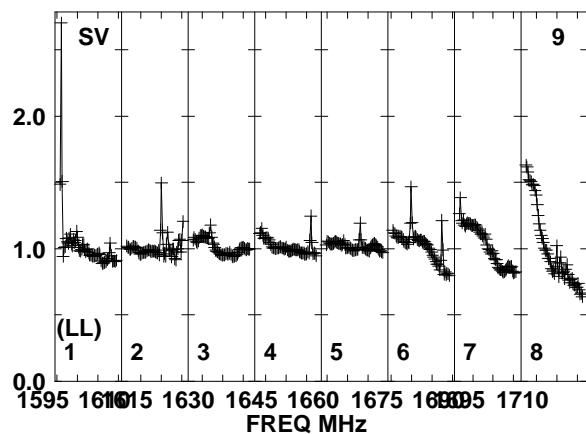
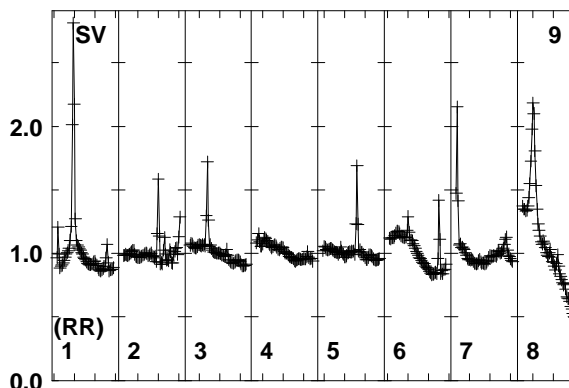
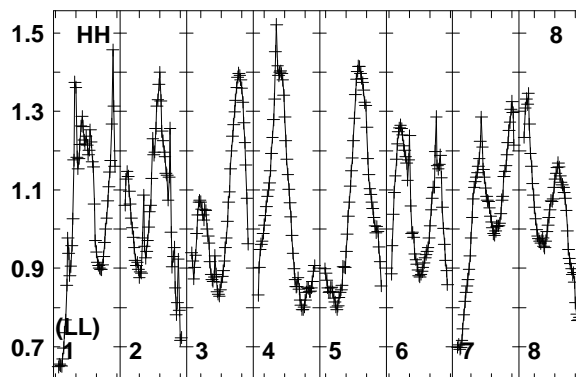
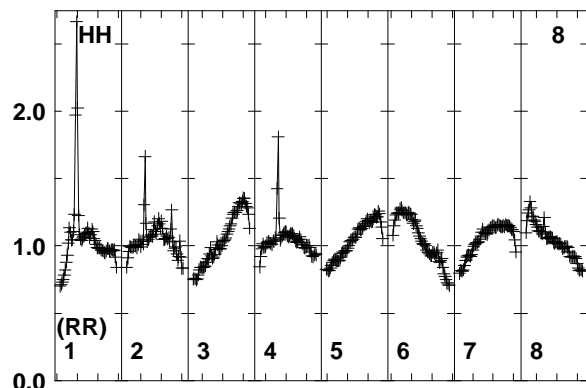
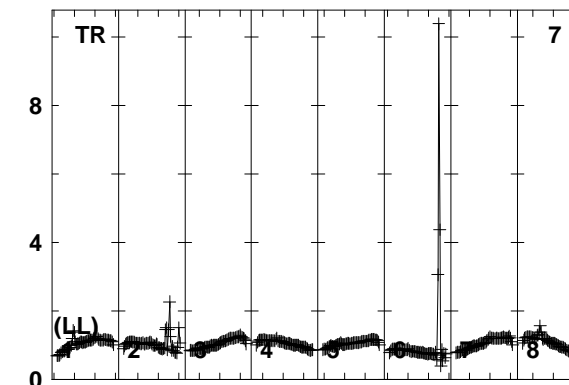
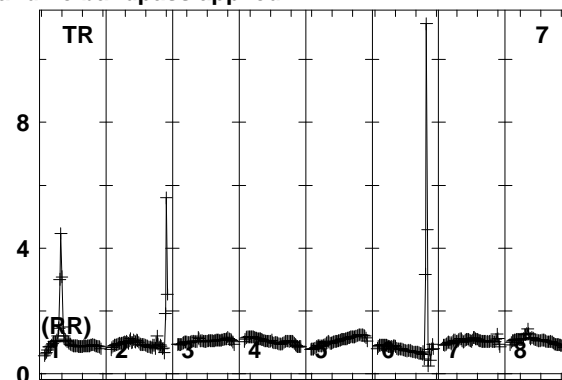
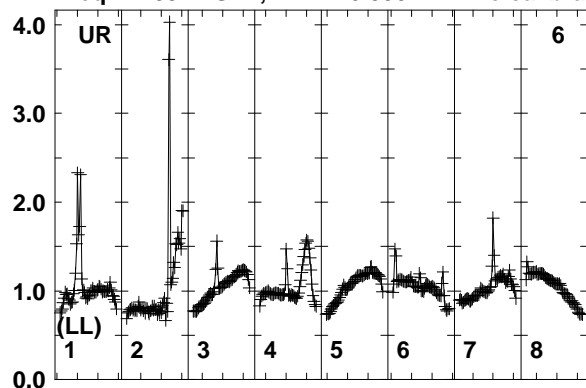

Lower frame: Real Jy
Total-power spectrum Antenna: UR (06)
Timerange: 00/03:51:01 to 00/03:51:59

Plot file version 100 created 04-NOV-2019 14:14:07

J2248-0541 EY034.UVDATA.1

Freq = 1.5947 GHz, Bw = 16.000 MH No calibration applied and no bandpass applied

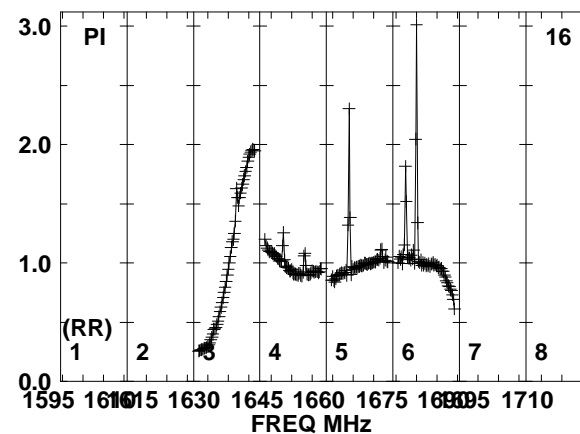
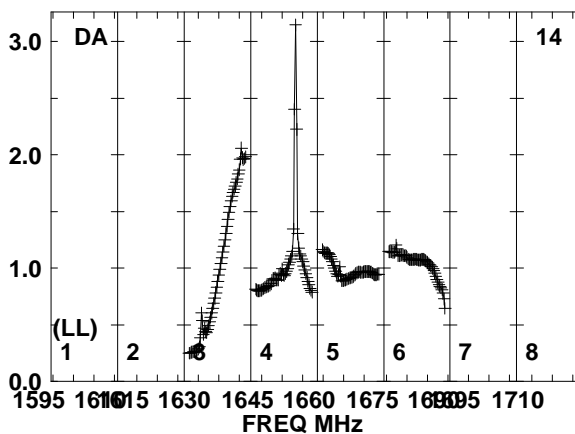
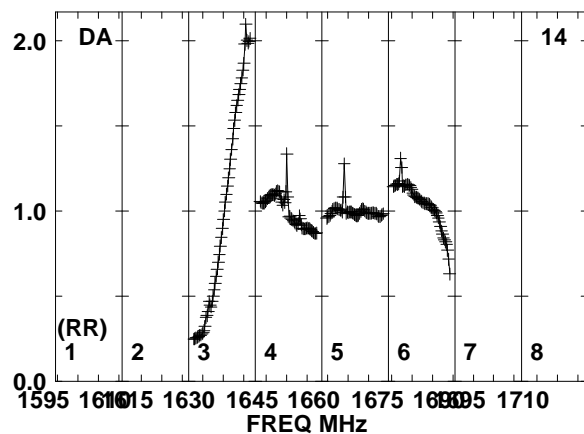
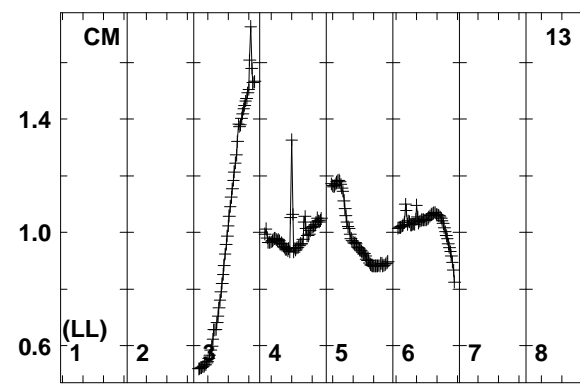
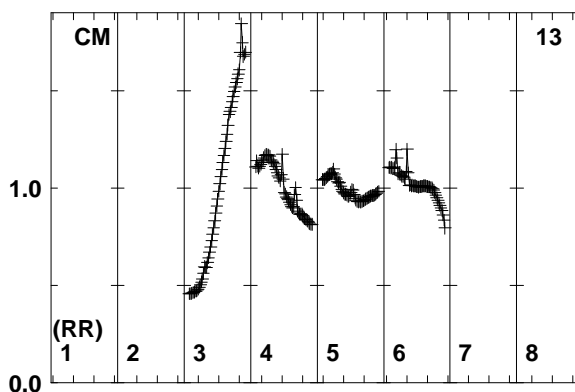
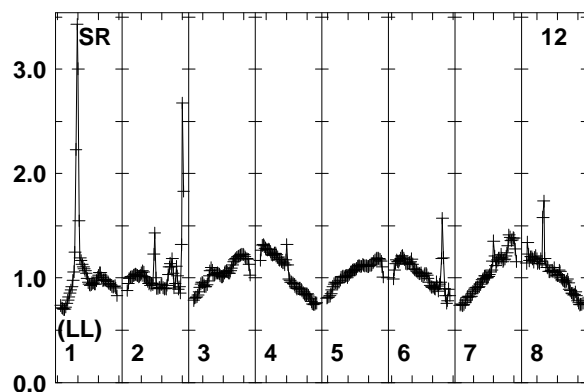
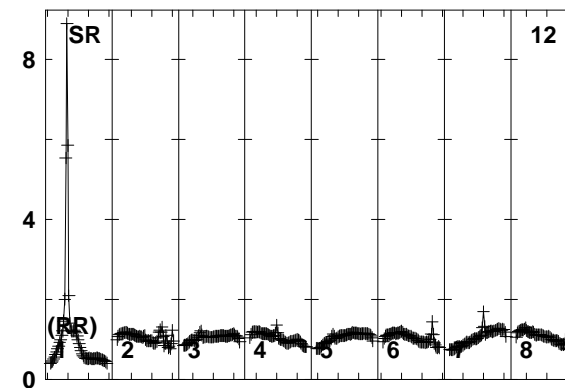
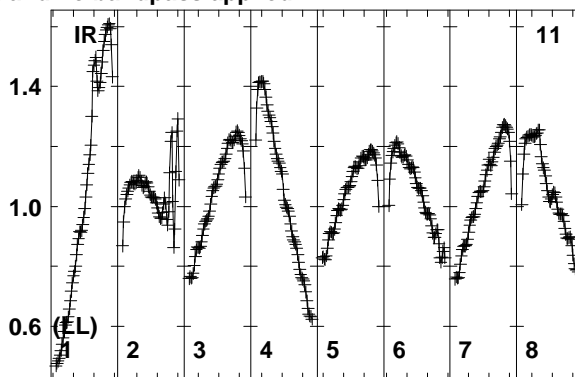
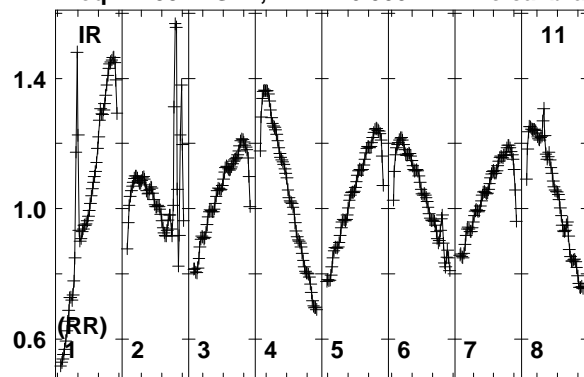

Lower frame: Real Jy
Total-power spectrum Antenna: IR (11)
Timerange: 00/03:51:01 to 00/03:51:59

Plot file version 101 created 04-NOV-2019 14:14:07

J2248-0541 EY034.UVDATA.1

Freq = 1.5947 GHz, Bw = 16.000 MH No calibration applied and no bandpass applied

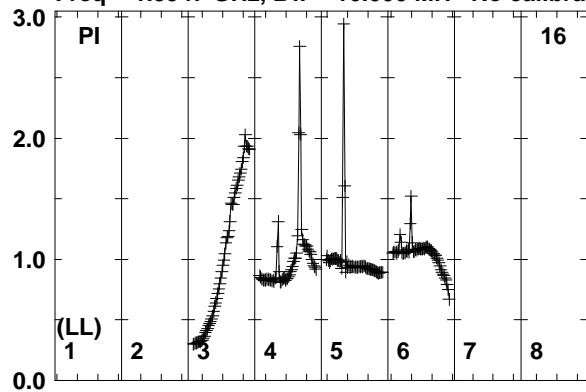

Lower frame: Real Jy
Total-power spectrum Antenna: PI (16)
Timerange: 00/03:51:01 to 00/03:51:59

Plot file version 102 created 04-NOV-2019 14:14:07

W2246-0526 EY034.UVDATA.1

Freq = 1.5947 GHz, Bw = 16.000 MH No calibration applied and no bandpass applied

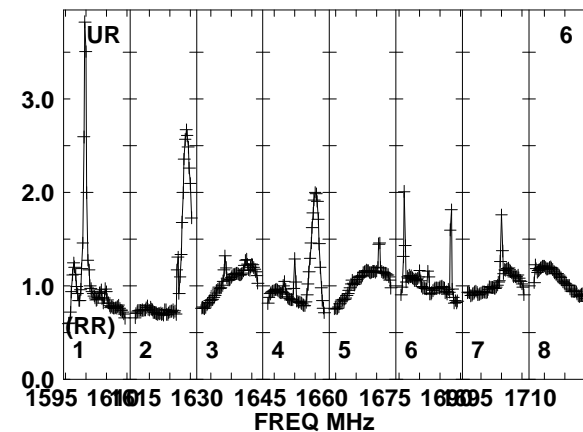
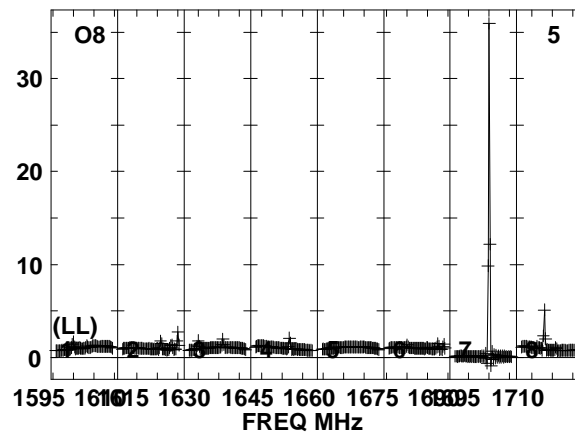
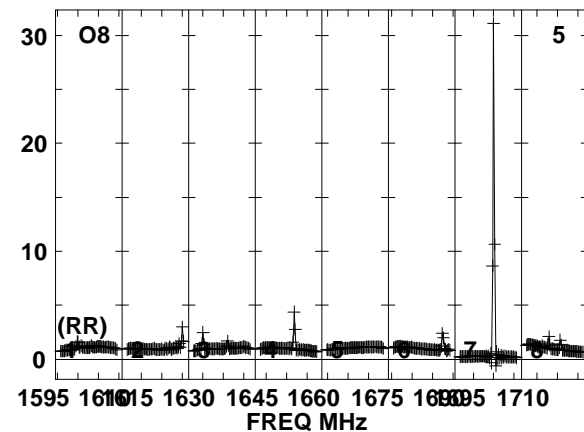
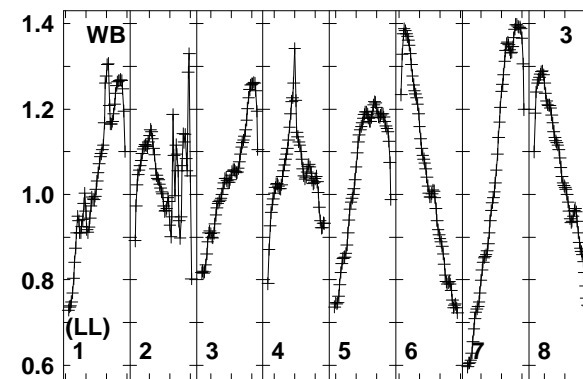
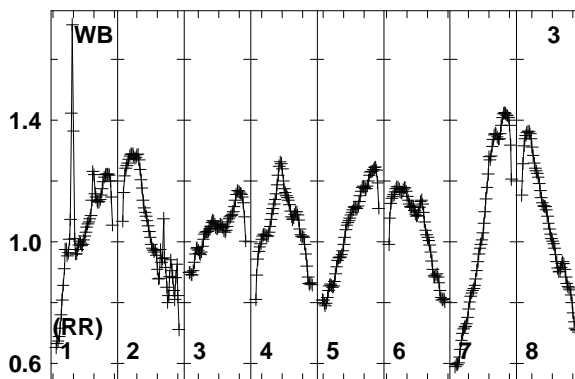
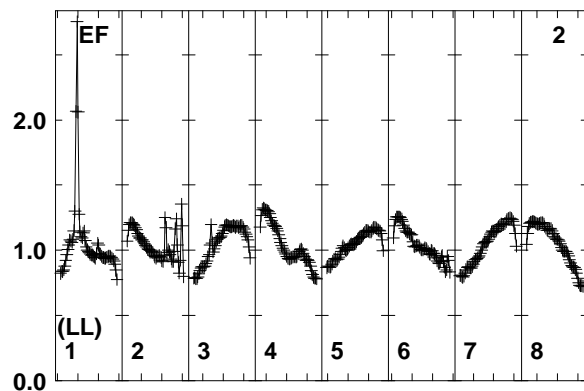
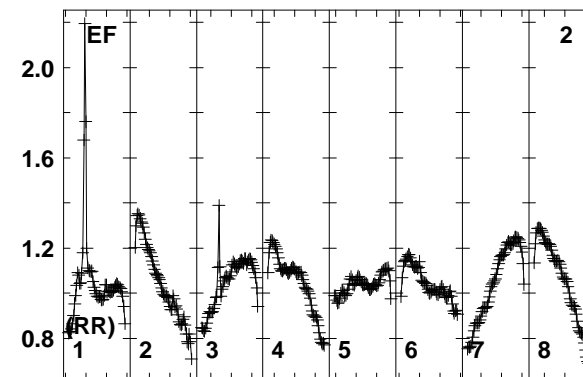
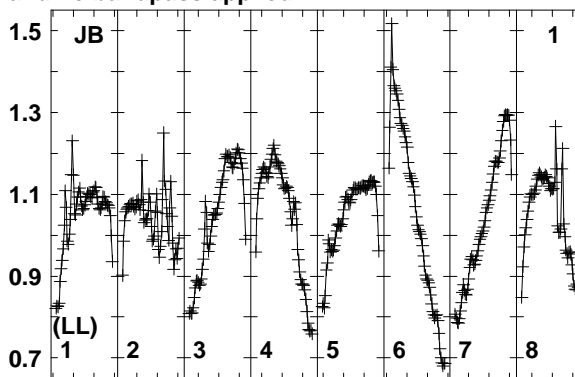
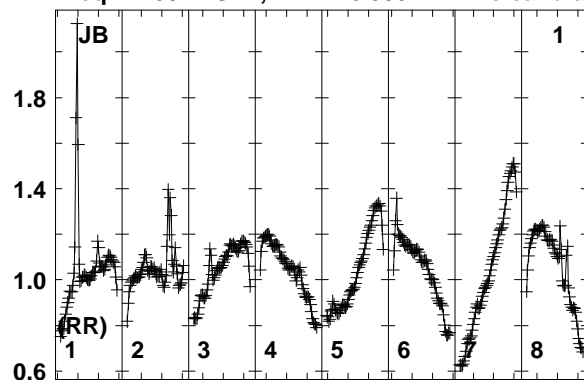

Lower frame: Real Jy
Total-power spectrum Antenna: JB (01)
Timerange: 00/03:52:01 to 00/03:54:29

Plot file version 103 created 04-NOV-2019 14:14:07

W2246-0526 EY034.UVDATA.1

Freq = 1.5947 GHz, Bw = 16.000 MH No calibration applied and no bandpass applied

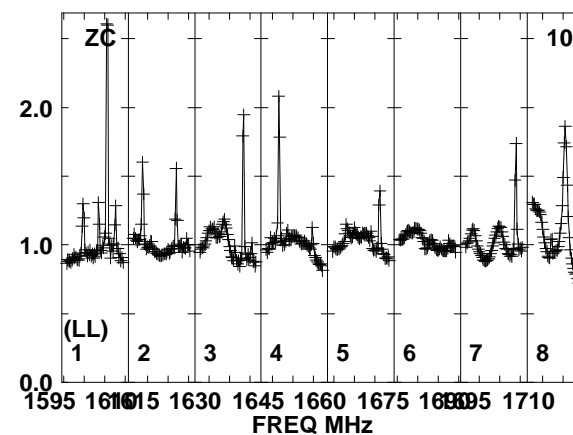
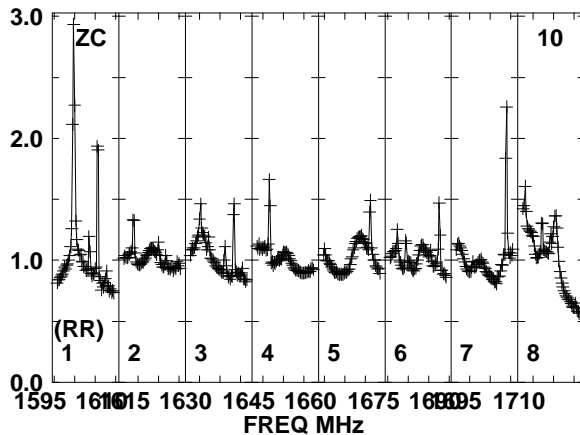
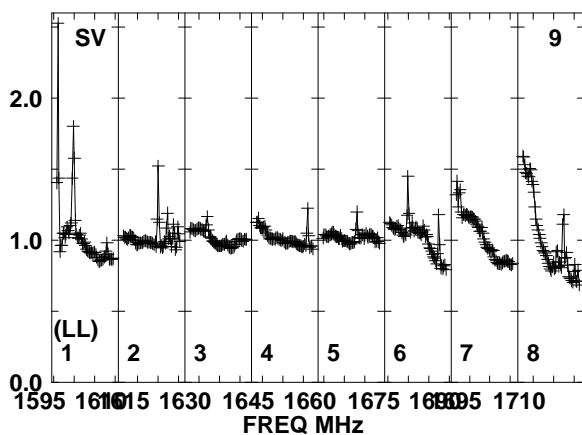
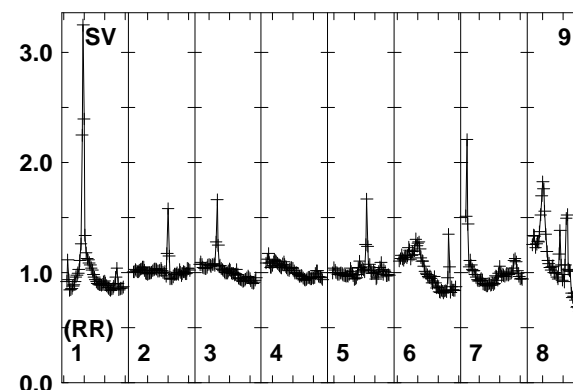
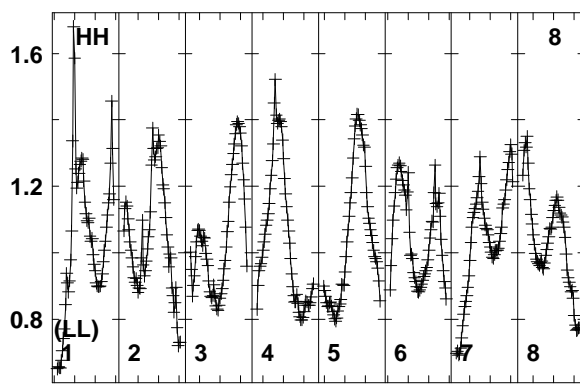
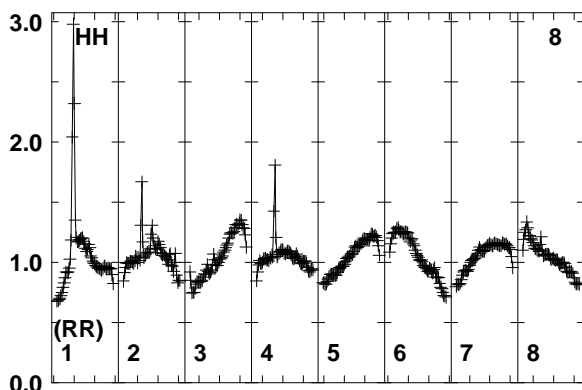
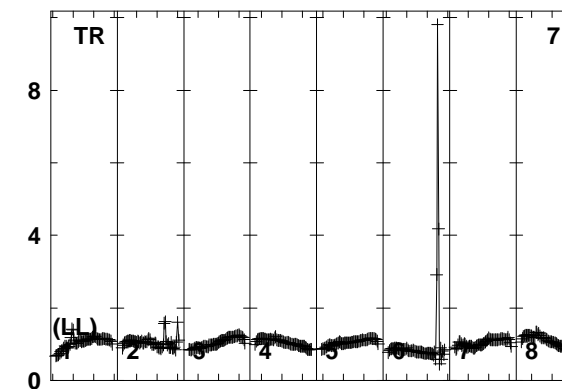
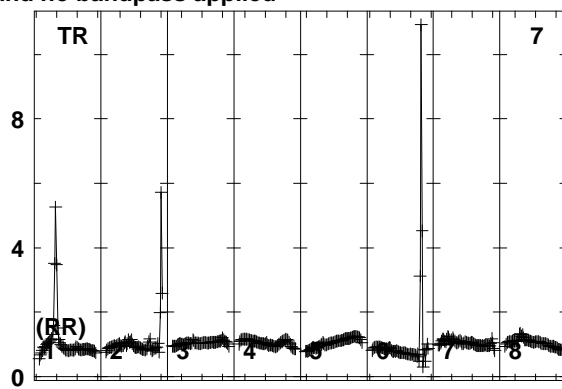
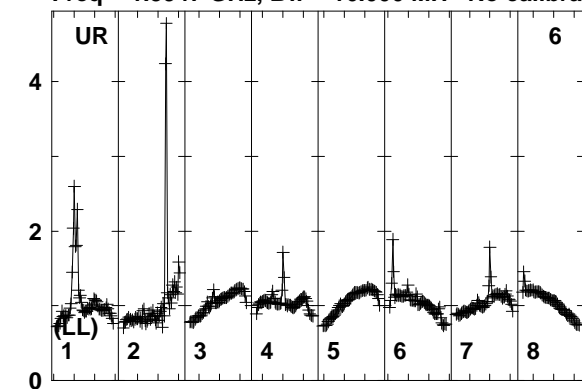

Lower frame: Real Jy
Total-power spectrum Antenna: UR (06)
Timerange: 00/03:52:01 to 00/03:54:29

Plot file version 104 created 04-NOV-2019 14:14:08

W2246-0526 EY034.UVDATA.1

Freq = 1.5947 GHz, Bw = 16.000 MH No calibration applied and no bandpass applied

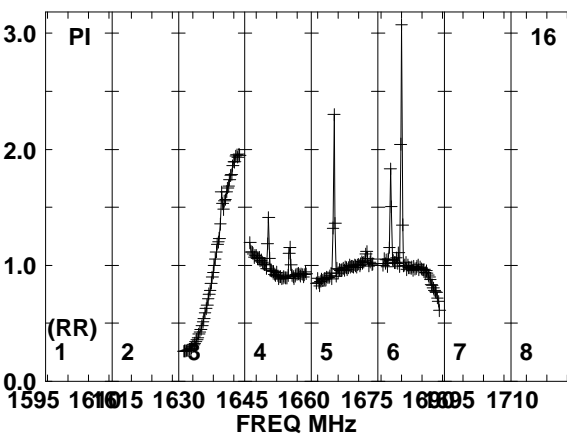
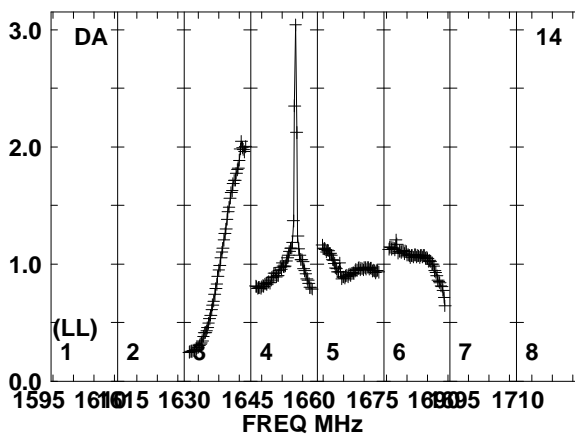
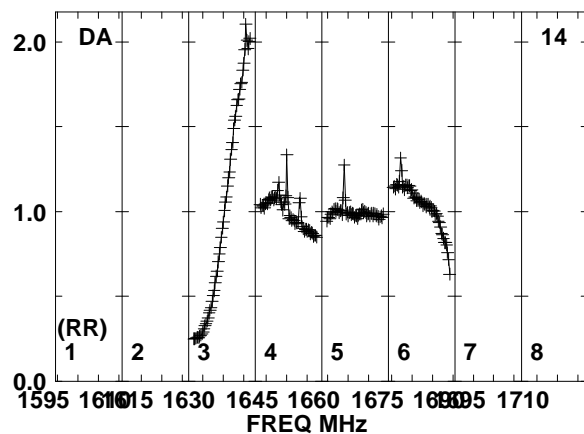
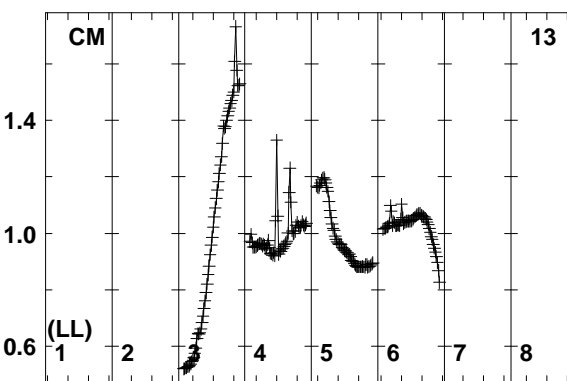
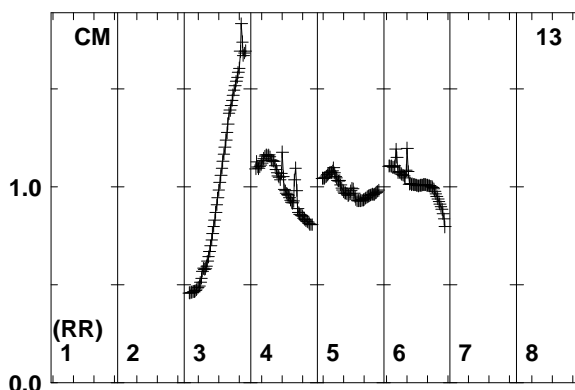
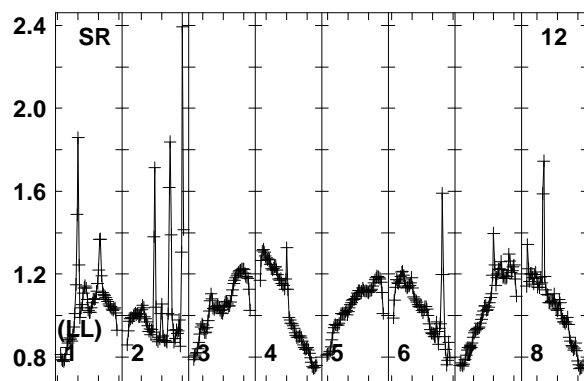
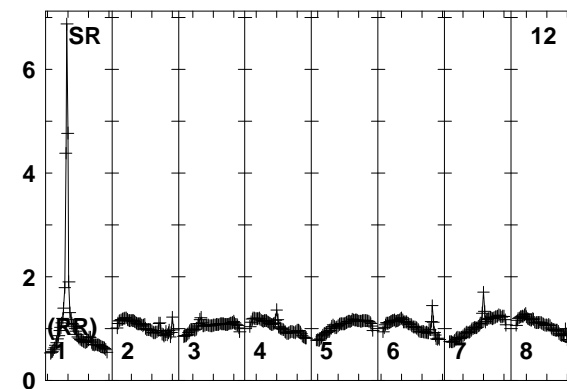
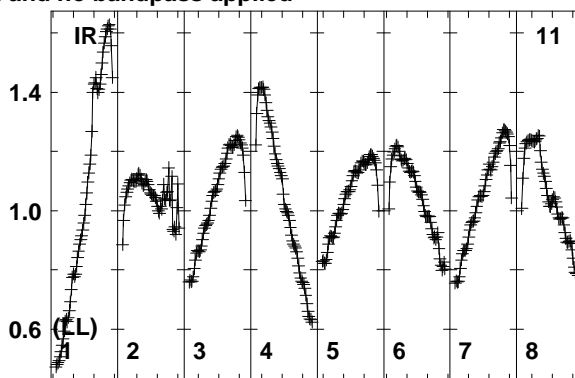
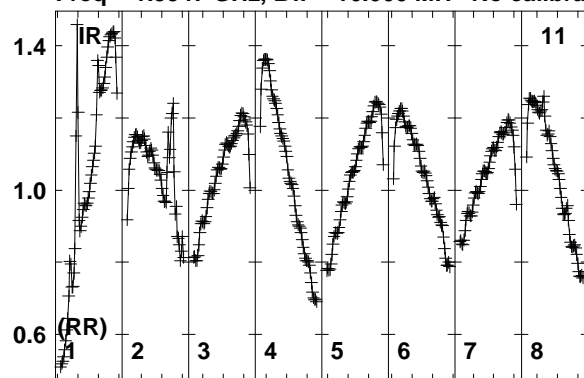

Lower frame: Real Jy
Total-power spectrum Antenna: IR (11)
Timerange: 00/03:52:01 to 00/03:54:29

Plot file version 105 created 04-NOV-2019 14:14:08
W2246-0526 EY034.UVDATA.1
Freq = 1.5947 GHz, Bw = 16.000 MH No calibration applied and no bandpass applied

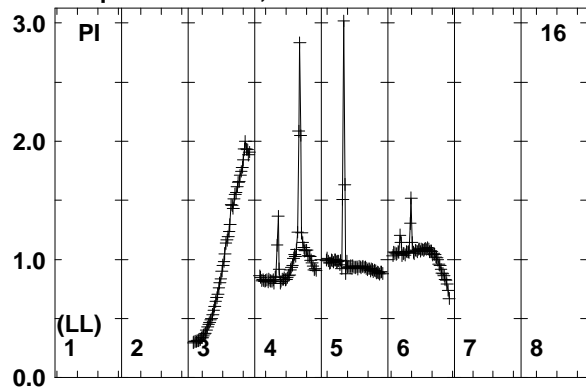

Lower frame: Real Jy
Total-power spectrum Antenna: PI (16)
Timerange: 00/03:52:01 to 00/03:54:29

Plot file version 106 created 04-NOV-2019 14:14:08

J2248-0541 EY034.UVDATA.1

Freq = 1.5947 GHz, Bw = 16.000 MH No calibration applied and no bandpass applied

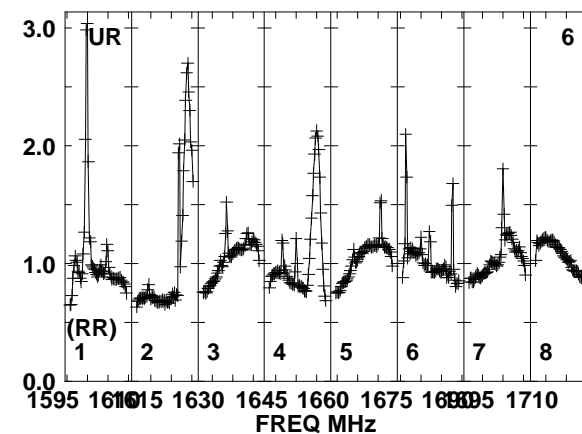
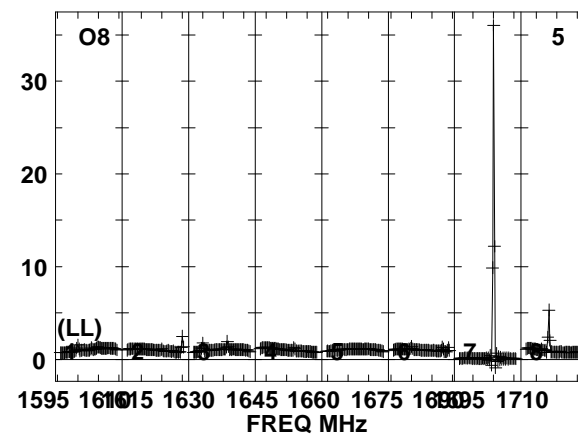
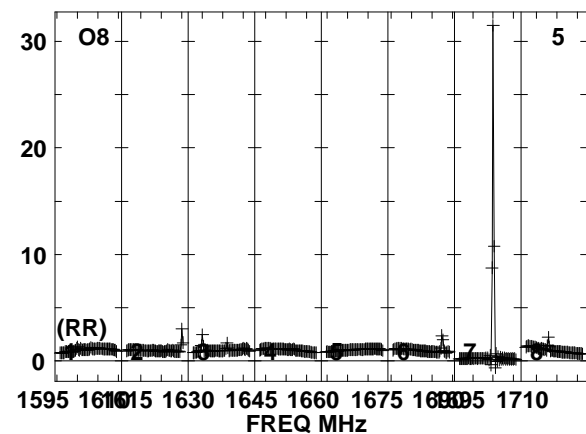
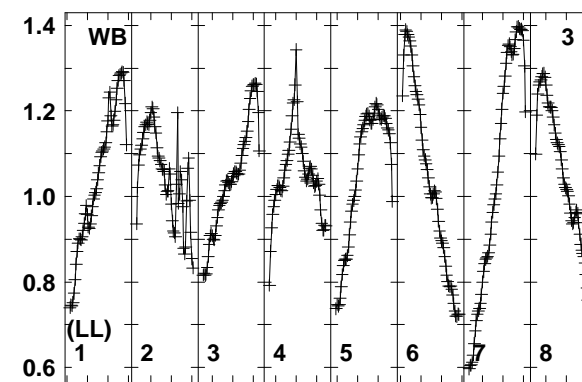
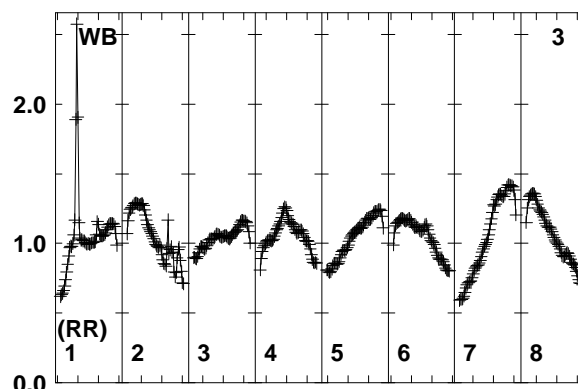
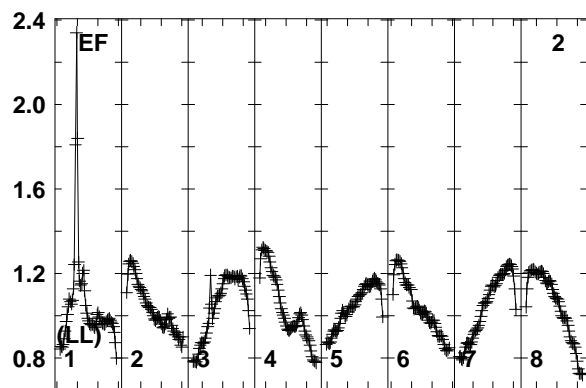
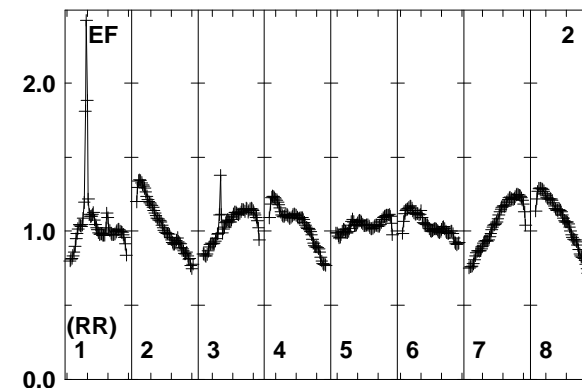
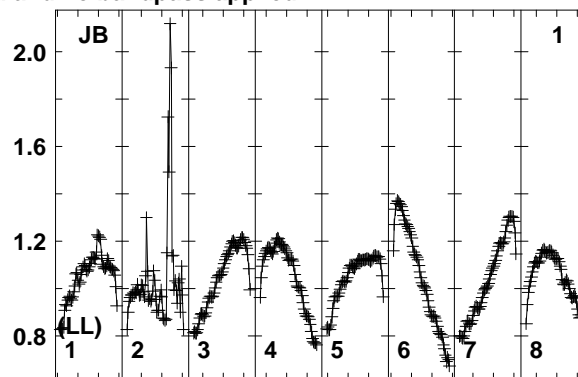
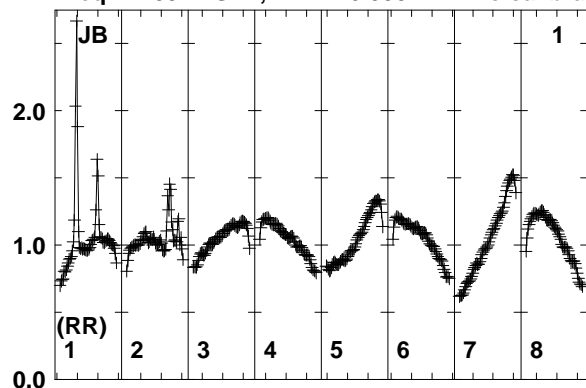

Lower frame: Real Jy
Total-power spectrum Antenna: JB (01)
Timerange: 00/03:54:46 to 00/03:55:44

Plot file version 107 created 04-NOV-2019 14:14:08

J2248-0541 EY034.UVDATA.1

Freq = 1.5947 GHz, Bw = 16.000 MH No calibration applied and no bandpass applied

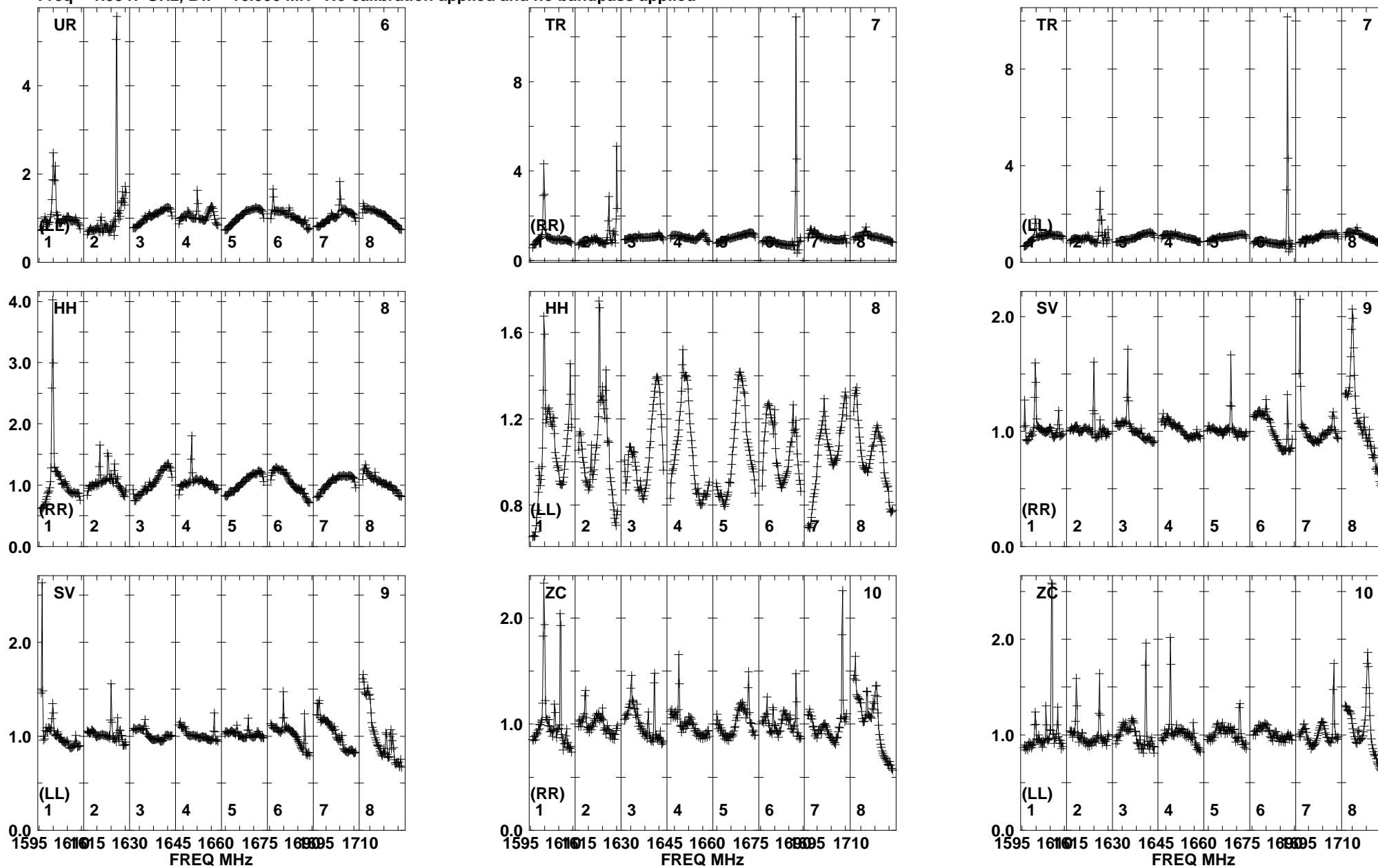

Lower frame: Real Jy
Total-power spectrum Antenna: UR (06)
Timerange: 00/03:54:46 to 00/03:55:44

Plot file version 108 created 04-NOV-2019 14:14:08

J2248-0541 EY034.UVDATA.1

Freq = 1.5947 GHz, Bw = 16.000 MH No calibration applied and no bandpass applied

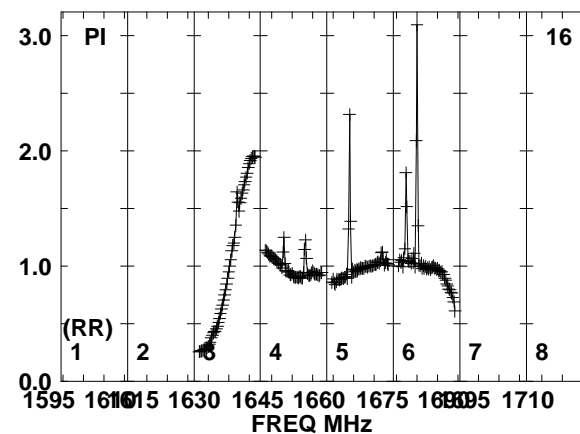
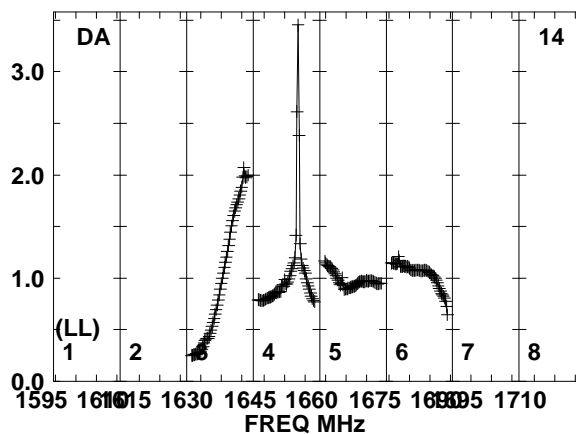
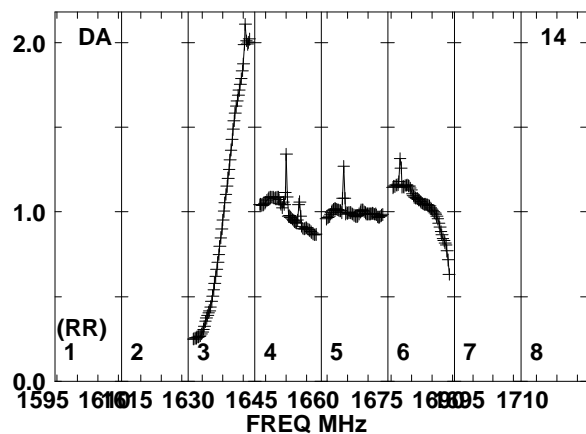
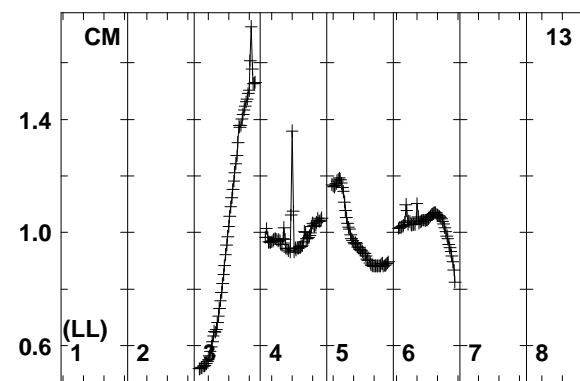
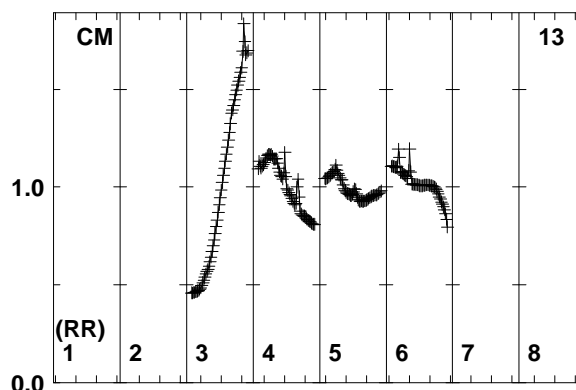
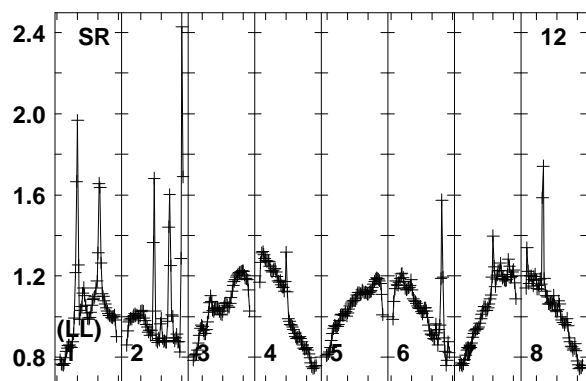
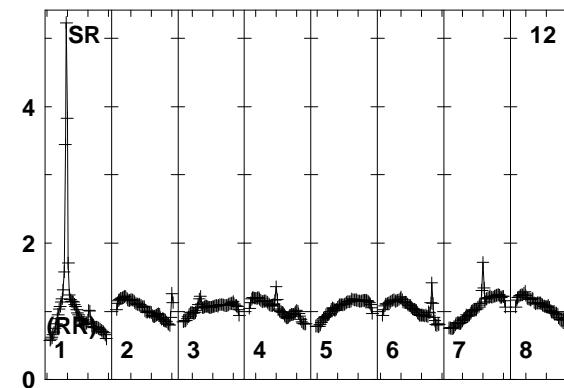
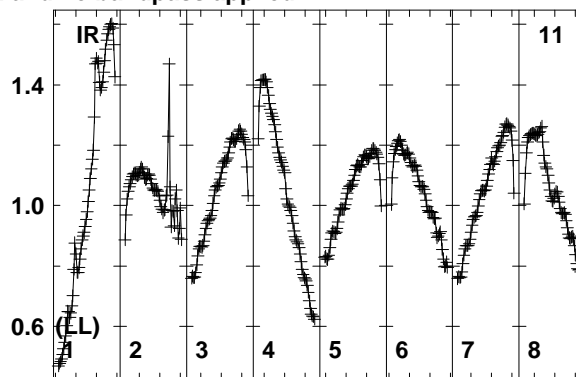
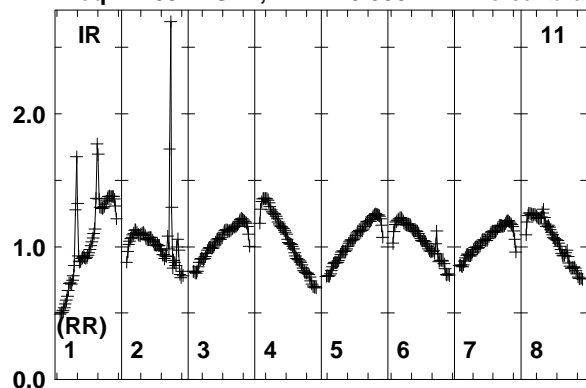

Lower frame: Real Jy
Total-power spectrum Antenna: IR (11)
Timerange: 00/03:54:46 to 00/03:55:44

Plot file version 109 created 04-NOV-2019 14:14:08
J2248-0541 EY034.UVDATA.1
Freq = 1.5947 GHz, Bw = 16.000 MH No calibration applied and no bandpass applied

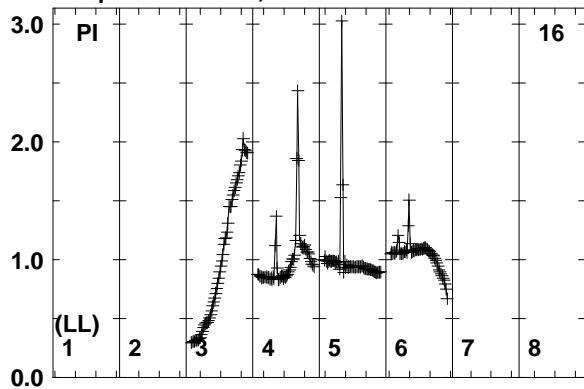

Lower frame: Real Jy
Total-power spectrum Antenna: PI (16)
Timerange: 00/03:54:46 to 00/03:55:44

Plot file version 110 created 04-NOV-2019 14:14:08

W2246-0526 EY034.UVDATA.1

Freq = 1.5947 GHz, Bw = 16.000 MH No calibration applied and no bandpass applied

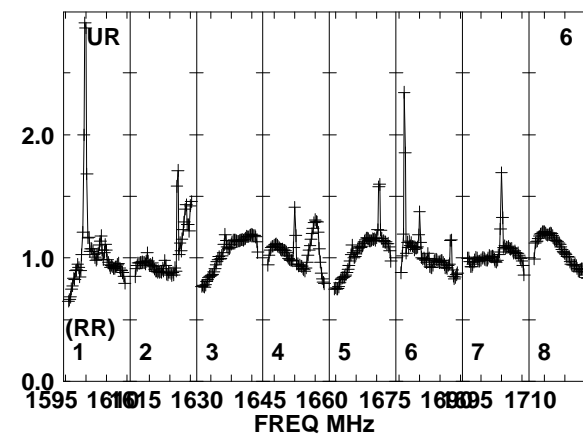
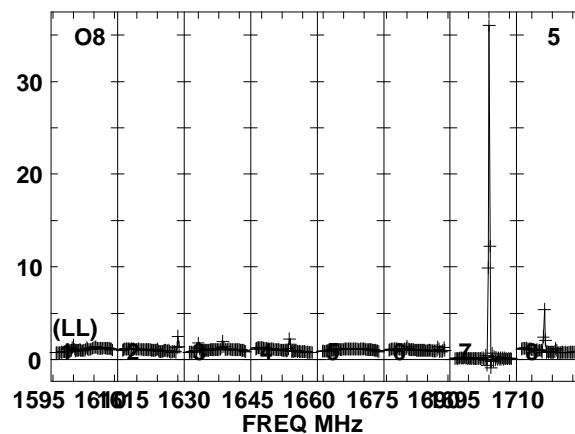
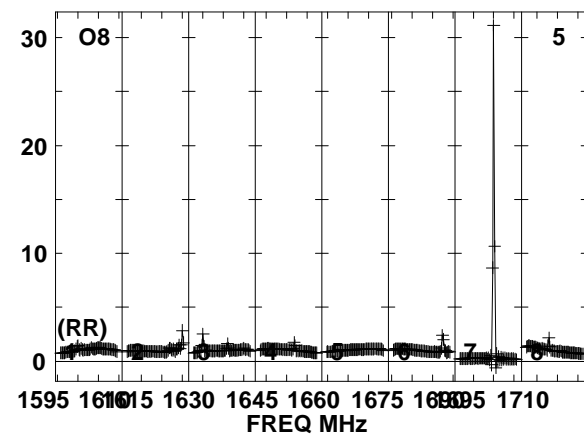
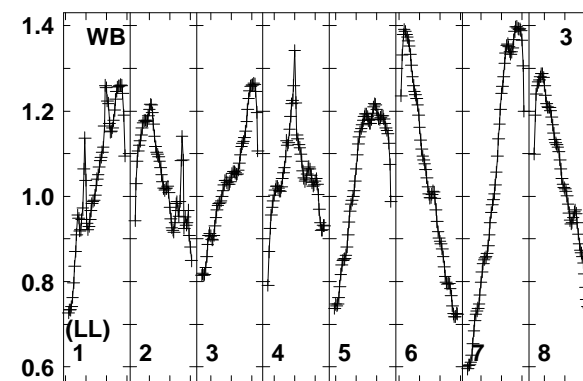
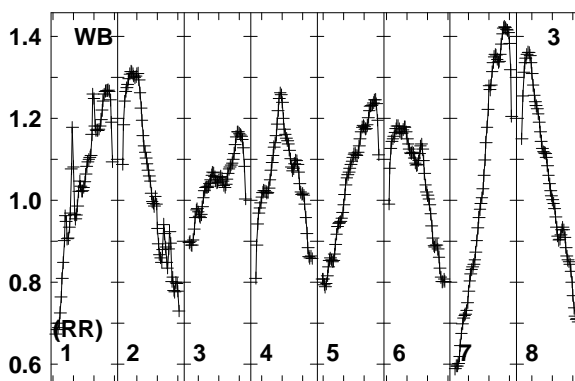
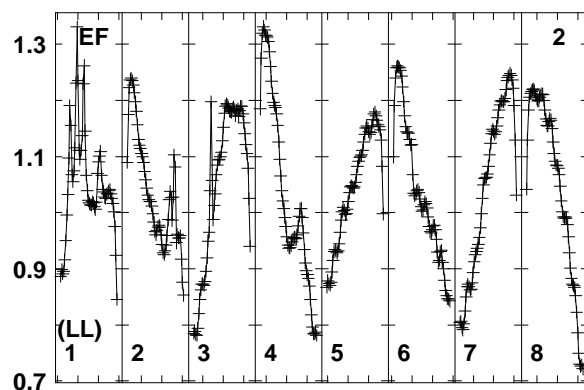
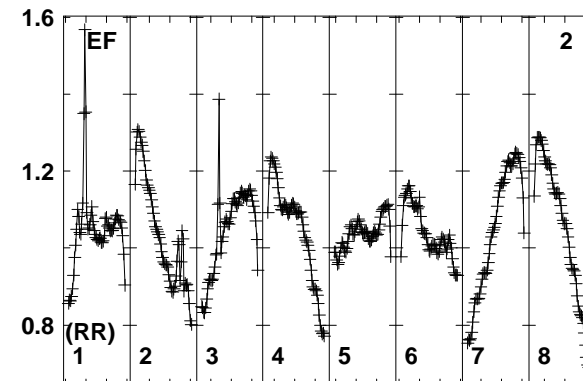
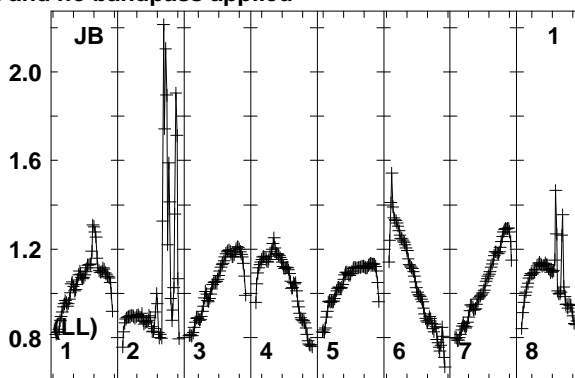
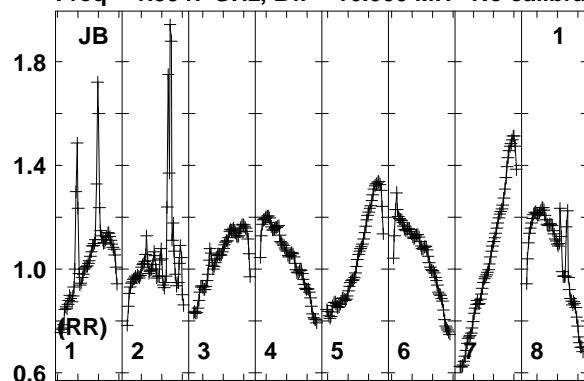

Lower frame: Real Jy
Total-power spectrum Antenna: JB (01)
Timerange: 00/03:55:46 to 00/03:58:24

Plot file version 111 created 04-NOV-2019 14:14:08

W2246-0526 EY034.UVDATA.1

Freq = 1.5947 GHz, Bw = 16.000 MH No calibration applied and no bandpass applied

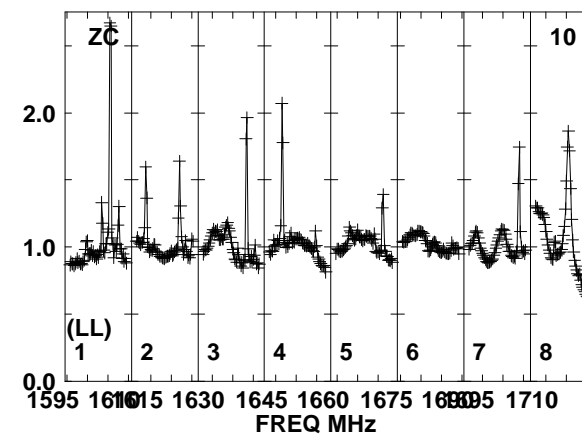
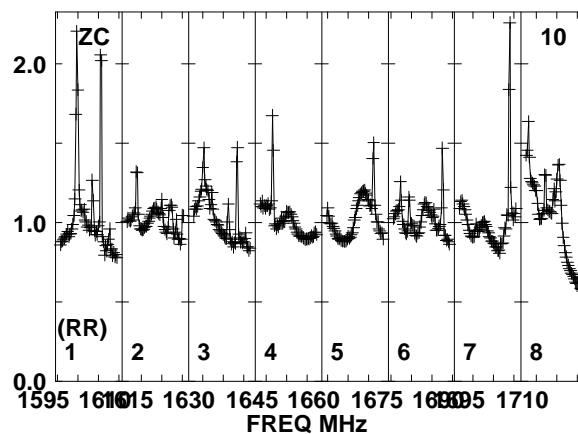
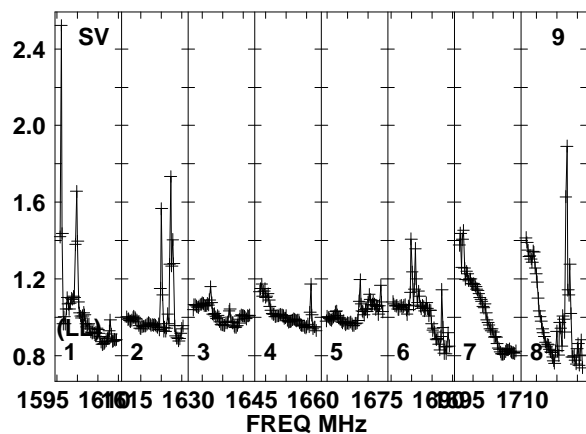
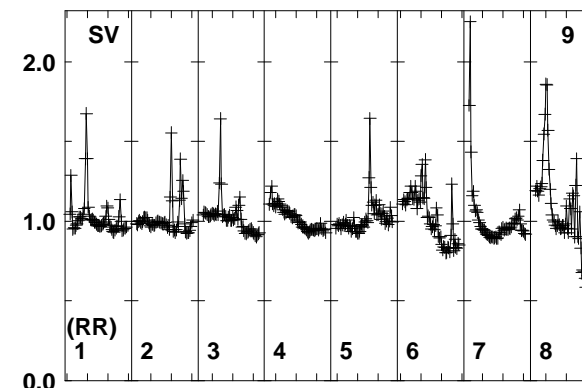
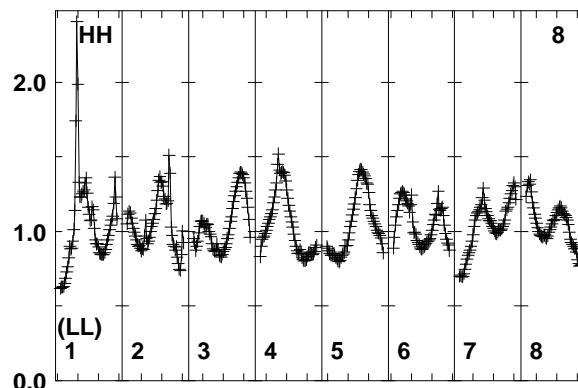
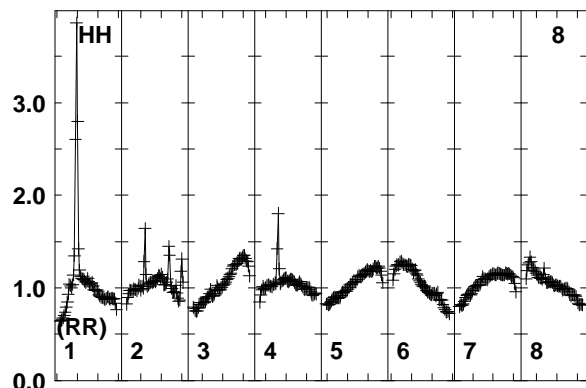
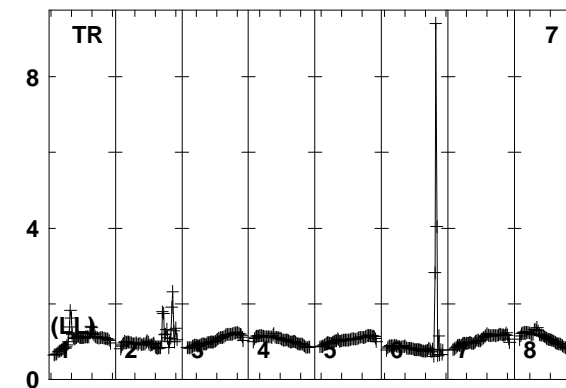
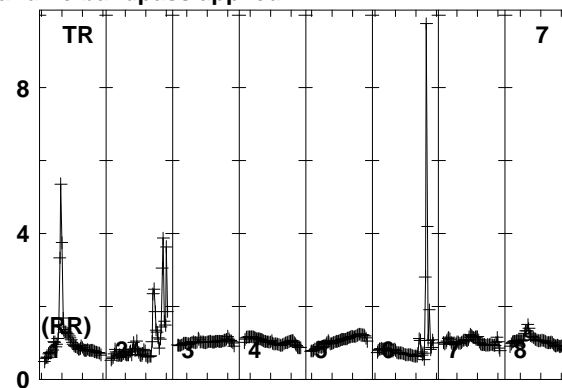
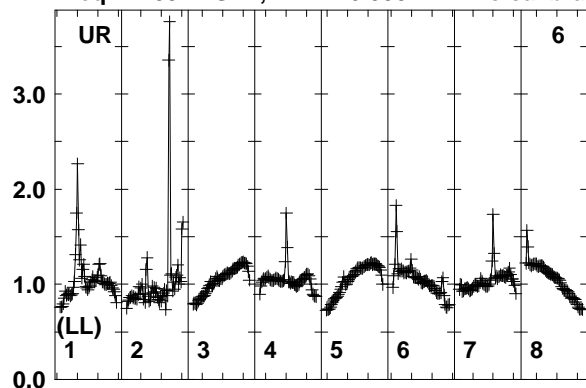

Lower frame: Real Jy
Total-power spectrum Antenna: UR (06)
Timerange: 00/03:55:46 to 00/03:58:24

Plot file version 112 created 04-NOV-2019 14:14:08

W2246-0526 EY034.UVDATA.1

Freq = 1.5947 GHz, Bw = 16.000 MH No calibration applied and no bandpass applied

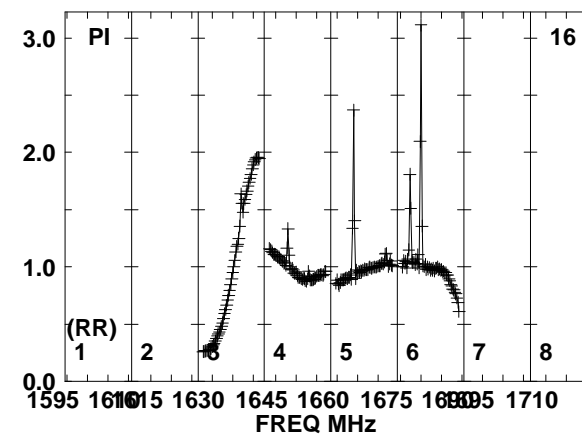
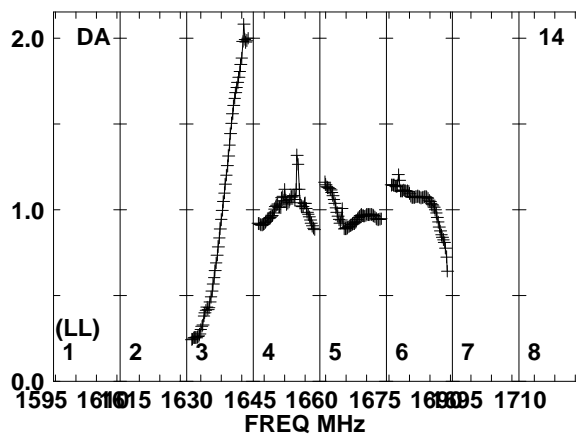
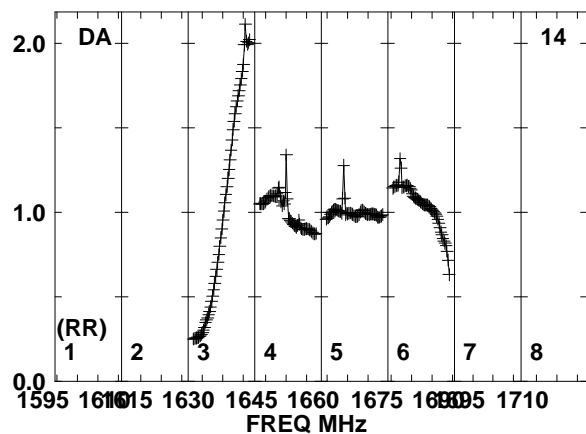
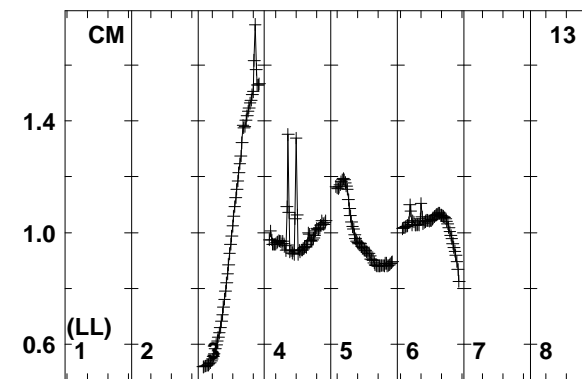
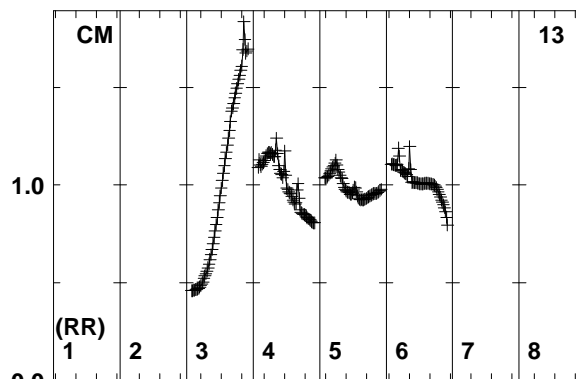
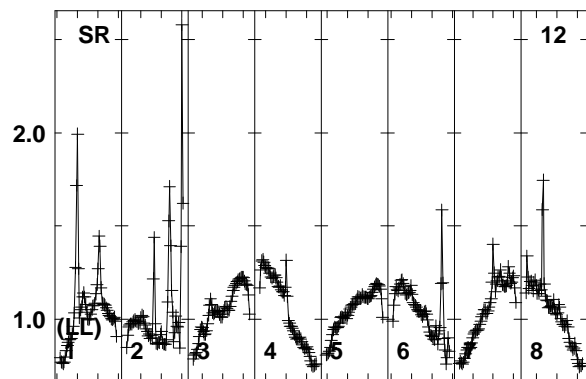
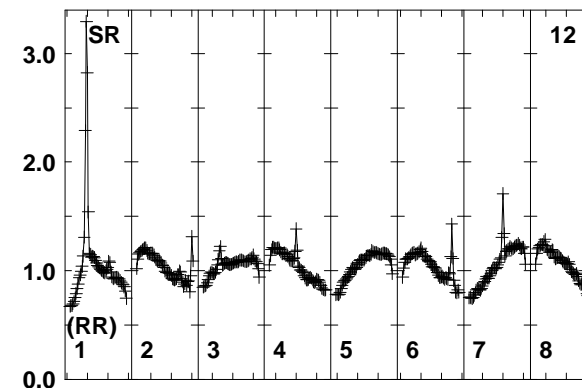
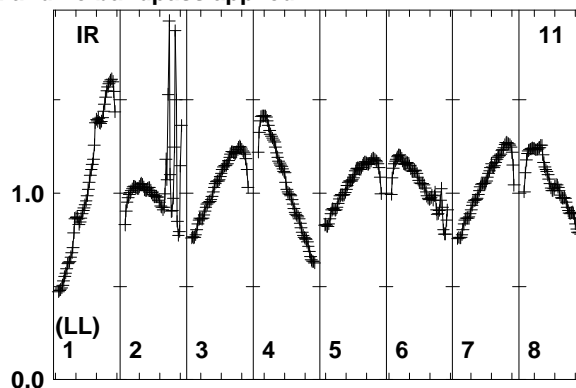
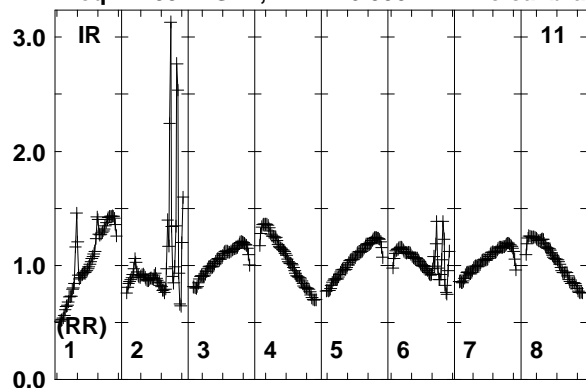

Lower frame: Real Jy
Total-power spectrum Antenna: IR (11)
Timerange: 00/03:55:46 to 00/03:58:24

Plot file version 113 created 04-NOV-2019 14:14:08
W2246-0526 EY034.UVDATA.1
Freq = 1.5947 GHz, Bw = 16.000 MH No calibration applied and no bandpass applied

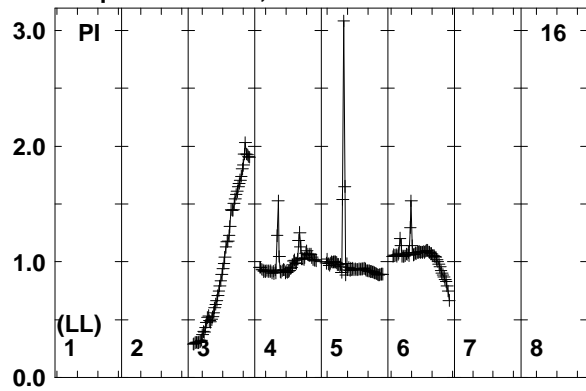

Lower frame: Real Jy
Total-power spectrum Antenna: PI (16)
Timerange: 00/03:55:46 to 00/03:58:24

Plot file version 114 created 04-NOV-2019 14:14:08

J2248-0541 EY034.UVDATA.1

Freq = 1.5947 GHz, Bw = 16.000 MH No calibration applied and no bandpass applied

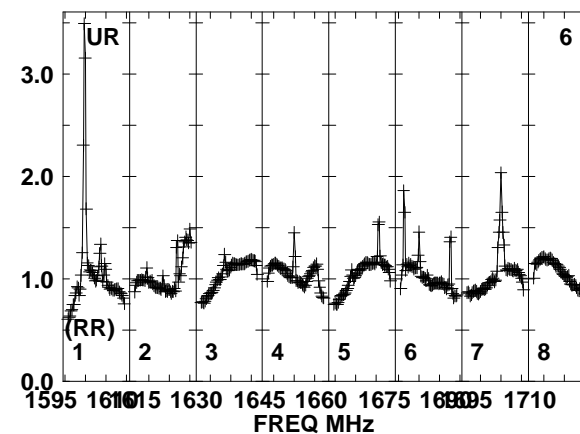
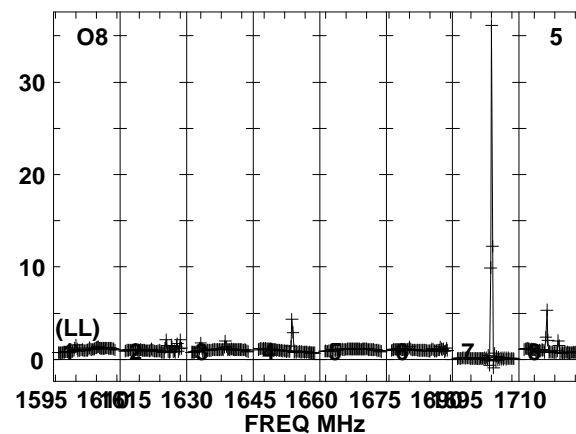
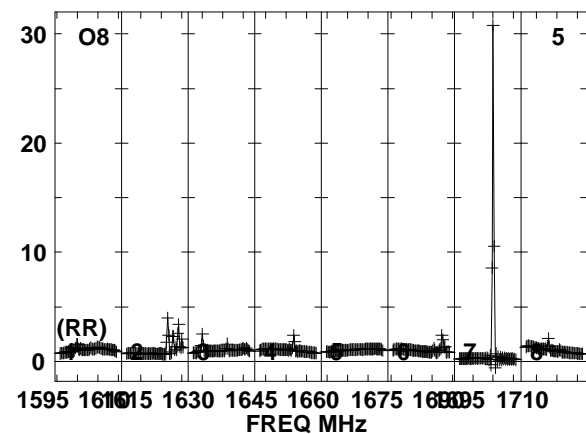
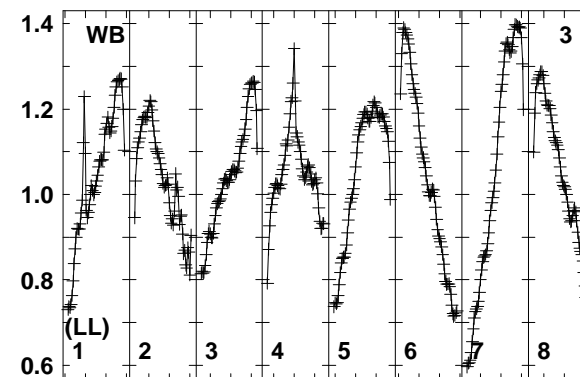
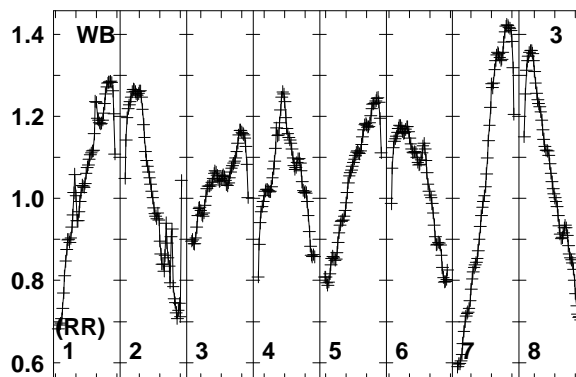
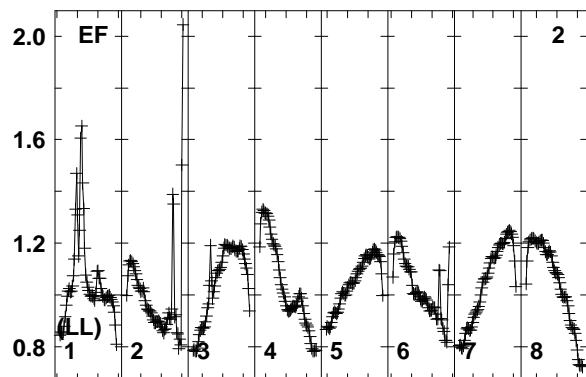
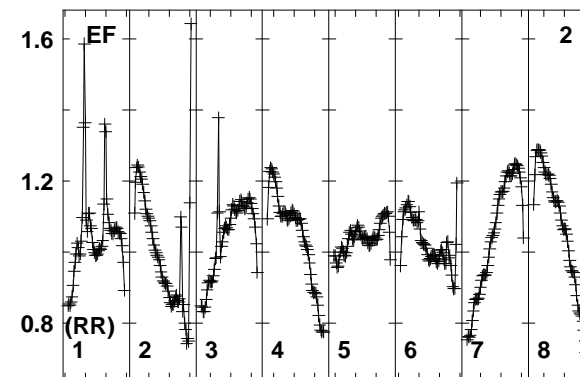
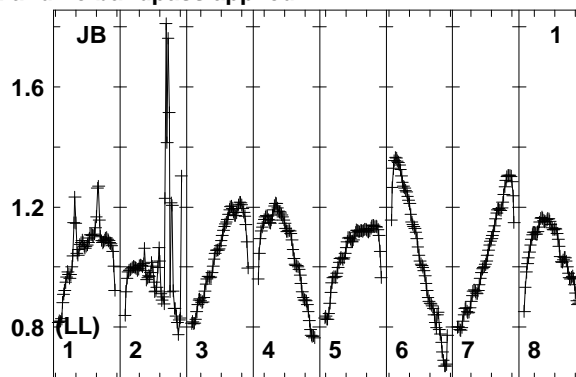
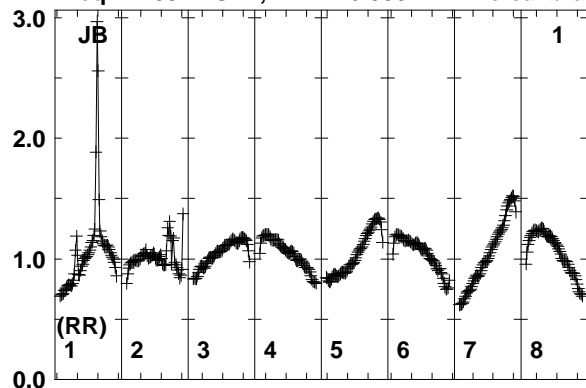

Lower frame: Real Jy
Total-power spectrum Antenna: JB (01)
Timerange: 00/03:58:41 to 00/03:59:39

Plot file version 115 created 04-NOV-2019 14:14:08

J2248-0541 EY034.UVDATA.1

Freq = 1.5947 GHz, Bw = 16.000 MH No calibration applied and no bandpass applied

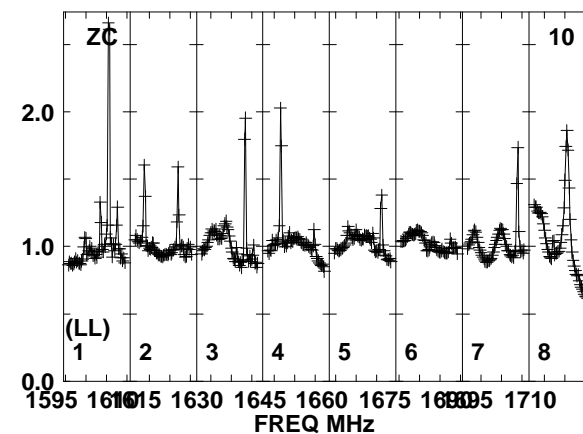
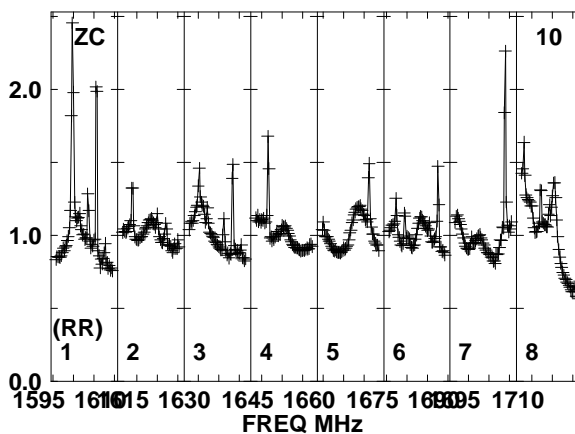
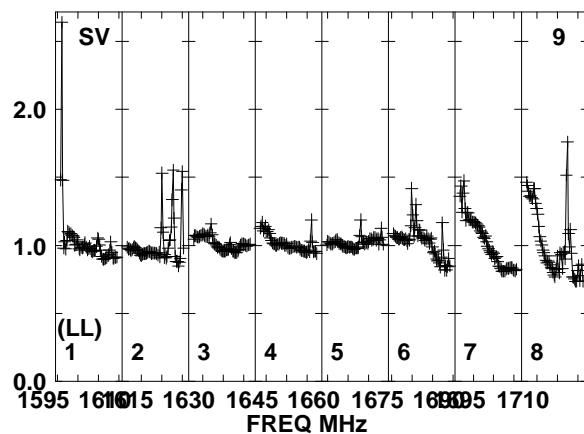
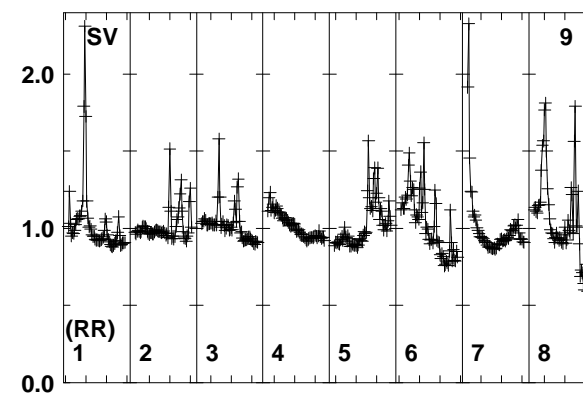
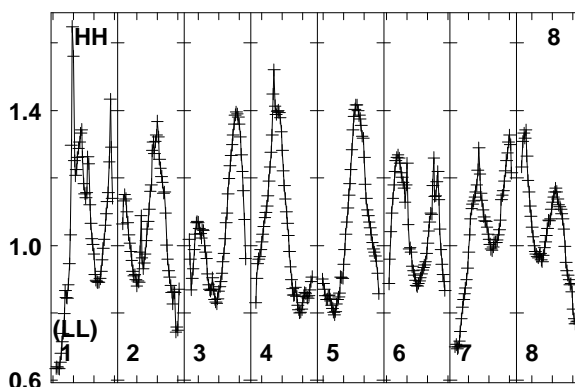
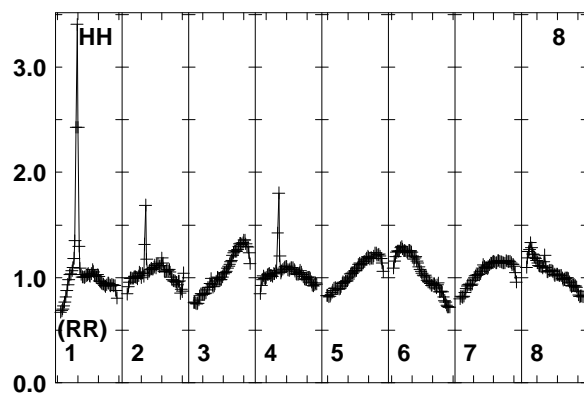
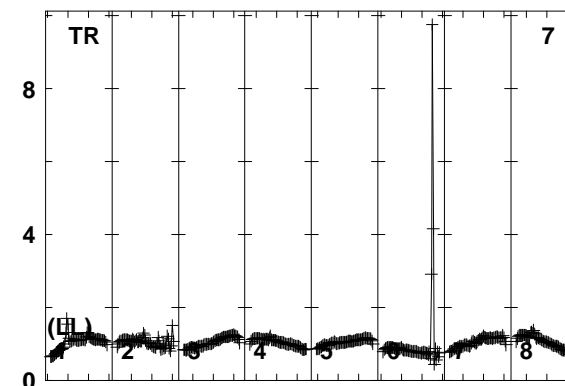
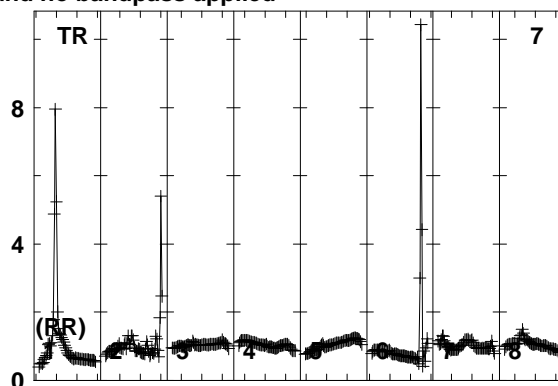
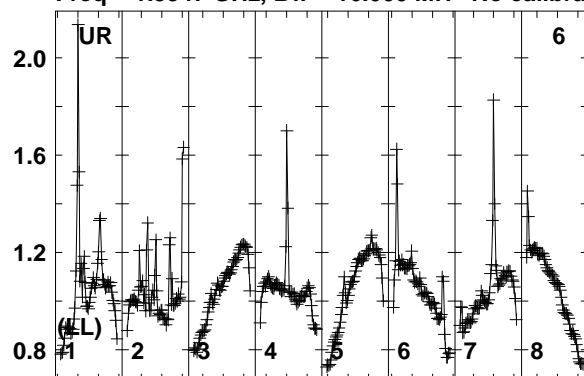

Lower frame: Real Jy
Total-power spectrum Antenna: UR (06)
Timerange: 00/03:58:41 to 00/03:59:39

Plot file version 116 created 04-NOV-2019 14:14:08

J2248-0541 EY034.UVDATA.1

Freq = 1.5947 GHz, Bw = 16.000 MH No calibration applied and no bandpass applied

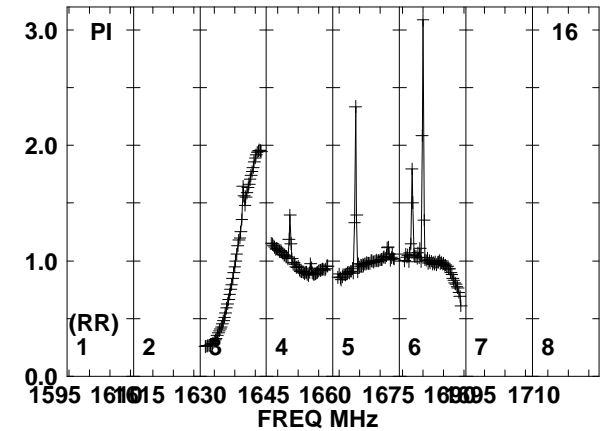
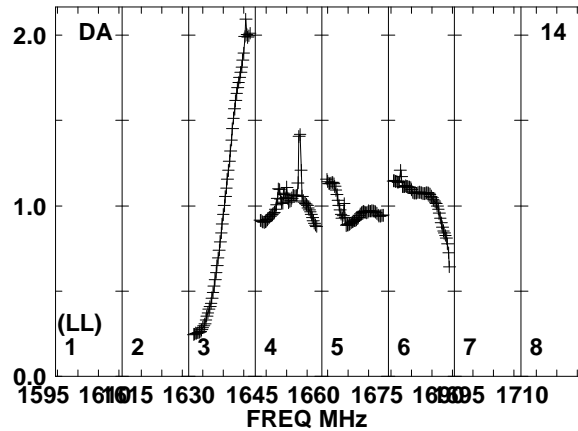
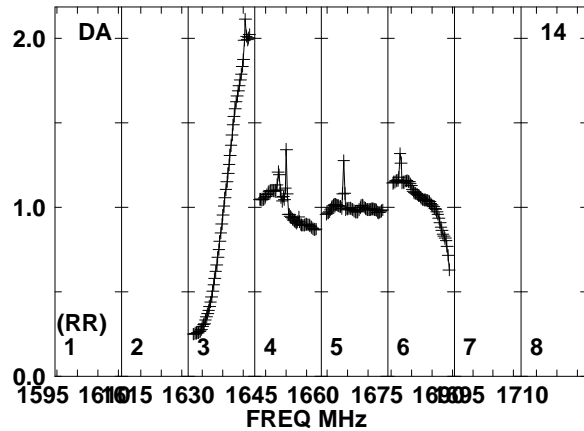
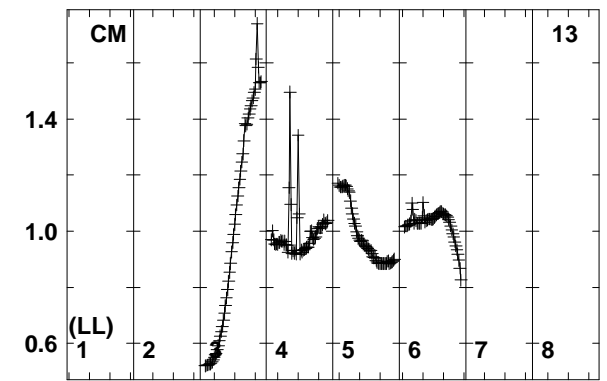
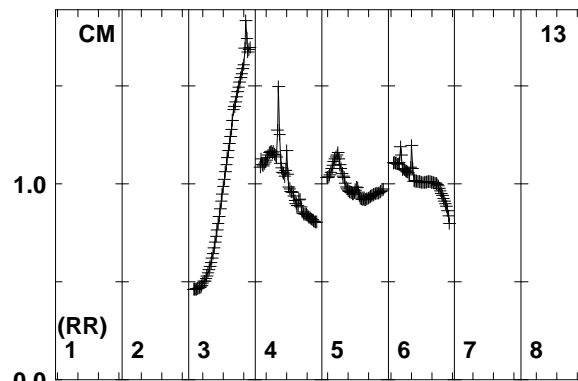
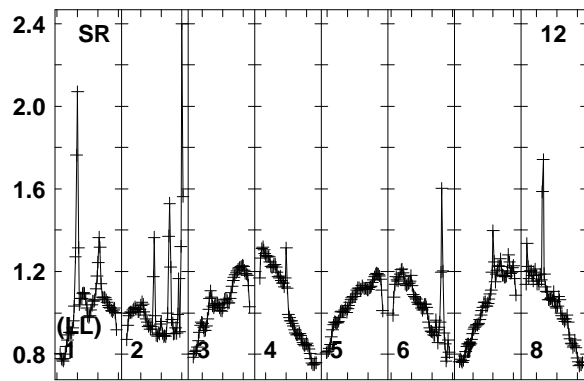
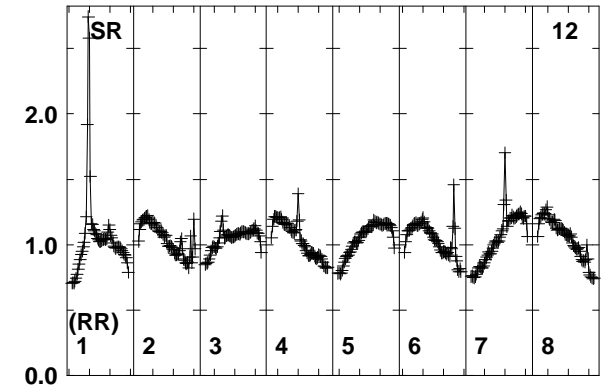
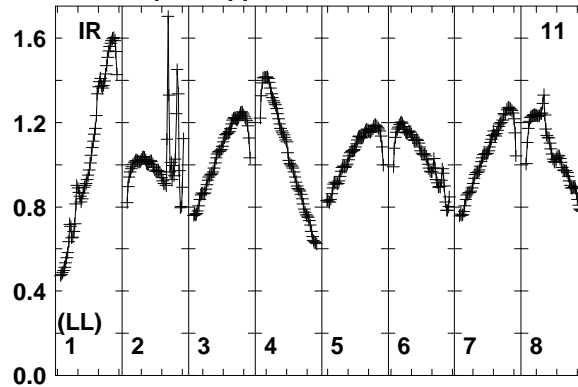
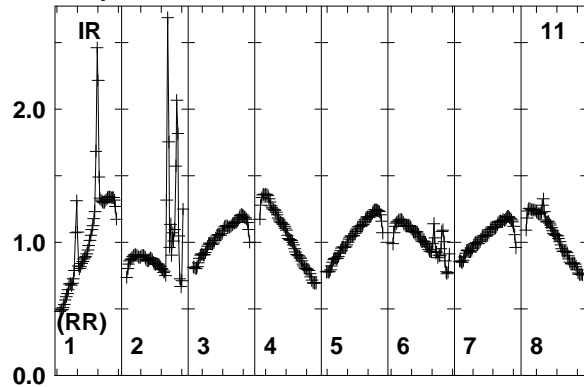

Lower frame: Real Jy
Total-power spectrum Antenna: IR (11)
Timerange: 00/03:58:41 to 00/03:59:39

Plot file version 117 created 04-NOV-2019 14:14:09
J2248-0541 EY034.UVDATA.1
Freq = 1.5947 GHz, Bw = 16.000 MH No calibration applied and no bandpass applied

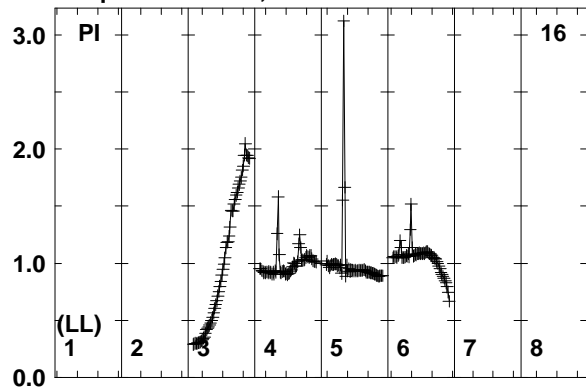

Lower frame: Real Jy
Total-power spectrum Antenna: PI (16)
Timerange: 00/03:58:41 to 00/03:59:39

Plot file version 118 created 04-NOV-2019 14:14:09

W2246-0526 EY034.UVDATA.1

Freq = 1.5947 GHz, Bw = 16.000 MH No calibration applied and no bandpass applied

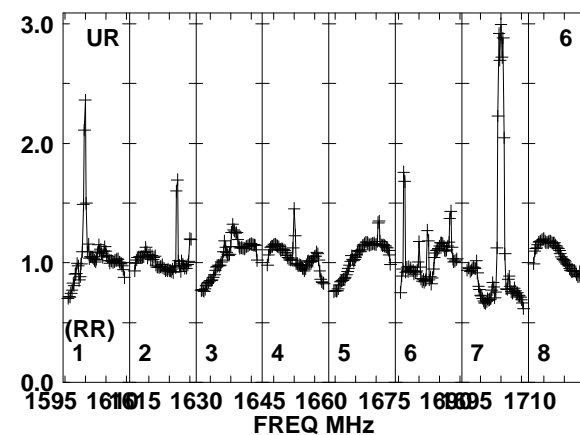
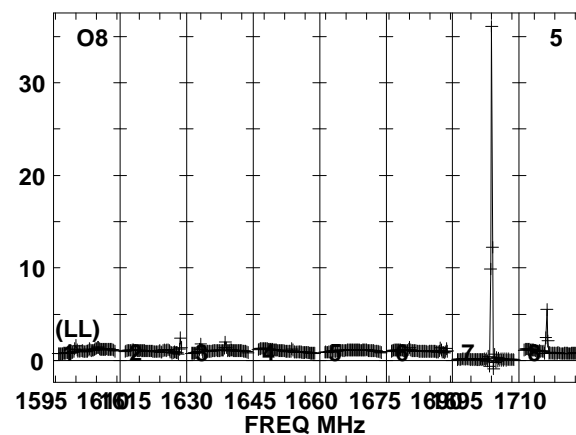
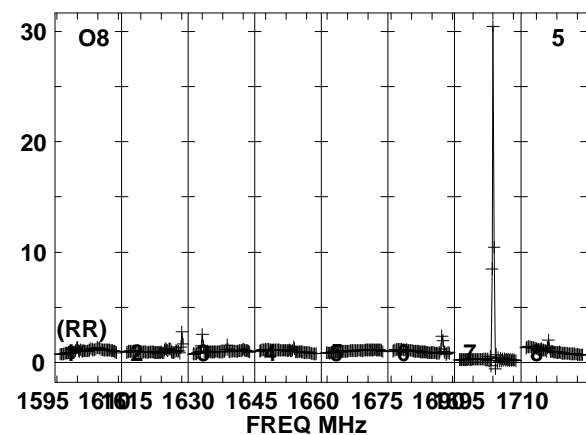
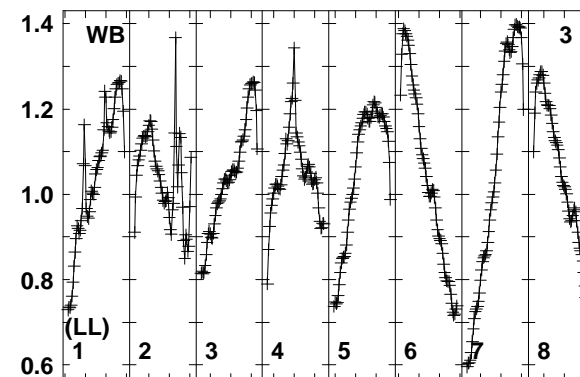
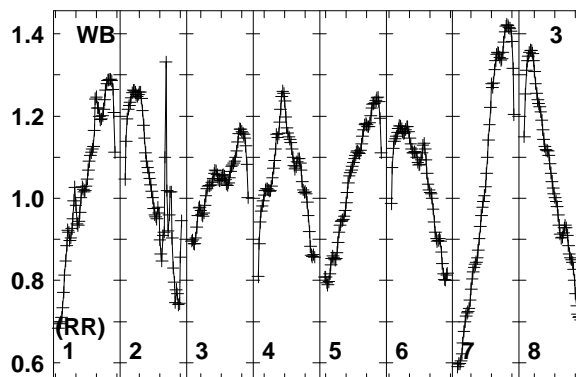
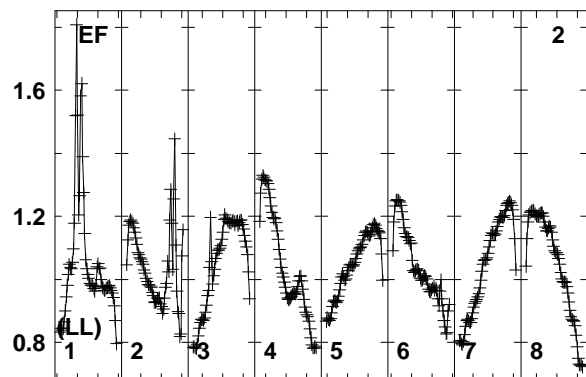
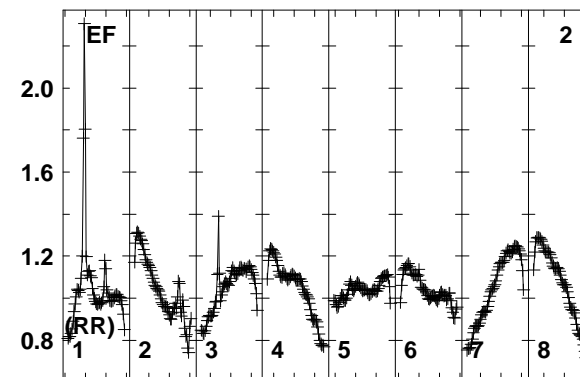
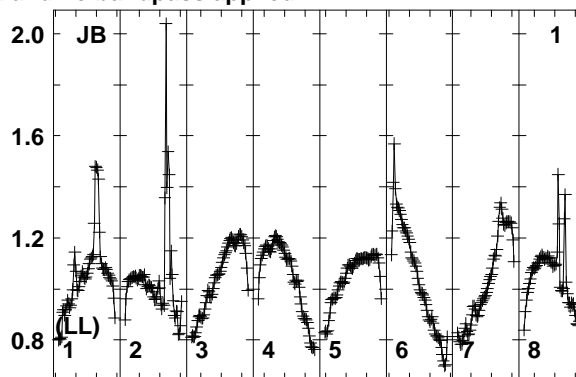
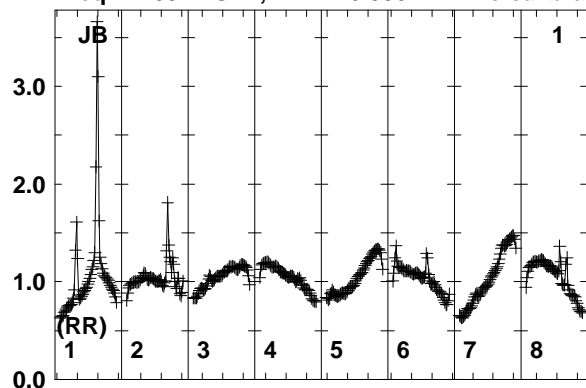

Lower frame: Real Jy
Total-power spectrum Antenna: JB (01)
Timerange: 00/03:59:41 to 00/04:02:19

Plot file version 119 created 04-NOV-2019 14:14:09

W2246-0526 EY034.UVDATA.1

Freq = 1.5947 GHz, Bw = 16.000 MH No calibration applied and no bandpass applied

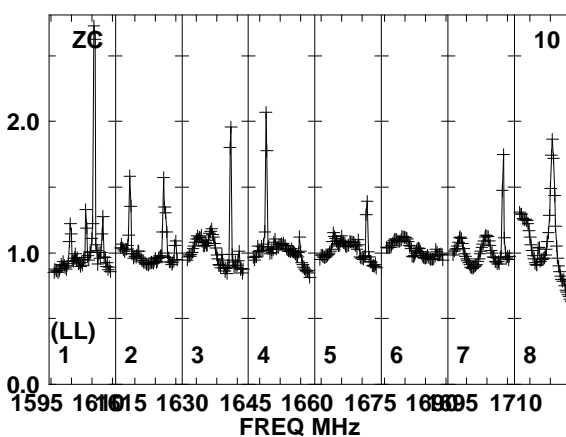
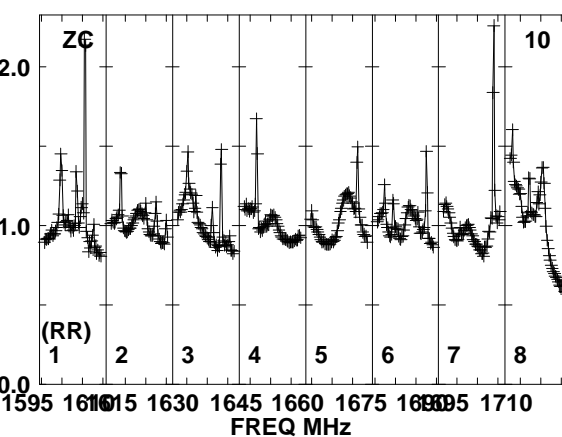
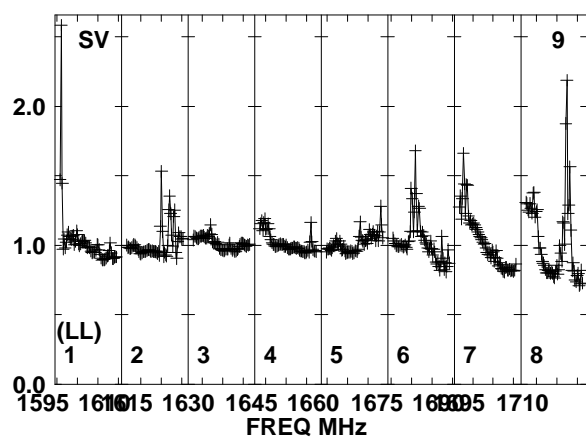
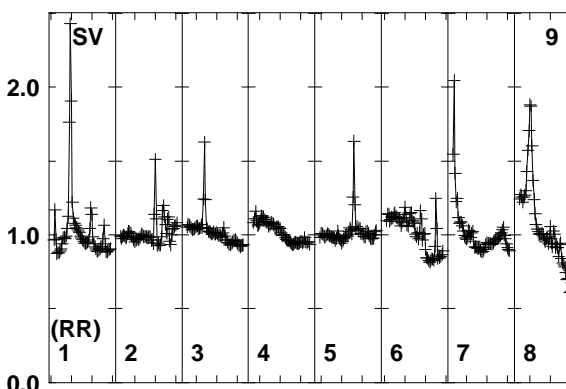
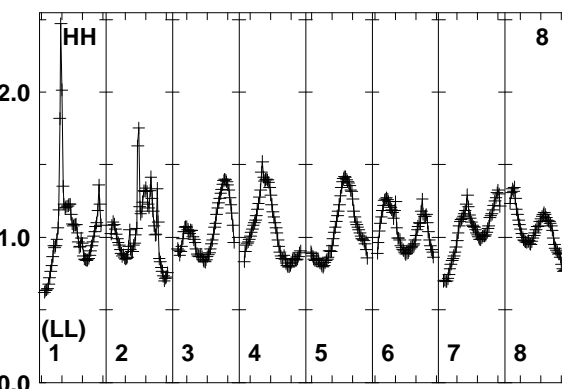
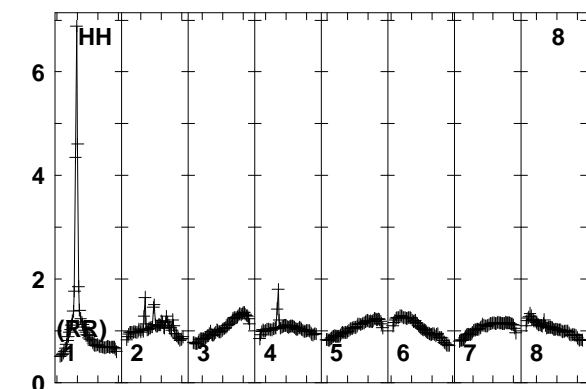
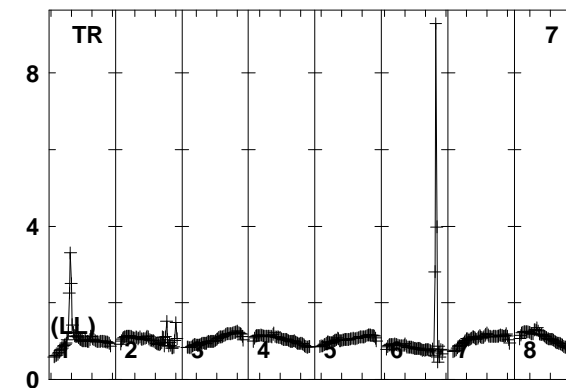
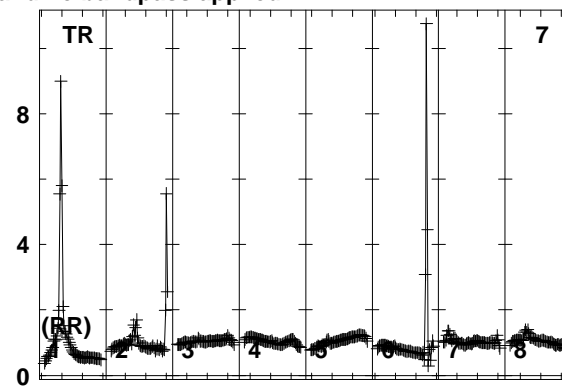
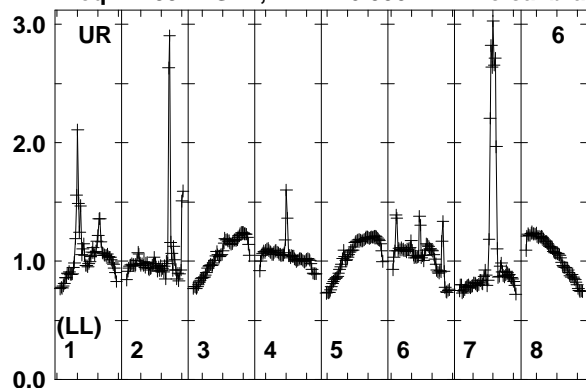

Lower frame: Real Jy
Total-power spectrum Antenna: UR (06)
Timerange: 00/03:59:41 to 00/04:02:19

Plot file version 120 created 04-NOV-2019 14:14:09

W2246-0526 EY034.UVDATA.1

Freq = 1.5947 GHz, Bw = 16.000 MH No calibration applied and no bandpass applied

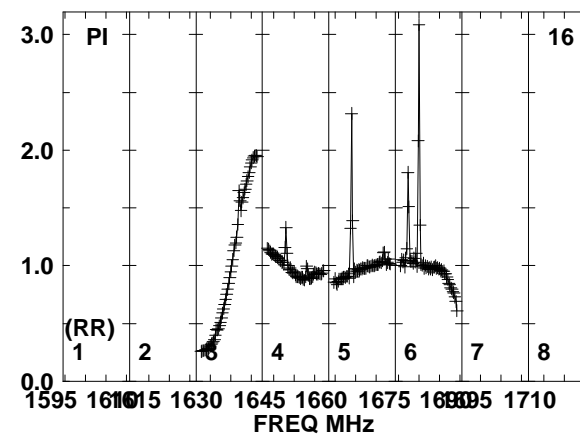
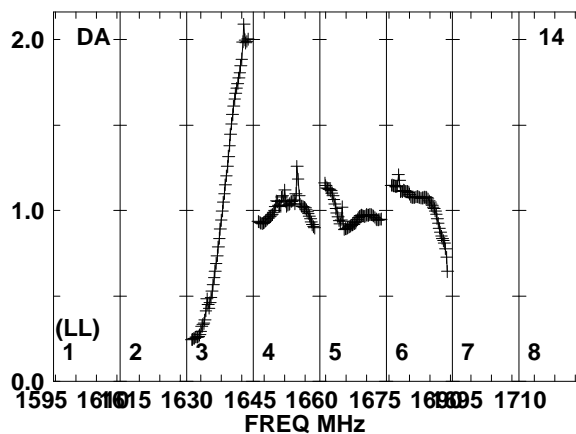
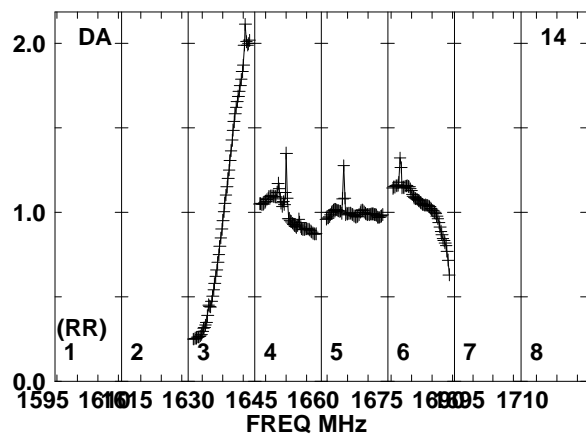
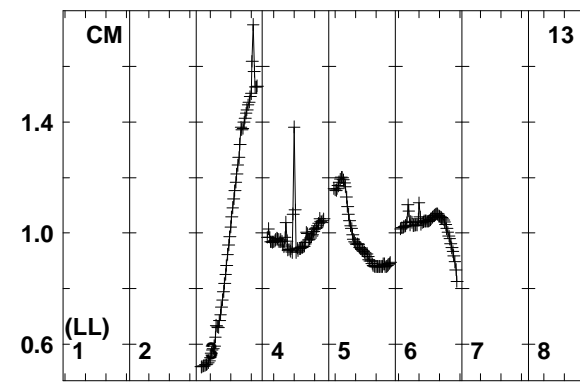
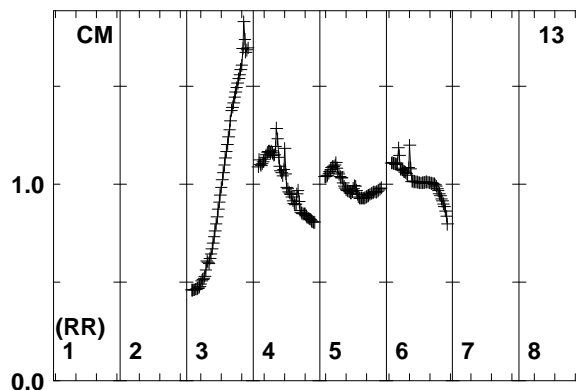
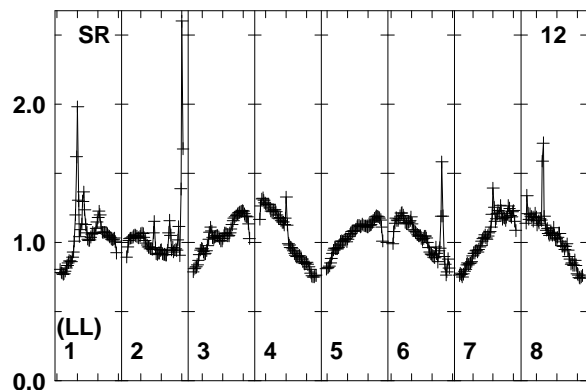
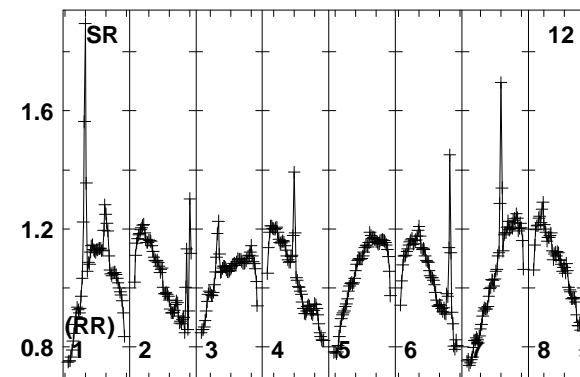
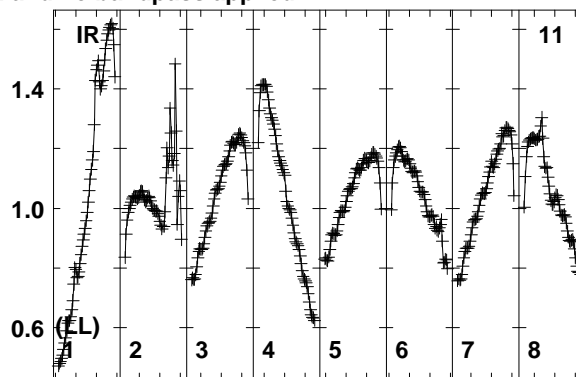
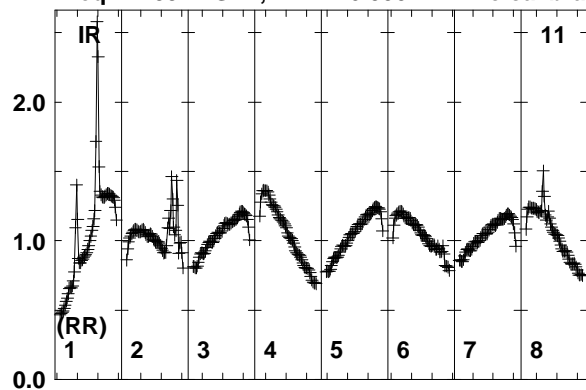

Lower frame: Real Jy
Total-power spectrum Antenna: IR (11)
Timerange: 00/03:59:41 to 00/04:02:19

Plot file version 121 created 04-NOV-2019 14:14:09
W2246-0526 EY034.UVDATA.1
Freq = 1.5947 GHz, Bw = 16.000 MH No calibration applied and no bandpass applied

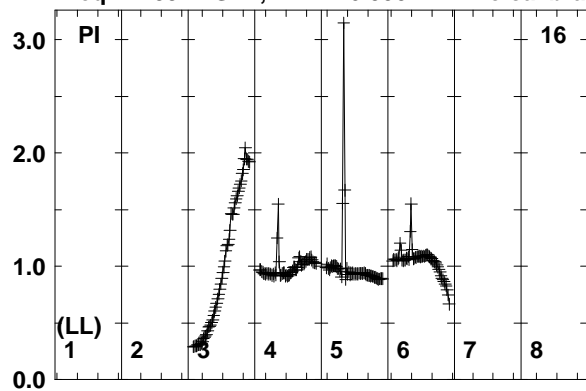

Lower frame: Real Jy
Total-power spectrum Antenna: PI (16)
Timerange: 00/03:59:41 to 00/04:02:19

Plot file version 122 created 04-NOV-2019 14:14:09

J2248-0541 EY034.UVDATA.1

Freq = 1.5947 GHz, Bw = 16.000 MH No calibration applied and no bandpass applied

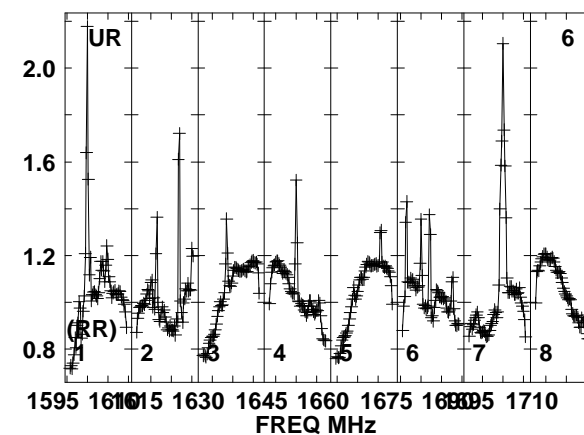
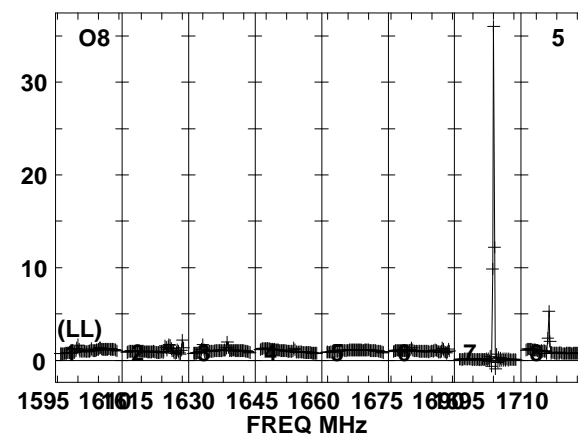
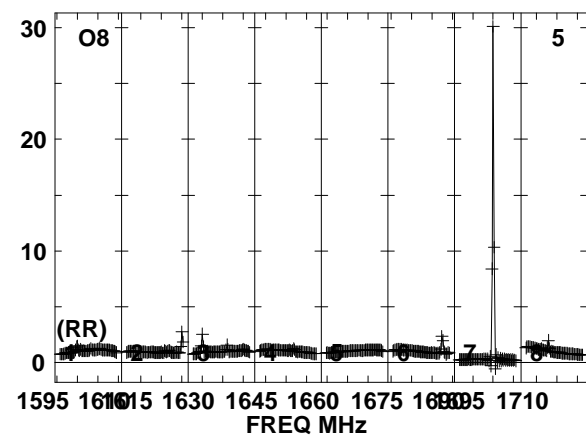
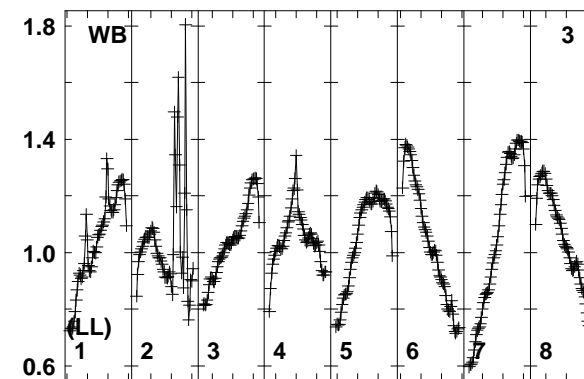
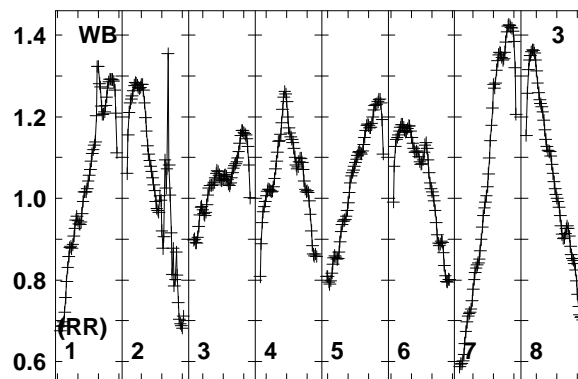
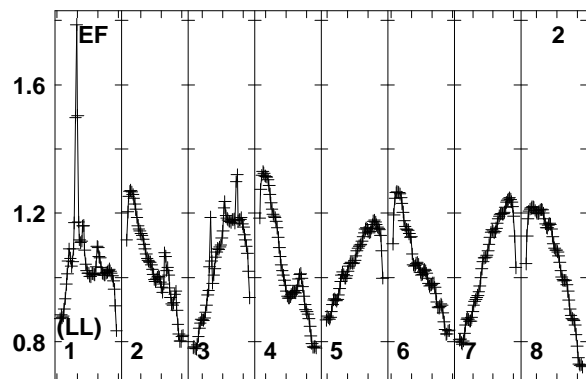
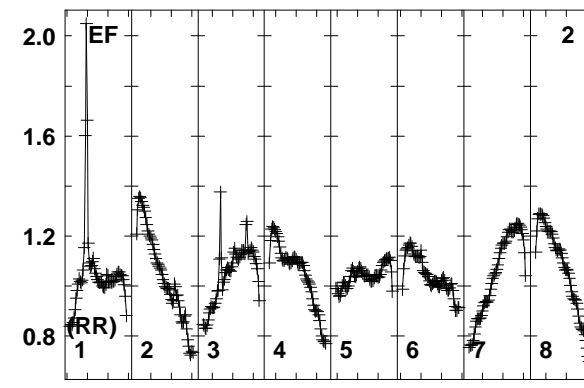
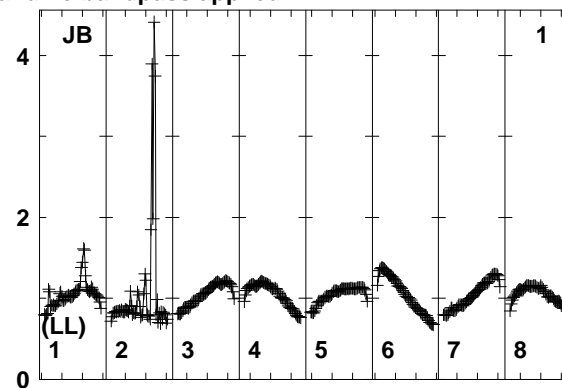
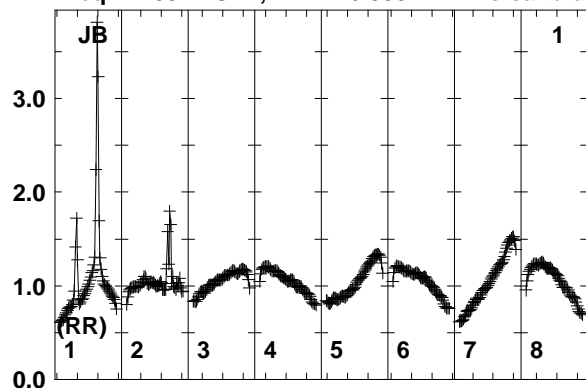

Lower frame: Real Jy
Total-power spectrum Antenna: JB (01)
Timerange: 00/04:02:36 to 00/04:03:34

Plot file version 123 created 04-NOV-2019 14:14:09

J2248-0541 EY034.UVDATA.1

Freq = 1.5947 GHz, Bw = 16.000 MH No calibration applied and no bandpass applied

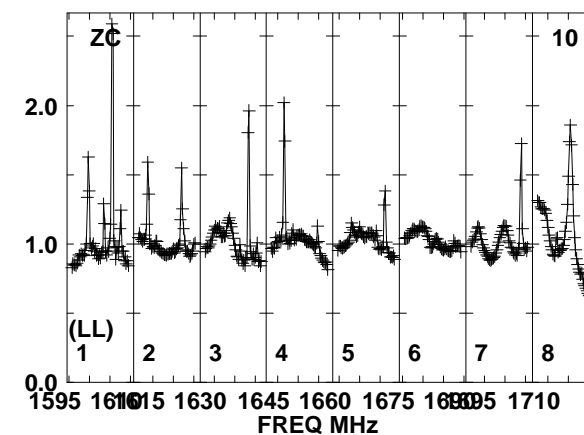
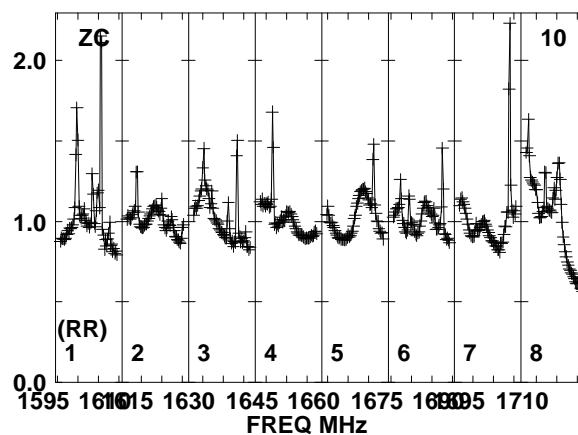
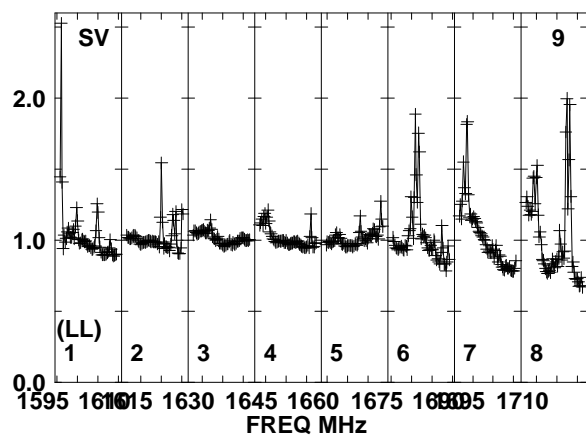
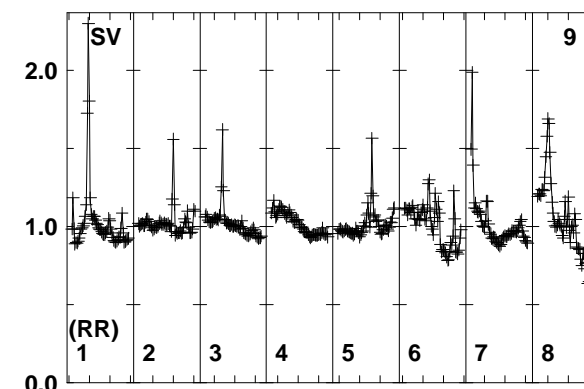
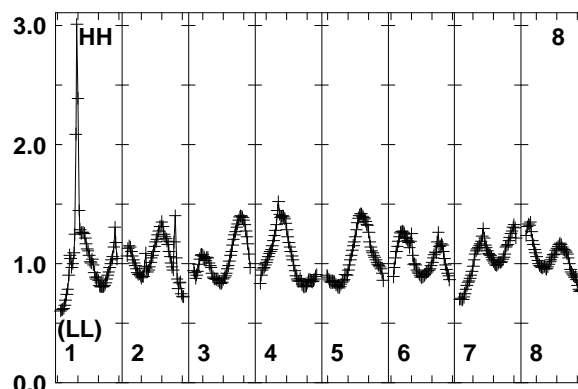
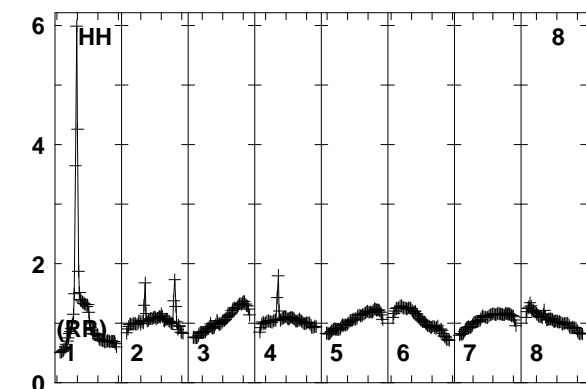
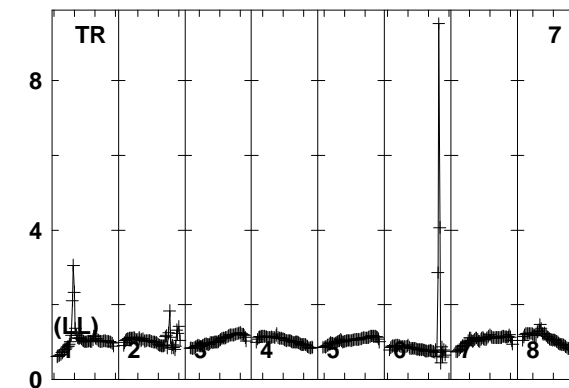
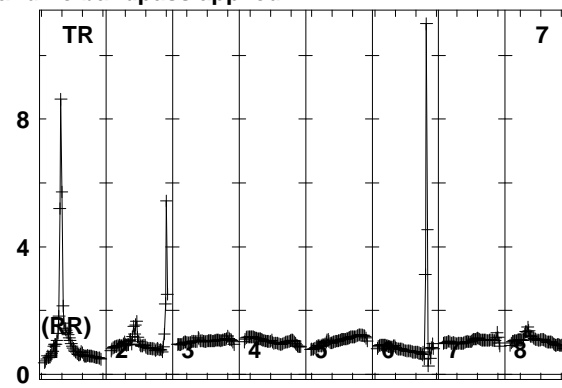
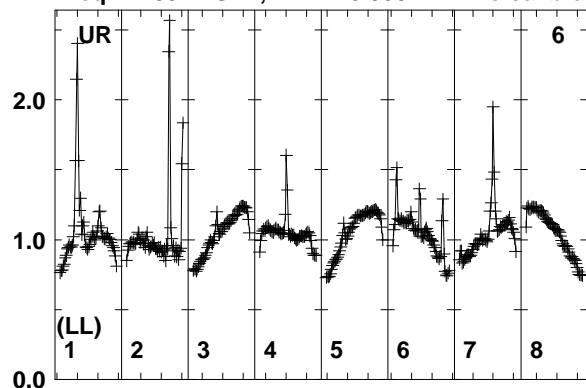

Lower frame: Real Jy
Total-power spectrum Antenna: UR (06)
Timerange: 00/04:02:36 to 00/04:03:34

Plot file version 124 created 04-NOV-2019 14:14:09

J2248-0541 EY034.UVDATA.1

Freq = 1.5947 GHz, Bw = 16.000 MH No calibration applied and no bandpass applied

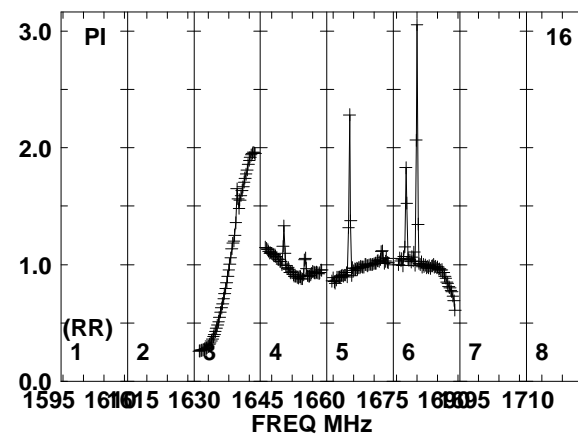
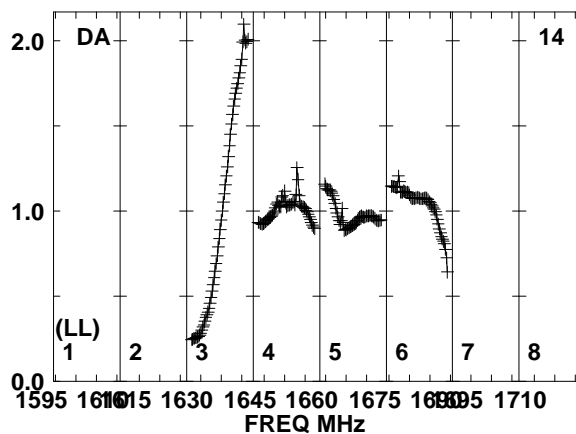
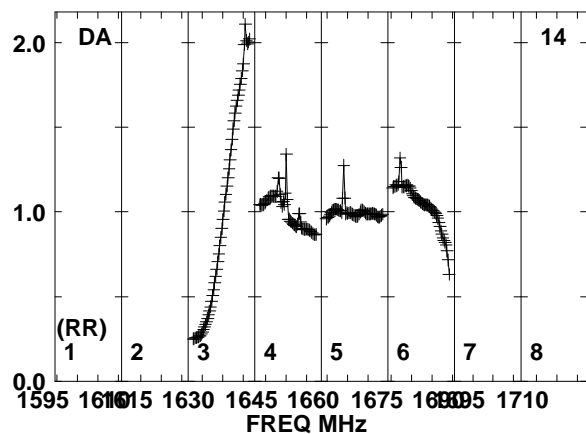
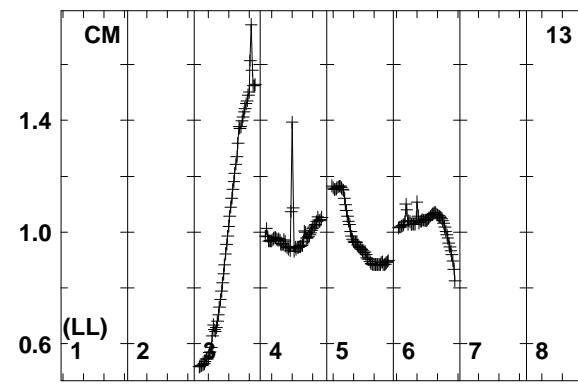
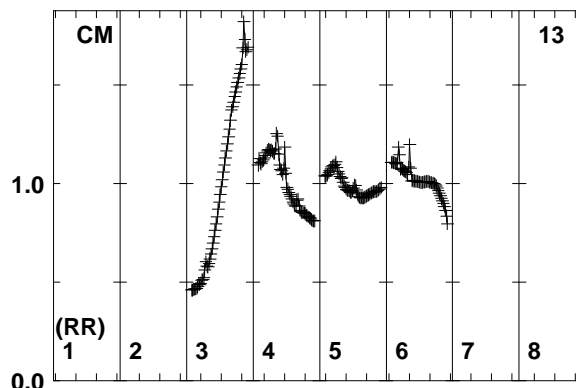
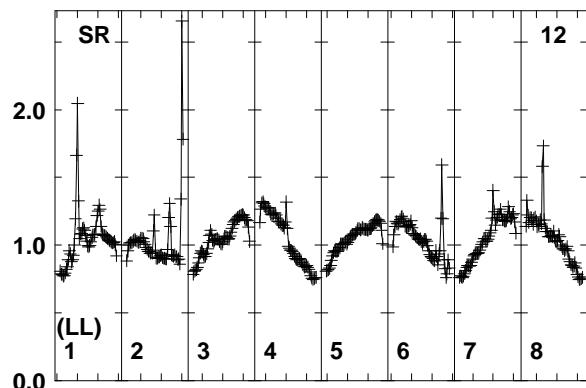
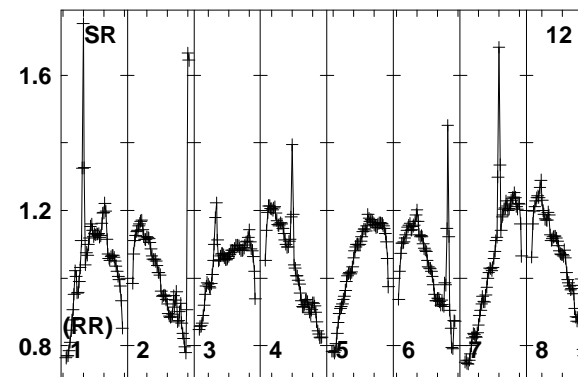
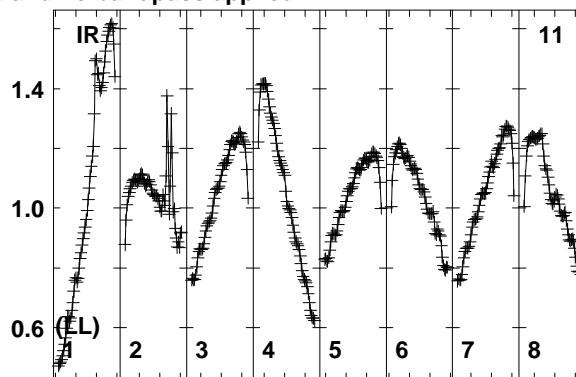
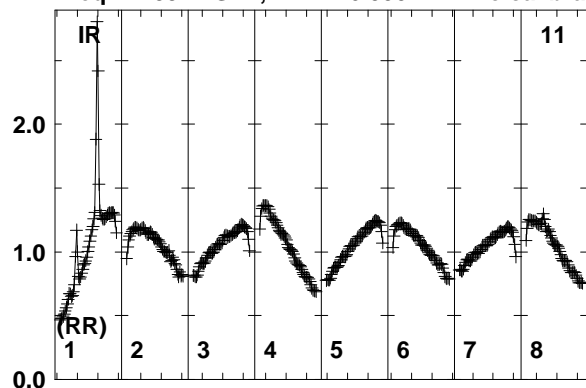

Lower frame: Real Jy
Total-power spectrum Antenna: IR (11)
Timerange: 00/04:02:36 to 00/04:03:34

Plot file version 125 created 04-NOV-2019 14:14:09
J2248-0541 EY034.UVDATA.1
Freq = 1.5947 GHz, Bw = 16.000 MH No calibration applied and no bandpass applied

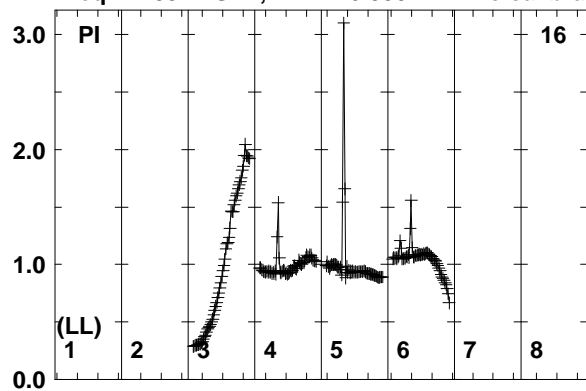

Lower frame: Real Jy
Total-power spectrum Antenna: PI (16)
Timerange: 00/04:02:36 to 00/04:03:34

Plot file version 126 created 04-NOV-2019 14:14:09

W2246-0526 EY034.UVDATA.1

Freq = 1.5947 GHz, Bw = 16.000 MH No calibration applied and no bandpass applied

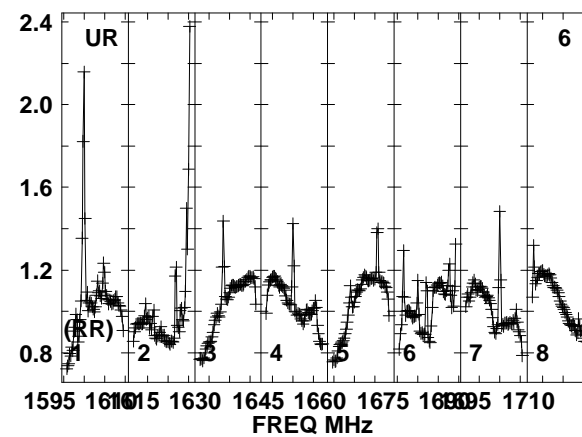
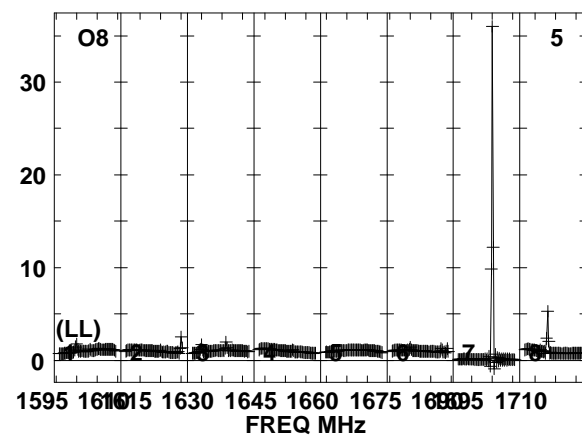
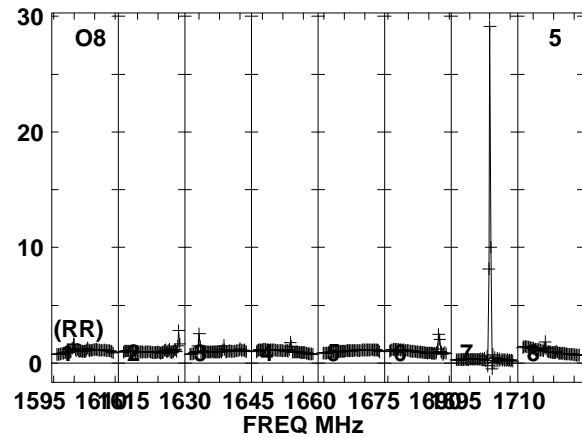
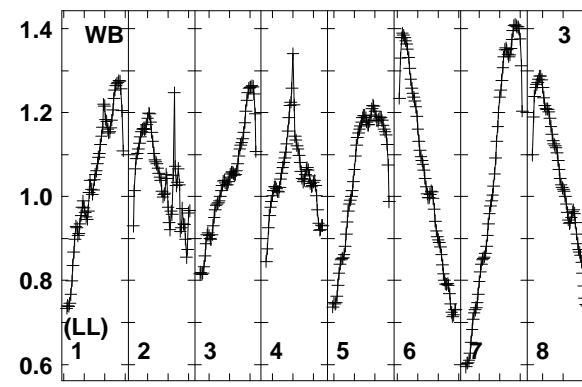
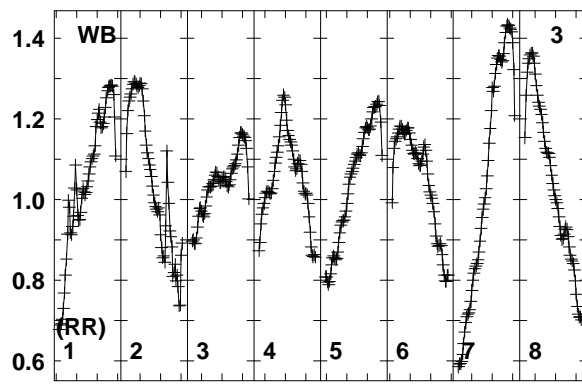
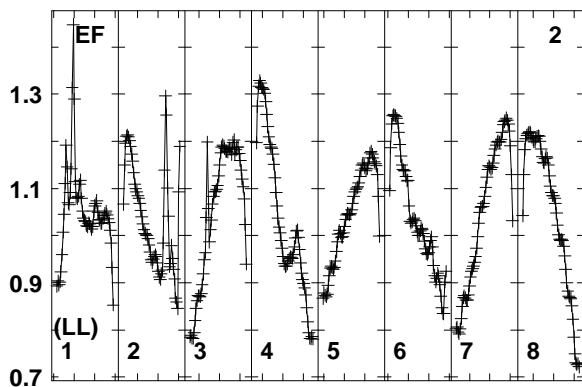
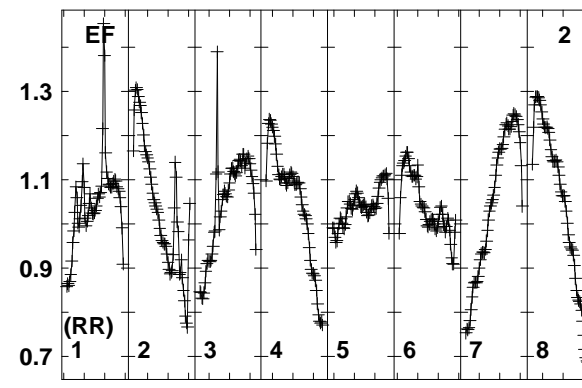
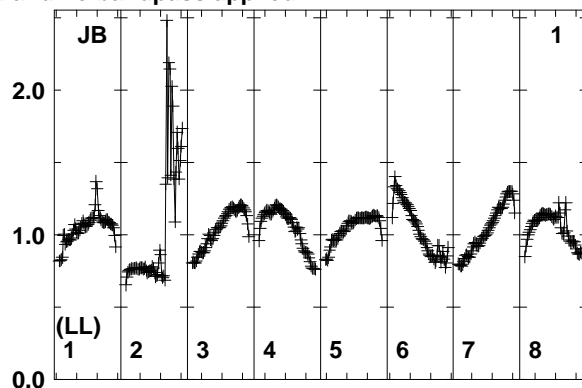
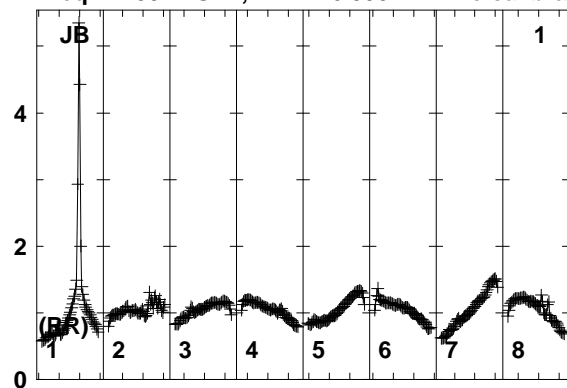

Lower frame: Real Jy
Total-power spectrum Antenna: JB (01)
Timerange: 00/04:03:36 to 00/04:06:14

Plot file version 127 created 04-NOV-2019 14:14:09

W2246-0526 EY034.UVDATA.1

Freq = 1.5947 GHz, Bw = 16.000 MH No calibration applied and no bandpass applied

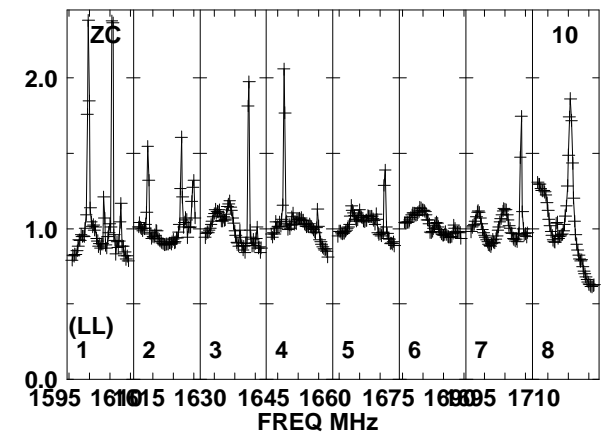
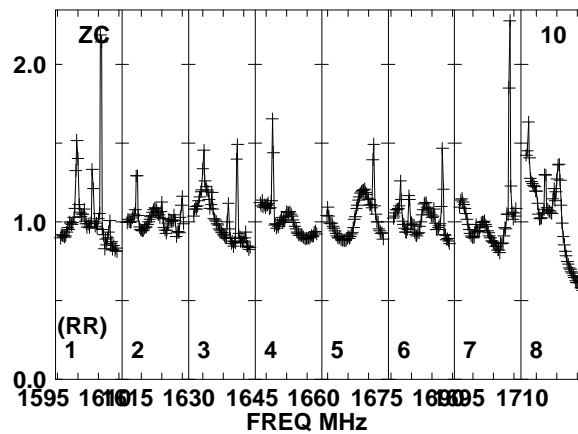
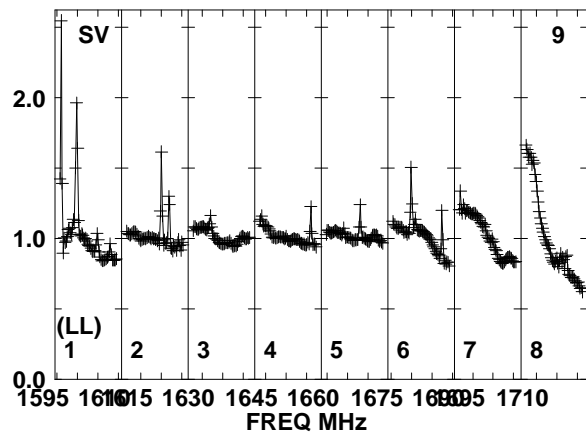
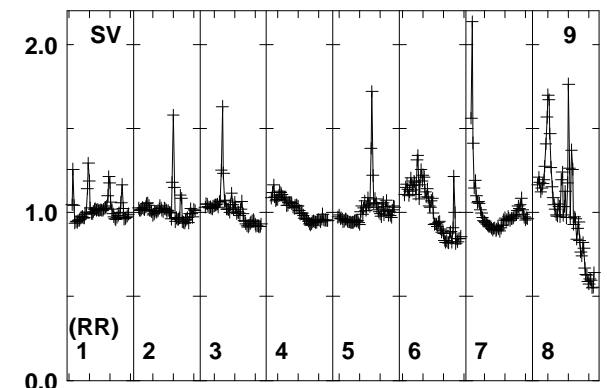
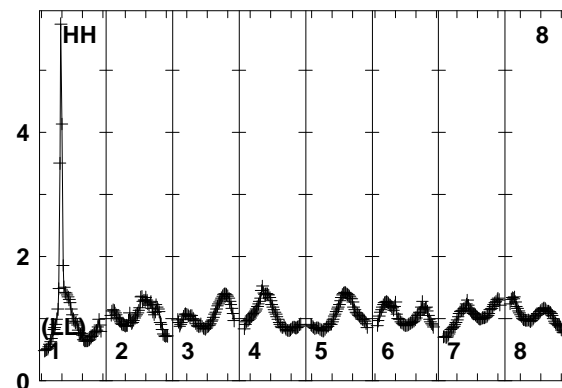
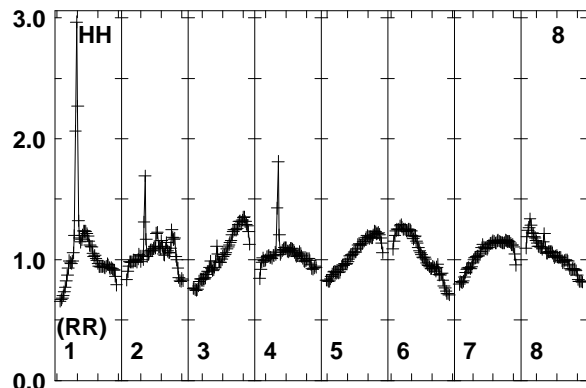
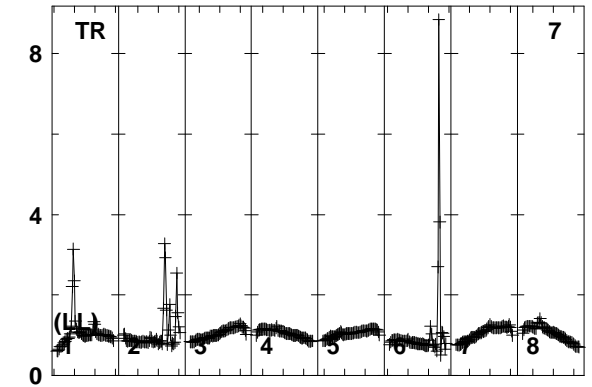
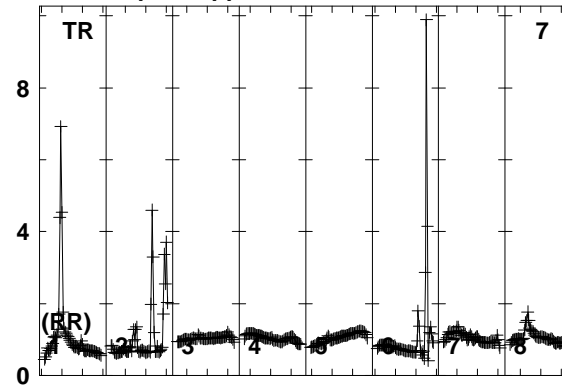
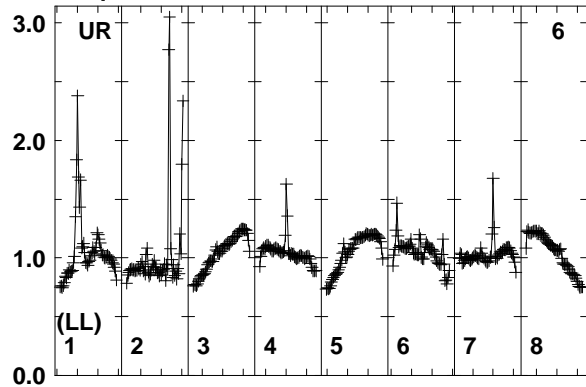

Lower frame: Real Jy
Total-power spectrum Antenna: UR (06)
Timerange: 00/04:03:36 to 00/04:06:14

Plot file version 128 created 04-NOV-2019 14:14:09

W2246-0526 EY034.UVDATA.1

Freq = 1.5947 GHz, Bw = 16.000 MH No calibration applied and no bandpass applied

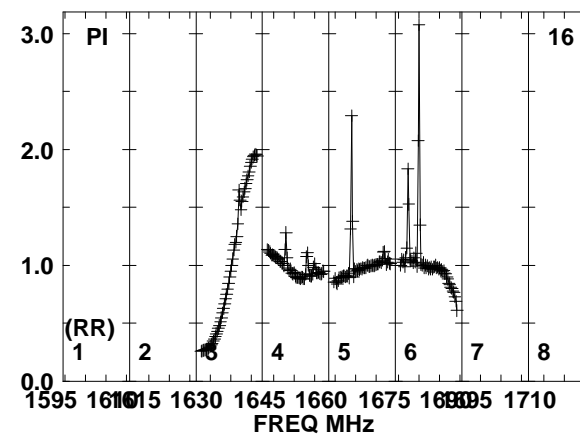
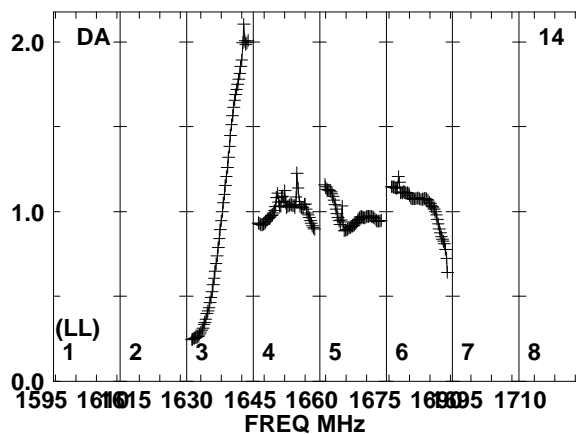
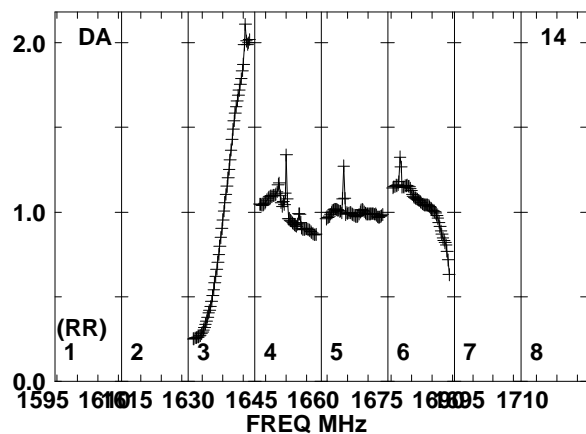
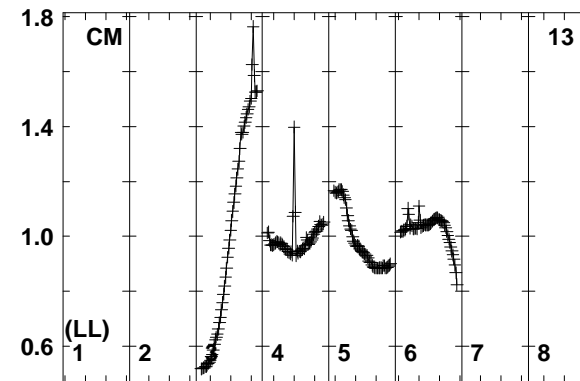
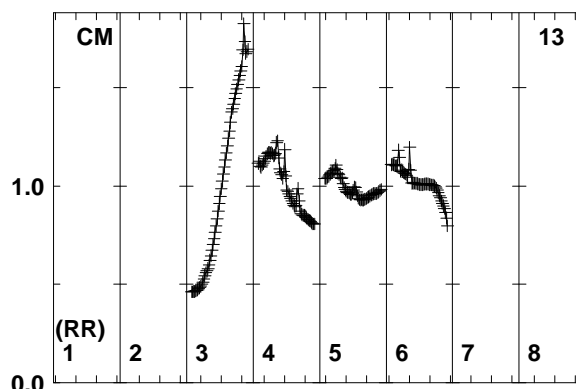
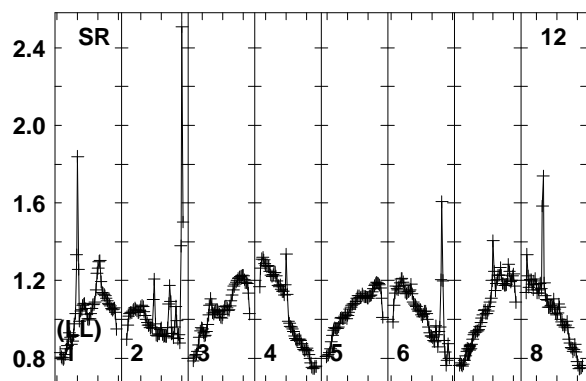
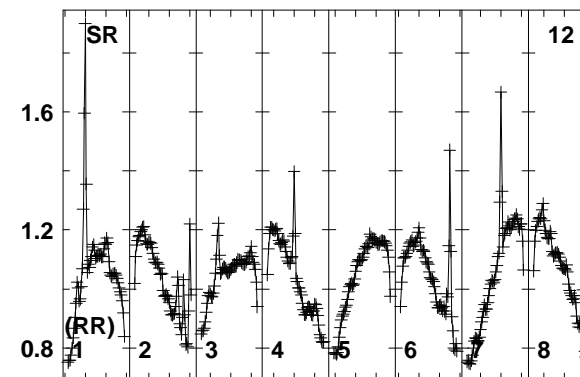
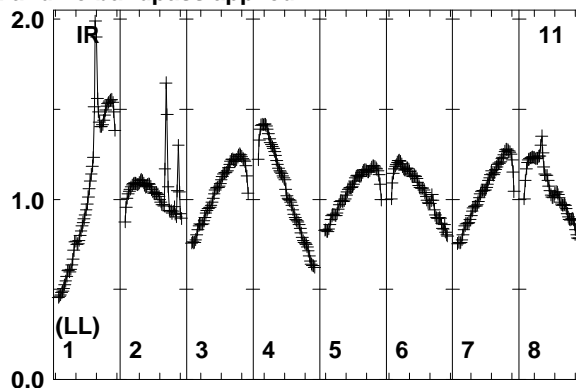
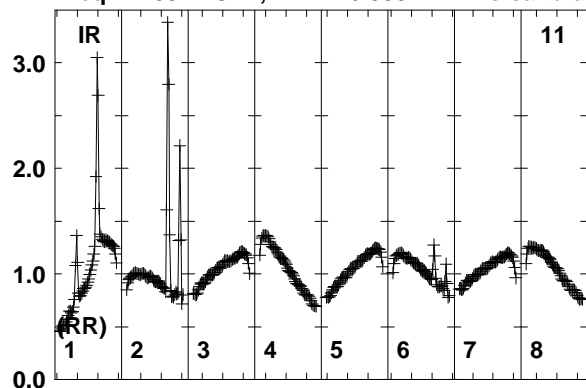

Lower frame: Real Jy
Total-power spectrum Antenna: IR (11)
Timerange: 00/04:03:36 to 00/04:06:14

Plot file version 129 created 04-NOV-2019 14:14:10

W2246-0526 EY034.UVDATA.1

Freq = 1.5947 GHz, Bw = 16.000 MH No calibration applied and no bandpass applied

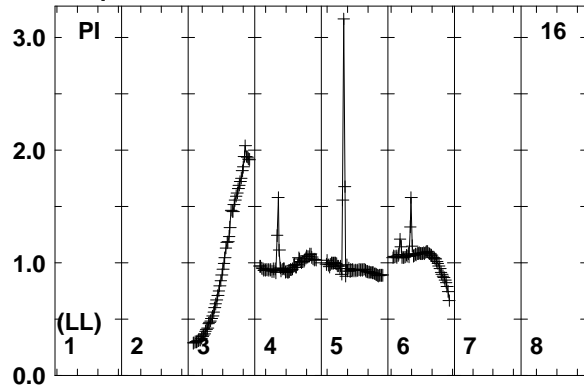

Lower frame: Real Jy
Total-power spectrum Antenna: PI (16)
Timerange: 00/04:03:36 to 00/04:06:14

Plot file version 130 created 04-NOV-2019 14:14:10

J2248-0541 EY034.UVDATA.1

Freq = 1.5947 GHz, Bw = 16.000 MH No calibration applied and no bandpass applied

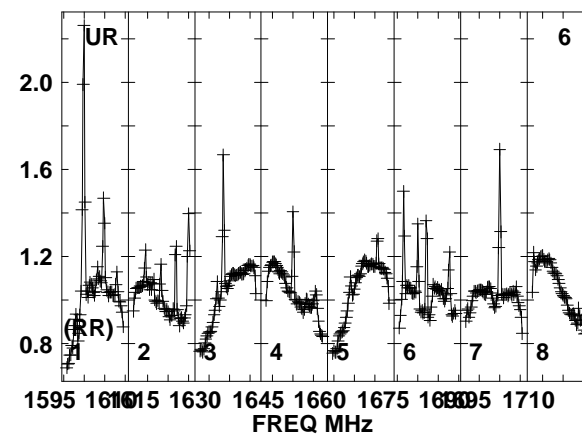
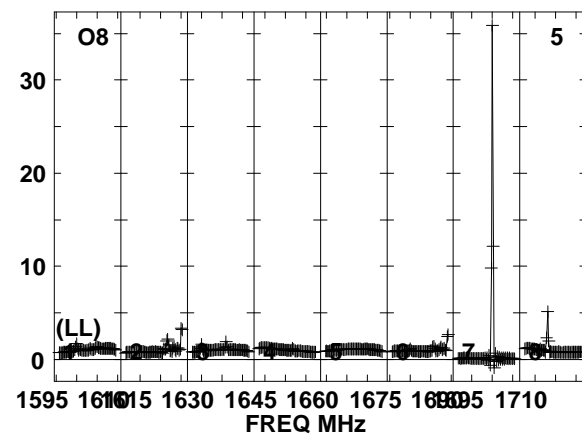
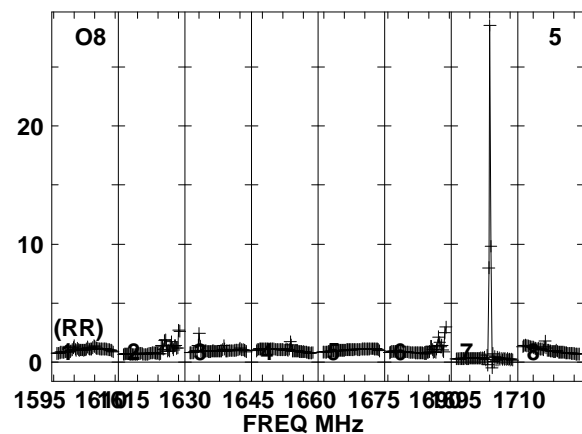
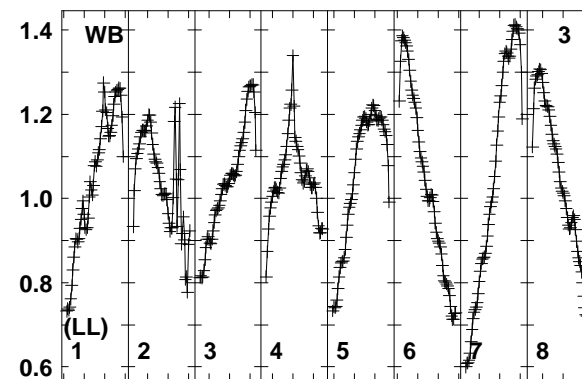
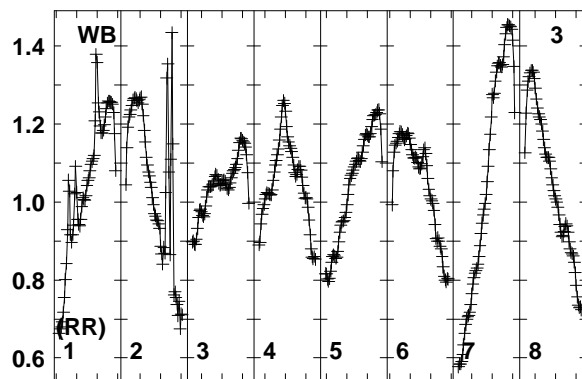
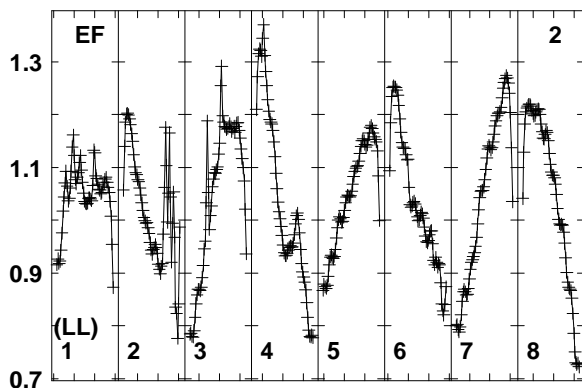
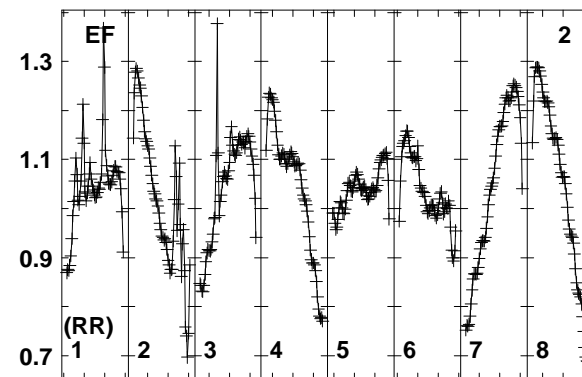
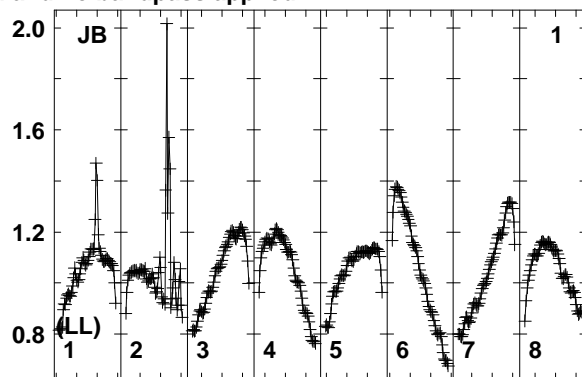
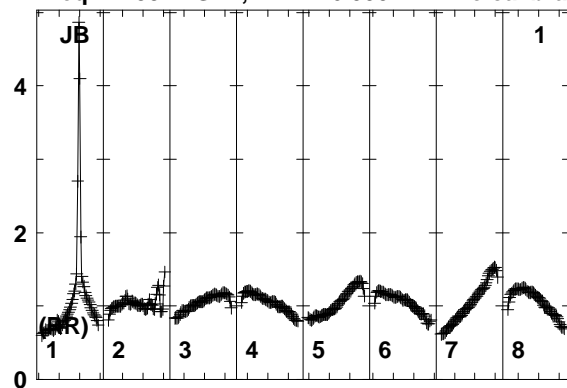

Lower frame: Real Jy
Total-power spectrum Antenna: JB (01)
Timerange: 00/04:06:51 to 00/04:07:49

Plot file version 131 created 04-NOV-2019 14:14:10

J2248-0541 EY034.UVDATA.1

Freq = 1.5947 GHz, Bw = 16.000 MH No calibration applied and no bandpass applied

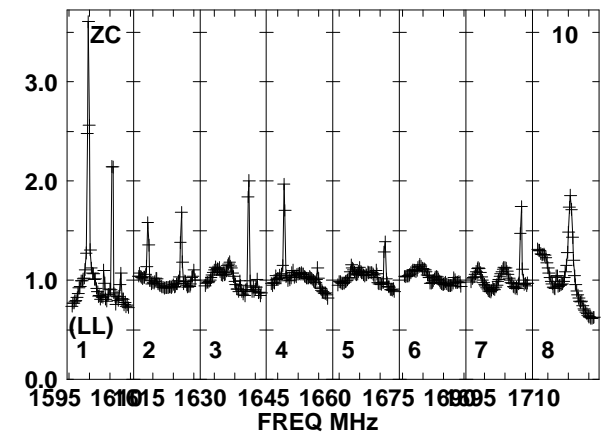
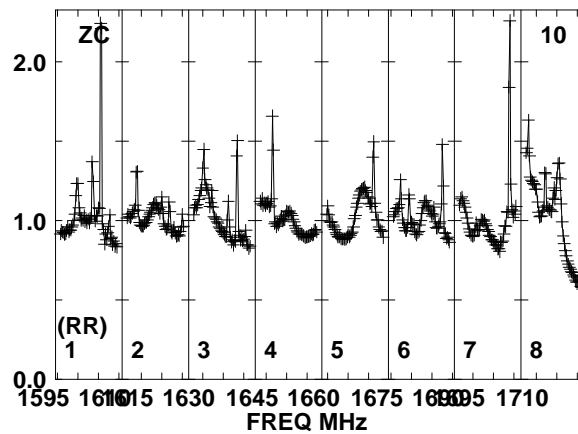
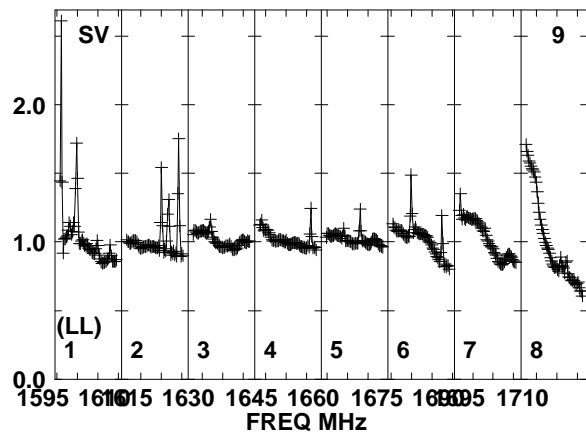
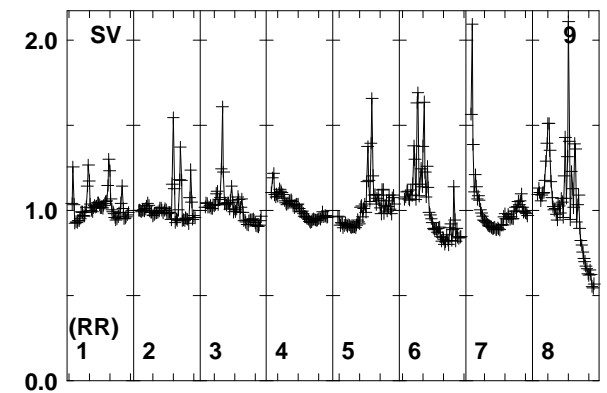
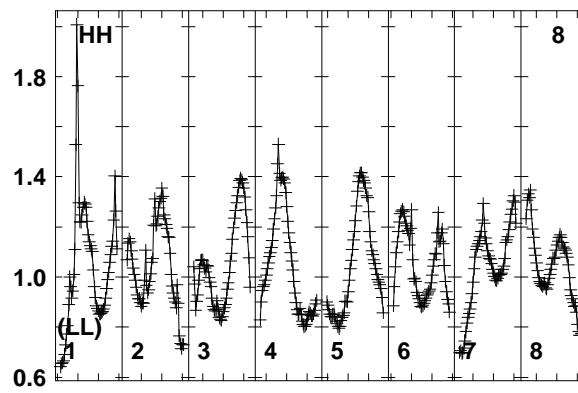
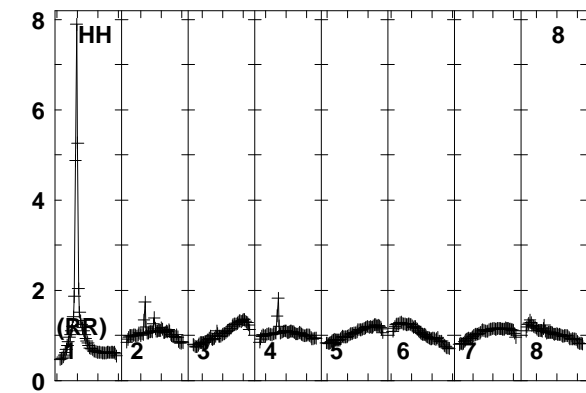
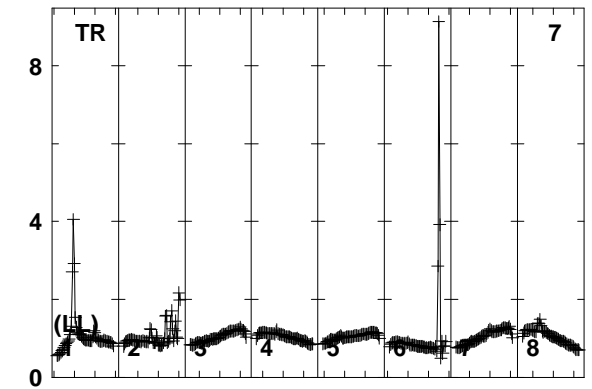
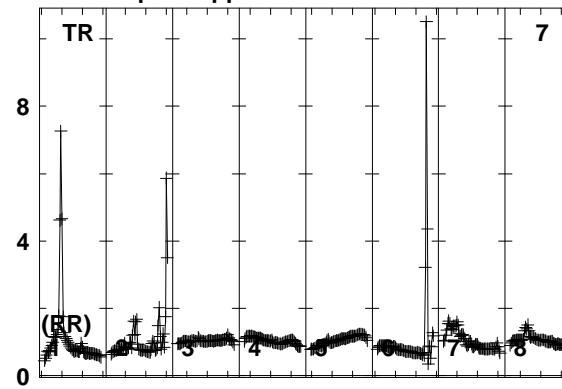
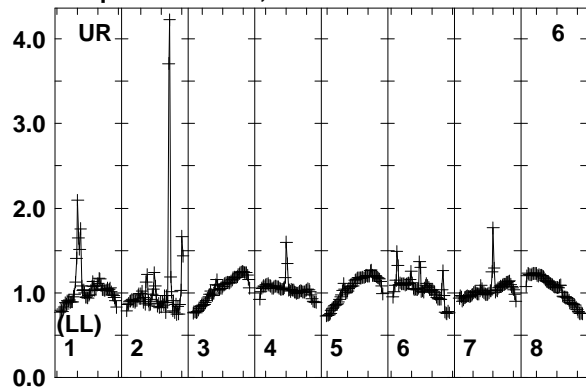

Lower frame: Real Jy
Total-power spectrum Antenna: UR (06)
Timerange: 00/04:06:51 to 00/04:07:49

Plot file version 132 created 04-NOV-2019 14:14:10

J2248-0541 EY034.UVDATA.1

Freq = 1.5947 GHz, Bw = 16.000 MH No calibration applied and no bandpass applied

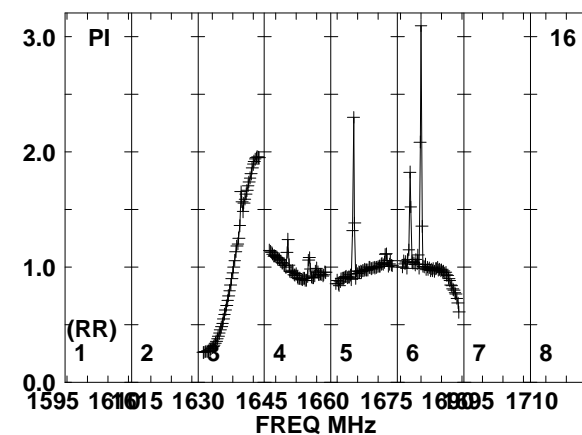
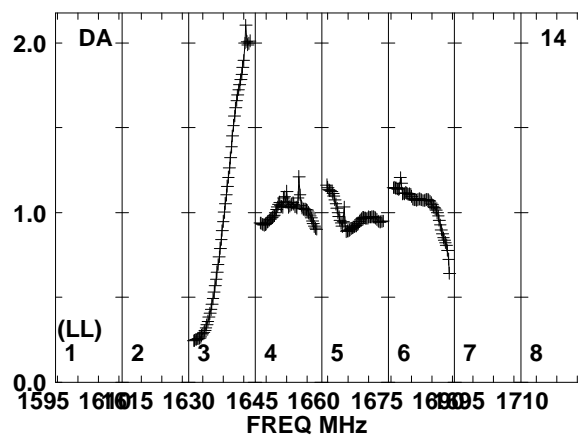
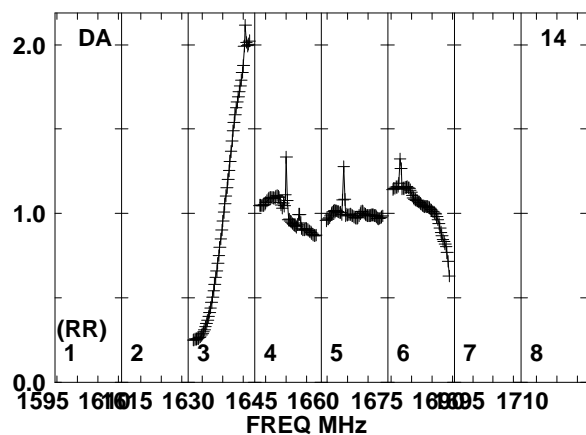
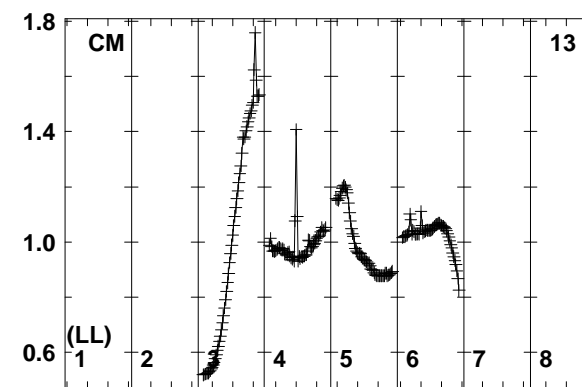
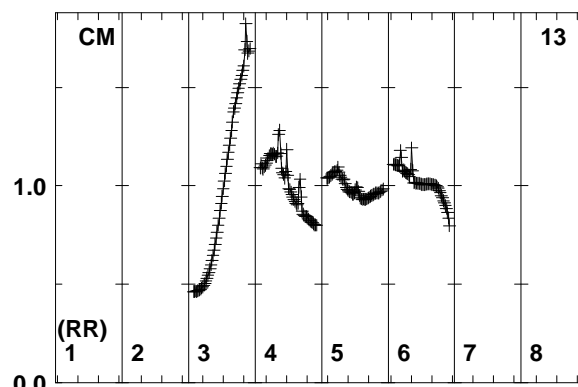
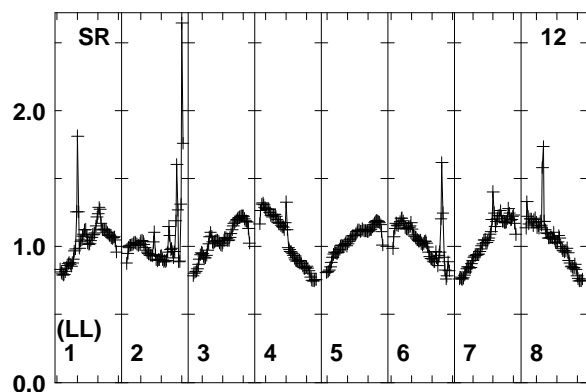
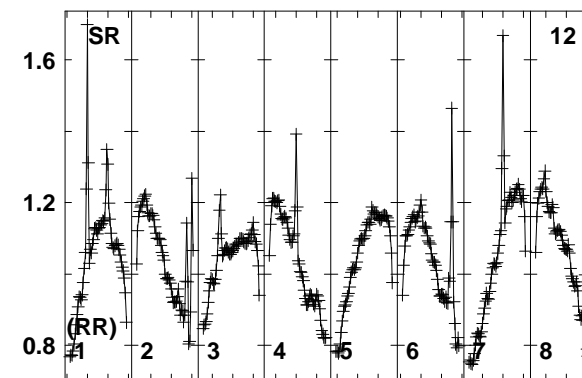
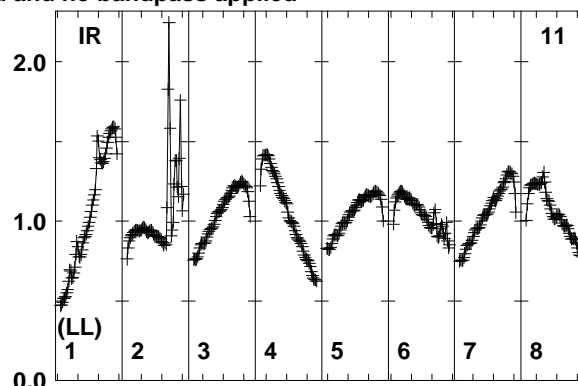
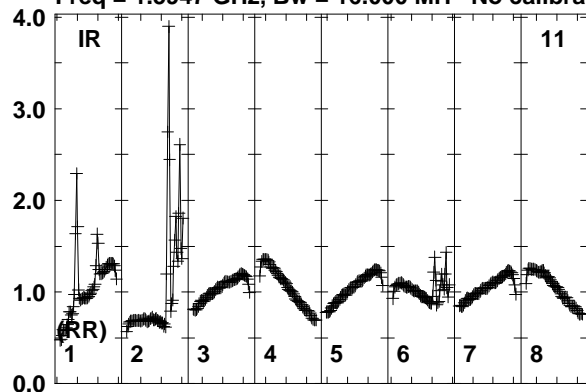

Lower frame: Real Jy
Total-power spectrum Antenna: IR (11)
Timerange: 00/04:06:51 to 00/04:07:49

Plot file version 133 created 04-NOV-2019 14:14:10
J2248-0541 EY034.UVDATA.1
Freq = 1.5947 GHz, Bw = 16.000 MH No calibration applied and no bandpass applied

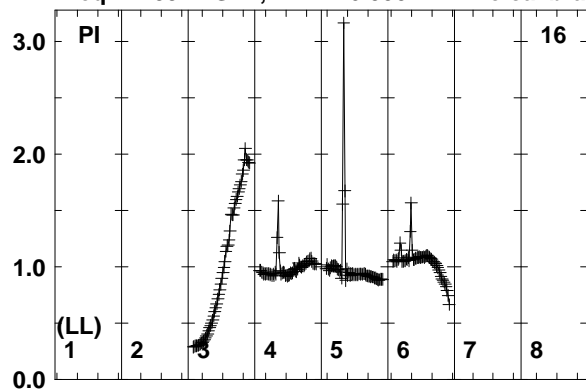

Lower frame: Real Jy
Total-power spectrum Antenna: PI (16)
Timerange: 00/04:06:51 to 00/04:07:49

Plot file version 134 created 04-NOV-2019 14:14:10

W2246-0526 EY034.UVDATA.1

Freq = 1.5947 GHz, Bw = 16.000 MH No calibration applied and no bandpass applied

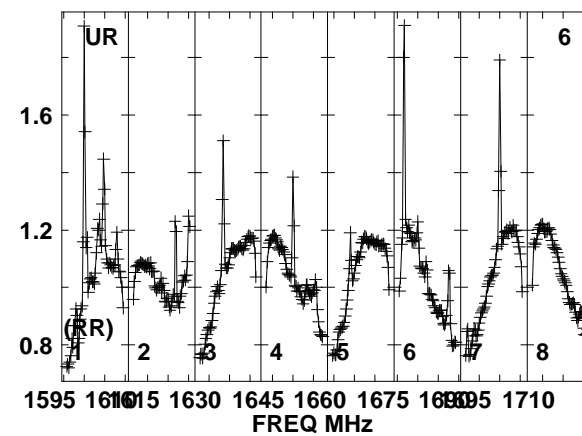
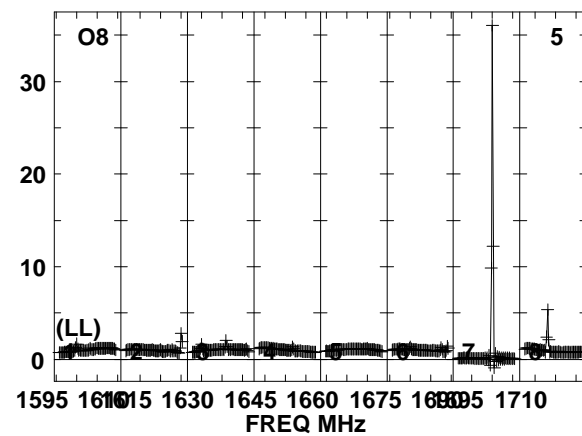
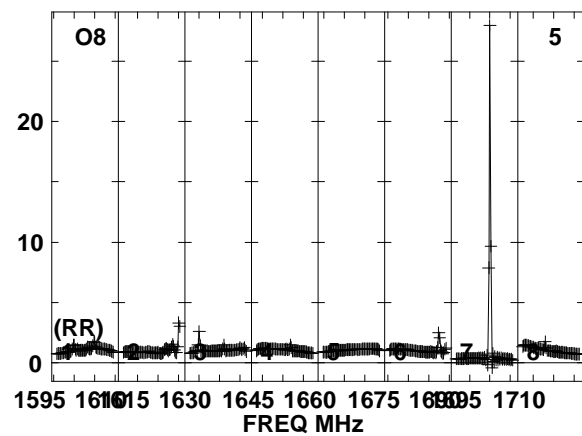
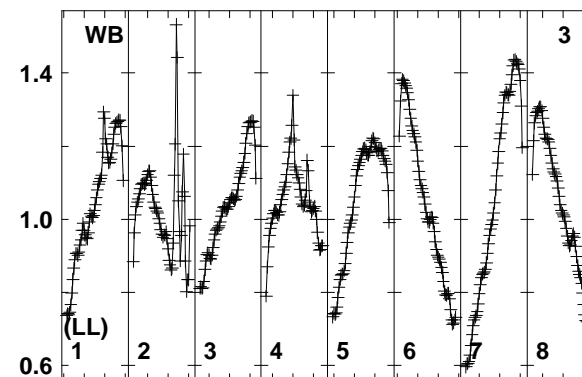
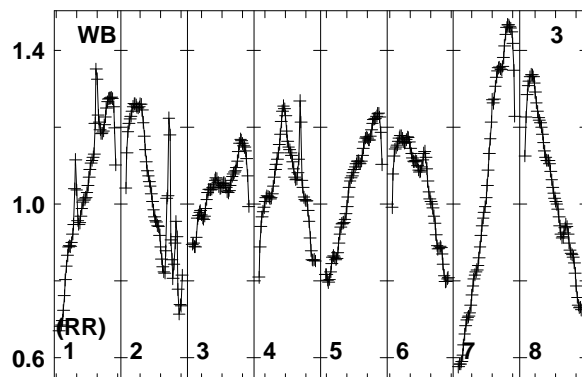
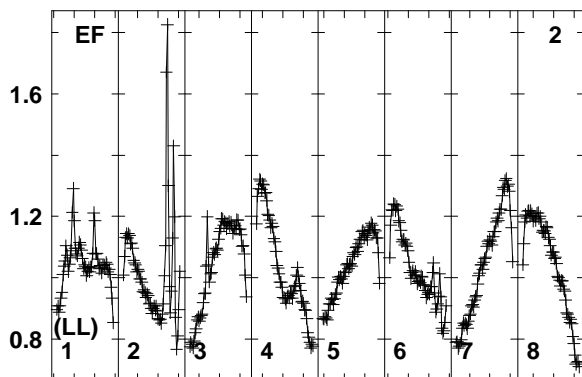
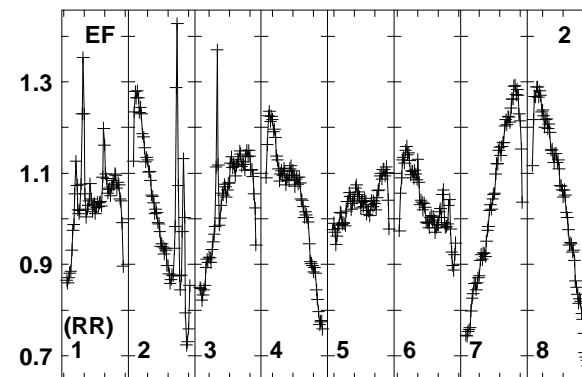
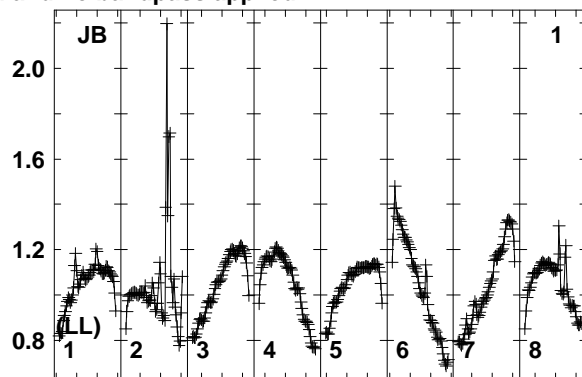
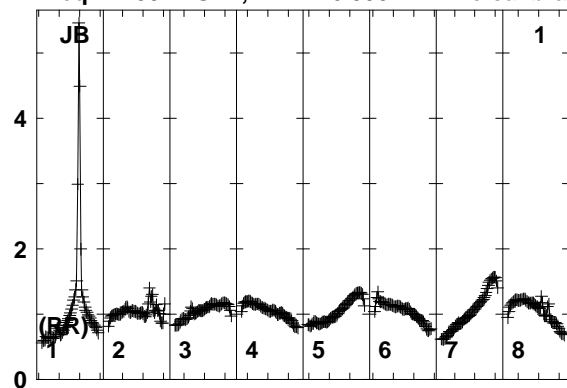

Lower frame: Real Jy
Total-power spectrum Antenna: JB (01)
Timerange: 00/04:07:51 to 00/04:10:29

Plot file version 135 created 04-NOV-2019 14:14:10

W2246-0526 EY034.UVDATA.1

Freq = 1.5947 GHz, Bw = 16.000 MH No calibration applied and no bandpass applied

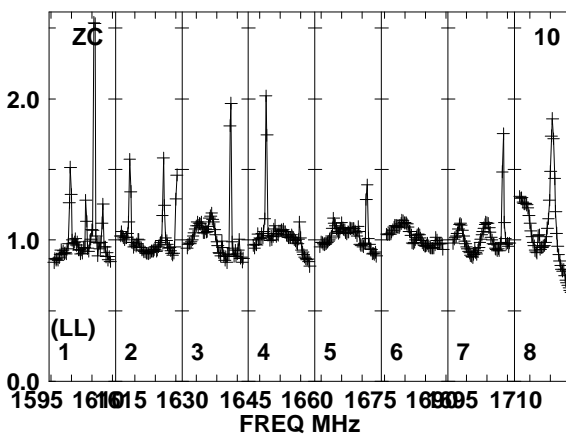
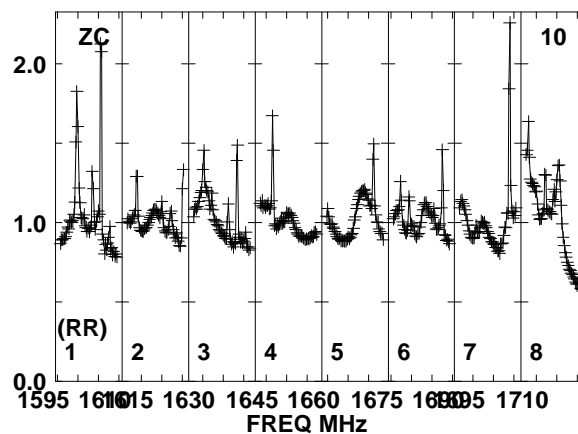
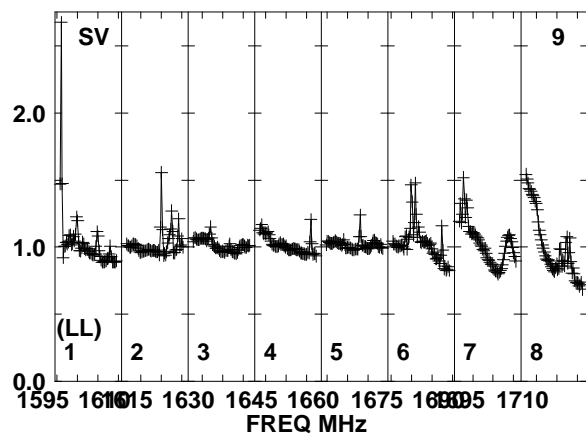
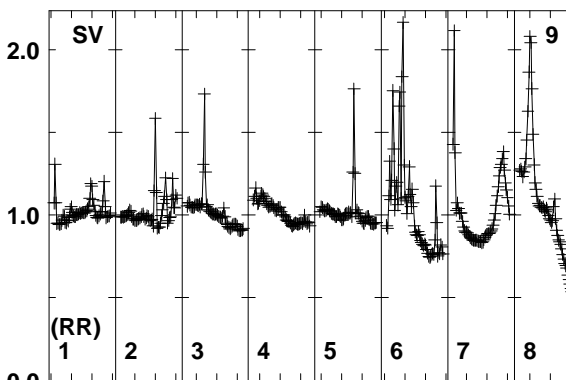
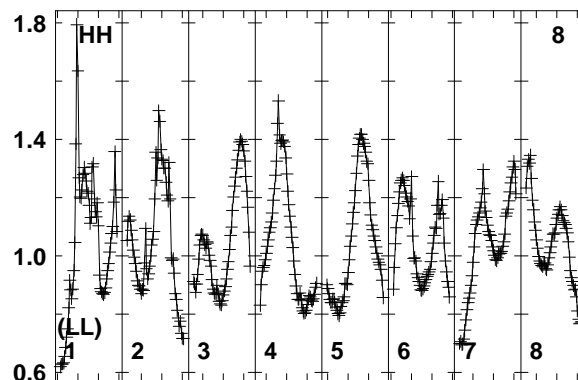
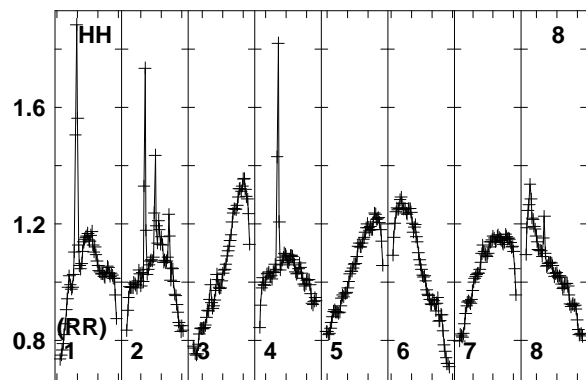
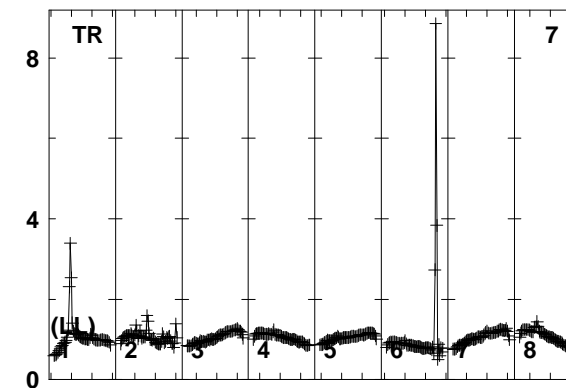
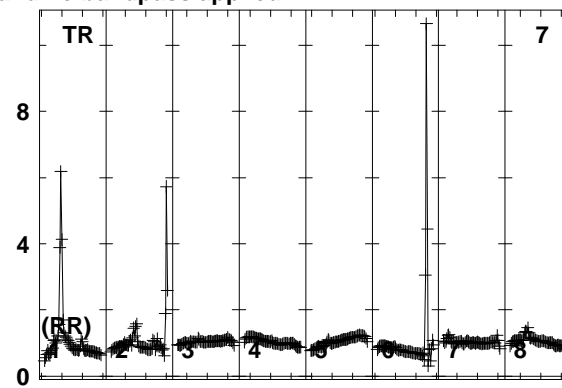
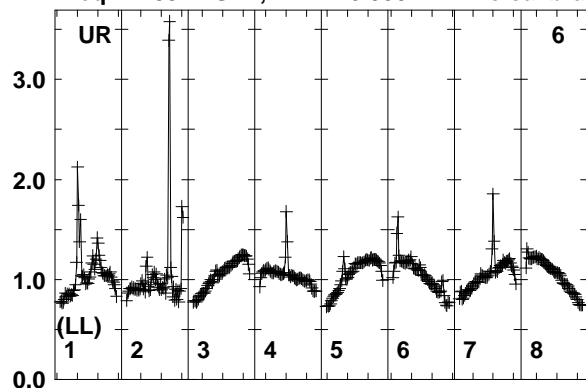

Lower frame: Real Jy
Total-power spectrum Antenna: UR (06)
Timerange: 00/04:07:51 to 00/04:10:29

Plot file version 136 created 04-NOV-2019 14:14:10

W2246-0526 EY034.UVDATA.1

Freq = 1.5947 GHz, Bw = 16.000 MH No calibration applied and no bandpass applied

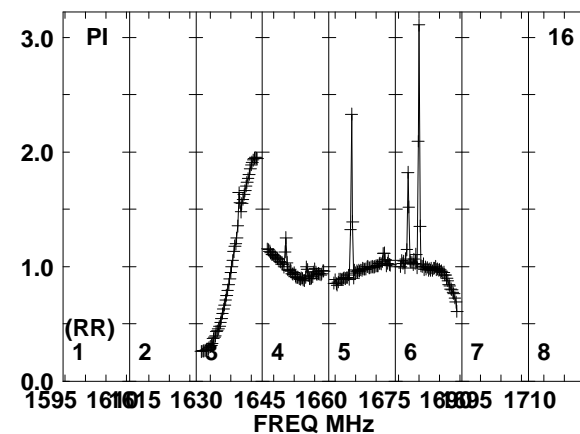
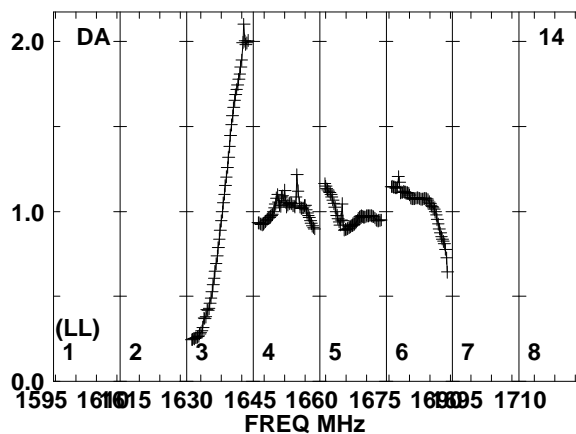
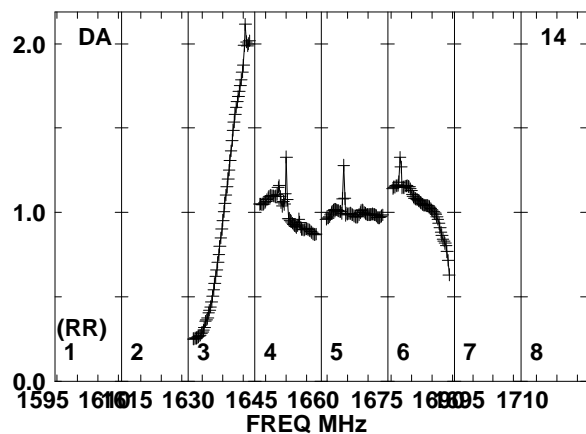
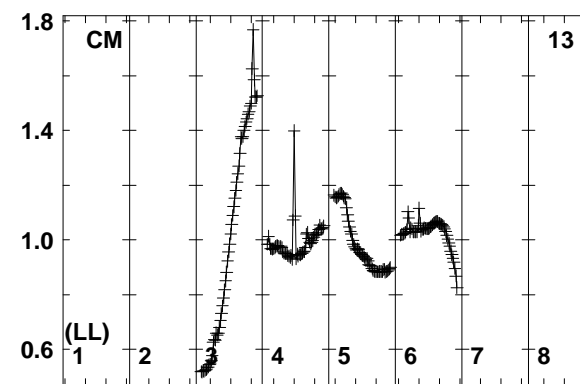
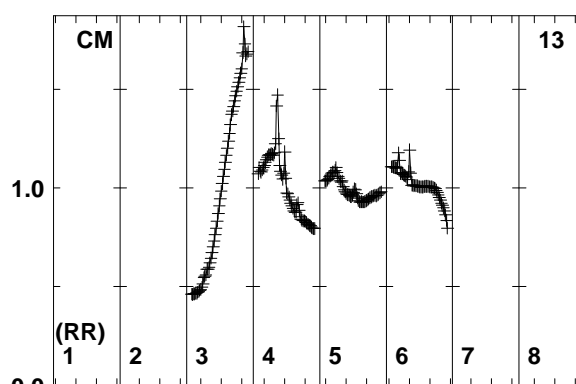
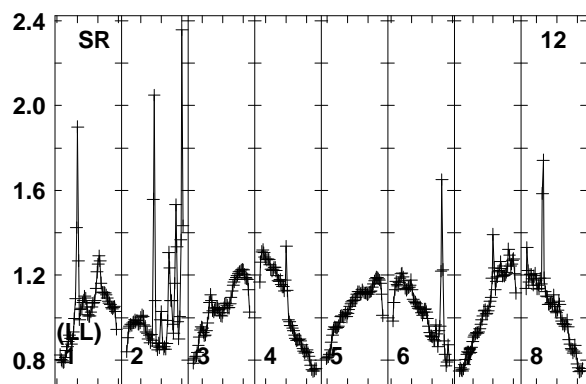
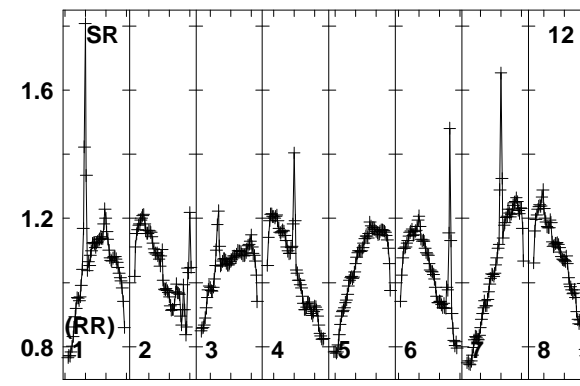
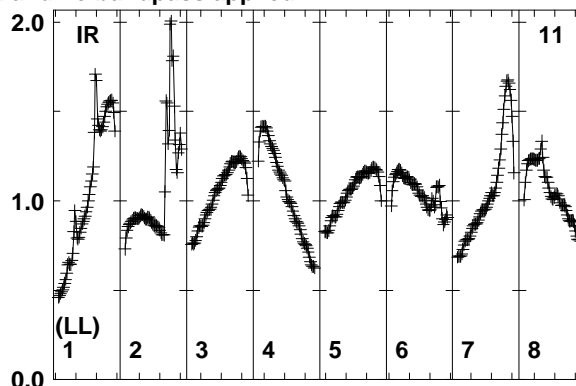
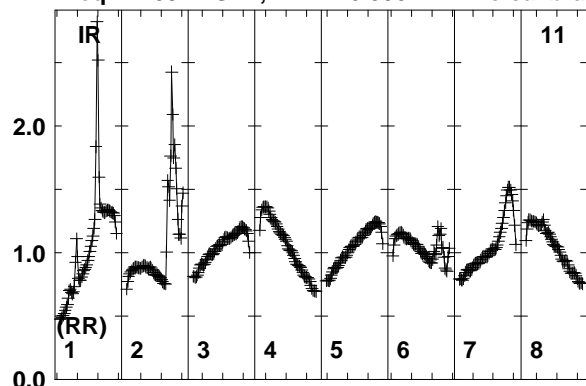

Lower frame: Real Jy
Total-power spectrum Antenna: IR (11)
Timerange: 00/04:07:51 to 00/04:10:29

Plot file version 137 created 04-NOV-2019 14:14:10
W2246-0526 EY034.UVDATA.1
Freq = 1.5947 GHz, Bw = 16.000 MH No calibration applied and no bandpass applied

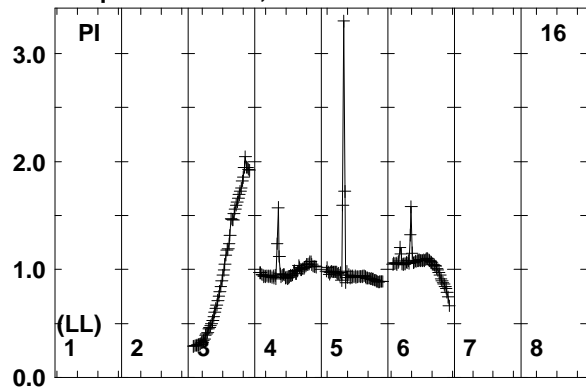

Lower frame: Real Jy
Total-power spectrum Antenna: PI (16)
Timerange: 00/04:07:51 to 00/04:10:29

Plot file version 138 created 04-NOV-2019 14:14:10

J2248-0541 EY034.UVDATA.1

Freq = 1.5947 GHz, Bw = 16.000 MH No calibration applied and no bandpass applied

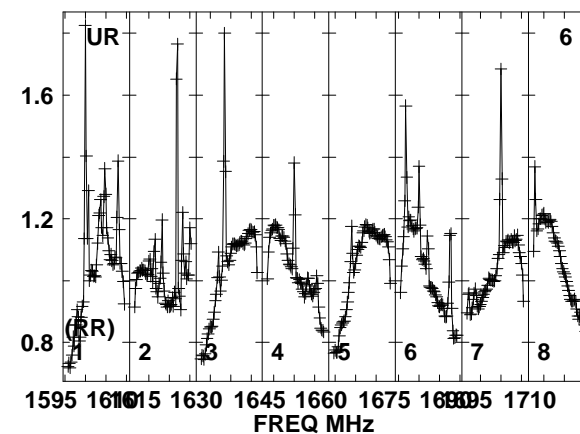
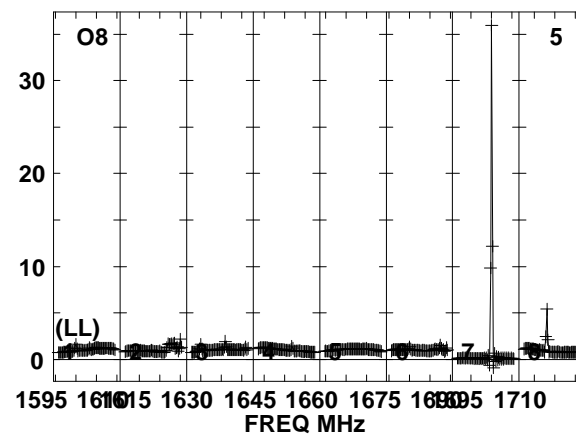
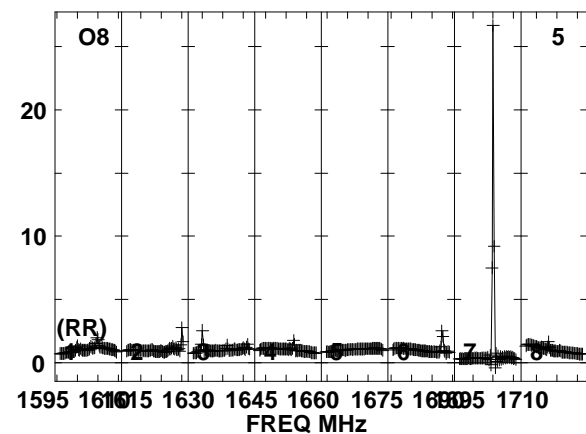
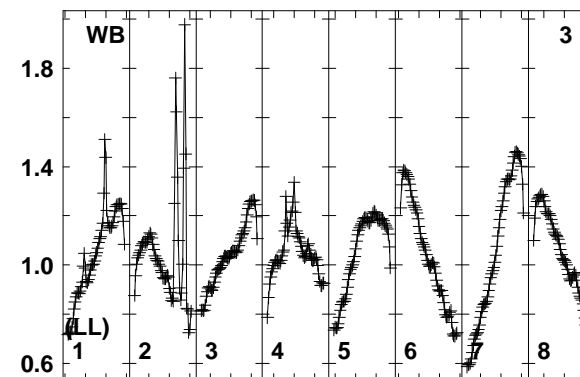
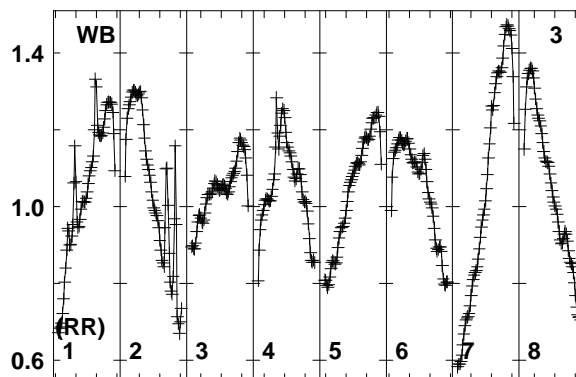
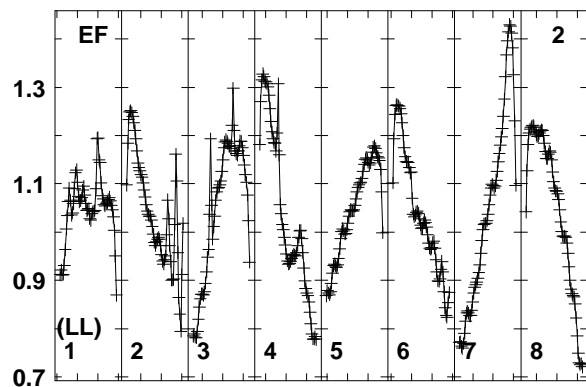
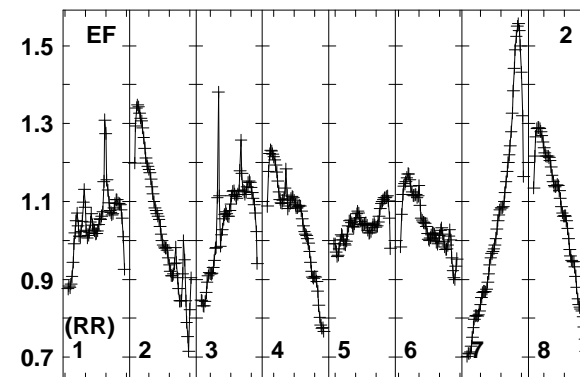
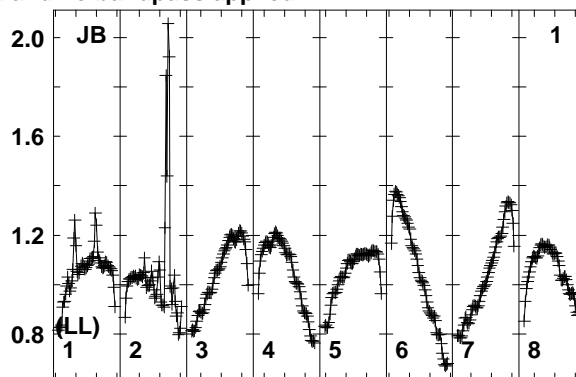
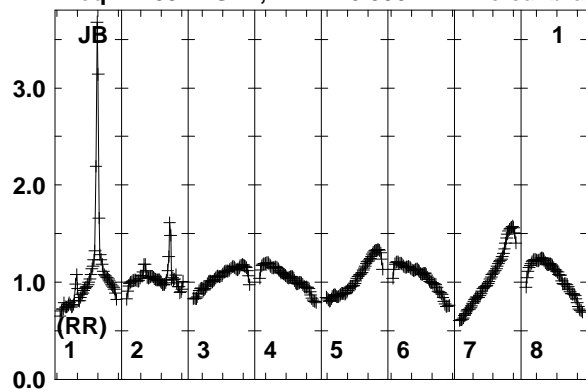

Lower frame: Real Jy
Total-power spectrum Antenna: JB (01)
Timerange: 00/04:10:46 to 00/04:11:44

Plot file version 139 created 04-NOV-2019 14:14:10

J2248-0541 EY034.UVDATA.1

Freq = 1.5947 GHz, Bw = 16.000 MH No calibration applied and no bandpass applied

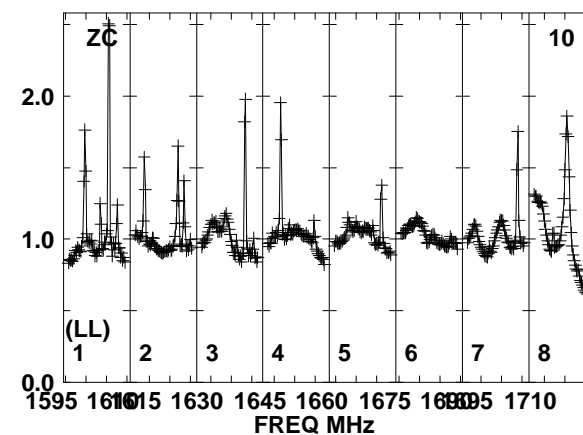
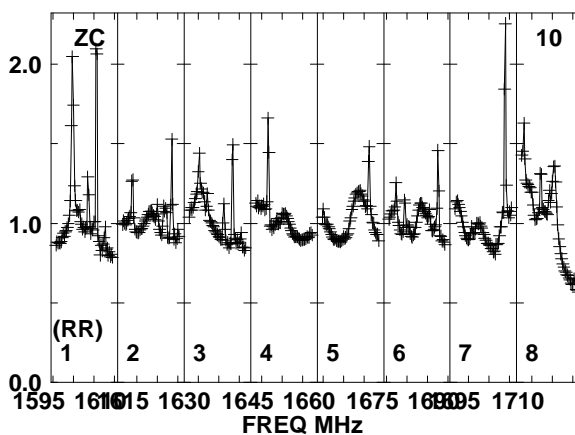
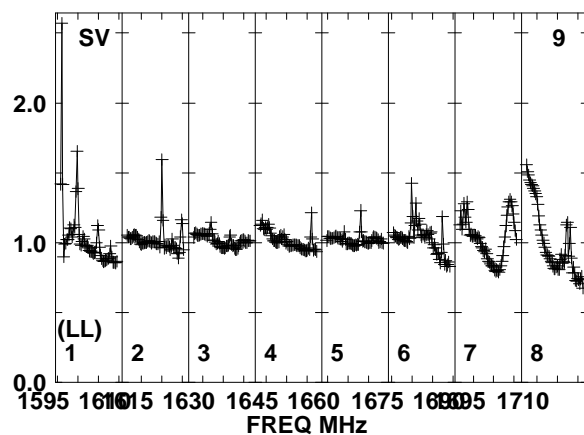
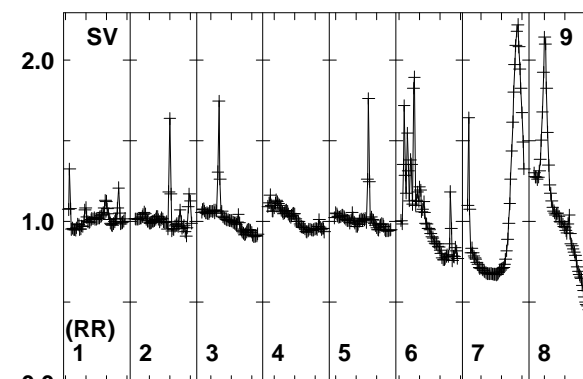
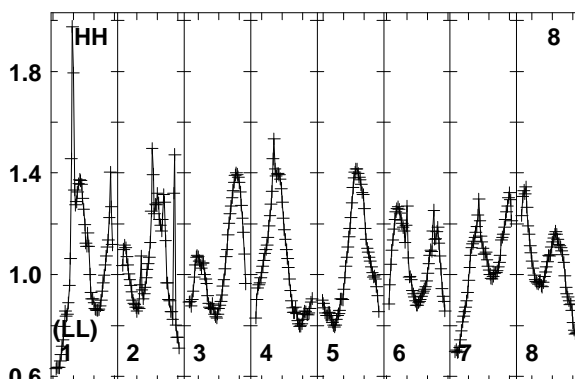
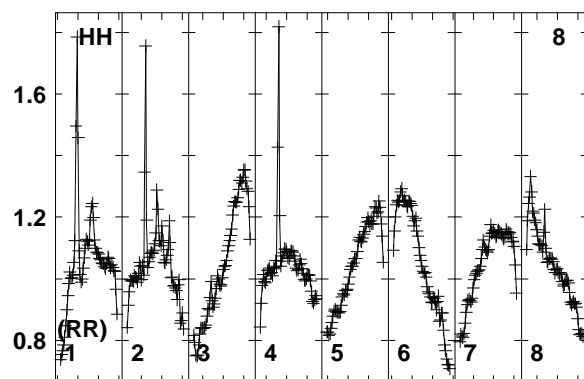
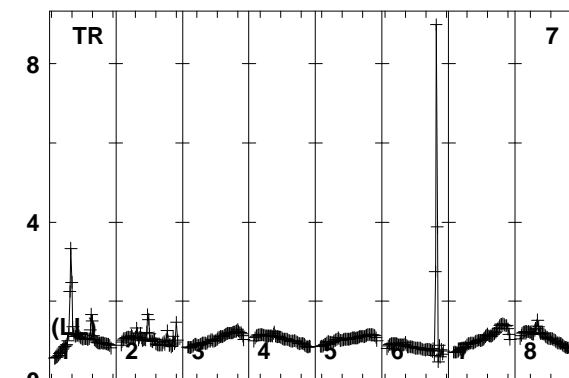
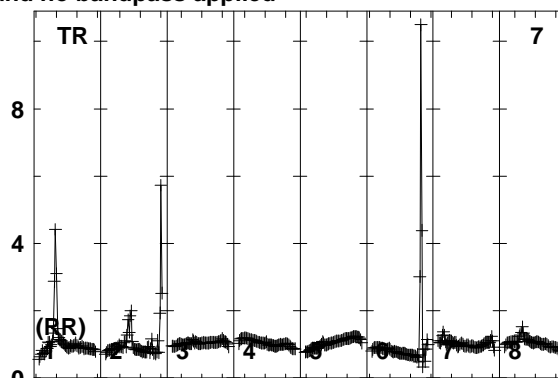
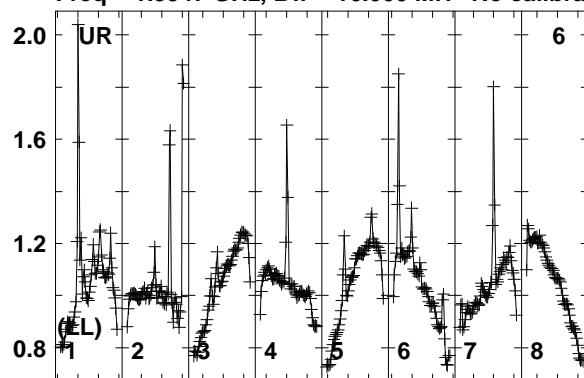

Lower frame: Real Jy
Total-power spectrum Antenna: UR (06)
Timerange: 00/04:10:46 to 00/04:11:44

Plot file version 140 created 04-NOV-2019 14:14:10

J2248-0541 EY034.UVDATA.1

Freq = 1.5947 GHz, Bw = 16.000 MH No calibration applied and no bandpass applied

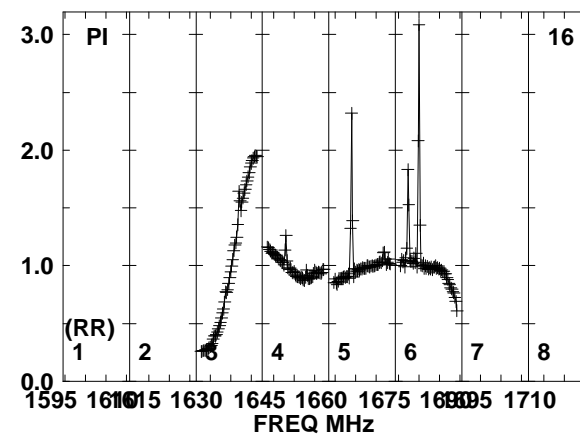
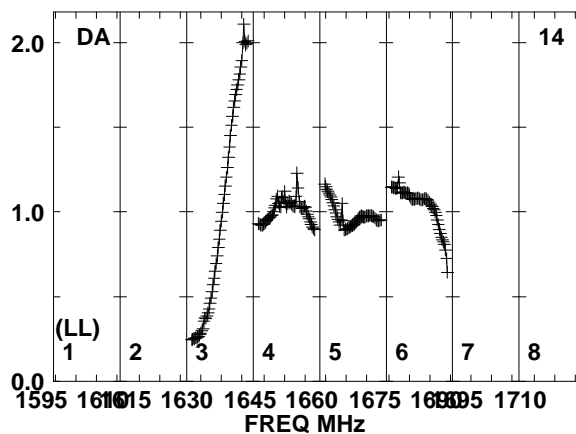
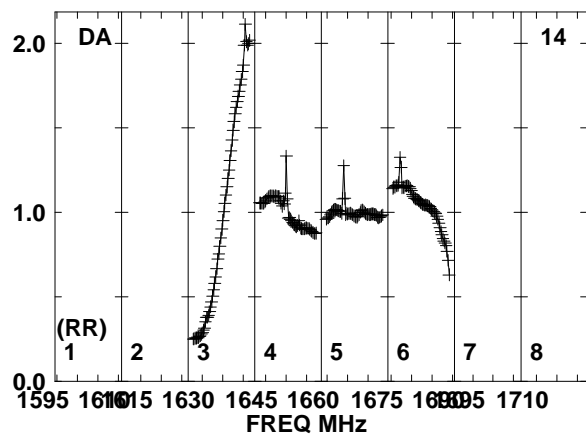
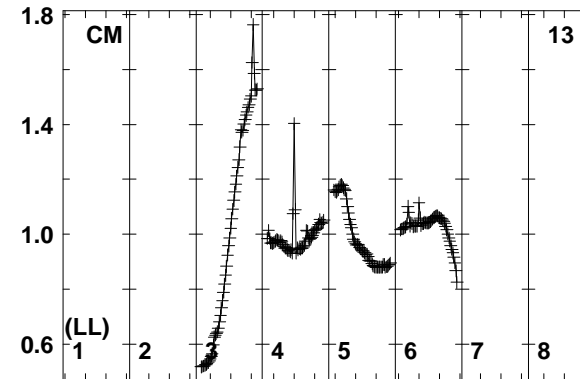
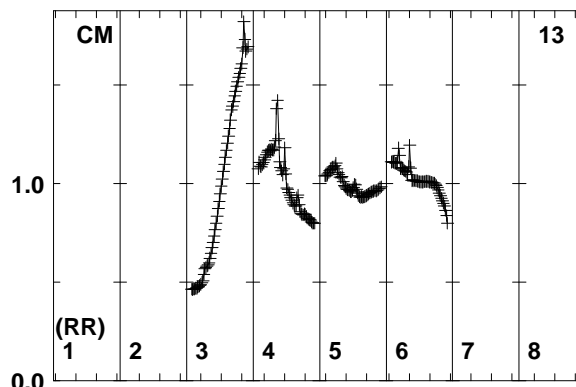
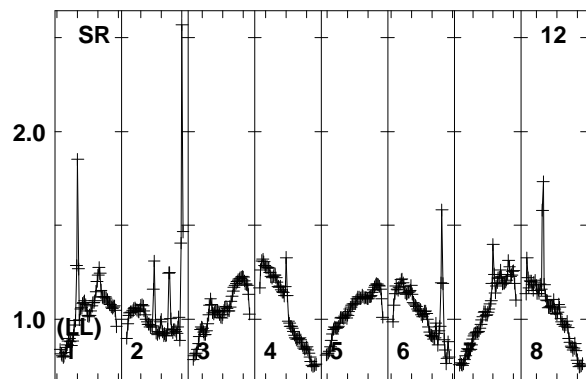
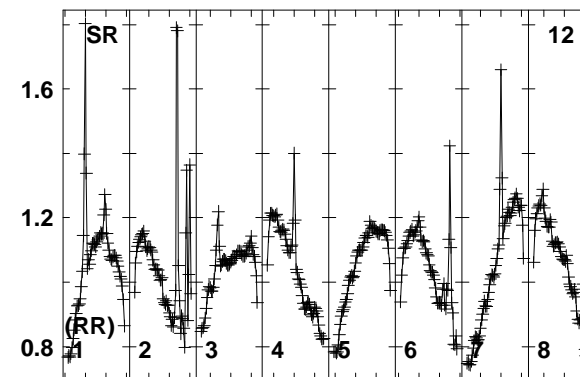
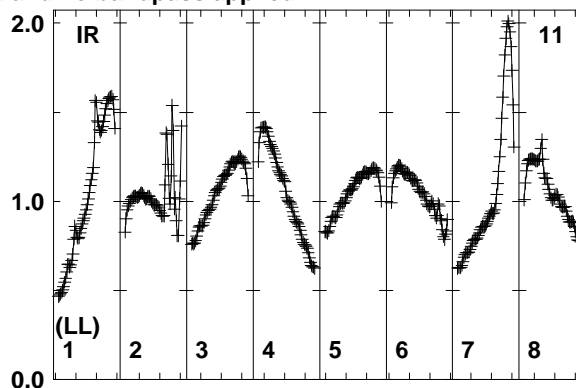
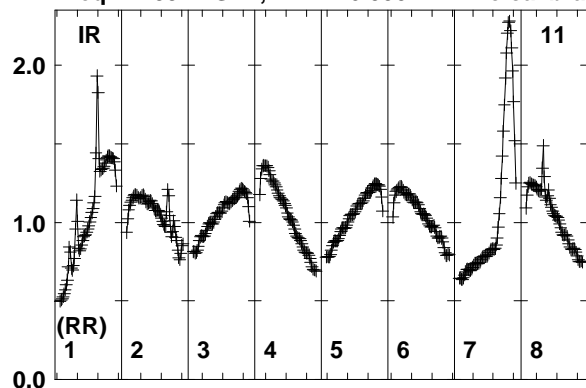

Lower frame: Real Jy
Total-power spectrum Antenna: IR (11)
Timerange: 00/04:10:46 to 00/04:11:44

Plot file version 141 created 04-NOV-2019 14:14:10
J2248-0541 EY034.UVDATA.1
Freq = 1.5947 GHz, Bw = 16.000 MH No calibration applied and no bandpass applied

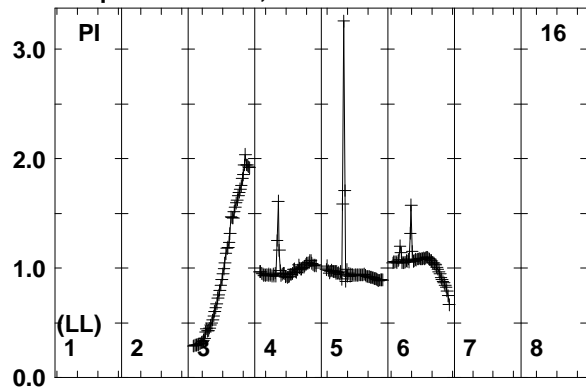

Lower frame: Real Jy
Total-power spectrum Antenna: PI (16)
Timerange: 00/04:10:46 to 00/04:11:44

Plot file version 142 created 04-NOV-2019 14:14:10

J2245-0755 EY034.UVDATA.1

Freq = 1.5947 GHz, Bw = 16.000 MH No calibration applied and no bandpass applied

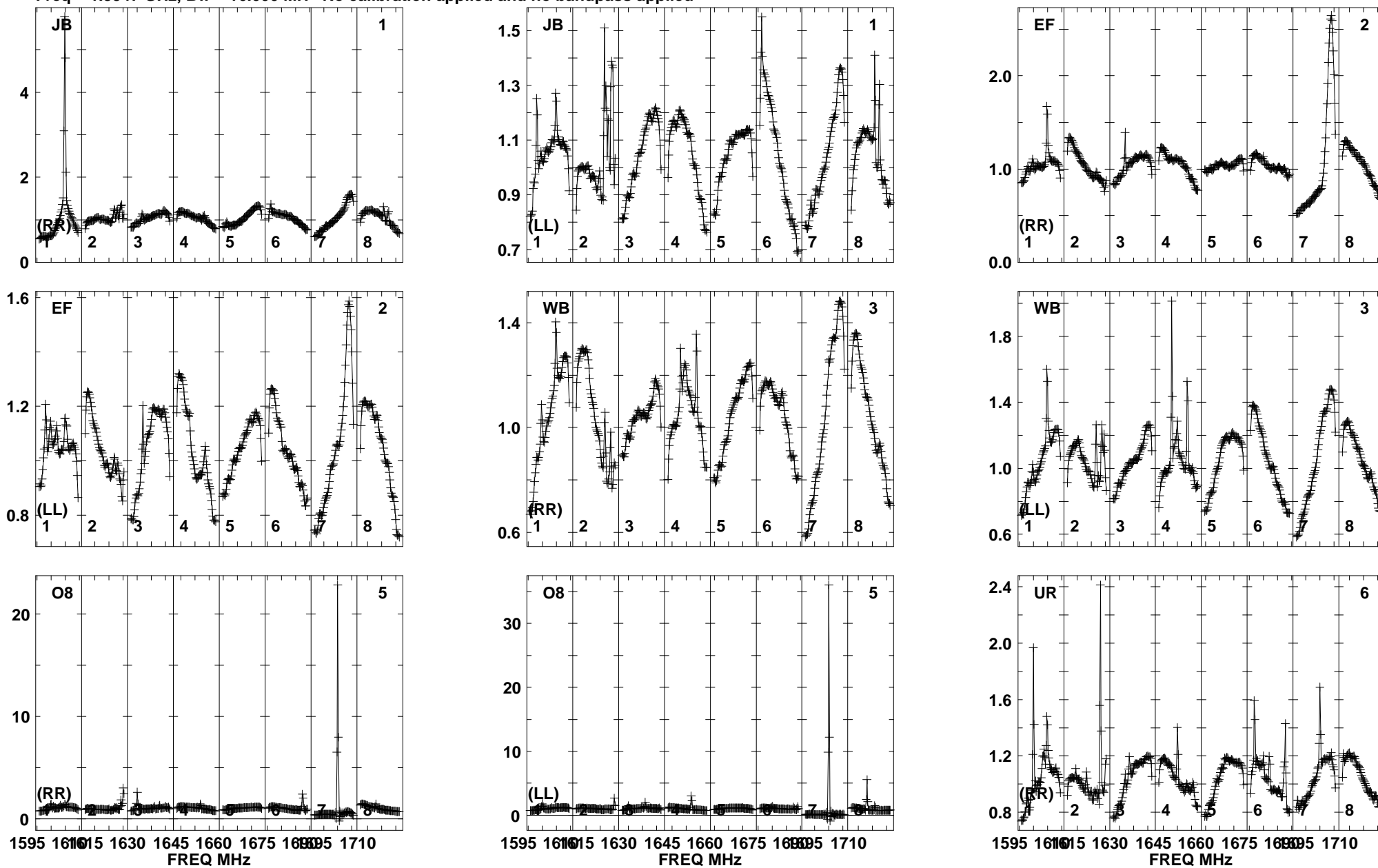

Lower frame: Real Jy
Total-power spectrum Antenna: JB (01)
Timerange: 00/04:12:01 to 00/04:12:59

Plot file version 143 created 04-NOV-2019 14:14:10

J2245-0755 EY034.UVDATA.1

Freq = 1.5947 GHz, Bw = 16.000 MH No calibration applied and no bandpass applied

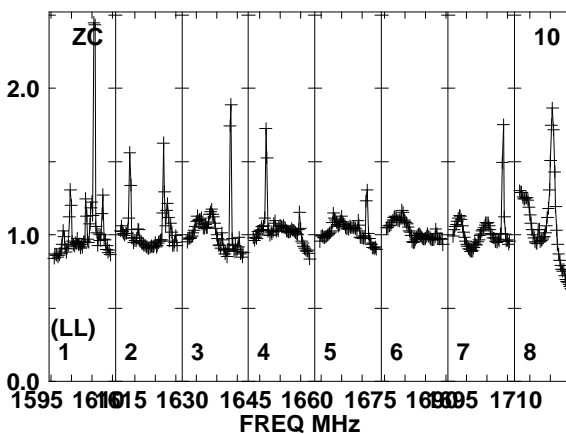
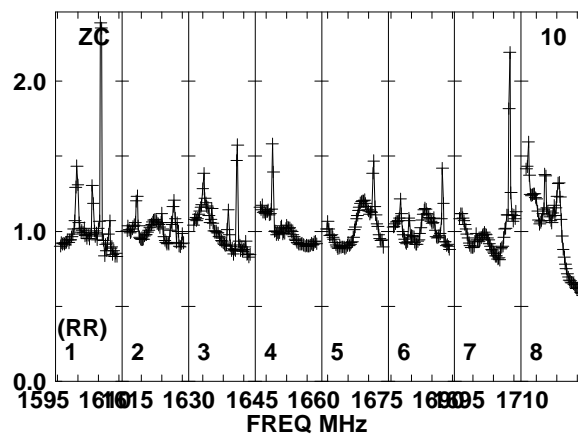
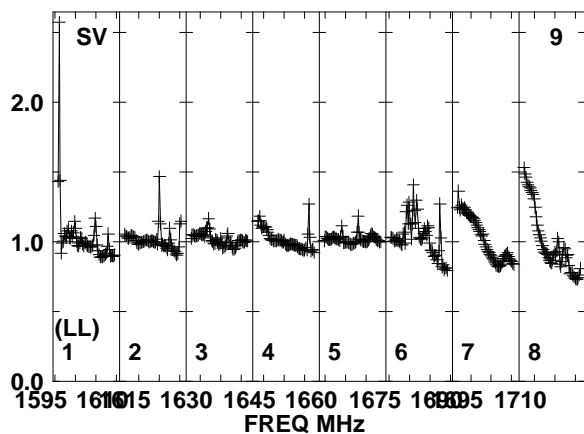
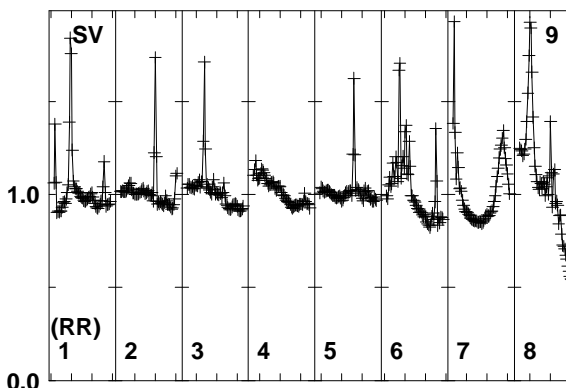
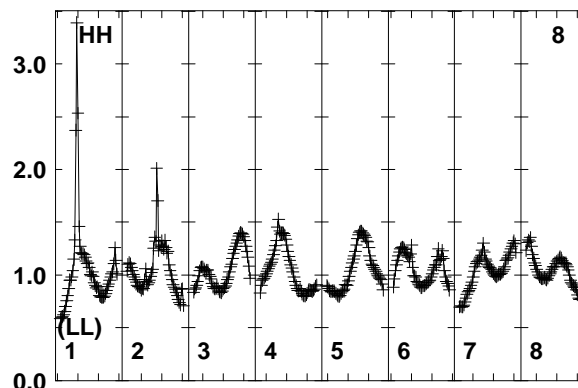
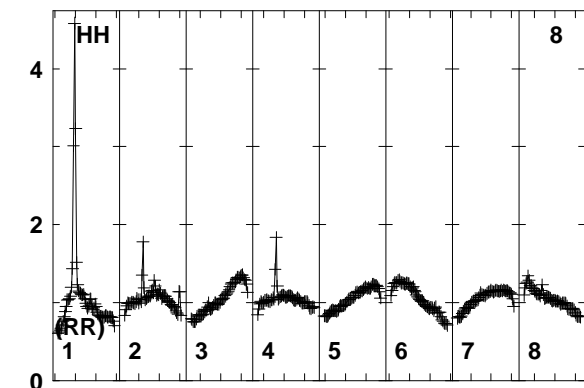
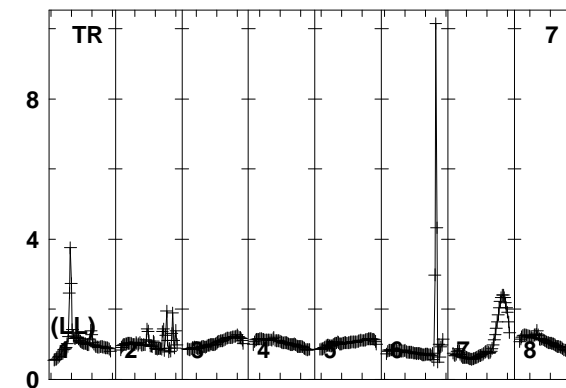
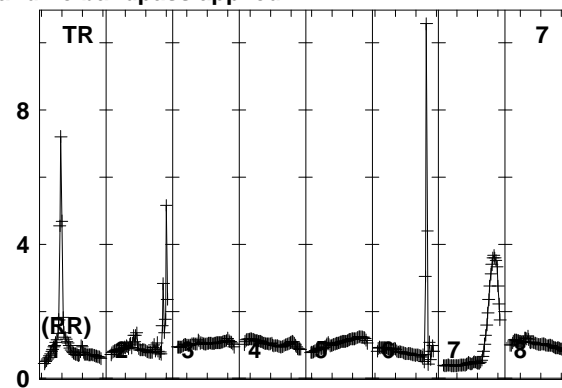
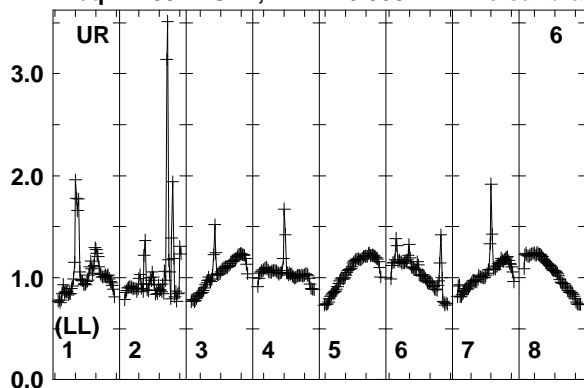

Lower frame: Real Jy
Total-power spectrum Antenna: UR (06)
Timerange: 00/04:12:01 to 00/04:12:59

Plot file version 144 created 04-NOV-2019 14:14:11

J2245-0755 EY034.UVDATA.1

Freq = 1.5947 GHz, Bw = 16.000 MH No calibration applied and no bandpass applied

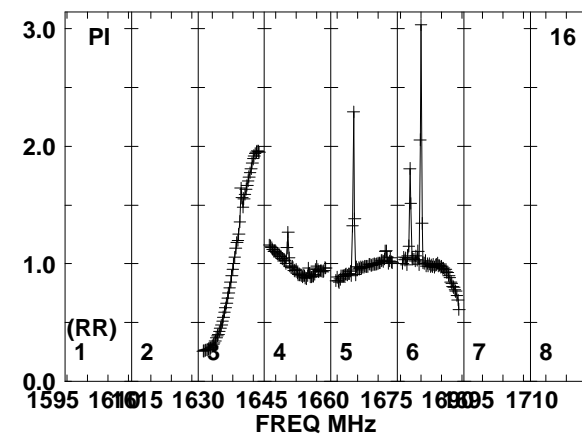
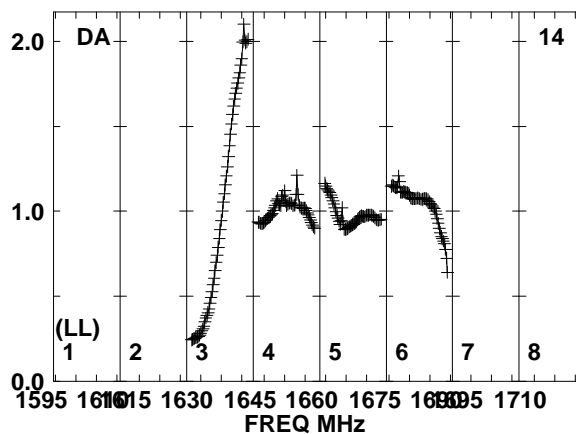
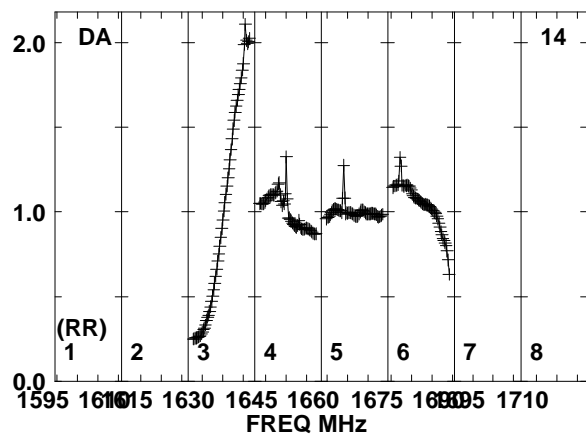
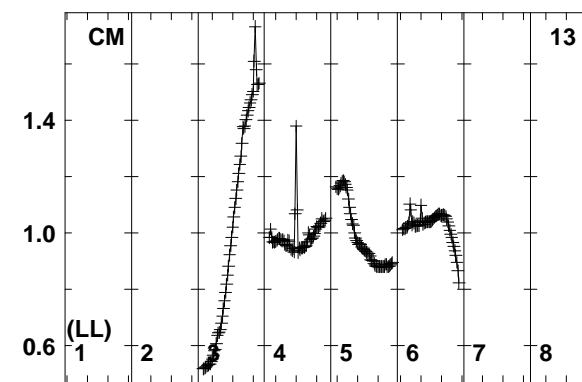
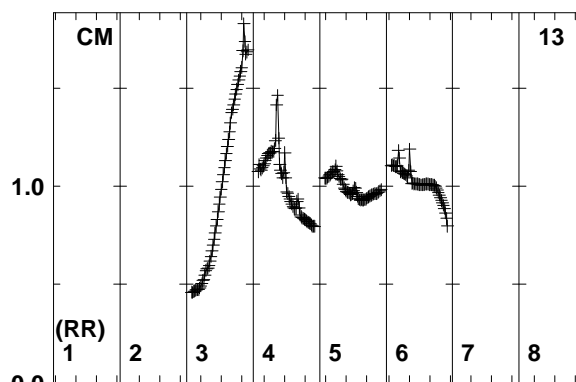
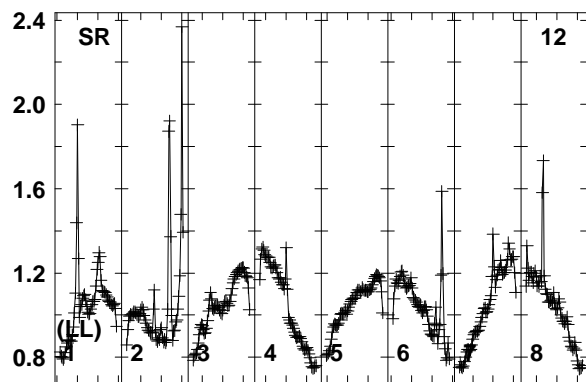
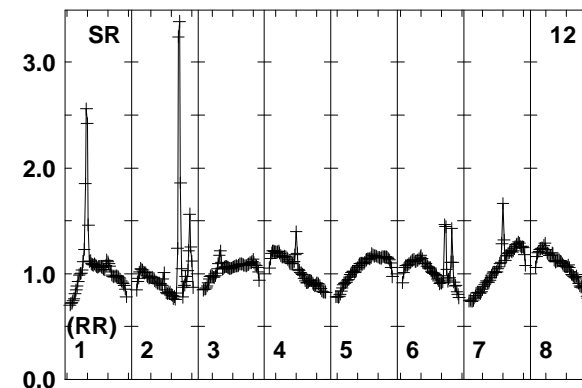
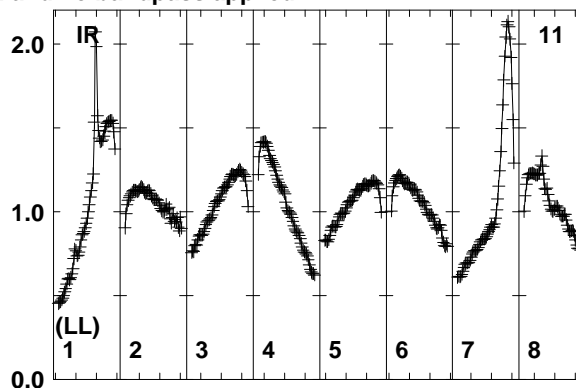
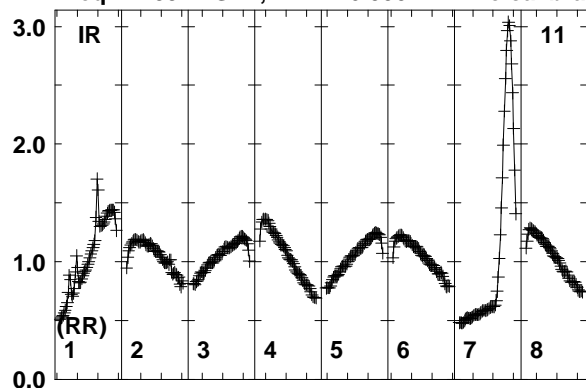

Lower frame: Real Jy
Total-power spectrum Antenna: IR (11)
Timerange: 00/04:12:01 to 00/04:12:59

Plot file version 145 created 04-NOV-2019 14:14:11

J2245-0755 EY034.UVDATA.1

Freq = 1.5947 GHz, Bw = 16.000 MH No calibration applied and no bandpass applied

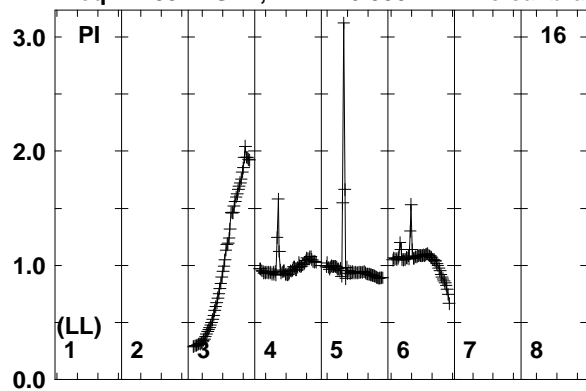

Lower frame: Real Jy
Total-power spectrum Antenna: PI (16)
Timerange: 00/04:12:01 to 00/04:12:59

Plot file version 146 created 04-NOV-2019 14:14:11

J2248-0541 EY034.UVDATA.1

Freq = 1.5947 GHz, Bw = 16.000 MH No calibration applied and no bandpass applied

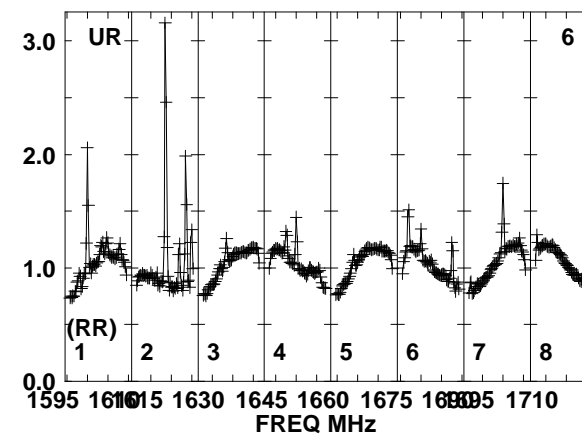
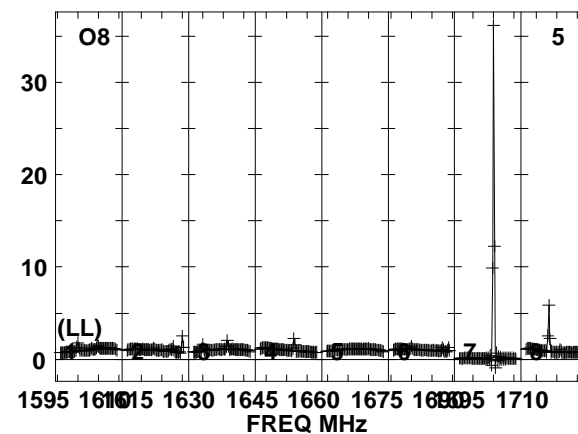
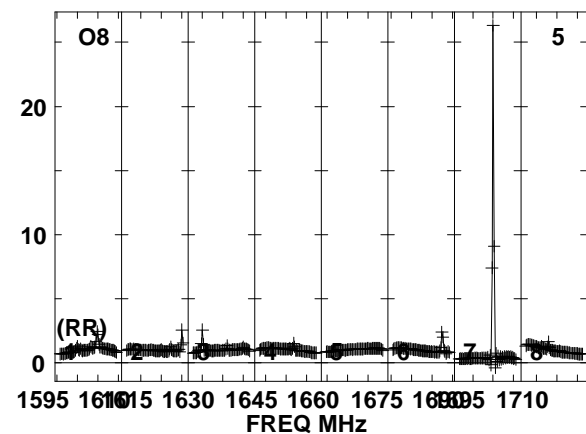
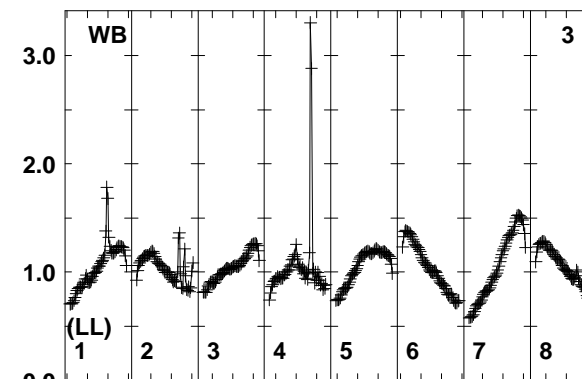
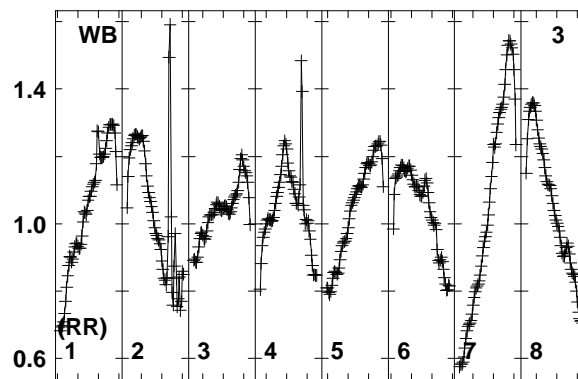
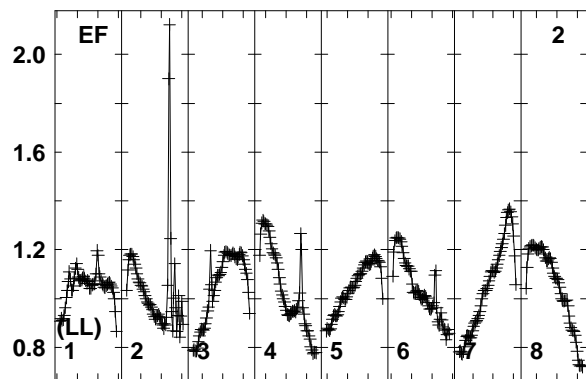
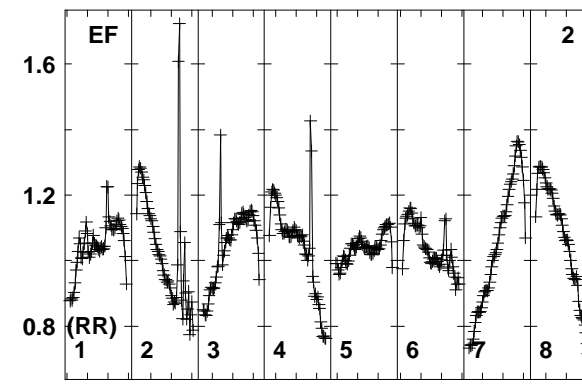
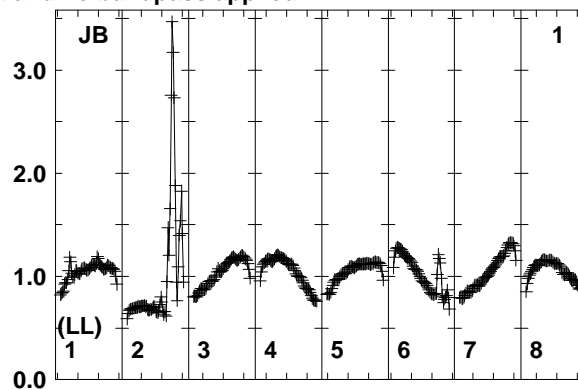
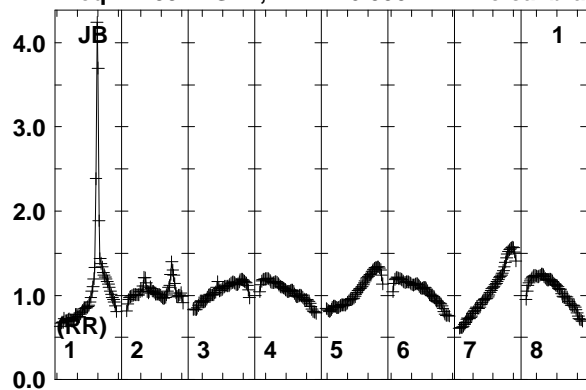

1595 1610 1630 1645 1660 1675 1690 1710
FREQ MHz

1595 1610 1630 1645 1660 1675 1690 1710
FREQ MHz

1595 1610 1630 1645 1660 1675 1690 1710
FREQ MHz

Lower frame: Real Jy
Total-power spectrum Antenna: JB (01)
Timerange: 00/04:13:46 to 00/04:14:44

Plot file version 147 created 04-NOV-2019 14:14:11

J2248-0541 EY034.UVDATA.1

Freq = 1.5947 GHz, Bw = 16.000 MH No calibration applied and no bandpass applied

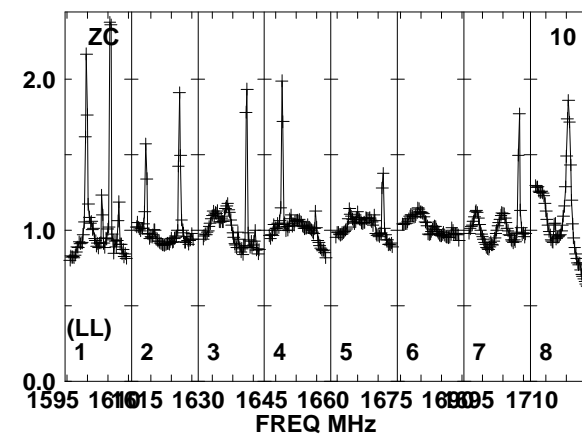
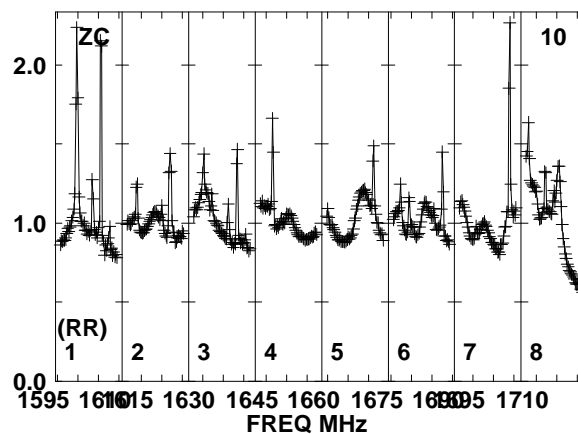
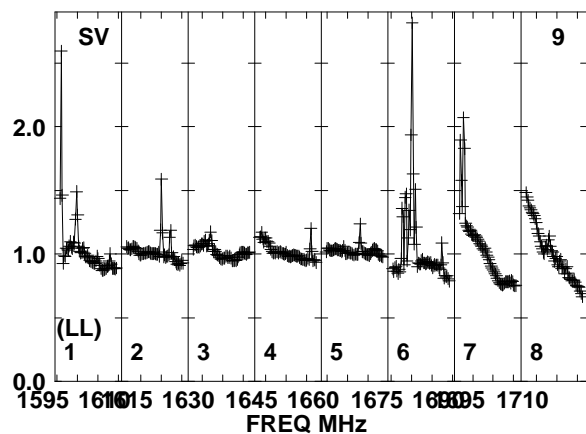
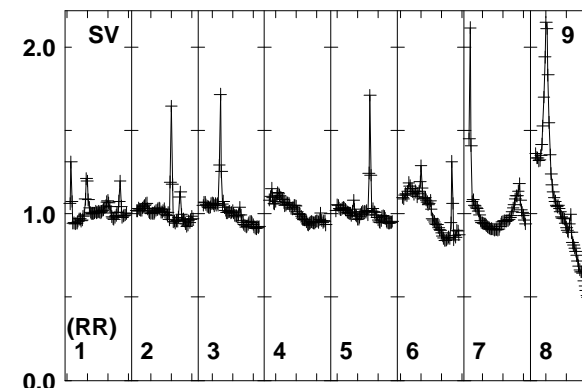
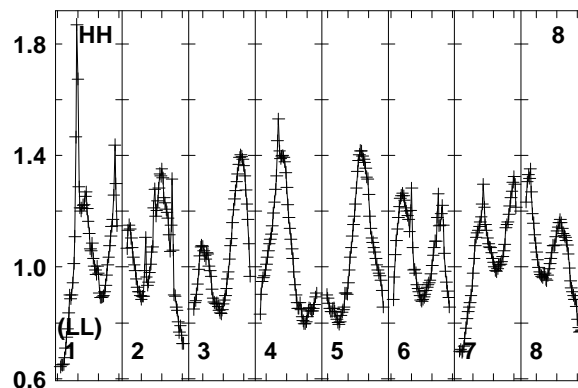
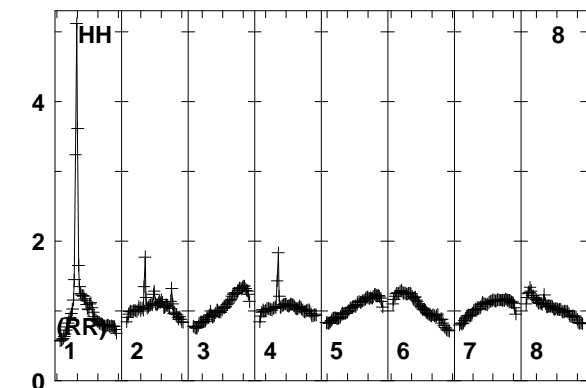
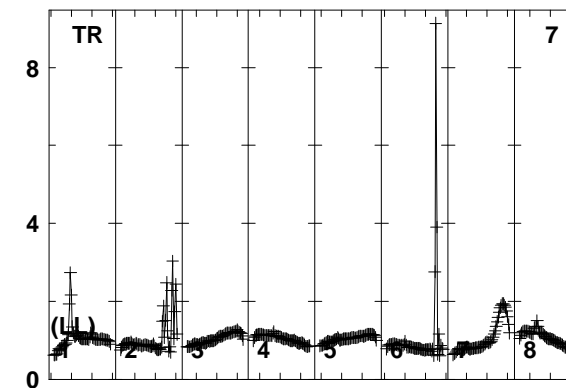
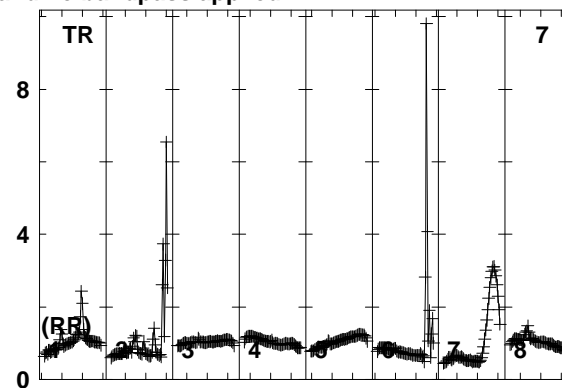
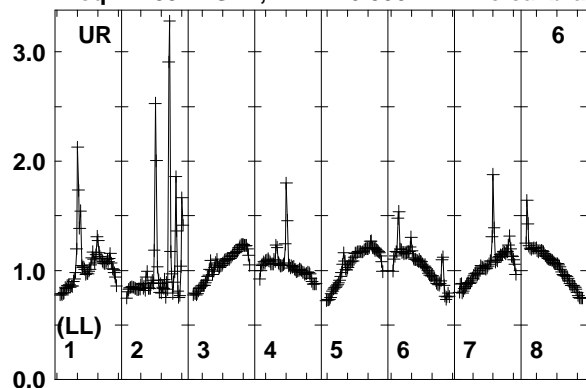

Lower frame: Real Jy
Total-power spectrum Antenna: UR (06)
Timerange: 00/04:13:46 to 00/04:14:44

Plot file version 148 created 04-NOV-2019 14:14:11

J2248-0541 EY034.UVDATA.1

Freq = 1.5947 GHz, Bw = 16.000 MH No calibration applied and no bandpass applied

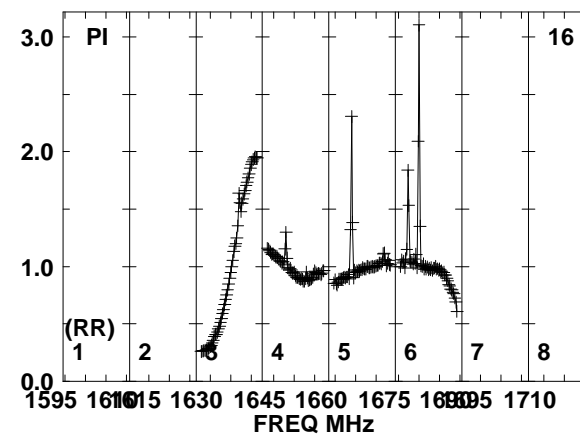
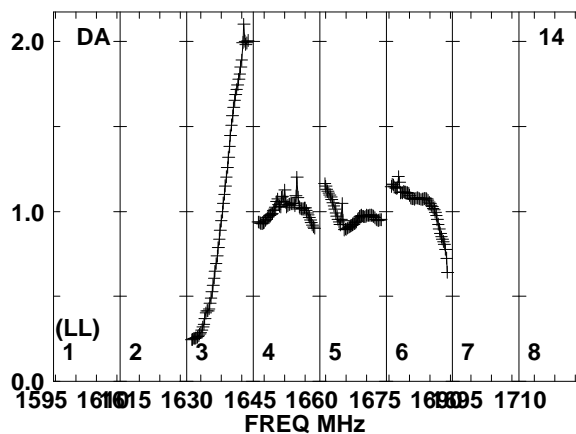
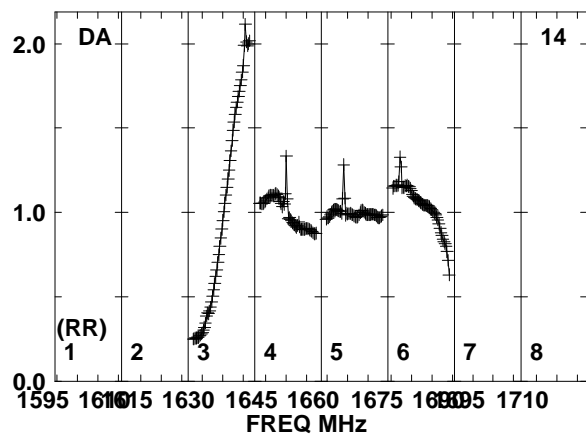
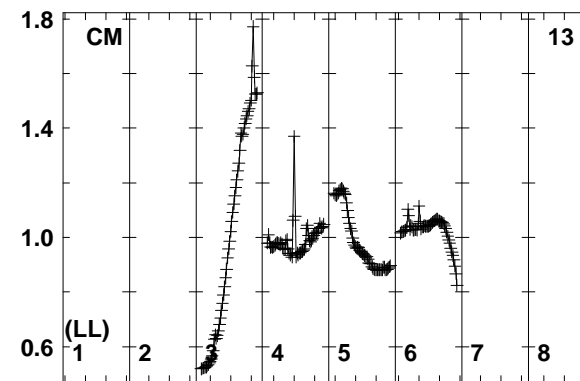
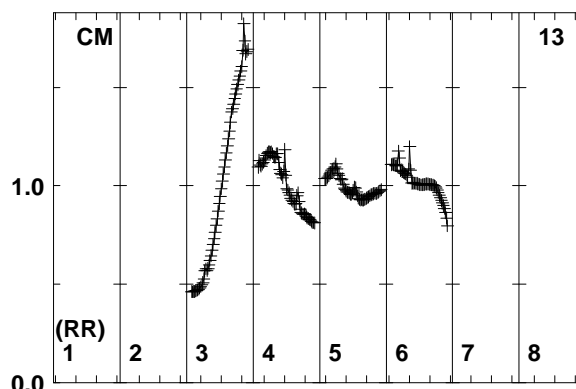
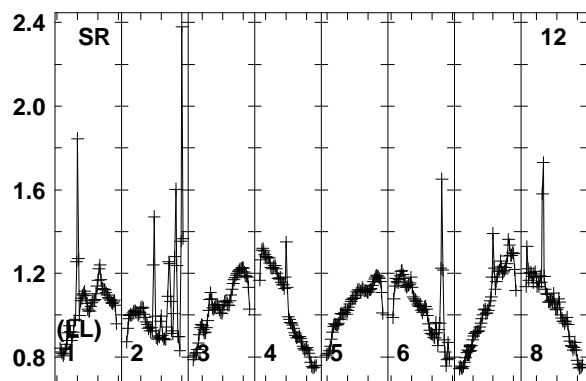
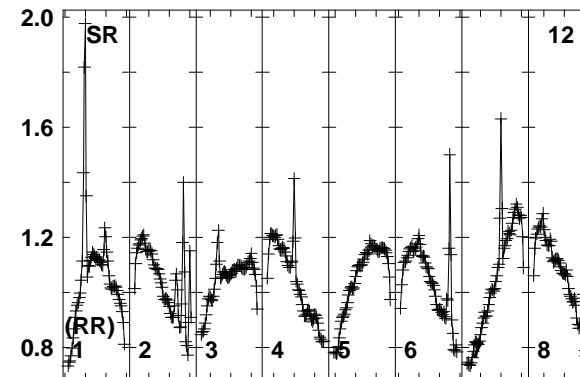
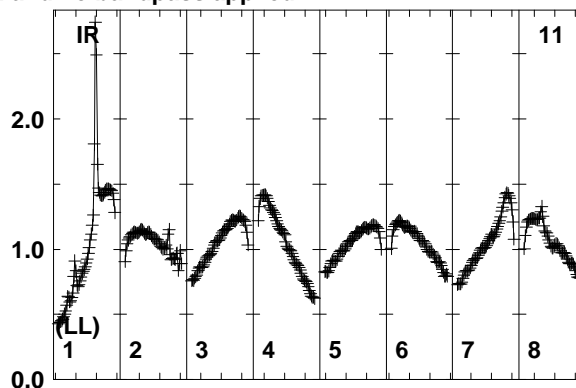
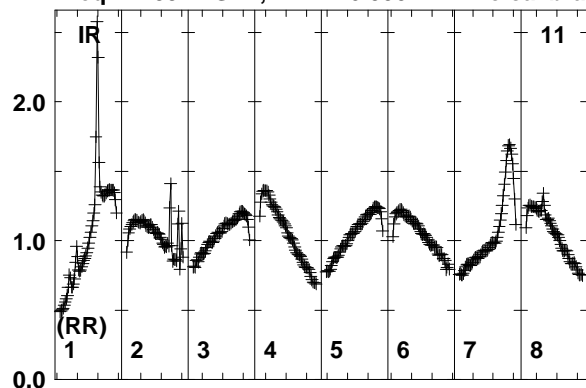

Lower frame: Real Jy
Total-power spectrum Antenna: IR (11)
Timerange: 00/04:13:46 to 00/04:14:44

Plot file version 149 created 04-NOV-2019 14:14:11
J2248-0541 EY034.UVDATA.1
Freq = 1.5947 GHz, Bw = 16.000 MH No calibration applied and no bandpass applied

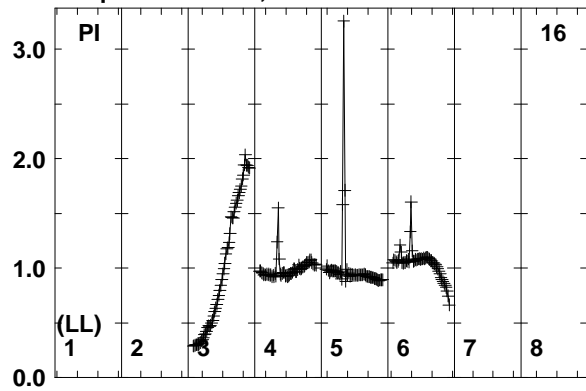

Lower frame: Real Jy
Total-power spectrum Antenna: PI (16)
Timerange: 00/04:13:46 to 00/04:14:44

Plot file version 150 created 04-NOV-2019 14:14:11

W2246-0526 EY034.UVDATA.1

Freq = 1.5947 GHz, Bw = 16.000 MH No calibration applied and no bandpass applied

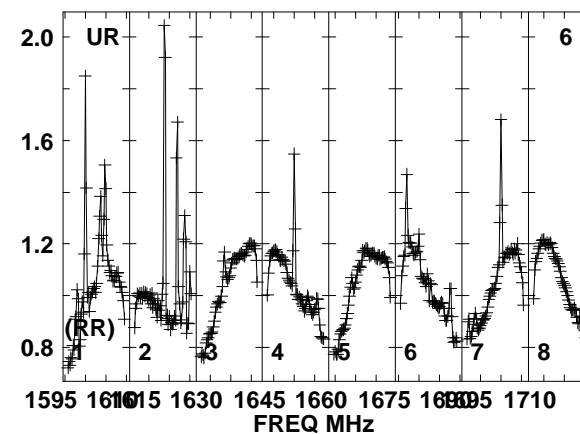
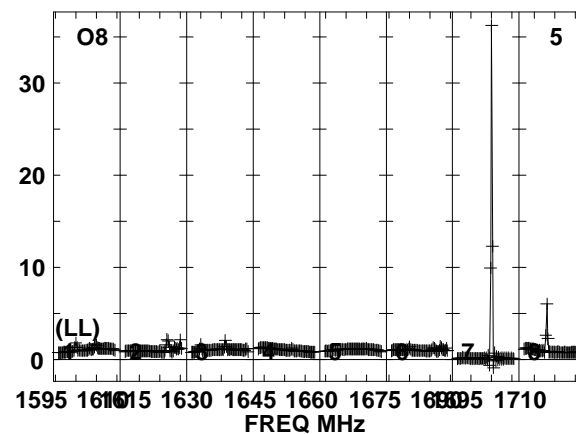
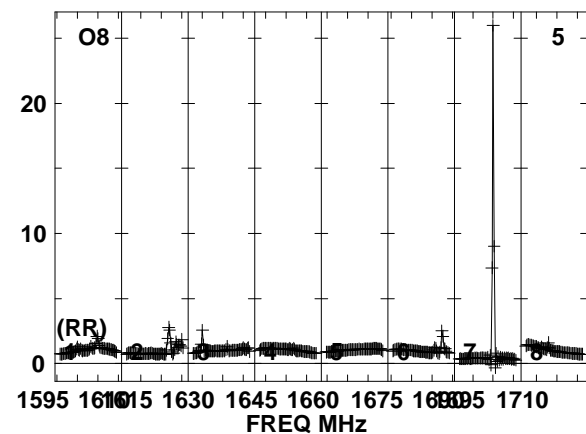
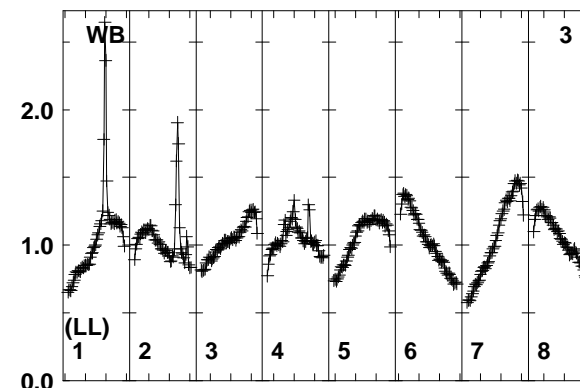
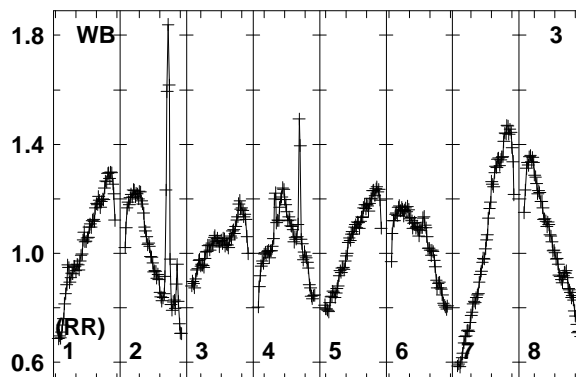
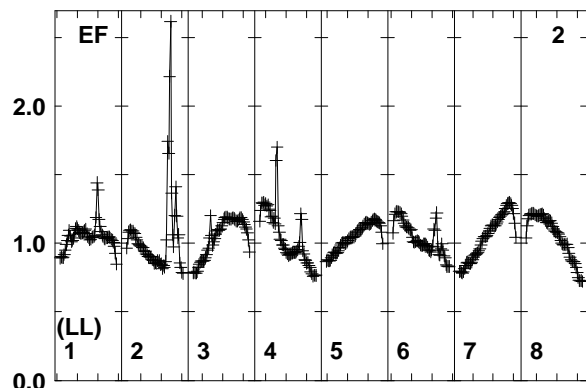
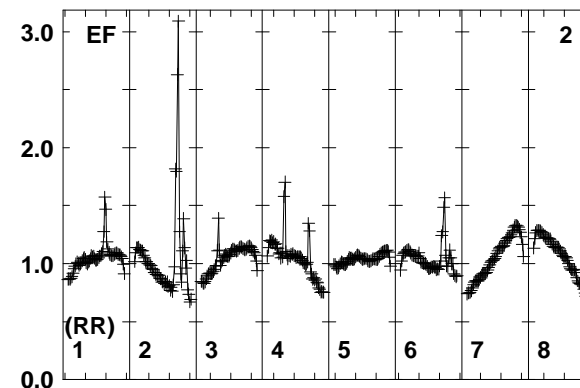
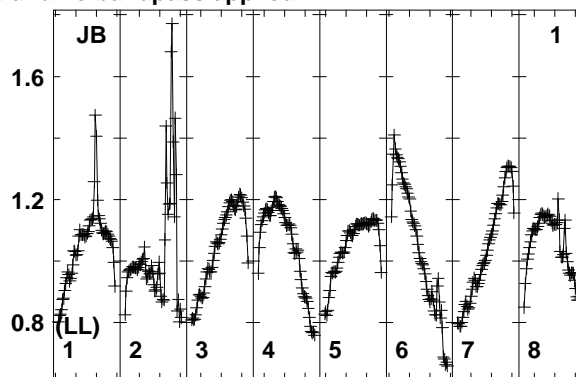
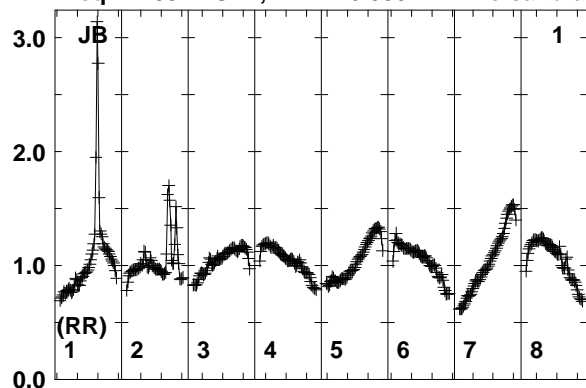

Lower frame: Real Jy
Total-power spectrum Antenna: JB (01)
Timerange: 00/04:14:46 to 00/04:17:14

Plot file version 151 created 04-NOV-2019 14:14:11

W2246-0526 EY034.UVDATA.1

Freq = 1.5947 GHz, Bw = 16.000 MH No calibration applied and no bandpass applied

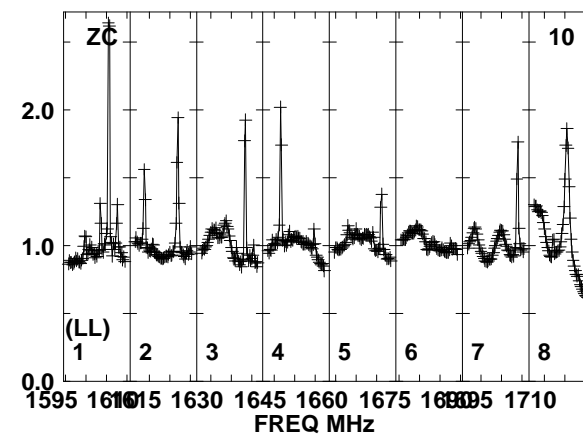
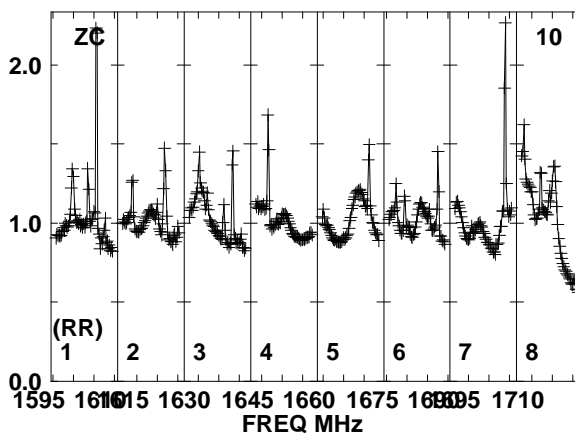
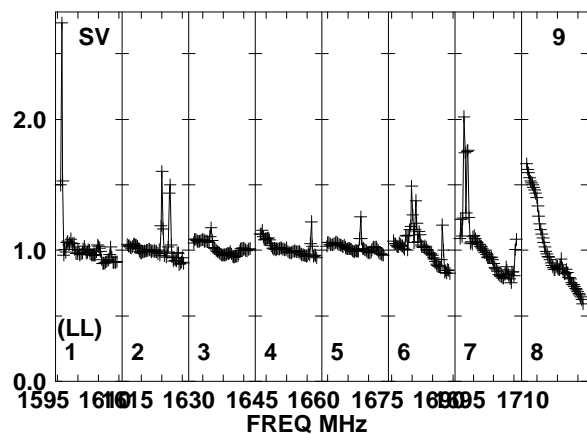
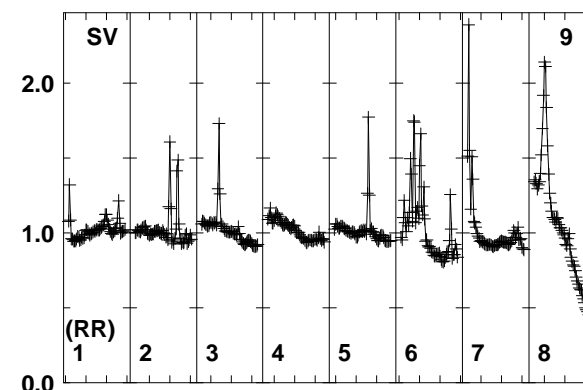
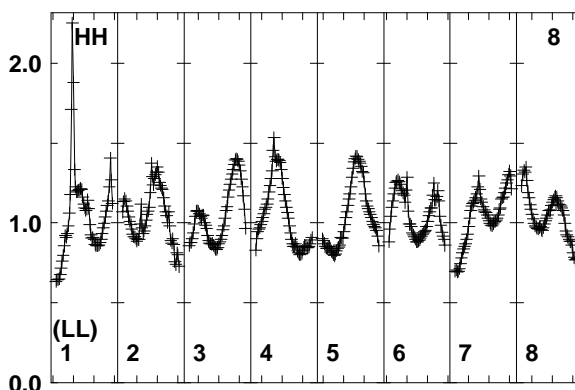
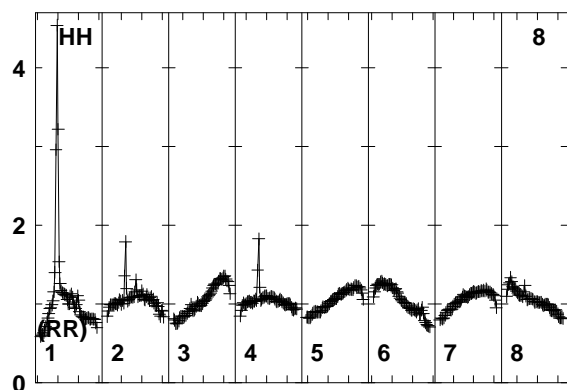
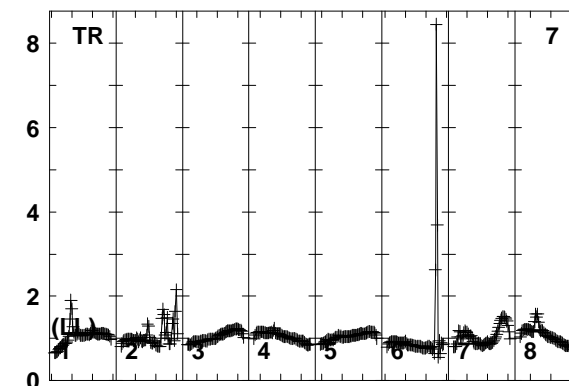
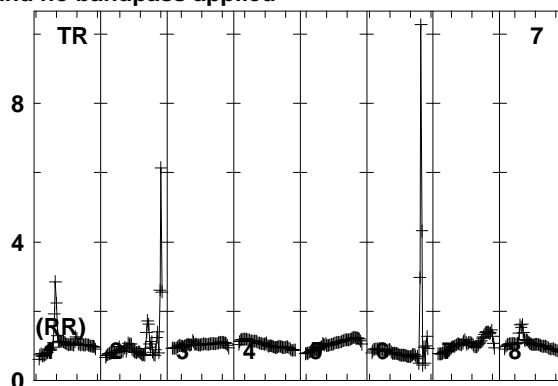
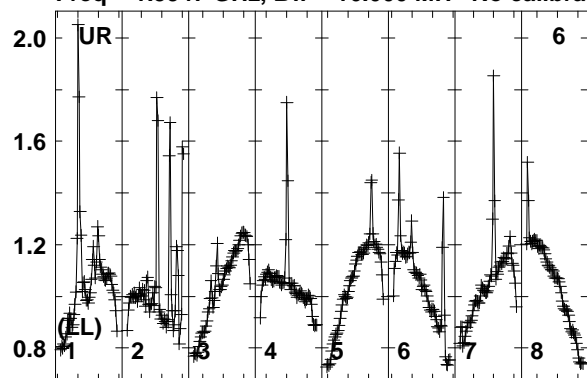

Lower frame: Real Jy
Total-power spectrum Antenna: UR (06)
Timerange: 00/04:14:46 to 00/04:17:14

Plot file version 152 created 04-NOV-2019 14:14:11

W2246-0526 EY034.UVDATA.1

Freq = 1.5947 GHz, Bw = 16.000 MH No calibration applied and no bandpass applied

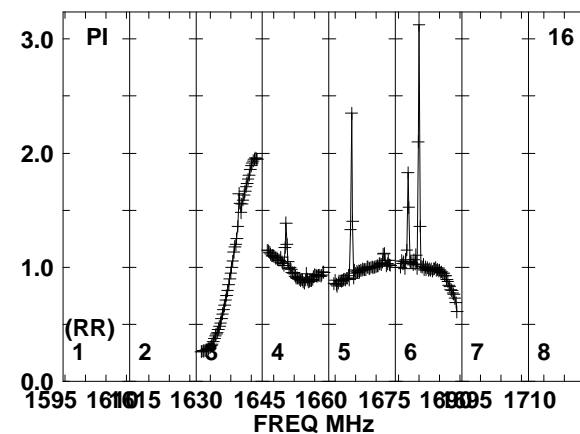
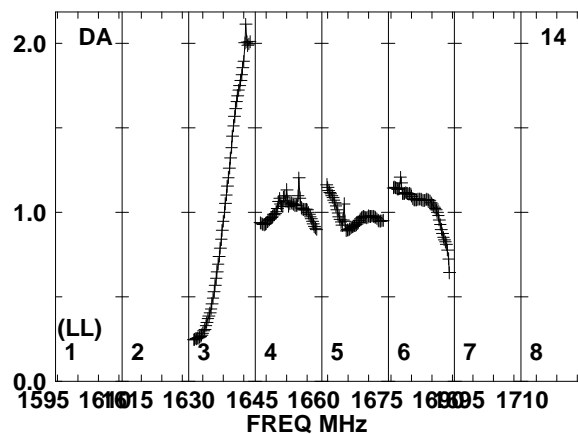
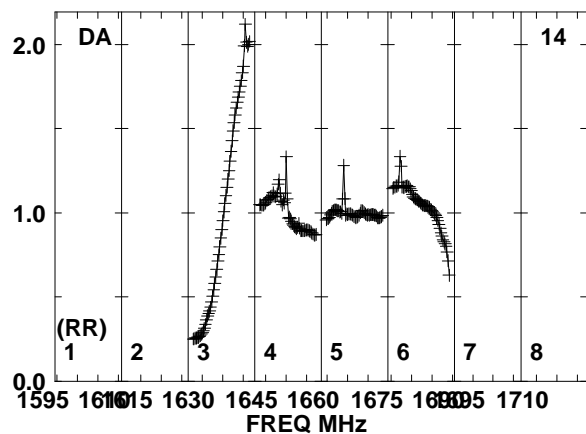
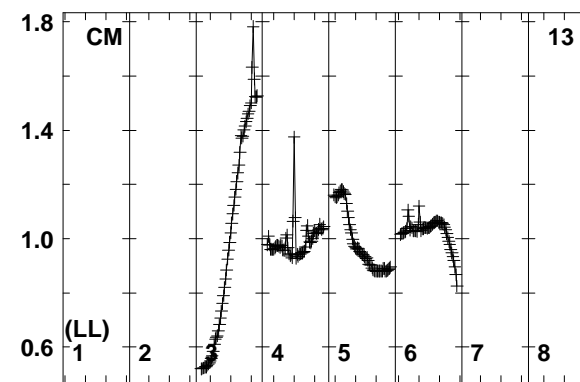
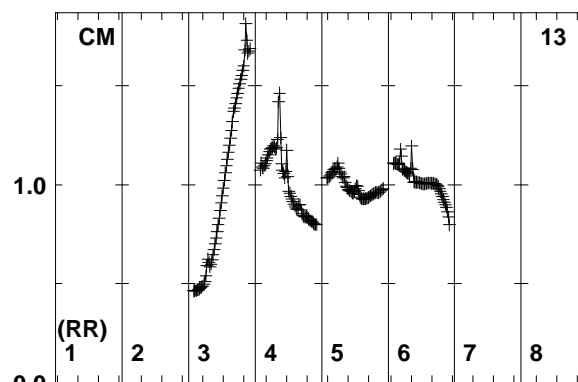
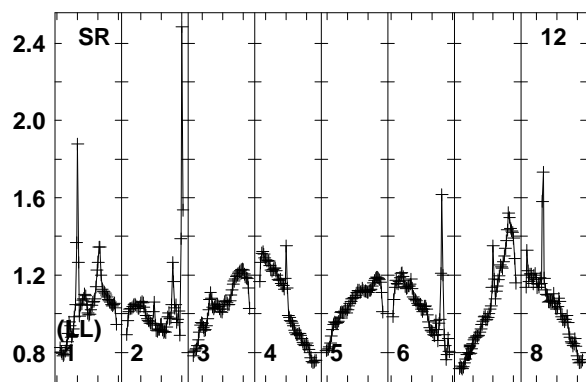
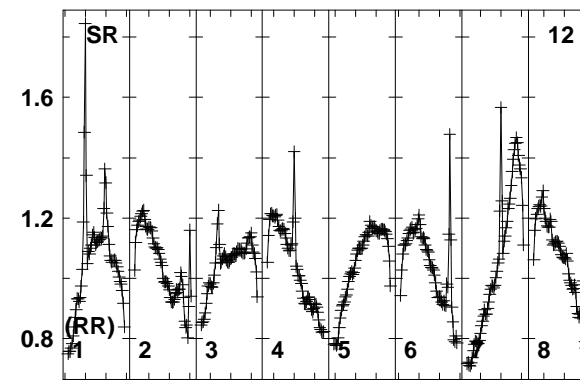
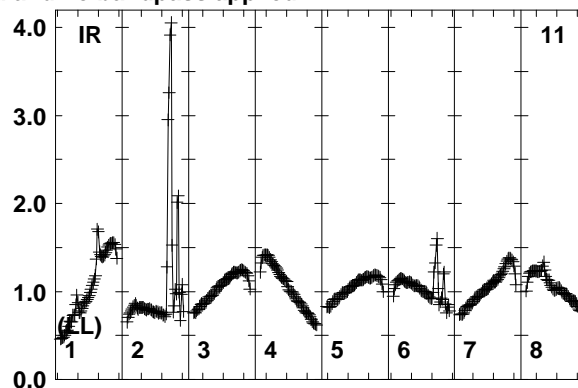
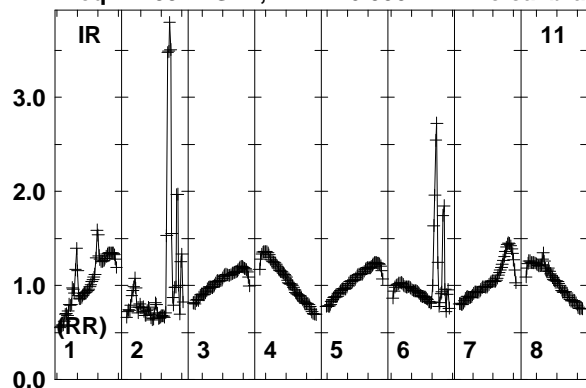

Lower frame: Real Jy
Total-power spectrum Antenna: IR (11)
Timerange: 00/04:14:46 to 00/04:17:14

Plot file version 153 created 04-NOV-2019 14:14:11
W2246-0526 EY034.UVDATA.1
Freq = 1.5947 GHz, Bw = 16.000 MH No calibration applied and no bandpass applied

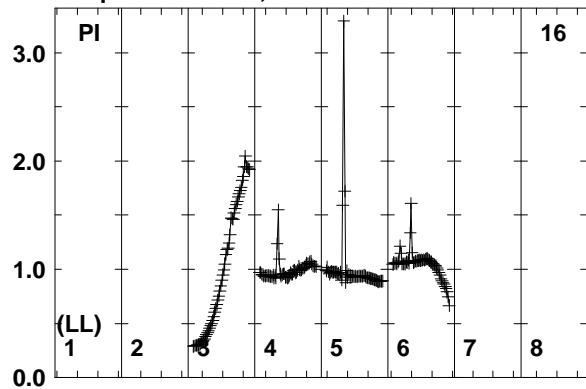

Lower frame: Real Jy
Total-power spectrum Antenna: PI (16)
Timerange: 00/04:14:46 to 00/04:17:14

Plot file version 154 created 04-NOV-2019 14:14:11

J2248-0541 EY034.UVDATA.1

Freq = 1.5947 GHz, Bw = 16.000 MH No calibration applied and no bandpass applied

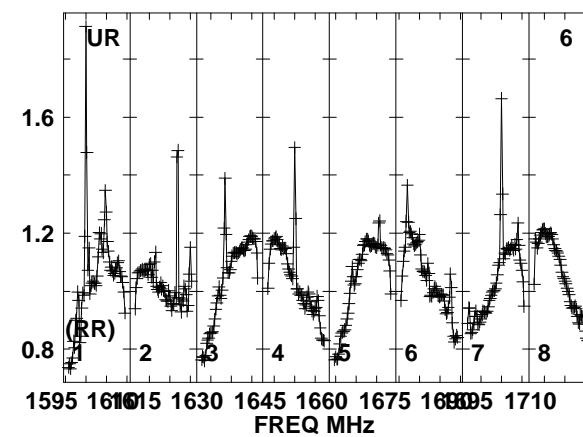
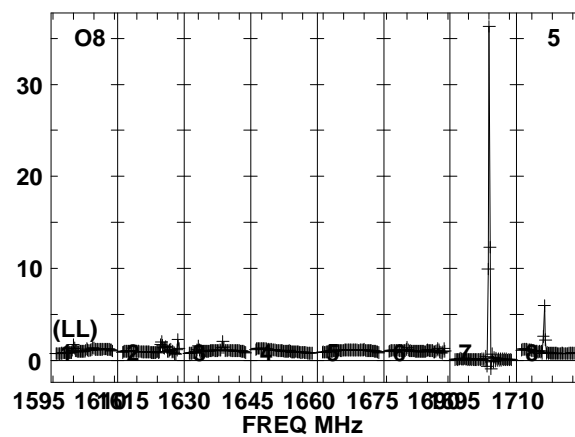
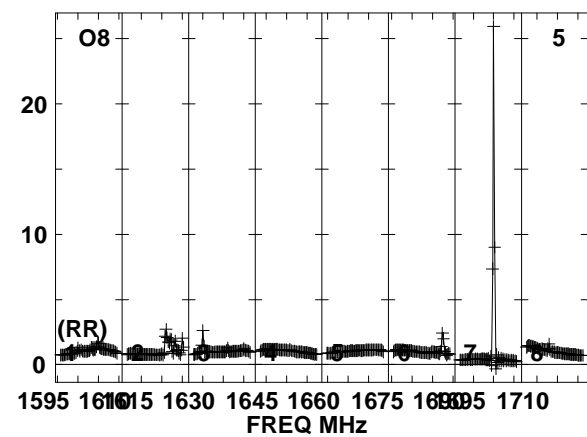
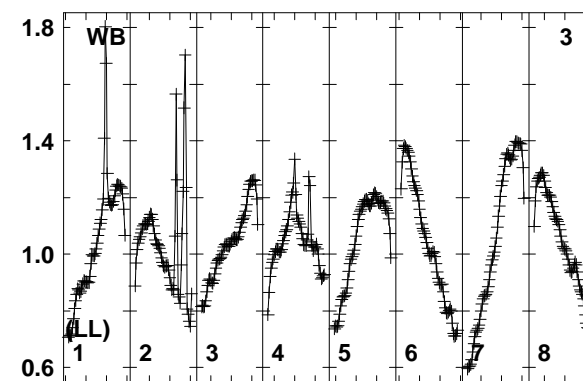
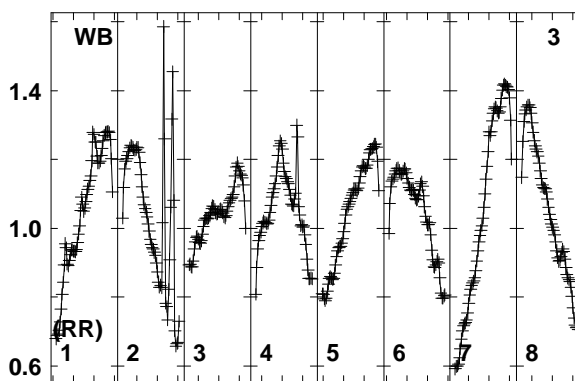
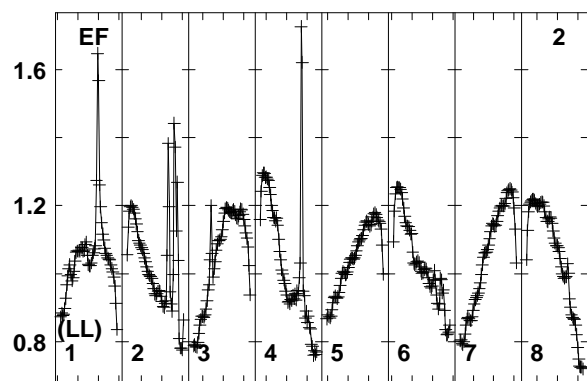
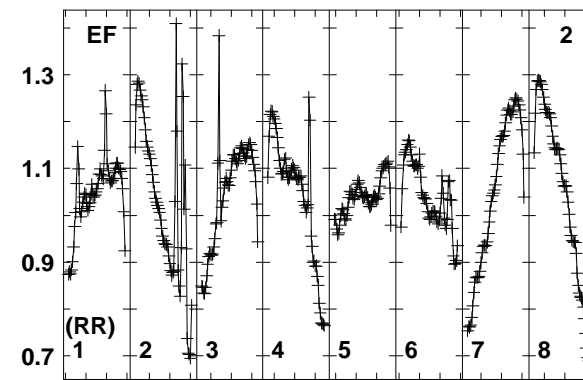
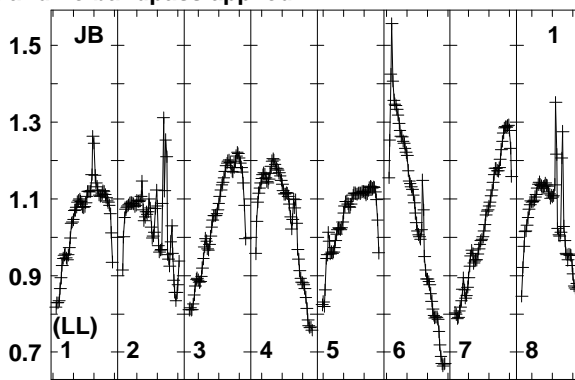
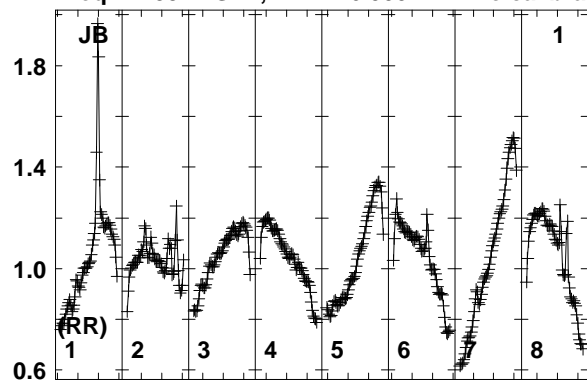

Lower frame: Real Jy
Total-power spectrum Antenna: JB (01)
Timerange: 00/04:17:31 to 00/04:18:29

Plot file version 155 created 04-NOV-2019 14:14:11

J2248-0541 EY034.UVDATA.1

Freq = 1.5947 GHz, Bw = 16.000 MH No calibration applied and no bandpass applied

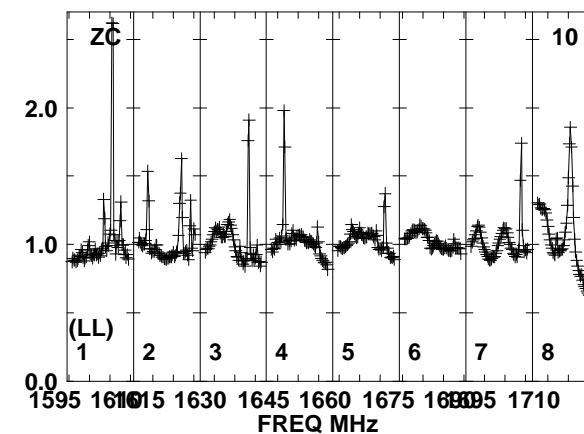
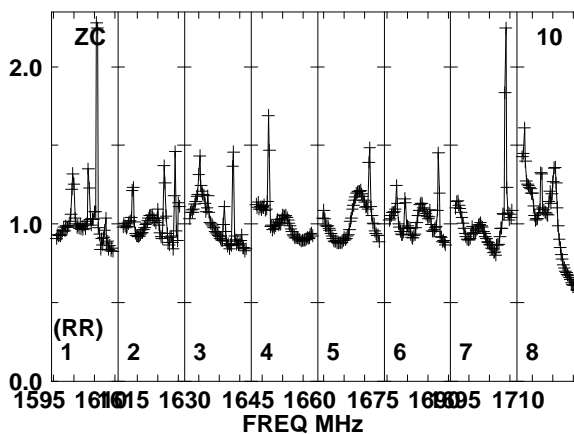
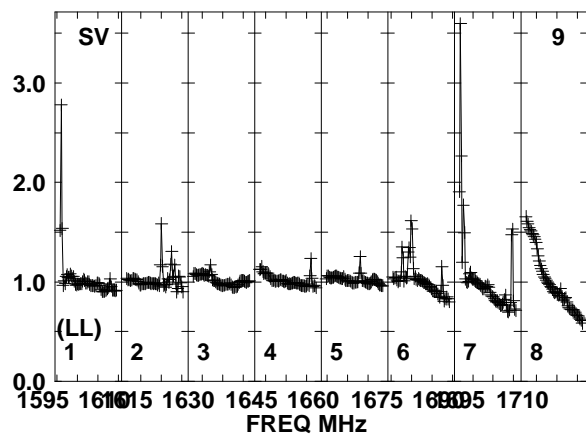
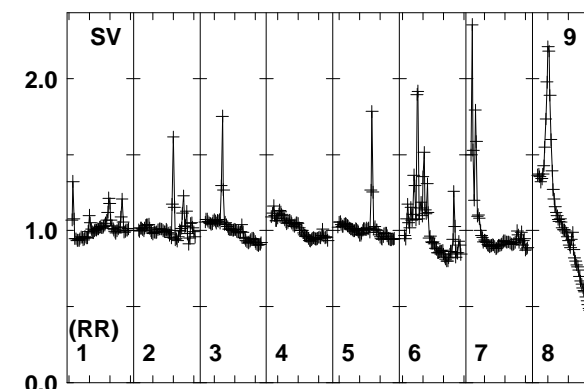
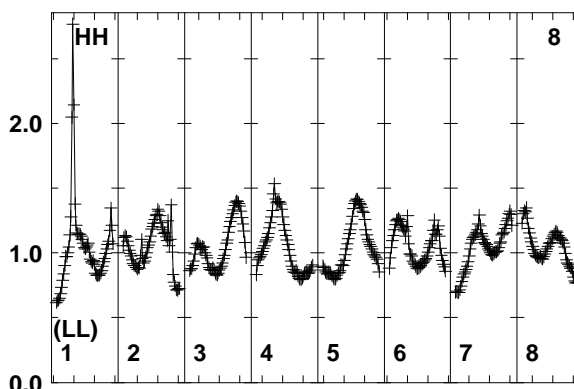
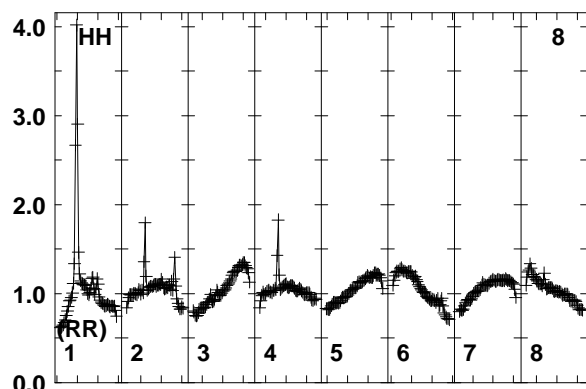
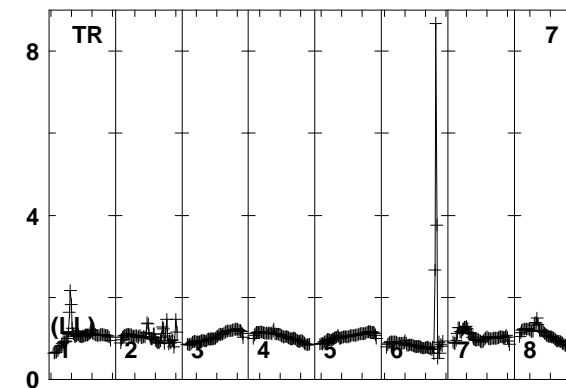
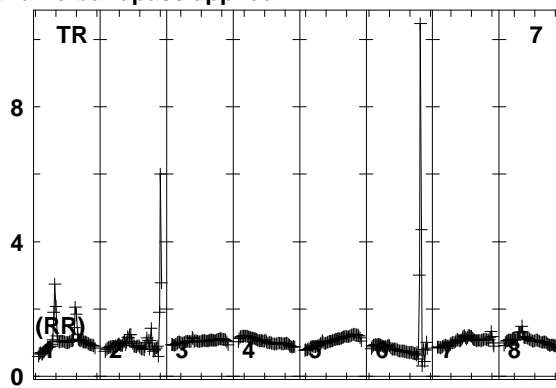
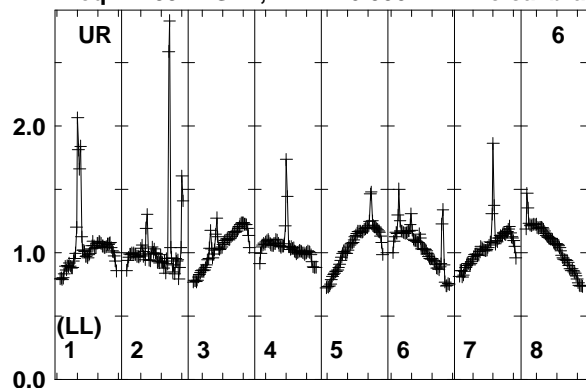

Lower frame: Real Jy
Total-power spectrum Antenna: UR (06)
Timerange: 00/04:17:31 to 00/04:18:29

Plot file version 156 created 04-NOV-2019 14:14:11

J2248-0541 EY034.UVDATA.1

Freq = 1.5947 GHz, Bw = 16.000 MH No calibration applied and no bandpass applied

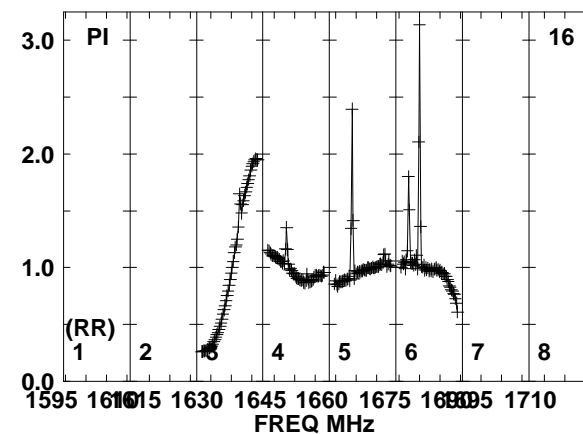
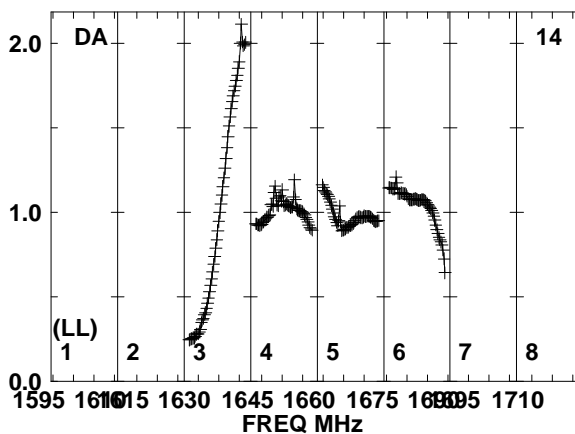
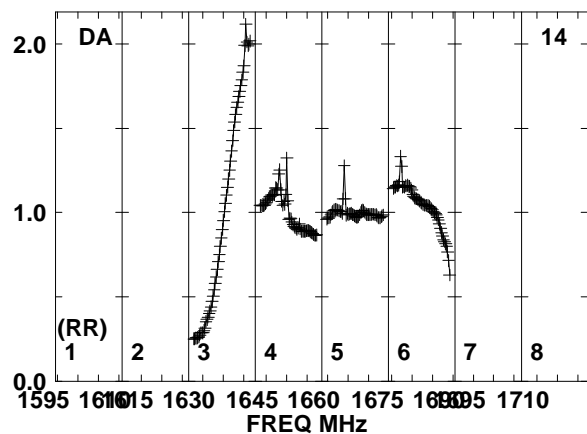
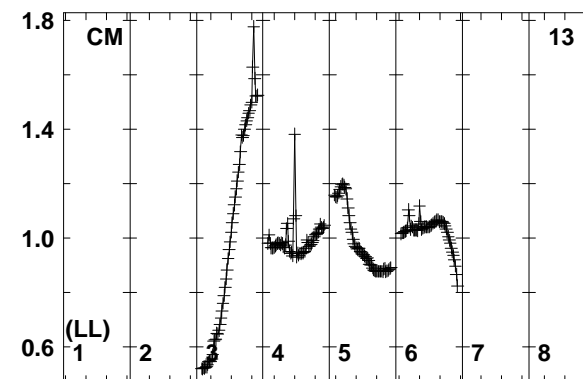
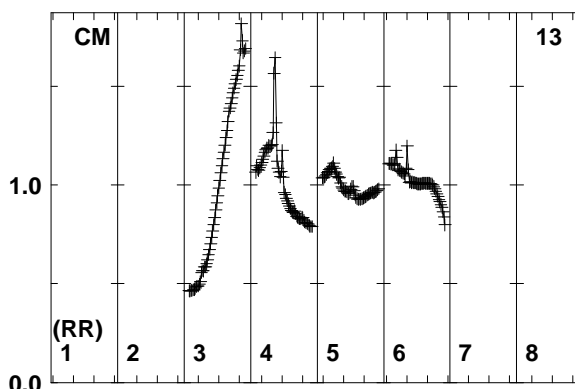
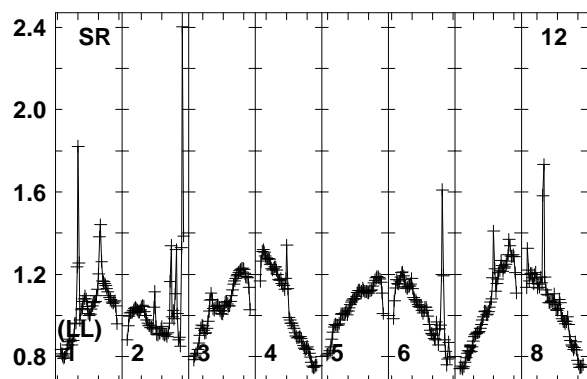
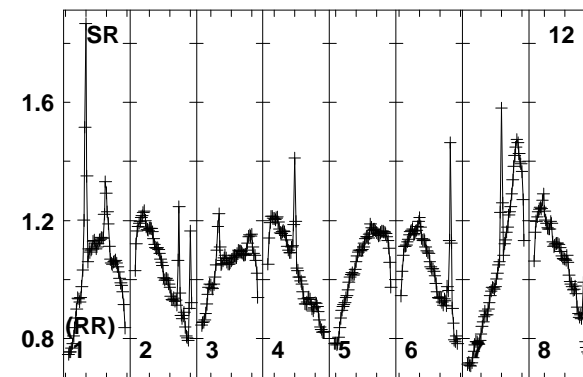
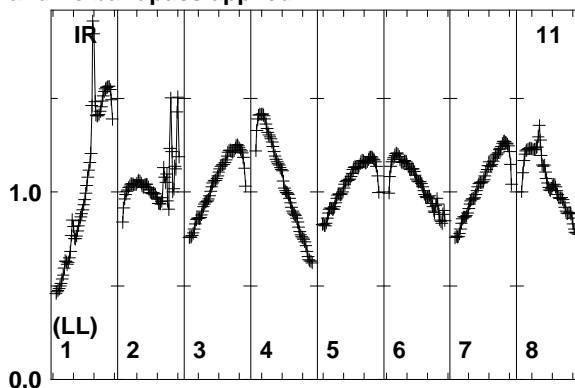
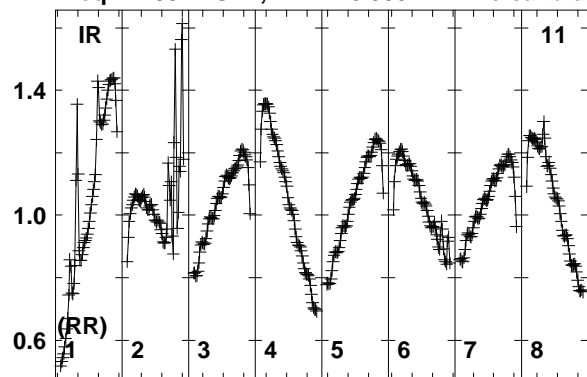

Lower frame: Real Jy
Total-power spectrum Antenna: IR (11)
Timerange: 00/04:17:31 to 00/04:18:29

Plot file version 157 created 04-NOV-2019 14:14:11
J2248-0541 EY034.UVDATA.1
Freq = 1.5947 GHz, Bw = 16.000 MH No calibration applied and no bandpass applied

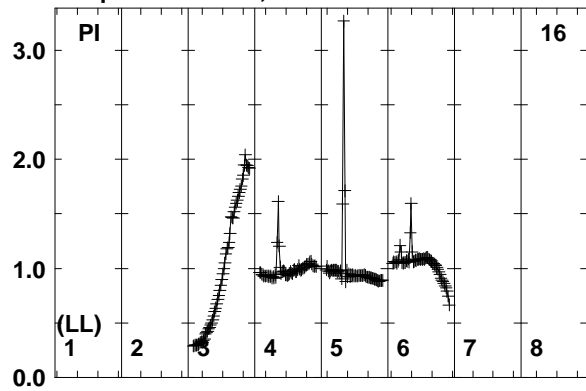

Lower frame: Real Jy
Total-power spectrum Antenna: PI (16)
Timerange: 00/04:17:31 to 00/04:18:29

Plot file version 158 created 04-NOV-2019 14:14:11

W2246-0526 EY034.UVDATA.1

Freq = 1.5947 GHz, Bw = 16.000 MH No calibration applied and no bandpass applied

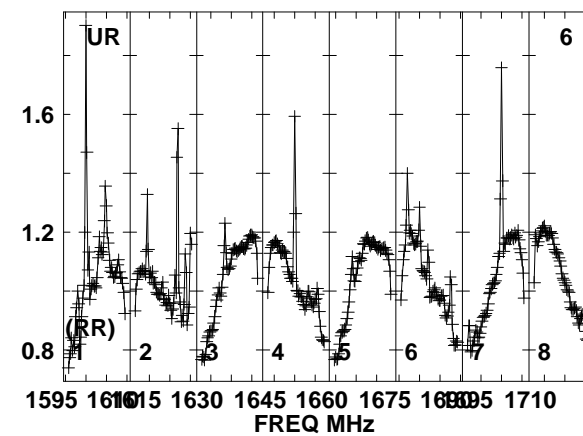
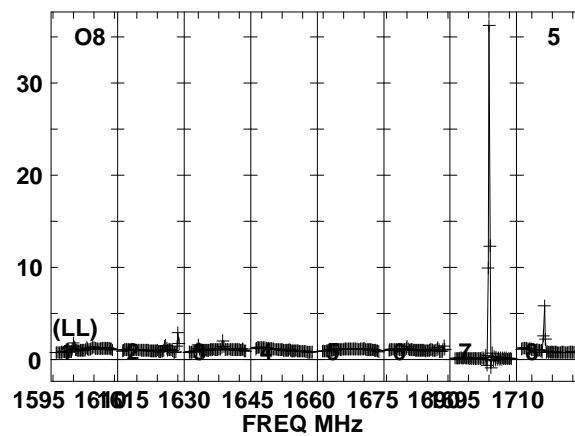
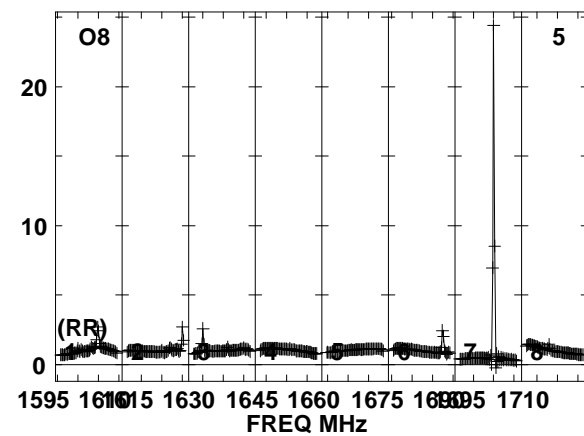
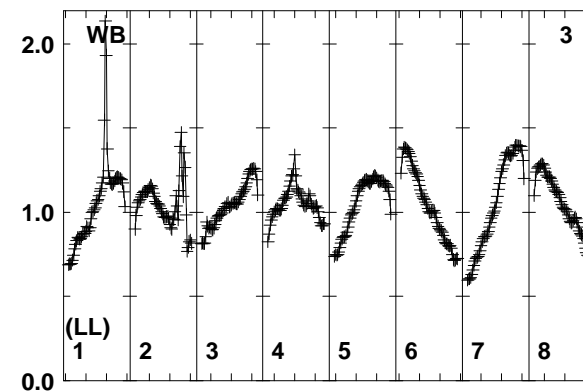
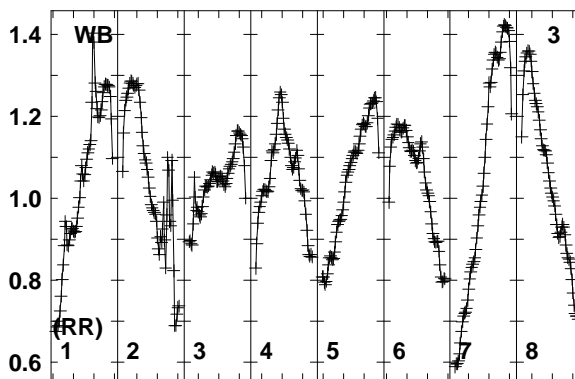
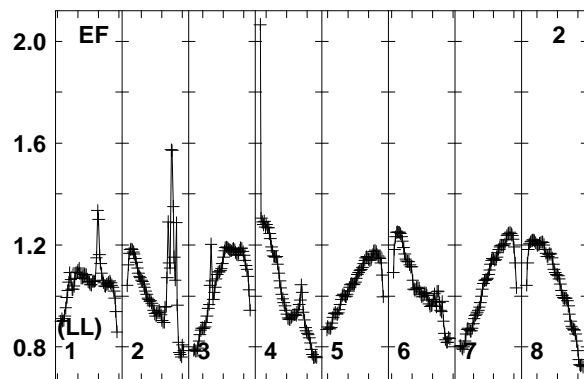
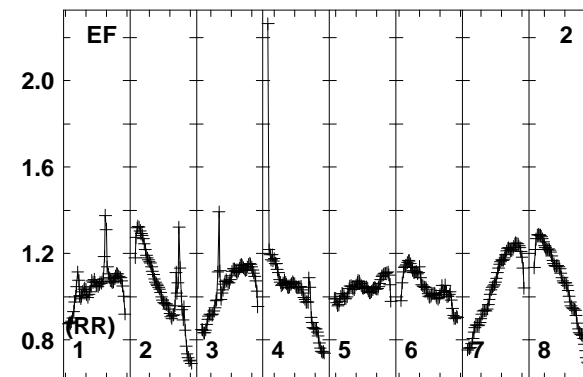
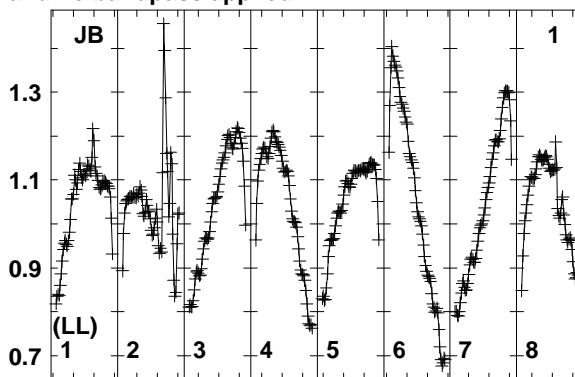
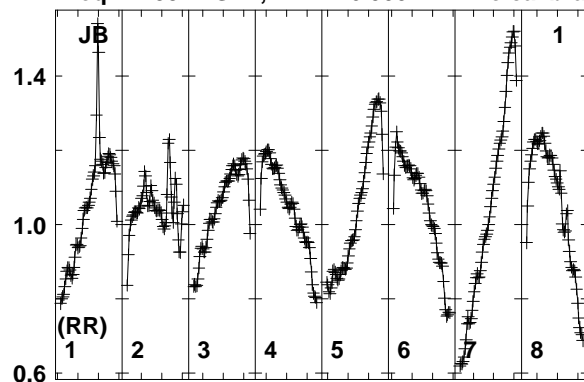

Lower frame: Real Jy
Total-power spectrum Antenna: JB (01)
Timerange: 00/04:18:31 to 00/04:21:09

Plot file version 159 created 04-NOV-2019 14:14:12

W2246-0526 EY034.UVDATA.1

Freq = 1.5947 GHz, Bw = 16.000 MH No calibration applied and no bandpass applied

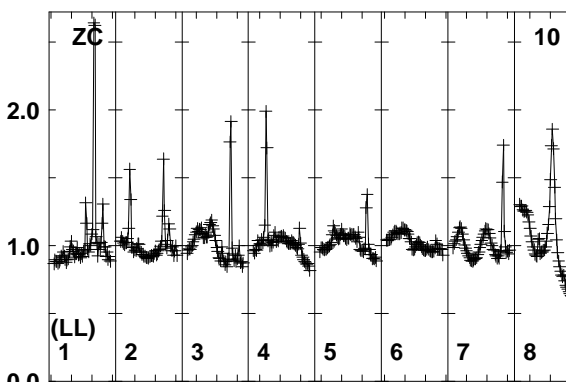
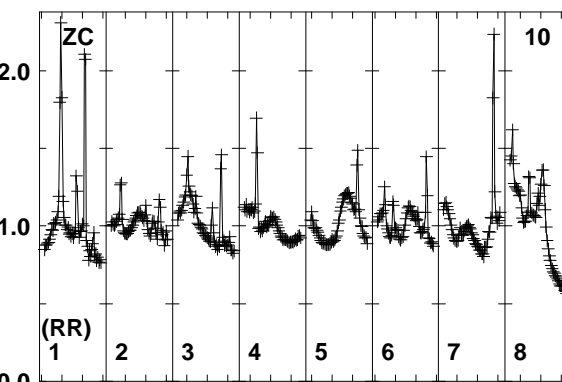
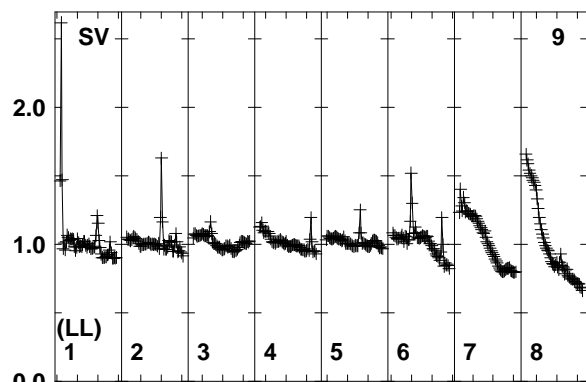
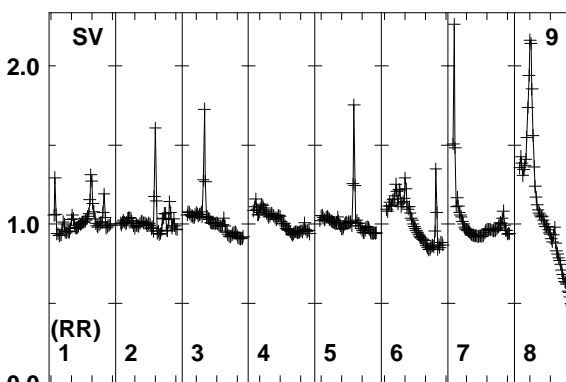
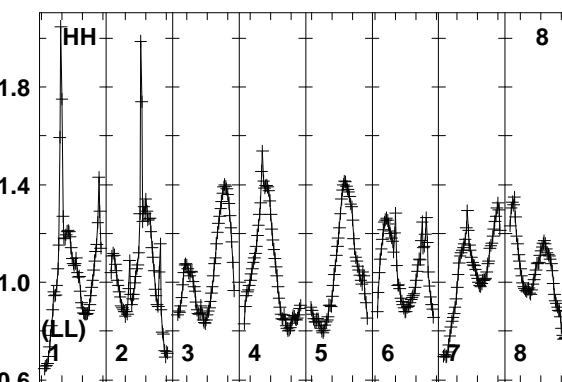
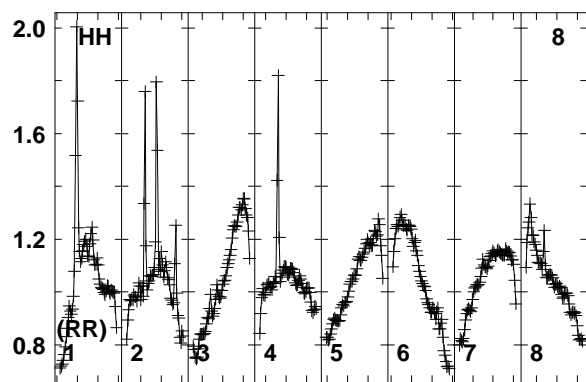
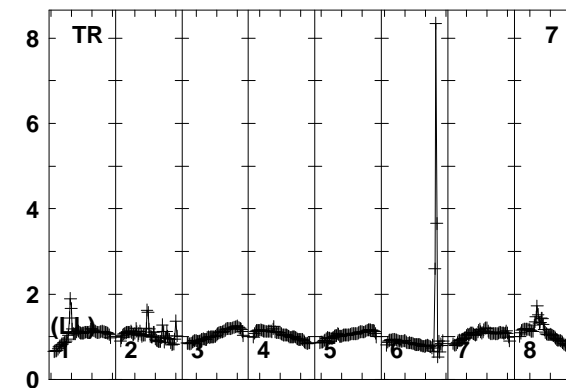
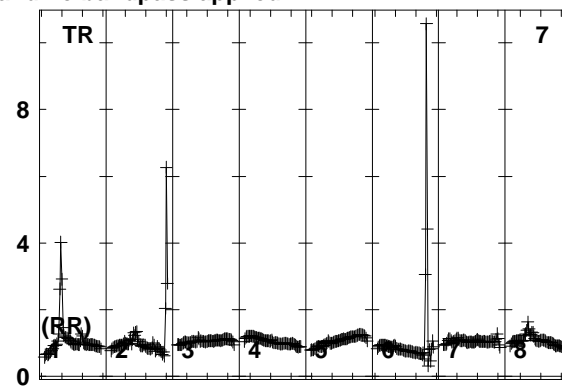
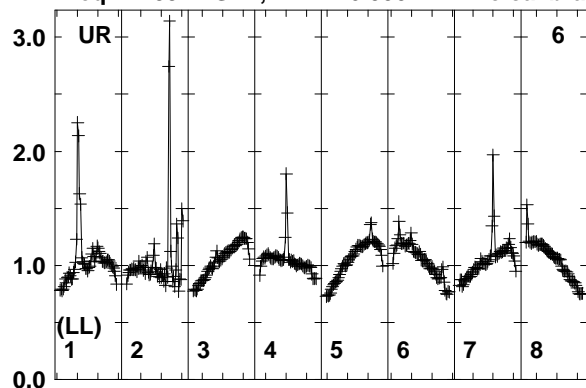

1595 1610 1630 1645 1660 1675 1690 1710
FREQ MHz

1595 1610 1630 1645 1660 1675 1690 1710
FREQ MHz

1595 1610 1630 1645 1660 1675 1690 1710
FREQ MHz

Lower frame: Real Jy
Total-power spectrum Antenna: UR (06)
Timerange: 00/04:18:31 to 00/04:21:09

Plot file version 160 created 04-NOV-2019 14:14:12

W2246-0526 EY034.UVDATA.1

Freq = 1.5947 GHz, Bw = 16.000 MH No calibration applied and no bandpass applied

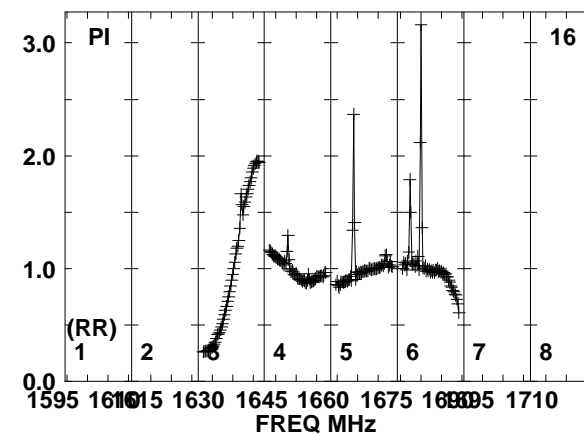
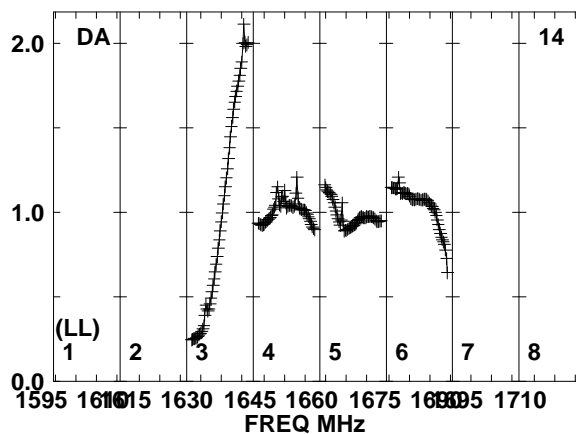
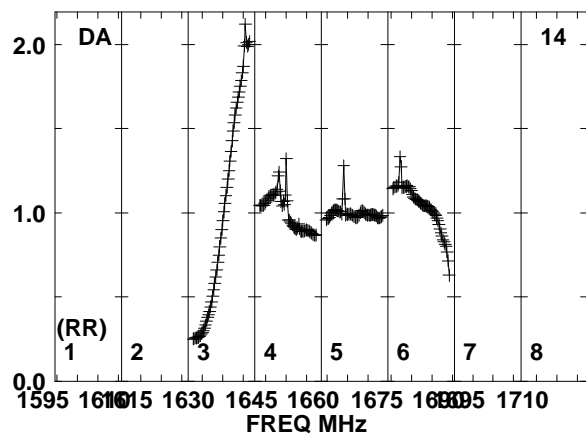
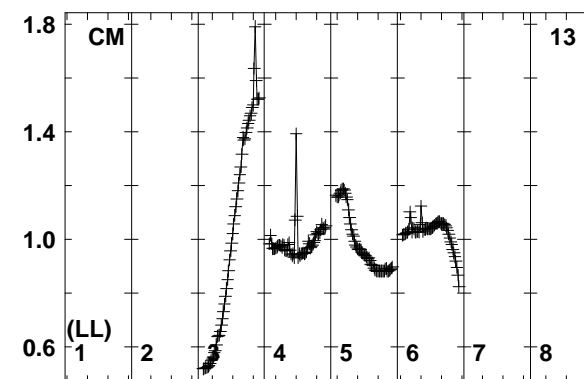
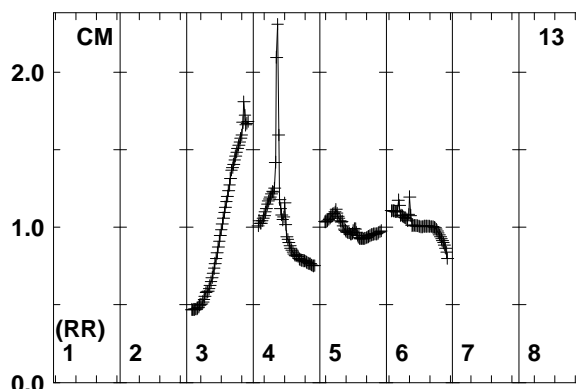
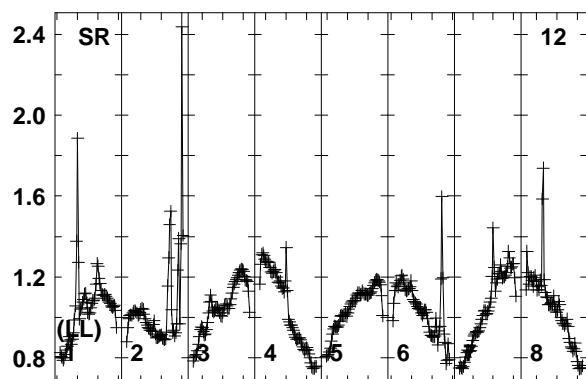
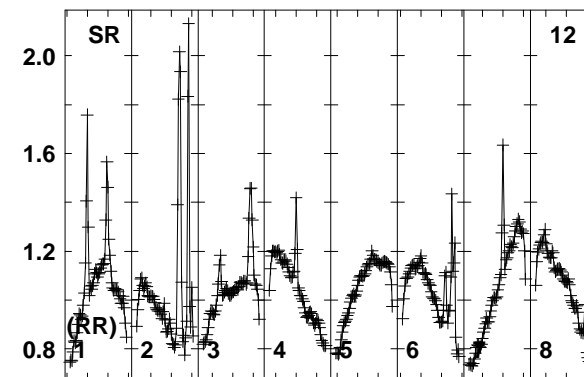
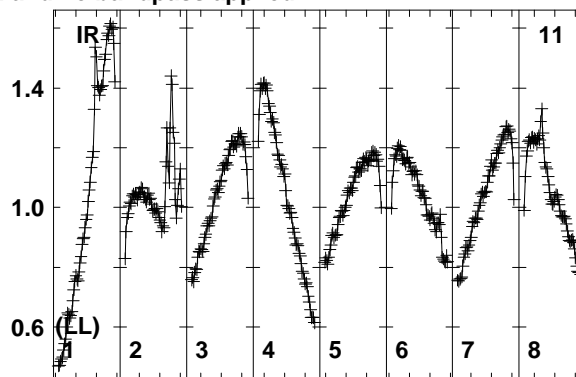
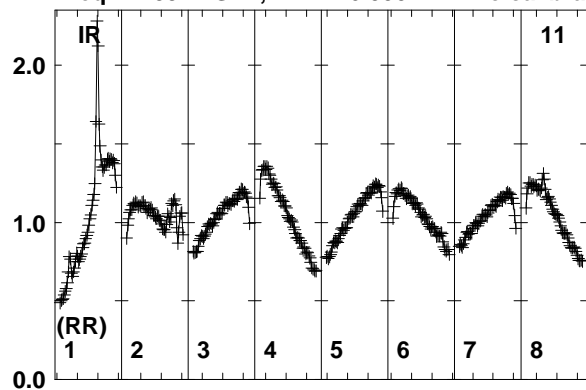

Lower frame: Real Jy
Total-power spectrum Antenna: IR (11)
Timerange: 00/04:18:31 to 00/04:21:09

Plot file version 161 created 04-NOV-2019 14:14:12
W2246-0526 EY034.UVDATA.1
Freq = 1.5947 GHz, Bw = 16.000 MH No calibration applied and no bandpass applied

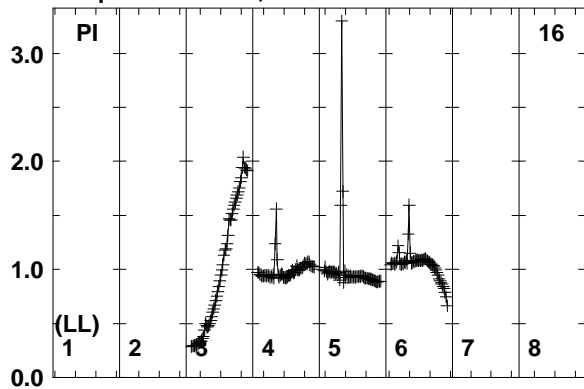

Lower frame: Real Jy
Total-power spectrum Antenna: PI (16)
Timerange: 00/04:18:31 to 00/04:21:09

Plot file version 162 created 04-NOV-2019 14:14:12

J2248-0541 EY034.UVDATA.1

Freq = 1.5947 GHz, Bw = 16.000 MH No calibration applied and no bandpass applied

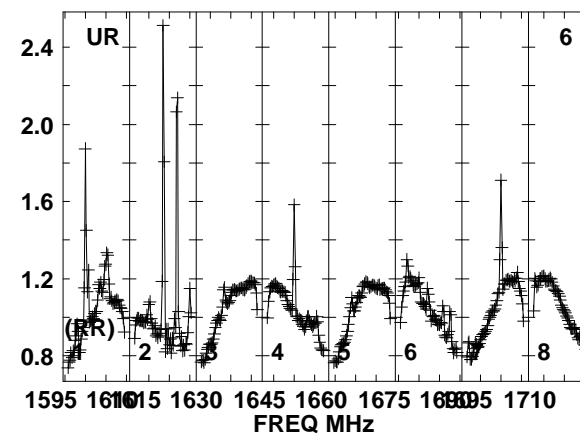
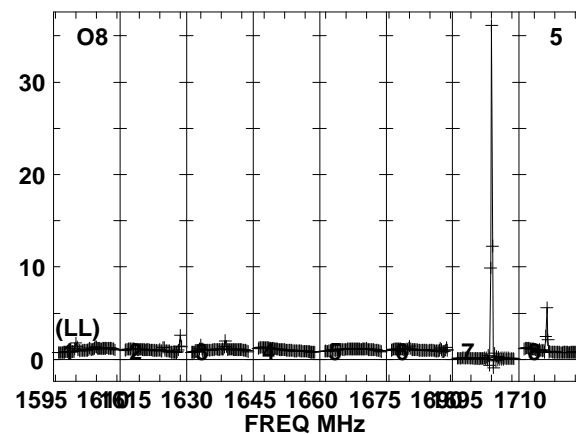
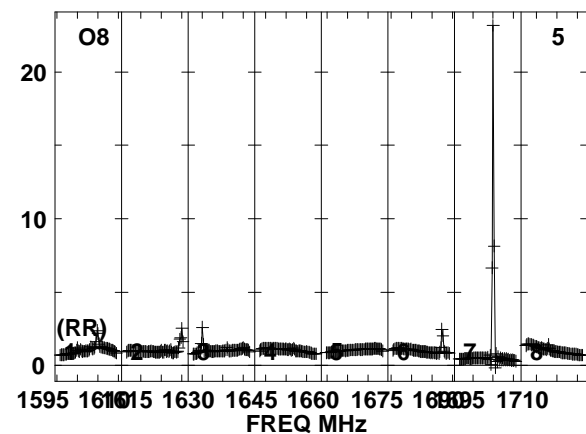
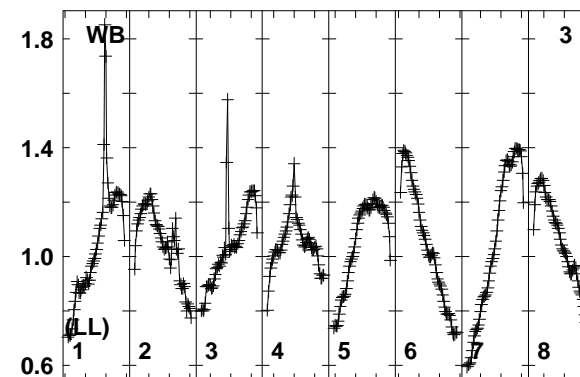
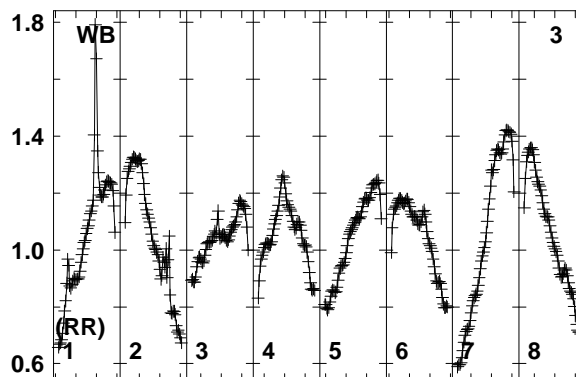
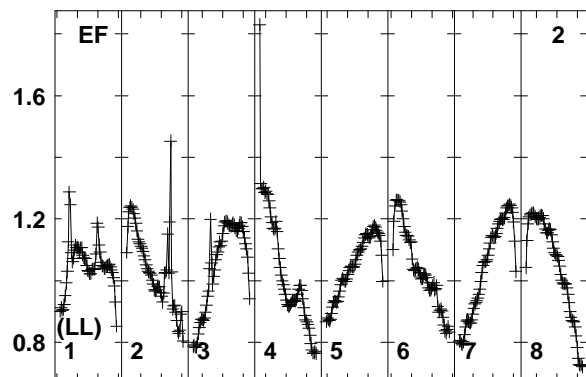
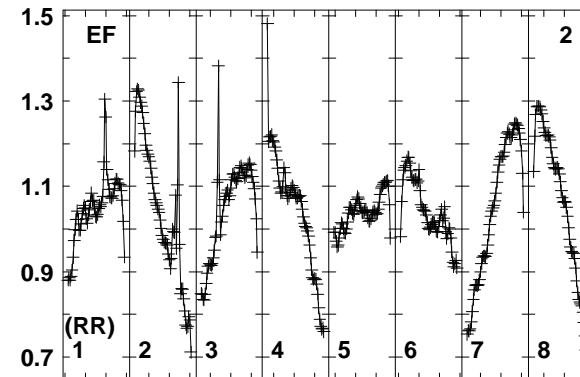
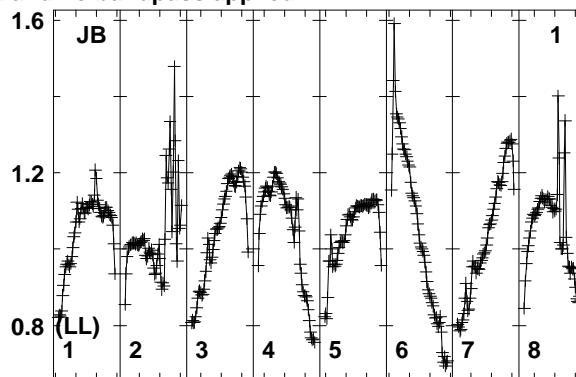
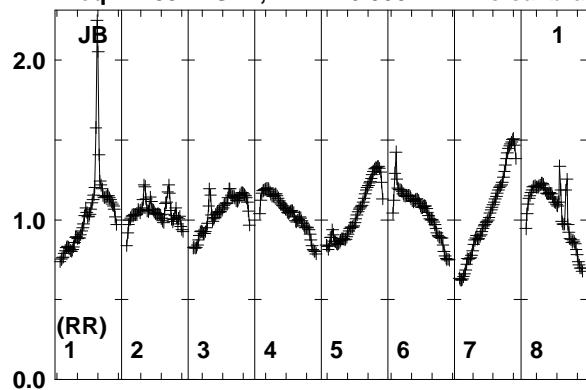

Lower frame: Real Jy
Total-power spectrum Antenna: JB (01)
Timerange: 00/04:21:26 to 00/04:22:24

Plot file version 163 created 04-NOV-2019 14:14:12

J2248-0541 EY034.UVDATA.1

Freq = 1.5947 GHz, Bw = 16.000 MH No calibration applied and no bandpass applied

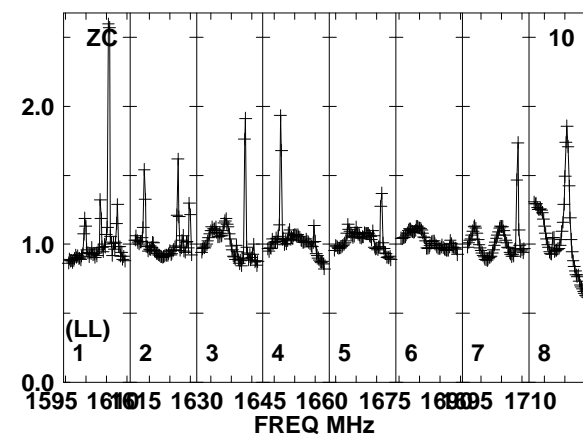
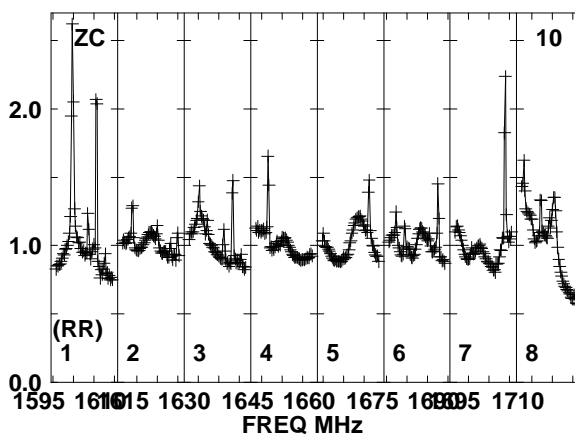
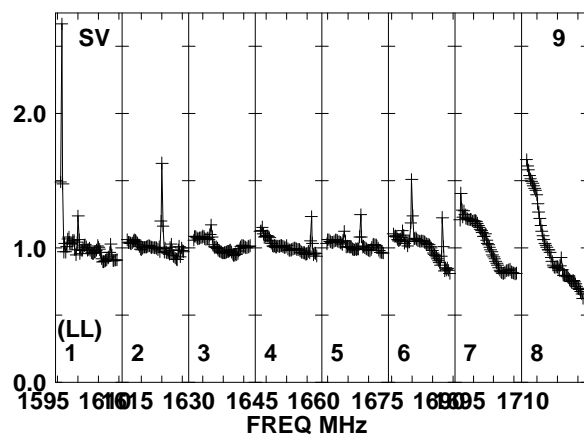
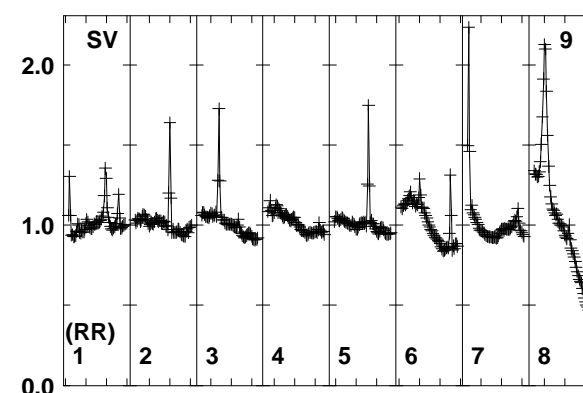
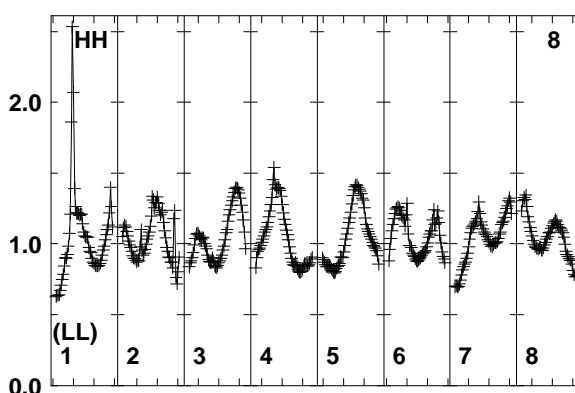
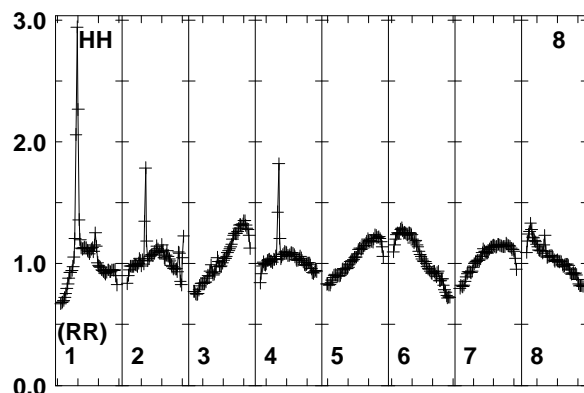
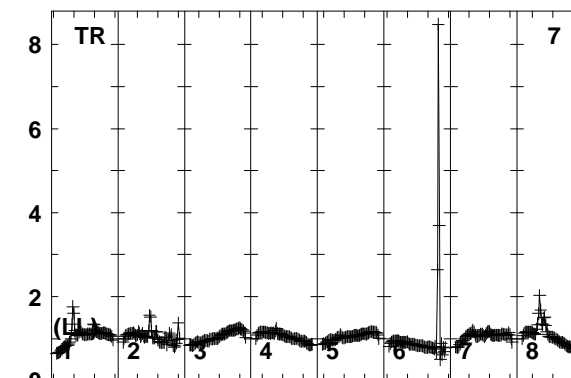
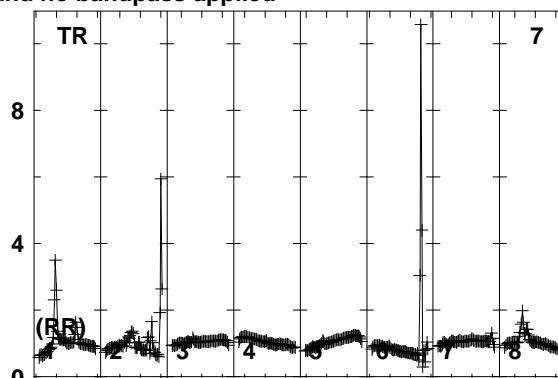
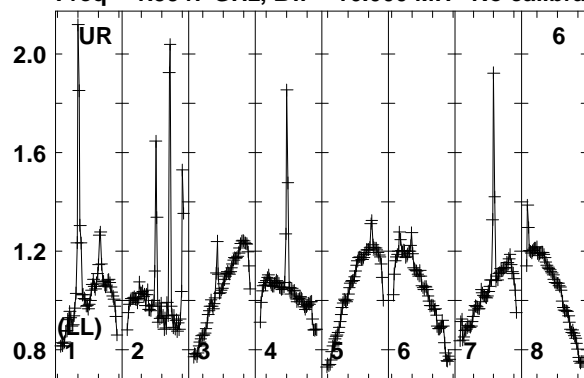

Lower frame: Real Jy
Total-power spectrum Antenna: UR (06)
Timerange: 00/04:21:26 to 00/04:22:24

Plot file version 164 created 04-NOV-2019 14:14:12

J2248-0541 EY034.UVDATA.1

Freq = 1.5947 GHz, Bw = 16.000 MH No calibration applied and no bandpass applied

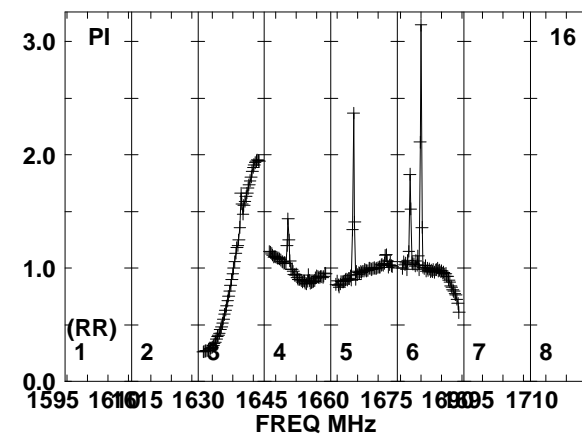
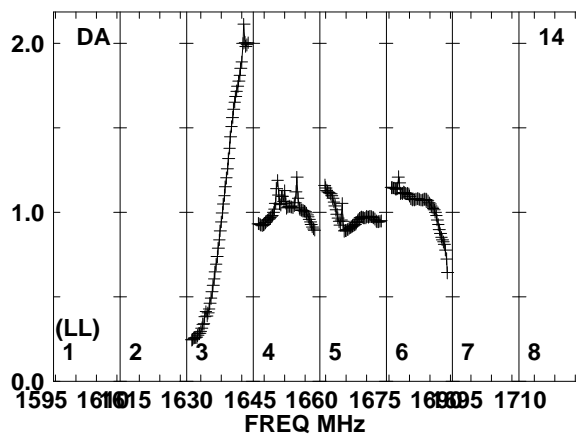
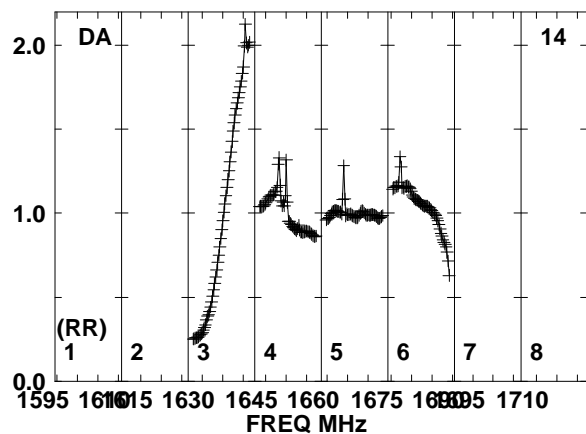
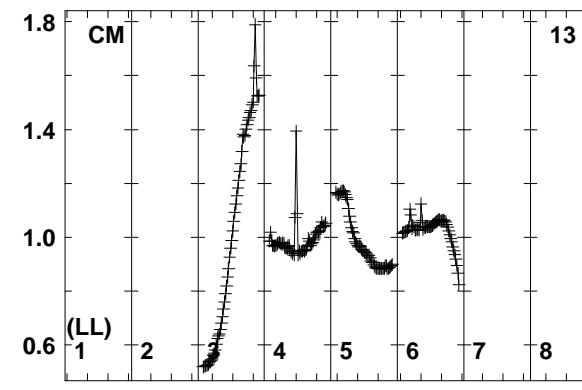
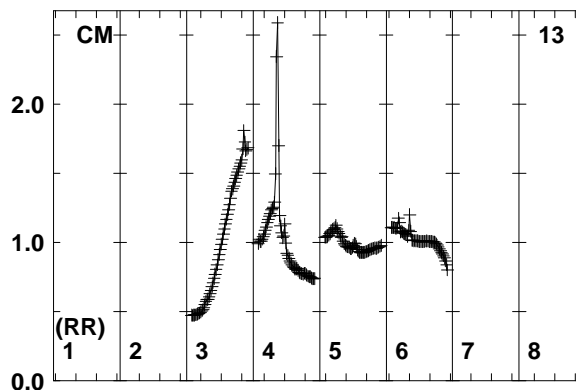
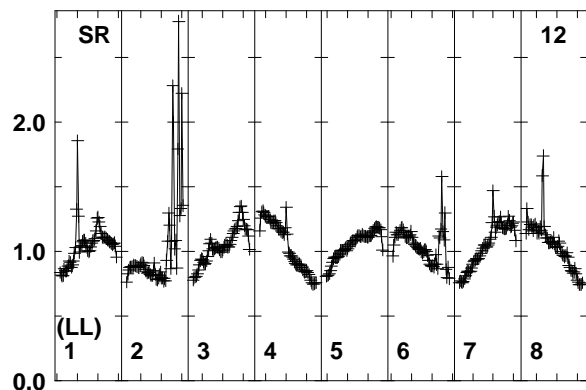
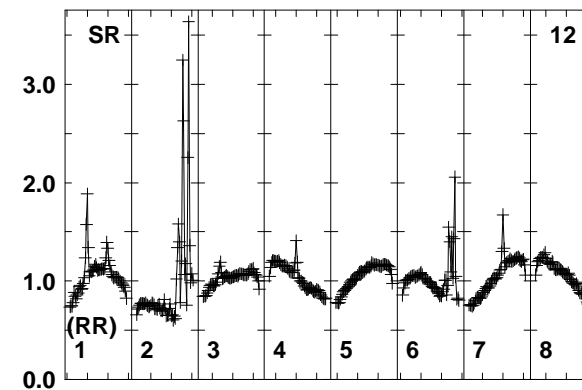
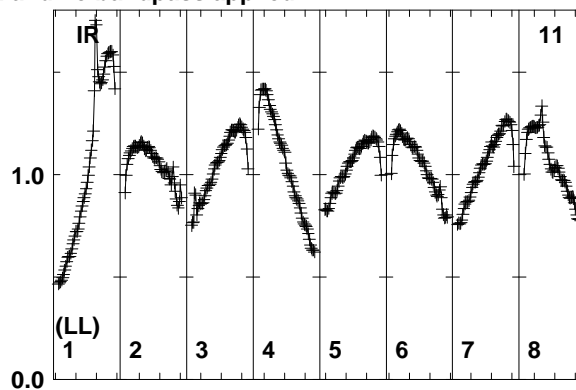
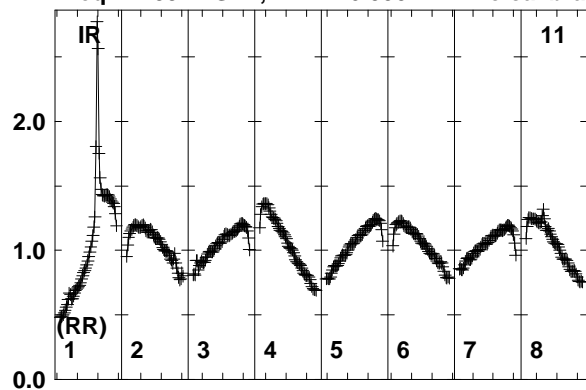

Lower frame: Real Jy
Total-power spectrum Antenna: IR (11)
Timerange: 00/04:21:26 to 00/04:22:24

Plot file version 165 created 04-NOV-2019 14:14:12
J2248-0541 EY034.UVDATA.1
Freq = 1.5947 GHz, Bw = 16.000 MH No calibration applied and no bandpass applied

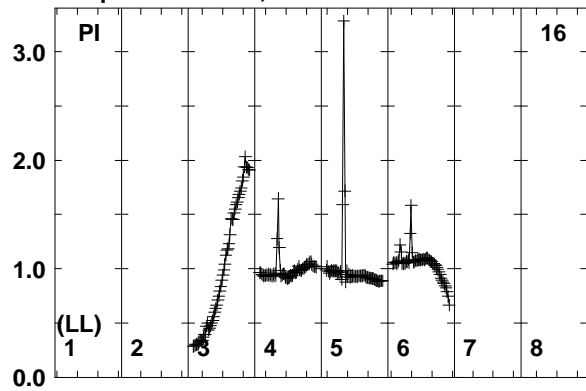

Lower frame: Real Jy
Total-power spectrum Antenna: PI (16)
Timerange: 00/04:21:26 to 00/04:22:24

Plot file version 166 created 04-NOV-2019 14:14:12

W2246-0526 EY034.UVDATA.1

Freq = 1.5947 GHz, Bw = 16.000 MH No calibration applied and no bandpass applied

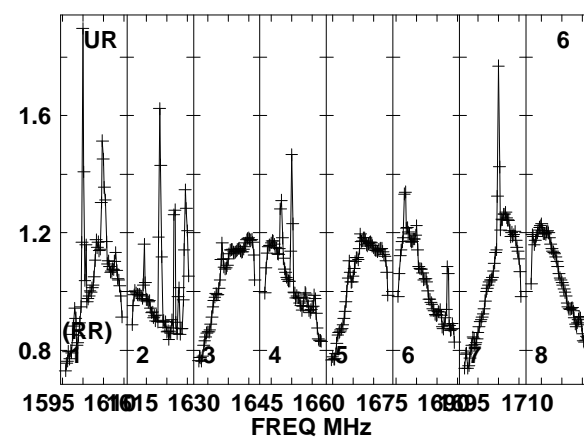
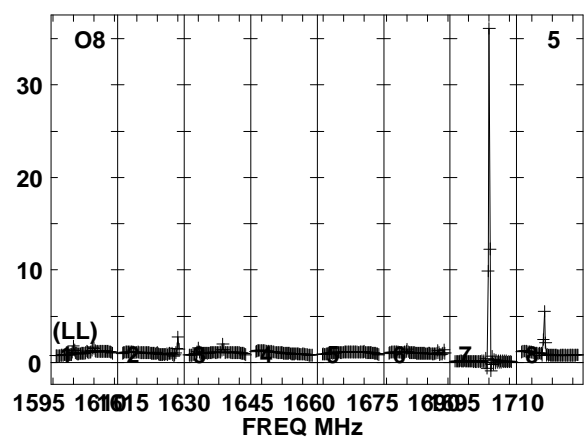
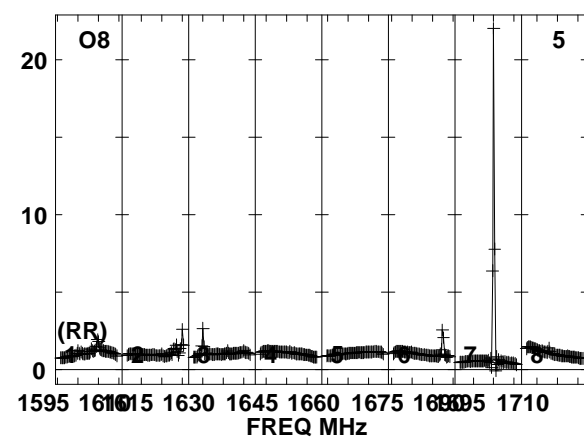
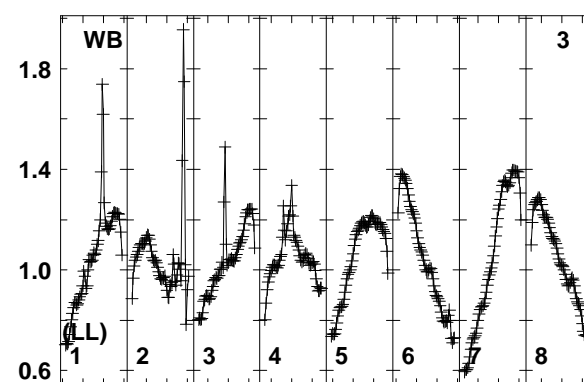
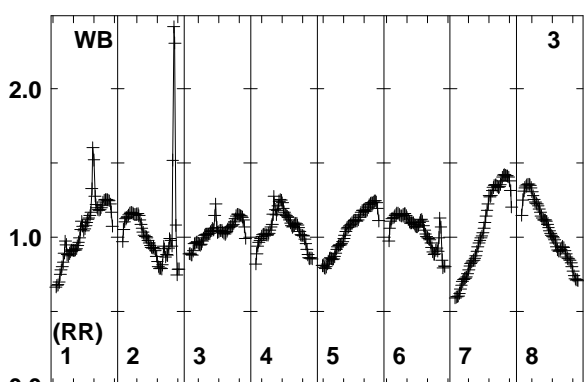
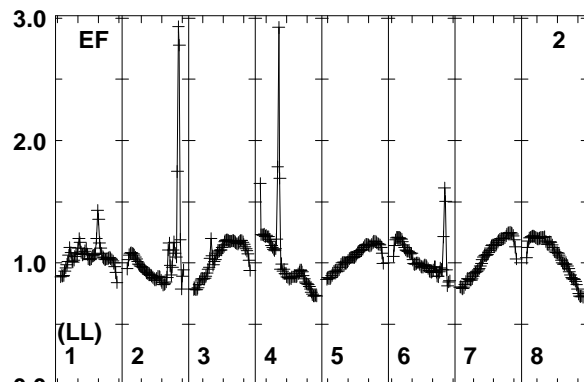
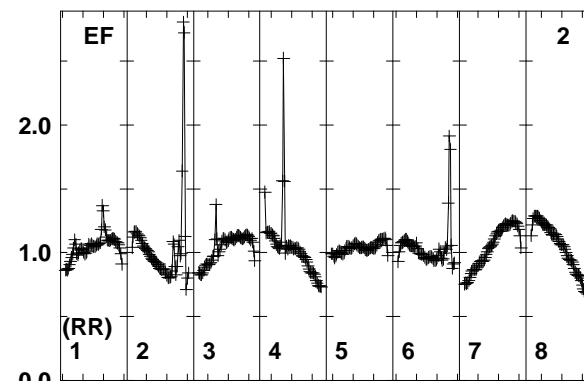
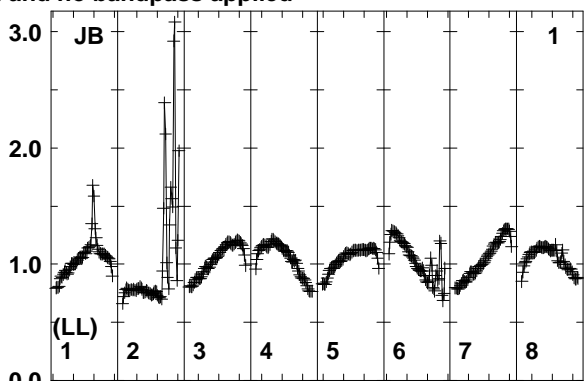
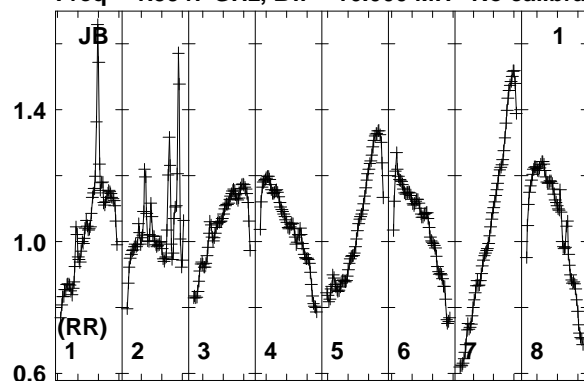

Lower frame: Real Jy
Total-power spectrum Antenna: JB (01)
Timerange: 00/04:22:26 to 00/04:25:04

Plot file version 167 created 04-NOV-2019 14:14:12

W2246-0526 EY034.UVDATA.1

Freq = 1.5947 GHz, Bw = 16.000 MH No calibration applied and no bandpass applied

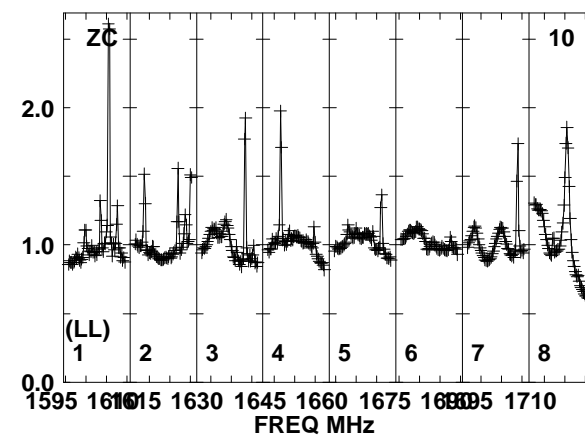
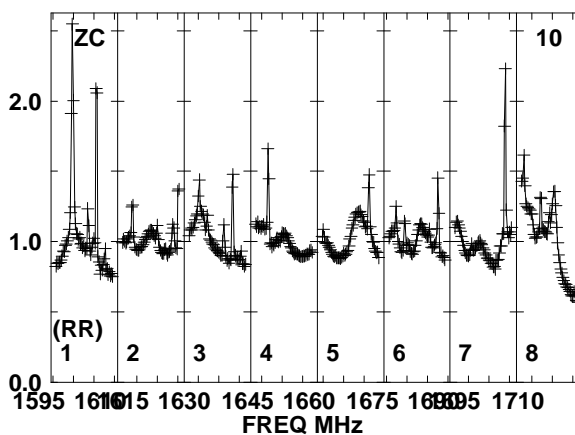
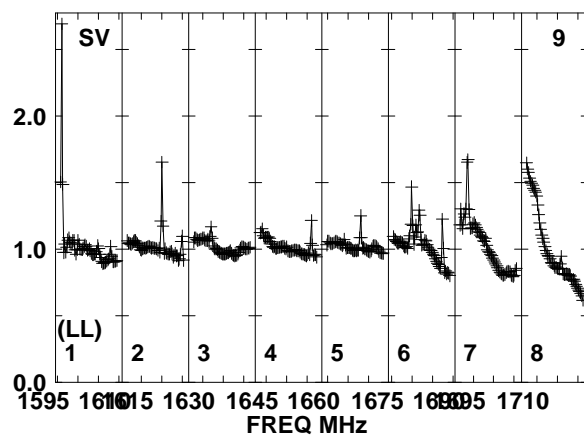
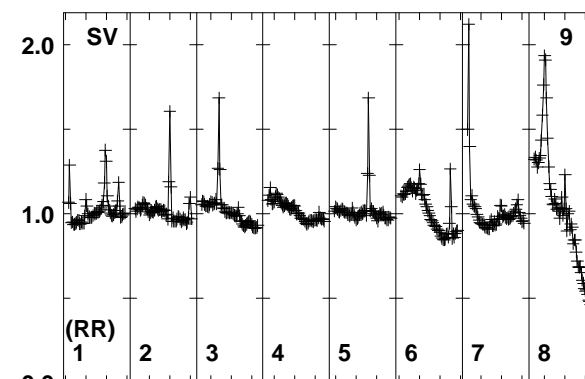
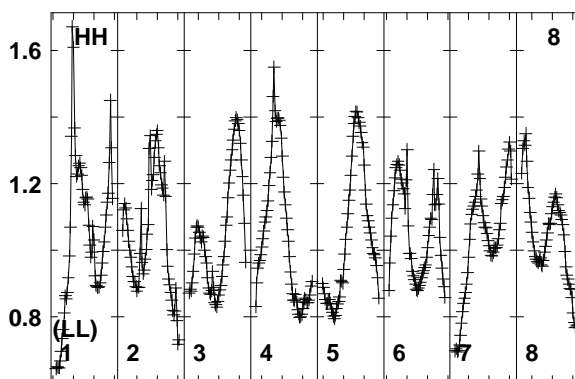
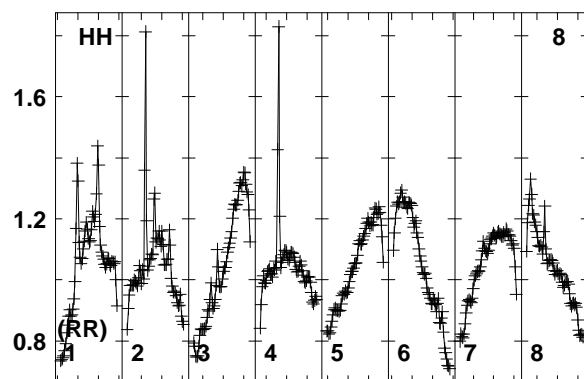
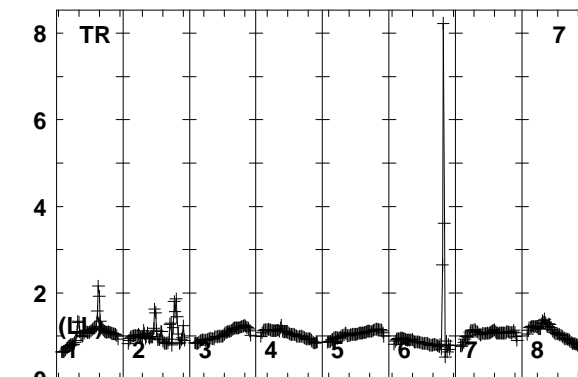
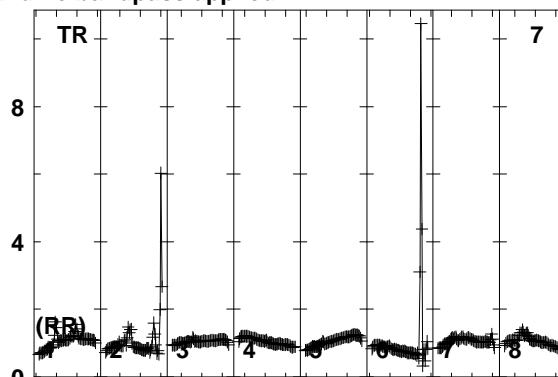
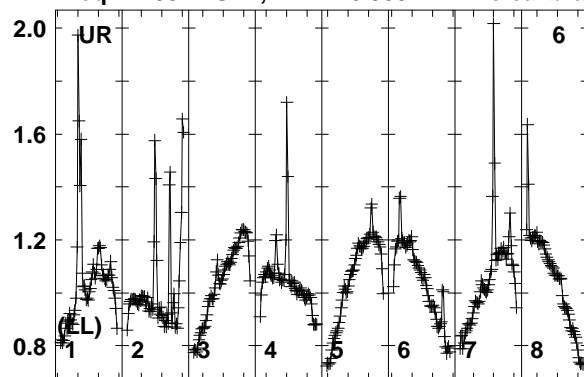

Lower frame: Real Jy
Total-power spectrum Antenna: UR (06)
Timerange: 00/04:22:26 to 00/04:25:04

Plot file version 168 created 04-NOV-2019 14:14:12

W2246-0526 EY034.UVDATA.1

Freq = 1.5947 GHz, Bw = 16.000 MH No calibration applied and no bandpass applied

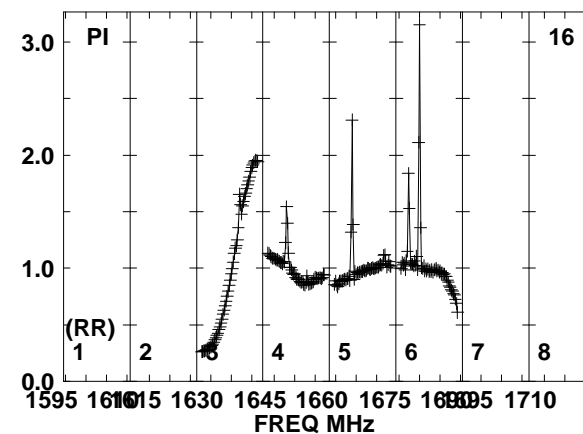
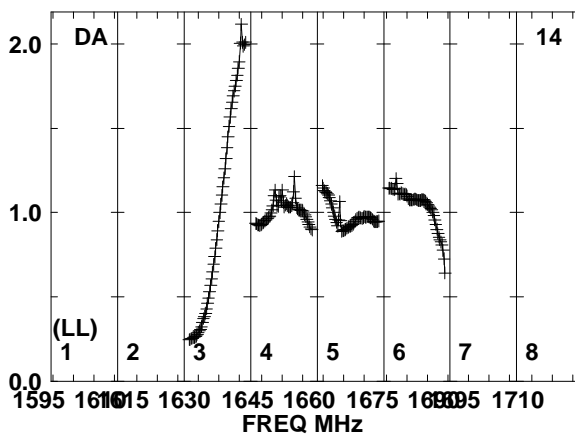
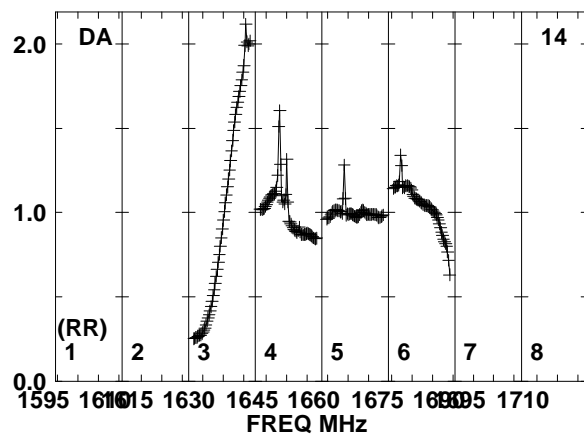
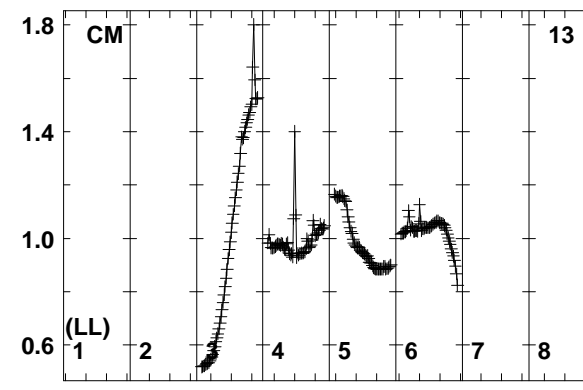
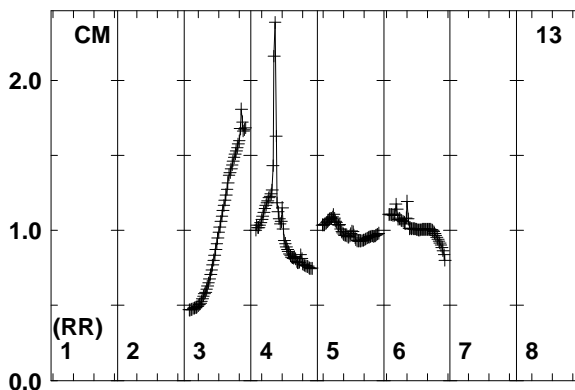
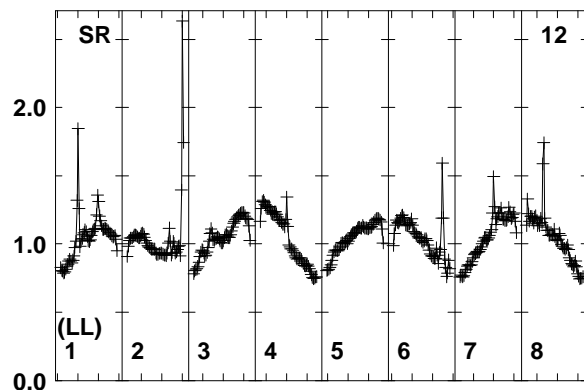
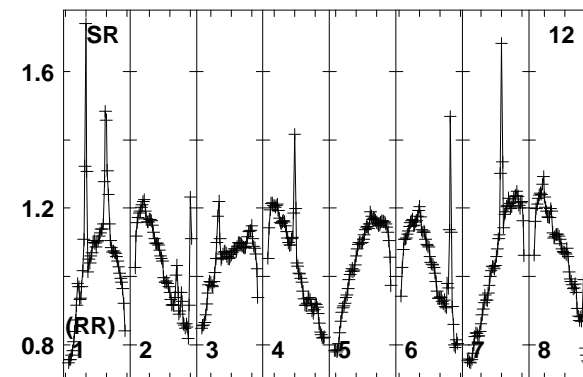
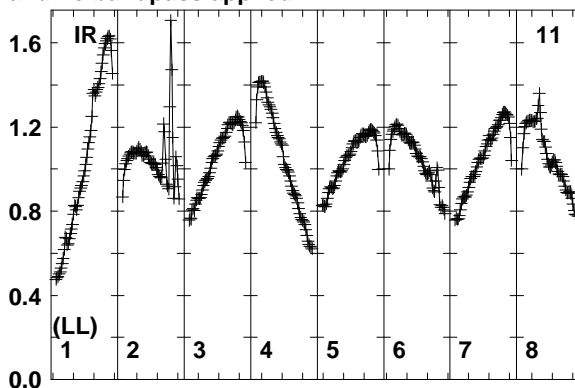
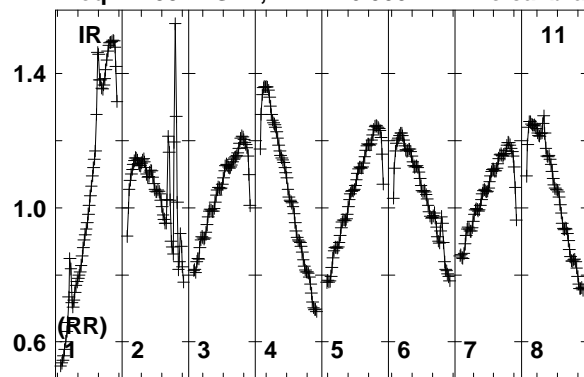

Lower frame: Real Jy
Total-power spectrum Antenna: IR (11)
Timerange: 00/04:22:26 to 00/04:25:04

Plot file version 169 created 04-NOV-2019 14:14:12
W2246-0526 EY034.UVDATA.1
Freq = 1.5947 GHz, Bw = 16.000 MH No calibration applied and no bandpass applied

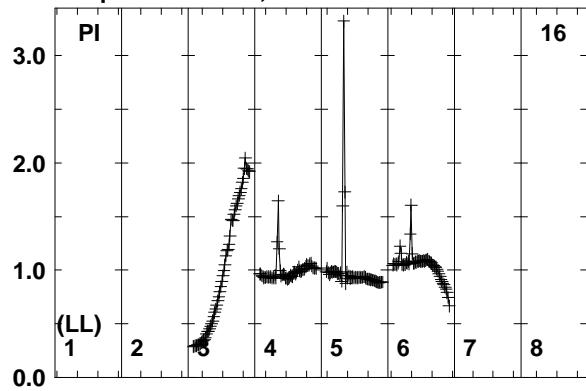

Lower frame: Real Jy
Total-power spectrum Antenna: PI (16)
Timerange: 00/04:22:26 to 00/04:25:04

Plot file version 170 created 04-NOV-2019 14:14:12

J2248-0541 EY034.UVDATA.1

Freq = 1.5947 GHz, Bw = 16.000 MH No calibration applied and no bandpass applied

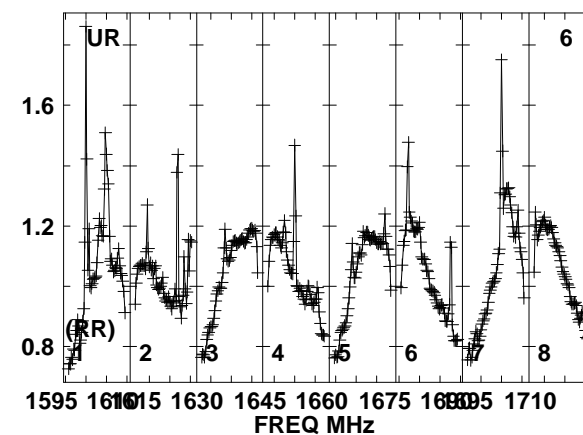
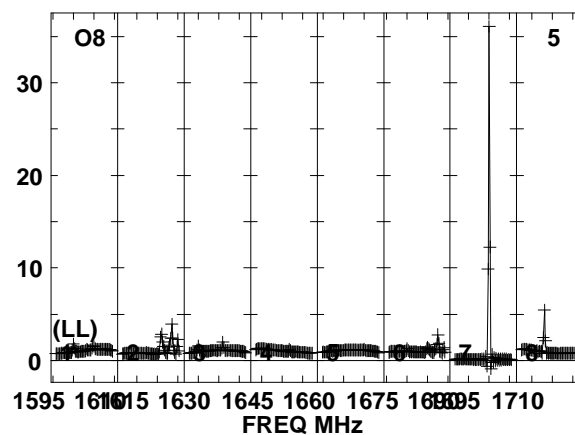
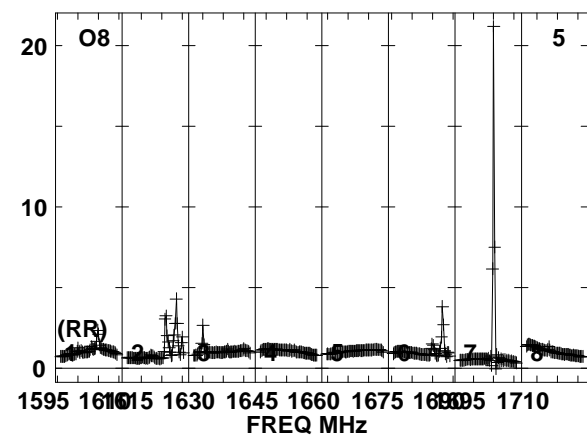
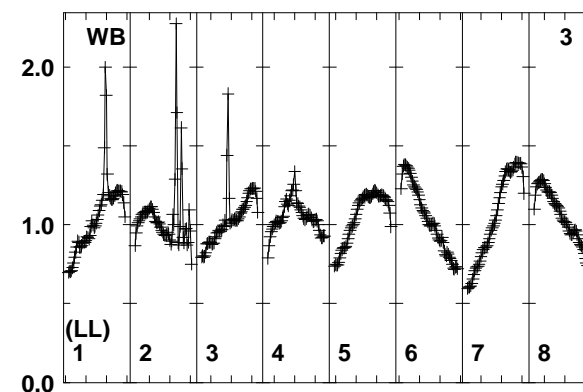
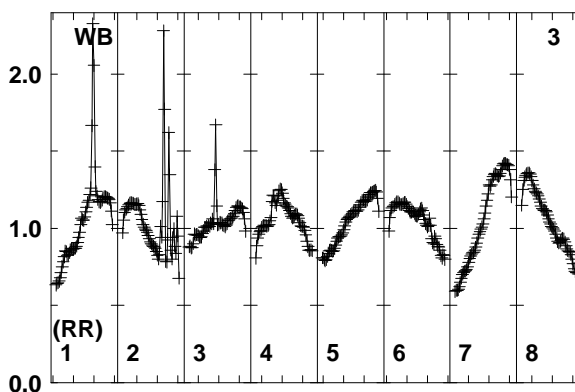
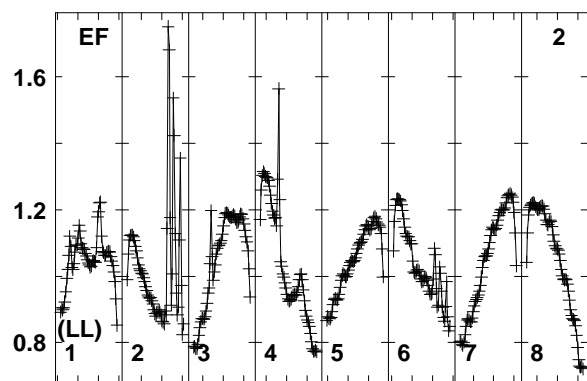
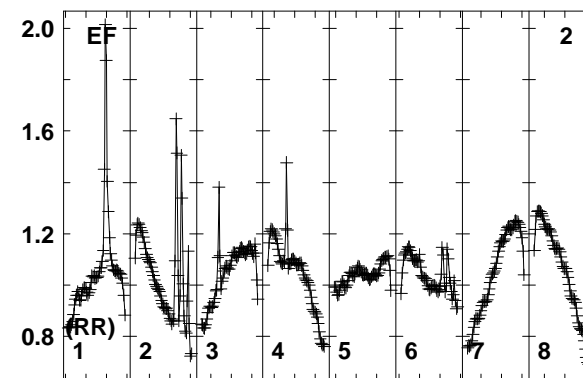
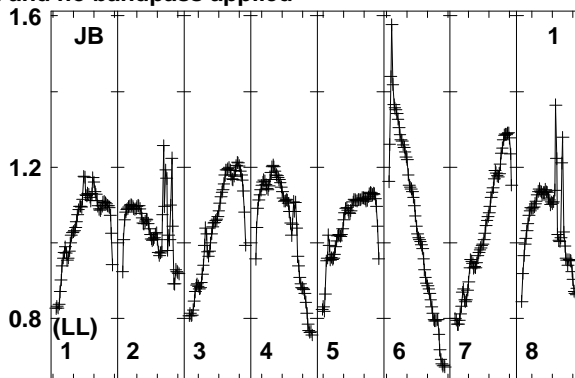
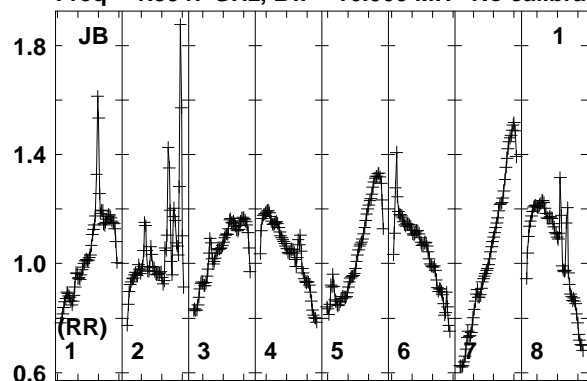

Lower frame: Real Jy
Total-power spectrum Antenna: JB (01)
Timerange: 00/04:25:21 to 00/04:26:19

Plot file version 171 created 04-NOV-2019 14:14:13

J2248-0541 EY034.UVDATA.1

Freq = 1.5947 GHz, Bw = 16.000 MH No calibration applied and no bandpass applied

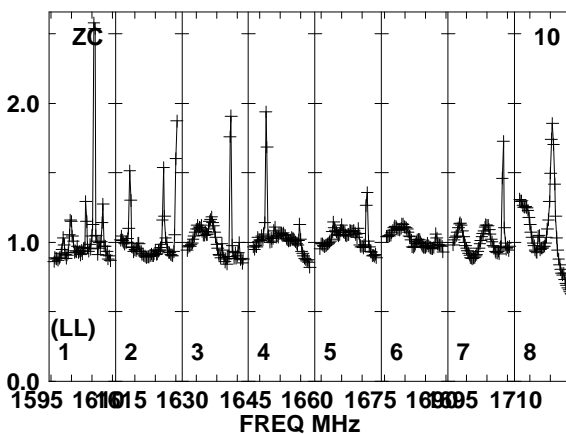
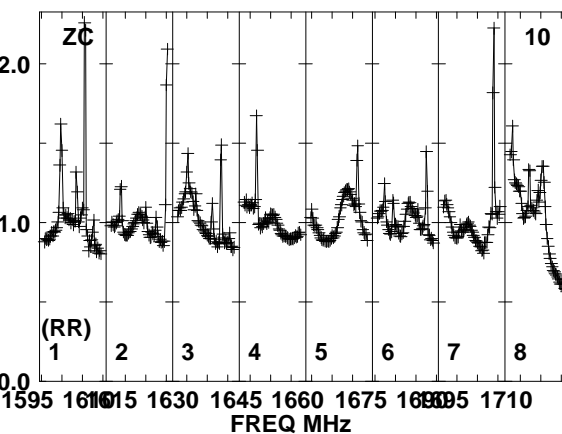
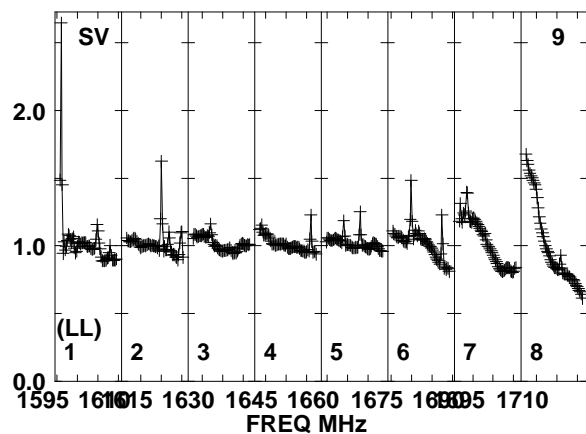
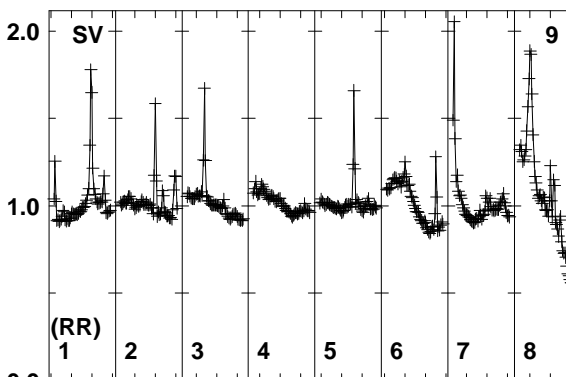
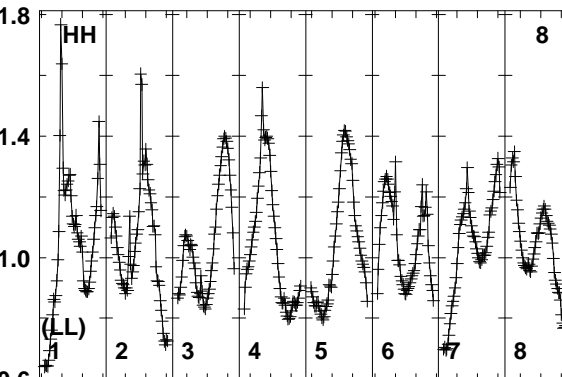
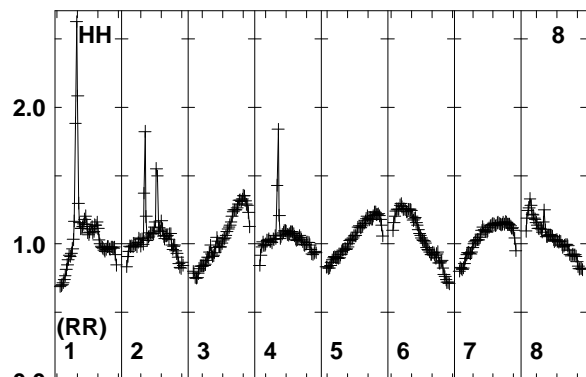
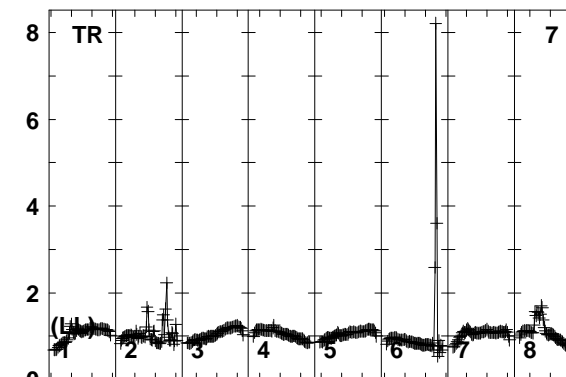
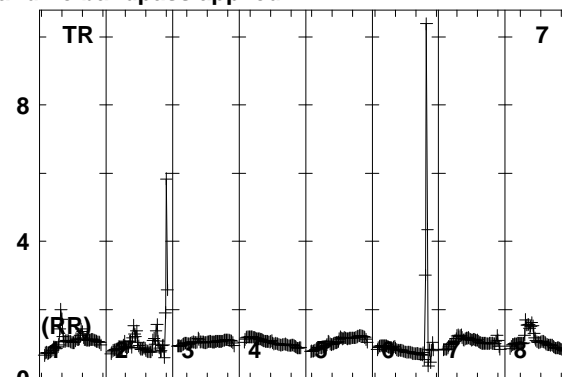
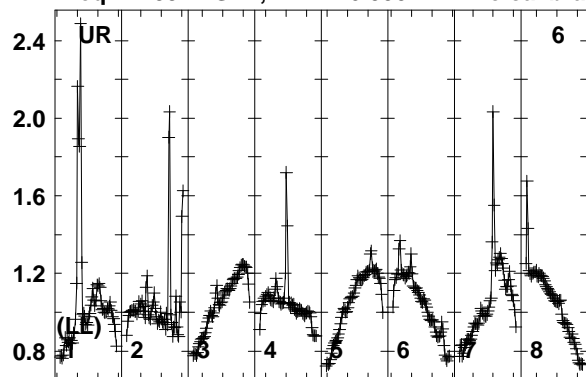

Lower frame: Real Jy
Total-power spectrum Antenna: UR (06)
Timerange: 00/04:25:21 to 00/04:26:19

Plot file version 172 created 04-NOV-2019 14:14:13

J2248-0541 EY034.UVDATA.1

Freq = 1.5947 GHz, Bw = 16.000 MH No calibration applied and no bandpass applied

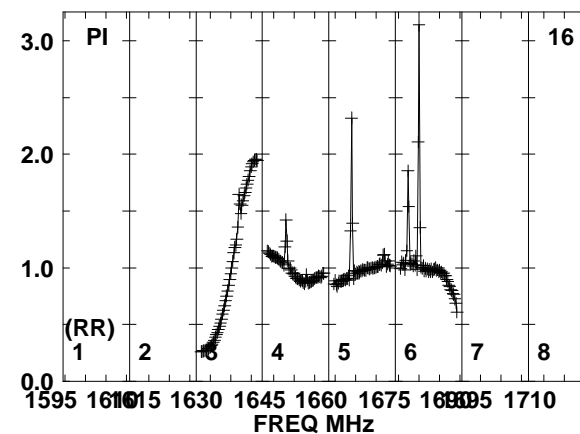
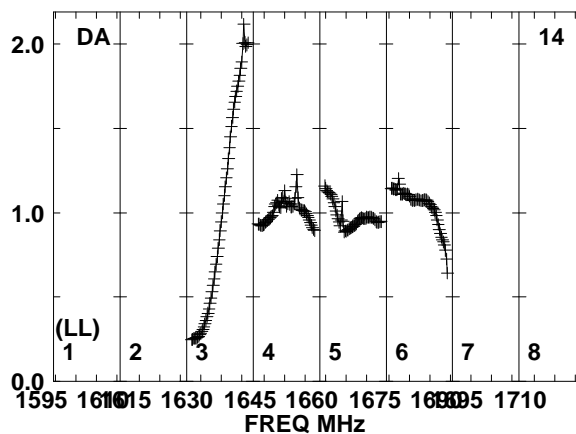
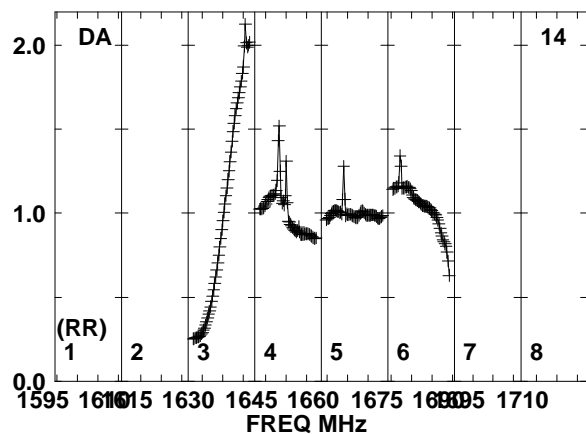
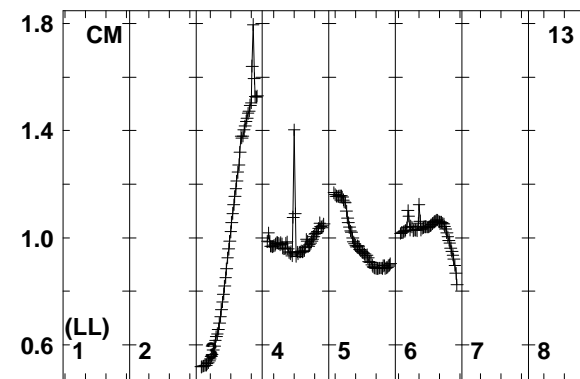
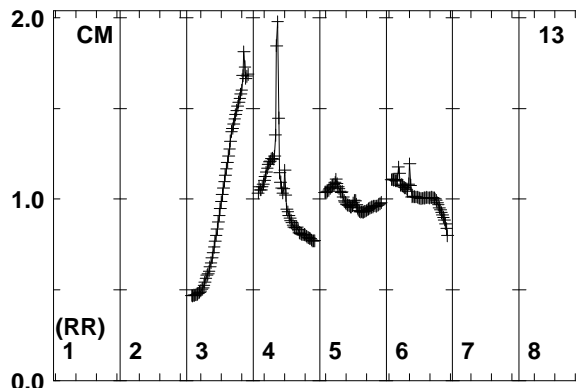
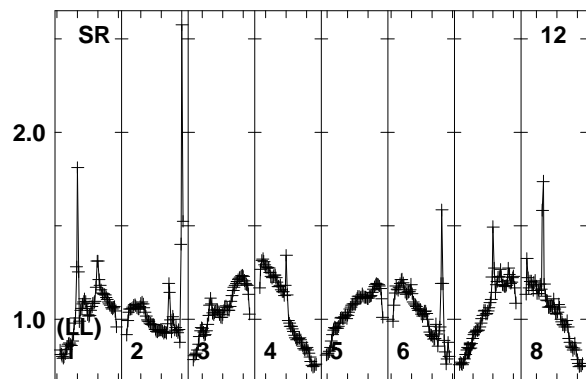
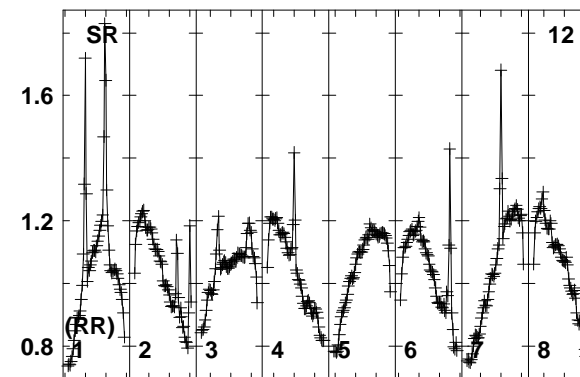
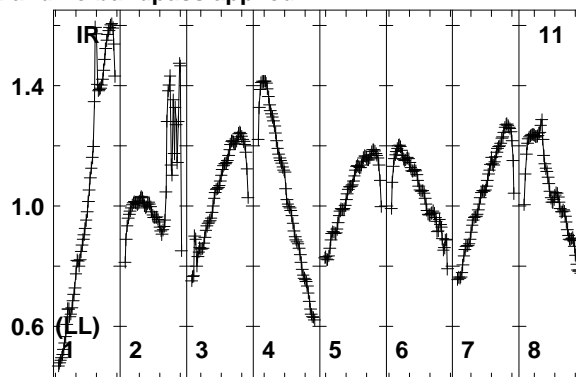
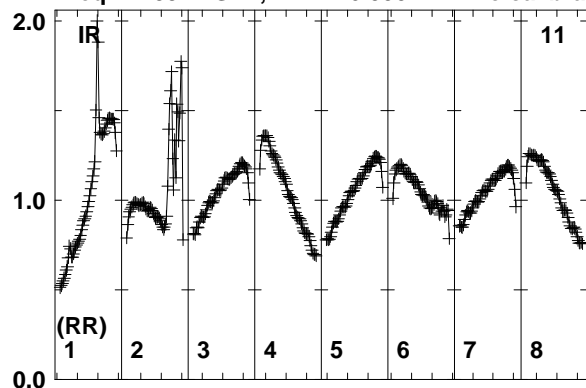

Lower frame: Real Jy
Total-power spectrum Antenna: IR (11)
Timerange: 00/04:25:21 to 00/04:26:19

Plot file version 173 created 04-NOV-2019 14:14:13
J2248-0541 EY034.UVDATA.1
Freq = 1.5947 GHz, Bw = 16.000 MH No calibration applied and no bandpass applied

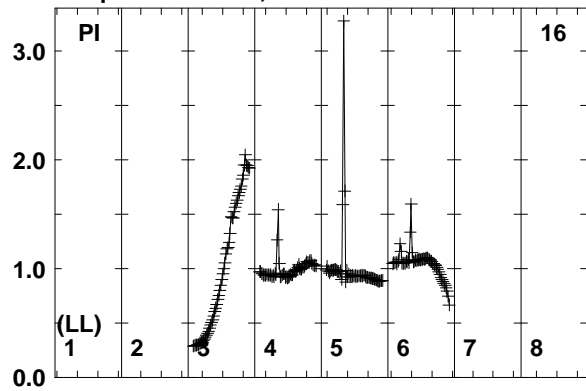

Lower frame: Real Jy
Total-power spectrum Antenna: PI (16)
Timerange: 00/04:25:21 to 00/04:26:19

Plot file version 174 created 04-NOV-2019 14:14:13

W2246-0526 EY034.UVDATA.1

Freq = 1.5947 GHz, Bw = 16.000 MH No calibration applied and no bandpass applied

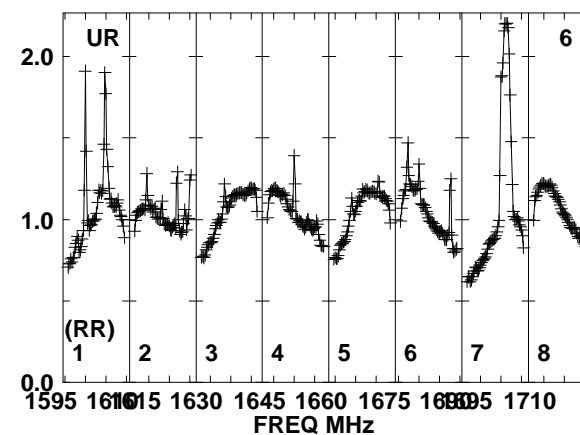
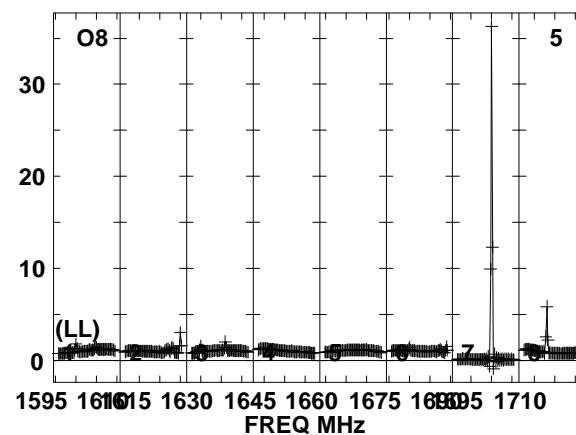
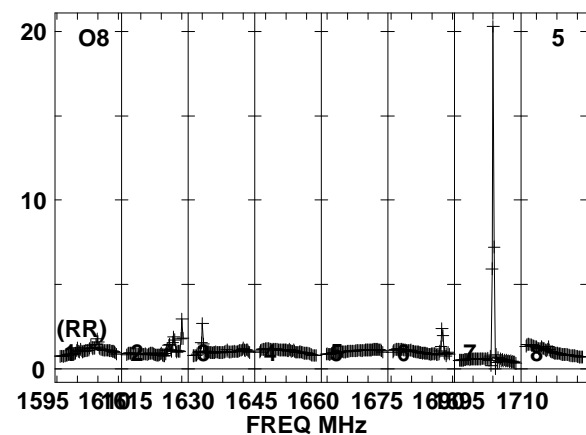
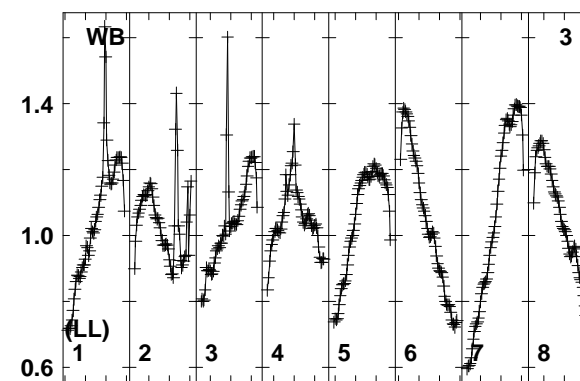
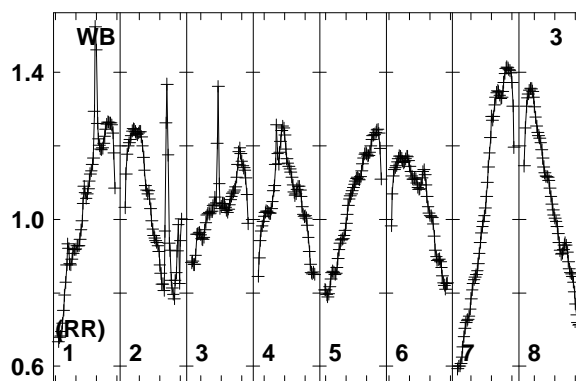
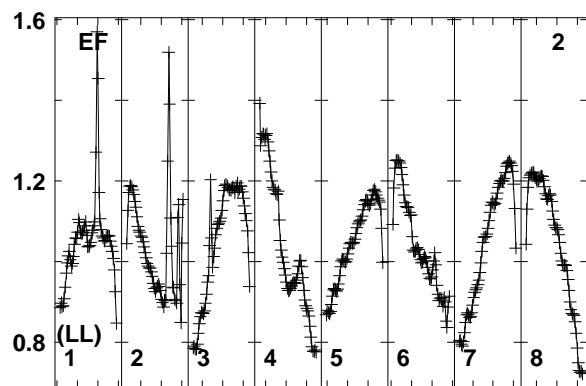
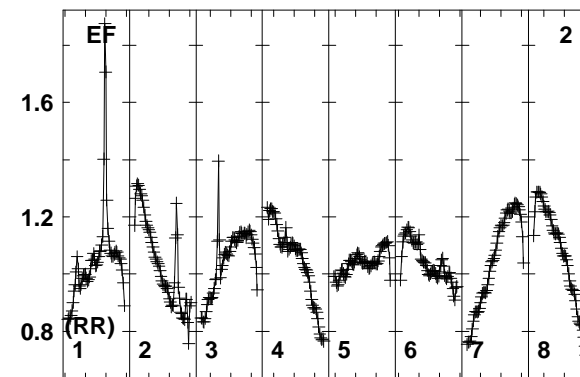
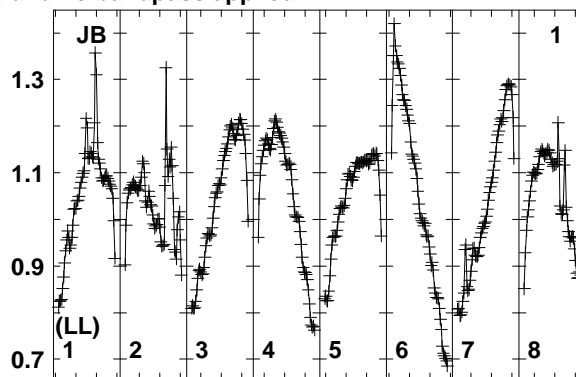
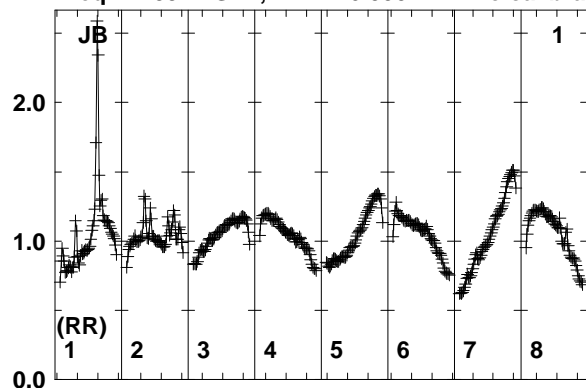

Lower frame: Real Jy
Total-power spectrum Antenna: JB (01)
Timerange: 00/04:26:21 to 00/04:28:59

Plot file version 175 created 04-NOV-2019 14:14:13

W2246-0526 EY034.UVDATA.1

Freq = 1.5947 GHz, Bw = 16.000 MH No calibration applied and no bandpass applied

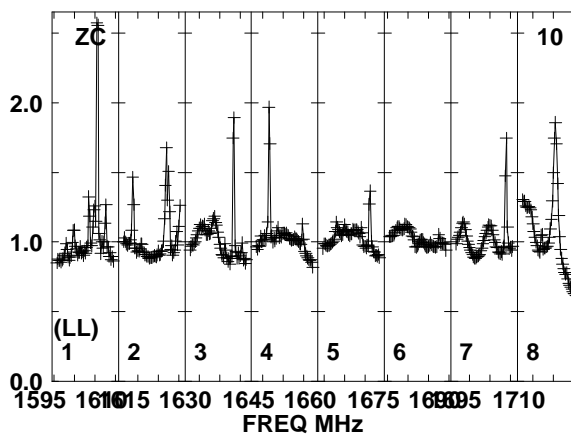
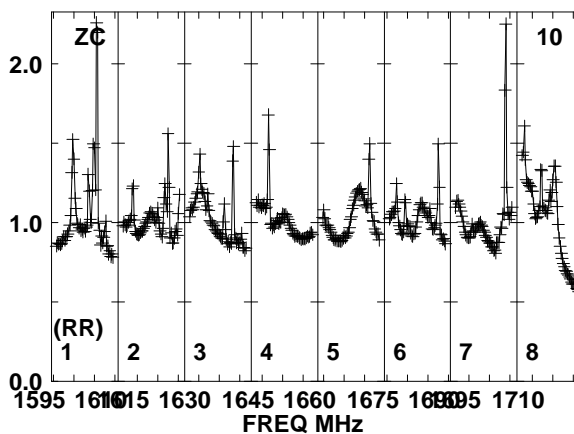
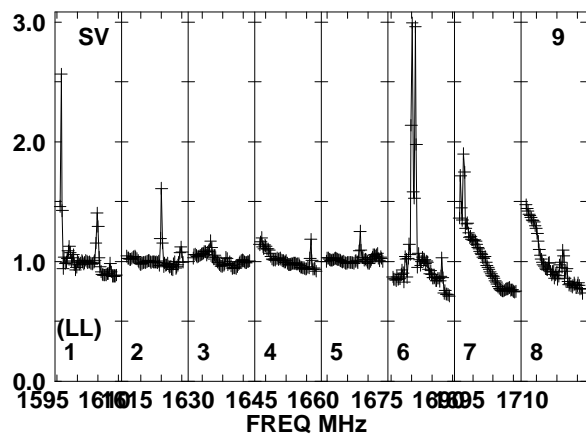
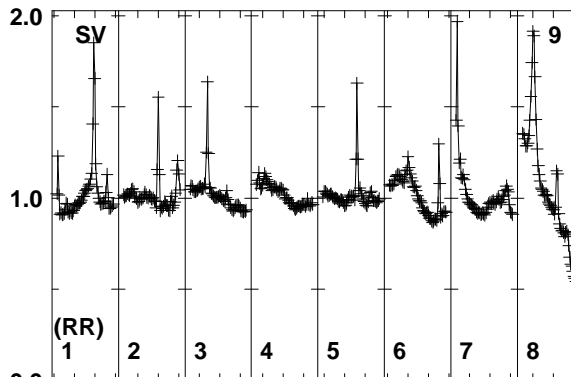
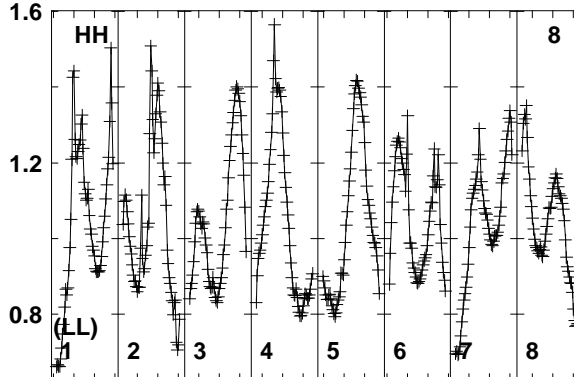
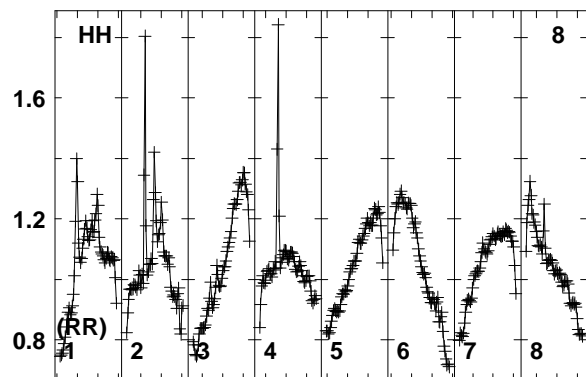
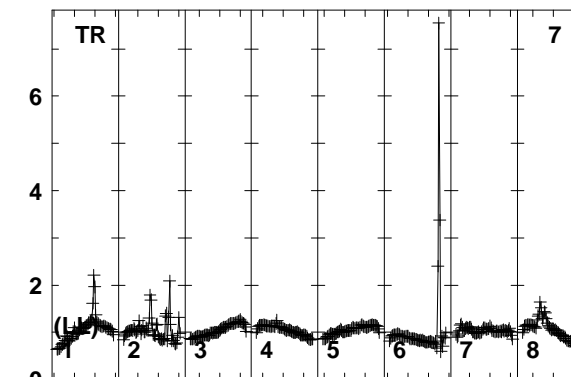
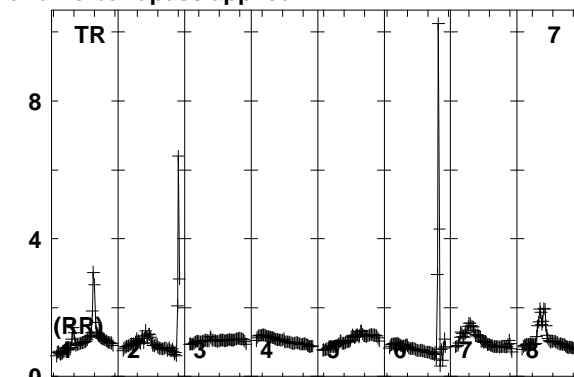
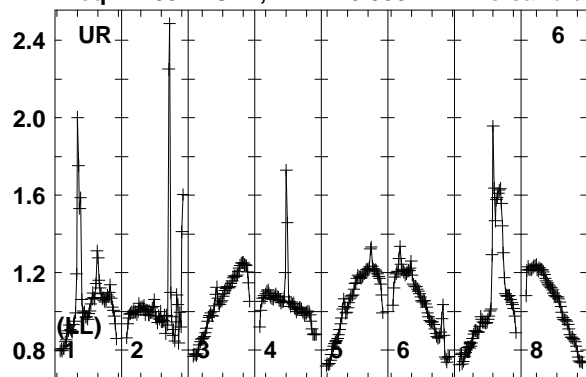

Lower frame: Real Jy
Total-power spectrum Antenna: UR (06)
Timerange: 00/04:26:21 to 00/04:28:59

Plot file version 176 created 04-NOV-2019 14:14:13

W2246-0526 EY034.UVDATA.1

Freq = 1.5947 GHz, Bw = 16.000 MH No calibration applied and no bandpass applied

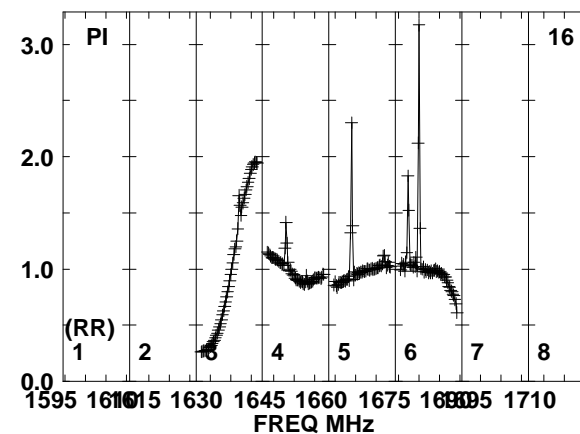
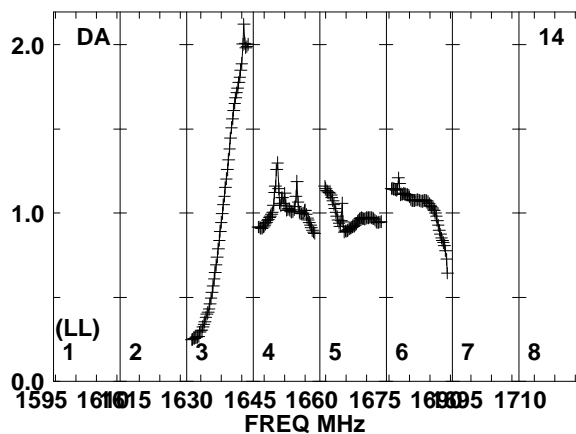
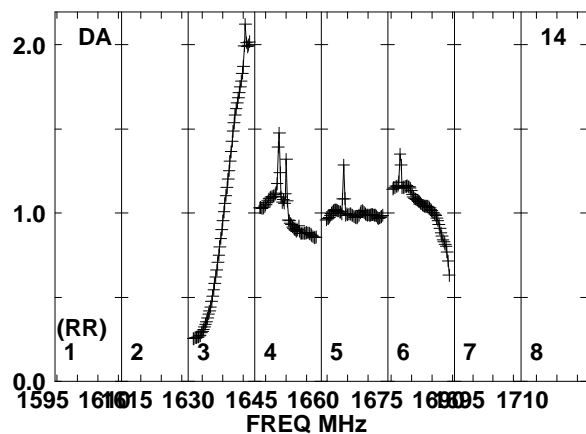
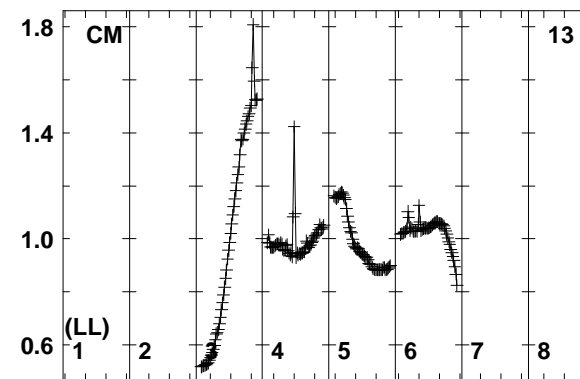
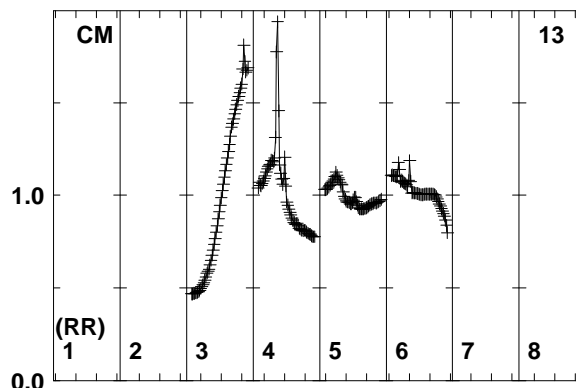
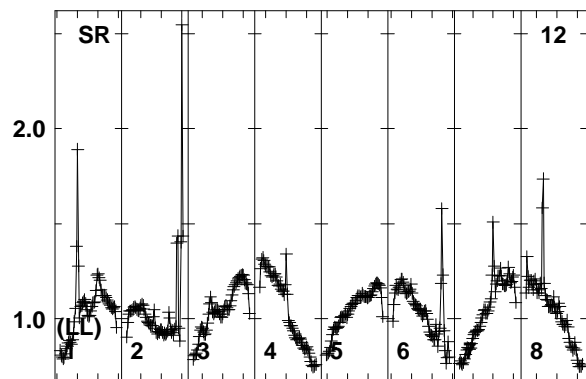
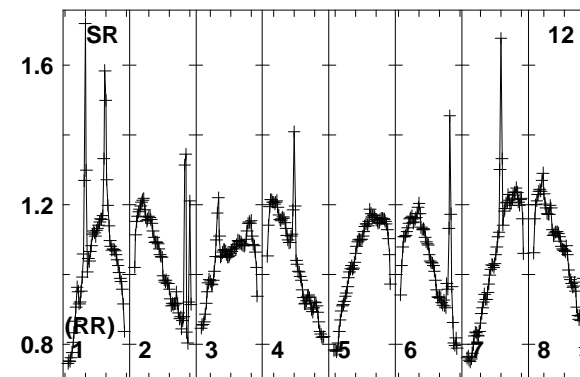
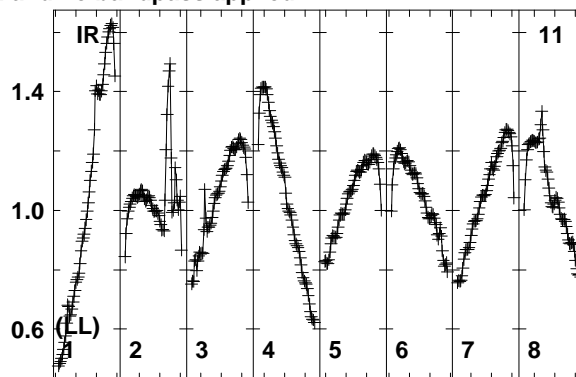
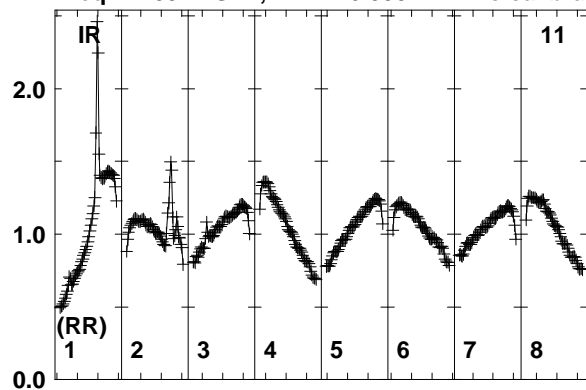

Lower frame: Real Jy
Total-power spectrum Antenna: IR (11)
Timerange: 00/04:26:21 to 00/04:28:59

Plot file version 177 created 04-NOV-2019 14:14:13
W2246-0526 EY034.UVDATA.1
Freq = 1.5947 GHz, Bw = 16.000 MH No calibration applied and no bandpass applied

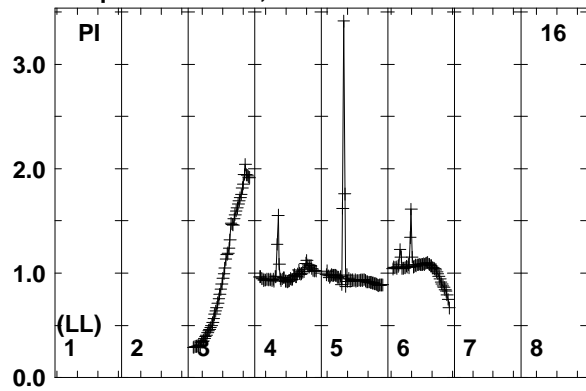

Lower frame: Real Jy
Total-power spectrum Antenna: PI (16)
Timerange: 00/04:26:21 to 00/04:28:59

Plot file version 178 created 04-NOV-2019 14:14:13

J2248-0541 EY034.UVDATA.1

Freq = 1.5947 GHz, Bw = 16.000 MH No calibration applied and no bandpass applied

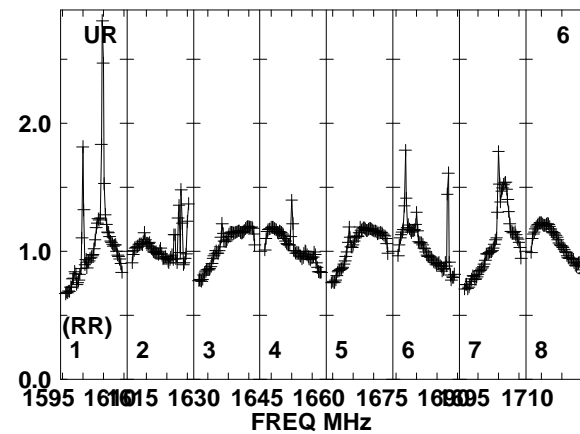
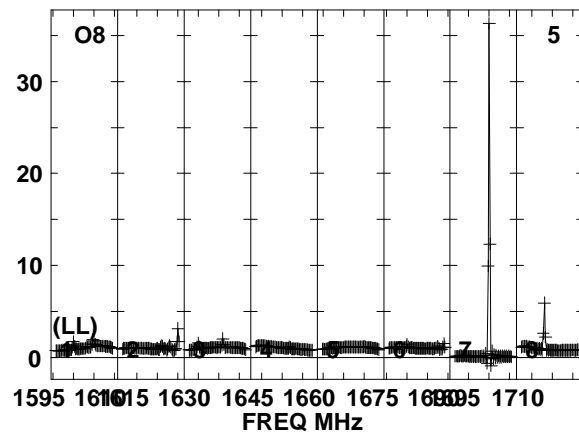
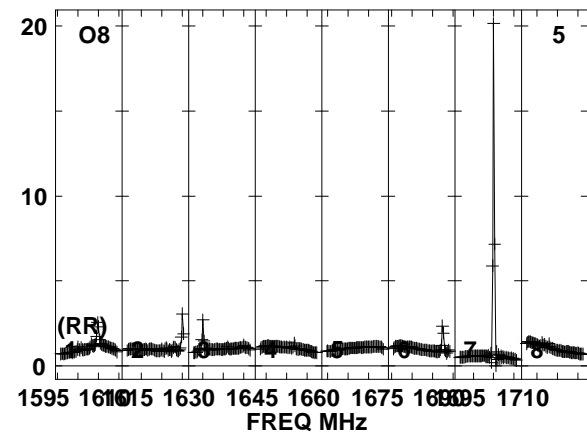
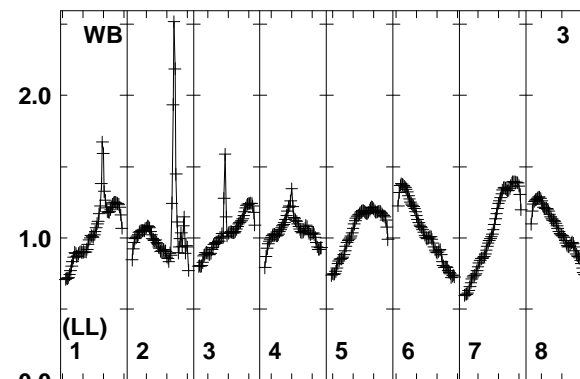
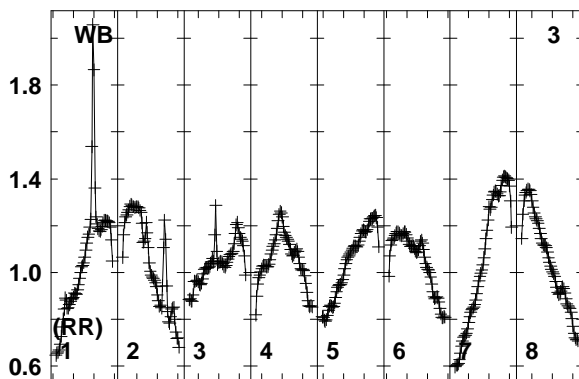
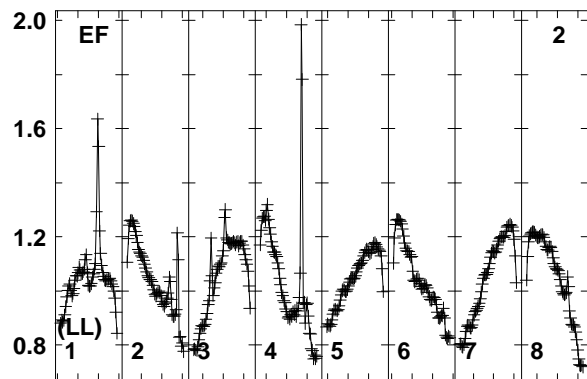
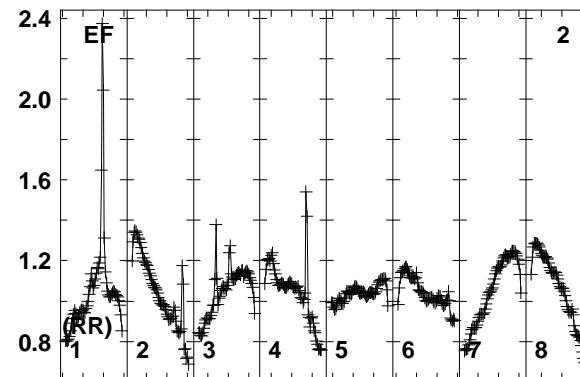
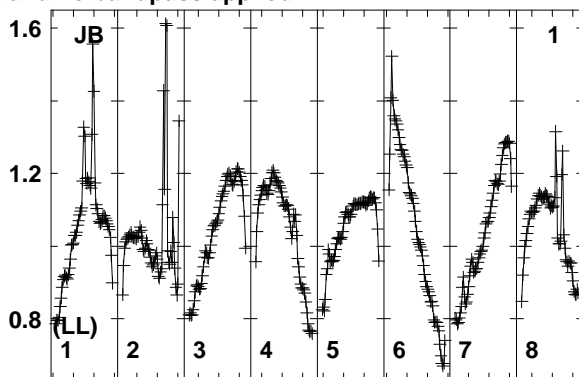
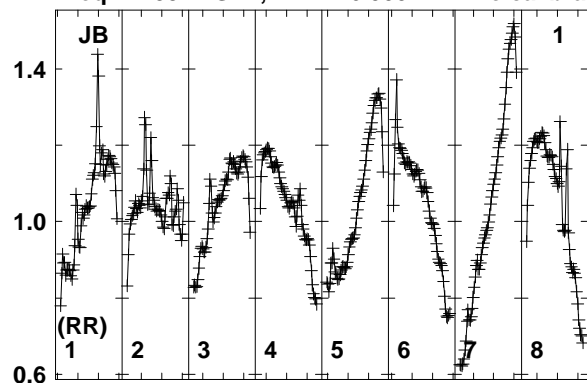

Lower frame: Real Jy
Total-power spectrum Antenna: JB (01)
Timerange: 00/04:29:36 to 00/04:30:34

Plot file version 179 created 04-NOV-2019 14:14:13

J2248-0541 EY034.UVDATA.1

Freq = 1.5947 GHz, Bw = 16.000 MH No calibration applied and no bandpass applied

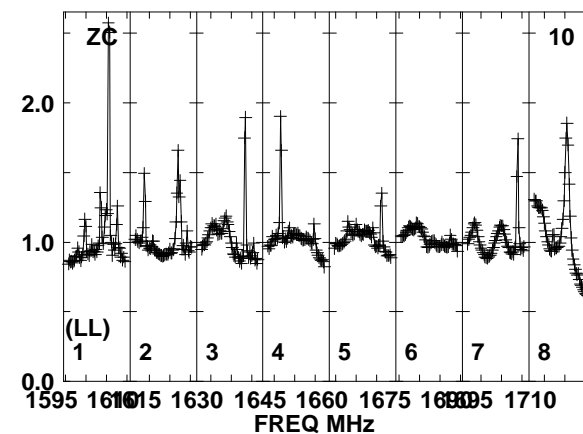
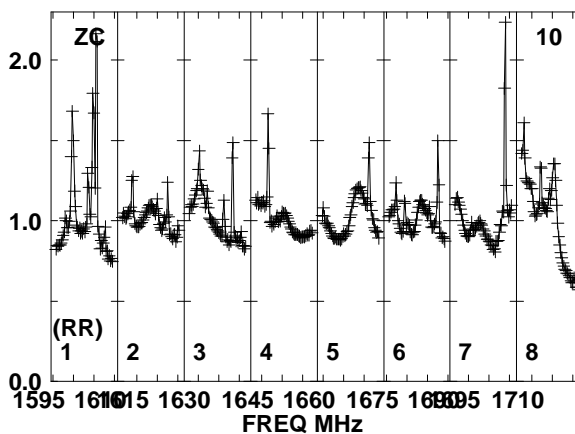
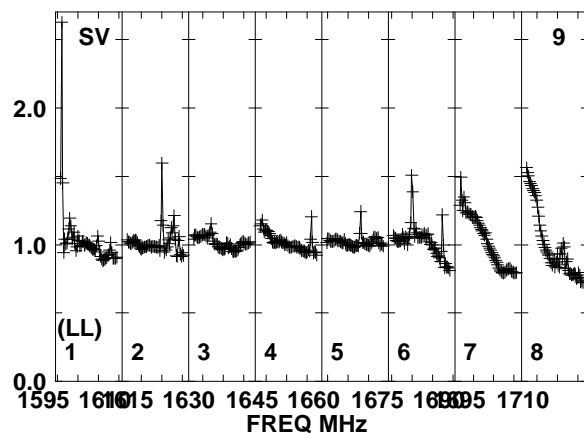
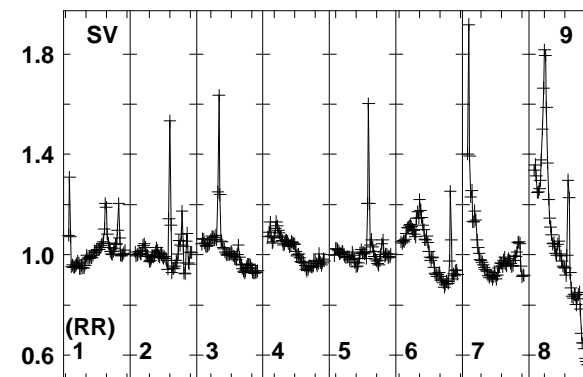
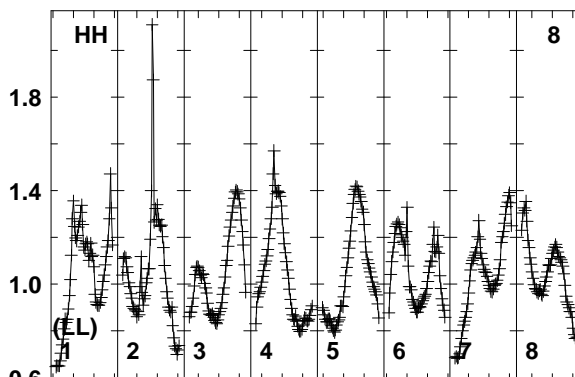
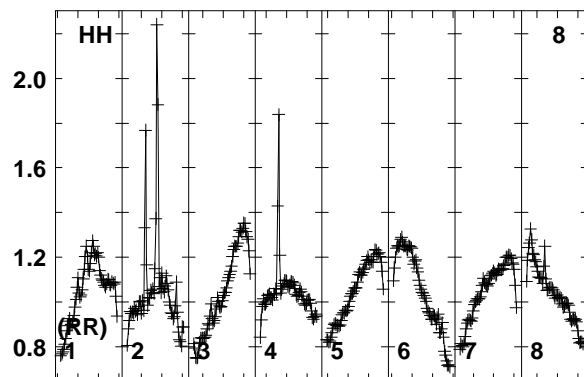
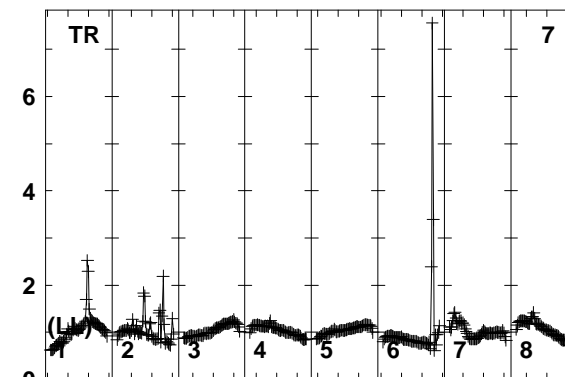
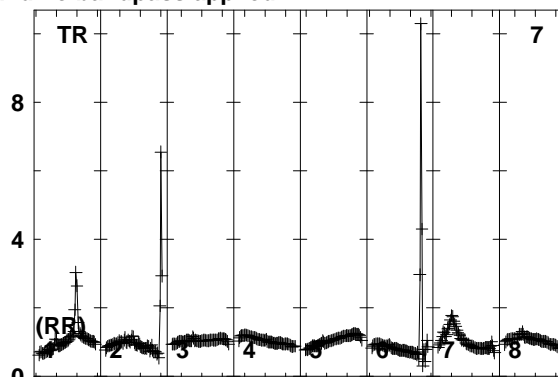
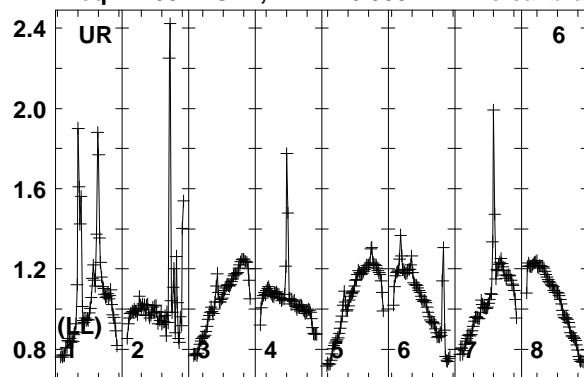

Lower frame: Real Jy
Total-power spectrum Antenna: UR (06)
Timerange: 00/04:29:36 to 00/04:30:34

Plot file version 180 created 04-NOV-2019 14:14:13

J2248-0541 EY034.UVDATA.1

Freq = 1.5947 GHz, Bw = 16.000 MH No calibration applied and no bandpass applied

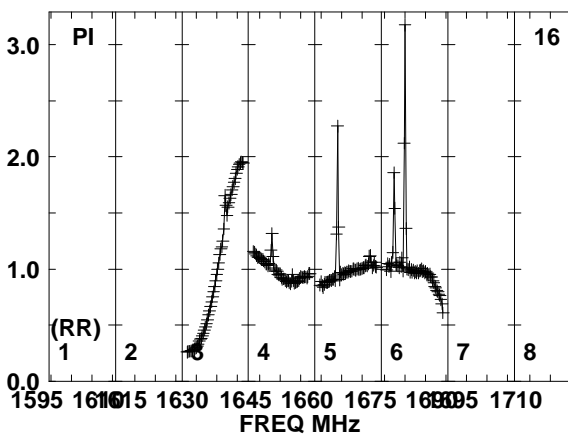
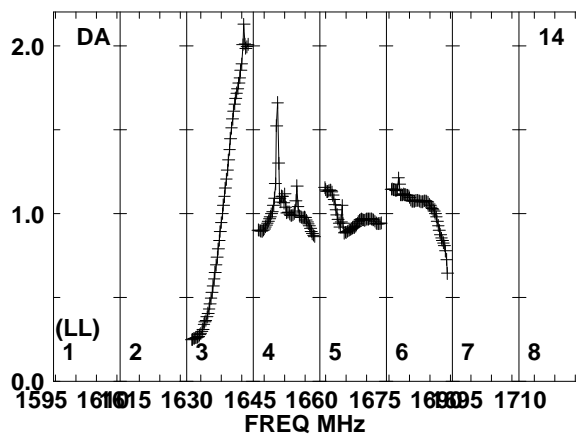
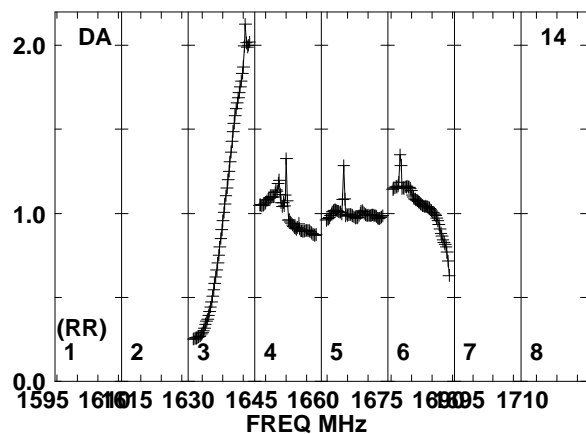
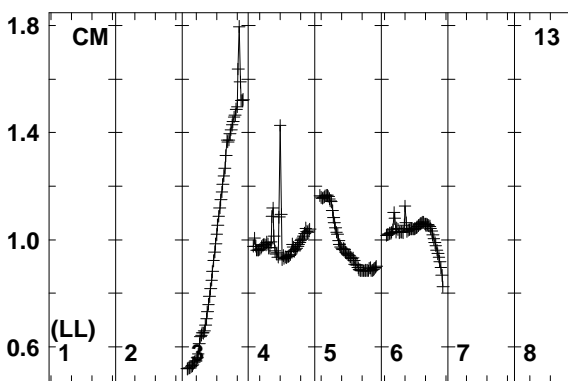
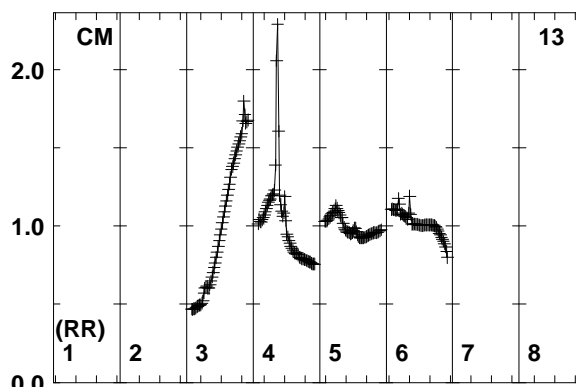
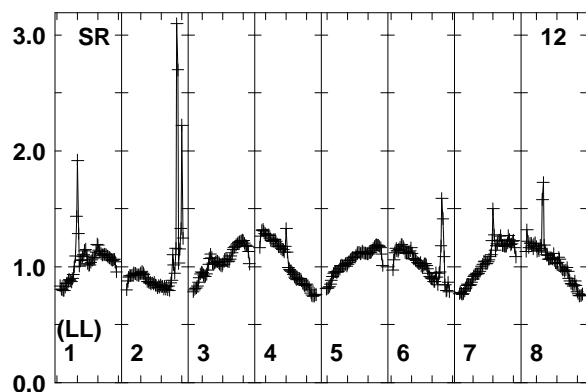
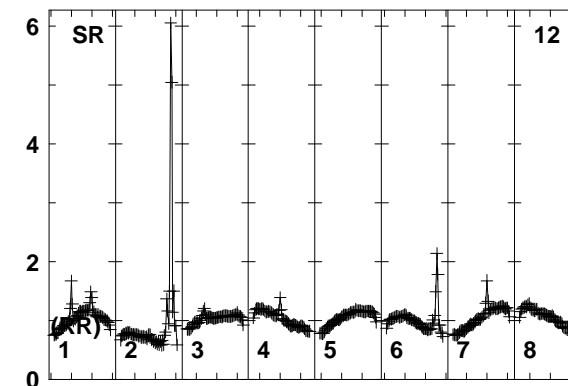
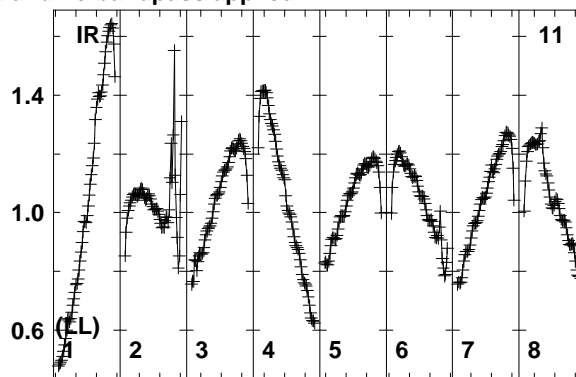
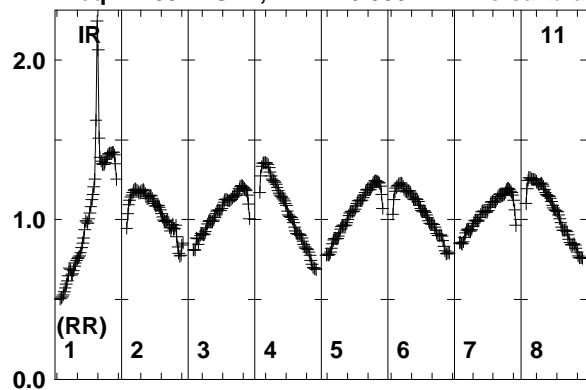

Lower frame: Real Jy
Total-power spectrum Antenna: IR (11)
Timerange: 00/04:29:36 to 00/04:30:34

Plot file version 181 created 04-NOV-2019 14:14:13
J2248-0541 EY034.UVDATA.1
Freq = 1.5947 GHz, Bw = 16.000 MH No calibration applied and no bandpass applied

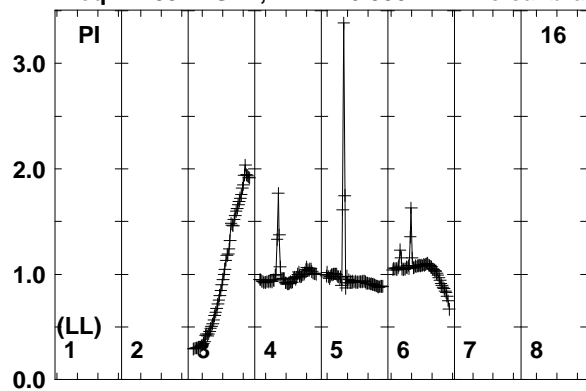

Lower frame: Real Jy
Total-power spectrum Antenna: PI (16)
Timerange: 00/04:29:36 to 00/04:30:34

Plot file version 182 created 04-NOV-2019 14:14:14

W2246-0526 EY034.UVDATA.1

Freq = 1.5947 GHz, Bw = 16.000 MH No calibration applied and no bandpass applied

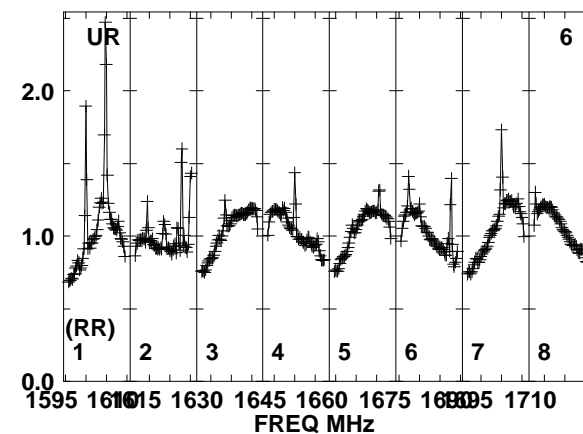
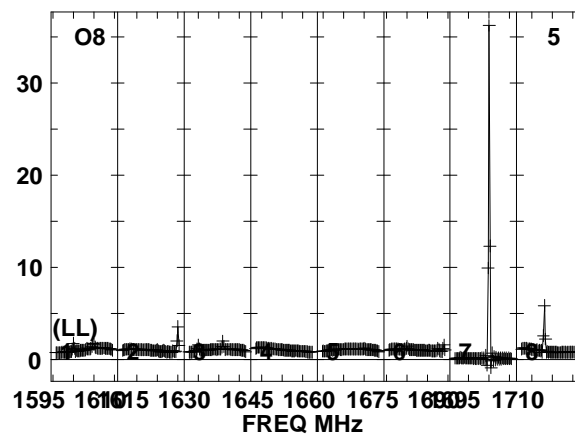
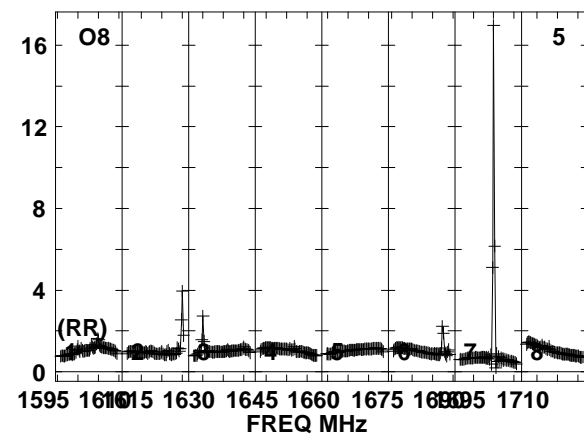
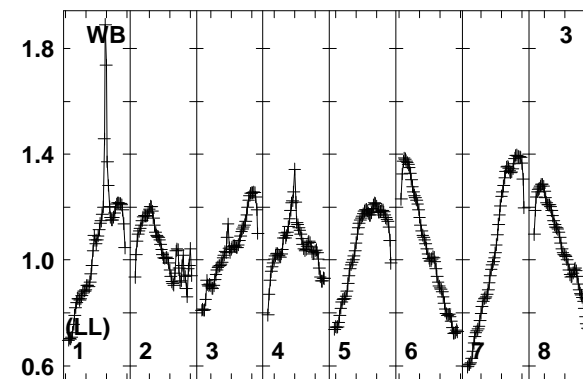
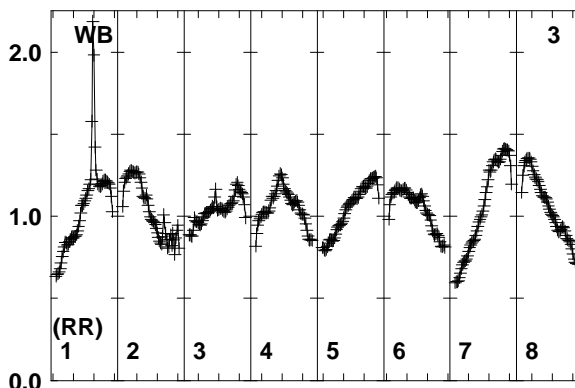
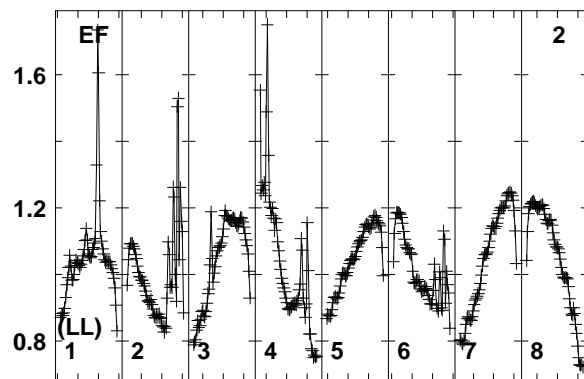
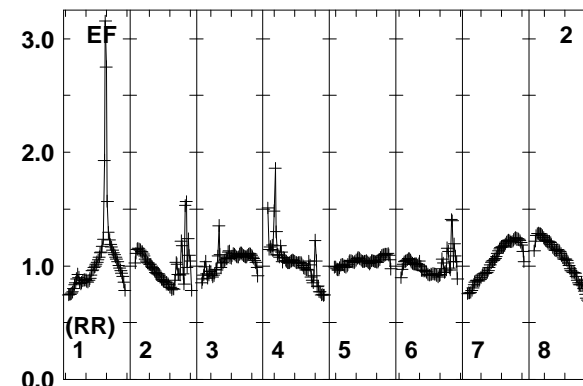
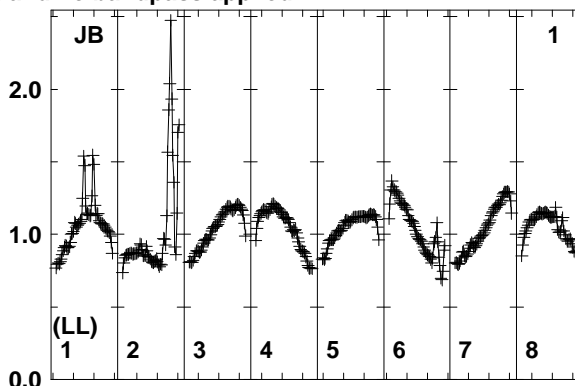
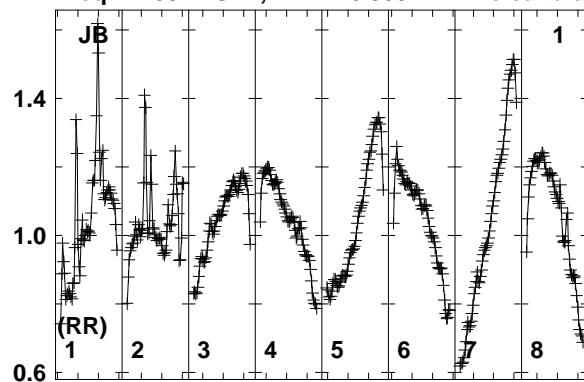

Lower frame: Real Jy
Total-power spectrum Antenna: JB (01)
Timerange: 00/04:30:36 to 00/04:33:14

Plot file version 183 created 04-NOV-2019 14:14:14

W2246-0526 EY034.UVDATA.1

Freq = 1.5947 GHz, Bw = 16.000 MH No calibration applied and no bandpass applied

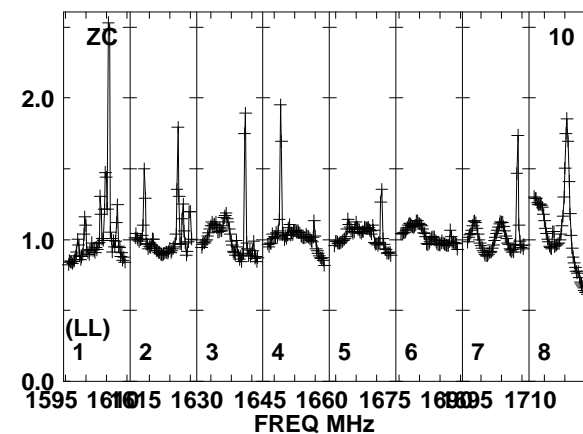
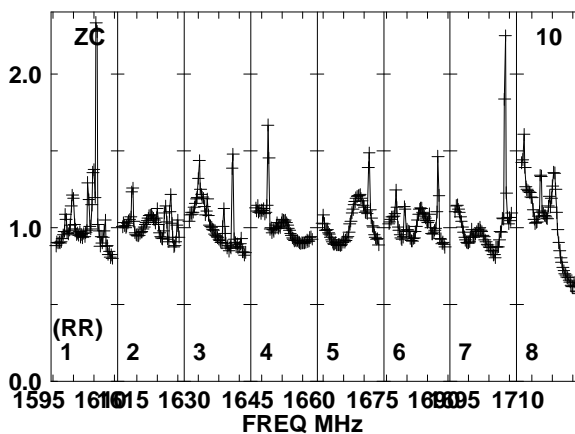
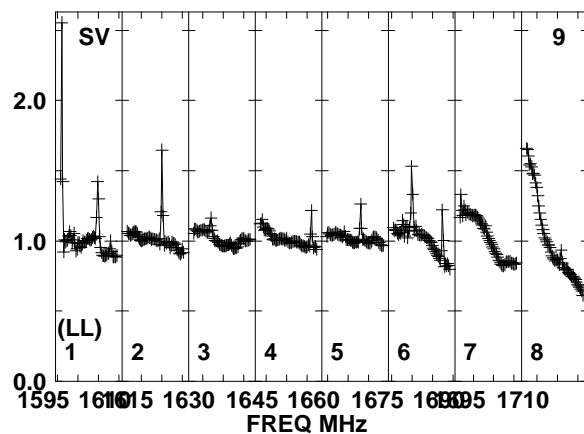
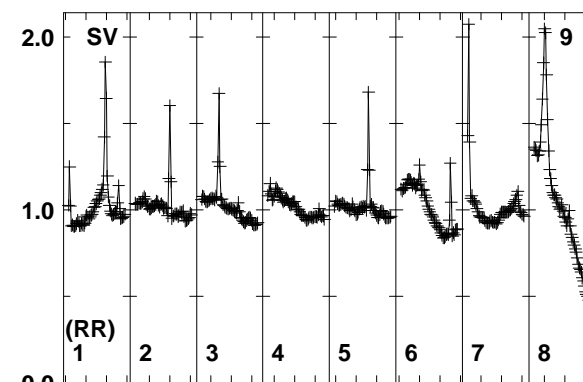
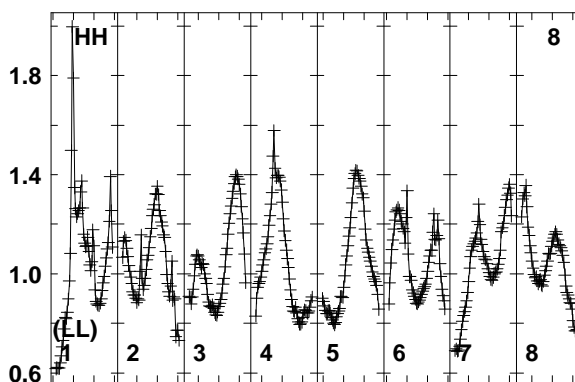
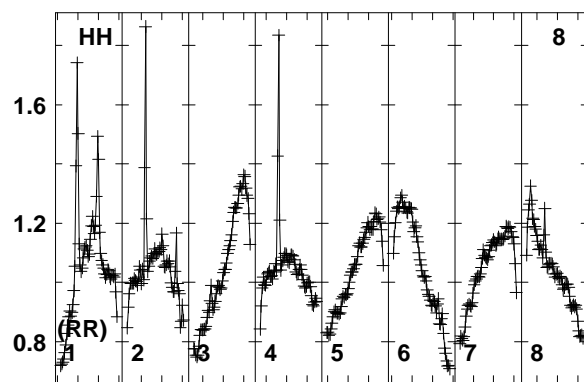
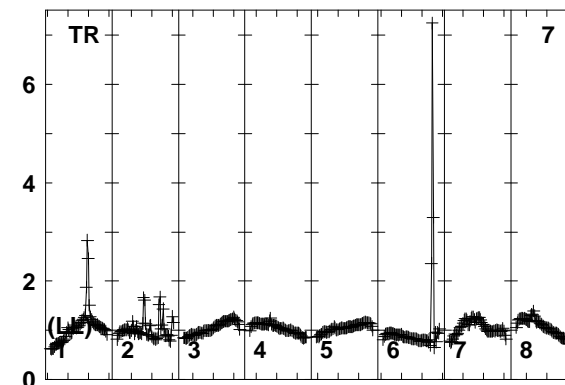
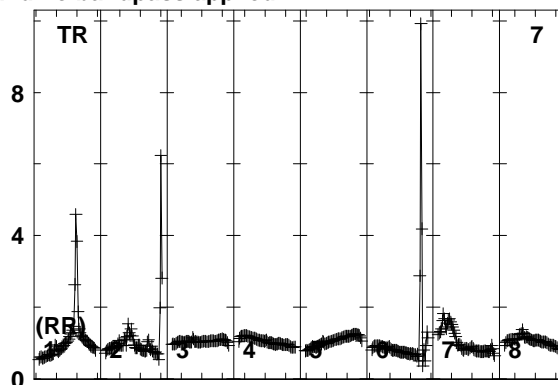
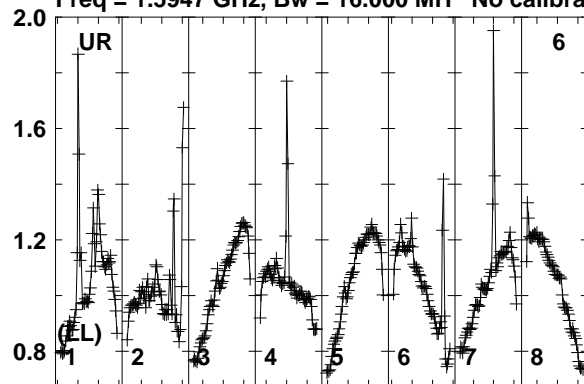

Lower frame: Real Jy
Total-power spectrum Antenna: UR (06)
Timerange: 00/04:30:36 to 00/04:33:14

Plot file version 184 created 04-NOV-2019 14:14:14

W2246-0526 EY034.UVDATA.1

Freq = 1.5947 GHz, Bw = 16.000 MH No calibration applied and no bandpass applied

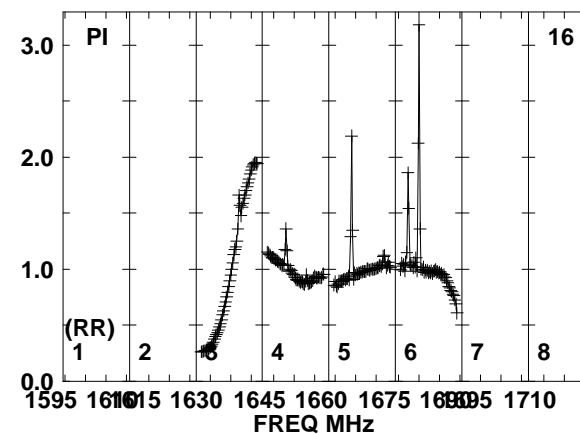
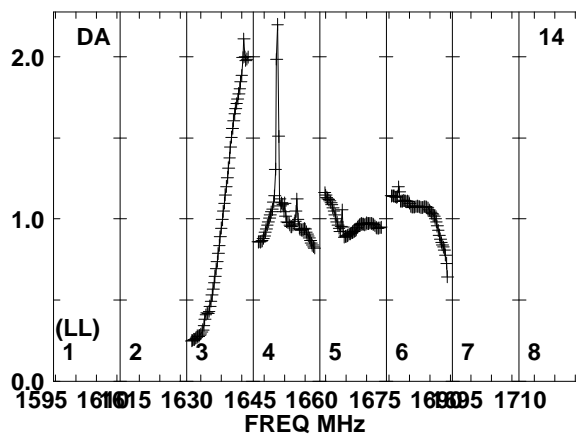
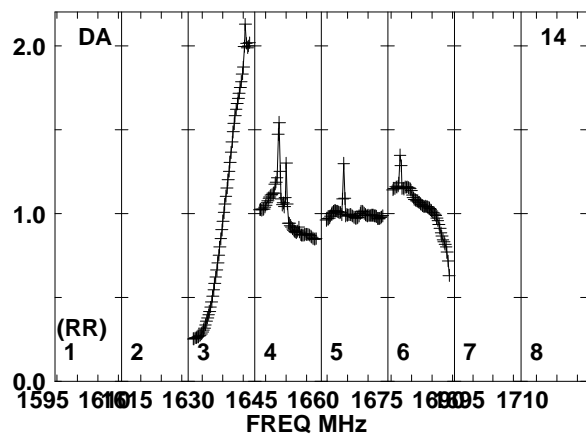
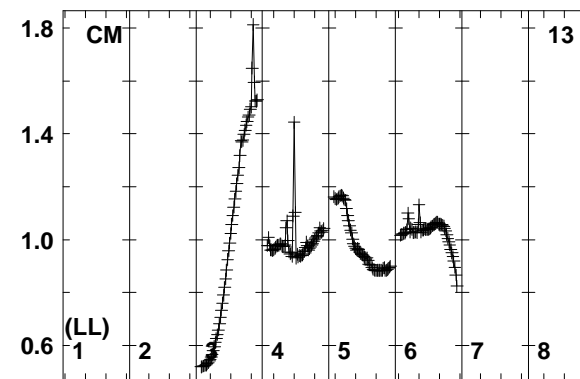
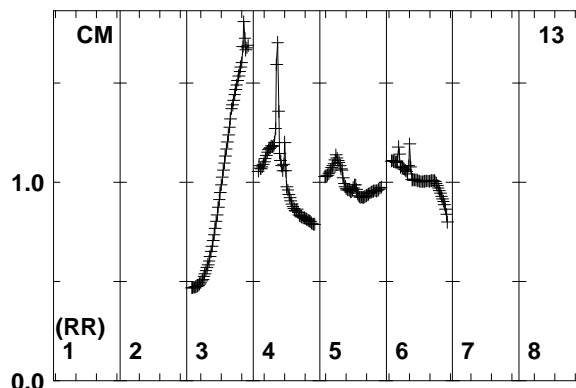
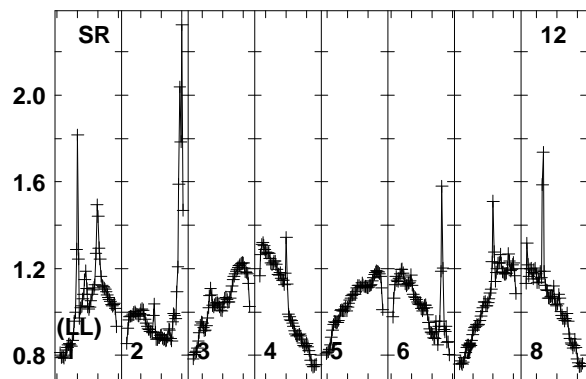
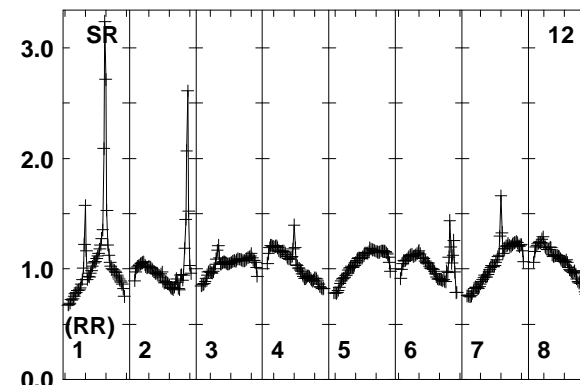
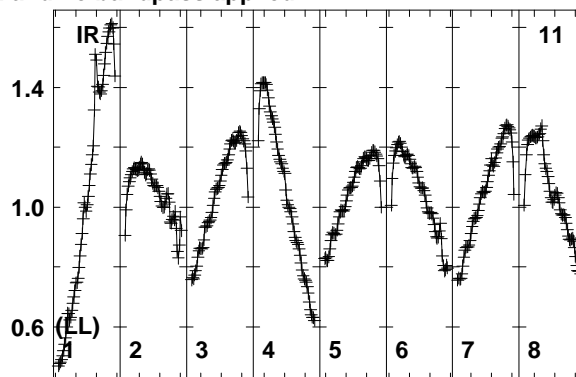
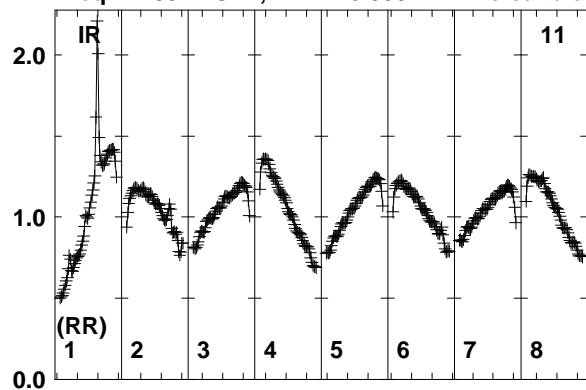

Lower frame: Real Jy
Total-power spectrum Antenna: IR (11)
Timerange: 00/04:30:36 to 00/04:33:14

Plot file version 185 created 04-NOV-2019 14:14:14
W2246-0526 EY034.UVDATA.1
Freq = 1.5947 GHz, Bw = 16.000 MH No calibration applied and no bandpass applied

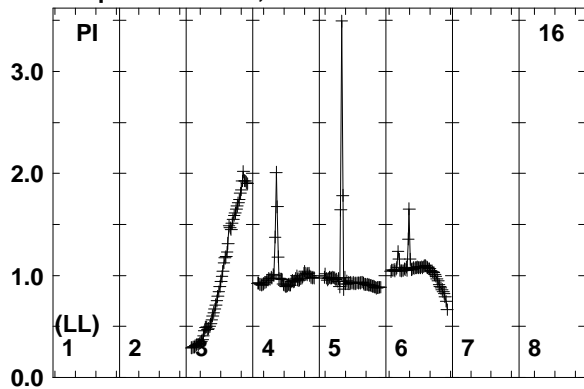

Lower frame: Real Jy
Total-power spectrum Antenna: PI (16)
Timerange: 00/04:30:36 to 00/04:33:14

Plot file version 186 created 04-NOV-2019 14:14:14

J2248-0541 EY034.UVDATA.1

Freq = 1.5947 GHz, Bw = 16.000 MH No calibration applied and no bandpass applied

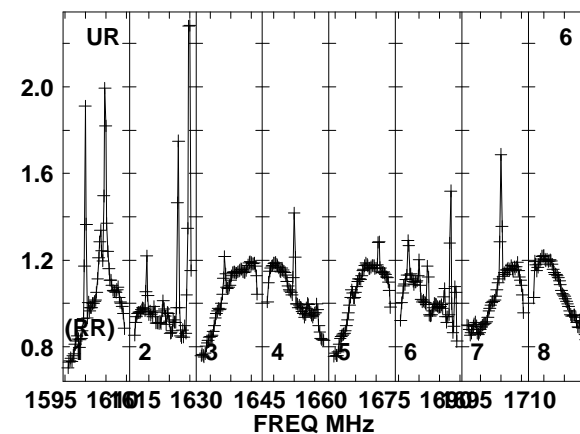
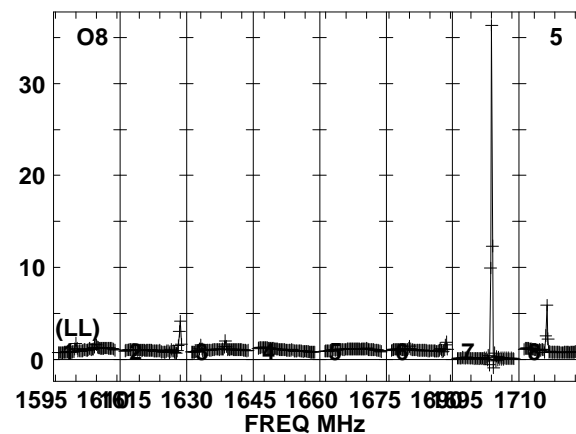
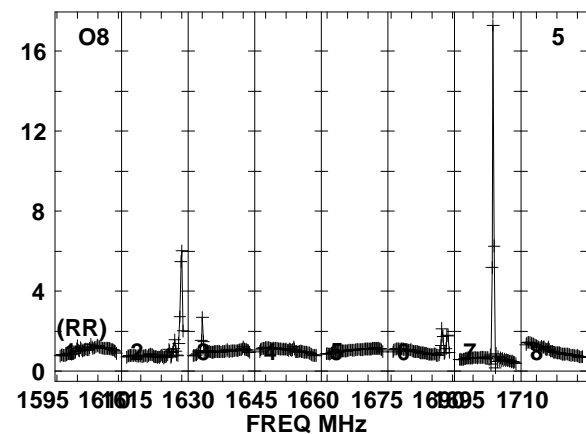
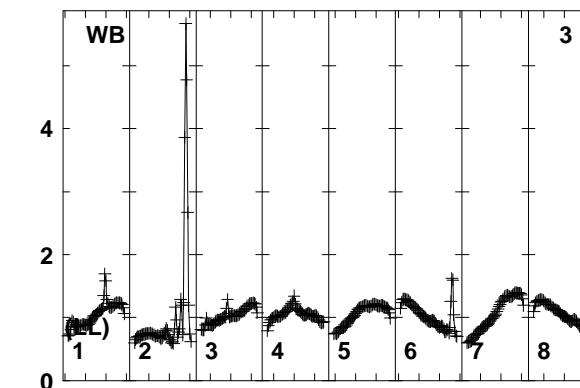
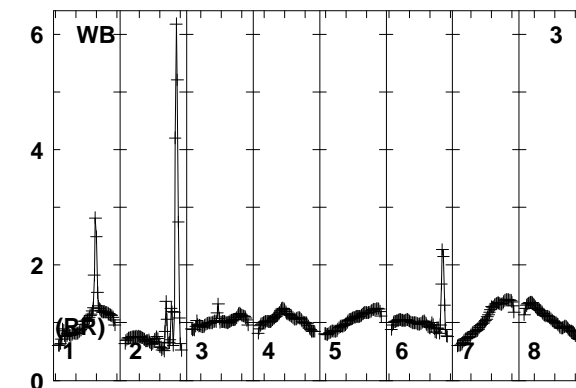
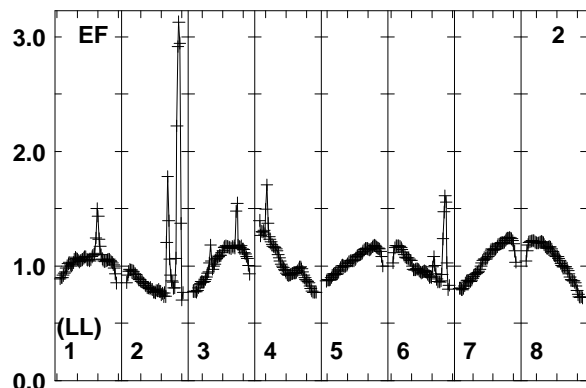
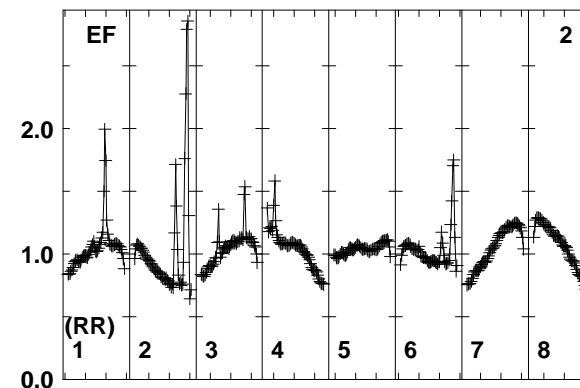
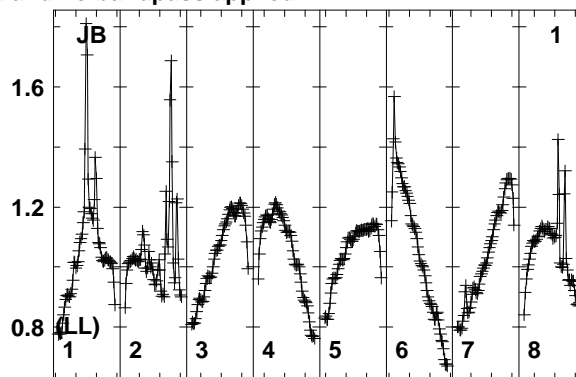
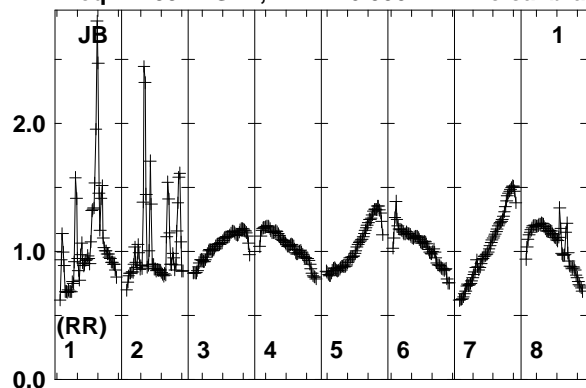

Lower frame: Real Jy
Total-power spectrum Antenna: JB (01)
Timerange: 00/04:33:31 to 00/04:34:29

Plot file version 187 created 04-NOV-2019 14:14:14

J2248-0541 EY034.UVDATA.1

Freq = 1.5947 GHz, Bw = 16.000 MH No calibration applied and no bandpass applied

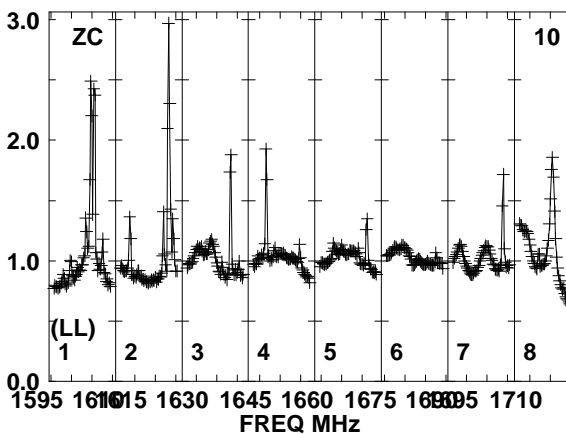
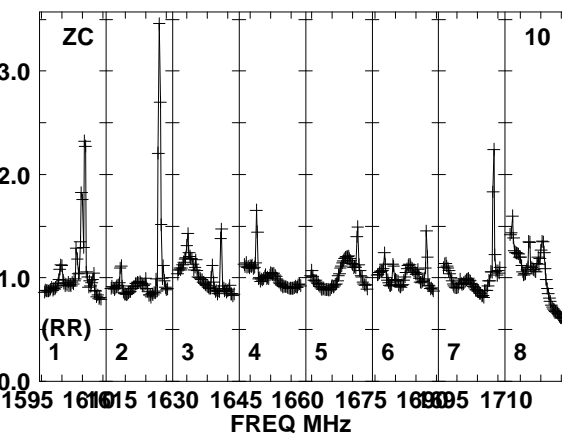
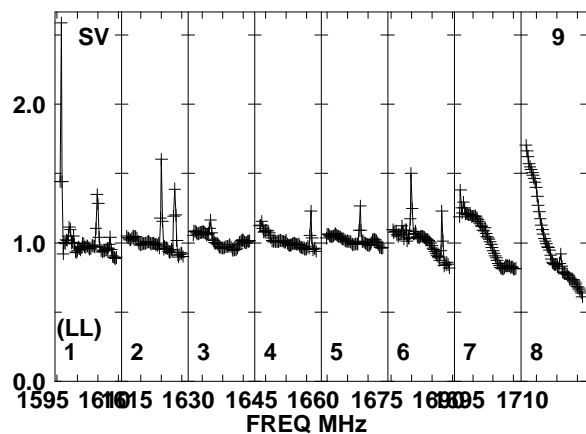
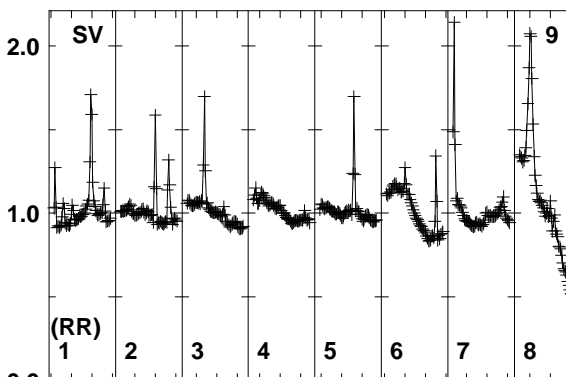
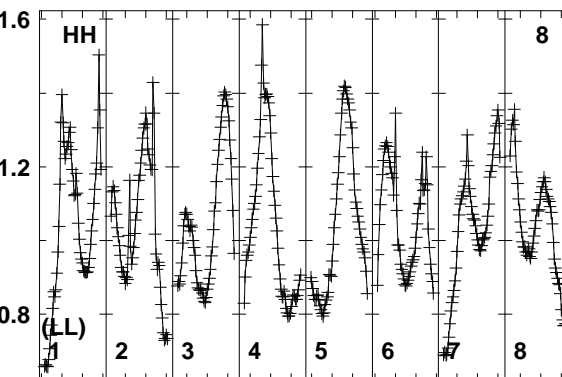
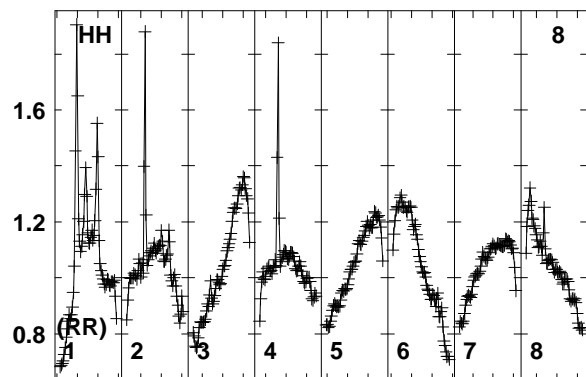
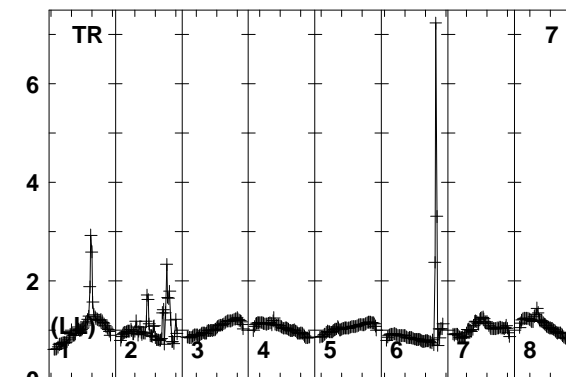
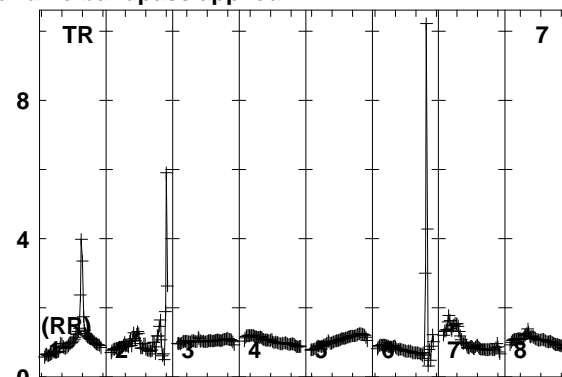
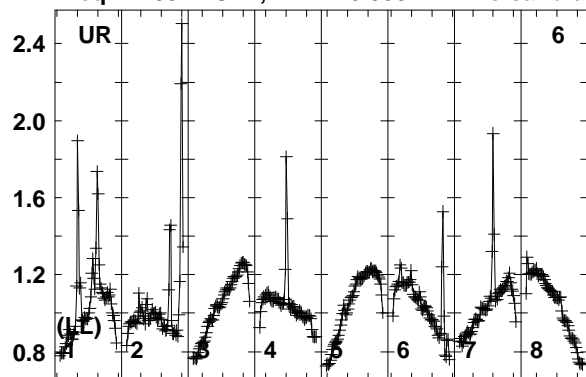

Lower frame: Real Jy
Total-power spectrum Antenna: UR (06)
Timerange: 00/04:33:31 to 00/04:34:29

Plot file version 188 created 04-NOV-2019 14:14:14

J2248-0541 EY034.UVDATA.1

Freq = 1.5947 GHz, Bw = 16.000 MH No calibration applied and no bandpass applied

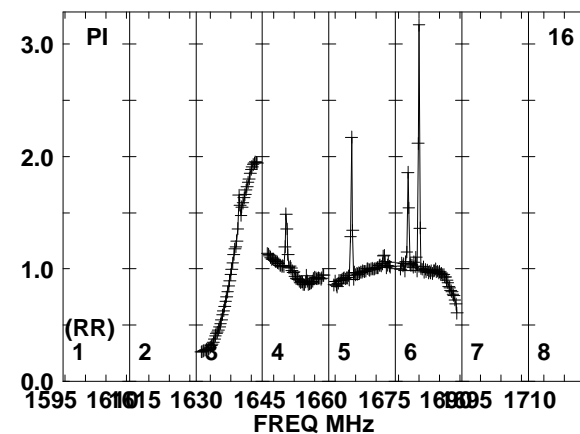
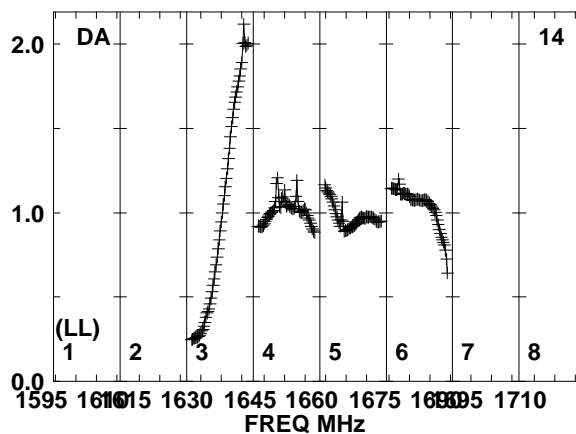
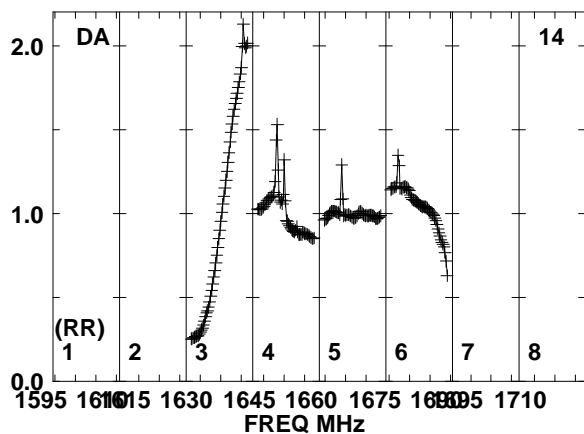
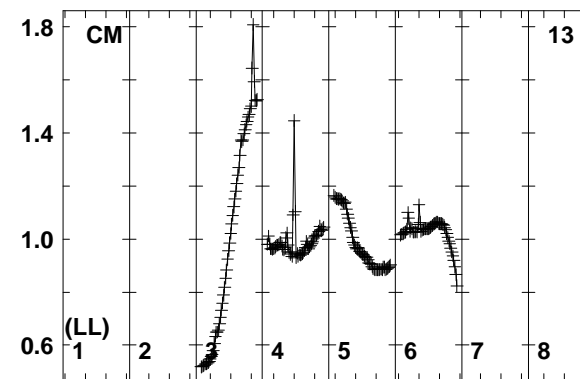
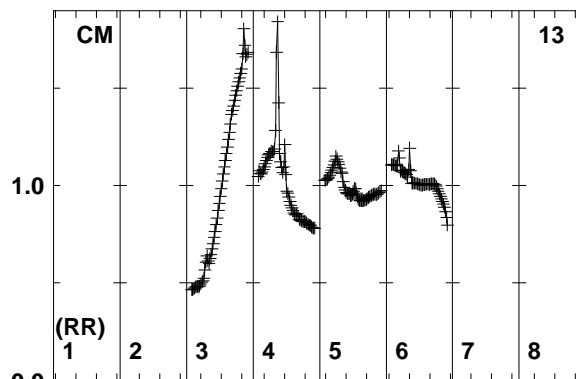
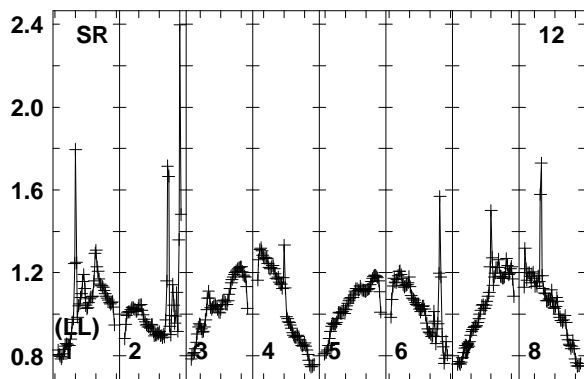
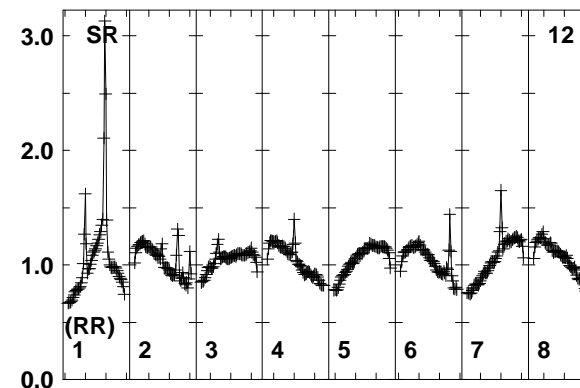
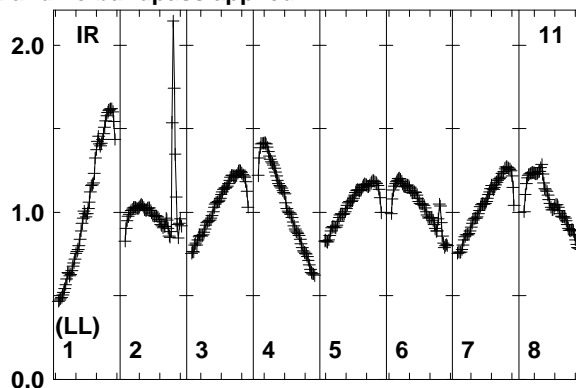
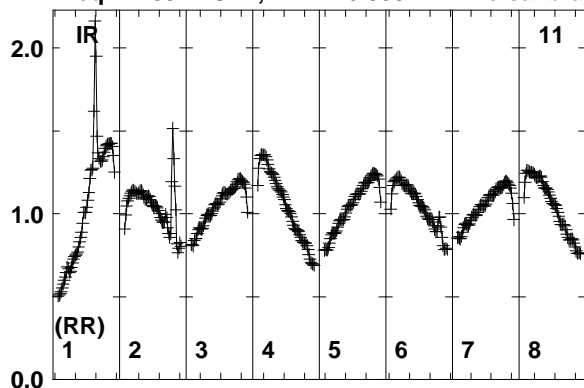

Lower frame: Real Jy
Total-power spectrum Antenna: IR (11)
Timerange: 00/04:33:31 to 00/04:34:29

Plot file version 189 created 04-NOV-2019 14:14:14
J2248-0541 EY034.UVDATA.1
Freq = 1.5947 GHz, Bw = 16.000 MH No calibration applied and no bandpass applied

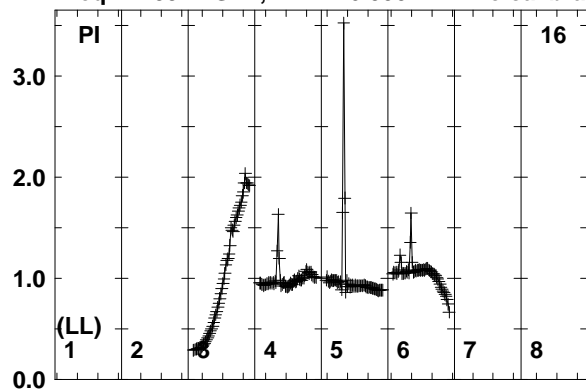

Lower frame: Real Jy
Total-power spectrum Antenna: PI (16)
Timerange: 00/04:33:31 to 00/04:34:29

Plot file version 190 created 04-NOV-2019 14:14:14

J2245-0755 EY034.UVDATA.1

Freq = 1.5947 GHz, Bw = 16.000 MH No calibration applied and no bandpass applied

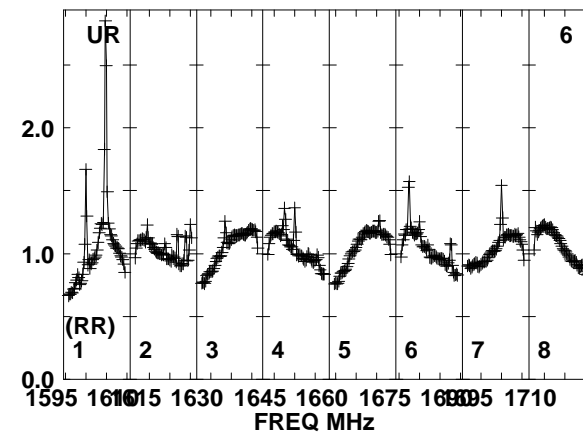
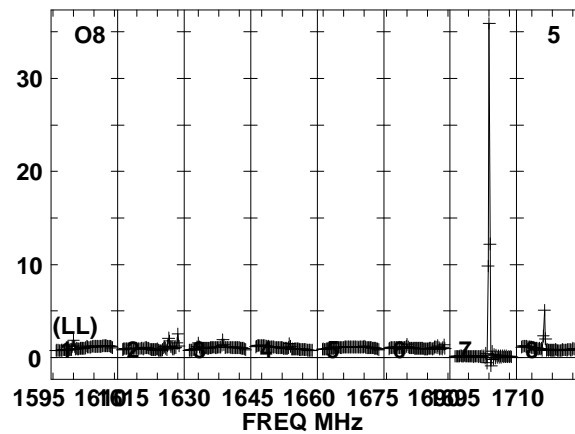
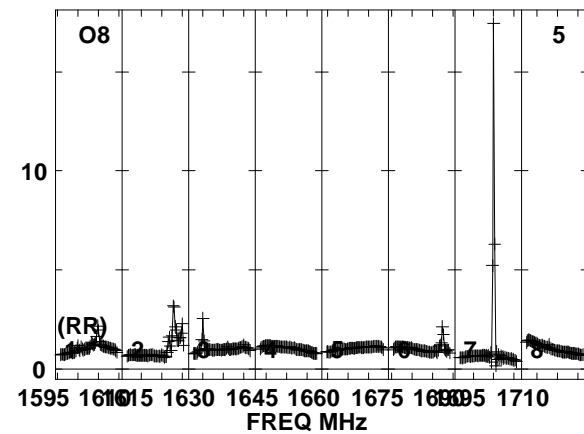
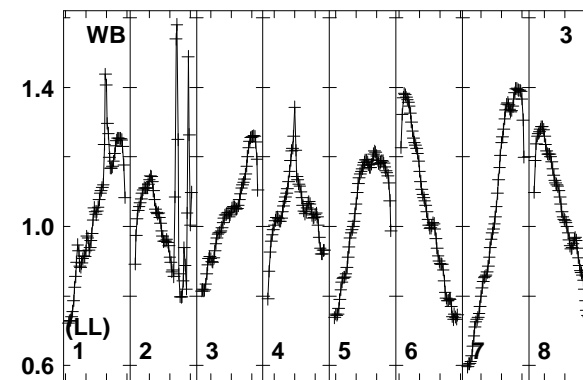
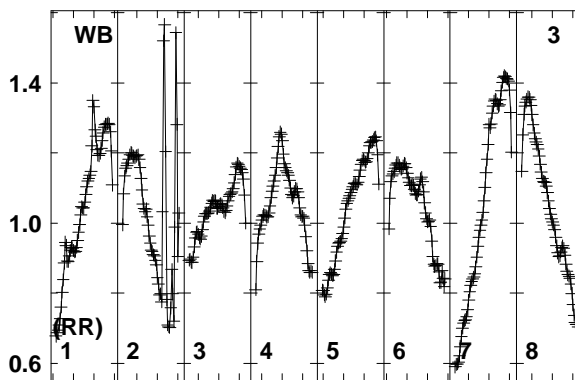
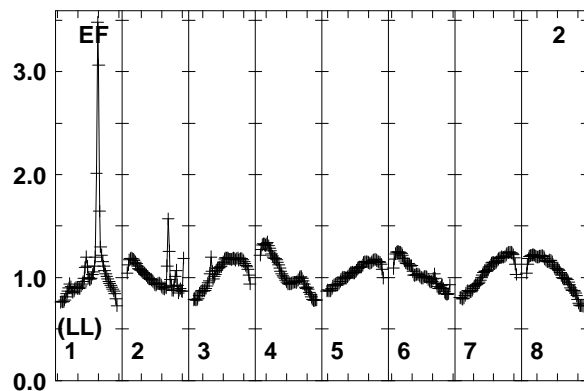
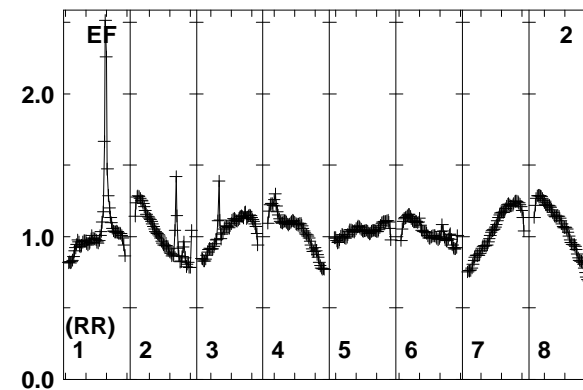
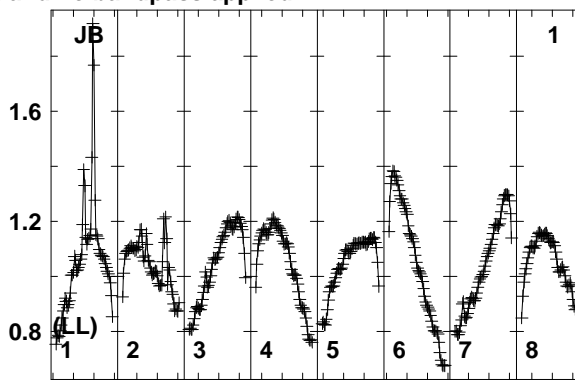
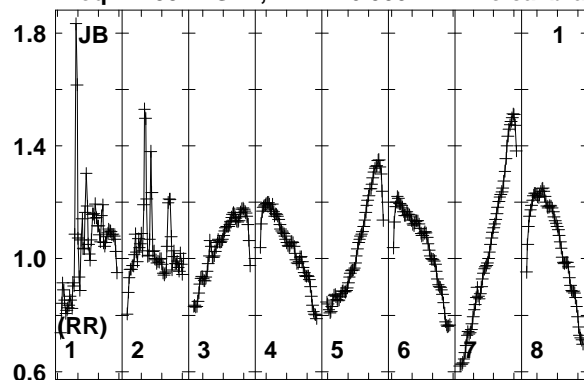

Lower frame: Real Jy
Total-power spectrum Antenna: JB (01)
Timerange: 00/04:34:46 to 00/04:35:44

Plot file version 191 created 04-NOV-2019 14:14:14

J2245-0755 EY034.UVDATA.1

Freq = 1.5947 GHz, Bw = 16.000 MH No calibration applied and no bandpass applied

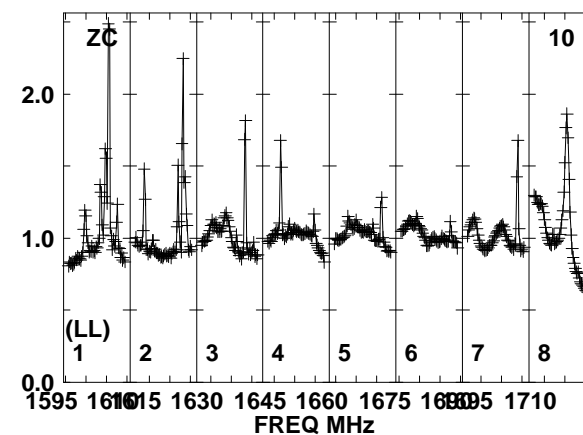
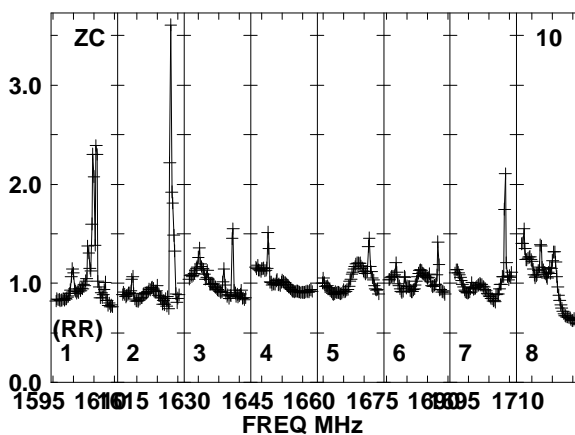
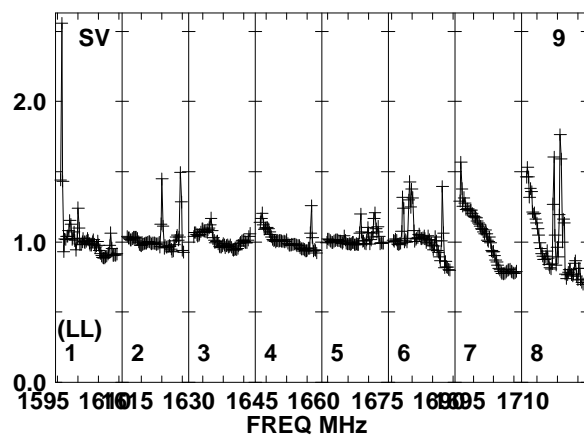
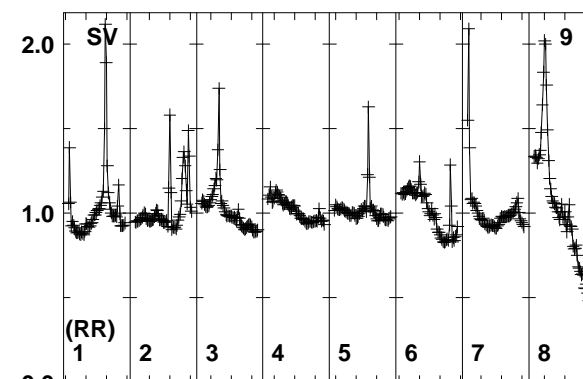
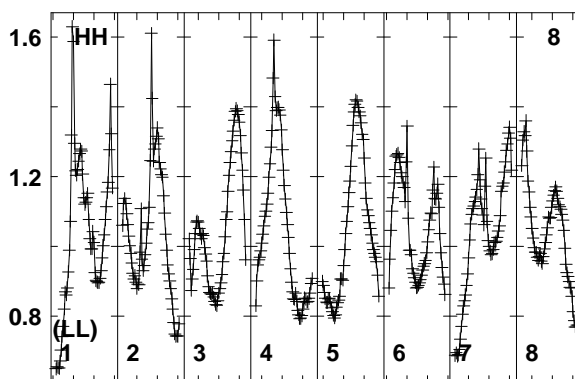
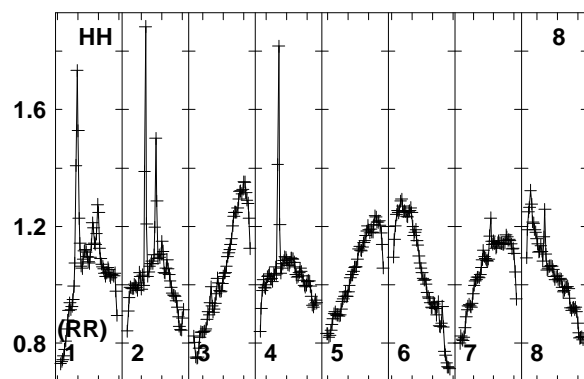
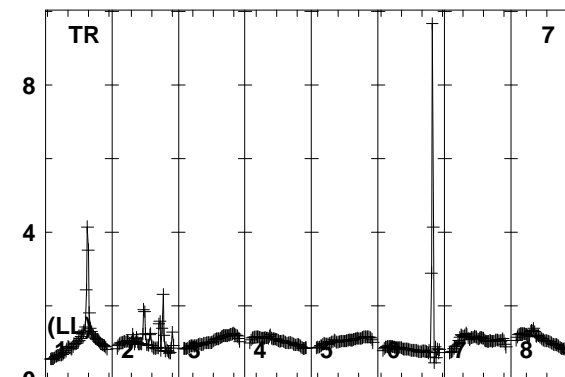
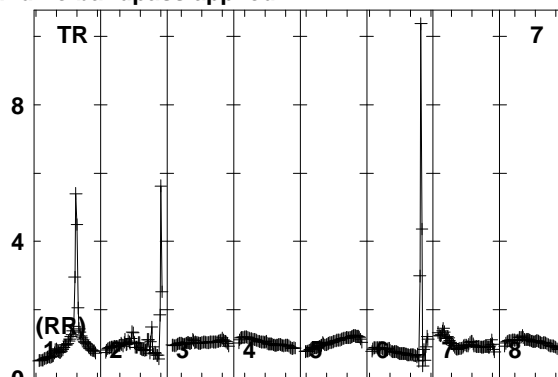
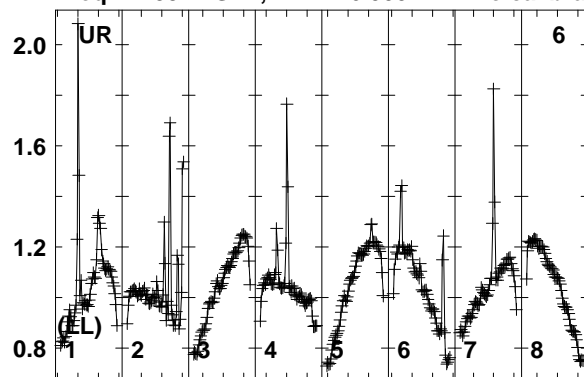

Lower frame: Real Jy
Total-power spectrum Antenna: UR (06)
Timerange: 00/04:34:46 to 00/04:35:44

Plot file version 192 created 04-NOV-2019 14:14:14

J2245-0755 EY034.UVDATA.1

Freq = 1.5947 GHz, Bw = 16.000 MH No calibration applied and no bandpass applied

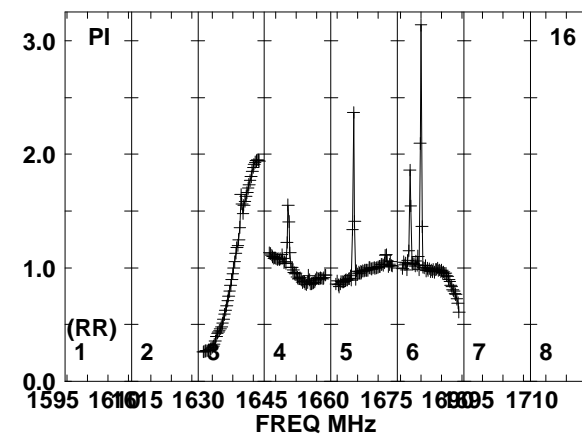
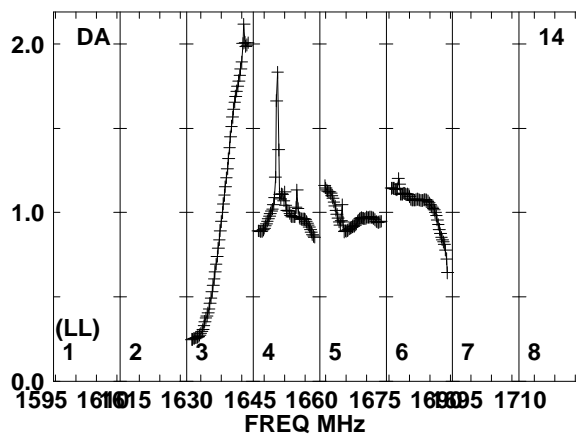
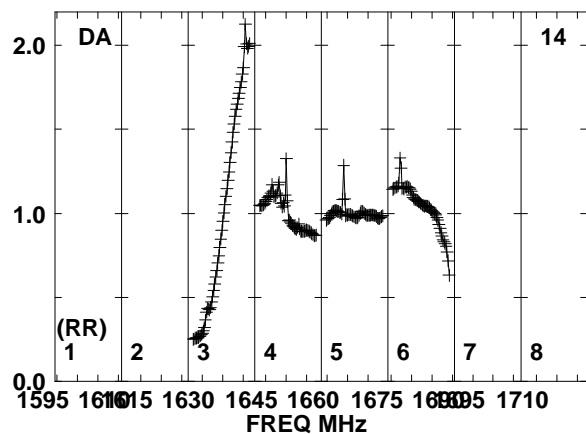
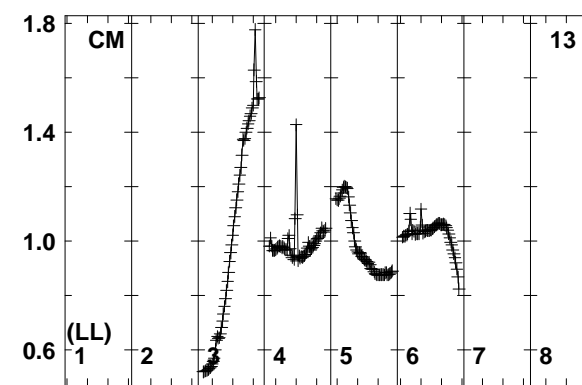
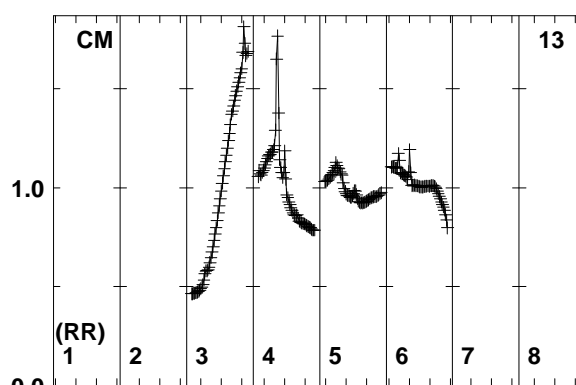
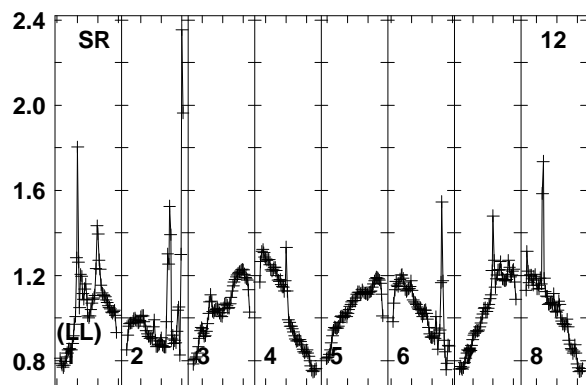
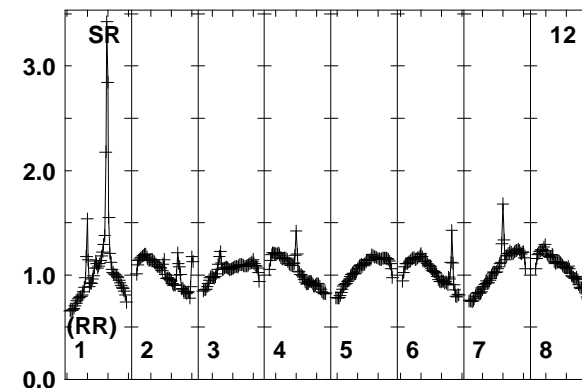
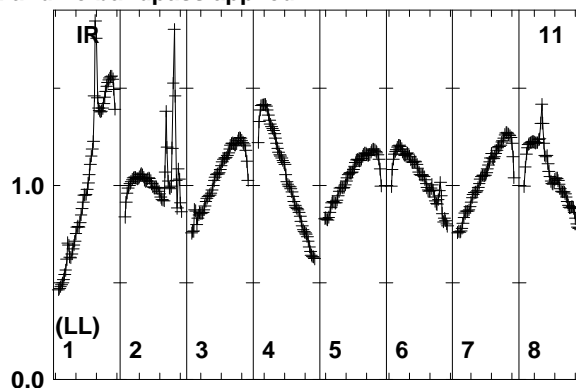
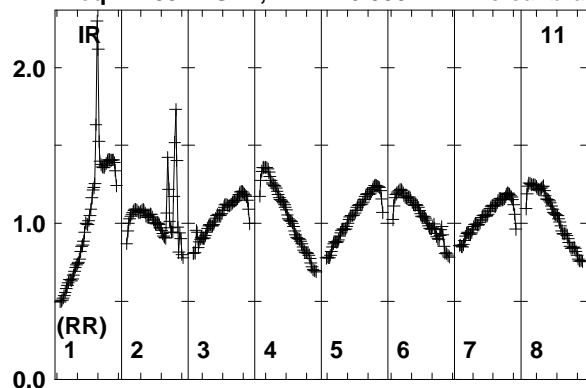

Lower frame: Real Jy
Total-power spectrum Antenna: IR (11)
Timerange: 00/04:34:46 to 00/04:35:44

Plot file version 193 created 04-NOV-2019 14:14:14
J2245-0755 EY034.UVDATA.1
Freq = 1.5947 GHz, Bw = 16.000 MH No calibration applied and no bandpass applied

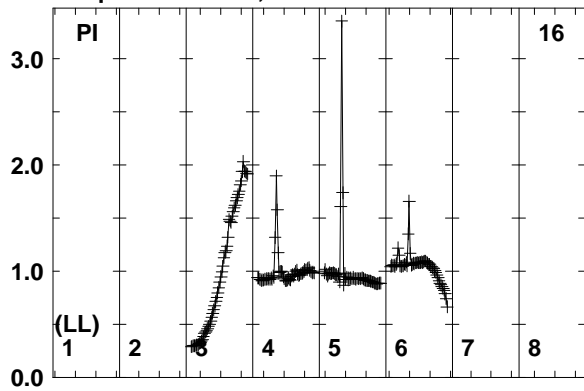

Lower frame: Real Jy
Total-power spectrum Antenna: PI (16)
Timerange: 00/04:34:46 to 00/04:35:44

Plot file version 194 created 04-NOV-2019 14:14:14

J2248-0541 EY034.UVDATA.1

Freq = 1.5947 GHz, Bw = 16.000 MH No calibration applied and no bandpass applied

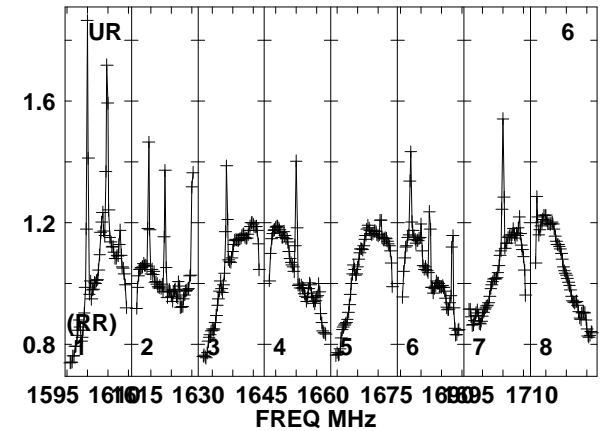
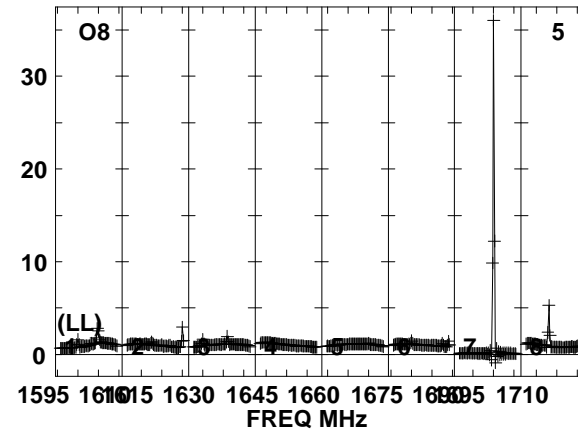
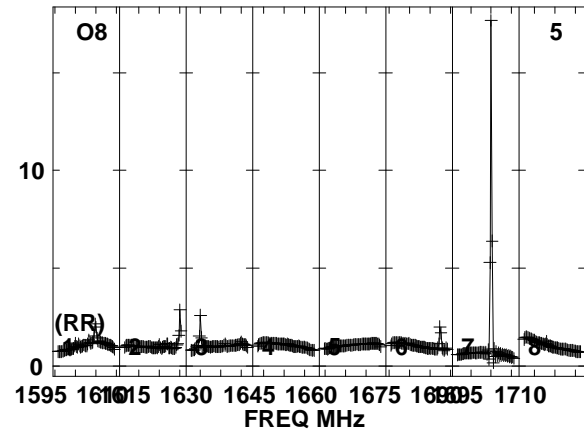
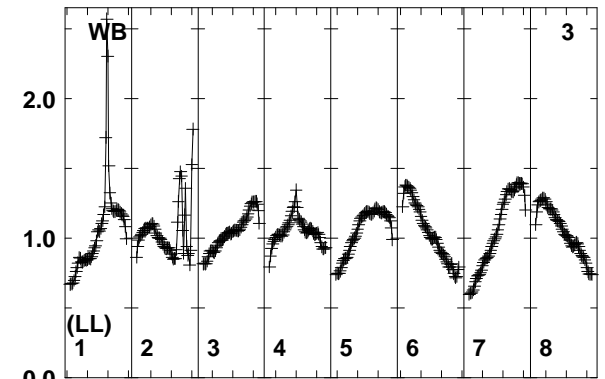
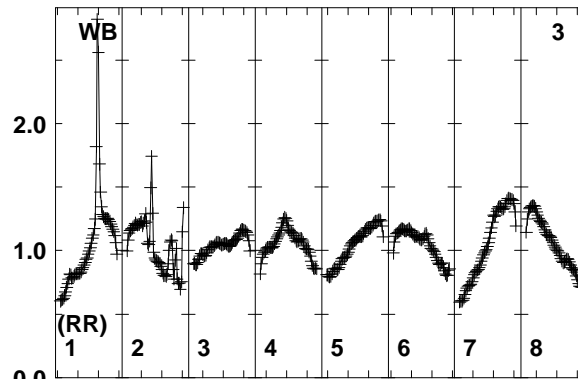
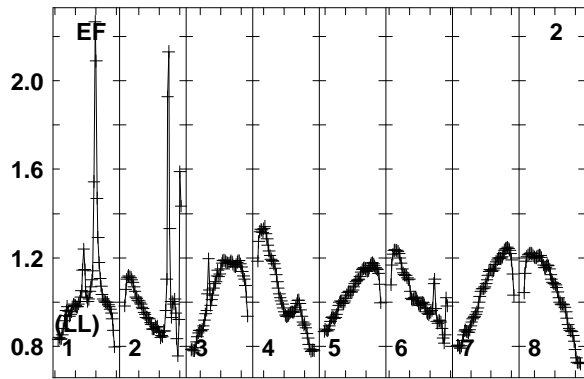
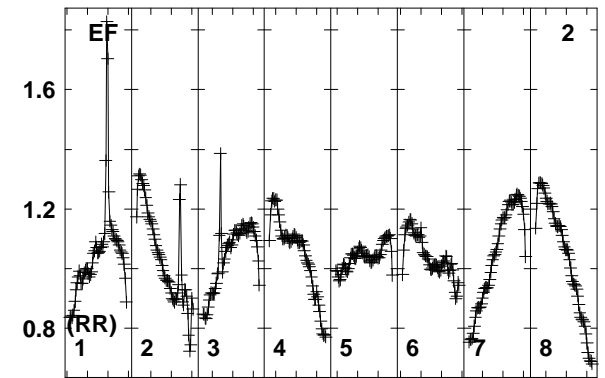
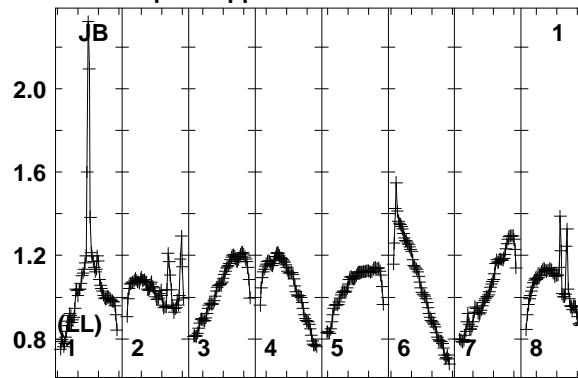
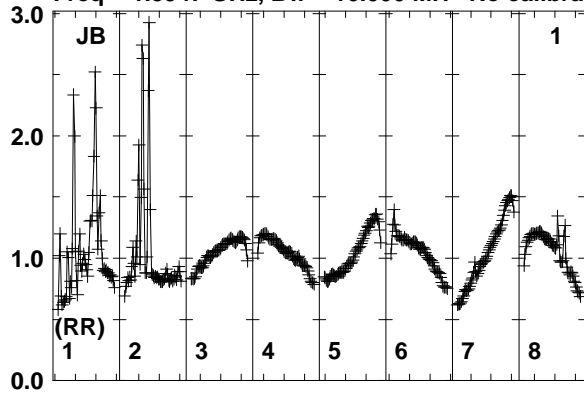

Lower frame: Real Jy
Total-power spectrum Antenna: JB (01)
Timerange: 00/04:36:31 to 00/04:37:29

Plot file version 195 created 04-NOV-2019 14:14:14

J2248-0541 EY034.UVDATA.1

Freq = 1.5947 GHz, Bw = 16.000 MH No calibration applied and no bandpass applied

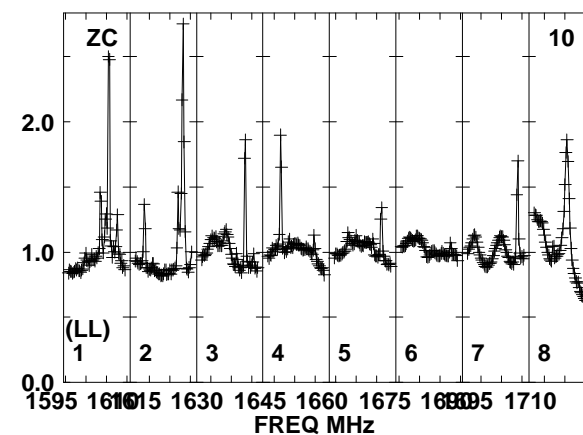
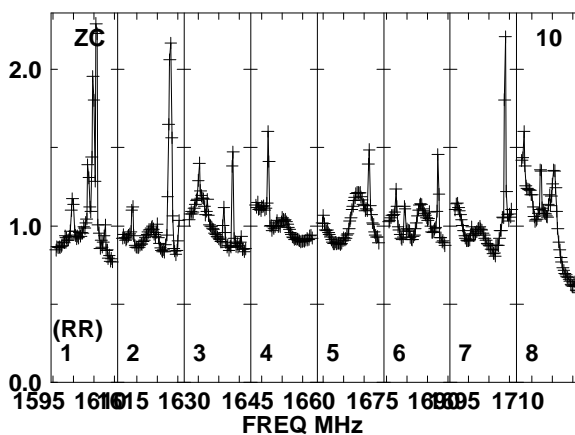
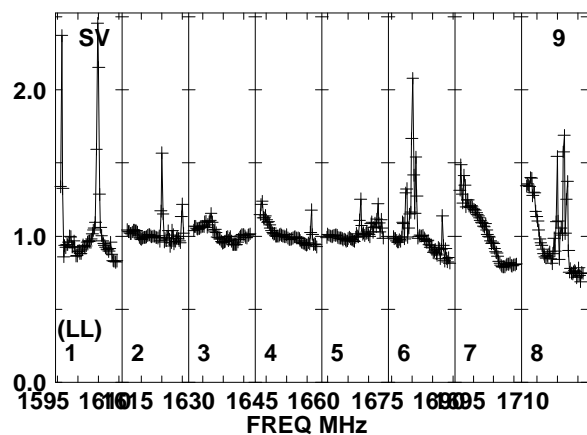
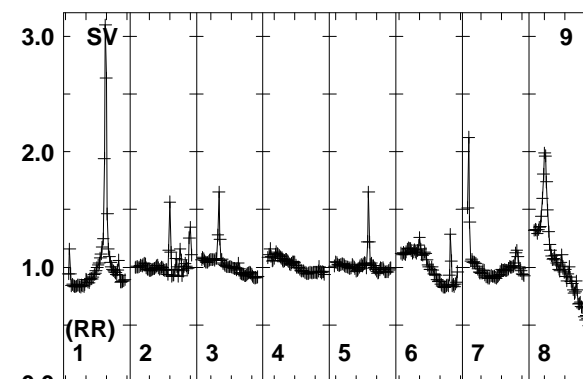
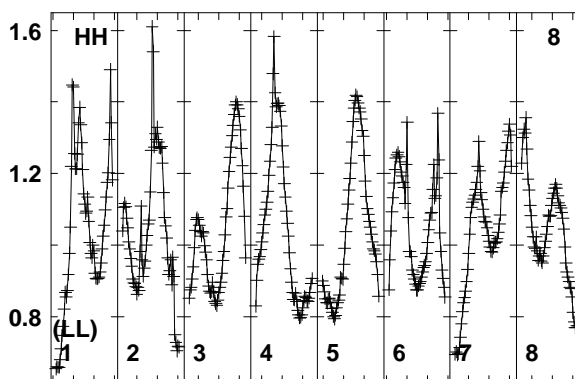
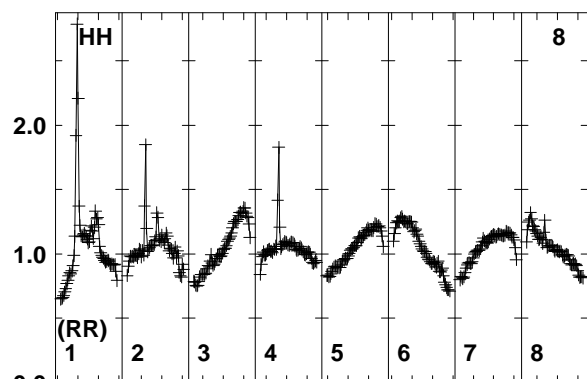
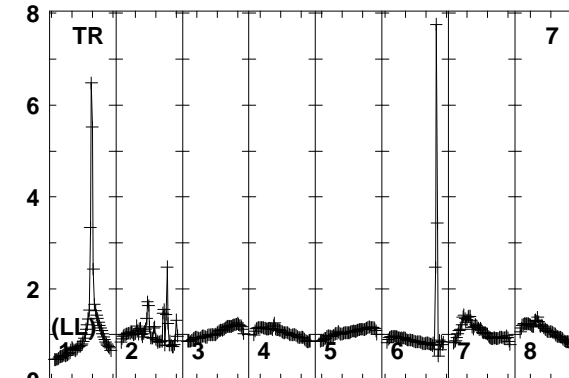
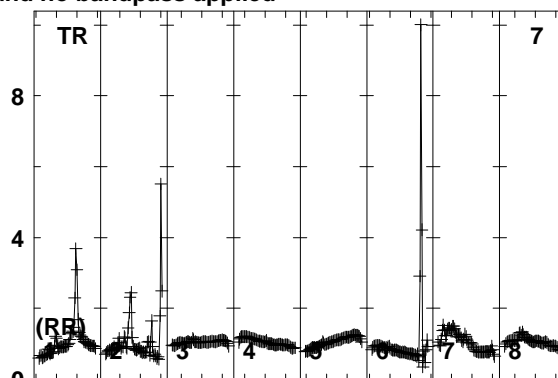
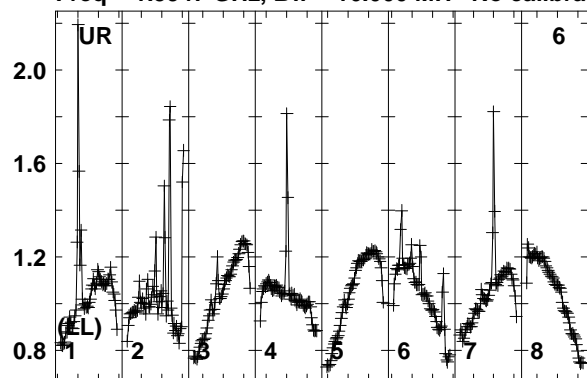

Lower frame: Real Jy
Total-power spectrum Antenna: UR (06)
Timerange: 00/04:36:31 to 00/04:37:29

Plot file version 196 created 04-NOV-2019 14:14:15

J2248-0541 EY034.UVDATA.1

Freq = 1.5947 GHz, Bw = 16.000 MH No calibration applied and no bandpass applied

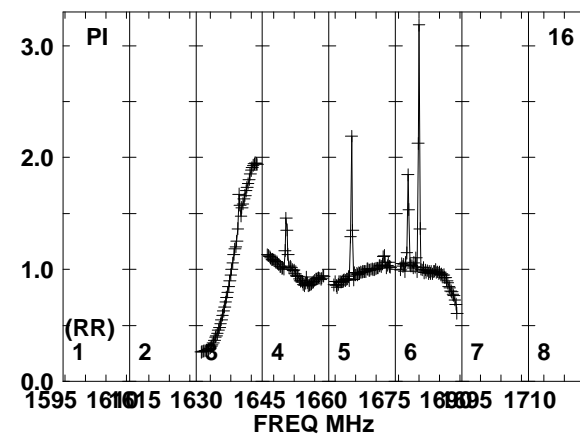
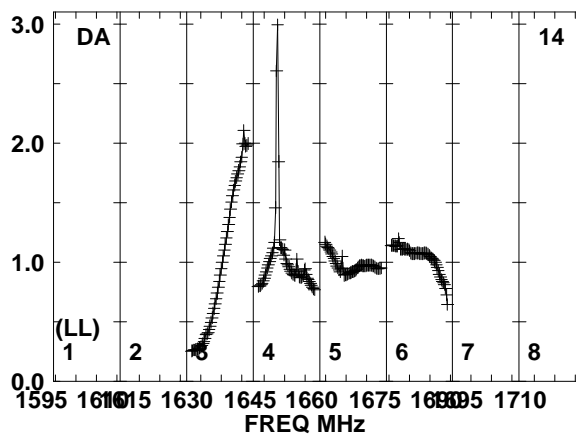
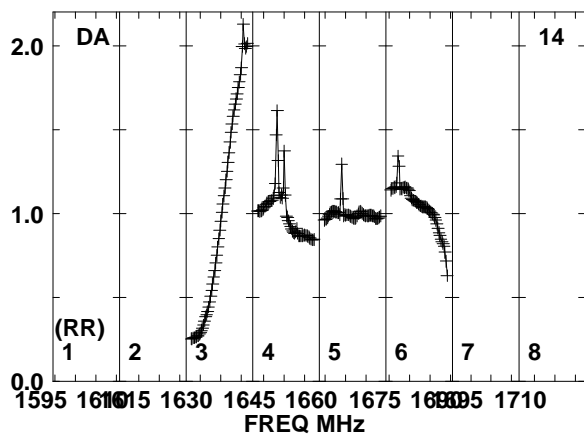
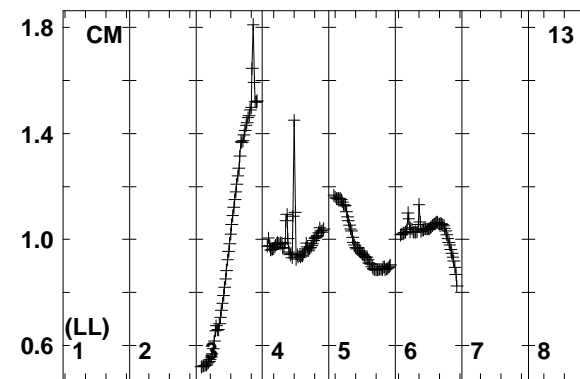
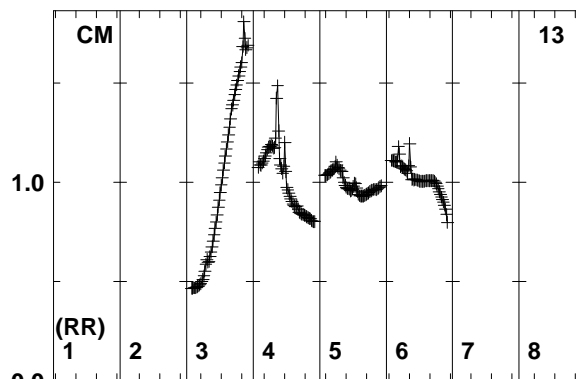
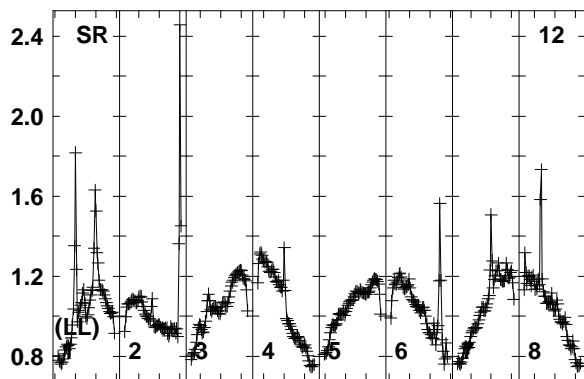
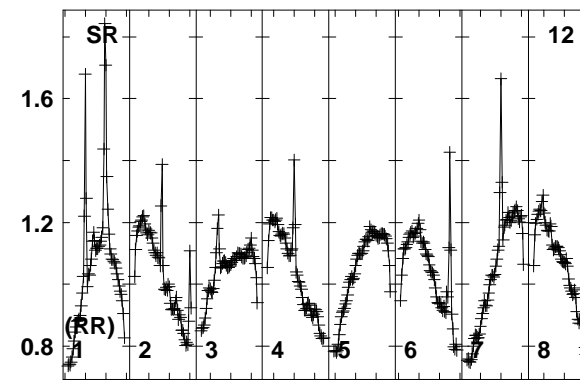
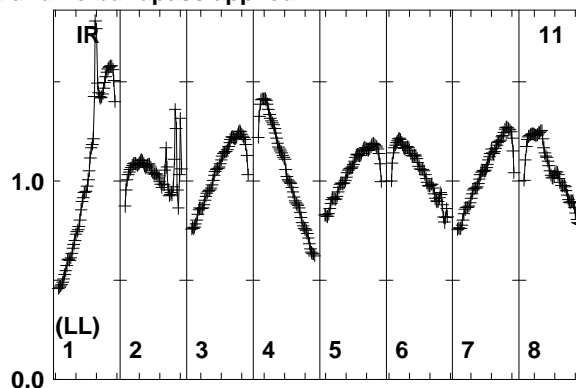
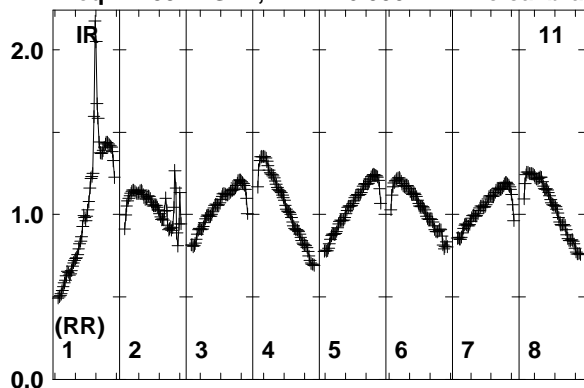

Lower frame: Real Jy
Total-power spectrum Antenna: IR (11)
Timerange: 00/04:36:31 to 00/04:37:29

Plot file version 197 created 04-NOV-2019 14:14:15
J2248-0541 EY034.UVDATA.1
Freq = 1.5947 GHz, Bw = 16.000 MH No calibration applied and no bandpass applied

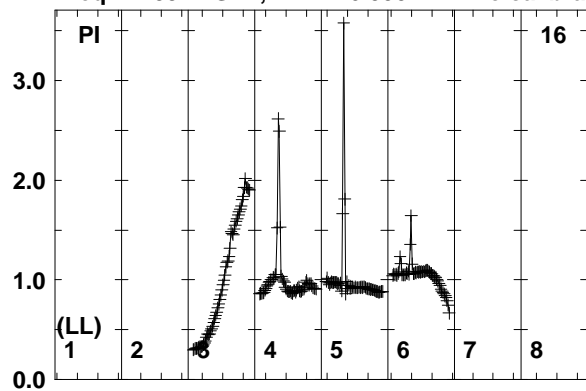

Lower frame: Real Jy
Total-power spectrum Antenna: PI (16)
Timerange: 00/04:36:31 to 00/04:37:29

Plot file version 198 created 04-NOV-2019 14:14:15
 W2246-0526 EY034.UVDATA.1
 Freq = 1.5947 GHz, Bw = 16.000 MH No calibration applied and no bandpass applied

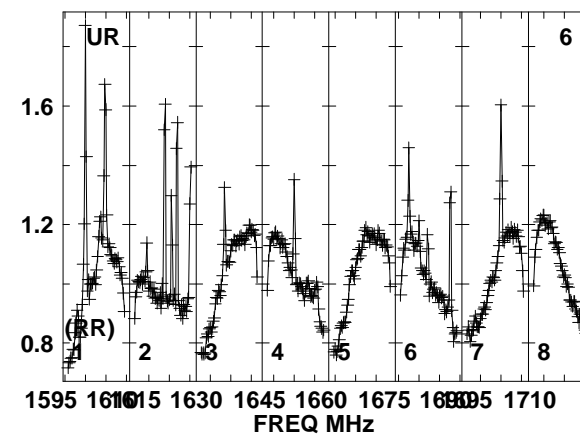
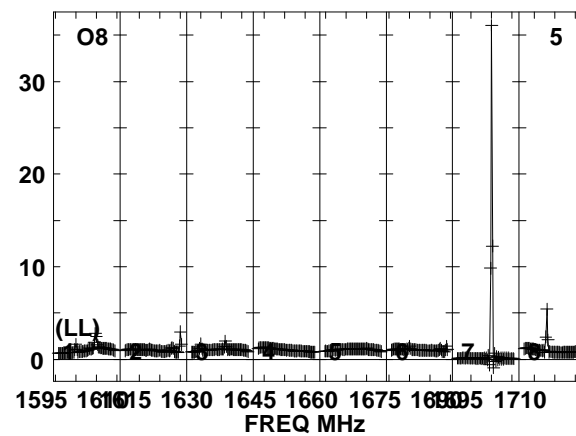
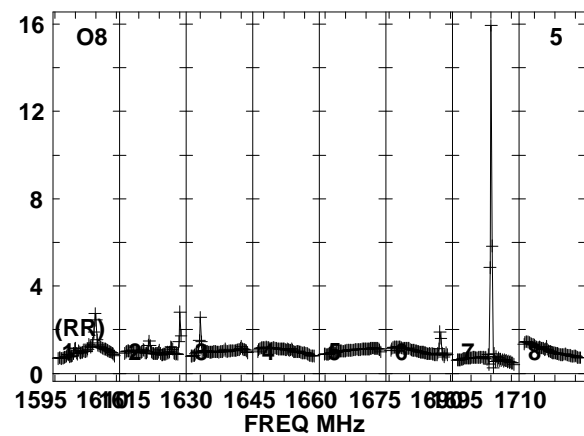
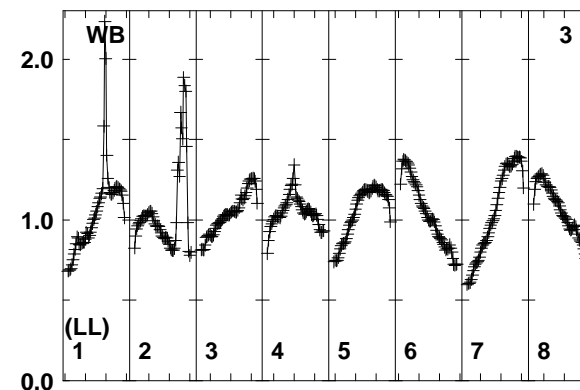
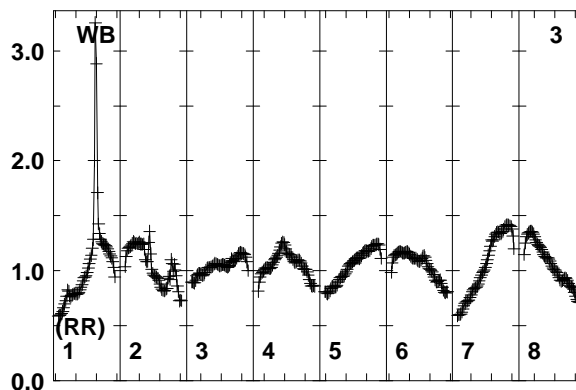
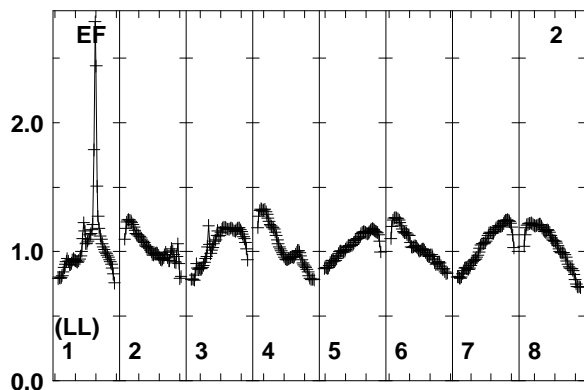
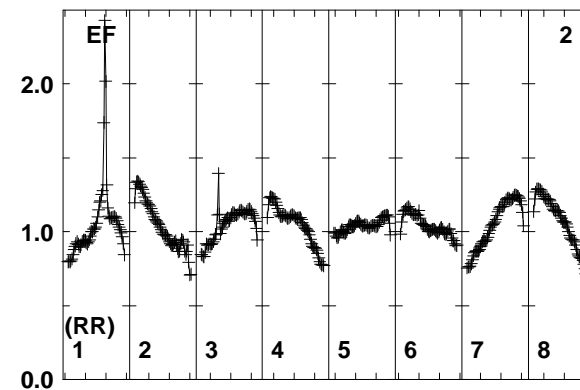
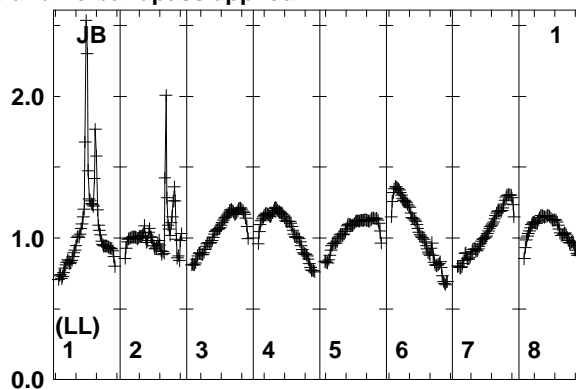
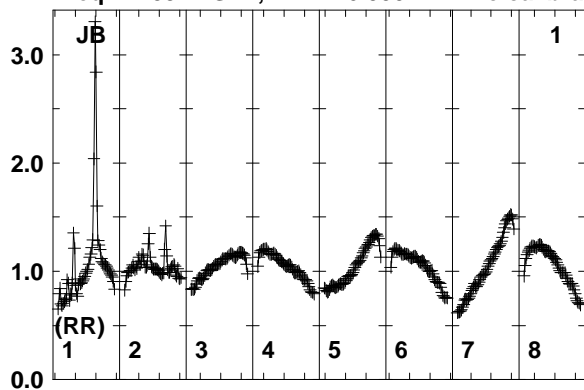

Lower frame: Real Jy
 Total-power spectrum Antenna: JB (01)
 Timerange: 00/04:37:31 to 00/04:39:59

Plot file version 199 created 04-NOV-2019 14:14:15

W2246-0526 EY034.UVDATA.1

Freq = 1.5947 GHz, Bw = 16.000 MH No calibration applied and no bandpass applied

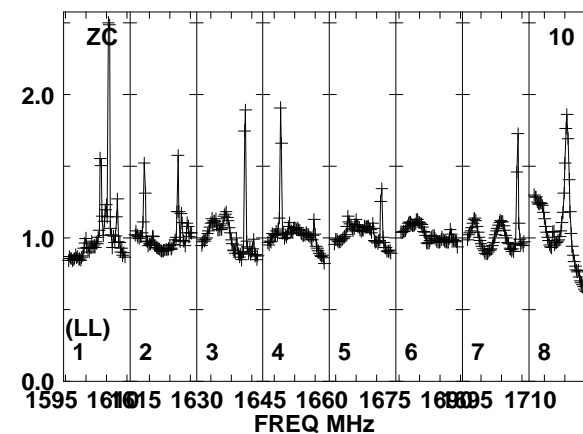
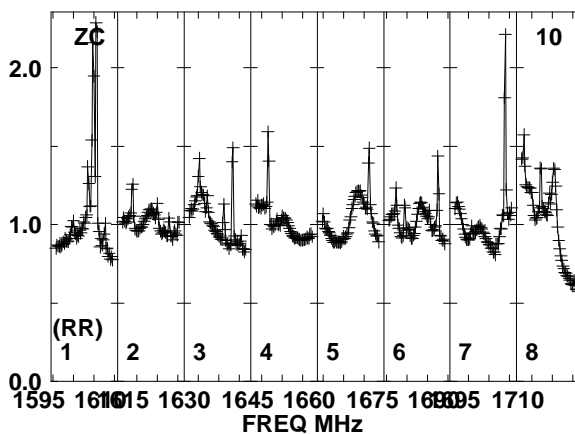
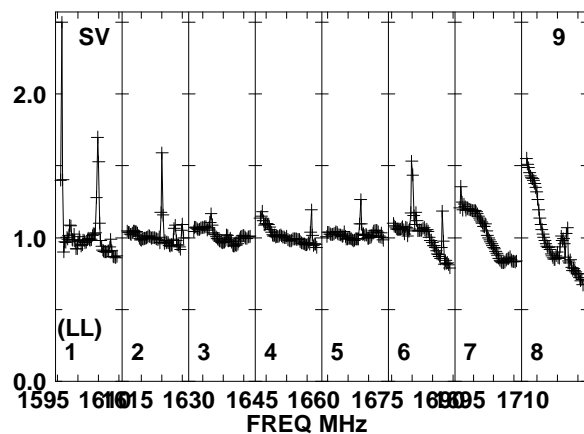
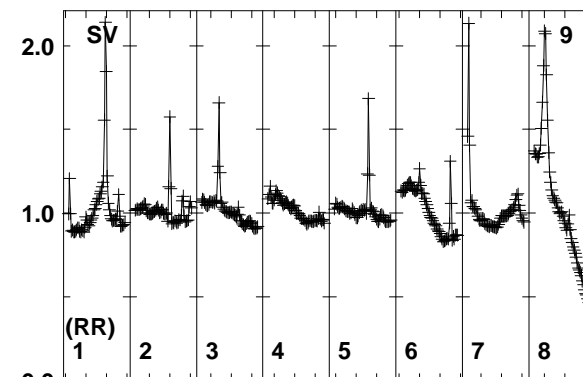
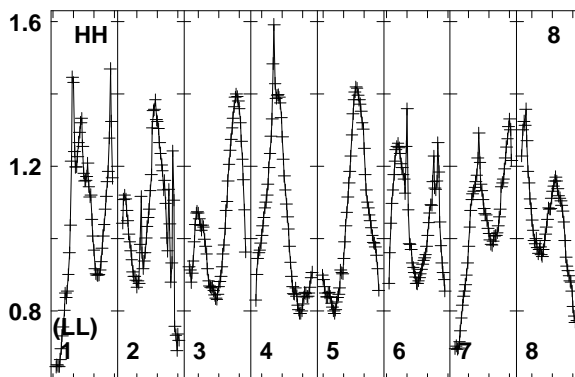
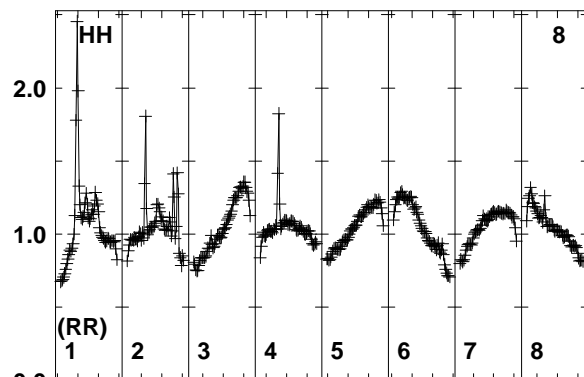
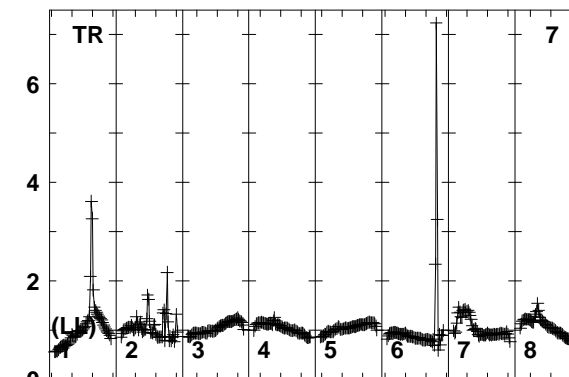
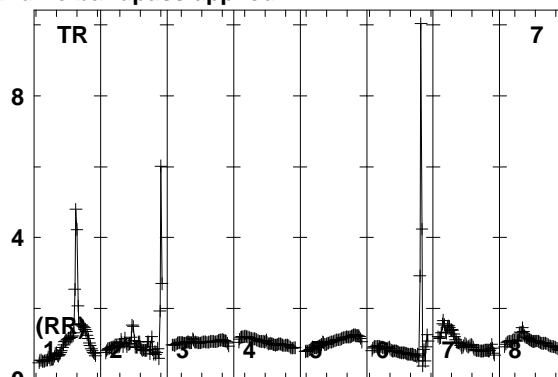
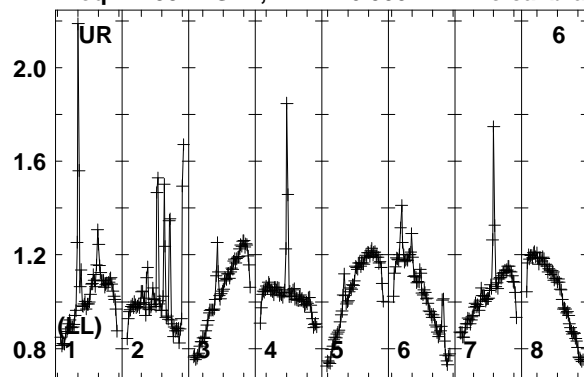

Lower frame: Real Jy
Total-power spectrum Antenna: UR (06)
Timerange: 00/04:37:31 to 00/04:39:59

Plot file version 200 created 04-NOV-2019 14:14:15

W2246-0526 EY034.UVDATA.1

Freq = 1.5947 GHz, Bw = 16.000 MH No calibration applied and no bandpass applied

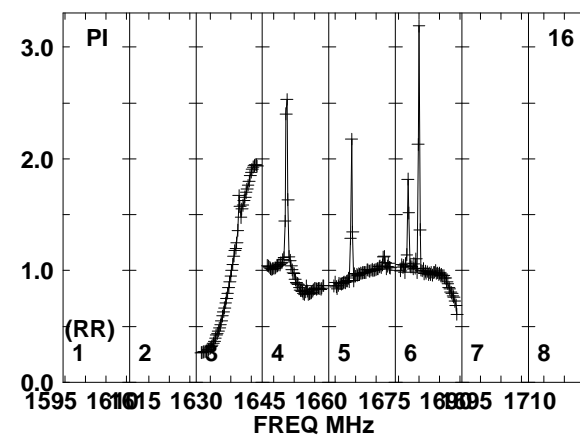
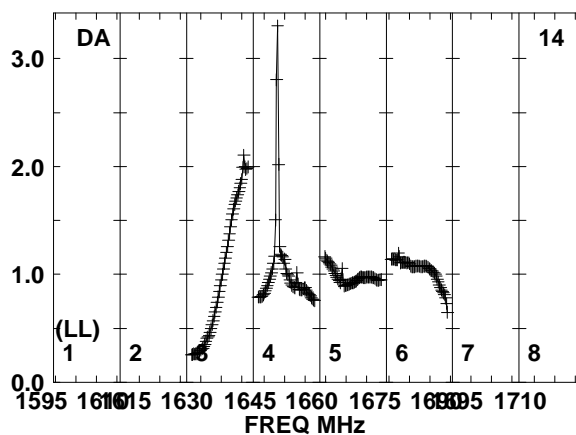
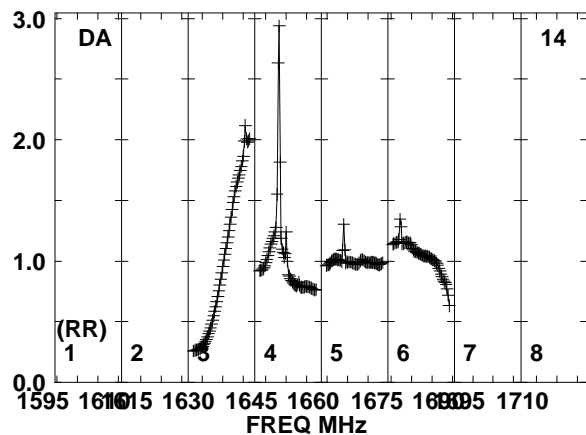
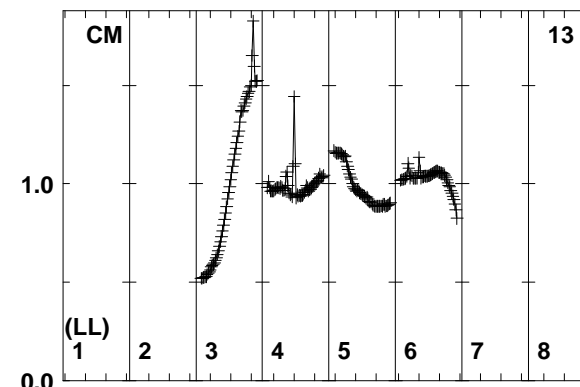
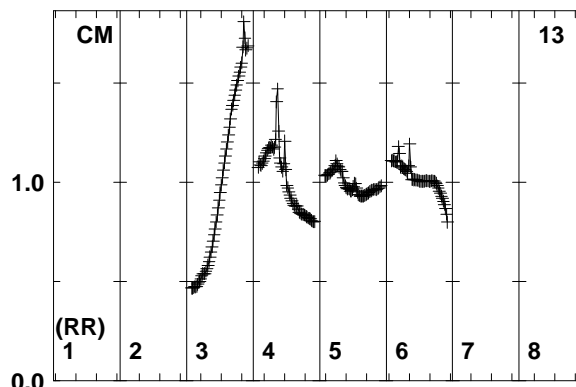
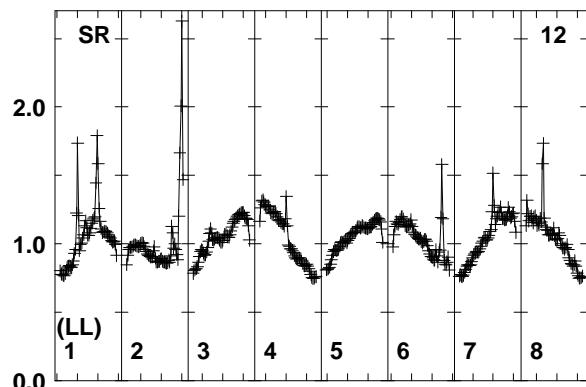
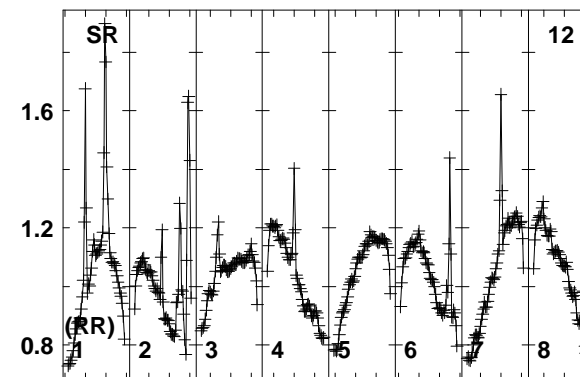
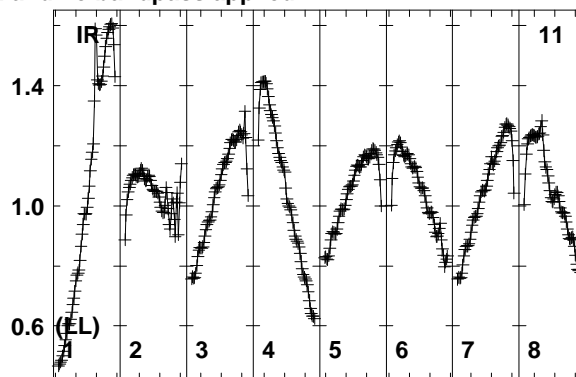
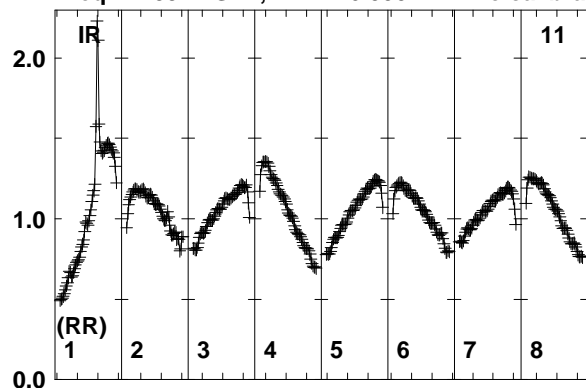

Lower frame: Real Jy
Total-power spectrum Antenna: IR (11)
Timerange: 00/04:37:31 to 00/04:39:59

Plot file version 201 created 04-NOV-2019 14:14:15
W2246-0526 EY034.UVDATA.1
Freq = 1.5947 GHz, Bw = 16.000 MH No calibration applied and no bandpass applied

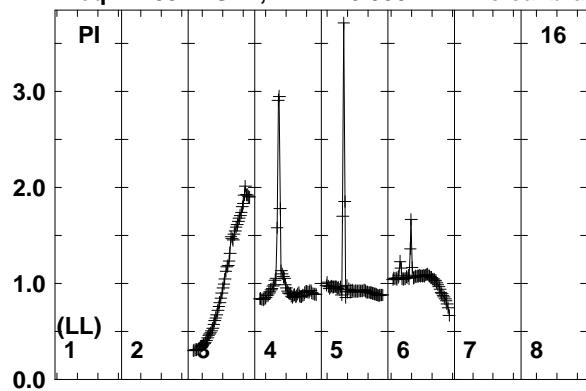

Lower frame: Real Jy
Total-power spectrum Antenna: PI (16)
Timerange: 00/04:37:31 to 00/04:39:59

Plot file version 202 created 04-NOV-2019 14:14:15

J2248-0541 EY034.UVDATA.1

Freq = 1.5947 GHz, Bw = 16.000 MH No calibration applied and no bandpass applied

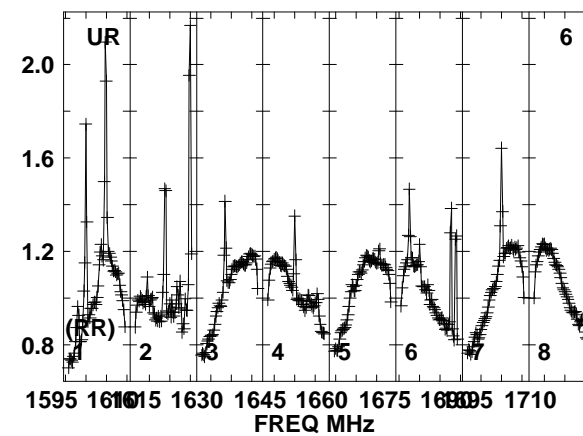
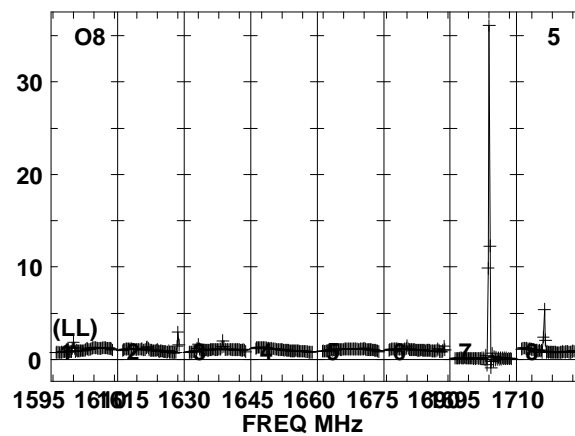
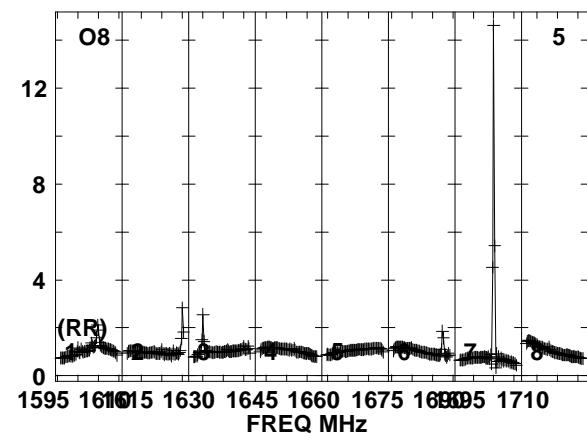
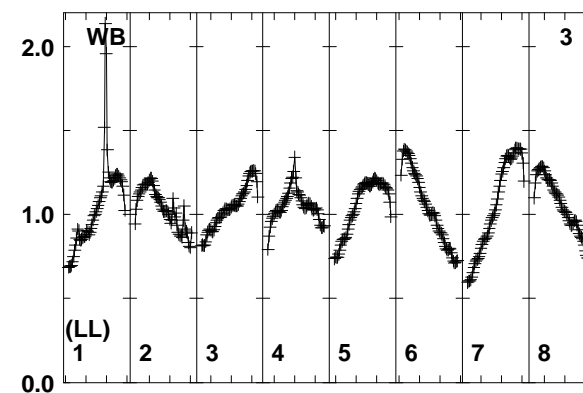
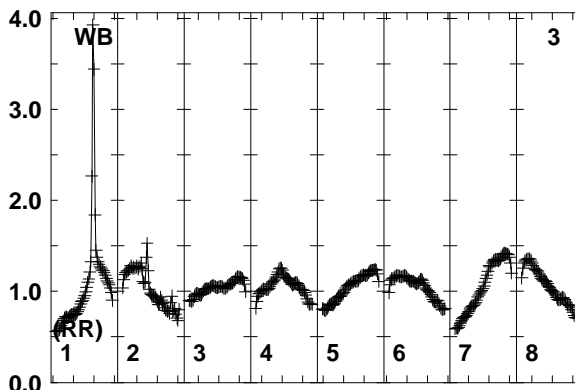
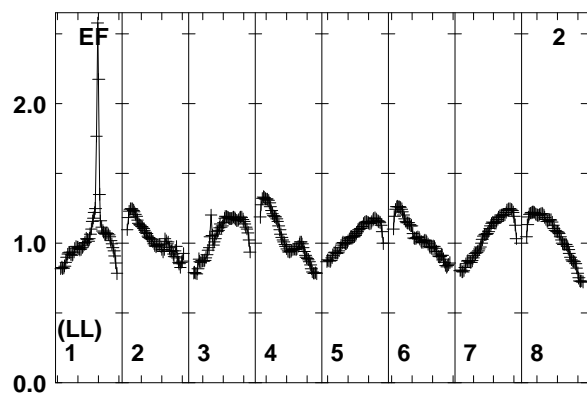
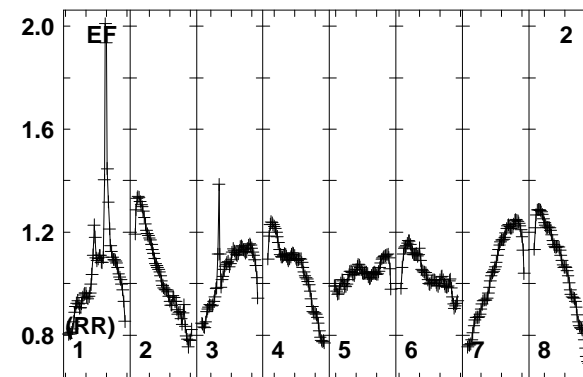
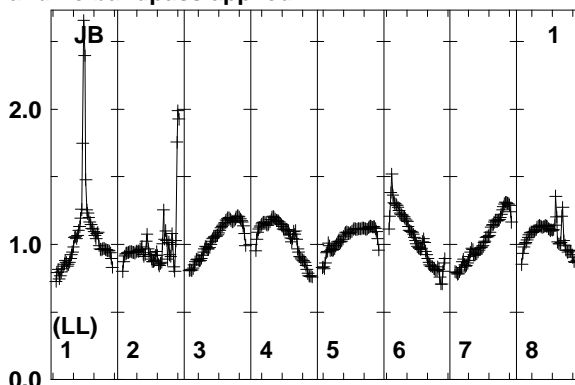
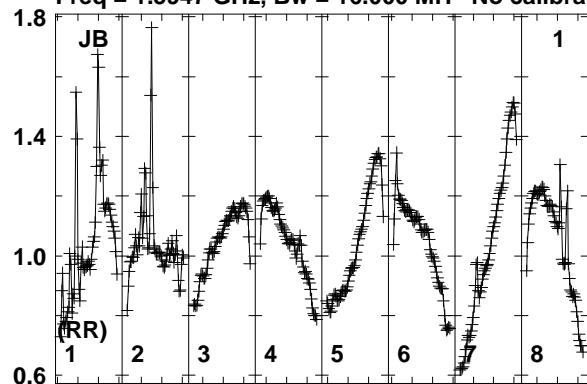

Lower frame: Real Jy
Total-power spectrum Antenna: JB (01)
Timerange: 00/04:40:16 to 00/04:41:14

Plot file version 203 created 04-NOV-2019 14:14:15

J2248-0541 EY034.UVDATA.1

Freq = 1.5947 GHz, Bw = 16.000 MH No calibration applied and no bandpass applied

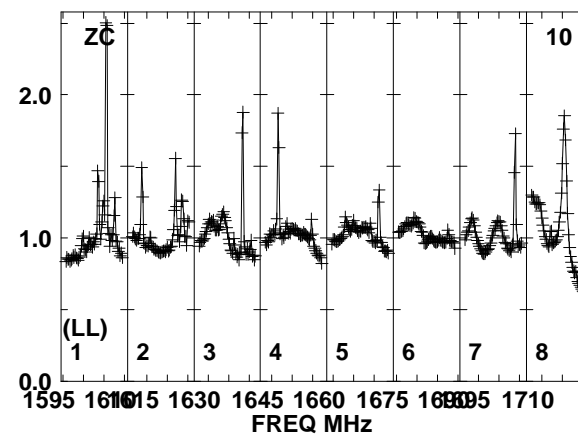
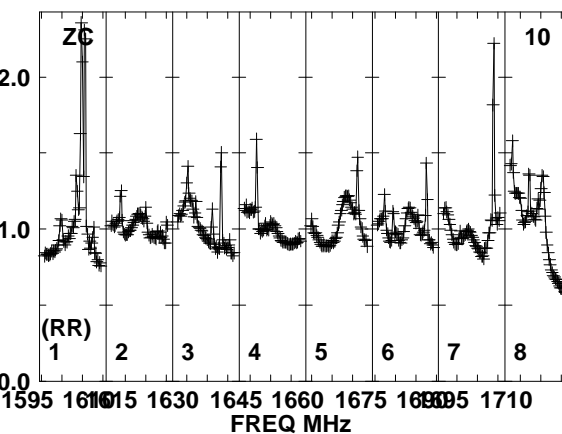
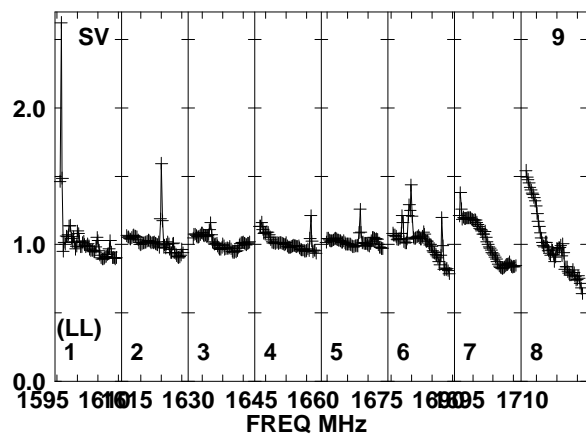
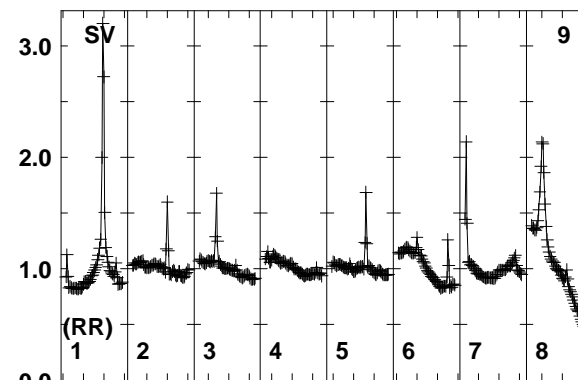
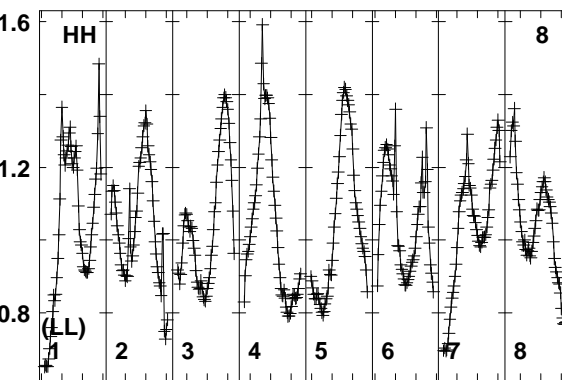
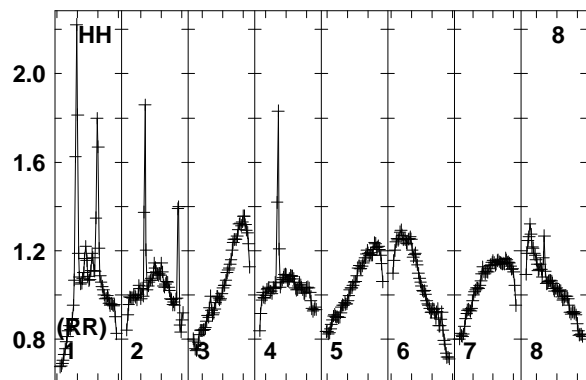
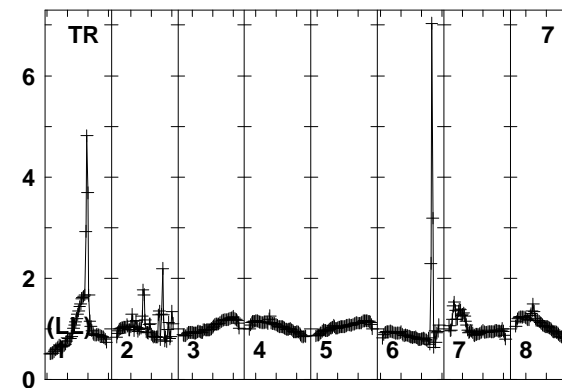
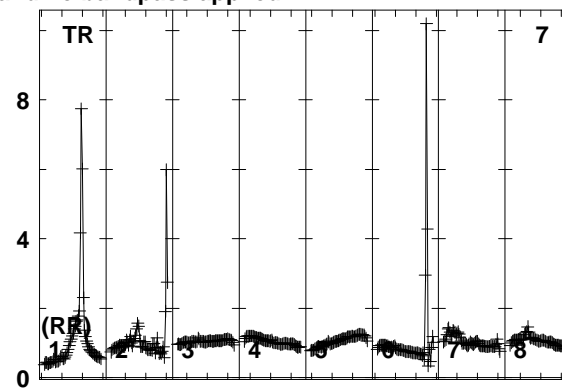
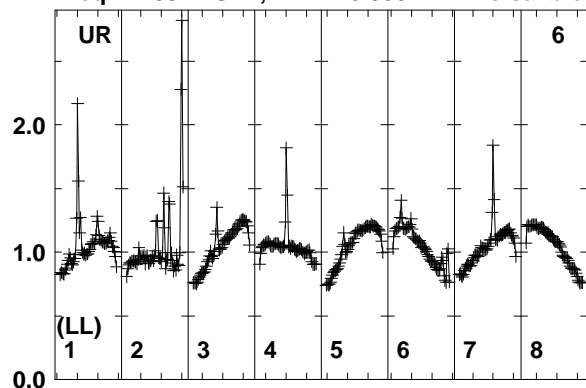

Lower frame: Real Jy
Total-power spectrum Antenna: UR (06)
Timerange: 00/04:40:16 to 00/04:41:14

Plot file version 204 created 04-NOV-2019 14:14:15

J2248-0541 EY034.UVDATA.1

Freq = 1.5947 GHz, Bw = 16.000 MH No calibration applied and no bandpass applied

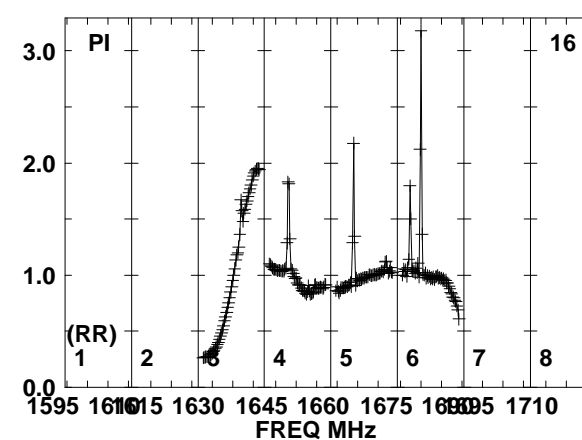
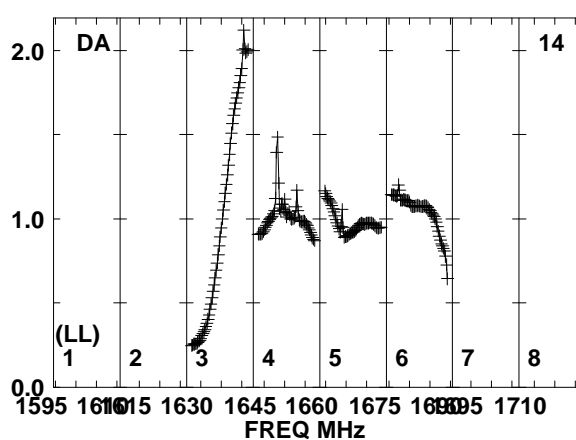
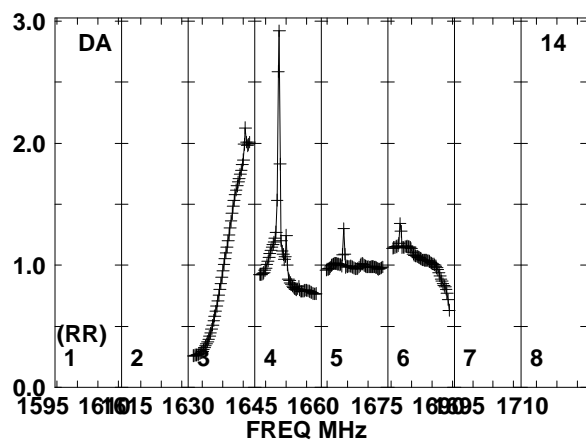
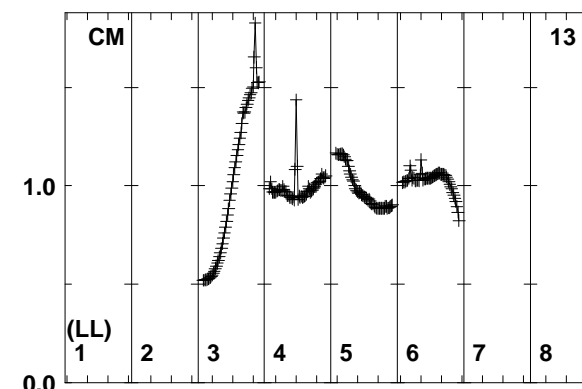
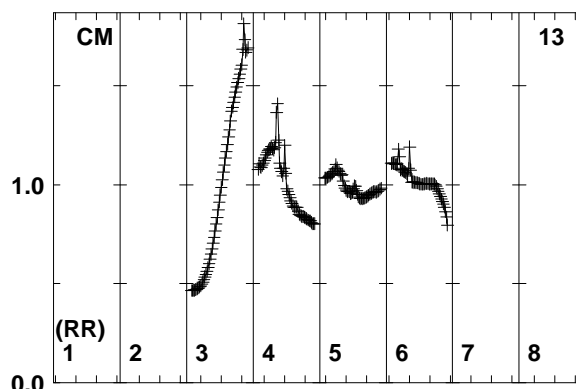
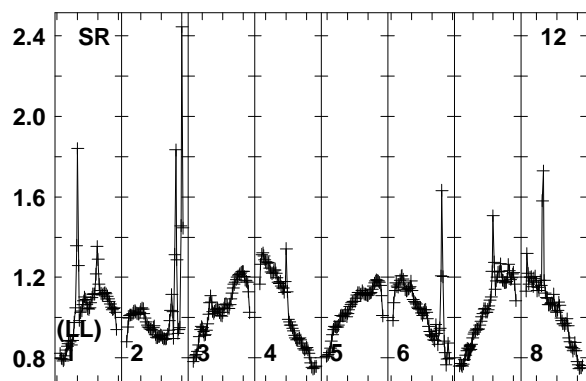
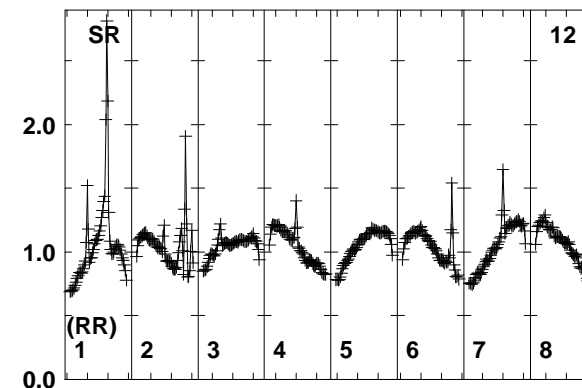
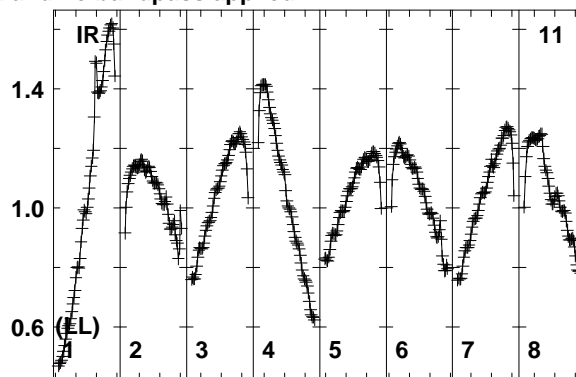
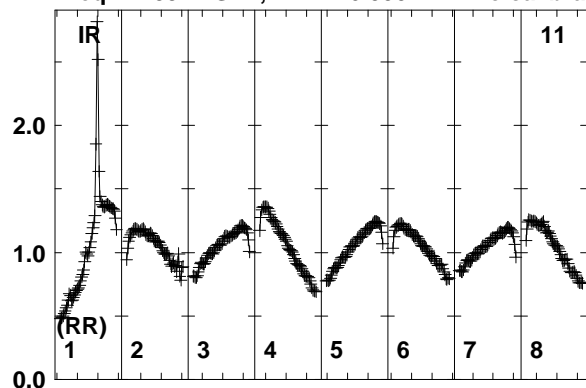

Lower frame: Real Jy
Total-power spectrum Antenna: IR (11)
Timerange: 00/04:40:16 to 00/04:41:14

Plot file version 205 created 04-NOV-2019 14:14:15
J2248-0541 EY034.UVDATA.1
Freq = 1.5947 GHz, Bw = 16.000 MH No calibration applied and no bandpass applied

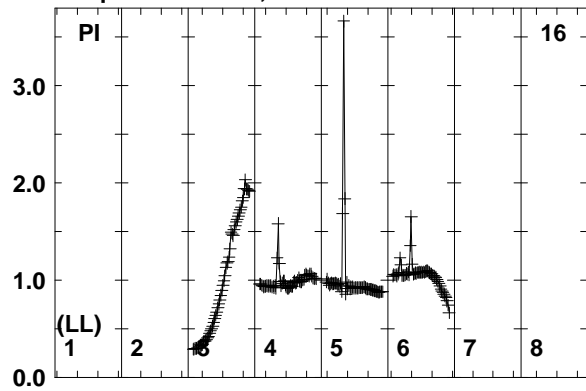

Lower frame: Real Jy
Total-power spectrum Antenna: PI (16)
Timerange: 00/04:40:16 to 00/04:41:14

Plot file version 206 created 04-NOV-2019 14:14:15

W2246-0526 EY034.UVDATA.1

Freq = 1.5947 GHz, Bw = 16.000 MH No calibration applied and no bandpass applied

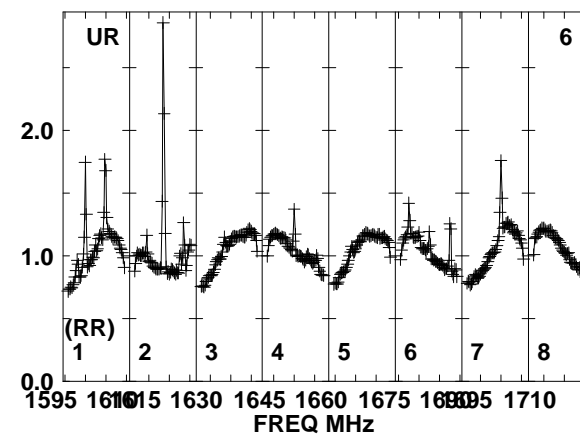
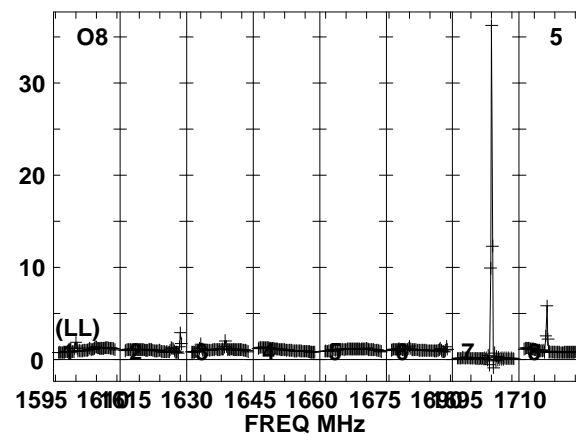
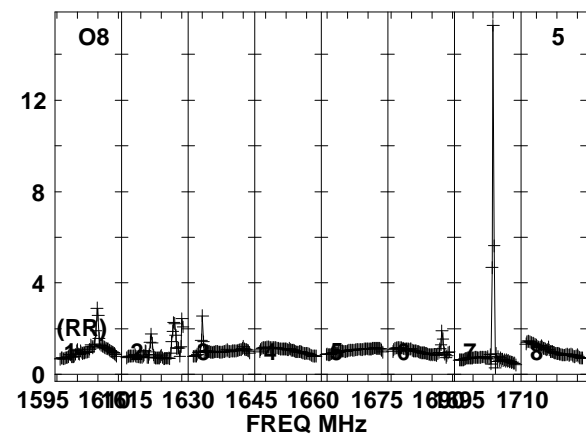
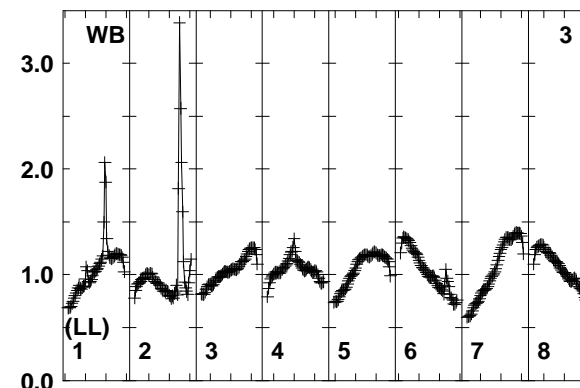
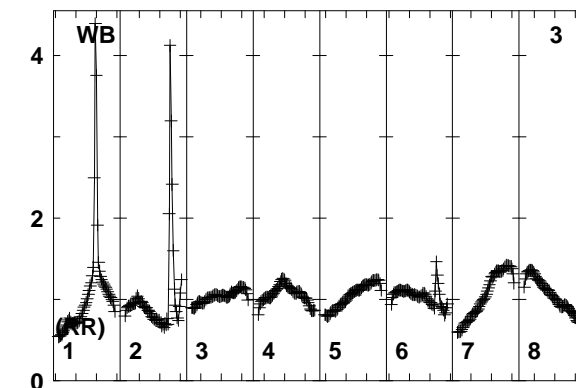
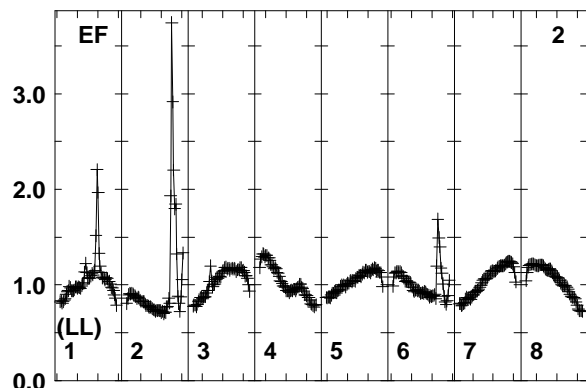
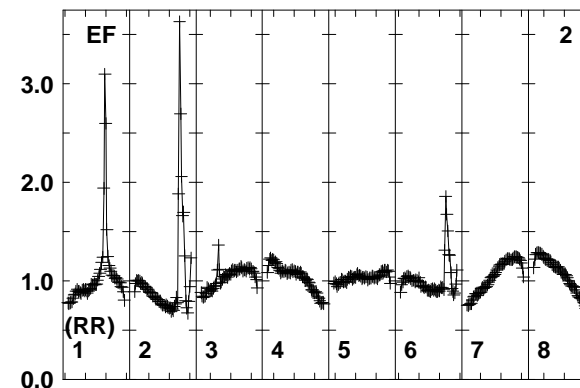
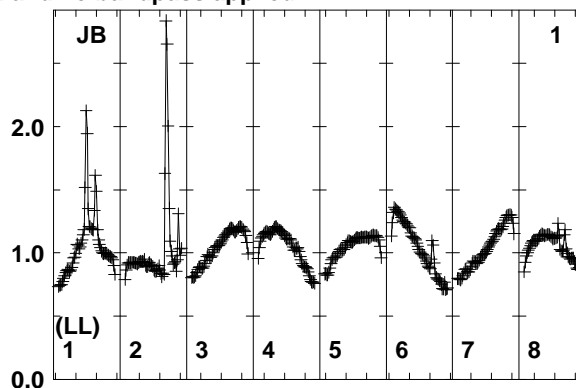
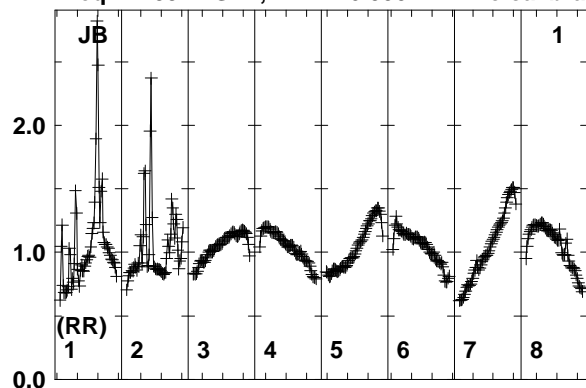

Lower frame: Real Jy
Total-power spectrum Antenna: JB (01)
Timerange: 00/04:41:16 to 00/04:43:54

Plot file version 207 created 04-NOV-2019 14:14:16

W2246-0526 EY034.UVDATA.1

Freq = 1.5947 GHz, Bw = 16.000 MH No calibration applied and no bandpass applied

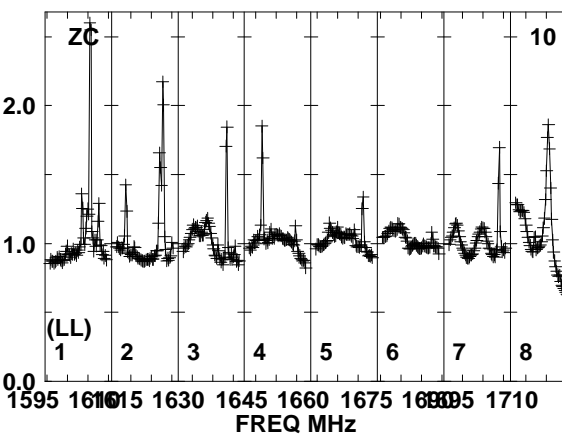
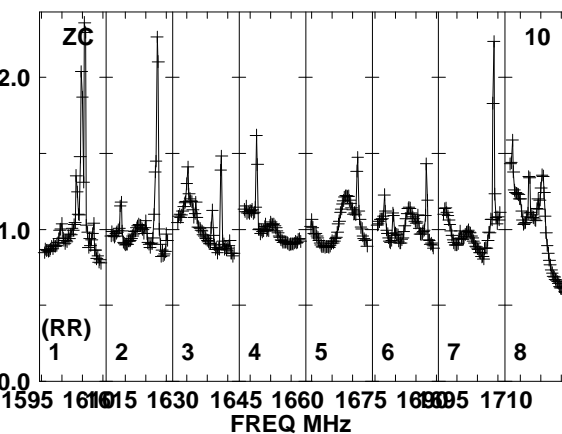
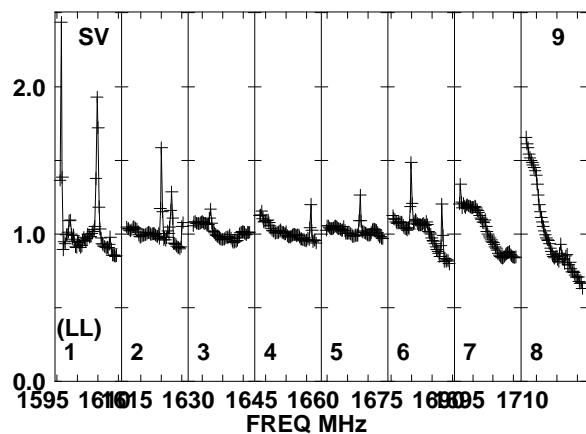
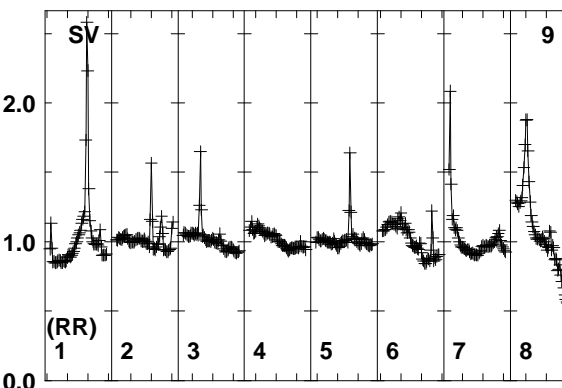
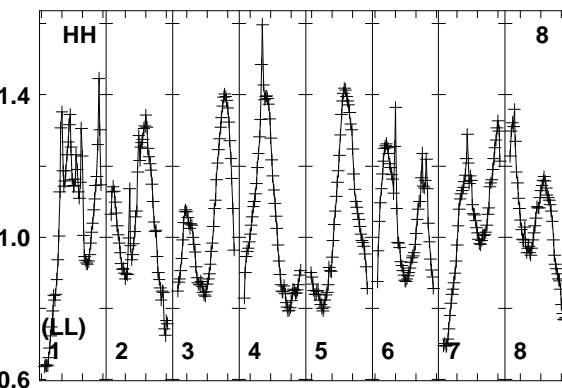
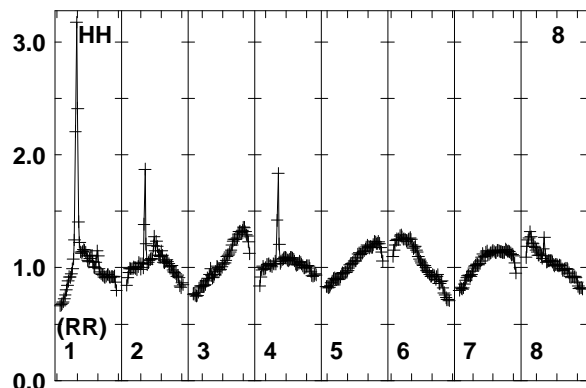
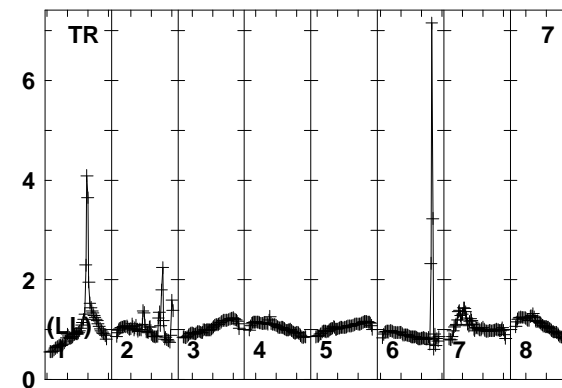
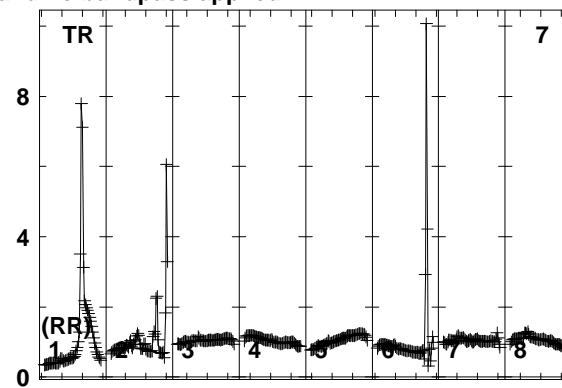
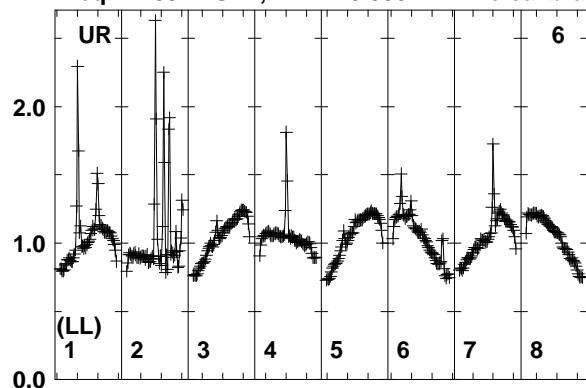

Lower frame: Real Jy
Total-power spectrum Antenna: UR (06)
Timerange: 00/04:41:16 to 00/04:43:54

Plot file version 208 created 04-NOV-2019 14:14:16

W2246-0526 EY034.UVDATA.1

Freq = 1.5947 GHz, Bw = 16.000 MH No calibration applied and no bandpass applied

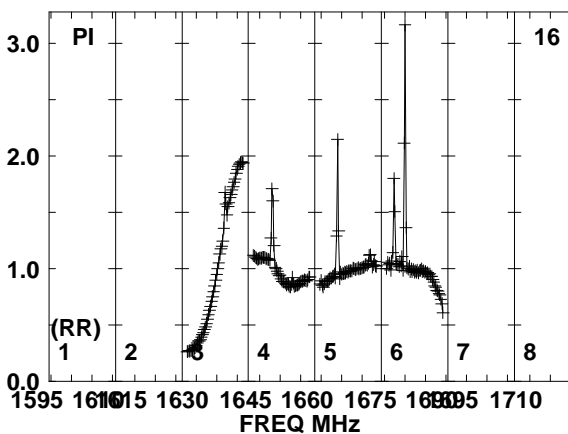
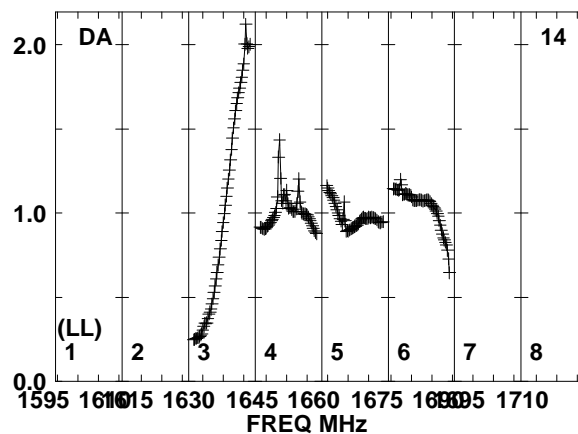
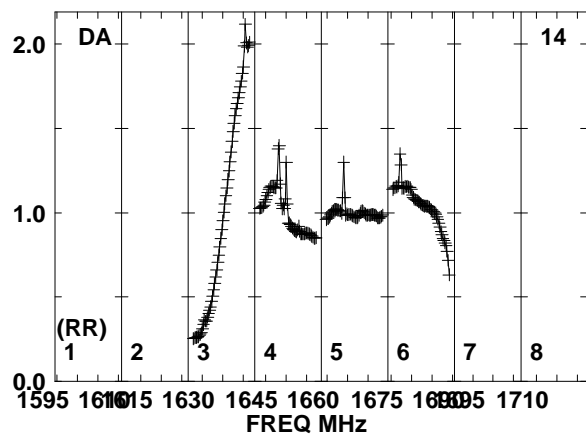
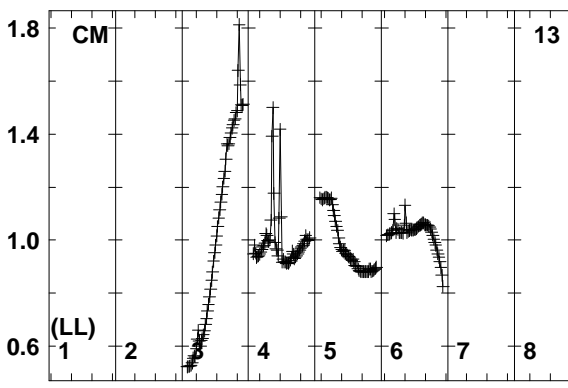
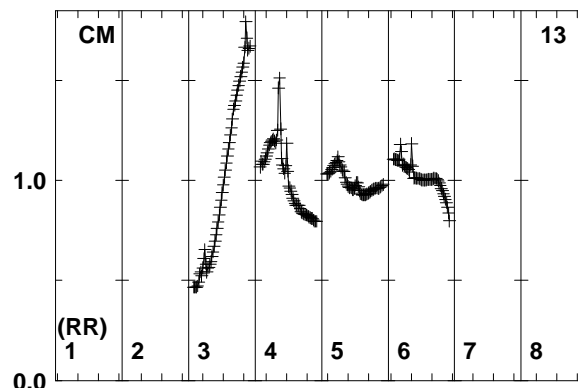
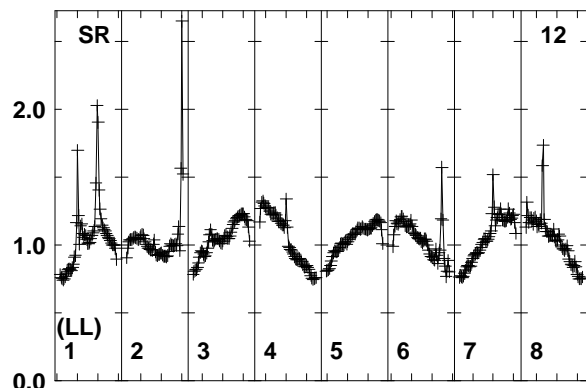
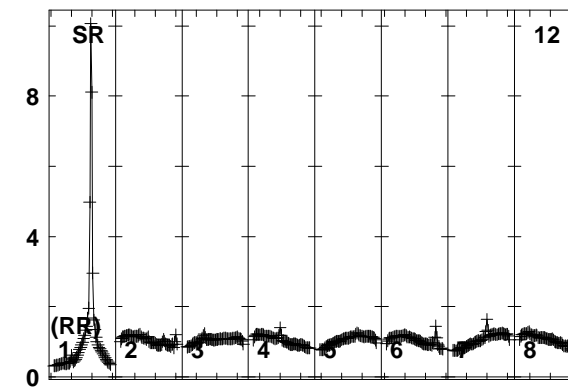
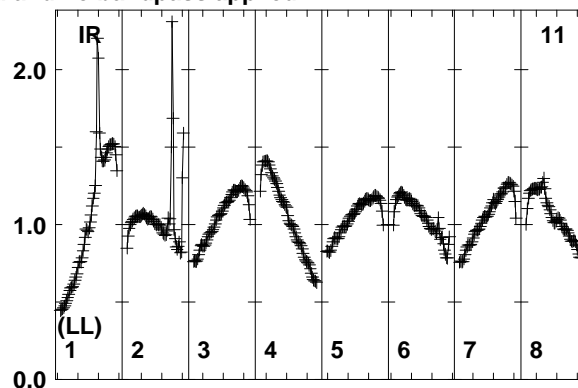
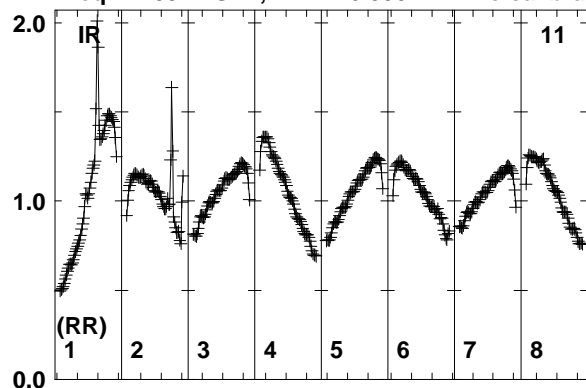

Lower frame: Real Jy
Total-power spectrum Antenna: IR (11)
Timerange: 00/04:41:16 to 00/04:43:54

Plot file version 209 created 04-NOV-2019 14:14:16
W2246-0526 EY034.UVDATA.1
Freq = 1.5947 GHz, Bw = 16.000 MH No calibration applied and no bandpass applied

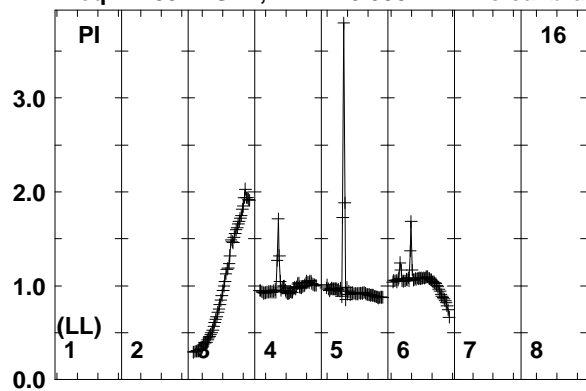

Lower frame: Real Jy
Total-power spectrum Antenna: PI (16)
Timerange: 00/04:41:16 to 00/04:43:54

Plot file version 210 created 04-NOV-2019 14:14:16

J2248-0541 EY034.UVDATA.1

Freq = 1.5947 GHz, Bw = 16.000 MH No calibration applied and no bandpass applied

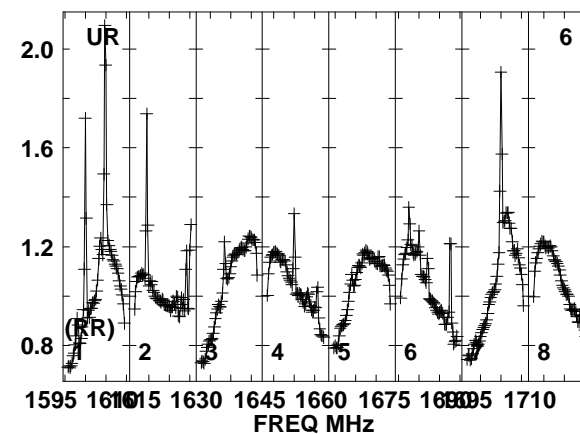
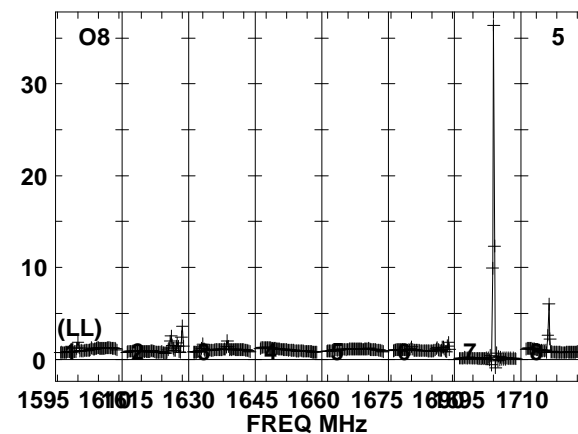
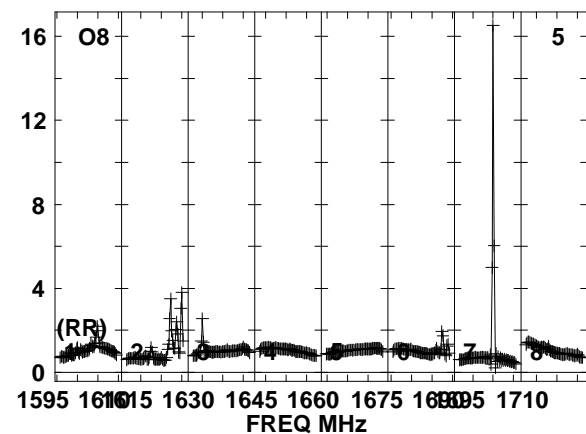
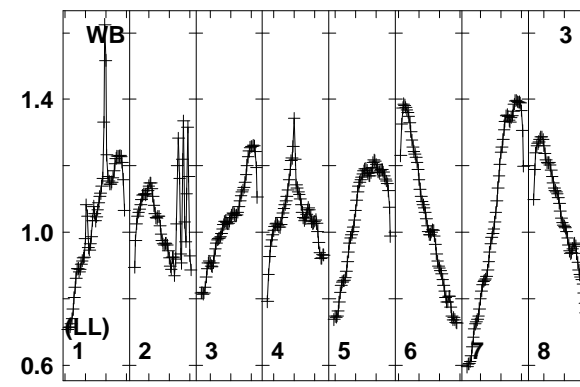
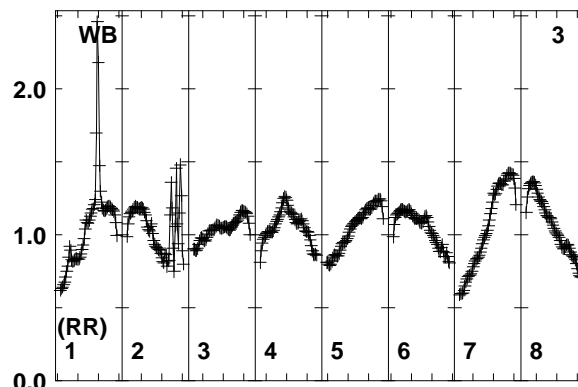
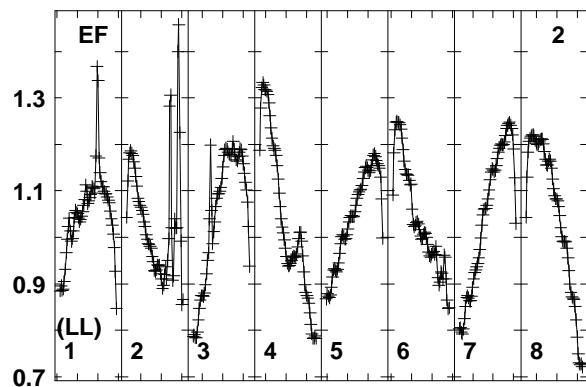
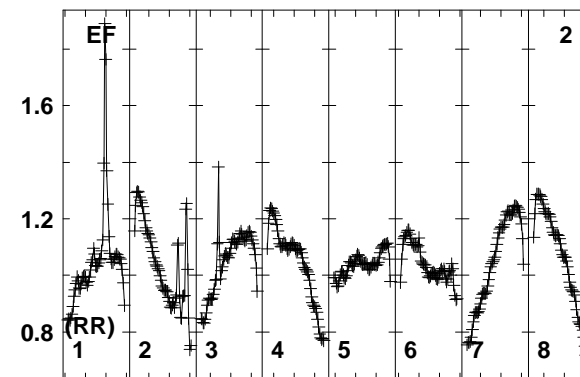
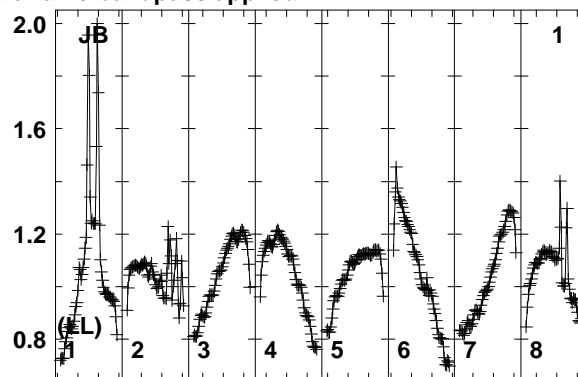
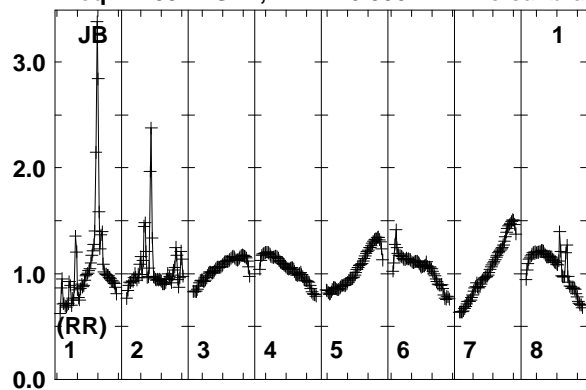

Lower frame: Real Jy
Total-power spectrum Antenna: JB (01)
Timerange: 00/04:44:11 to 00/04:45:09

Plot file version 211 created 04-NOV-2019 14:14:16

J2248-0541 EY034.UVDATA.1

Freq = 1.5947 GHz, Bw = 16.000 MH No calibration applied and no bandpass applied

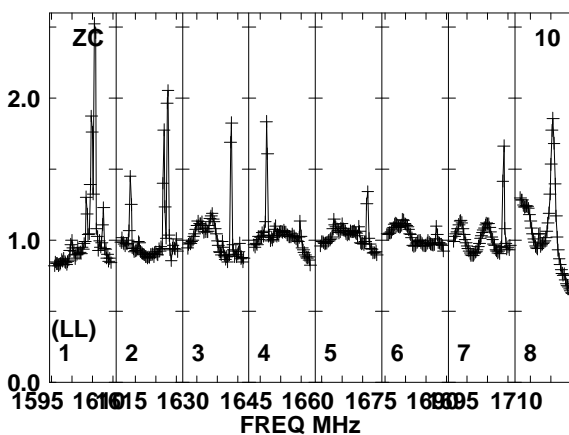
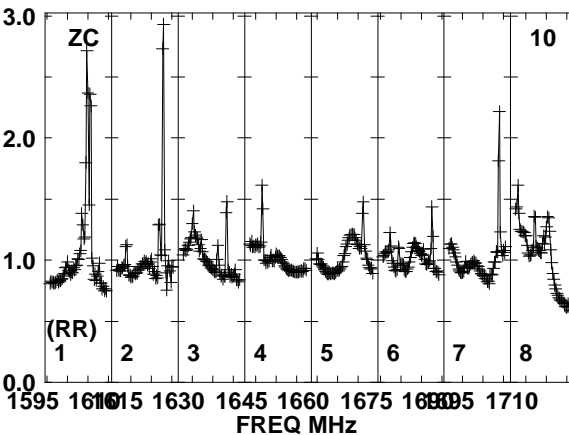
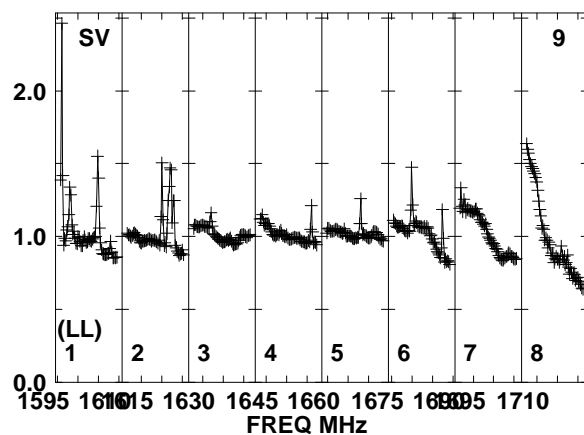
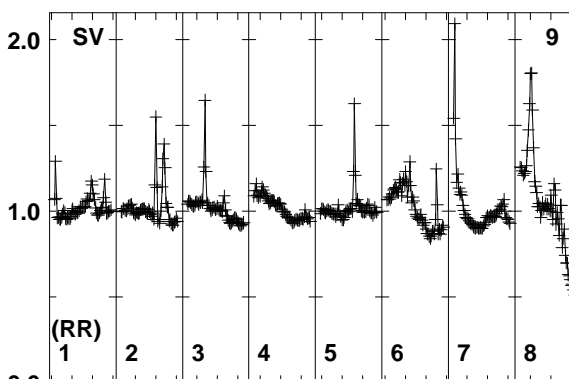
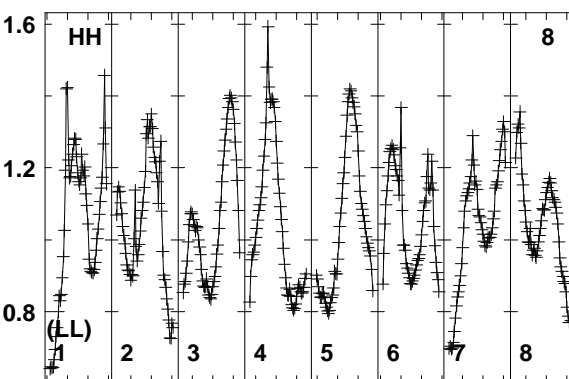
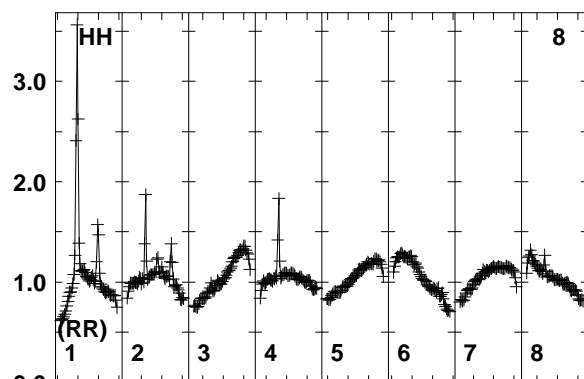
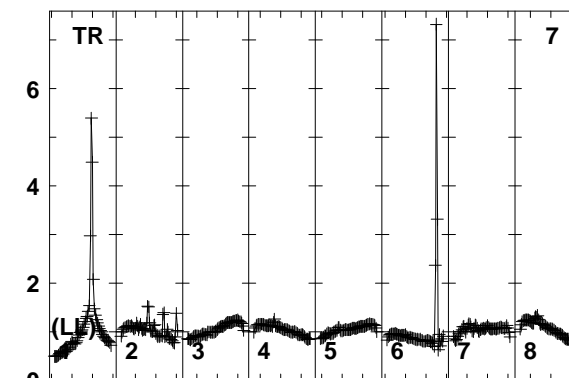
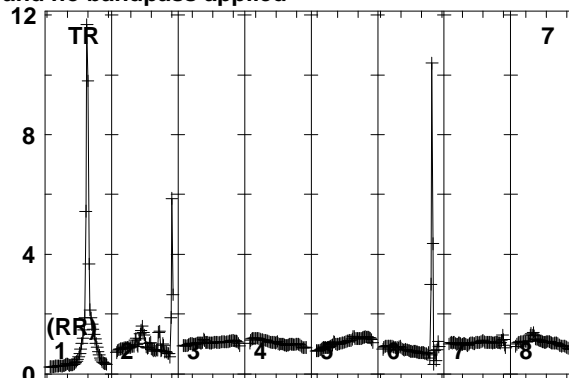
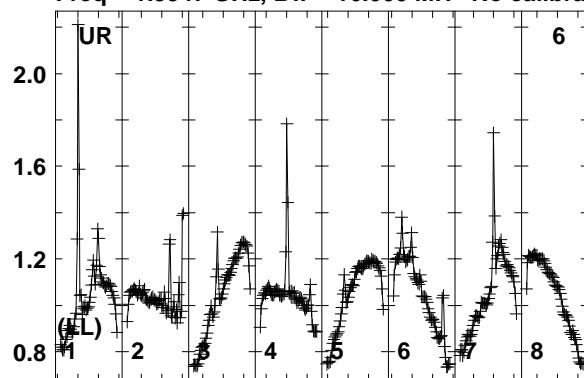

Lower frame: Real Jy
Total-power spectrum Antenna: UR (06)
Timerange: 00/04:44:11 to 00/04:45:09

Plot file version 212 created 04-NOV-2019 14:14:16

J2248-0541 EY034.UVDATA.1

Freq = 1.5947 GHz, Bw = 16.000 MH No calibration applied and no bandpass applied

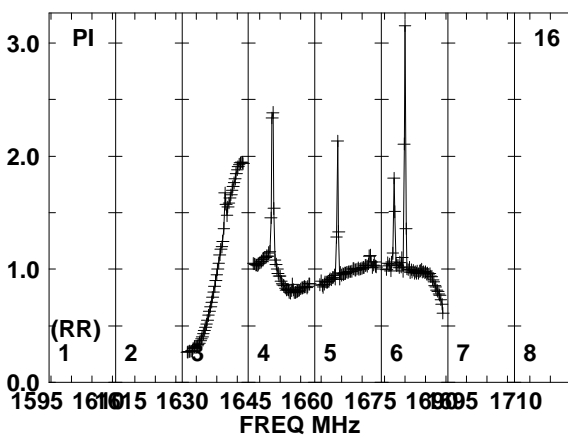
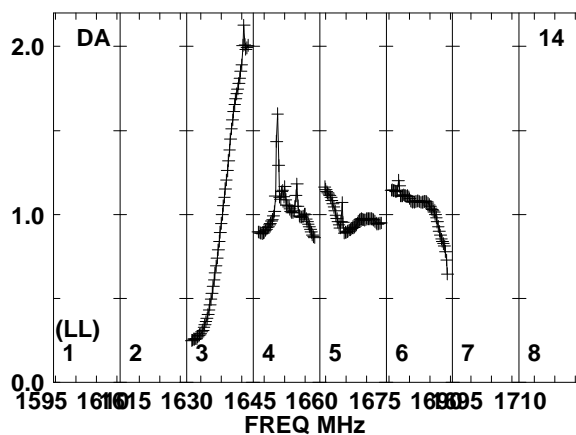
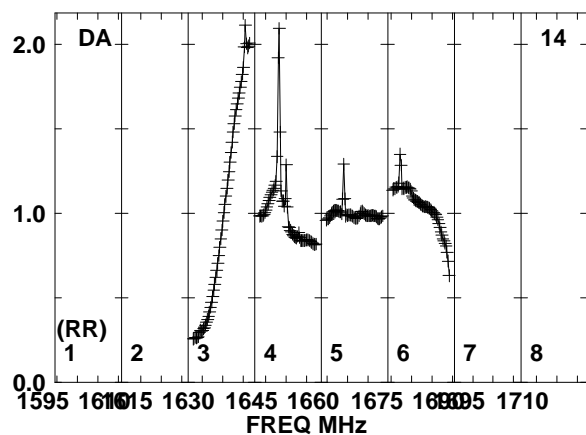
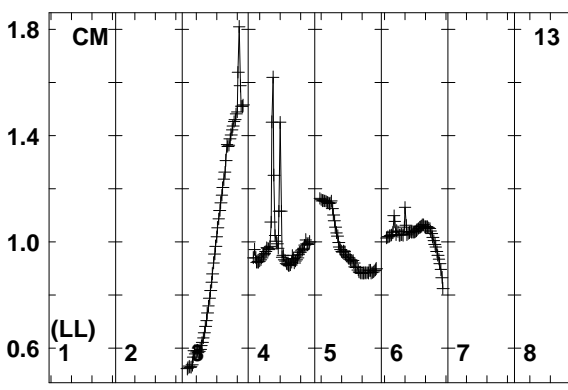
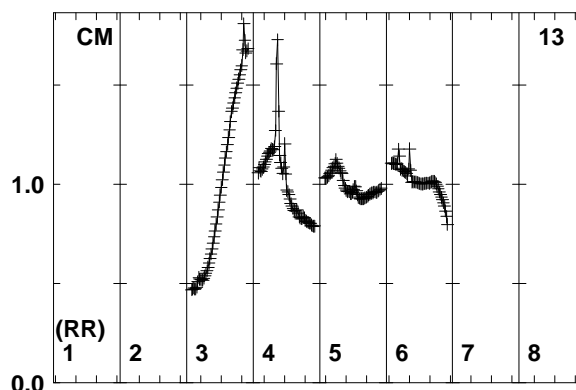
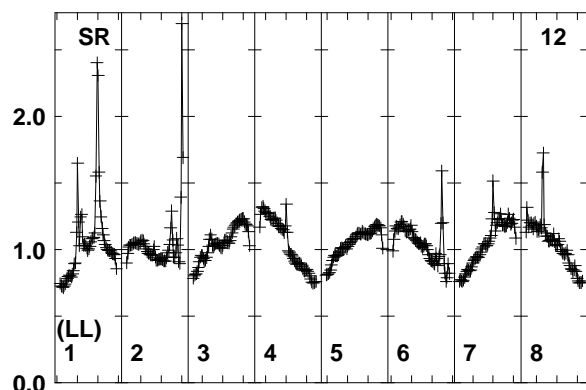
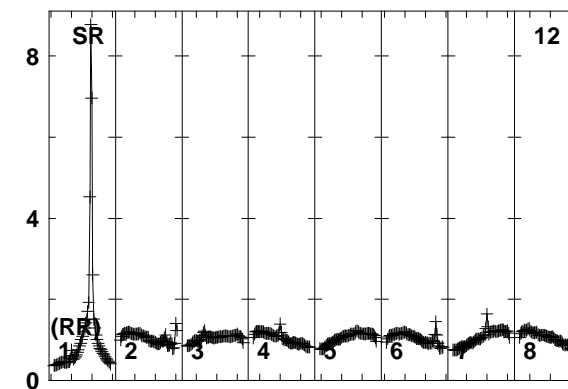
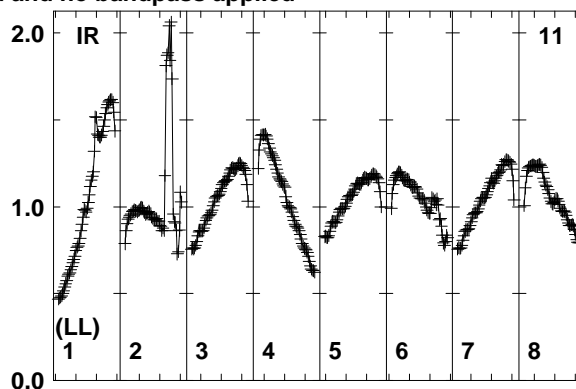
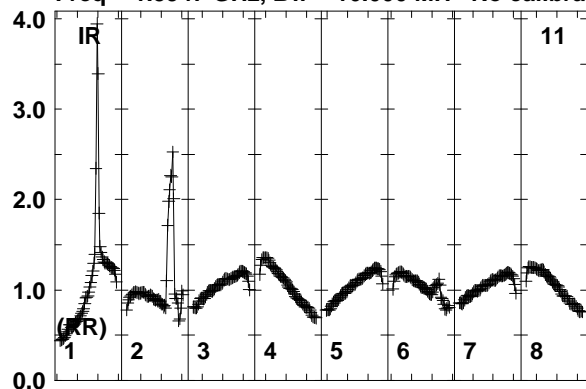

Lower frame: Real Jy
Total-power spectrum Antenna: IR (11)
Timerange: 00/04:44:11 to 00/04:45:09

Plot file version 213 created 04-NOV-2019 14:14:16
J2248-0541 EY034.UVDATA.1
Freq = 1.5947 GHz, Bw = 16.000 MH No calibration applied and no bandpass applied

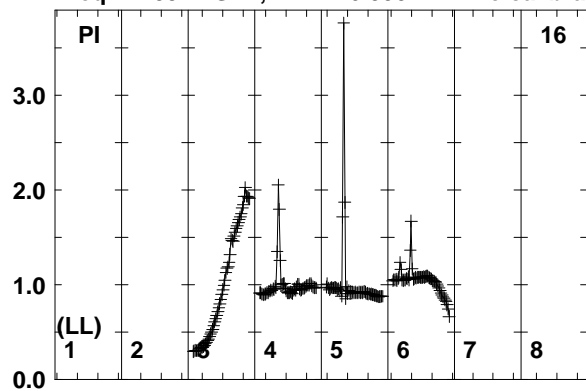

Lower frame: Real Jy
Total-power spectrum Antenna: PI (16)
Timerange: 00/04:44:11 to 00/04:45:09

Plot file version 214 created 04-NOV-2019 14:14:16

W2246-0526 EY034.UVDATA.1

Freq = 1.5947 GHz, Bw = 16.000 MH No calibration applied and no bandpass applied

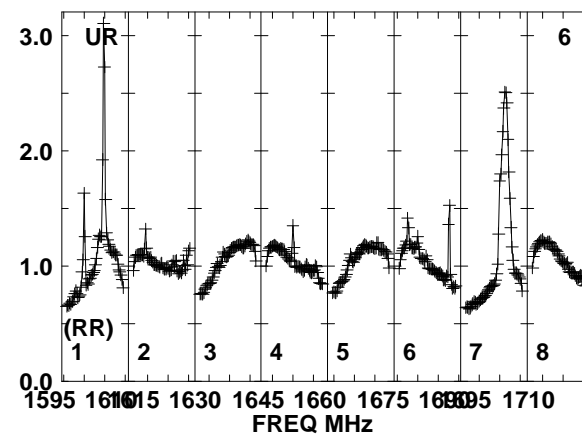
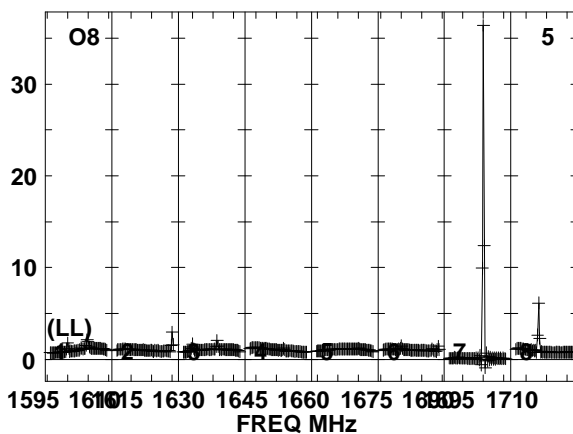
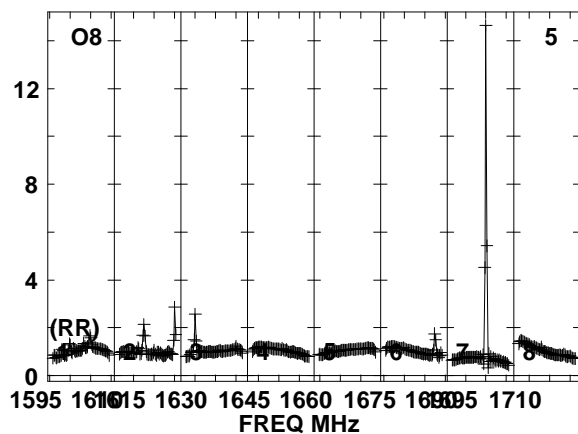
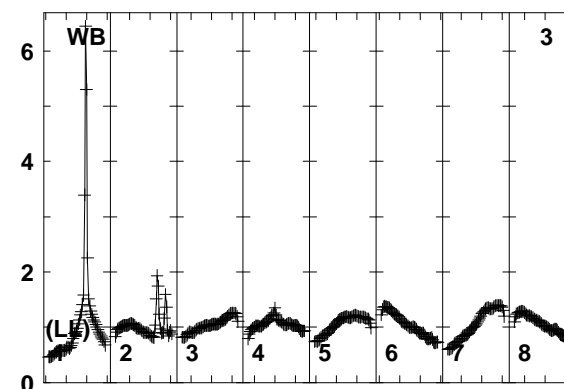
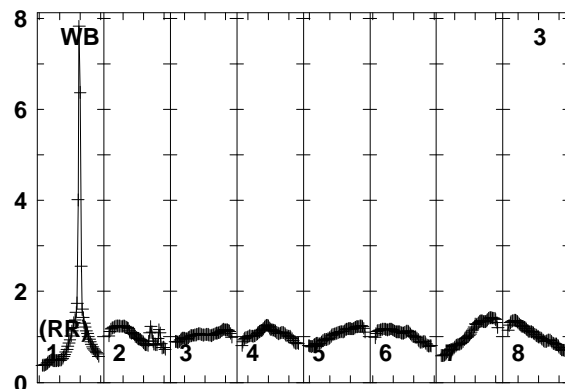
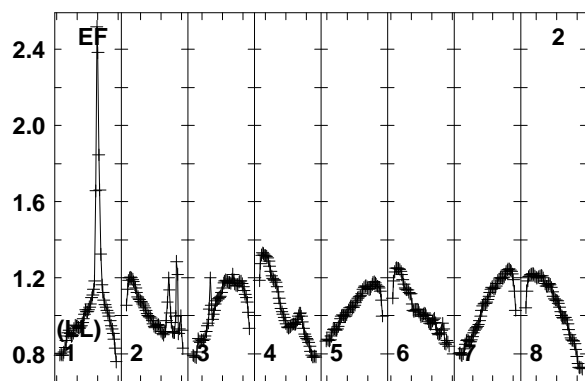
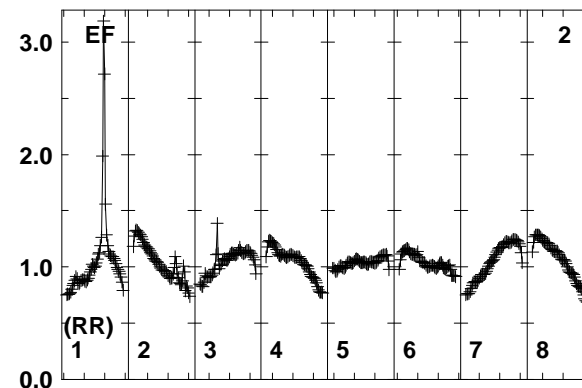
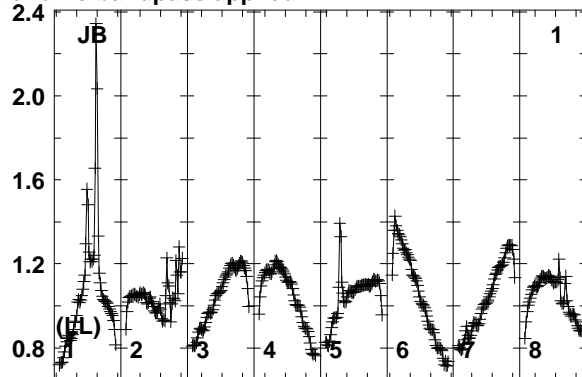
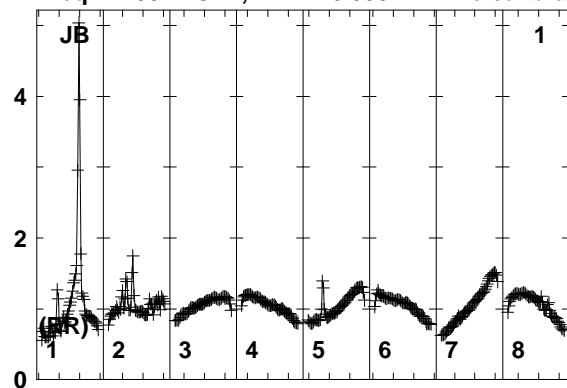

Lower frame: Real Jy
Total-power spectrum Antenna: JB (01)
Timerange: 00/04:45:11 to 00/04:47:49

Plot file version 215 created 04-NOV-2019 14:14:16

W2246-0526 EY034.UVDATA.1

Freq = 1.5947 GHz, Bw = 16.000 MH No calibration applied and no bandpass applied

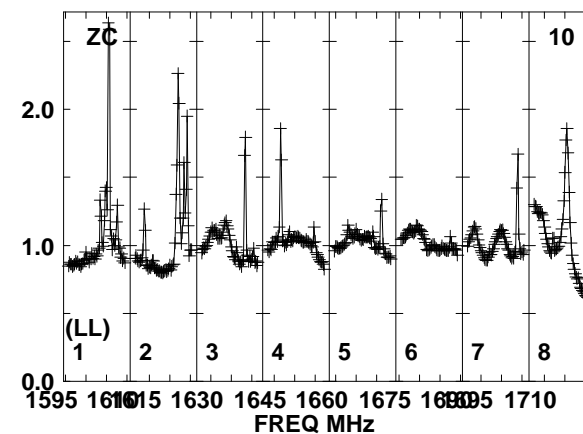
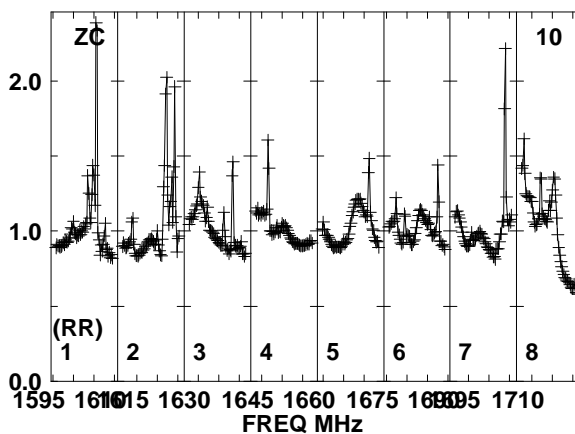
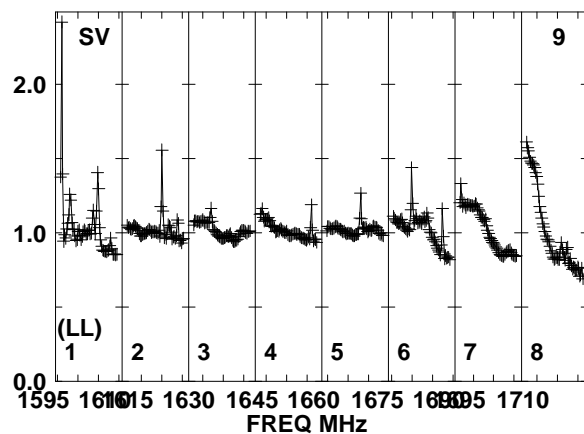
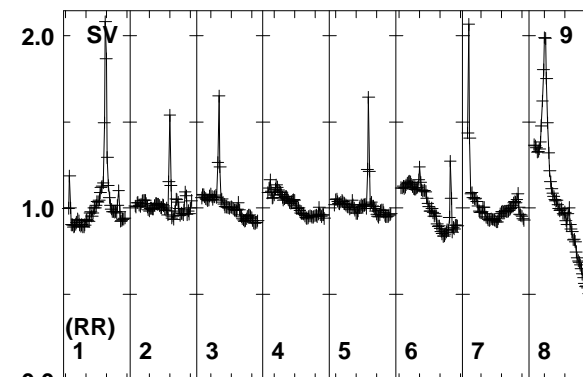
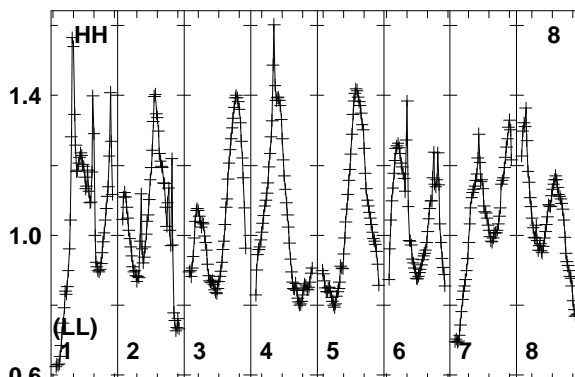
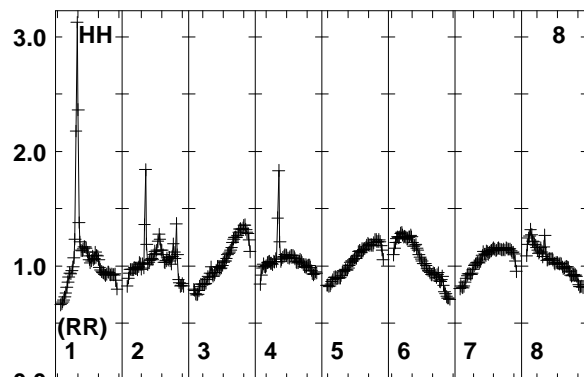
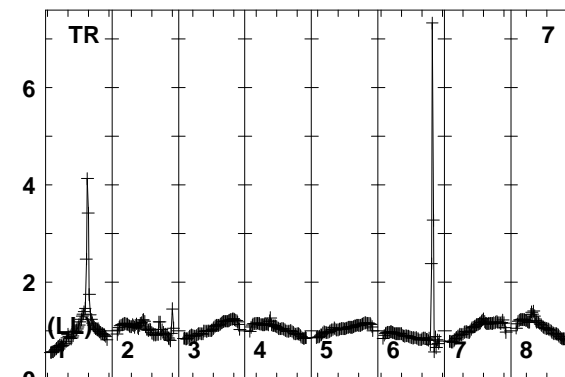
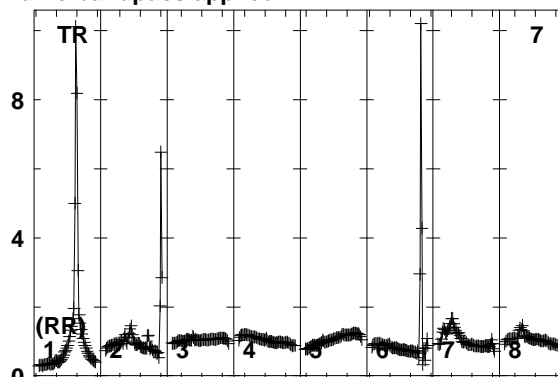
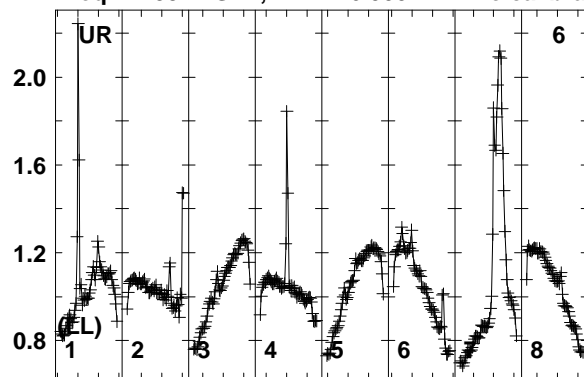

Lower frame: Real Jy
Total-power spectrum Antenna: UR (06)
Timerange: 00/04:45:11 to 00/04:47:49

Plot file version 216 created 04-NOV-2019 14:14:16

W2246-0526 EY034.UVDATA.1

Freq = 1.5947 GHz, Bw = 16.000 MH No calibration applied and no bandpass applied

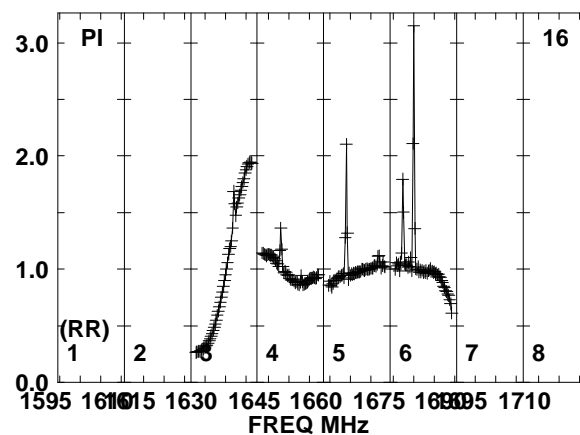
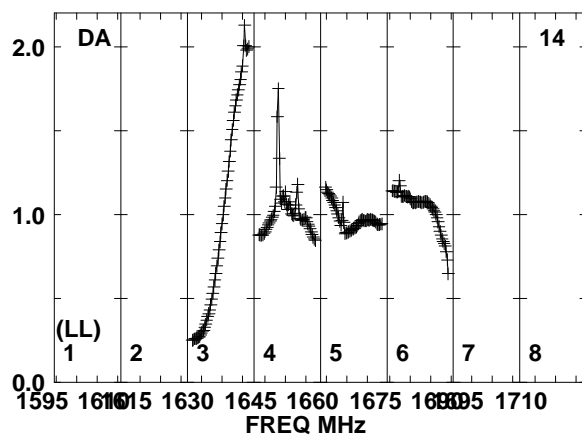
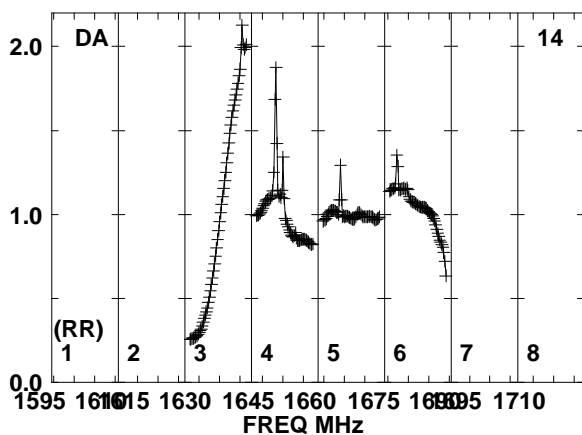
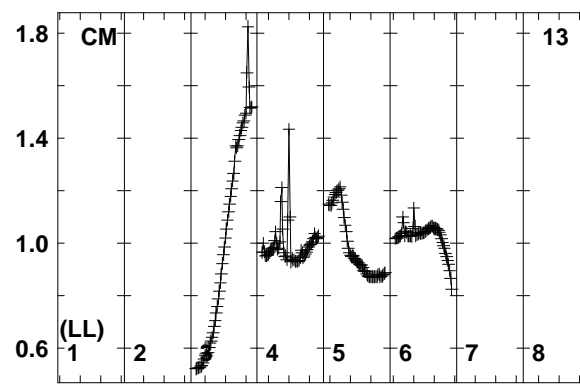
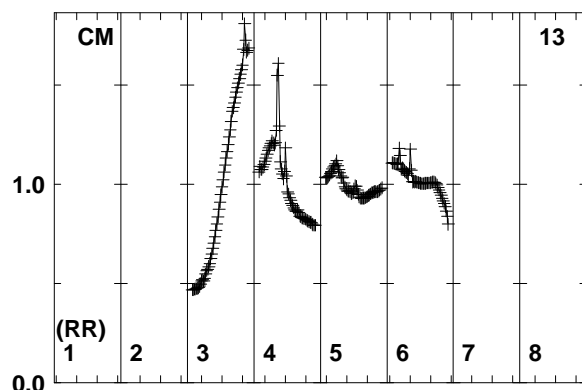
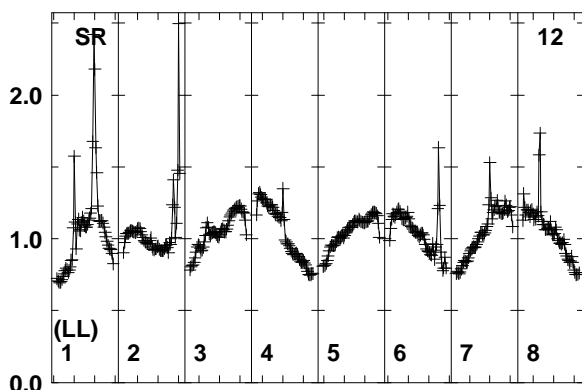
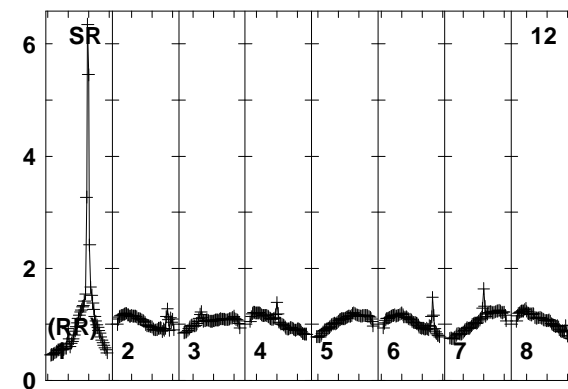
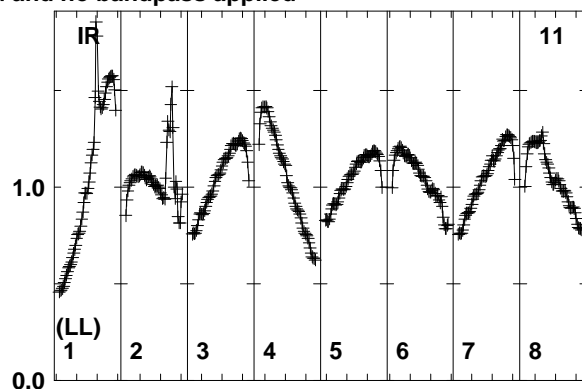
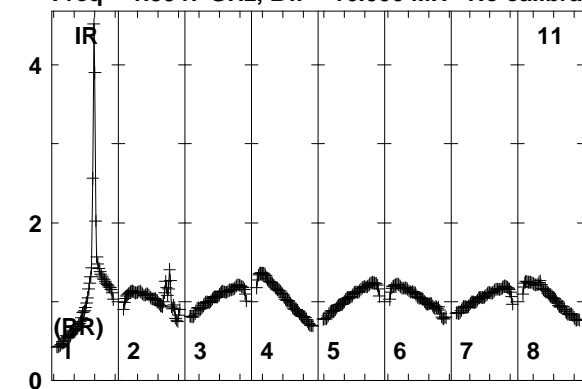

Lower frame: Real Jy
Total-power spectrum Antenna: IR (11)
Timerange: 00/04:45:11 to 00/04:47:49

Plot file version 217 created 04-NOV-2019 14:14:16
W2246-0526 EY034.UVDATA.1
Freq = 1.5947 GHz, Bw = 16.000 MH No calibration applied and no bandpass applied

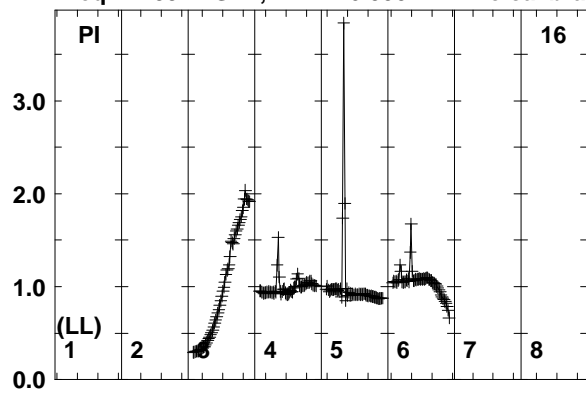

Lower frame: Real Jy
Total-power spectrum Antenna: PI (16)
Timerange: 00/04:45:11 to 00/04:47:49

Plot file version 218 created 04-NOV-2019 14:14:17

J2248-0541 EY034.UVDATA.1

Freq = 1.5947 GHz, Bw = 16.000 MH No calibration applied and no bandpass applied

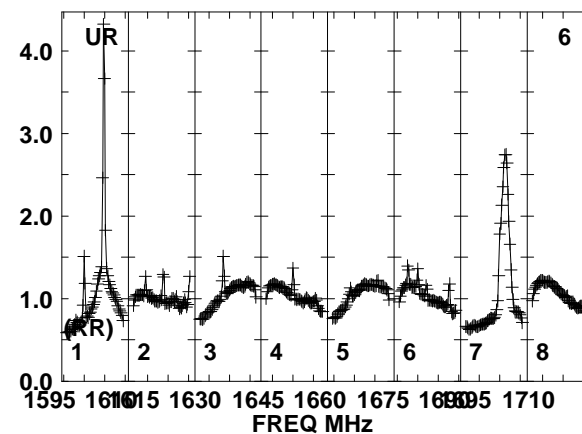
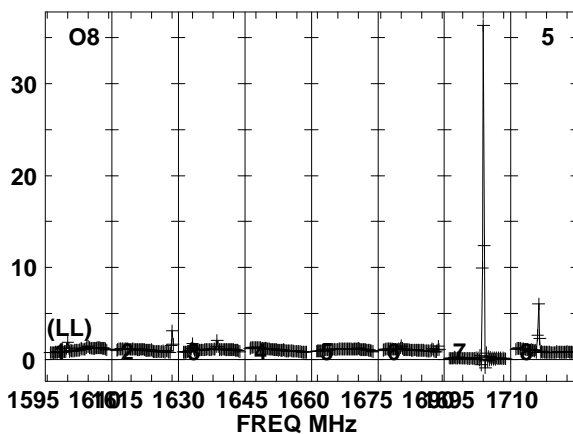
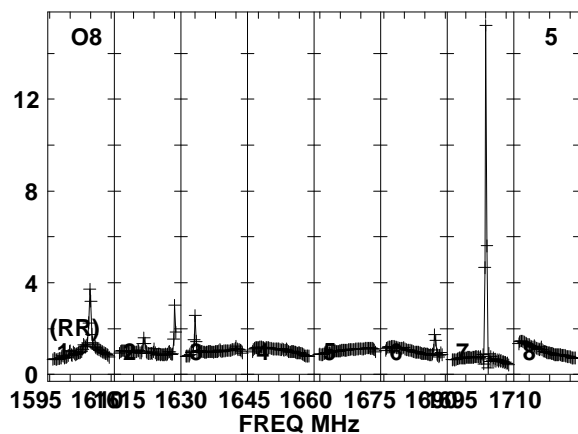
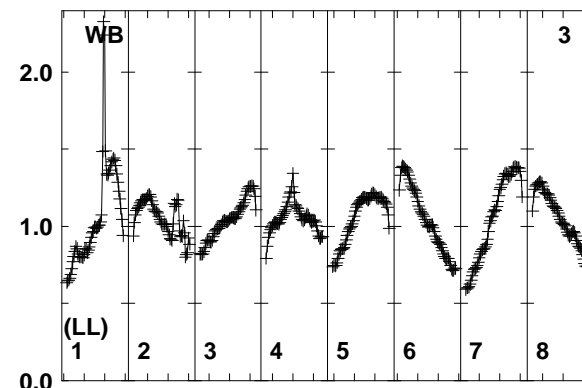
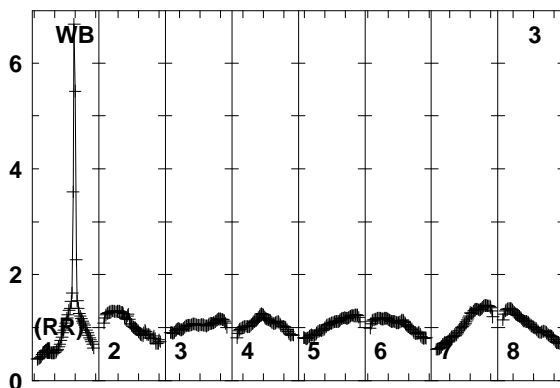
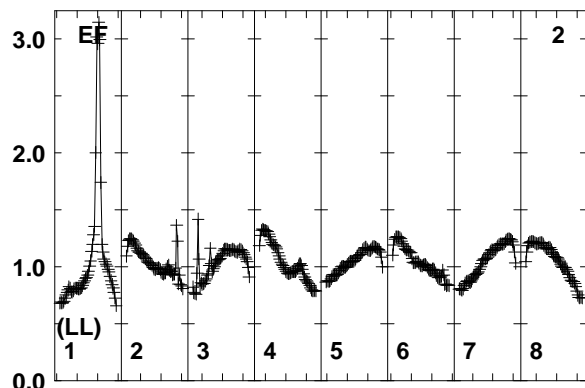
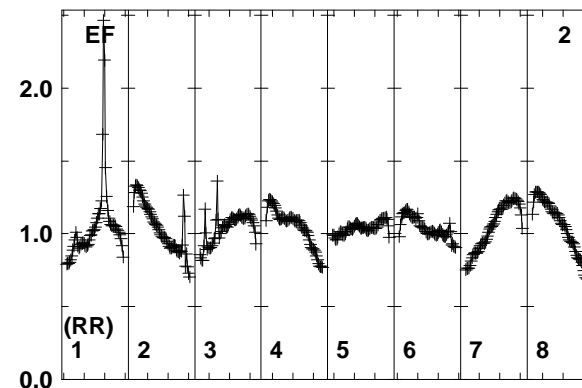
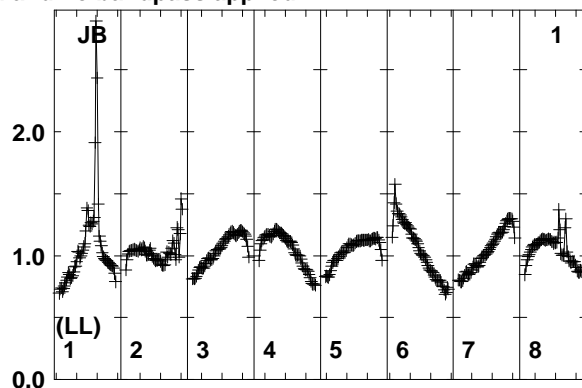
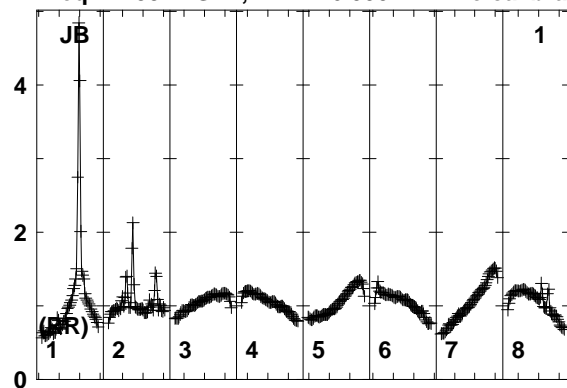

Lower frame: Real Jy
Total-power spectrum Antenna: JB (01)
Timerange: 00/04:48:06 to 00/04:49:04

Plot file version 219 created 04-NOV-2019 14:14:17

J2248-0541 EY034.UVDATA.1

Freq = 1.5947 GHz, Bw = 16.000 MH No calibration applied and no bandpass applied

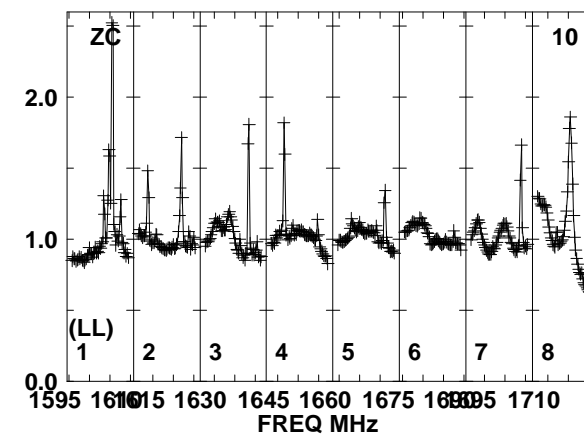
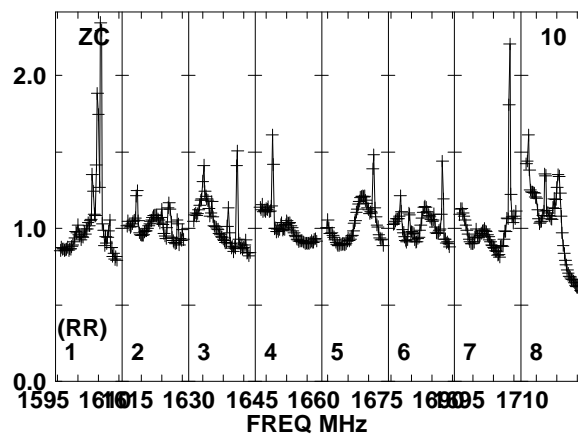
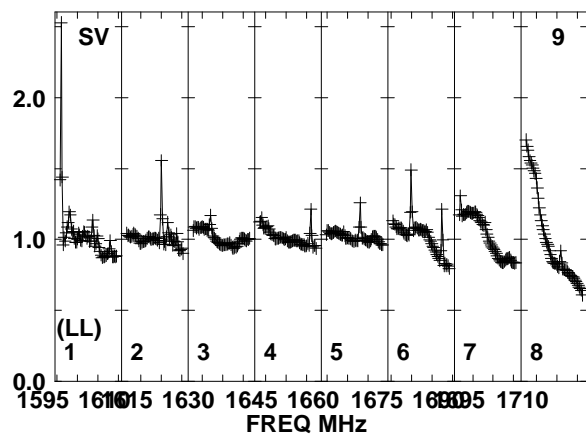
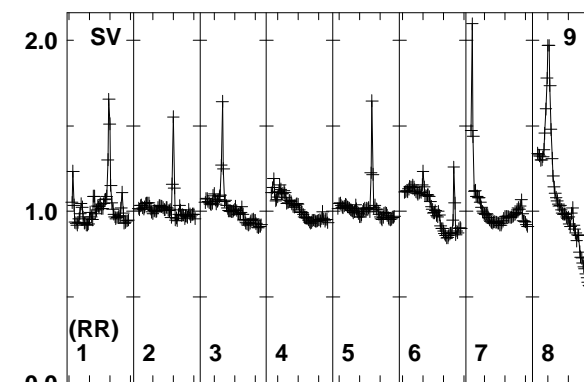
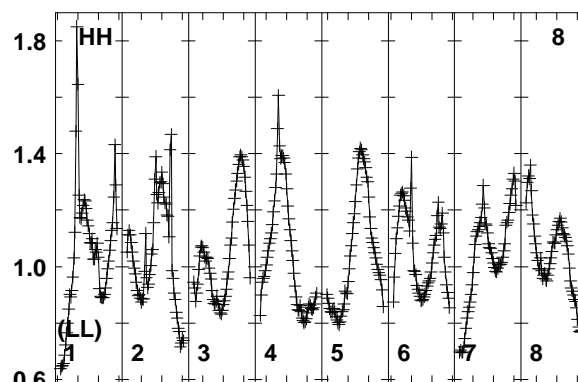
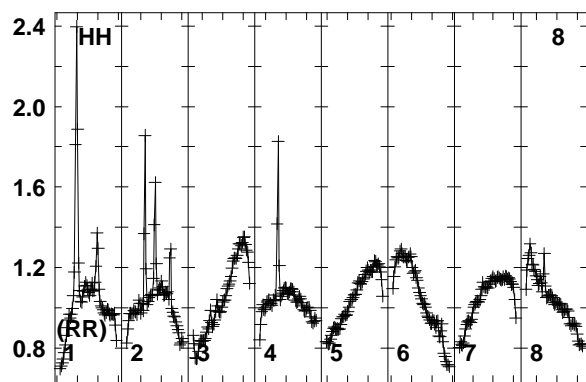
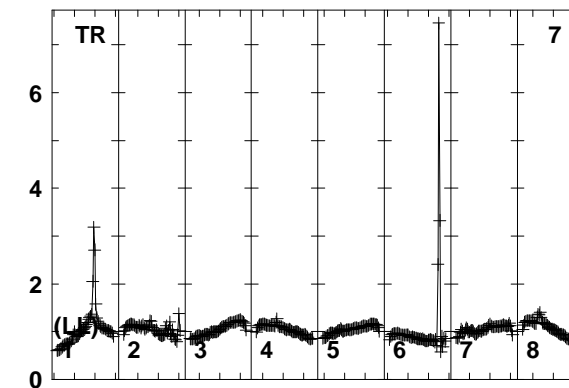
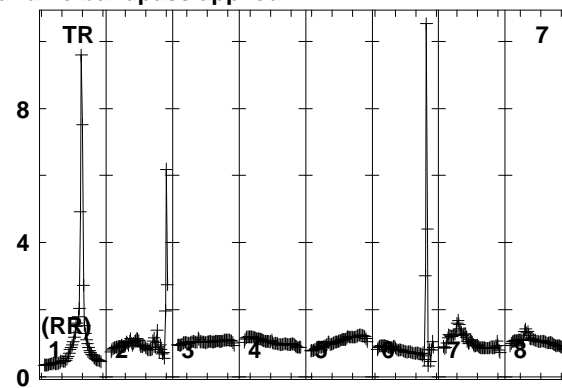
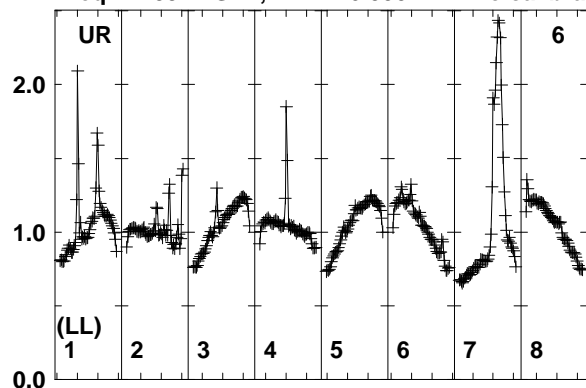

Lower frame: Real Jy
Total-power spectrum Antenna: UR (06)
Timerange: 00/04:48:06 to 00/04:49:04

Plot file version 220 created 04-NOV-2019 14:14:17

J2248-0541 EY034.UVDATA.1

Freq = 1.5947 GHz, Bw = 16.000 MH No calibration applied and no bandpass applied

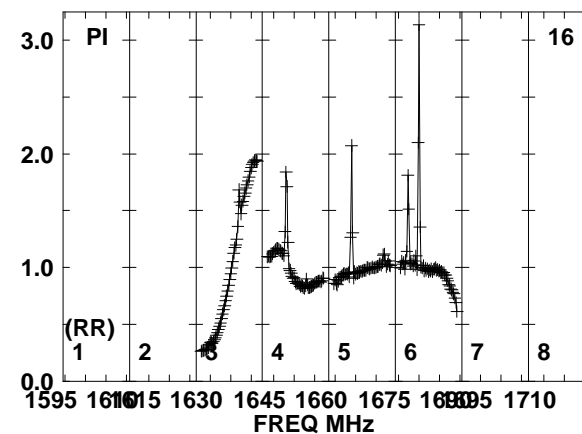
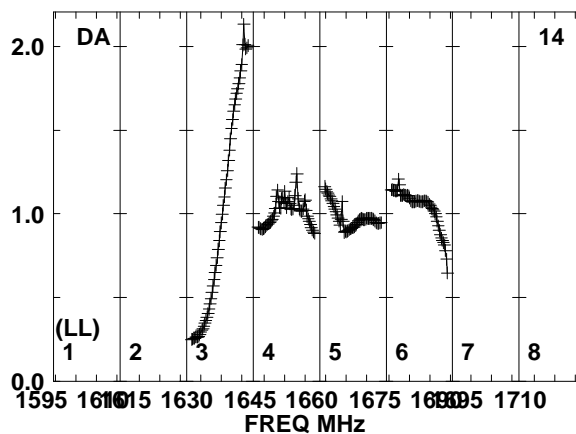
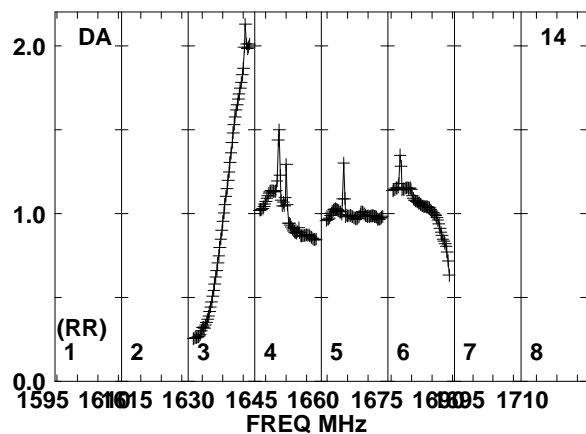
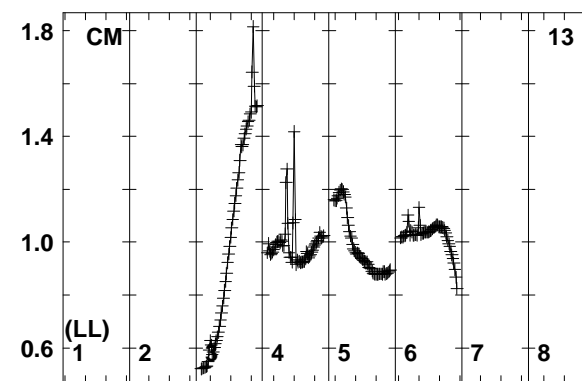
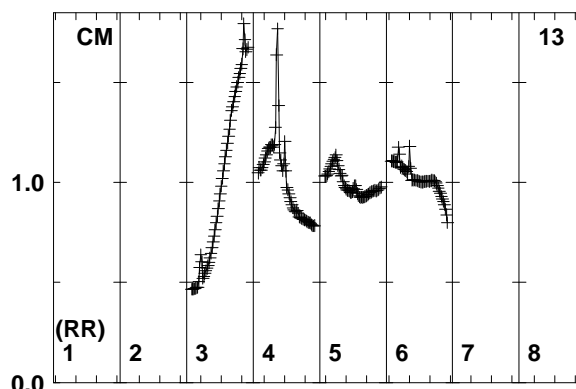
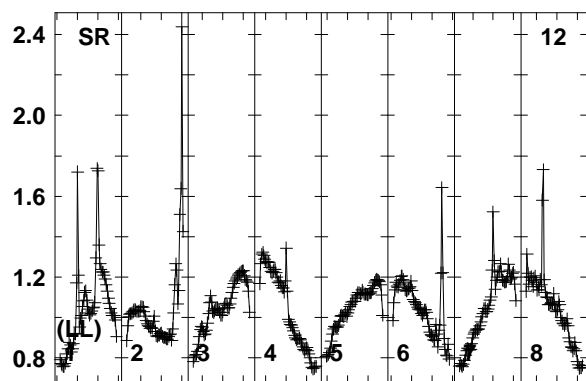
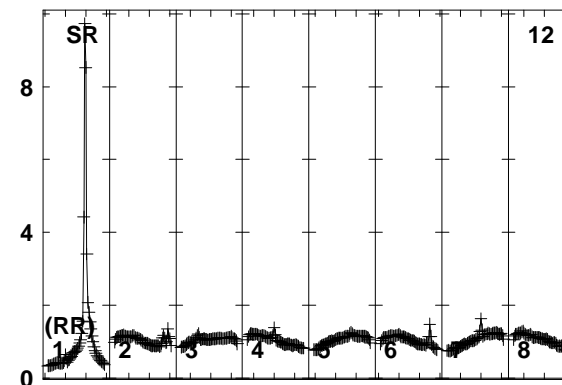
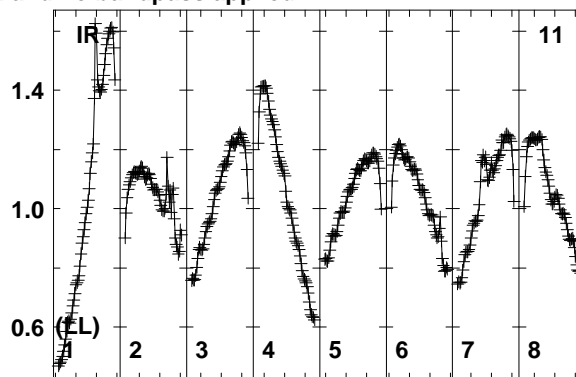
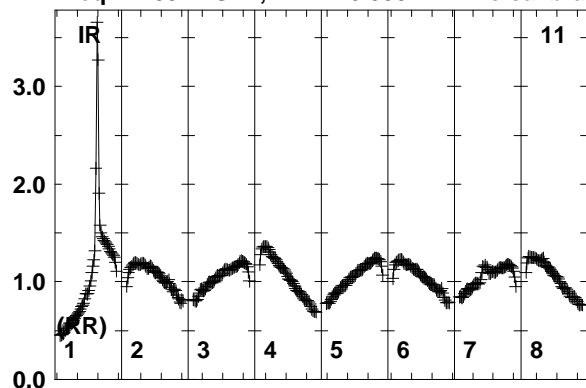

Lower frame: Real Jy
Total-power spectrum Antenna: IR (11)
Timerange: 00/04:48:06 to 00/04:49:04

Plot file version 221 created 04-NOV-2019 14:14:17

J2248-0541 EY034.UVDATA.1

Freq = 1.5947 GHz, Bw = 16.000 MH No calibration applied and no bandpass applied

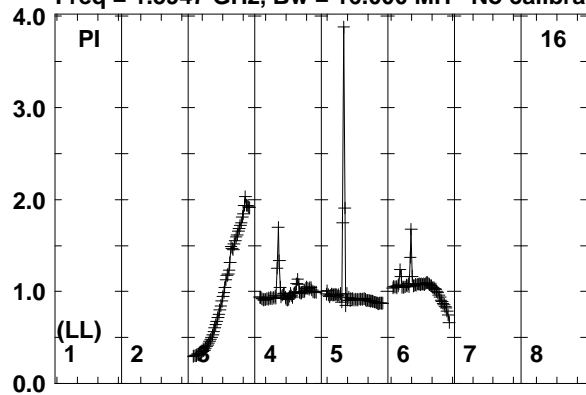

Lower frame: Real Jy
Total-power spectrum Antenna: PI (16)
Timerange: 00/04:48:06 to 00/04:49:04

Plot file version 222 created 04-NOV-2019 14:14:17

W2246-0526 EY034.UVDATA.1

Freq = 1.5947 GHz, Bw = 16.000 MH No calibration applied and no bandpass applied

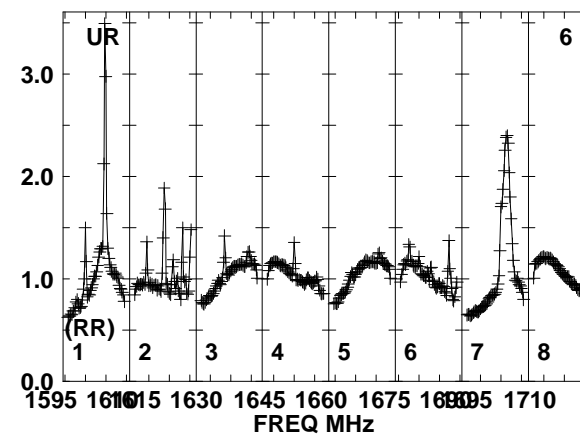
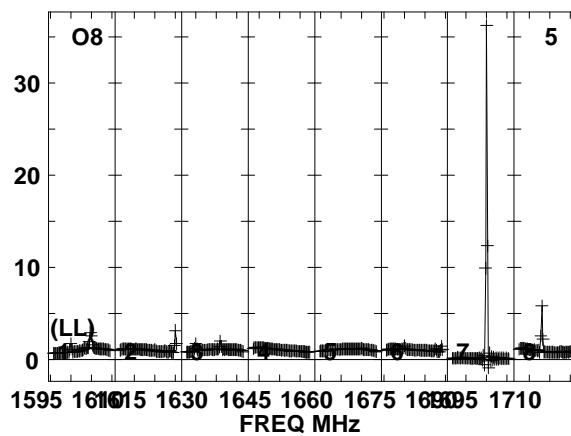
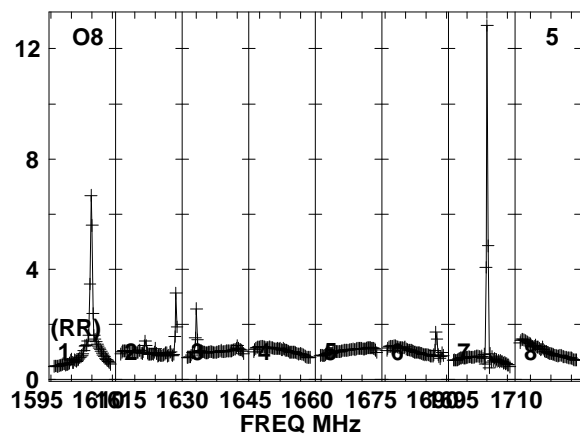
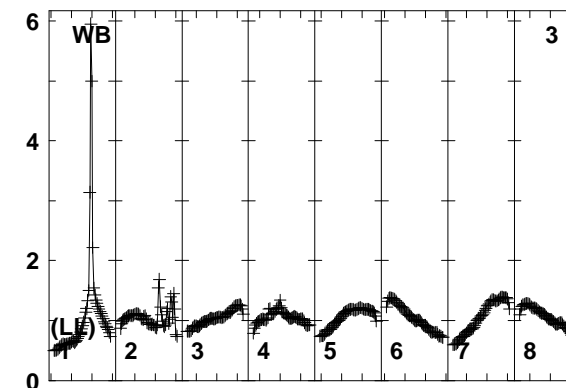
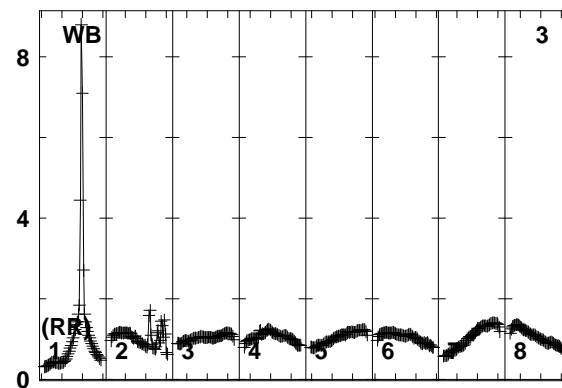
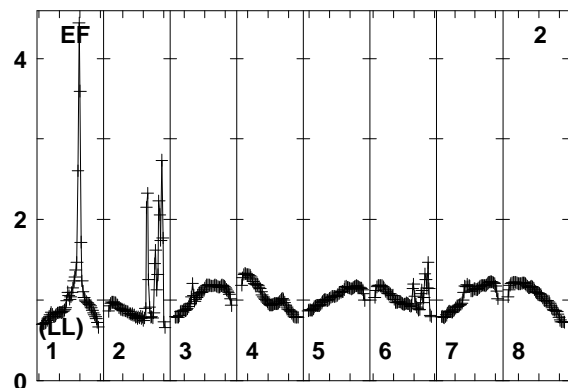
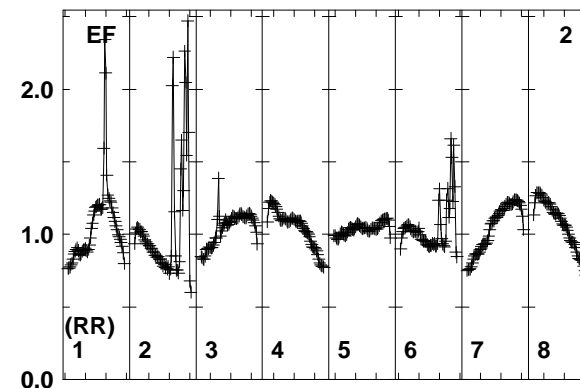
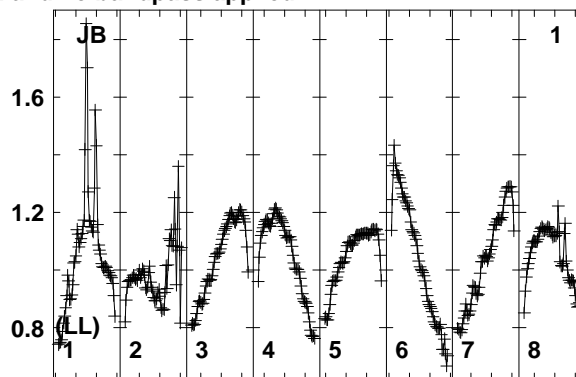
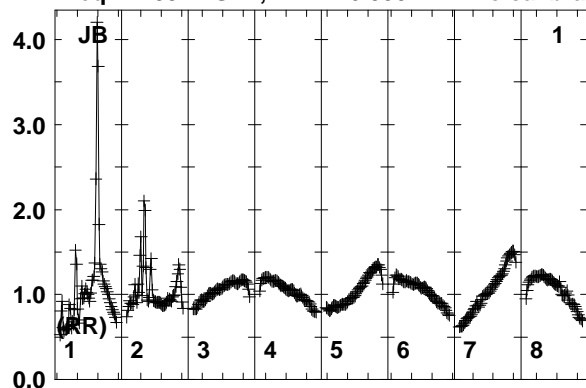

Lower frame: Real Jy
Total-power spectrum Antenna: JB (01)
Timerange: 00/04:49:06 to 00/04:51:44

Plot file version 223 created 04-NOV-2019 14:14:17

W2246-0526 EY034.UVDATA.1

Freq = 1.5947 GHz, Bw = 16.000 MH No calibration applied and no bandpass applied

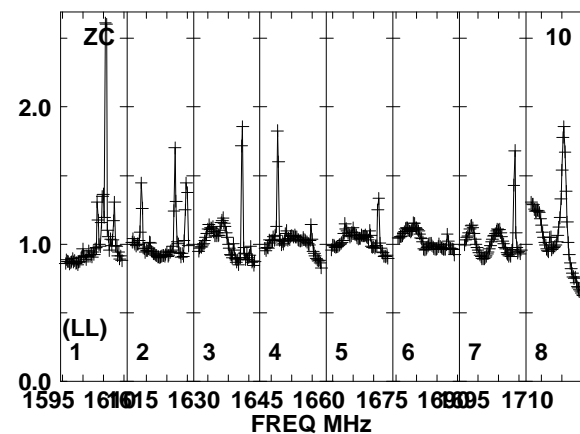
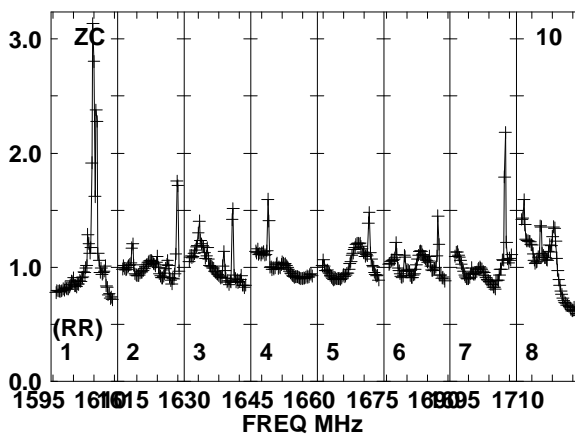
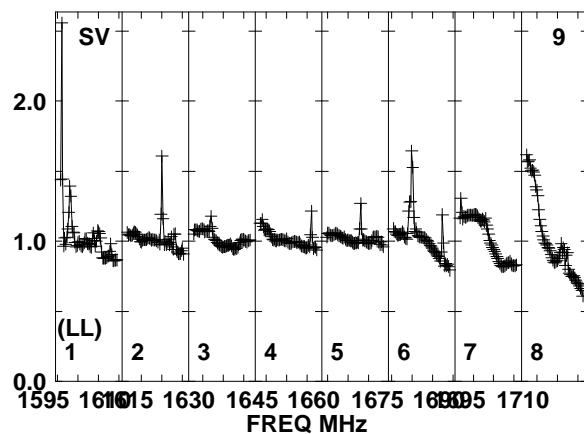
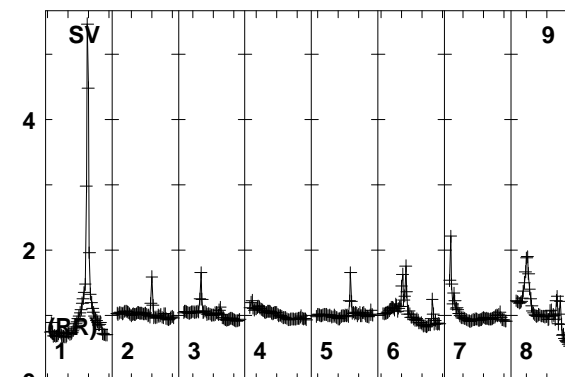
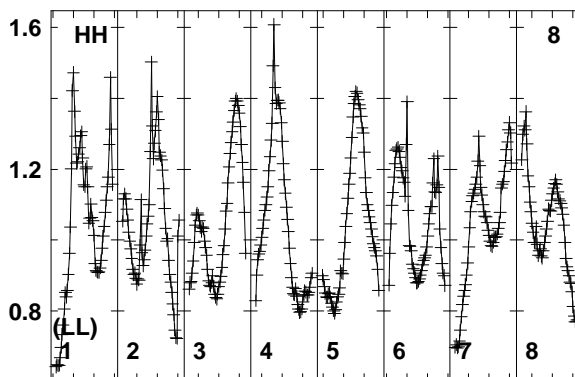
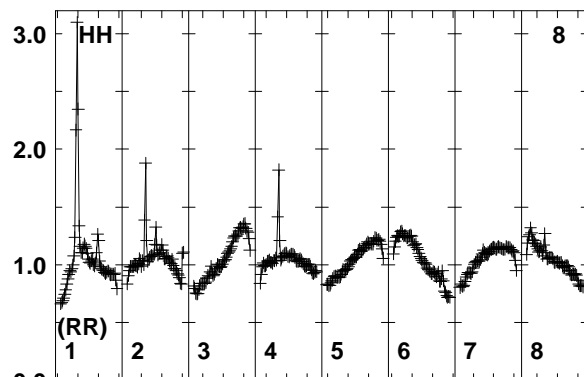
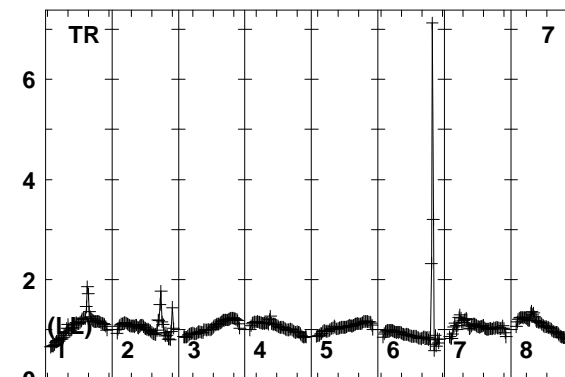
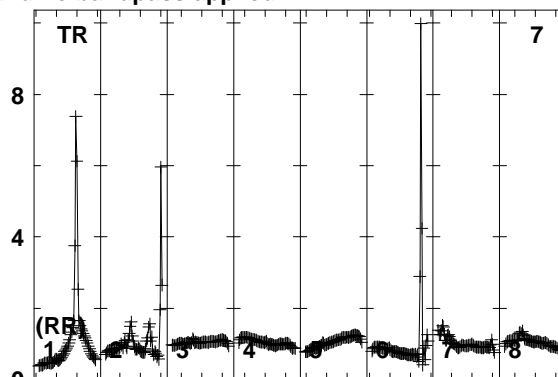
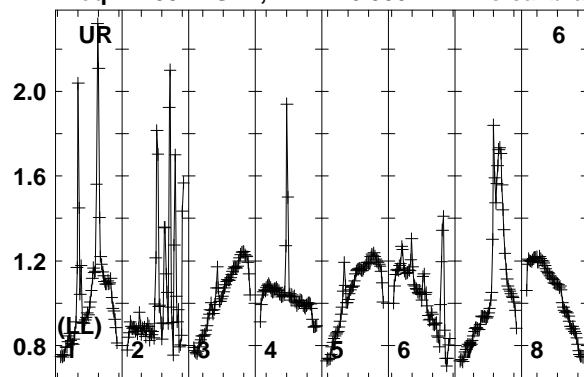

Lower frame: Real Jy
Total-power spectrum Antenna: UR (06)
Timerange: 00/04:49:06 to 00/04:51:44

Plot file version 224 created 04-NOV-2019 14:14:17

W2246-0526 EY034.UVDATA.1

Freq = 1.5947 GHz, Bw = 16.000 MH No calibration applied and no bandpass applied

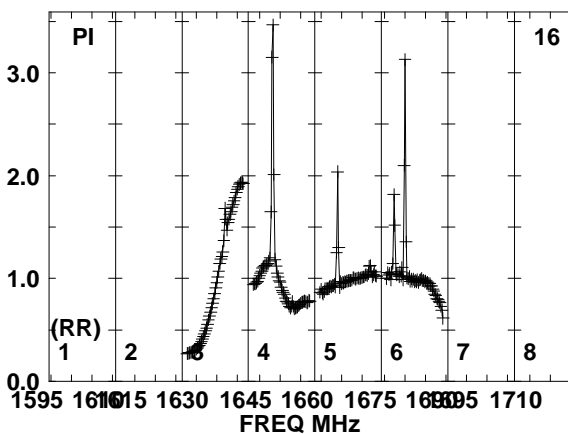
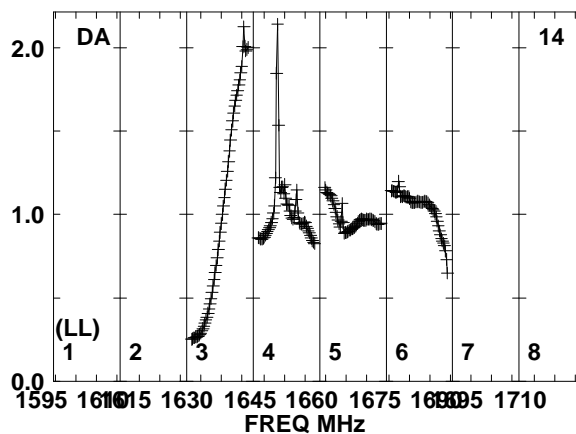
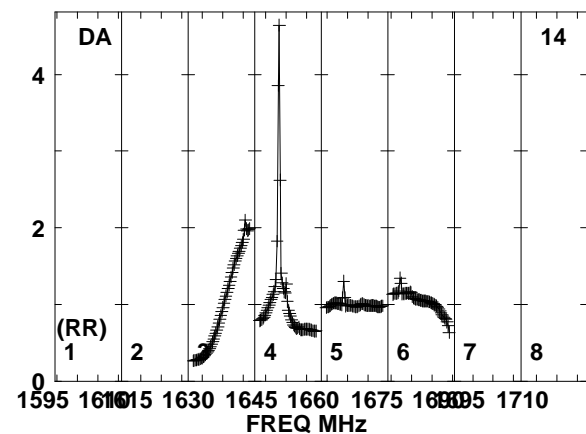
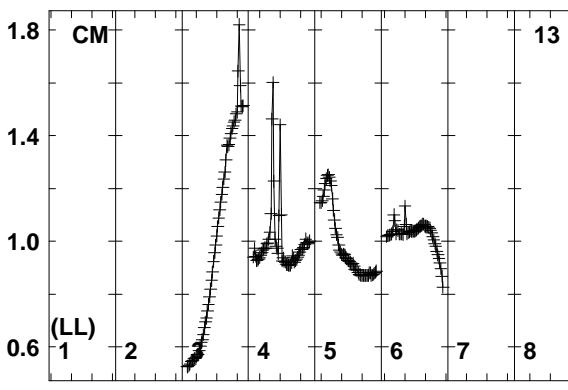
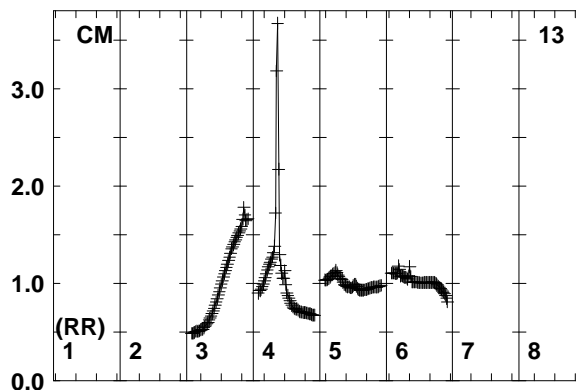
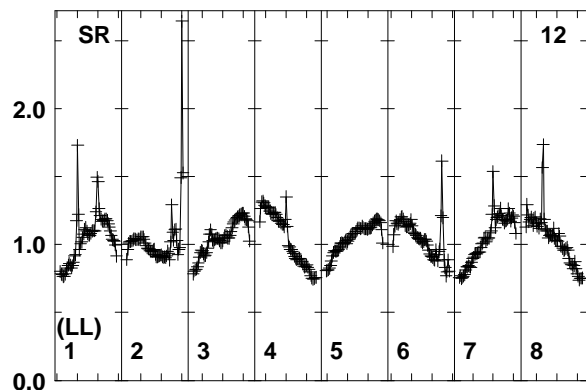
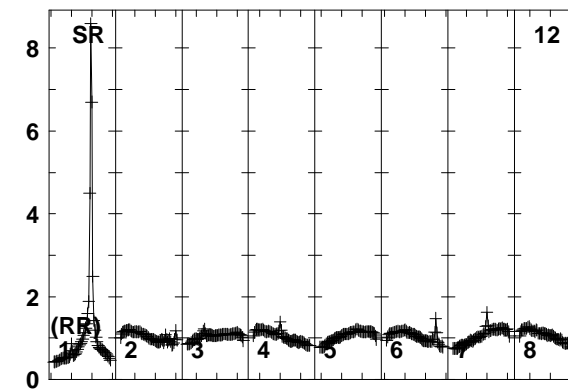
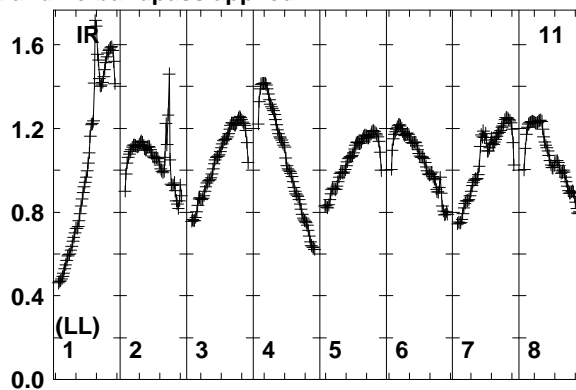
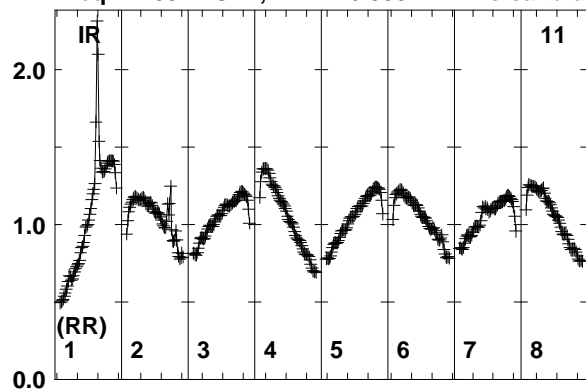

Lower frame: Real Jy
Total-power spectrum Antenna: IR (11)
Timerange: 00/04:49:06 to 00/04:51:44

Plot file version 225 created 04-NOV-2019 14:14:17
W2246-0526 EY034.UVDATA.1
Freq = 1.5947 GHz, Bw = 16.000 MH No calibration applied and no bandpass applied

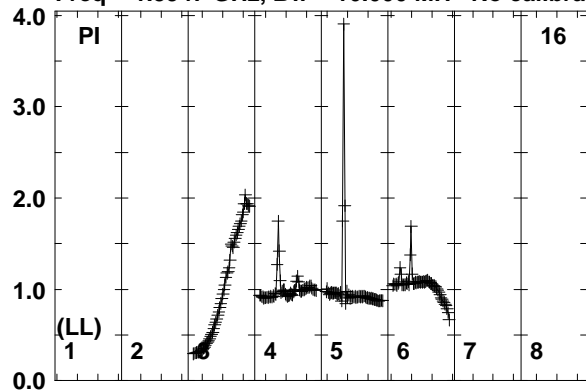

Lower frame: Real Jy
Total-power spectrum Antenna: PI (16)
Timerange: 00/04:49:06 to 00/04:51:44

Plot file version 226 created 04-NOV-2019 14:14:17

J2248-0541 EY034.UVDATA.1

Freq = 1.5947 GHz, Bw = 16.000 MH No calibration applied and no bandpass applied

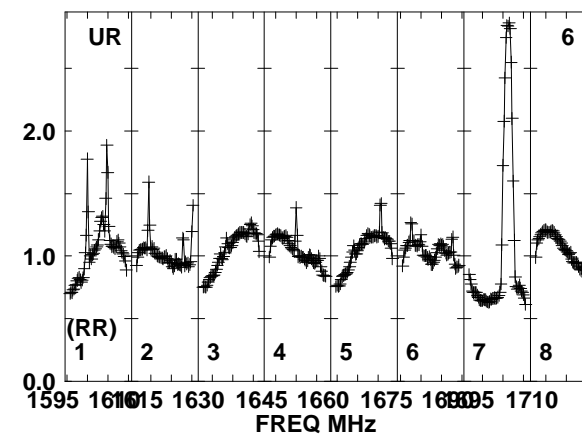
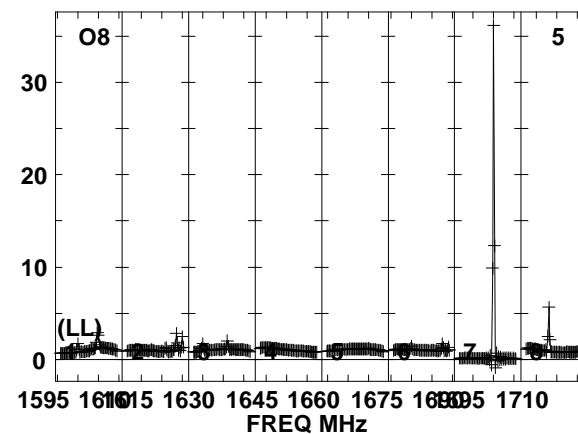
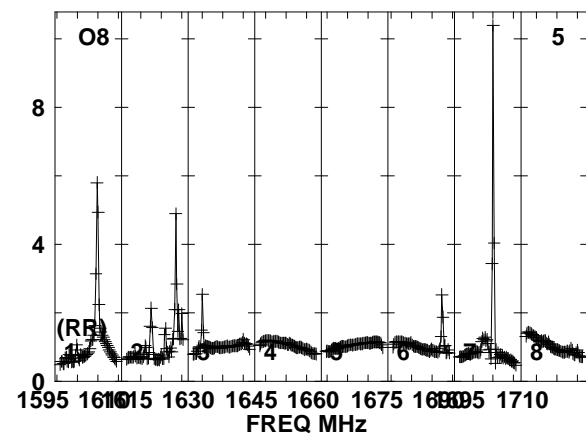
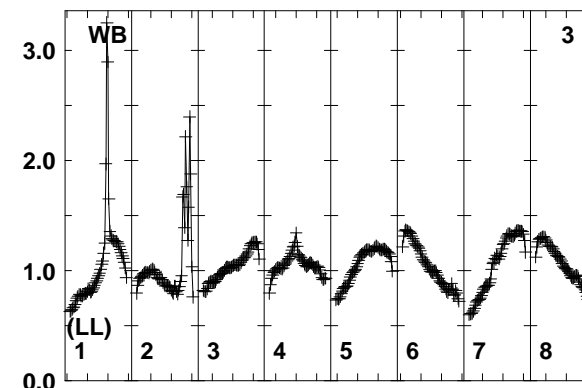
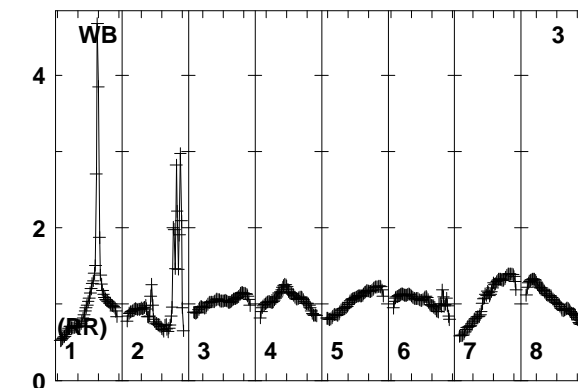
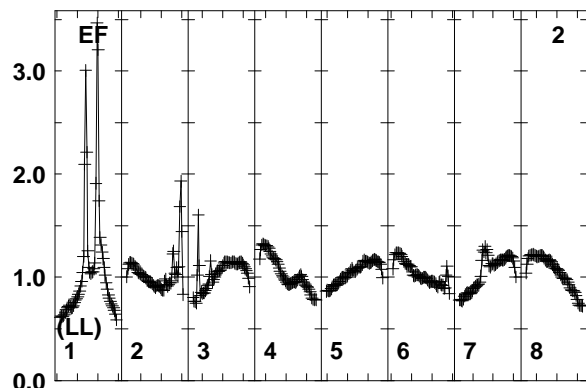
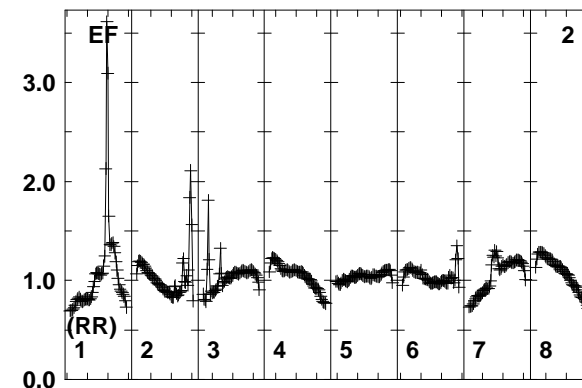
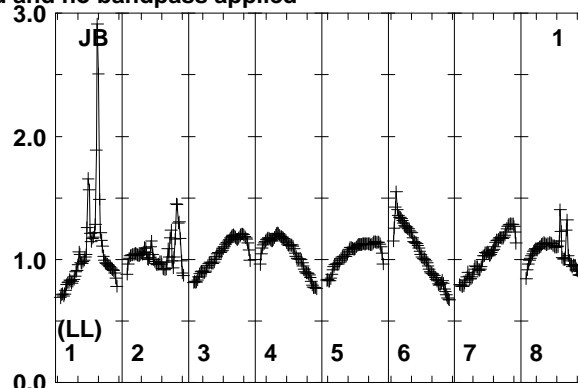
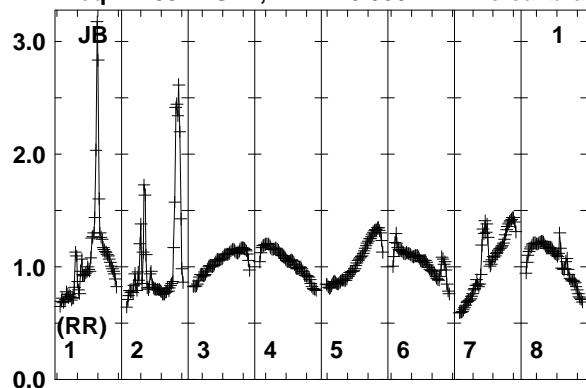

Lower frame: Real Jy
Total-power spectrum Antenna: JB (01)
Timerange: 00/04:52:21 to 00/04:53:19

Plot file version 227 created 04-NOV-2019 14:14:17

J2248-0541 EY034.UVDATA.1

Freq = 1.5947 GHz, Bw = 16.000 MH No calibration applied and no bandpass applied

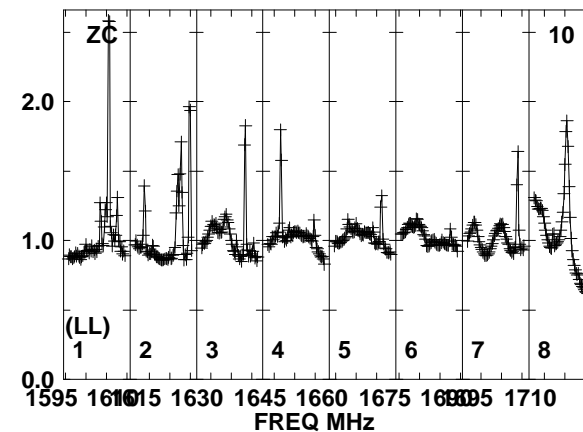
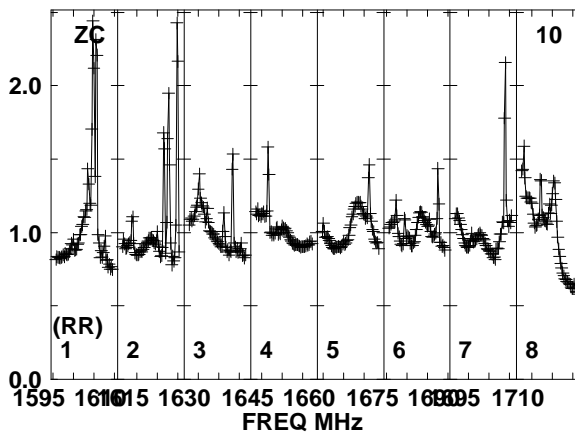
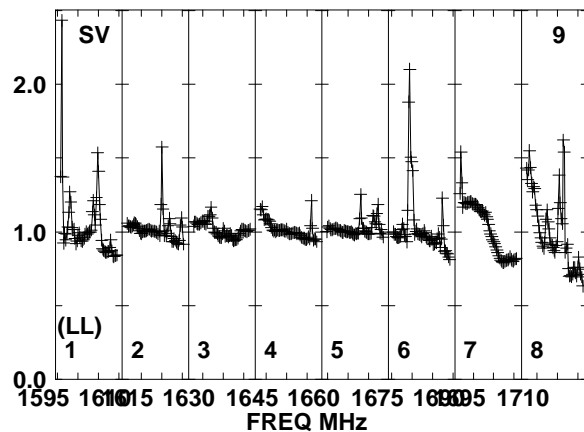
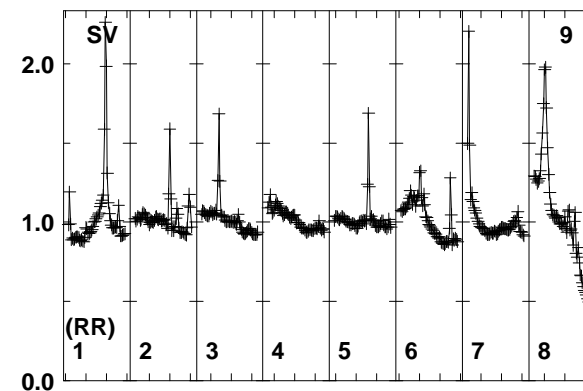
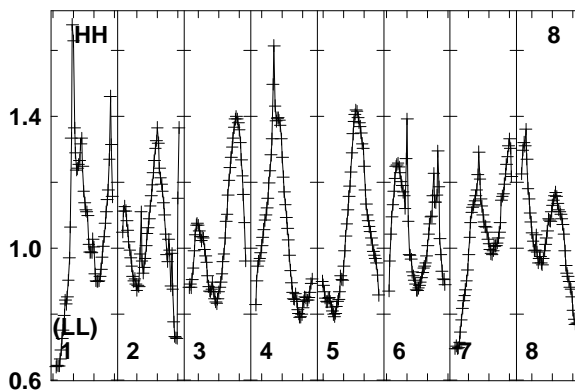
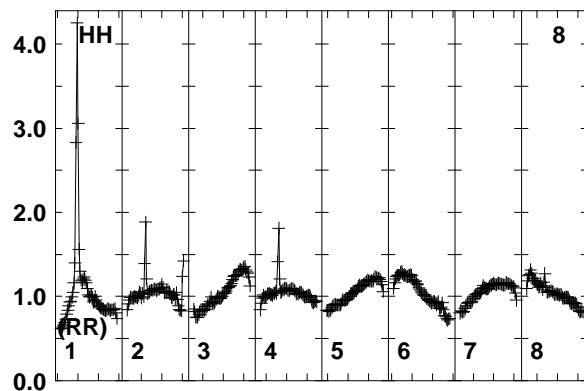
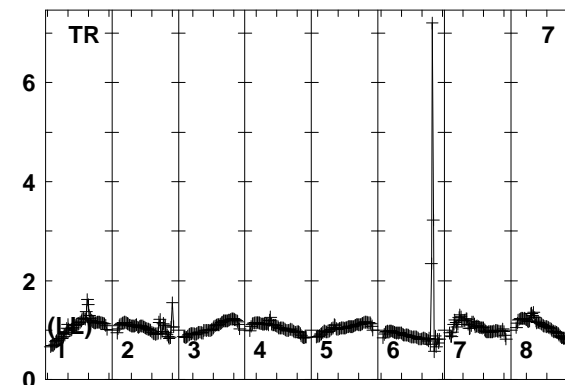
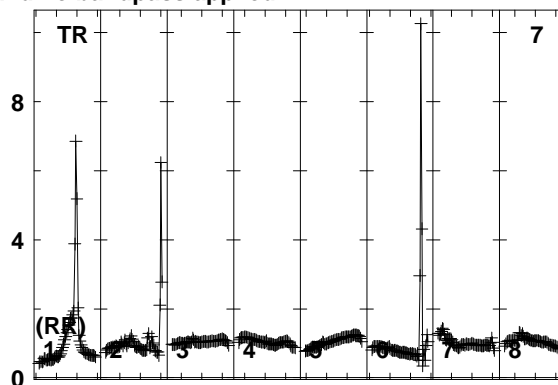
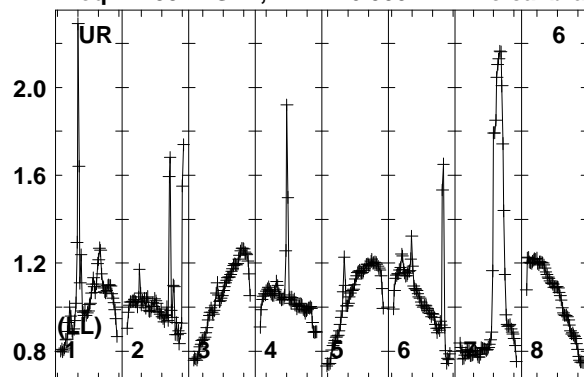

Lower frame: Real Jy
Total-power spectrum Antenna: UR (06)
Timerange: 00/04:52:21 to 00/04:53:19

Plot file version 228 created 04-NOV-2019 14:14:17

J2248-0541 EY034.UVDATA.1

Freq = 1.5947 GHz, Bw = 16.000 MH No calibration applied and no bandpass applied

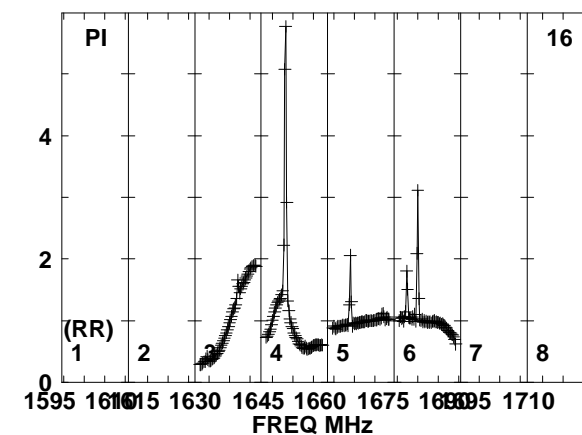
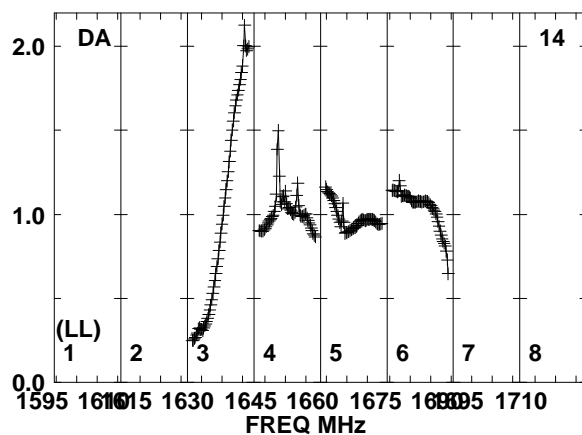
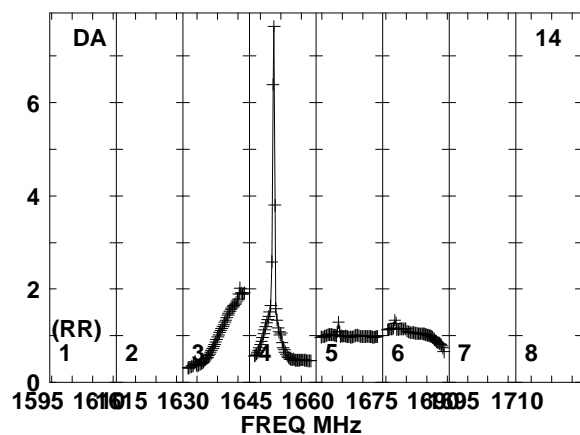
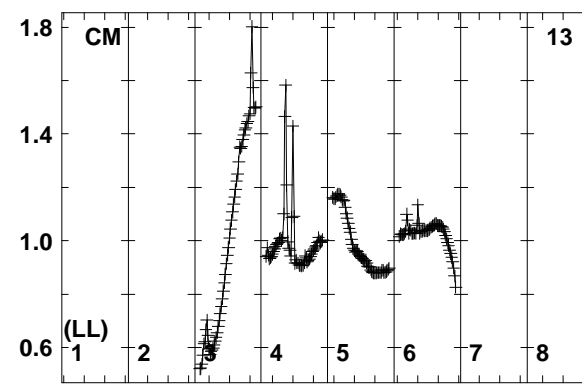
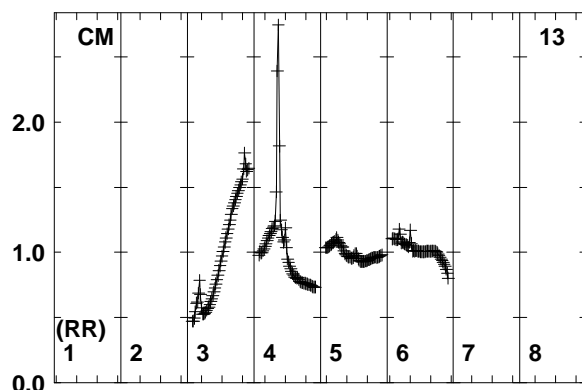
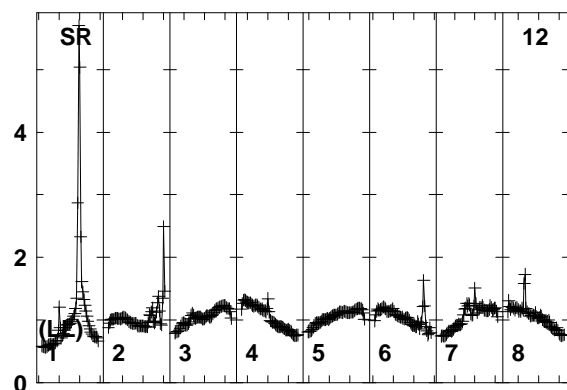
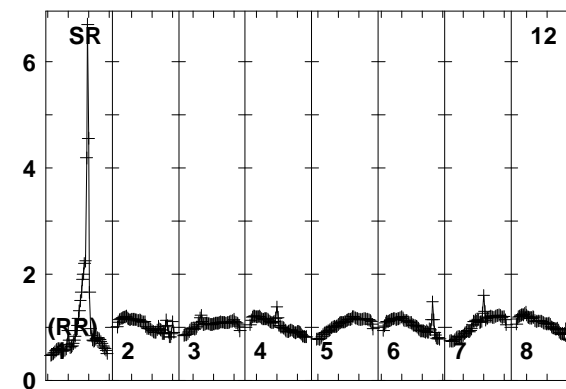
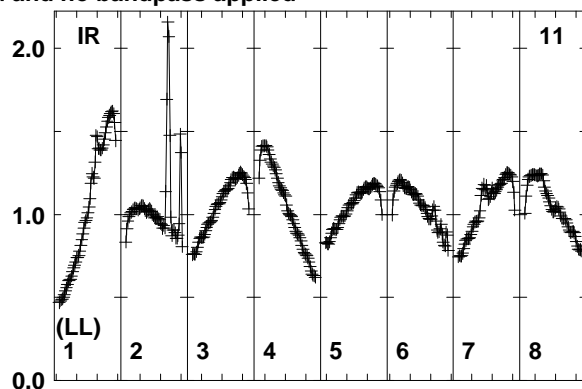
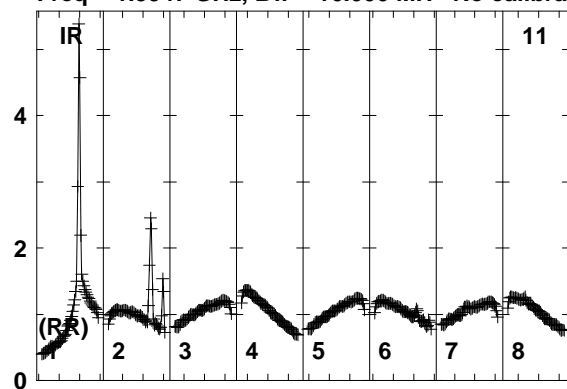

Lower frame: Real Jy
Total-power spectrum Antenna: IR (11)
Timerange: 00/04:52:21 to 00/04:53:19

Plot file version 229 created 04-NOV-2019 14:14:18
J2248-0541 EY034.UVDATA.1
Freq = 1.5947 GHz, Bw = 16.000 MH No calibration applied and no bandpass applied

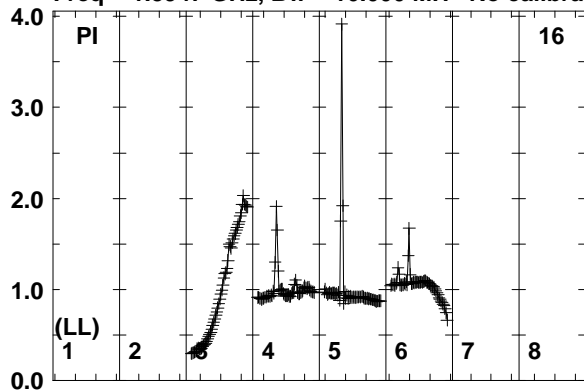

Lower frame: Real Jy
Total-power spectrum Antenna: PI (16)
Timerange: 00/04:52:21 to 00/04:53:19

Plot file version 230 created 04-NOV-2019 14:14:18

W2246-0526 EY034.UVDATA.1

Freq = 1.5947 GHz, Bw = 16.000 MH No calibration applied and no bandpass applied

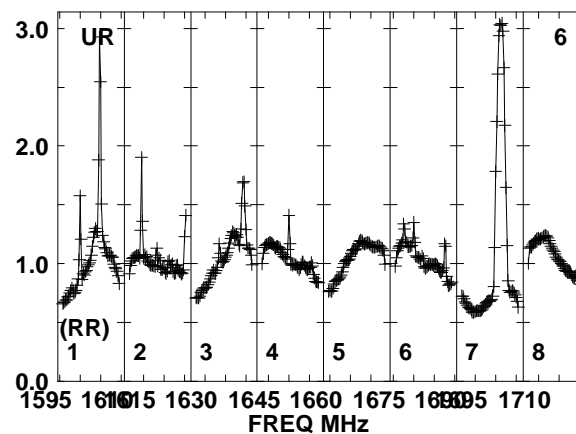
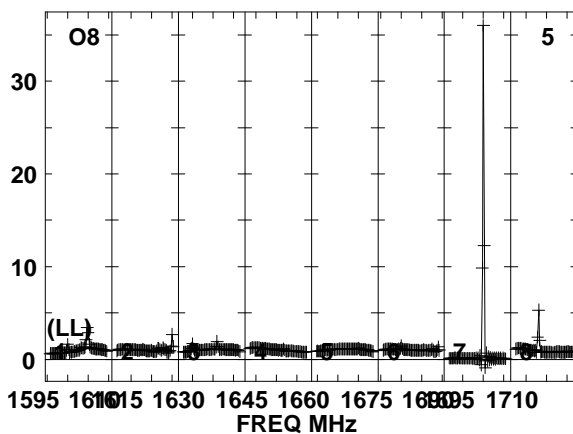
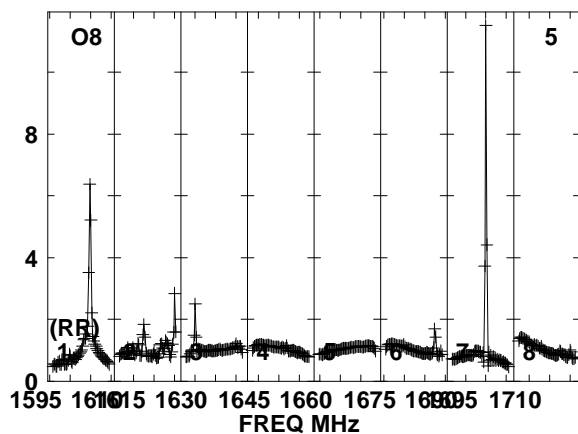
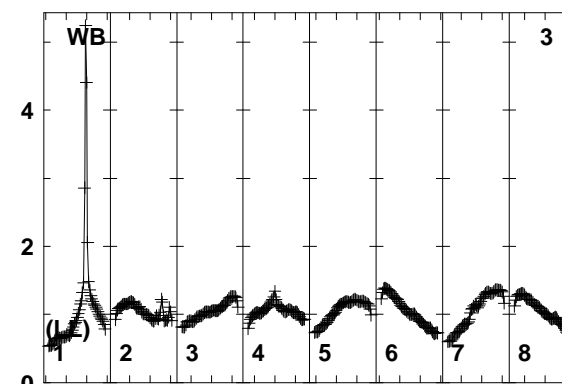
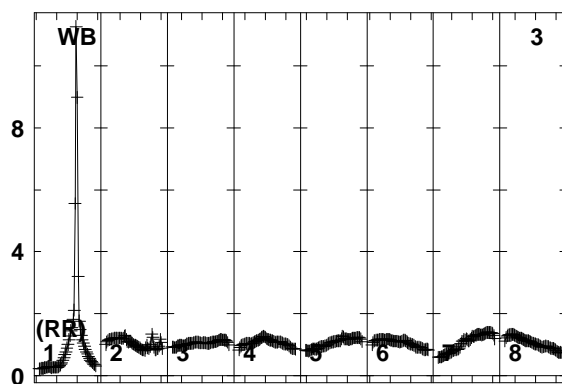
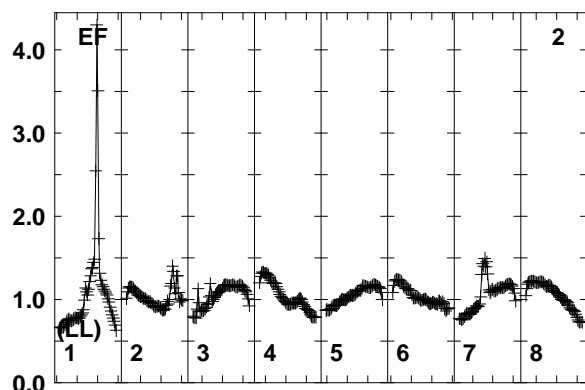
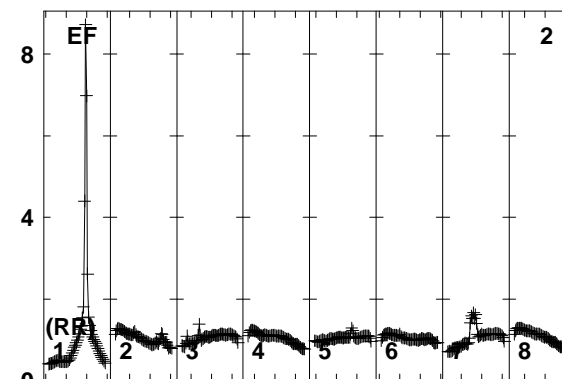
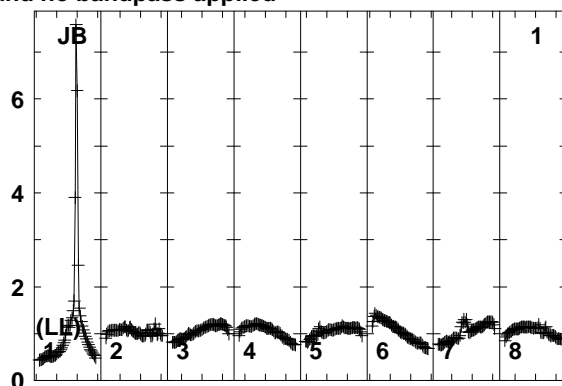
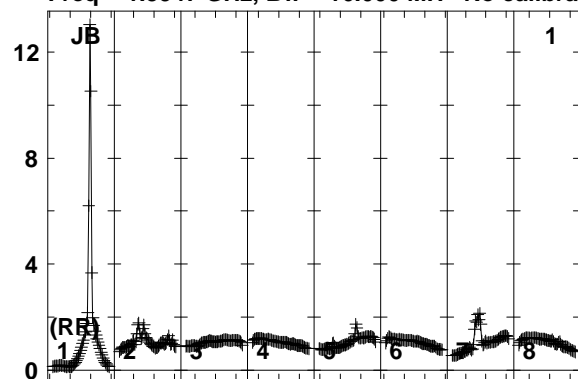

Lower frame: Real Jy
Total-power spectrum Antenna: JB (01)
Timerange: 00/04:53:21 to 00/04:55:59

Plot file version 231 created 04-NOV-2019 14:14:18

W2246-0526 EY034.UVDATA.1

Freq = 1.5947 GHz, Bw = 16.000 MH No calibration applied and no bandpass applied

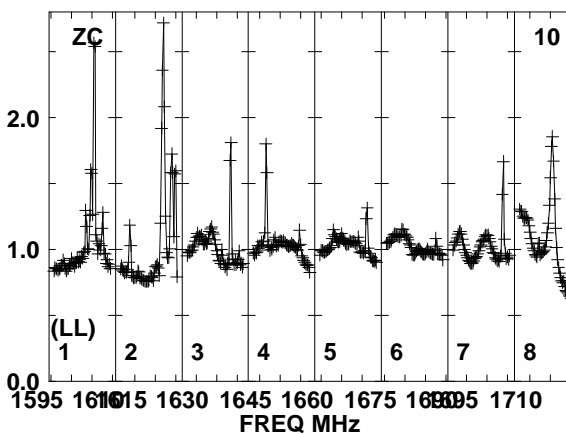
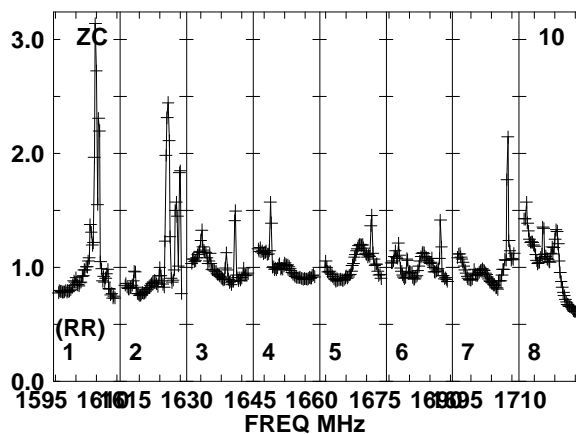
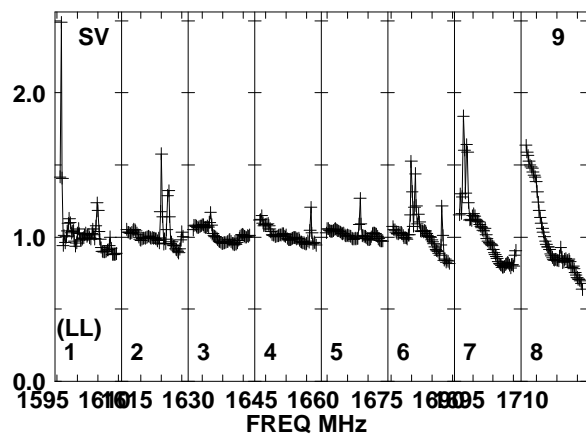
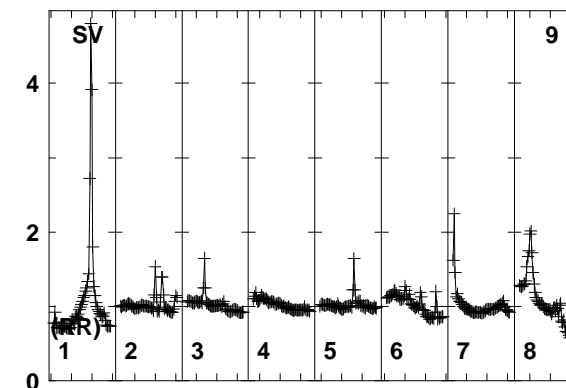
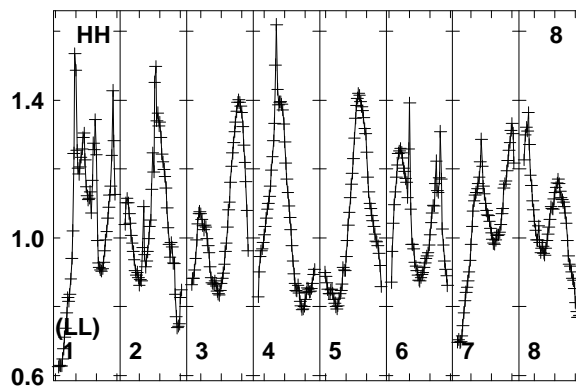
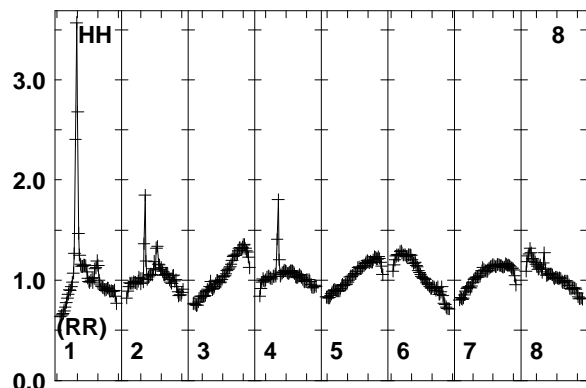
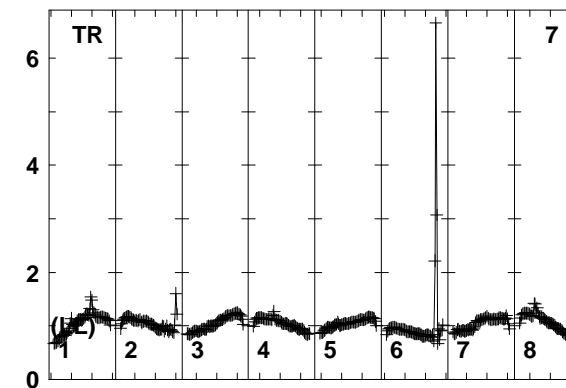
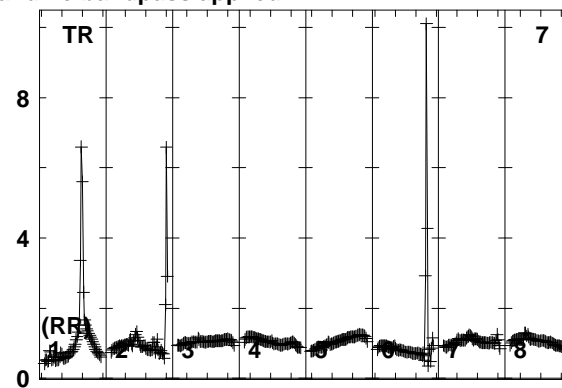
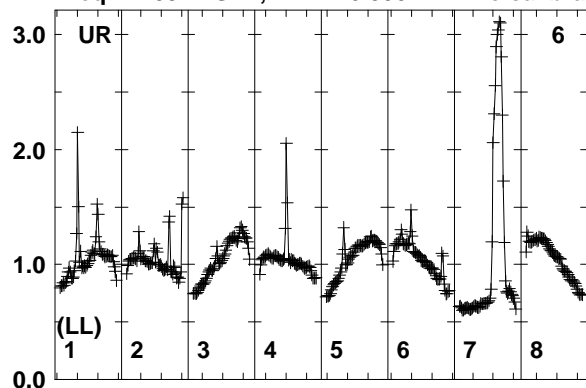

Lower frame: Real Jy
Total-power spectrum Antenna: UR (06)
Timerange: 00/04:53:21 to 00/04:55:59

Plot file version 232 created 04-NOV-2019 14:14:18

W2246-0526 EY034.UVDATA.1

Freq = 1.5947 GHz, Bw = 16.000 MH No calibration applied and no bandpass applied

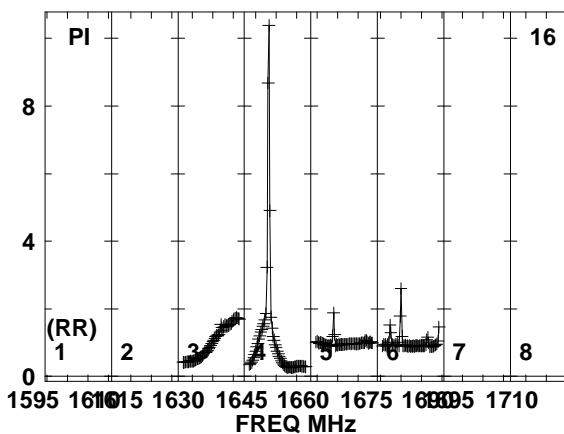
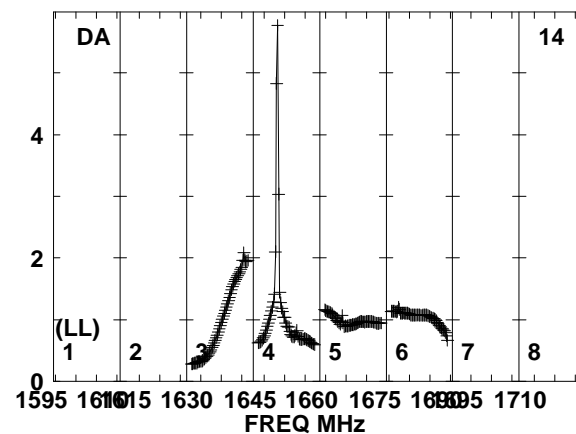
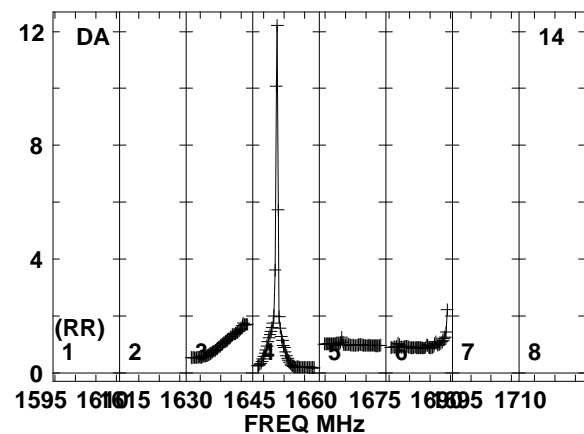
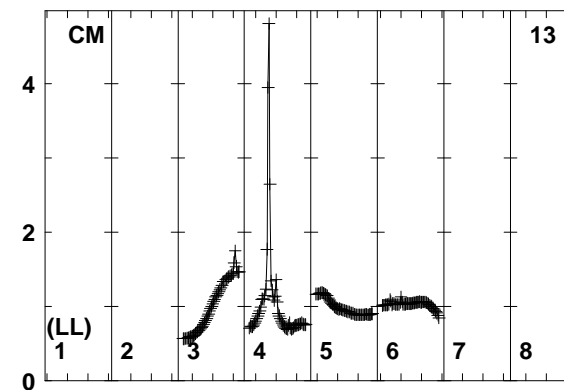
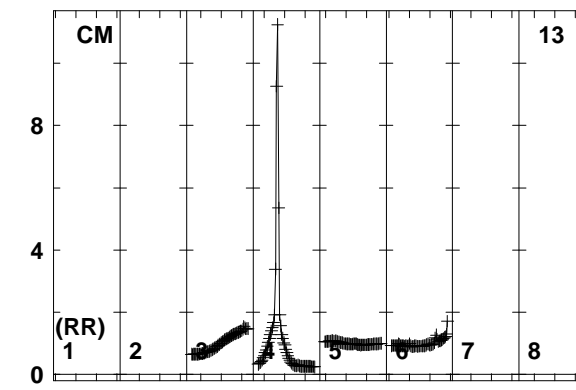
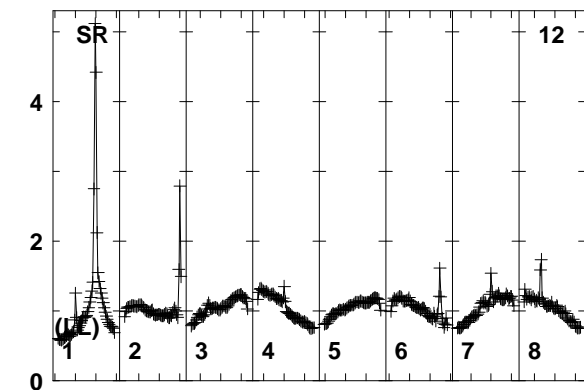
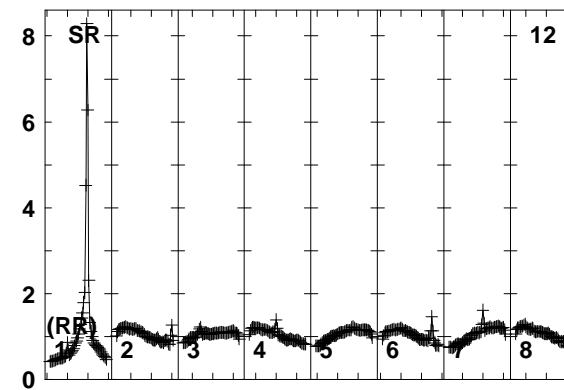
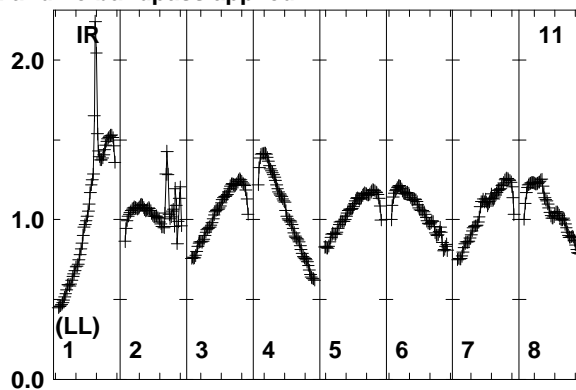
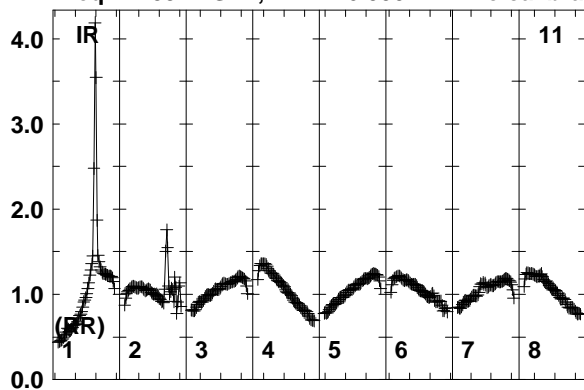

Lower frame: Real Jy
Total-power spectrum Antenna: IR (11)
Timerange: 00/04:53:21 to 00/04:55:59

Plot file version 233 created 04-NOV-2019 14:14:18

W2246-0526 EY034.UVDATA.1

Freq = 1.5947 GHz, Bw = 16.000 MH No calibration applied and no bandpass applied

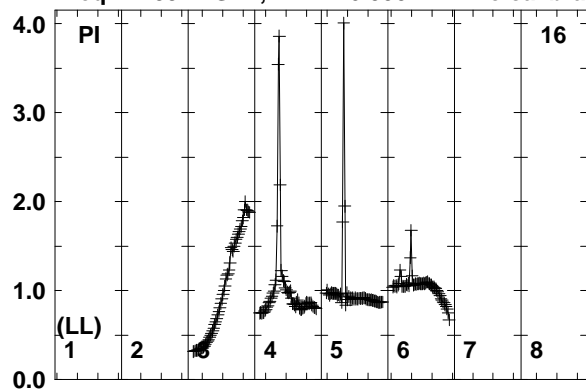

Lower frame: Real Jy
Total-power spectrum Antenna: PI (16)
Timerange: 00/04:53:21 to 00/04:55:59

Plot file version 234 created 04-NOV-2019 14:14:18

J2248-0541 EY034.UVDATA.1

Freq = 1.5947 GHz, Bw = 16.000 MH No calibration applied and no bandpass applied

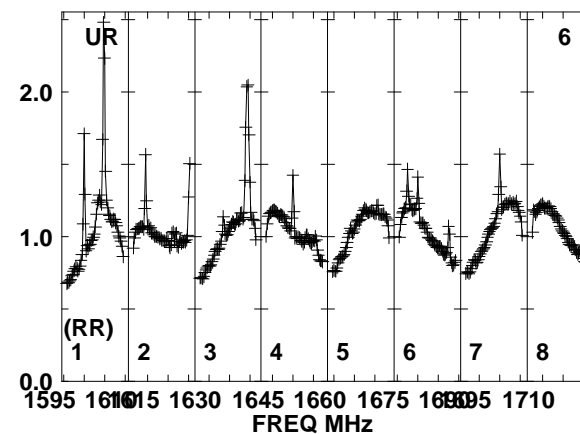
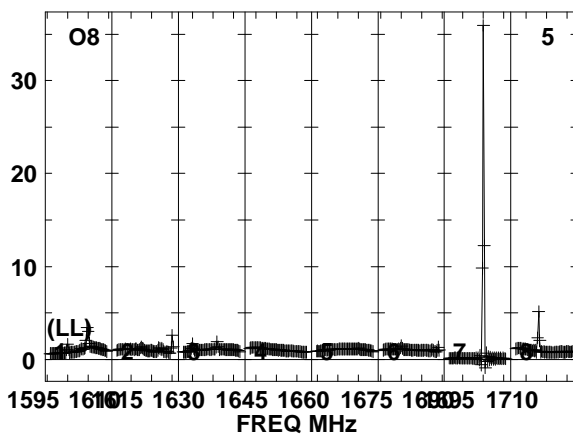
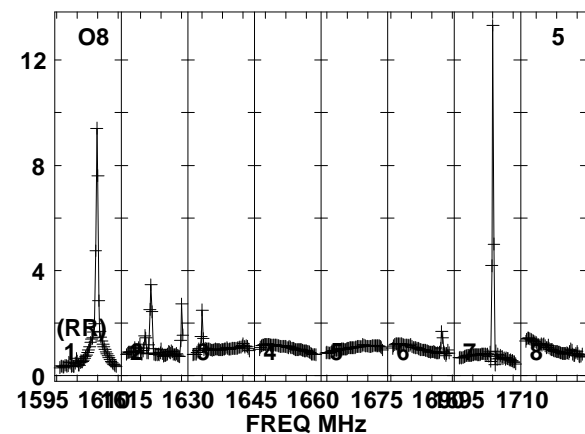
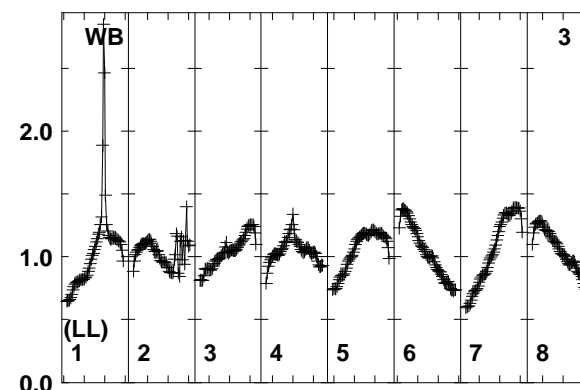
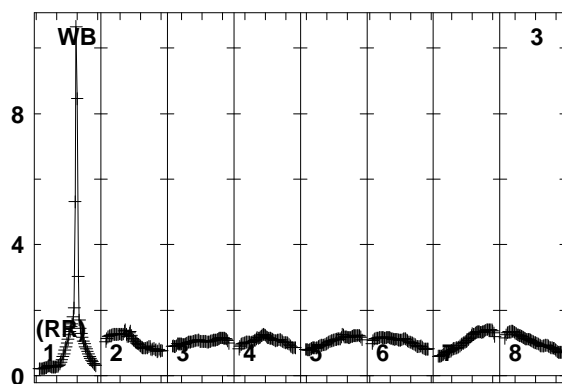
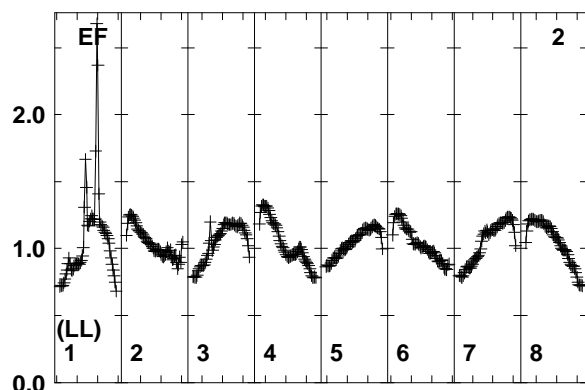
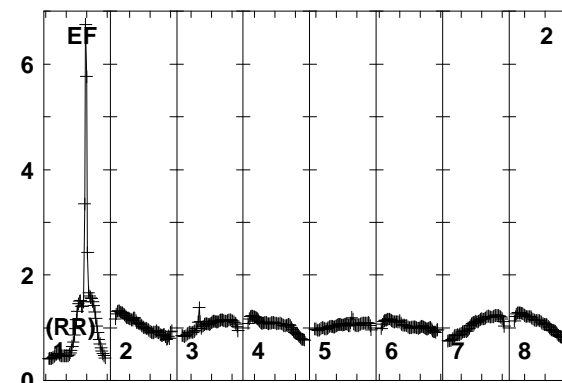
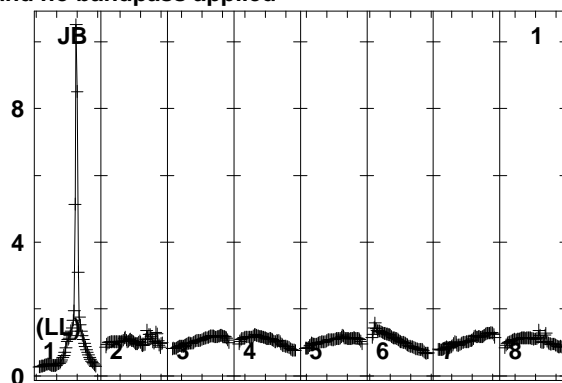
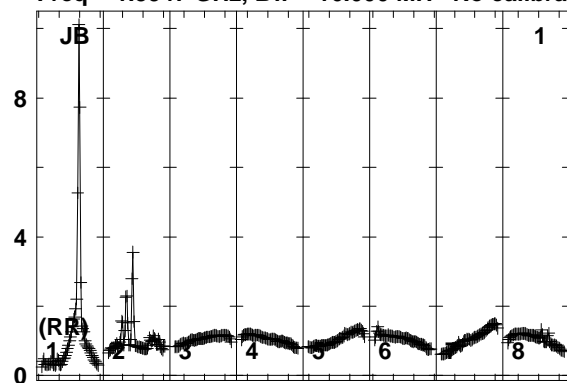

Lower frame: Real Jy
Total-power spectrum Antenna: JB (01)
Timerange: 00/04:56:16 to 00/04:57:14

Plot file version 235 created 04-NOV-2019 14:14:18

J2248-0541 EY034.UVDATA.1

Freq = 1.5947 GHz, Bw = 16.000 MH No calibration applied and no bandpass applied

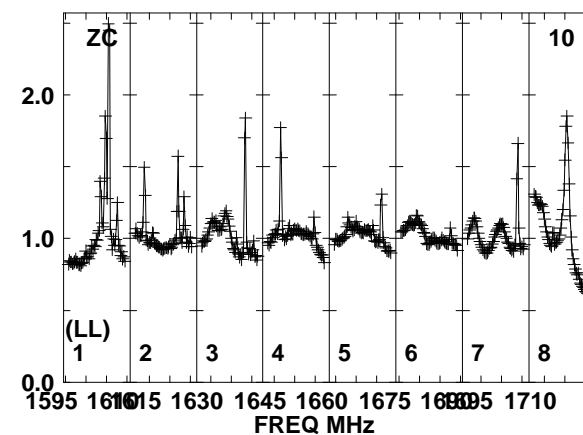
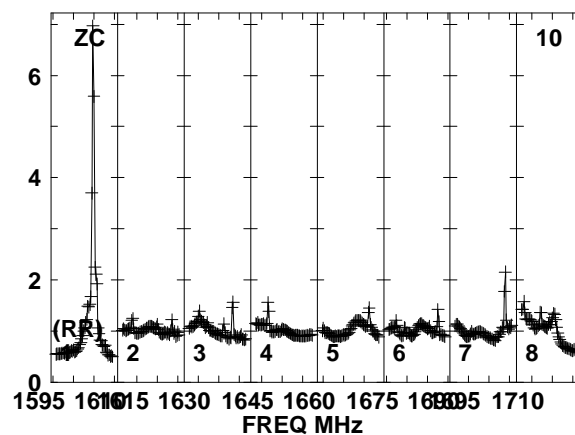
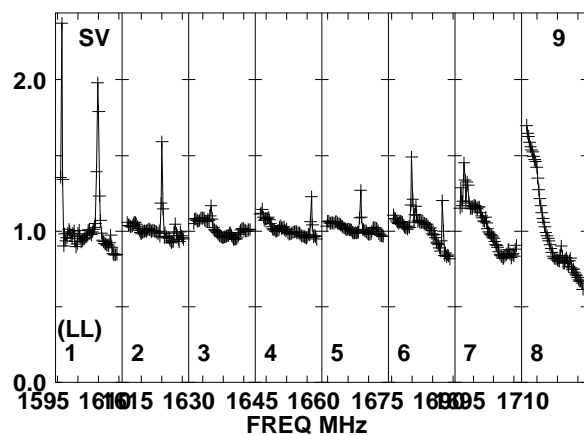
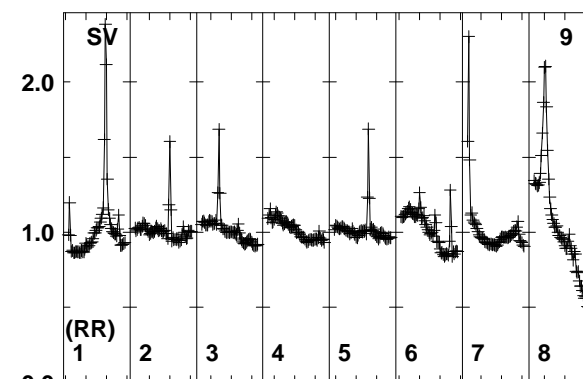
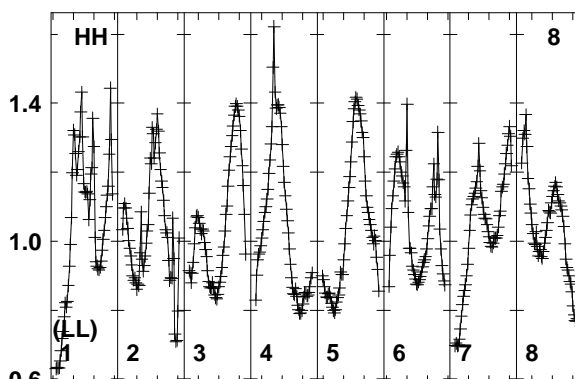
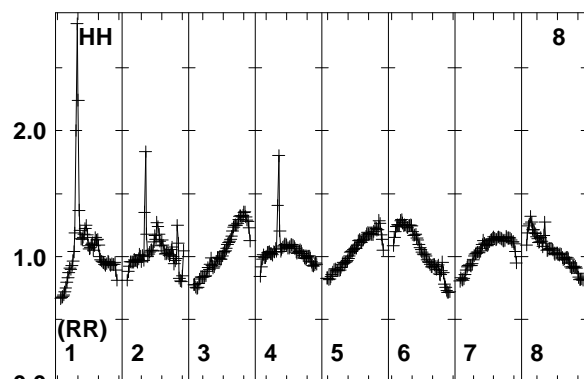
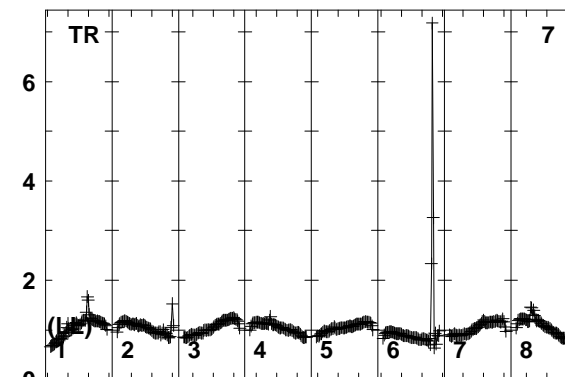
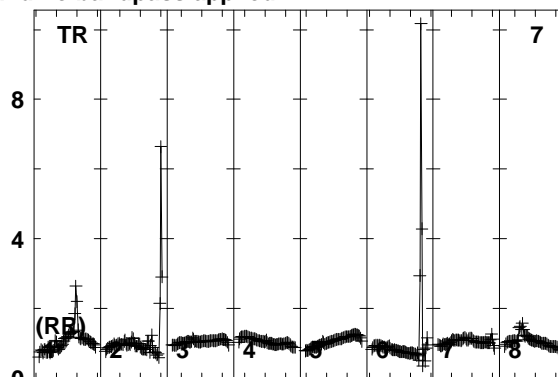
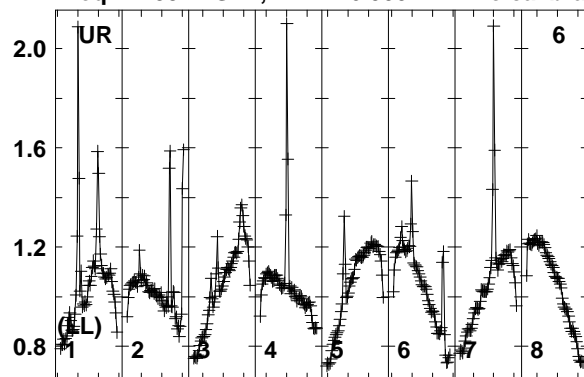

Lower frame: Real Jy
Total-power spectrum Antenna: UR (06)
Timerange: 00/04:56:16 to 00/04:57:14

Plot file version 236 created 04-NOV-2019 14:14:18

J2248-0541 EY034.UVDATA.1

Freq = 1.5947 GHz, Bw = 16.000 MH No calibration applied and no bandpass applied

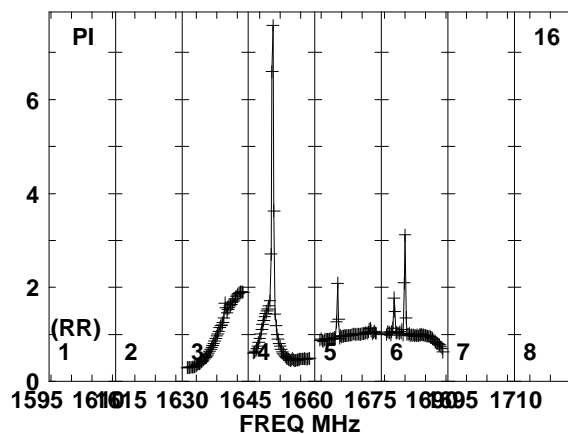
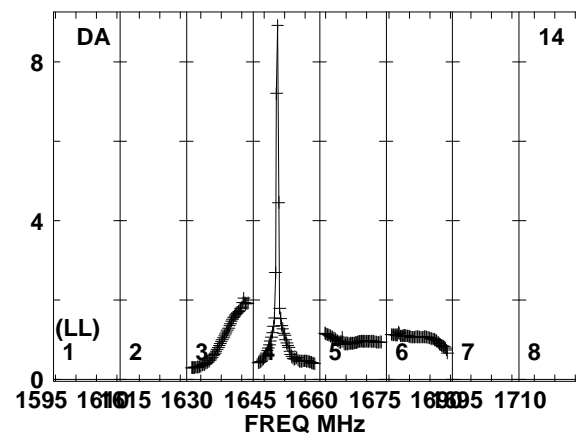
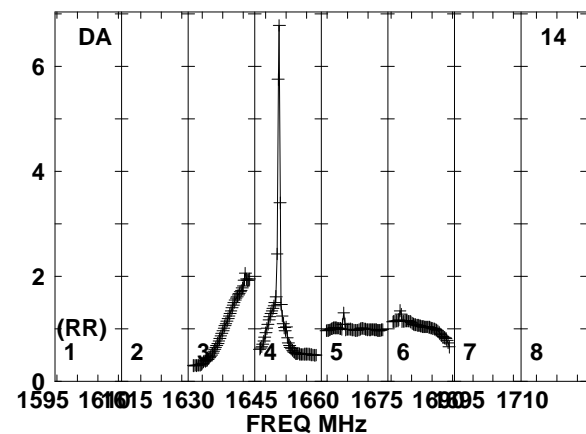
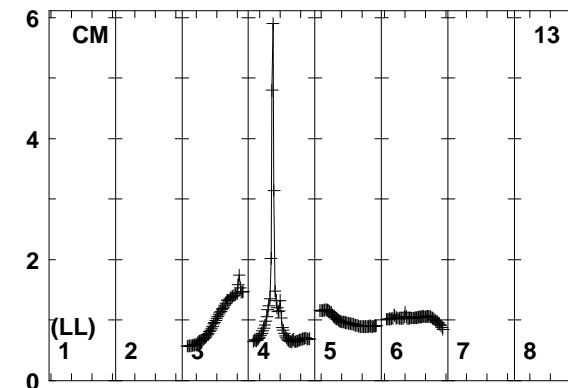
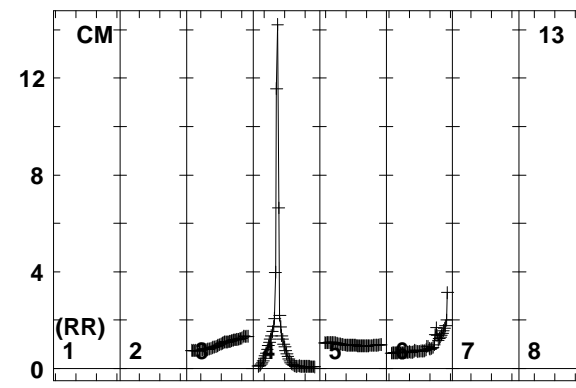
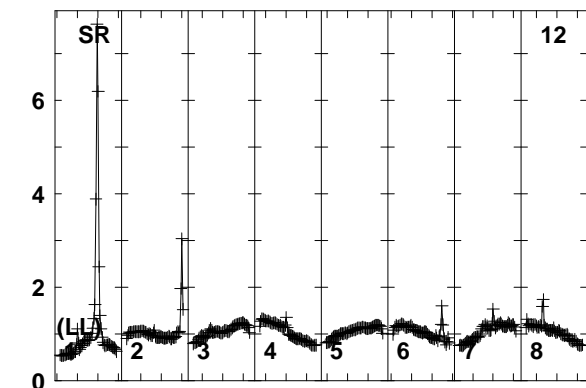
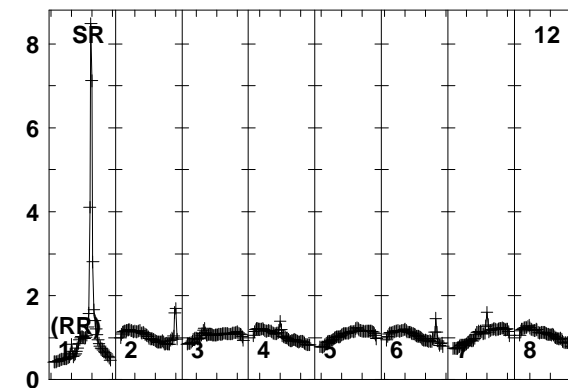
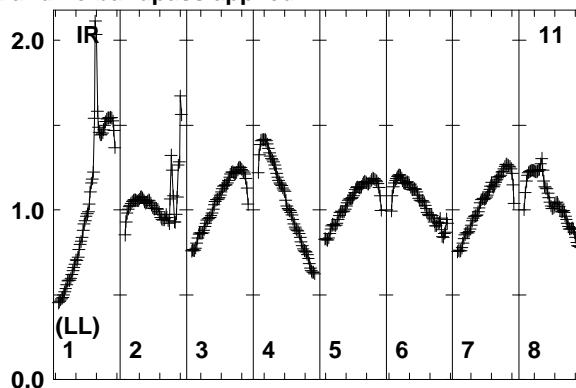
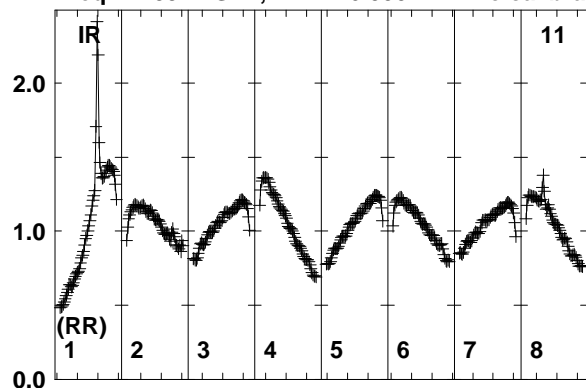

Lower frame: Real Jy
Total-power spectrum Antenna: IR (11)
Timerange: 00/04:56:16 to 00/04:57:14

Plot file version 237 created 04-NOV-2019 14:14:18
J2248-0541 EY034.UVDATA.1
Freq = 1.5947 GHz, Bw = 16.000 MH No calibration applied and no bandpass applied

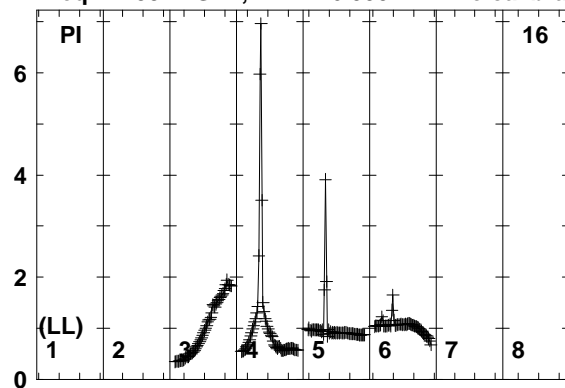

Lower frame: Real Jy
Total-power spectrum Antenna: PI (16)
Timerange: 00/04:56:16 to 00/04:57:14

Plot file version 238 created 04-NOV-2019 14:14:18

J2245-0755 EY034.UVDATA.1

Freq = 1.5947 GHz, Bw = 16.000 MH No calibration applied and no bandpass applied

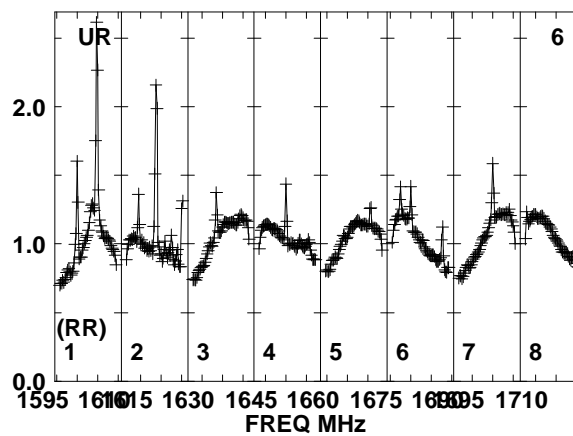
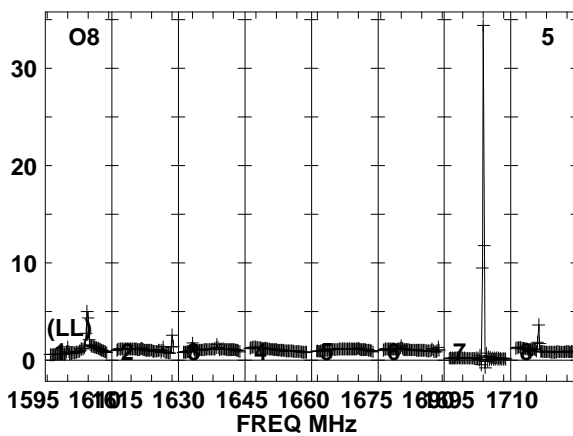
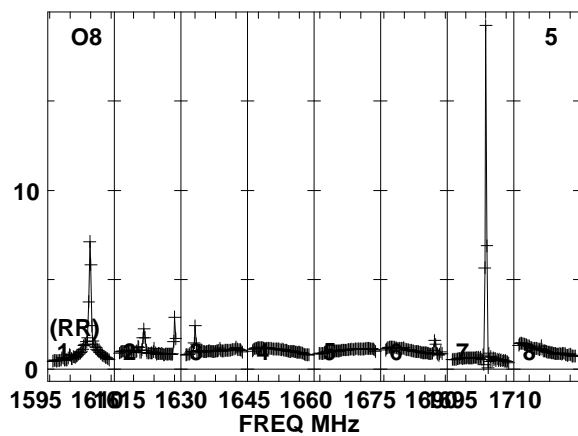
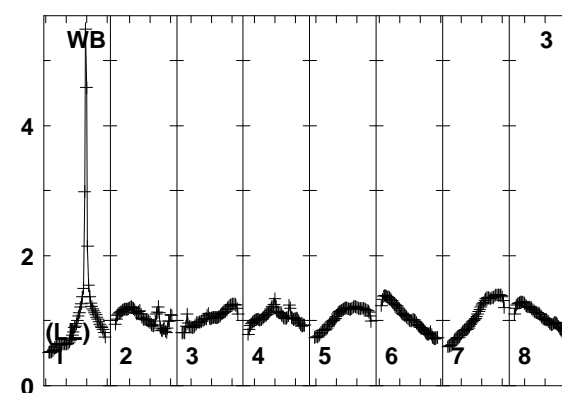
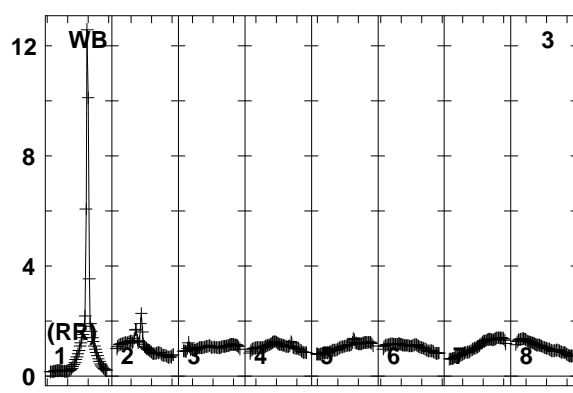
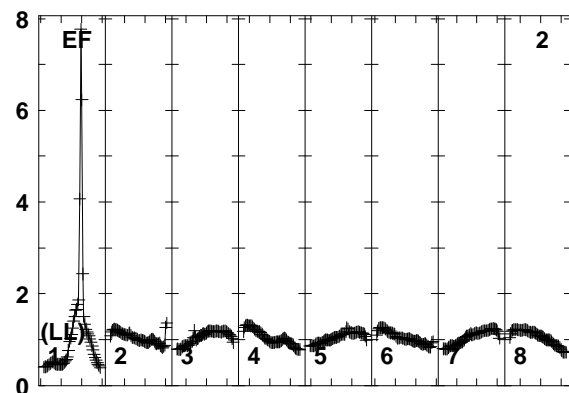
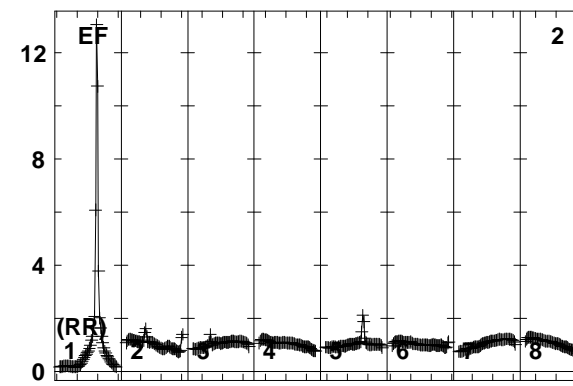
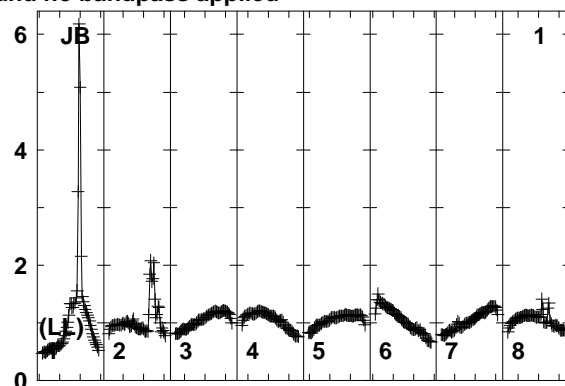
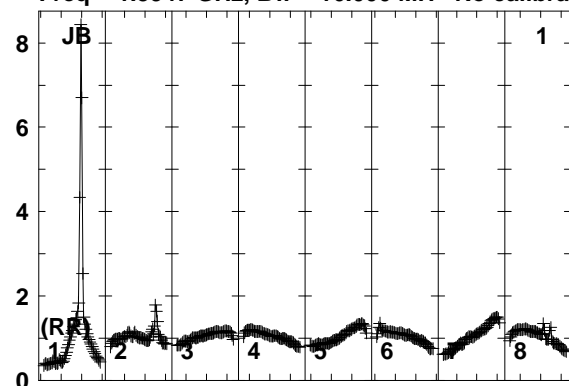

Lower frame: Real Jy
Total-power spectrum Antenna: JB (01)
Timerange: 00/04:57:31 to 00/04:58:29

Plot file version 239 created 04-NOV-2019 14:14:18

J2245-0755 EY034.UVDATA.1

Freq = 1.5947 GHz, Bw = 16.000 MH No calibration applied and no bandpass applied

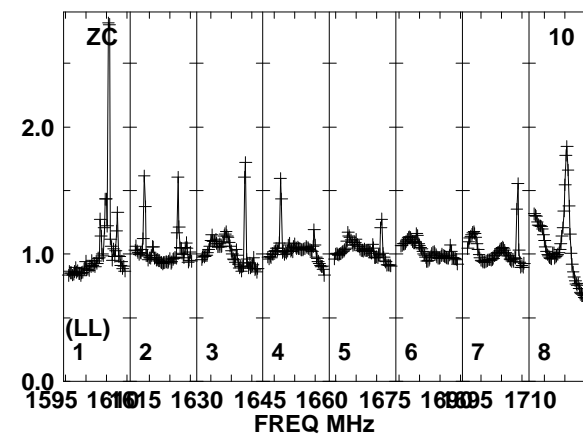
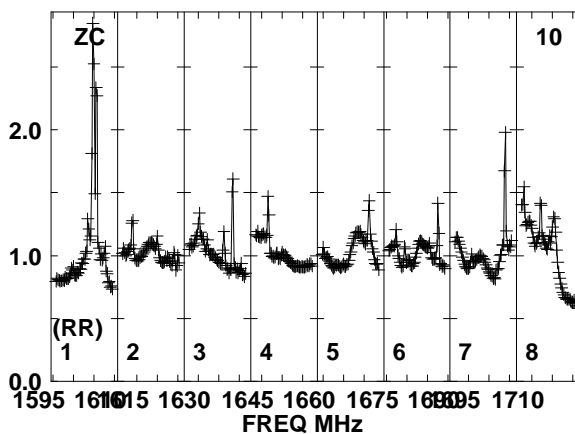
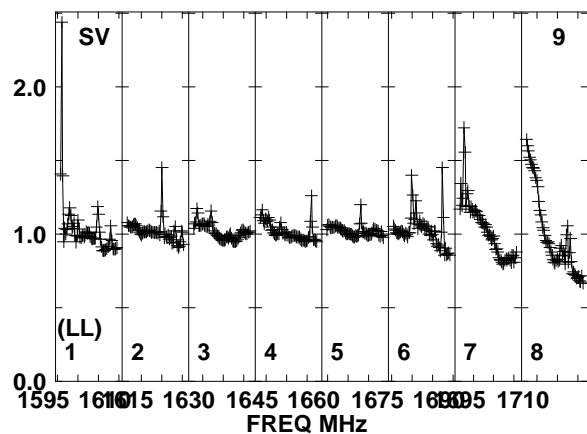
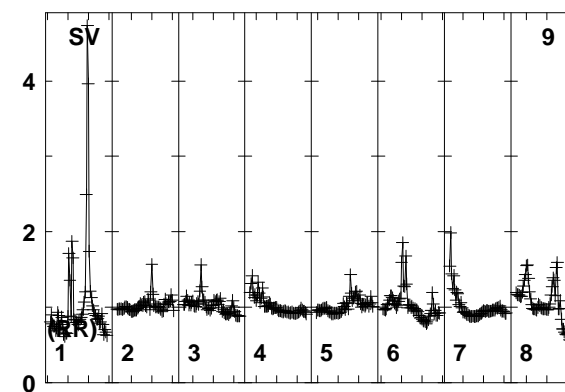
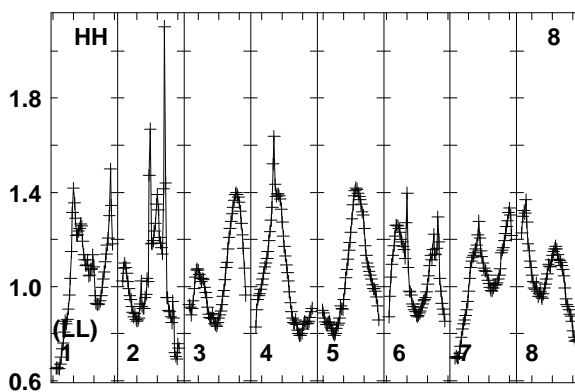
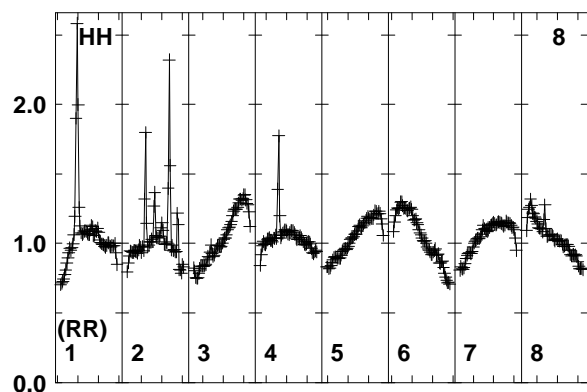
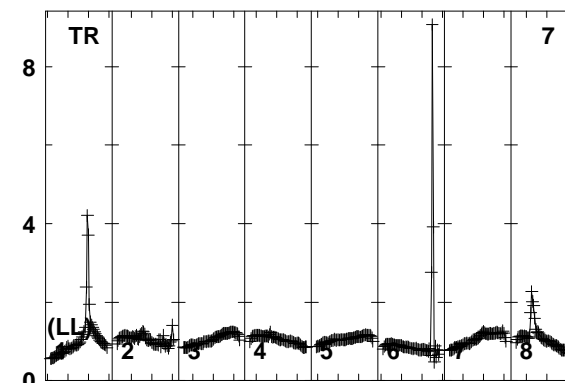
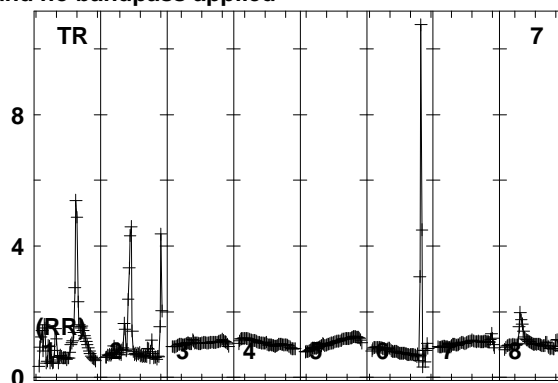
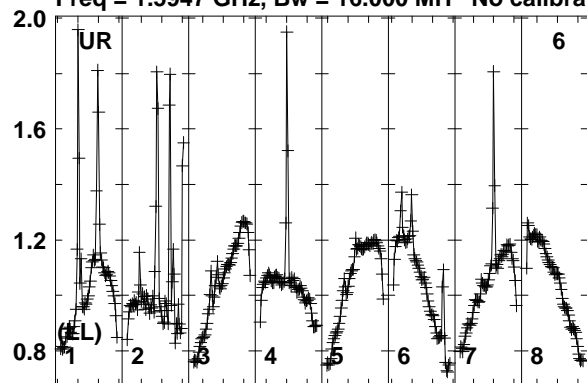

Lower frame: Real Jy
Total-power spectrum Antenna: UR (06)
Timerange: 00/04:57:31 to 00/04:58:29

Plot file version 240 created 04-NOV-2019 14:14:18

J2245-0755 EY034.UVDATA.1

Freq = 1.5947 GHz, Bw = 16.000 MH No calibration applied and no bandpass applied

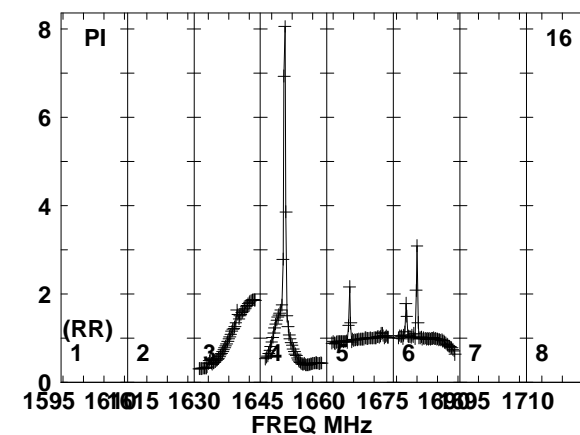
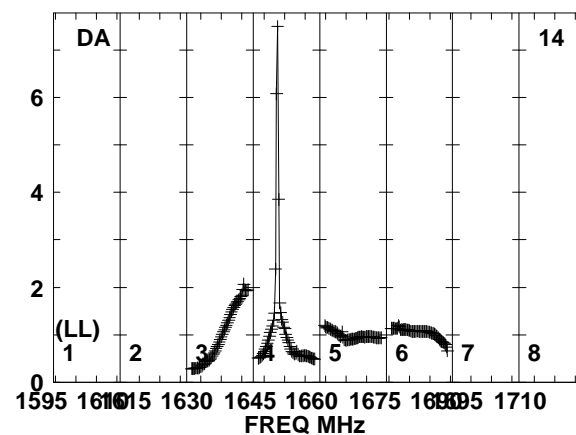
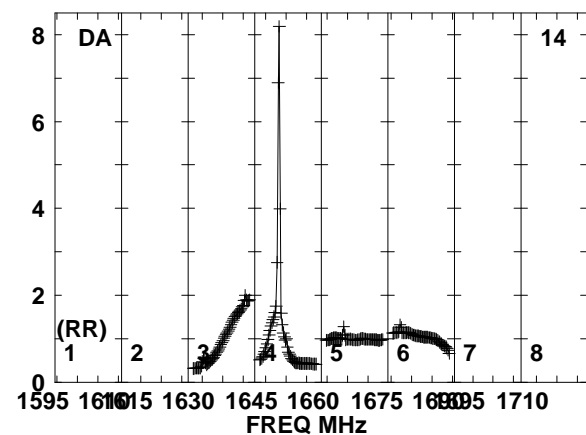
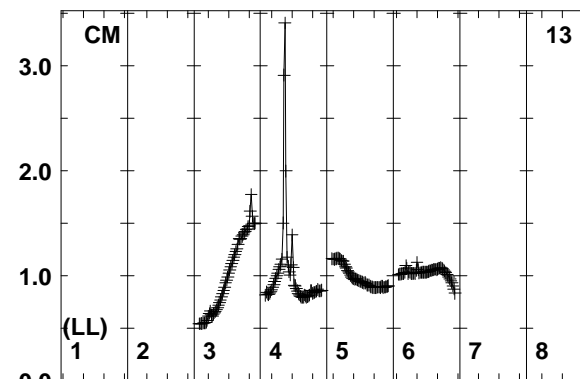
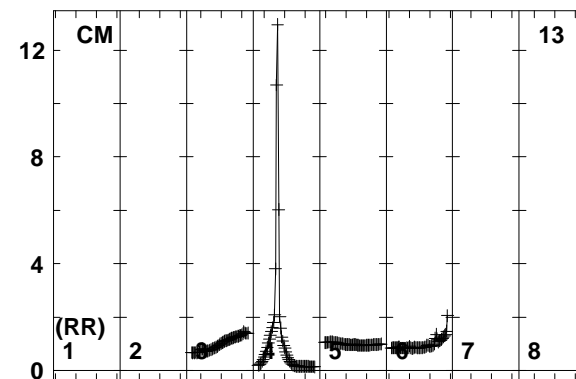
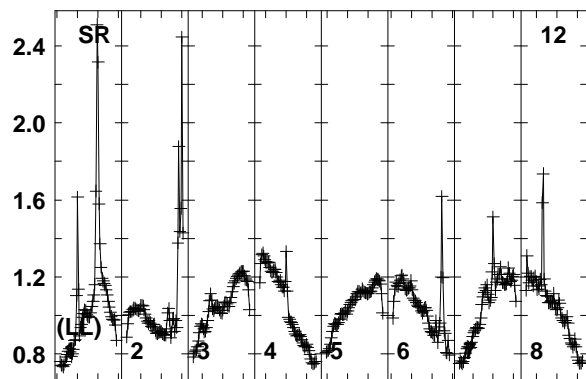
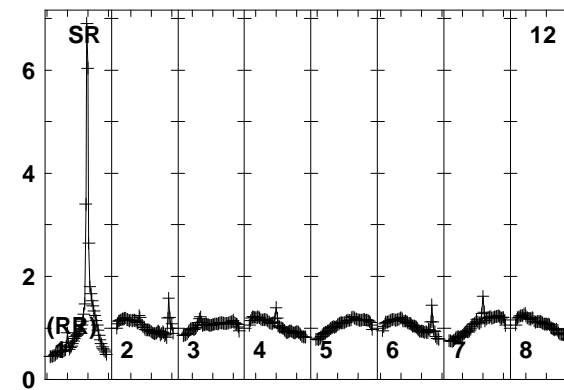
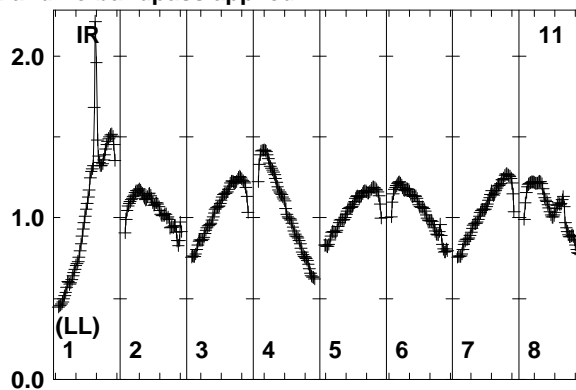
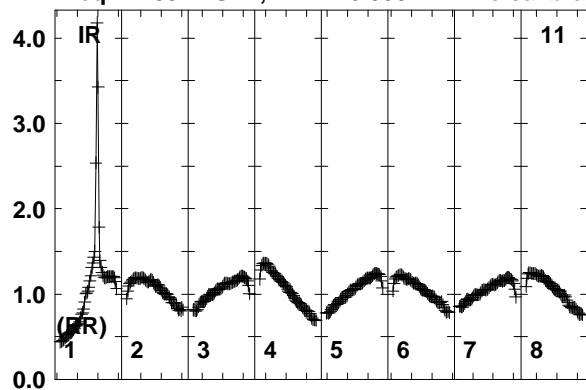

Lower frame: Real Jy
Total-power spectrum Antenna: IR (11)
Timerange: 00/04:57:31 to 00/04:58:29

Plot file version 241 created 04-NOV-2019 14:14:18
J2245-0755 EY034.UVDATA.1
Freq = 1.5947 GHz, Bw = 16.000 MH No calibration applied and no bandpass applied

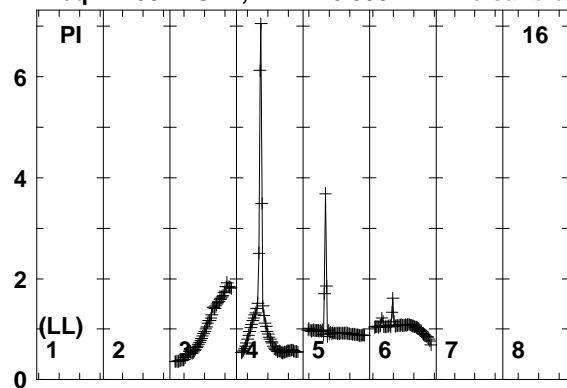

Lower frame: Real Jy
Total-power spectrum Antenna: PI (16)
Timerange: 00/04:57:31 to 00/04:58:29

Plot file version 242 created 04-NOV-2019 14:14:18

J2248-0541 EY034.UVDATA.1

Freq = 1.5947 GHz, Bw = 16.000 MH No calibration applied and no bandpass applied

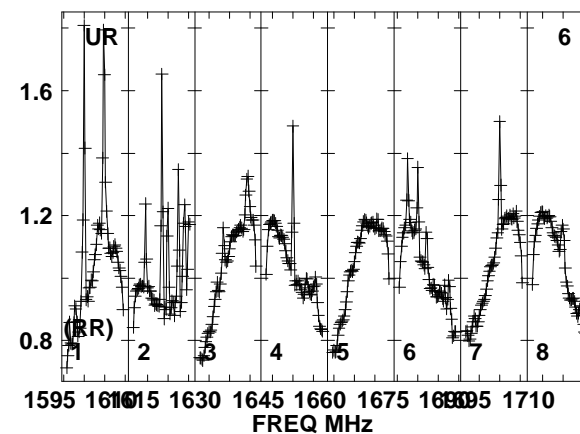
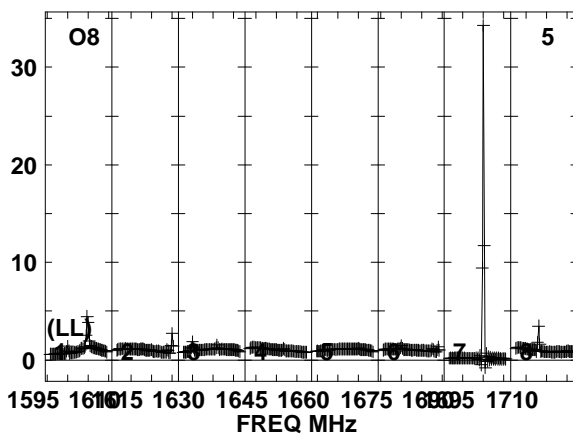
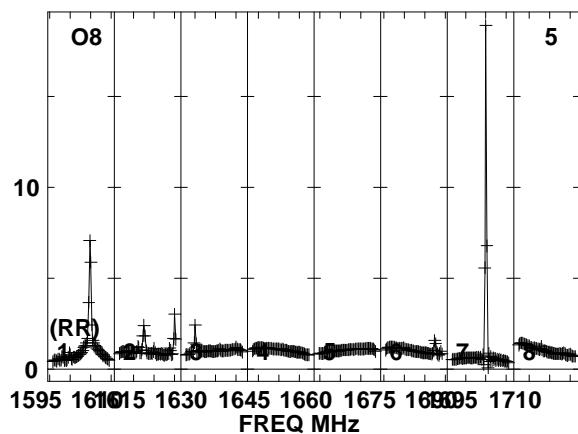
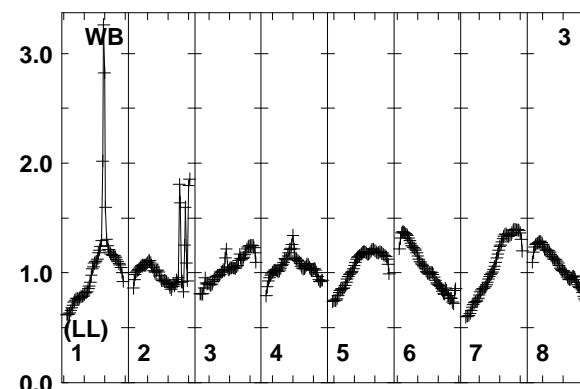
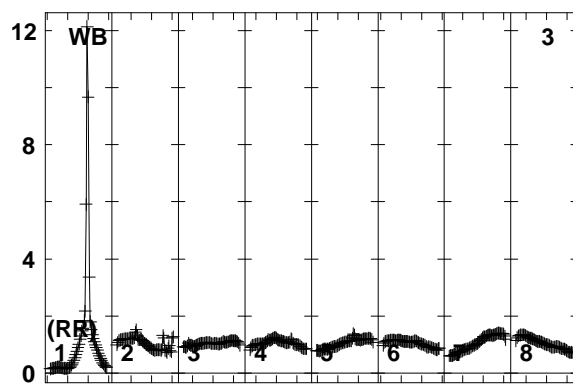
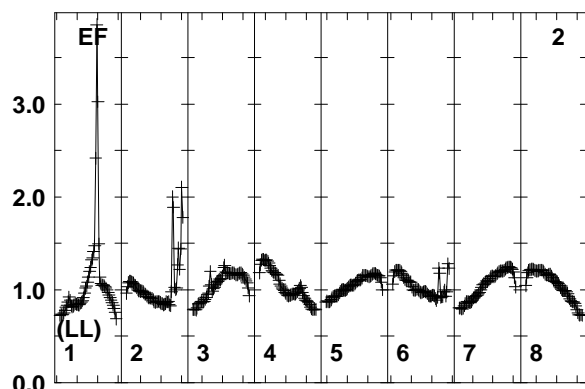
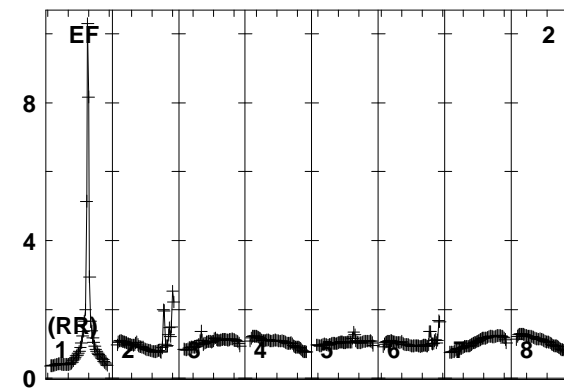
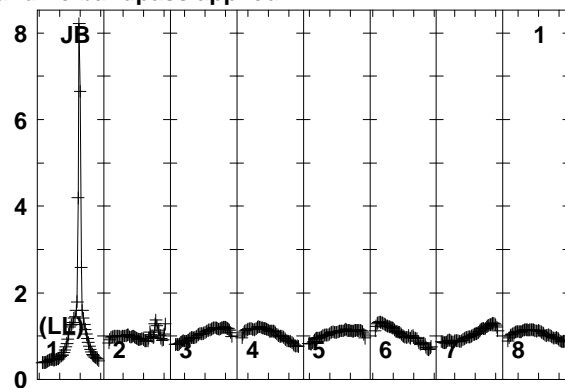
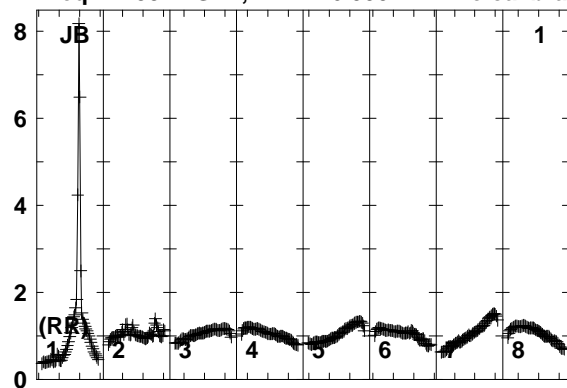

Lower frame: Real Jy
Total-power spectrum Antenna: JB (01)
Timerange: 00/04:59:16 to 00/05:00:14

Plot file version 243 created 04-NOV-2019 14:14:18

J2248-0541 EY034.UVDATA.1

Freq = 1.5947 GHz, Bw = 16.000 MH No calibration applied and no bandpass applied

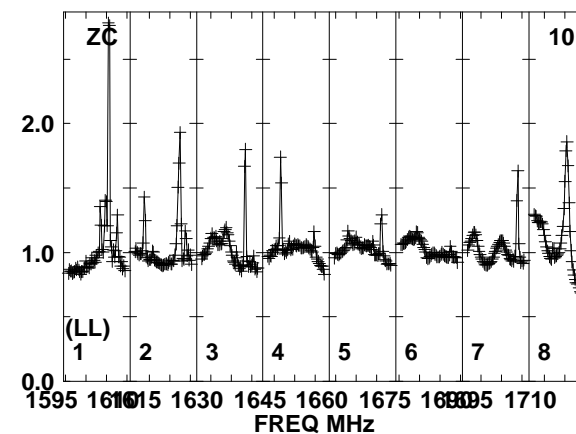
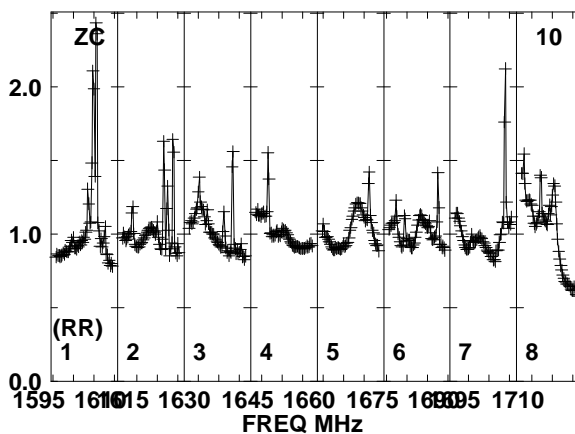
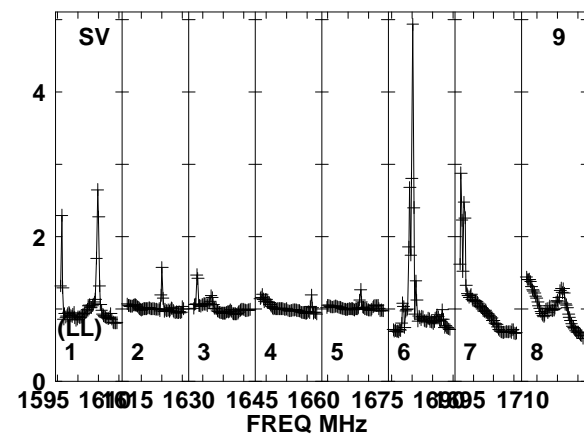
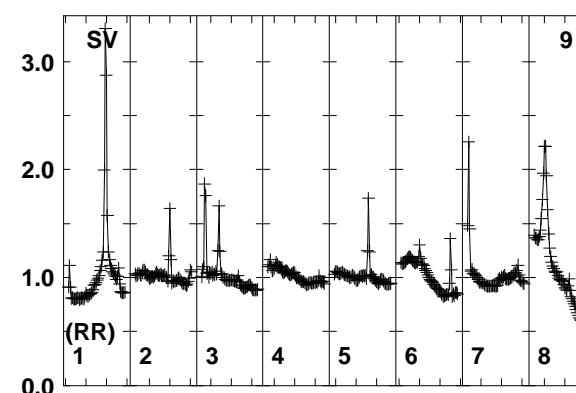
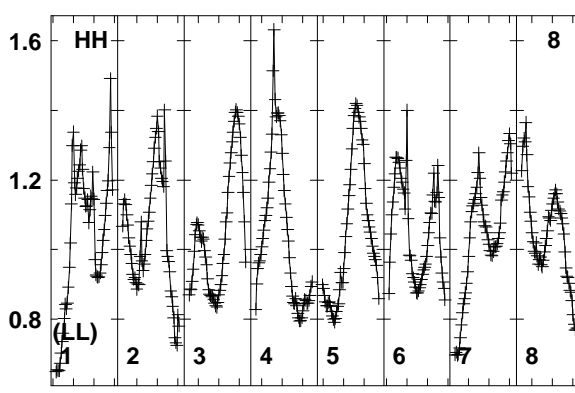
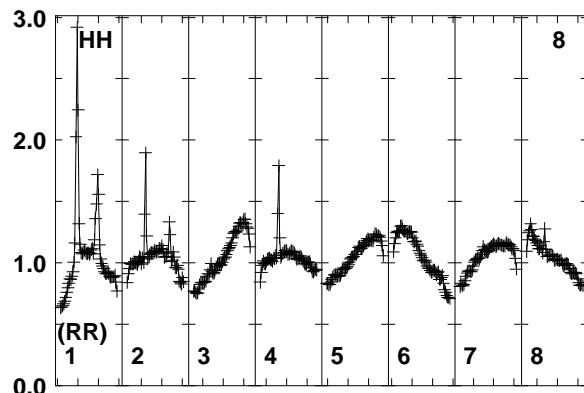
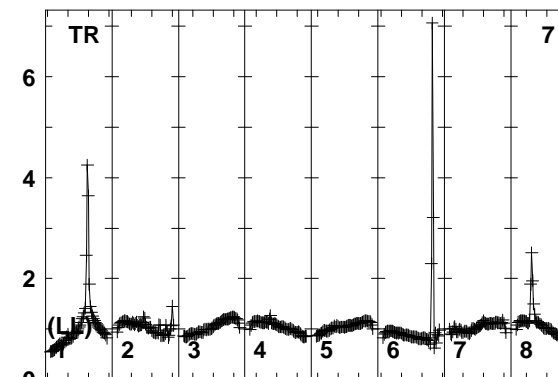
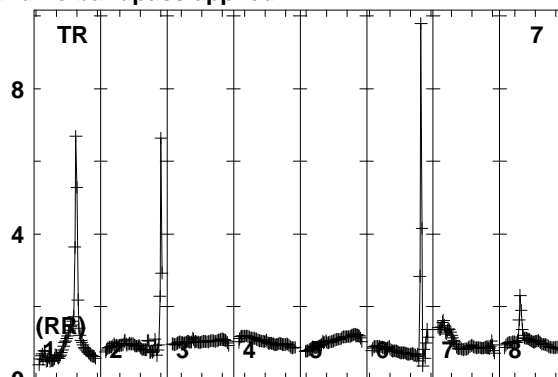
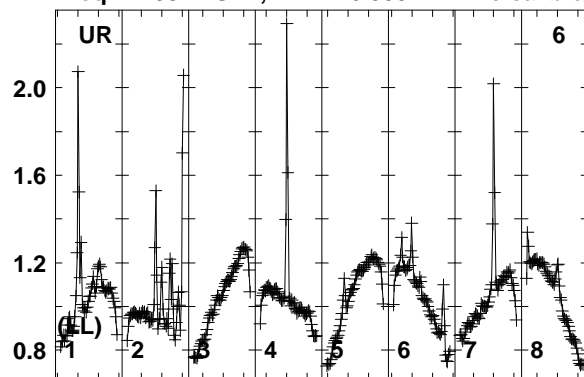

Lower frame: Real Jy
Total-power spectrum Antenna: UR (06)
Timerange: 00/04:59:16 to 00/05:00:14

Plot file version 244 created 04-NOV-2019 14:14:19

J2248-0541 EY034.UVDATA.1

Freq = 1.5947 GHz, Bw = 16.000 MH No calibration applied and no bandpass applied

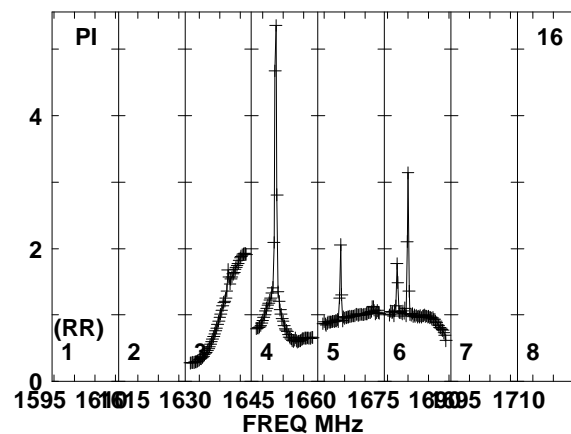
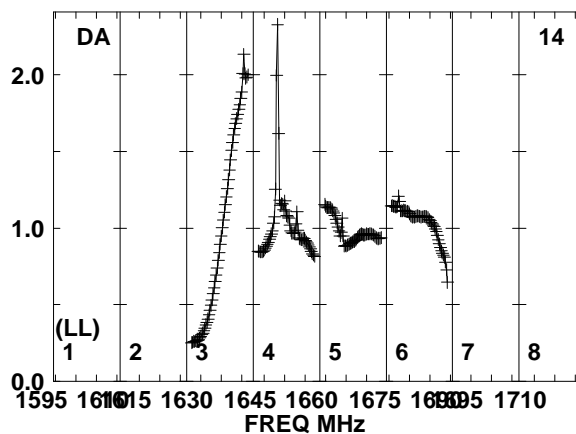
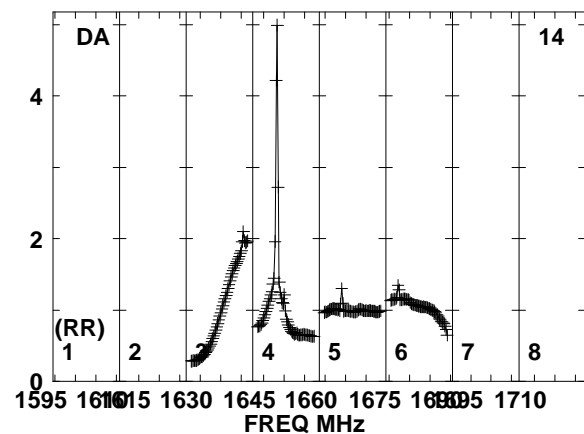
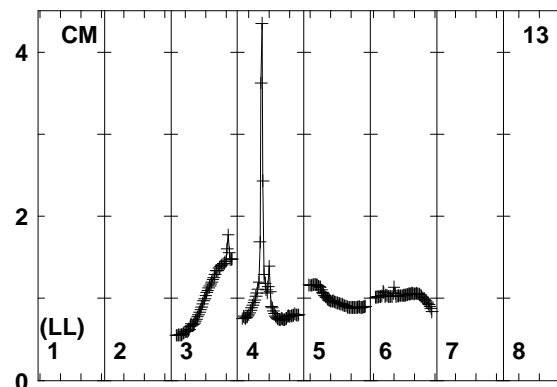
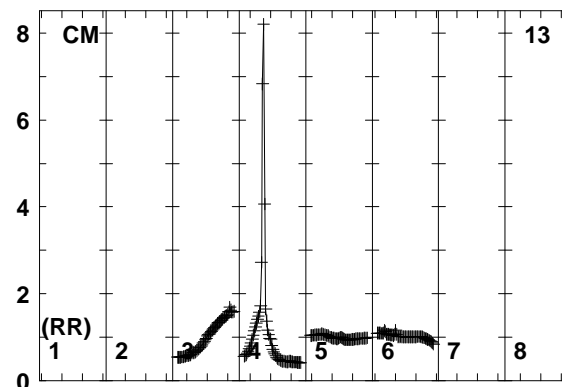
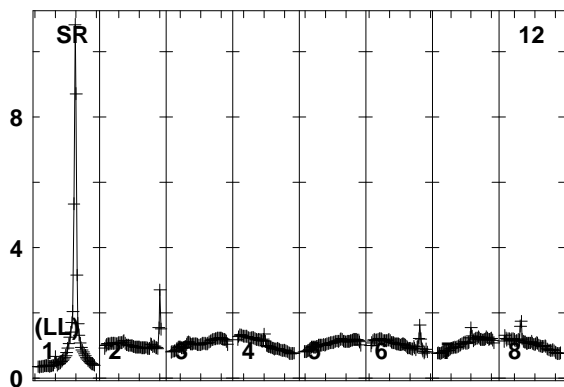
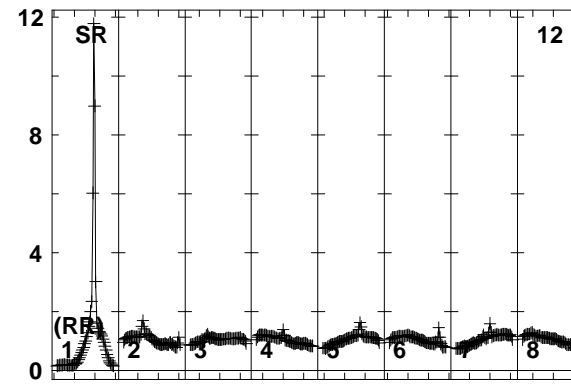
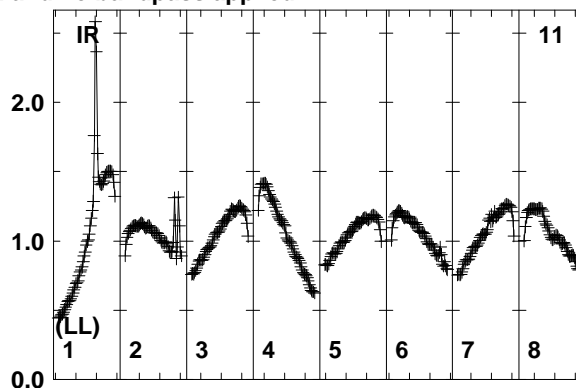
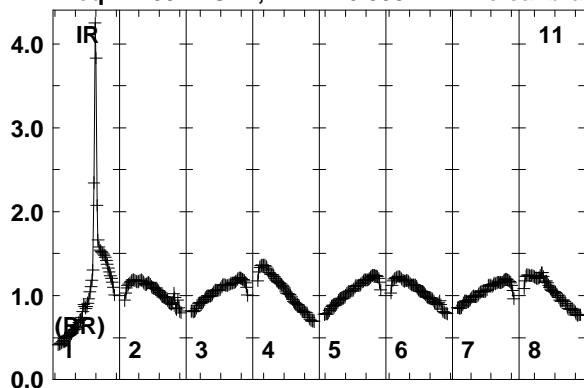

Lower frame: Real Jy
Total-power spectrum Antenna: IR (11)
Timerange: 00/04:59:16 to 00/05:00:14

Plot file version 245 created 04-NOV-2019 14:14:19

J2248-0541 EY034.UVDATA.1

Freq = 1.5947 GHz, Bw = 16.000 MH No calibration applied and no bandpass applied

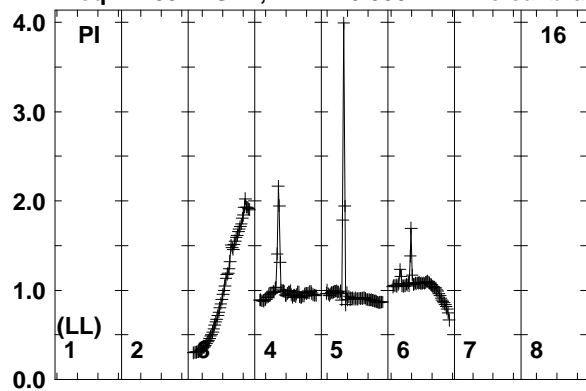

Lower frame: Real Jy
Total-power spectrum Antenna: PI (16)
Timerange: 00/04:59:16 to 00/05:00:14

Plot file version 246 created 04-NOV-2019 14:14:19

W2246-0526 EY034.UVDATA.1

Freq = 1.5947 GHz, Bw = 16.000 MH No calibration applied and no bandpass applied

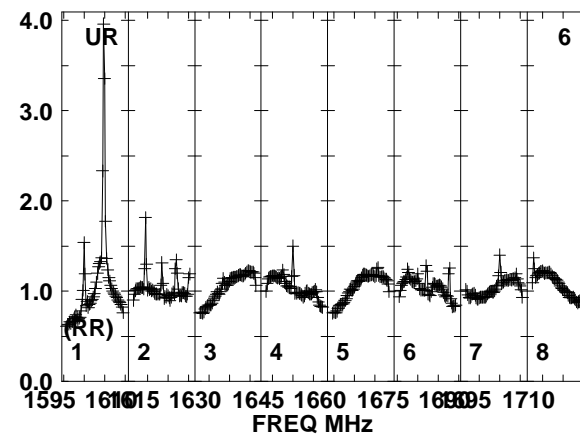
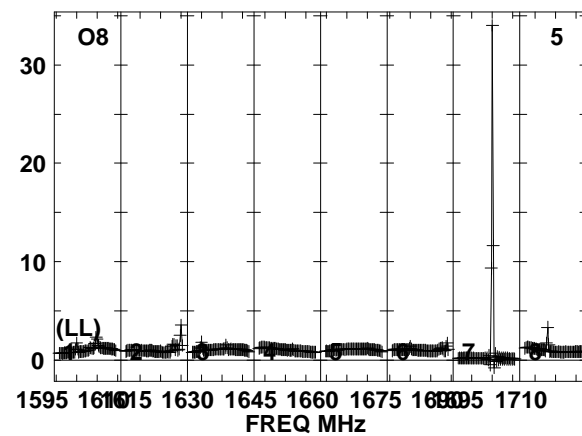
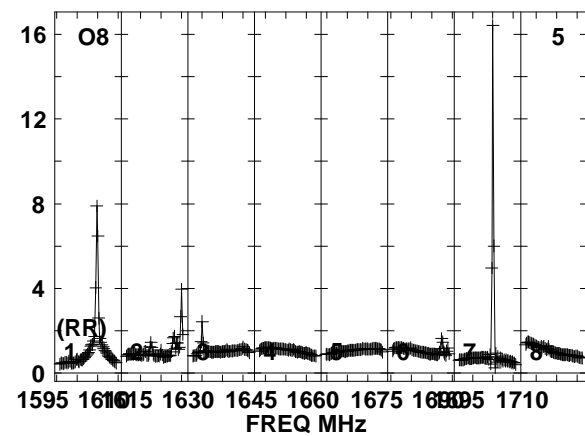
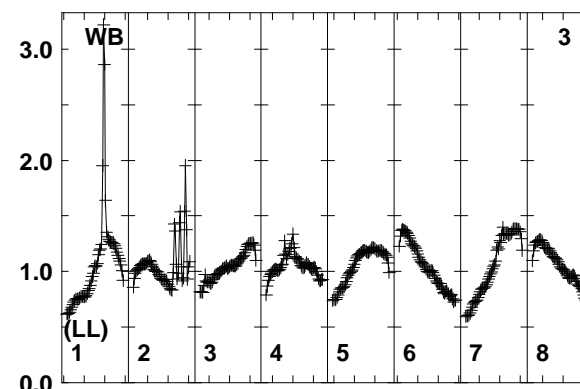
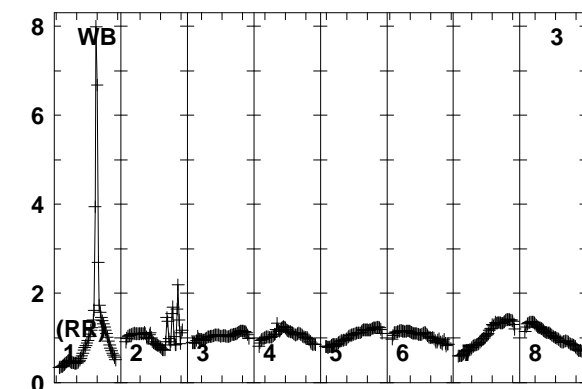
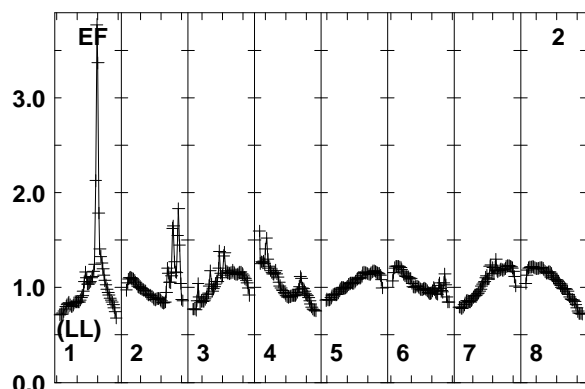
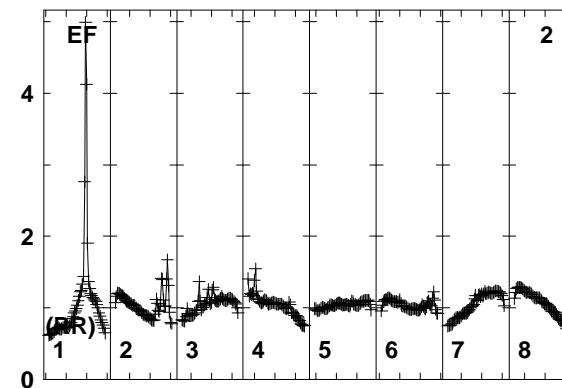
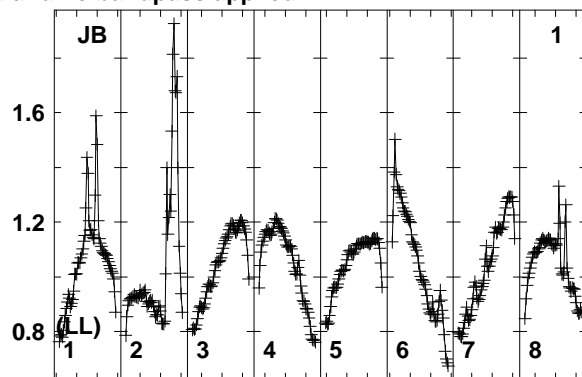
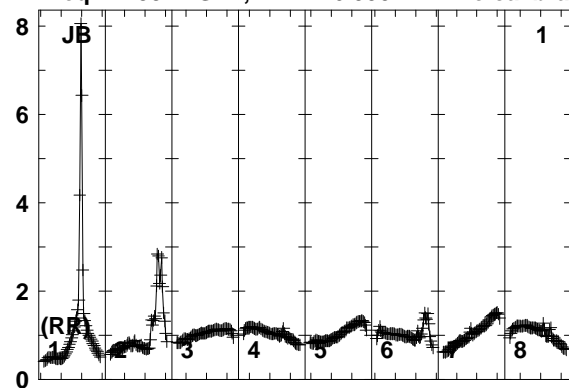

Lower frame: Real Jy
Total-power spectrum Antenna: JB (01)
Timerange: 00/05:00:16 to 00/05:02:44

Plot file version 247 created 04-NOV-2019 14:14:19

W2246-0526 EY034.UVDATA.1

Freq = 1.5947 GHz, Bw = 16.000 MH No calibration applied and no bandpass applied

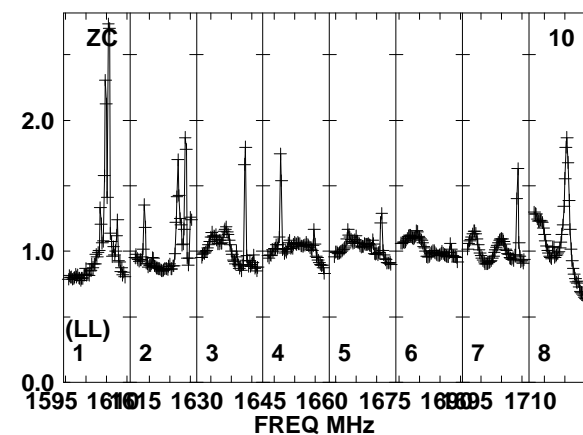
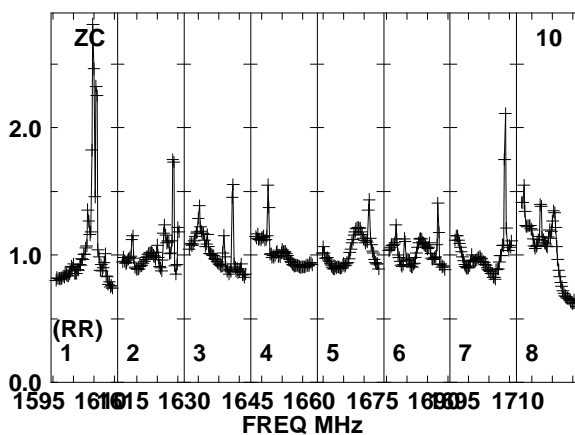
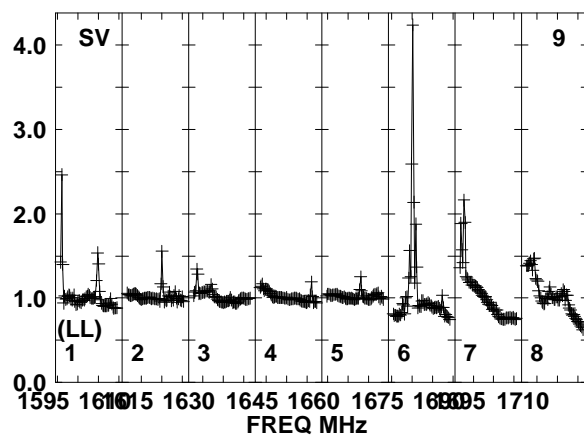
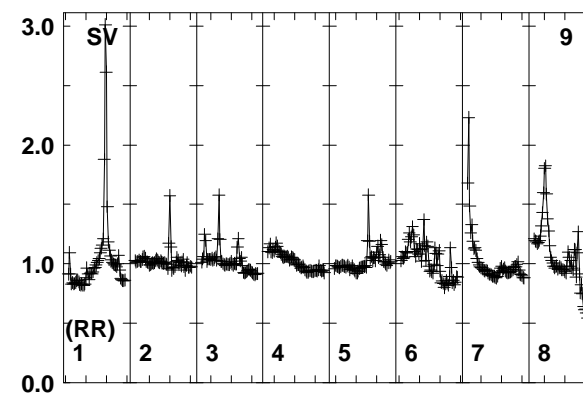
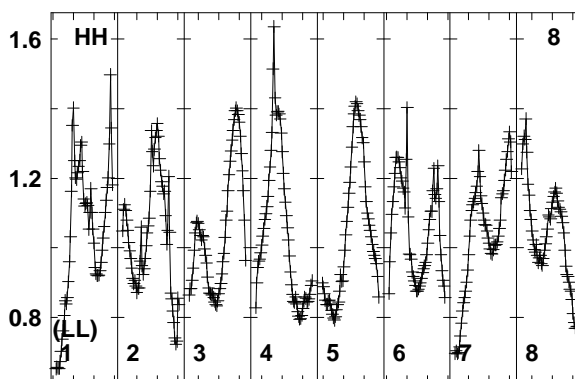
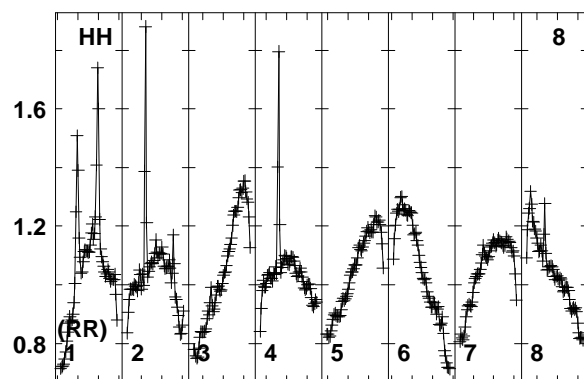
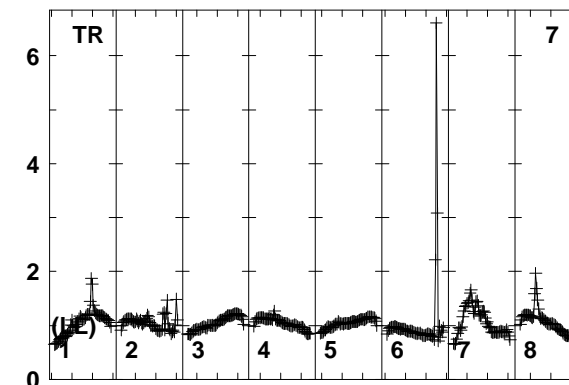
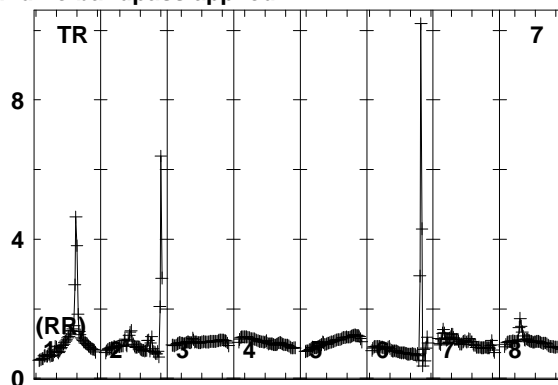
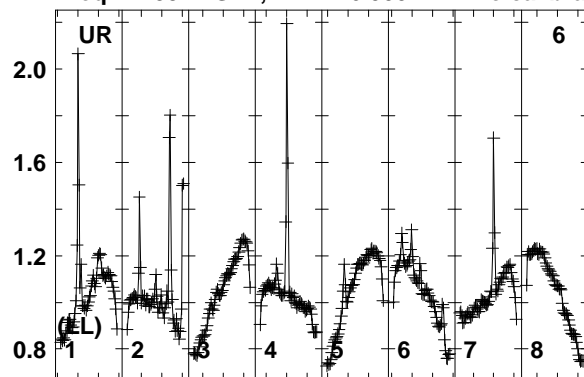

Lower frame: Real Jy
Total-power spectrum Antenna: UR (06)
Timerange: 00/05:00:16 to 00/05:02:44

Plot file version 248 created 04-NOV-2019 14:14:19
 W2246-0526 EY034.UVDATA.1
 Freq = 1.5947 GHz, Bw = 16.000 MH No calibration applied and no bandpass applied

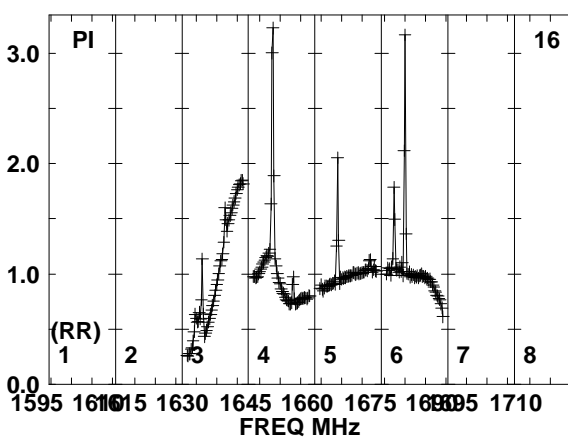
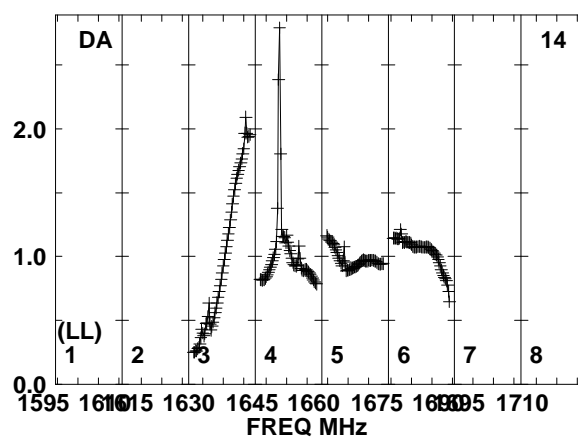
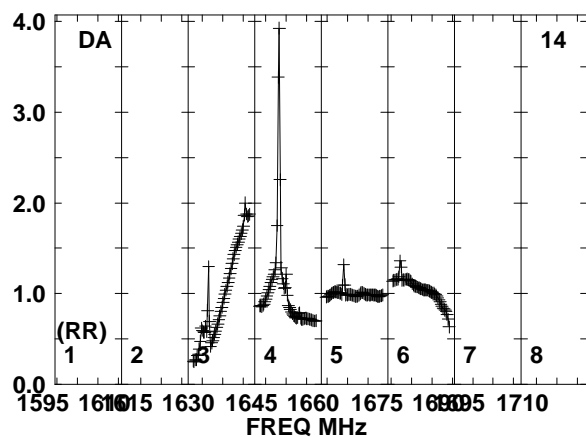
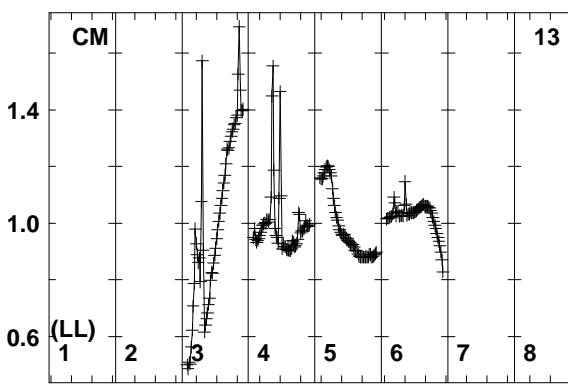
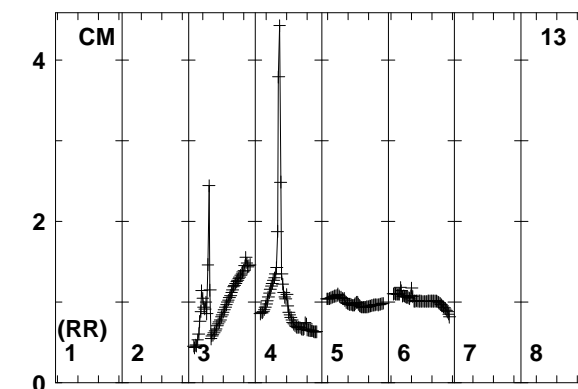
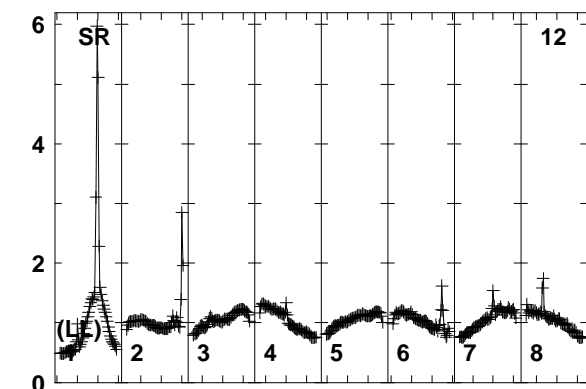
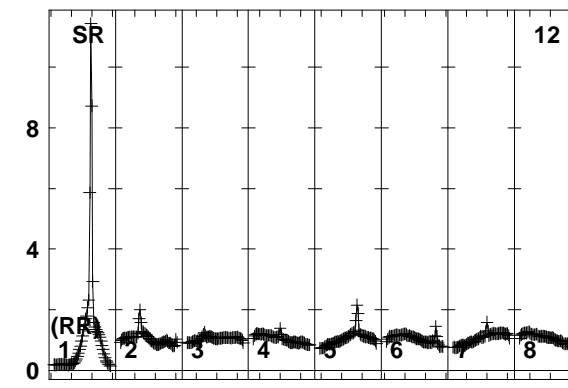
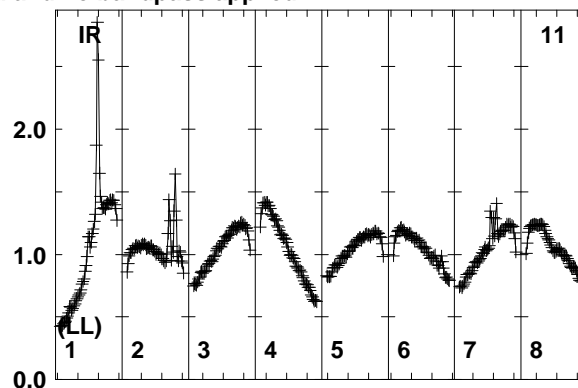
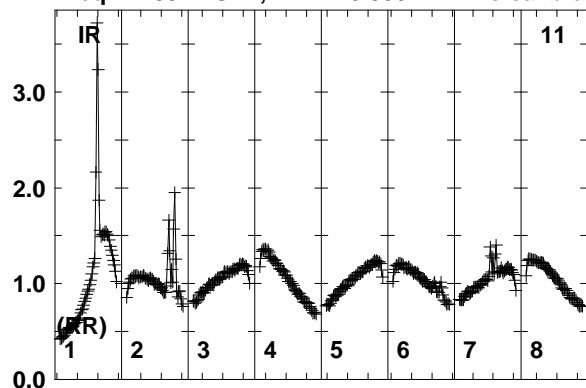

Lower frame: Real Jy
 Total-power spectrum Antenna: IR (11)
 Timerange: 00/05:00:16 to 00/05:02:44

Plot file version 249 created 04-NOV-2019 14:14:19
W2246-0526 EY034.UVDATA.1
Freq = 1.5947 GHz, Bw = 16.000 MH No calibration applied and no bandpass applied

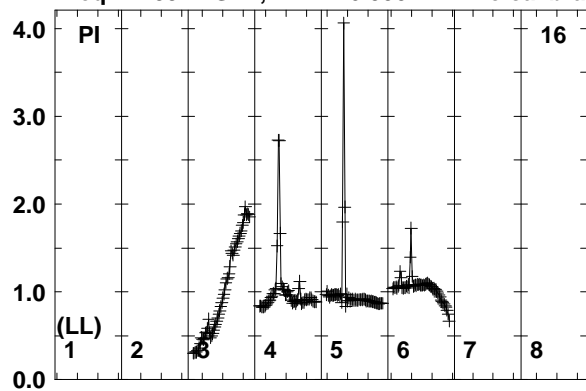

Lower frame: Real Jy
Total-power spectrum Antenna: PI (16)
Timerange: 00/05:00:16 to 00/05:02:44

Plot file version 250 created 04-NOV-2019 14:14:19

J2248-0541 EY034.UVDATA.1

Freq = 1.5947 GHz, Bw = 16.000 MH No calibration applied and no bandpass applied

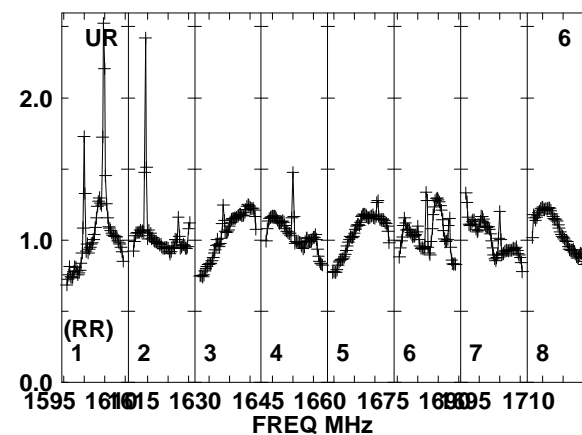
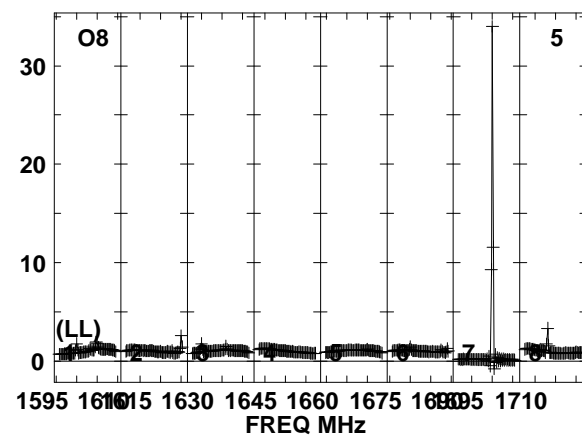
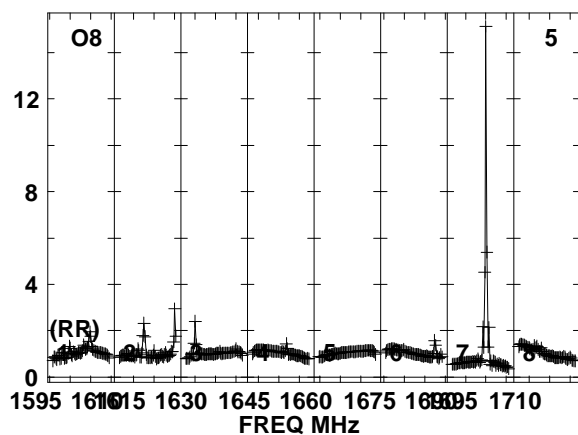
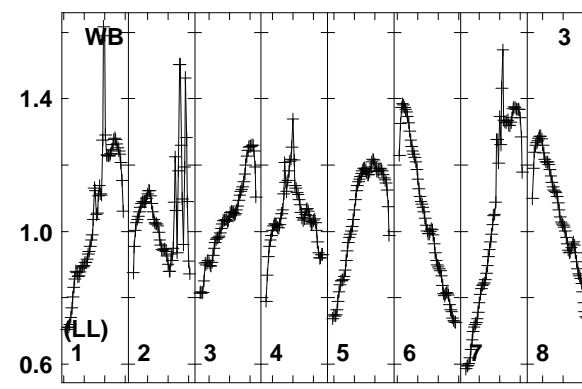
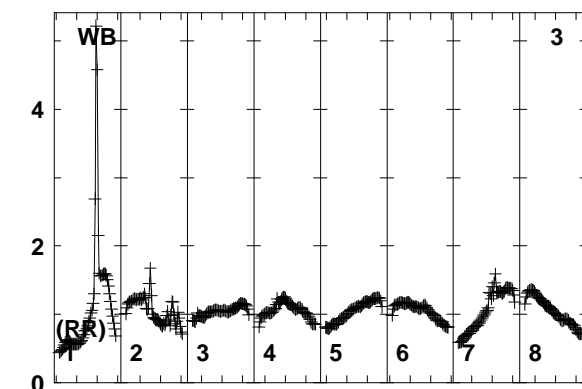
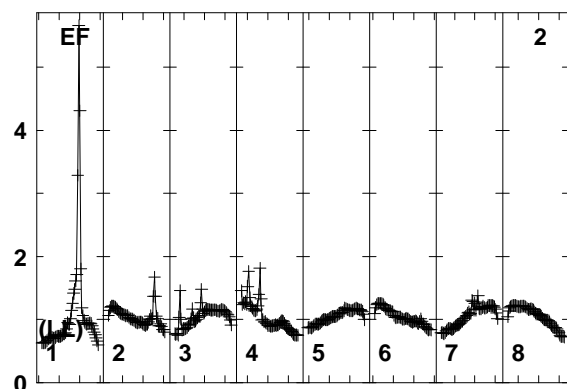
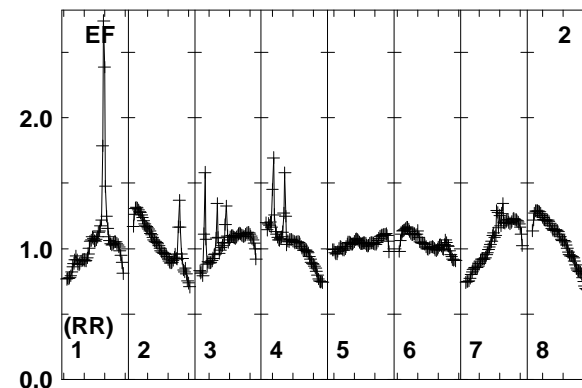
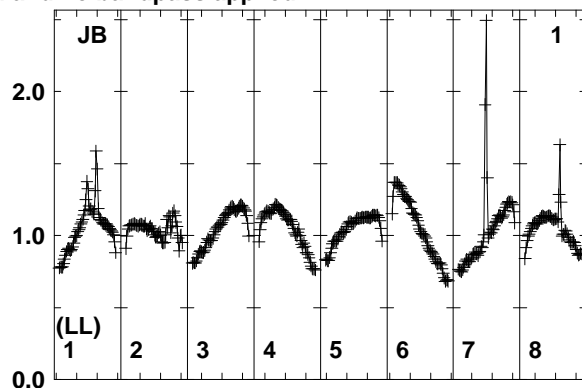
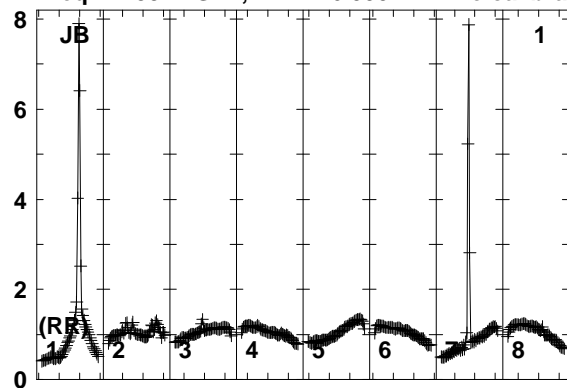

Lower frame: Real Jy
Total-power spectrum Antenna: JB (01)
Timerange: 00/05:03:01 to 00/05:03:59

Plot file version 251 created 04-NOV-2019 14:14:19

J2248-0541 EY034.UVDATA.1

Freq = 1.5947 GHz, Bw = 16.000 MH No calibration applied and no bandpass applied

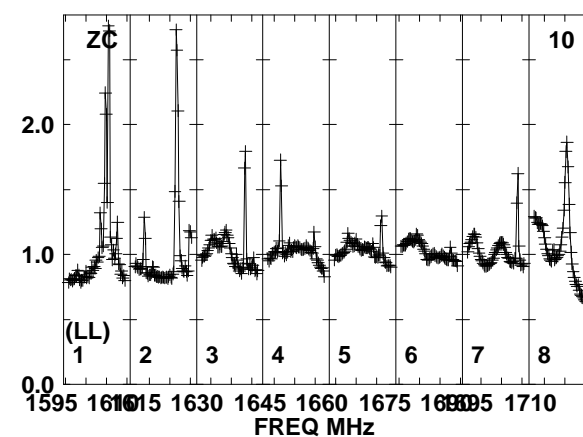
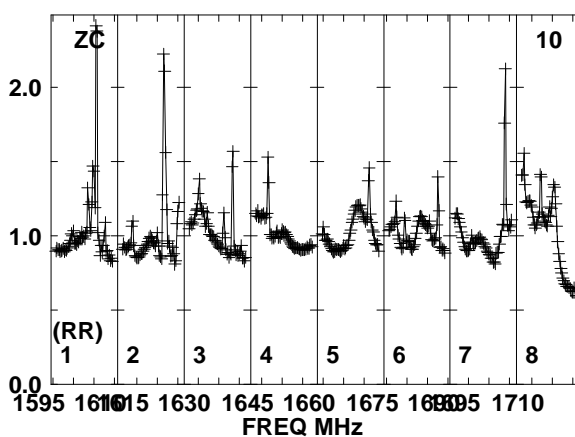
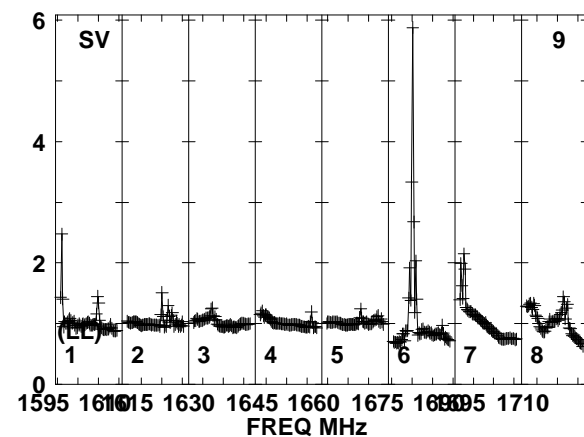
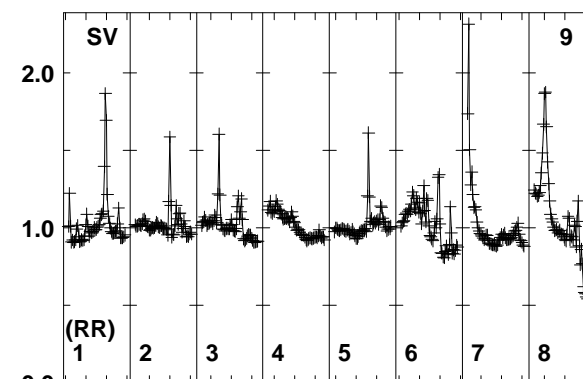
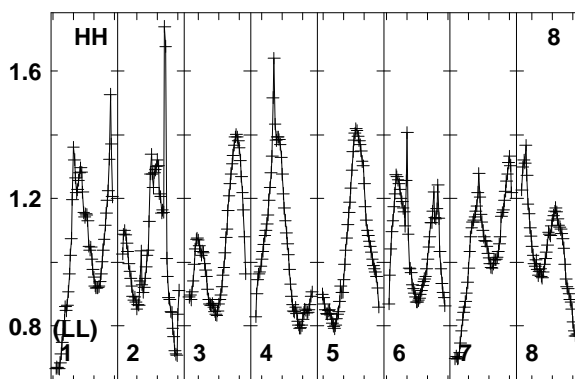
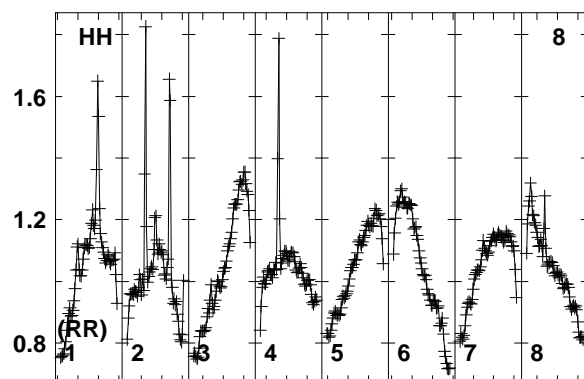
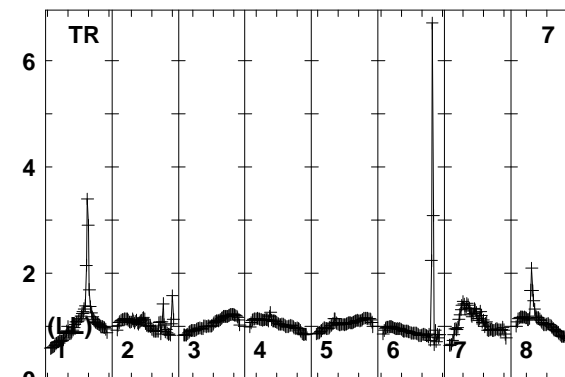
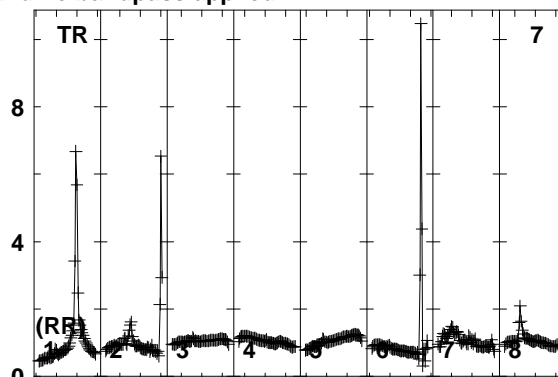
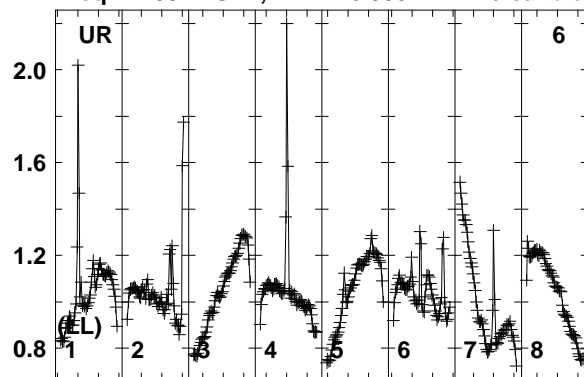

Lower frame: Real Jy
Total-power spectrum Antenna: UR (06)
Timerange: 00/05:03:01 to 00/05:03:59

Plot file version 252 created 04-NOV-2019 14:14:19

J2248-0541 EY034.UVDATA.1

Freq = 1.5947 GHz, Bw = 16.000 MH No calibration applied and no bandpass applied

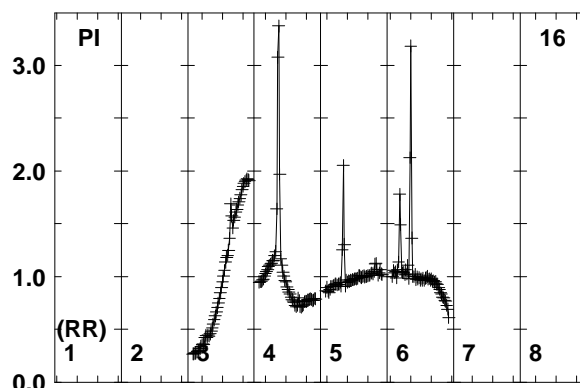
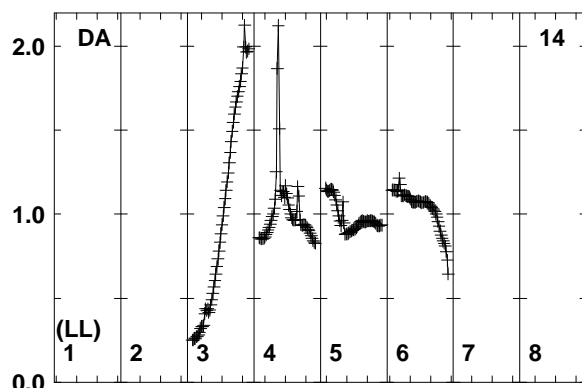
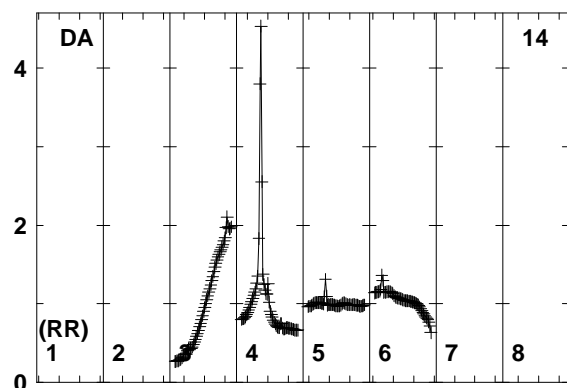
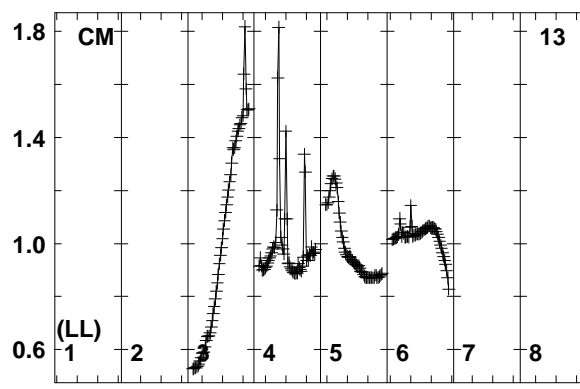
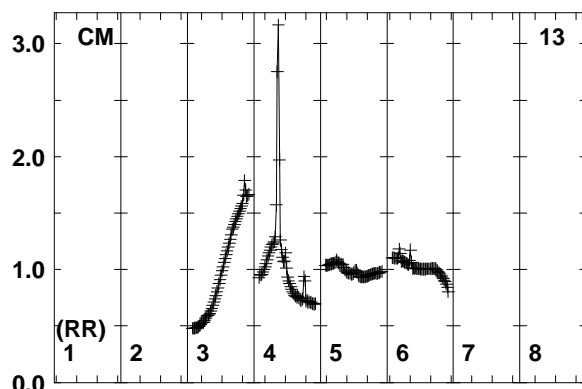
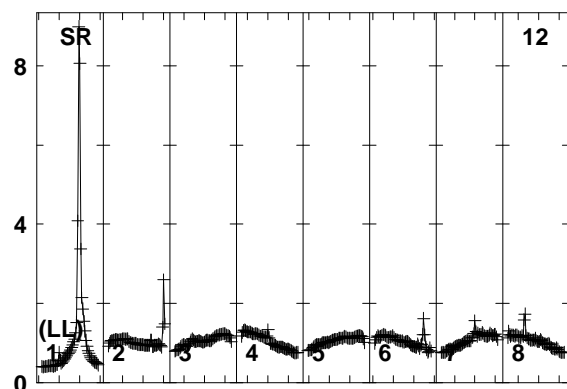
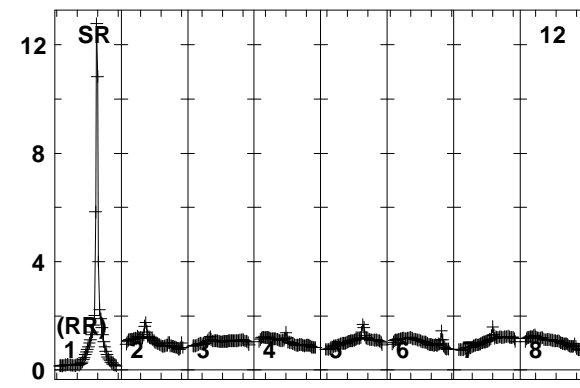
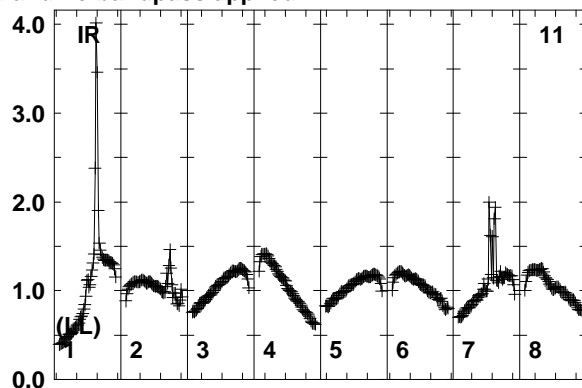
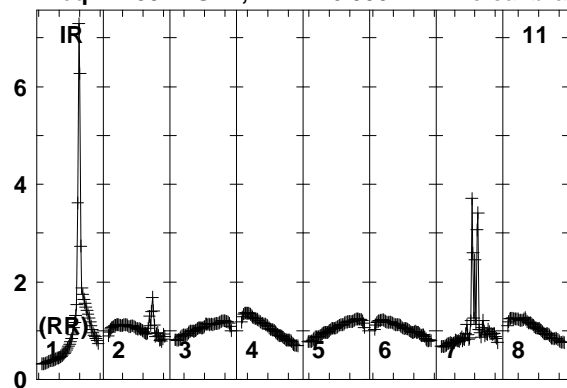

1595 1610 1630 1645 1660 1675 1690 1710
FREQ MHz

Lower frame: Real Jy
Total-power spectrum Antenna: IR (11)
Timerange: 00/05:03:01 to 00/05:03:59

1595 1610 1630 1645 1660 1675 1690 1710
FREQ MHz

1595 1610 1630 1645 1660 1675 1690 1710
FREQ MHz

Plot file version 253 created 04-NOV-2019 14:14:19

J2248-0541 EY034.UVDATA.1

Freq = 1.5947 GHz, Bw = 16.000 MH No calibration applied and no bandpass applied

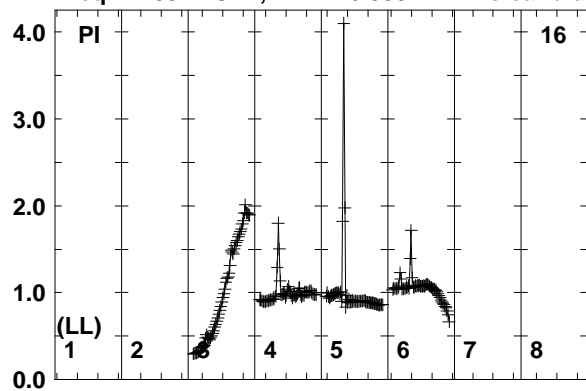

Lower frame: Real Jy
Total-power spectrum Antenna: PI (16)
Timerange: 00/05:03:01 to 00/05:03:59

Plot file version 254 created 04-NOV-2019 14:14:19

W2246-0526 EY034.UVDATA.1

Freq = 1.5947 GHz, Bw = 16.000 MH No calibration applied and no bandpass applied

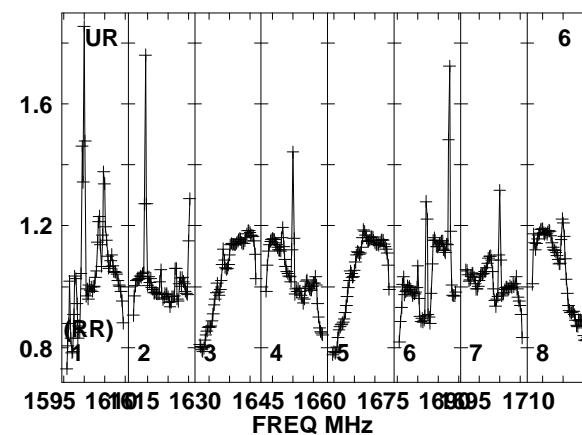
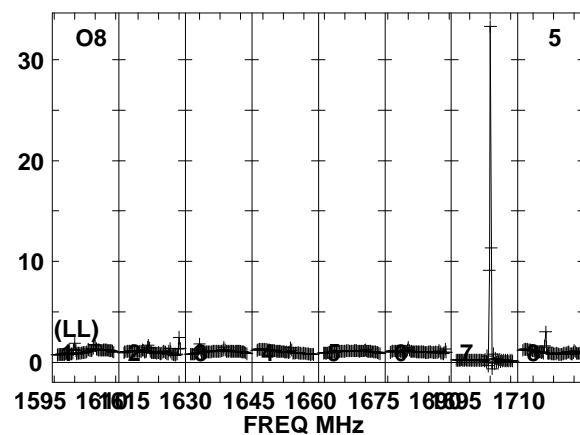
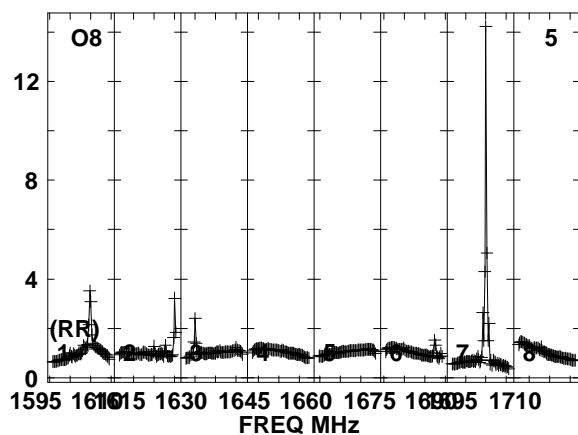
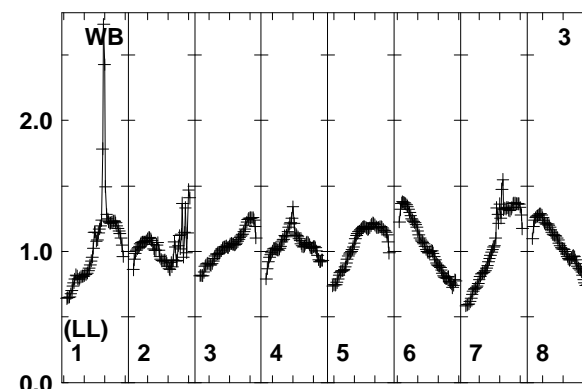
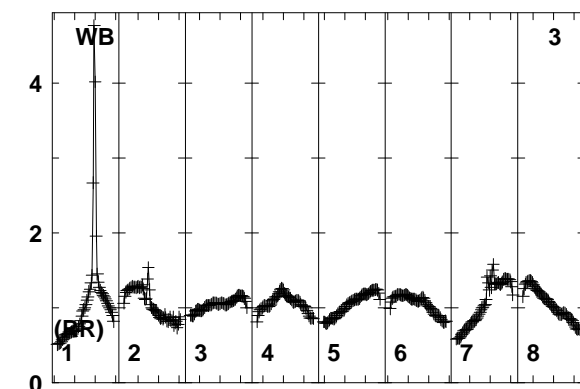
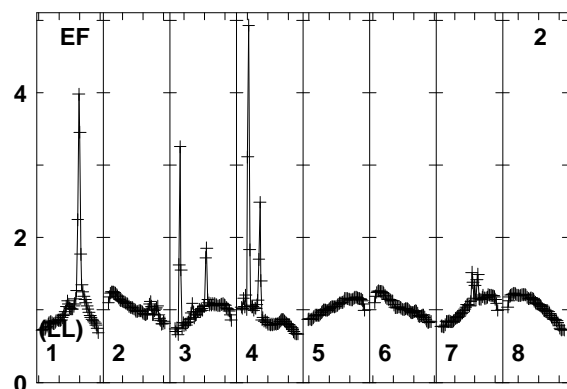
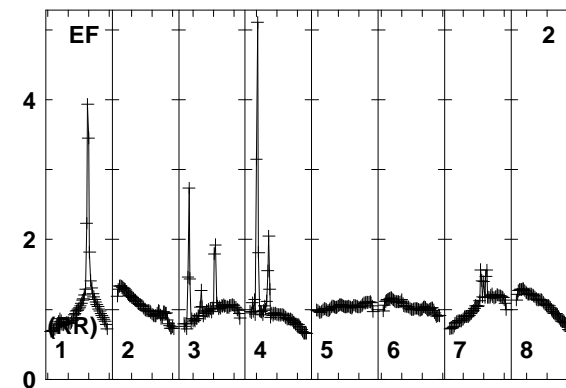
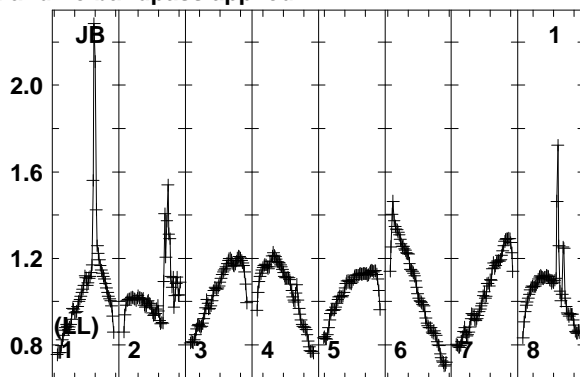
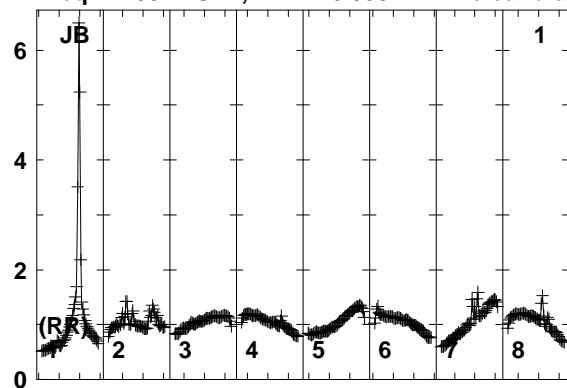

Lower frame: Real Jy
Total-power spectrum Antenna: JB (01)
Timerange: 00/05:04:01 to 00/05:06:39

Plot file version 255 created 04-NOV-2019 14:14:19

W2246-0526 EY034.UVDATA.1

Freq = 1.5947 GHz, Bw = 16.000 MH No calibration applied and no bandpass applied

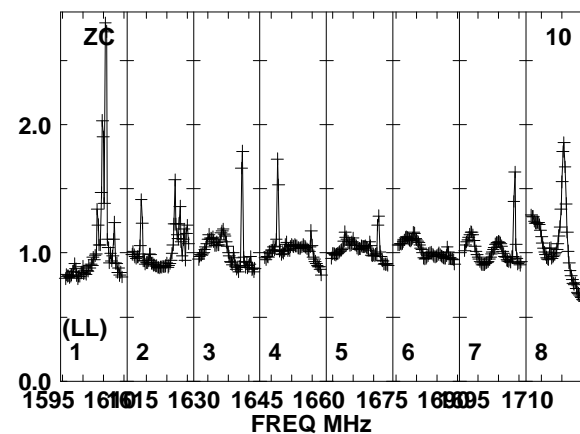
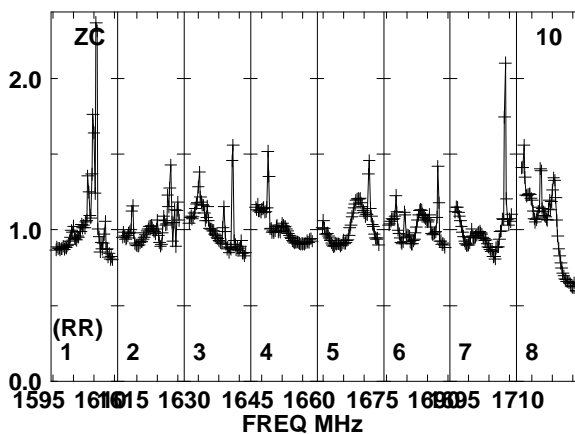
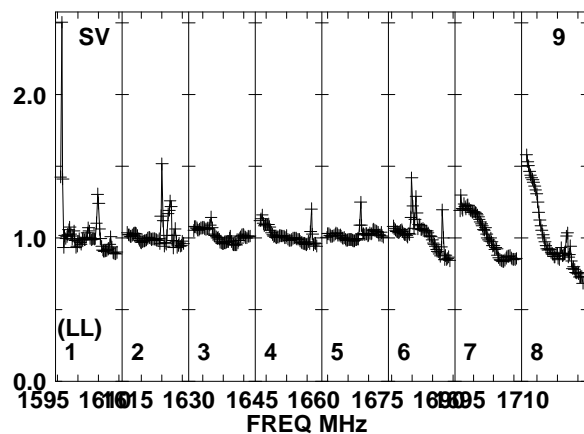
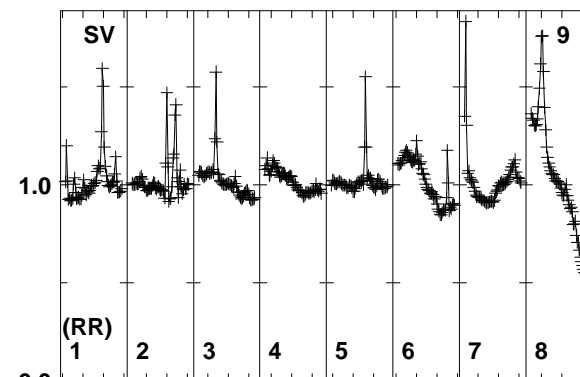
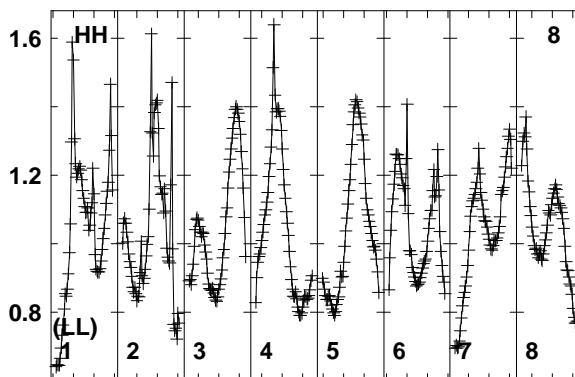
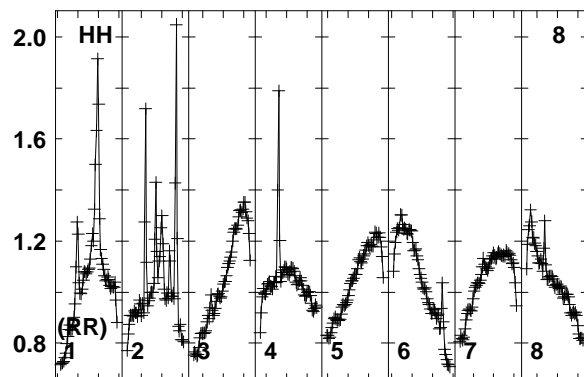
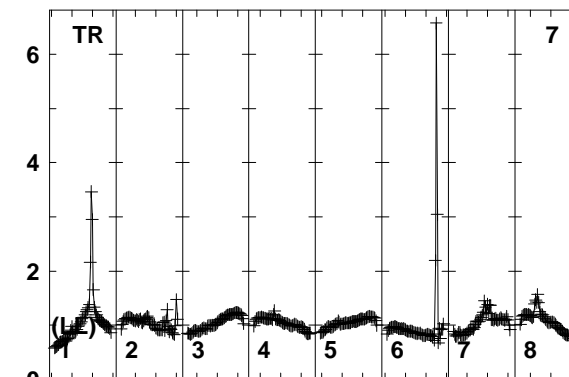
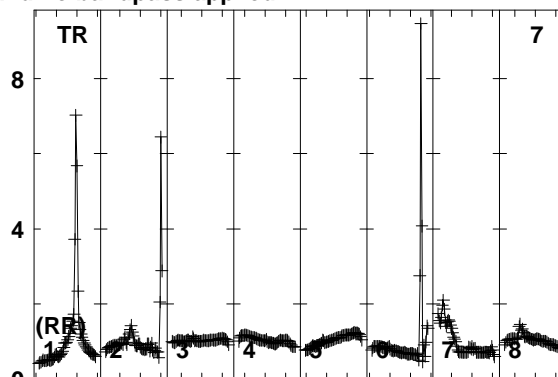
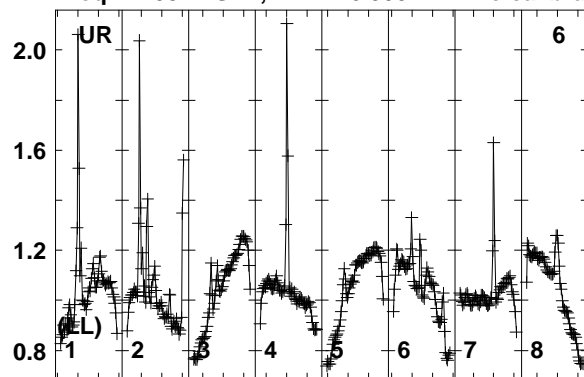

Lower frame: Real Jy
Total-power spectrum Antenna: UR (06)
Timerange: 00/05:04:01 to 00/05:06:39

Plot file version 256 created 04-NOV-2019 14:14:20

W2246-0526 EY034.UVDATA.1

Freq = 1.5947 GHz, Bw = 16.000 MH No calibration applied and no bandpass applied

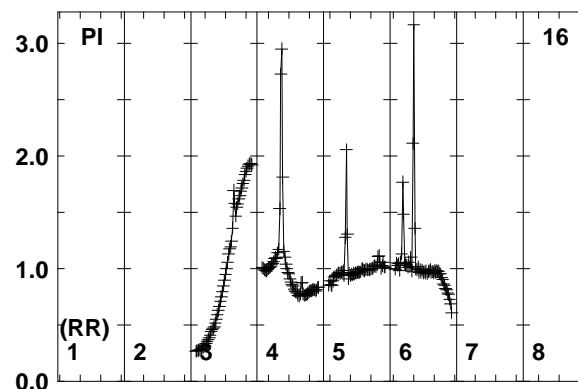
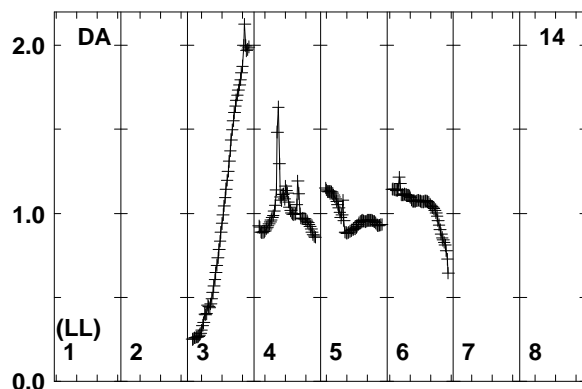
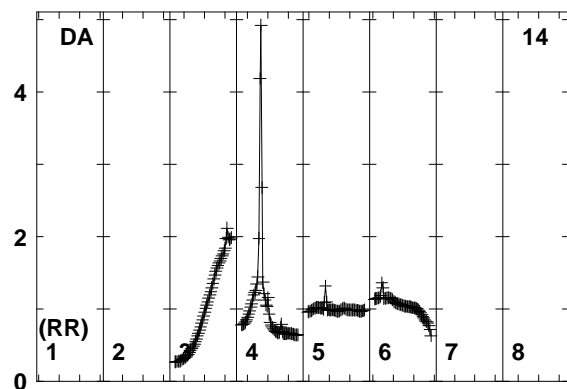
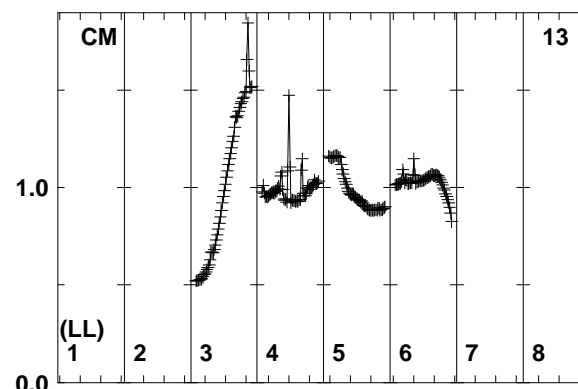
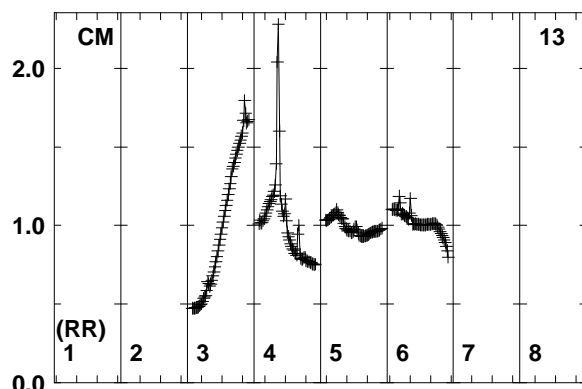
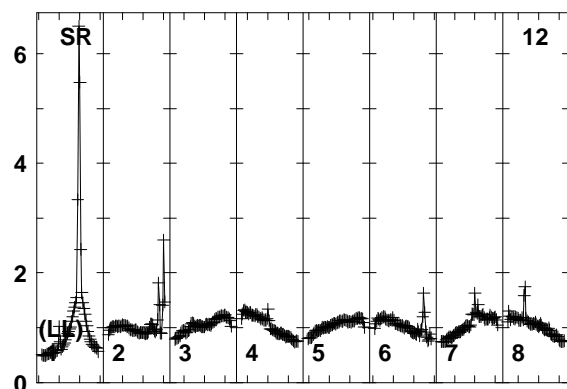
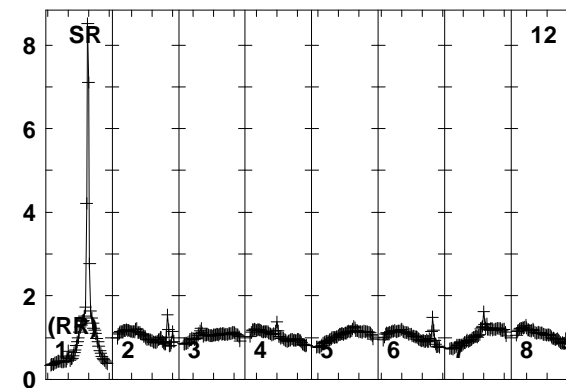
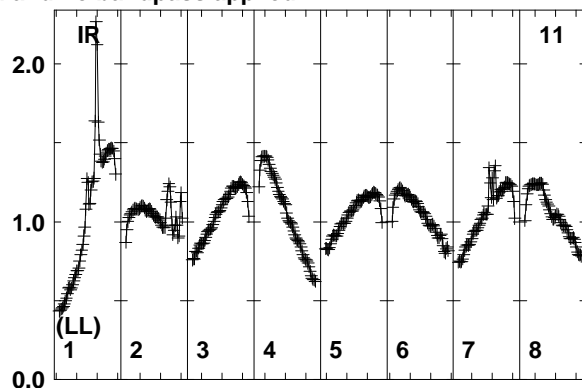
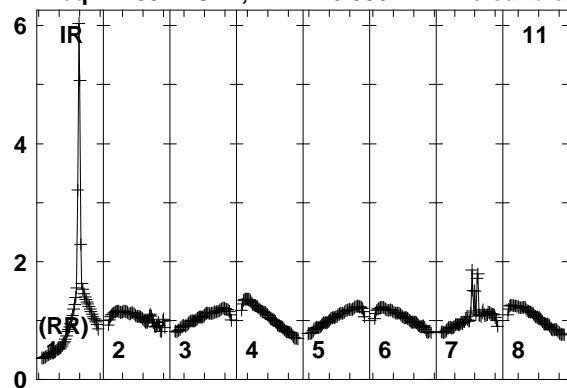

Lower frame: Real Jy
Total-power spectrum Antenna: IR (11)
Timerange: 00/05:04:01 to 00/05:06:39

Plot file version 257 created 04-NOV-2019 14:14:20
W2246-0526 EY034.UVDATA.1
Freq = 1.5947 GHz, Bw = 16.000 MH No calibration applied and no bandpass applied

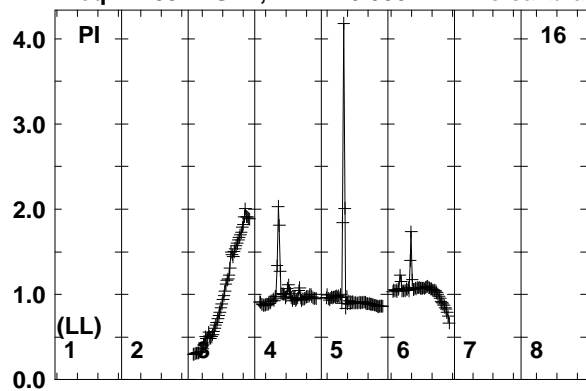

Lower frame: Real Jy
Total-power spectrum Antenna: PI (16)
Timerange: 00/05:04:01 to 00/05:06:39

Plot file version 258 created 04-NOV-2019 14:14:20

J2248-0541 EY034.UVDATA.1

Freq = 1.5947 GHz, Bw = 16.000 MH No calibration applied and no bandpass applied

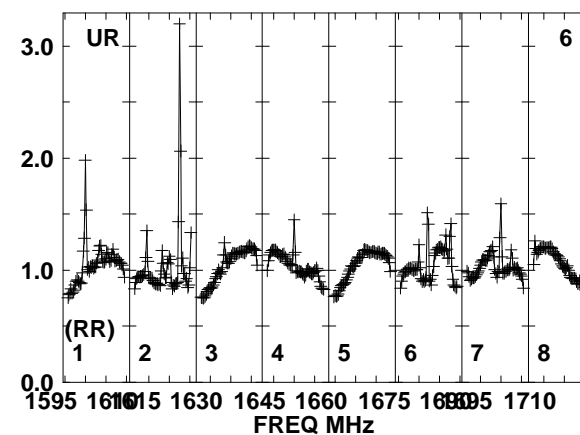
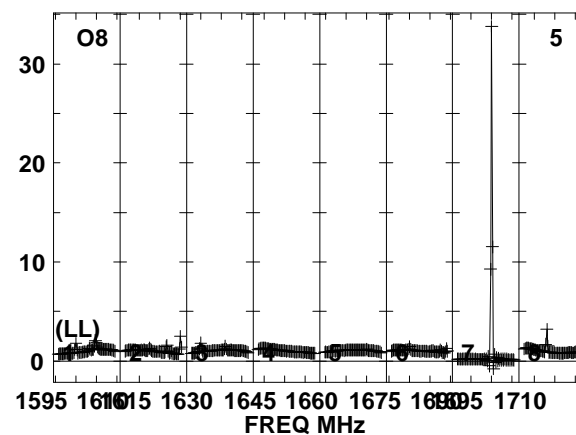
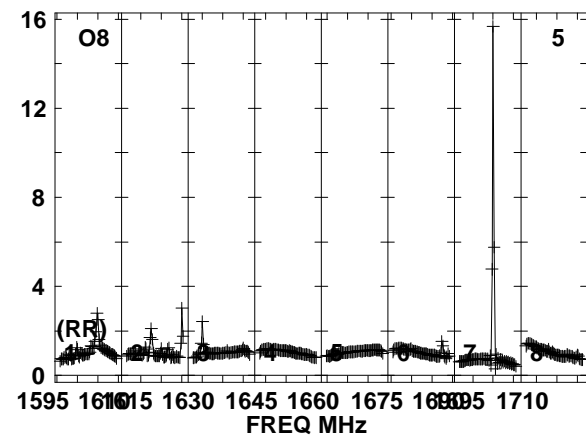
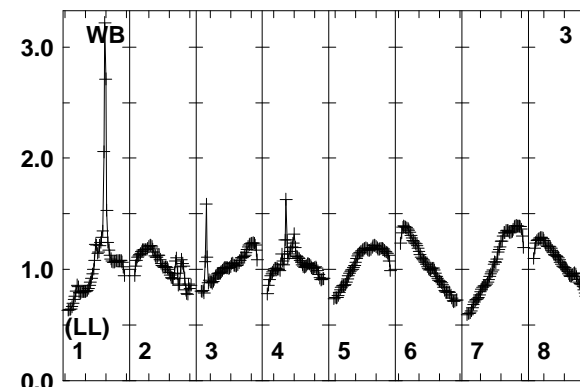
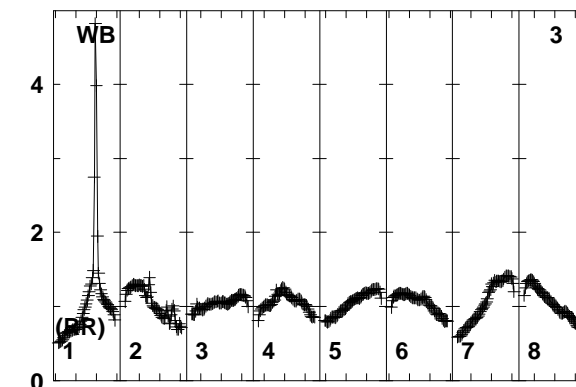
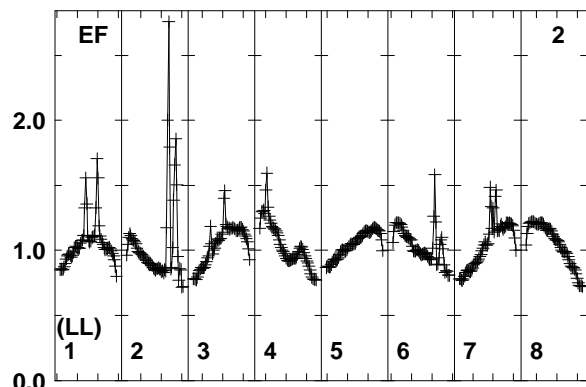
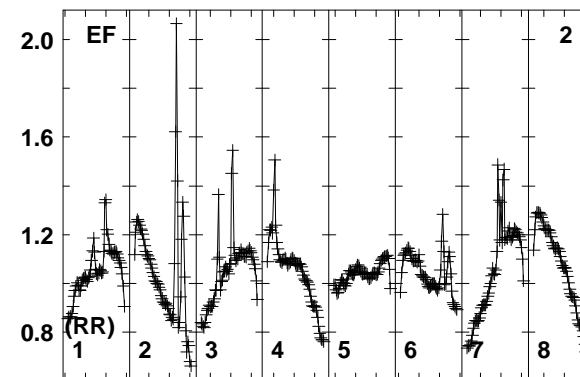
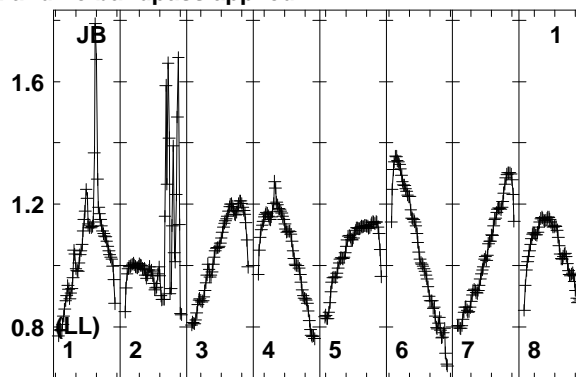
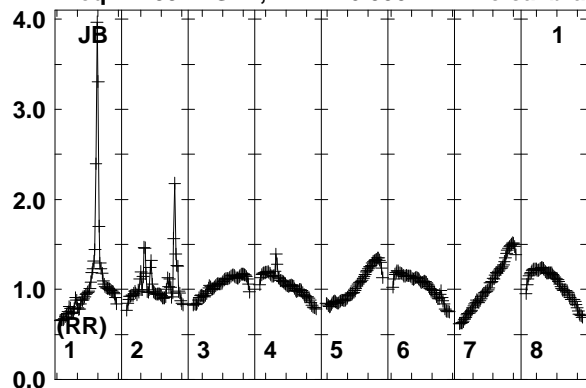

Lower frame: Real Jy
Total-power spectrum Antenna: JB (01)
Timerange: 00/05:06:56 to 00/05:07:54

Plot file version 259 created 04-NOV-2019 14:14:20

J2248-0541 EY034.UVDATA.1

Freq = 1.5947 GHz, Bw = 16.000 MH No calibration applied and no bandpass applied

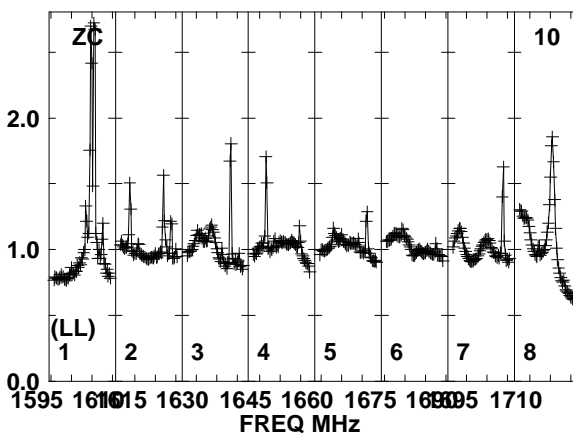
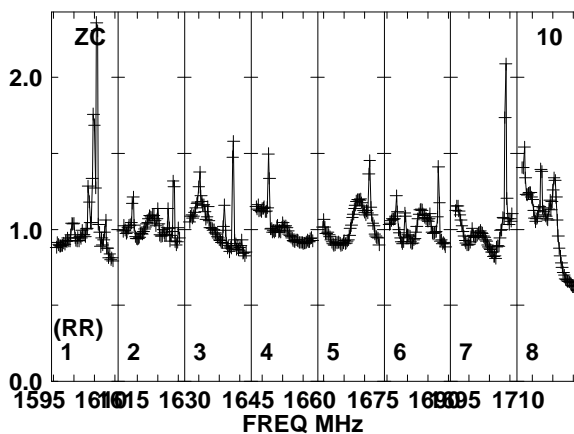
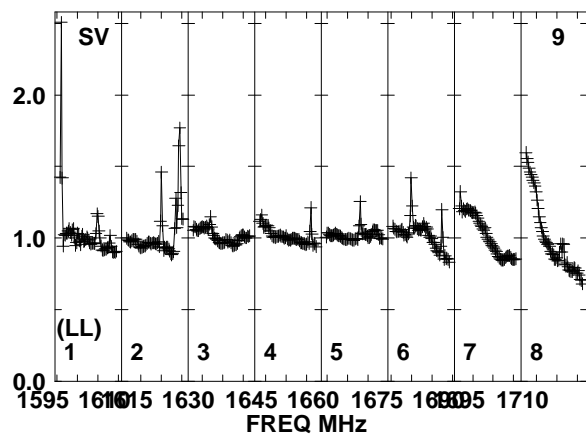
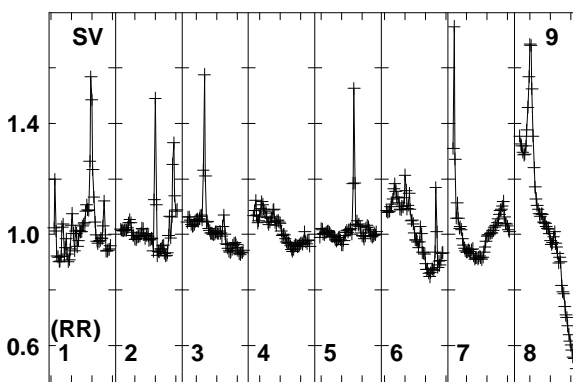
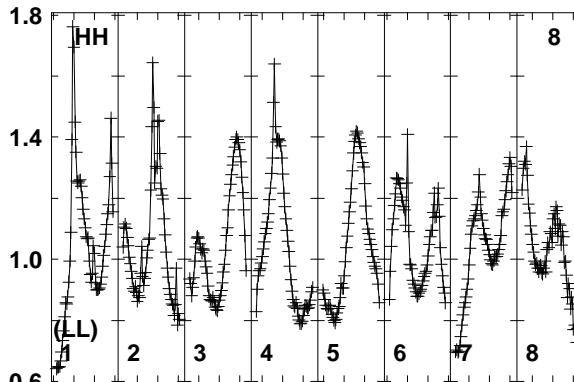
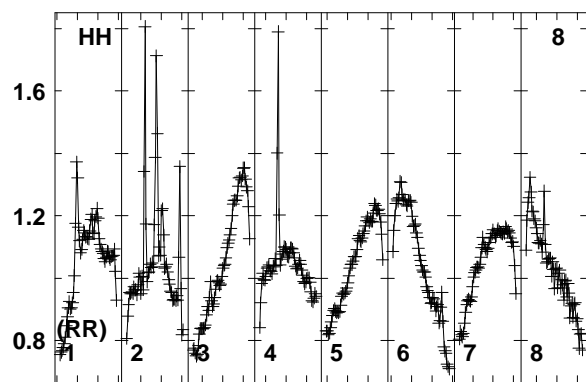
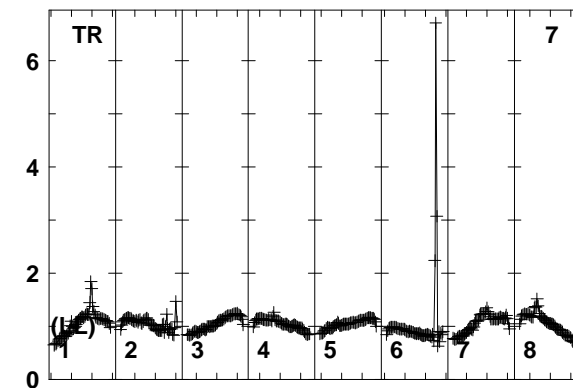
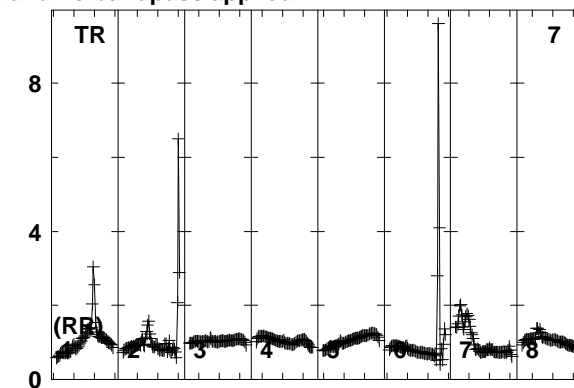
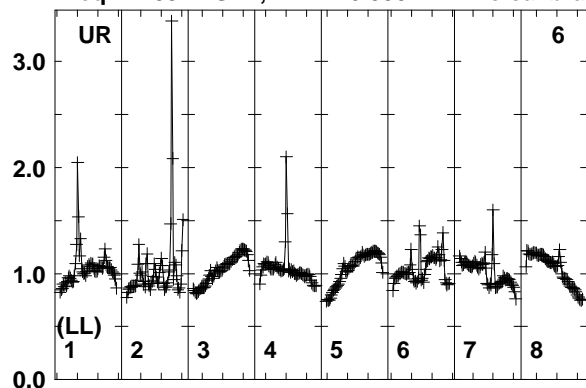

Lower frame: Real Jy
Total-power spectrum Antenna: UR (06)
Timerange: 00/05:06:56 to 00/05:07:54

Plot file version 260 created 04-NOV-2019 14:14:20

J2248-0541 EY034.UVDATA.1

Freq = 1.5947 GHz, Bw = 16.000 MH No calibration applied and no bandpass applied

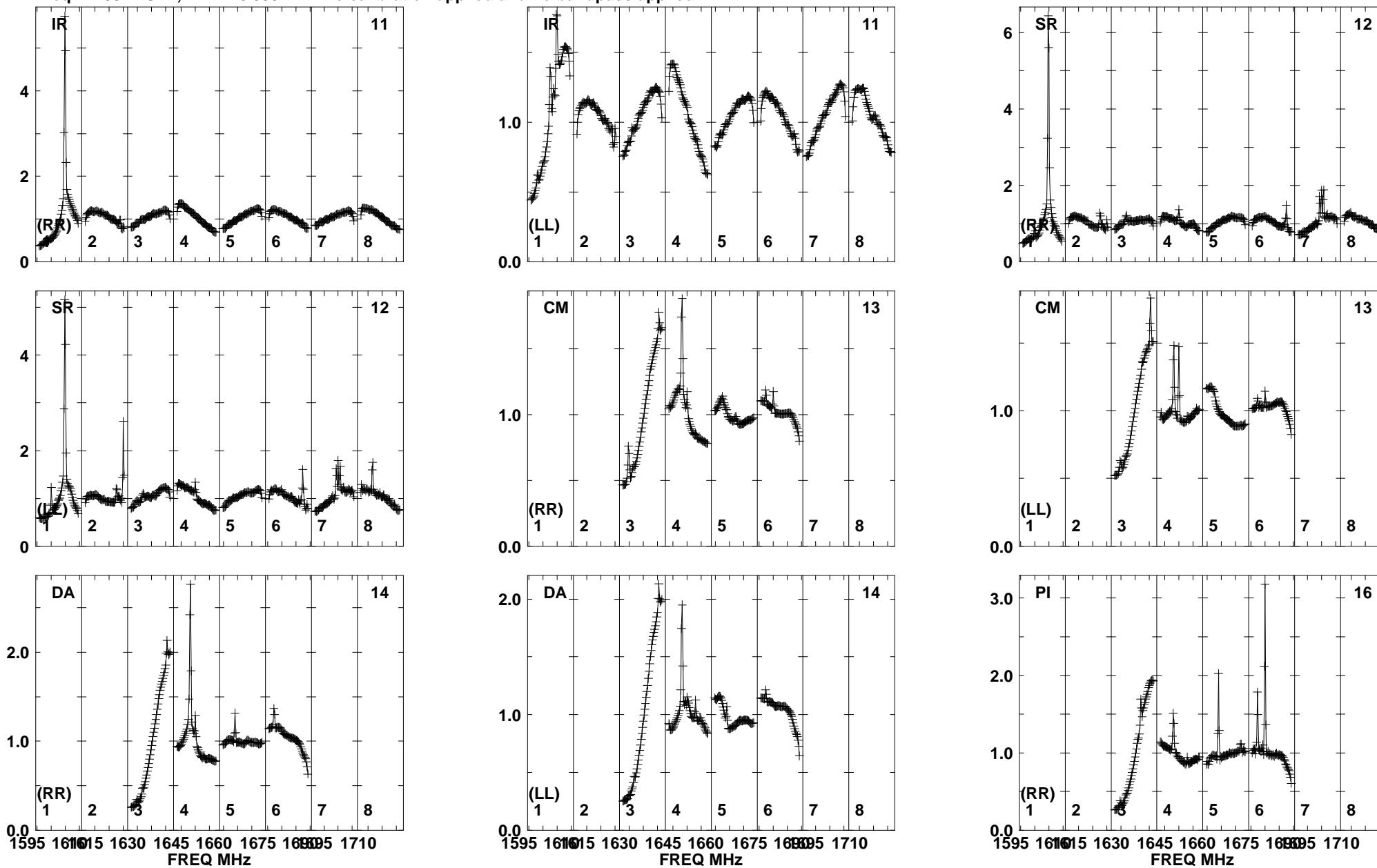

Lower frame: Real Jy
Total-power spectrum Antenna: IR (11)
Timerange: 00/05:06:56 to 00/05:07:54

Plot file version 261 created 04-NOV-2019 14:14:20

J2248-0541 EY034.UVDATA.1

Freq = 1.5947 GHz, Bw = 16.000 MH No calibration applied and no bandpass applied

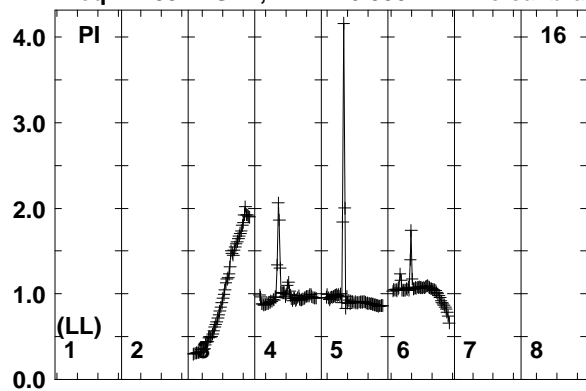

Lower frame: Real Jy
Total-power spectrum Antenna: PI (16)
Timerange: 00/05:06:56 to 00/05:07:54

Plot file version 262 created 04-NOV-2019 14:14:20

W2246-0526 EY034.UVDATA.1

Freq = 1.5947 GHz, Bw = 16.000 MH No calibration applied and no bandpass applied

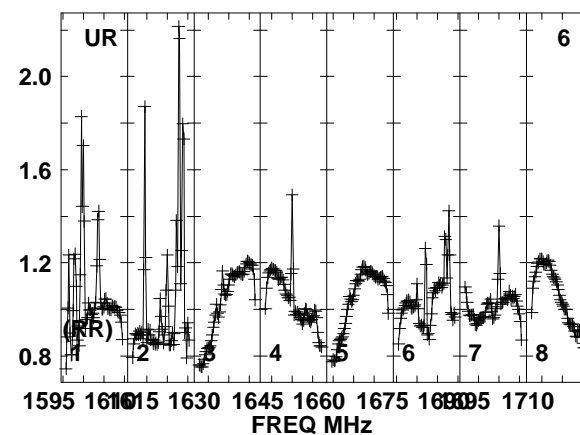
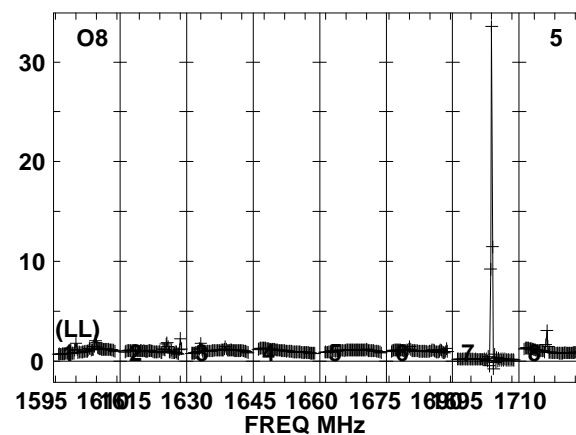
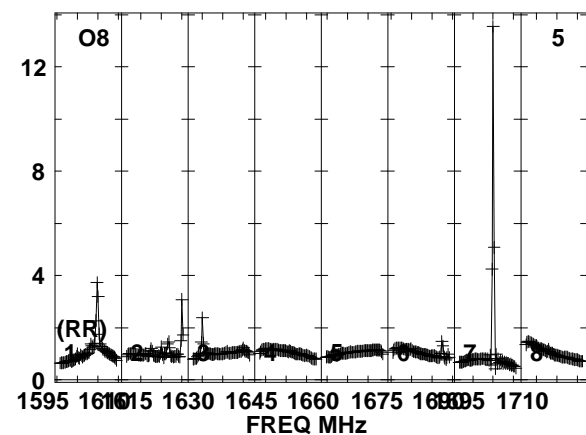
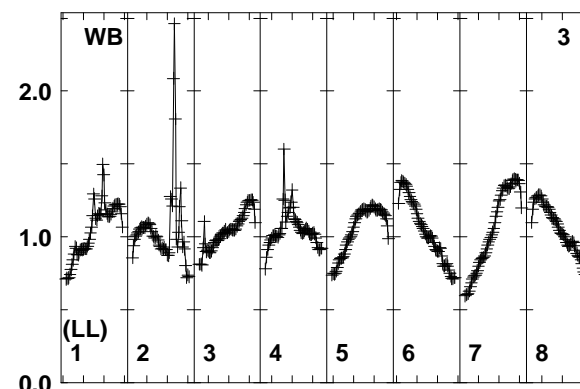
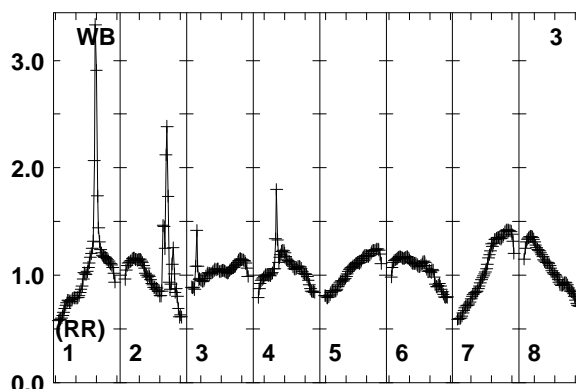
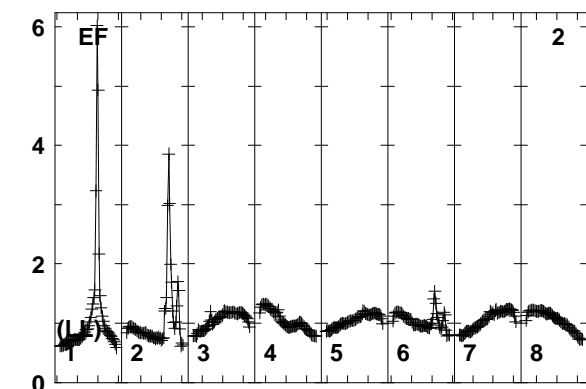
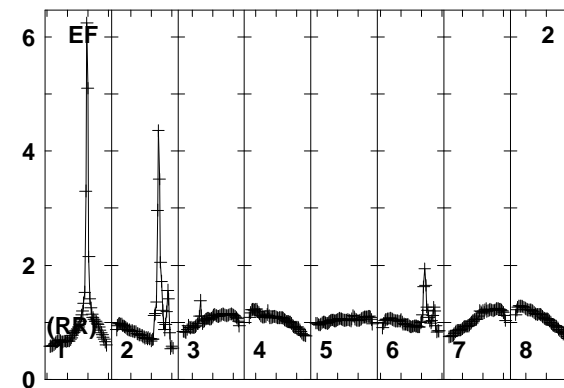
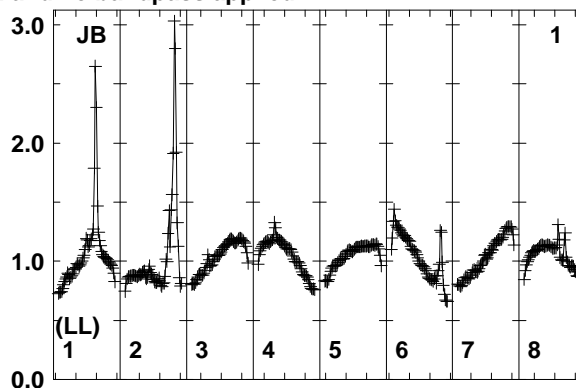
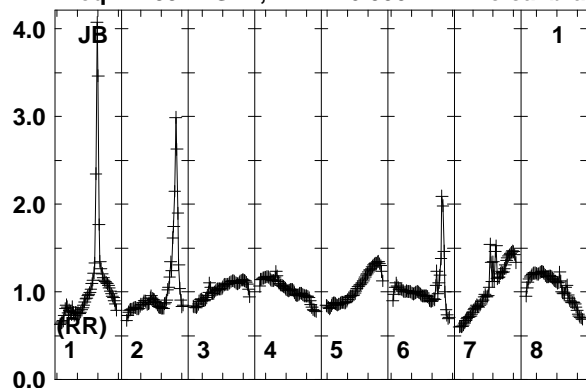

Lower frame: Real Jy
Total-power spectrum Antenna: JB (01)
Timerange: 00/05:07:56 to 00/05:10:34

Plot file version 263 created 04-NOV-2019 14:14:20

W2246-0526 EY034.UVDATA.1

Freq = 1.5947 GHz, Bw = 16.000 MH No calibration applied and no bandpass applied

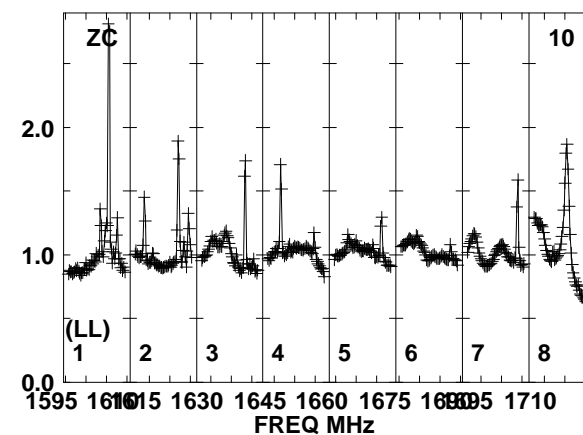
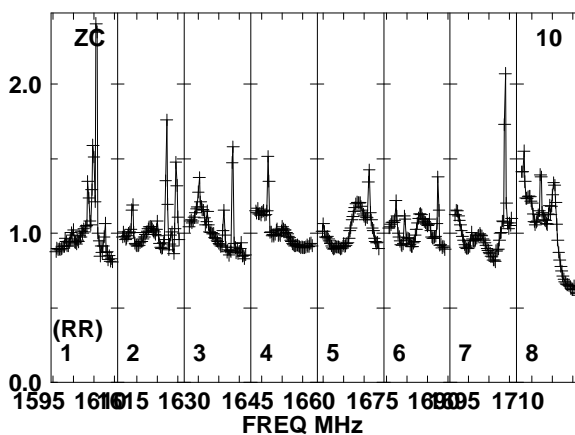
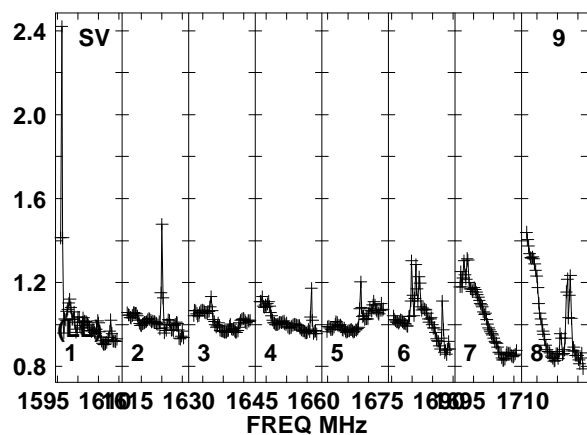
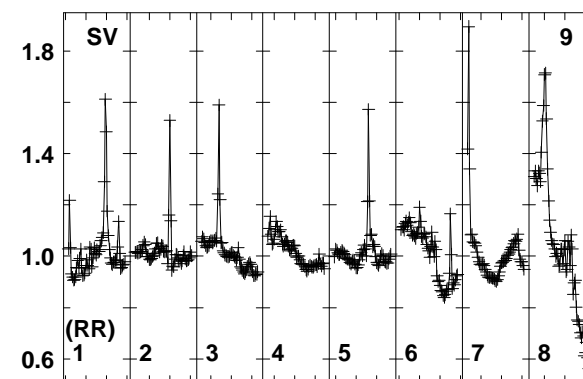
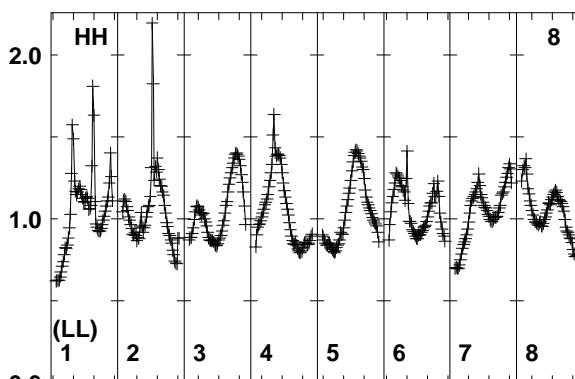
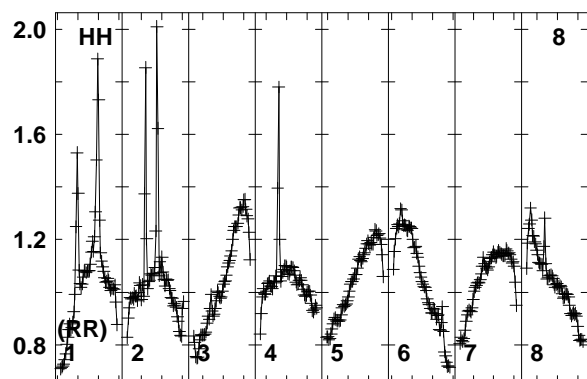
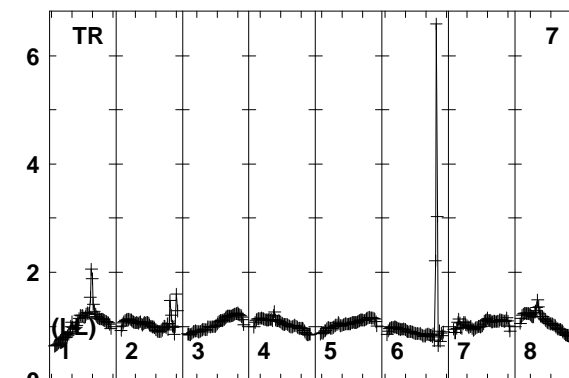
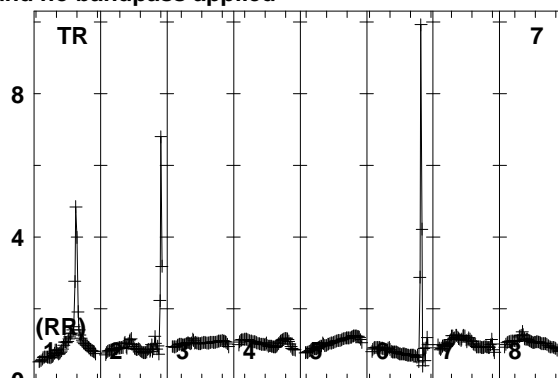
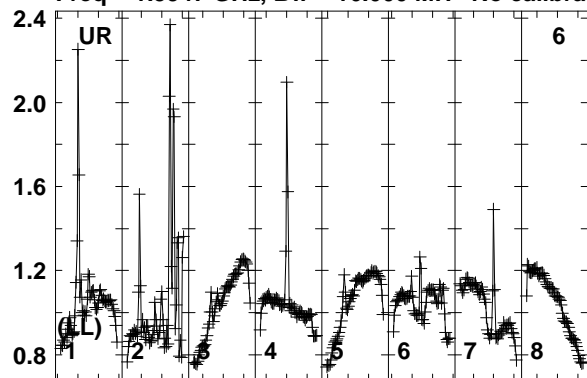

Lower frame: Real Jy
Total-power spectrum Antenna: UR (06)
Timerange: 00/05:07:56 to 00/05:10:34

Plot file version 264 created 04-NOV-2019 14:14:20

W2246-0526 EY034.UVDATA.1

Freq = 1.5947 GHz, Bw = 16.000 MH No calibration applied and no bandpass applied

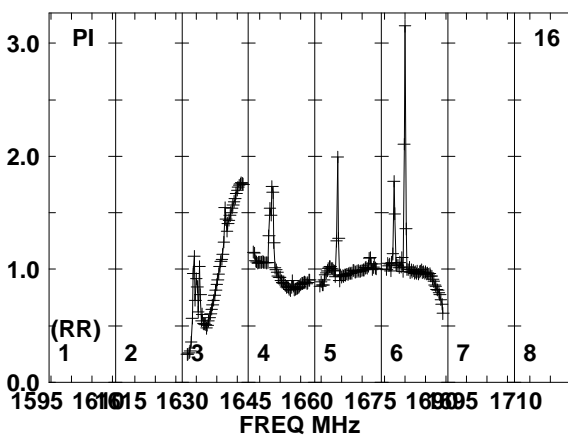
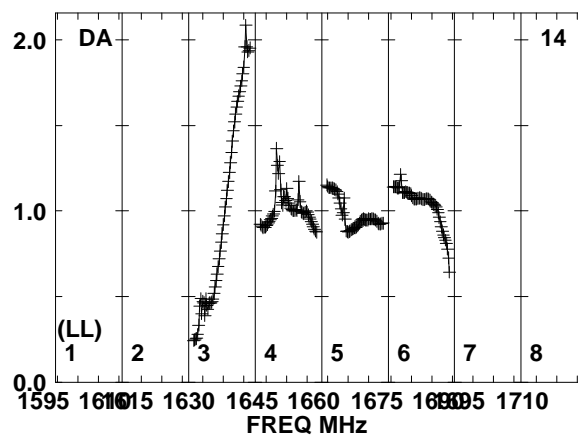
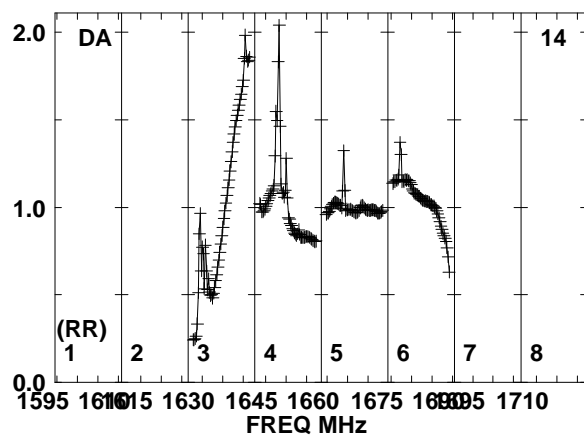
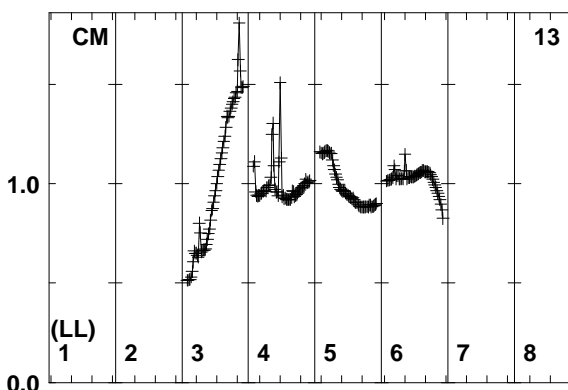
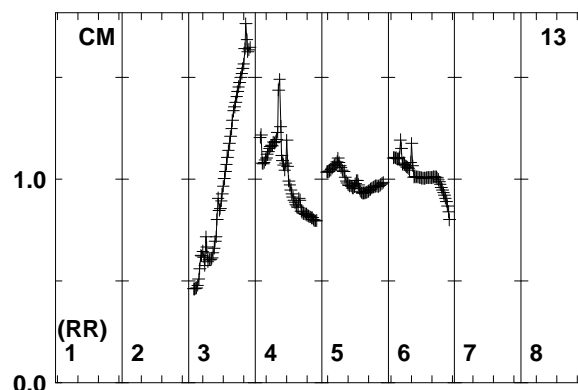
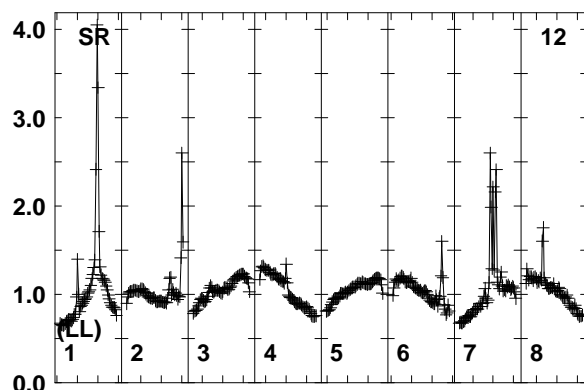
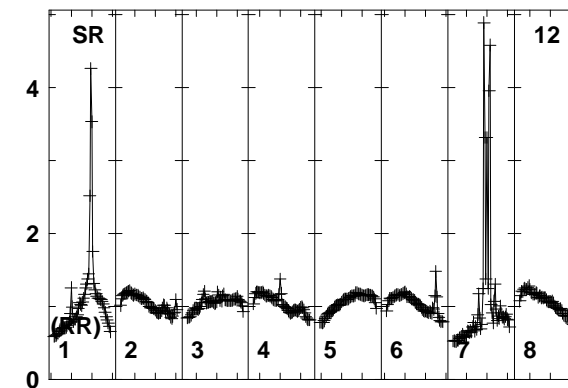
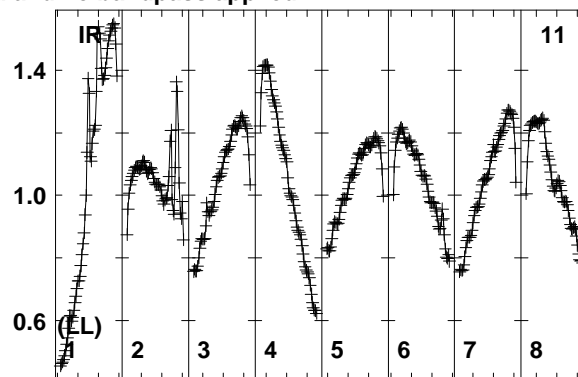
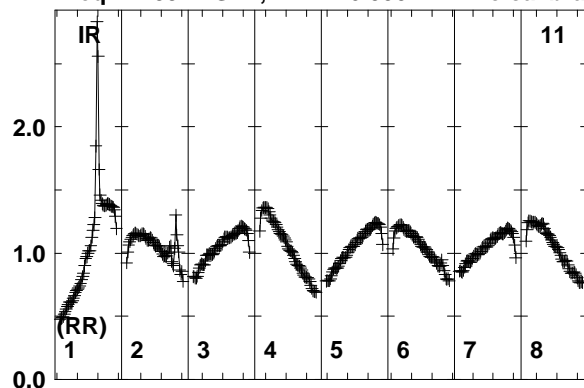

Lower frame: Real Jy
Total-power spectrum Antenna: IR (11)
Timerange: 00/05:07:56 to 00/05:10:34

Plot file version 265 created 04-NOV-2019 14:14:20
W2246-0526 EY034.UVDATA.1
Freq = 1.5947 GHz, Bw = 16.000 MH No calibration applied and no bandpass applied

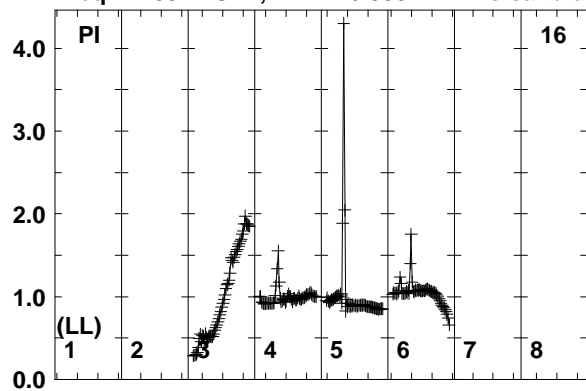

Lower frame: Real Jy
Total-power spectrum Antenna: PI (16)
Timerange: 00/05:07:56 to 00/05:10:34

Plot file version 266 created 04-NOV-2019 14:14:20

J2248-0541 EY034.UVDATA.1

Freq = 1.5947 GHz, Bw = 16.000 MH No calibration applied and no bandpass applied

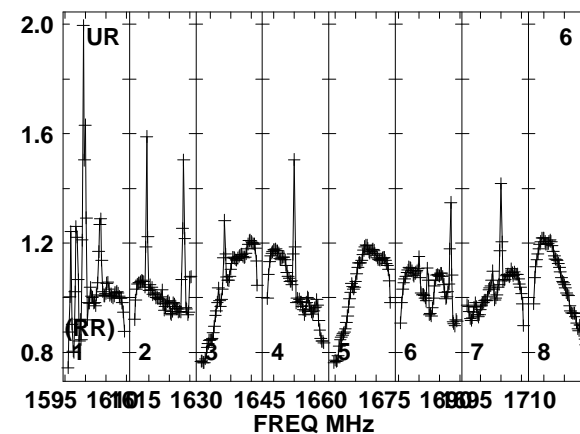
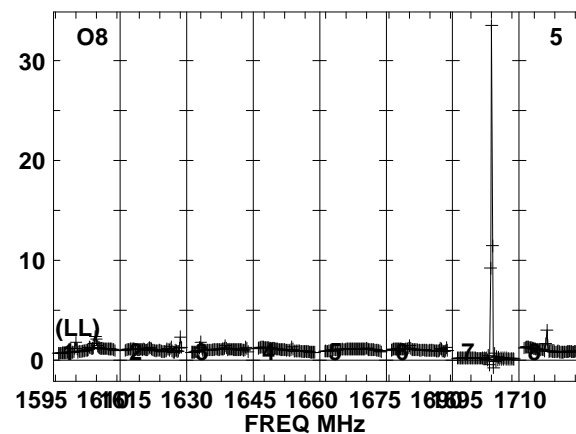
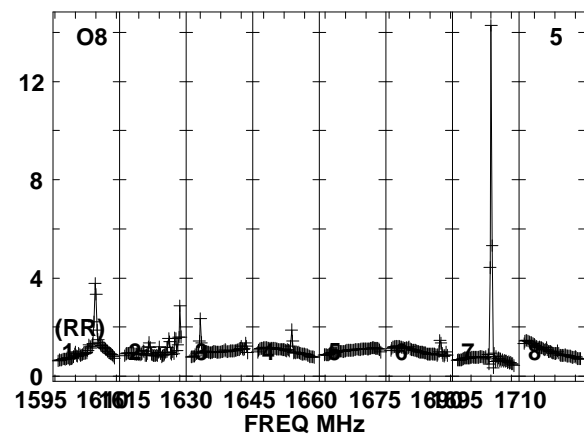
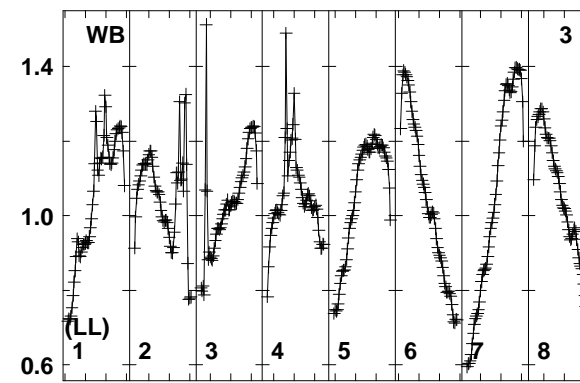
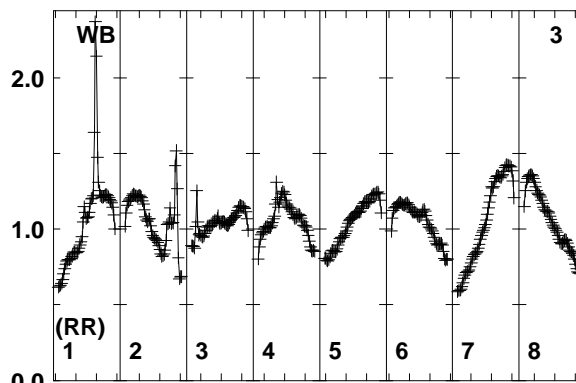
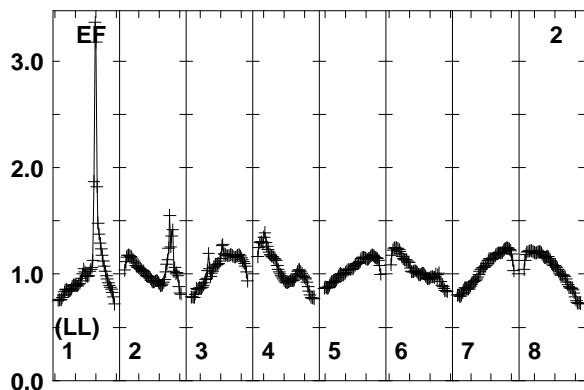
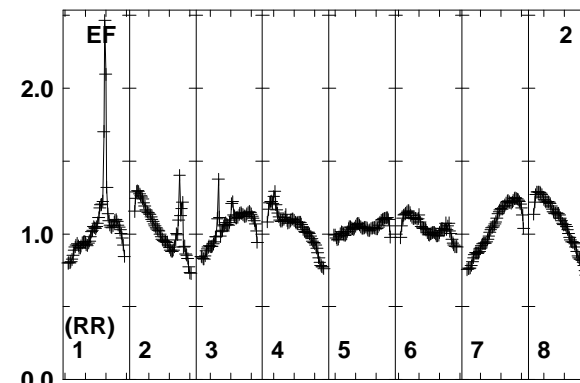
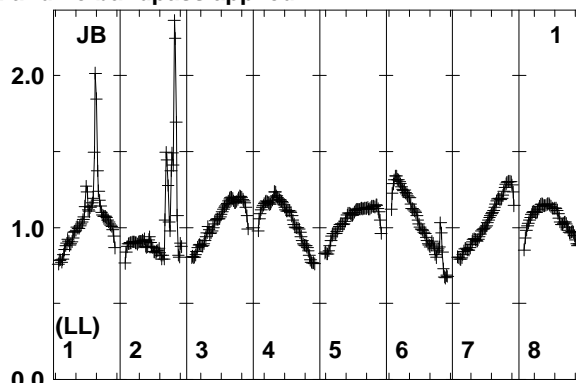
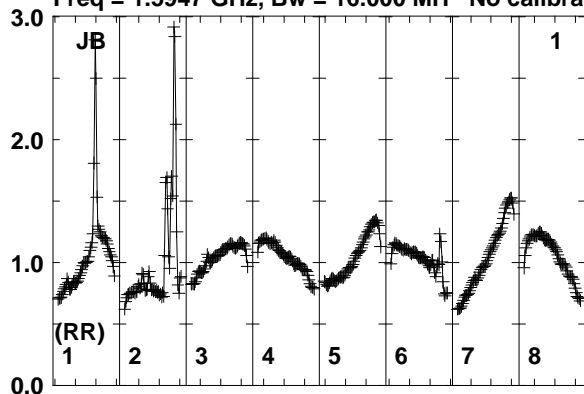

Lower frame: Real Jy
Total-power spectrum Antenna: JB (01)
Timerange: 00/05:10:51 to 00/05:11:49

Plot file version 267 created 04-NOV-2019 14:14:20

J2248-0541 EY034.UVDATA.1

Freq = 1.5947 GHz, Bw = 16.000 MH No calibration applied and no bandpass applied

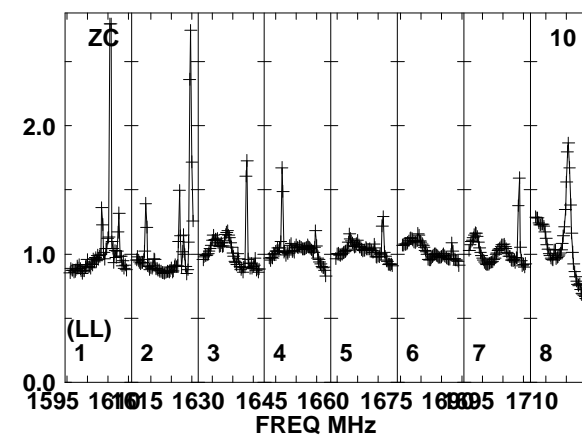
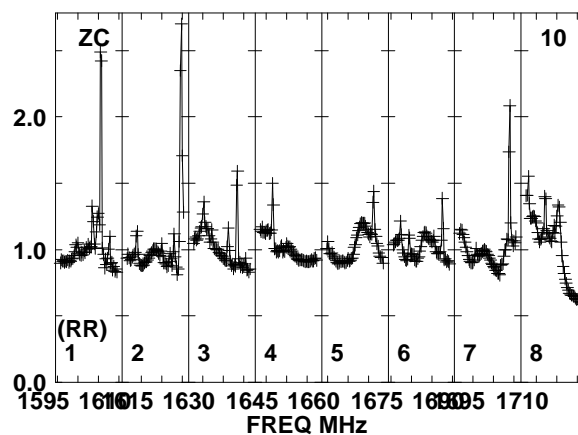
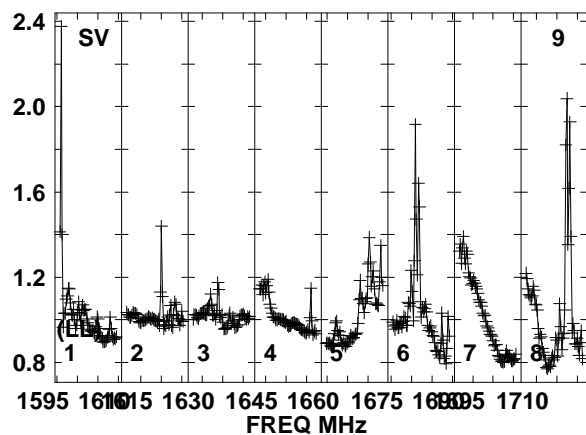
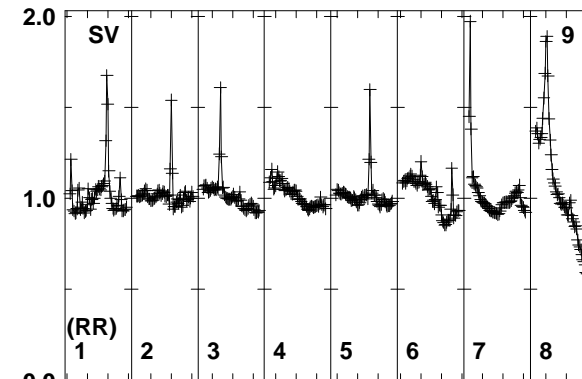
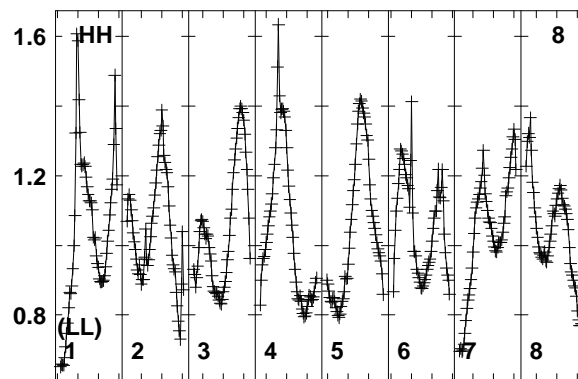
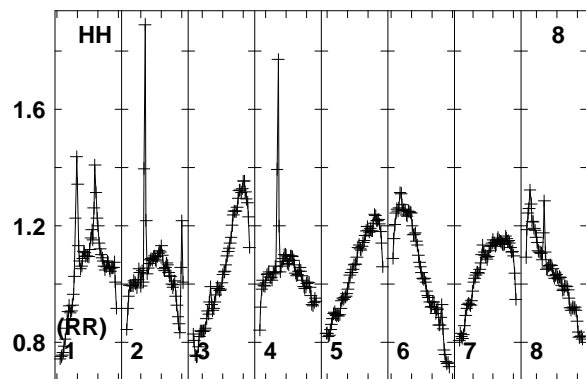
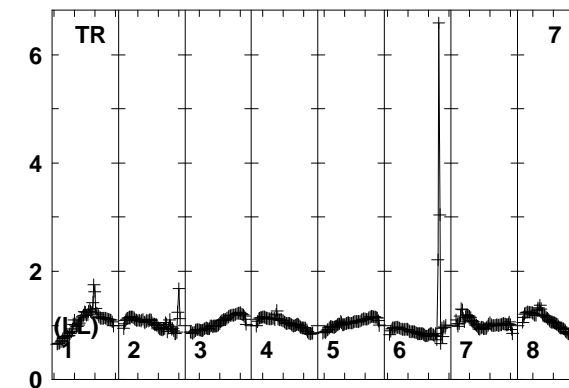
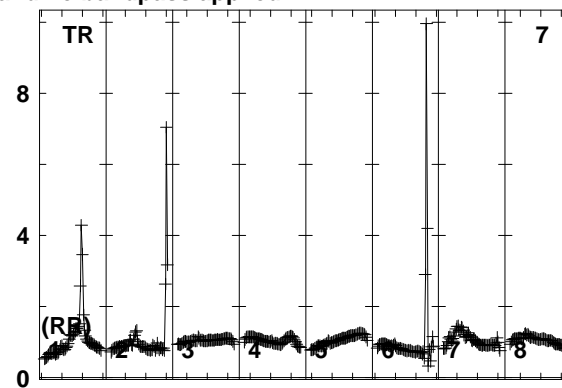
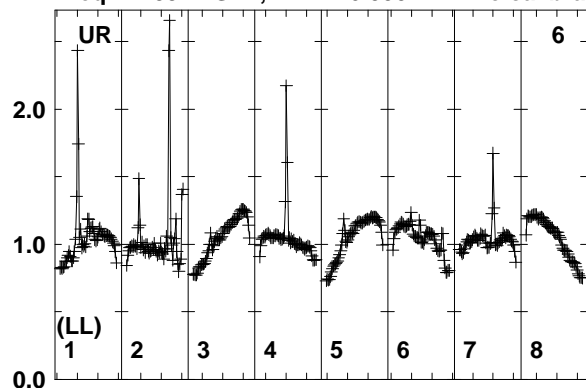

Lower frame: Real Jy
Total-power spectrum Antenna: UR (06)
Timerange: 00/05:10:51 to 00/05:11:49

Plot file version 268 created 04-NOV-2019 14:14:21

J2248-0541 EY034.UVDATA.1

Freq = 1.5947 GHz, Bw = 16.000 MH No calibration applied and no bandpass applied

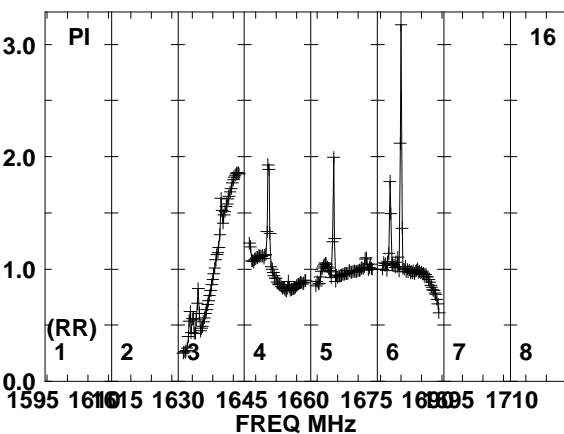
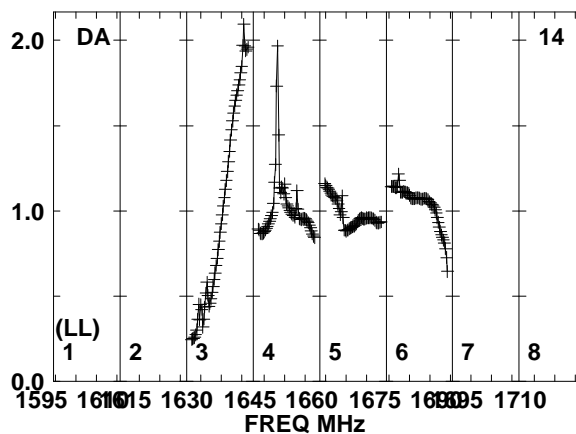
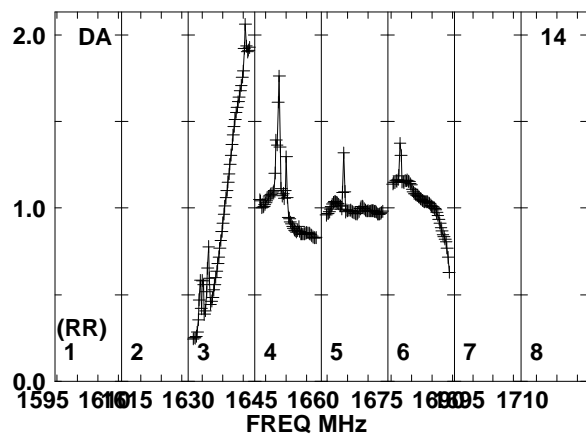
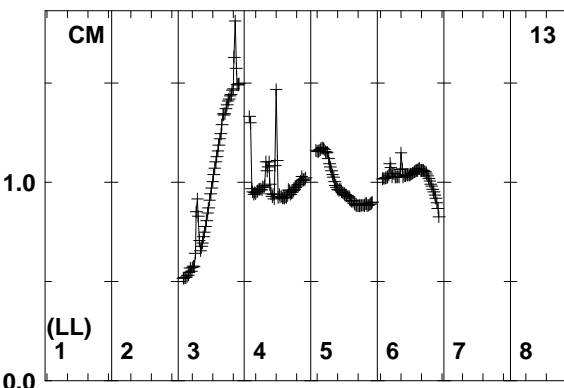
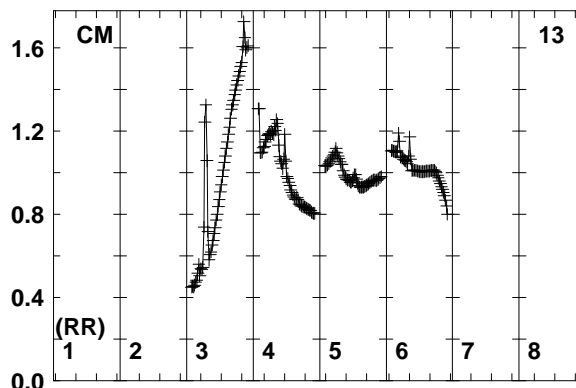
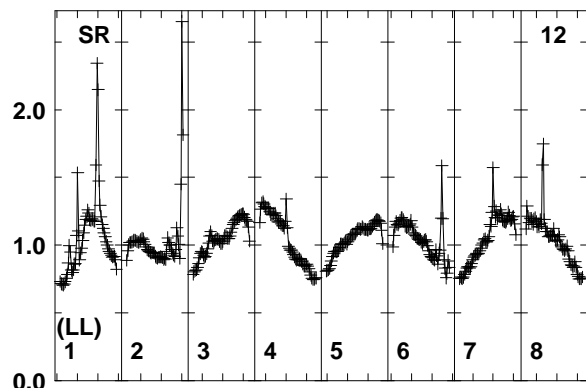
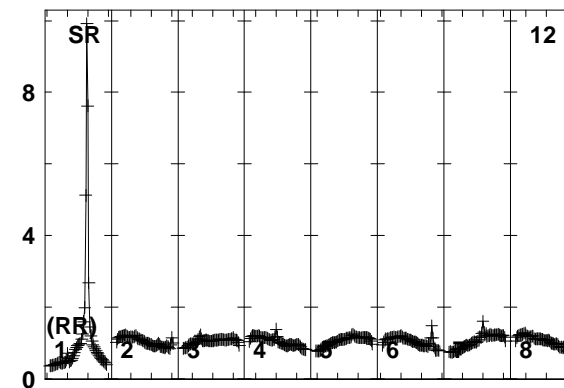
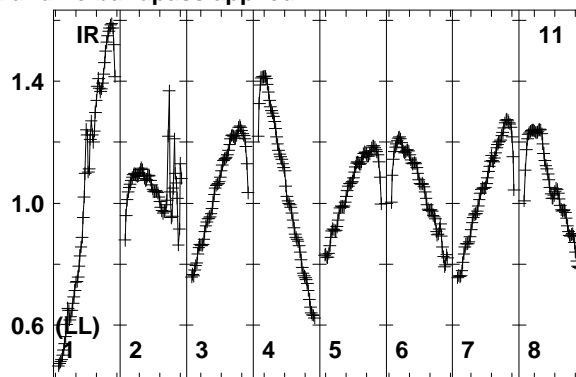
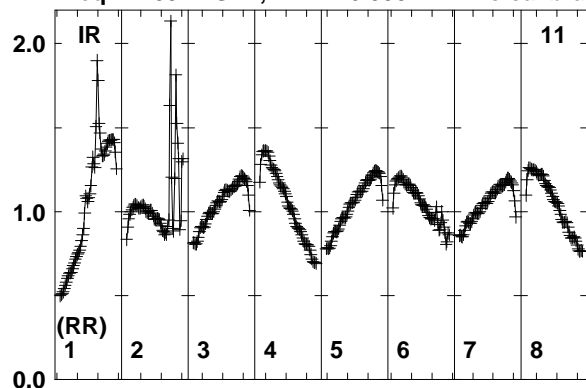

Lower frame: Real Jy
Total-power spectrum Antenna: IR (11)
Timerange: 00/05:10:51 to 00/05:11:49

Plot file version 269 created 04-NOV-2019 14:14:21
J2248-0541 EY034.UVDATA.1
Freq = 1.5947 GHz, Bw = 16.000 MH No calibration applied and no bandpass applied

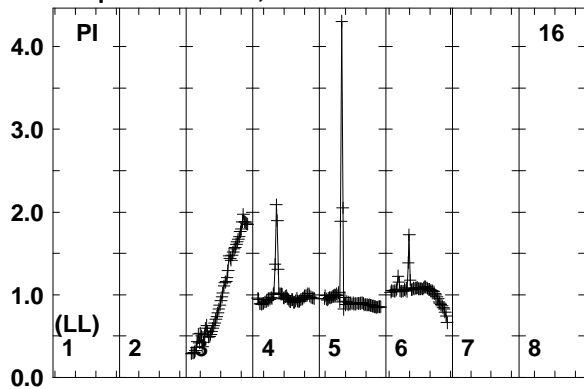

Lower frame: Real Jy
Total-power spectrum Antenna: PI (16)
Timerange: 00/05:10:51 to 00/05:11:49

Plot file version 270 created 04-NOV-2019 14:14:21

W2246-0526 EY034.UVDATA.1

Freq = 1.5947 GHz, Bw = 16.000 MH No calibration applied and no bandpass applied

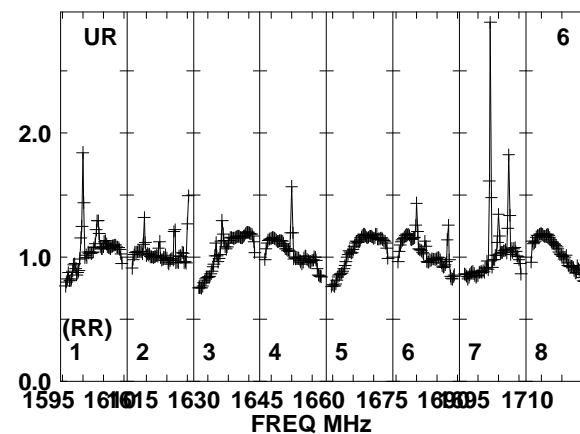
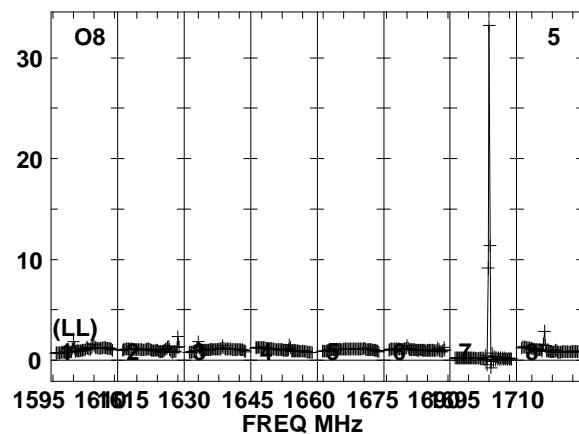
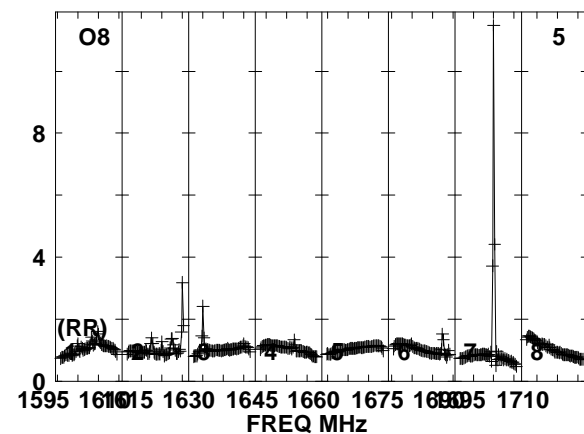
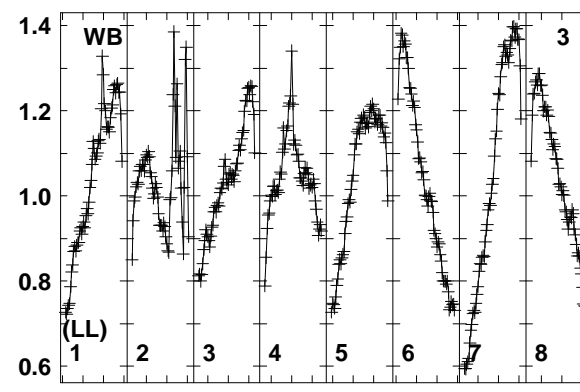
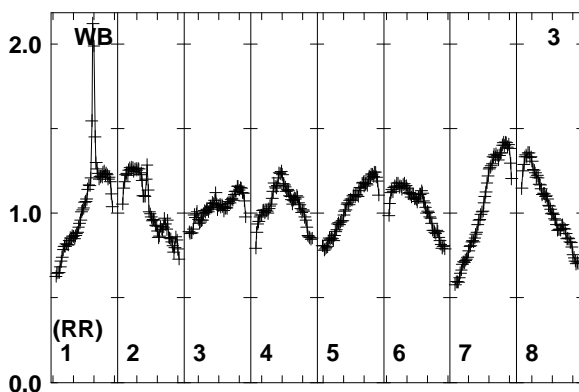
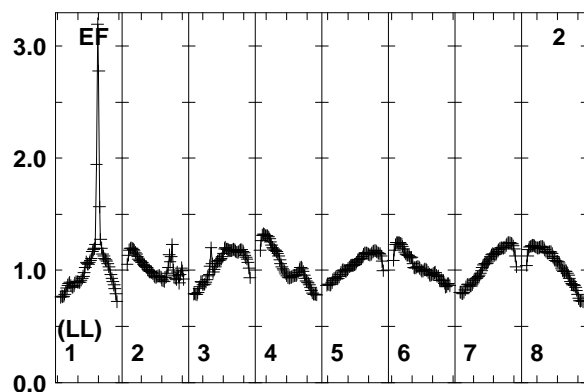
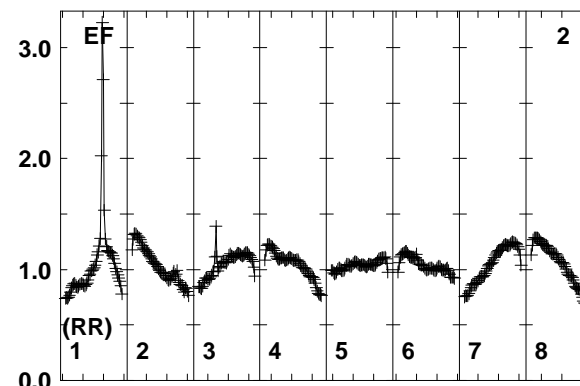
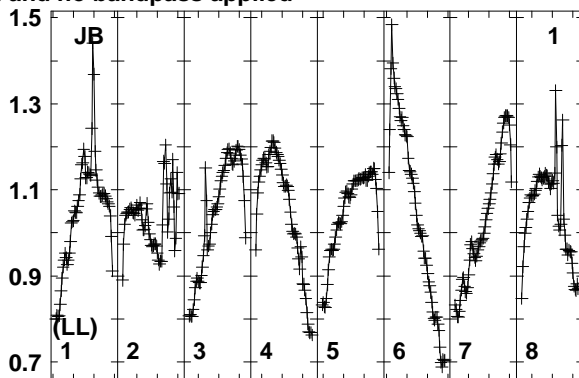
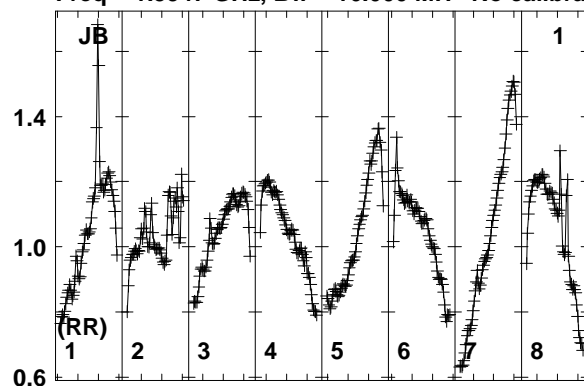

Lower frame: Real Jy
Total-power spectrum Antenna: JB (01)
Timerange: 00/05:11:51 to 00/05:14:29

Plot file version 271 created 04-NOV-2019 14:14:21

W2246-0526 EY034.UVDATA.1

Freq = 1.5947 GHz, Bw = 16.000 MH No calibration applied and no bandpass applied

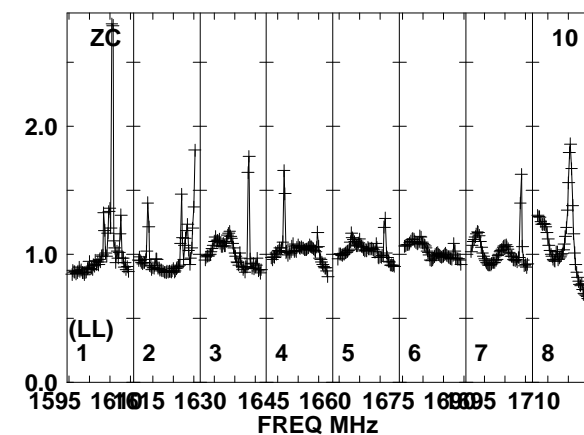
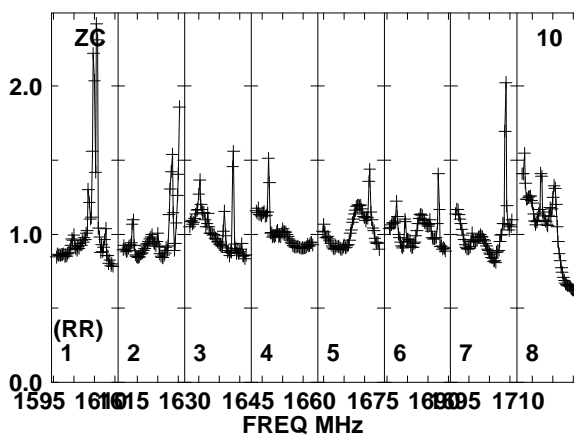
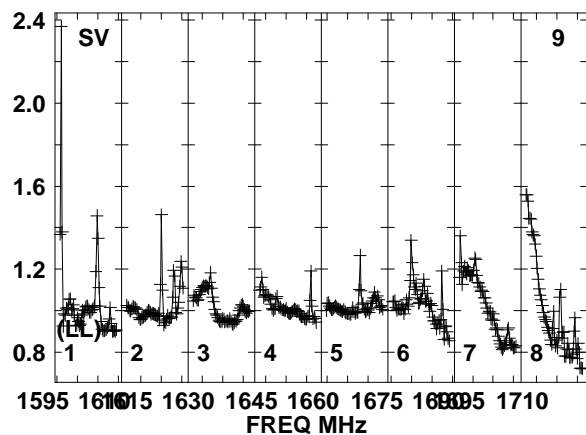
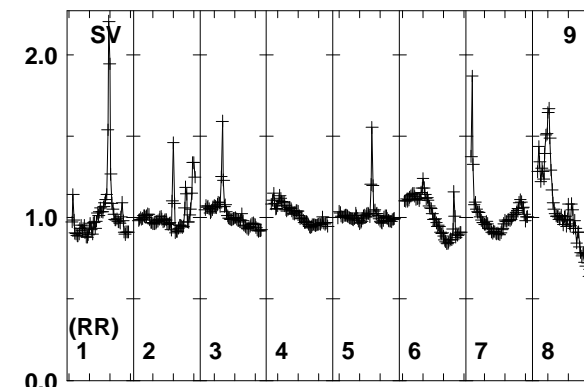
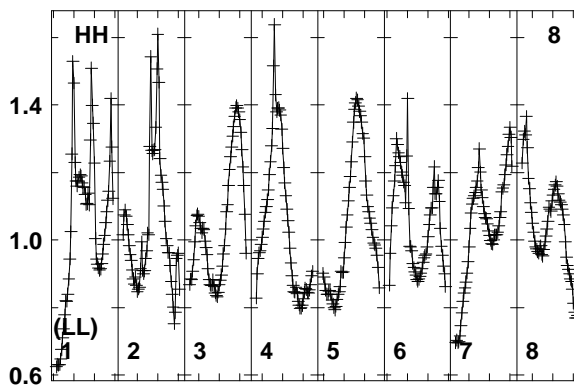
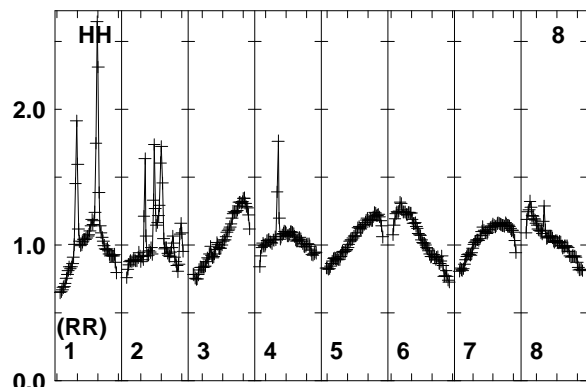
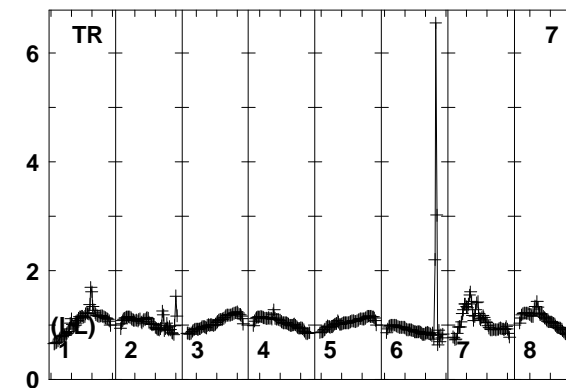
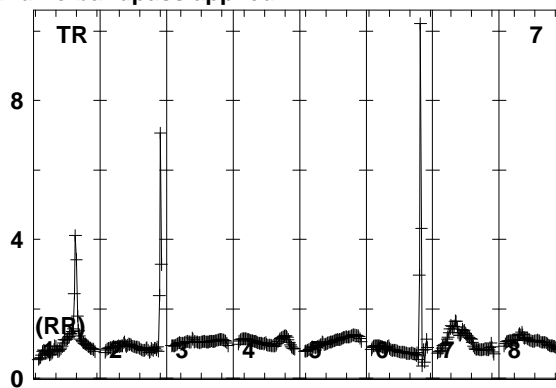
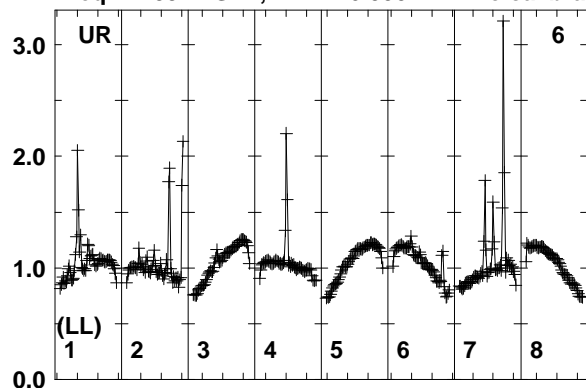

Lower frame: Real Jy
Total-power spectrum Antenna: UR (06)
Timerange: 00/05:11:51 to 00/05:14:29

Plot file version 272 created 04-NOV-2019 14:14:21

W2246-0526 EY034.UVDATA.1

Freq = 1.5947 GHz, Bw = 16.000 MH No calibration applied and no bandpass applied

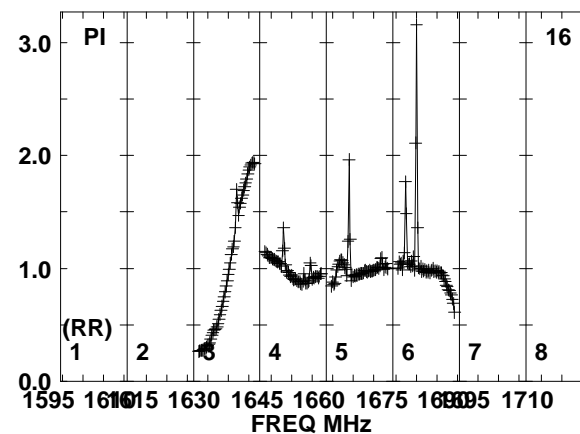
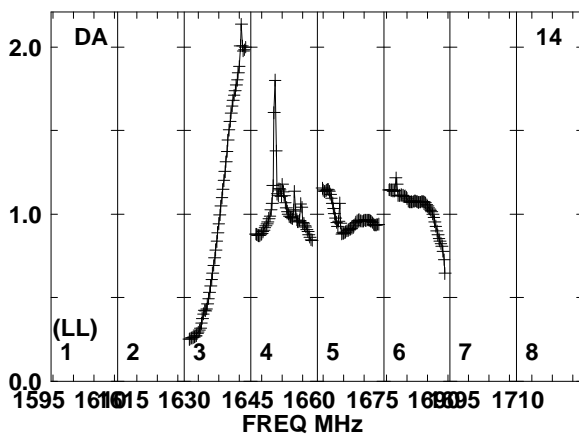
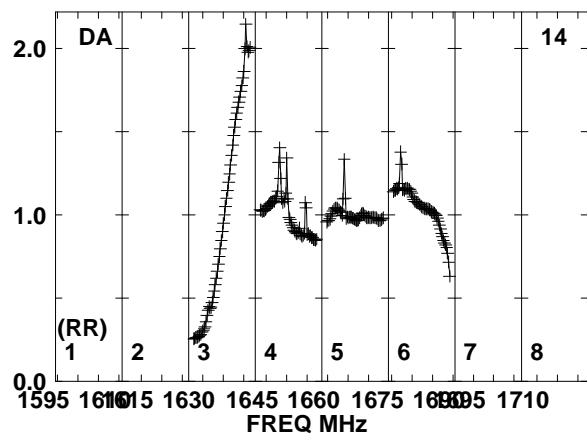
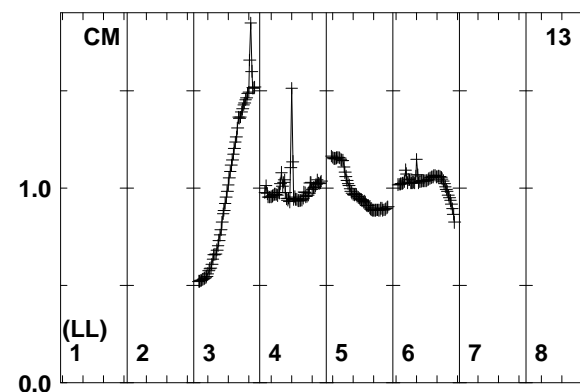
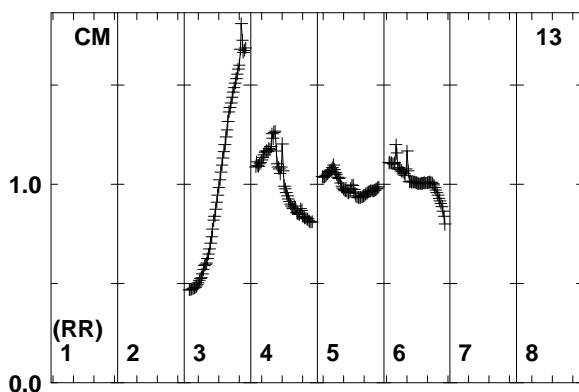
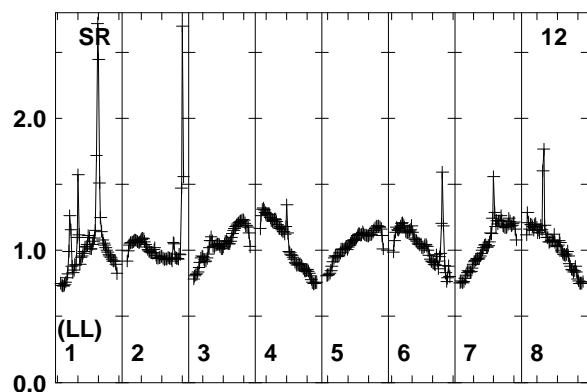
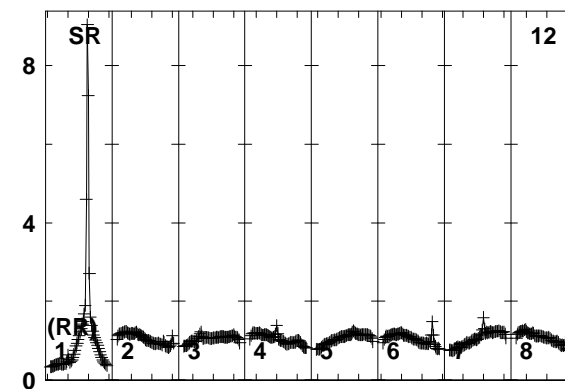
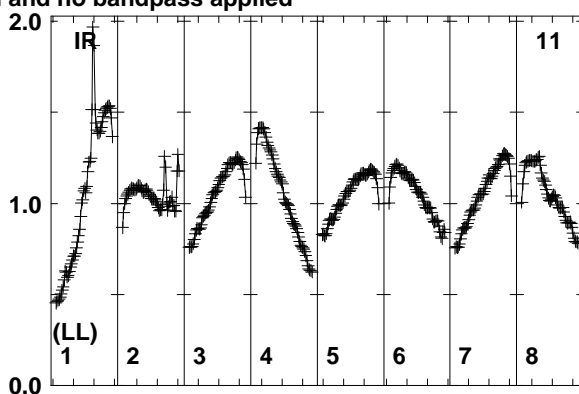
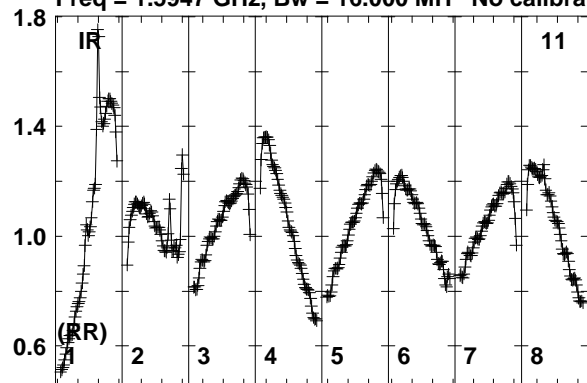

Lower frame: Real Jy
Total-power spectrum Antenna: IR (11)
Timerange: 00/05:11:51 to 00/05:14:29

Plot file version 273 created 04-NOV-2019 14:14:21

W2246-0526 EY034.UVDATA.1

Freq = 1.5947 GHz, Bw = 16.000 MH No calibration applied and no bandpass applied

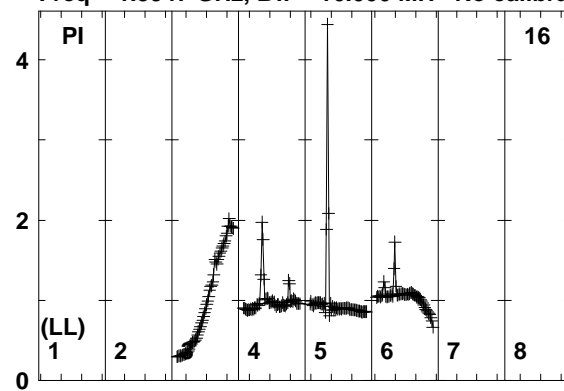

Lower frame: Real Jy
Total-power spectrum Antenna: PI (16)
Timerange: 00/05:11:51 to 00/05:14:29

Plot file version 274 created 04-NOV-2019 14:14:21

J2248-0541 EY034.UVDATA.1

Freq = 1.5947 GHz, Bw = 16.000 MH No calibration applied and no bandpass applied

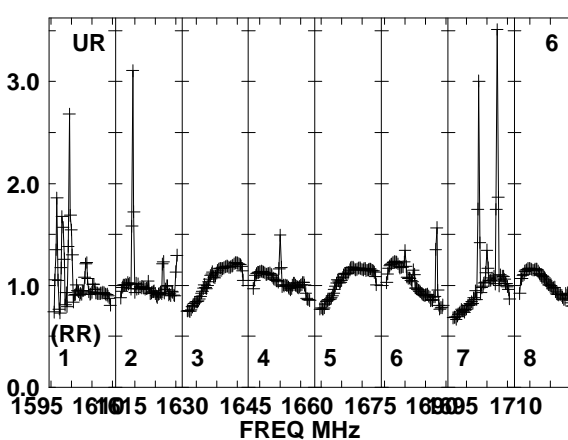
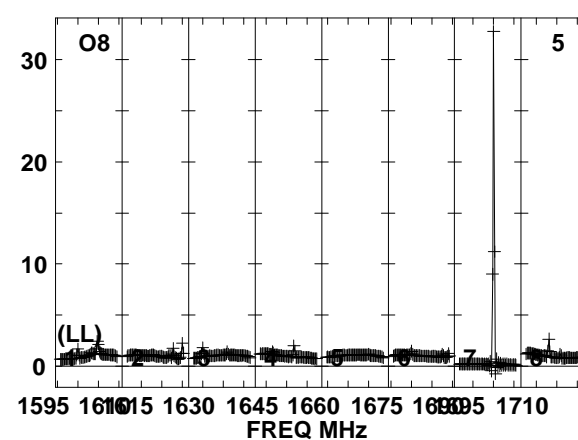
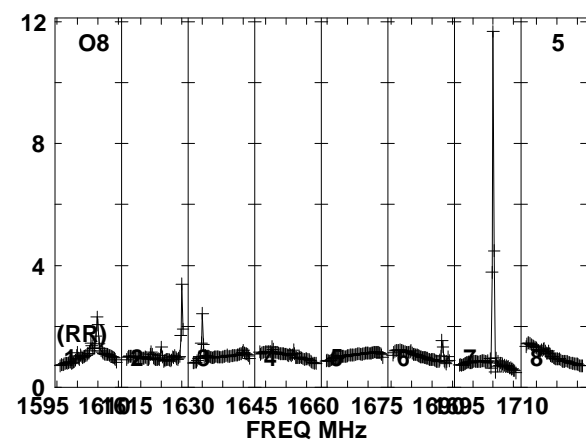
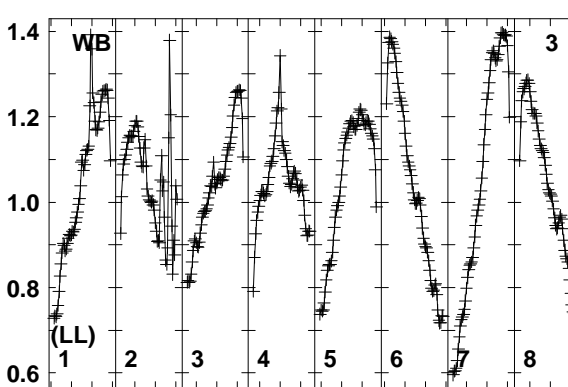
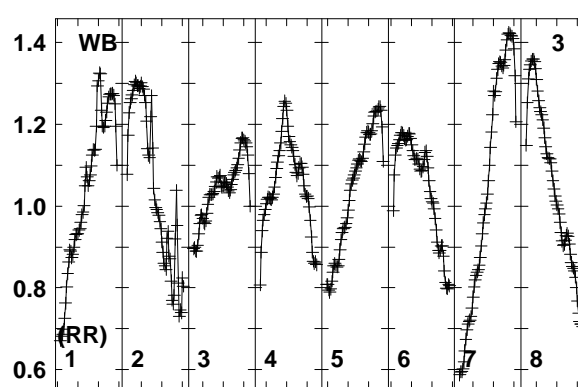
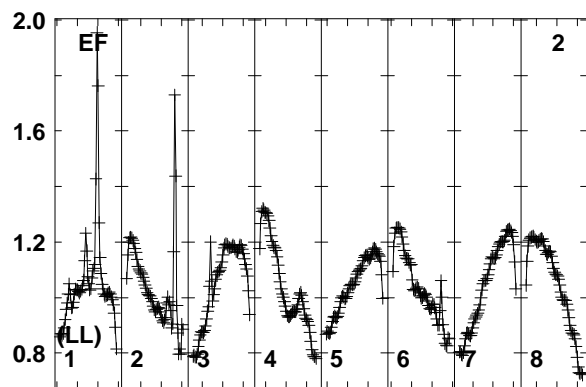
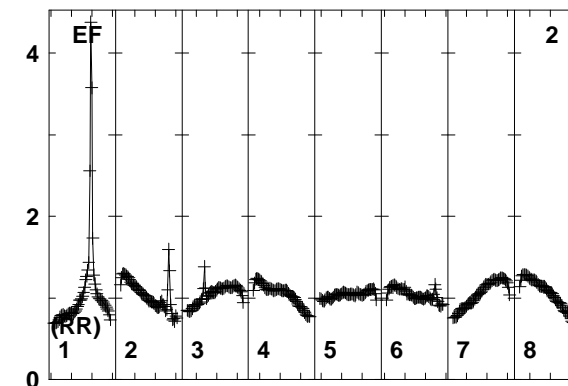
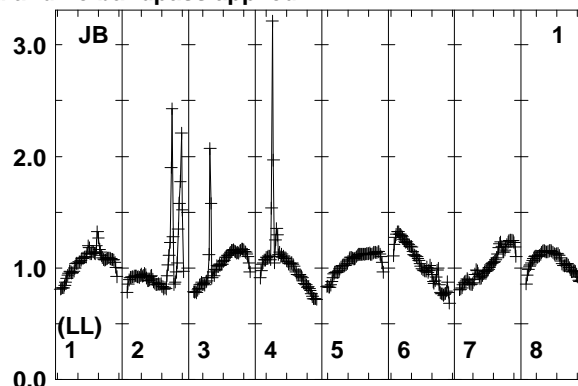
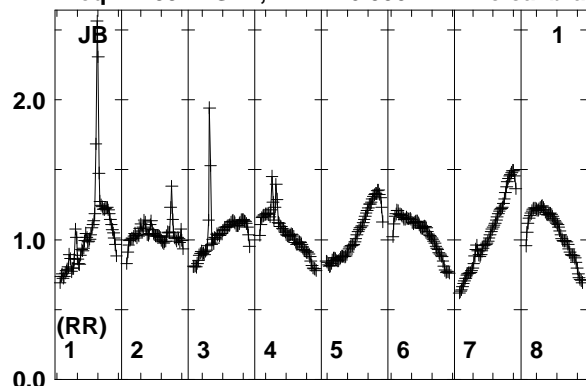

Lower frame: Real Jy
Total-power spectrum Antenna: JB (01)
Timerange: 00/05:15:06 to 00/05:16:04

Plot file version 275 created 04-NOV-2019 14:14:21

J2248-0541 EY034.UVDATA.1

Freq = 1.5947 GHz, Bw = 16.000 MH No calibration applied and no bandpass applied

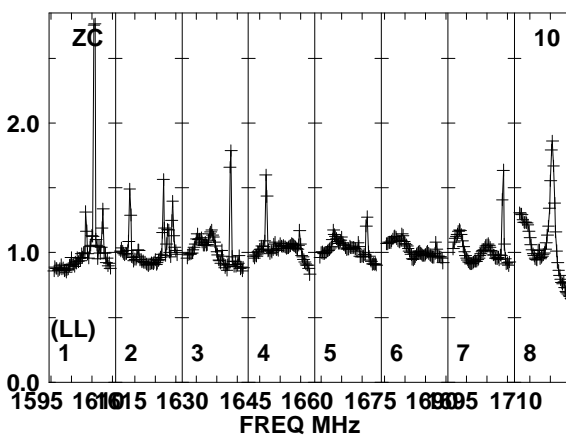
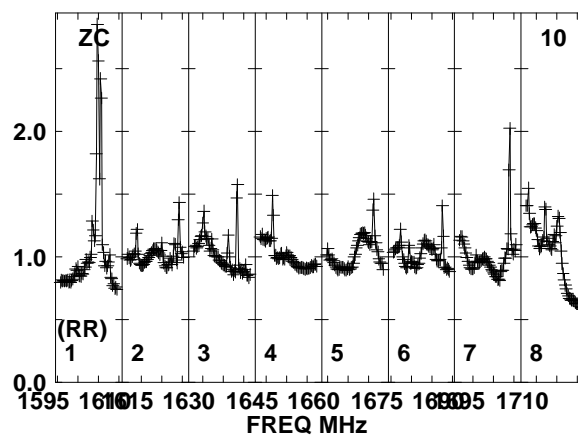
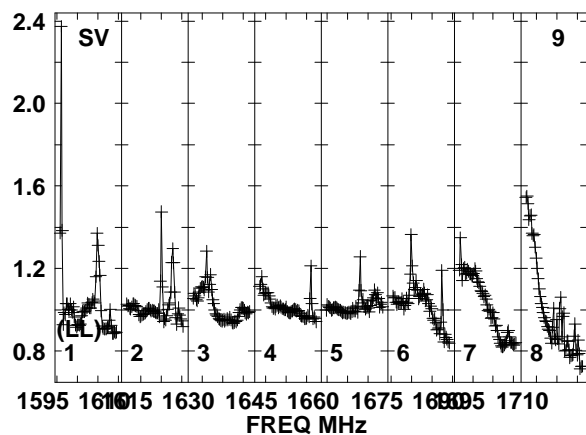
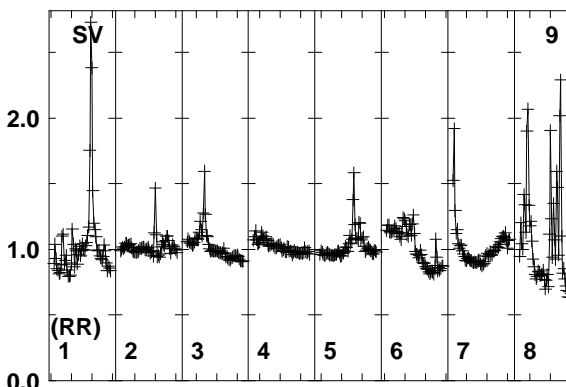
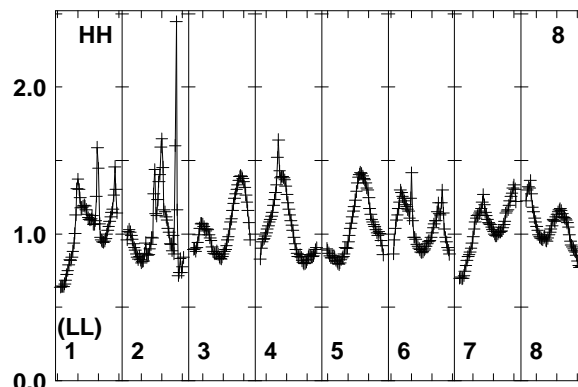
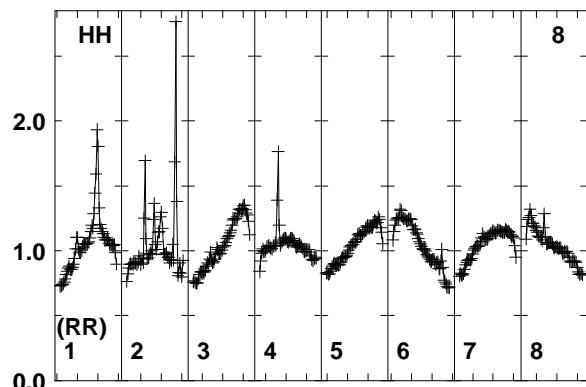
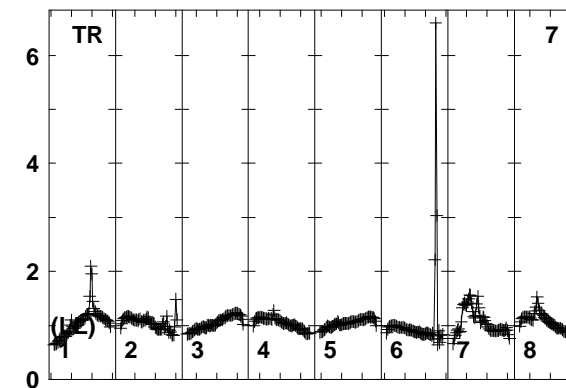
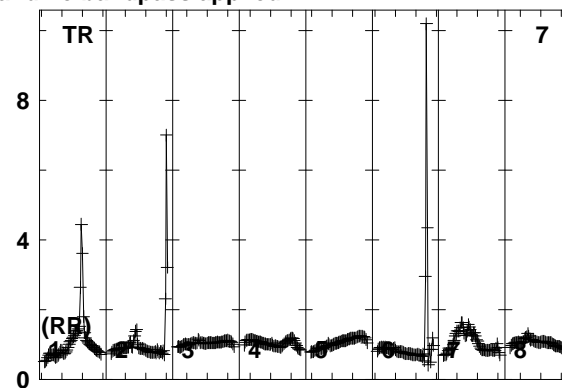
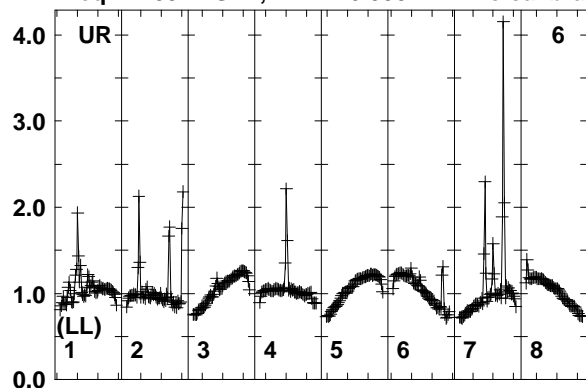

Lower frame: Real Jy
Total-power spectrum Antenna: UR (06)
Timerange: 00/05:15:06 to 00/05:16:04

Plot file version 276 created 04-NOV-2019 14:14:21

J2248-0541 EY034.UVDATA.1

Freq = 1.5947 GHz, Bw = 16.000 MH No calibration applied and no bandpass applied

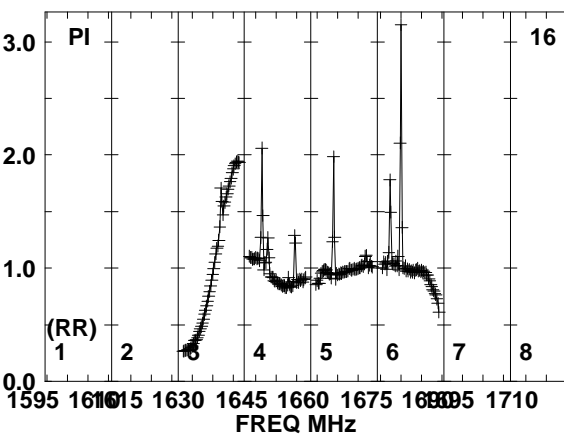
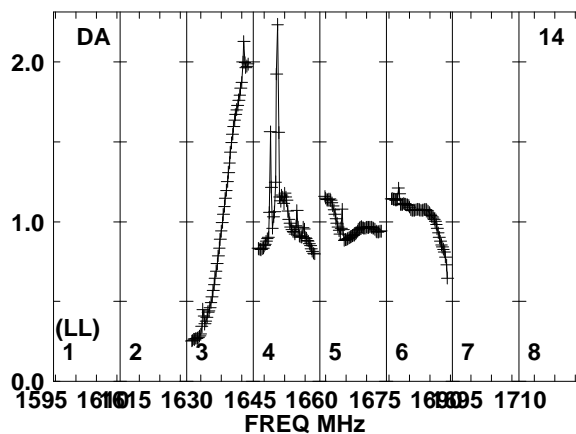
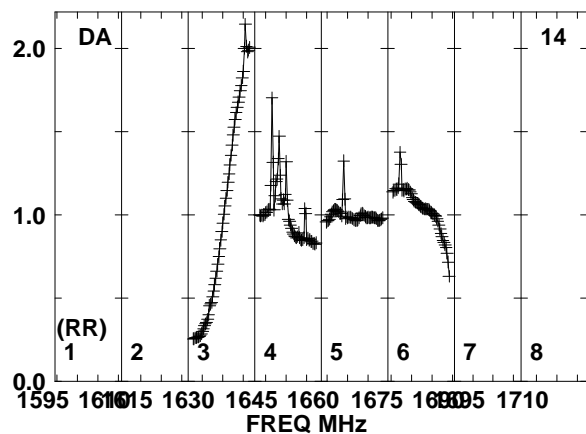
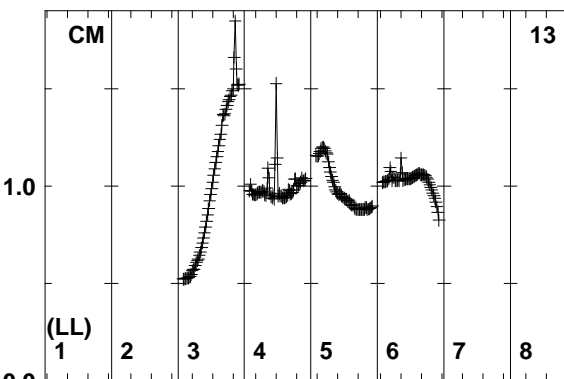
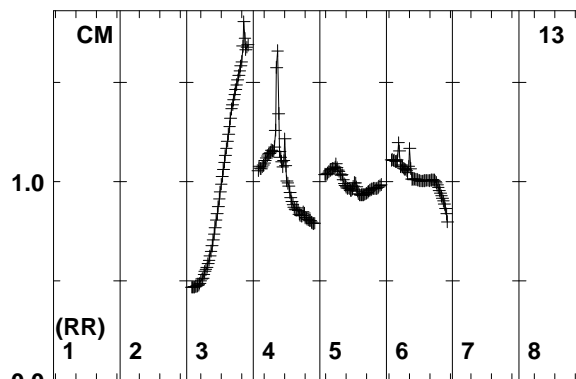
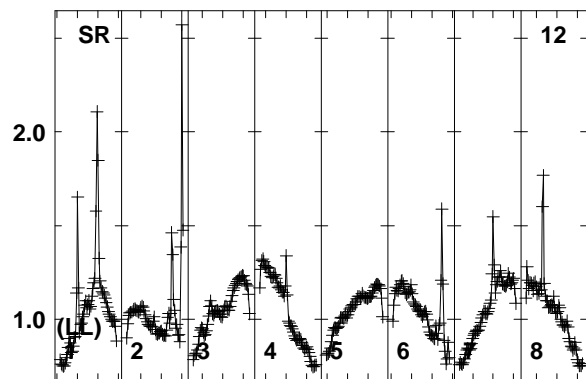
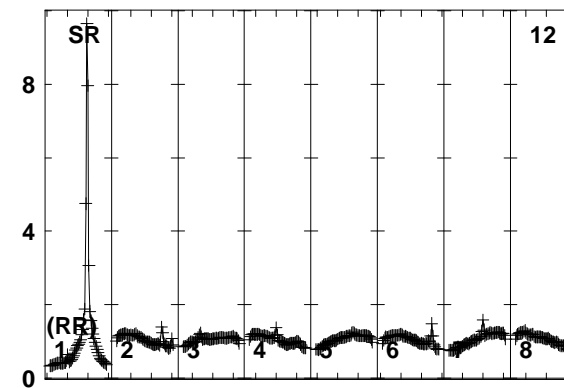
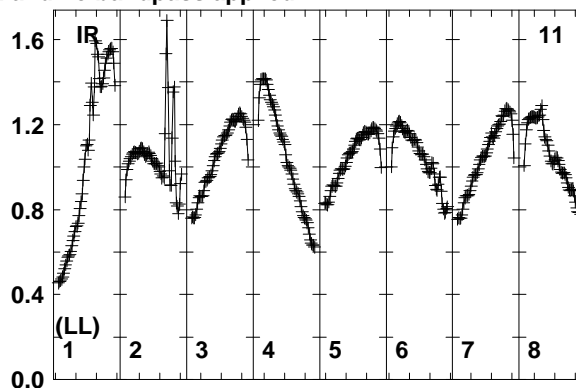
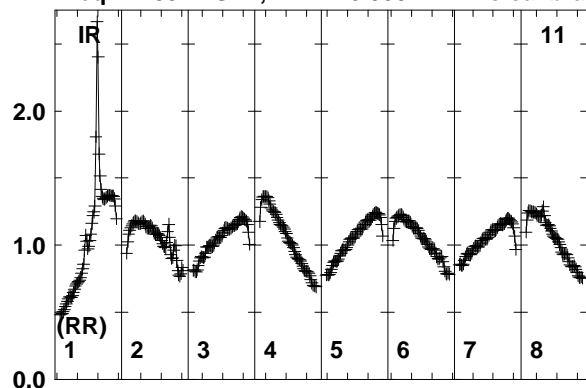

Lower frame: Real Jy
Total-power spectrum Antenna: IR (11)
Timerange: 00/05:15:06 to 00/05:16:04

Plot file version 277 created 04-NOV-2019 14:14:21
J2248-0541 EY034.UVDATA.1
Freq = 1.5947 GHz, Bw = 16.000 MH No calibration applied and no bandpass applied

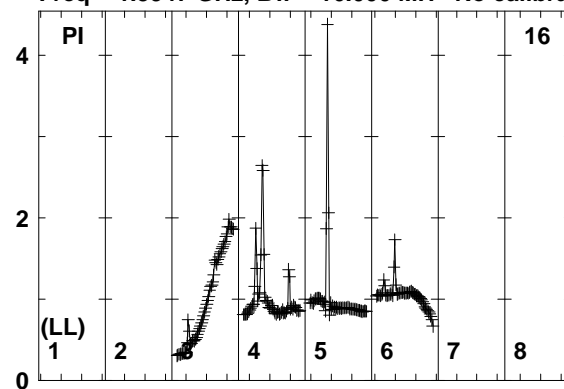

Lower frame: Real Jy
Total-power spectrum Antenna: PI (16)
Timerange: 00/05:15:06 to 00/05:16:04

Plot file version 278 created 04-NOV-2019 14:14:21

W2246-0526 EY034.UVDATA.1

Freq = 1.5947 GHz, Bw = 16.000 MH No calibration applied and no bandpass applied

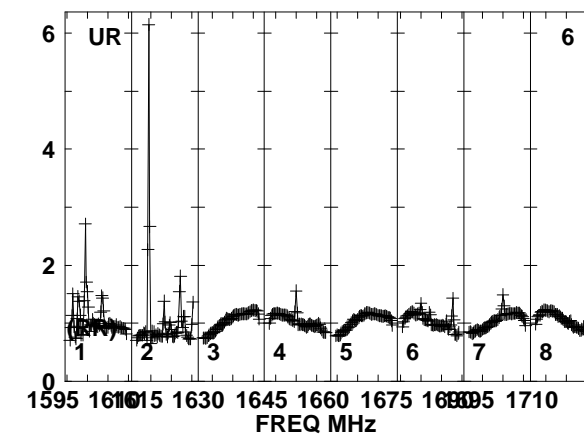
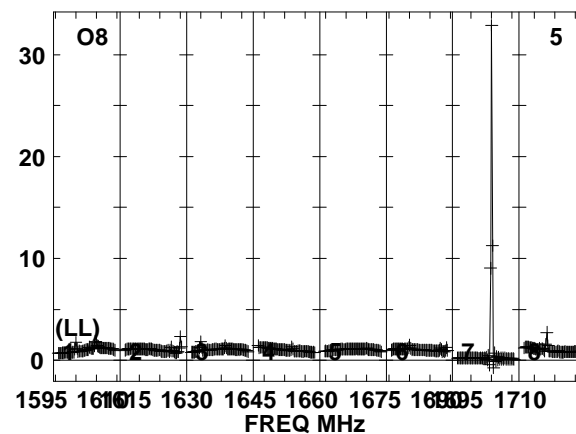
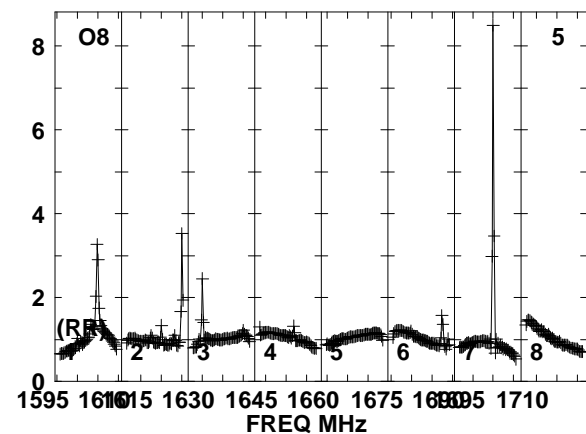
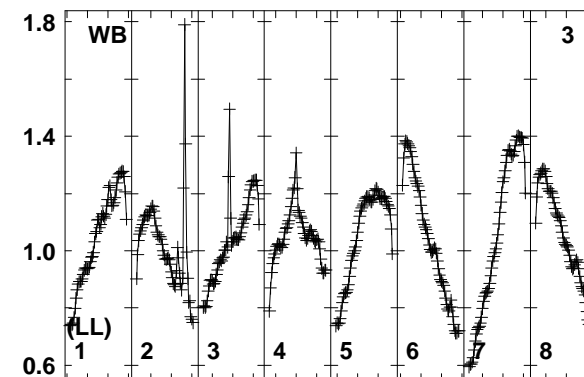
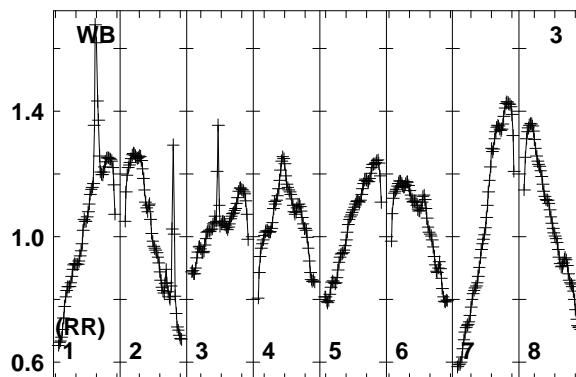
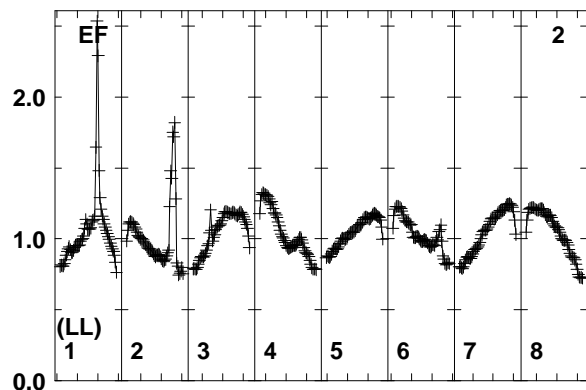
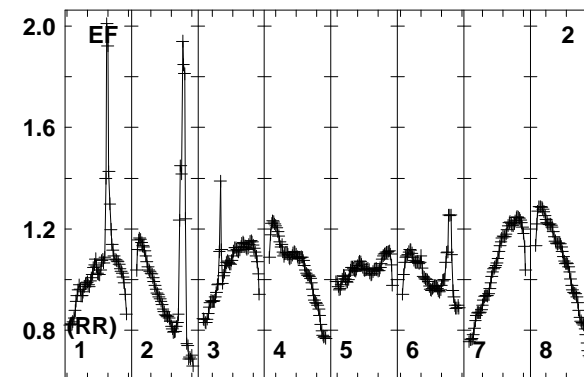
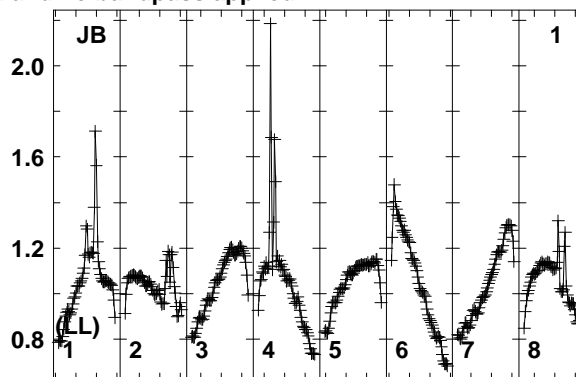
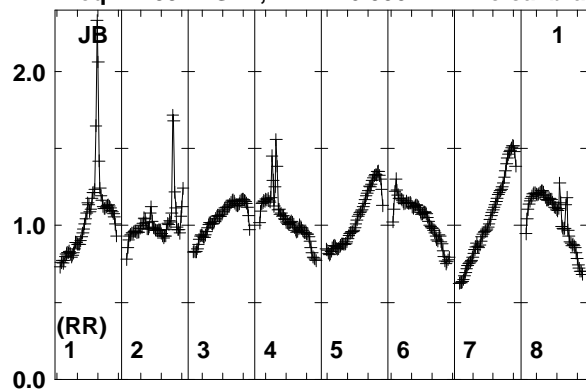

Lower frame: Real Jy
Total-power spectrum Antenna: JB (01)
Timerange: 00/05:16:06 to 00/05:18:44

Plot file version 279 created 04-NOV-2019 14:14:22

W2246-0526 EY034.UVDATA.1

Freq = 1.5947 GHz, Bw = 16.000 MH No calibration applied and no bandpass applied

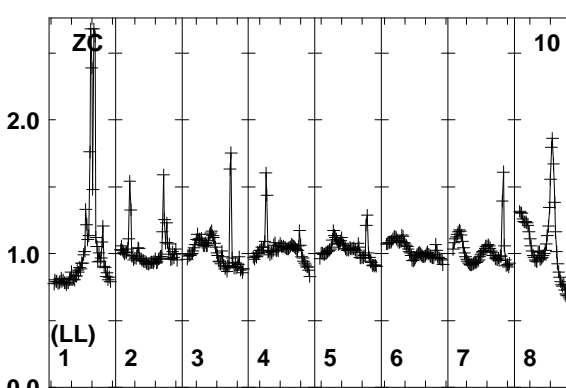
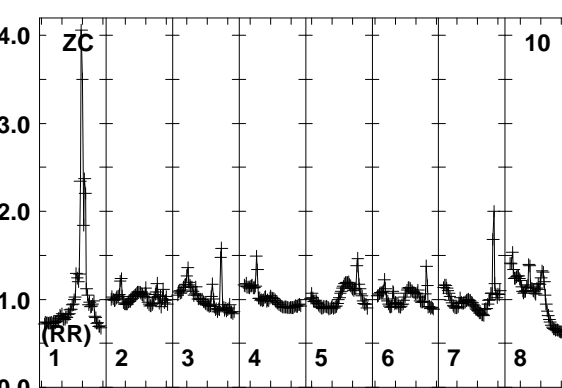
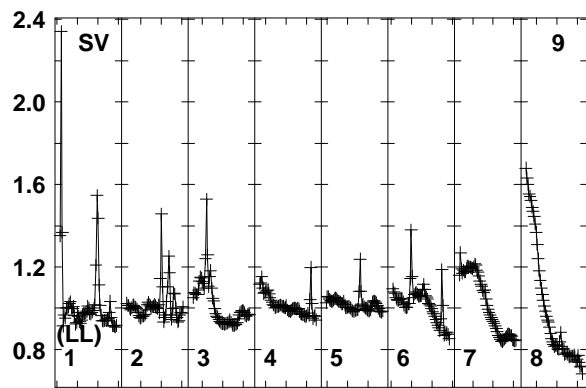
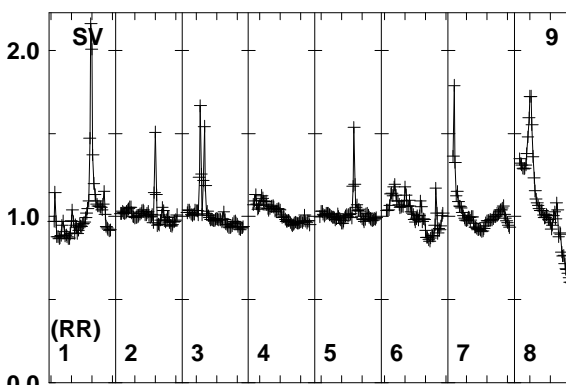
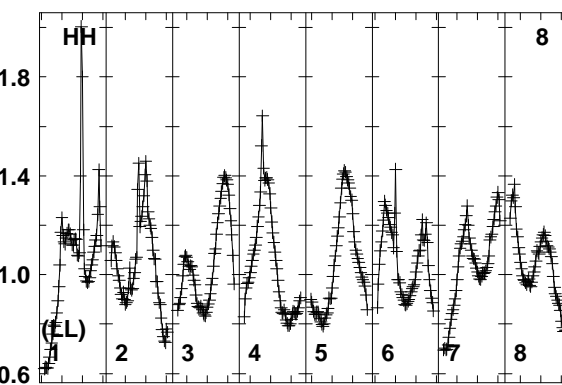
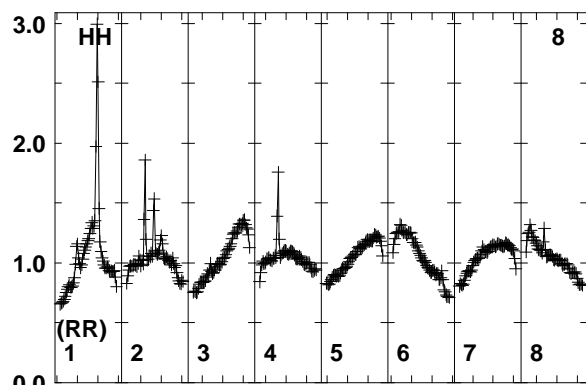
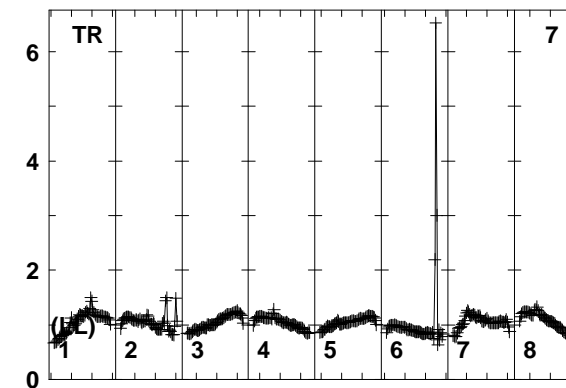
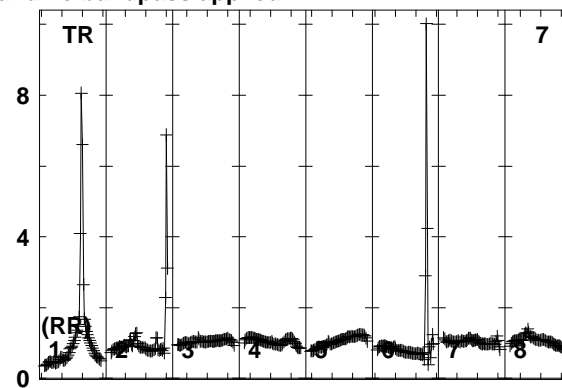
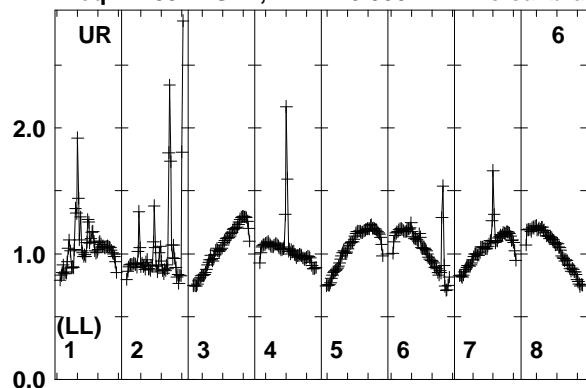

1595 1610 1630 1645 1660 1675 1690 1710
FREQ MHz

1595 1610 1630 1645 1660 1675 1690 1710
FREQ MHz

1595 1610 1630 1645 1660 1675 1690 1710
FREQ MHz

Lower frame: Real Jy
Total-power spectrum Antenna: UR (06)
Timerange: 00/05:16:06 to 00/05:18:44

Plot file version 280 created 04-NOV-2019 14:14:22

W2246-0526 EY034.UVDATA.1

Freq = 1.5947 GHz, Bw = 16.000 MH No calibration applied and no bandpass applied

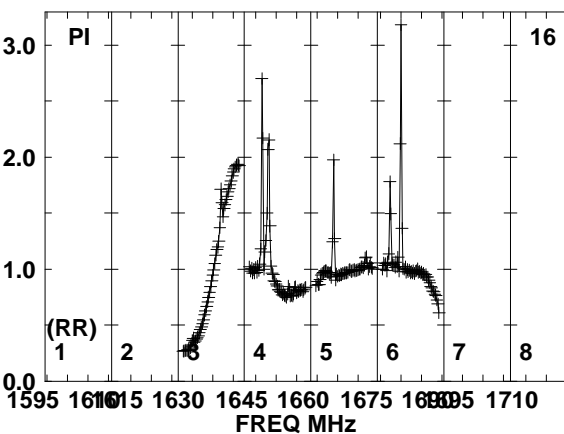
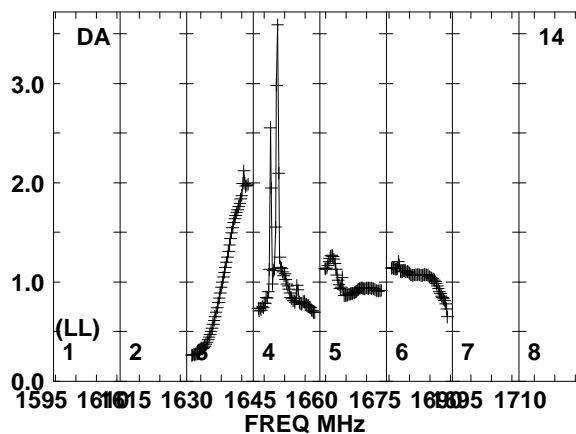
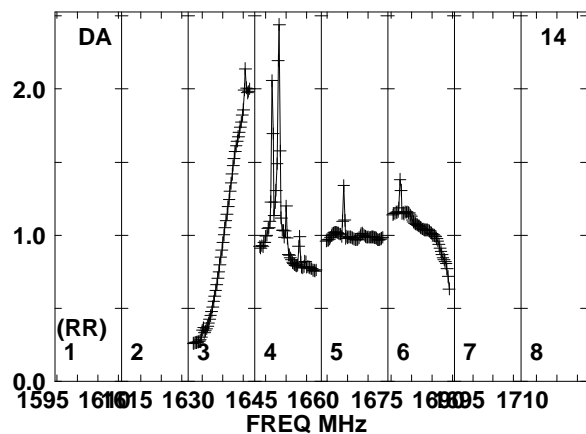
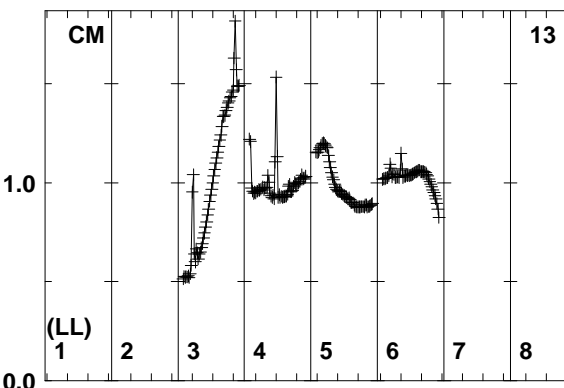
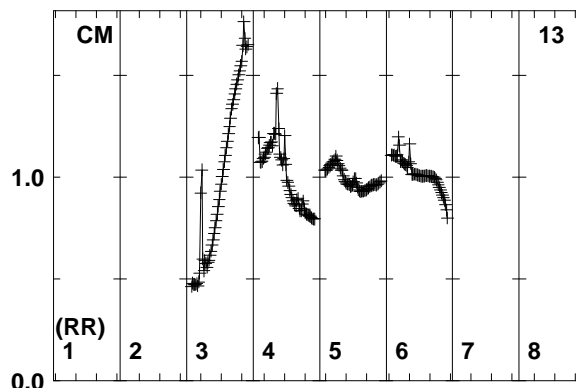
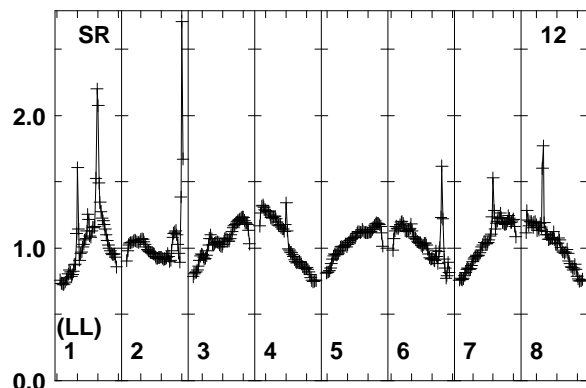
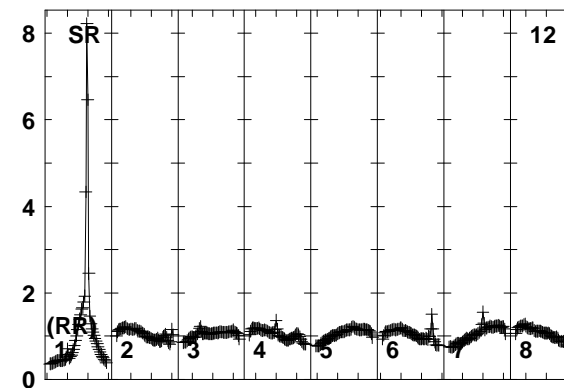
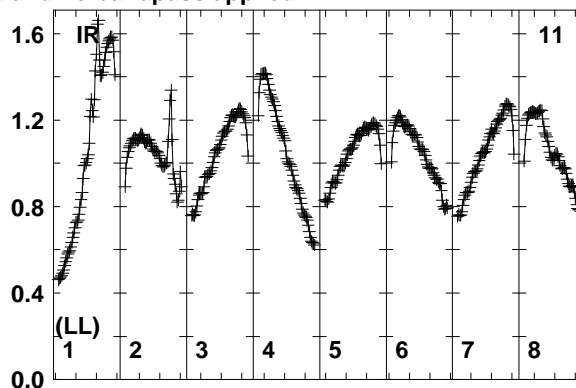
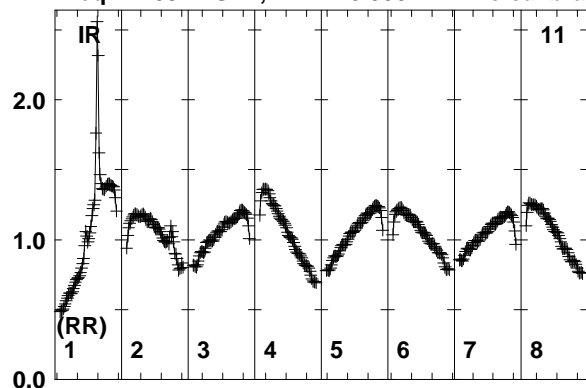

Lower frame: Real Jy
Total-power spectrum Antenna: IR (11)
Timerange: 00/05:16:06 to 00/05:18:44

Plot file version 281 created 04-NOV-2019 14:14:22
W2246-0526 EY034.UVDATA.1
Freq = 1.5947 GHz, Bw = 16.000 MH No calibration applied and no bandpass applied

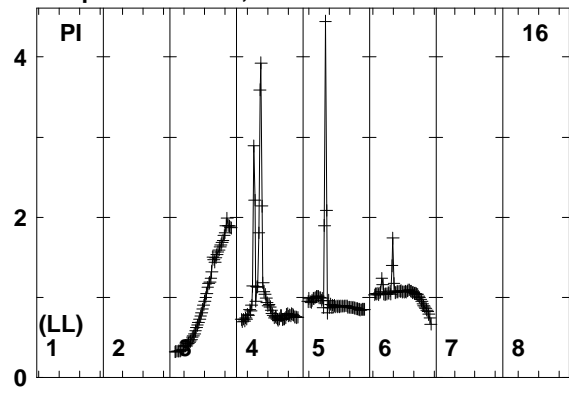

Lower frame: Real Jy
Total-power spectrum Antenna: PI (16)
Timerange: 00/05:16:06 to 00/05:18:44

Plot file version 282 created 04-NOV-2019 14:14:22

J2248-0541 EY034.UVDATA.1

Freq = 1.5947 GHz, Bw = 16.000 MH No calibration applied and no bandpass applied

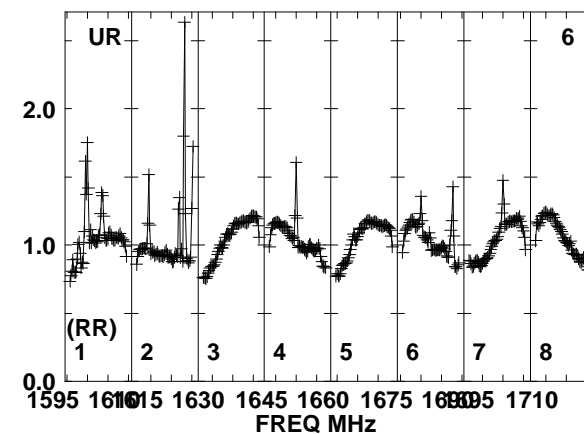
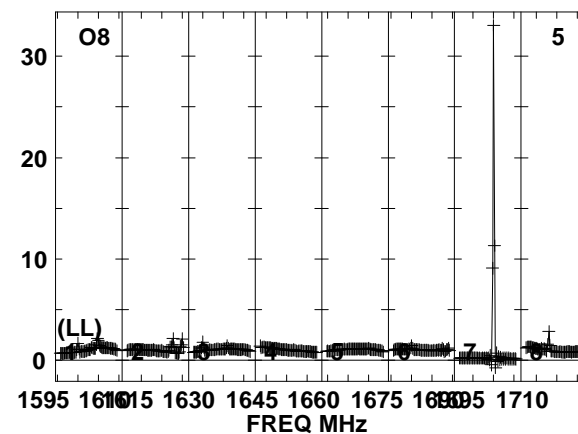
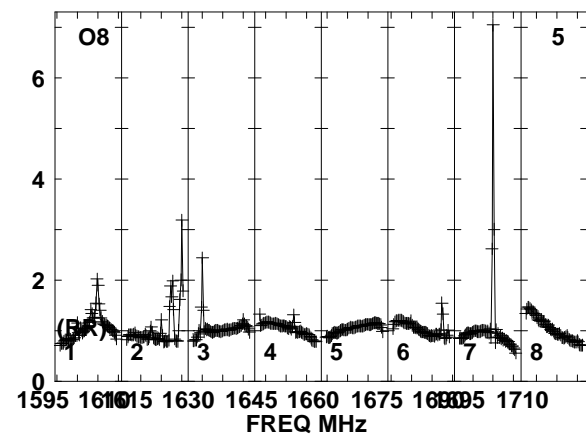
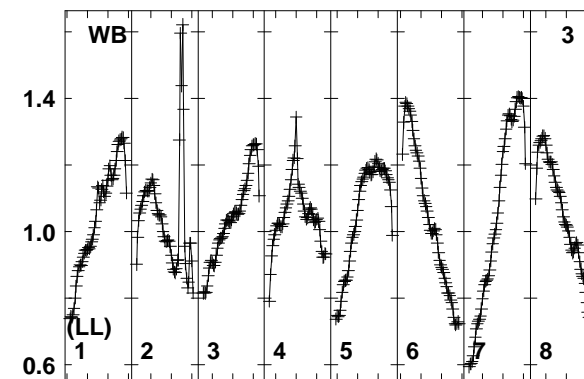
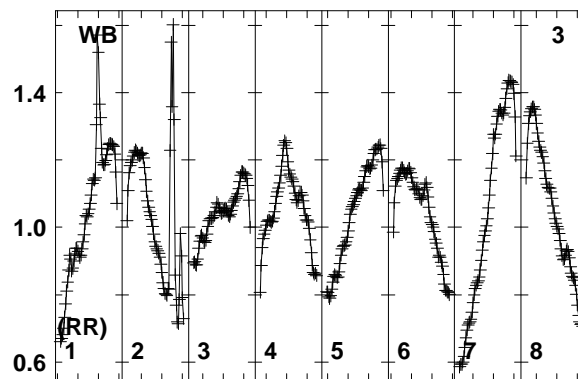
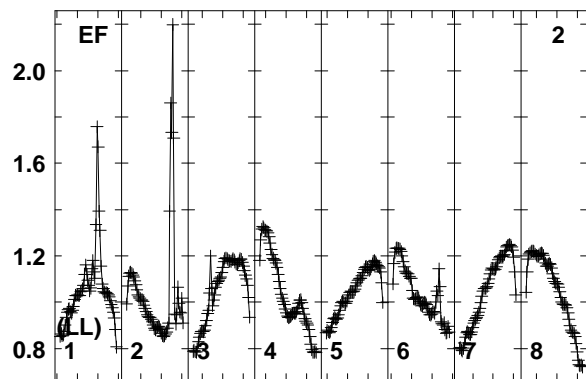
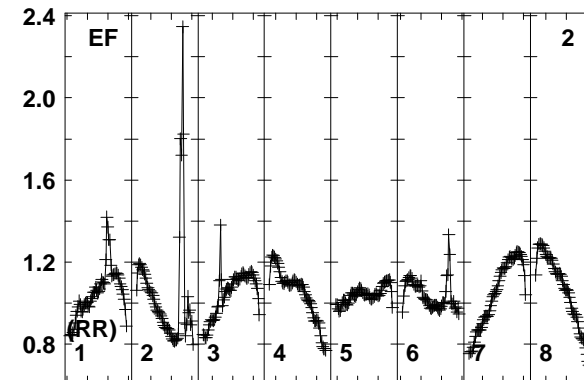
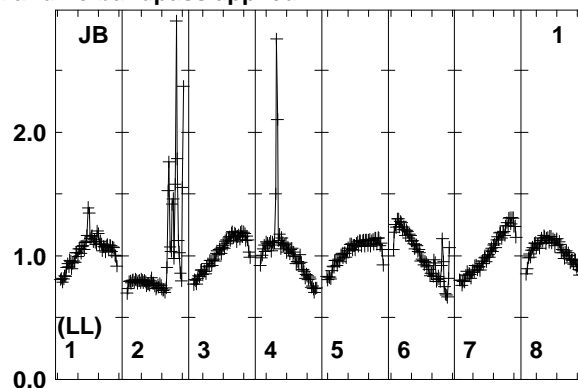
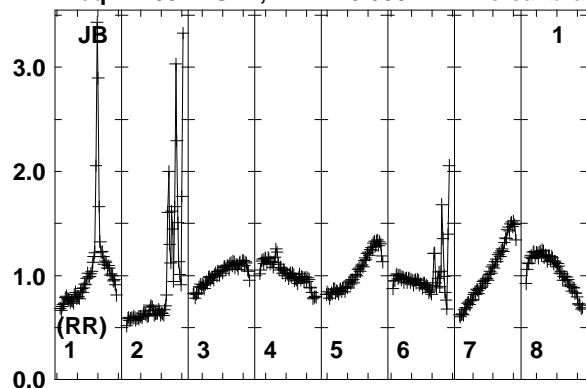

Lower frame: Real Jy
Total-power spectrum Antenna: JB (01)
Timerange: 00/05:19:01 to 00/05:19:59

Plot file version 283 created 04-NOV-2019 14:14:22

J2248-0541 EY034.UVDATA.1

Freq = 1.5947 GHz, Bw = 16.000 MH No calibration applied and no bandpass applied

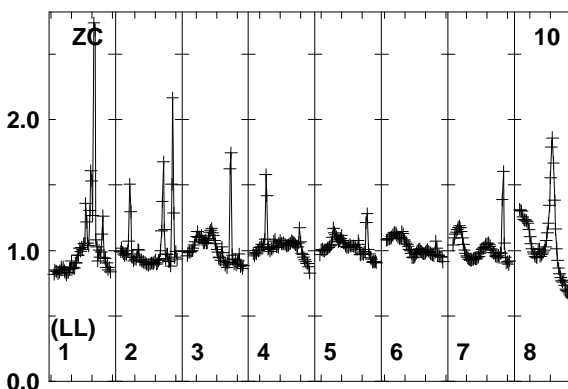
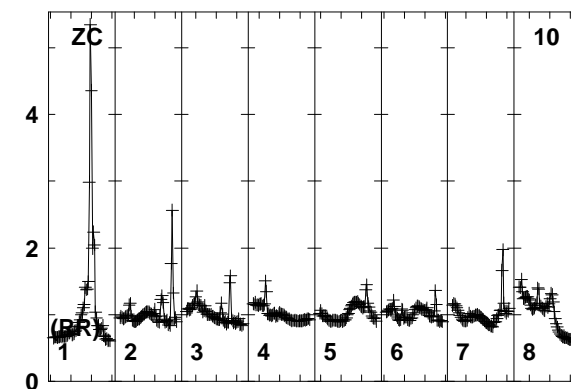
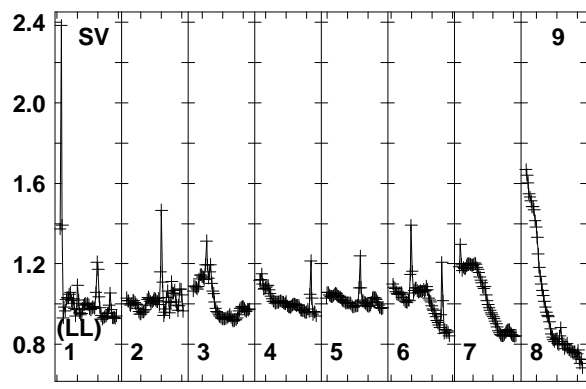
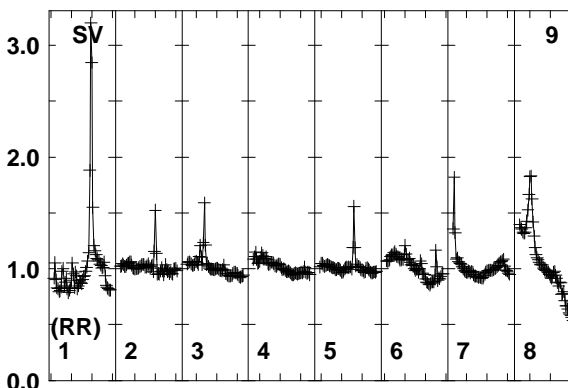
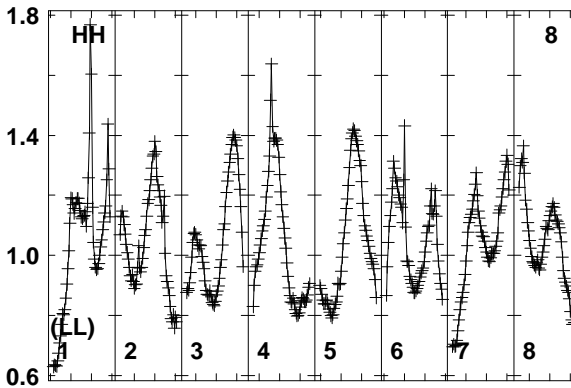
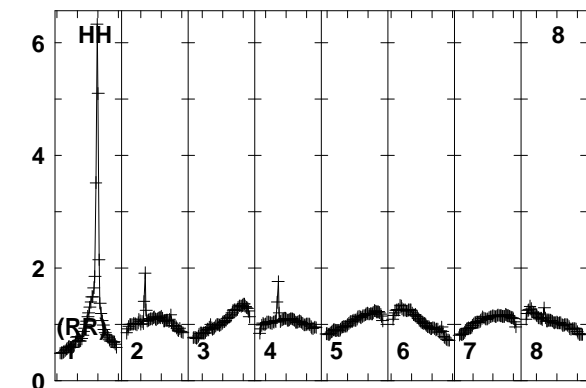
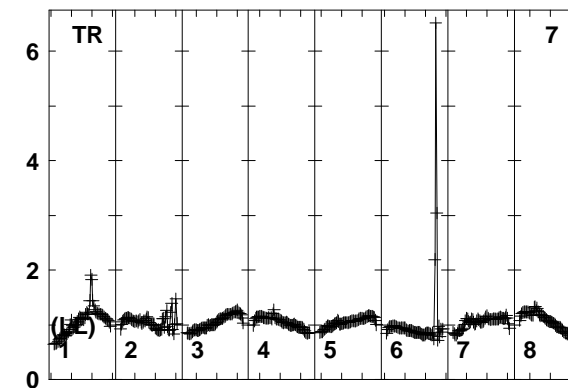
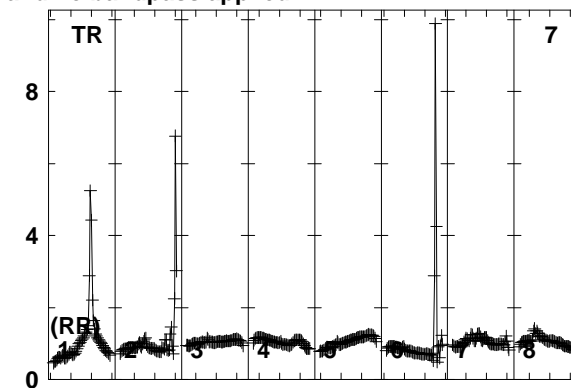
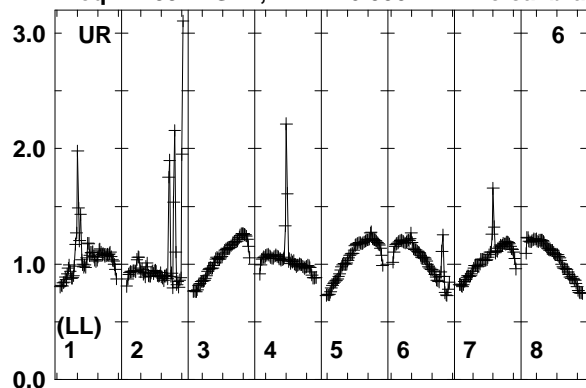

1595 1610 1630 1645 1660 1675 1690 1710
FREQ MHz

1595 1610 1630 1645 1660 1675 1690 1710
FREQ MHz

1595 1610 1630 1645 1660 1675 1690 1710
FREQ MHz

Lower frame: Real Jy
Total-power spectrum Antenna: UR (06)
Timerange: 00/05:19:01 to 00/05:19:59

Plot file version 284 created 04-NOV-2019 14:14:22

J2248-0541 EY034.UVDATA.1

Freq = 1.5947 GHz, Bw = 16.000 MH No calibration applied and no bandpass applied

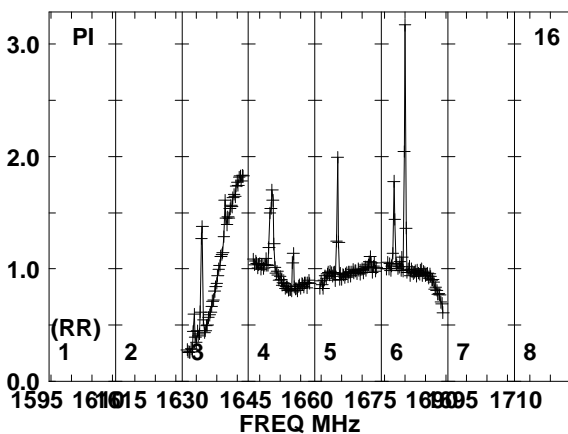
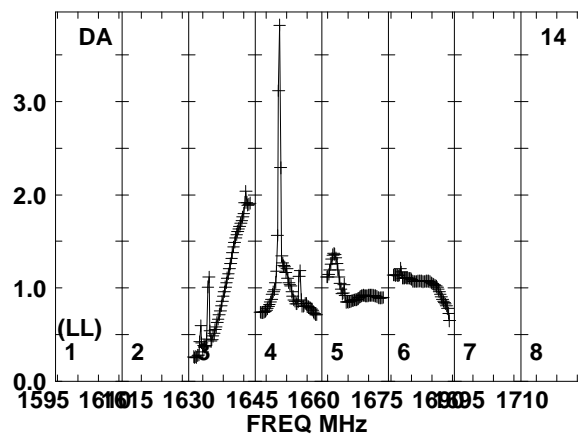
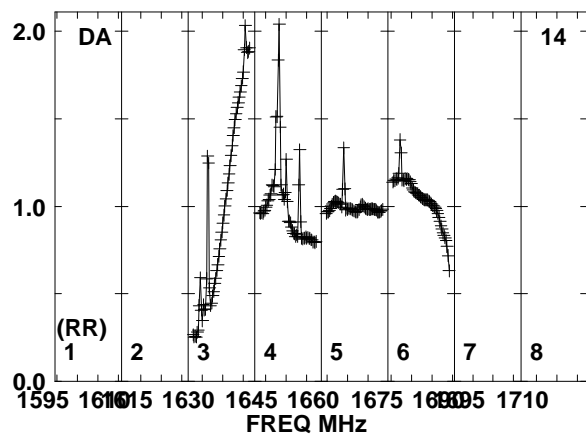
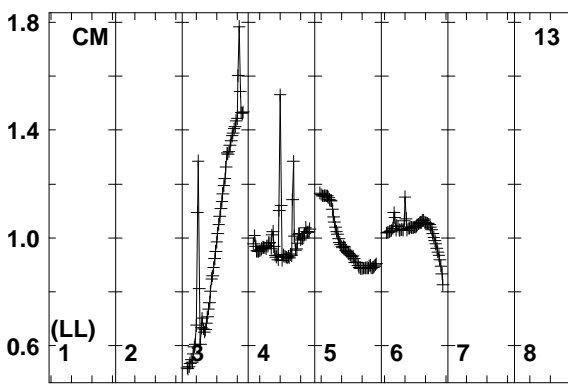
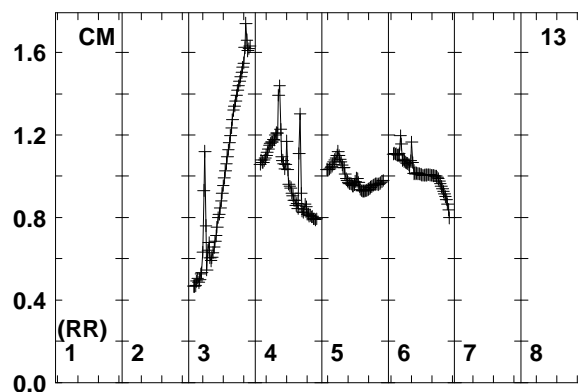
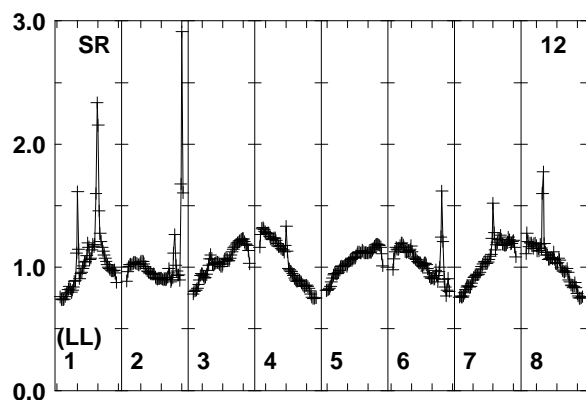
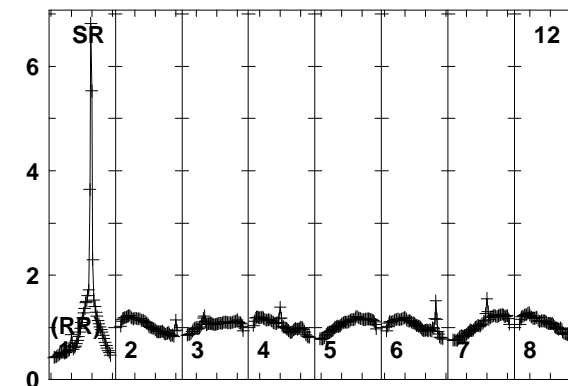
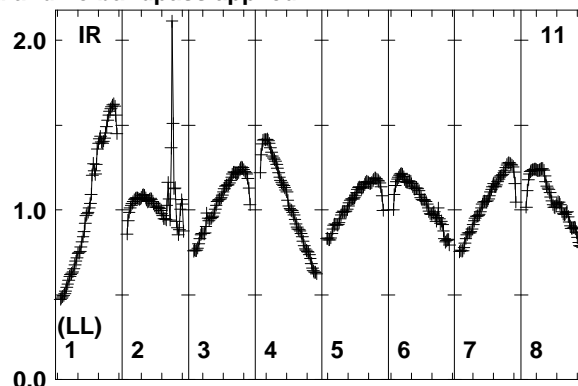
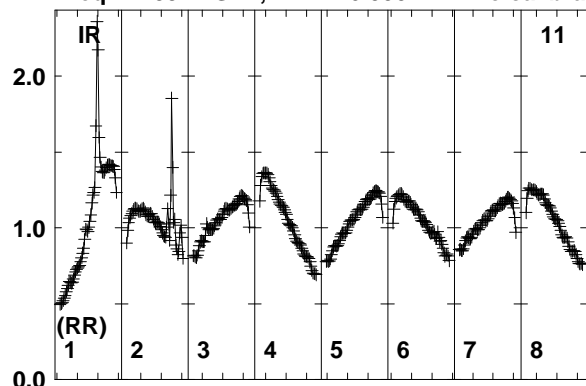

Lower frame: Real Jy
Total-power spectrum Antenna: IR (11)
Timerange: 00/05:19:01 to 00/05:19:59

Plot file version 285 created 04-NOV-2019 14:14:22
J2248-0541 EY034.UVDATA.1
Freq = 1.5947 GHz, Bw = 16.000 MH No calibration applied and no bandpass applied

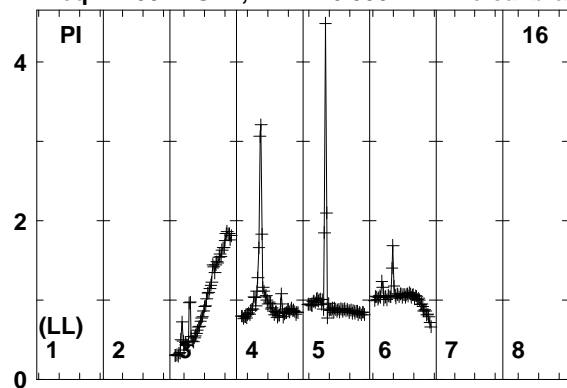

Lower frame: Real Jy
Total-power spectrum Antenna: PI (16)
Timerange: 00/05:19:01 to 00/05:19:59

Plot file version 286 created 04-NOV-2019 14:14:22

J2245-0755 EY034.UVDATA.1

Freq = 1.5947 GHz, Bw = 16.000 MH No calibration applied and no bandpass applied

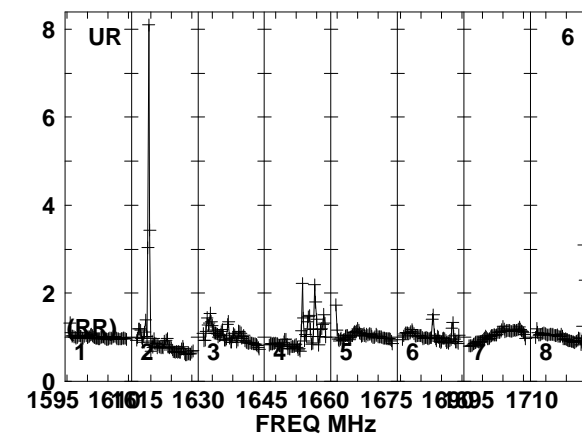
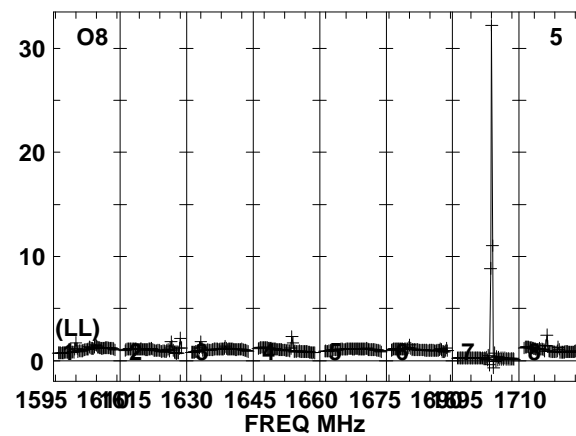
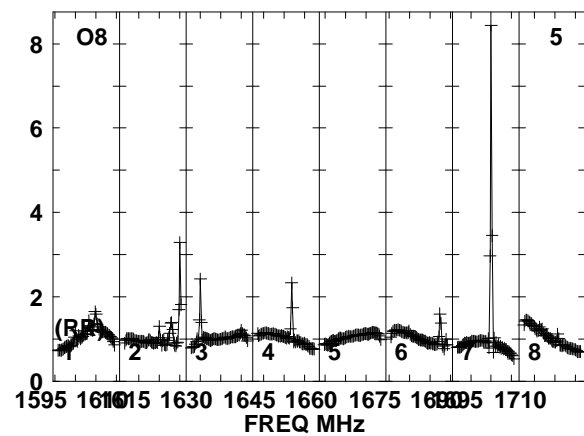
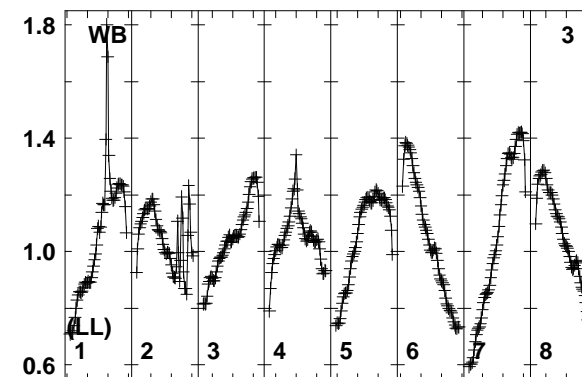
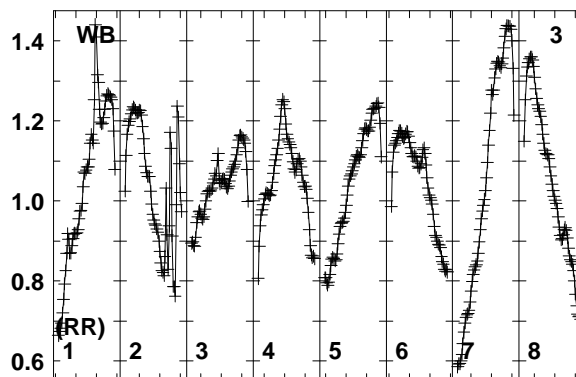
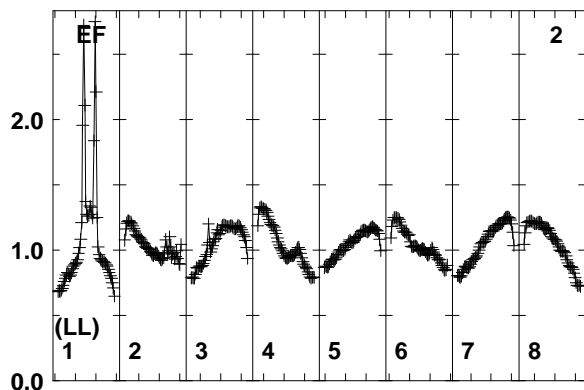
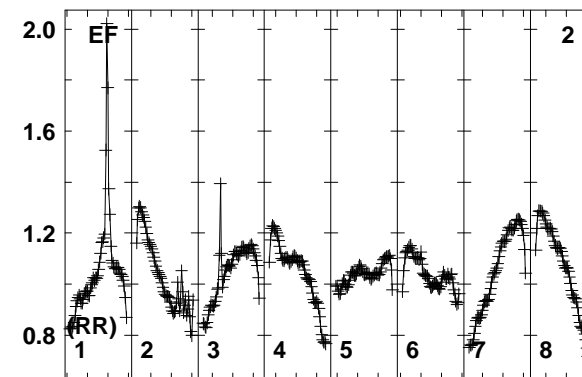
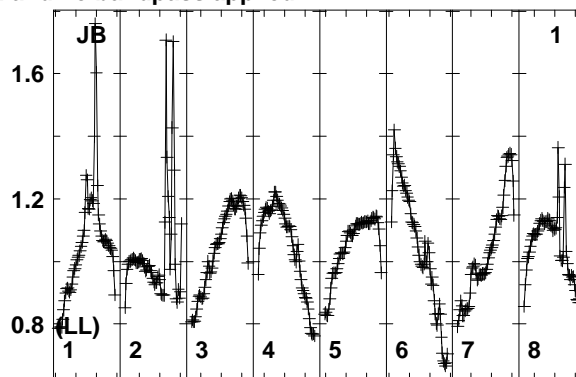
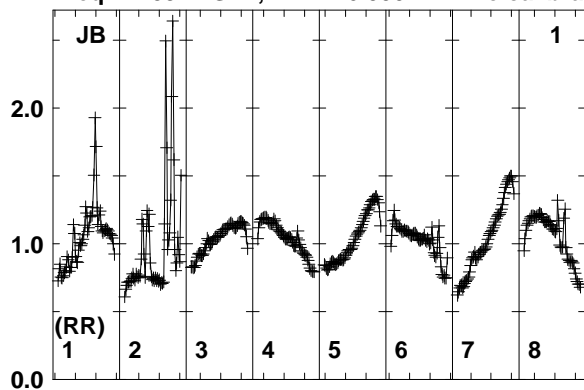

Lower frame: Real Jy
Total-power spectrum Antenna: JB (01)
Timerange: 00/05:20:16 to 00/05:21:14

Plot file version 287 created 04-NOV-2019 14:14:22

J2245-0755 EY034.UVDATA.1

Freq = 1.5947 GHz, Bw = 16.000 MH No calibration applied and no bandpass applied

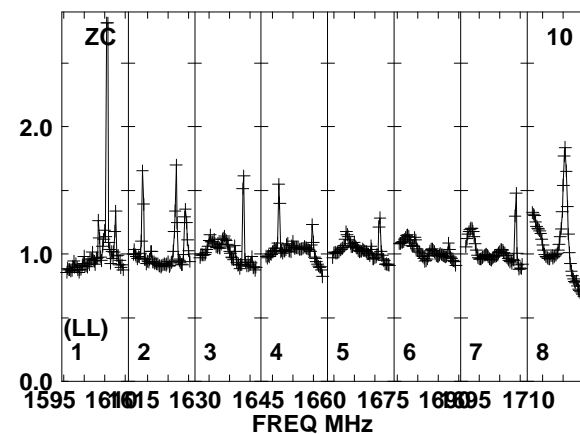
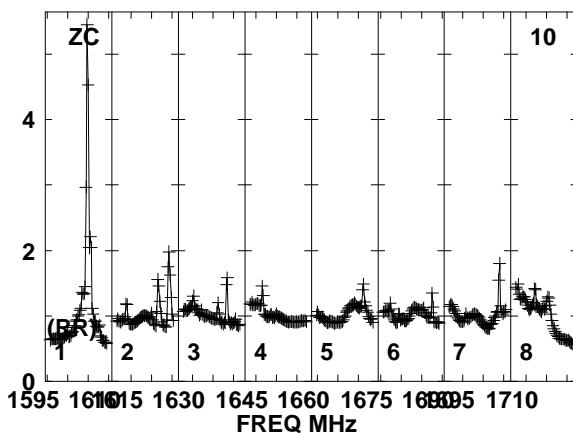
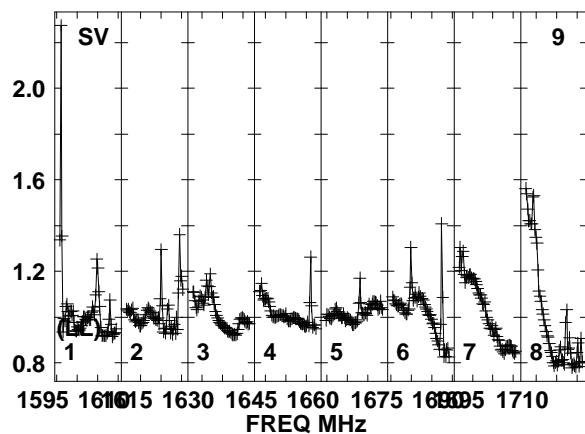
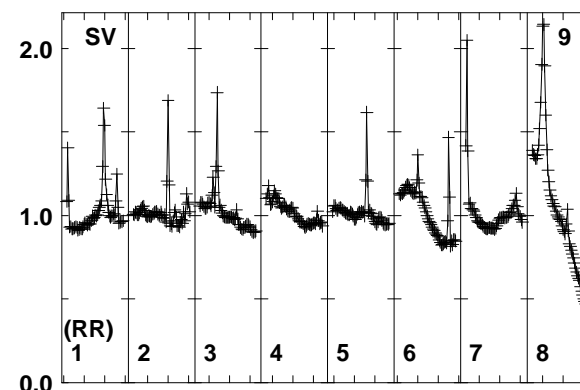
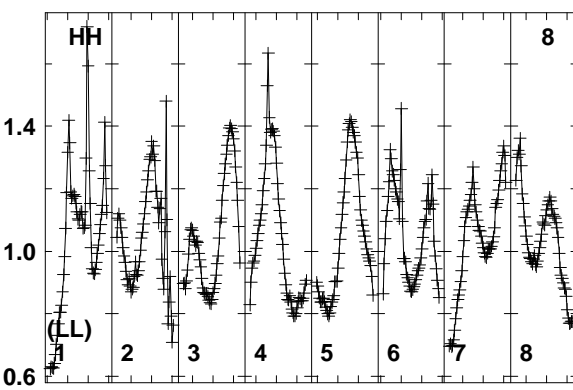
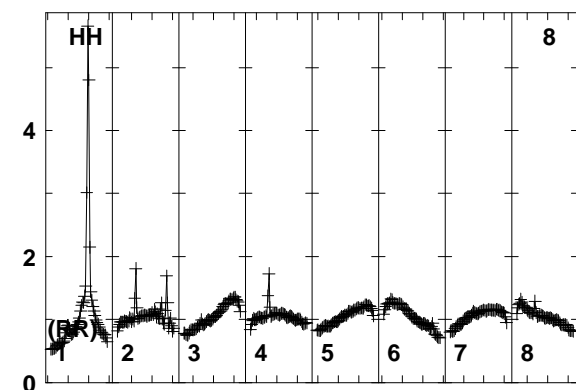
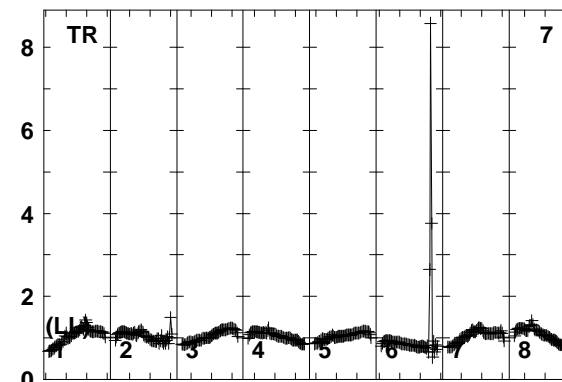
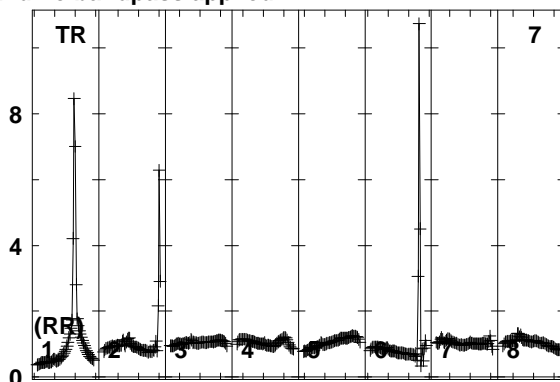
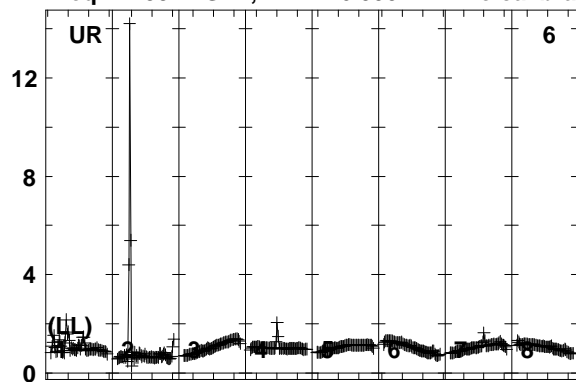

Lower frame: Real Jy
Total-power spectrum Antenna: UR (06)
Timerange: 00/05:20:16 to 00/05:21:14

Plot file version 288 created 04-NOV-2019 14:14:22

J2245-0755 EY034.UVDATA.1

Freq = 1.5947 GHz, Bw = 16.000 MH No calibration applied and no bandpass applied

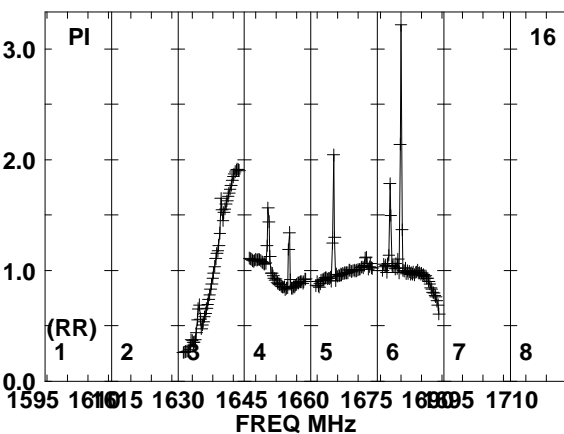
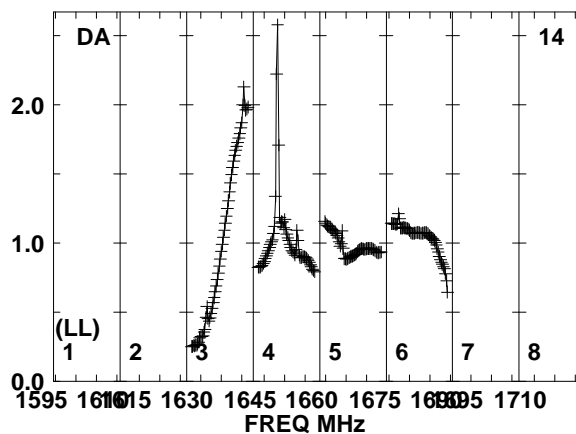
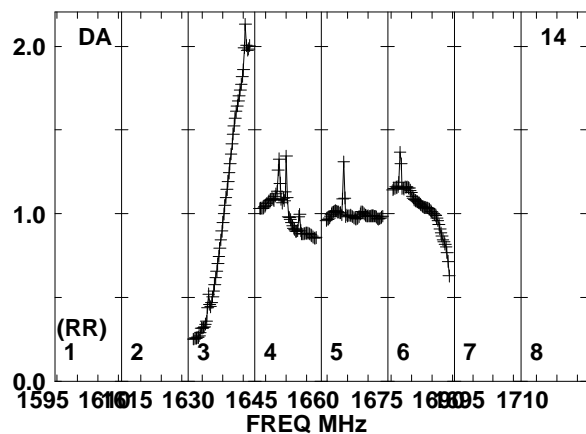
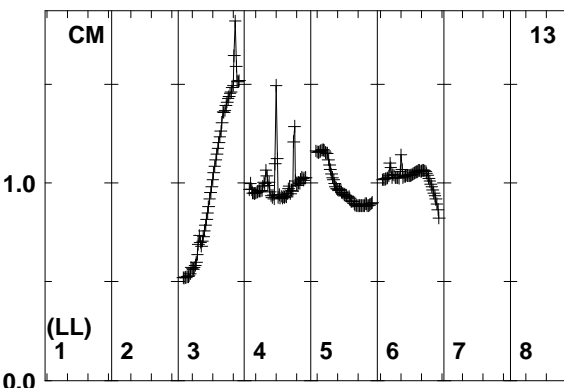
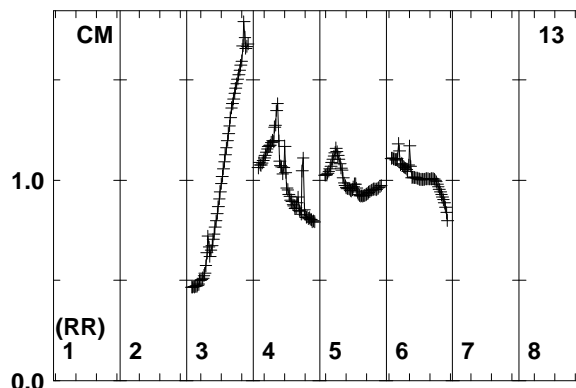
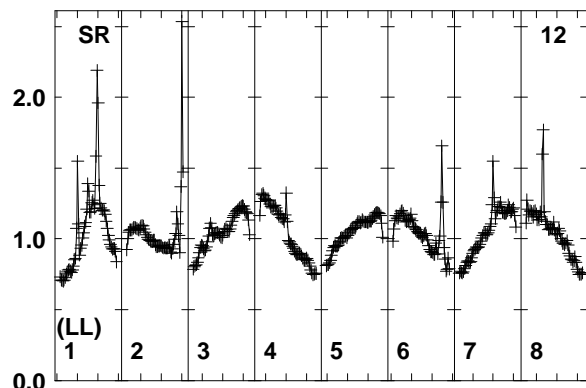
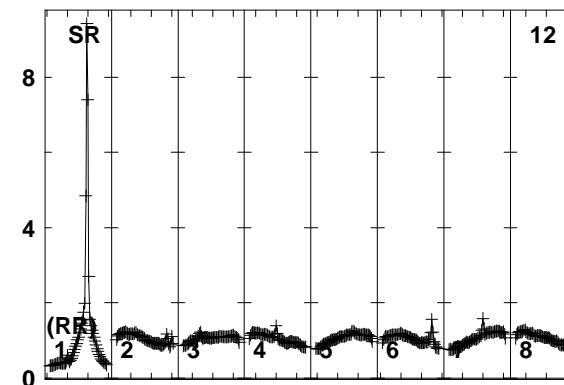
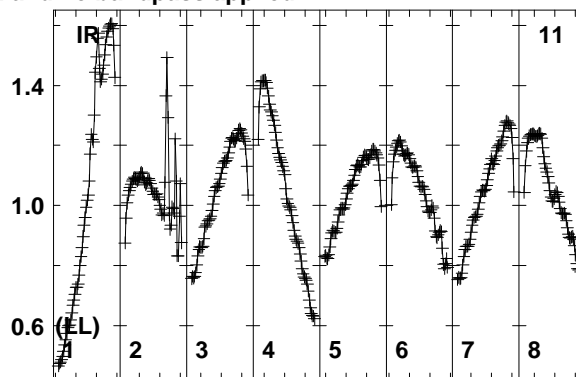
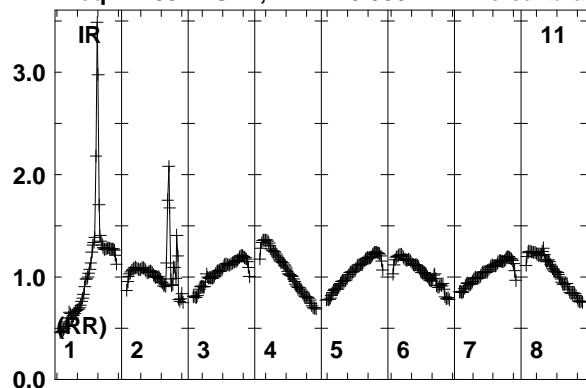

Lower frame: Real Jy
Total-power spectrum Antenna: IR (11)
Timerange: 00/05:20:16 to 00/05:21:14

Plot file version 289 created 04-NOV-2019 14:14:22

J2245-0755 EY034.UVDATA.1

Freq = 1.5947 GHz, Bw = 16.000 MH No calibration applied and no bandpass applied

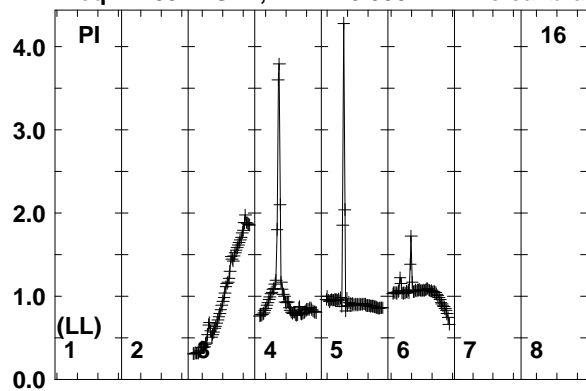

Lower frame: Real Jy
Total-power spectrum Antenna: PI (16)
Timerange: 00/05:20:16 to 00/05:21:14

Plot file version 290 created 04-NOV-2019 14:14:22
J2248-0541 EY034.UVDATA.1
Freq = 1.5947 GHz, Bw = 16.000 MH No calibration applied and no bandpass applied

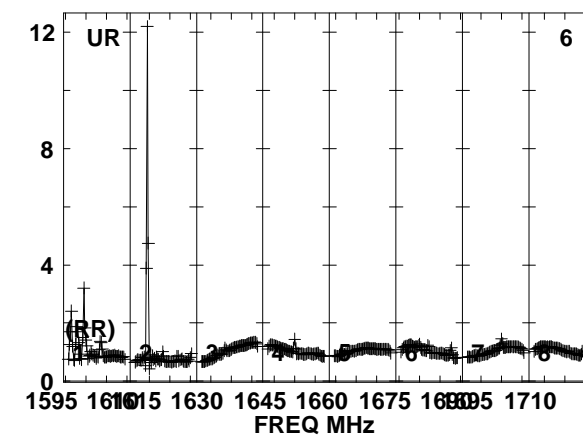
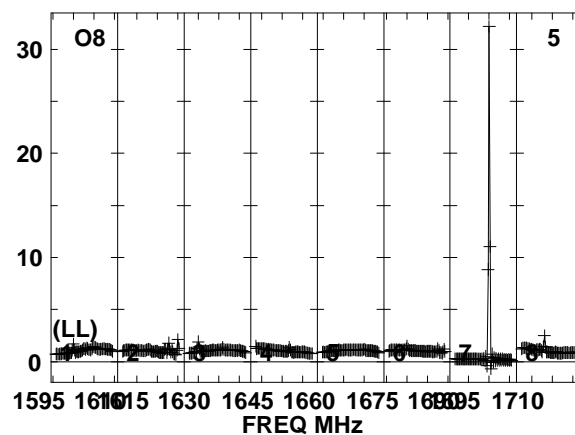
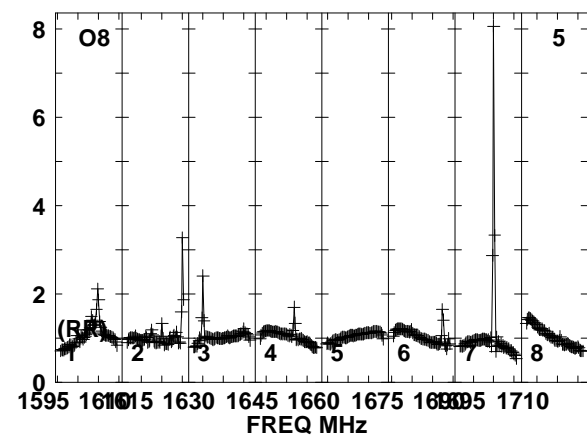
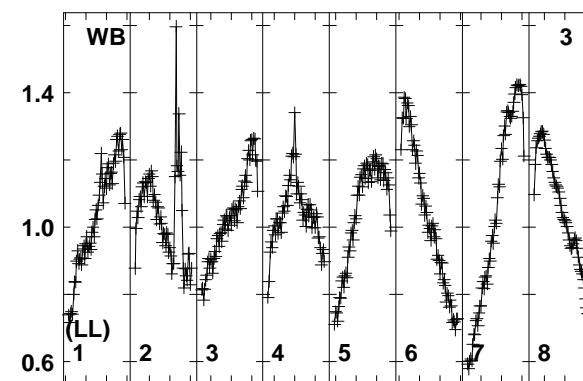
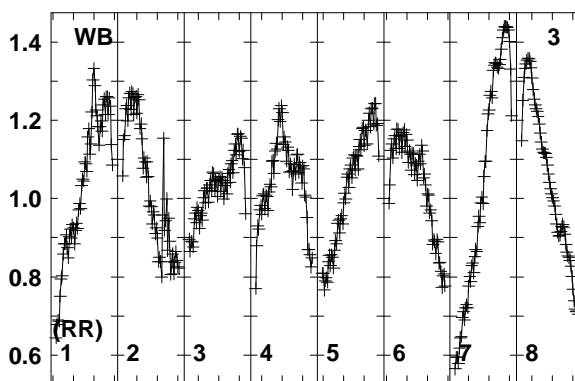
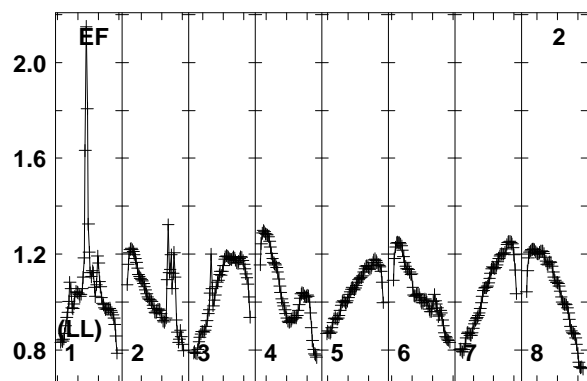
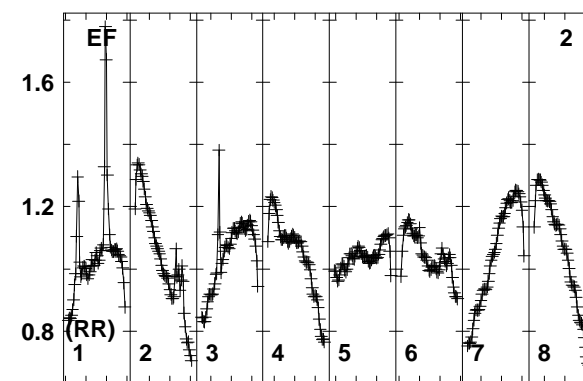
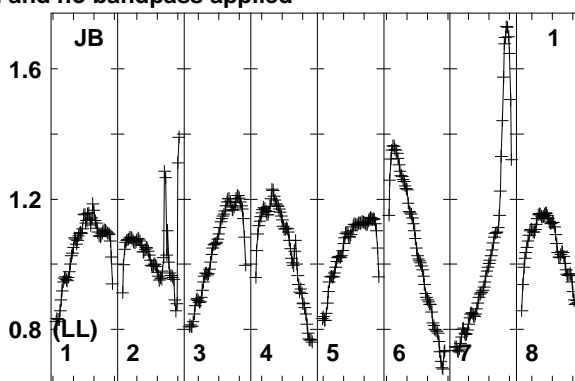
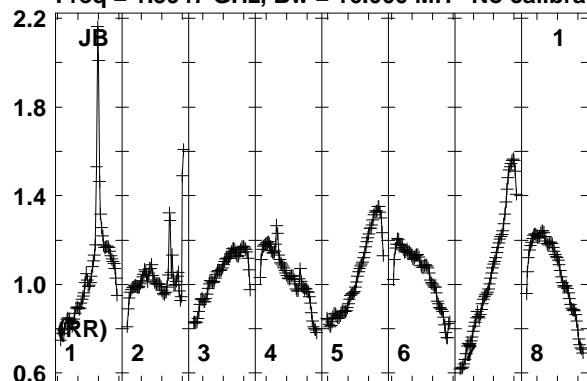

Lower frame: Real Jy
Total-power spectrum Antenna: JB (01)
Timerange: 00/05:22:01 to 00/05:22:59

Plot file version 291 created 04-NOV-2019 14:14:22

J2248-0541 EY034.UVDATA.1

Freq = 1.5947 GHz, Bw = 16.000 MH No calibration applied and no bandpass applied

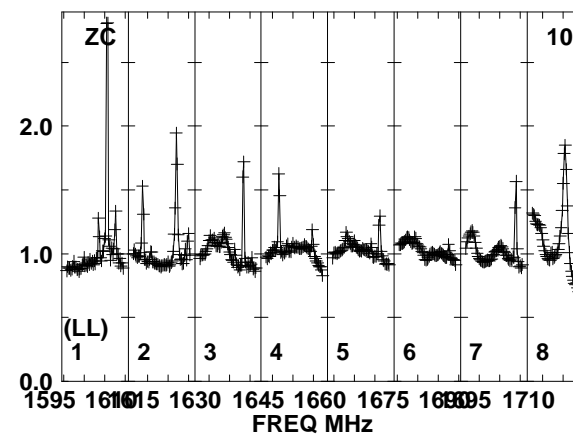
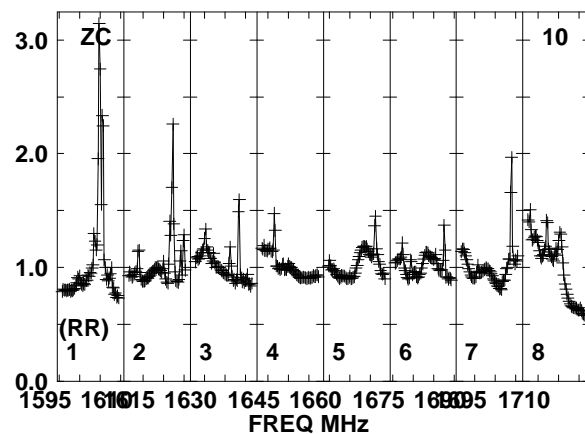
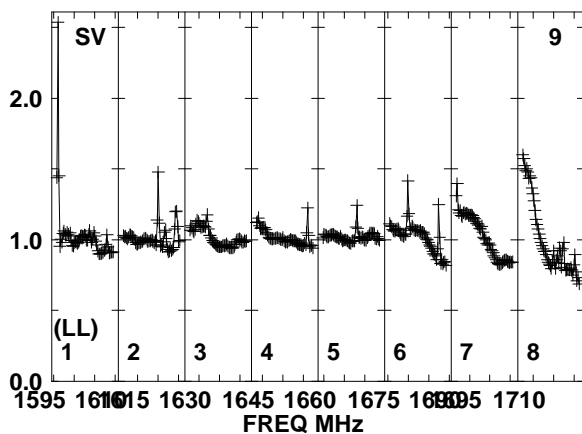
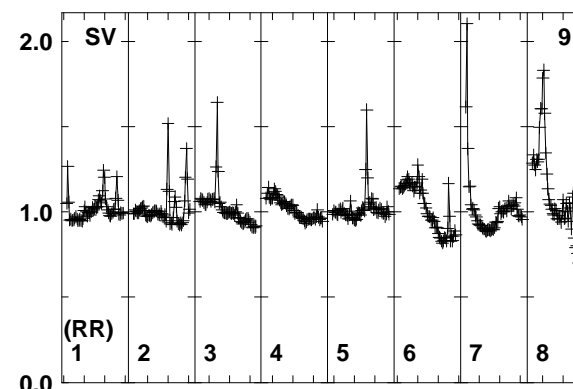
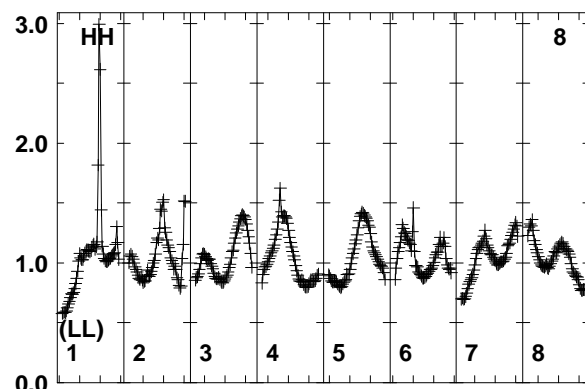
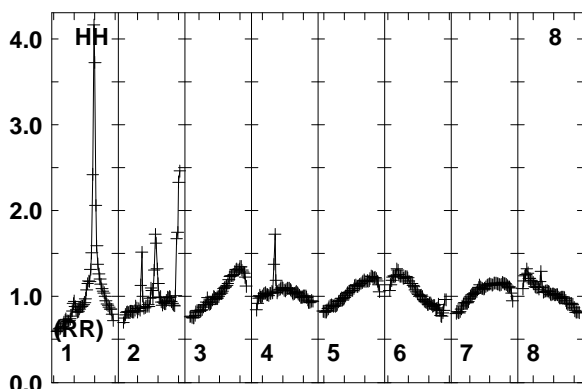
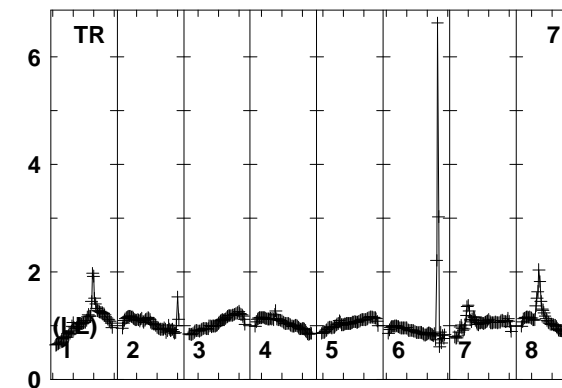
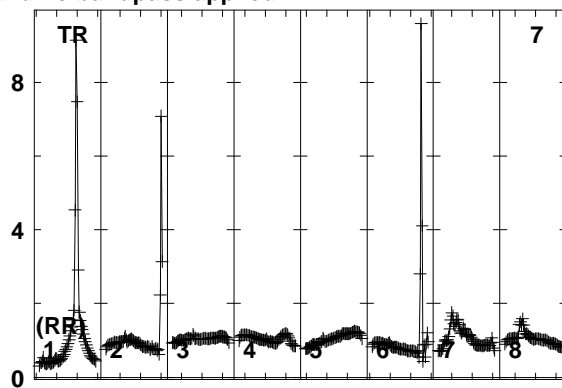
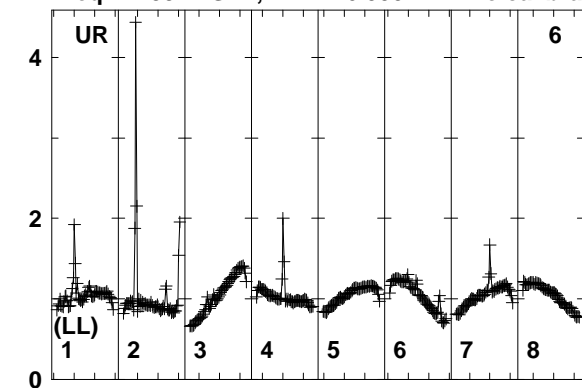

Lower frame: Real Jy
Total-power spectrum Antenna: UR (06)
Timerange: 00/05:22:01 to 00/05:22:59

Plot file version 292 created 04-NOV-2019 14:14:22

J2248-0541 EY034.UVDATA.1

Freq = 1.5947 GHz, Bw = 16.000 MH No calibration applied and no bandpass applied

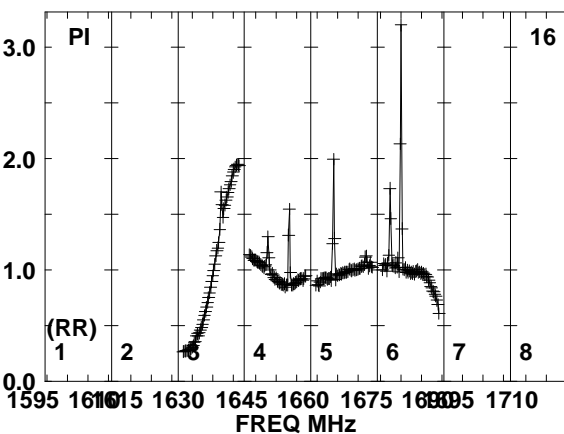
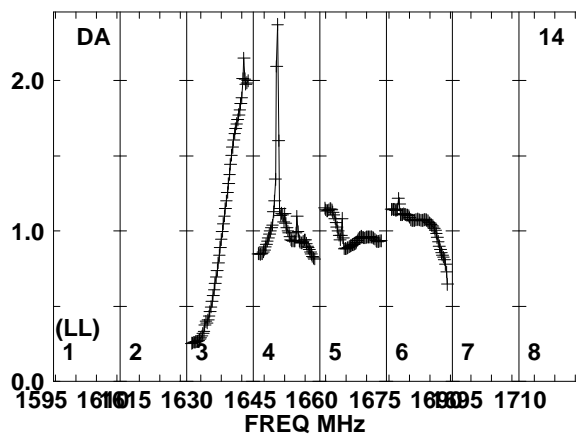
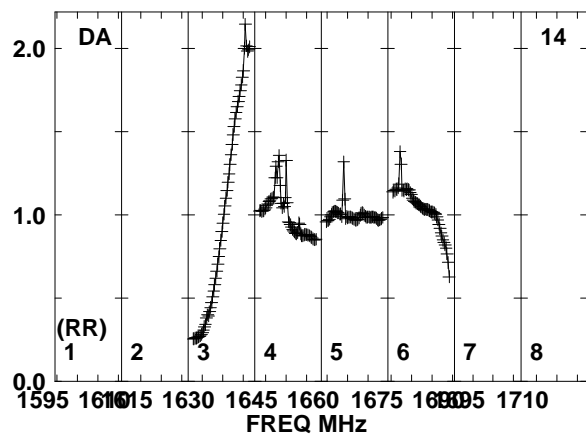
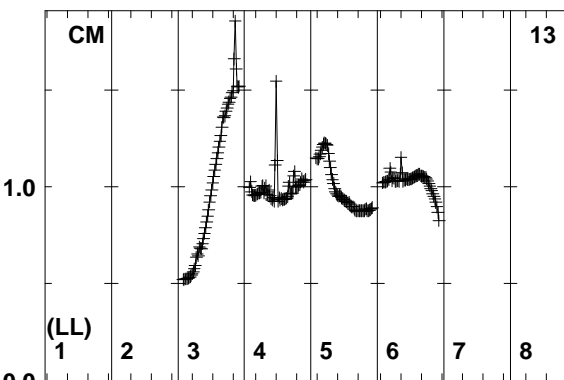
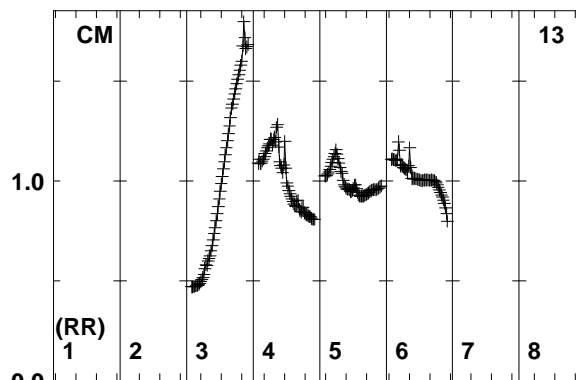
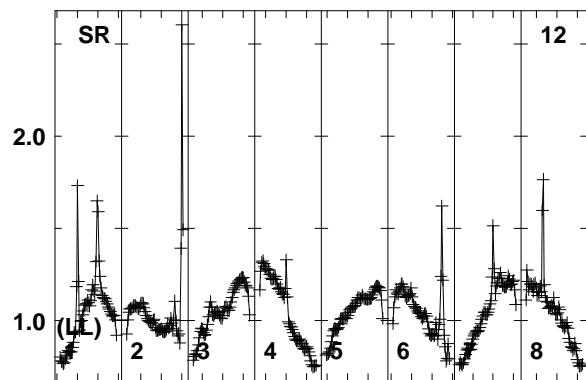
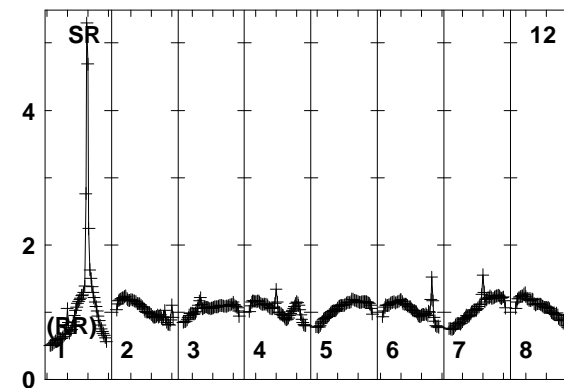
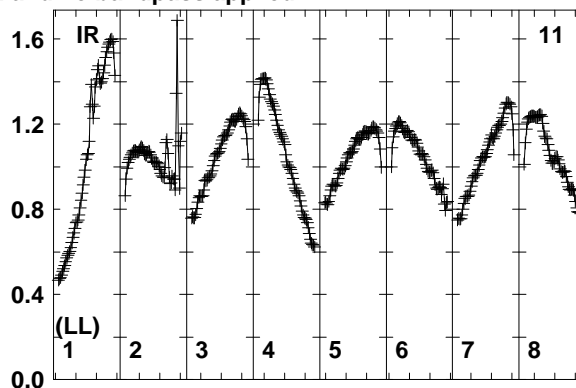
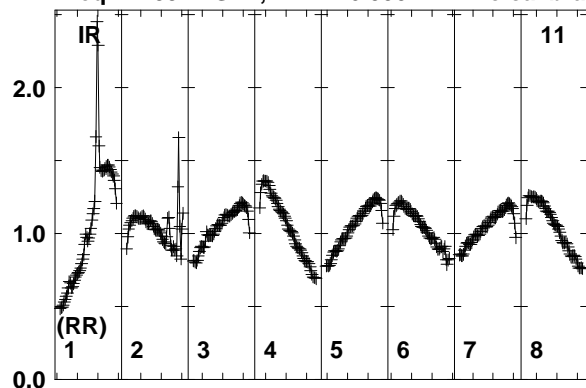

Lower frame: Real Jy
Total-power spectrum Antenna: IR (11)
Timerange: 00/05:22:01 to 00/05:22:59

Plot file version 293 created 04-NOV-2019 14:14:23
J2248-0541 EY034.UVDATA.1
Freq = 1.5947 GHz, Bw = 16.000 MH No calibration applied and no bandpass applied

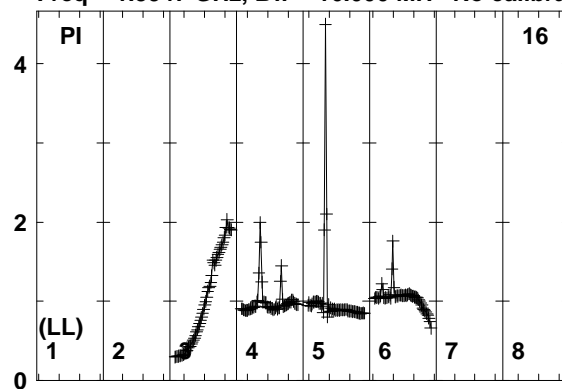

Lower frame: Real Jy
Total-power spectrum Antenna: PI (16)
Timerange: 00/05:22:01 to 00/05:22:59

Plot file version 294 created 04-NOV-2019 14:14:23

W2246-0526 EY034.UVDATA.1

Freq = 1.5947 GHz, Bw = 16.000 MH No calibration applied and no bandpass applied

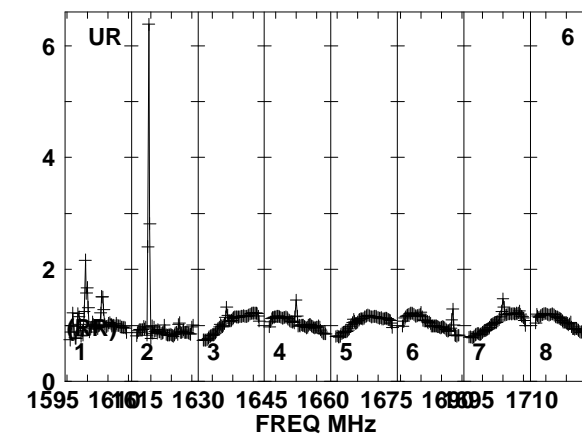
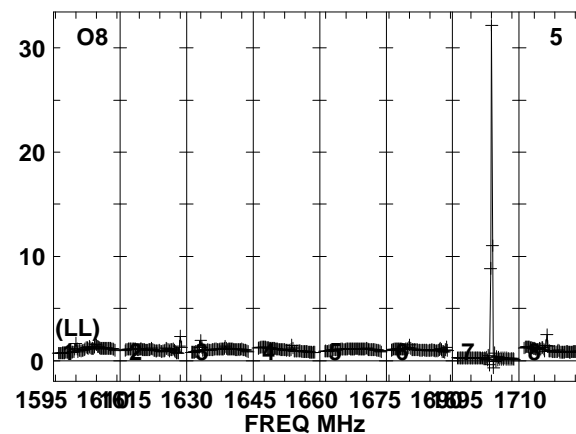
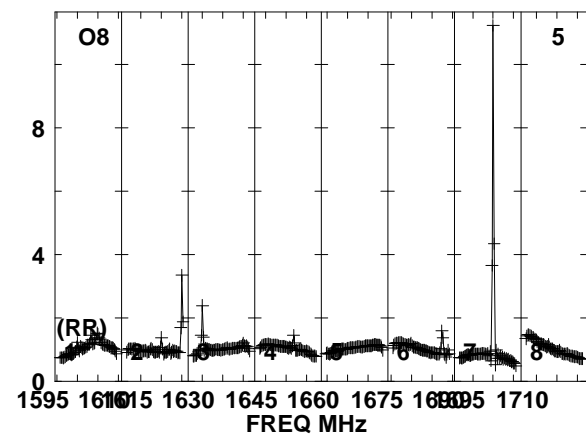
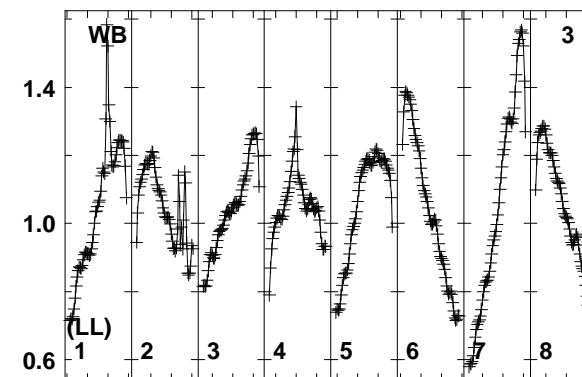
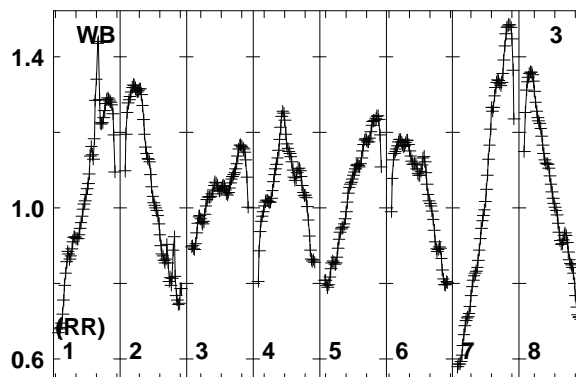
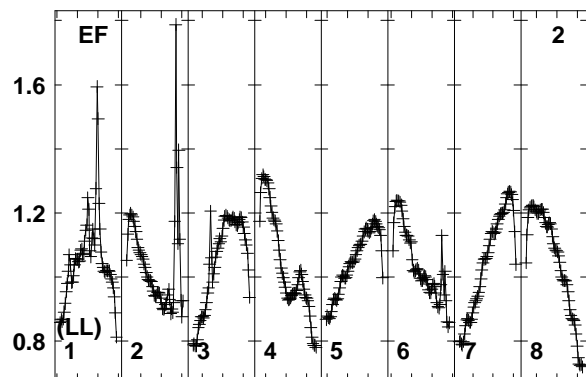
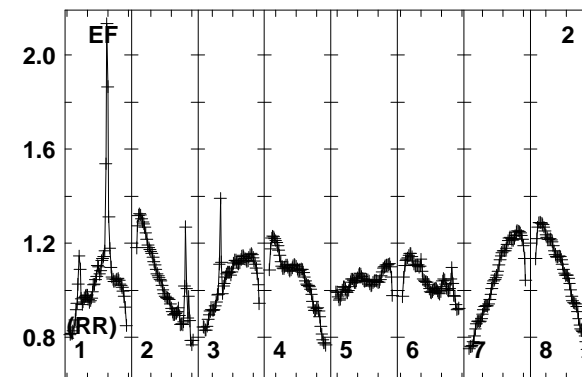
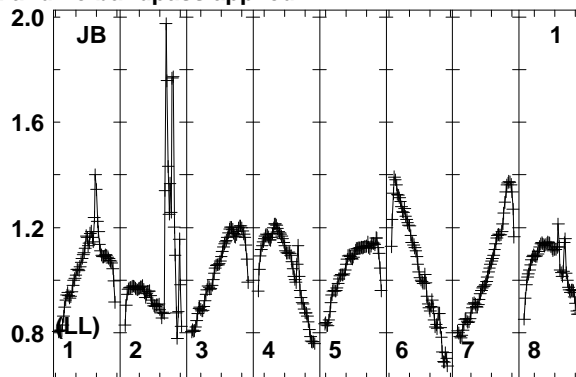
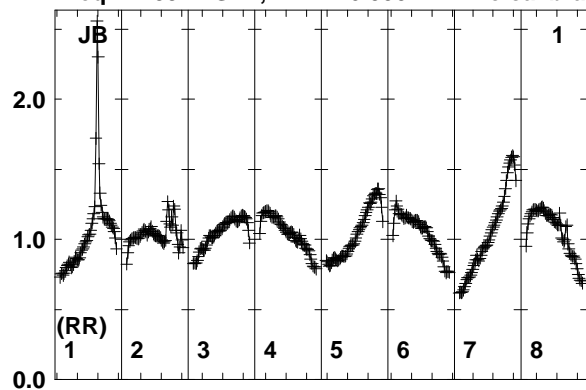

Lower frame: Real Jy
Total-power spectrum Antenna: JB (01)
Timerange: 00/05:23:01 to 00/05:25:29

Plot file version 295 created 04-NOV-2019 14:14:23

W2246-0526 EY034.UVDATA.1

Freq = 1.5947 GHz, Bw = 16.000 MH No calibration applied and no bandpass applied

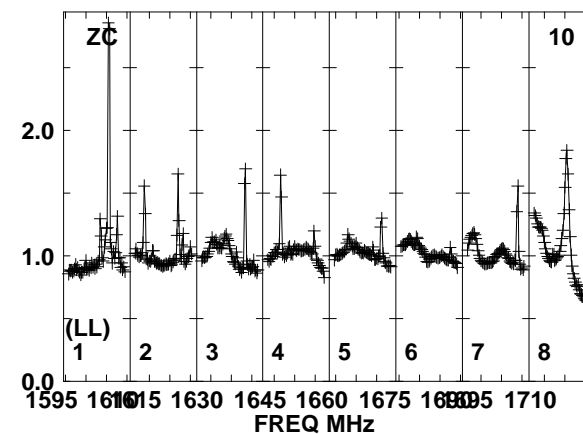
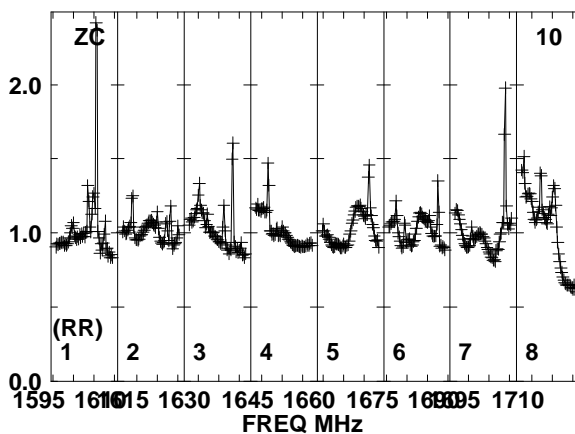
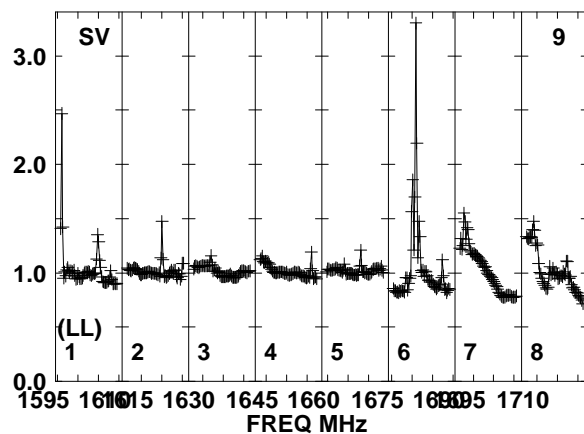
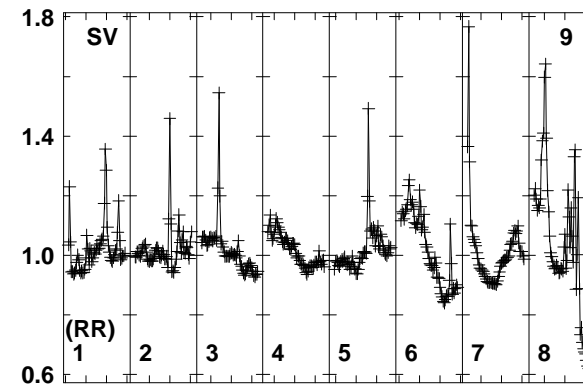
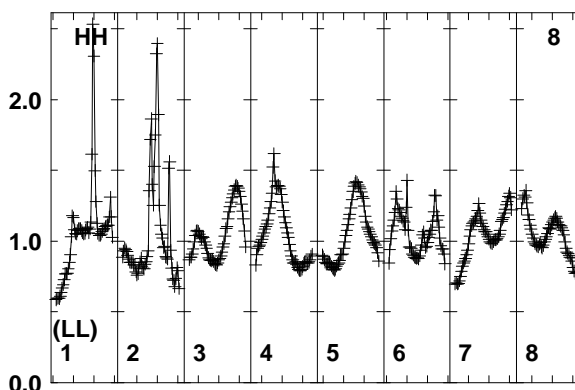
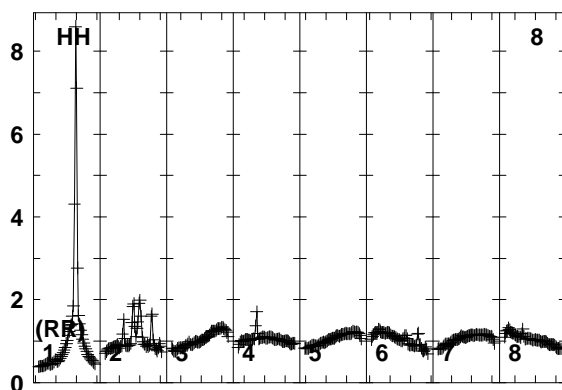
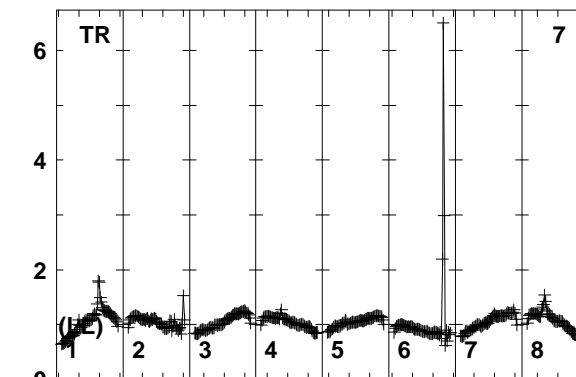
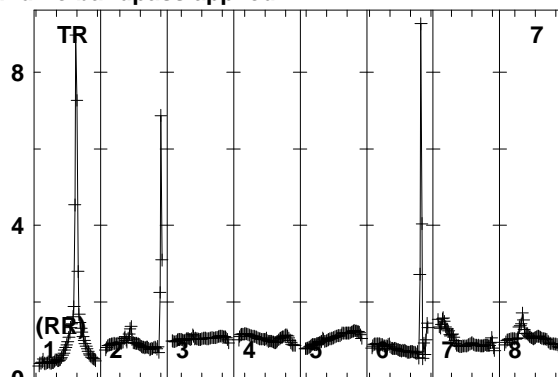
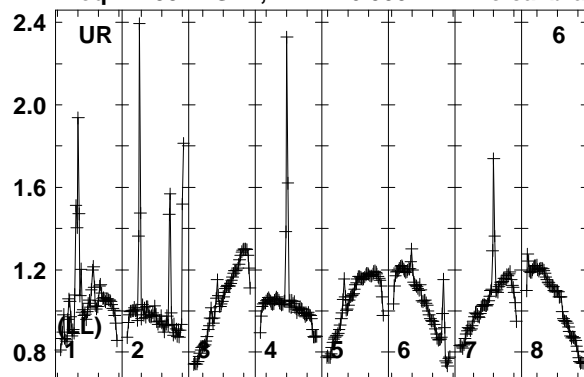

Lower frame: Real Jy
Total-power spectrum Antenna: UR (06)
Timerange: 00/05:23:01 to 00/05:25:29

Plot file version 296 created 04-NOV-2019 14:14:23

W2246-0526 EY034.UVDATA.1

Freq = 1.5947 GHz, Bw = 16.000 MH No calibration applied and no bandpass applied

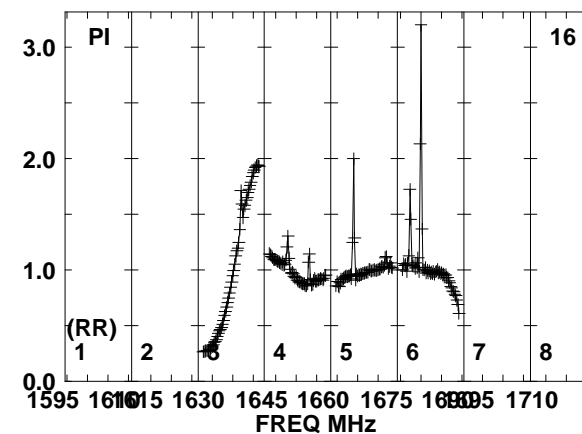
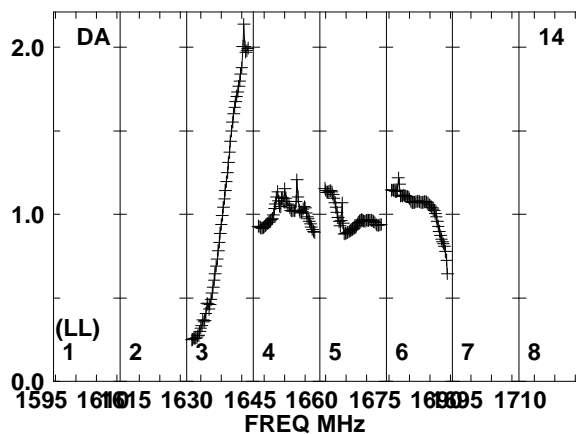
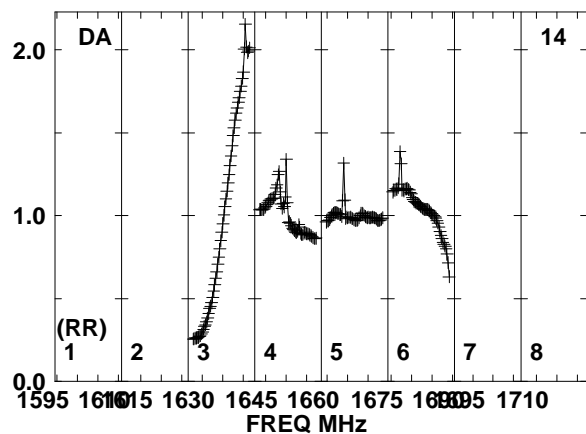
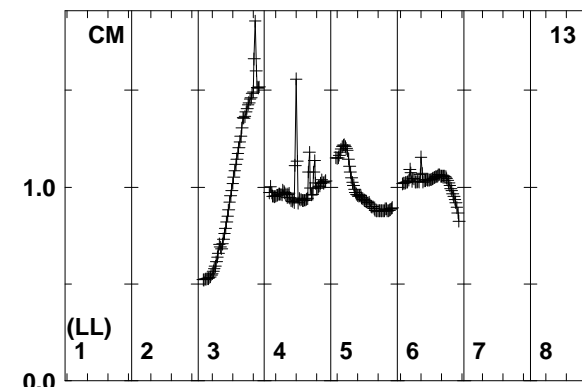
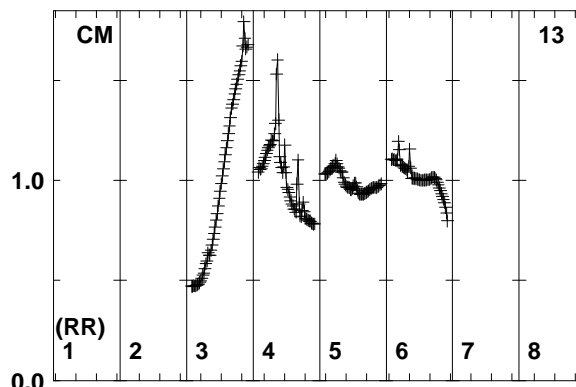
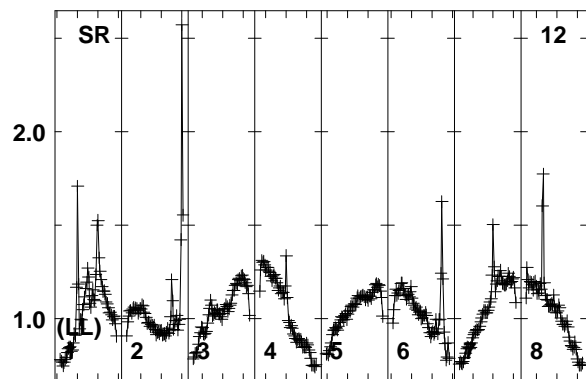
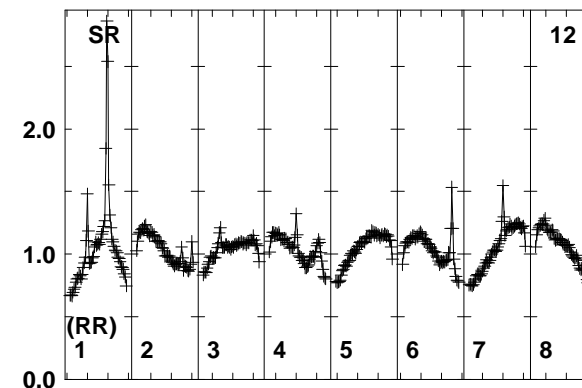
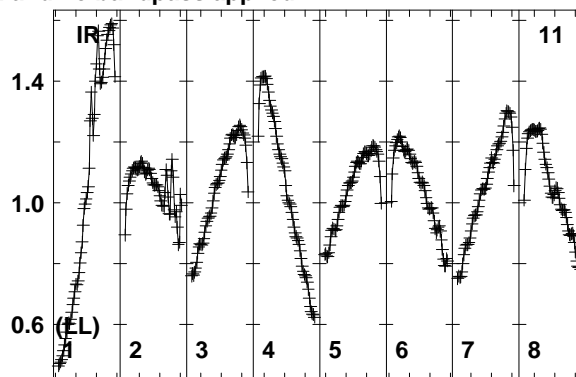
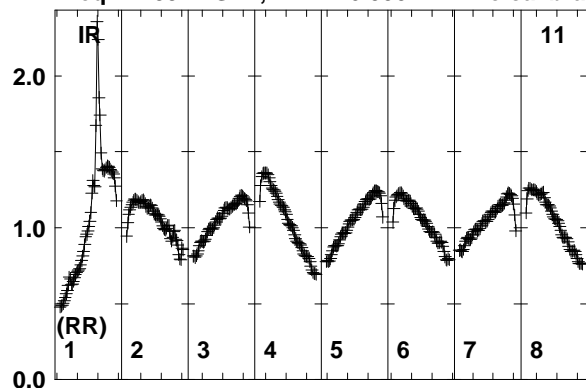

Lower frame: Real Jy
Total-power spectrum Antenna: IR (11)
Timerange: 00/05:23:01 to 00/05:25:29

Plot file version 297 created 04-NOV-2019 14:14:23
W2246-0526 EY034.UVDATA.1
Freq = 1.5947 GHz, Bw = 16.000 MH No calibration applied and no bandpass applied

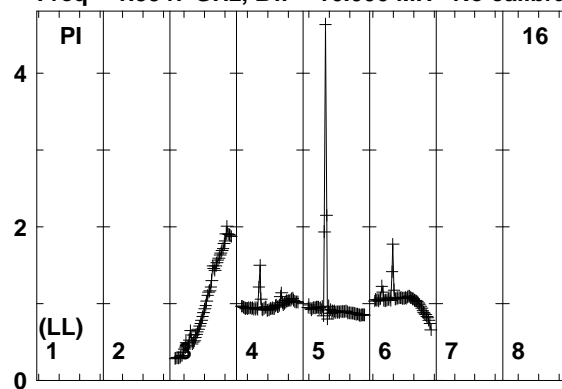

Lower frame: Real Jy
Total-power spectrum Antenna: PI (16)
Timerange: 00/05:23:01 to 00/05:25:29

Plot file version 298 created 04-NOV-2019 14:14:23

J2248-0541 EY034.UVDATA.1

Freq = 1.5947 GHz, Bw = 16.000 MH No calibration applied and no bandpass applied

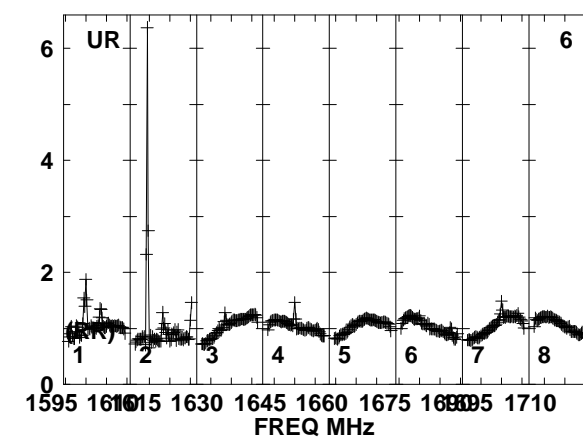
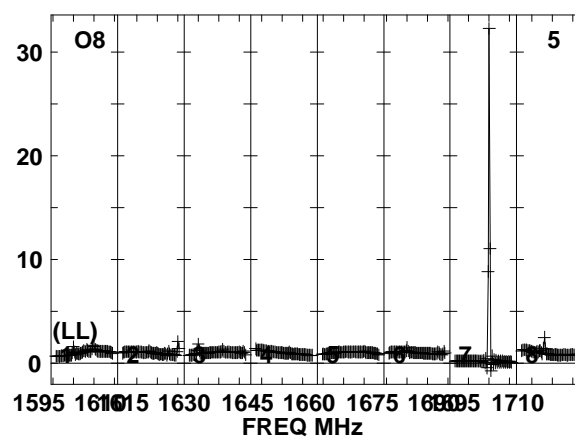
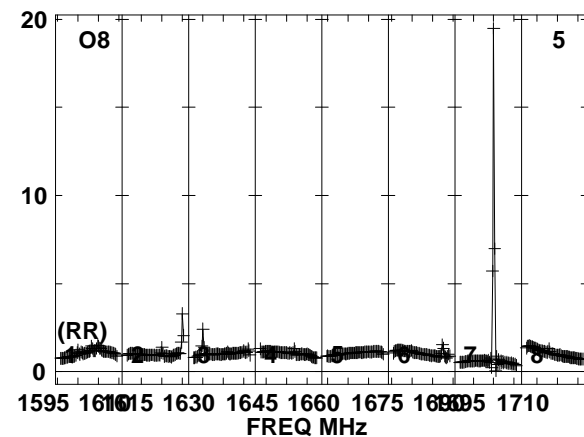
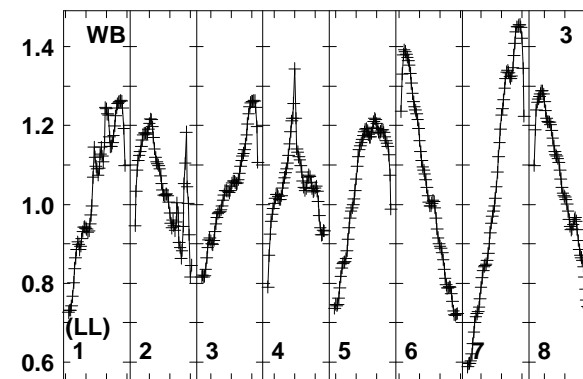
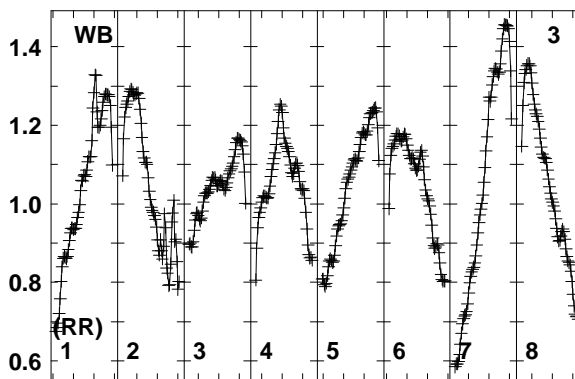
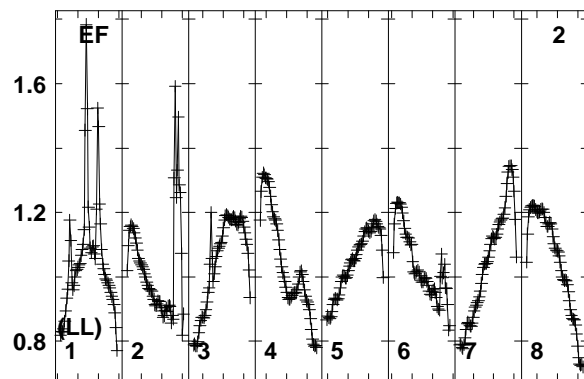
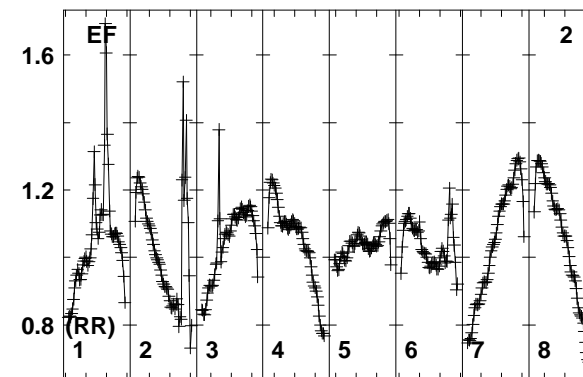
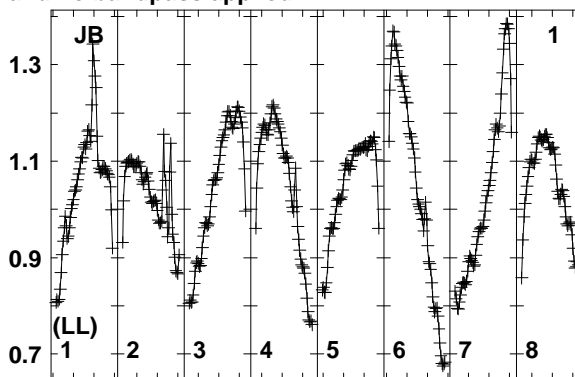
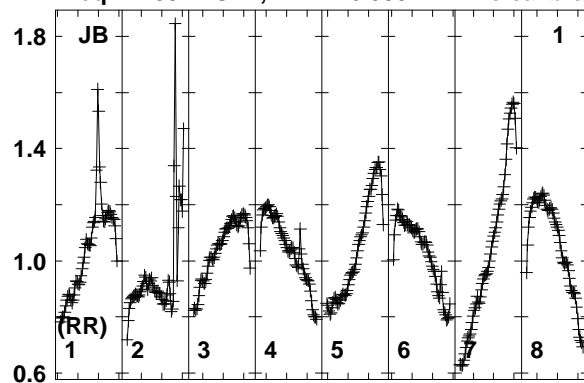

Lower frame: Real Jy
Total-power spectrum Antenna: JB (01)
Timerange: 00/05:25:46 to 00/05:26:44

Plot file version 299 created 04-NOV-2019 14:14:23

J2248-0541 EY034.UVDATA.1

Freq = 1.5947 GHz, Bw = 16.000 MH No calibration applied and no bandpass applied

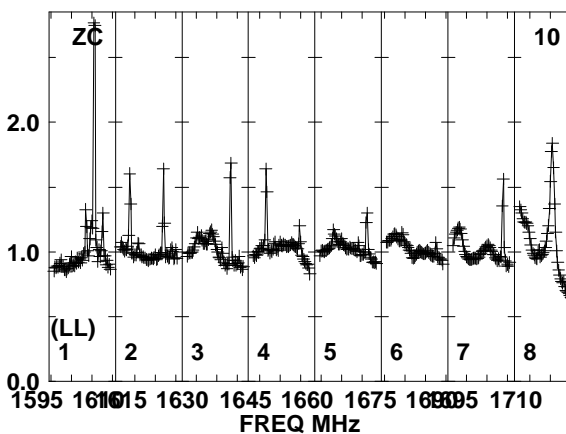
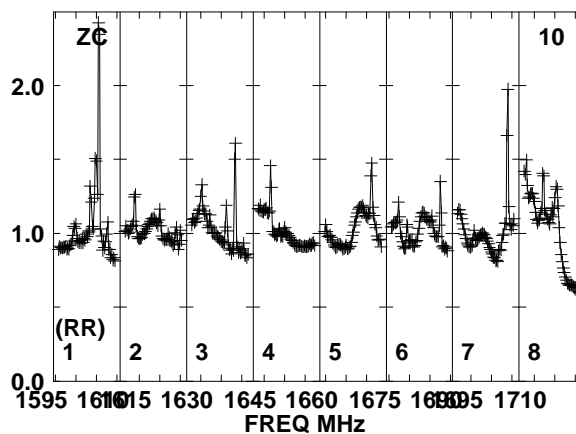
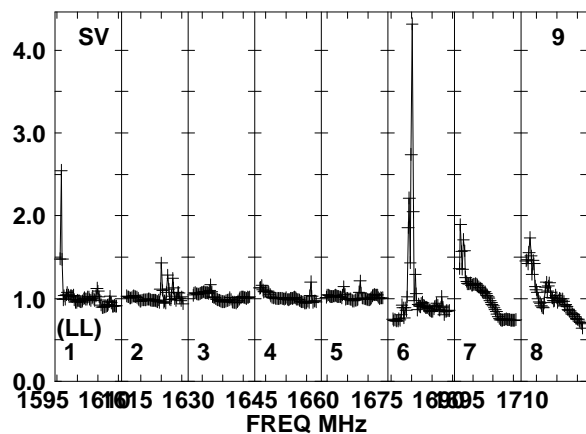
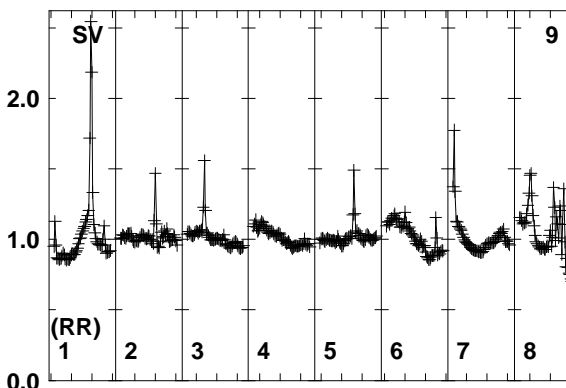
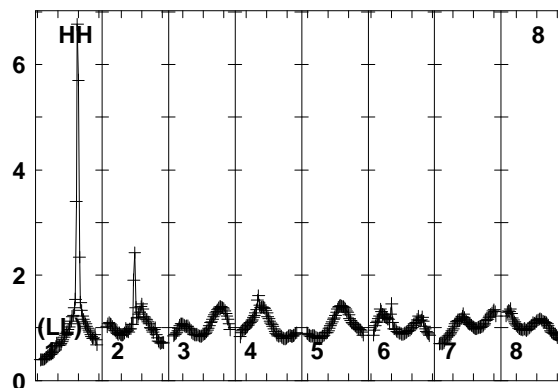
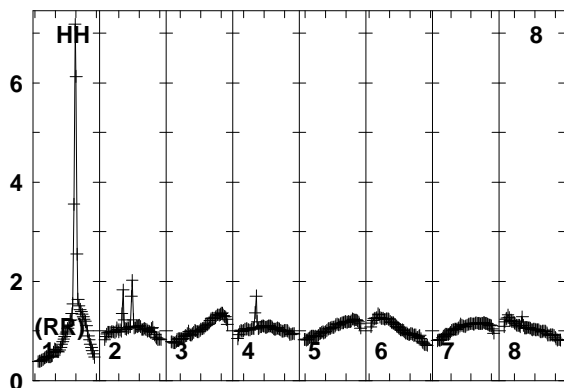
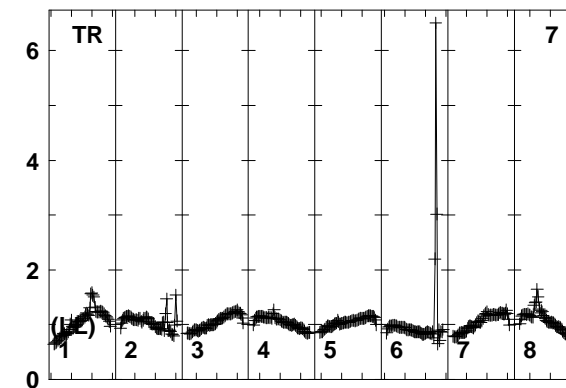
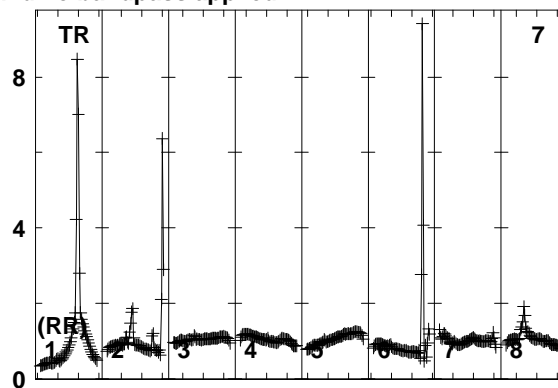
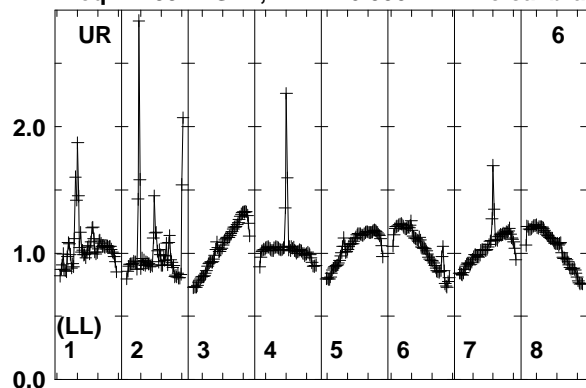

Lower frame: Real Jy
Total-power spectrum Antenna: UR (06)
Timerange: 00/05:25:46 to 00/05:26:44

Plot file version 300 created 04-NOV-2019 14:14:23

J2248-0541 EY034.UVDATA.1

Freq = 1.5947 GHz, Bw = 16.000 MH No calibration applied and no bandpass applied

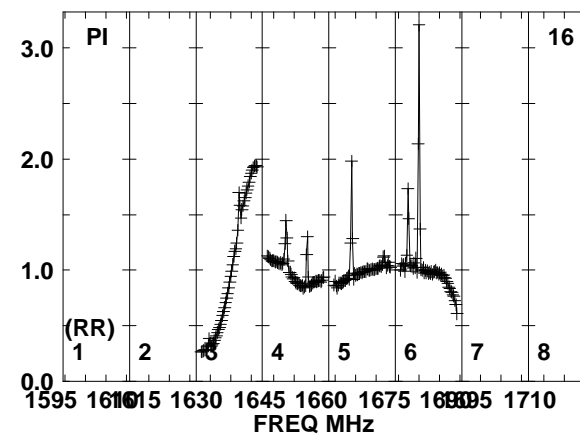
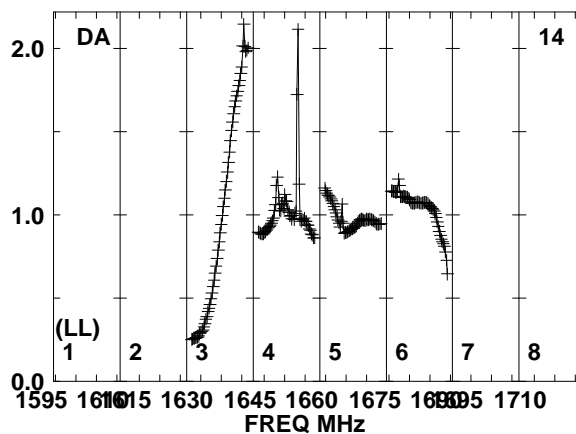
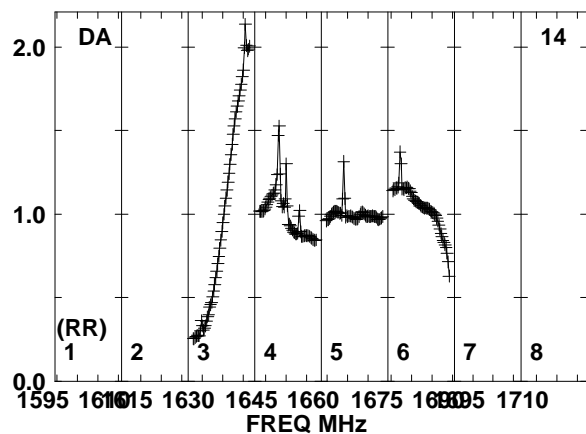
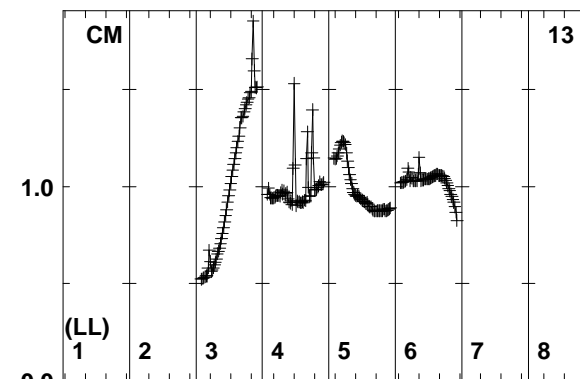
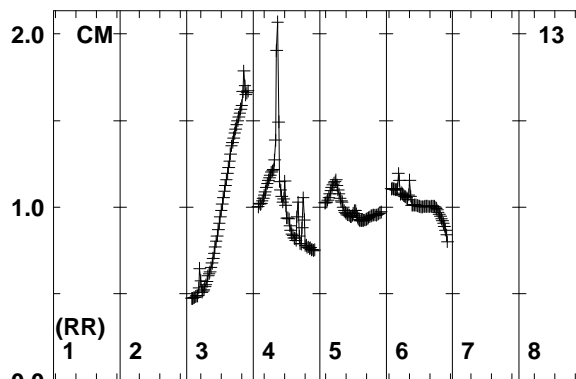
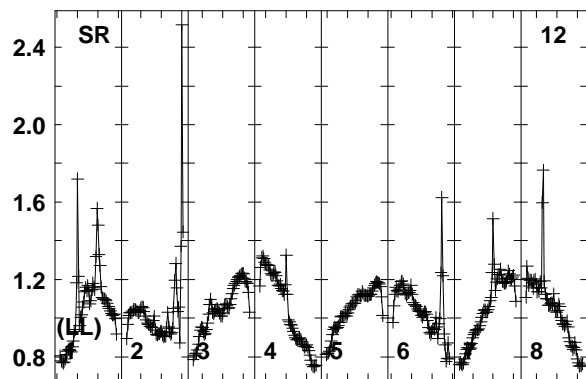
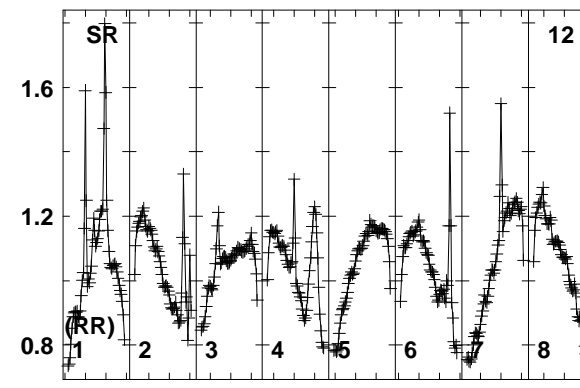
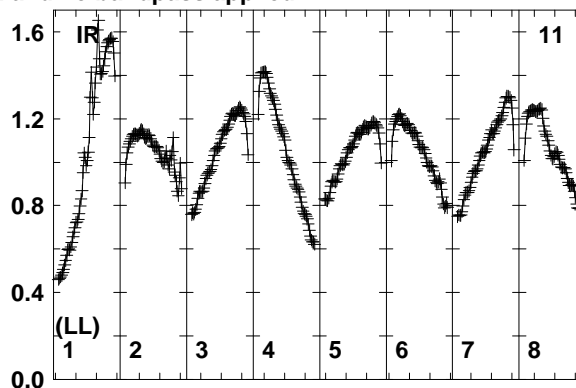
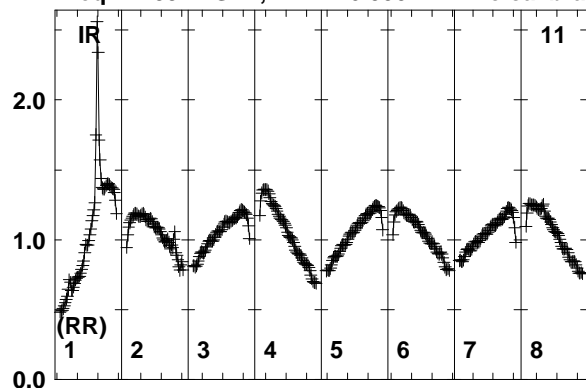

Lower frame: Real Jy
Total-power spectrum Antenna: IR (11)
Timerange: 00/05:25:46 to 00/05:26:44

Plot file version 301 created 04-NOV-2019 14:14:23
J2248-0541 EY034.UVDATA.1
Freq = 1.5947 GHz, Bw = 16.000 MH No calibration applied and no bandpass applied

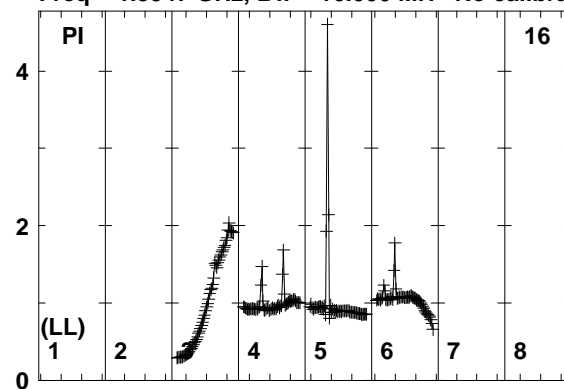

Lower frame: Real Jy
Total-power spectrum Antenna: PI (16)
Timerange: 00/05:25:46 to 00/05:26:44

Plot file version 302 created 04-NOV-2019 14:14:23

W2246-0526 EY034.UVDATA.1

Freq = 1.5947 GHz, Bw = 16.000 MH No calibration applied and no bandpass applied

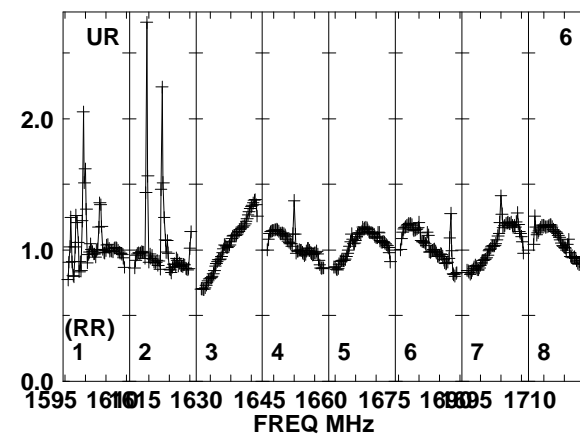
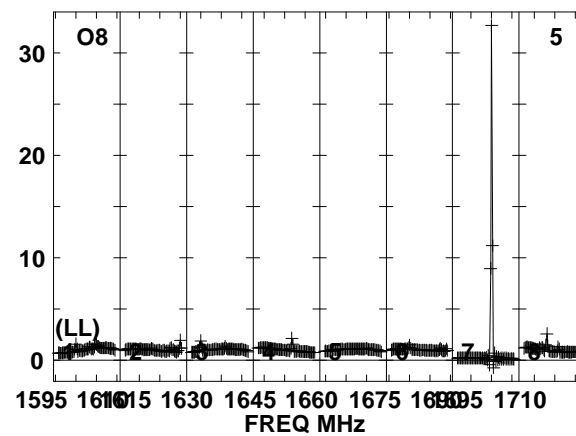
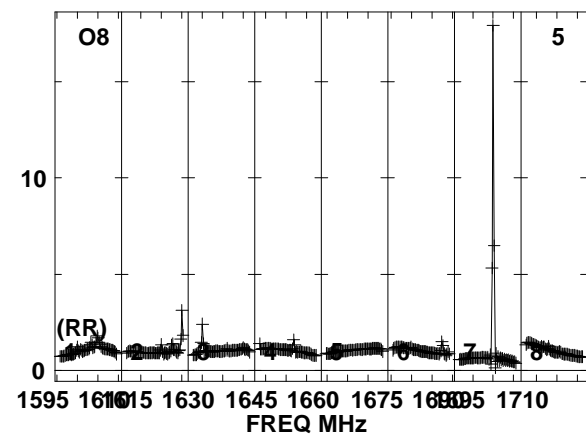
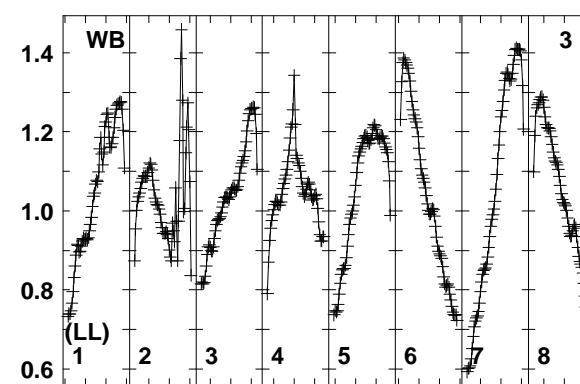
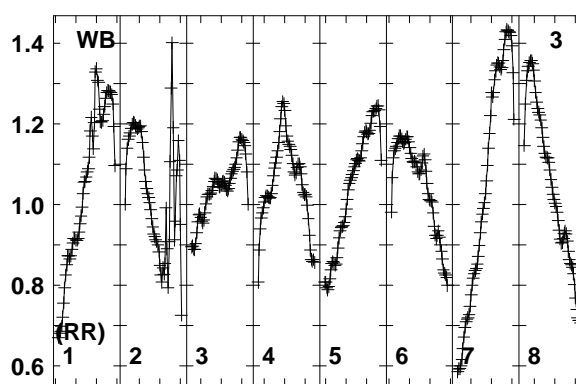
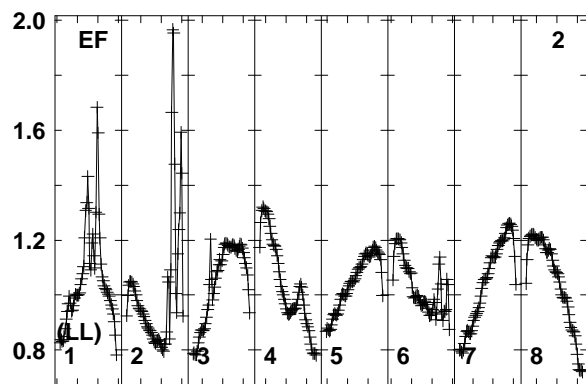
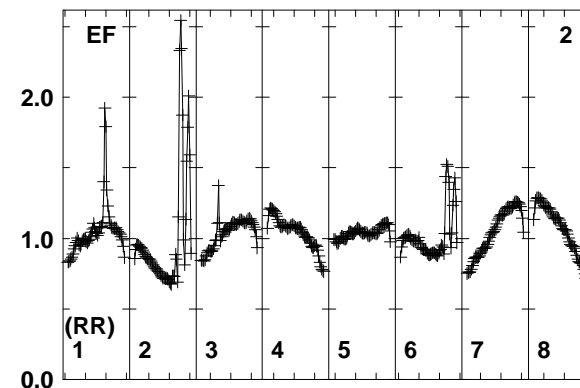
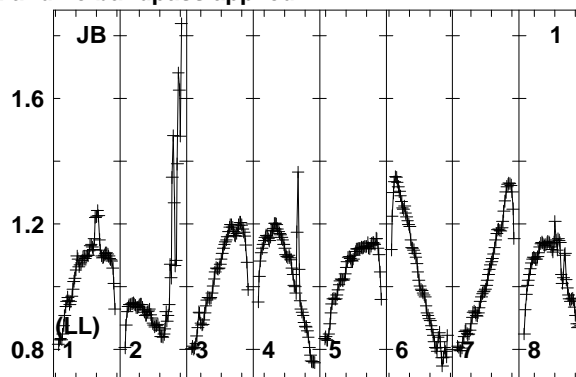
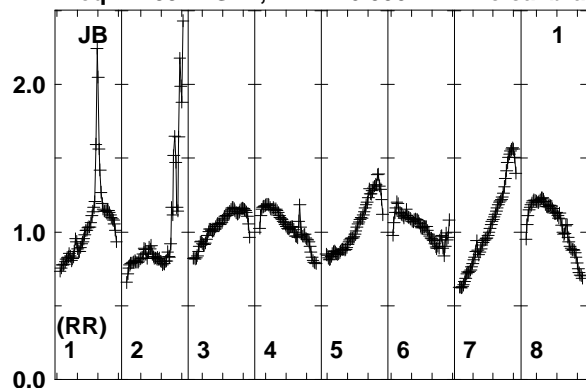

Lower frame: Real Jy
Total-power spectrum Antenna: JB (01)
Timerange: 00/05:26:46 to 00/05:29:24

Plot file version 303 created 04-NOV-2019 14:14:23

W2246-0526 EY034.UVDATA.1

Freq = 1.5947 GHz, Bw = 16.000 MH No calibration applied and no bandpass applied

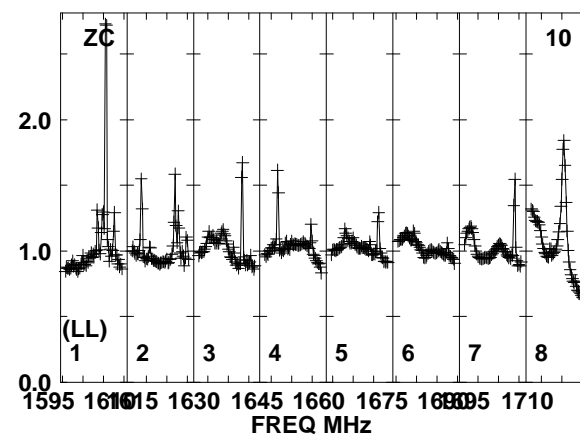
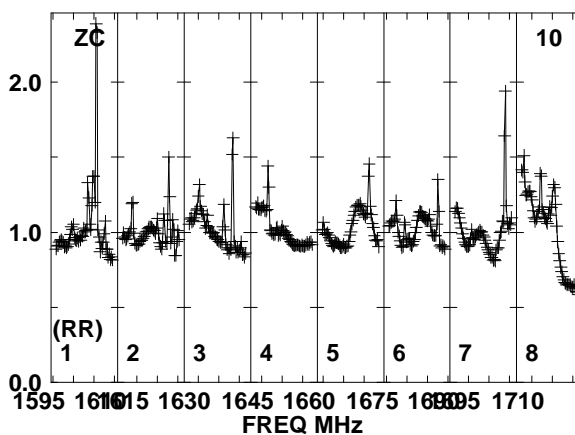
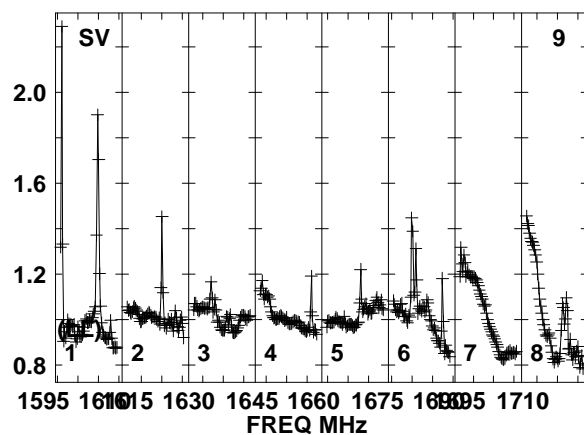
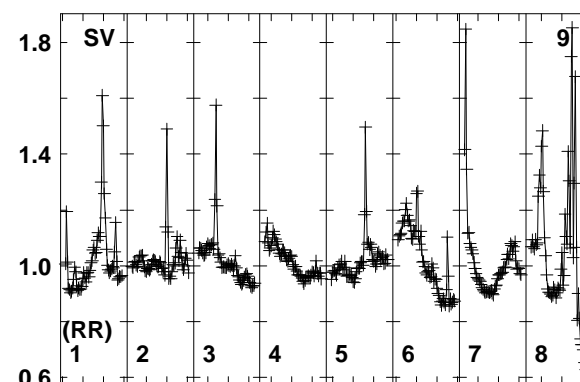
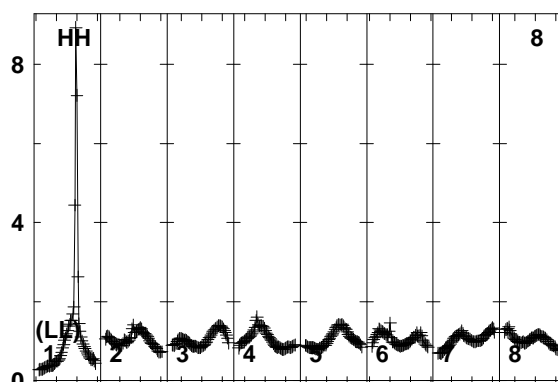
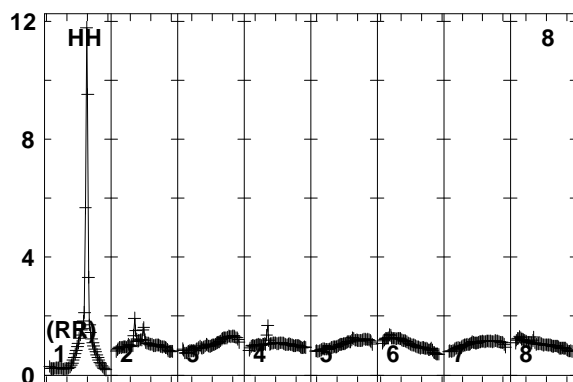
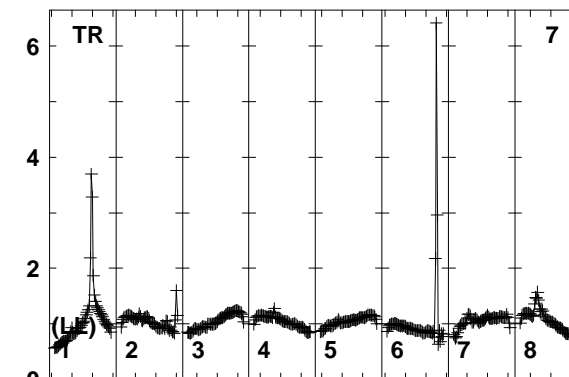
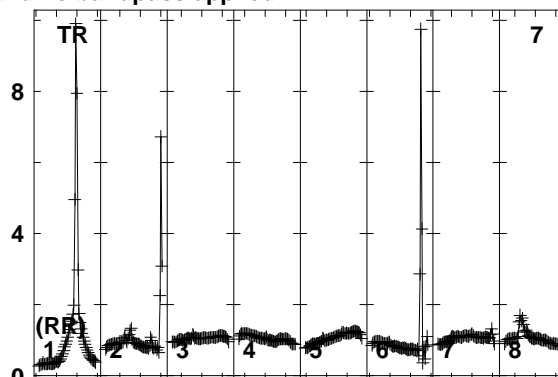
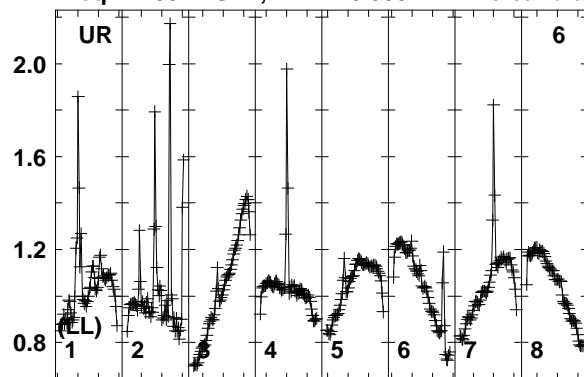

Lower frame: Real Jy
Total-power spectrum Antenna: UR (06)
Timerange: 00/05:26:46 to 00/05:29:24

Plot file version 304 created 04-NOV-2019 14:14:24

W2246-0526 EY034.UVDATA.1

Freq = 1.5947 GHz, Bw = 16.000 MH No calibration applied and no bandpass applied

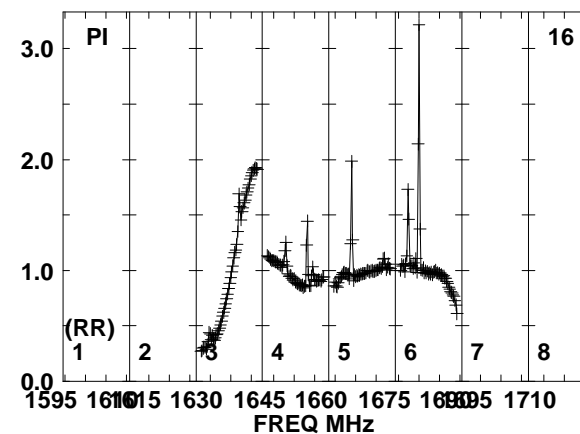
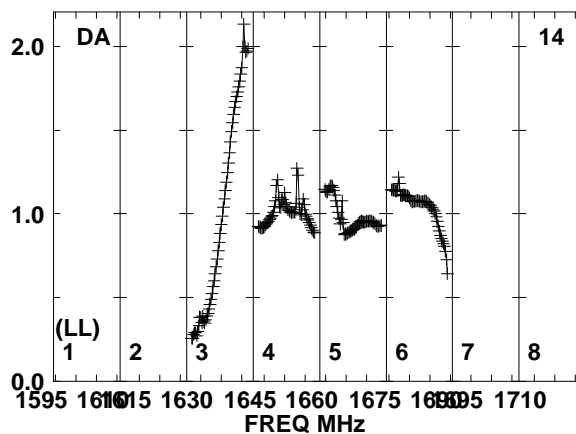
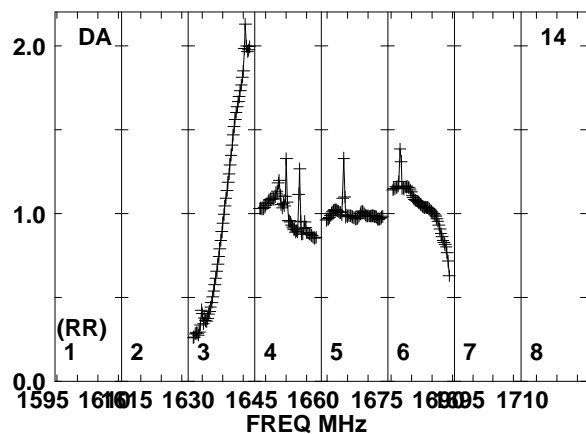
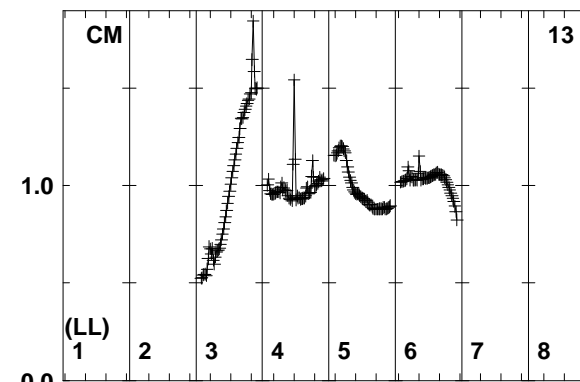
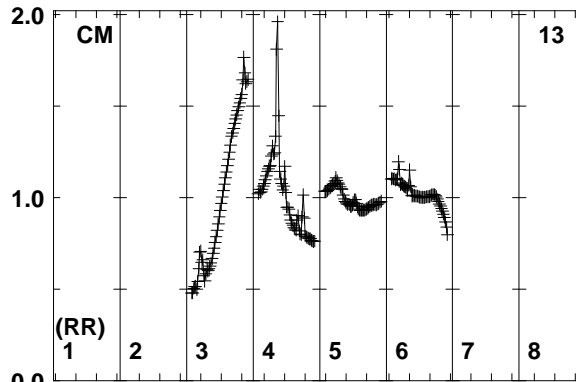
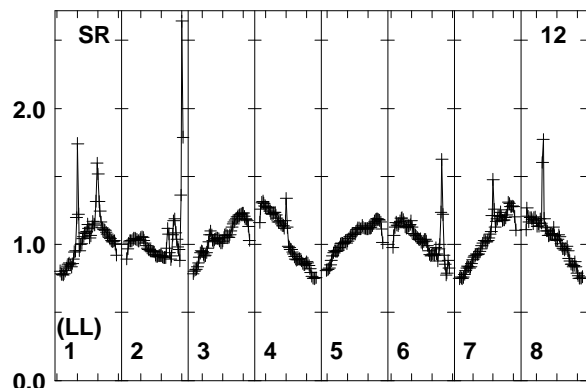
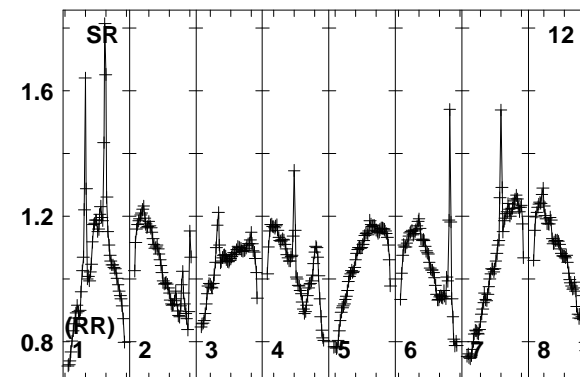
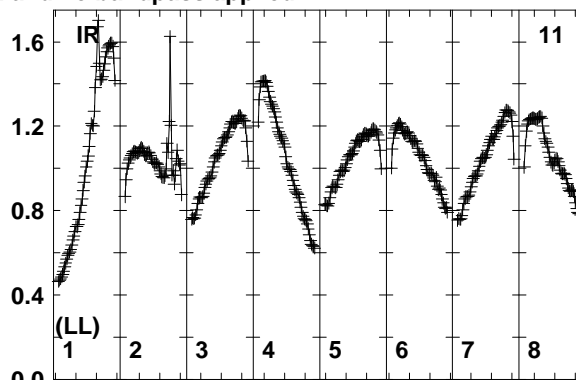
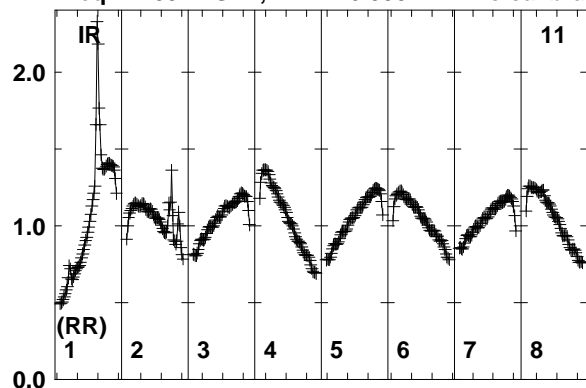

Lower frame: Real Jy
Total-power spectrum Antenna: IR (11)
Timerange: 00/05:26:46 to 00/05:29:24

Plot file version 305 created 04-NOV-2019 14:14:24
W2246-0526 EY034.UVDATA.1
Freq = 1.5947 GHz, Bw = 16.000 MH No calibration applied and no bandpass applied

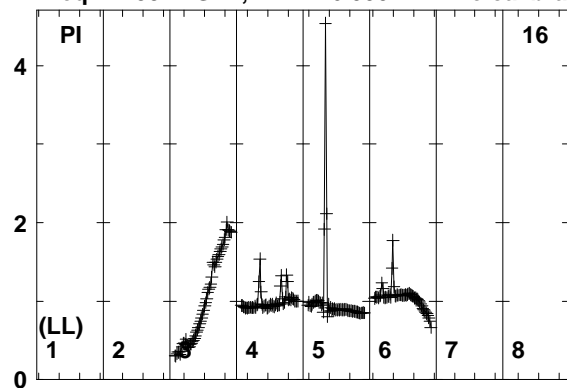

Lower frame: Real Jy
Total-power spectrum Antenna: PI (16)
Timerange: 00/05:26:46 to 00/05:29:24

Plot file version 306 created 04-NOV-2019 14:14:24

J2248-0541 EY034.UVDATA.1

Freq = 1.5947 GHz, Bw = 16.000 MH No calibration applied and no bandpass applied

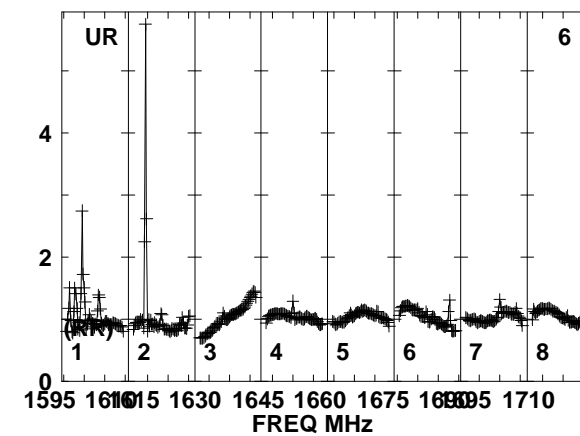
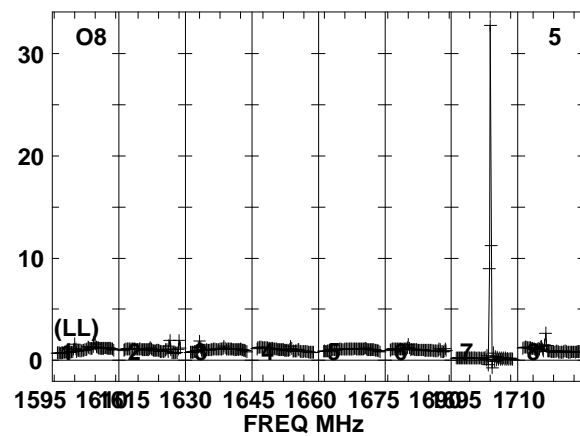
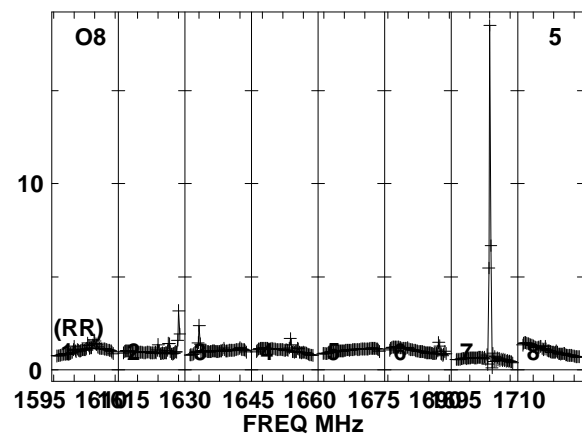
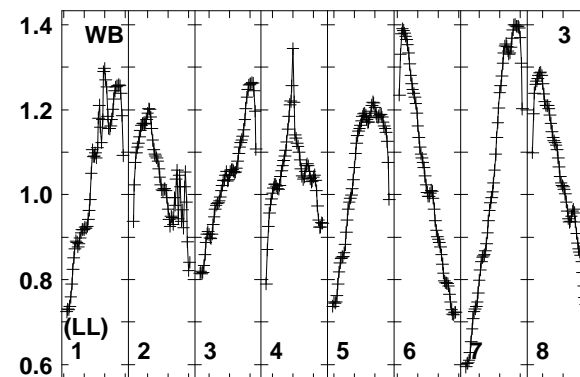
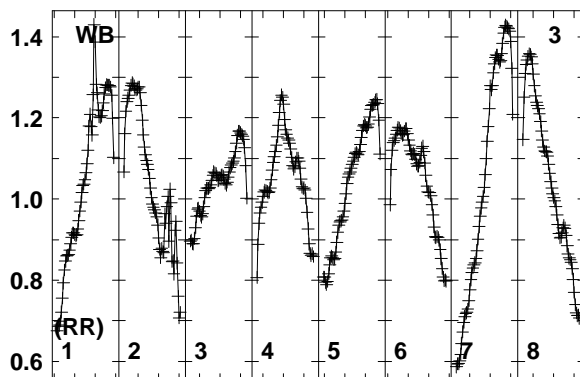
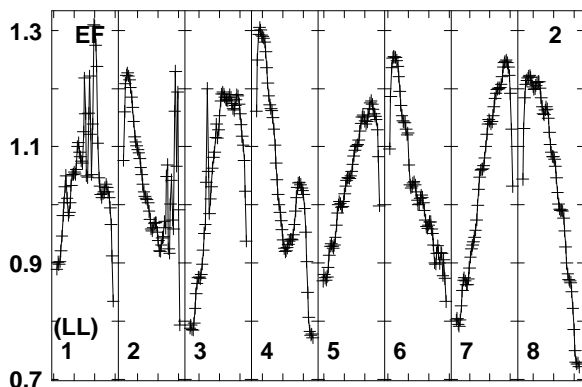
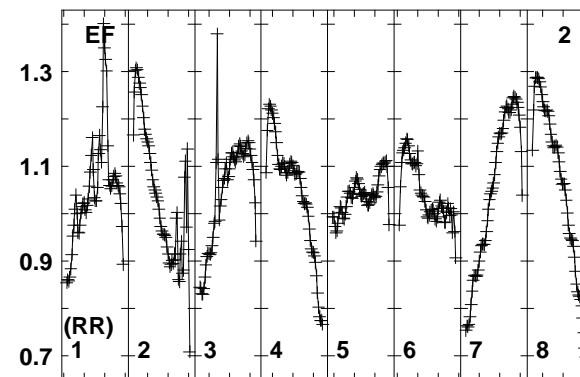
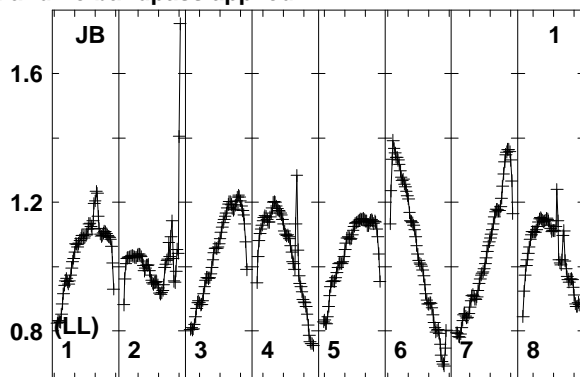
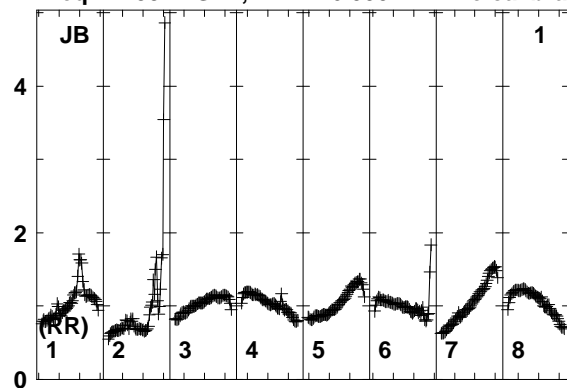

Lower frame: Real Jy
Total-power spectrum Antenna: JB (01)
Timerange: 00/05:29:41 to 00/05:30:39

Plot file version 307 created 04-NOV-2019 14:14:24

J2248-0541 EY034.UVDATA.1

Freq = 1.5947 GHz, Bw = 16.000 MH No calibration applied and no bandpass applied

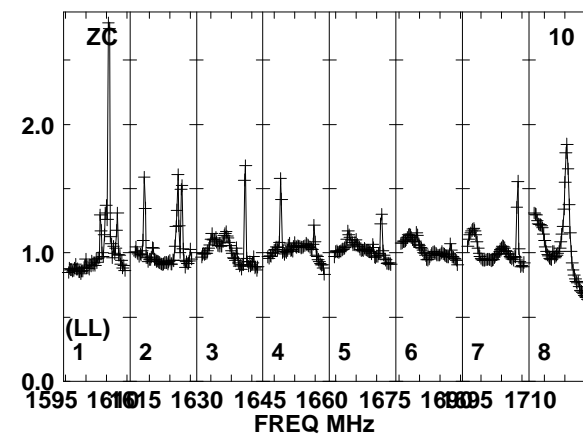
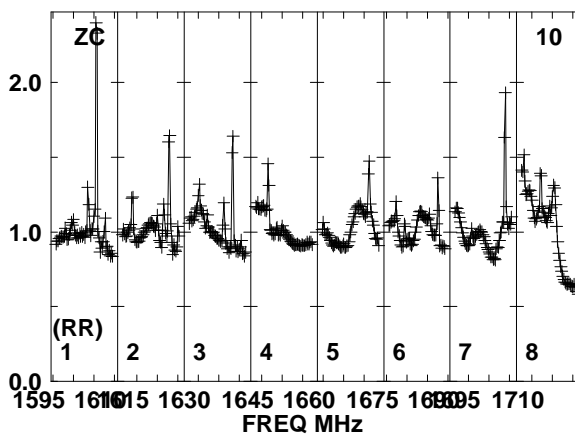
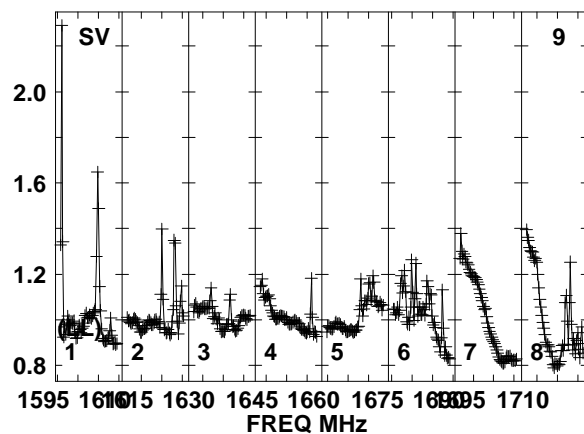
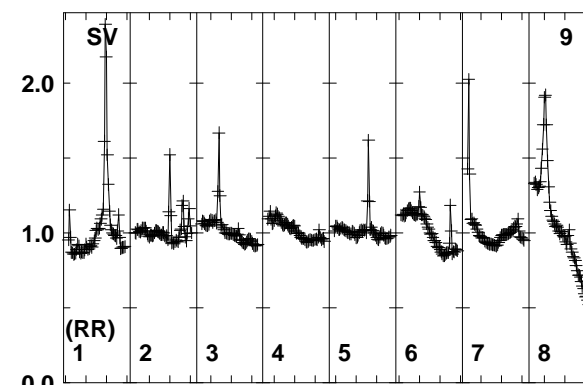
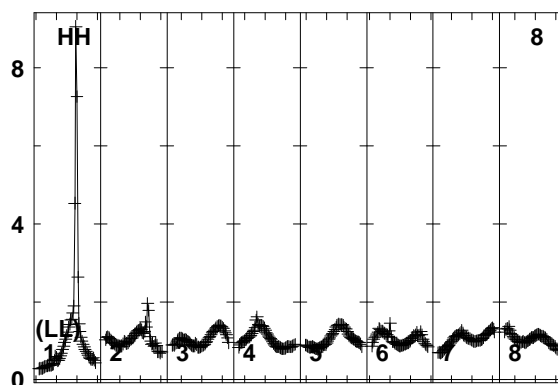
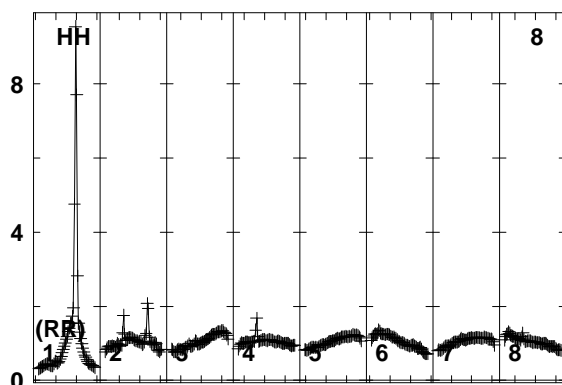
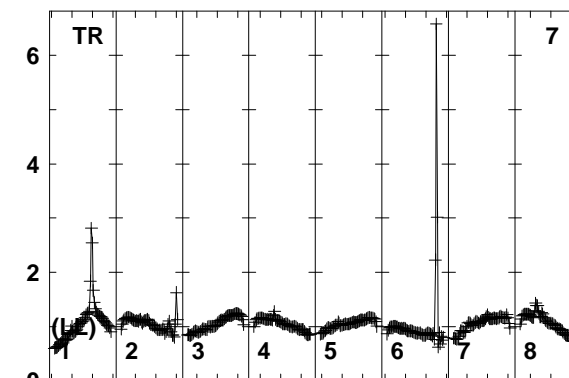
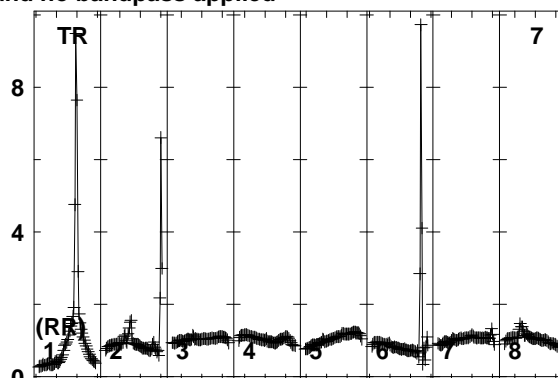
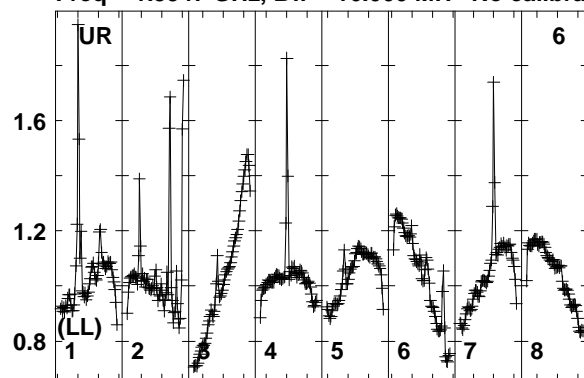

Lower frame: Real Jy
Total-power spectrum Antenna: UR (06)
Timerange: 00/05:29:41 to 00/05:30:39

Plot file version 308 created 04-NOV-2019 14:14:24

J2248-0541 EY034.UVDATA.1

Freq = 1.5947 GHz, Bw = 16.000 MH No calibration applied and no bandpass applied

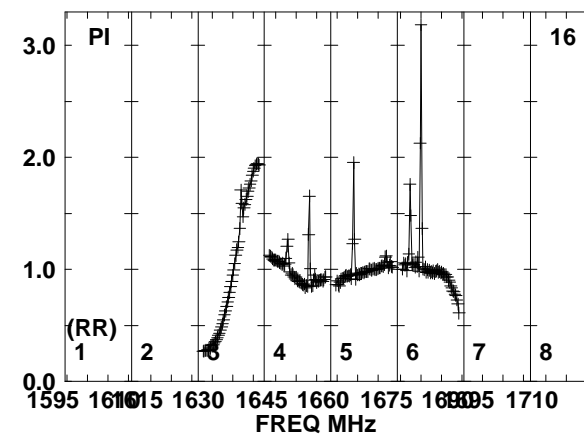
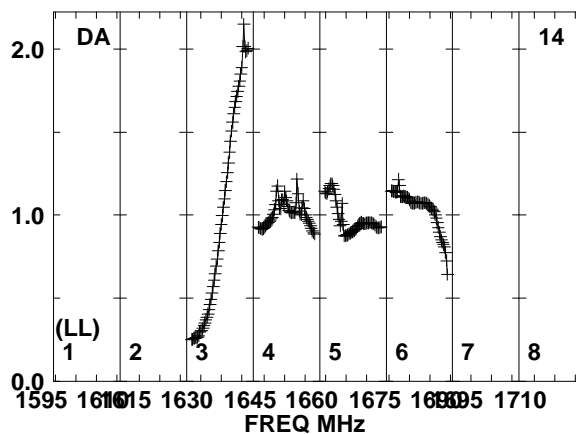
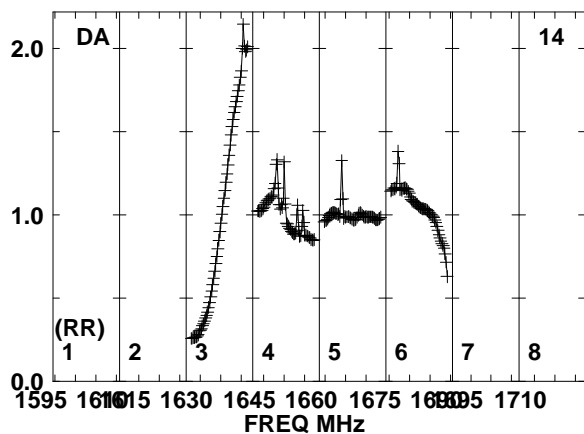
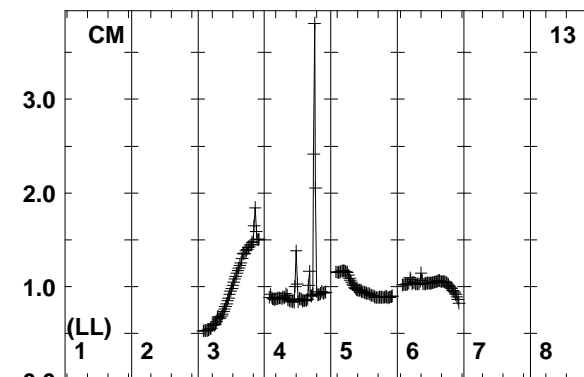
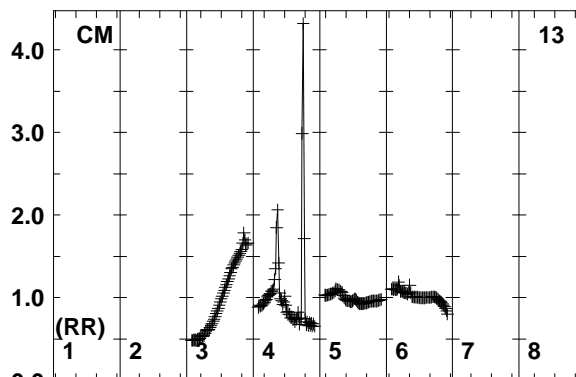
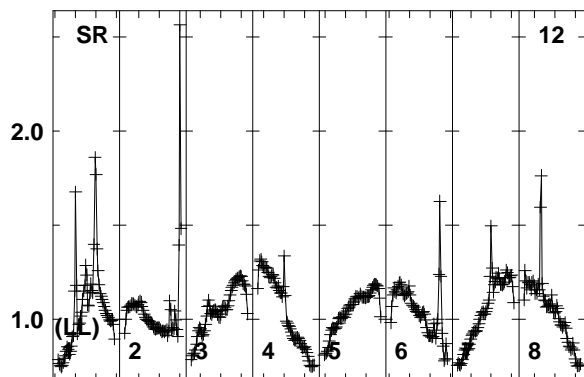
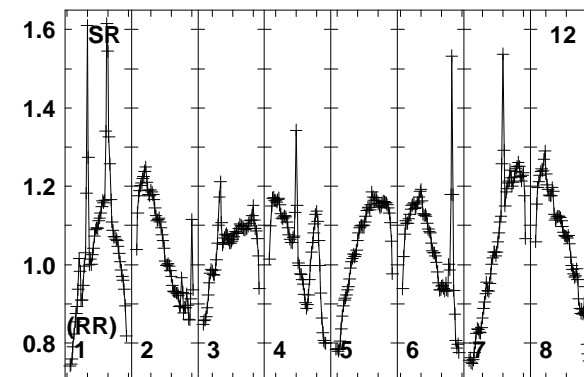
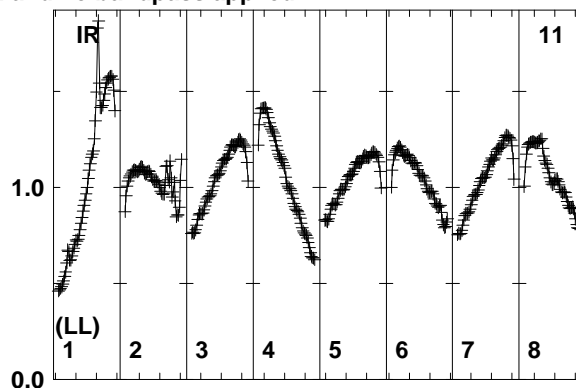
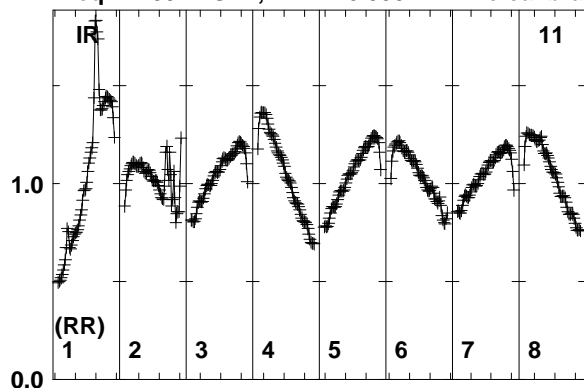

Lower frame: Real Jy
Total-power spectrum Antenna: IR (11)
Timerange: 00/05:29:41 to 00/05:30:39

Plot file version 309 created 04-NOV-2019 14:14:24
J2248-0541 EY034.UVDATA.1
Freq = 1.5947 GHz, Bw = 16.000 MH No calibration applied and no bandpass applied

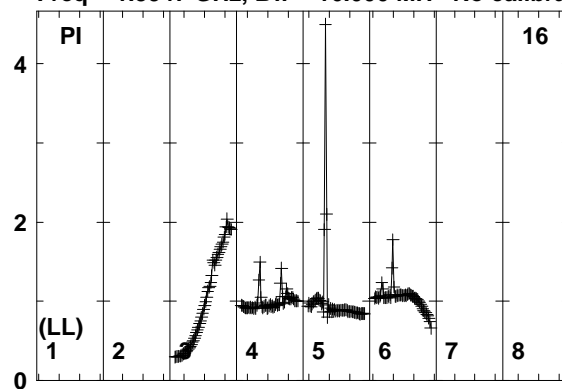

Lower frame: Real Jy
Total-power spectrum Antenna: PI (16)
Timerange: 00/05:29:41 to 00/05:30:39

Plot file version 310 created 04-NOV-2019 14:14:24

W2246-0526 EY034.UVDATA.1

Freq = 1.5947 GHz, Bw = 16.000 MH No calibration applied and no bandpass applied

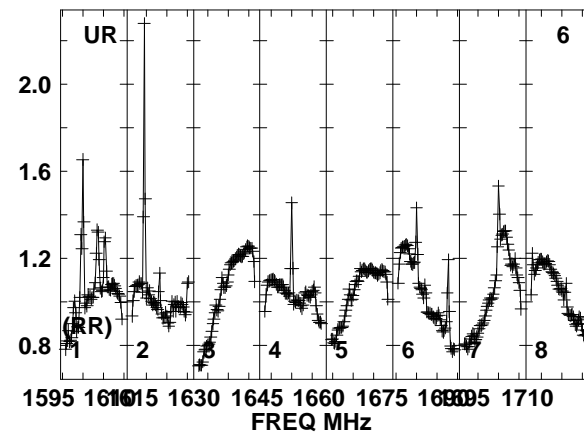
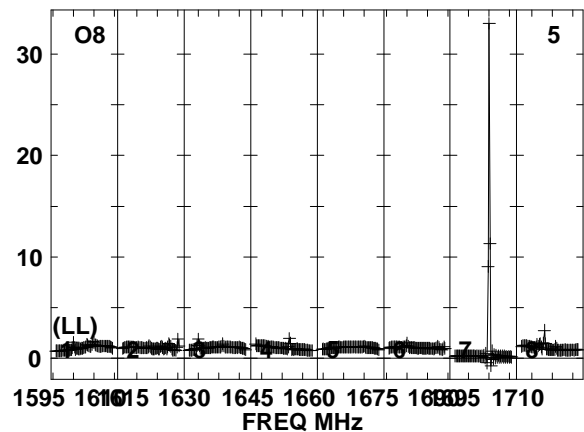
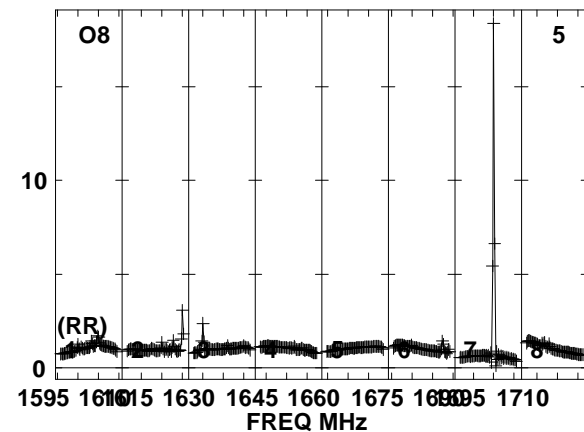
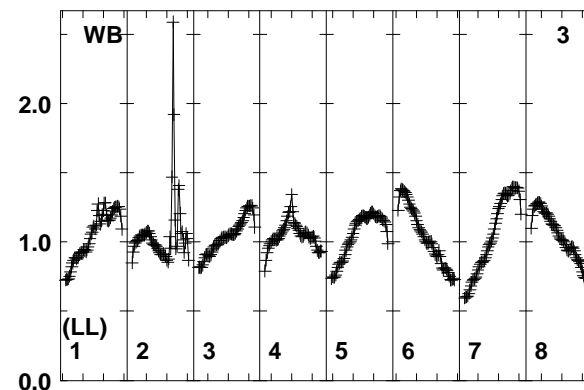
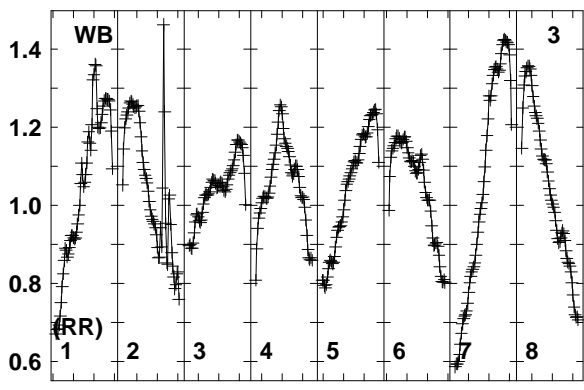
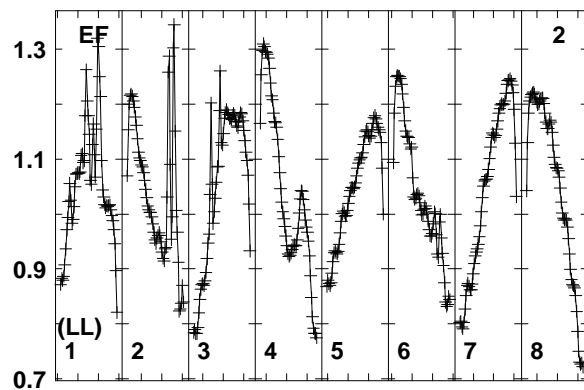
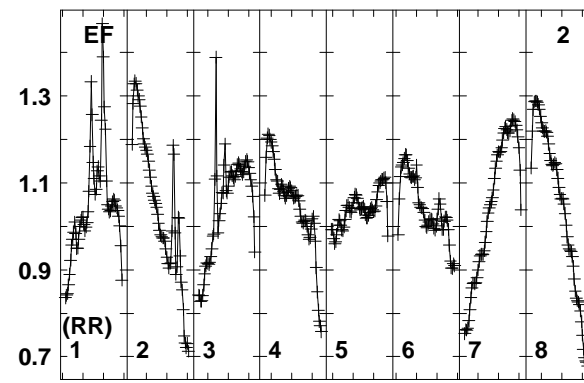
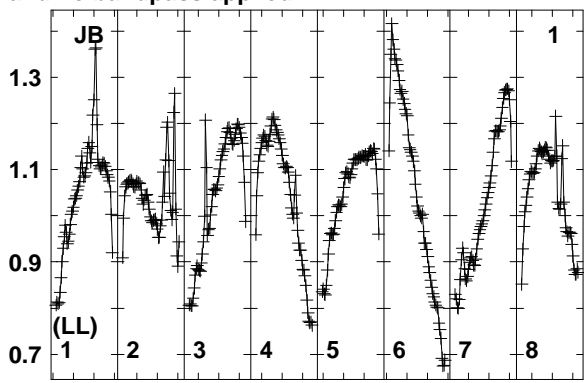
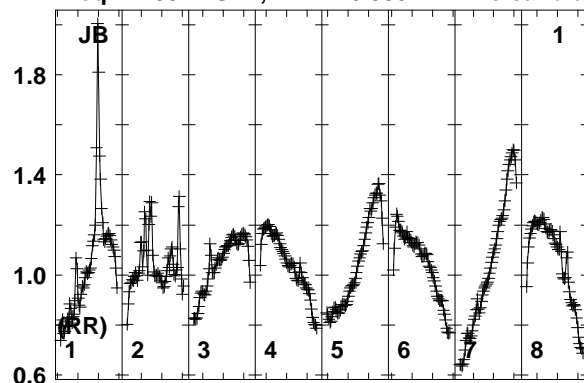

Lower frame: Real Jy
Total-power spectrum Antenna: JB (01)
Timerange: 00/05:30:41 to 00/05:33:19

Plot file version 311 created 04-NOV-2019 14:14:24

W2246-0526 EY034.UVDATA.1

Freq = 1.5947 GHz, Bw = 16.000 MH No calibration applied and no bandpass applied

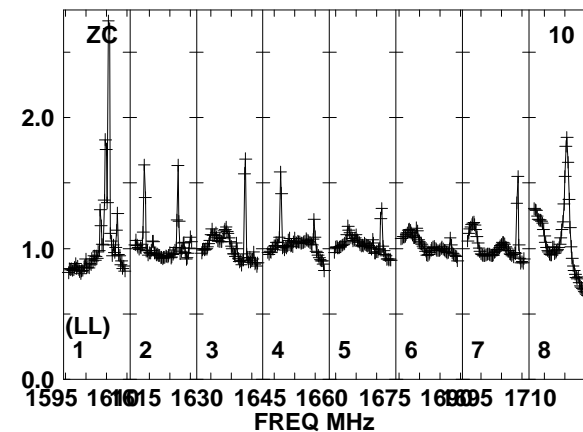
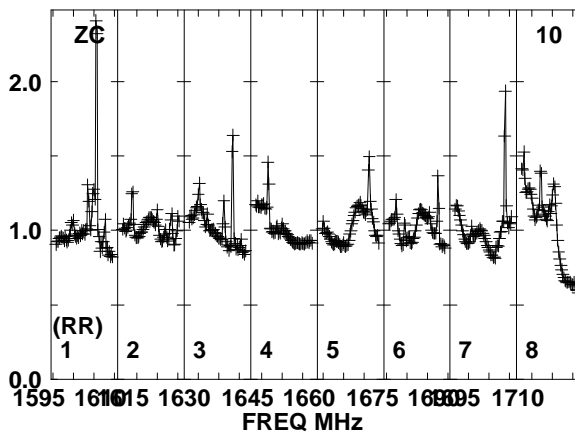
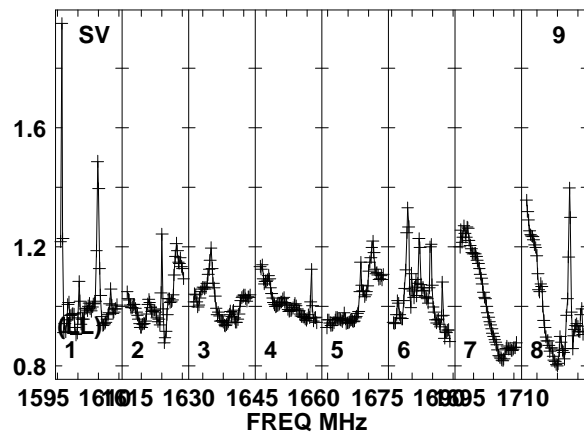
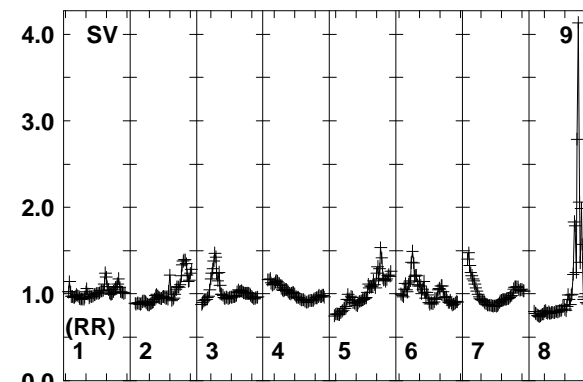
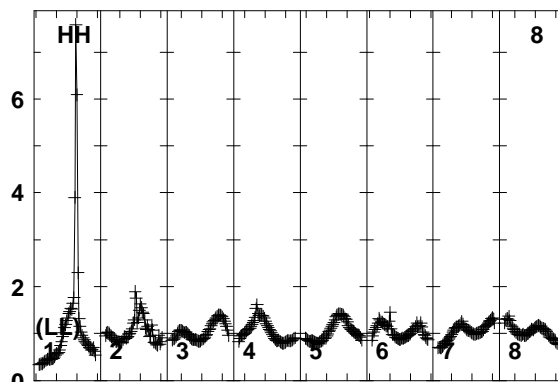
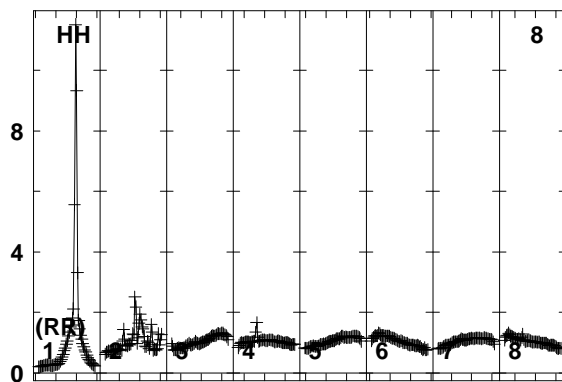
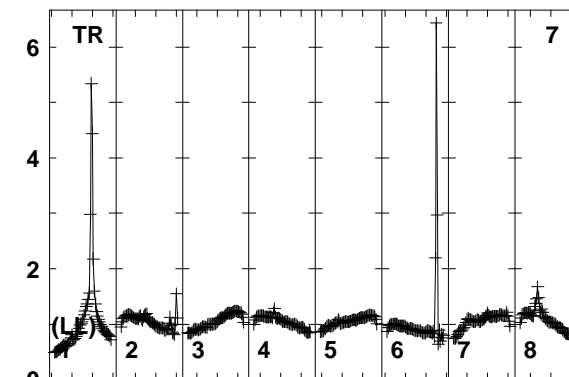
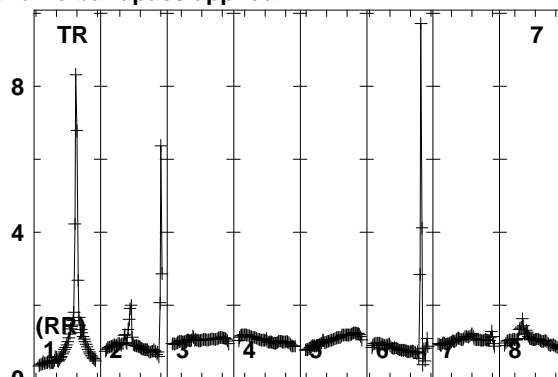
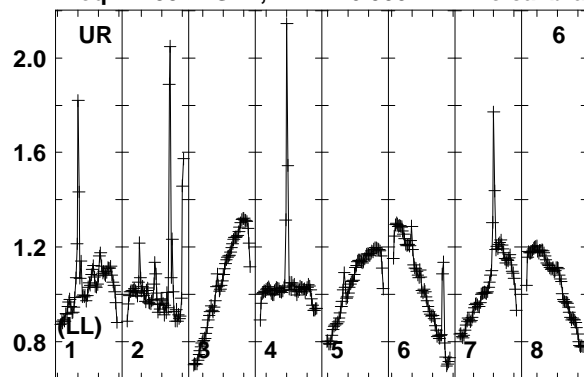

Lower frame: Real Jy
Total-power spectrum Antenna: UR (06)
Timerange: 00/05:30:41 to 00/05:33:19

Plot file version 312 created 04-NOV-2019 14:14:24

W2246-0526 EY034.UVDATA.1

Freq = 1.5947 GHz, Bw = 16.000 MH No calibration applied and no bandpass applied

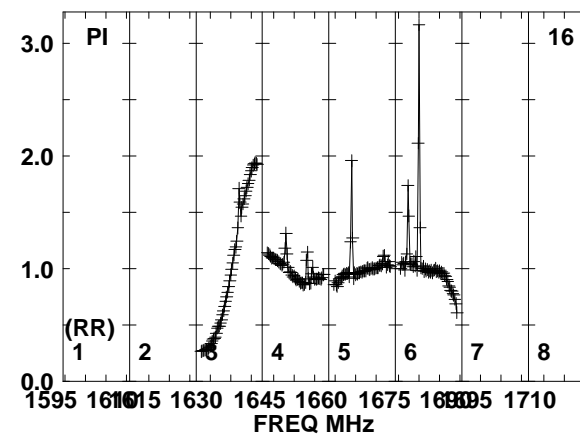
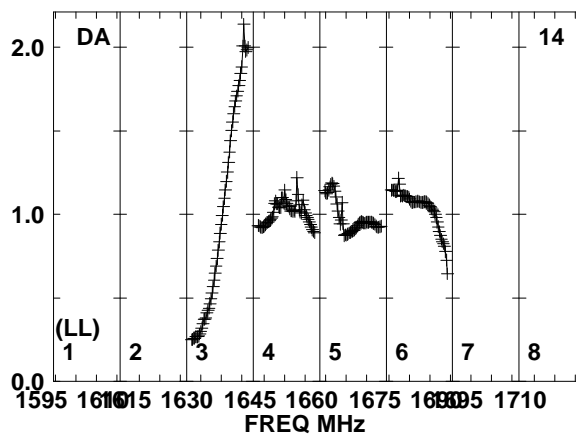
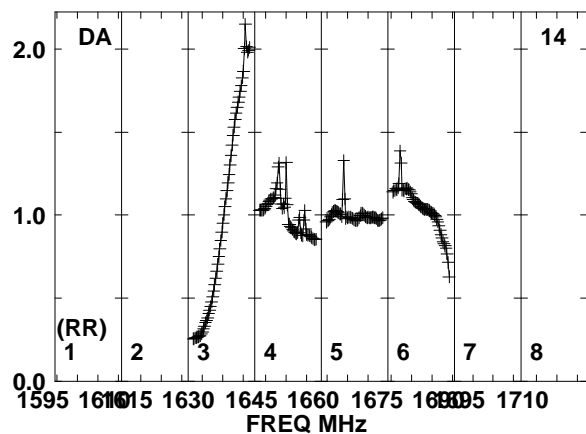
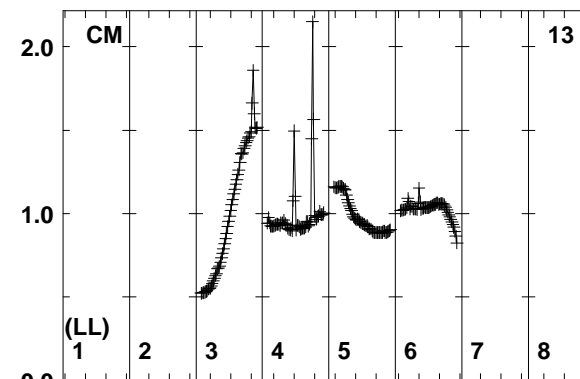
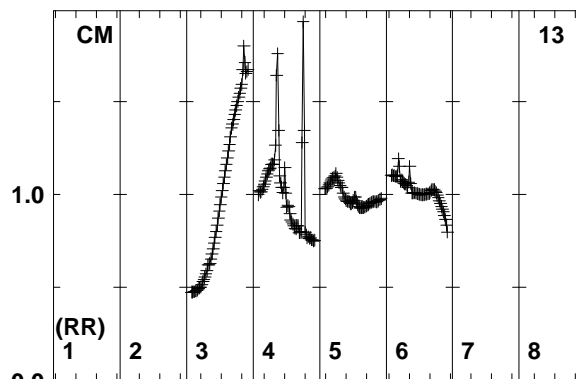
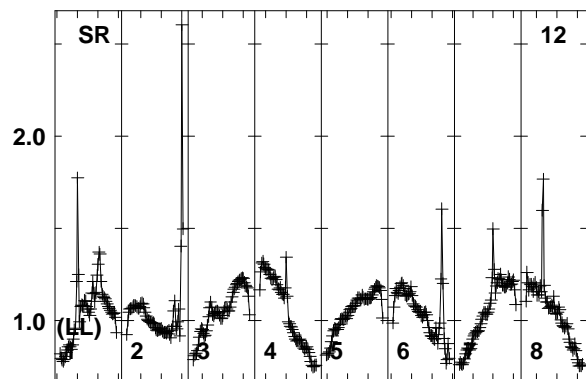
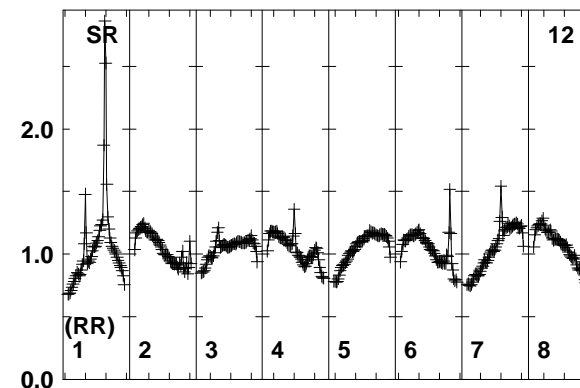
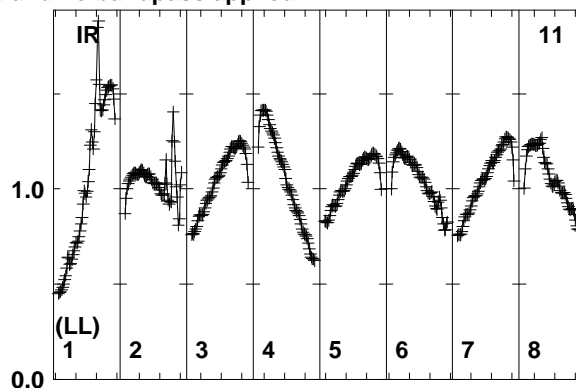
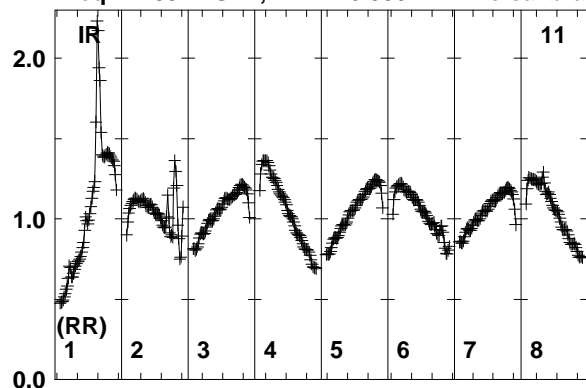

Lower frame: Real Jy
Total-power spectrum Antenna: IR (11)
Timerange: 00/05:30:41 to 00/05:33:19

Plot file version 313 created 04-NOV-2019 14:14:24
W2246-0526 EY034.UVDATA.1
Freq = 1.5947 GHz, Bw = 16.000 MH No calibration applied and no bandpass applied

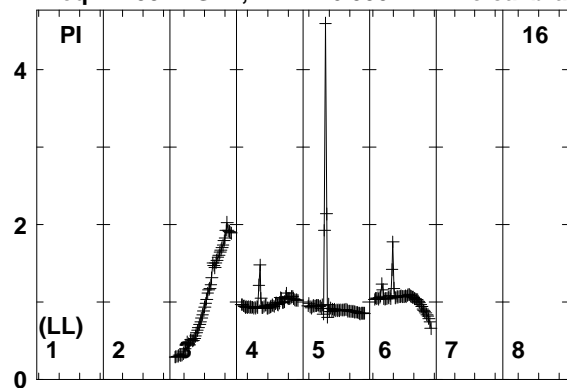

Lower frame: Real Jy
Total-power spectrum Antenna: PI (16)
Timerange: 00/05:30:41 to 00/05:33:19

Plot file version 314 created 04-NOV-2019 14:14:24

J2248-0541 EY034.UVDATA.1

Freq = 1.5947 GHz, Bw = 16.000 MH No calibration applied and no bandpass applied

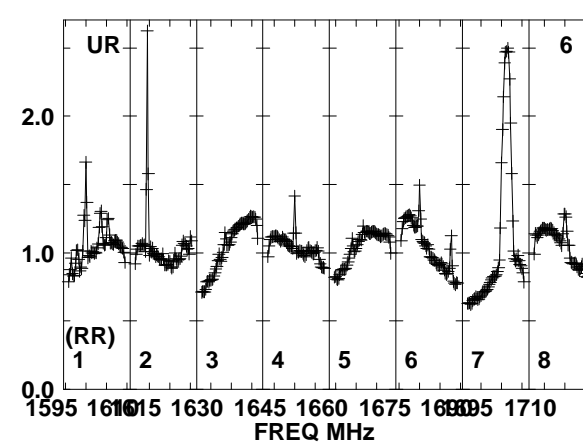
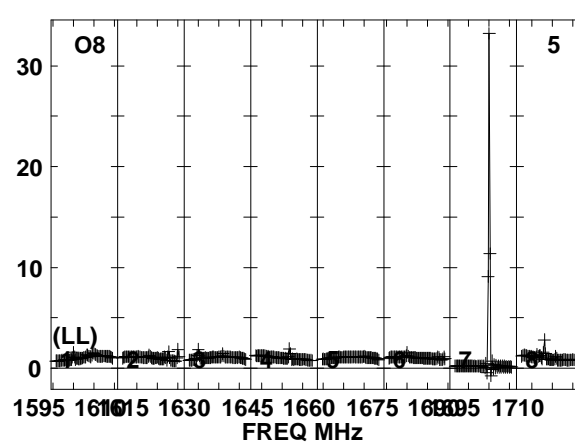
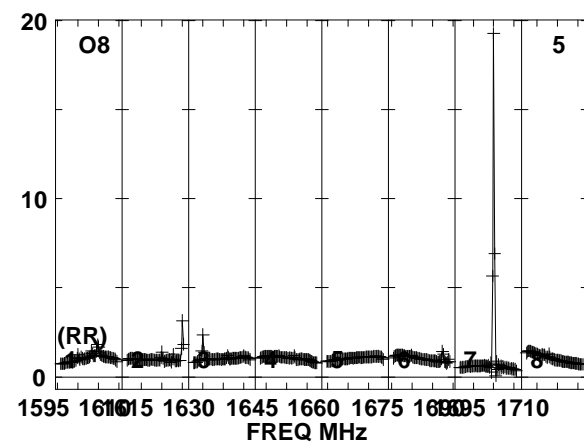
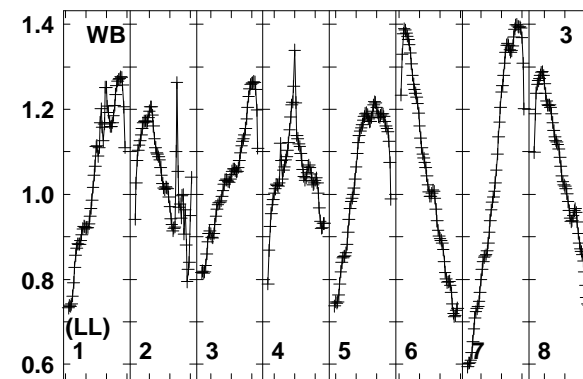
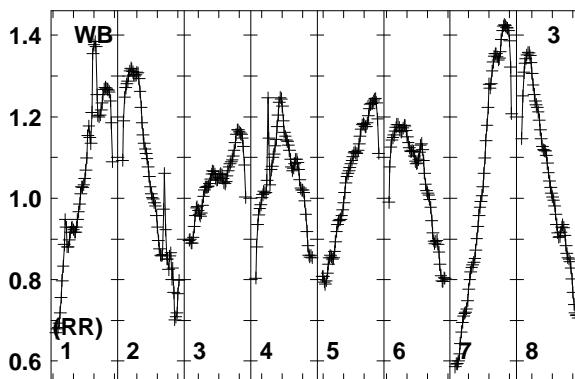
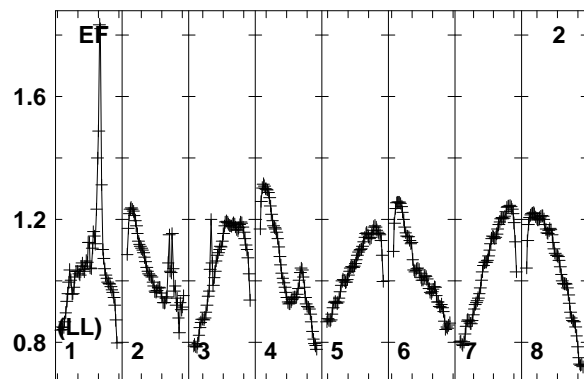
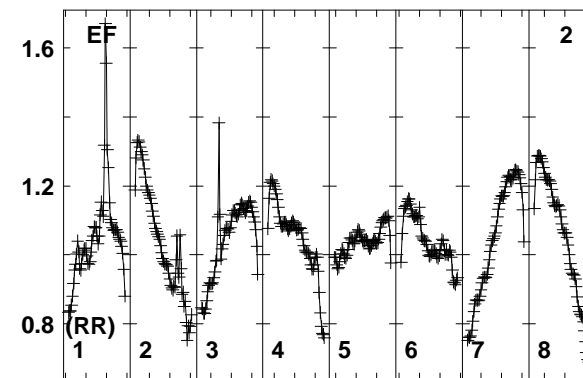
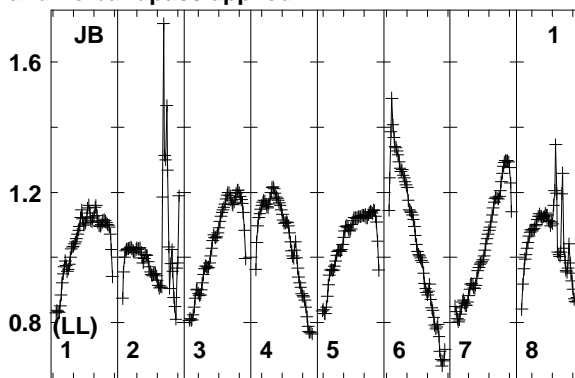
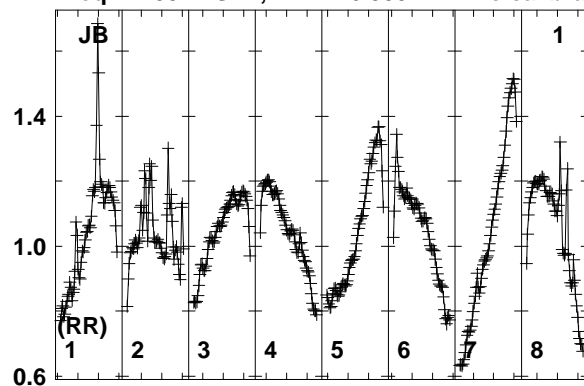

Lower frame: Real Jy
Total-power spectrum Antenna: JB (01)
Timerange: 00/05:33:36 to 00/05:34:34

Plot file version 315 created 04-NOV-2019 14:14:25

J2248-0541 EY034.UVDATA.1

Freq = 1.5947 GHz, Bw = 16.000 MH No calibration applied and no bandpass applied

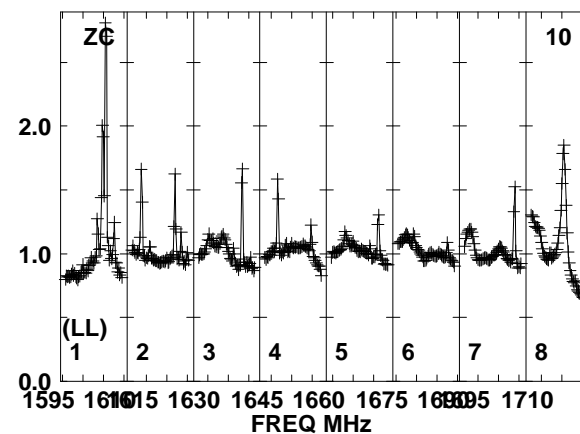
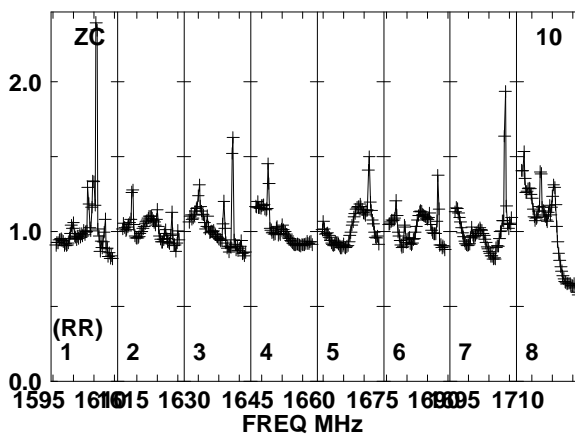
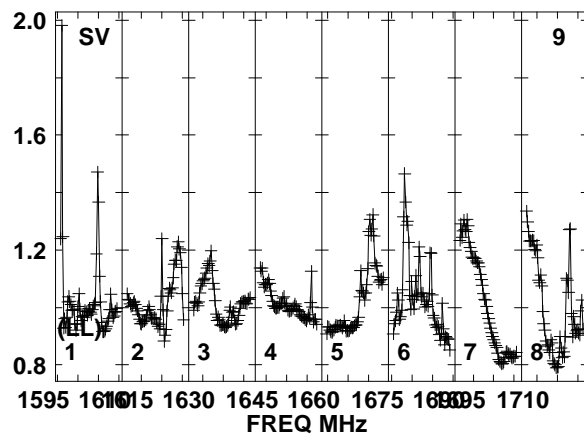
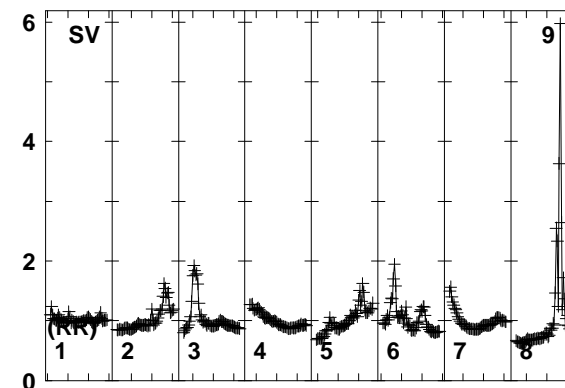
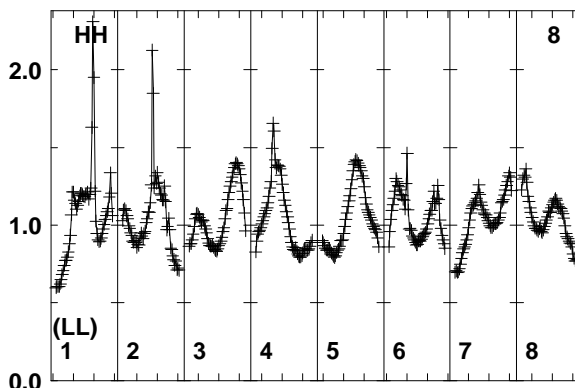
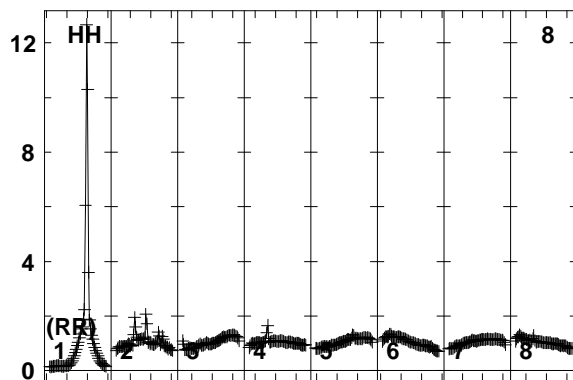
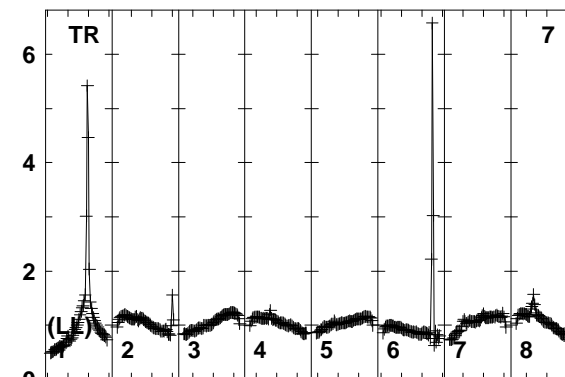
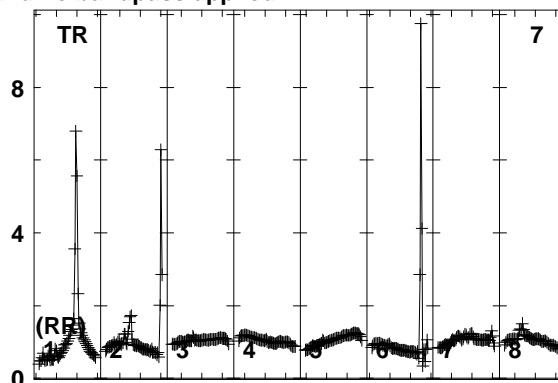
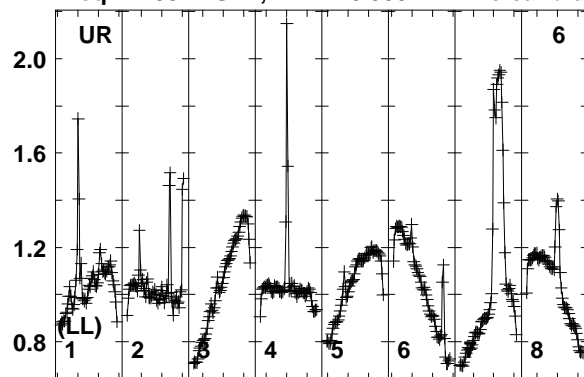

Lower frame: Real Jy
Total-power spectrum Antenna: UR (06)
Timerange: 00/05:33:36 to 00/05:34:34

Plot file version 316 created 04-NOV-2019 14:14:25

J2248-0541 EY034.UVDATA.1

Freq = 1.5947 GHz, Bw = 16.000 MH No calibration applied and no bandpass applied

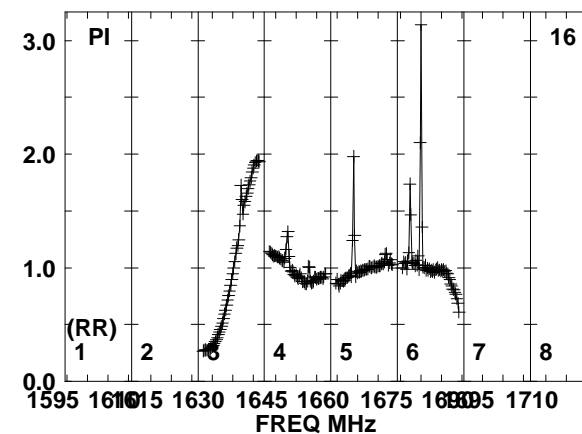
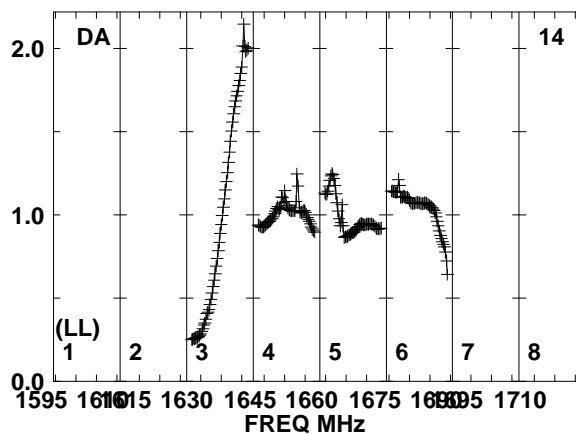
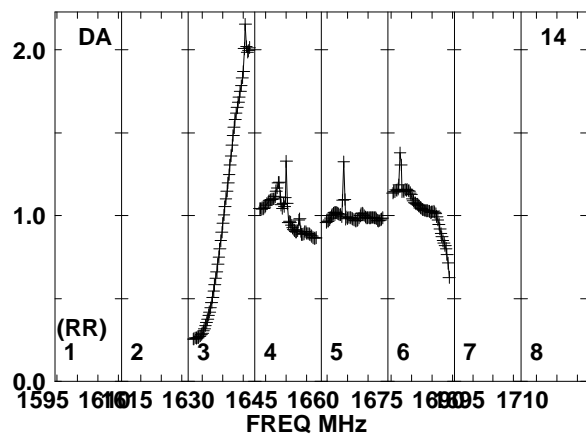
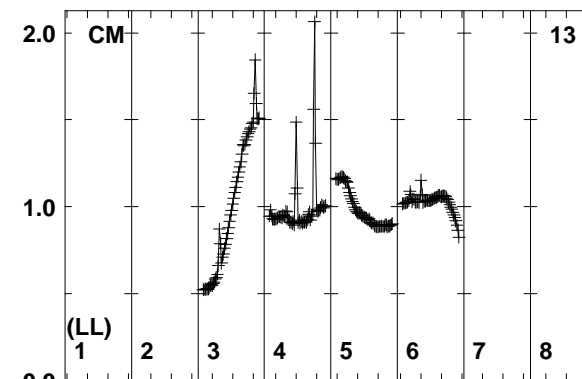
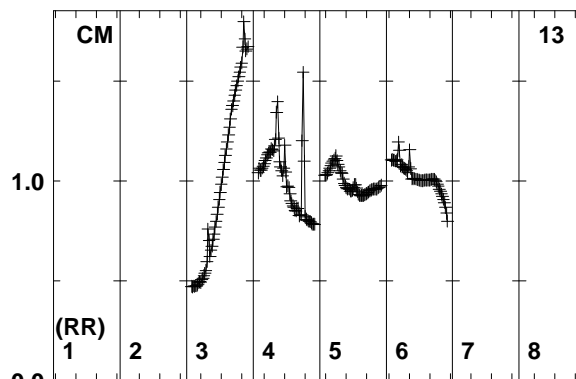
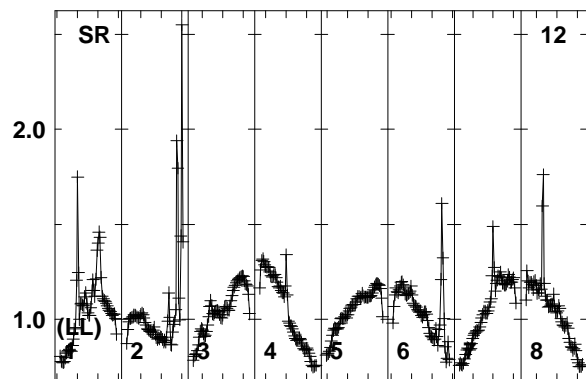
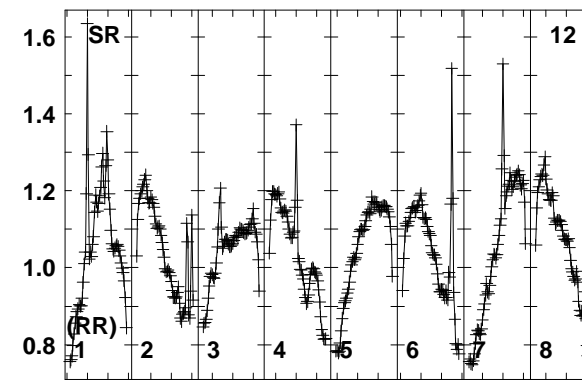
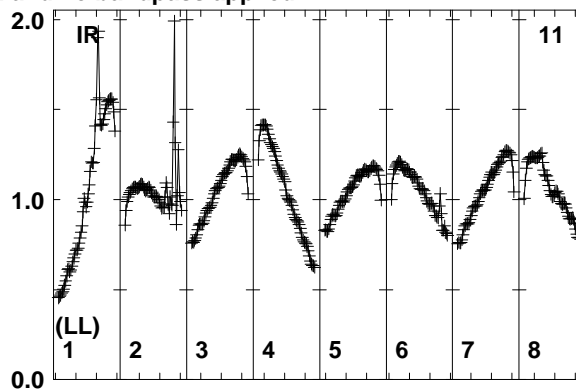
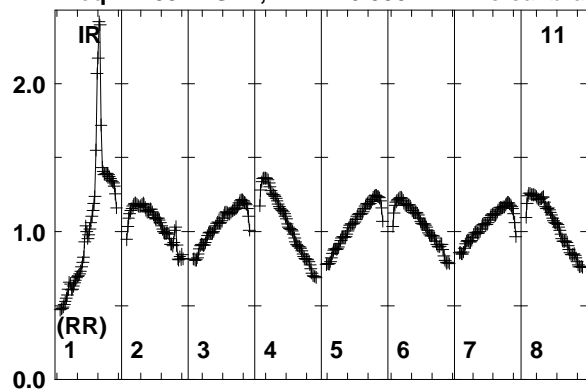

Lower frame: Real Jy
Total-power spectrum Antenna: IR (11)
Timerange: 00/05:33:36 to 00/05:34:34

Plot file version 317 created 04-NOV-2019 14:14:25
J2248-0541 EY034.UVDATA.1
Freq = 1.5947 GHz, Bw = 16.000 MH No calibration applied and no bandpass applied

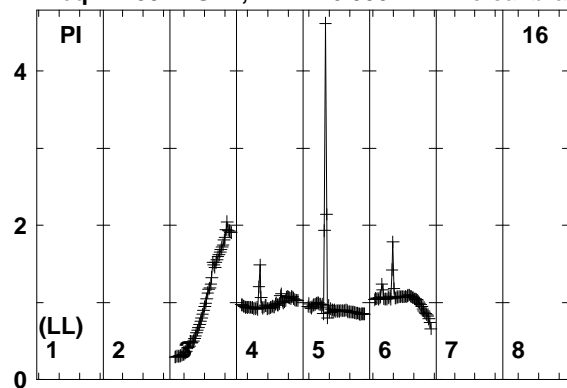

Lower frame: Real Jy
Total-power spectrum Antenna: PI (16)
Timerange: 00/05:33:36 to 00/05:34:34

Plot file version 318 created 04-NOV-2019 14:14:25

W2246-0526 EY034.UVDATA.1

Freq = 1.5947 GHz, Bw = 16.000 MH No calibration applied and no bandpass applied

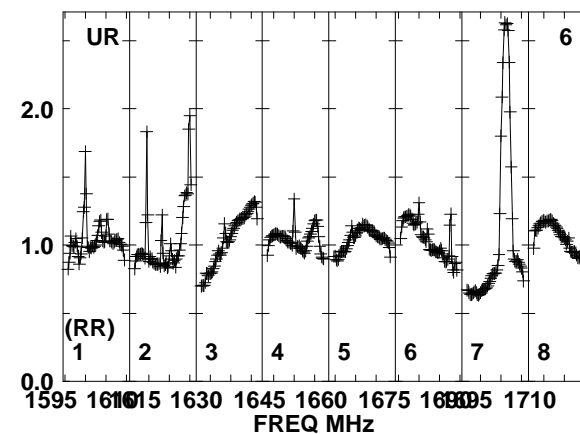
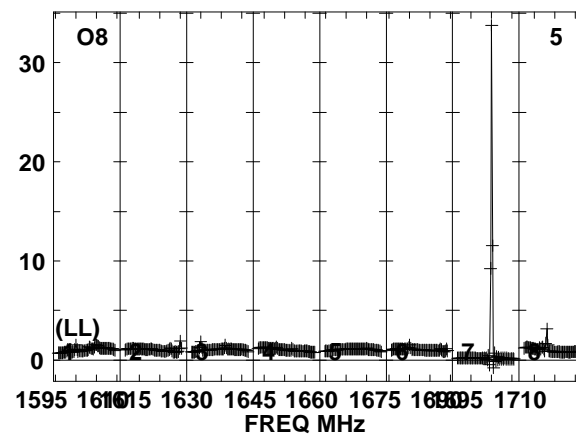
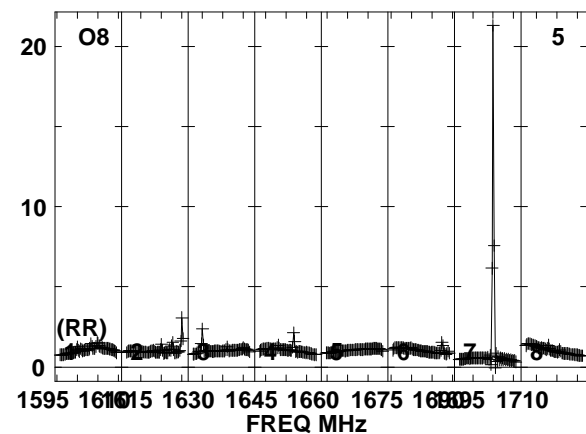
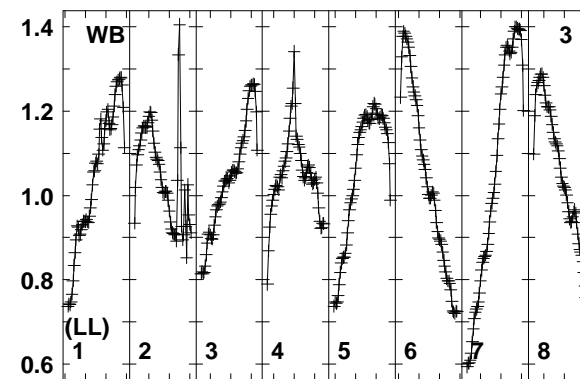
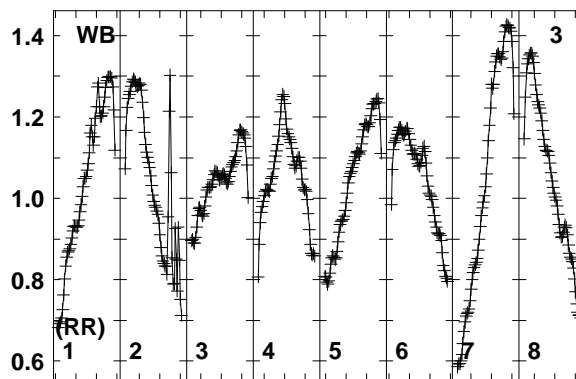
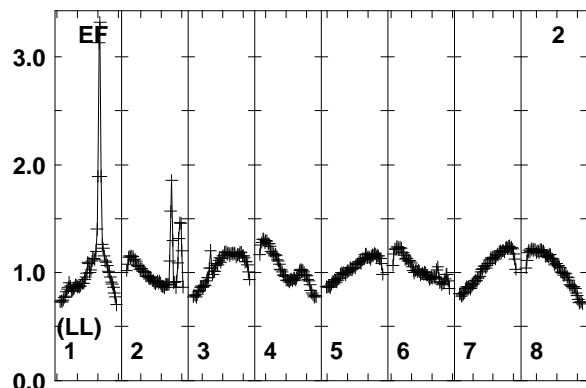
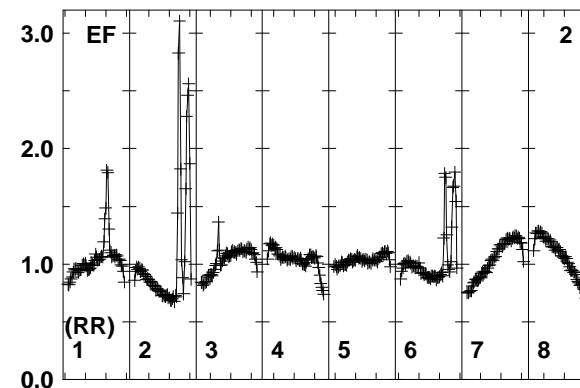
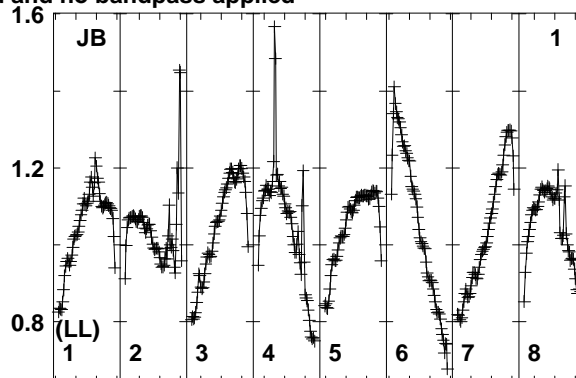
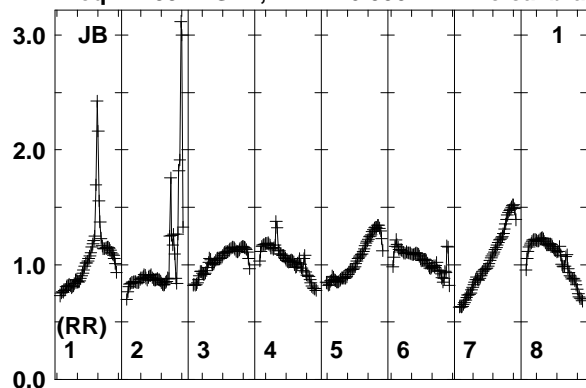

Lower frame: Real Jy
Total-power spectrum Antenna: JB (01)
Timerange: 00/05:34:36 to 00/05:37:14

Plot file version 319 created 04-NOV-2019 14:14:25

W2246-0526 EY034.UVDATA.1

Freq = 1.5947 GHz, Bw = 16.000 MH No calibration applied and no bandpass applied

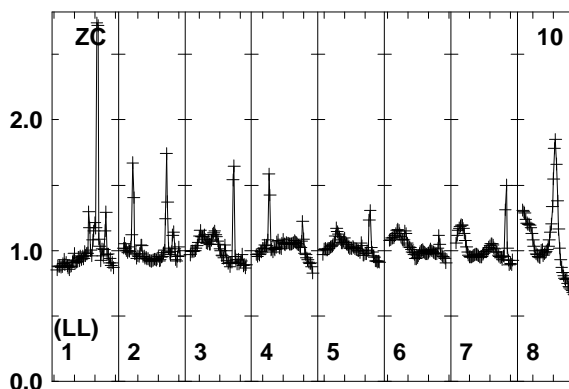
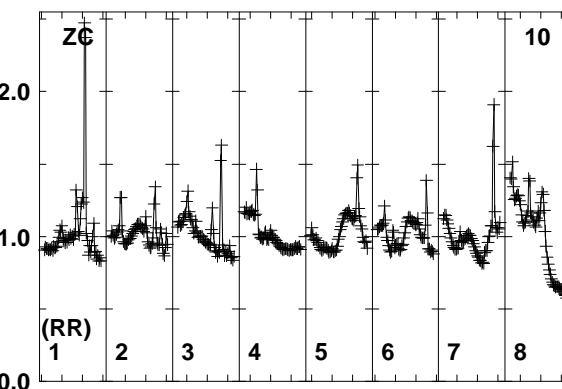
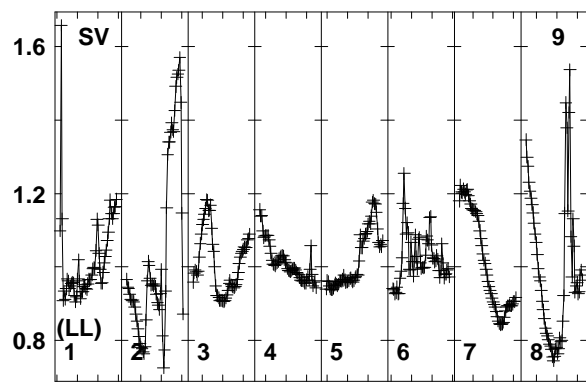
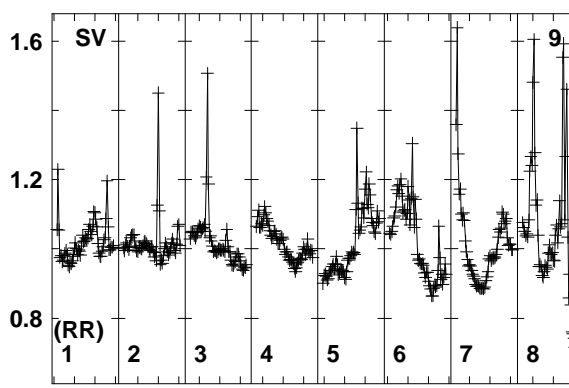
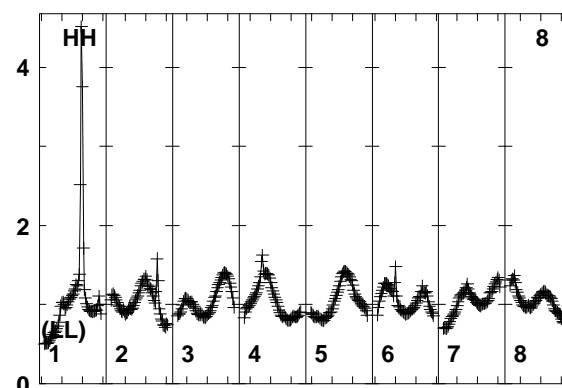
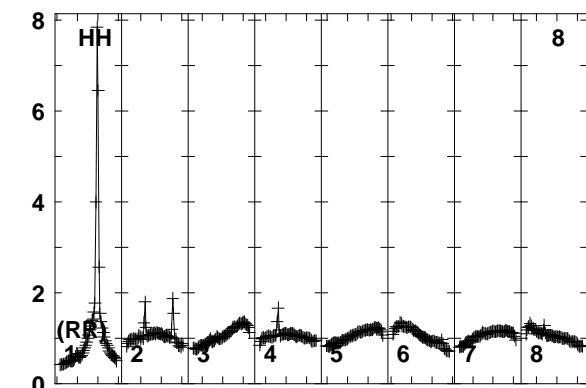
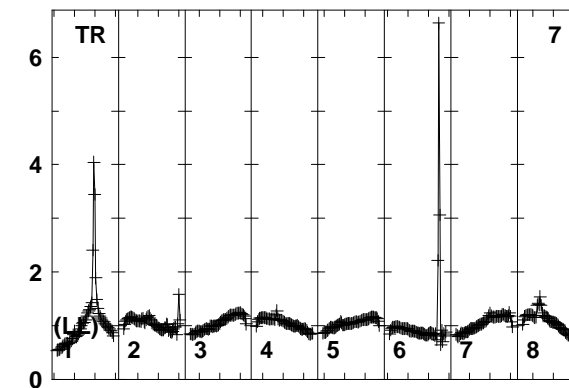
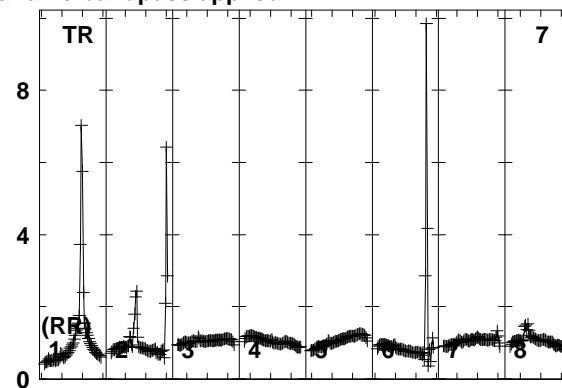
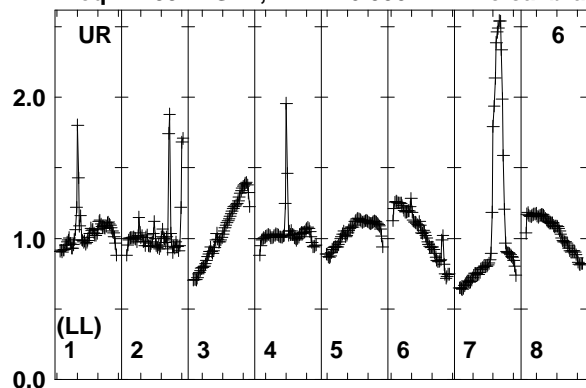

1595 1610 1630 1645 1660 1675 1690 1710
FREQ MHz

1595 1610 1630 1645 1660 1675 1690 1710
FREQ MHz

1595 1610 1630 1645 1660 1675 1690 1710
FREQ MHz

Lower frame: Real Jy
Total-power spectrum Antenna: UR (06)
Timerange: 00/05:34:36 to 00/05:37:14

Plot file version 320 created 04-NOV-2019 14:14:25

W2246-0526 EY034.UVDATA.1

Freq = 1.5947 GHz, Bw = 16.000 MH No calibration applied and no bandpass applied

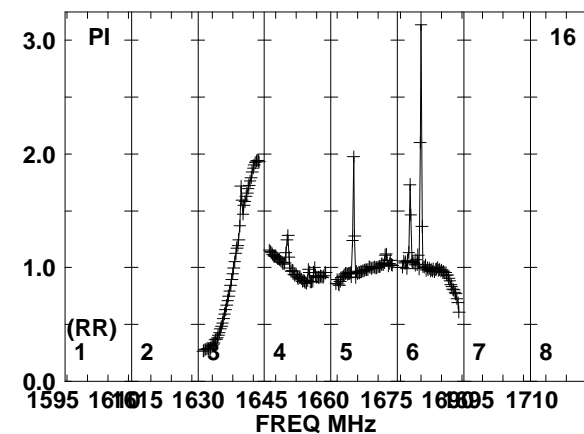
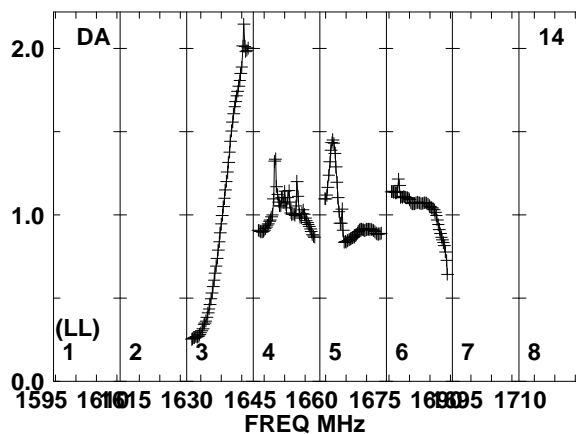
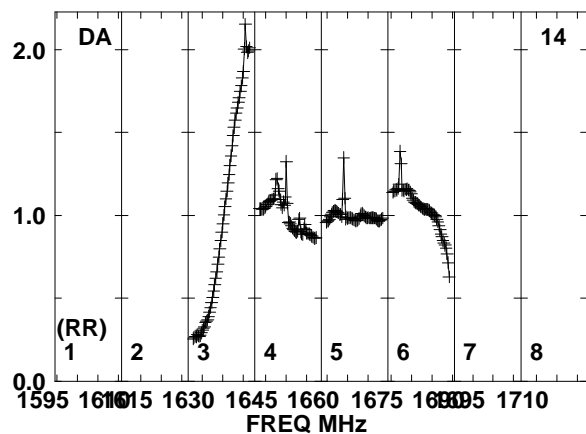
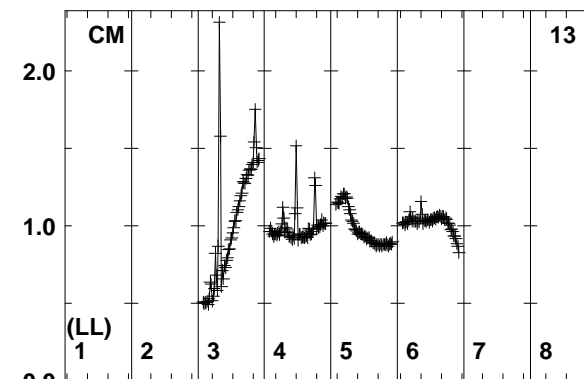
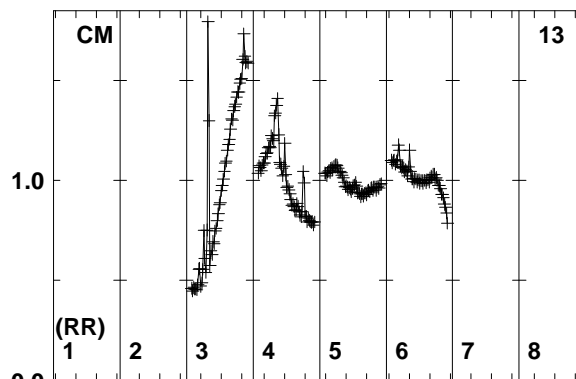
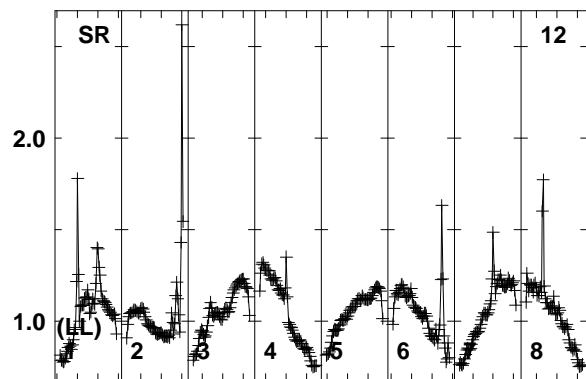
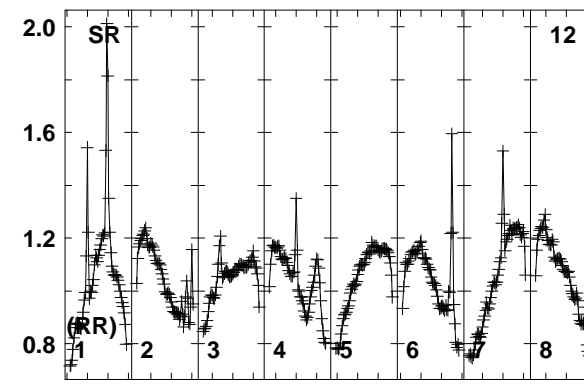
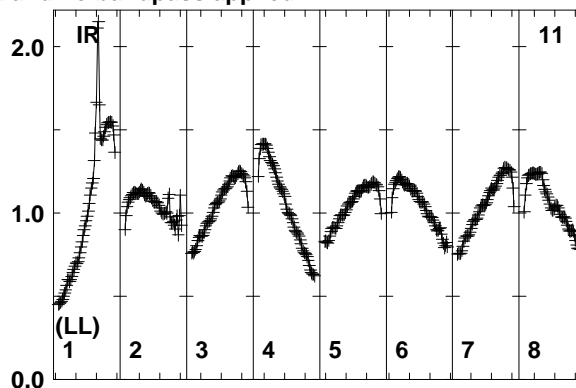
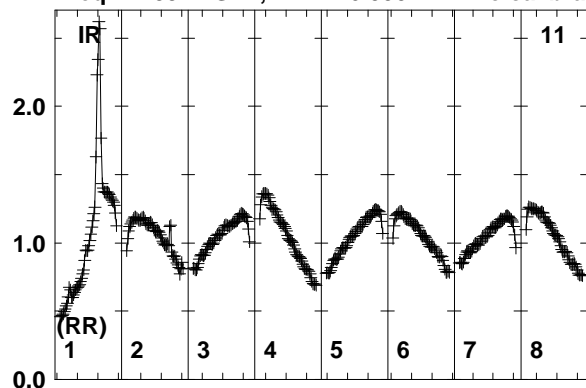

Lower frame: Real Jy
Total-power spectrum Antenna: IR (11)
Timerange: 00/05:34:36 to 00/05:37:14

Plot file version 321 created 04-NOV-2019 14:14:25
W2246-0526 EY034.UVDATA.1
Freq = 1.5947 GHz, Bw = 16.000 MH No calibration applied and no bandpass applied

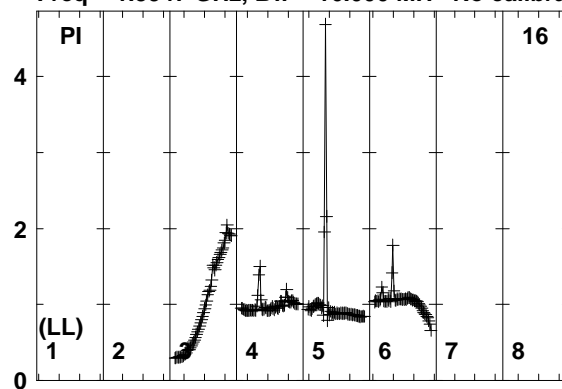

Lower frame: Real Jy
Total-power spectrum Antenna: PI (16)
Timerange: 00/05:34:36 to 00/05:37:14

Plot file version 322 created 04-NOV-2019 14:14:25

J2248-0541 EY034.UVDATA.1

Freq = 1.5947 GHz, Bw = 16.000 MH No calibration applied and no bandpass applied

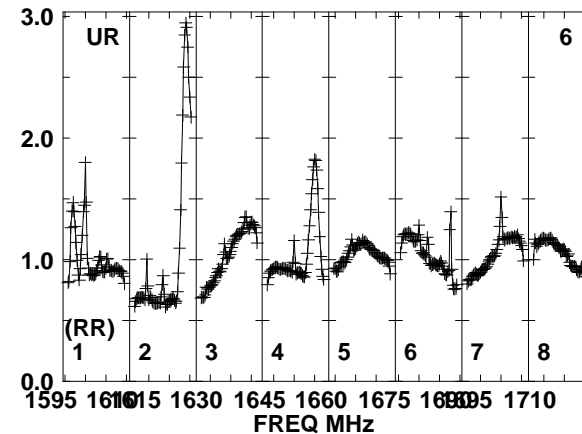
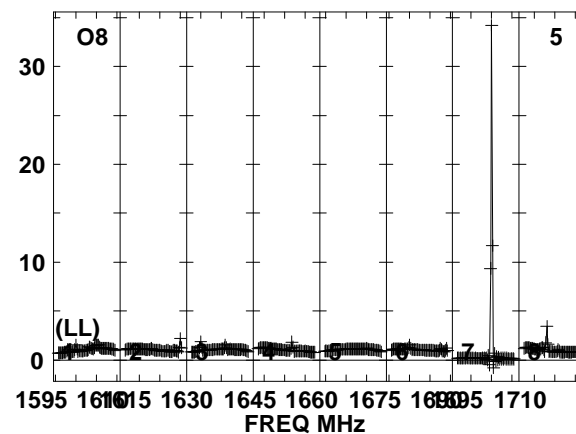
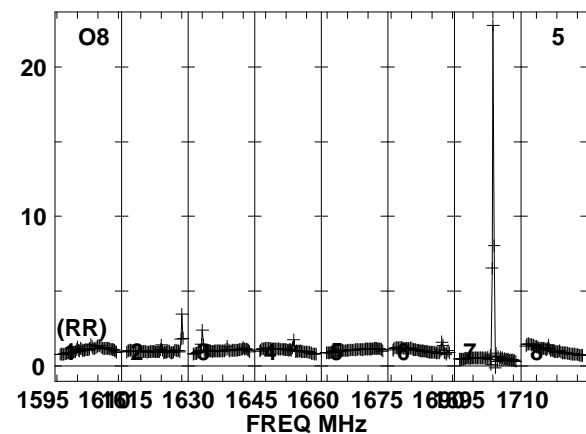
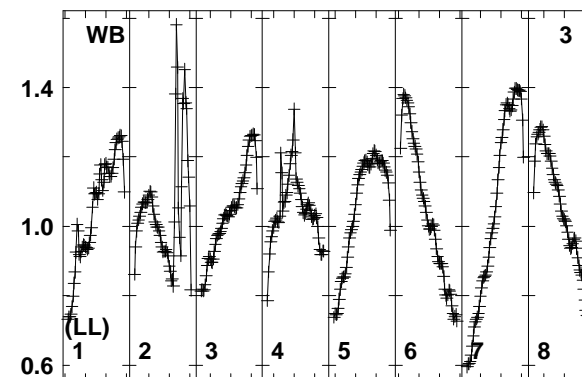
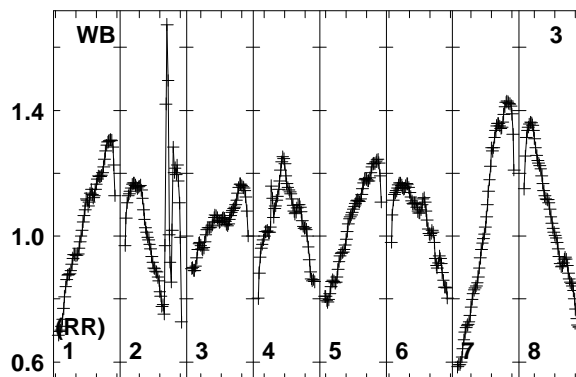
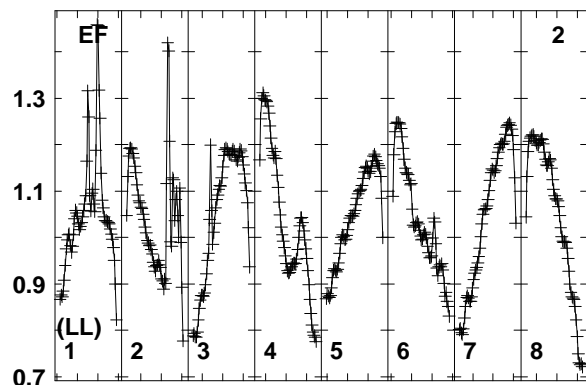
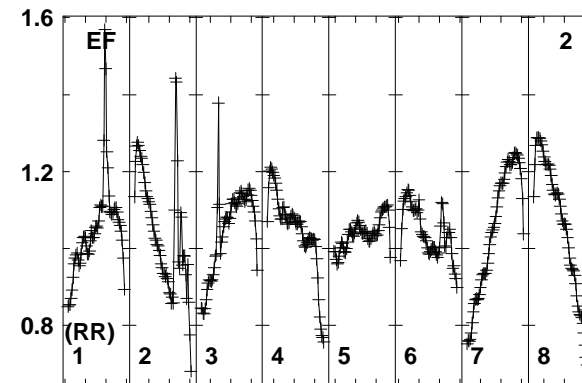
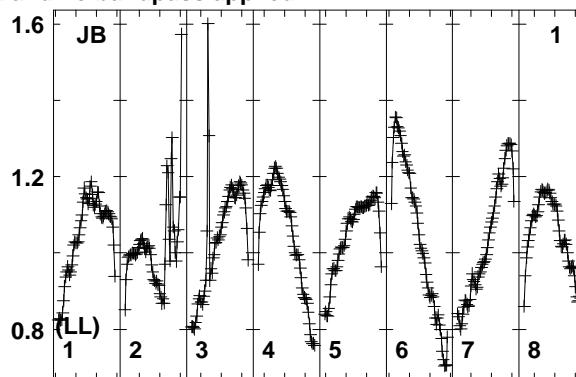
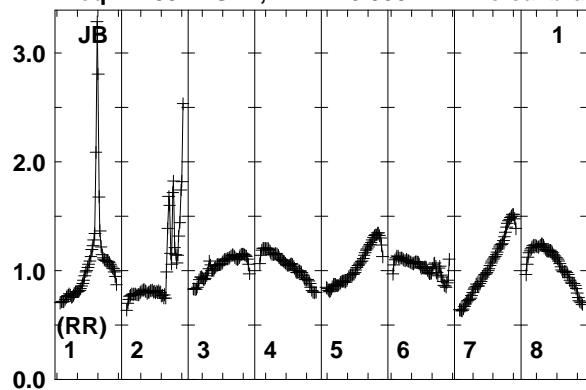

Lower frame: Real Jy
Total-power spectrum Antenna: JB (01)
Timerange: 00/05:37:51 to 00/05:38:49

Plot file version 323 created 04-NOV-2019 14:14:25

J2248-0541 EY034.UVDATA.1

Freq = 1.5947 GHz, Bw = 16.000 MH No calibration applied and no bandpass applied

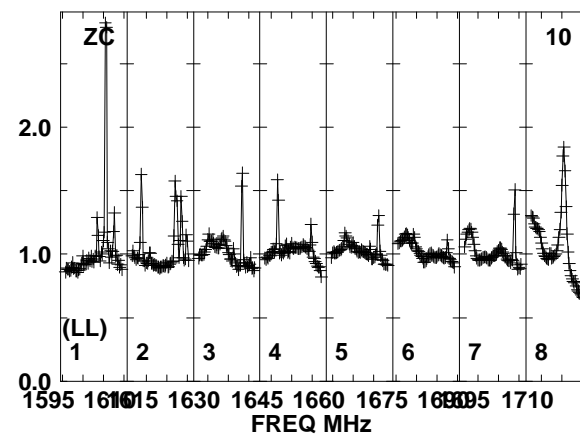
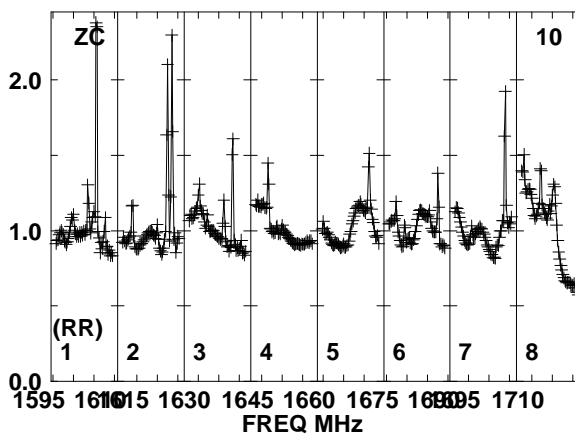
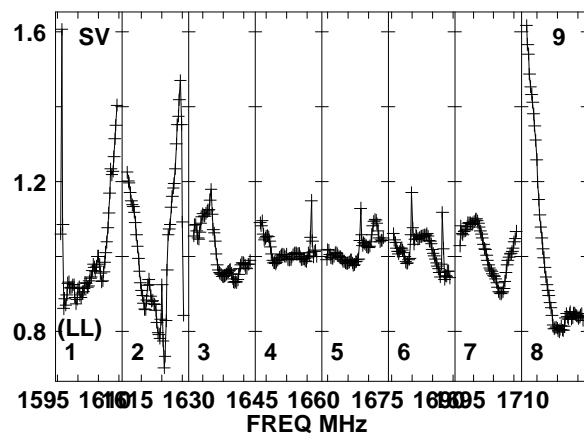
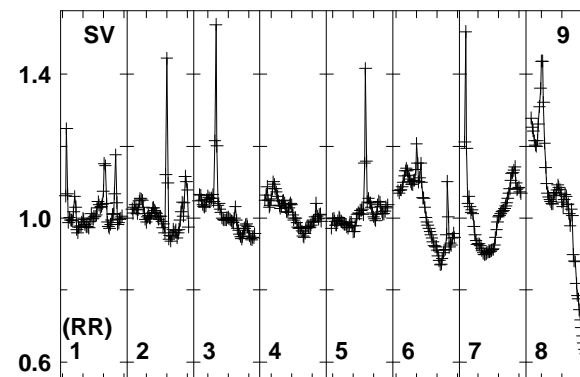
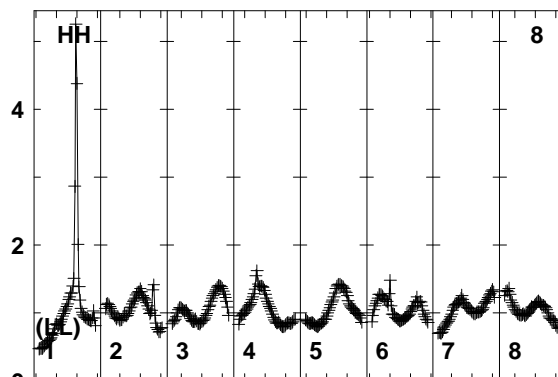
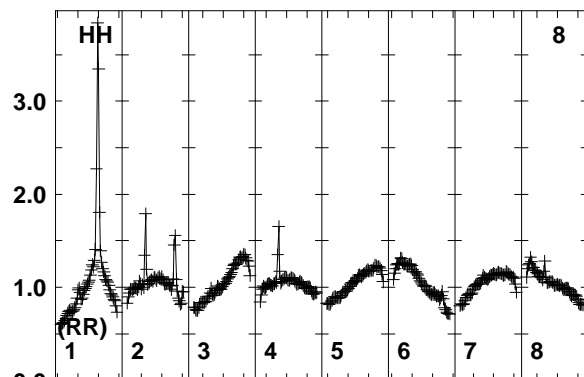
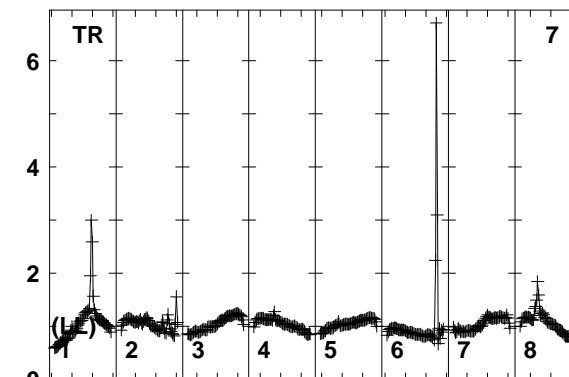
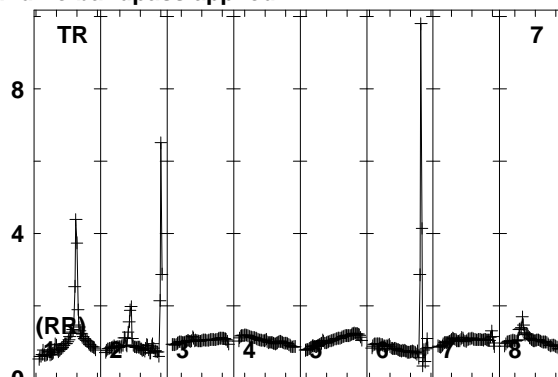
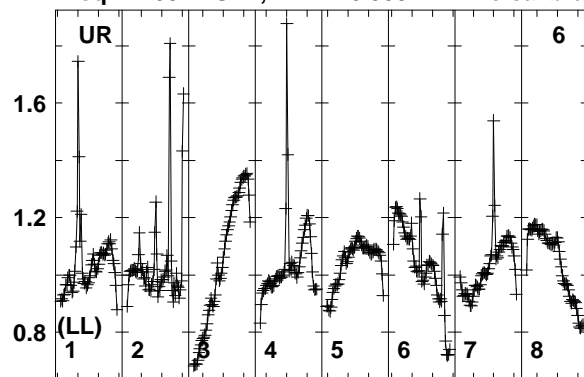

Lower frame: Real Jy
Total-power spectrum Antenna: UR (06)
Timerange: 00/05:37:51 to 00/05:38:49

Plot file version 324 created 04-NOV-2019 14:14:25

J2248-0541 EY034.UVDATA.1

Freq = 1.5947 GHz, Bw = 16.000 MH No calibration applied and no bandpass applied

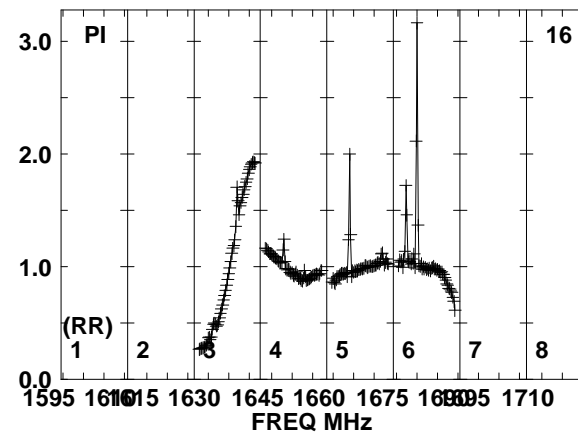
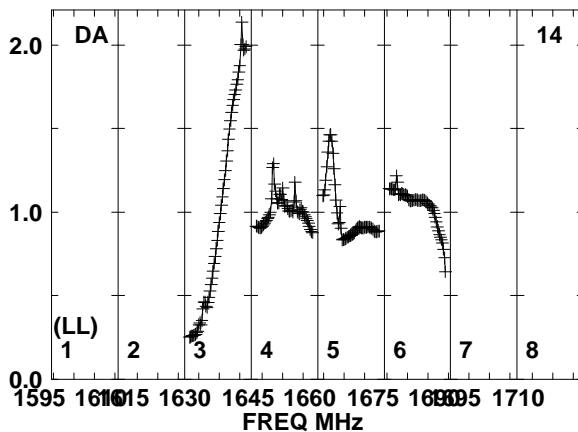
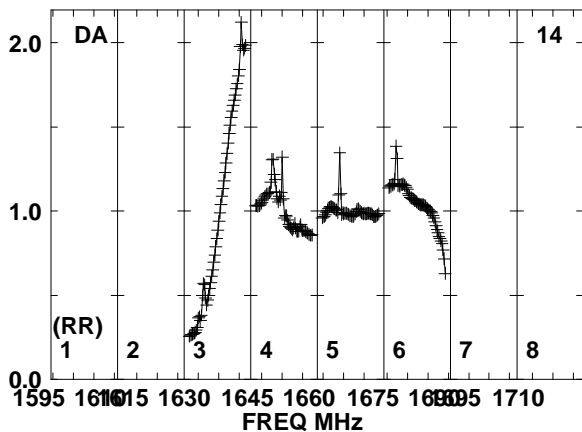
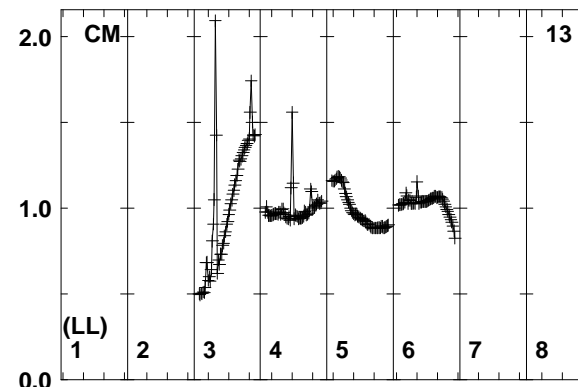
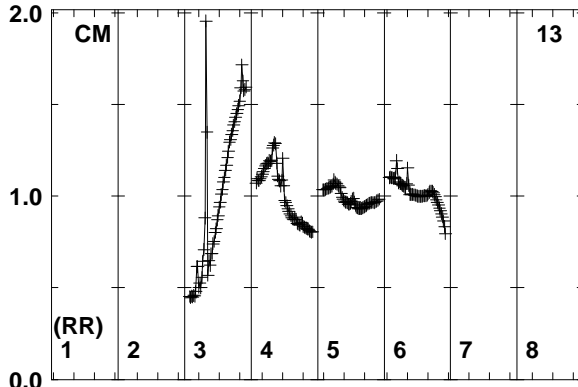
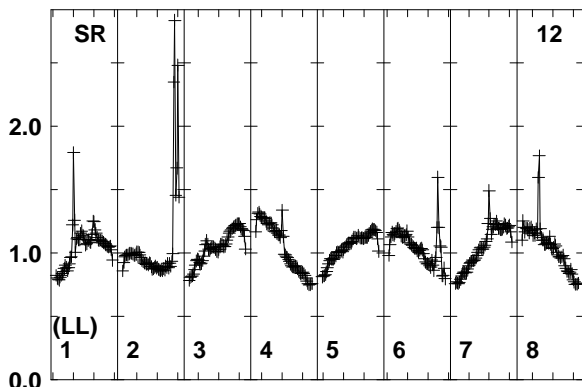
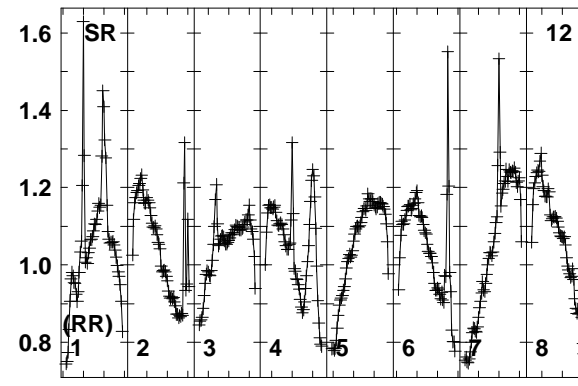
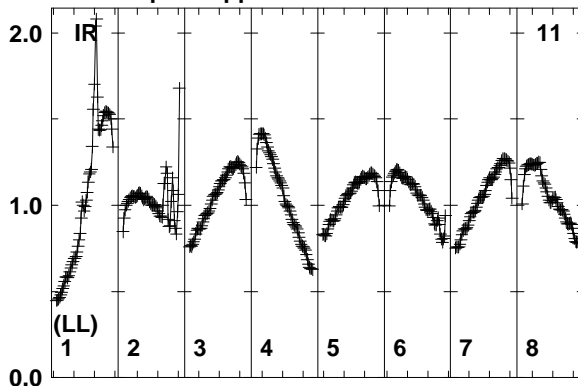
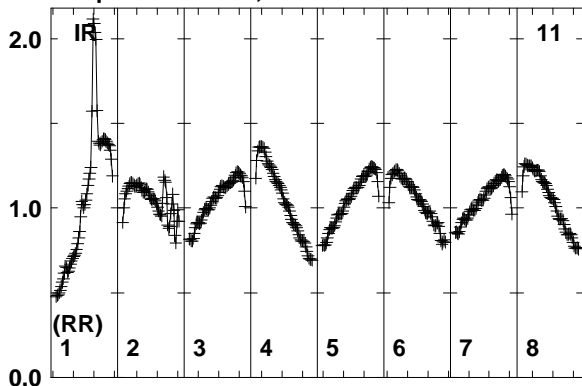

Lower frame: Real Jy
Total-power spectrum Antenna: IR (11)
Timerange: 00/05:37:51 to 00/05:38:49

Plot file version 325 created 04-NOV-2019 14:14:25
J2248-0541 EY034.UVDATA.1
Freq = 1.5947 GHz, Bw = 16.000 MH No calibration applied and no bandpass applied

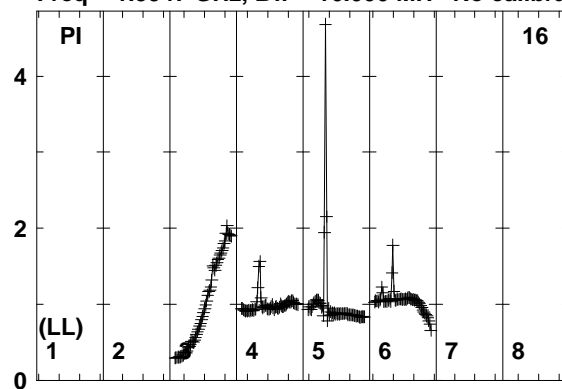

Lower frame: Real Jy
Total-power spectrum Antenna: PI (16)
Timerange: 00/05:37:51 to 00/05:38:49

Plot file version 326 created 04-NOV-2019 14:14:25

W2246-0526 EY034.UVDATA.1

Freq = 1.5947 GHz, Bw = 16.000 MH No calibration applied and no bandpass applied

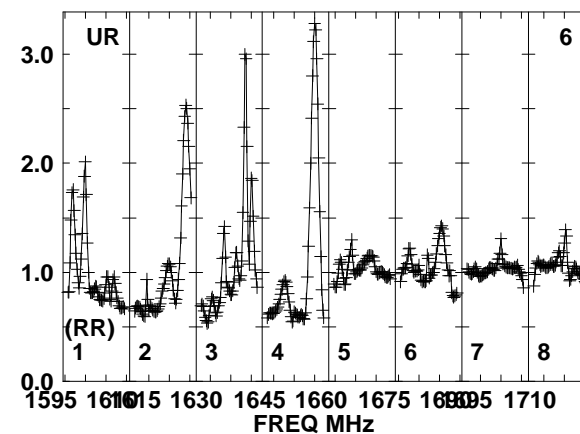
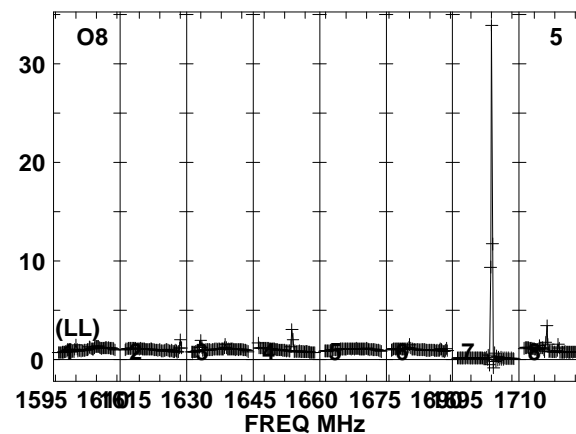
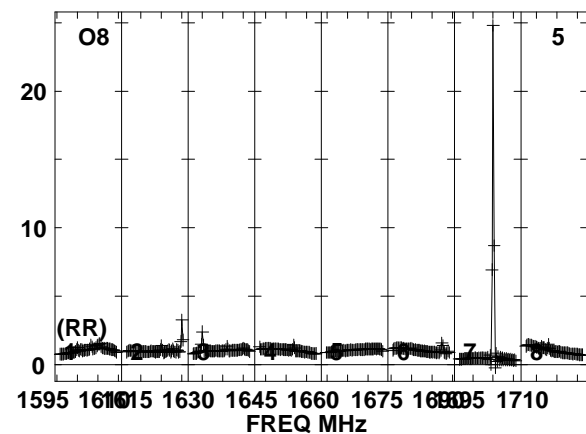
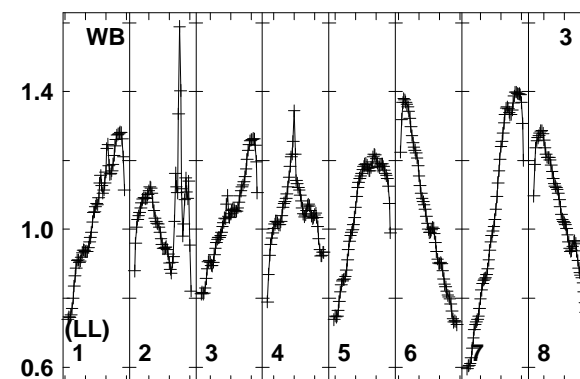
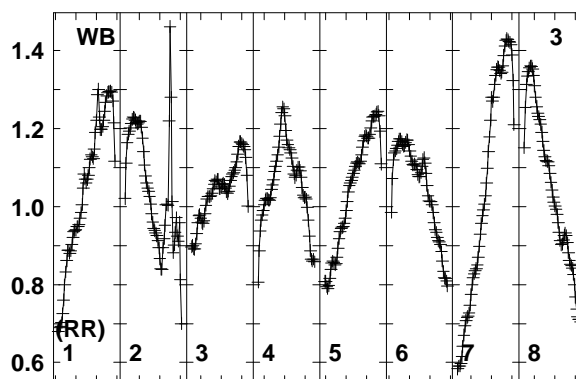
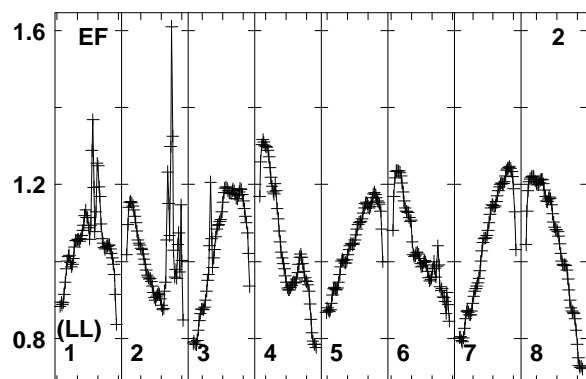
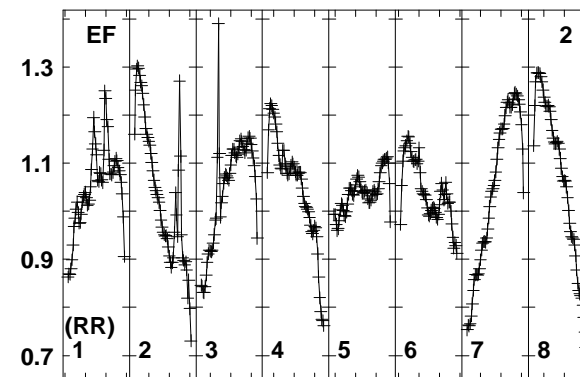
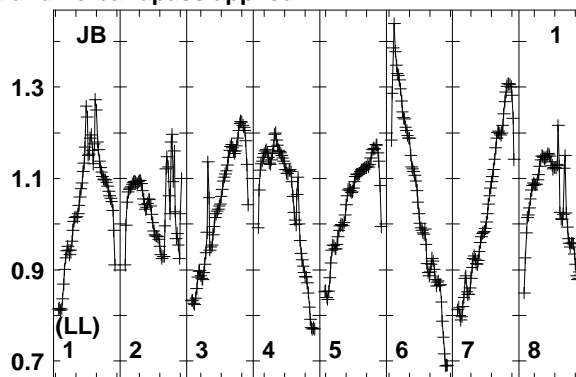
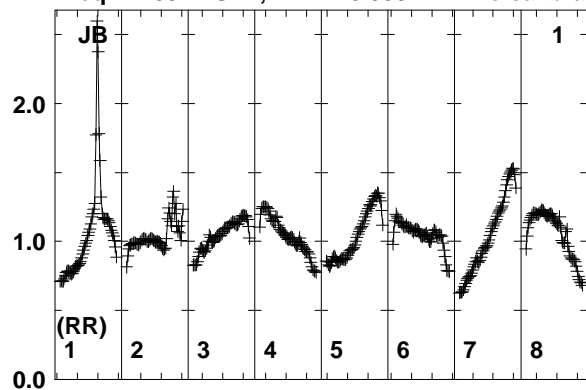

Lower frame: Real Jy
Total-power spectrum Antenna: JB (01)
Timerange: 00/05:38:51 to 00/05:41:29

Plot file version 327 created 04-NOV-2019 14:14:26

W2246-0526 EY034.UVDATA.1

Freq = 1.5947 GHz, Bw = 16.000 MH No calibration applied and no bandpass applied

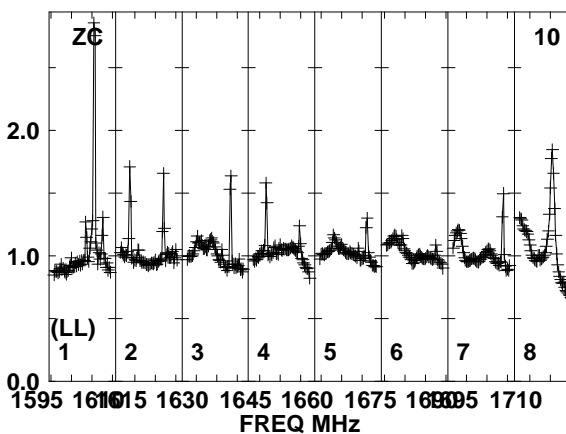
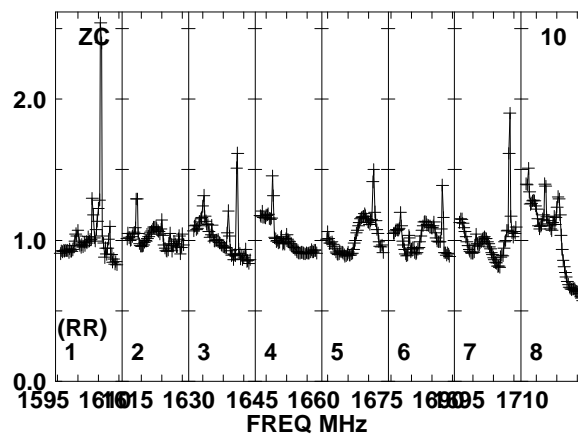
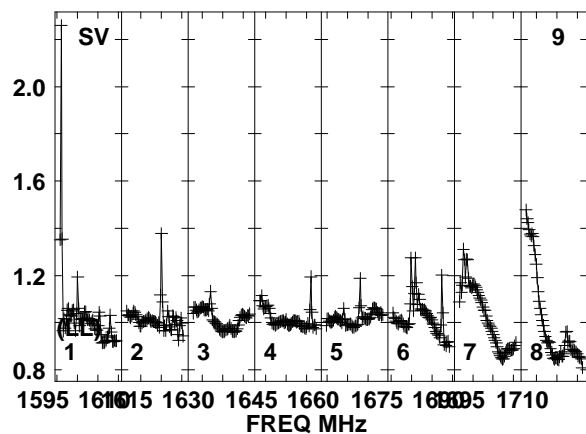
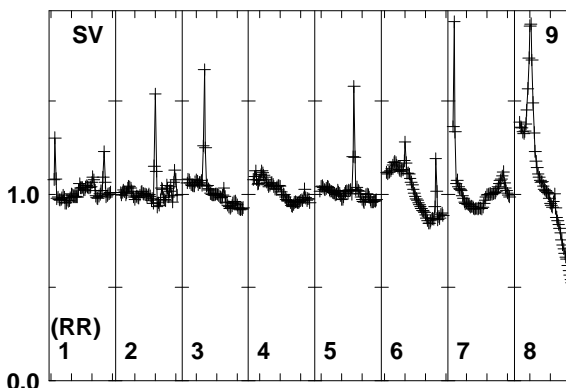
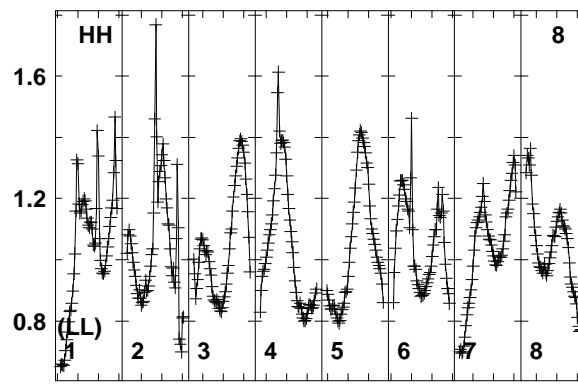
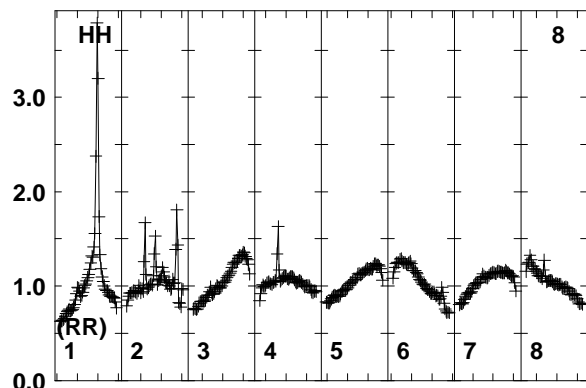
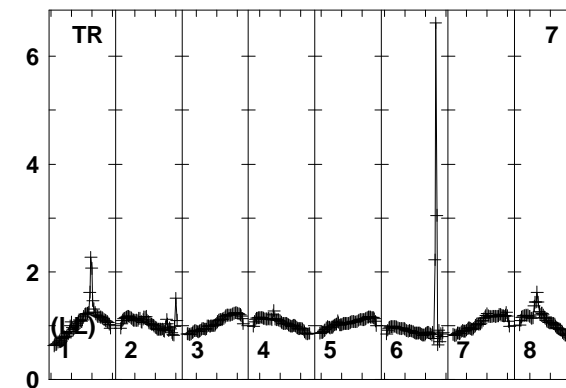
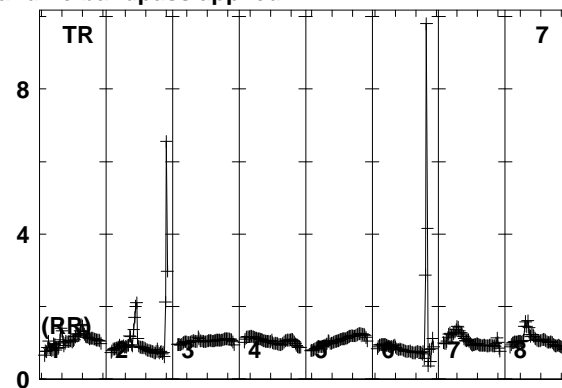
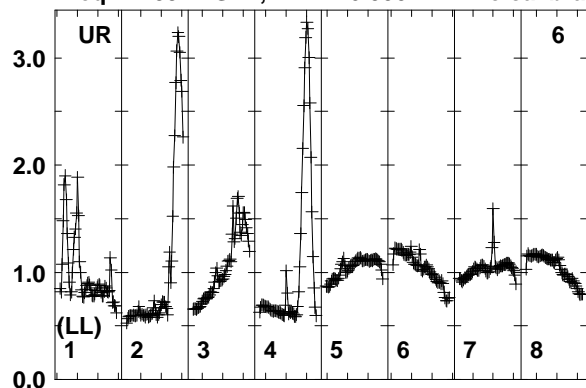

Lower frame: Real Jy
Total-power spectrum Antenna: UR (06)
Timerange: 00/05:38:51 to 00/05:41:29

Plot file version 328 created 04-NOV-2019 14:14:26

W2246-0526 EY034.UVDATA.1

Freq = 1.5947 GHz, Bw = 16.000 MH No calibration applied and no bandpass applied

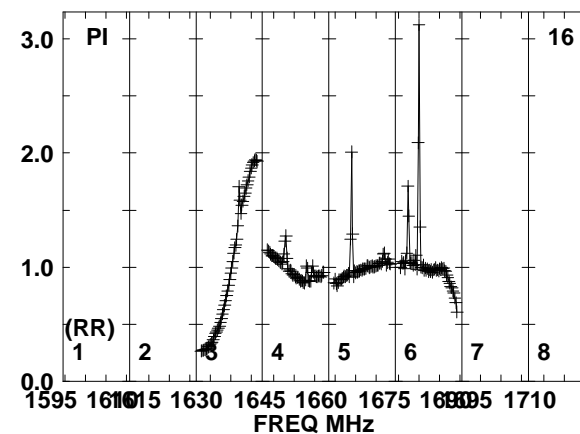
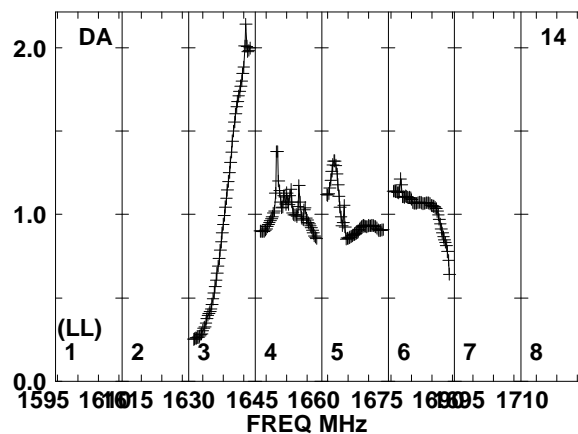
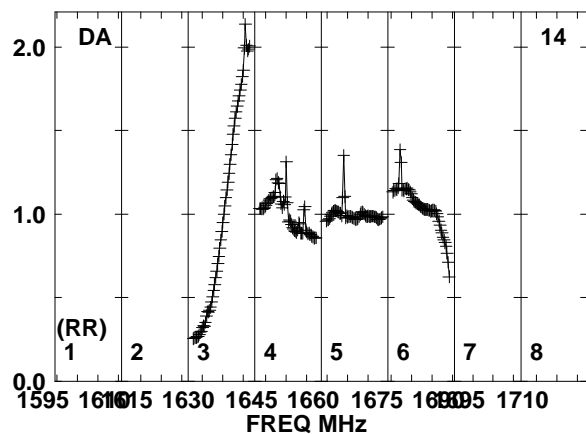
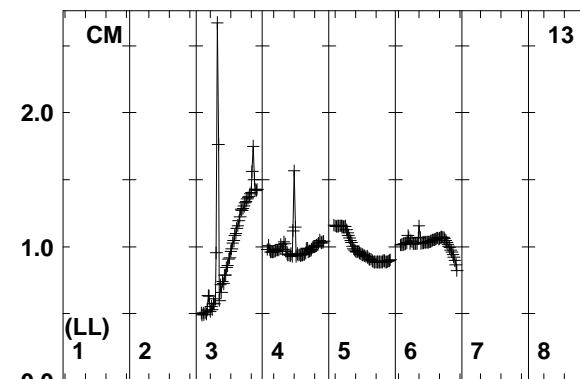
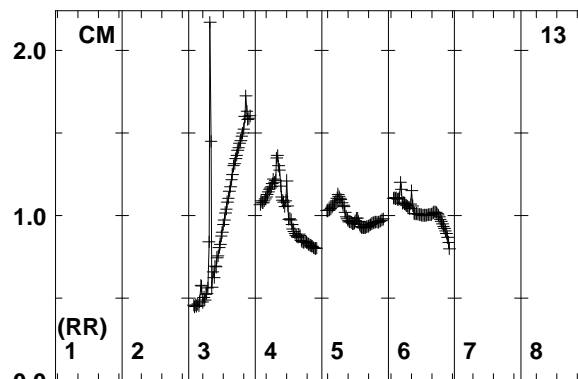
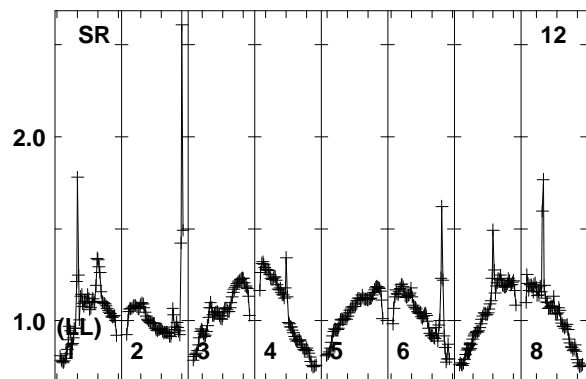
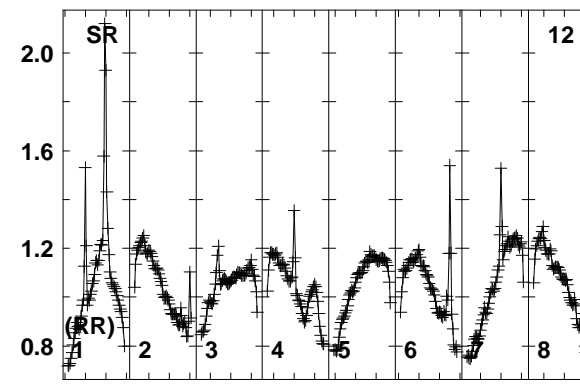
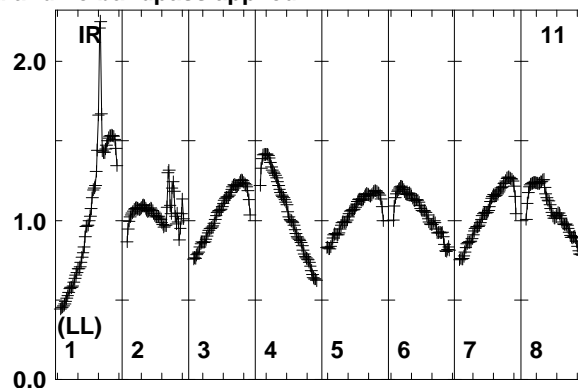
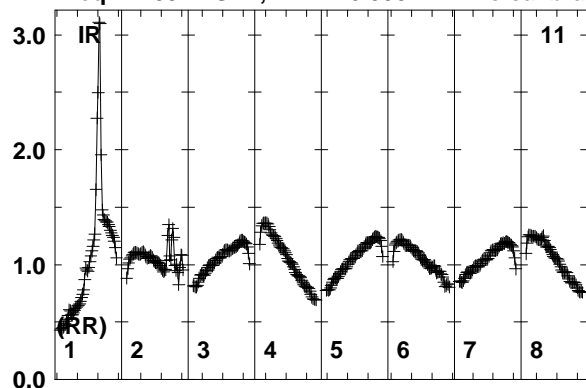

Lower frame: Real Jy
Total-power spectrum Antenna: IR (11)
Timerange: 00/05:38:51 to 00/05:41:29

Plot file version 329 created 04-NOV-2019 14:14:26
W2246-0526 EY034.UVDATA.1
Freq = 1.5947 GHz, Bw = 16.000 MH No calibration applied and no bandpass applied

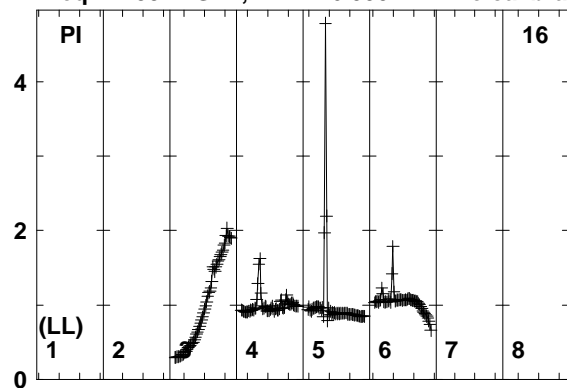

Lower frame: Real Jy
Total-power spectrum Antenna: PI (16)
Timerange: 00/05:38:51 to 00/05:41:29

Plot file version 330 created 04-NOV-2019 14:14:26

J2248-0541 EY034.UVDATA.1

Freq = 1.5947 GHz, Bw = 16.000 MH No calibration applied and no bandpass applied

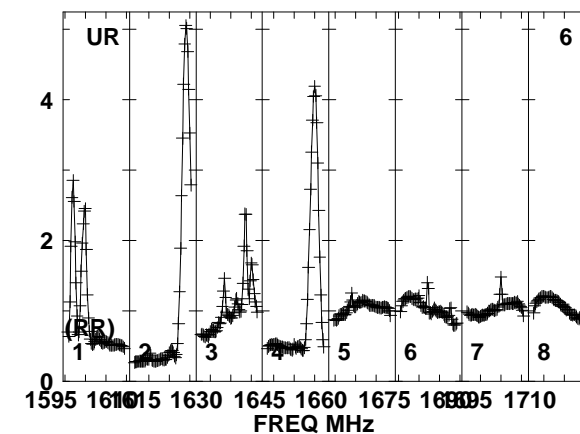
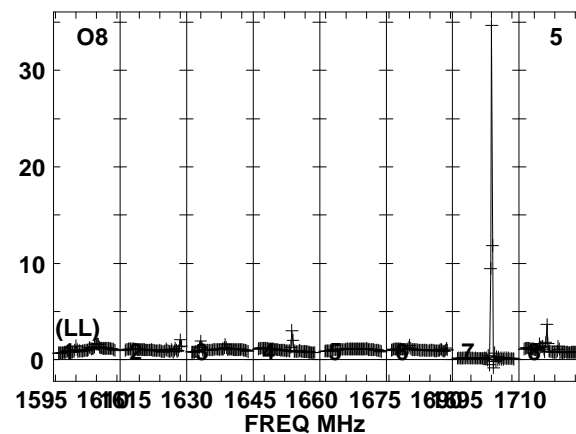
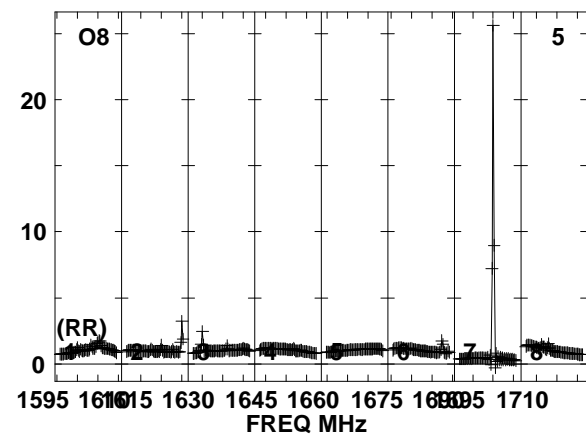
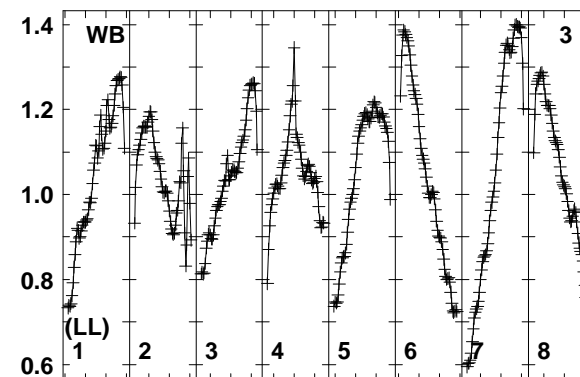
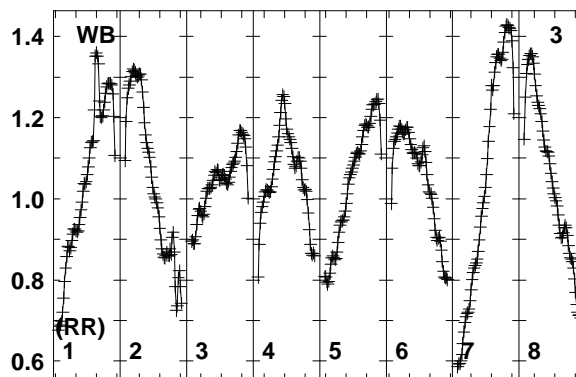
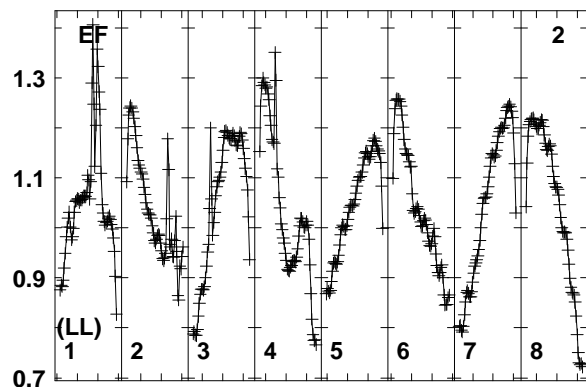
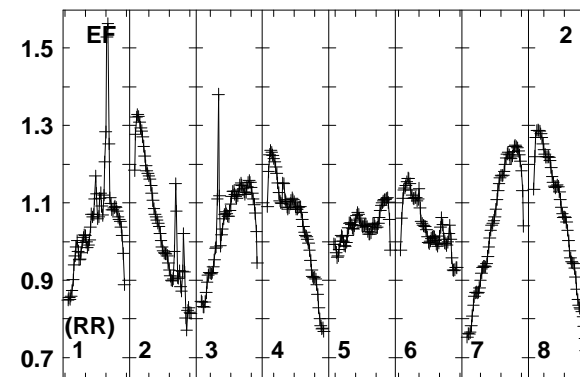
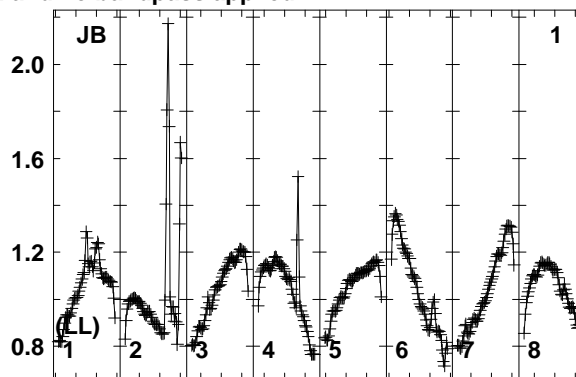
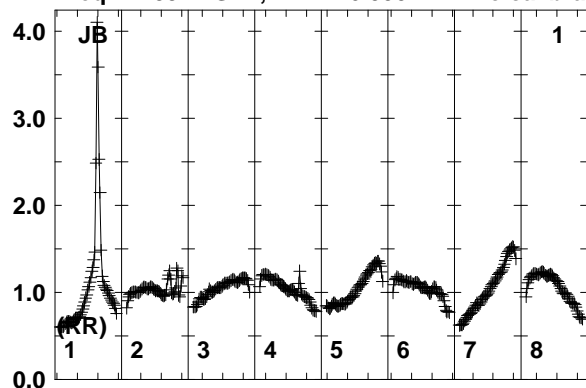

Lower frame: Real Jy
Total-power spectrum Antenna: JB (01)
Timerange: 00/05:41:46 to 00/05:42:44

Plot file version 331 created 04-NOV-2019 14:14:26

J2248-0541 EY034.UVDATA.1

Freq = 1.5947 GHz, Bw = 16.000 MH No calibration applied and no bandpass applied

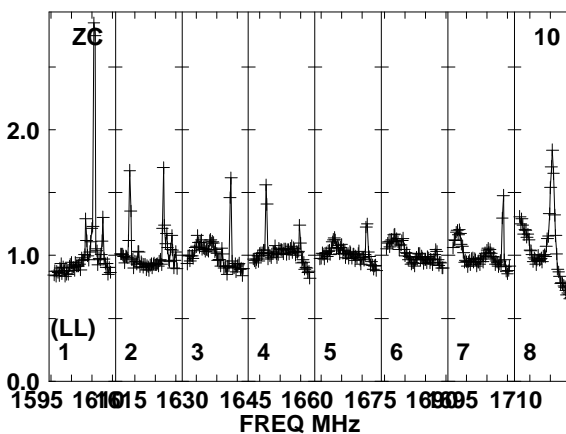
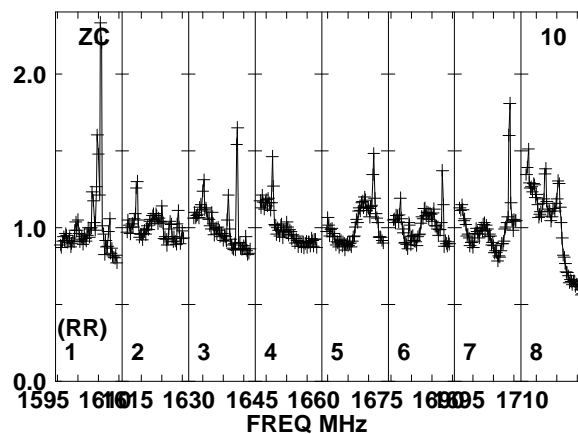
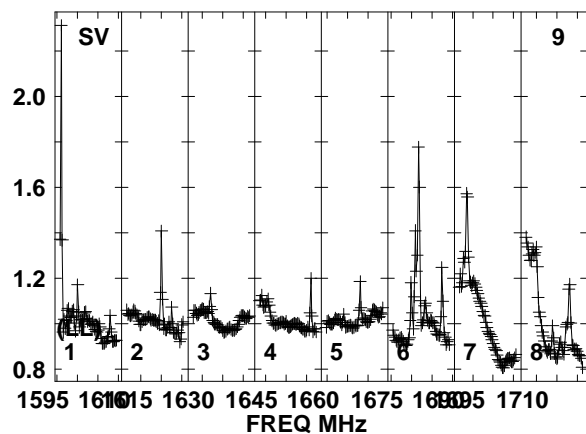
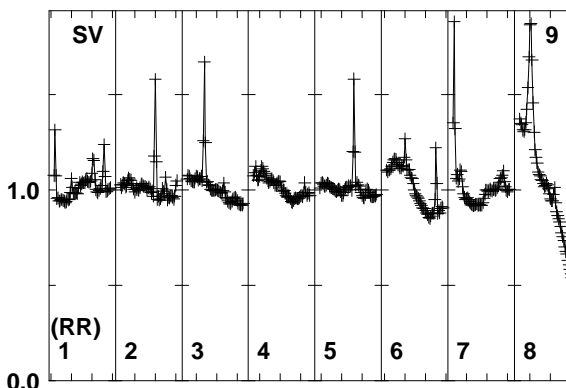
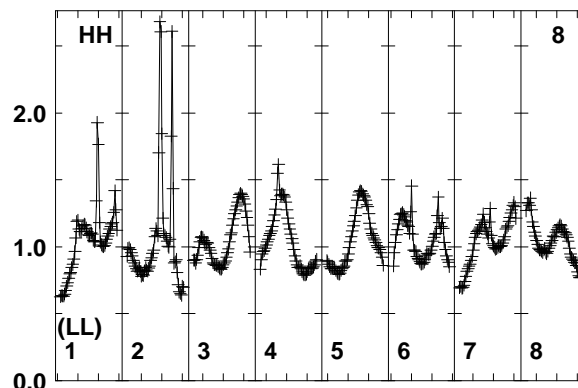
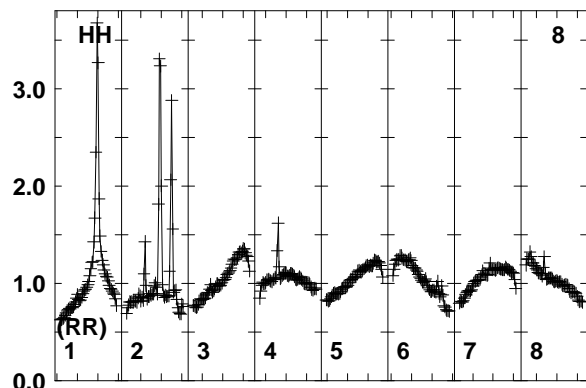
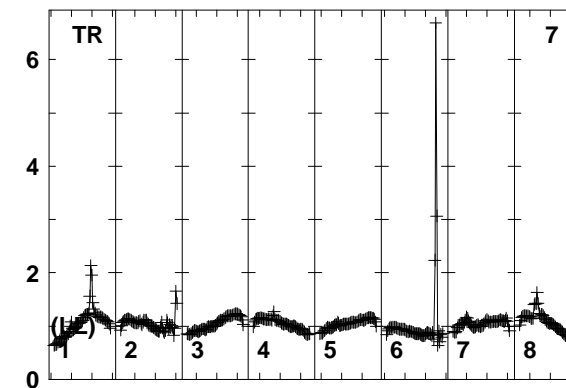
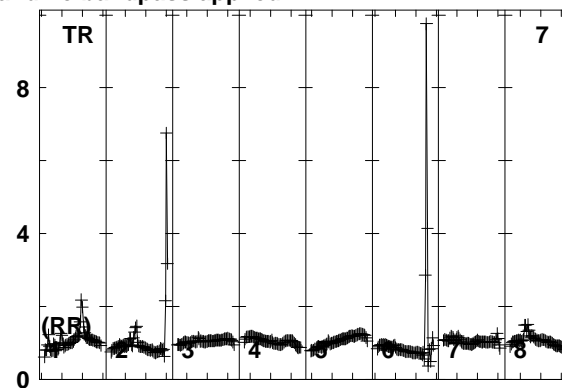
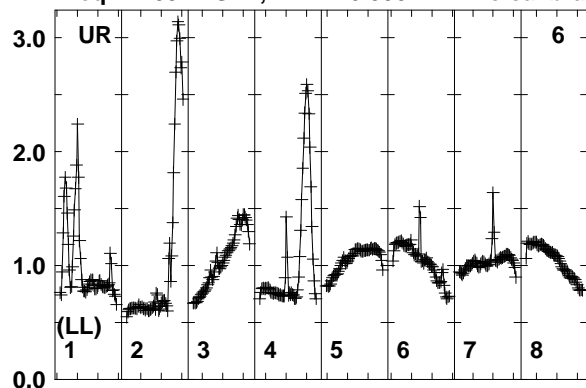

Lower frame: Real Jy
Total-power spectrum Antenna: UR (06)
Timerange: 00/05:41:46 to 00/05:42:44

Plot file version 332 created 04-NOV-2019 14:14:26

J2248-0541 EY034.UVDATA.1

Freq = 1.5947 GHz, Bw = 16.000 MH No calibration applied and no bandpass applied

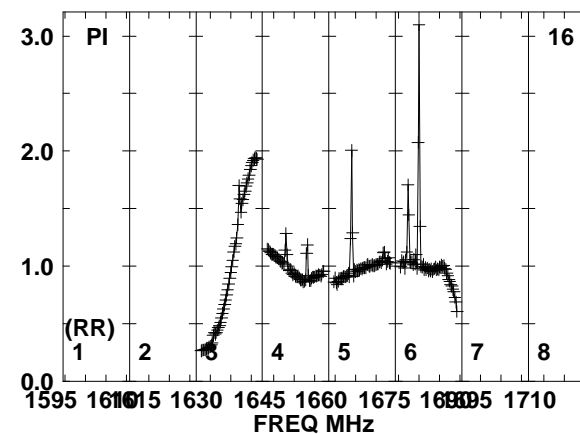
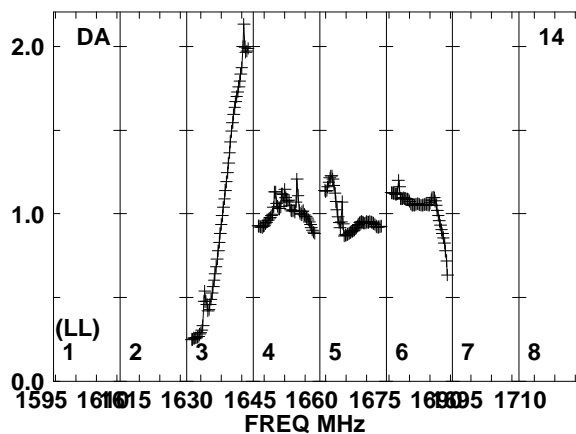
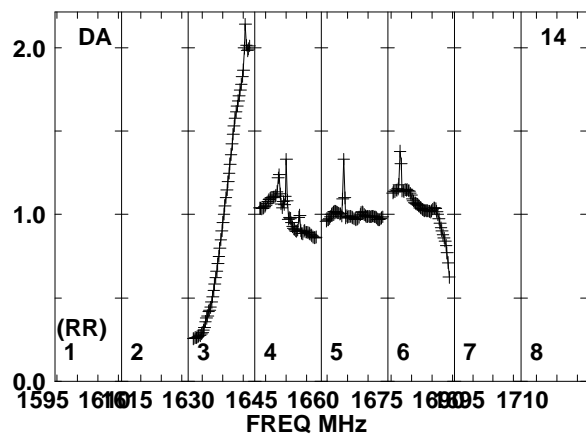
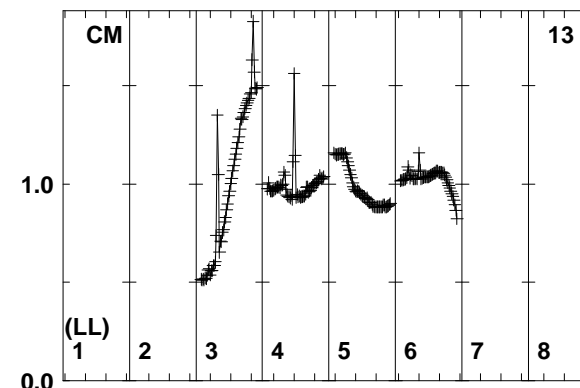
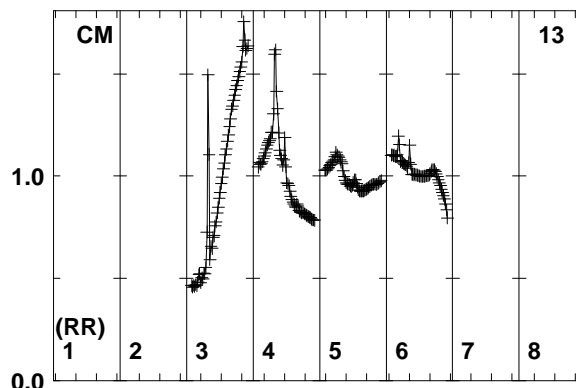
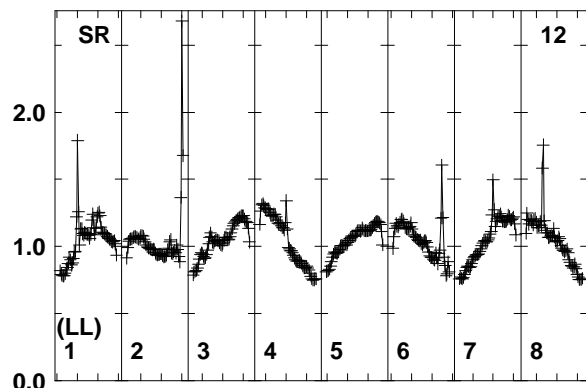
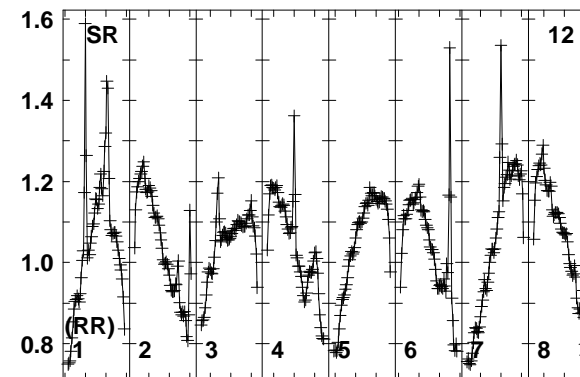
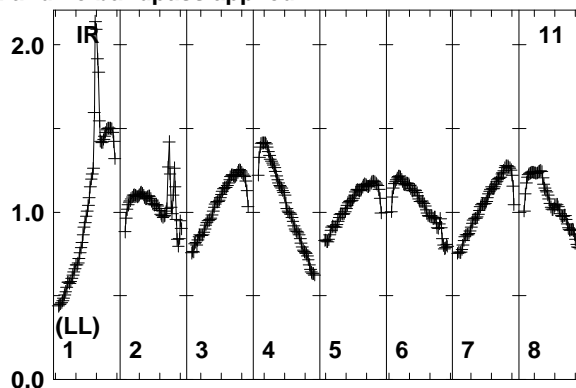
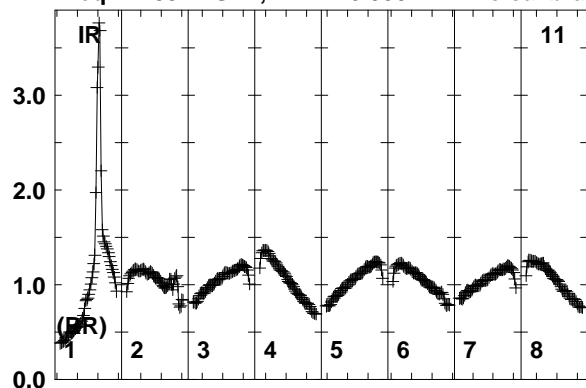

Lower frame: Real Jy
Total-power spectrum Antenna: IR (11)
Timerange: 00/05:41:46 to 00/05:42:44

Plot file version 333 created 04-NOV-2019 14:14:26
J2248-0541 EY034.UVDATA.1
Freq = 1.5947 GHz, Bw = 16.000 MH No calibration applied and no bandpass applied

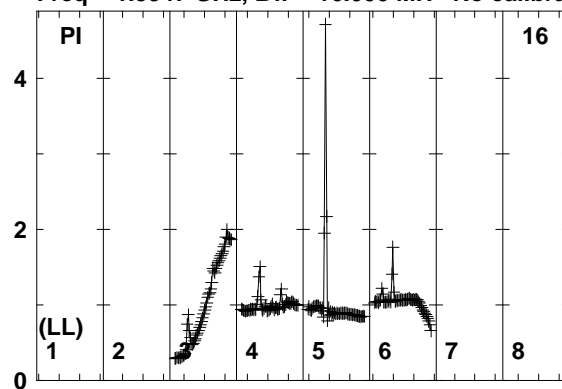

Lower frame: Real Jy
Total-power spectrum Antenna: PI (16)
Timerange: 00/05:41:46 to 00/05:42:44

Plot file version 334 created 04-NOV-2019 14:14:26

J2245-0755 EY034.UVDATA.1

Freq = 1.5947 GHz, Bw = 16.000 MH No calibration applied and no bandpass applied

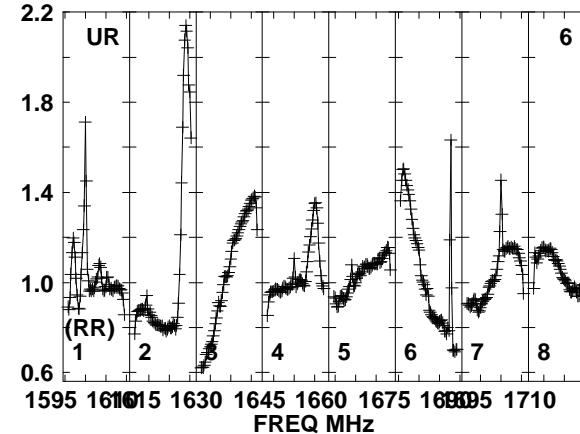
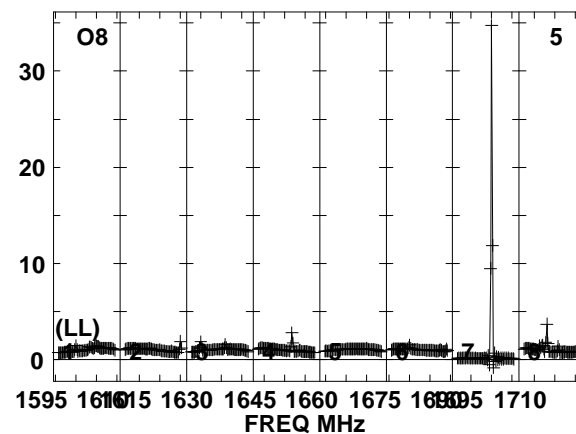
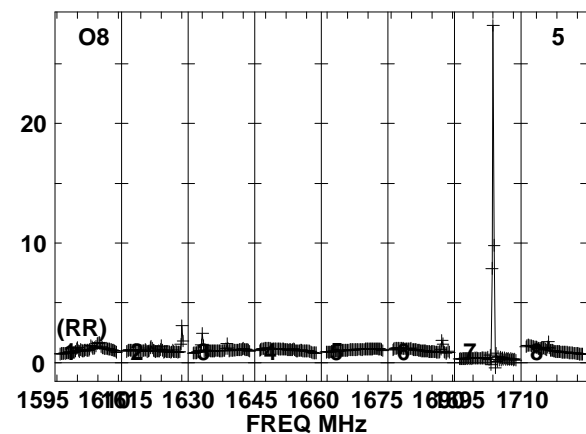
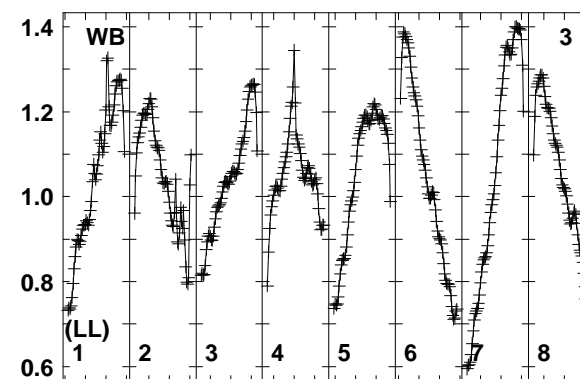
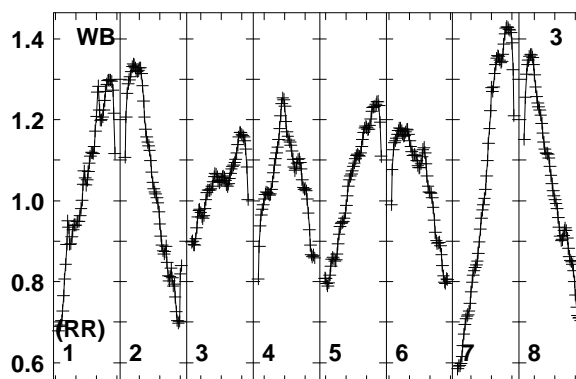
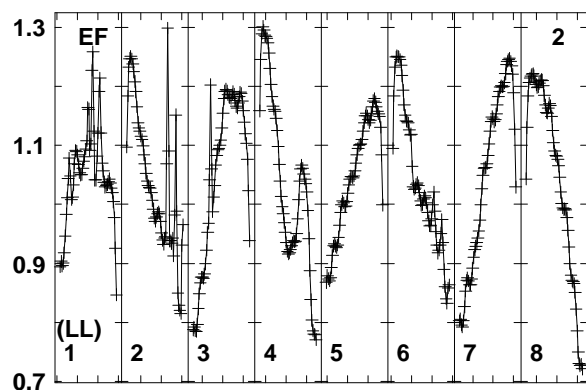
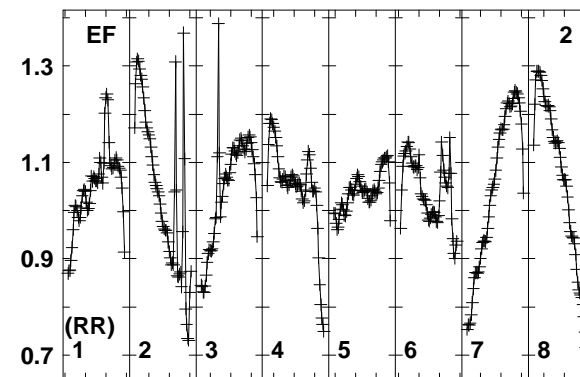
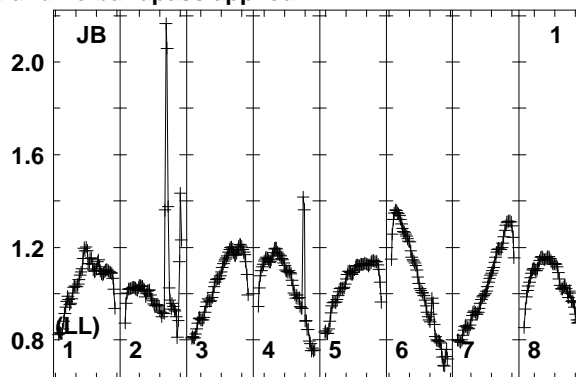
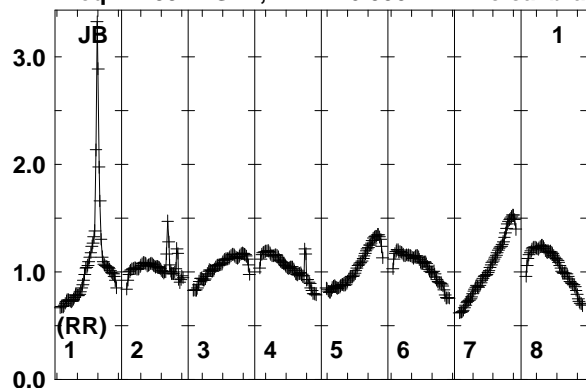

Lower frame: Real Jy
Total-power spectrum Antenna: JB (01)
Timerange: 00/05:43:01 to 00/05:43:59

Plot file version 335 created 04-NOV-2019 14:14:26

J2245-0755 EY034.UVDATA.1

Freq = 1.5947 GHz, Bw = 16.000 MH No calibration applied and no bandpass applied

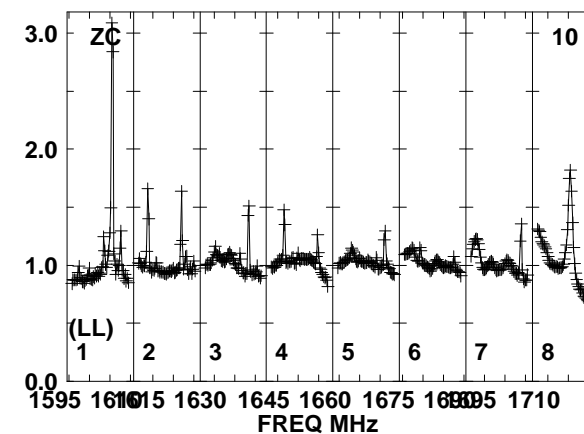
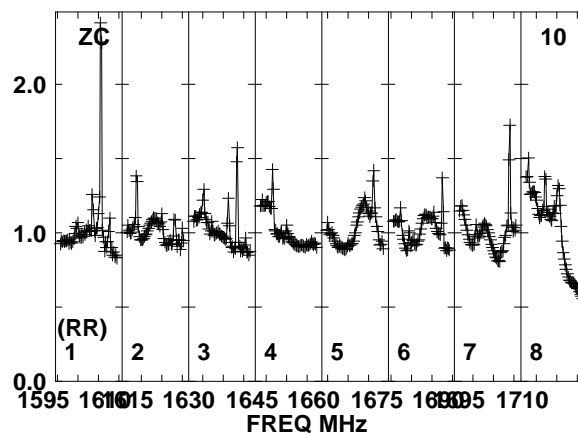
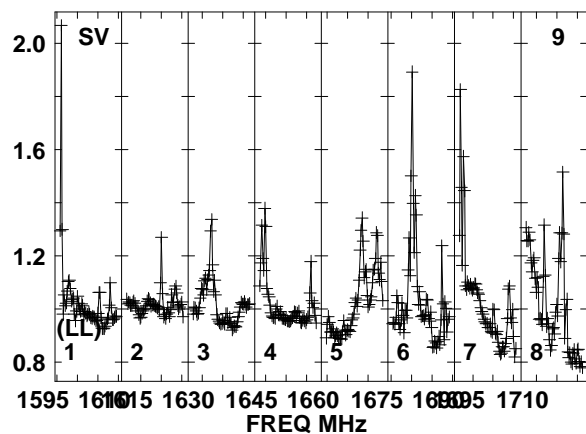
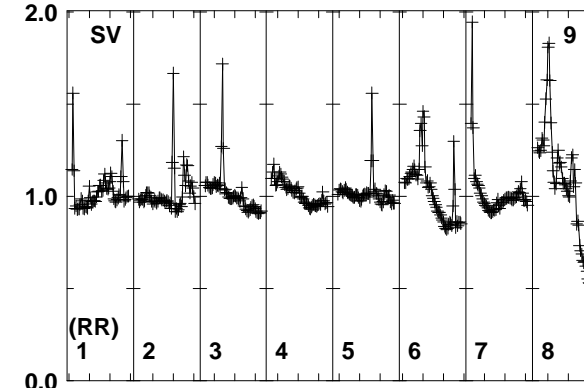
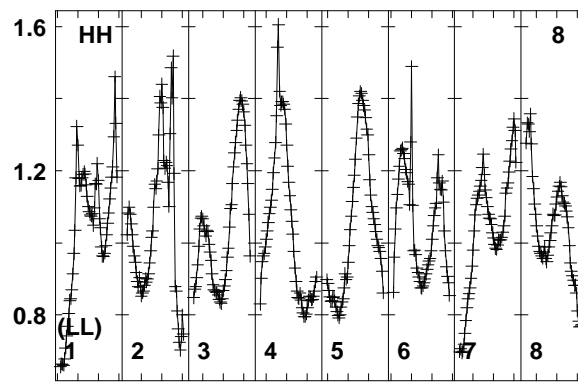
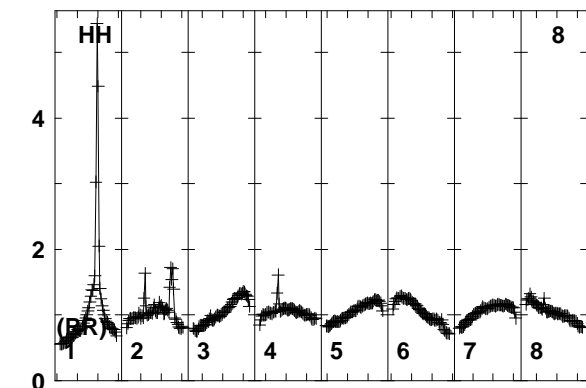
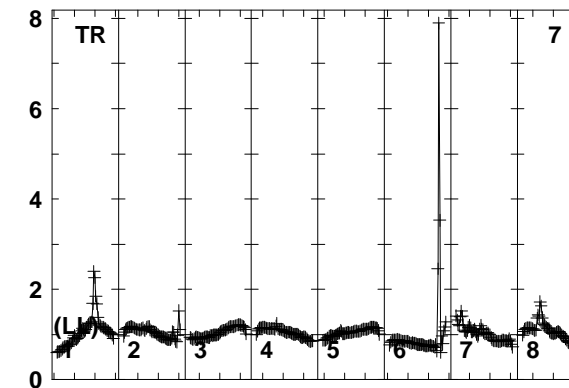
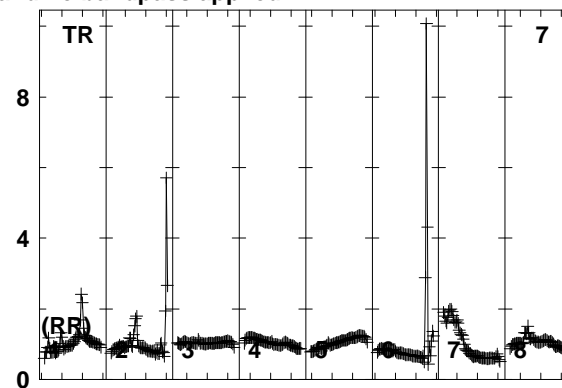
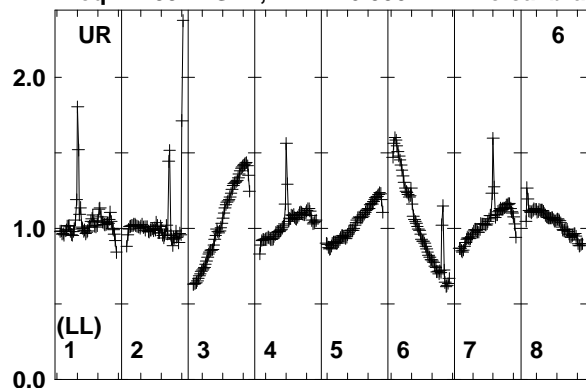

Lower frame: Real Jy
Total-power spectrum Antenna: UR (06)
Timerange: 00/05:43:01 to 00/05:43:59

Plot file version 336 created 04-NOV-2019 14:14:26

J2245-0755 EY034.UVDATA.1

Freq = 1.5947 GHz, Bw = 16.000 MH No calibration applied and no bandpass applied

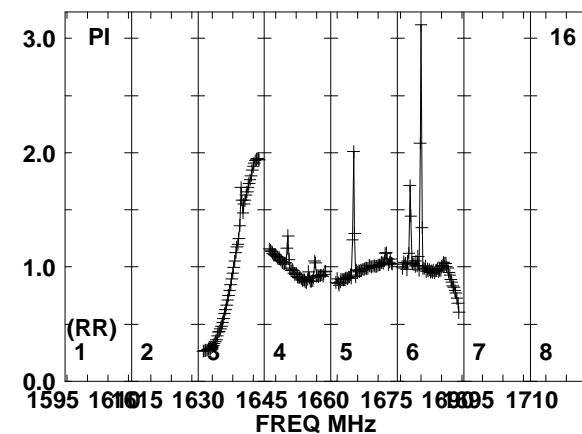
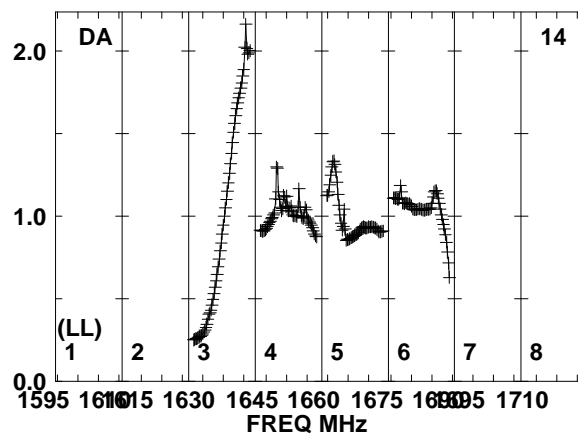
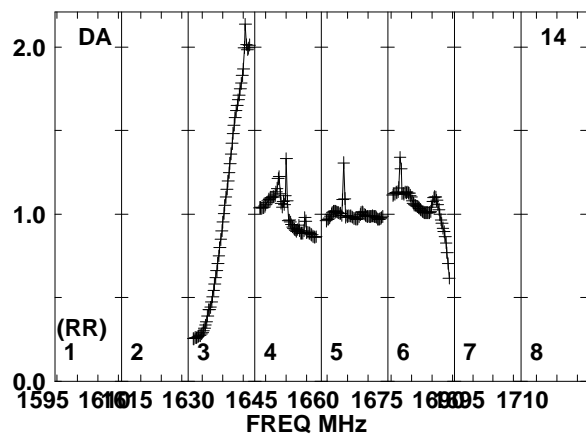
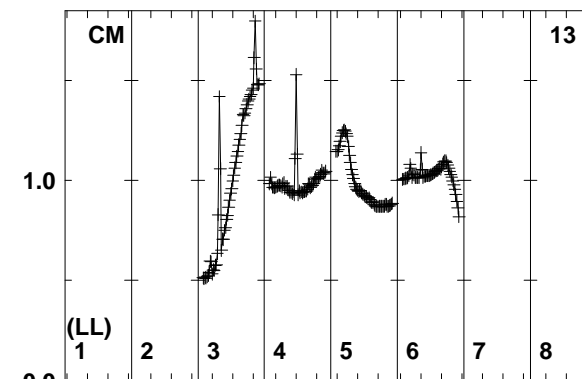
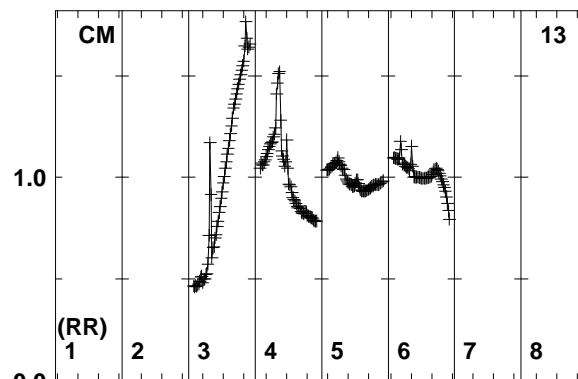
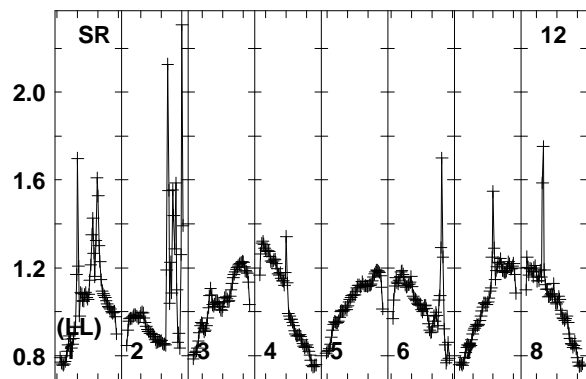
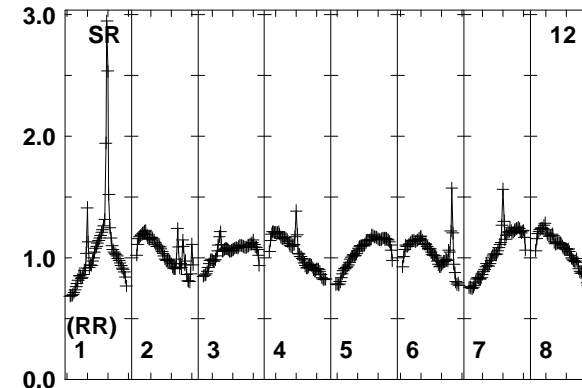
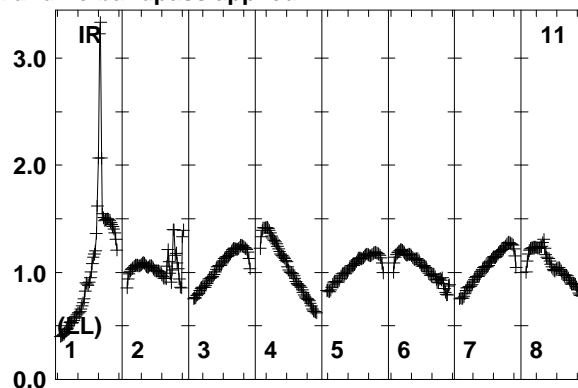
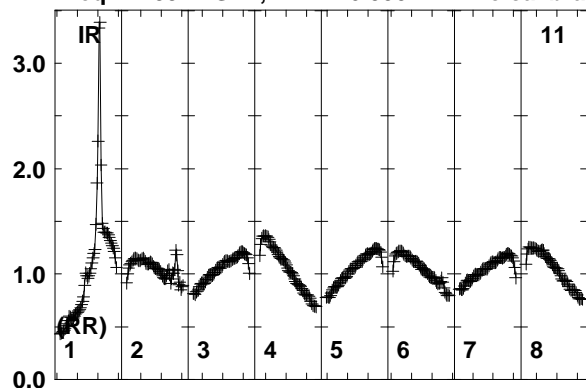

Lower frame: Real Jy
Total-power spectrum Antenna: IR (11)
Timerange: 00/05:43:01 to 00/05:43:59

Plot file version 337 created 04-NOV-2019 14:14:26
J2245-0755 EY034.UVDATA.1
Freq = 1.5947 GHz, Bw = 16.000 MH No calibration applied and no bandpass applied

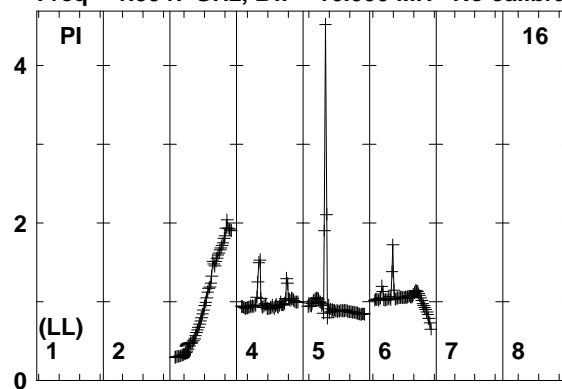

Lower frame: Real Jy
Total-power spectrum Antenna: PI (16)
Timerange: 00/05:43:01 to 00/05:43:59

Plot file version 338 created 04-NOV-2019 14:14:26

J2248-0541 EY034.UVDATA.1

Freq = 1.5947 GHz, Bw = 16.000 MH No calibration applied and no bandpass applied

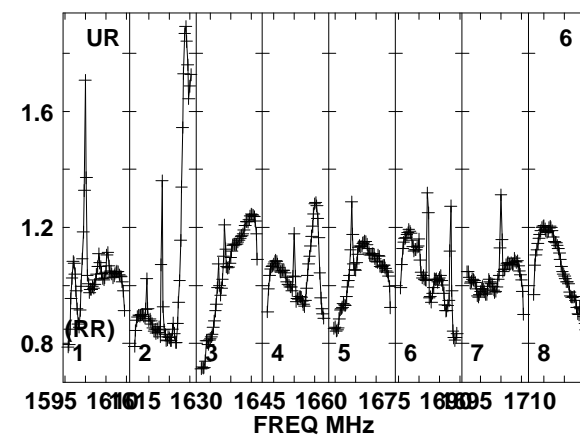
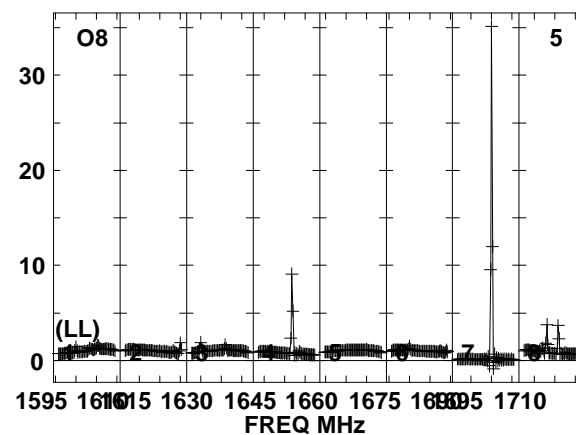
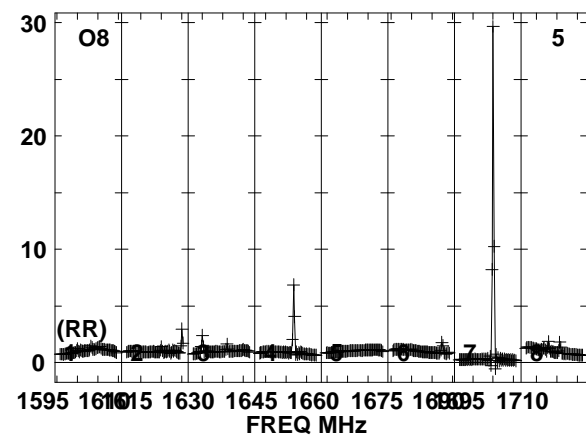
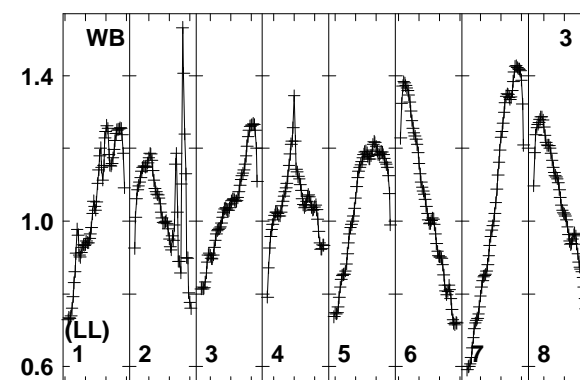
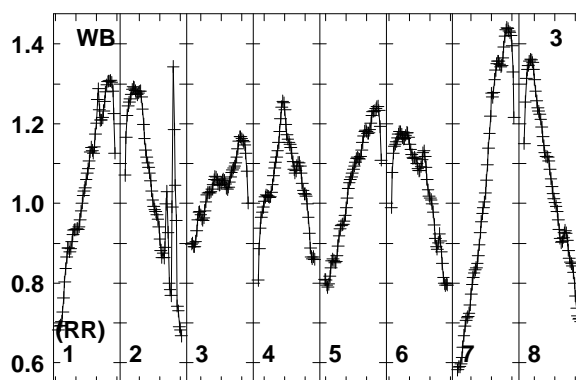
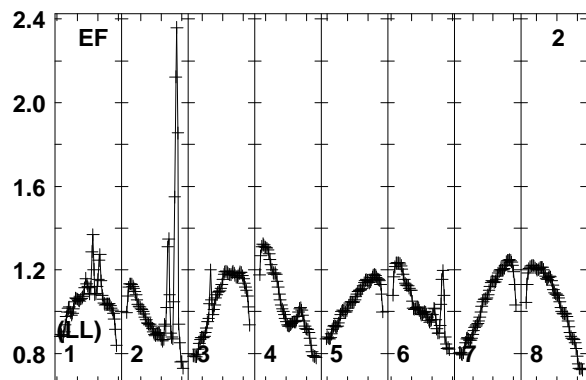
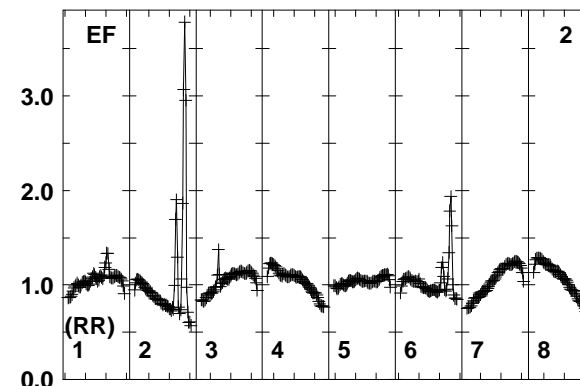
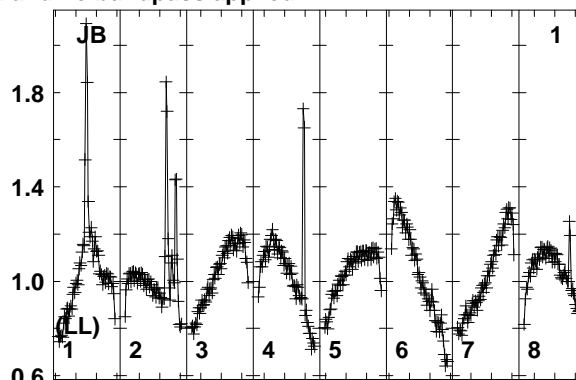
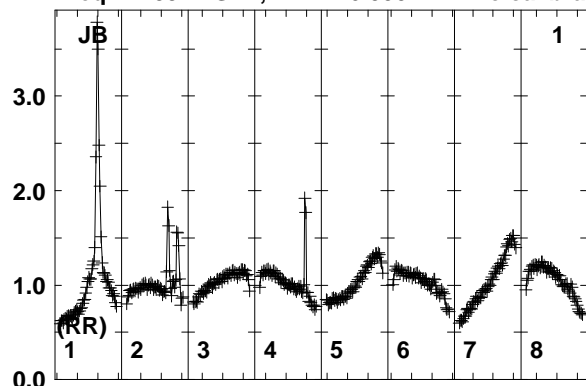

Lower frame: Real Jy
Total-power spectrum Antenna: JB (01)
Timerange: 00/05:44:46 to 00/05:45:44

Plot file version 339 created 04-NOV-2019 14:14:26

J2248-0541 EY034.UVDATA.1

Freq = 1.5947 GHz, Bw = 16.000 MH No calibration applied and no bandpass applied

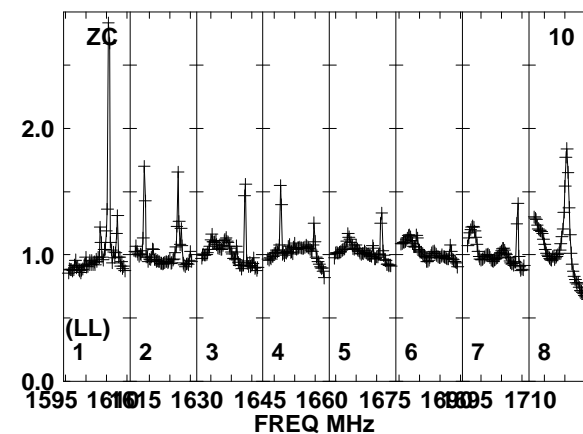
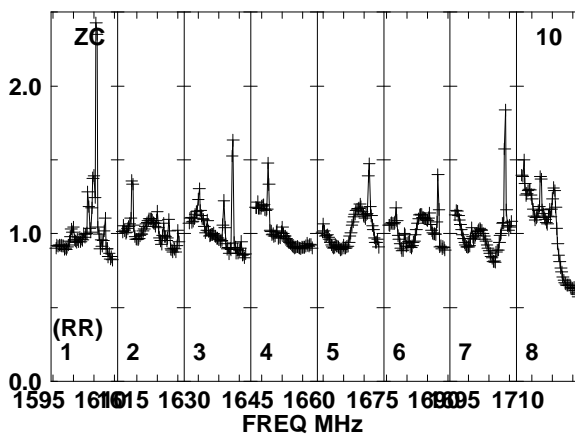
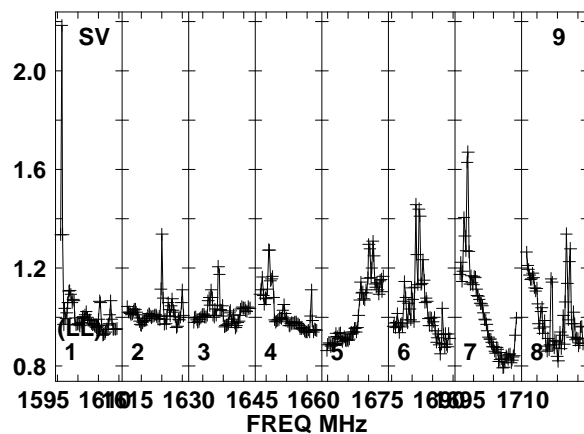
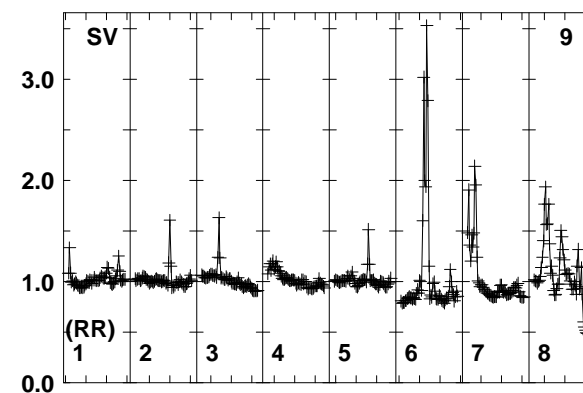
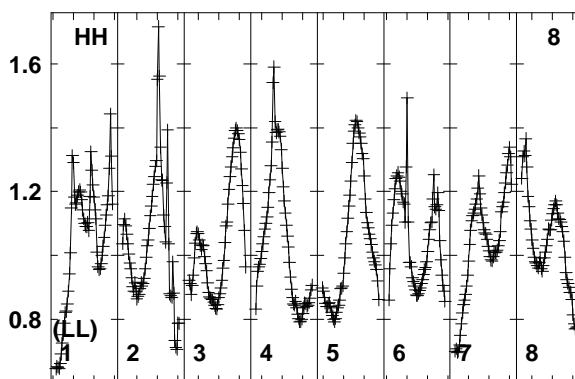
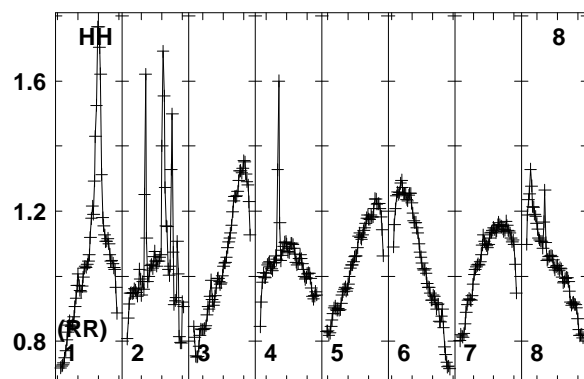
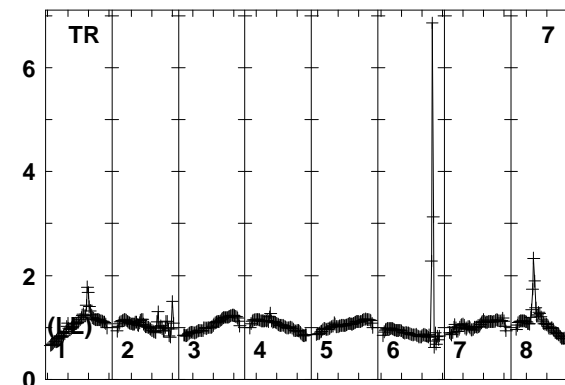
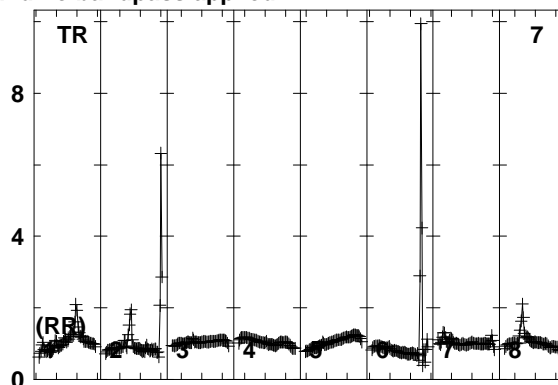
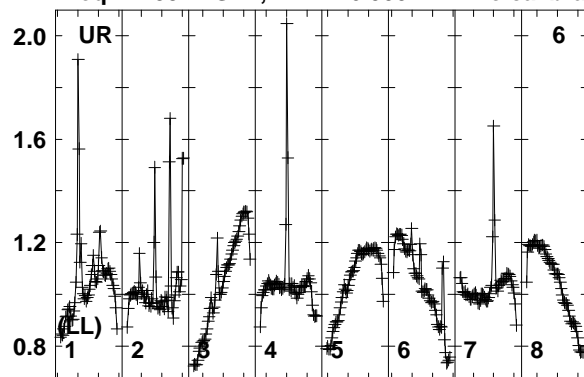

Lower frame: Real Jy
Total-power spectrum Antenna: UR (06)
Timerange: 00/05:44:46 to 00/05:45:44

Plot file version 340 created 04-NOV-2019 14:14:26

J2248-0541 EY034.UVDATA.1

Freq = 1.5947 GHz, Bw = 16.000 MH No calibration applied and no bandpass applied

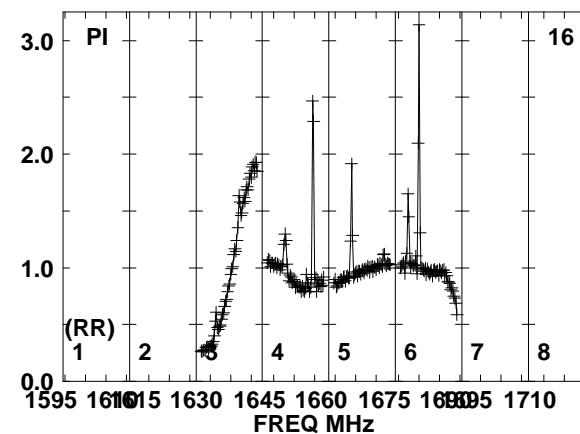
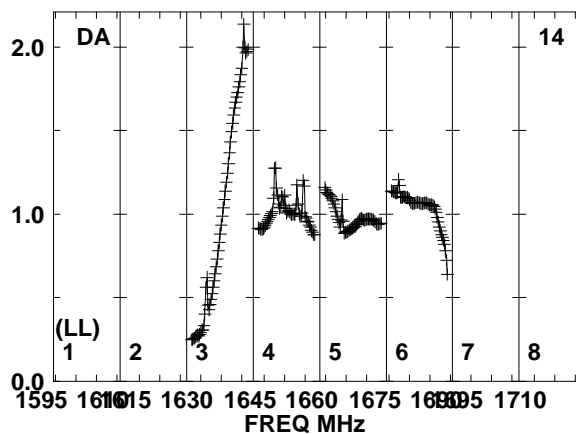
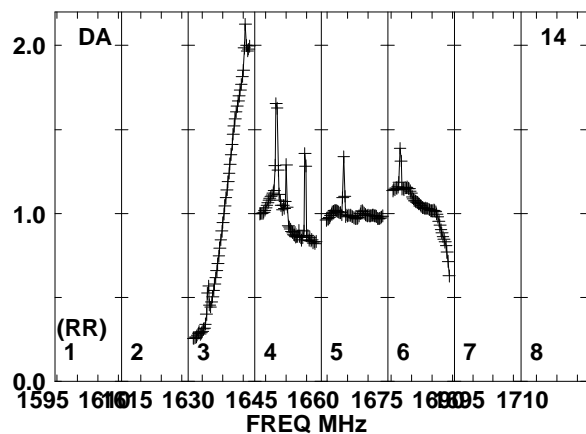
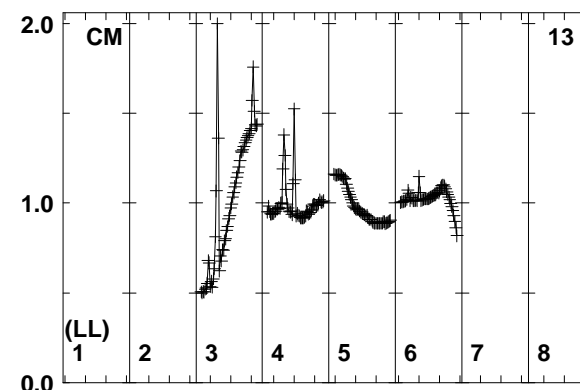
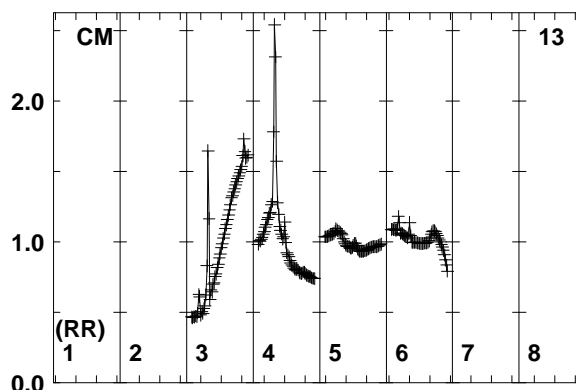
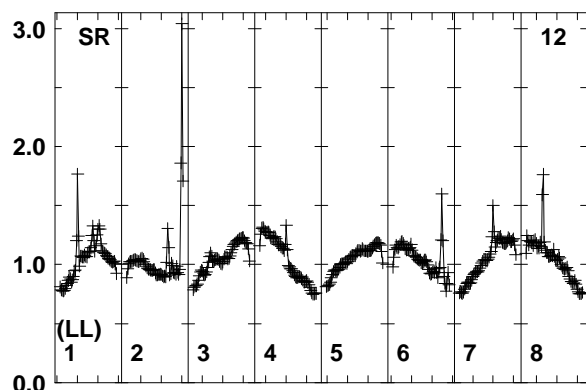
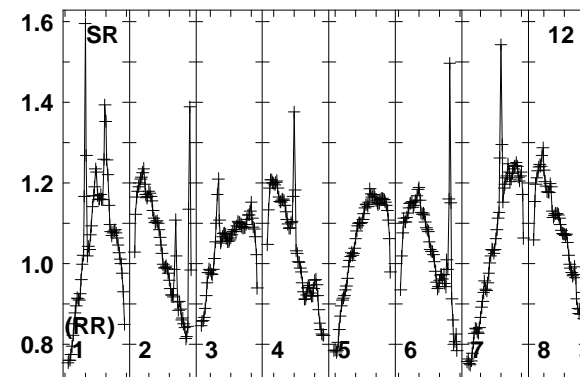
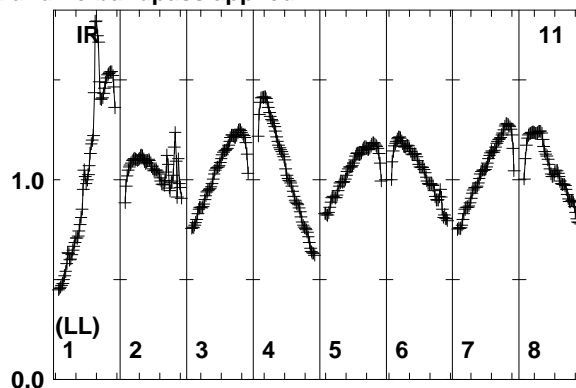
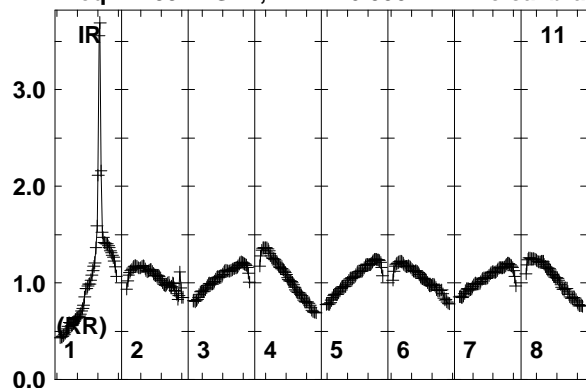

Lower frame: Real Jy
Total-power spectrum Antenna: IR (11)
Timerange: 00/05:44:46 to 00/05:45:44

Plot file version 341 created 04-NOV-2019 14:14:26
J2248-0541 EY034.UVDATA.1
Freq = 1.5947 GHz, Bw = 16.000 MH No calibration applied and no bandpass applied

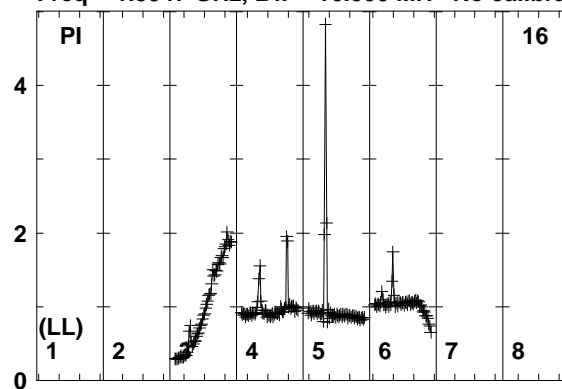

Lower frame: Real Jy
Total-power spectrum Antenna: PI (16)
Timerange: 00/05:44:46 to 00/05:45:44

Plot file version 342 created 04-NOV-2019 14:14:27

W2246-0526 EY034.UVDATA.1

Freq = 1.5947 GHz, Bw = 16.000 MH No calibration applied and no bandpass applied

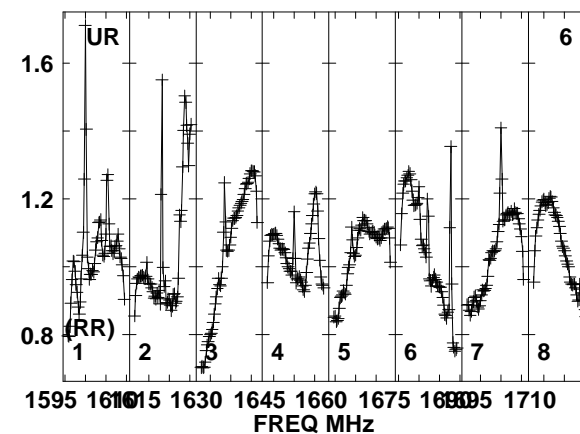
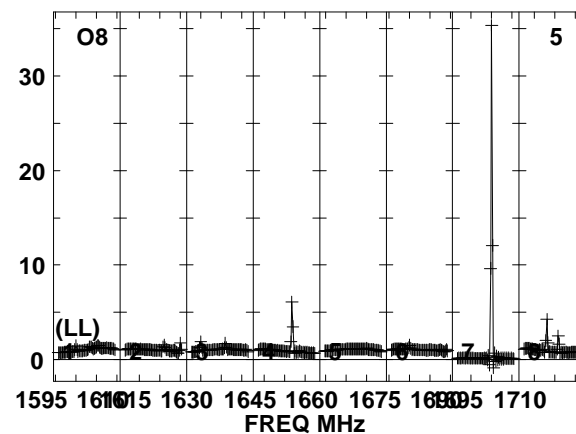
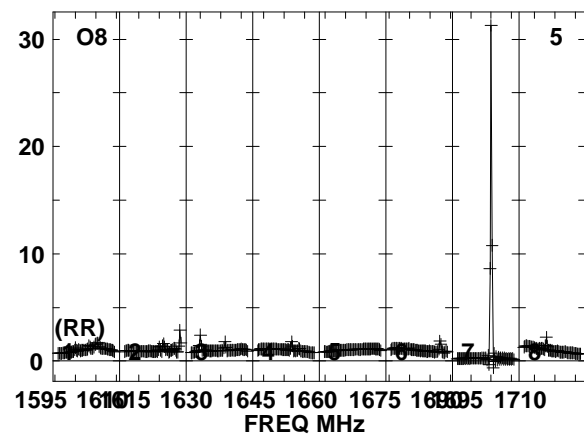
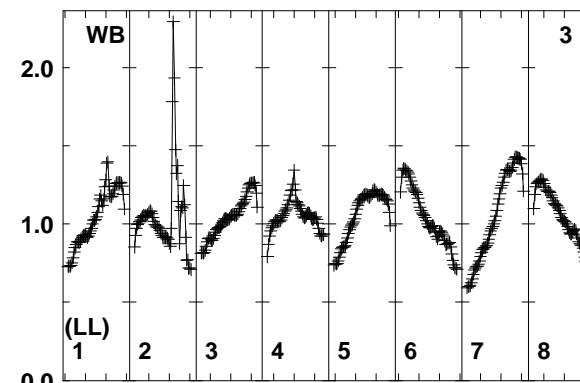
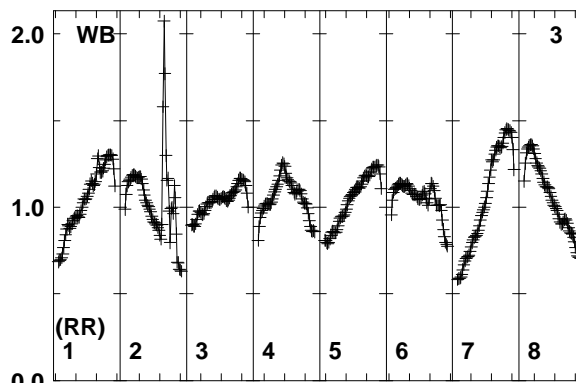
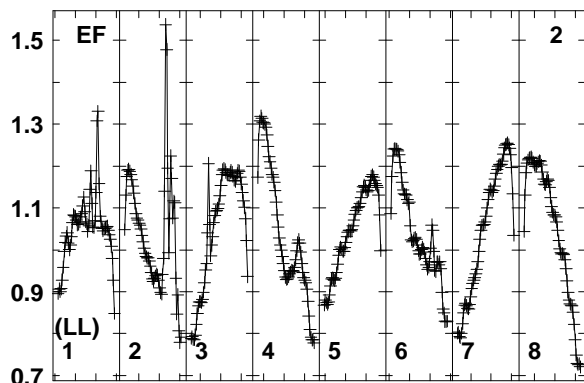
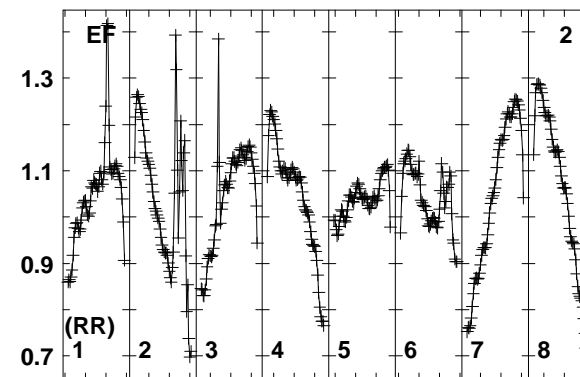
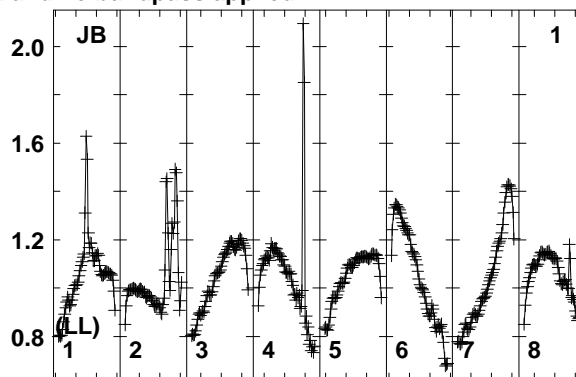
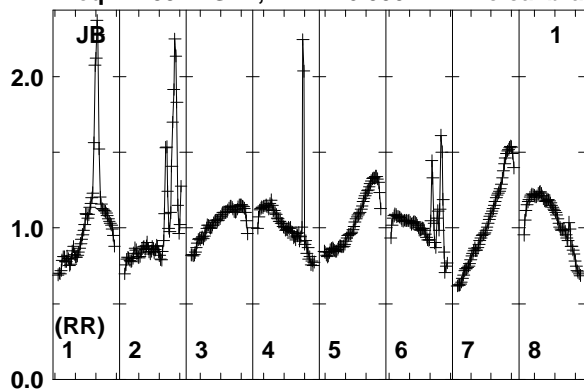

Lower frame: Real Jy
Total-power spectrum Antenna: JB (01)
Timerange: 00/05:45:46 to 00/05:48:14

Plot file version 343 created 04-NOV-2019 14:14:27

W2246-0526 EY034.UVDATA.1

Freq = 1.5947 GHz, Bw = 16.000 MH No calibration applied and no bandpass applied

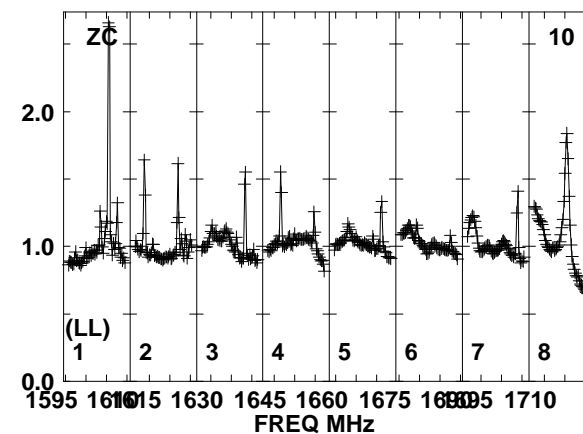
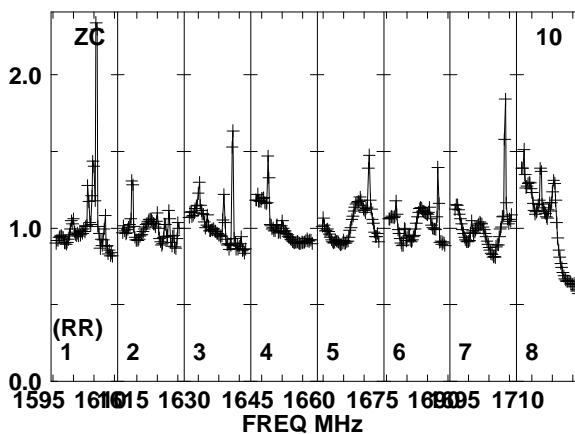
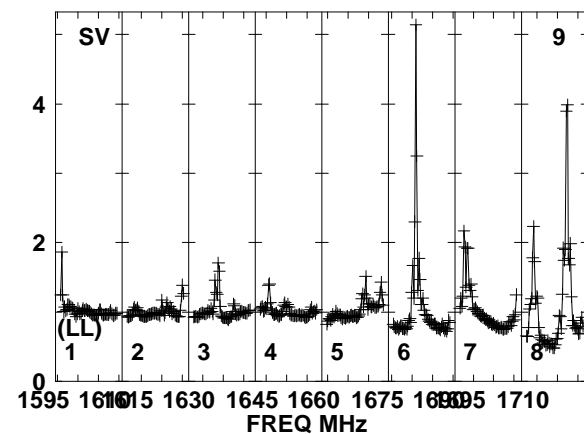
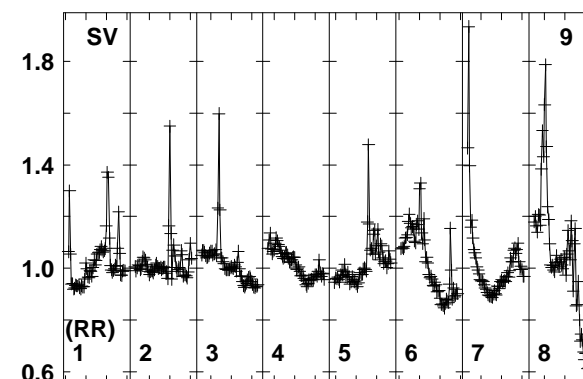
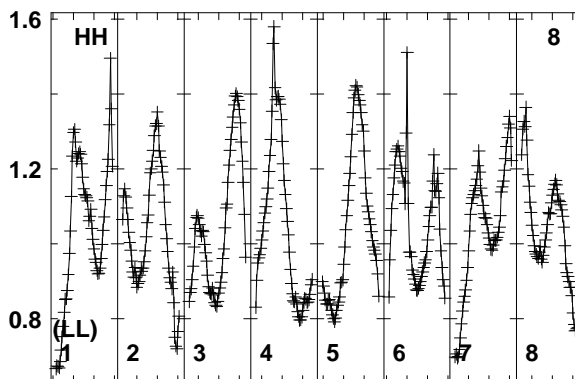
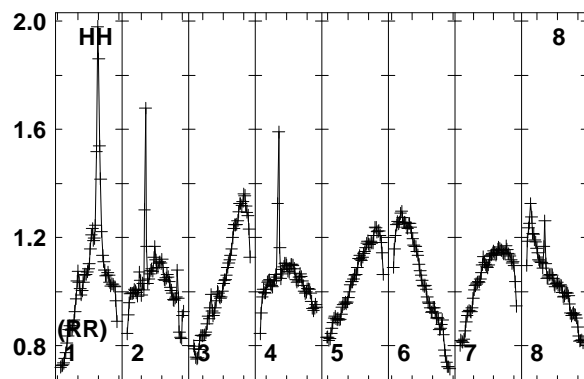
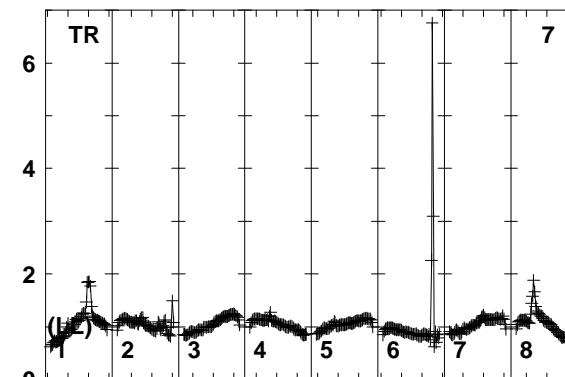
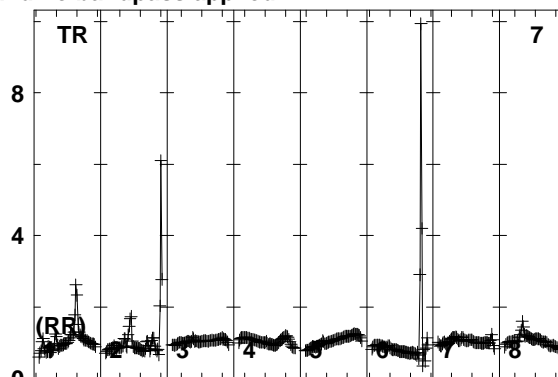
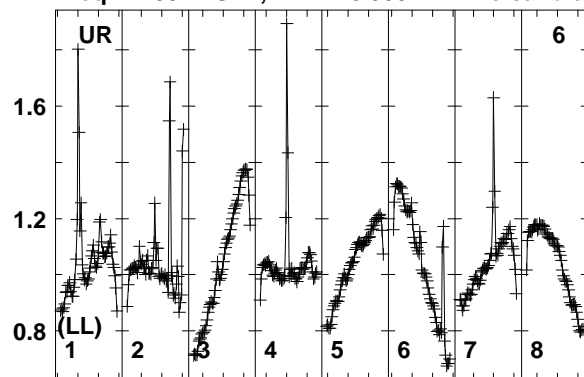

Lower frame: Real Jy
Total-power spectrum Antenna: UR (06)
Timerange: 00/05:45:46 to 00/05:48:14

Plot file version 344 created 04-NOV-2019 14:14:27

W2246-0526 EY034.UVDATA.1

Freq = 1.5947 GHz, Bw = 16.000 MH No calibration applied and no bandpass applied

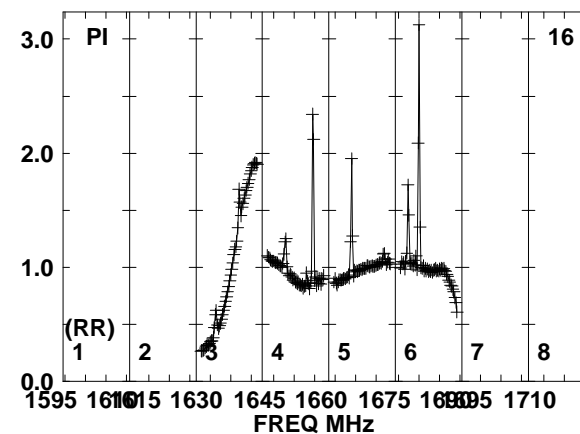
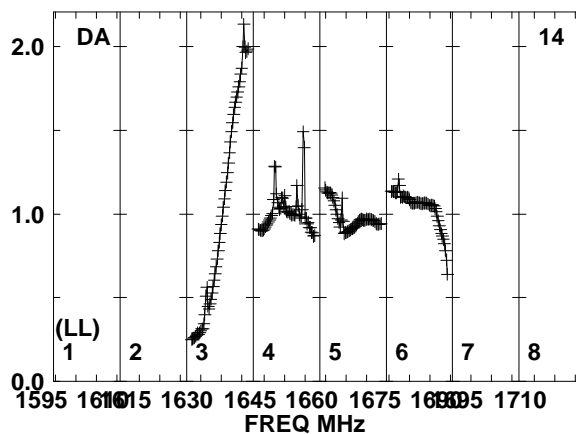
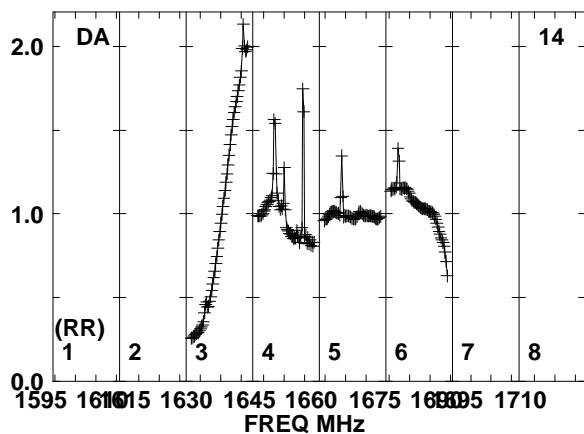
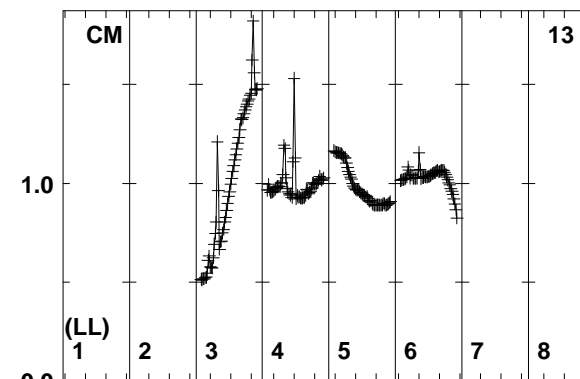
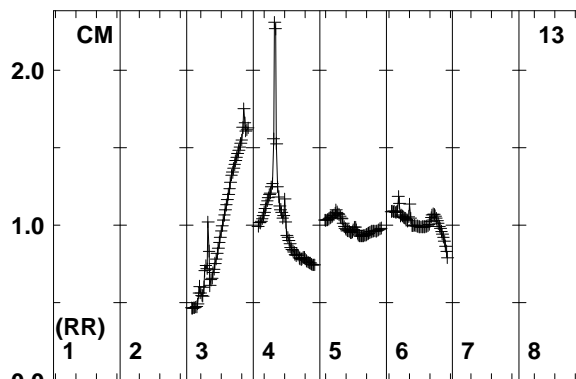
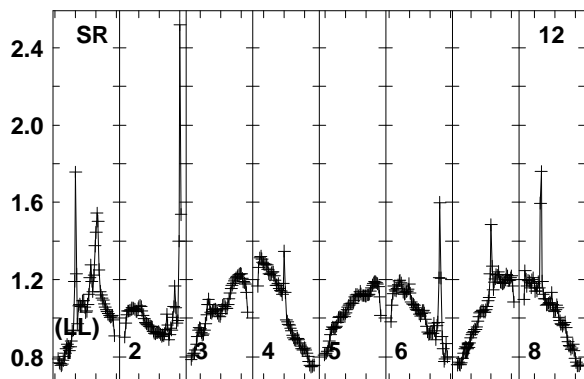
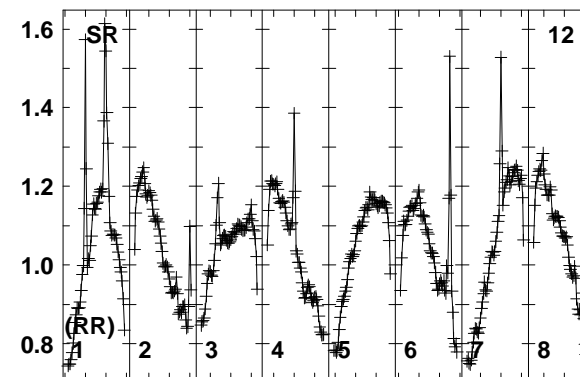
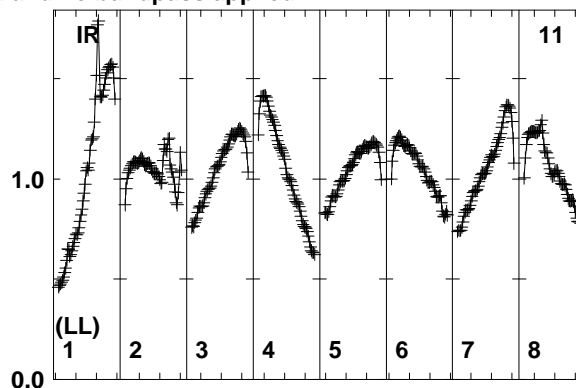
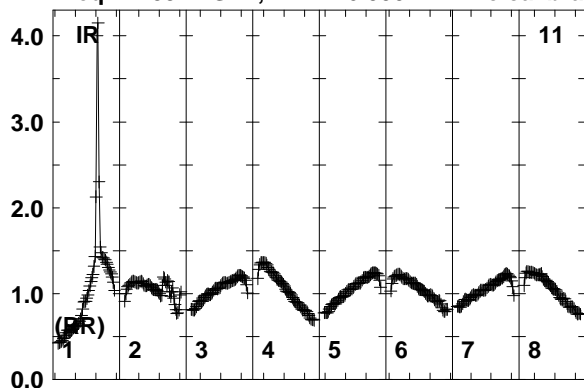

Lower frame: Real Jy
Total-power spectrum Antenna: IR (11)
Timerange: 00/05:45:46 to 00/05:48:14

Plot file version 345 created 04-NOV-2019 14:14:27

W2246-0526 EY034.UVDATA.1

Freq = 1.5947 GHz, Bw = 16.000 MH No calibration applied and no bandpass applied

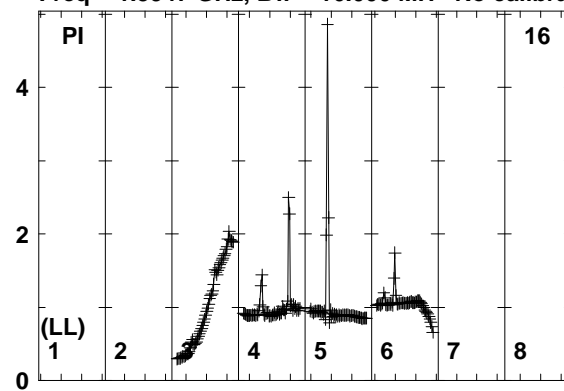

Lower frame: Real Jy

Total-power spectrum Antenna: PI (16)

Timerange: 00/05:45:46 to 00/05:48:14

Plot file version 346 created 04-NOV-2019 14:14:27

J2248-0541 EY034.UVDATA.1

Freq = 1.5947 GHz, Bw = 16.000 MH No calibration applied and no bandpass applied

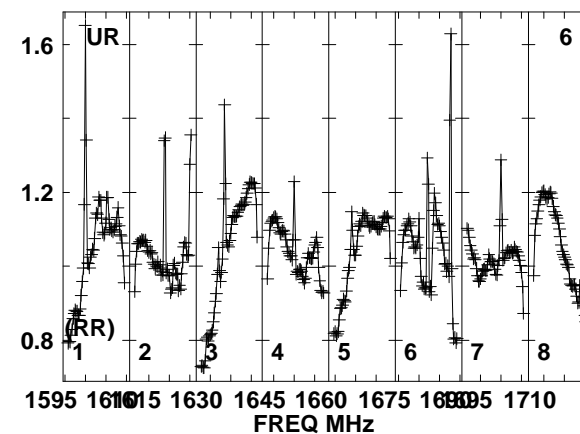
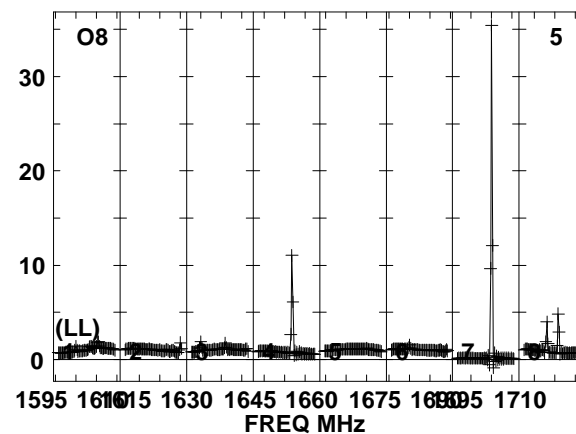
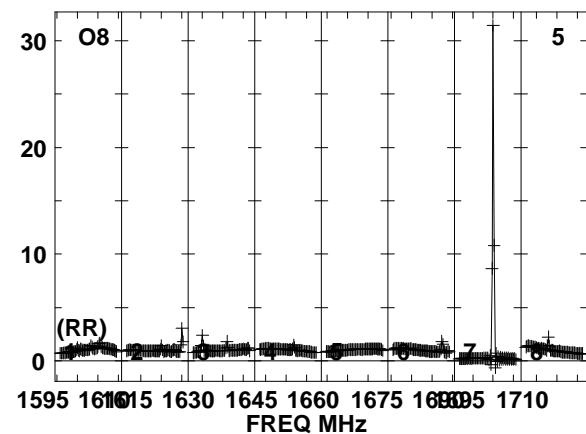
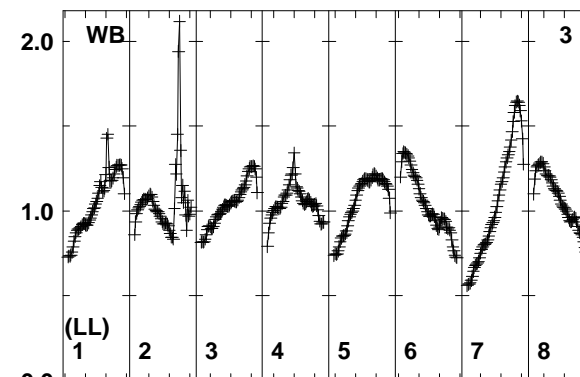
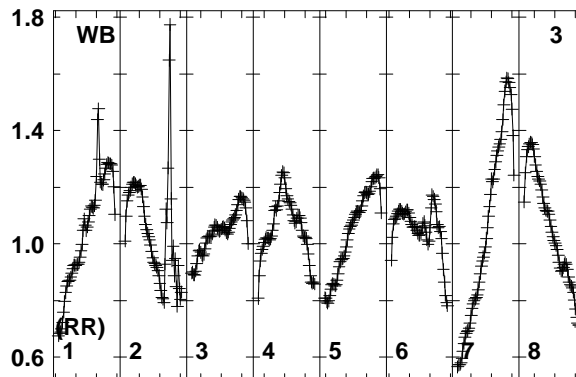
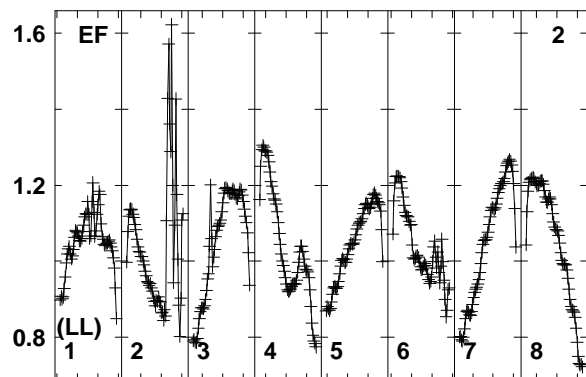
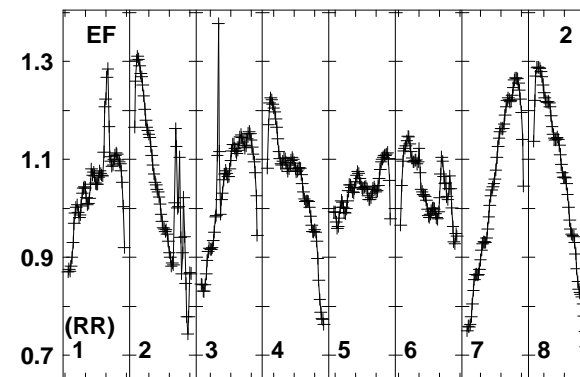
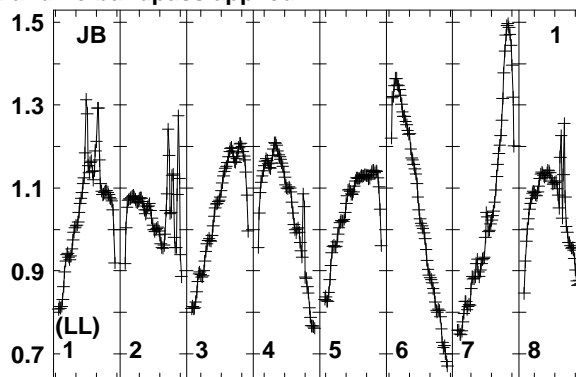
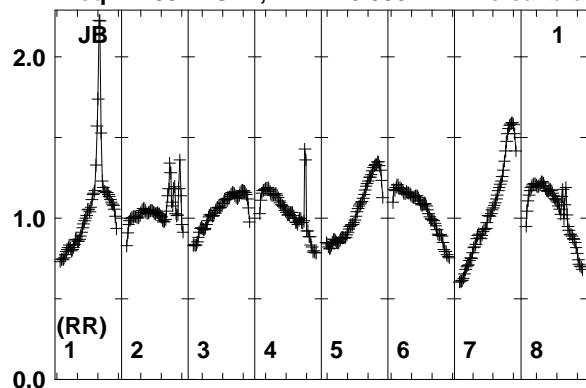

Lower frame: Real Jy
Total-power spectrum Antenna: JB (01)
Timerange: 00/05:48:31 to 00/05:49:29

Plot file version 347 created 04-NOV-2019 14:14:27

J2248-0541 EY034.UVDATA.1

Freq = 1.5947 GHz, Bw = 16.000 MH No calibration applied and no bandpass applied

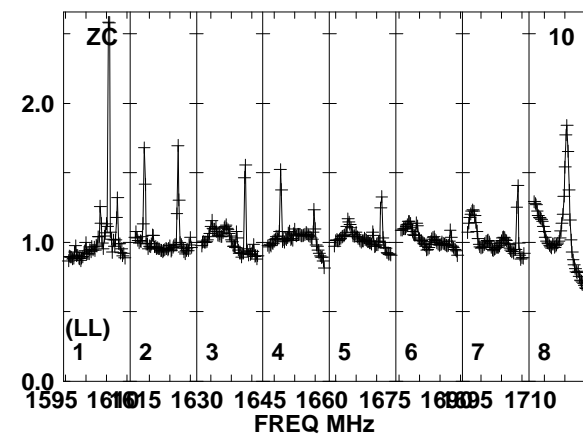
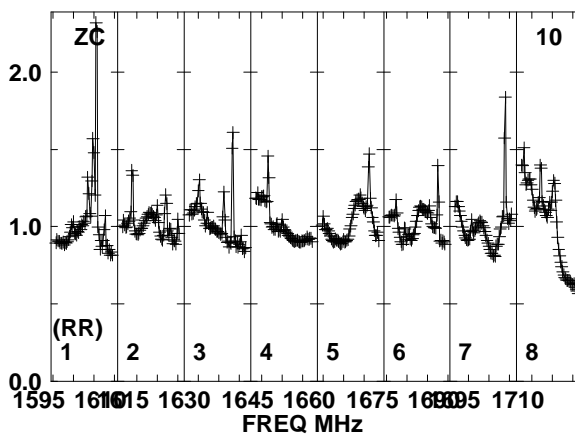
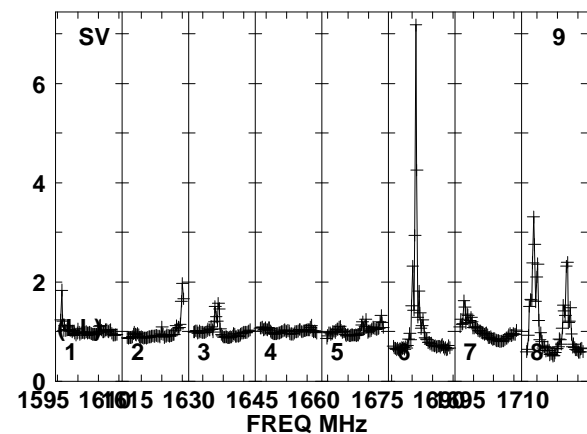
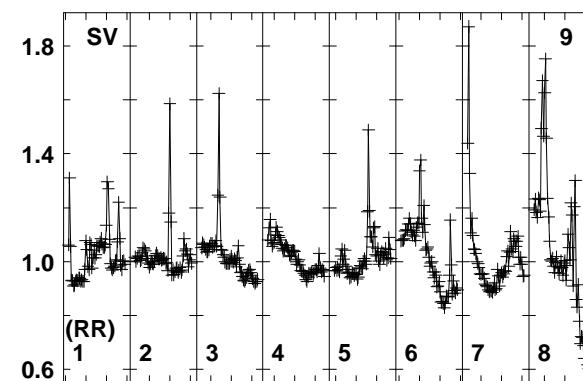
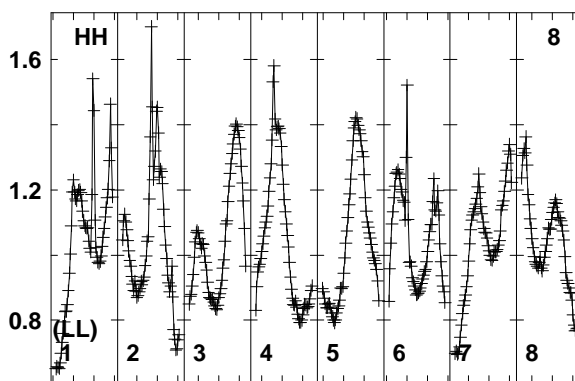
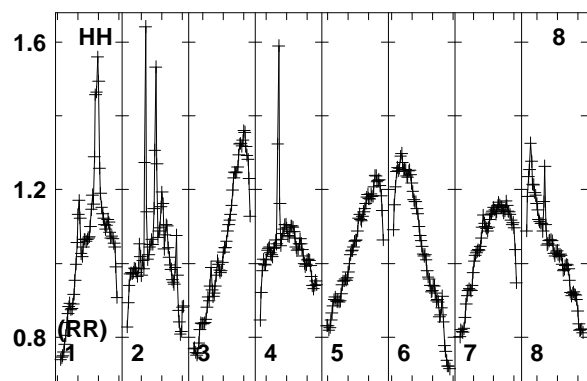
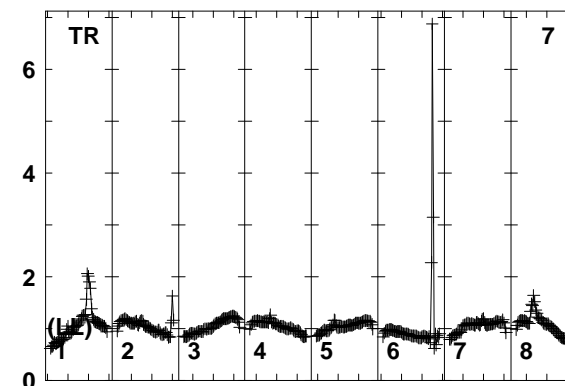
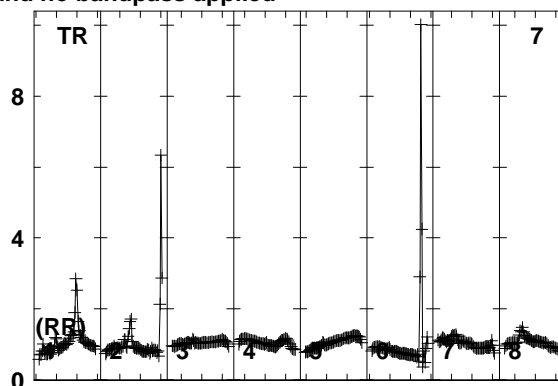
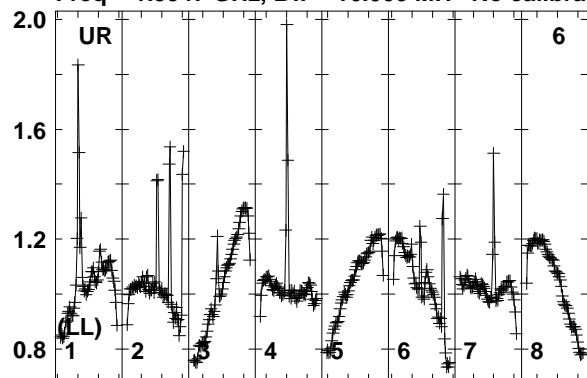

Lower frame: Real Jy
Total-power spectrum Antenna: UR (06)
Timerange: 00/05:48:31 to 00/05:49:29

Plot file version 348 created 04-NOV-2019 14:14:27

J2248-0541 EY034.UVDATA.1

Freq = 1.5947 GHz, Bw = 16.000 MH No calibration applied and no bandpass applied

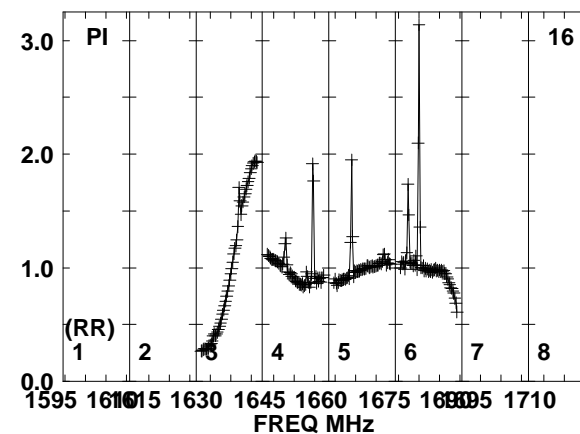
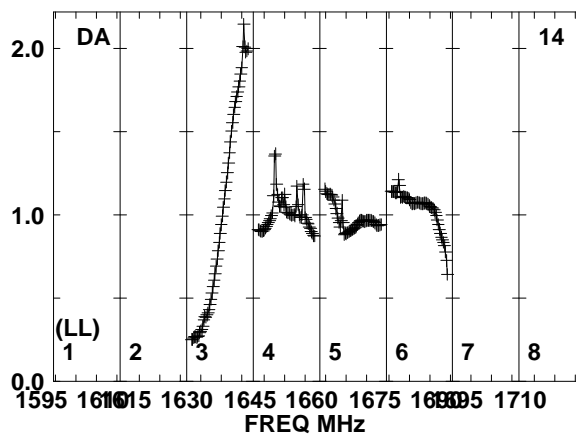
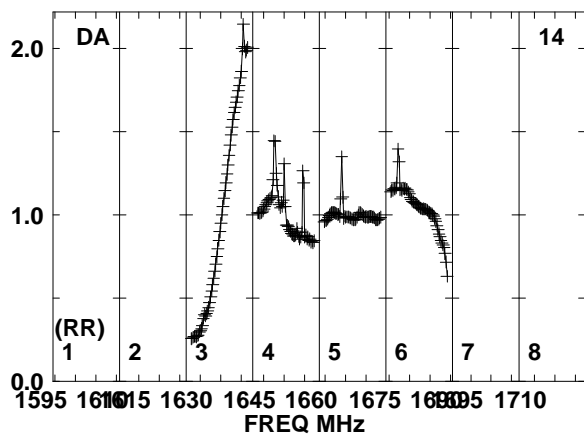
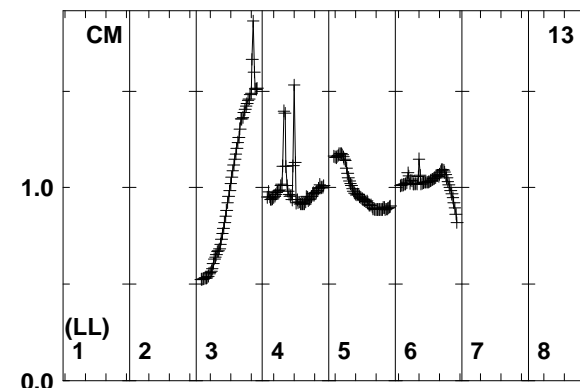
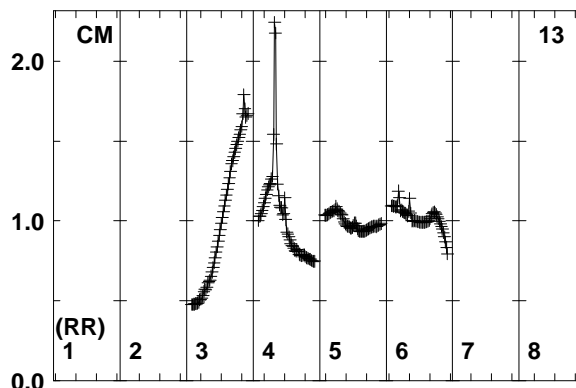
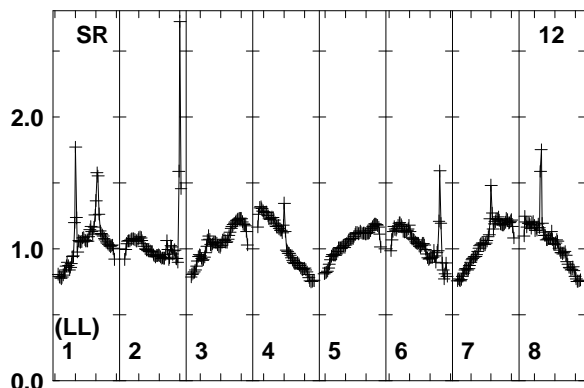
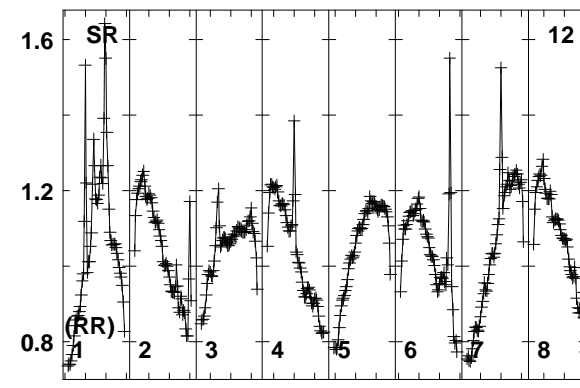
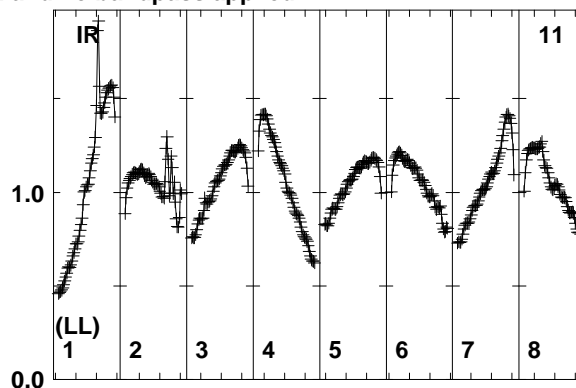
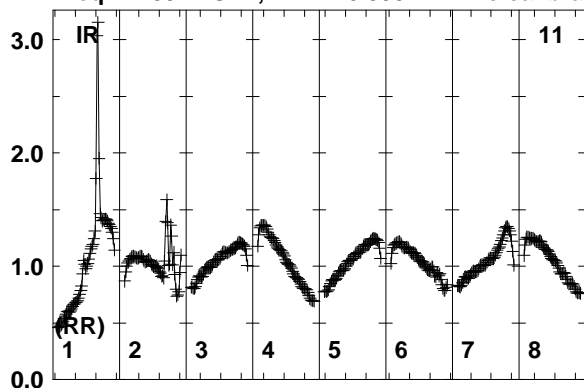

Lower frame: Real Jy
Total-power spectrum Antenna: IR (11)
Timerange: 00/05:48:31 to 00/05:49:29

Plot file version 349 created 04-NOV-2019 14:14:27
J2248-0541 EY034.UVDATA.1
Freq = 1.5947 GHz, Bw = 16.000 MH No calibration applied and no bandpass applied

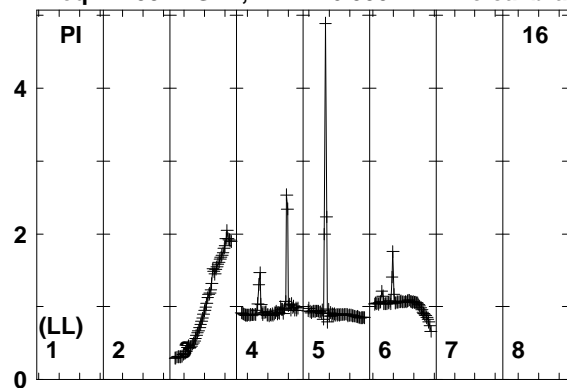

Lower frame: Real Jy
Total-power spectrum Antenna: PI (16)
Timerange: 00/05:48:31 to 00/05:49:29

Plot file version 350 created 04-NOV-2019 14:14:27

W2246-0526 EY034.UVDATA.1

Freq = 1.5947 GHz, Bw = 16.000 MH No calibration applied and no bandpass applied

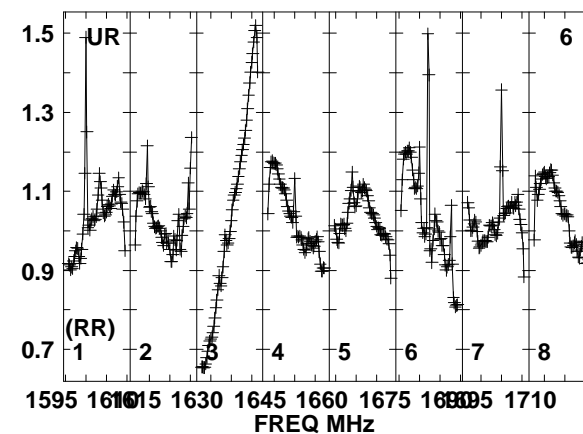
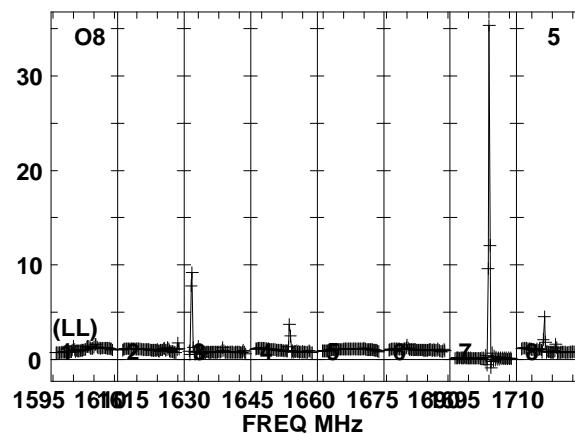
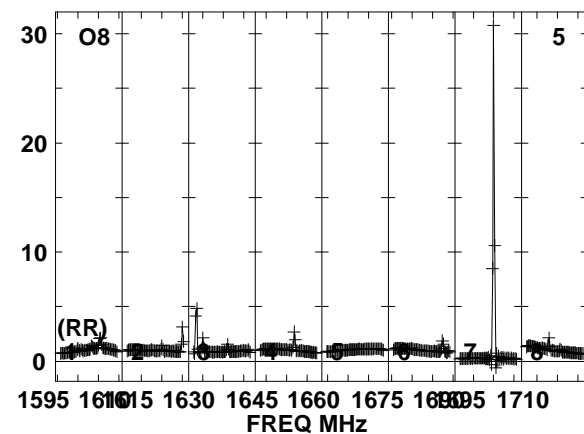
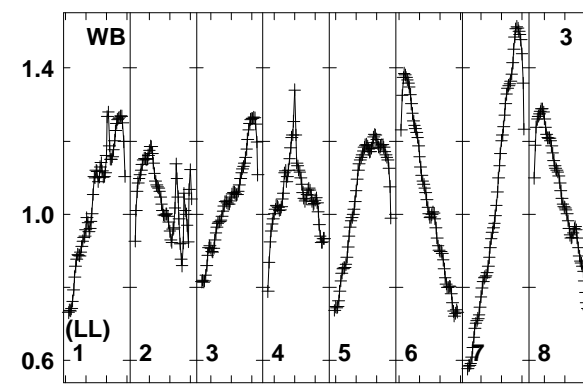
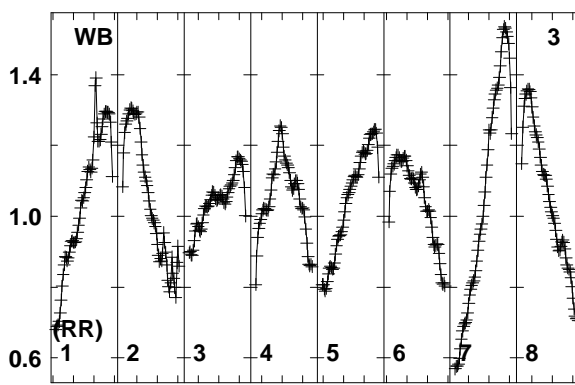
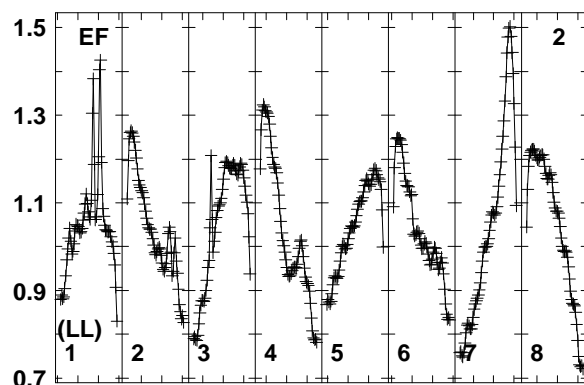
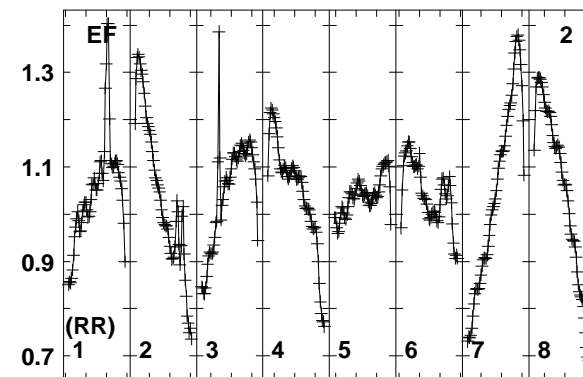
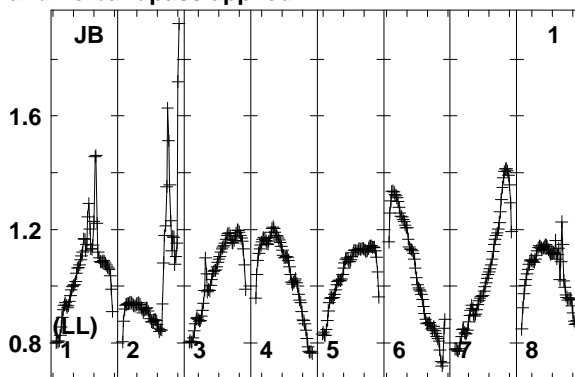
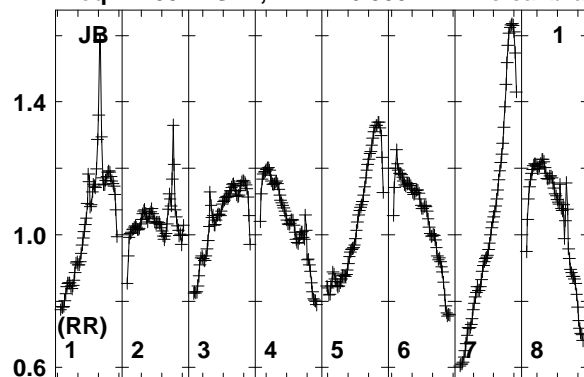

Lower frame: Real Jy
Total-power spectrum Antenna: JB (01)
Timerange: 00/05:49:31 to 00/05:52:09

Plot file version 351 created 04-NOV-2019 14:14:27

W2246-0526 EY034.UVDATA.1

Freq = 1.5947 GHz, Bw = 16.000 MH No calibration applied and no bandpass applied

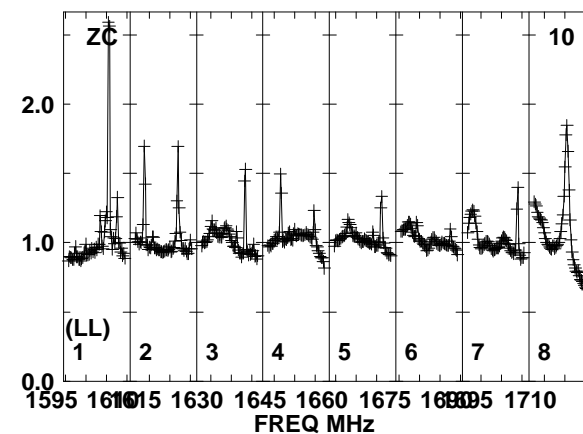
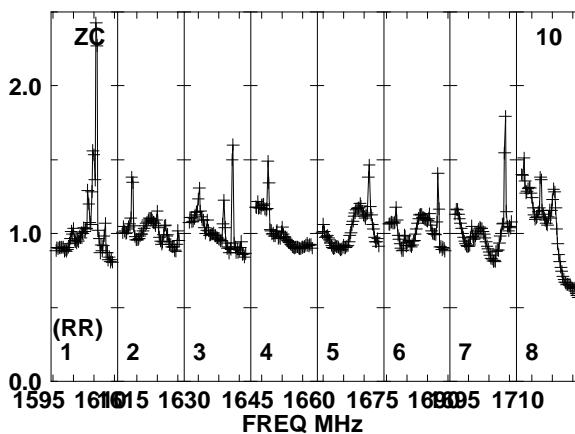
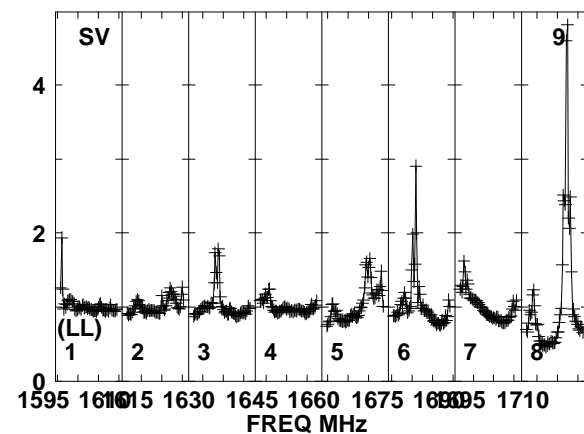
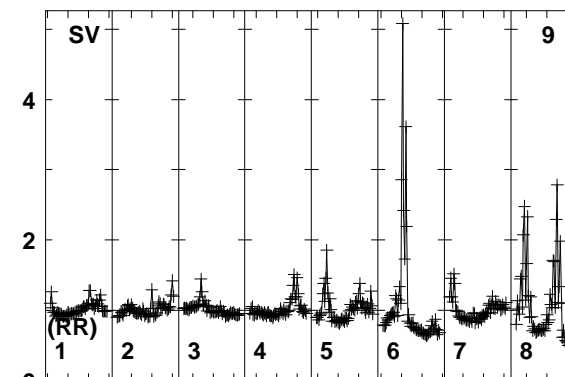
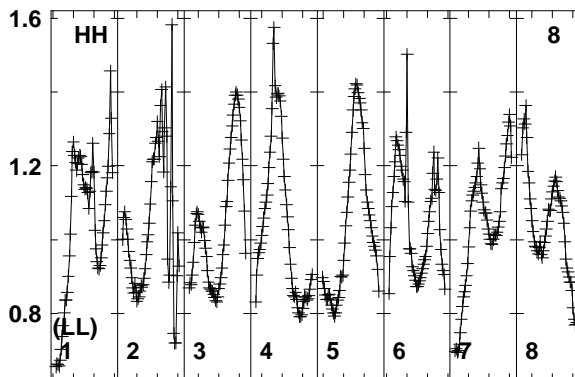
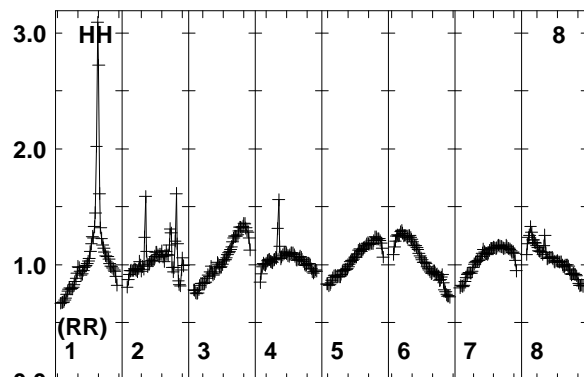
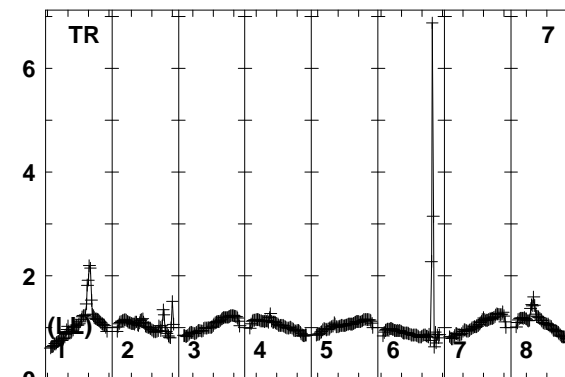
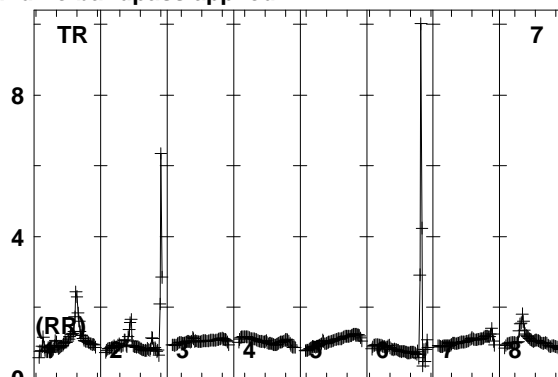
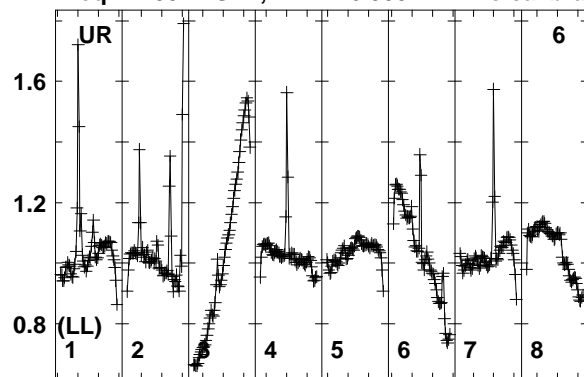

Lower frame: Real Jy
Total-power spectrum Antenna: UR (06)
Timerange: 00/05:49:31 to 00/05:52:09

Plot file version 352 created 04-NOV-2019 14:14:27

W2246-0526 EY034.UVDATA.1

Freq = 1.5947 GHz, Bw = 16.000 MH No calibration applied and no bandpass applied

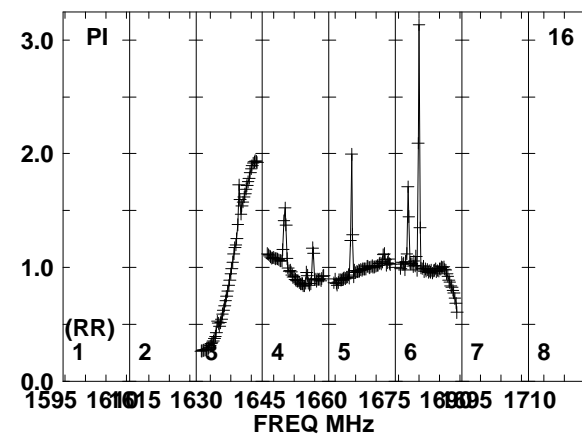
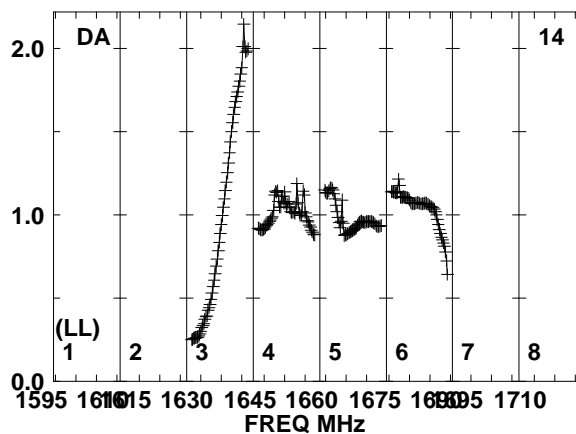
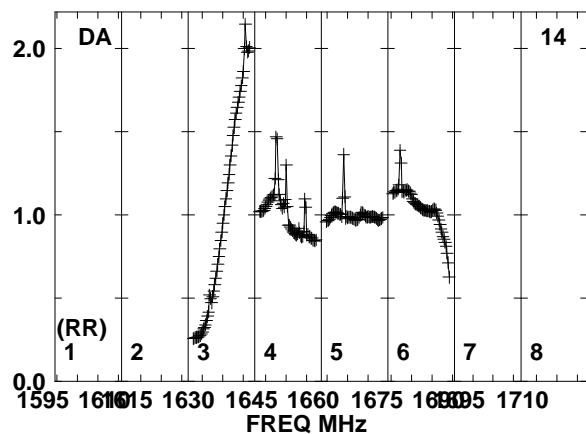
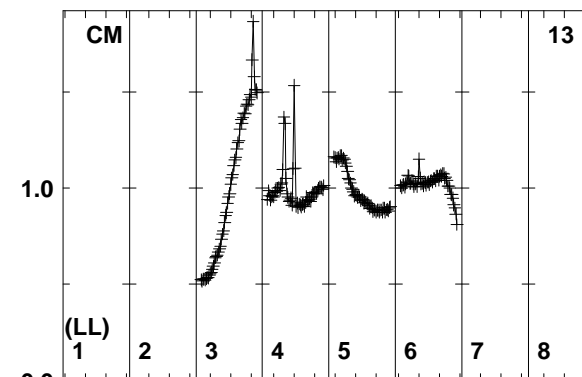
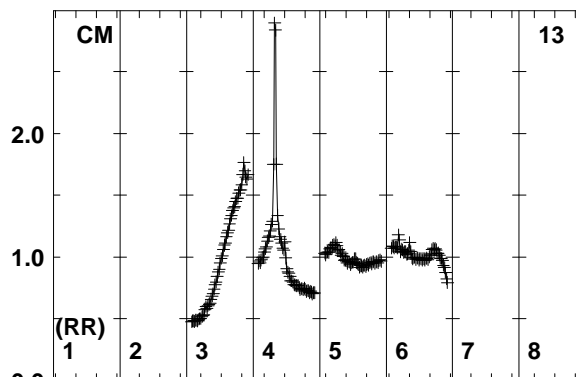
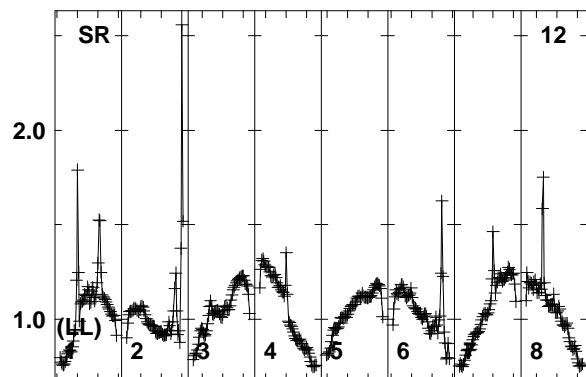
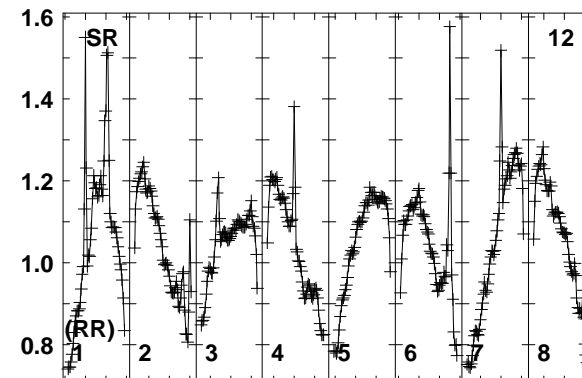
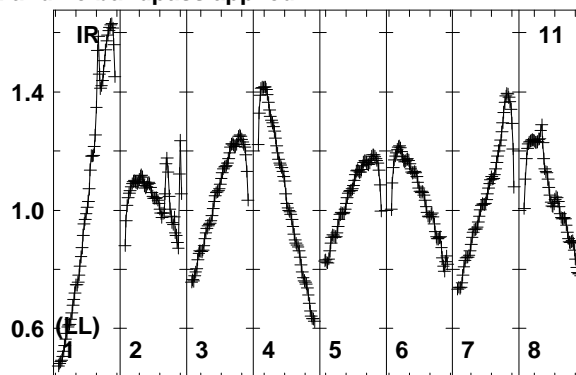
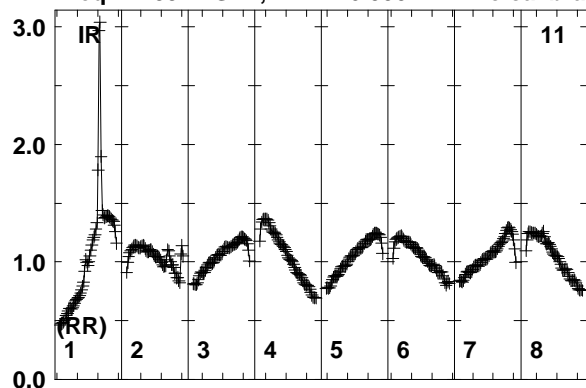

Lower frame: Real Jy
Total-power spectrum Antenna: IR (11)
Timerange: 00/05:49:31 to 00/05:52:09

Plot file version 353 created 04-NOV-2019 14:14:28
W2246-0526 EY034.UVDATA.1
Freq = 1.5947 GHz, Bw = 16.000 MH No calibration applied and no bandpass applied

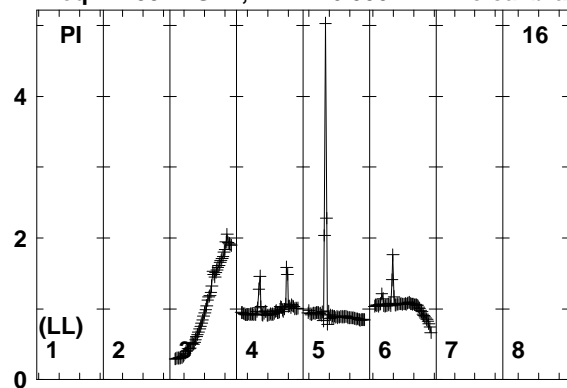

Lower frame: Real Jy
Total-power spectrum Antenna: PI (16)
Timerange: 00/05:49:31 to 00/05:52:09

Plot file version 354 created 04-NOV-2019 14:14:28

J2248-0541 EY034.UVDATA.1

Freq = 1.5947 GHz, Bw = 16.000 MH No calibration applied and no bandpass applied

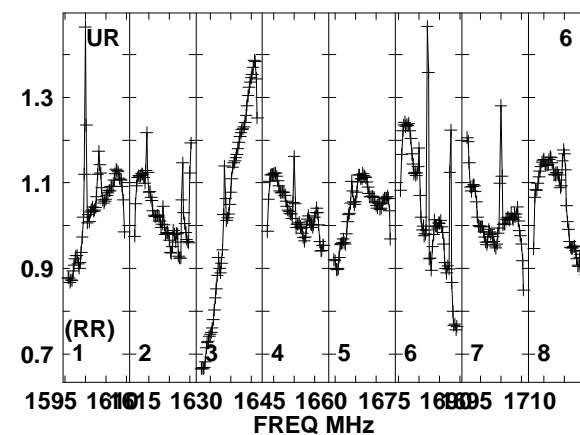
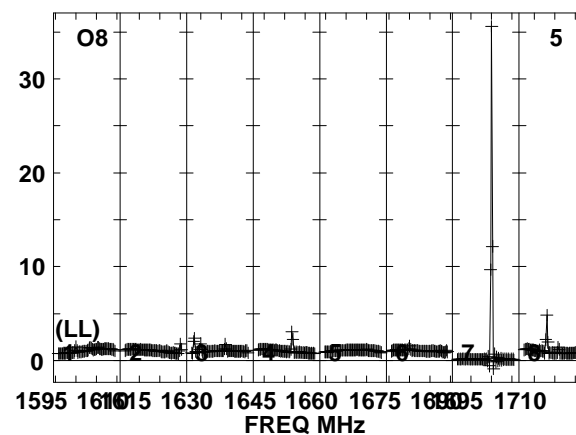
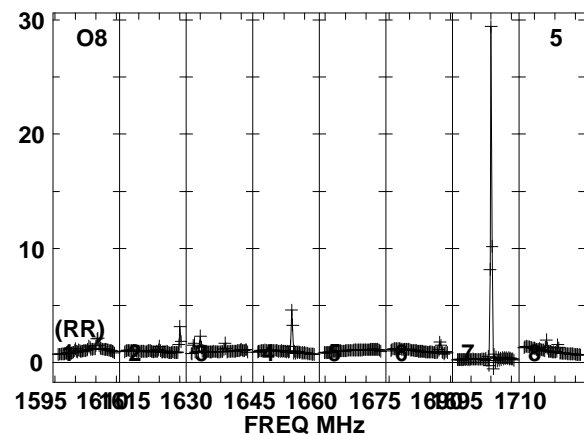
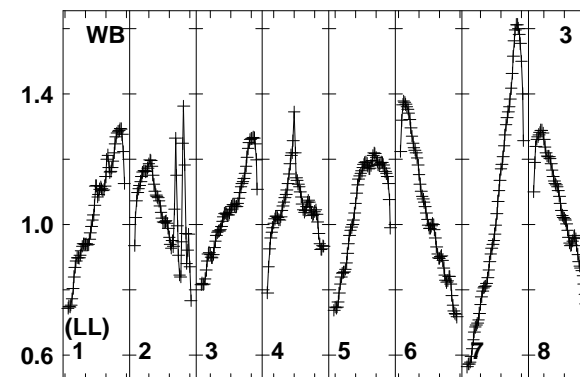
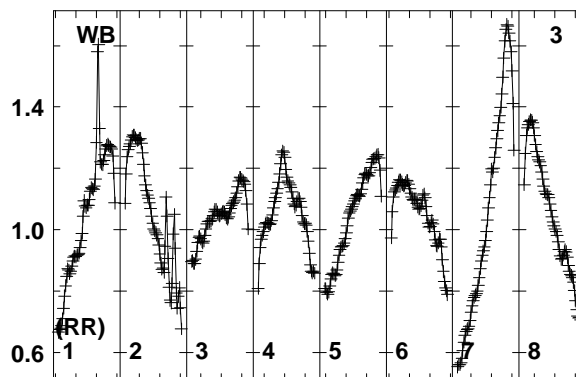
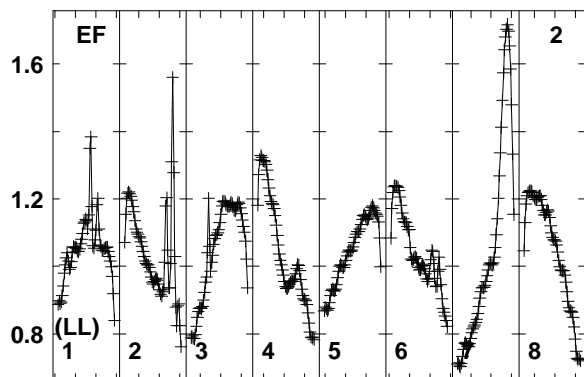
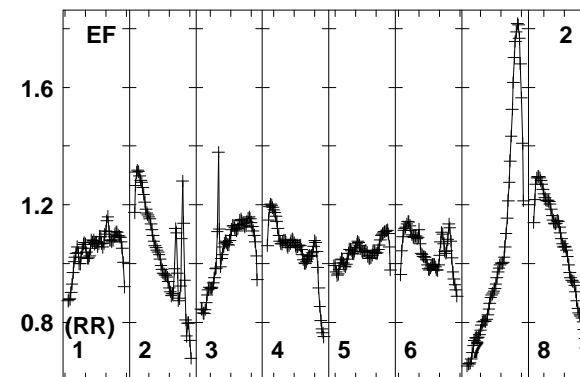
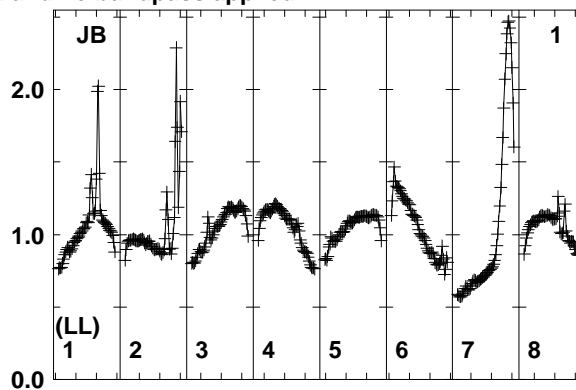
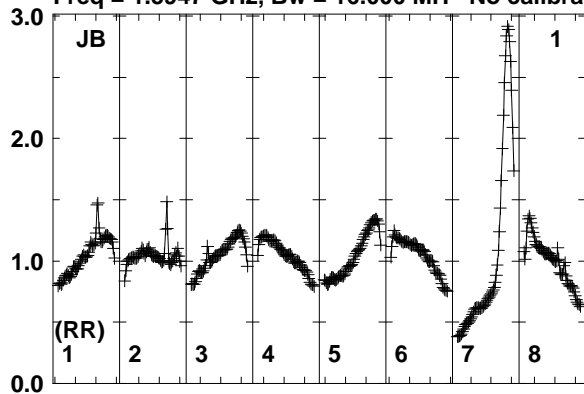

Lower frame: Real Jy
Total-power spectrum Antenna: JB (01)
Timerange: 00/05:52:26 to 00/05:53:24

Plot file version 355 created 04-NOV-2019 14:14:28

J2248-0541 EY034.UVDATA.1

Freq = 1.5947 GHz, Bw = 16.000 MH No calibration applied and no bandpass applied

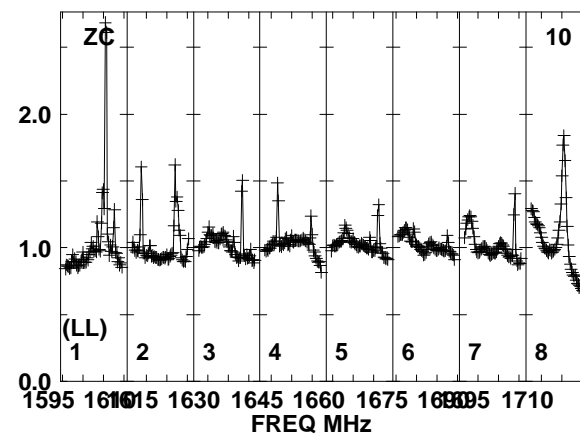
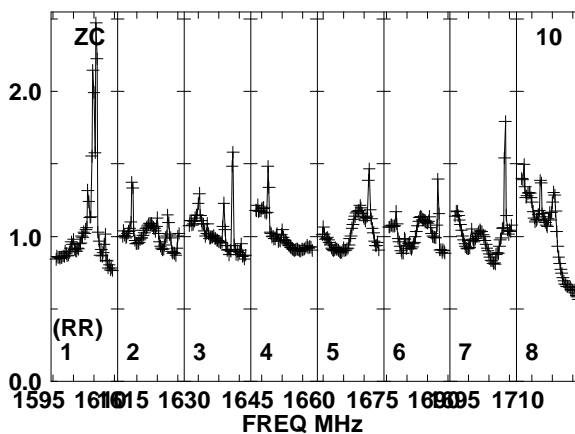
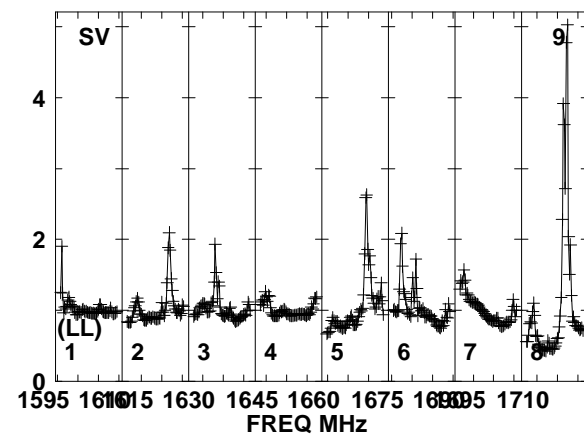
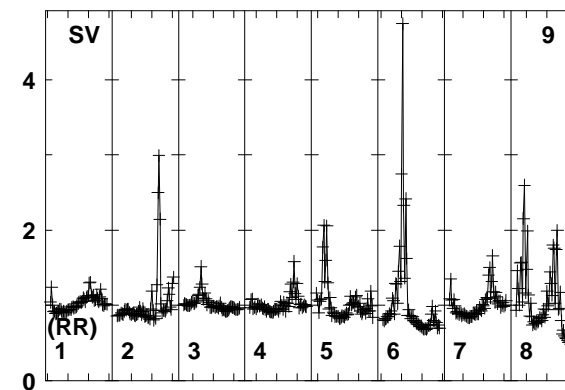
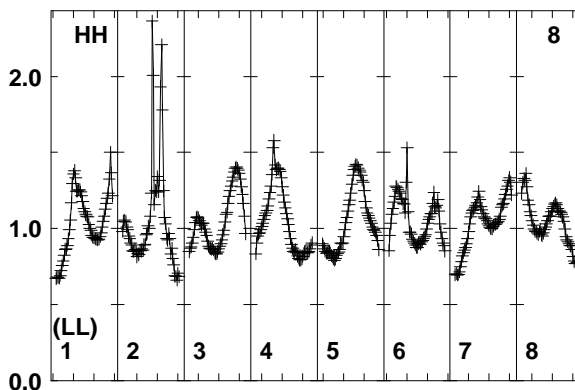
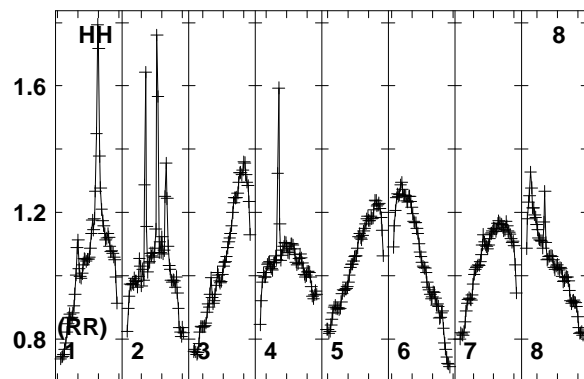
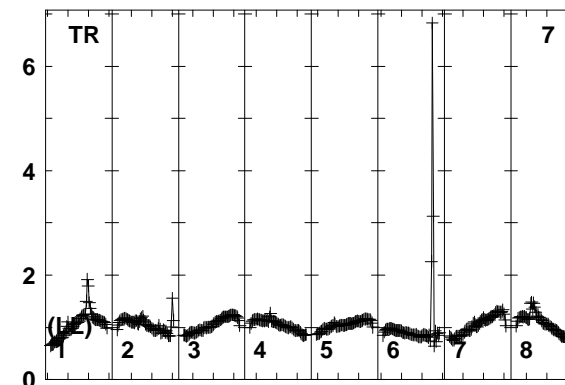
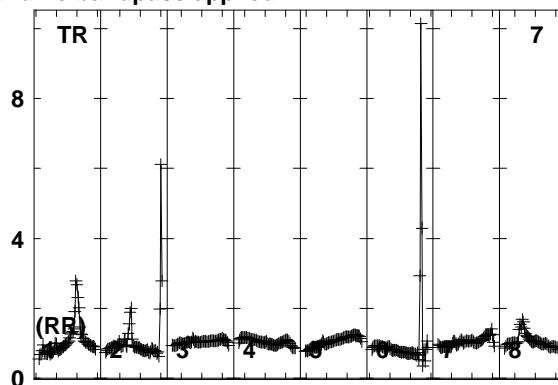
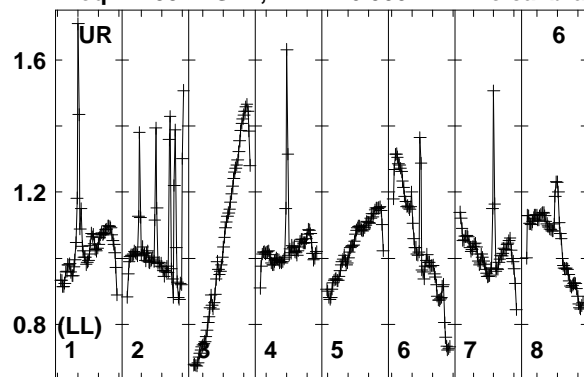

Lower frame: Real Jy
Total-power spectrum Antenna: UR (06)
Timerange: 00/05:52:26 to 00/05:53:24

Plot file version 356 created 04-NOV-2019 14:14:28

J2248-0541 EY034.UVDATA.1

Freq = 1.5947 GHz, Bw = 16.000 MH No calibration applied and no bandpass applied

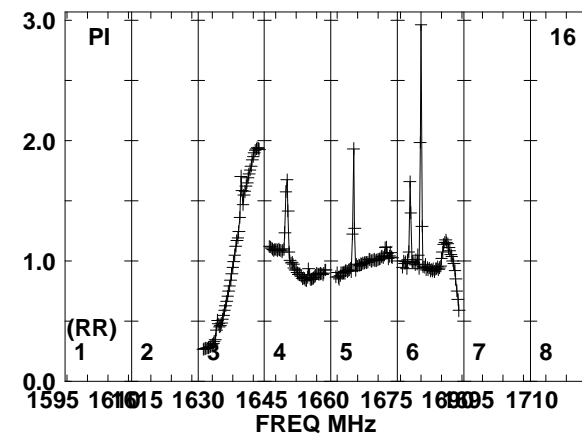
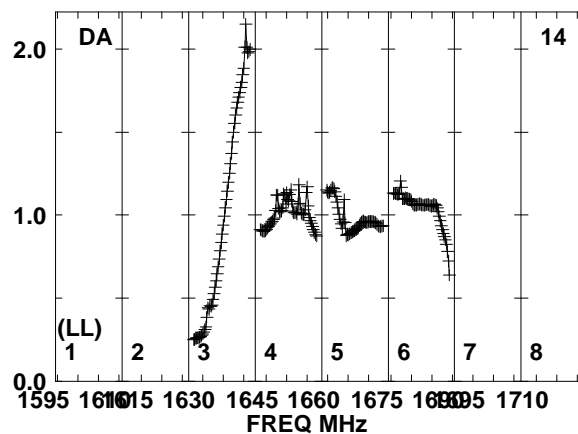
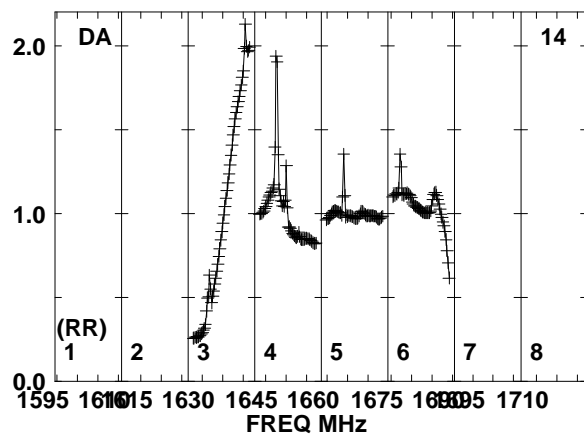
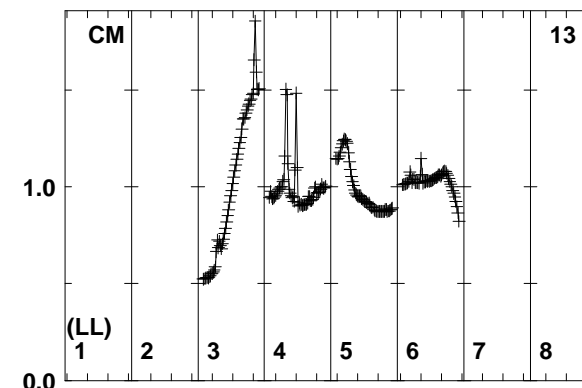
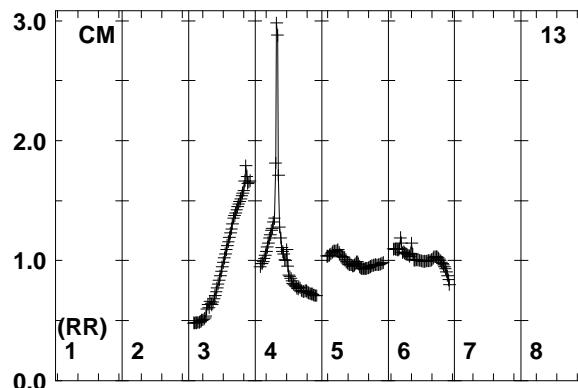
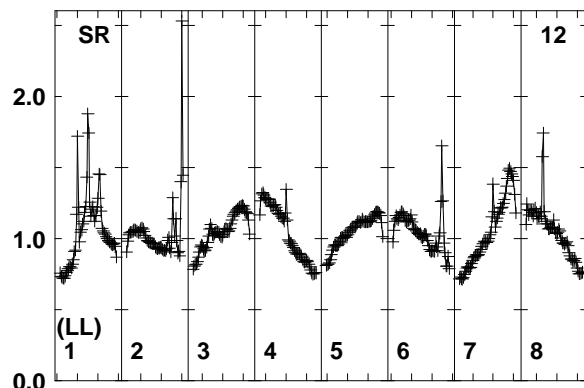
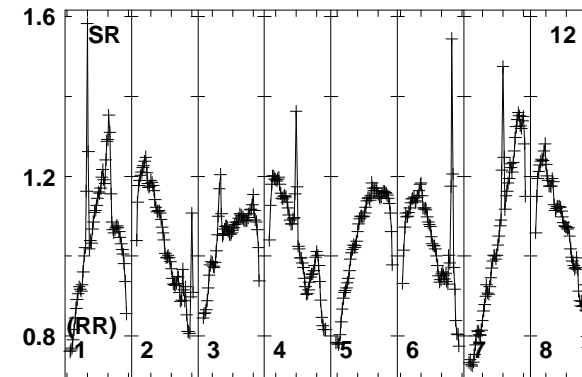
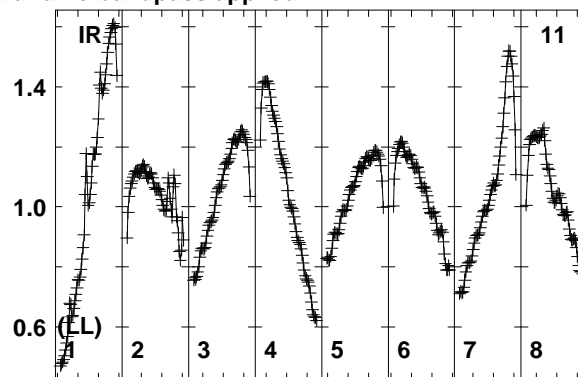
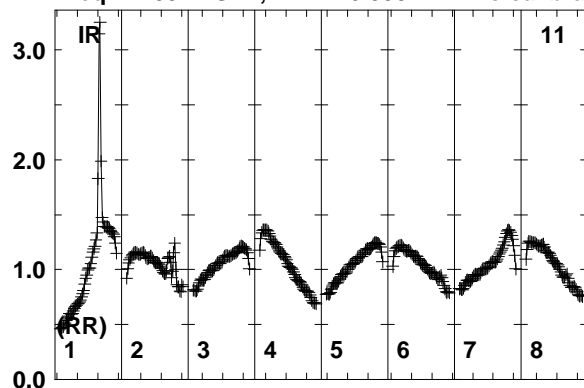

Lower frame: Real Jy
Total-power spectrum Antenna: IR (11)
Timerange: 00/05:52:26 to 00/05:53:24

Plot file version 357 created 04-NOV-2019 14:14:28
J2248-0541 EY034.UVDATA.1
Freq = 1.5947 GHz, Bw = 16.000 MH No calibration applied and no bandpass applied

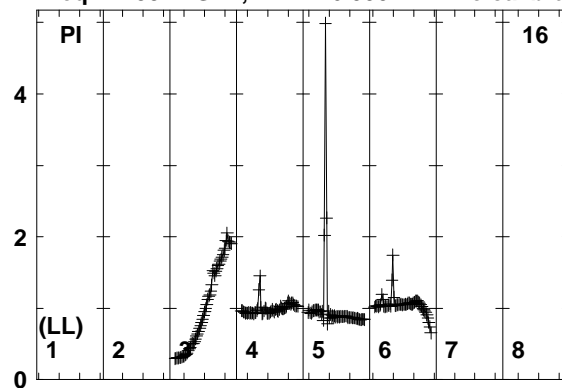

Lower frame: Real Jy
Total-power spectrum Antenna: PI (16)
Timerange: 00/05:52:26 to 00/05:53:24

Plot file version 358 created 04-NOV-2019 14:14:28

W2246-0526 EY034.UVDATA.1

Freq = 1.5947 GHz, Bw = 16.000 MH No calibration applied and no bandpass applied

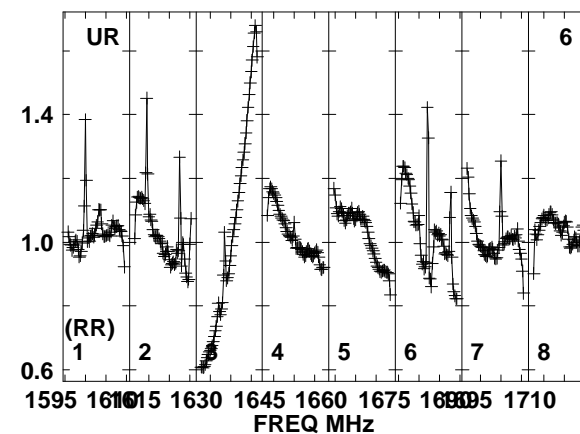
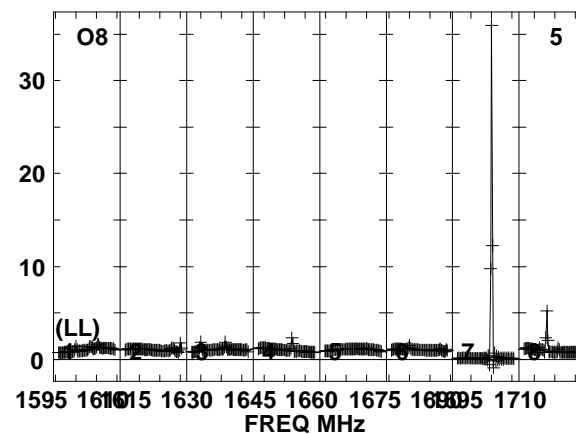
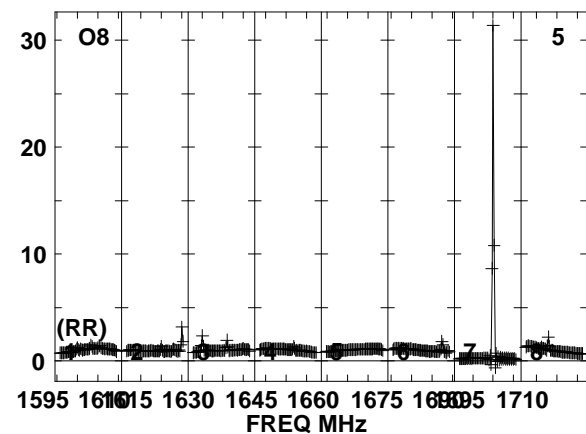
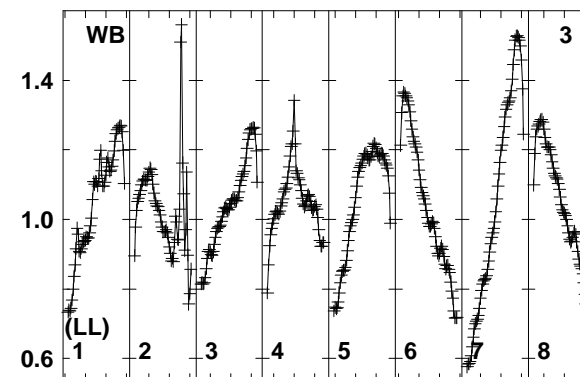
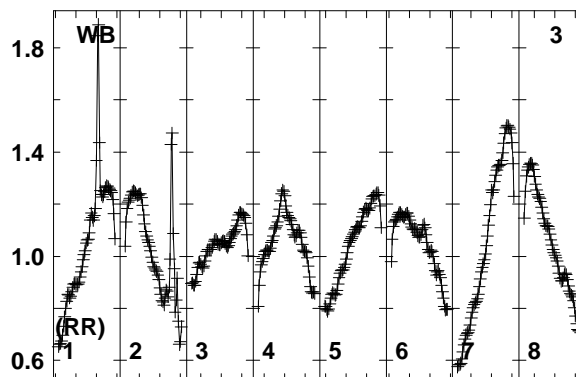
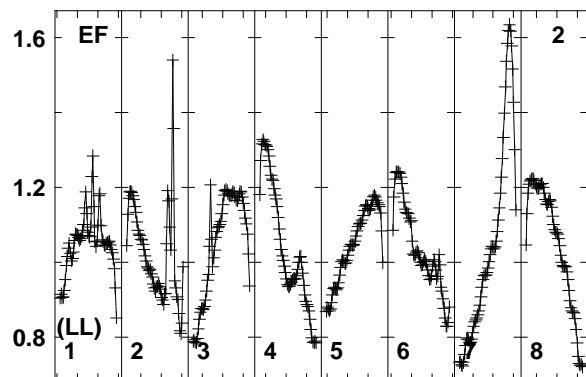
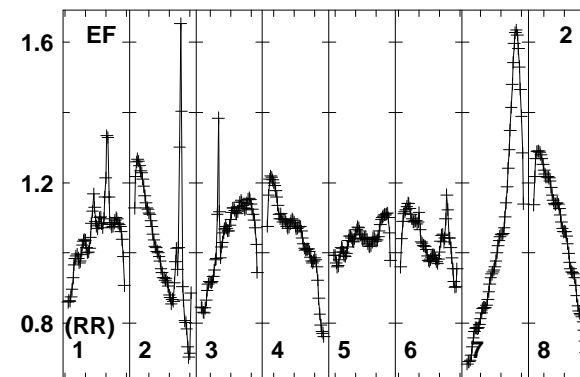
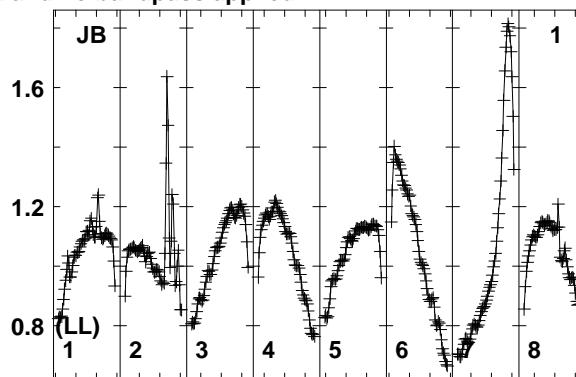
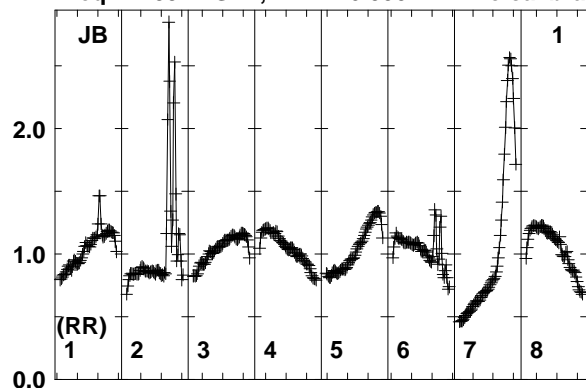

Lower frame: Real Jy
Total-power spectrum Antenna: JB (01)
Timerange: 00/05:53:26 to 00/05:56:04

Plot file version 359 created 04-NOV-2019 14:14:28

W2246-0526 EY034.UVDATA.1

Freq = 1.5947 GHz, Bw = 16.000 MH No calibration applied and no bandpass applied

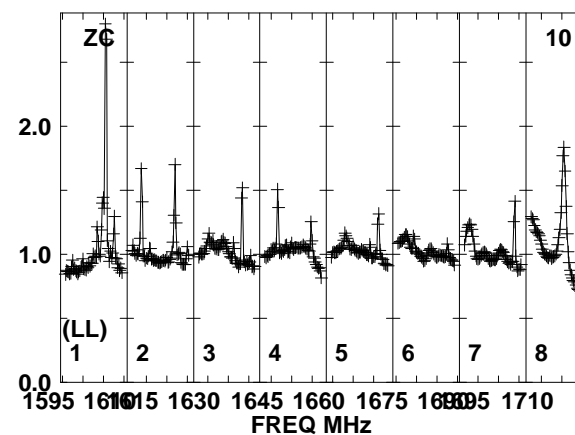
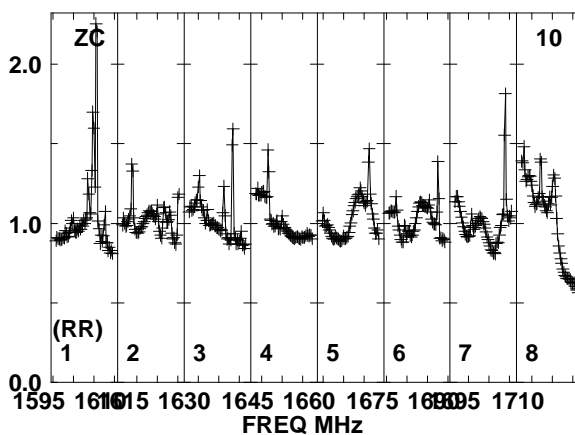
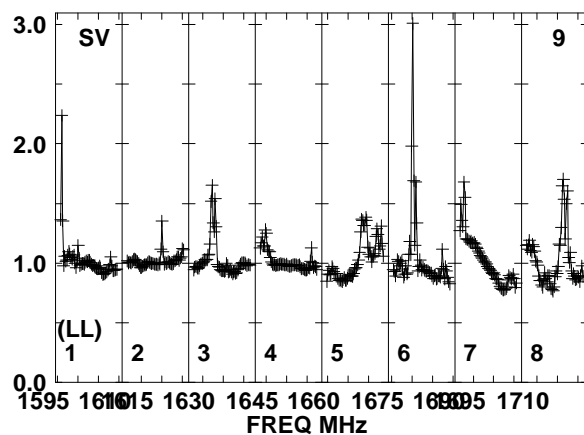
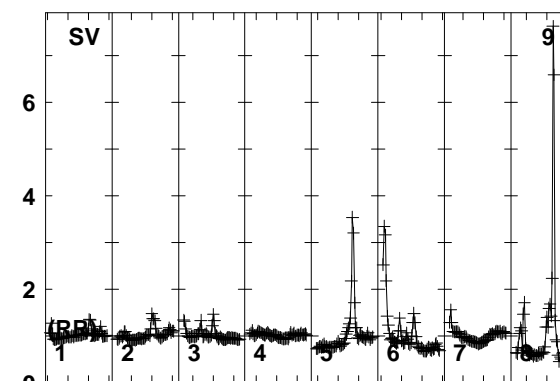
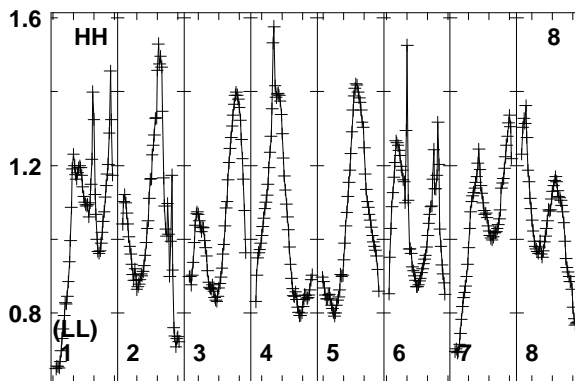
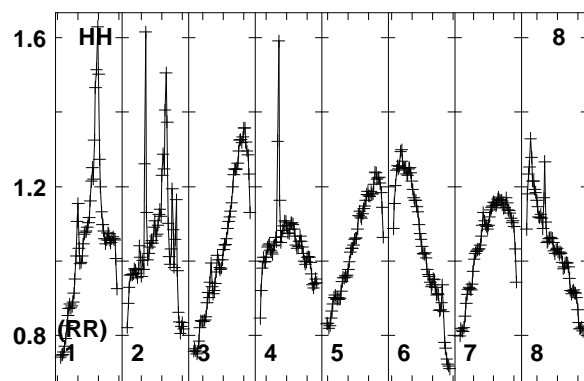
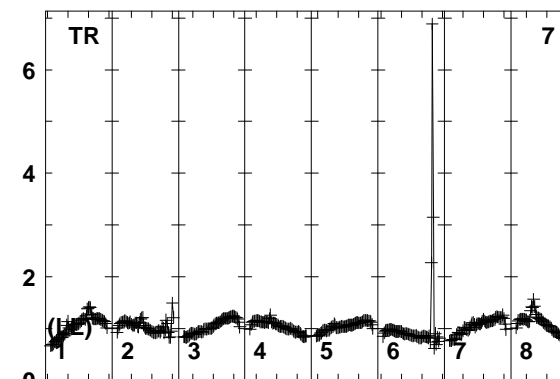
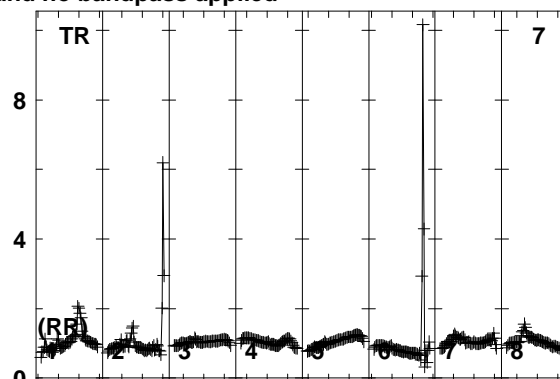
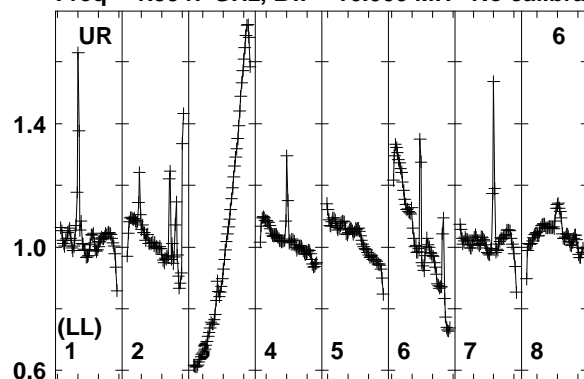

Lower frame: Real Jy
Total-power spectrum Antenna: UR (06)
Timerange: 00/05:53:26 to 00/05:56:04

Plot file version 360 created 04-NOV-2019 14:14:28

W2246-0526 EY034.UVDATA.1

Freq = 1.5947 GHz, Bw = 16.000 MH No calibration applied and no bandpass applied

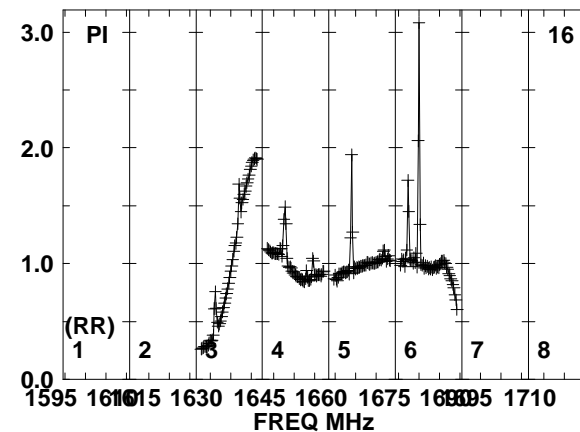
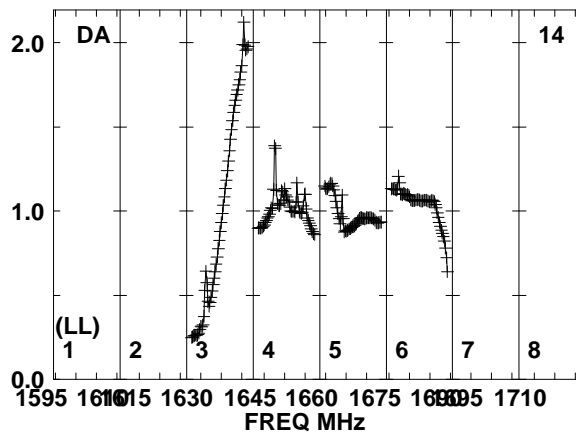
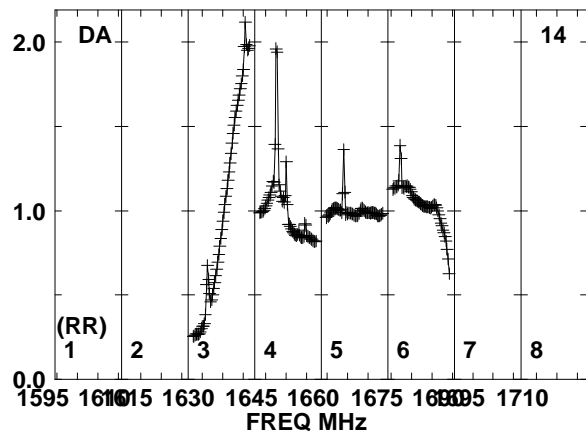
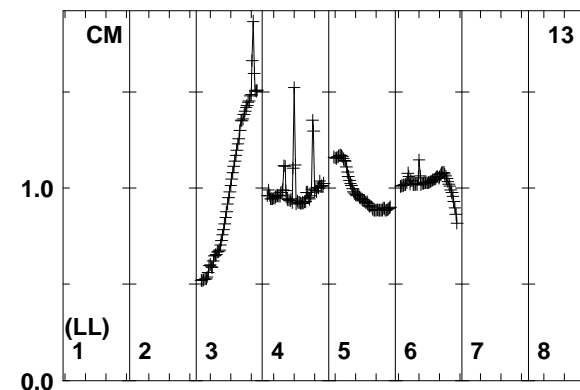
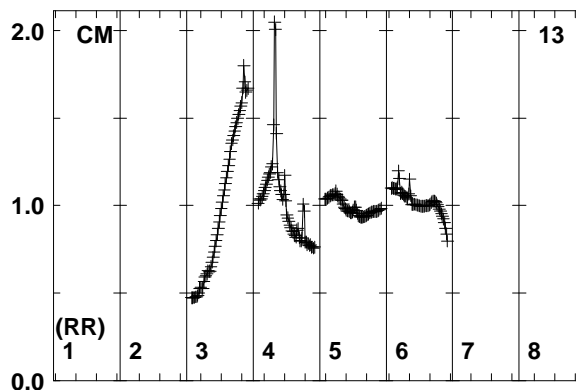
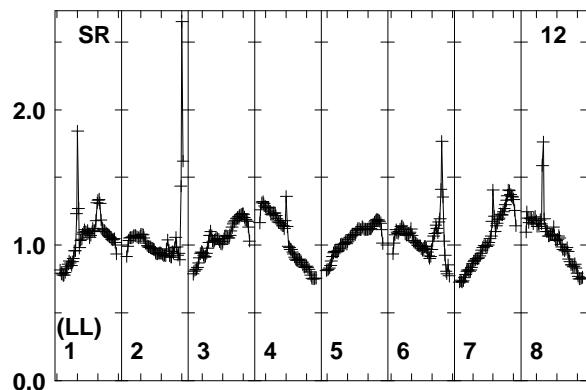
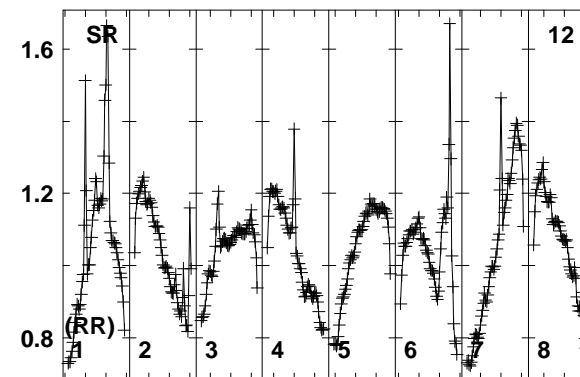
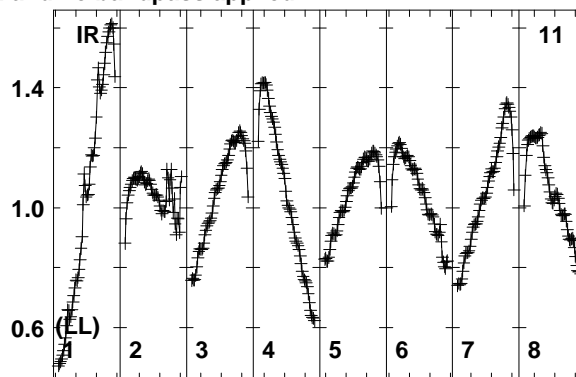
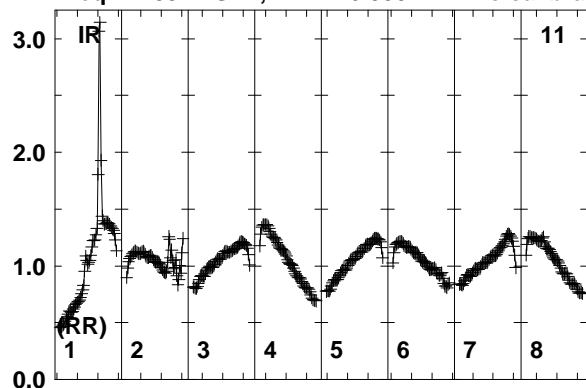

Lower frame: Real Jy
Total-power spectrum Antenna: IR (11)
Timerange: 00/05:53:26 to 00/05:56:04

Plot file version 361 created 04-NOV-2019 14:14:28
W2246-0526 EY034.UVDATA.1
Freq = 1.5947 GHz, Bw = 16.000 MH No calibration applied and no bandpass applied

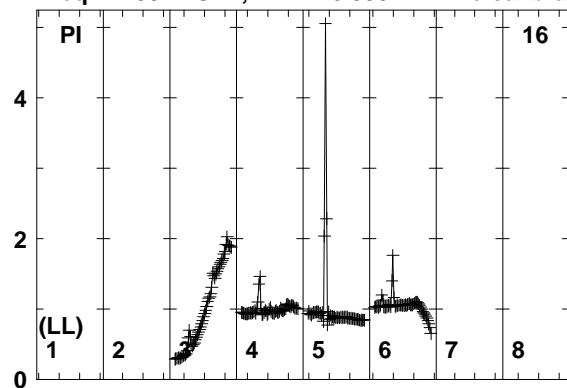

Lower frame: Real Jy
Total-power spectrum Antenna: PI (16)
Timerange: 00/05:53:26 to 00/05:56:04

Plot file version 362 created 04-NOV-2019 14:14:28

J2248-0541 EY034.UVDATA.1

Freq = 1.5947 GHz, Bw = 16.000 MH No calibration applied and no bandpass applied

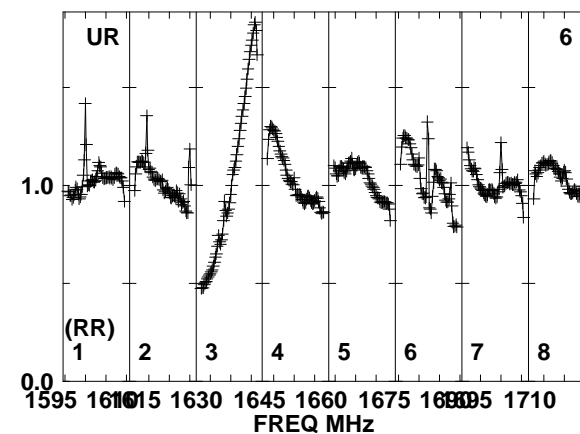
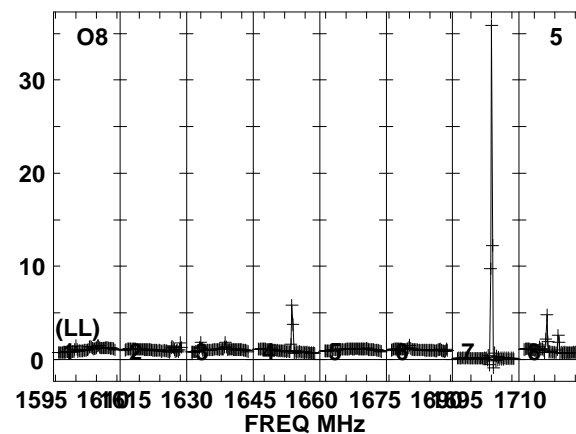
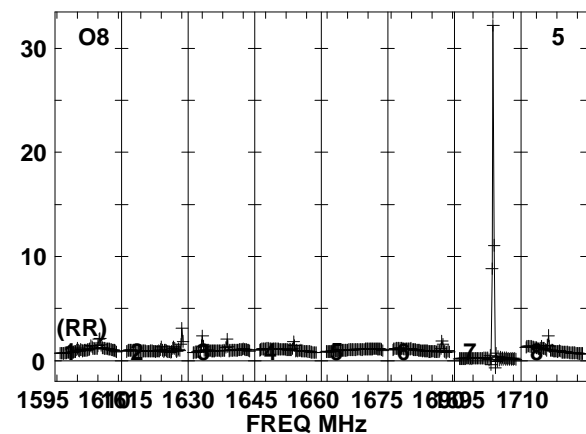
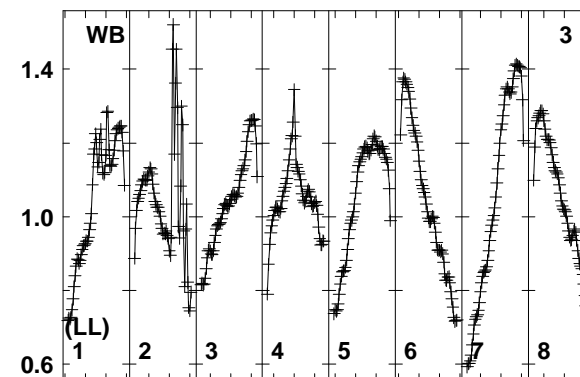
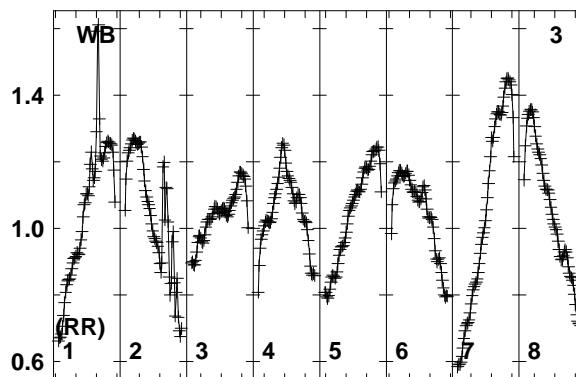
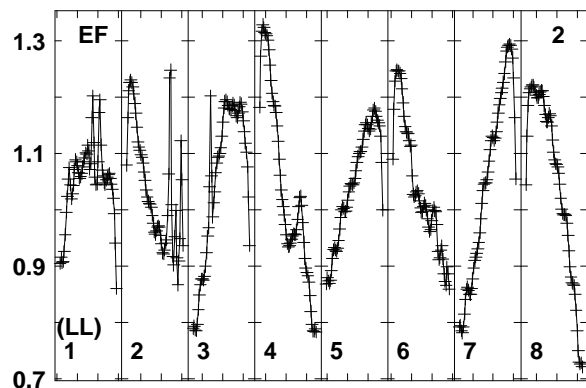
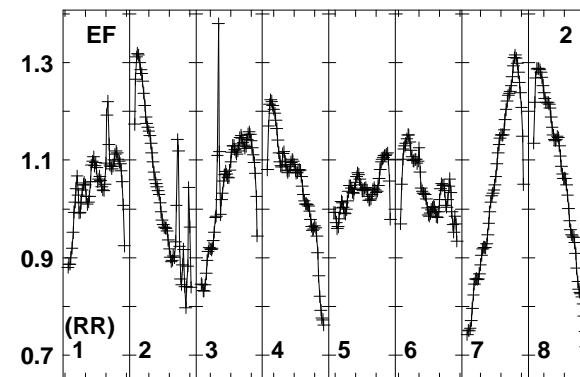
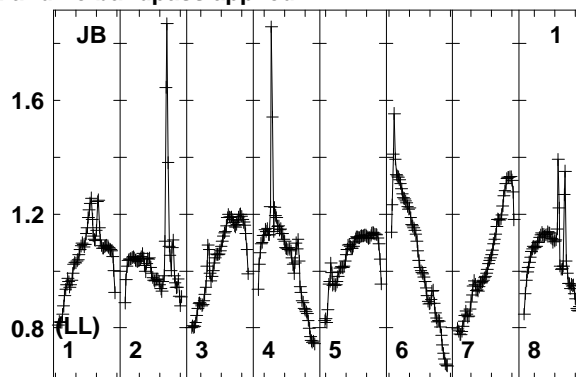
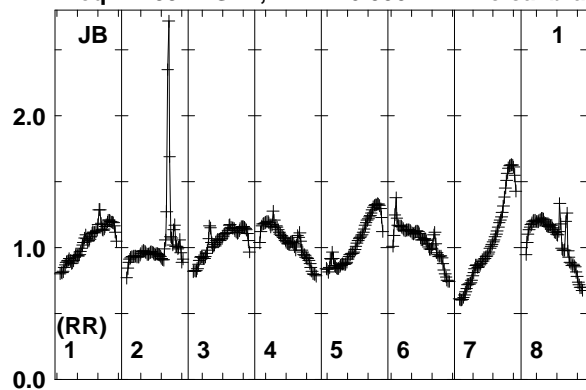

Lower frame: Real Jy
Total-power spectrum Antenna: JB (01)
Timerange: 00/05:56:21 to 00/05:57:19

Plot file version 363 created 04-NOV-2019 14:14:28

J2248-0541 EY034.UVDATA.1

Freq = 1.5947 GHz, Bw = 16.000 MH No calibration applied and no bandpass applied

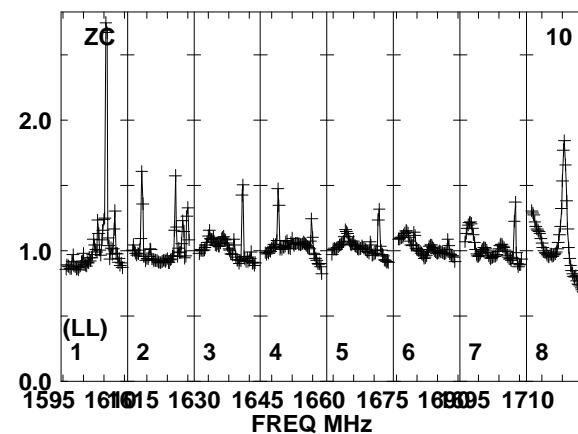
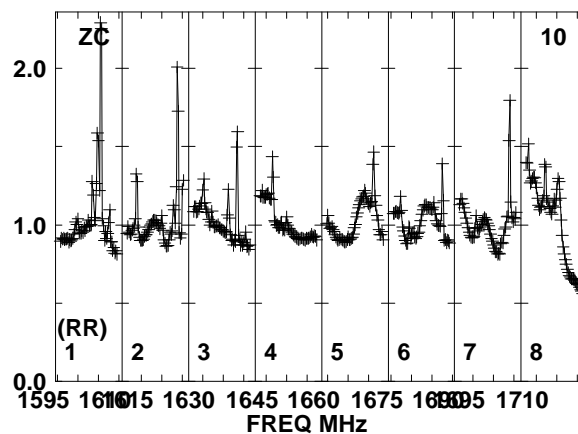
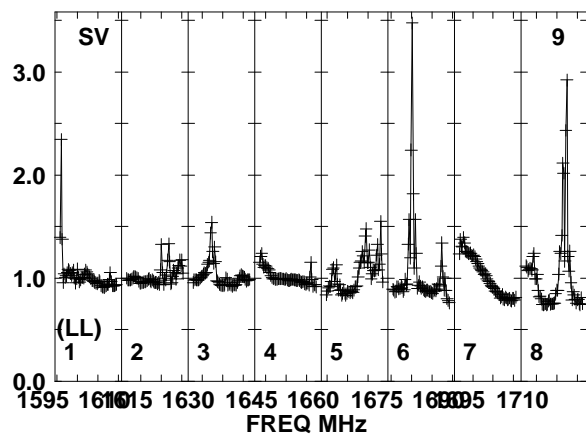
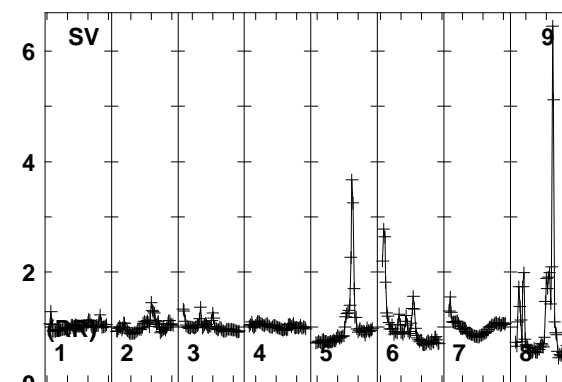
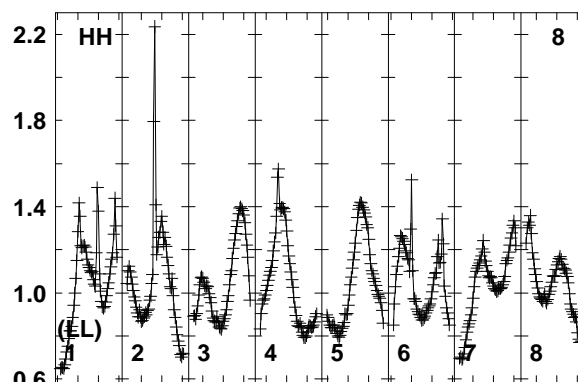
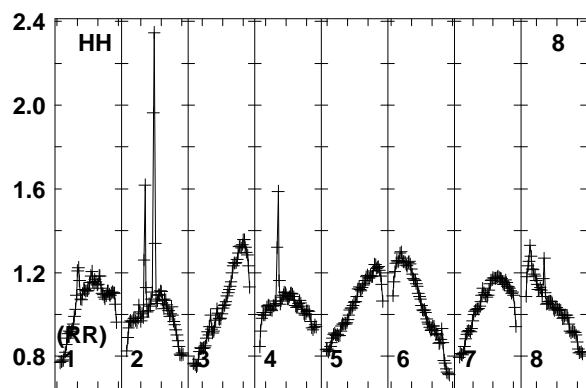
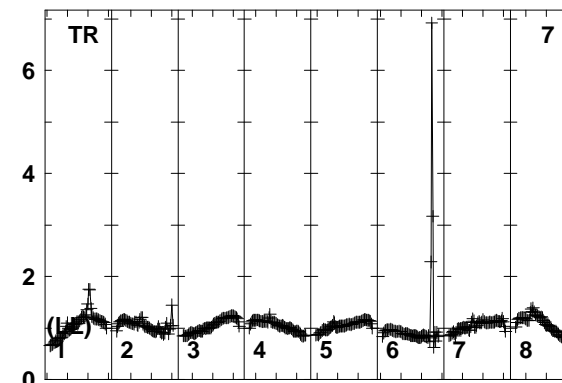
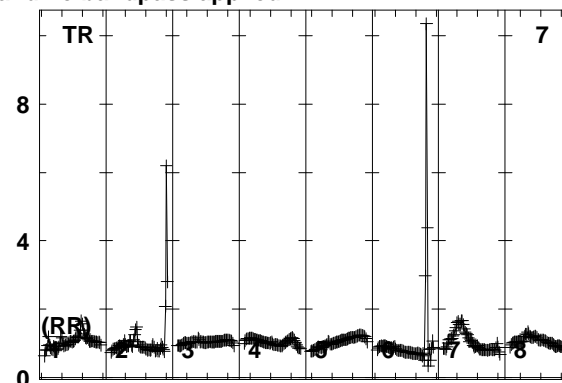
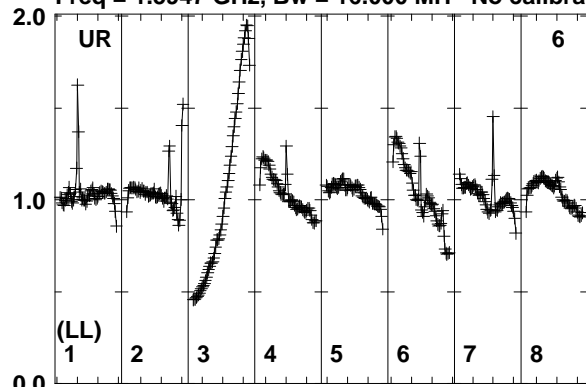

Lower frame: Real Jy
Total-power spectrum Antenna: UR (06)
Timerange: 00/05:56:21 to 00/05:57:19

Plot file version 364 created 04-NOV-2019 14:14:29

J2248-0541 EY034.UVDATA.1

Freq = 1.5947 GHz, Bw = 16.000 MH No calibration applied and no bandpass applied

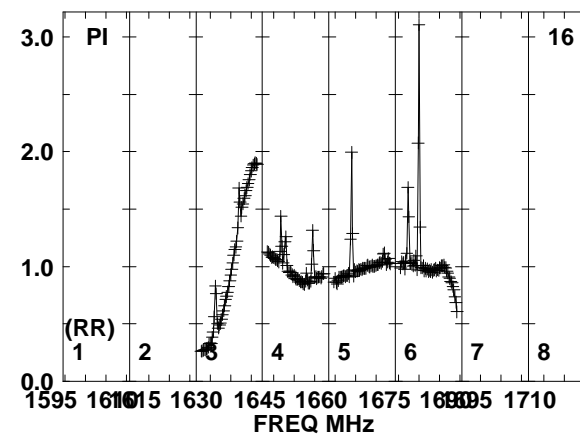
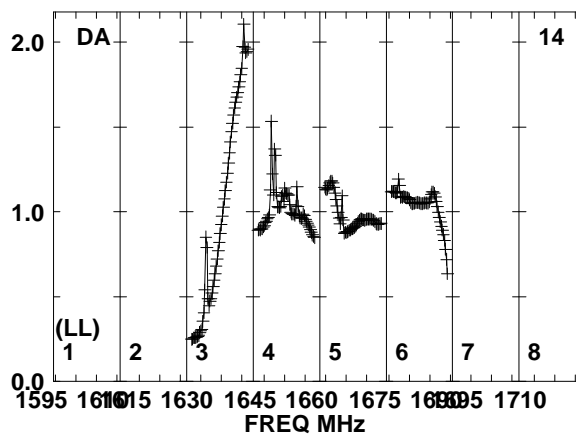
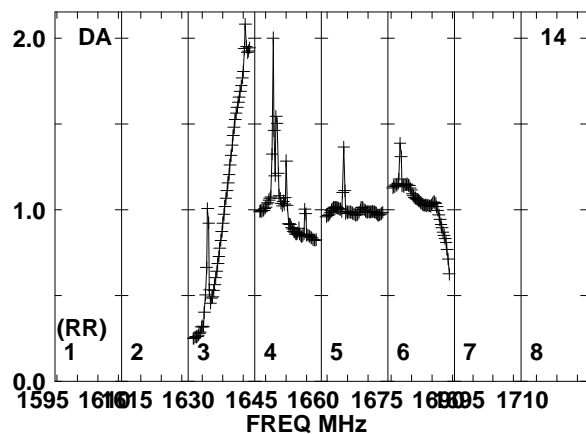
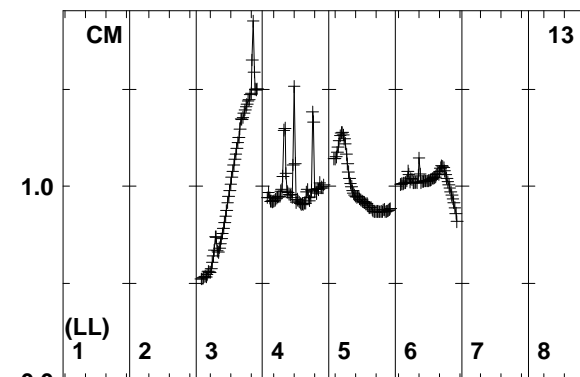
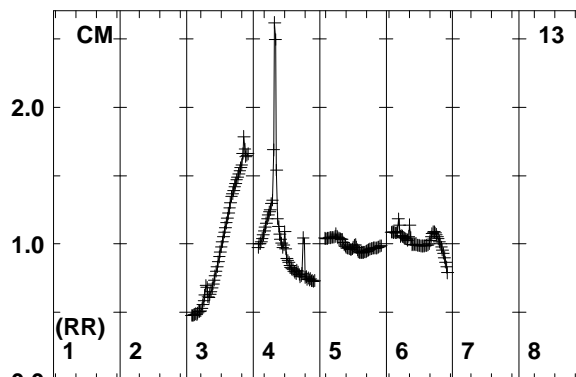
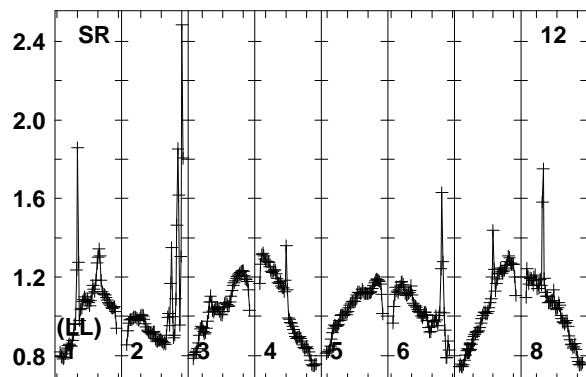
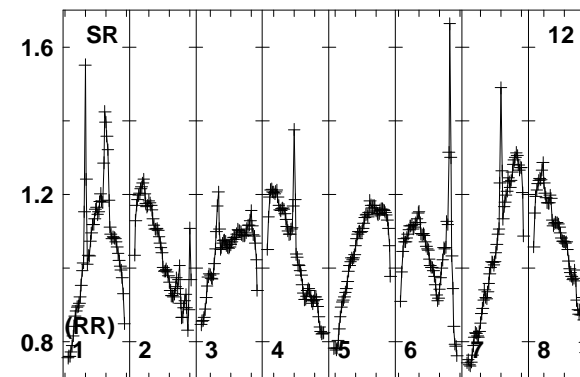
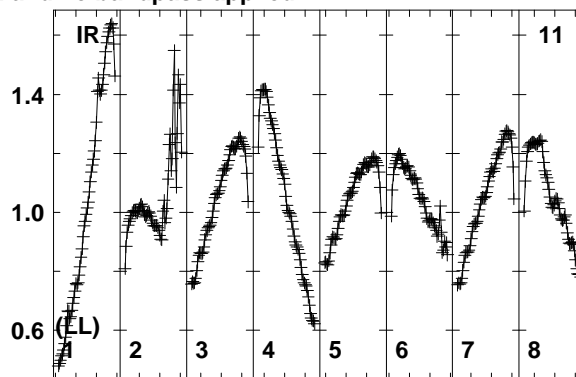
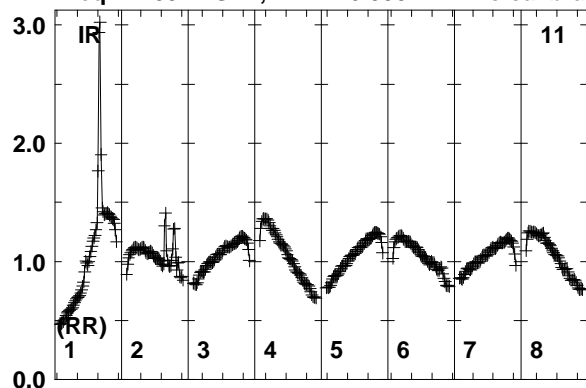

Lower frame: Real Jy
Total-power spectrum Antenna: IR (11)
Timerange: 00/05:56:21 to 00/05:57:19

Plot file version 365 created 04-NOV-2019 14:14:29
J2248-0541 EY034.UVDATA.1
Freq = 1.5947 GHz, Bw = 16.000 MH No calibration applied and no bandpass applied

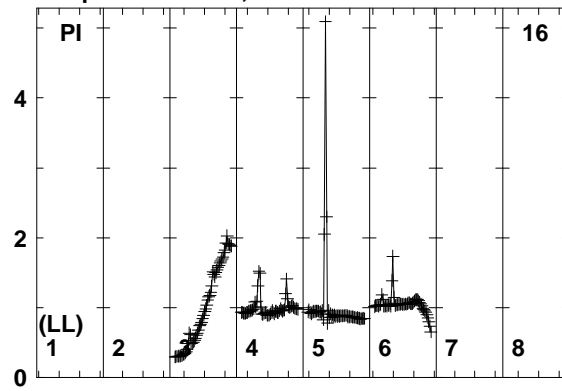

Lower frame: Real Jy
Total-power spectrum Antenna: PI (16)
Timerange: 00/05:56:21 to 00/05:57:19

Plot file version 366 created 04-NOV-2019 14:14:29

W2246-0526 EY034.UVDATA.1

Freq = 1.5947 GHz, Bw = 16.000 MH No calibration applied and no bandpass applied

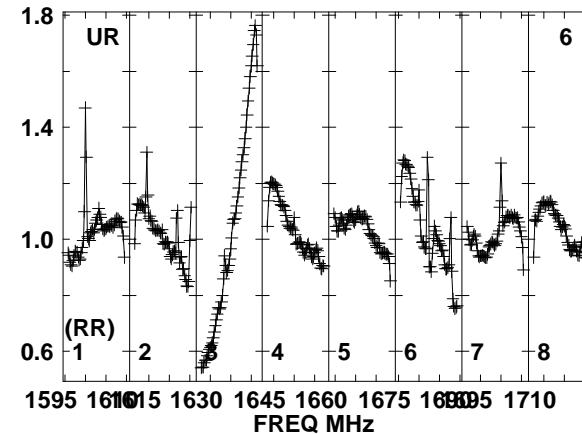
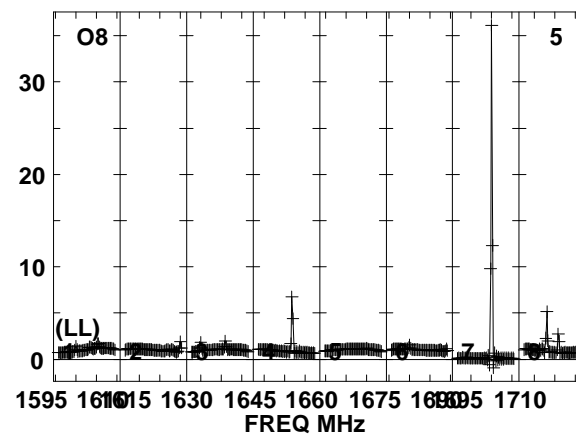
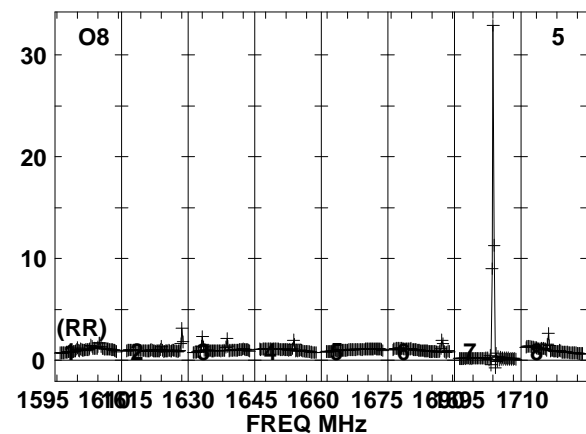
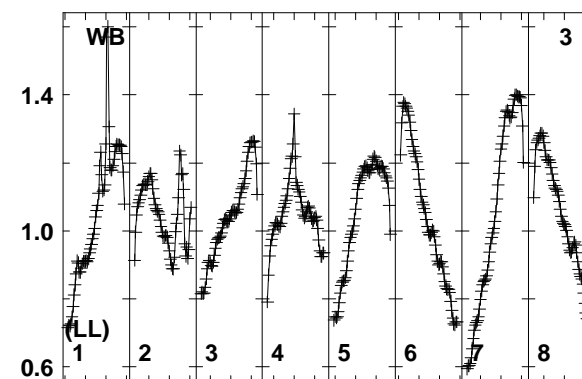
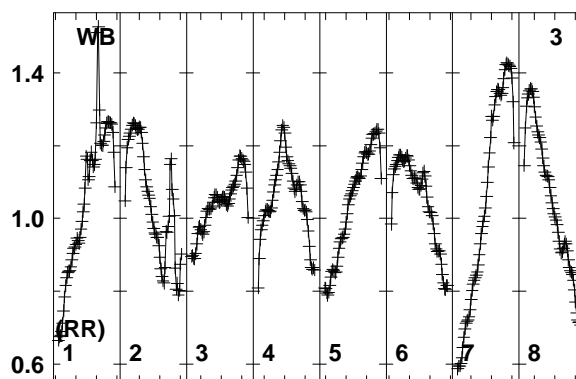
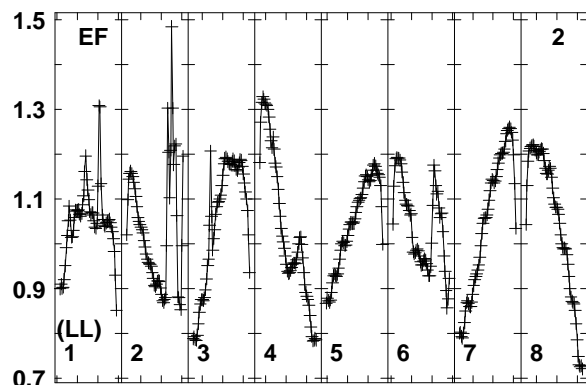
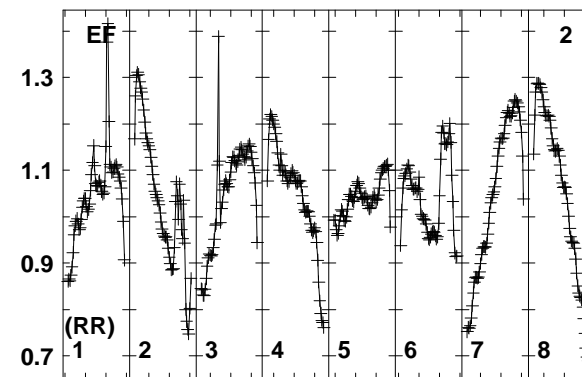
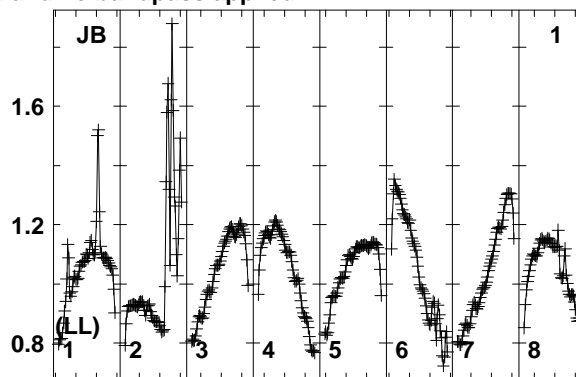
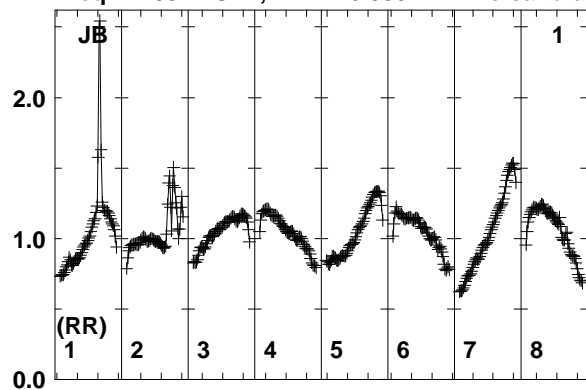

Lower frame: Real Jy
Total-power spectrum Antenna: JB (01)
Timerange: 00/05:57:21 to 00/05:59:59

Plot file version 367 created 04-NOV-2019 14:14:29

W2246-0526 EY034.UVDATA.1

Freq = 1.5947 GHz, Bw = 16.000 MH No calibration applied and no bandpass applied

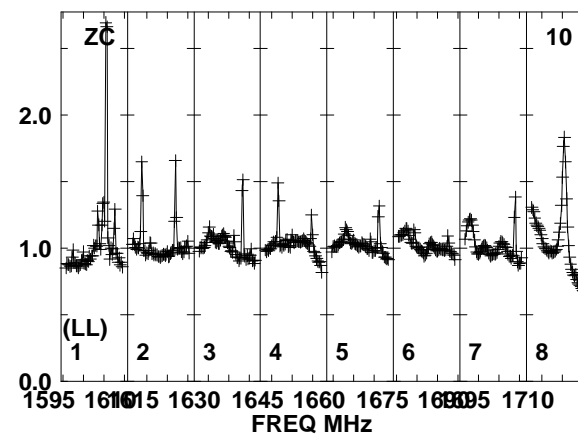
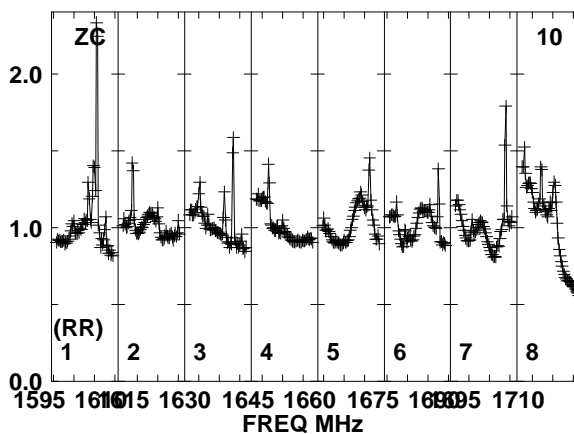
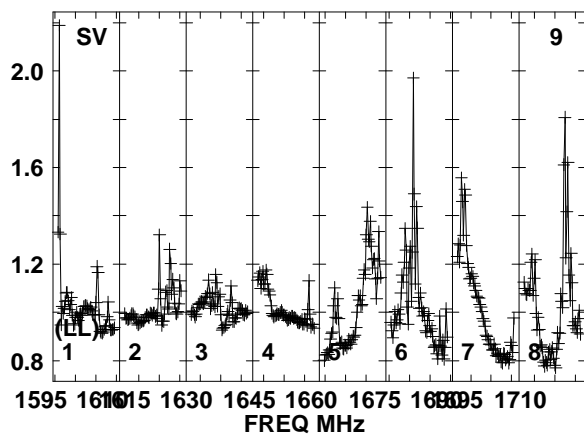
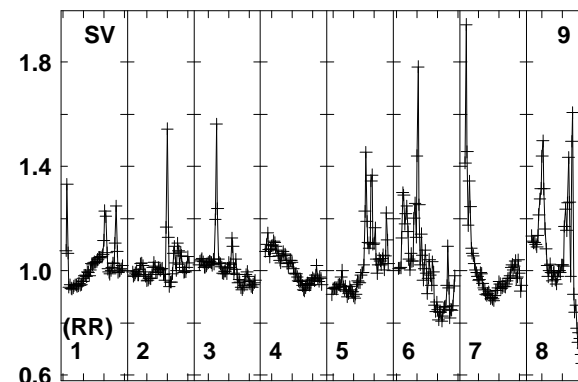
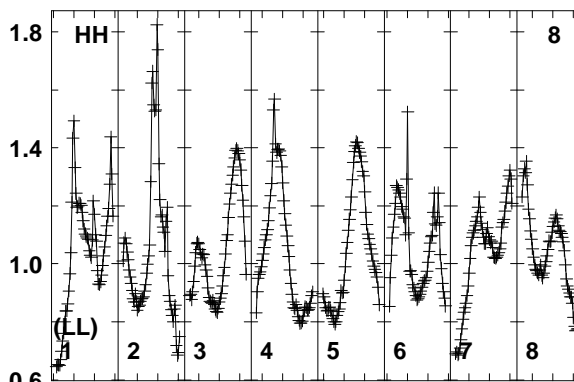
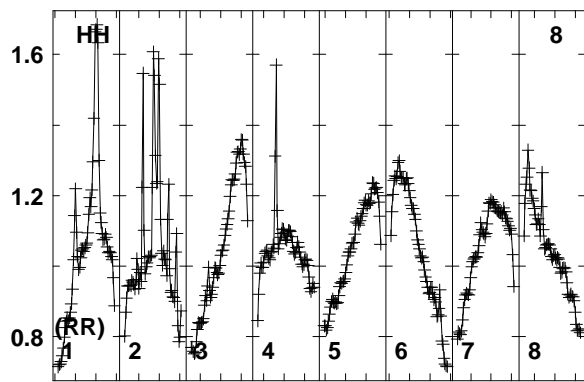
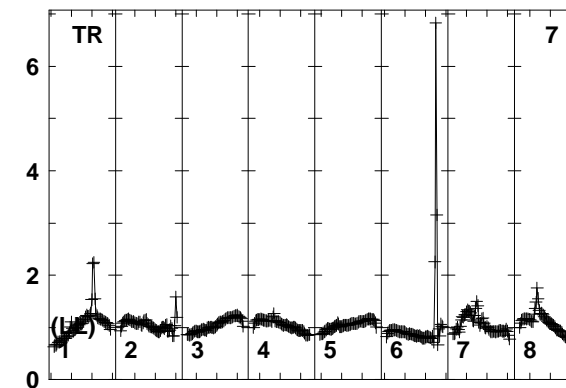
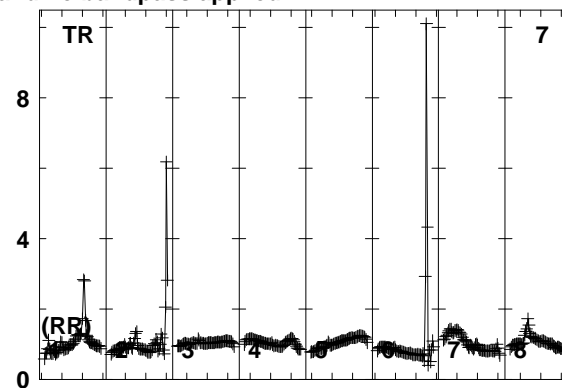
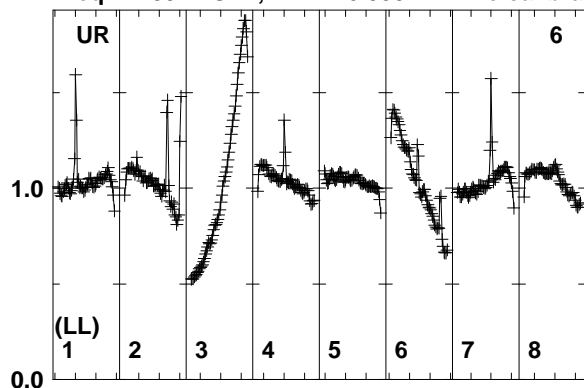

Lower frame: Real Jy
Total-power spectrum Antenna: UR (06)
Timerange: 00/05:57:21 to 00/05:59:59

Plot file version 368 created 04-NOV-2019 14:14:29

W2246-0526 EY034.UVDATA.1

Freq = 1.5947 GHz, Bw = 16.000 MH No calibration applied and no bandpass applied

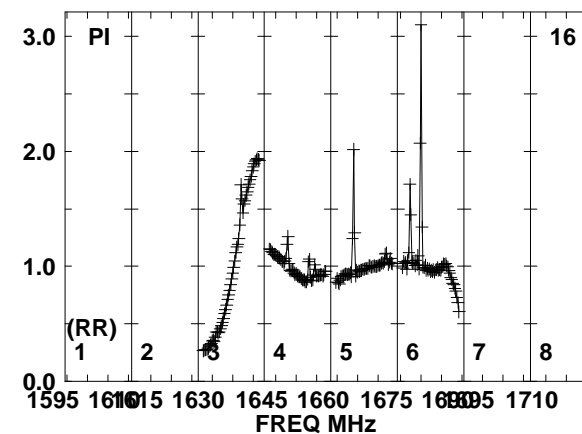
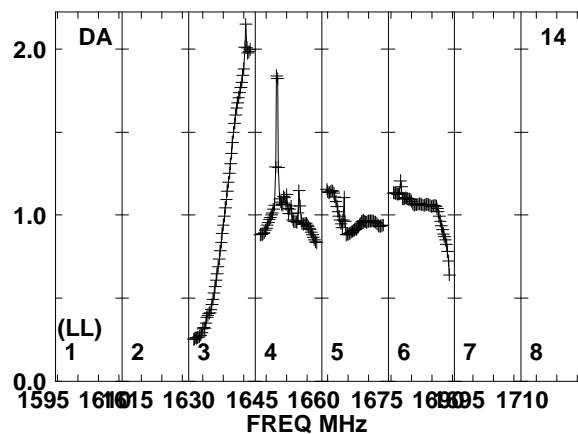
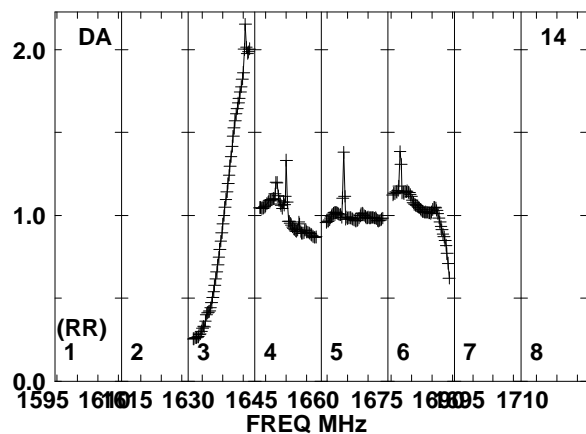
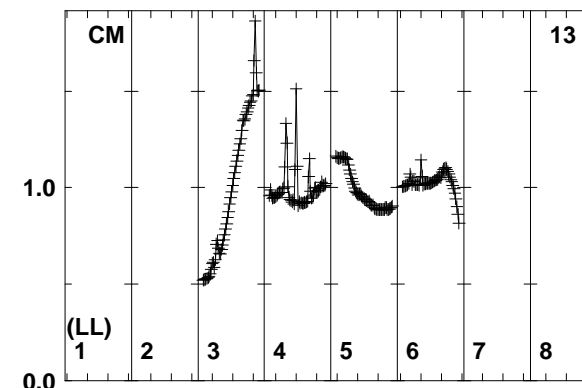
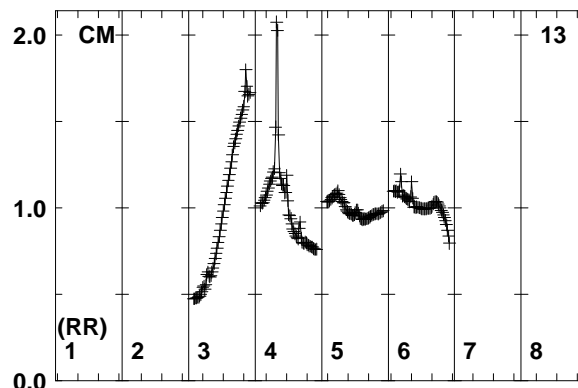
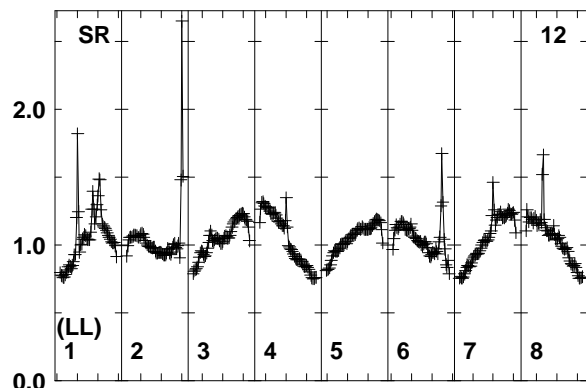
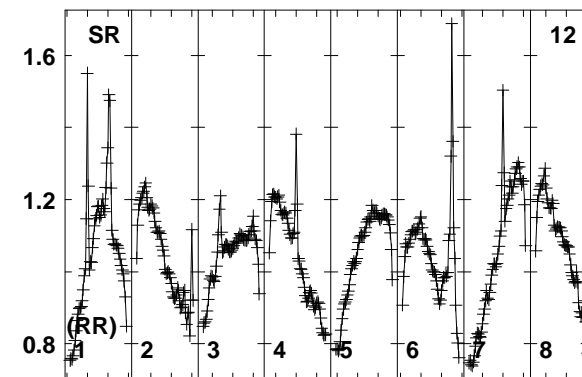
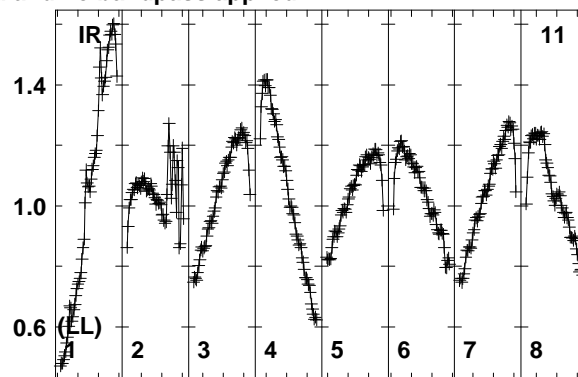
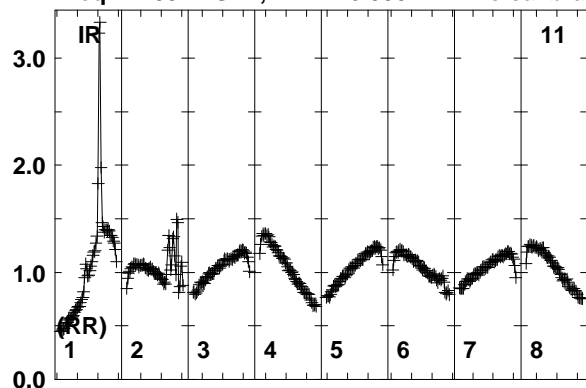

Lower frame: Real Jy
Total-power spectrum Antenna: IR (11)
Timerange: 00/05:57:21 to 00/05:59:59

Plot file version 369 created 04-NOV-2019 14:14:29
W2246-0526 EY034.UVDATA.1
Freq = 1.5947 GHz, Bw = 16.000 MH No calibration applied and no bandpass applied

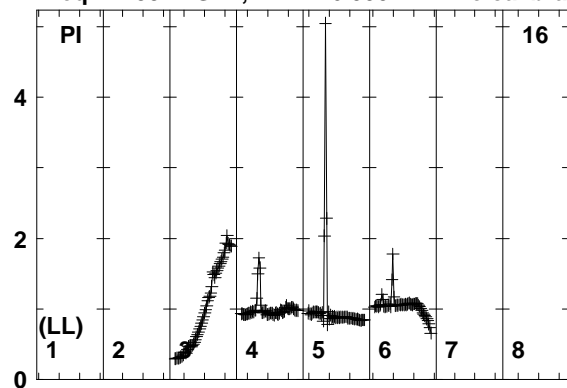

Lower frame: Real Jy
Total-power spectrum Antenna: PI (16)
Timerange: 00/05:57:21 to 00/05:59:59

Plot file version 370 created 04-NOV-2019 14:14:29

J2248-0541 EY034.UVDATA.1

Freq = 1.5947 GHz, Bw = 16.000 MH No calibration applied and no bandpass applied

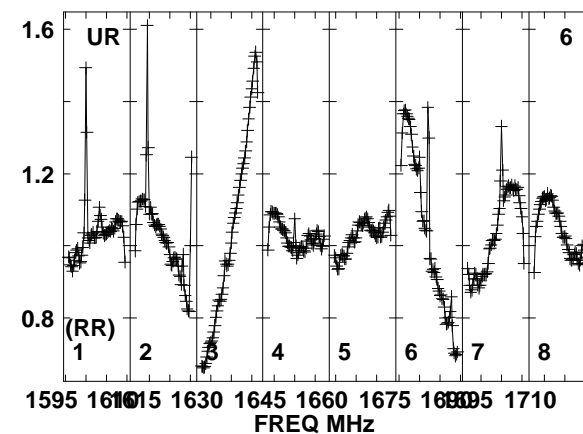
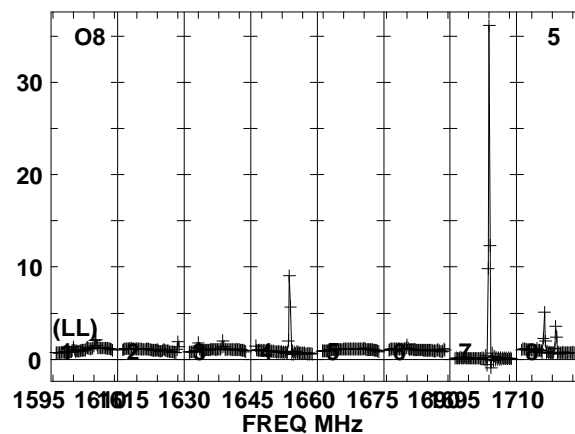
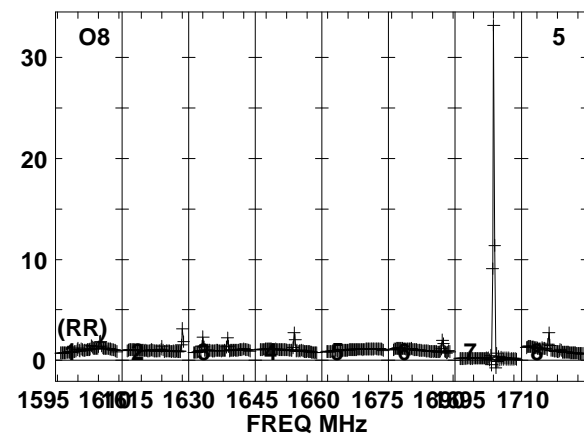
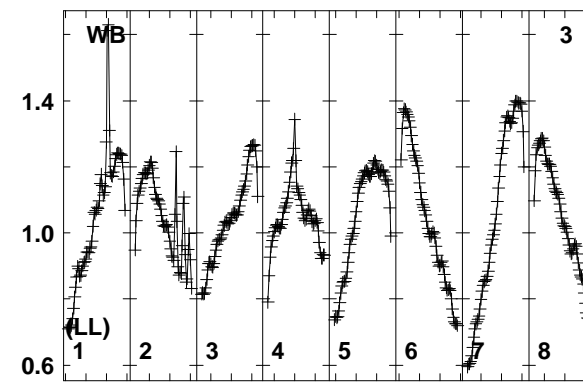
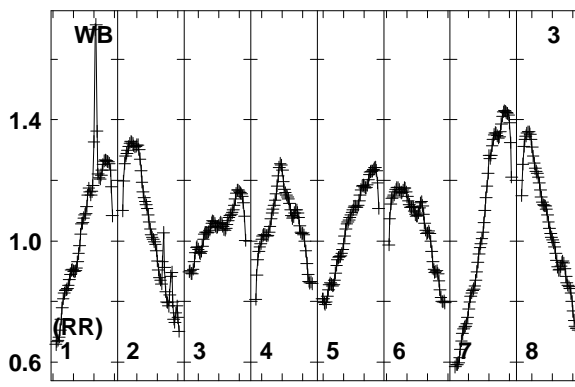
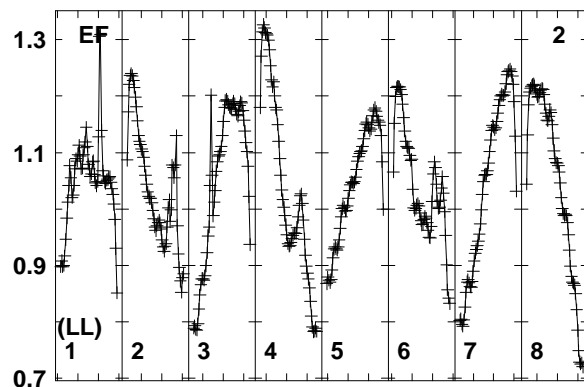
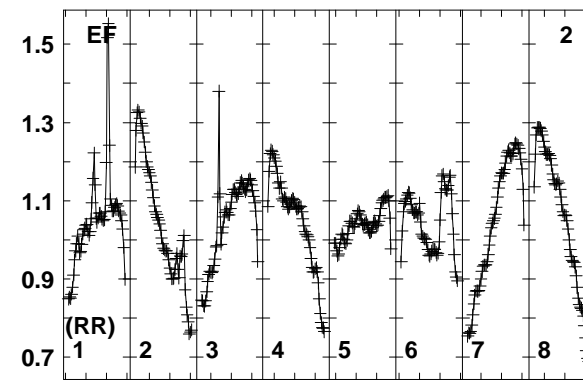
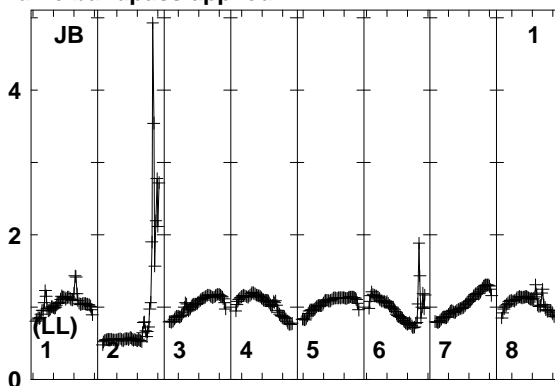
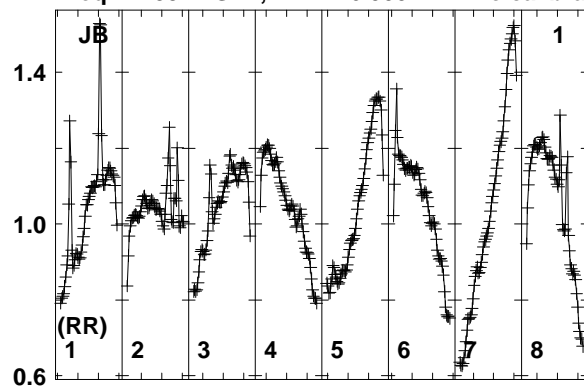

Lower frame: Real Jy
Total-power spectrum Antenna: JB (01)
Timerange: 00/06:00:36 to 00/06:01:34

Plot file version 371 created 04-NOV-2019 14:14:29

J2248-0541 EY034.UVDATA.1

Freq = 1.5947 GHz, Bw = 16.000 MH No calibration applied and no bandpass applied

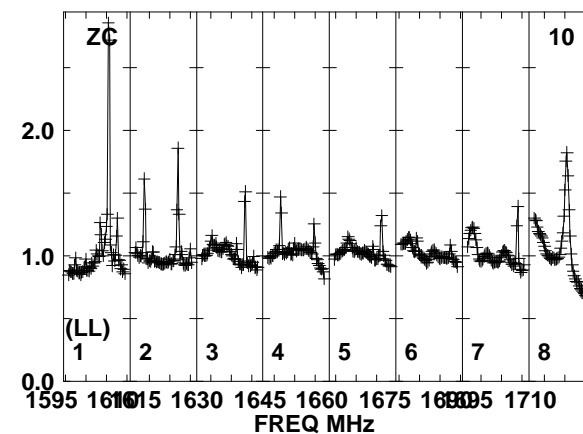
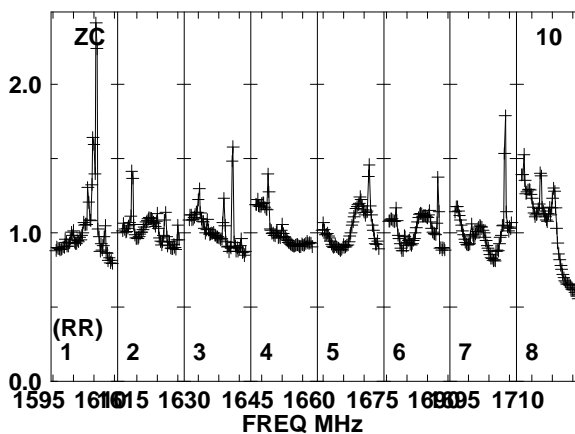
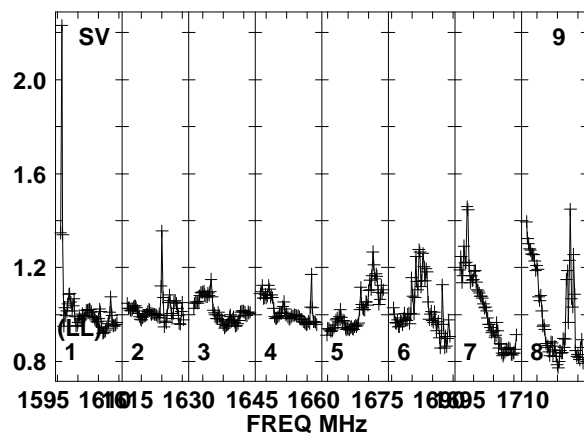
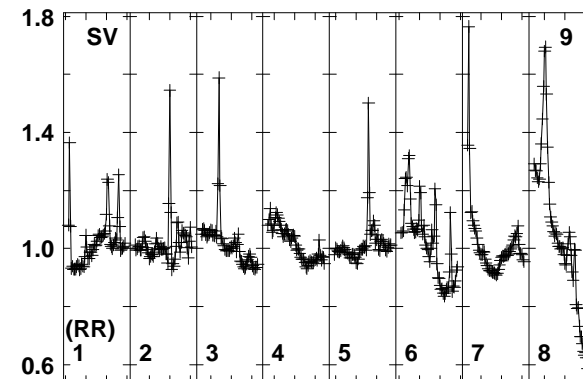
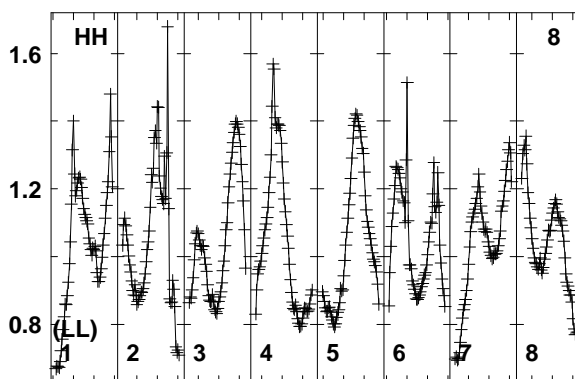
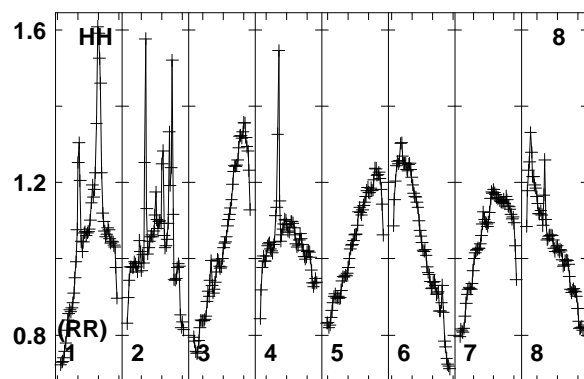
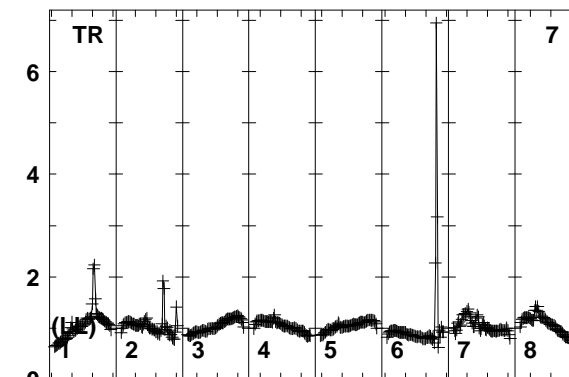
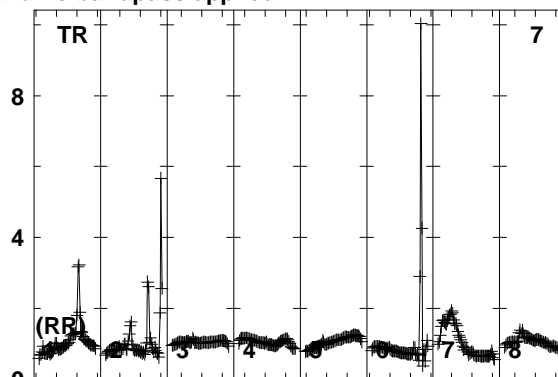
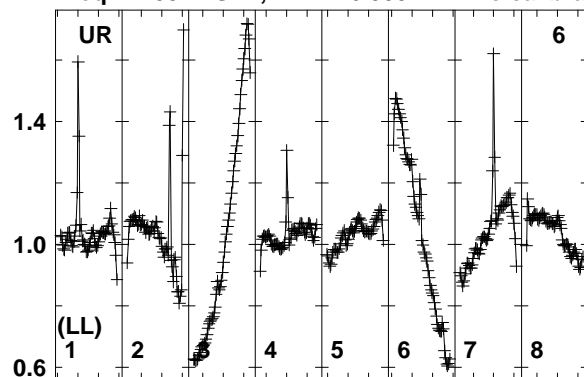

Lower frame: Real Jy
Total-power spectrum Antenna: UR (06)
Timerange: 00/06:00:36 to 00/06:01:34

Plot file version 372 created 04-NOV-2019 14:14:29

J2248-0541 EY034.UVDATA.1

Freq = 1.5947 GHz, Bw = 16.000 MH No calibration applied and no bandpass applied

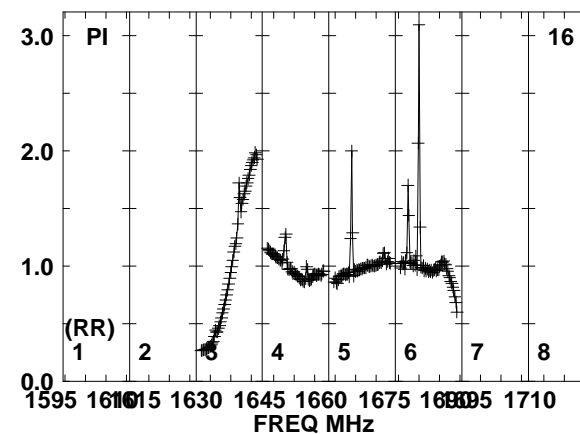
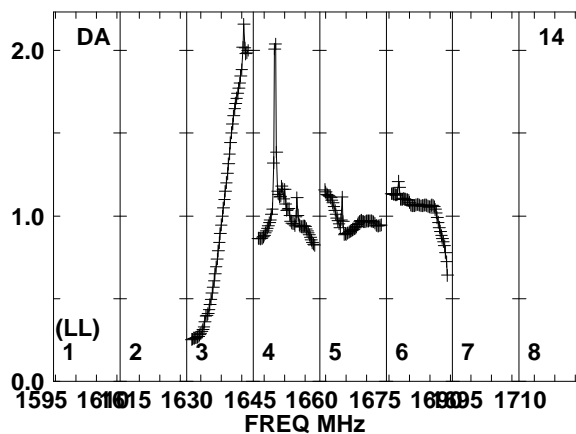
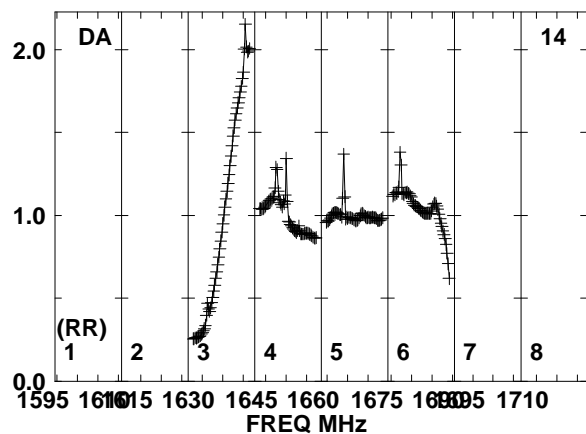
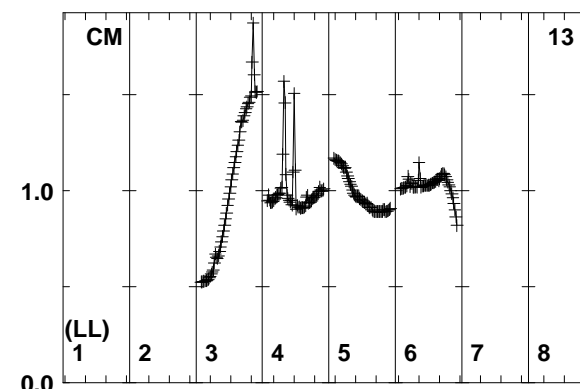
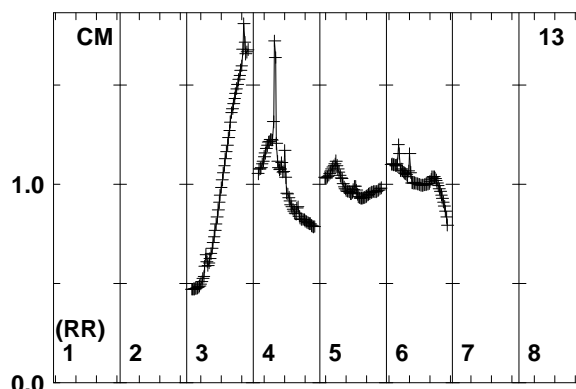
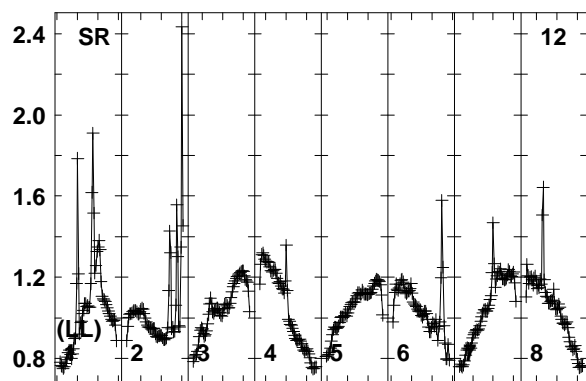
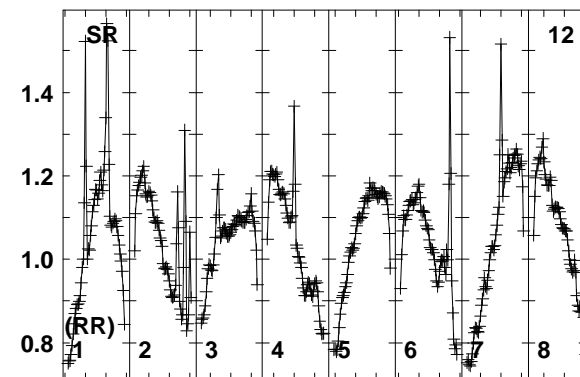
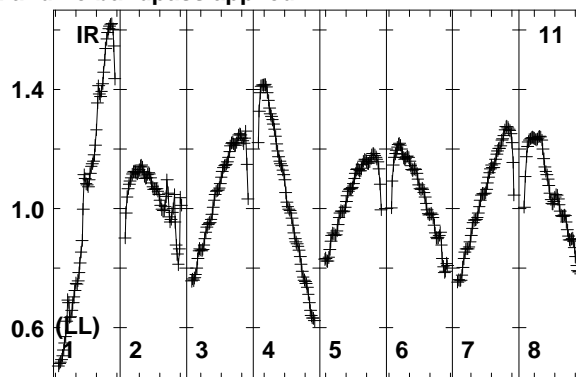
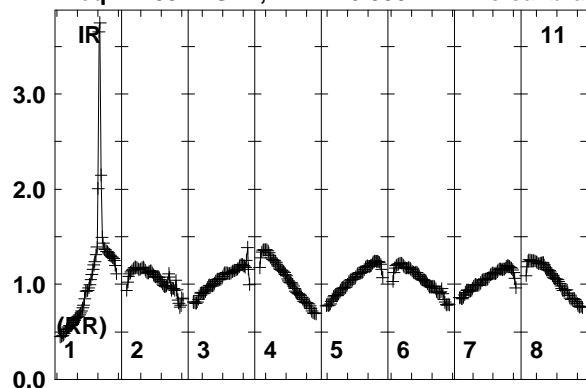

Lower frame: Real Jy
Total-power spectrum Antenna: IR (11)
Timerange: 00/06:00:36 to 00/06:01:34

Plot file version 373 created 04-NOV-2019 14:14:29
J2248-0541 EY034.UVDATA.1
Freq = 1.5947 GHz, Bw = 16.000 MH No calibration applied and no bandpass applied

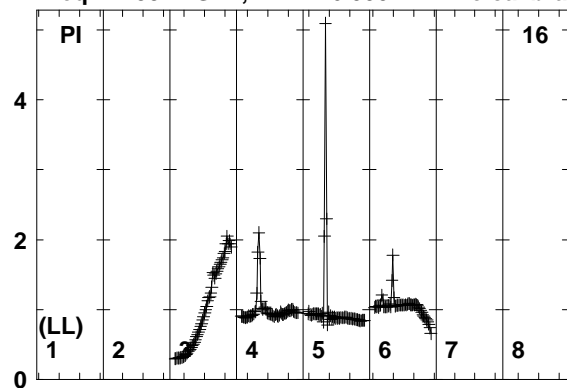

Lower frame: Real Jy
Total-power spectrum Antenna: PI (16)
Timerange: 00/06:00:36 to 00/06:01:34

Plot file version 374 created 04-NOV-2019 14:14:29

W2246-0526 EY034.UVDATA.1

Freq = 1.5947 GHz, Bw = 16.000 MH No calibration applied and no bandpass applied

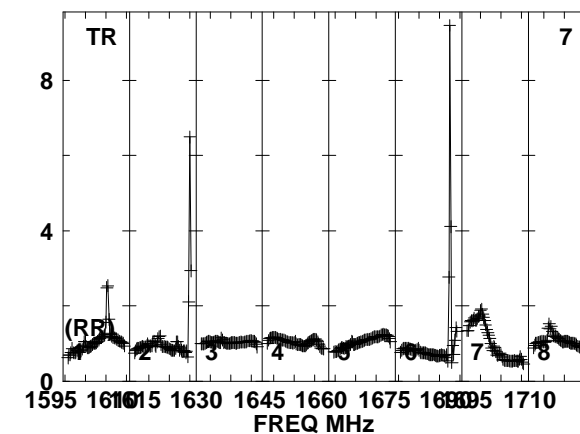
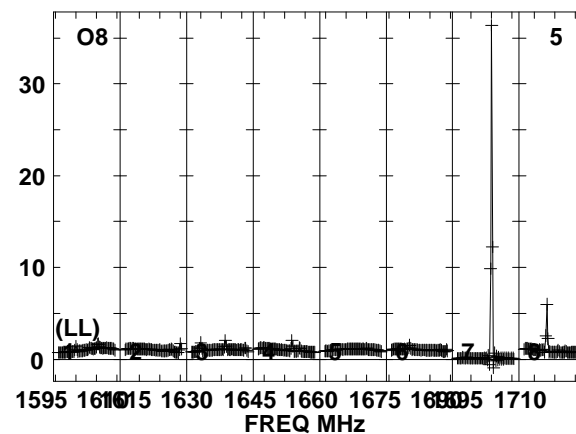
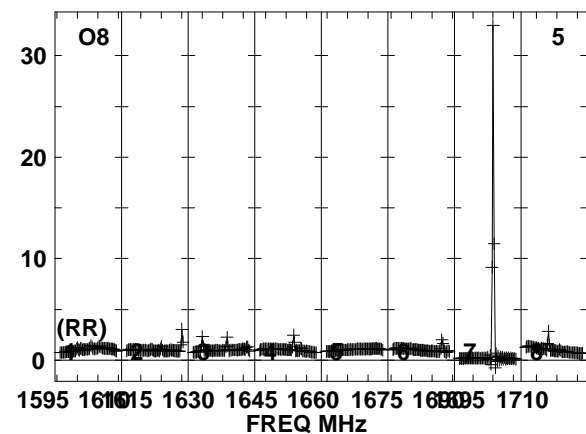
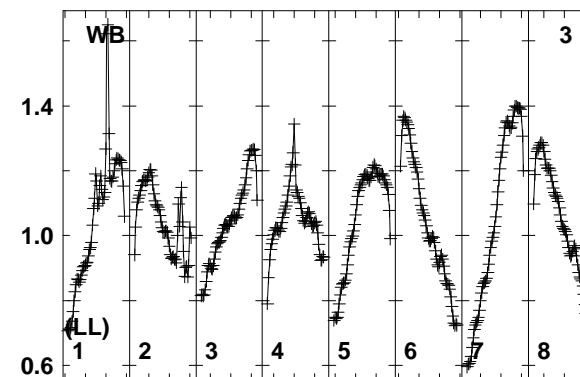
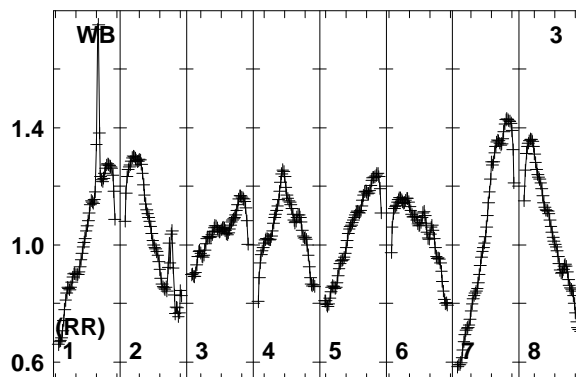
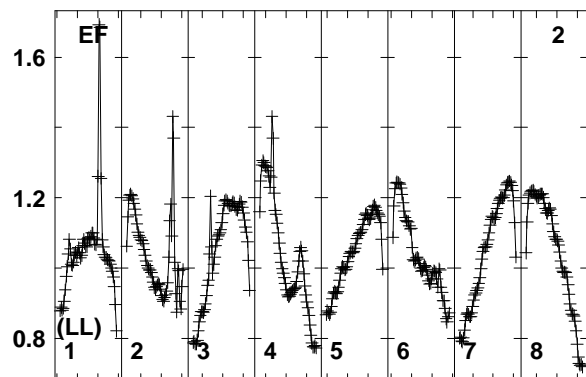
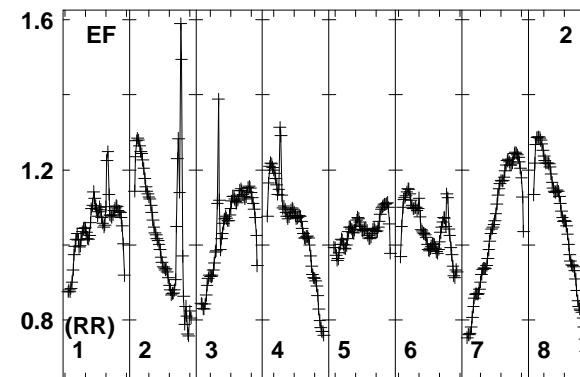
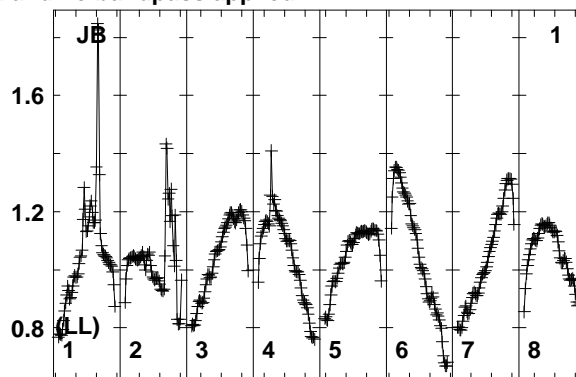
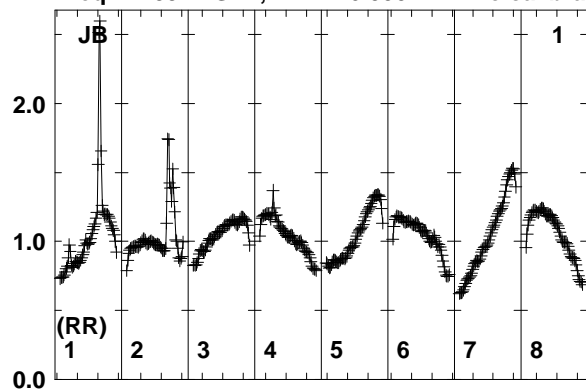

Lower frame: Real Jy
Total-power spectrum Antenna: JB (01)
Timerange: 00/06:01:36 to 00/06:04:14

Plot file version 375 created 04-NOV-2019 14:14:29

W2246-0526 EY034.UVDATA.1

Freq = 1.5947 GHz, Bw = 16.000 MH No calibration applied and no bandpass applied

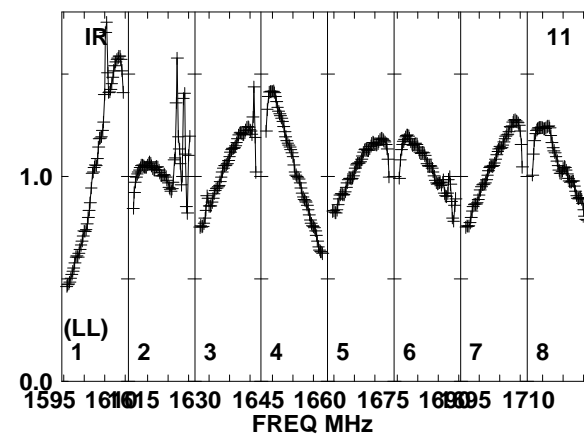
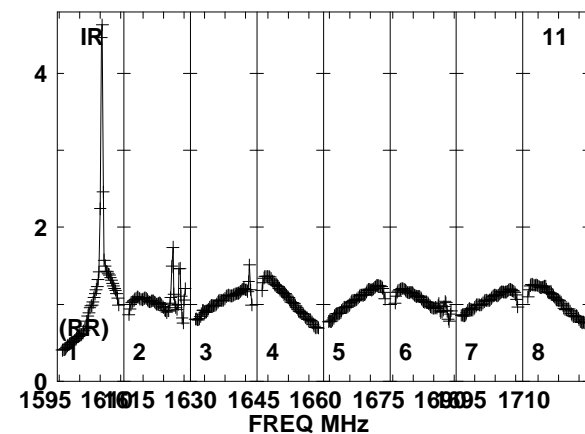
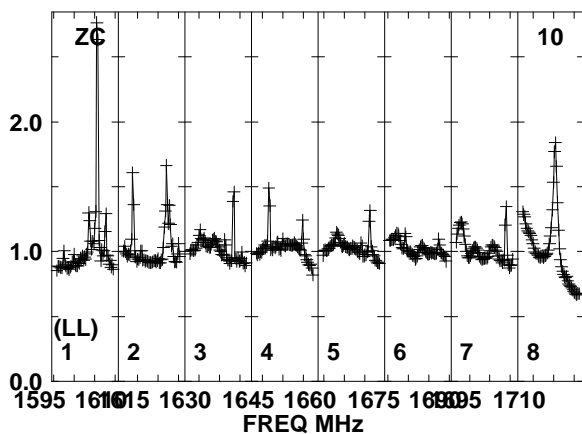
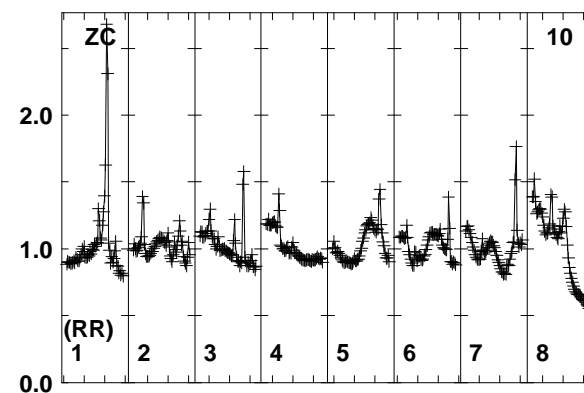
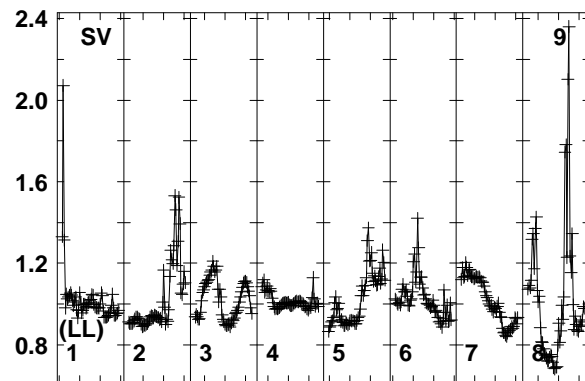
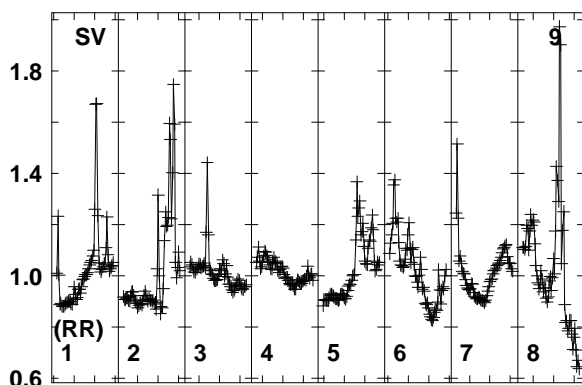
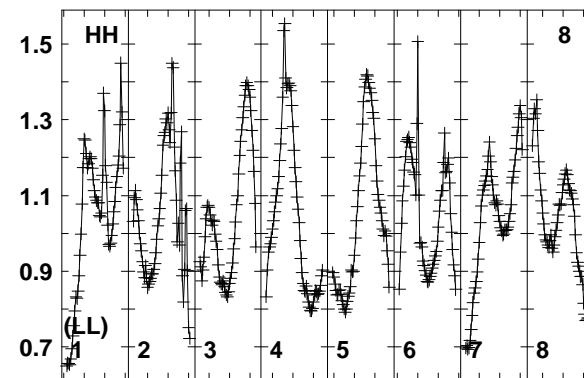
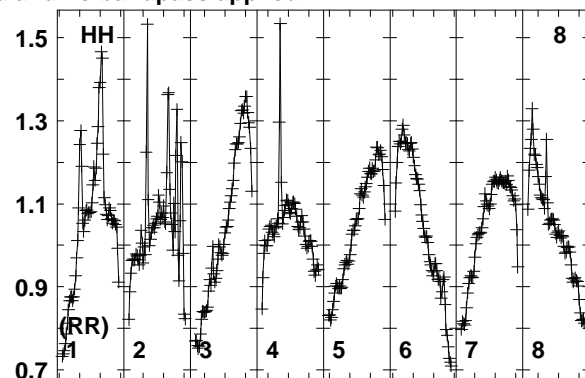
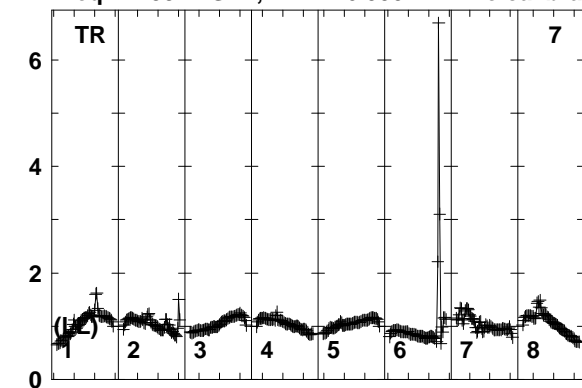

Lower frame: Real Jy
Total-power spectrum Antenna: TR (07)
Timerange: 00/06:01:36 to 00/06:04:14

Plot file version 376 created 04-NOV-2019 14:14:30

W2246-0526 EY034.UVDATA.1

Freq = 1.5947 GHz, Bw = 16.000 MH No calibration applied and no bandpass applied

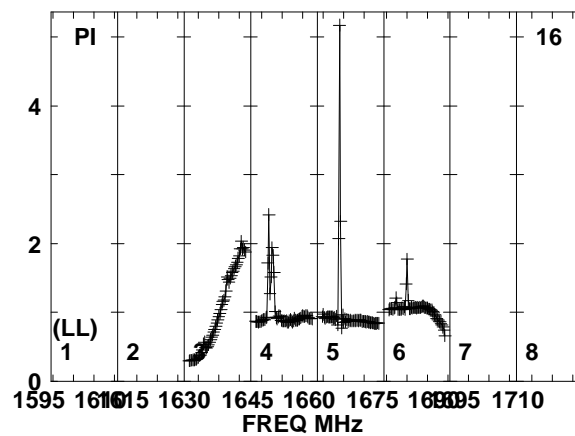
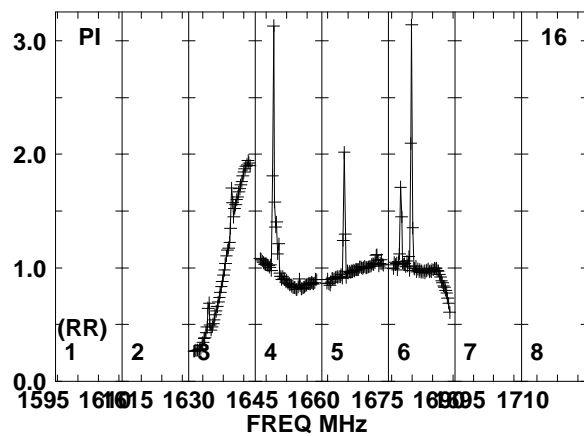
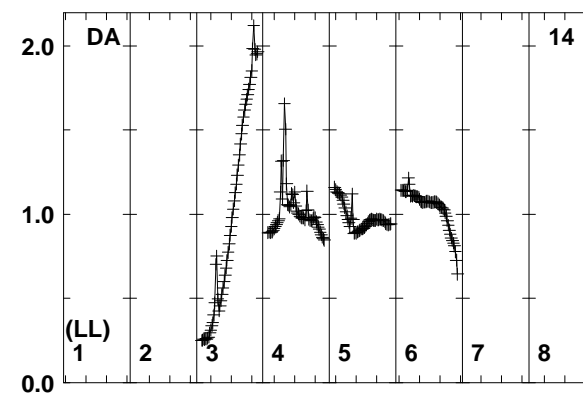
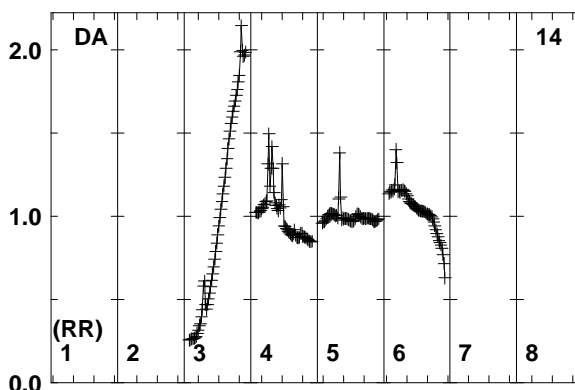
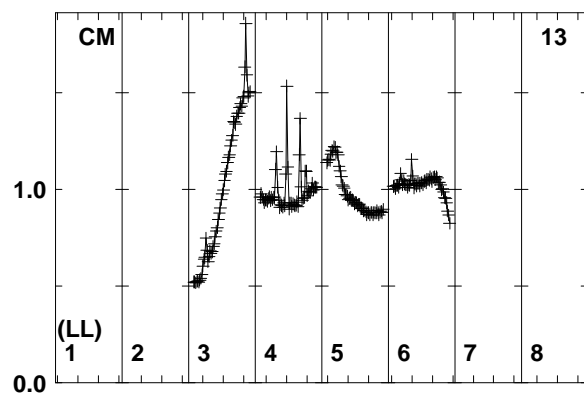
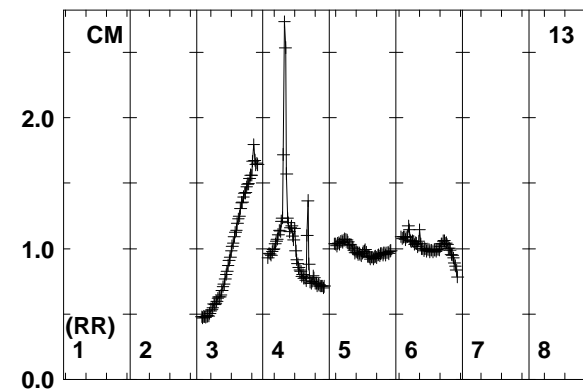
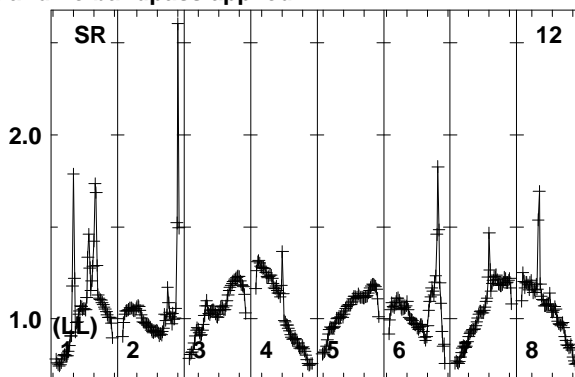
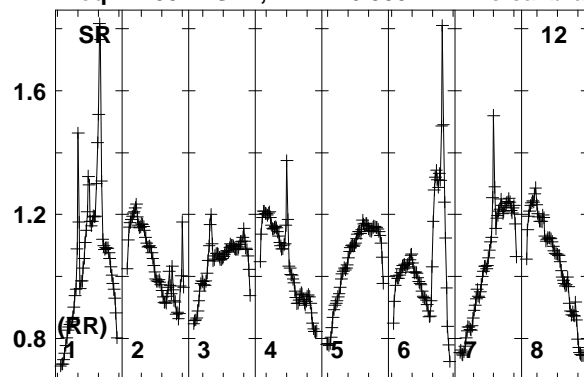

Lower frame: Real Jy
Total-power spectrum Antenna: SR (12)
Timerange: 00/06:01:36 to 00/06:04:14

Plot file version 377 created 04-NOV-2019 14:14:30

J2248-0541 EY034.UVDATA.1

Freq = 1.5947 GHz, Bw = 16.000 MH No calibration applied and no bandpass applied

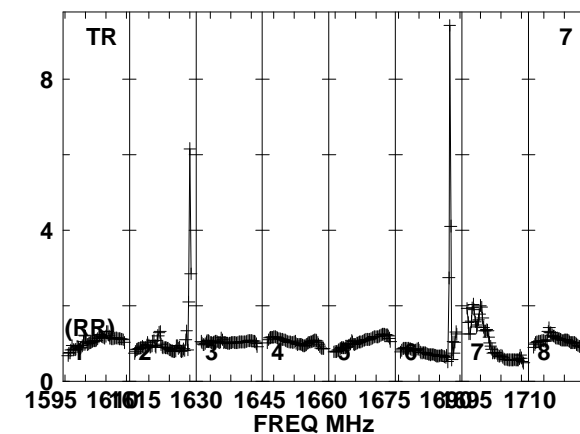
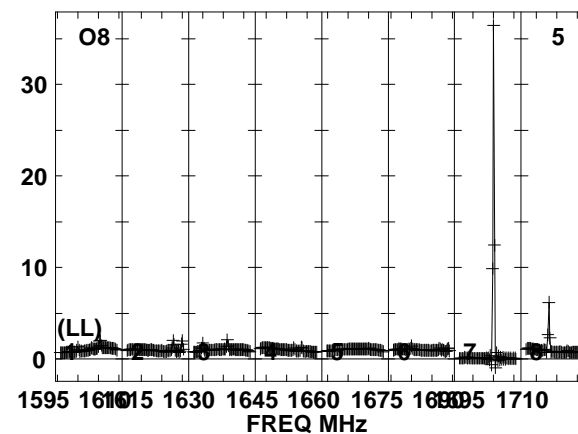
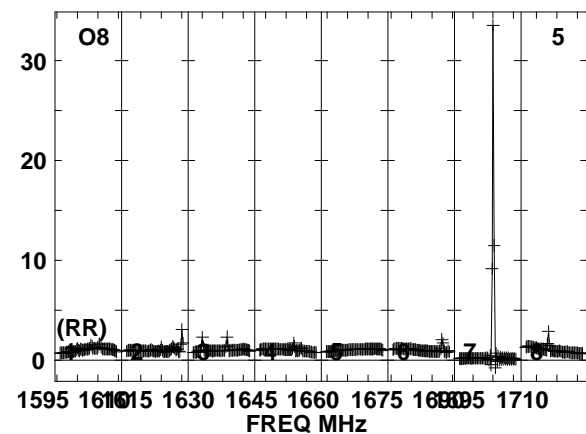
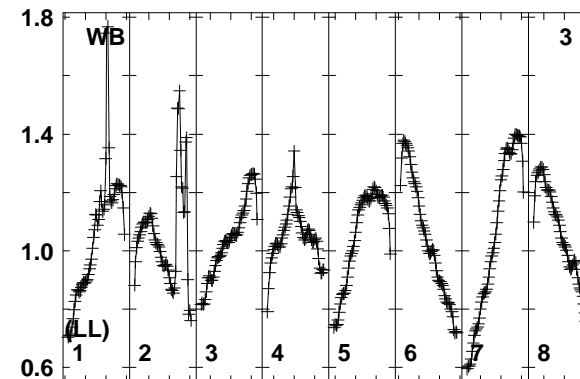
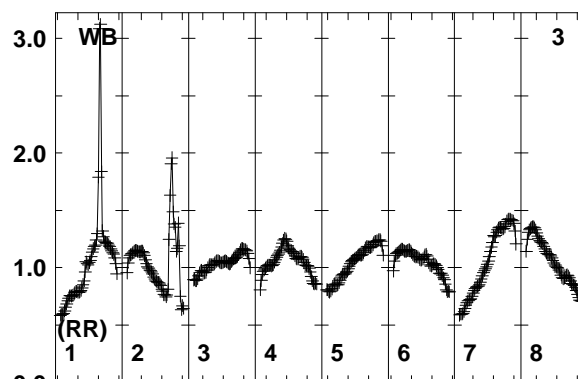
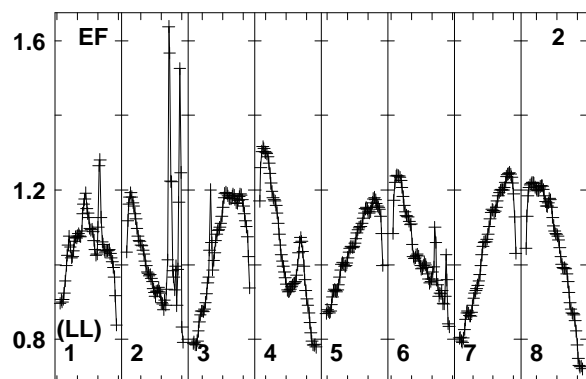
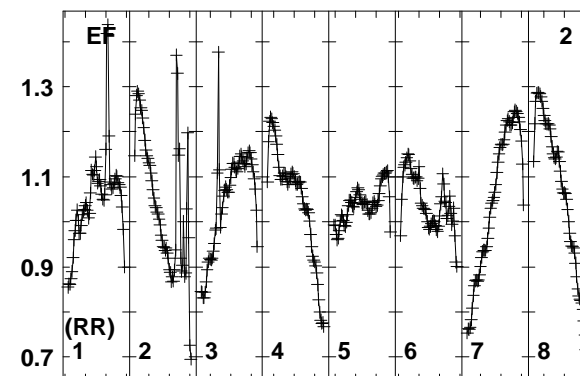
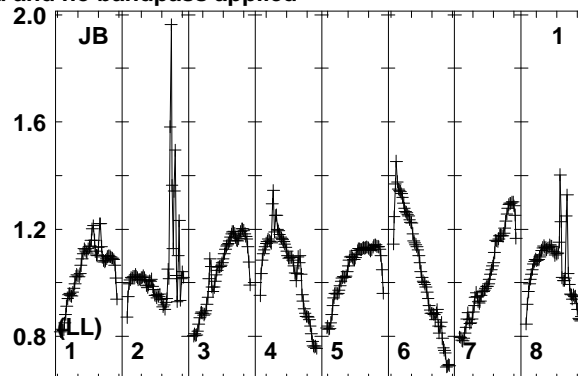
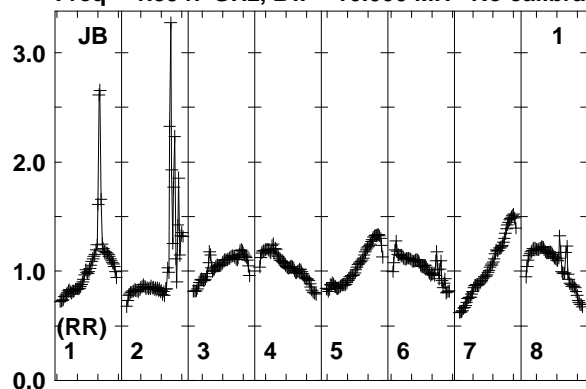

Lower frame: Real Jy
Total-power spectrum Antenna: JB (01)
Timerange: 00/06:04:31 to 00/06:05:29

Plot file version 378 created 04-NOV-2019 14:14:30

J2248-0541 EY034.UVDATA.1

Freq = 1.5947 GHz, Bw = 16.000 MH No calibration applied and no bandpass applied

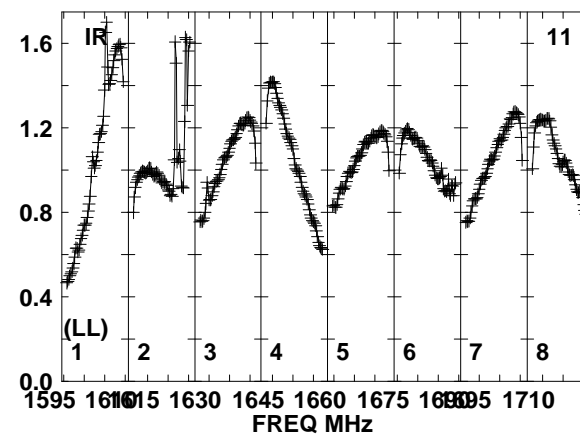
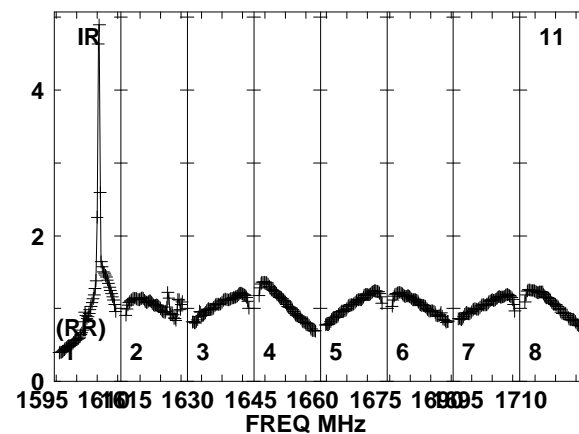
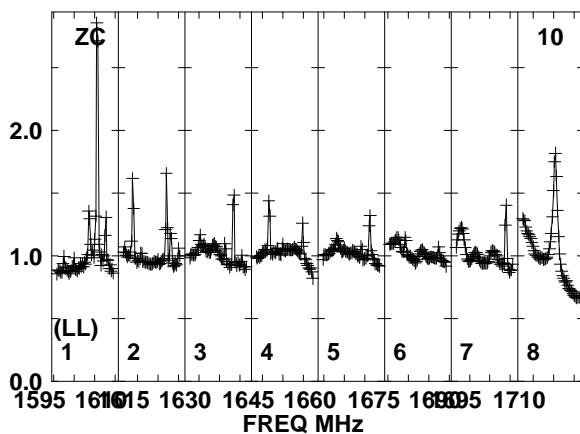
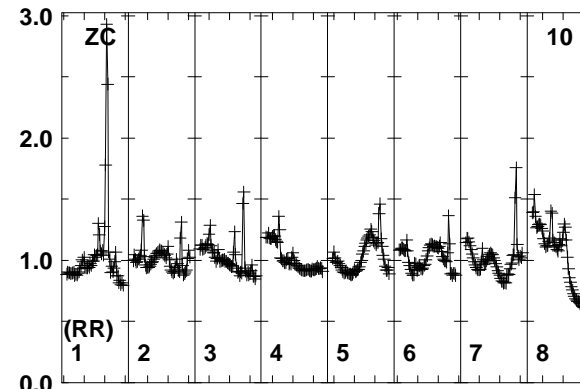
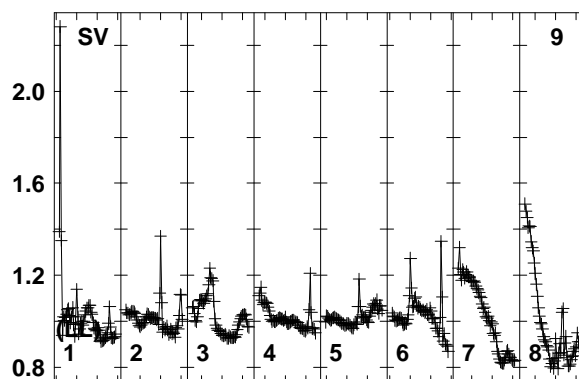
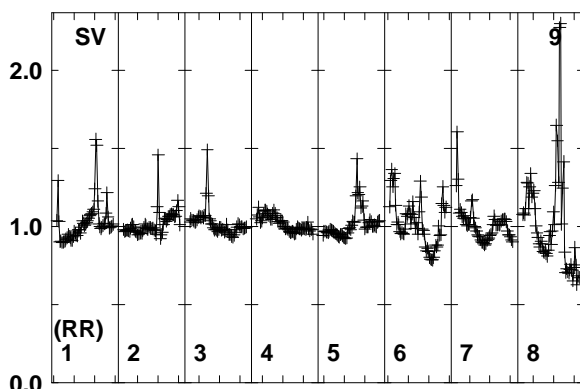
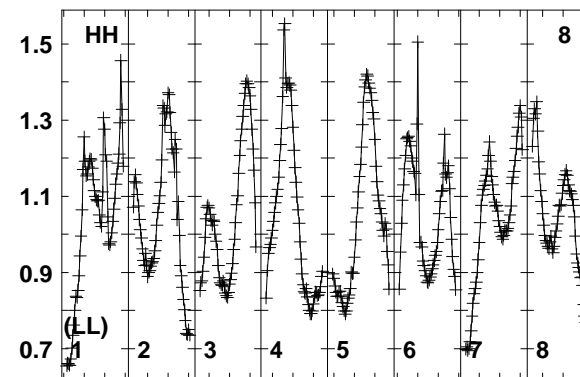
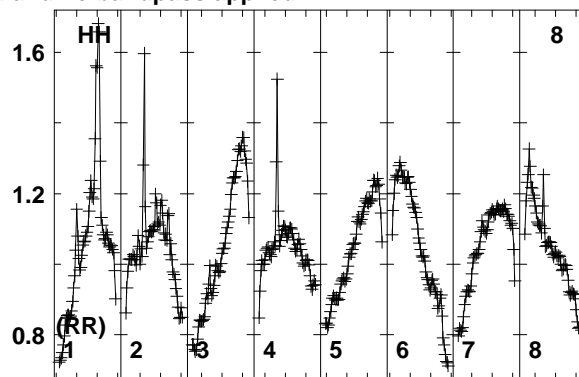
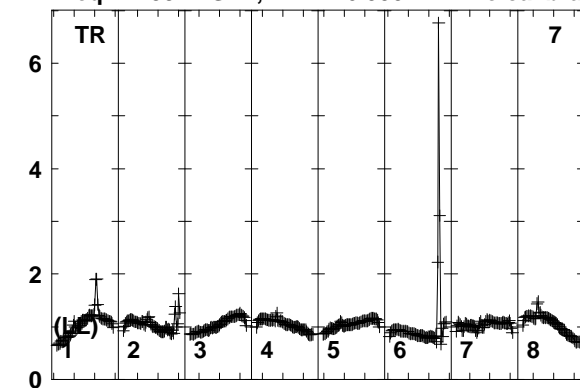

Lower frame: Real Jy
Total-power spectrum Antenna: TR (07)
Timerange: 00/06:04:31 to 00/06:05:29

Plot file version 379 created 04-NOV-2019 14:14:30

J2248-0541 EY034.UVDATA.1

Freq = 1.5947 GHz, Bw = 16.000 MH No calibration applied and no bandpass applied

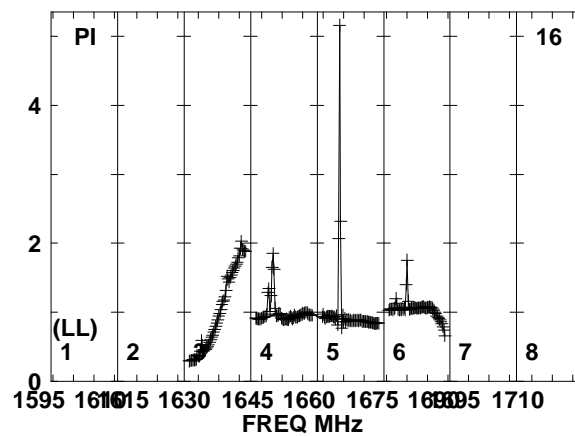
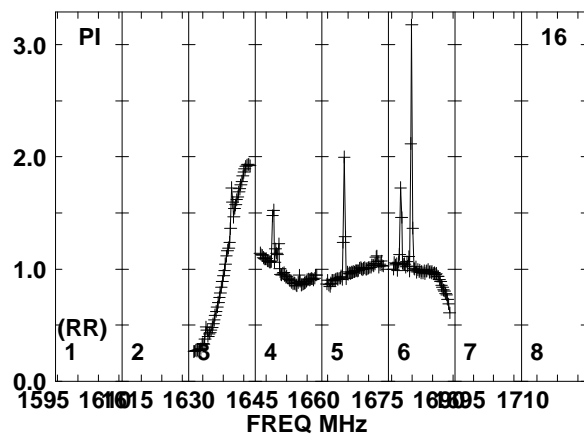
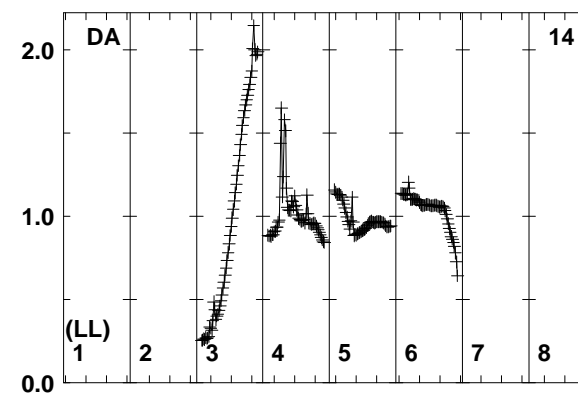
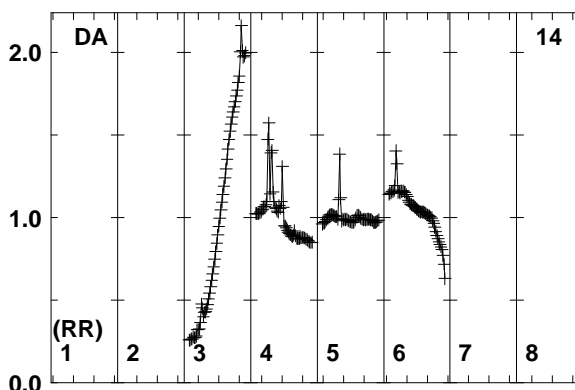
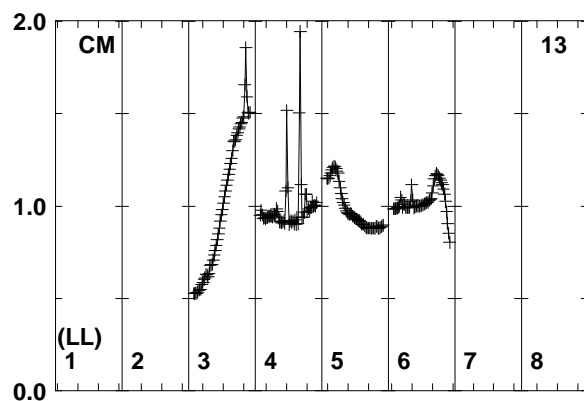
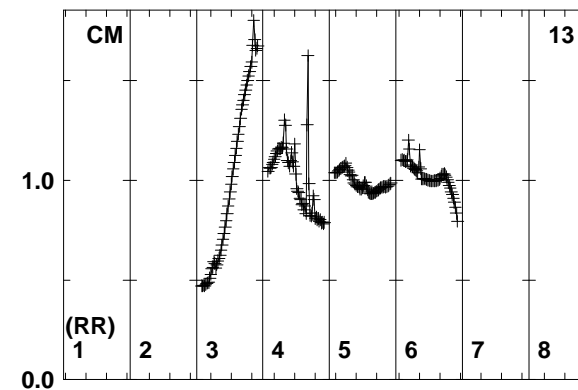
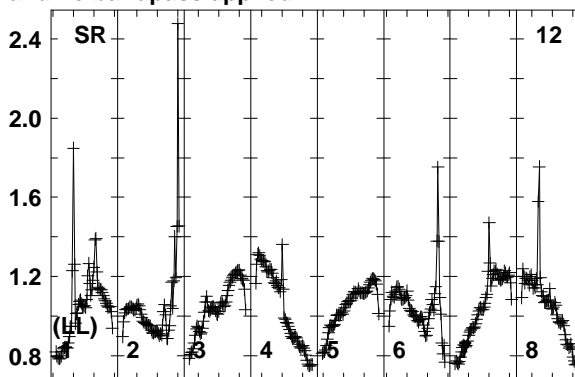
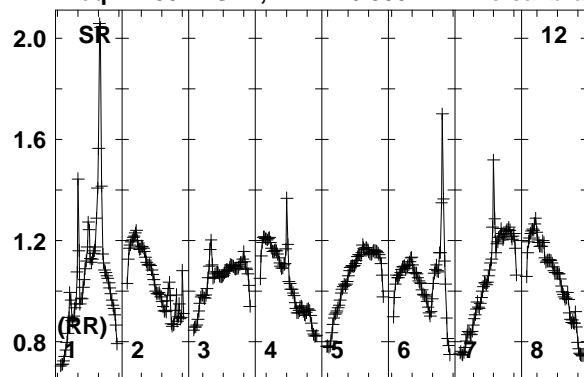

Lower frame: Real Jy
Total-power spectrum Antenna: SR (12)
Timerange: 00/06:04:31 to 00/06:05:29

Plot file version 380 created 04-NOV-2019 14:14:30

J2245-0755 EY034.UVDATA.1

Freq = 1.5947 GHz, Bw = 16.000 MH No calibration applied and no bandpass applied

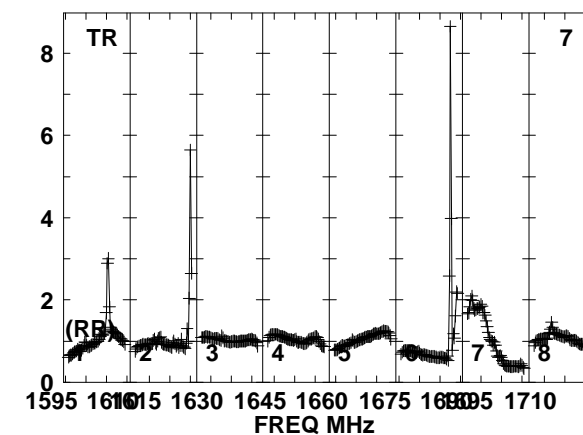
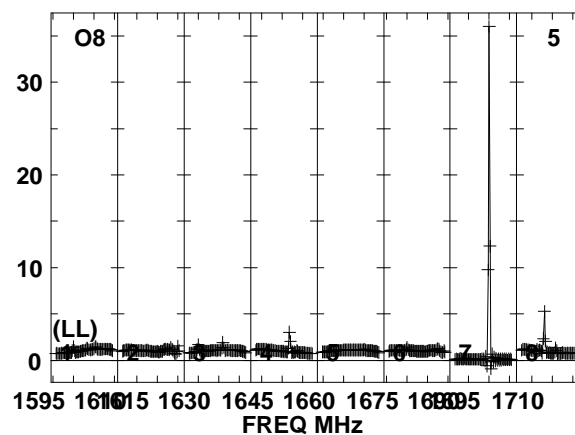
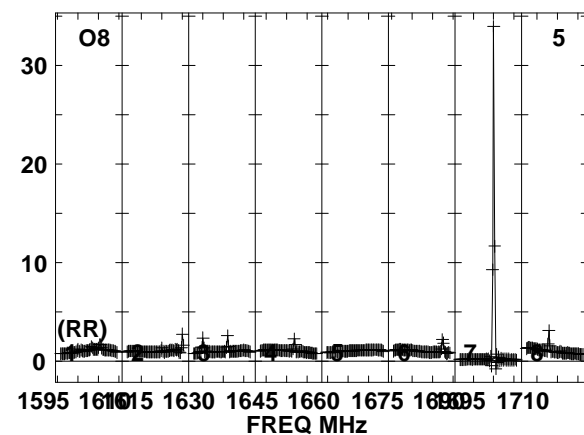
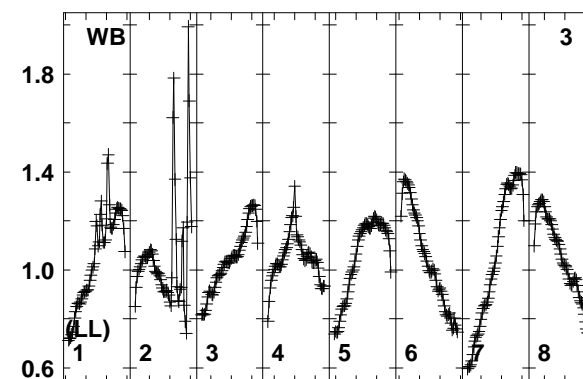
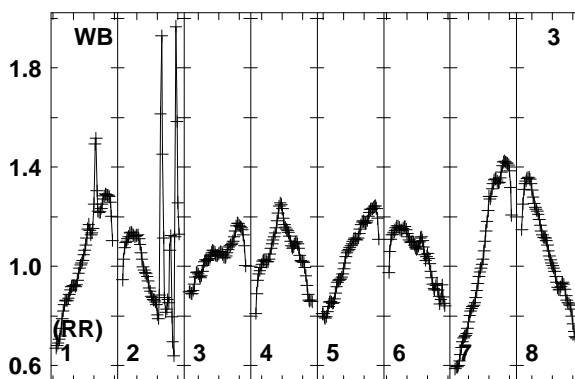
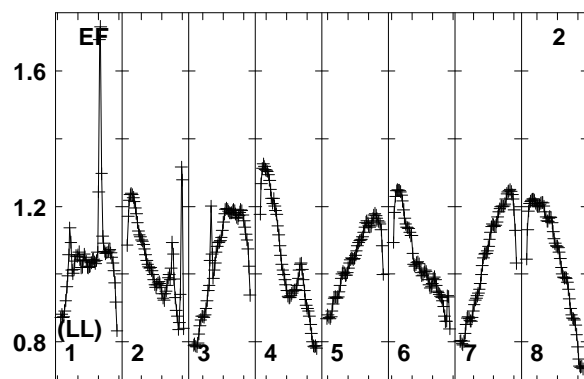
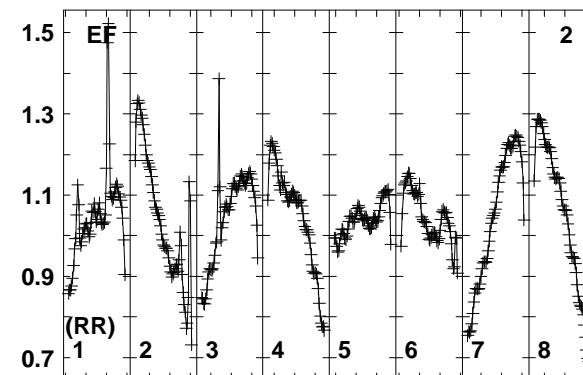
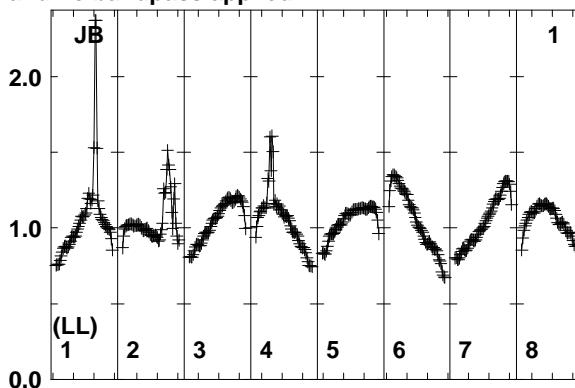
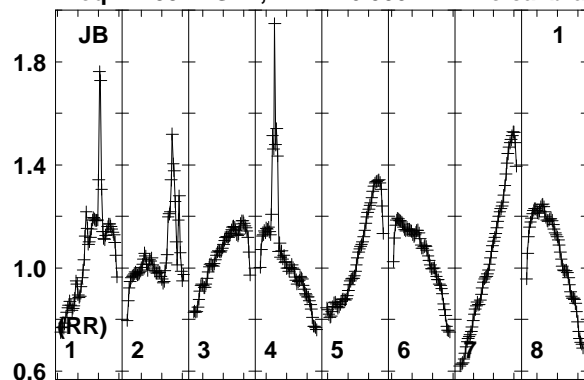

Lower frame: Real Jy
Total-power spectrum Antenna: JB (01)
Timerange: 00/06:05:46 to 00/06:06:44

Plot file version 381 created 04-NOV-2019 14:14:30

J2245-0755 EY034.UVDATA.1

Freq = 1.5947 GHz, Bw = 16.000 MH No calibration applied and no bandpass applied

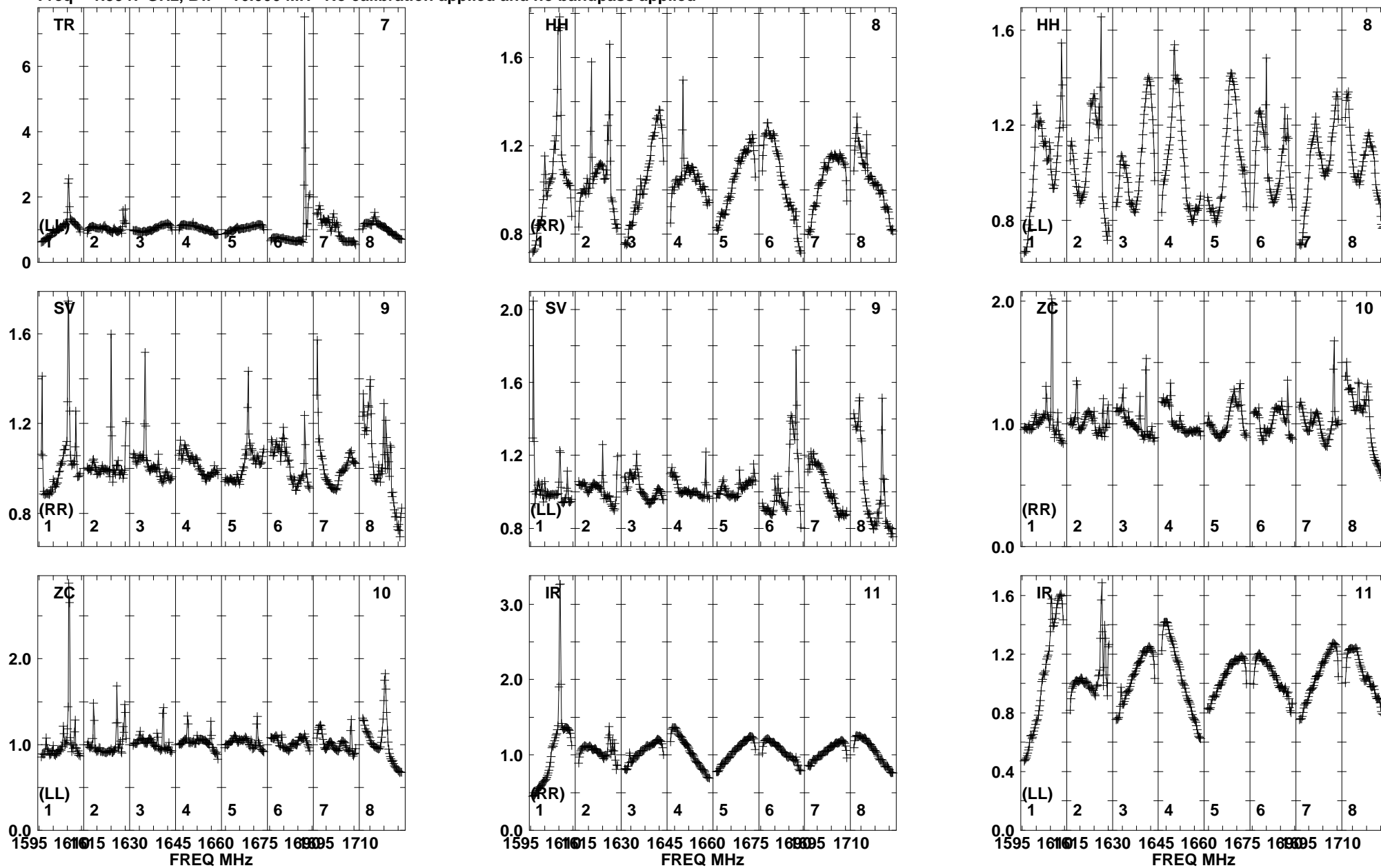

Lower frame: Real Jy
Total-power spectrum Antenna: TR (07)
Timerange: 00/06:05:46 to 00/06:06:44

Plot file version 382 created 04-NOV-2019 14:14:30

J2245-0755 EY034.UVDATA.1

Freq = 1.5947 GHz, Bw = 16.000 MH No calibration applied and no bandpass applied

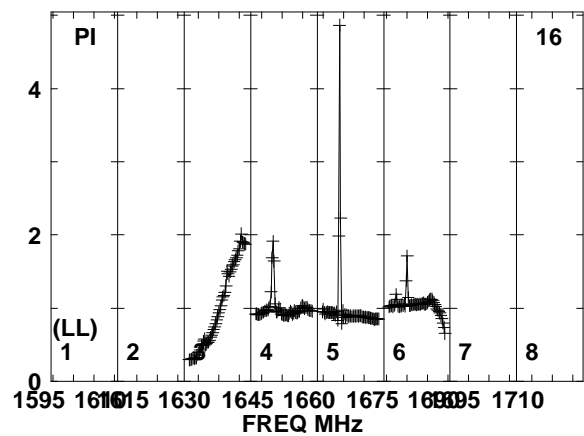
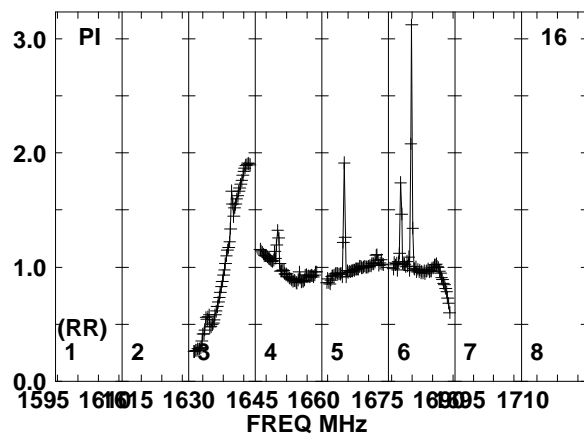
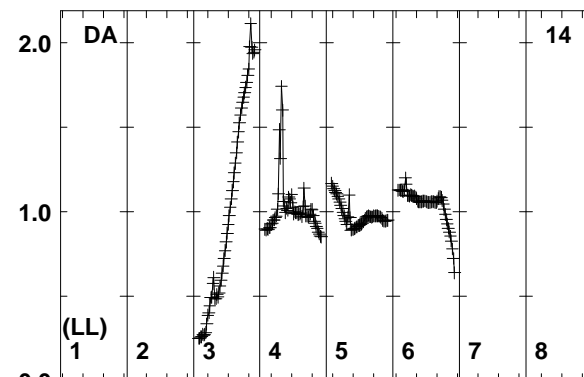
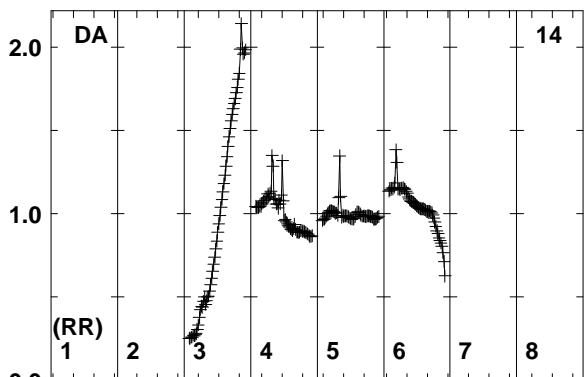
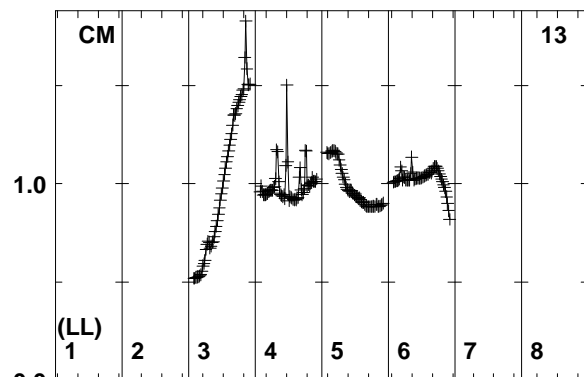
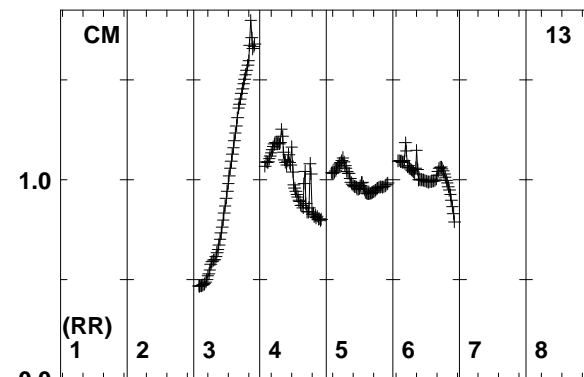
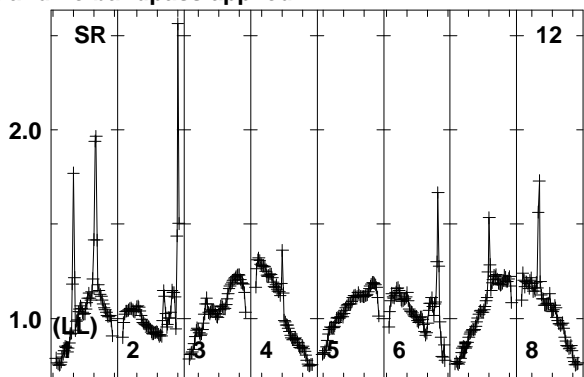
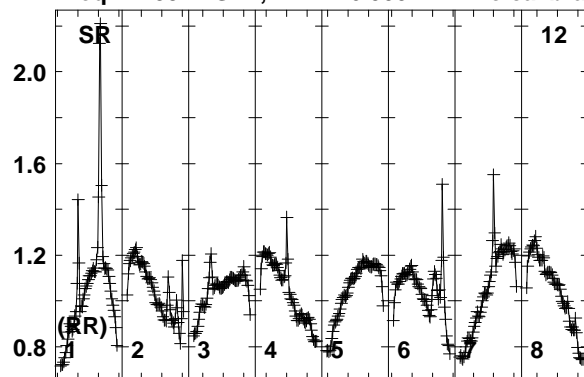

Lower frame: Real Jy
Total-power spectrum Antenna: SR (12)
Timerange: 00/06:05:46 to 00/06:06:44

Plot file version 383 created 04-NOV-2019 14:14:30

3C454.3 EY034.UVDATA.1

Freq = 1.5947 GHz, Bw = 16.000 MH No calibration applied and no bandpass applied

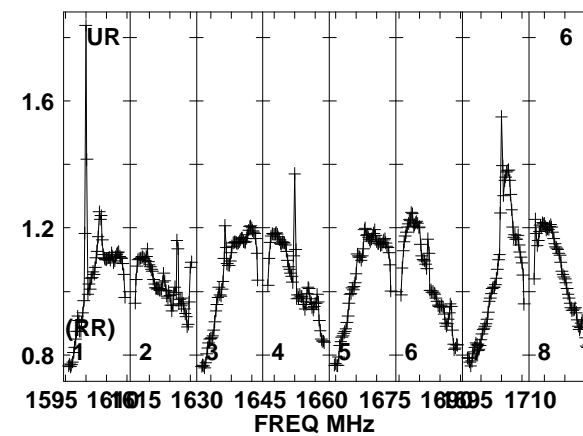
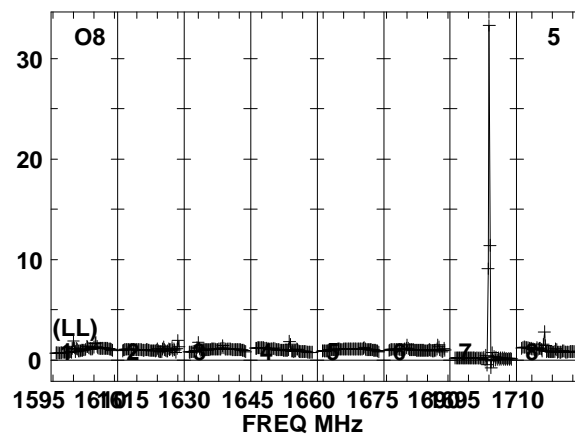
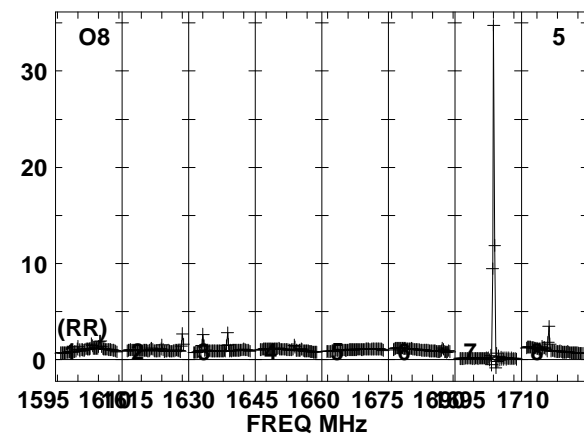
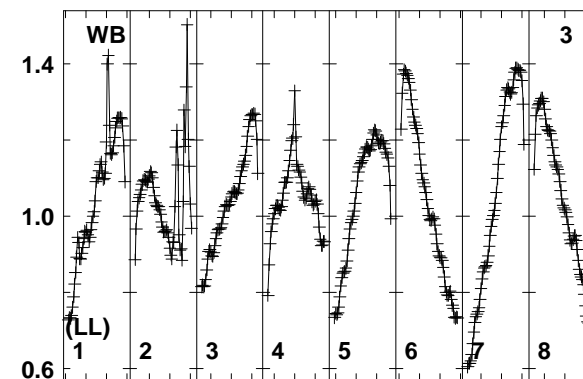
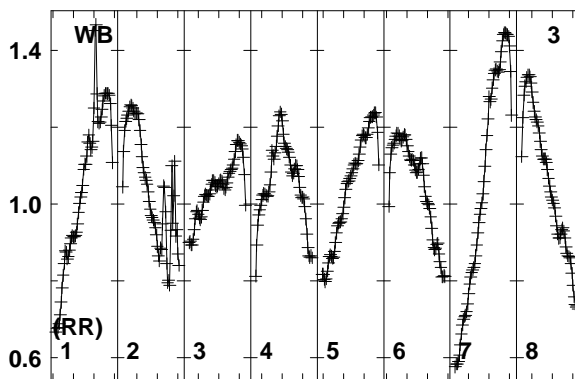
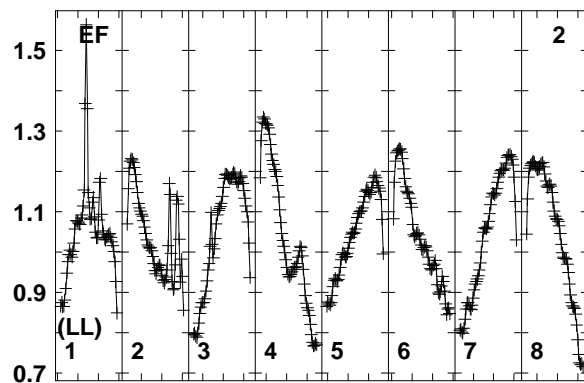
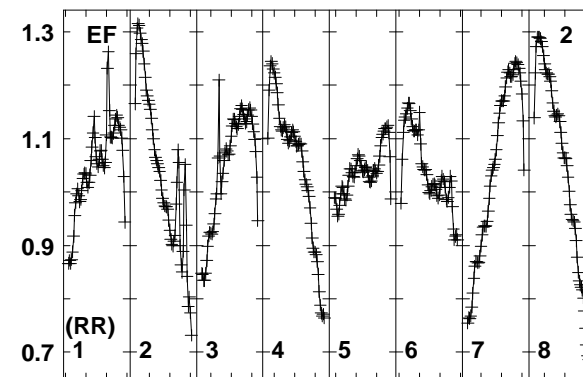
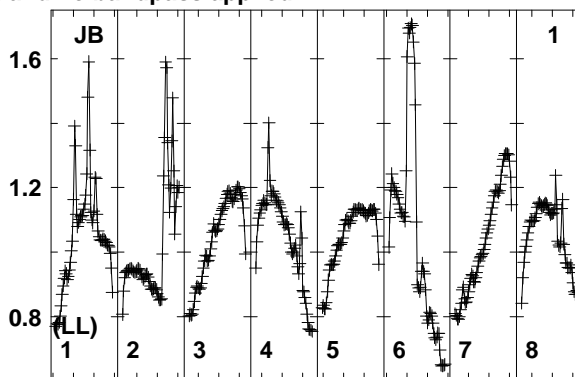
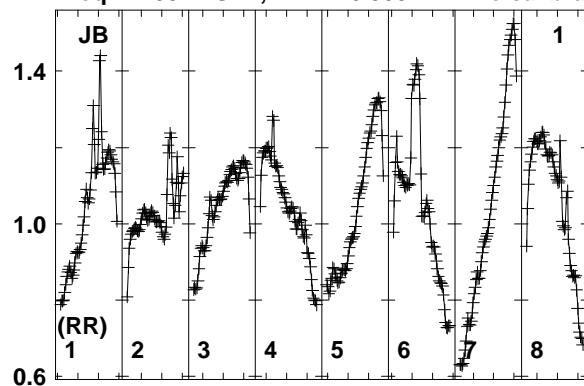

Lower frame: Real Jy
Total-power spectrum Antenna: JB (01)
Timerange: 00/06:07:46 to 00/06:11:14

Plot file version 384 created 04-NOV-2019 14:14:30

3C454.3 EY034.UVDATA.1

Freq = 1.5947 GHz, Bw = 16.000 MH No calibration applied and no bandpass applied

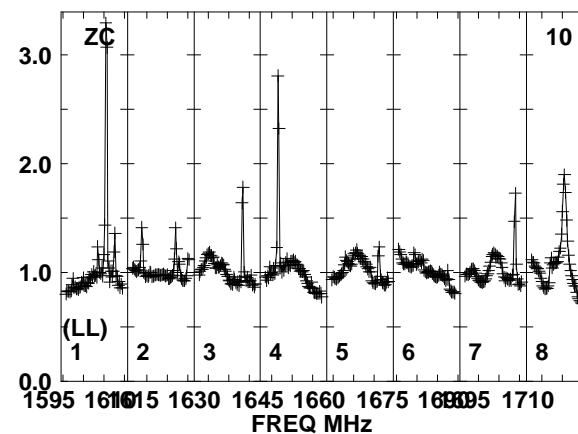
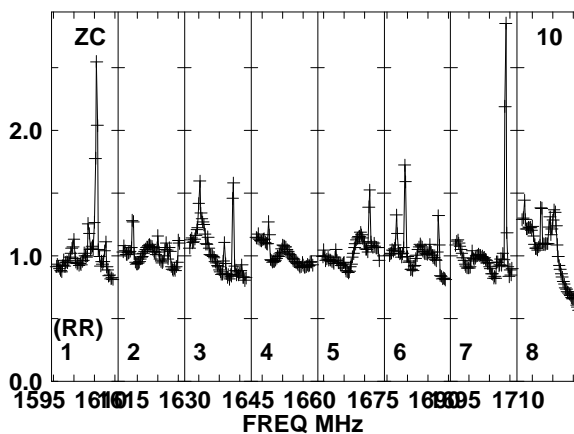
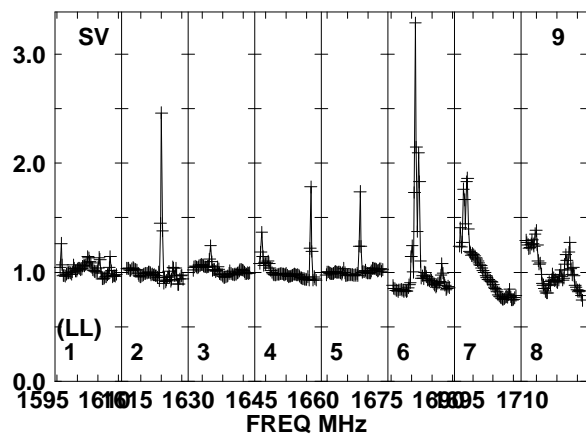
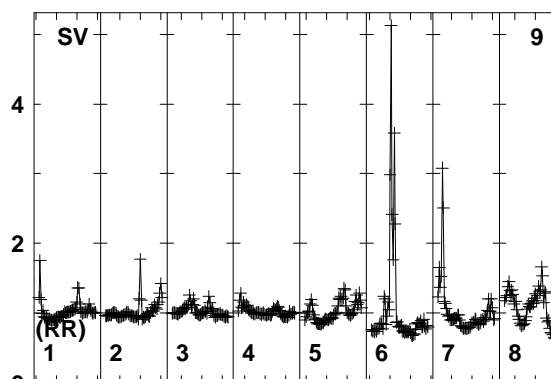
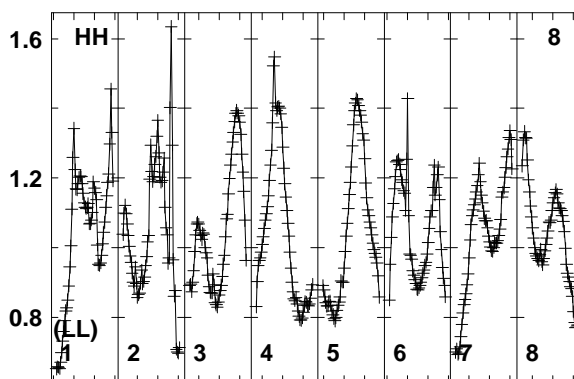
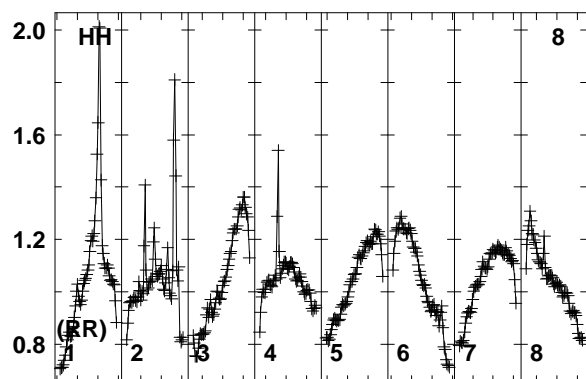
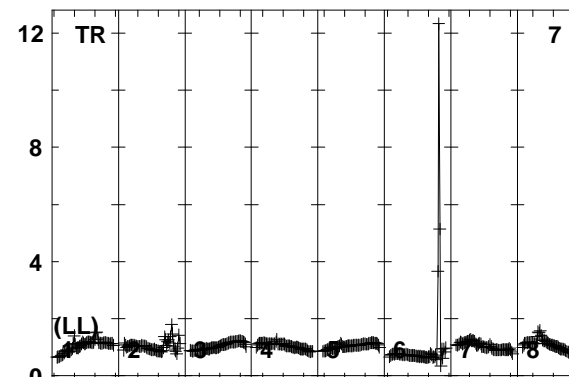
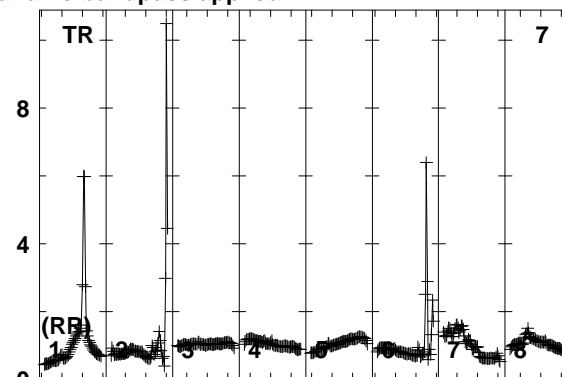
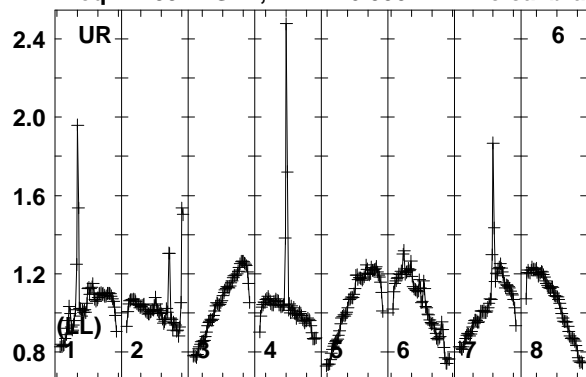

Lower frame: Real Jy
Total-power spectrum Antenna: UR (06)
Timerange: 00/06:07:46 to 00/06:11:14

Plot file version 385 created 04-NOV-2019 14:14:30

3C454.3 EY034.UVDATA.1

Freq = 1.5947 GHz, Bw = 16.000 MH No calibration applied and no bandpass applied

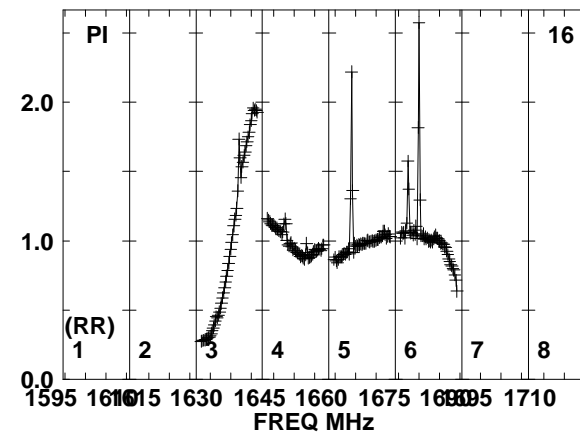
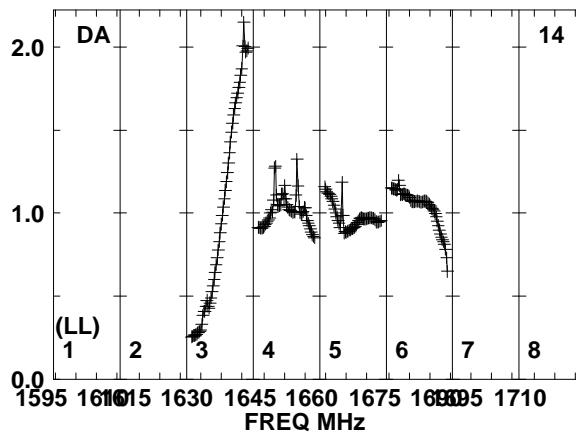
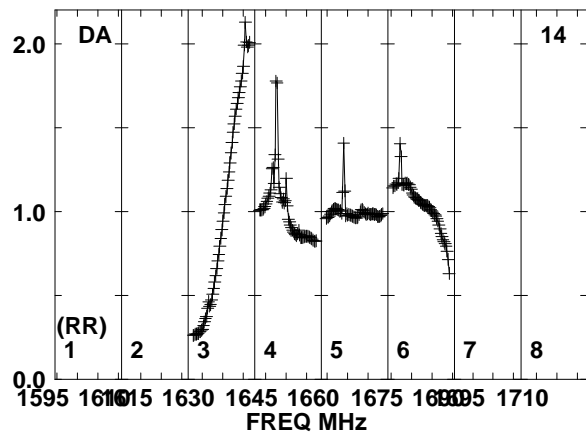
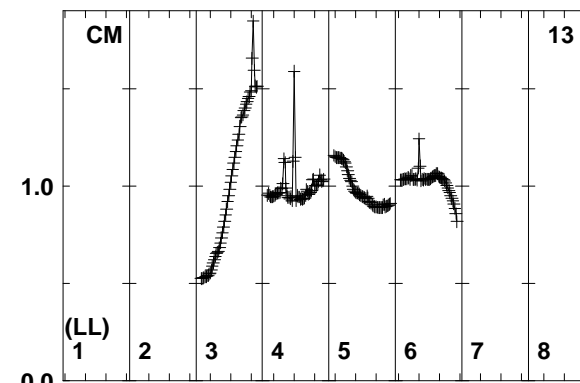
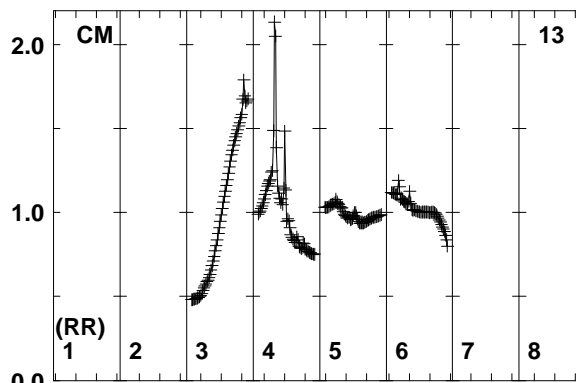
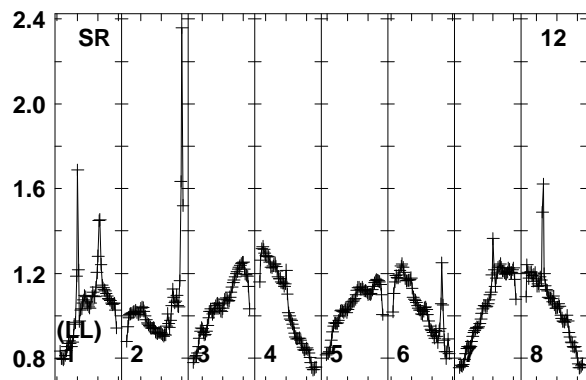
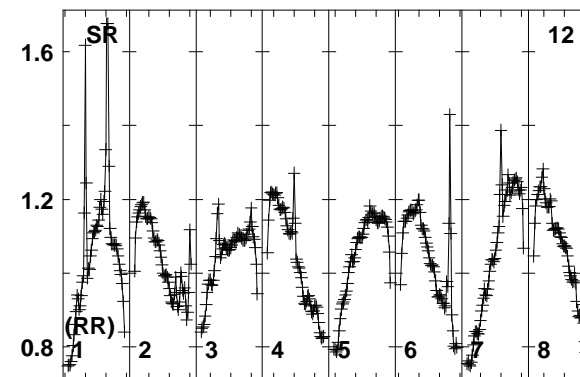
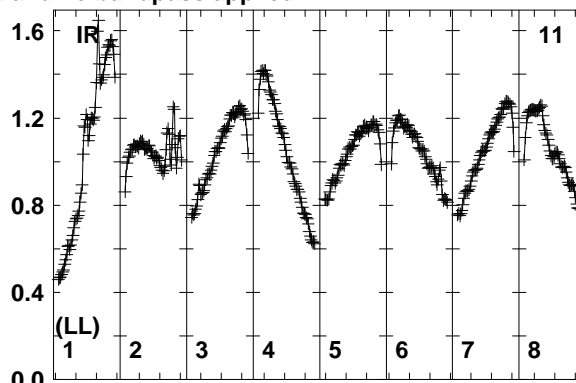
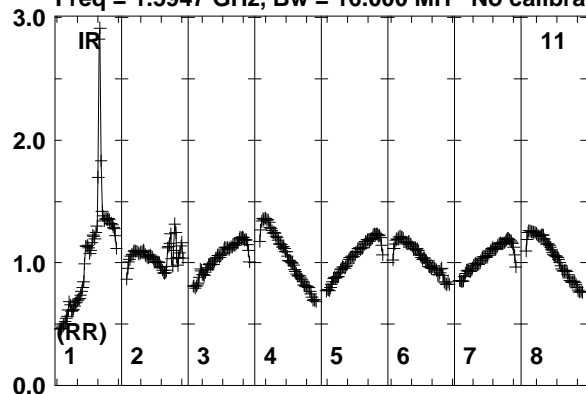

Lower frame: Real Jy
Total-power spectrum Antenna: IR (11)
Timerange: 00/06:07:46 to 00/06:11:14

Plot file version 386 created 04-NOV-2019 14:14:31
3C454.3 EY034.UVDATA.1
Freq = 1.5947 GHz, Bw = 16.000 MH No calibration applied and no bandpass applied

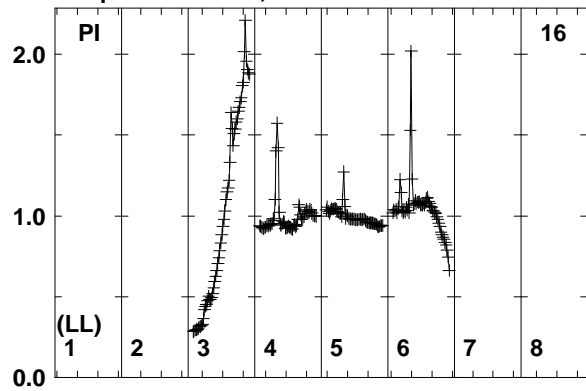

Lower frame: Real Jy
Total-power spectrum Antenna: PI (16)
Timerange: 00/06:07:46 to 00/06:11:14

Plot file version 387 created 04-NOV-2019 14:14:31

J2248-0541 EY034.UVDATA.1

Freq = 1.5947 GHz, Bw = 16.000 MH No calibration applied and no bandpass applied

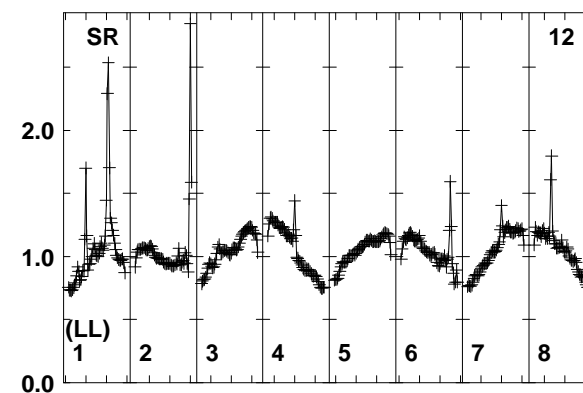
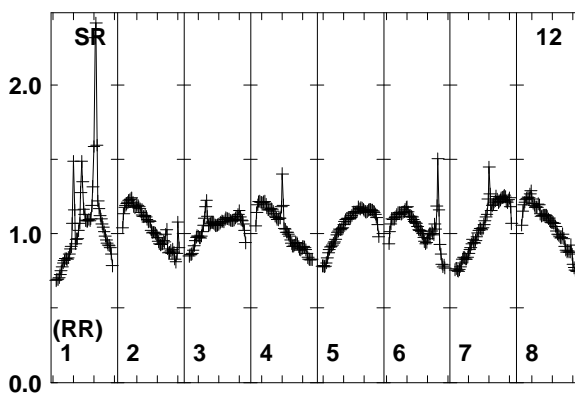
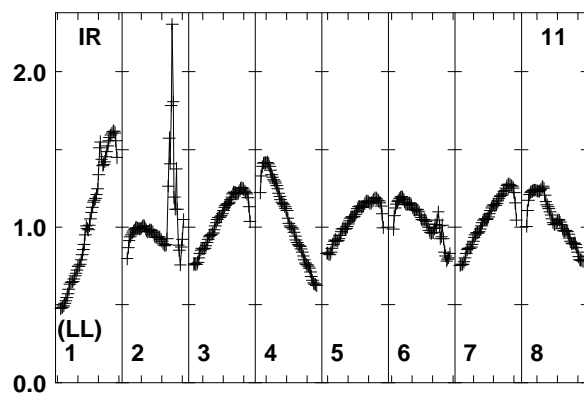
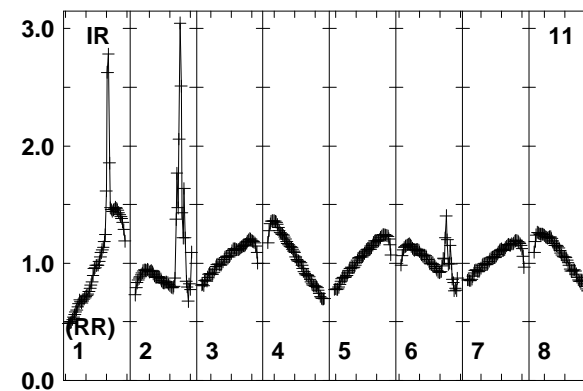
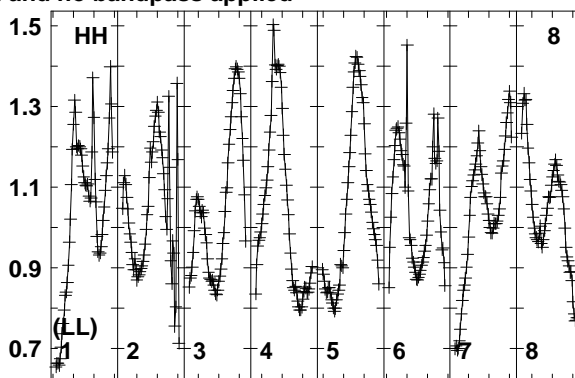
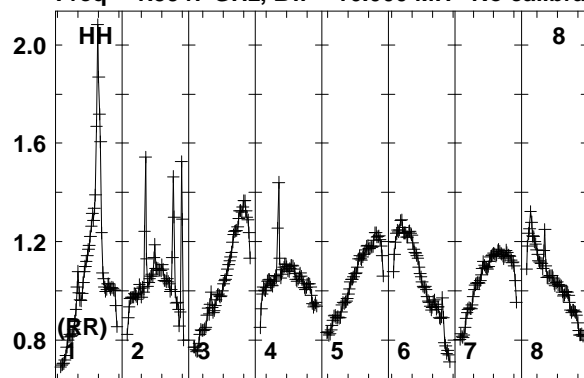

Lower frame: Real Jy
Total-power spectrum Antenna: HH (08)
Timerange: 00/06:12:01 to 00/06:12:29

Plot file version 388 created 04-NOV-2019 14:14:31

J2248-0541 EY034.UVDATA.1

Freq = 1.5947 GHz, Bw = 16.000 MH No calibration applied and no bandpass applied

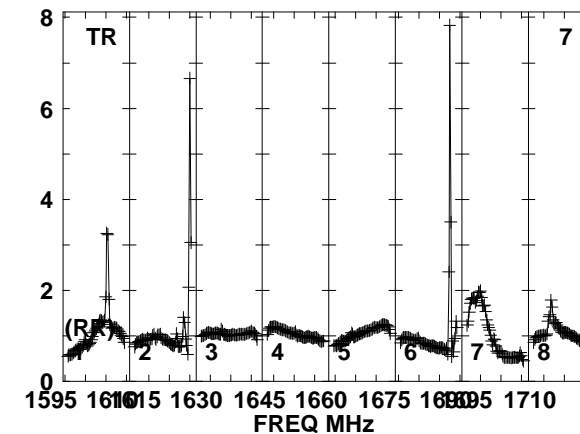
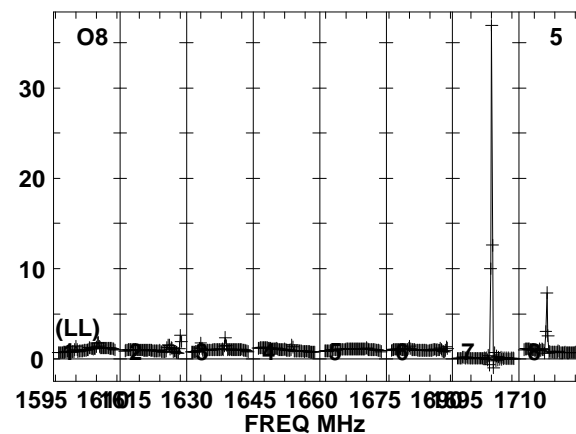
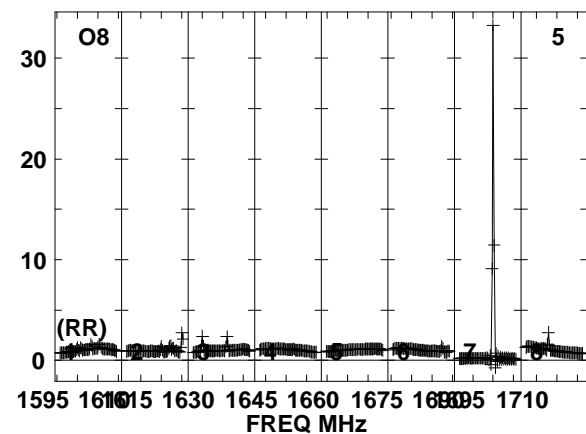
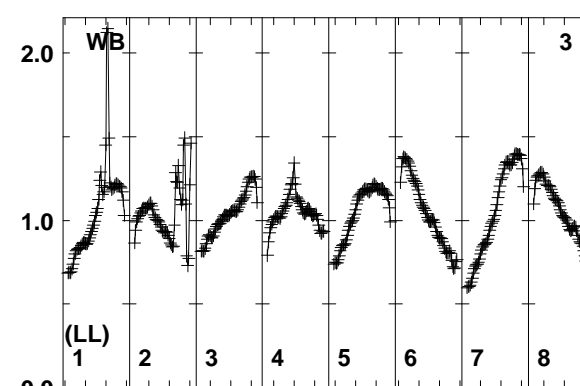
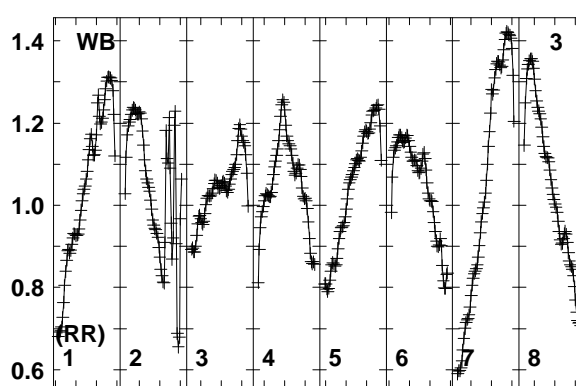
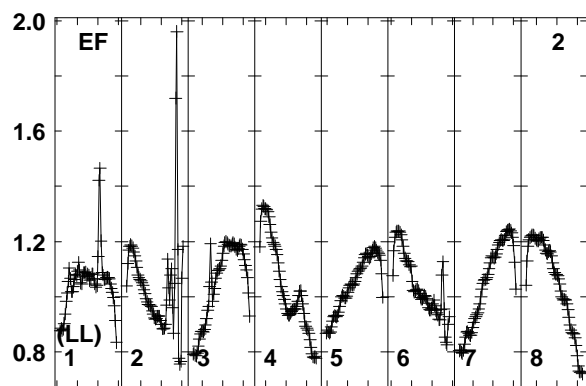
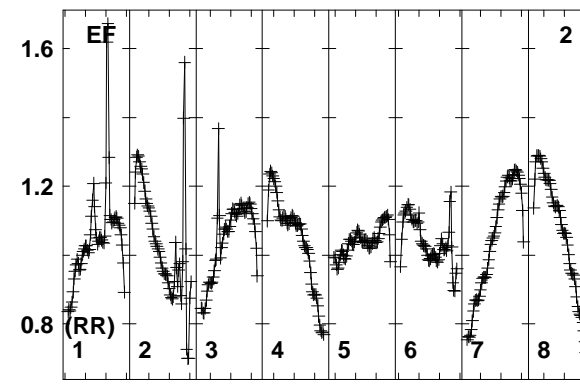
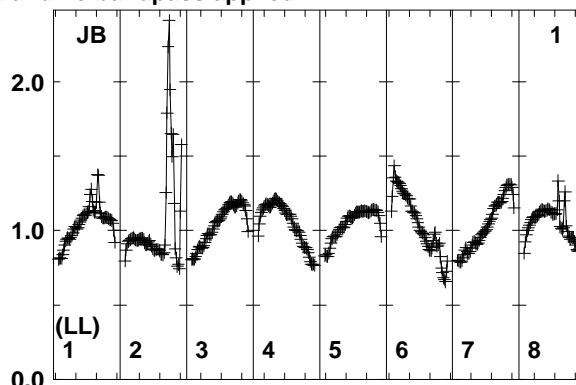
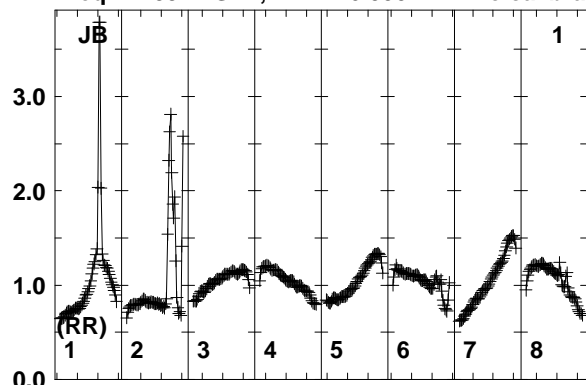

Lower frame: Real Jy
Total-power spectrum Antenna: JB (01)
Timerange: 00/06:13:16 to 00/06:14:14

Plot file version 389 created 04-NOV-2019 14:14:31

J2248-0541 EY034.UVDATA.1

Freq = 1.5947 GHz, Bw = 16.000 MH No calibration applied and no bandpass applied

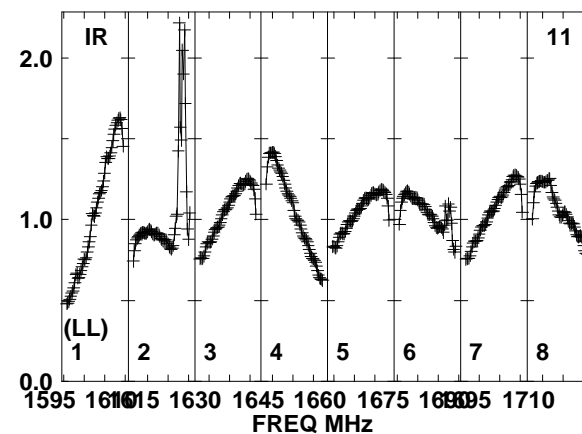
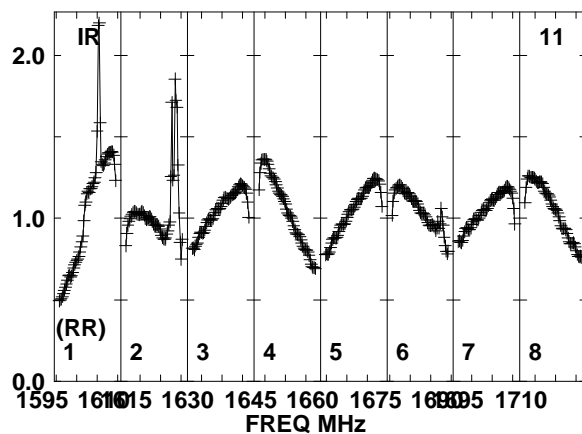
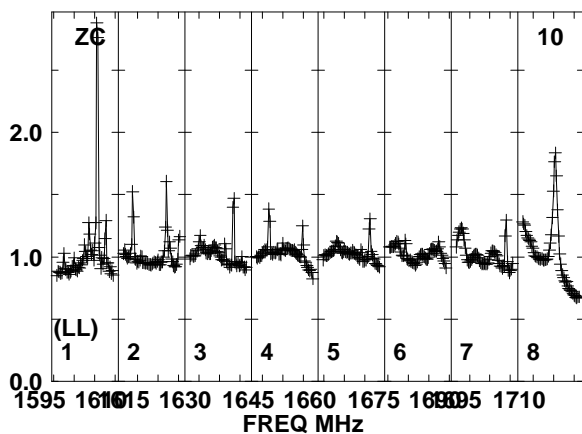
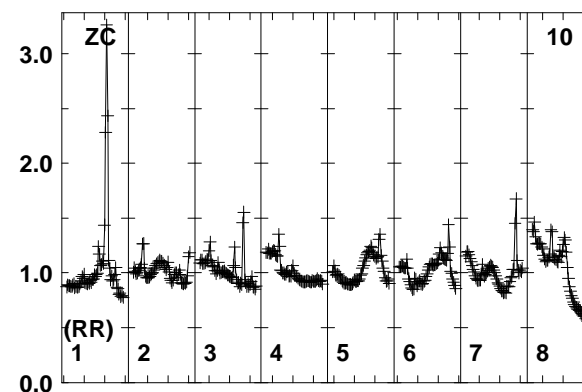
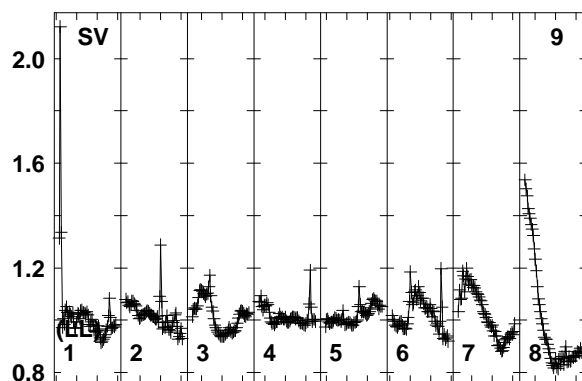
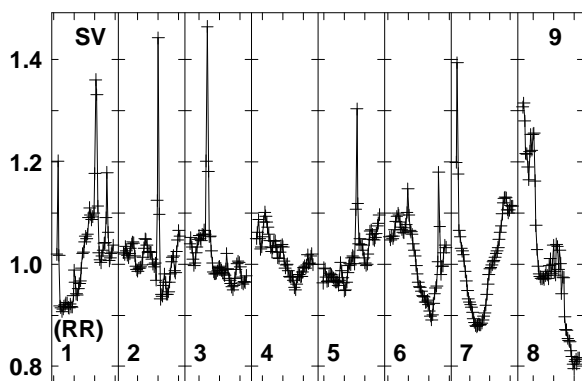
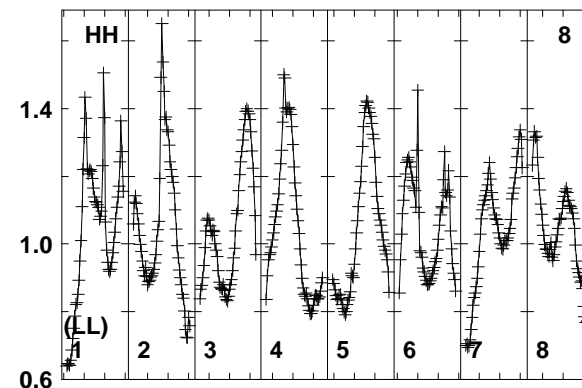
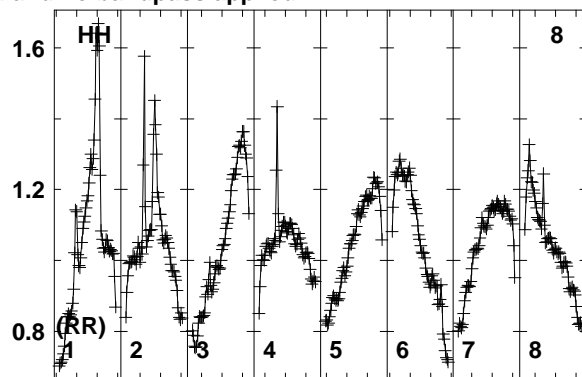
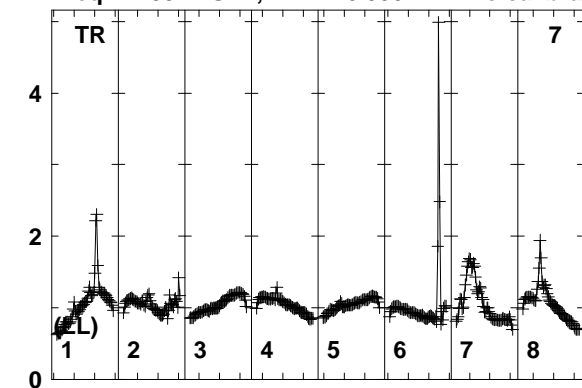

Lower frame: Real Jy
Total-power spectrum Antenna: TR (07)
Timerange: 00/06:13:16 to 00/06:14:14

Plot file version 390 created 04-NOV-2019 14:14:31

J2248-0541 EY034.UVDATA.1

Freq = 1.5947 GHz, Bw = 16.000 MH No calibration applied and no bandpass applied

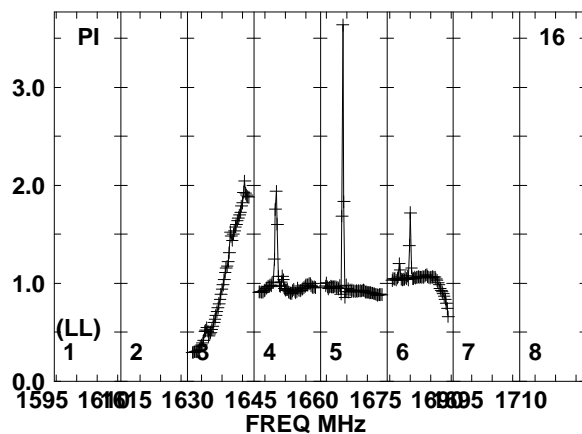
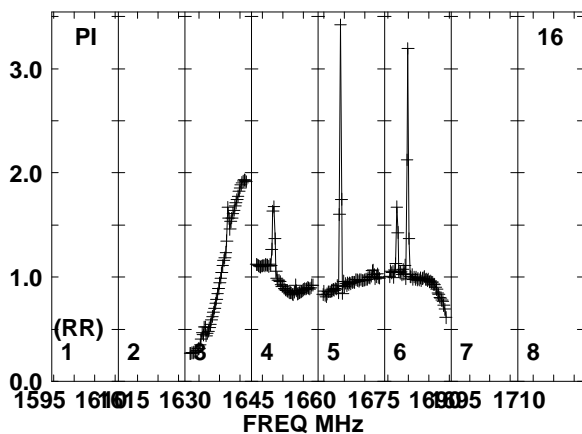
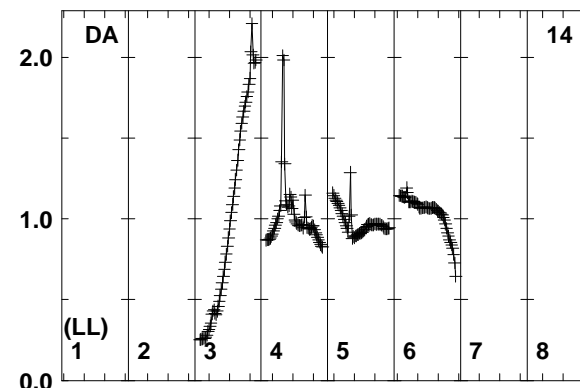
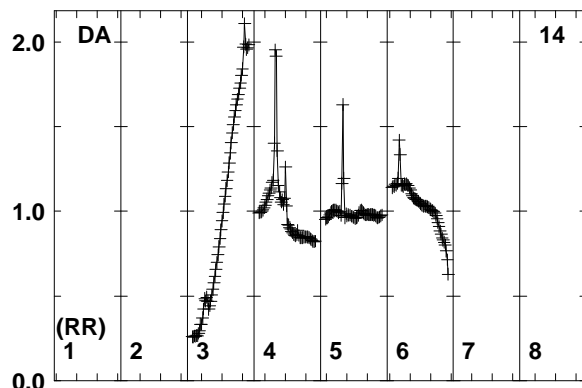
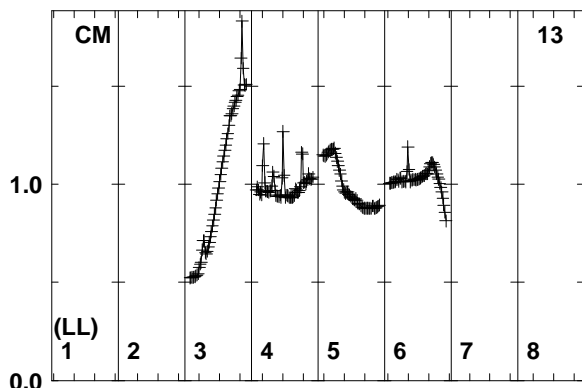
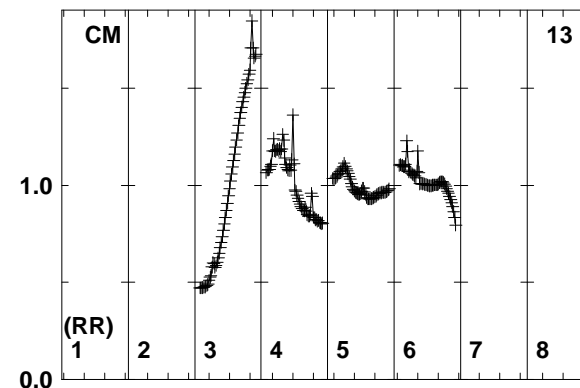
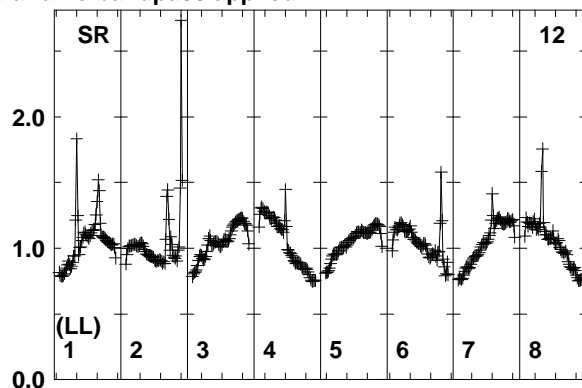
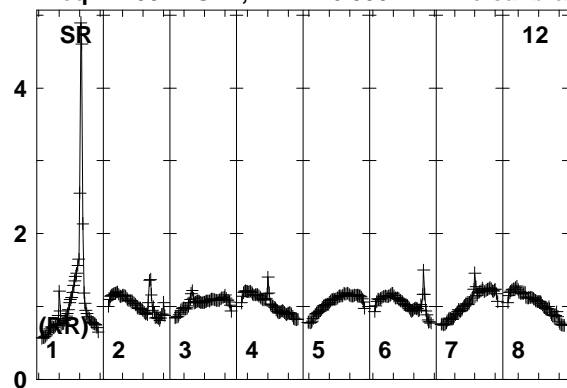

Lower frame: Real Jy
Total-power spectrum Antenna: SR (12)
Timerange: 00/06:13:16 to 00/06:14:14

Plot file version 391 created 04-NOV-2019 14:14:31

W2246-0526 EY034.UVDATA.1

Freq = 1.5947 GHz, Bw = 16.000 MH No calibration applied and no bandpass applied

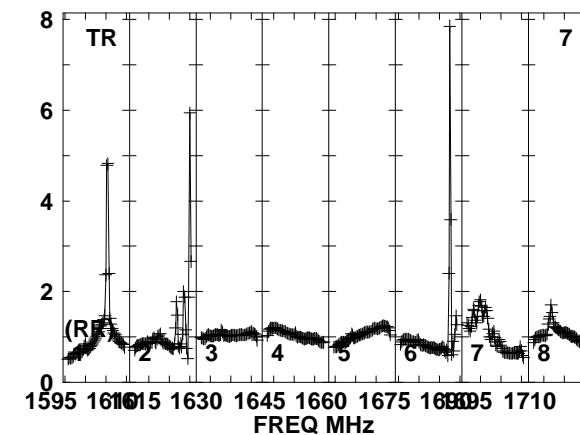
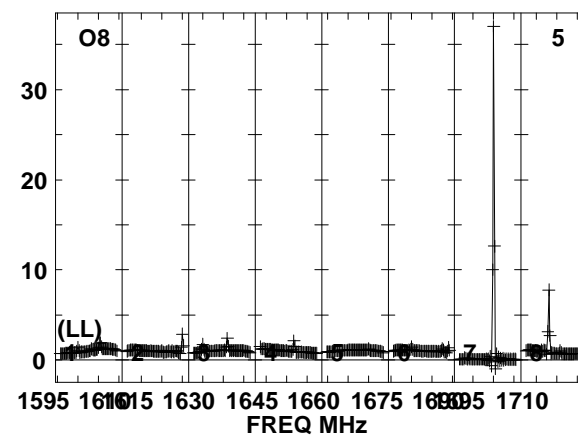
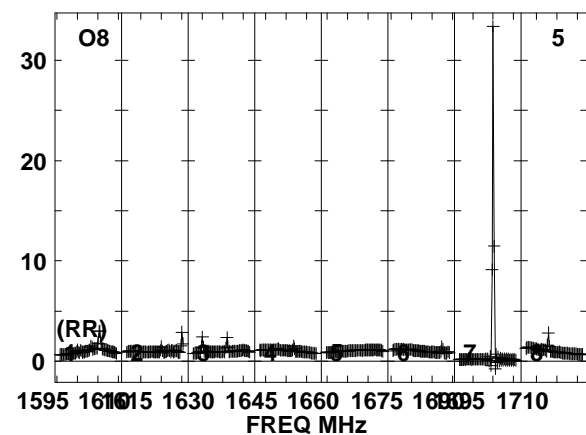
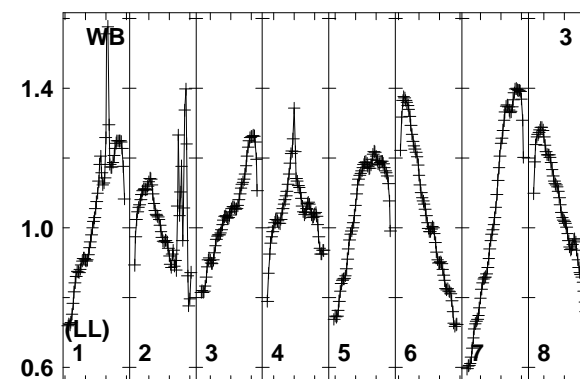
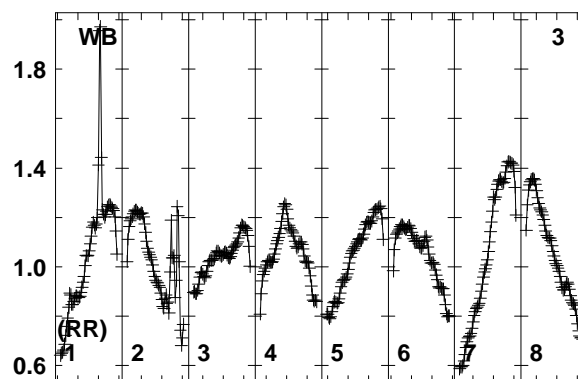
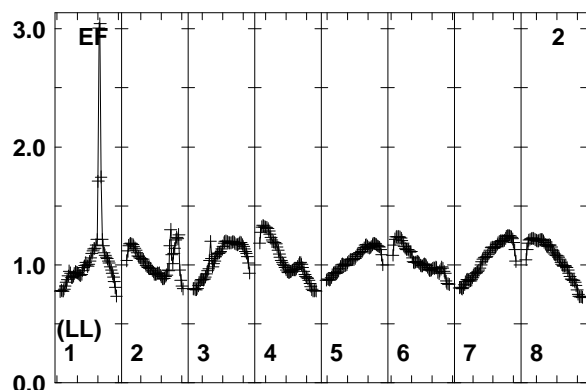
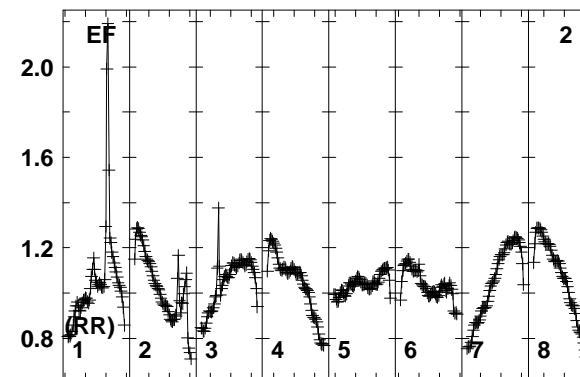
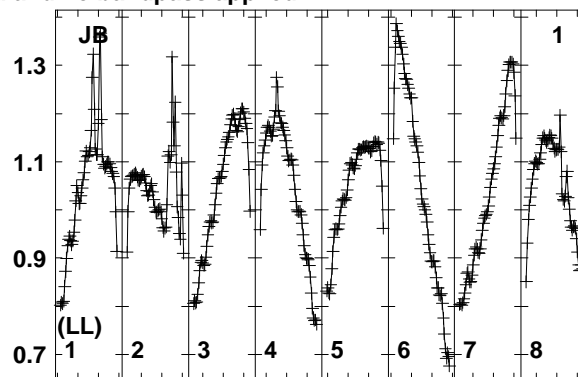
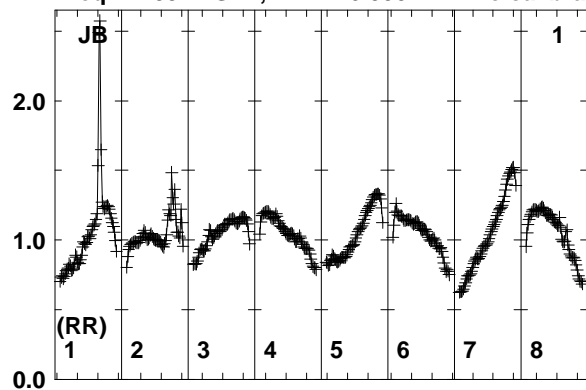

Lower frame: Real Jy
Total-power spectrum Antenna: JB (01)
Timerange: 00/06:14:16 to 00/06:16:44

Plot file version 392 created 04-NOV-2019 14:14:31

W2246-0526 EY034.UVDATA.1

Freq = 1.5947 GHz, Bw = 16.000 MH No calibration applied and no bandpass applied

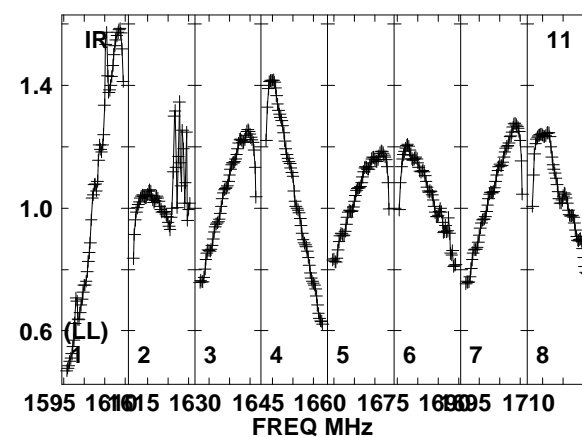
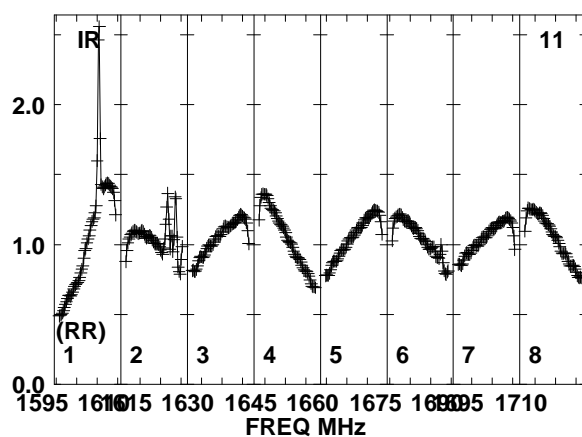
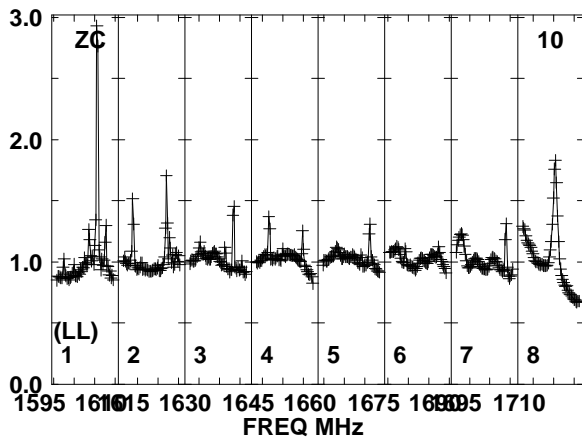
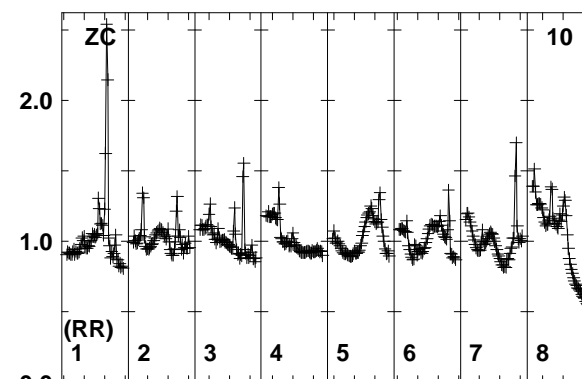
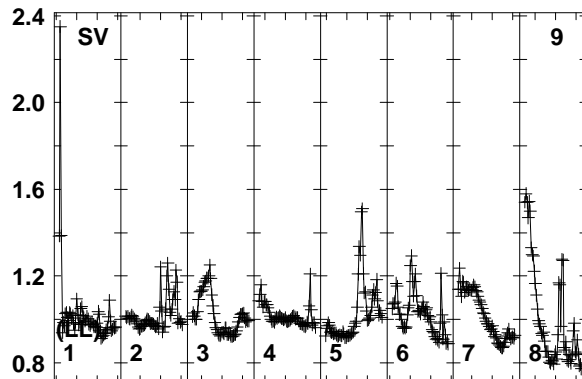
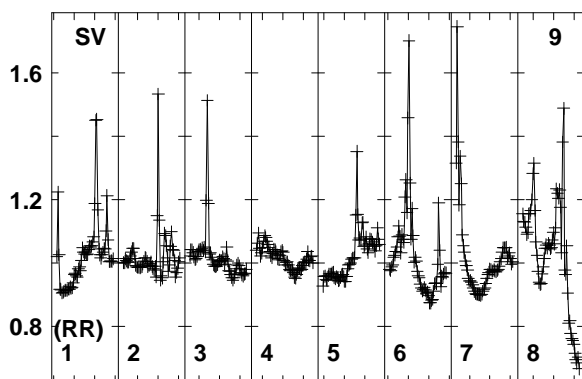
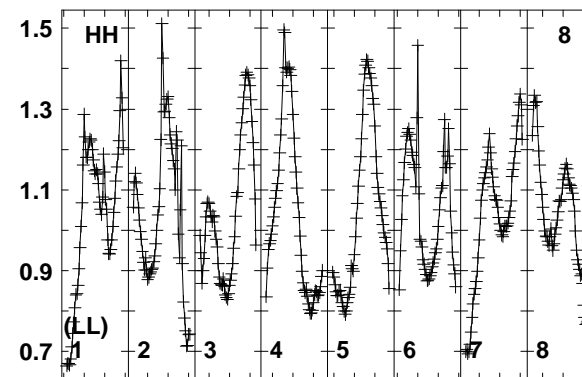
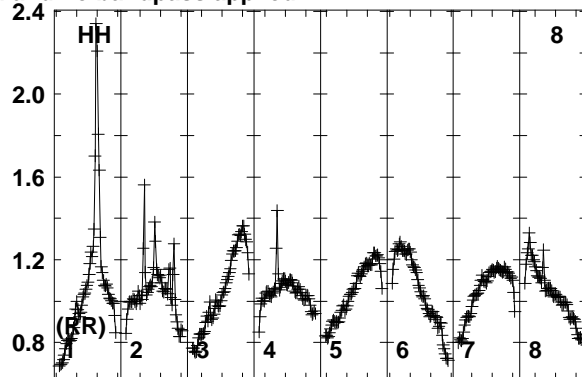
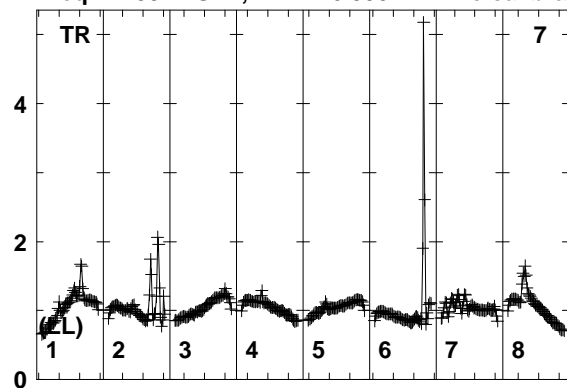

Lower frame: Real Jy
Total-power spectrum Antenna: TR (07)
Timerange: 00/06:14:16 to 00/06:16:44

Plot file version 393 created 04-NOV-2019 14:14:31

W2246-0526 EY034.UVDATA.1

Freq = 1.5947 GHz, Bw = 16.000 MH No calibration applied and no bandpass applied

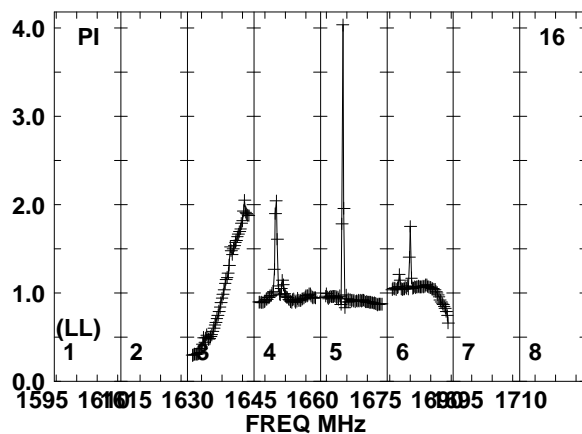
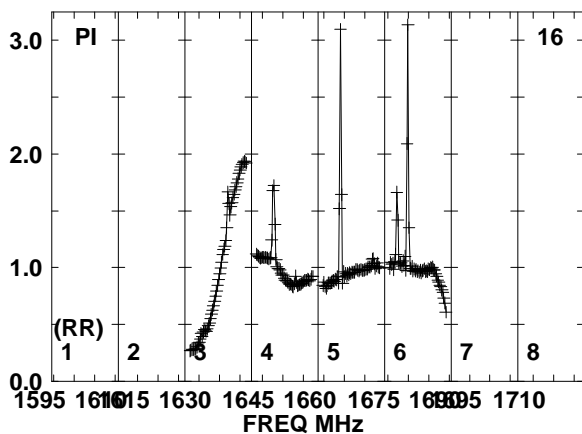
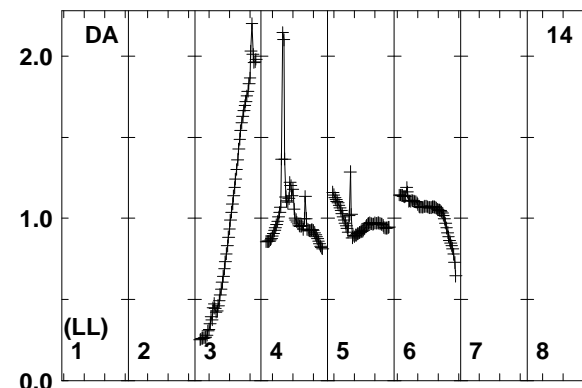
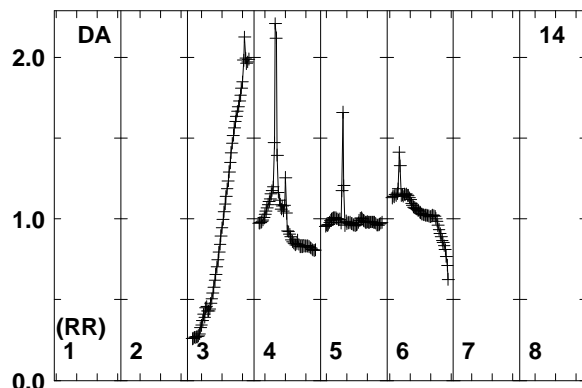
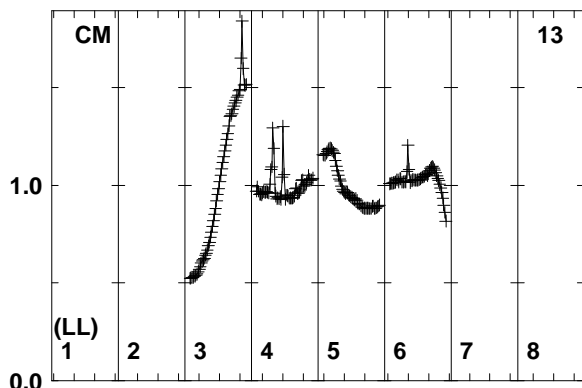
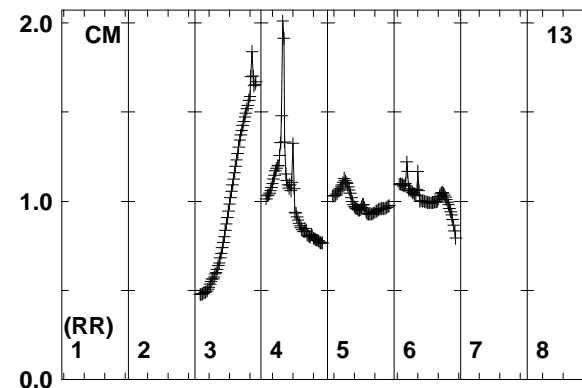
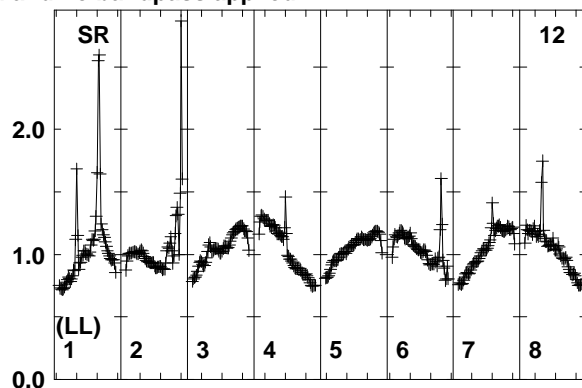
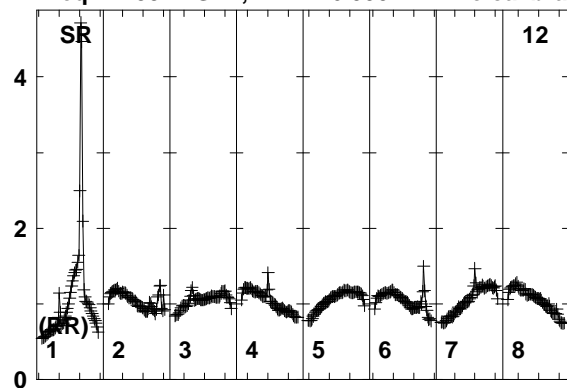

Lower frame: Real Jy
Total-power spectrum Antenna: SR (12)
Timerange: 00/06:14:16 to 00/06:16:44

Plot file version 394 created 04-NOV-2019 14:14:31

J2248-0541 EY034.UVDATA.1

Freq = 1.5947 GHz, Bw = 16.000 MH No calibration applied and no bandpass applied

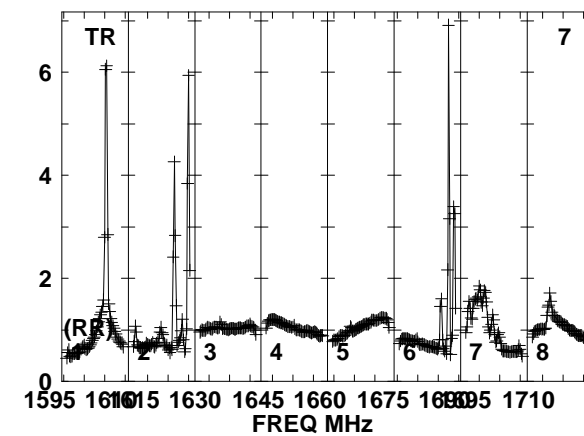
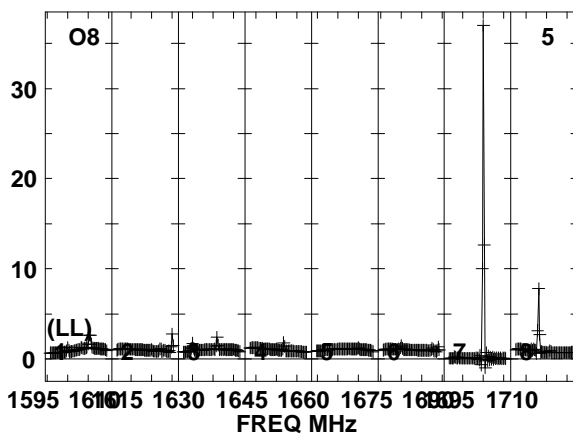
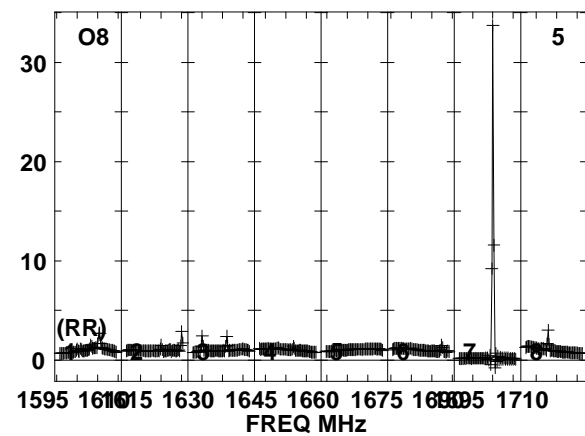
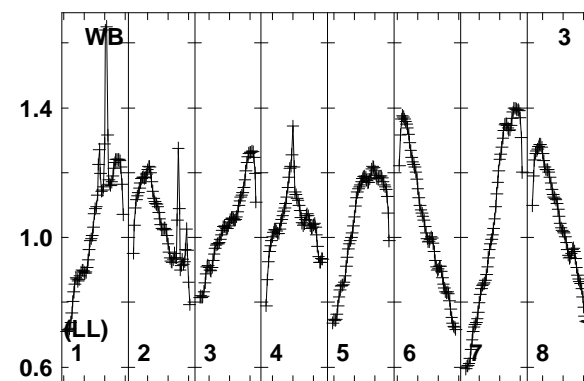
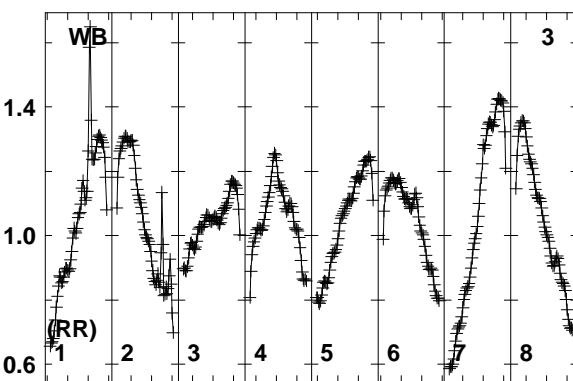
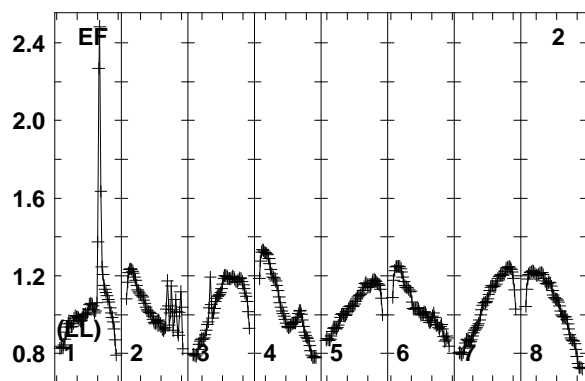
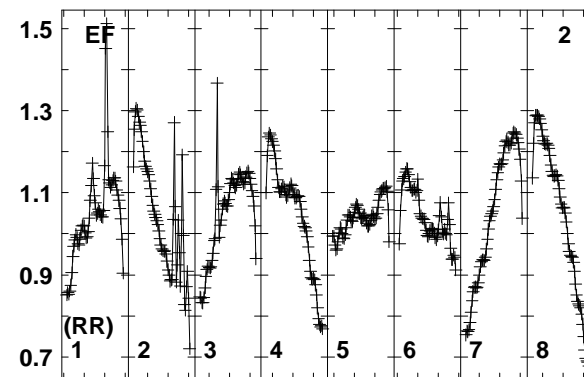
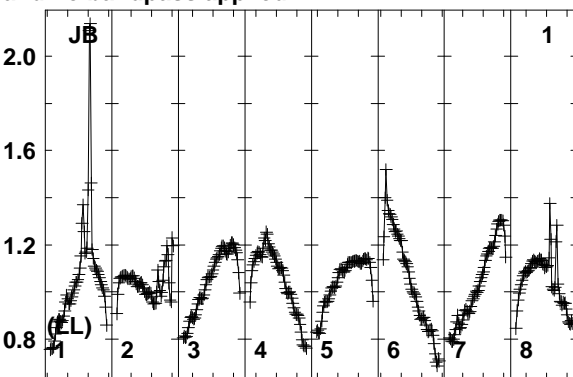
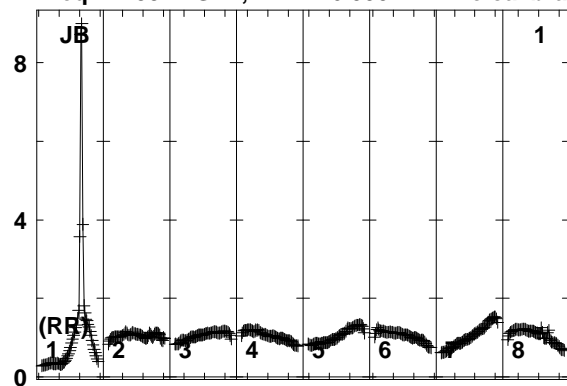

Lower frame: Real Jy
Total-power spectrum Antenna: JB (01)
Timerange: 00/06:17:01 to 00/06:17:59

Plot file version 395 created 04-NOV-2019 14:14:31

J2248-0541 EY034.UVDATA.1

Freq = 1.5947 GHz, Bw = 16.000 MH No calibration applied and no bandpass applied

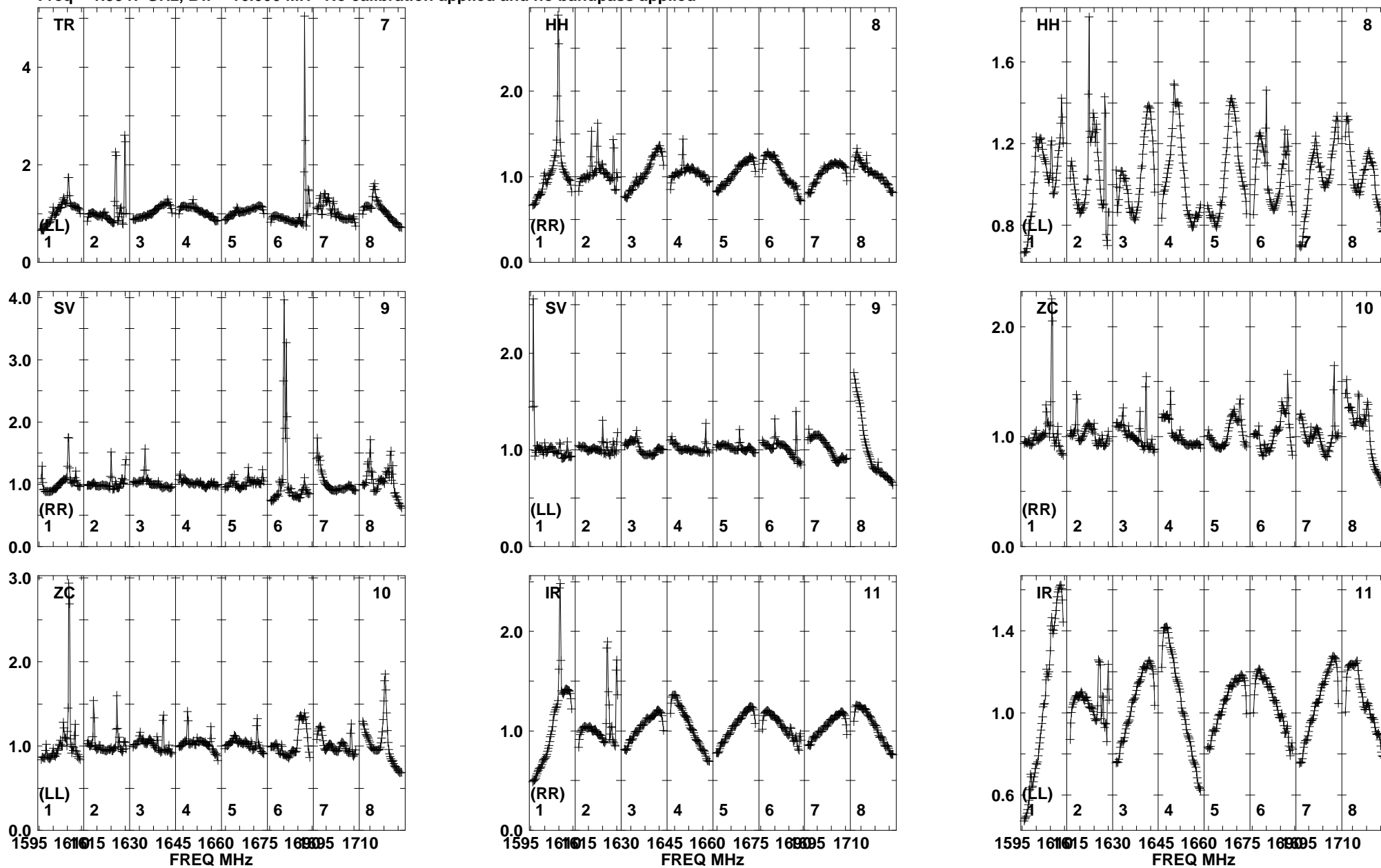

Lower frame: Real Jy
Total-power spectrum Antenna: TR (07)
Timerange: 00/06:17:01 to 00/06:17:59

Plot file version 396 created 04-NOV-2019 14:14:31

J2248-0541 EY034.UVDATA.1

Freq = 1.5947 GHz, Bw = 16.000 MH No calibration applied and no bandpass applied

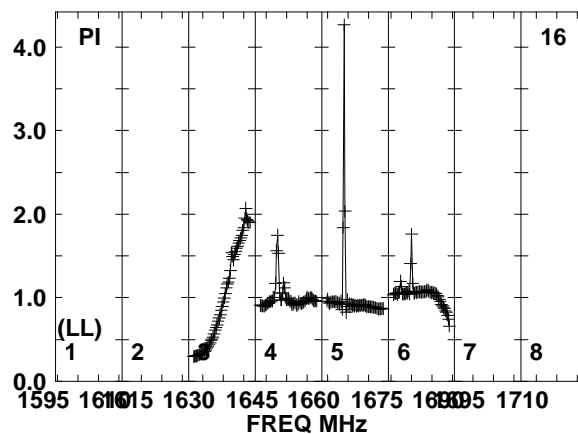
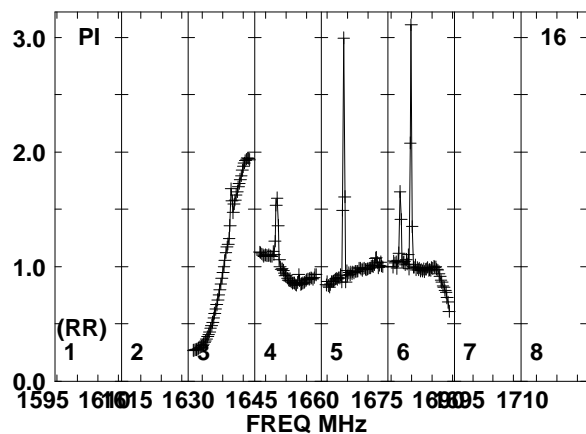
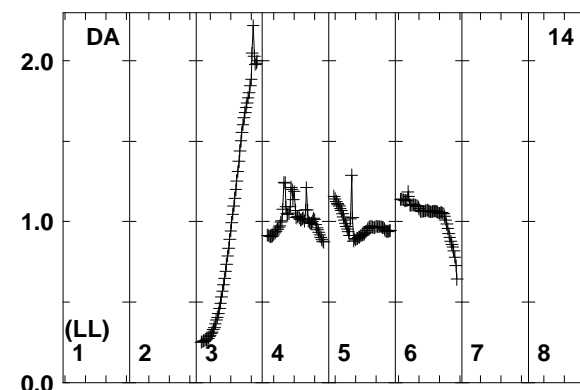
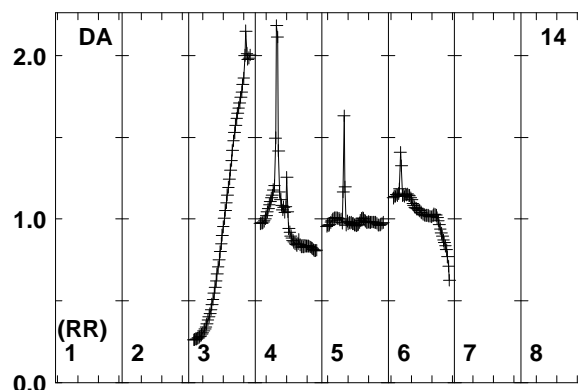
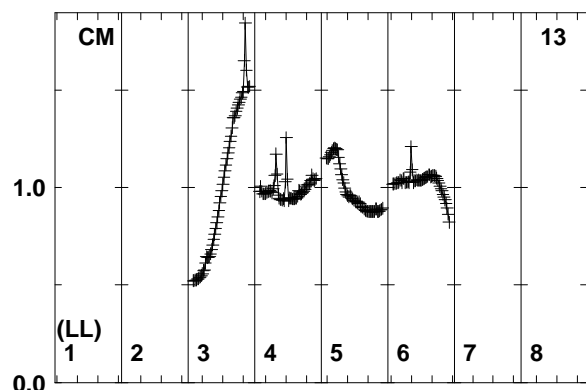
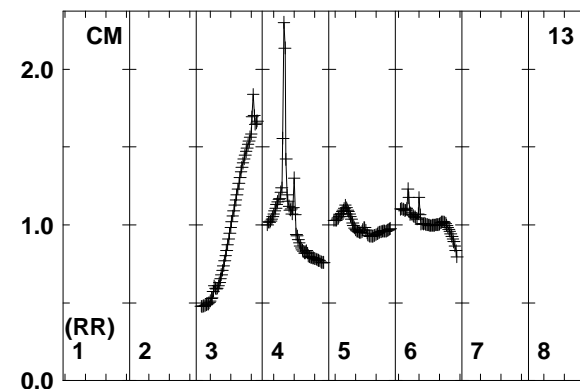
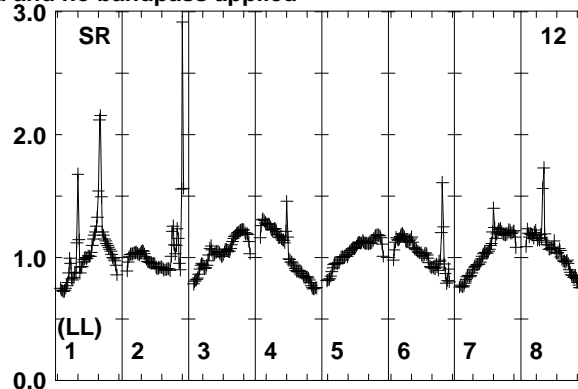
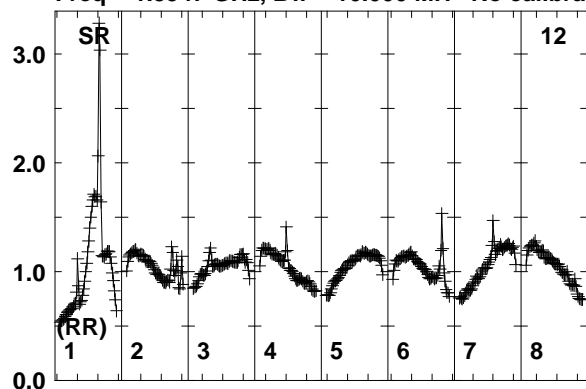

Lower frame: Real Jy
Total-power spectrum Antenna: SR (12)
Timerange: 00/06:17:01 to 00/06:17:59

Plot file version 397 created 04-NOV-2019 14:14:31

W2246-0526 EY034.UVDATA.1

Freq = 1.5947 GHz, Bw = 16.000 MH No calibration applied and no bandpass applied

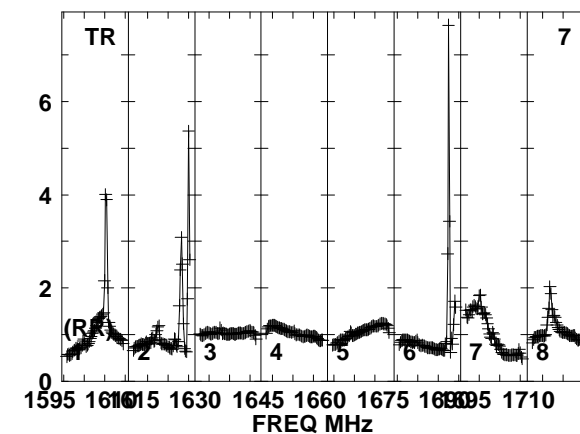
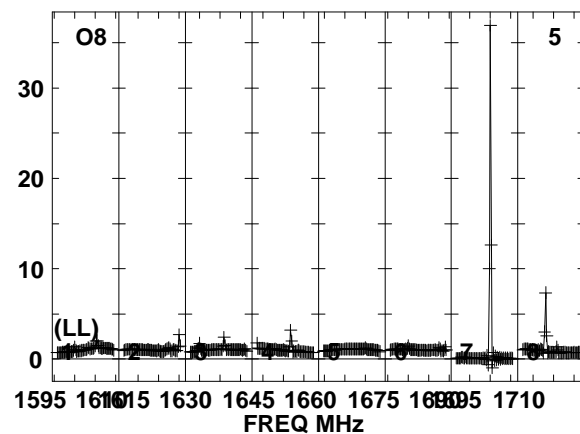
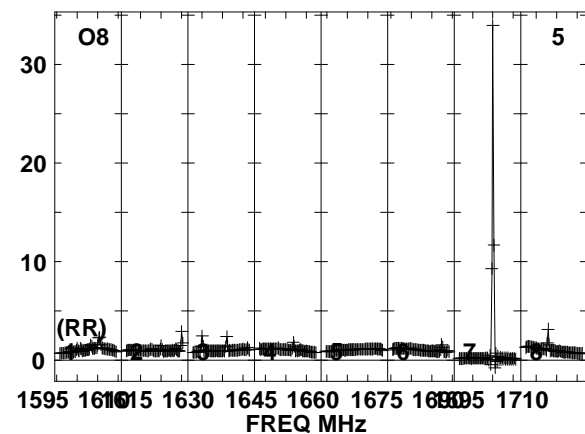
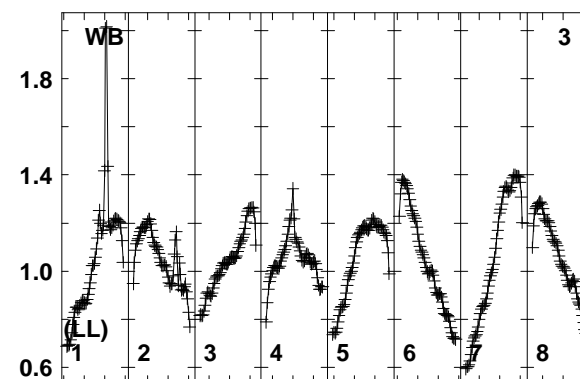
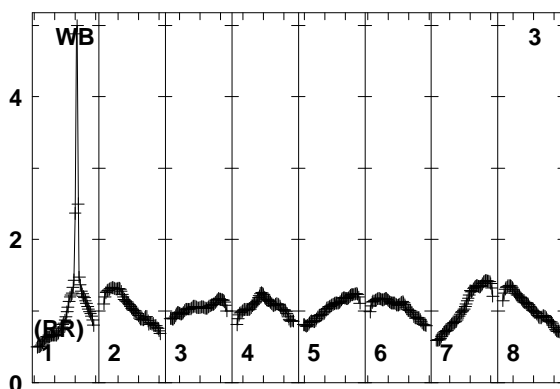
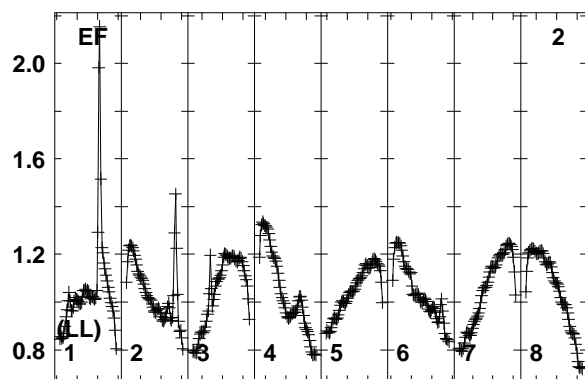
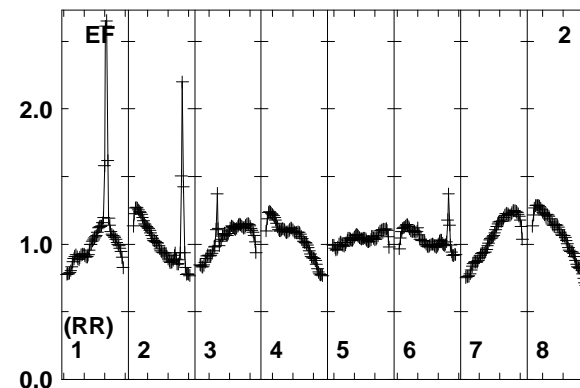
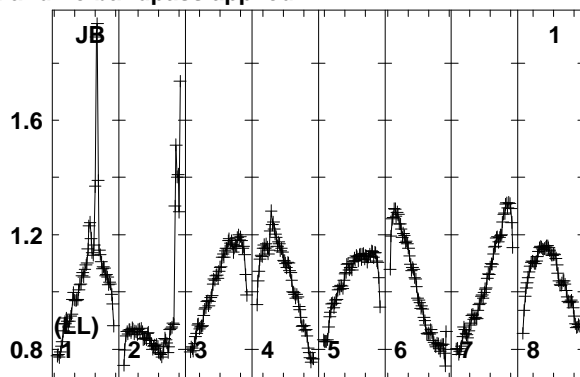
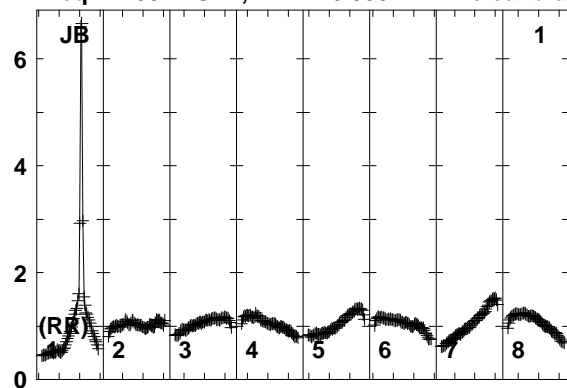

Lower frame: Real Jy
Total-power spectrum Antenna: JB (01)
Timerange: 00/06:18:01 to 00/06:20:39

Plot file version 398 created 04-NOV-2019 14:14:32

W2246-0526 EY034.UVDATA.1

Freq = 1.5947 GHz, Bw = 16.000 MH No calibration applied and no bandpass applied

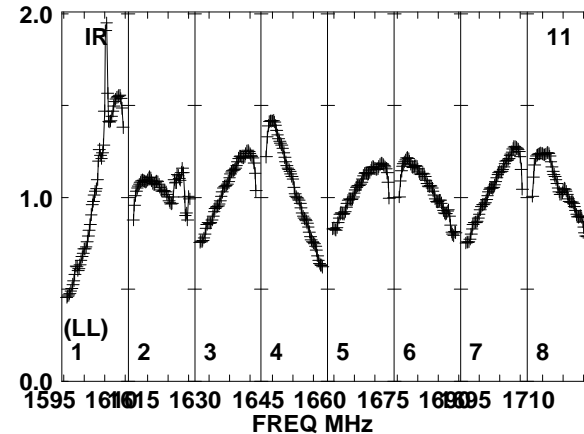
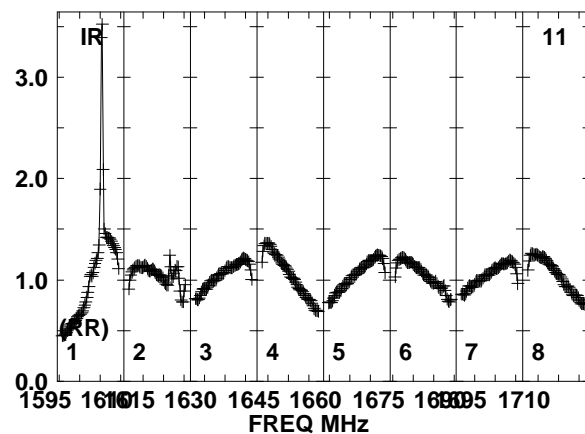
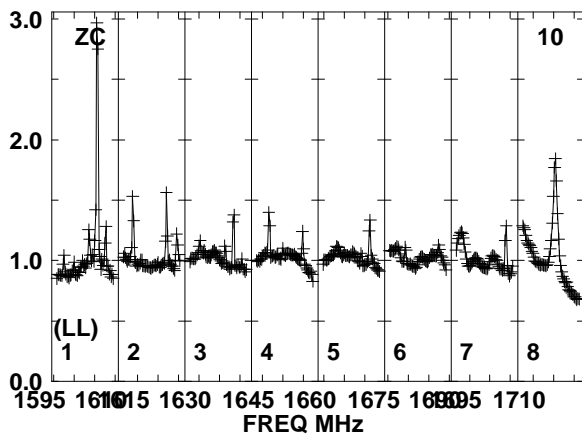
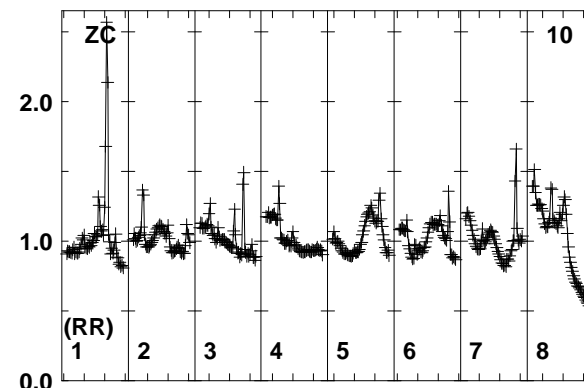
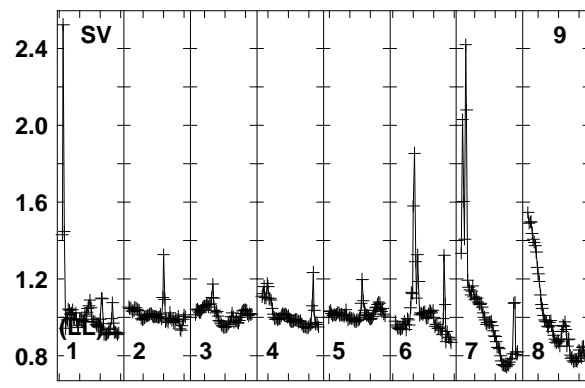
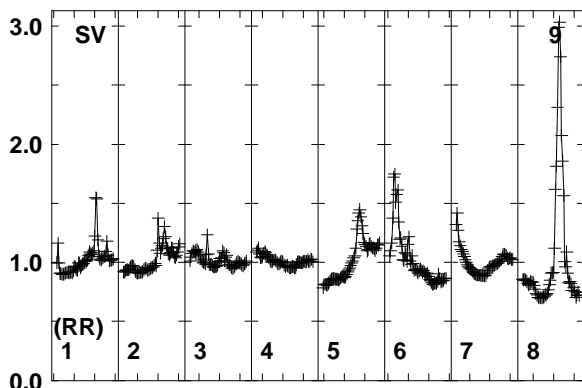
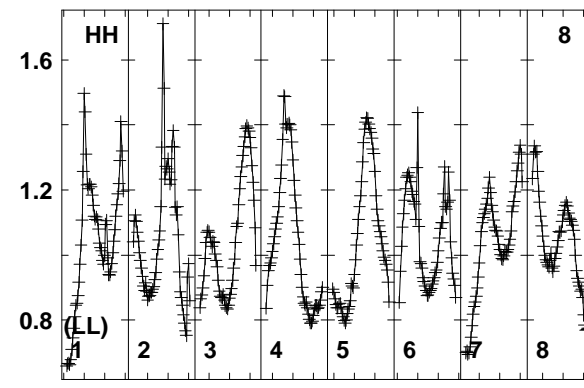
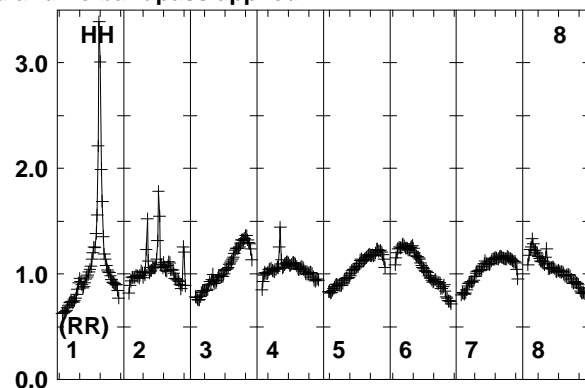
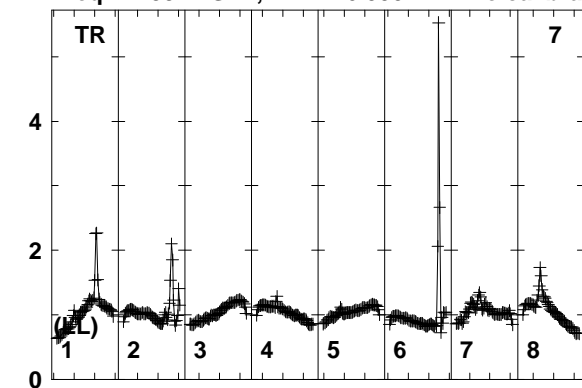

Lower frame: Real Jy
Total-power spectrum Antenna: TR (07)
Timerange: 00/06:18:01 to 00/06:20:39

Plot file version 399 created 04-NOV-2019 14:14:32

W2246-0526 EY034.UVDATA.1

Freq = 1.5947 GHz, Bw = 16.000 MH No calibration applied and no bandpass applied

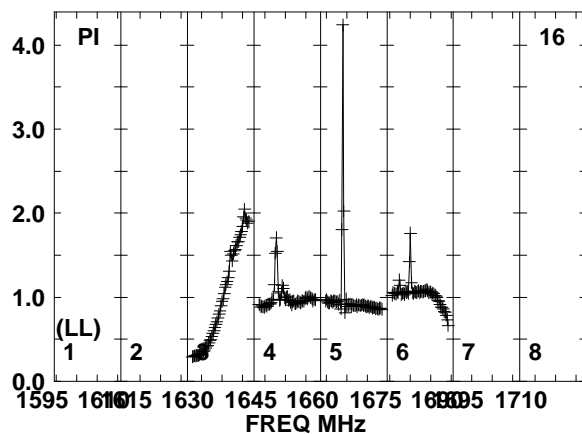
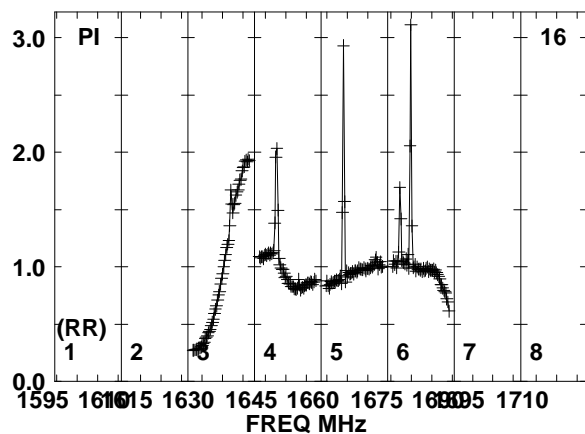
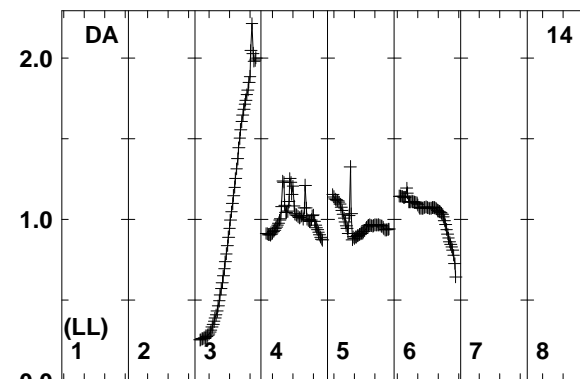
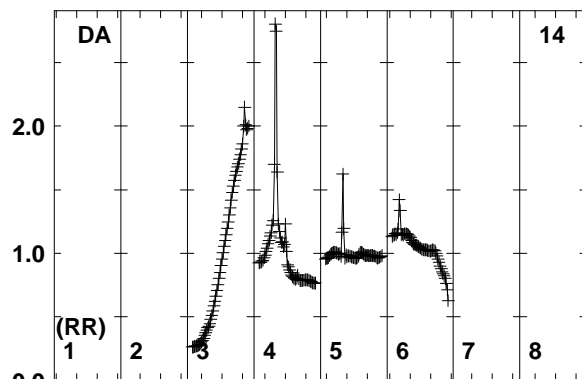
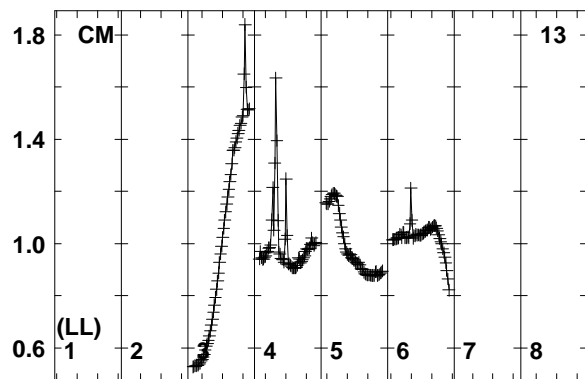
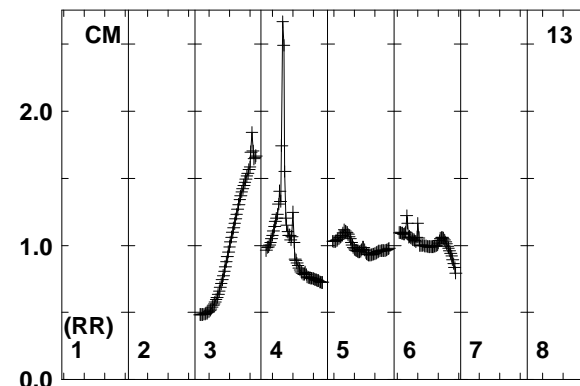
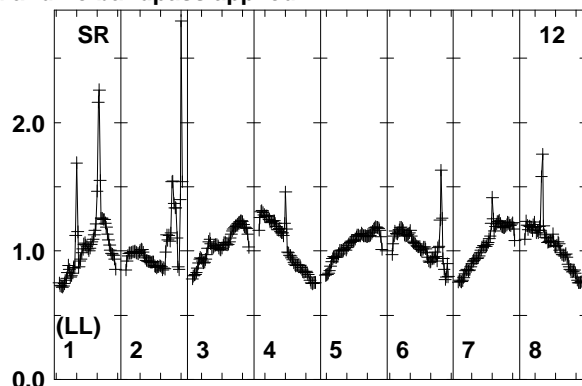
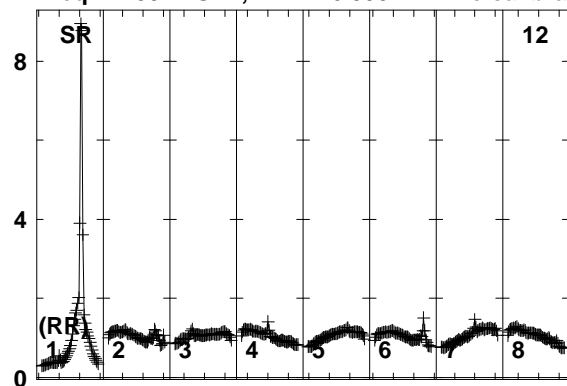

Lower frame: Real Jy
Total-power spectrum Antenna: SR (12)
Timerange: 00/06:18:01 to 00/06:20:39

Plot file version 400 created 04-NOV-2019 14:14:32

J2248-0541 EY034.UVDATA.1

Freq = 1.5947 GHz, Bw = 16.000 MH No calibration applied and no bandpass applied

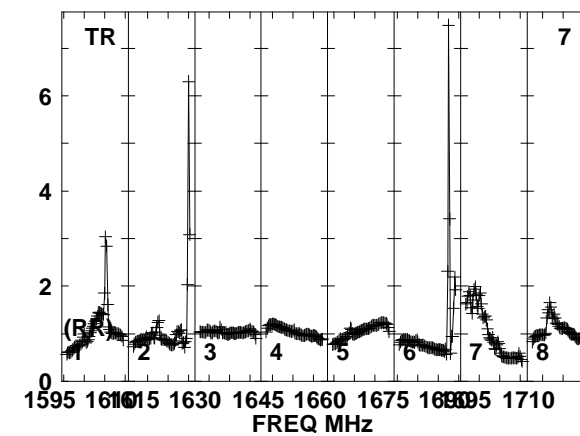
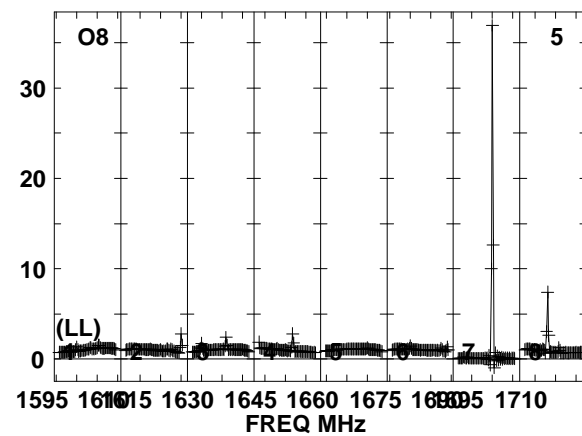
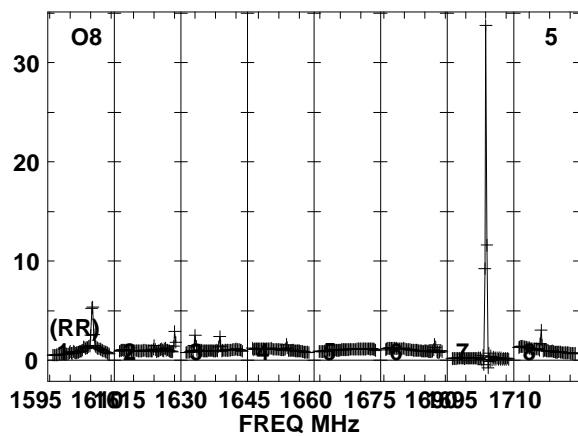
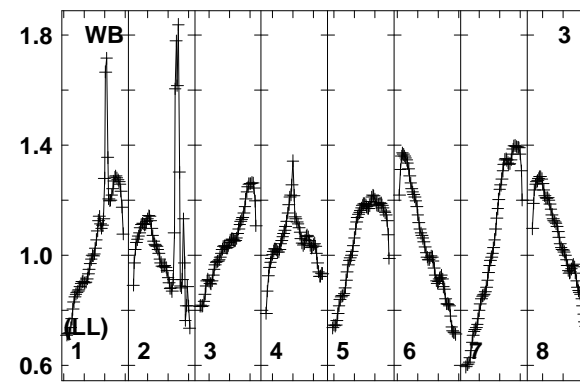
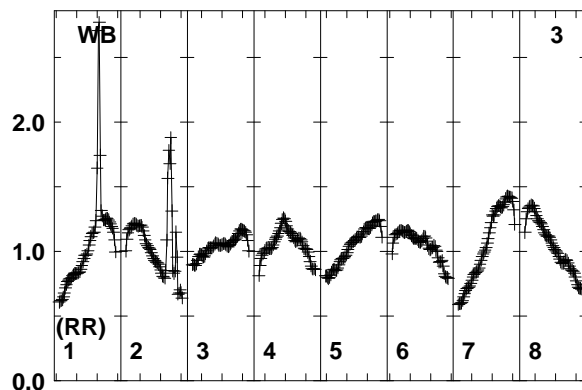
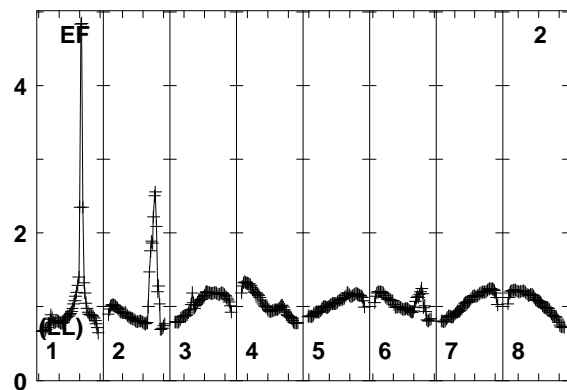
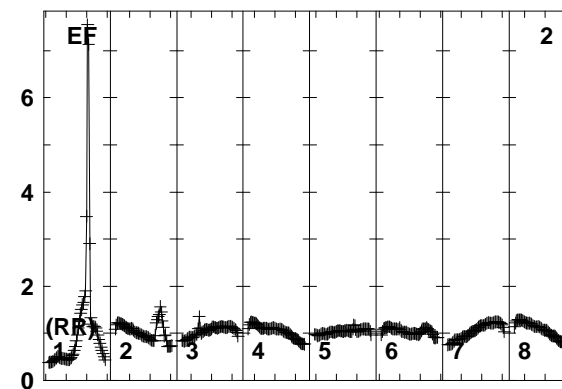
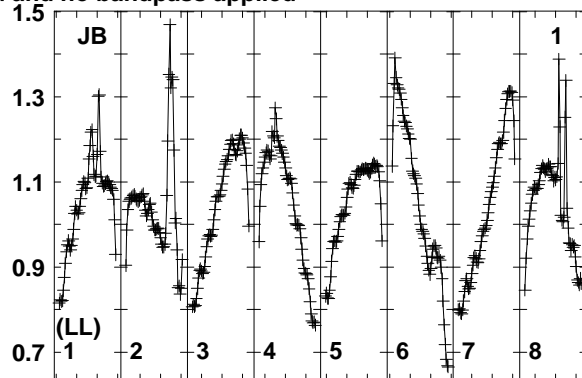
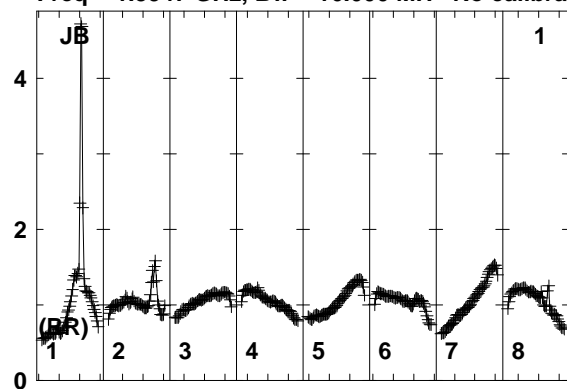

Lower frame: Real Jy
Total-power spectrum Antenna: JB (01)
Timerange: 00/06:20:56 to 00/06:21:54

Plot file version 401 created 04-NOV-2019 14:14:32

J2248-0541 EY034.UVDATA.1

Freq = 1.5947 GHz, Bw = 16.000 MH No calibration applied and no bandpass applied

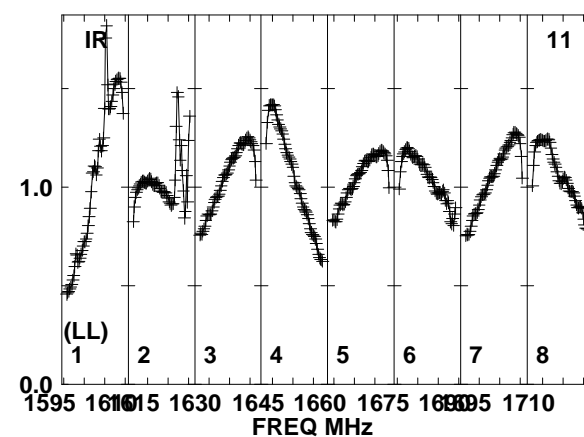
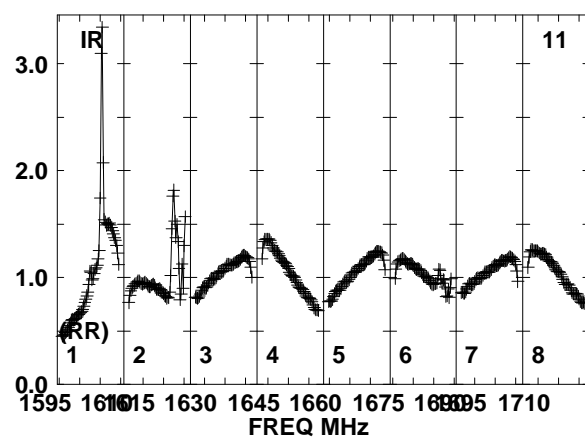
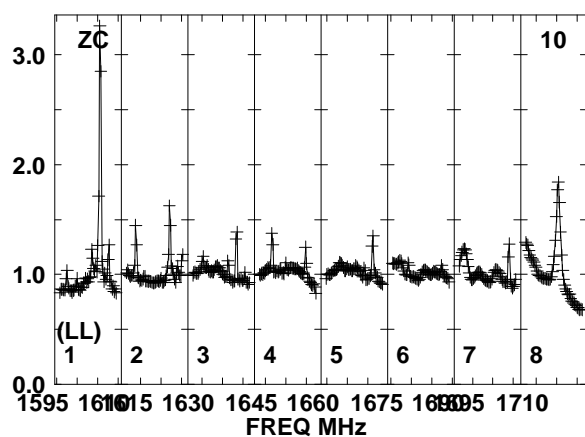
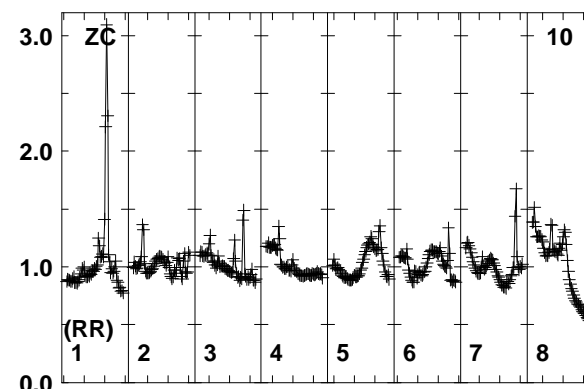
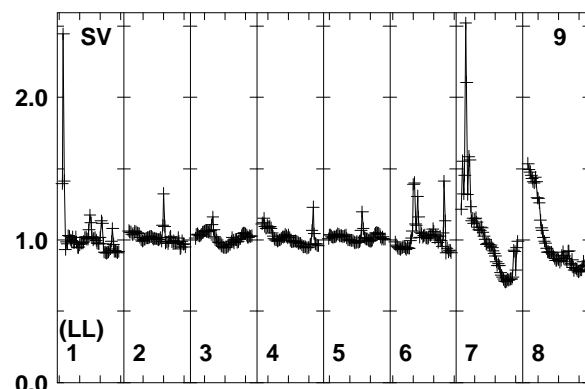
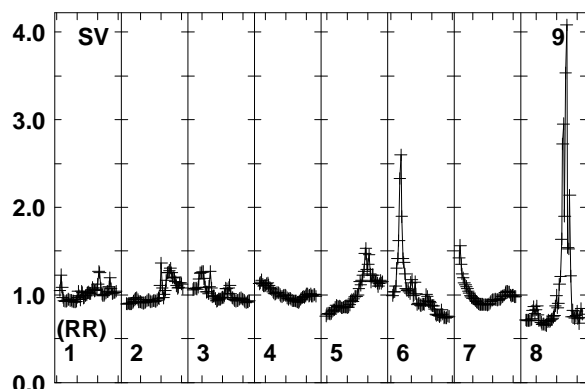
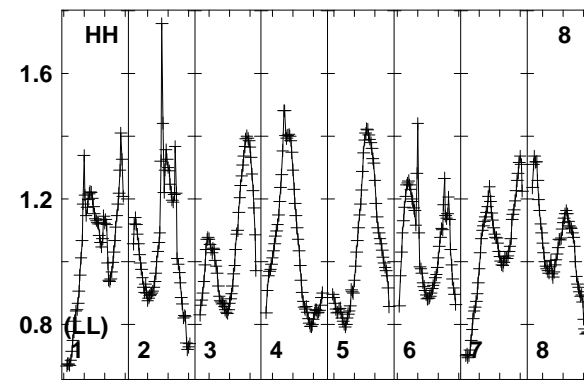
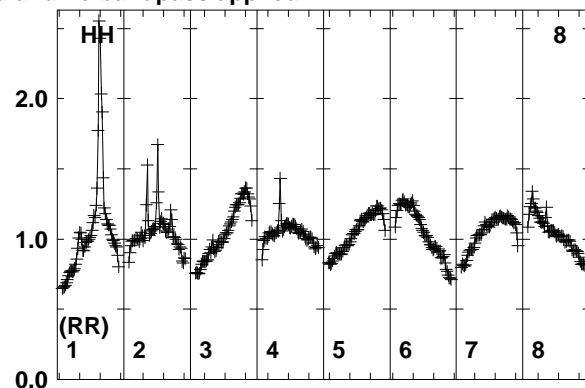
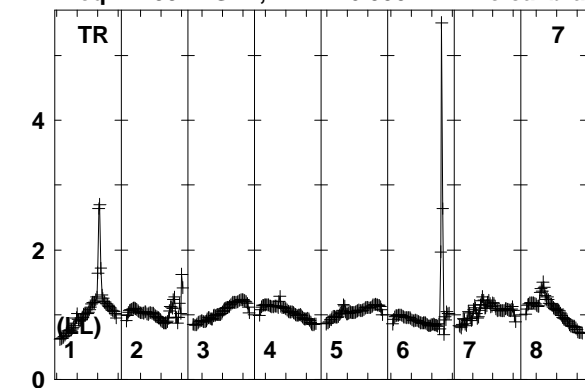

Lower frame: Real Jy
Total-power spectrum Antenna: TR (07)
Timerange: 00/06:20:56 to 00/06:21:54

Plot file version 402 created 04-NOV-2019 14:14:32

J2248-0541 EY034.UVDATA.1

Freq = 1.5947 GHz, Bw = 16.000 MH No calibration applied and no bandpass applied

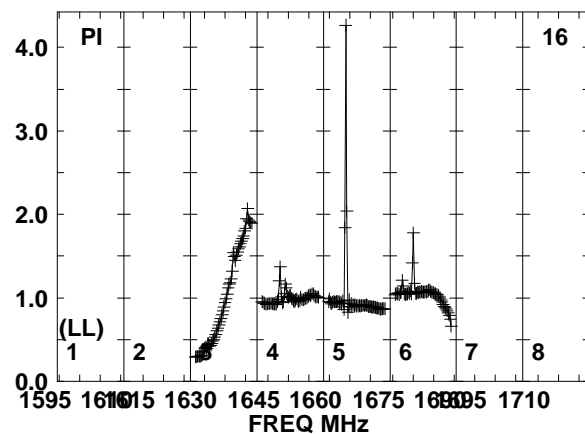
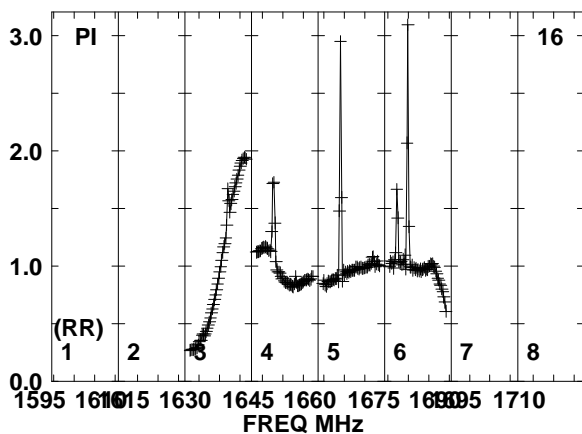
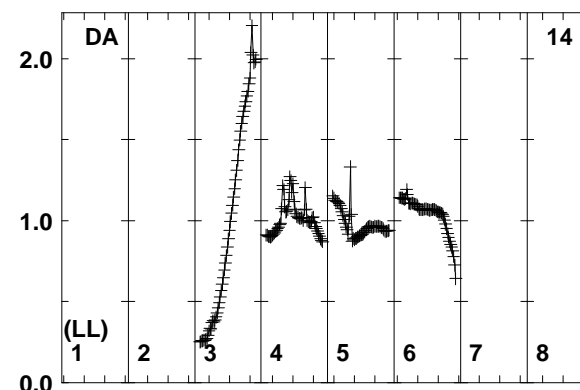
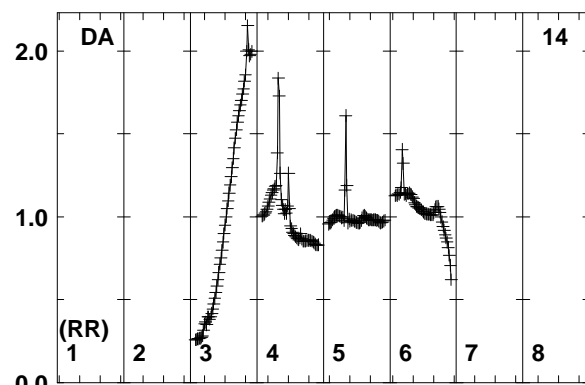
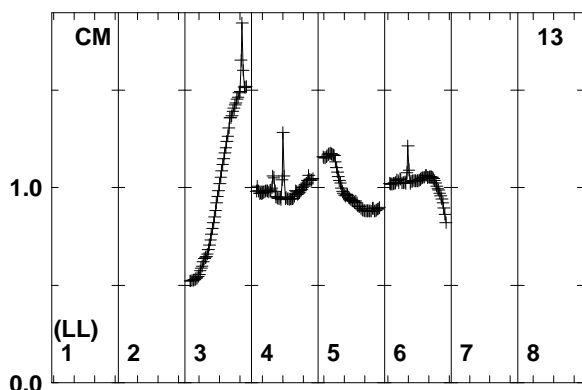
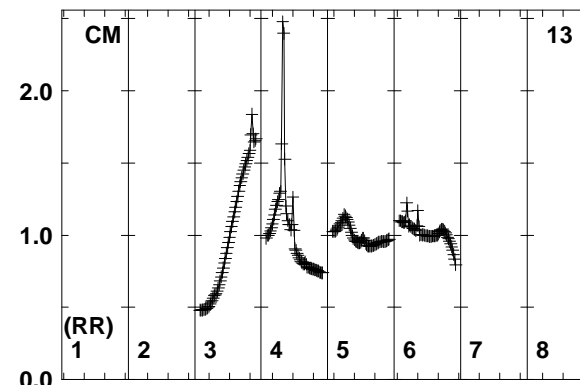
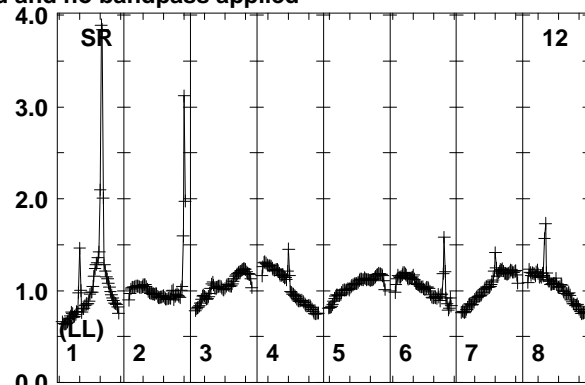
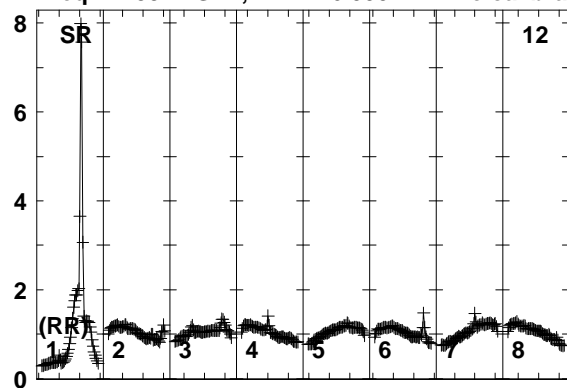

Lower frame: Real Jy
Total-power spectrum Antenna: SR (12)
Timerange: 00/06:20:56 to 00/06:21:54

Plot file version 403 created 04-NOV-2019 14:14:32

W2246-0526 EY034.UVDATA.1

Freq = 1.5947 GHz, Bw = 16.000 MH No calibration applied and no bandpass applied

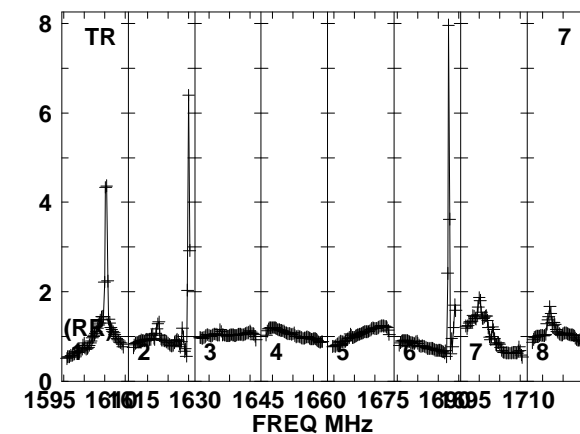
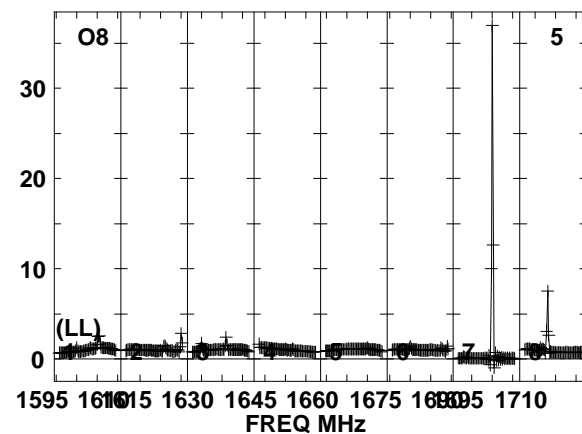
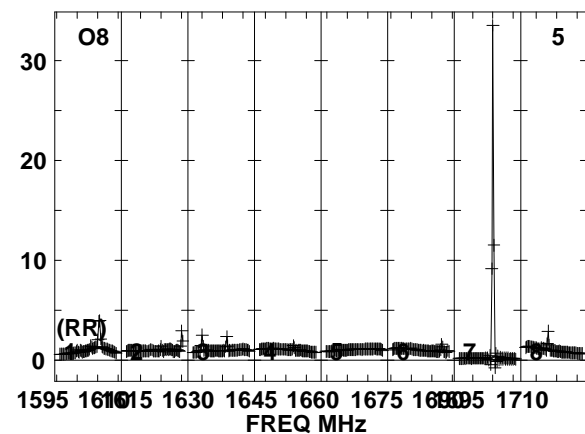
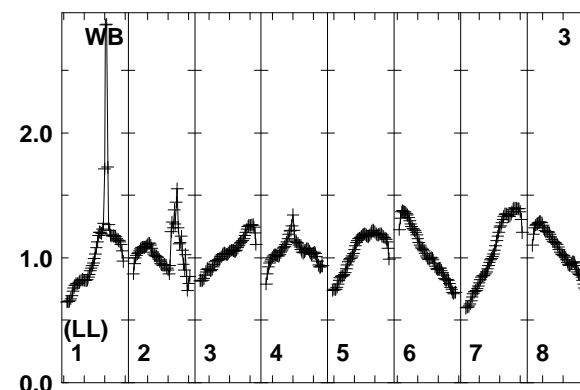
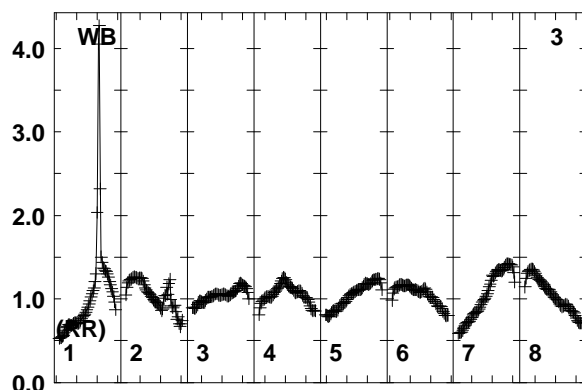
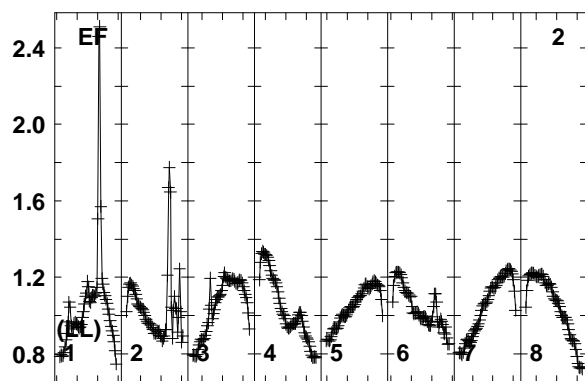
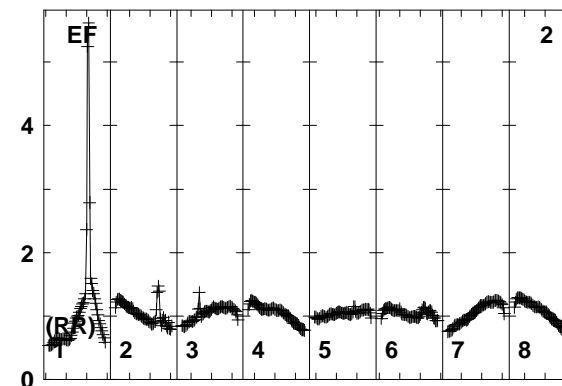
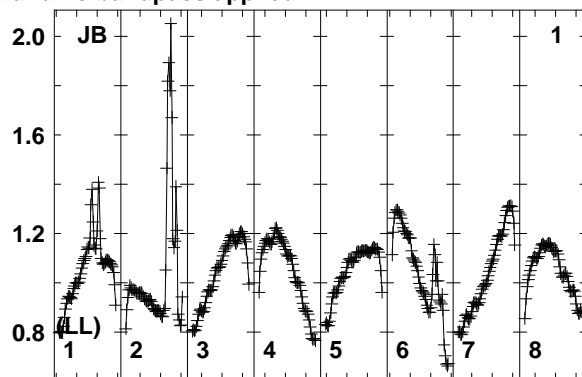
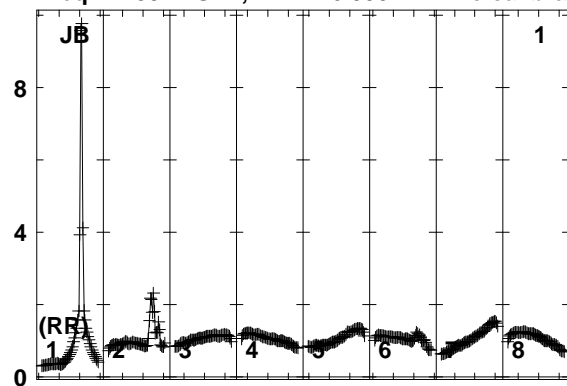

Lower frame: Real Jy
Total-power spectrum Antenna: JB (01)
Timerange: 00/06:21:56 to 00/06:24:34

Plot file version 404 created 04-NOV-2019 14:14:32

W2246-0526 EY034.UVDATA.1

Freq = 1.5947 GHz, Bw = 16.000 MH No calibration applied and no bandpass applied

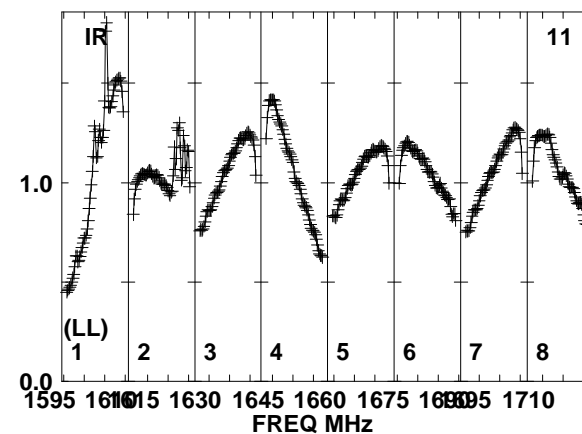
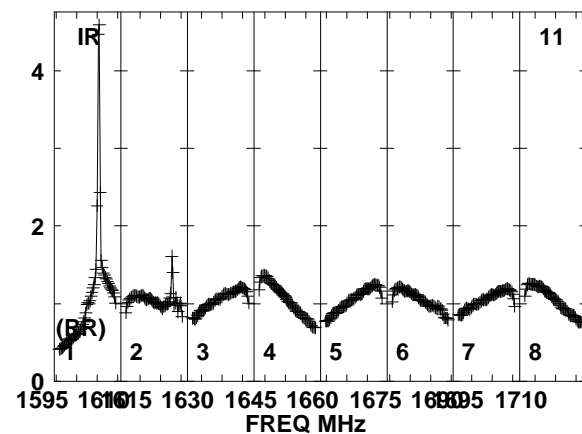
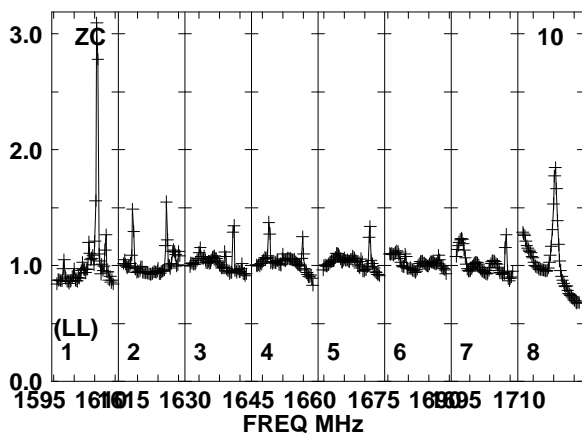
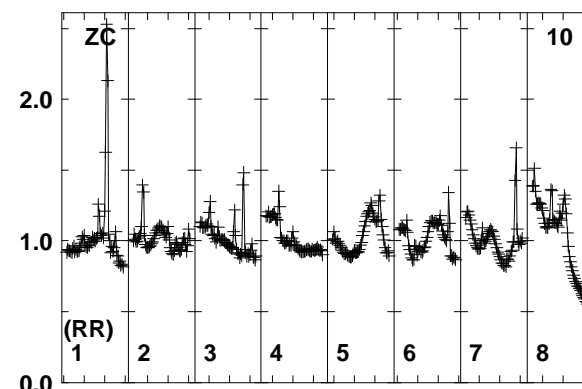
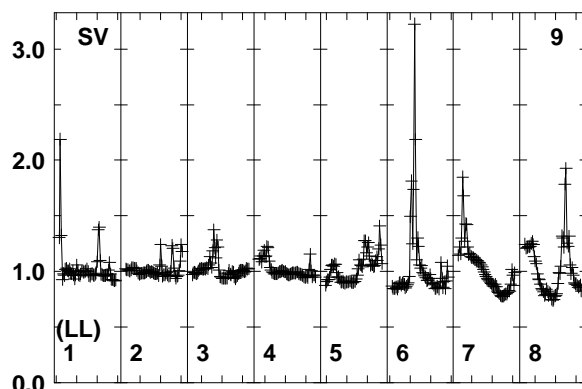
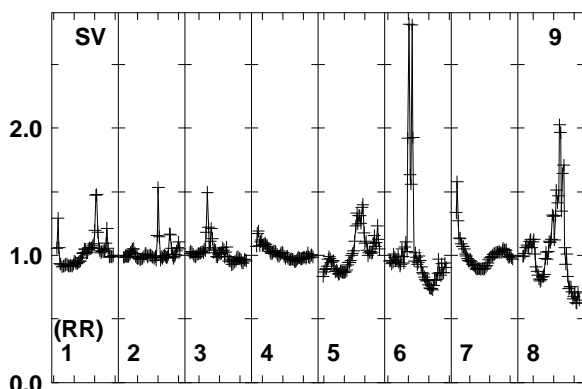
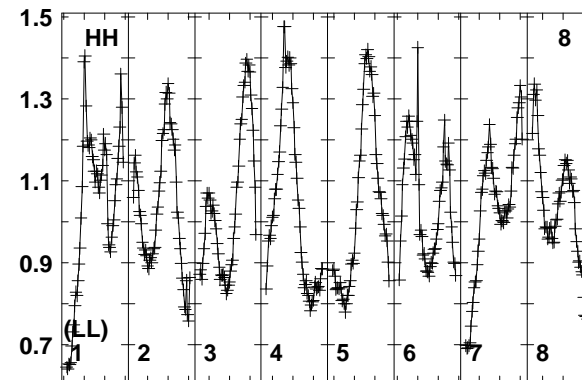
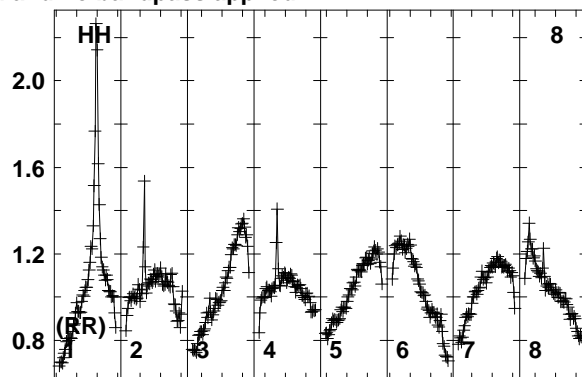
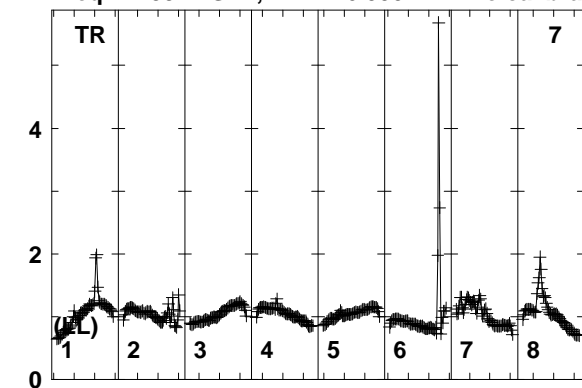

Lower frame: Real Jy
Total-power spectrum Antenna: TR (07)
Timerange: 00/06:21:56 to 00/06:24:34

Plot file version 405 created 04-NOV-2019 14:14:32

W2246-0526 EY034.UVDATA.1

Freq = 1.5947 GHz, Bw = 16.000 MH No calibration applied and no bandpass applied

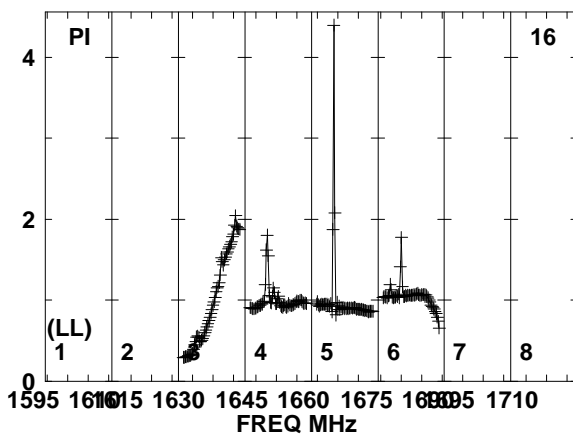
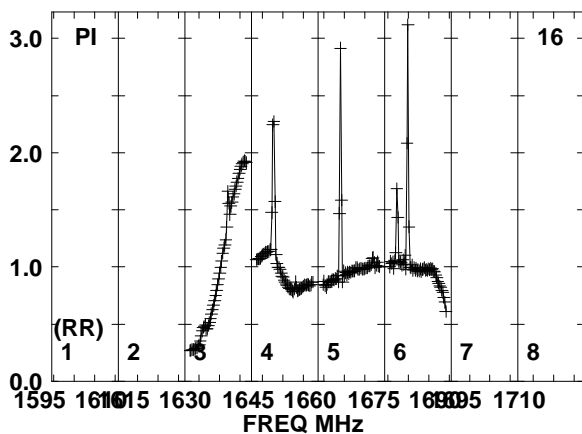
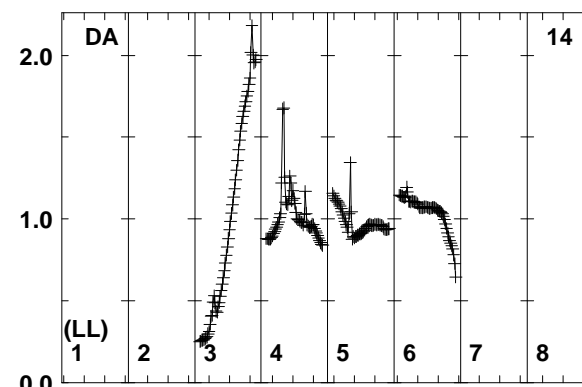
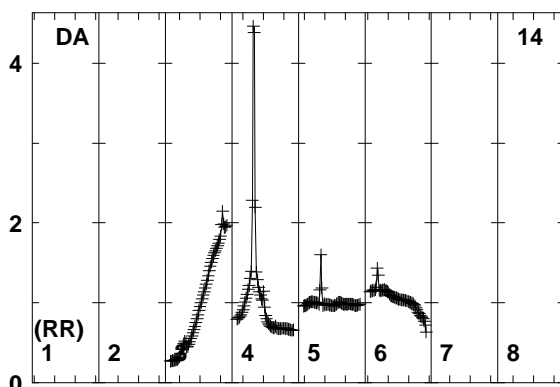
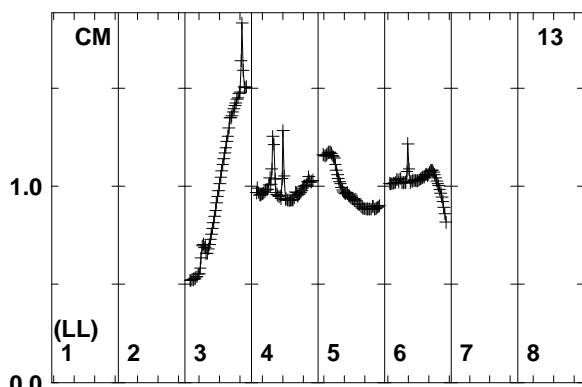
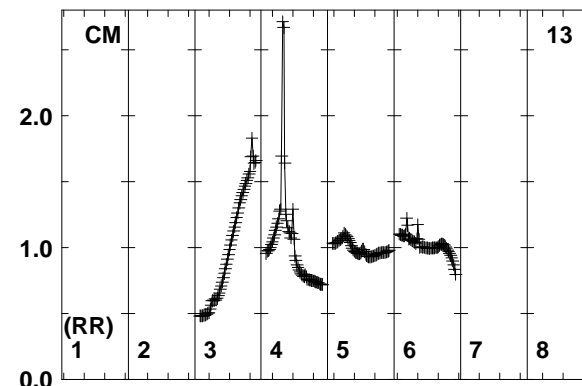
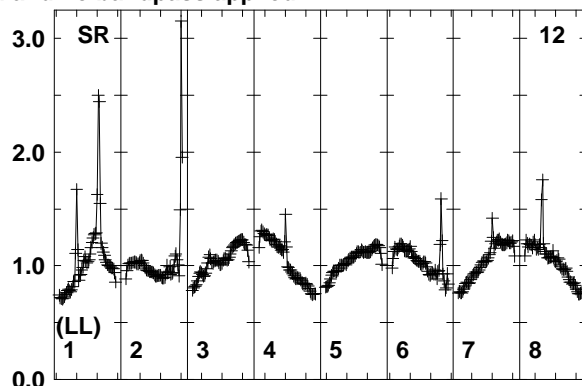
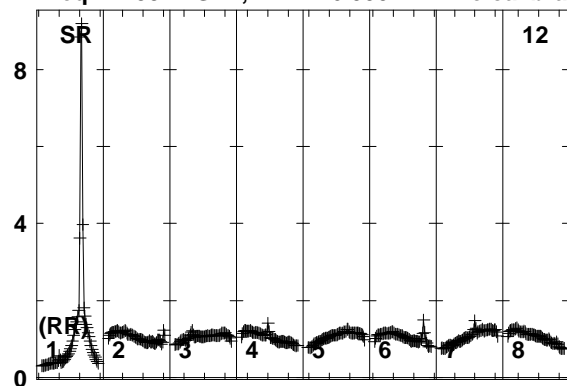

Lower frame: Real Jy
Total-power spectrum Antenna: SR (12)
Timerange: 00/06:21:56 to 00/06:24:34

Plot file version 406 created 04-NOV-2019 14:14:32

J2248-0541 EY034.UVDATA.1

Freq = 1.5947 GHz, Bw = 16.000 MH No calibration applied and no bandpass applied

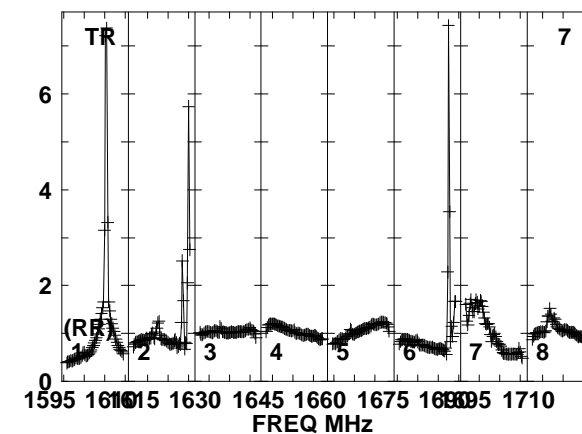
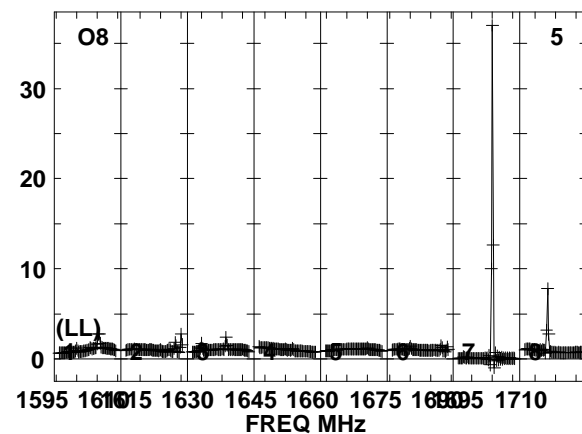
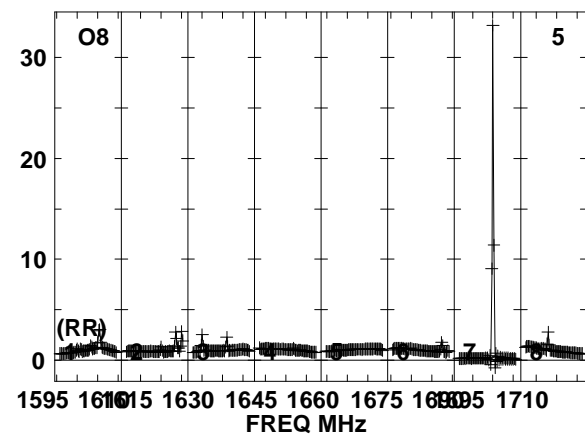
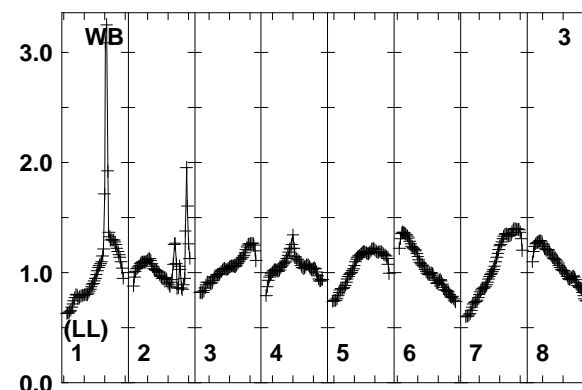
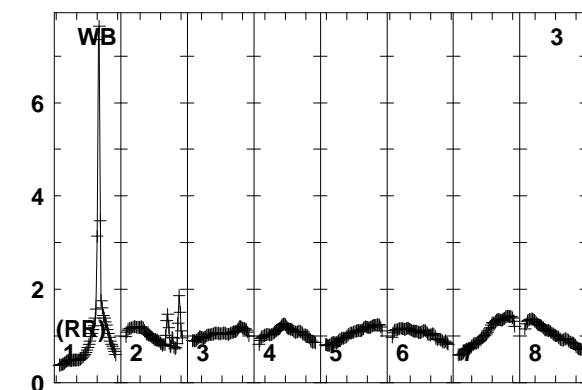
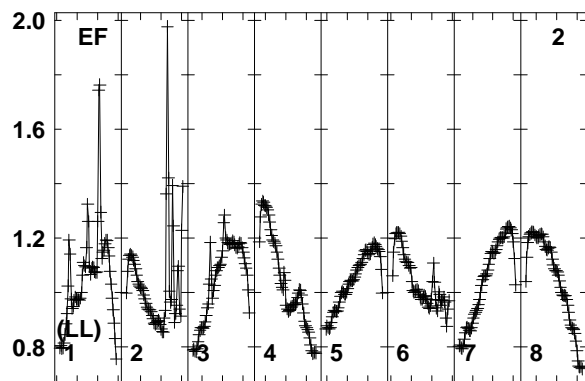
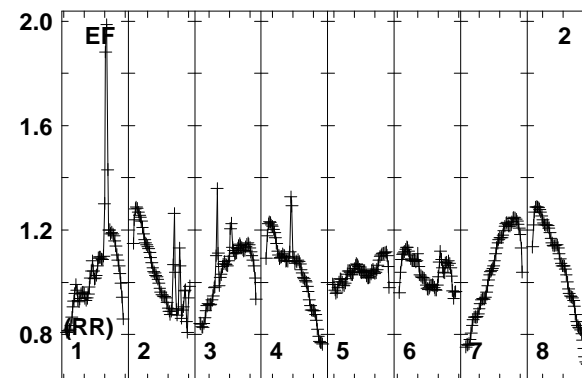
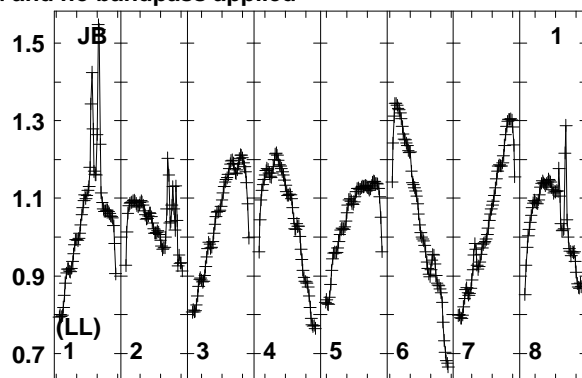
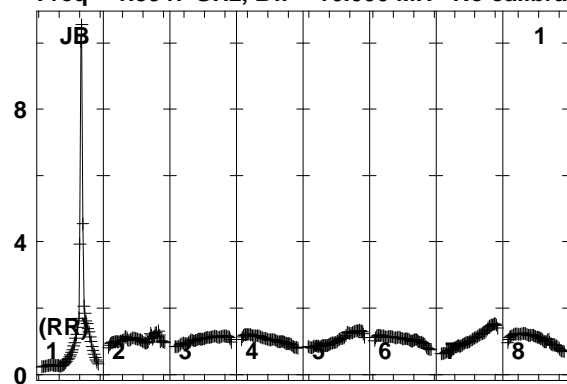

Lower frame: Real Jy
Total-power spectrum Antenna: JB (01)
Timerange: 00/06:24:51 to 00/06:25:49

Plot file version 407 created 04-NOV-2019 14:14:32

J2248-0541 EY034.UVDATA.1

Freq = 1.5947 GHz, Bw = 16.000 MH No calibration applied and no bandpass applied

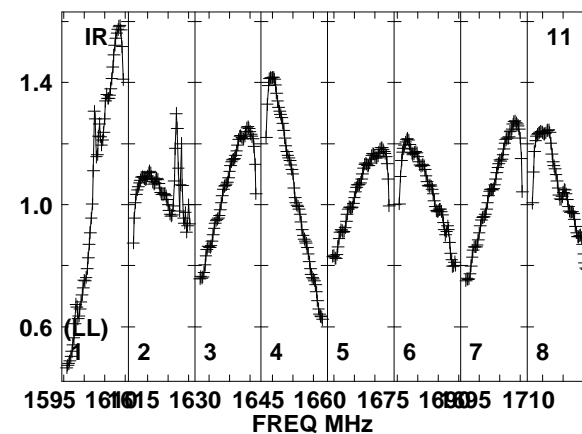
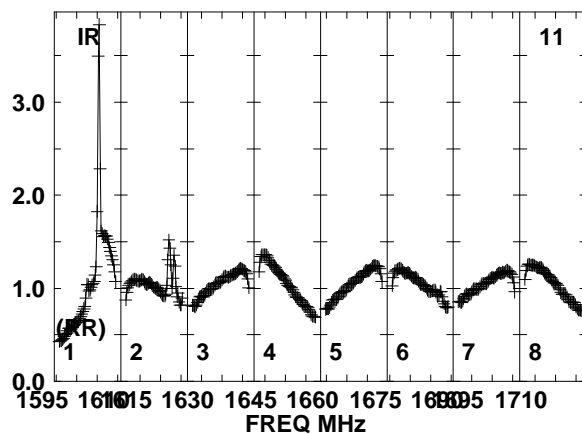
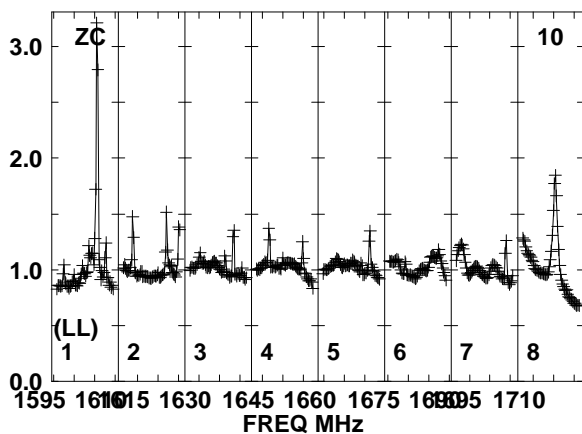
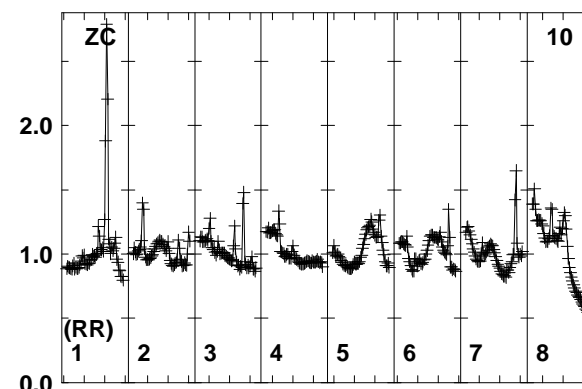
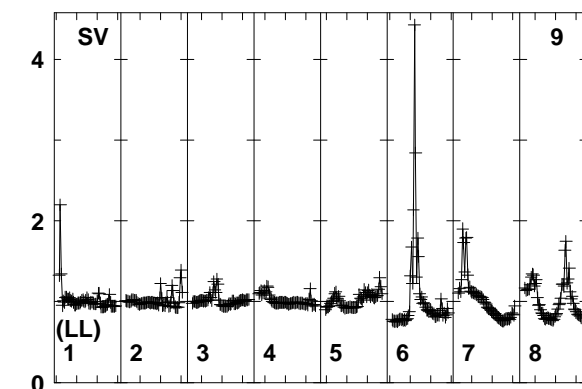
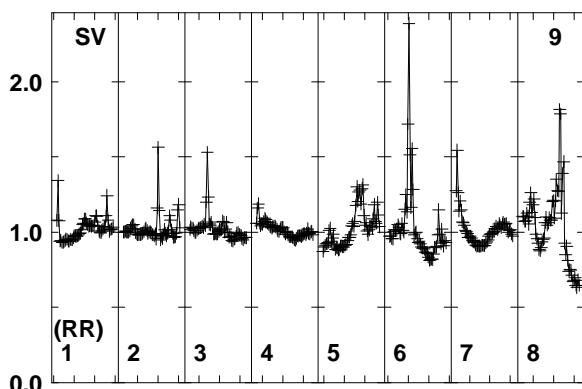
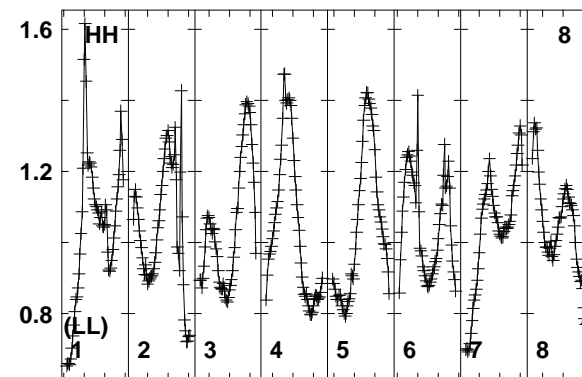
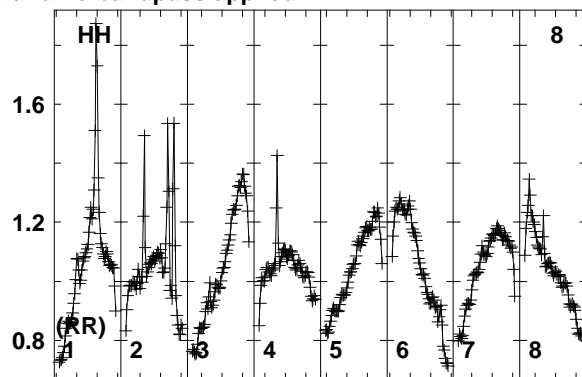
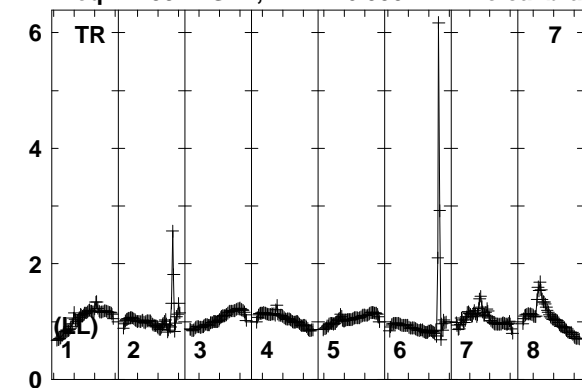

Lower frame: Real Jy
Total-power spectrum Antenna: TR (07)
Timerange: 00/06:24:51 to 00/06:25:49

Plot file version 408 created 04-NOV-2019 14:14:33

J2248-0541 EY034.UVDATA.1

Freq = 1.5947 GHz, Bw = 16.000 MH No calibration applied and no bandpass applied

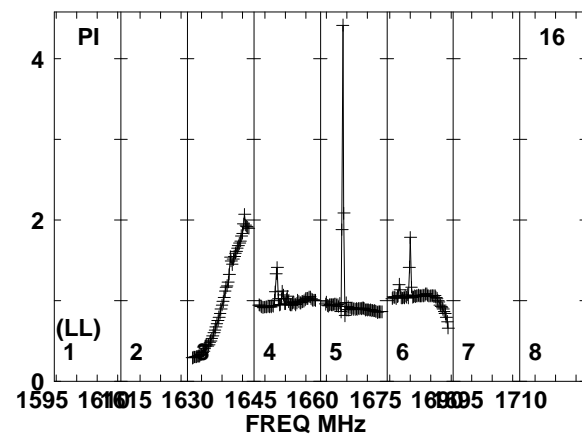
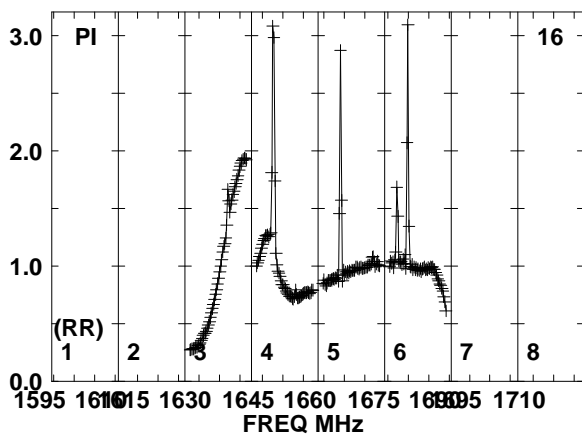
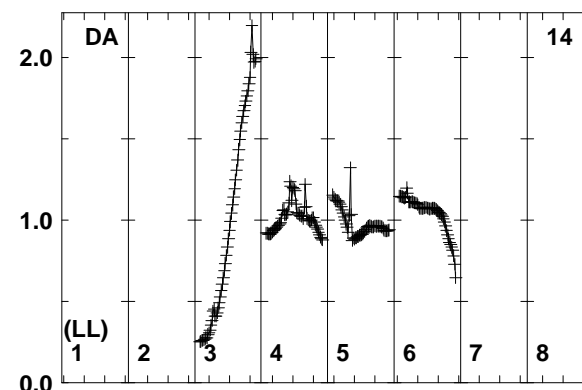
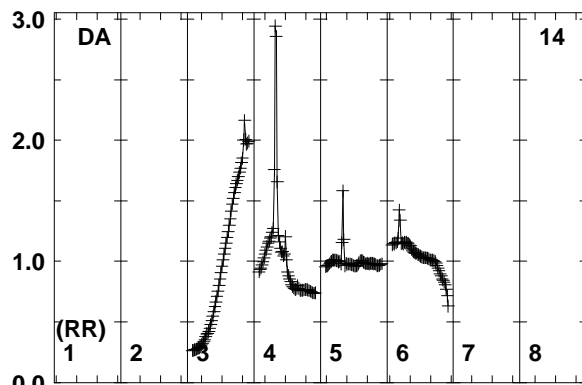
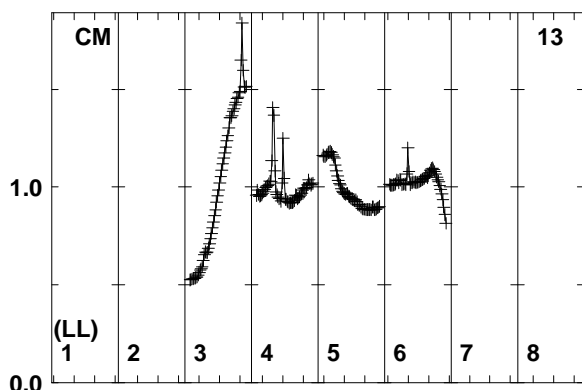
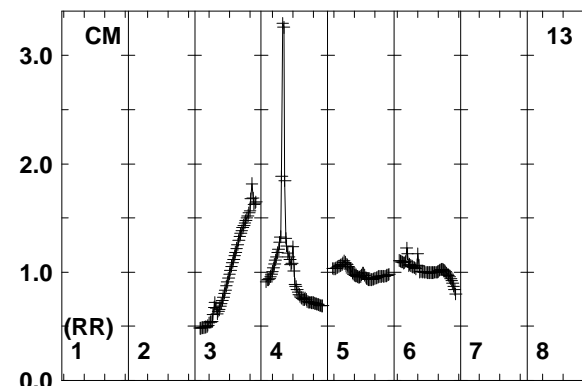
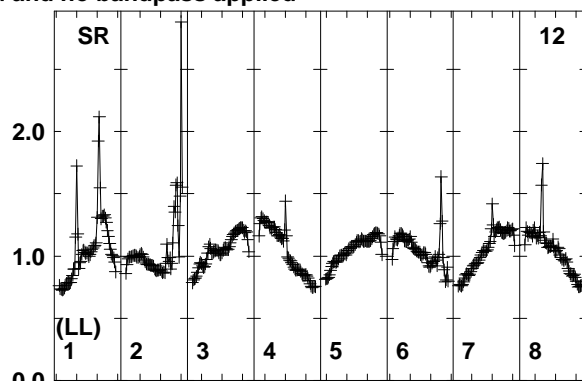
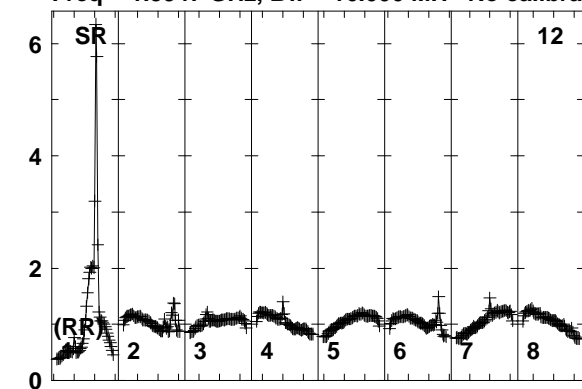

Lower frame: Real Jy
Total-power spectrum Antenna: SR (12)
Timerange: 00/06:24:51 to 00/06:25:49

Plot file version 409 created 04-NOV-2019 14:14:33

W2246-0526 EY034.UVDATA.1

Freq = 1.5947 GHz, Bw = 16.000 MHz No calibration applied and no bandpass applied

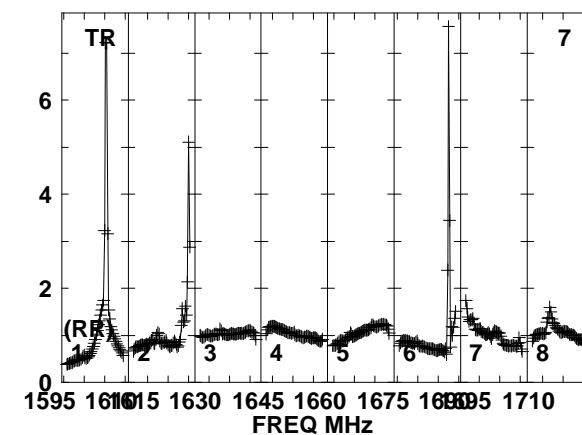
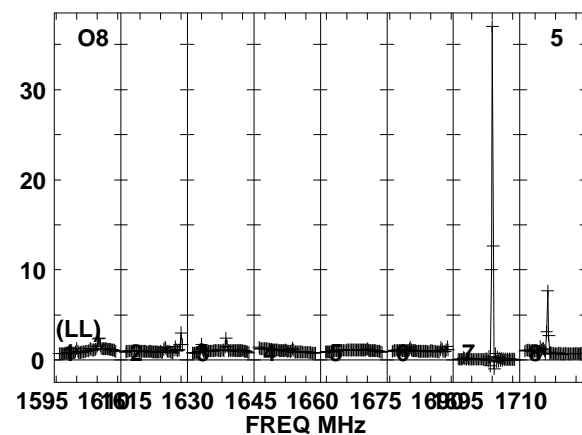
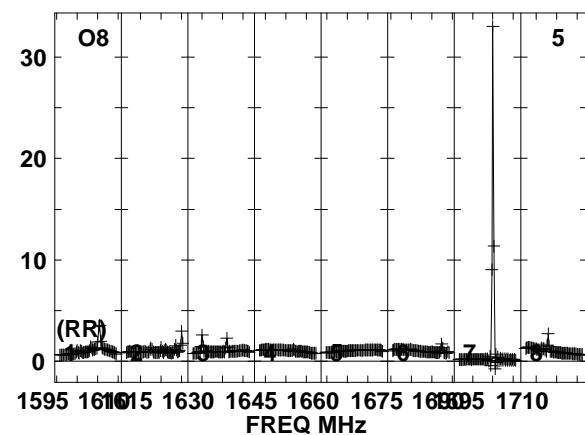
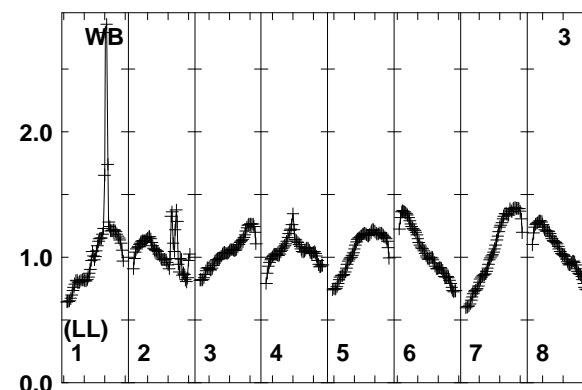
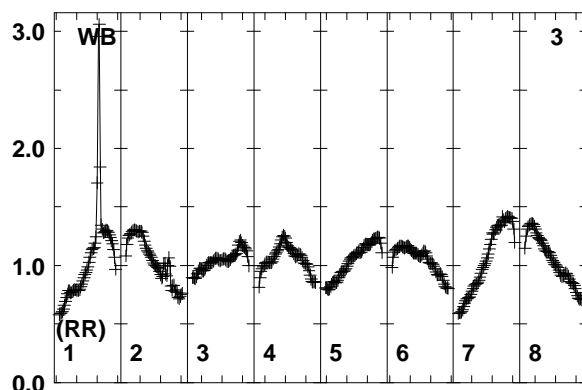
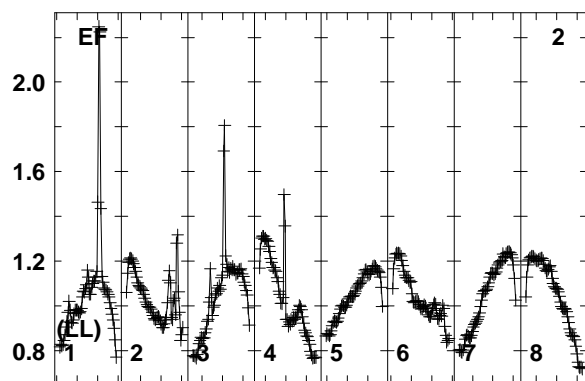
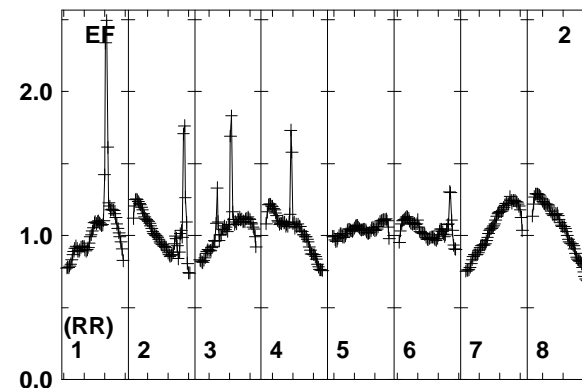
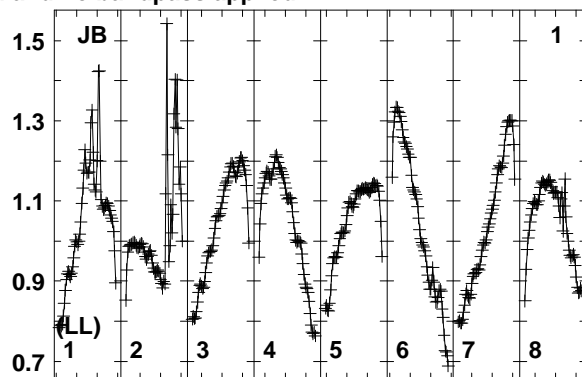
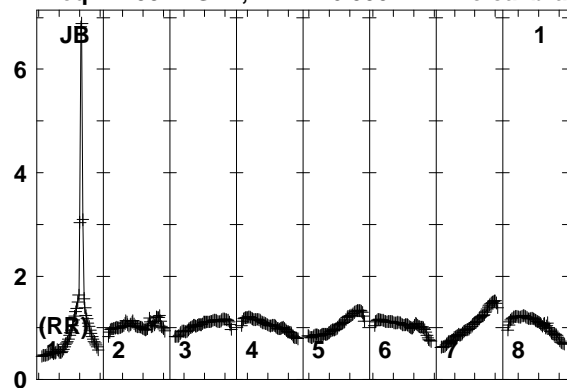

Lower frame: Real Jy
Total-power spectrum Antenna: JB (01)
Timerange: 00/06:25:51 to 00/06:28:29

Plot file version 410 created 04-NOV-2019 14:14:33

W2246-0526 EY034.UVDATA.1

Freq = 1.5947 GHz, Bw = 16.000 MH No calibration applied and no bandpass applied

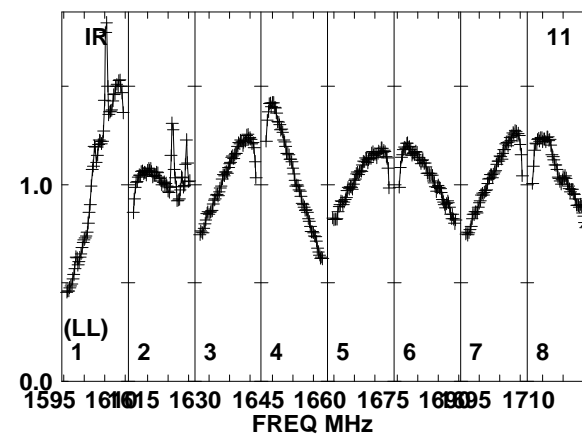
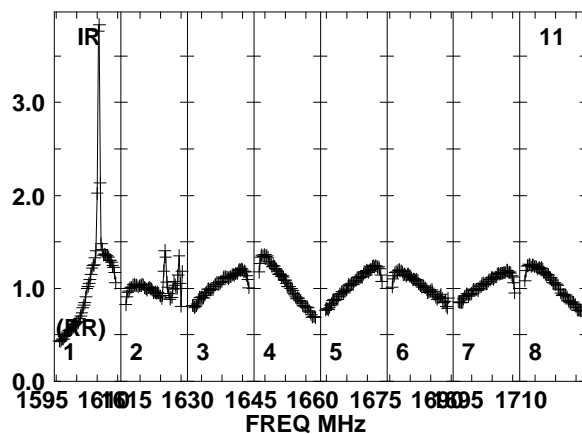
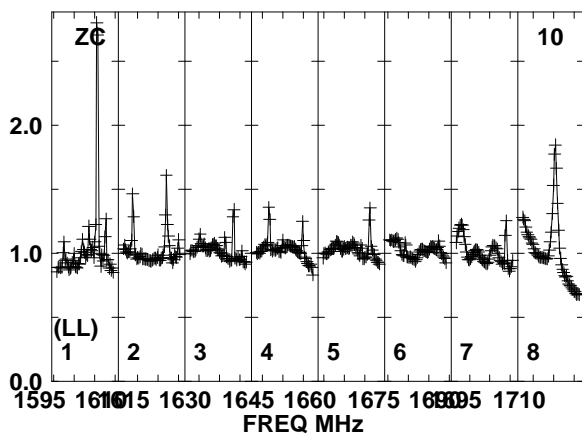
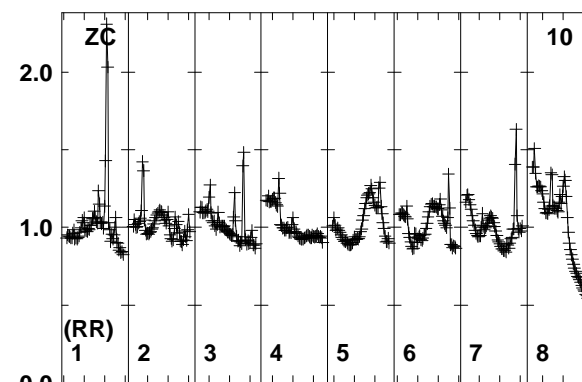
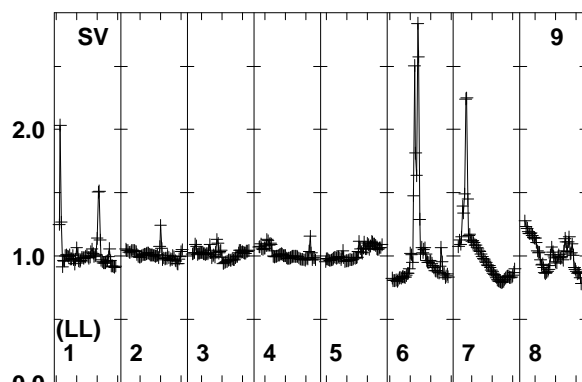
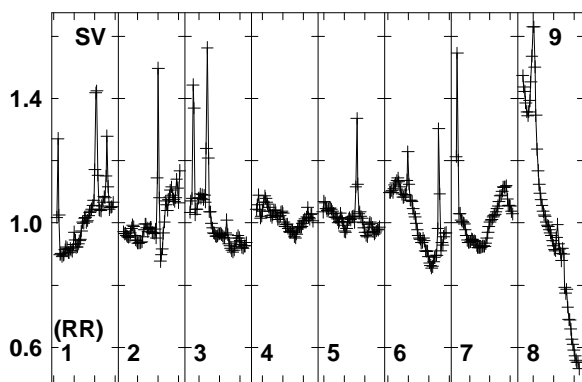
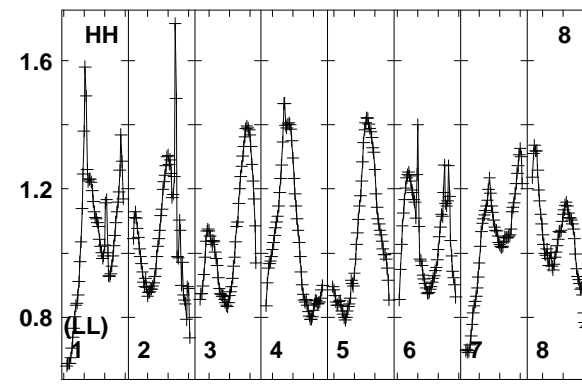
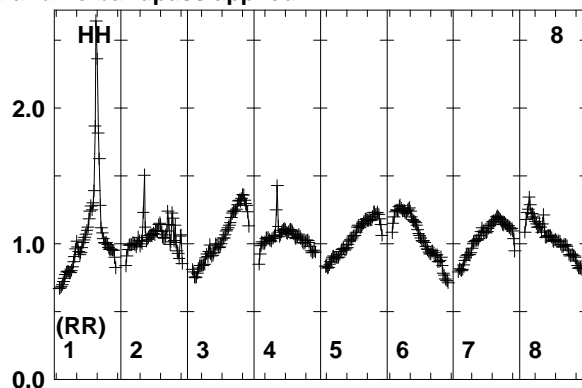
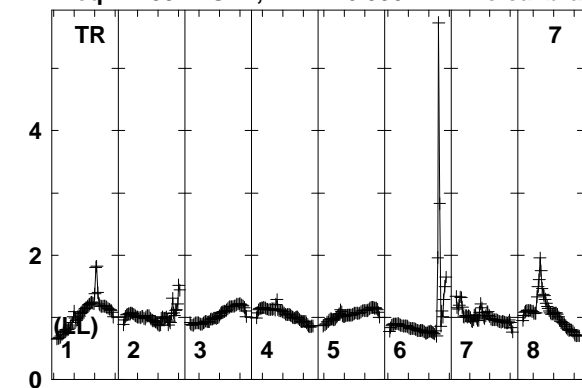

Lower frame: Real Jy
Total-power spectrum Antenna: TR (07)
Timerange: 00/06:25:51 to 00/06:28:29

Plot file version 411 created 04-NOV-2019 14:14:33

W2246-0526 EY034.UVDATA.1

Freq = 1.5947 GHz, Bw = 16.000 MH No calibration applied and no bandpass applied

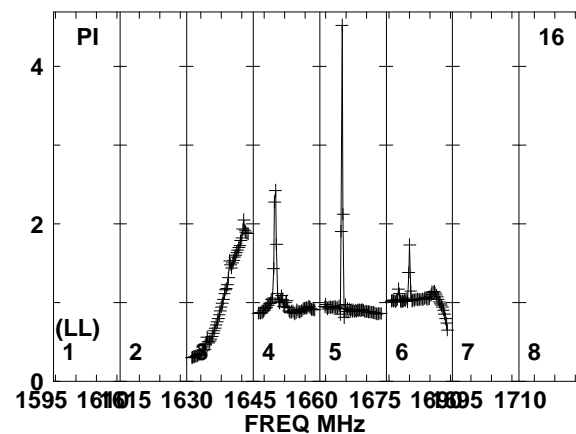
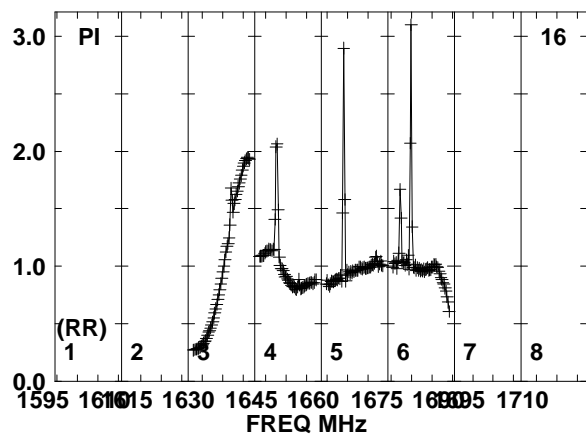
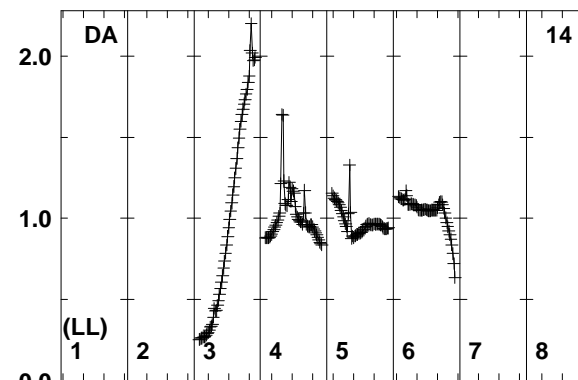
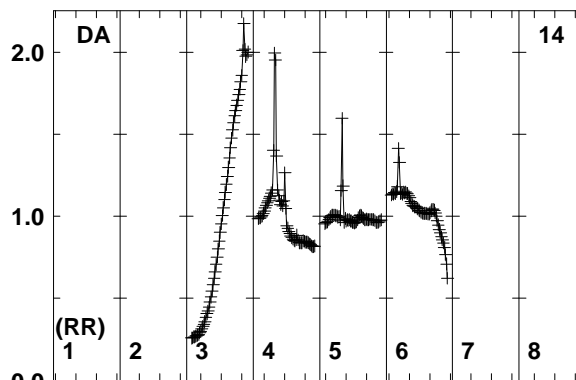
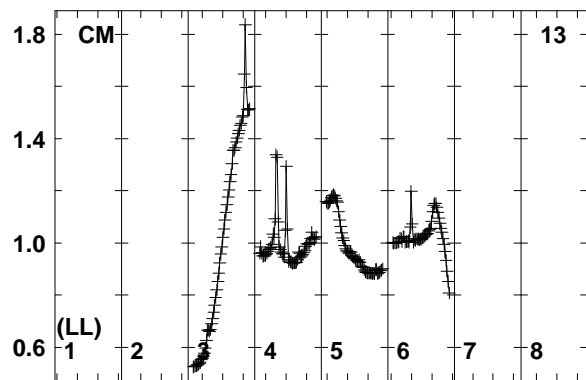
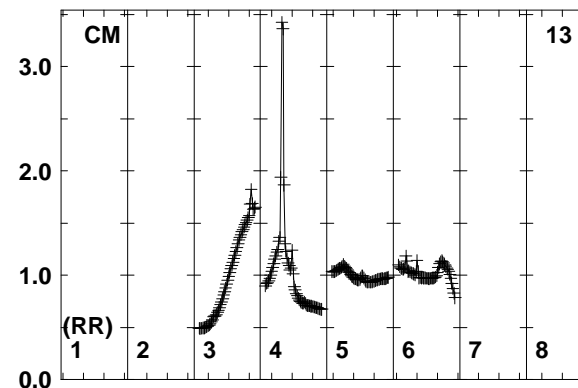
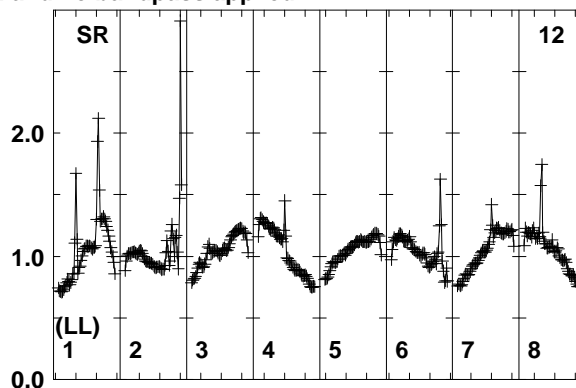
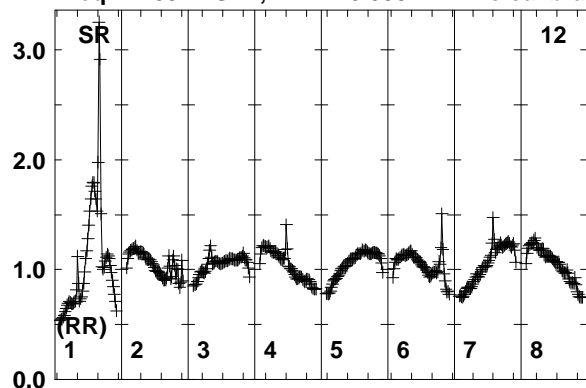

Lower frame: Real Jy
Total-power spectrum Antenna: SR (12)
Timerange: 00/06:25:51 to 00/06:28:29

Plot file version 412 created 04-NOV-2019 14:14:33

J2248-0541 EY034.UVDATA.1

Freq = 1.5947 GHz, Bw = 16.000 MH No calibration applied and no bandpass applied

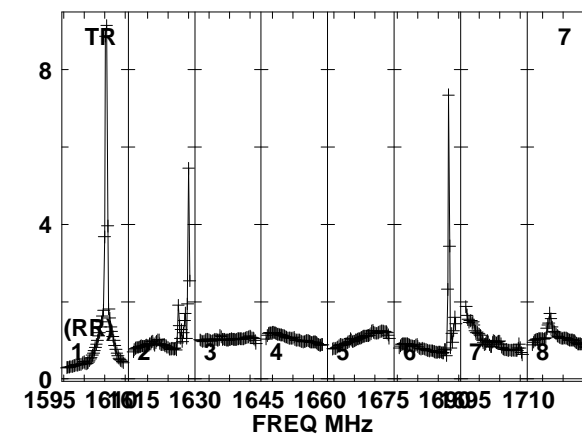
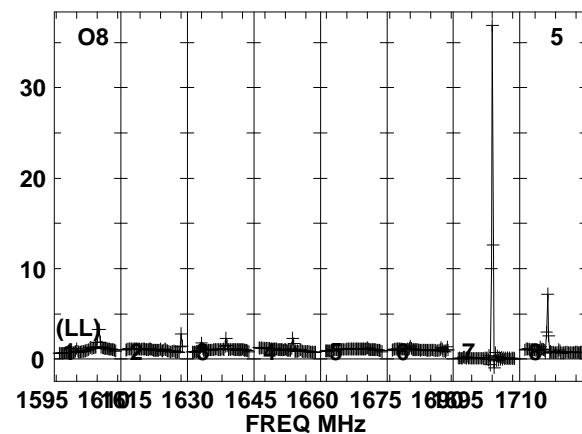
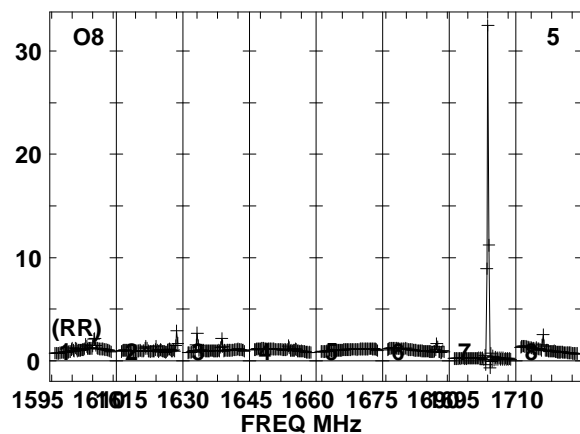
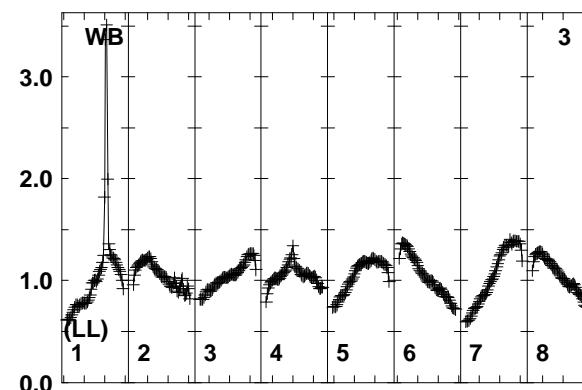
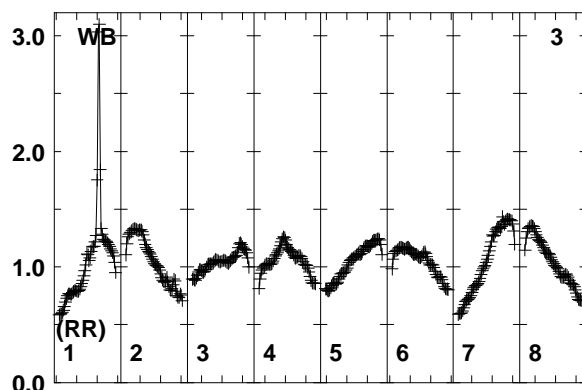
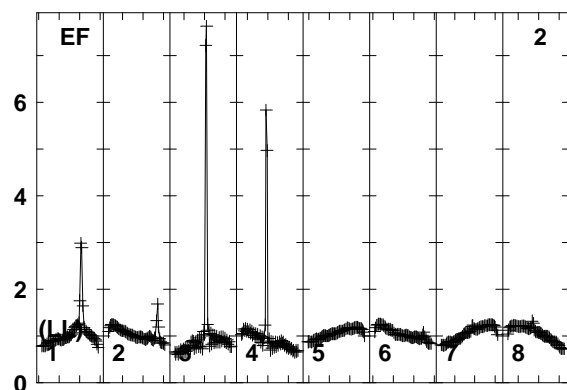
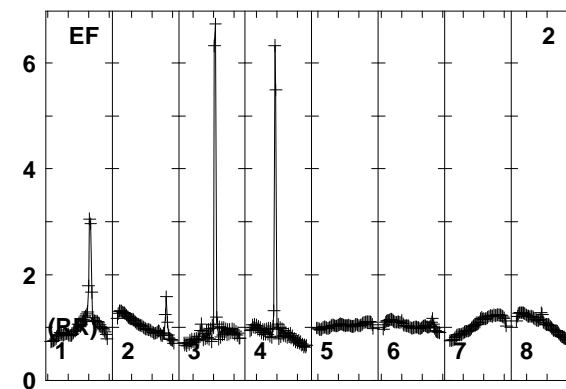
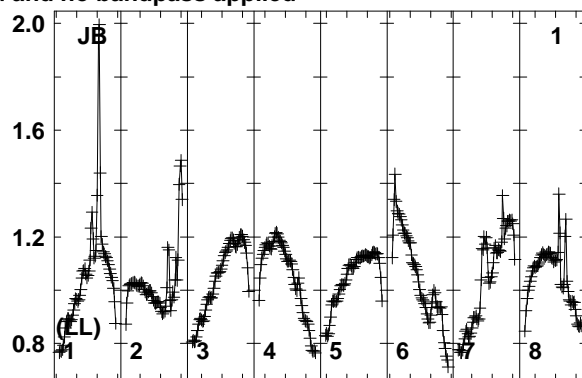
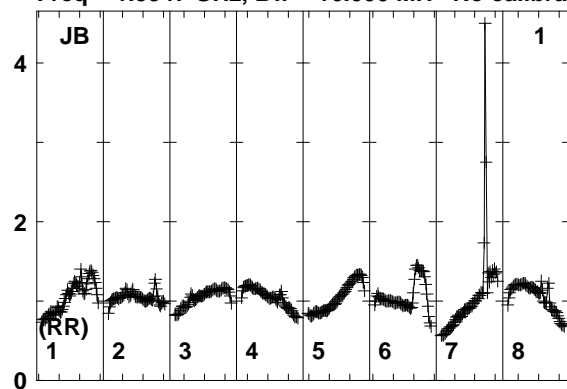

Lower frame: Real Jy
Total-power spectrum Antenna: JB (01)
Timerange: 00/06:29:06 to 00/06:30:04

Plot file version 413 created 04-NOV-2019 14:14:33

J2248-0541 EY034.UVDATA.1

Freq = 1.5947 GHz, Bw = 16.000 MH No calibration applied and no bandpass applied

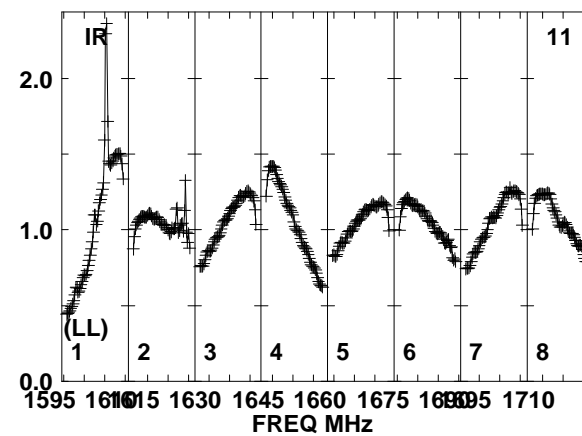
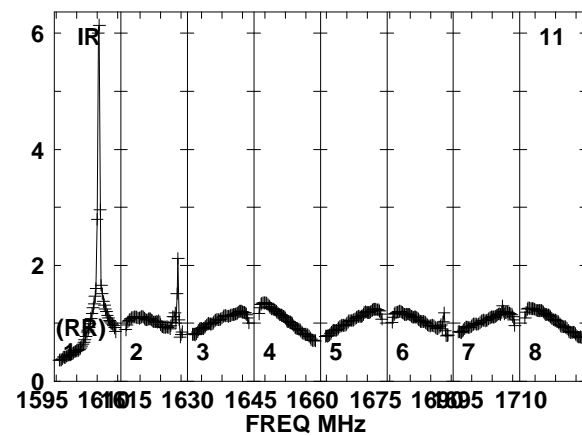
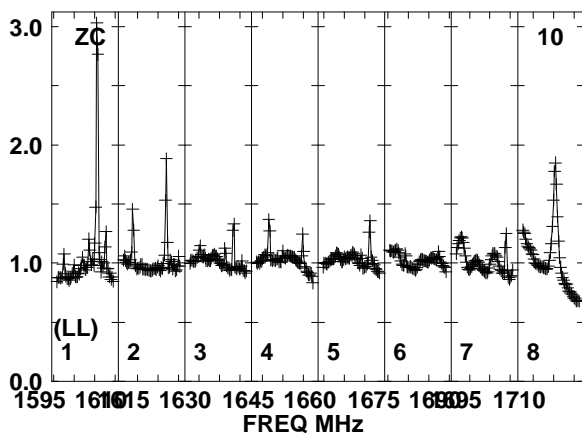
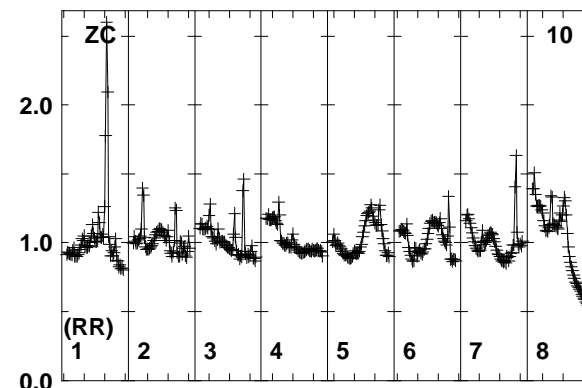
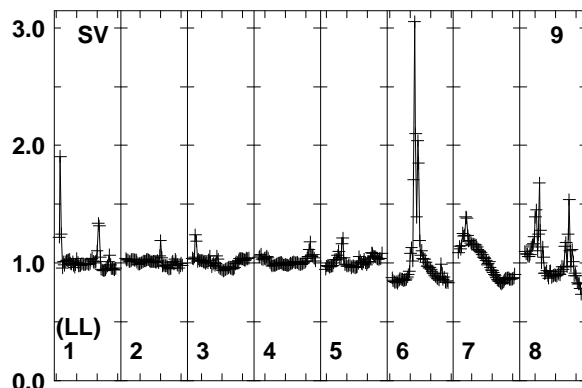
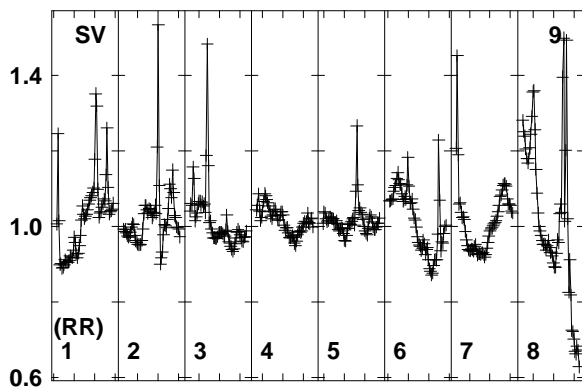
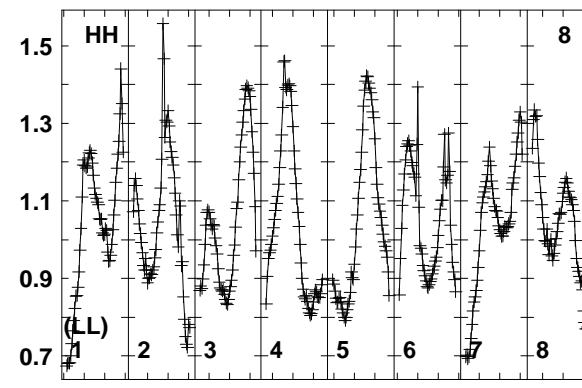
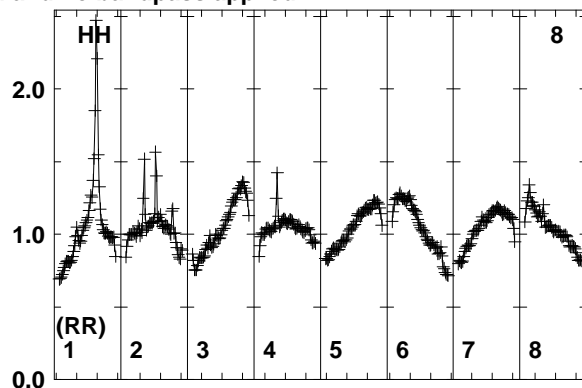
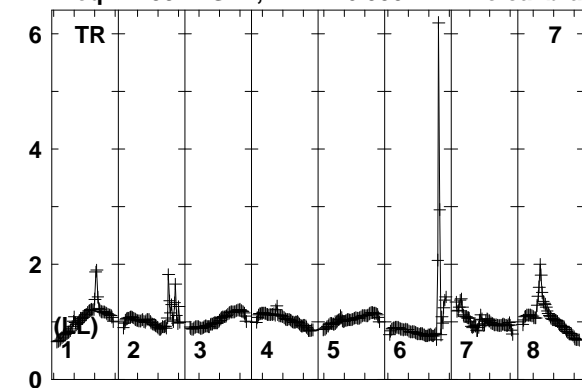

Lower frame: Real Jy
Total-power spectrum Antenna: TR (07)
Timerange: 00/06:29:06 to 00/06:30:04

Plot file version 414 created 04-NOV-2019 14:14:33

J2248-0541 EY034.UVDATA.1

Freq = 1.5947 GHz, Bw = 16.000 MH No calibration applied and no bandpass applied

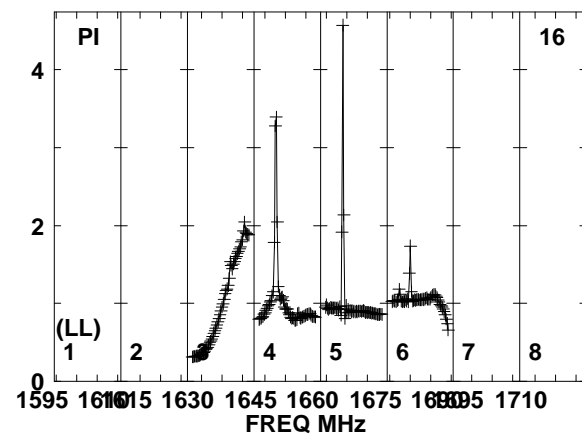
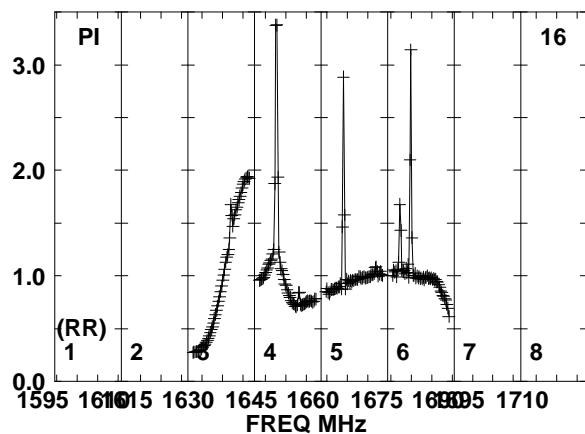
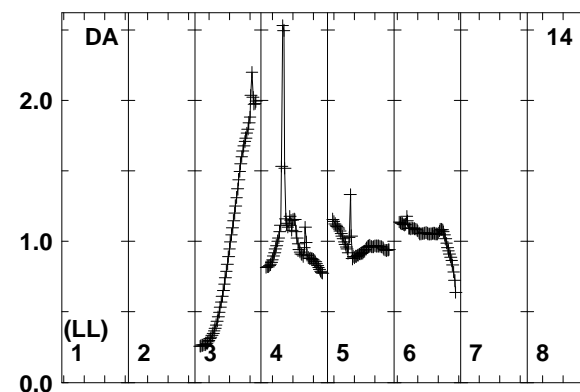
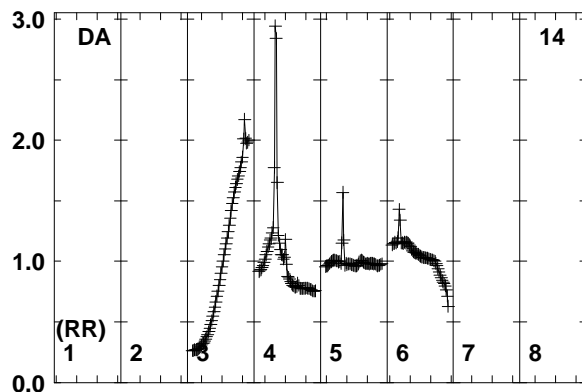
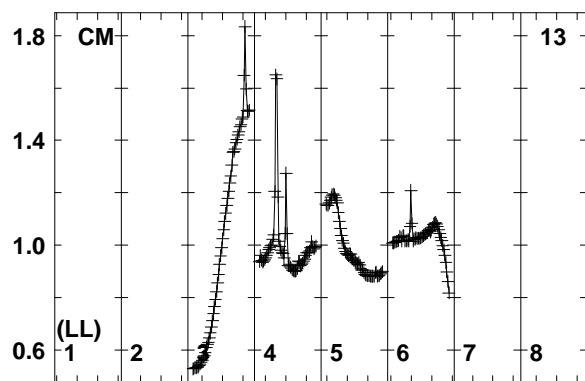
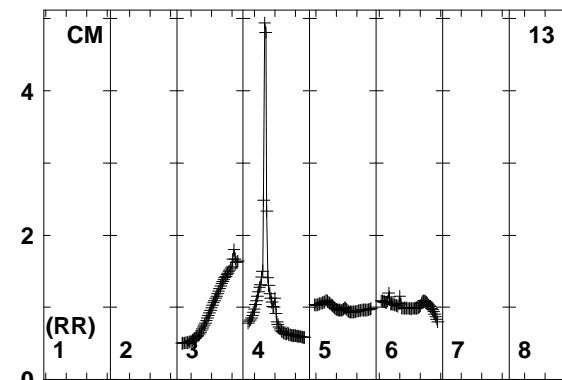
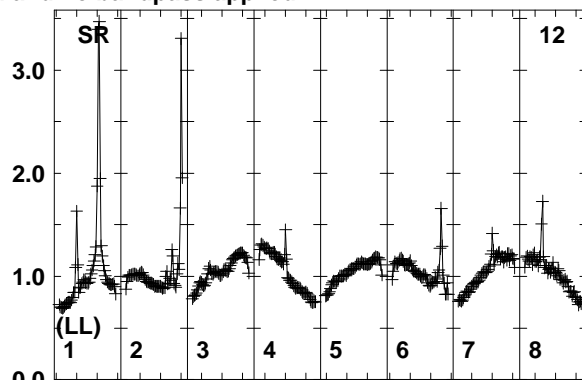
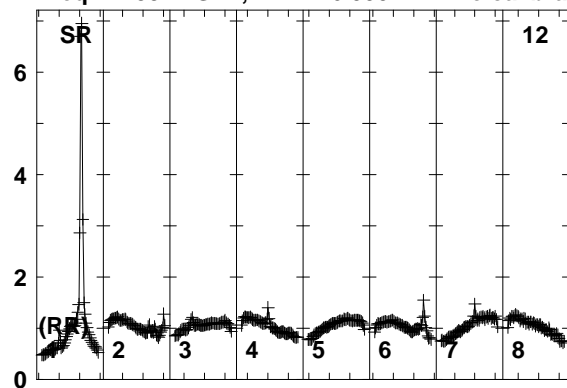

Lower frame: Real Jy
Total-power spectrum Antenna: SR (12)
Timerange: 00/06:29:06 to 00/06:30:04

Plot file version 415 created 04-NOV-2019 14:14:33

W2246-0526 EY034.UVDATA.1

Freq = 1.5947 GHz, Bw = 16.000 MH No calibration applied and no bandpass applied

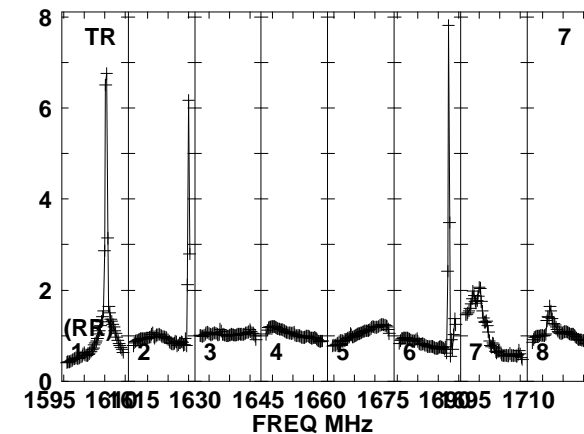
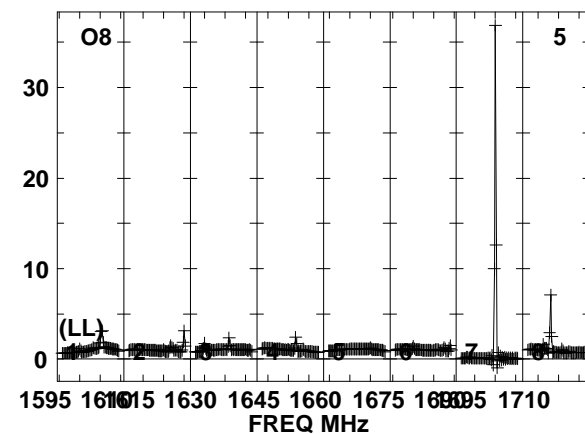
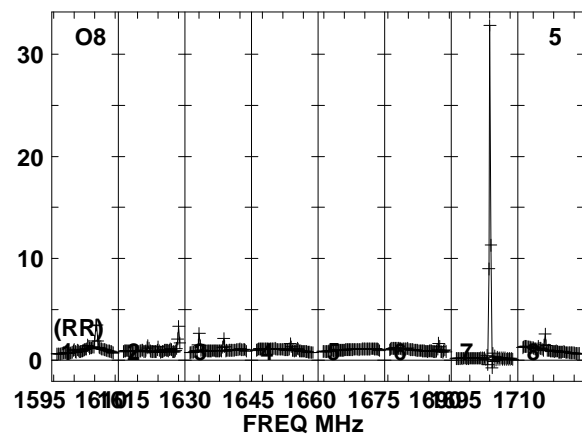
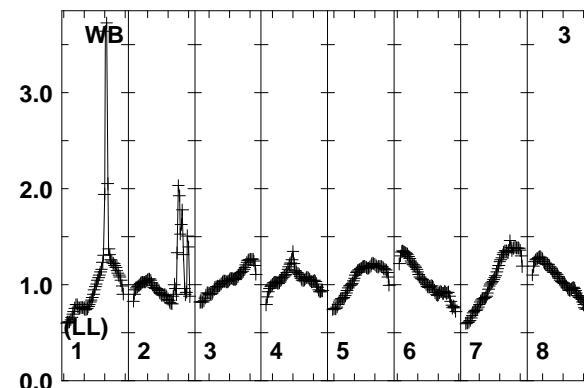
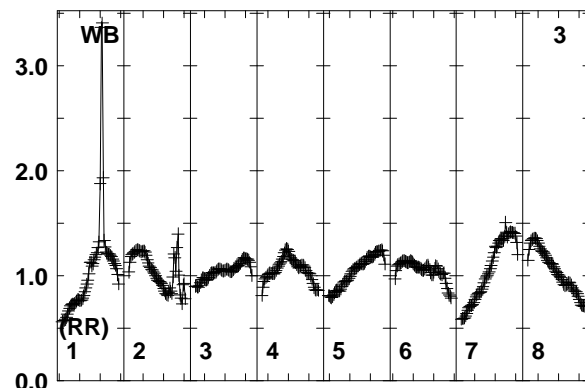
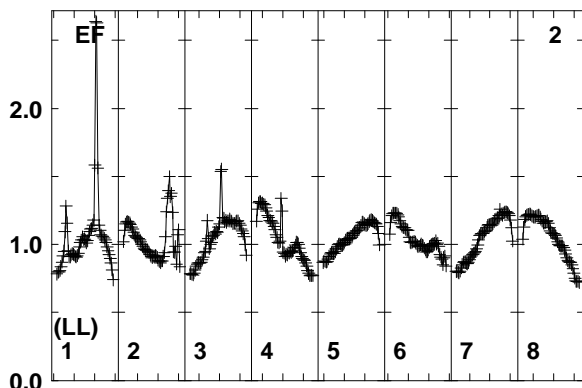
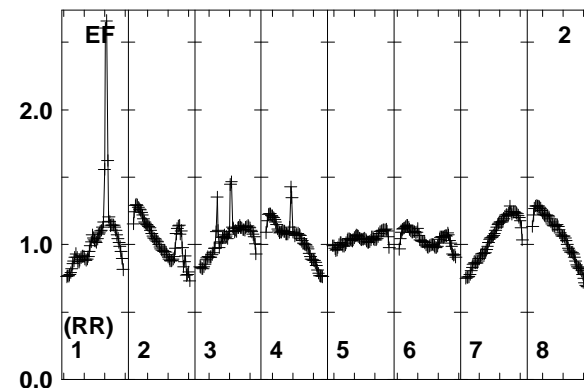
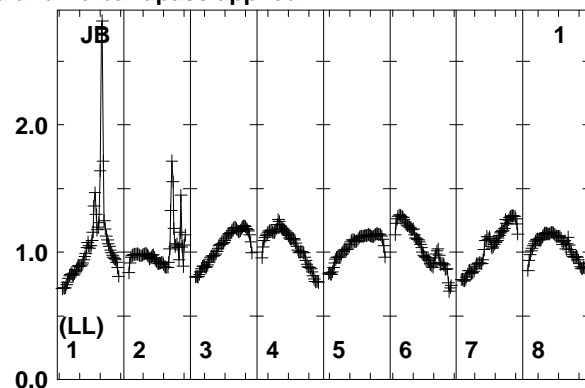
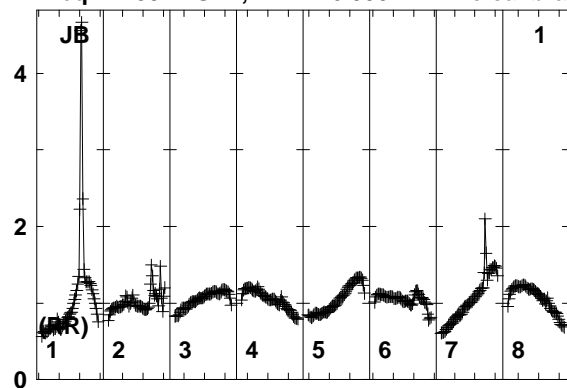

Lower frame: Real Jy
Total-power spectrum Antenna: JB (01)
Timerange: 00/06:30:06 to 00/06:32:44

Plot file version 416 created 04-NOV-2019 14:14:33

W2246-0526 EY034.UVDATA.1

Freq = 1.5947 GHz, Bw = 16.000 MH No calibration applied and no bandpass applied

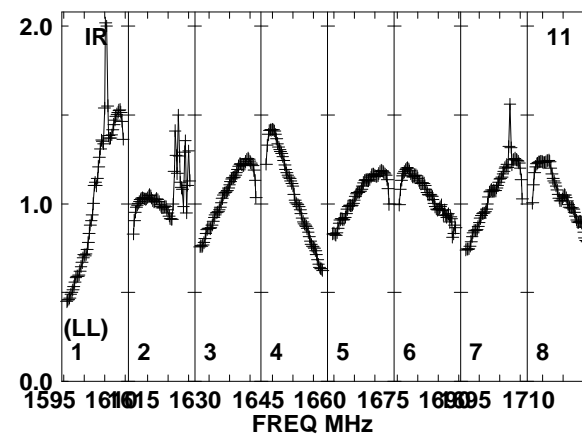
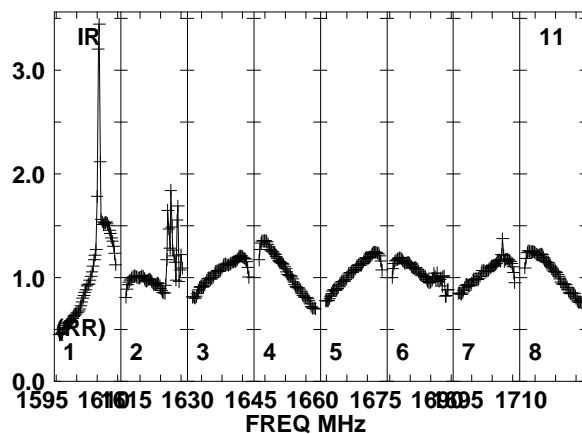
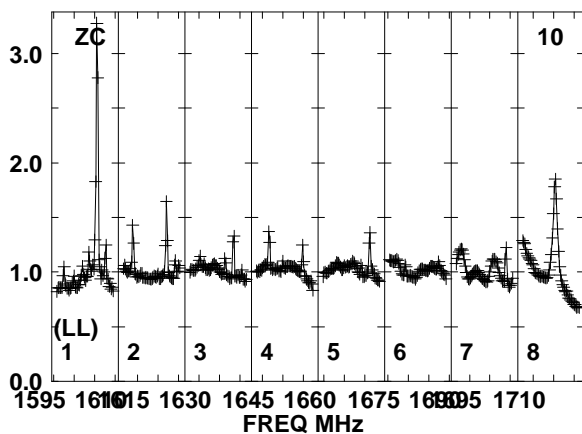
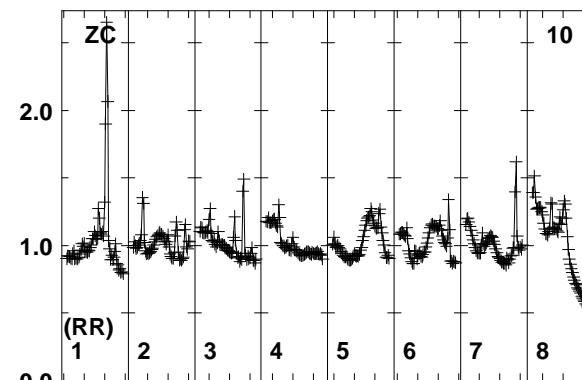
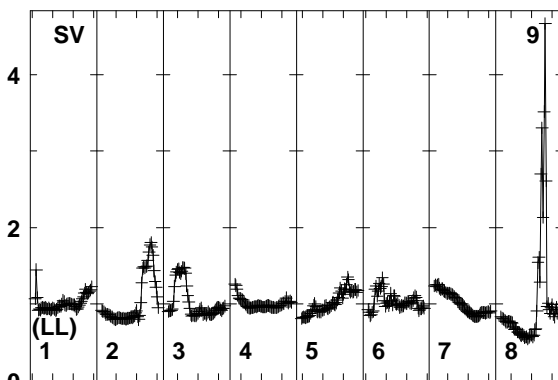
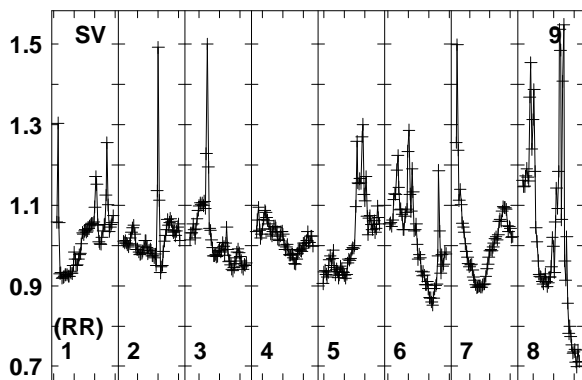
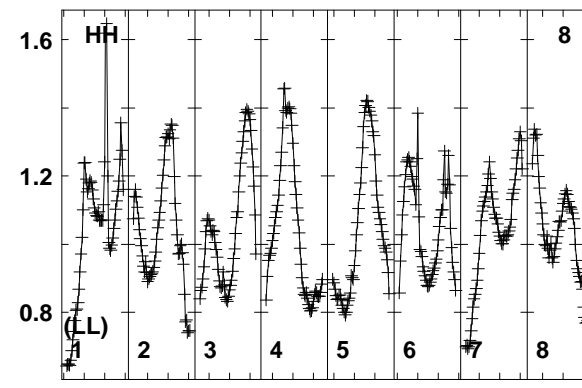
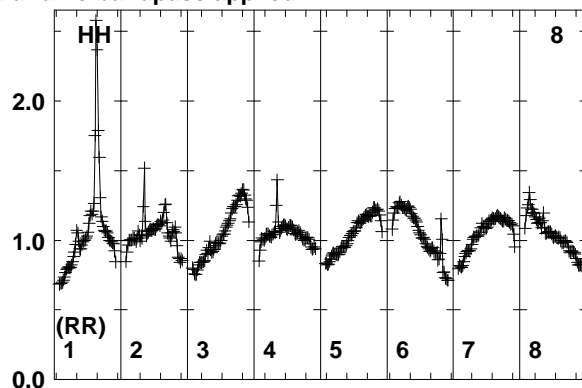
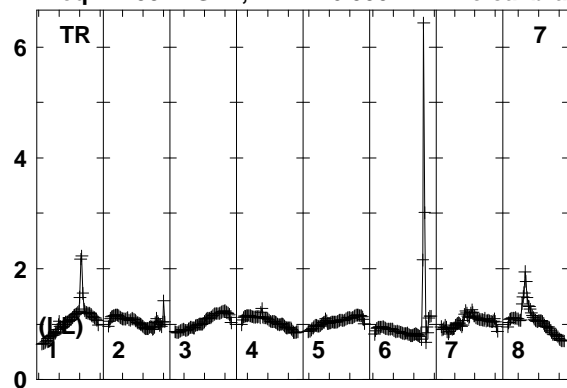

Lower frame: Real Jy
Total-power spectrum Antenna: TR (07)
Timerange: 00/06:30:06 to 00/06:32:44

Plot file version 417 created 04-NOV-2019 14:14:33

W2246-0526 EY034.UVDATA.1

Freq = 1.5947 GHz, Bw = 16.000 MH No calibration applied and no bandpass applied

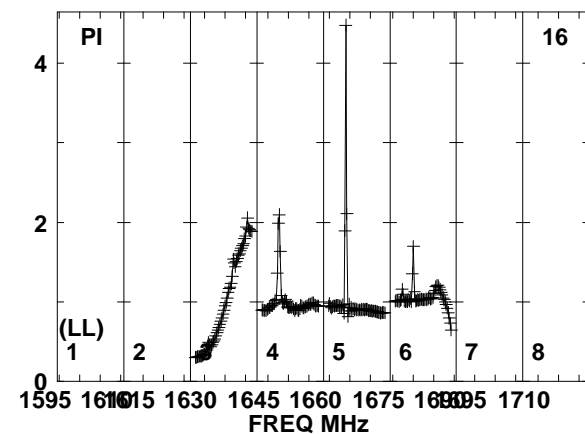
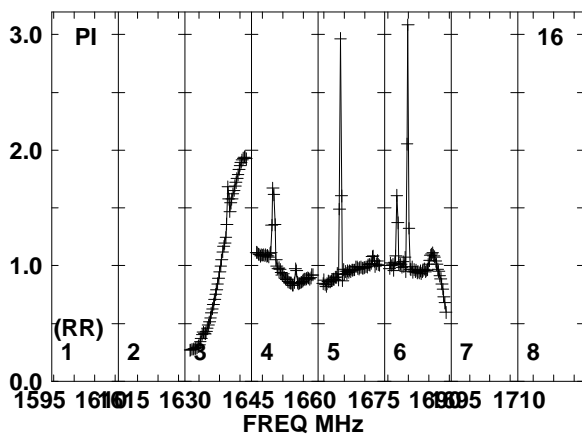
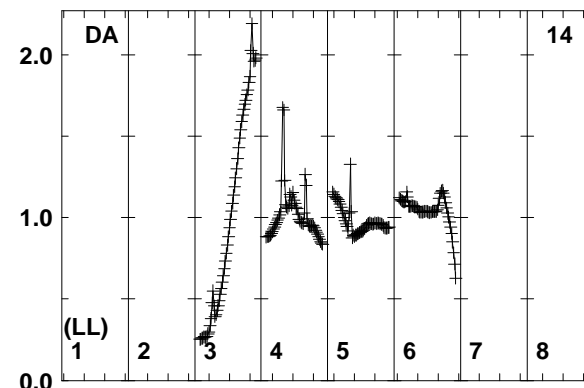
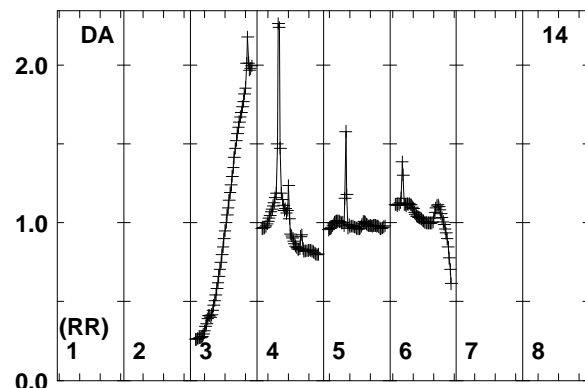
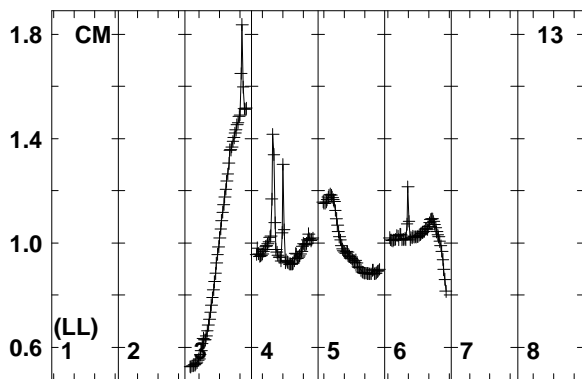
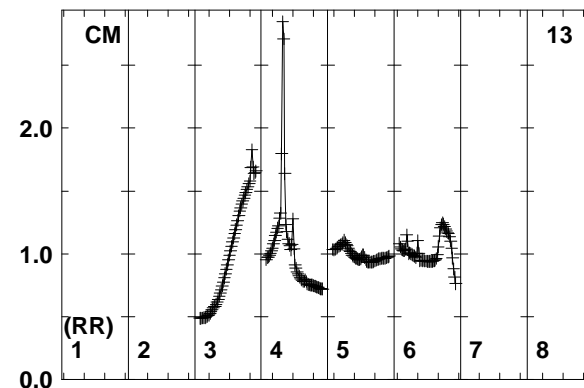
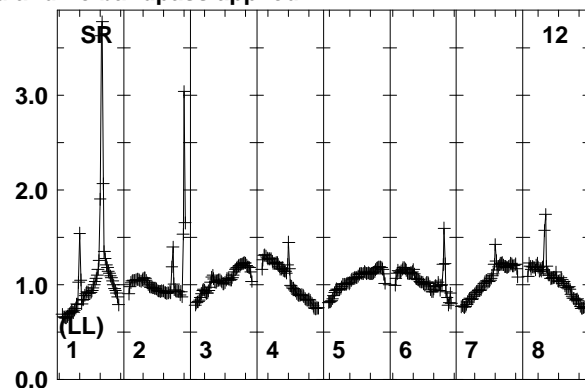
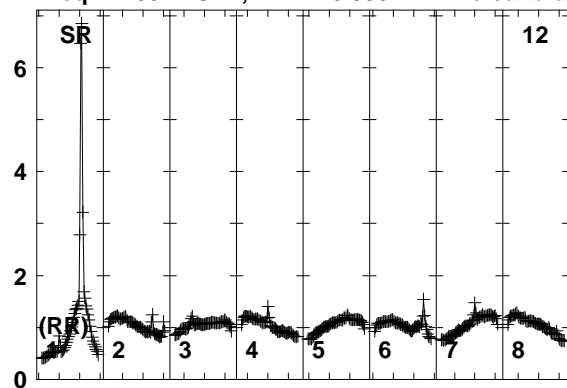

Lower frame: Real Jy
Total-power spectrum Antenna: SR (12)
Timerange: 00/06:30:06 to 00/06:32:44

Plot file version 418 created 04-NOV-2019 14:14:34

J2248-0541 EY034.UVDATA.1

Freq = 1.5947 GHz, Bw = 16.000 MH No calibration applied and no bandpass applied

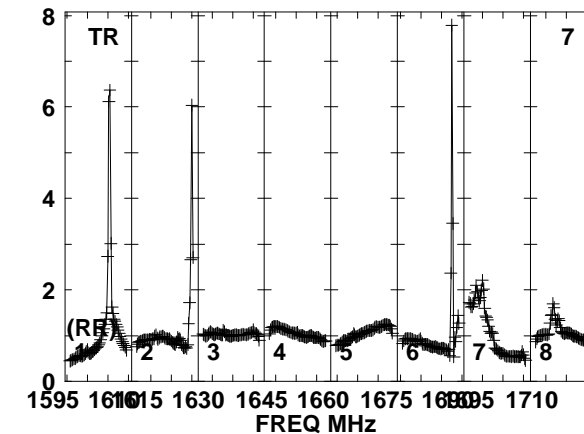
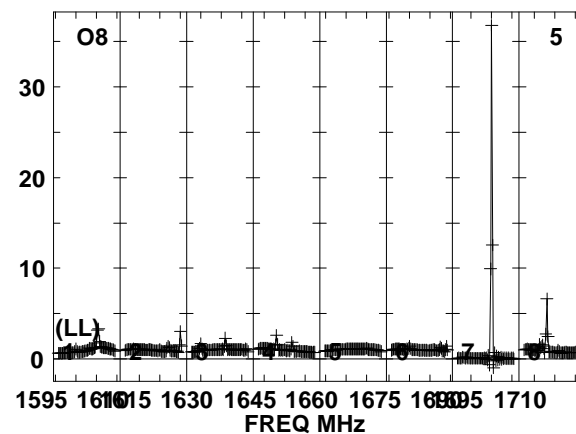
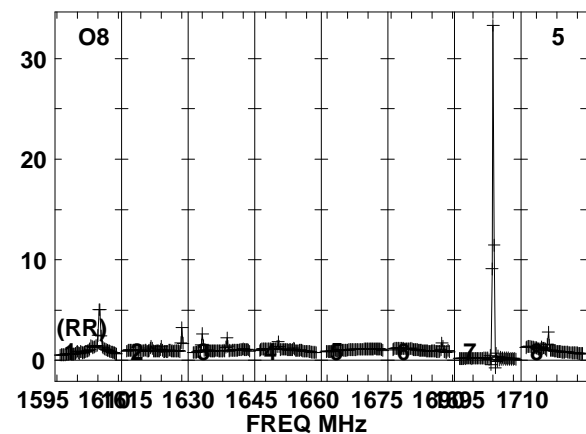
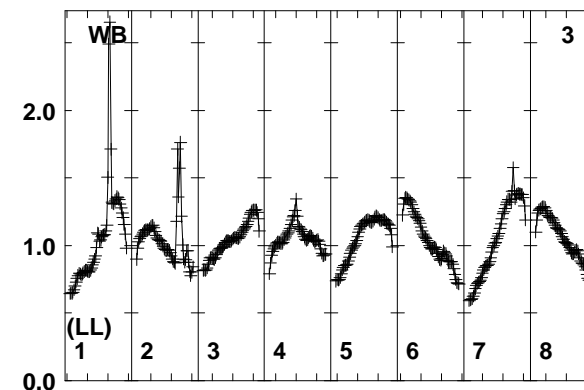
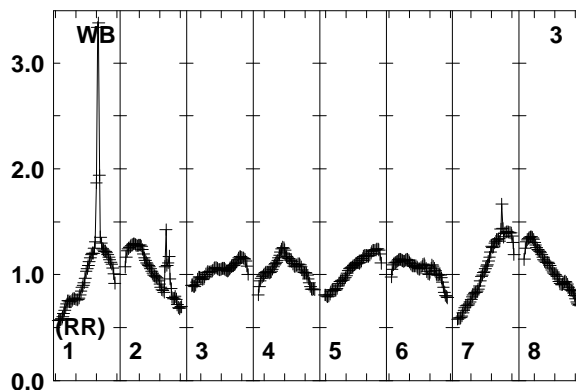
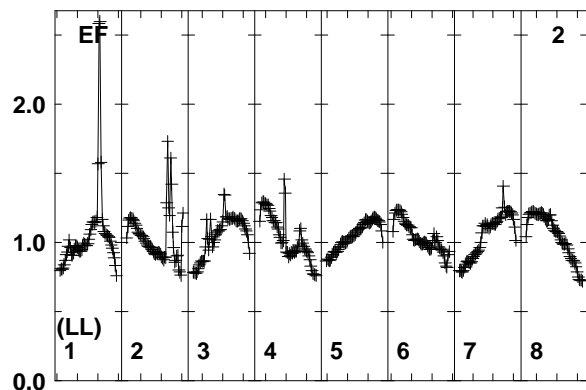
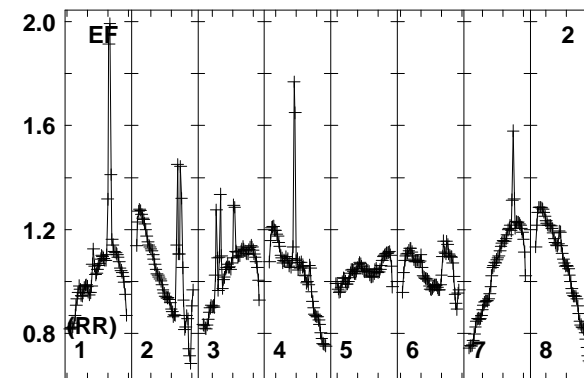
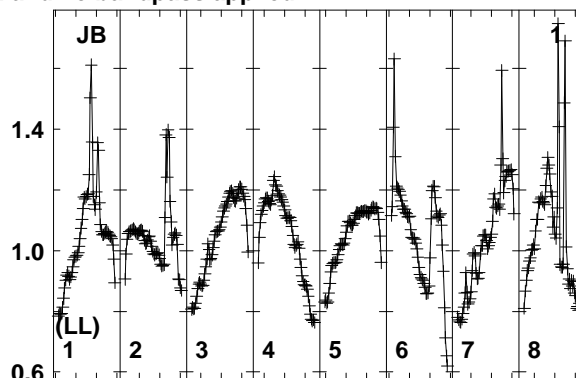
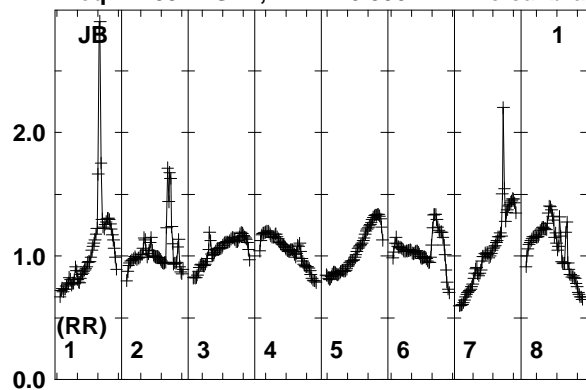

Lower frame: Real Jy
Total-power spectrum Antenna: JB (01)
Timerange: 00/06:33:01 to 00/06:33:59

Plot file version 419 created 04-NOV-2019 14:14:34

J2248-0541 EY034.UVDATA.1

Freq = 1.5947 GHz, Bw = 16.000 MH No calibration applied and no bandpass applied

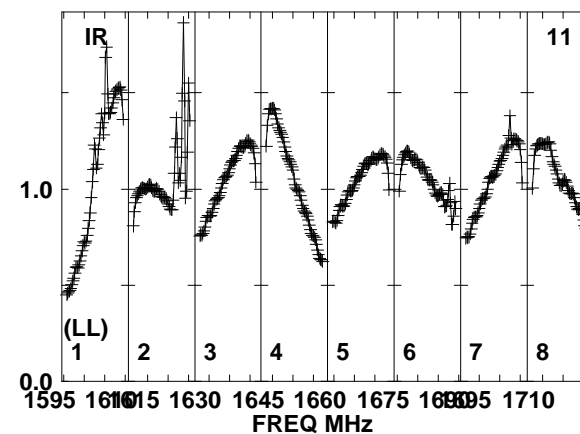
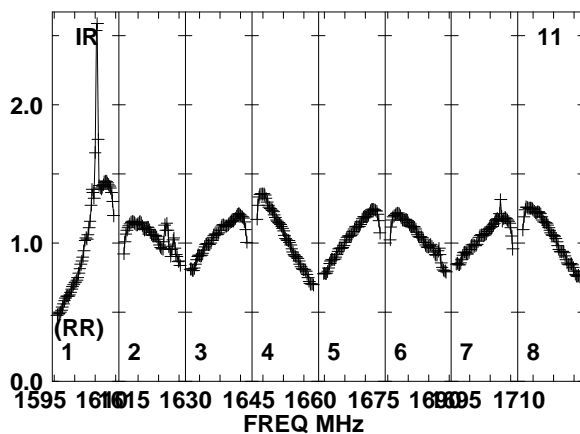
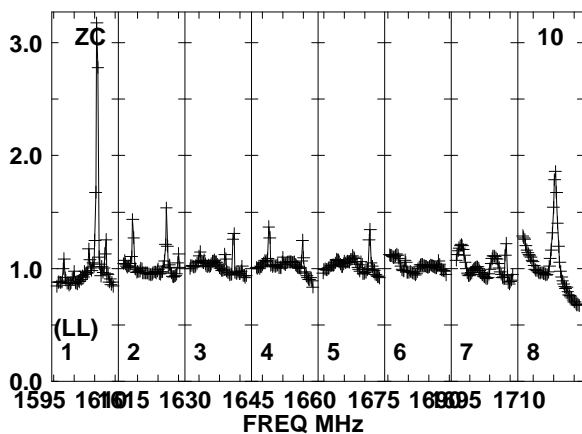
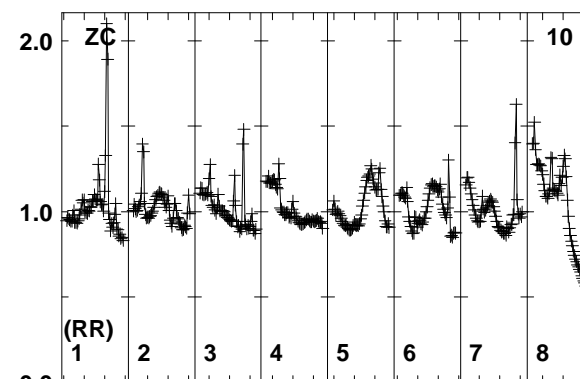
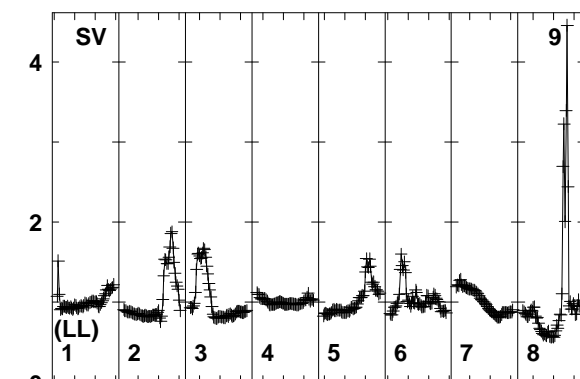
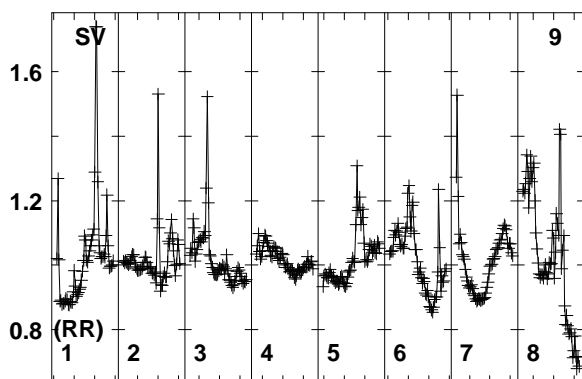
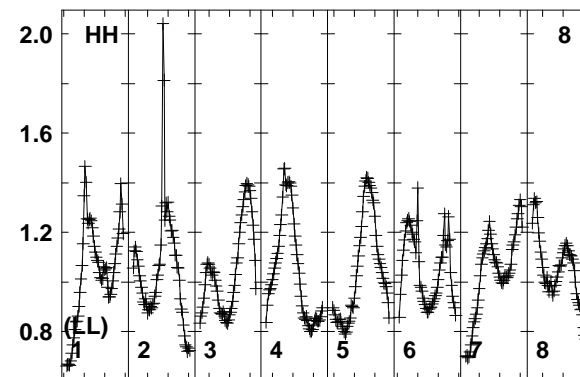
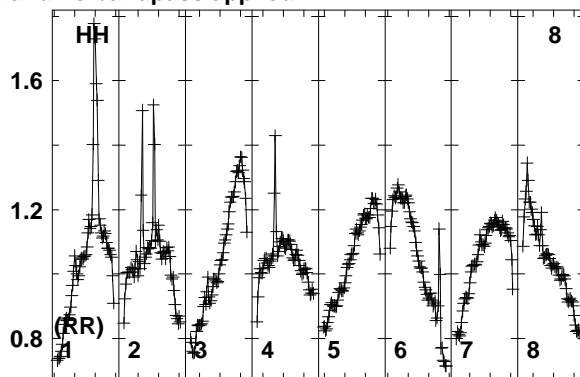
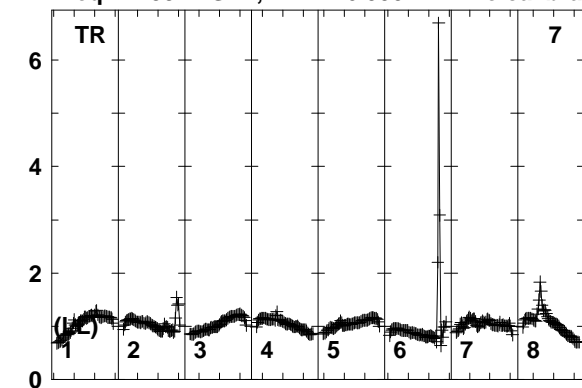

Lower frame: Real Jy
Total-power spectrum Antenna: TR (07)
Timerange: 00/06:33:01 to 00/06:33:59

Plot file version 420 created 04-NOV-2019 14:14:34

J2248-0541 EY034.UVDATA.1

Freq = 1.5947 GHz, Bw = 16.000 MH No calibration applied and no bandpass applied

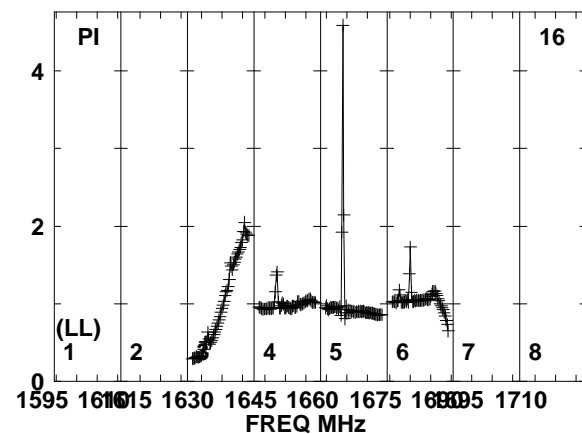
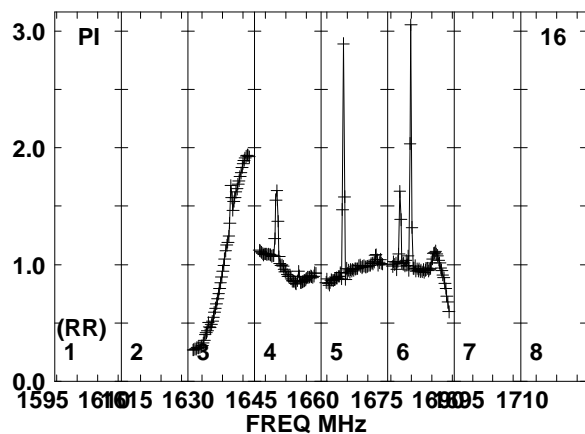
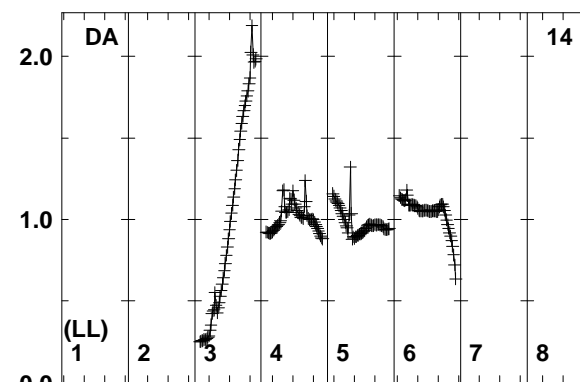
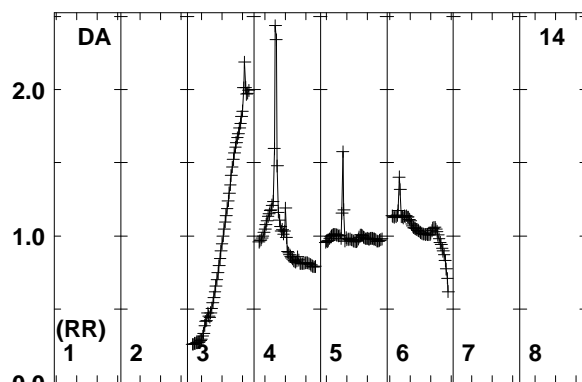
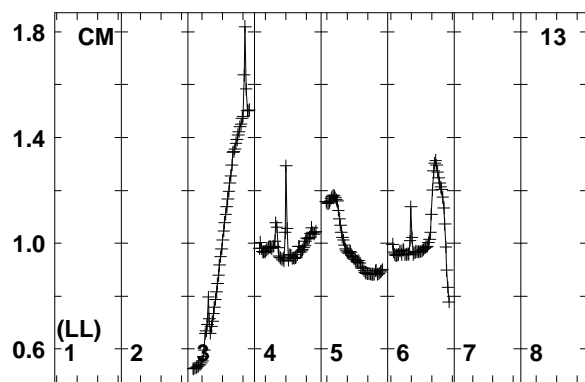
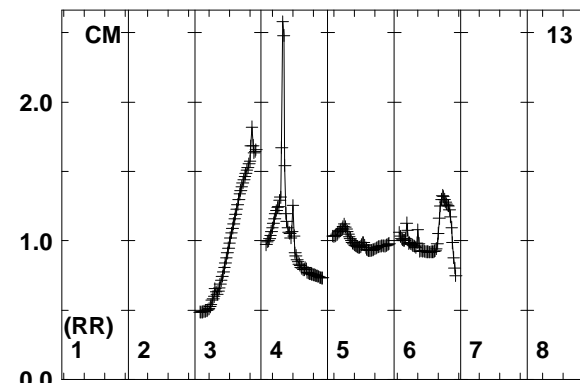
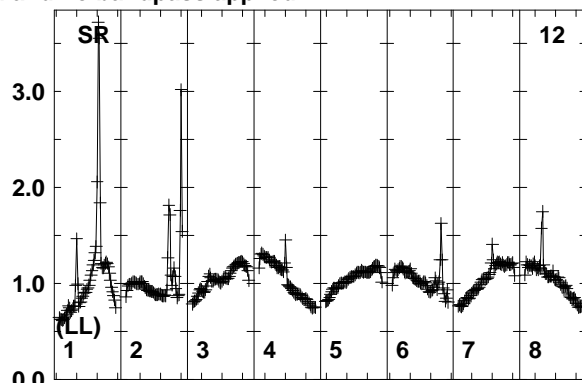
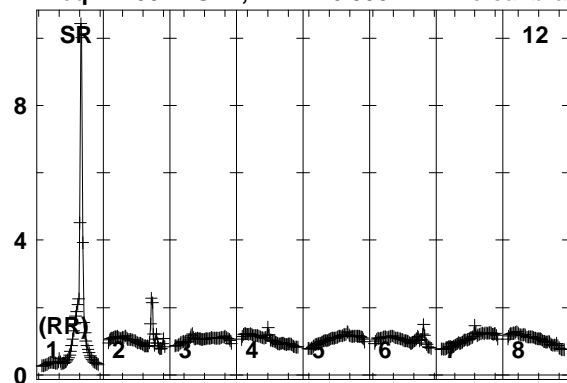

Lower frame: Real Jy
Total-power spectrum Antenna: SR (12)
Timerange: 00/06:33:01 to 00/06:33:59

Plot file version 421 created 04-NOV-2019 14:14:34

J2245-0755 EY034.UVDATA.1

Freq = 1.5947 GHz, Bw = 16.000 MH No calibration applied and no bandpass applied

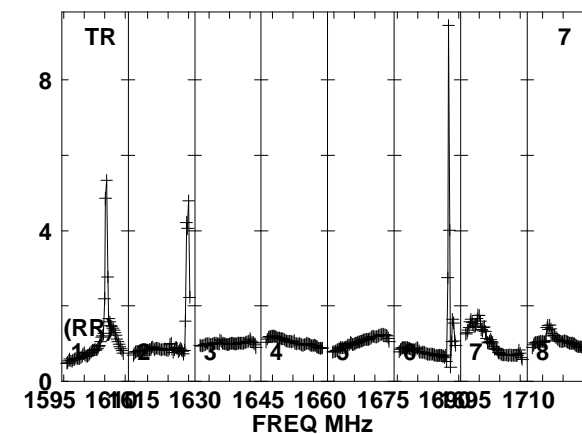
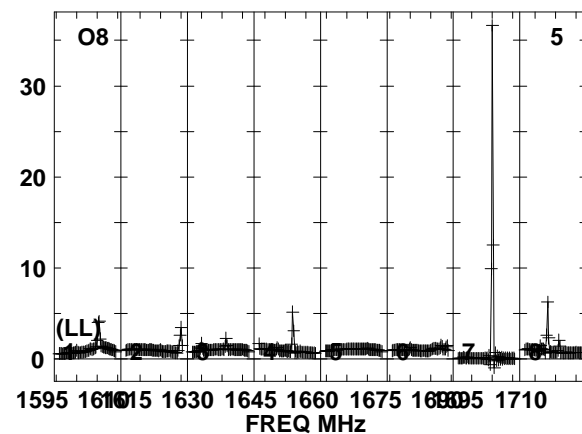
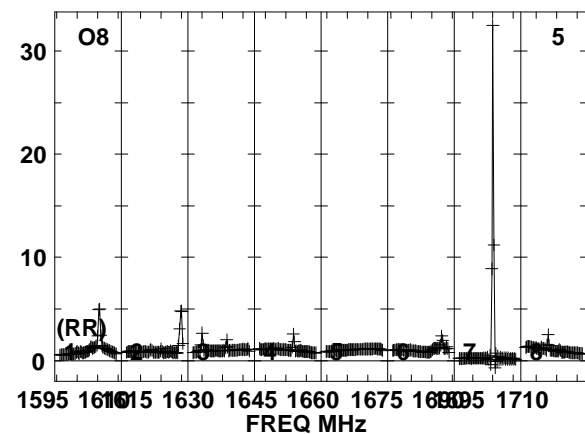
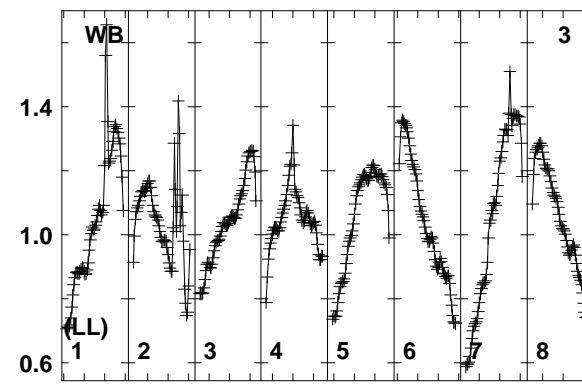
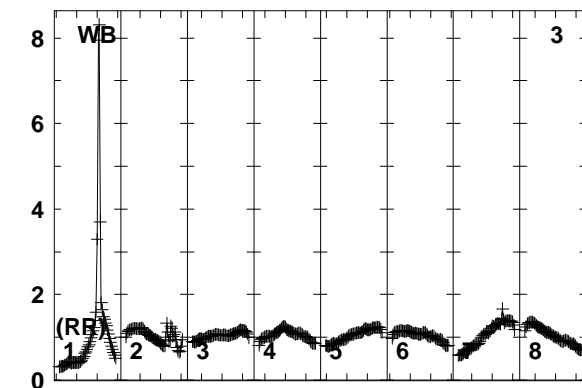
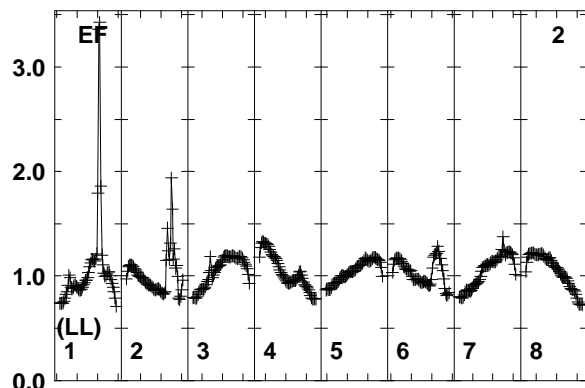
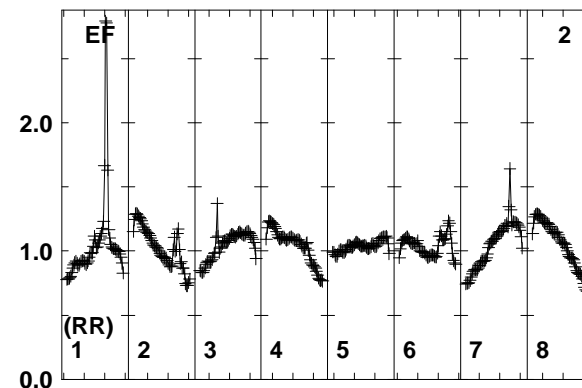
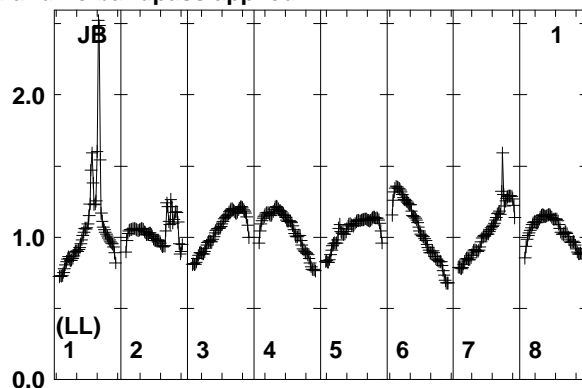
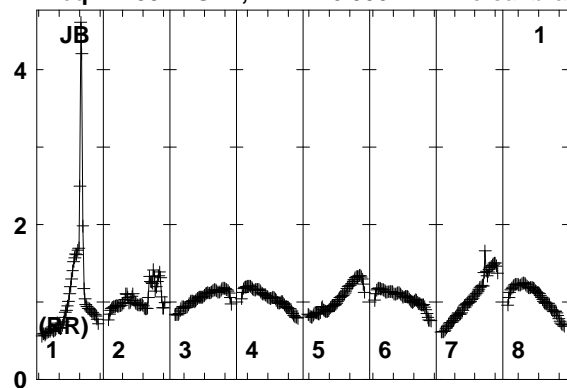

Lower frame: Real Jy
Total-power spectrum Antenna: JB (01)
Timerange: 00/06:34:16 to 00/06:35:14

Plot file version 422 created 04-NOV-2019 14:14:34

J2245-0755 EY034.UVDATA.1

Freq = 1.5947 GHz, Bw = 16.000 MH No calibration applied and no bandpass applied

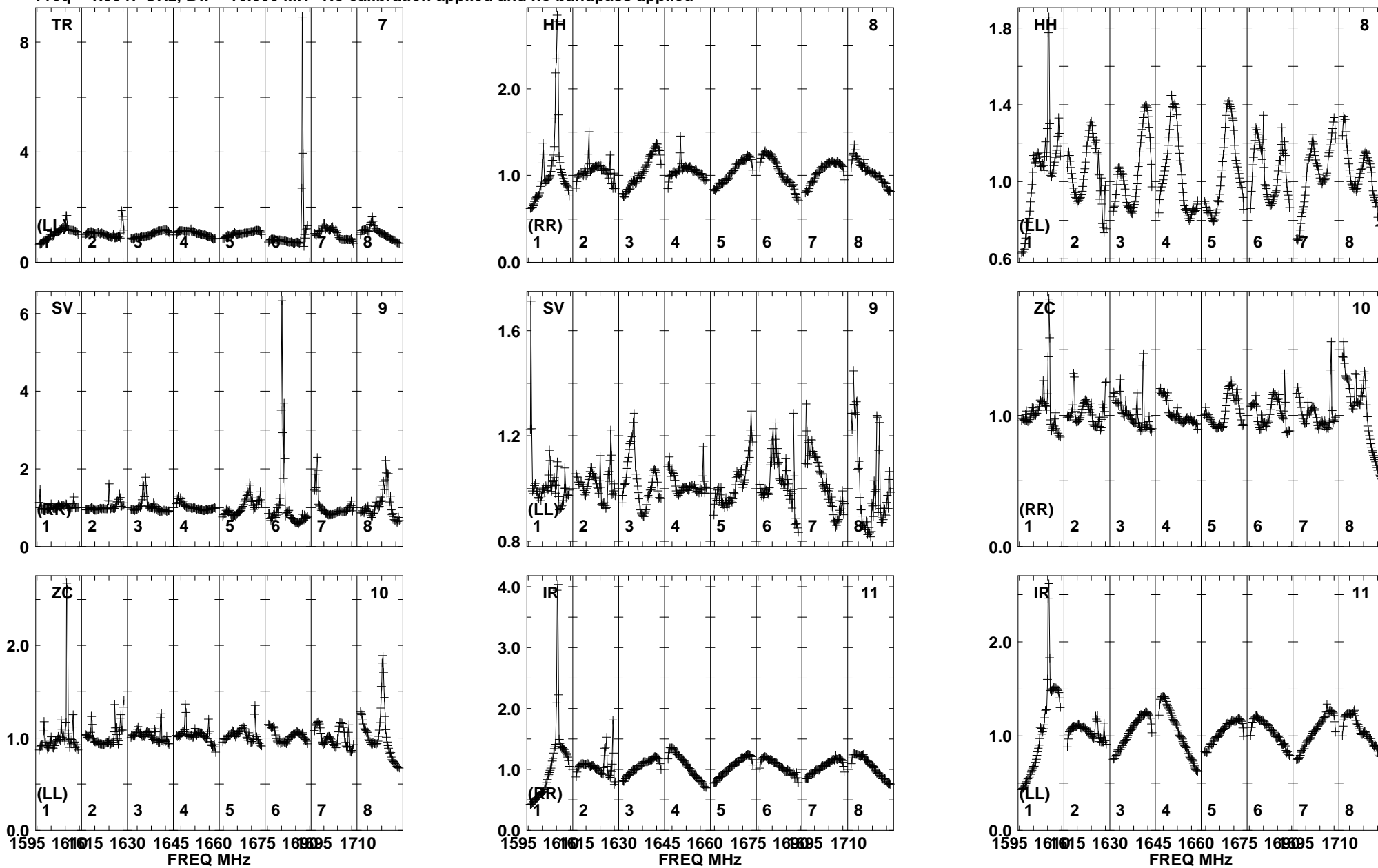

Lower frame: Real Jy
Total-power spectrum Antenna: TR (07)
Timerange: 00/06:34:16 to 00/06:35:14

Plot file version 423 created 04-NOV-2019 14:14:34

J2245-0755 EY034.UVDATA.1

Freq = 1.5947 GHz, Bw = 16.000 MH No calibration applied and no bandpass applied

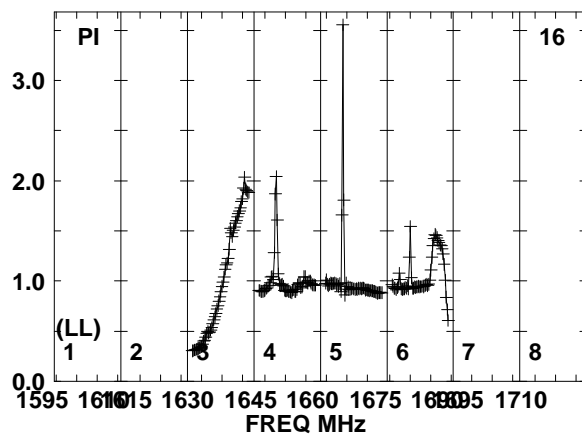
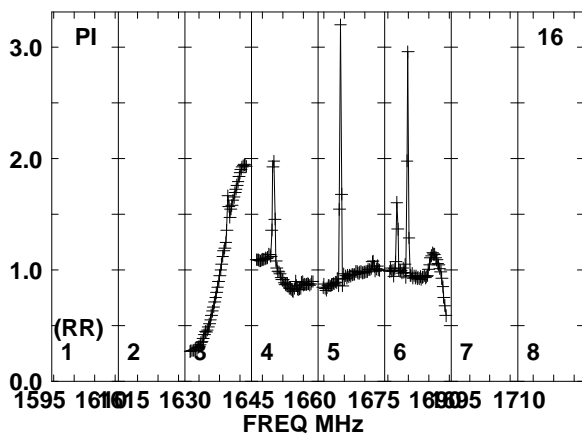
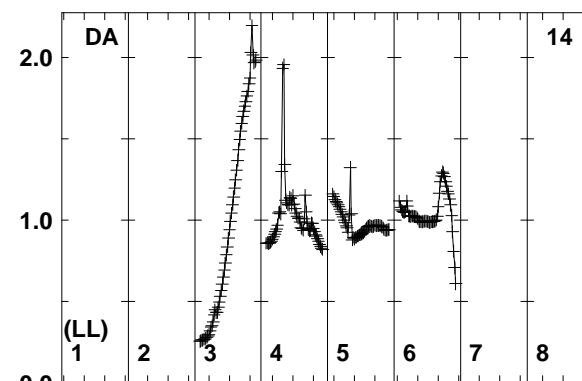
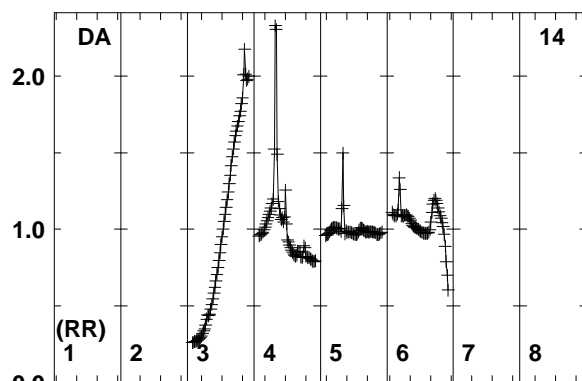
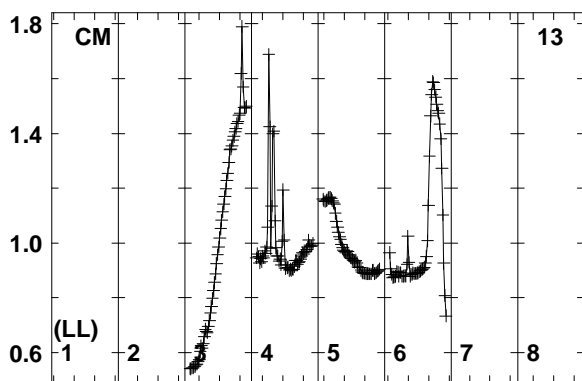
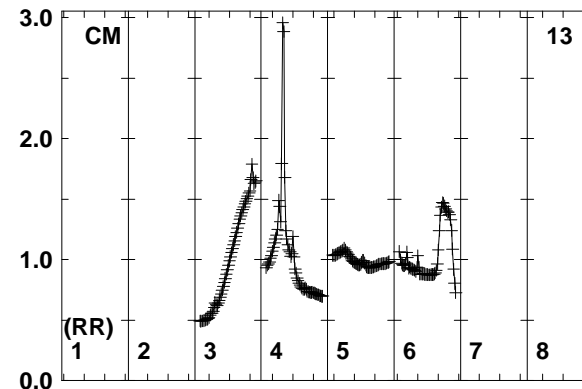
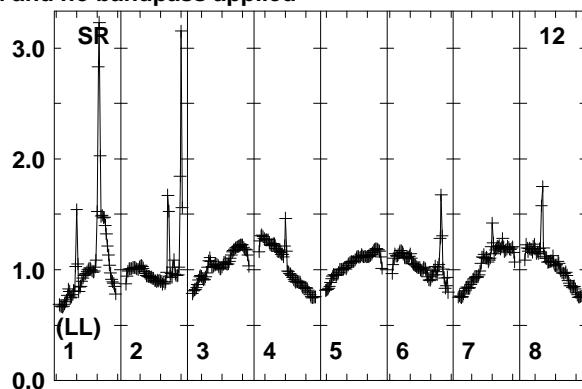
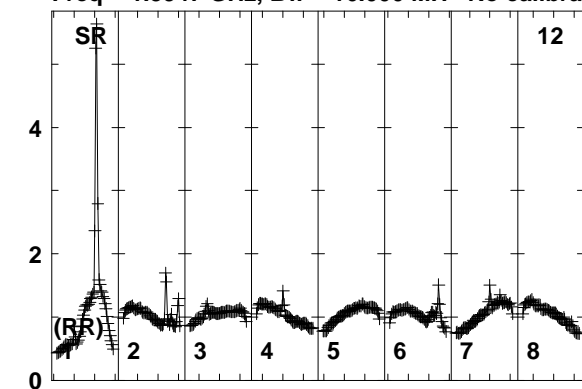

Lower frame: Real Jy
Total-power spectrum Antenna: SR (12)
Timerange: 00/06:34:16 to 00/06:35:14

Plot file version 424 created 04-NOV-2019 14:14:34

J2248-0541 EY034.UVDATA.1

Freq = 1.5947 GHz, Bw = 16.000 MH No calibration applied and no bandpass applied

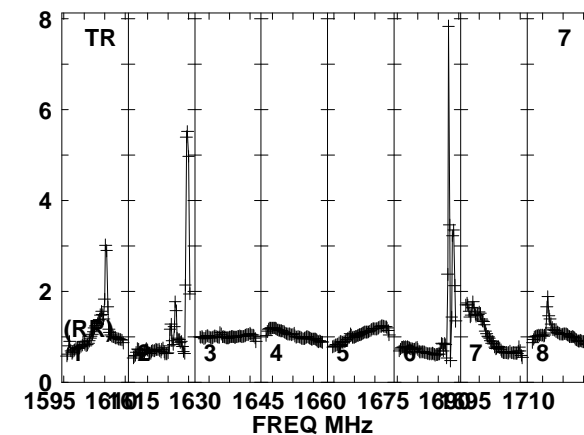
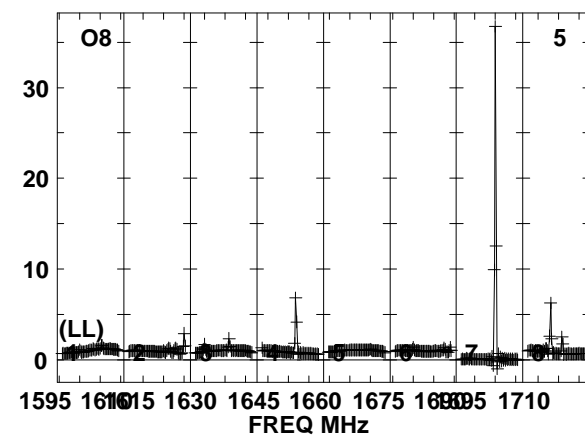
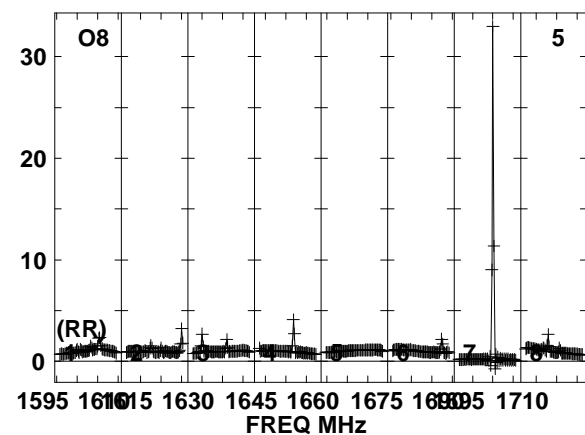
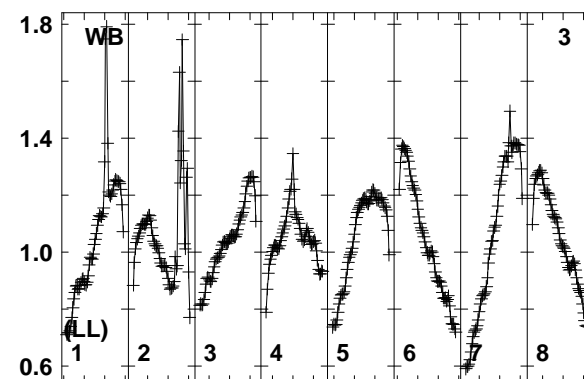
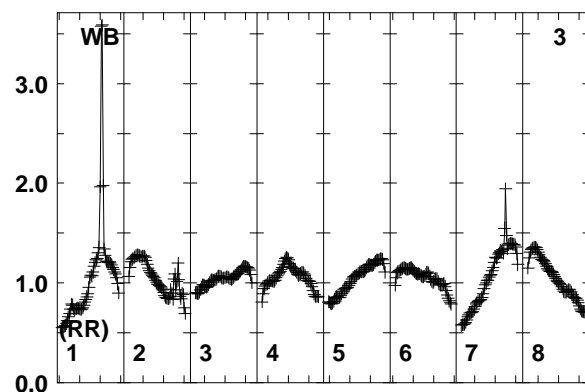
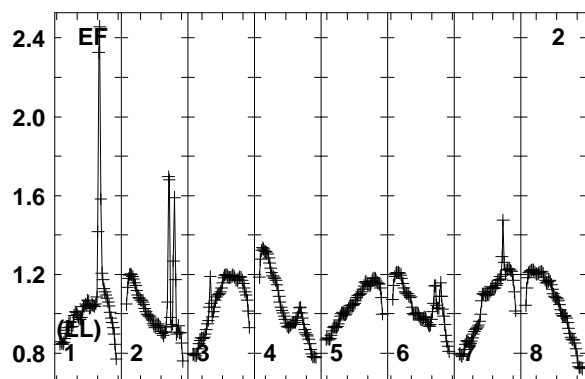
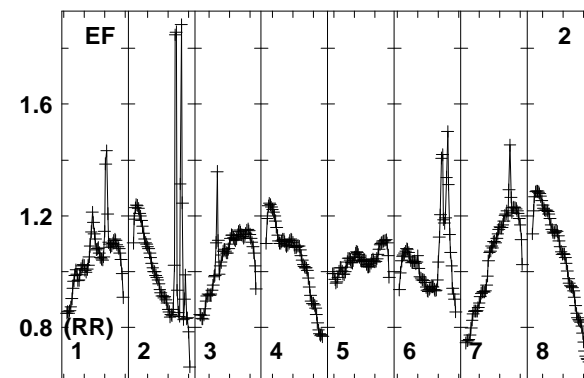
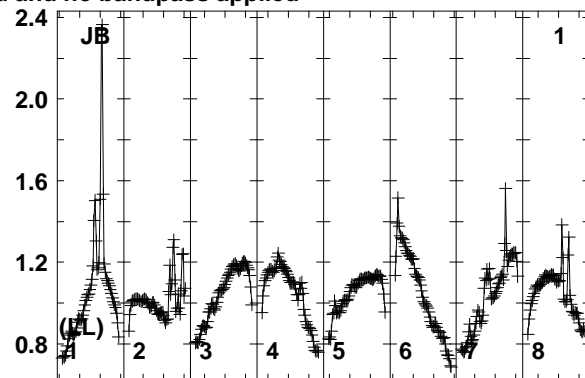
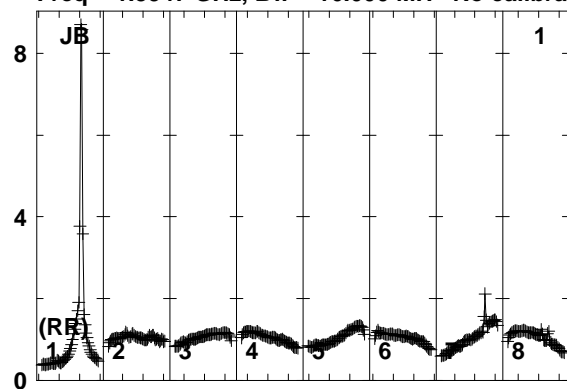

Lower frame: Real Jy
Total-power spectrum Antenna: JB (01)
Timerange: 00/06:36:01 to 00/06:36:59

Plot file version 425 created 04-NOV-2019 14:14:34

J2248-0541 EY034.UVDATA.1

Freq = 1.5947 GHz, Bw = 16.000 MH No calibration applied and no bandpass applied

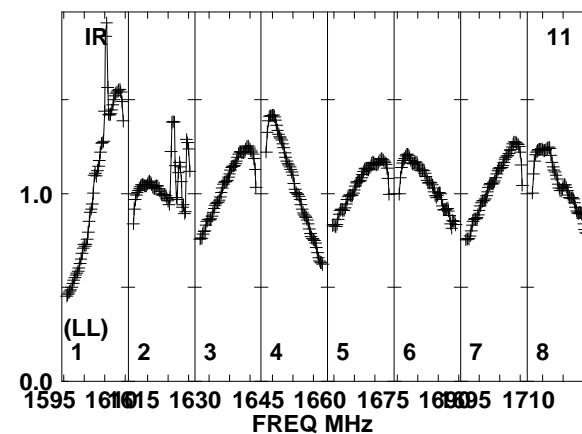
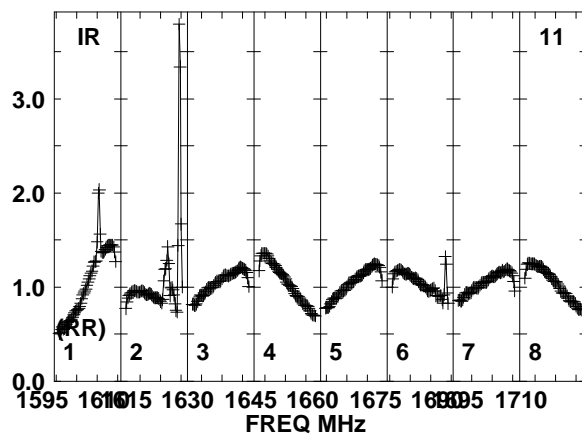
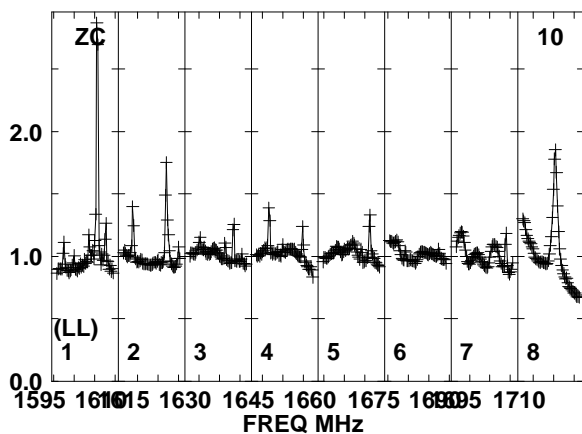
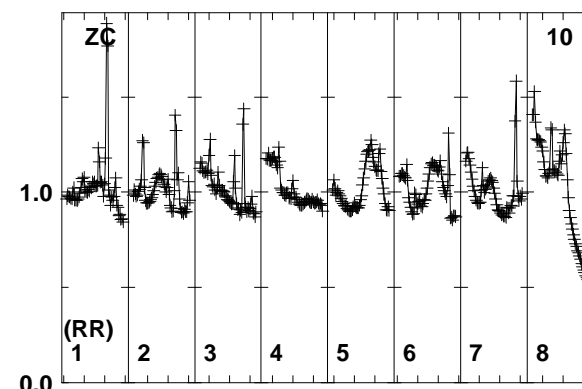
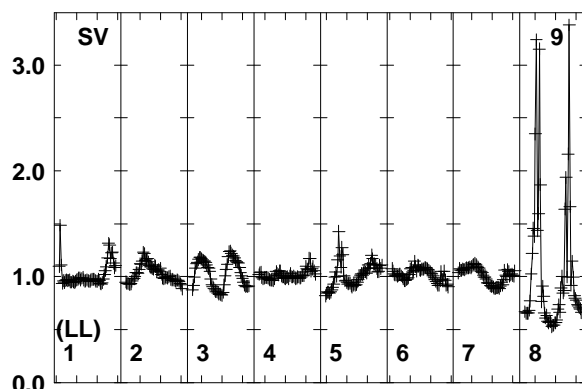
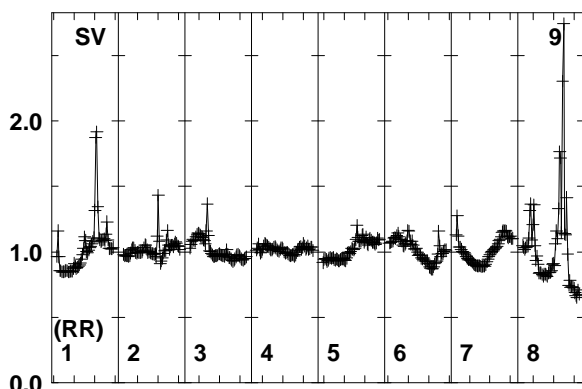
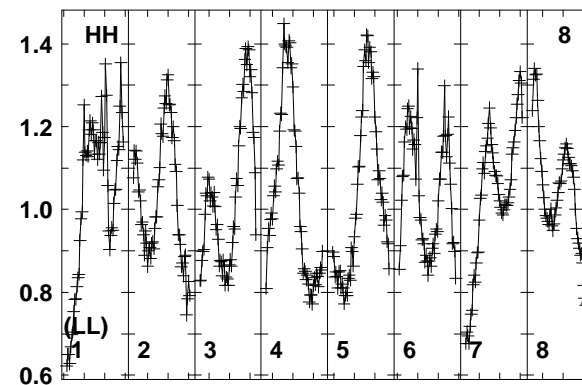
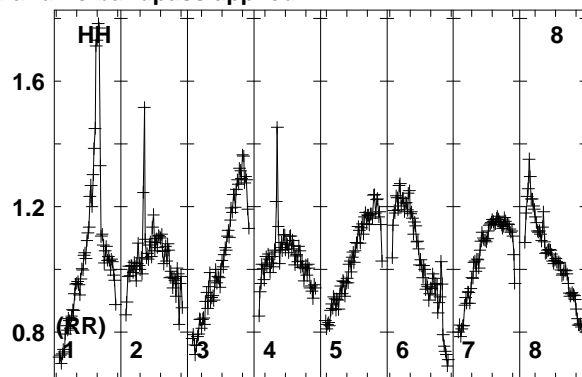
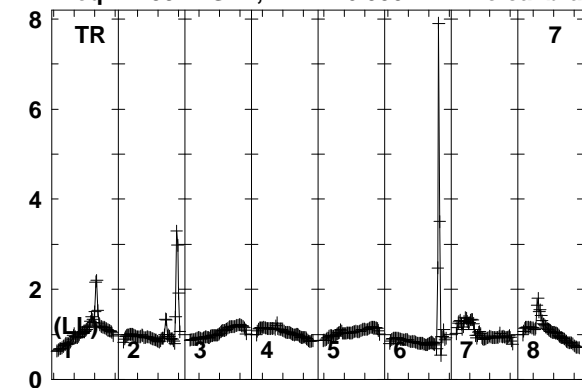

Lower frame: Real Jy
Total-power spectrum Antenna: TR (07)
Timerange: 00/06:36:01 to 00/06:36:59

Plot file version 426 created 04-NOV-2019 14:14:34

J2248-0541 EY034.UVDATA.1

Freq = 1.5947 GHz, Bw = 16.000 MH No calibration applied and no bandpass applied

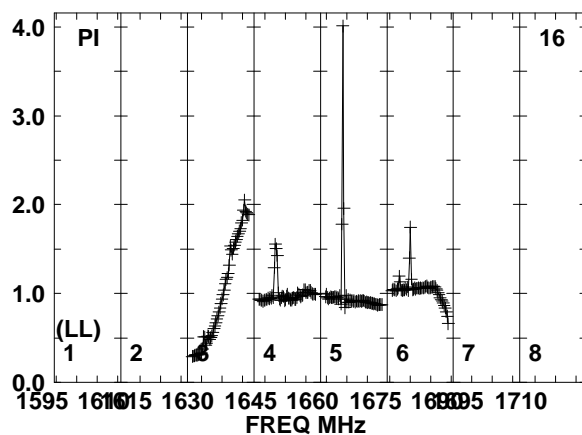
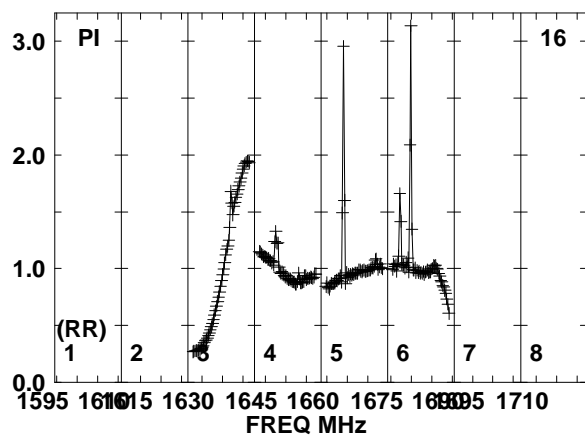
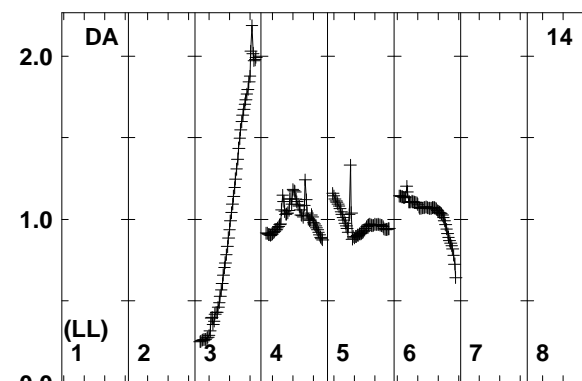
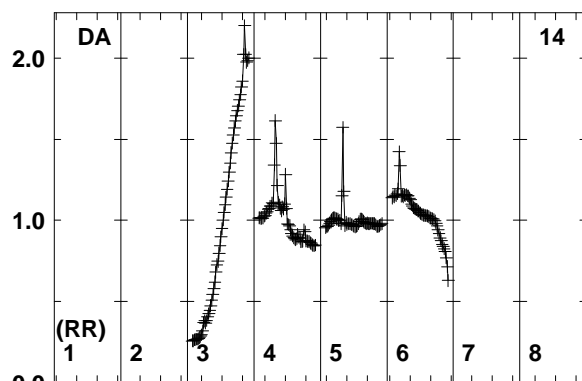
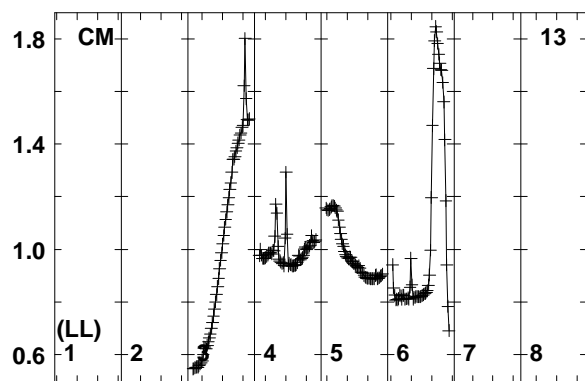
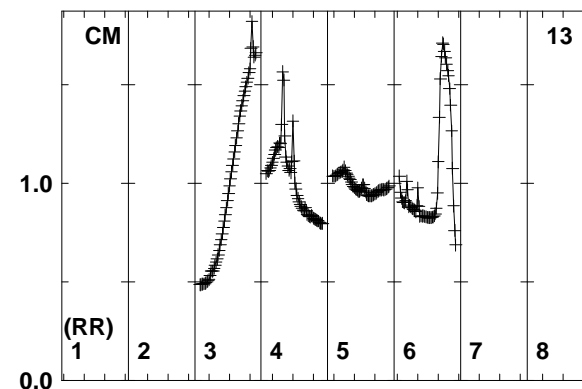
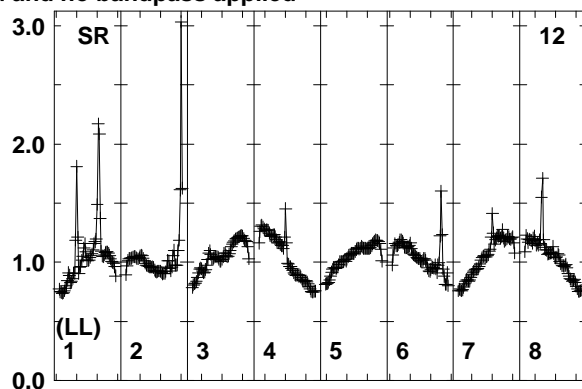
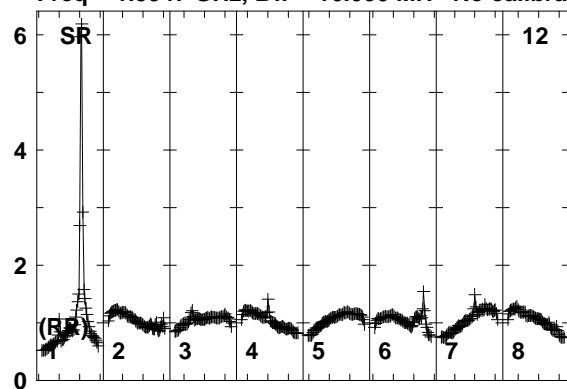

Lower frame: Real Jy
Total-power spectrum Antenna: SR (12)
Timerange: 00/06:36:01 to 00/06:36:59

Plot file version 427 created 04-NOV-2019 14:14:34

W2246-0526 EY034.UVDATA.1

Freq = 1.5947 GHz, Bw = 16.000 MH No calibration applied and no bandpass applied

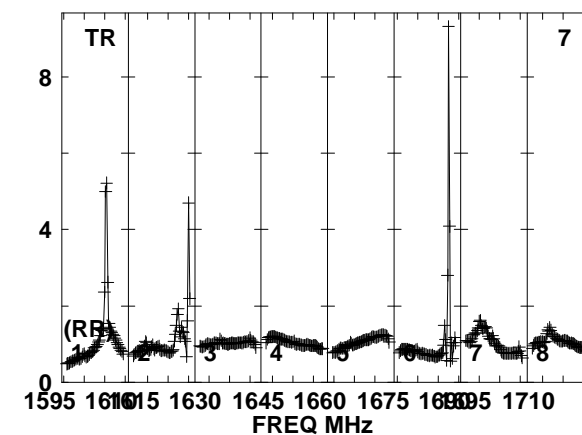
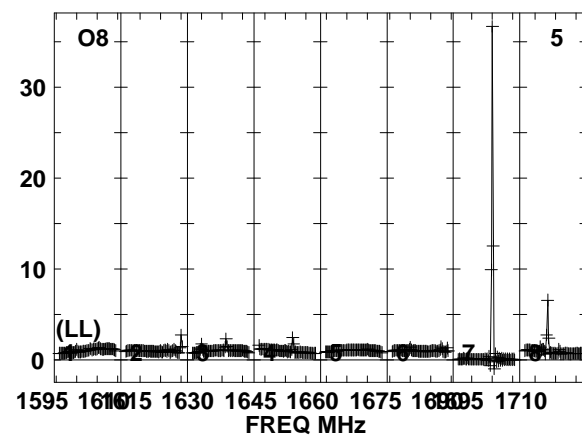
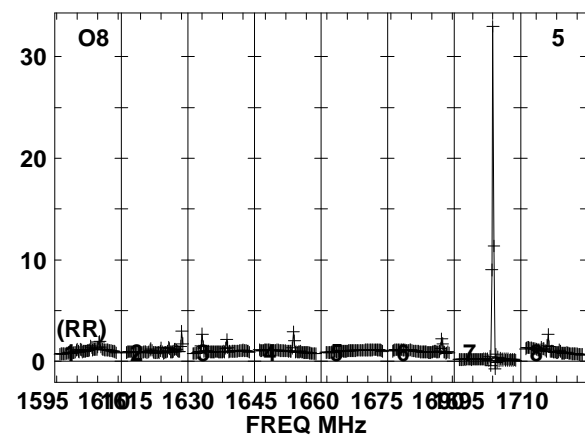
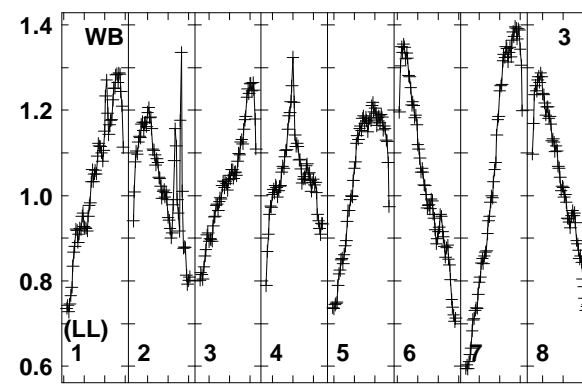
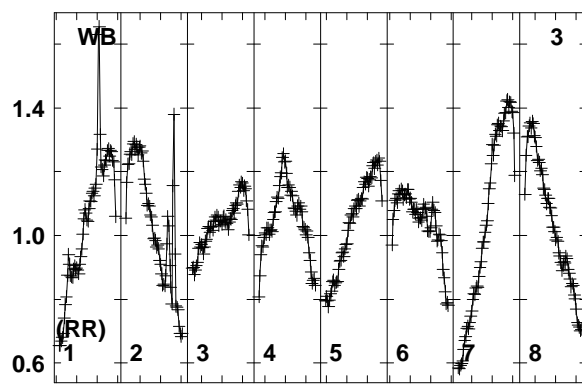
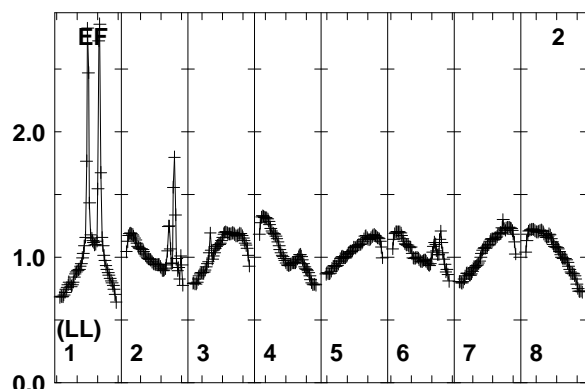
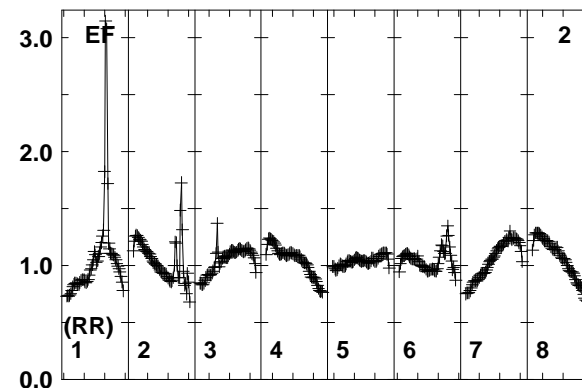
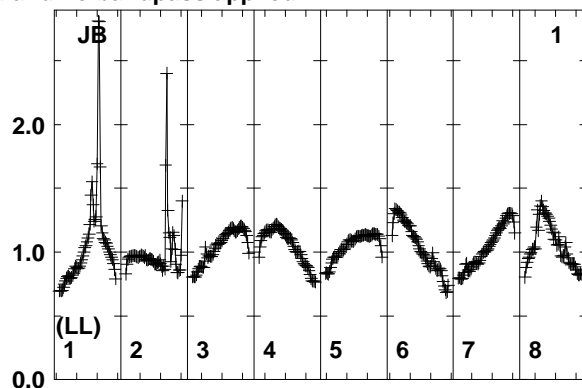
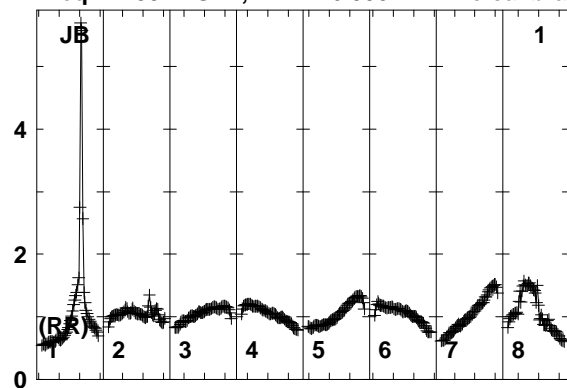

Lower frame: Real Jy
Total-power spectrum Antenna: JB (01)
Timerange: 00/06:37:01 to 00/06:39:29

Plot file version 428 created 04-NOV-2019 14:14:34

W2246-0526 EY034.UVDATA.1

Freq = 1.5947 GHz, Bw = 16.000 MH No calibration applied and no bandpass applied

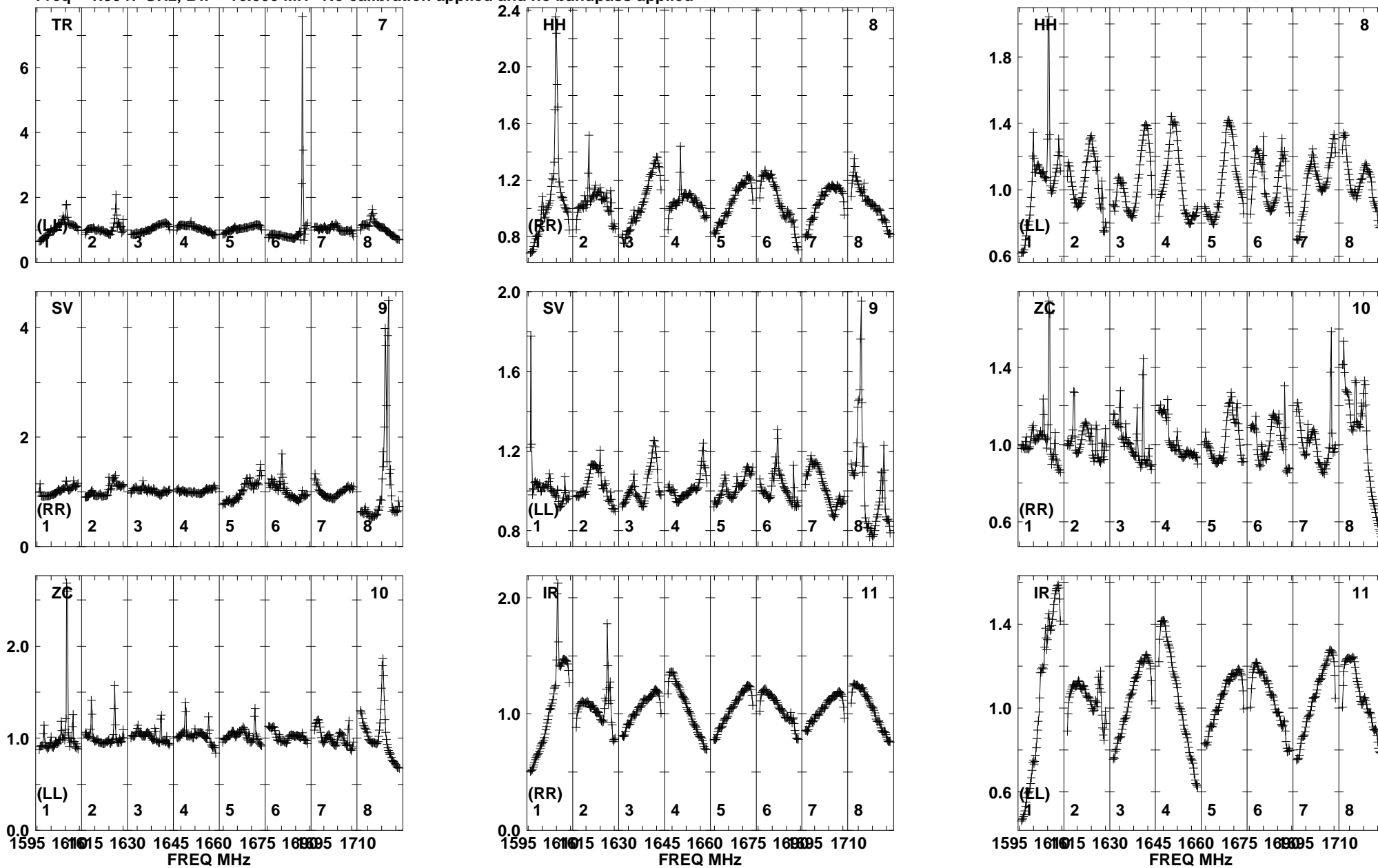

Lower frame: Real Jy
Total-power spectrum Antenna: TR (07)
Timerange: 00/06:37:01 to 00/06:39:29

Plot file version 429 created 04-NOV-2019 14:14:34

W2246-0526 EY034.UVDATA.1

Freq = 1.5947 GHz, Bw = 16.000 MH No calibration applied and no bandpass applied

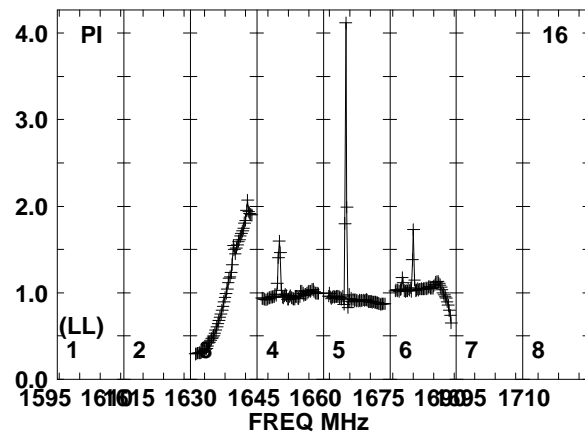
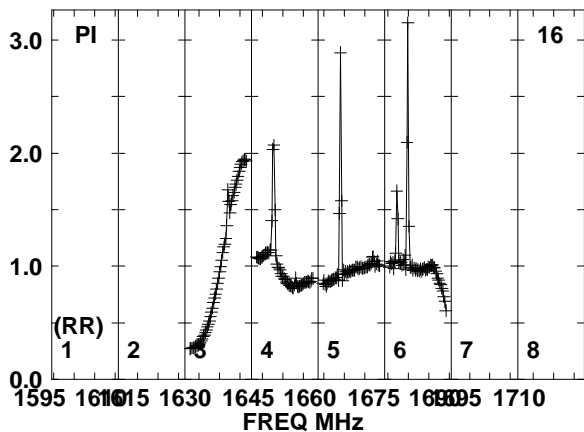
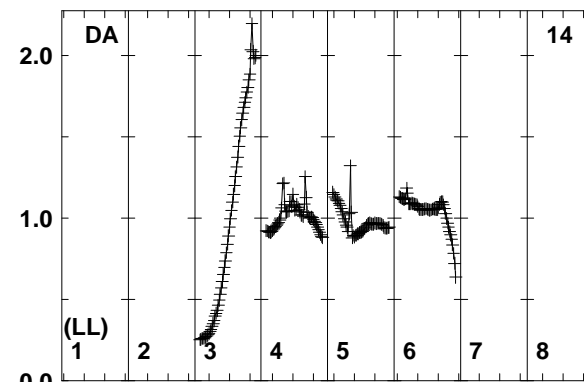
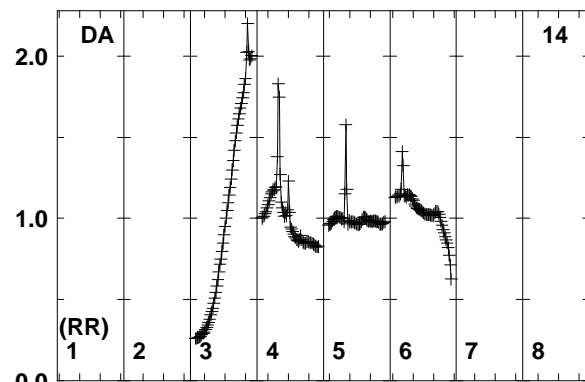
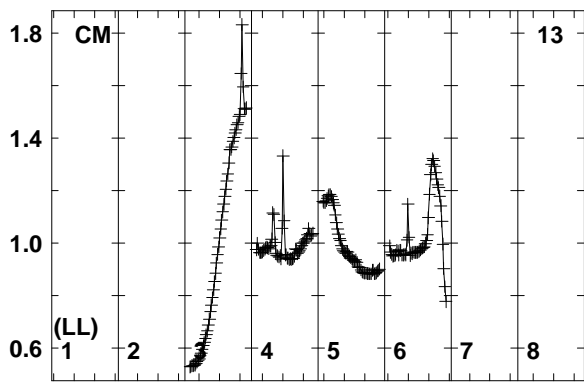
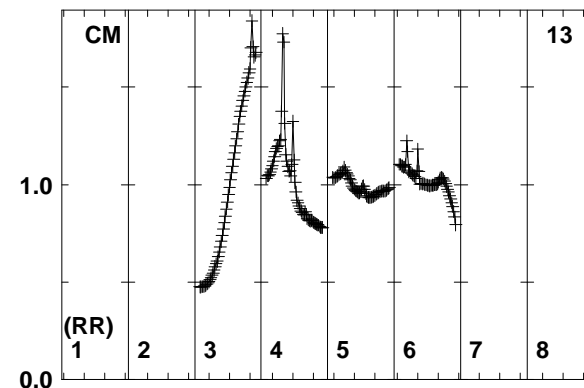
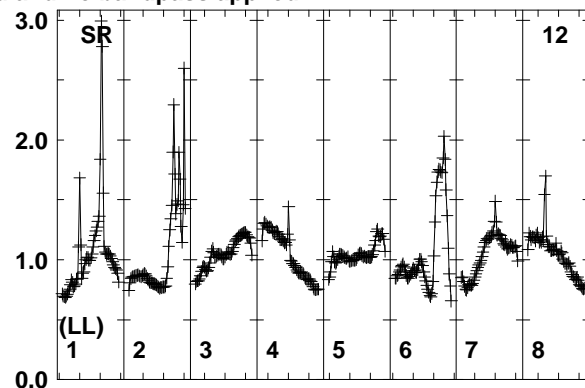
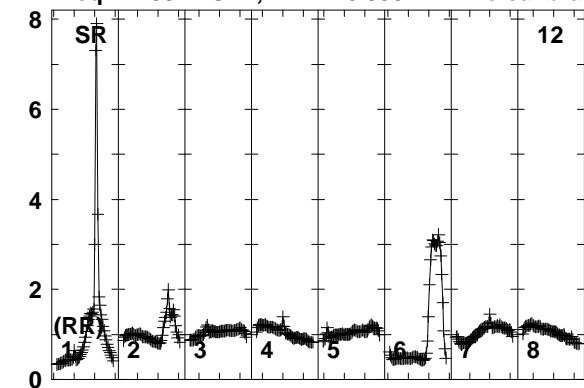

Lower frame: Real Jy
Total-power spectrum Antenna: SR (12)
Timerange: 00/06:37:01 to 00/06:39:29

Plot file version 430 created 04-NOV-2019 14:14:35

J2248-0541 EY034.UVDATA.1

Freq = 1.5947 GHz, Bw = 16.000 MH No calibration applied and no bandpass applied

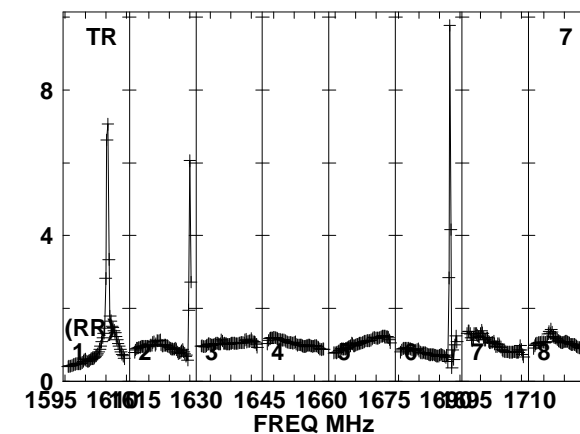
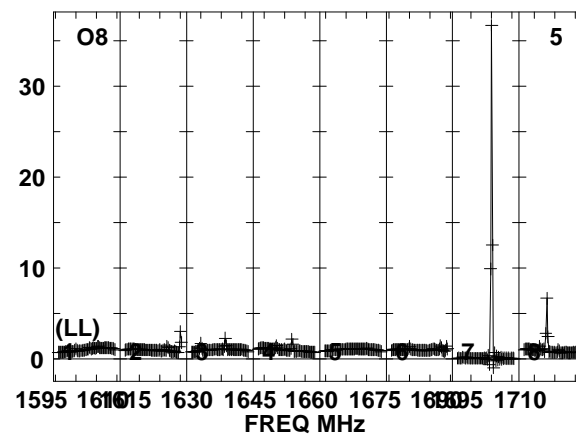
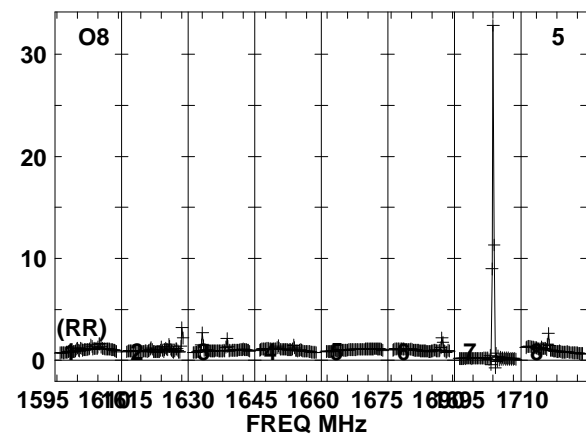
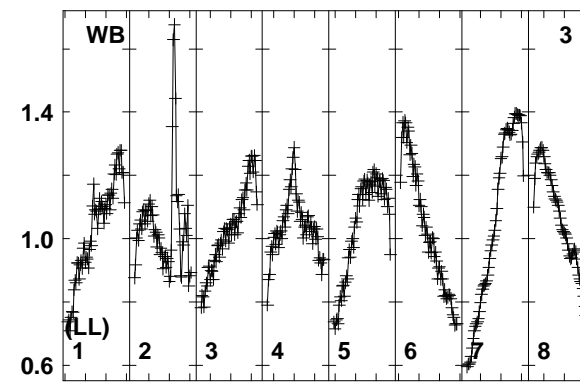
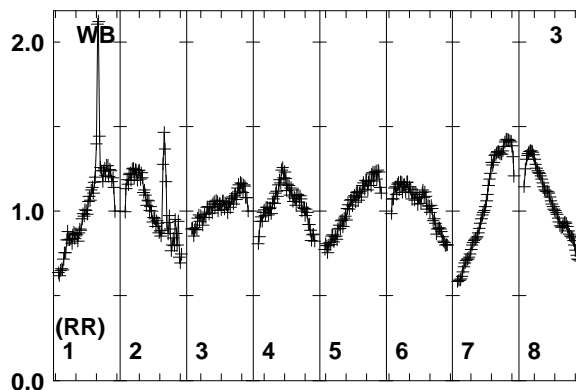
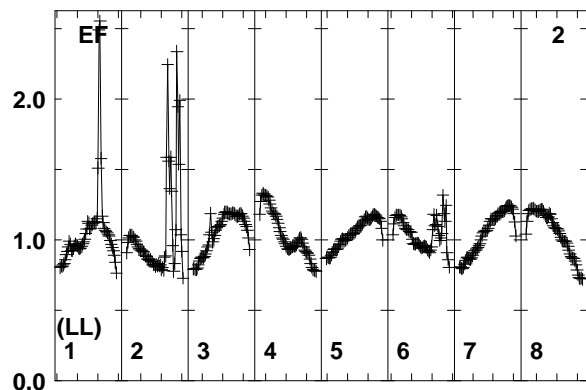
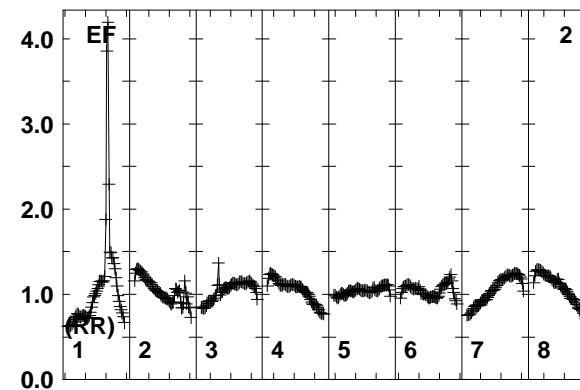
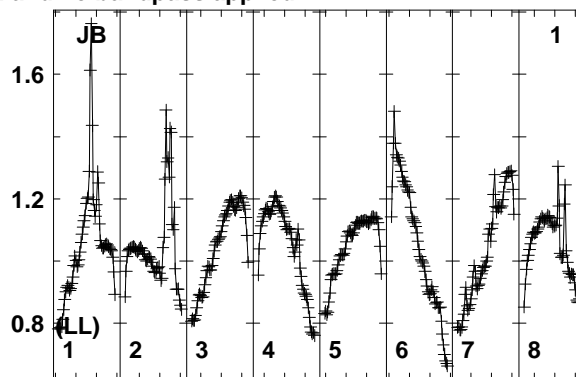
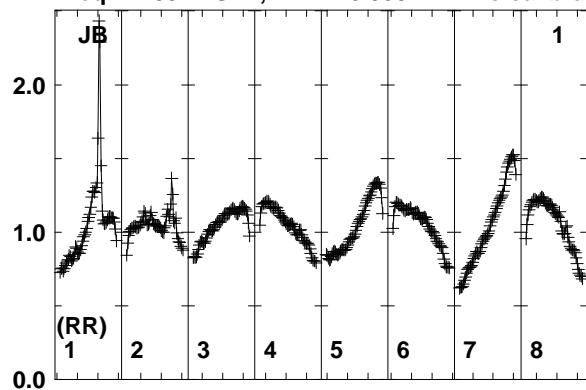

Lower frame: Real Jy
Total-power spectrum Antenna: JB (01)
Timerange: 00/06:39:46 to 00/06:40:44

Plot file version 431 created 04-NOV-2019 14:14:35

J2248-0541 EY034.UVDATA.1

Freq = 1.5947 GHz, Bw = 16.000 MH No calibration applied and no bandpass applied

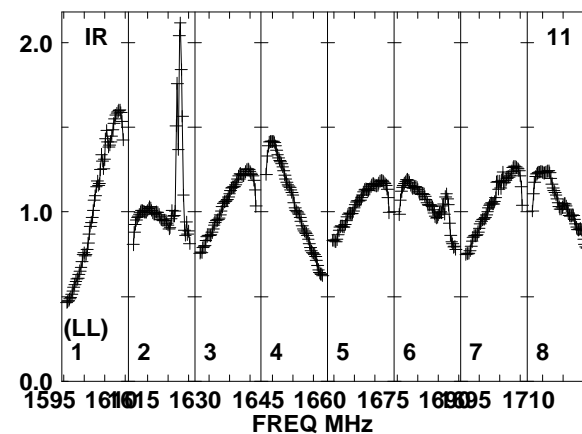
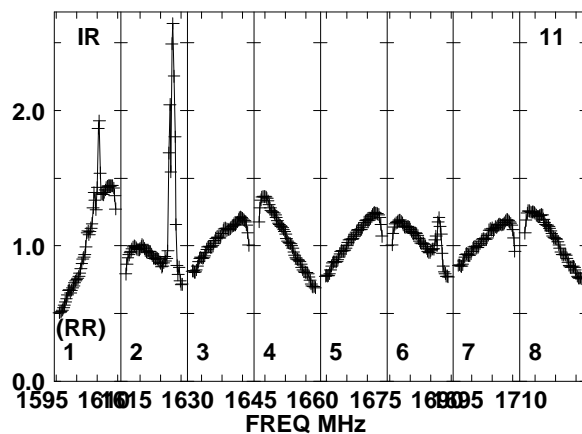
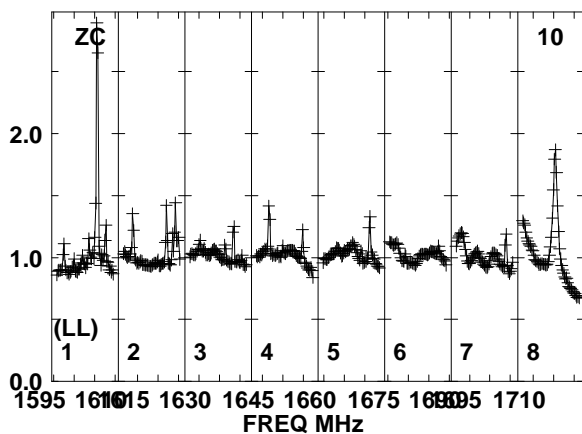
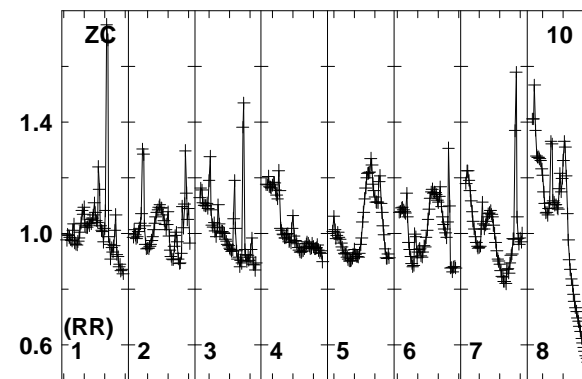
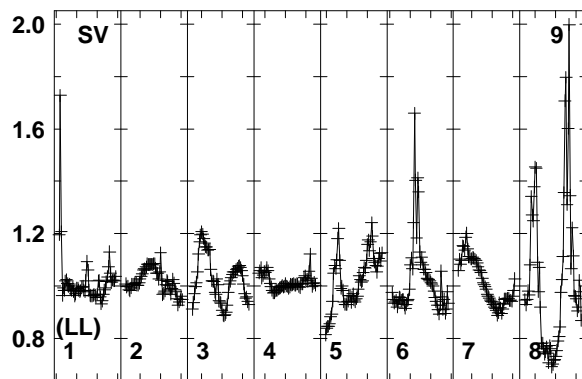
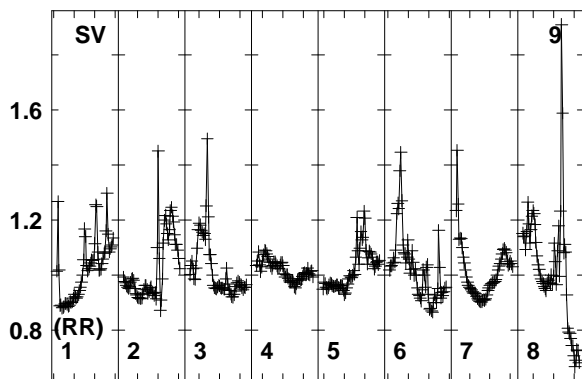
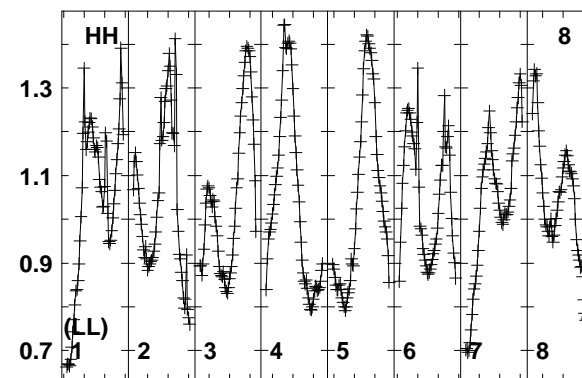
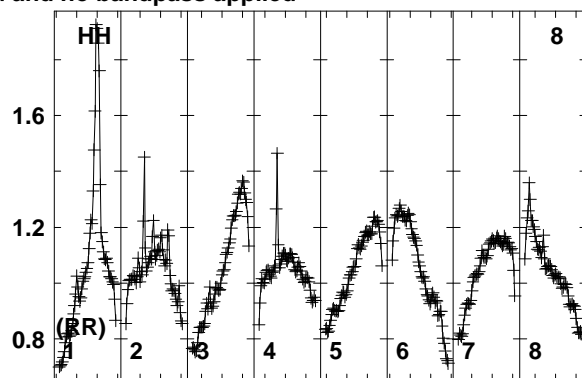
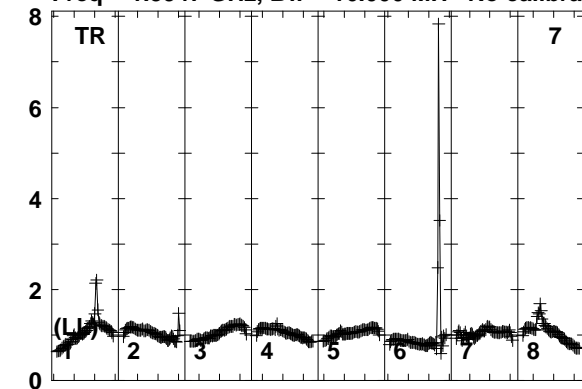

Lower frame: Real Jy
Total-power spectrum Antenna: TR (07)
Timerange: 00/06:39:46 to 00/06:40:44

Plot file version 432 created 04-NOV-2019 14:14:35

J2248-0541 EY034.UVDATA.1

Freq = 1.5947 GHz, Bw = 16.000 MH No calibration applied and no bandpass applied

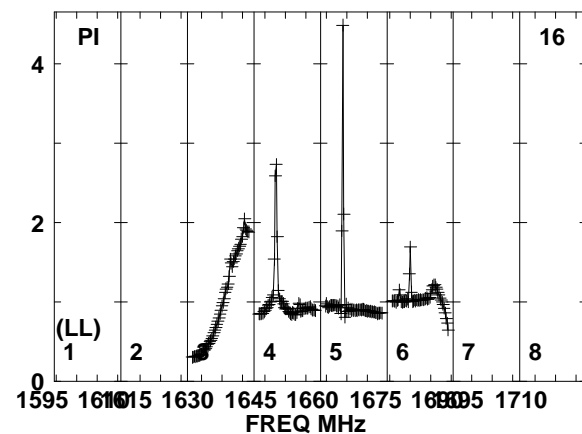
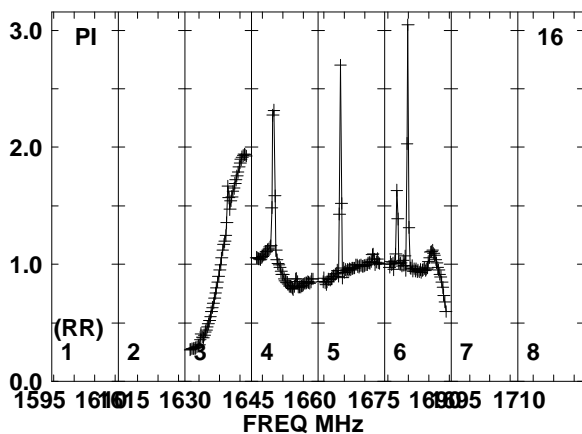
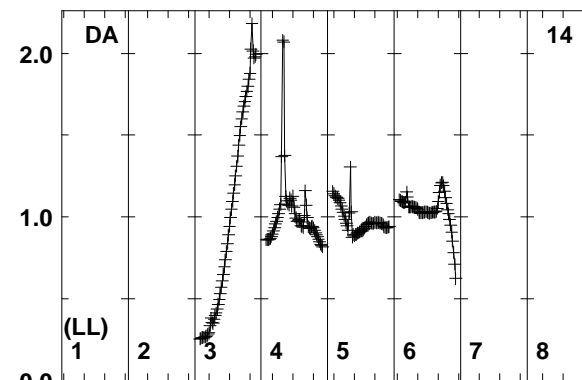
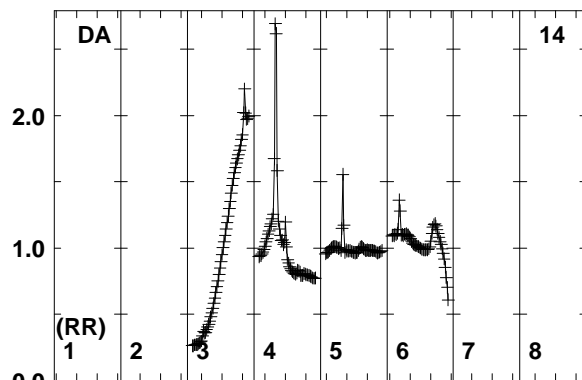
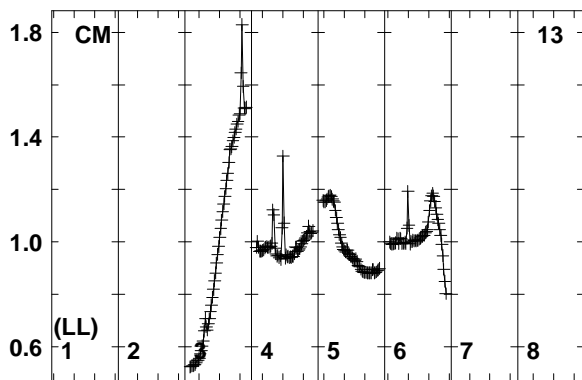
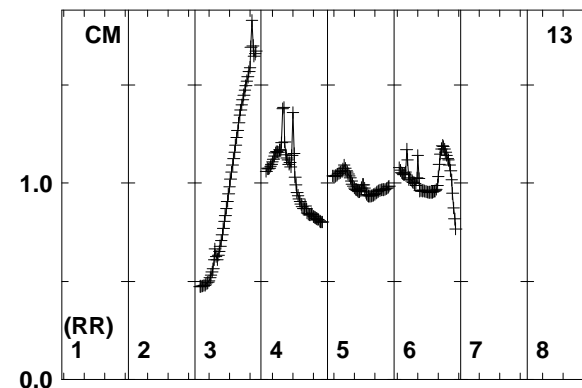
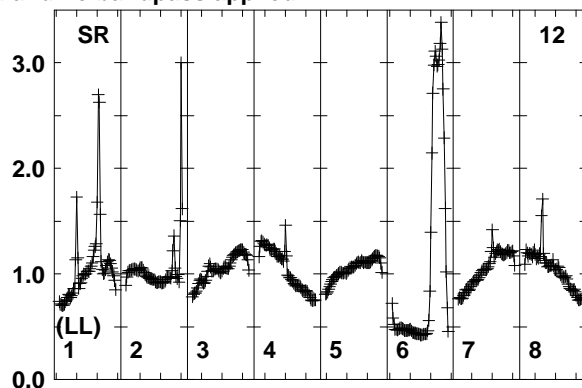
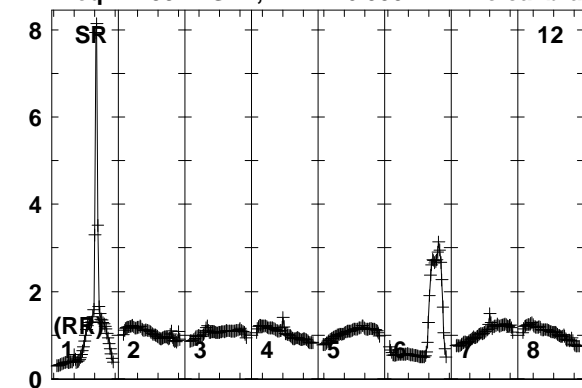

Lower frame: Real Jy
Total-power spectrum Antenna: SR (12)
Timerange: 00/06:39:46 to 00/06:40:44

Plot file version 433 created 04-NOV-2019 14:14:35
 W2246-0526 EY034.UVDATA.1
 Freq = 1.5947 GHz, Bw = 16.000 MH No calibration applied and no bandpass applied

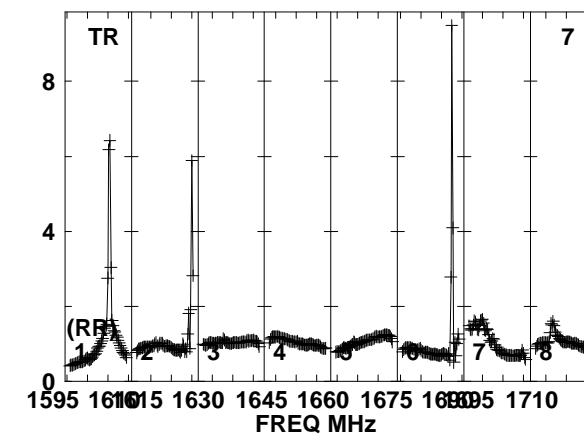
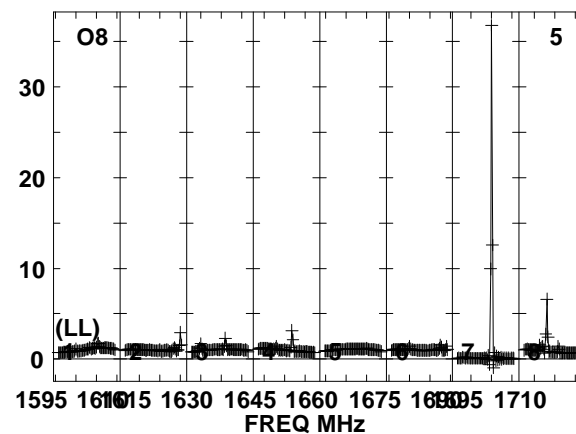
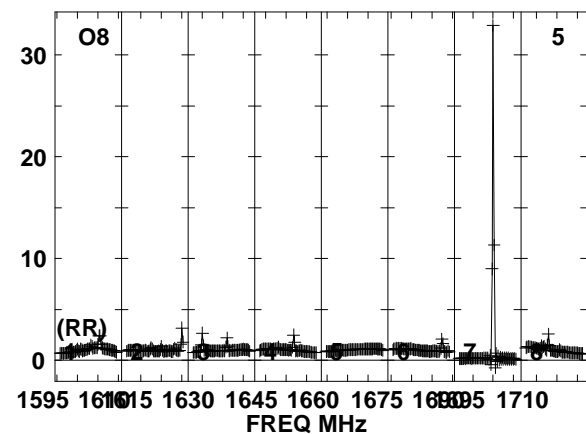
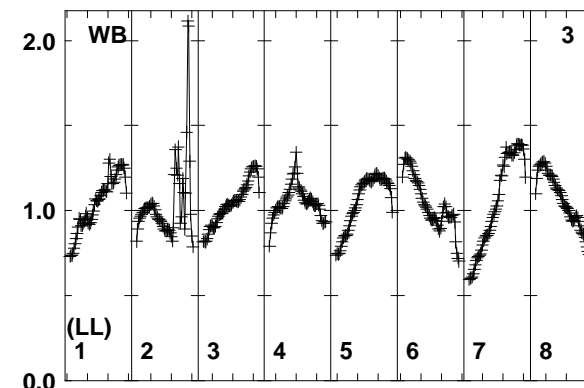
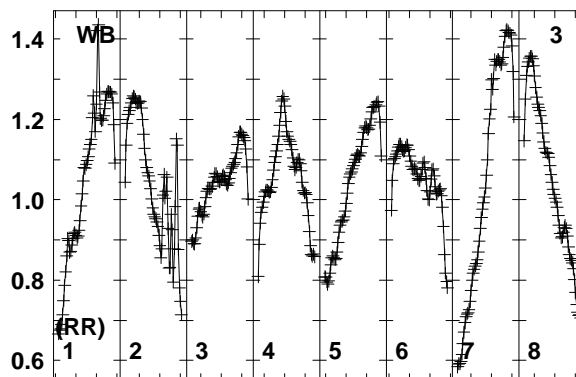
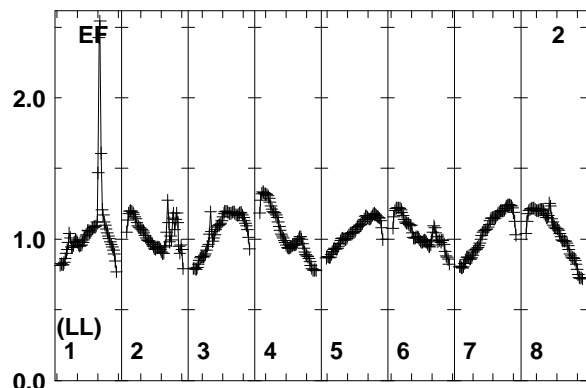
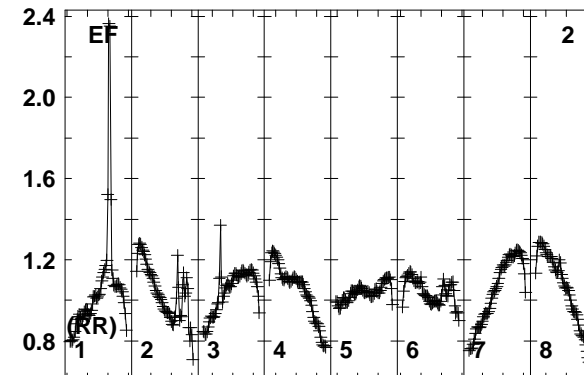
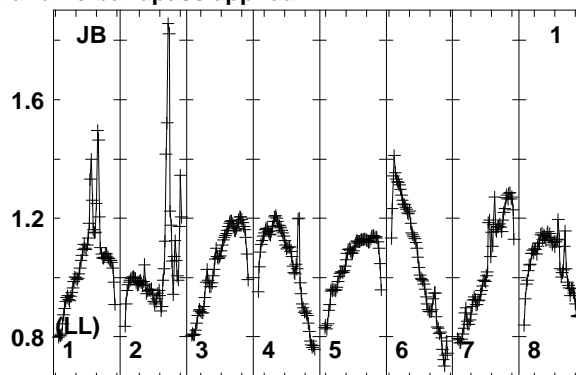
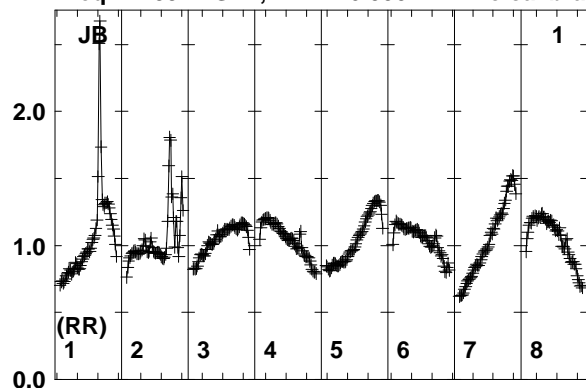

Lower frame: Real Jy
 Total-power spectrum Antenna: JB (01)
 Timerange: 00/06:40:46 to 00/06:43:24

Plot file version 434 created 04-NOV-2019 14:14:35

W2246-0526 EY034.UVDATA.1

Freq = 1.5947 GHz, Bw = 16.000 MH No calibration applied and no bandpass applied

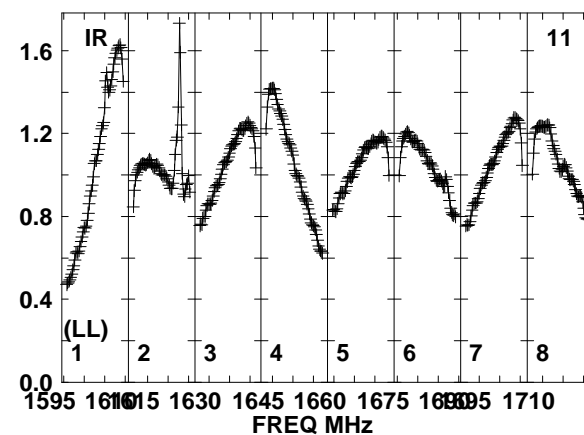
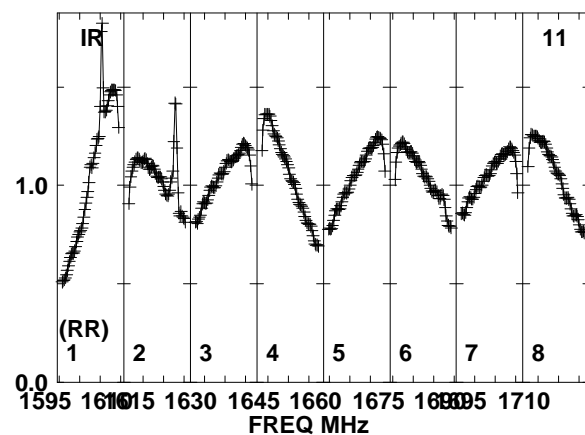
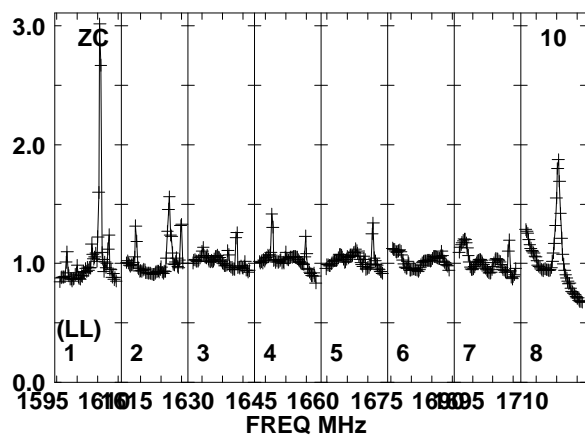
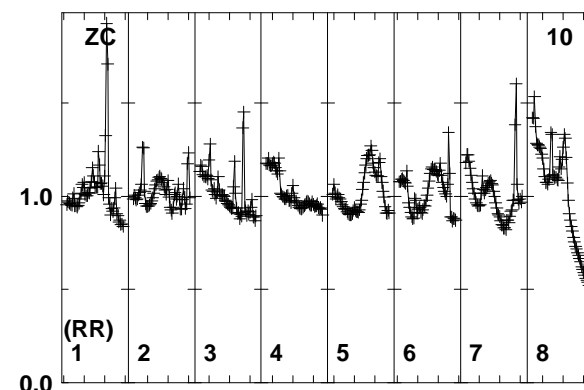
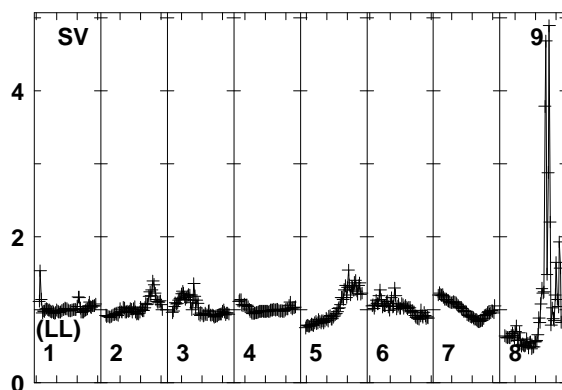
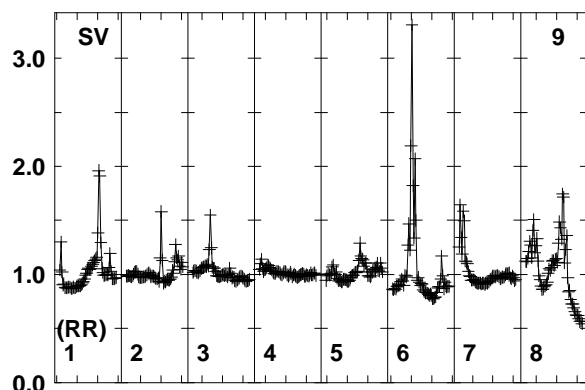
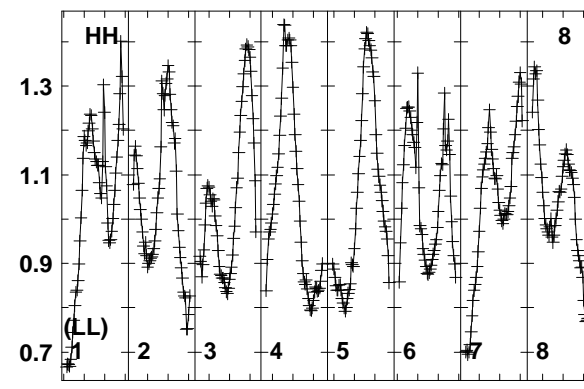
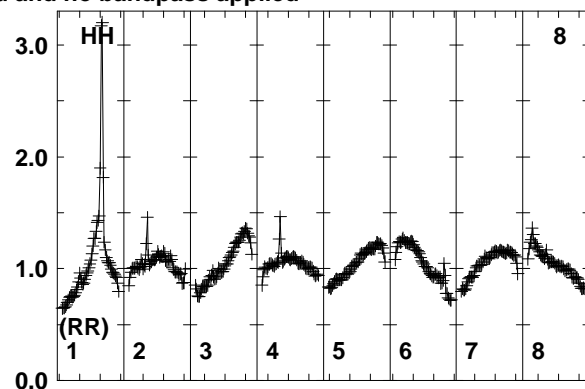
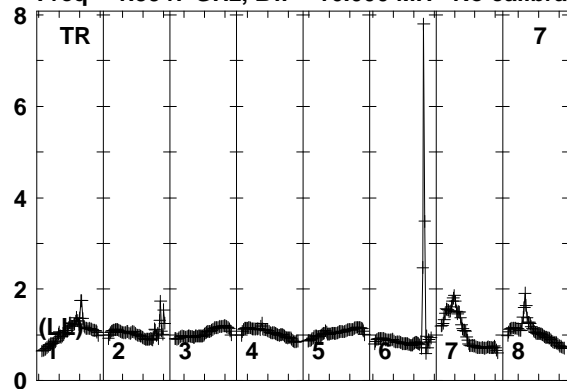

Lower frame: Real Jy
Total-power spectrum Antenna: TR (07)
Timerange: 00/06:40:46 to 00/06:43:24

Plot file version 435 created 04-NOV-2019 14:14:35

W2246-0526 EY034.UVDATA.1

Freq = 1.5947 GHz, Bw = 16.000 MH No calibration applied and no bandpass applied

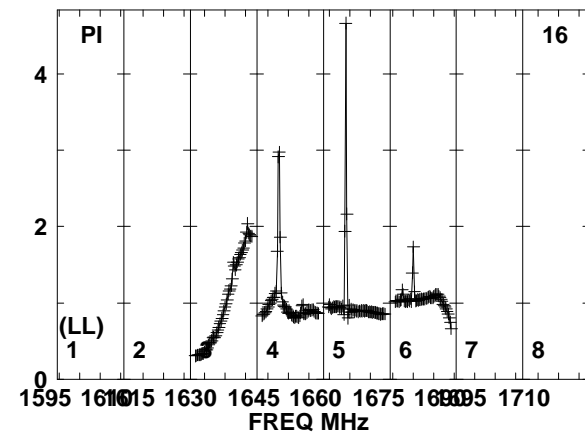
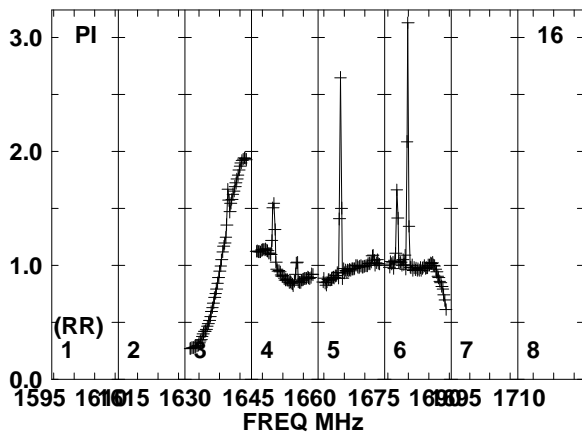
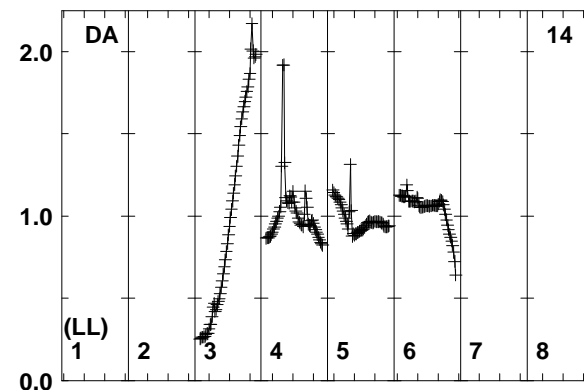
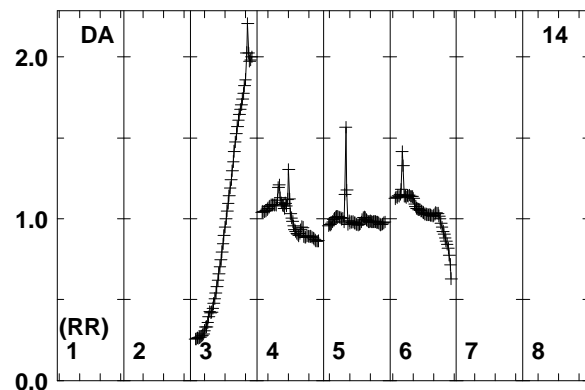
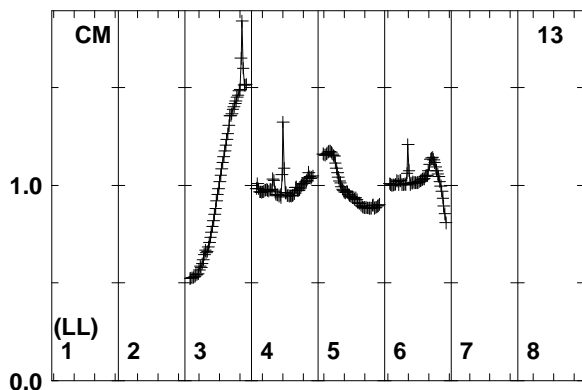
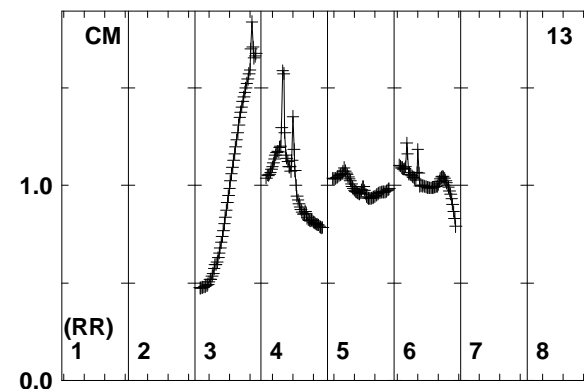
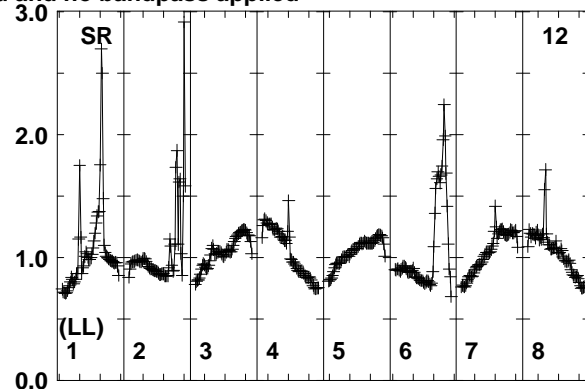
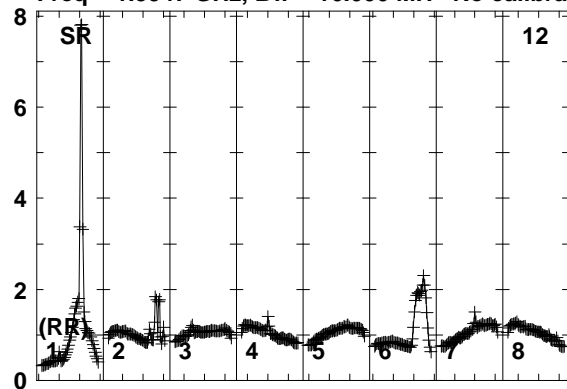

Lower frame: Real Jy
Total-power spectrum Antenna: SR (12)
Timerange: 00/06:40:46 to 00/06:43:24

Plot file version 436 created 04-NOV-2019 14:14:35

J2248-0541 EY034.UVDATA.1

Freq = 1.5947 GHz, Bw = 16.000 MH No calibration applied and no bandpass applied

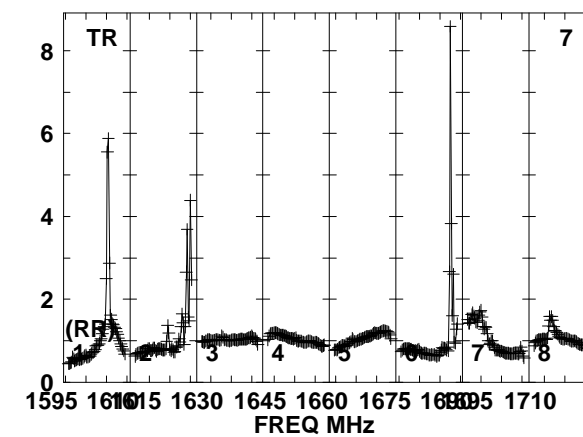
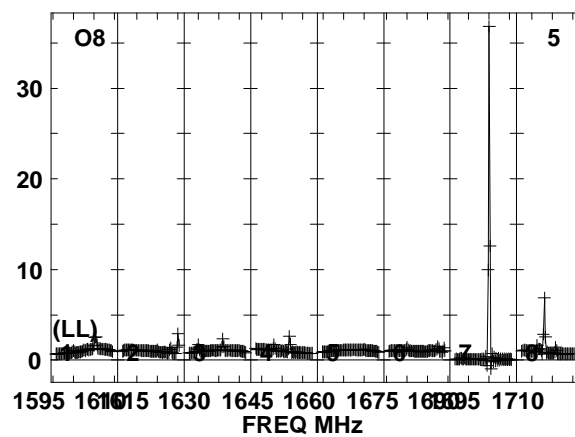
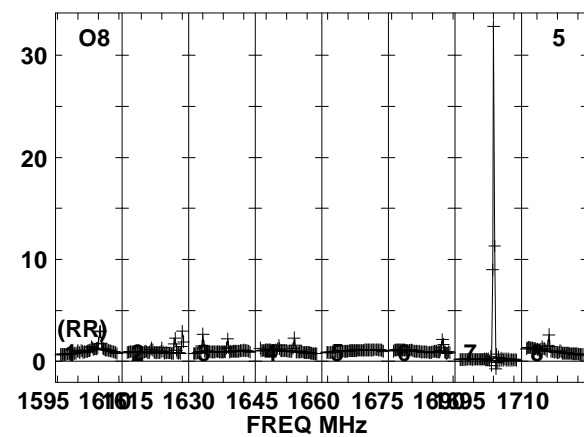
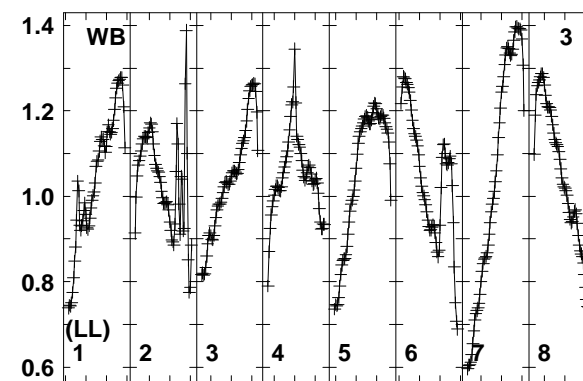
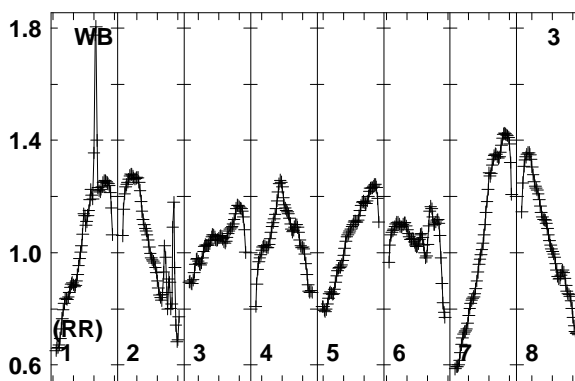
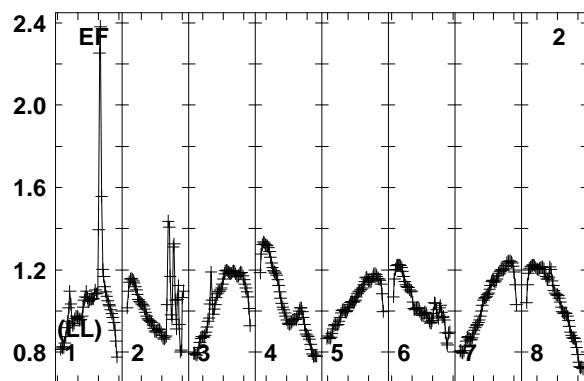
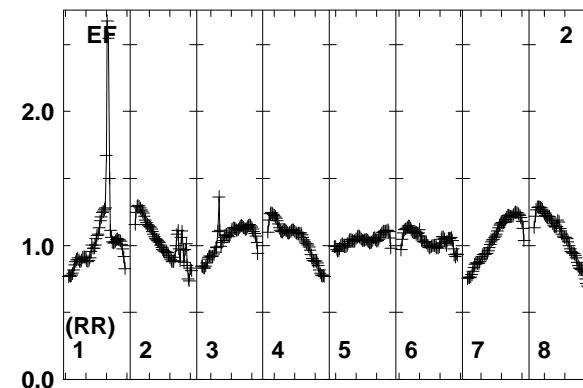
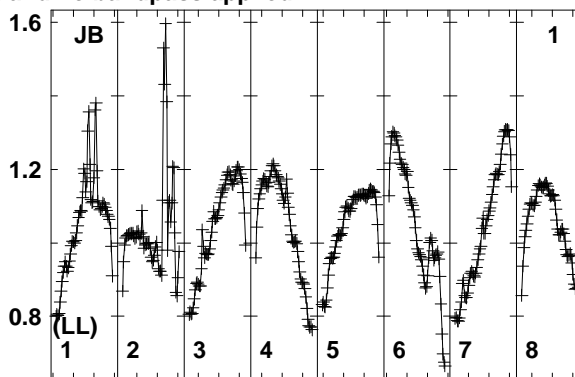
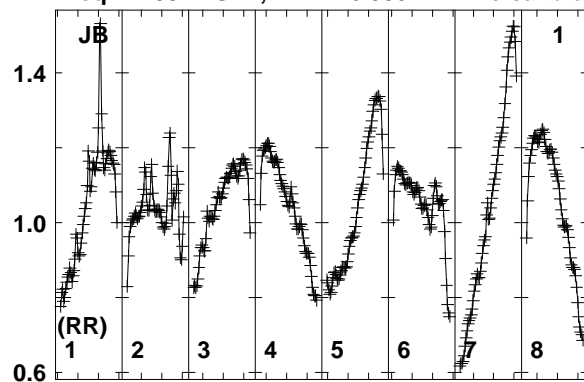

Lower frame: Real Jy
Total-power spectrum Antenna: JB (01)
Timerange: 00/06:43:41 to 00/06:44:39

Plot file version 437 created 04-NOV-2019 14:14:35

J2248-0541 EY034.UVDATA.1

Freq = 1.5947 GHz, Bw = 16.000 MH No calibration applied and no bandpass applied

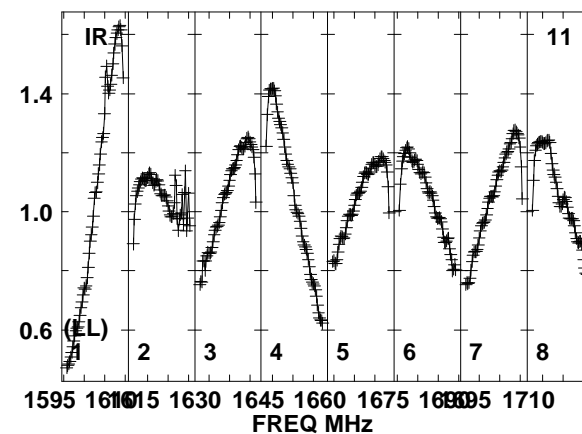
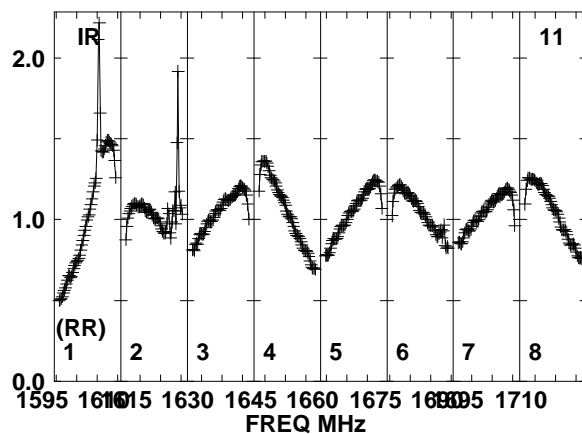
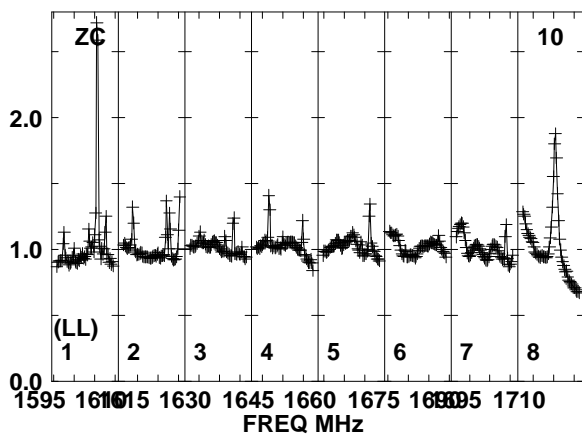
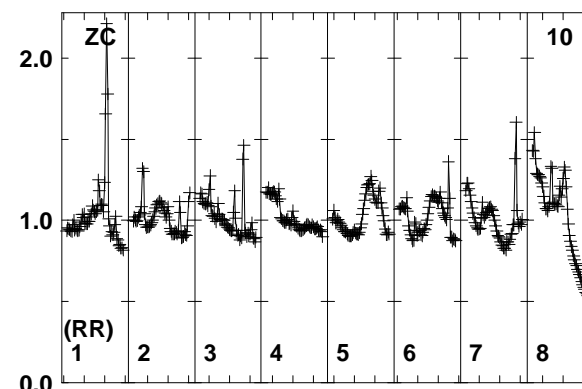
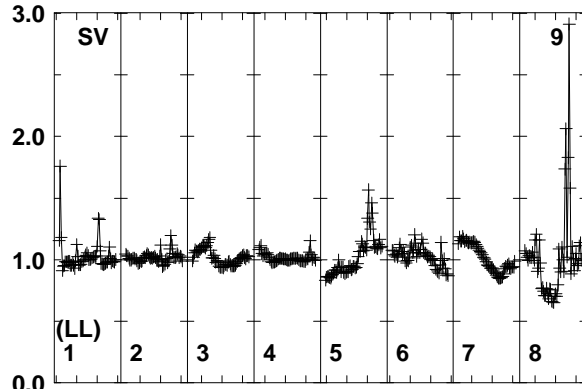
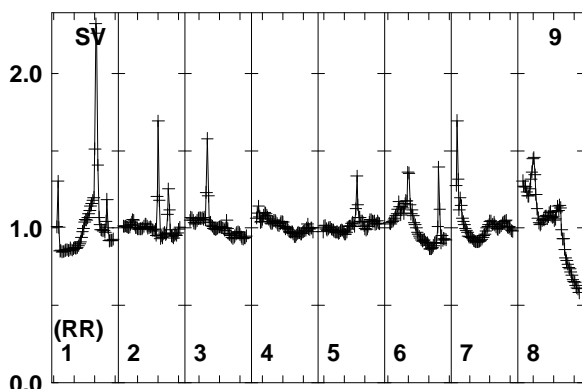
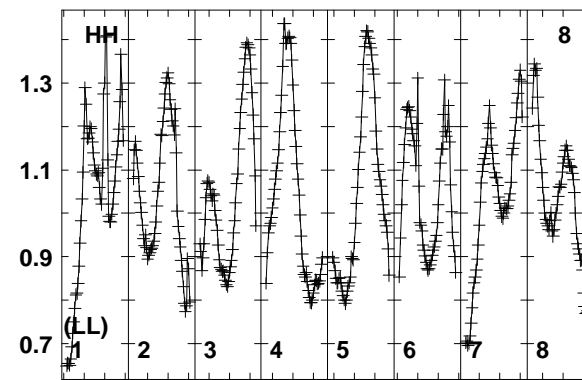
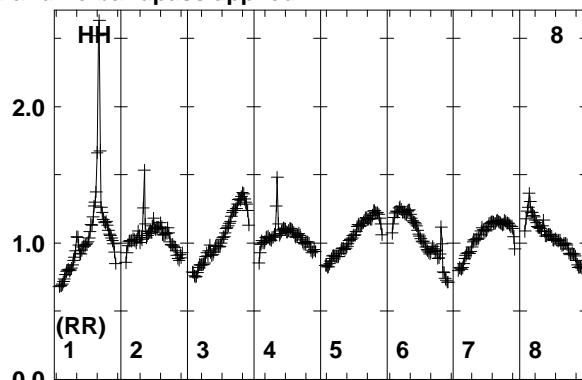
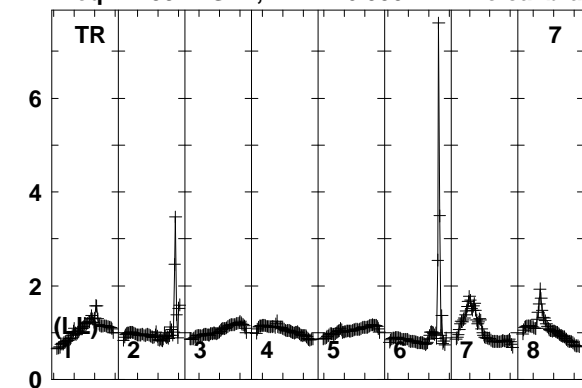

Lower frame: Real Jy
Total-power spectrum Antenna: TR (07)
Timerange: 00/06:43:41 to 00/06:44:39

Plot file version 438 created 04-NOV-2019 14:14:35

J2248-0541 EY034.UVDATA.1

Freq = 1.5947 GHz, Bw = 16.000 MH No calibration applied and no bandpass applied

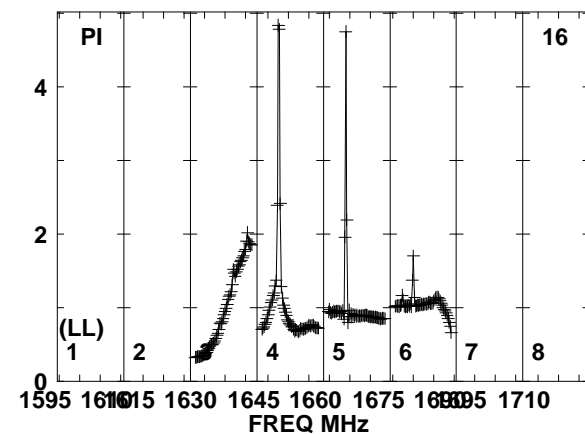
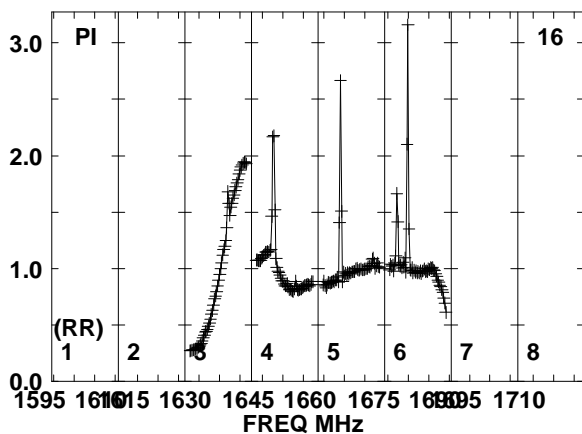
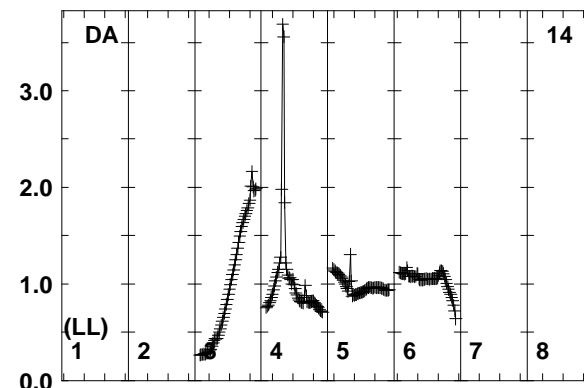
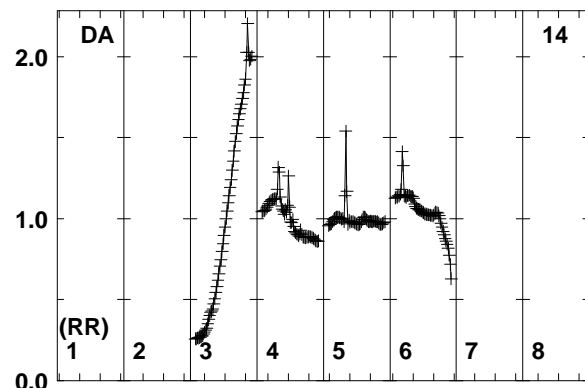
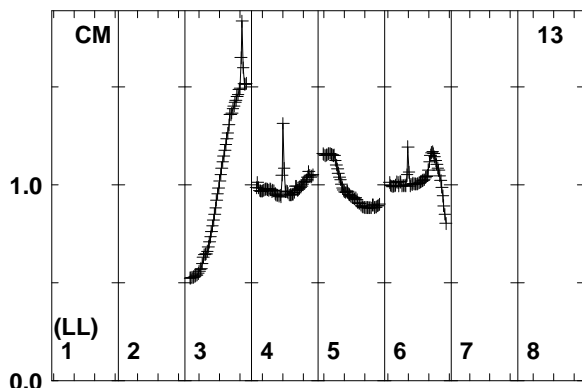
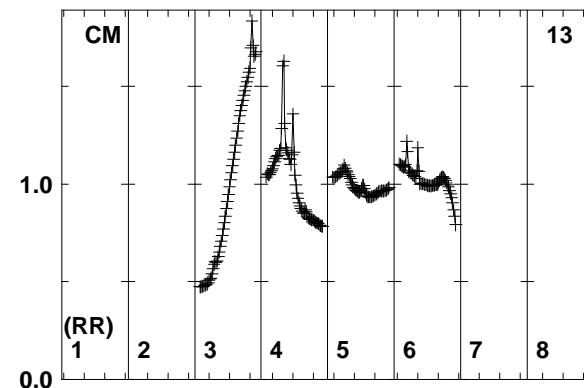
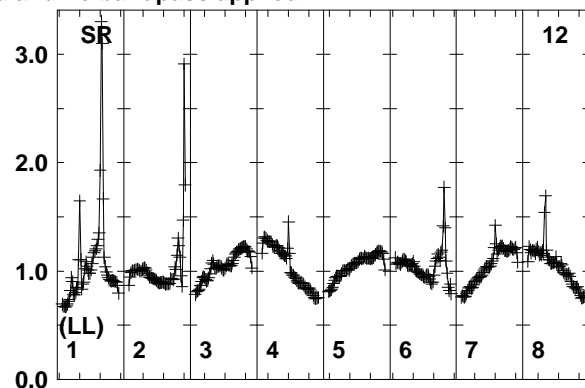
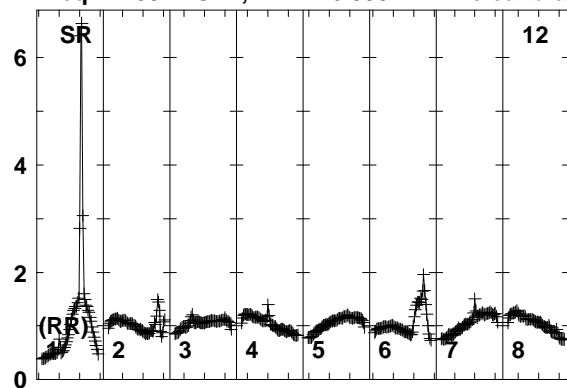

Lower frame: Real Jy
Total-power spectrum Antenna: SR (12)
Timerange: 00/06:43:41 to 00/06:44:39

Plot file version 439 created 04-NOV-2019 14:14:35

W2246-0526 EY034.UVDATA.1

Freq = 1.5947 GHz, Bw = 16.000 MH No calibration applied and no bandpass applied

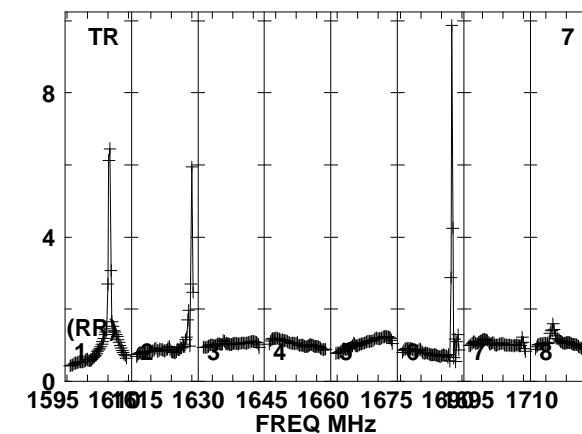
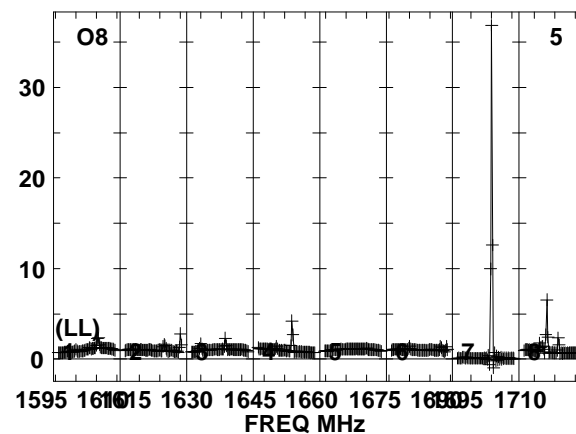
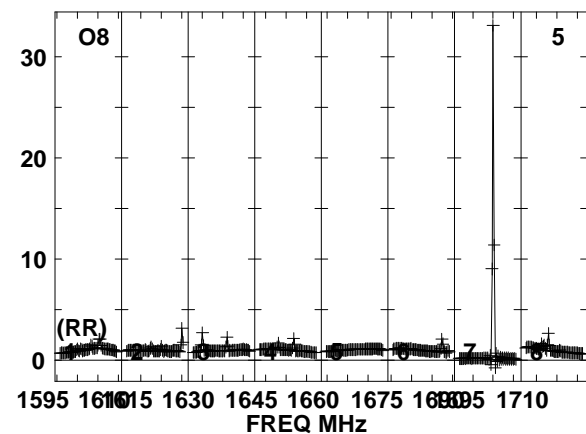
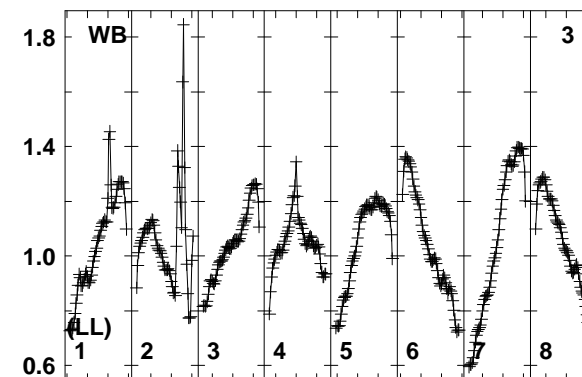
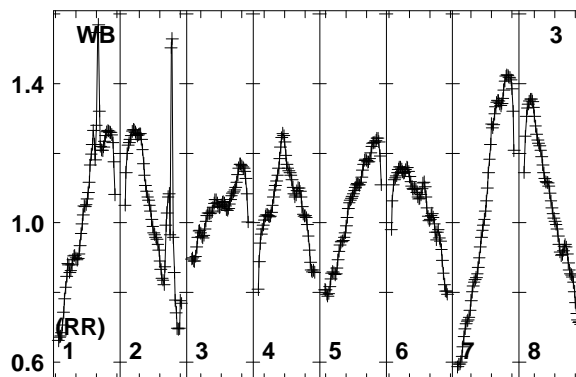
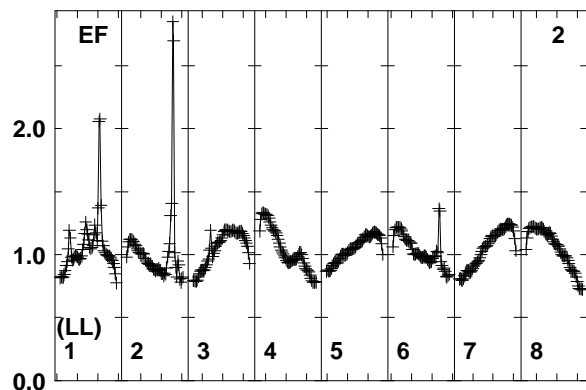
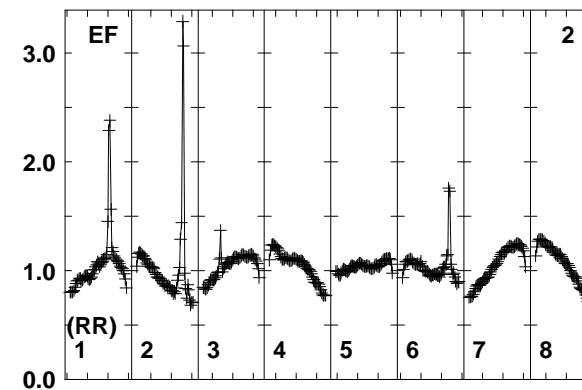
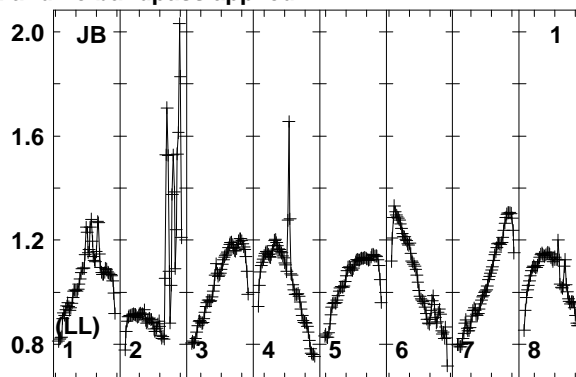
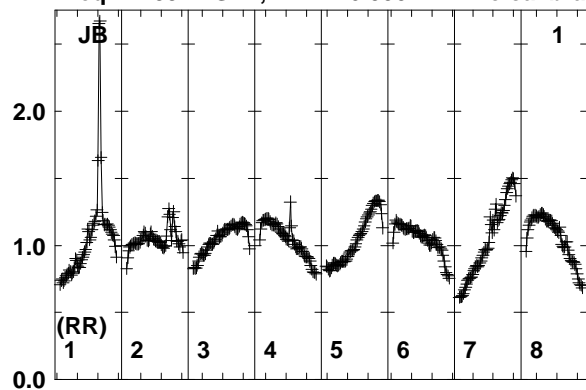

Lower frame: Real Jy
Total-power spectrum Antenna: JB (01)
Timerange: 00/06:44:41 to 00/06:47:19

Plot file version 440 created 04-NOV-2019 14:14:35

W2246-0526 EY034.UVDATA.1

Freq = 1.5947 GHz, Bw = 16.000 MH No calibration applied and no bandpass applied

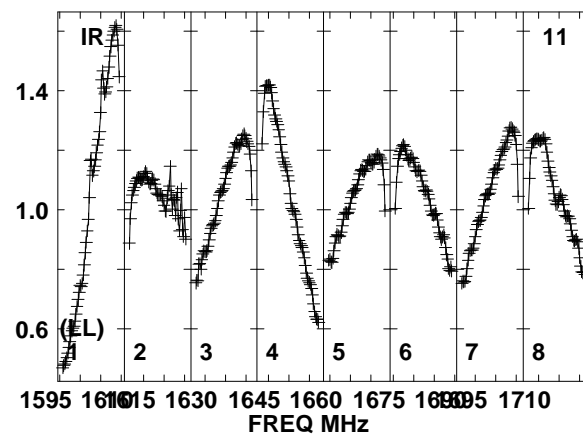
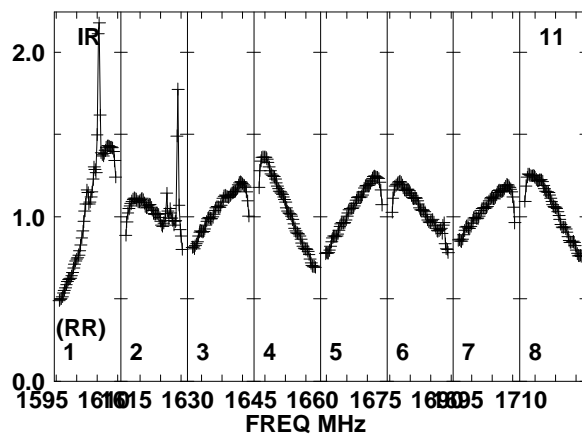
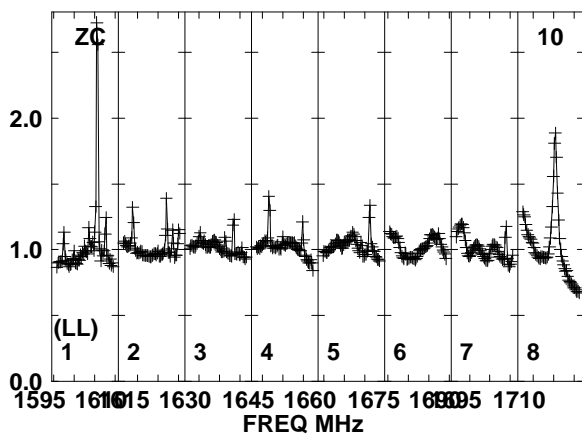
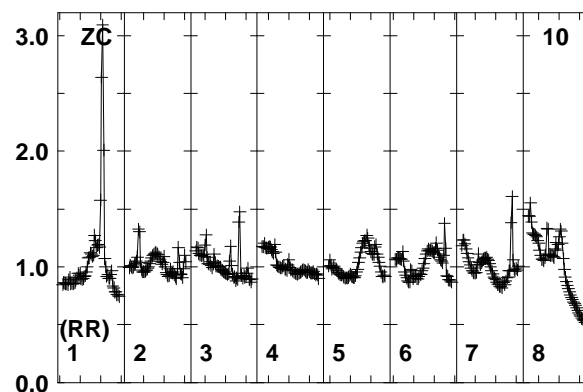
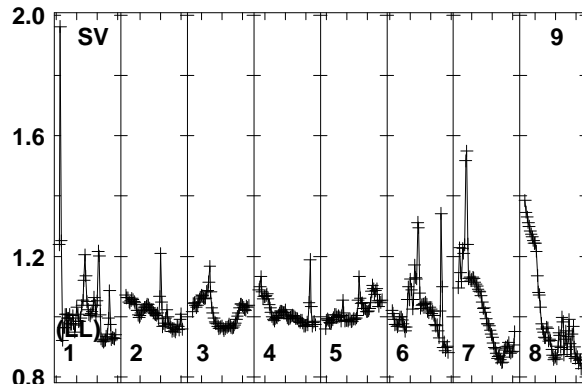
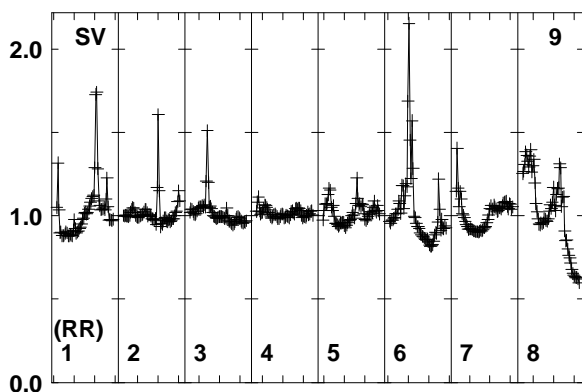
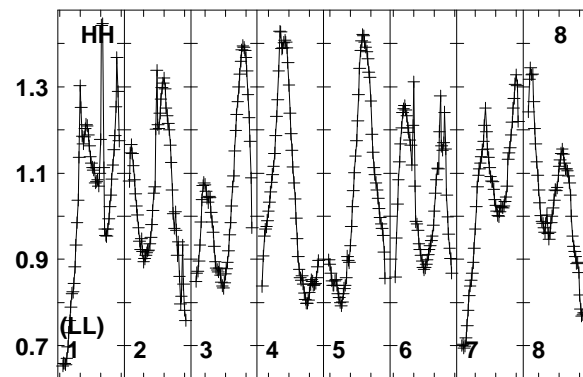
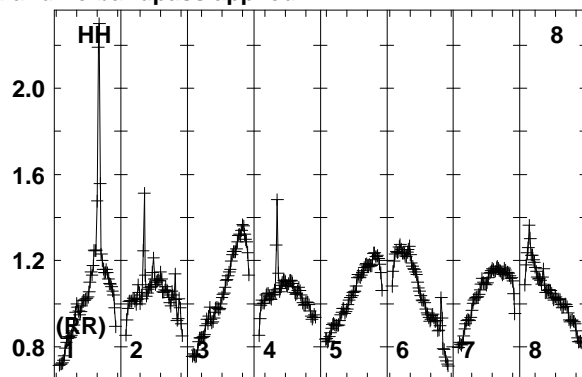
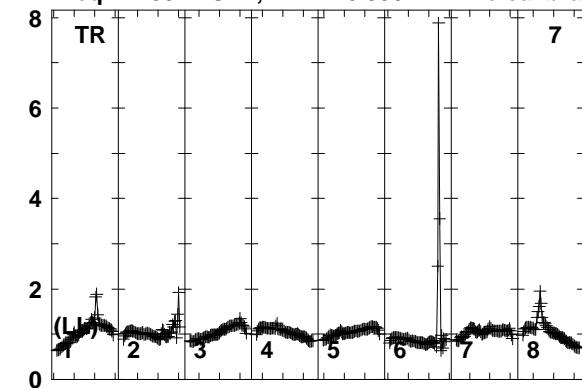

Lower frame: Real Jy
Total-power spectrum Antenna: TR (07)
Timerange: 00/06:44:41 to 00/06:47:19

Plot file version 441 created 04-NOV-2019 14:14:36

W2246-0526 EY034.UVDATA.1

Freq = 1.5947 GHz, Bw = 16.000 MHz No calibration applied and no bandpass applied

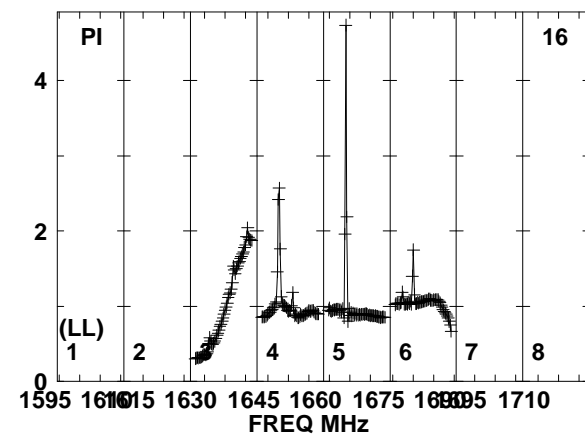
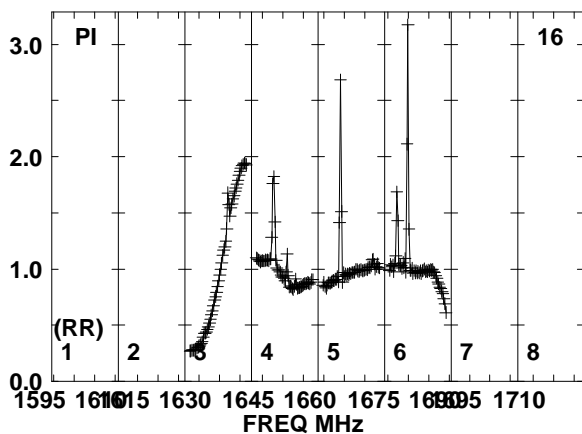
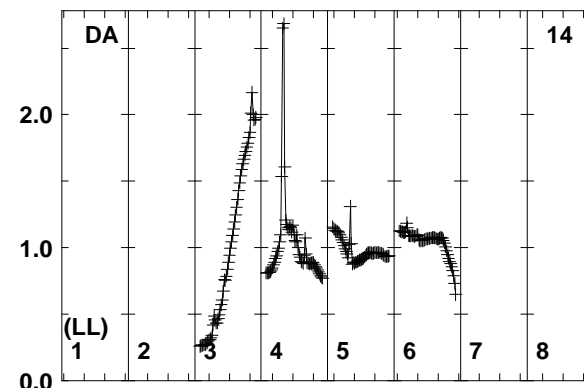
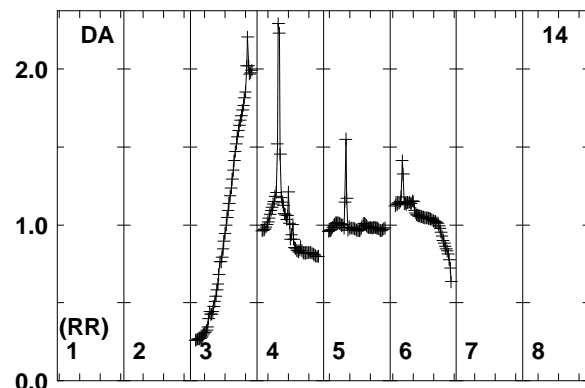
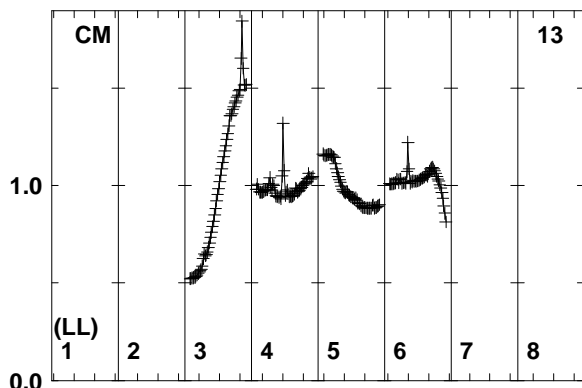
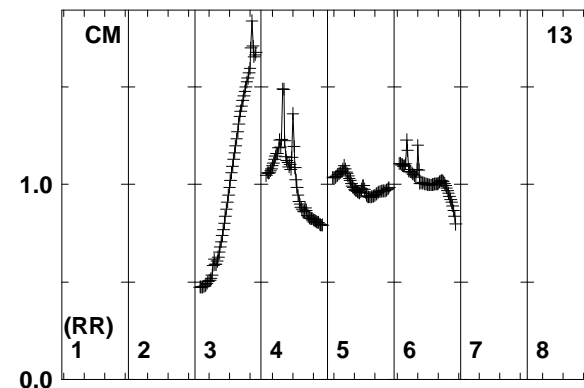
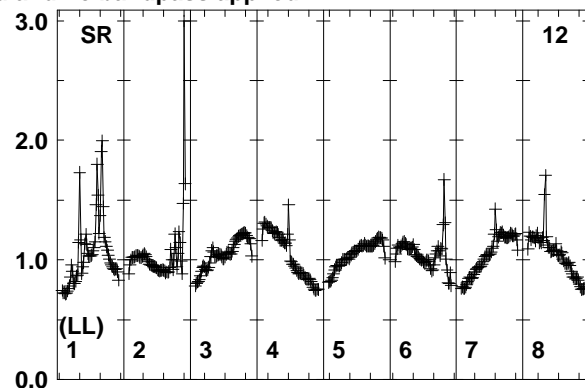
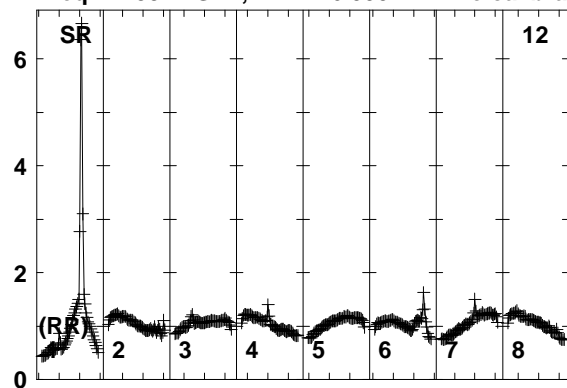

Lower frame: Real Jy
Total-power spectrum Antenna: SR (12)
Timerange: 00/06:44:41 to 00/06:47:19

Plot file version 442 created 04-NOV-2019 14:14:36

J2248-0541 EY034.UVDATA.1

Freq = 1.5947 GHz, Bw = 16.000 MH No calibration applied and no bandpass applied

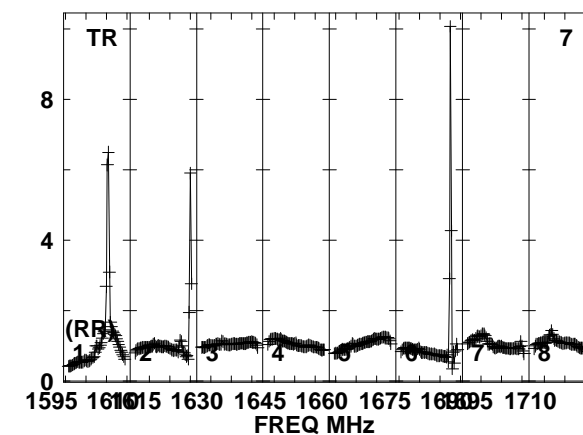
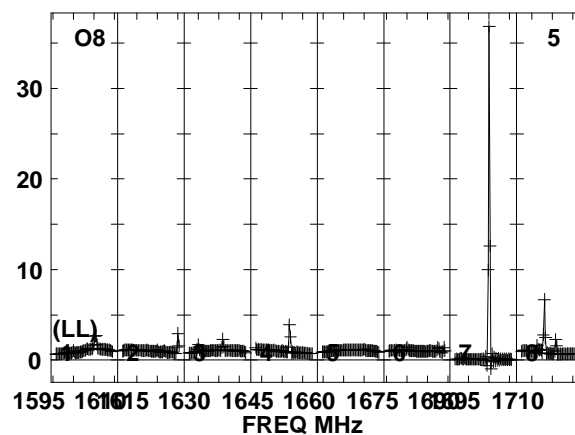
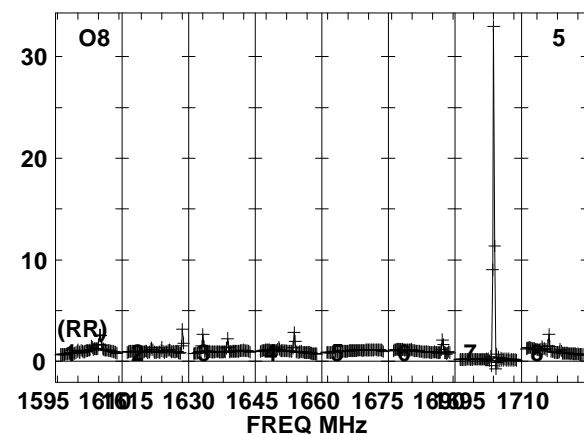
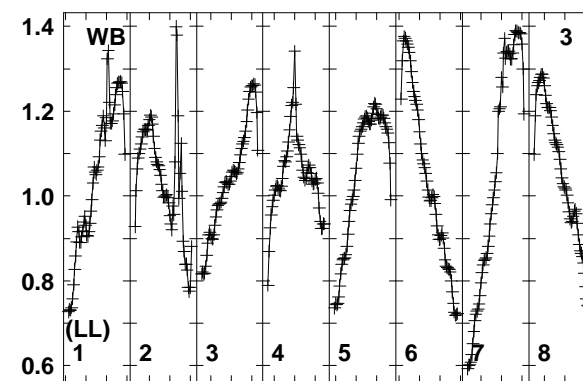
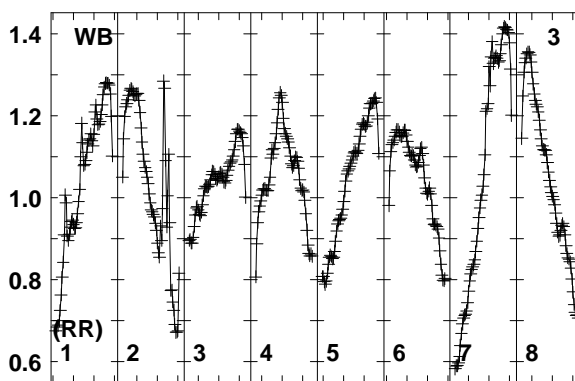
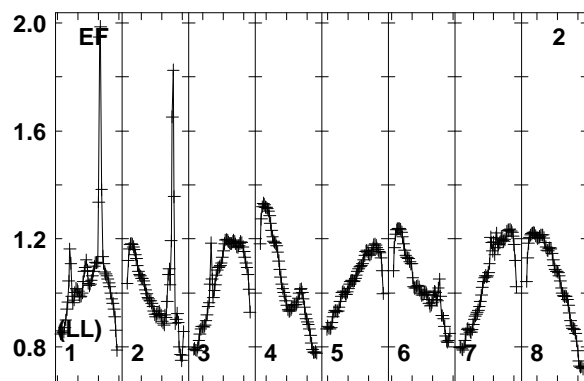
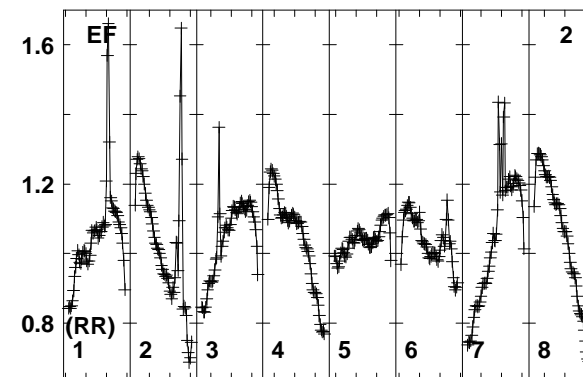
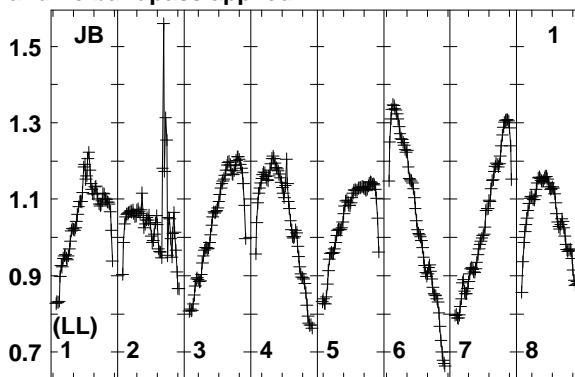
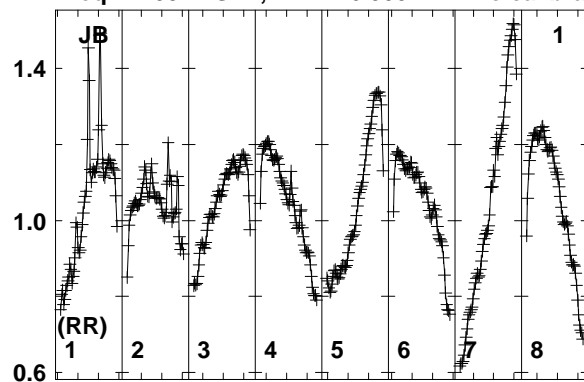

Lower frame: Real Jy
Total-power spectrum Antenna: JB (01)
Timerange: 00/06:47:36 to 00/06:48:34

Plot file version 443 created 04-NOV-2019 14:14:36

J2248-0541 EY034.UVDATA.1

Freq = 1.5947 GHz, Bw = 16.000 MH No calibration applied and no bandpass applied

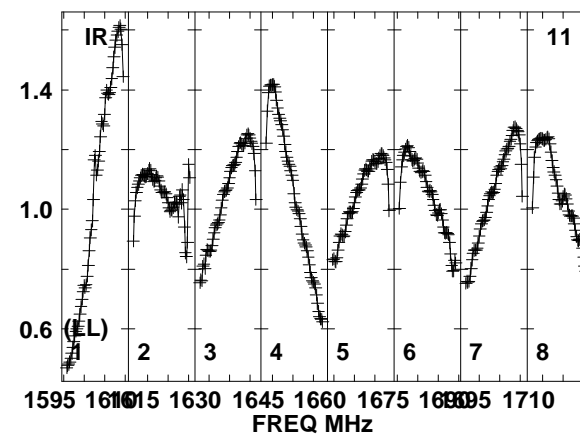
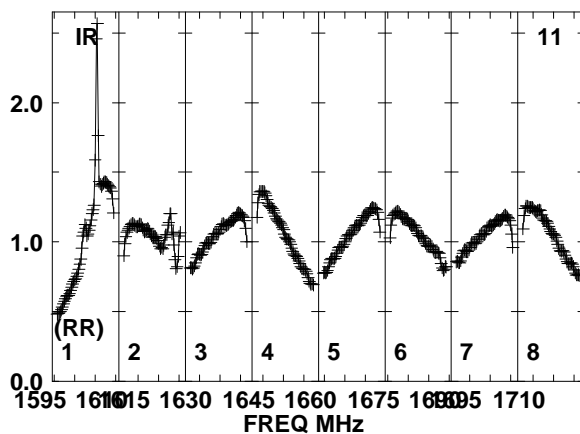
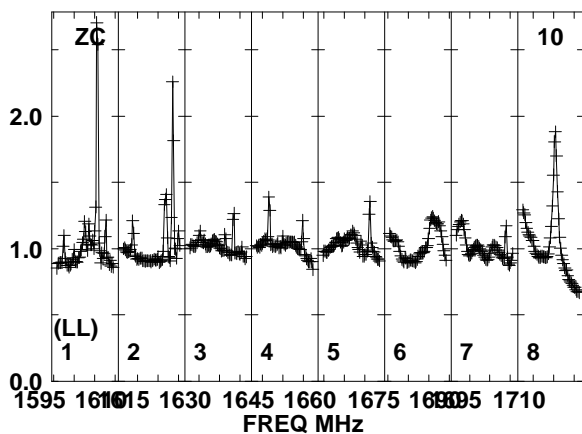
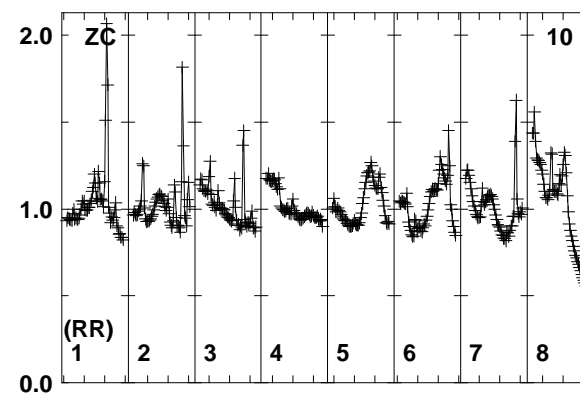
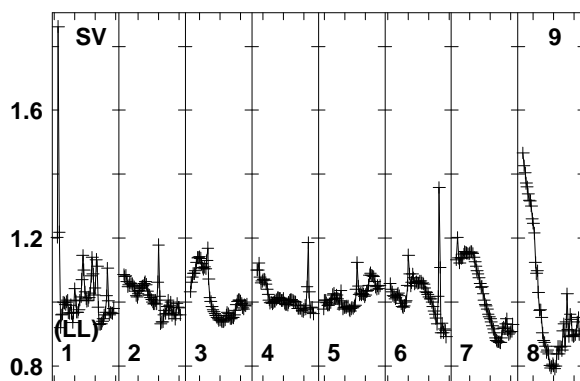
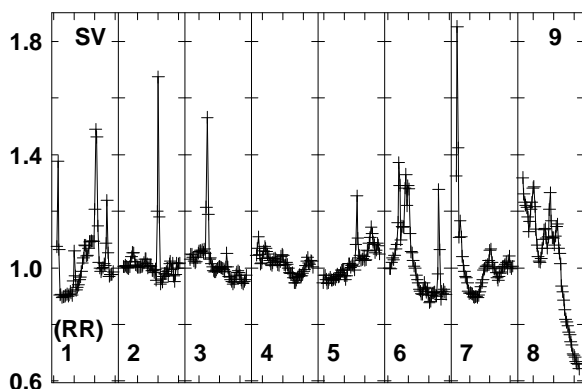
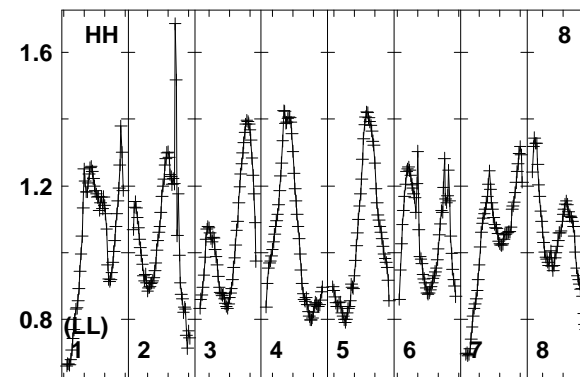
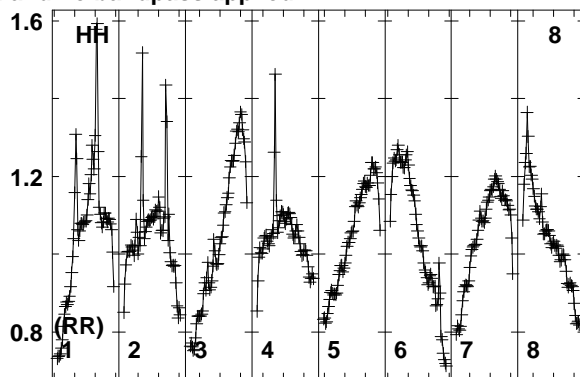
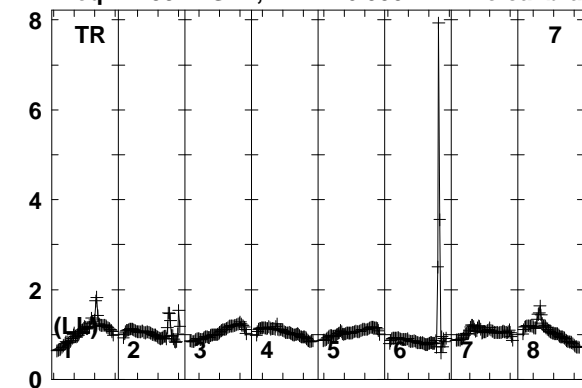

Lower frame: Real Jy
Total-power spectrum Antenna: TR (07)
Timerange: 00/06:47:36 to 00/06:48:34

Plot file version 444 created 04-NOV-2019 14:14:36

J2248-0541 EY034.UVDATA.1

Freq = 1.5947 GHz, Bw = 16.000 MH No calibration applied and no bandpass applied

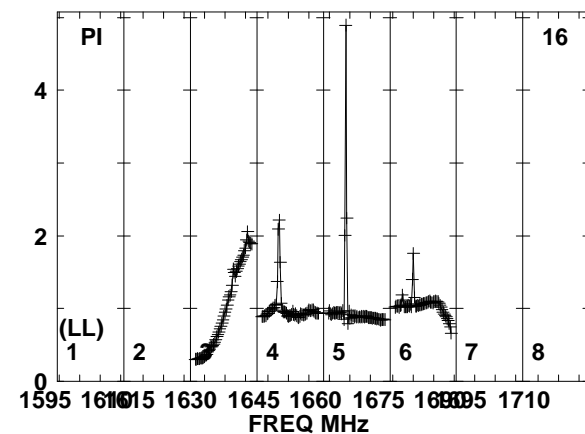
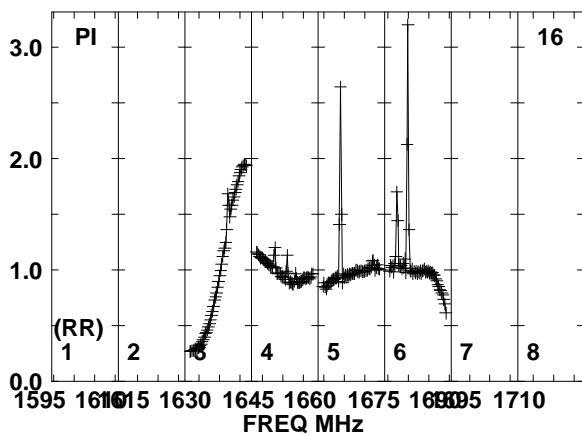
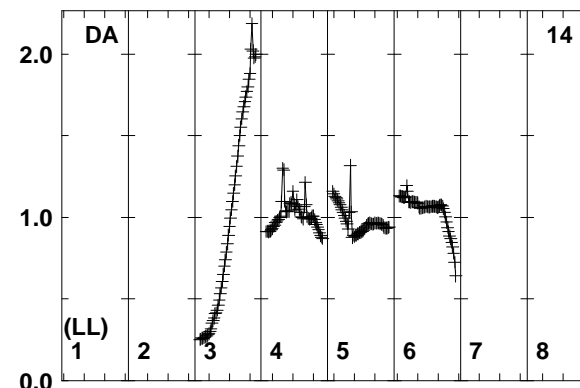
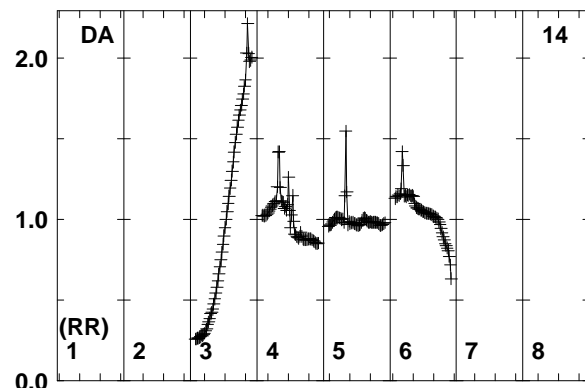
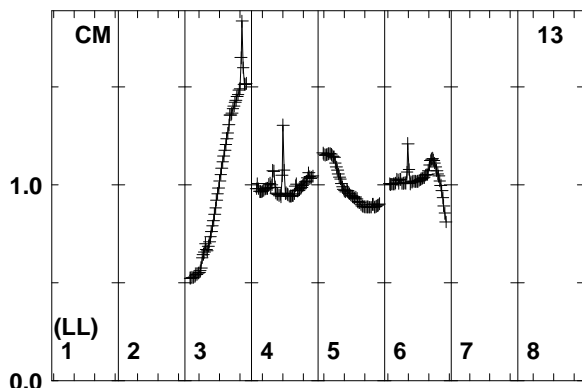
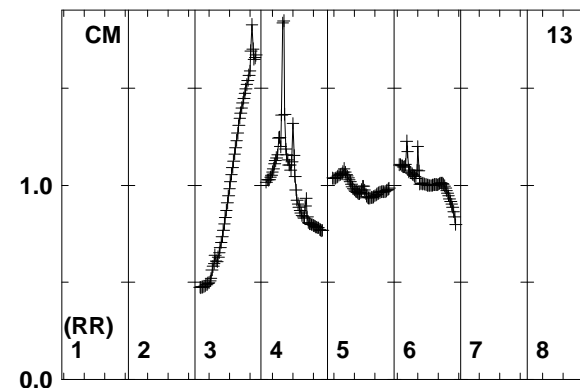
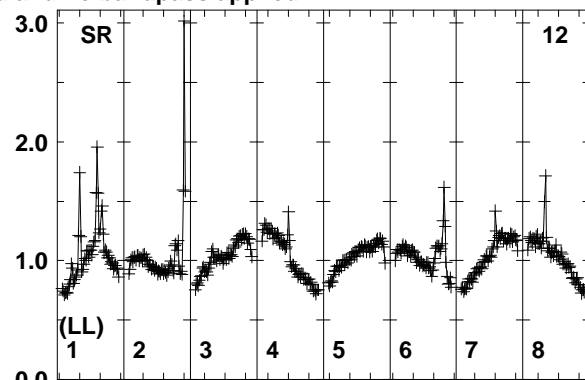
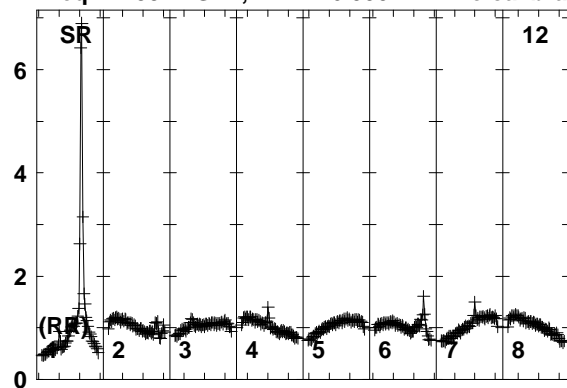

Lower frame: Real Jy
Total-power spectrum Antenna: SR (12)
Timerange: 00/06:47:36 to 00/06:48:34

Plot file version 445 created 04-NOV-2019 14:14:36

W2246-0526 EY034.UVDATA.1

Freq = 1.5947 GHz, Bw = 16.000 MH No calibration applied and no bandpass applied

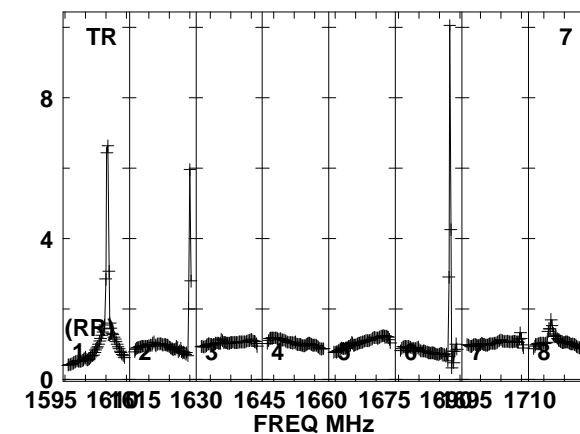
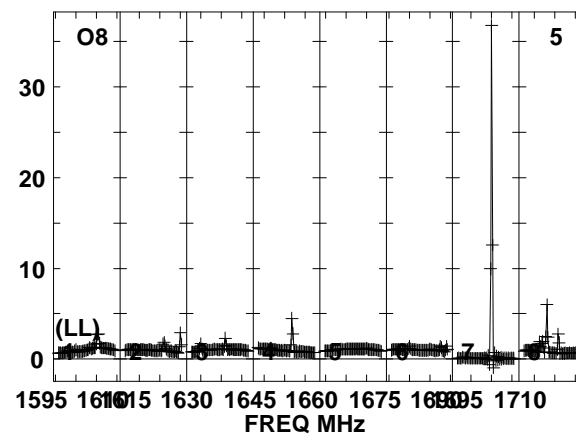
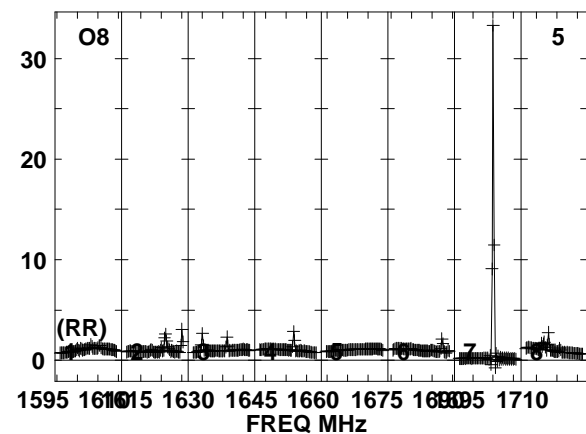
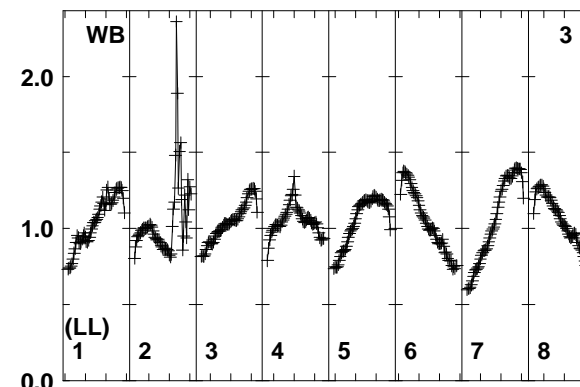
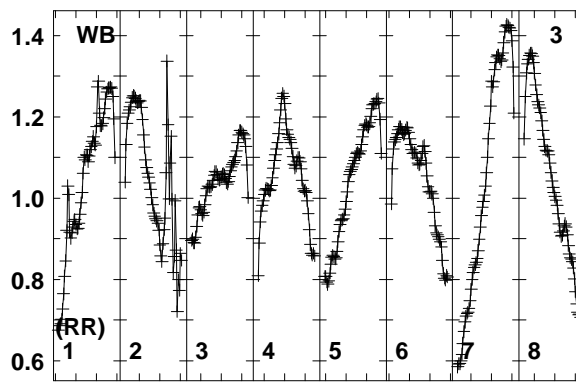
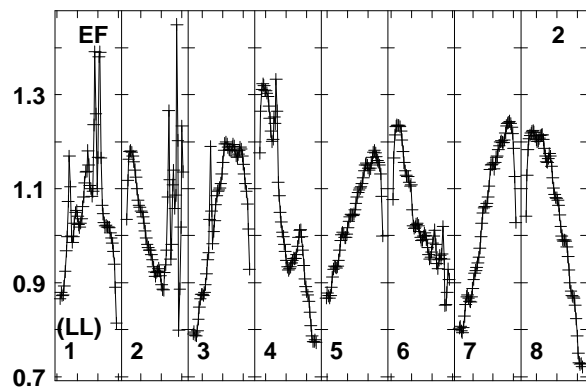
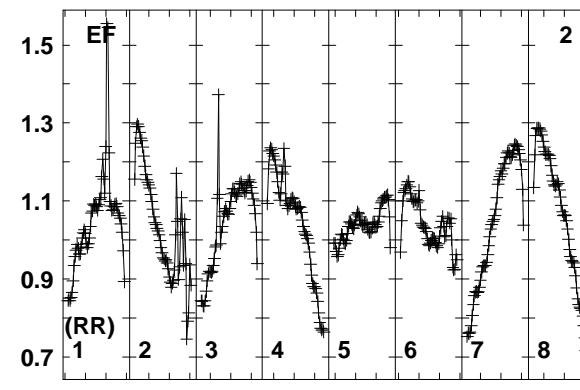
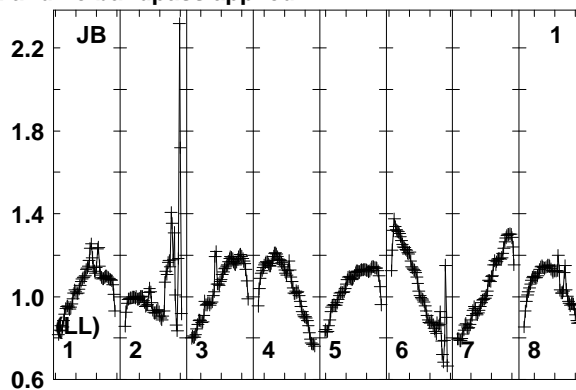
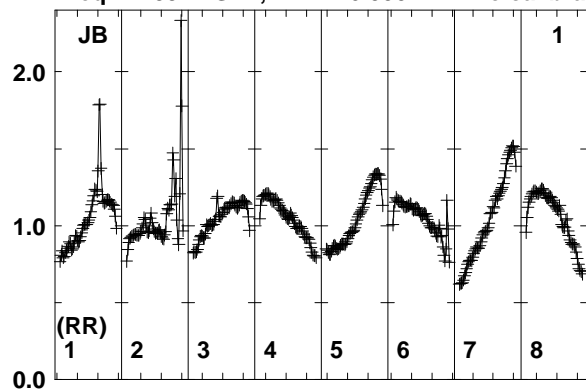

Lower frame: Real Jy
Total-power spectrum Antenna: JB (01)
Timerange: 00/06:48:36 to 00/06:51:14

Plot file version 446 created 04-NOV-2019 14:14:36

W2246-0526 EY034.UVDATA.1

Freq = 1.5947 GHz, Bw = 16.000 MH No calibration applied and no bandpass applied

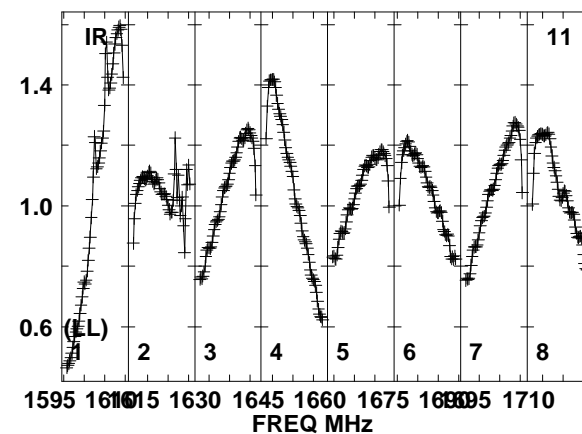
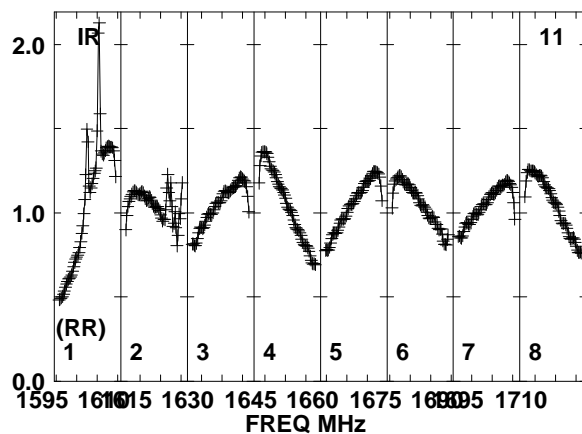
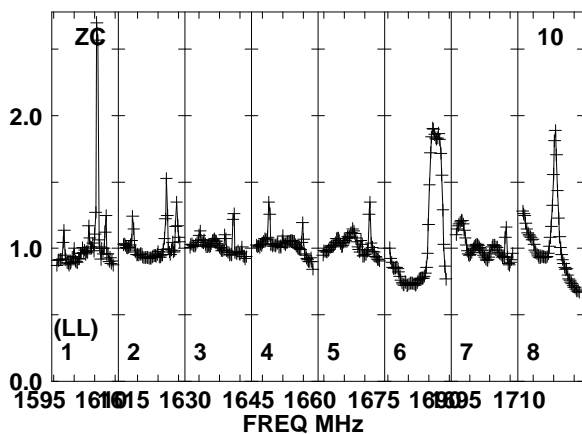
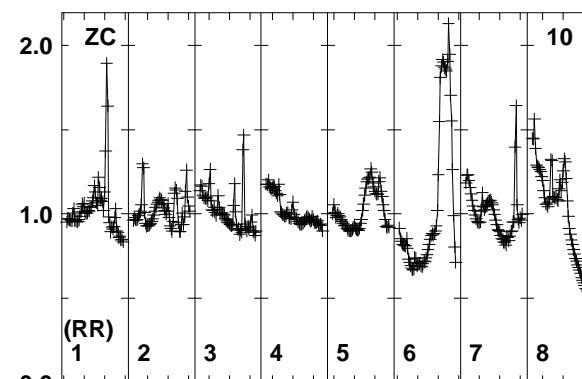
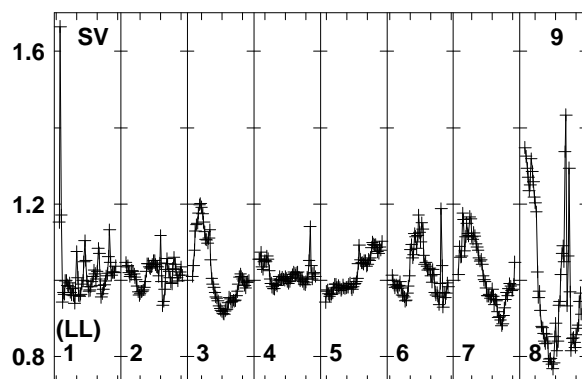
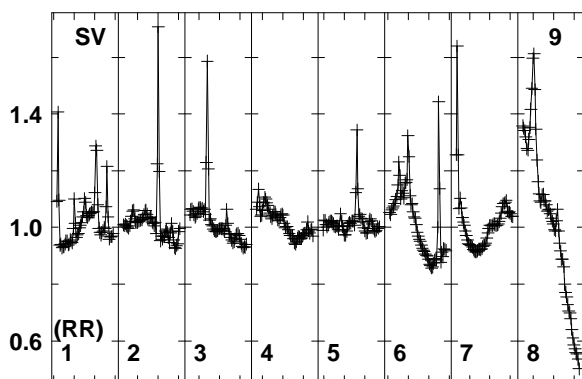
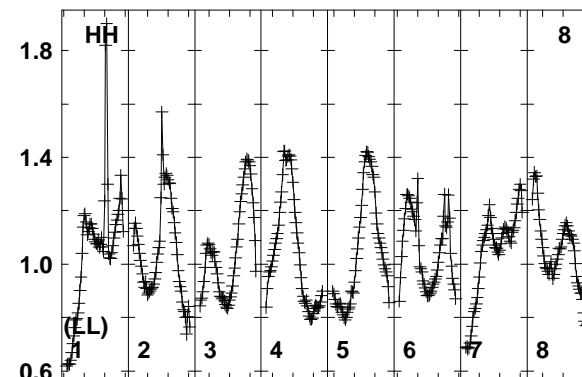
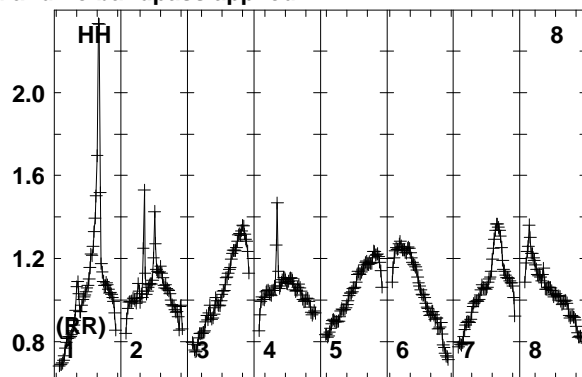
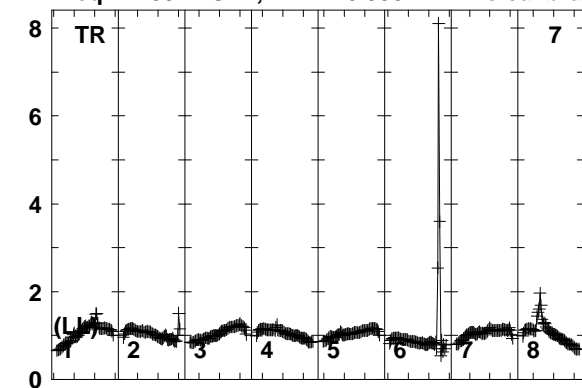

Lower frame: Real Jy
Total-power spectrum Antenna: TR (07)
Timerange: 00/06:48:36 to 00/06:51:14

Plot file version 447 created 04-NOV-2019 14:14:36

W2246-0526 EY034.UVDATA.1

Freq = 1.5947 GHz, Bw = 16.000 MH No calibration applied and no bandpass applied

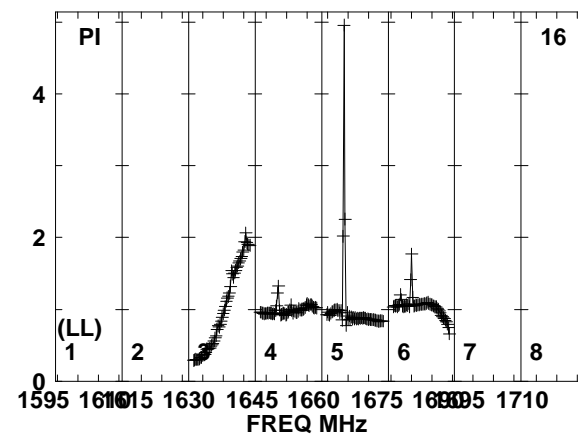
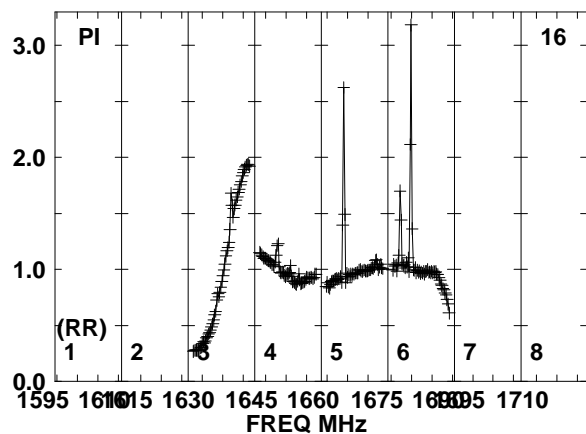
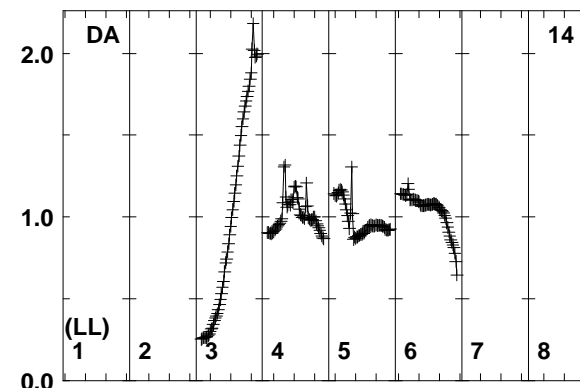
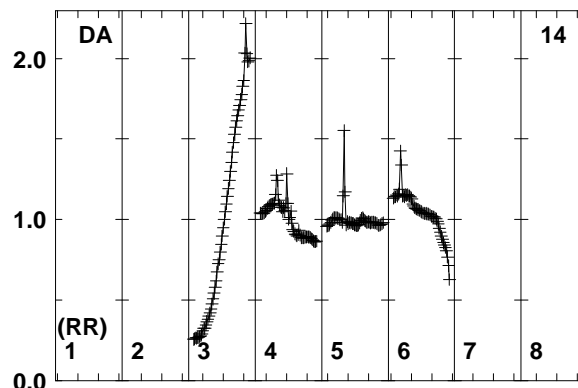
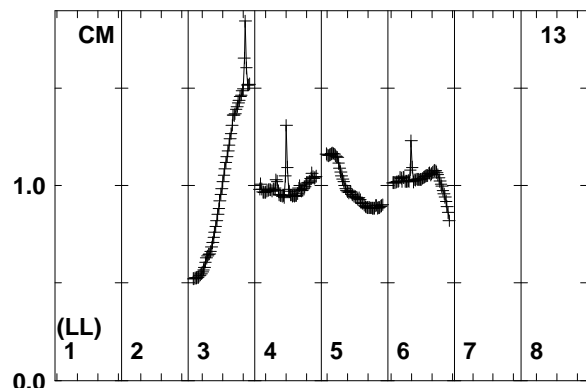
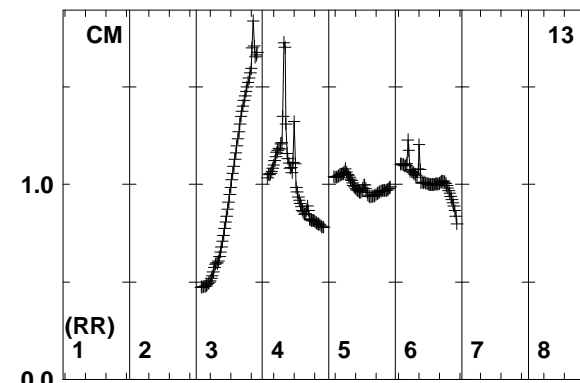
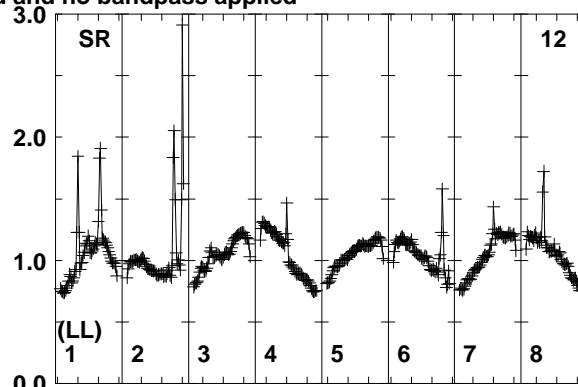
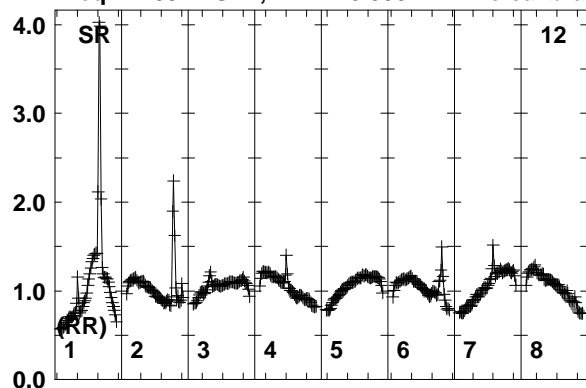

Lower frame: Real Jy
Total-power spectrum Antenna: SR (12)
Timerange: 00/06:48:36 to 00/06:51:14

Plot file version 448 created 04-NOV-2019 14:14:36

J2248-0541 EY034.UVDATA.1

Freq = 1.5947 GHz, Bw = 16.000 MH No calibration applied and no bandpass applied

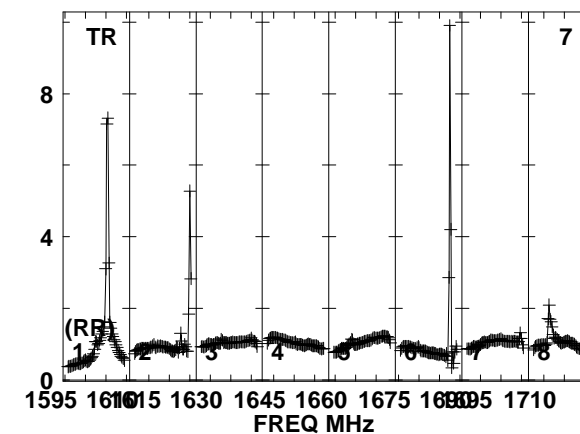
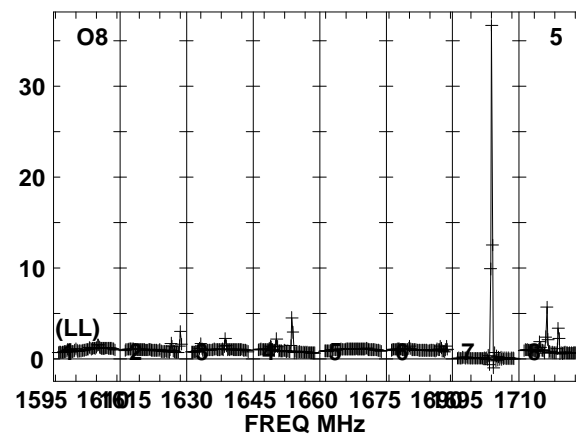
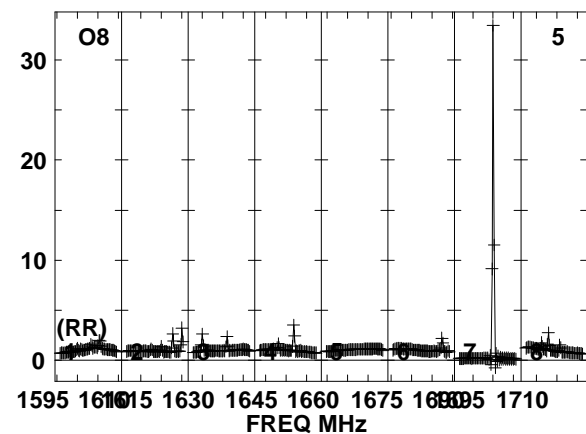
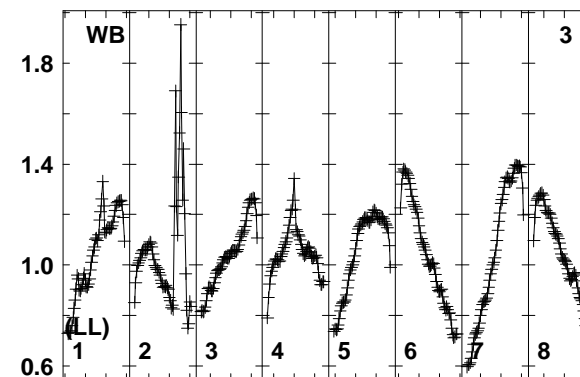
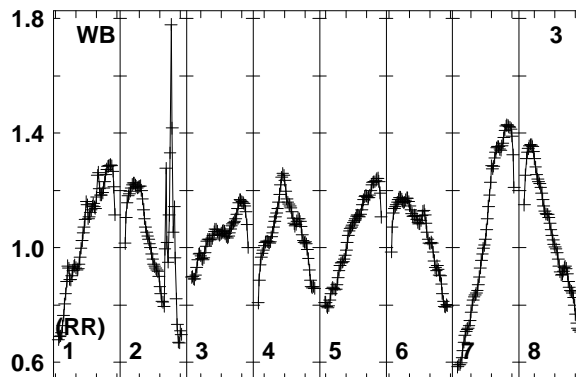
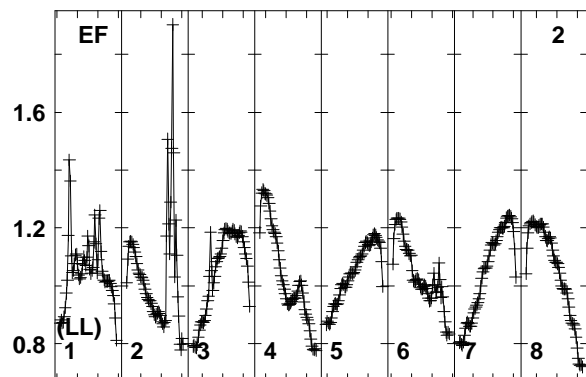
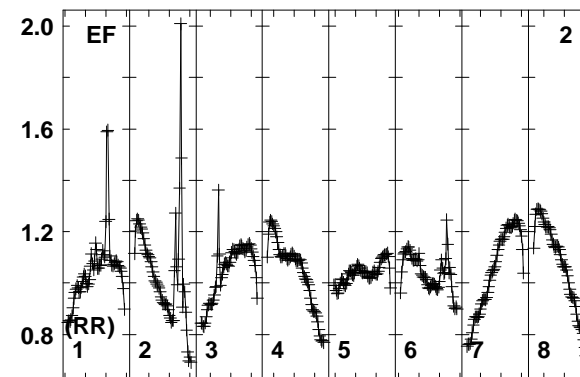
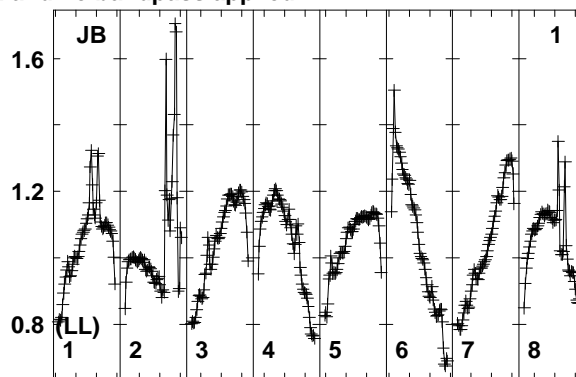
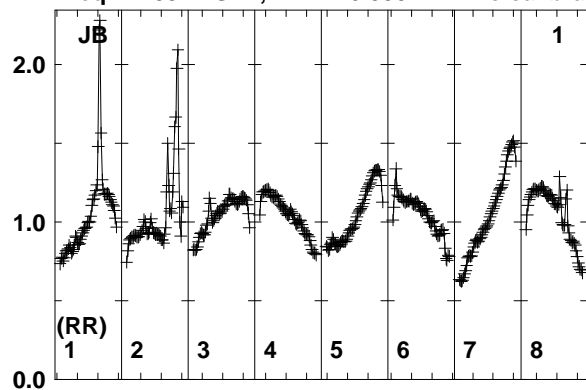

Lower frame: Real Jy
Total-power spectrum Antenna: JB (01)
Timerange: 00/06:51:51 to 00/06:52:49

Plot file version 449 created 04-NOV-2019 14:14:36

J2248-0541 EY034.UVDATA.1

Freq = 1.5947 GHz, Bw = 16.000 MH No calibration applied and no bandpass applied

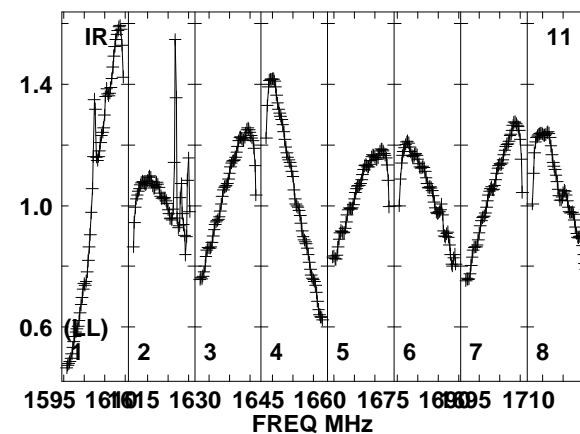
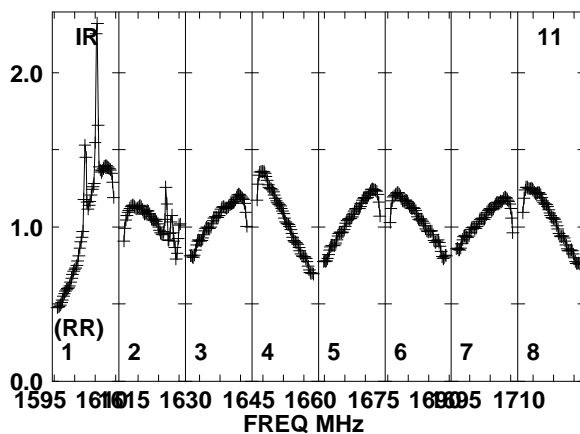
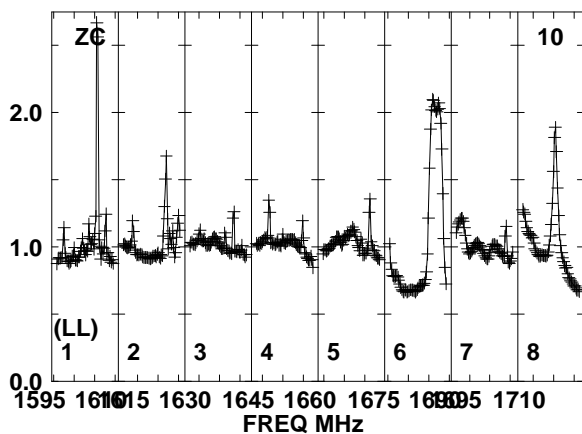
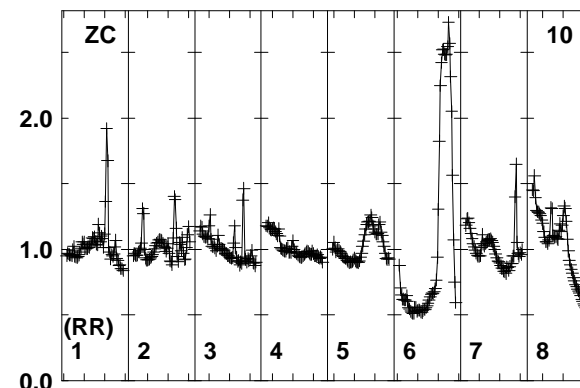
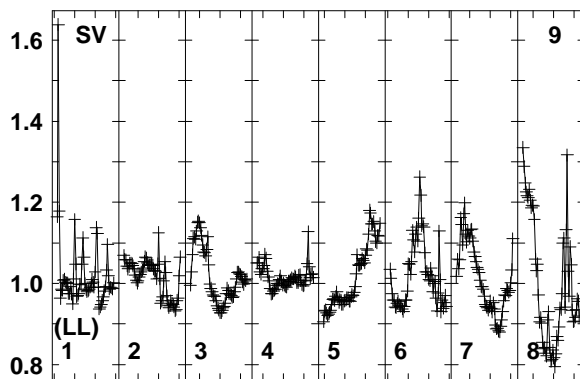
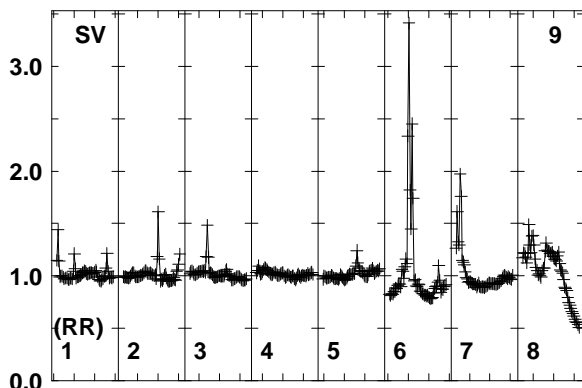
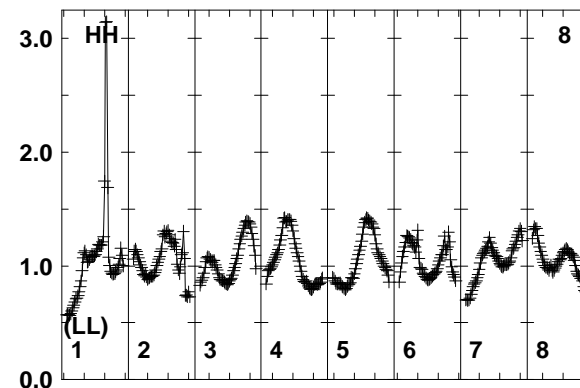
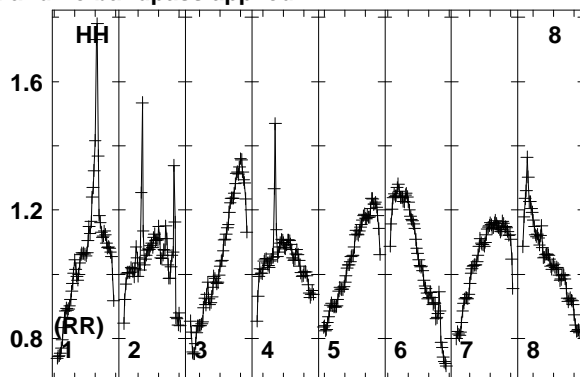
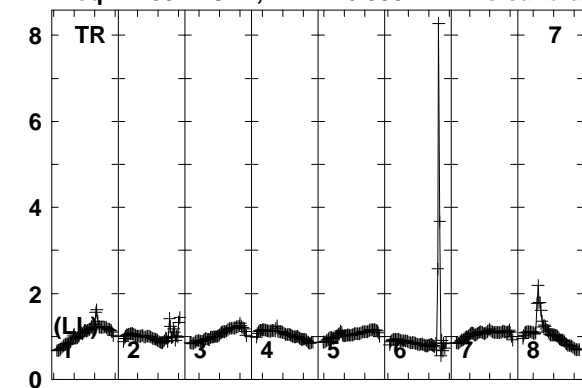

Lower frame: Real Jy
Total-power spectrum Antenna: TR (07)
Timerange: 00/06:51:51 to 00/06:52:49

Plot file version 450 created 04-NOV-2019 14:14:36

J2248-0541 EY034.UVDATA.1

Freq = 1.5947 GHz, Bw = 16.000 MH No calibration applied and no bandpass applied

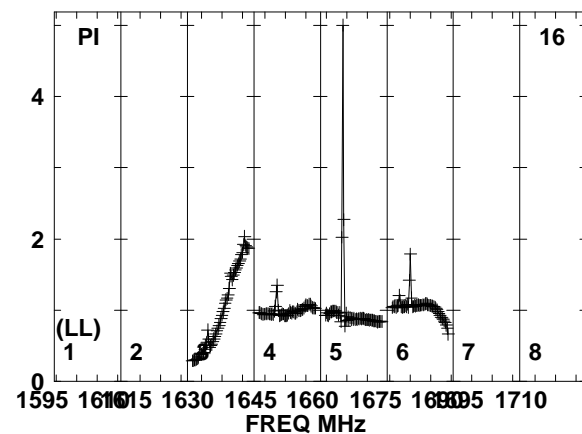
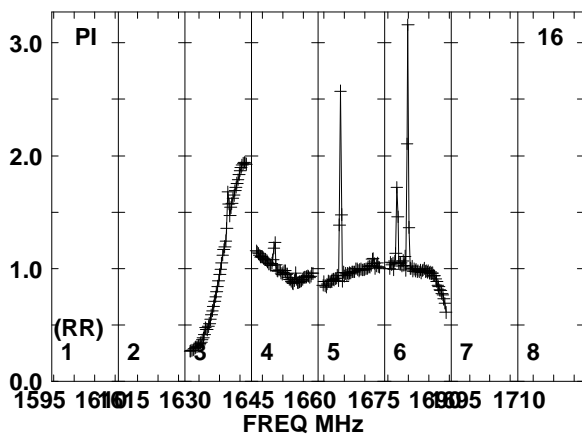
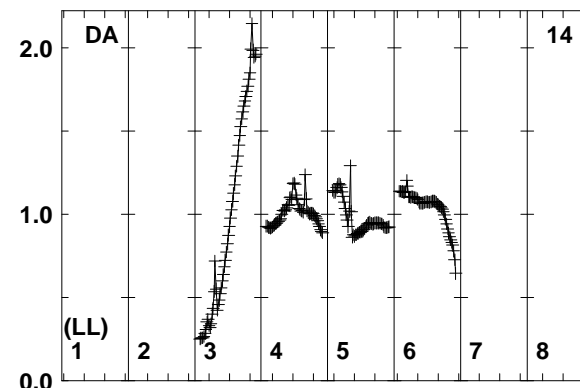
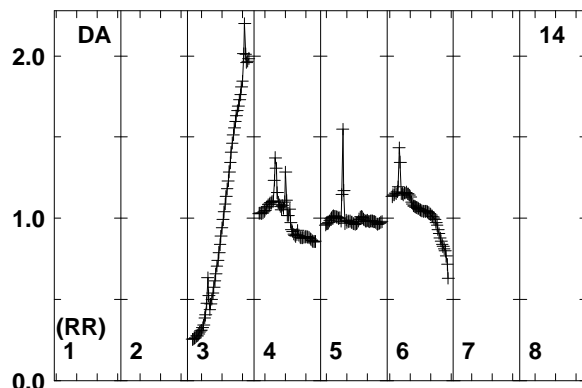
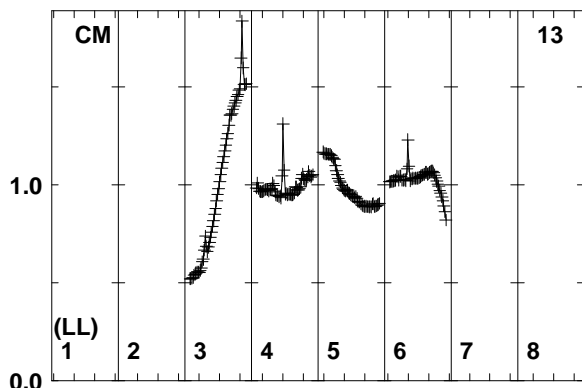
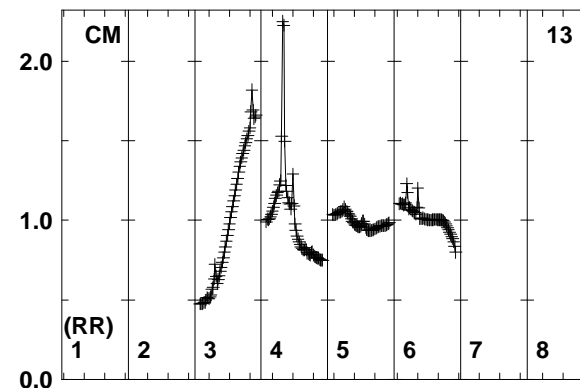
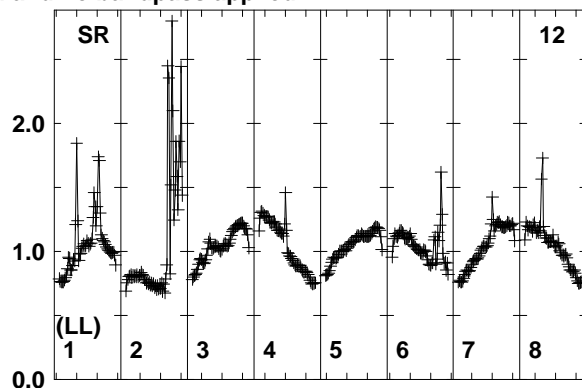
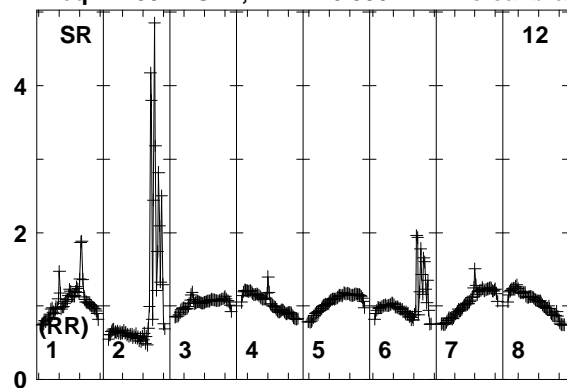

Lower frame: Real Jy
Total-power spectrum Antenna: SR (12)
Timerange: 00/06:51:51 to 00/06:52:49

Plot file version 451 created 04-NOV-2019 14:14:36

W2246-0526 EY034.UVDATA.1

Freq = 1.5947 GHz, Bw = 16.000 MH No calibration applied and no bandpass applied

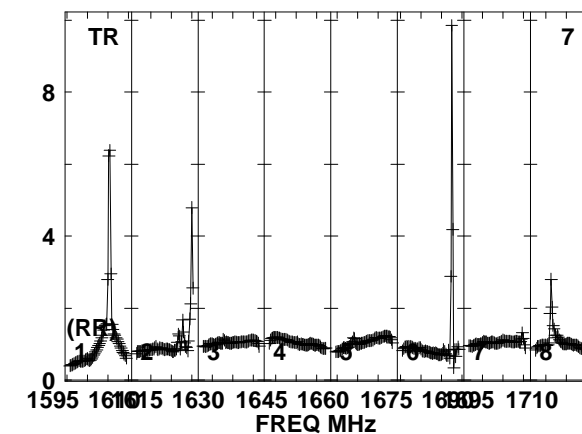
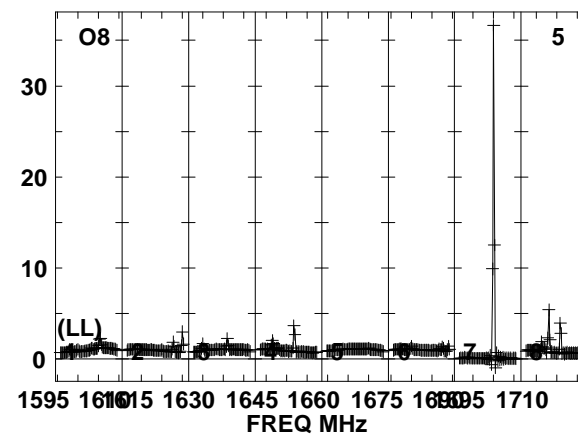
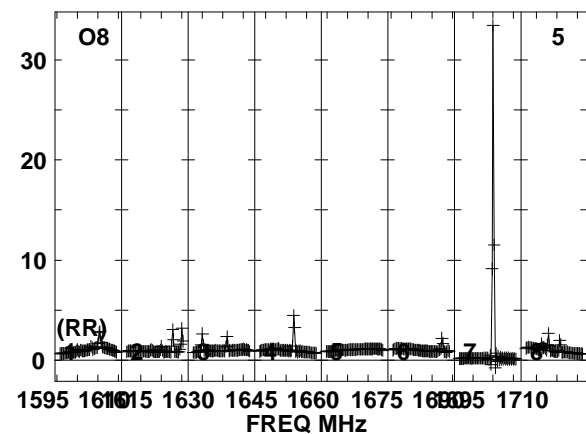
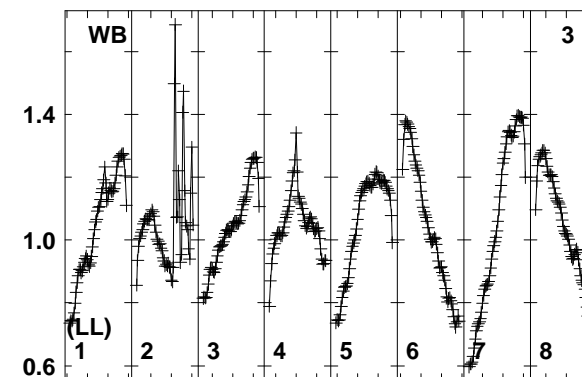
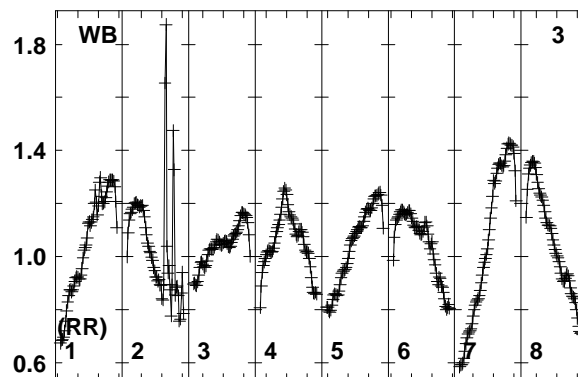
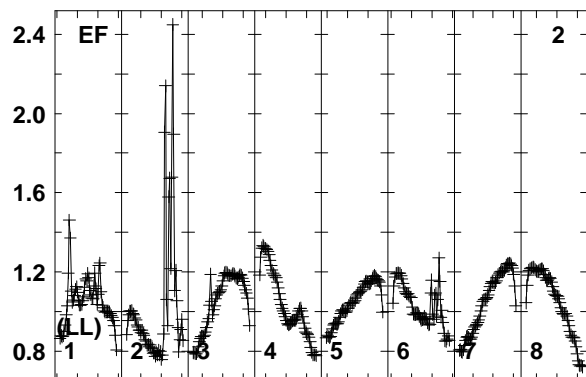
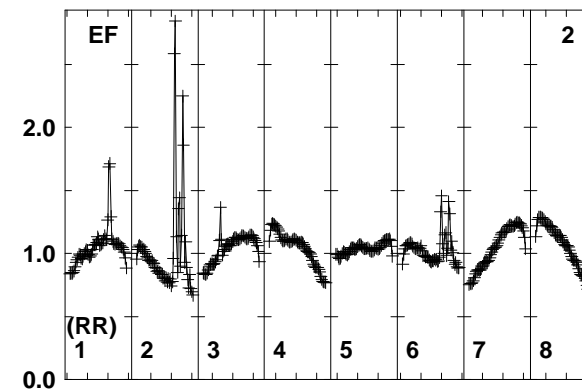
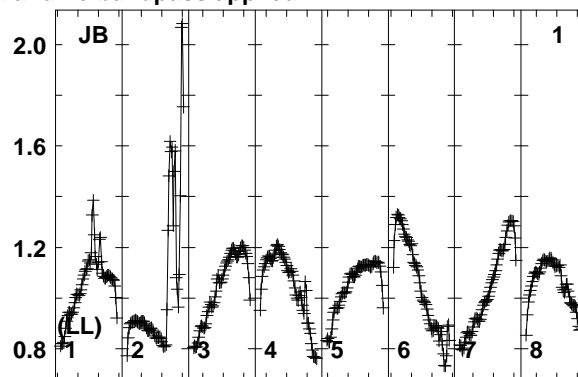
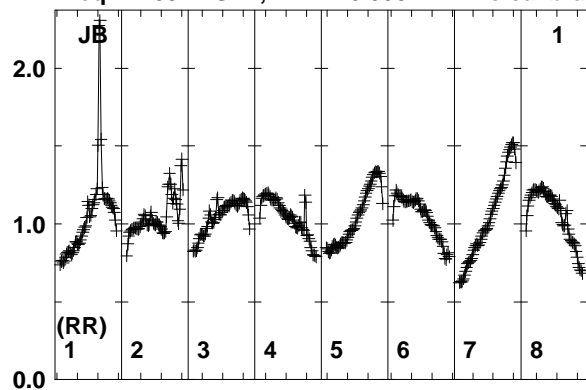

Lower frame: Real Jy
Total-power spectrum Antenna: JB (01)
Timerange: 00/06:52:51 to 00/06:55:29

Plot file version 452 created 04-NOV-2019 14:14:37

W2246-0526 EY034.UVDATA.1

Freq = 1.5947 GHz, Bw = 16.000 MH No calibration applied and no bandpass applied

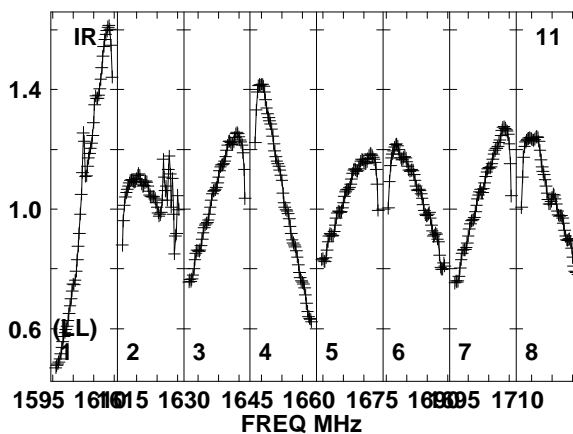
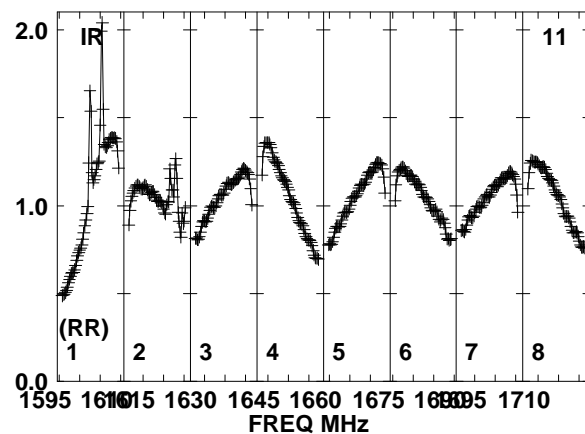
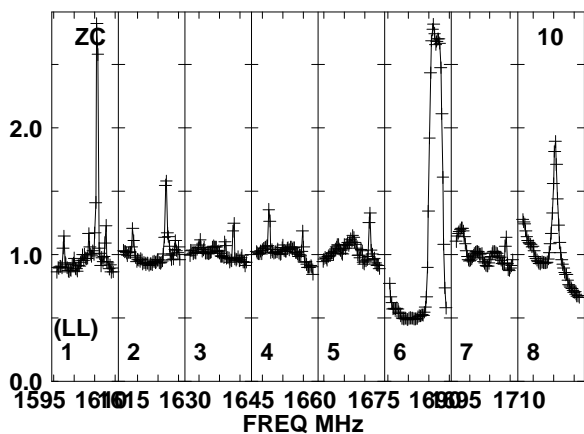
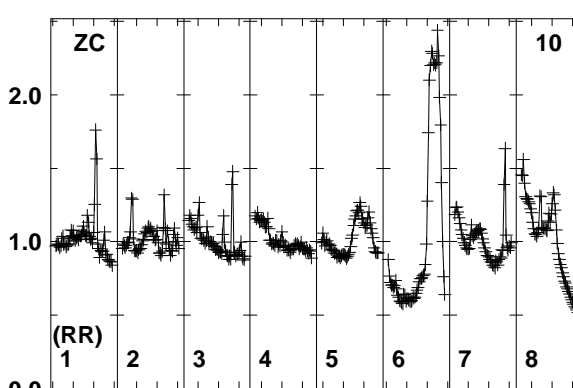
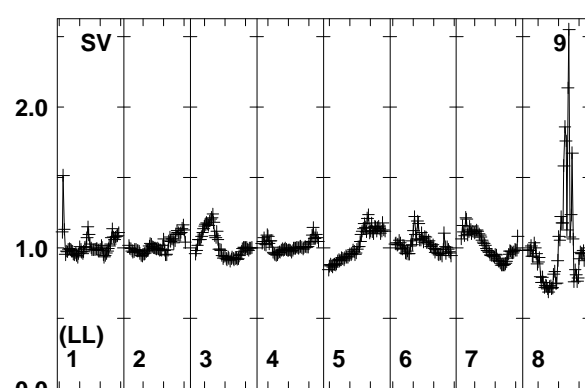
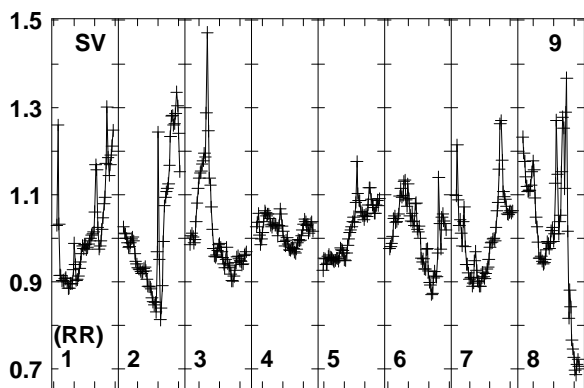
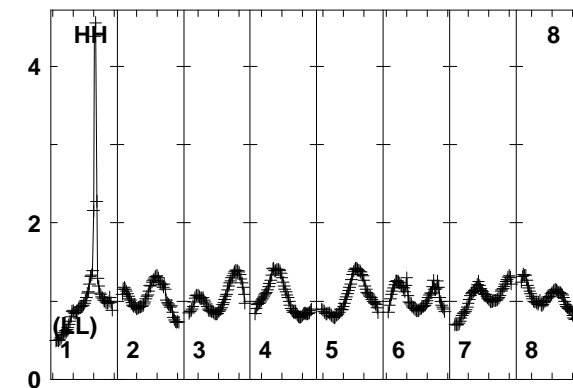
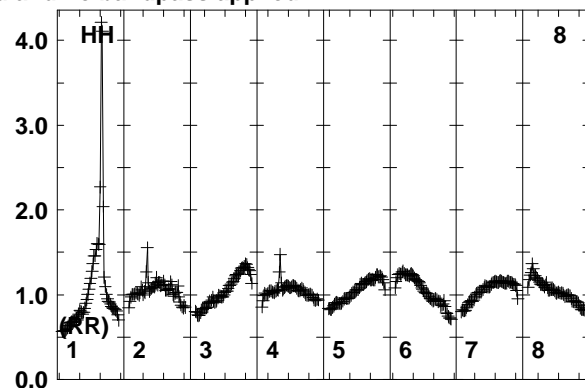
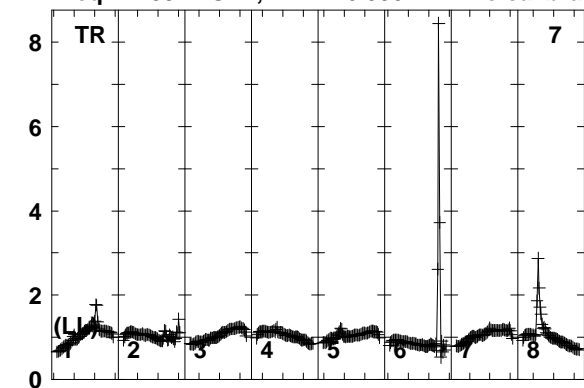

Lower frame: Real Jy
Total-power spectrum Antenna: TR (07)
Timerange: 00/06:52:51 to 00/06:55:29

Plot file version 453 created 04-NOV-2019 14:14:37

W2246-0526 EY034.UVDATA.1

Freq = 1.5947 GHz, Bw = 16.000 MH No calibration applied and no bandpass applied

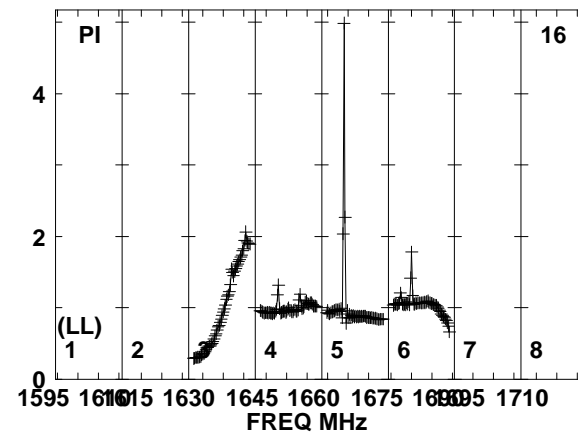
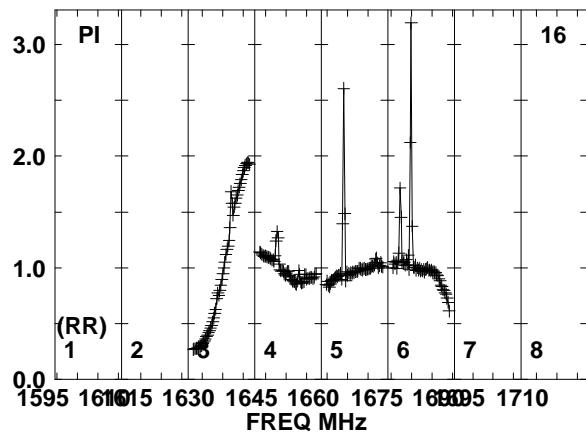
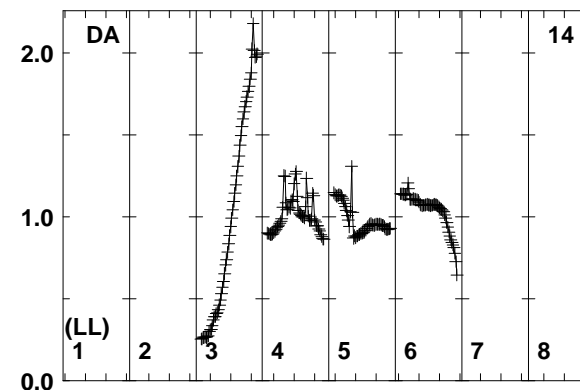
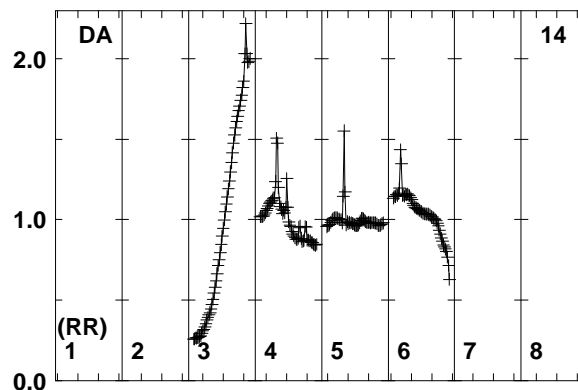
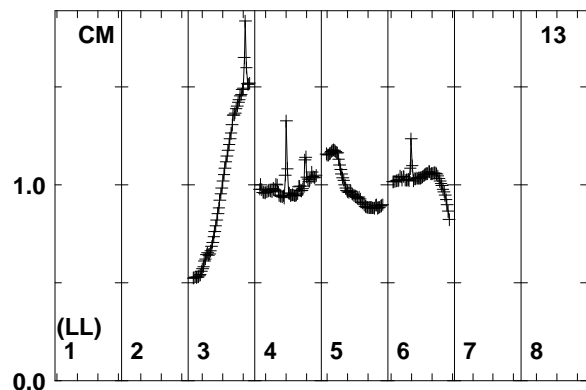
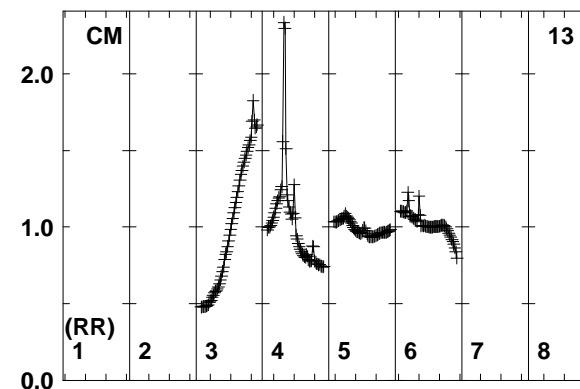
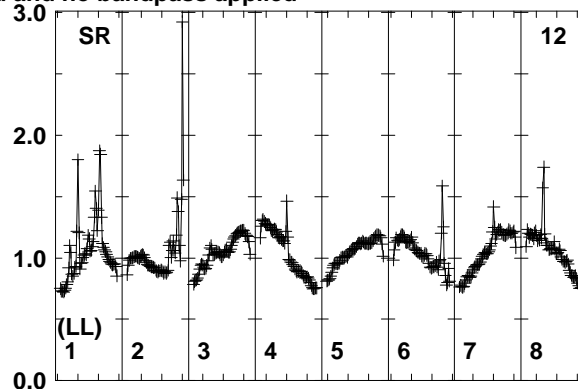
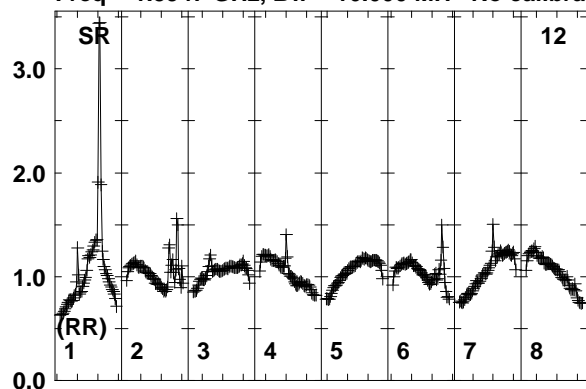

Lower frame: Real Jy
Total-power spectrum Antenna: SR (12)
Timerange: 00/06:52:51 to 00/06:55:29

Plot file version 454 created 04-NOV-2019 14:14:37

J2248-0541 EY034.UVDATA.1

Freq = 1.5947 GHz, Bw = 16.000 MH No calibration applied and no bandpass applied

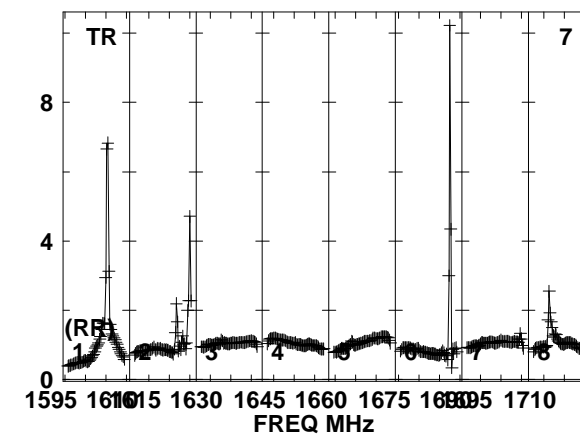
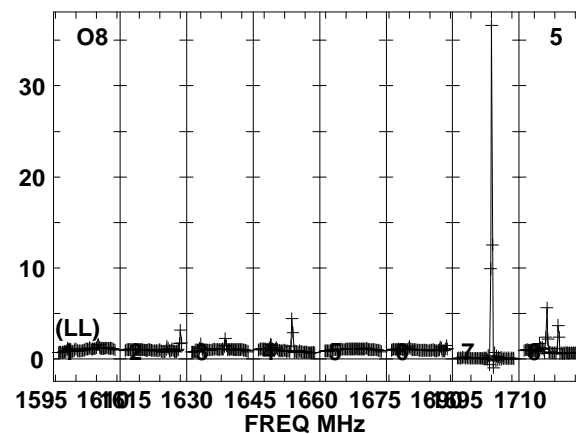
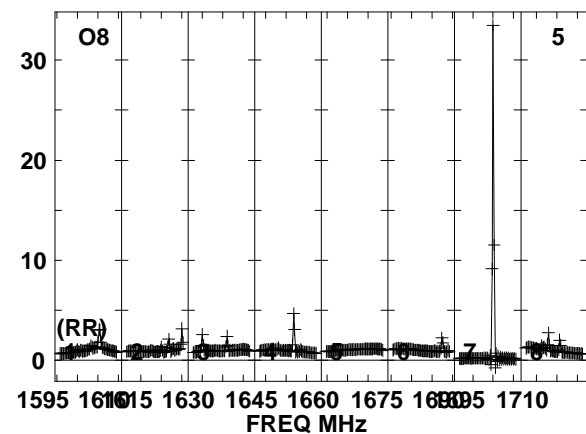
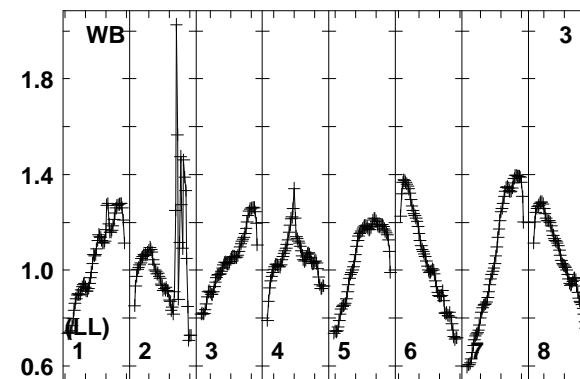
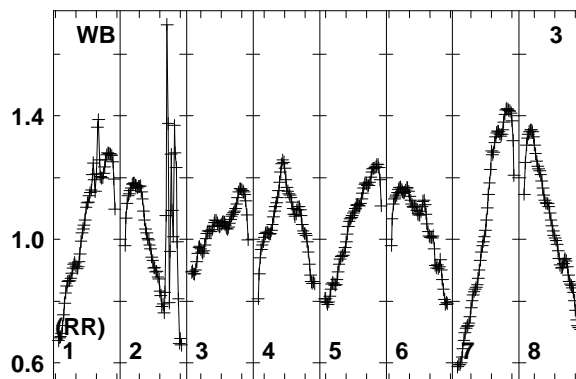
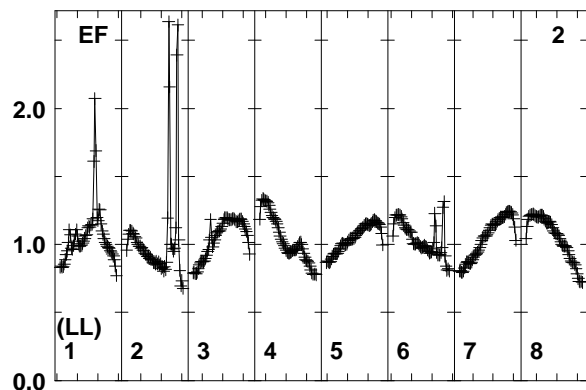
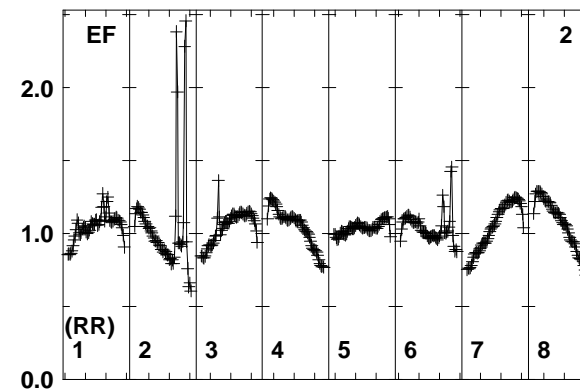
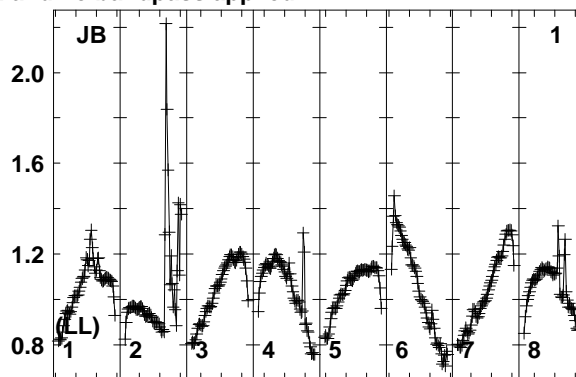
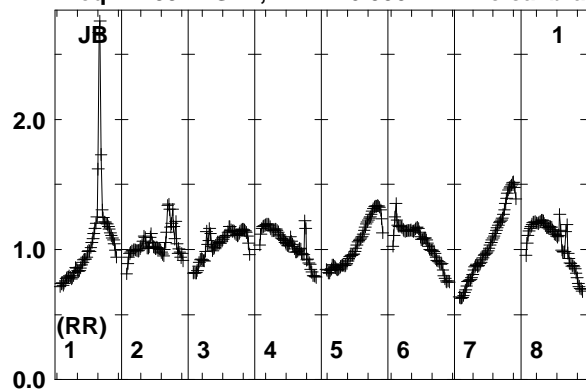

Lower frame: Real Jy
Total-power spectrum Antenna: JB (01)
Timerange: 00/06:55:46 to 00/06:56:44

Plot file version 455 created 04-NOV-2019 14:14:37

J2248-0541 EY034.UVDATA.1

Freq = 1.5947 GHz, Bw = 16.000 MH No calibration applied and no bandpass applied

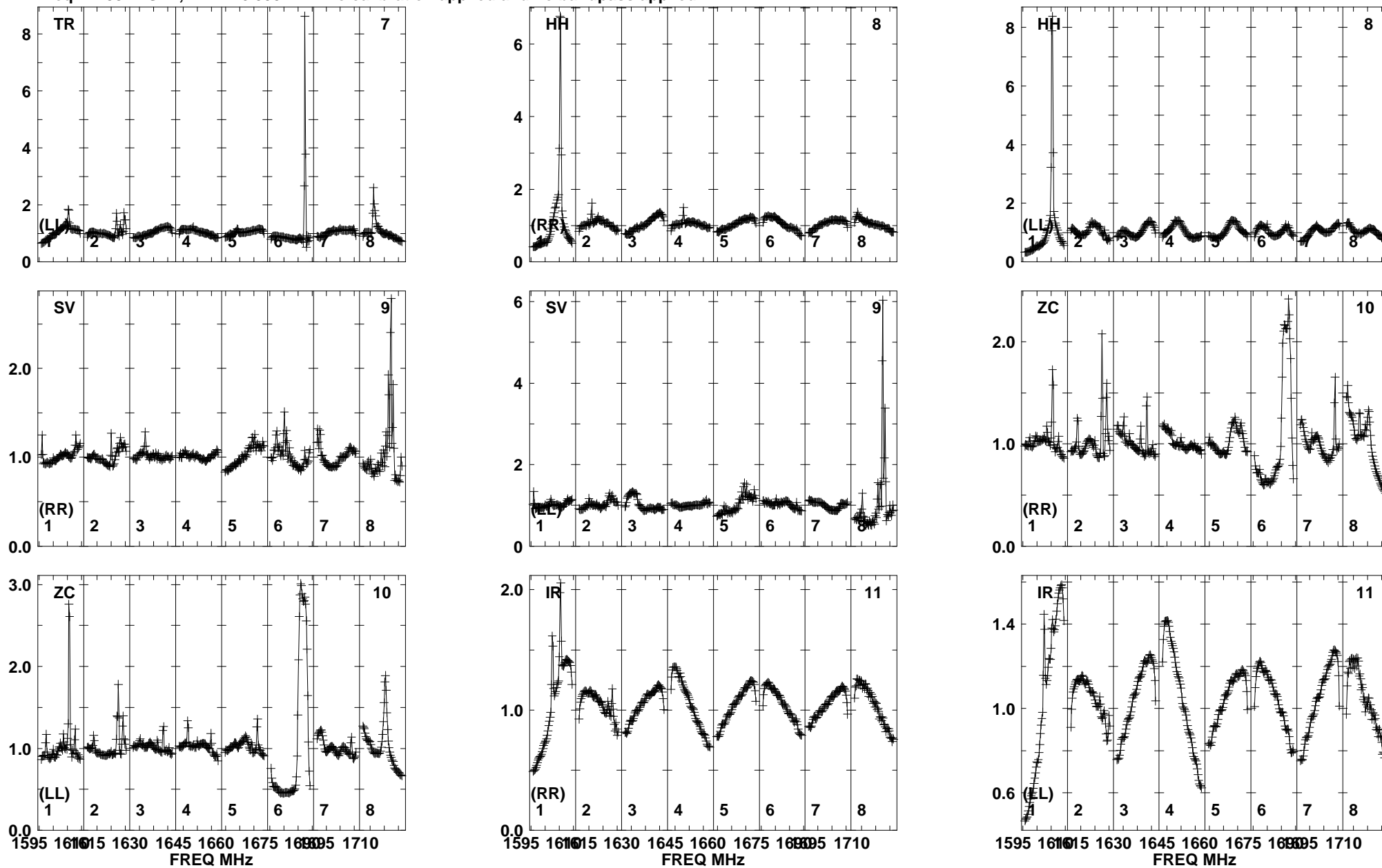

Lower frame: Real Jy
Total-power spectrum Antenna: TR (07)
Timerange: 00/06:55:46 to 00/06:56:44

Plot file version 456 created 04-NOV-2019 14:14:37

J2248-0541 EY034.UVDATA.1

Freq = 1.5947 GHz, Bw = 16.000 MH No calibration applied and no bandpass applied

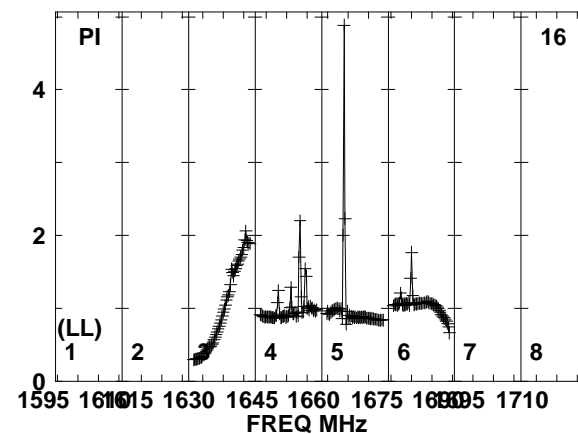
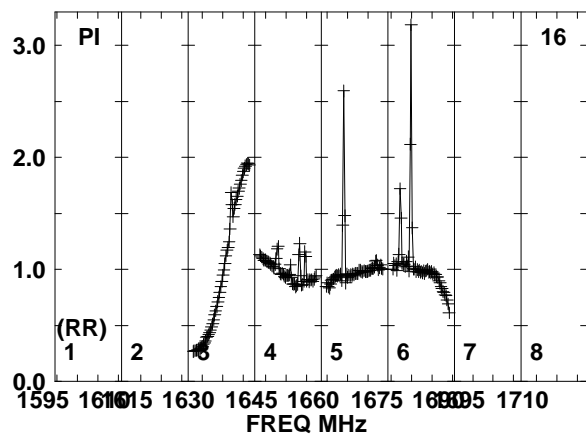
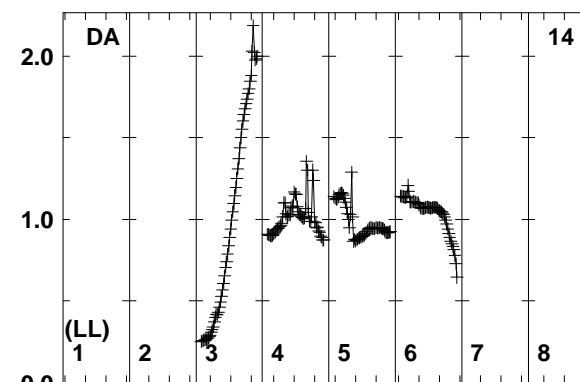
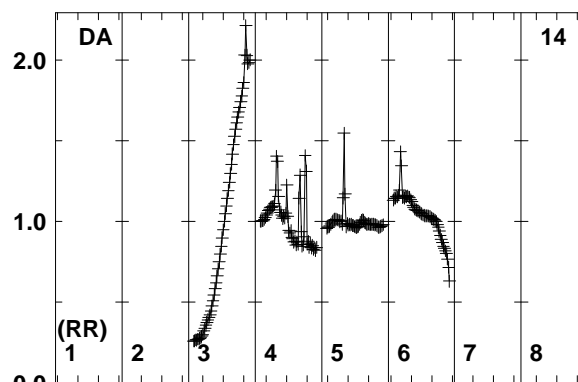
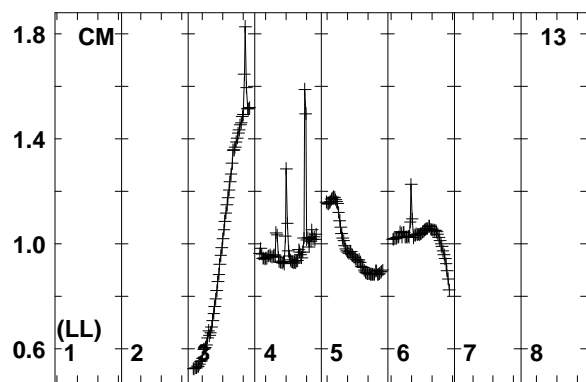
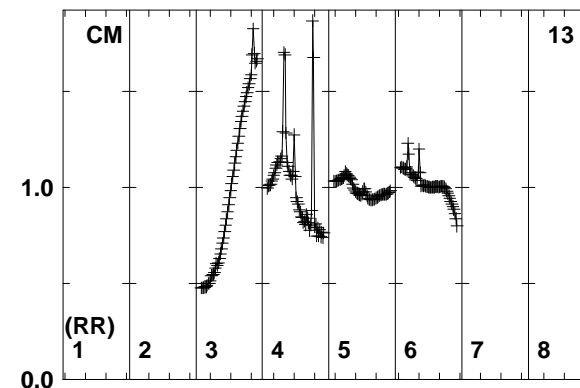
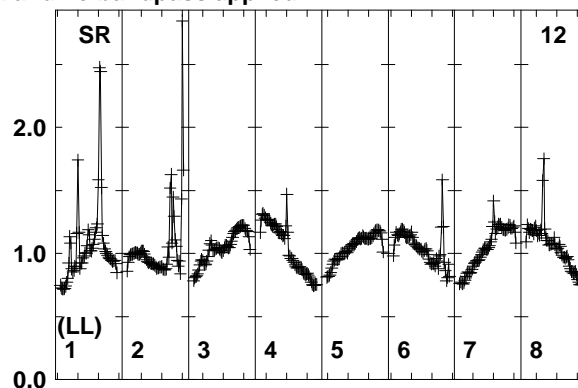
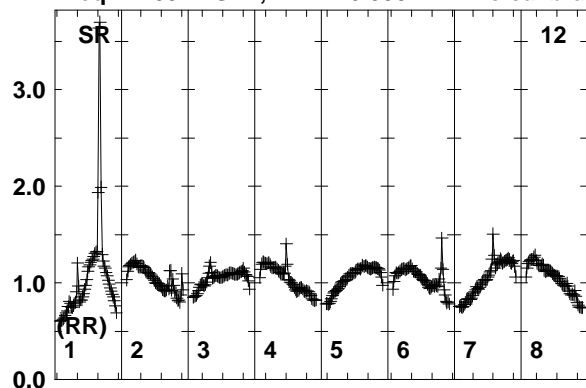

Lower frame: Real Jy
Total-power spectrum Antenna: SR (12)
Timerange: 00/06:55:46 to 00/06:56:44

Plot file version 457 created 04-NOV-2019 14:14:37

J2245-0755 EY034.UVDATA.1

Freq = 1.5947 GHz, Bw = 16.000 MH No calibration applied and no bandpass applied

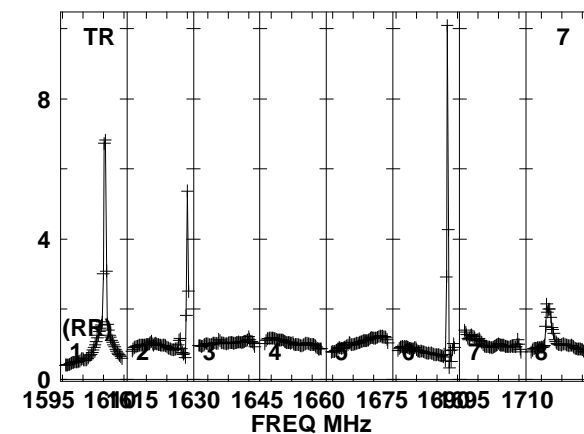
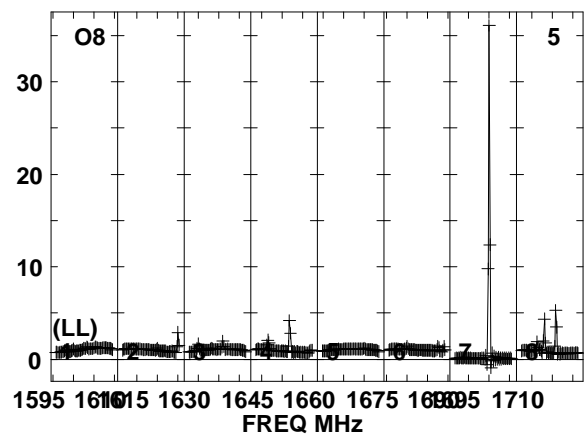
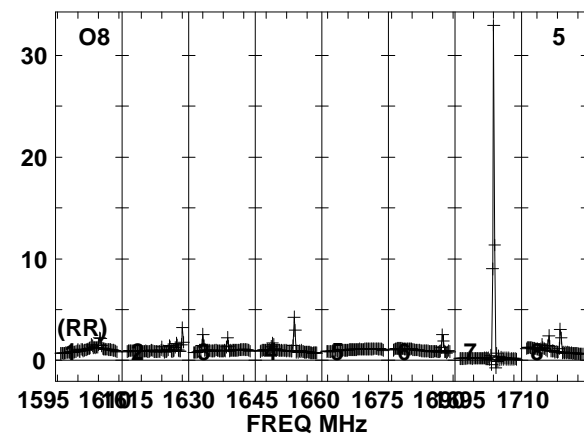
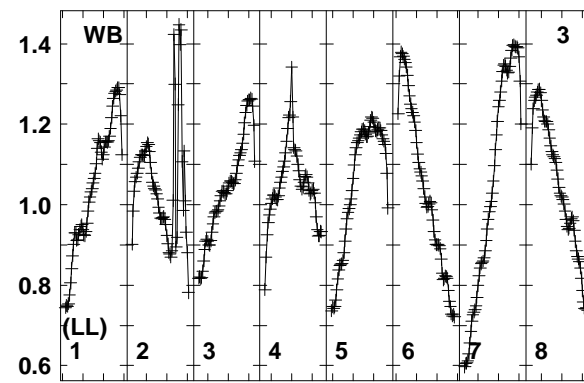
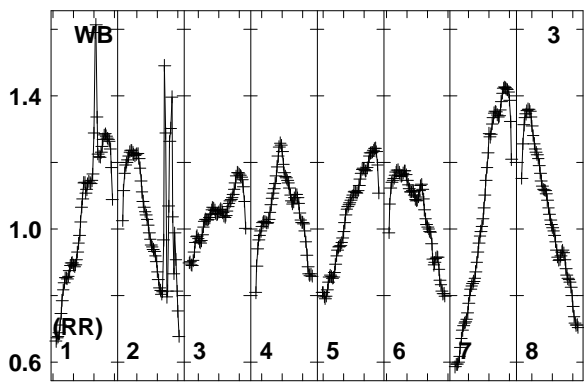
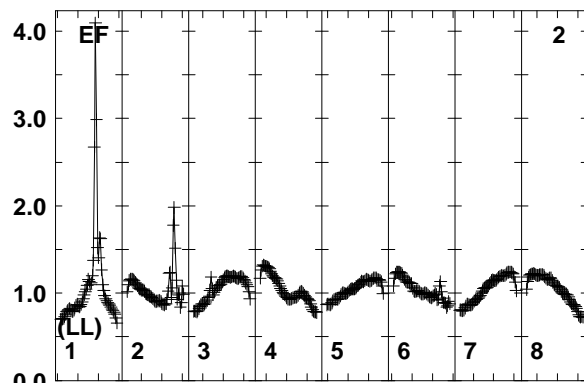
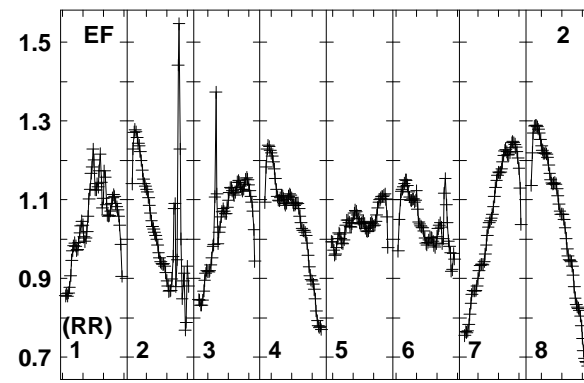
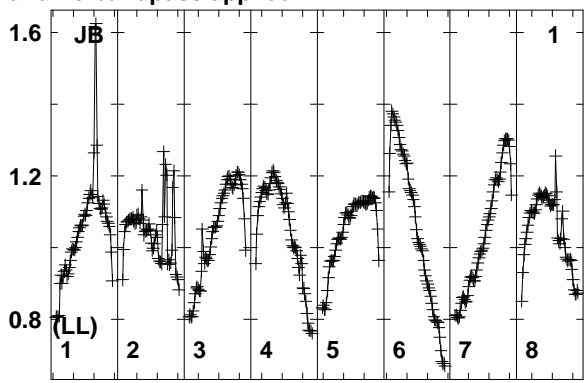
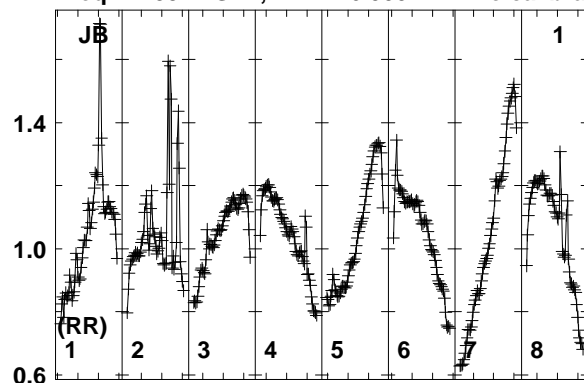

Lower frame: Real Jy
Total-power spectrum Antenna: JB (01)
Timerange: 00/06:57:01 to 00/06:57:59

Plot file version 458 created 04-NOV-2019 14:14:37

J2245-0755 EY034.UVDATA.1

Freq = 1.5947 GHz, Bw = 16.000 MH No calibration applied and no bandpass applied

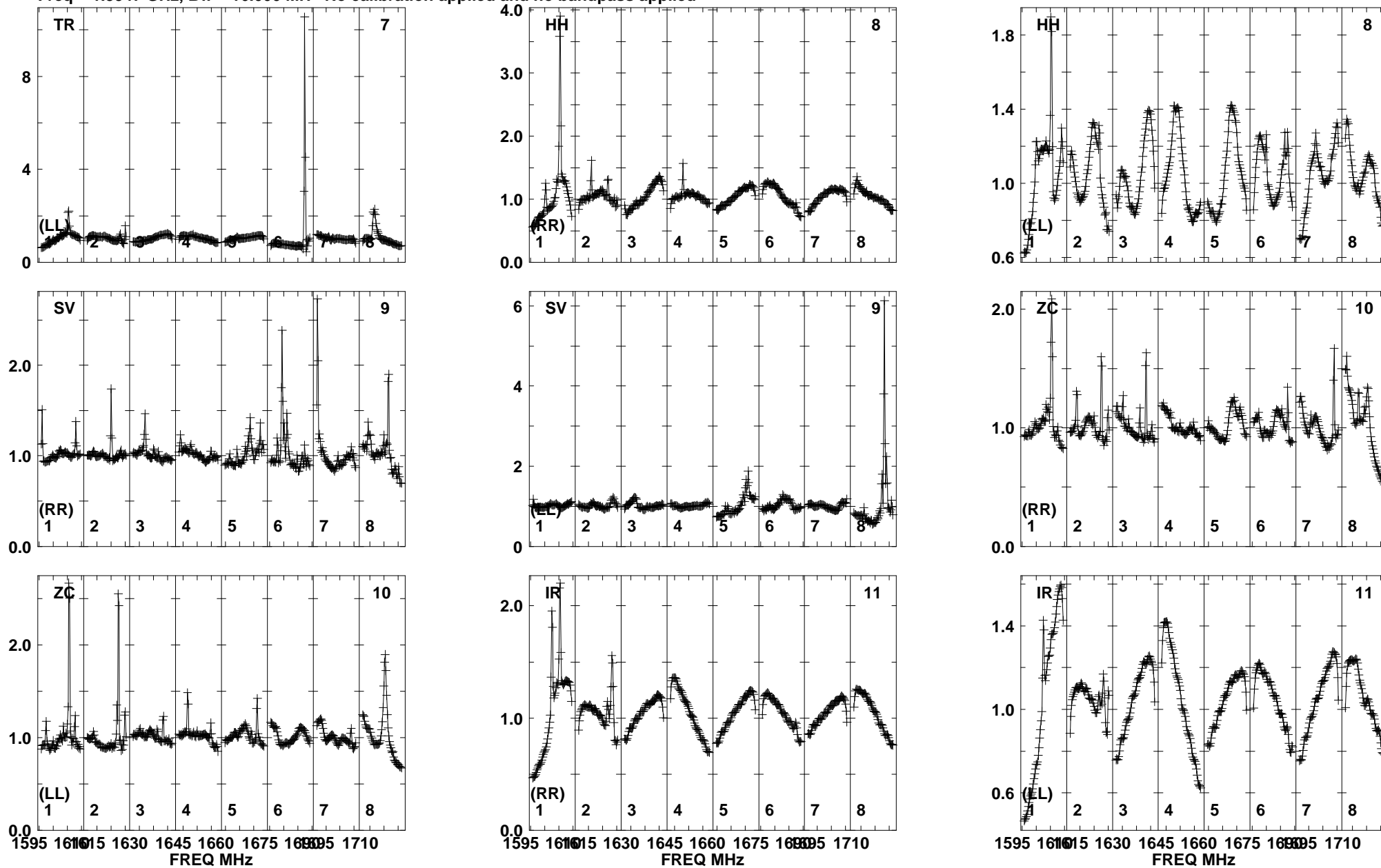

Lower frame: Real Jy
Total-power spectrum Antenna: TR (07)
Timerange: 00/06:57:01 to 00/06:57:59

Plot file version 459 created 04-NOV-2019 14:14:37

J2245-0755 EY034.UVDATA.1

Freq = 1.5947 GHz, Bw = 16.000 MH No calibration applied and no bandpass applied

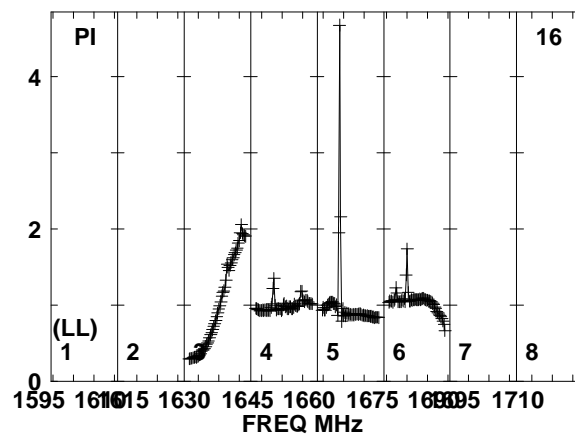
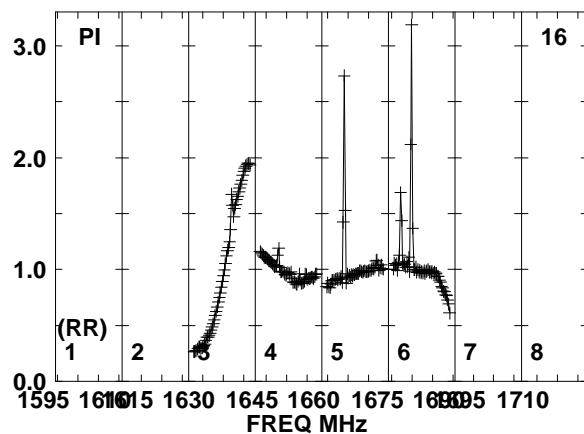
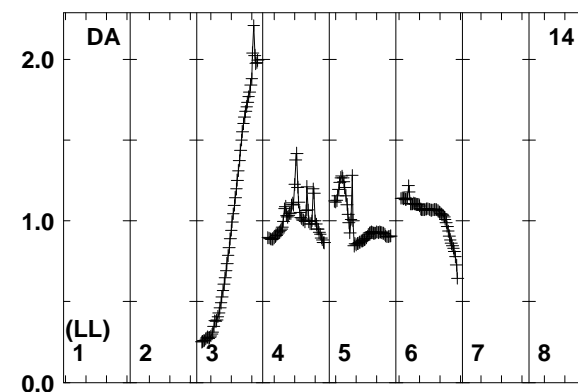
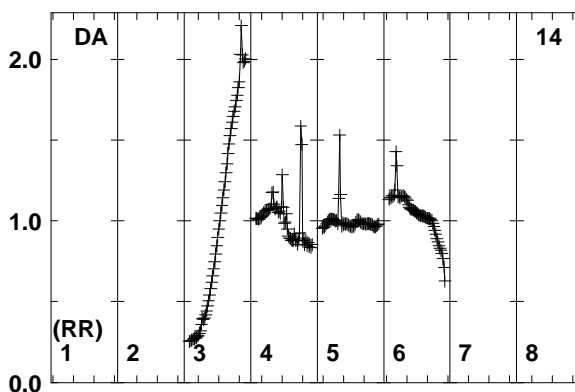
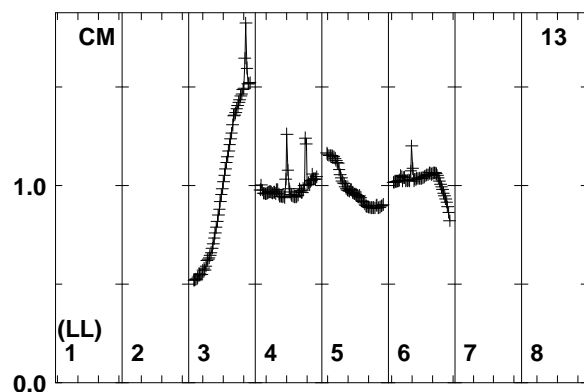
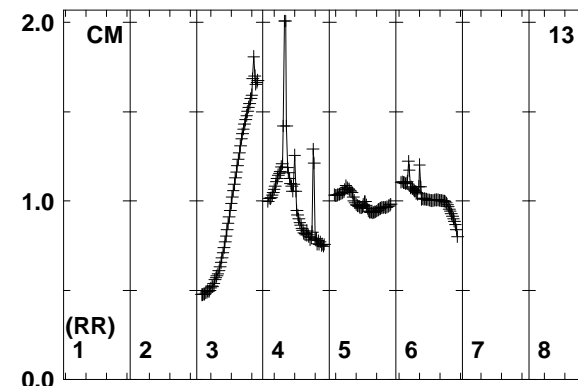
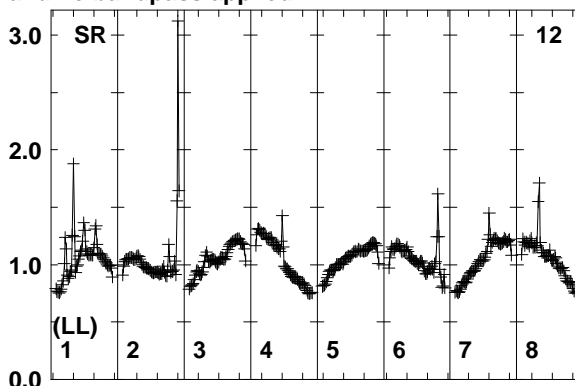
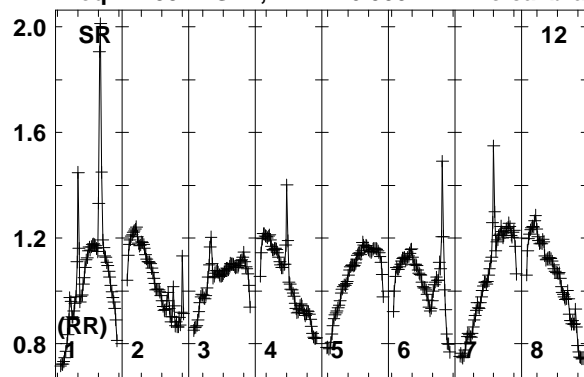

Lower frame: Real Jy
Total-power spectrum Antenna: SR (12)
Timerange: 00/06:57:01 to 00/06:57:59

Plot file version 460 created 04-NOV-2019 14:14:37

J2248-0541 EY034.UVDATA.1

Freq = 1.5947 GHz, Bw = 16.000 MH No calibration applied and no bandpass applied

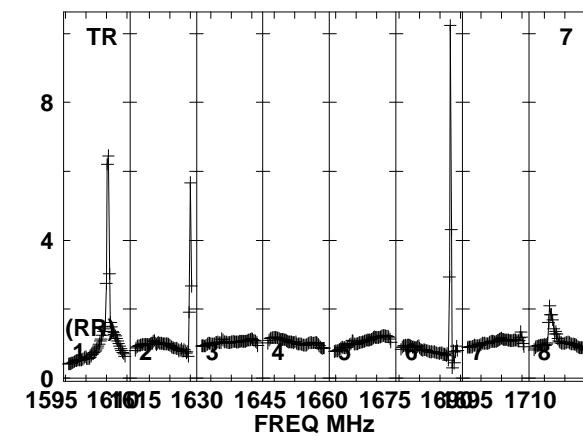
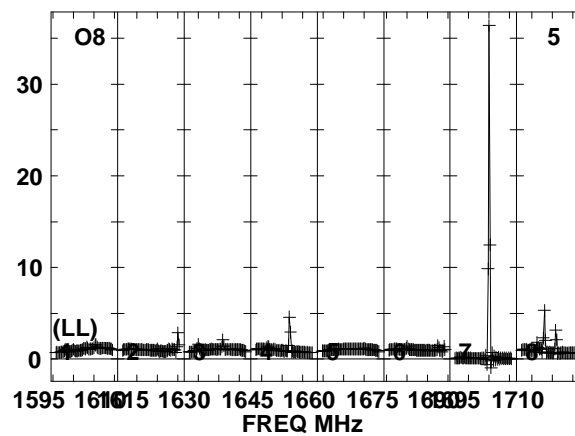
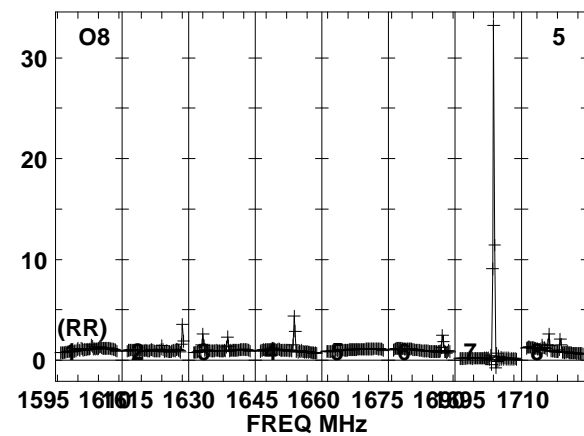
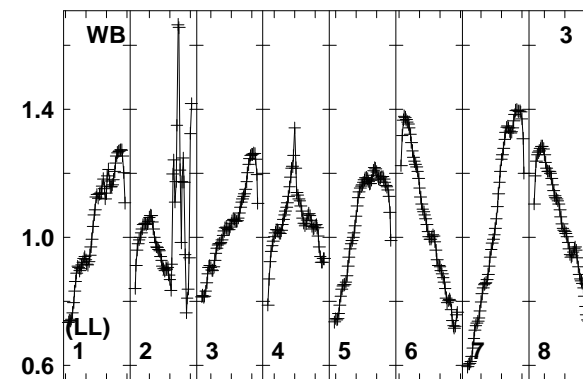
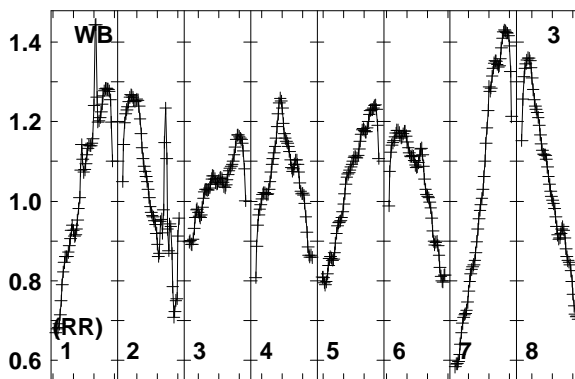
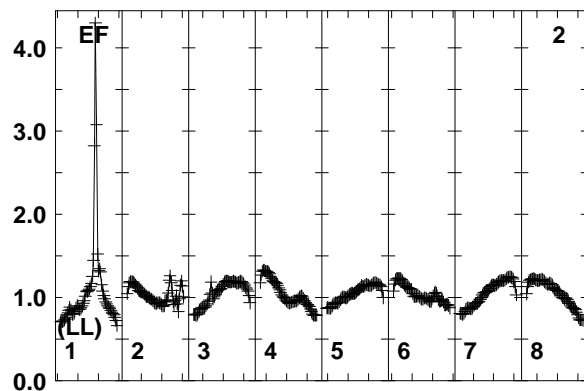
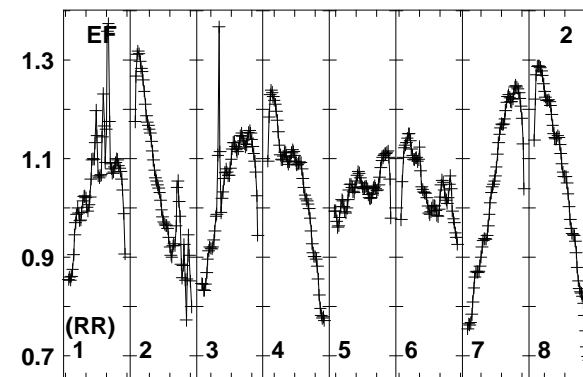
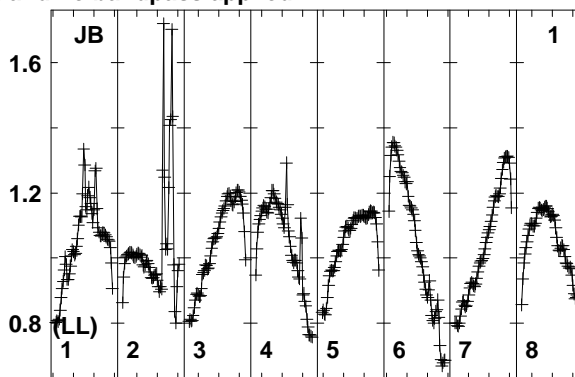
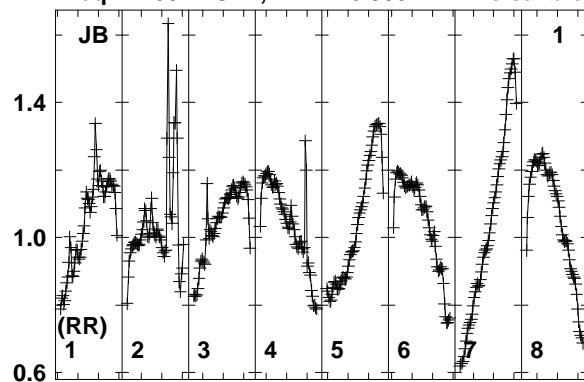

Lower frame: Real Jy
Total-power spectrum Antenna: JB (01)
Timerange: 00/06:58:46 to 00/06:59:44

Plot file version 461 created 04-NOV-2019 14:14:37

J2248-0541 EY034.UVDATA.1

Freq = 1.5947 GHz, Bw = 16.000 MH No calibration applied and no bandpass applied

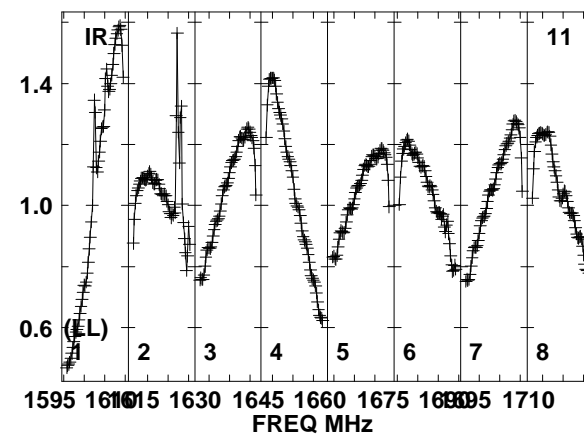
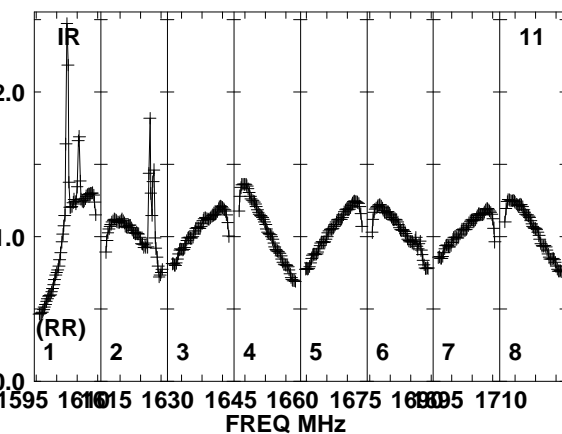
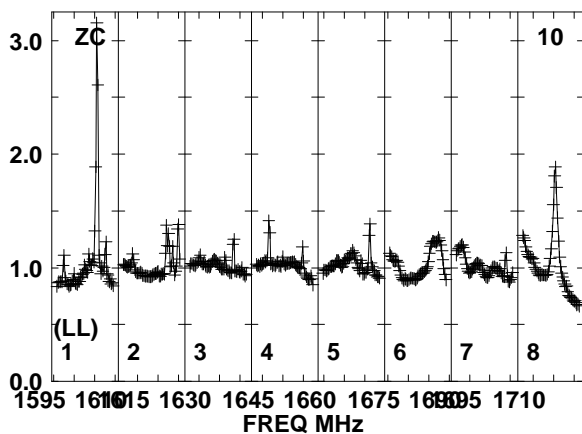
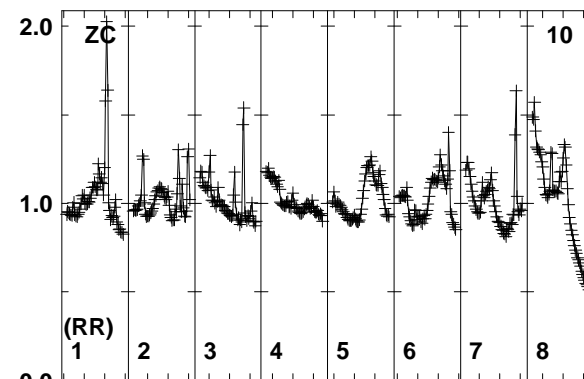
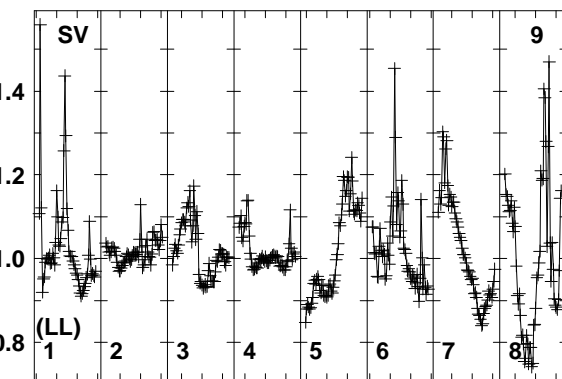
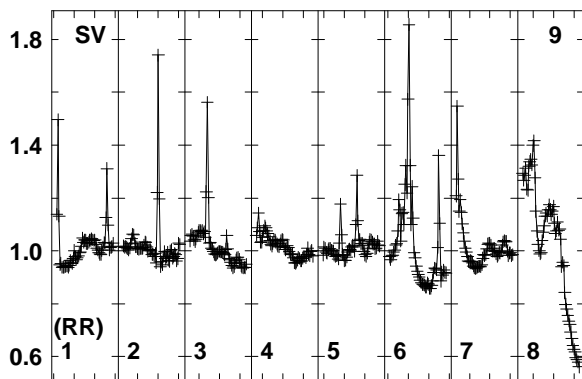
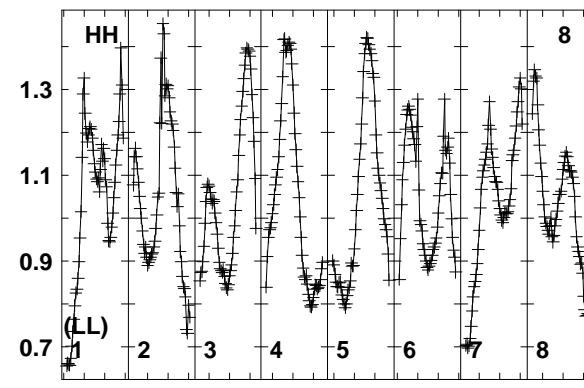
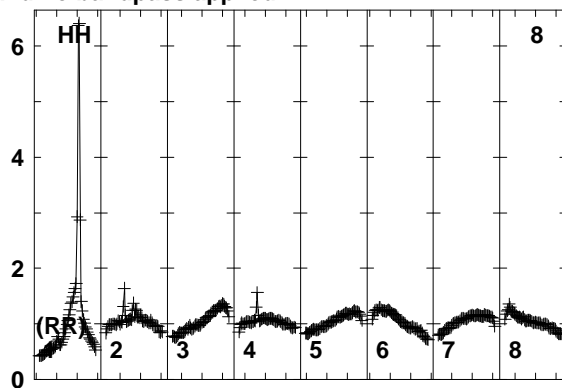
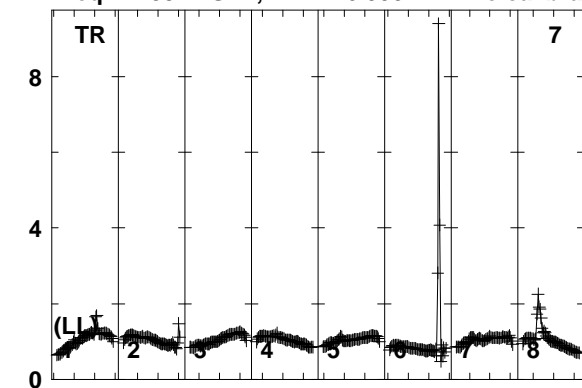

Lower frame: Real Jy
Total-power spectrum Antenna: TR (07)
Timerange: 00/06:58:46 to 00/06:59:44

Plot file version 462 created 04-NOV-2019 14:14:37

J2248-0541 EY034.UVDATA.1

Freq = 1.5947 GHz, Bw = 16.000 MH No calibration applied and no bandpass applied

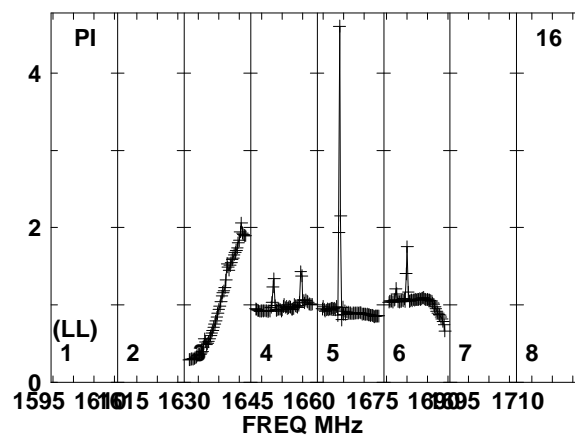
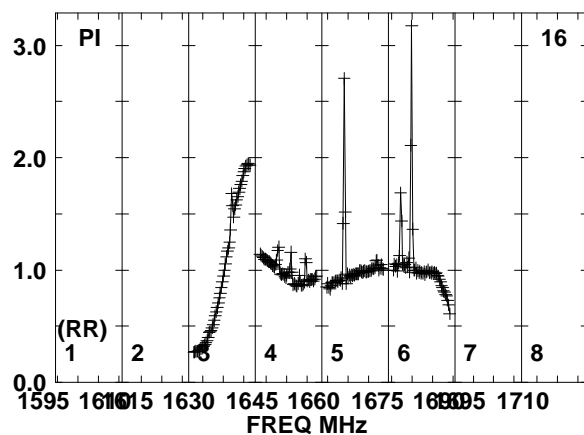
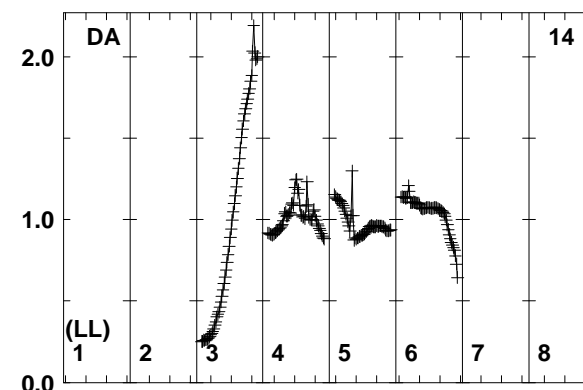
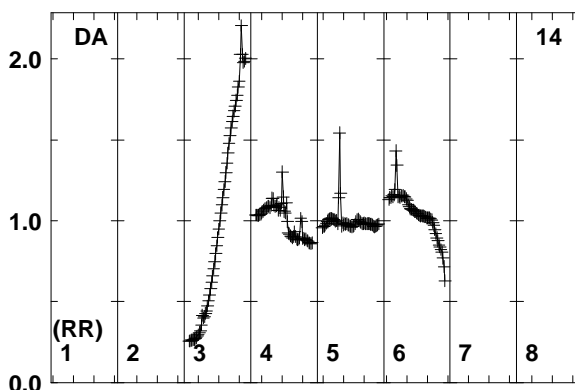
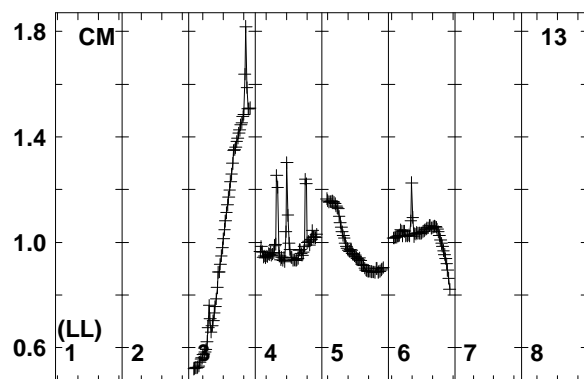
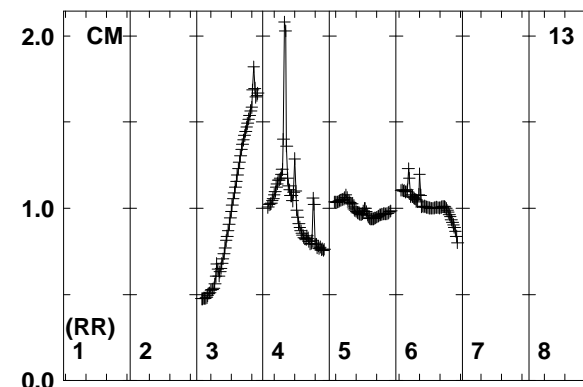
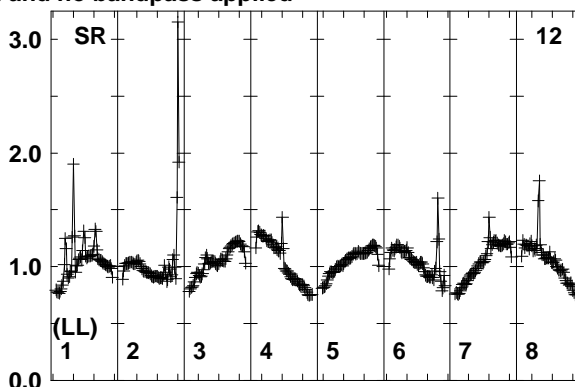
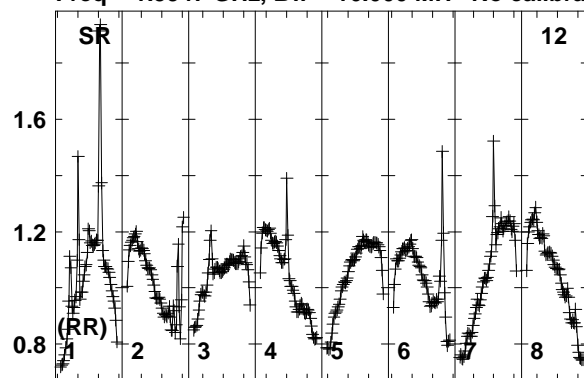

Lower frame: Real Jy
Total-power spectrum Antenna: SR (12)
Timerange: 00/06:58:46 to 00/06:59:44

Plot file version 463 created 04-NOV-2019 14:14:37

W2246-0526 EY034.UVDATA.1

Freq = 1.5947 GHz, Bw = 16.000 MH No calibration applied and no bandpass applied

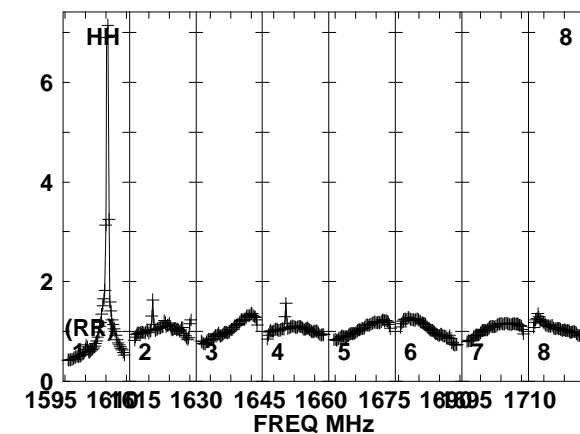
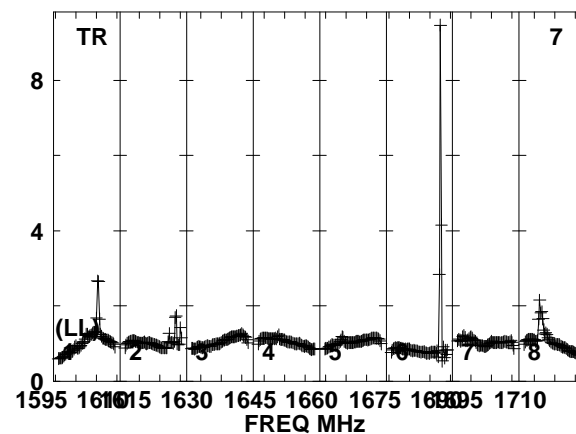
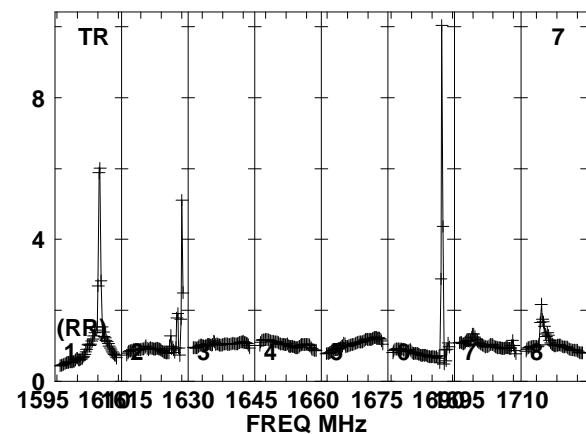
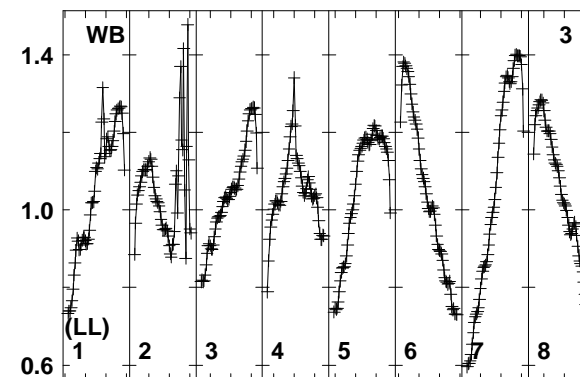
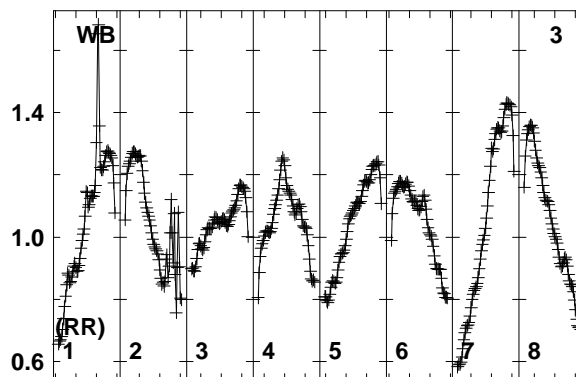
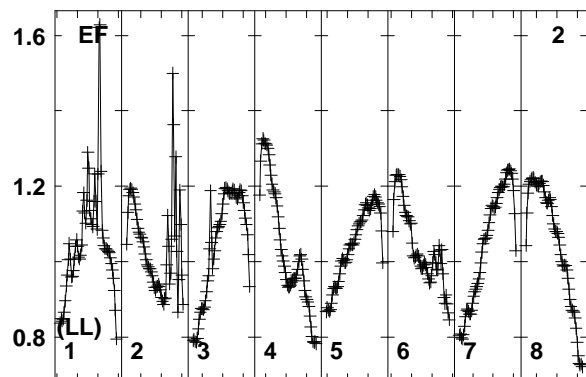
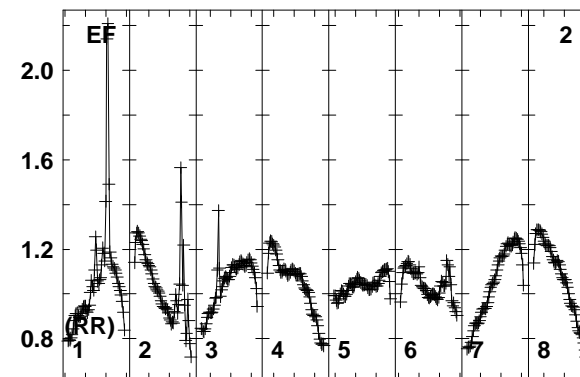
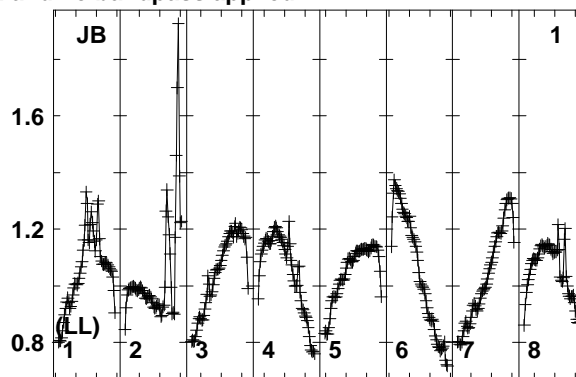
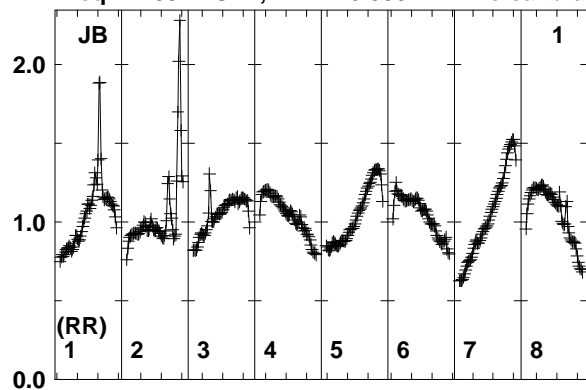

Lower frame: Real Jy
Total-power spectrum Antenna: JB (01)
Timerange: 00/06:59:46 to 00/07:02:14

Plot file version 464 created 04-NOV-2019 14:14:37

W2246-0526 EY034.UVDATA.1

Freq = 1.5947 GHz, Bw = 16.000 MH No calibration applied and no bandpass applied

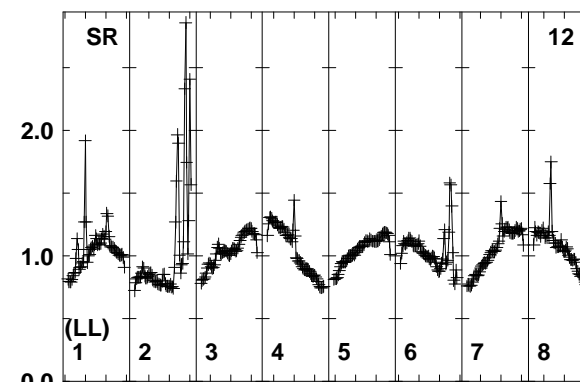
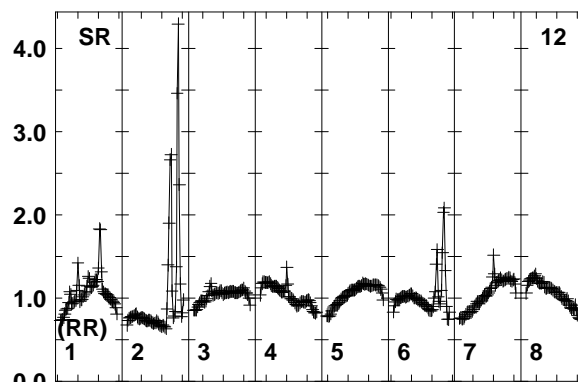
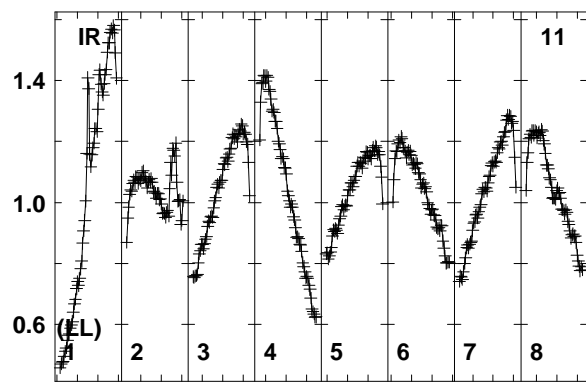
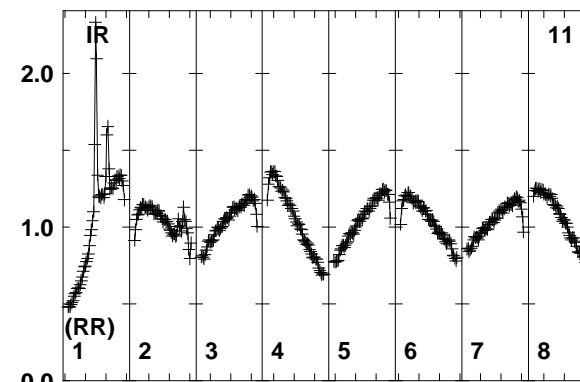
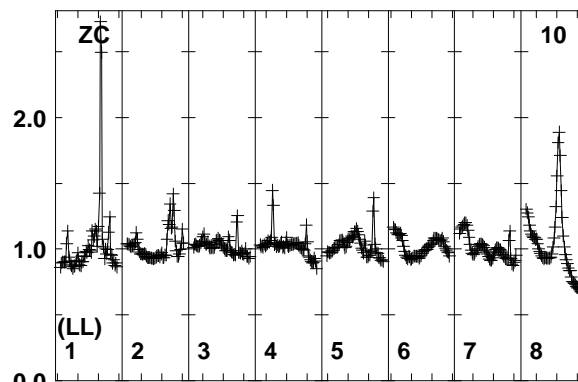
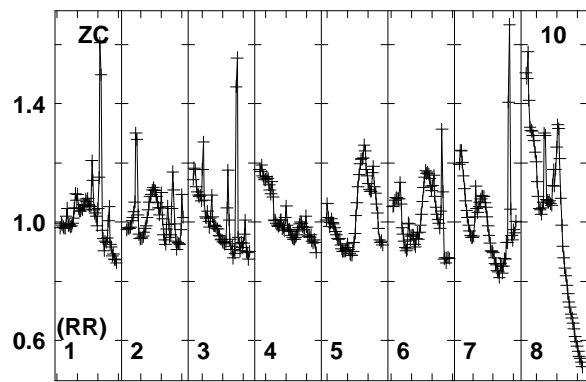
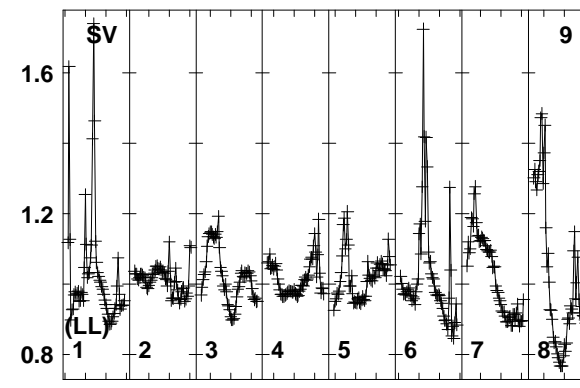
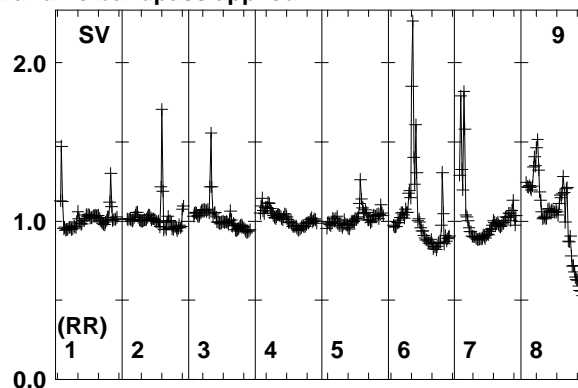
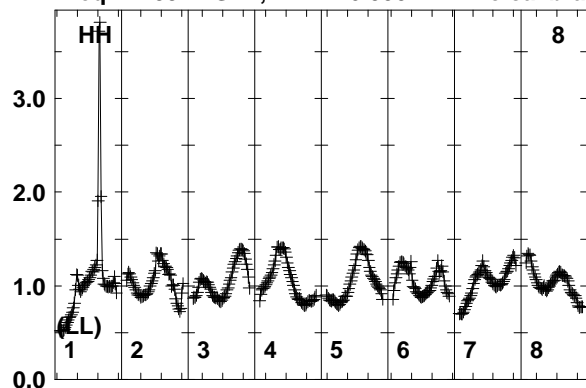

1595 1610 1630 1645 1660 1675 1690 1710
FREQ MHz
Lower frame: Real Jy
Total-power spectrum Antenna: HH (08)
Timerange: 00/06:59:46 to 00/07:02:14

Plot file version 465 created 04-NOV-2019 14:14:38

W2246-0526 EY034.UVDATA.1

Freq = 1.5947 GHz, Bw = 16.000 MH No calibration applied and no bandpass applied

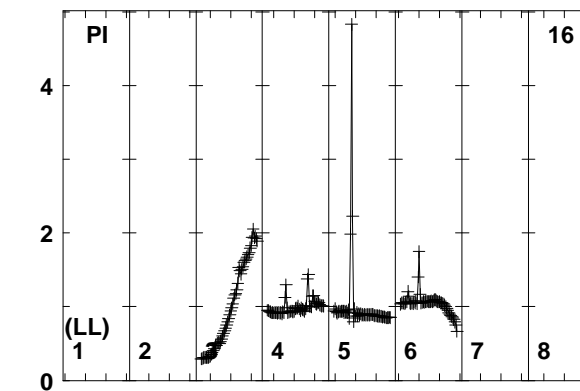
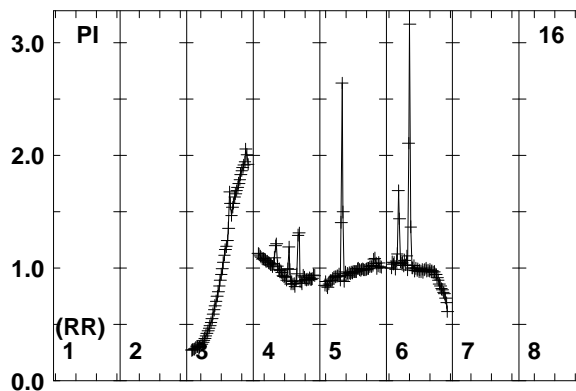
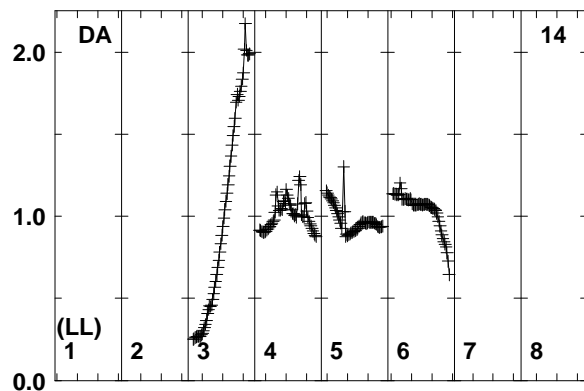
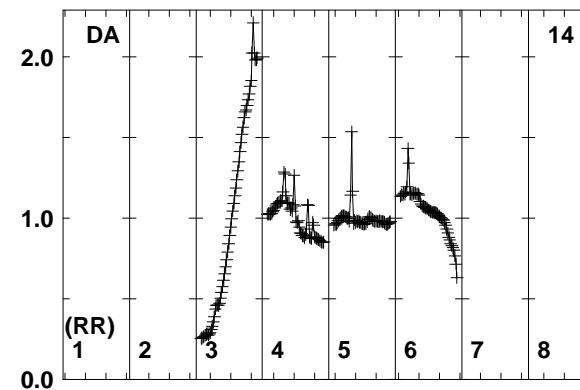
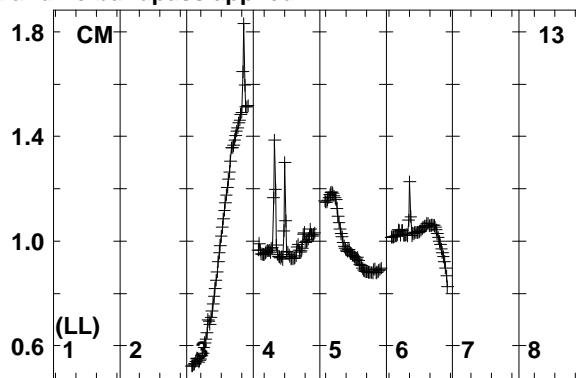
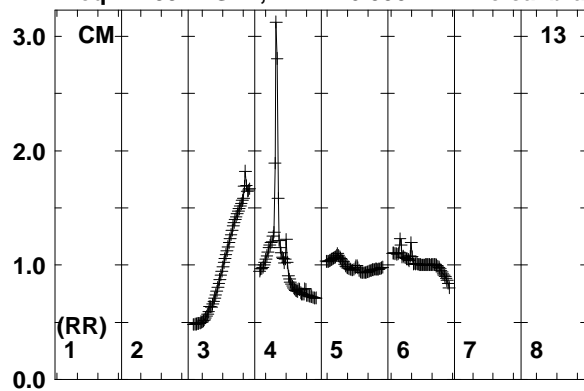

Lower frame: Real Jy
Total-power spectrum Antenna: CM (13)
Timerange: 00/06:59:46 to 00/07:02:14

Plot file version 466 created 04-NOV-2019 14:14:38

J2248-0541 EY034.UVDATA.1

Freq = 1.5947 GHz, Bw = 16.000 MH No calibration applied and no bandpass applied

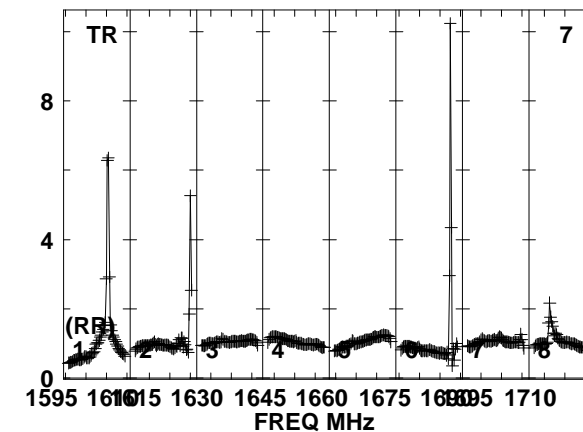
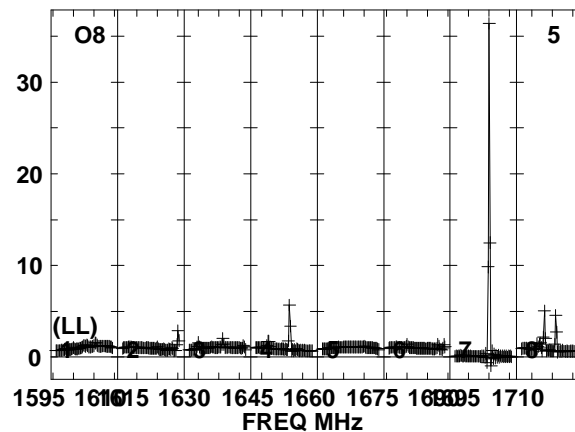
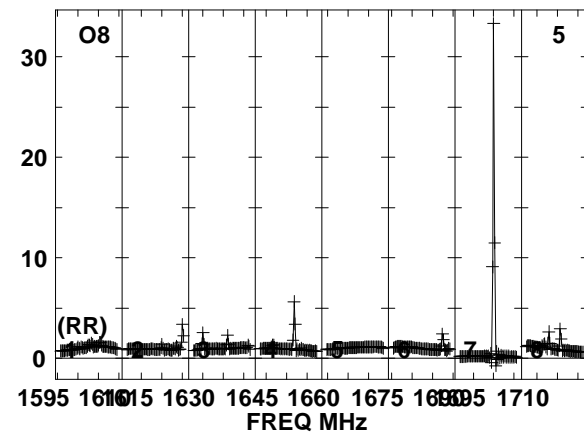
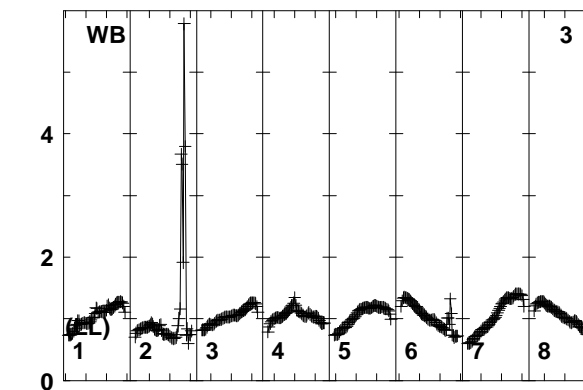
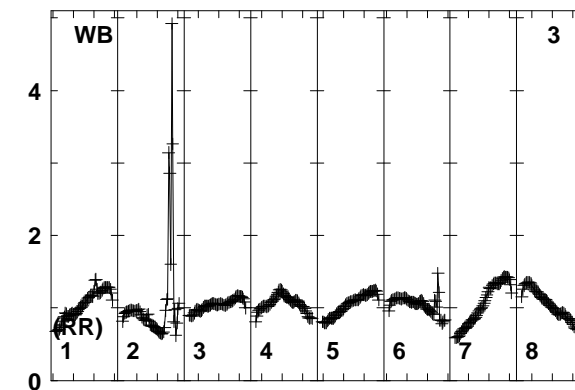
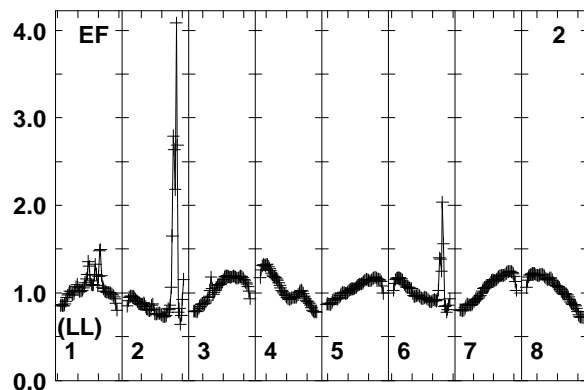
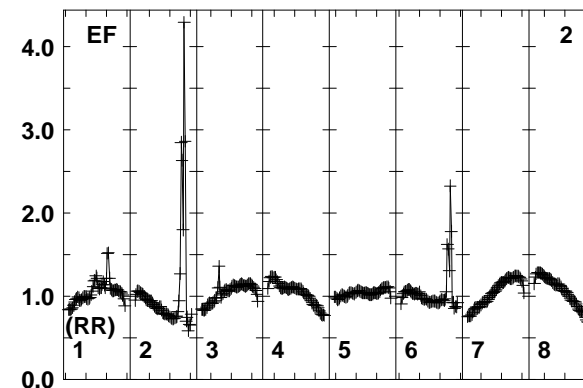
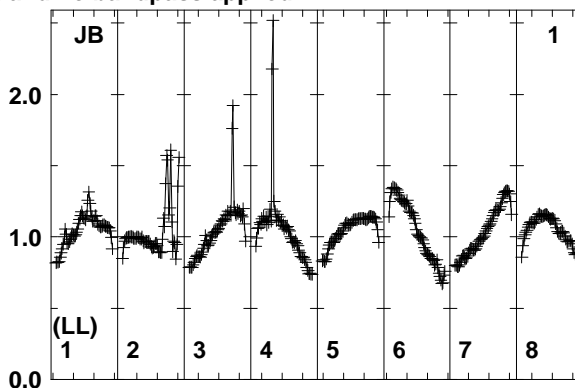
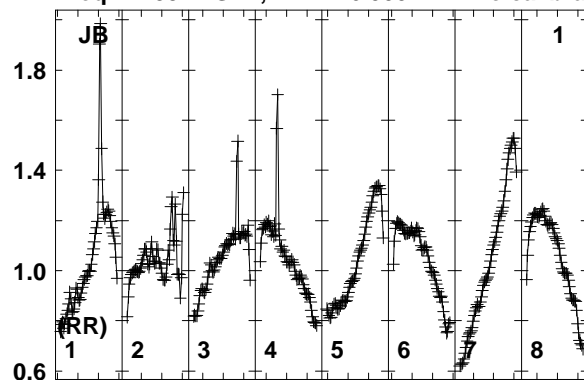

Lower frame: Real Jy
Total-power spectrum Antenna: JB (01)
Timerange: 00/07:02:31 to 00/07:03:29

Plot file version 467 created 04-NOV-2019 14:14:38

J2248-0541 EY034.UVDATA.1

Freq = 1.5947 GHz, Bw = 16.000 MH No calibration applied and no bandpass applied

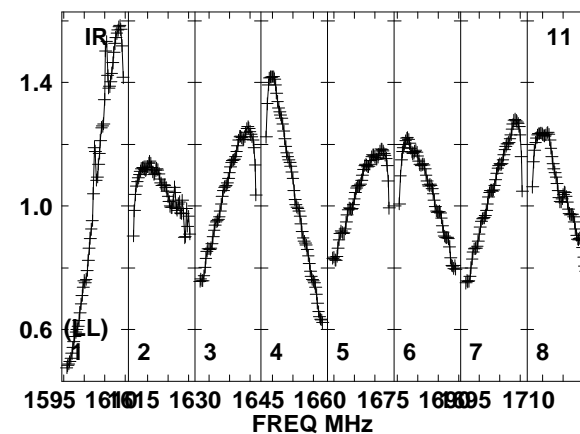
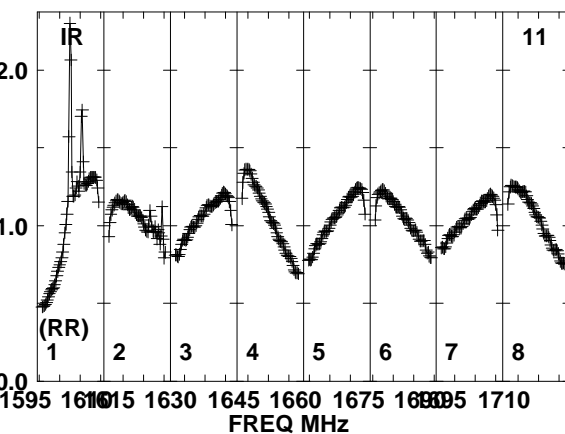
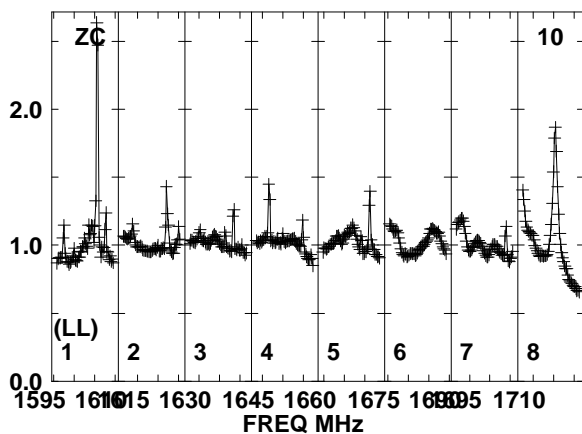
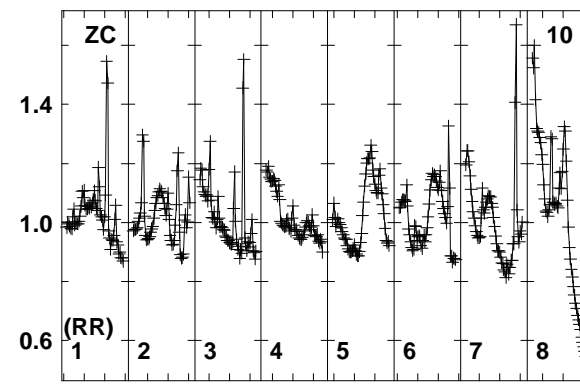
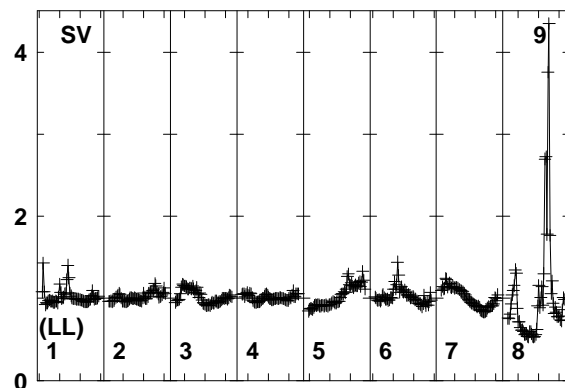
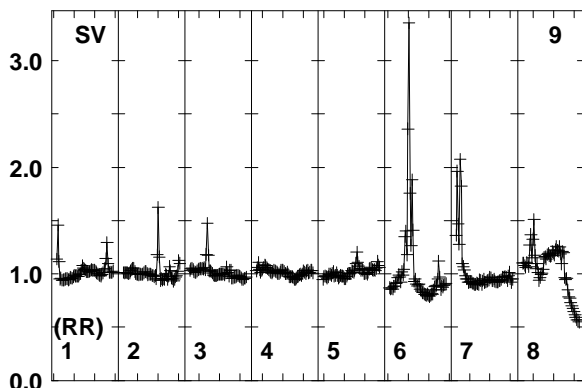
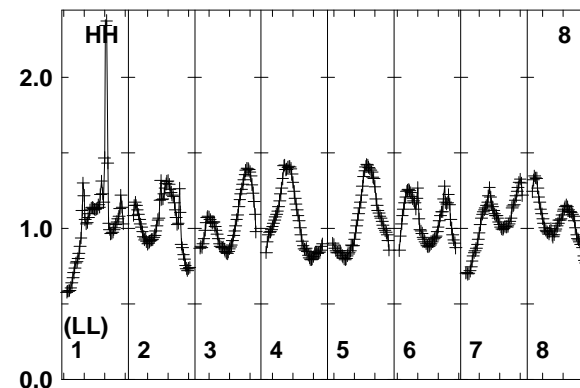
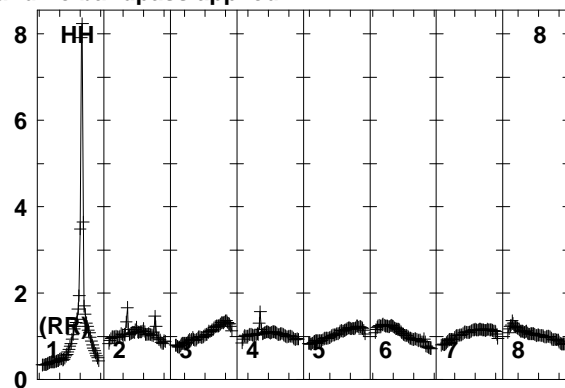
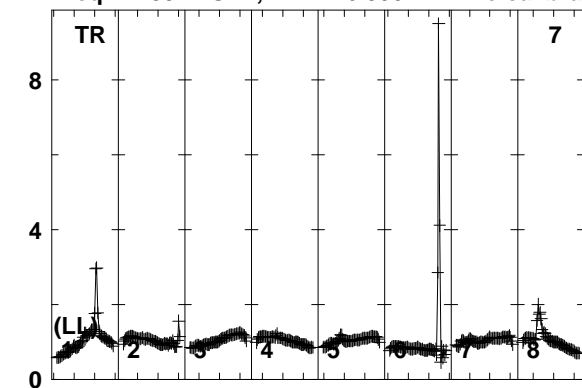

Lower frame: Real Jy
Total-power spectrum Antenna: TR (07)
Timerange: 00/07:02:31 to 00/07:03:29

Plot file version 468 created 04-NOV-2019 14:14:38

J2248-0541 EY034.UVDATA.1

Freq = 1.5947 GHz, Bw = 16.000 MH No calibration applied and no bandpass applied

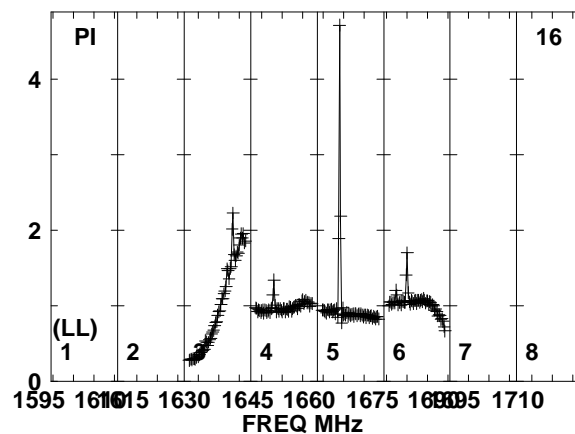
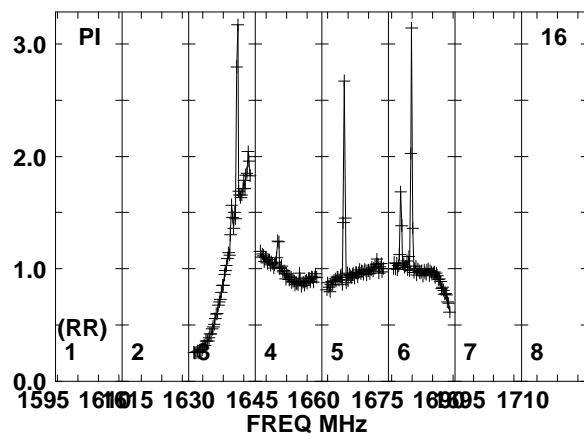
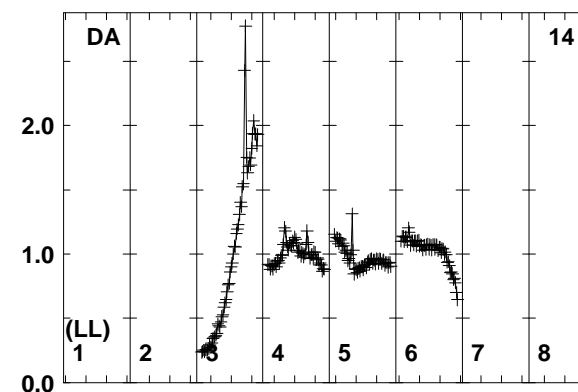
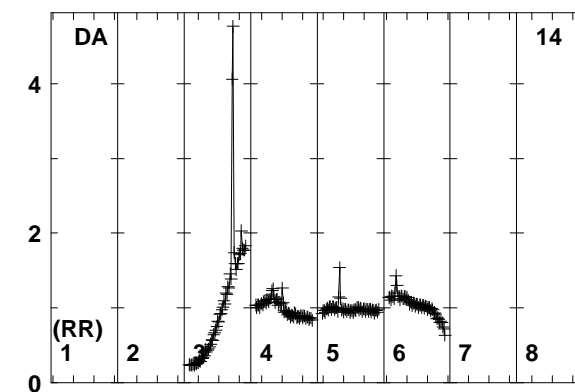
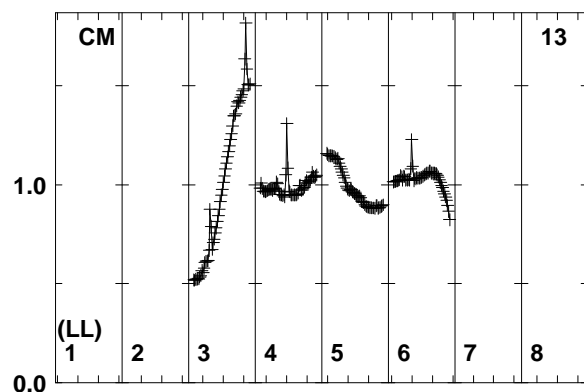
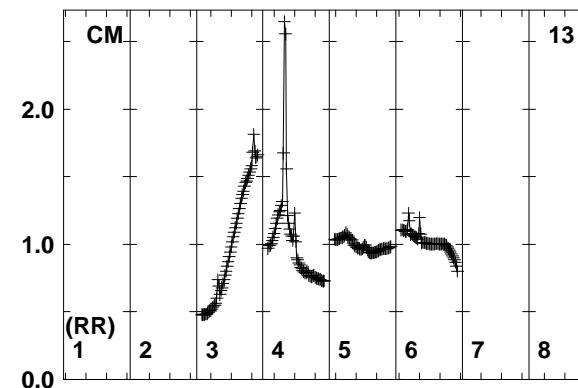
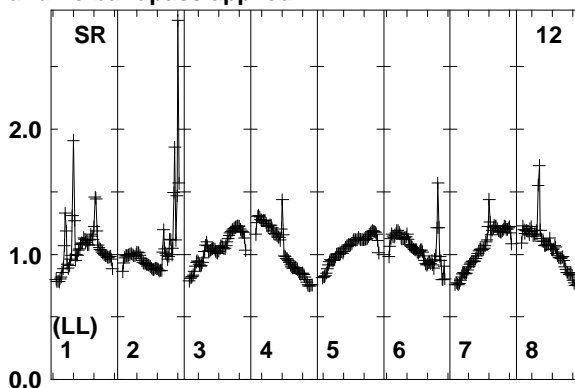
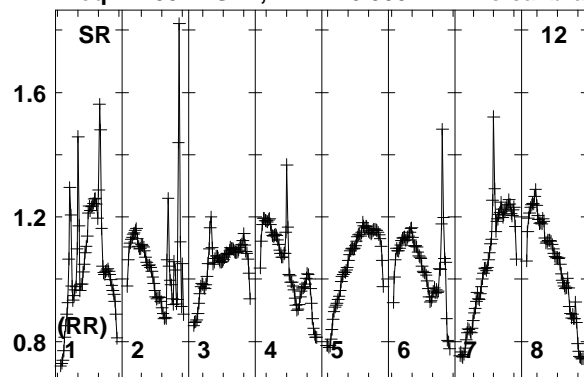

Lower frame: Real Jy
Total-power spectrum Antenna: SR (12)
Timerange: 00/07:02:31 to 00/07:03:29

Plot file version 469 created 04-NOV-2019 14:14:38

W2246-0526 EY034.UVDATA.1

Freq = 1.5947 GHz, Bw = 16.000 MH No calibration applied and no bandpass applied

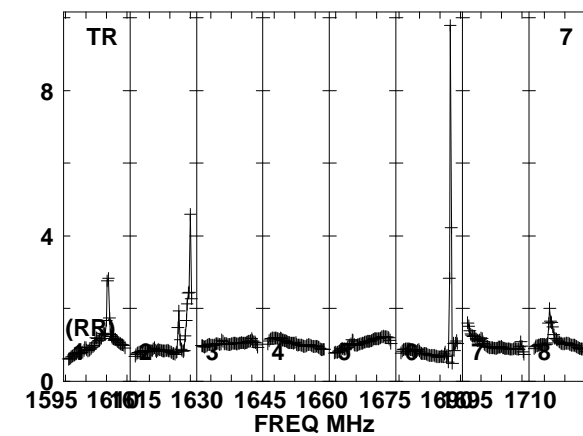
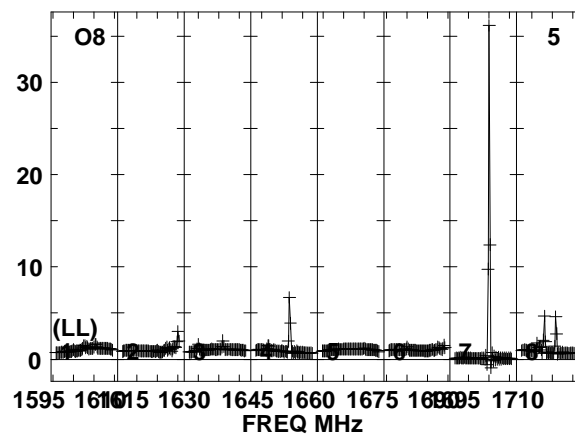
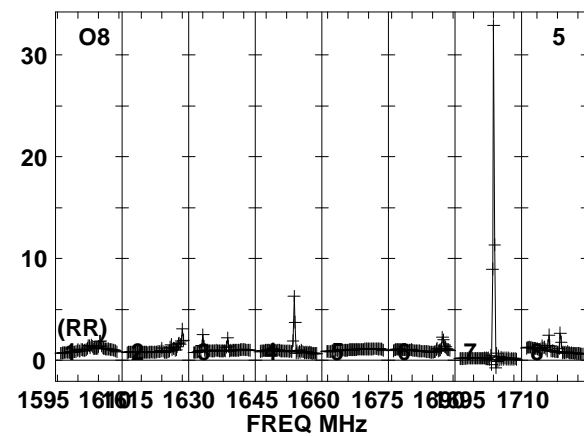
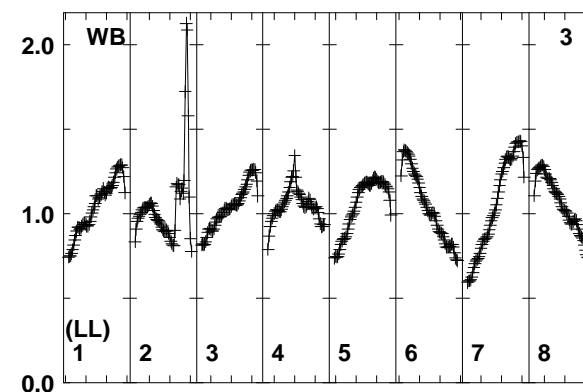
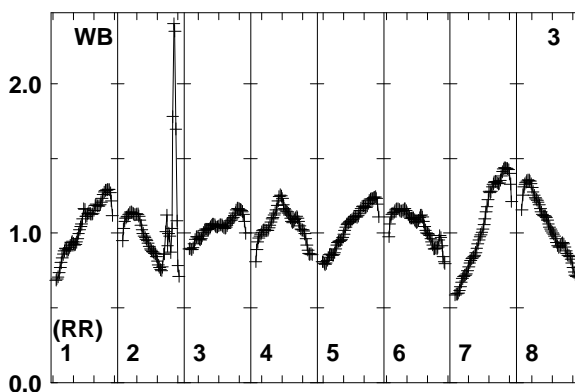
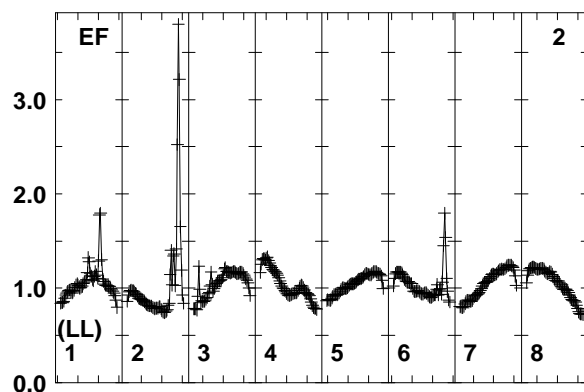
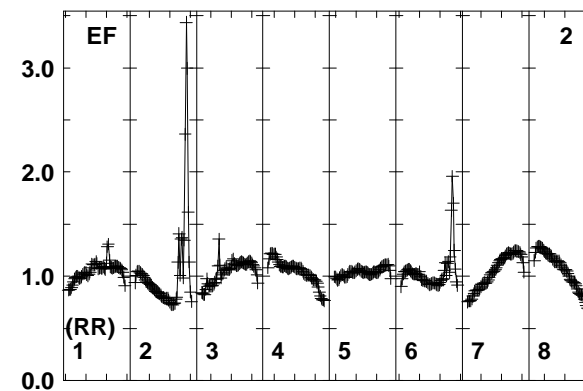
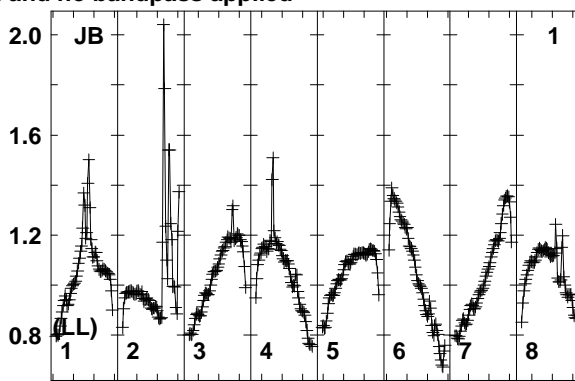
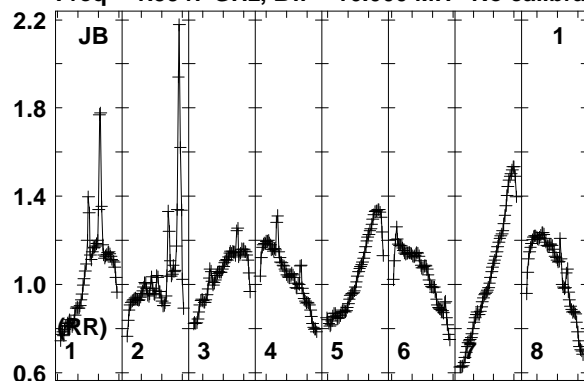

Lower frame: Real Jy
Total-power spectrum Antenna: JB (01)
Timerange: 00/07:03:31 to 00/07:06:09

Plot file version 470 created 04-NOV-2019 14:14:38

W2246-0526 EY034.UVDATA.1

Freq = 1.5947 GHz, Bw = 16.000 MH No calibration applied and no bandpass applied

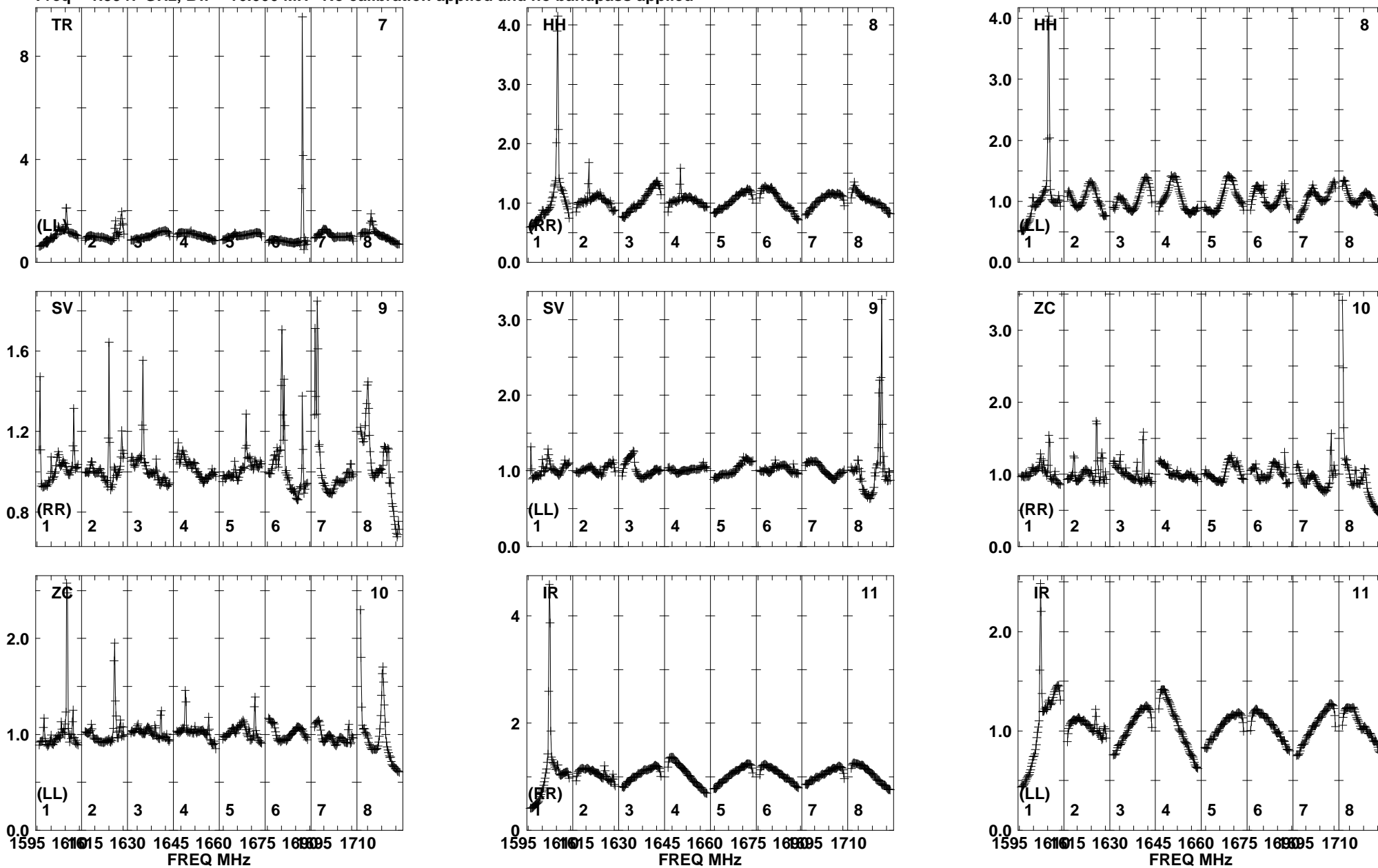

Lower frame: Real Jy
Total-power spectrum Antenna: TR (07)
Timerange: 00/07:03:31 to 00/07:06:09

Plot file version 471 created 04-NOV-2019 14:14:38

W2246-0526 EY034.UVDATA.1

Freq = 1.5947 GHz, Bw = 16.000 MH No calibration applied and no bandpass applied

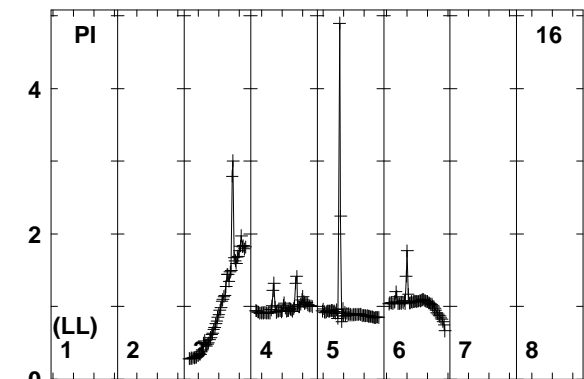
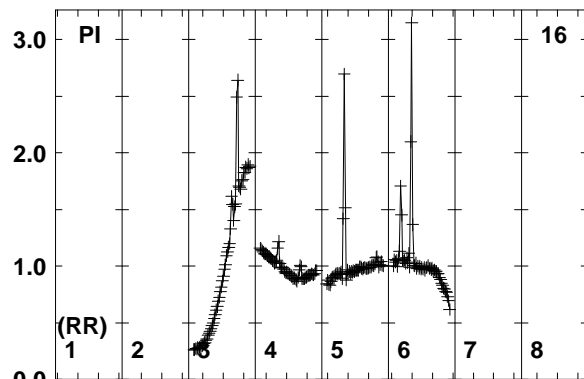
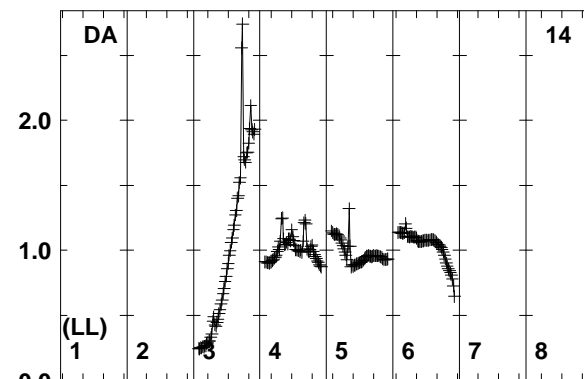
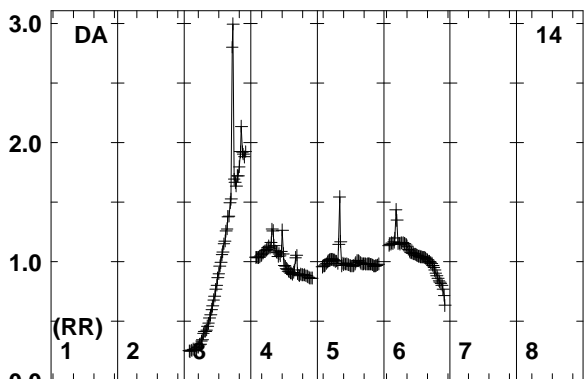
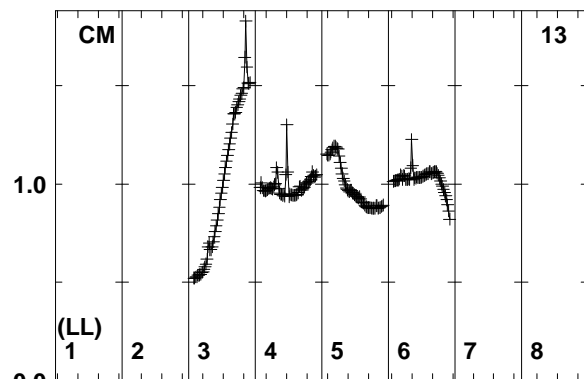
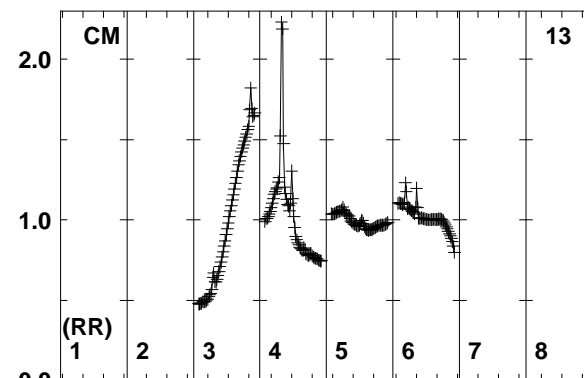
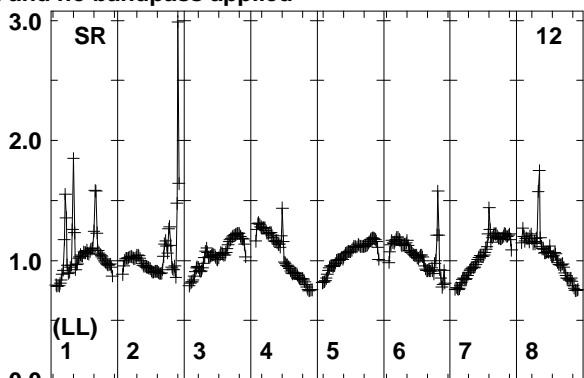
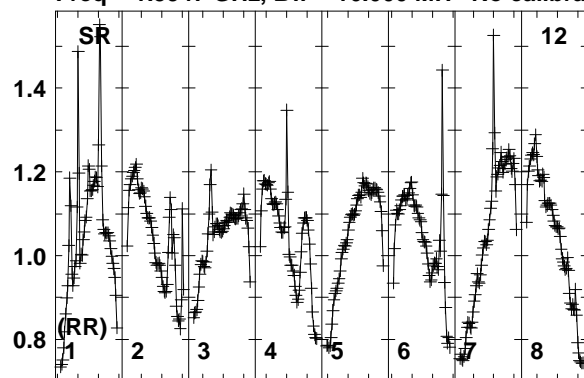

1595 1610 1615 1630 1645 1660 1675 1690 1710
FREQ MHz

1595 1610 1615 1630 1645 1660 1675 1690 1710
FREQ MHz

Lower frame: Real Jy
Total-power spectrum Antenna: SR (12)
Timerange: 00/07:03:31 to 00/07:06:09

Plot file version 472 created 04-NOV-2019 14:14:38

J2248-0541 EY034.UVDATA.1

Freq = 1.5947 GHz, Bw = 16.000 MH No calibration applied and no bandpass applied

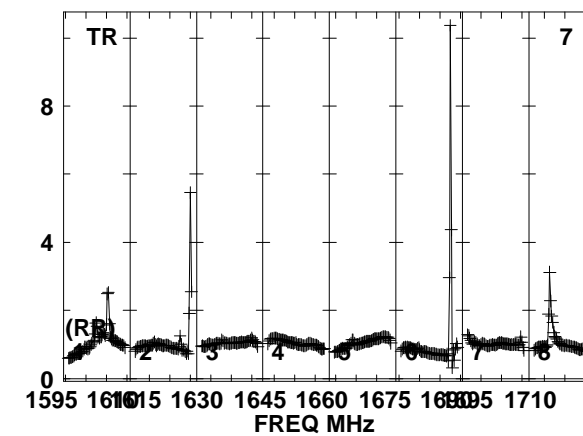
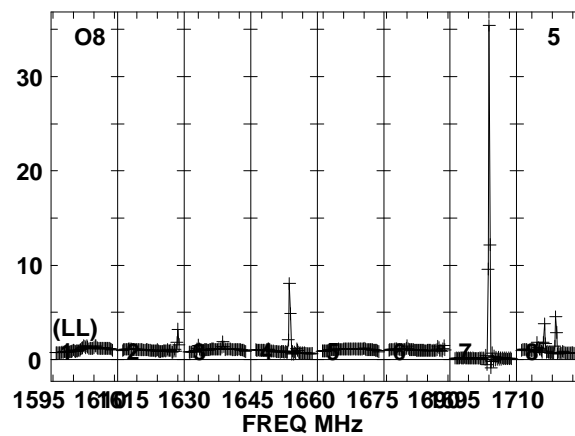
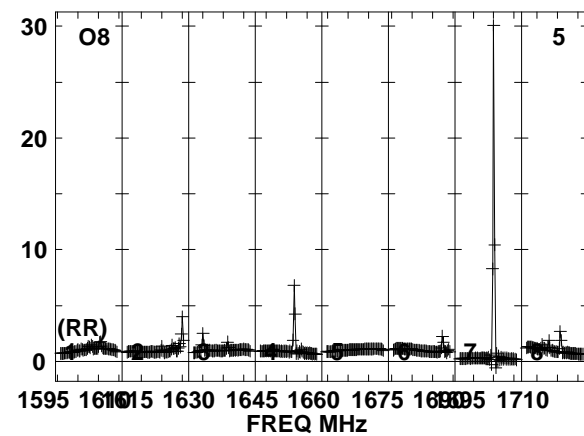
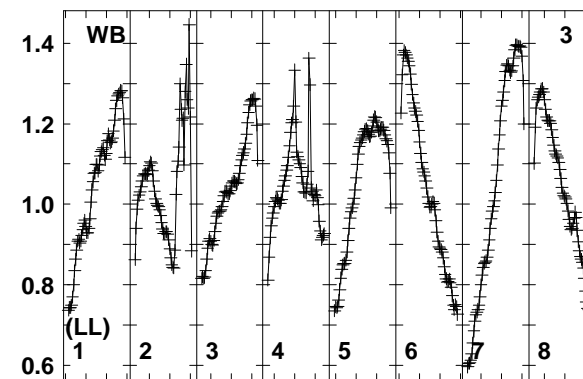
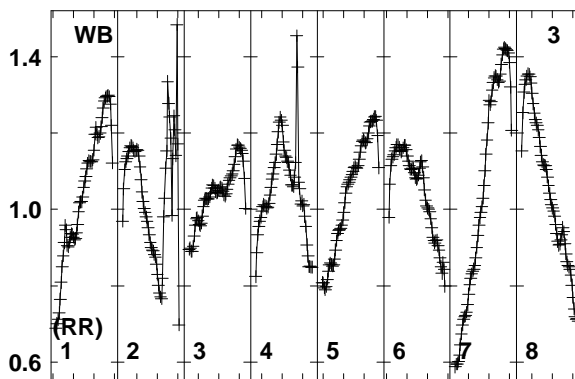
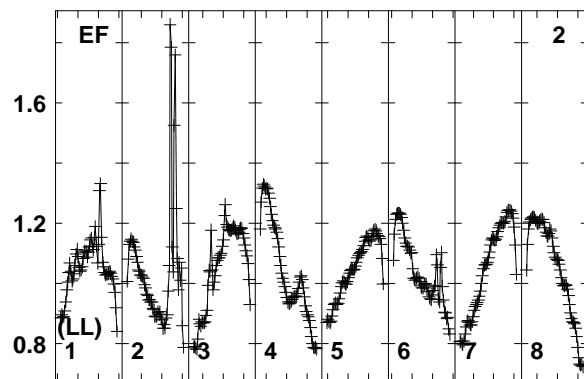
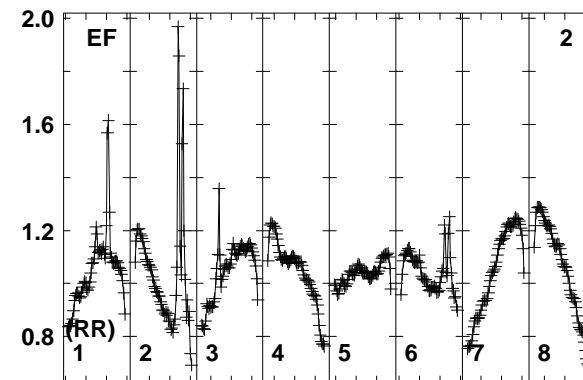
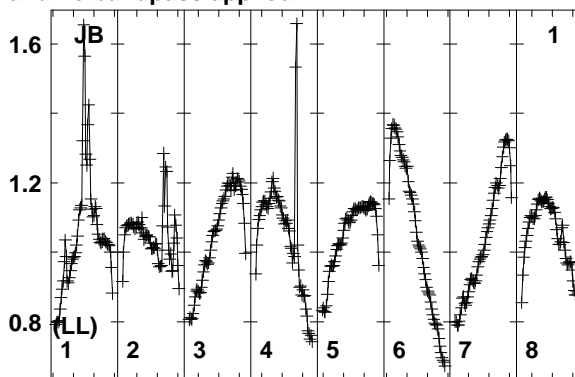
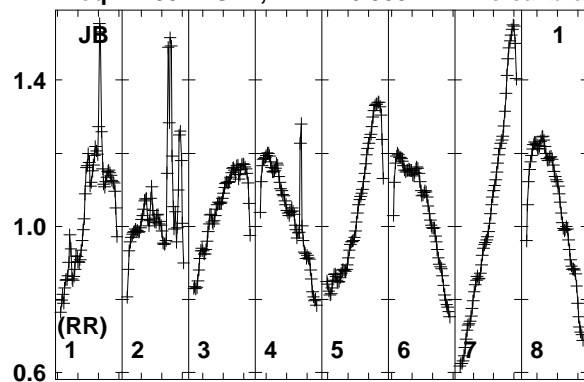

Lower frame: Real Jy
Total-power spectrum Antenna: JB (01)
Timerange: 00/07:06:26 to 00/07:07:24

Plot file version 473 created 04-NOV-2019 14:14:38

J2248-0541 EY034.UVDATA.1

Freq = 1.5947 GHz, Bw = 16.000 MH No calibration applied and no bandpass applied

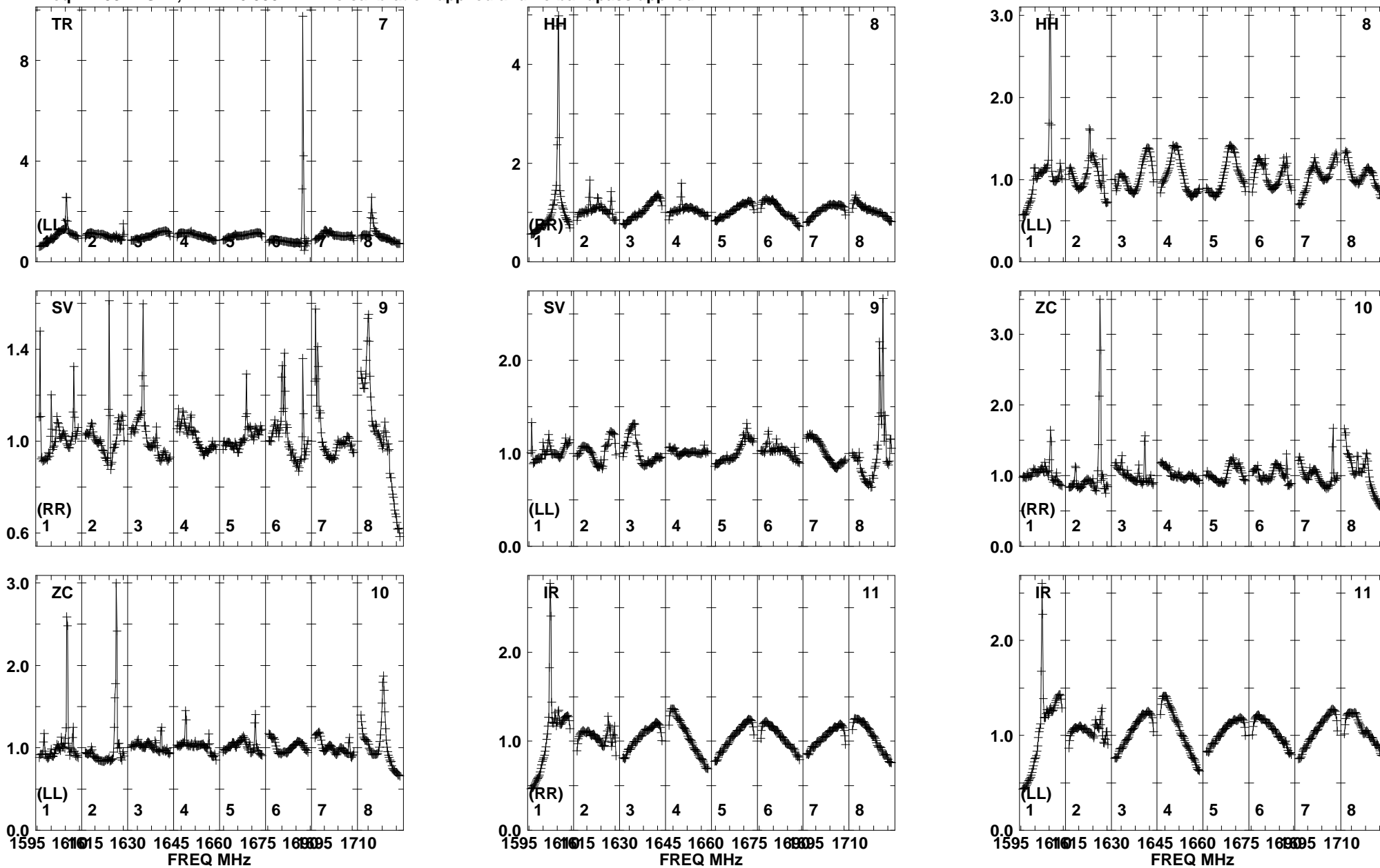

Lower frame: Real Jy
Total-power spectrum Antenna: TR (07)
Timerange: 00/07:06:26 to 00/07:07:24

Plot file version 474 created 04-NOV-2019 14:14:38

J2248-0541 EY034.UVDATA.1

Freq = 1.5947 GHz, Bw = 16.000 MH No calibration applied and no bandpass applied

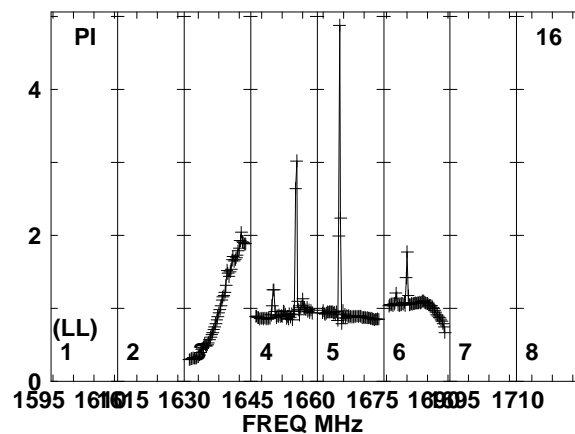
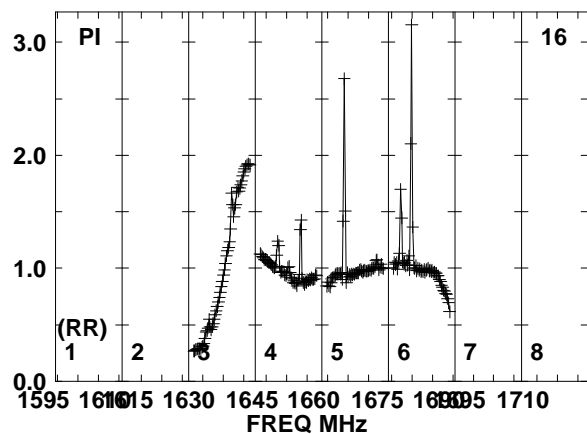
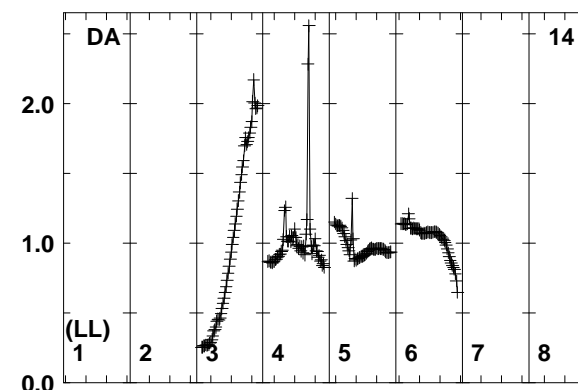
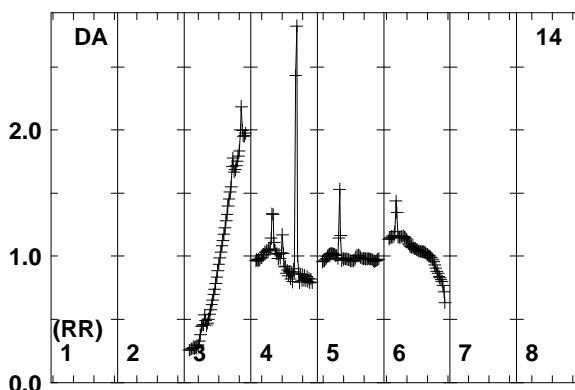
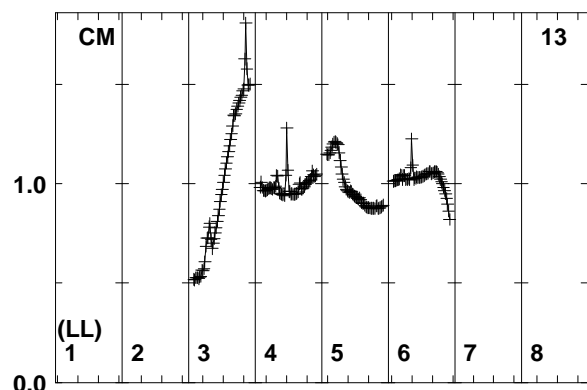
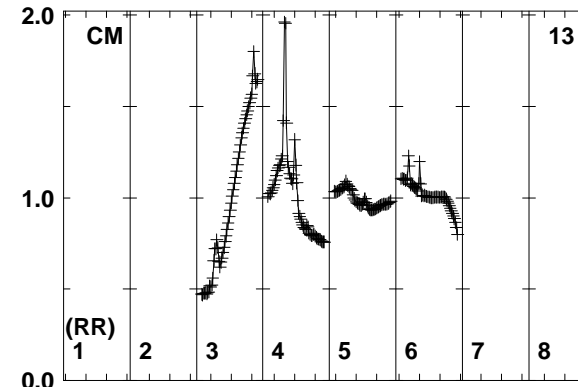
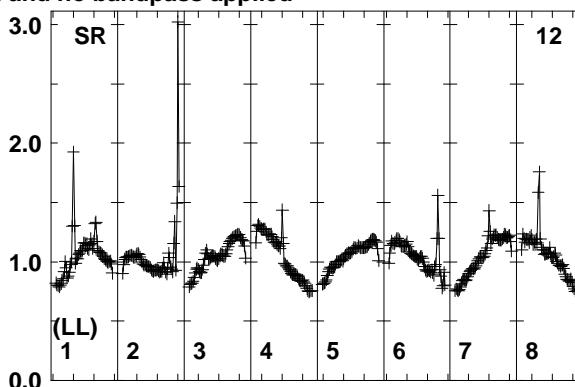
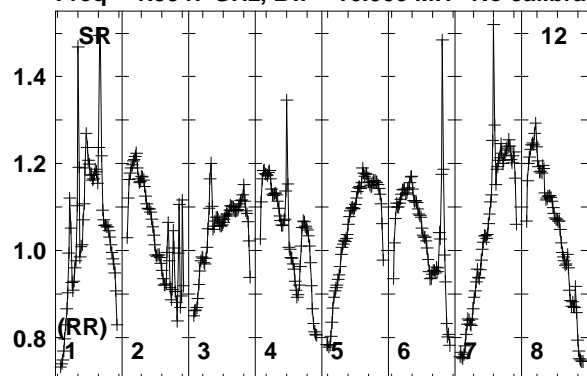

Lower frame: Real Jy
Total-power spectrum Antenna: SR (12)
Timerange: 00/07:06:26 to 00/07:07:24

Plot file version 475 created 04-NOV-2019 14:14:38

W2246-0526 EY034.UVDATA.1

Freq = 1.5947 GHz, Bw = 16.000 MH No calibration applied and no bandpass applied

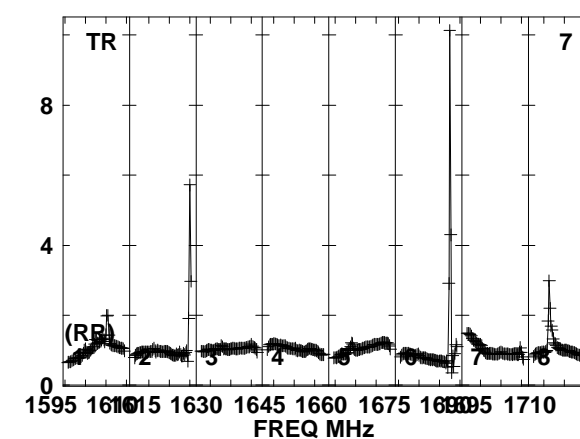
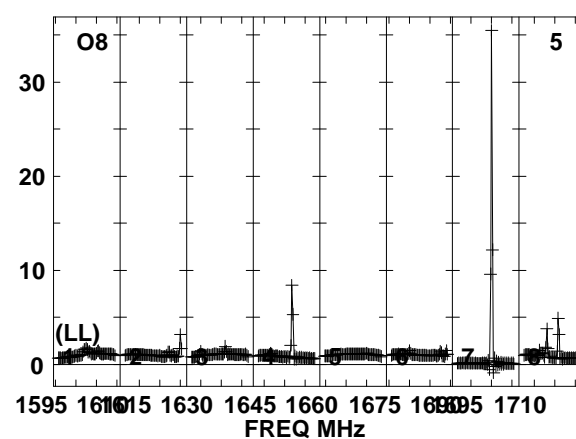
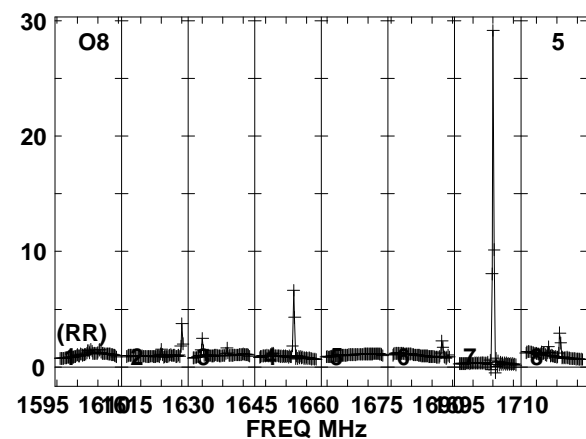
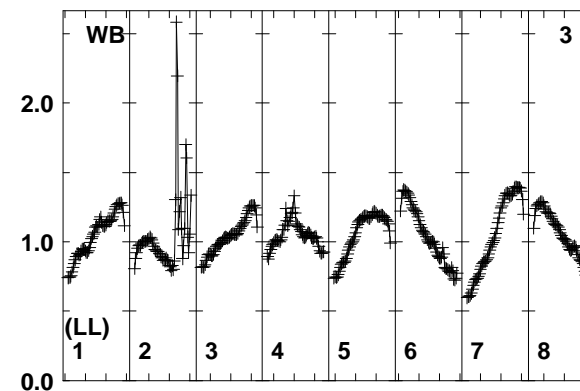
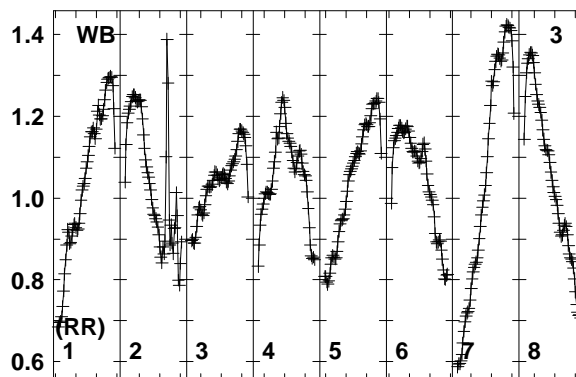
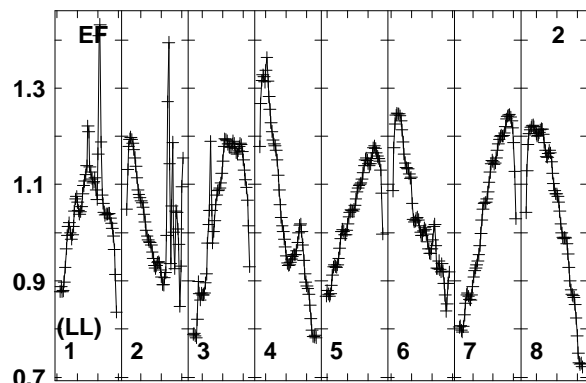
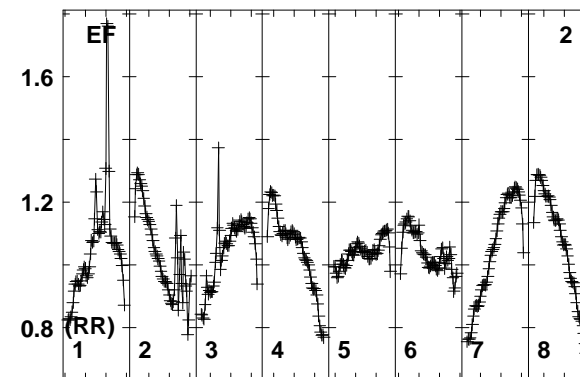
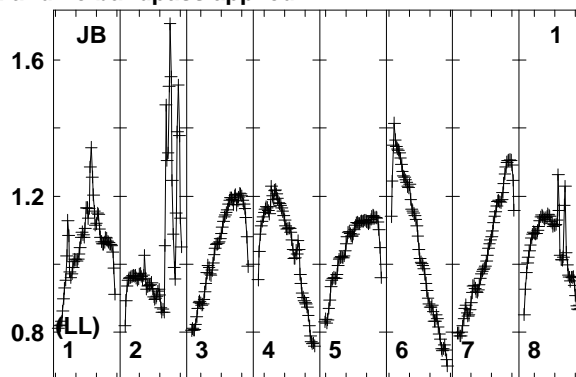
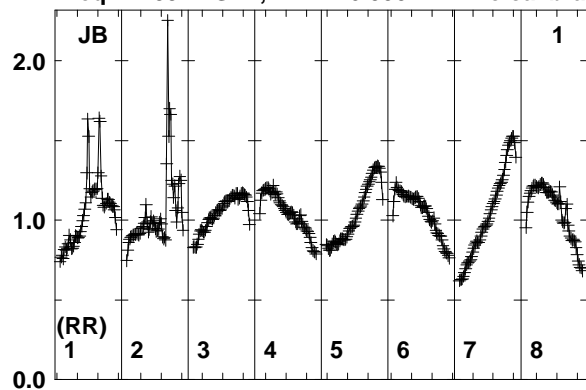

Lower frame: Real Jy
Total-power spectrum Antenna: JB (01)
Timerange: 00/07:07:26 to 00/07:10:04

Plot file version 476 created 04-NOV-2019 14:14:39

W2246-0526 EY034.UVDATA.1

Freq = 1.5947 GHz, Bw = 16.000 MH No calibration applied and no bandpass applied

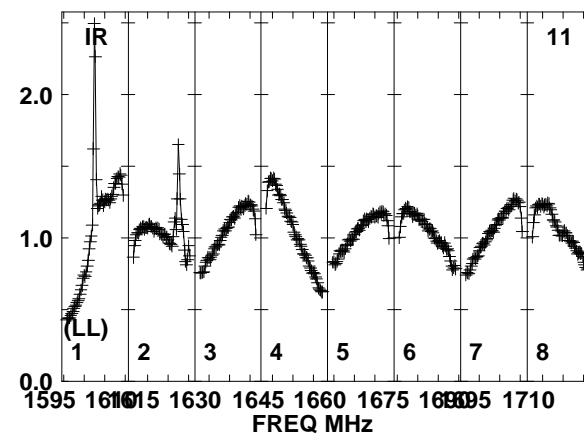
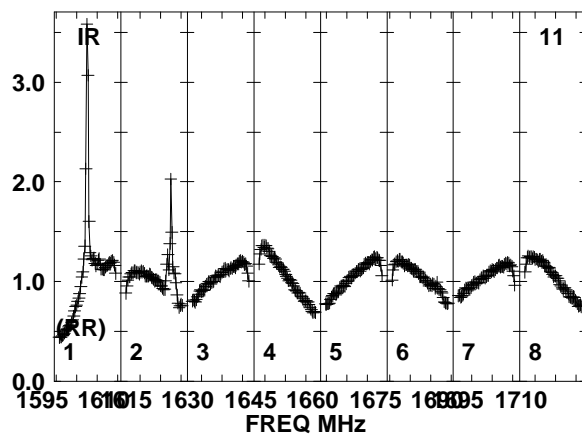
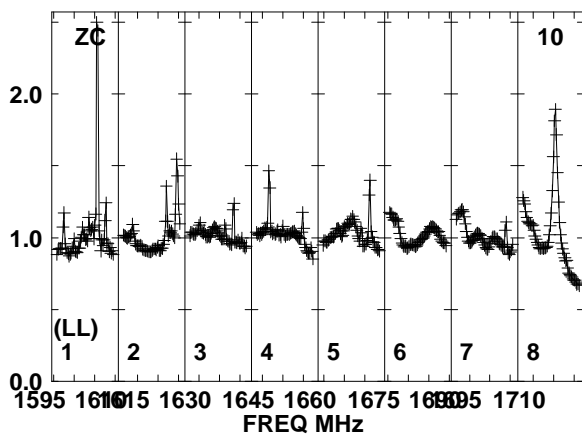
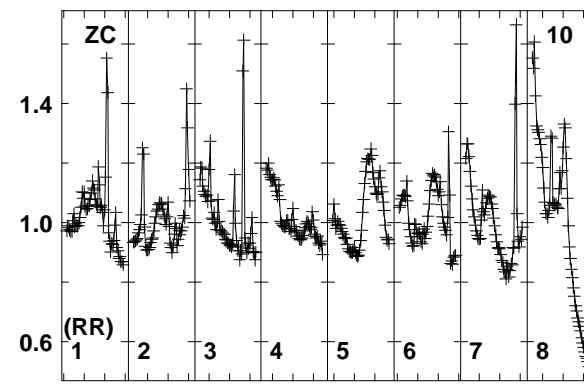
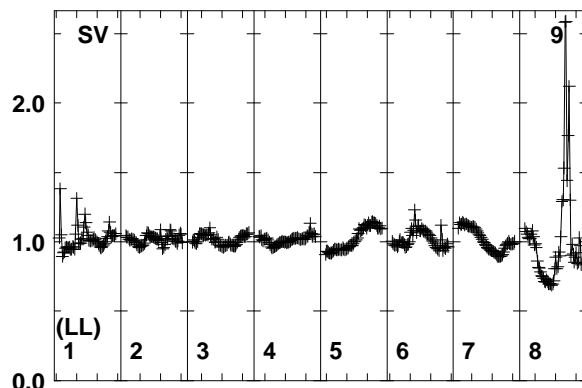
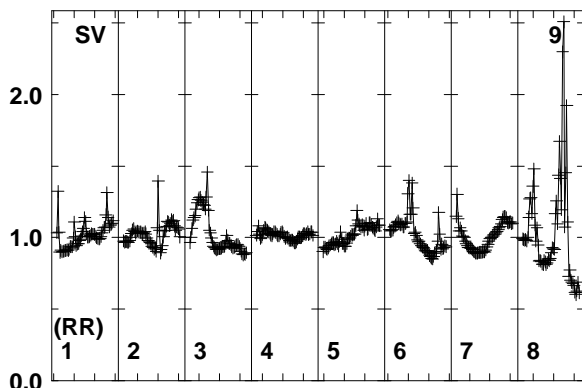
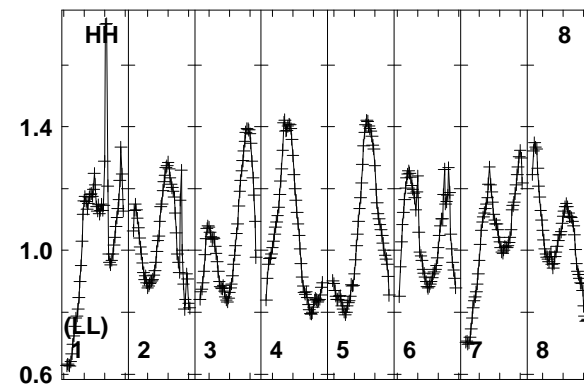
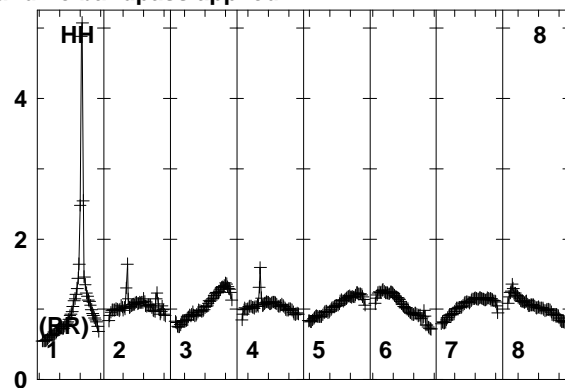
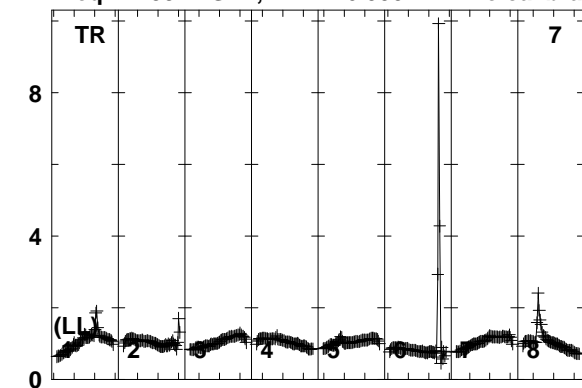

Lower frame: Real Jy
Total-power spectrum Antenna: TR (07)
Timerange: 00/07:07:26 to 00/07:10:04

Plot file version 477 created 04-NOV-2019 14:14:39

W2246-0526 EY034.UVDATA.1

Freq = 1.5947 GHz, Bw = 16.000 MH No calibration applied and no bandpass applied

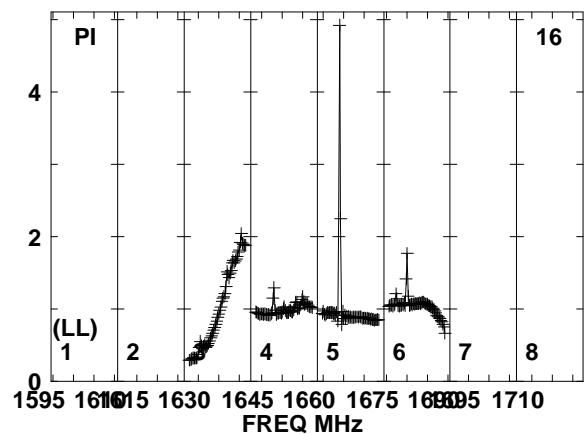
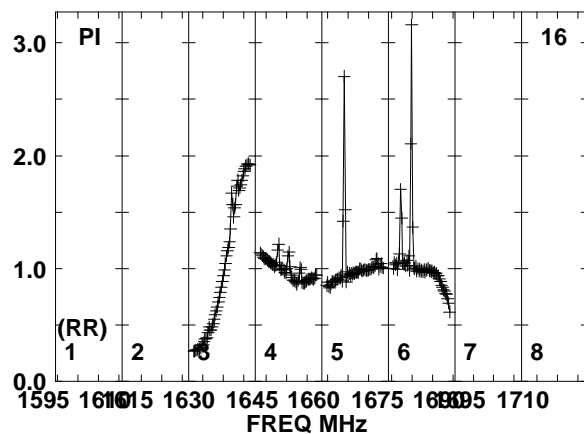
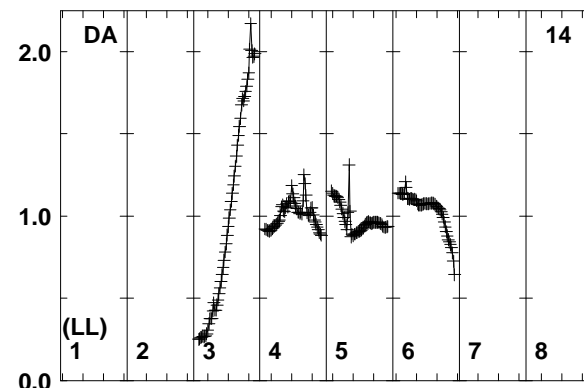
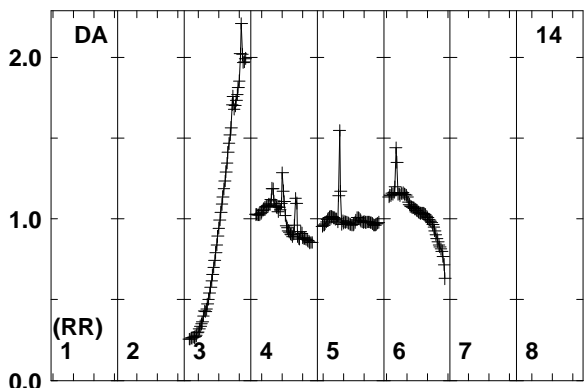
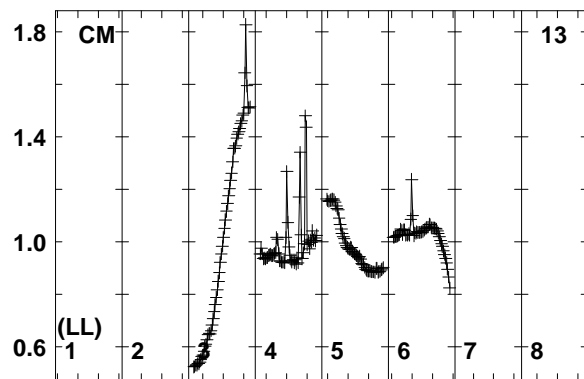
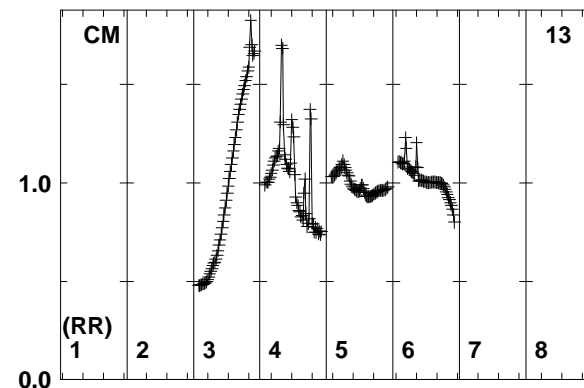
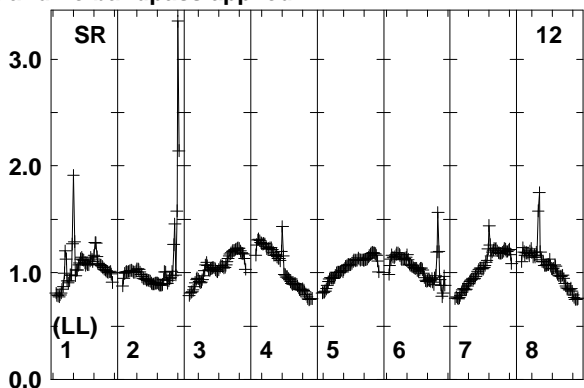
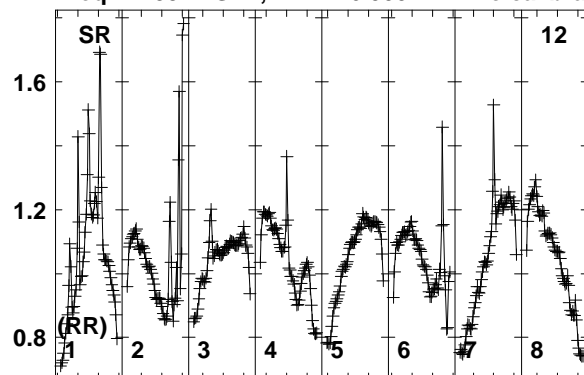

Lower frame: Real Jy
Total-power spectrum Antenna: SR (12)
Timerange: 00/07:07:26 to 00/07:10:04

Plot file version 478 created 04-NOV-2019 14:14:39

J2248-0541 EY034.UVDATA.1

Freq = 1.5947 GHz, Bw = 16.000 MH No calibration applied and no bandpass applied

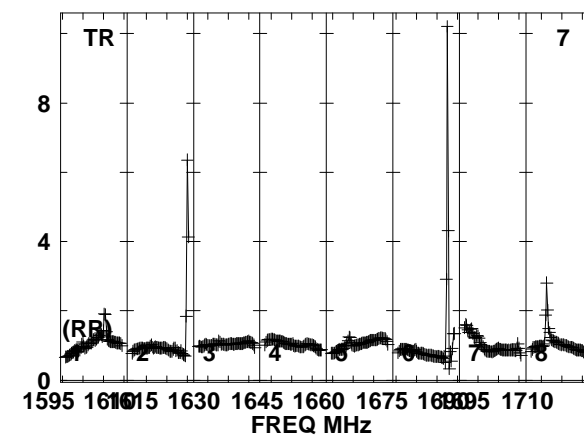
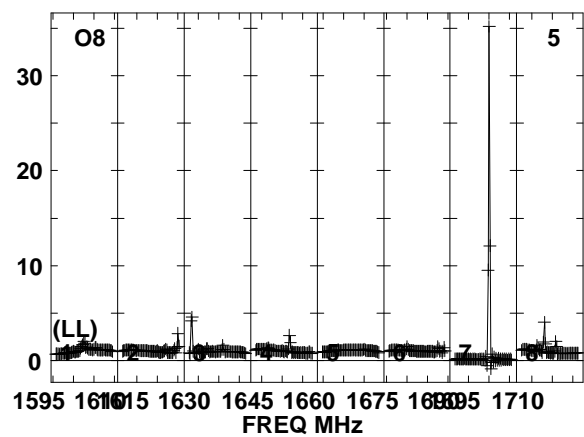
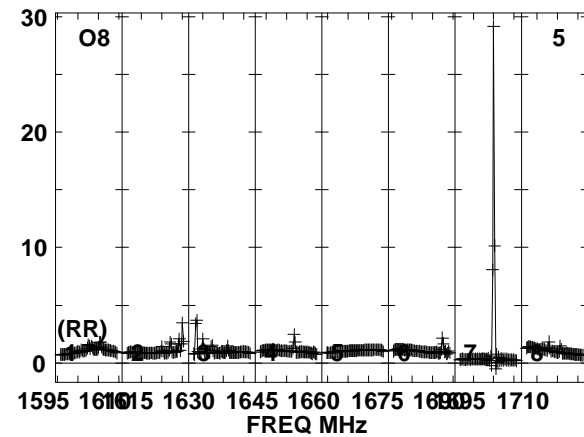
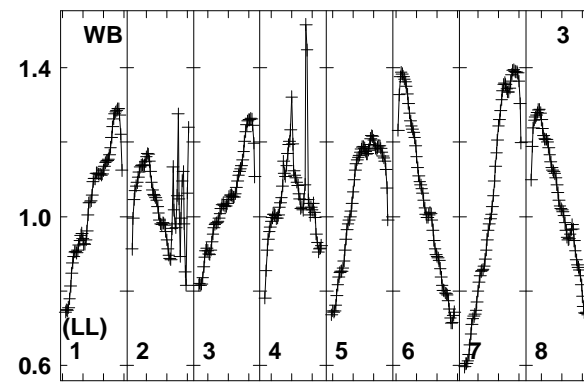
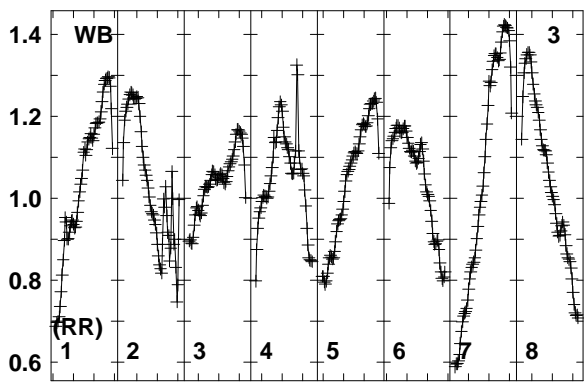
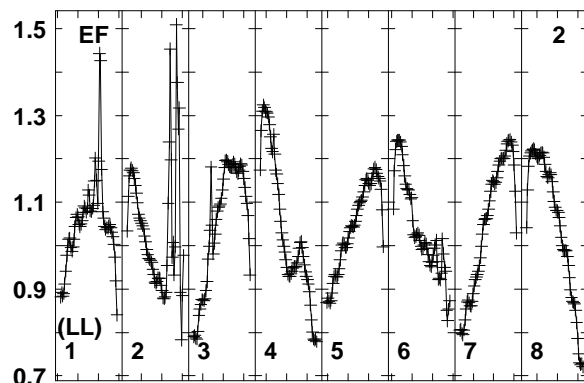
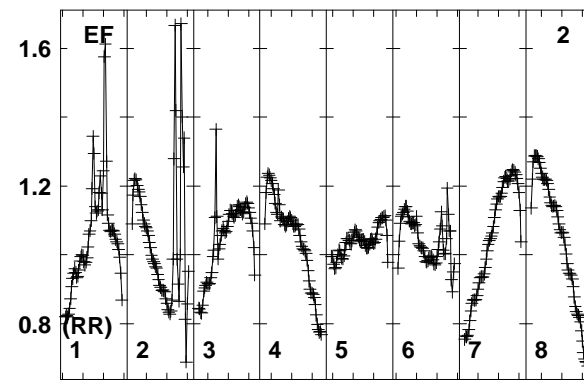
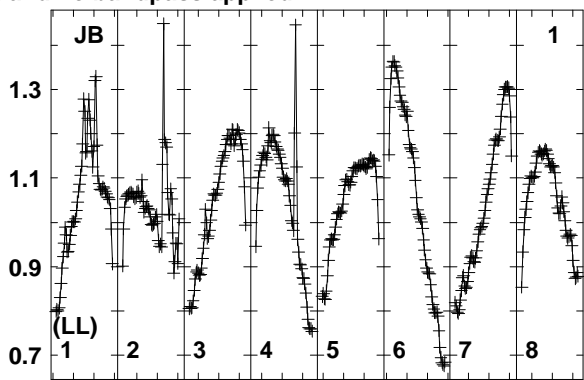
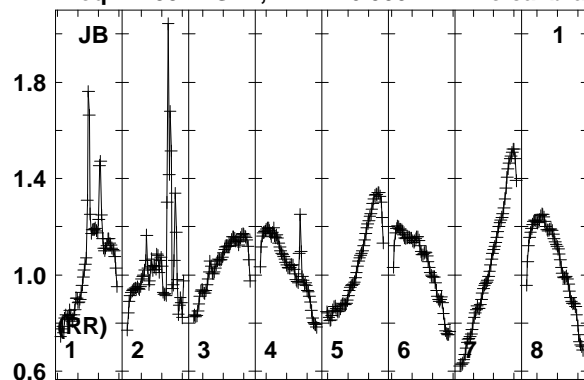

Lower frame: Real Jy
Total-power spectrum Antenna: JB (01)
Timerange: 00/07:10:21 to 00/07:11:19

Plot file version 479 created 04-NOV-2019 14:14:39

J2248-0541 EY034.UVDATA.1

Freq = 1.5947 GHz, Bw = 16.000 MH No calibration applied and no bandpass applied

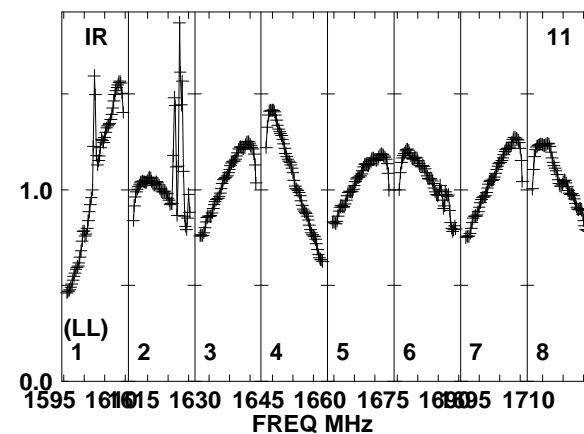
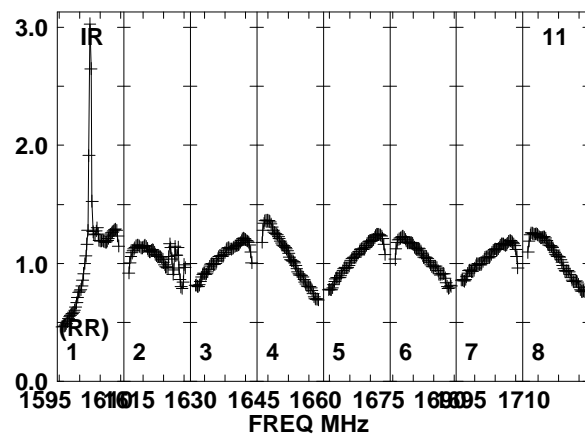
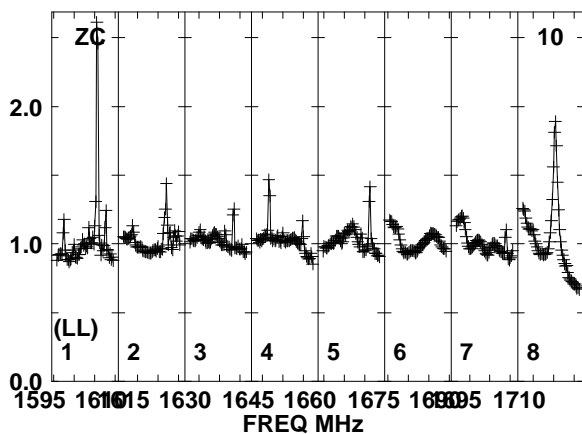
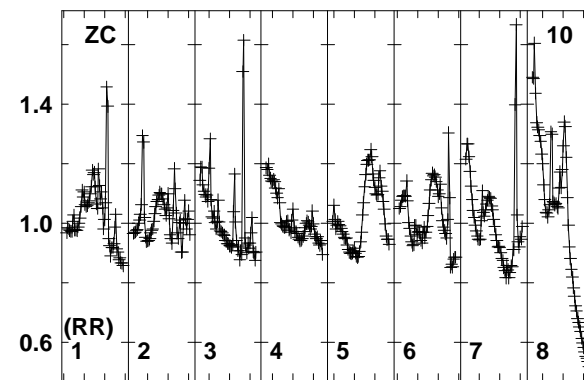
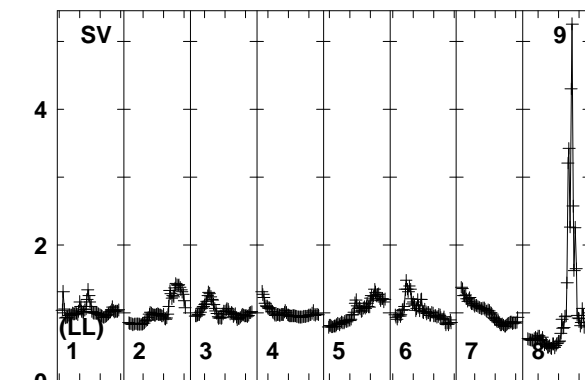
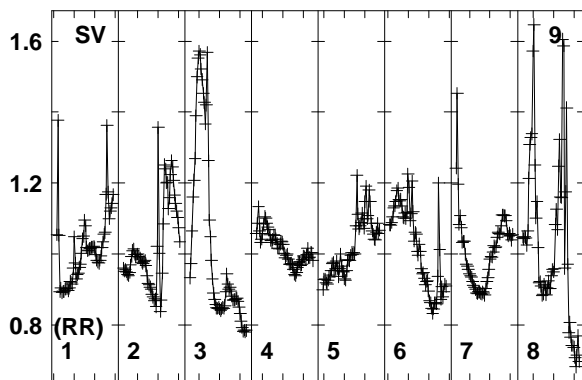
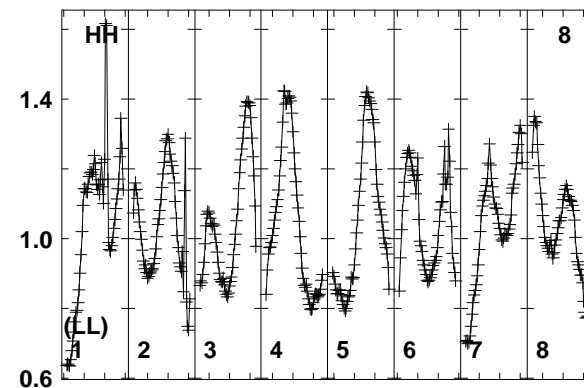
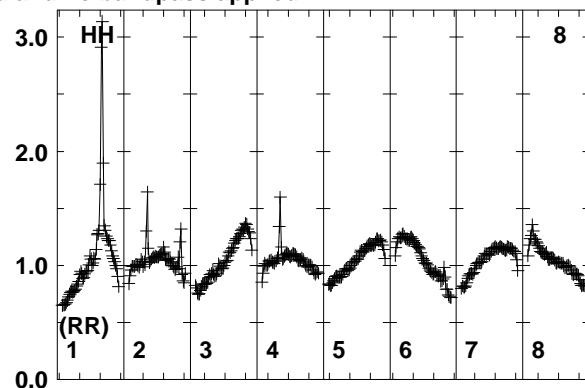
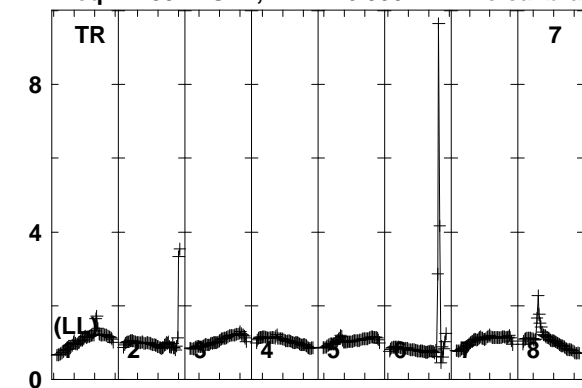

Lower frame: Real Jy
Total-power spectrum Antenna: TR (07)
Timerange: 00/07:10:21 to 00/07:11:19

Plot file version 480 created 04-NOV-2019 14:14:39

J2248-0541 EY034.UVDATA.1

Freq = 1.5947 GHz, Bw = 16.000 MH No calibration applied and no bandpass applied

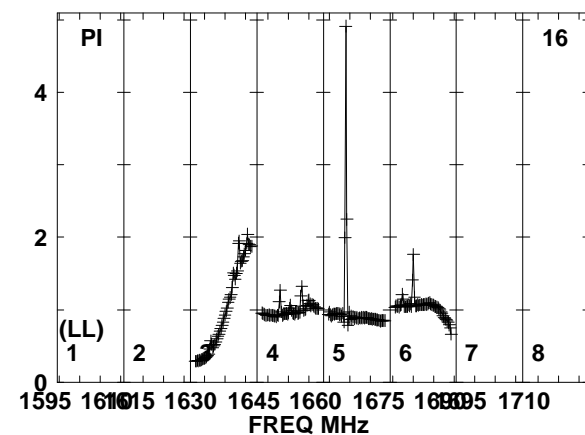
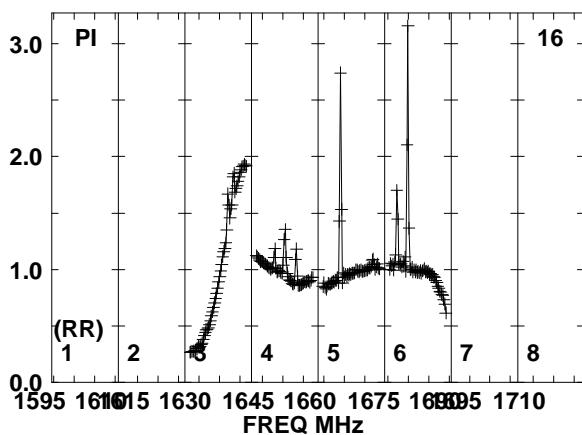
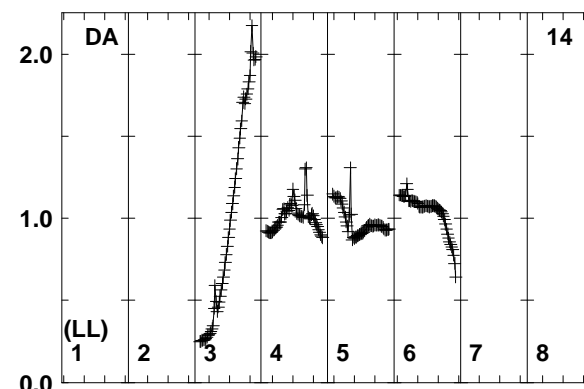
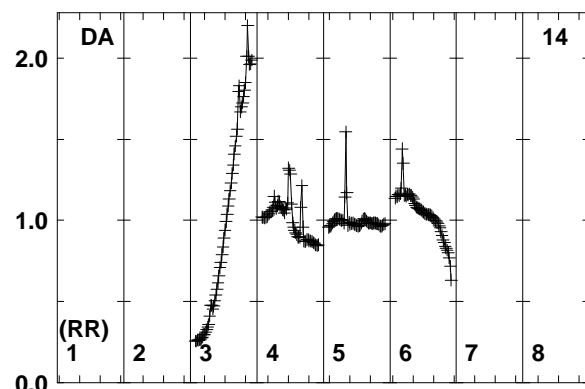
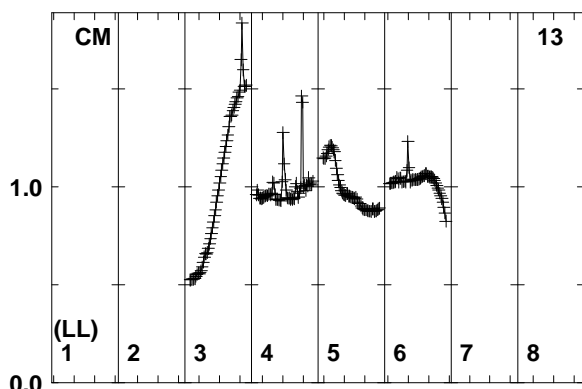
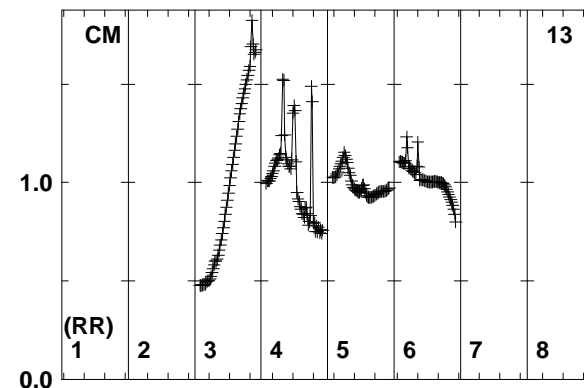
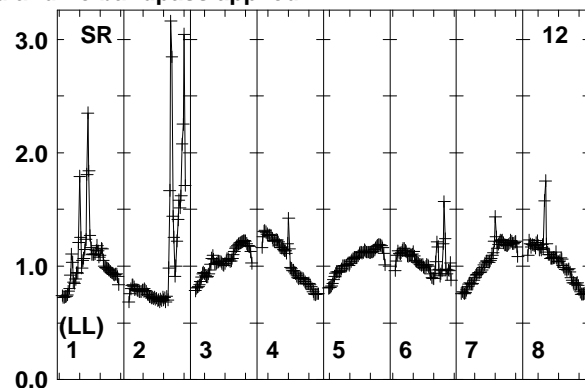
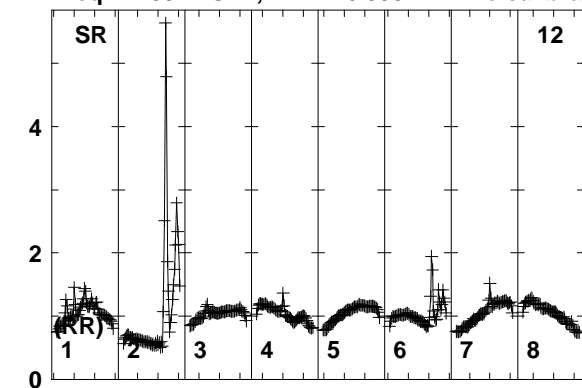

Lower frame: Real Jy
Total-power spectrum Antenna: SR (12)
Timerange: 00/07:10:21 to 00/07:11:19

Plot file version 481 created 04-NOV-2019 14:14:39

W2246-0526 EY034.UVDATA.1

Freq = 1.5947 GHz, Bw = 16.000 MH No calibration applied and no bandpass applied

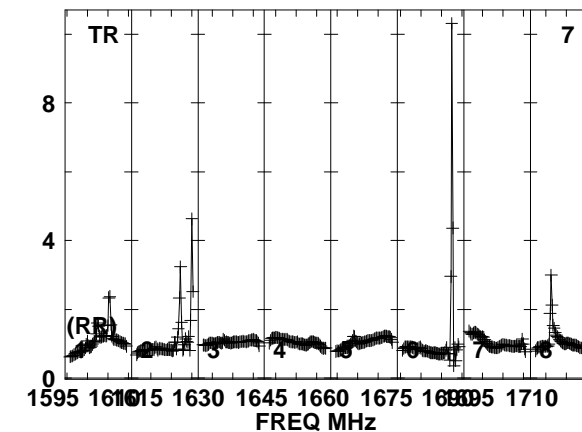
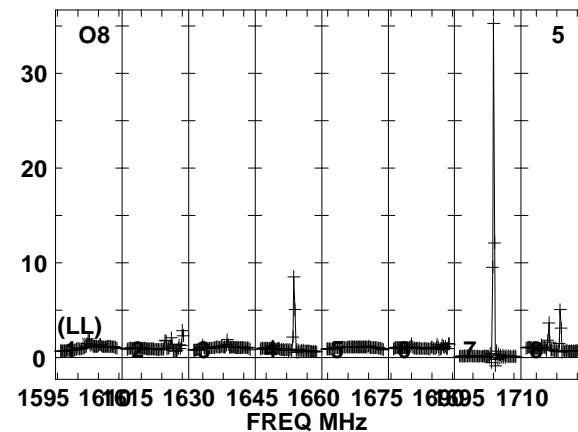
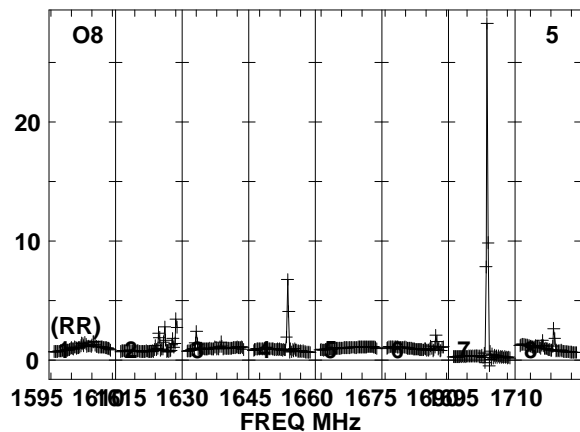
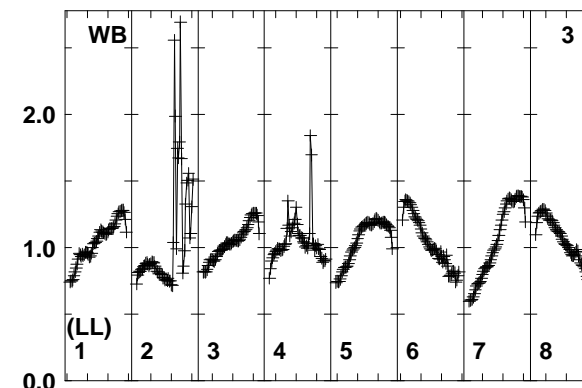
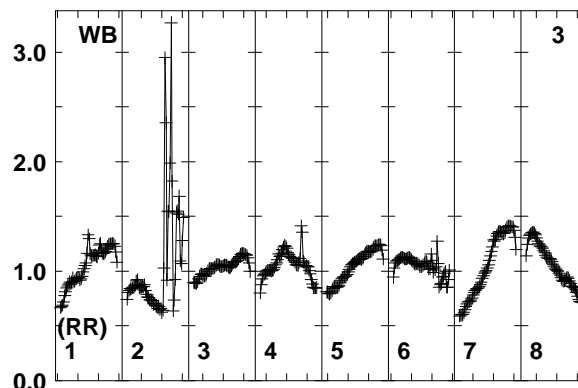
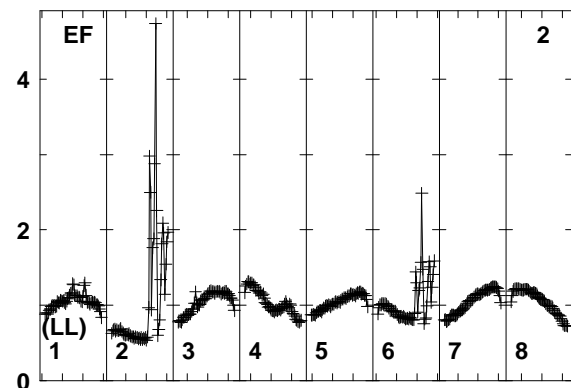
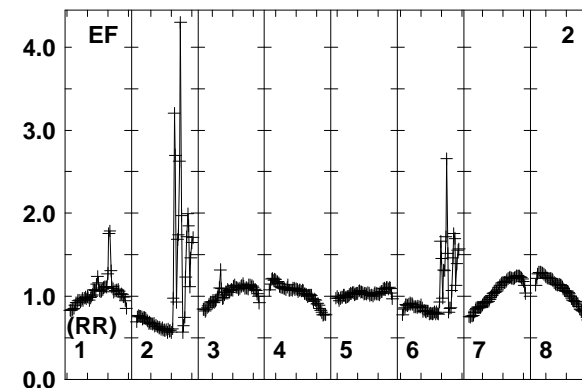
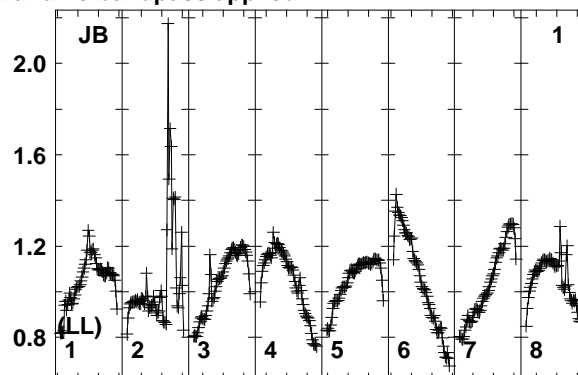
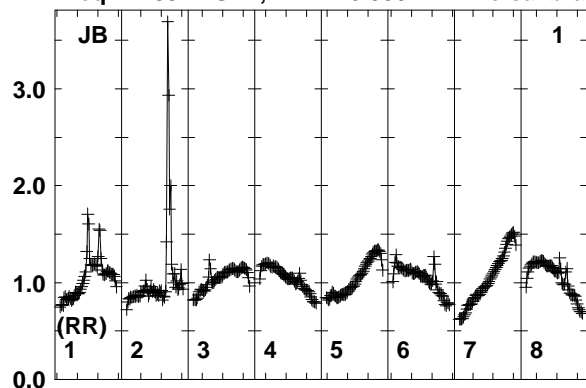

Lower frame: Real Jy
Total-power spectrum Antenna: JB (01)
Timerange: 00/07:11:21 to 00/07:13:59

Plot file version 482 created 04-NOV-2019 14:14:39

W2246-0526 EY034.UVDATA.1

Freq = 1.5947 GHz, Bw = 16.000 MH No calibration applied and no bandpass applied

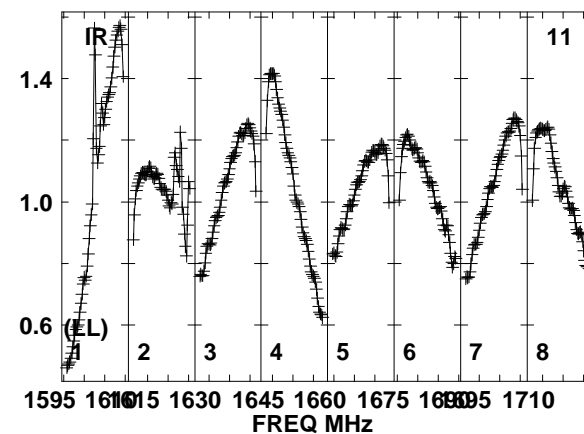
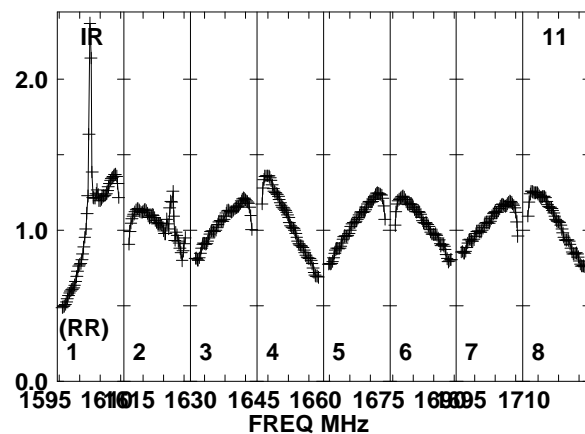
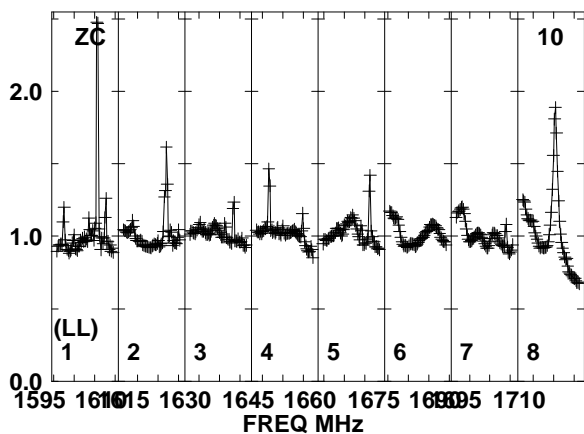
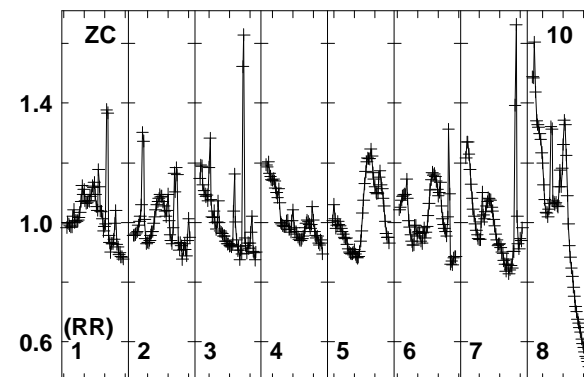
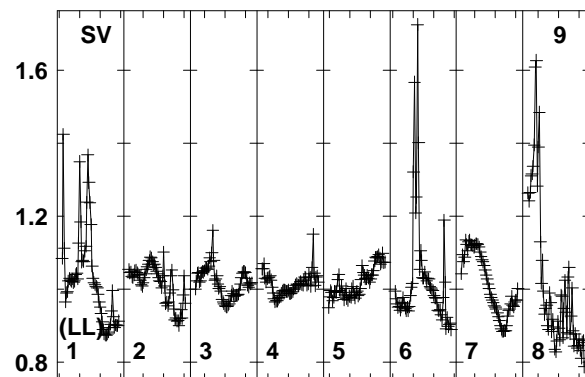
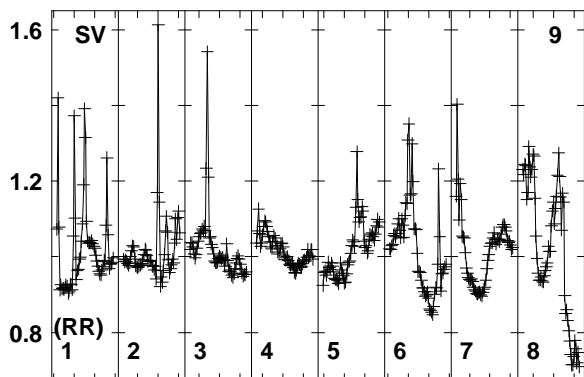
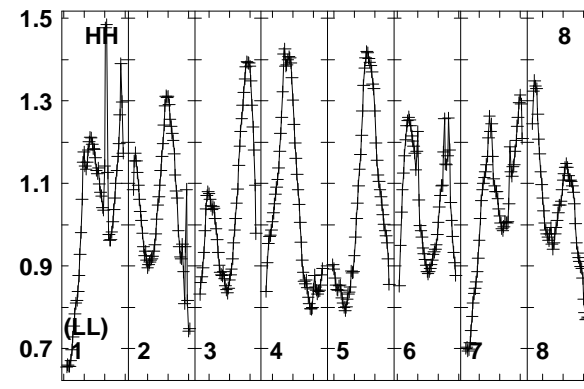
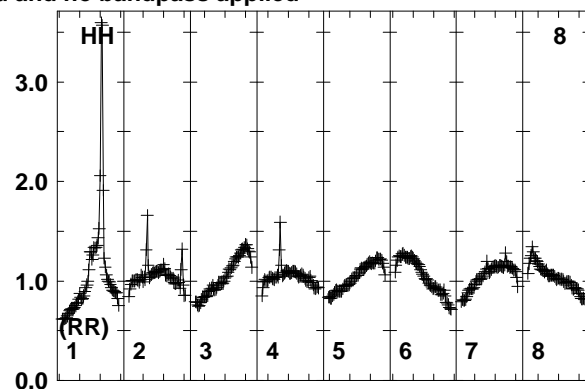
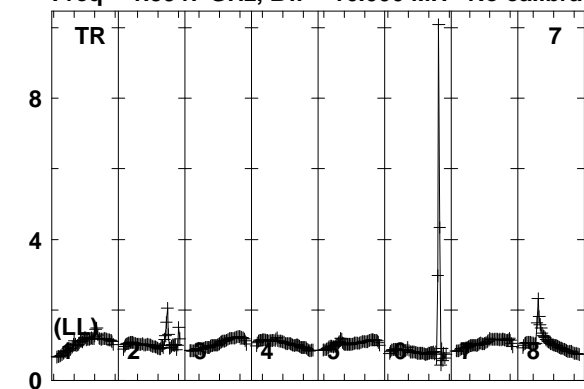

Lower frame: Real Jy
Total-power spectrum Antenna: TR (07)
Timerange: 00/07:11:21 to 00/07:13:59

Plot file version 483 created 04-NOV-2019 14:14:39

W2246-0526 EY034.UVDATA.1

Freq = 1.5947 GHz, Bw = 16.000 MH No calibration applied and no bandpass applied

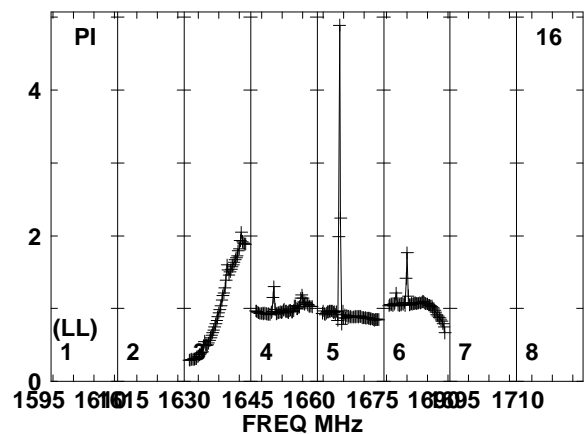
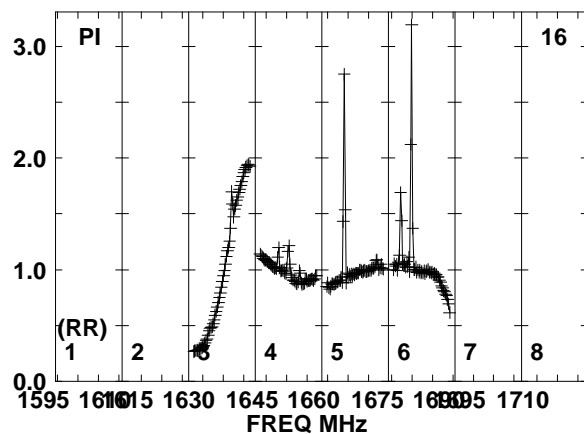
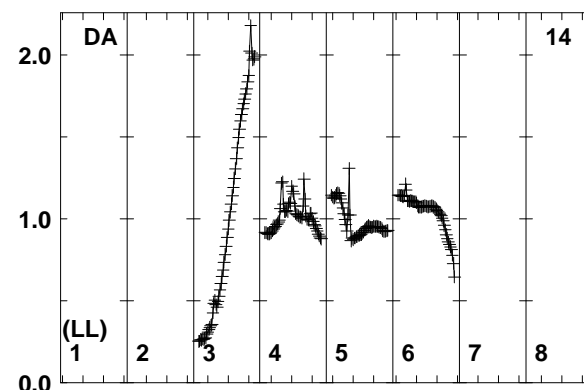
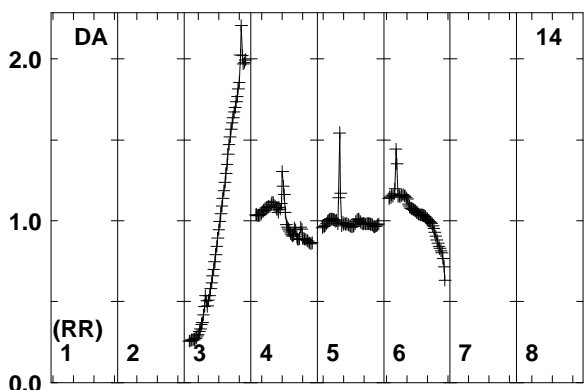
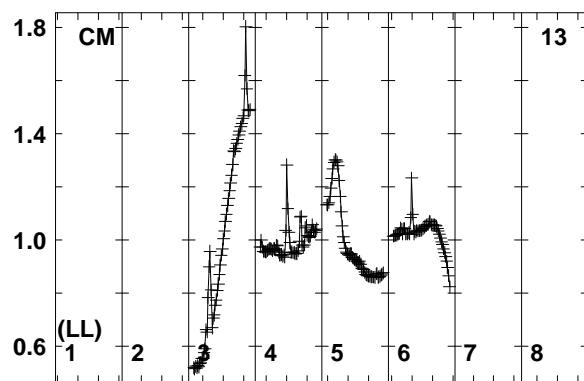
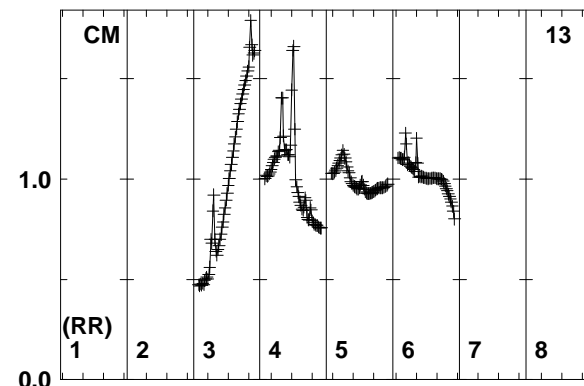
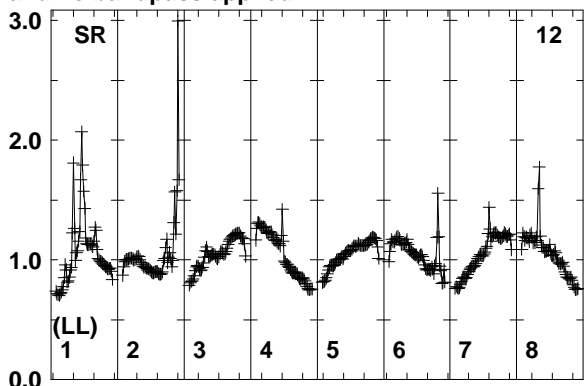
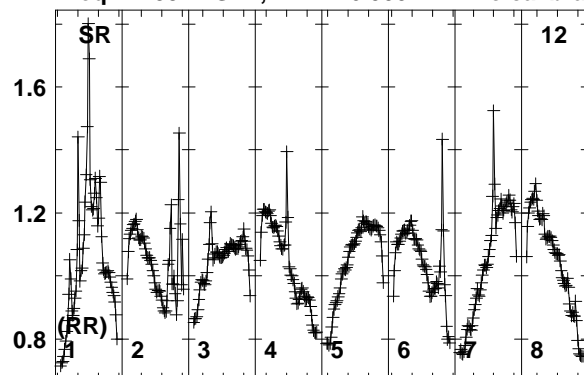

Lower frame: Real Jy
Total-power spectrum Antenna: SR (12)
Timerange: 00/07:11:21 to 00/07:13:59

Plot file version 484 created 04-NOV-2019 14:14:39

J2248-0541 EY034.UVDATA.1

Freq = 1.5947 GHz, Bw = 16.000 MH No calibration applied and no bandpass applied

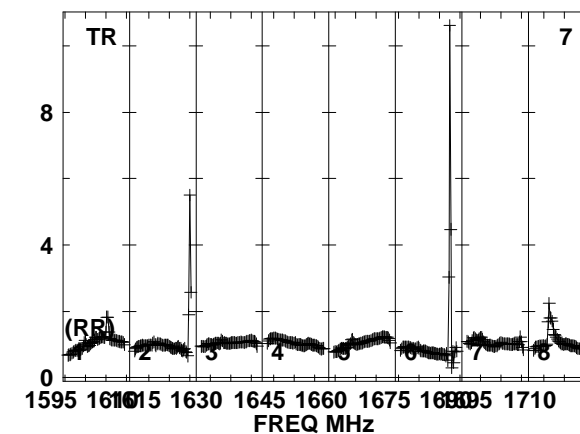
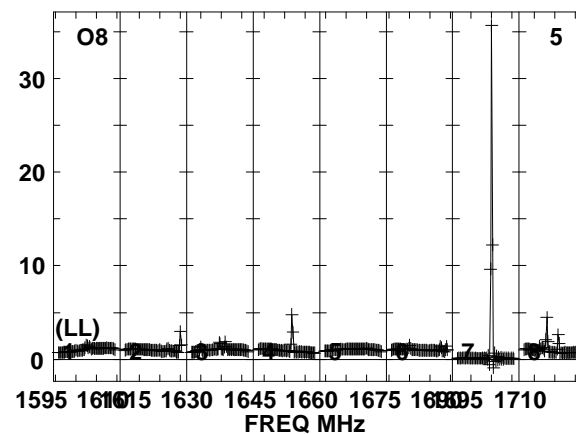
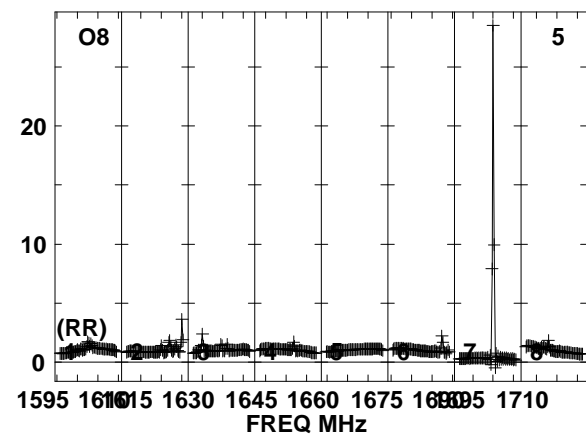
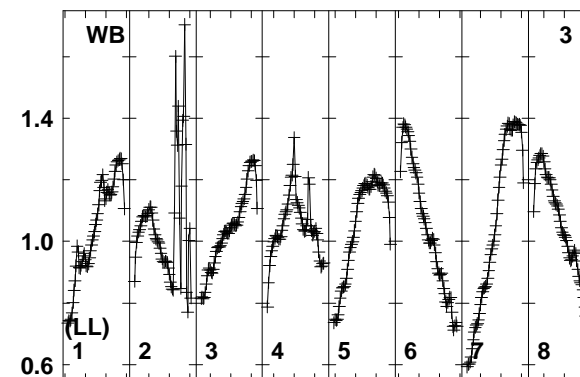
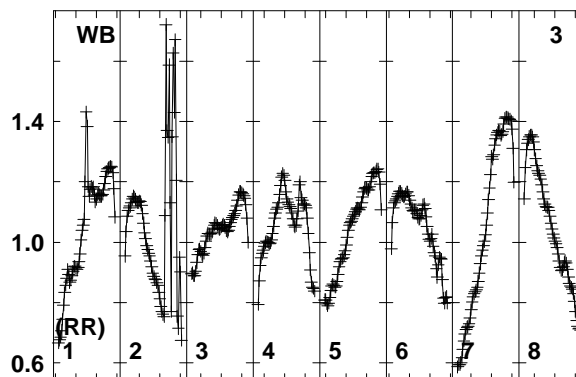
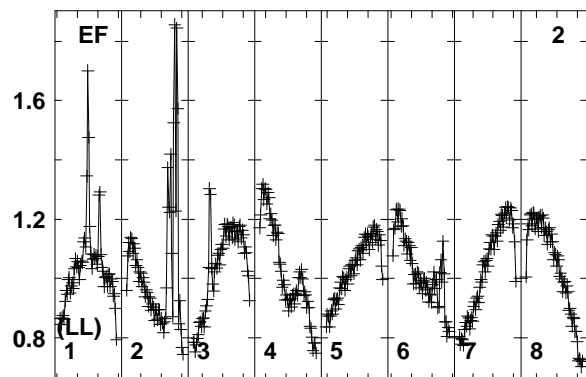
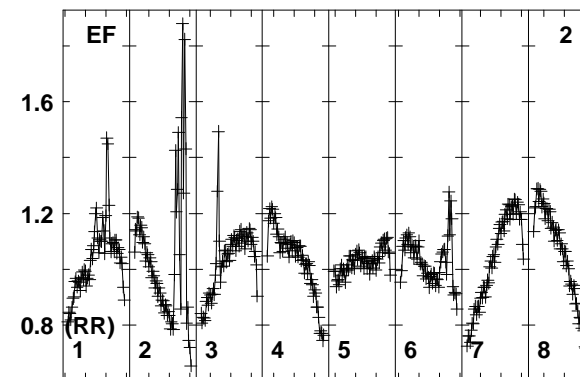
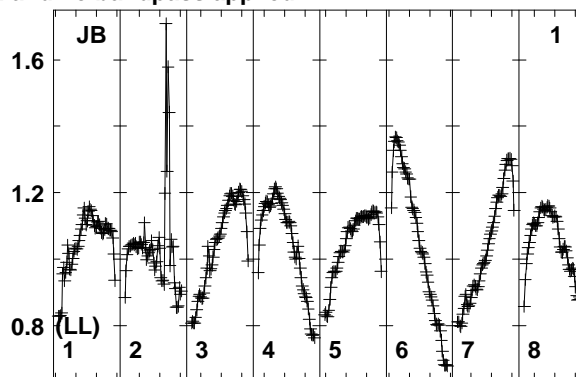
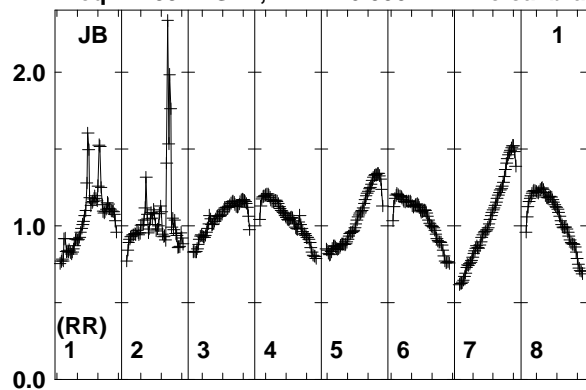

Lower frame: Real Jy
Total-power spectrum Antenna: JB (01)
Timerange: 00/07:14:36 to 00/07:15:34

Plot file version 485 created 04-NOV-2019 14:14:39

J2248-0541 EY034.UVDATA.1

Freq = 1.5947 GHz, Bw = 16.000 MH No calibration applied and no bandpass applied

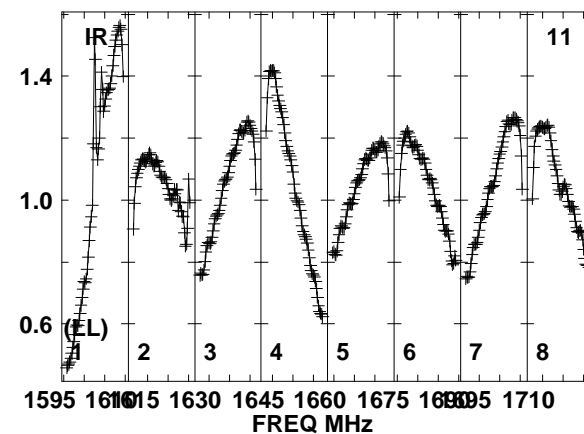
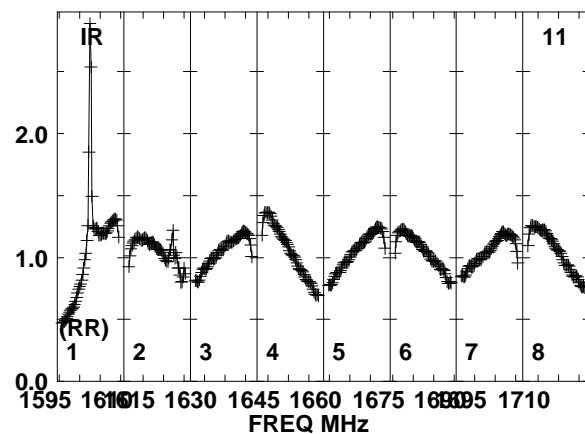
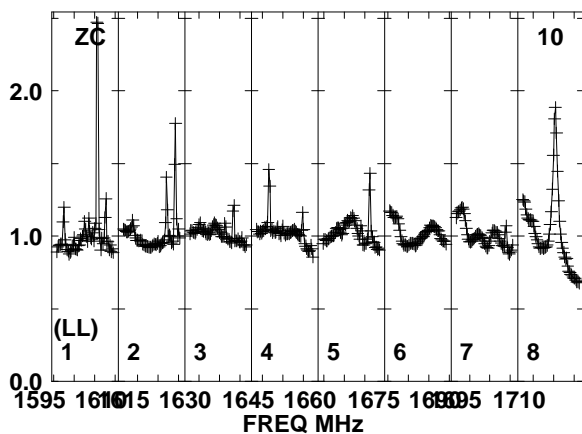
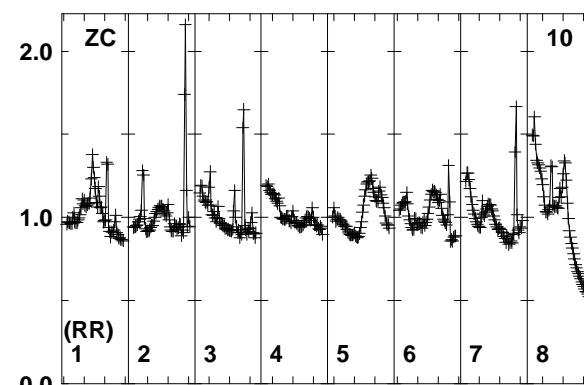
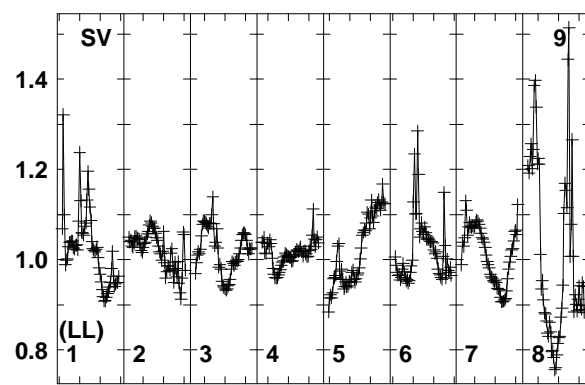
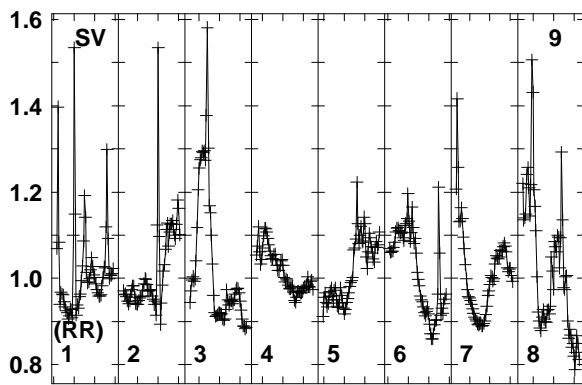
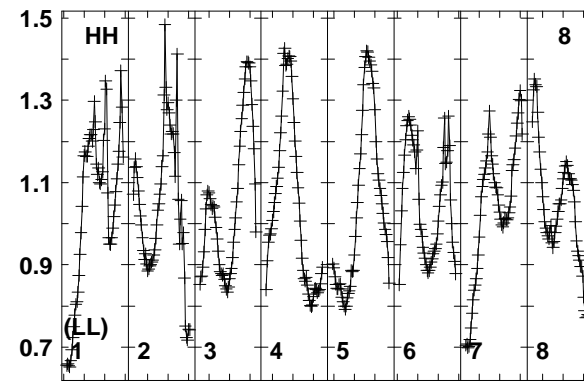
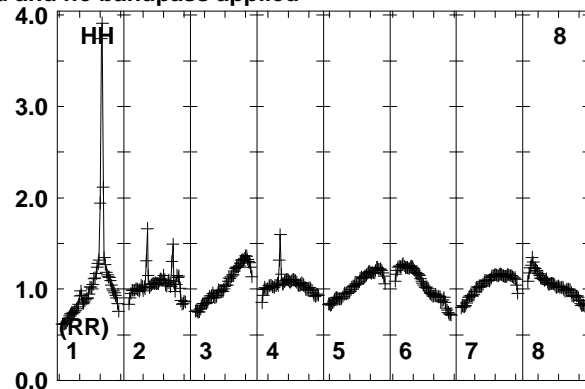
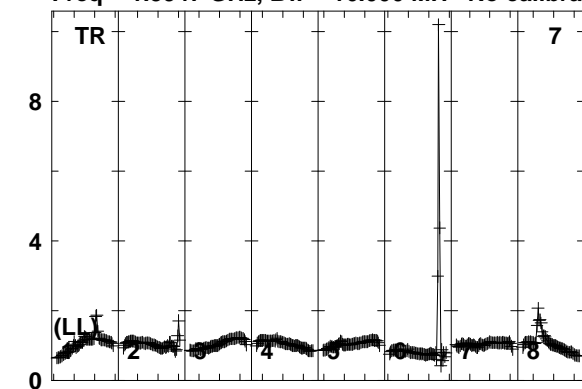

Lower frame: Real Jy
Total-power spectrum Antenna: TR (07)
Timerange: 00/07:14:36 to 00/07:15:34

Plot file version 486 created 04-NOV-2019 14:14:40

J2248-0541 EY034.UVDATA.1

Freq = 1.5947 GHz, Bw = 16.000 MH No calibration applied and no bandpass applied

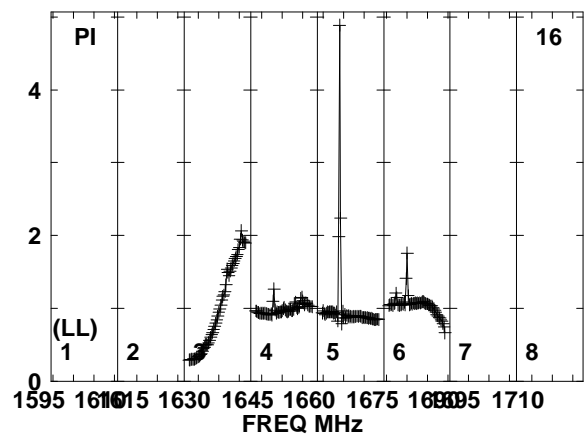
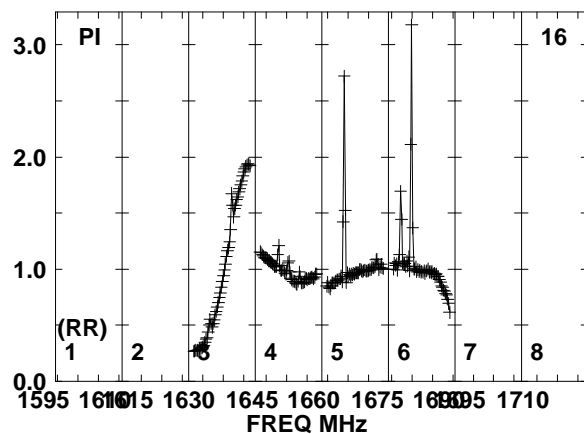
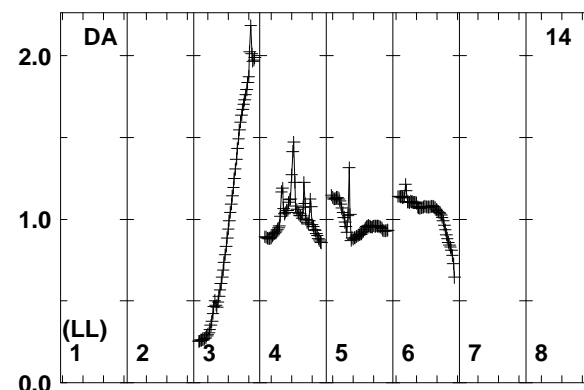
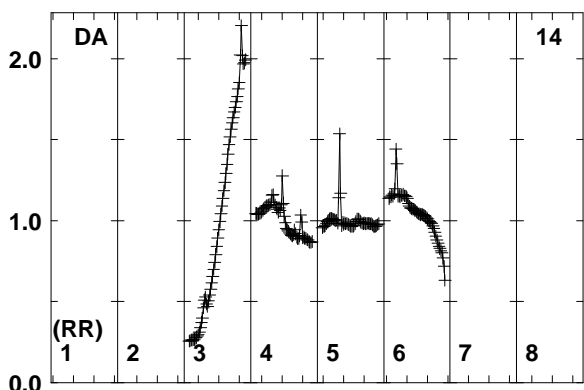
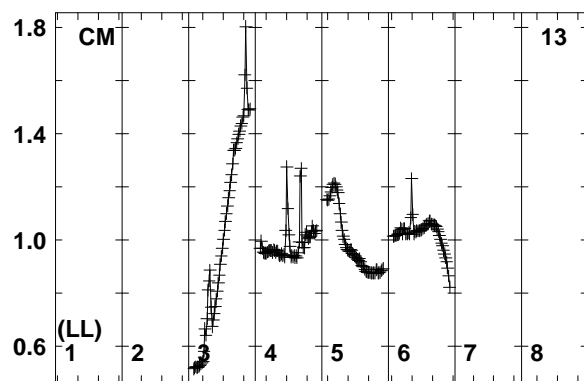
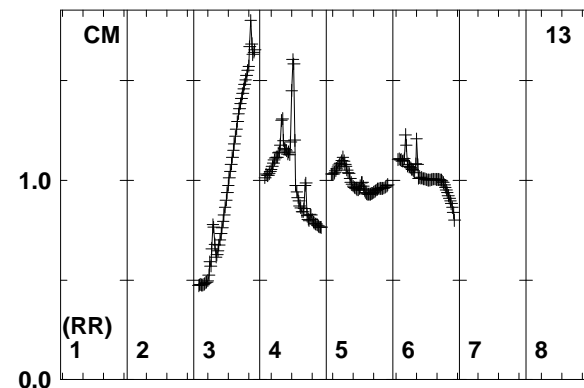
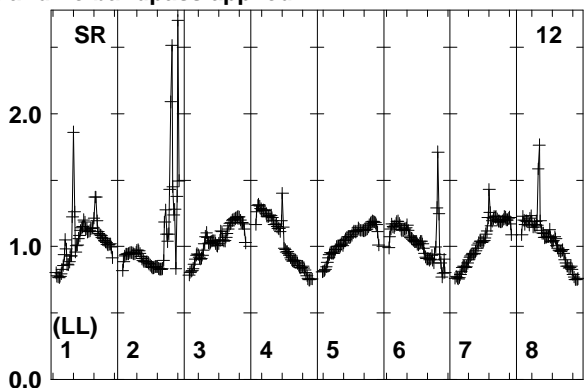
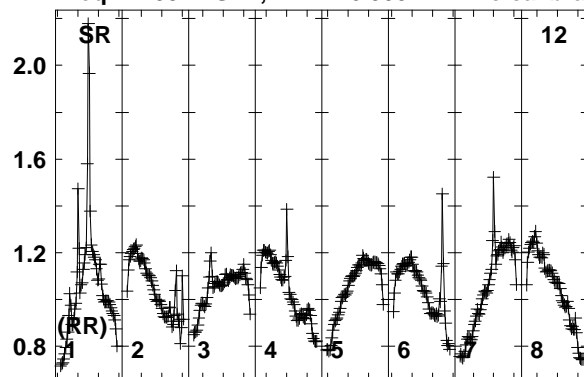

Lower frame: Real Jy
Total-power spectrum Antenna: SR (12)
Timerange: 00/07:14:36 to 00/07:15:34

Plot file version 487 created 04-NOV-2019 14:14:40

W2246-0526 EY034.UVDATA.1

Freq = 1.5947 GHz, Bw = 16.000 MH No calibration applied and no bandpass applied

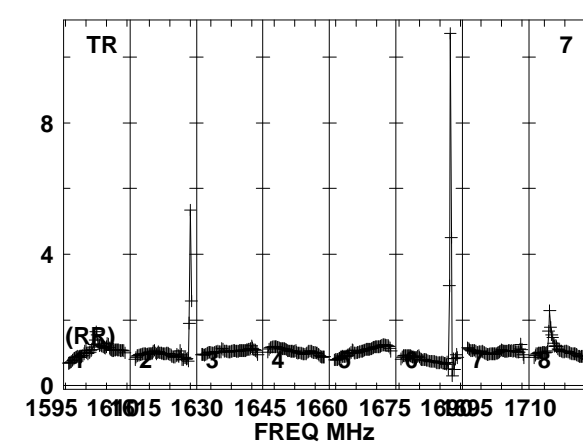
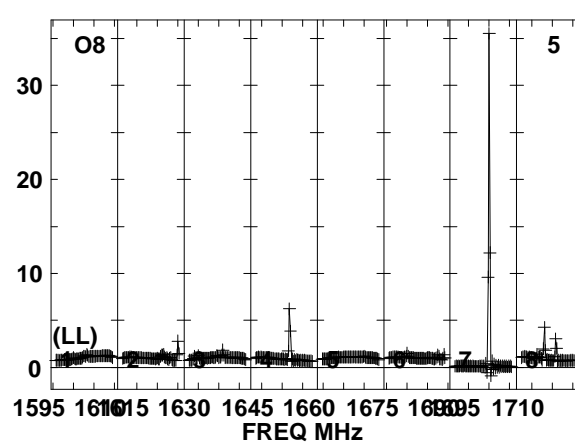
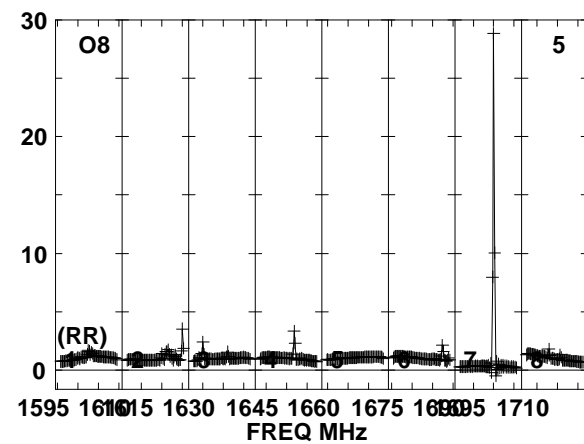
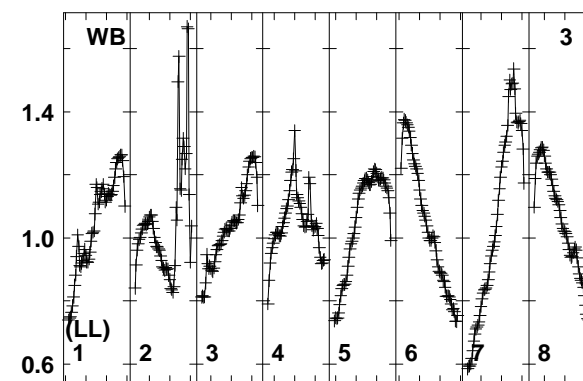
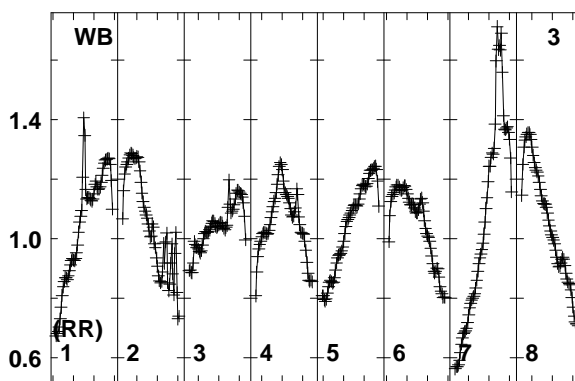
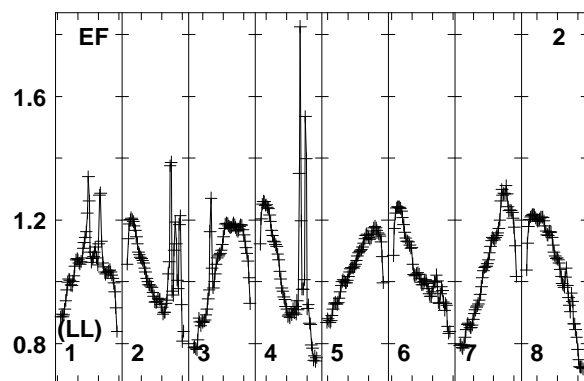
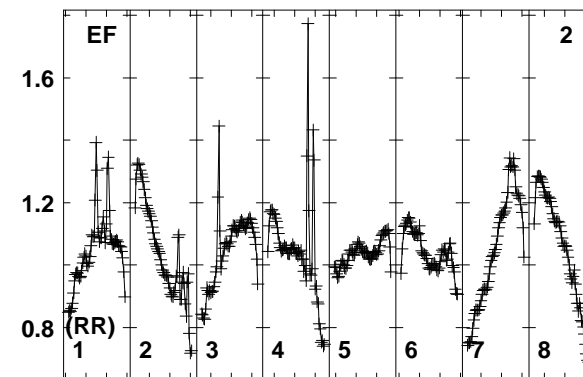
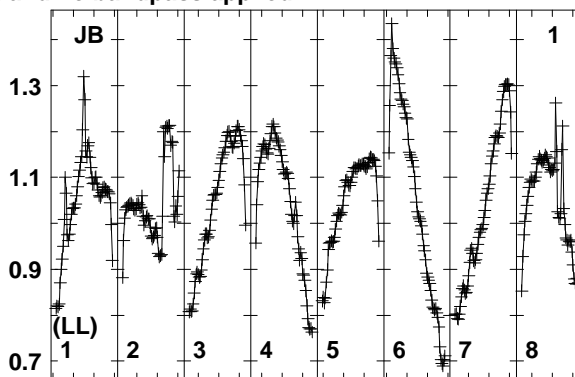
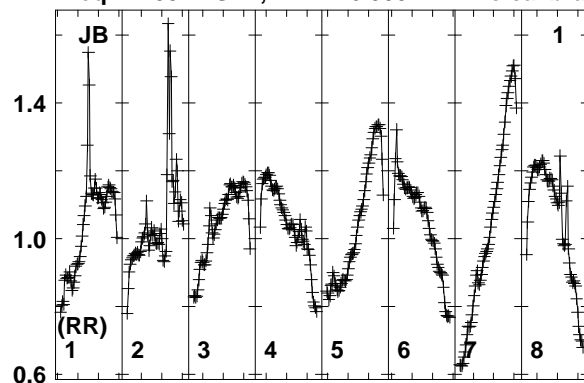

Lower frame: Real Jy
Total-power spectrum Antenna: JB (01)
Timerange: 00/07:15:36 to 00/07:18:14

Plot file version 488 created 04-NOV-2019 14:14:40

W2246-0526 EY034.UVDATA.1

Freq = 1.5947 GHz, Bw = 16.000 MH No calibration applied and no bandpass applied

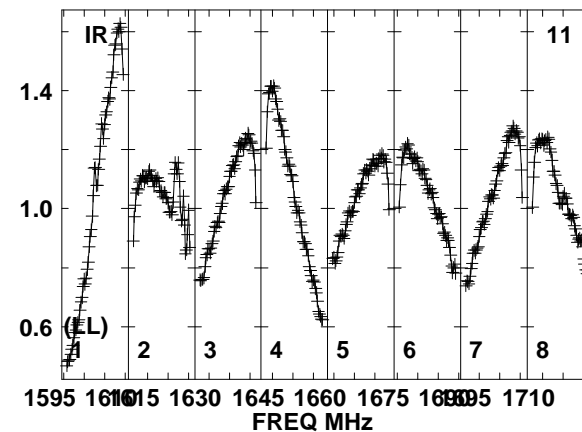
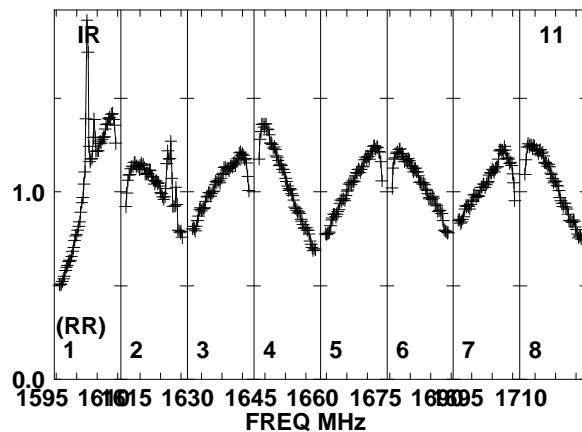
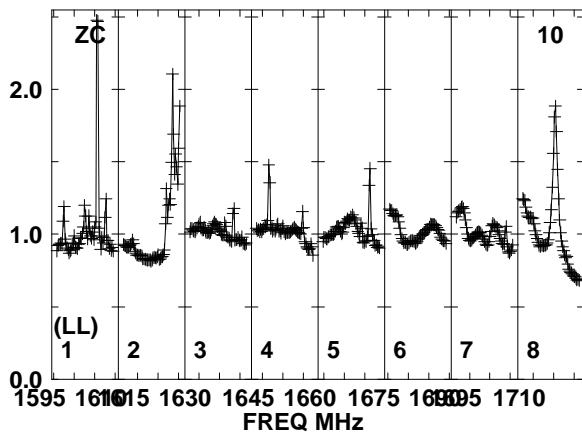
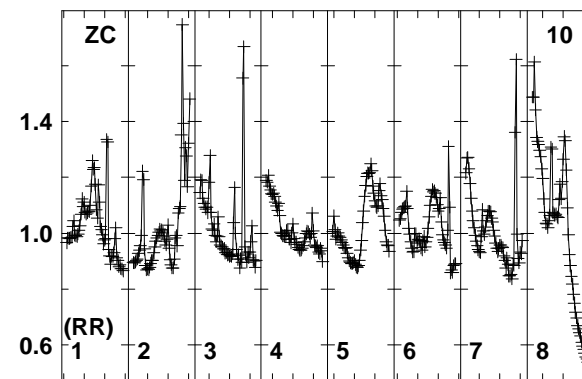
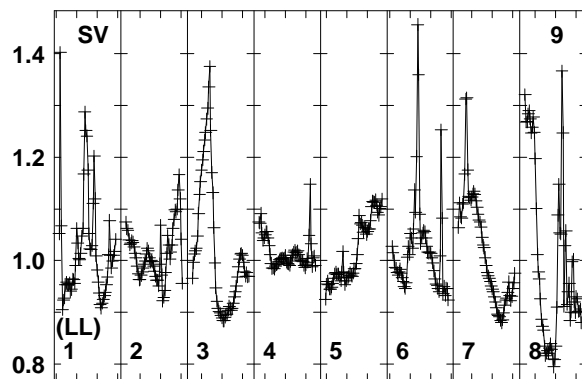
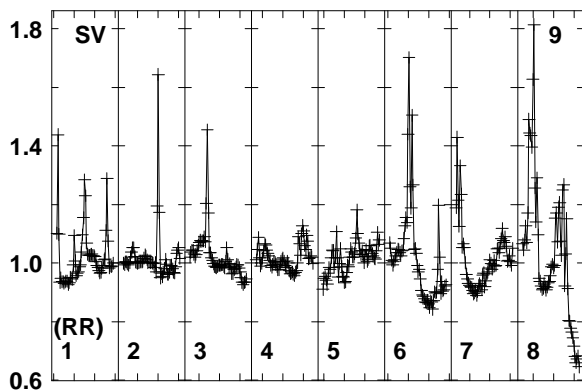
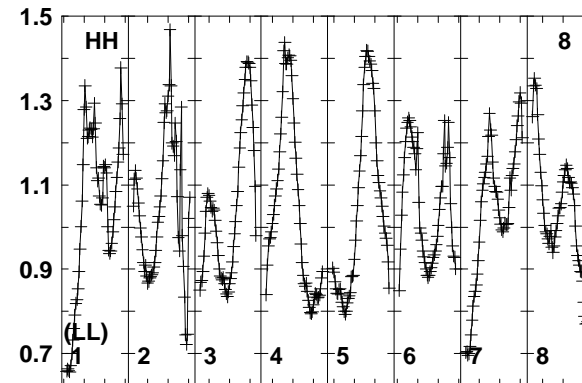
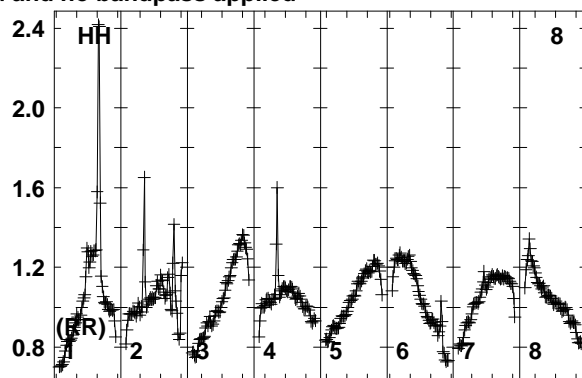
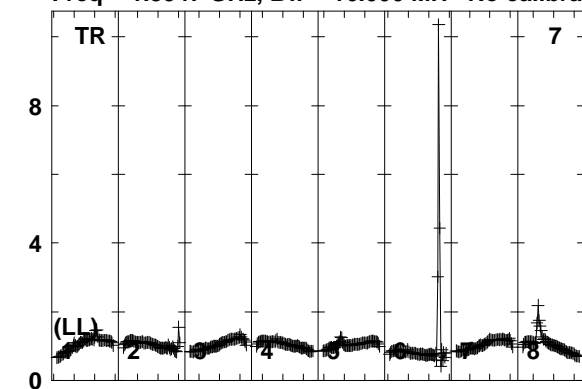

Lower frame: Real Jy
Total-power spectrum Antenna: TR (07)
Timerange: 00/07:15:36 to 00/07:18:14

Plot file version 489 created 04-NOV-2019 14:14:40

W2246-0526 EY034.UVDATA.1

Freq = 1.5947 GHz, Bw = 16.000 MH No calibration applied and no bandpass applied

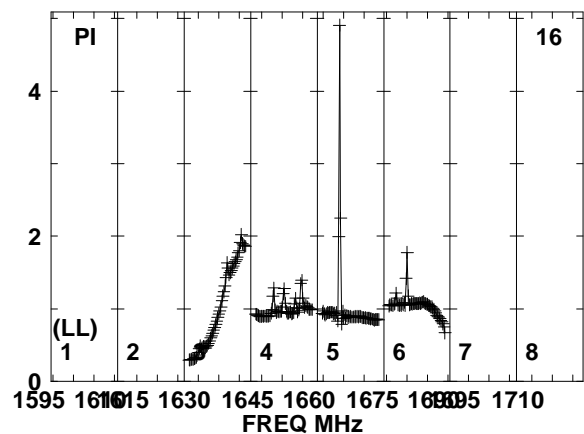
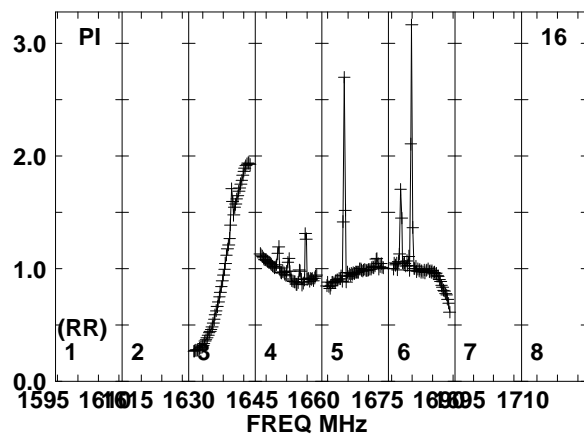
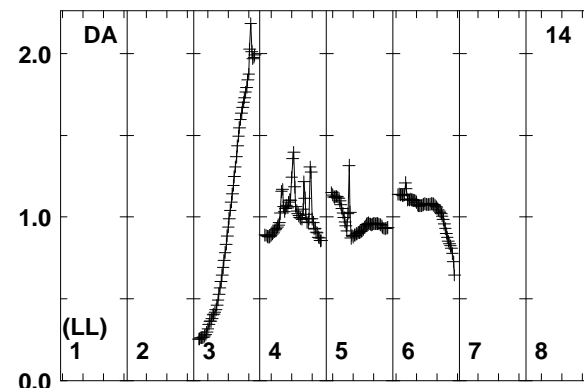
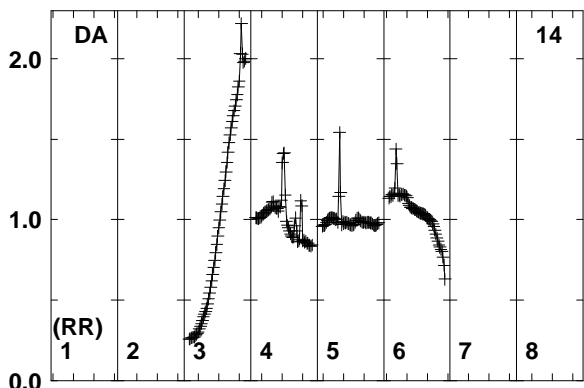
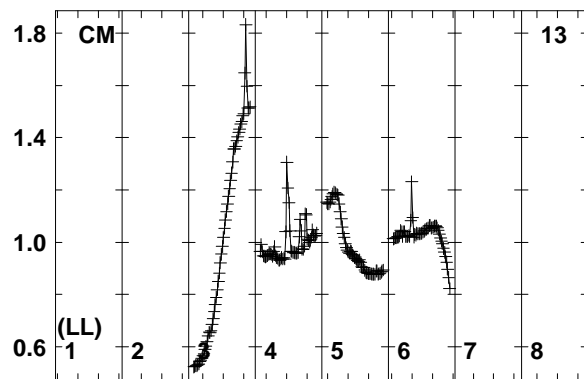
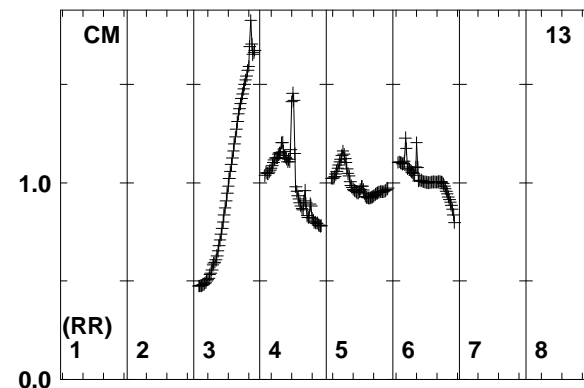
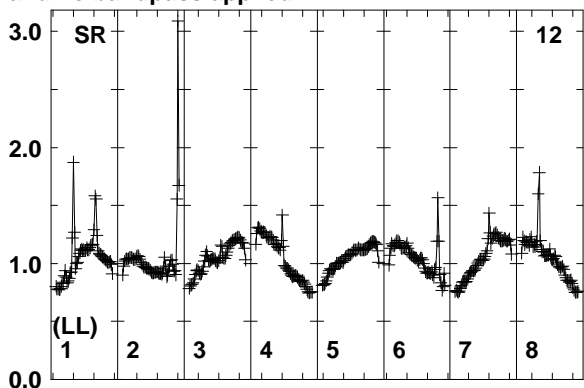
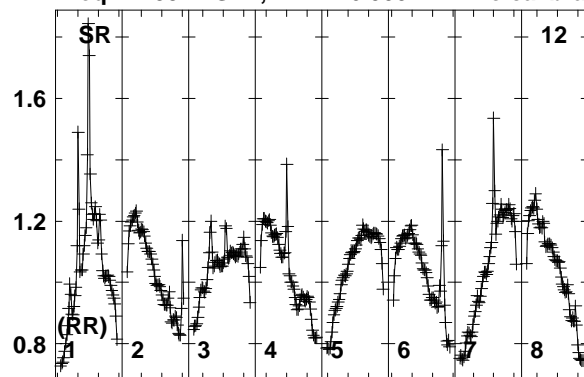

Lower frame: Real Jy
Total-power spectrum Antenna: SR (12)
Timerange: 00/07:15:36 to 00/07:18:14

Plot file version 490 created 04-NOV-2019 14:14:40

J2248-0541 EY034.UVDATA.1

Freq = 1.5947 GHz, Bw = 16.000 MH No calibration applied and no bandpass applied

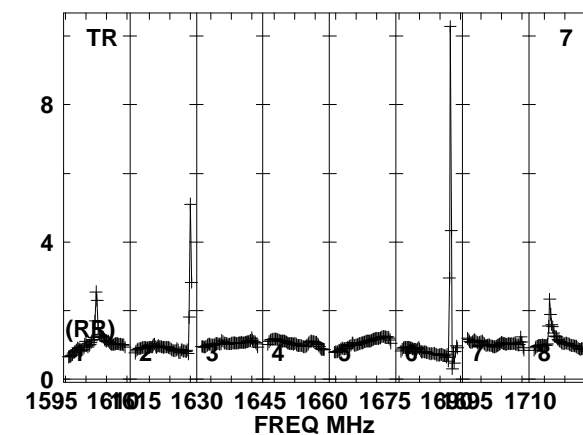
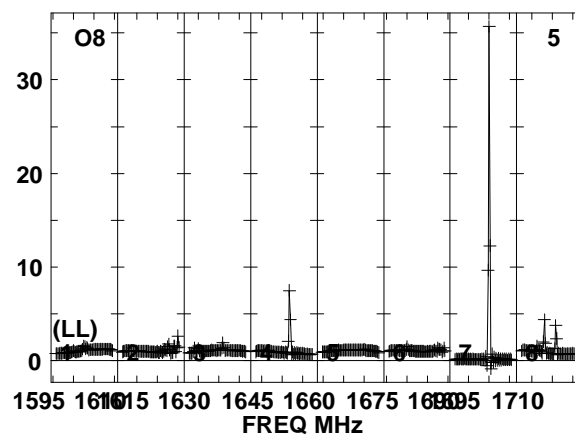
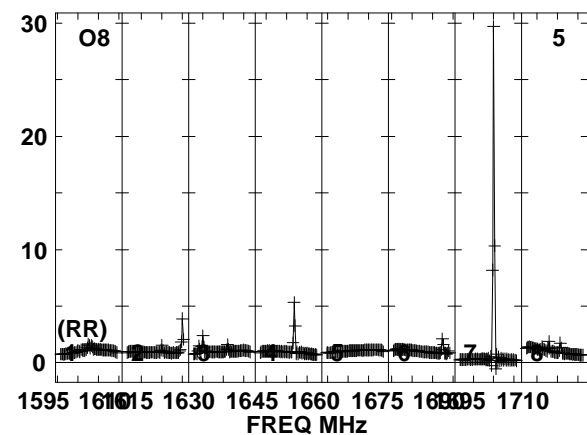
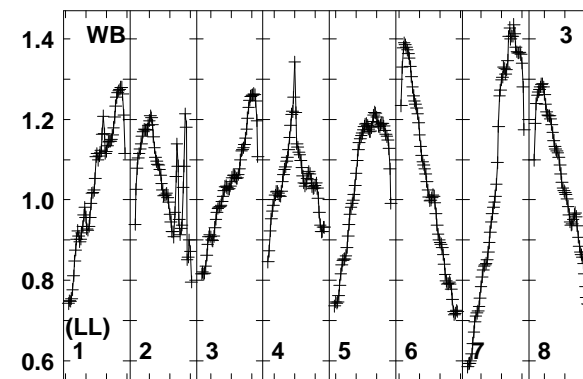
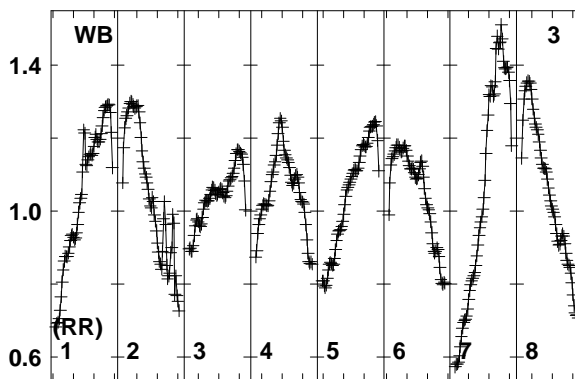
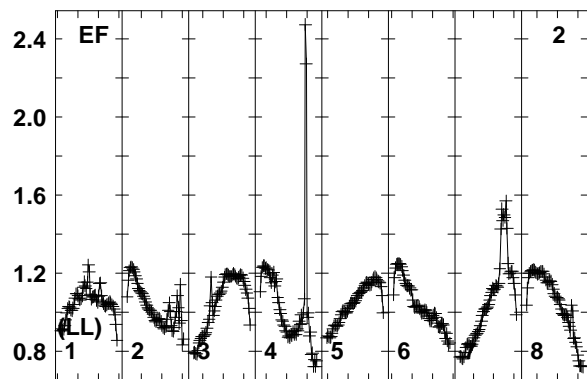
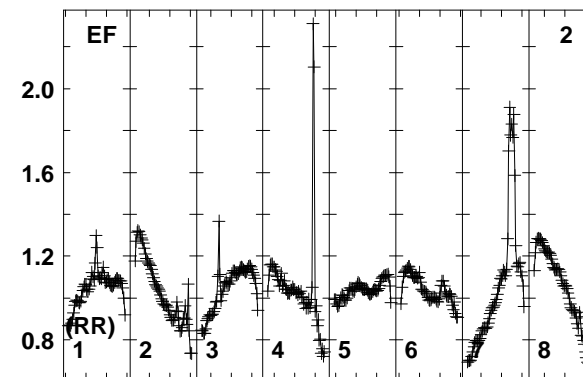
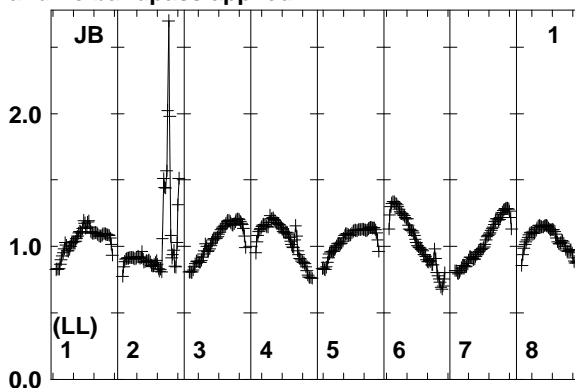
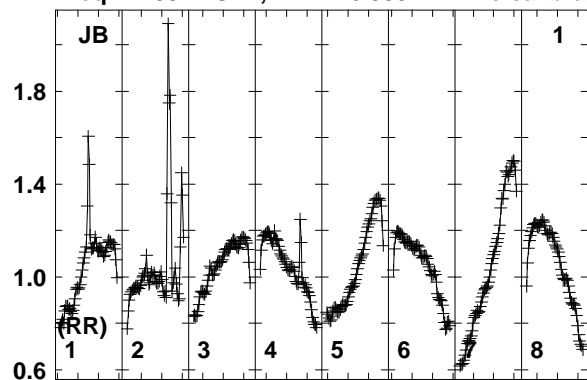

Lower frame: Real Jy
Total-power spectrum Antenna: JB (01)
Timerange: 00/07:18:31 to 00/07:19:29

Plot file version 491 created 04-NOV-2019 14:14:40

J2248-0541 EY034.UVDATA.1

Freq = 1.5947 GHz, Bw = 16.000 MH No calibration applied and no bandpass applied

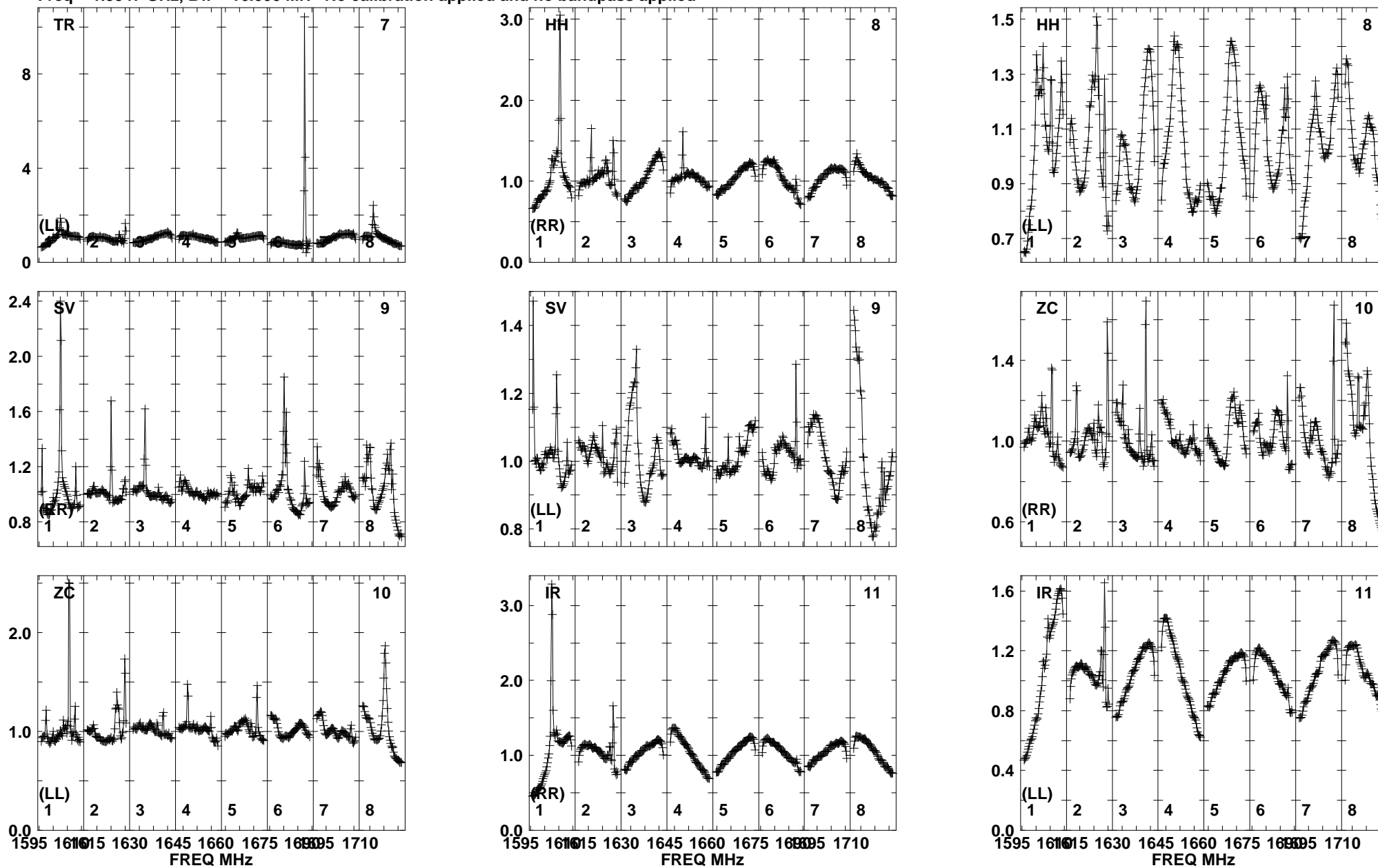

Lower frame: Real Jy
Total-power spectrum Antenna: TR (07)
Timerange: 00/07:18:31 to 00/07:19:29

Plot file version 492 created 04-NOV-2019 14:14:40

J2248-0541 EY034.UVDATA.1

Freq = 1.5947 GHz, Bw = 16.000 MH No calibration applied and no bandpass applied

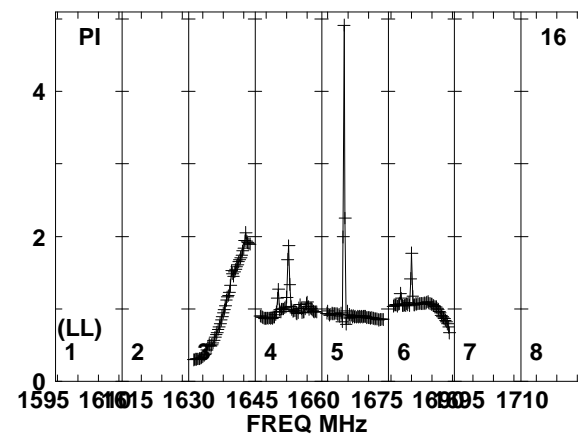
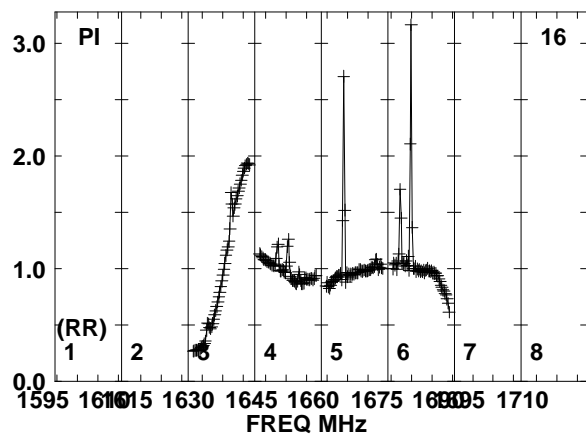
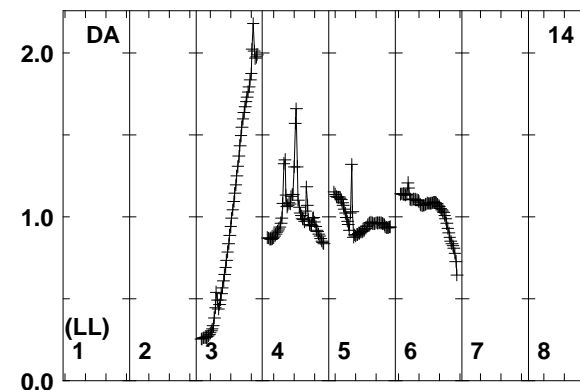
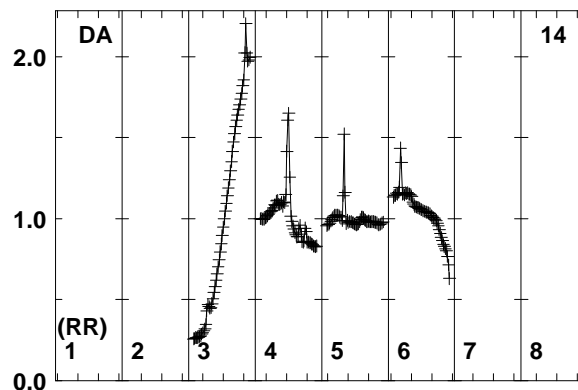
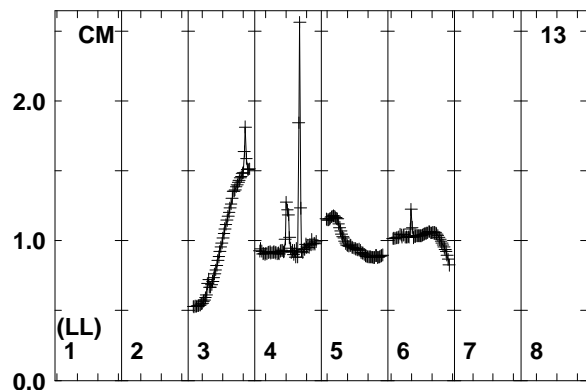
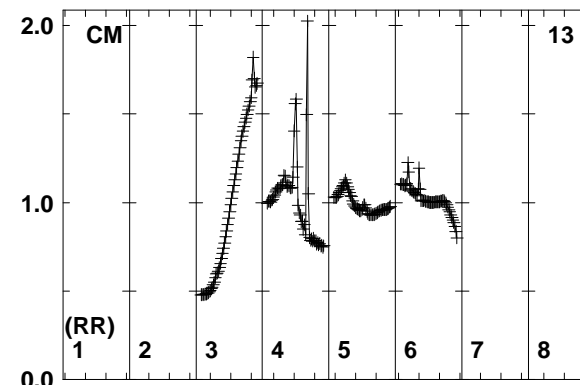
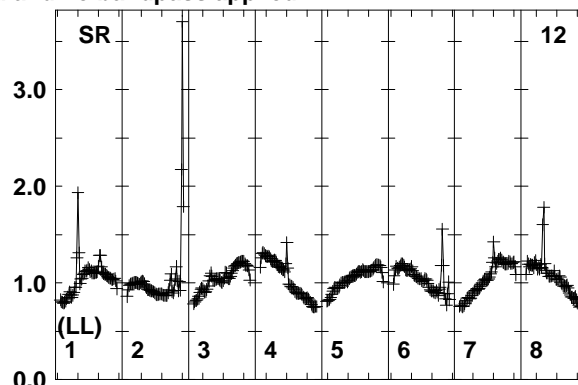
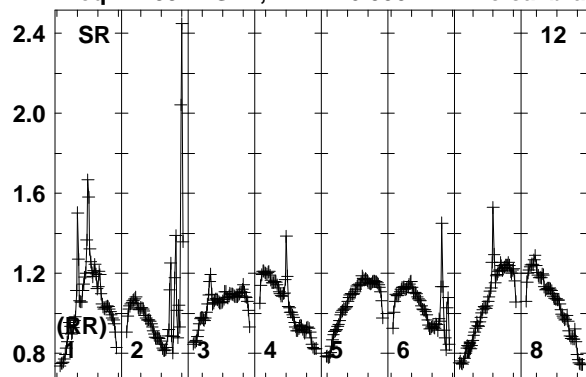

Lower frame: Real Jy
Total-power spectrum Antenna: SR (12)
Timerange: 00/07:18:31 to 00/07:19:29

Plot file version 493 created 04-NOV-2019 14:14:40

J2245-0755 EY034.UVDATA.1

Freq = 1.5947 GHz, Bw = 16.000 MH No calibration applied and no bandpass applied

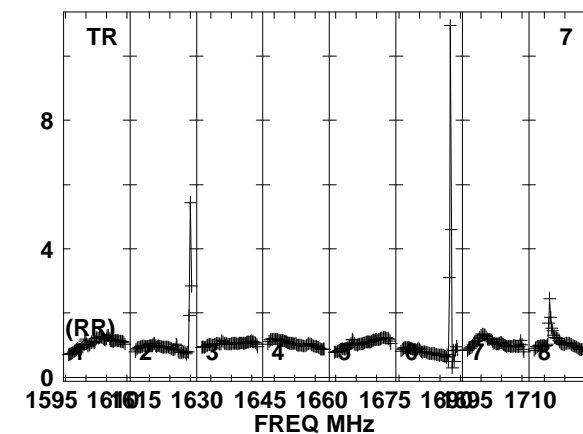
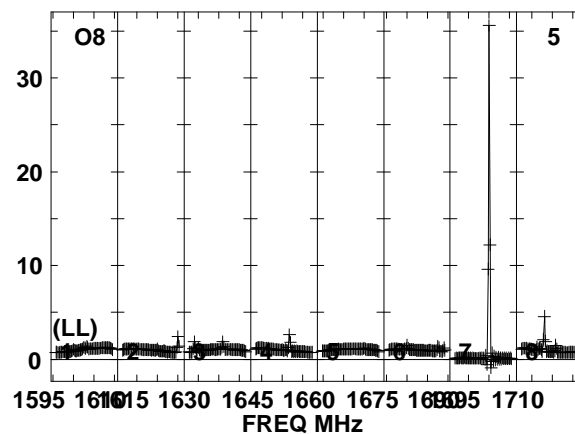
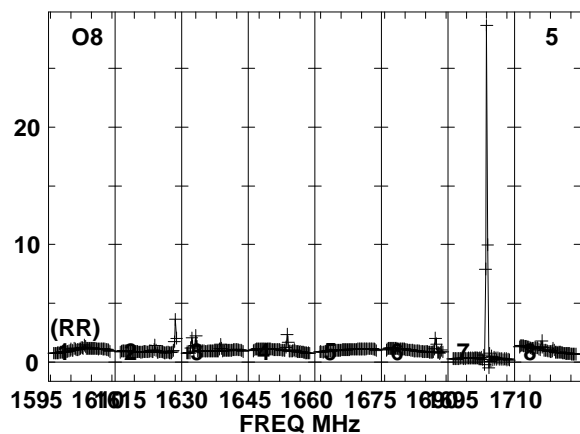
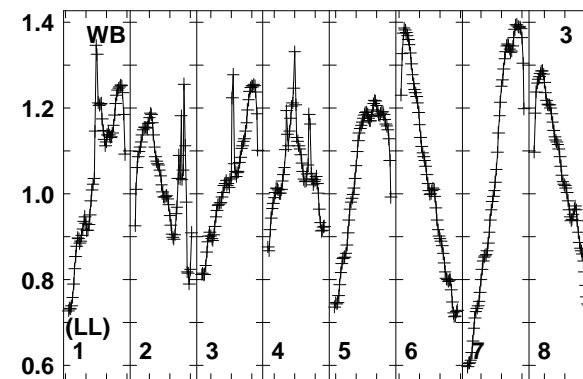
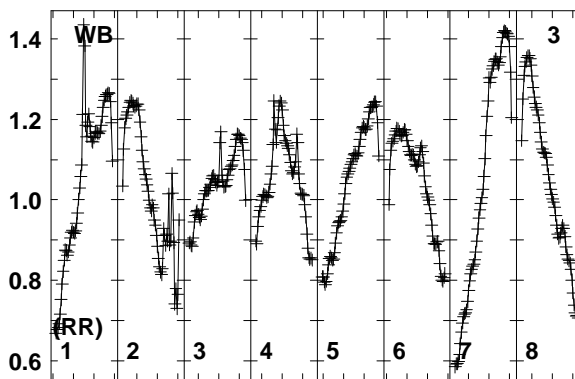
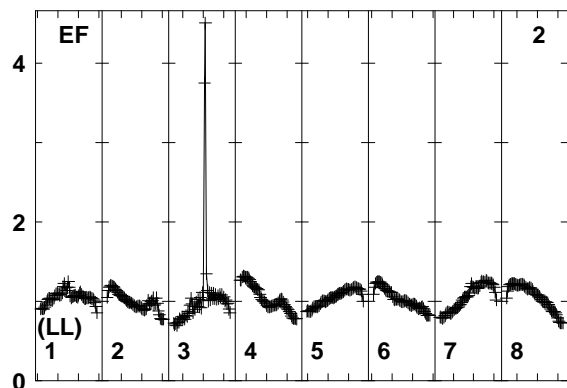
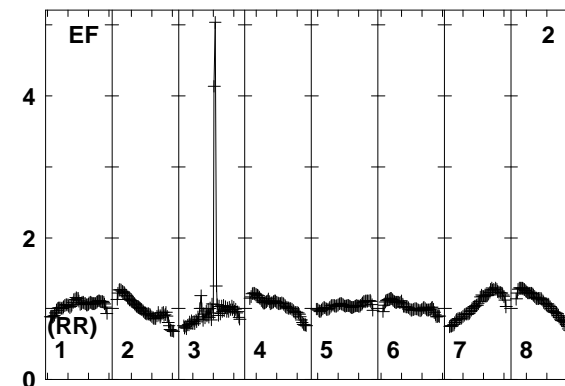
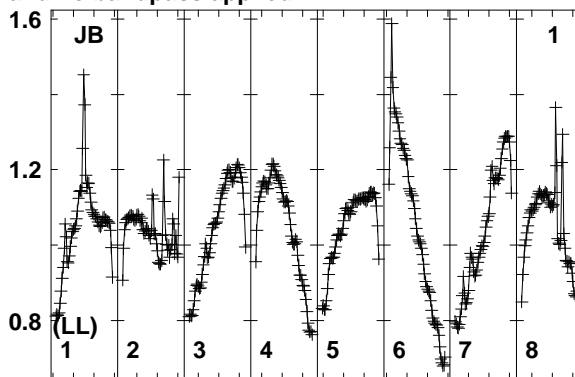
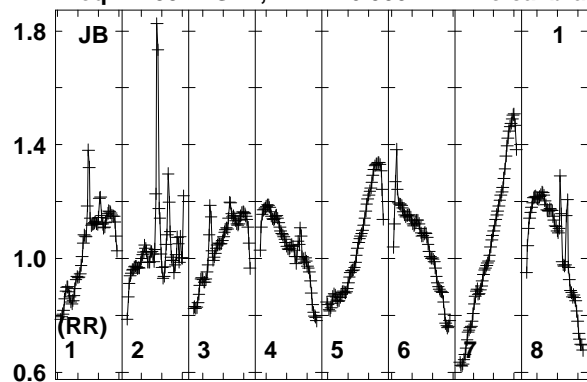

Lower frame: Real Jy
Total-power spectrum Antenna: JB (01)
Timerange: 00/07:19:46 to 00/07:20:44

Plot file version 494 created 04-NOV-2019 14:14:40

J2245-0755 EY034.UVDATA.1

Freq = 1.5947 GHz, Bw = 16.000 MH No calibration applied and no bandpass applied

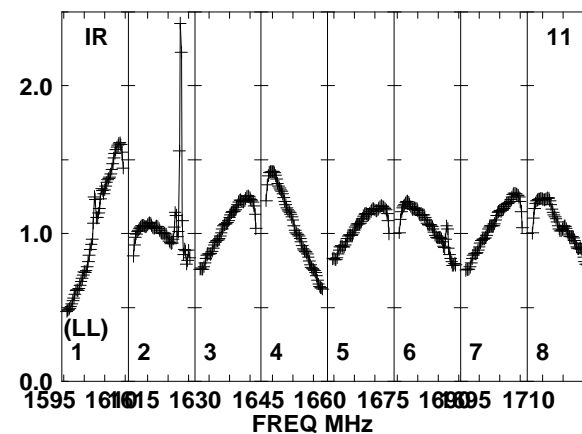
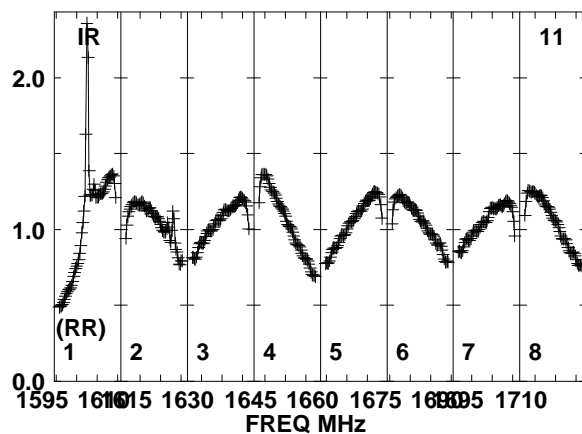
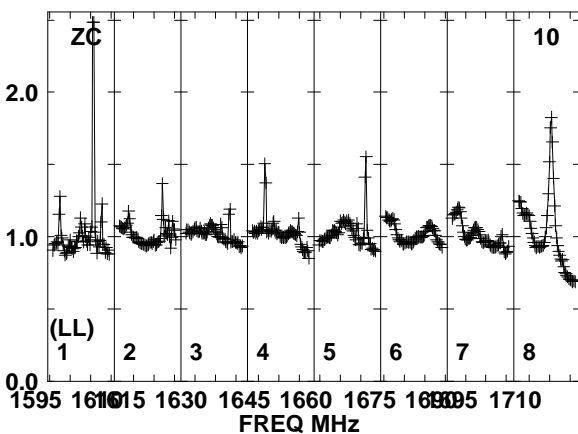
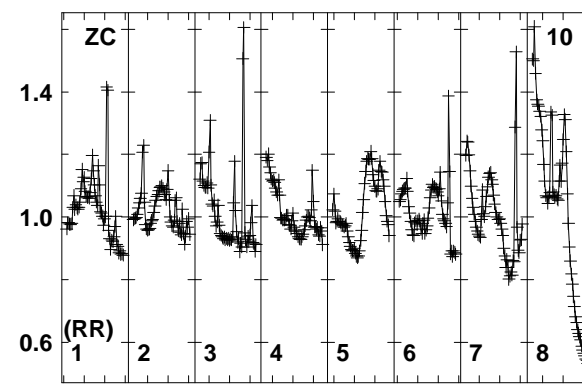
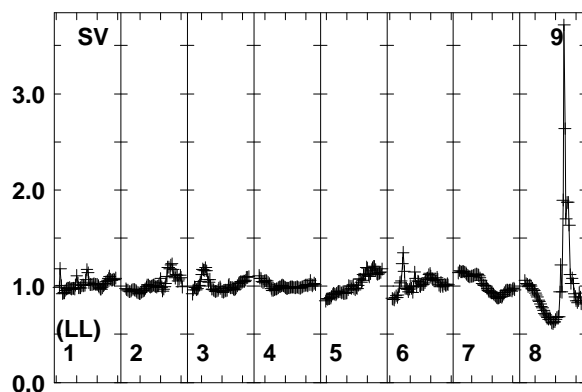
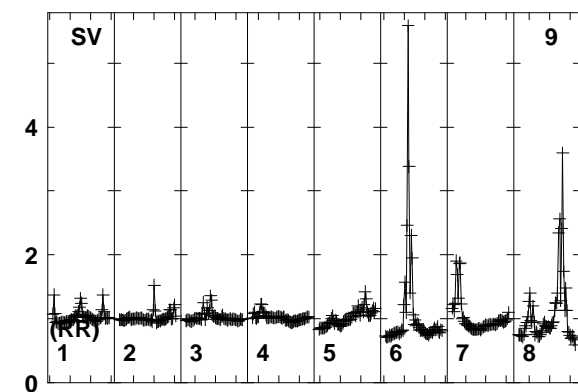
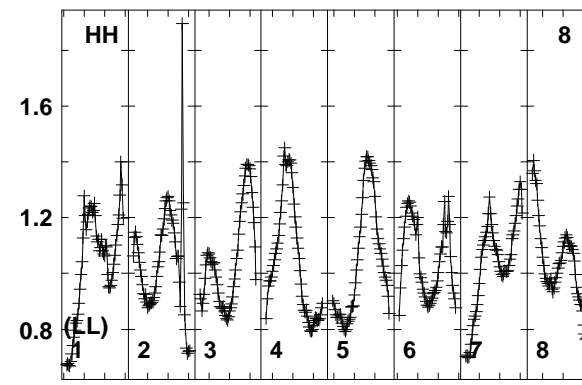
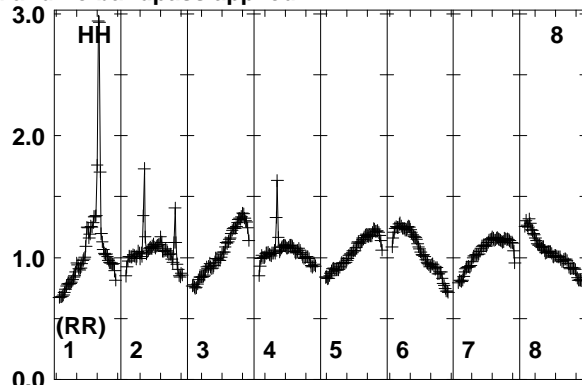
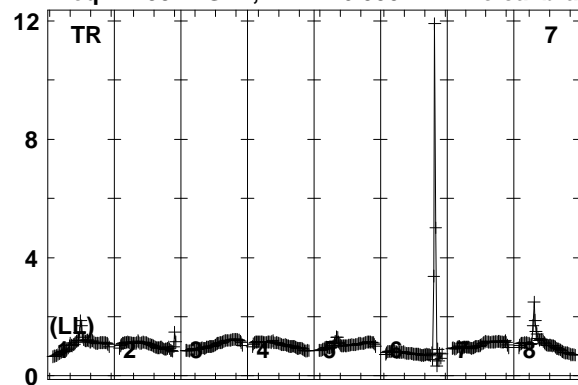

Lower frame: Real Jy
Total-power spectrum Antenna: TR (07)
Timerange: 00/07:19:46 to 00/07:20:44

Plot file version 495 created 04-NOV-2019 14:14:40

J2245-0755 EY034.UVDATA.1

Freq = 1.5947 GHz, Bw = 16.000 MH No calibration applied and no bandpass applied

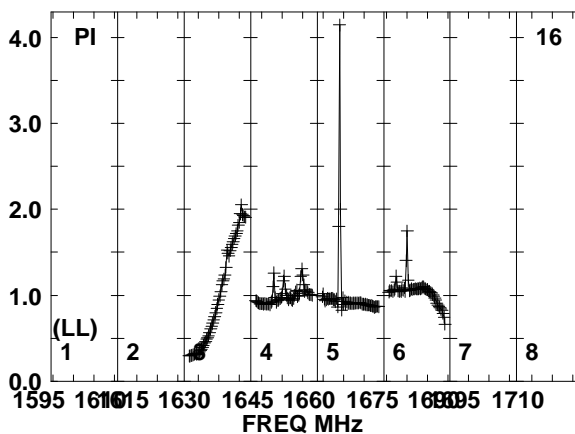
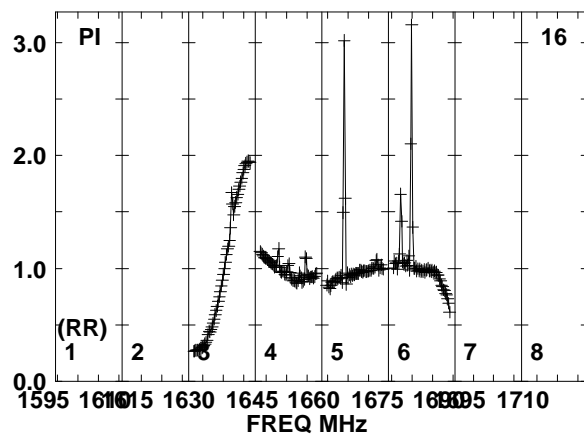
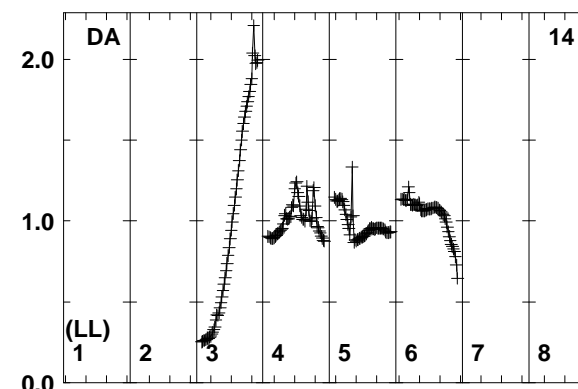
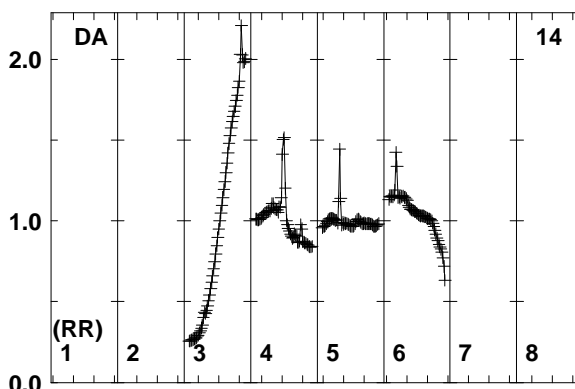
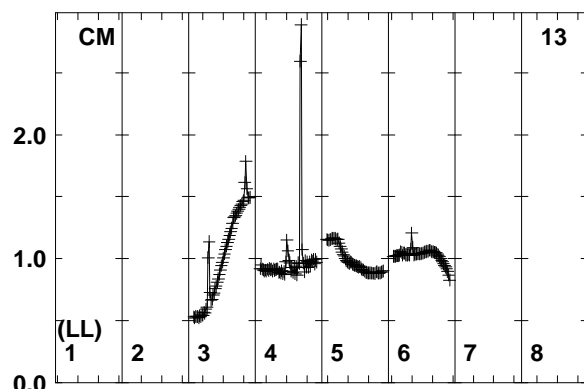
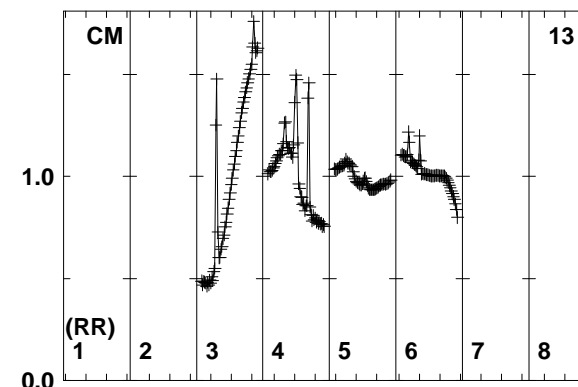
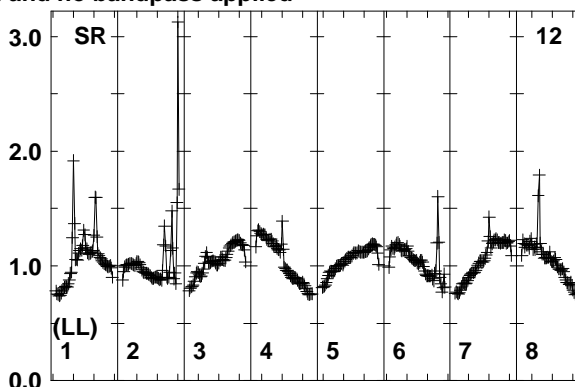
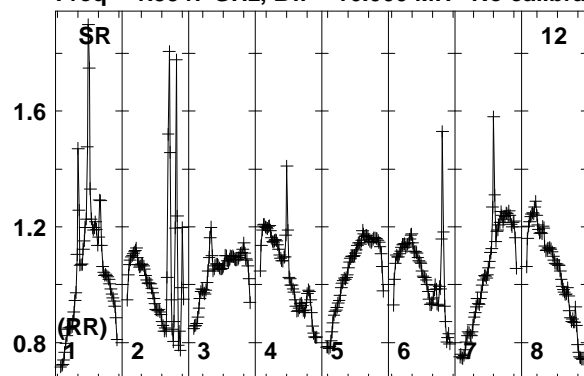

Lower frame: Real Jy
Total-power spectrum Antenna: SR (12)
Timerange: 00/07:19:46 to 00/07:20:44

Plot file version 496 created 04-NOV-2019 14:14:40

J2248-0541 EY034.UVDATA.1

Freq = 1.5947 GHz, Bw = 16.000 MH No calibration applied and no bandpass applied

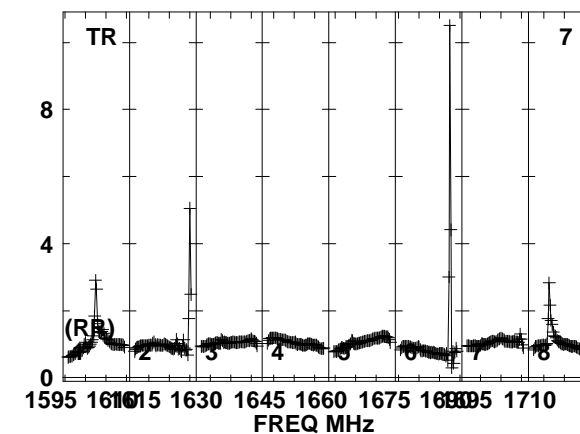
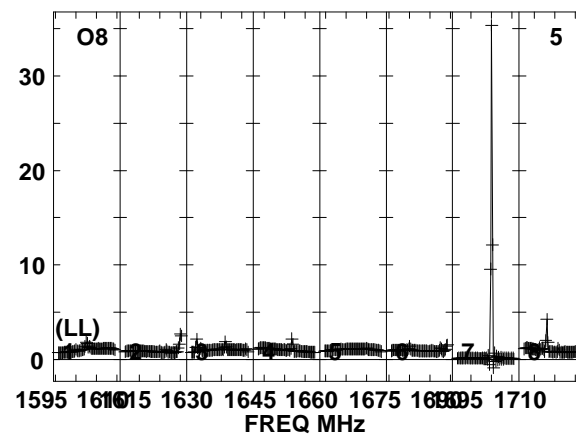
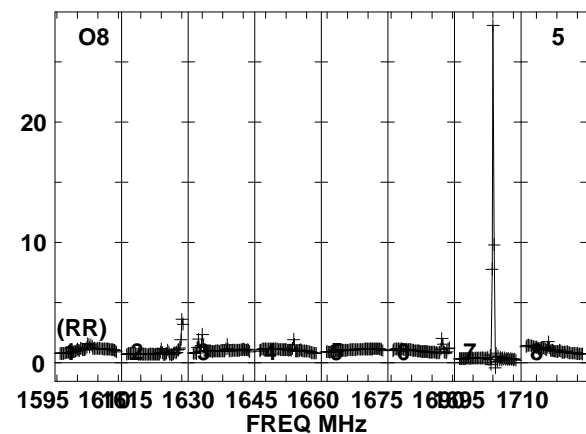
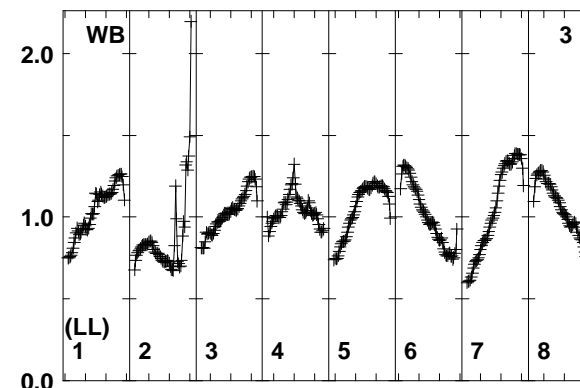
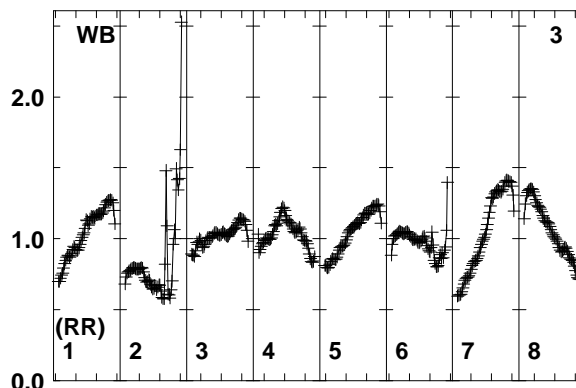
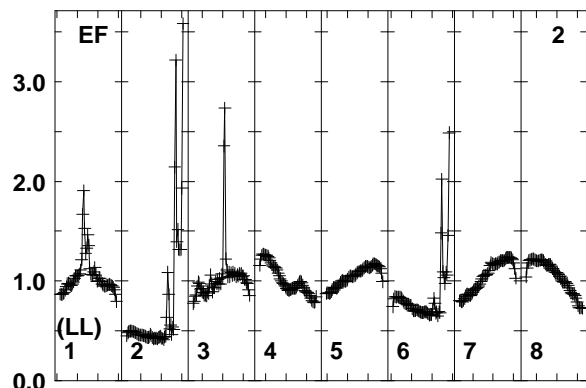
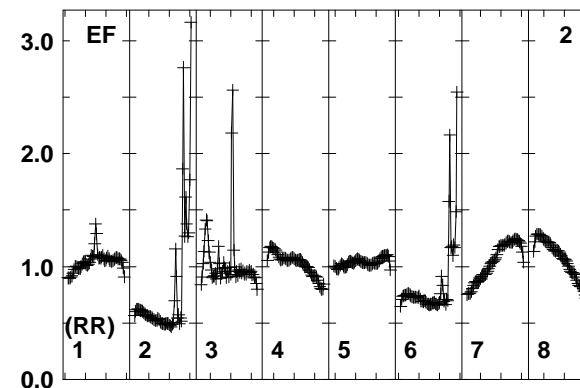
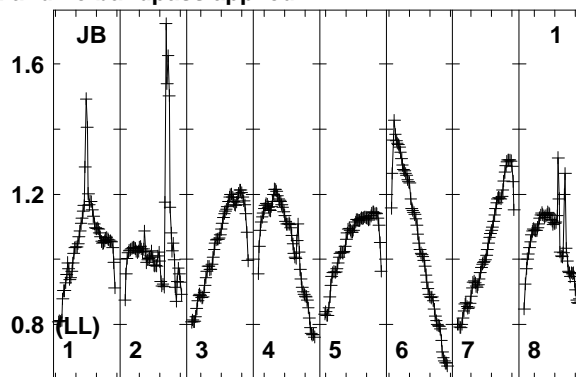
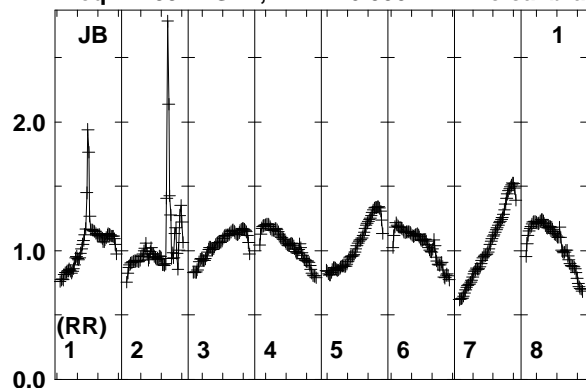

Lower frame: Real Jy
Total-power spectrum Antenna: JB (01)
Timerange: 00/07:21:31 to 00/07:22:29

Plot file version 497 created 04-NOV-2019 14:14:40

J2248-0541 EY034.UVDATA.1

Freq = 1.5947 GHz, Bw = 16.000 MH No calibration applied and no bandpass applied

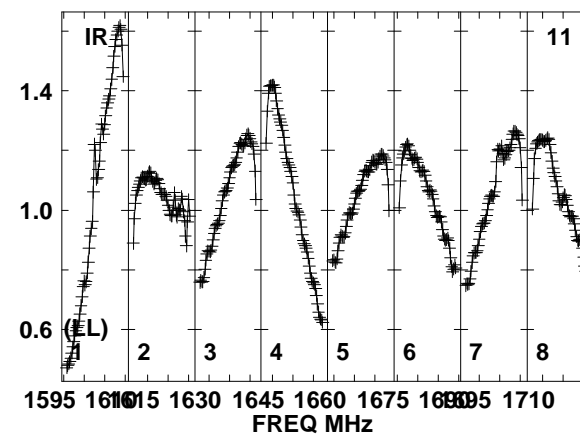
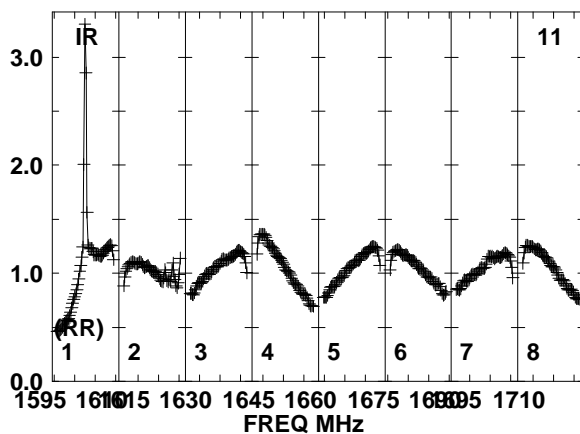
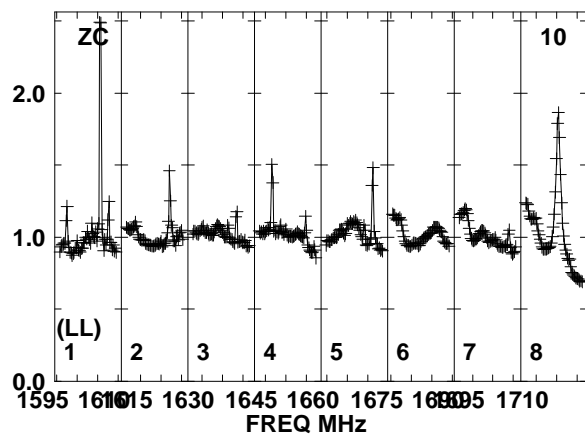
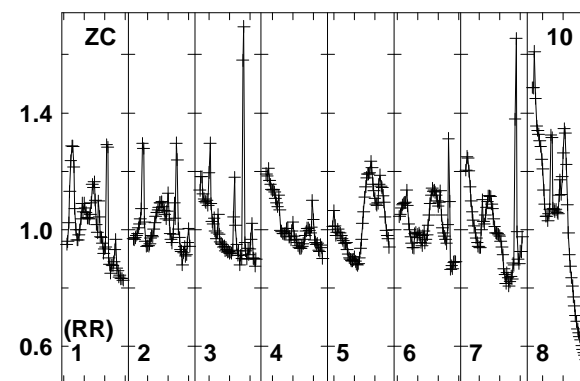
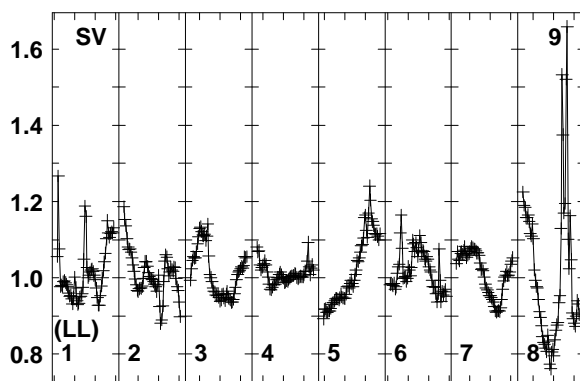
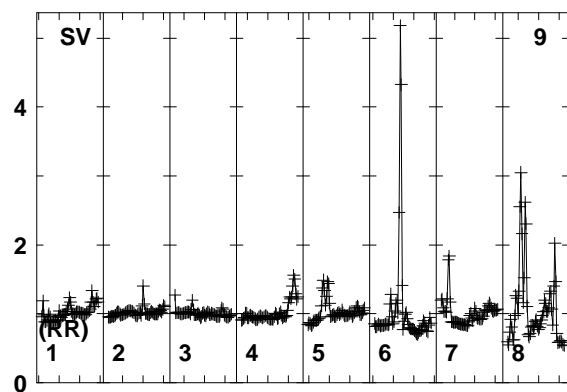
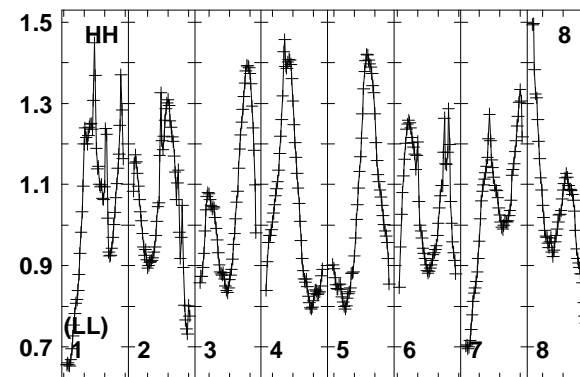
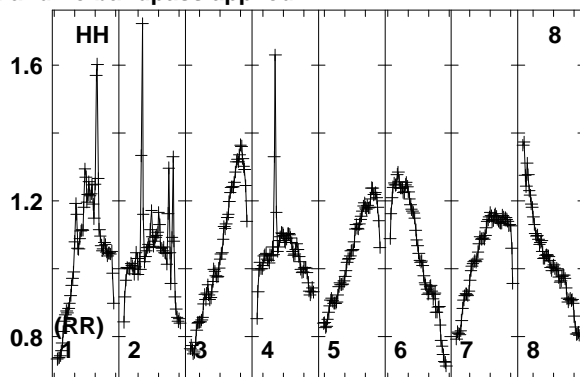
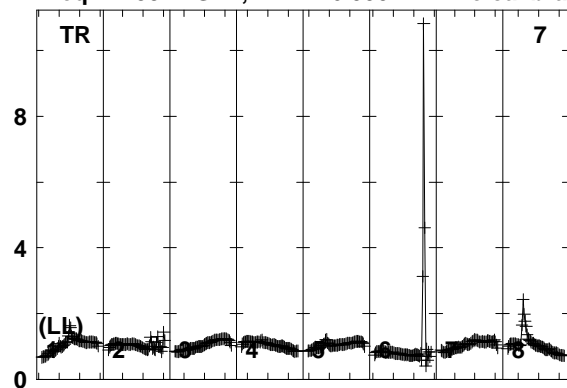

Lower frame: Real Jy
Total-power spectrum Antenna: TR (07)
Timerange: 00/07:21:31 to 00/07:22:29

Plot file version 498 created 04-NOV-2019 14:14:40

J2248-0541 EY034.UVDATA.1

Freq = 1.5947 GHz, Bw = 16.000 MH No calibration applied and no bandpass applied

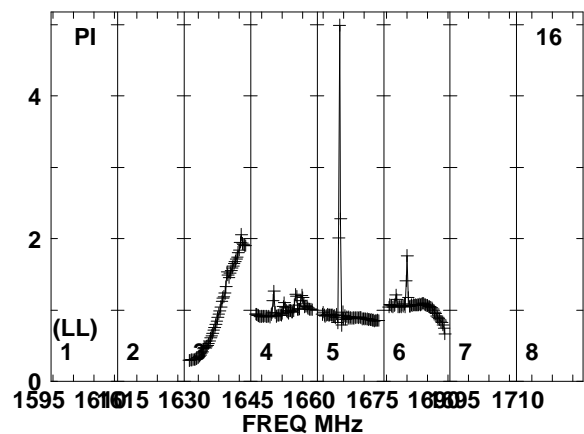
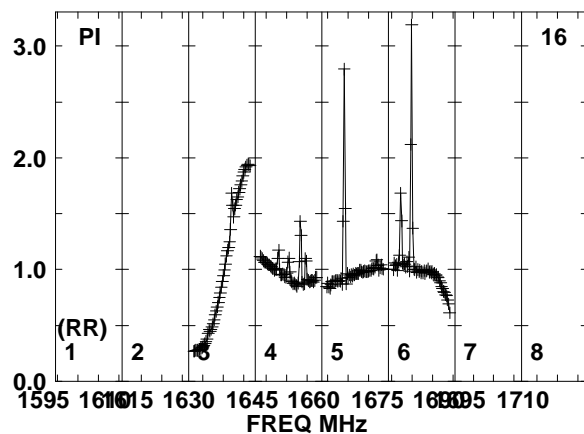
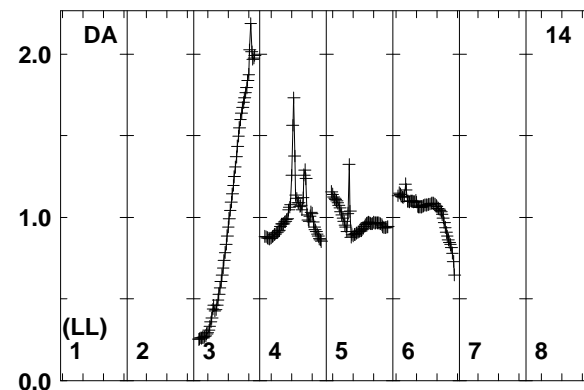
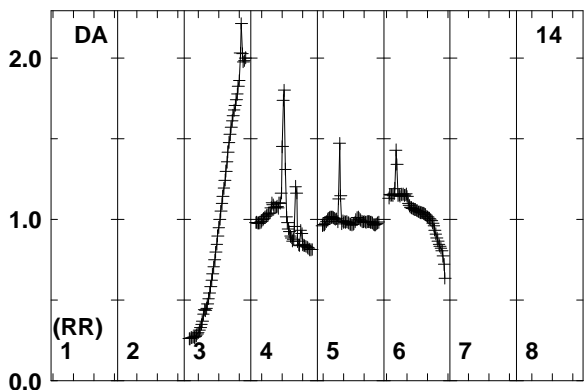
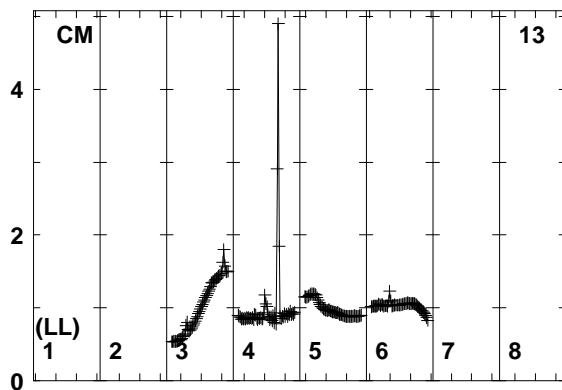
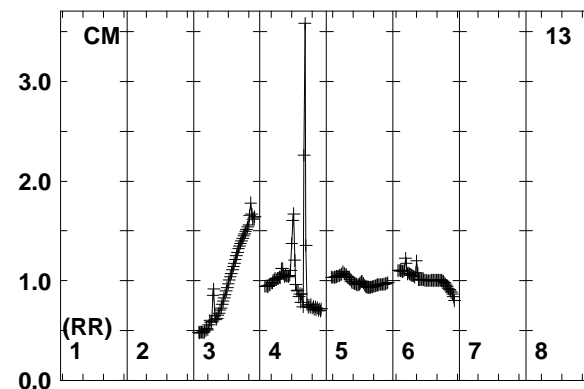
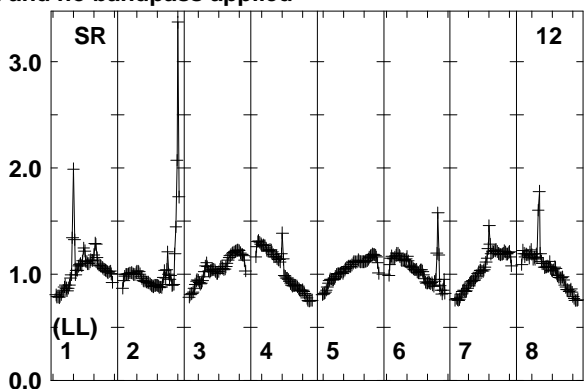
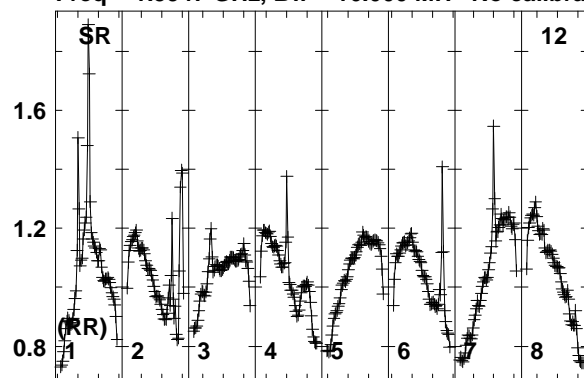

Lower frame: Real Jy
Total-power spectrum Antenna: SR (12)
Timerange: 00/07:21:31 to 00/07:22:29

Plot file version 499 created 04-NOV-2019 14:14:41

W2246-0526 EY034.UVDATA.1

Freq = 1.5947 GHz, Bw = 16.000 MH No calibration applied and no bandpass applied

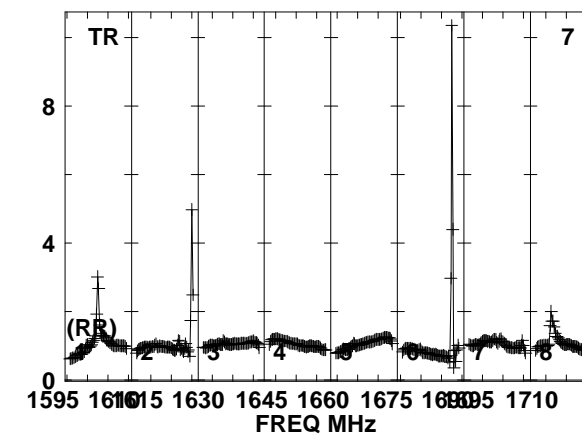
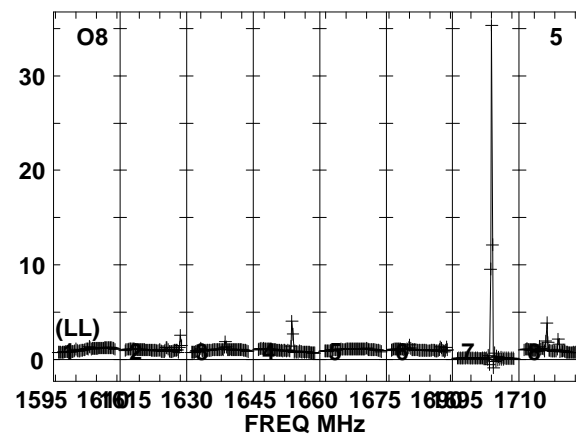
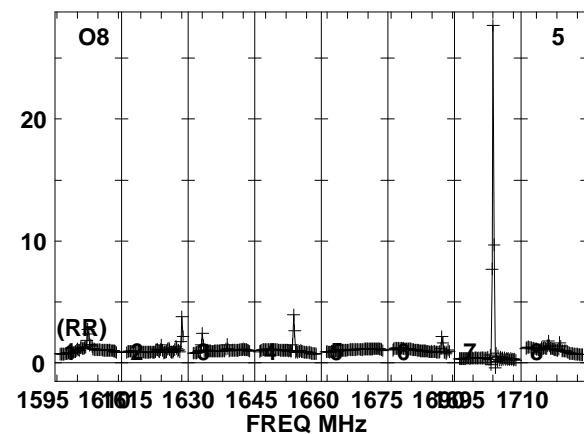
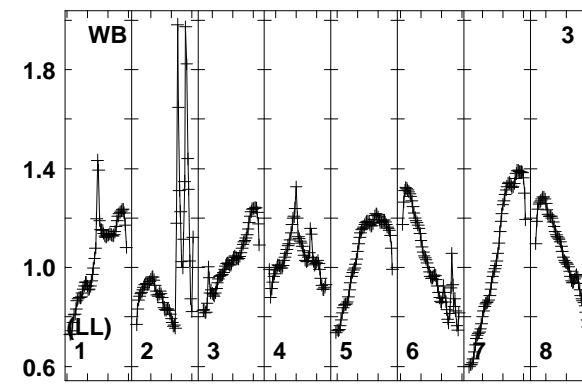
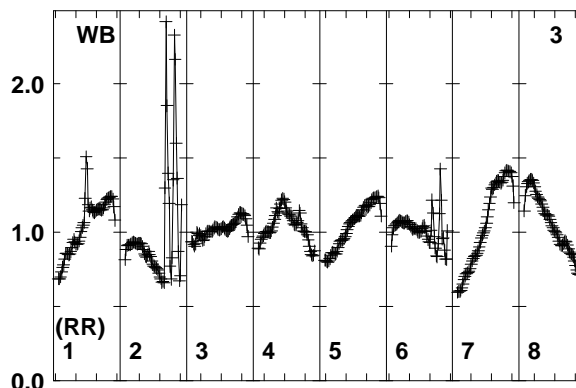
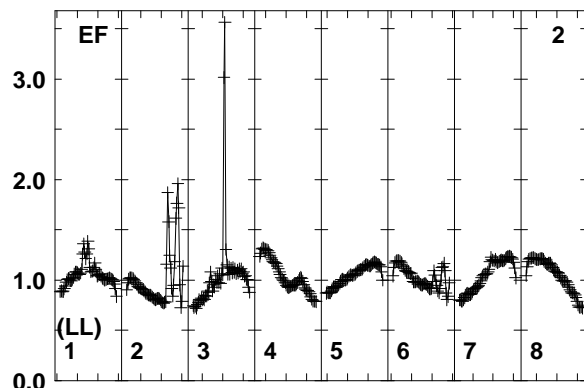
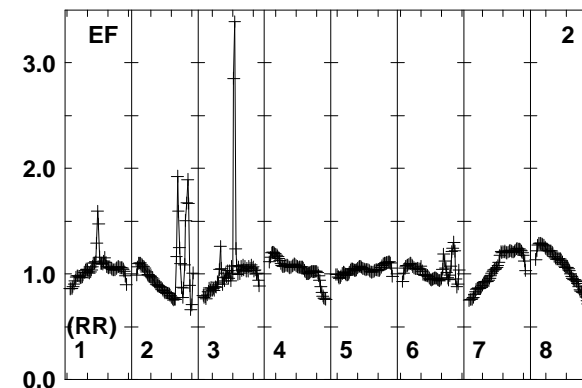
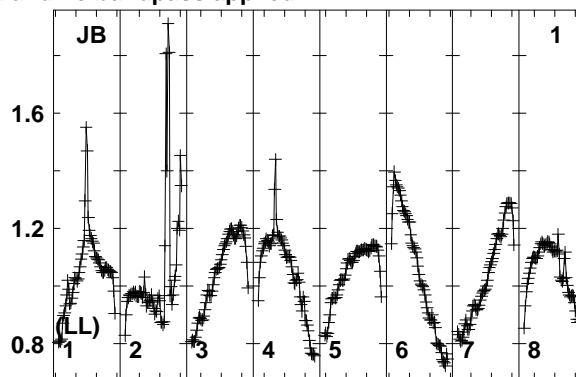
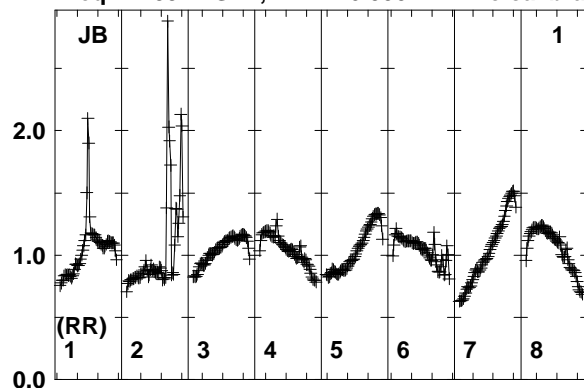

Lower frame: Real Jy
Total-power spectrum Antenna: JB (01)
Timerange: 00/07:22:31 to 00/07:24:59

Plot file version 500 created 04-NOV-2019 14:14:41

W2246-0526 EY034.UVDATA.1

Freq = 1.5947 GHz, Bw = 16.000 MH No calibration applied and no bandpass applied

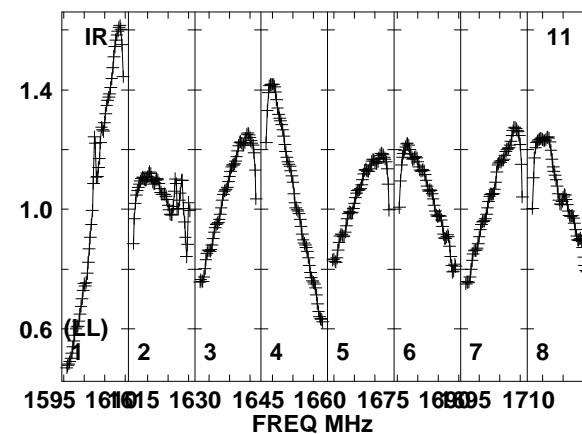
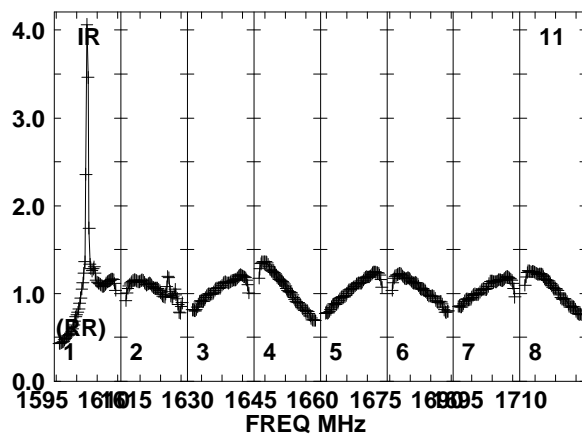
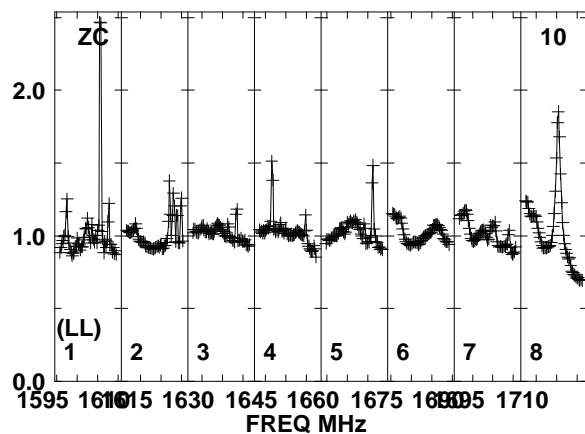
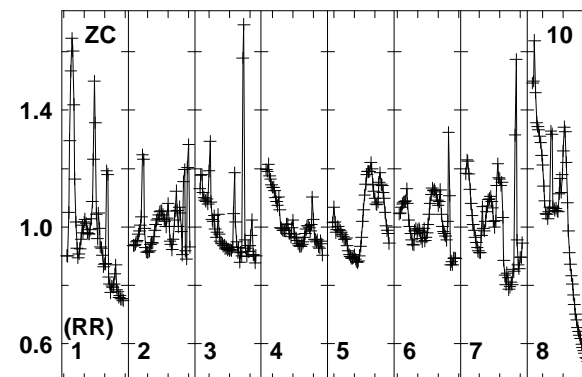
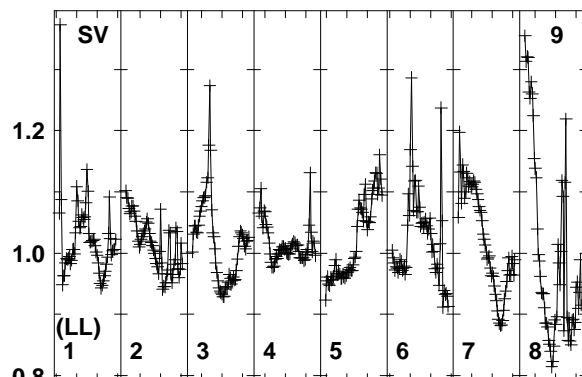
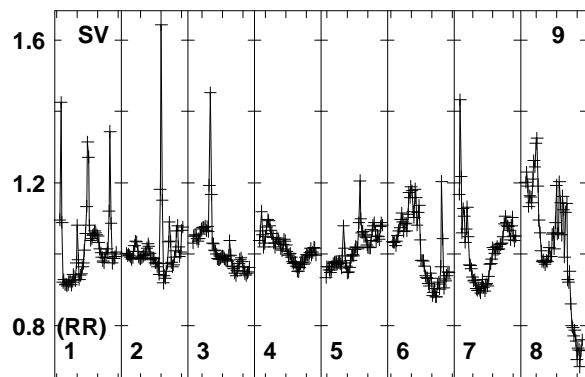
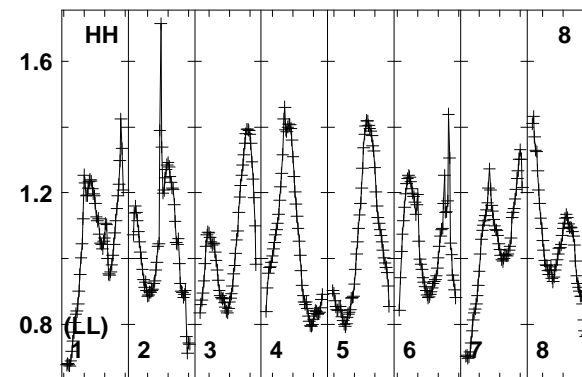
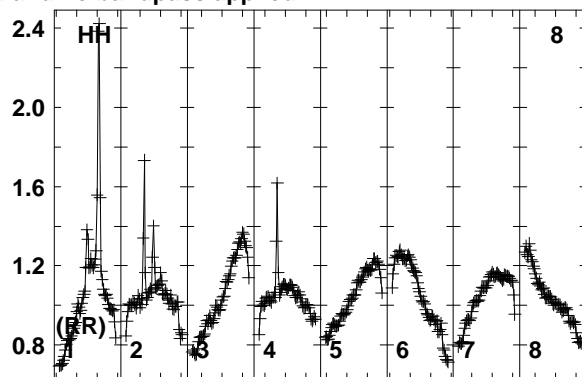
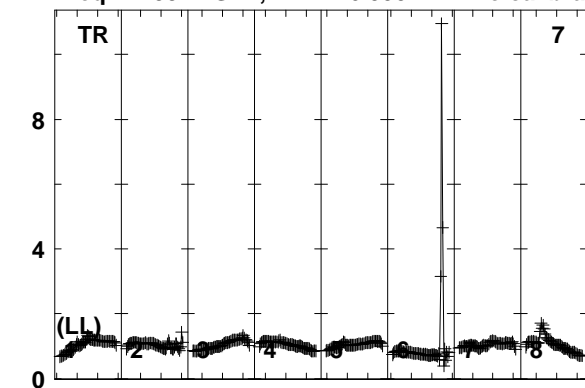

Lower frame: Real Jy
Total-power spectrum Antenna: TR (07)
Timerange: 00/07:22:31 to 00/07:24:59

Plot file version 501 created 04-NOV-2019 14:14:41

W2246-0526 EY034.UVDATA.1

Freq = 1.5947 GHz, Bw = 16.000 MH No calibration applied and no bandpass applied

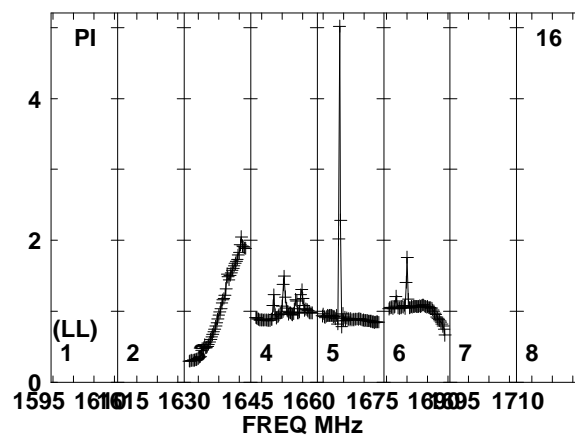
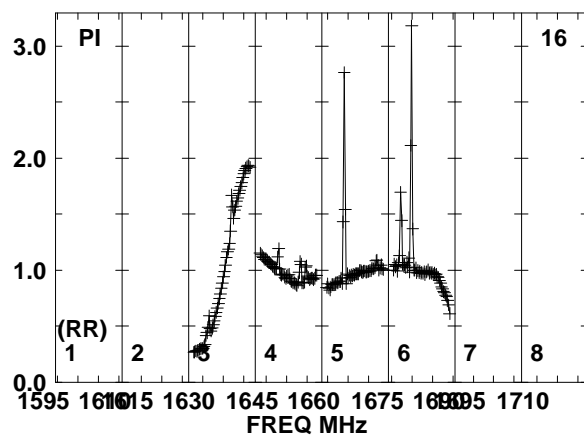
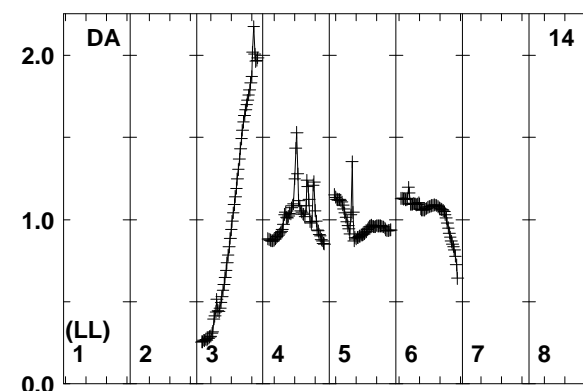
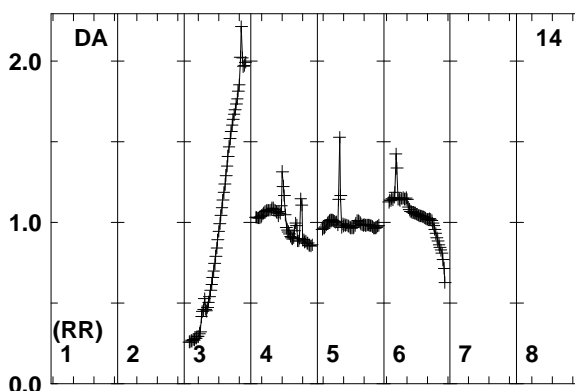
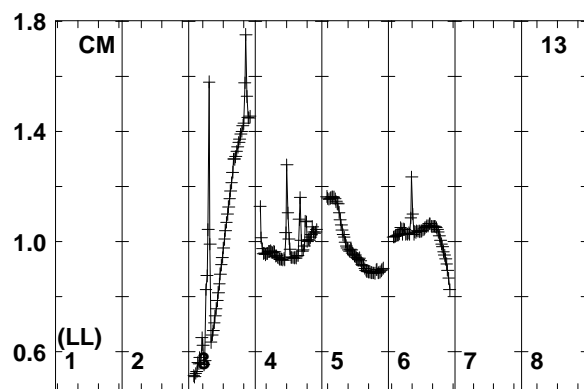
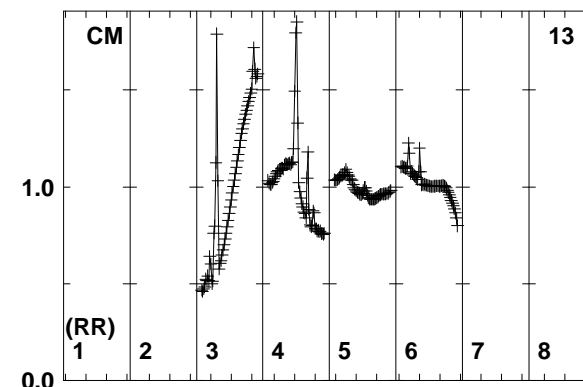
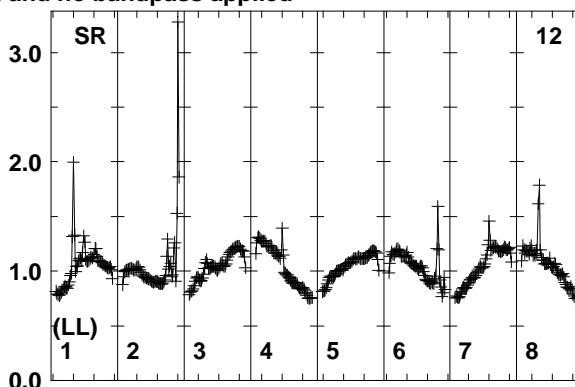
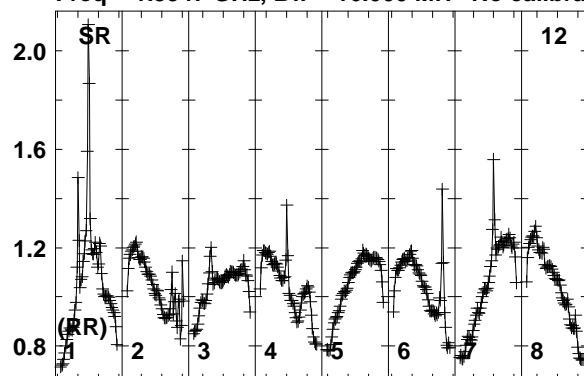

Lower frame: Real Jy
Total-power spectrum Antenna: SR (12)
Timerange: 00/07:22:31 to 00/07:24:59

Plot file version 502 created 04-NOV-2019 14:14:41

J2248-0541 EY034.UVDATA.1

Freq = 1.5947 GHz, Bw = 16.000 MH No calibration applied and no bandpass applied

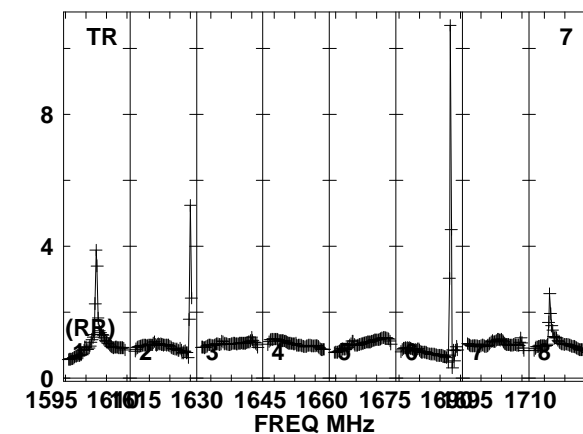
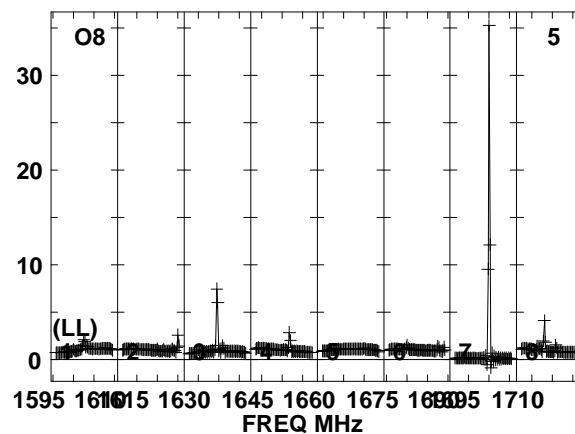
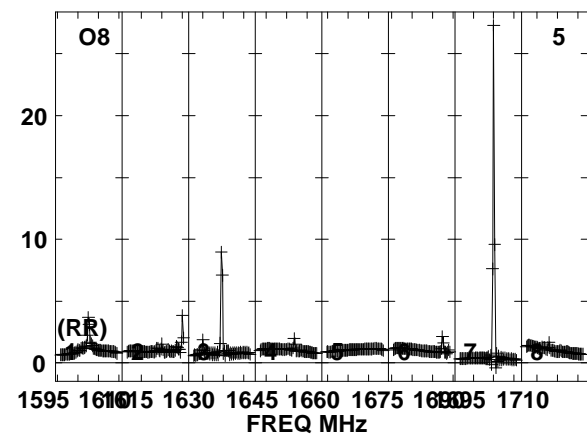
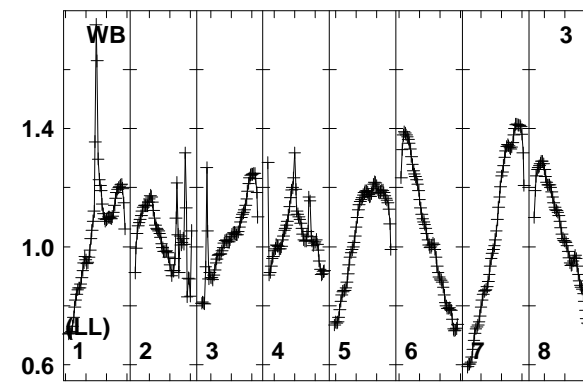
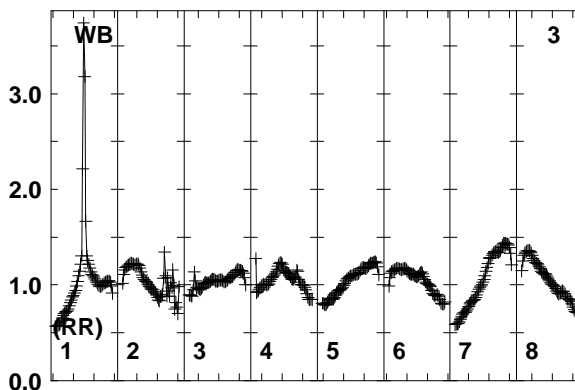
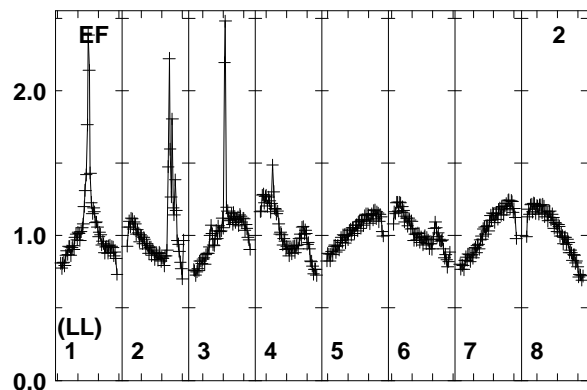
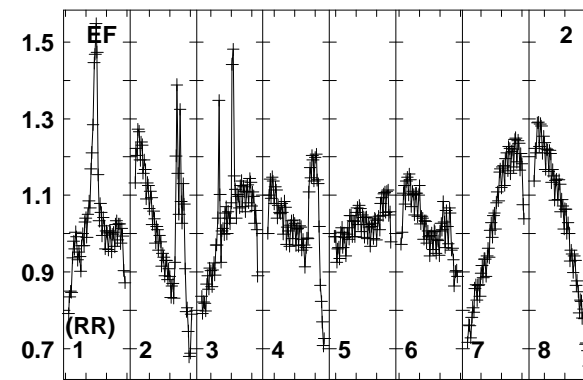
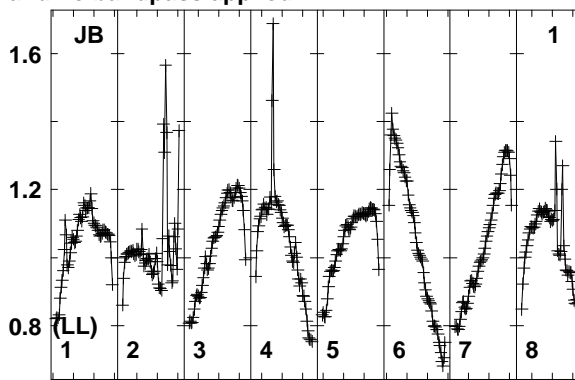
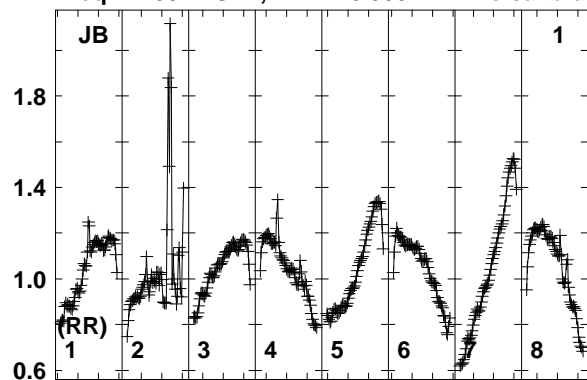

Lower frame: Real Jy
Total-power spectrum Antenna: JB (01)
Timerange: 00/07:25:16 to 00/07:26:14

Plot file version 503 created 04-NOV-2019 14:14:41

J2248-0541 EY034.UVDATA.1

Freq = 1.5947 GHz, Bw = 16.000 MH No calibration applied and no bandpass applied

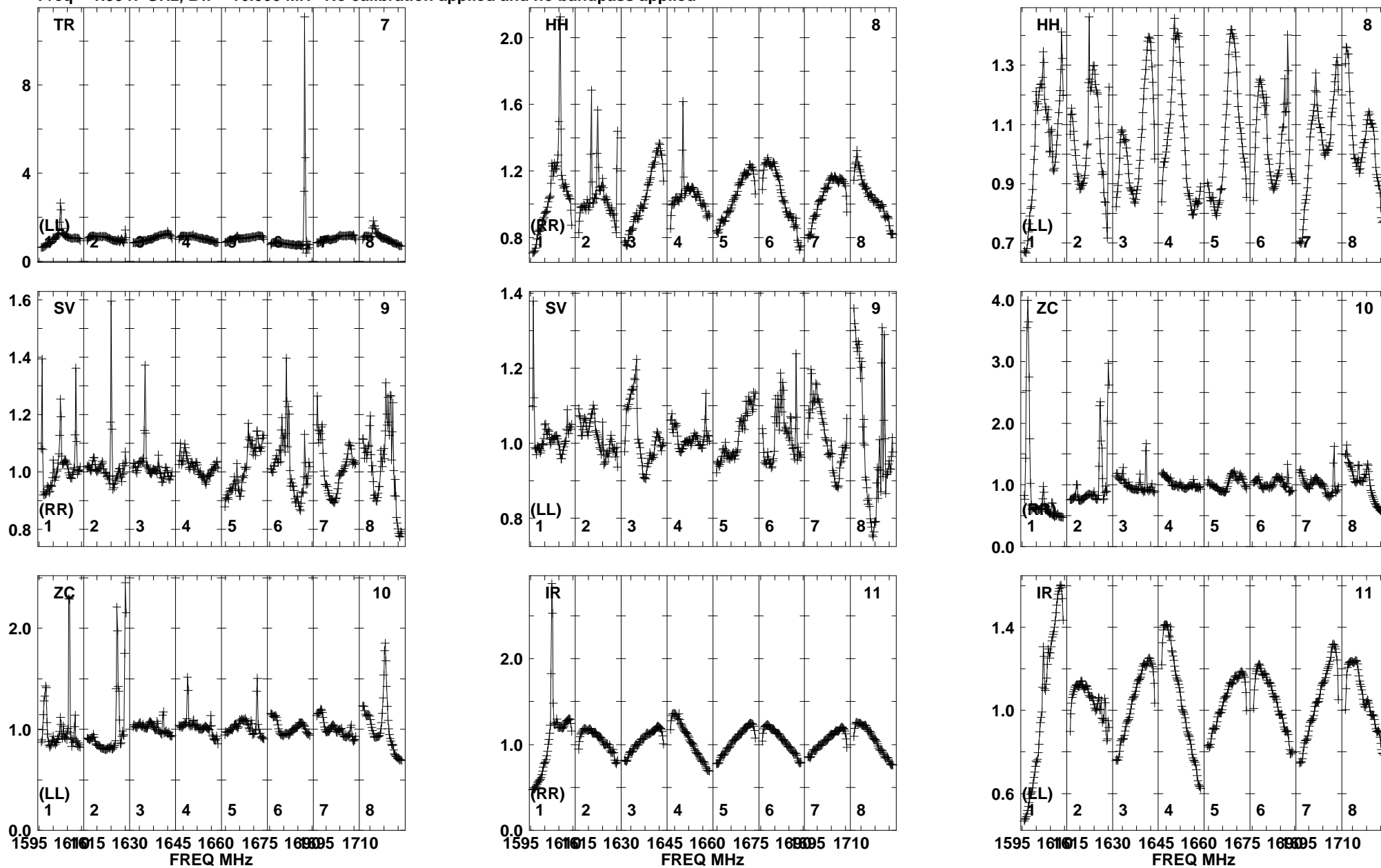

Lower frame: Real Jy
Total-power spectrum Antenna: TR (07)
Timerange: 00/07:25:16 to 00/07:26:14

Plot file version 504 created 04-NOV-2019 14:14:41

J2248-0541 EY034.UVDATA.1

Freq = 1.5947 GHz, Bw = 16.000 MH No calibration applied and no bandpass applied

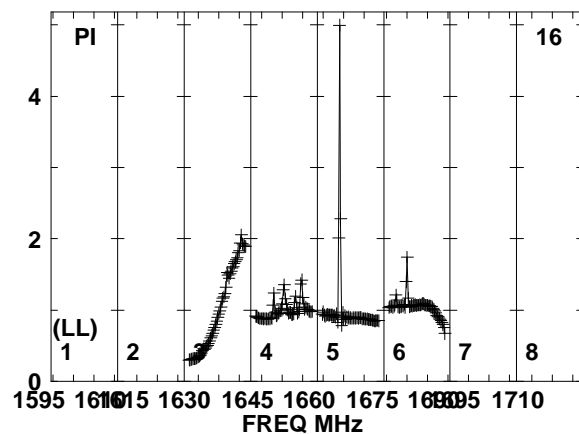
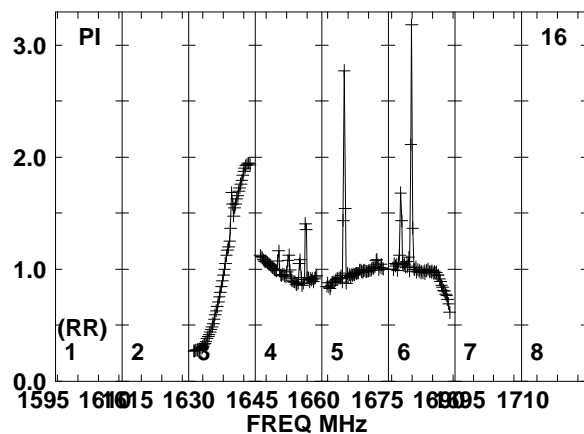
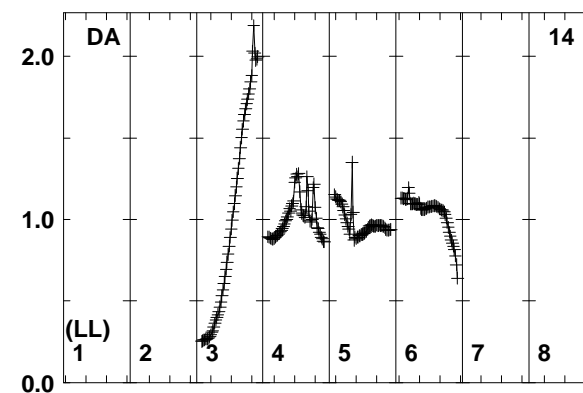
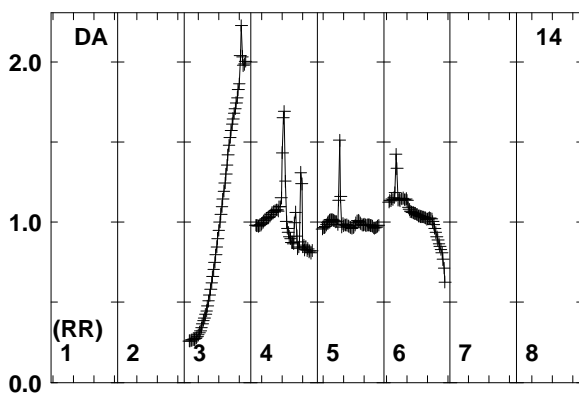
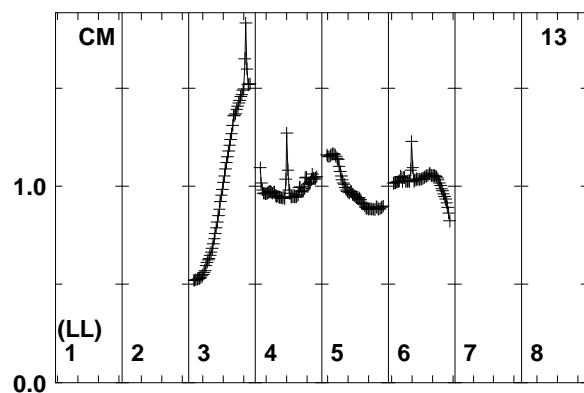
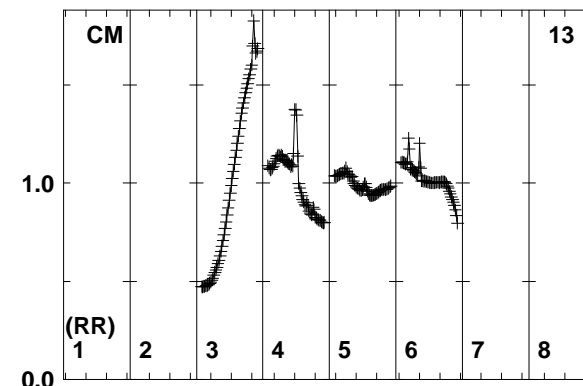
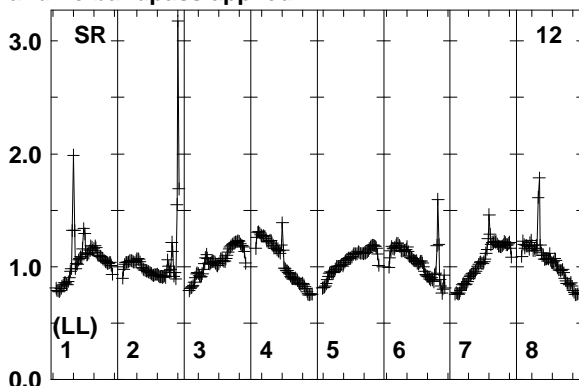
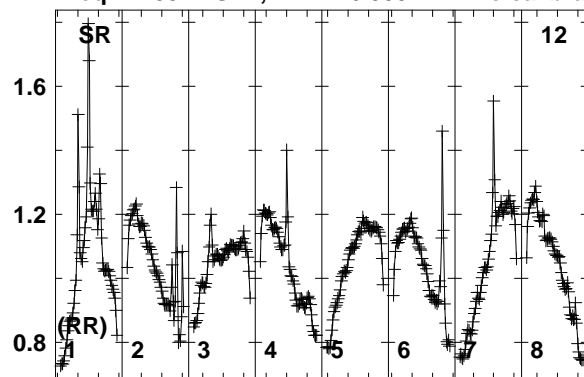

Lower frame: Real Jy
Total-power spectrum Antenna: SR (12)
Timerange: 00/07:25:16 to 00/07:26:14

Plot file version 505 created 04-NOV-2019 14:14:41

W2246-0526 EY034.UVDATA.1

Freq = 1.5947 GHz, Bw = 16.000 MH No calibration applied and no bandpass applied

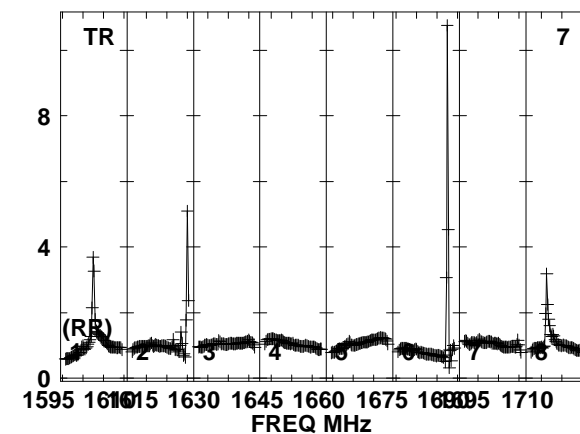
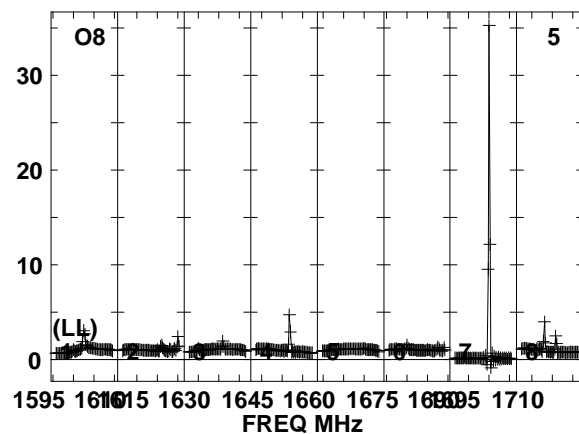
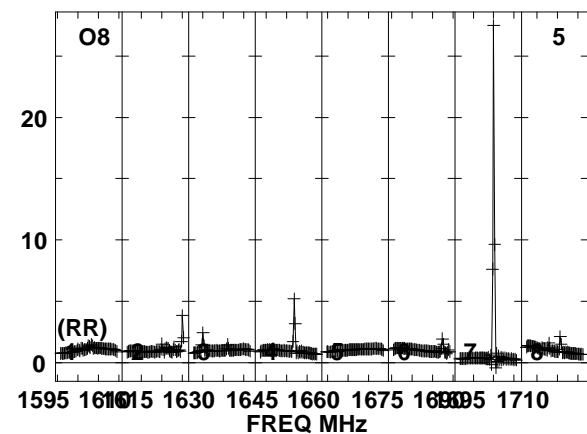
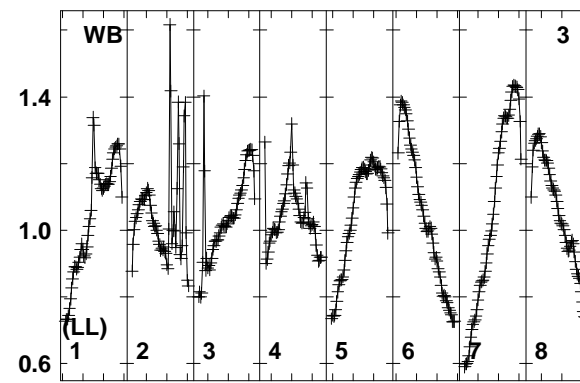
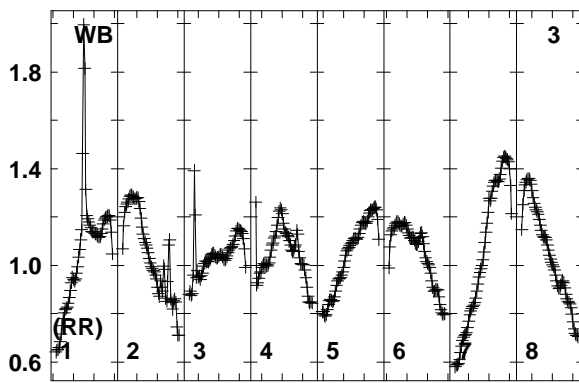
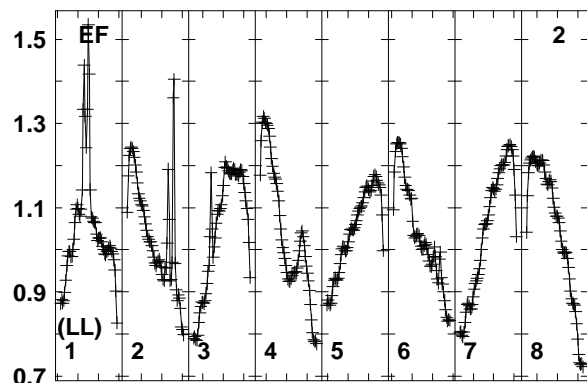
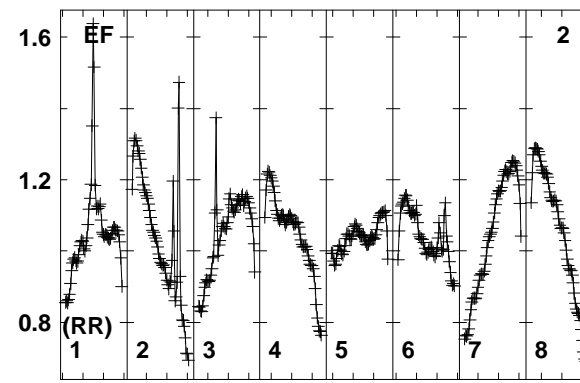
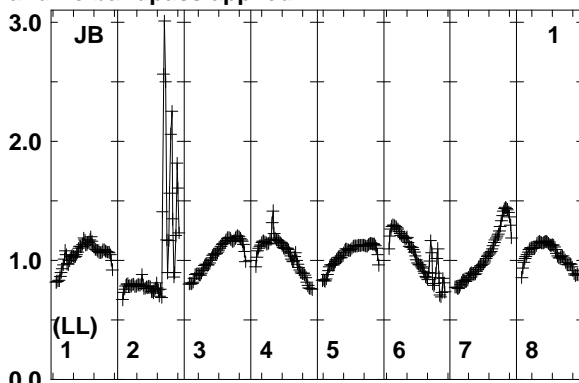
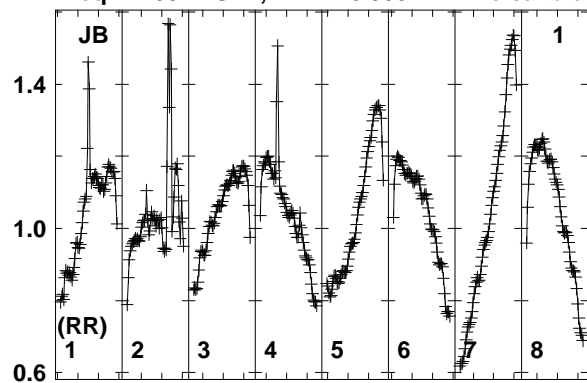

Lower frame: Real Jy
Total-power spectrum Antenna: JB (01)
Timerange: 00/07:26:16 to 00/07:28:54

Plot file version 506 created 04-NOV-2019 14:14:41

W2246-0526 EY034.UVDATA.1

Freq = 1.5947 GHz, Bw = 16.000 MH No calibration applied and no bandpass applied

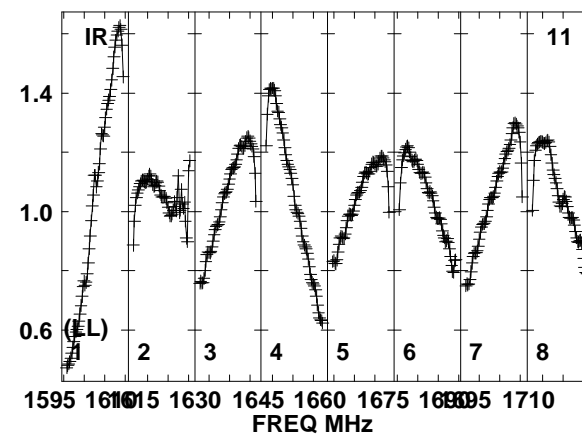
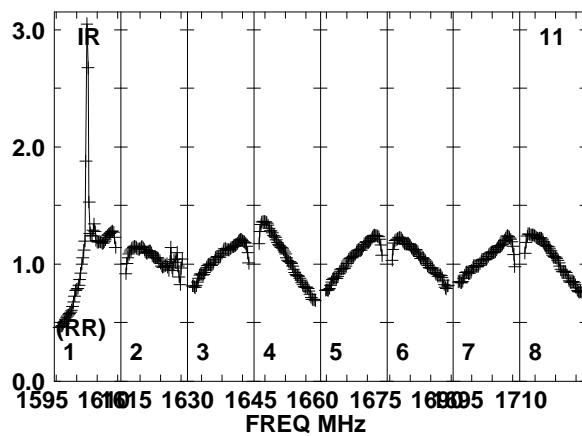
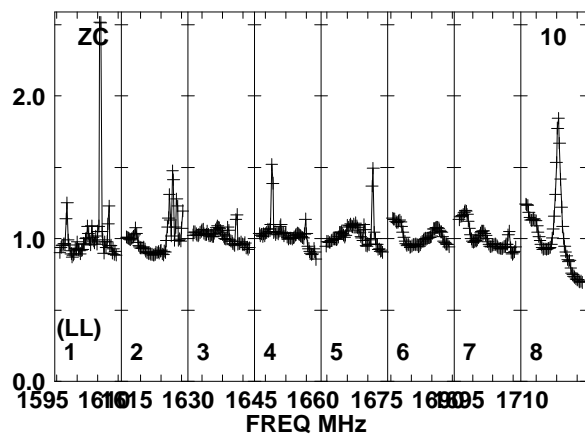
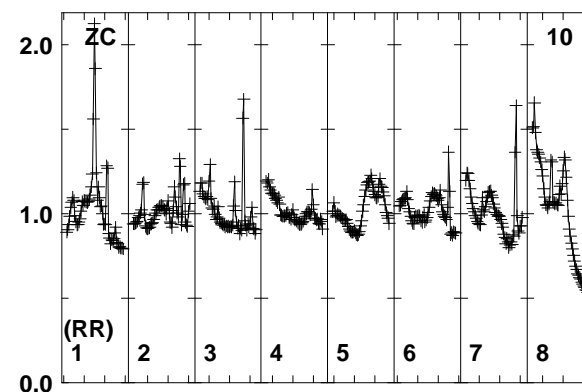
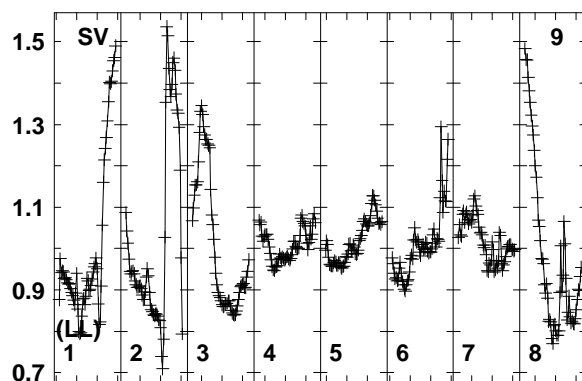
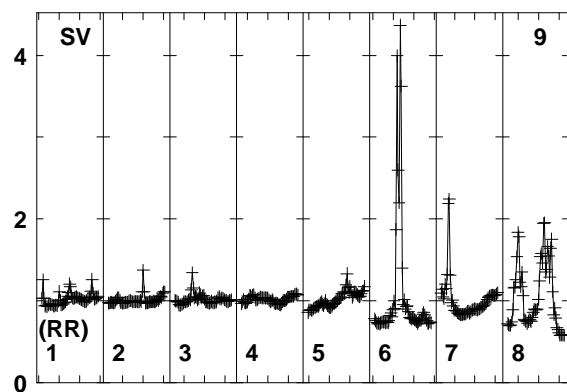
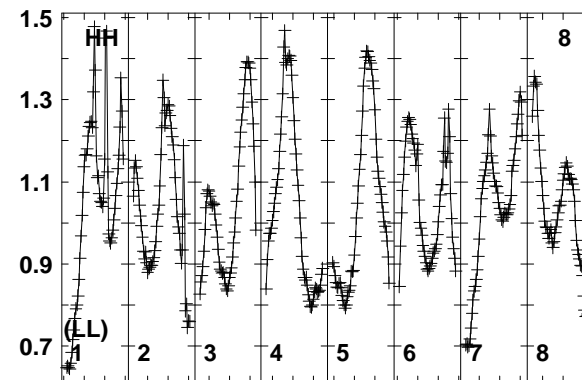
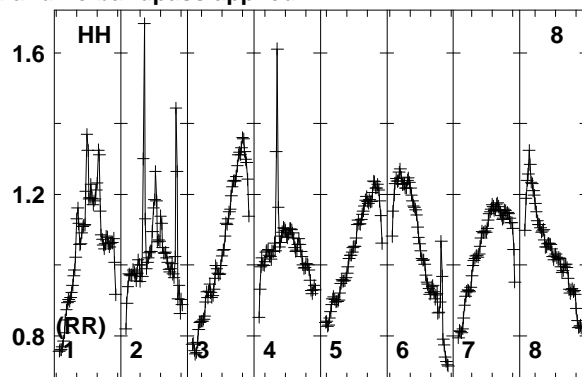
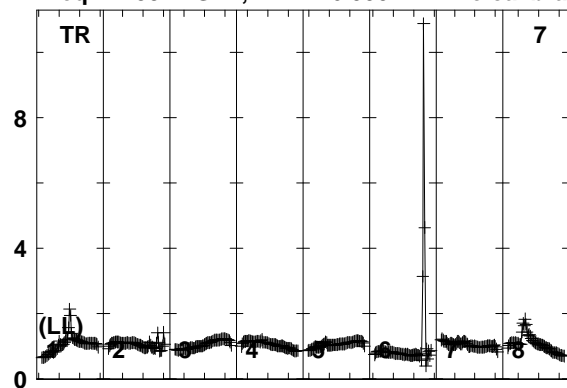

Lower frame: Real Jy
Total-power spectrum Antenna: TR (07)
Timerange: 00/07:26:16 to 00/07:28:54

Plot file version 507 created 04-NOV-2019 14:14:41

W2246-0526 EY034.UVDATA.1

Freq = 1.5947 GHz, Bw = 16.000 MH No calibration applied and no bandpass applied

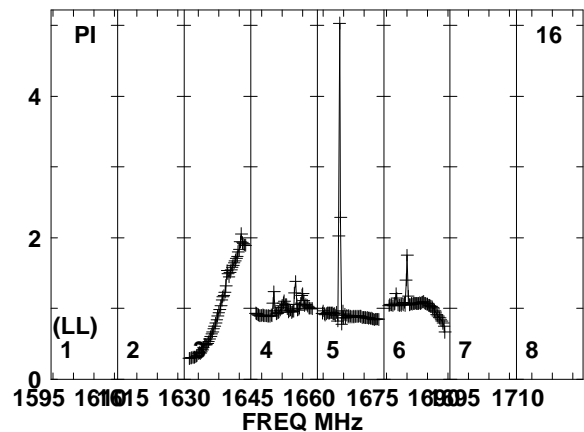
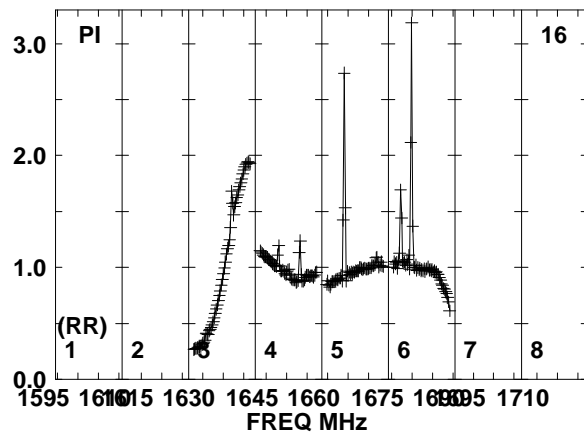
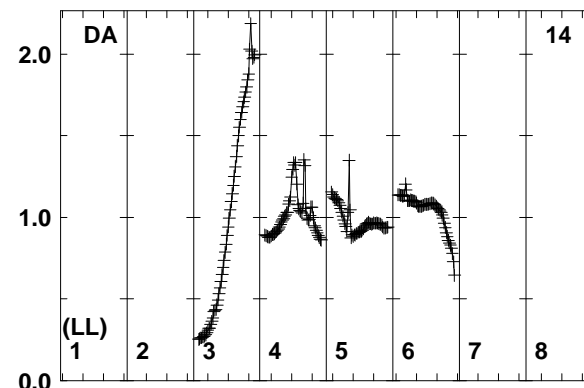
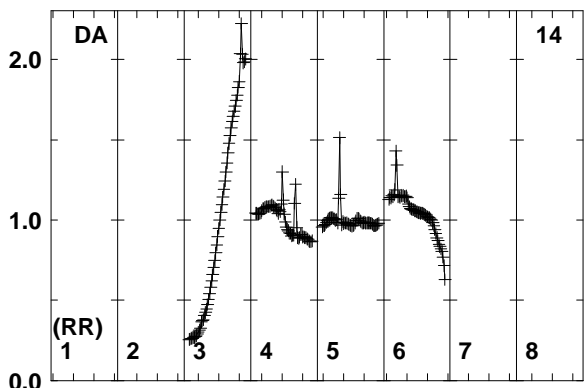
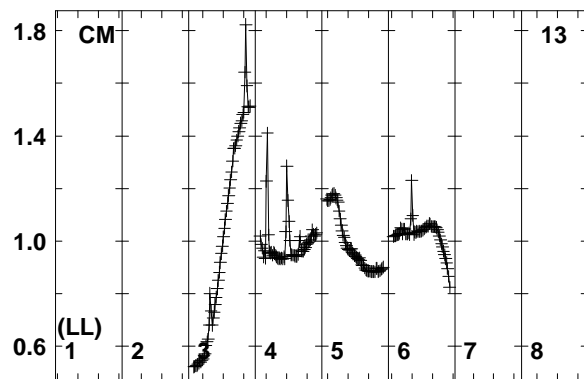
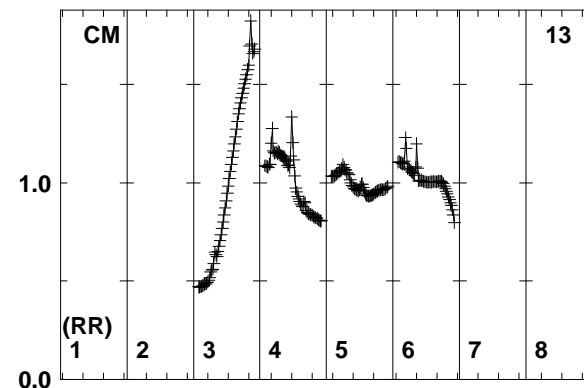
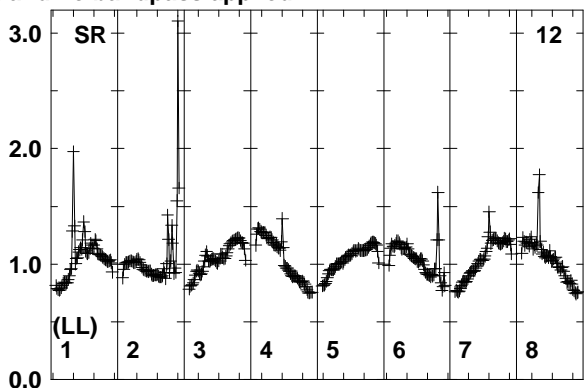
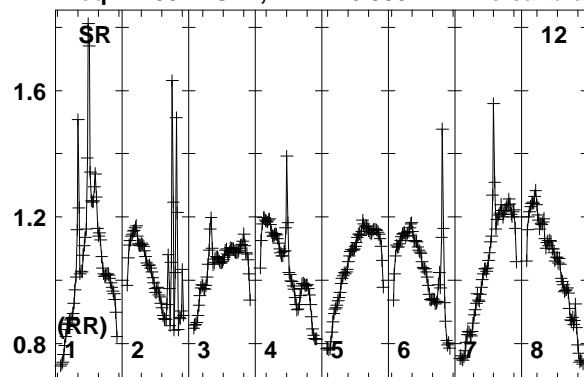

Lower frame: Real Jy
Total-power spectrum Antenna: SR (12)
Timerange: 00/07:26:16 to 00/07:28:54

Plot file version 508 created 04-NOV-2019 14:14:41

J2248-0541 EY034.UVDATA.1

Freq = 1.5947 GHz, Bw = 16.000 MH No calibration applied and no bandpass applied

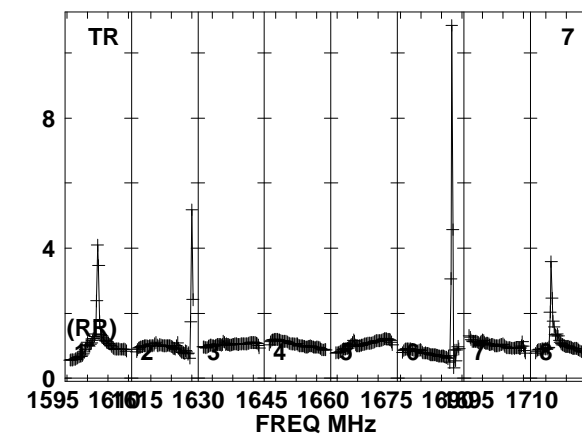
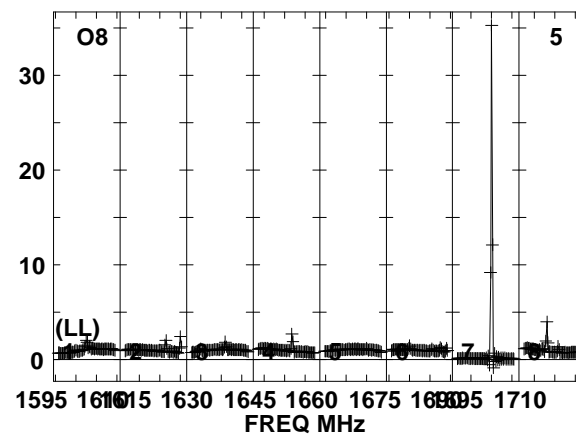
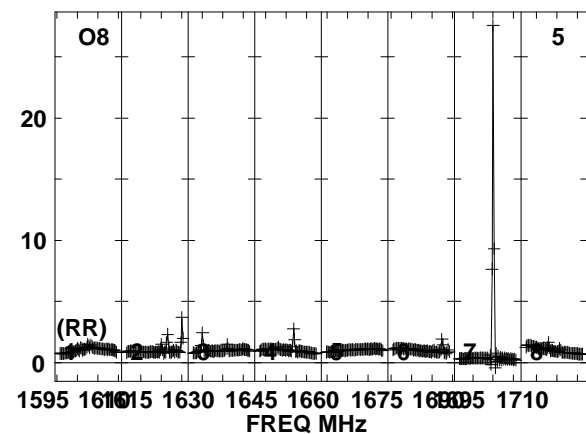
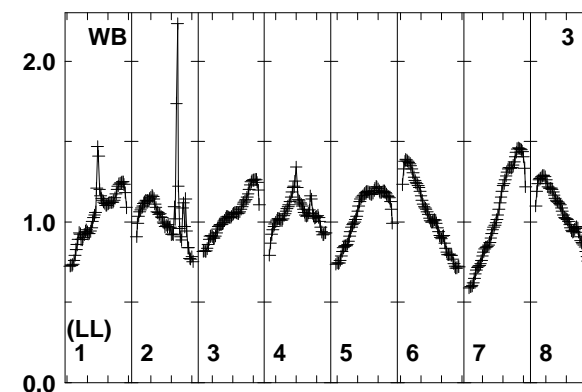
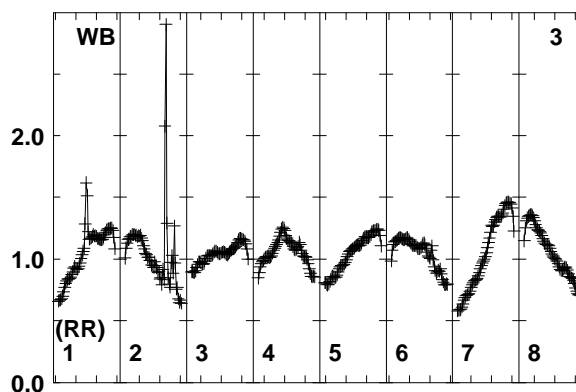
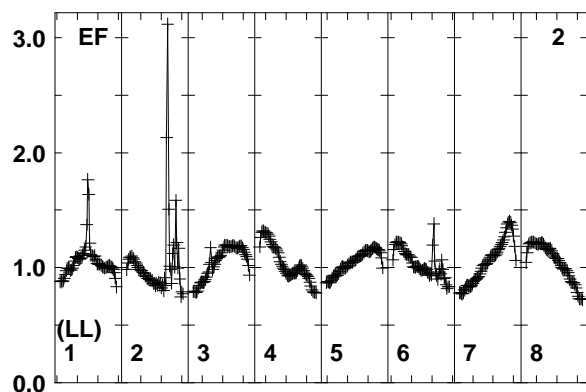
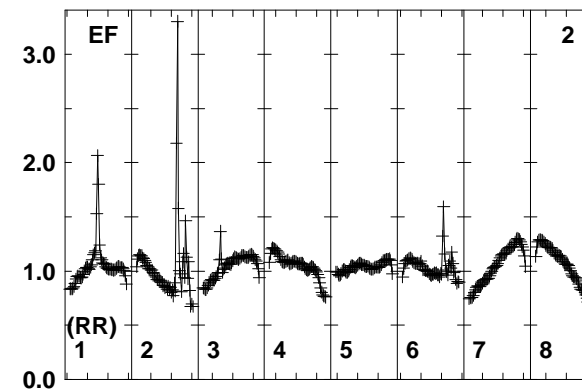
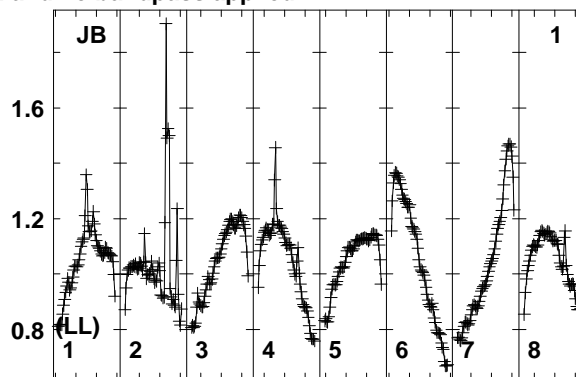
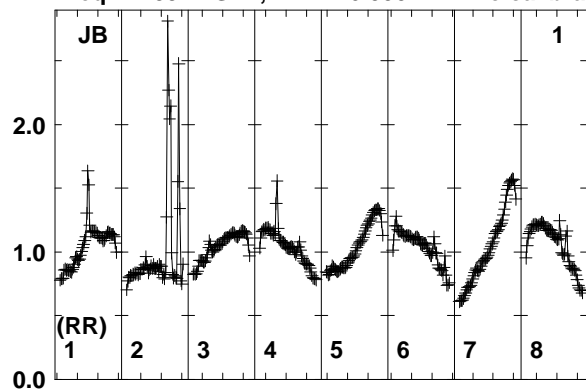

Lower frame: Real Jy
Total-power spectrum Antenna: JB (01)
Timerange: 00/07:29:11 to 00/07:30:09

Plot file version 509 created 04-NOV-2019 14:14:41

J2248-0541 EY034.UVDATA.1

Freq = 1.5947 GHz, Bw = 16.000 MH No calibration applied and no bandpass applied

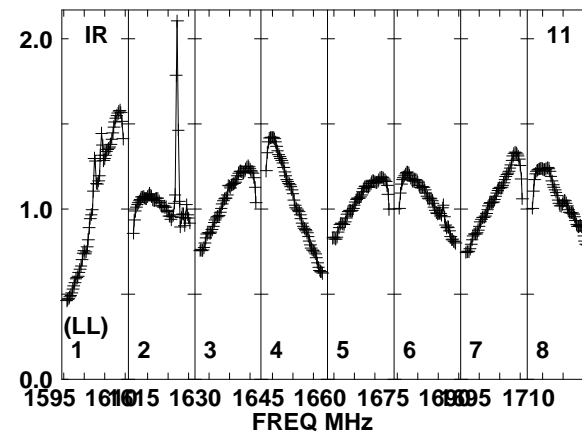
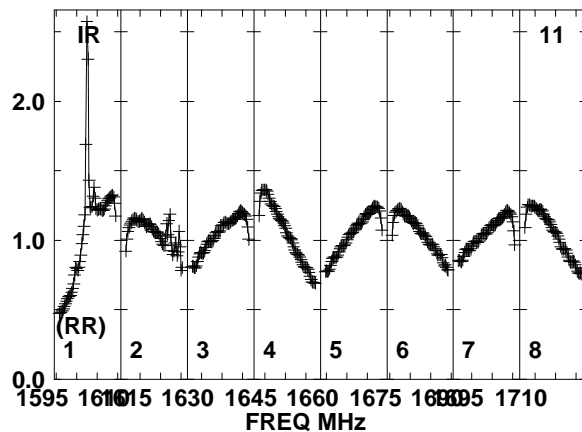
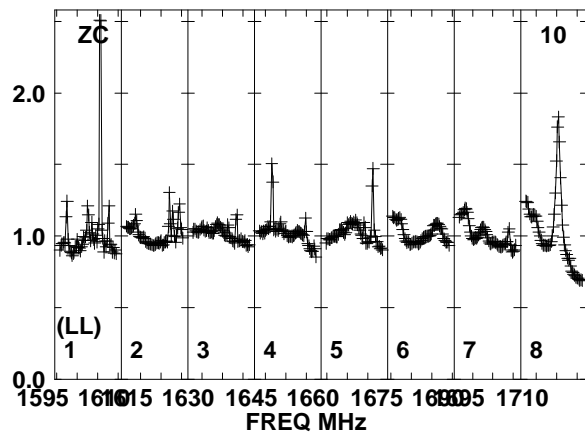
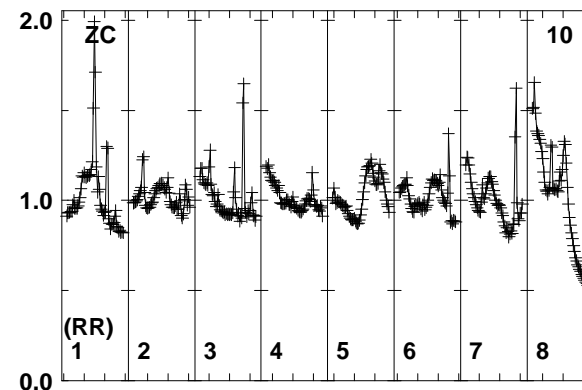
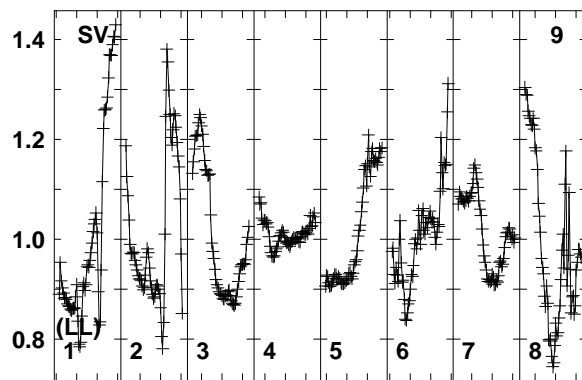
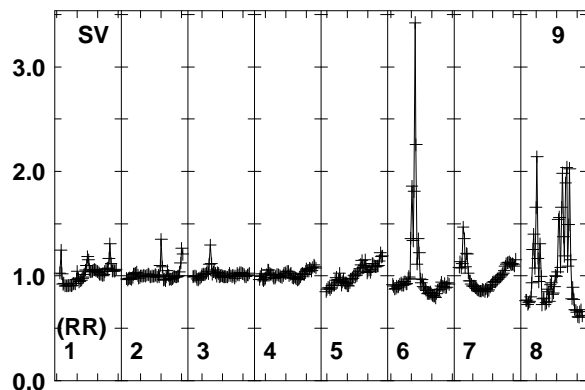
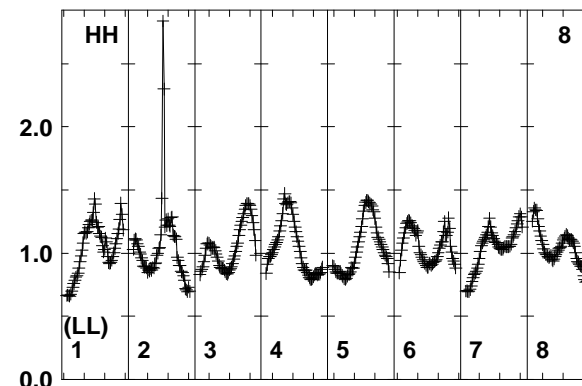
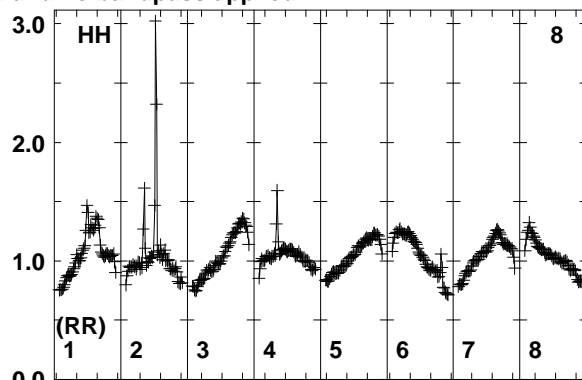
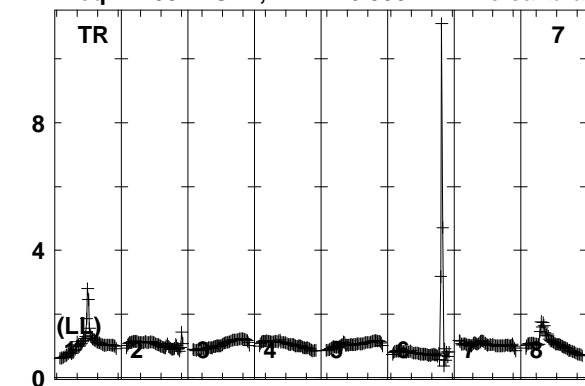

Lower frame: Real Jy
Total-power spectrum Antenna: TR (07)
Timerange: 00/07:29:11 to 00/07:30:09

Plot file version 510 created 04-NOV-2019 14:14:42

J2248-0541 EY034.UVDATA.1

Freq = 1.5947 GHz, Bw = 16.000 MH No calibration applied and no bandpass applied

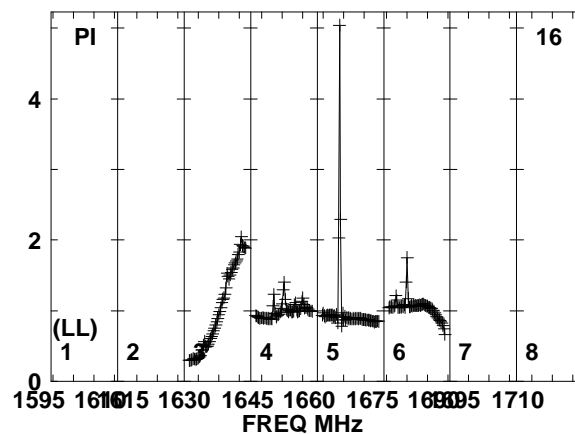
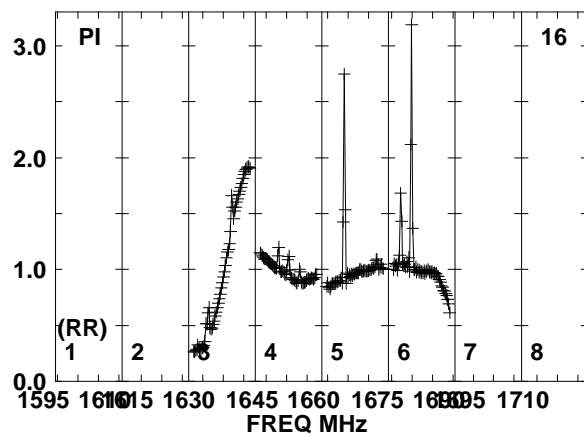
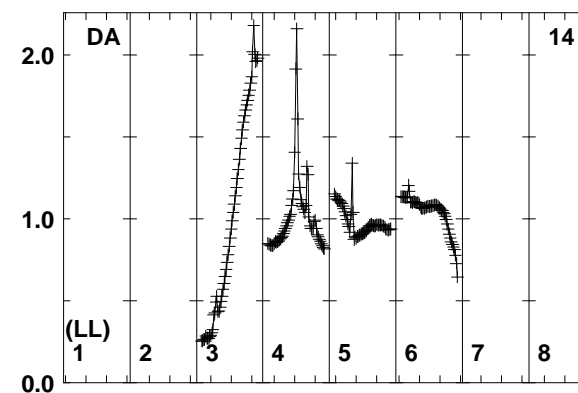
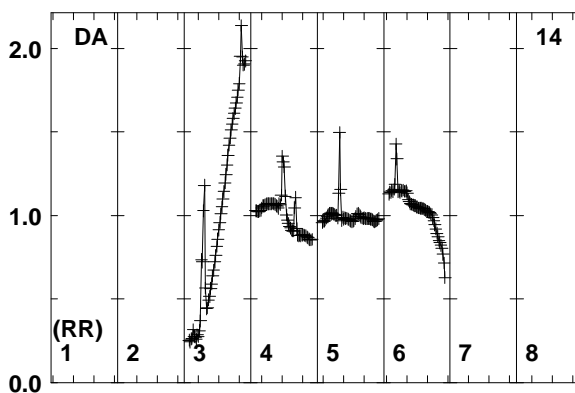
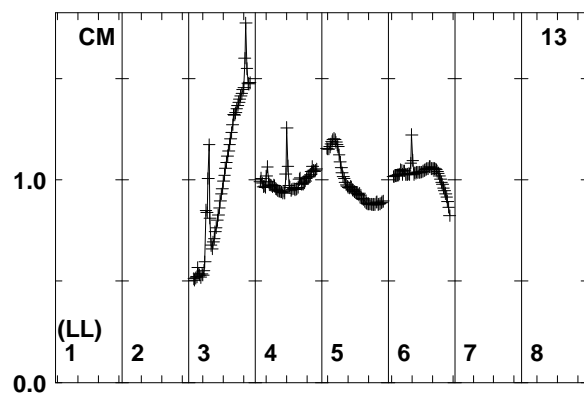
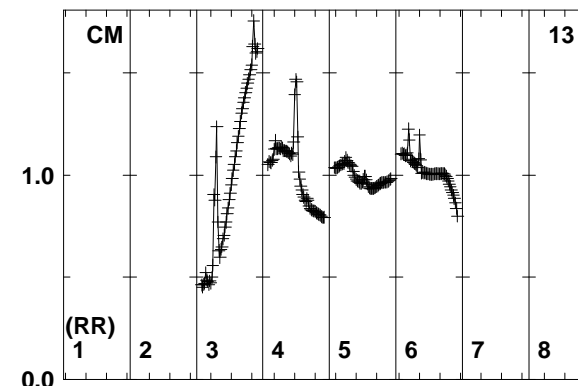
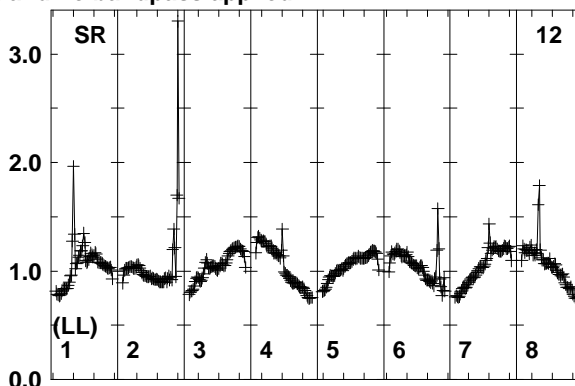
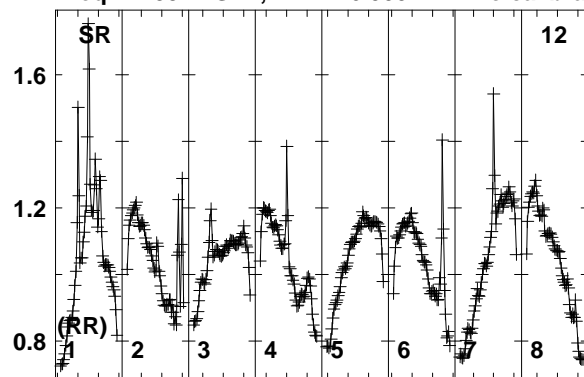

Lower frame: Real Jy
Total-power spectrum Antenna: SR (12)
Timerange: 00/07:29:11 to 00/07:30:09

Plot file version 511 created 04-NOV-2019 14:14:42

W2246-0526 EY034.UVDATA.1

Freq = 1.5947 GHz, Bw = 16.000 MH No calibration applied and no bandpass applied

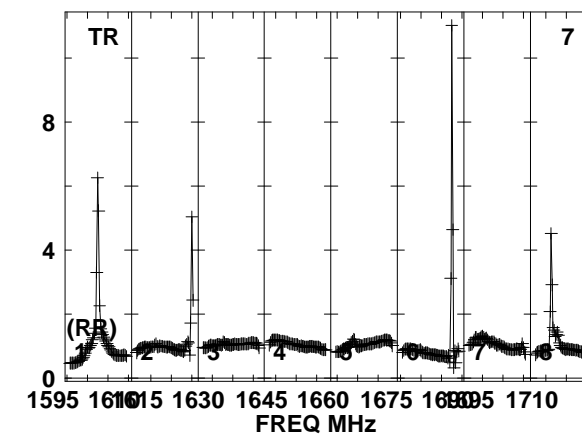
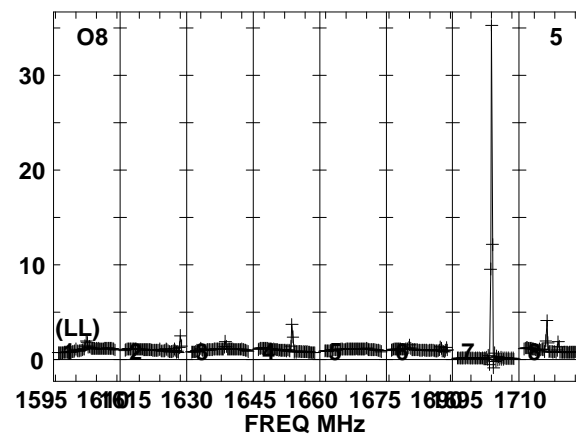
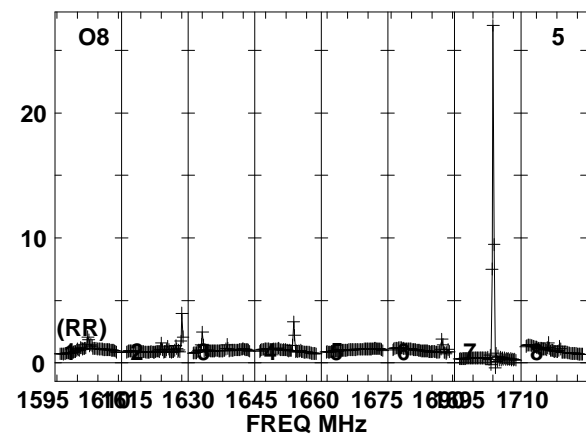
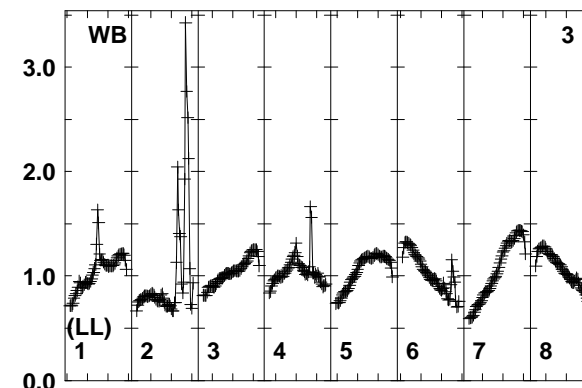
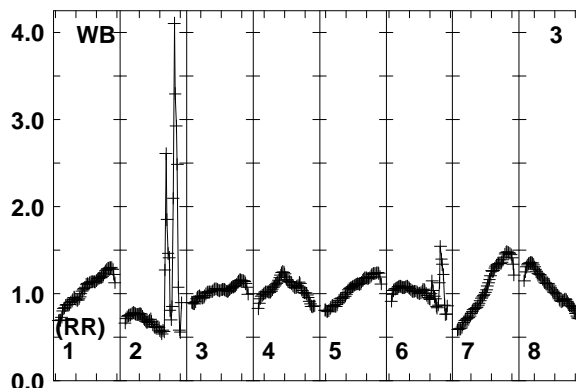
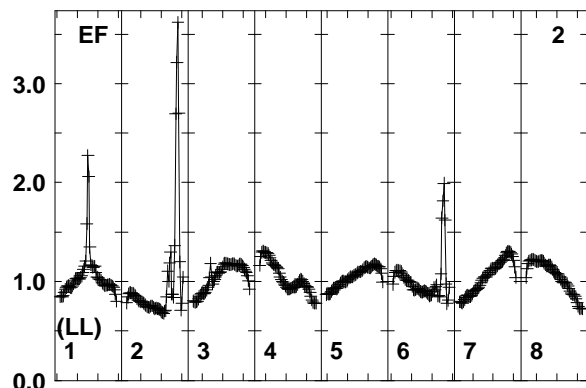
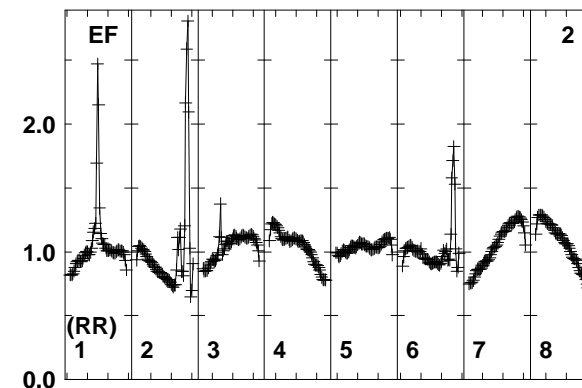
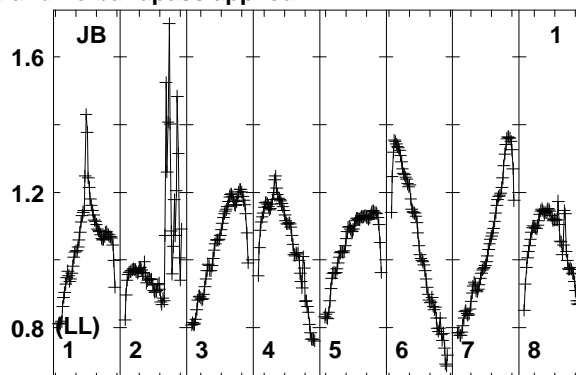
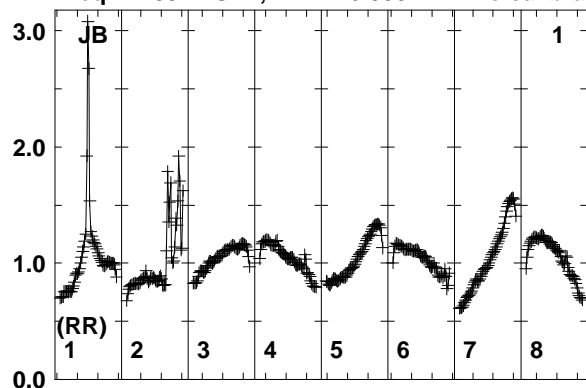

Lower frame: Real Jy
Total-power spectrum Antenna: JB (01)
Timerange: 00/07:30:11 to 00/07:32:49

Plot file version 512 created 04-NOV-2019 14:14:42

W2246-0526 EY034.UVDATA.1

Freq = 1.5947 GHz, Bw = 16.000 MH No calibration applied and no bandpass applied

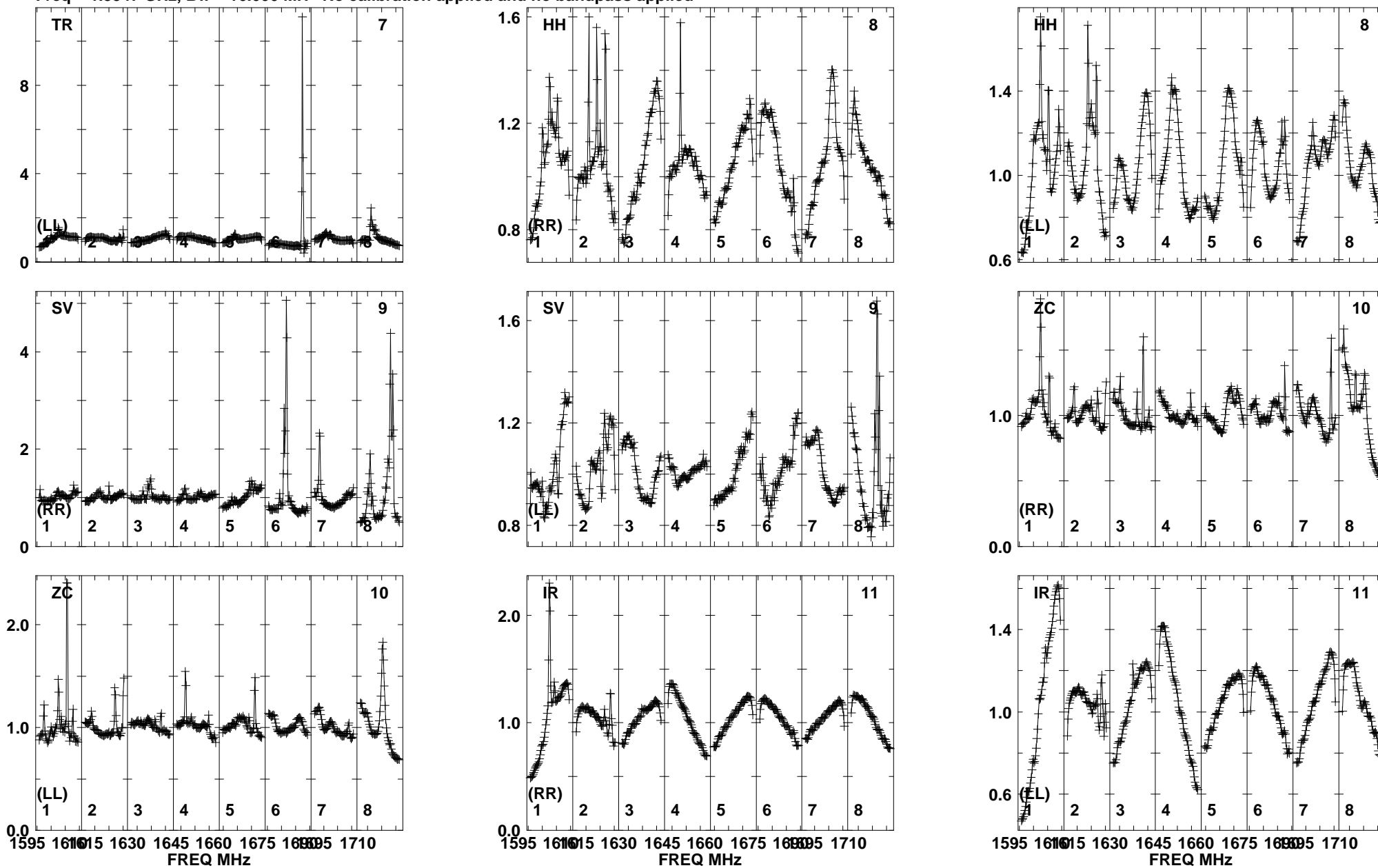

Lower frame: Real Jy
Total-power spectrum Antenna: TR (07)
Timerange: 00/07:30:11 to 00/07:32:49

Plot file version 513 created 04-NOV-2019 14:14:42

W2246-0526 EY034.UVDATA.1

Freq = 1.5947 GHz, Bw = 16.000 MH No calibration applied and no bandpass applied

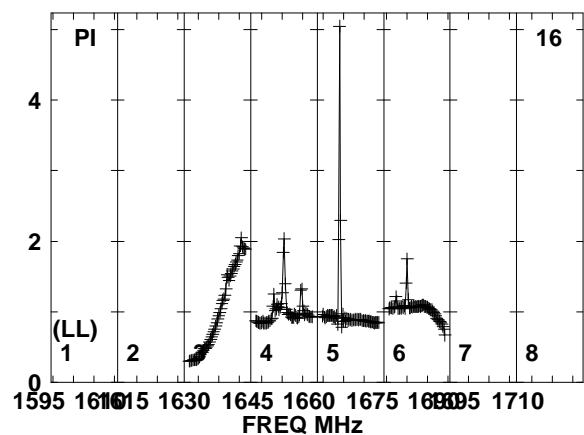
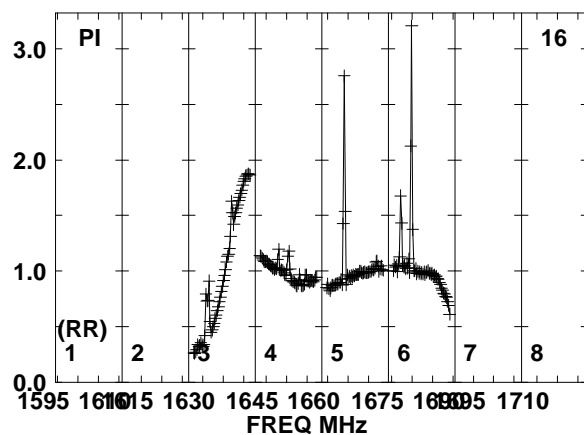
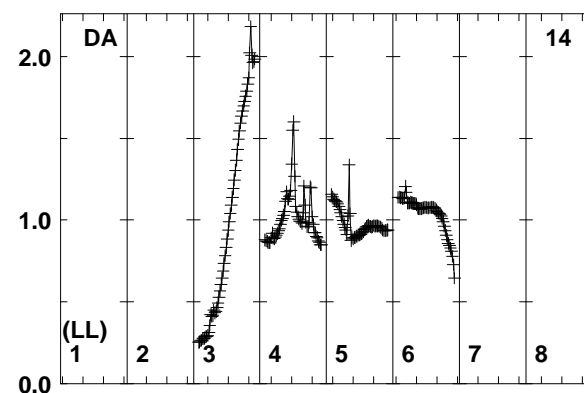
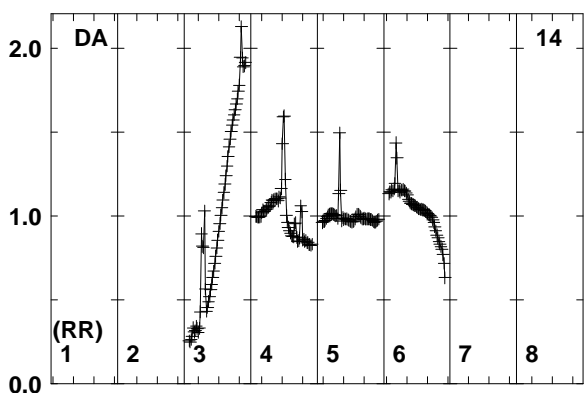
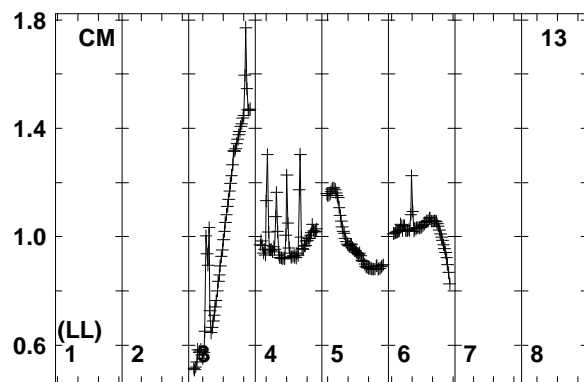
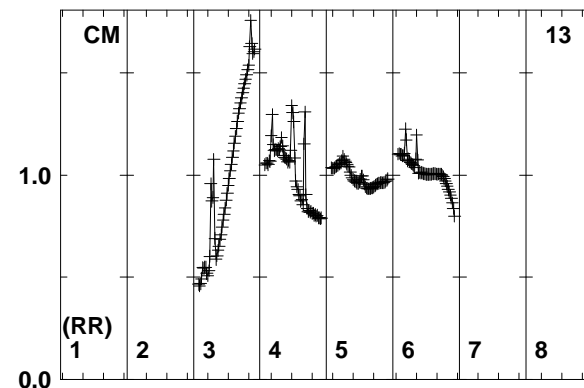
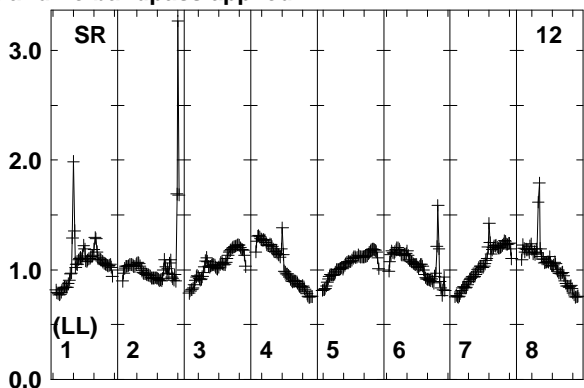
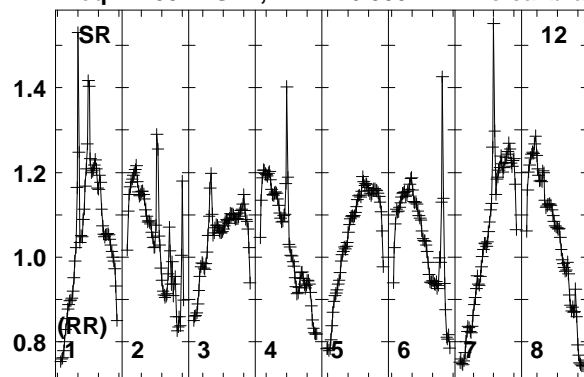

Lower frame: Real Jy
Total-power spectrum Antenna: SR (12)
Timerange: 00/07:30:11 to 00/07:32:49

Plot file version 514 created 04-NOV-2019 14:14:42

J2248-0541 EY034.UVDATA.1

Freq = 1.5947 GHz, Bw = 16.000 MH No calibration applied and no bandpass applied

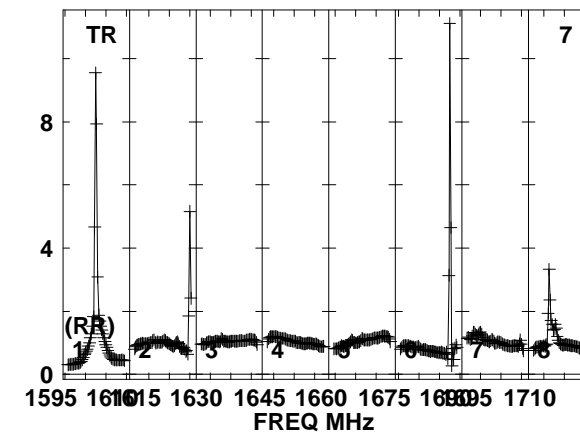
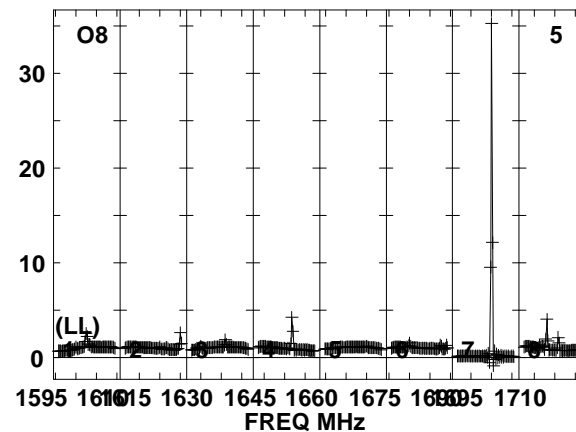
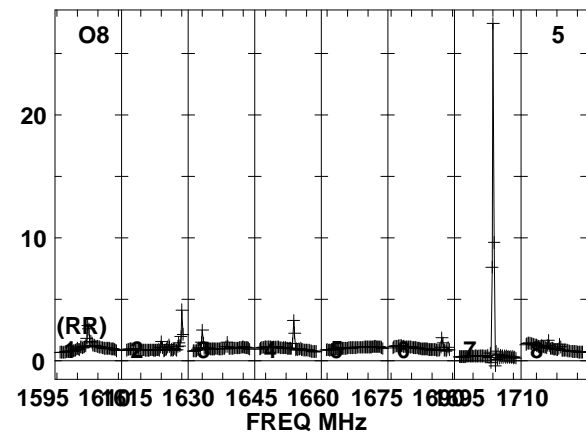
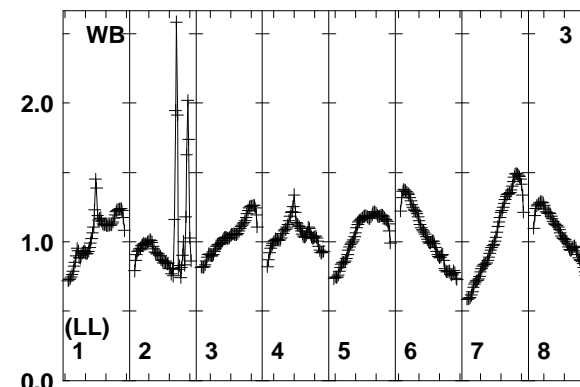
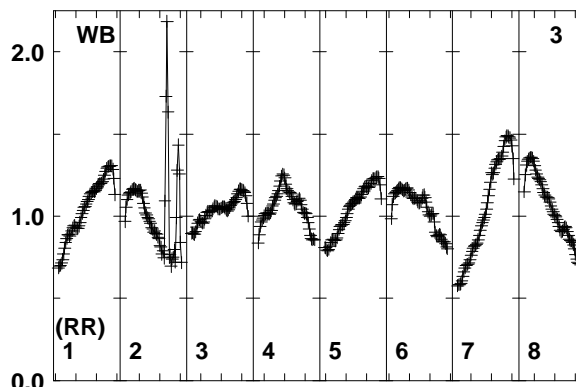
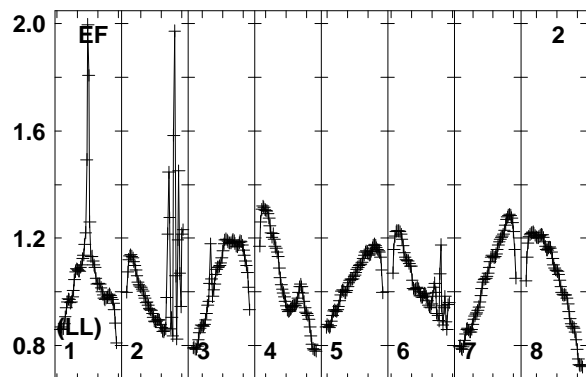
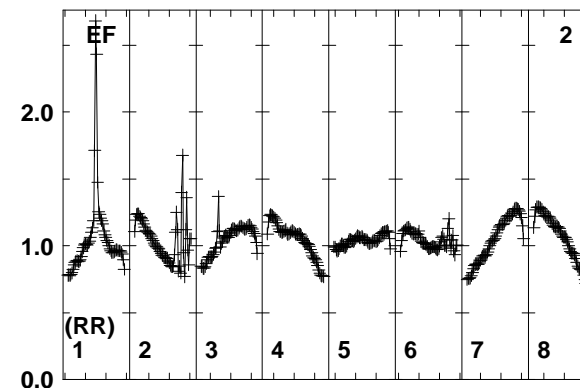
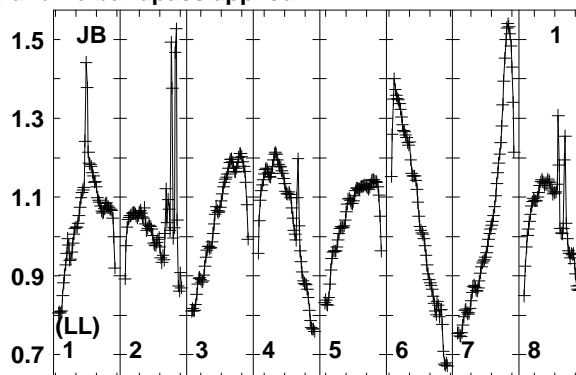
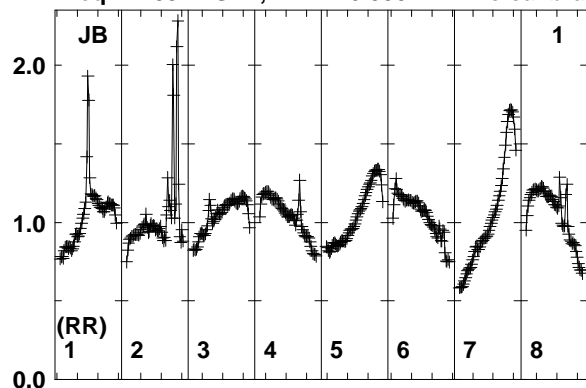

Lower frame: Real Jy
Total-power spectrum Antenna: JB (01)
Timerange: 00/07:33:06 to 00/07:34:04

Plot file version 515 created 04-NOV-2019 14:14:42

J2248-0541 EY034.UVDATA.1

Freq = 1.5947 GHz, Bw = 16.000 MH No calibration applied and no bandpass applied

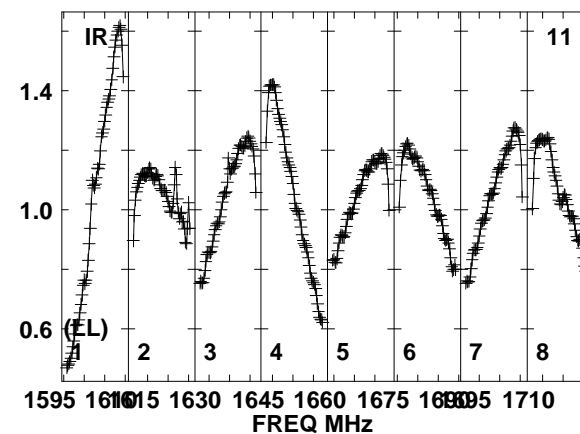
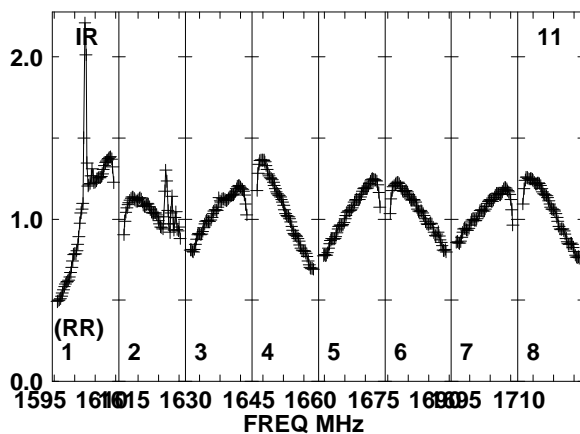
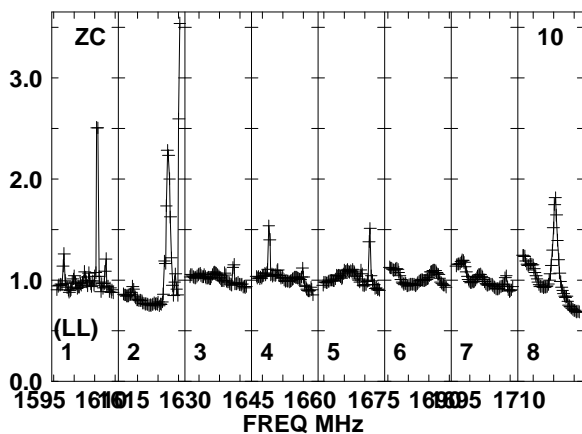
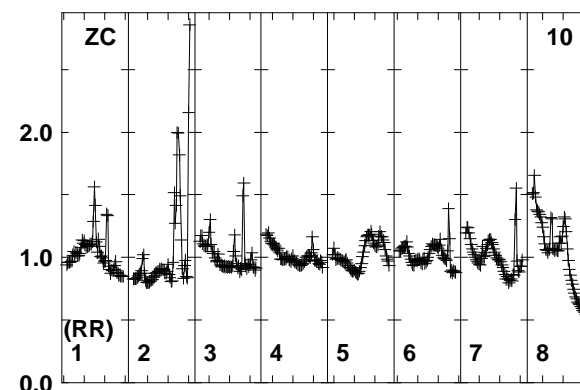
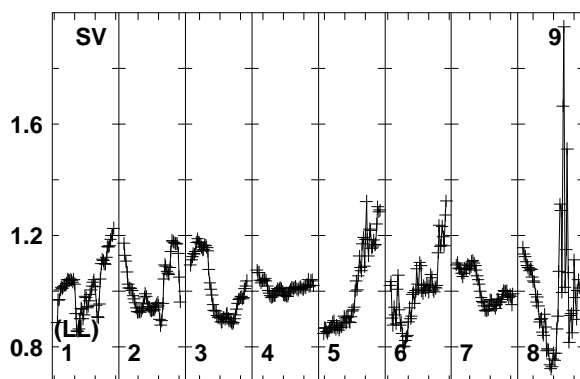
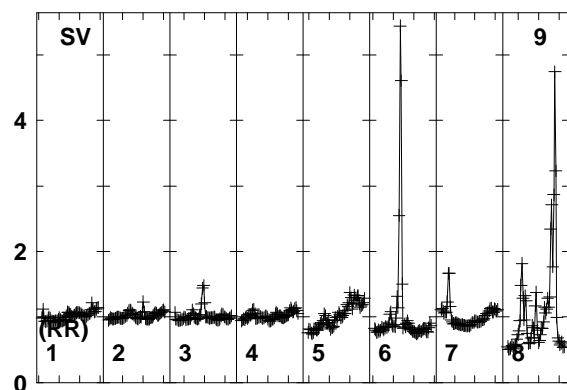
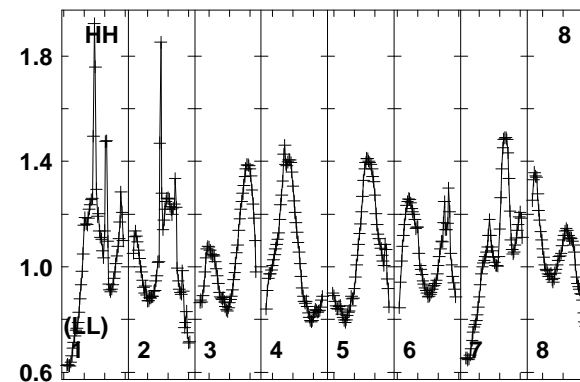
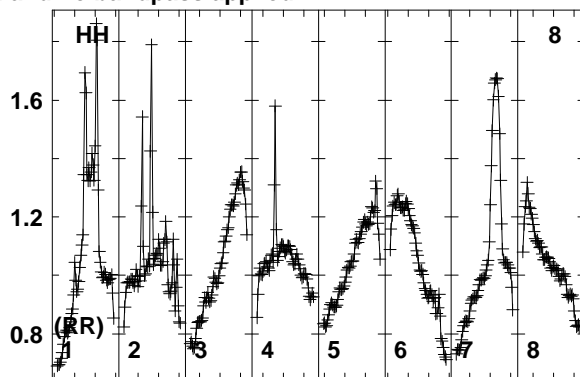
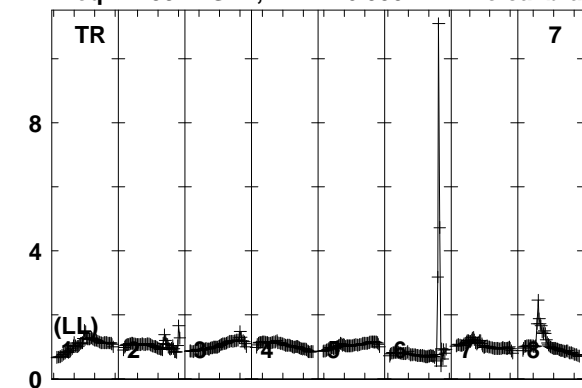

Lower frame: Real Jy
Total-power spectrum Antenna: TR (07)
Timerange: 00/07:33:06 to 00/07:34:04

Plot file version 516 created 04-NOV-2019 14:14:42

J2248-0541 EY034.UVDATA.1

Freq = 1.5947 GHz, Bw = 16.000 MH No calibration applied and no bandpass applied

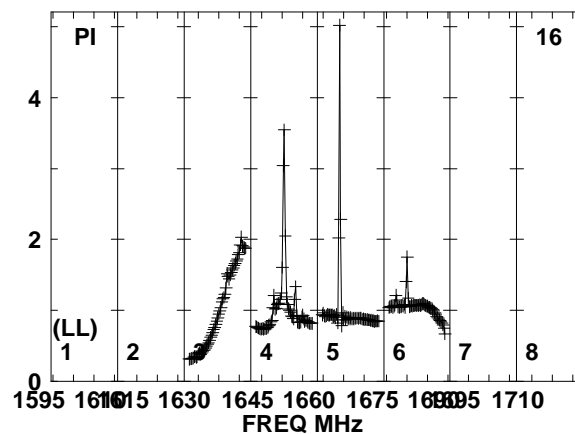
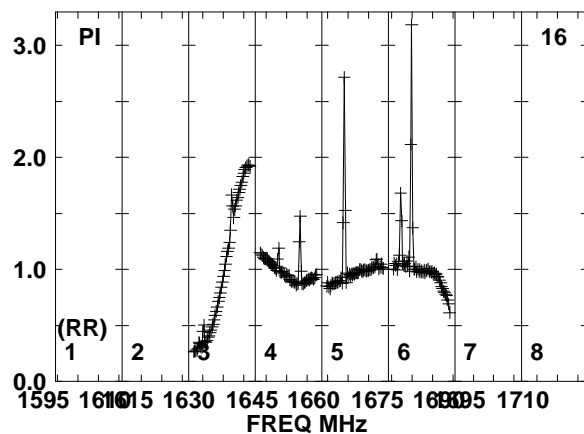
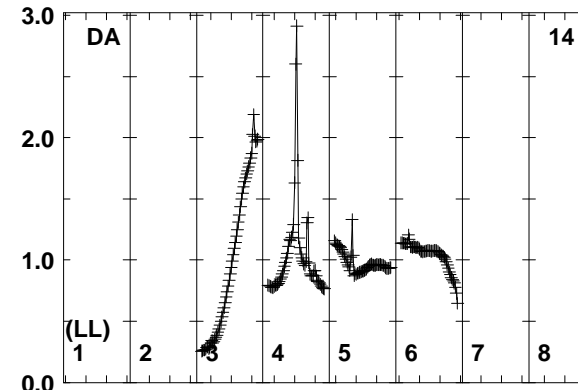
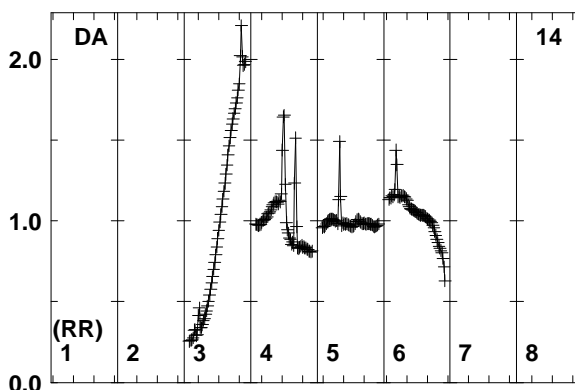
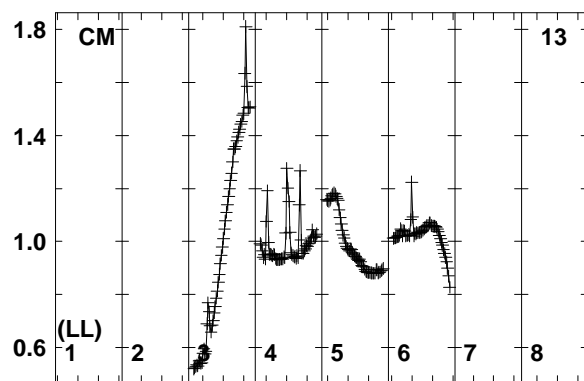
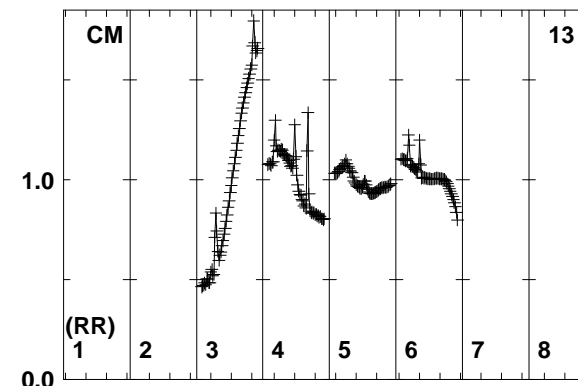
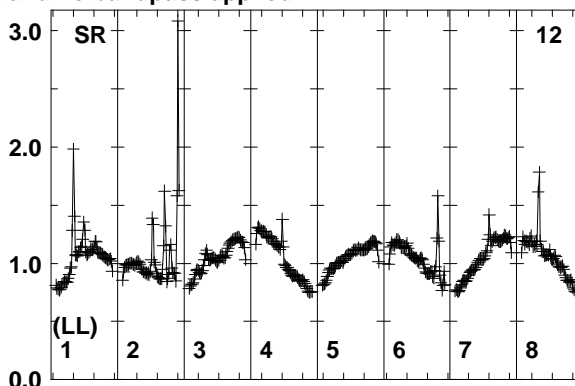
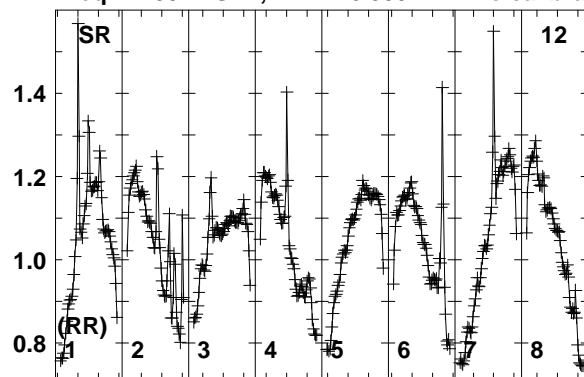

Lower frame: Real Jy
Total-power spectrum Antenna: SR (12)
Timerange: 00/07:33:06 to 00/07:34:04

Plot file version 517 created 04-NOV-2019 14:14:42

W2246-0526 EY034.UVDATA.1

Freq = 1.5947 GHz, Bw = 16.000 MH No calibration applied and no bandpass applied

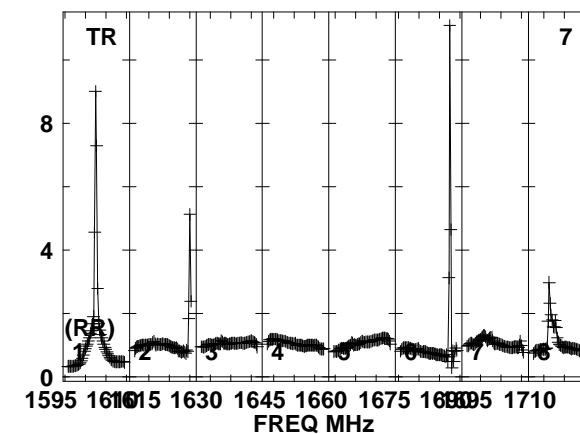
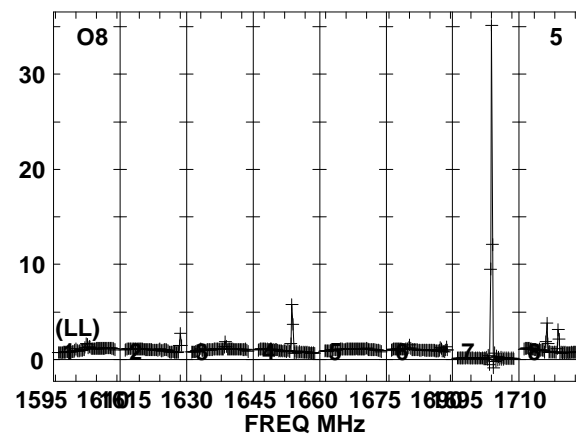
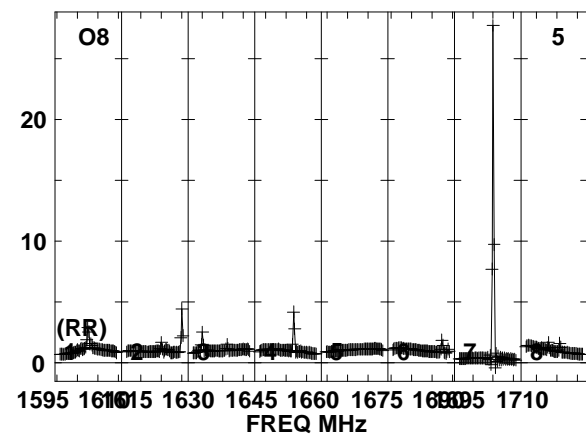
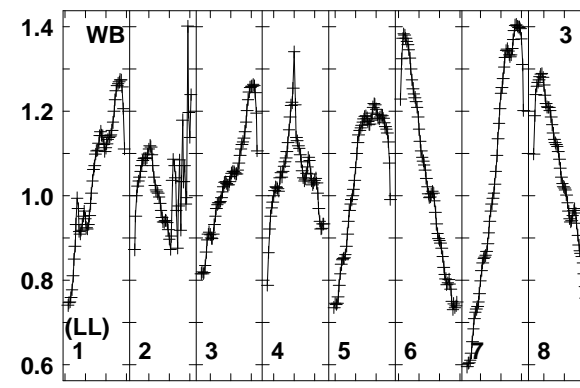
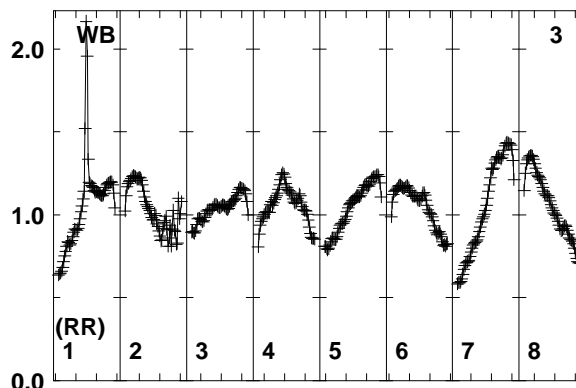
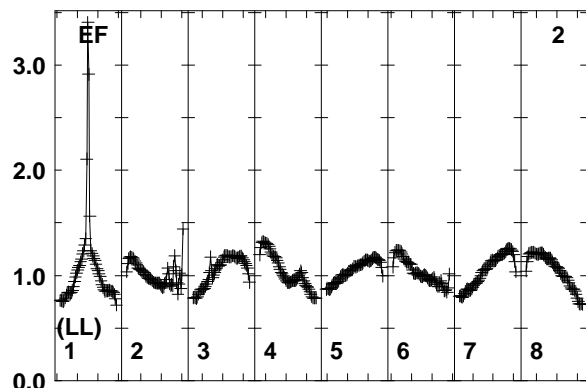
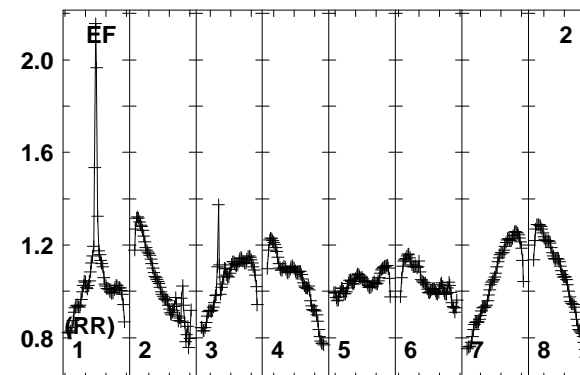
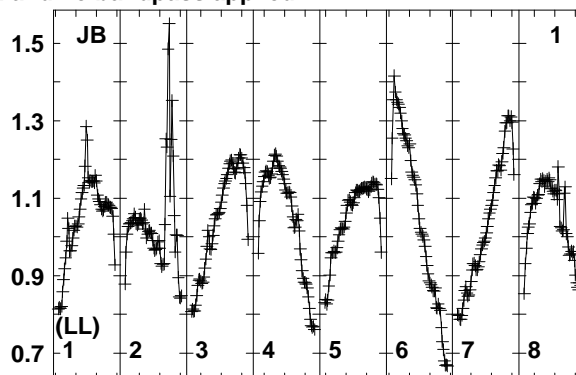
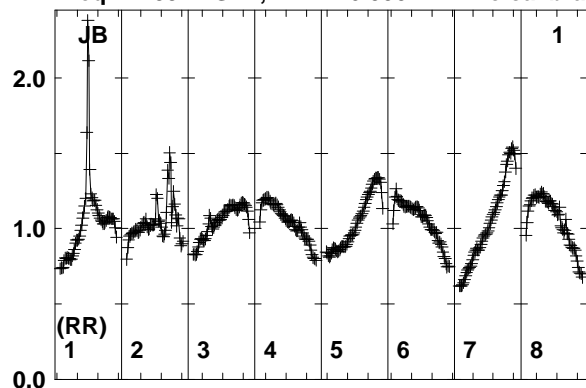

Lower frame: Real Jy
Total-power spectrum Antenna: JB (01)
Timerange: 00/07:34:06 to 00/07:36:44

Plot file version 518 created 04-NOV-2019 14:14:42

W2246-0526 EY034.UVDATA.1

Freq = 1.5947 GHz, Bw = 16.000 MH No calibration applied and no bandpass applied

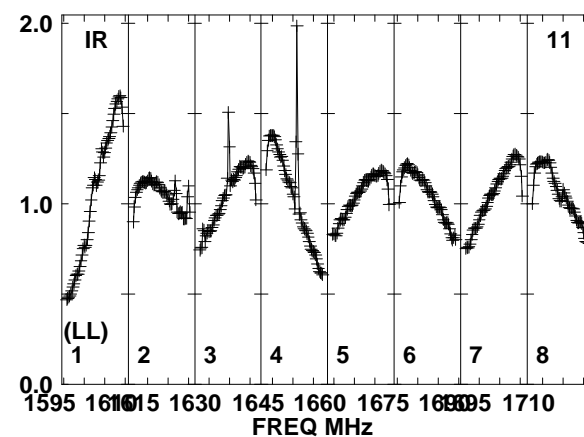
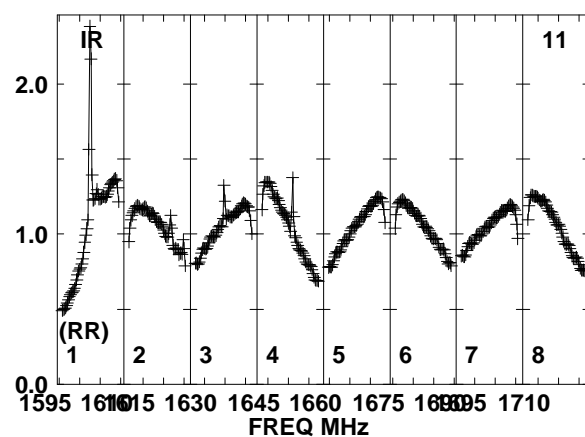
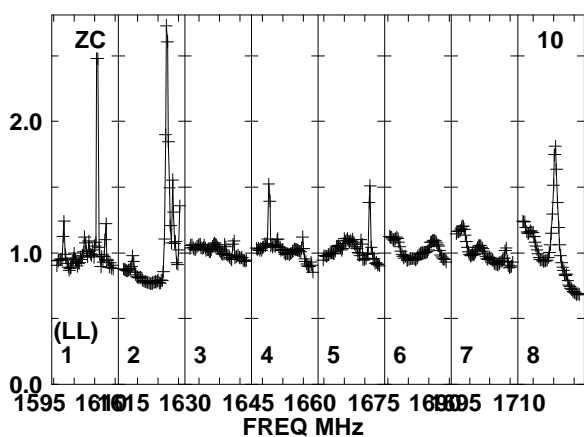
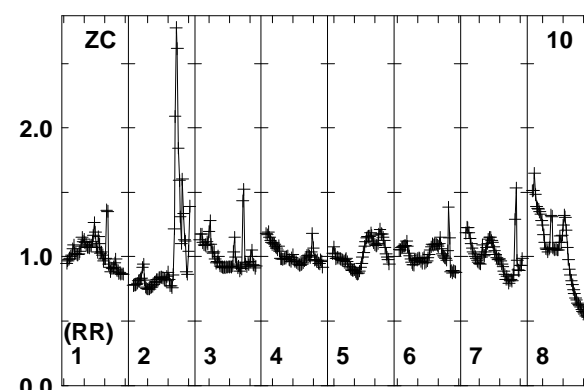
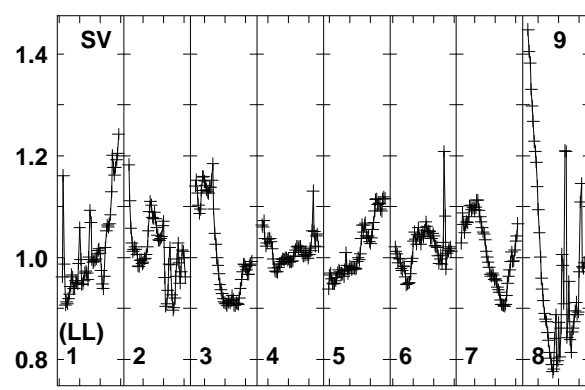
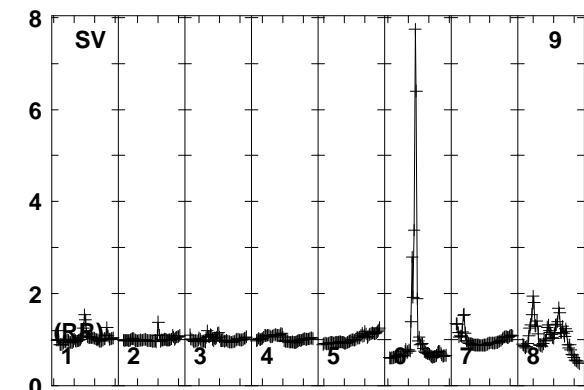
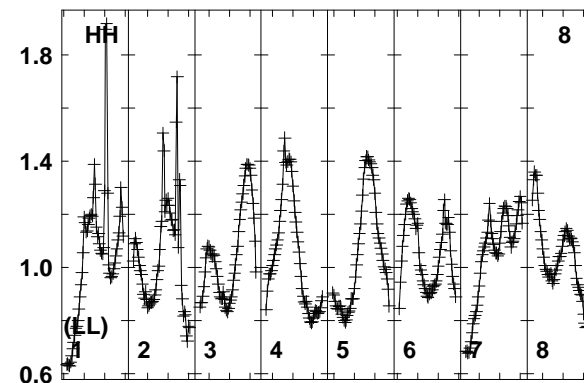
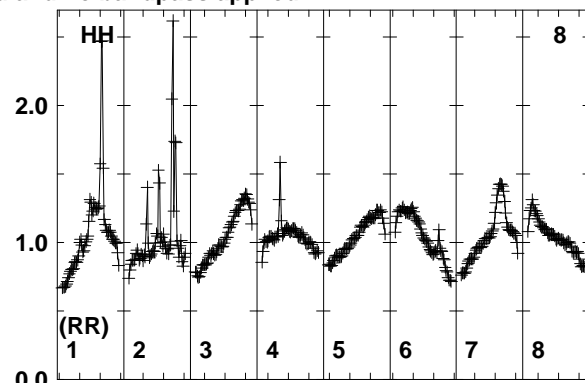
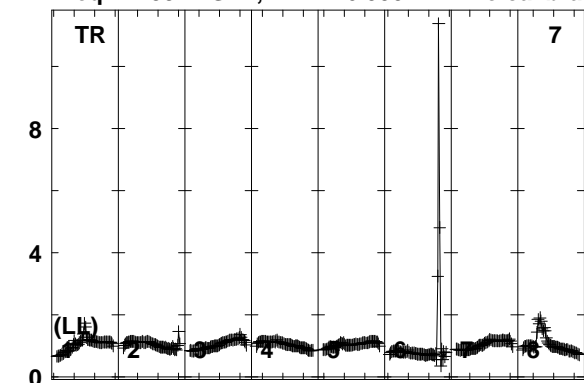

Lower frame: Real Jy
Total-power spectrum Antenna: TR (07)
Timerange: 00/07:34:06 to 00/07:36:44

Plot file version 519 created 04-NOV-2019 14:14:42

W2246-0526 EY034.UVDATA.1

Freq = 1.5947 GHz, Bw = 16.000 MH No calibration applied and no bandpass applied

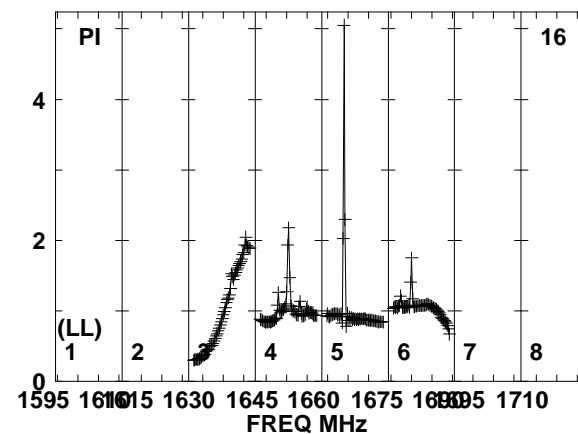
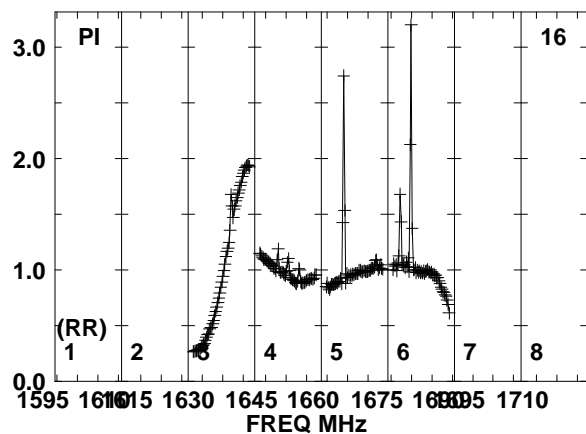
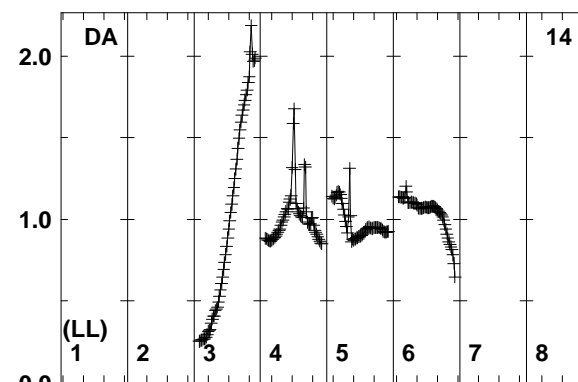
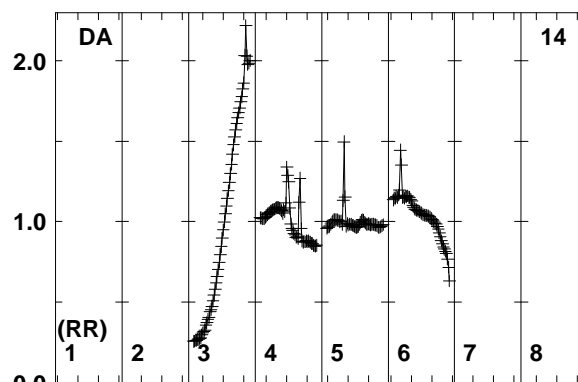
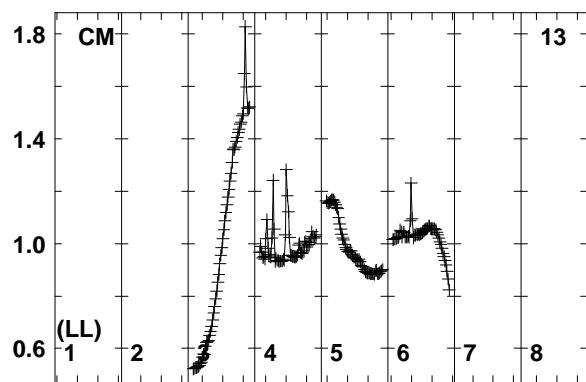
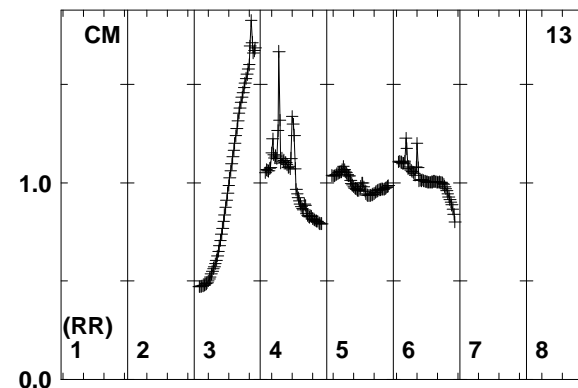
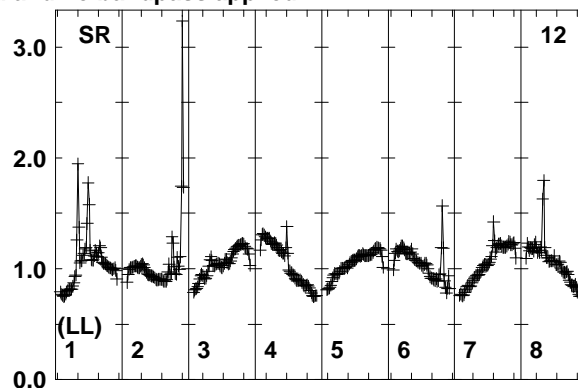
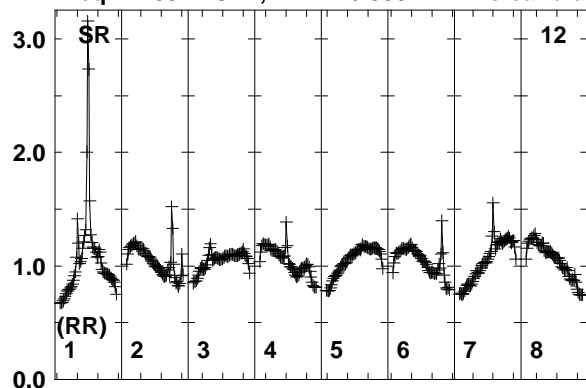

Lower frame: Real Jy
Total-power spectrum Antenna: SR (12)
Timerange: 00/07:34:06 to 00/07:36:44

Plot file version 520 created 04-NOV-2019 14:14:43

J2248-0541 EY034.UVDATA.1

Freq = 1.5947 GHz, Bw = 16.000 MH No calibration applied and no bandpass applied

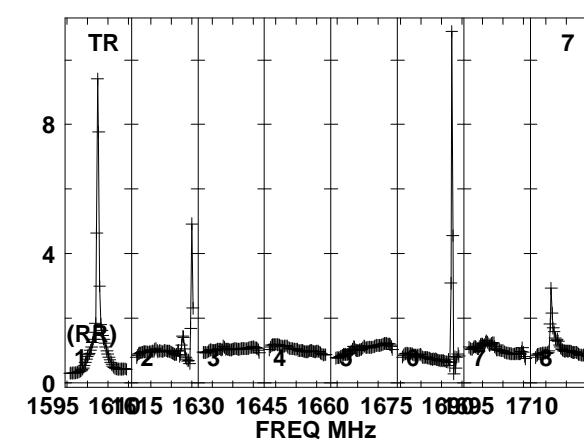
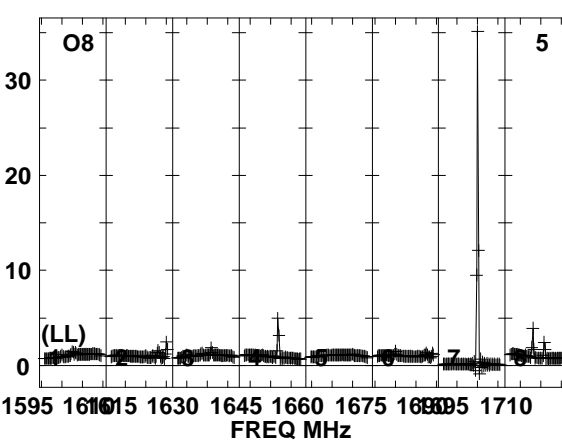
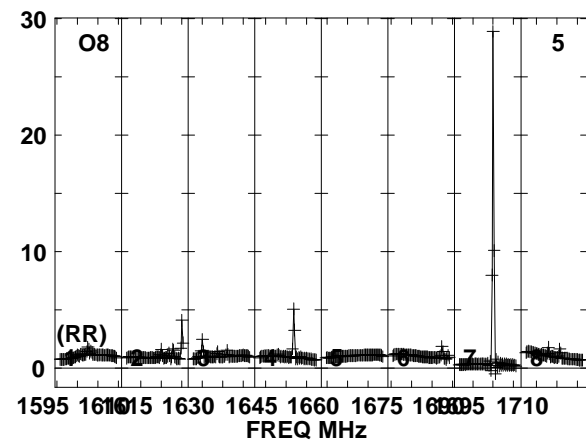
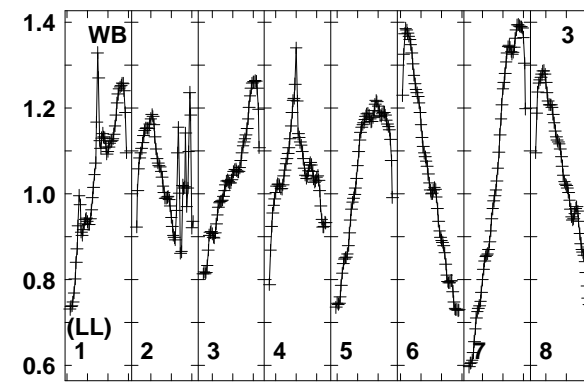
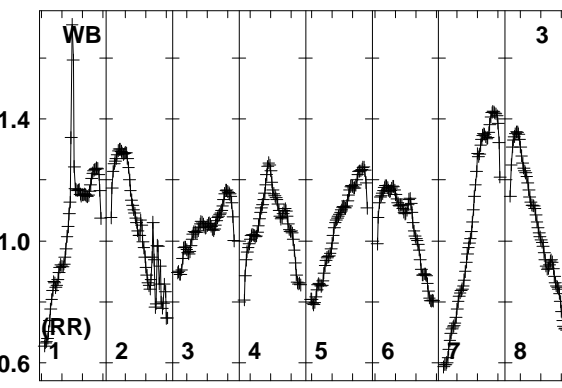
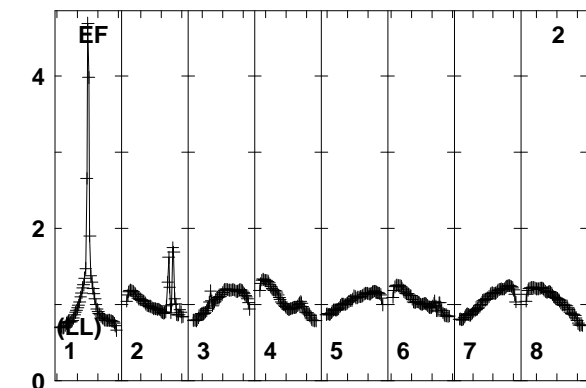
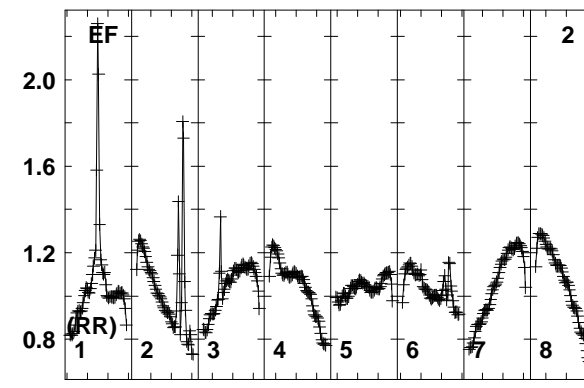
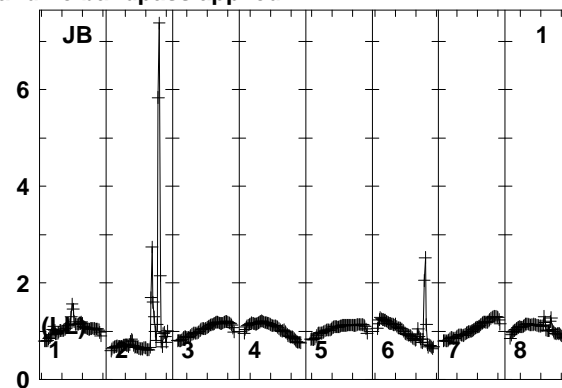
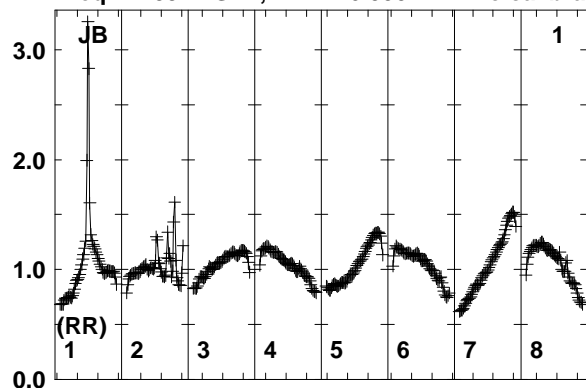

Lower frame: Real Jy
Total-power spectrum Antenna: JB (01)
Timerange: 00/07:37:21 to 00/07:38:19

Plot file version 521 created 04-NOV-2019 14:14:43

J2248-0541 EY034.UVDATA.1

Freq = 1.5947 GHz, Bw = 16.000 MH No calibration applied and no bandpass applied

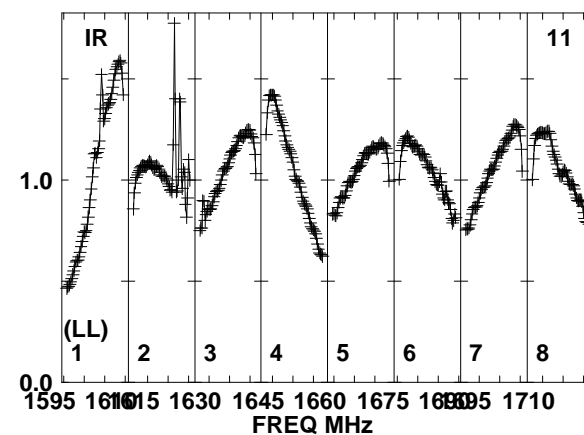
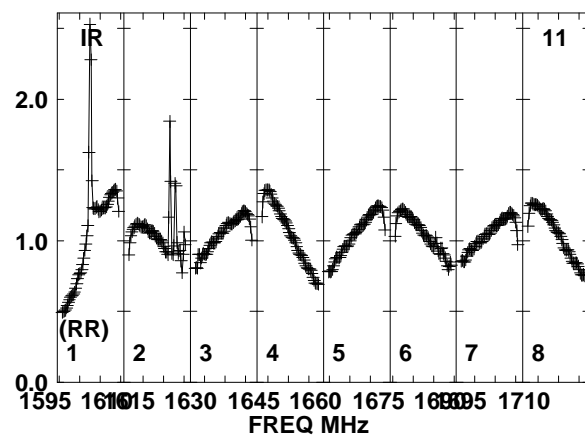
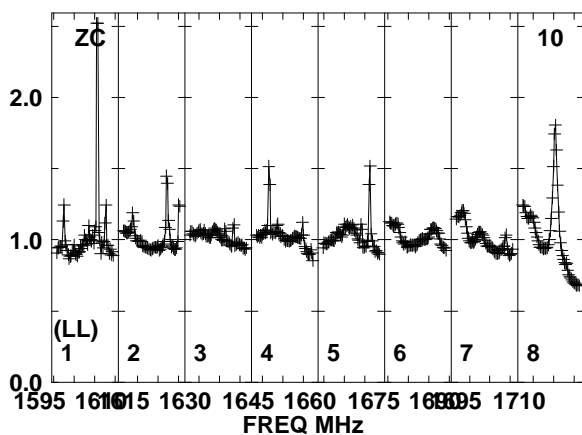
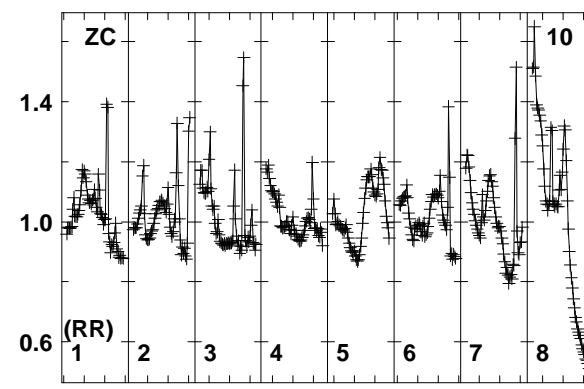
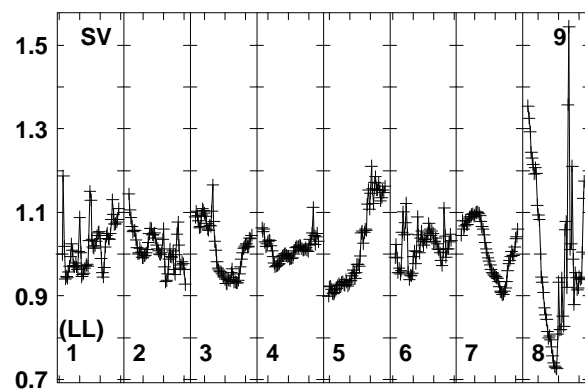
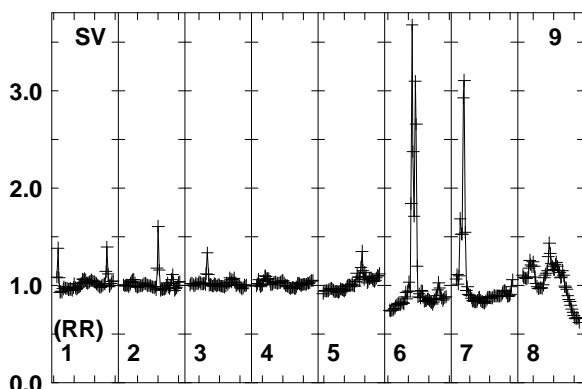
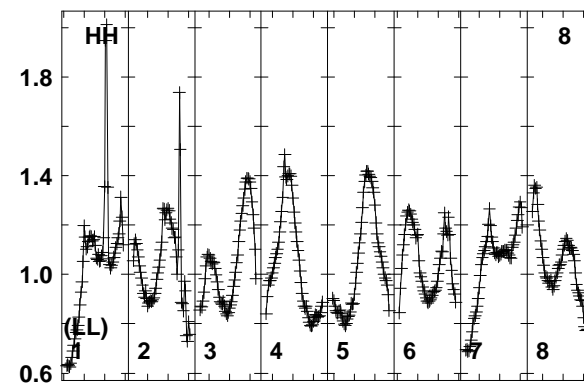
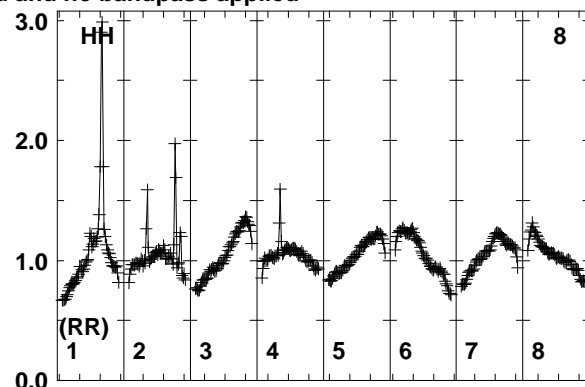
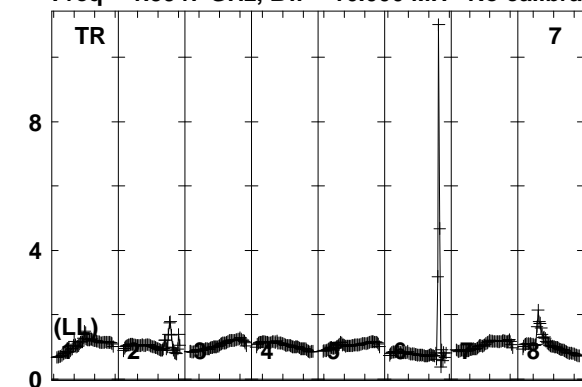

Lower frame: Real Jy
Total-power spectrum Antenna: TR (07)
Timerange: 00/07:37:21 to 00/07:38:19

Plot file version 522 created 04-NOV-2019 14:14:43

J2248-0541 EY034.UVDATA.1

Freq = 1.5947 GHz, Bw = 16.000 MH No calibration applied and no bandpass applied

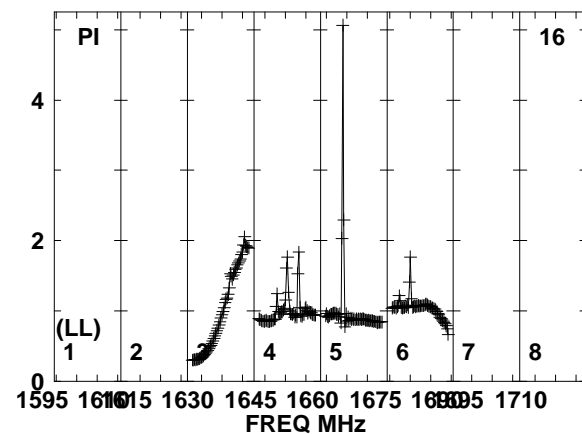
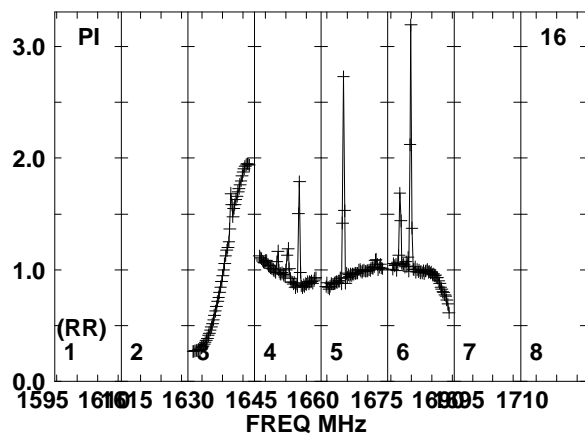
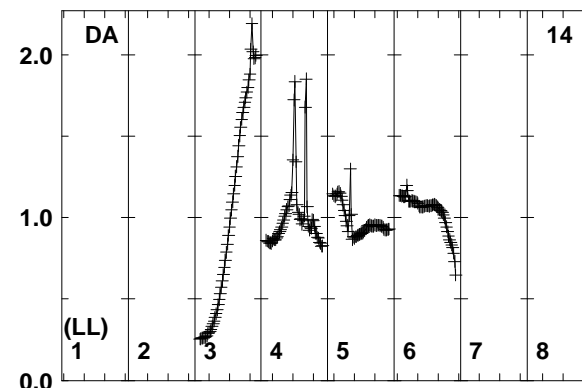
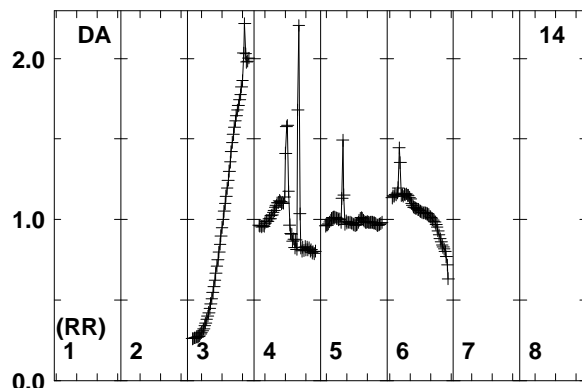
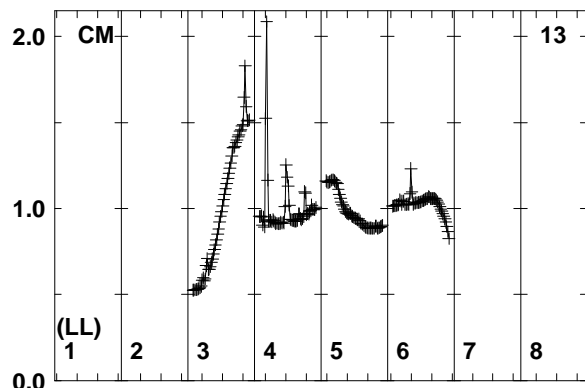
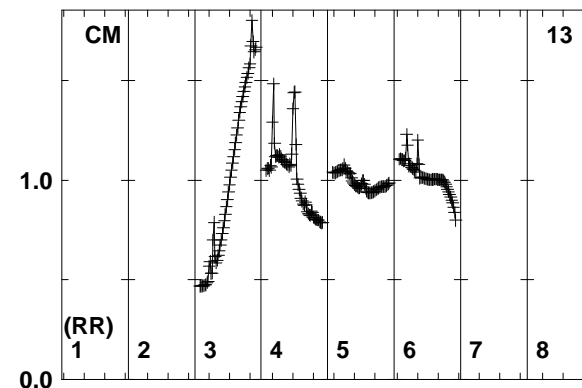
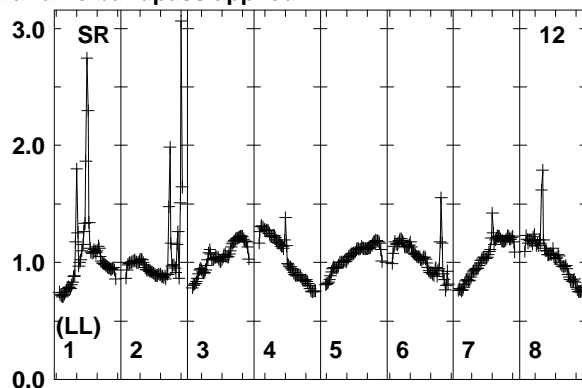
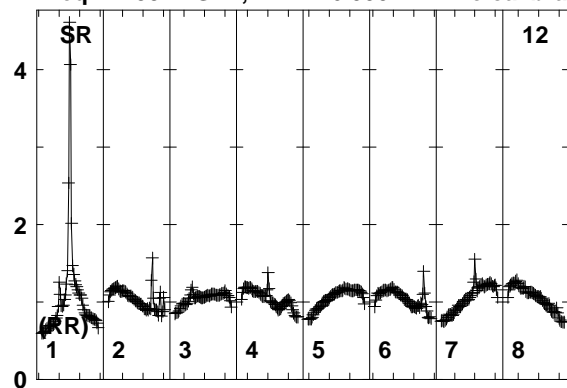

Lower frame: Real Jy
Total-power spectrum Antenna: SR (12)
Timerange: 00/07:37:21 to 00/07:38:19

Plot file version 523 created 04-NOV-2019 14:14:43

W2246-0526 EY034.UVDATA.1

Freq = 1.5947 GHz, Bw = 16.000 MH No calibration applied and no bandpass applied

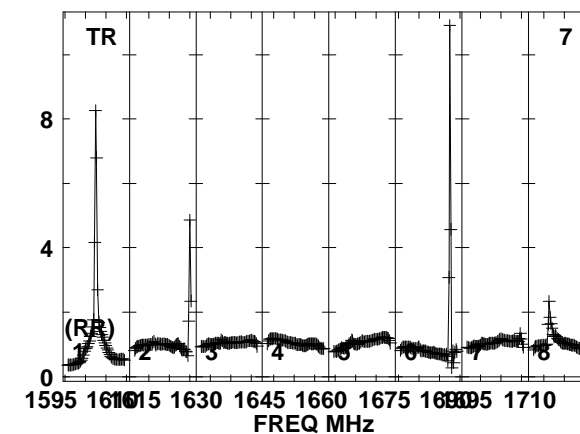
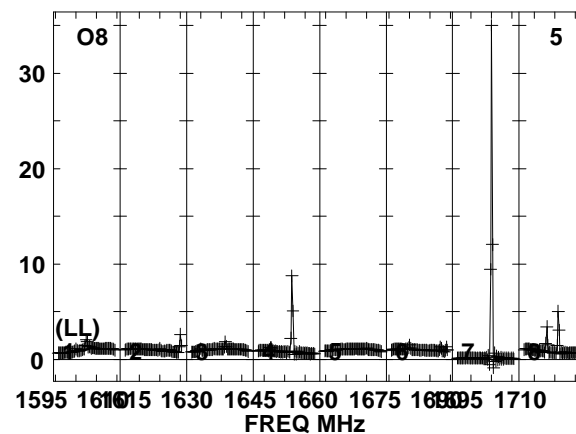
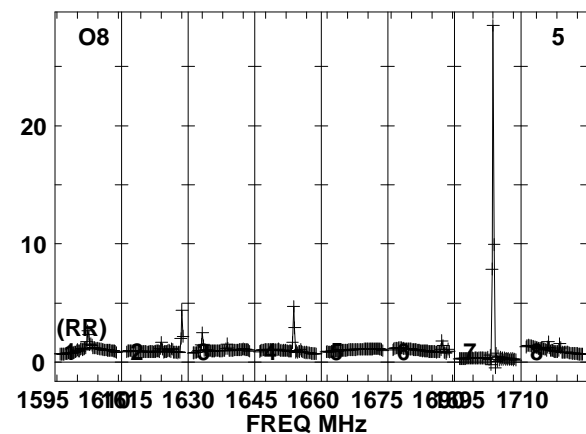
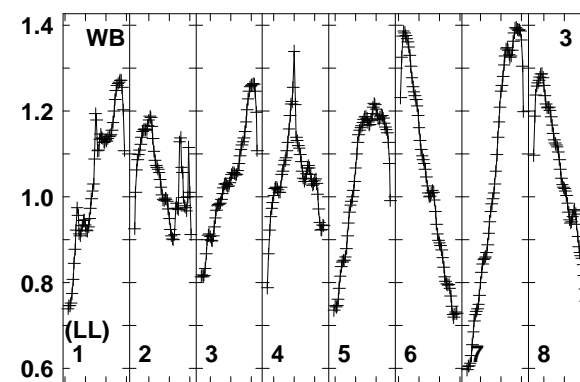
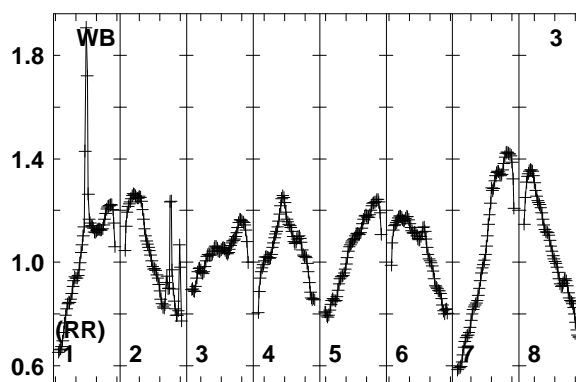
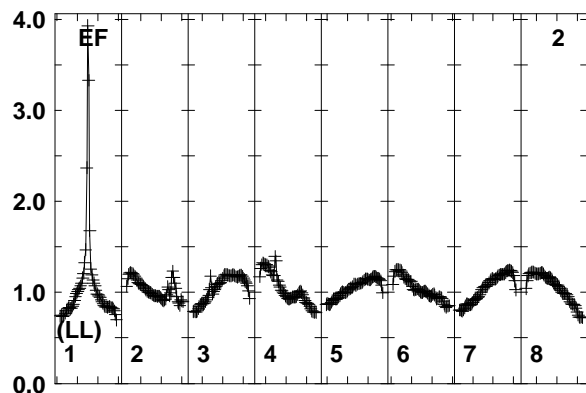
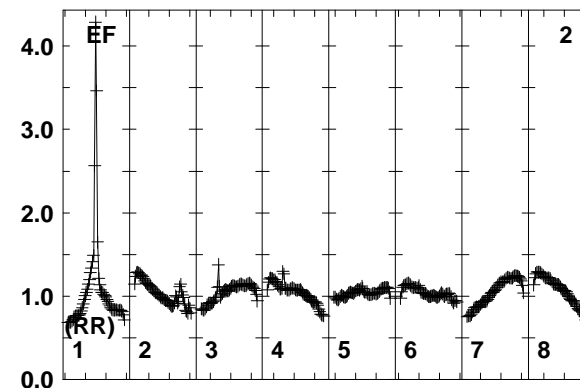
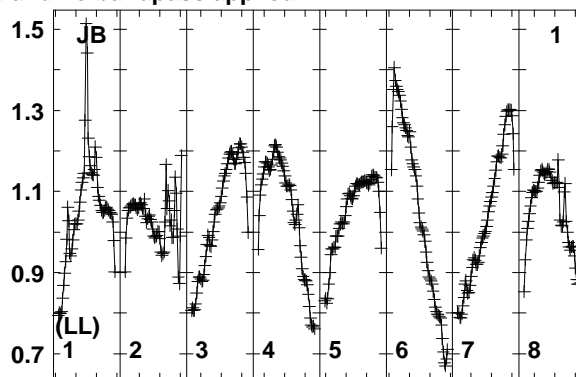
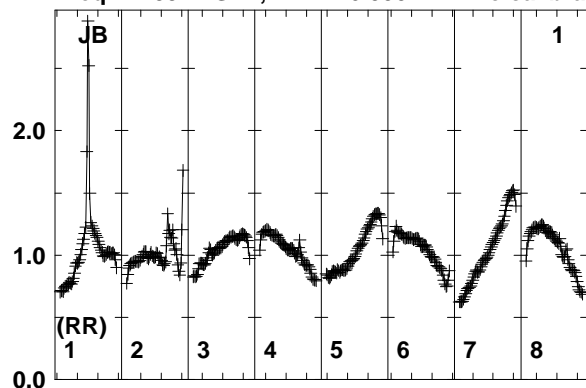

Lower frame: Real Jy
Total-power spectrum Antenna: JB (01)
Timerange: 00/07:38:21 to 00/07:40:59

Plot file version 524 created 04-NOV-2019 14:14:43

W2246-0526 EY034.UVDATA.1

Freq = 1.5947 GHz, Bw = 16.000 MH No calibration applied and no bandpass applied

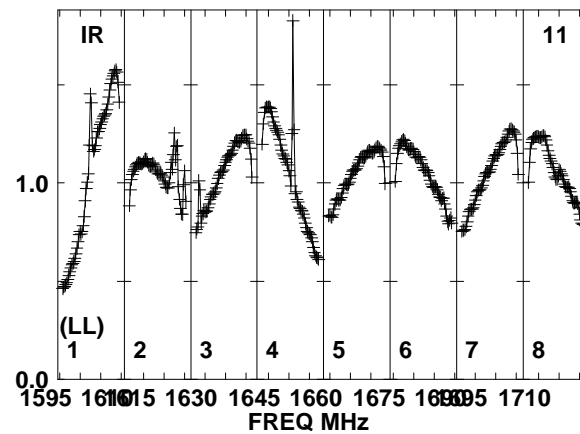
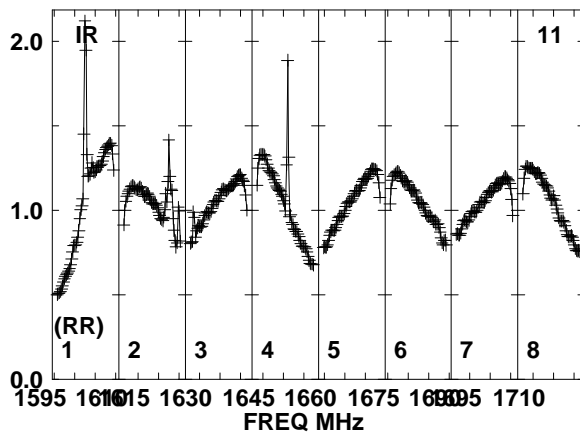
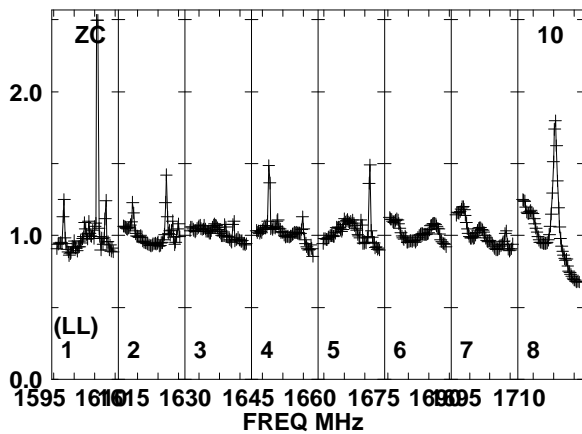
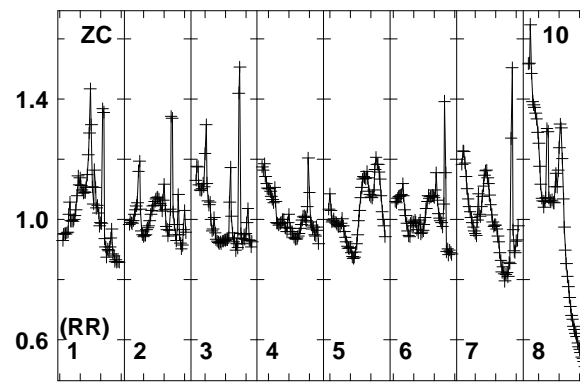
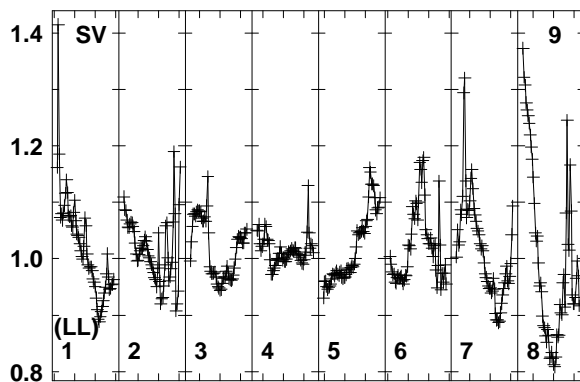
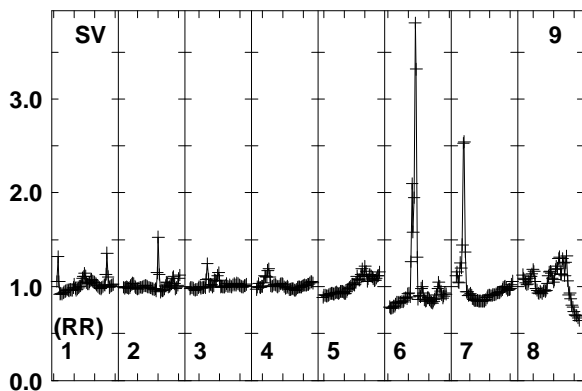
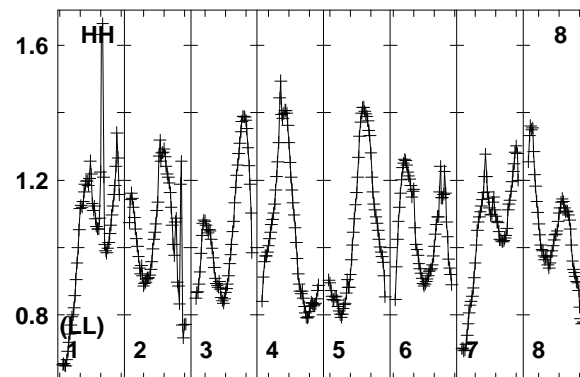
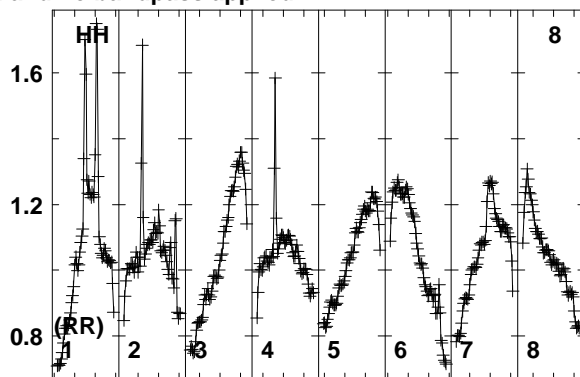
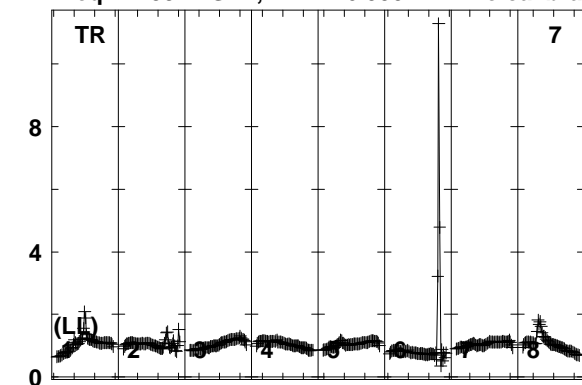

Lower frame: Real Jy
Total-power spectrum Antenna: TR (07)
Timerange: 00/07:38:21 to 00/07:40:59

Plot file version 525 created 04-NOV-2019 14:14:43

W2246-0526 EY034.UVDATA.1

Freq = 1.5947 GHz, Bw = 16.000 MH No calibration applied and no bandpass applied

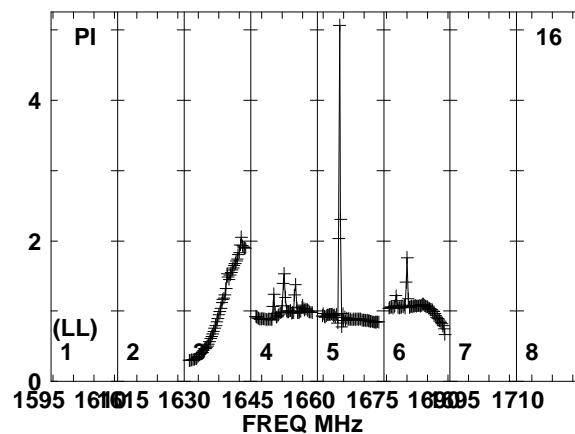
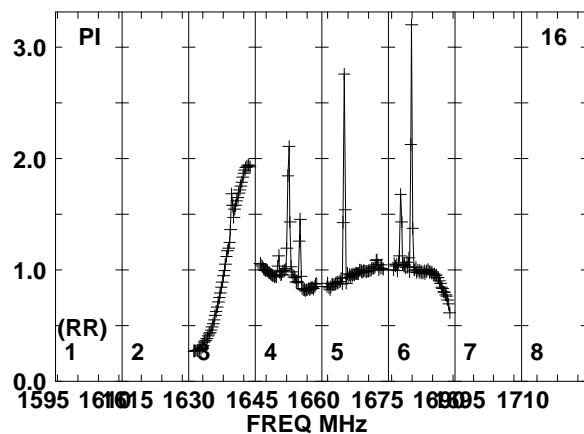
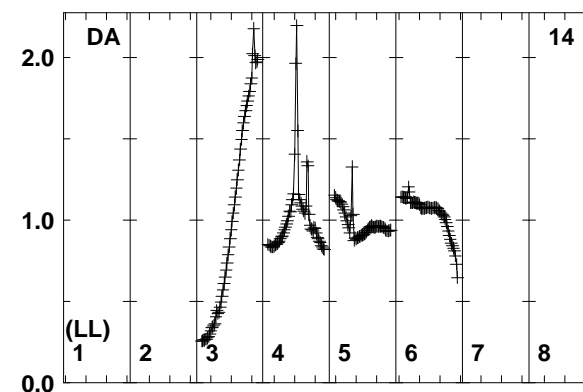
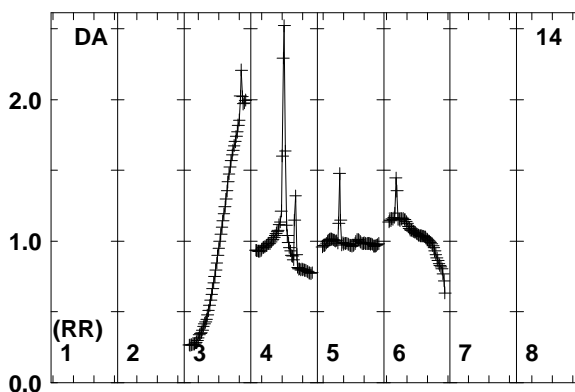
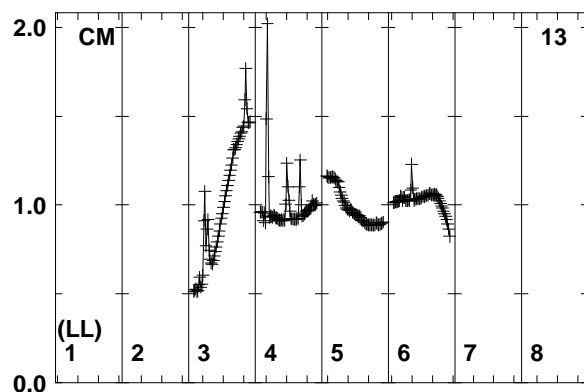
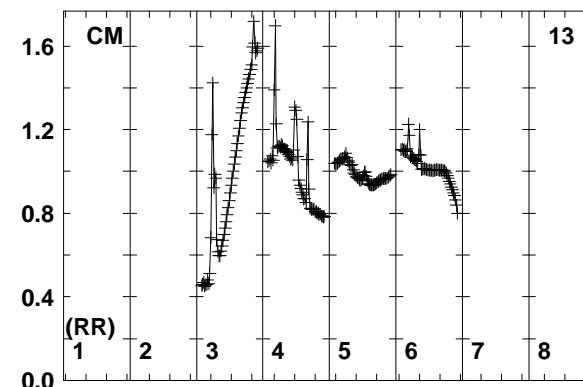
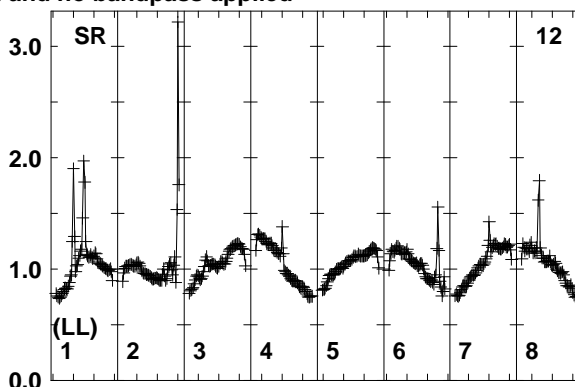
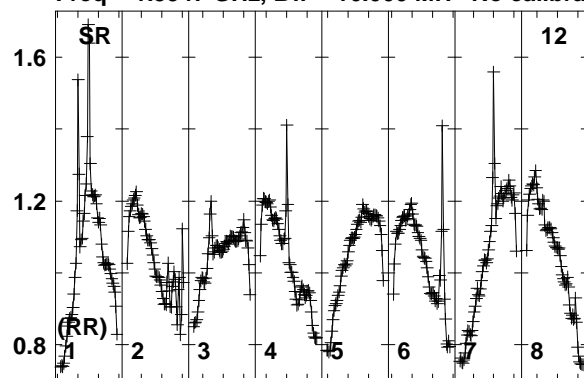

Lower frame: Real Jy
Total-power spectrum Antenna: SR (12)
Timerange: 00/07:38:21 to 00/07:40:59

Plot file version 526 created 04-NOV-2019 14:14:43

J2248-0541 EY034.UVDATA.1

Freq = 1.5947 GHz, Bw = 16.000 MH No calibration applied and no bandpass applied

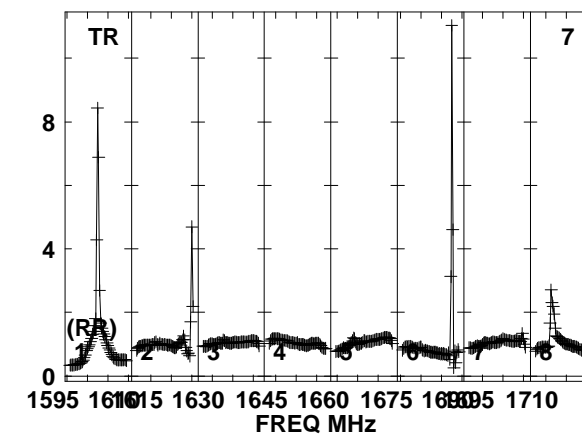
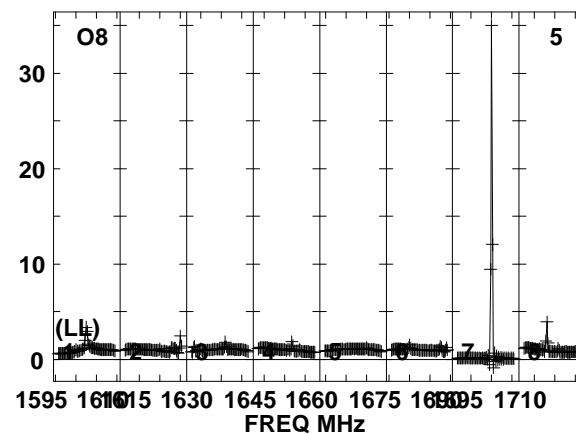
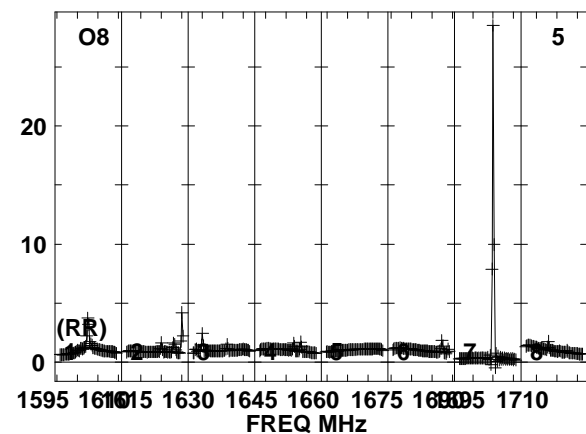
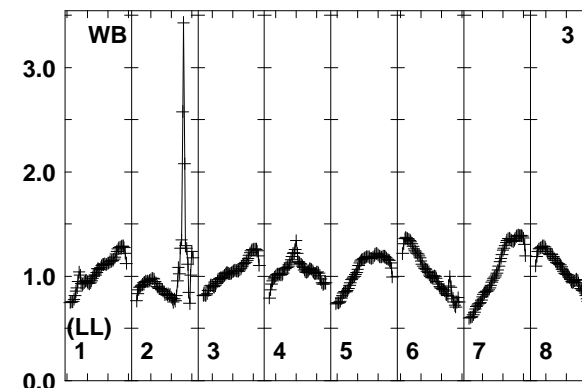
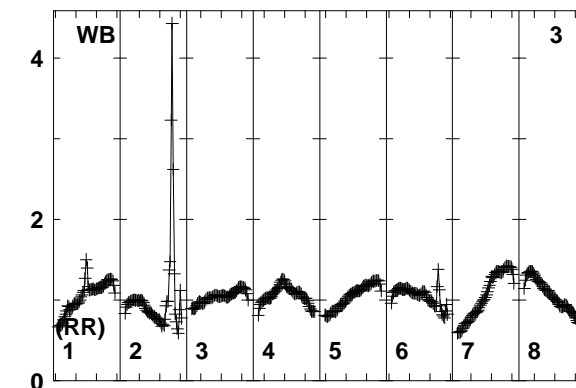
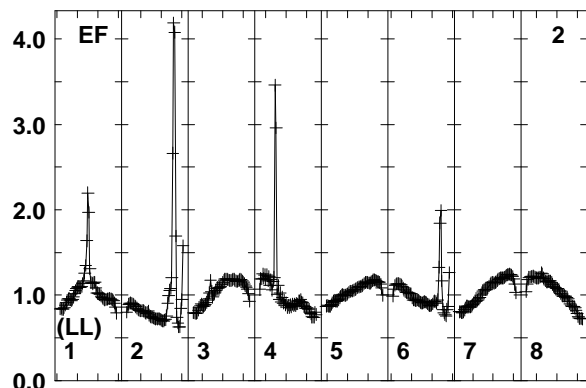
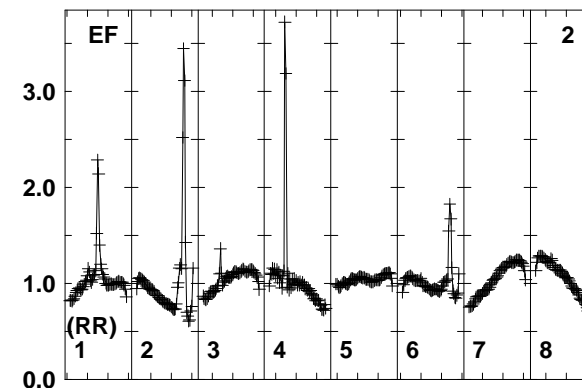
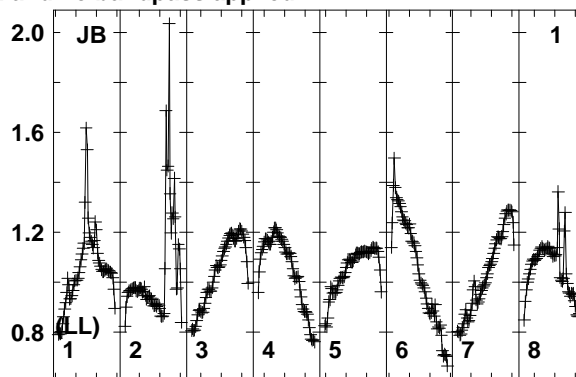
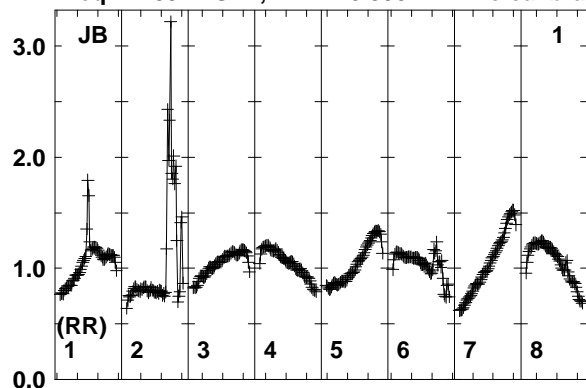

Lower frame: Real Jy
Total-power spectrum Antenna: JB (01)
Timerange: 00/07:41:16 to 00/07:42:14

Plot file version 527 created 04-NOV-2019 14:14:43

J2248-0541 EY034.UVDATA.1

Freq = 1.5947 GHz, Bw = 16.000 MH No calibration applied and no bandpass applied

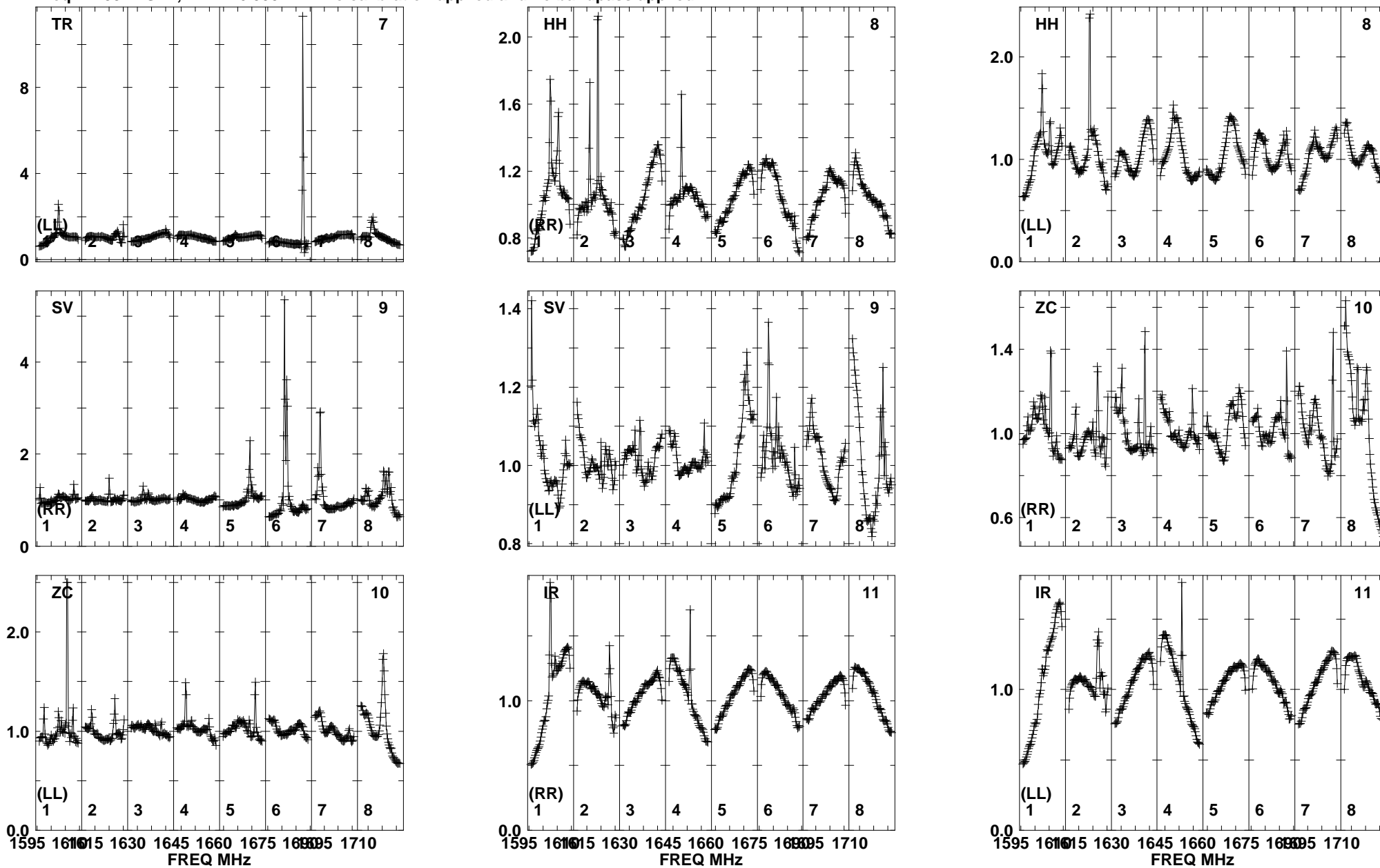

Lower frame: Real Jy
Total-power spectrum Antenna: TR (07)
Timerange: 00/07:41:16 to 00/07:42:14

Plot file version 528 created 04-NOV-2019 14:14:43

J2248-0541 EY034.UVDATA.1

Freq = 1.5947 GHz, Bw = 16.000 MH No calibration applied and no bandpass applied

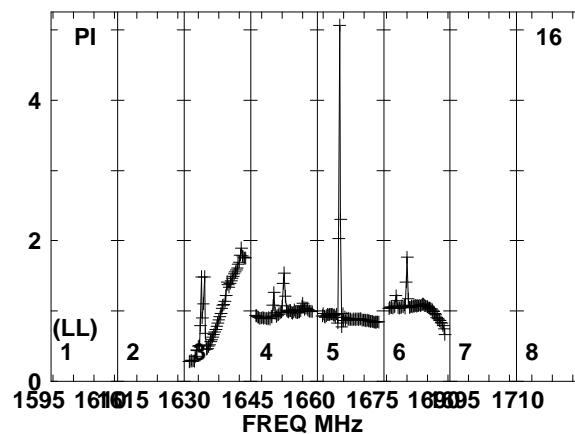
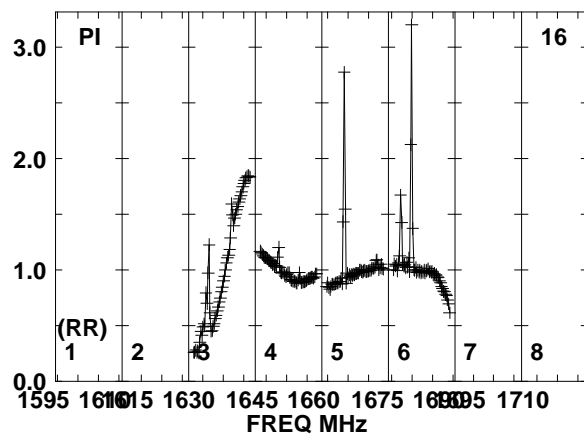
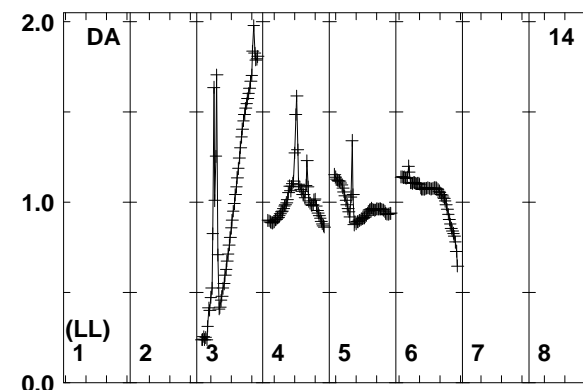
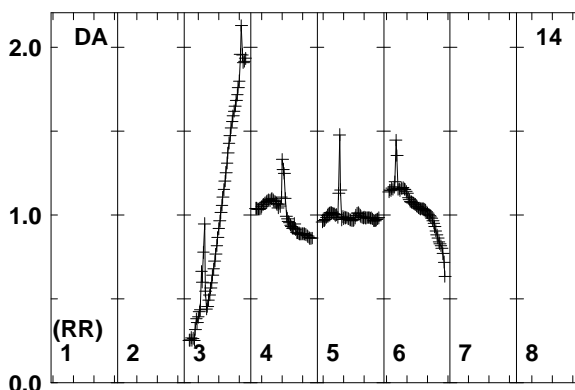
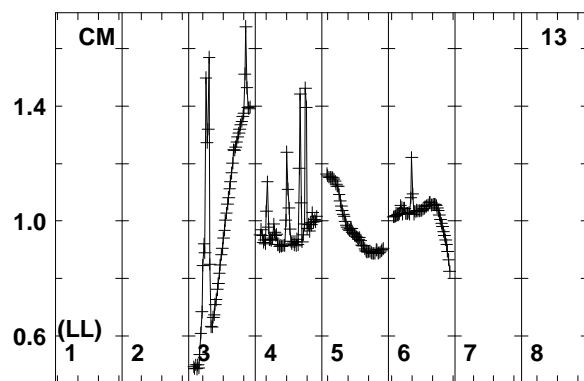
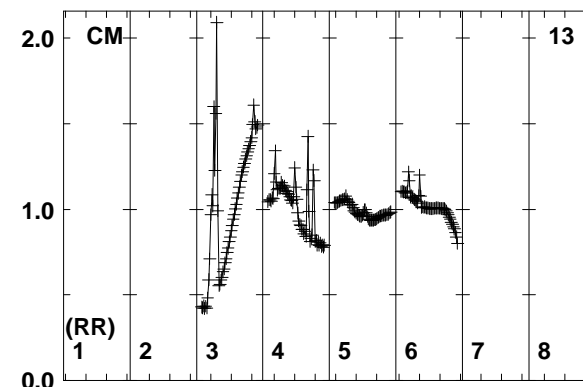
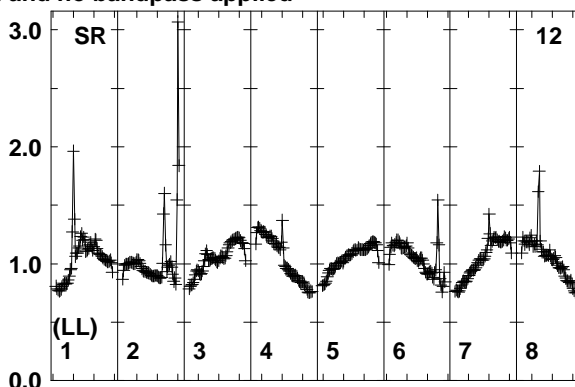
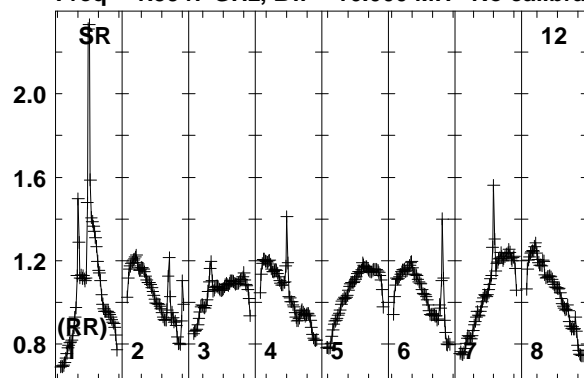

Lower frame: Real Jy
Total-power spectrum Antenna: SR (12)
Timerange: 00/07:41:16 to 00/07:42:14

Plot file version 529 created 04-NOV-2019 14:14:43

J2245-0755 EY034.UVDATA.1

Freq = 1.5947 GHz, Bw = 16.000 MH No calibration applied and no bandpass applied

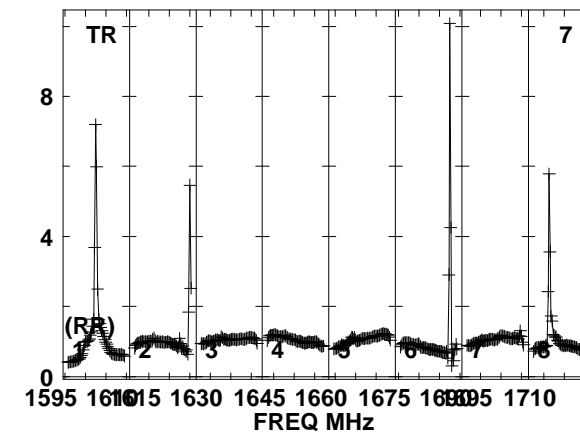
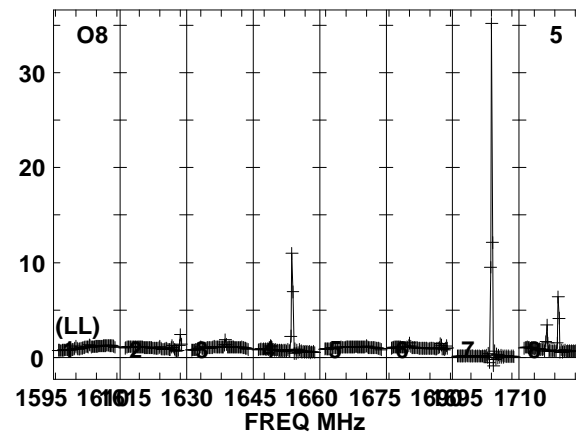
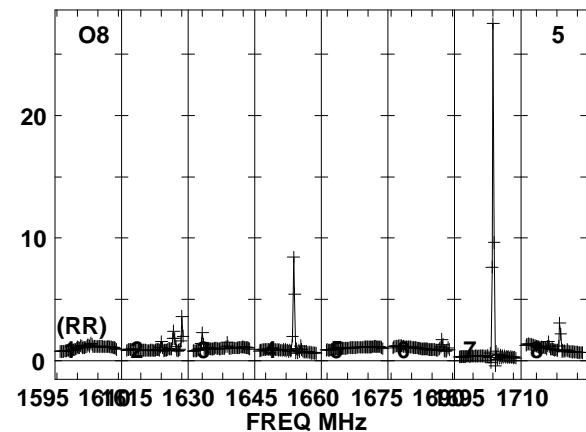
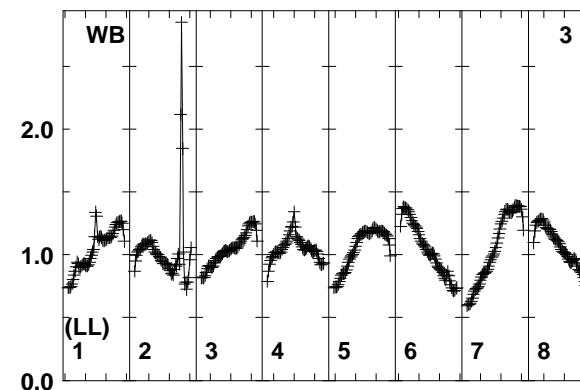
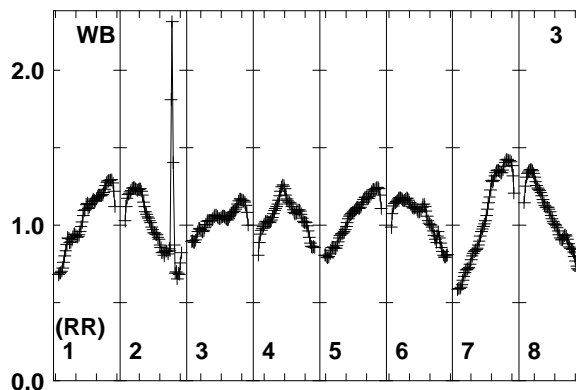
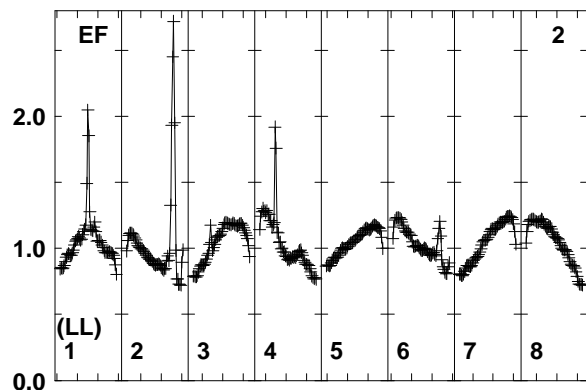
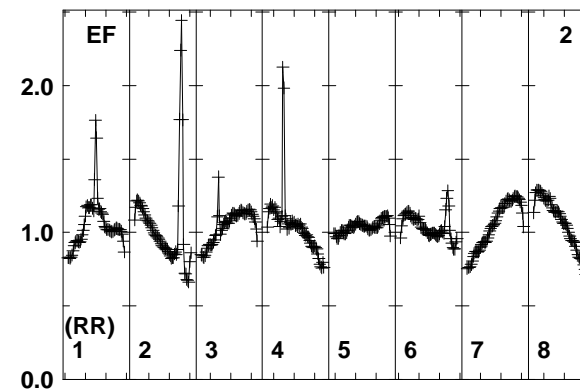
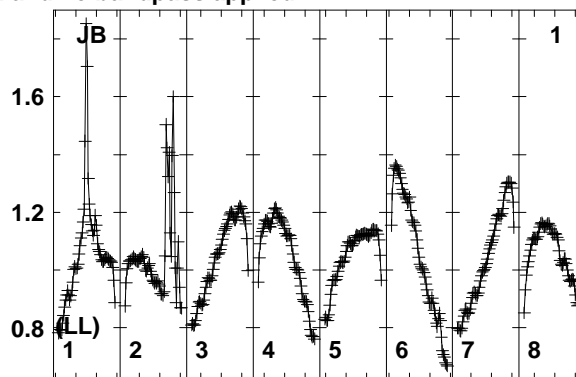
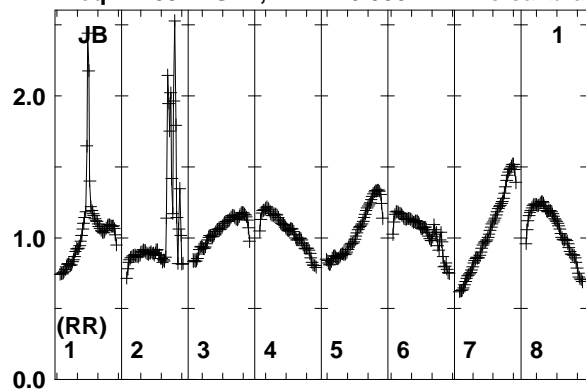

Lower frame: Real Jy
Total-power spectrum Antenna: JB (01)
Timerange: 00/07:42:31 to 00/07:43:29

Plot file version 530 created 04-NOV-2019 14:14:43

J2245-0755 EY034.UVDATA.1

Freq = 1.5947 GHz, Bw = 16.000 MH No calibration applied and no bandpass applied

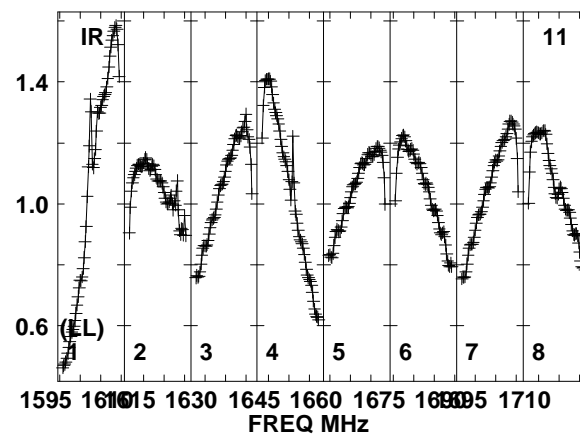
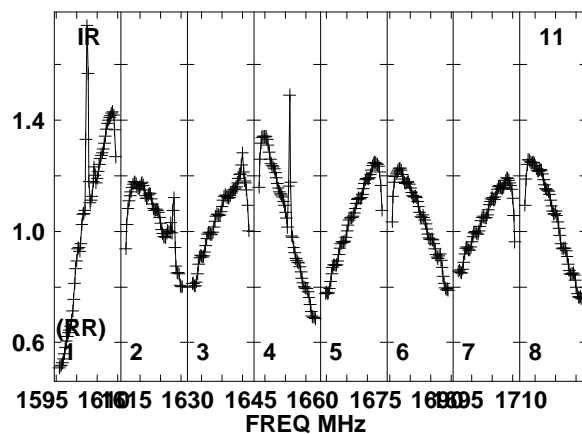
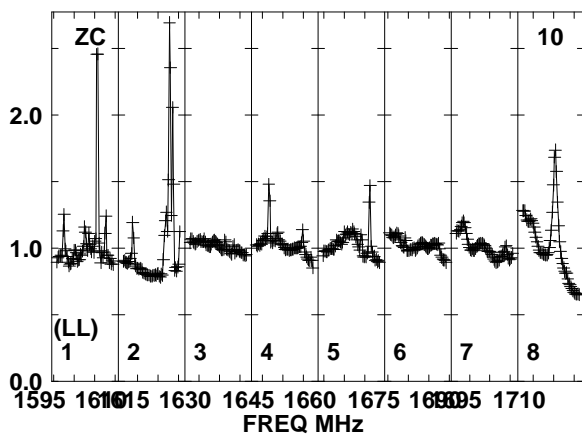
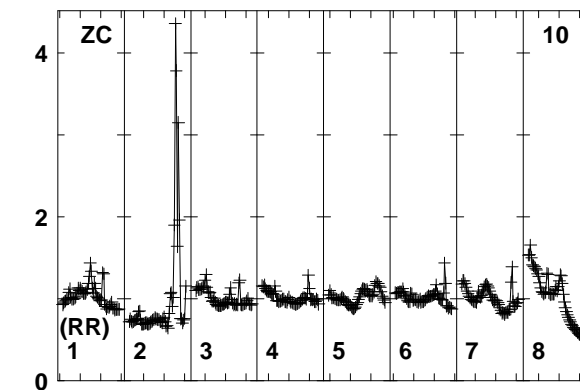
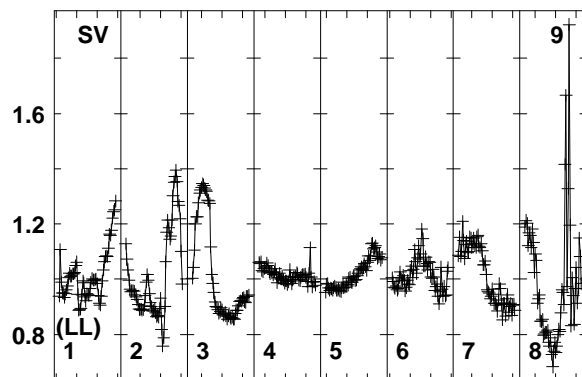
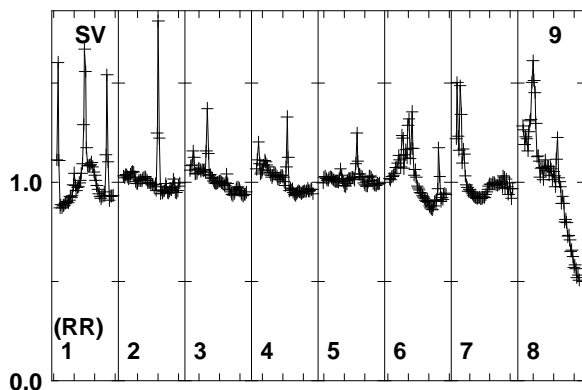
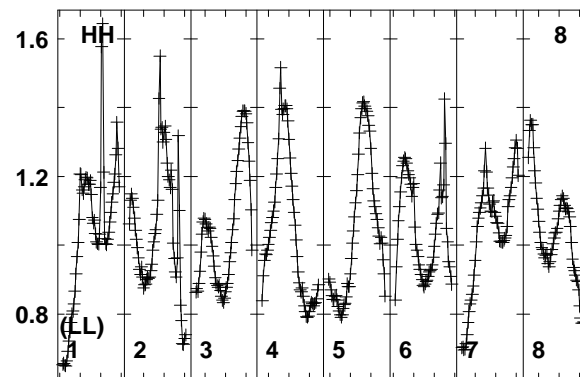
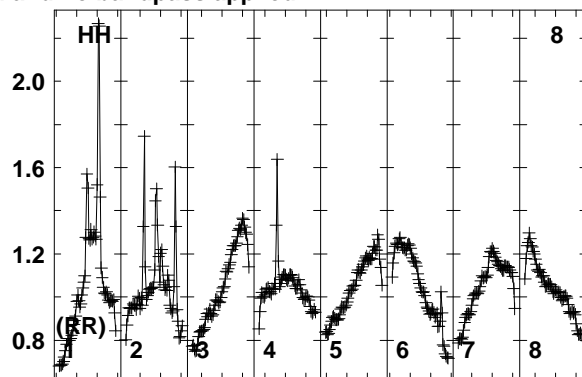
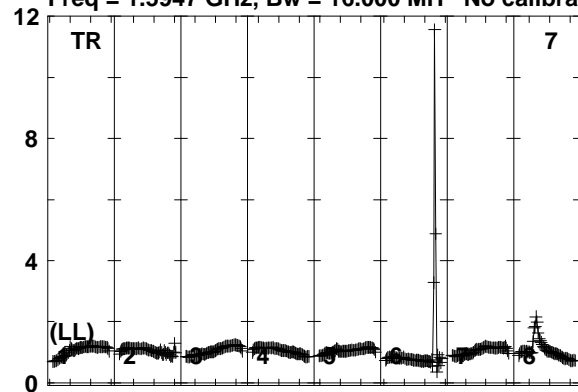

Lower frame: Real Jy
Total-power spectrum Antenna: TR (07)
Timerange: 00/07:42:31 to 00/07:43:29

Plot file version 531 created 04-NOV-2019 14:14:43

J2245-0755 EY034.UVDATA.1

Freq = 1.5947 GHz, Bw = 16.000 MH No calibration applied and no bandpass applied

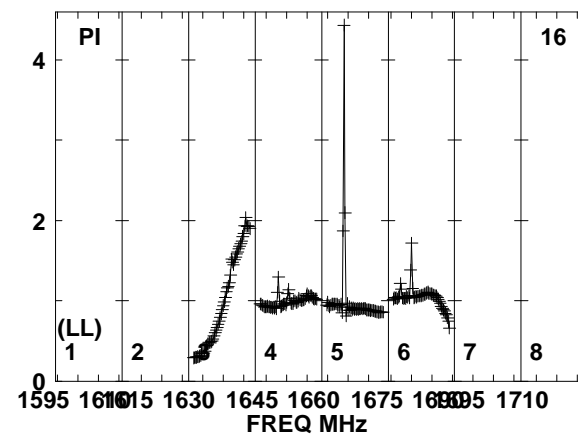
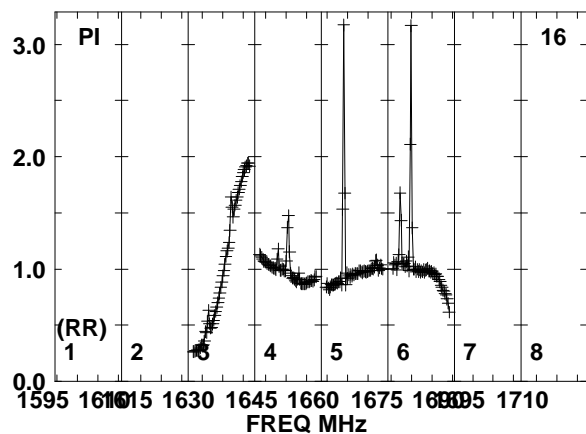
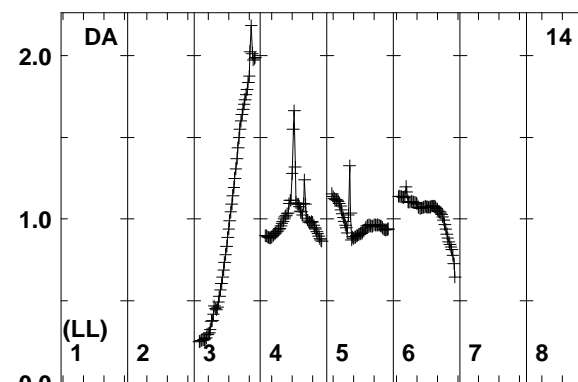
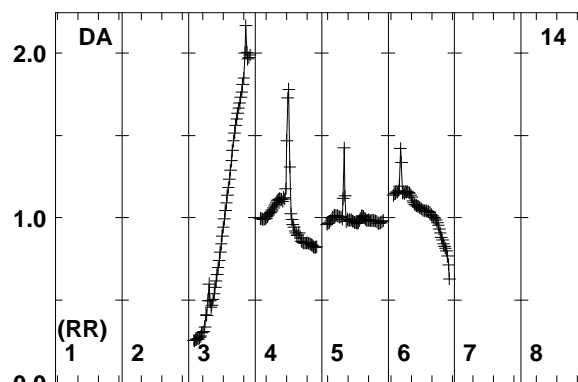
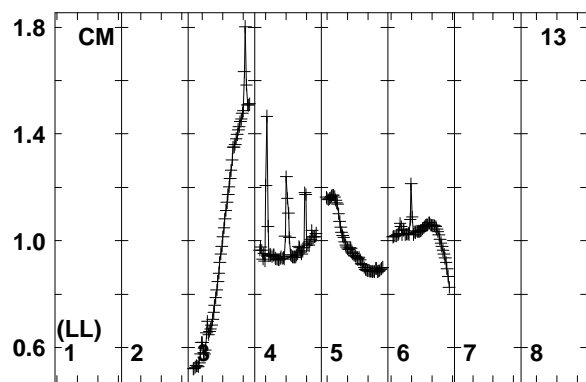
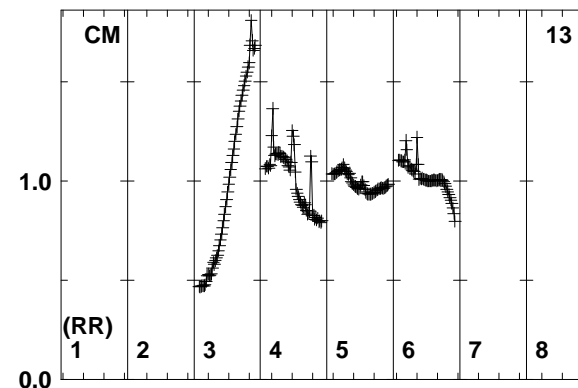
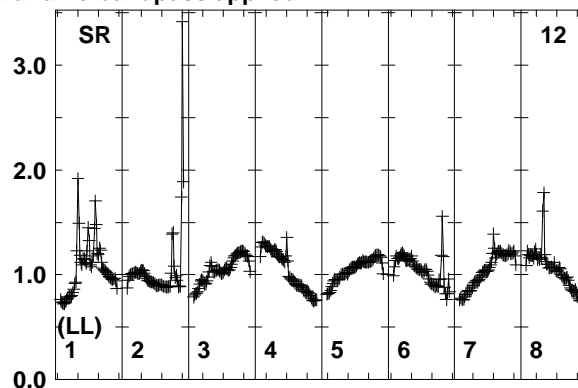
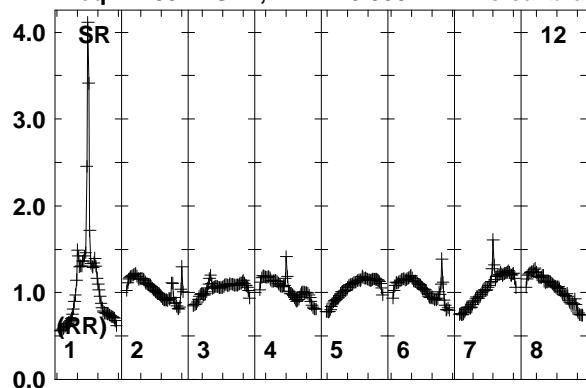

Lower frame: Real Jy
Total-power spectrum Antenna: SR (12)
Timerange: 00/07:42:31 to 00/07:43:29

Plot file version 532 created 04-NOV-2019 14:14:44

J2248-0541 EY034.UVDATA.1

Freq = 1.5947 GHz, Bw = 16.000 MH No calibration applied and no bandpass applied

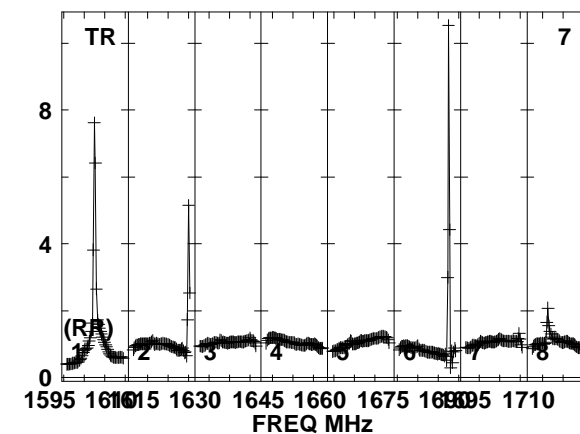
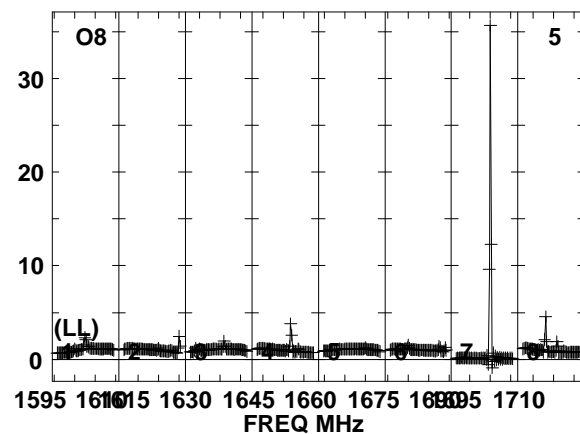
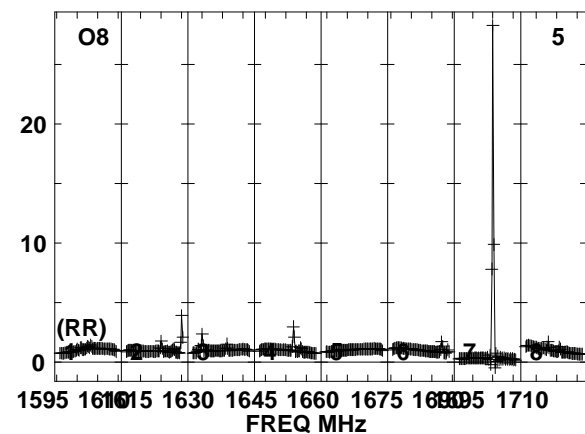
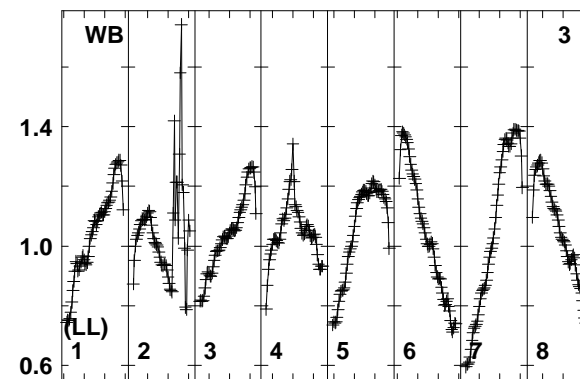
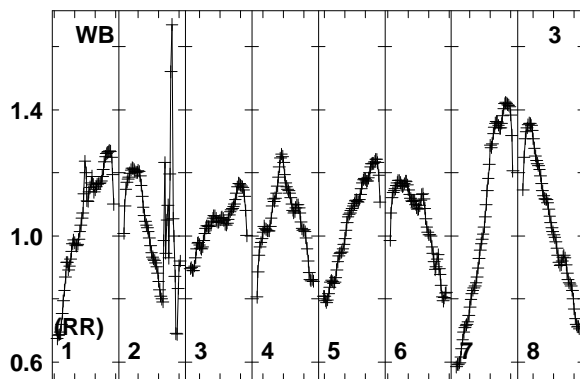
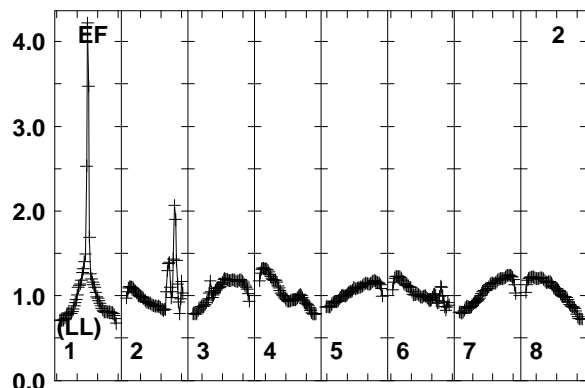
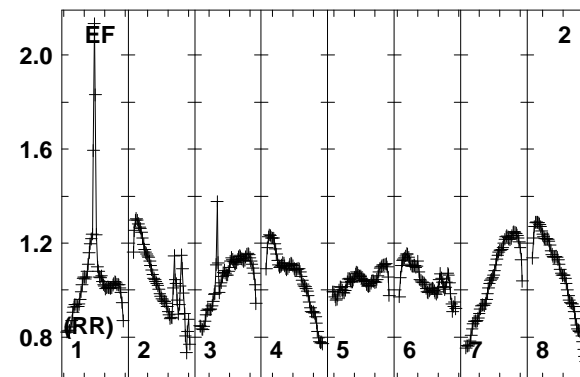
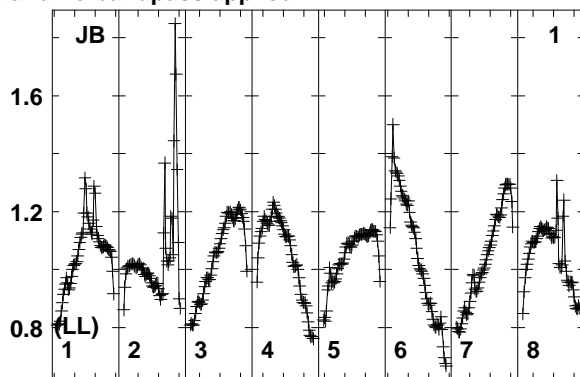
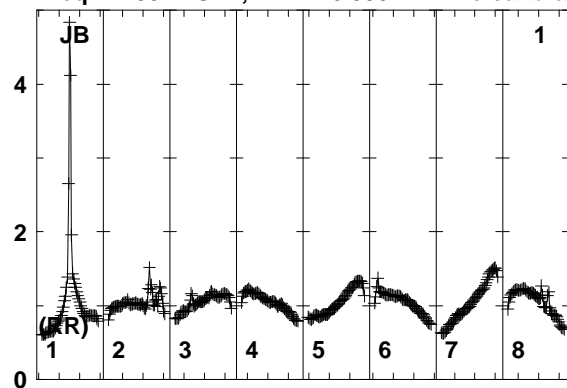

Lower frame: Real Jy
Total-power spectrum Antenna: JB (01)
Timerange: 00/07:44:16 to 00/07:45:14

Plot file version 533 created 04-NOV-2019 14:14:44

J2248-0541 EY034.UVDATA.1

Freq = 1.5947 GHz, Bw = 16.000 MH No calibration applied and no bandpass applied

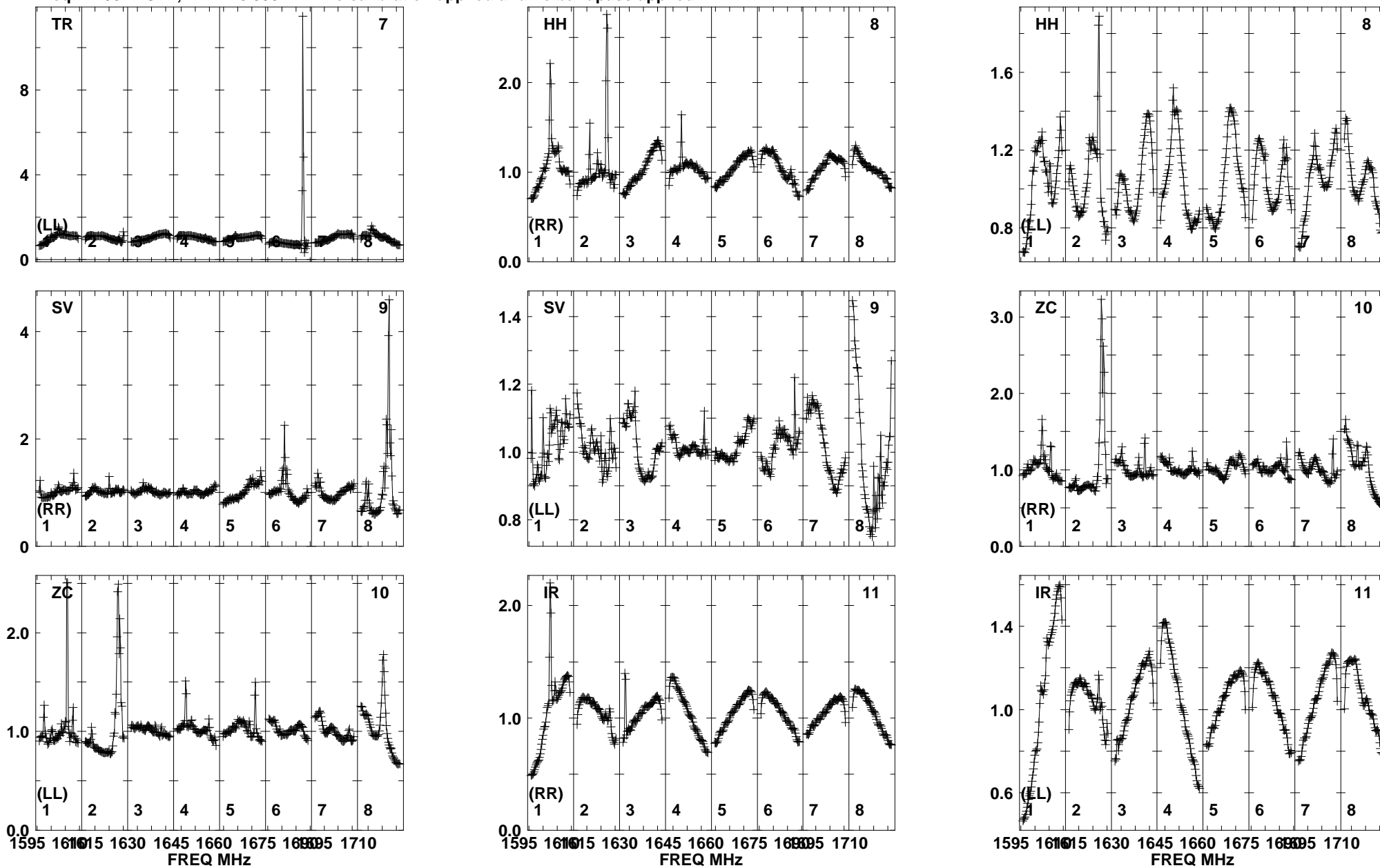

Lower frame: Real Jy
Total-power spectrum Antenna: TR (07)
Timerange: 00/07:44:16 to 00/07:45:14

Plot file version 534 created 04-NOV-2019 14:14:44

J2248-0541 EY034.UVDATA.1

Freq = 1.5947 GHz, Bw = 16.000 MH No calibration applied and no bandpass applied

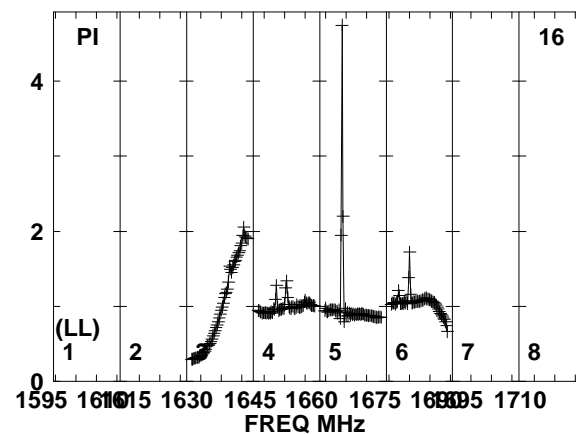
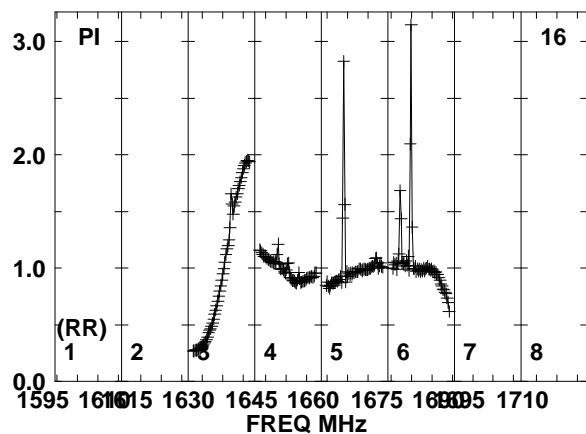
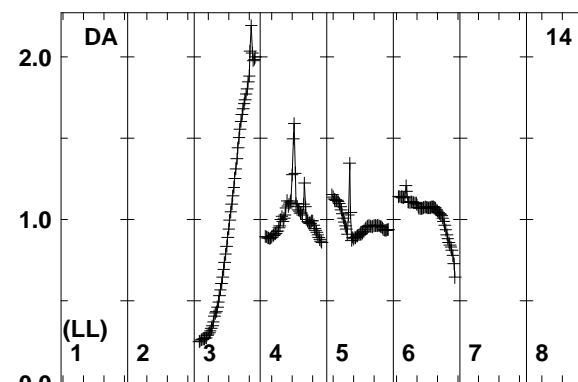
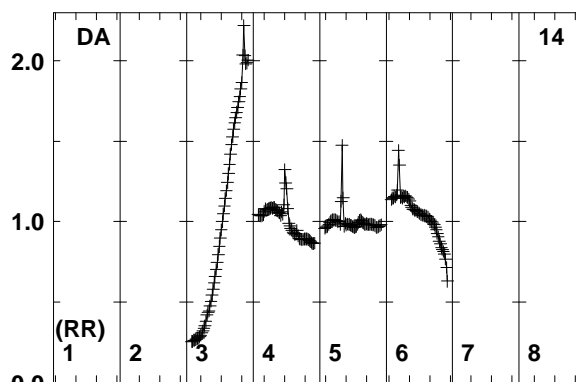
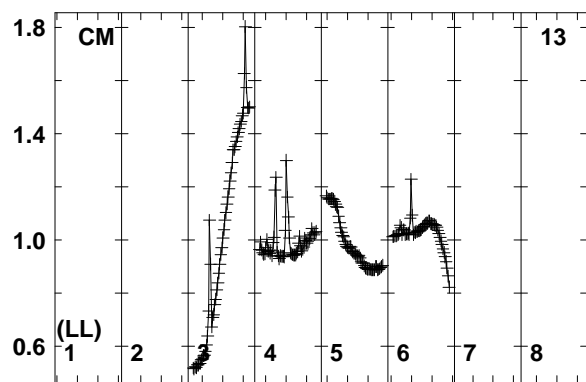
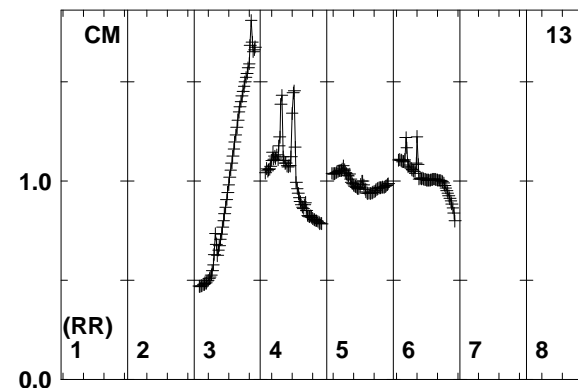
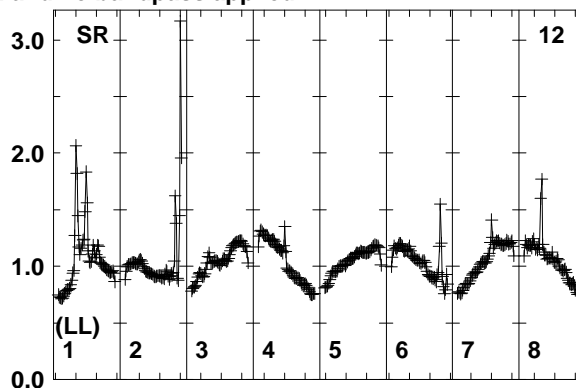
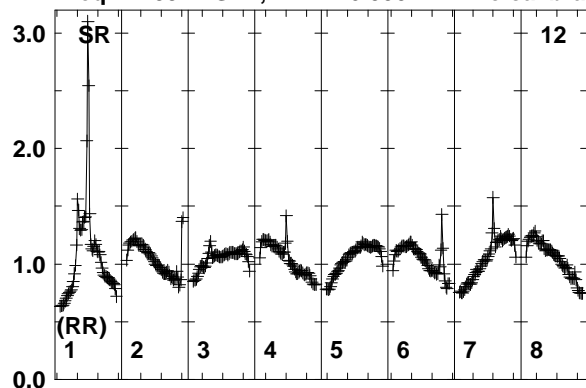

Lower frame: Real Jy
Total-power spectrum Antenna: SR (12)
Timerange: 00/07:44:16 to 00/07:45:14

Plot file version 535 created 04-NOV-2019 14:14:44

W2246-0526 EY034.UVDATA.1

Freq = 1.5947 GHz, Bw = 16.000 MH No calibration applied and no bandpass applied

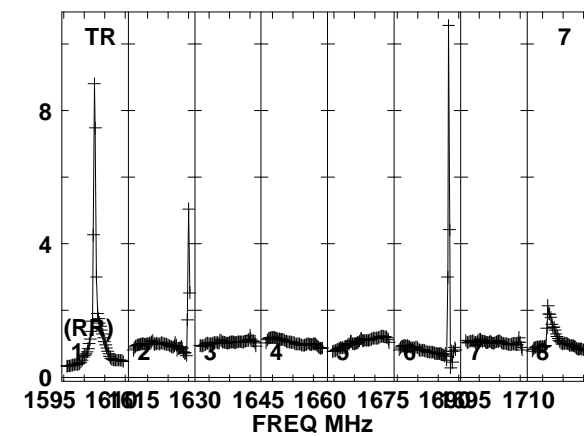
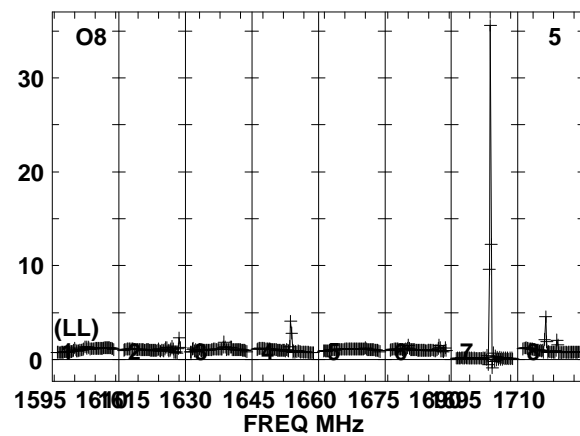
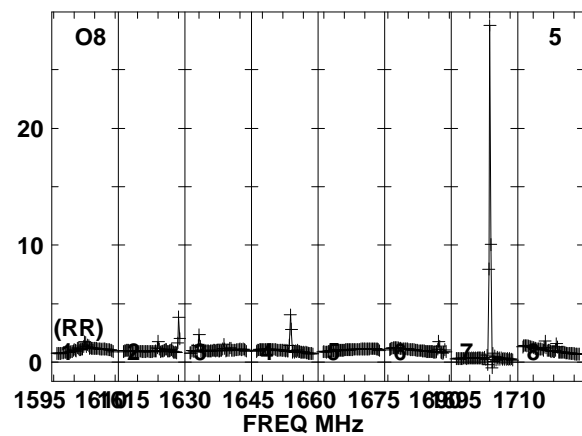
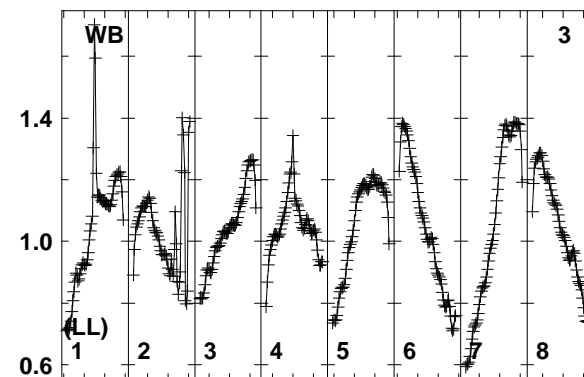
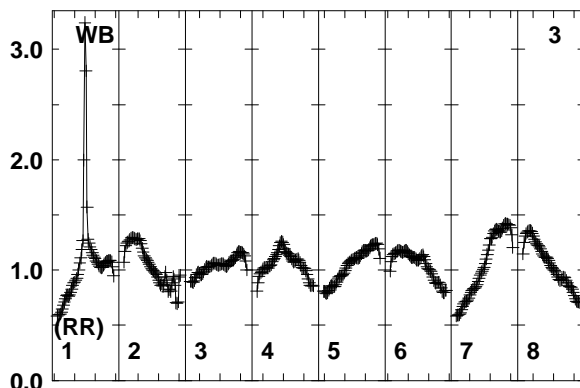
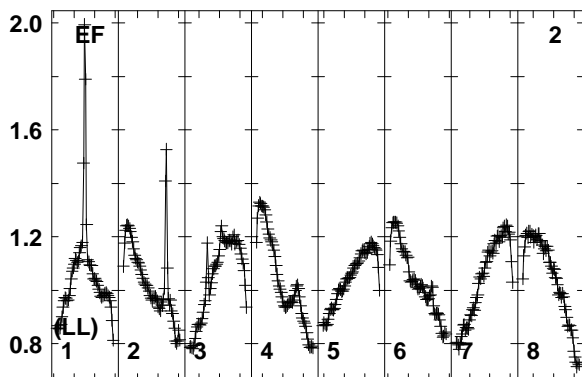
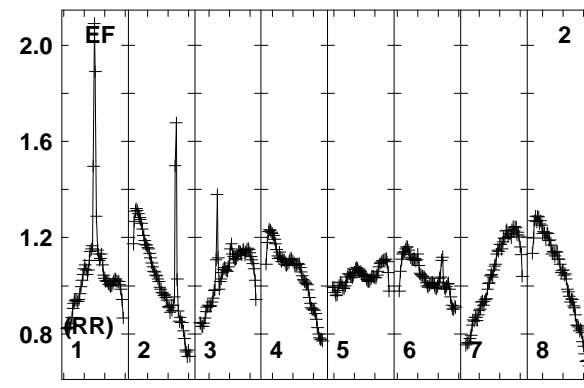
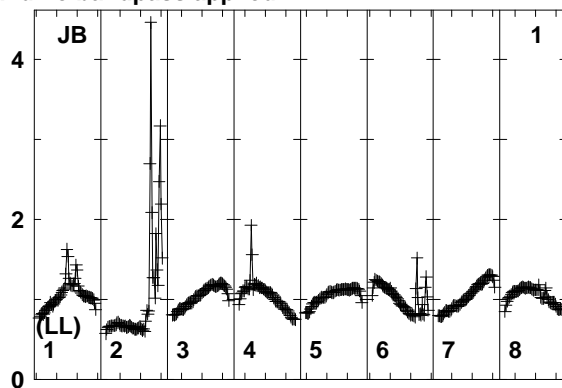
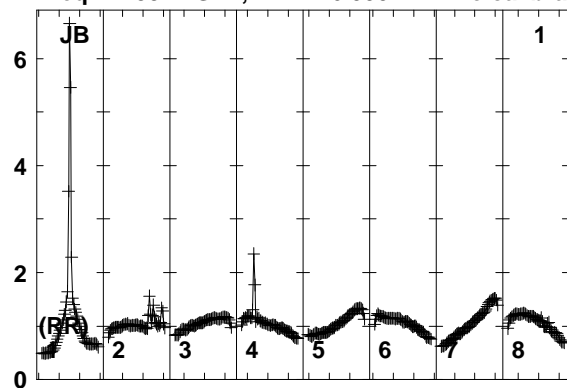

Lower frame: Real Jy
Total-power spectrum Antenna: JB (01)
Timerange: 00/07:45:16 to 00/07:47:44

Plot file version 536 created 04-NOV-2019 14:14:44

W2246-0526 EY034.UVDATA.1

Freq = 1.5947 GHz, Bw = 16.000 MH No calibration applied and no bandpass applied

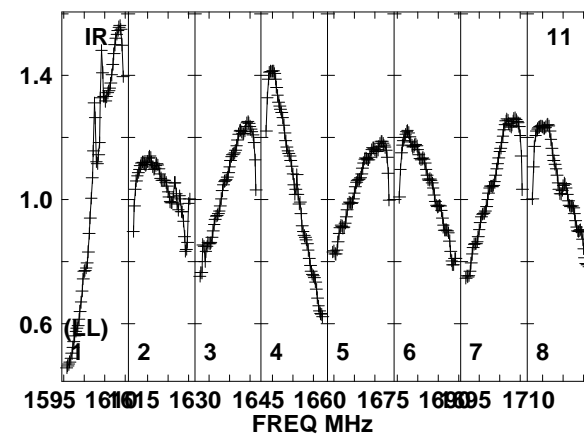
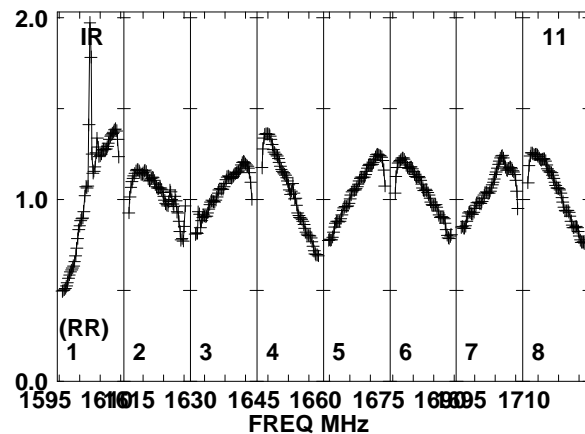
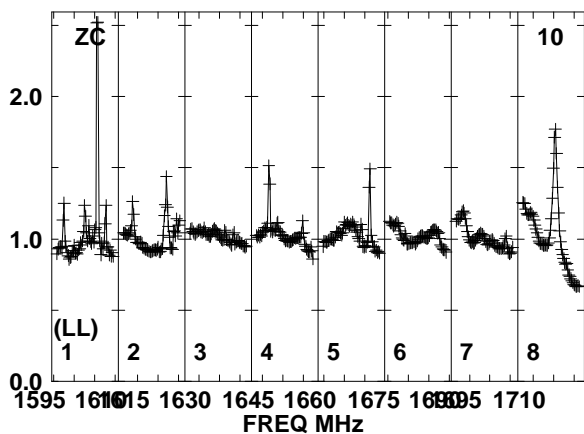
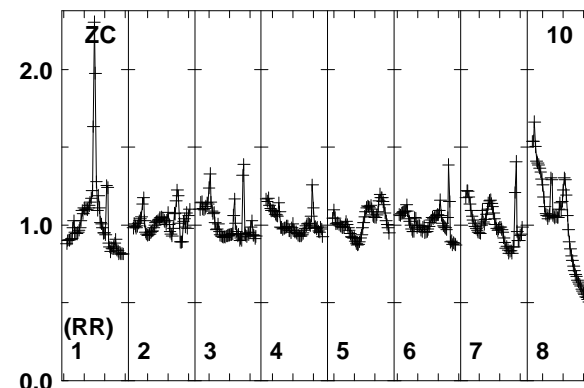
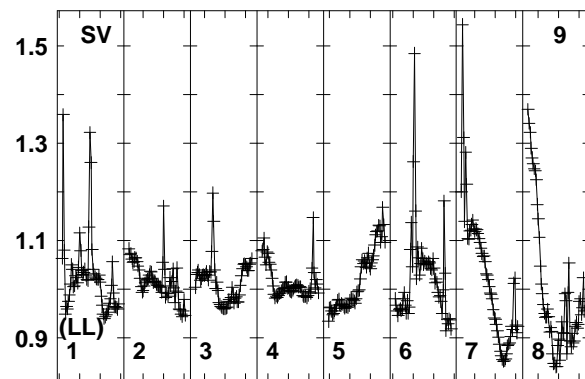
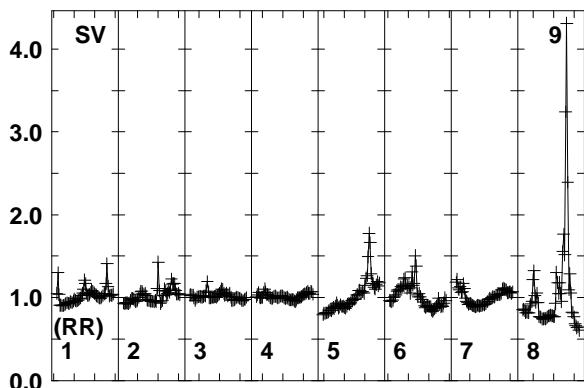
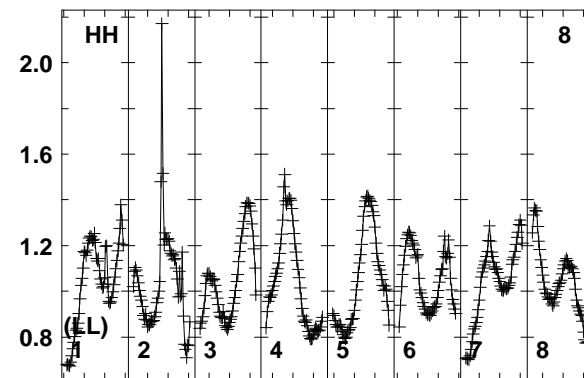
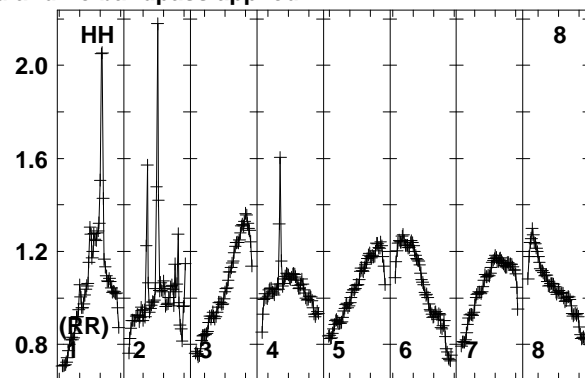
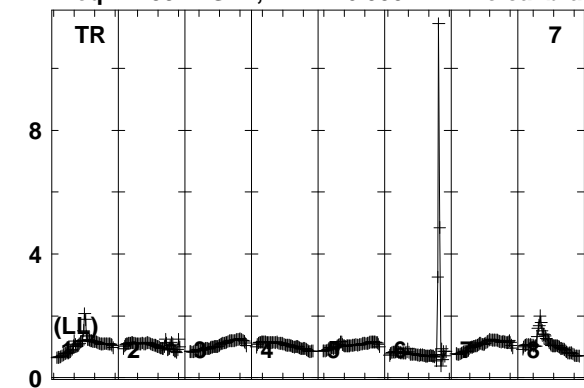

Lower frame: Real Jy
Total-power spectrum Antenna: TR (07)
Timerange: 00/07:45:16 to 00/07:47:44

Plot file version 537 created 04-NOV-2019 14:14:44

W2246-0526 EY034.UVDATA.1

Freq = 1.5947 GHz, Bw = 16.000 MH No calibration applied and no bandpass applied

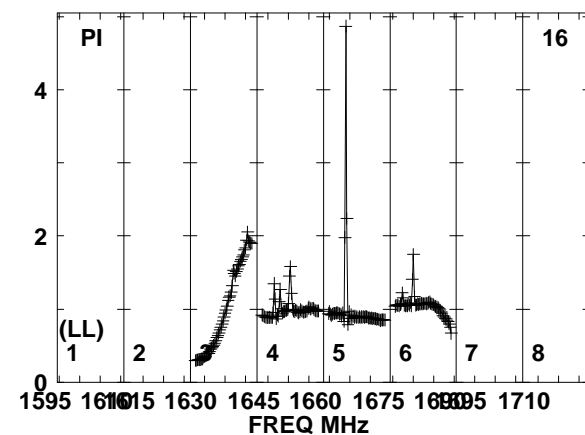
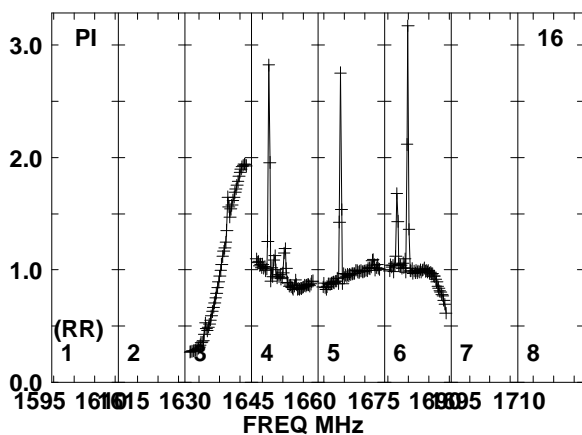
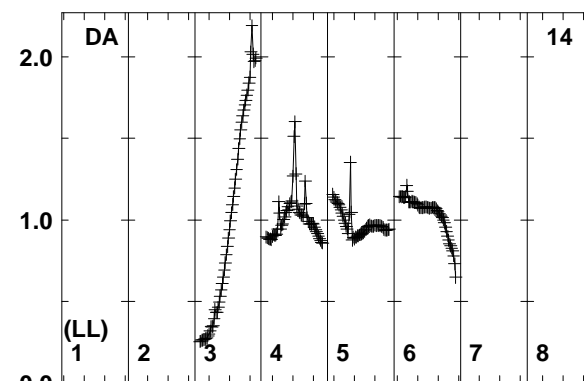
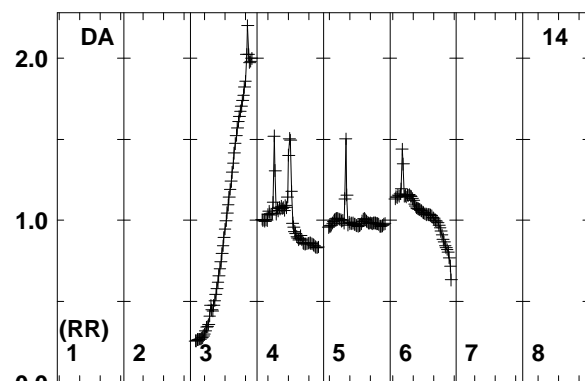
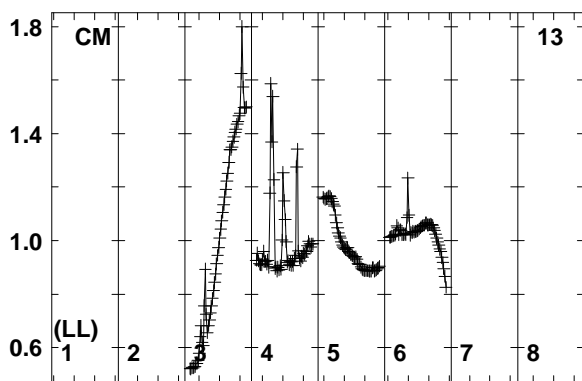
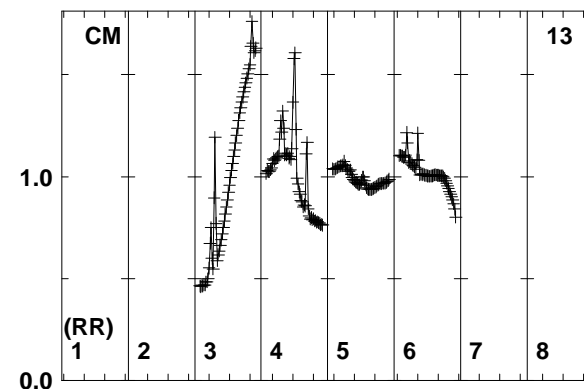
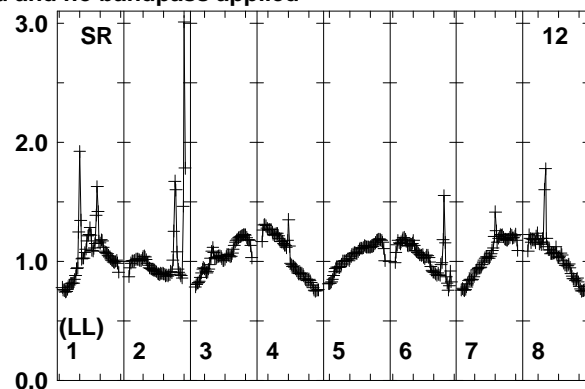
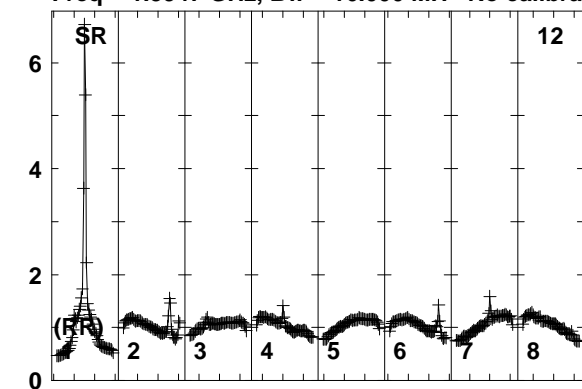

Lower frame: Real Jy
Total-power spectrum Antenna: SR (12)
Timerange: 00/07:45:16 to 00/07:47:44

Plot file version 538 created 04-NOV-2019 14:14:44

J2248-0541 EY034.UVDATA.1

Freq = 1.5947 GHz, Bw = 16.000 MH No calibration applied and no bandpass applied

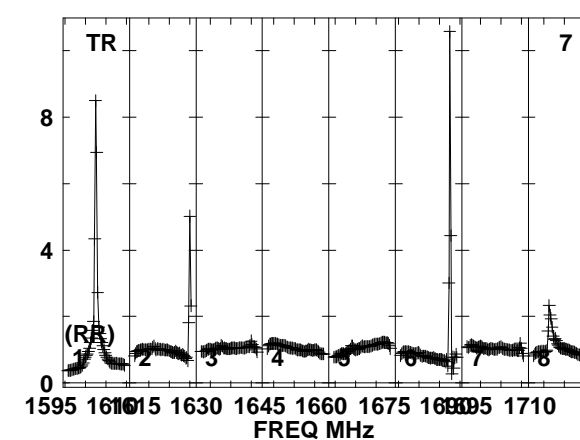
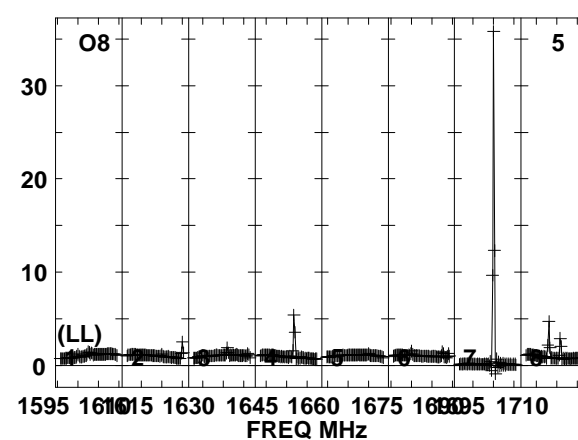
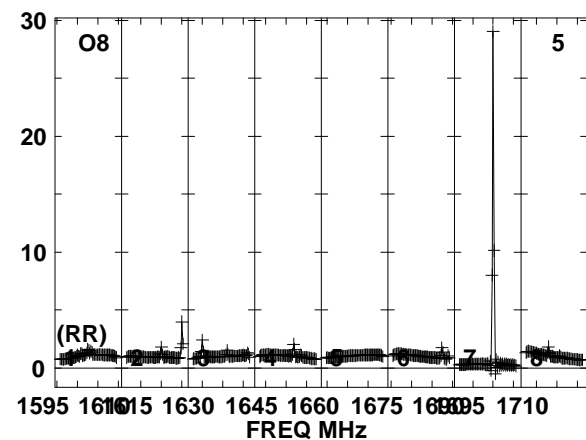
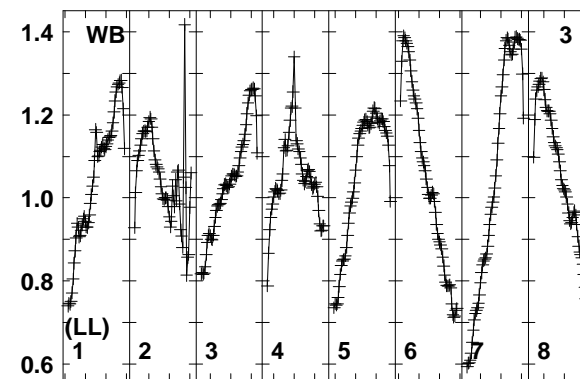
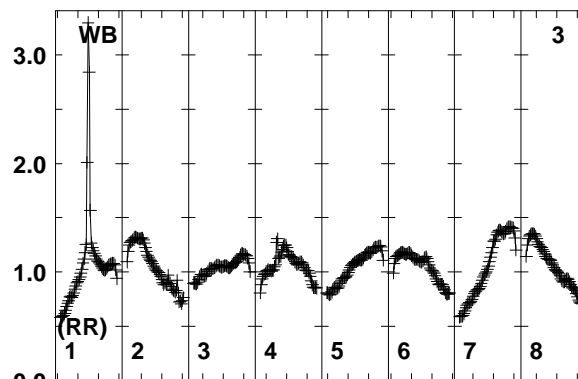
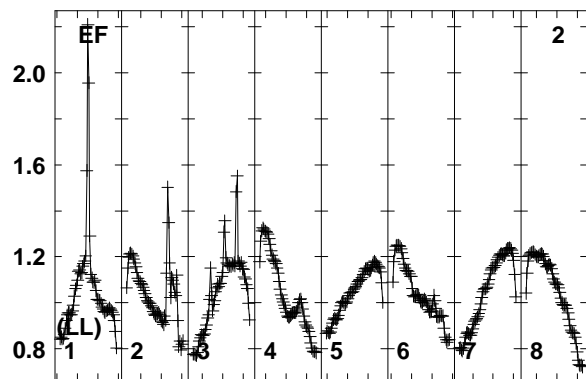
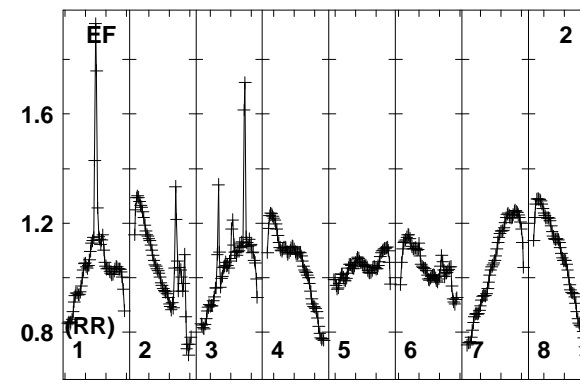
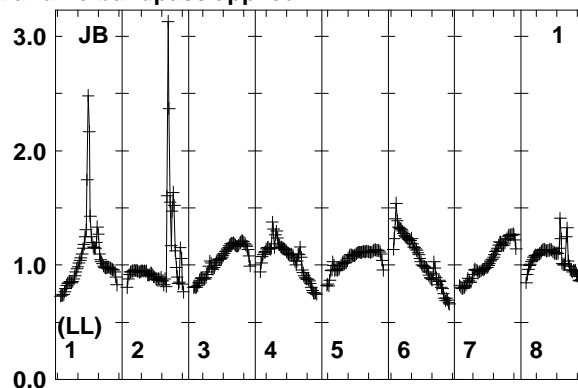
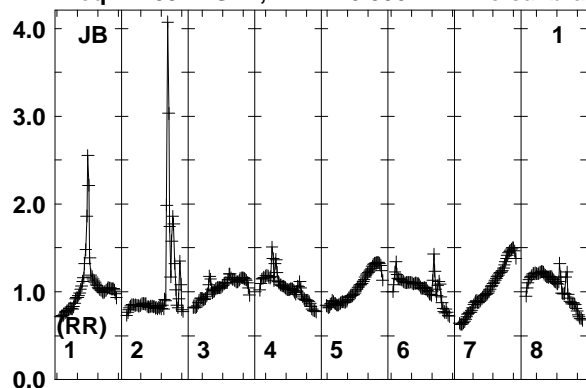

Lower frame: Real Jy
Total-power spectrum Antenna: JB (01)
Timerange: 00/07:48:01 to 00/07:48:59

Plot file version 539 created 04-NOV-2019 14:14:44

J2248-0541 EY034.UVDATA.1

Freq = 1.5947 GHz, Bw = 16.000 MH No calibration applied and no bandpass applied

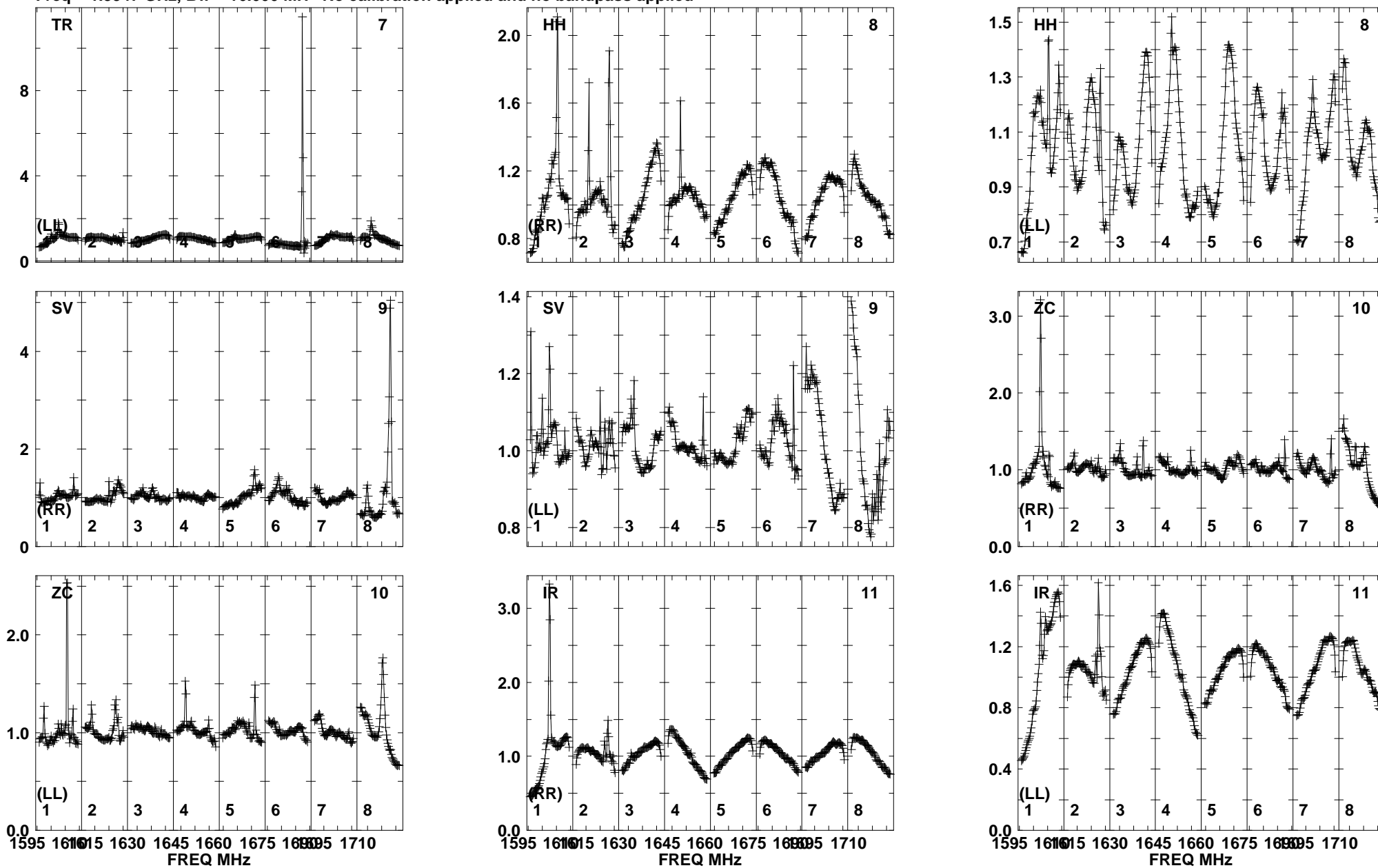

Lower frame: Real Jy
Total-power spectrum Antenna: TR (07)
Timerange: 00/07:48:01 to 00/07:48:59

Plot file version 540 created 04-NOV-2019 14:14:44

J2248-0541 EY034.UVDATA.1

Freq = 1.5947 GHz, Bw = 16.000 MH No calibration applied and no bandpass applied

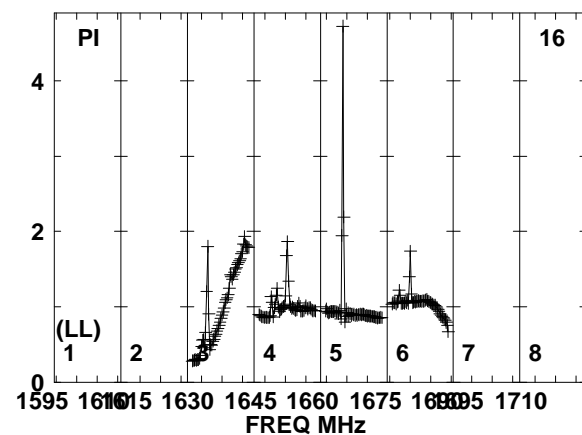
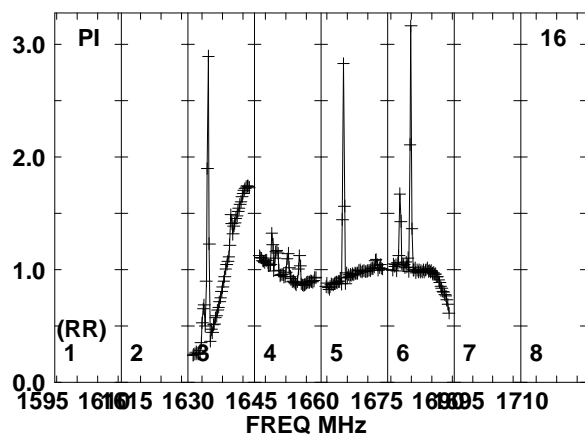
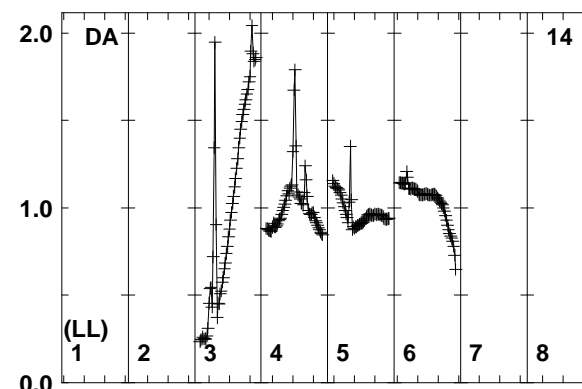
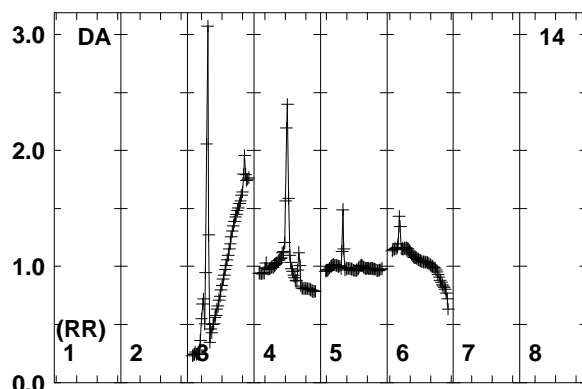
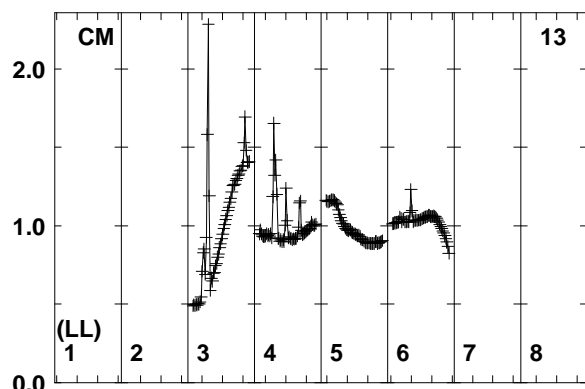
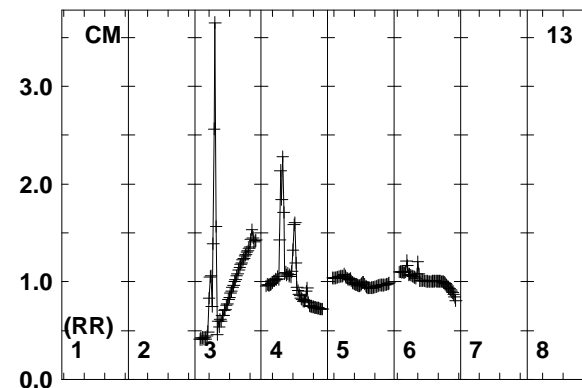
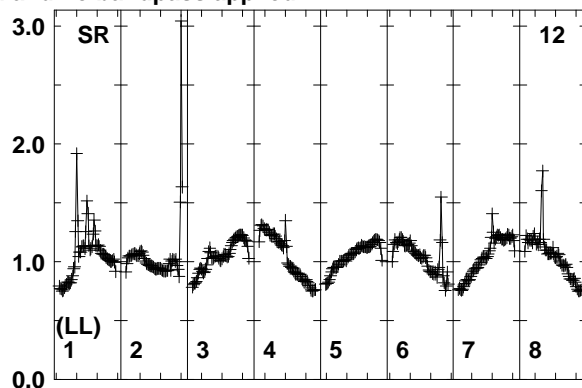
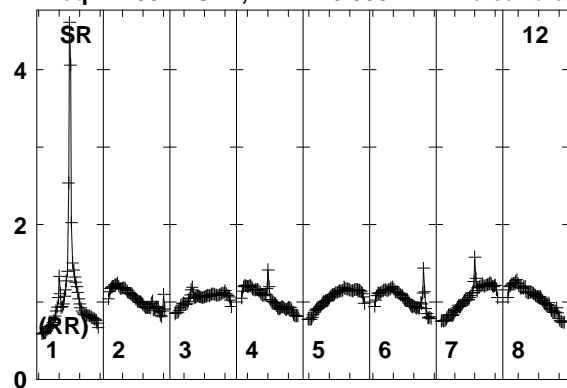

Lower frame: Real Jy
Total-power spectrum Antenna: SR (12)
Timerange: 00/07:48:01 to 00/07:48:59

Plot file version 541 created 04-NOV-2019 14:14:44

W2246-0526 EY034.UVDATA.1

Freq = 1.5947 GHz, Bw = 16.000 MH No calibration applied and no bandpass applied

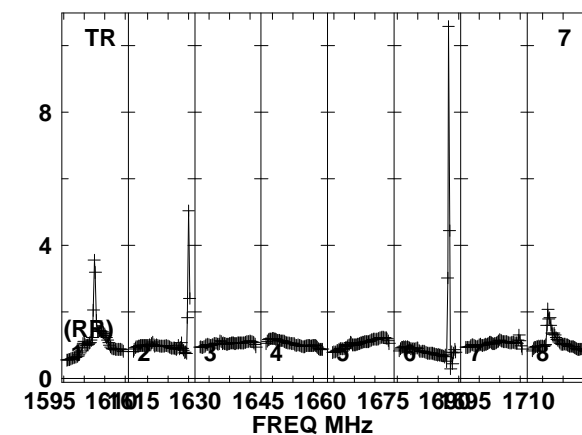
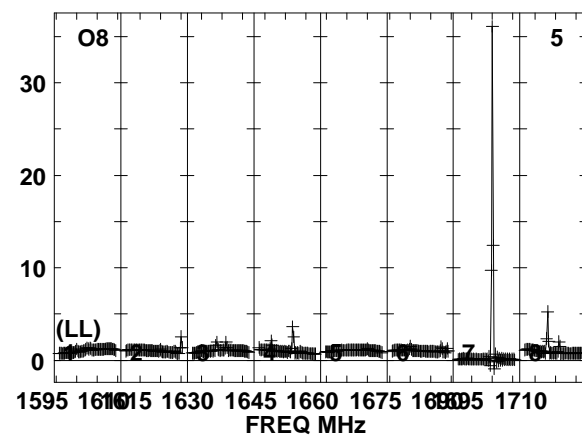
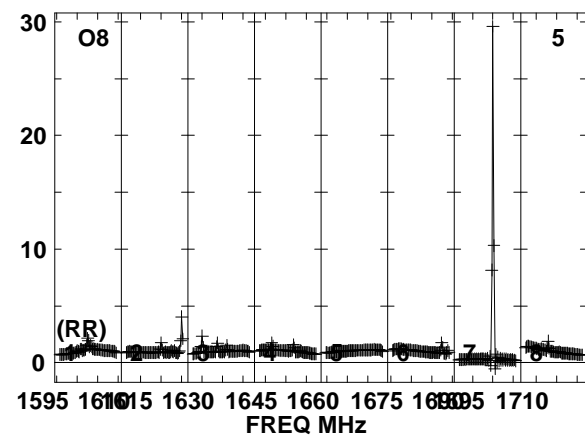
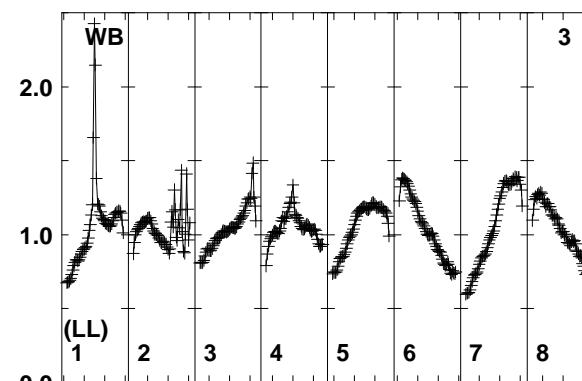
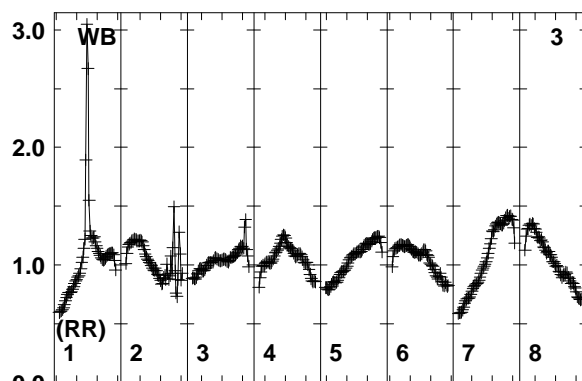
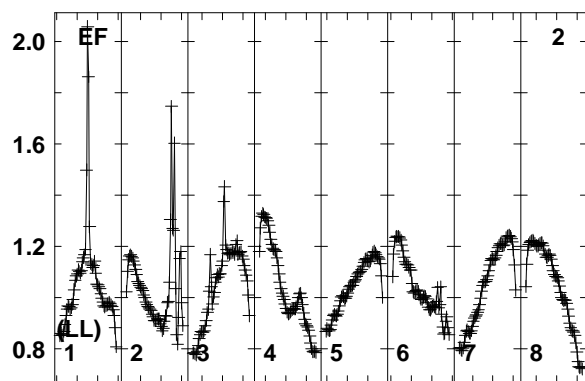
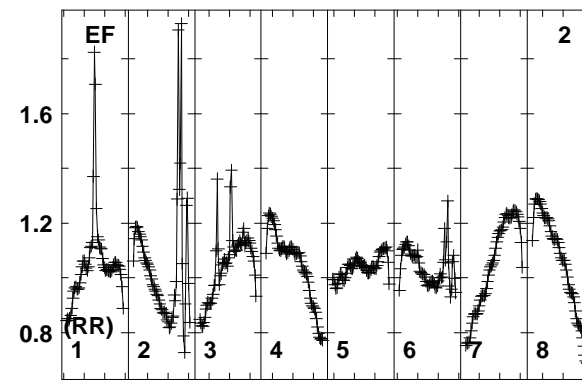
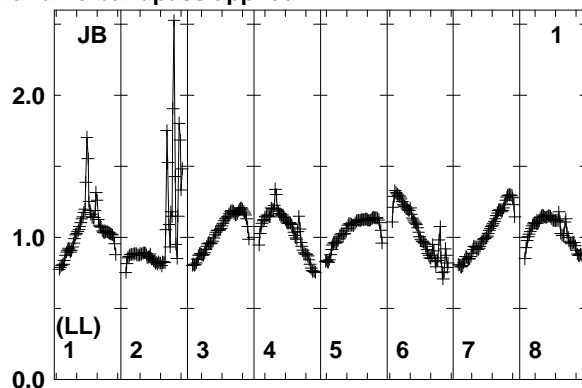
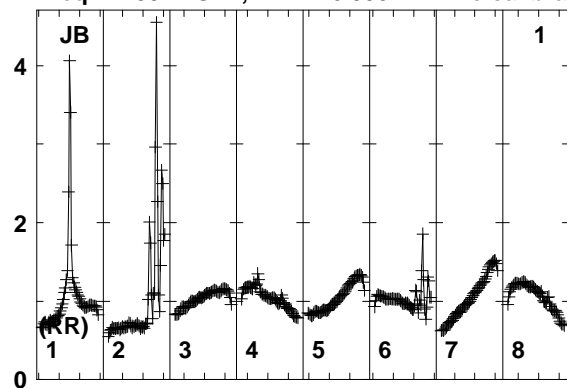

Lower frame: Real Jy
Total-power spectrum Antenna: JB (01)
Timerange: 00/07:49:01 to 00/07:51:39

Plot file version 542 created 04-NOV-2019 14:14:45

W2246-0526 EY034.UVDATA.1

Freq = 1.5947 GHz, Bw = 16.000 MH No calibration applied and no bandpass applied

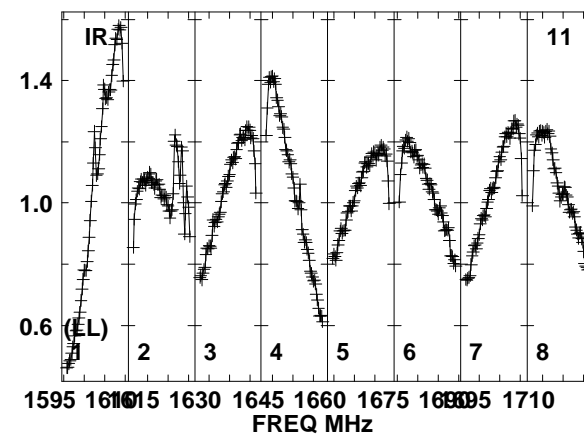
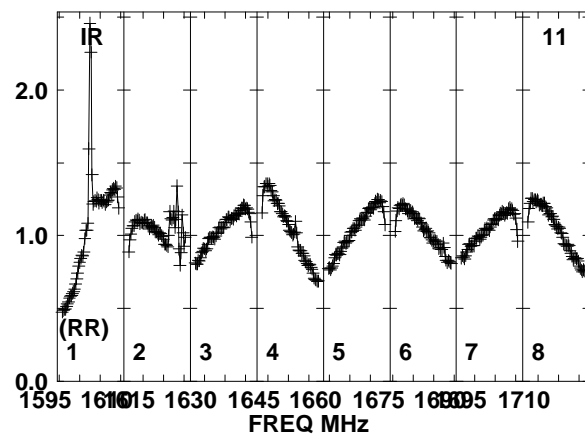
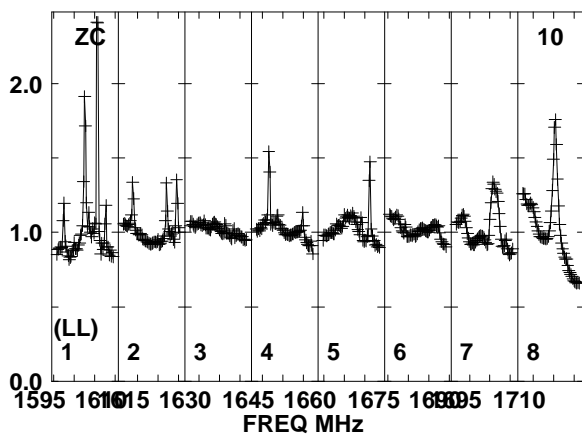
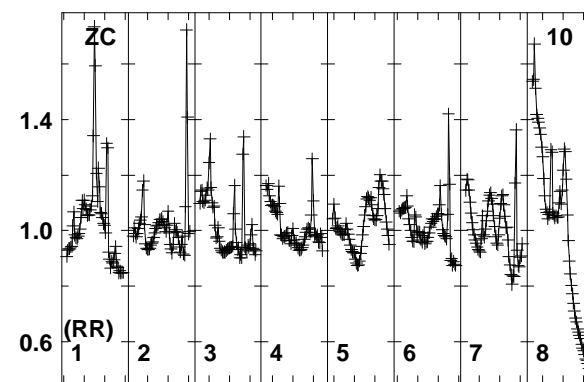
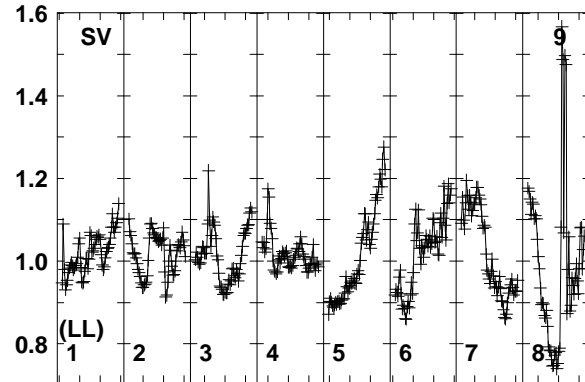
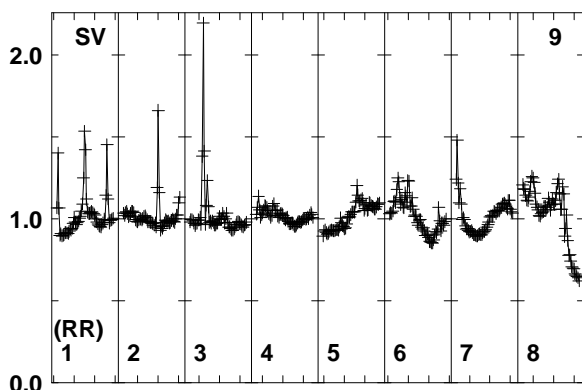
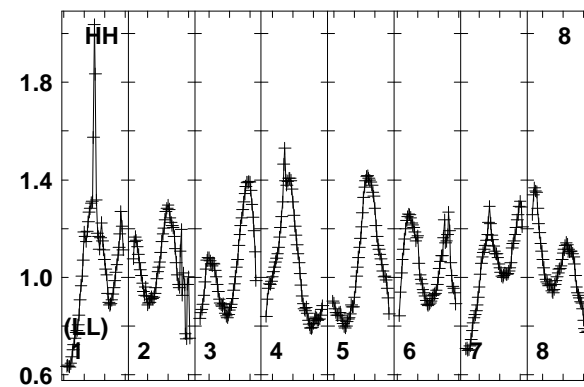
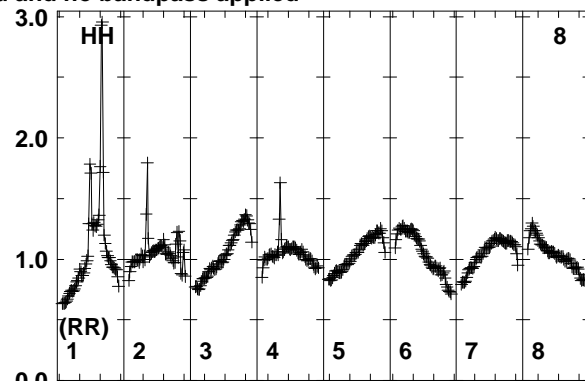
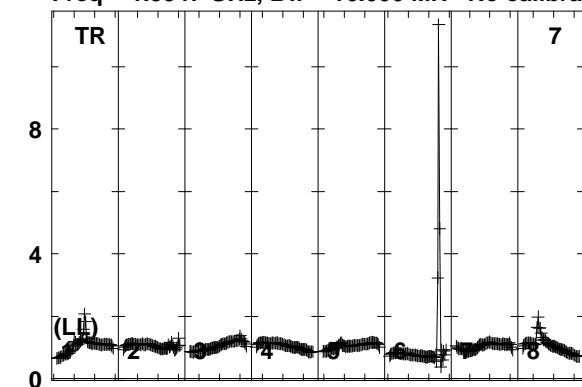

Lower frame: Real Jy
Total-power spectrum Antenna: TR (07)
Timerange: 00/07:49:01 to 00/07:51:39

Plot file version 543 created 04-NOV-2019 14:14:45

W2246-0526 EY034.UVDATA.1

Freq = 1.5947 GHz, Bw = 16.000 MH No calibration applied and no bandpass applied

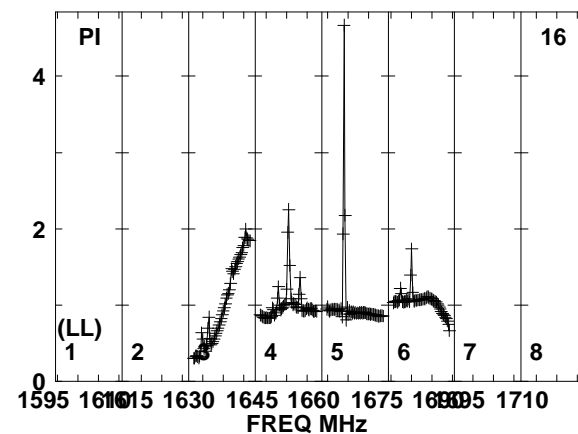
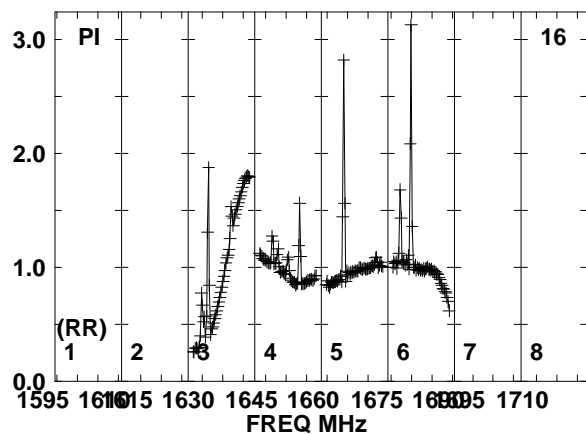
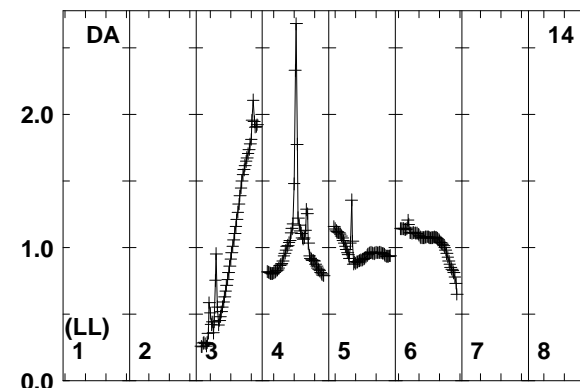
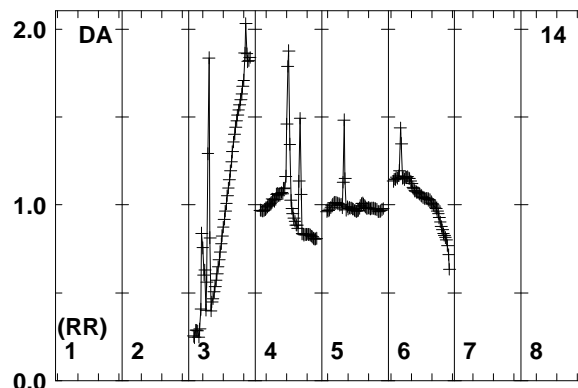
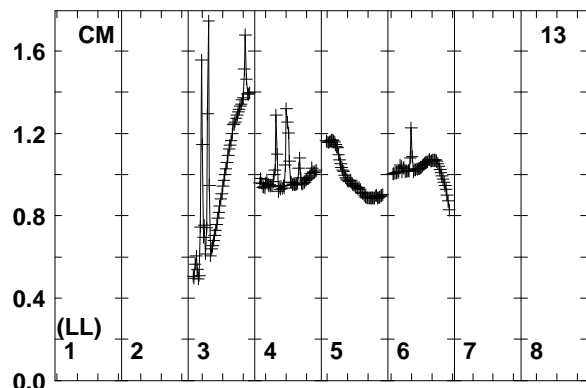
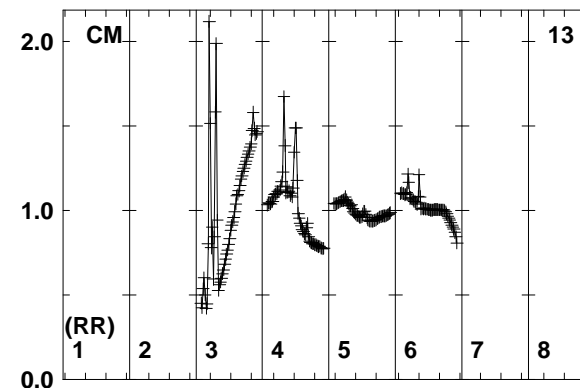
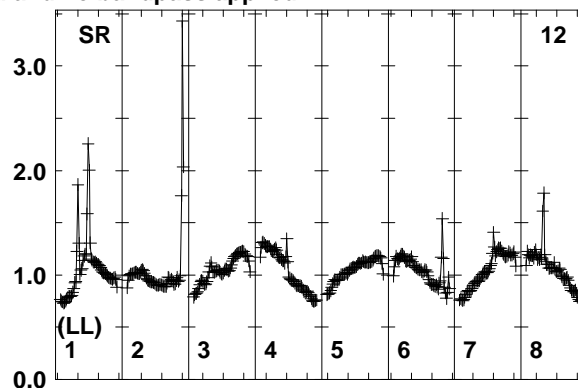
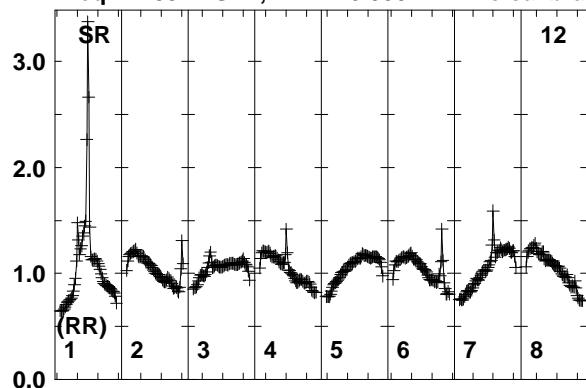

Lower frame: Real Jy
Total-power spectrum Antenna: SR (12)
Timerange: 00/07:49:01 to 00/07:51:39

Plot file version 544 created 04-NOV-2019 14:14:45

J2248-0541 EY034.UVDATA.1

Freq = 1.5947 GHz, Bw = 16.000 MH No calibration applied and no bandpass applied

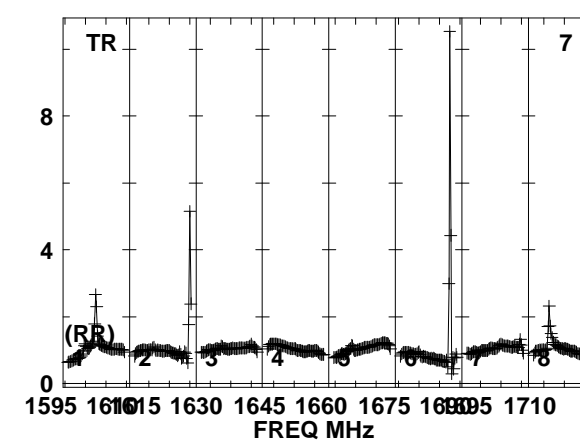
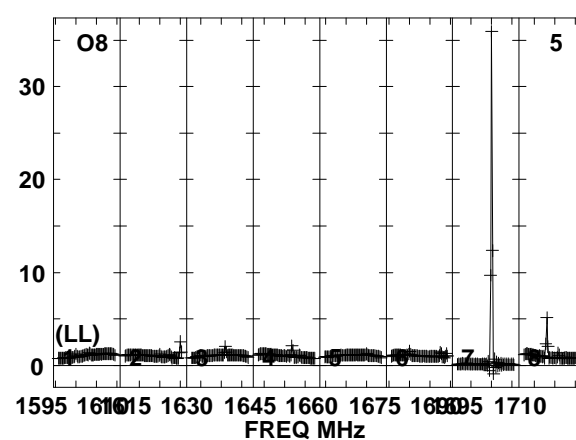
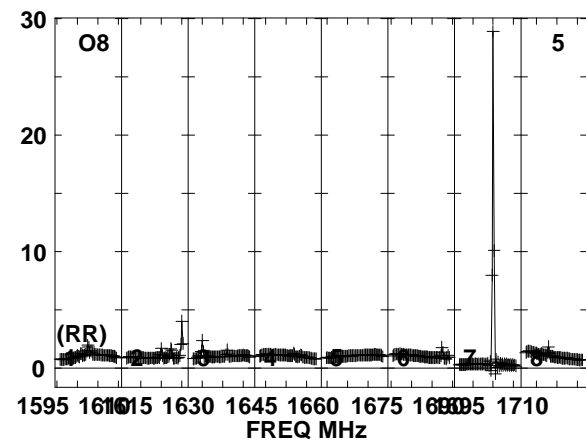
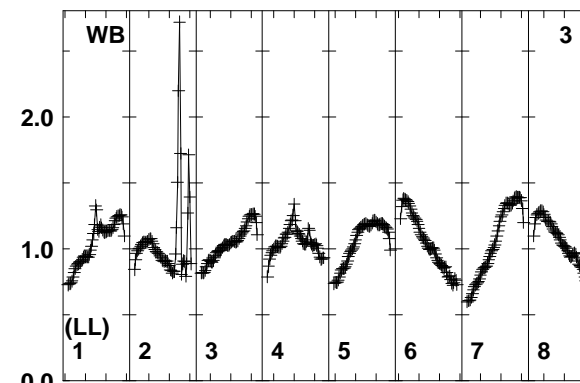
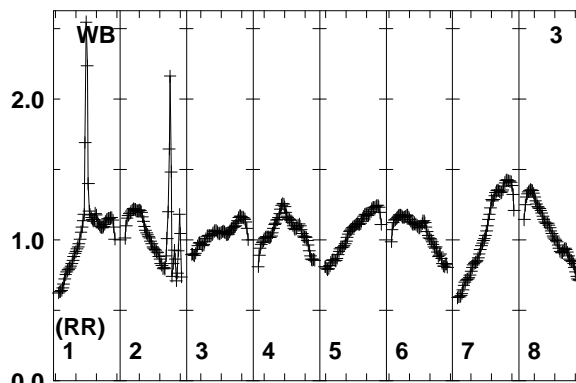
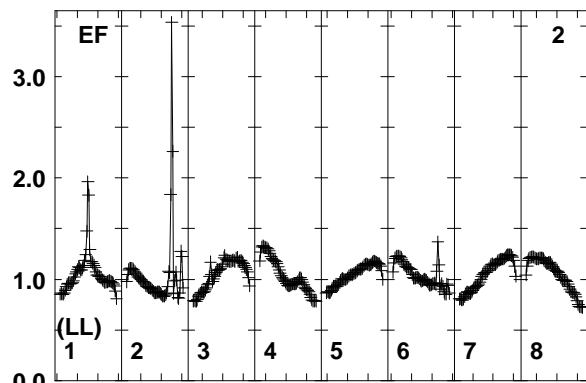
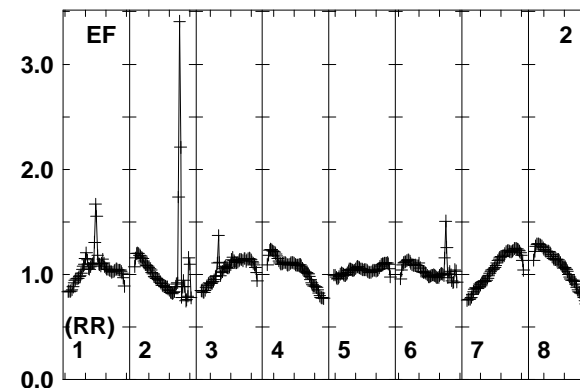
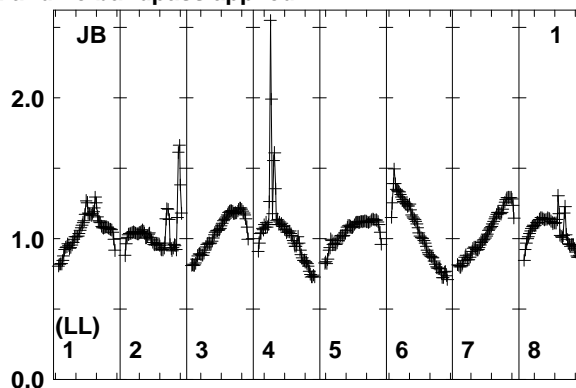
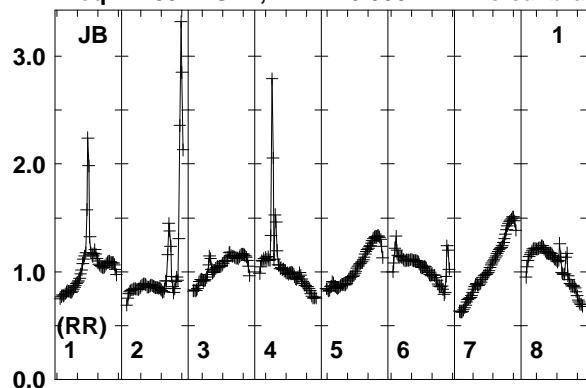

Lower frame: Real Jy
Total-power spectrum Antenna: JB (01)
Timerange: 00/07:51:56 to 00/07:52:54

Plot file version 545 created 04-NOV-2019 14:14:45

J2248-0541 EY034.UVDATA.1

Freq = 1.5947 GHz, Bw = 16.000 MH No calibration applied and no bandpass applied

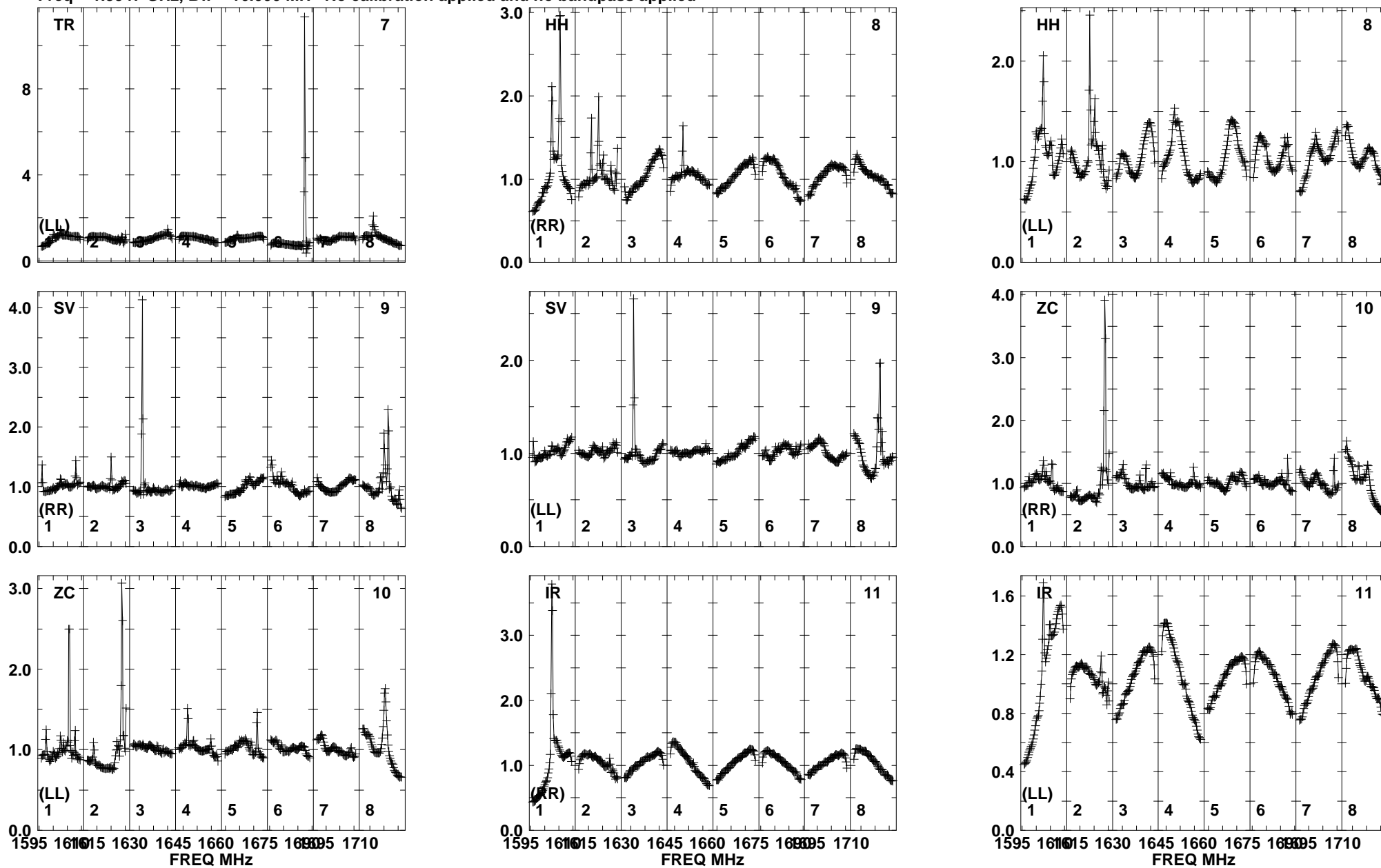

Lower frame: Real Jy
Total-power spectrum Antenna: TR (07)
Timerange: 00/07:51:56 to 00/07:52:54

Plot file version 546 created 04-NOV-2019 14:14:45

J2248-0541 EY034.UVDATA.1

Freq = 1.5947 GHz, Bw = 16.000 MH No calibration applied and no bandpass applied

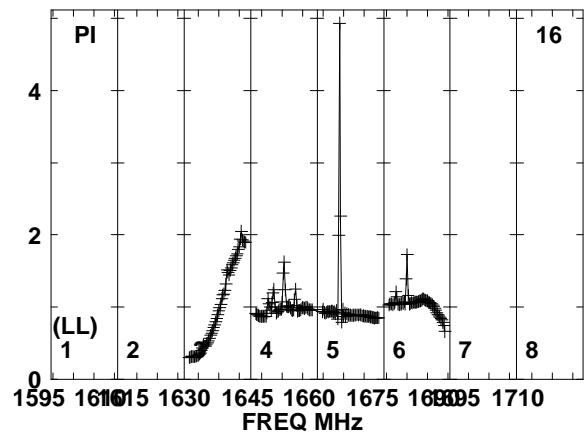
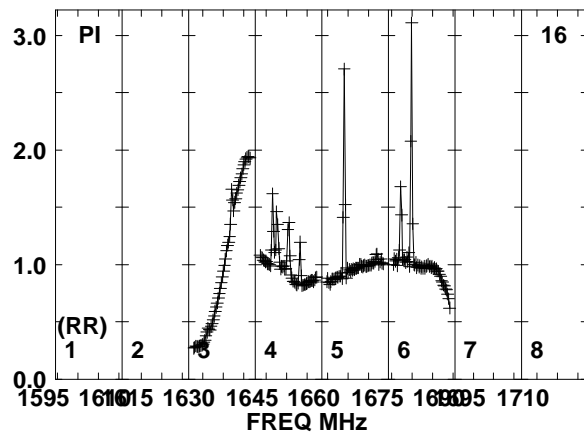
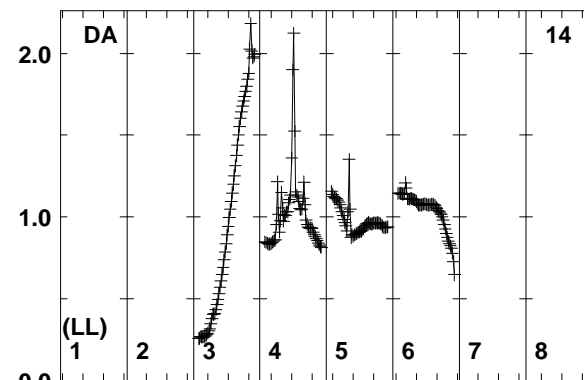
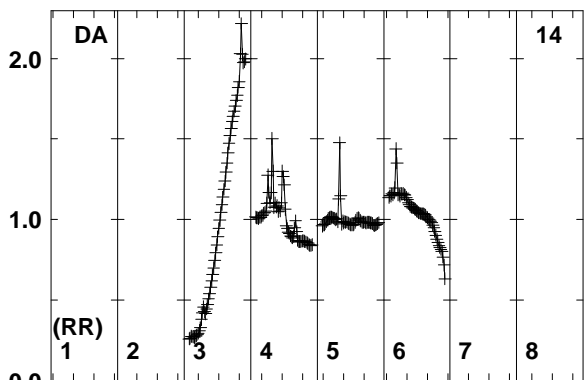
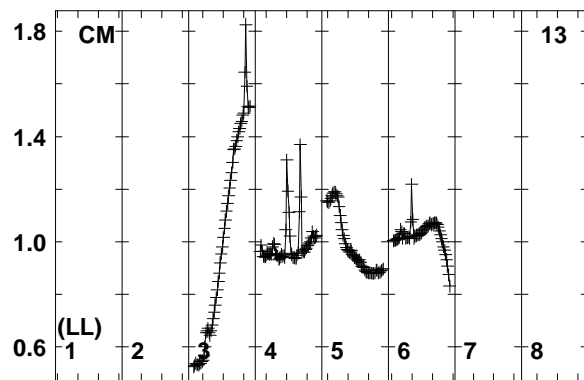
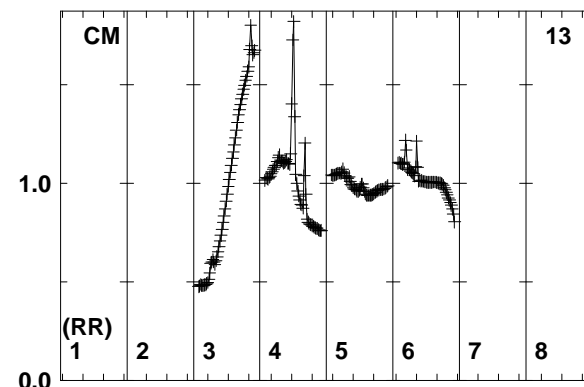
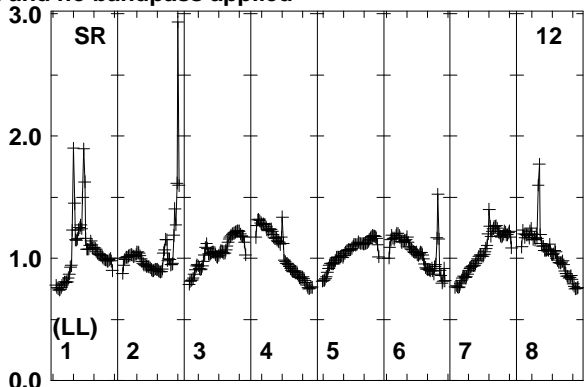
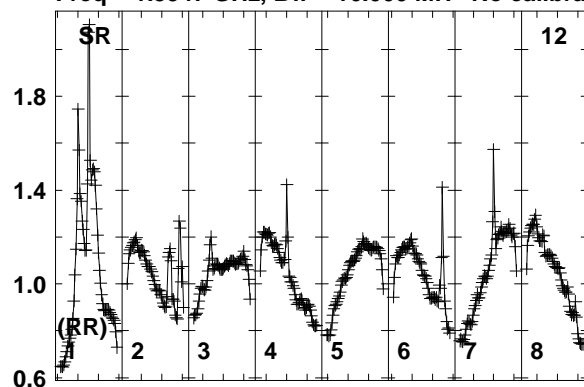

Lower frame: Real Jy
Total-power spectrum Antenna: SR (12)
Timerange: 00/07:51:56 to 00/07:52:54

Plot file version 547 created 04-NOV-2019 14:14:45

W2246-0526 EY034.UVDATA.1

Freq = 1.5947 GHz, Bw = 16.000 MH No calibration applied and no bandpass applied

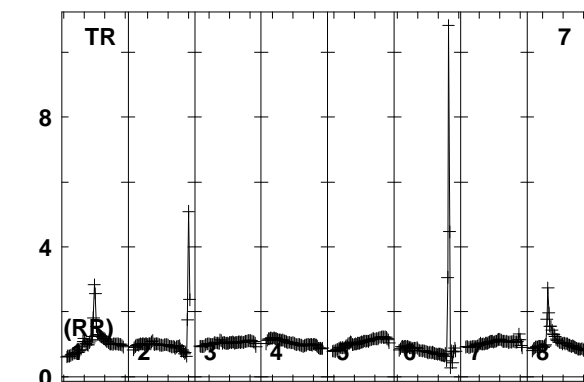
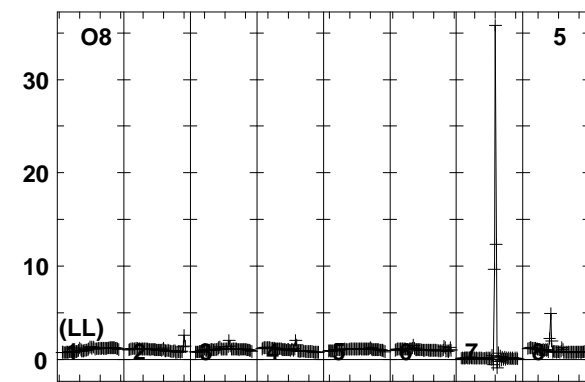
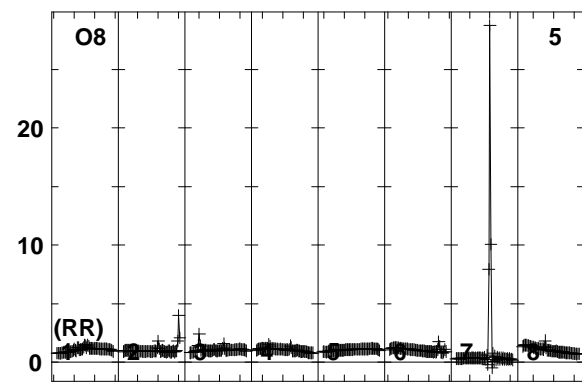
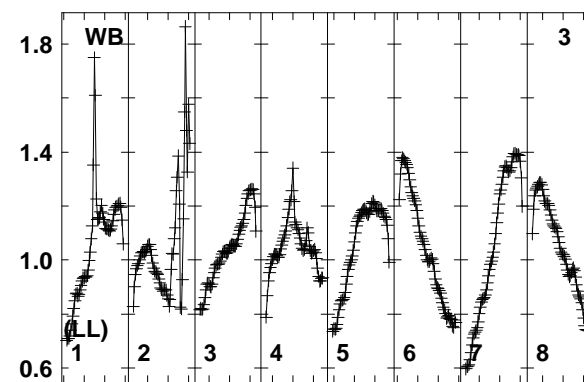
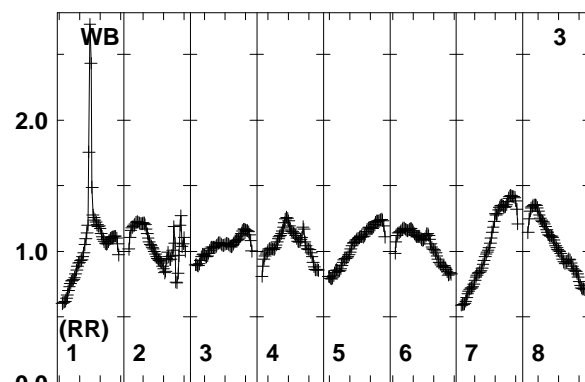
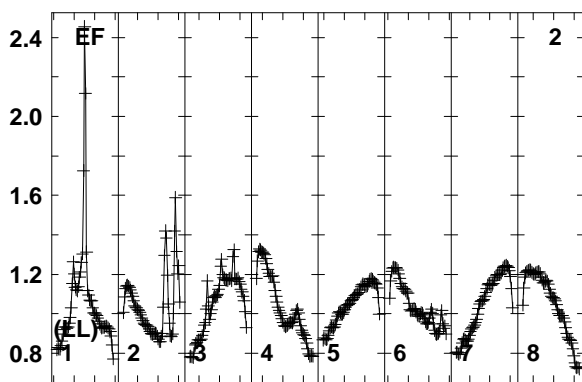
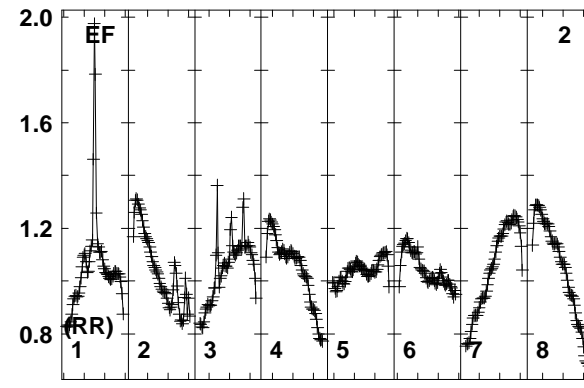
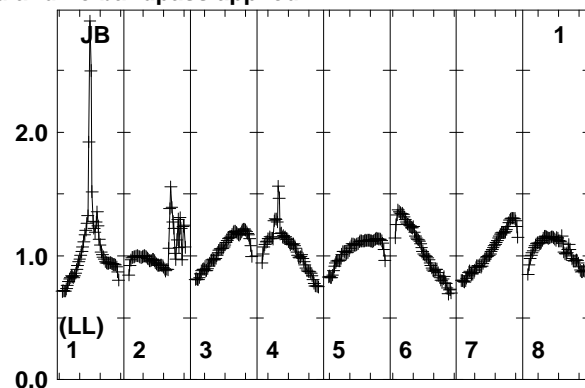
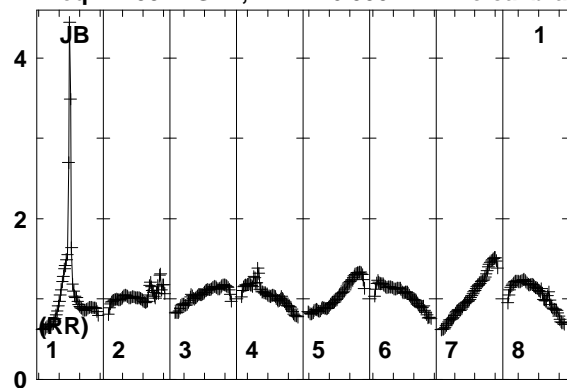

1595 1610 1630 1645 1660 1675 1690 1710
FREQ MHz

1595 1610 1630 1645 1660 1675 1690 1710
FREQ MHz

1595 1610 1630 1645 1660 1675 1690 1710
FREQ MHz

Lower frame: Real Jy
Total-power spectrum Antenna: JB (01)
Timerange: 00/07:52:56 to 00/07:55:34

Plot file version 548 created 04-NOV-2019 14:14:45

W2246-0526 EY034.UVDATA.1

Freq = 1.5947 GHz, Bw = 16.000 MH No calibration applied and no bandpass applied

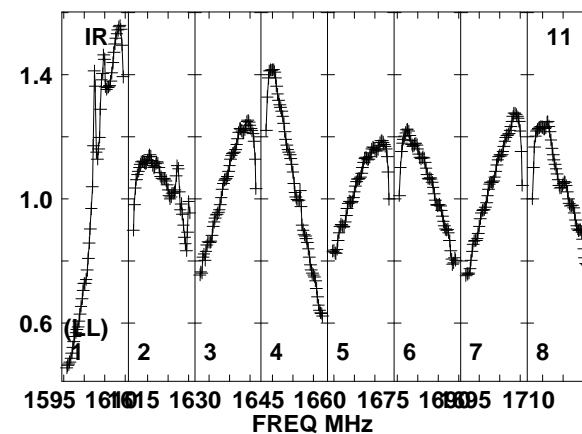
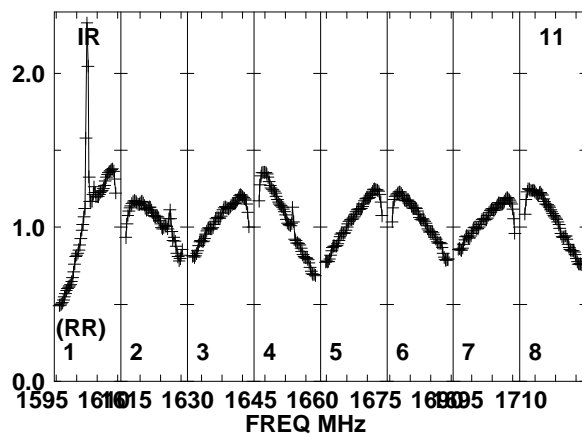
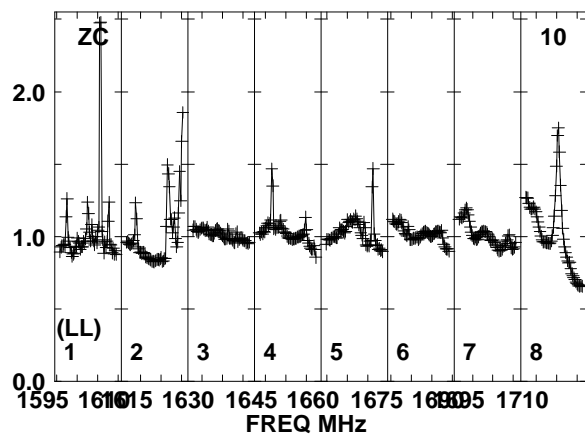
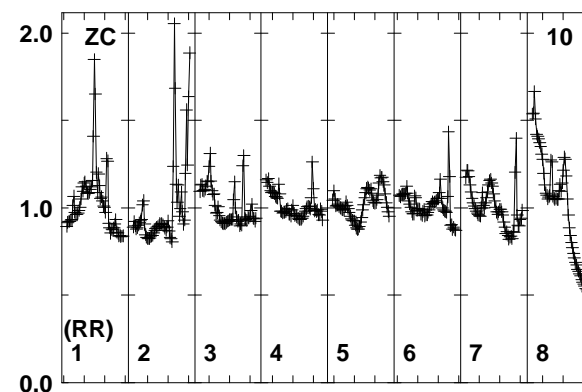
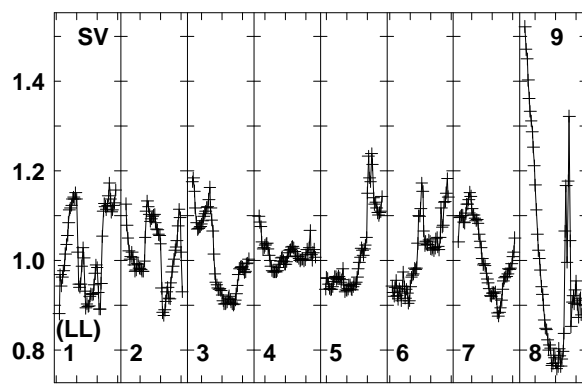
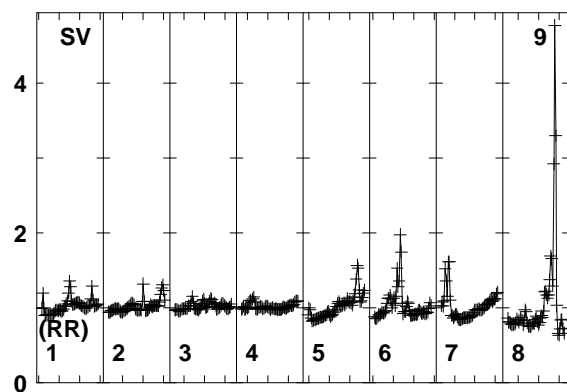
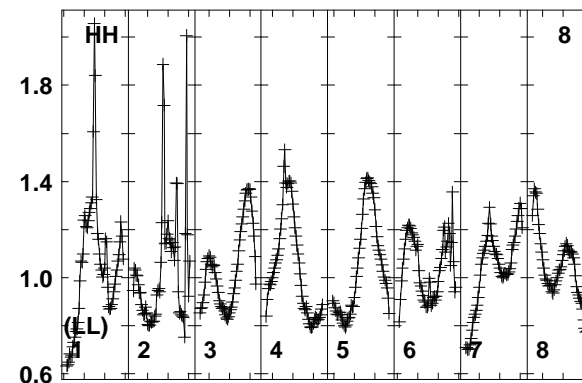
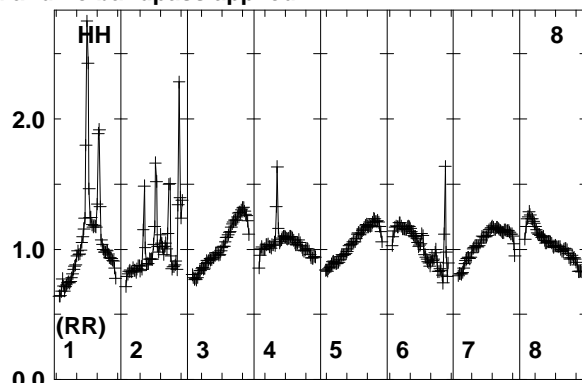
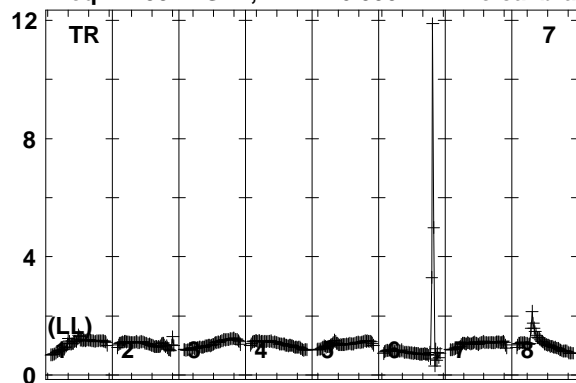

Lower frame: Real Jy
Total-power spectrum Antenna: TR (07)
Timerange: 00/07:52:56 to 00/07:55:34

Plot file version 549 created 04-NOV-2019 14:14:45

W2246-0526 EY034.UVDATA.1

Freq = 1.5947 GHz, Bw = 16.000 MH No calibration applied and no bandpass applied

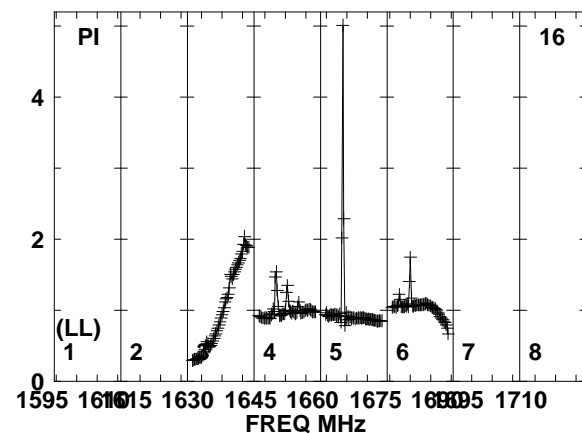
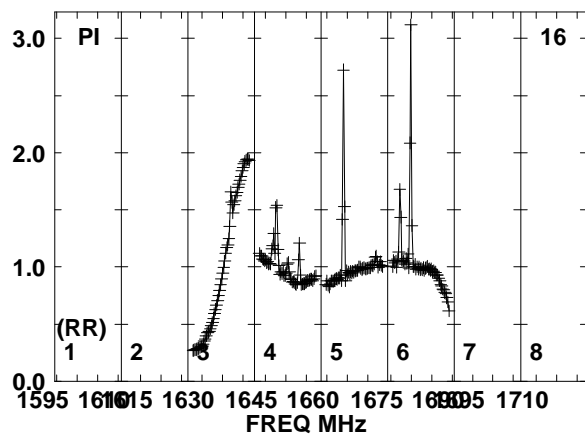
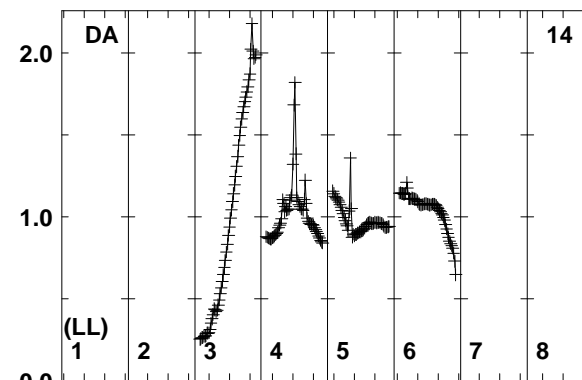
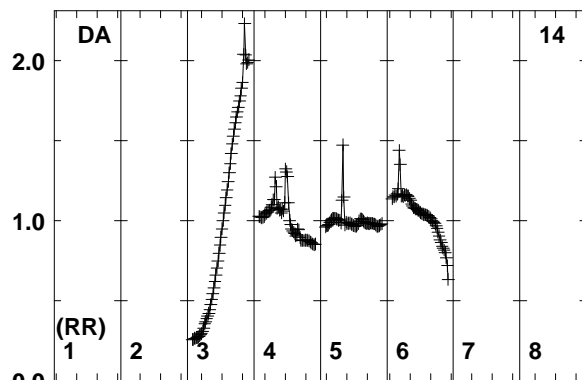
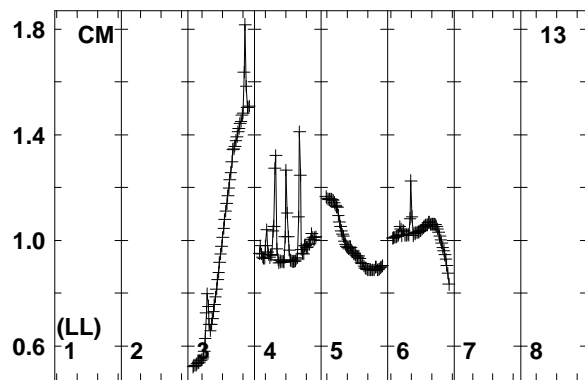
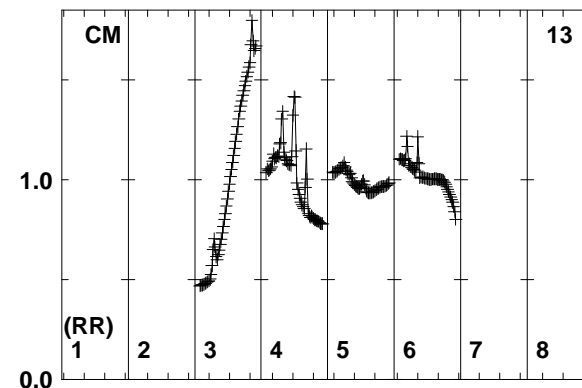
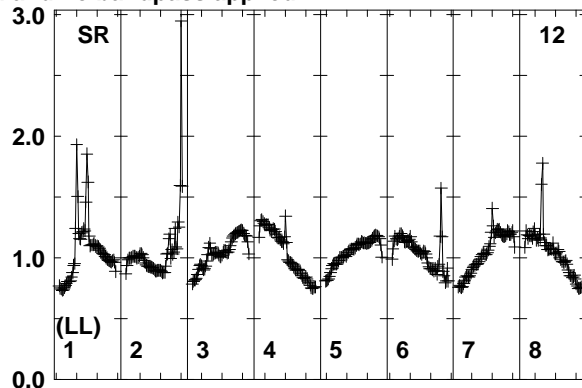
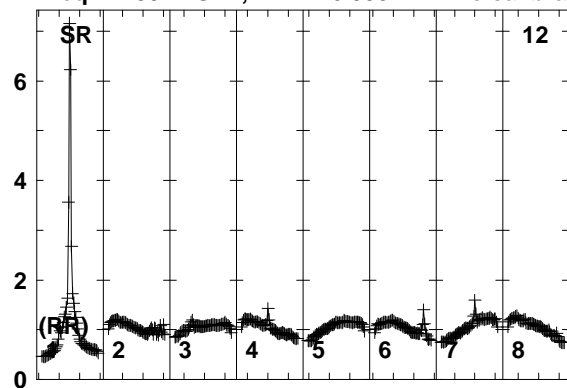

Lower frame: Real Jy
Total-power spectrum Antenna: SR (12)
Timerange: 00/07:52:56 to 00/07:55:34

Plot file version 550 created 04-NOV-2019 14:14:45

J2248-0541 EY034.UVDATA.1

Freq = 1.5947 GHz, Bw = 16.000 MH No calibration applied and no bandpass applied

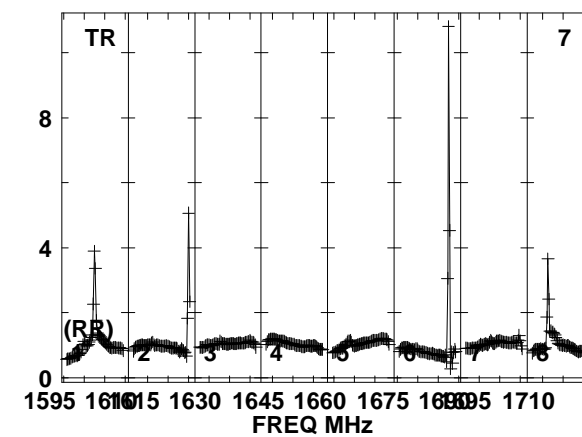
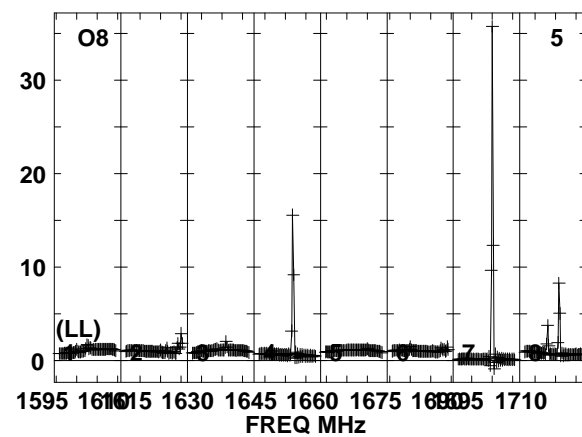
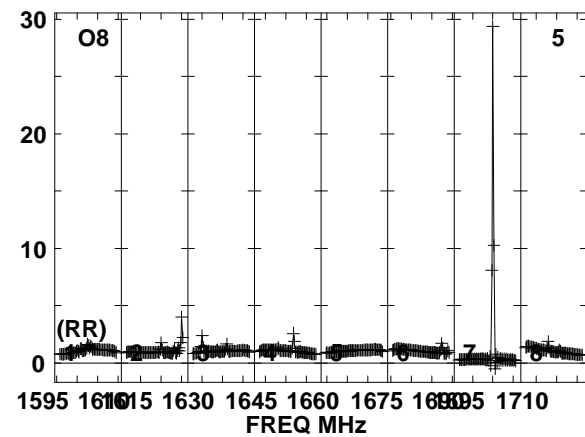
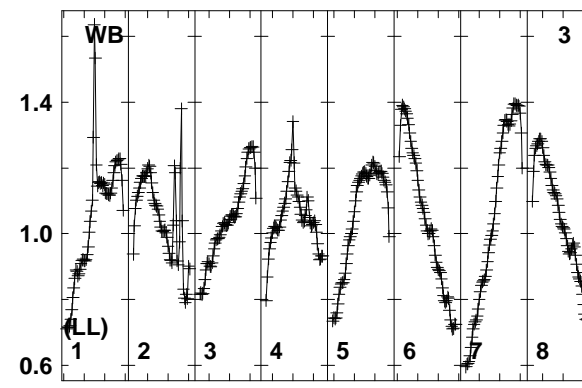
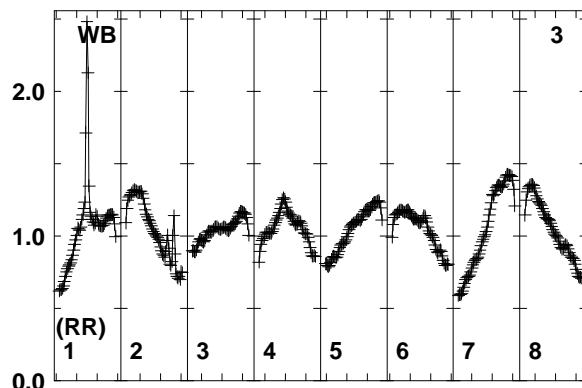
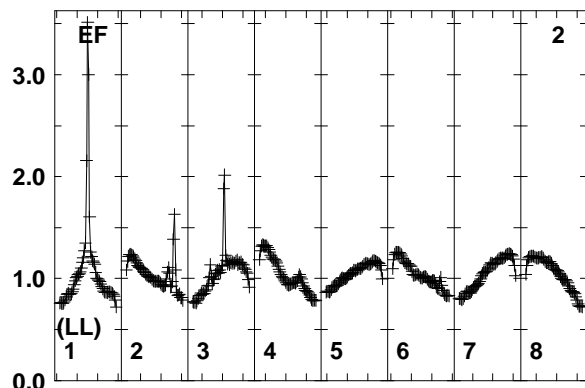
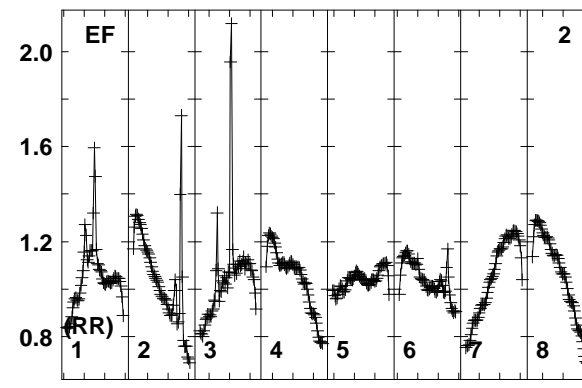
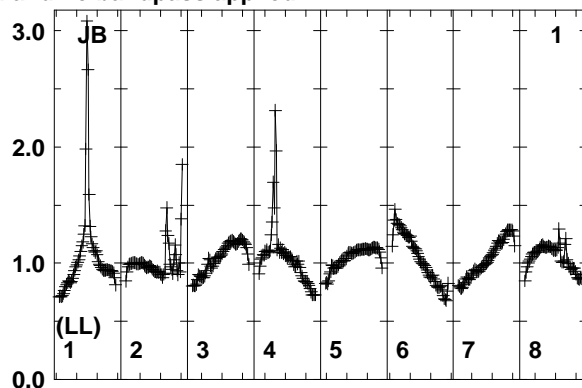
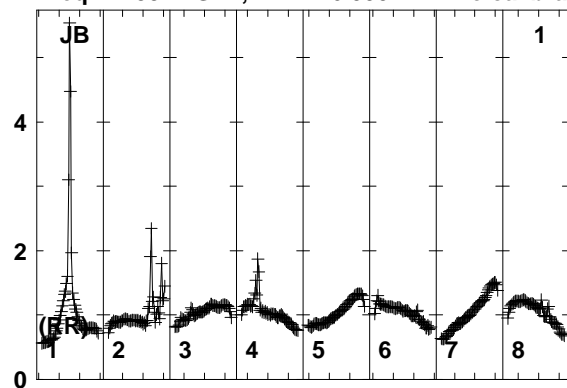

Lower frame: Real Jy
Total-power spectrum Antenna: JB (01)
Timerange: 00/07:55:51 to 00/07:56:49

Plot file version 551 created 04-NOV-2019 14:14:45

J2248-0541 EY034.UVDATA.1

Freq = 1.5947 GHz, Bw = 16.000 MH No calibration applied and no bandpass applied

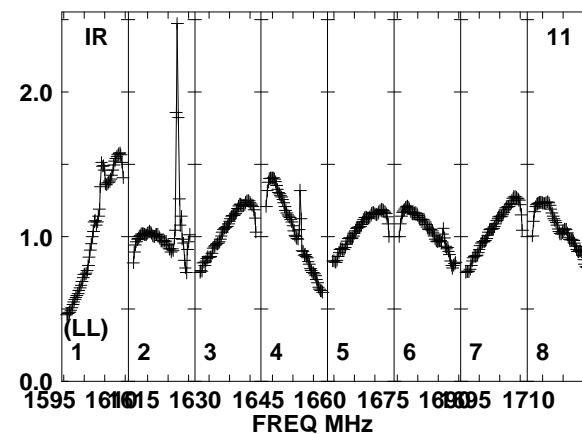
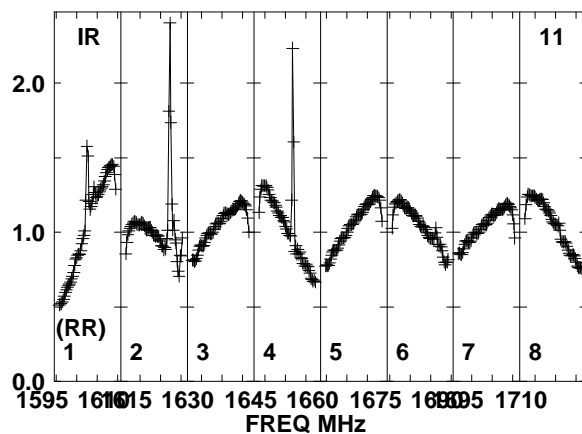
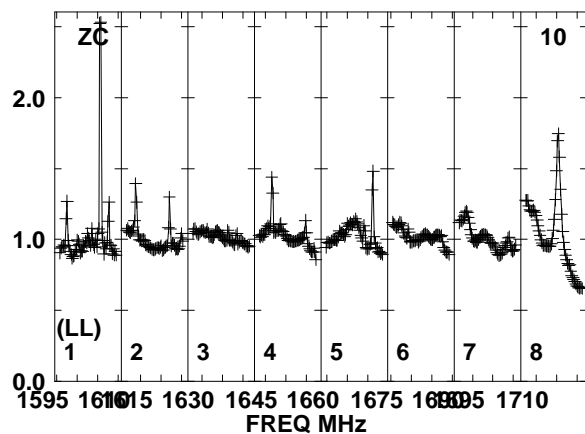
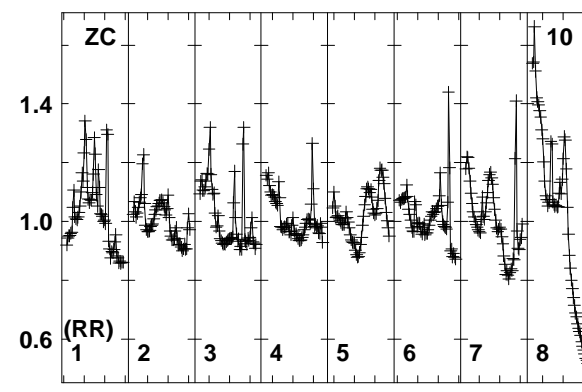
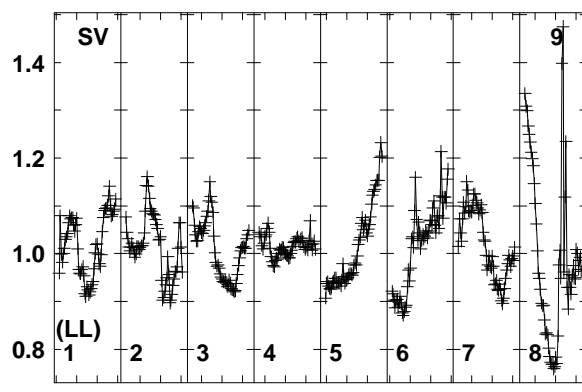
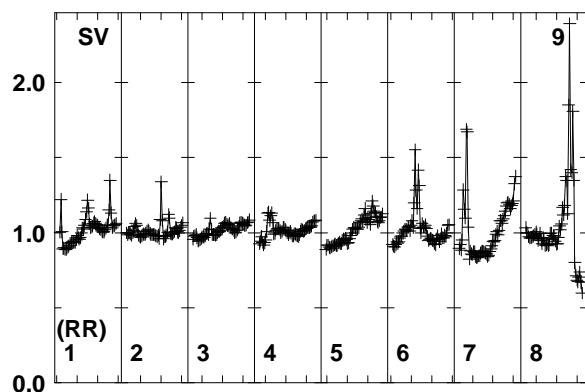
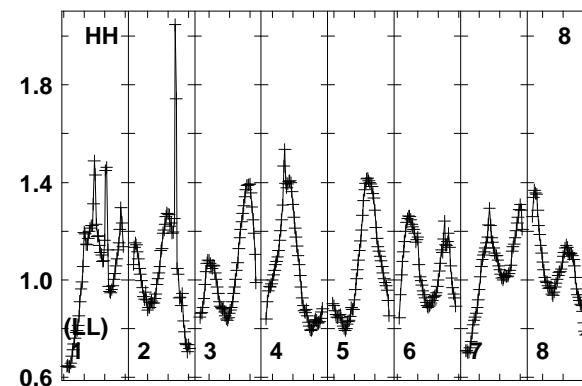
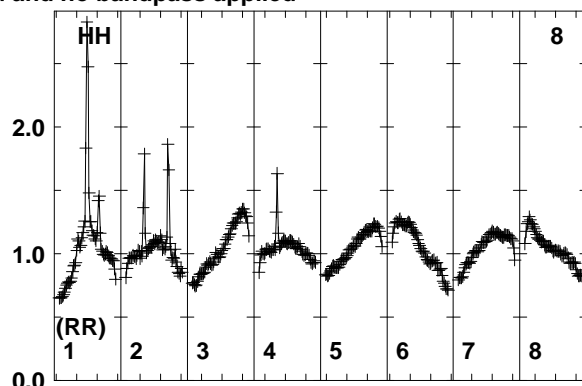
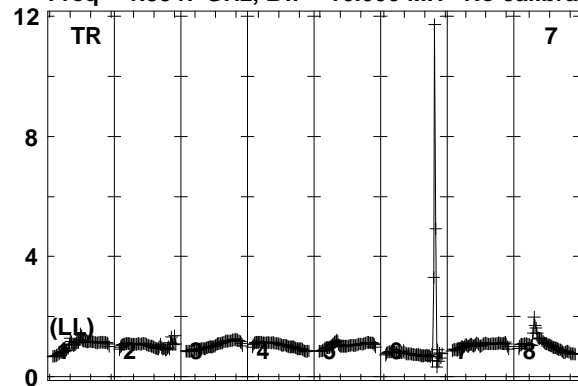

Lower frame: Real Jy
Total-power spectrum Antenna: TR (07)
Timerange: 00/07:55:51 to 00/07:56:49

Plot file version 552 created 04-NOV-2019 14:14:45

J2248-0541 EY034.UVDATA.1

Freq = 1.5947 GHz, Bw = 16.000 MH No calibration applied and no bandpass applied

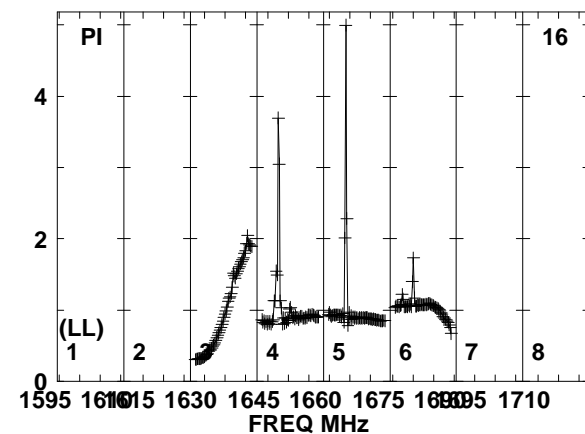
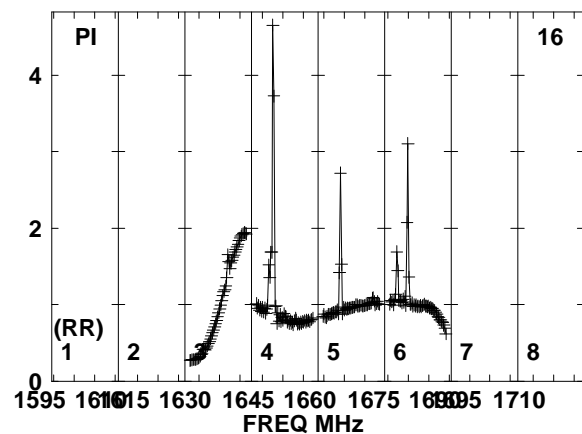
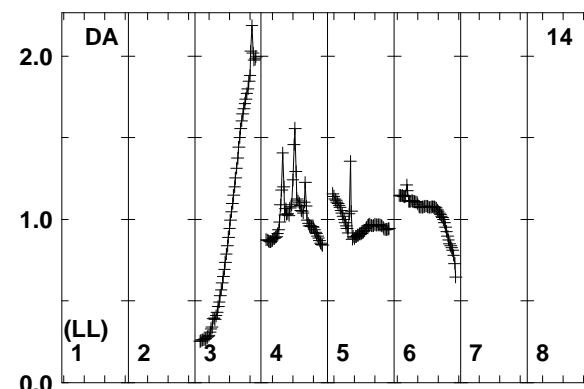
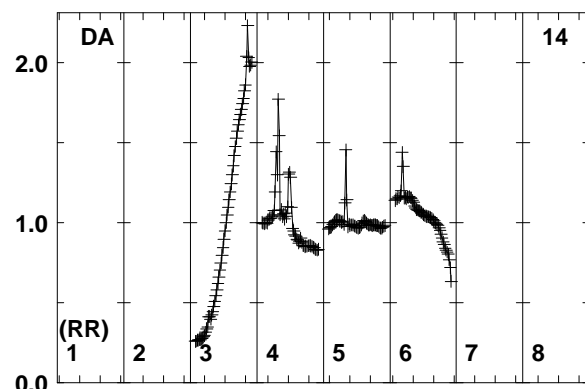
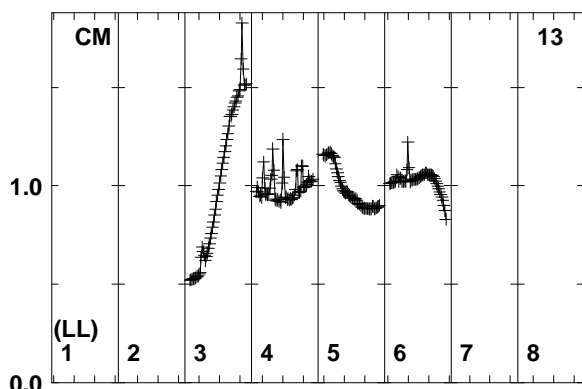
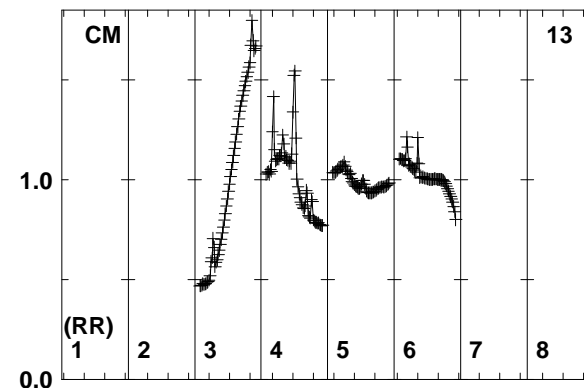
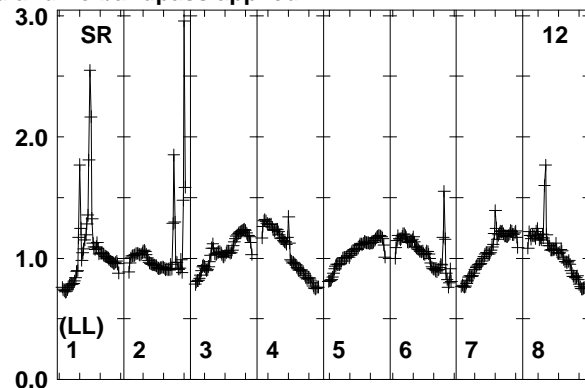
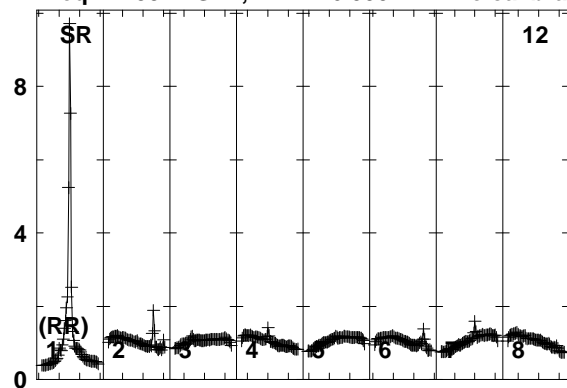

Lower frame: Real Jy
Total-power spectrum Antenna: SR (12)
Timerange: 00/07:55:51 to 00/07:56:49

Plot file version 553 created 04-NOV-2019 14:14:46

W2246-0526 EY034.UVDATA.1

Freq = 1.5947 GHz, Bw = 16.000 MH No calibration applied and no bandpass applied

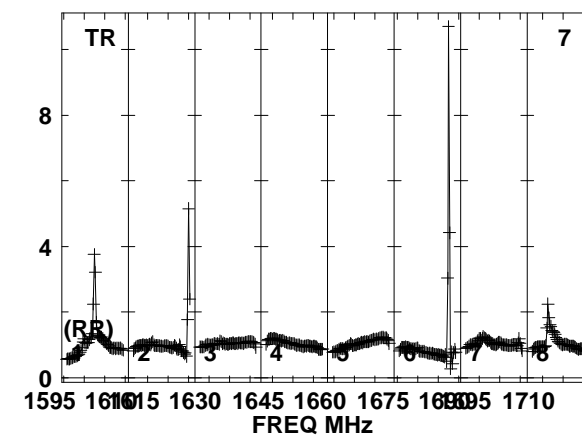
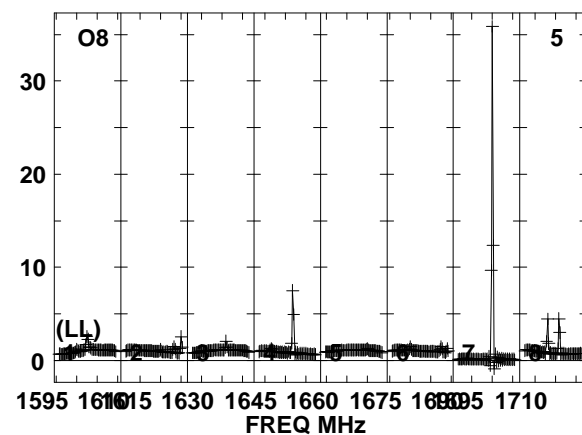
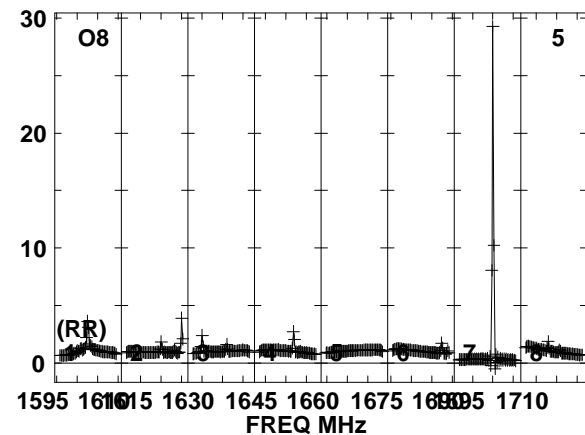
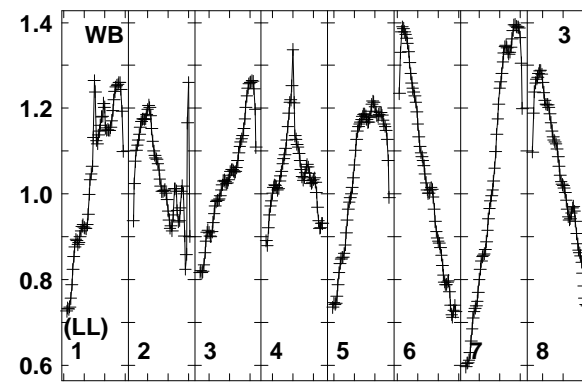
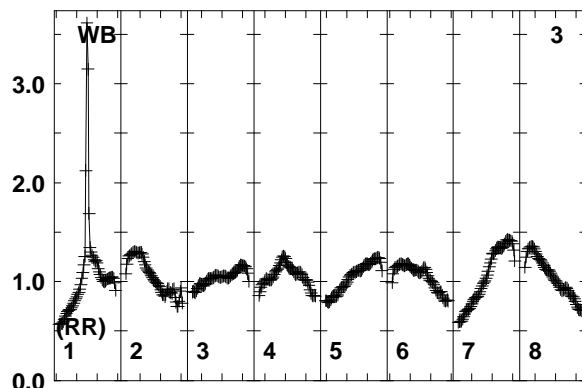
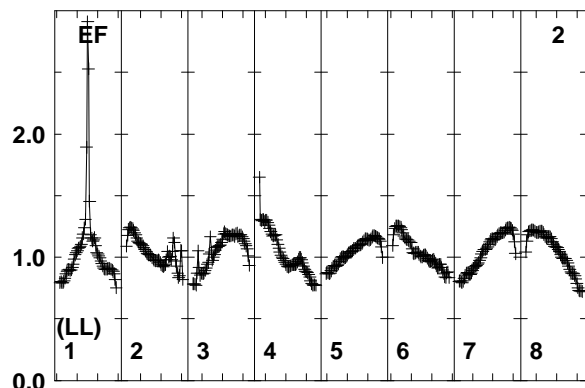
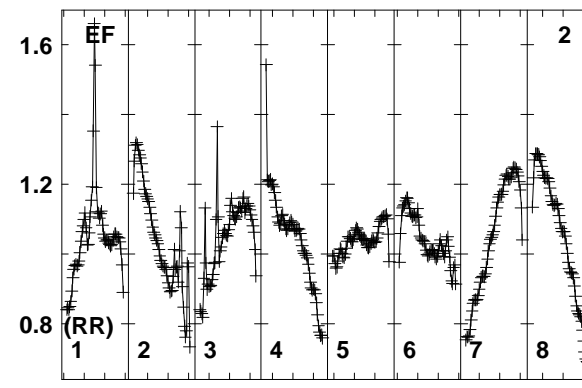
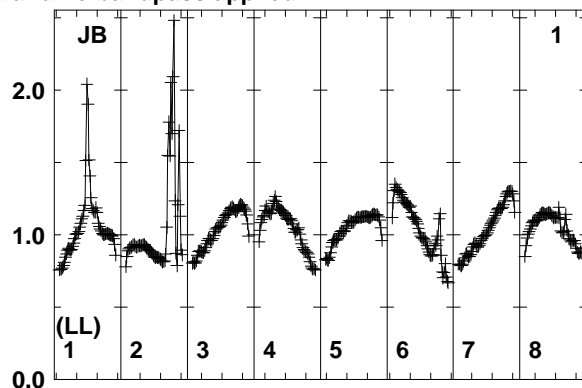
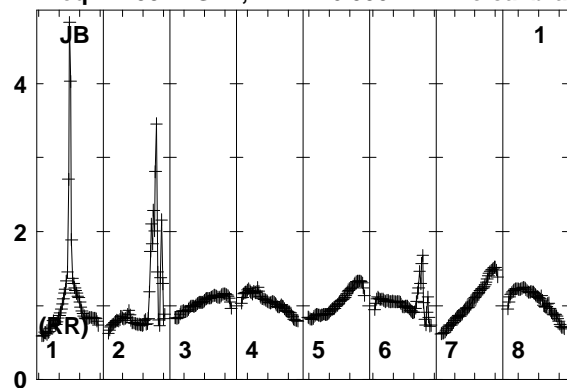

Lower frame: Real Jy
Total-power spectrum Antenna: JB (01)
Timerange: 00/07:56:51 to 00/07:59:29

Plot file version 554 created 04-NOV-2019 14:14:46

W2246-0526 EY034.UVDATA.1

Freq = 1.5947 GHz, Bw = 16.000 MH No calibration applied and no bandpass applied

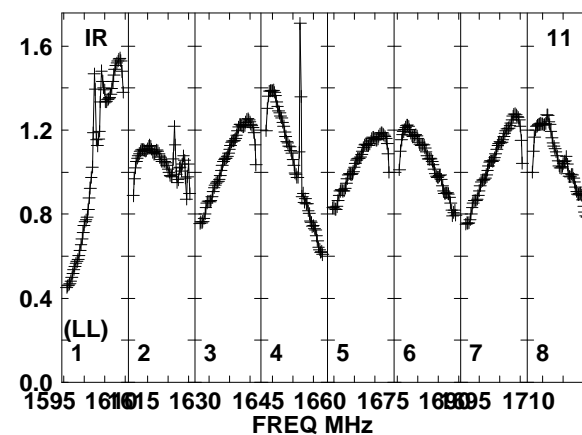
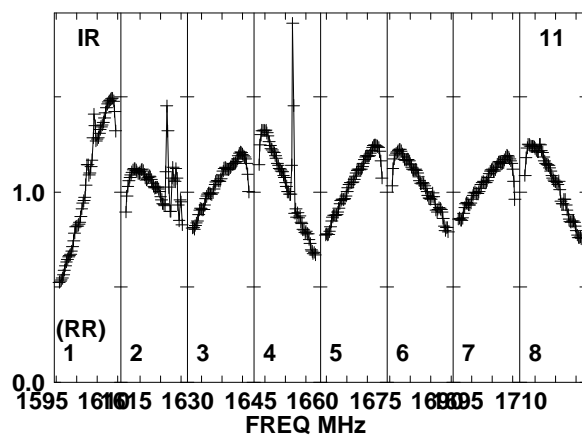
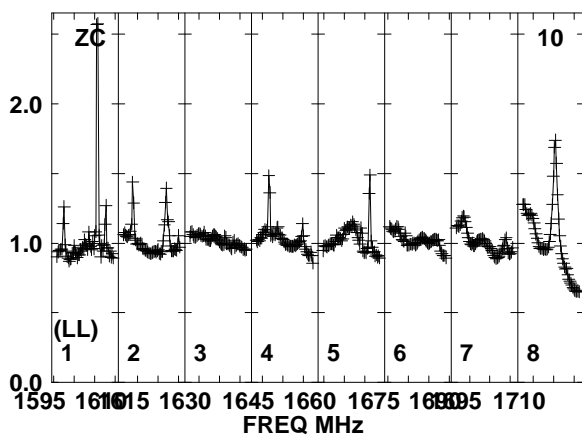
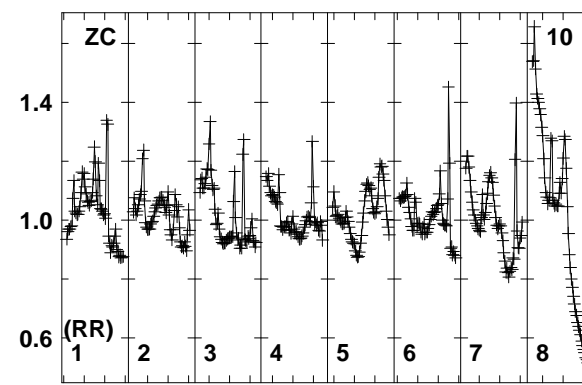
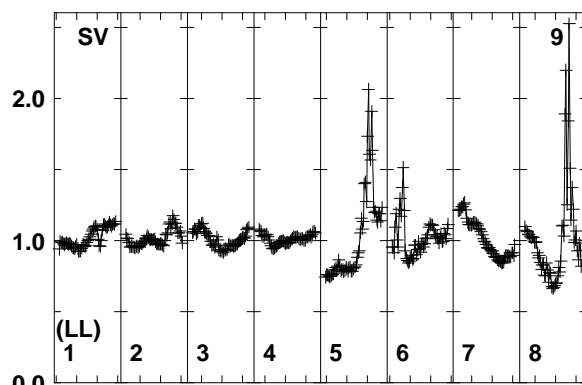
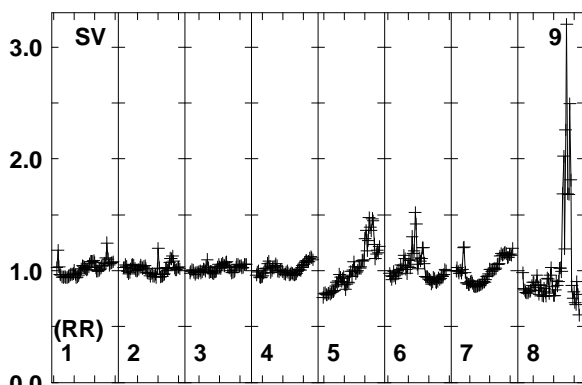
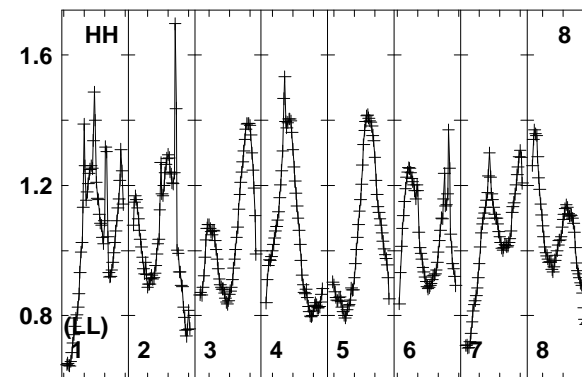
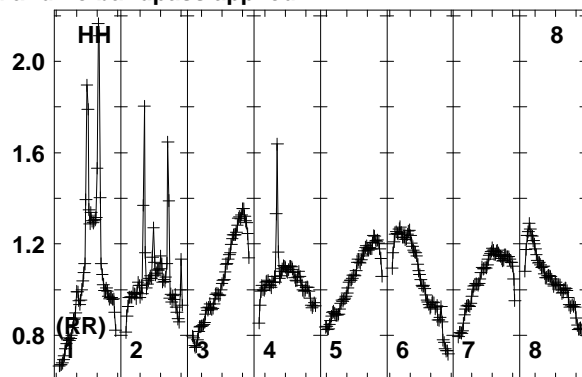
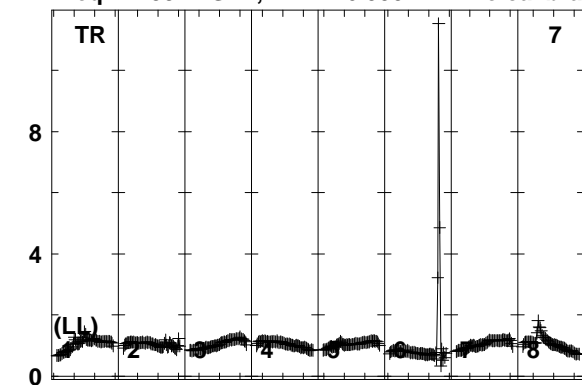

Lower frame: Real Jy
Total-power spectrum Antenna: TR (07)
Timerange: 00/07:56:51 to 00/07:59:29

Plot file version 555 created 04-NOV-2019 14:14:46

W2246-0526 EY034.UVDATA.1

Freq = 1.5947 GHz, Bw = 16.000 MH No calibration applied and no bandpass applied

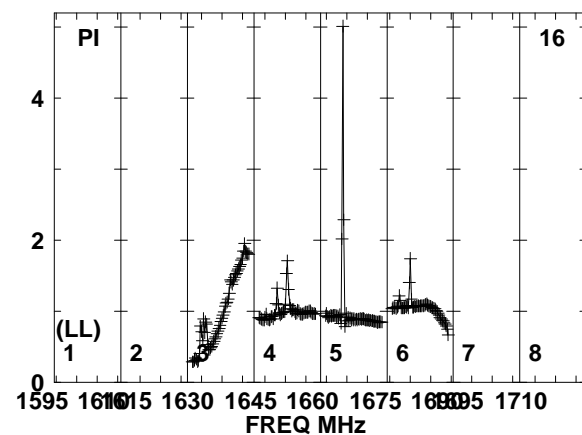
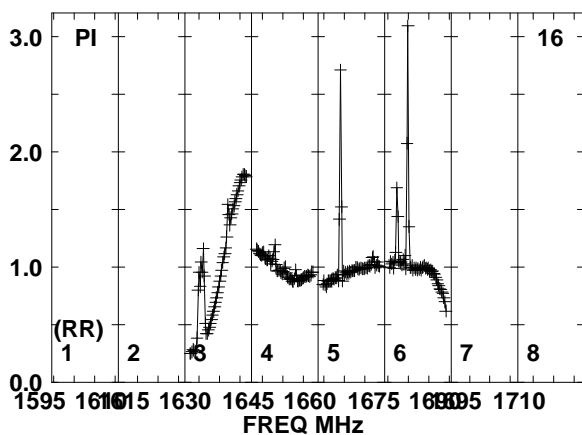
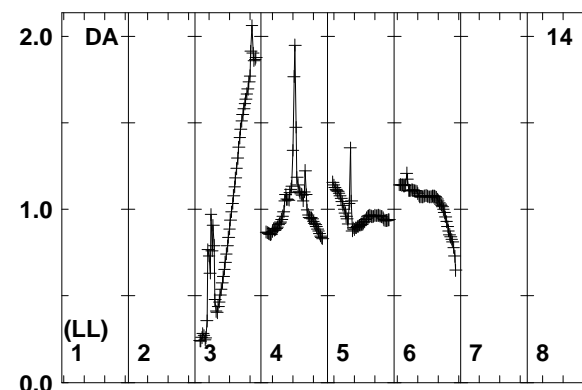
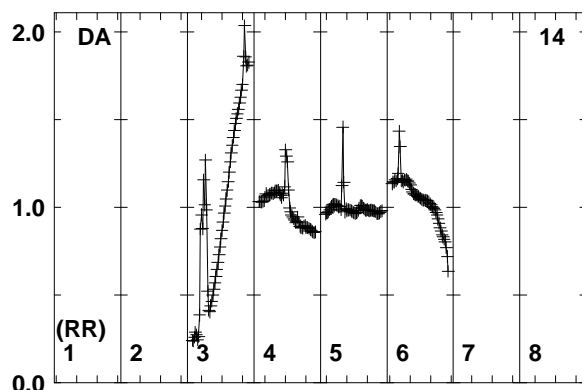
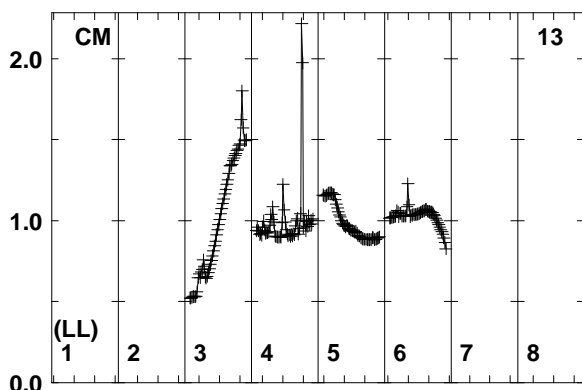
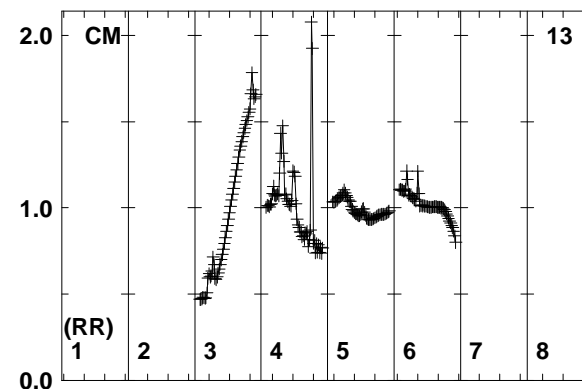
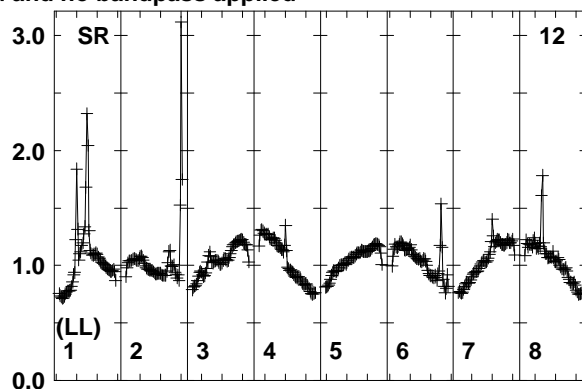
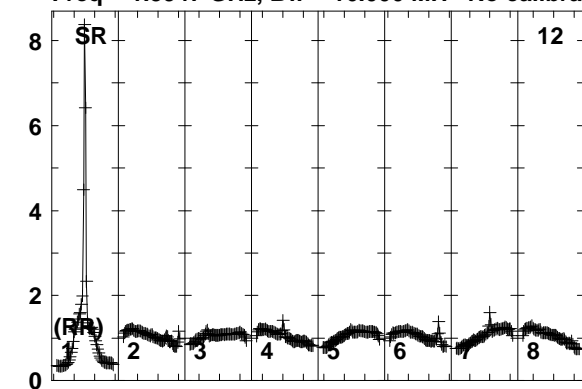

Lower frame: Real Jy
Total-power spectrum Antenna: SR (12)
Timerange: 00/07:56:51 to 00/07:59:29

Plot file version 556 created 04-NOV-2019 14:14:46

J2248-0541 EY034.UVDATA.1

Freq = 1.5947 GHz, Bw = 16.000 MH No calibration applied and no bandpass applied

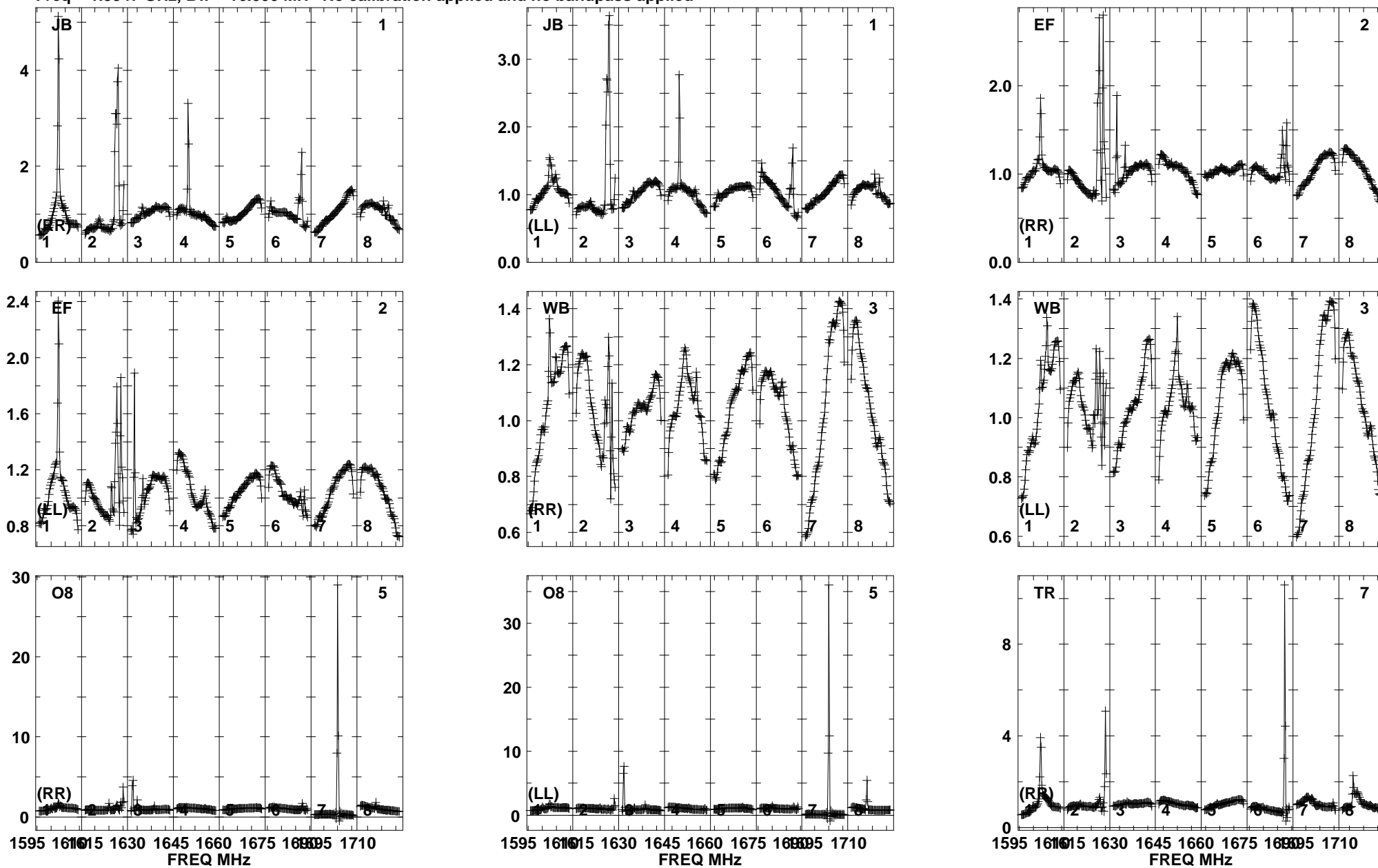

Lower frame: Real Jy
Total-power spectrum Antenna: JB (01)
Timerange: 00/08:00:06 to 00/08:01:04

Plot file version 557 created 04-NOV-2019 14:14:46

J2248-0541 EY034.UVDATA.1

Freq = 1.5947 GHz, Bw = 16.000 MH No calibration applied and no bandpass applied

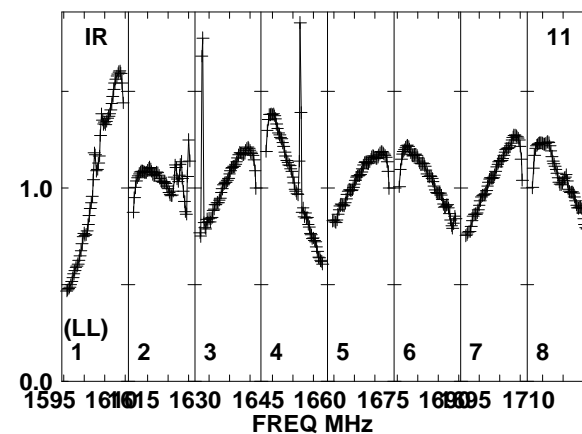
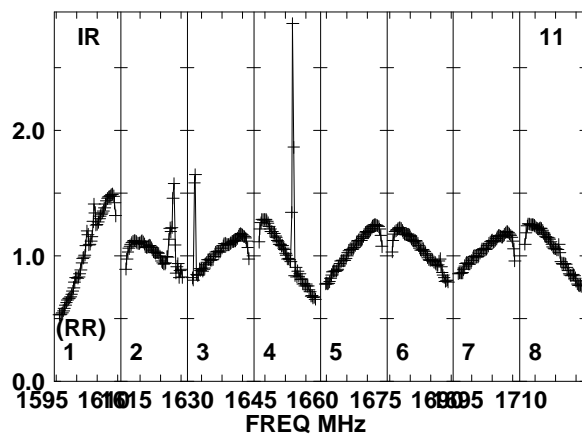
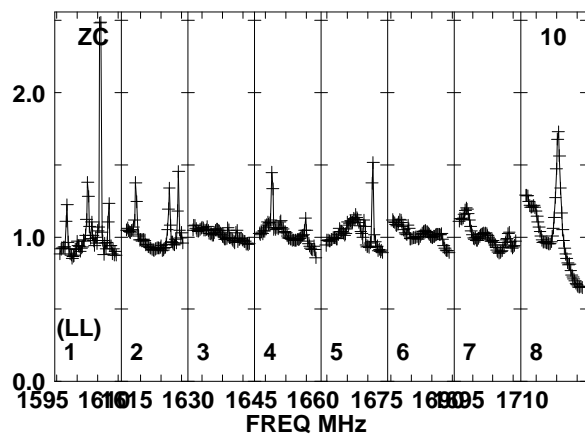
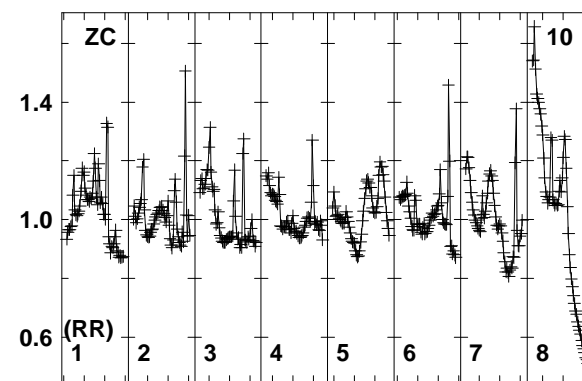
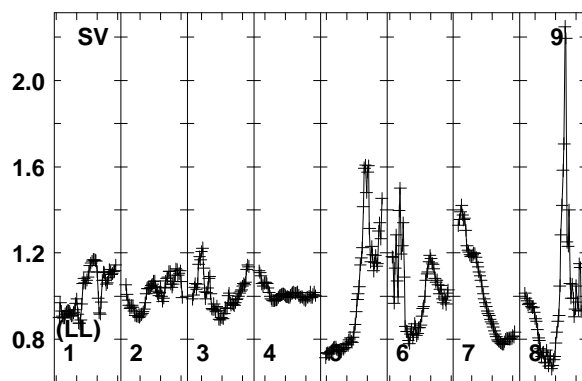
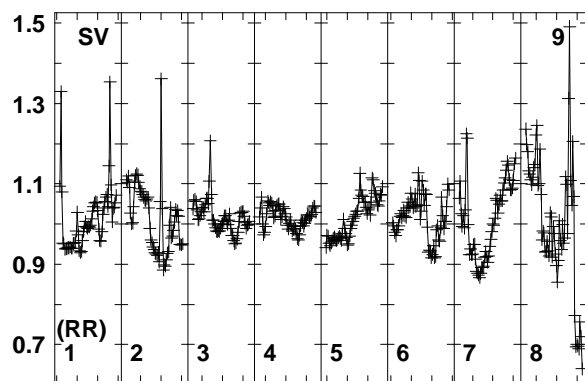
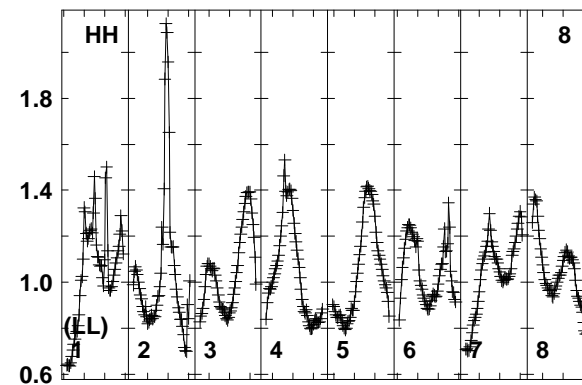
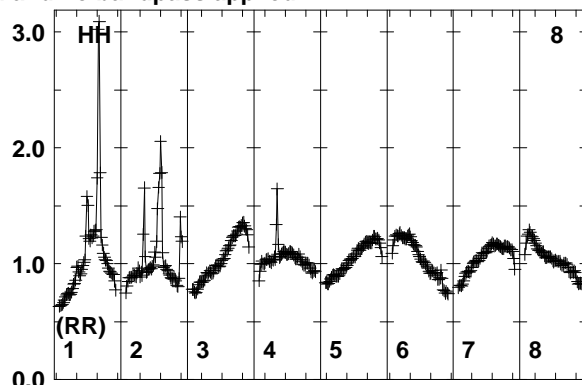
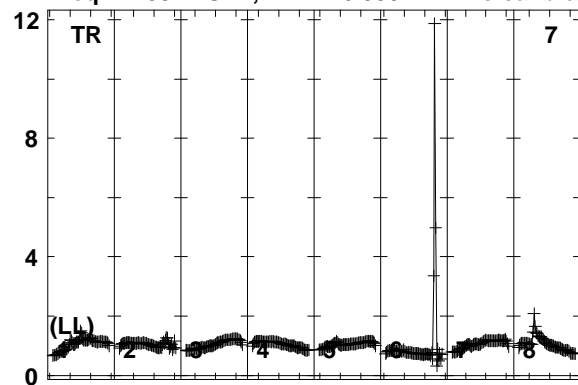

Lower frame: Real Jy
Total-power spectrum Antenna: TR (07)
Timerange: 00/08:00:06 to 00/08:01:04

Plot file version 558 created 04-NOV-2019 14:14:46

J2248-0541 EY034.UVDATA.1

Freq = 1.5947 GHz, Bw = 16.000 MH No calibration applied and no bandpass applied

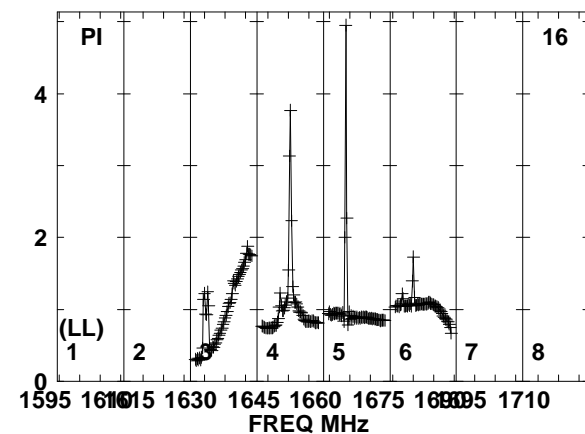
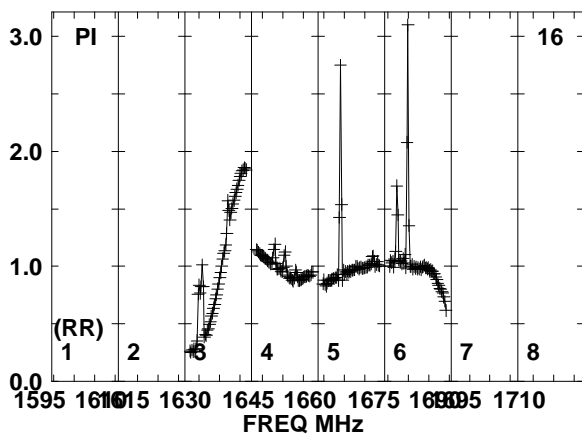
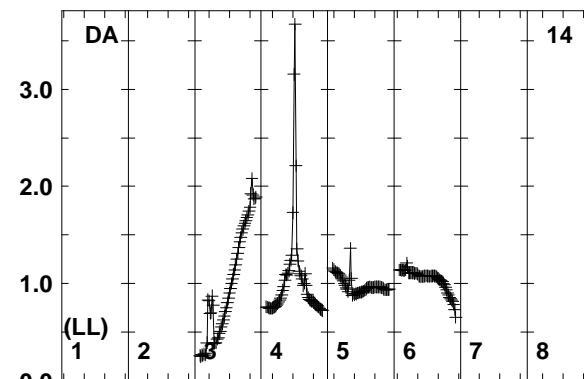
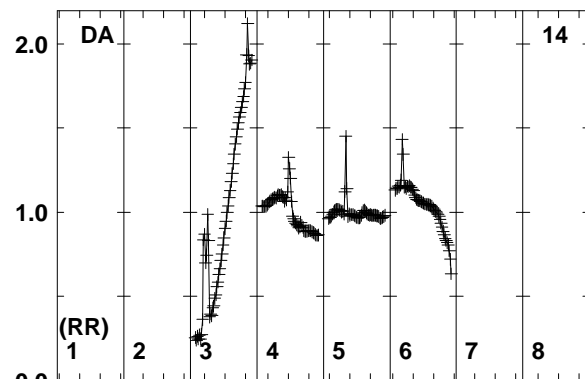
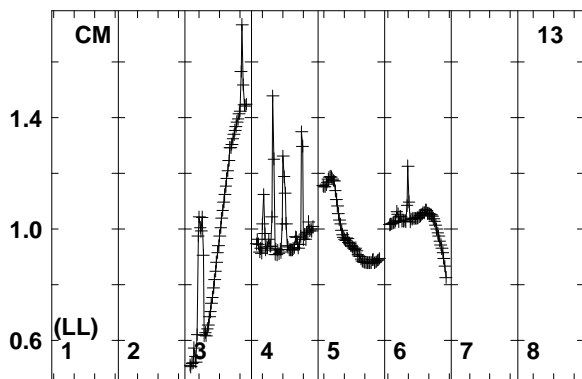
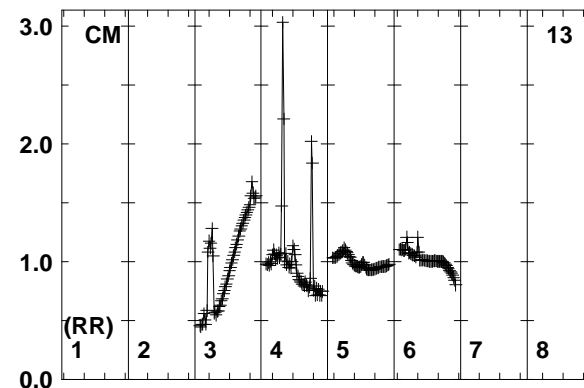
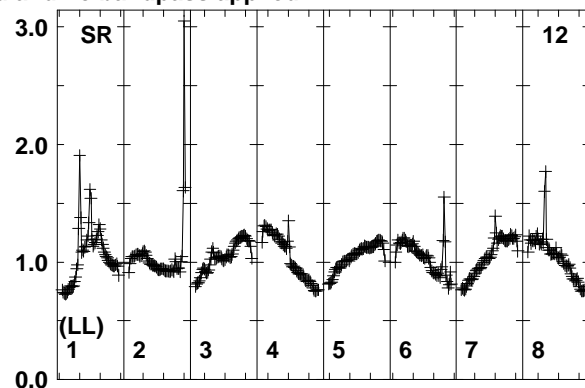
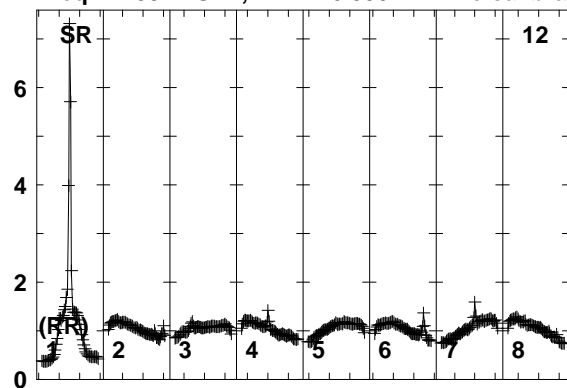

Lower frame: Real Jy
Total-power spectrum Antenna: SR (12)
Timerange: 00/08:00:06 to 00/08:01:04

Plot file version 559 created 04-NOV-2019 14:14:46

W2246-0526 EY034.UVDATA.1

Freq = 1.5947 GHz, Bw = 16.000 MH No calibration applied and no bandpass applied

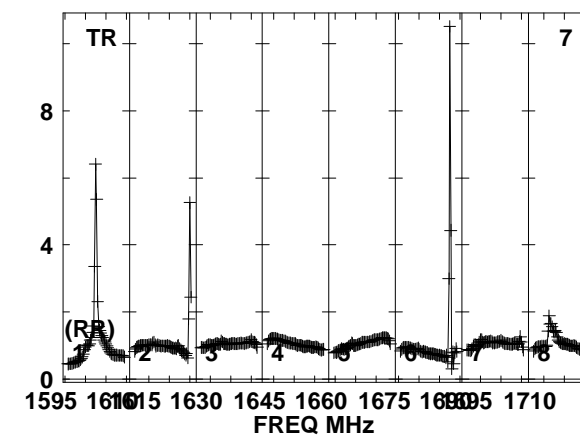
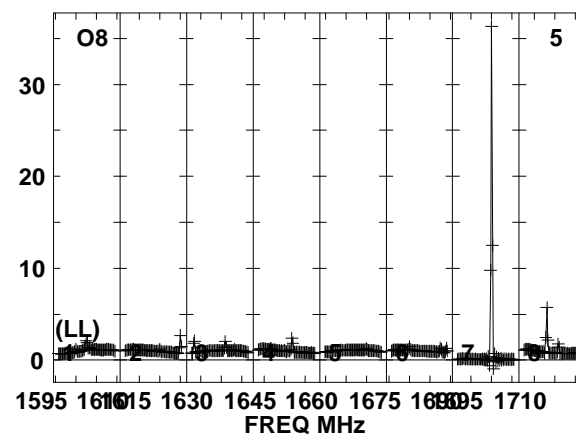
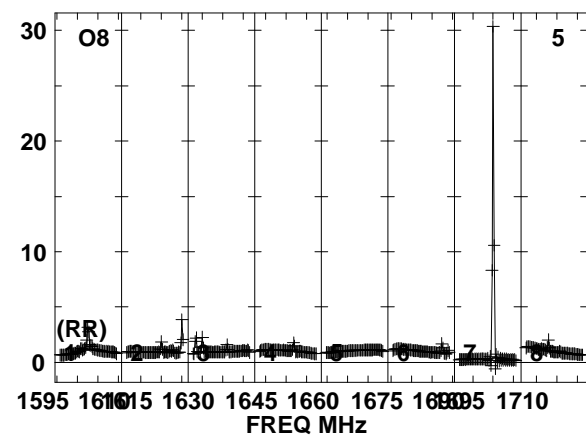
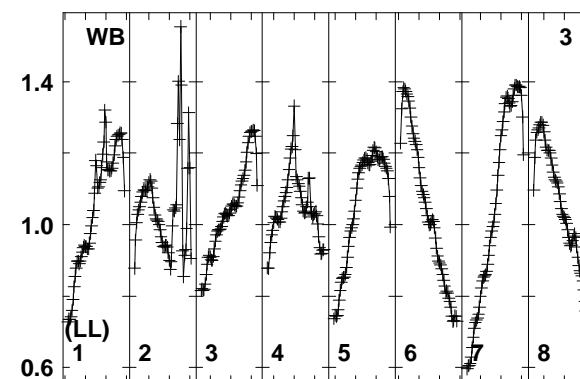
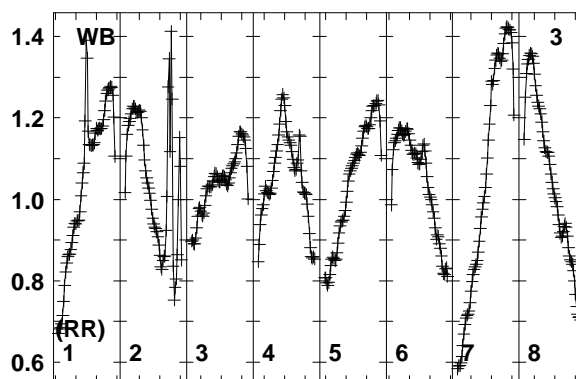
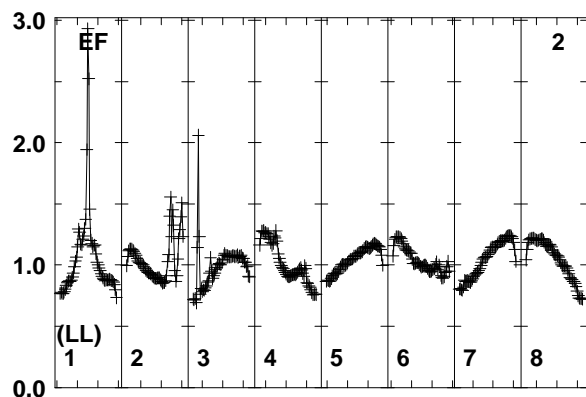
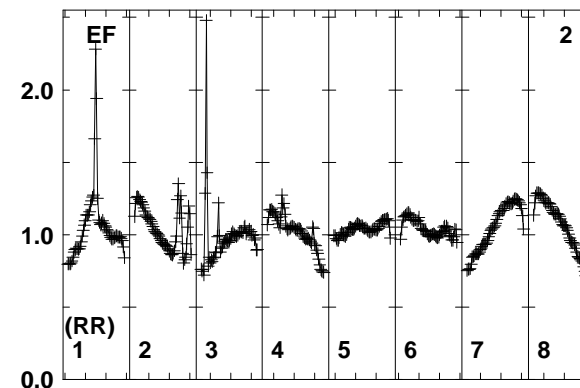
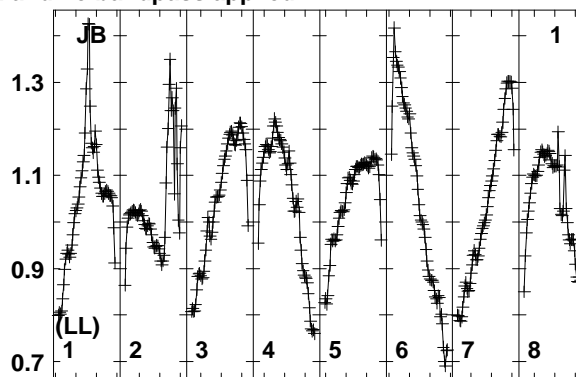
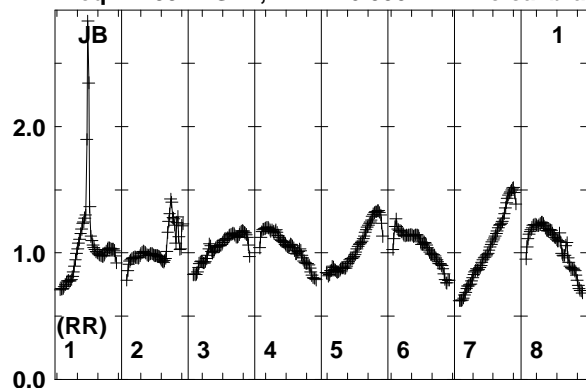

Lower frame: Real Jy
Total-power spectrum Antenna: JB (01)
Timerange: 00/08:01:06 to 00/08:03:44

Plot file version 560 created 04-NOV-2019 14:14:46

W2246-0526 EY034.UVDATA.1

Freq = 1.5947 GHz, Bw = 16.000 MH No calibration applied and no bandpass applied

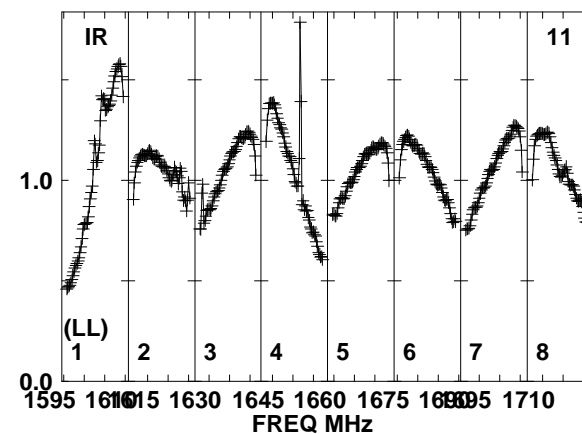
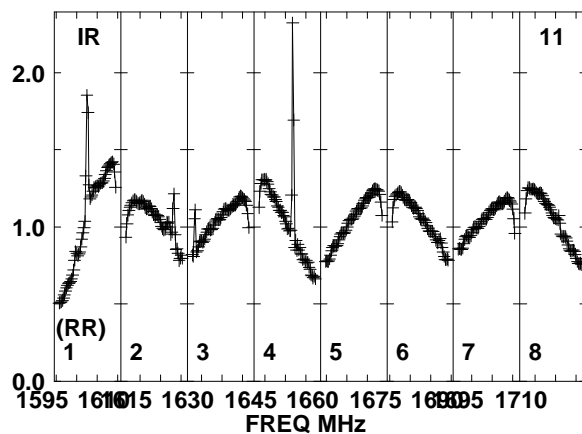
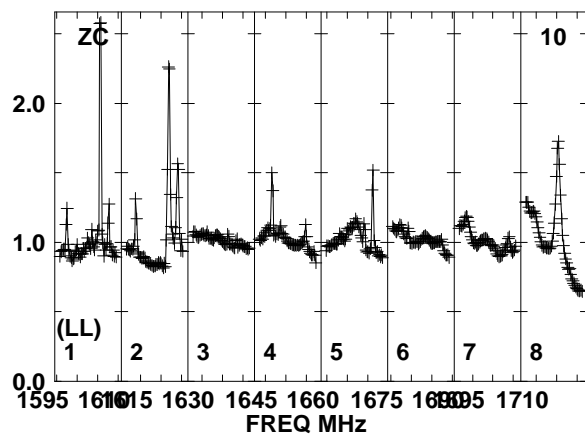
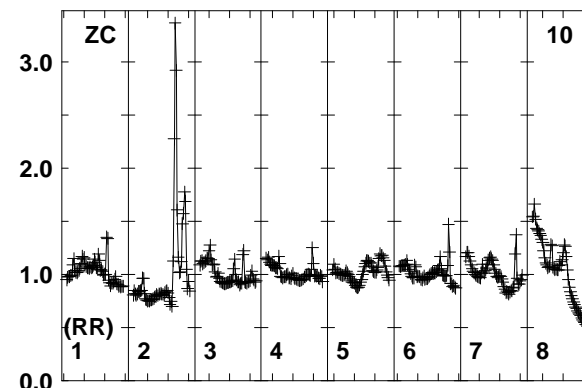
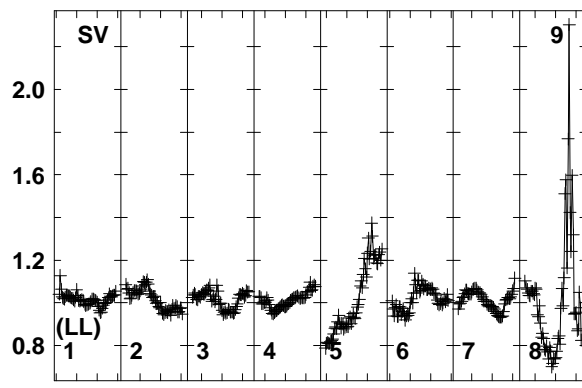
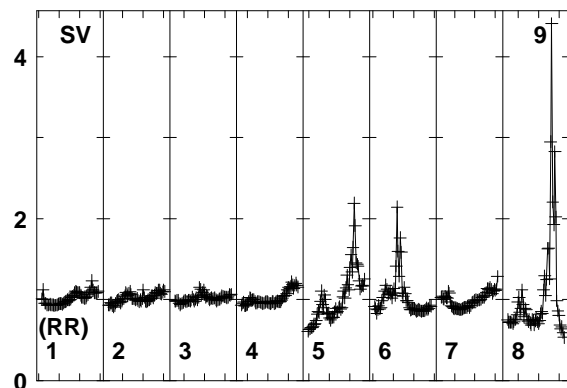
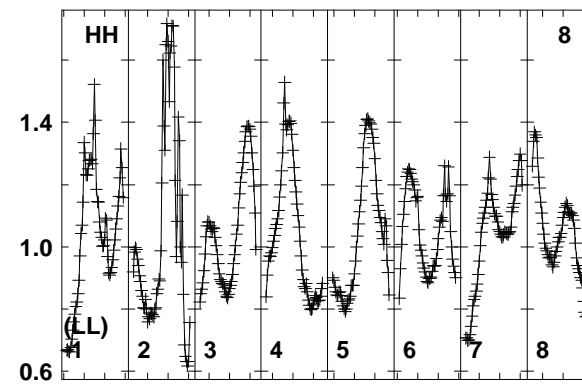
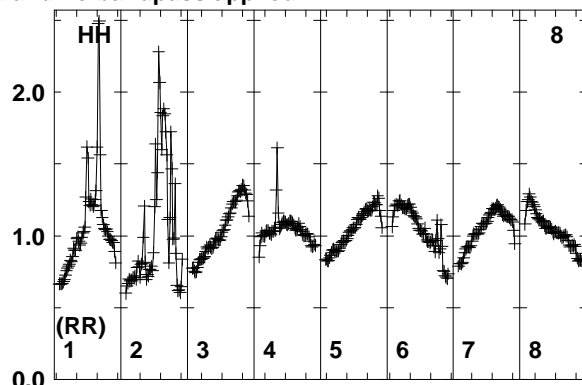
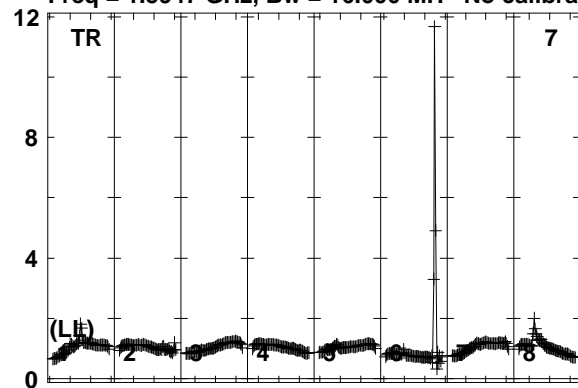

Lower frame: Real Jy
Total-power spectrum Antenna: TR (07)
Timerange: 00/08:01:06 to 00/08:03:44

Plot file version 561 created 04-NOV-2019 14:14:46

W2246-0526 EY034.UVDATA.1

Freq = 1.5947 GHz, Bw = 16.000 MH No calibration applied and no bandpass applied

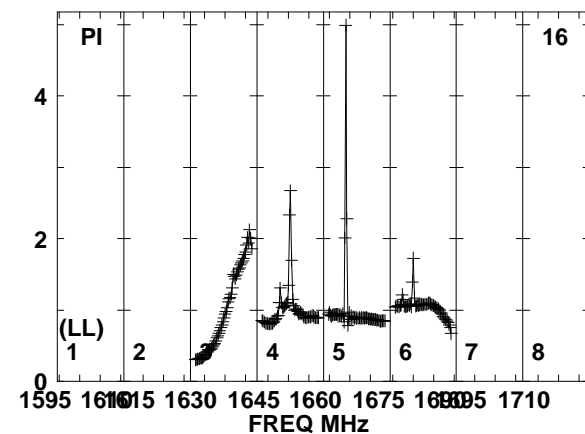
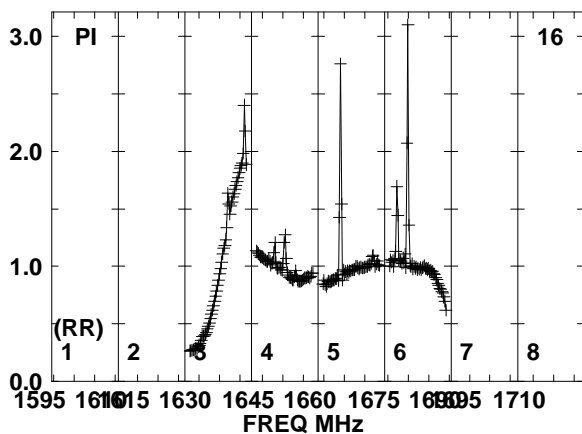
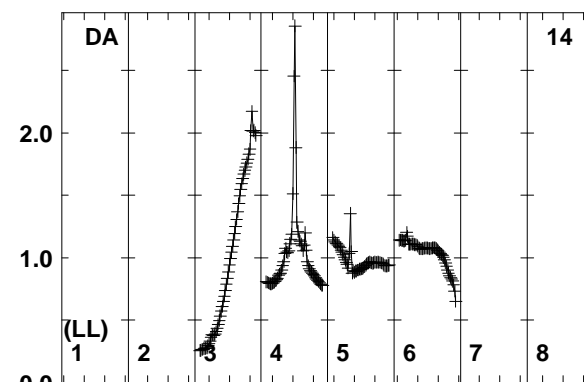
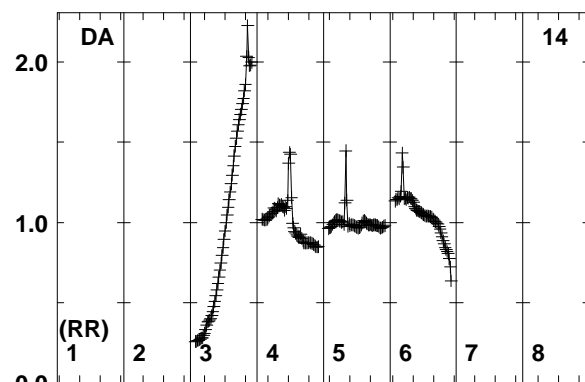
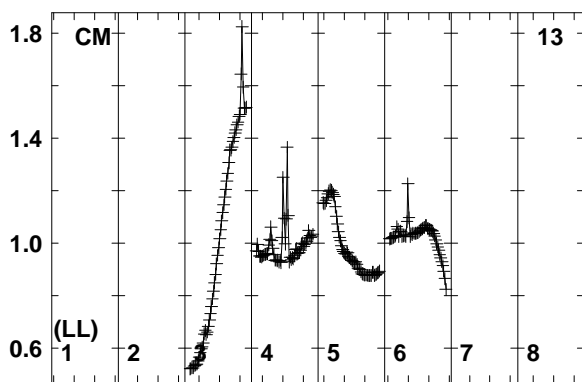
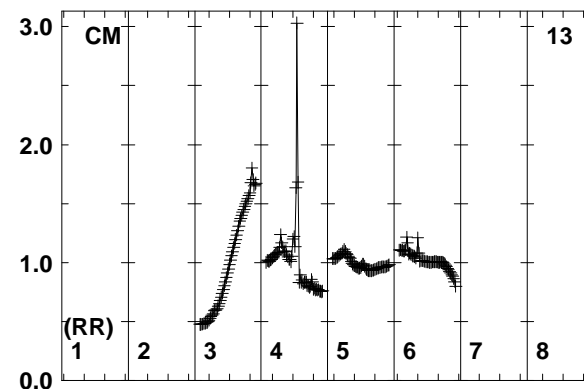
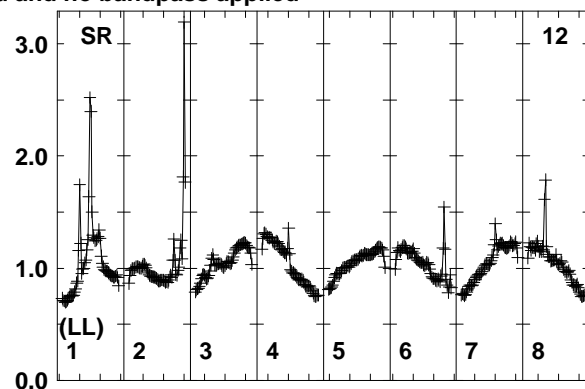
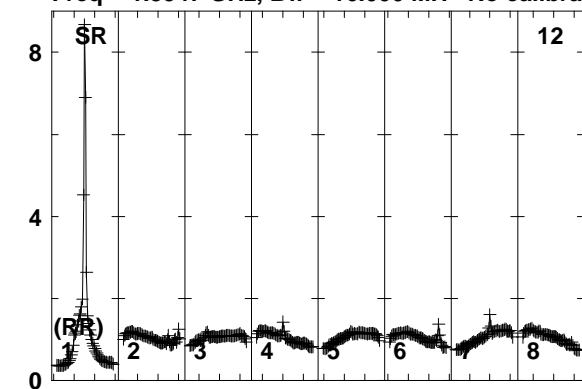

Lower frame: Real Jy
Total-power spectrum Antenna: SR (12)
Timerange: 00/08:01:06 to 00/08:03:44

Plot file version 562 created 04-NOV-2019 14:14:46

J2248-0541 EY034.UVDATA.1

Freq = 1.5947 GHz, Bw = 16.000 MH No calibration applied and no bandpass applied

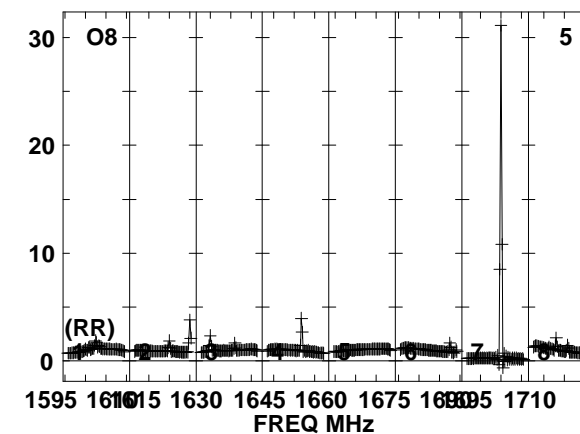
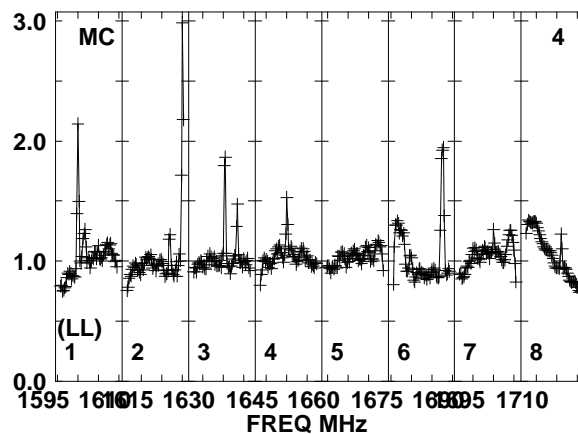
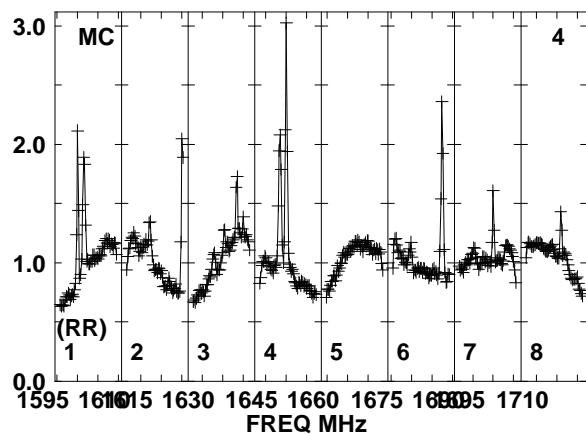
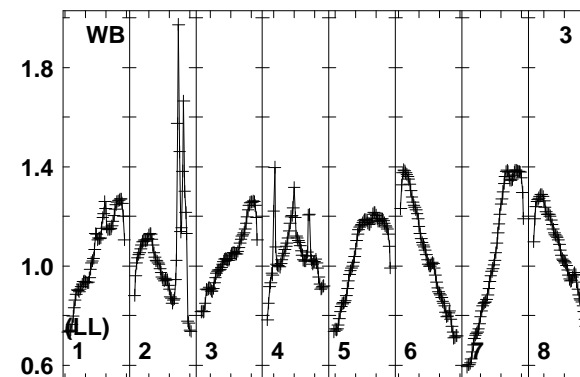
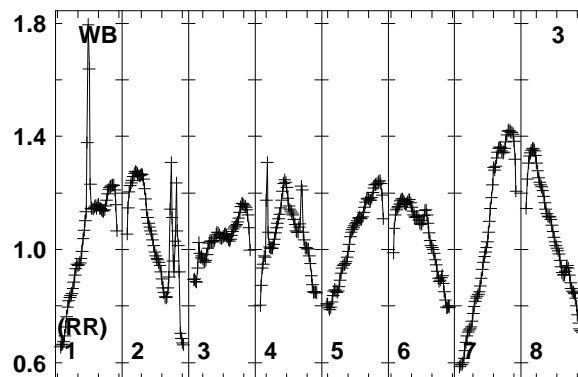
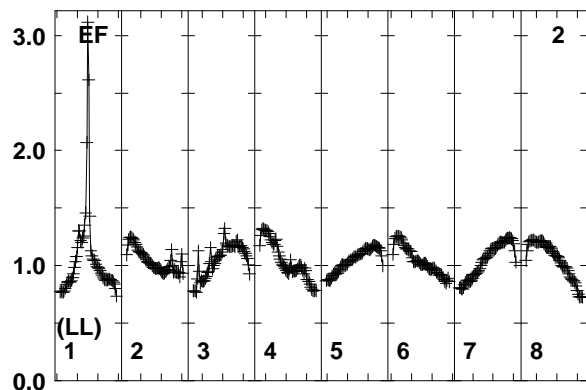
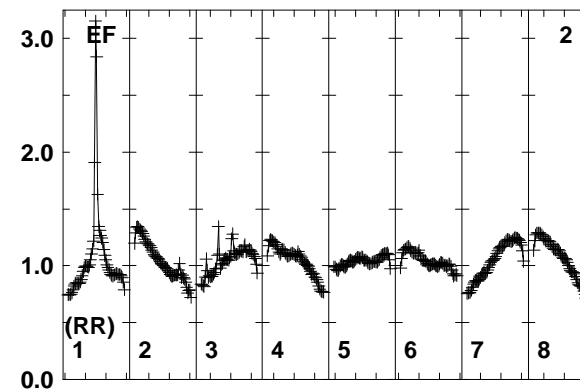
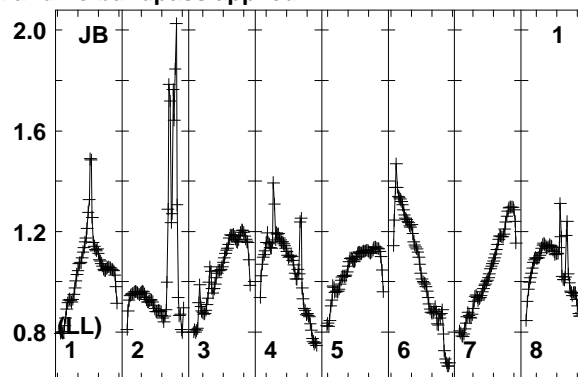
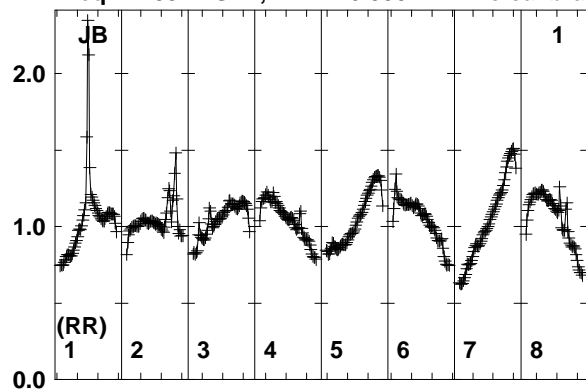

Lower frame: Real Jy
Total-power spectrum Antenna: JB (01)
Timerange: 00/08:04:01 to 00/08:04:59

Plot file version 563 created 04-NOV-2019 14:14:47

J2248-0541 EY034.UVDATA.1

Freq = 1.5947 GHz, Bw = 16.000 MH No calibration applied and no bandpass applied

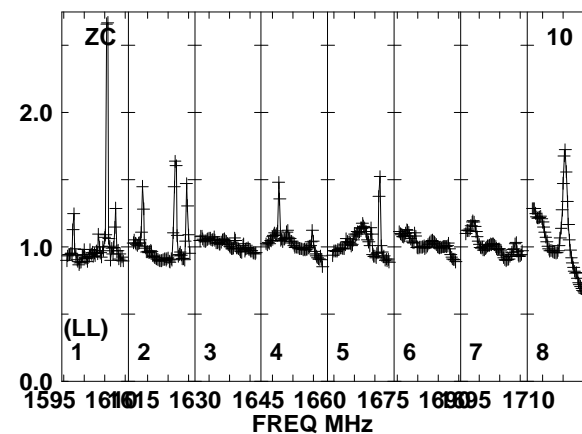
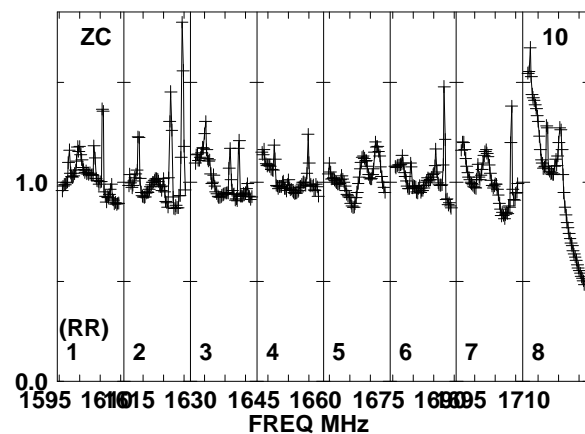
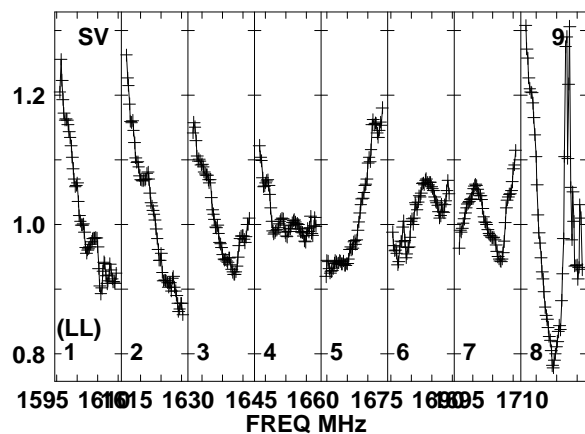
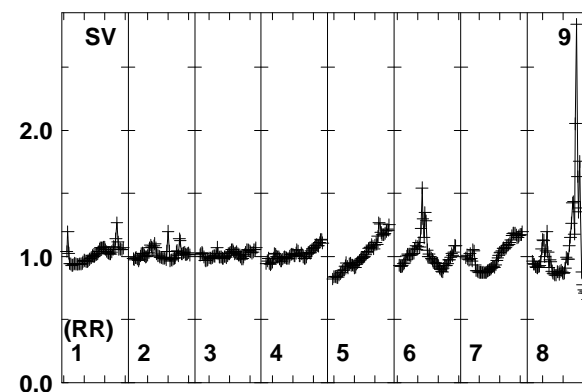
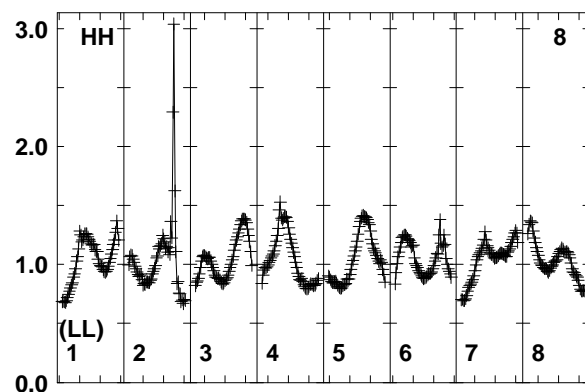
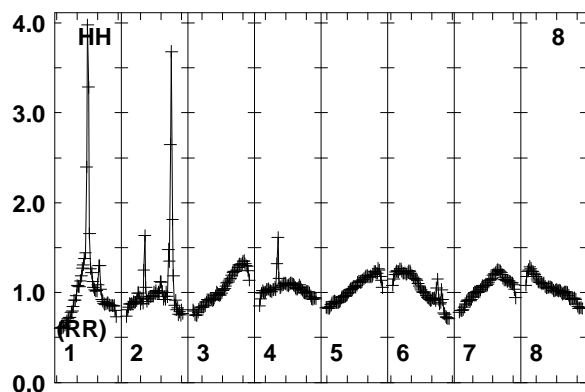
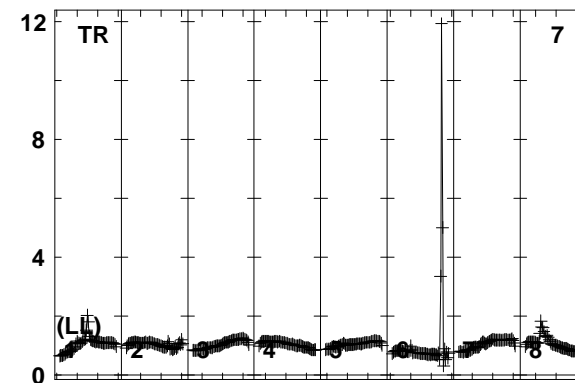
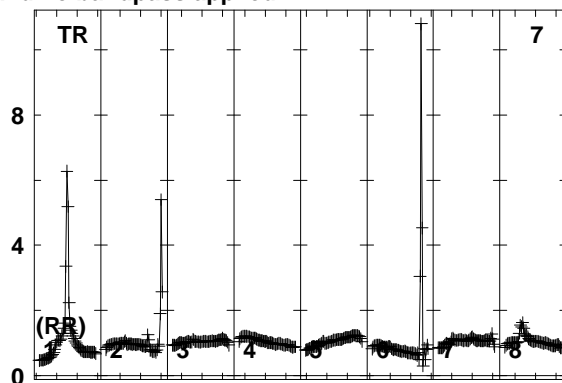
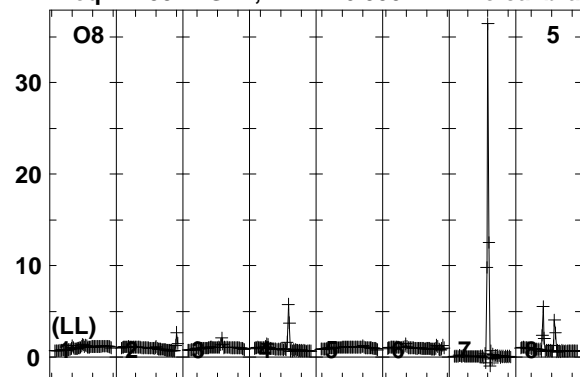

Lower frame: Real Jy
Total-power spectrum Antenna: O8 (05)
Timerange: 00/08:04:01 to 00/08:04:59

Plot file version 564 created 04-NOV-2019 14:14:47

J2248-0541 EY034.UVDATA.1

Freq = 1.5947 GHz, Bw = 16.000 MH No calibration applied and no bandpass applied

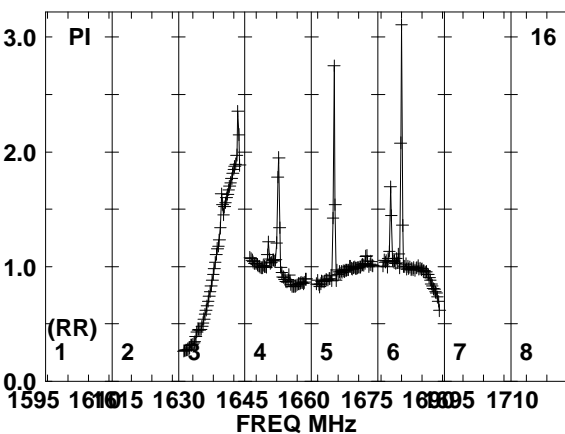
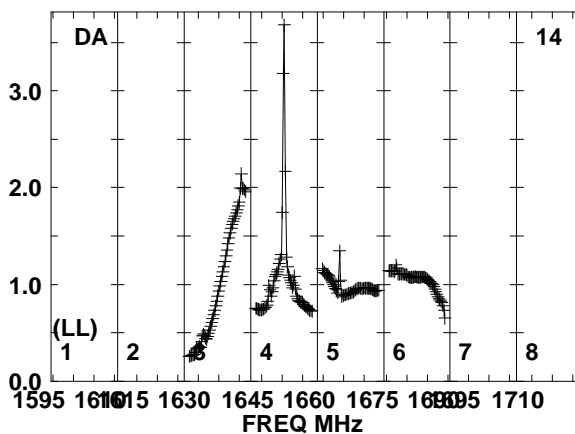
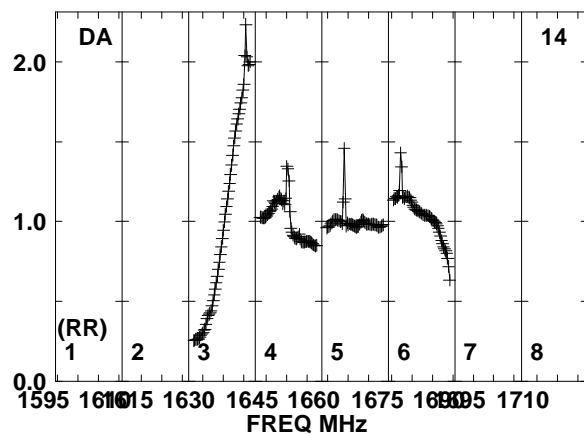
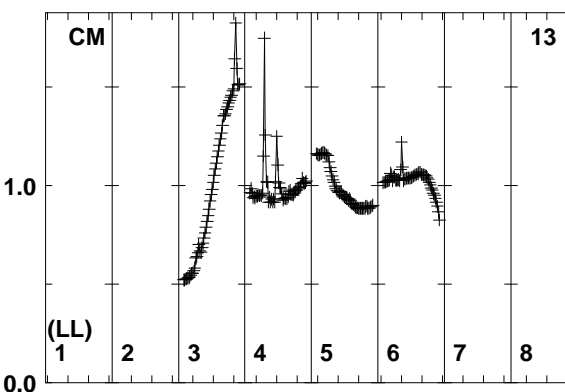
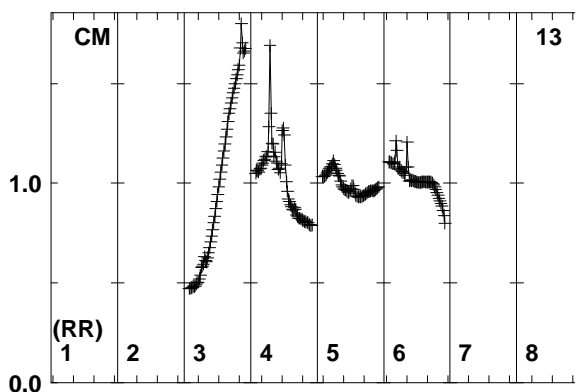
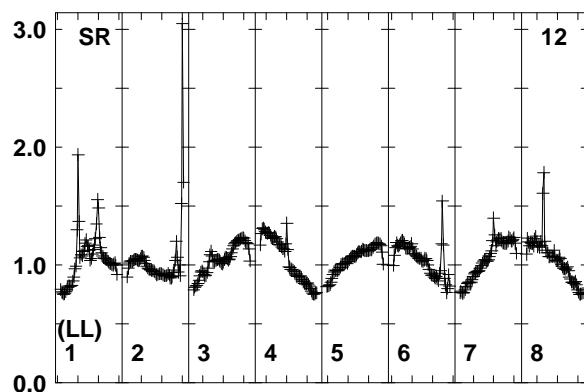
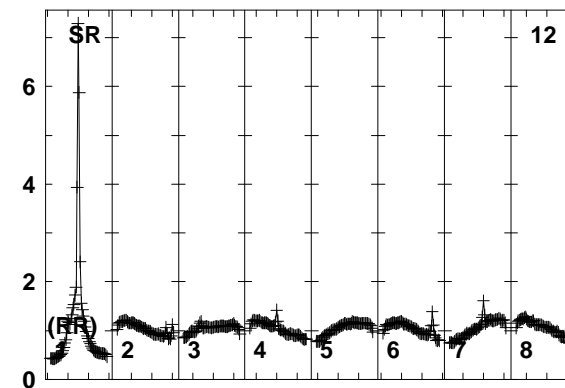
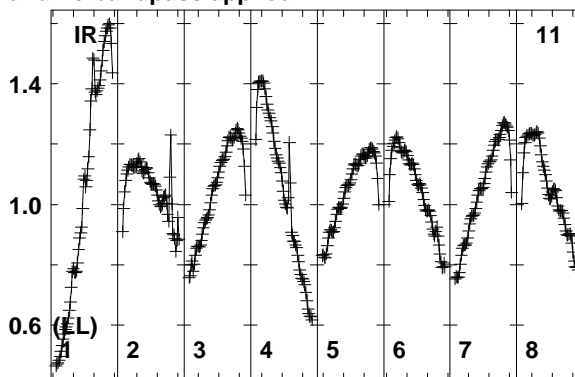
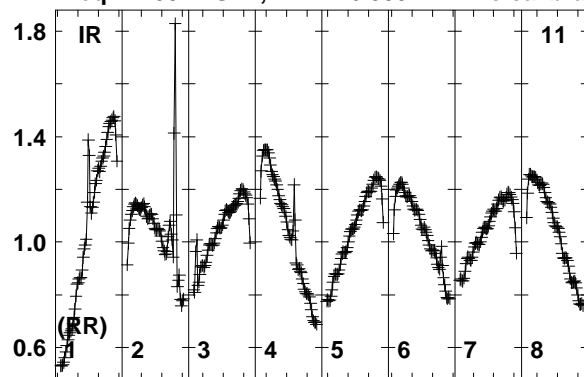

Lower frame: Real Jy
Total-power spectrum Antenna: IR (11)
Timerange: 00/08:04:01 to 00/08:04:59

Plot file version 565 created 04-NOV-2019 14:14:47
J2248-0541 EY034.UVDATA.1
Freq = 1.5947 GHz, Bw = 16.000 MH No calibration applied and no bandpass applied

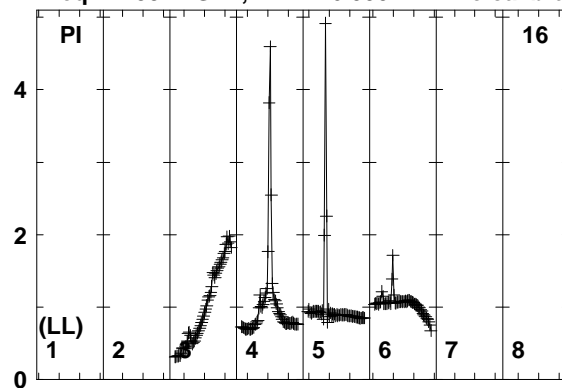

Lower frame: Real Jy
Total-power spectrum Antenna: PI (16)
Timerange: 00/08:04:01 to 00/08:04:59

Plot file version 566 created 04-NOV-2019 14:14:47

J2245-0755 EY034.UVDATA.1

Freq = 1.5947 GHz, Bw = 16.000 MH No calibration applied and no bandpass applied

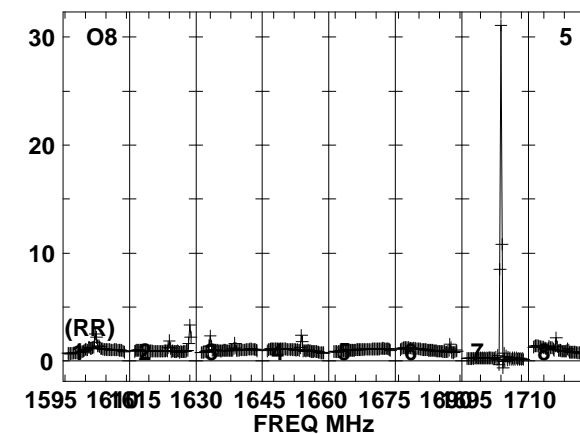
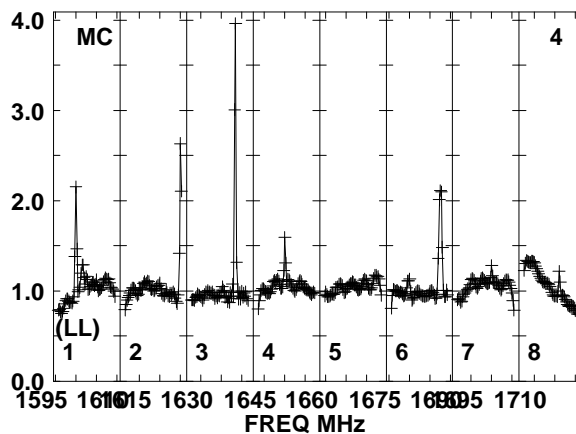
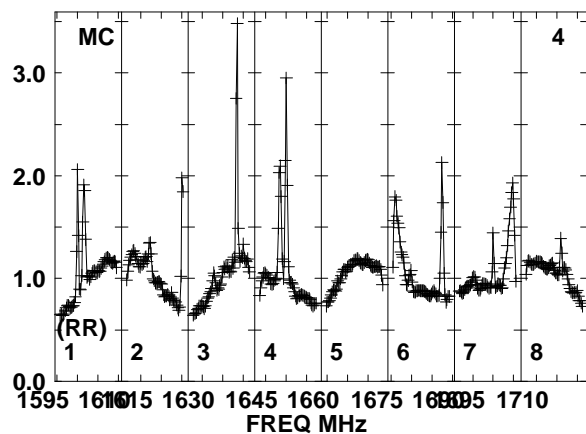
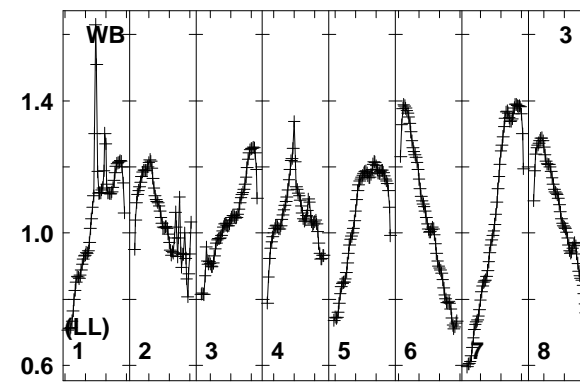
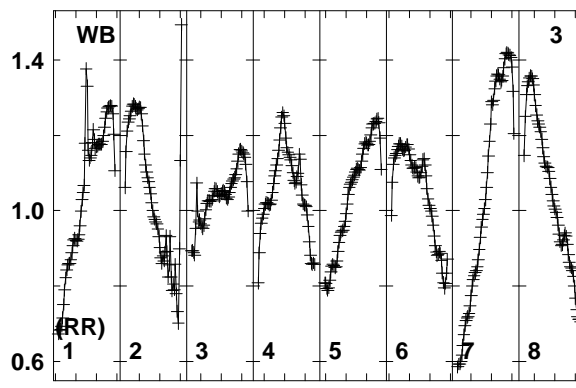
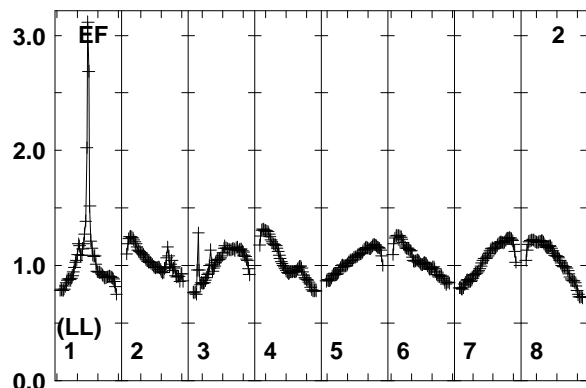
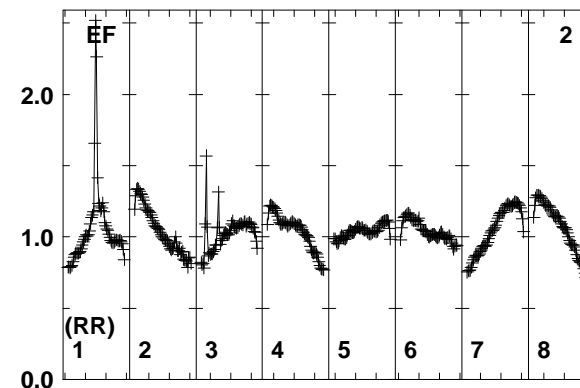
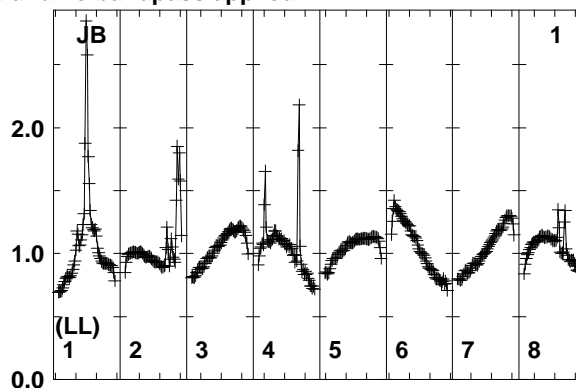
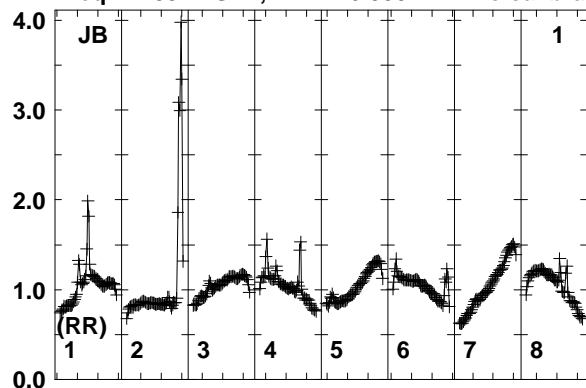

Lower frame: Real Jy
Total-power spectrum Antenna: JB (01)
Timerange: 00/08:05:16 to 00/08:06:14

Plot file version 567 created 04-NOV-2019 14:14:47

J2245-0755 EY034.UVDATA.1

Freq = 1.5947 GHz, Bw = 16.000 MH No calibration applied and no bandpass applied

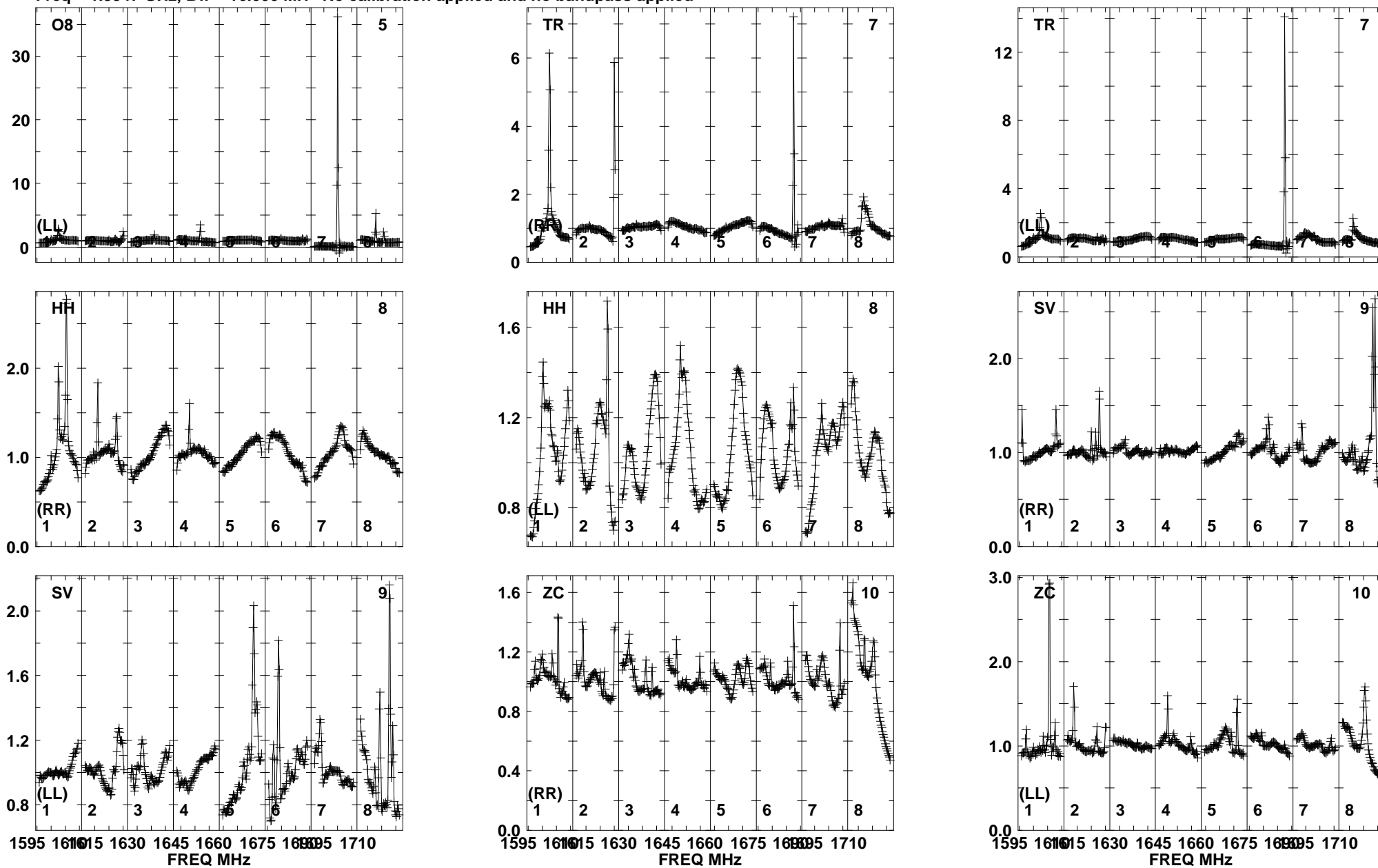

Lower frame: Real Jy
Total-power spectrum Antenna: O8 (05)
Timerange: 00/08:05:16 to 00/08:06:14

Plot file version 568 created 04-NOV-2019 14:14:47

J2245-0755 EY034.UVDATA.1

Freq = 1.5947 GHz, Bw = 16.000 MH No calibration applied and no bandpass applied

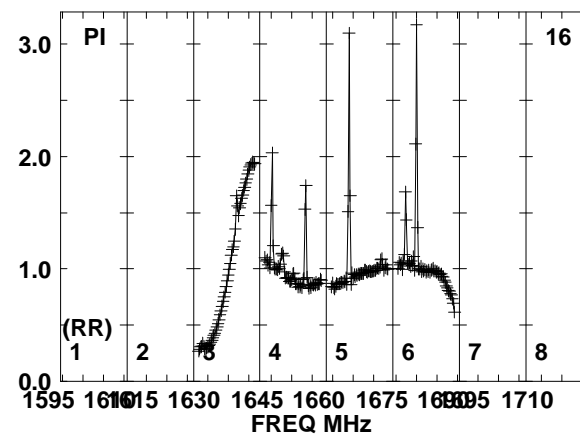
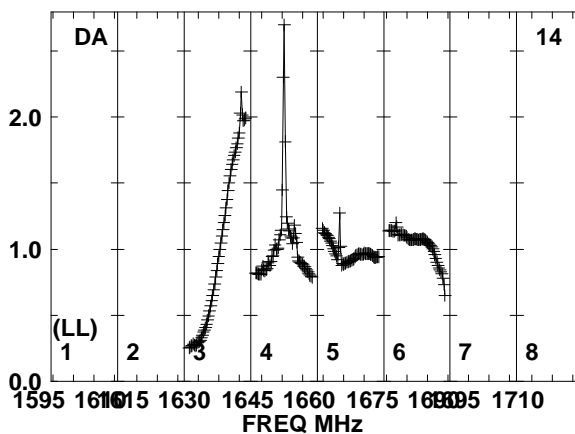
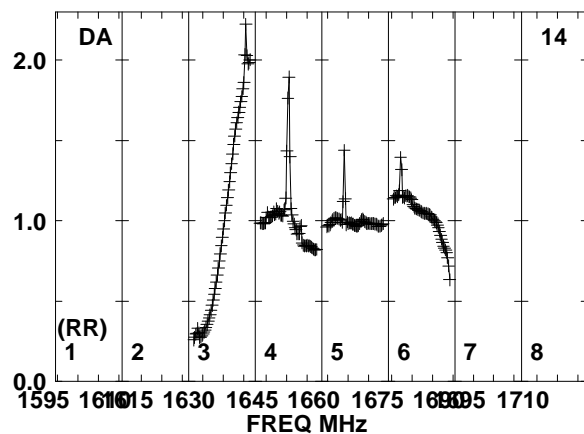
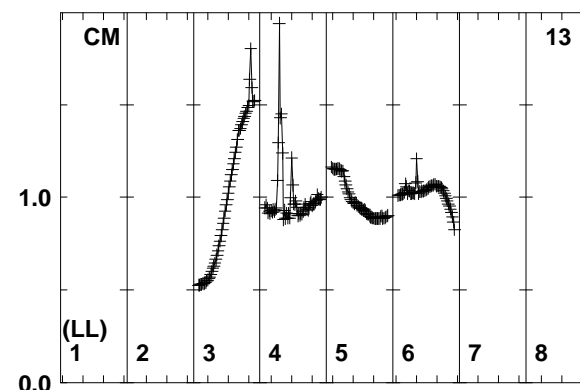
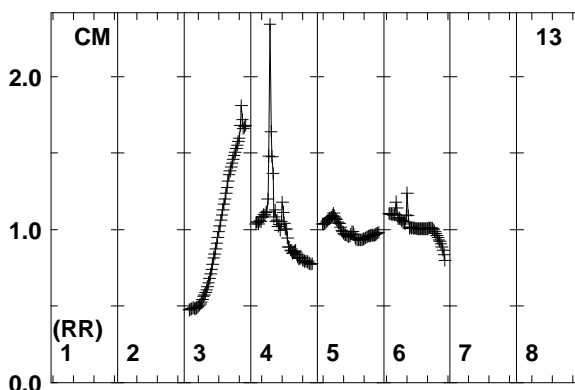
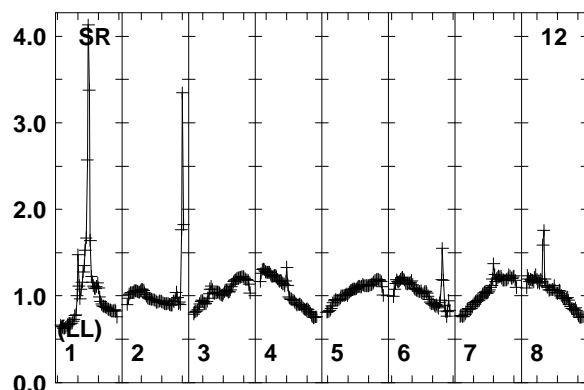
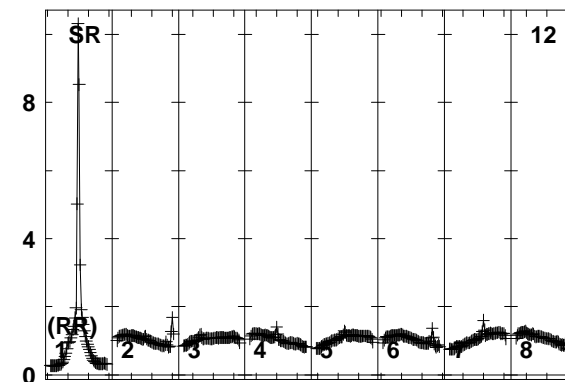
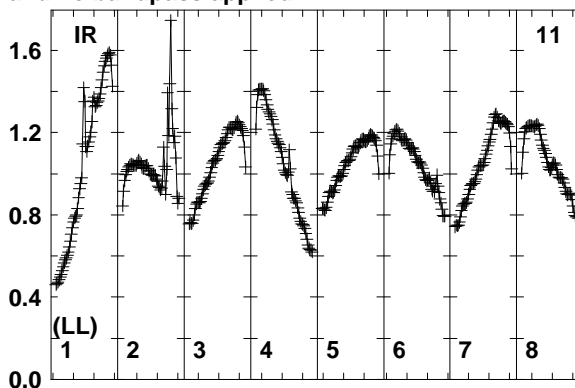
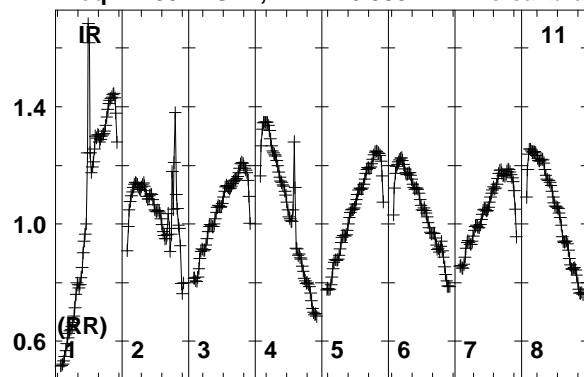

Lower frame: Real Jy
Total-power spectrum Antenna: IR (11)
Timerange: 00/08:05:16 to 00/08:06:14

Plot file version 569 created 04-NOV-2019 14:14:47
J2245-0755 EY034.UVDATA.1
Freq = 1.5947 GHz, Bw = 16.000 MH No calibration applied and no bandpass applied

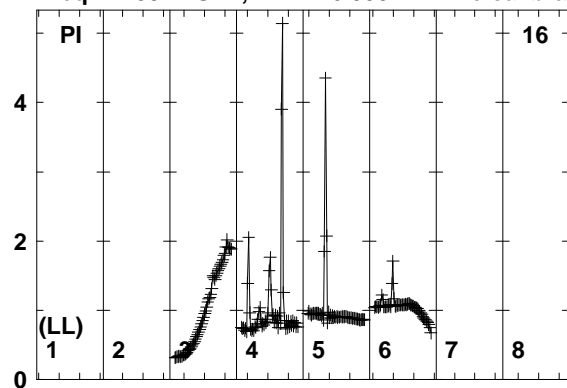

Lower frame: Real Jy
Total-power spectrum Antenna: PI (16)
Timerange: 00/08:05:16 to 00/08:06:14

Plot file version 570 created 04-NOV-2019 14:14:47

J2248-0541 EY034.UVDATA.1

Freq = 1.5947 GHz, Bw = 16.000 MH No calibration applied and no bandpass applied

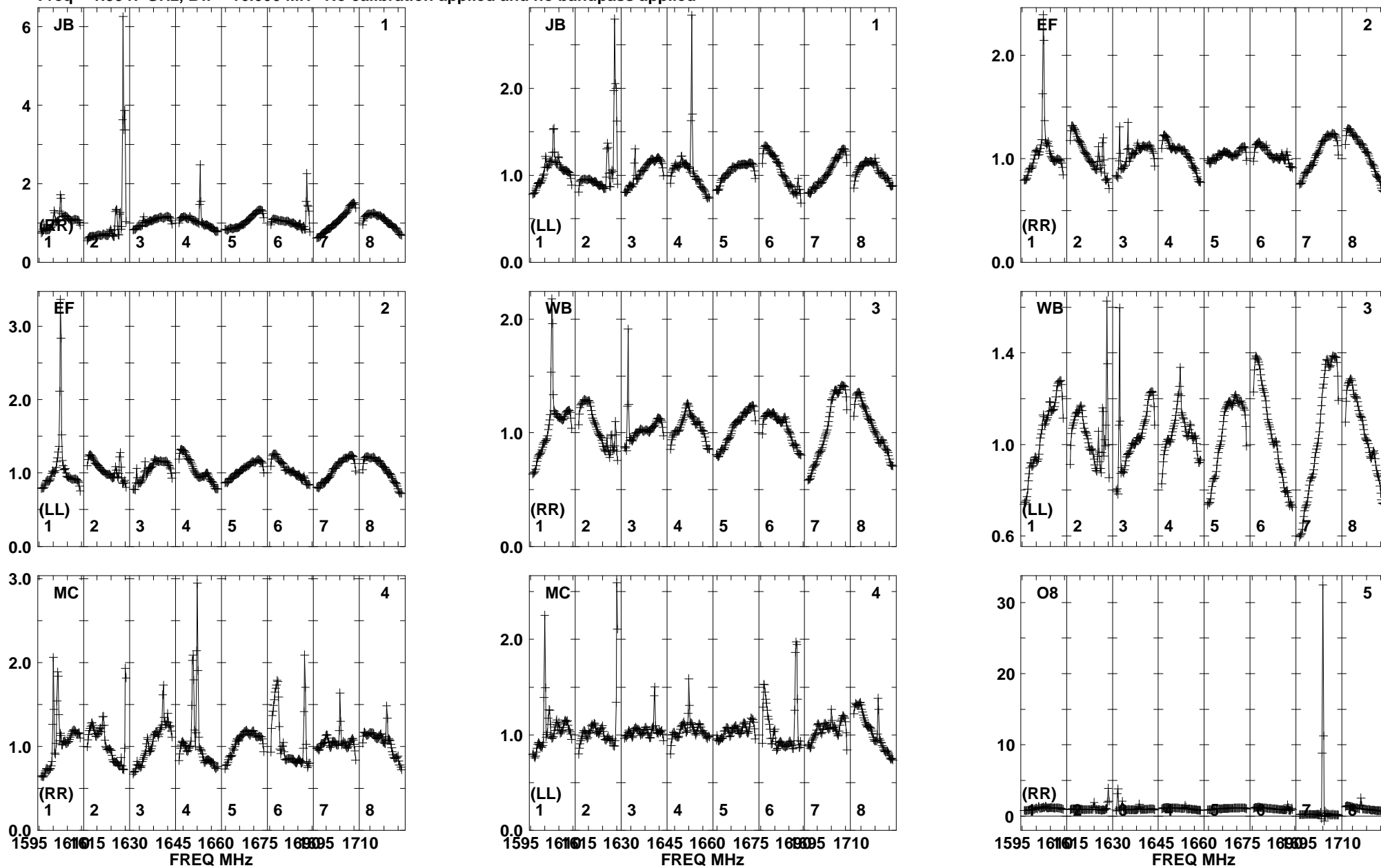

Lower frame: Real Jy
Total-power spectrum Antenna: JB (01)
Timerange: 00/08:07:01 to 00/08:07:59

Plot file version 571 created 04-NOV-2019 14:14:47

J2248-0541 EY034.UVDATA.1

Freq = 1.5947 GHz, Bw = 16.000 MH No calibration applied and no bandpass applied

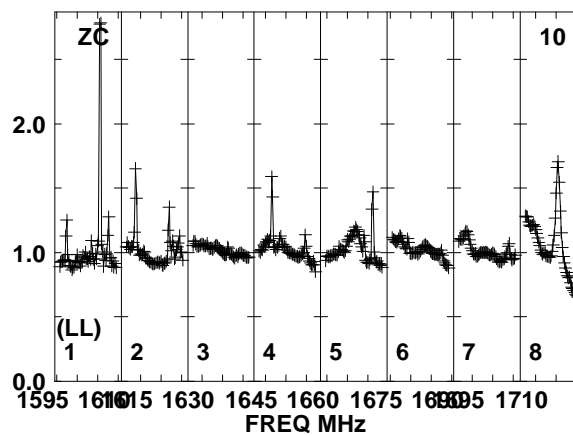
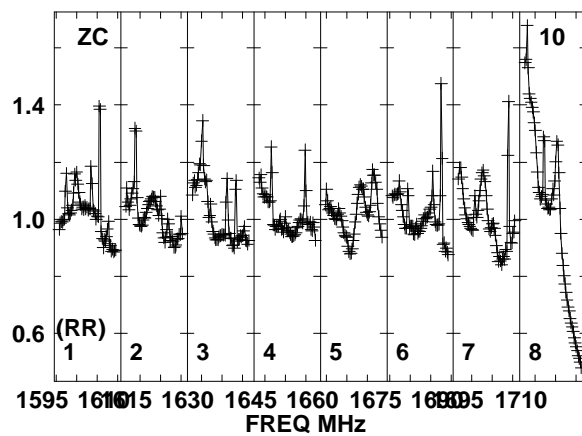
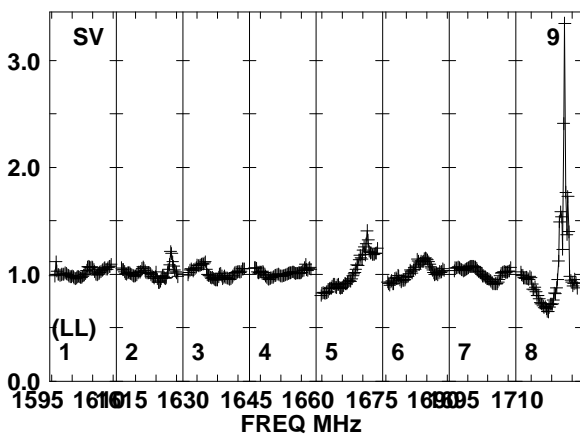
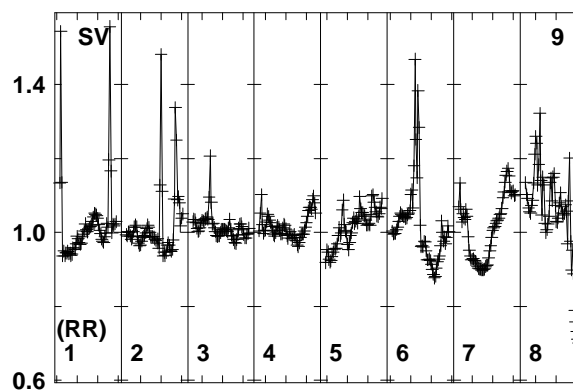
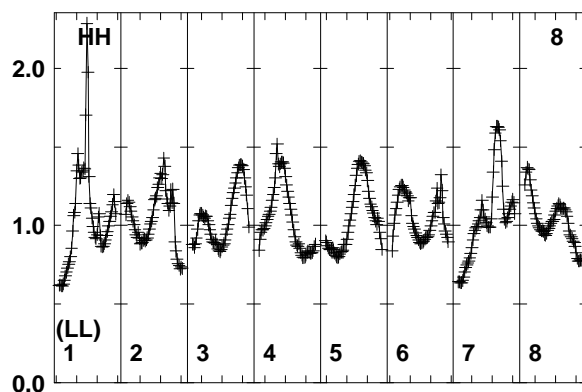
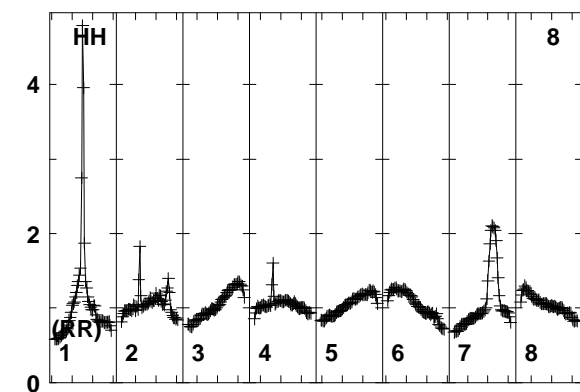
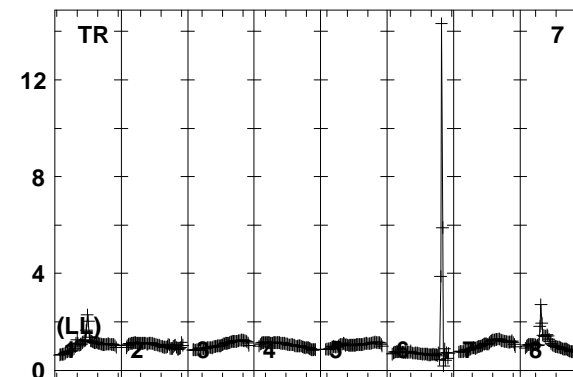
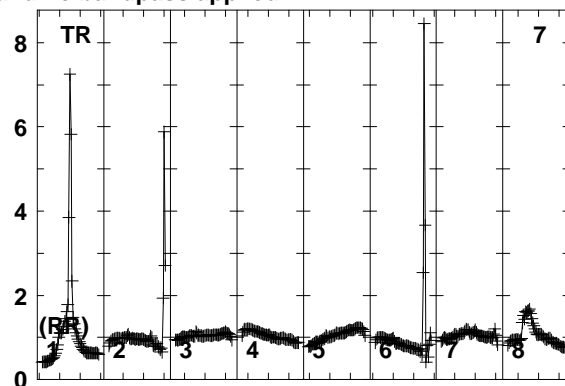
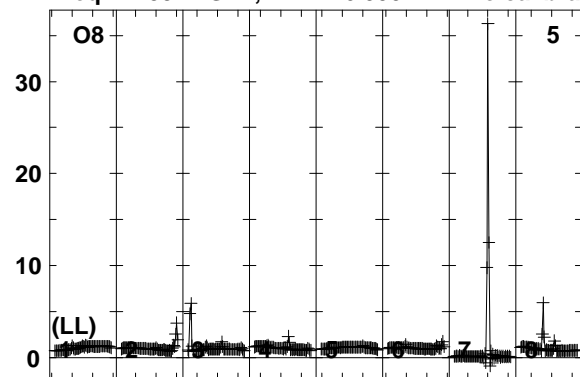

Lower frame: Real Jy
Total-power spectrum Antenna: O8 (05)
Timerange: 00/08:07:01 to 00/08:07:59

Plot file version 572 created 04-NOV-2019 14:14:47

J2248-0541 EY034.UVDATA.1

Freq = 1.5947 GHz, Bw = 16.000 MH No calibration applied and no bandpass applied

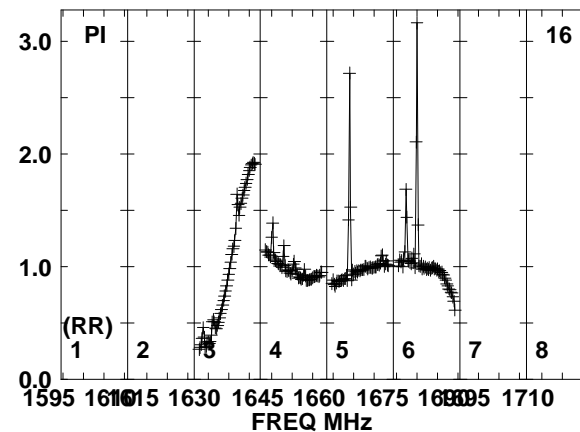
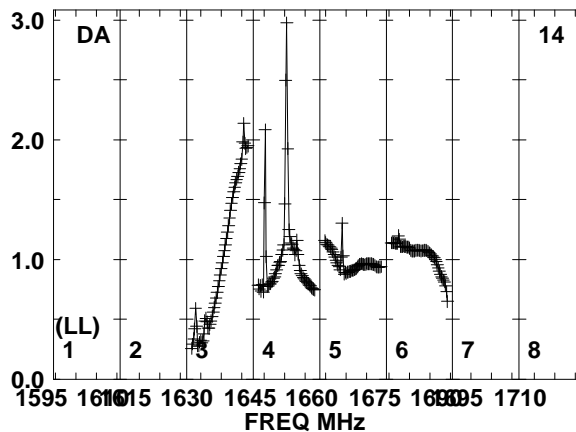
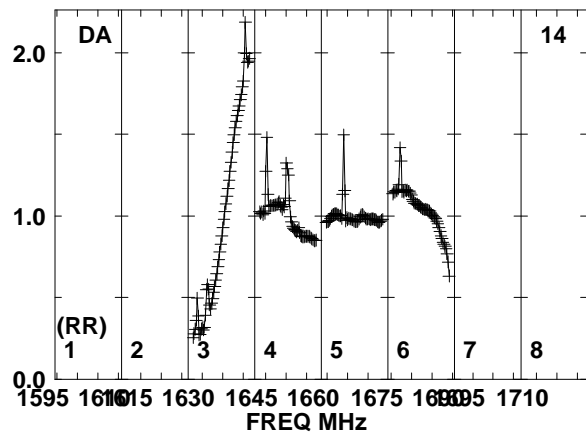
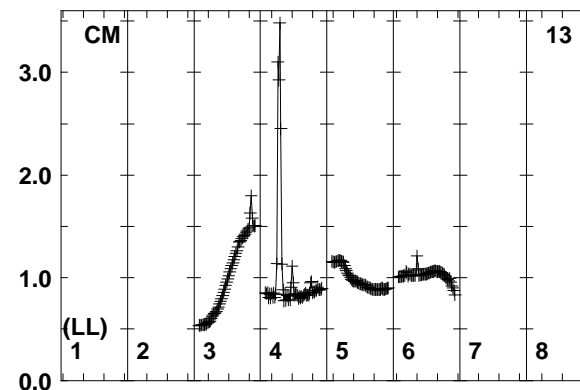
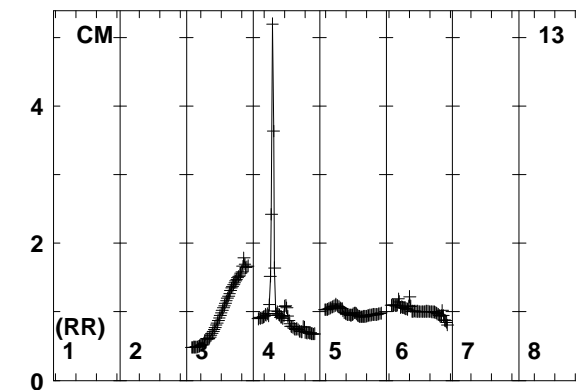
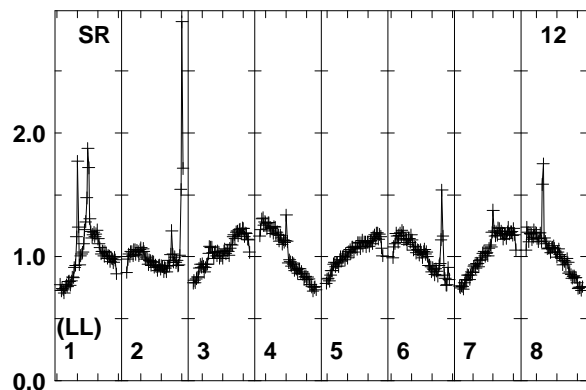
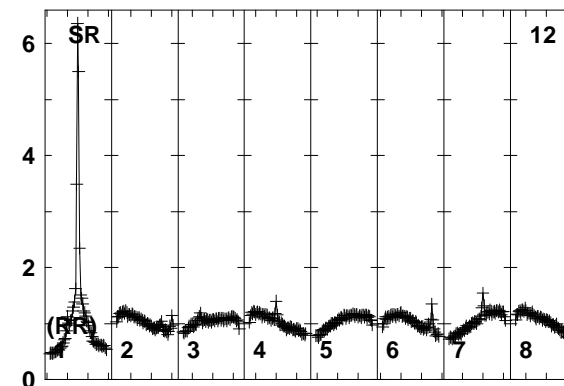
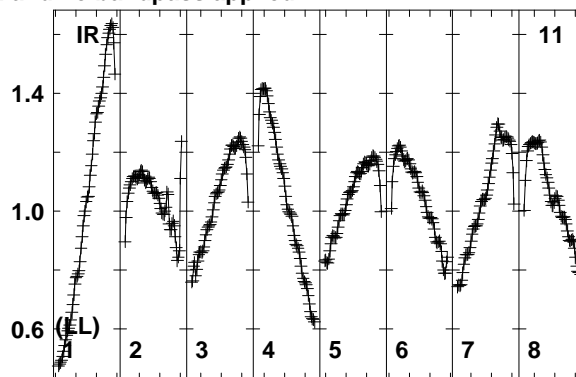
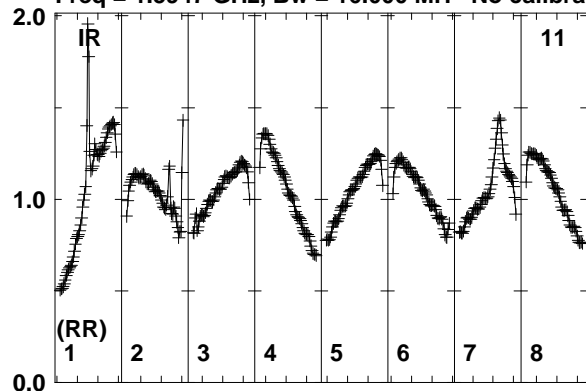

Lower frame: Real Jy
Total-power spectrum Antenna: IR (11)
Timerange: 00/08:07:01 to 00/08:07:59

Plot file version 573 created 04-NOV-2019 14:14:47
J2248-0541 EY034.UVDATA.1
Freq = 1.5947 GHz, Bw = 16.000 MH No calibration applied and no bandpass applied

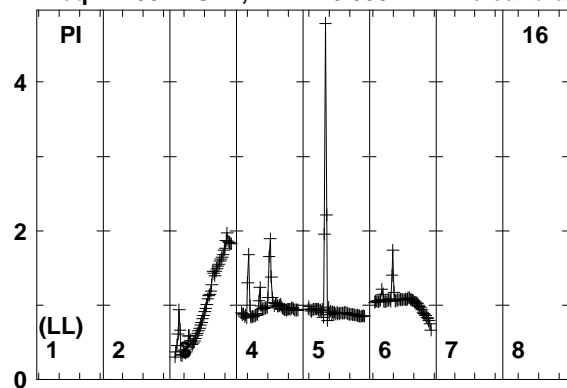

Lower frame: Real Jy
Total-power spectrum Antenna: PI (16)
Timerange: 00/08:07:01 to 00/08:07:59

Plot file version 574 created 04-NOV-2019 14:14:47

W2246-0526 EY034.UVDATA.1

Freq = 1.5947 GHz, Bw = 16.000 MH No calibration applied and no bandpass applied

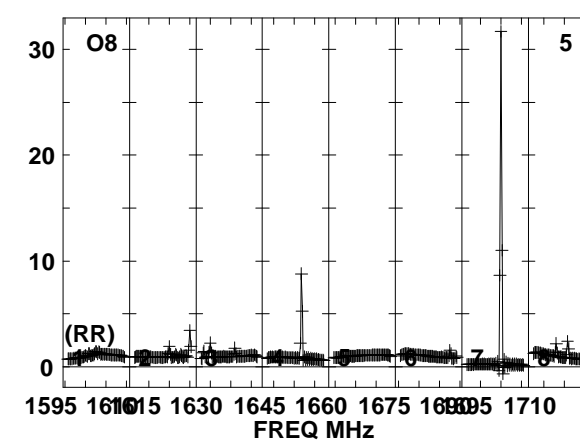
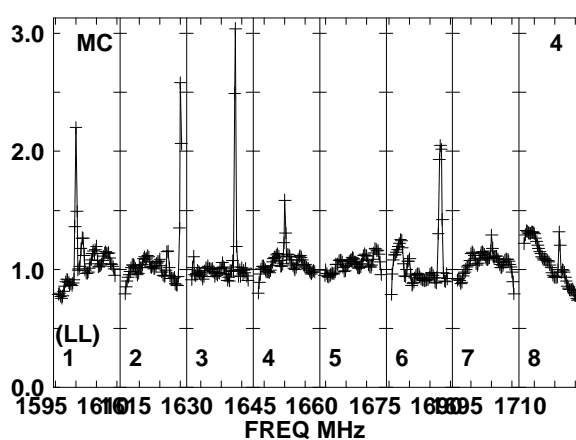
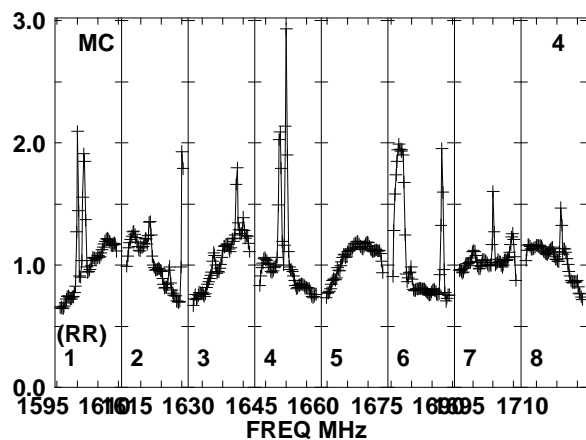
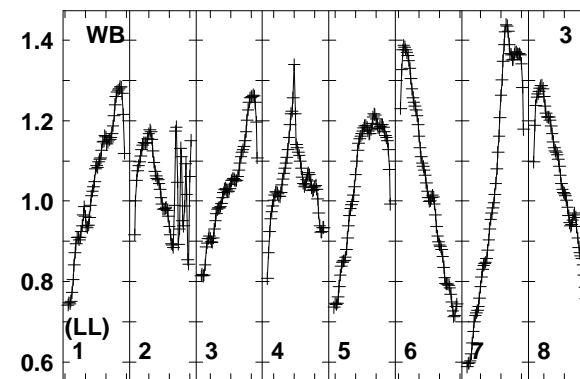
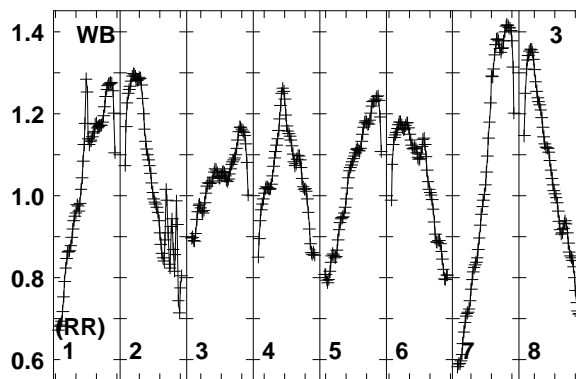
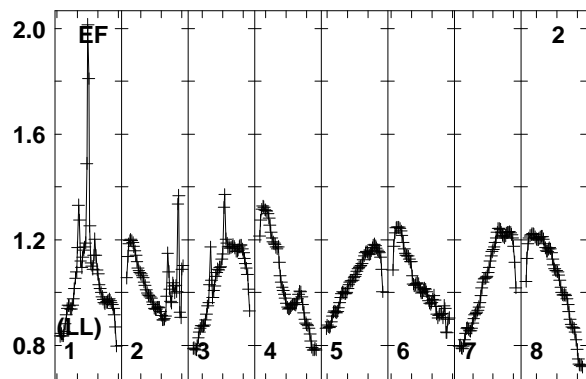
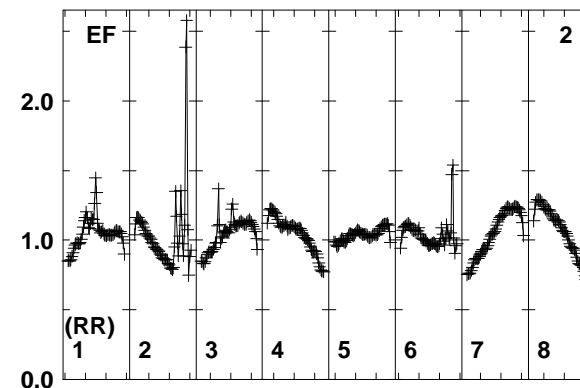
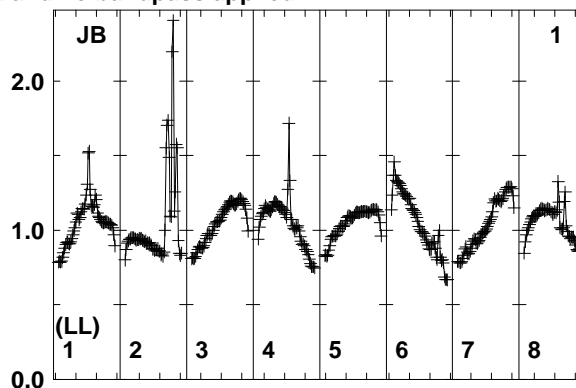
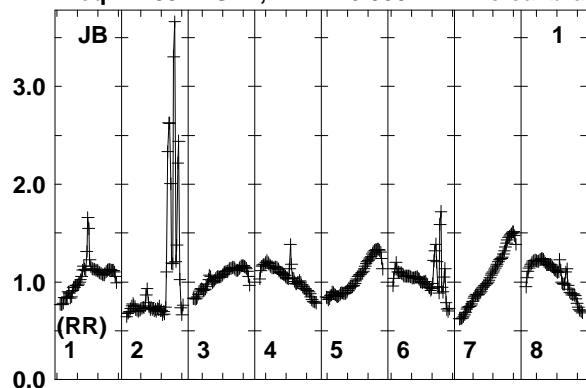

Lower frame: Real Jy
Total-power spectrum Antenna: JB (01)
Timerange: 00/08:08:01 to 00/08:10:29

Plot file version 575 created 04-NOV-2019 14:14:47

W2246-0526 EY034.UVDATA.1

Freq = 1.5947 GHz, Bw = 16.000 MH No calibration applied and no bandpass applied

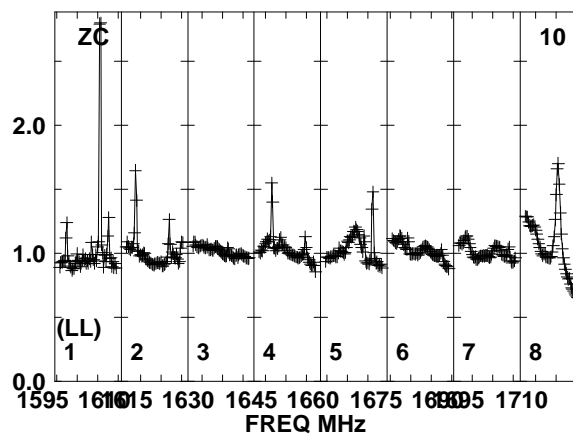
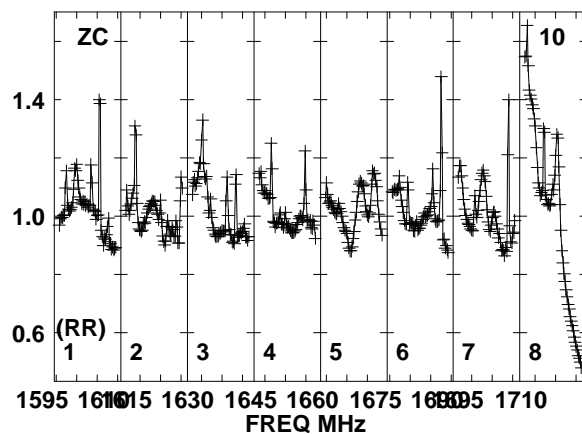
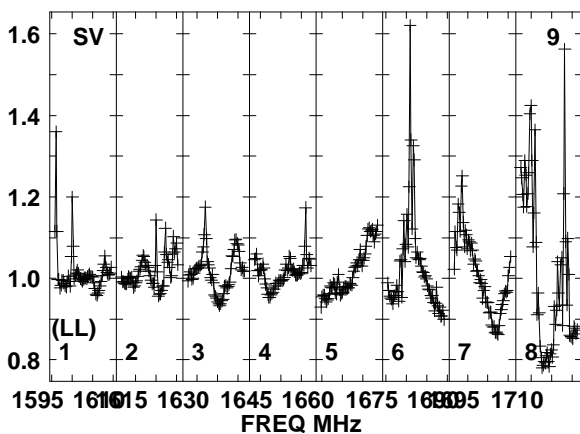
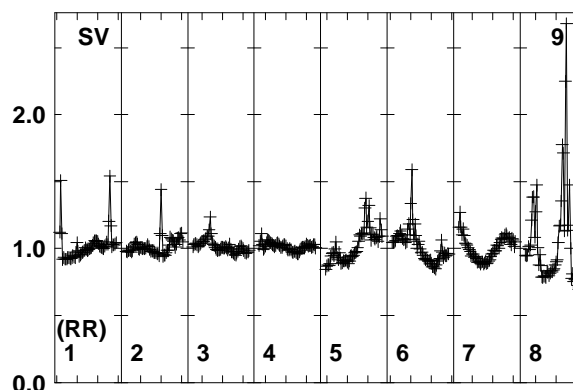
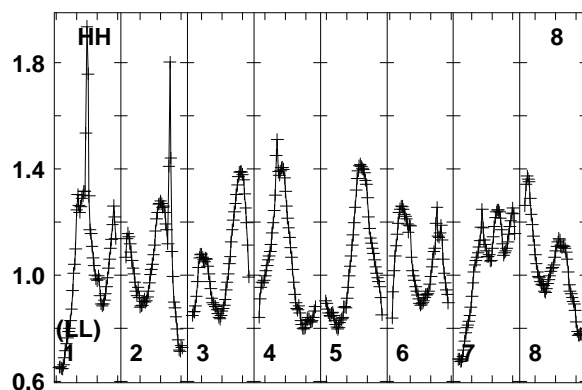
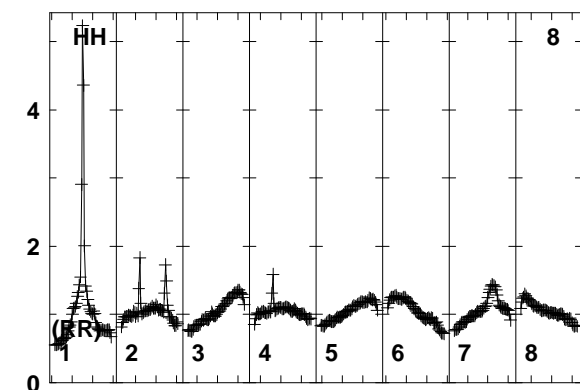
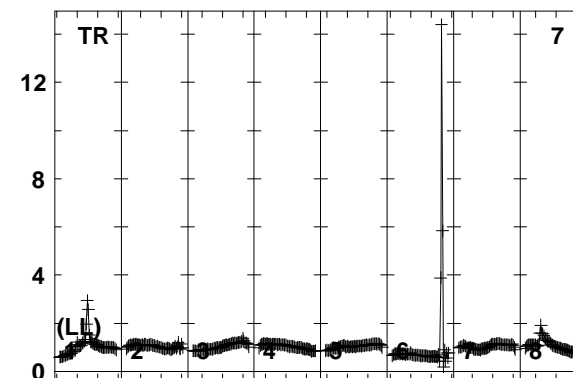
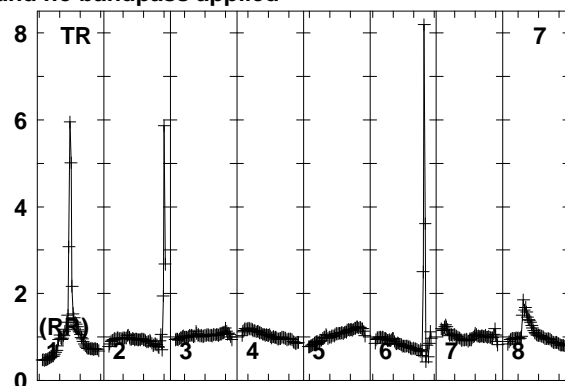
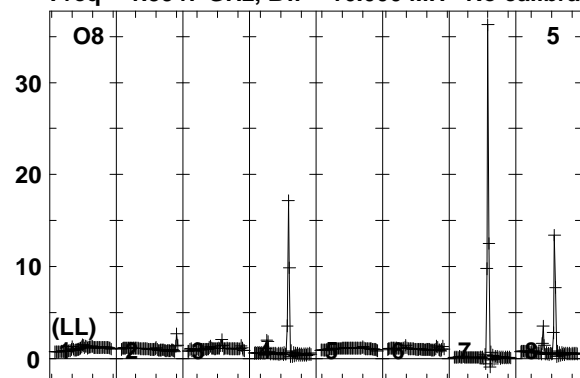

Lower frame: Real Jy
Total-power spectrum Antenna: O8 (05)
Timerange: 00/08:08:01 to 00/08:10:29

Plot file version 576 created 04-NOV-2019 14:14:47

W2246-0526 EY034.UVDATA.1

Freq = 1.5947 GHz, Bw = 16.000 MH No calibration applied and no bandpass applied

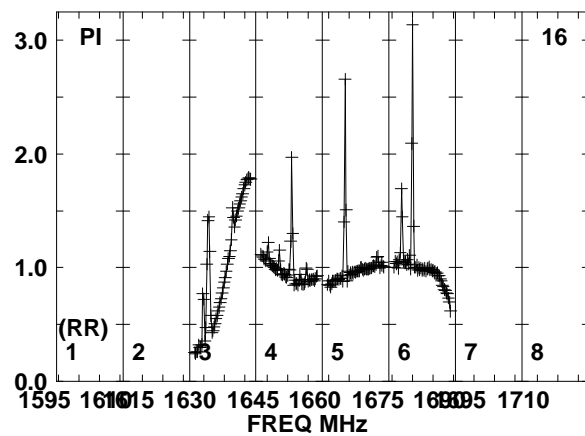
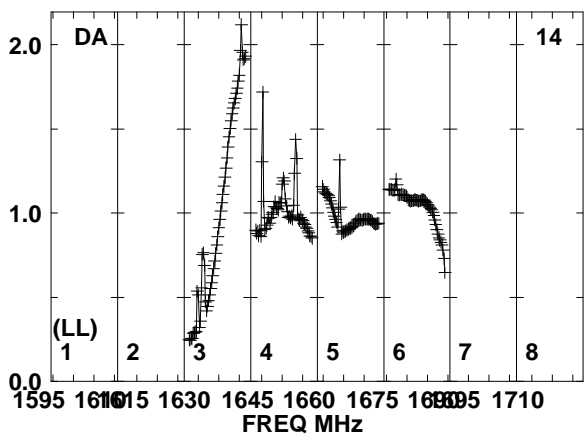
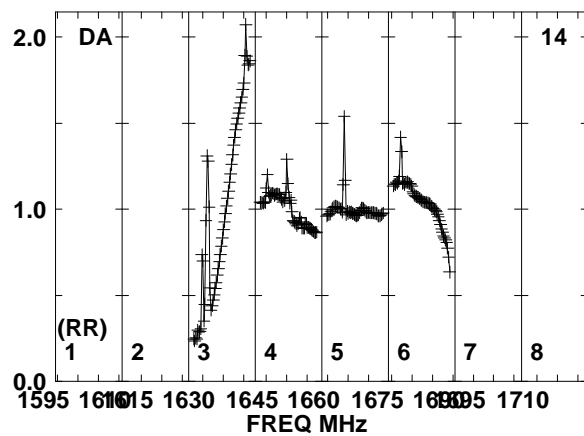
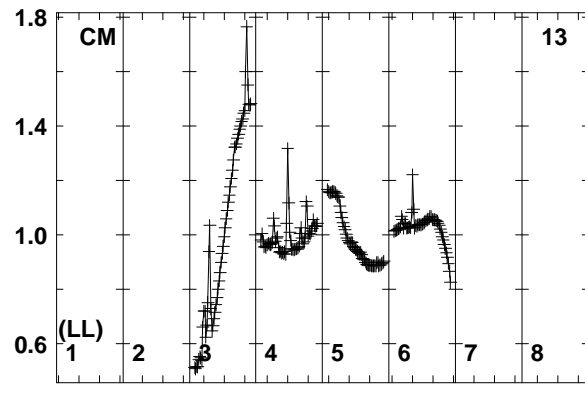
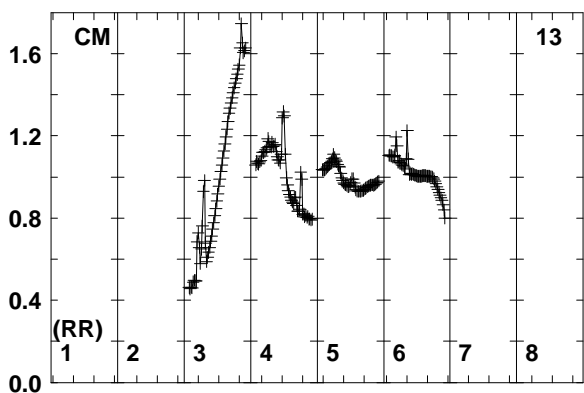
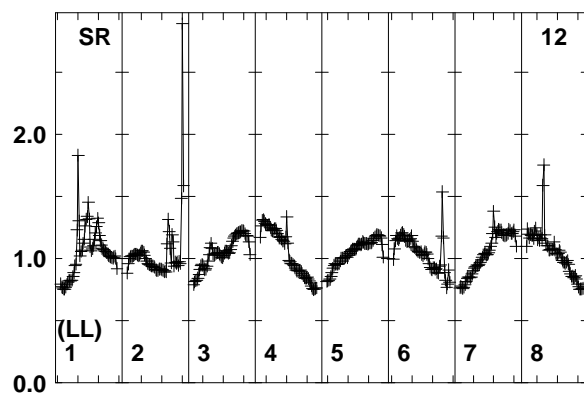
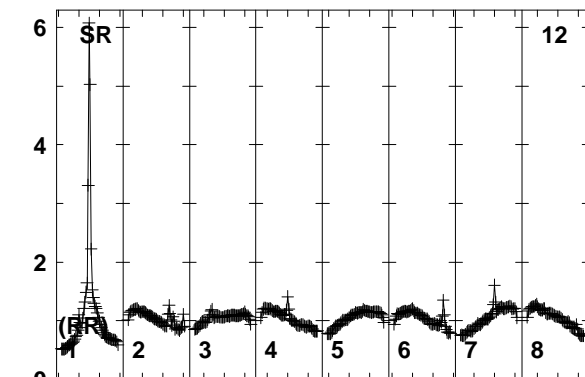
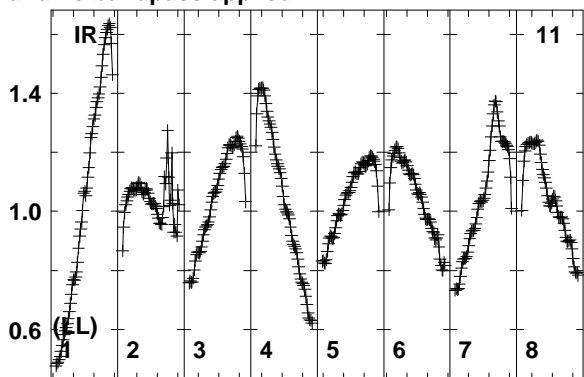
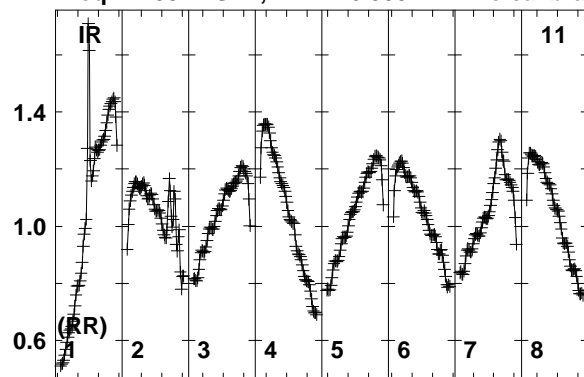

Lower frame: Real Jy
Total-power spectrum Antenna: IR (11)
Timerange: 00/08:08:01 to 00/08:10:29

Plot file version 577 created 04-NOV-2019 14:14:47
W2246-0526 EY034.UVDATA.1
Freq = 1.5947 GHz, Bw = 16.000 MH No calibration applied and no bandpass applied

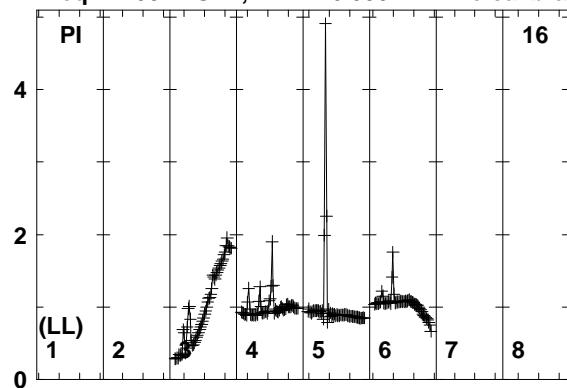

Lower frame: Real Jy
Total-power spectrum Antenna: PI (16)
Timerange: 00/08:08:01 to 00/08:10:29

Plot file version 578 created 04-NOV-2019 14:14:48

J2248-0541 EY034.UVDATA.1

Freq = 1.5947 GHz, Bw = 16.000 MH No calibration applied and no bandpass applied

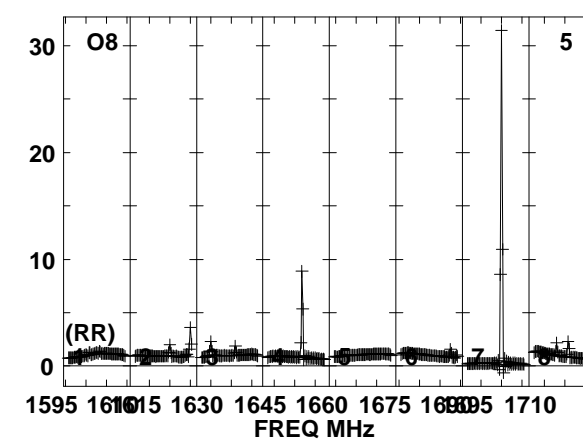
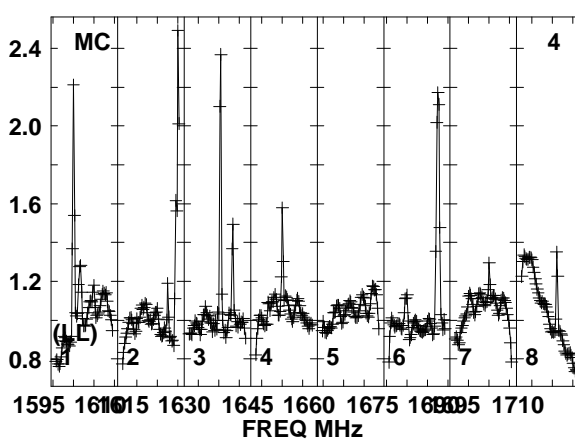
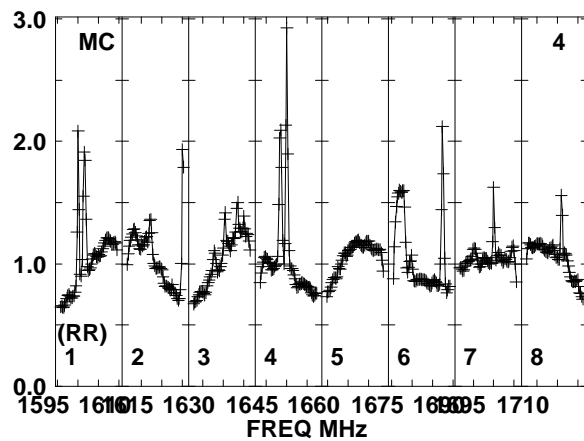
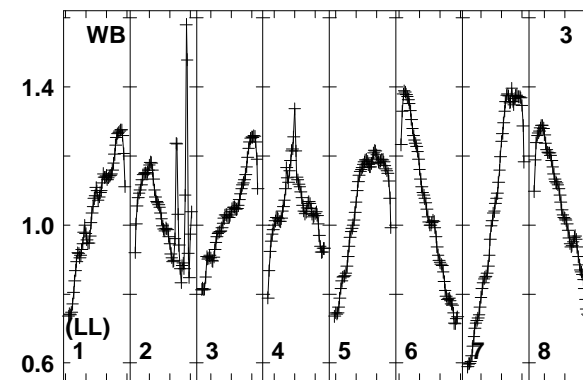
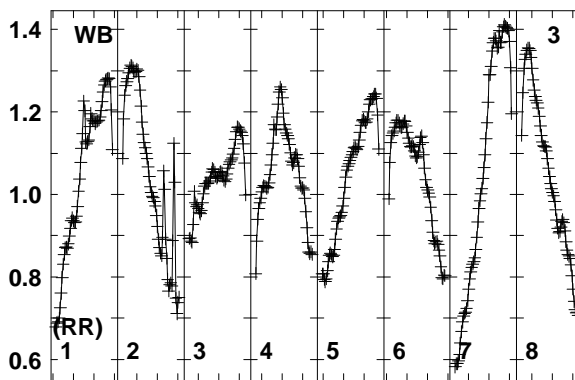
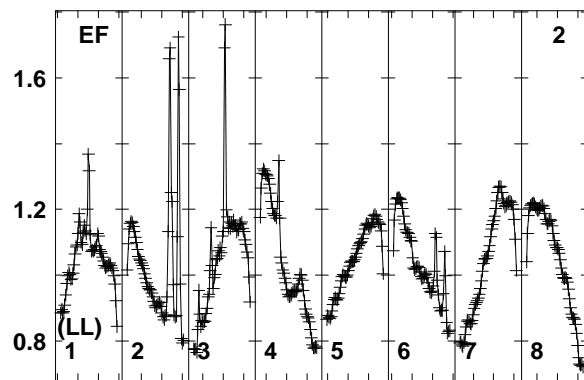
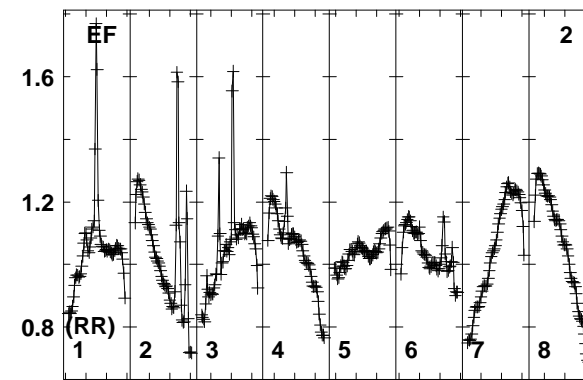
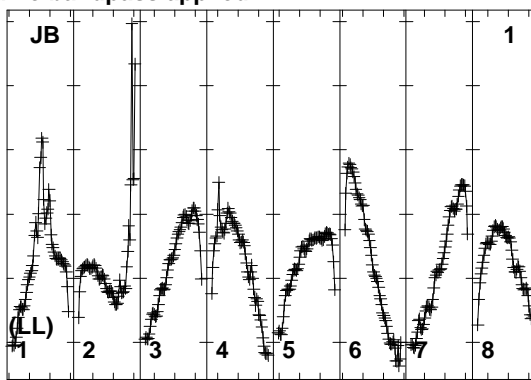
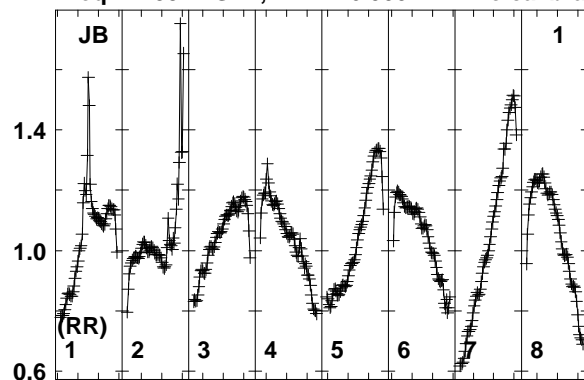

Lower frame: Real Jy
Total-power spectrum Antenna: JB (01)
Timerange: 00/08:10:46 to 00/08:11:44

Plot file version 579 created 04-NOV-2019 14:14:48

J2248-0541 EY034.UVDATA.1

Freq = 1.5947 GHz, Bw = 16.000 MH No calibration applied and no bandpass applied

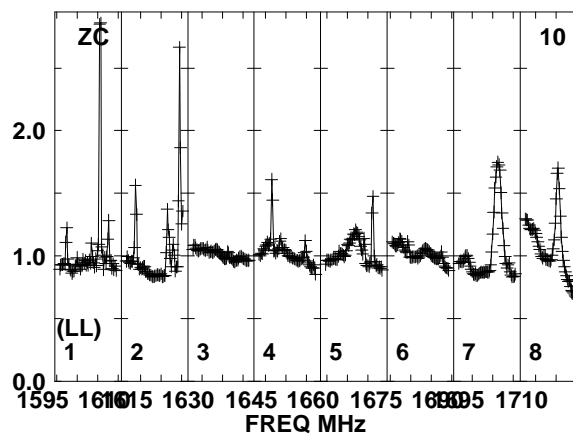
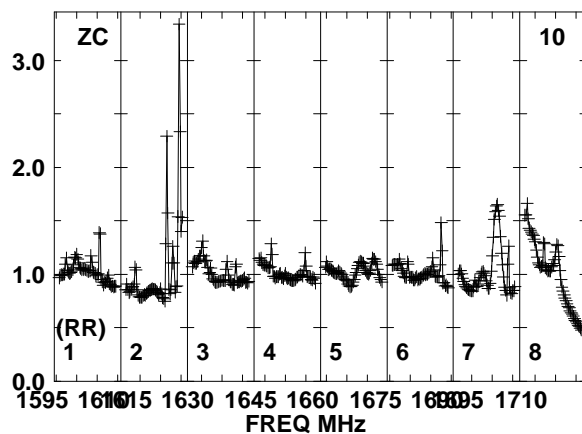
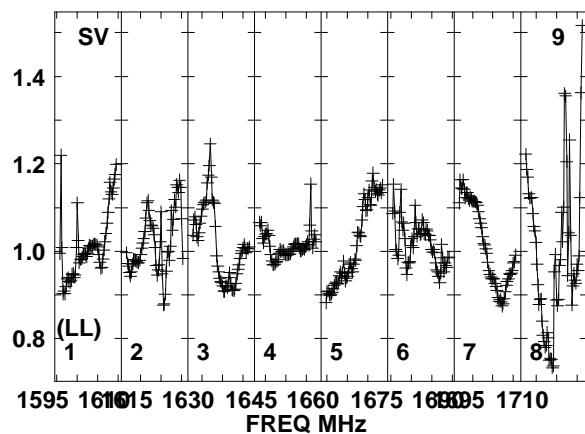
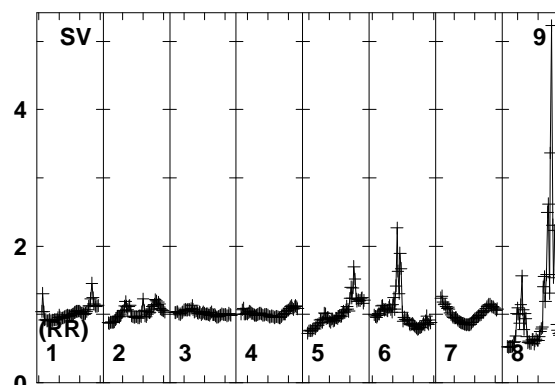
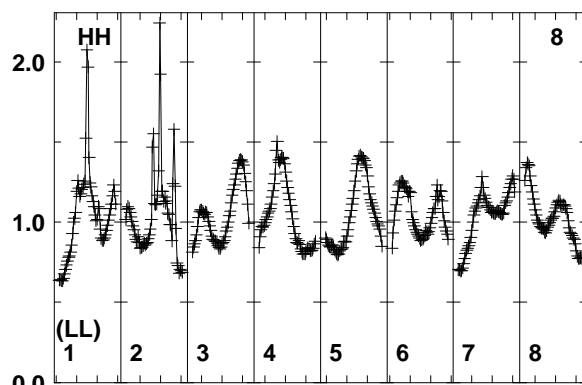
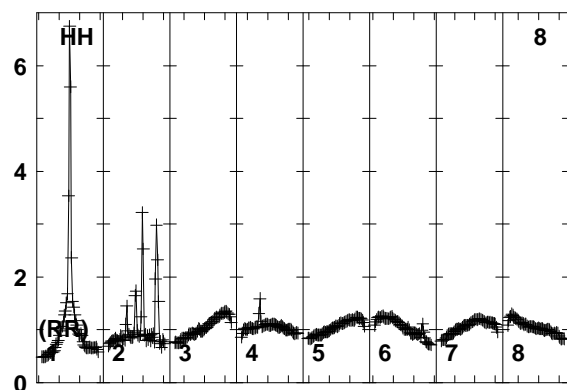
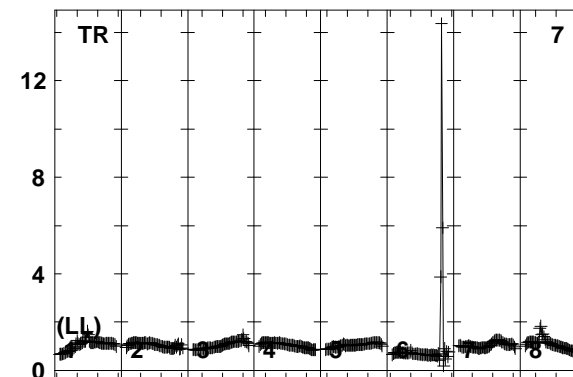
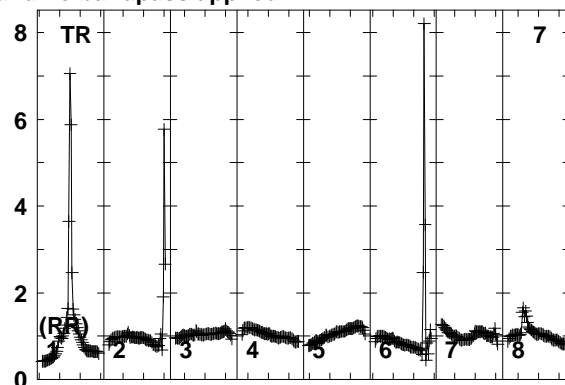
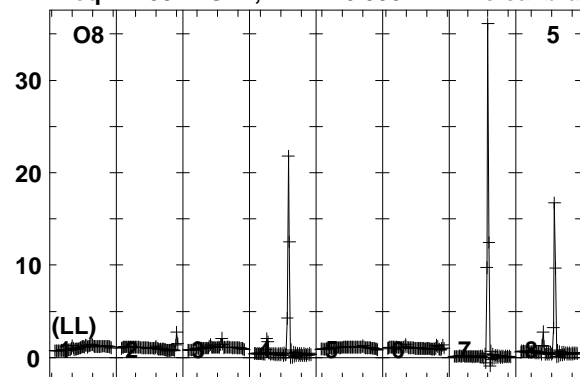

Lower frame: Real Jy
Total-power spectrum Antenna: O8 (05)
Timerange: 00/08:10:46 to 00/08:11:44

Plot file version 580 created 04-NOV-2019 14:14:48

J2248-0541 EY034.UVDATA.1

Freq = 1.5947 GHz, Bw = 16.000 MH No calibration applied and no bandpass applied

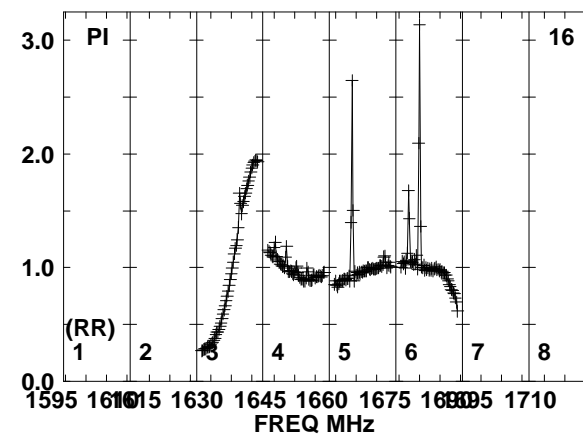
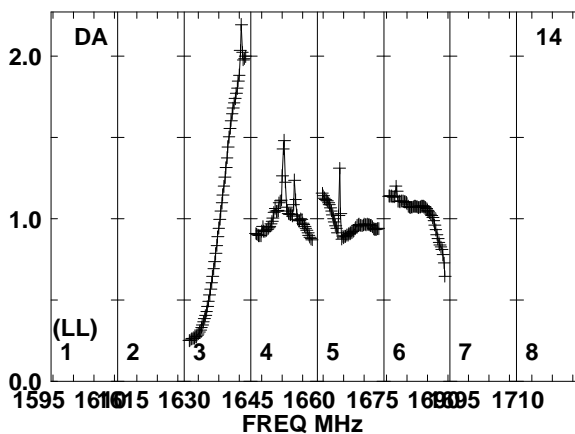
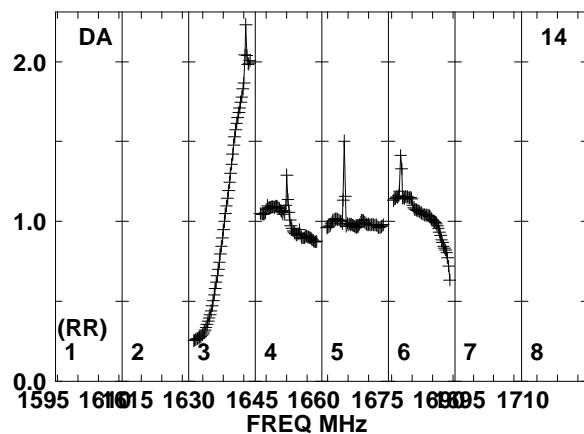
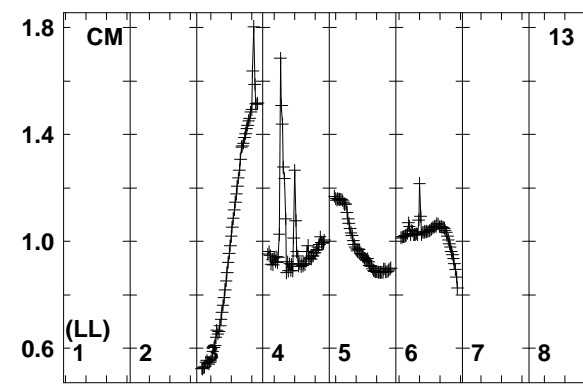
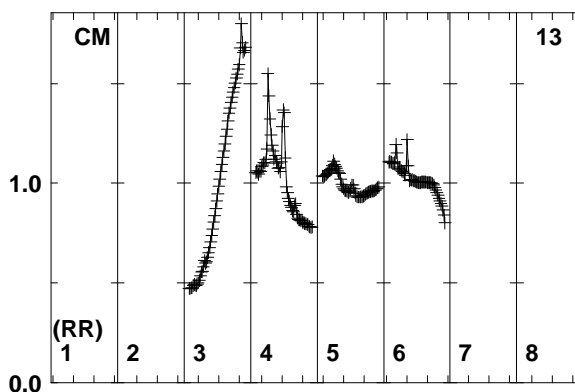
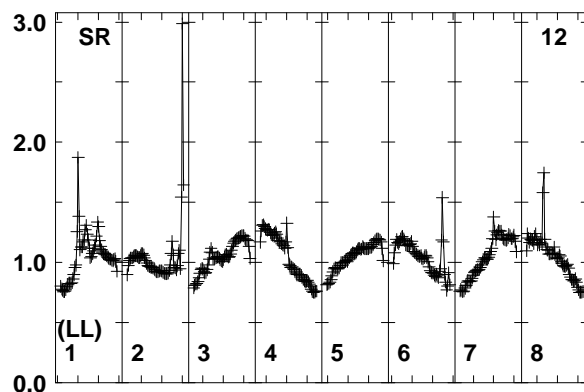
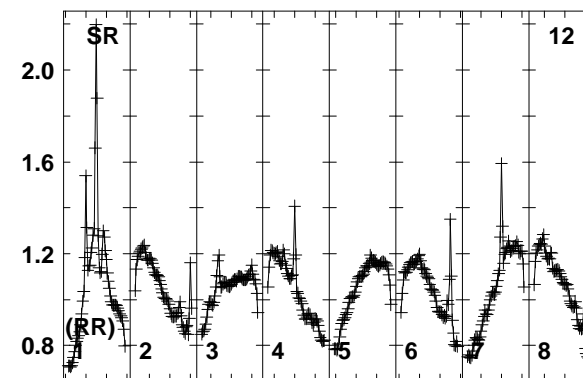
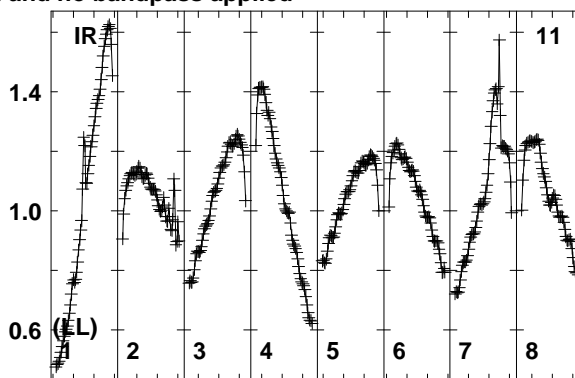
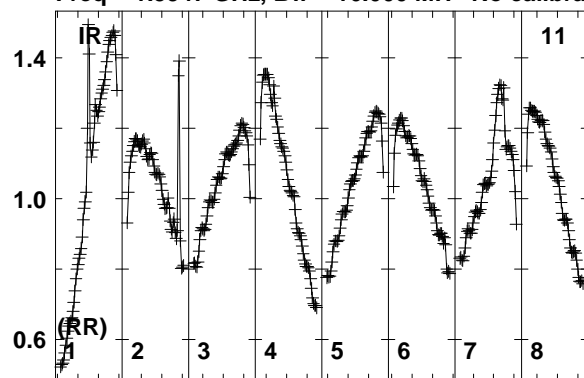

Lower frame: Real Jy
Total-power spectrum Antenna: IR (11)
Timerange: 00/08:10:46 to 00/08:11:44

Plot file version 581 created 04-NOV-2019 14:14:48
J2248-0541 EY034.UVDATA.1
Freq = 1.5947 GHz, Bw = 16.000 MH No calibration applied and no bandpass applied

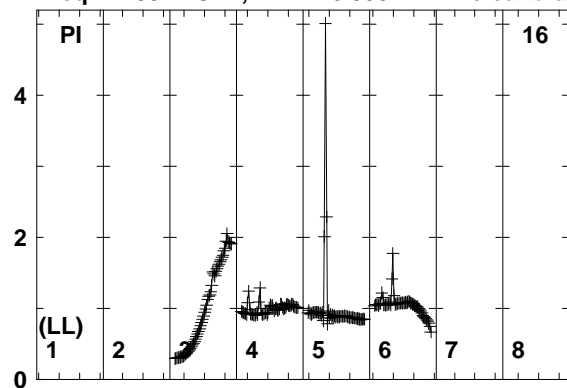

Lower frame: Real Jy
Total-power spectrum Antenna: PI (16)
Timerange: 00/08:10:46 to 00/08:11:44

Plot file version 582 created 04-NOV-2019 14:14:48

W2246-0526 EY034.UVDATA.1

Freq = 1.5947 GHz, Bw = 16.000 MH No calibration applied and no bandpass applied

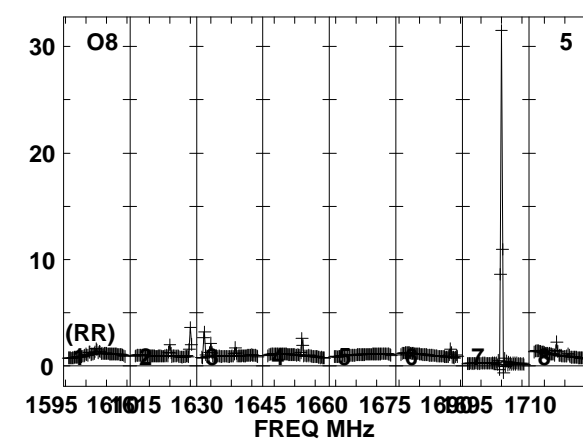
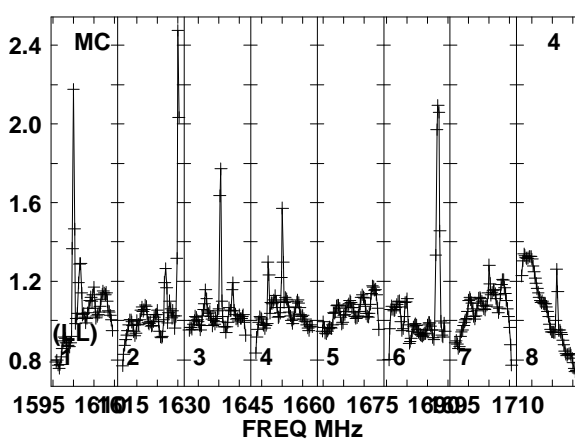
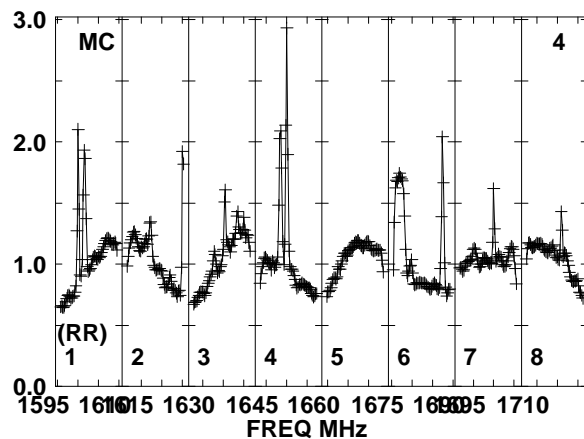
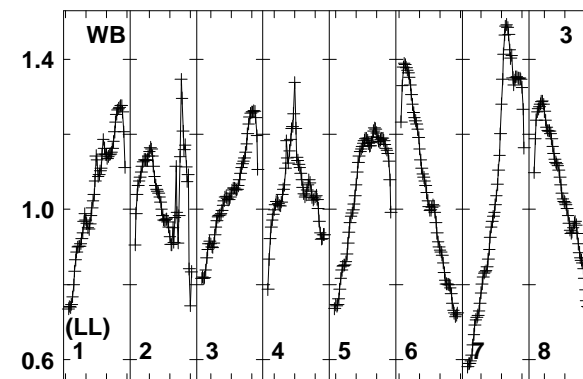
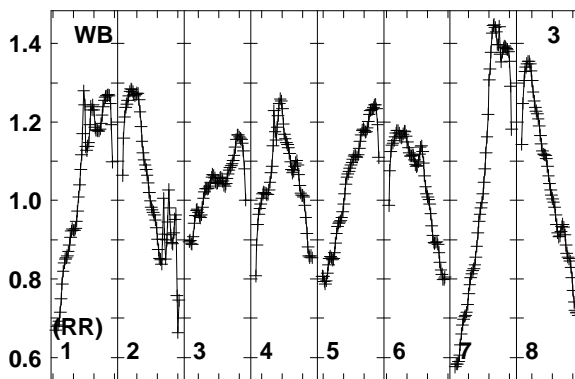
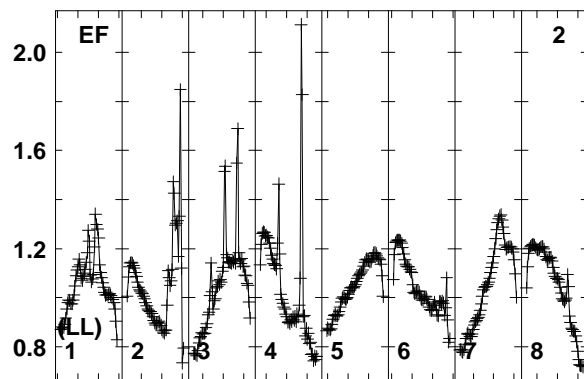
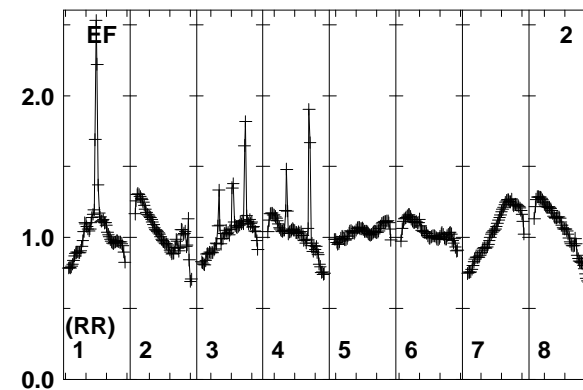
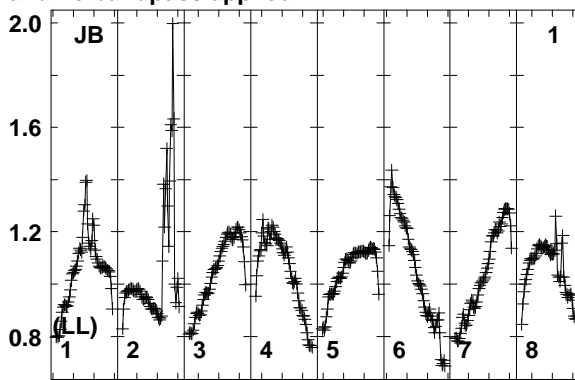
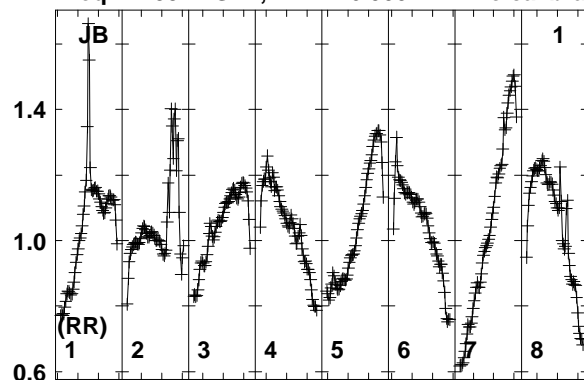

Lower frame: Real Jy
Total-power spectrum Antenna: JB (01)
Timerange: 00/08:11:46 to 00/08:14:24

Plot file version 583 created 04-NOV-2019 14:14:48

W2246-0526 EY034.UVDATA.1

Freq = 1.5947 GHz, Bw = 16.000 MH No calibration applied and no bandpass applied

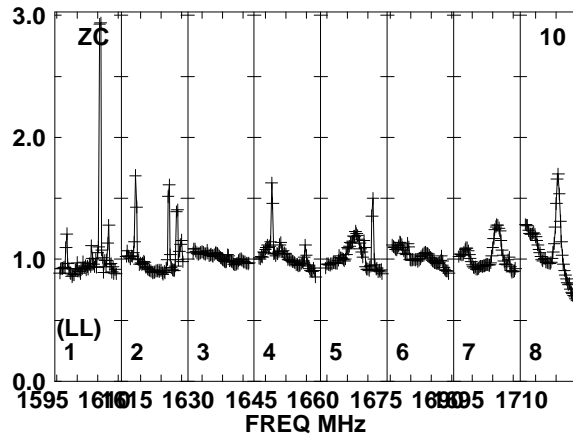
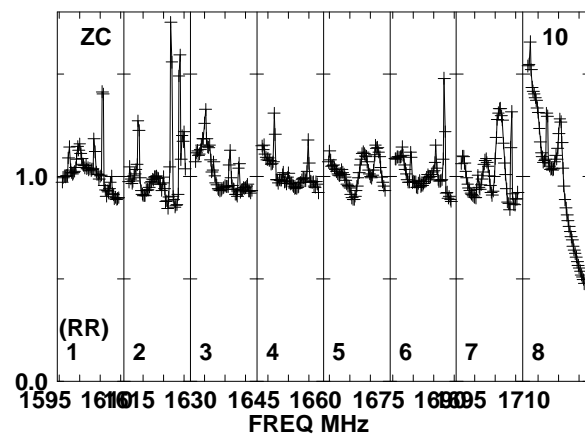
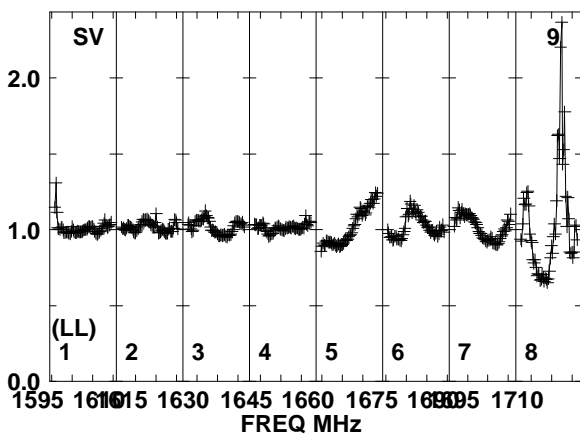
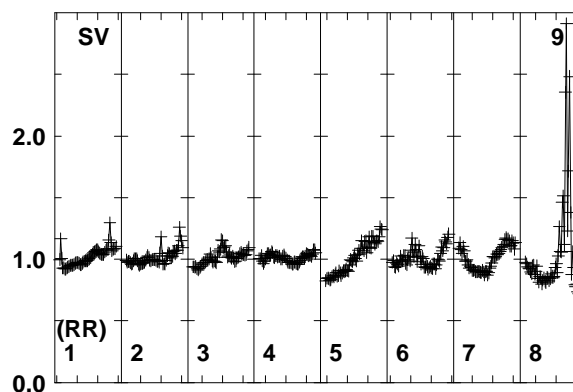
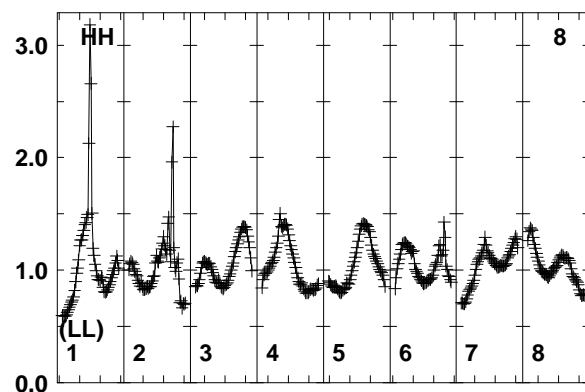
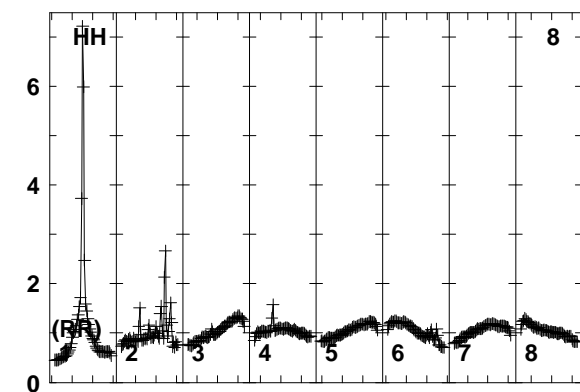
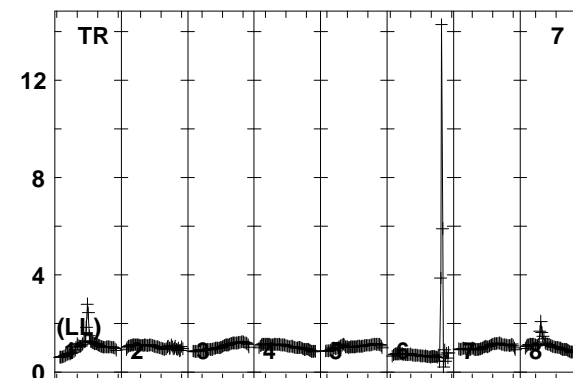
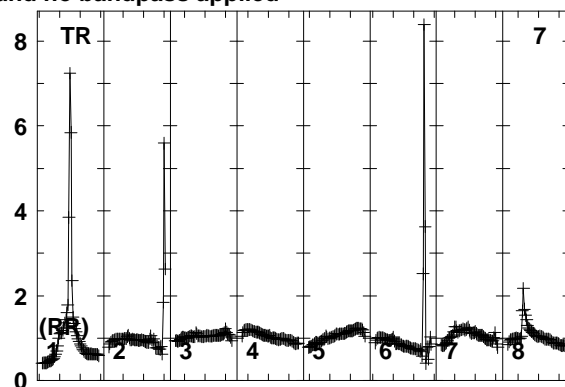
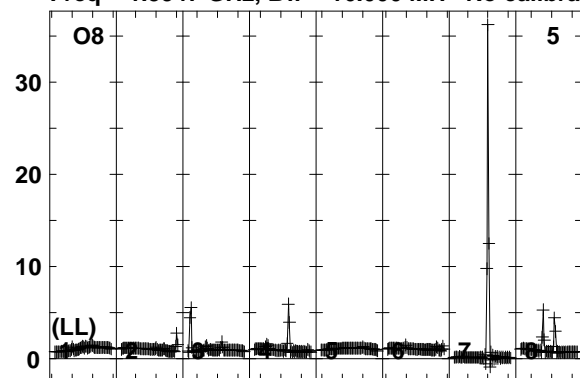

Lower frame: Real Jy
Total-power spectrum Antenna: O8 (05)
Timerange: 00/08:11:46 to 00/08:14:24

Plot file version 584 created 04-NOV-2019 14:14:48

W2246-0526 EY034.UVDATA.1

Freq = 1.5947 GHz, Bw = 16.000 MH No calibration applied and no bandpass applied

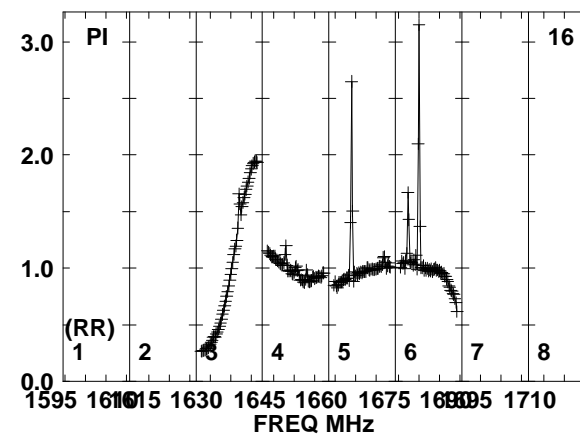
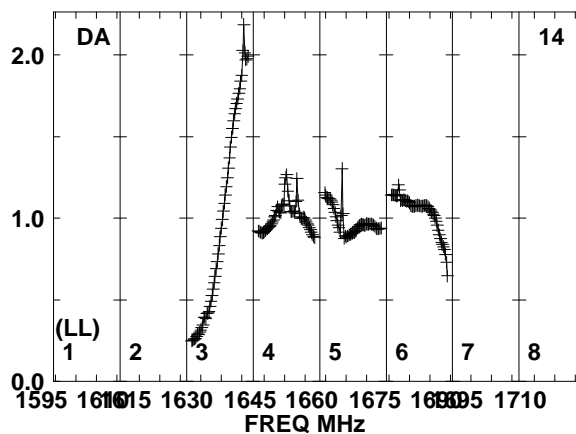
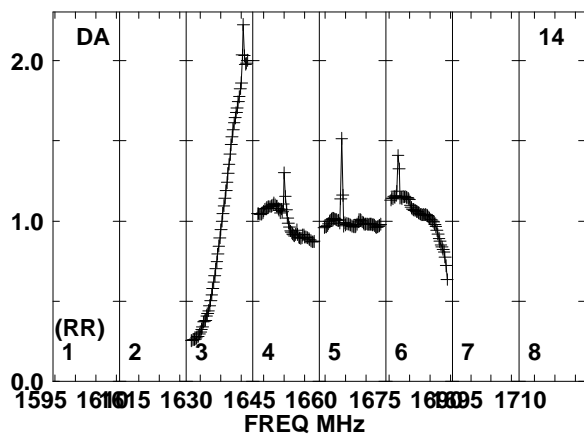
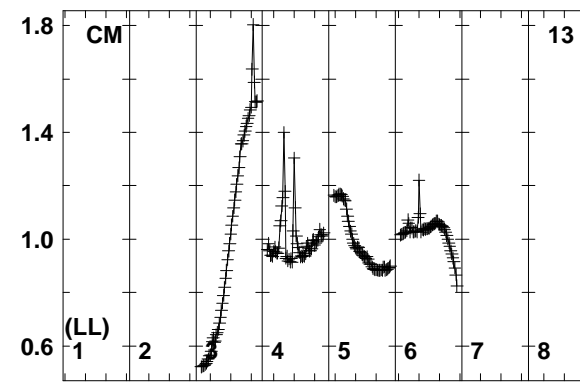
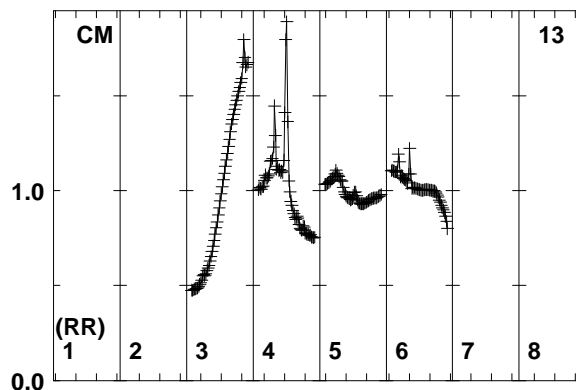
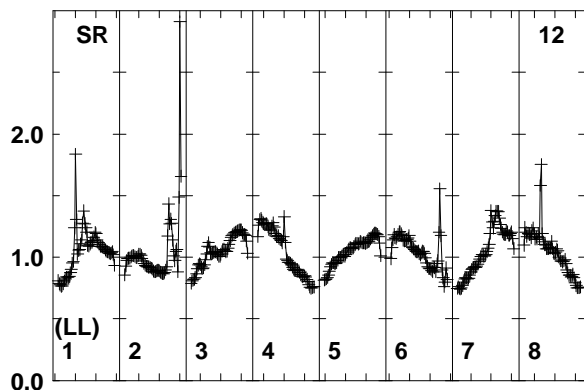
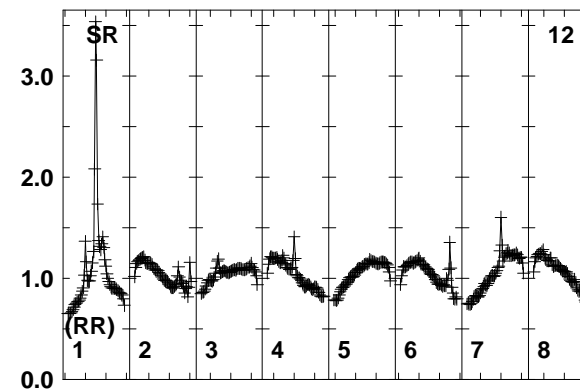
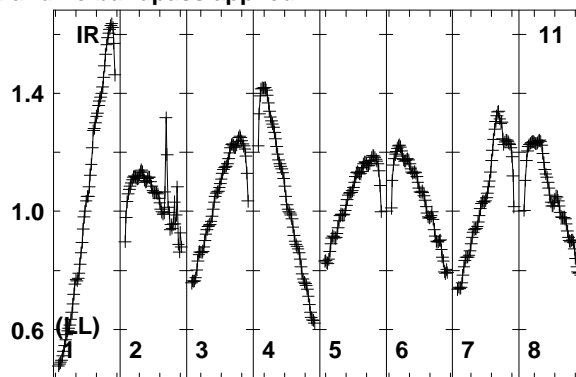
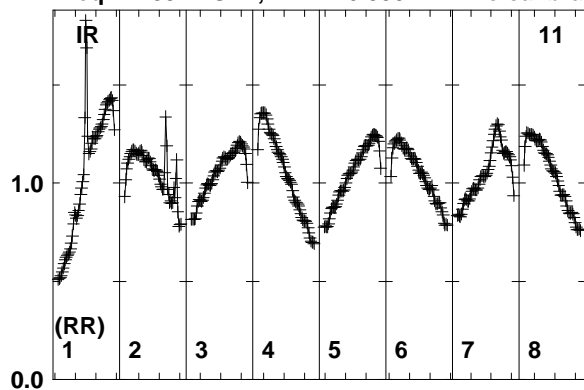

Lower frame: Real Jy
Total-power spectrum Antenna: IR (11)
Timerange: 00/08:11:46 to 00/08:14:24

Plot file version 585 created 04-NOV-2019 14:14:48
W2246-0526 EY034.UVDATA.1
Freq = 1.5947 GHz, Bw = 16.000 MH No calibration applied and no bandpass applied

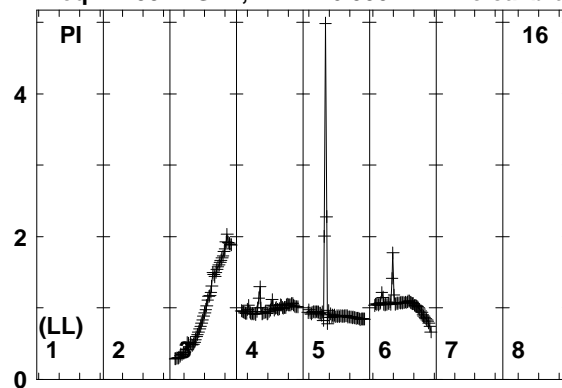

Lower frame: Real Jy
Total-power spectrum Antenna: PI (16)
Timerange: 00/08:11:46 to 00/08:14:24

Plot file version 586 created 04-NOV-2019 14:14:48

J2248-0541 EY034.UVDATA.1

Freq = 1.5947 GHz, Bw = 16.000 MH No calibration applied and no bandpass applied

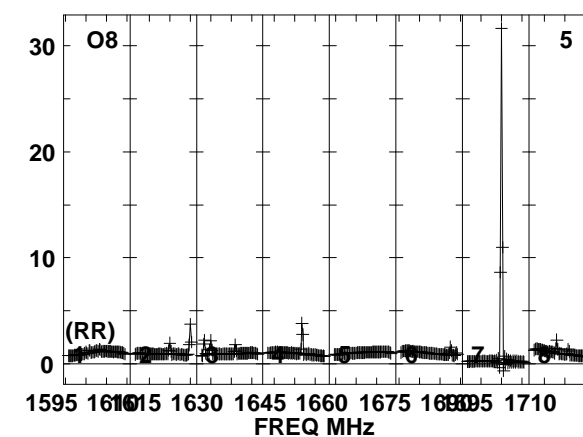
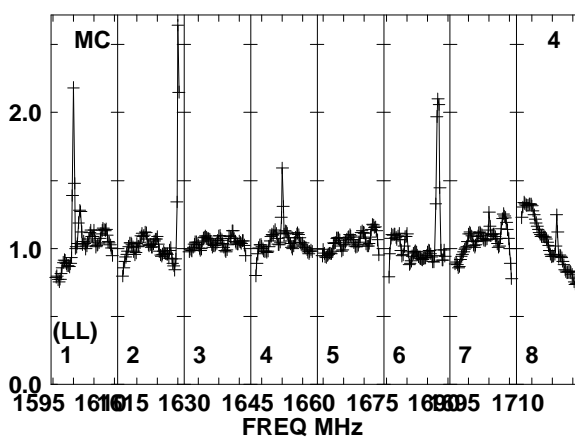
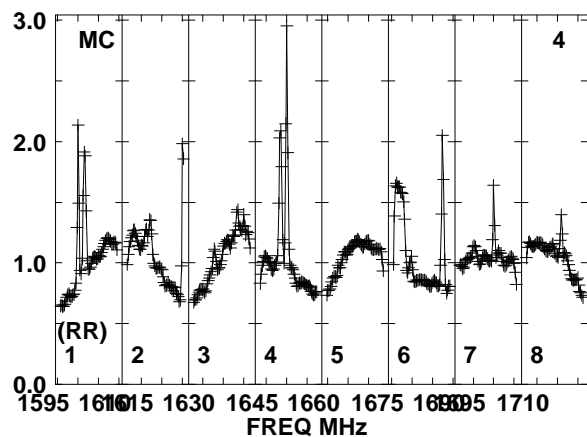
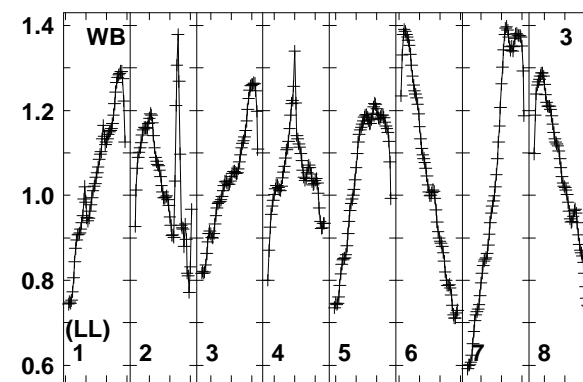
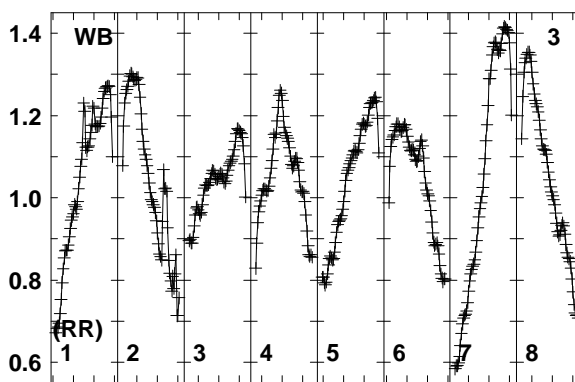
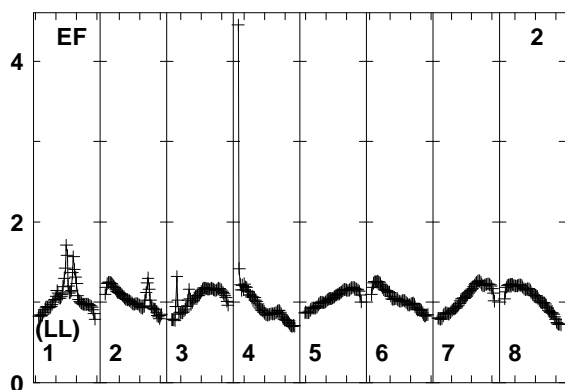
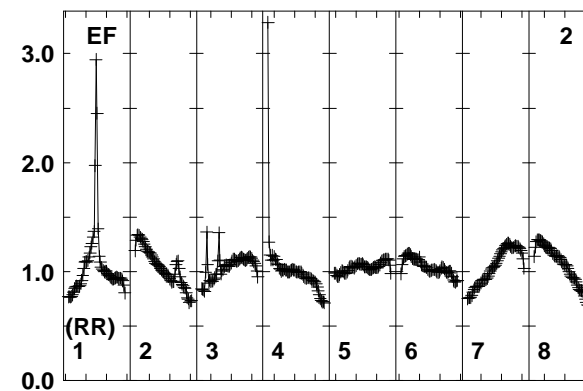
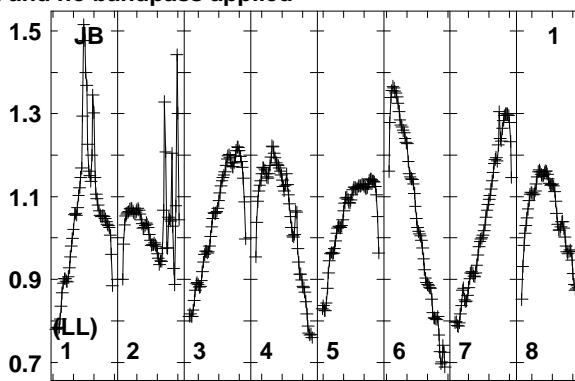
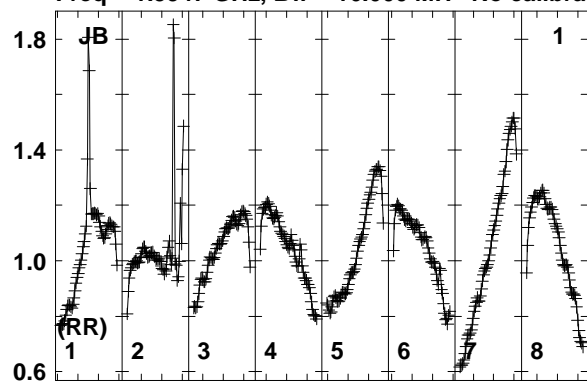

Lower frame: Real Jy
Total-power spectrum Antenna: JB (01)
Timerange: 00/08:14:41 to 00/08:15:39

Plot file version 587 created 04-NOV-2019 14:14:48

J2248-0541 EY034.UVDATA.1

Freq = 1.5947 GHz, Bw = 16.000 MH No calibration applied and no bandpass applied

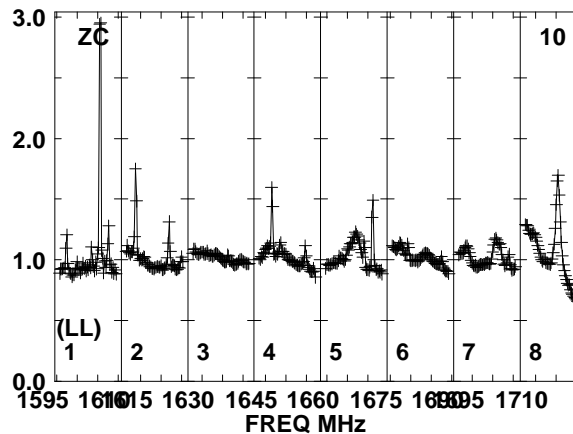
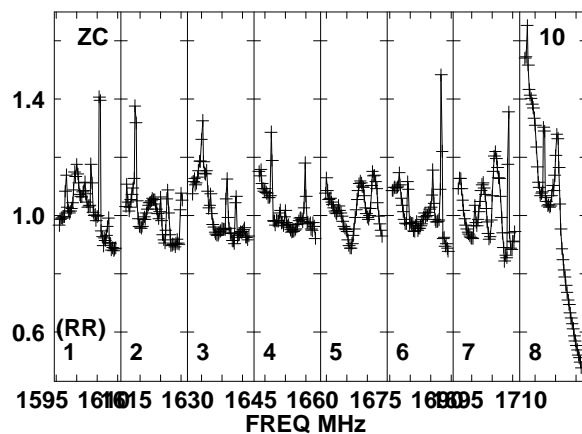
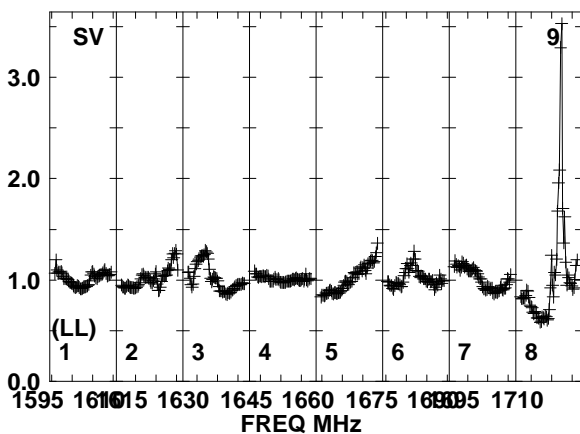
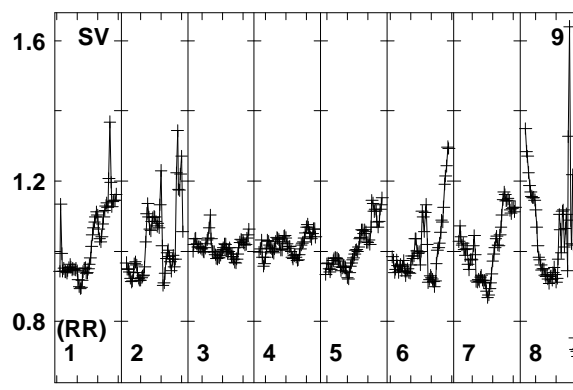
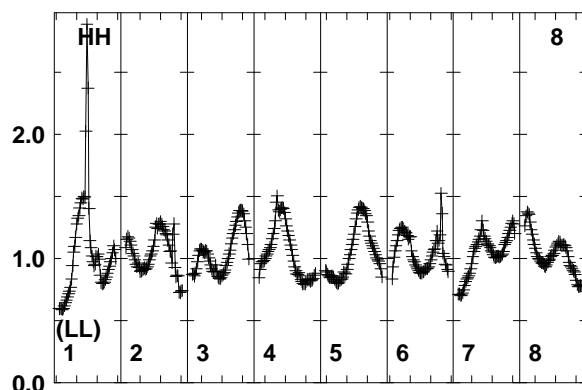
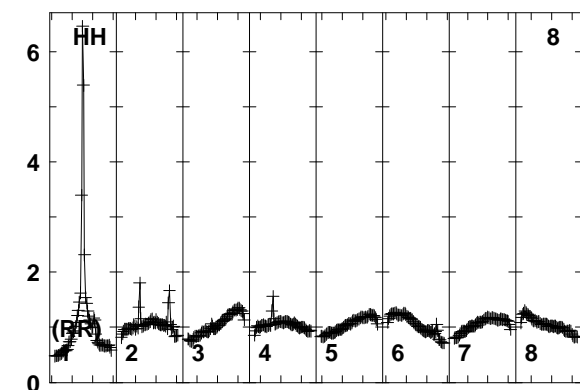
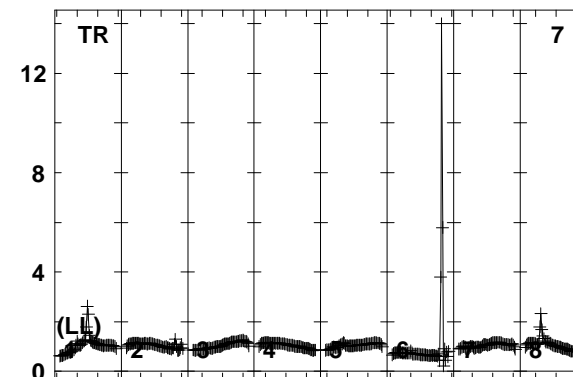
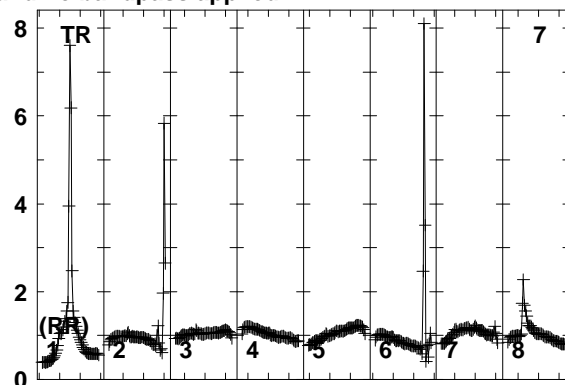
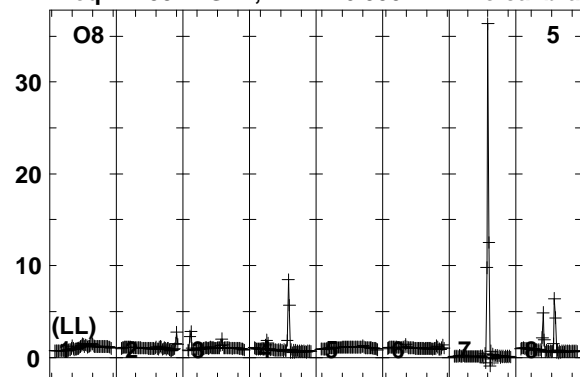

Lower frame: Real Jy
Total-power spectrum Antenna: O8 (05)
Timerange: 00/08:14:41 to 00/08:15:39

Plot file version 588 created 04-NOV-2019 14:14:48

J2248-0541 EY034.UVDATA.1

Freq = 1.5947 GHz, Bw = 16.000 MH No calibration applied and no bandpass applied

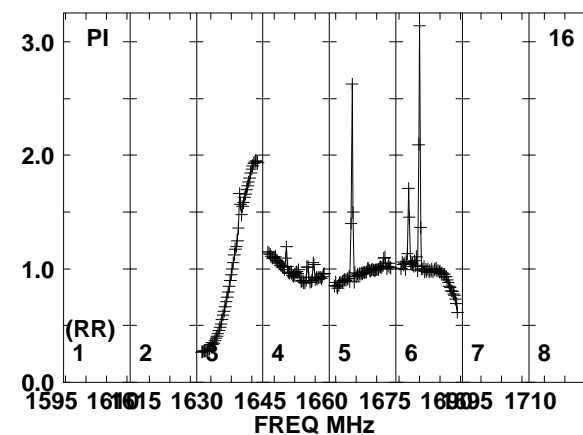
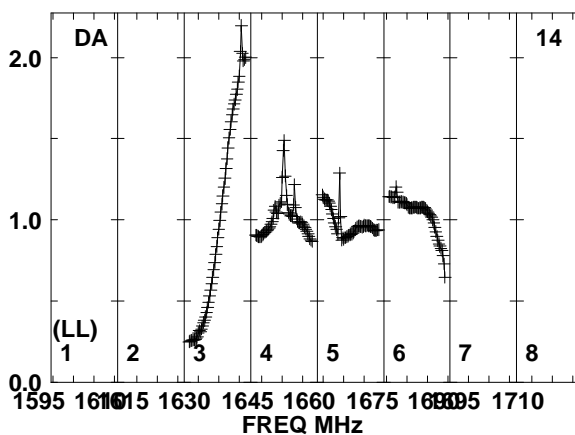
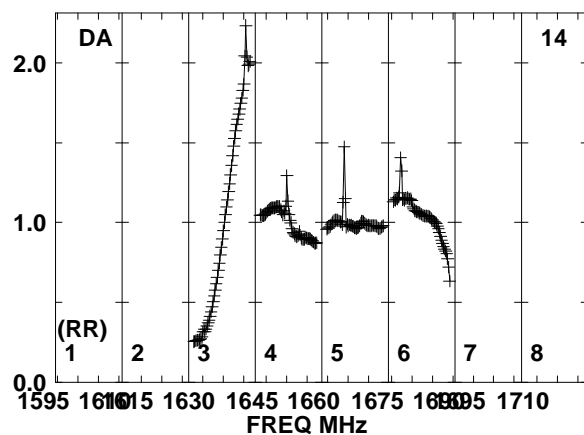
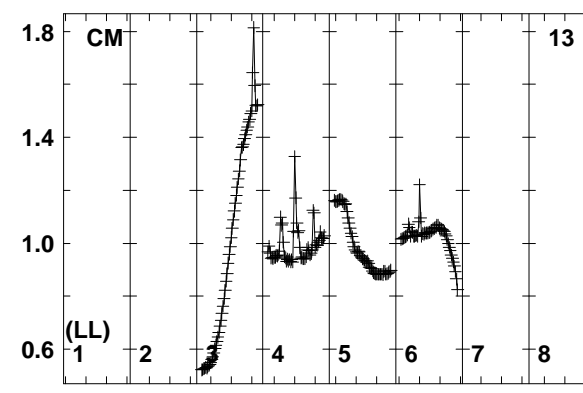
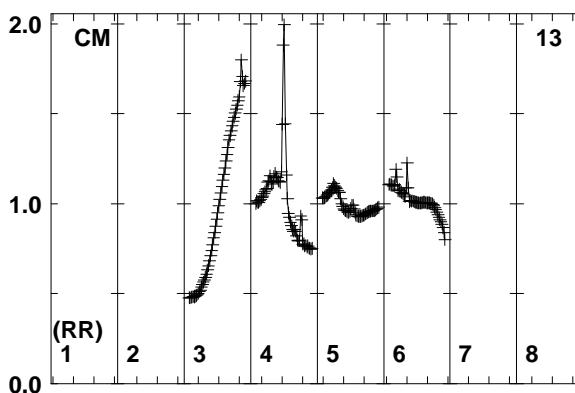
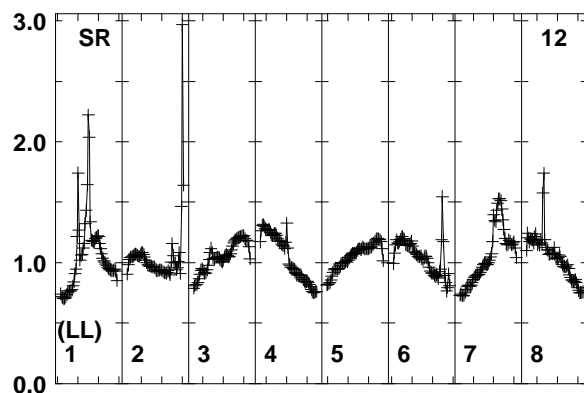
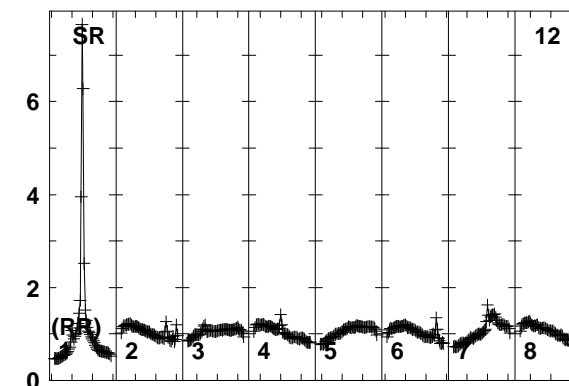
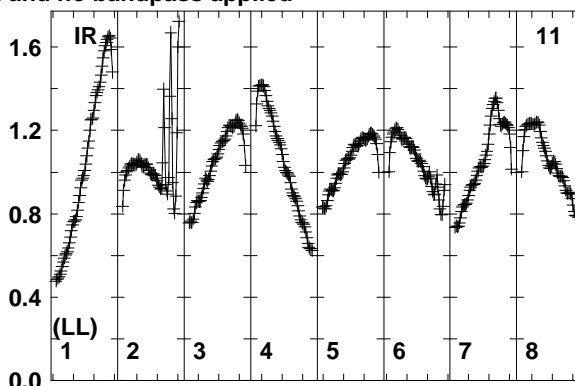
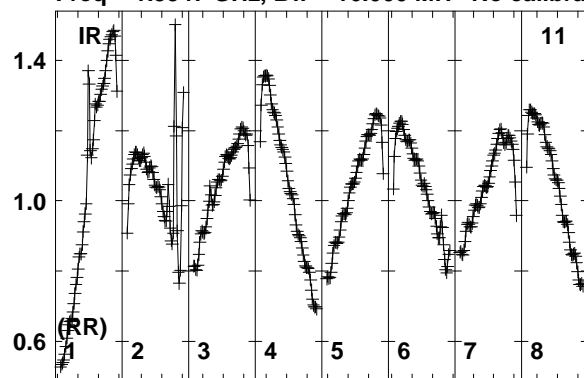

Lower frame: Real Jy
Total-power spectrum Antenna: IR (11)
Timerange: 00/08:14:41 to 00/08:15:39

Plot file version 589 created 04-NOV-2019 14:14:48
J2248-0541 EY034.UVDATA.1
Freq = 1.5947 GHz, Bw = 16.000 MH No calibration applied and no bandpass applied

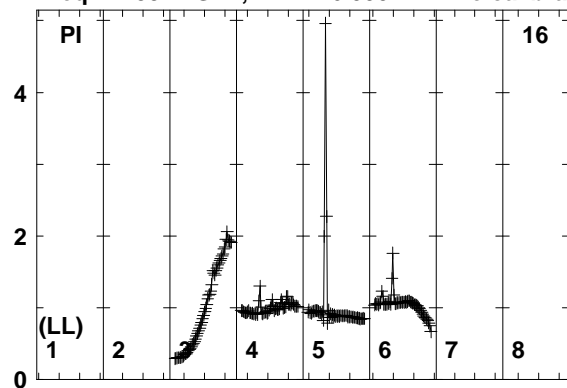

Lower frame: Real Jy
Total-power spectrum Antenna: PI (16)
Timerange: 00/08:14:41 to 00/08:15:39

Plot file version 590 created 04-NOV-2019 14:14:48

W2246-0526 EY034.UVDATA.1

Freq = 1.5947 GHz, Bw = 16.000 MH No calibration applied and no bandpass applied

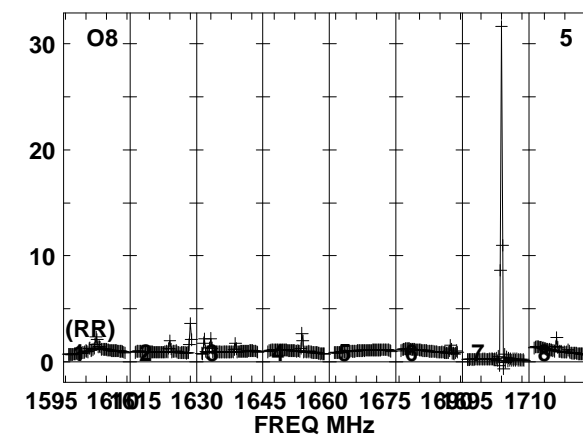
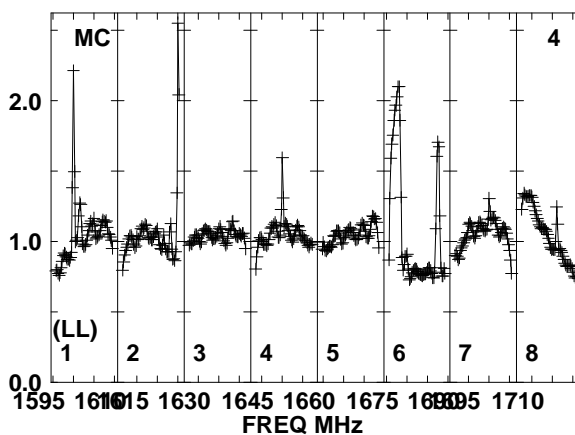
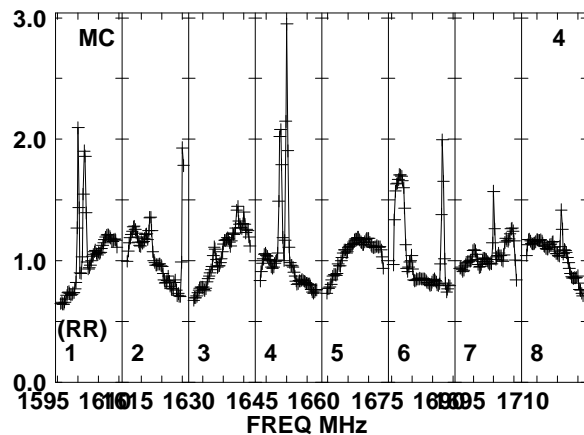
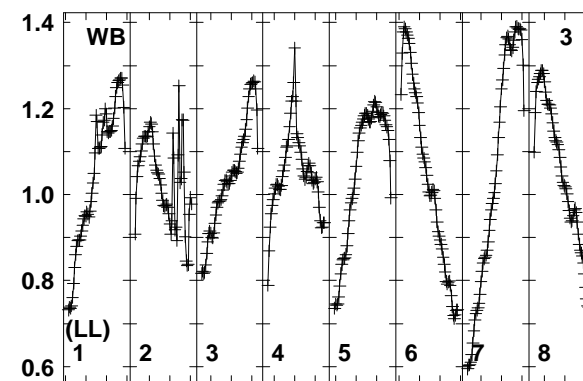
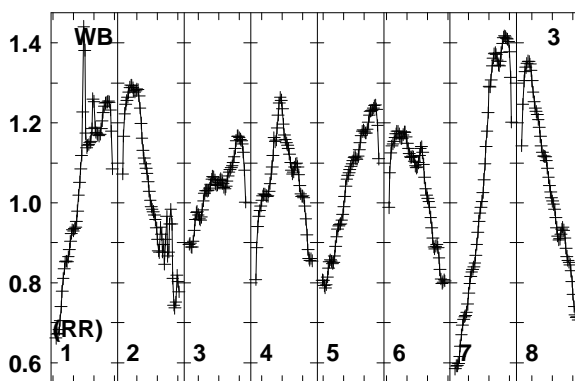
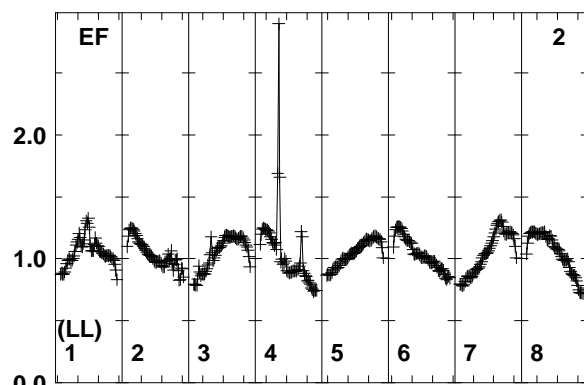
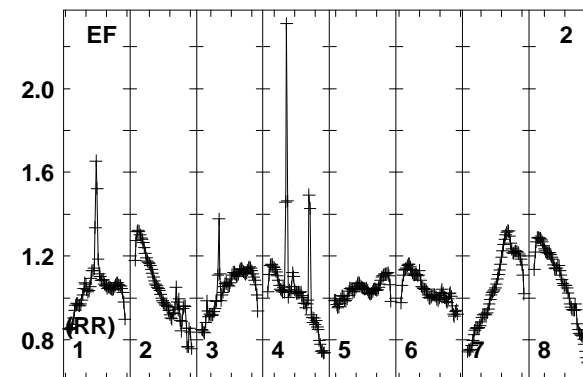
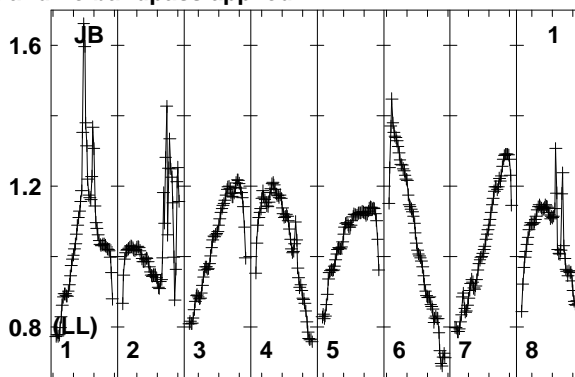
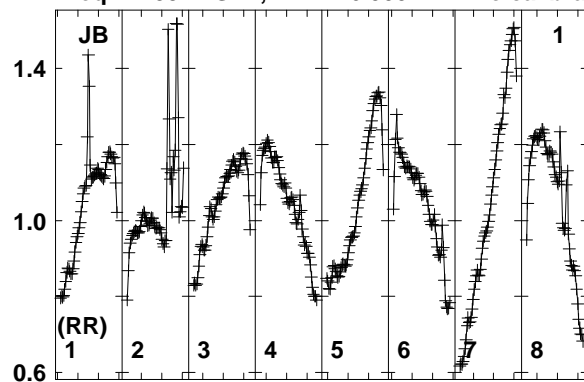

Lower frame: Real Jy
Total-power spectrum Antenna: JB (01)
Timerange: 00/08:15:41 to 00/08:18:19

Plot file version 591 created 04-NOV-2019 14:14:49

W2246-0526 EY034.UVDATA.1

Freq = 1.5947 GHz, Bw = 16.000 MH No calibration applied and no bandpass applied

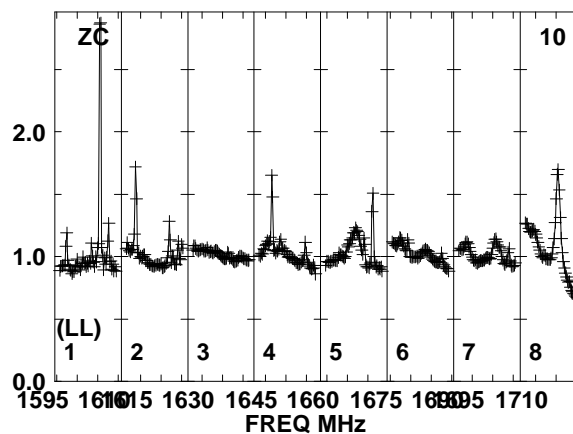
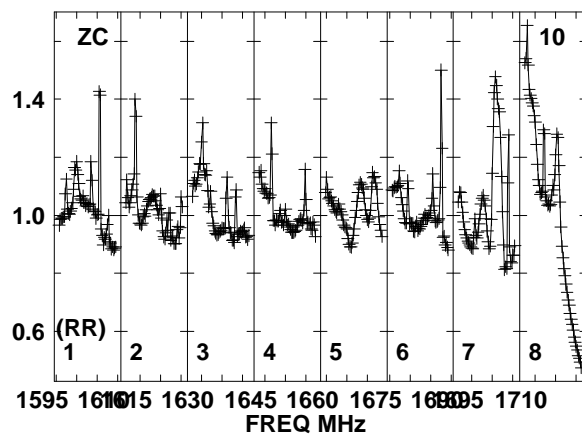
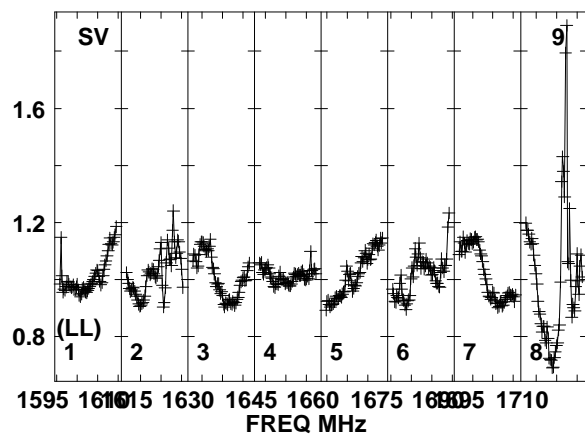
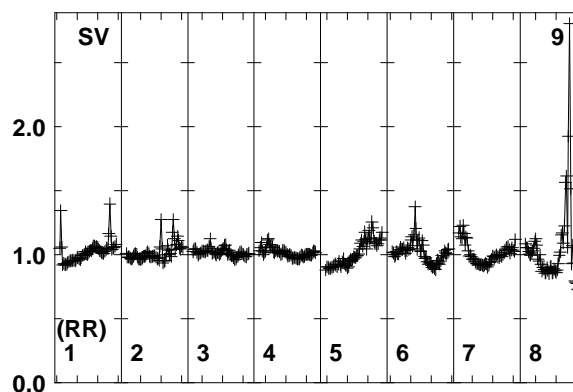
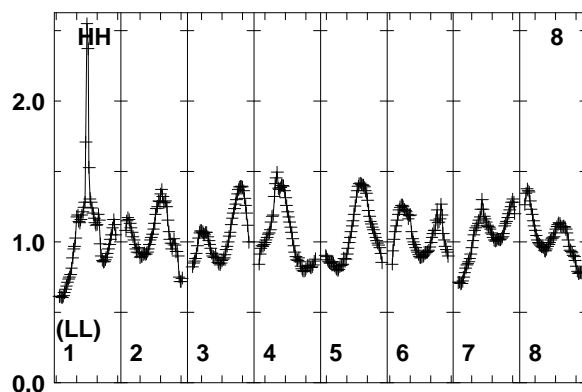
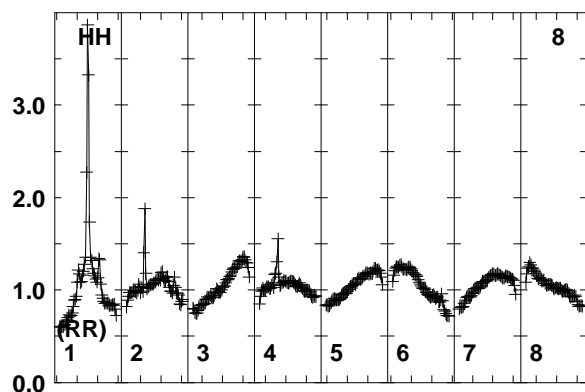
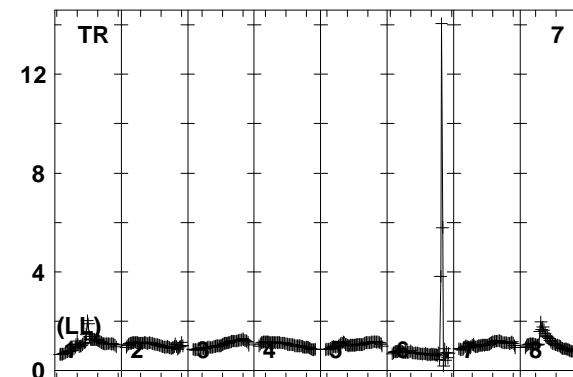
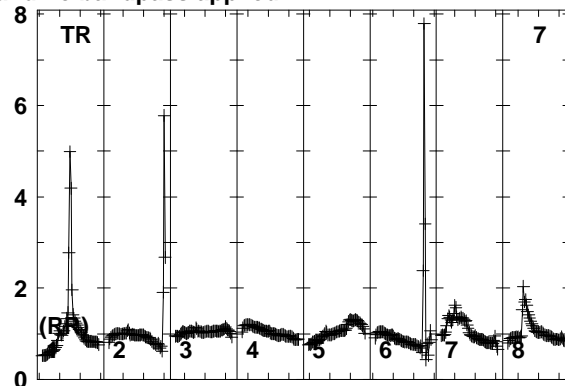
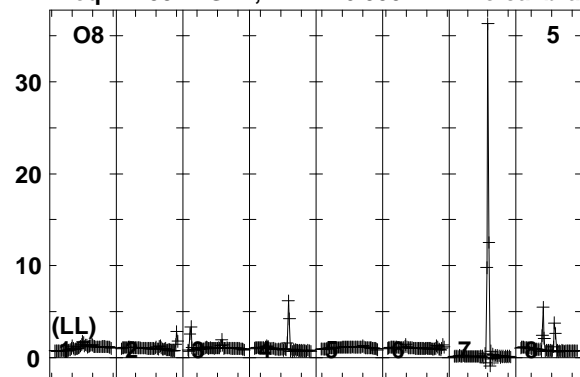

Lower frame: Real Jy
Total-power spectrum Antenna: O8 (05)
Timerange: 00/08:15:41 to 00/08:18:19

Plot file version 592 created 04-NOV-2019 14:14:49

W2246-0526 EY034.UVDATA.1

Freq = 1.5947 GHz, Bw = 16.000 MH No calibration applied and no bandpass applied

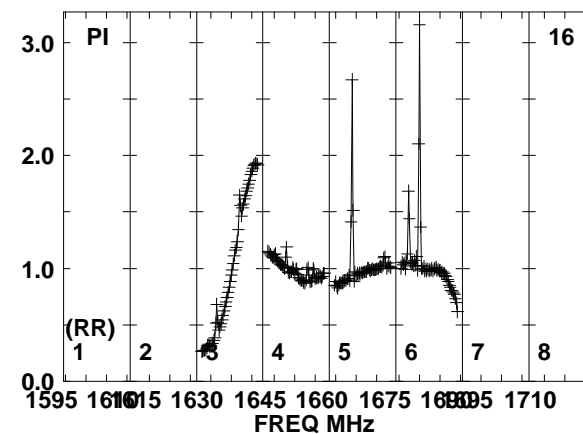
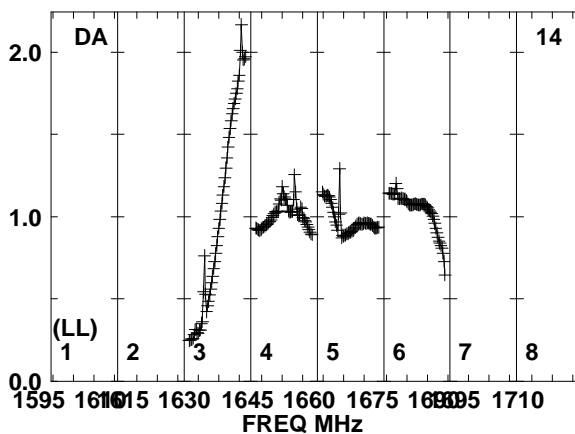
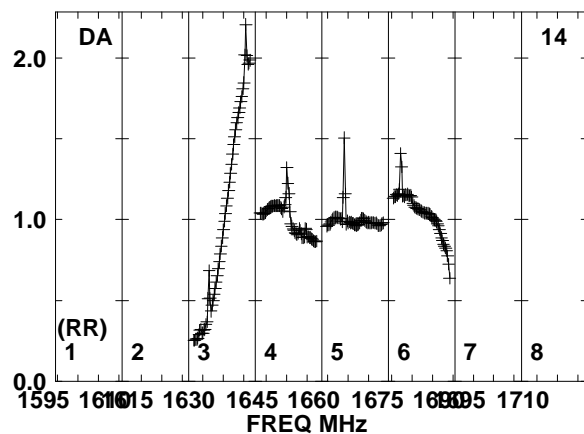
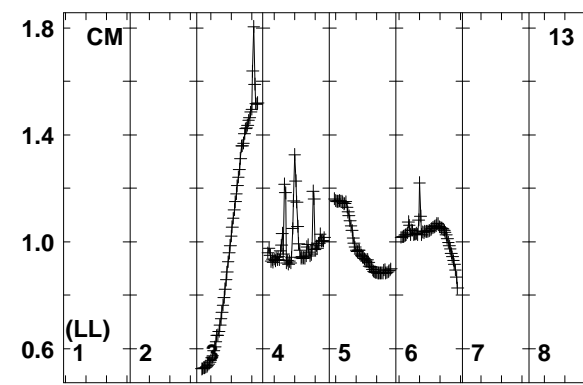
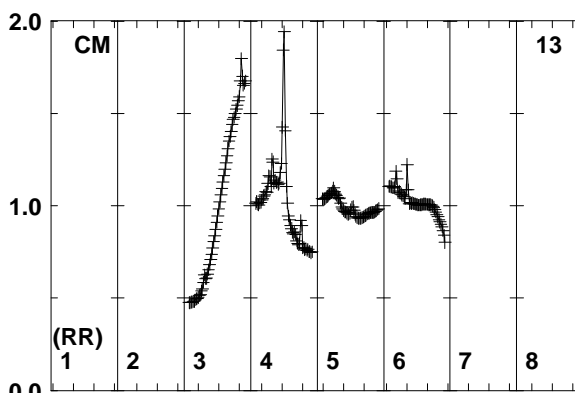
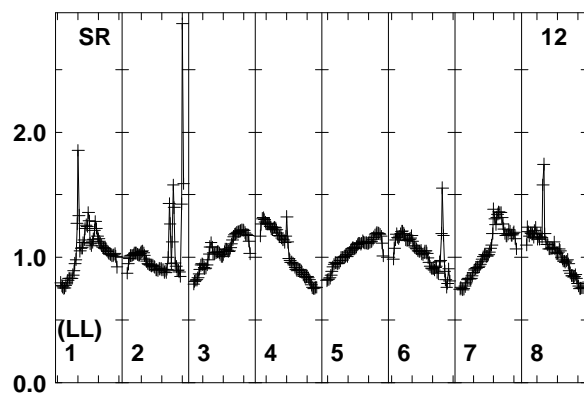
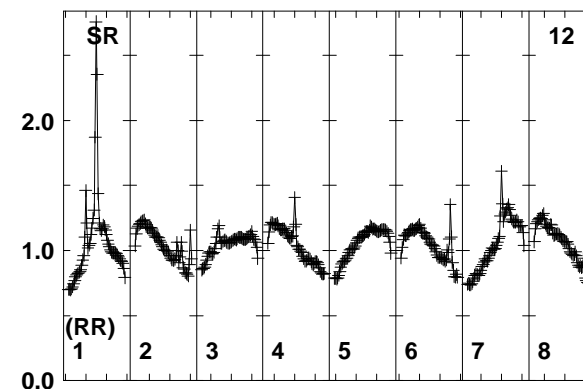
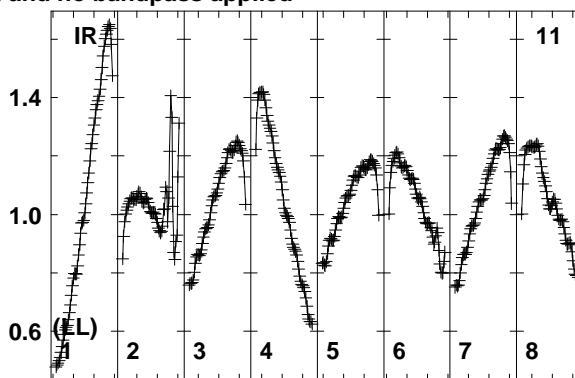
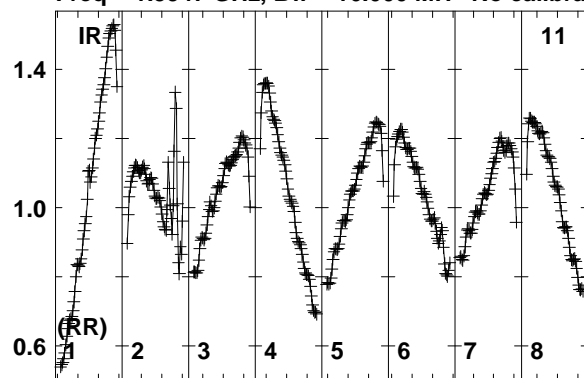

Lower frame: Real Jy
Total-power spectrum Antenna: IR (11)
Timerange: 00/08:15:41 to 00/08:18:19

Plot file version 593 created 04-NOV-2019 14:14:49
W2246-0526 EY034.UVDATA.1
Freq = 1.5947 GHz, Bw = 16.000 MH No calibration applied and no bandpass applied

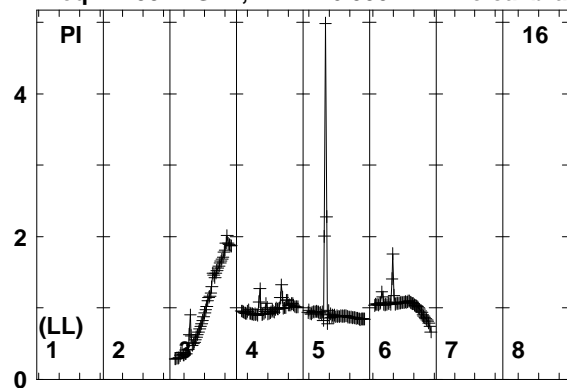

Lower frame: Real Jy
Total-power spectrum Antenna: PI (16)
Timerange: 00/08:15:41 to 00/08:18:19

Plot file version 594 created 04-NOV-2019 14:14:49

J2248-0541 EY034.UVDATA.1

Freq = 1.5947 GHz, Bw = 16.000 MH No calibration applied and no bandpass applied

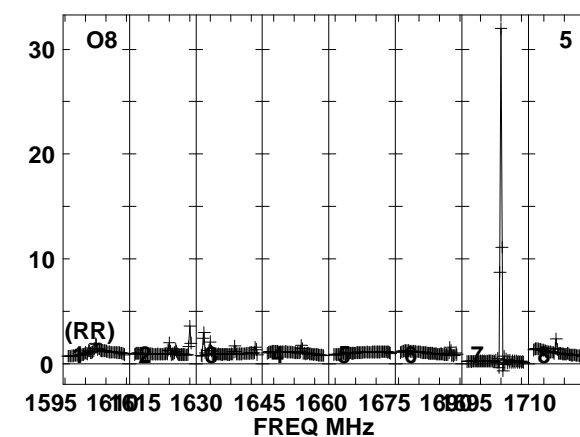
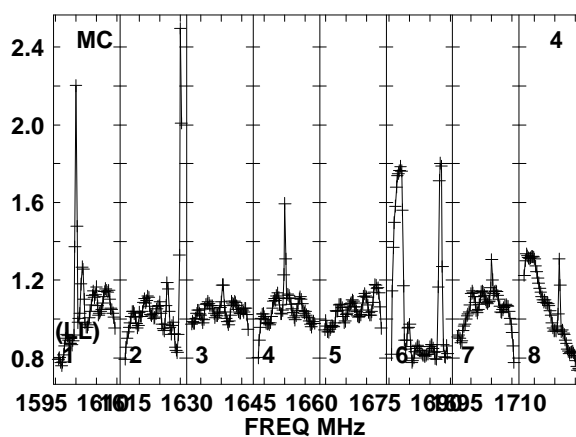
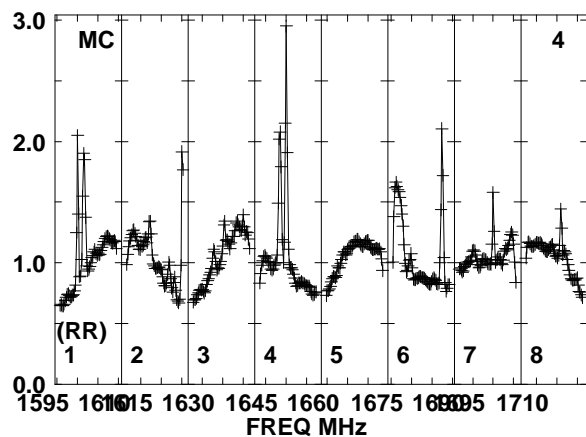
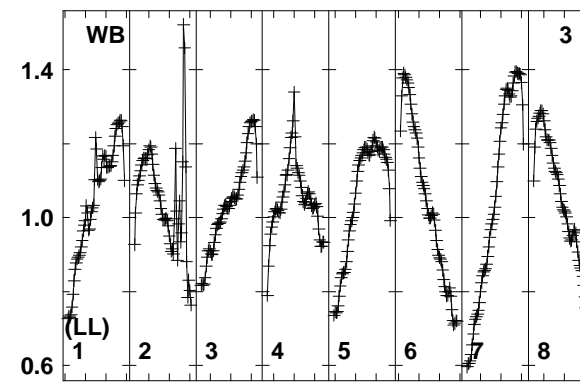
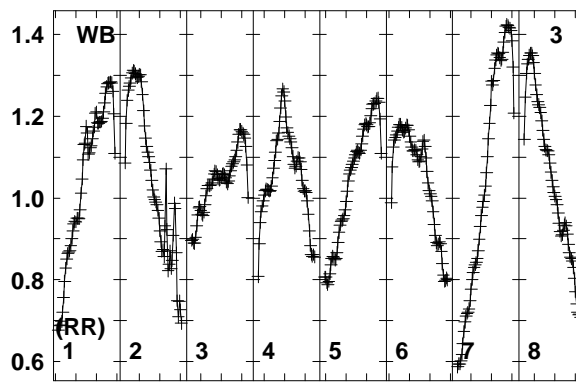
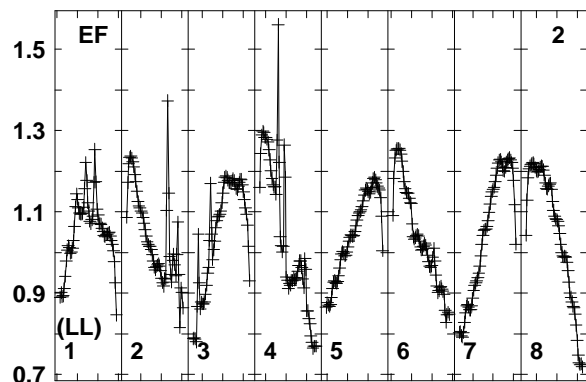
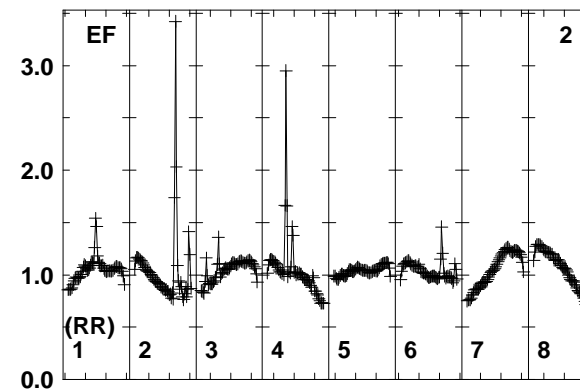
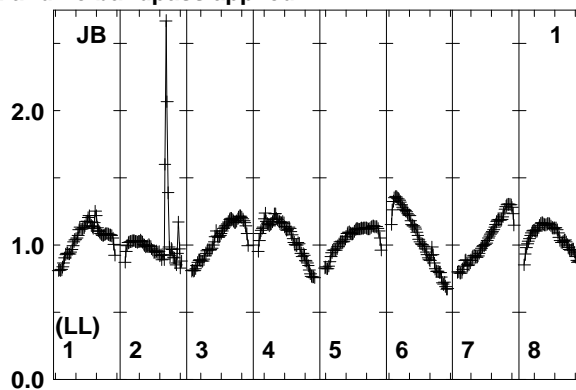
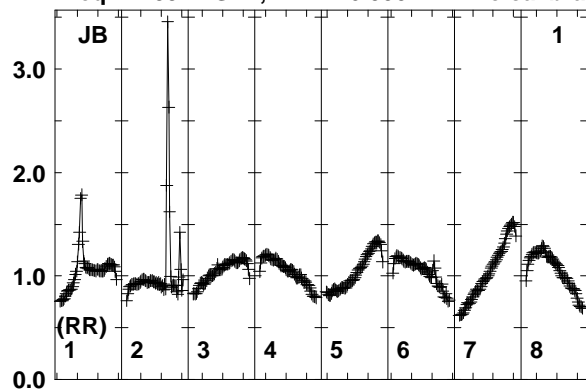

Lower frame: Real Jy
Total-power spectrum Antenna: JB (01)
Timerange: 00/08:18:36 to 00/08:19:34

Plot file version 595 created 04-NOV-2019 14:14:49

J2248-0541 EY034.UVDATA.1

Freq = 1.5947 GHz, Bw = 16.000 MH No calibration applied and no bandpass applied

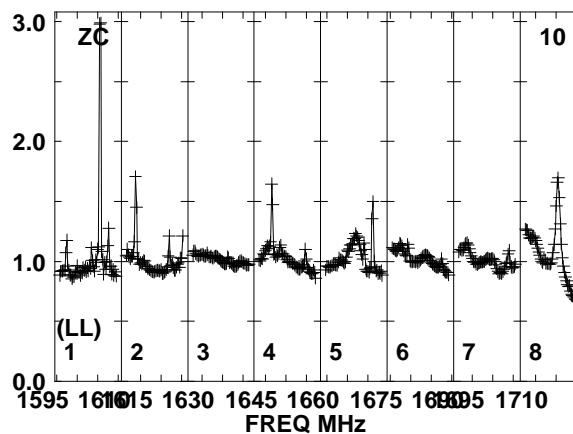
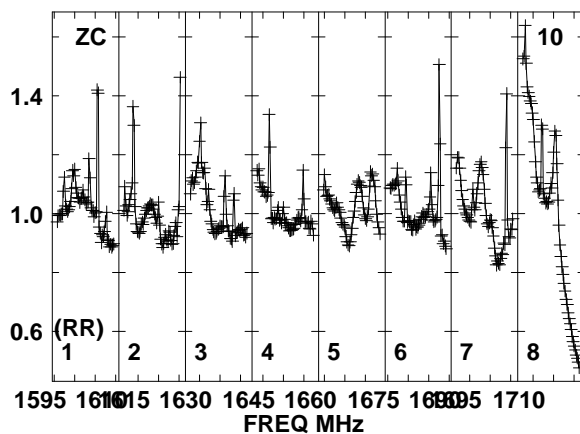
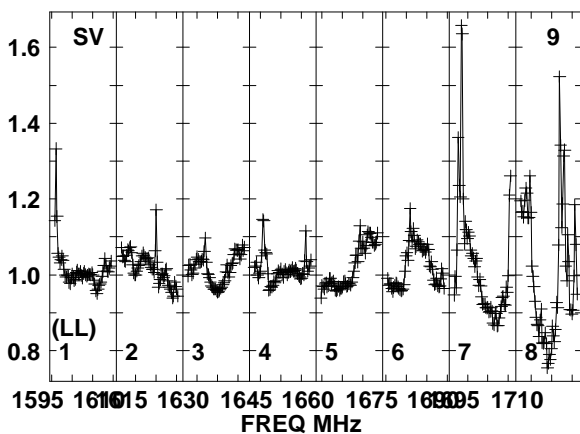
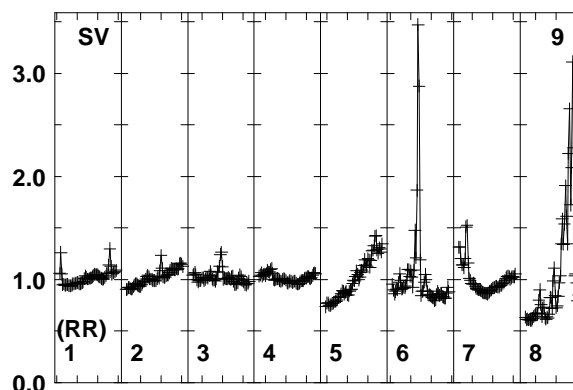
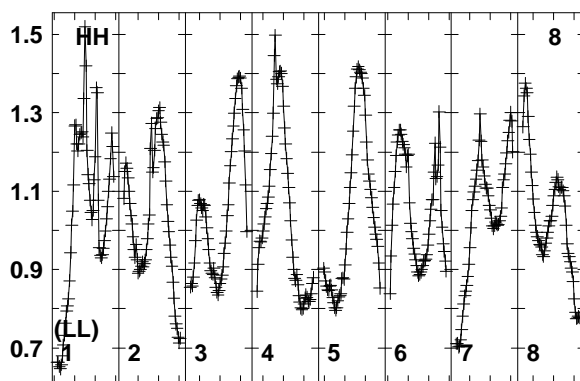
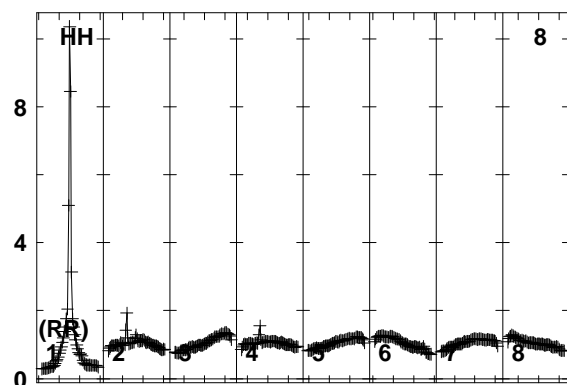
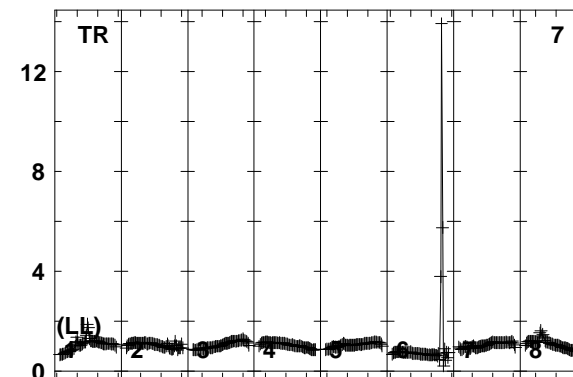
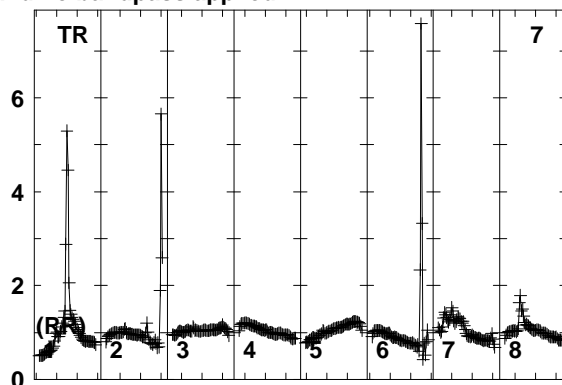
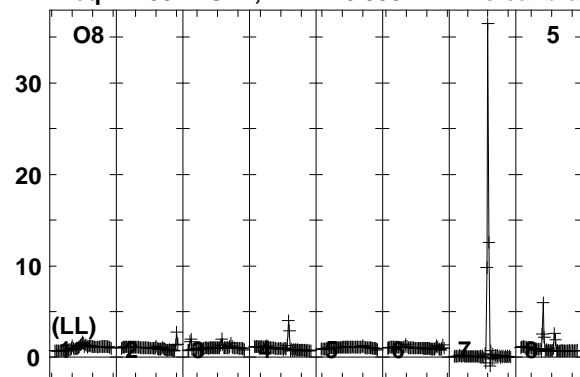

Lower frame: Real Jy
Total-power spectrum Antenna: O8 (05)
Timerange: 00/08:18:36 to 00/08:19:34

Plot file version 596 created 04-NOV-2019 14:14:49

J2248-0541 EY034.UVDATA.1

Freq = 1.5947 GHz, Bw = 16.000 MH No calibration applied and no bandpass applied

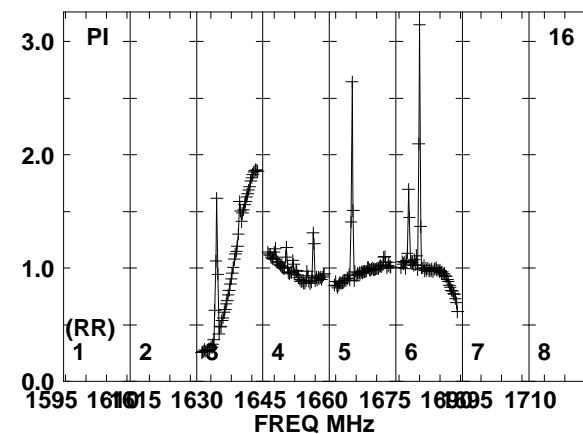
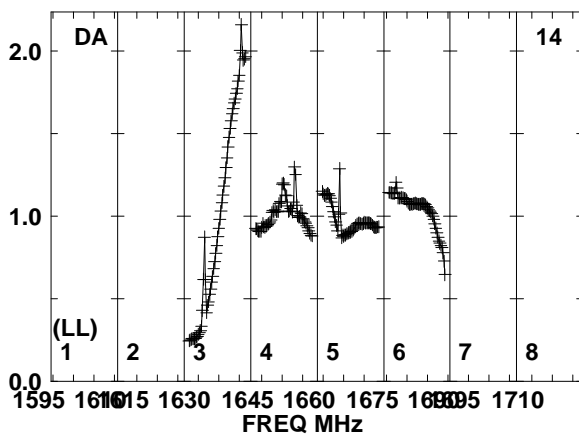
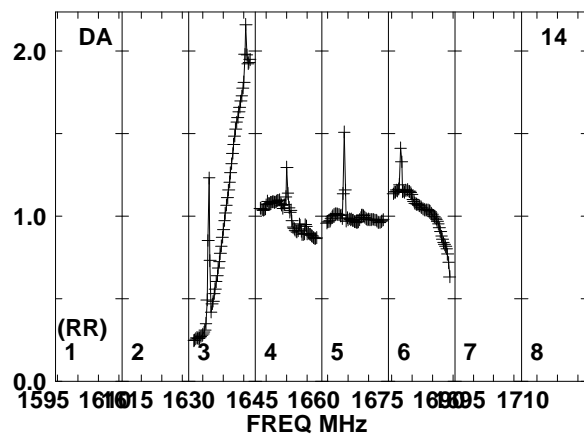
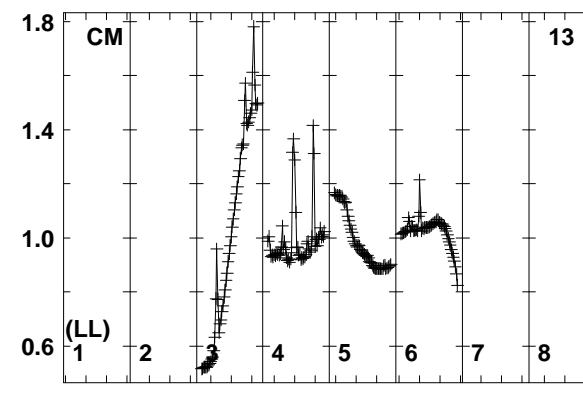
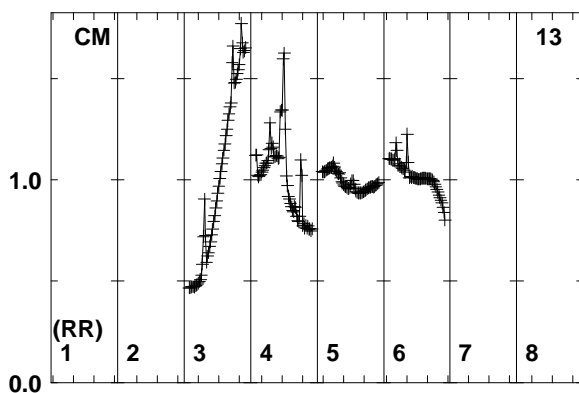
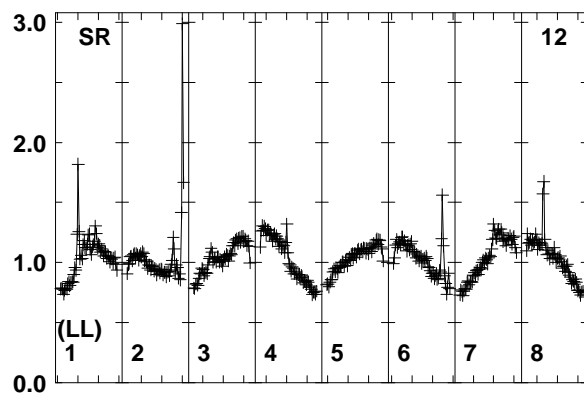
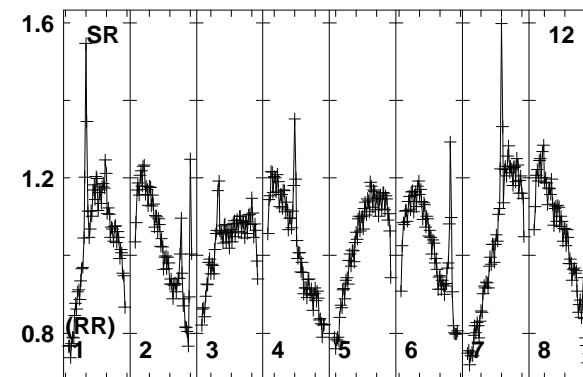
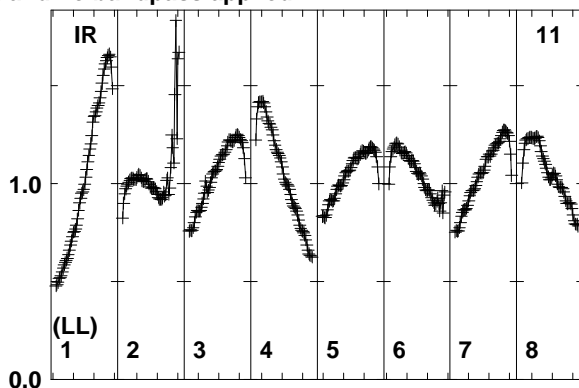
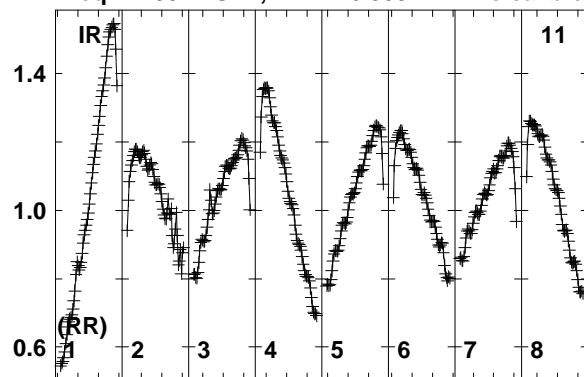

Lower frame: Real Jy
Total-power spectrum Antenna: IR (11)
Timerange: 00/08:18:36 to 00/08:19:34

Plot file version 597 created 04-NOV-2019 14:14:49
J2248-0541 EY034.UVDATA.1
Freq = 1.5947 GHz, Bw = 16.000 MH No calibration applied and no bandpass applied

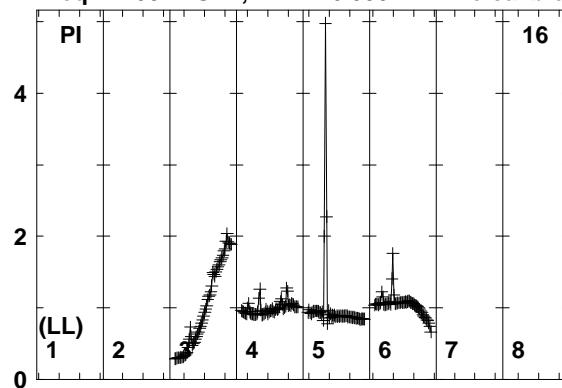

Lower frame: Real Jy
Total-power spectrum Antenna: PI (16)
Timerange: 00/08:18:36 to 00/08:19:34

Plot file version 598 created 04-NOV-2019 14:14:49

W2246-0526 EY034.UVDATA.1

Freq = 1.5947 GHz, Bw = 16.000 MH No calibration applied and no bandpass applied

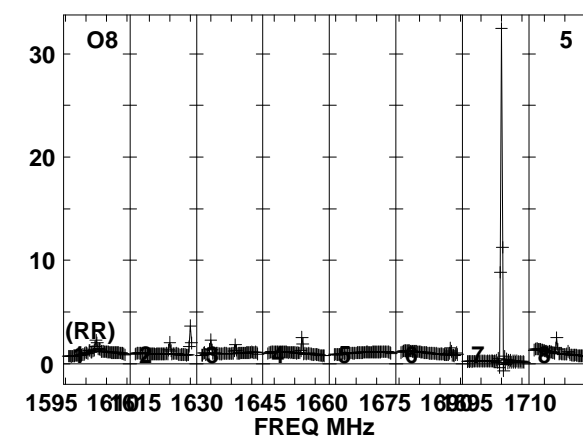
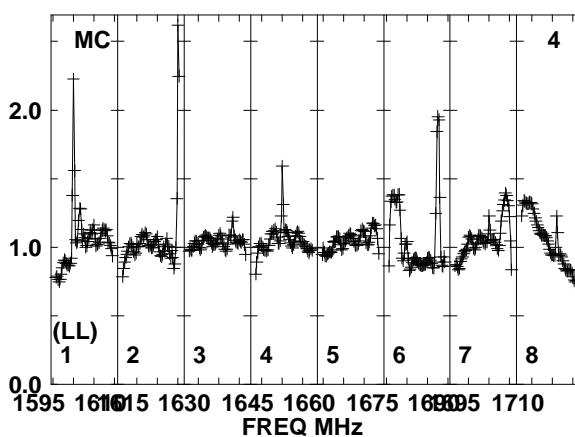
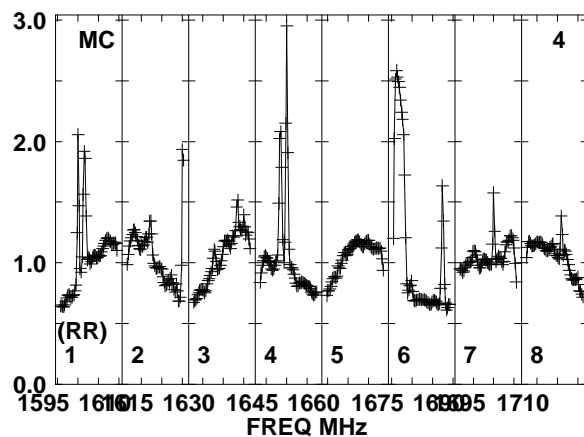
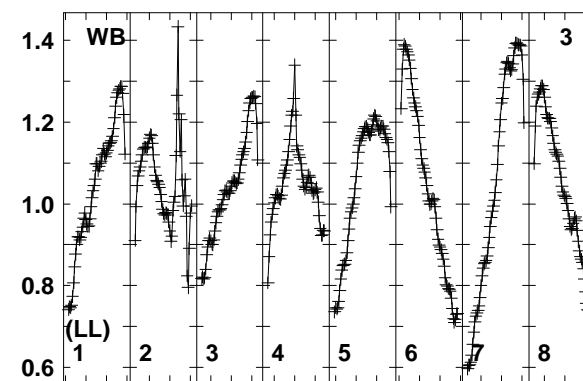
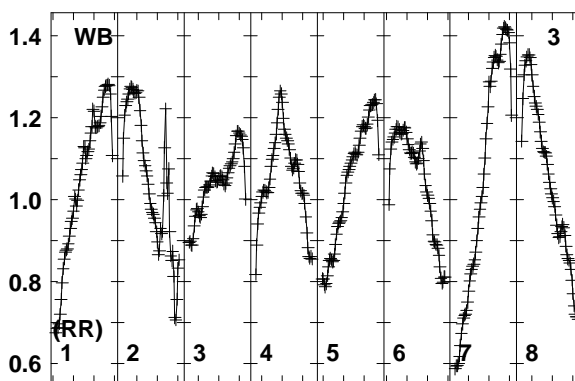
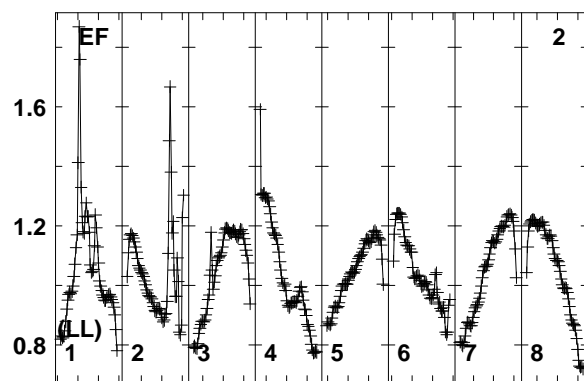
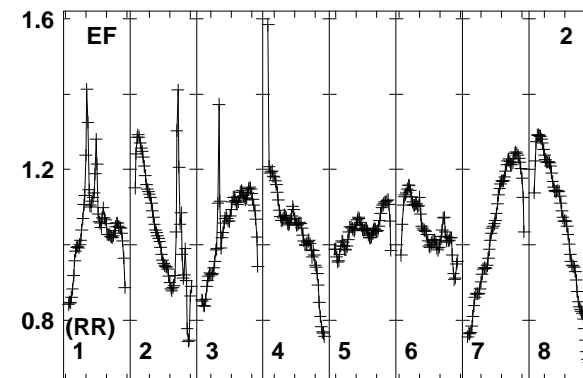
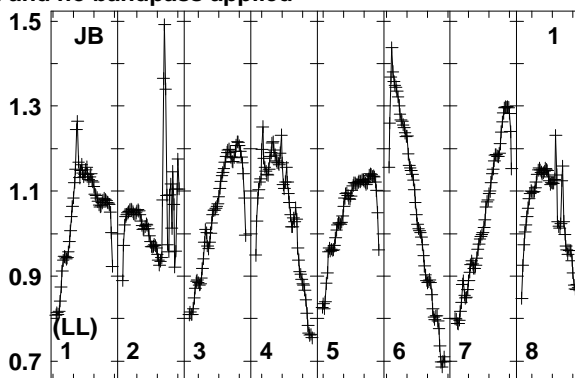
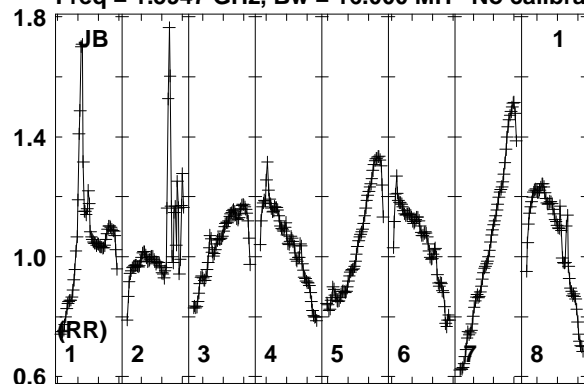

Lower frame: Real Jy
Total-power spectrum Antenna: JB (01)
Timerange: 00/08:19:36 to 00/08:22:14

Plot file version 599 created 04-NOV-2019 14:14:49

W2246-0526 EY034.UVDATA.1

Freq = 1.5947 GHz, Bw = 16.000 MH No calibration applied and no bandpass applied

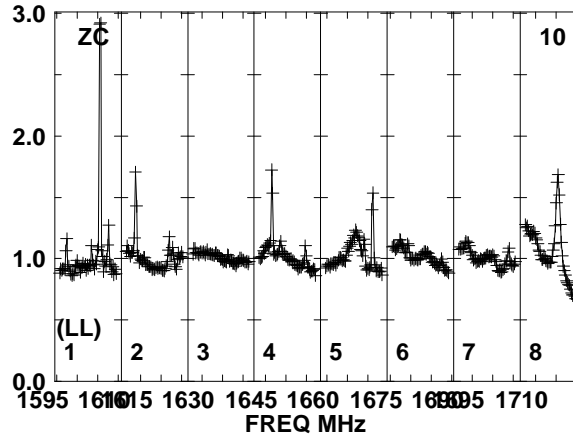
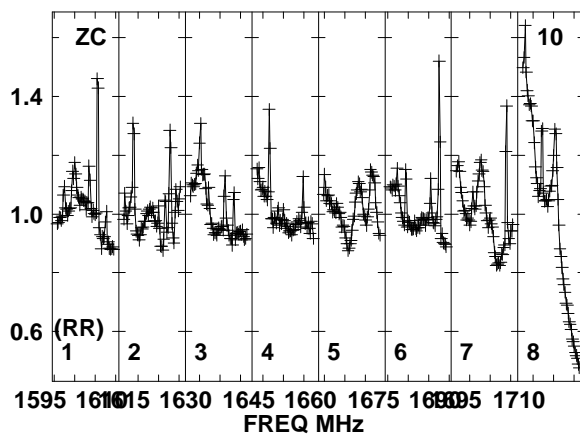
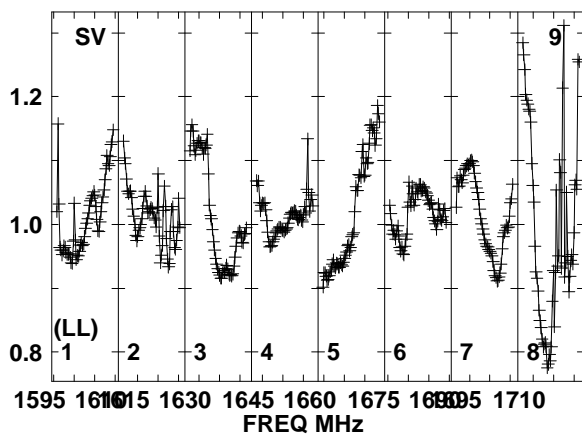
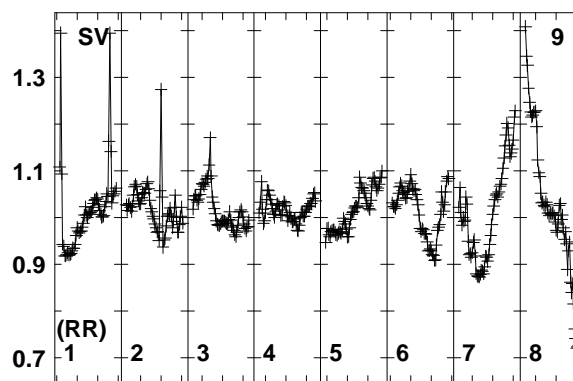
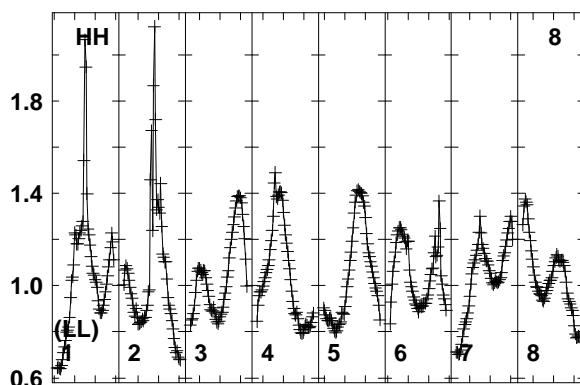
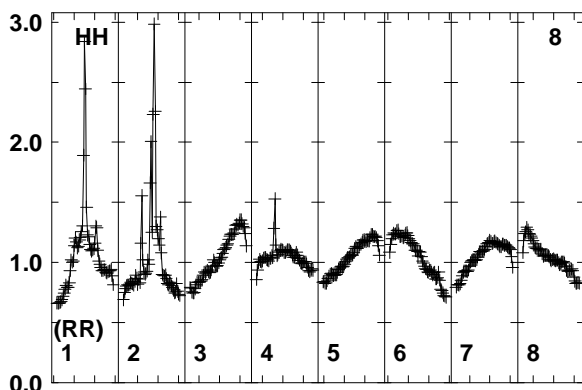
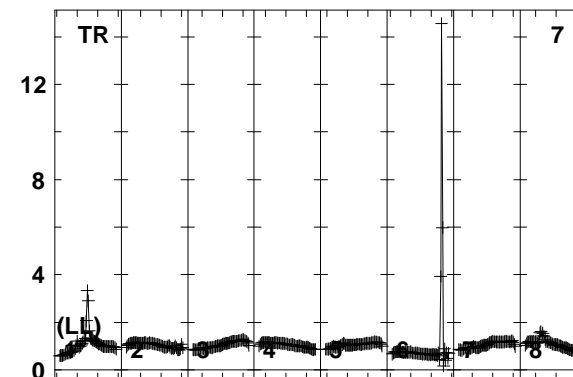
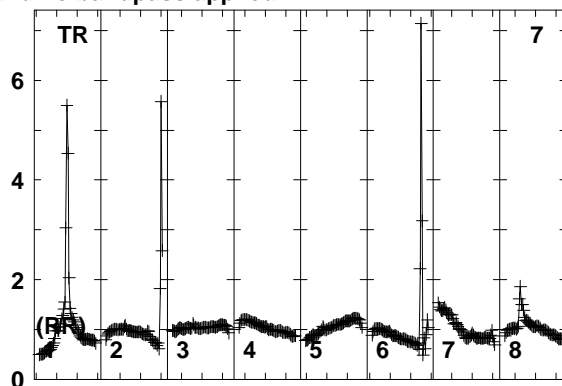
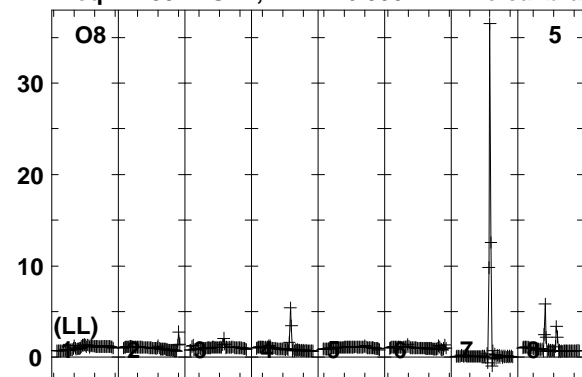

Lower frame: Real Jy
Total-power spectrum Antenna: O8 (05)
Timerange: 00/08:19:36 to 00/08:22:14

Plot file version 600 created 04-NOV-2019 14:14:49

W2246-0526 EY034.UVDATA.1

Freq = 1.5947 GHz, Bw = 16.000 MH No calibration applied and no bandpass applied

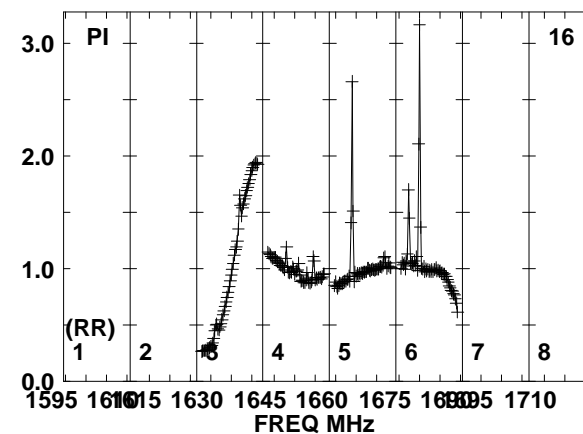
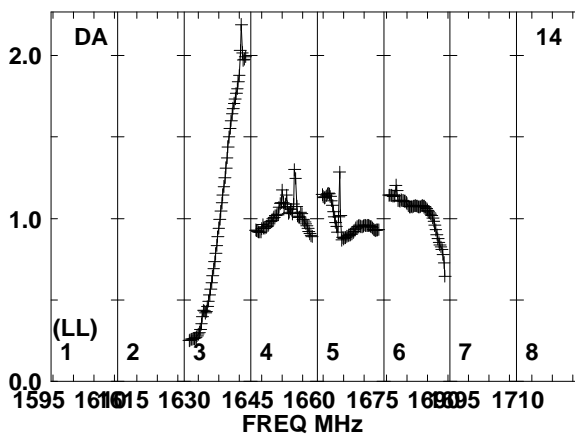
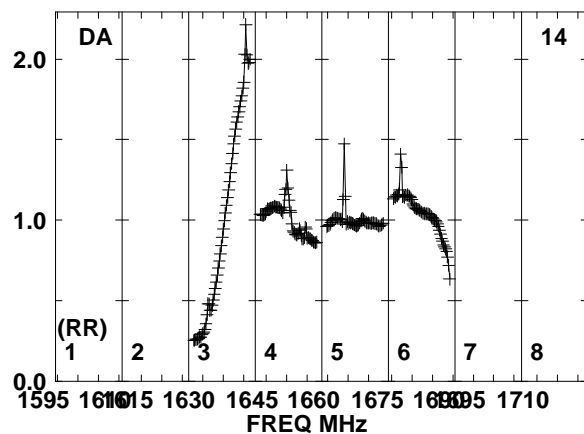
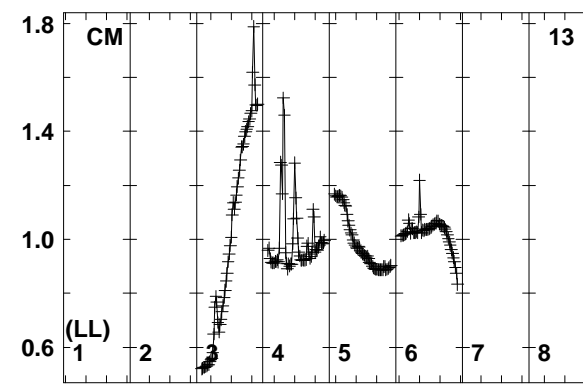
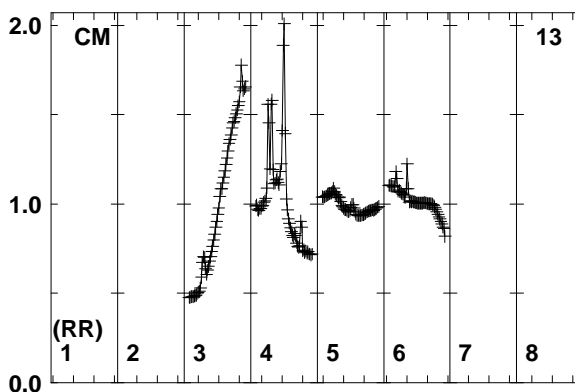
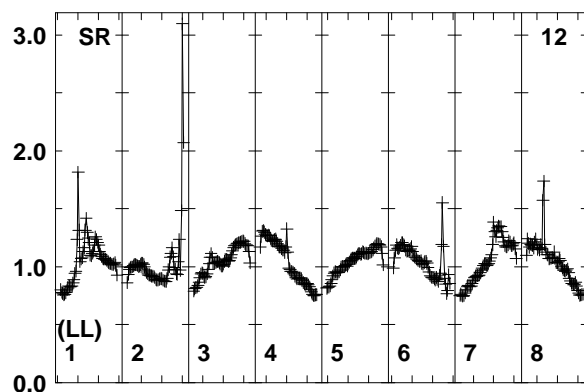
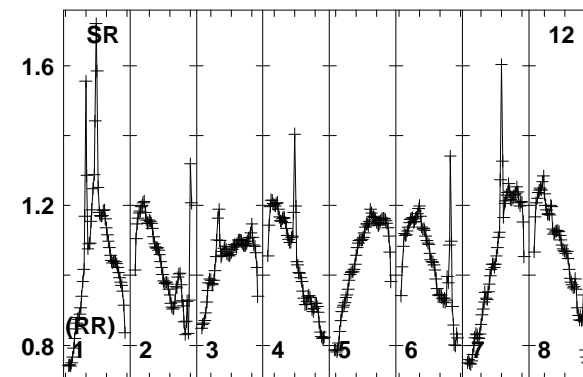
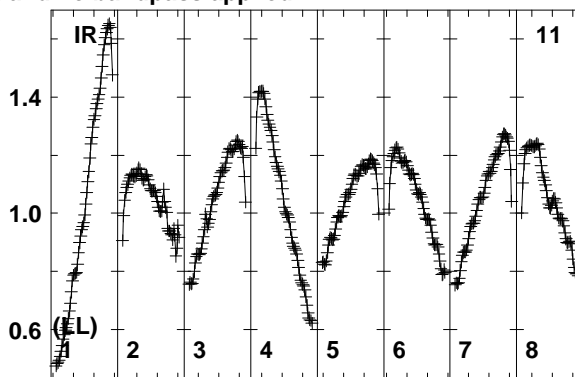
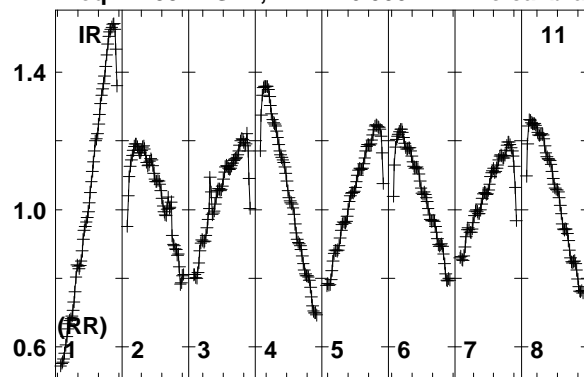

Lower frame: Real Jy
Total-power spectrum Antenna: IR (11)
Timerange: 00/08:19:36 to 00/08:22:14

Plot file version 601 created 04-NOV-2019 14:14:49
W2246-0526 EY034.UVDATA.1
Freq = 1.5947 GHz, Bw = 16.000 MH No calibration applied and no bandpass applied

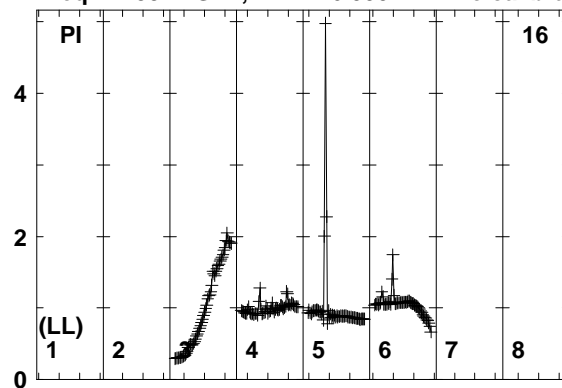

Lower frame: Real Jy
Total-power spectrum Antenna: PI (16)
Timerange: 00/08:19:36 to 00/08:22:14

Plot file version 602 created 04-NOV-2019 14:14:49

J2248-0541 EY034.UVDATA.1

Freq = 1.5947 GHz, Bw = 16.000 MH No calibration applied and no bandpass applied

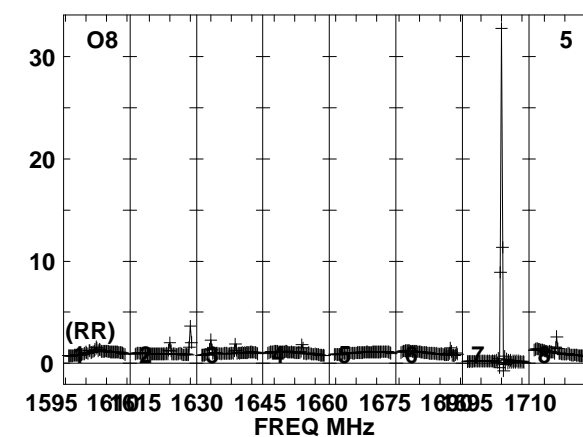
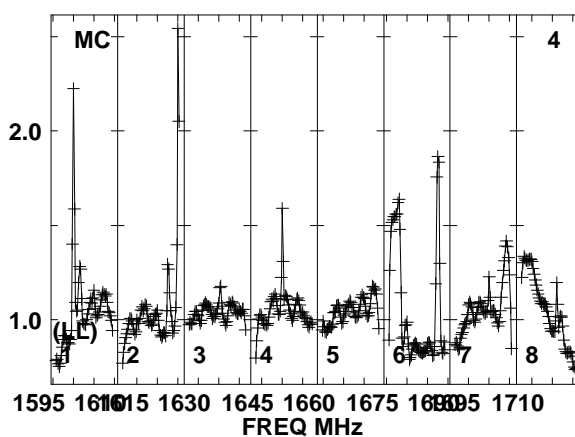
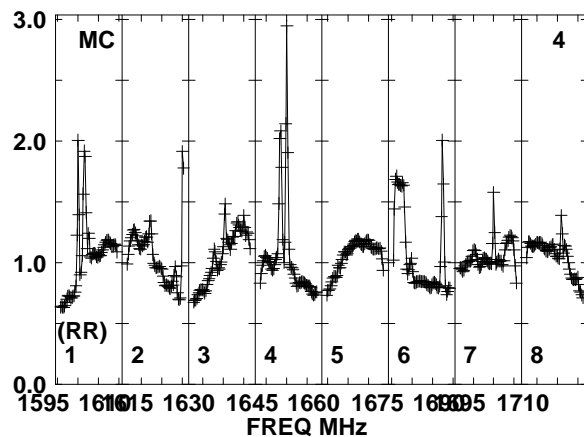
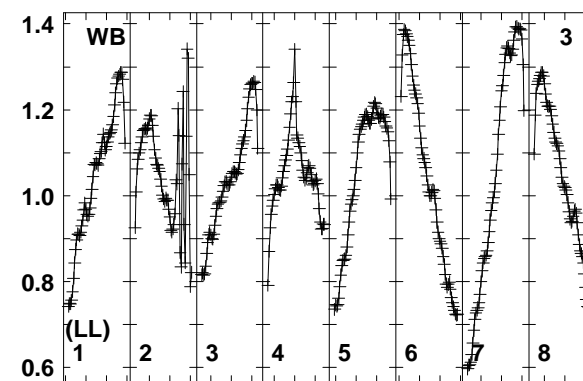
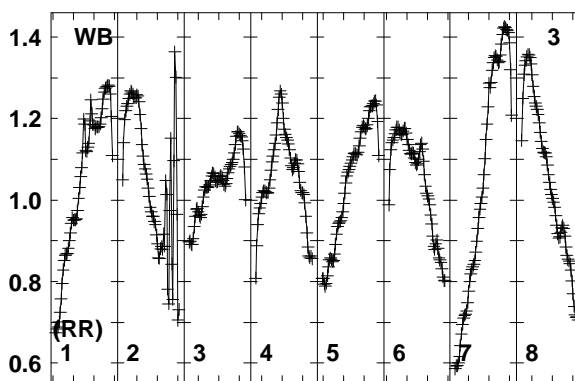
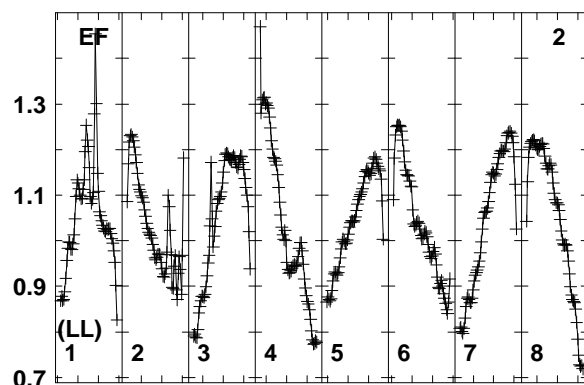
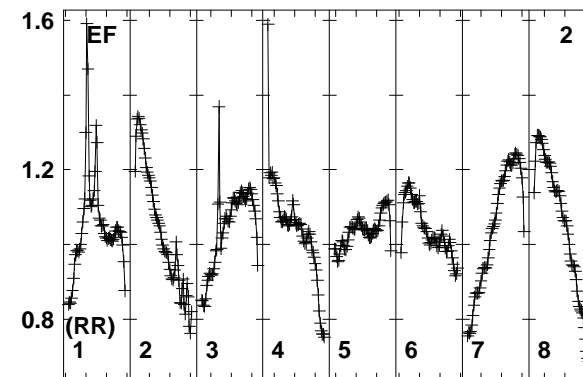
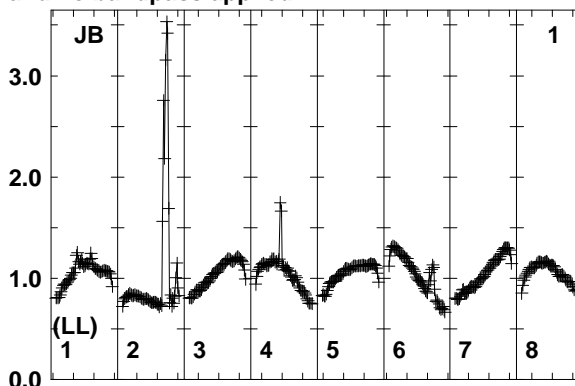
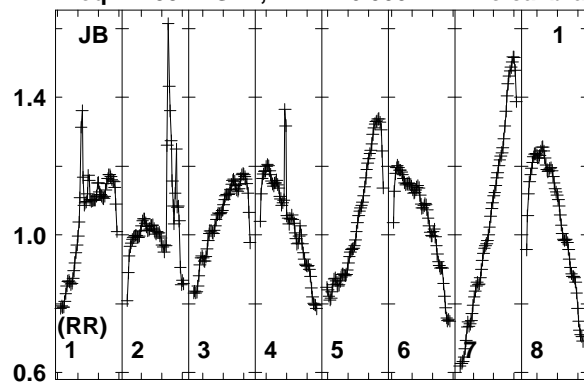

Lower frame: Real Jy
Total-power spectrum Antenna: JB (01)
Timerange: 00/08:22:51 to 00/08:23:49

Plot file version 603 created 04-NOV-2019 14:14:50

J2248-0541 EY034.UVDATA.1

Freq = 1.5947 GHz, Bw = 16.000 MH No calibration applied and no bandpass applied

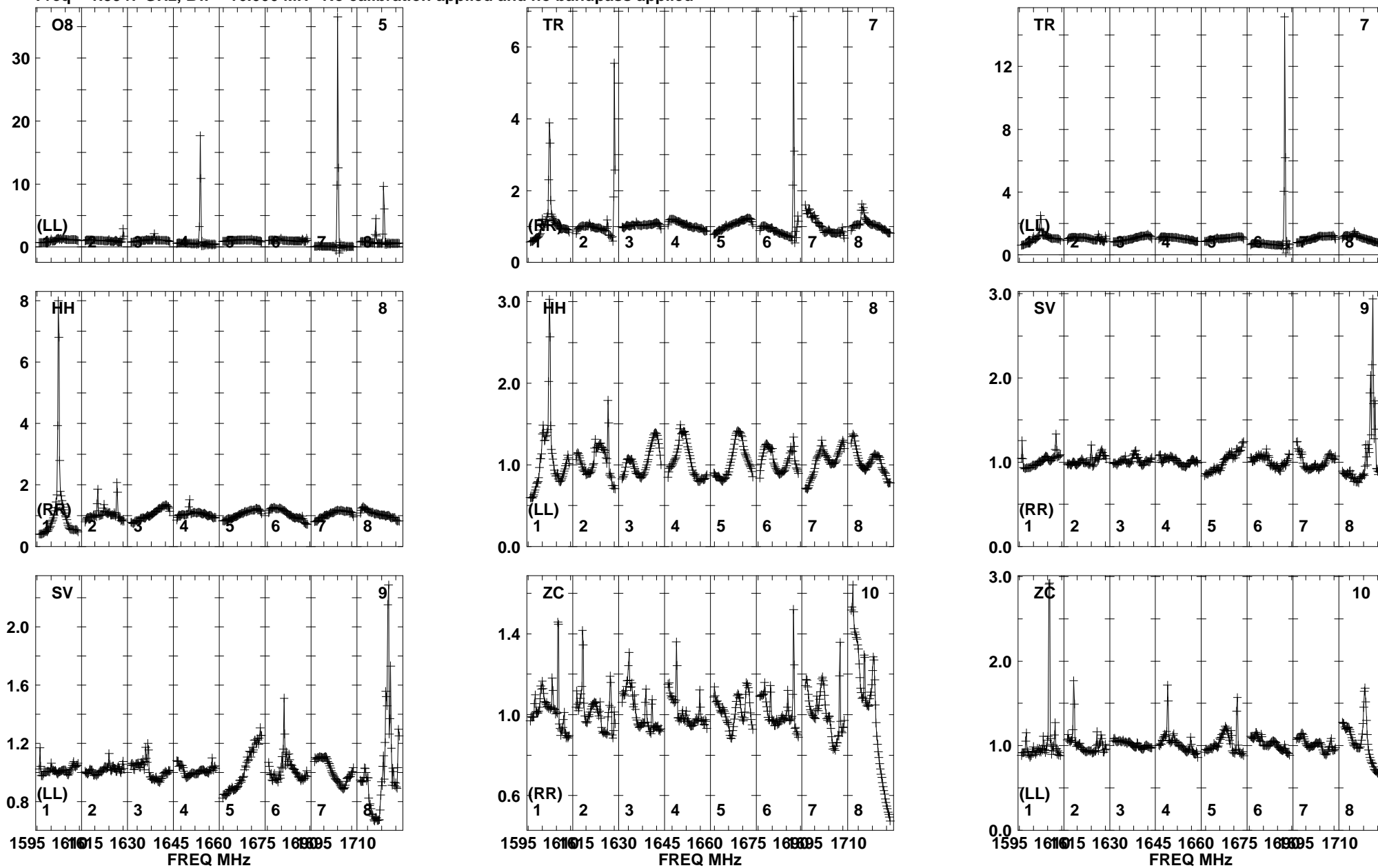

Lower frame: Real Jy
Total-power spectrum Antenna: O8 (05)
Timerange: 00/08:22:51 to 00/08:23:49

Plot file version 604 created 04-NOV-2019 14:14:50

J2248-0541 EY034.UVDATA.1

Freq = 1.5947 GHz, Bw = 16.000 MH No calibration applied and no bandpass applied

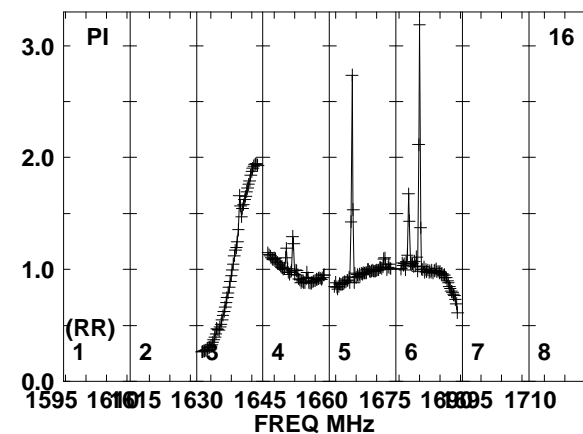
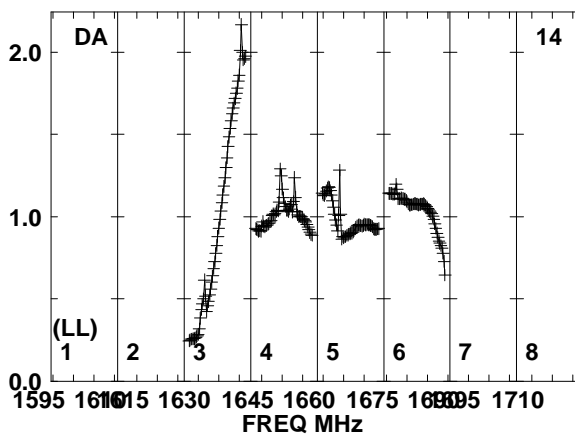
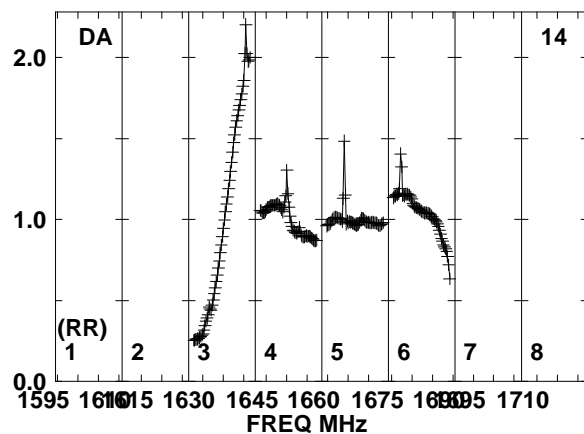
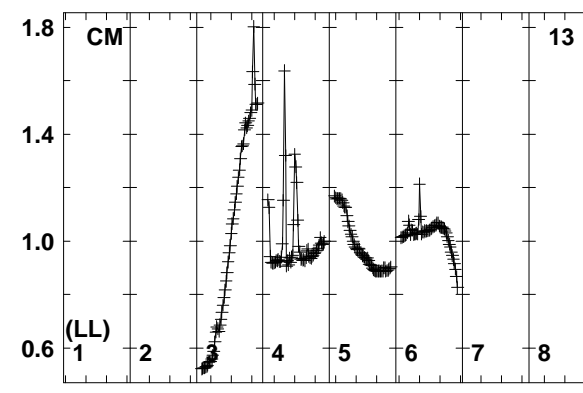
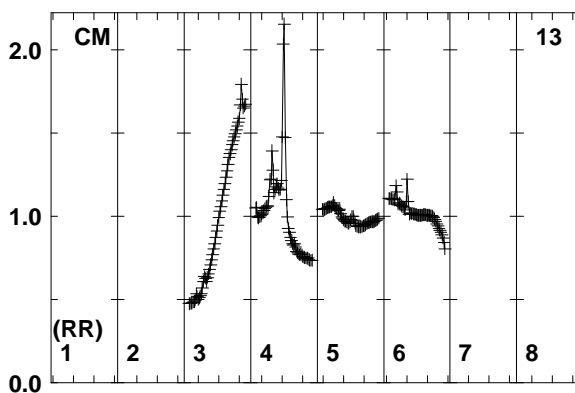
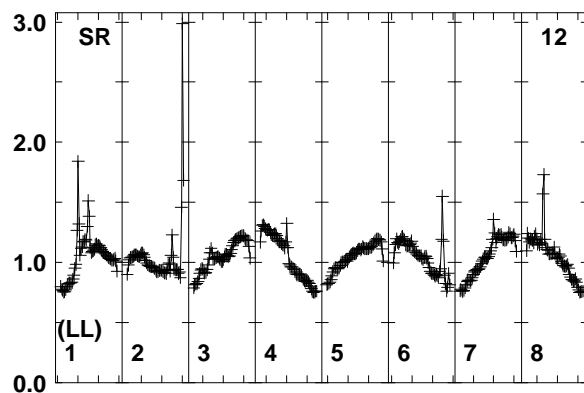
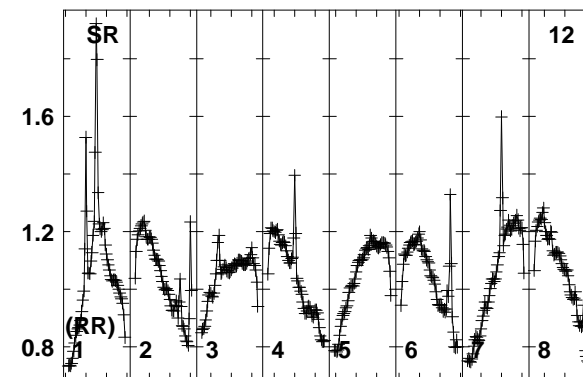
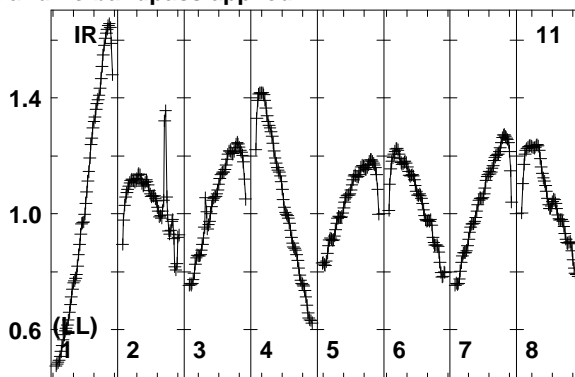
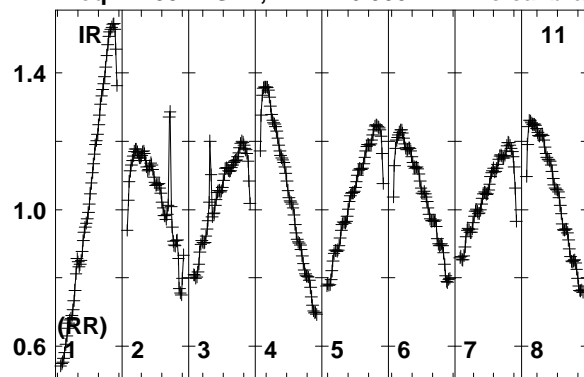

Lower frame: Real Jy
Total-power spectrum Antenna: IR (11)
Timerange: 00/08:22:51 to 00/08:23:49

Plot file version 605 created 04-NOV-2019 14:14:50
J2248-0541 EY034.UVDATA.1
Freq = 1.5947 GHz, Bw = 16.000 MH No calibration applied and no bandpass applied

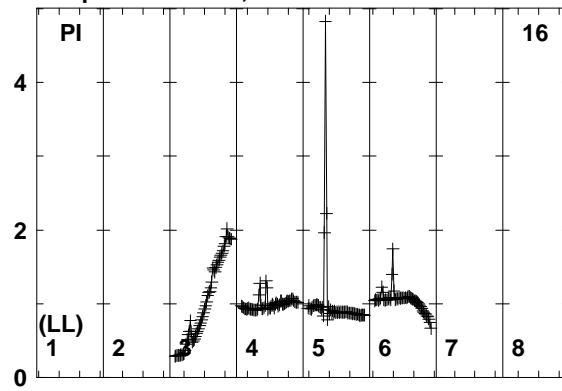

Lower frame: Real Jy
Total-power spectrum Antenna: PI (16)
Timerange: 00/08:22:51 to 00/08:23:49

Plot file version 606 created 04-NOV-2019 14:14:50

W2246-0526 EY034.UVDATA.1

Freq = 1.5947 GHz, Bw = 16.000 MH No calibration applied and no bandpass applied

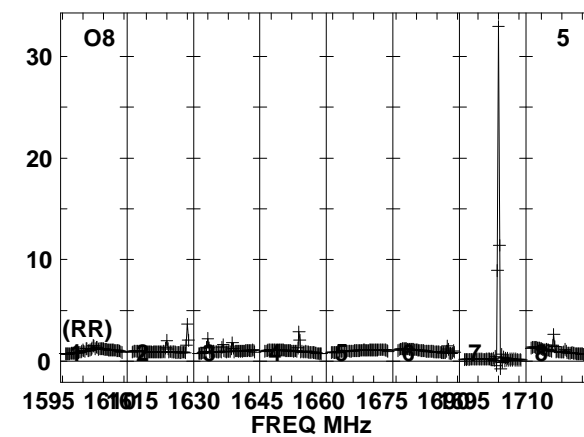
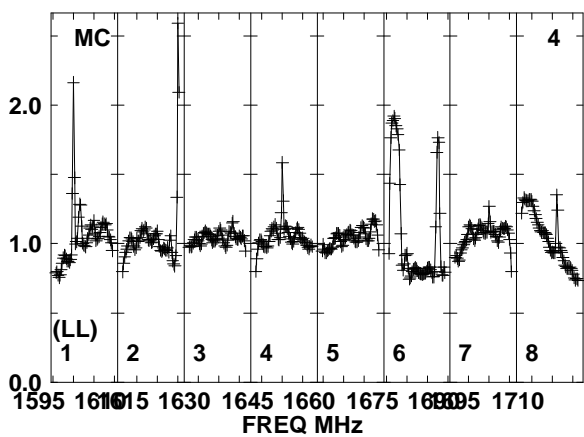
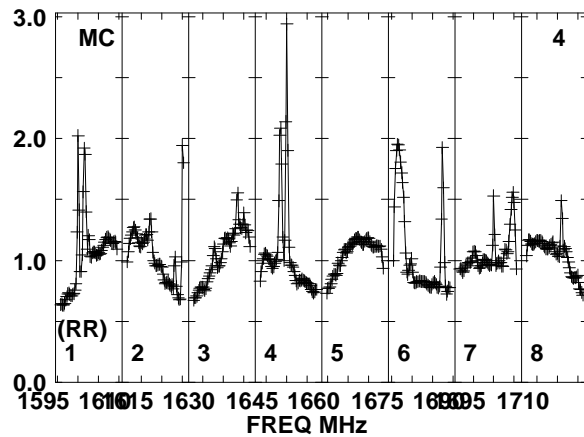
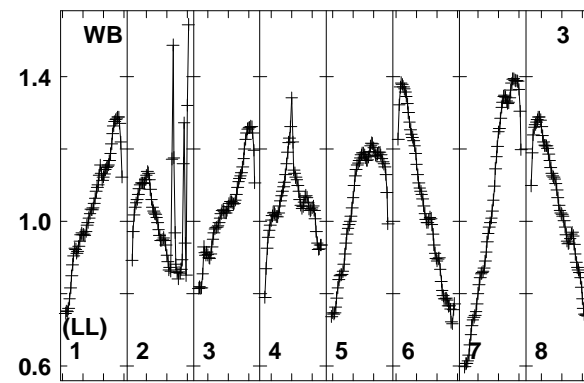
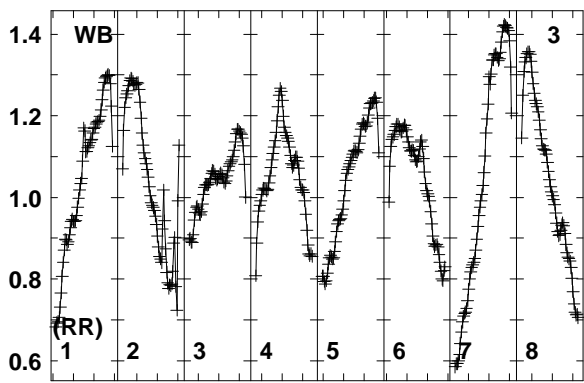
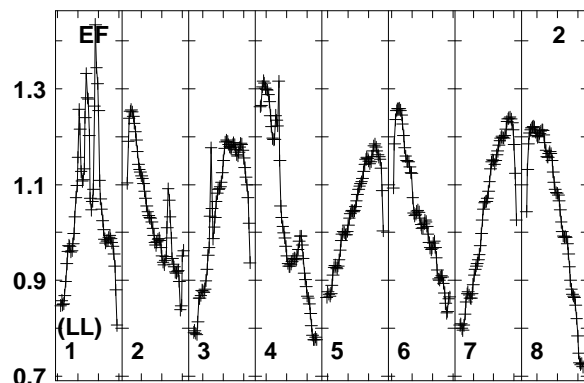
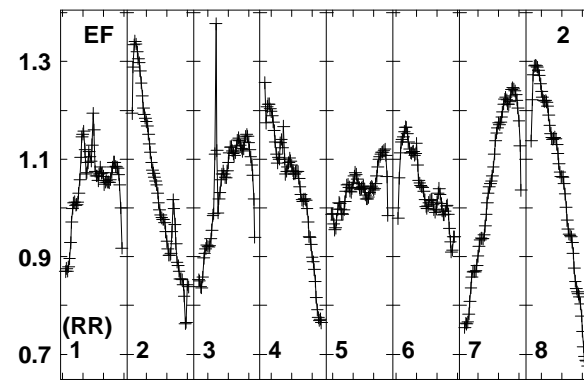
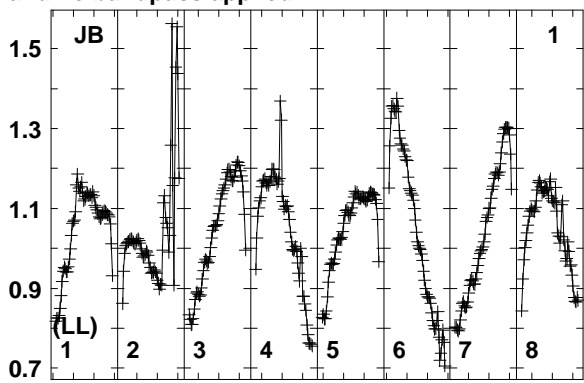
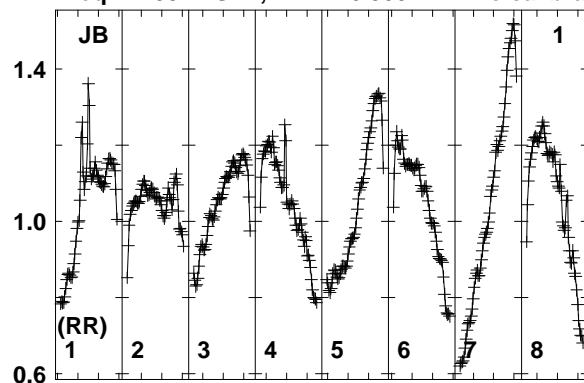

Lower frame: Real Jy
Total-power spectrum Antenna: JB (01)
Timerange: 00/08:23:51 to 00/08:26:29

Plot file version 607 created 04-NOV-2019 14:14:50

W2246-0526 EY034.UVDATA.1

Freq = 1.5947 GHz, Bw = 16.000 MH No calibration applied and no bandpass applied

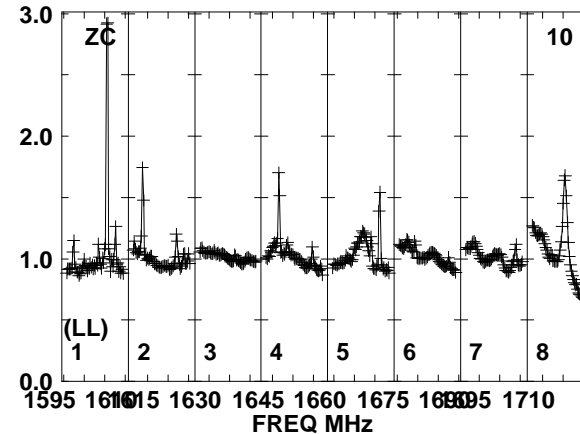
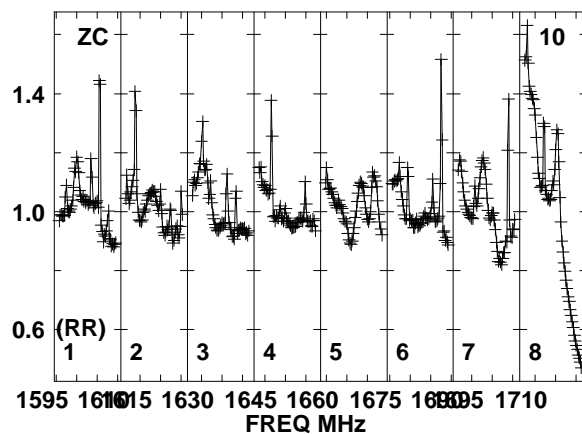
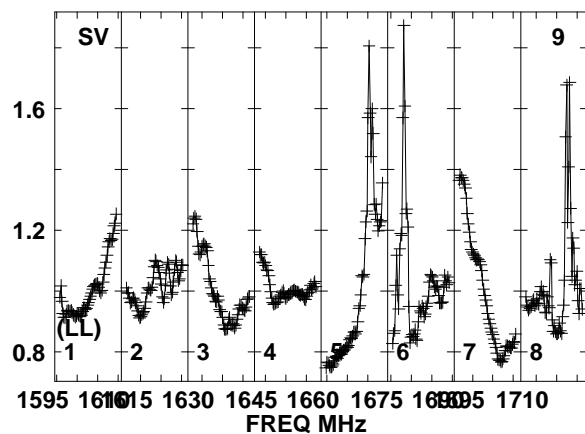
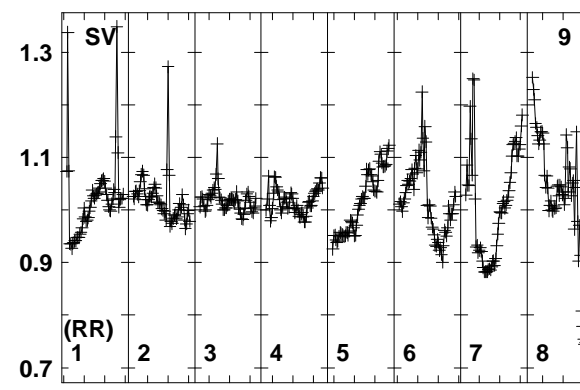
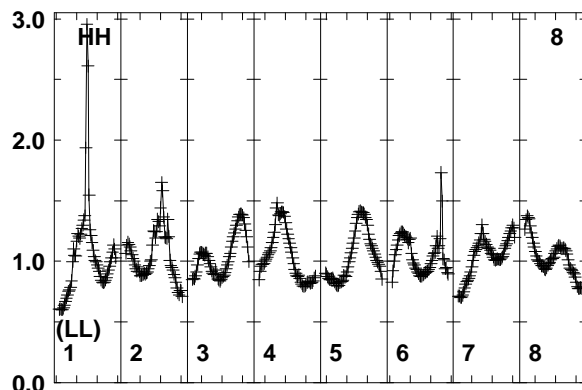
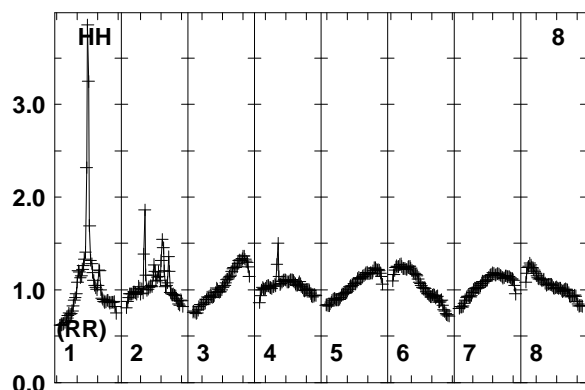
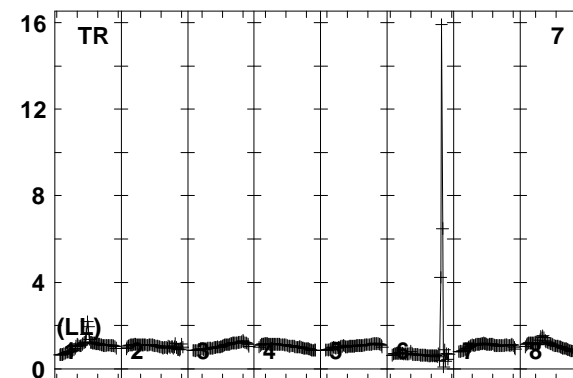
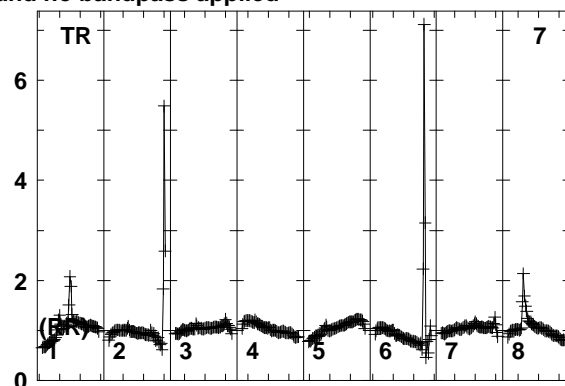
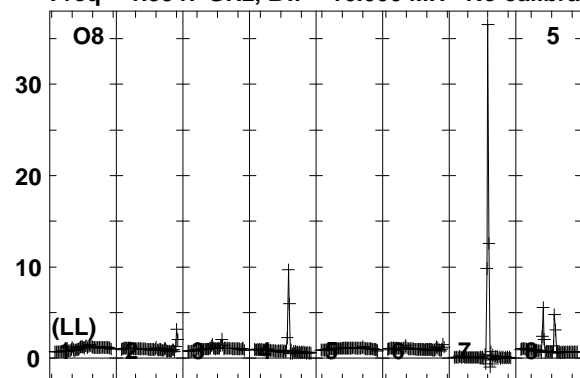

Lower frame: Real Jy
Total-power spectrum Antenna: O8 (05)
Timerange: 00/08:23:51 to 00/08:26:29

Plot file version 608 created 04-NOV-2019 14:14:50

W2246-0526 EY034.UVDATA.1

Freq = 1.5947 GHz, Bw = 16.000 MH No calibration applied and no bandpass applied

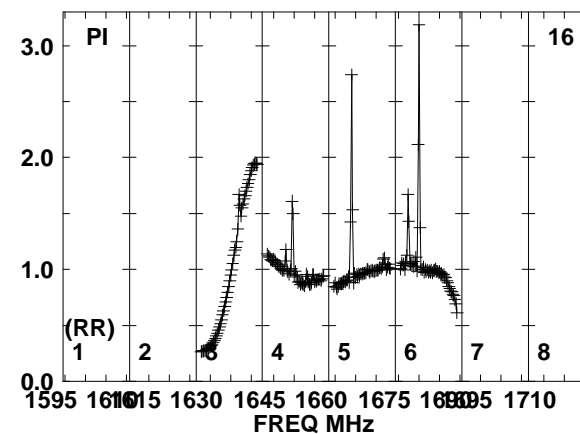
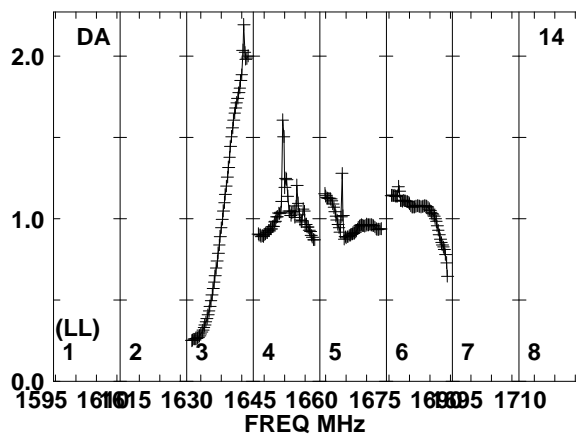
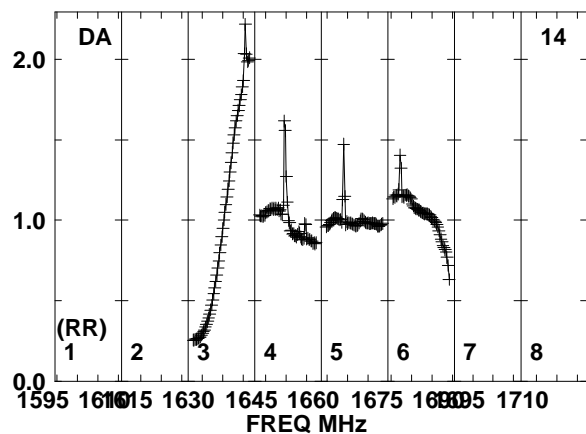
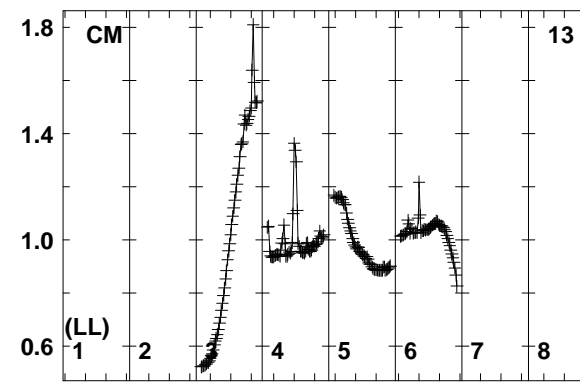
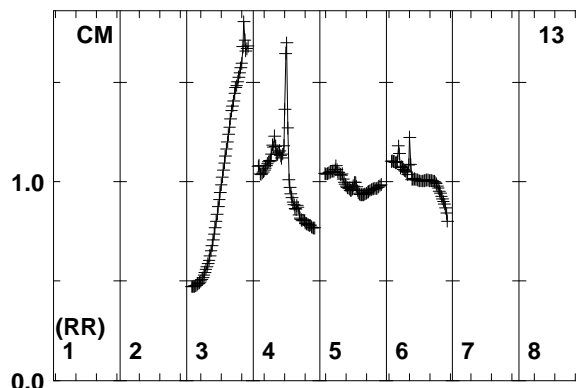
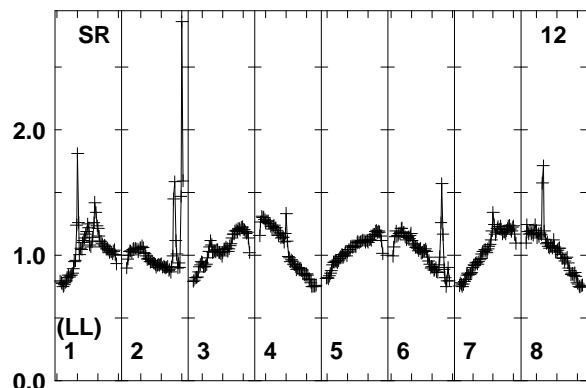
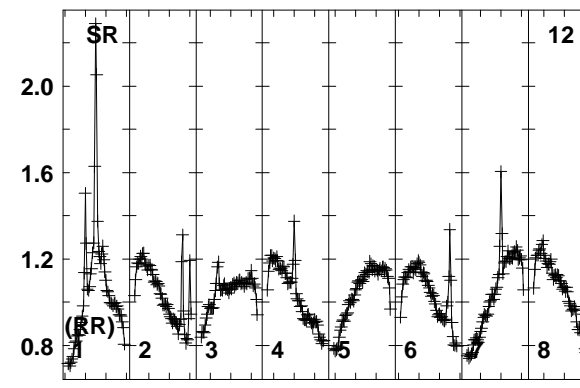
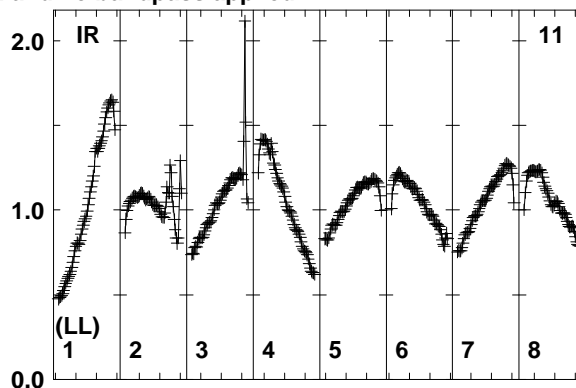
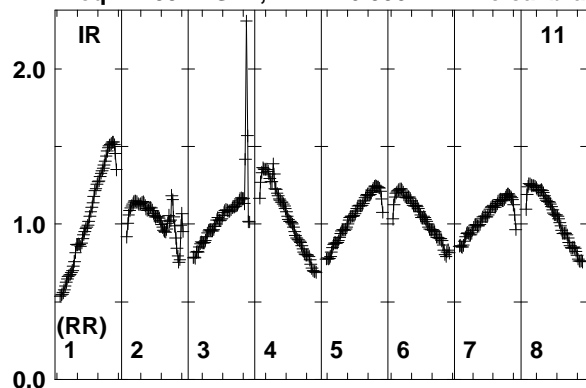

Lower frame: Real Jy
Total-power spectrum Antenna: IR (11)
Timerange: 00/08:23:51 to 00/08:26:29

Plot file version 609 created 04-NOV-2019 14:14:50

W2246-0526 EY034.UVDATA.1

Freq = 1.5947 GHz, Bw = 16.000 MH No calibration applied and no bandpass applied

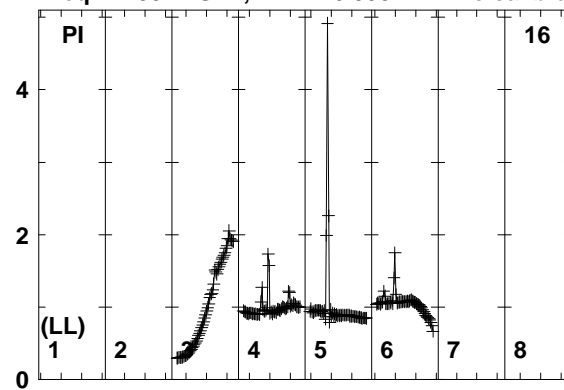

Lower frame: Real Jy
Total-power spectrum Antenna: PI (16)
Timerange: 00/08:23:51 to 00/08:26:29

Plot file version 610 created 04-NOV-2019 14:14:50

J2248-0541 EY034.UVDATA.1

Freq = 1.5947 GHz, Bw = 16.000 MH No calibration applied and no bandpass applied

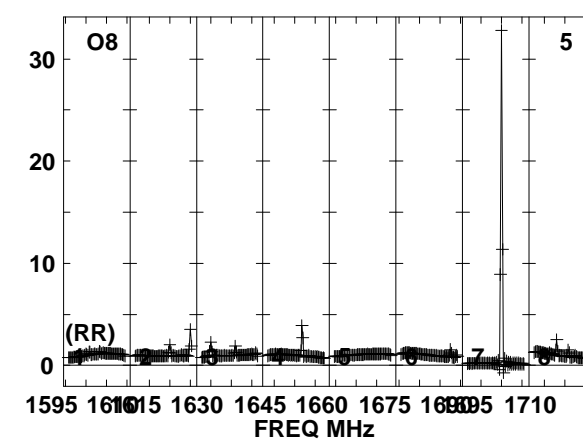
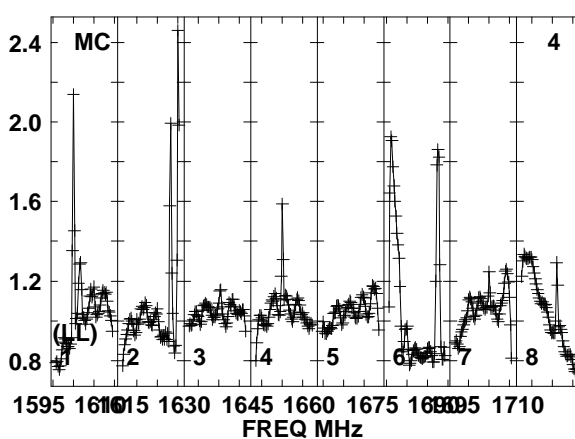
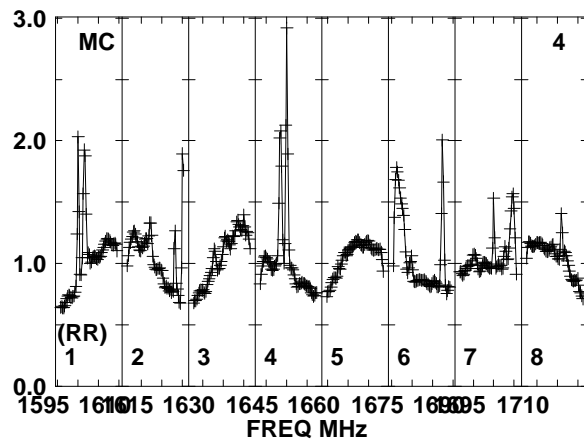
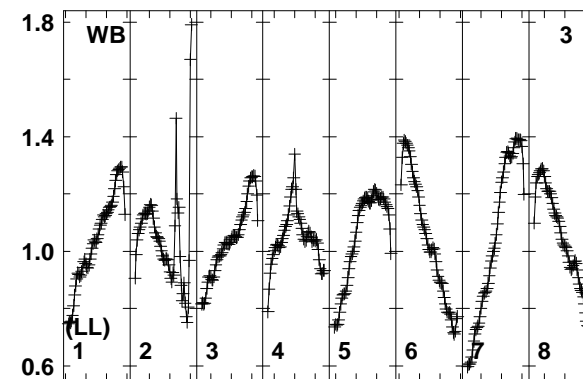
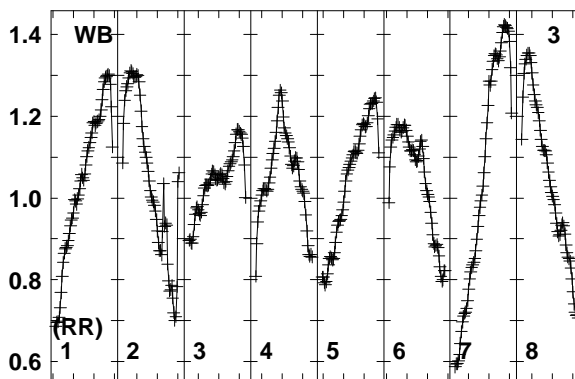
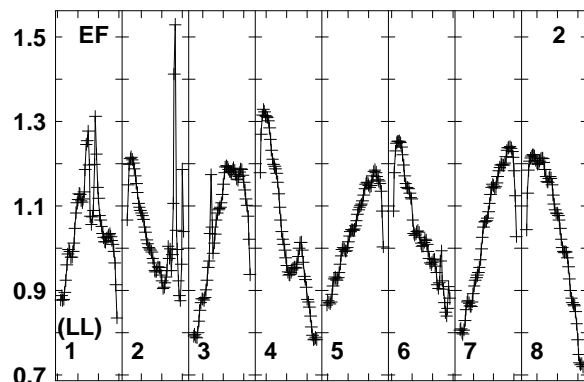
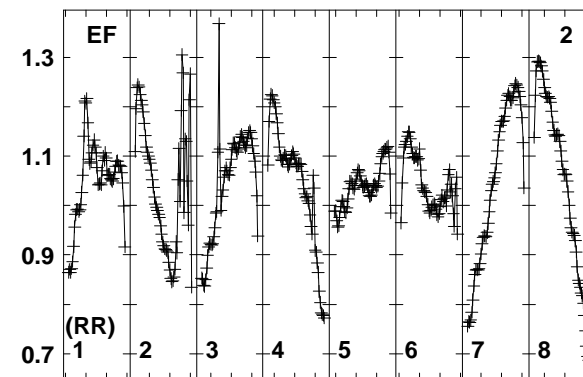
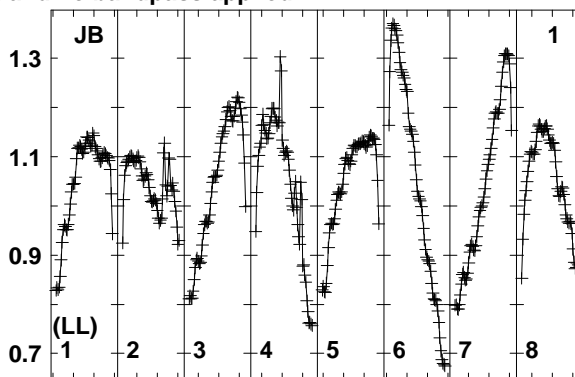
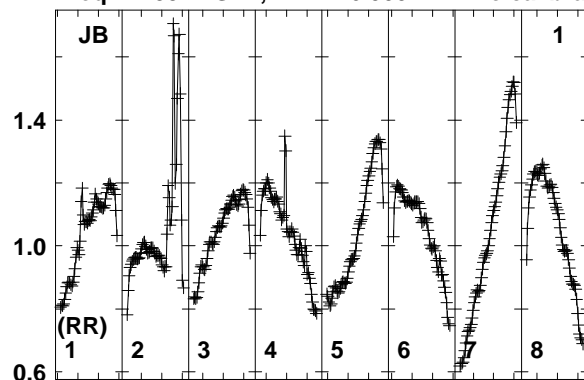

Lower frame: Real Jy
Total-power spectrum Antenna: JB (01)
Timerange: 00/08:26:46 to 00/08:27:44

Plot file version 611 created 04-NOV-2019 14:14:50

J2248-0541 EY034.UVDATA.1

Freq = 1.5947 GHz, Bw = 16.000 MH No calibration applied and no bandpass applied

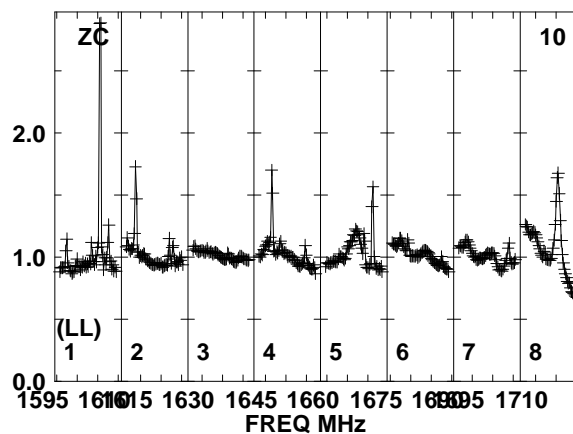
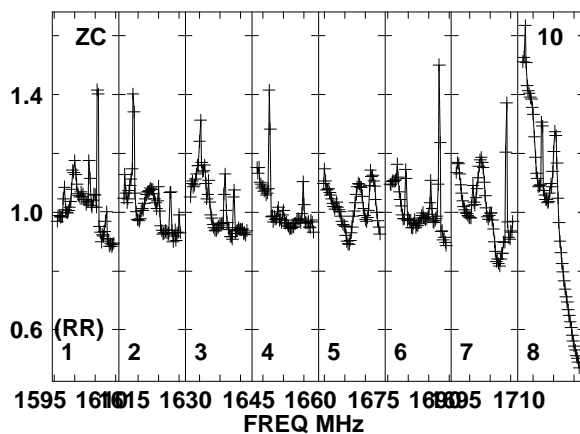
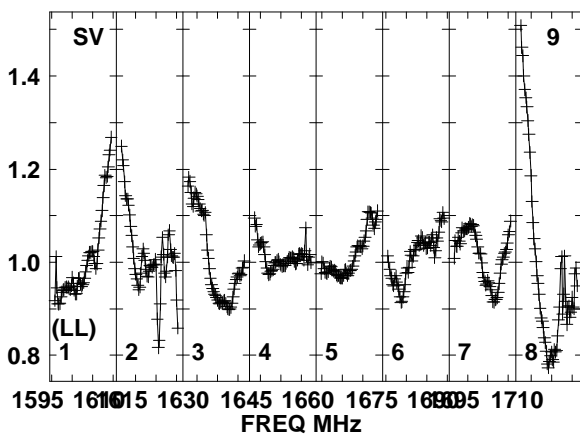
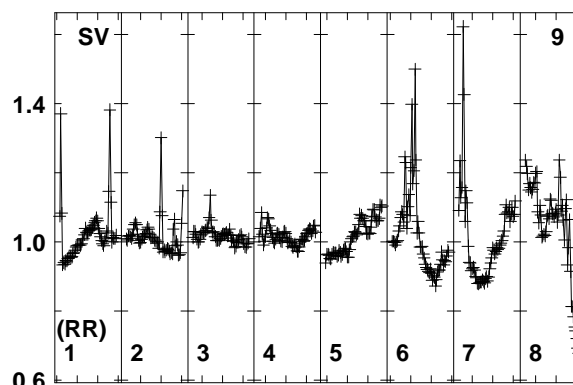
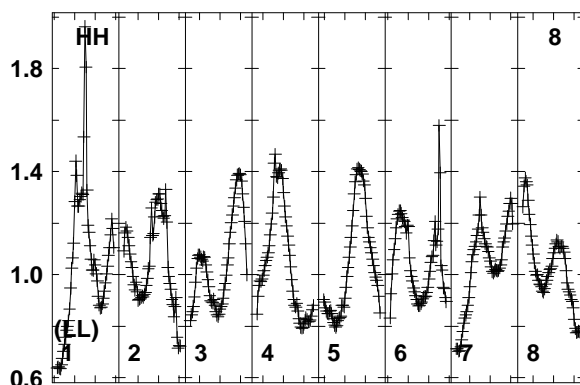
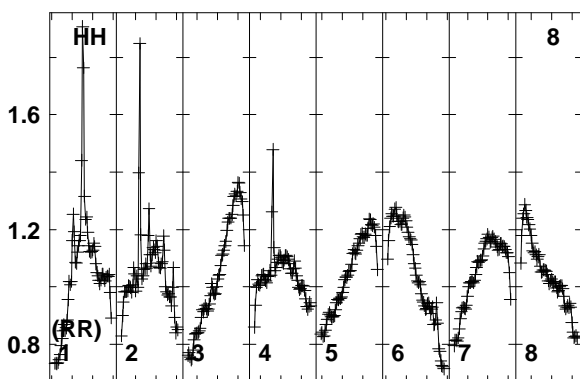
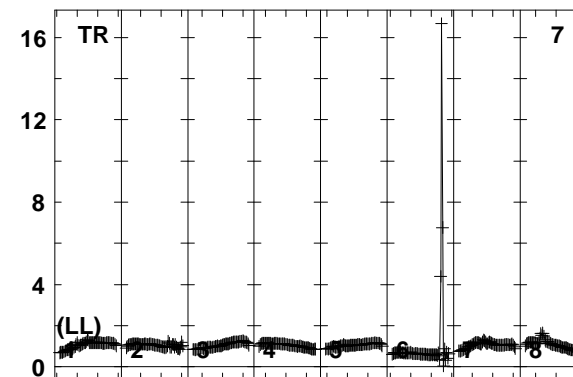
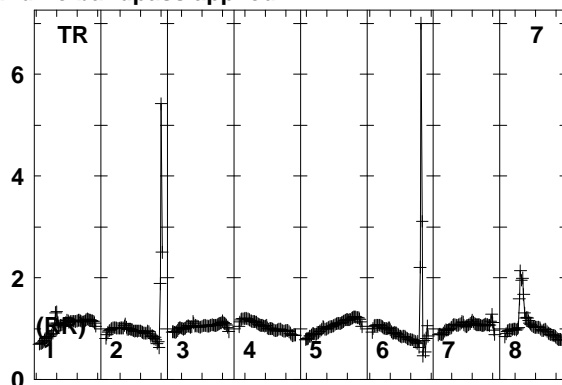
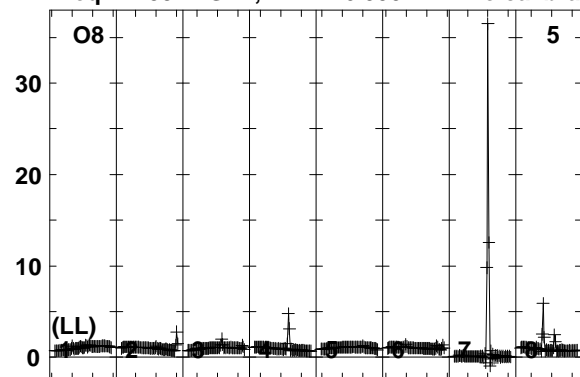

Lower frame: Real Jy
Total-power spectrum Antenna: O8 (05)
Timerange: 00/08:26:46 to 00/08:27:44

Plot file version 612 created 04-NOV-2019 14:14:50

J2248-0541 EY034.UVDATA.1

Freq = 1.5947 GHz, Bw = 16.000 MH No calibration applied and no bandpass applied

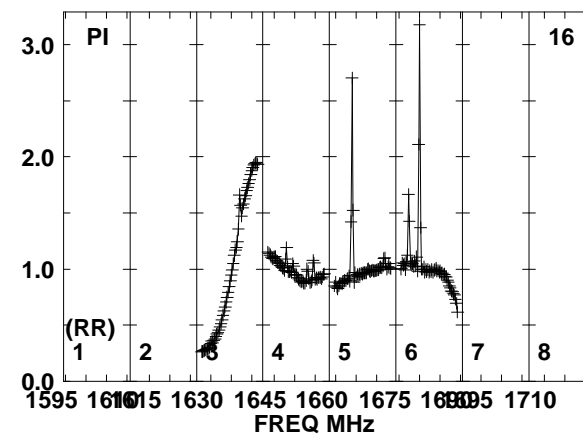
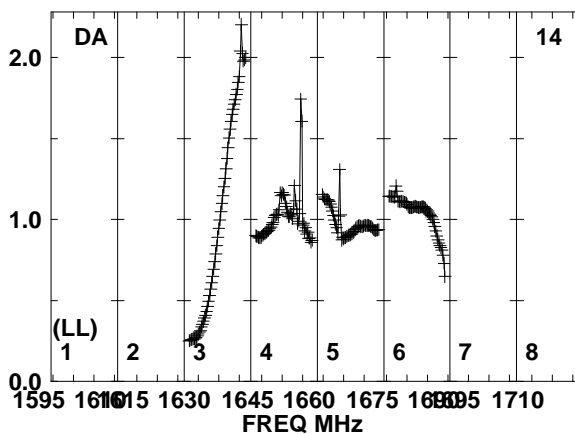
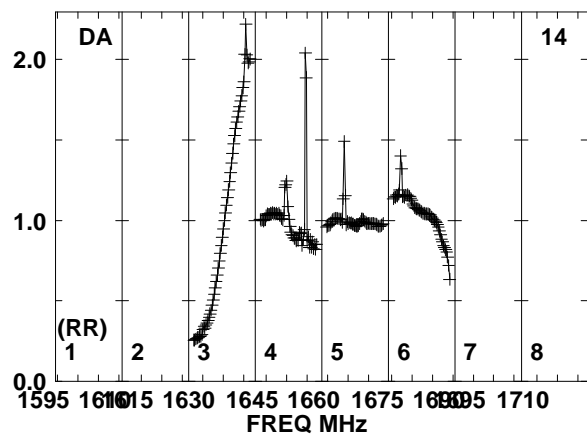
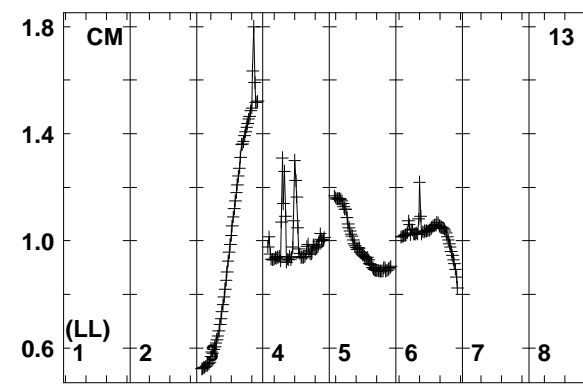
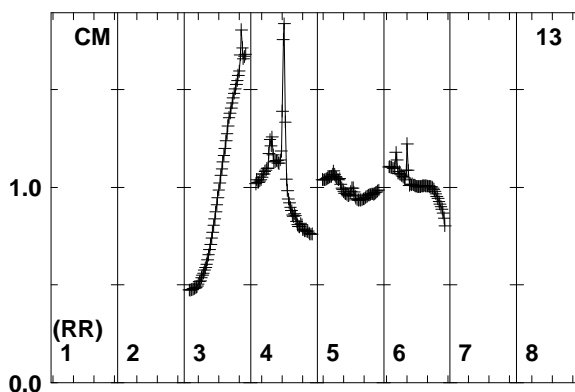
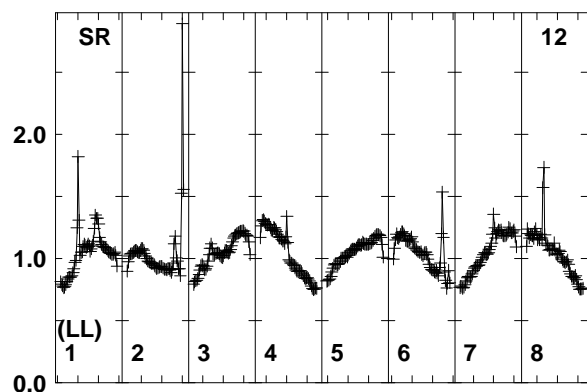
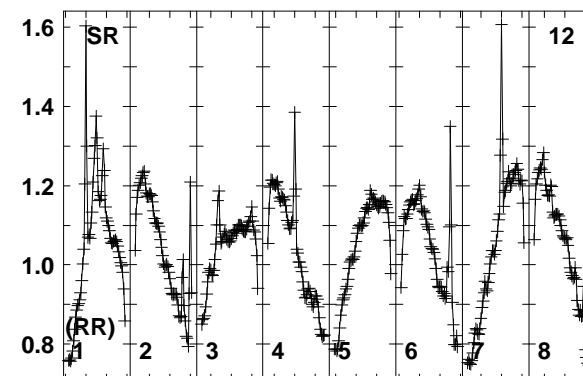
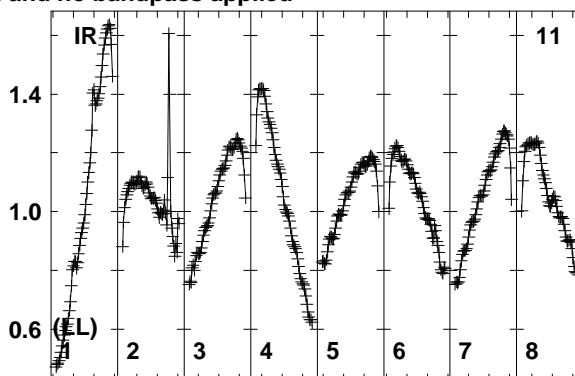
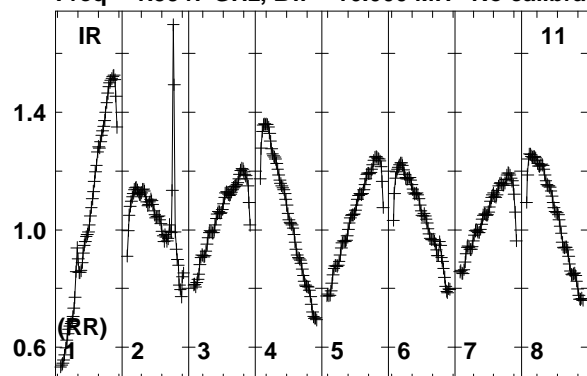

Lower frame: Real Jy
Total-power spectrum Antenna: IR (11)
Timerange: 00/08:26:46 to 00/08:27:44

Plot file version 613 created 04-NOV-2019 14:14:50
J2248-0541 EY034.UVDATA.1
Freq = 1.5947 GHz, Bw = 16.000 MH No calibration applied and no bandpass applied

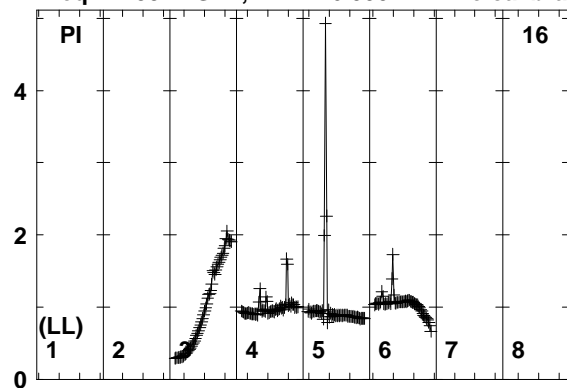

Lower frame: Real Jy
Total-power spectrum Antenna: PI (16)
Timerange: 00/08:26:46 to 00/08:27:44

Plot file version 614 created 04-NOV-2019 14:14:50

J2245-0755 EY034.UVDATA.1

Freq = 1.5947 GHz, Bw = 16.000 MH No calibration applied and no bandpass applied

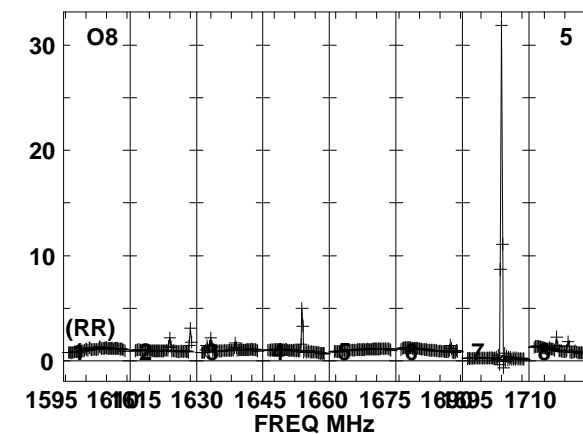
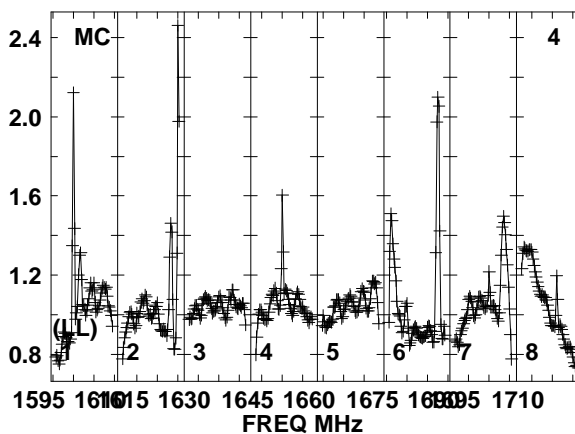
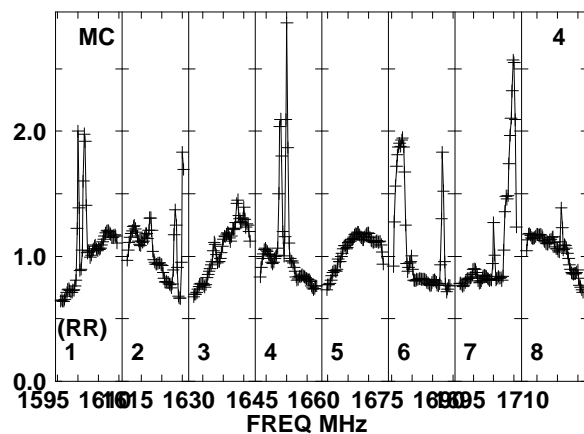
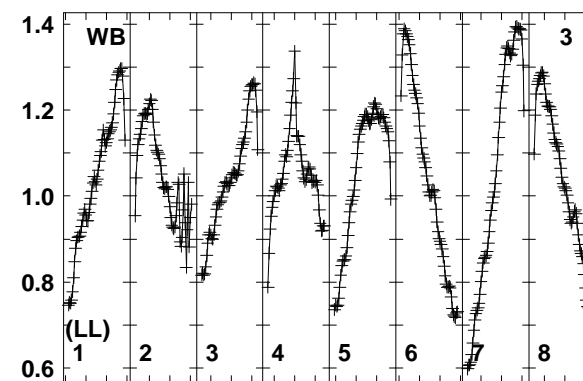
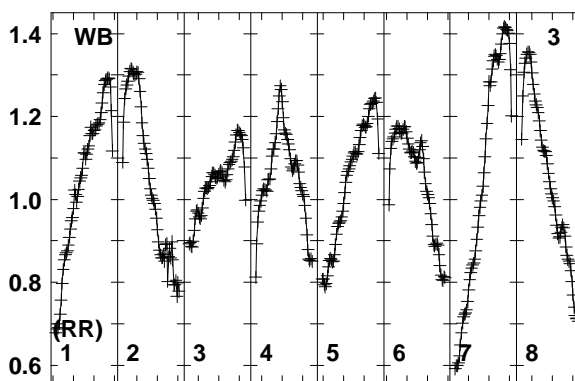
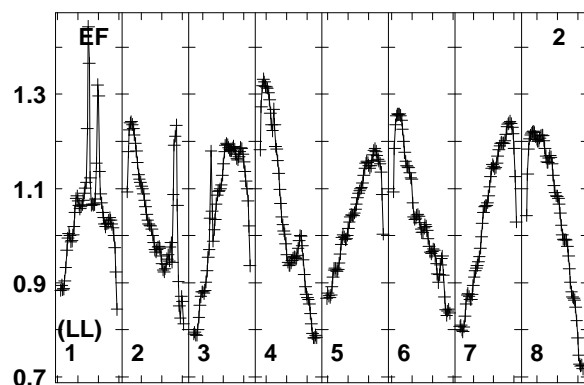
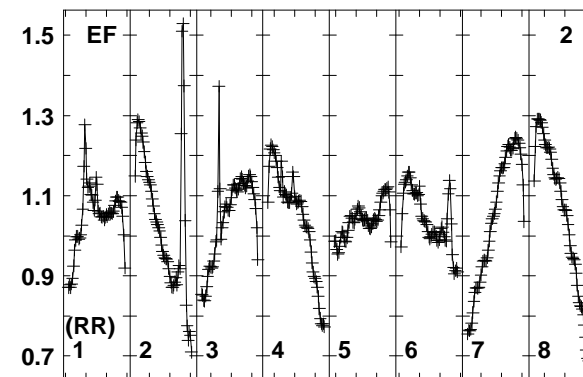
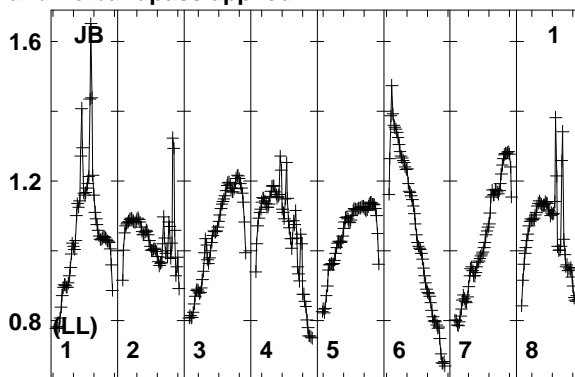
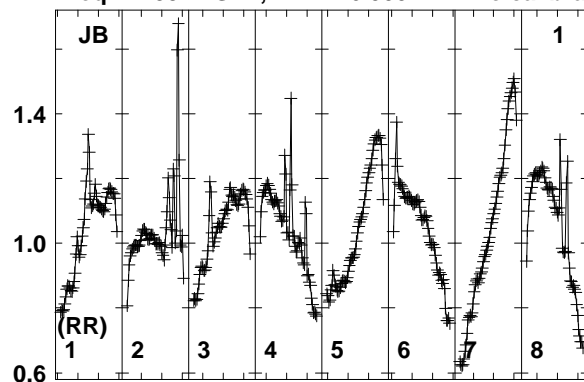

Lower frame: Real Jy
Total-power spectrum Antenna: JB (01)
Timerange: 00/08:28:01 to 00/08:28:59

Plot file version 615 created 04-NOV-2019 14:14:50

J2245-0755 EY034.UVDATA.1

Freq = 1.5947 GHz, Bw = 16.000 MH No calibration applied and no bandpass applied

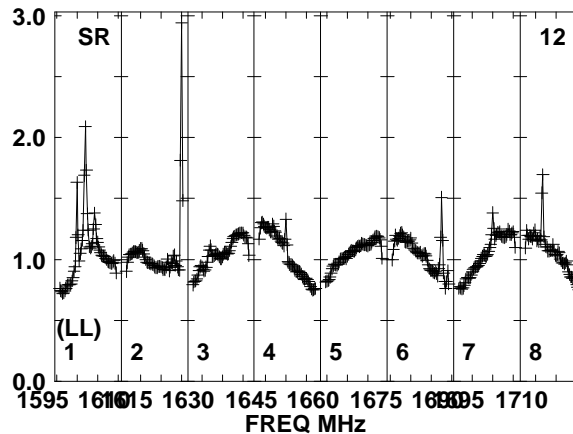
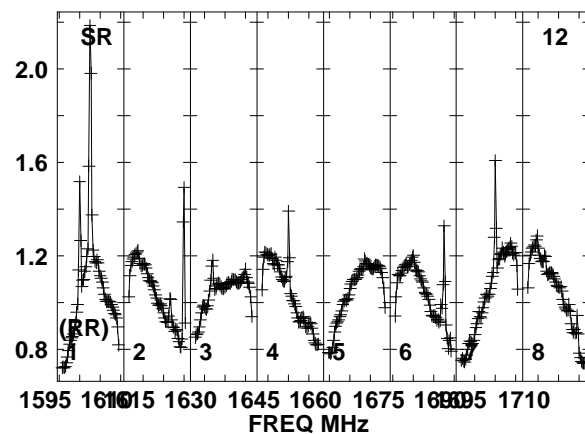
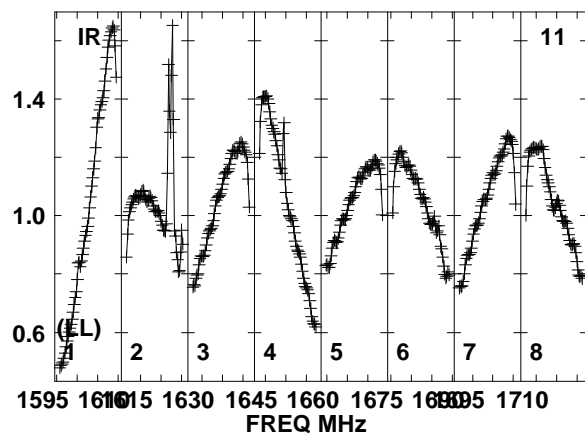
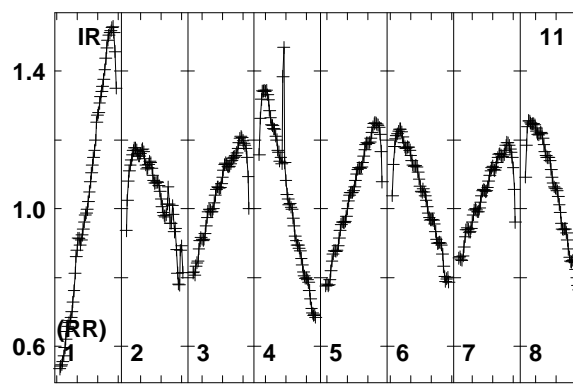
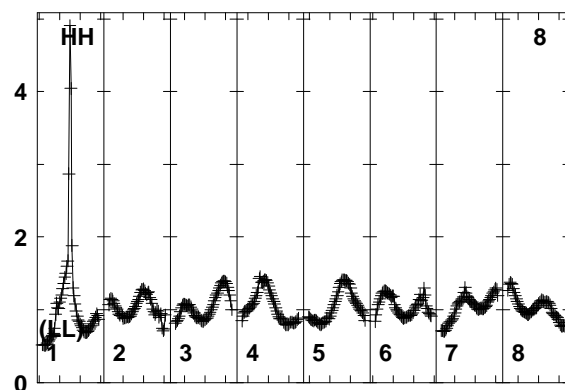
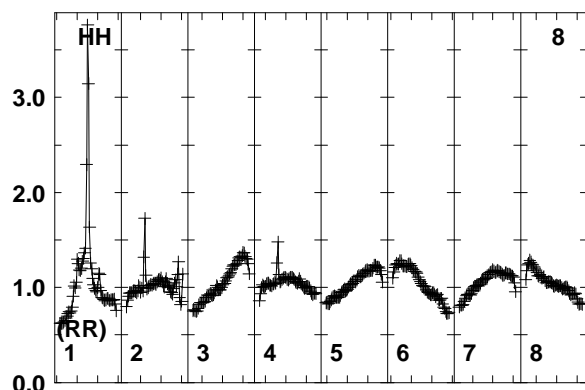
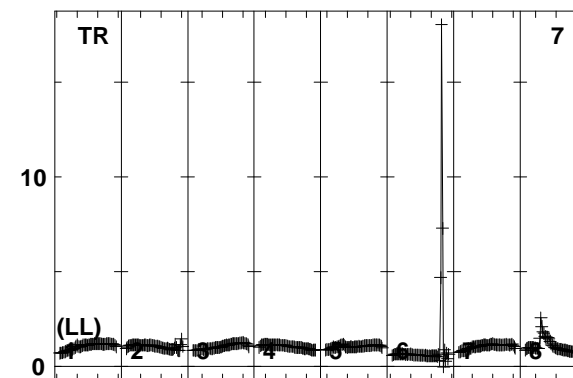
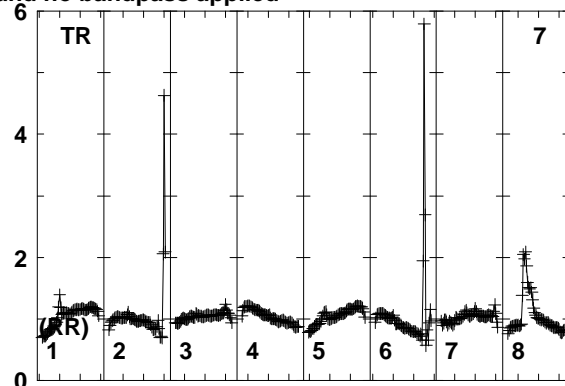
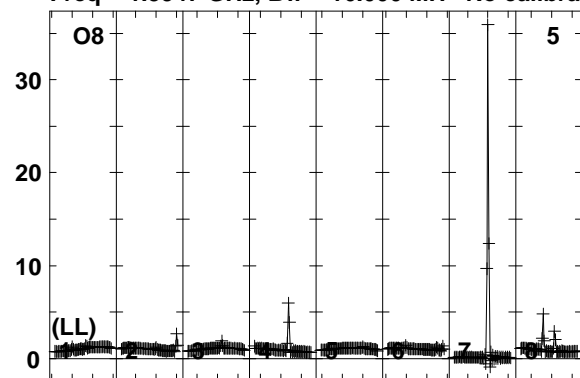

Lower frame: Real Jy
Total-power spectrum Antenna: O8 (05)
Timerange: 00/08:28:01 to 00/08:28:59

Plot file version 616 created 04-NOV-2019 14:14:50

J2245-0755 EY034.UVDATA.1

Freq = 1.5947 GHz, Bw = 16.000 MH No calibration applied and no bandpass applied

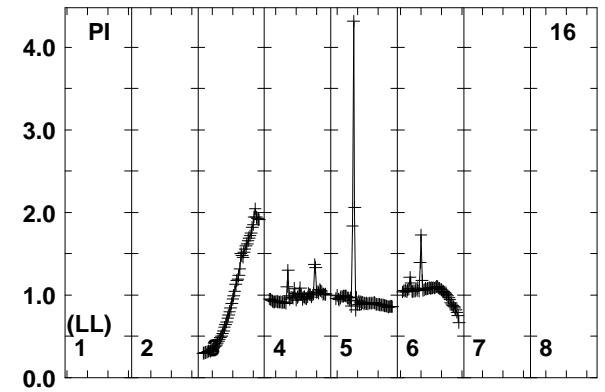
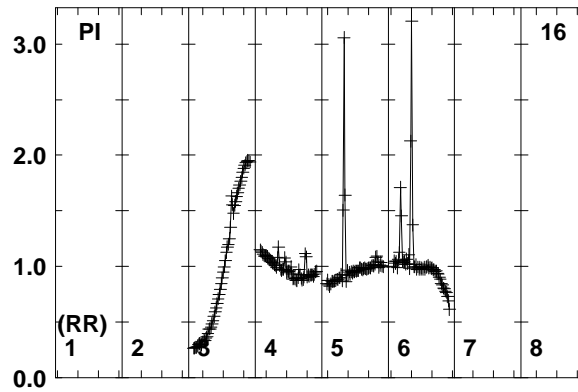
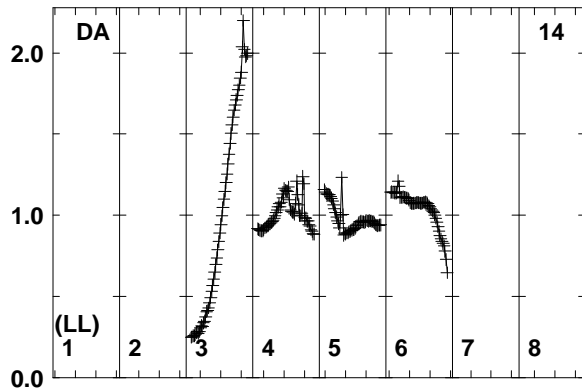
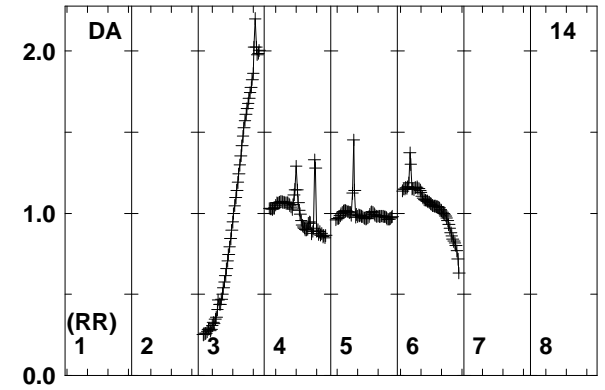
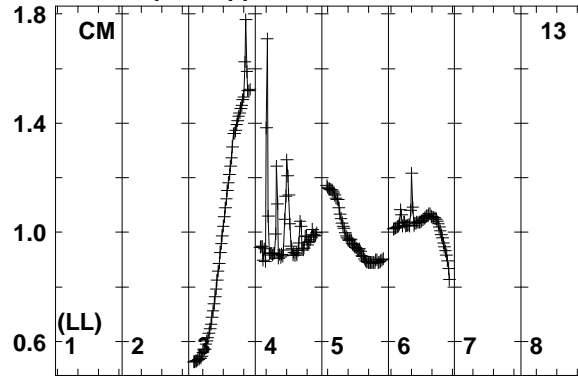
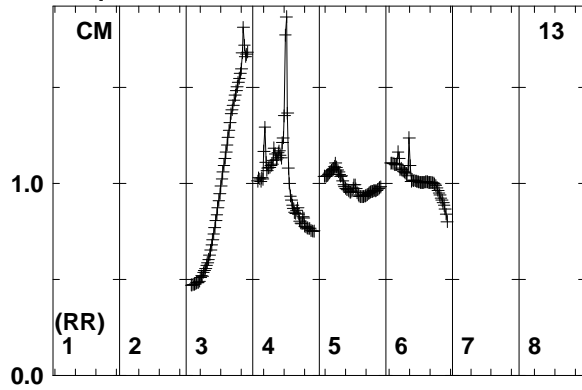

Lower frame: Real Jy
Total-power spectrum Antenna: CM (13)
Timerange: 00/08:28:01 to 00/08:28:59

Plot file version 617 created 04-NOV-2019 14:14:50

J2248-0541 EY034.UVDATA.1

Freq = 1.5947 GHz, Bw = 16.000 MH No calibration applied and no bandpass applied

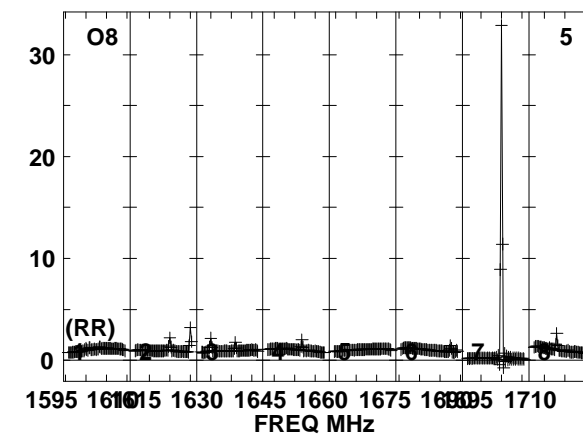
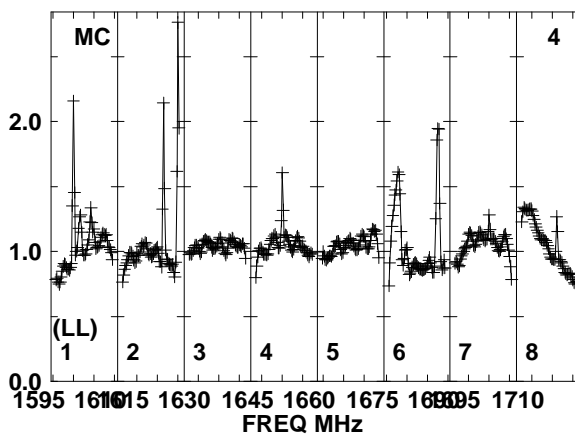
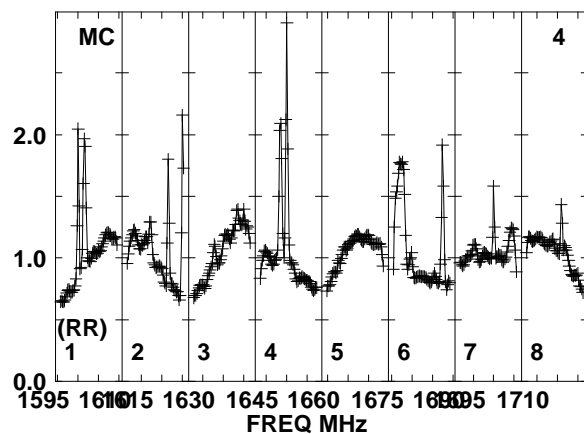
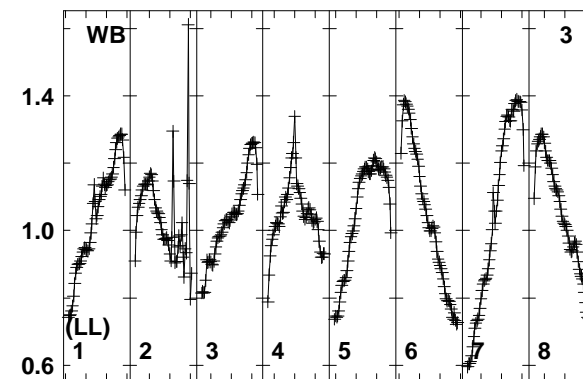
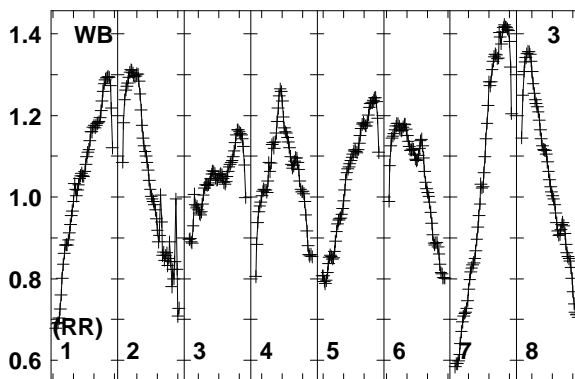
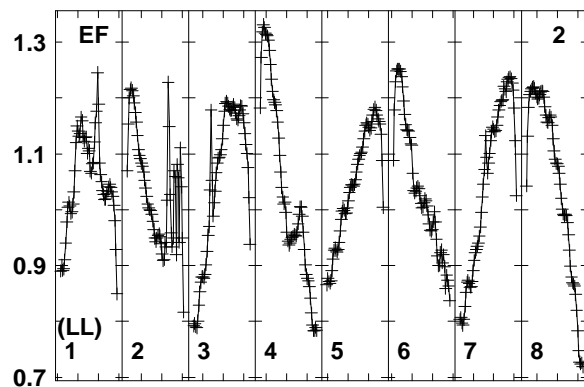
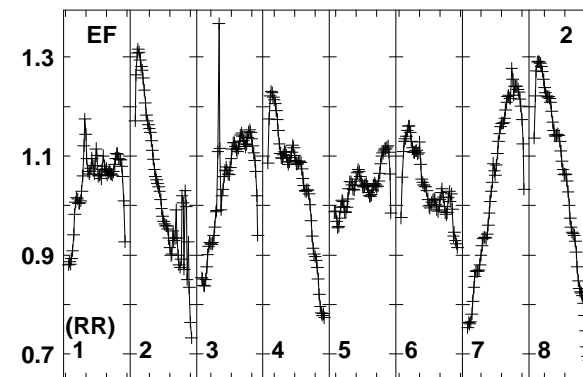
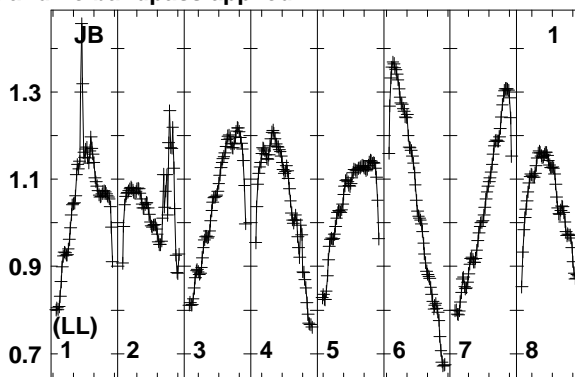
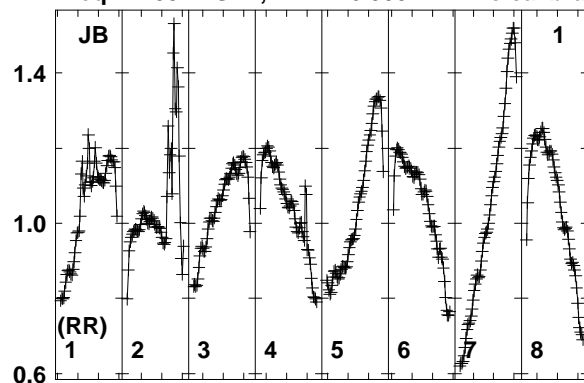

Lower frame: Real Jy
Total-power spectrum Antenna: JB (01)
Timerange: 00/08:29:46 to 00/08:30:44

Plot file version 618 created 04-NOV-2019 14:14:50

J2248-0541 EY034.UVDATA.1

Freq = 1.5947 GHz, Bw = 16.000 MH No calibration applied and no bandpass applied

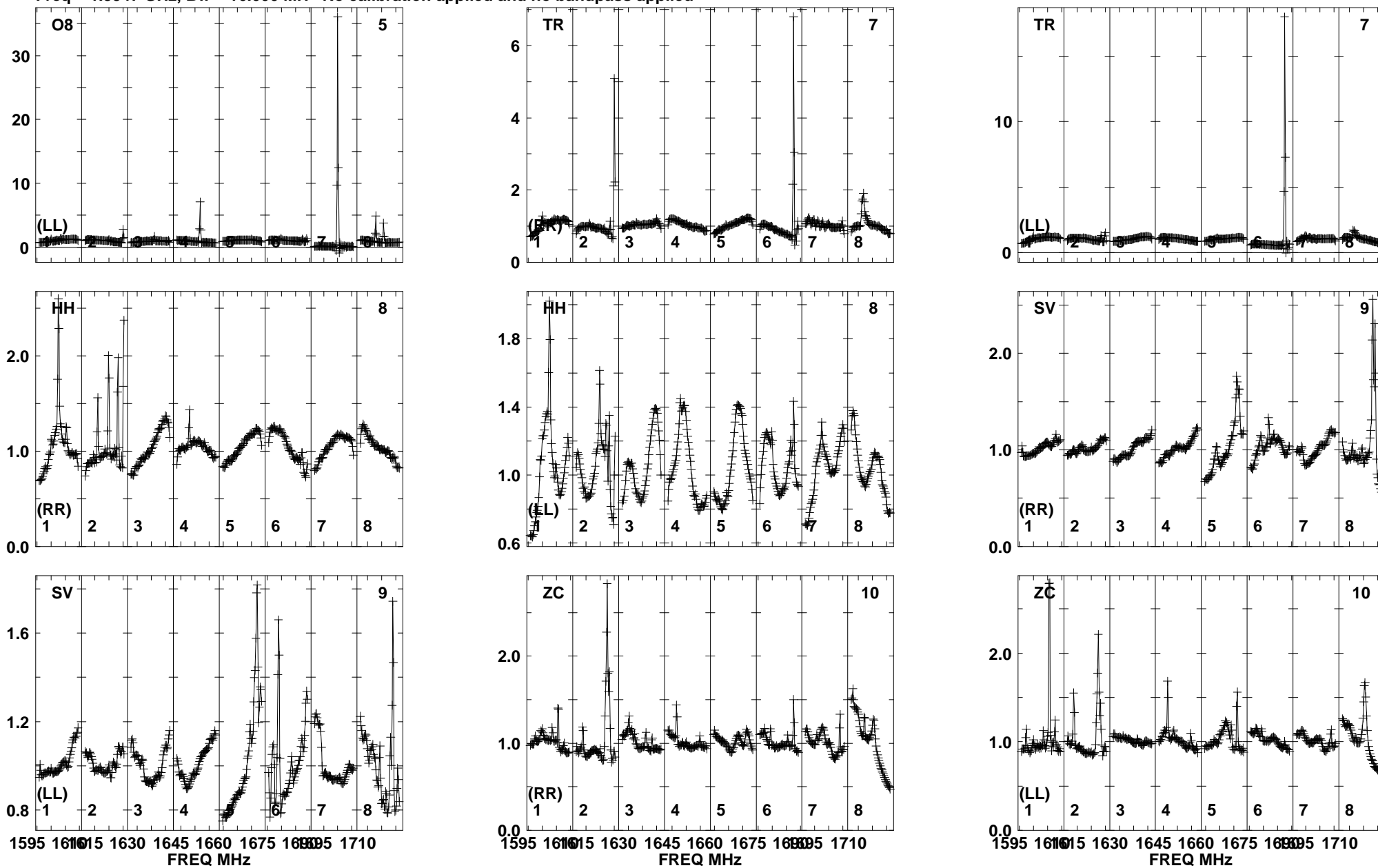

Lower frame: Real Jy
Total-power spectrum Antenna: O8 (05)
Timerange: 00/08:29:46 to 00/08:30:44

Plot file version 619 created 04-NOV-2019 14:14:51

J2248-0541 EY034.UVDATA.1

Freq = 1.5947 GHz, Bw = 16.000 MH No calibration applied and no bandpass applied

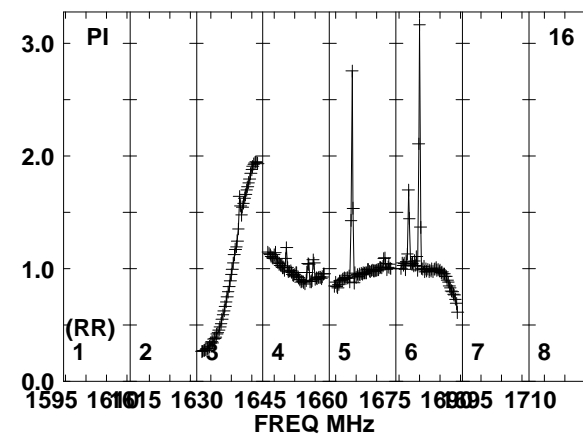
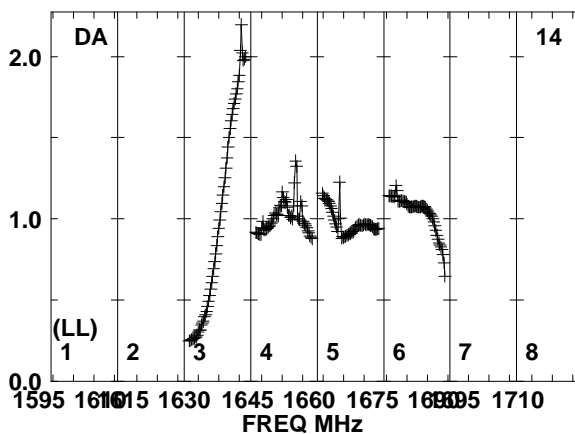
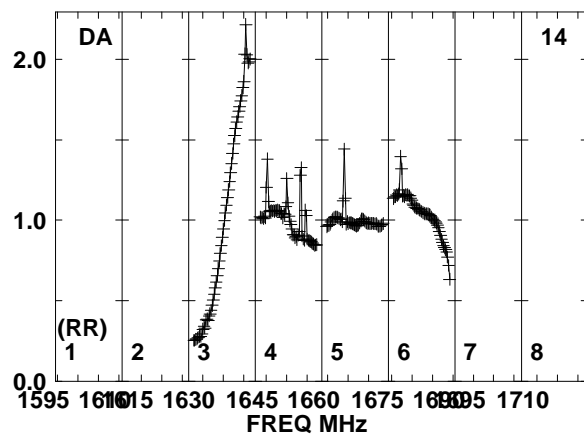
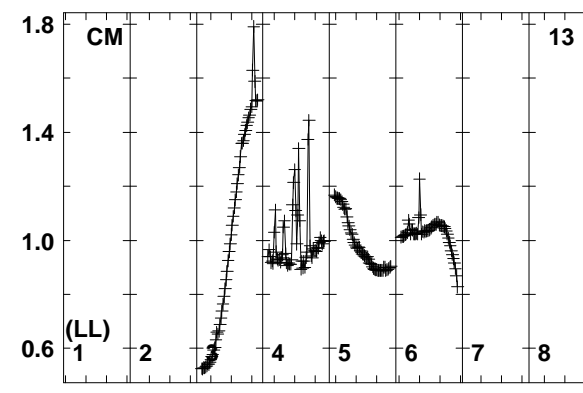
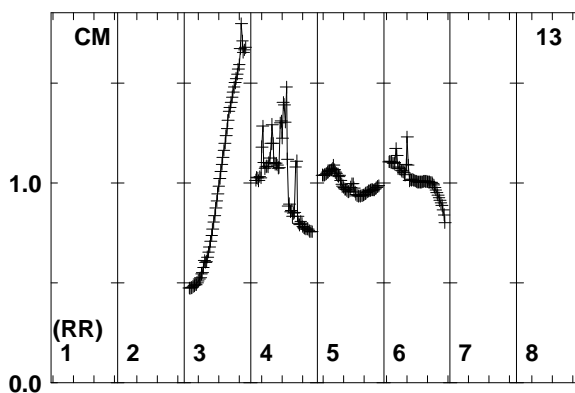
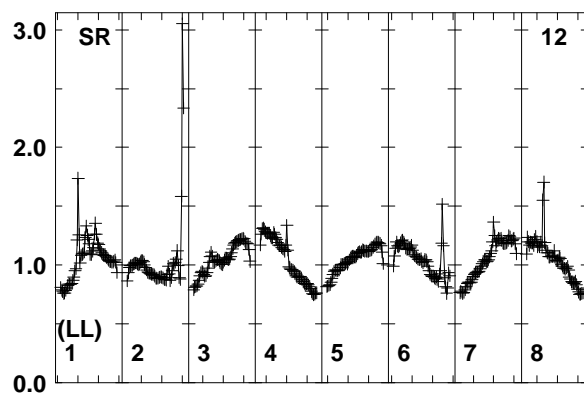
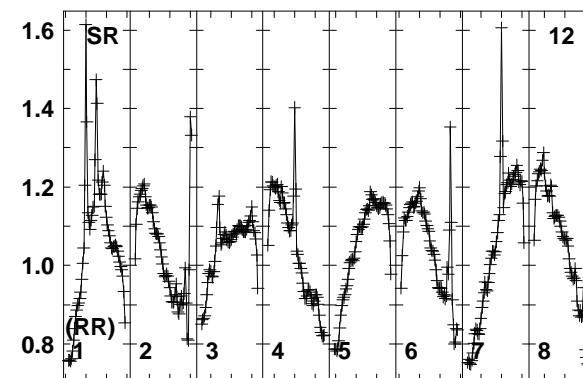
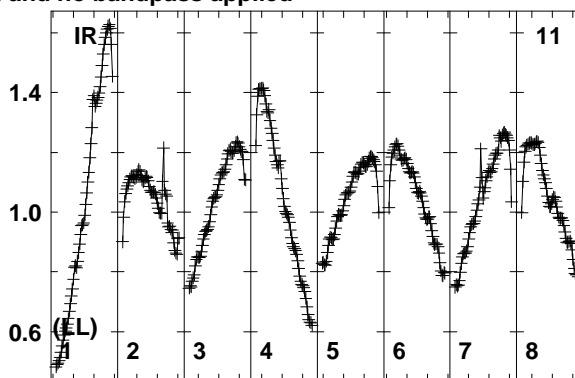
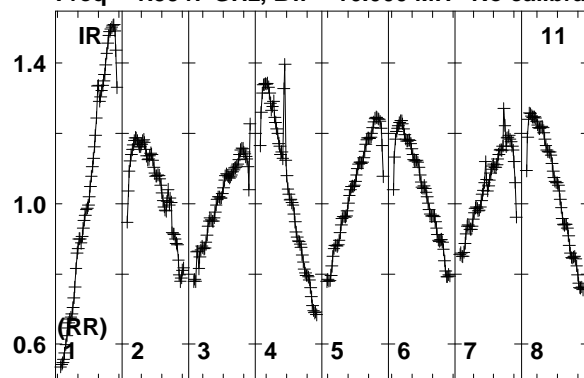

Lower frame: Real Jy
Total-power spectrum Antenna: IR (11)
Timerange: 00/08:29:46 to 00/08:30:44

Plot file version 620 created 04-NOV-2019 14:14:51
J2248-0541 EY034.UVDATA.1
Freq = 1.5947 GHz, Bw = 16.000 MH No calibration applied and no bandpass applied

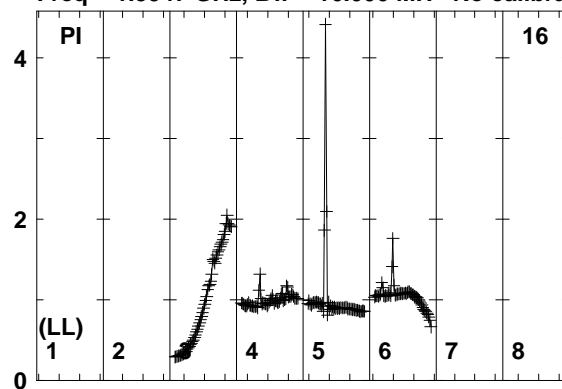

Lower frame: Real Jy
Total-power spectrum Antenna: PI (16)
Timerange: 00/08:29:46 to 00/08:30:44

Plot file version 621 created 04-NOV-2019 14:14:51

W2246-0526 EY034.UVDATA.1

Freq = 1.5947 GHz, Bw = 16.000 MH No calibration applied and no bandpass applied

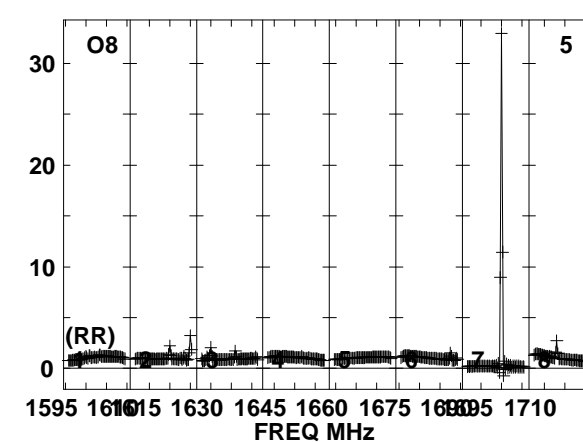
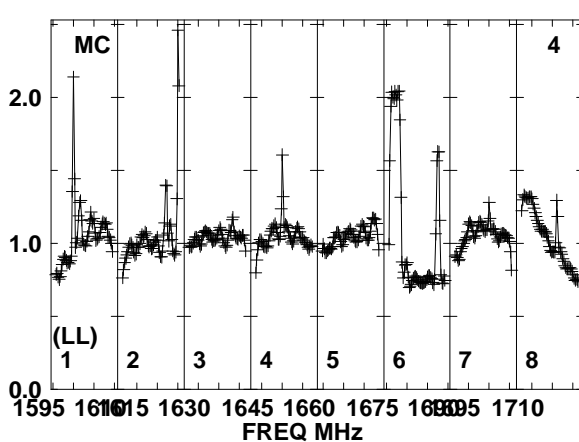
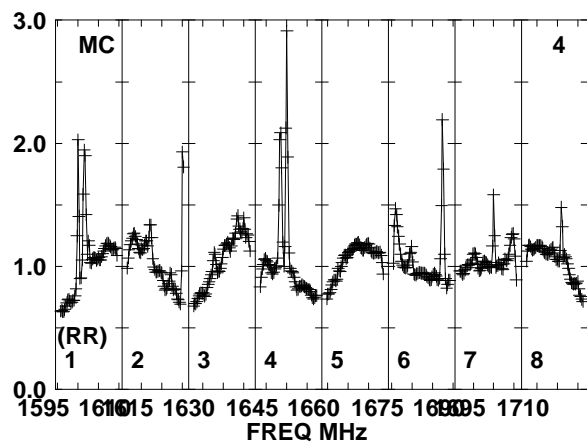
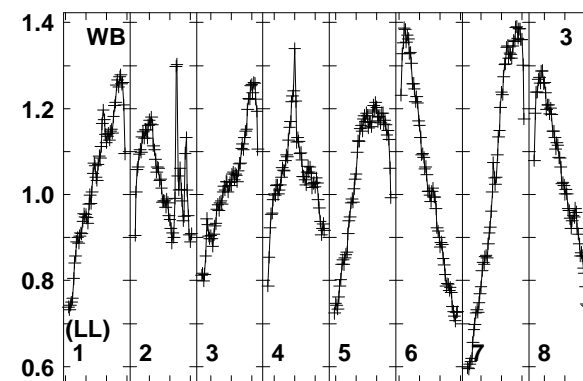
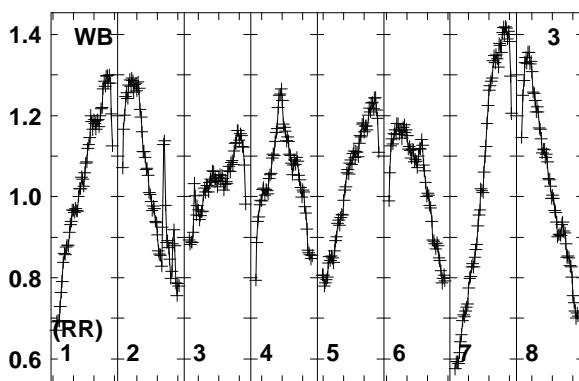
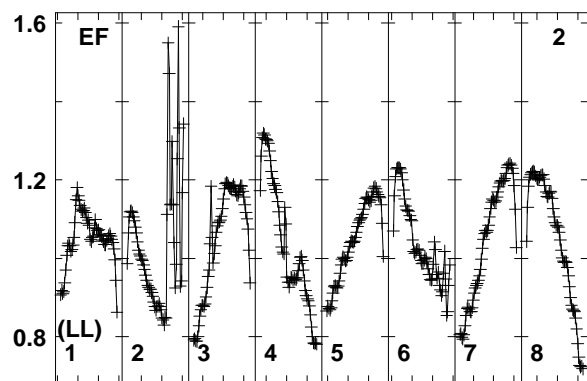
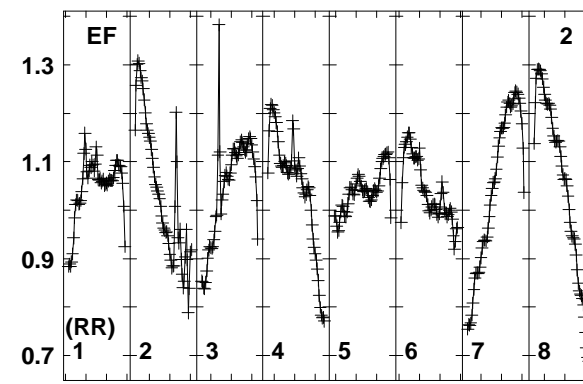
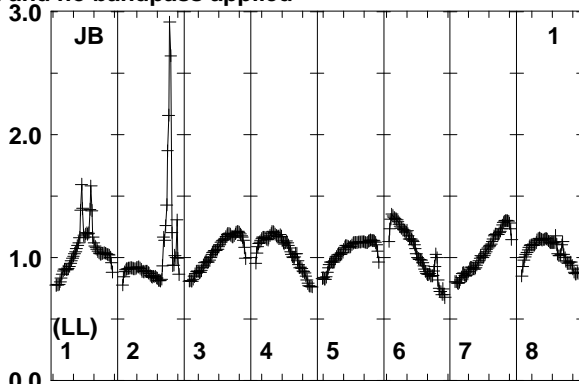
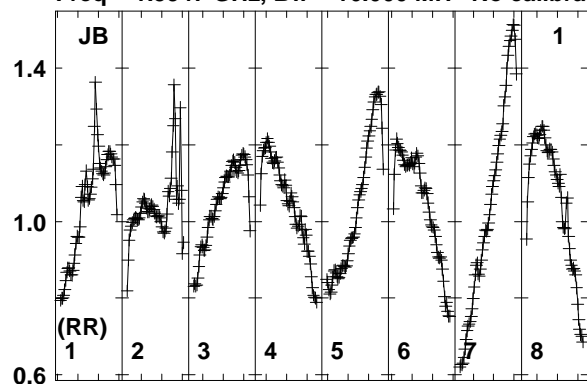

Lower frame: Real Jy
Total-power spectrum Antenna: JB (01)
Timerange: 00/08:30:46 to 00/08:33:14

Plot file version 622 created 04-NOV-2019 14:14:51

W2246-0526 EY034.UVDATA.1

Freq = 1.5947 GHz, Bw = 16.000 MH No calibration applied and no bandpass applied

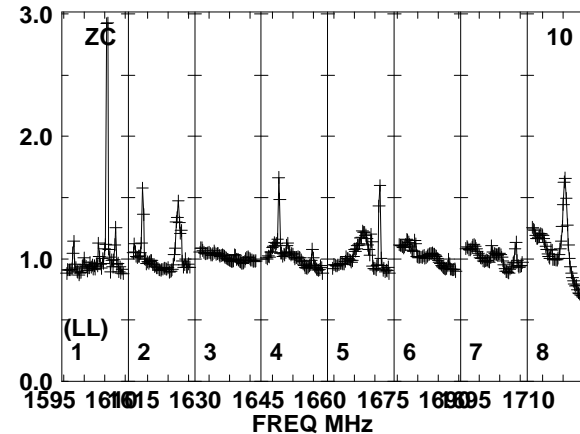
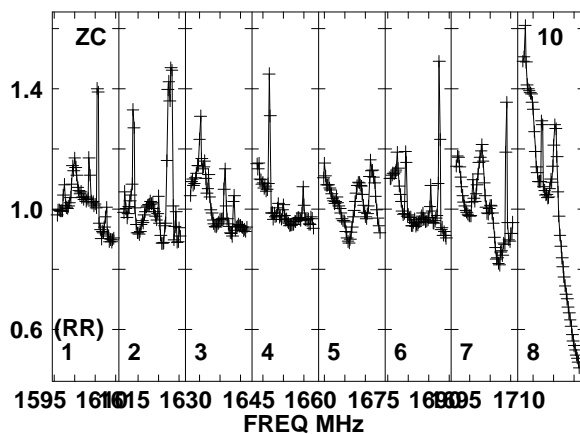
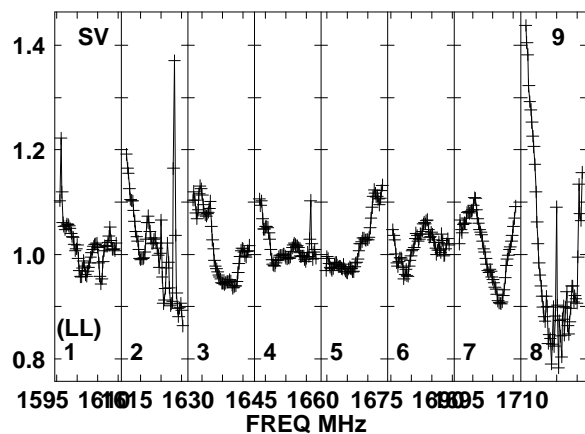
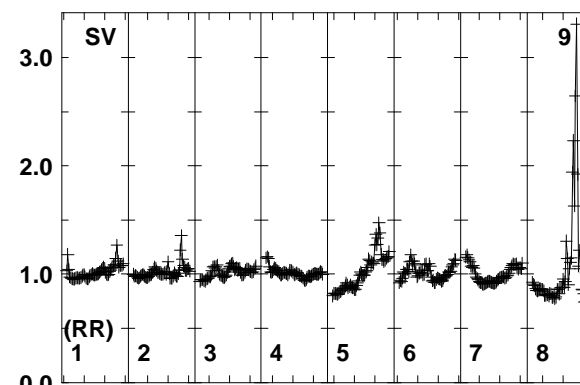
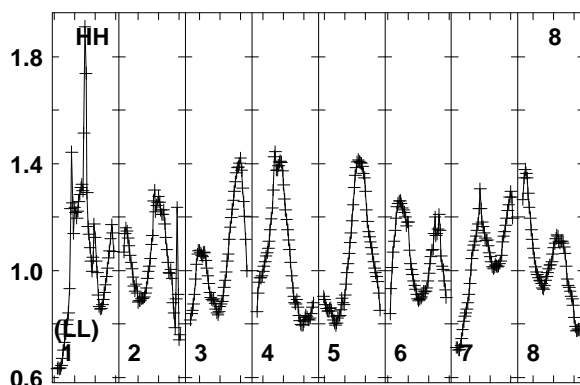
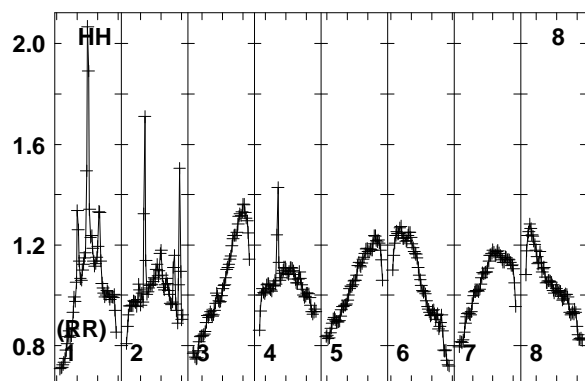
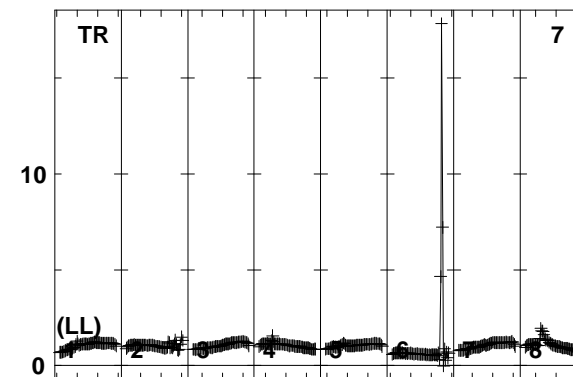
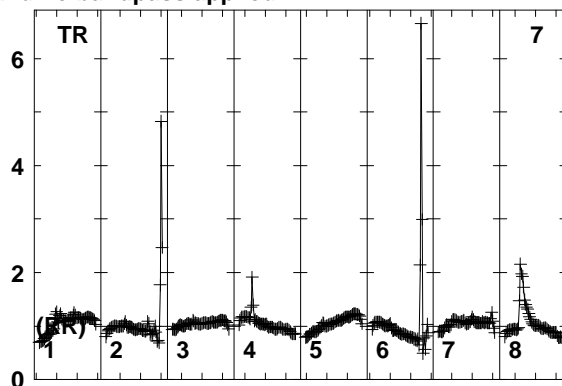
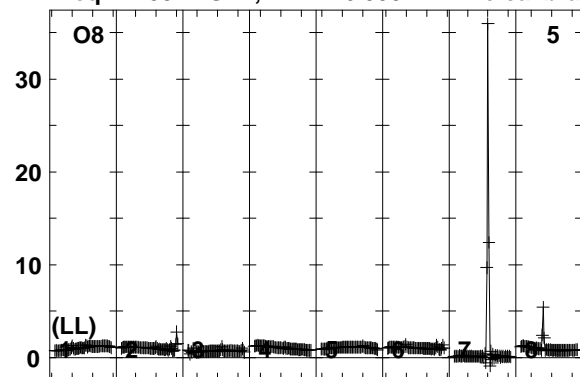

Lower frame: Real Jy
Total-power spectrum Antenna: O8 (05)
Timerange: 00/08:30:46 to 00/08:33:14

Plot file version 623 created 04-NOV-2019 14:14:51

W2246-0526 EY034.UVDATA.1

Freq = 1.5947 GHz, Bw = 16.000 MH No calibration applied and no bandpass applied

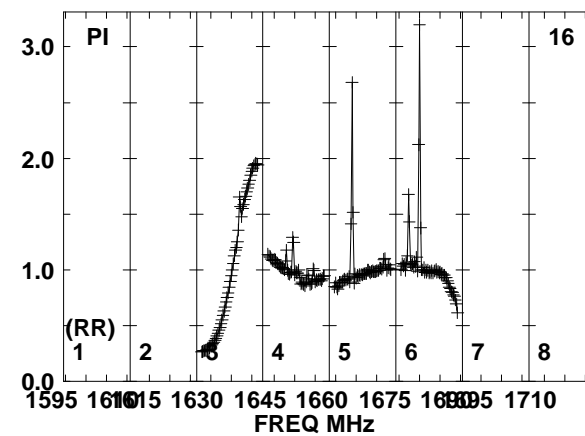
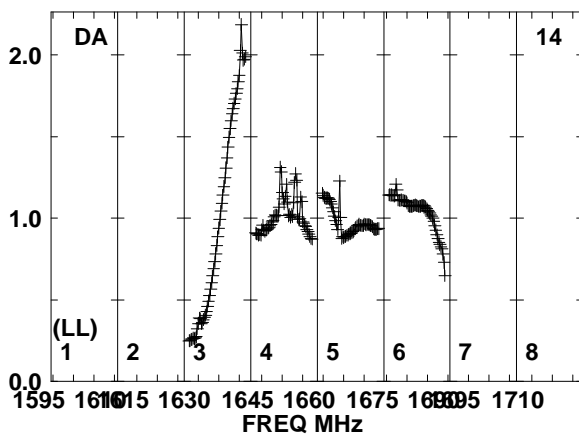
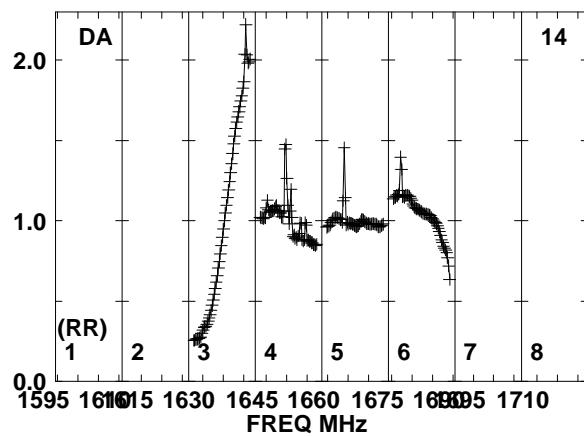
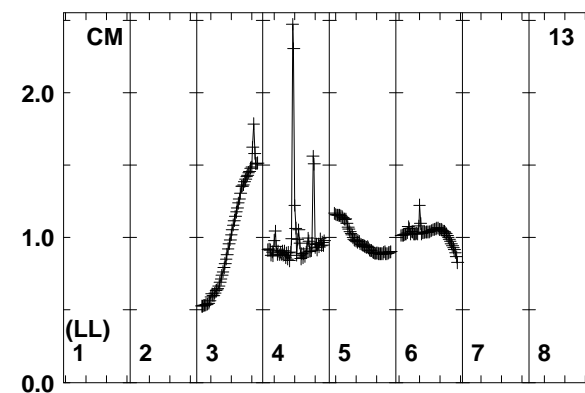
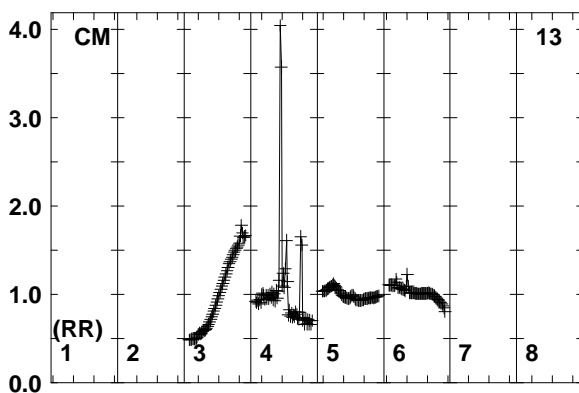
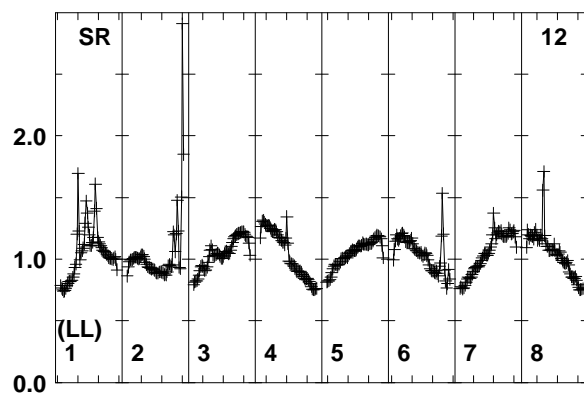
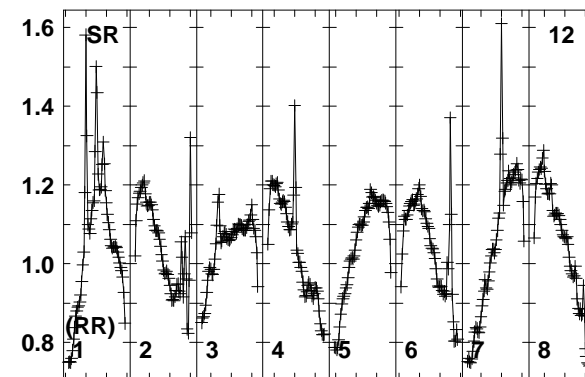
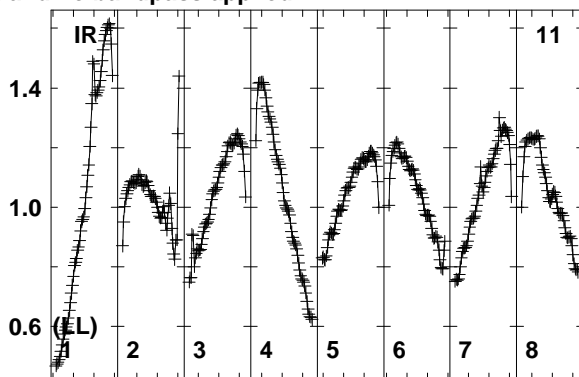
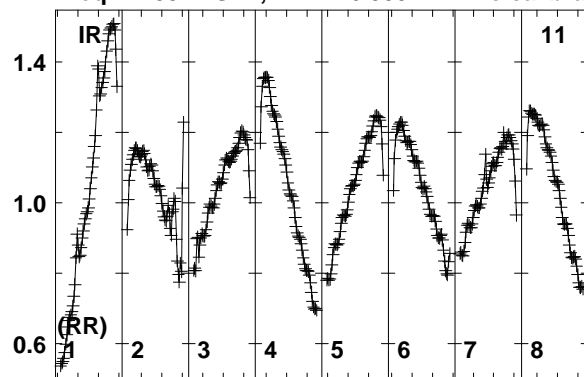

Lower frame: Real Jy
Total-power spectrum Antenna: IR (11)
Timerange: 00/08:30:46 to 00/08:33:14

Plot file version 624 created 04-NOV-2019 14:14:51
W2246-0526 EY034.UVDATA.1
Freq = 1.5947 GHz, Bw = 16.000 MH No calibration applied and no bandpass applied

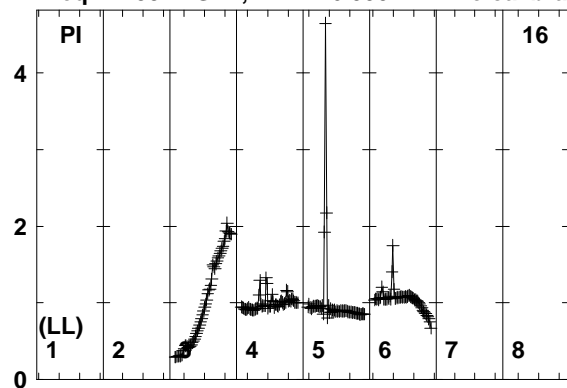

Lower frame: Real Jy
Total-power spectrum Antenna: PI (16)
Timerange: 00/08:30:46 to 00/08:33:14

Plot file version 625 created 04-NOV-2019 14:14:51

J2248-0541 EY034.UVDATA.1

Freq = 1.5947 GHz, Bw = 16.000 MH No calibration applied and no bandpass applied

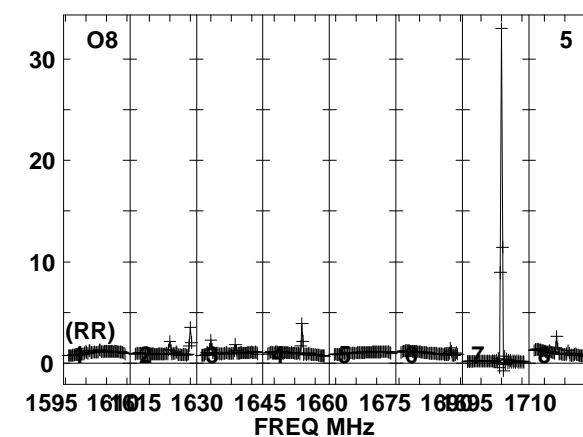
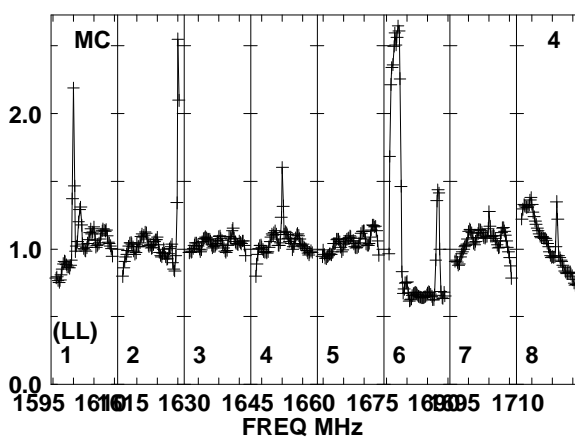
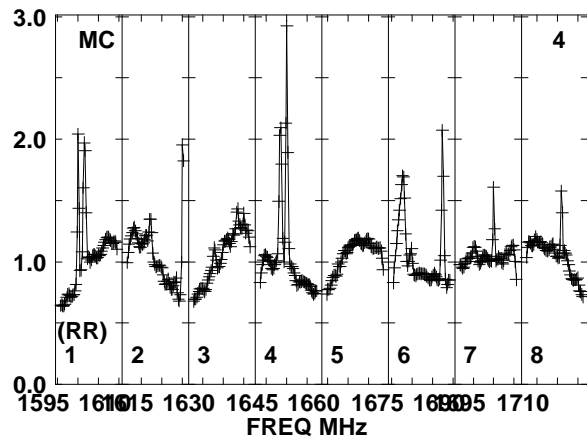
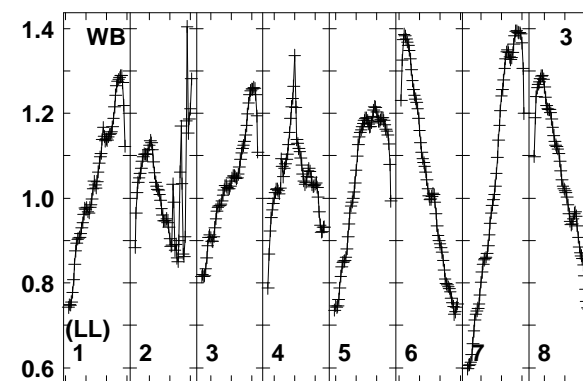
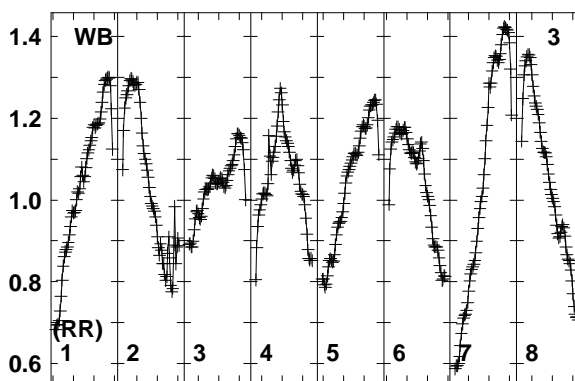
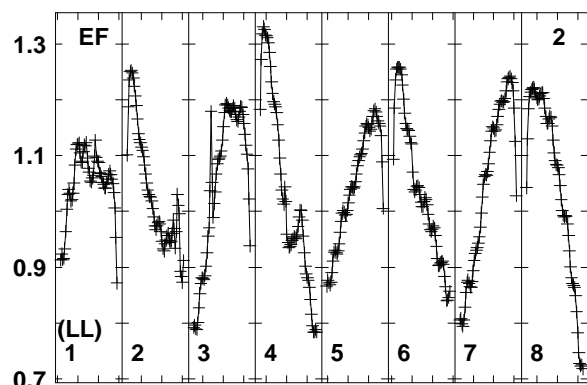
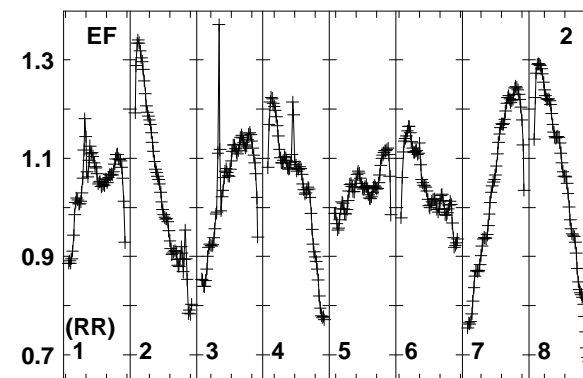
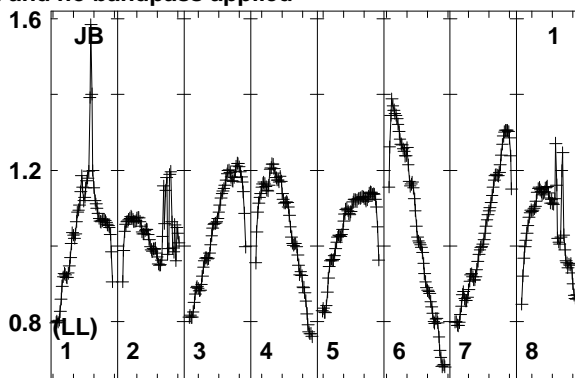
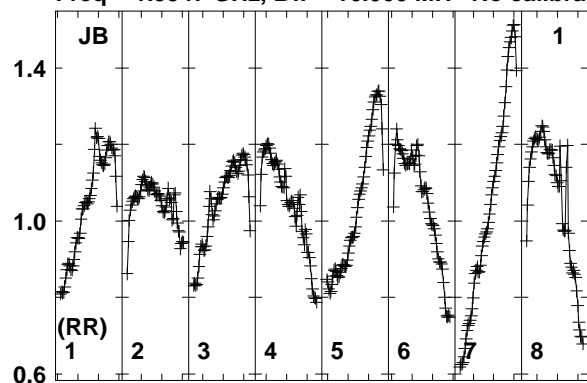

Lower frame: Real Jy
Total-power spectrum Antenna: JB (01)
Timerange: 00/08:33:31 to 00/08:34:29

Plot file version 626 created 04-NOV-2019 14:14:51

J2248-0541 EY034.UVDATA.1

Freq = 1.5947 GHz, Bw = 16.000 MH No calibration applied and no bandpass applied

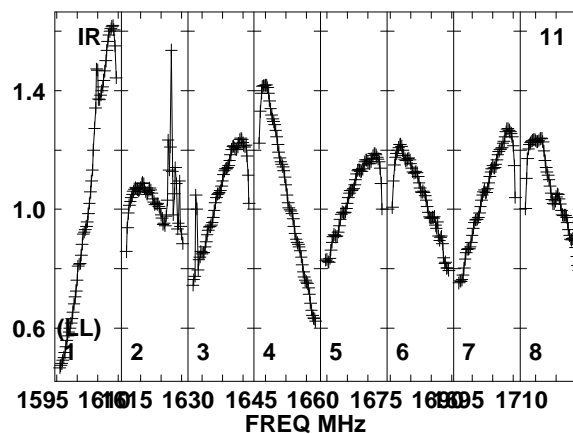
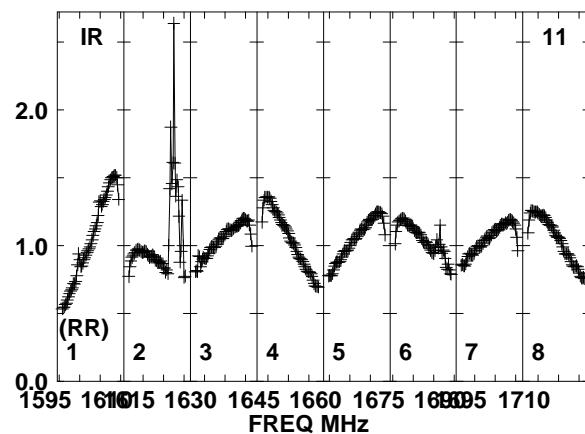
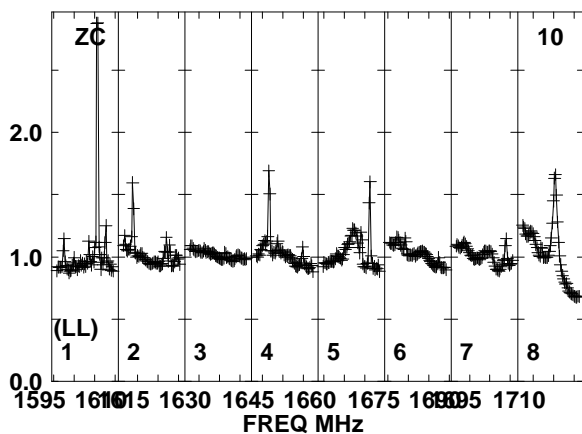
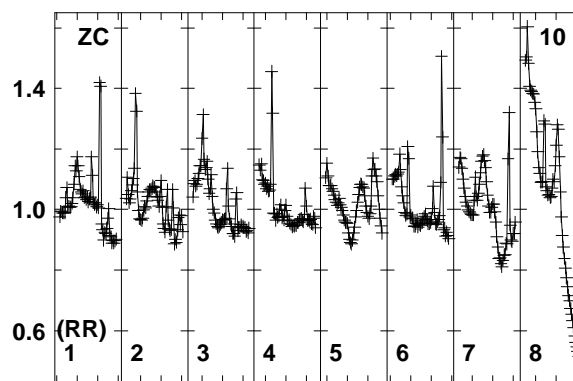
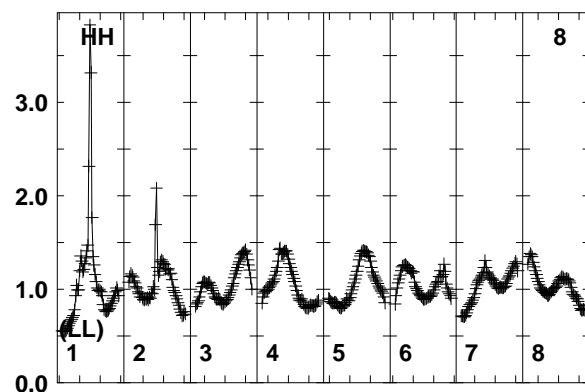
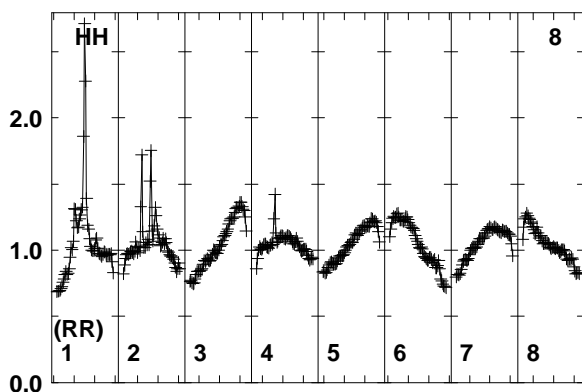
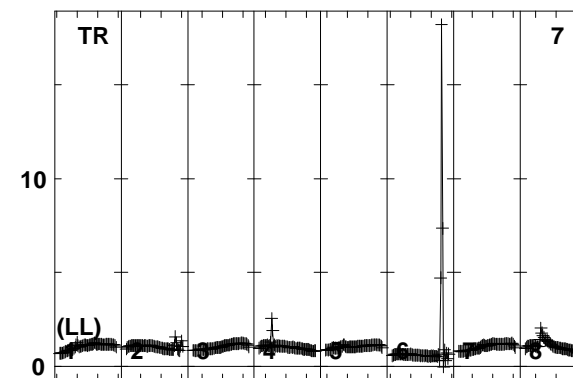
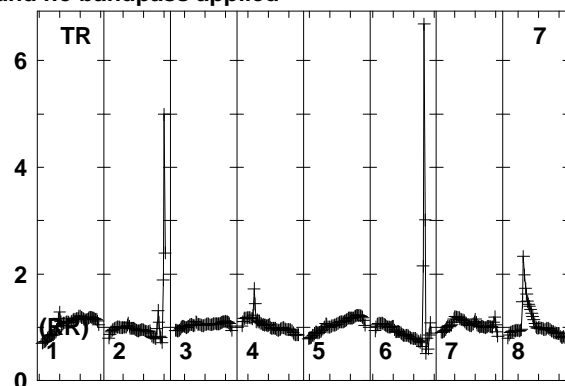
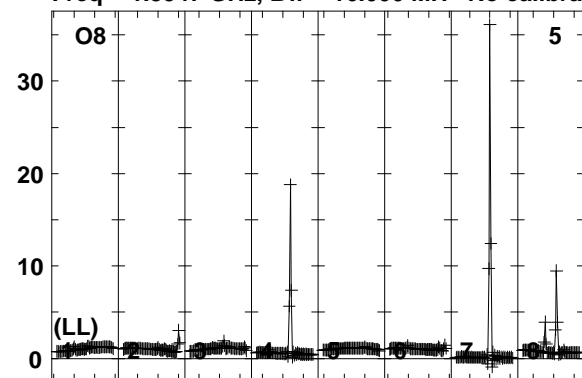

Lower frame: Real Jy
Total-power spectrum Antenna: O8 (05)
Timerange: 00/08:33:31 to 00/08:34:29

Plot file version 627 created 04-NOV-2019 14:14:51

J2248-0541 EY034.UVDATA.1

Freq = 1.5947 GHz, Bw = 16.000 MH No calibration applied and no bandpass applied

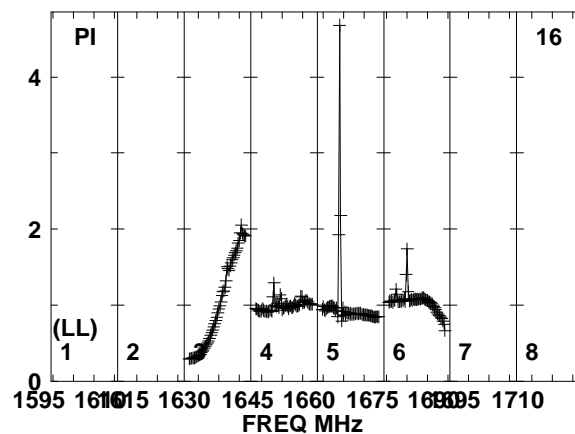
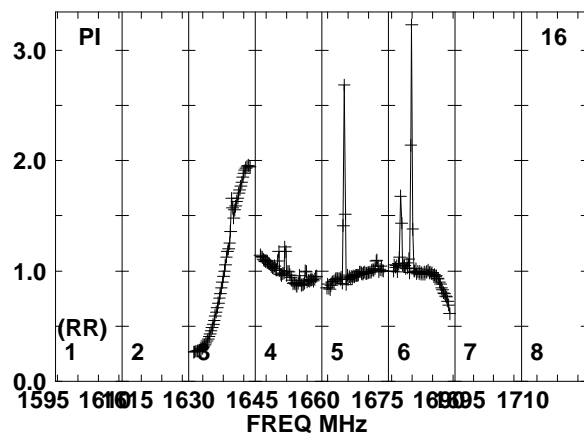
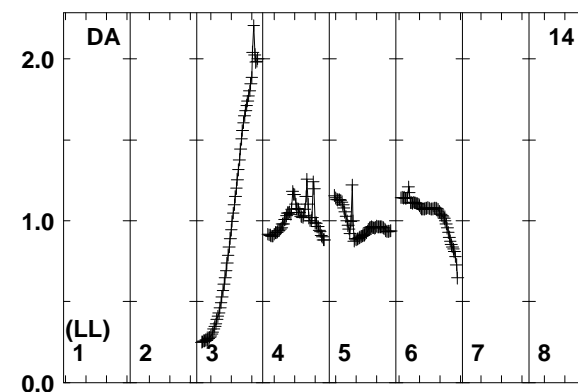
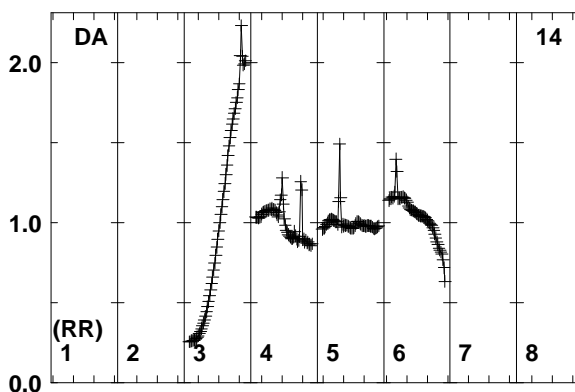
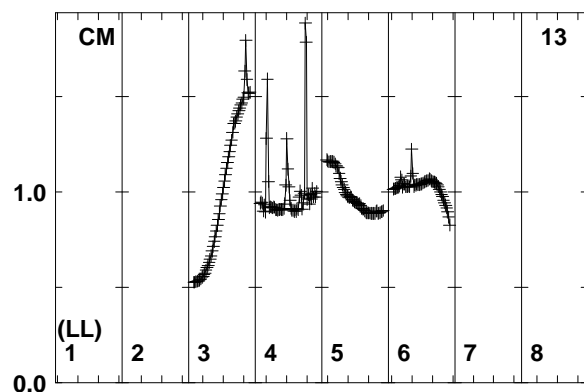
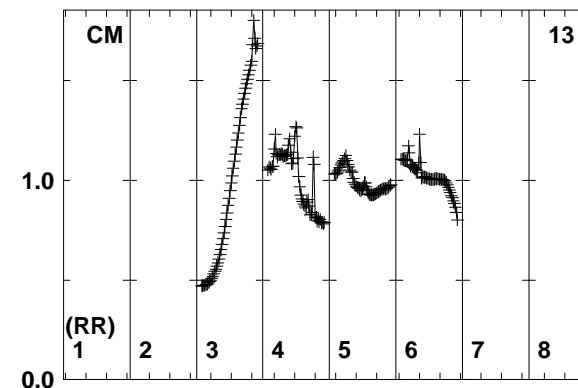
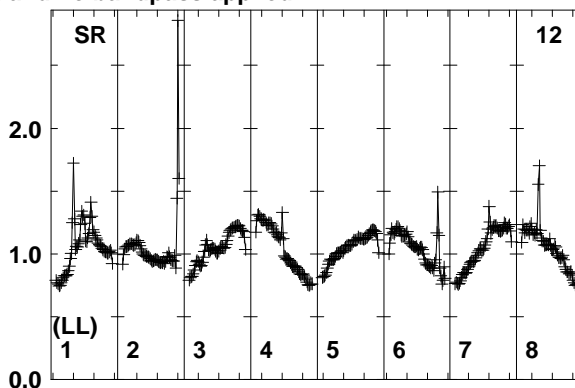
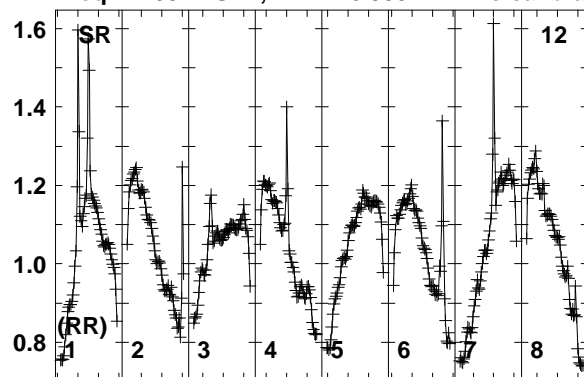

Lower frame: Real Jy
Total-power spectrum Antenna: SR (12)
Timerange: 00/08:33:31 to 00/08:34:29

Plot file version 628 created 04-NOV-2019 14:14:51

W2246-0526 EY034.UVDATA.1

Freq = 1.5947 GHz, Bw = 16.000 MH No calibration applied and no bandpass applied

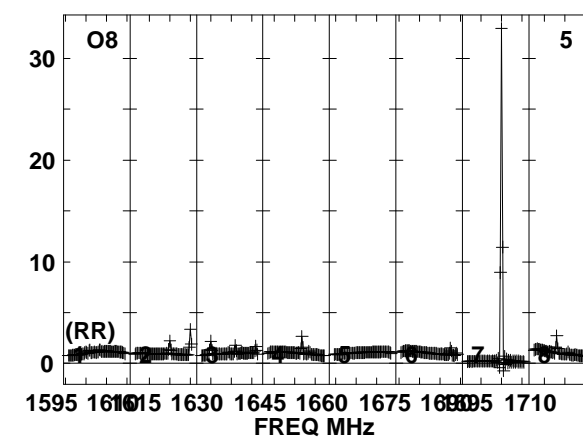
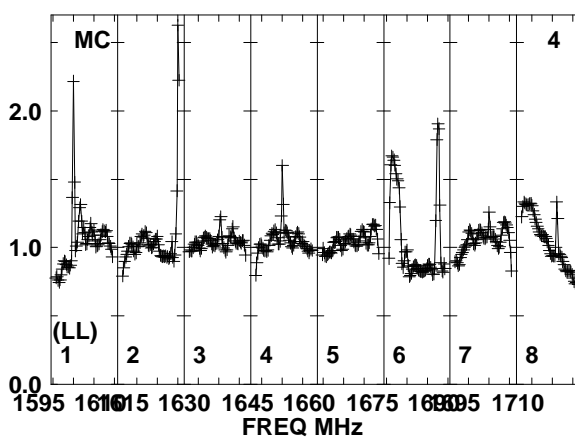
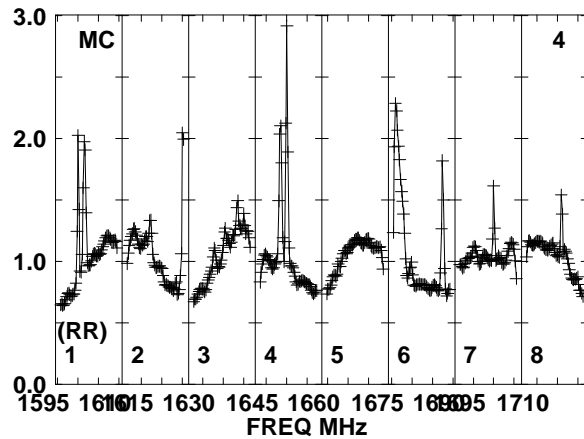
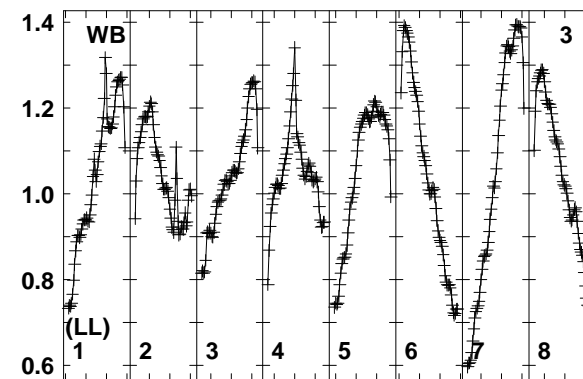
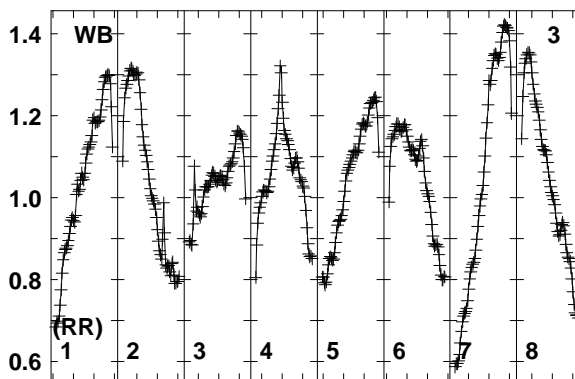
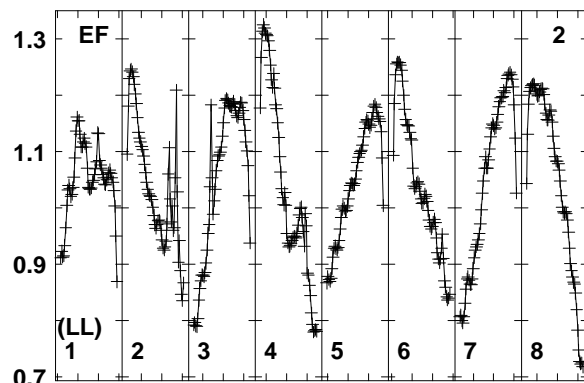
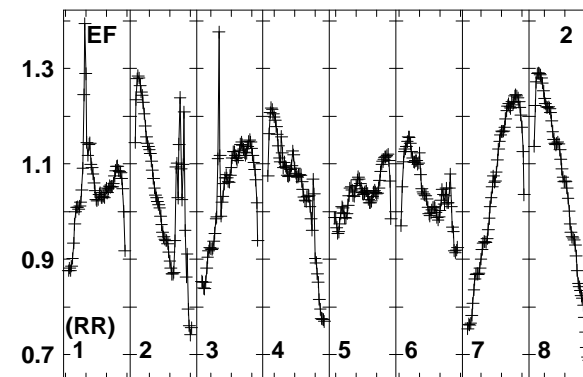
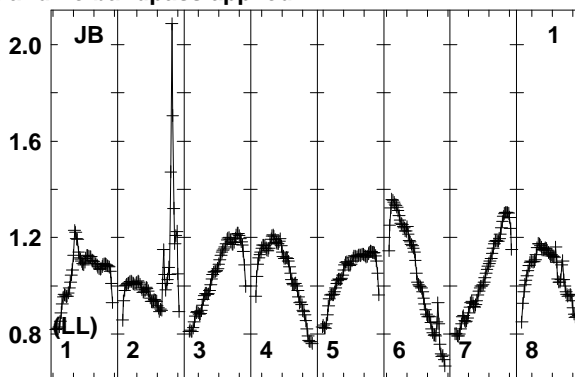
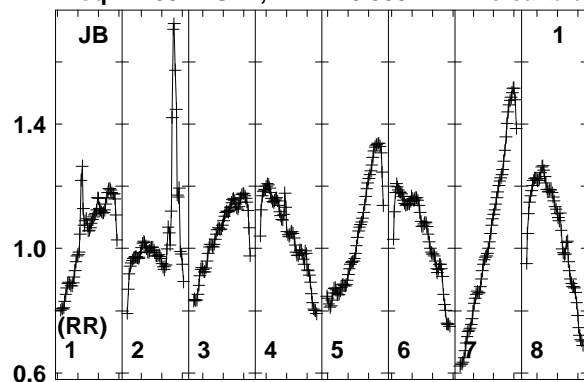

Lower frame: Real Jy
Total-power spectrum Antenna: JB (01)
Timerange: 00/08:34:31 to 00/08:37:09

Plot file version 629 created 04-NOV-2019 14:14:51

W2246-0526 EY034.UVDATA.1

Freq = 1.5947 GHz, Bw = 16.000 MH No calibration applied and no bandpass applied

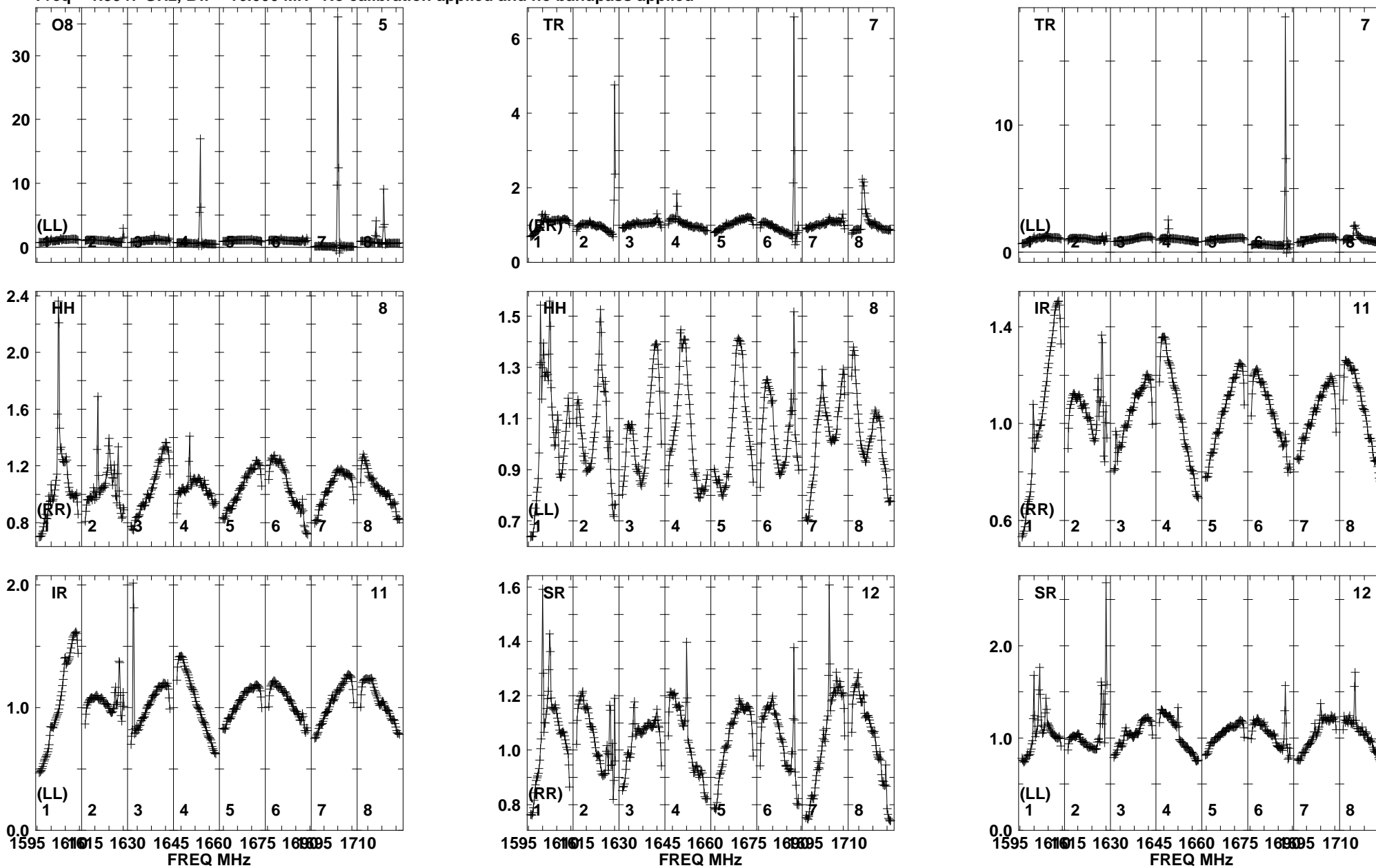

Lower frame: Real Jy
Total-power spectrum Antenna: O8 (05)
Timerange: 00/08:34:31 to 00/08:37:09

Plot file version 630 created 04-NOV-2019 14:14:51

W2246-0526 EY034.UVDATA.1

Freq = 1.5947 GHz, Bw = 16.000 MH No calibration applied and no bandpass applied

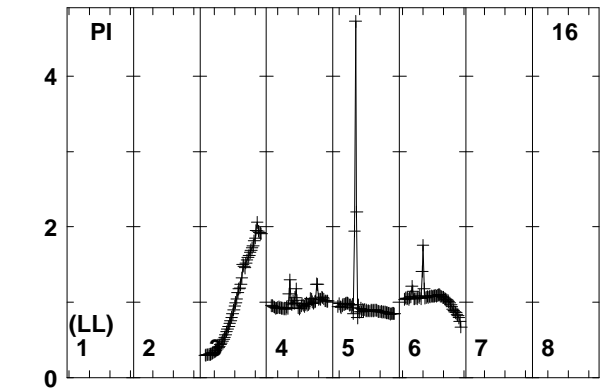
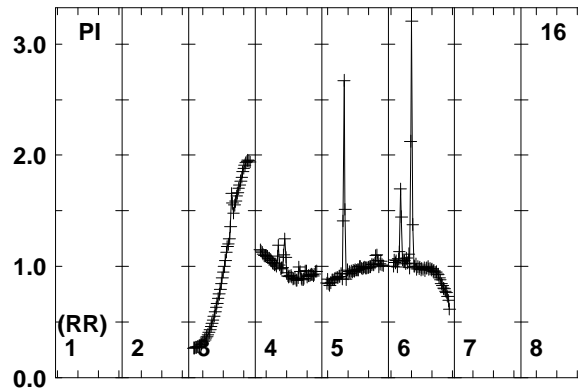
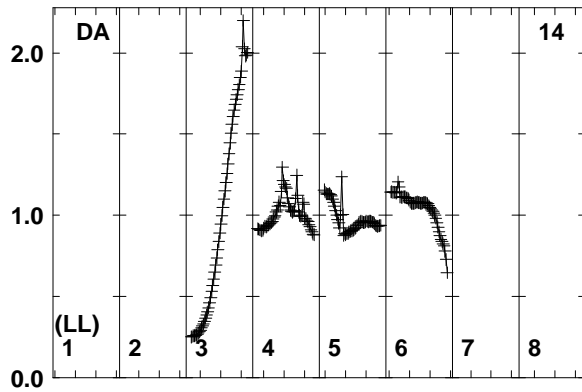
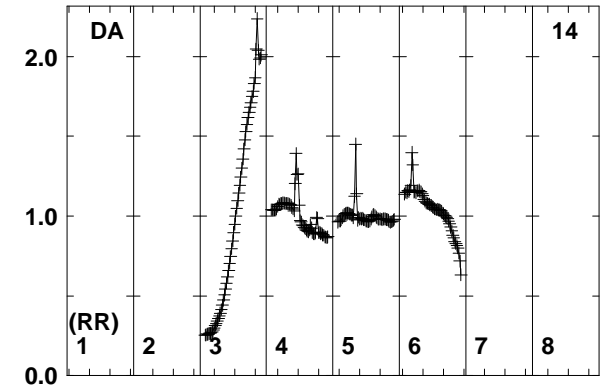
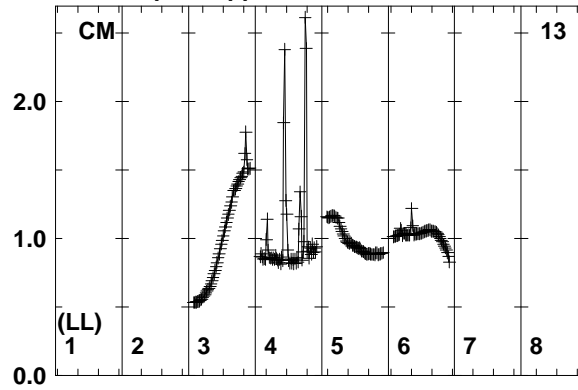
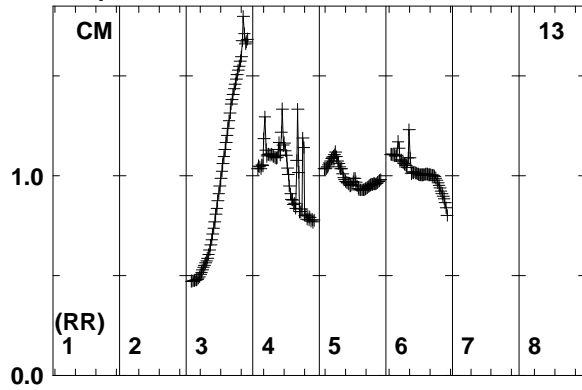

Lower frame: Real Jy
Total-power spectrum Antenna: CM (13)
Timerange: 00/08:34:31 to 00/08:37:09

Plot file version 631 created 04-NOV-2019 14:14:51

J2248-0541 EY034.UVDATA.1

Freq = 1.5947 GHz, Bw = 16.000 MH No calibration applied and no bandpass applied

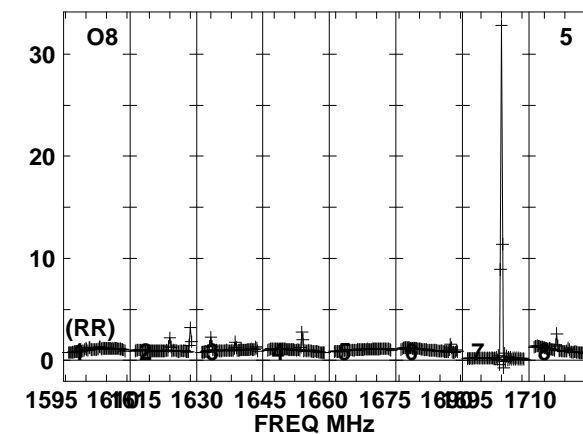
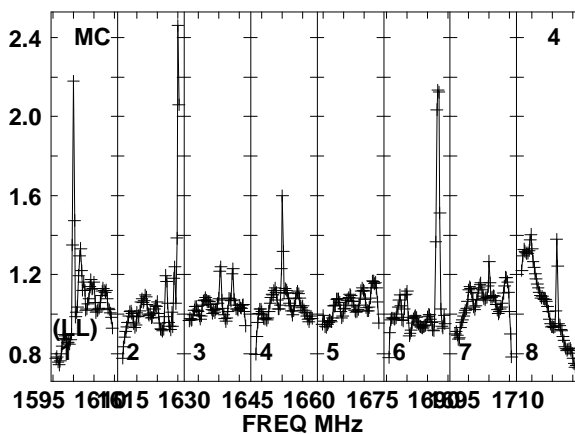
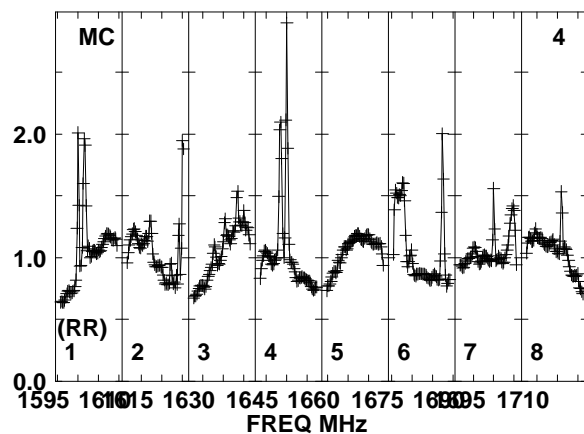
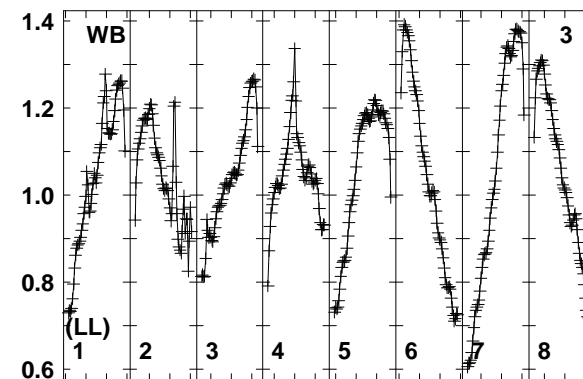
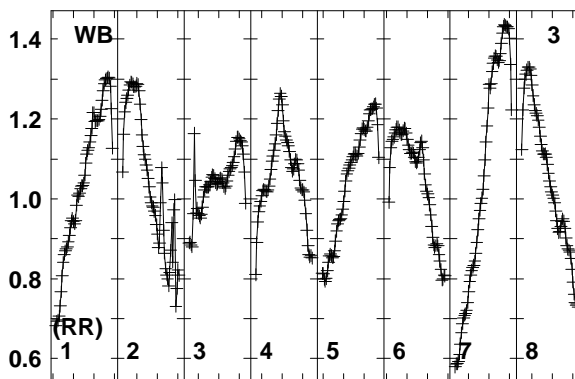
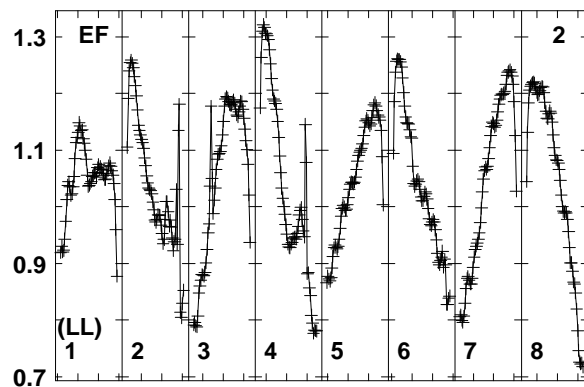
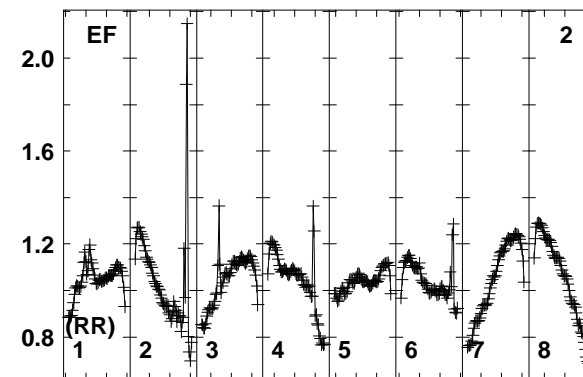
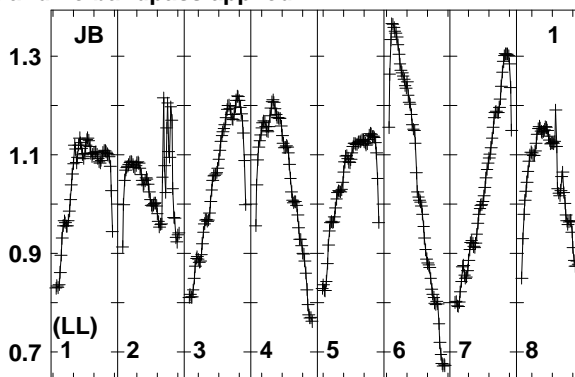
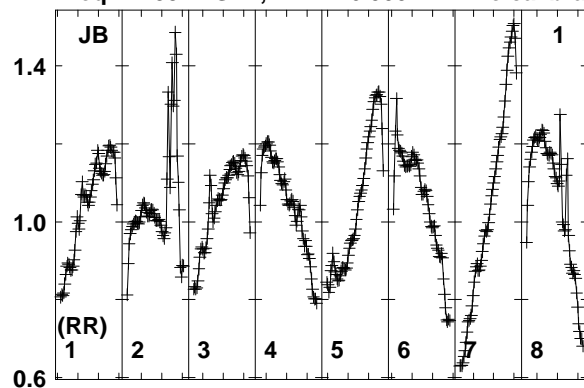

Lower frame: Real Jy
Total-power spectrum Antenna: JB (01)
Timerange: 00/08:37:26 to 00/08:38:24

Plot file version 632 created 04-NOV-2019 14:14:52

J2248-0541 EY034.UVDATA.1

Freq = 1.5947 GHz, Bw = 16.000 MH No calibration applied and no bandpass applied

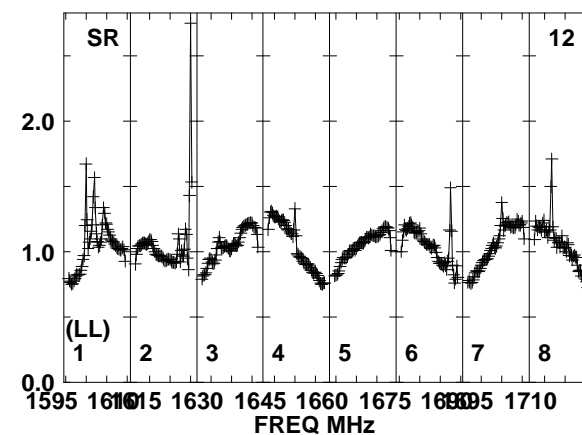
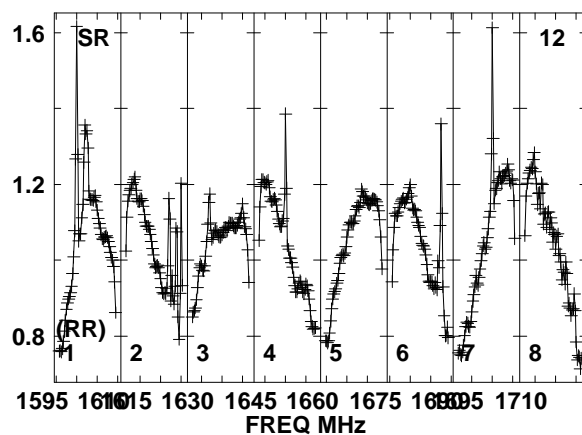
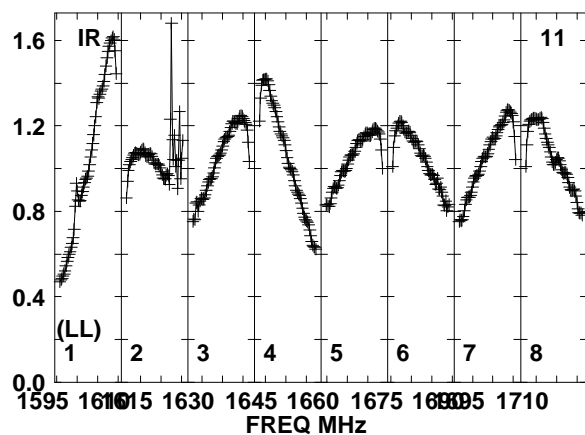
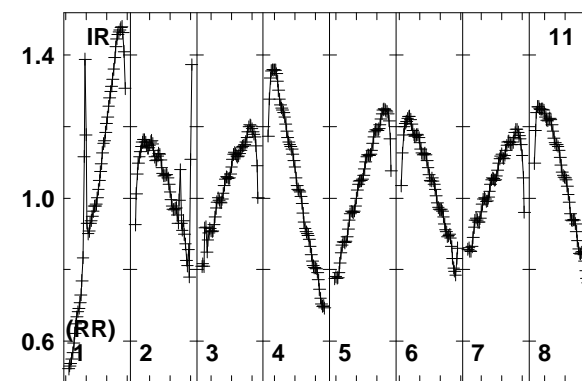
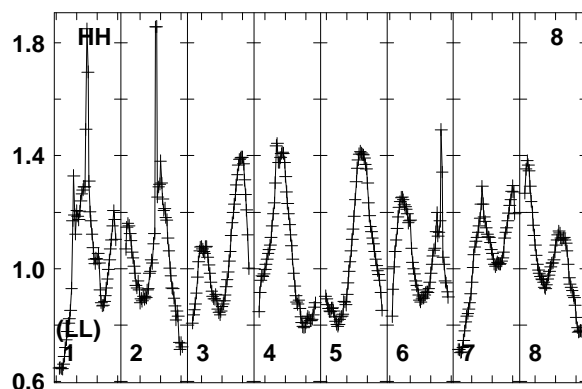
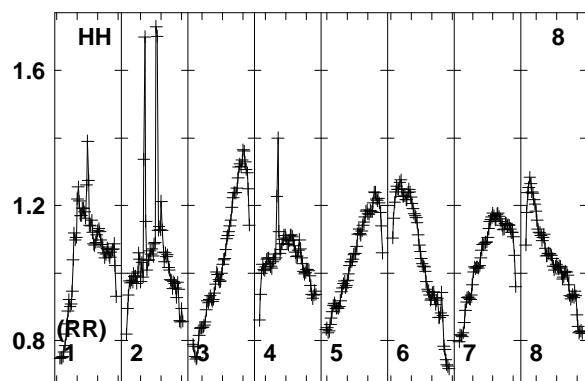
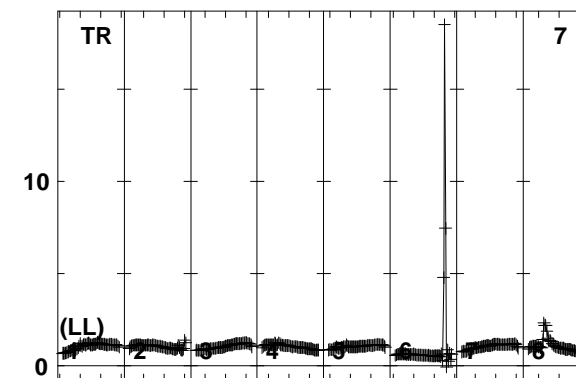
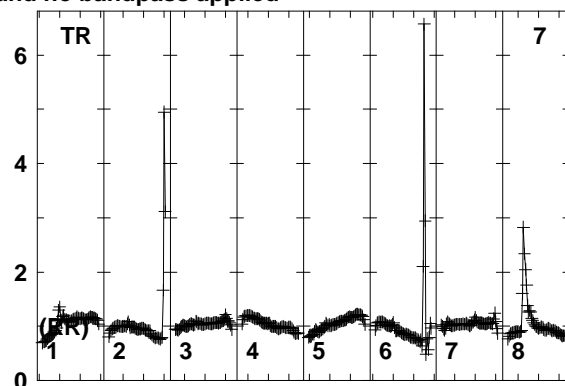
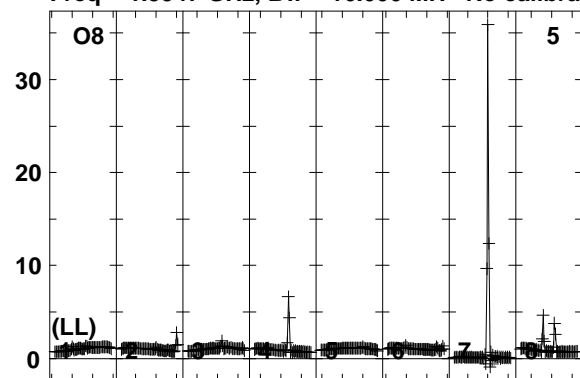

Lower frame: Real Jy
Total-power spectrum Antenna: O8 (05)
Timerange: 00/08:37:26 to 00/08:38:24

Plot file version 633 created 04-NOV-2019 14:14:52

J2248-0541 EY034.UVDATA.1

Freq = 1.5947 GHz, Bw = 16.000 MH No calibration applied and no bandpass applied

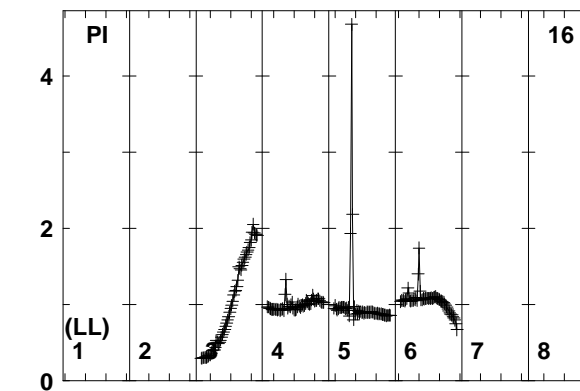
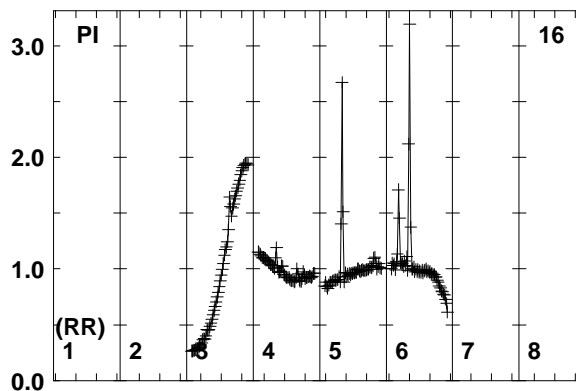
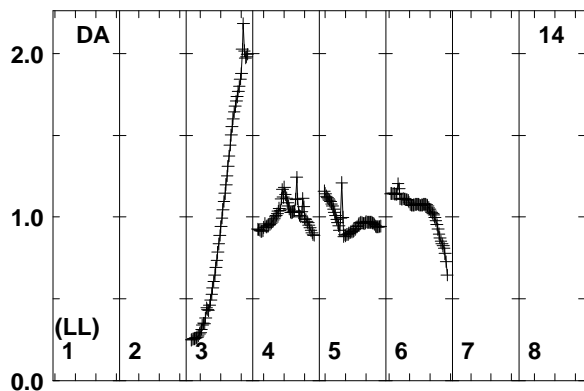
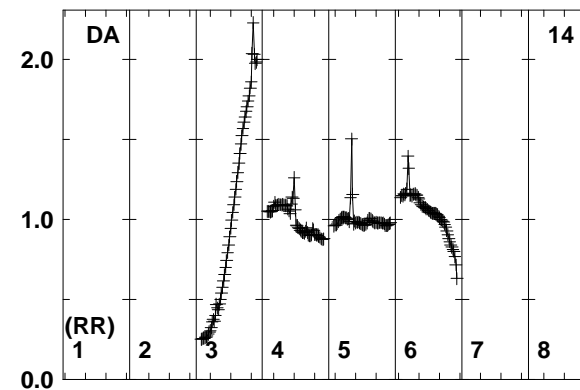
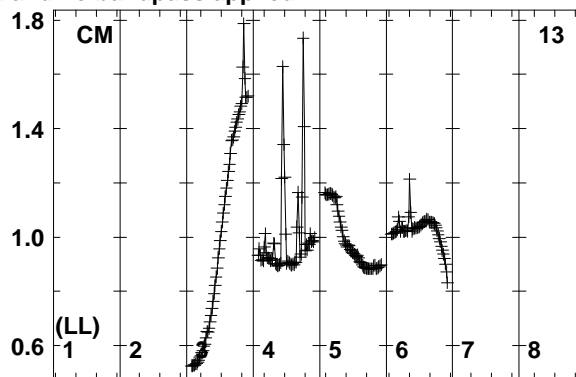
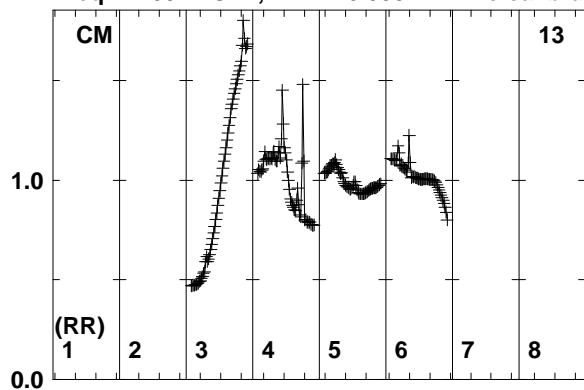

Lower frame: Real Jy
Total-power spectrum Antenna: CM (13)
Timerange: 00/08:37:26 to 00/08:38:24

Plot file version 634 created 04-NOV-2019 14:14:52

W2246-0526 EY034.UVDATA.1

Freq = 1.5947 GHz, Bw = 16.000 MH No calibration applied and no bandpass applied

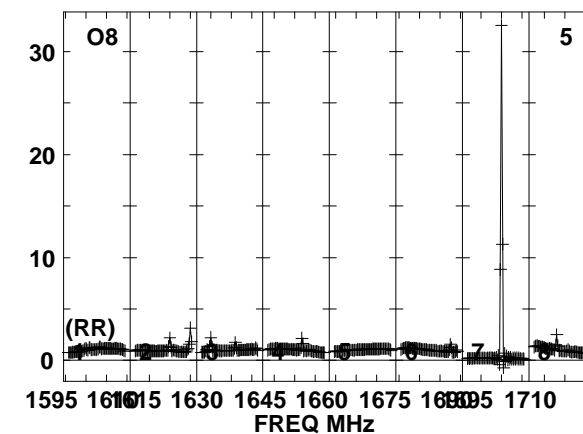
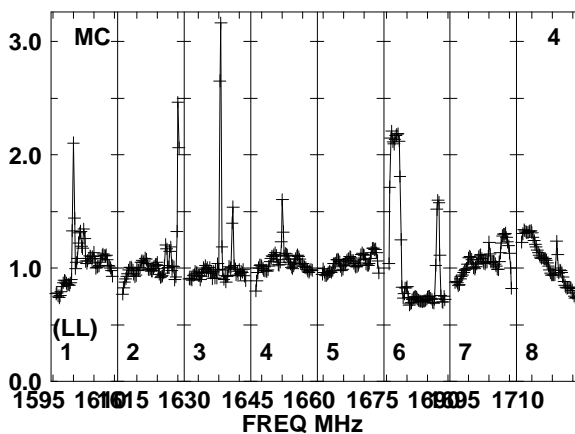
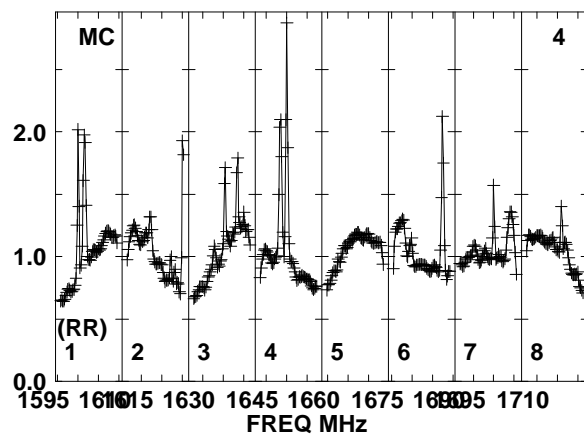
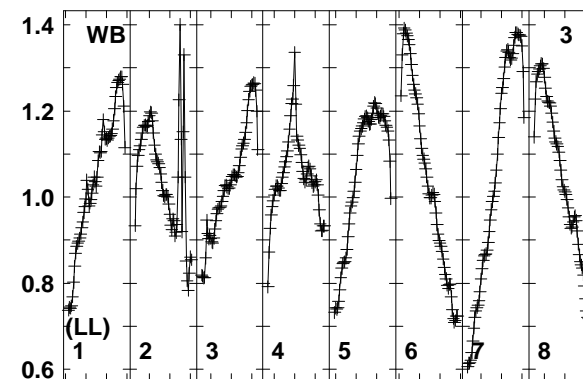
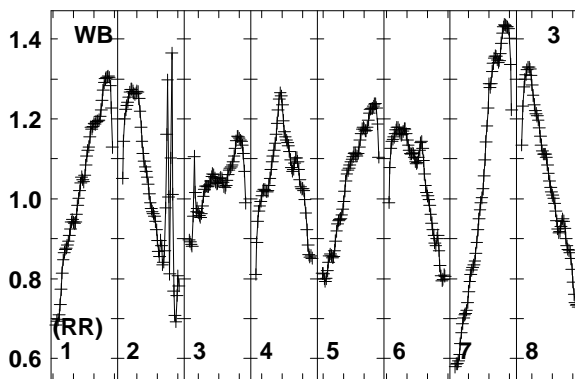
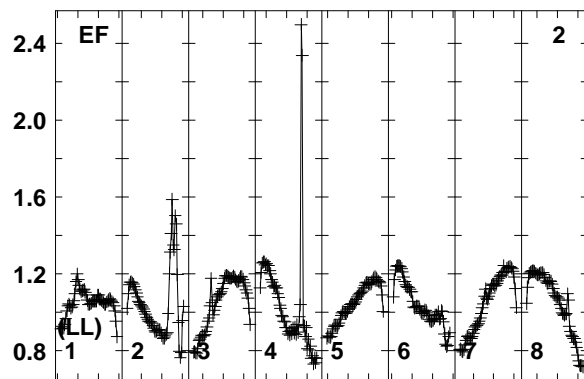
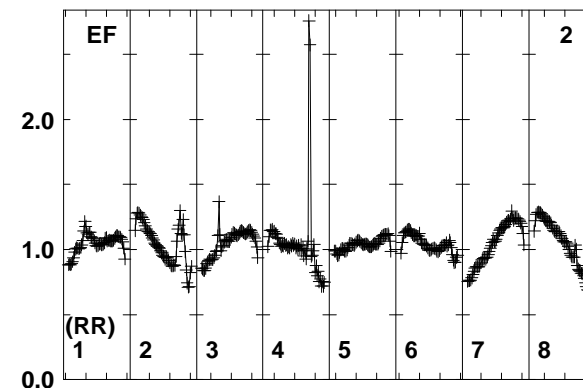
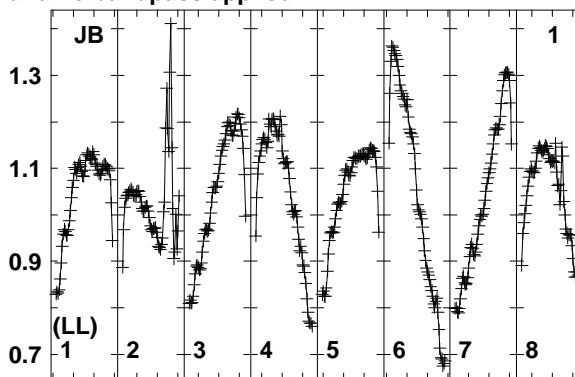
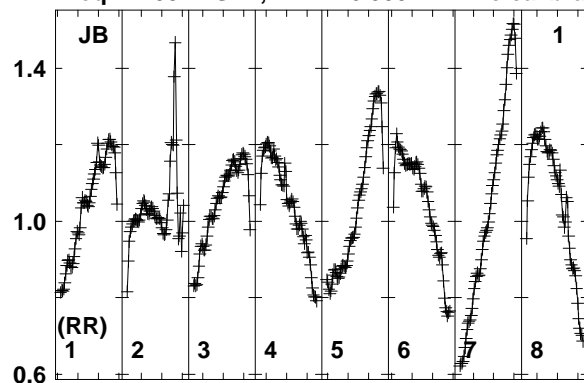

Lower frame: Real Jy
Total-power spectrum Antenna: JB (01)
Timerange: 00/08:38:26 to 00/08:41:04

Plot file version 635 created 04-NOV-2019 14:14:52

W2246-0526 EY034.UVDATA.1

Freq = 1.5947 GHz, Bw = 16.000 MH No calibration applied and no bandpass applied

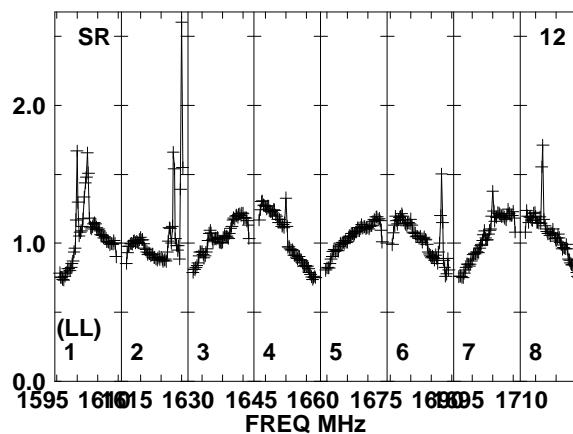
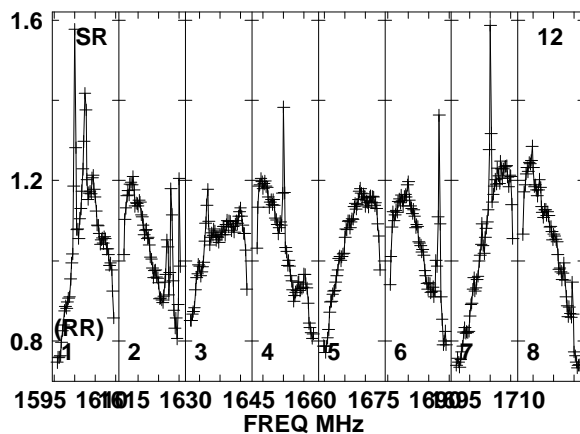
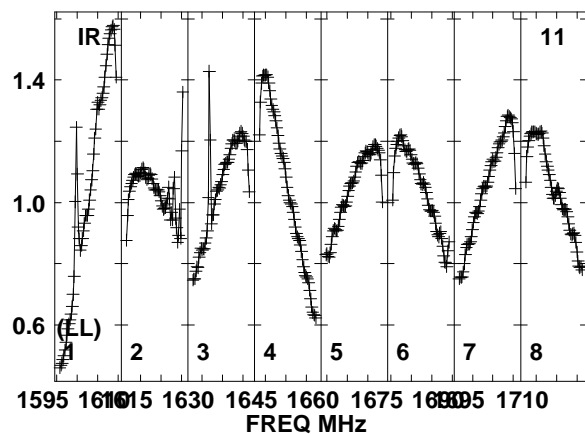
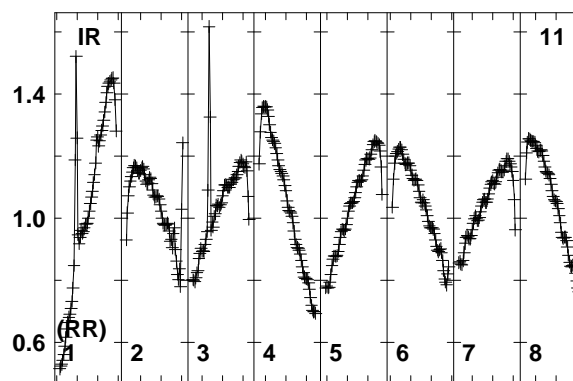
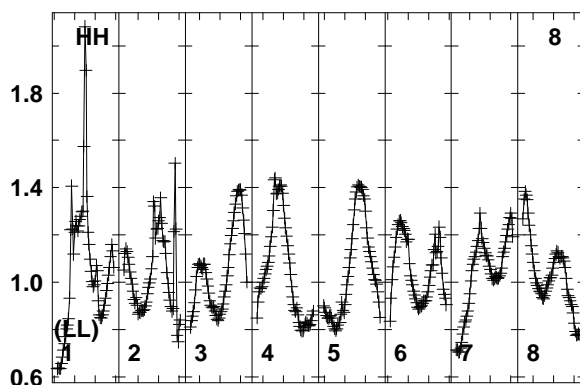
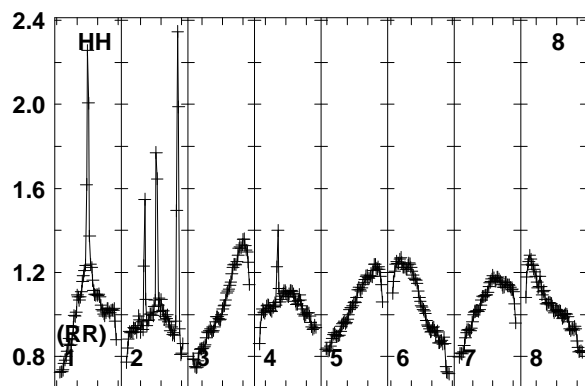
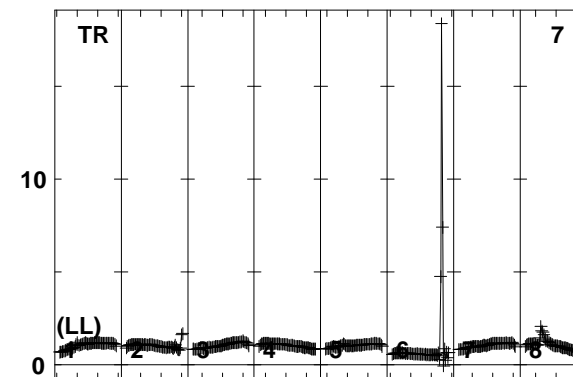
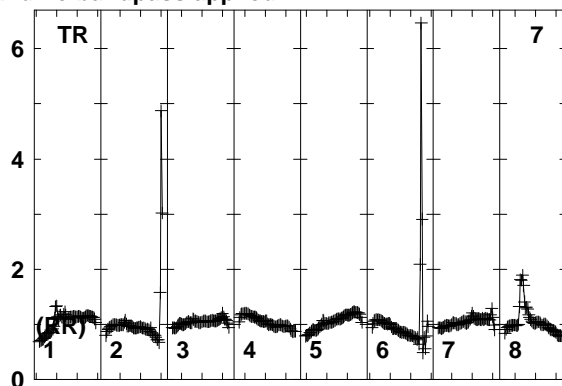
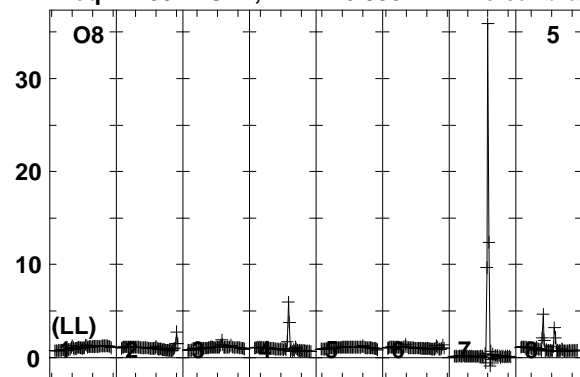

Lower frame: Real Jy
Total-power spectrum Antenna: O8 (05)
Timerange: 00/08:38:26 to 00/08:41:04

Plot file version 636 created 04-NOV-2019 14:14:52

W2246-0526 EY034.UVDATA.1

Freq = 1.5947 GHz, Bw = 16.000 MH No calibration applied and no bandpass applied

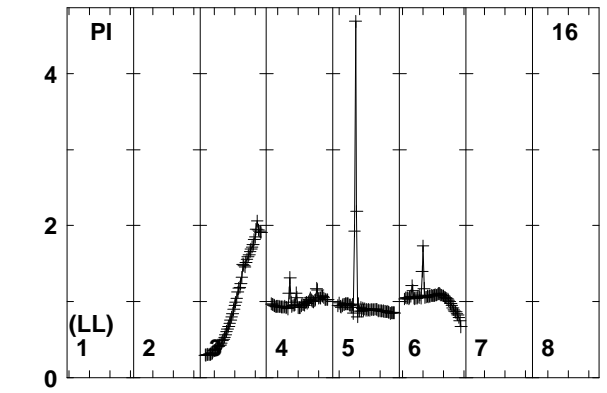
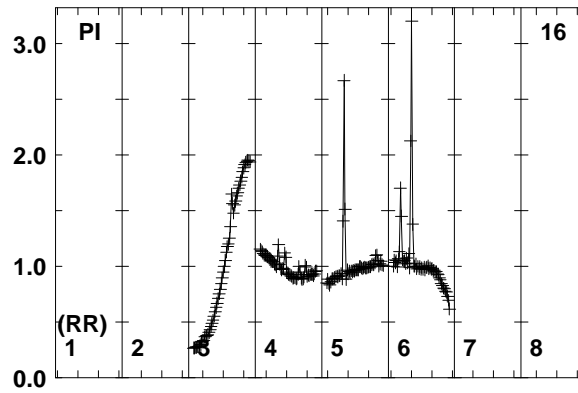
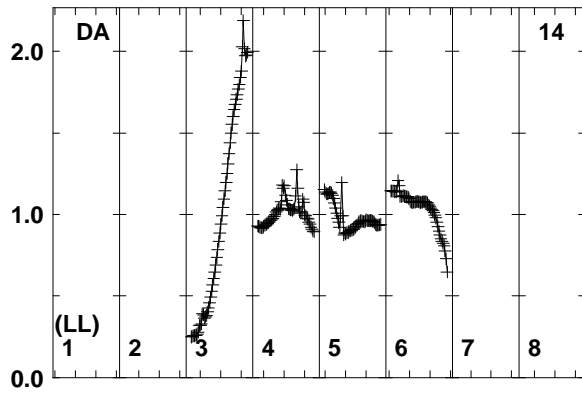
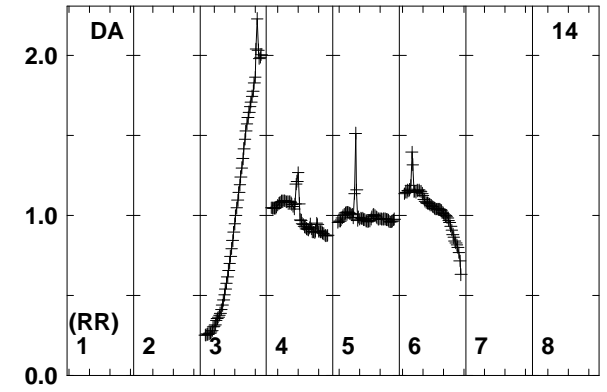
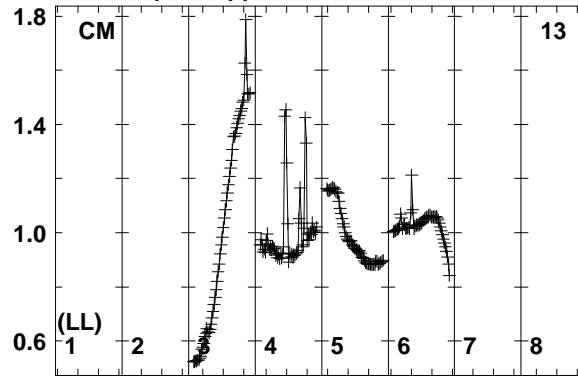
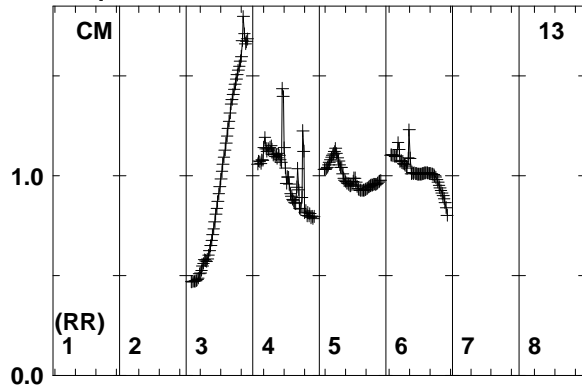

Lower frame: Real Jy
Total-power spectrum Antenna: CM (13)
Timerange: 00/08:38:26 to 00/08:41:04

Plot file version 637 created 04-NOV-2019 14:14:52

J2248-0541 EY034.UVDATA.1

Freq = 1.5947 GHz, Bw = 16.000 MH No calibration applied and no bandpass applied

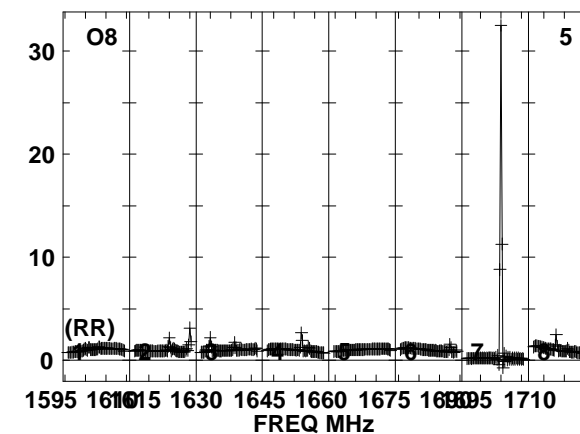
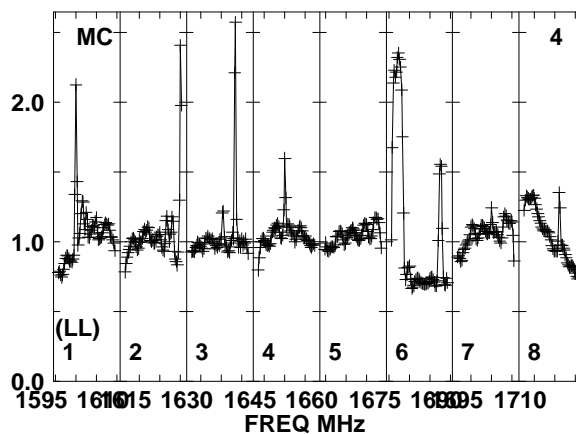
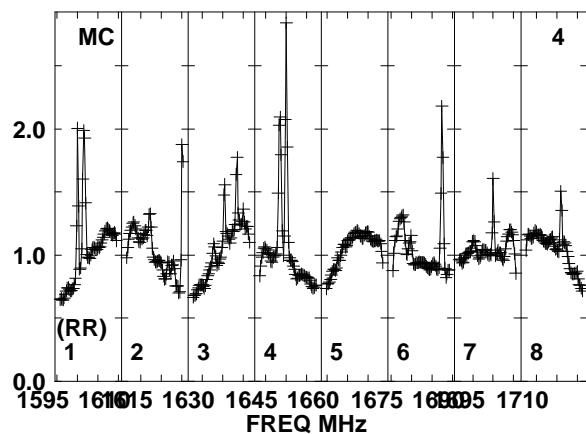
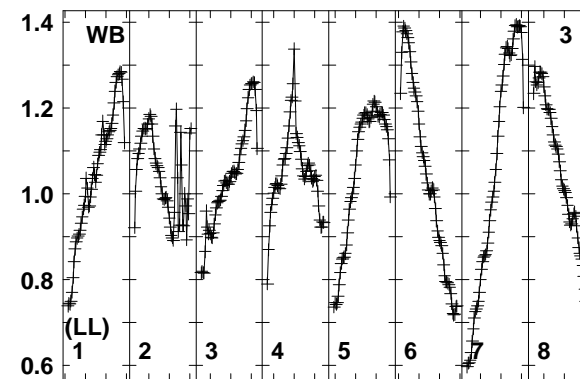
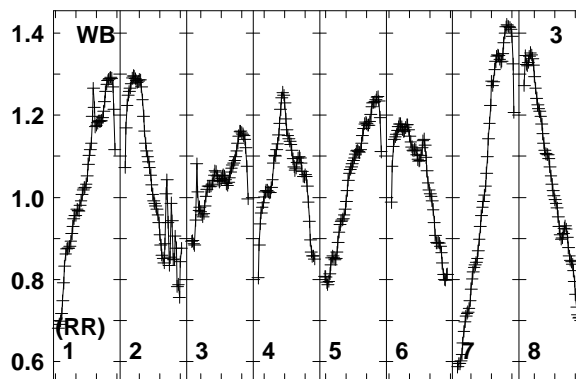
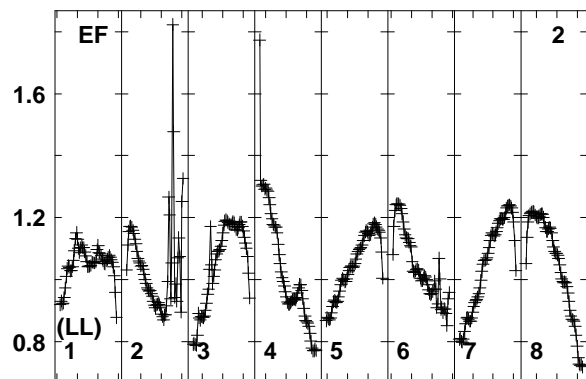
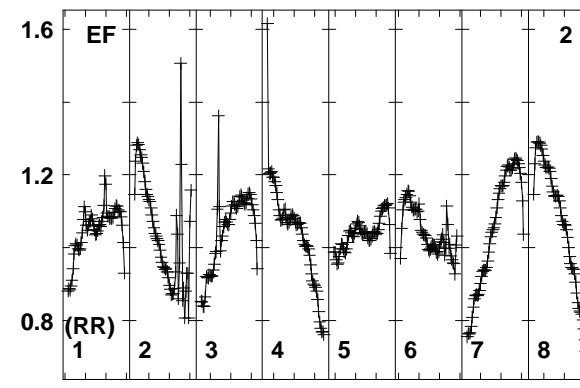
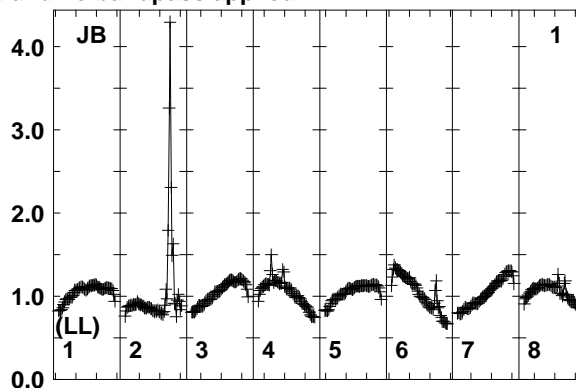
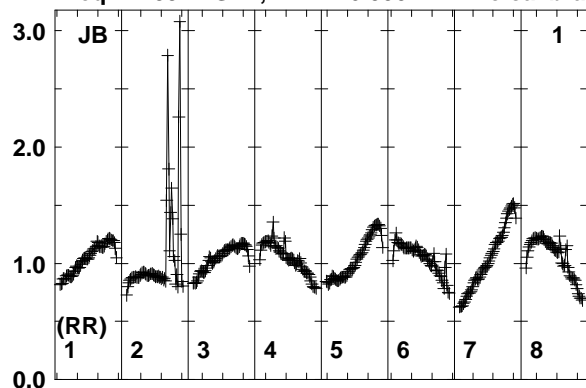

Lower frame: Real Jy
Total-power spectrum Antenna: JB (01)
Timerange: 00/08:41:21 to 00/08:42:19

Plot file version 638 created 04-NOV-2019 14:14:52

J2248-0541 EY034.UVDATA.1

Freq = 1.5947 GHz, Bw = 16.000 MH No calibration applied and no bandpass applied

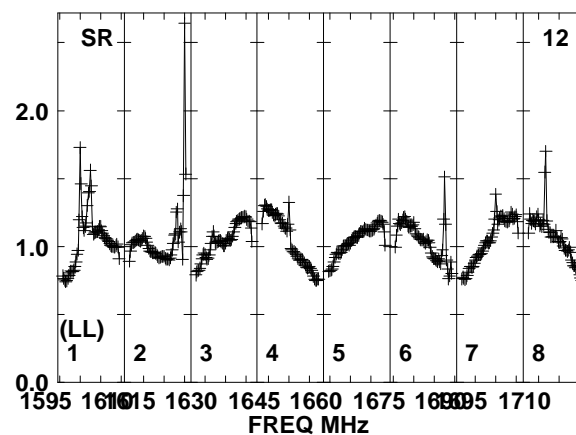
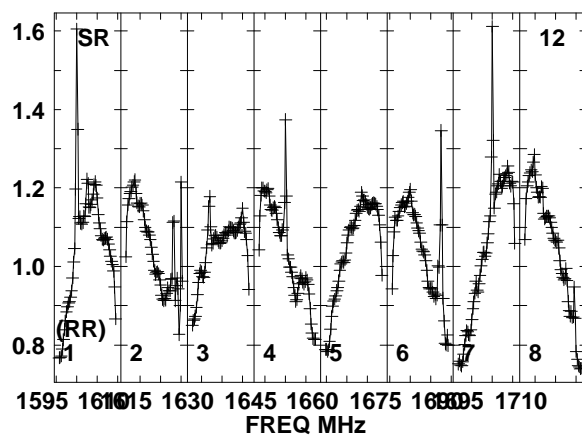
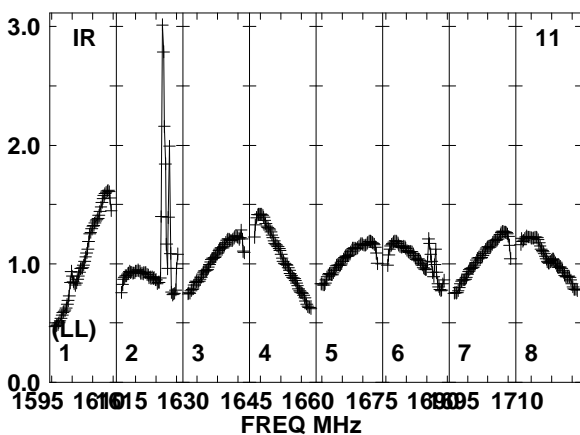
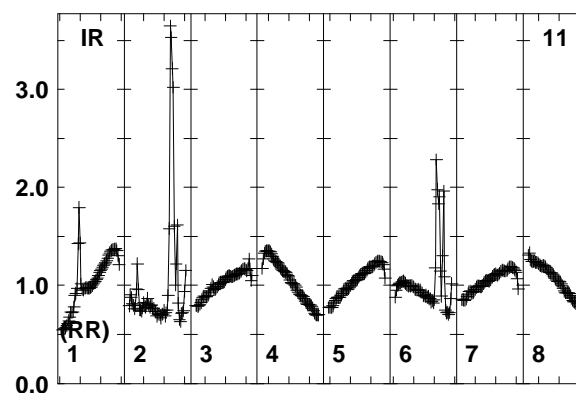
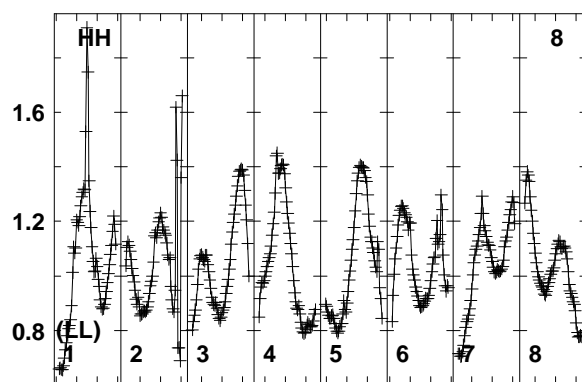
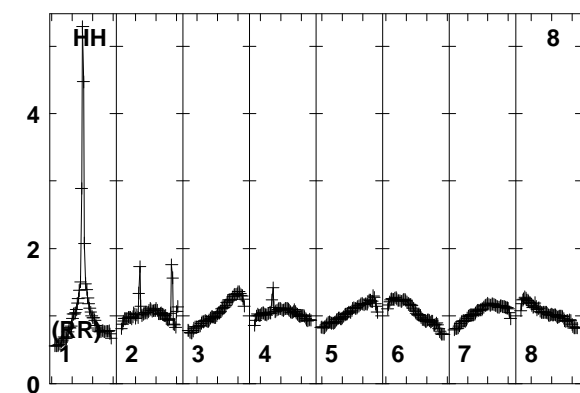
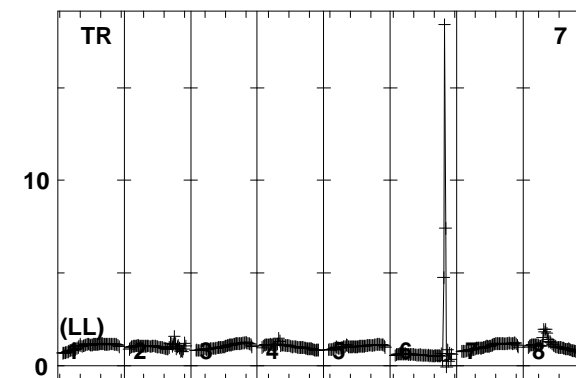
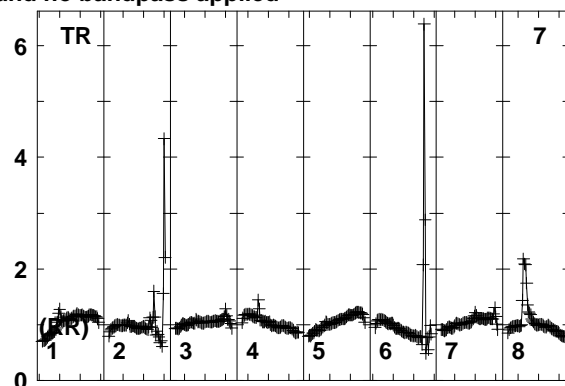
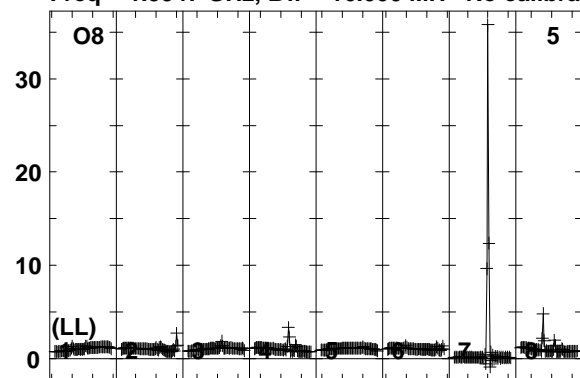

Lower frame: Real Jy
Total-power spectrum Antenna: O8 (05)
Timerange: 00/08:41:21 to 00/08:42:19

Plot file version 639 created 04-NOV-2019 14:14:52

J2248-0541 EY034.UVDATA.1

Freq = 1.5947 GHz, Bw = 16.000 MH No calibration applied and no bandpass applied

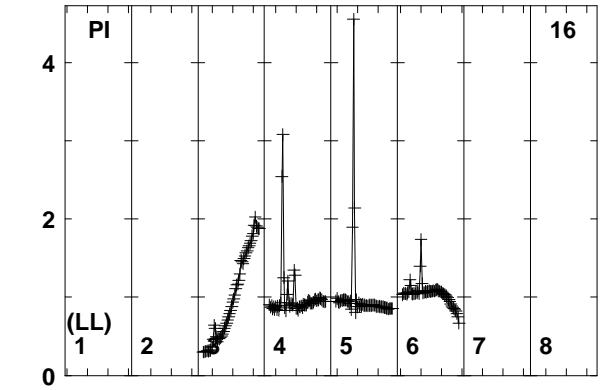
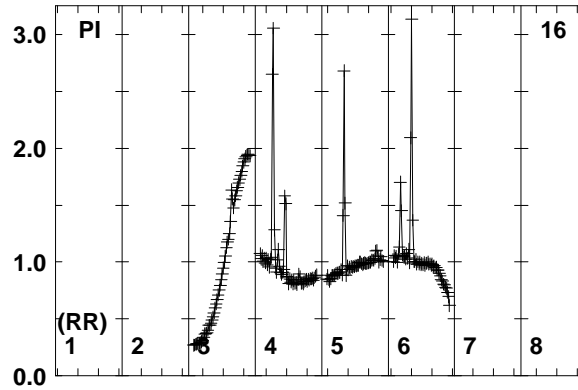
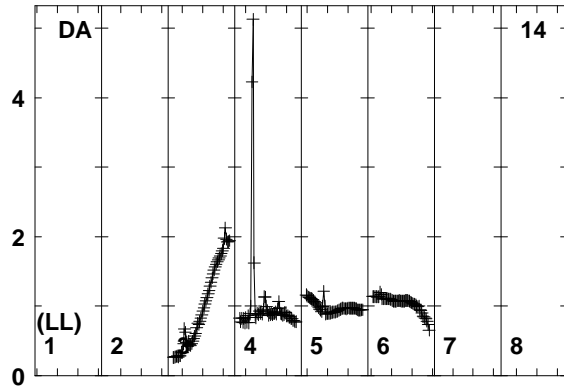
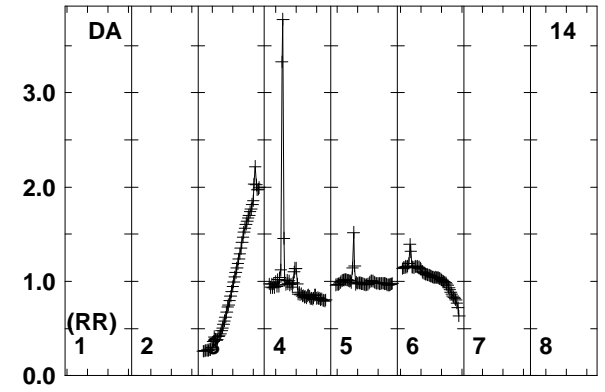
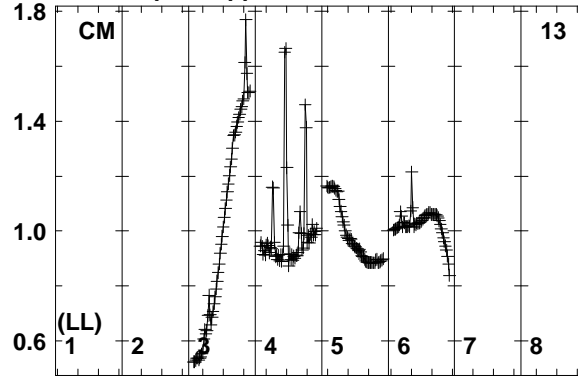
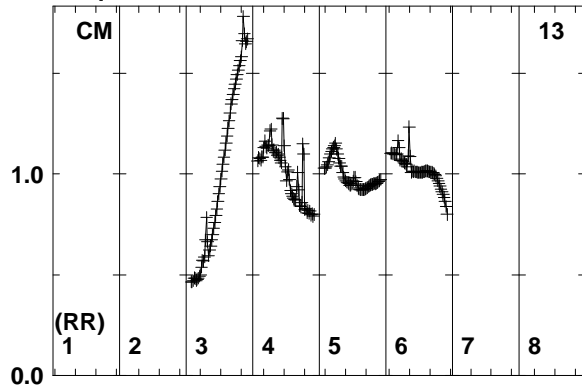

Lower frame: Real Jy
Total-power spectrum Antenna: CM (13)
Timerange: 00/08:41:21 to 00/08:42:19

Plot file version 640 created 04-NOV-2019 14:14:52

W2246-0526 EY034.UVDATA.1

Freq = 1.5947 GHz, Bw = 16.000 MH No calibration applied and no bandpass applied

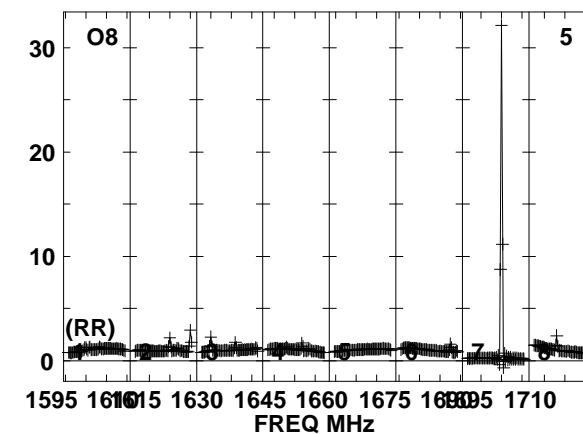
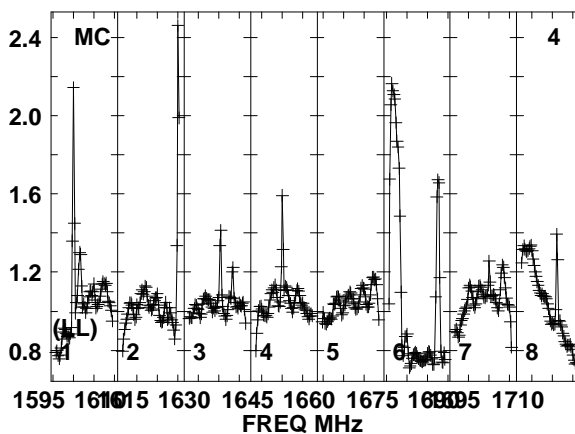
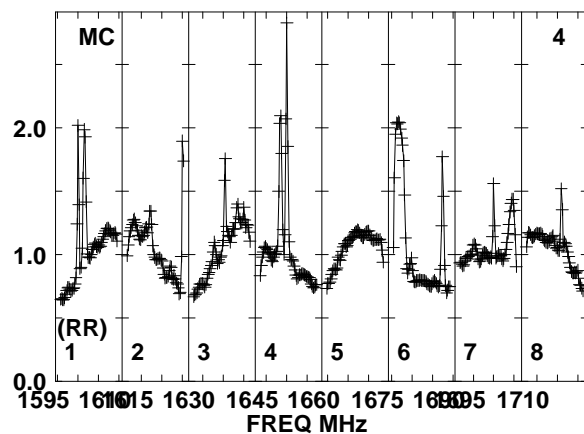
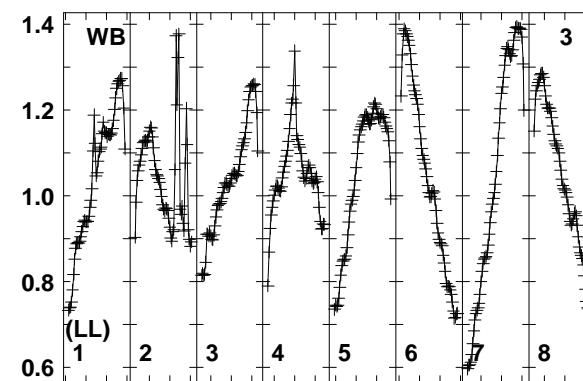
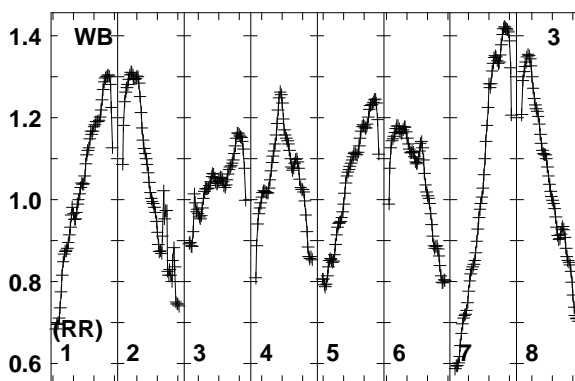
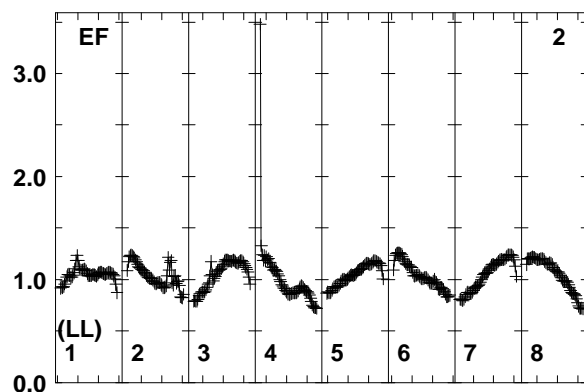
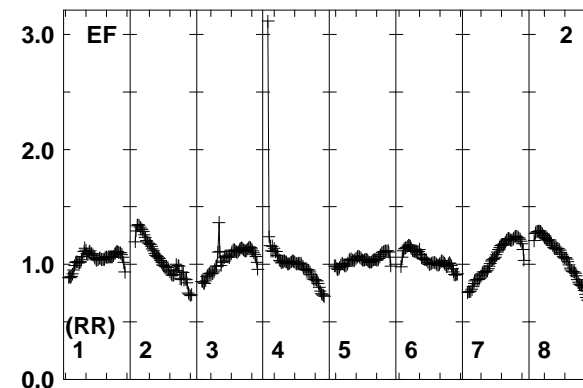
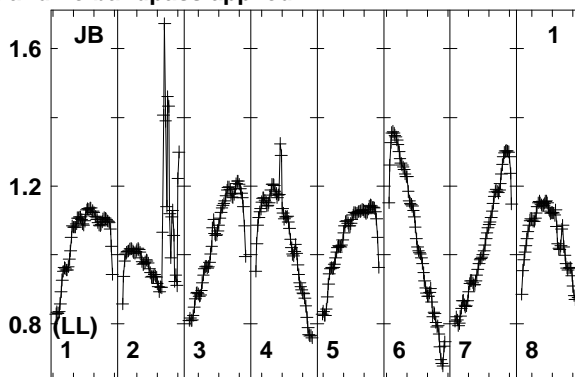
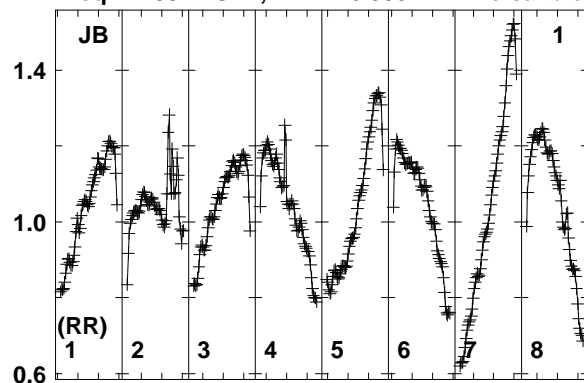

Lower frame: Real Jy
Total-power spectrum Antenna: JB (01)
Timerange: 00/08:42:21 to 00/08:44:59

Plot file version 641 created 04-NOV-2019 14:14:52

W2246-0526 EY034.UVDATA.1

Freq = 1.5947 GHz, Bw = 16.000 MH No calibration applied and no bandpass applied

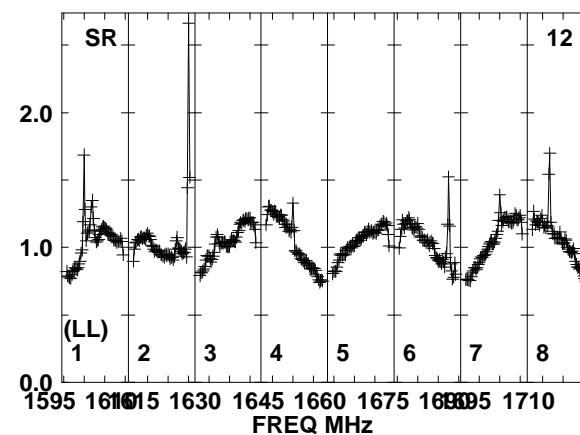
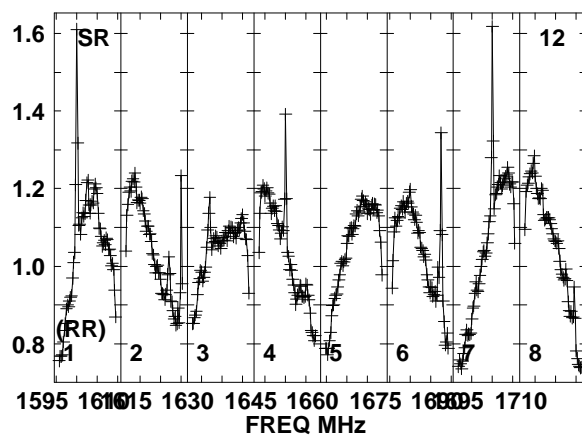
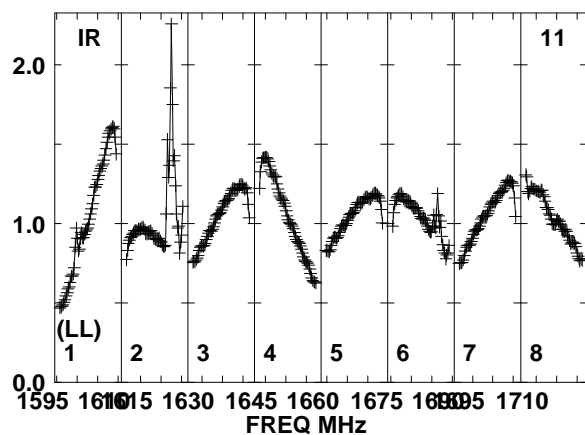
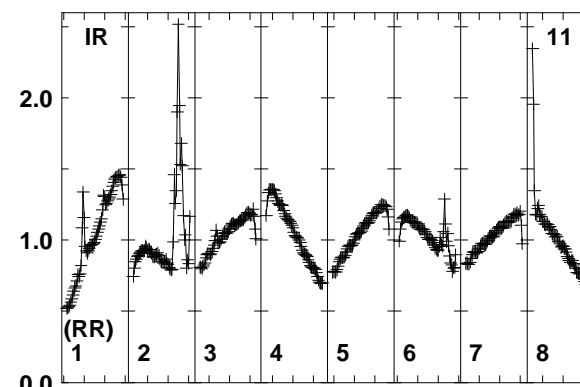
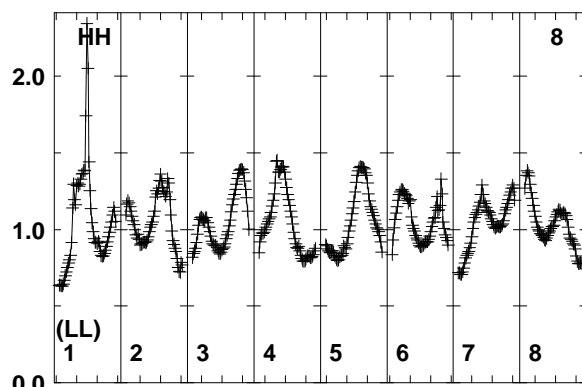
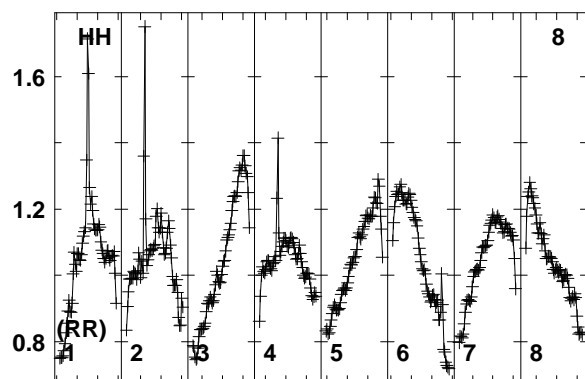
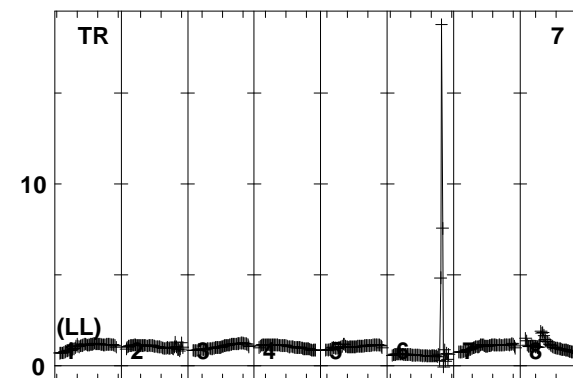
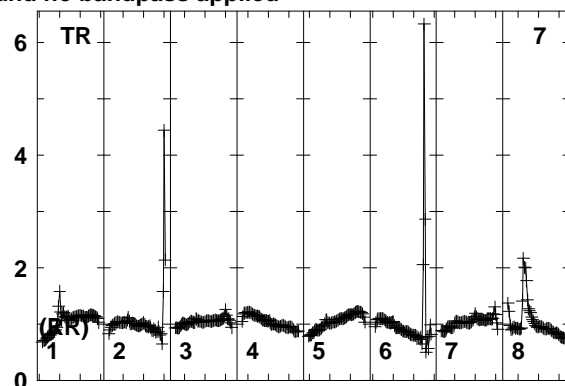
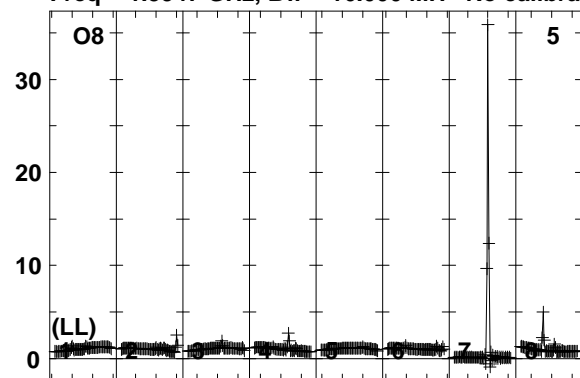

Lower frame: Real Jy
Total-power spectrum Antenna: O8 (05)
Timerange: 00/08:42:21 to 00/08:44:59

Plot file version 642 created 04-NOV-2019 14:14:52

W2246-0526 EY034.UVDATA.1

Freq = 1.5947 GHz, Bw = 16.000 MH No calibration applied and no bandpass applied

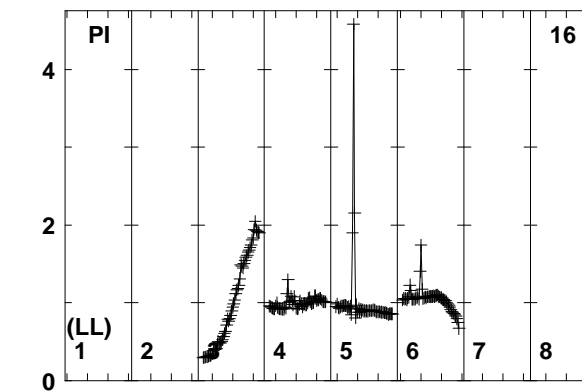
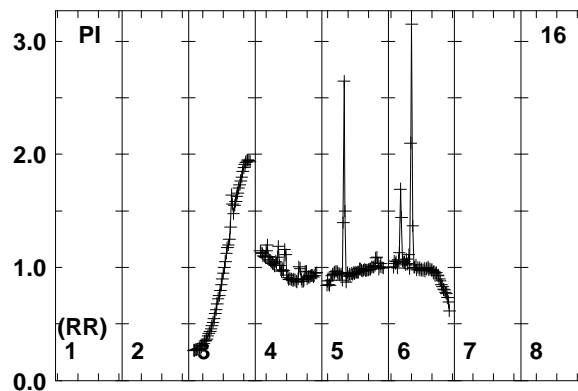
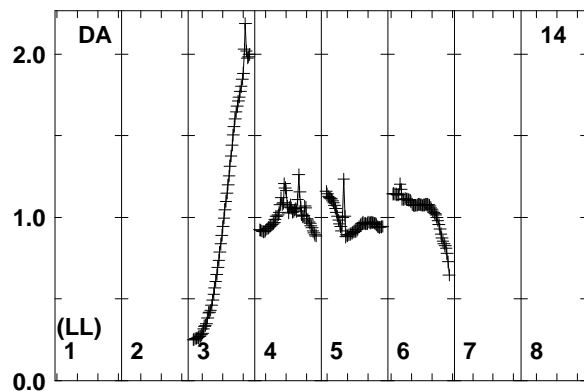
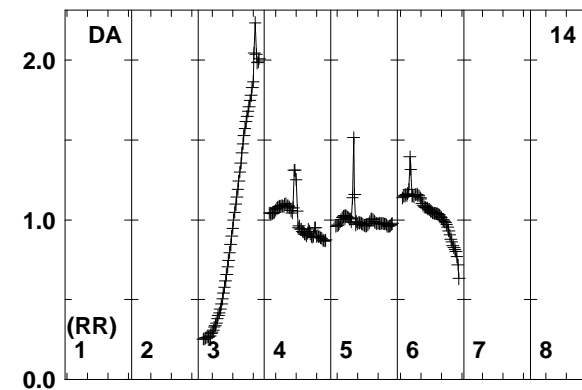
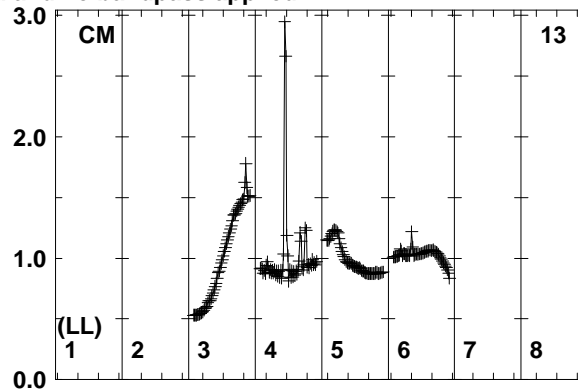
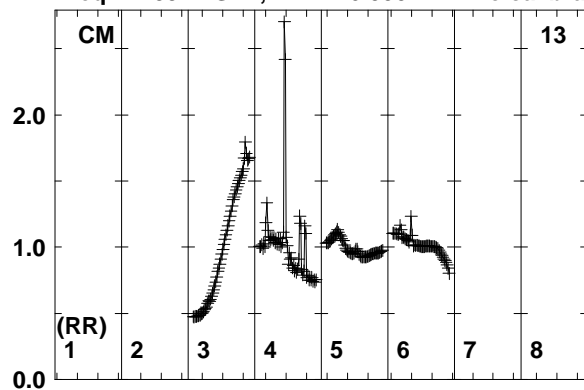

Lower frame: Real Jy
Total-power spectrum Antenna: CM (13)
Timerange: 00/08:42:21 to 00/08:44:59

Plot file version 643 created 04-NOV-2019 14:14:53

J2248-0541 EY034.UVDATA.1

Freq = 1.5947 GHz, Bw = 16.000 MH No calibration applied and no bandpass applied

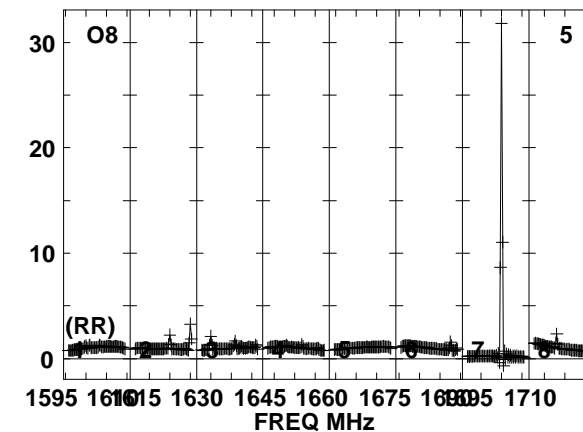
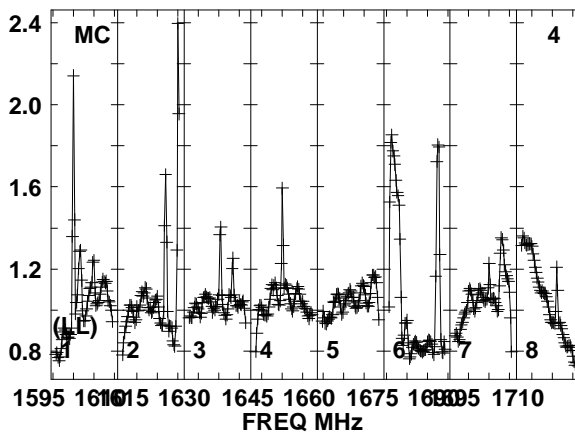
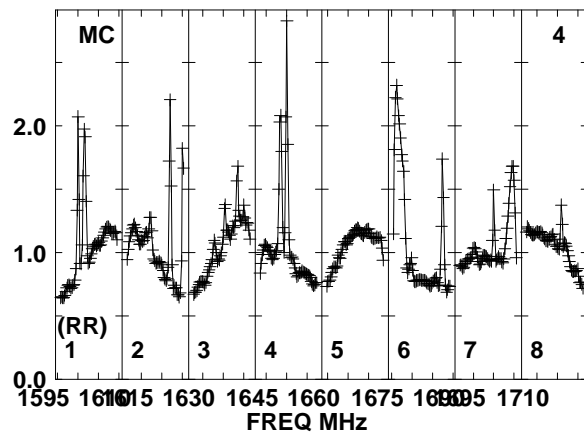
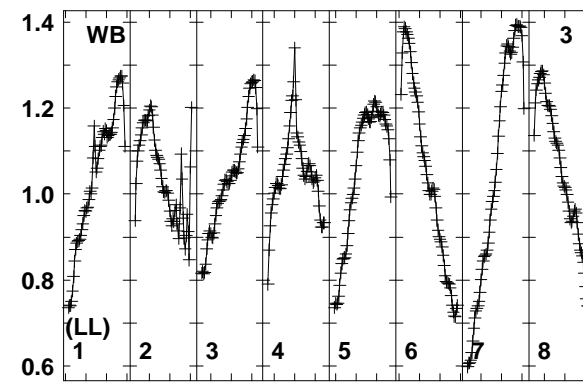
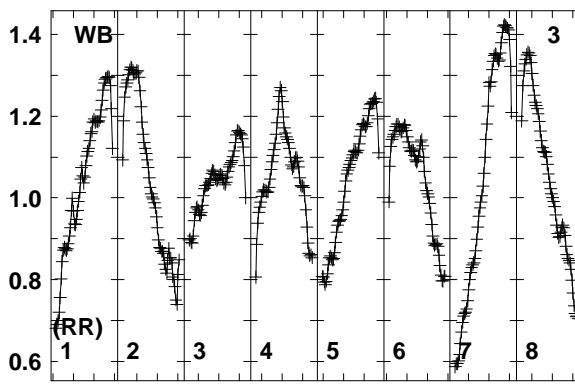
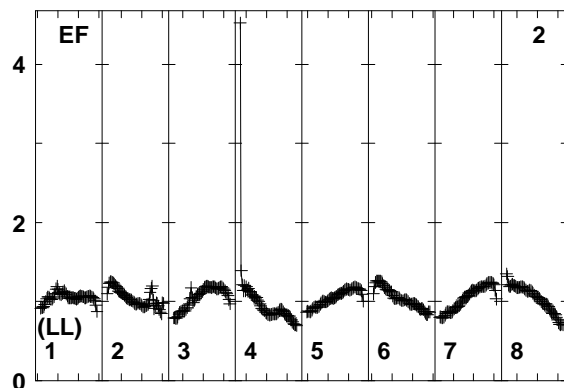
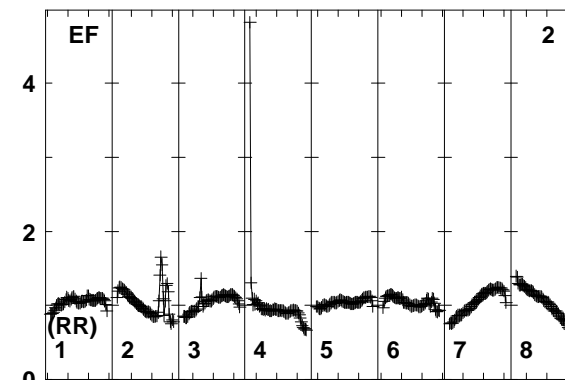
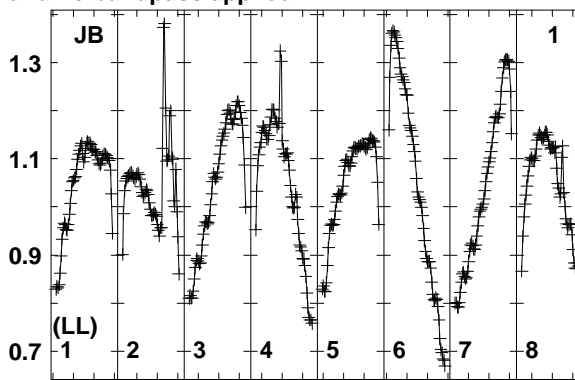
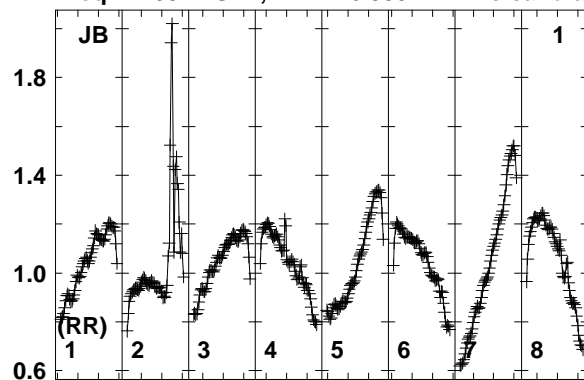

Lower frame: Real Jy
Total-power spectrum Antenna: JB (01)
Timerange: 00/08:45:36 to 00/08:46:34

Plot file version 644 created 04-NOV-2019 14:14:53

J2248-0541 EY034.UVDATA.1

Freq = 1.5947 GHz, Bw = 16.000 MH No calibration applied and no bandpass applied

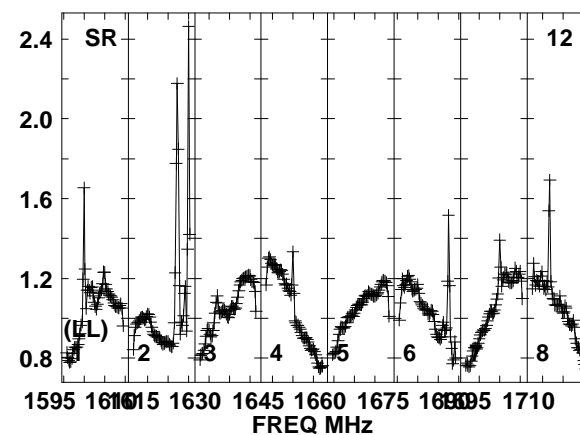
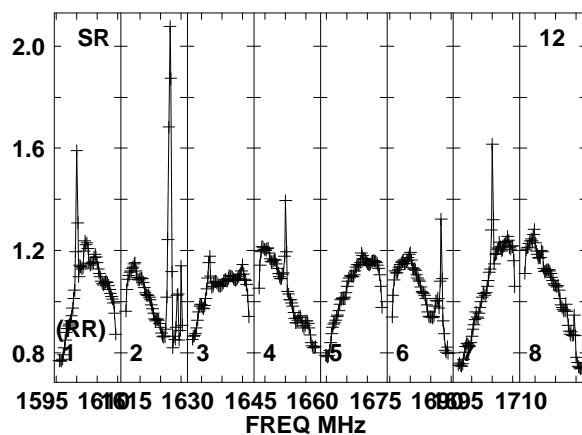
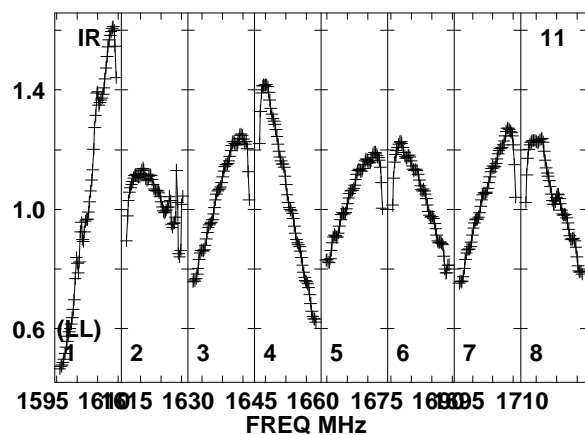
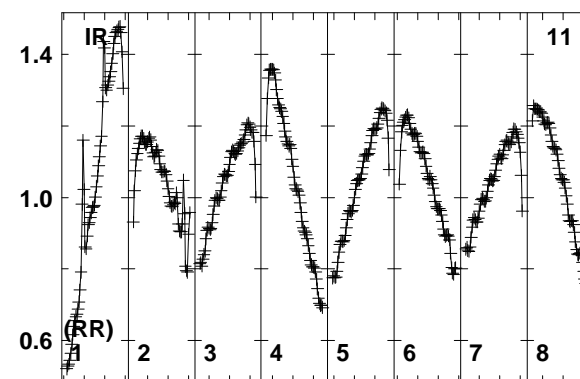
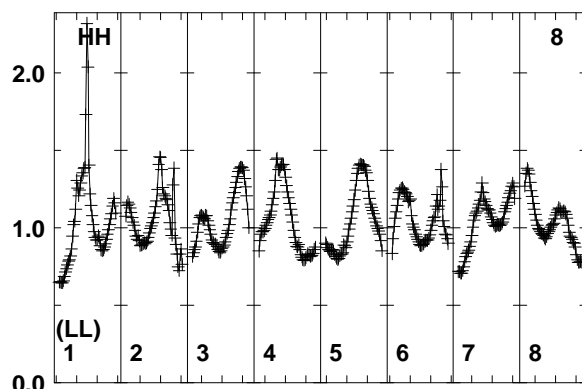
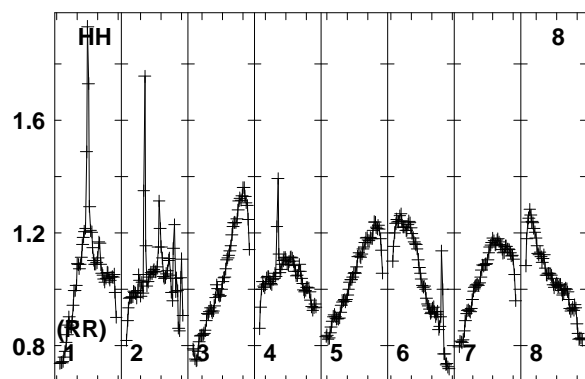
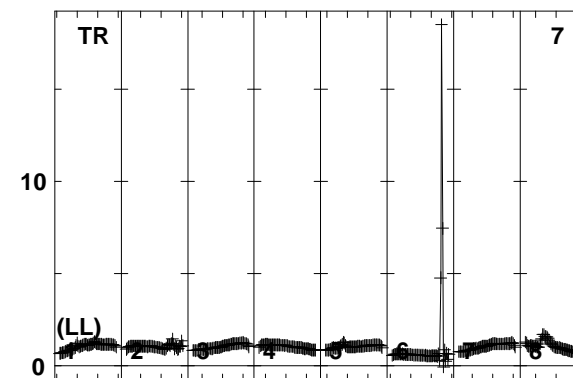
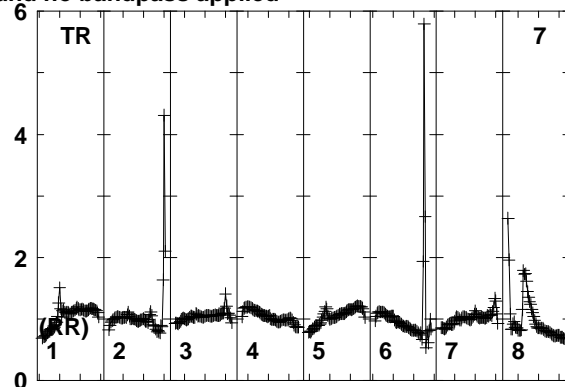
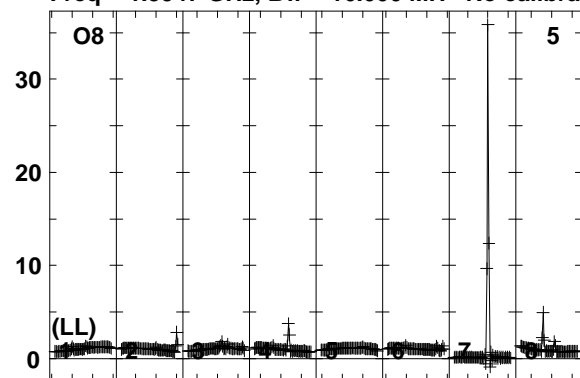

Lower frame: Real Jy
Total-power spectrum Antenna: O8 (05)
Timerange: 00/08:45:36 to 00/08:46:34

Plot file version 645 created 04-NOV-2019 14:14:53

J2248-0541 EY034.UVDATA.1

Freq = 1.5947 GHz, Bw = 16.000 MH No calibration applied and no bandpass applied

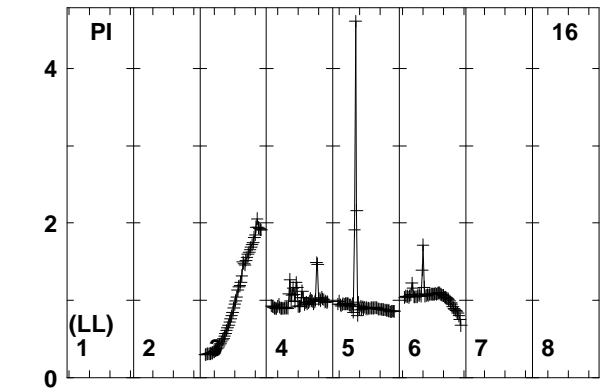
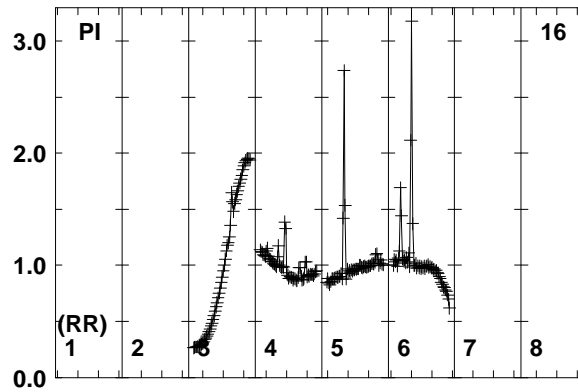
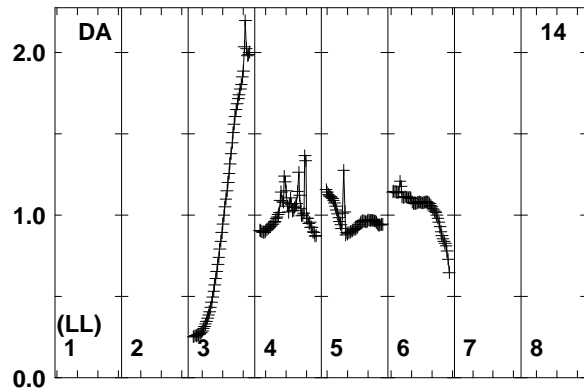
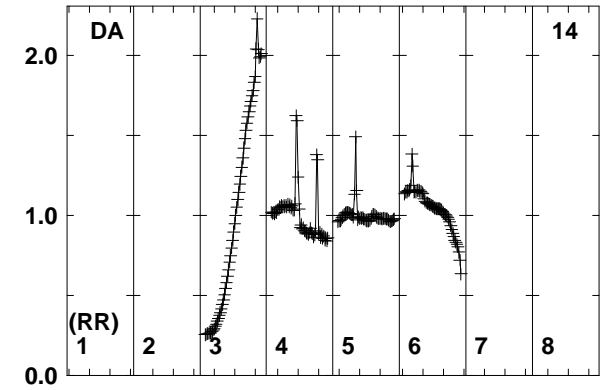
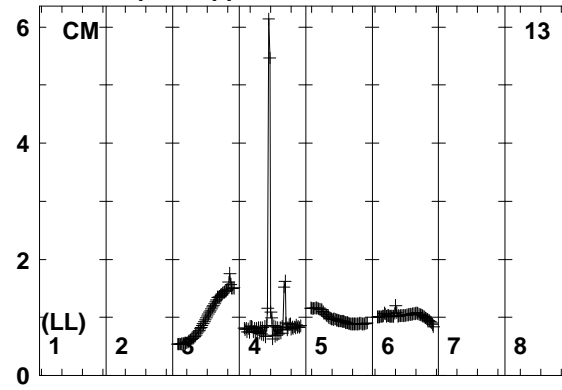
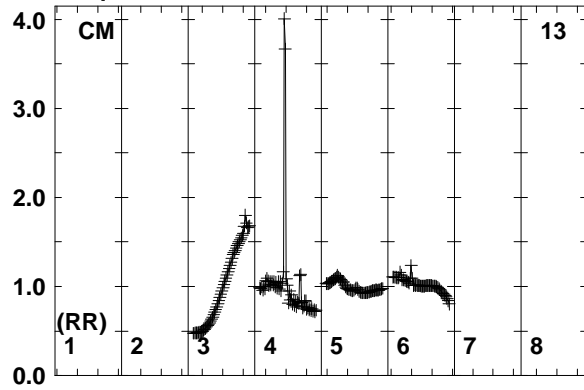

Lower frame: Real Jy
Total-power spectrum Antenna: CM (13)
Timerange: 00/08:45:36 to 00/08:46:34

Plot file version 646 created 04-NOV-2019 14:14:53

W2246-0526 EY034.UVDATA.1

Freq = 1.5947 GHz, Bw = 16.000 MH No calibration applied and no bandpass applied

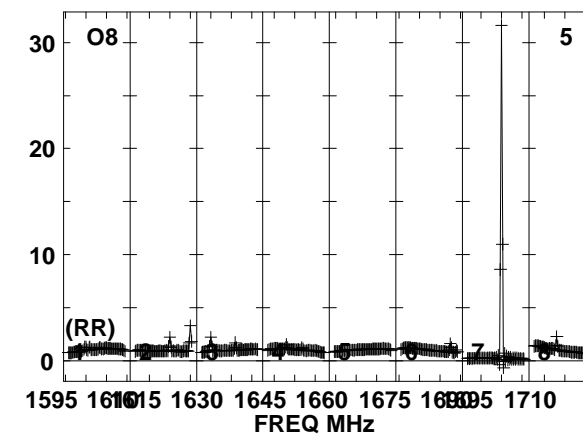
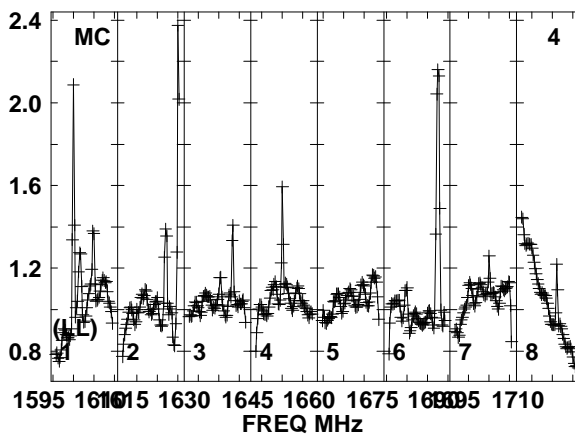
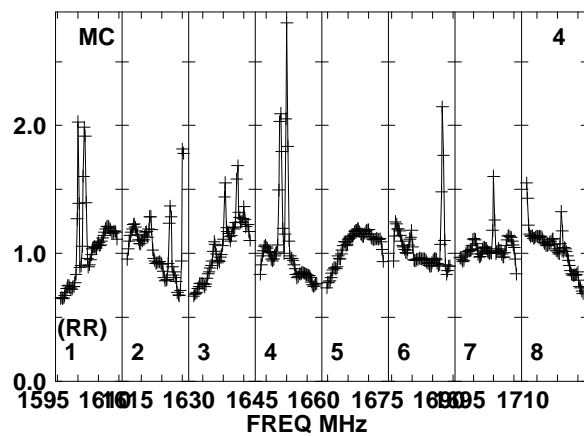
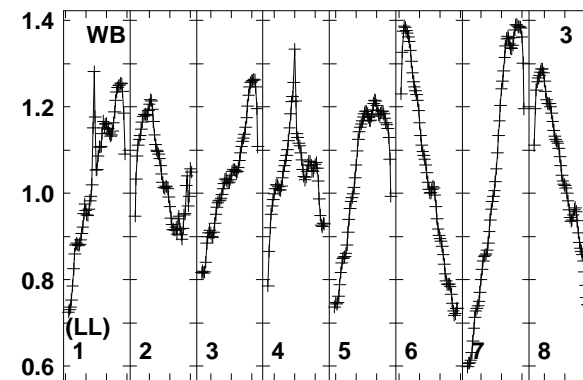
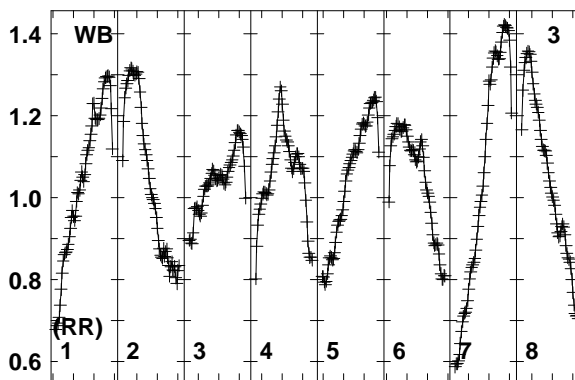
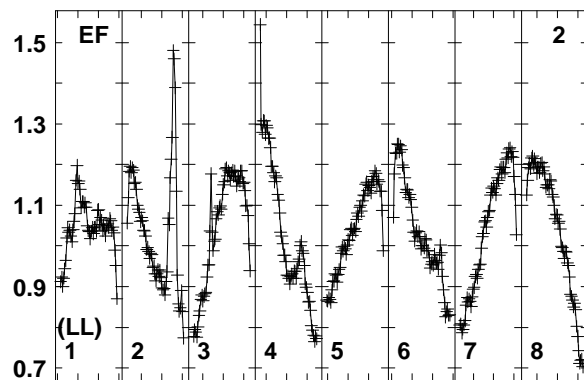
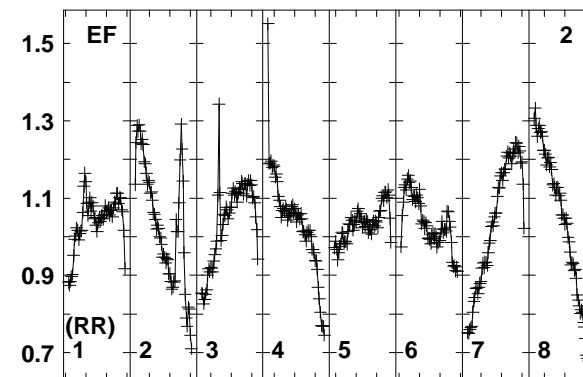
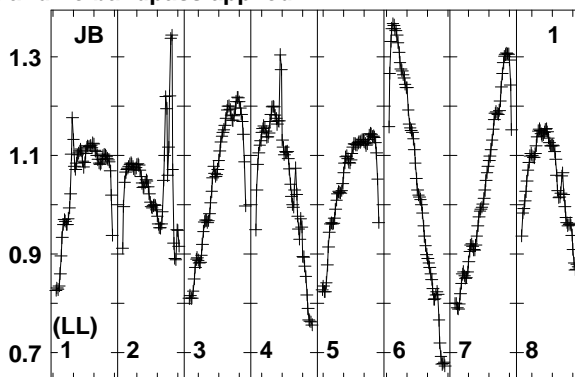
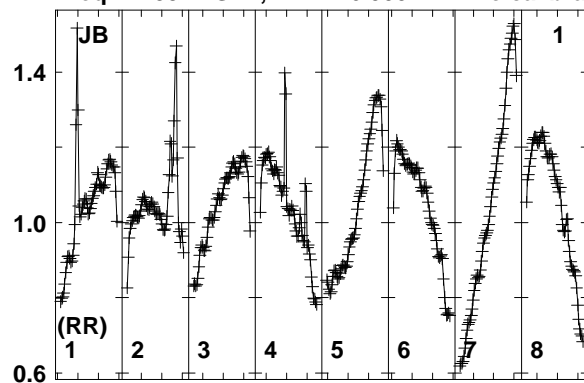

Lower frame: Real Jy
Total-power spectrum Antenna: JB (01)
Timerange: 00/08:46:36 to 00/08:49:14

Plot file version 647 created 04-NOV-2019 14:14:53

W2246-0526 EY034.UVDATA.1

Freq = 1.5947 GHz, Bw = 16.000 MH No calibration applied and no bandpass applied

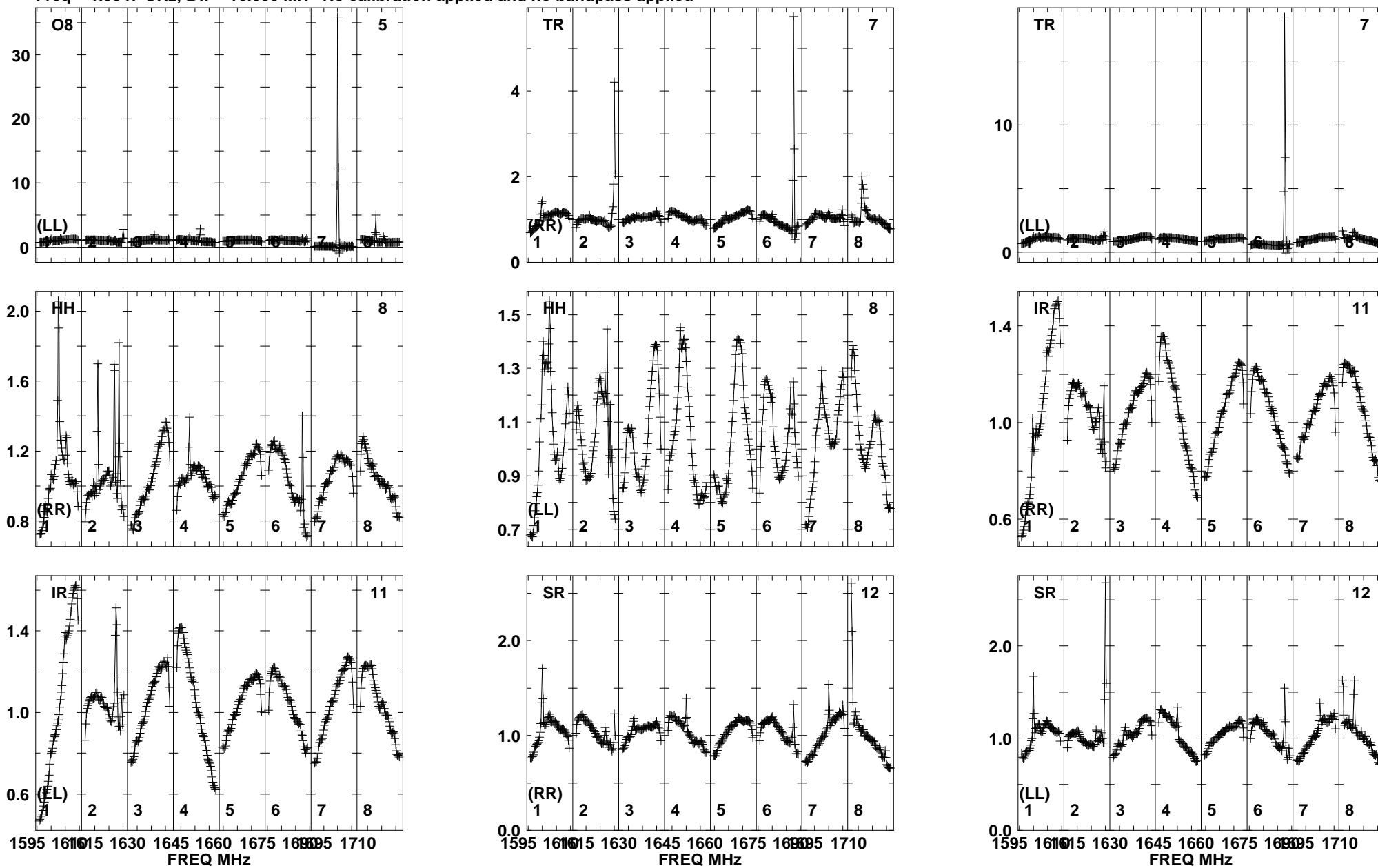

Lower frame: Real Jy
Total-power spectrum Antenna: O8 (05)
Timerange: 00/08:46:36 to 00/08:49:14

Plot file version 648 created 04-NOV-2019 14:14:53

W2246-0526 EY034.UVDATA.1

Freq = 1.5947 GHz, Bw = 16.000 MH No calibration applied and no bandpass applied

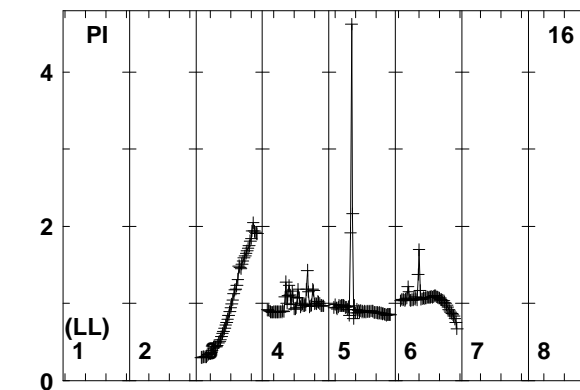
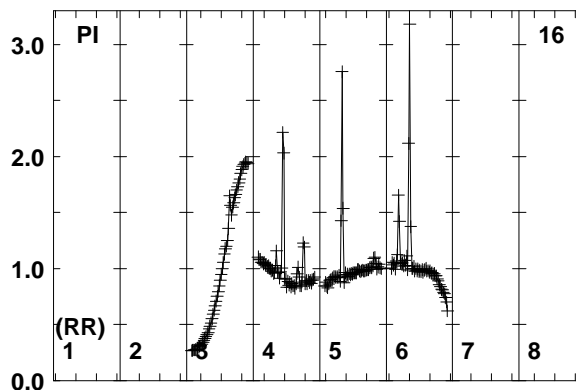
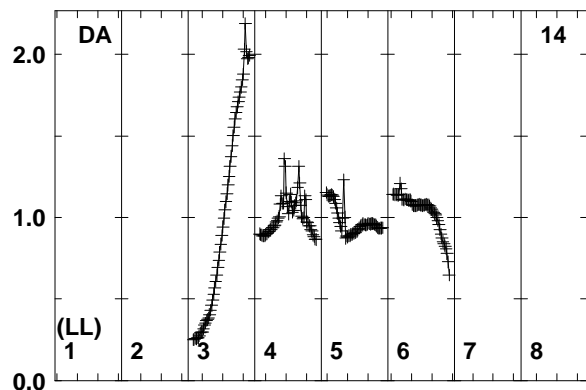
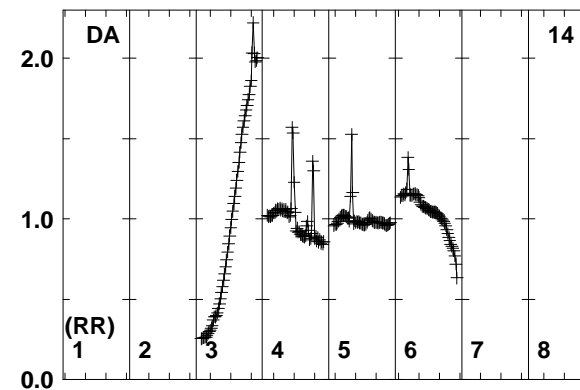
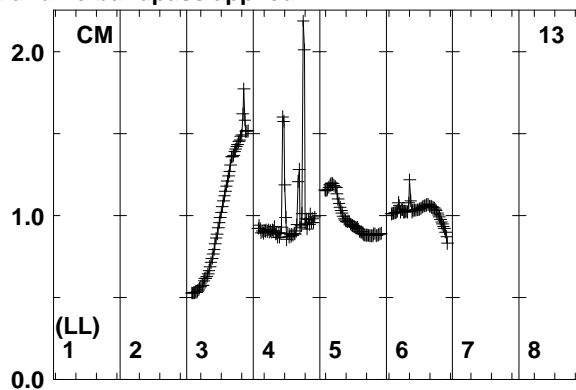
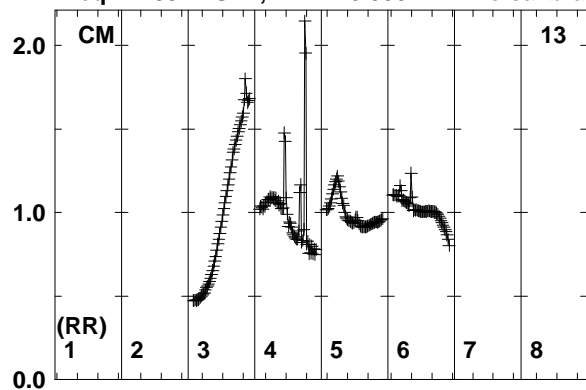

Lower frame: Real Jy
Total-power spectrum Antenna: CM (13)
Timerange: 00/08:46:36 to 00/08:49:14

Plot file version 649 created 04-NOV-2019 14:14:53

J2248-0541 EY034.UVDATA.1

Freq = 1.5947 GHz, Bw = 16.000 MH No calibration applied and no bandpass applied

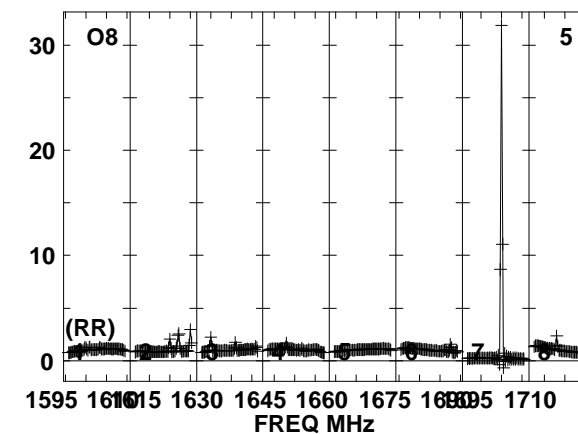
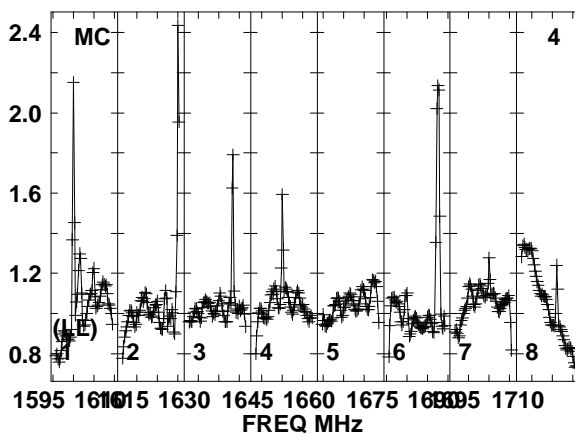
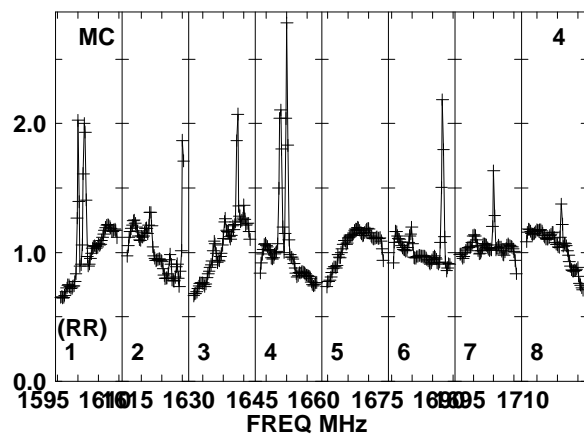
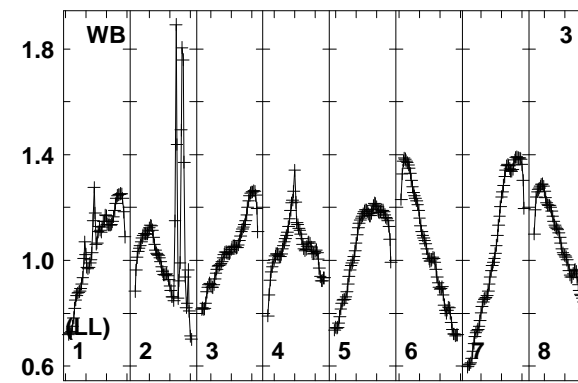
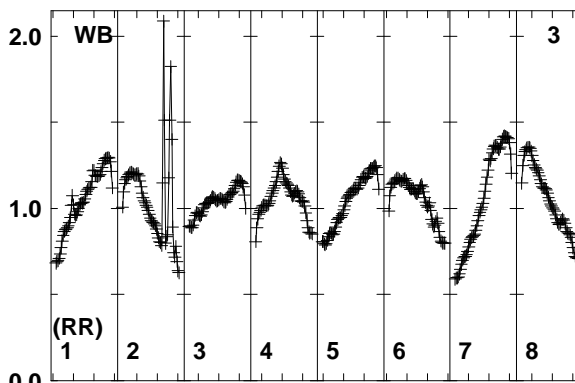
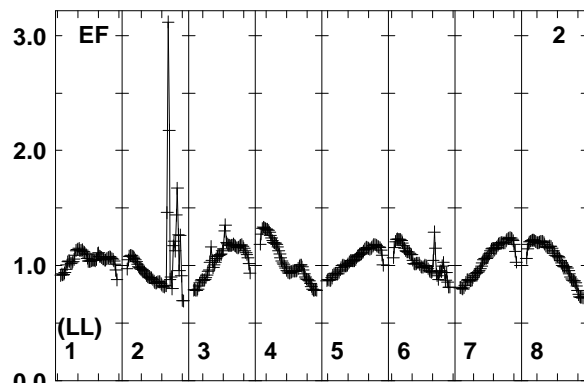
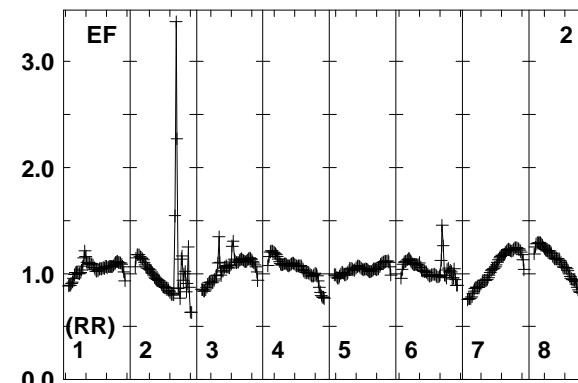
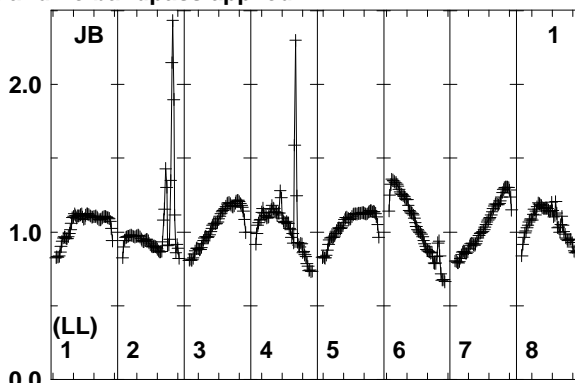
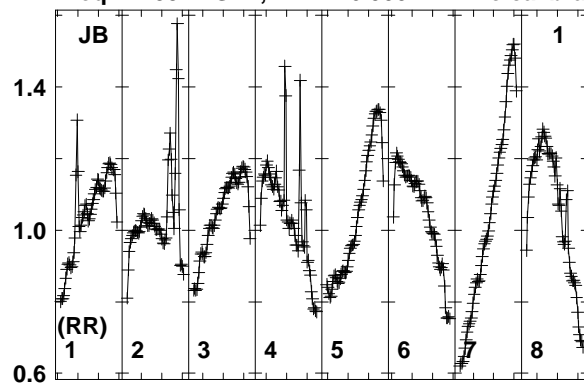

Lower frame: Real Jy
Total-power spectrum Antenna: JB (01)
Timerange: 00/08:49:31 to 00/08:50:29

Plot file version 650 created 04-NOV-2019 14:14:53

J2248-0541 EY034.UVDATA.1

Freq = 1.5947 GHz, Bw = 16.000 MH No calibration applied and no bandpass applied

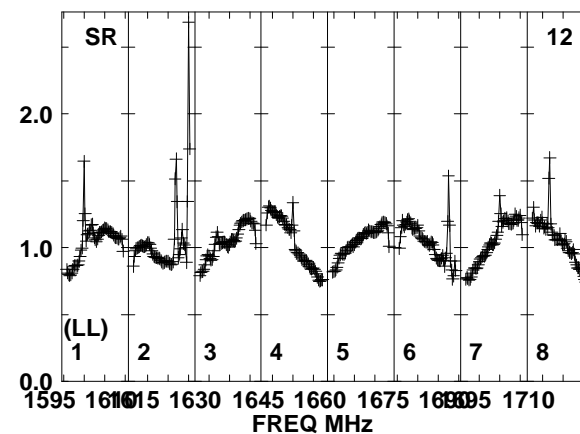
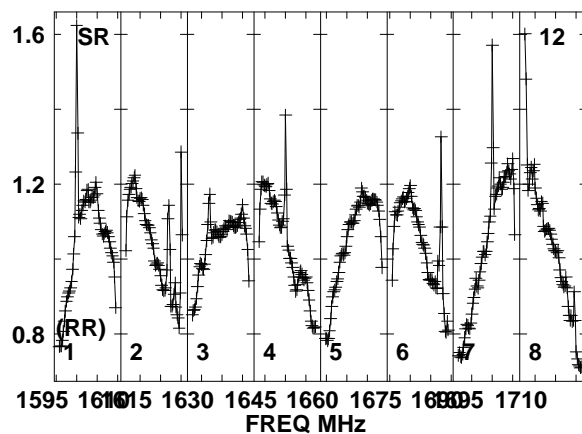
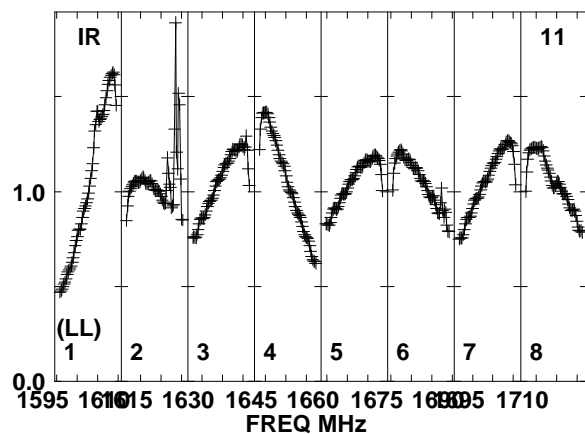
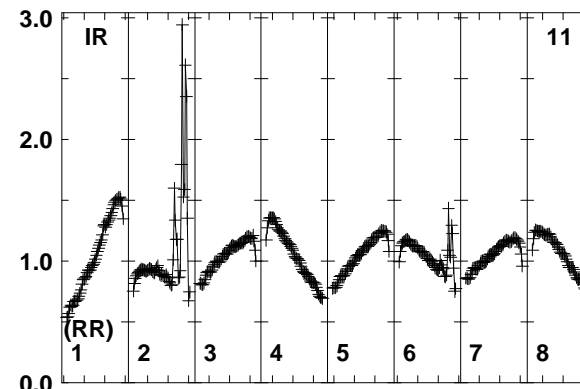
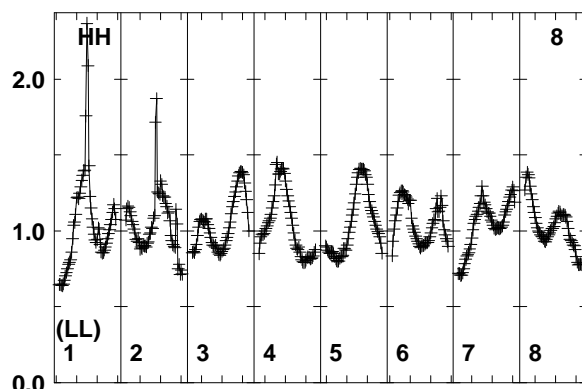
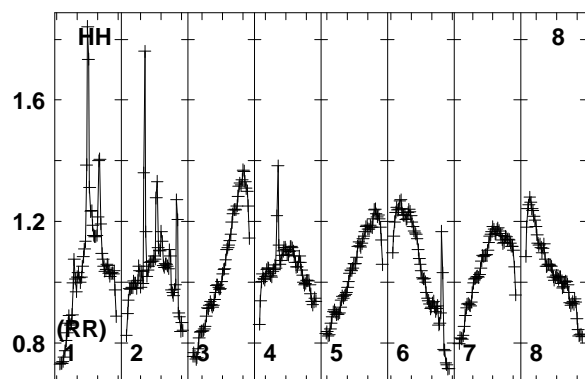
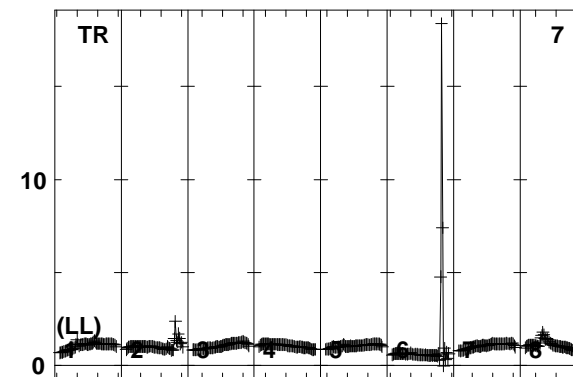
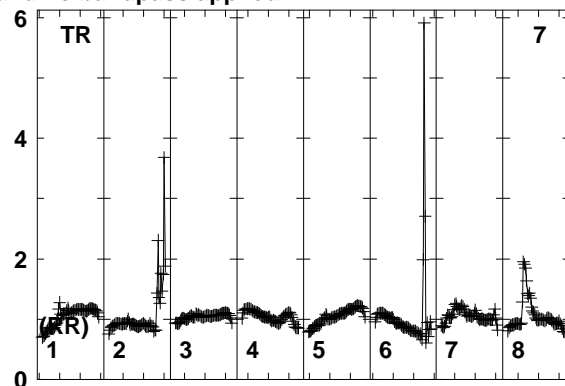
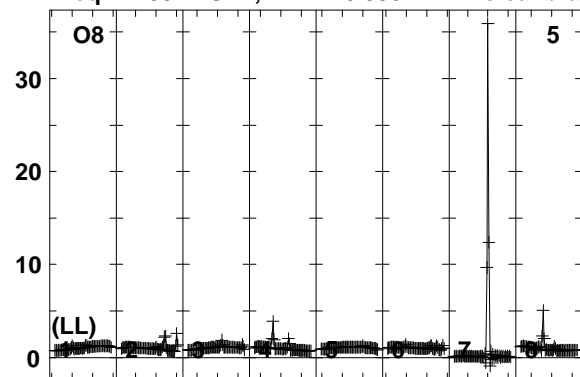

Lower frame: Real Jy
Total-power spectrum Antenna: O8 (05)
Timerange: 00/08:49:31 to 00/08:50:29

Plot file version 651 created 04-NOV-2019 14:14:53

J2248-0541 EY034.UVDATA.1

Freq = 1.5947 GHz, Bw = 16.000 MH No calibration applied and no bandpass applied

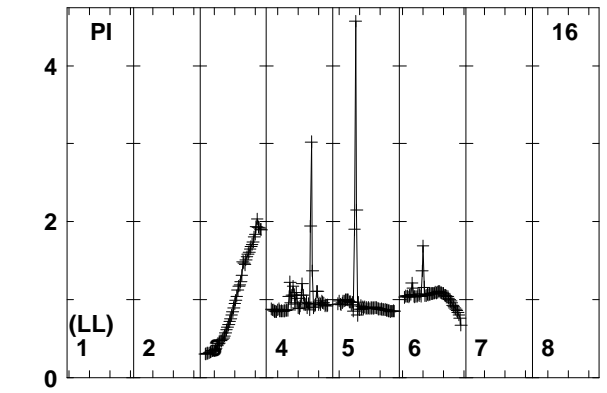
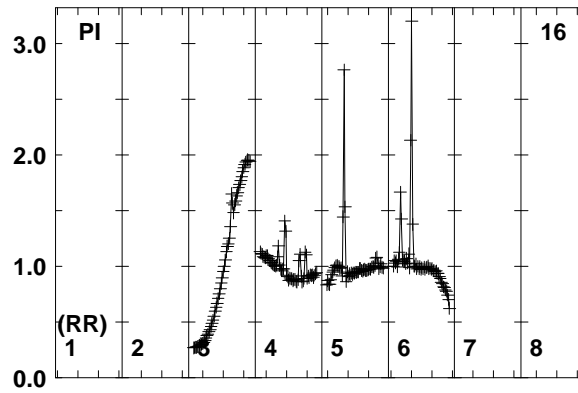
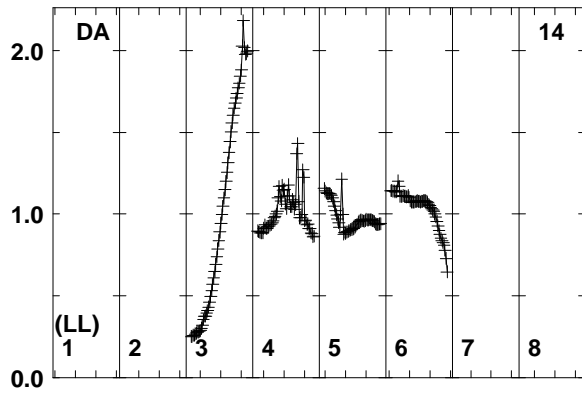
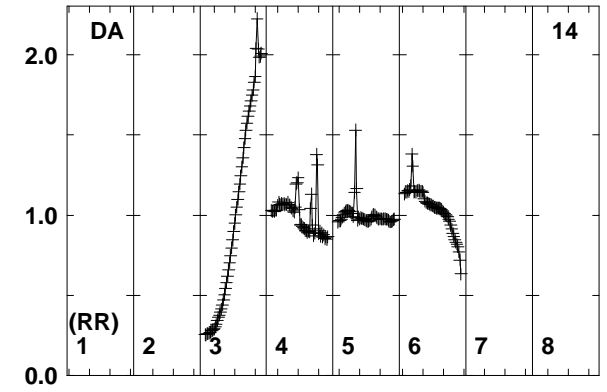
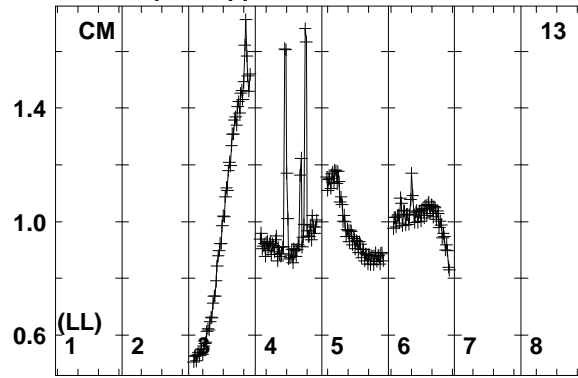
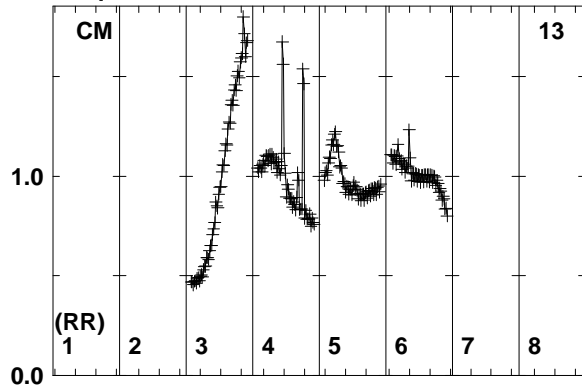

Lower frame: Real Jy
Total-power spectrum Antenna: CM (13)
Timerange: 00/08:49:31 to 00/08:50:29

Plot file version 652 created 04-NOV-2019 14:14:53

J2245-0755 EY034.UVDATA.1

Freq = 1.5947 GHz, Bw = 16.000 MH No calibration applied and no bandpass applied

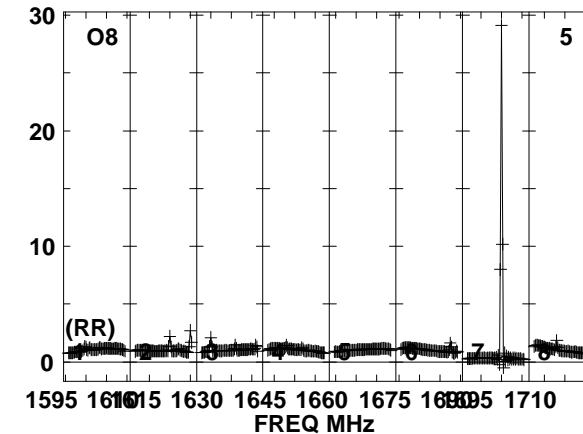
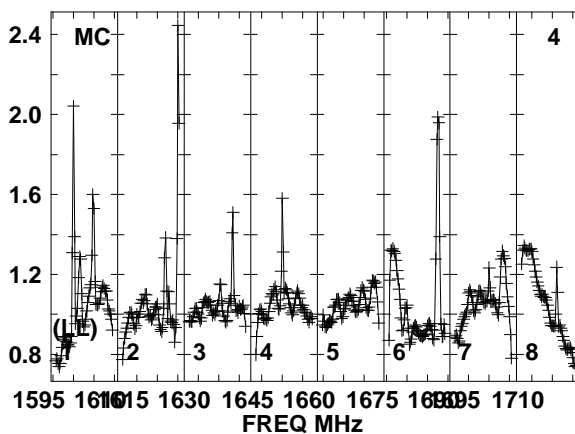
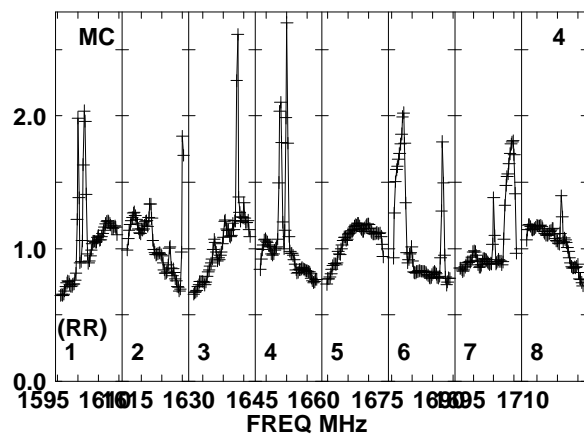
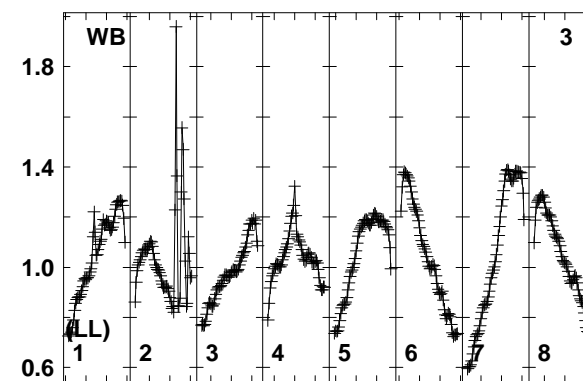
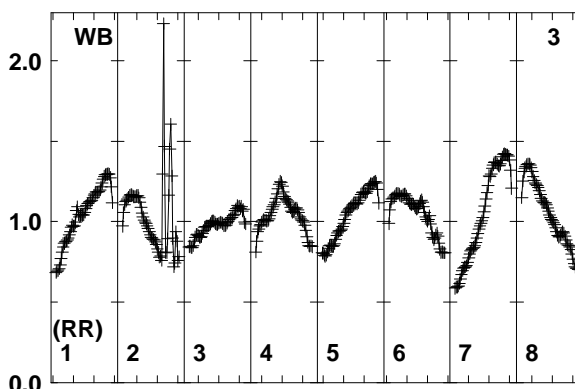
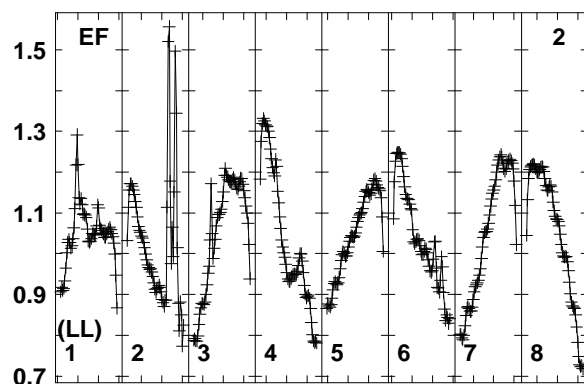
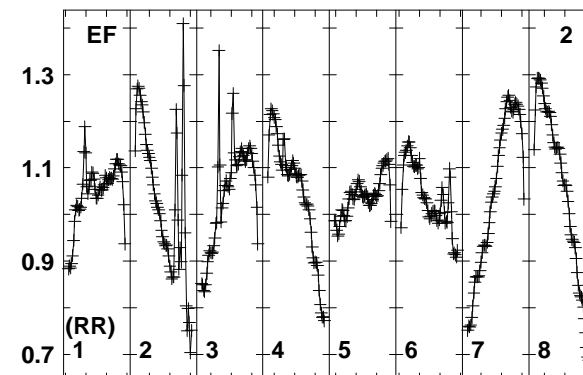
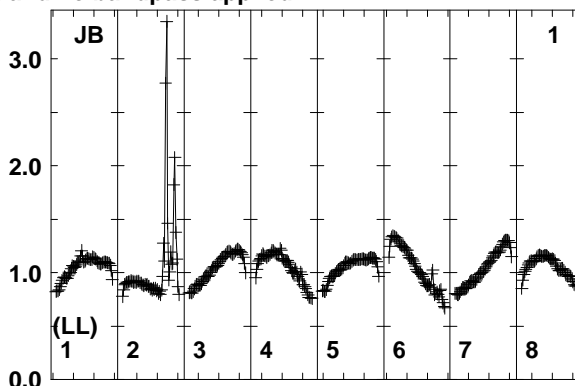
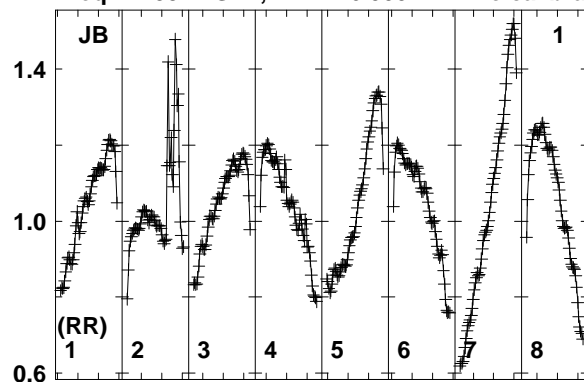

Lower frame: Real Jy
Total-power spectrum Antenna: JB (01)
Timerange: 00/08:50:46 to 00/08:51:44

Plot file version 653 created 04-NOV-2019 14:14:53

J2245-0755 EY034.UVDATA.1

Freq = 1.5947 GHz, Bw = 16.000 MH No calibration applied and no bandpass applied

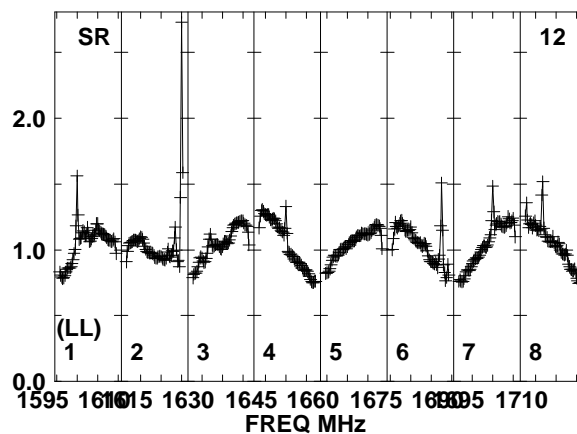
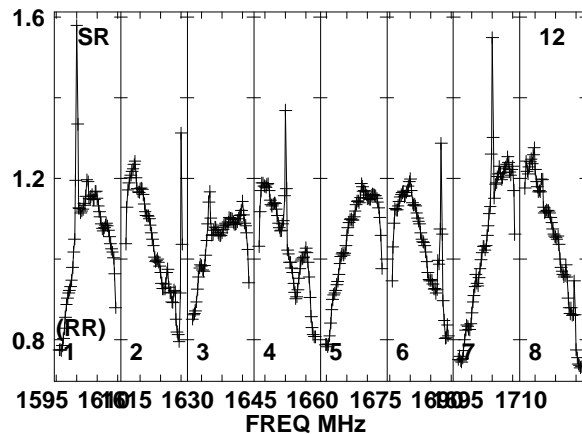
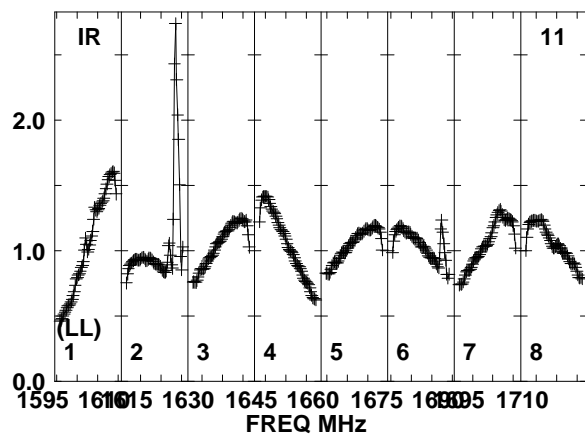
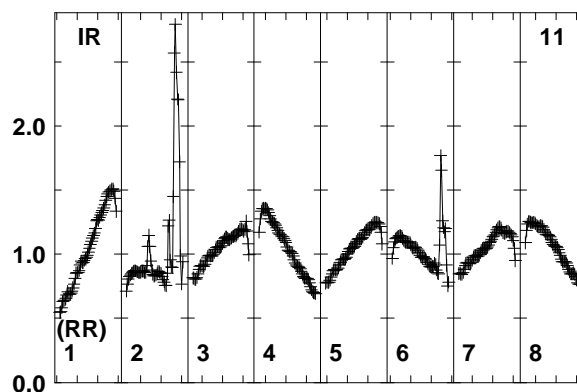
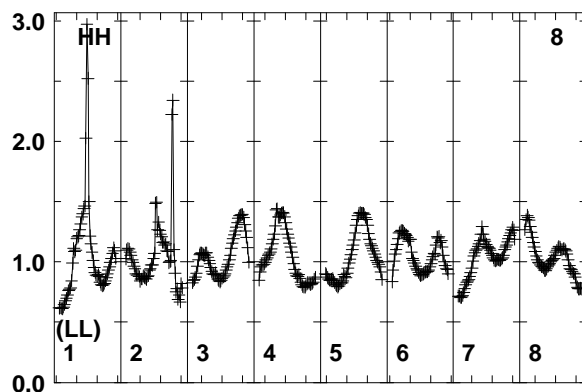
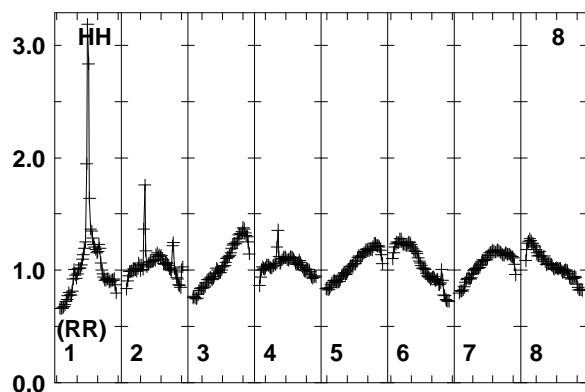
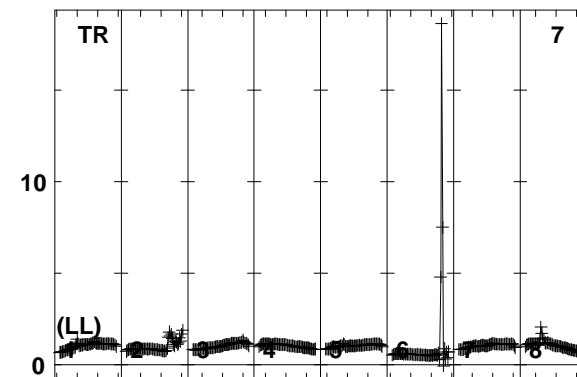
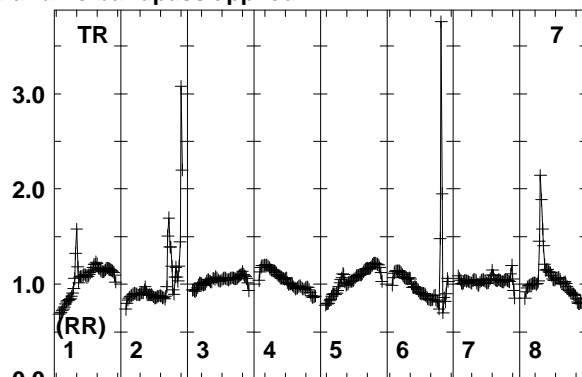
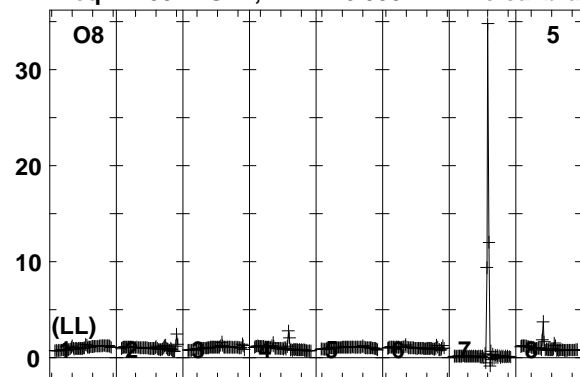

Lower frame: Real Jy
Total-power spectrum Antenna: O8 (05)
Timerange: 00/08:50:46 to 00/08:51:44

Plot file version 654 created 04-NOV-2019 14:14:53

J2245-0755 EY034.UVDATA.1

Freq = 1.5947 GHz, Bw = 16.000 MH No calibration applied and no bandpass applied

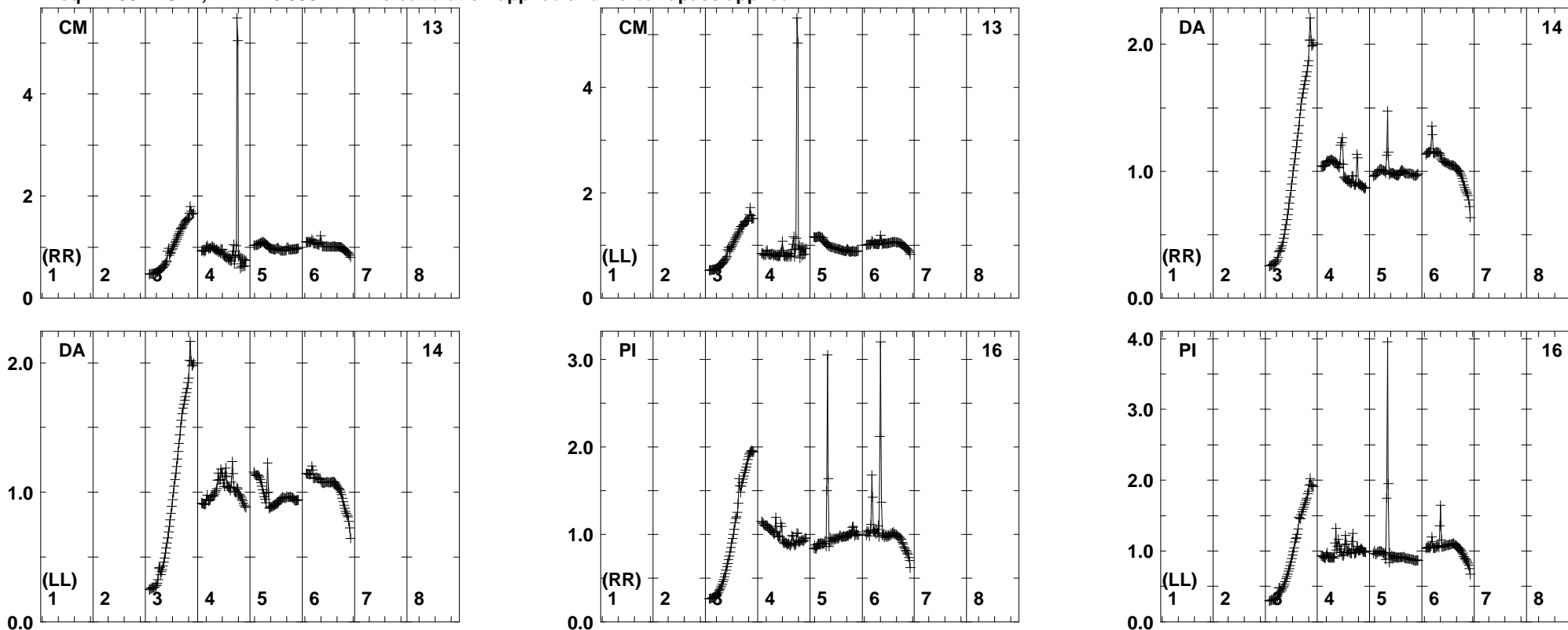

Lower frame: Real Jy
Total-power spectrum Antenna: CM (13)
Timerange: 00/08:50:46 to 00/08:51:44

Plot file version 655 created 04-NOV-2019 14:14:53

J2248-0541 EY034.UVDATA.1

Freq = 1.5947 GHz, Bw = 16.000 MH No calibration applied and no bandpass applied

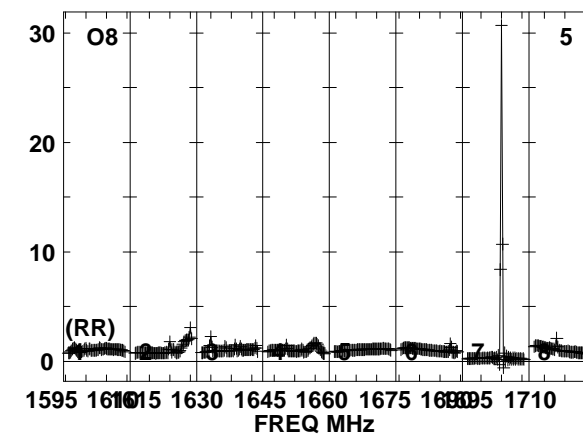
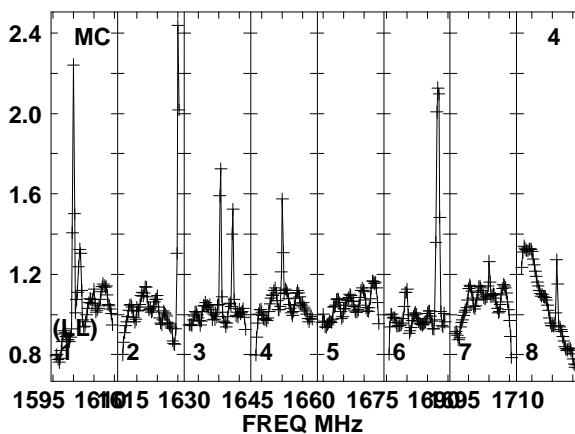
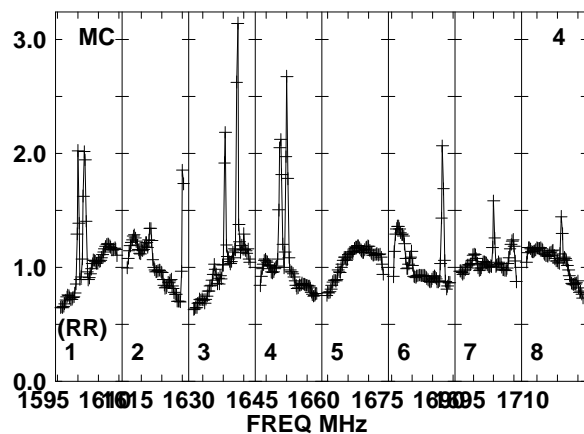
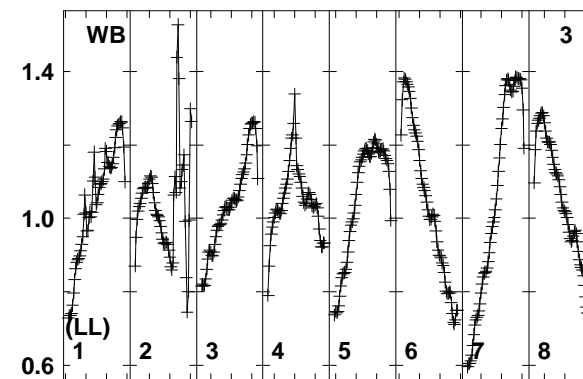
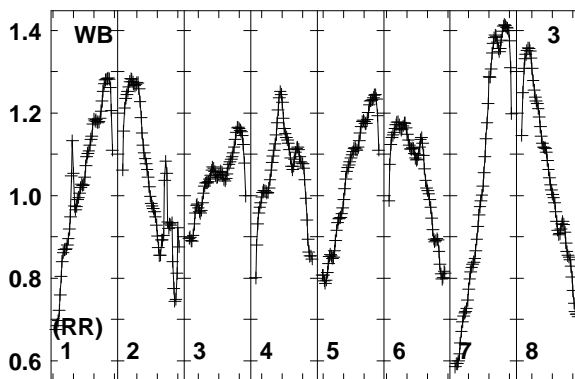
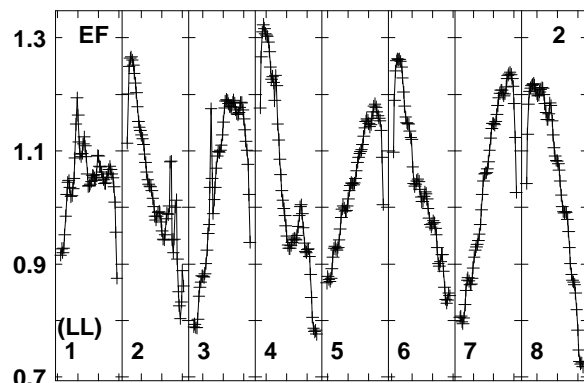
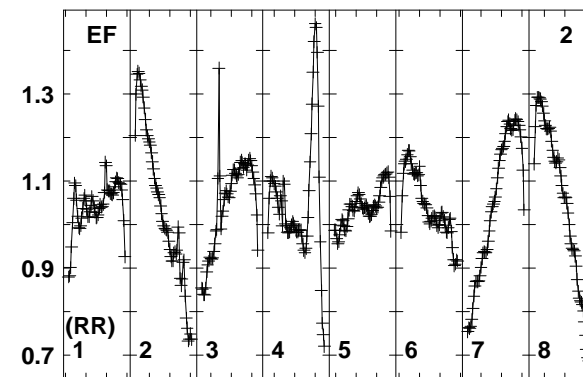
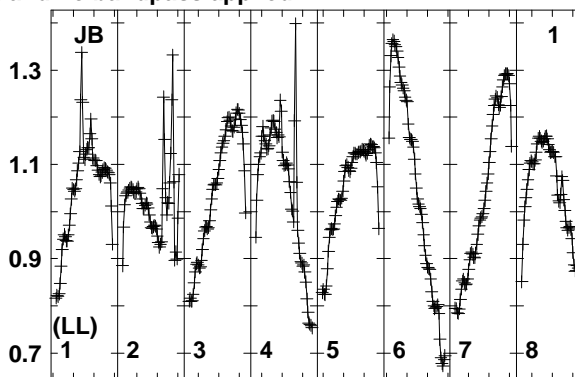
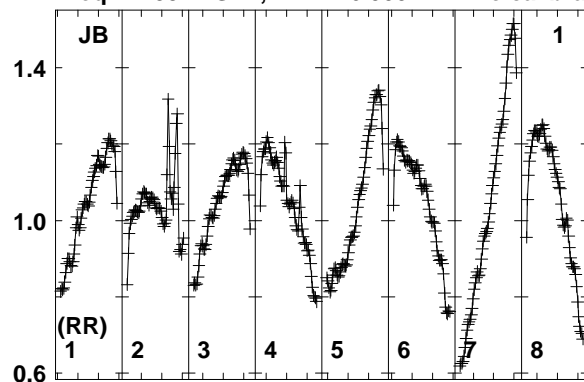

Lower frame: Real Jy
Total-power spectrum Antenna: JB (01)
Timerange: 00/08:52:31 to 00/08:53:29

Plot file version 656 created 04-NOV-2019 14:14:53

J2248-0541 EY034.UVDATA.1

Freq = 1.5947 GHz, Bw = 16.000 MH No calibration applied and no bandpass applied

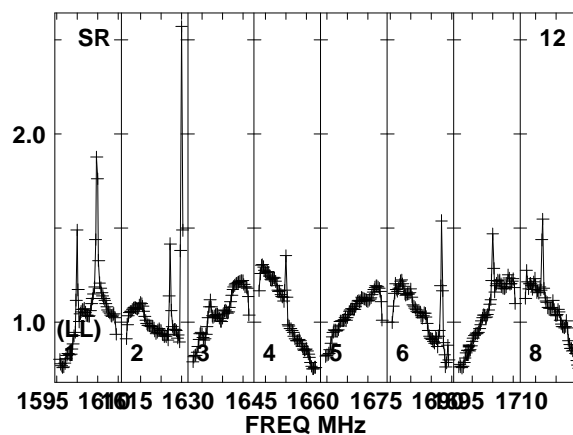
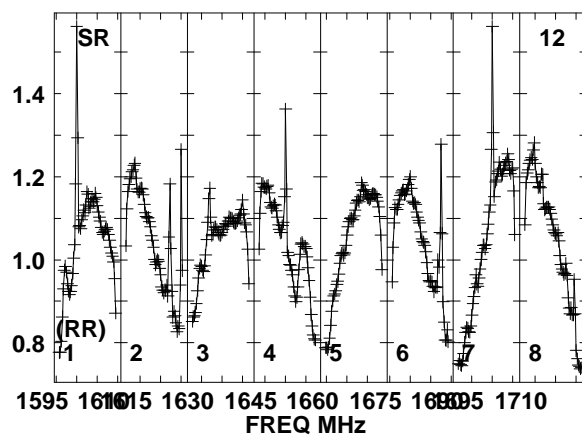
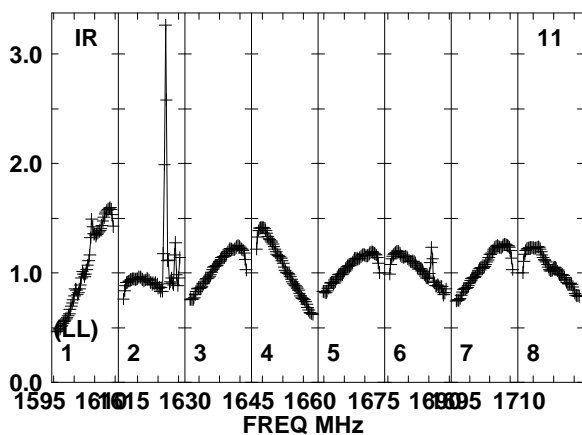
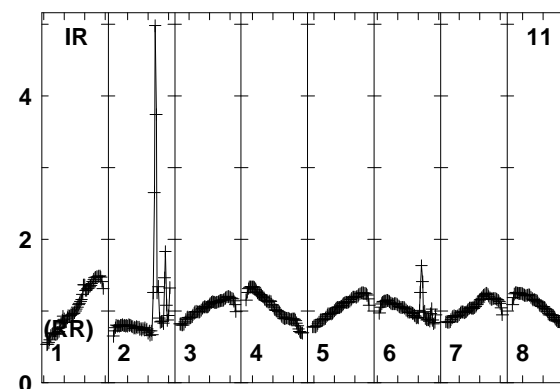
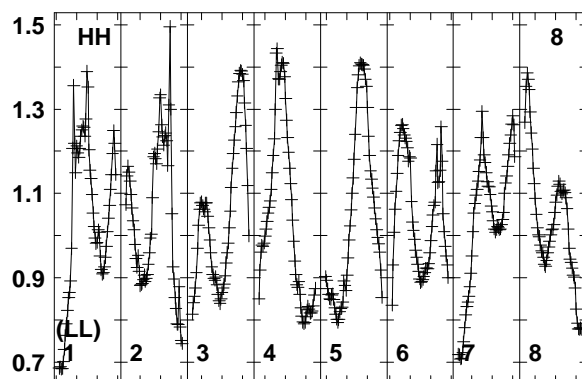
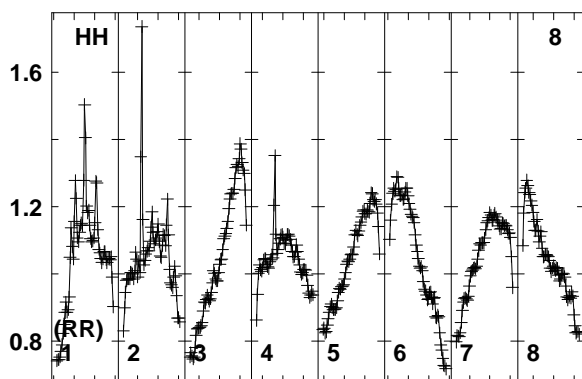
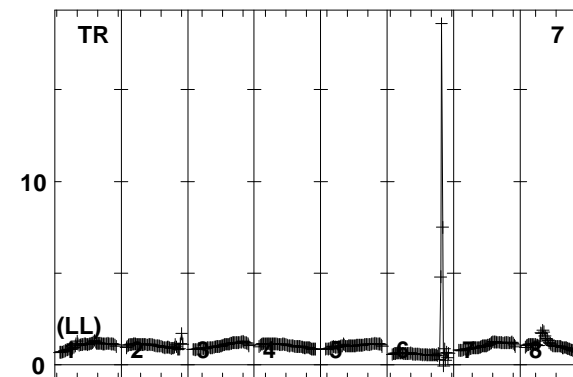
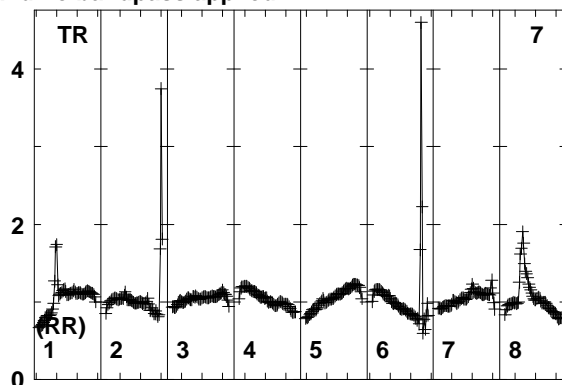
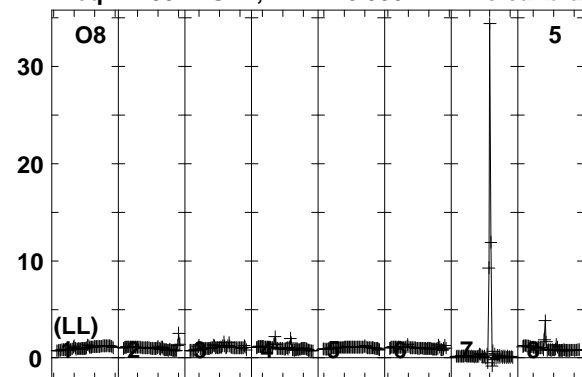

Lower frame: Real Jy
Total-power spectrum Antenna: O8 (05)
Timerange: 00/08:52:31 to 00/08:53:29

Plot file version 657 created 04-NOV-2019 14:14:54

J2248-0541 EY034.UVDATA.1

Freq = 1.5947 GHz, Bw = 16.000 MH No calibration applied and no bandpass applied

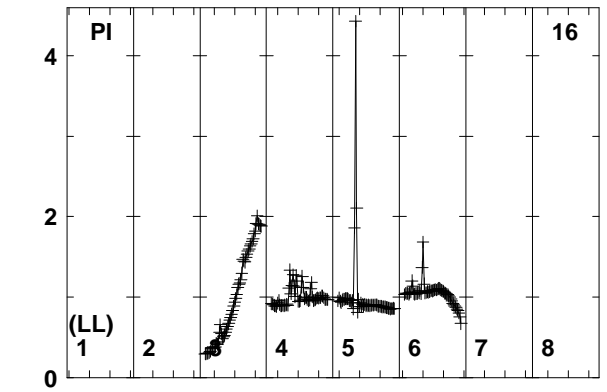
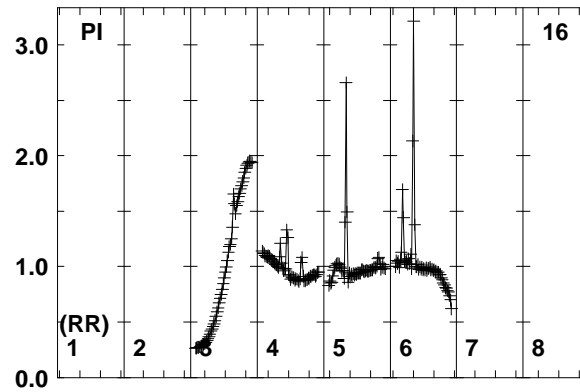
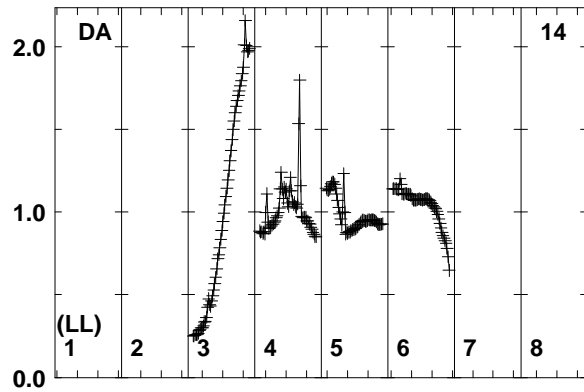
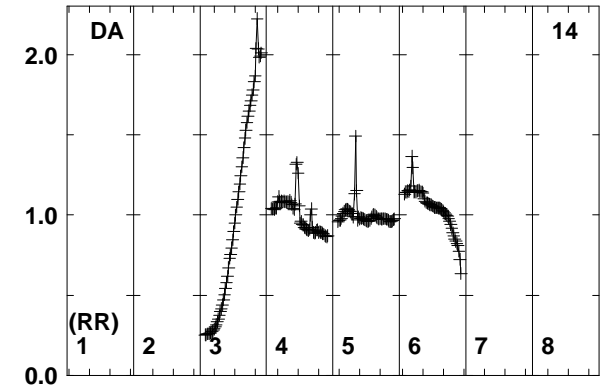
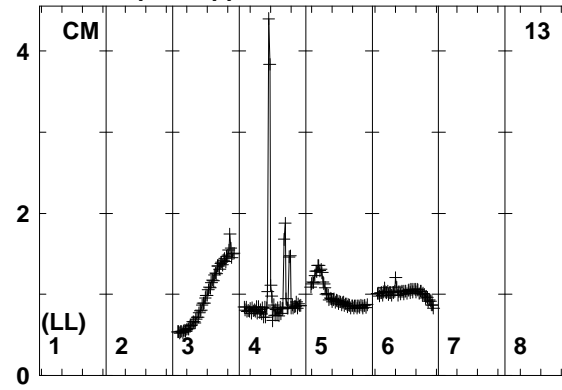
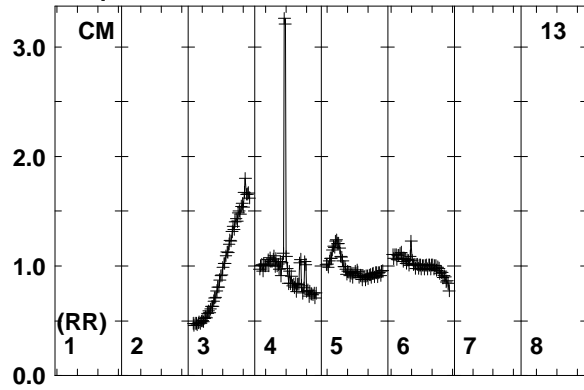

Lower frame: Real Jy
Total-power spectrum Antenna: CM (13)
Timerange: 00/08:52:31 to 00/08:53:29

Plot file version 658 created 04-NOV-2019 14:14:54

W2246-0526 EY034.UVDATA.1

Freq = 1.5947 GHz, Bw = 16.000 MH No calibration applied and no bandpass applied

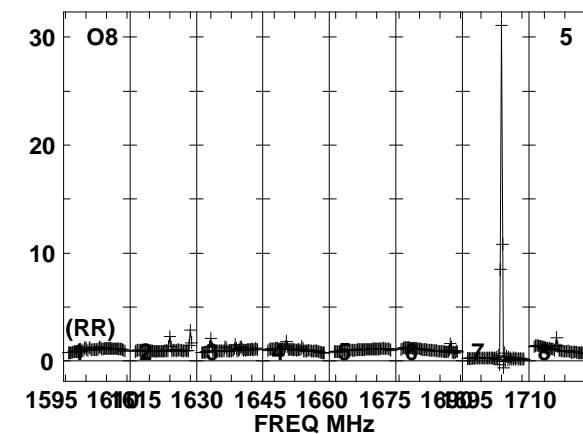
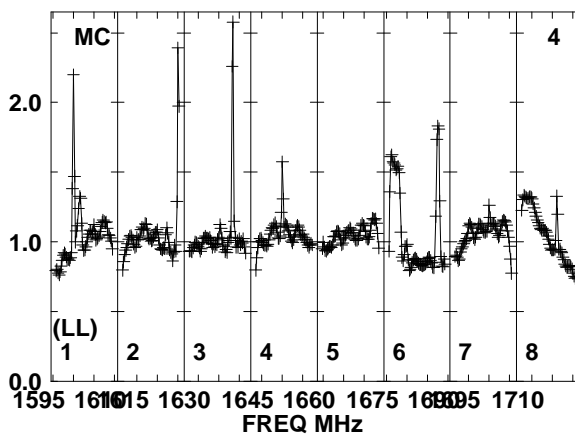
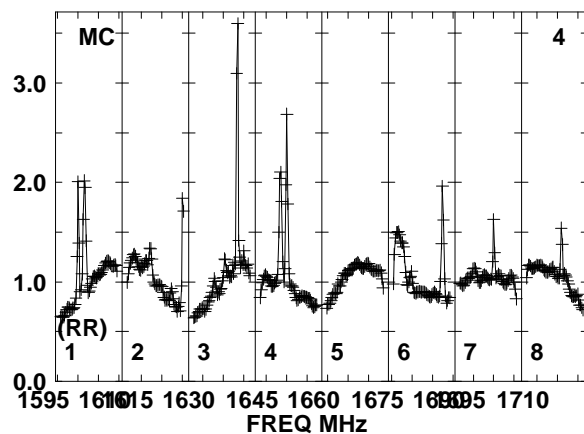
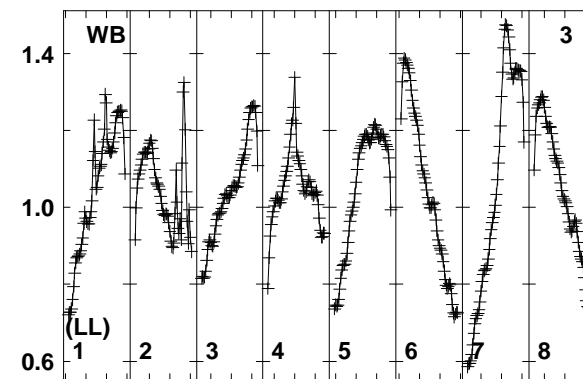
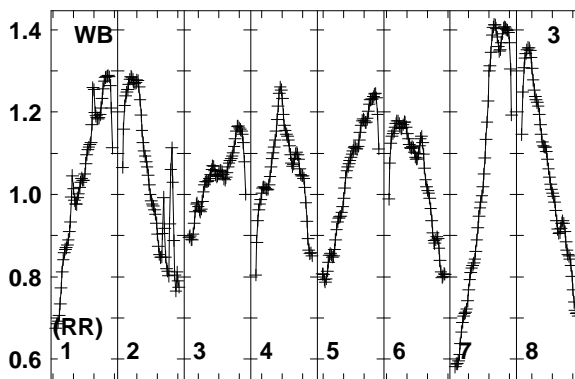
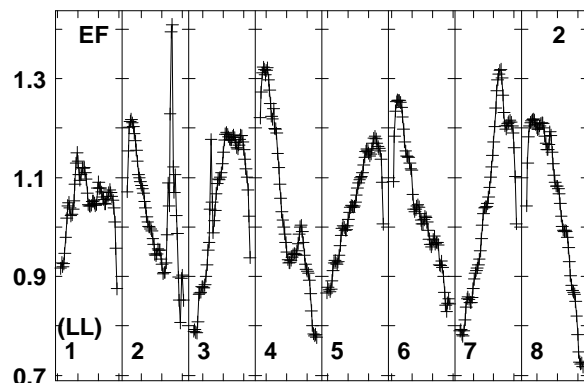
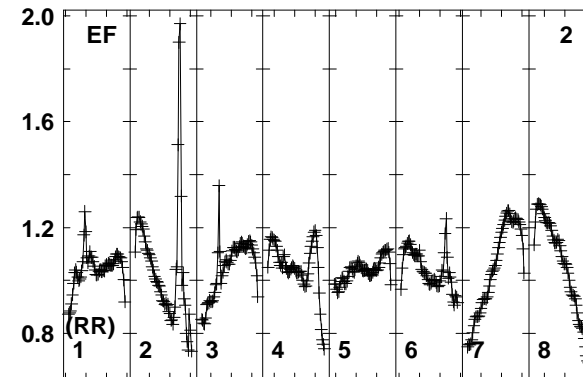
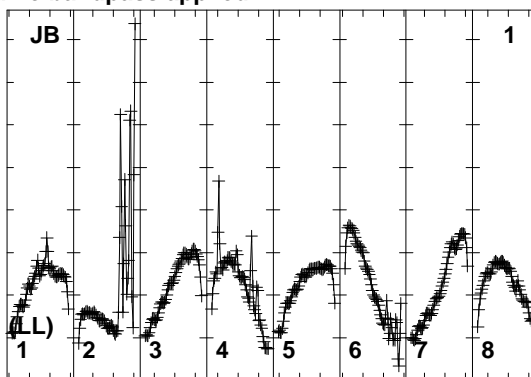
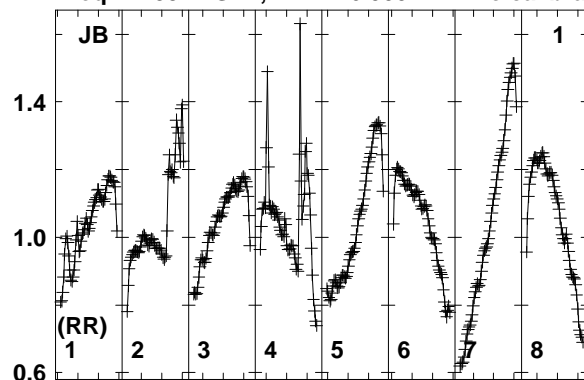

Lower frame: Real Jy
Total-power spectrum Antenna: JB (01)
Timerange: 00/08:53:31 to 00/08:55:59

Plot file version 659 created 04-NOV-2019 14:14:54

W2246-0526 EY034.UVDATA.1

Freq = 1.5947 GHz, Bw = 16.000 MH No calibration applied and no bandpass applied

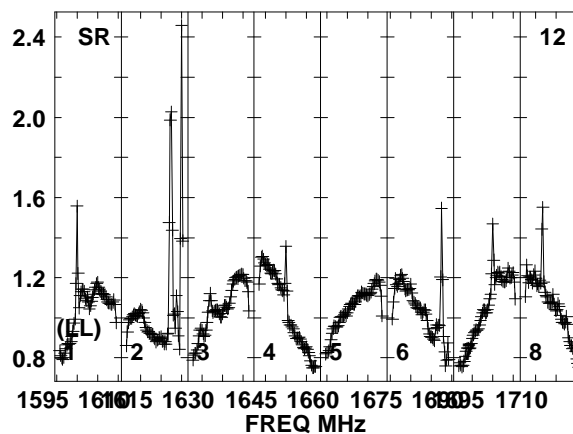
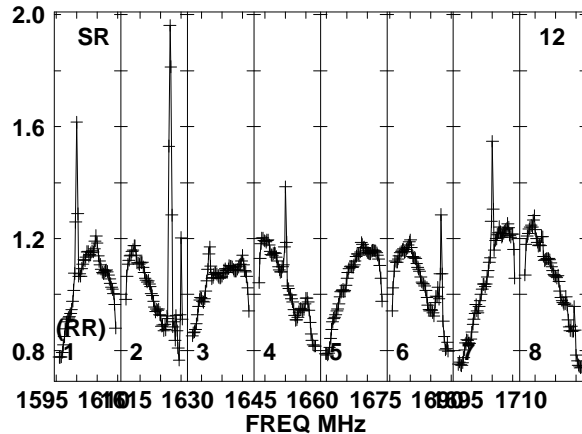
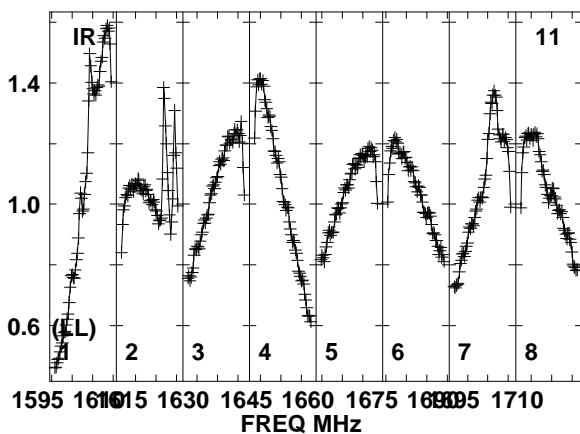
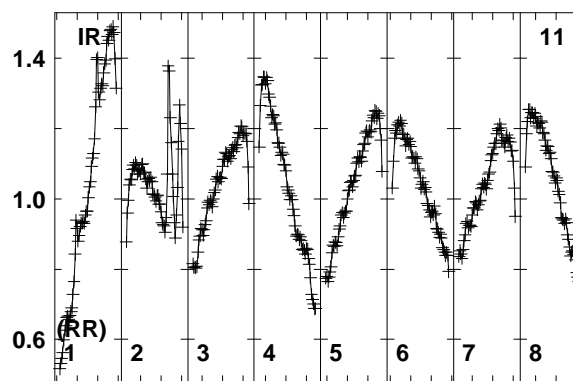
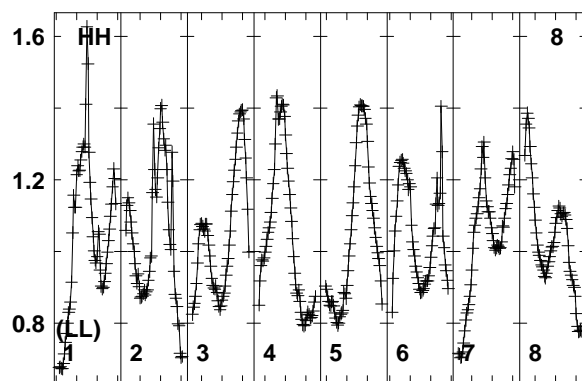
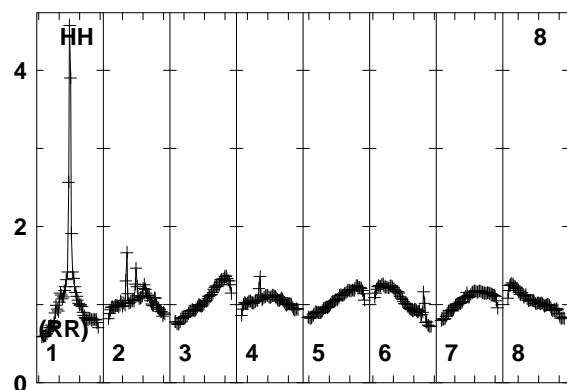
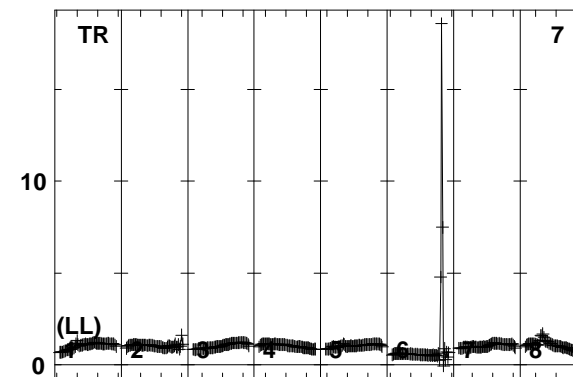
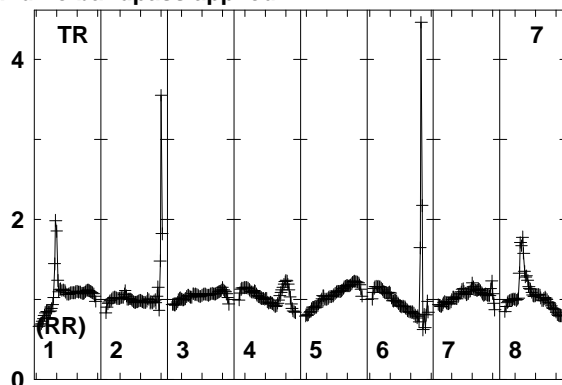
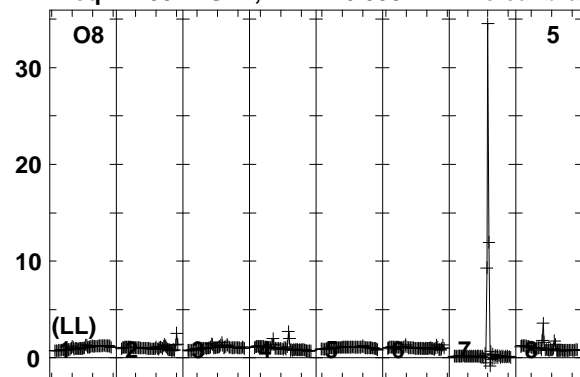

Lower frame: Real Jy
Total-power spectrum Antenna: O8 (05)
Timerange: 00/08:53:31 to 00/08:55:59

Plot file version 660 created 04-NOV-2019 14:14:54
W2246-0526 EY034.UVDATA.1
Freq = 1.5947 GHz, Bw = 16.000 MH No calibration applied and no bandpass applied

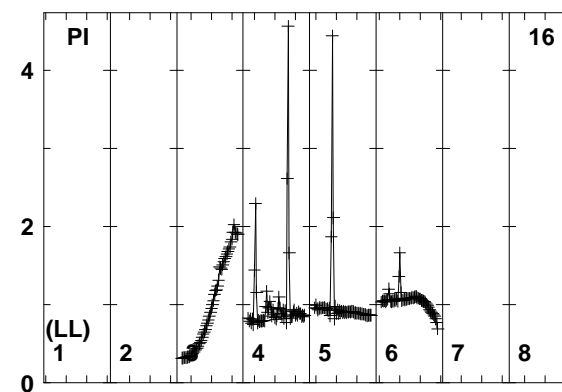
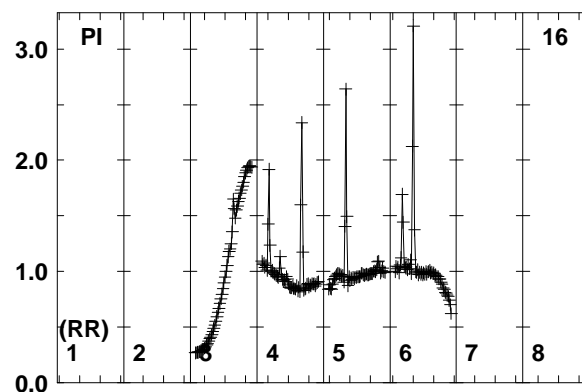
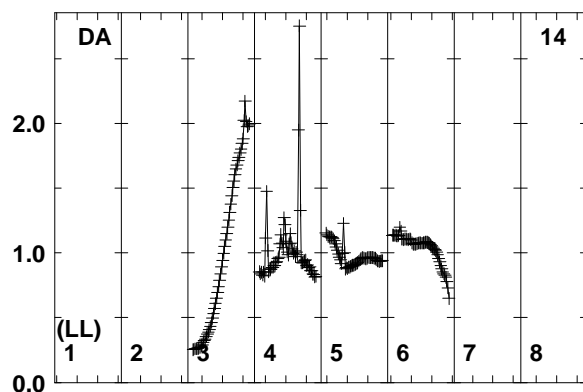
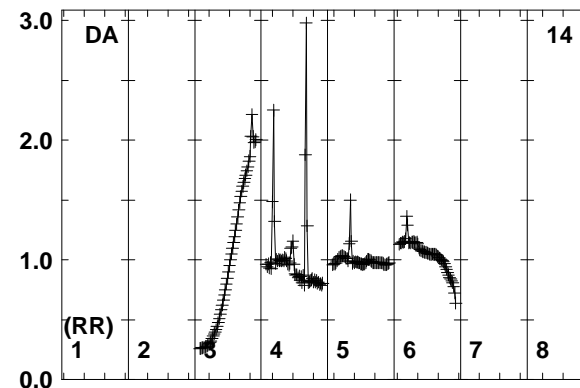
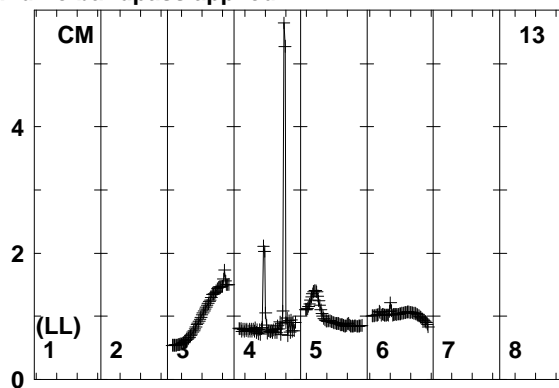
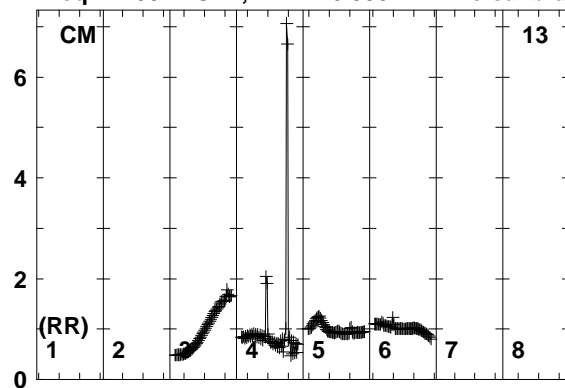

Lower frame: Real Jy
Total-power spectrum Antenna: CM (13)
Timerange: 00/08:53:31 to 00/08:55:59

Plot file version 661 created 04-NOV-2019 14:14:54

J2248-0541 EY034.UVDATA.1

Freq = 1.5947 GHz, Bw = 16.000 MH No calibration applied and no bandpass applied

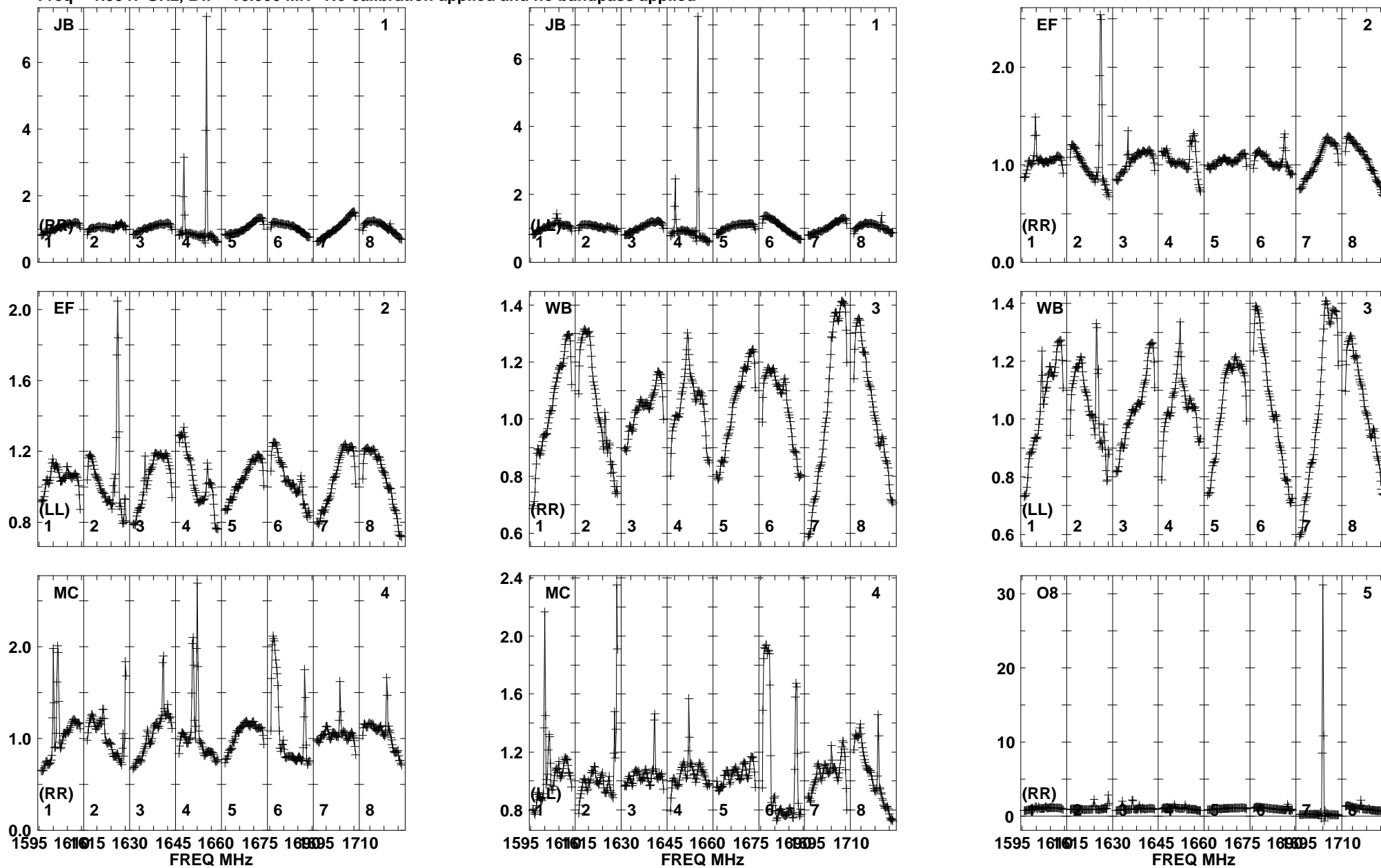

Lower frame: Real Jy
Total-power spectrum Antenna: JB (01)
Timerange: 00/08:56:16 to 00/08:57:14

Plot file version 662 created 04-NOV-2019 14:14:54

J2248-0541 EY034.UVDATA.1

Freq = 1.5947 GHz, Bw = 16.000 MH No calibration applied and no bandpass applied

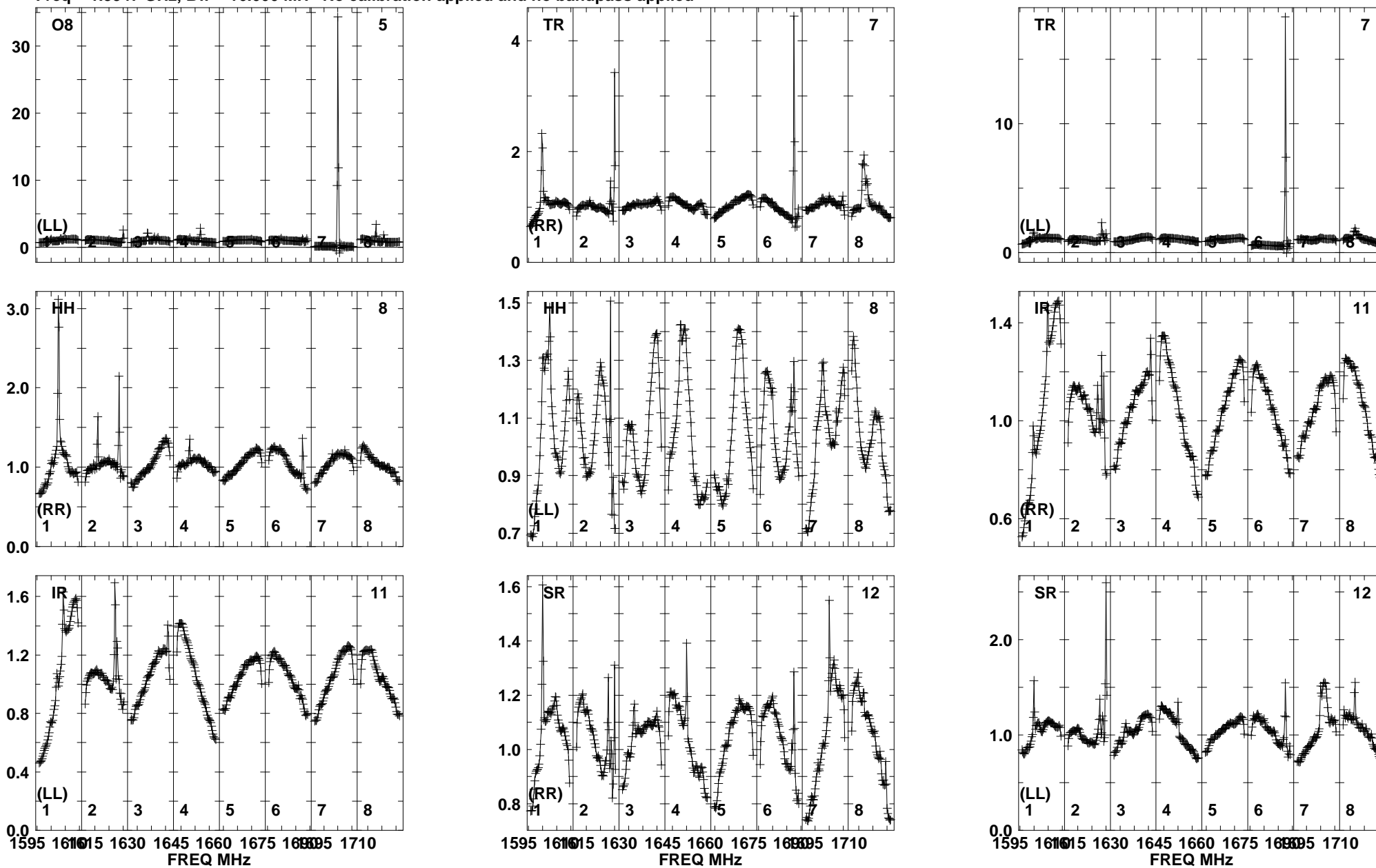

Lower frame: Real Jy
Total-power spectrum Antenna: O8 (05)
Timerange: 00/08:56:16 to 00/08:57:14

Plot file version 663 created 04-NOV-2019 14:14:54

J2248-0541 EY034.UVDATA.1

Freq = 1.5947 GHz, Bw = 16.000 MH No calibration applied and no bandpass applied

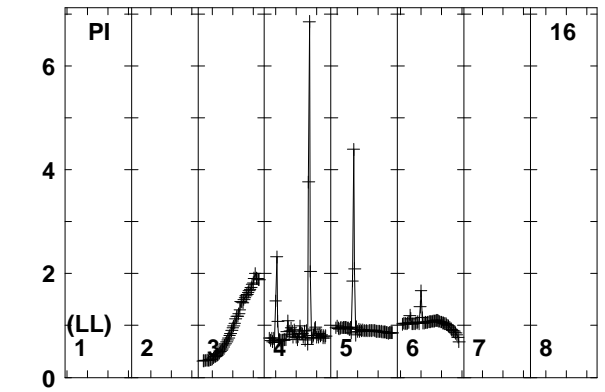
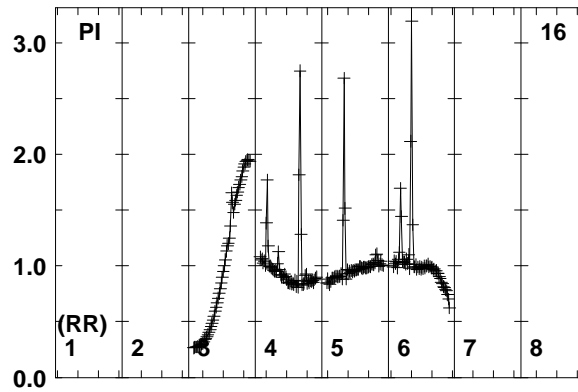
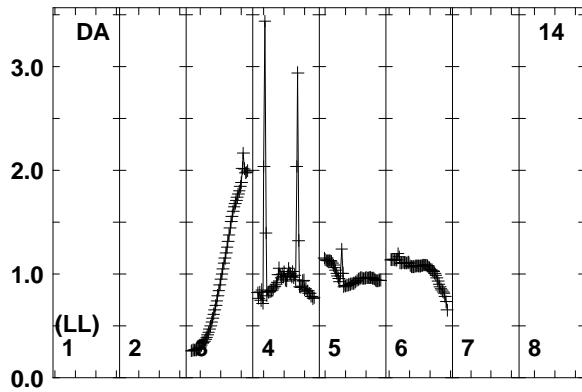
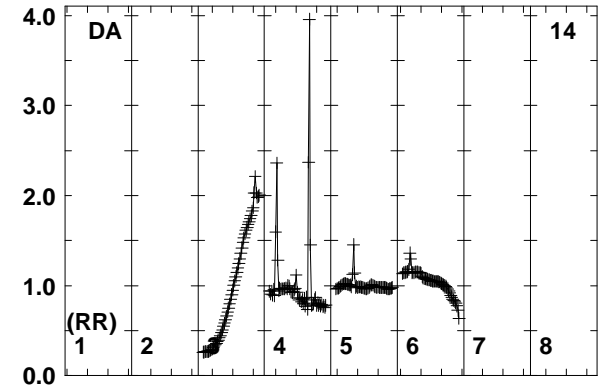
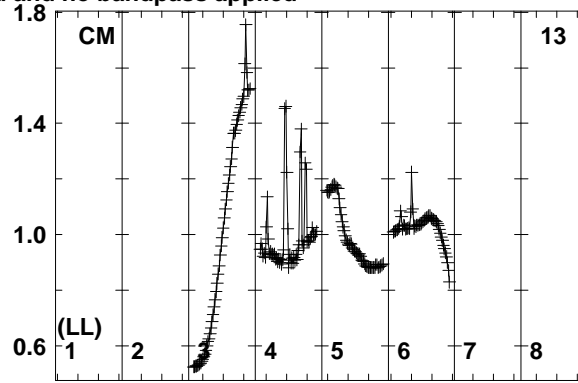
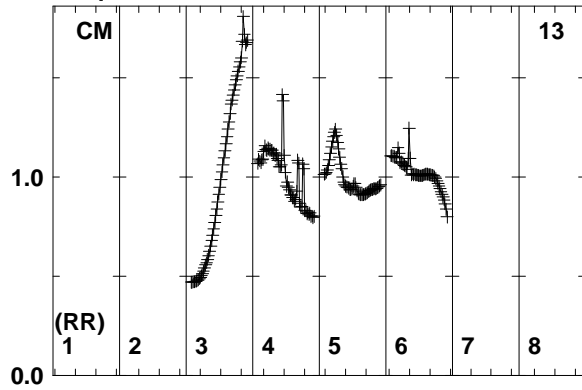

Lower frame: Real Jy
Total-power spectrum Antenna: CM (13)
Timerange: 00/08:56:16 to 00/08:57:14

Plot file version 664 created 04-NOV-2019 14:14:54

W2246-0526 EY034.UVDATA.1

Freq = 1.5947 GHz, Bw = 16.000 MH No calibration applied and no bandpass applied

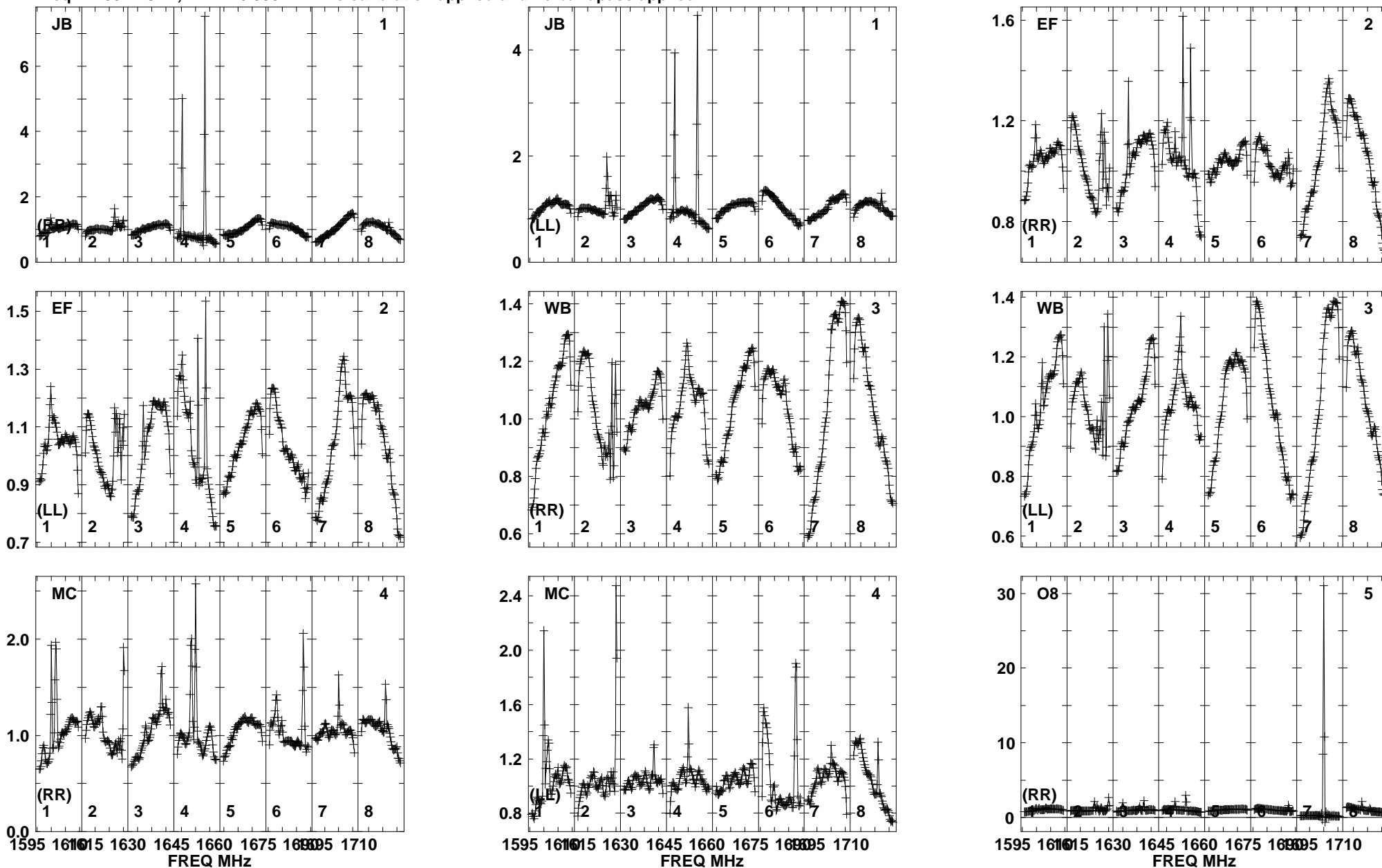

Lower frame: Real Jy
Total-power spectrum Antenna: JB (01)
Timerange: 00/08:57:16 to 00/08:59:54

Plot file version 665 created 04-NOV-2019 14:14:54

W2246-0526 EY034.UVDATA.1

Freq = 1.5947 GHz, Bw = 16.000 MH No calibration applied and no bandpass applied

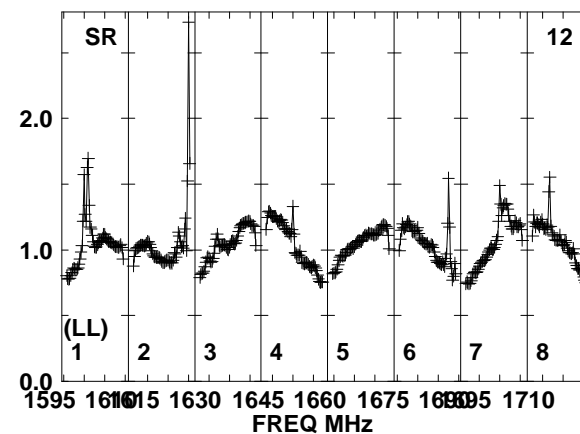
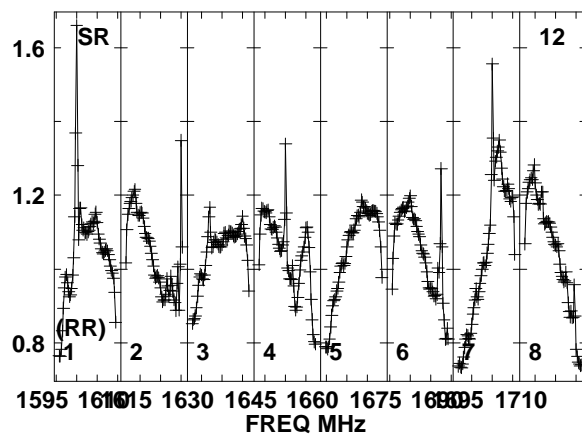
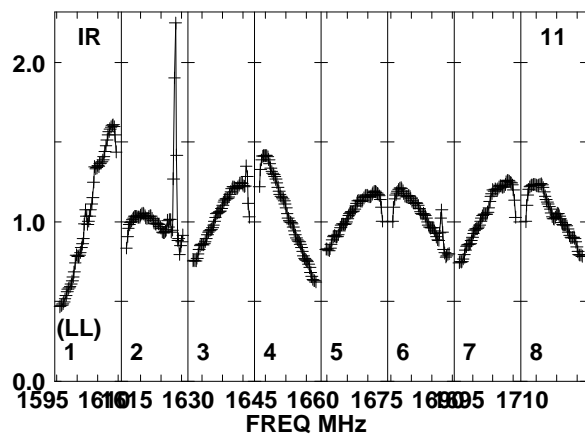
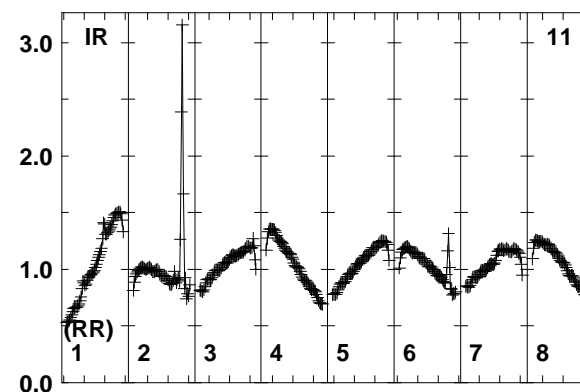
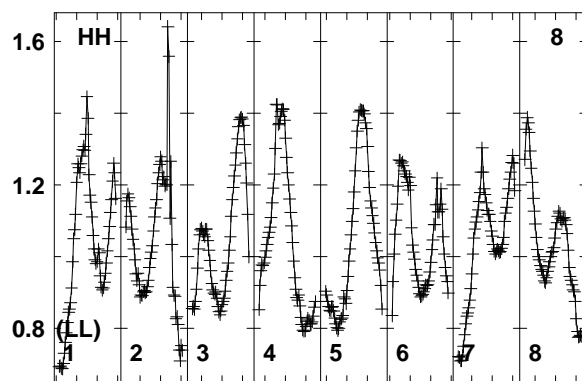
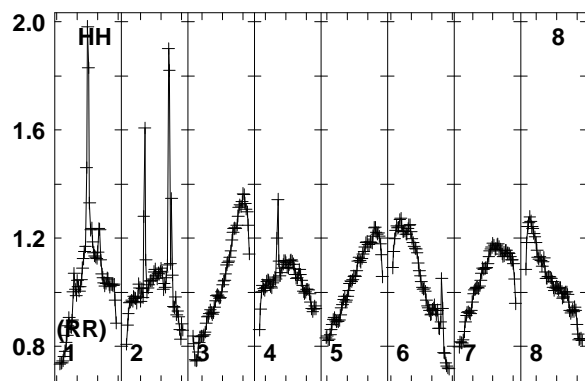
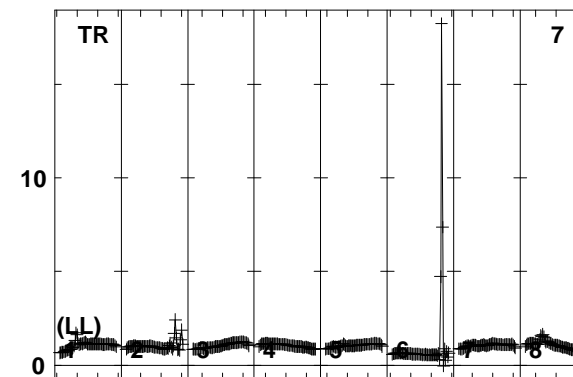
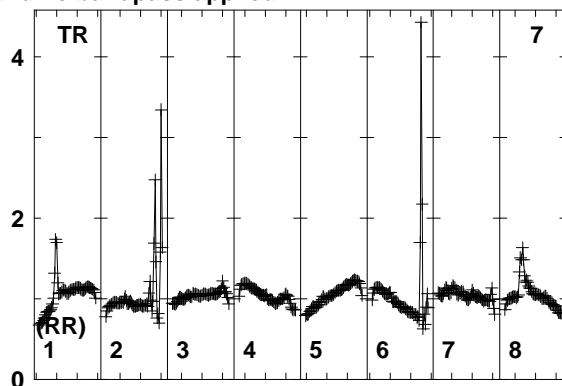
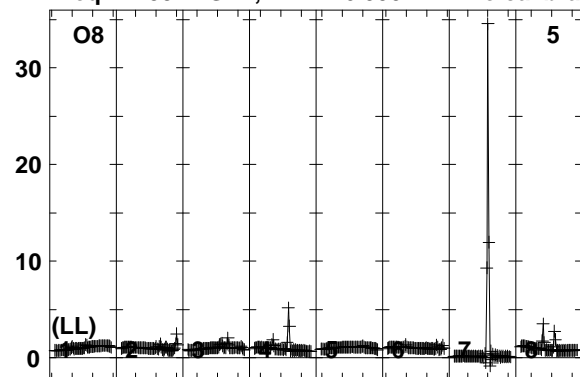

Lower frame: Real Jy
Total-power spectrum Antenna: O8 (05)
Timerange: 00/08:57:16 to 00/08:59:54

Plot file version 666 created 04-NOV-2019 14:14:54

W2246-0526 EY034.UVDATA.1

Freq = 1.5947 GHz, Bw = 16.000 MH No calibration applied and no bandpass applied

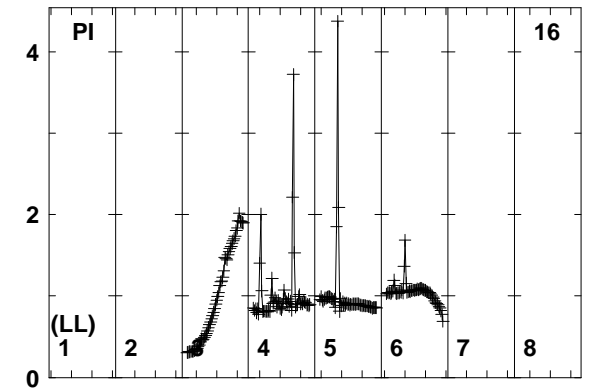
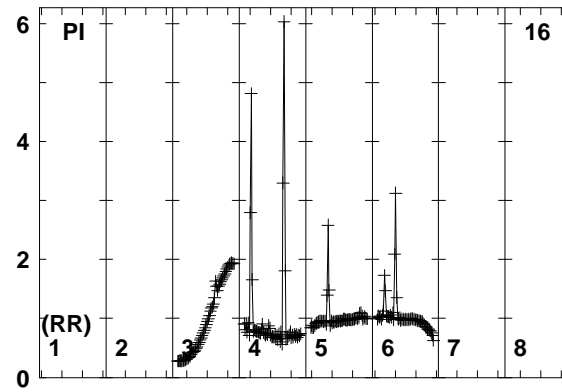
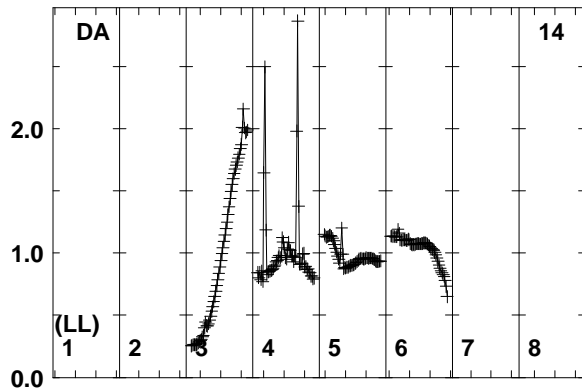
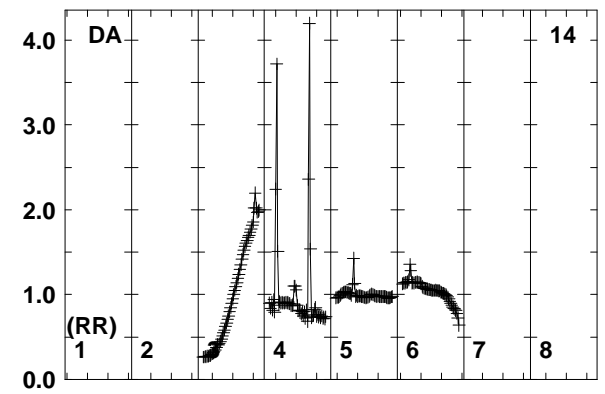
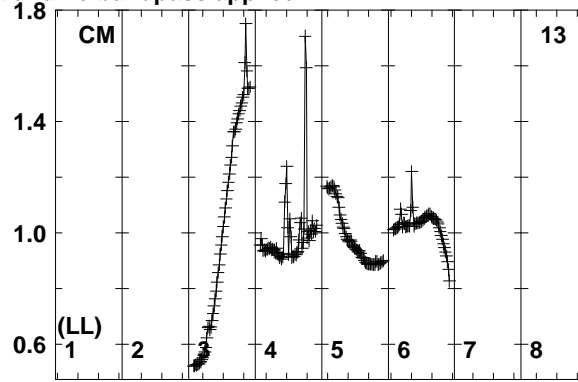
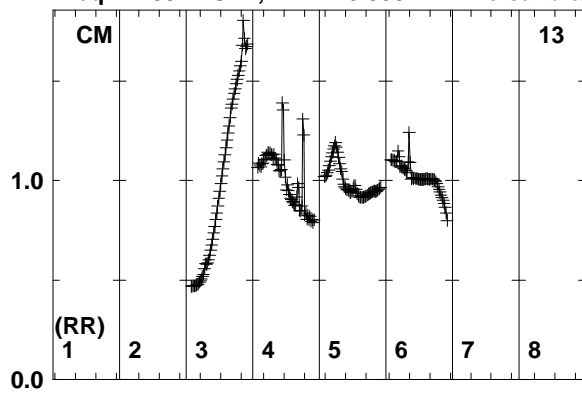

Lower frame: Real Jy
Total-power spectrum Antenna: CM (13)
Timerange: 00/08:57:16 to 00/08:59:54

Plot file version 667 created 04-NOV-2019 14:14:54

J2248-0541 EY034.UVDATA.1

Freq = 1.5947 GHz, Bw = 16.000 MH No calibration applied and no bandpass applied

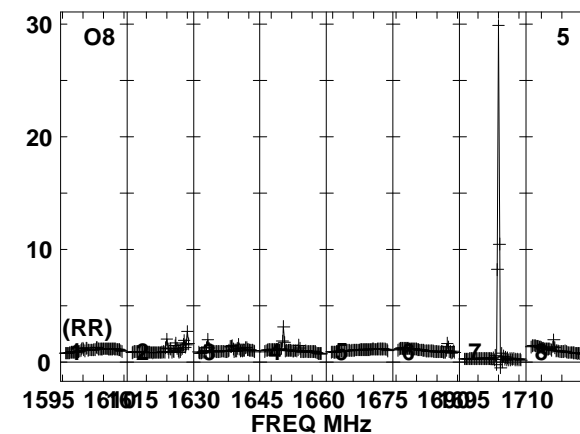
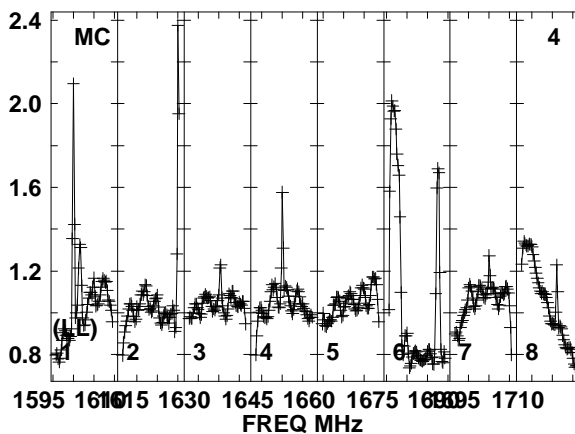
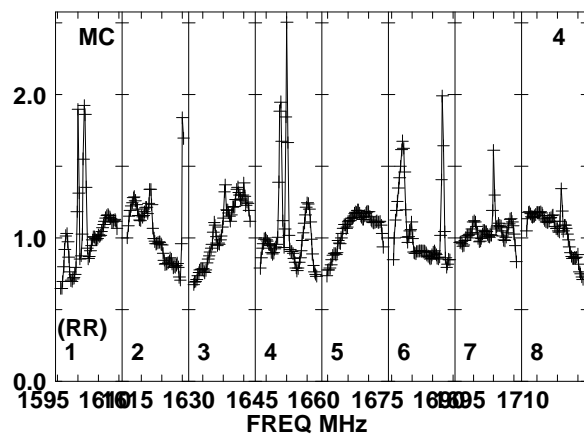
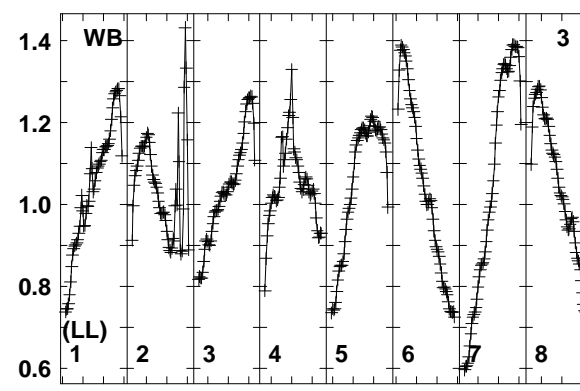
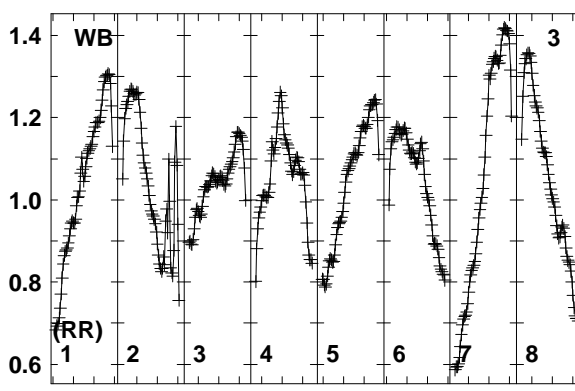
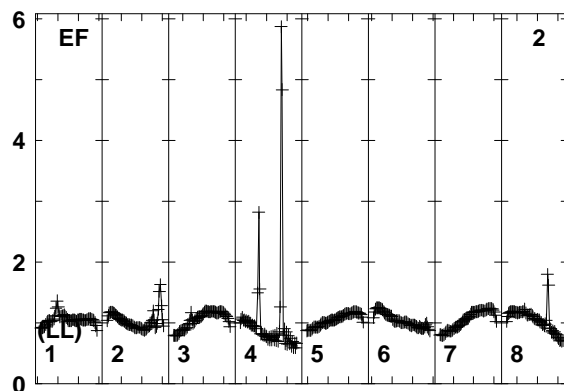
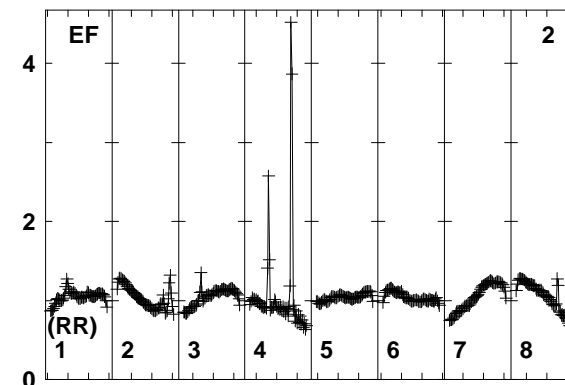
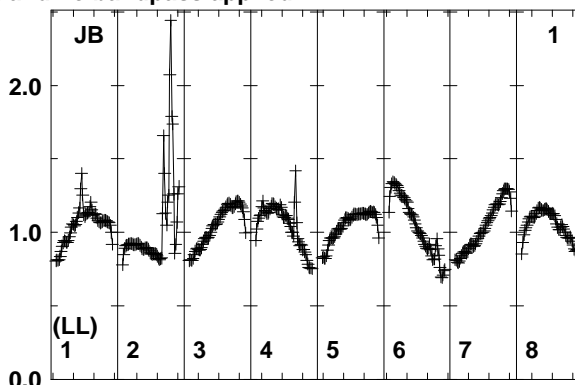
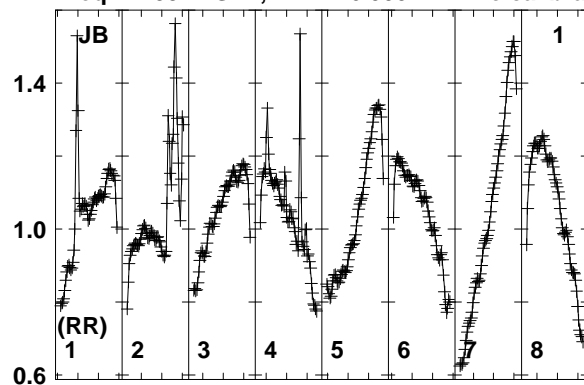

Lower frame: Real Jy
Total-power spectrum Antenna: JB (01)
Timerange: 00/09:00:11 to 00/09:01:09

Plot file version 668 created 04-NOV-2019 14:14:54

J2248-0541 EY034.UVDATA.1

Freq = 1.5947 GHz, Bw = 16.000 MH No calibration applied and no bandpass applied

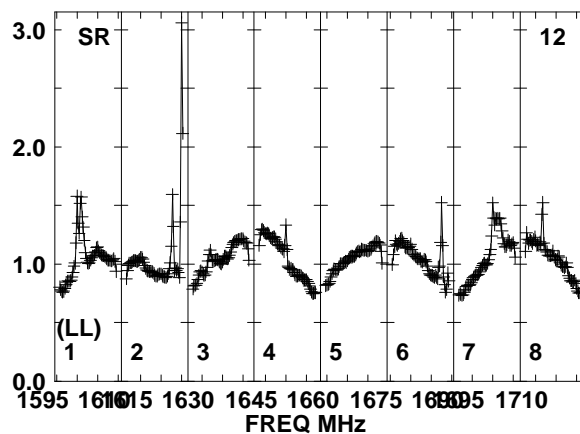
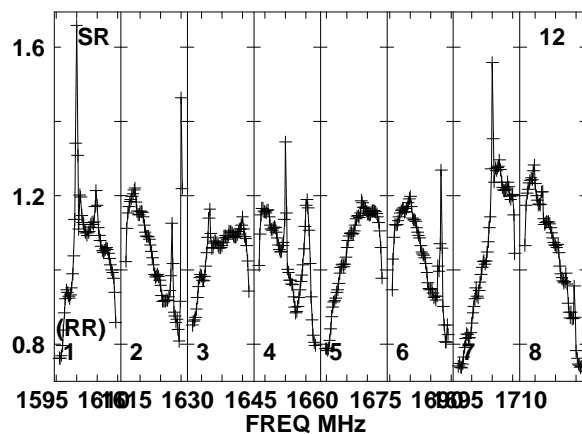
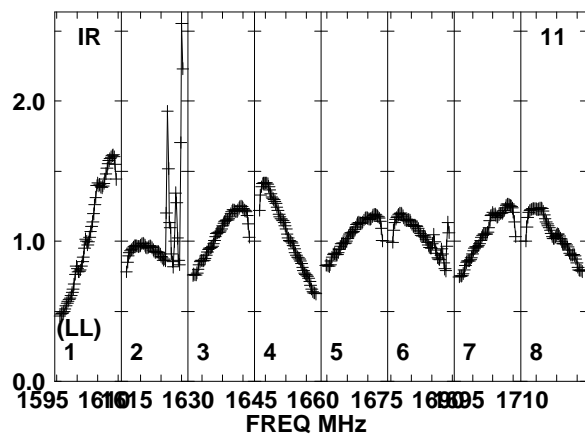
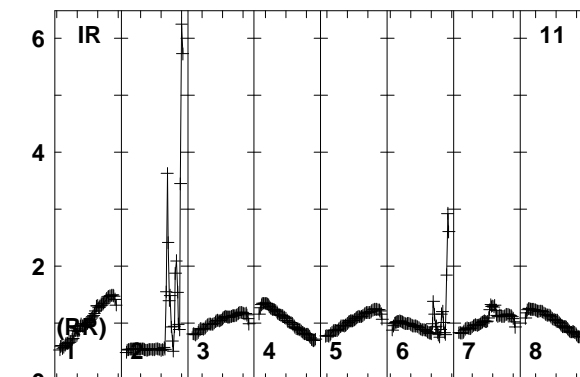
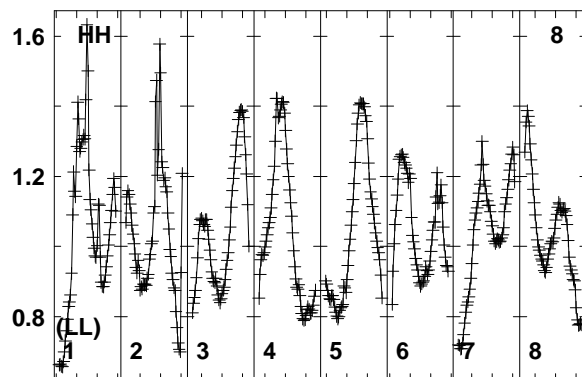
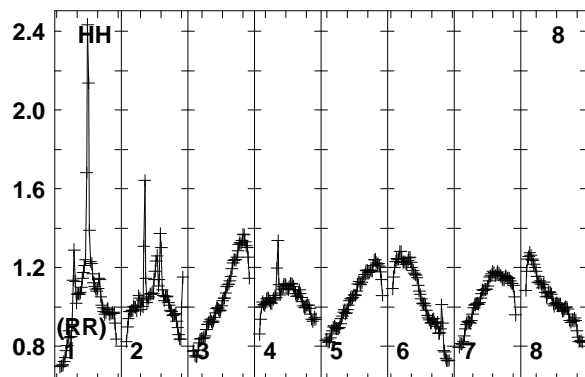
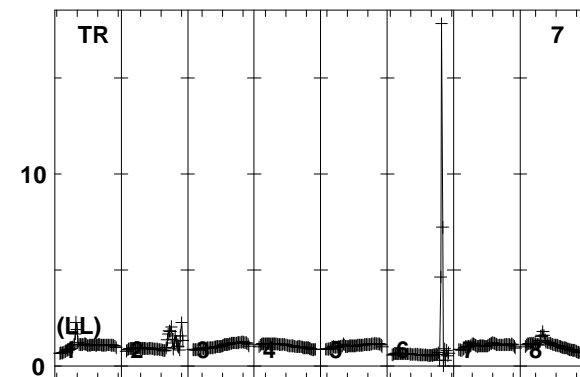
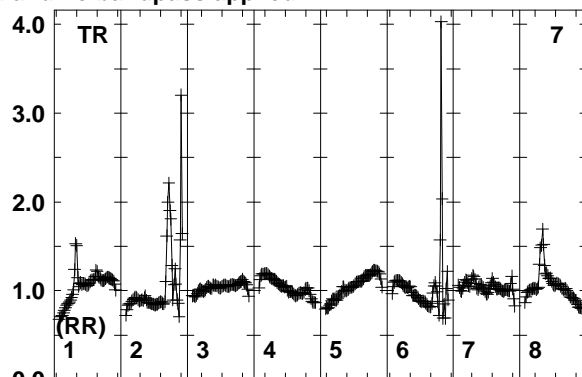
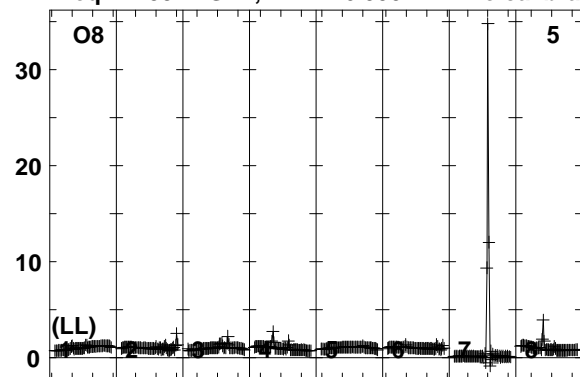

Lower frame: Real Jy
Total-power spectrum Antenna: O8 (05)
Timerange: 00/09:00:11 to 00/09:01:09

Plot file version 669 created 04-NOV-2019 14:14:55

J2248-0541 EY034.UVDATA.1

Freq = 1.5947 GHz, Bw = 16.000 MH No calibration applied and no bandpass applied

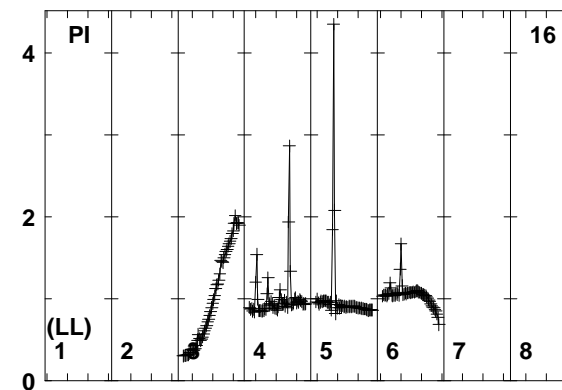
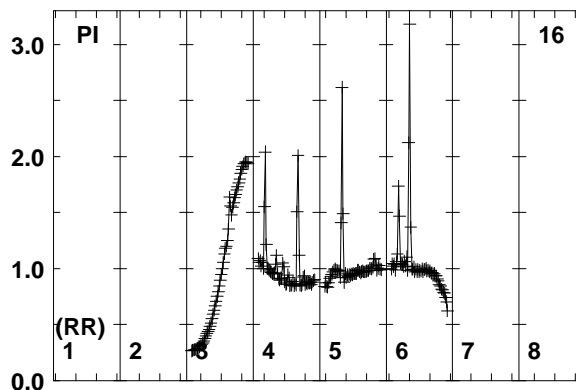
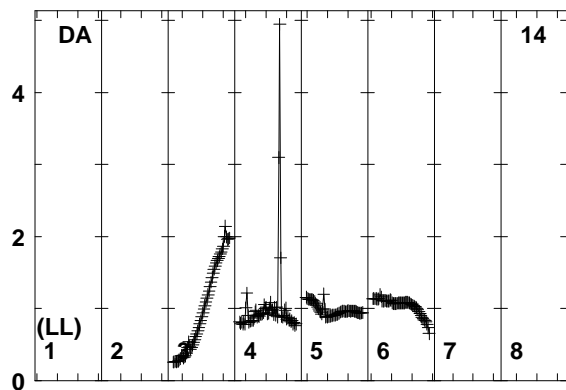
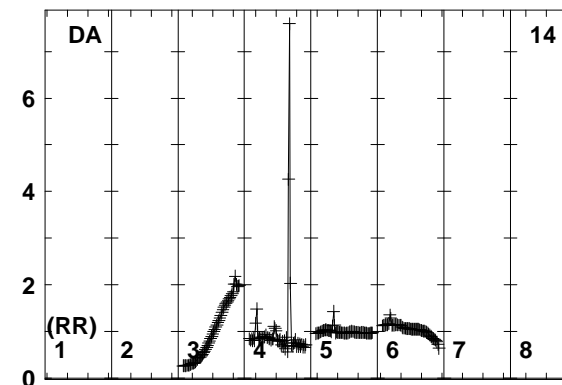
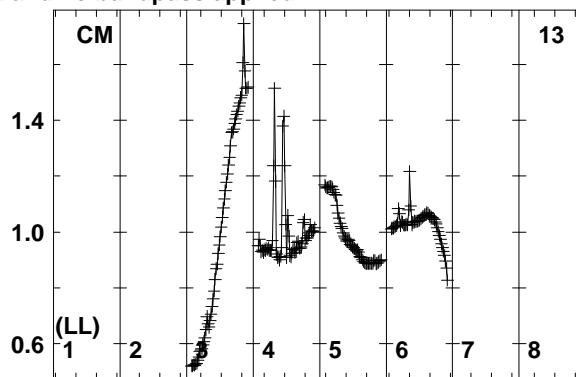
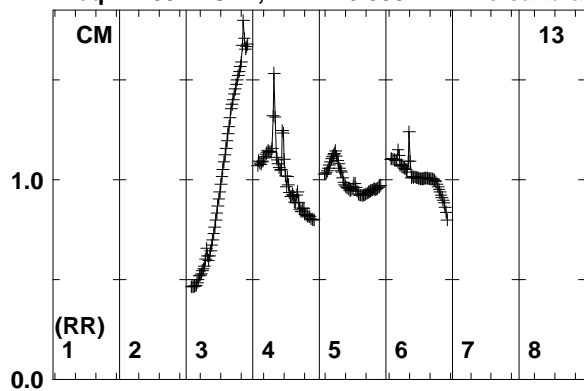

Lower frame: Real Jy
Total-power spectrum Antenna: CM (13)
Timerange: 00/09:00:11 to 00/09:01:09

Plot file version 670 created 04-NOV-2019 14:14:55

W2246-0526 EY034.UVDATA.1

Freq = 1.5947 GHz, Bw = 16.000 MH No calibration applied and no bandpass applied

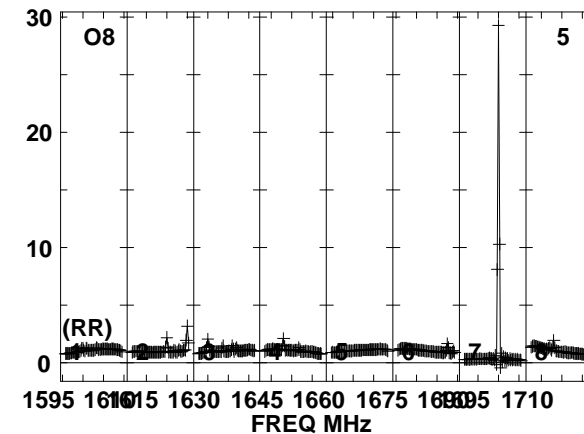
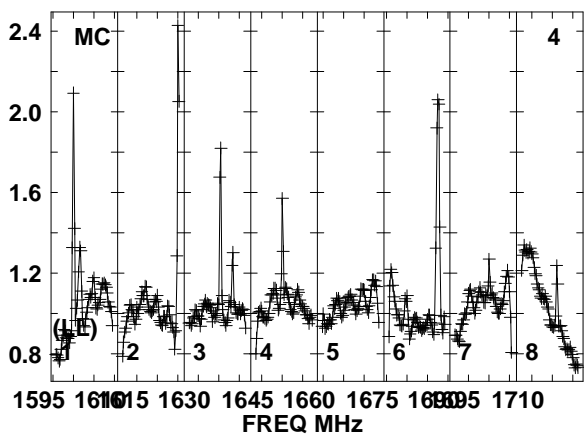
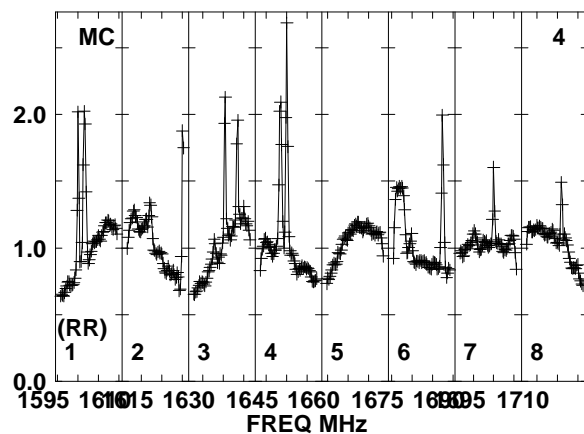
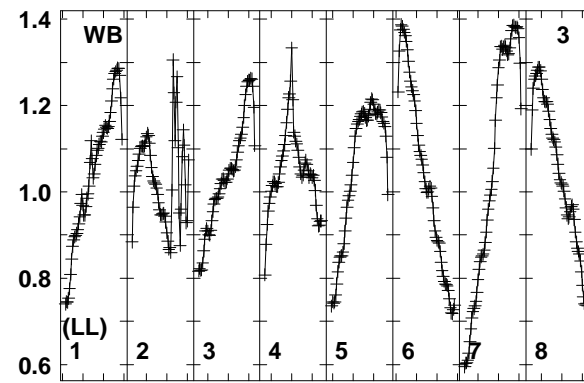
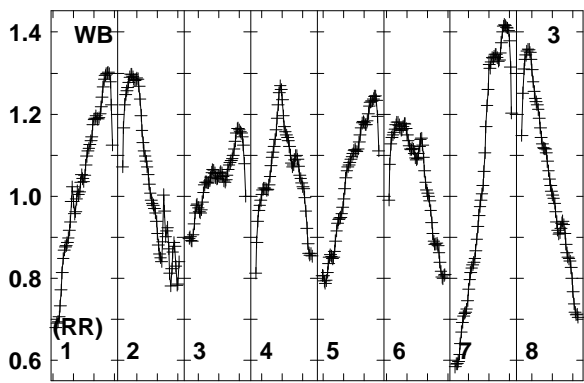
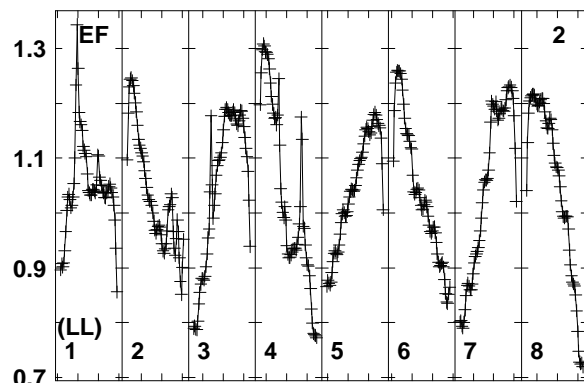
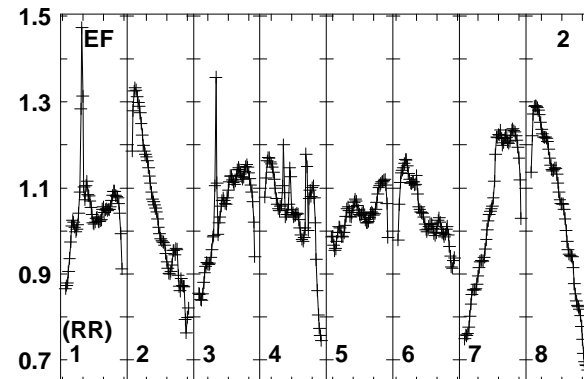
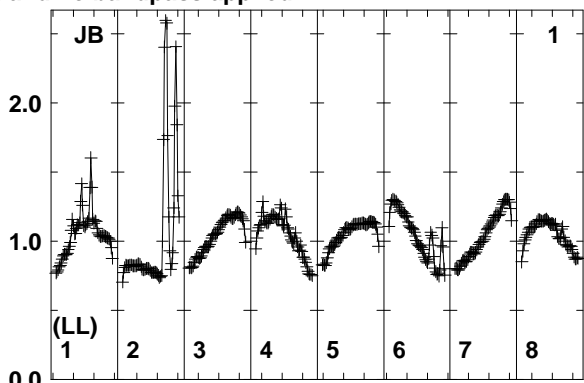
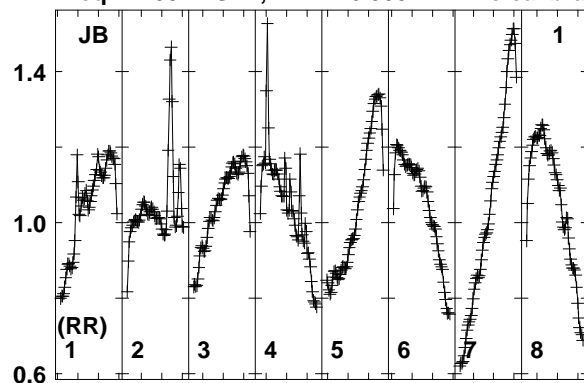

Lower frame: Real Jy
Total-power spectrum Antenna: JB (01)
Timerange: 00/09:01:11 to 00/09:03:49

Plot file version 671 created 04-NOV-2019 14:14:55

W2246-0526 EY034.UVDATA.1

Freq = 1.5947 GHz, Bw = 16.000 MH No calibration applied and no bandpass applied

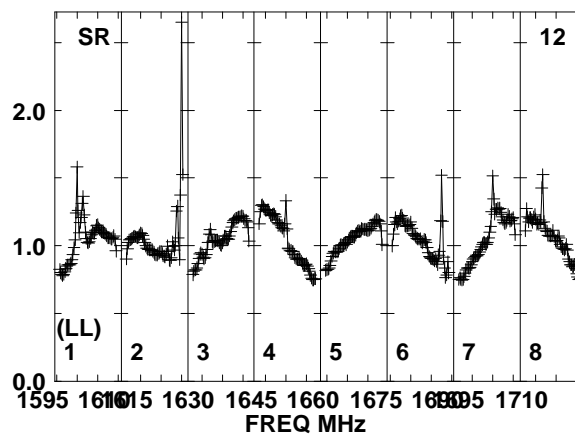
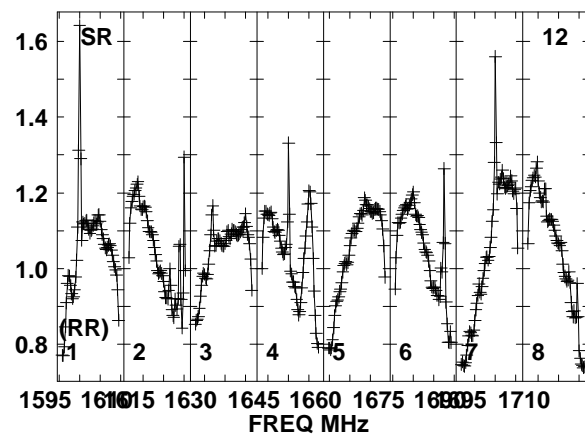
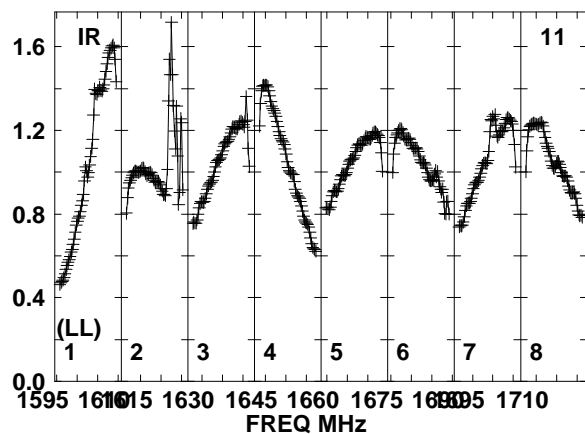
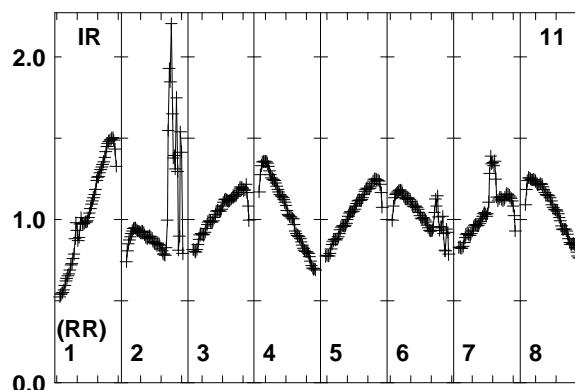
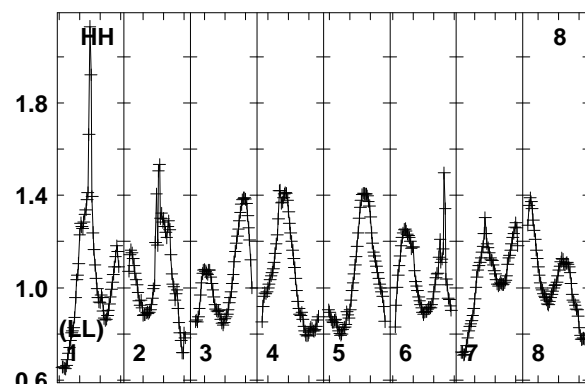
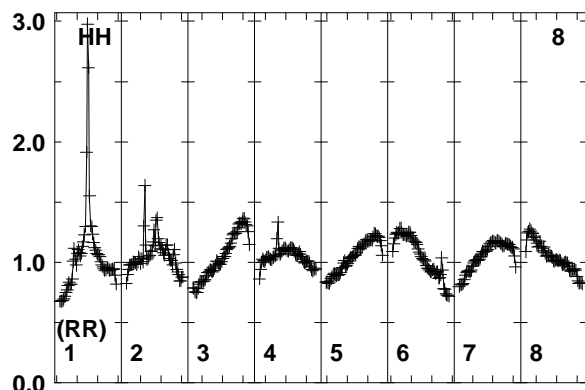
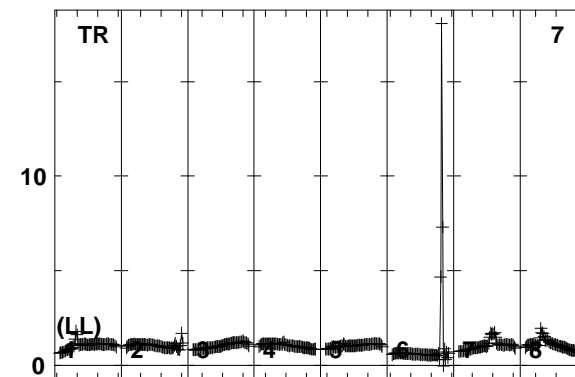
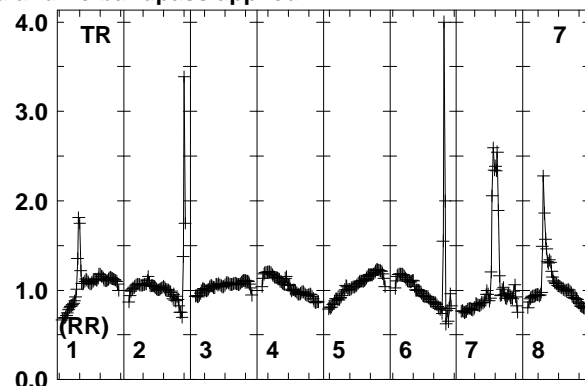
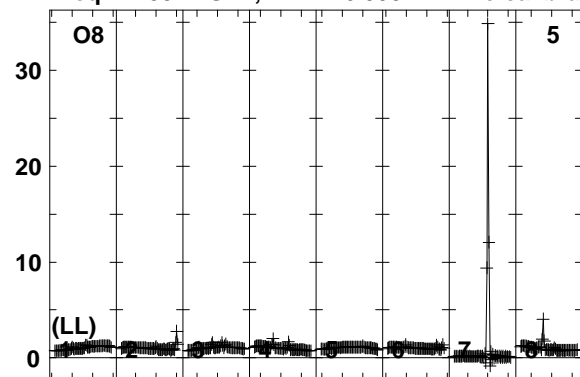

Lower frame: Real Jy
Total-power spectrum Antenna: O8 (05)
Timerange: 00/09:01:11 to 00/09:03:49

Plot file version 672 created 04-NOV-2019 14:14:55
W2246-0526 EY034.UVDATA.1
Freq = 1.5947 GHz, Bw = 16.000 MH No calibration applied and no bandpass applied

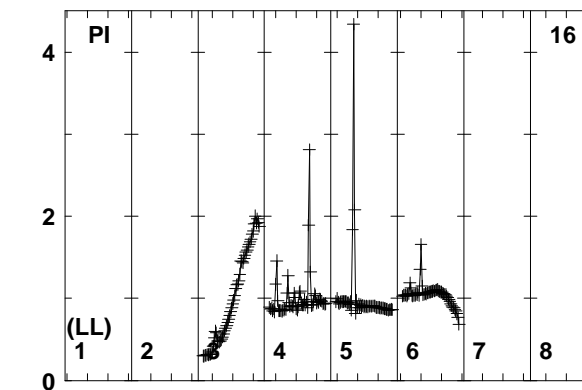
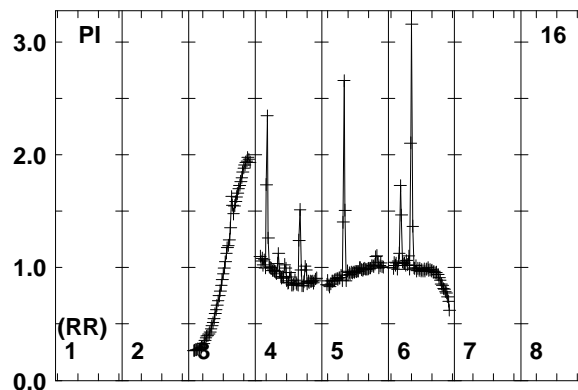
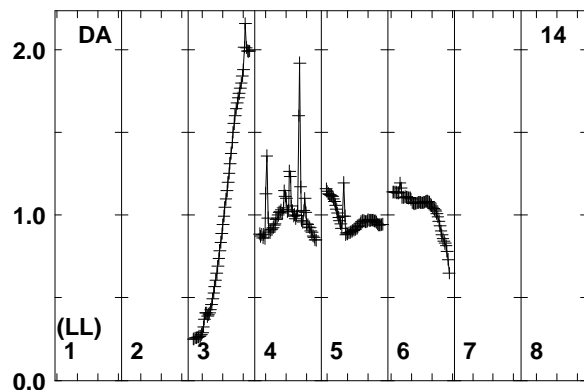
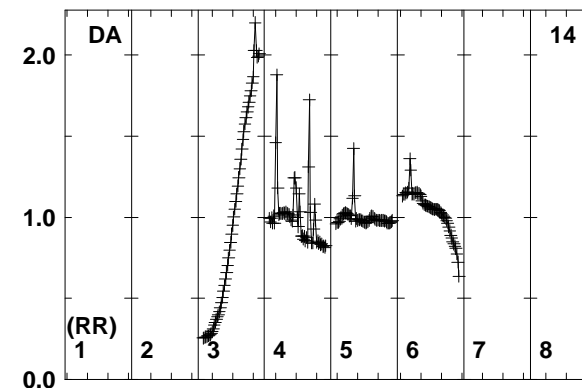
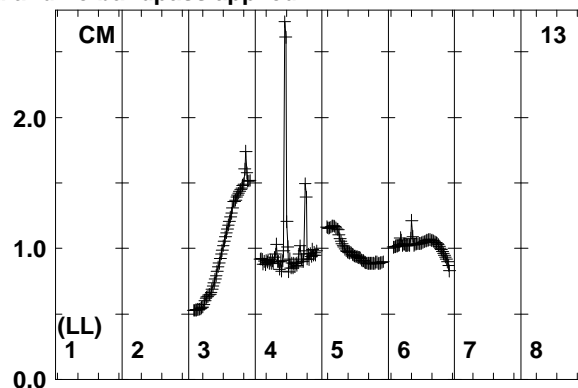
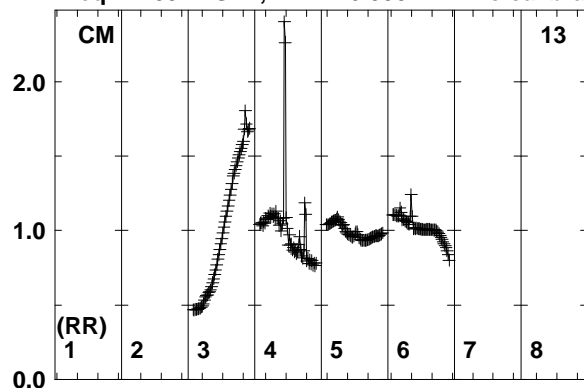

Lower frame: Real Jy
Total-power spectrum Antenna: CM (13)
Timerange: 00/09:01:11 to 00/09:03:49

Plot file version 673 created 04-NOV-2019 14:14:55

J2248-0541 EY034.UVDATA.1

Freq = 1.5947 GHz, Bw = 16.000 MH No calibration applied and no bandpass applied

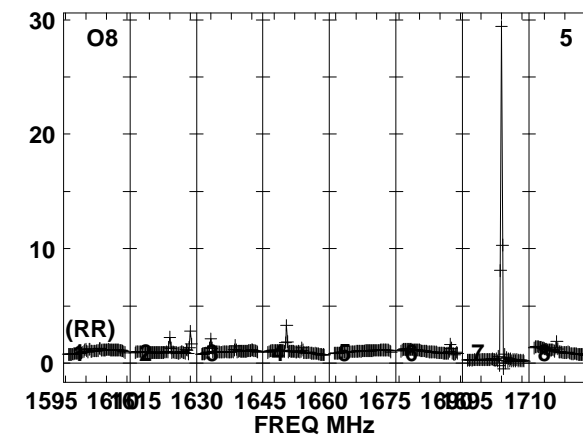
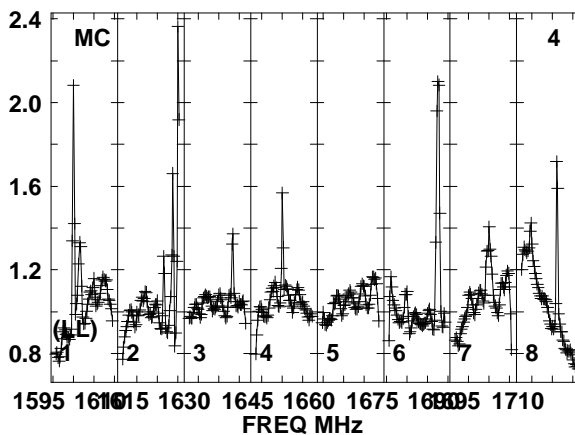
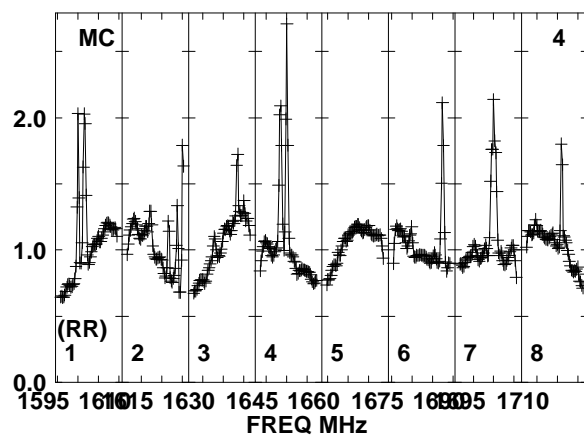
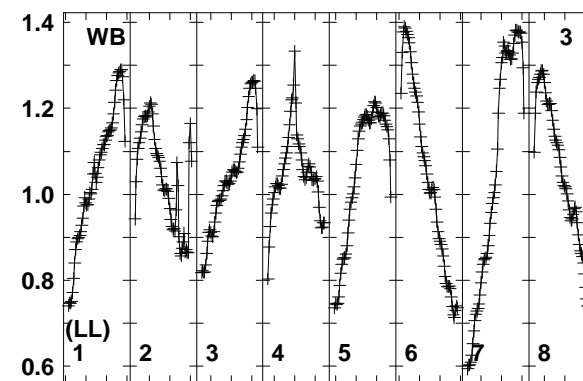
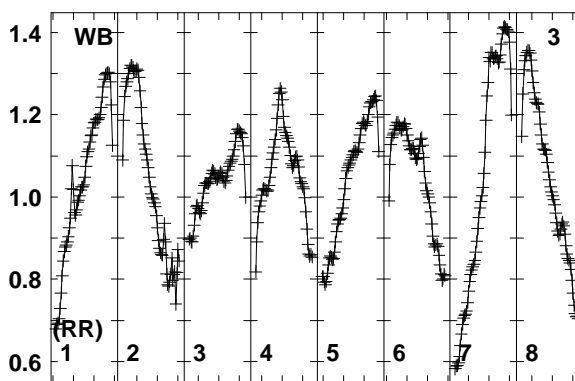
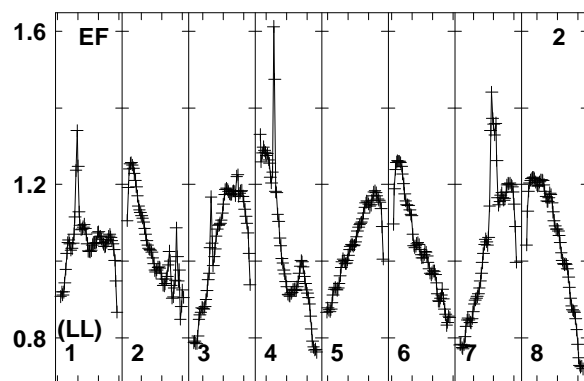
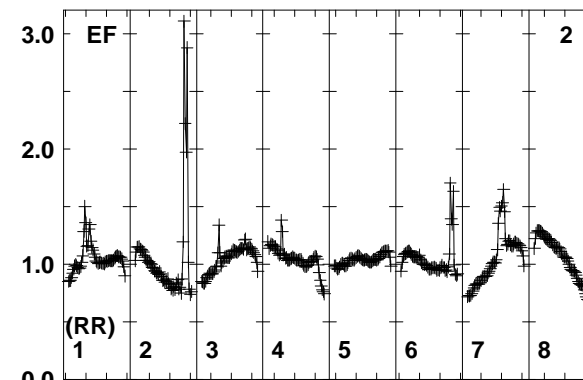
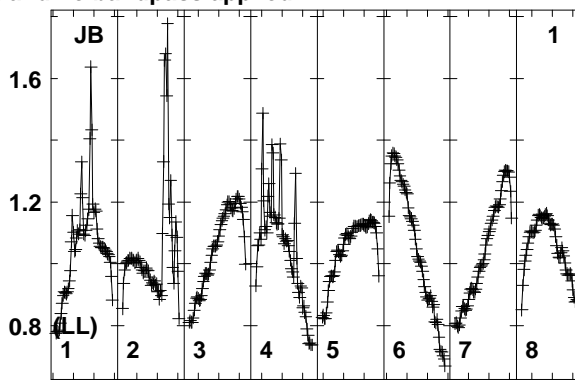
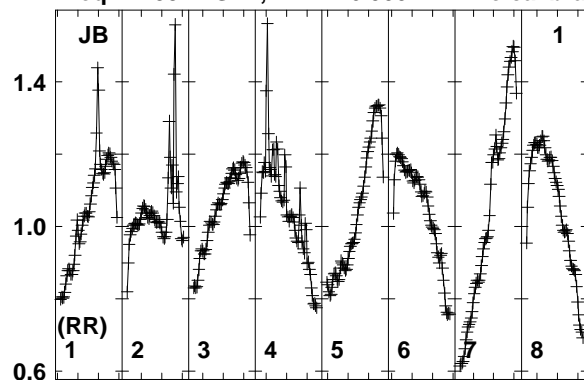

Lower frame: Real Jy
Total-power spectrum Antenna: JB (01)
Timerange: 00/09:04:06 to 00/09:05:04

Plot file version 674 created 04-NOV-2019 14:14:55

J2248-0541 EY034.UVDATA.1

Freq = 1.5947 GHz, Bw = 16.000 MH No calibration applied and no bandpass applied

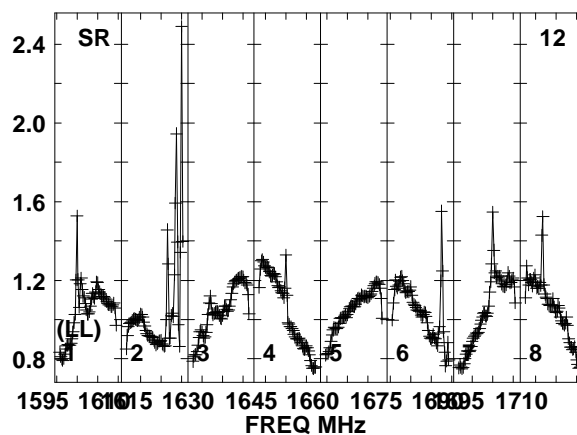
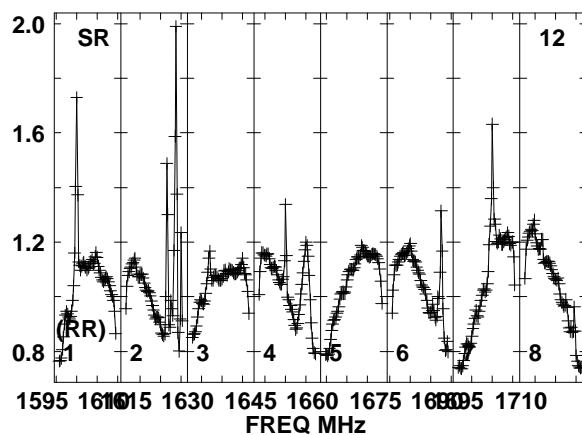
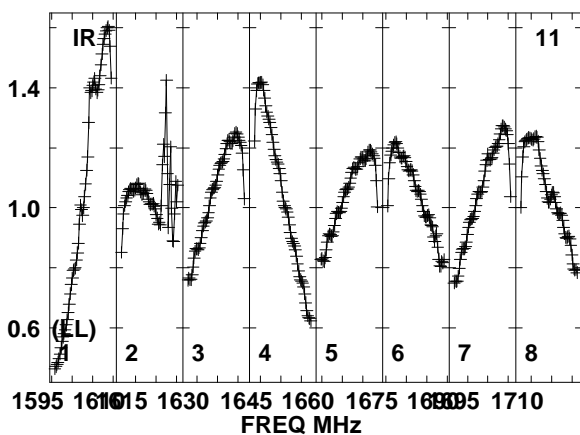
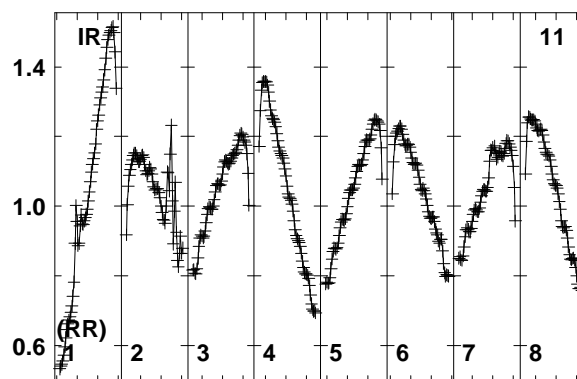
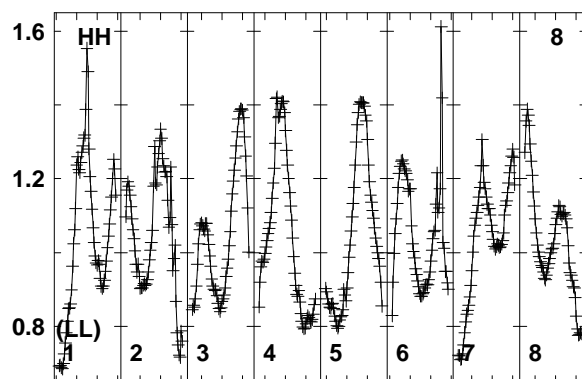
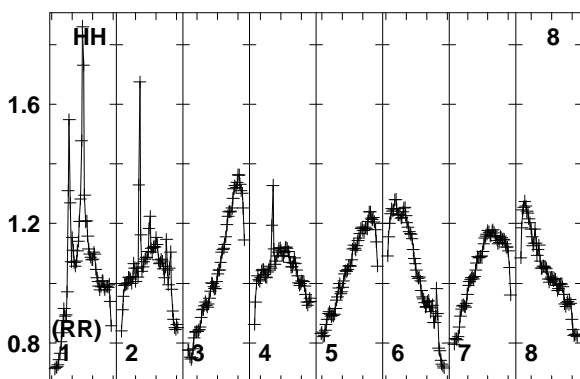
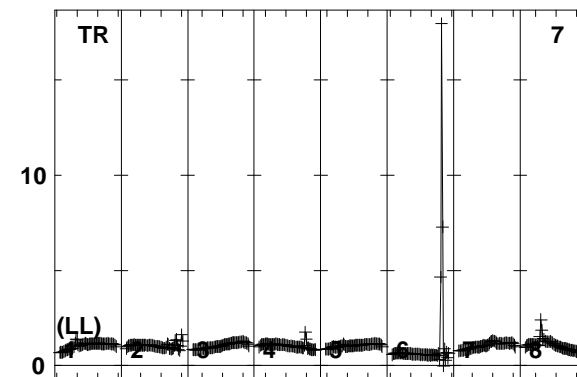
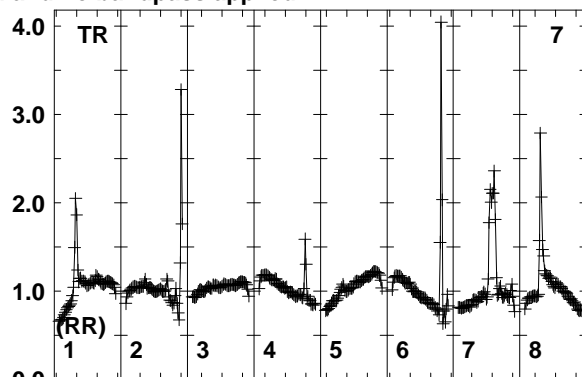
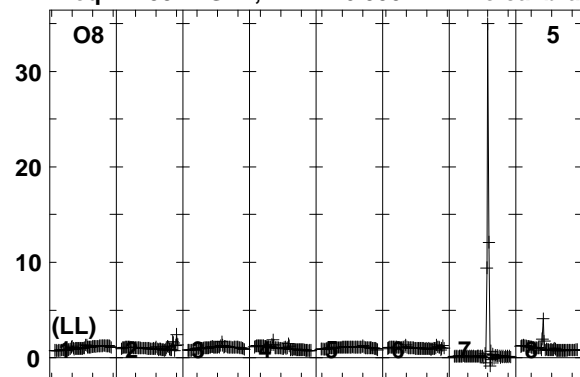

Lower frame: Real Jy
Total-power spectrum Antenna: O8 (05)
Timerange: 00/09:04:06 to 00/09:05:04

Plot file version 675 created 04-NOV-2019 14:14:55

J2248-0541 EY034.UVDATA.1

Freq = 1.5947 GHz, Bw = 16.000 MH No calibration applied and no bandpass applied

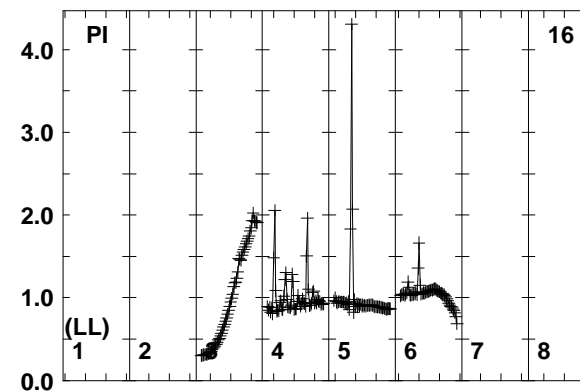
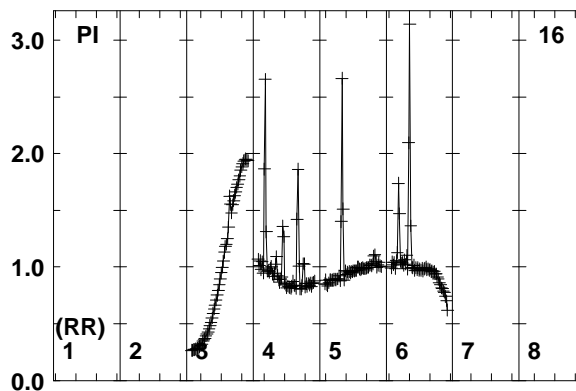
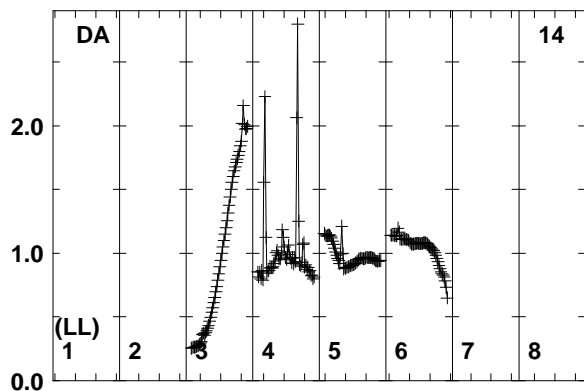
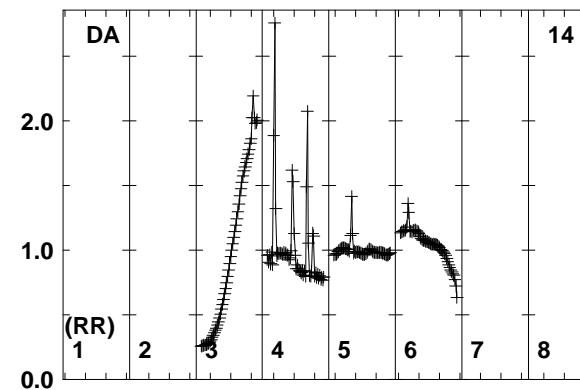
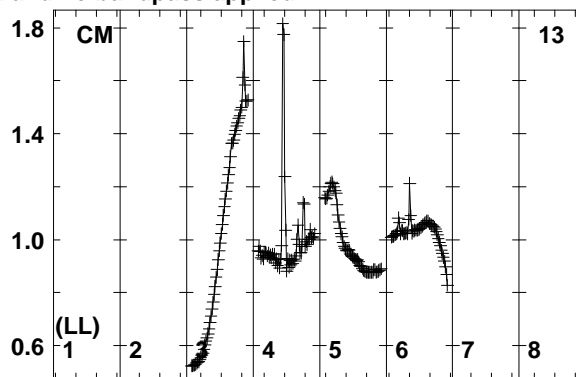
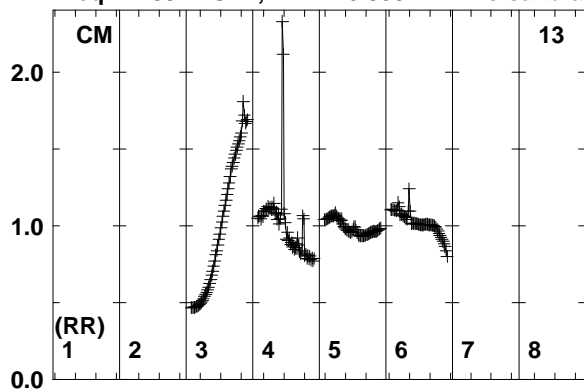

Lower frame: Real Jy
Total-power spectrum Antenna: CM (13)
Timerange: 00/09:04:06 to 00/09:05:04

Plot file version 676 created 04-NOV-2019 14:14:55

W2246-0526 EY034.UVDATA.1

Freq = 1.5947 GHz, Bw = 16.000 MH No calibration applied and no bandpass applied

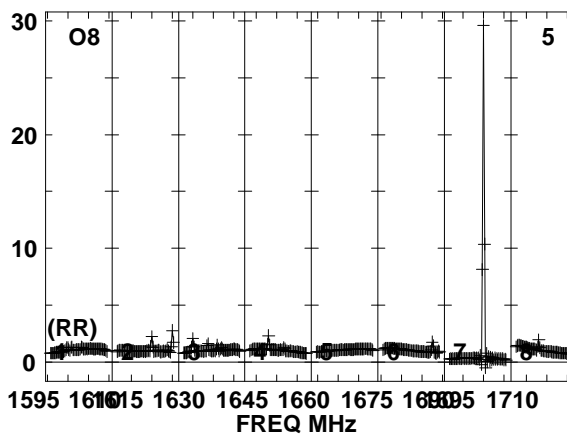
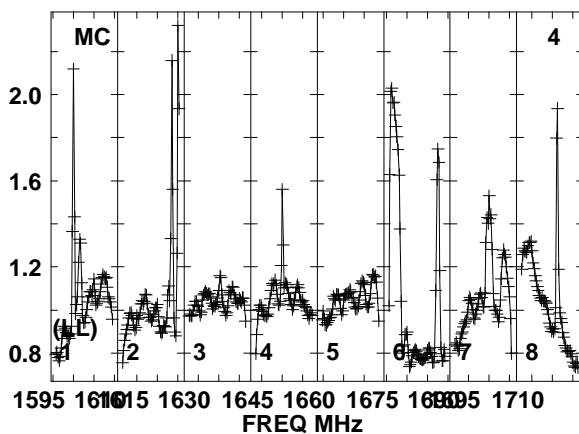
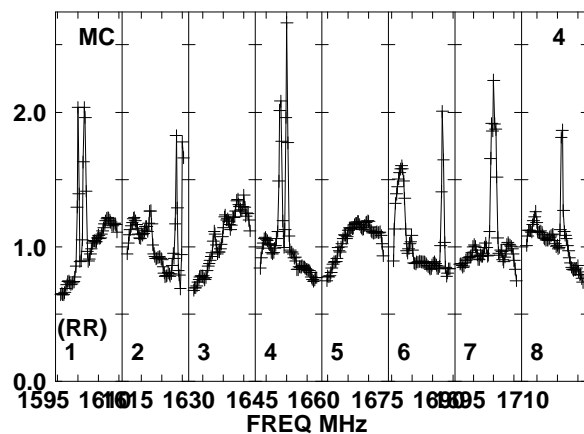
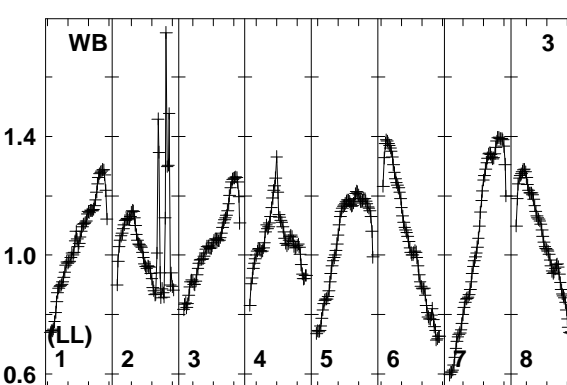
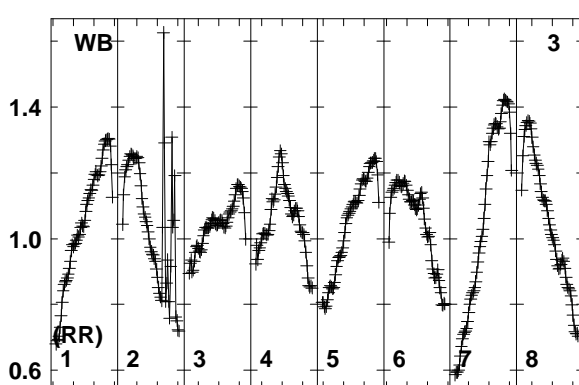
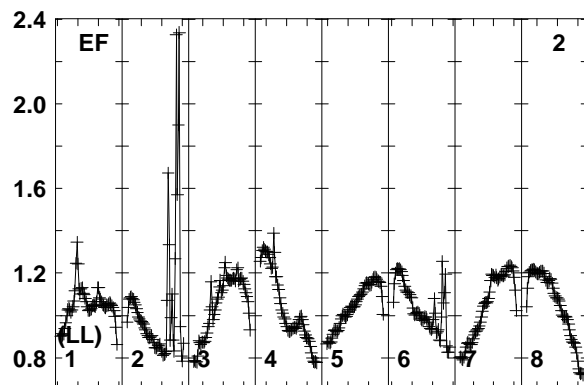
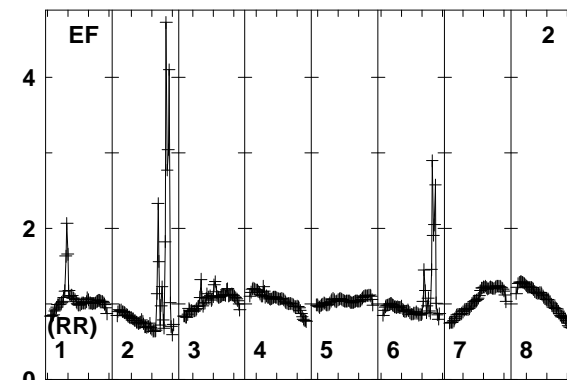
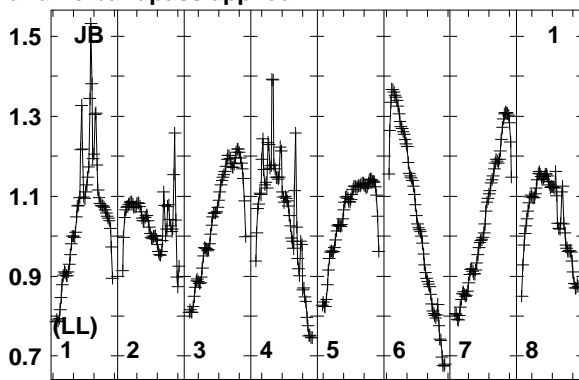
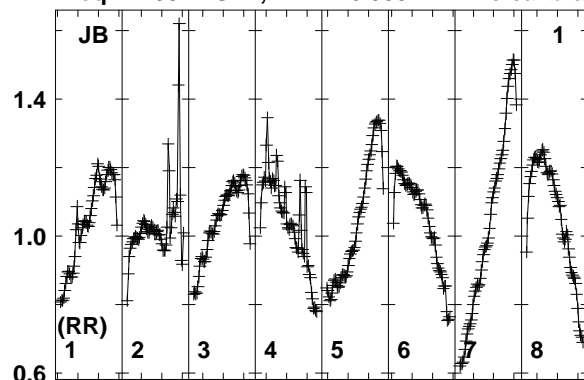

Lower frame: Real Jy
Total-power spectrum Antenna: JB (01)
Timerange: 00/09:05:06 to 00/09:07:44

Plot file version 677 created 04-NOV-2019 14:14:55

W2246-0526 EY034.UVDATA.1

Freq = 1.5947 GHz, Bw = 16.000 MH No calibration applied and no bandpass applied

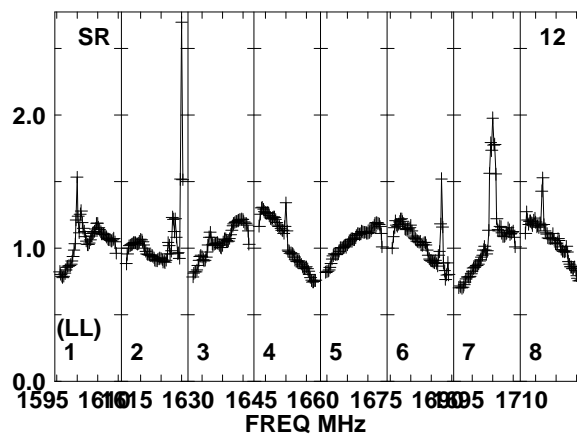
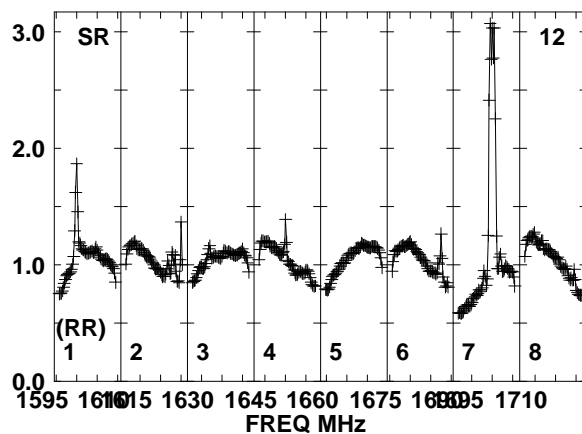
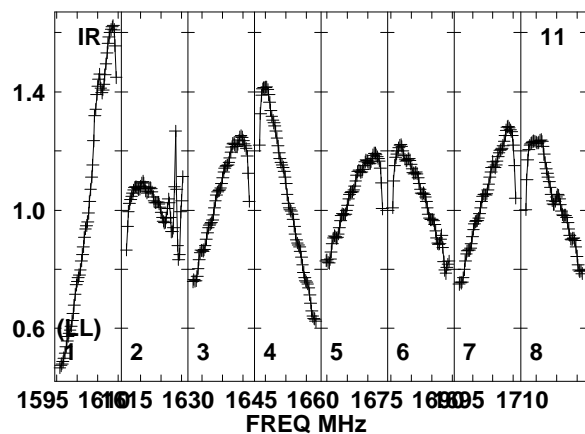
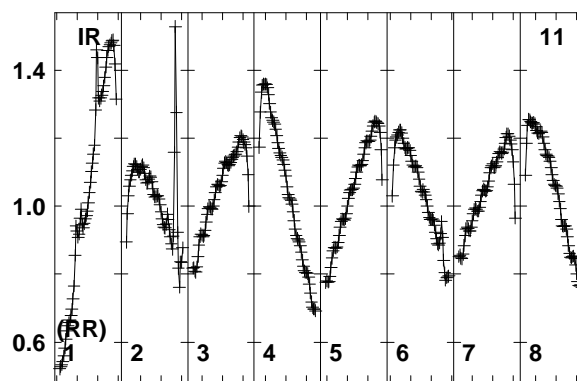
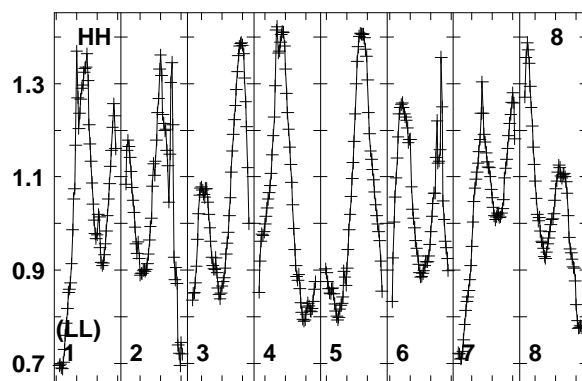
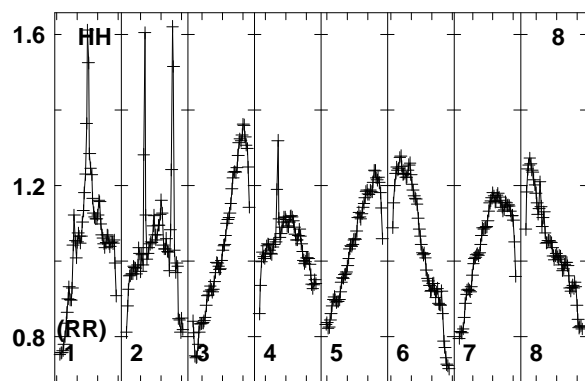
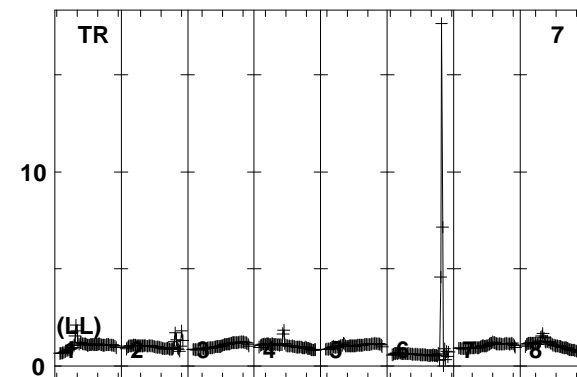
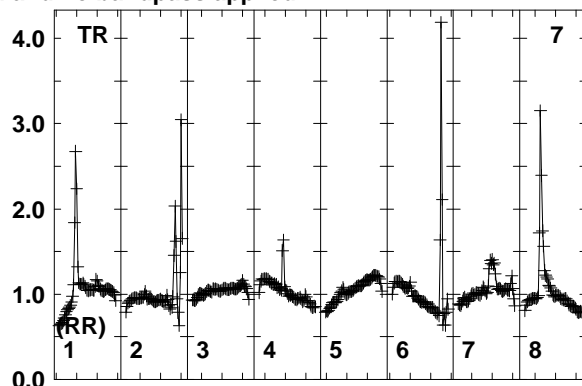
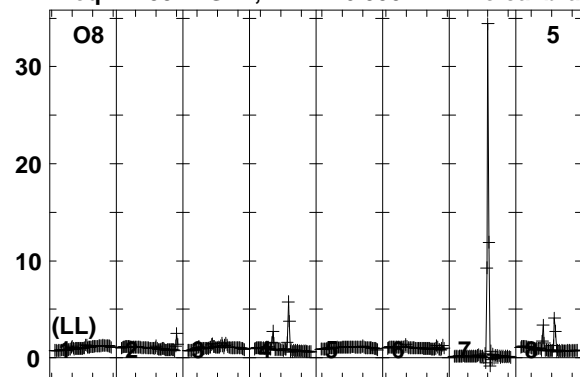

Lower frame: Real Jy
Total-power spectrum Antenna: O8 (05)
Timerange: 00/09:05:06 to 00/09:07:44

Plot file version 678 created 04-NOV-2019 14:14:55

W2246-0526 EY034.UVDATA.1

Freq = 1.5947 GHz, Bw = 16.000 MH No calibration applied and no bandpass applied

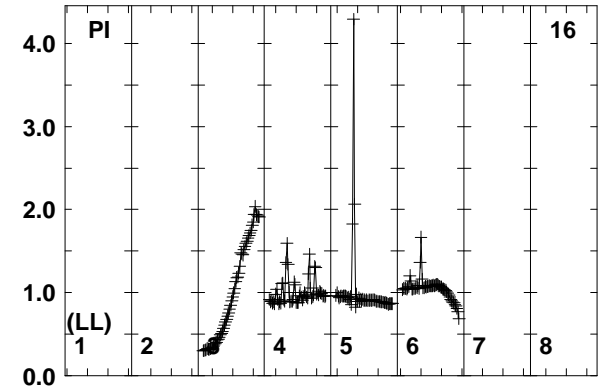
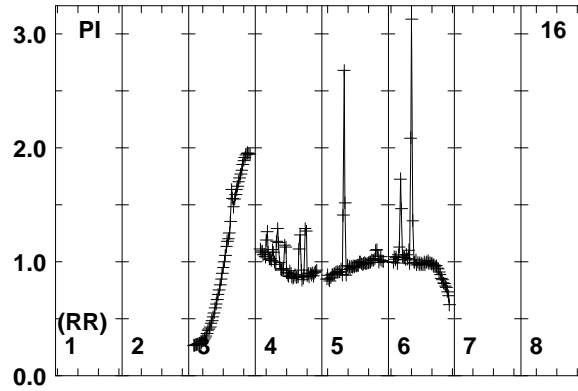
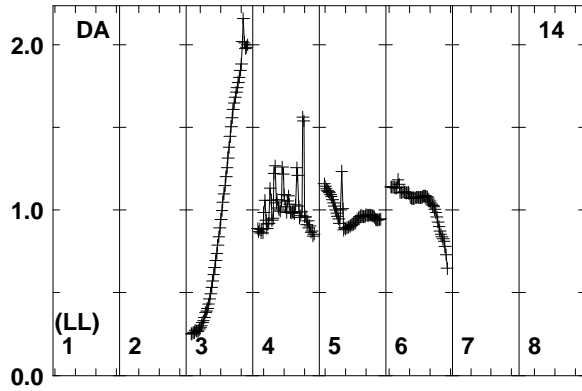
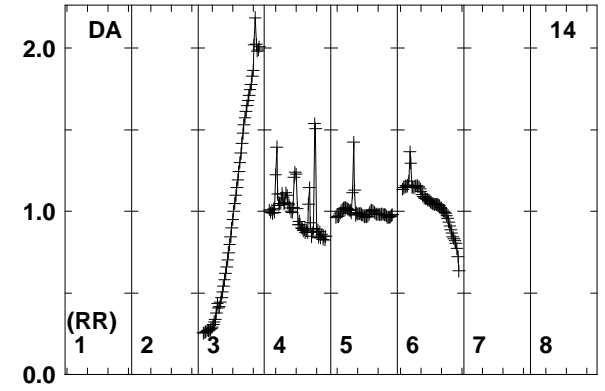
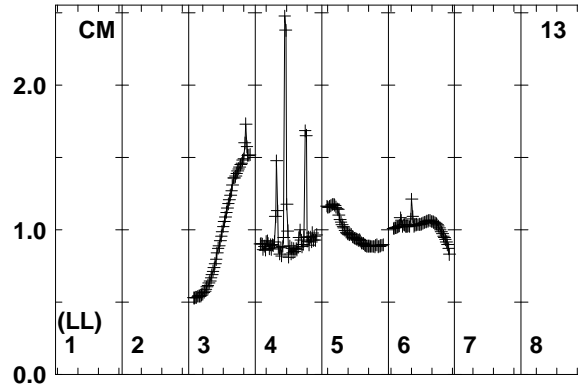
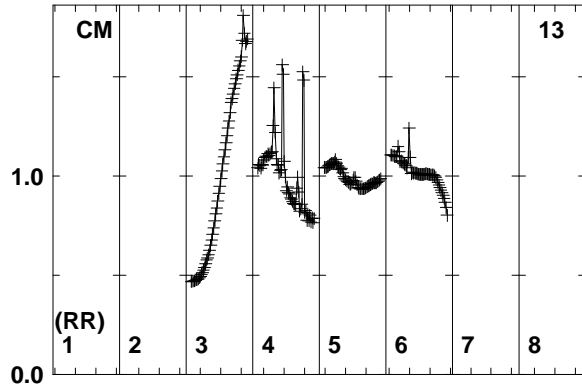

Lower frame: Real Jy
Total-power spectrum Antenna: CM (13)
Timerange: 00/09:05:06 to 00/09:07:44

Plot file version 679 created 04-NOV-2019 14:14:55

J2248-0541 EY034.UVDATA.1

Freq = 1.5947 GHz, Bw = 16.000 MH No calibration applied and no bandpass applied

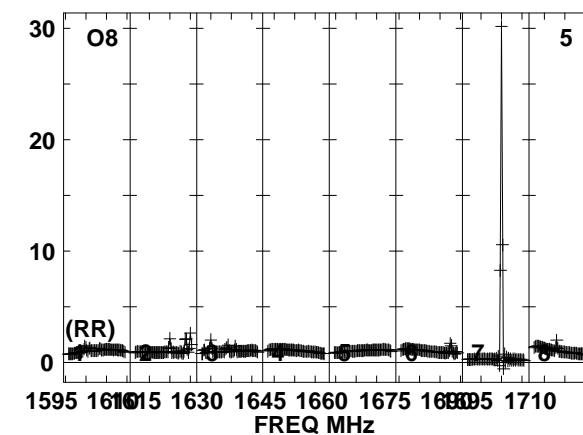
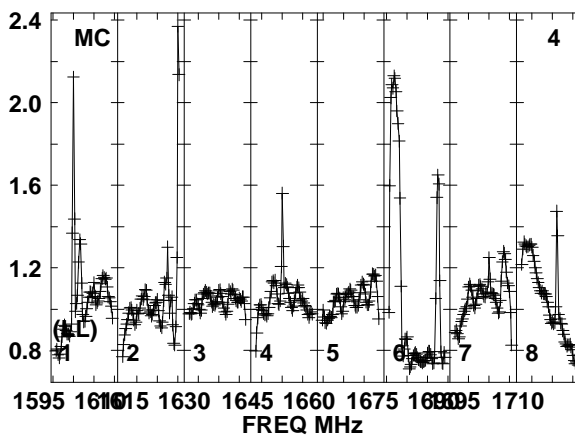
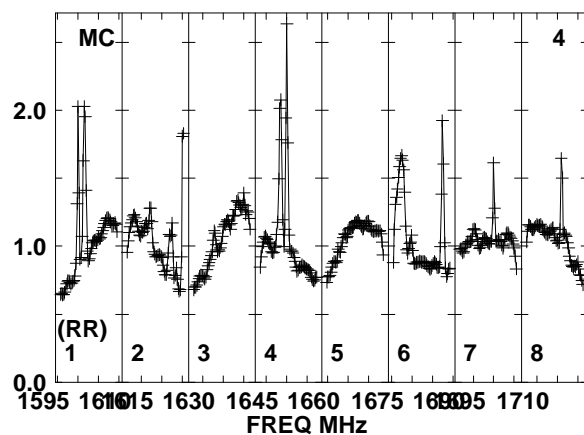
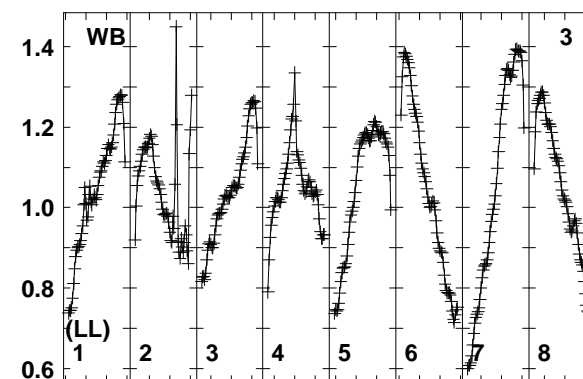
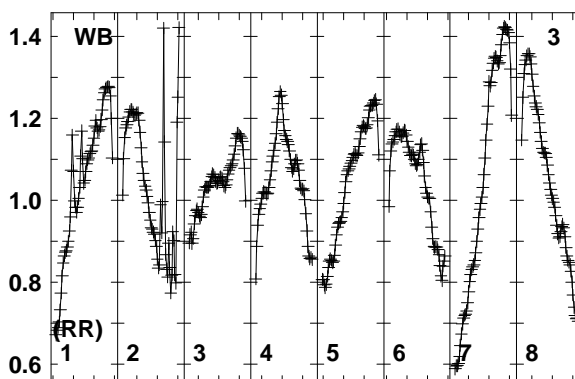
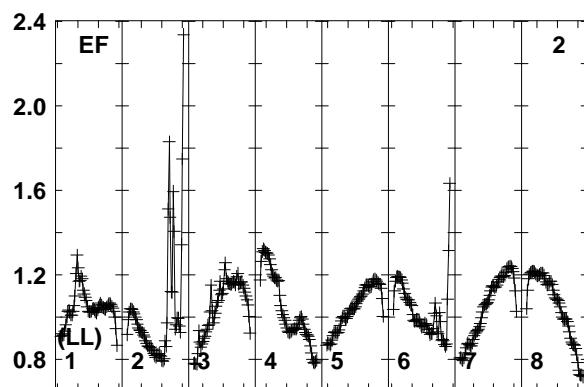
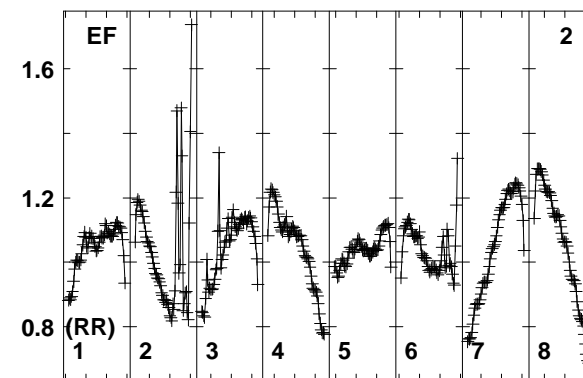
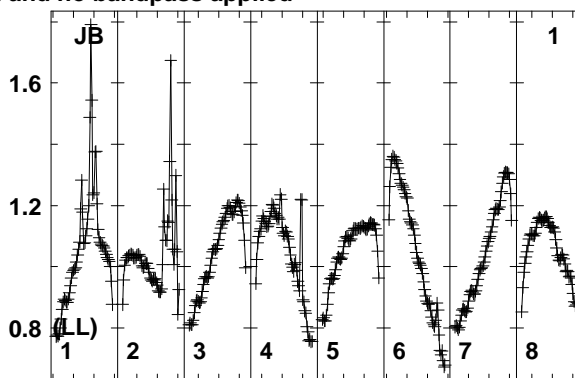
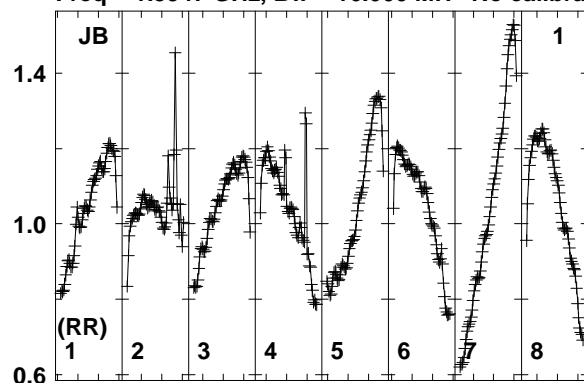

Lower frame: Real Jy
Total-power spectrum Antenna: JB (01)
Timerange: 00/09:08:21 to 00/09:09:19

Plot file version 680 created 04-NOV-2019 14:14:56

J2248-0541 EY034.UVDATA.1

Freq = 1.5947 GHz, Bw = 16.000 MH No calibration applied and no bandpass applied

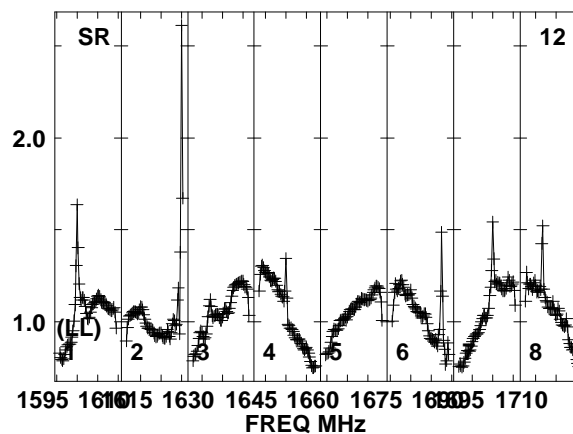
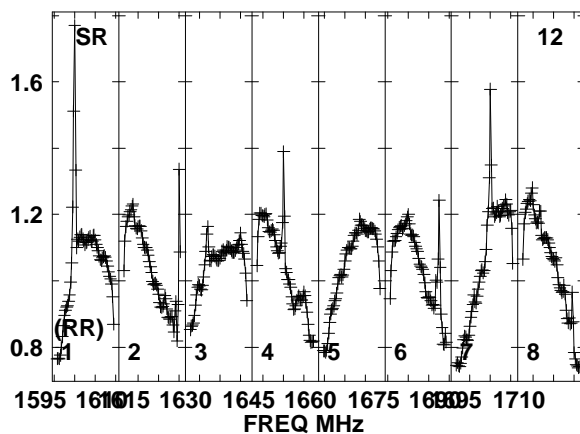
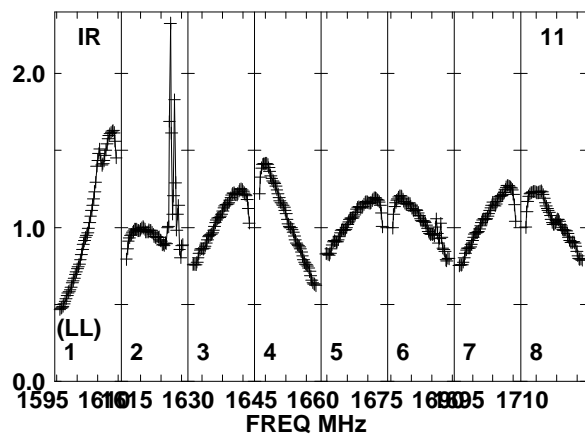
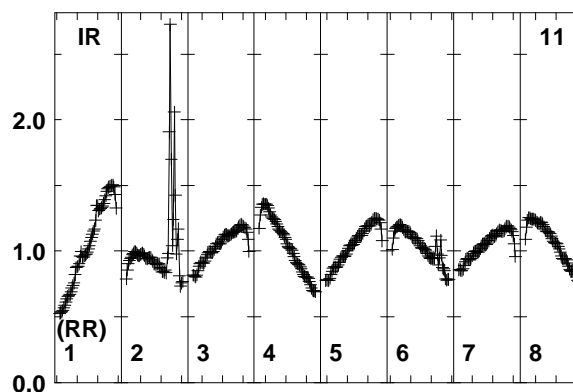
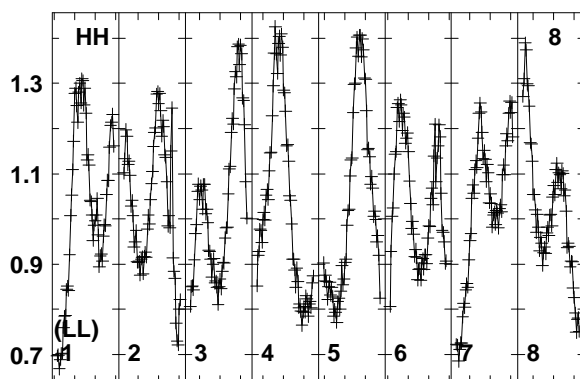
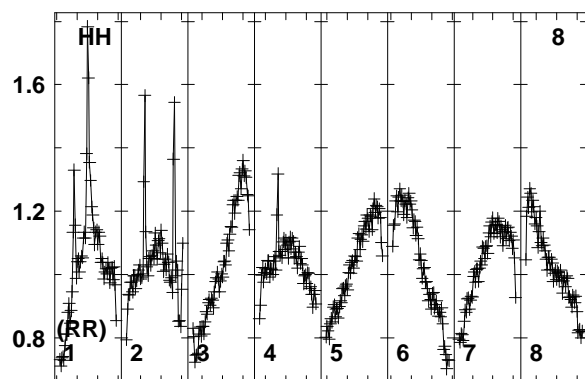
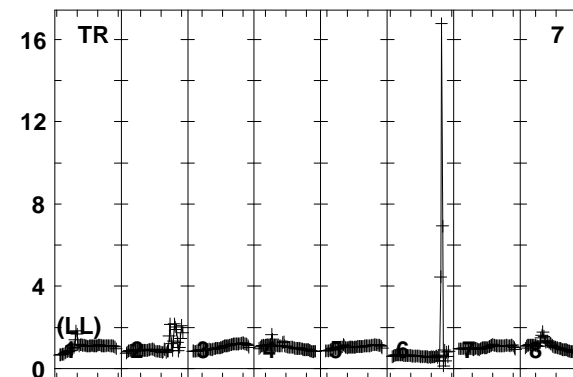
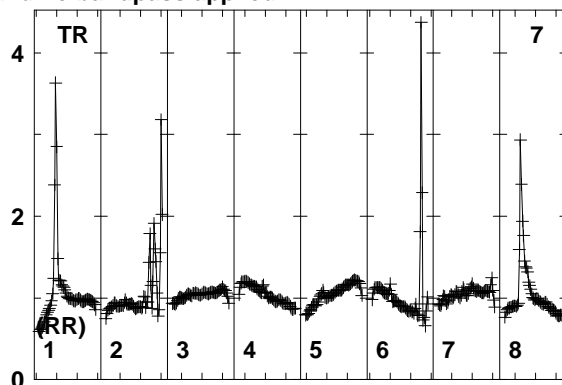
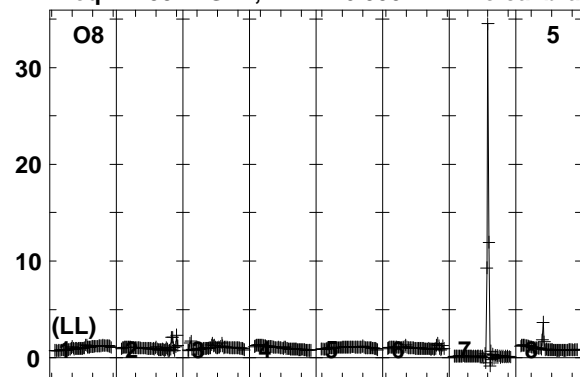

Lower frame: Real Jy
Total-power spectrum Antenna: O8 (05)
Timerange: 00/09:08:21 to 00/09:09:19

Plot file version 681 created 04-NOV-2019 14:14:56

J2248-0541 EY034.UVDATA.1

Freq = 1.5947 GHz, Bw = 16.000 MH No calibration applied and no bandpass applied

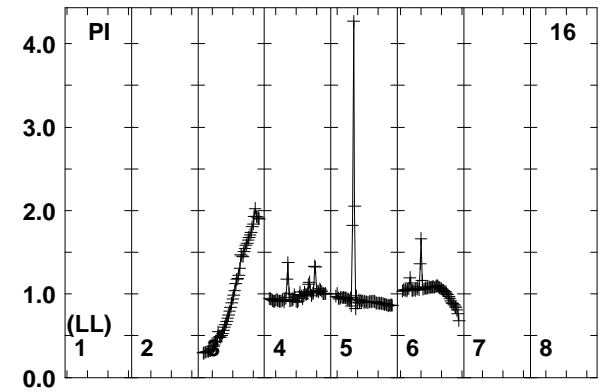
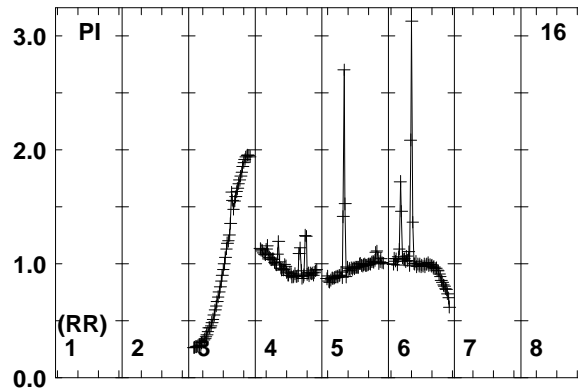
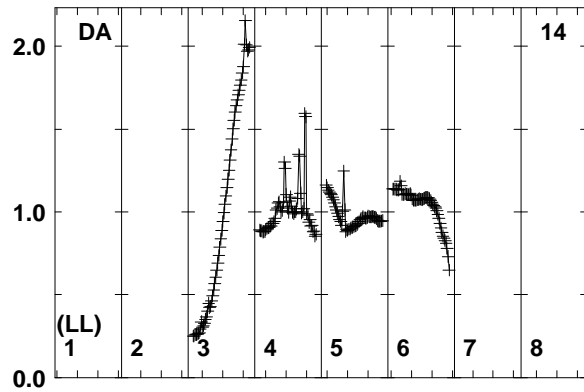
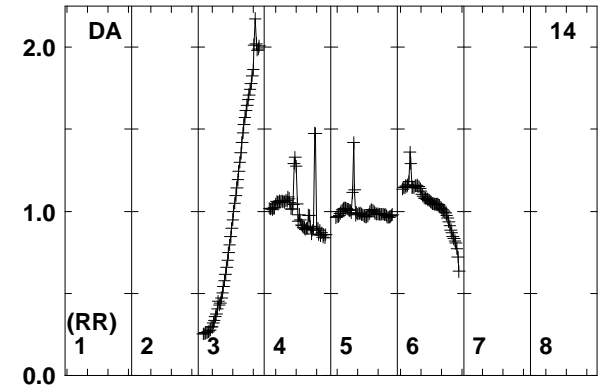
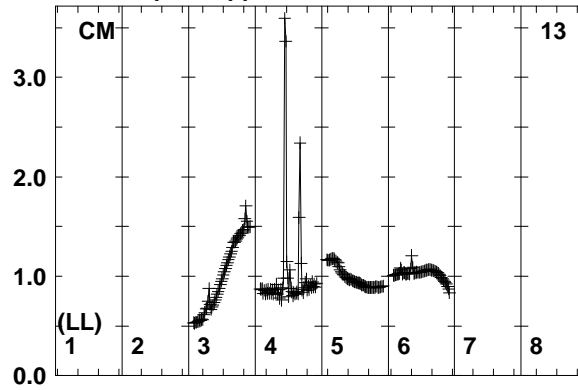
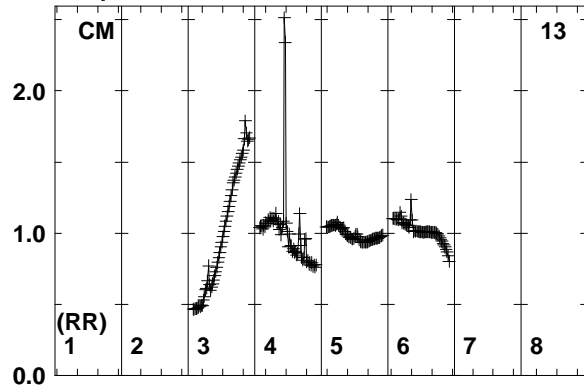

Lower frame: Real Jy
Total-power spectrum Antenna: CM (13)
Timerange: 00/09:08:21 to 00/09:09:19

Plot file version 682 created 04-NOV-2019 14:14:56

W2246-0526 EY034.UVDATA.1

Freq = 1.5947 GHz, Bw = 16.000 MH No calibration applied and no bandpass applied

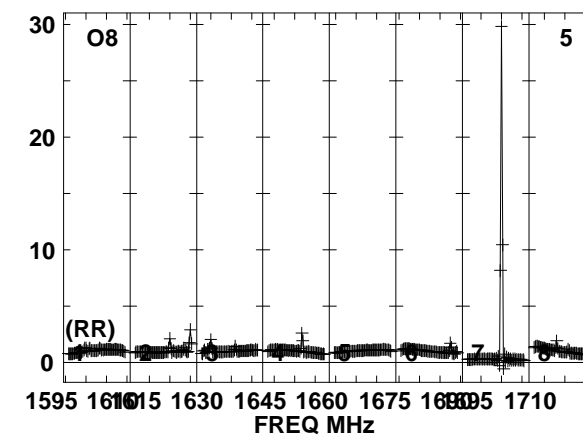
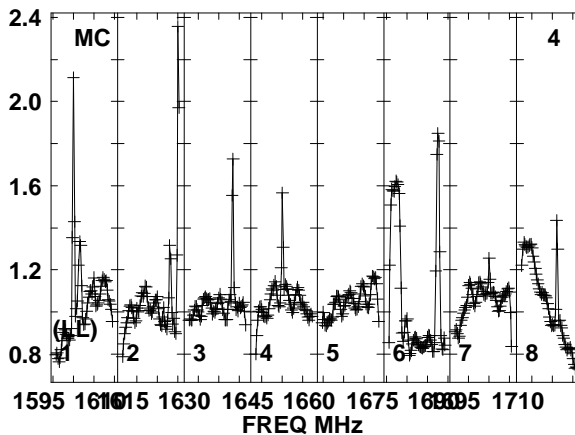
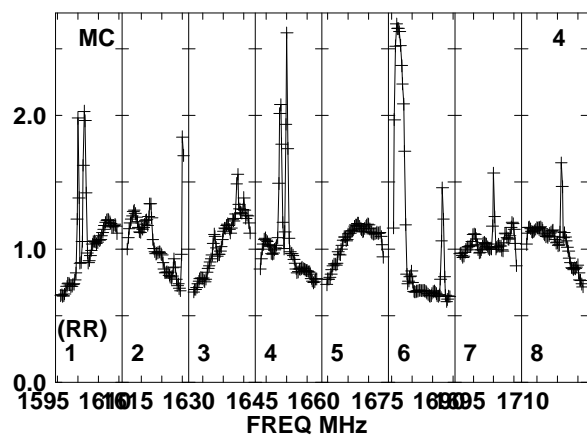
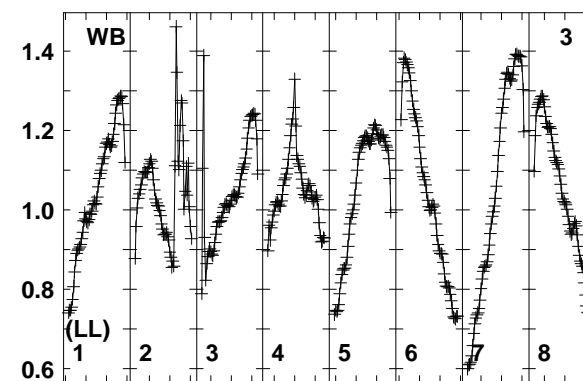
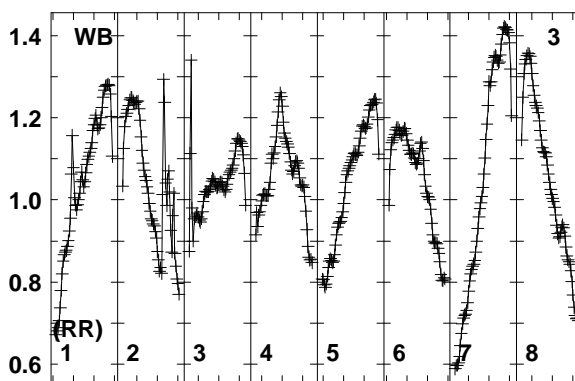
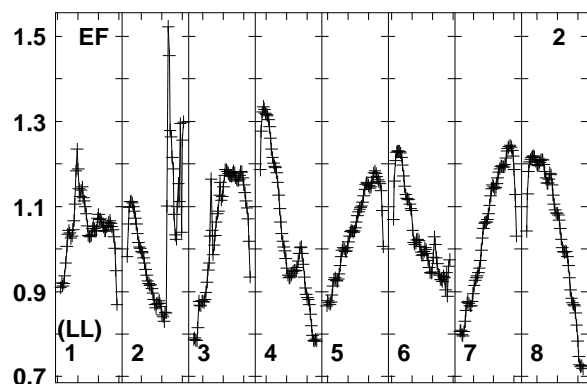
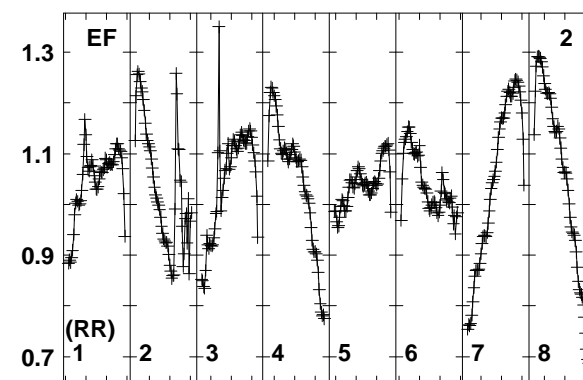
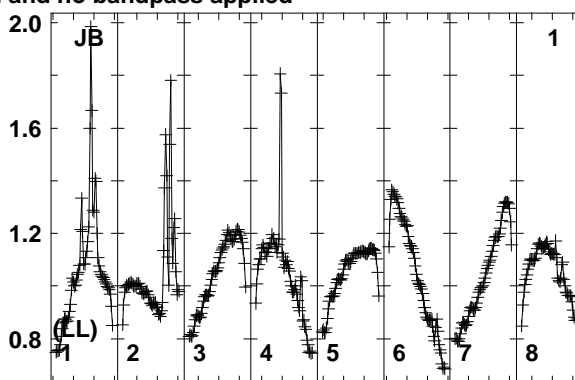
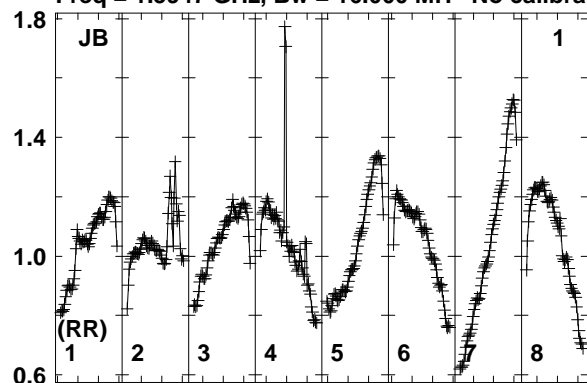

Lower frame: Real Jy
Total-power spectrum Antenna: JB (01)
Timerange: 00/09:09:21 to 00/09:11:59

Plot file version 683 created 04-NOV-2019 14:14:56

W2246-0526 EY034.UVDATA.1

Freq = 1.5947 GHz, Bw = 16.000 MH No calibration applied and no bandpass applied

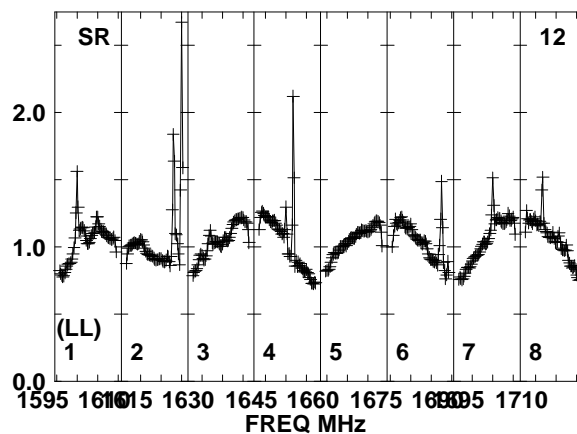
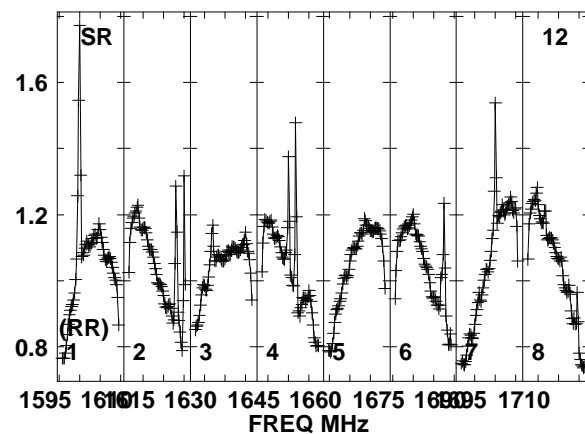
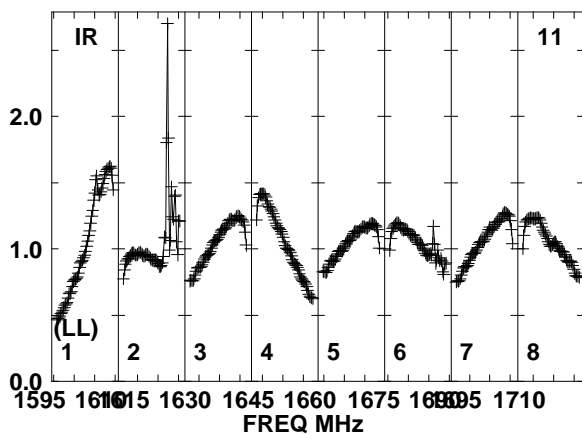
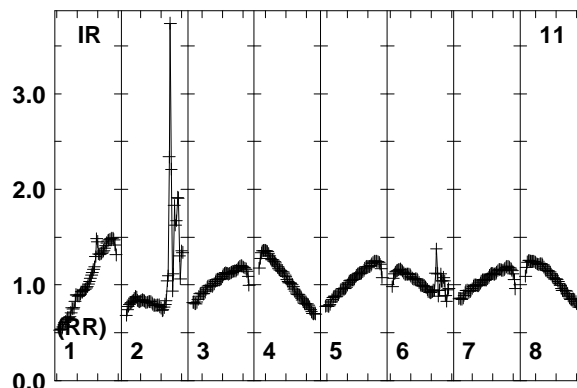
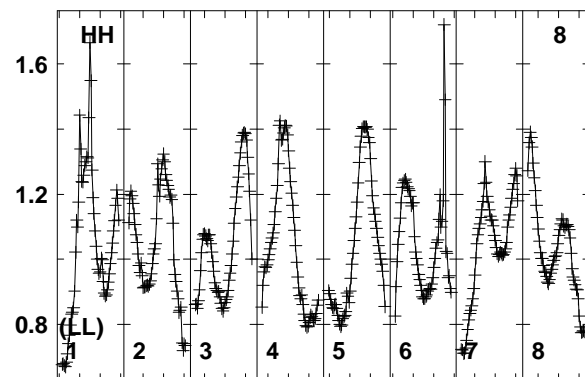
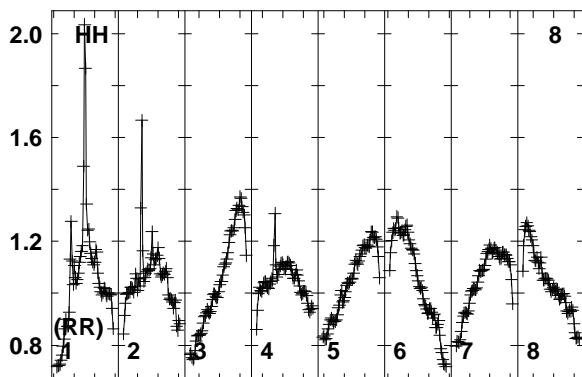
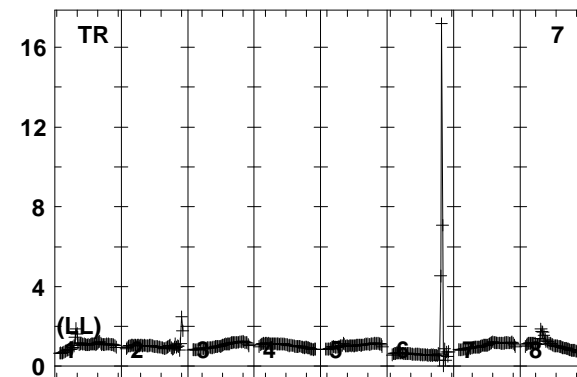
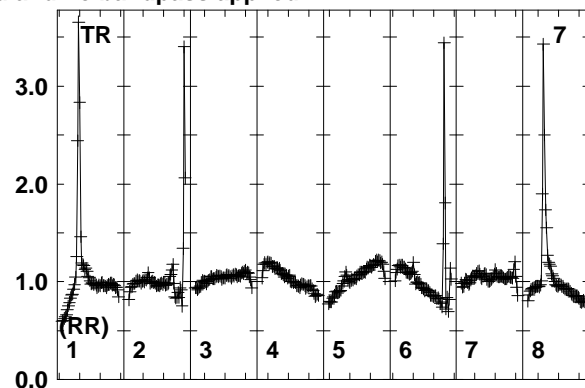
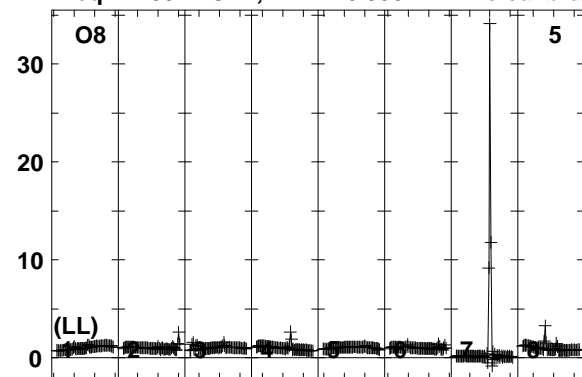

Lower frame: Real Jy
Total-power spectrum Antenna: O8 (05)
Timerange: 00/09:09:21 to 00/09:11:59

Plot file version 684 created 04-NOV-2019 14:14:56

W2246-0526 EY034.UVDATA.1

Freq = 1.5947 GHz, Bw = 16.000 MH No calibration applied and no bandpass applied

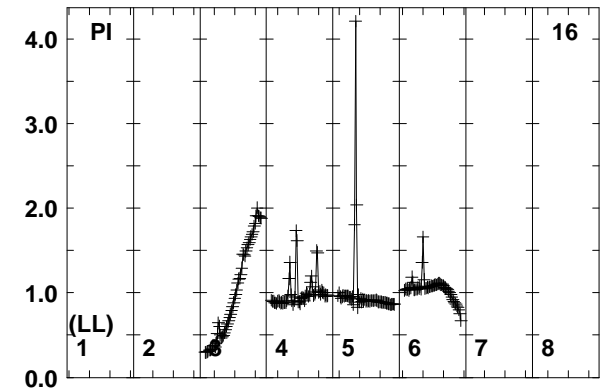
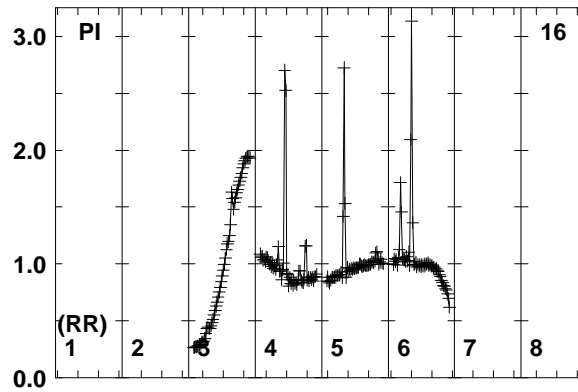
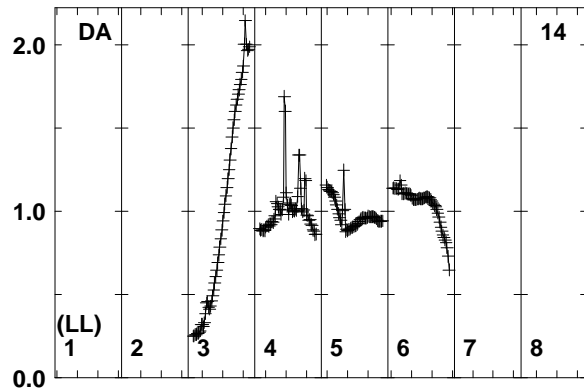
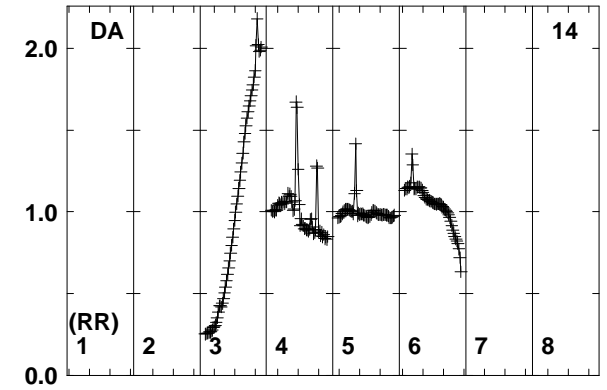
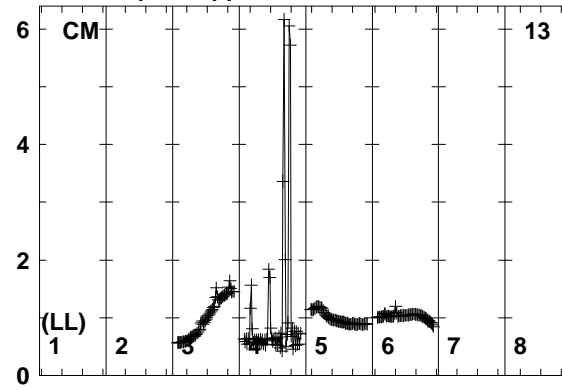
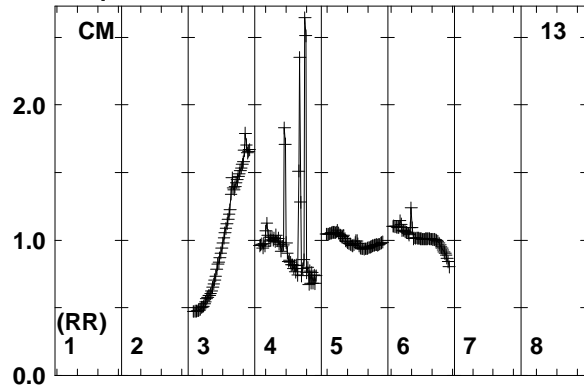

Lower frame: Real Jy
Total-power spectrum Antenna: CM (13)
Timerange: 00/09:09:21 to 00/09:11:59

Plot file version 685 created 04-NOV-2019 14:14:56

J2248-0541 EY034.UVDATA.1

Freq = 1.5947 GHz, Bw = 16.000 MH No calibration applied and no bandpass applied

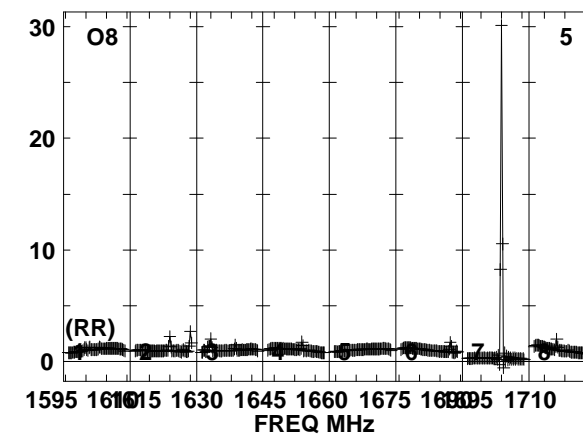
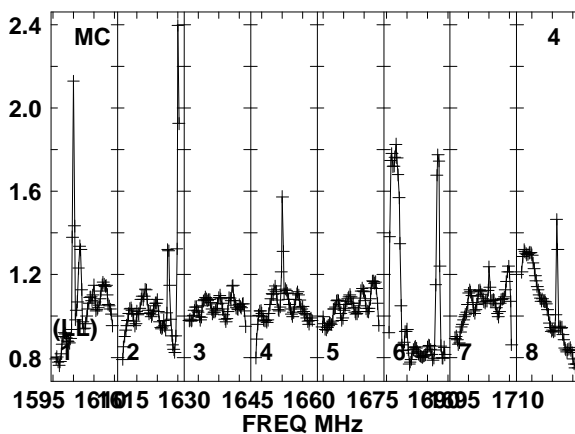
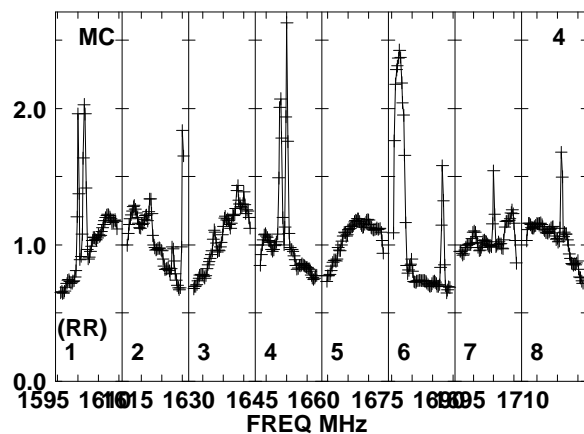
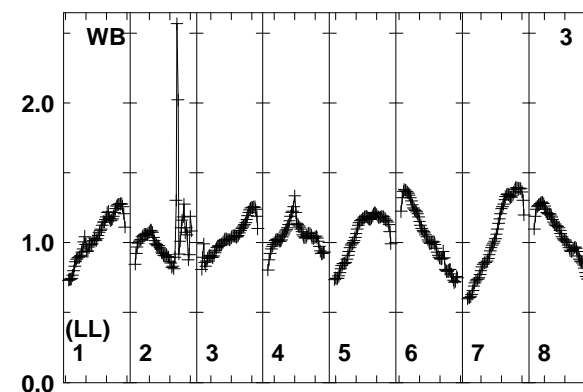
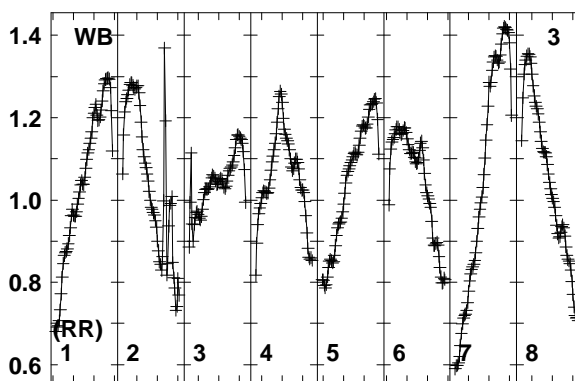
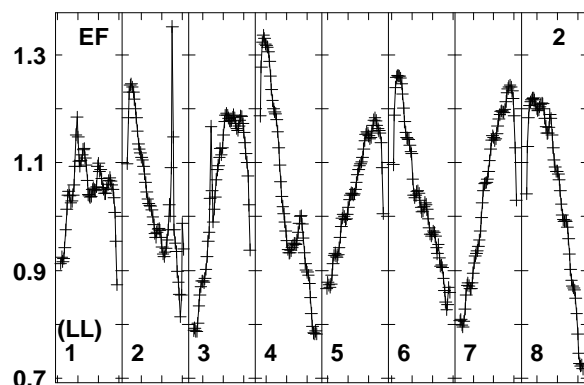
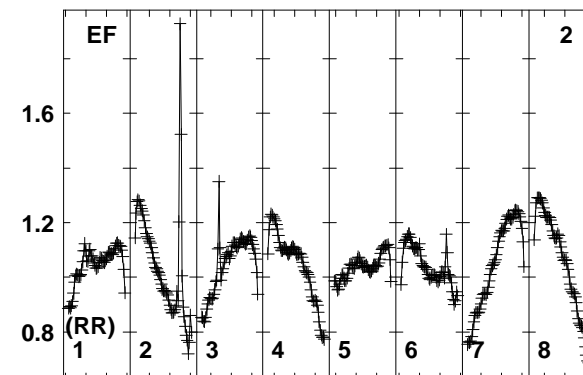
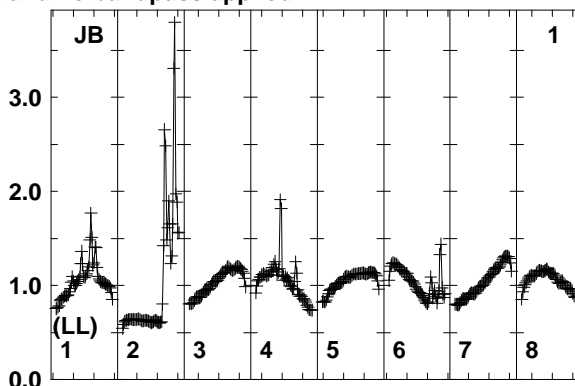
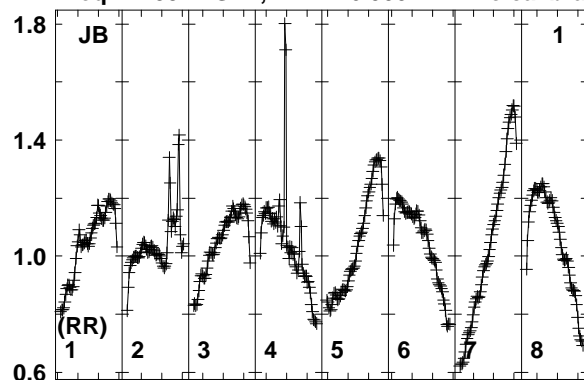

Lower frame: Real Jy
Total-power spectrum Antenna: JB (01)
Timerange: 00/09:12:16 to 00/09:13:14

Plot file version 686 created 04-NOV-2019 14:14:56

J2248-0541 EY034.UVDATA.1

Freq = 1.5947 GHz, Bw = 16.000 MH No calibration applied and no bandpass applied

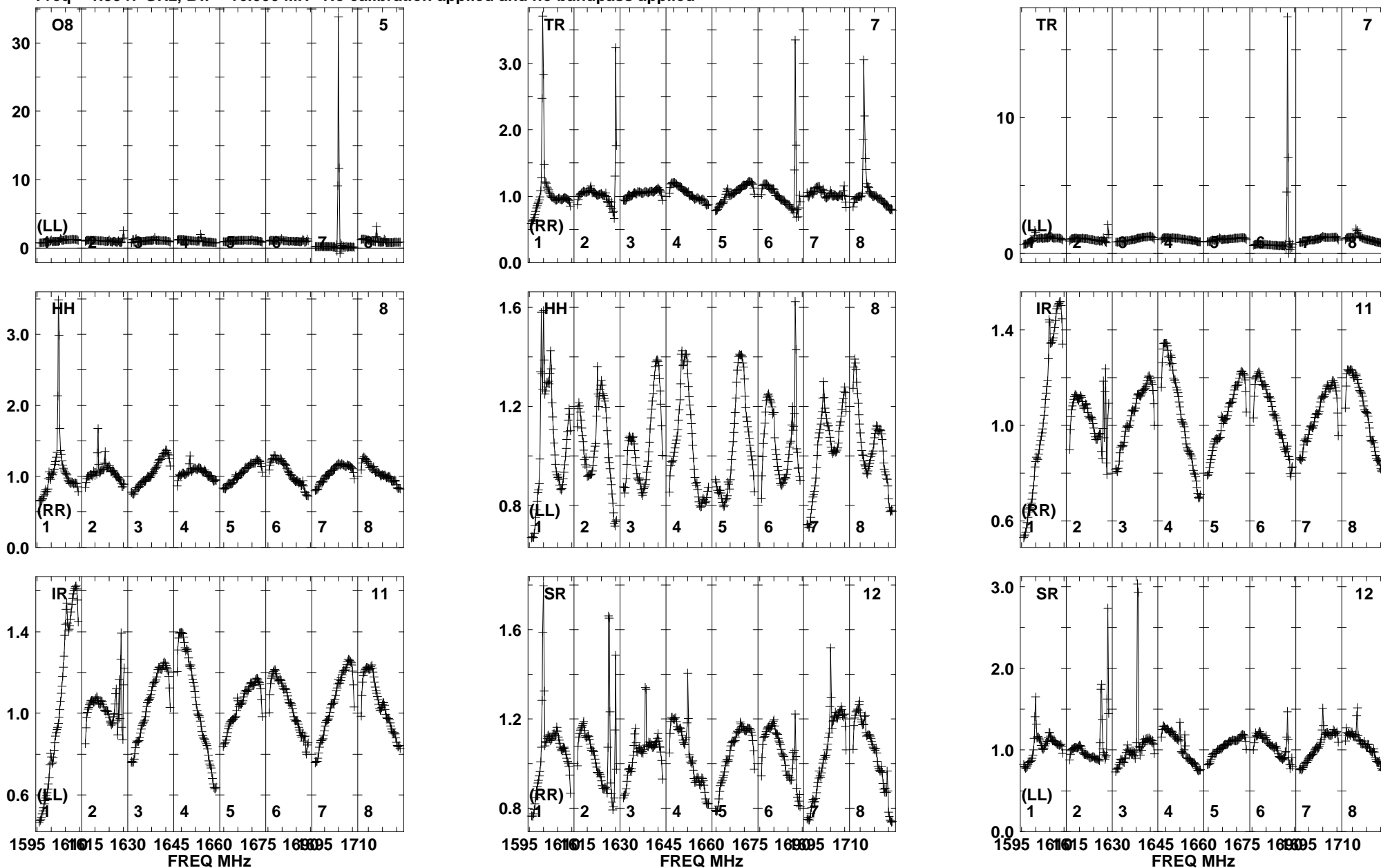

Lower frame: Real Jy
Total-power spectrum Antenna: O8 (05)
Timerange: 00/09:12:16 to 00/09:13:14

Plot file version 687 created 04-NOV-2019 14:14:56

J2248-0541 EY034.UVDATA.1

Freq = 1.5947 GHz, Bw = 16.000 MH No calibration applied and no bandpass applied

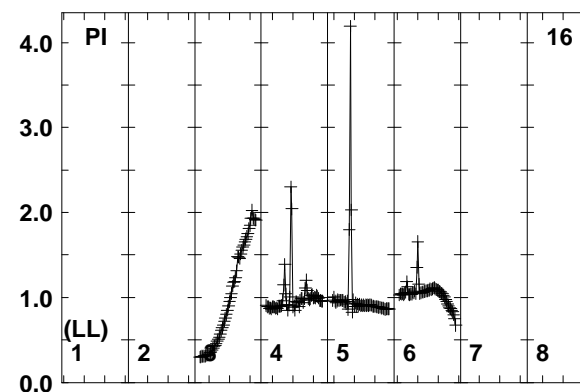
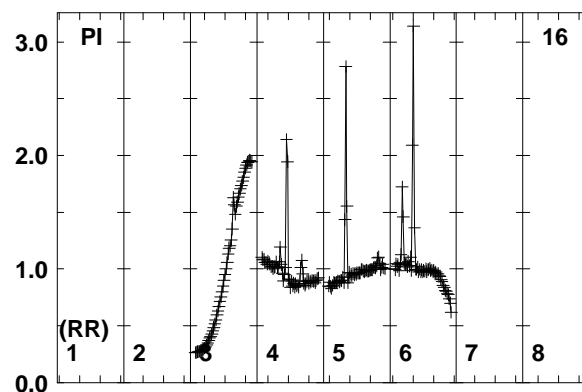
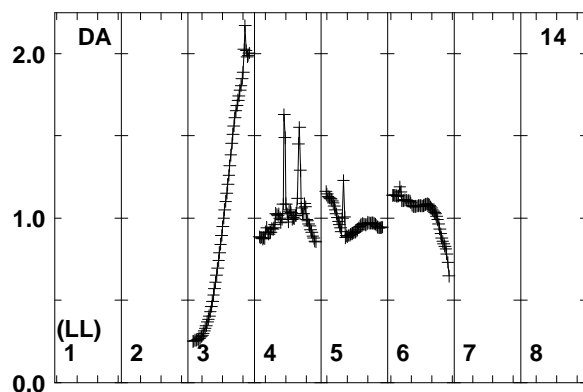
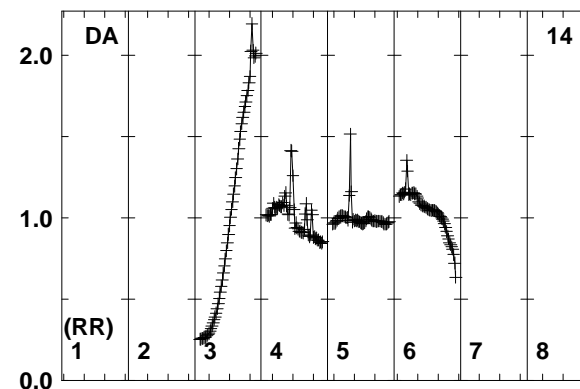
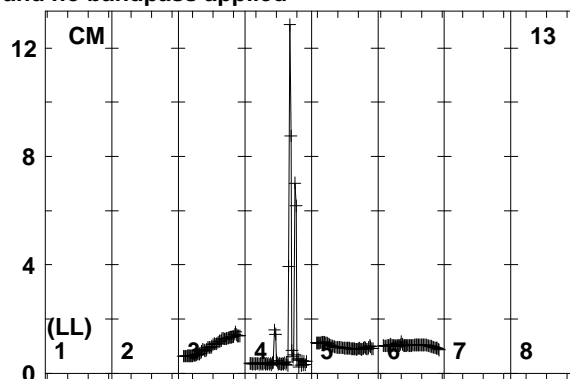
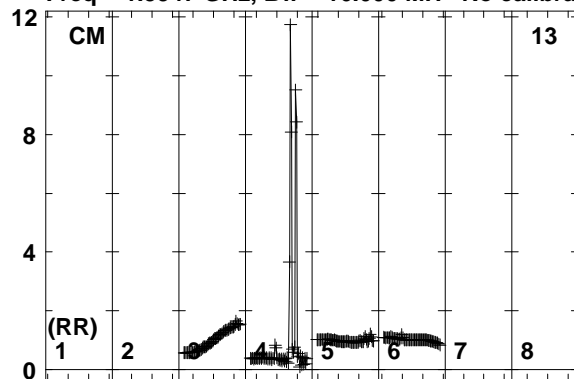

Lower frame: Real Jy
Total-power spectrum Antenna: CM (13)
Timerange: 00/09:12:16 to 00/09:13:14

Plot file version 688 created 04-NOV-2019 14:14:56

J2245-0755 EY034.UVDATA.1

Freq = 1.5947 GHz, Bw = 16.000 MH No calibration applied and no bandpass applied

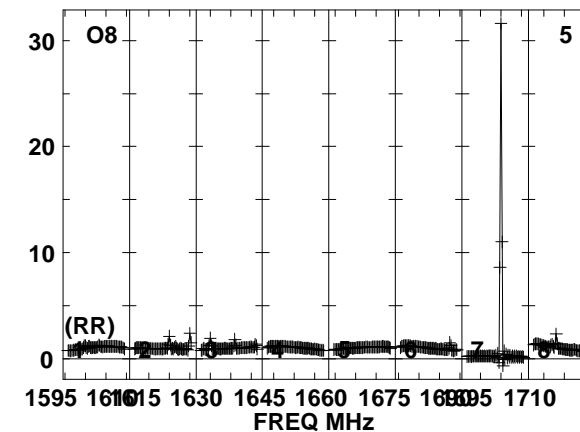
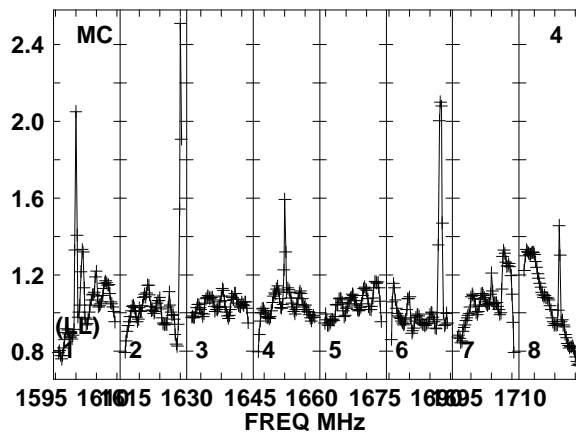
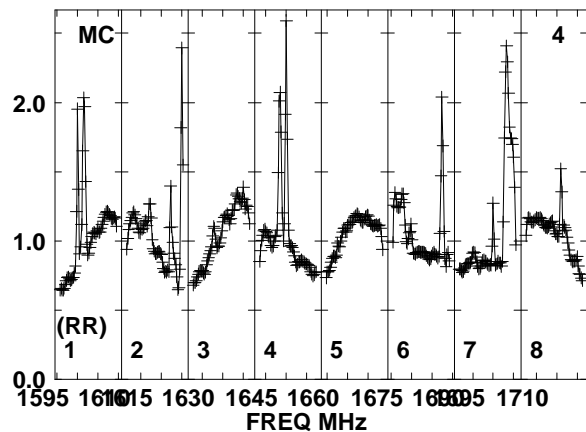
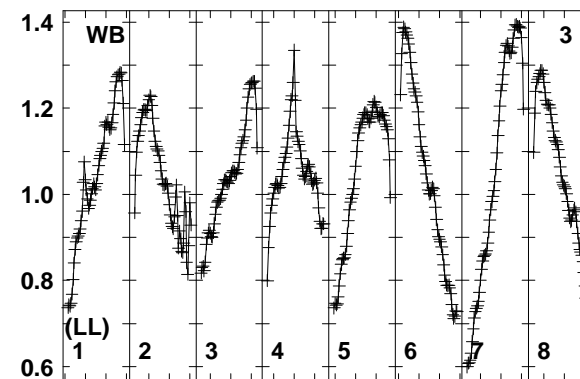
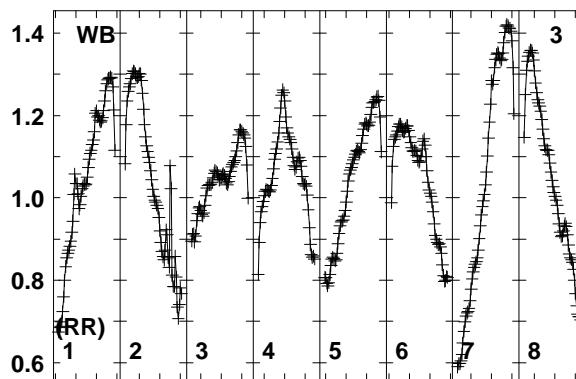
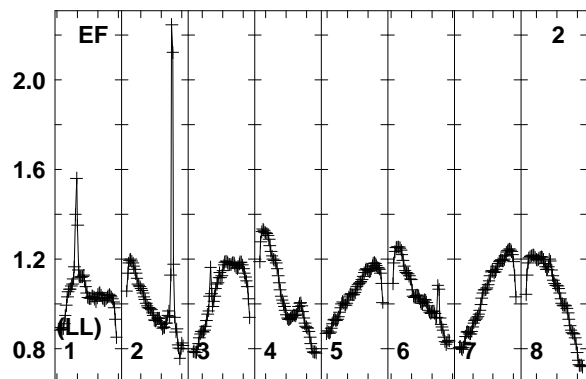
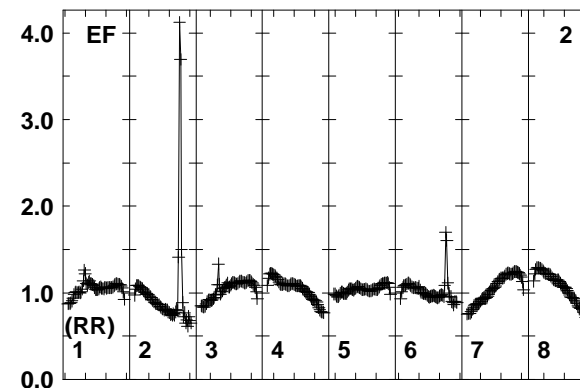
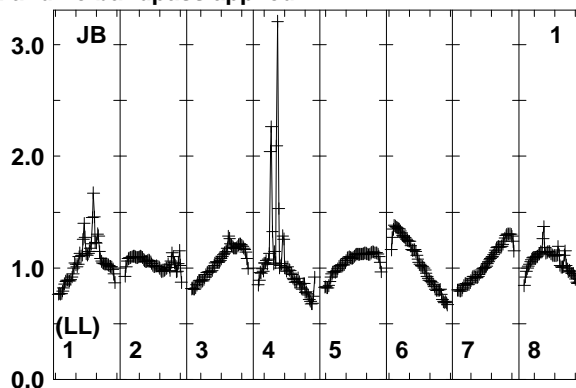
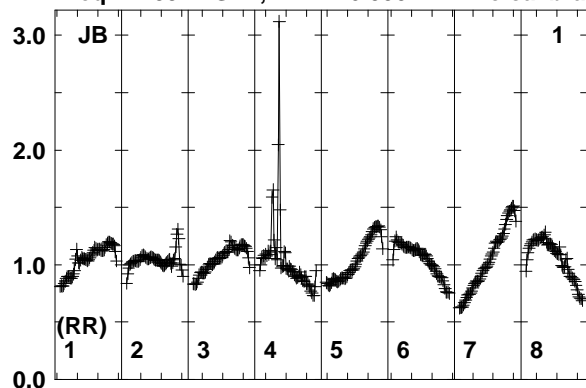

Lower frame: Real Jy
Total-power spectrum Antenna: JB (01)
Timerange: 00/09:13:31 to 00/09:14:29

Plot file version 689 created 04-NOV-2019 14:14:56

J2245-0755 EY034.UVDATA.1

Freq = 1.5947 GHz, Bw = 16.000 MH No calibration applied and no bandpass applied

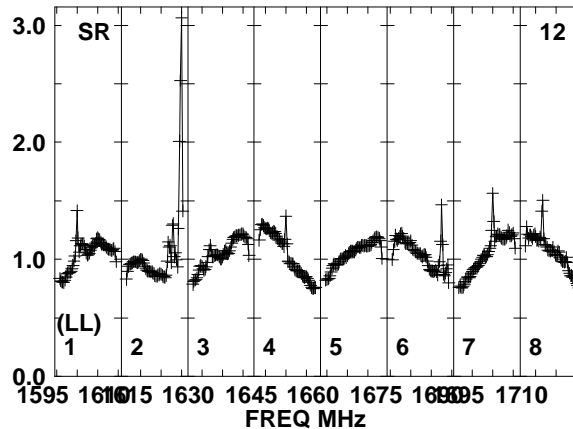
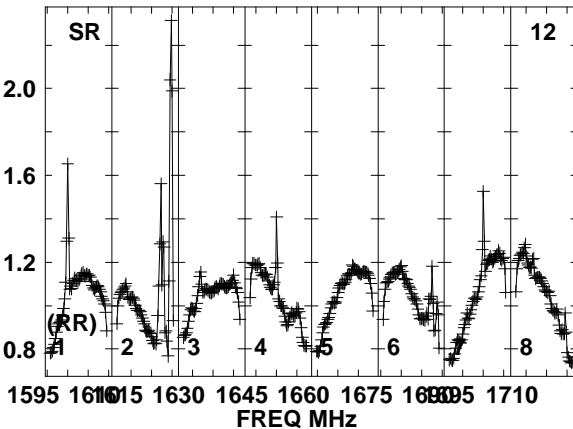
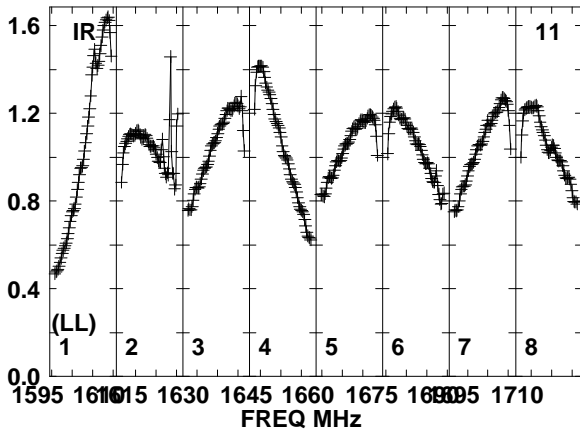
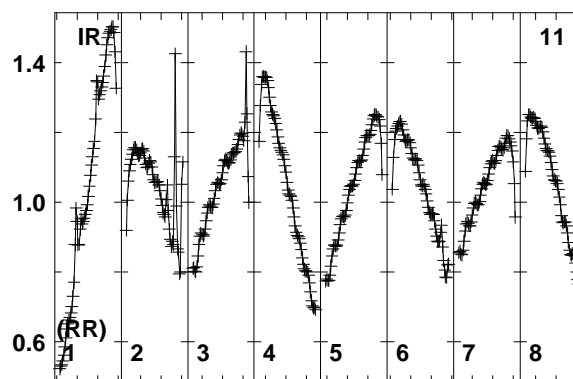
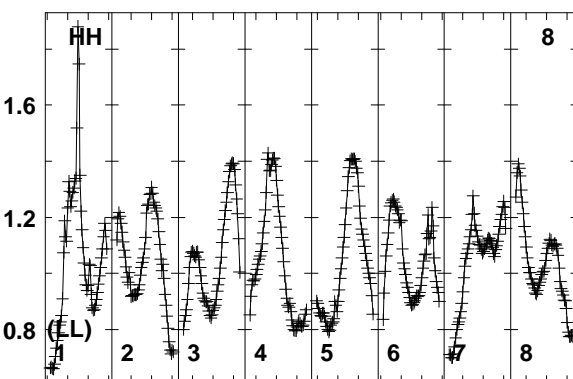
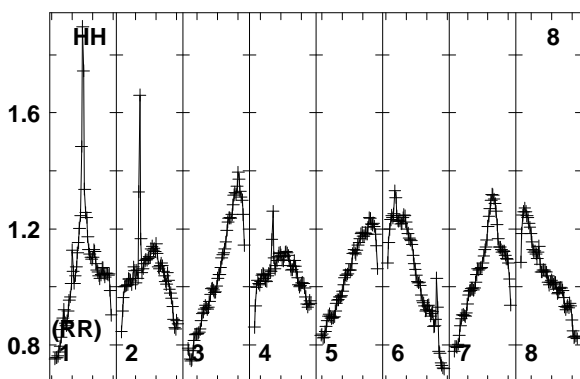
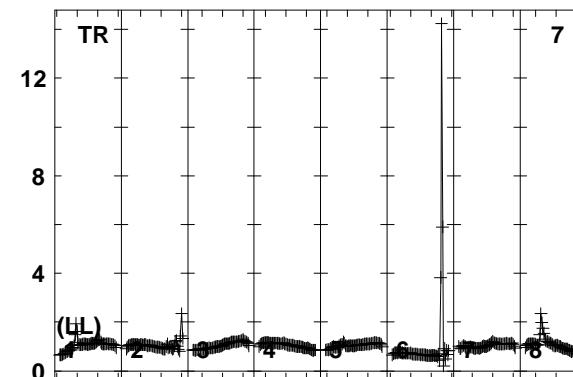
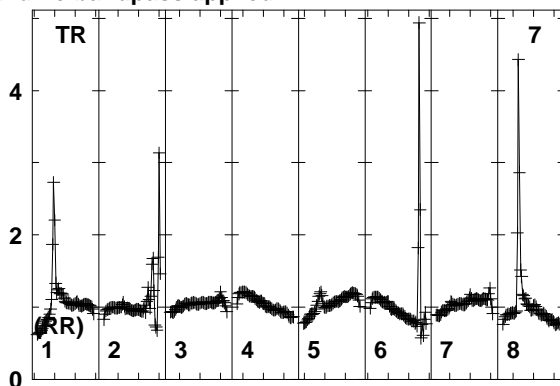
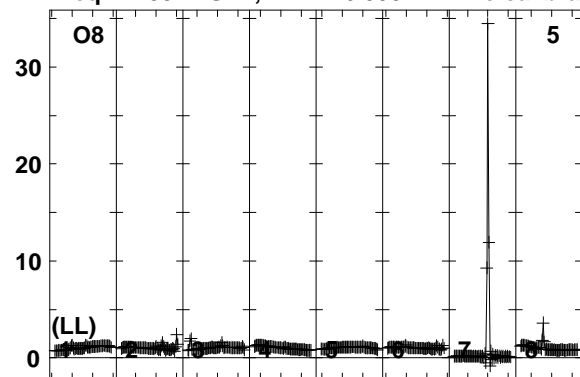

Lower frame: Real Jy
Total-power spectrum Antenna: O8 (05)
Timerange: 00/09:13:31 to 00/09:14:29

Plot file version 690 created 04-NOV-2019 14:14:56

J2245-0755 EY034.UVDATA.1

Freq = 1.5947 GHz, Bw = 16.000 MH No calibration applied and no bandpass applied

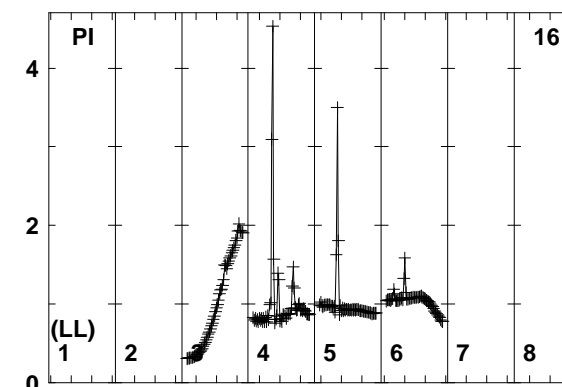
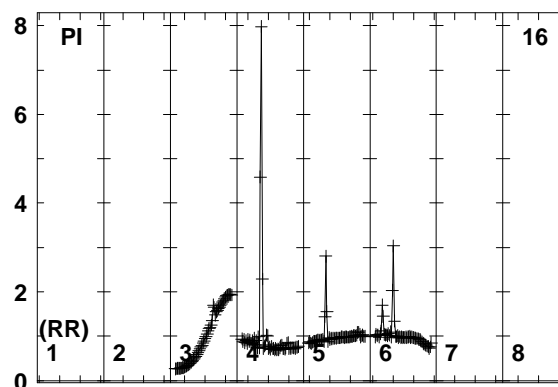
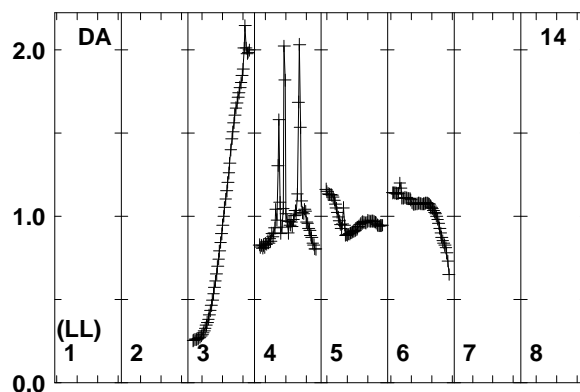
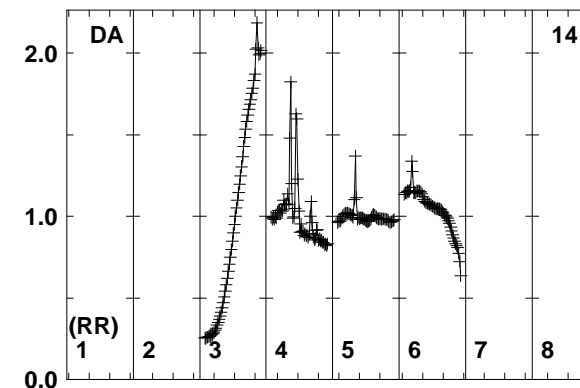
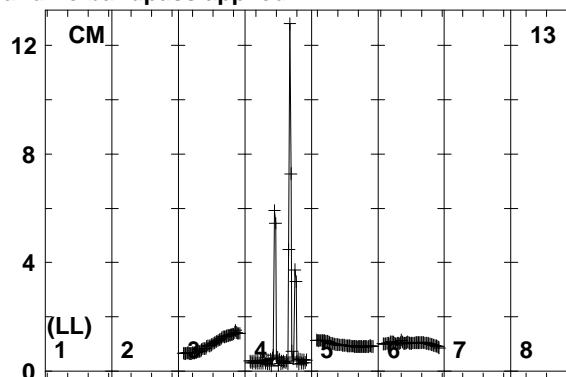
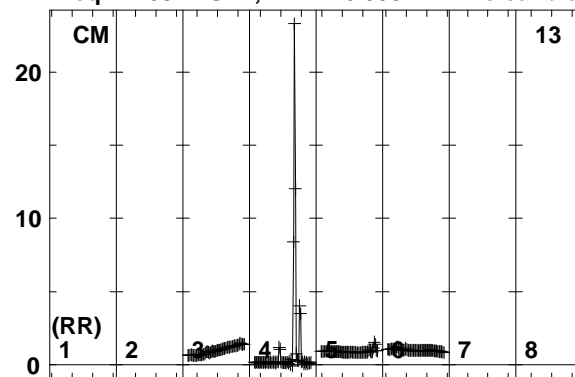

Lower frame: Real Jy
Total-power spectrum Antenna: CM (13)
Timerange: 00/09:13:31 to 00/09:14:29

Plot file version 691 created 04-NOV-2019 14:14:56

J2248-0541 EY034.UVDATA.1

Freq = 1.5947 GHz, Bw = 16.000 MH No calibration applied and no bandpass applied

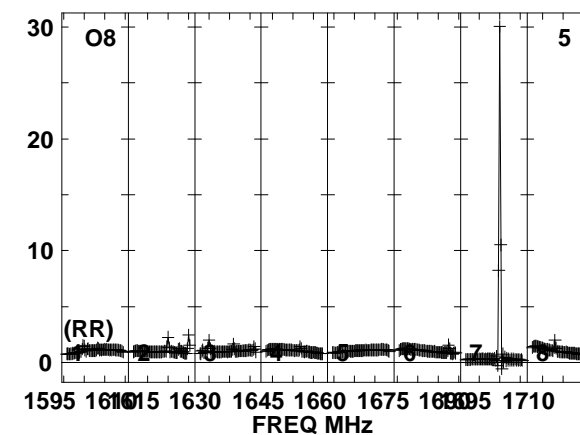
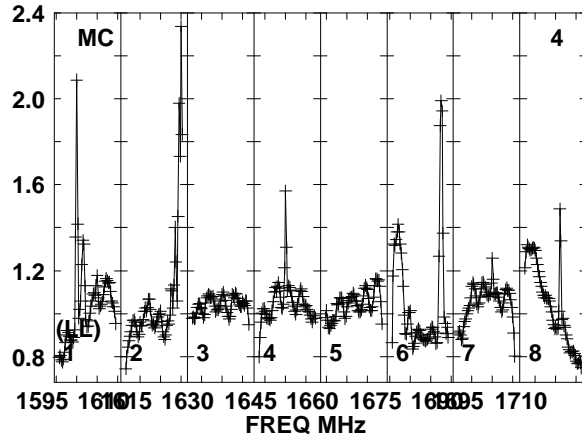
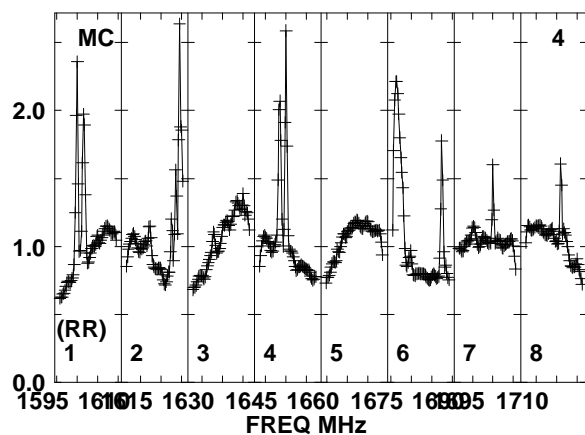
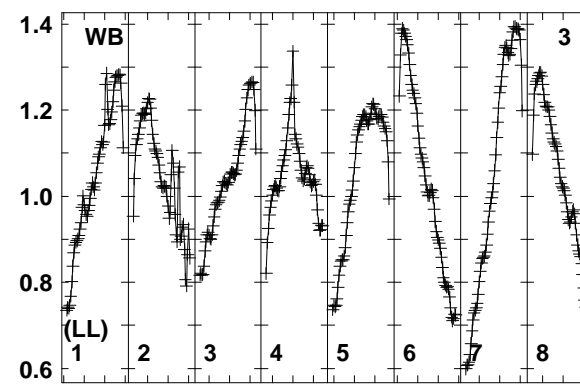
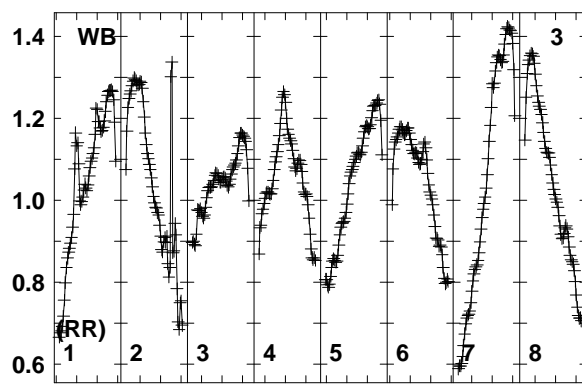
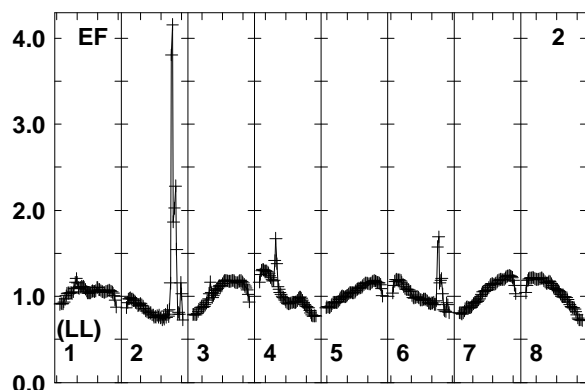
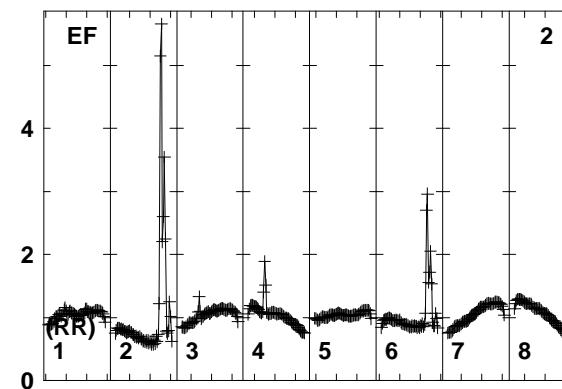
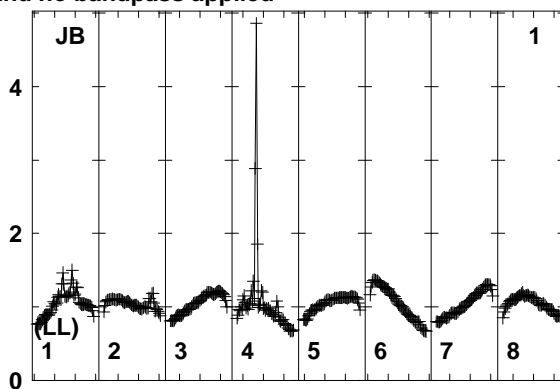
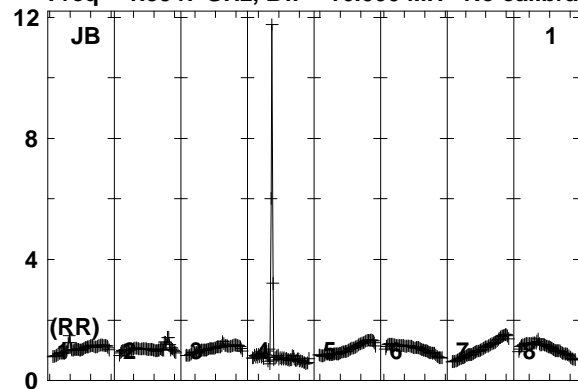

Lower frame: Real Jy
Total-power spectrum Antenna: JB (01)
Timerange: 00/09:15:16 to 00/09:16:14

Plot file version 692 created 04-NOV-2019 14:14:56

J2248-0541 EY034.UVDATA.1

Freq = 1.5947 GHz, Bw = 16.000 MH No calibration applied and no bandpass applied

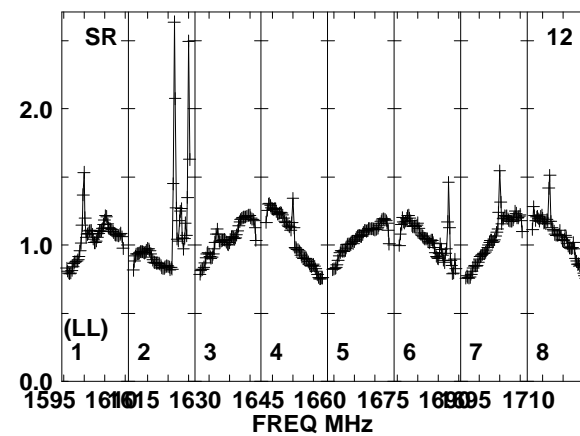
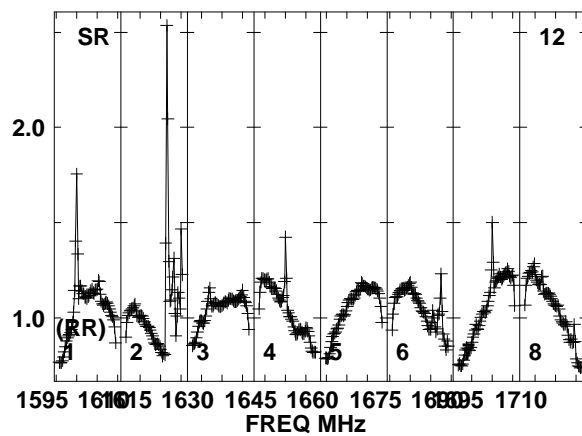
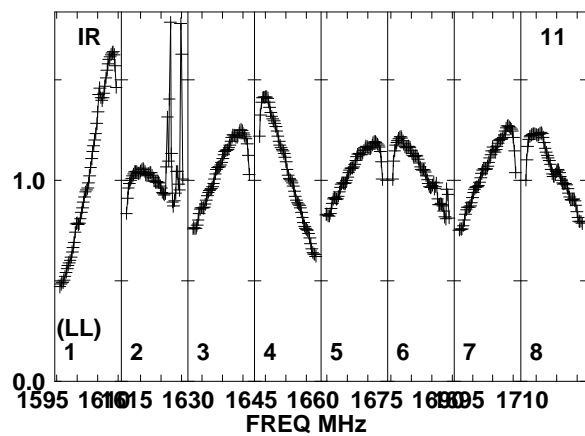
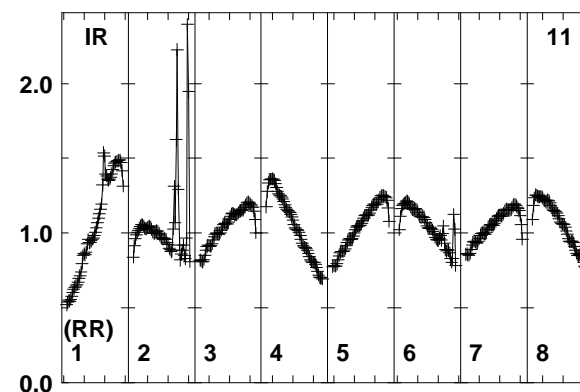
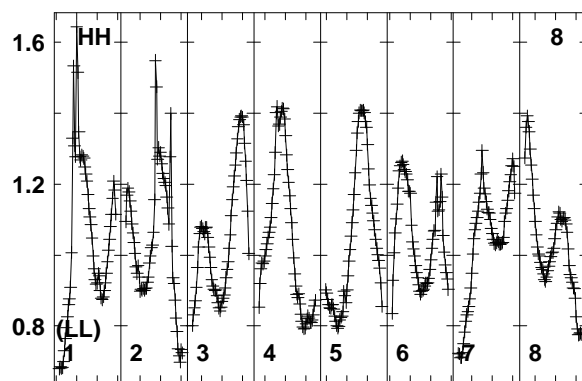
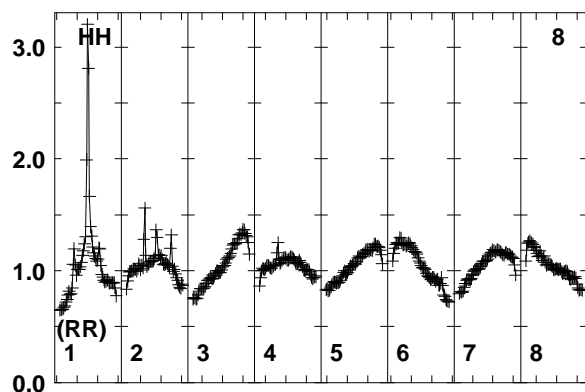
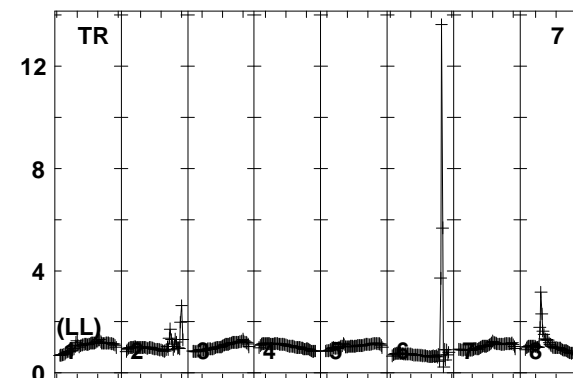
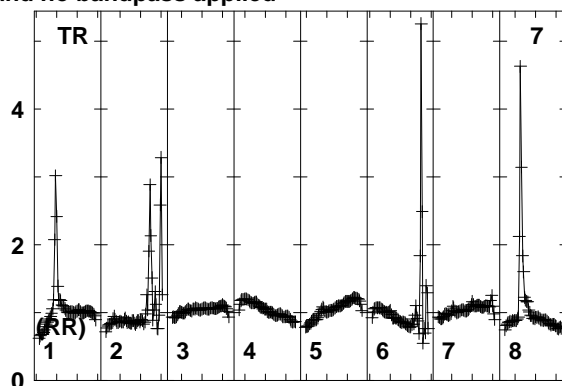
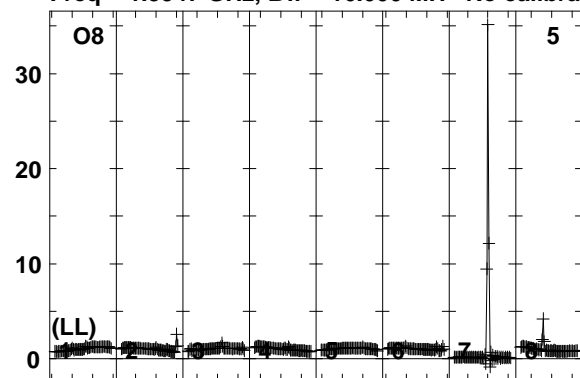

Lower frame: Real Jy
Total-power spectrum Antenna: O8 (05)
Timerange: 00/09:15:16 to 00/09:16:14

Plot file version 693 created 04-NOV-2019 14:14:56

J2248-0541 EY034.UVDATA.1

Freq = 1.5947 GHz, Bw = 16.000 MH No calibration applied and no bandpass applied

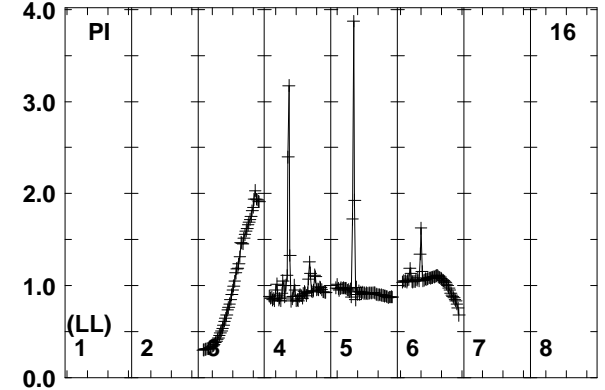
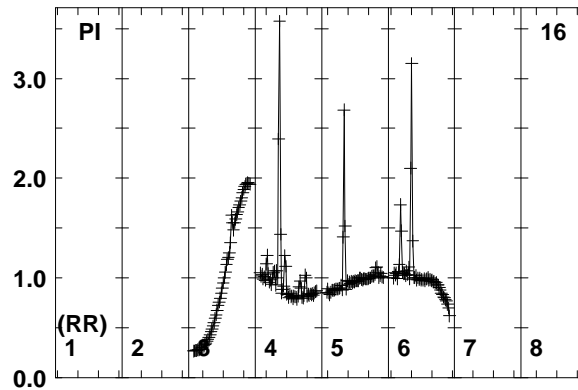
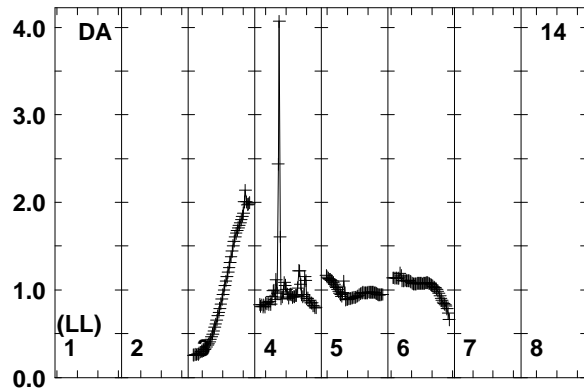
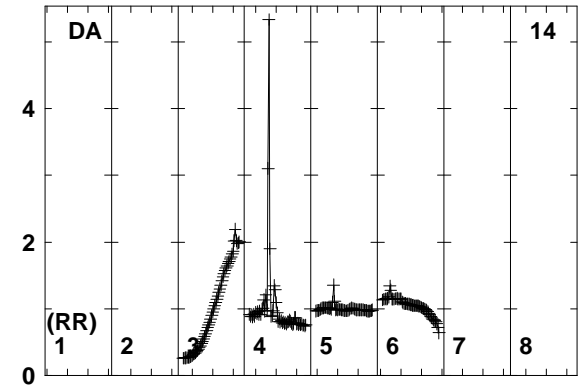
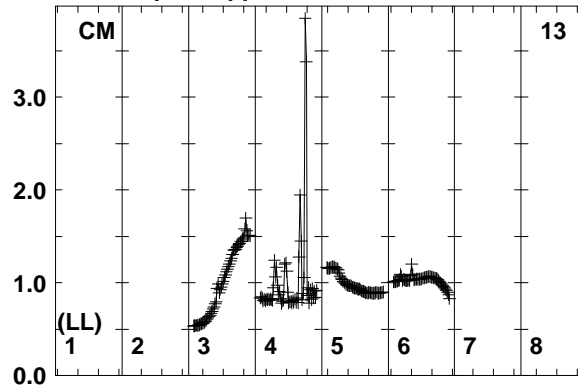
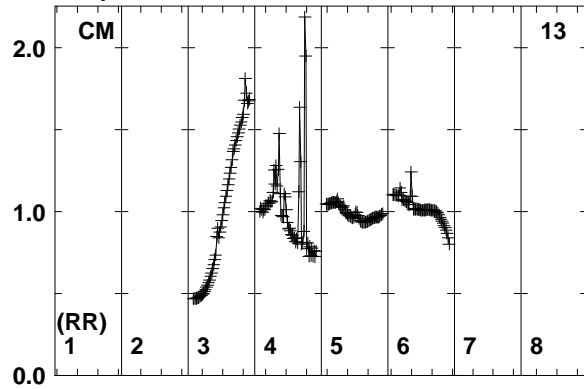

Lower frame: Real Jy
Total-power spectrum Antenna: CM (13)
Timerange: 00/09:15:16 to 00/09:16:14

Plot file version 694 created 04-NOV-2019 14:14:57

W2246-0526 EY034.UVDATA.1

Freq = 1.5947 GHz, Bw = 16.000 MH No calibration applied and no bandpass applied

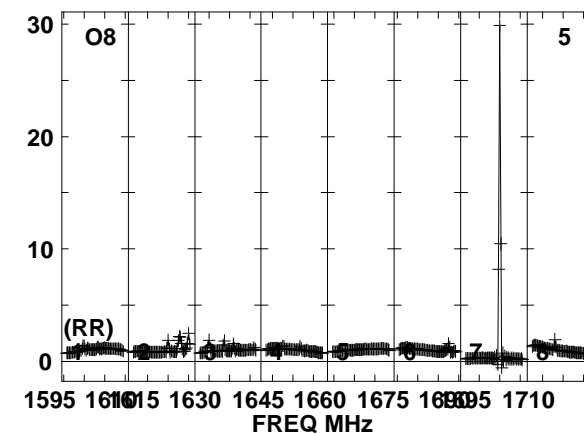
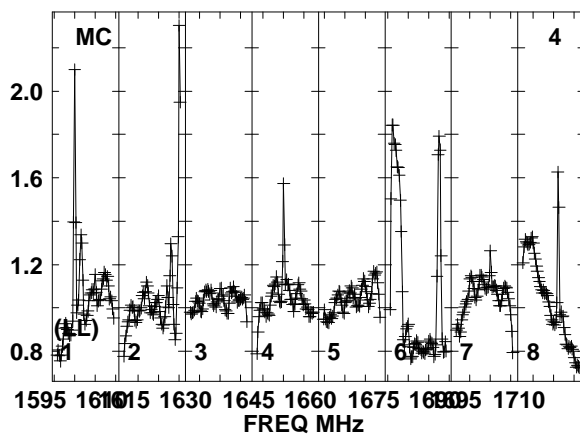
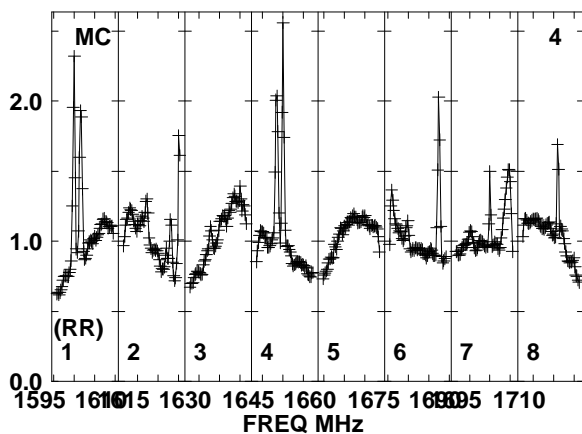
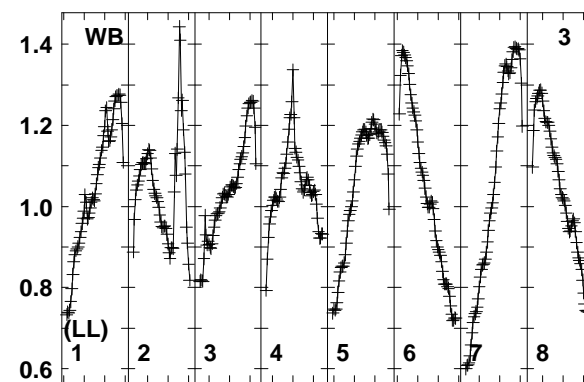
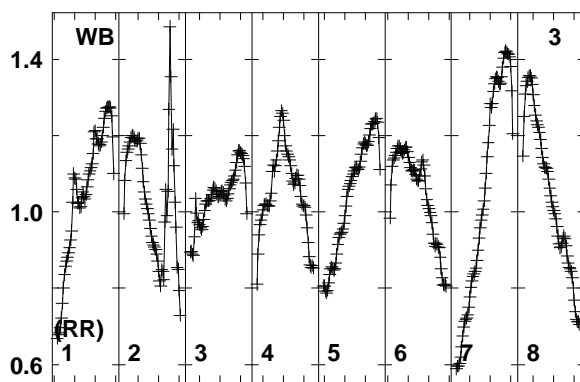
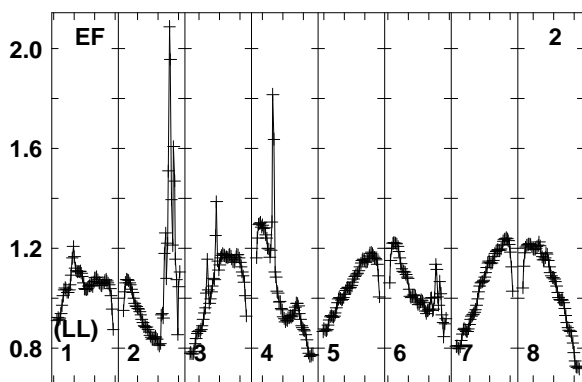
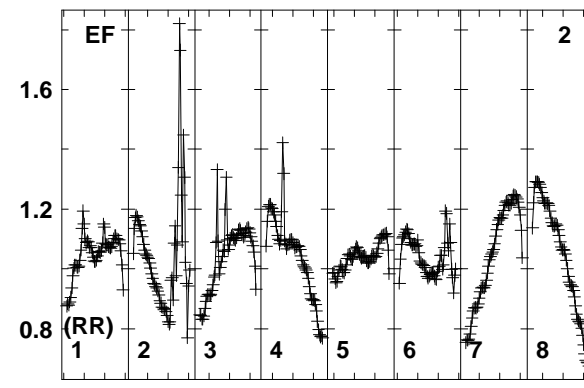
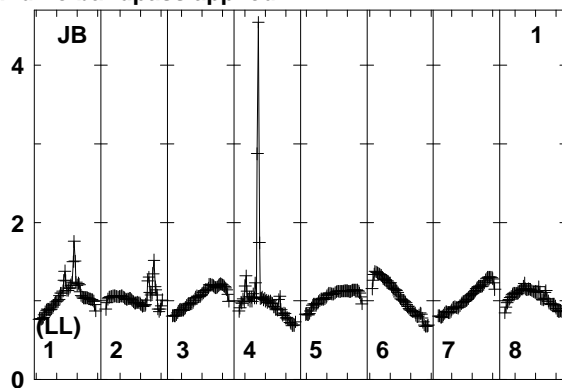
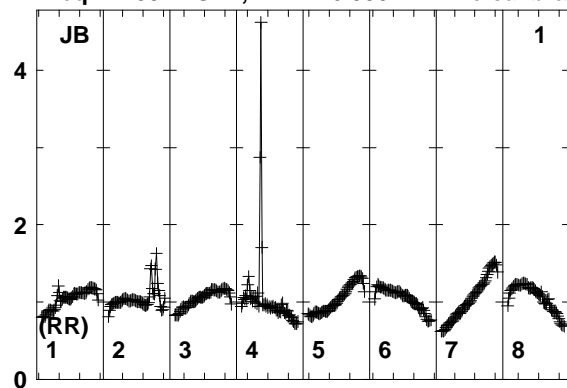

Lower frame: Real Jy
Total-power spectrum Antenna: JB (01)
Timerange: 00/09:16:16 to 00/09:18:44

Plot file version 695 created 04-NOV-2019 14:14:57

W2246-0526 EY034.UVDATA.1

Freq = 1.5947 GHz, Bw = 16.000 MH No calibration applied and no bandpass applied

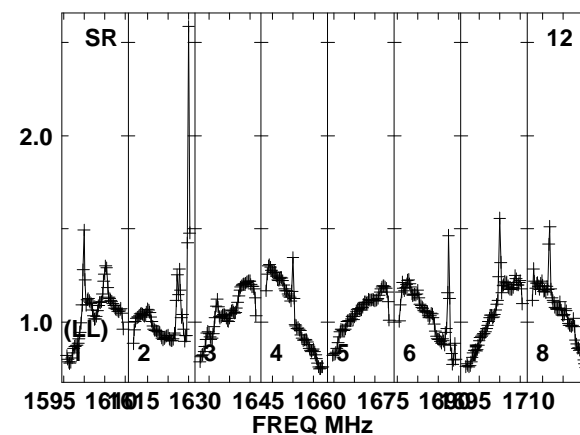
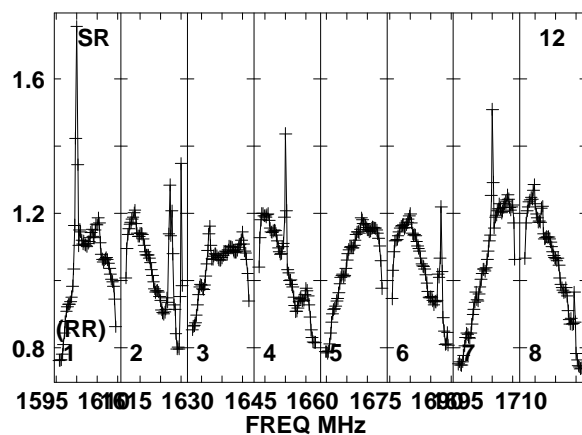
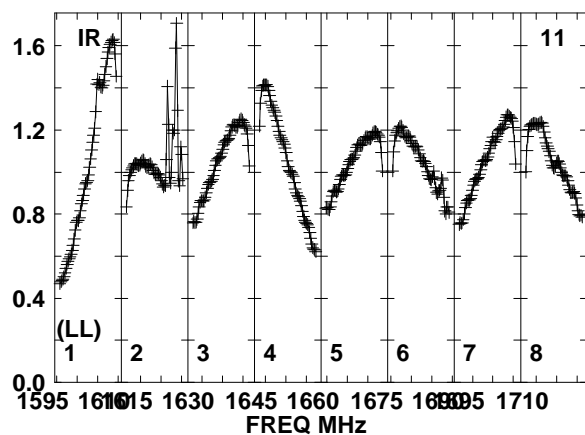
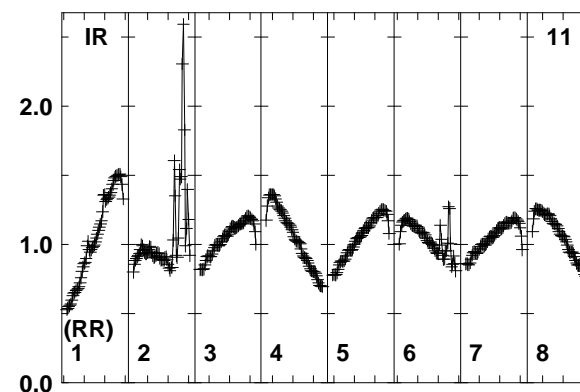
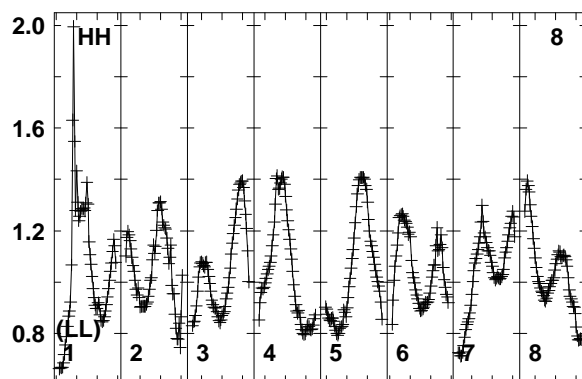
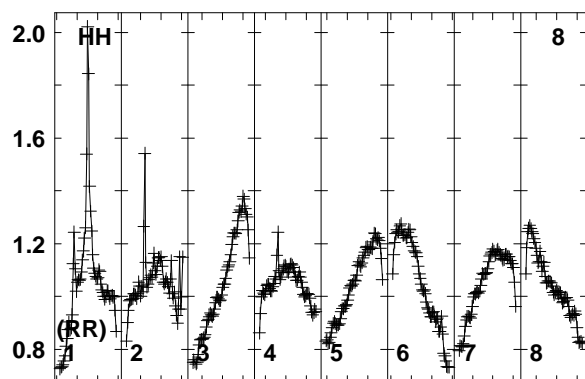
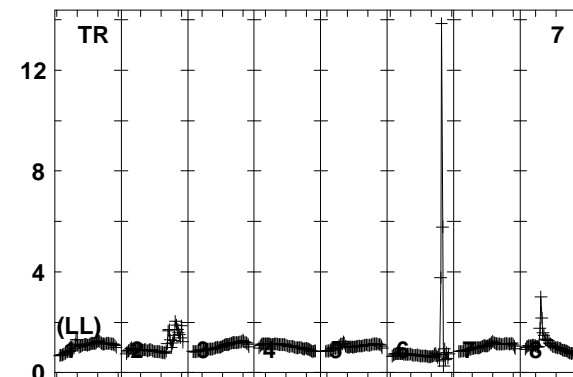
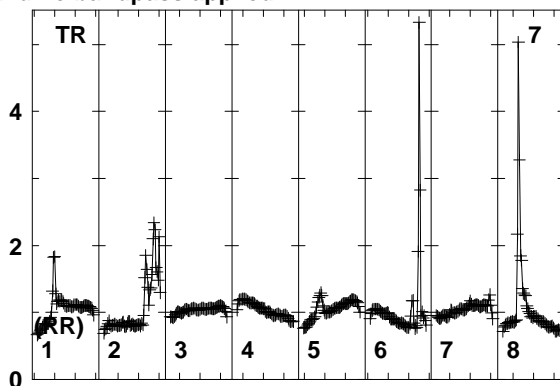
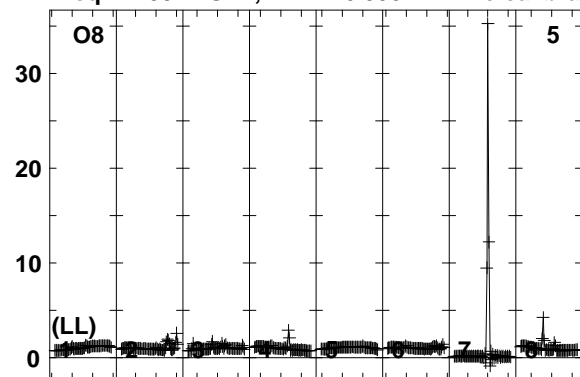

Lower frame: Real Jy
Total-power spectrum Antenna: O8 (05)
Timerange: 00/09:16:16 to 00/09:18:44

Plot file version 696 created 04-NOV-2019 14:14:57

W2246-0526 EY034.UVDATA.1

Freq = 1.5947 GHz, Bw = 16.000 MH No calibration applied and no bandpass applied

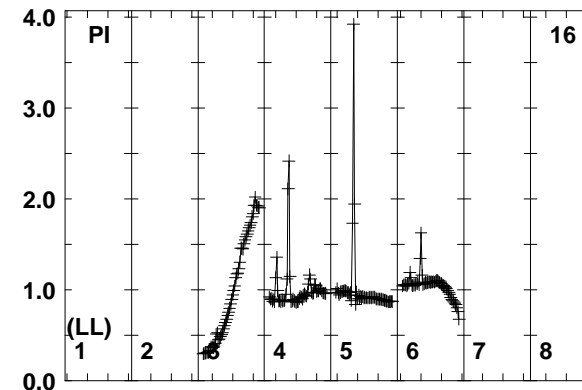
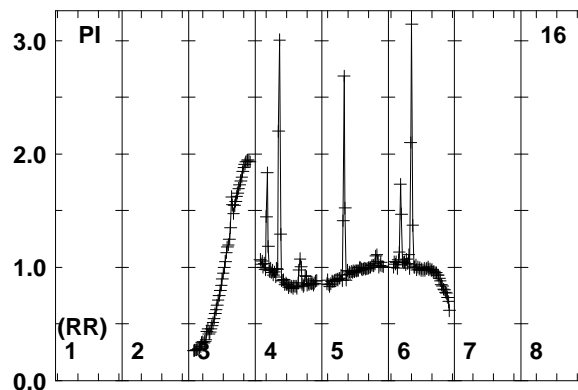
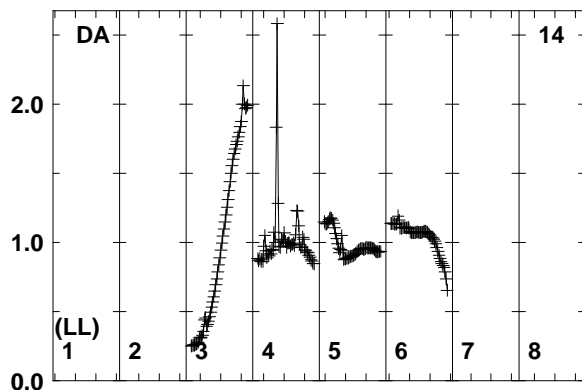
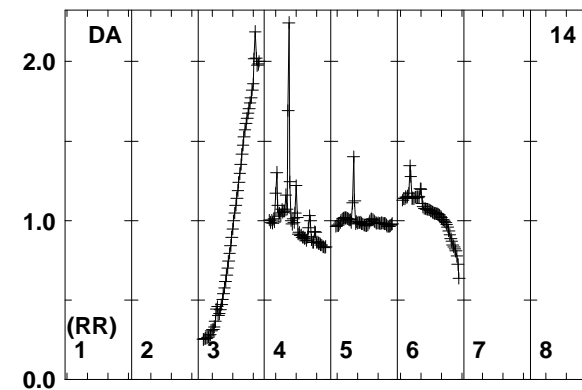
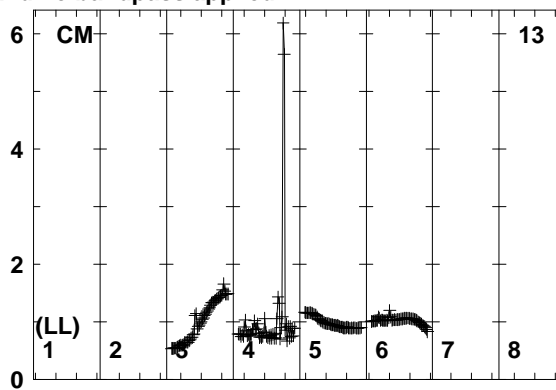
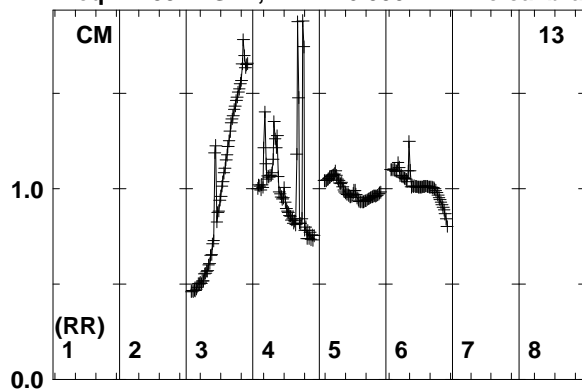

Lower frame: Real Jy
Total-power spectrum Antenna: CM (13)
Timerange: 00/09:16:16 to 00/09:18:44

Plot file version 697 created 04-NOV-2019 14:14:57

J2248-0541 EY034.UVDATA.1

Freq = 1.5947 GHz, Bw = 16.000 MH No calibration applied and no bandpass applied

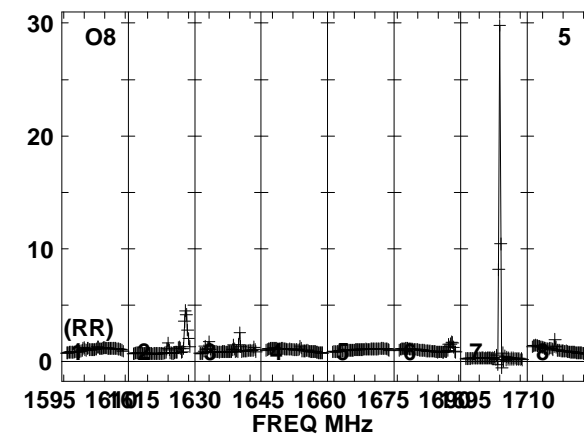
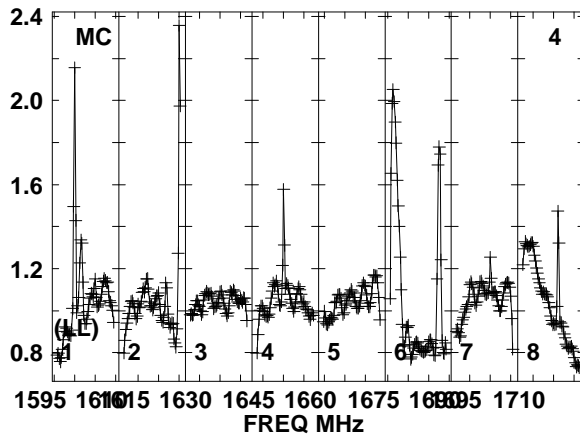
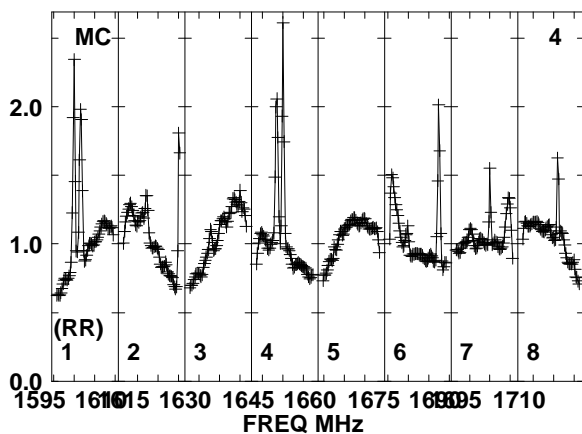
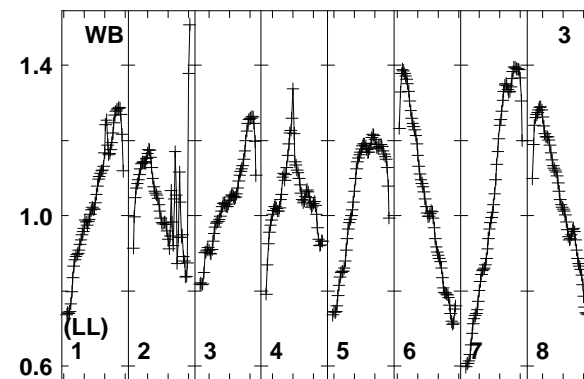
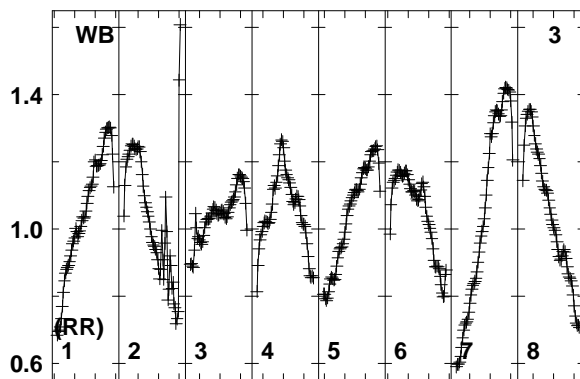
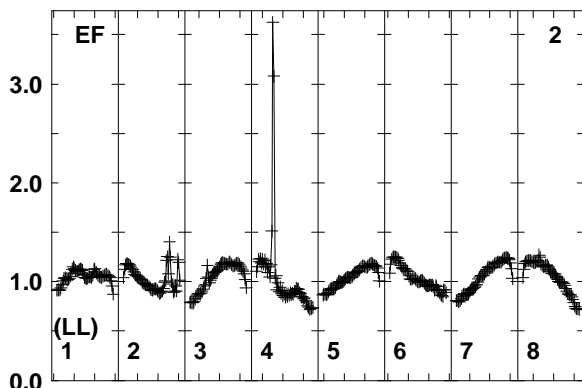
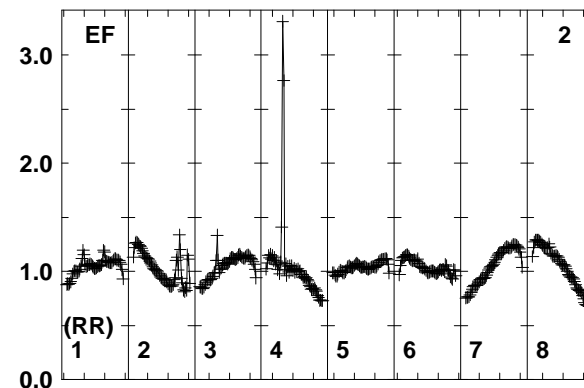
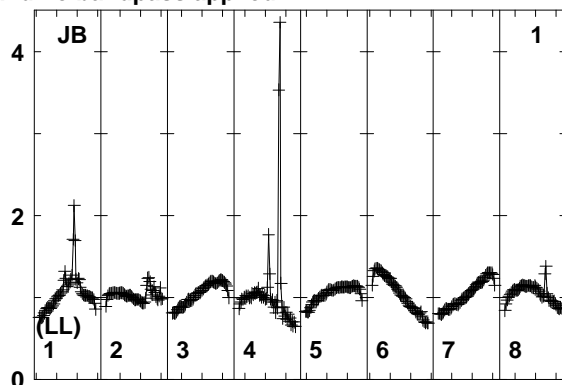
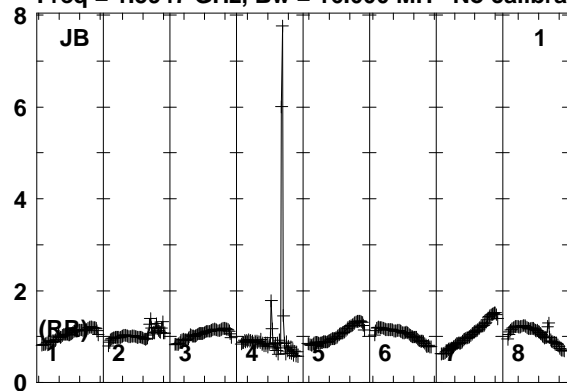

Lower frame: Real Jy
Total-power spectrum Antenna: JB (01)
Timerange: 00/09:19:01 to 00/09:19:59

Plot file version 698 created 04-NOV-2019 14:14:57

J2248-0541 EY034.UVDATA.1

Freq = 1.5947 GHz, Bw = 16.000 MH No calibration applied and no bandpass applied

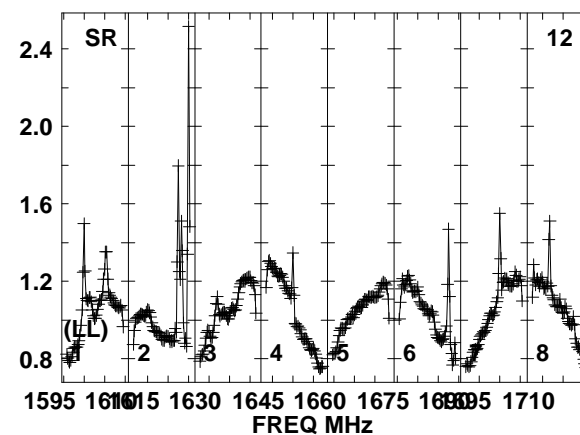
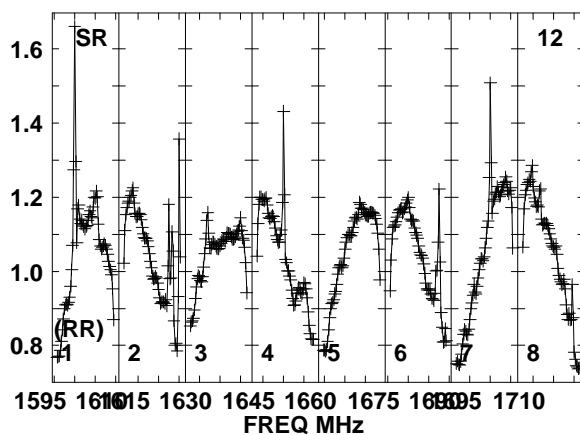
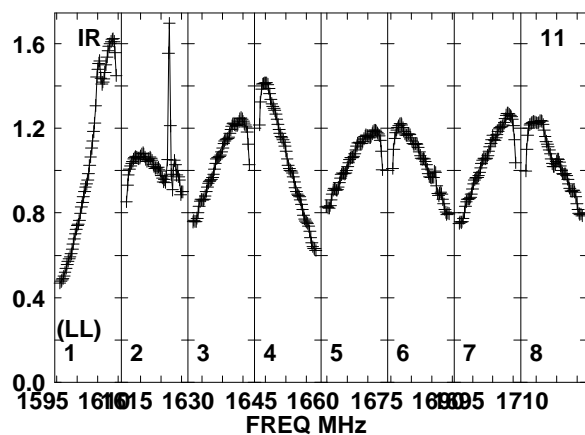
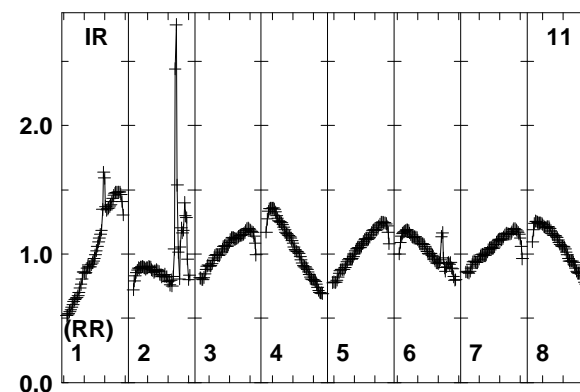
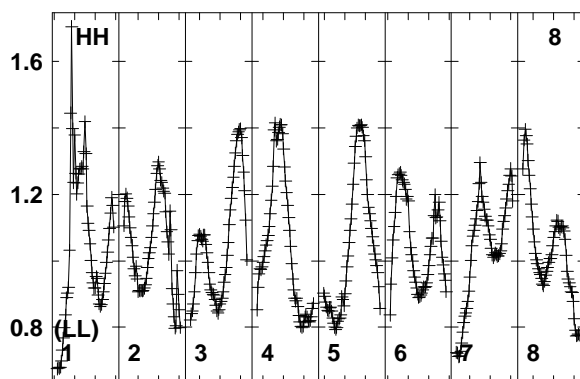
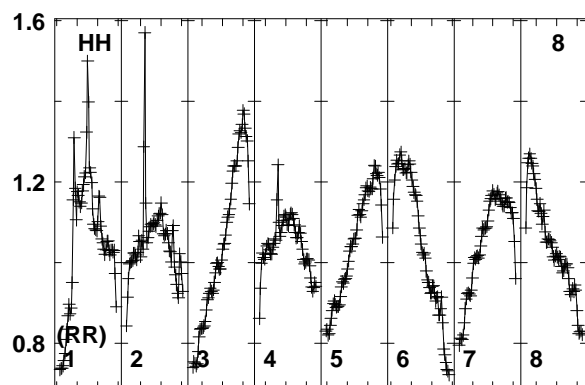
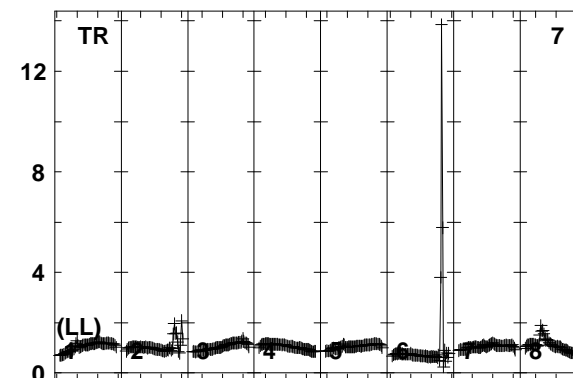
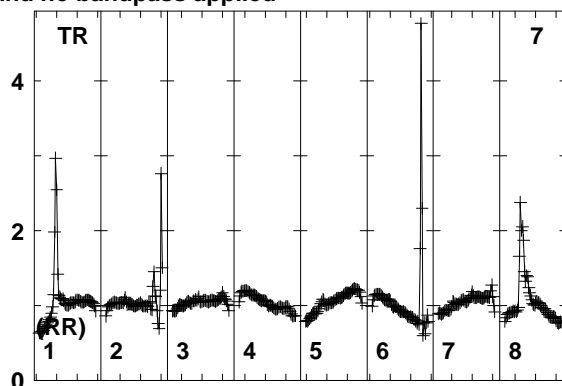
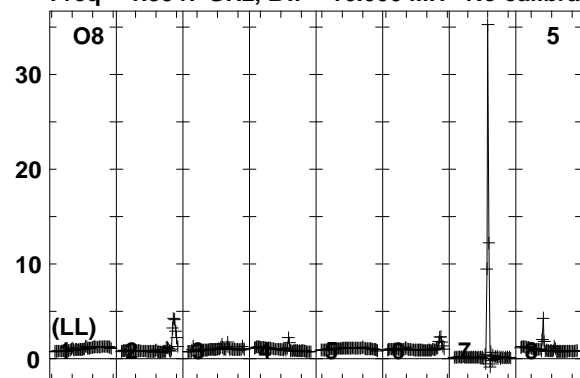

Lower frame: Real Jy
Total-power spectrum Antenna: O8 (05)
Timerange: 00/09:19:01 to 00/09:19:59

Plot file version 699 created 04-NOV-2019 14:14:57

J2248-0541 EY034.UVDATA.1

Freq = 1.5947 GHz, Bw = 16.000 MH No calibration applied and no bandpass applied

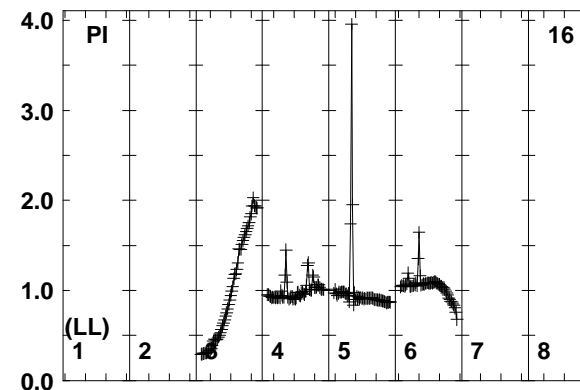
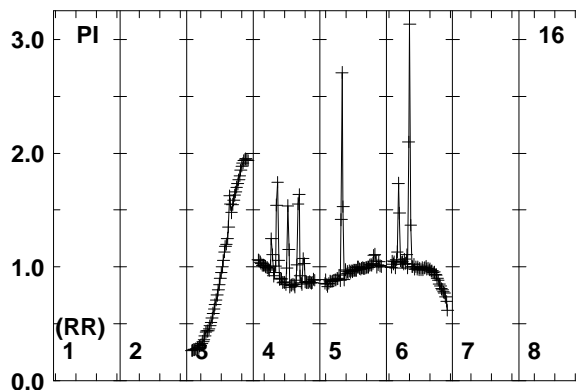
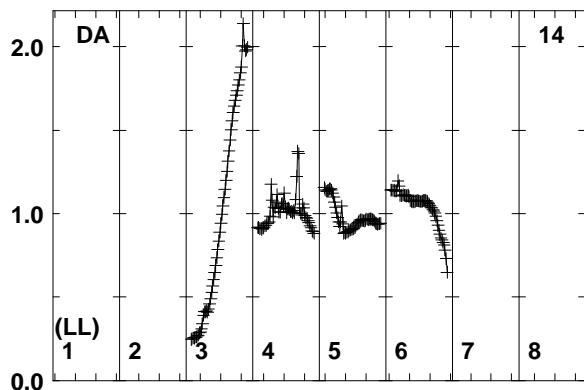
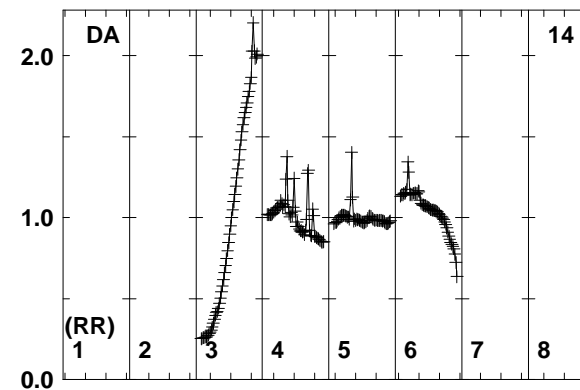
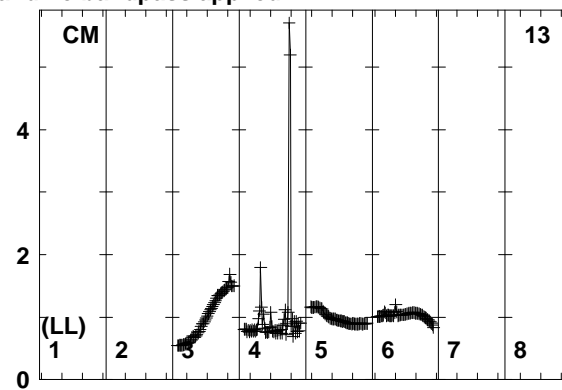
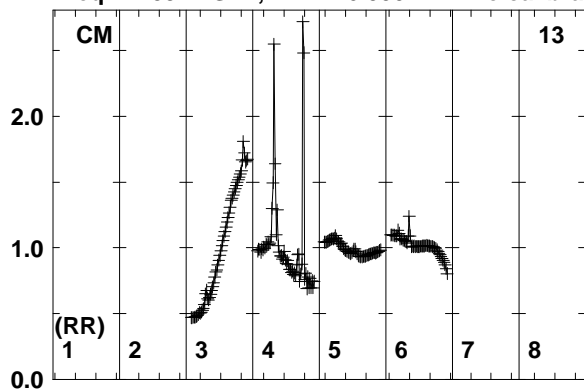

Lower frame: Real Jy
Total-power spectrum Antenna: CM (13)
Timerange: 00/09:19:01 to 00/09:19:59

Plot file version 700 created 04-NOV-2019 14:14:57

W2246-0526 EY034.UVDATA.1

Freq = 1.5947 GHz, Bw = 16.000 MH No calibration applied and no bandpass applied

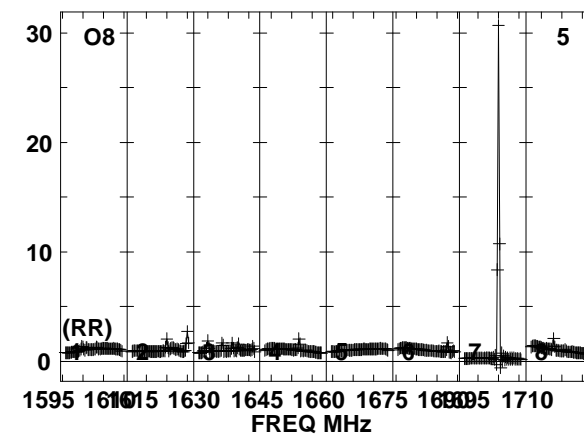
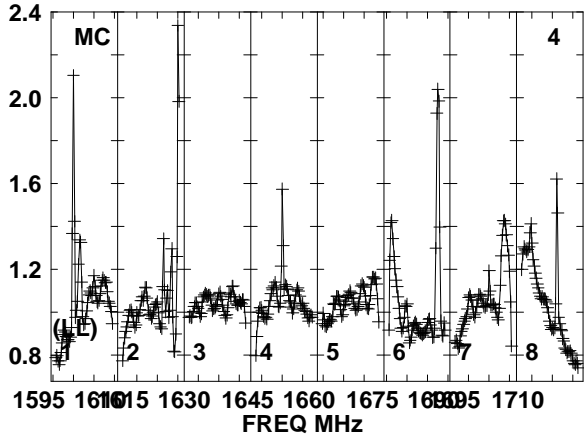
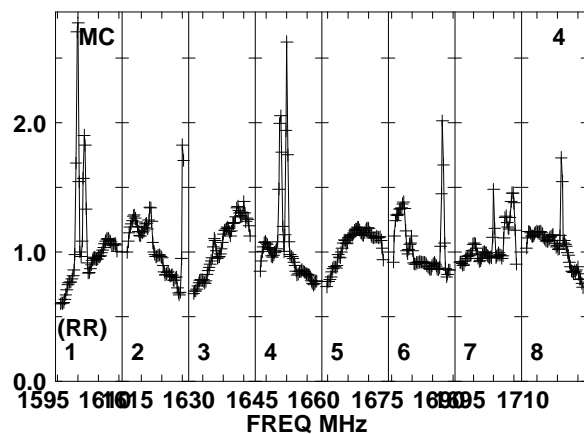
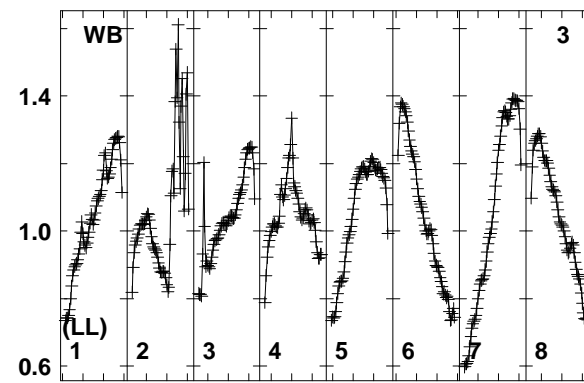
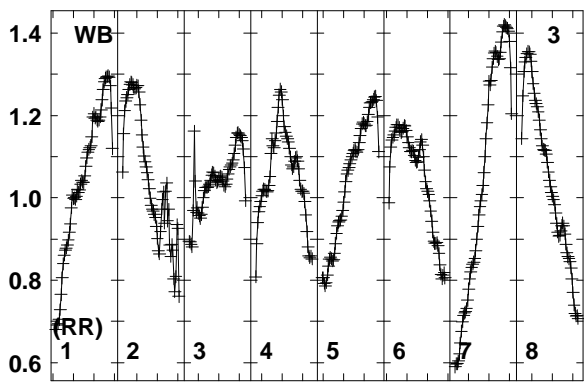
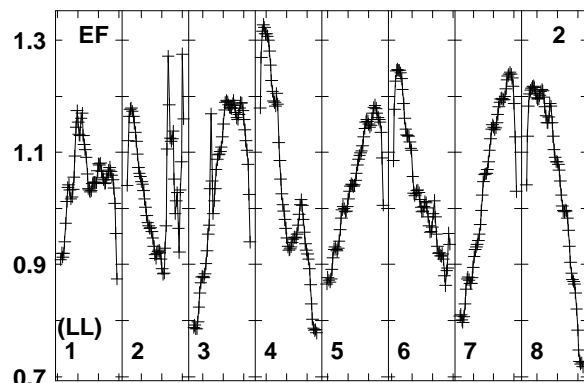
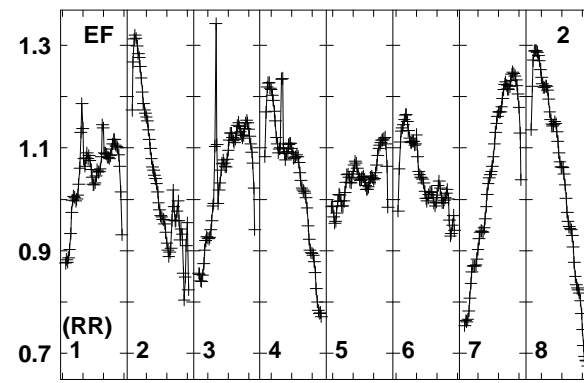
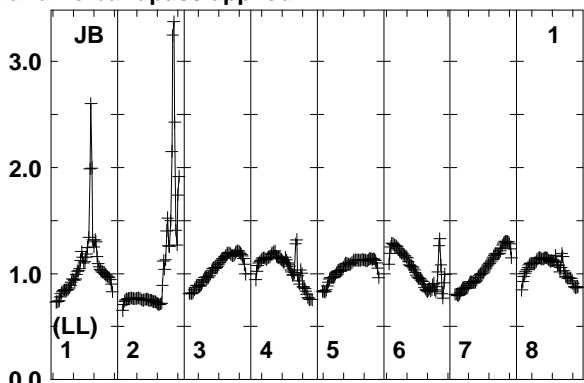
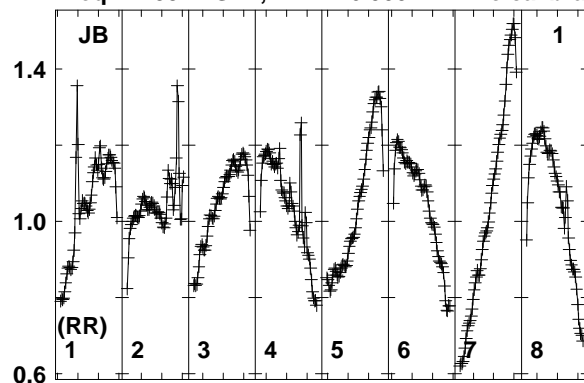

Lower frame: Real Jy
Total-power spectrum Antenna: JB (01)
Timerange: 00/09:20:01 to 00/09:22:39

Plot file version 701 created 04-NOV-2019 14:14:57

W2246-0526 EY034.UVDATA.1

Freq = 1.5947 GHz, Bw = 16.000 MH No calibration applied and no bandpass applied

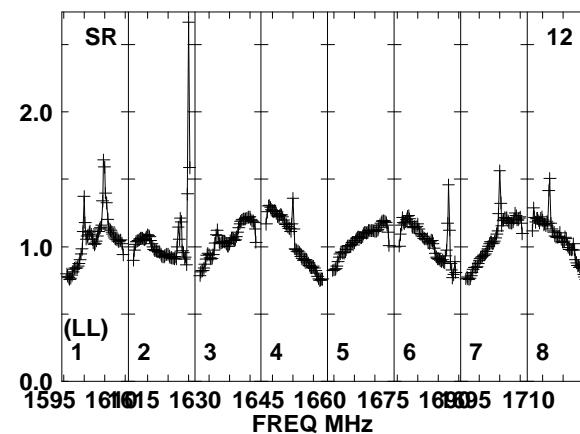
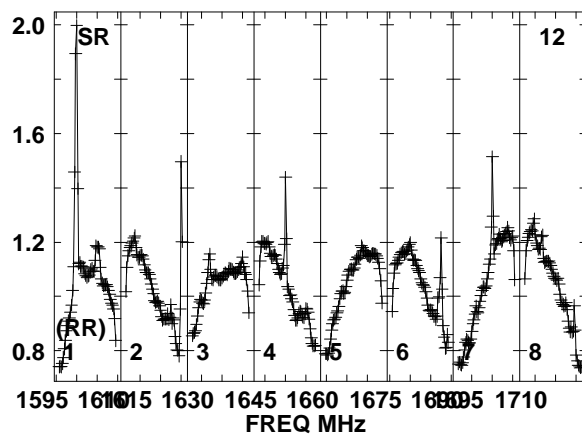
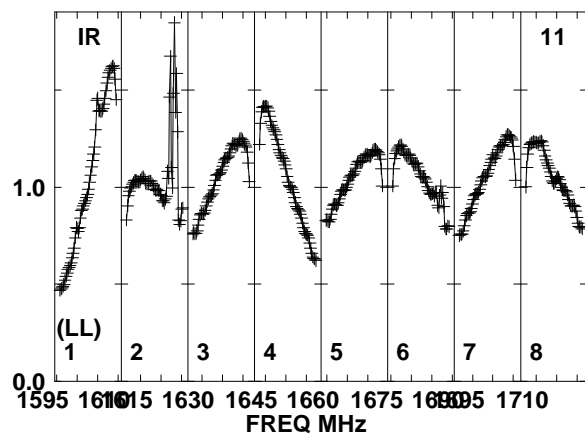
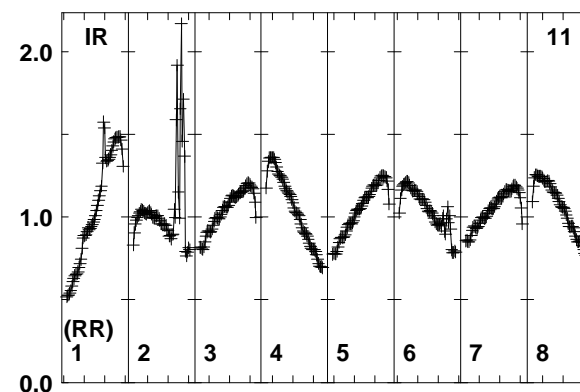
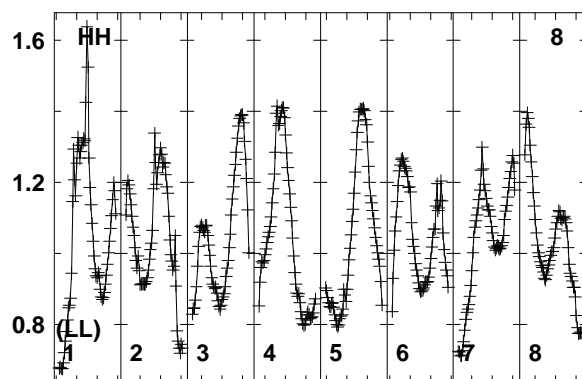
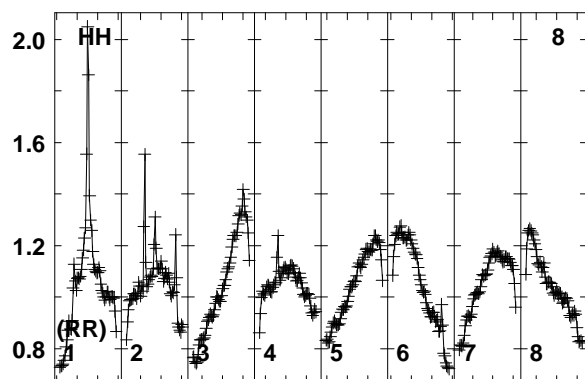
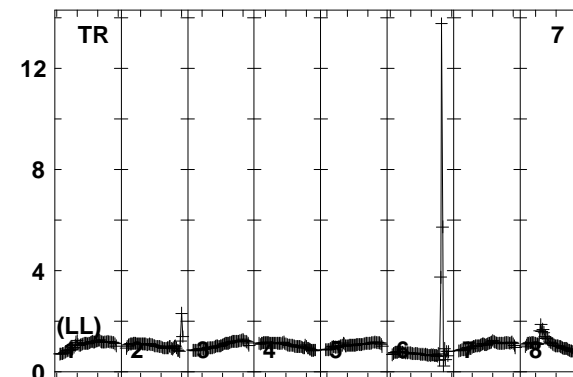
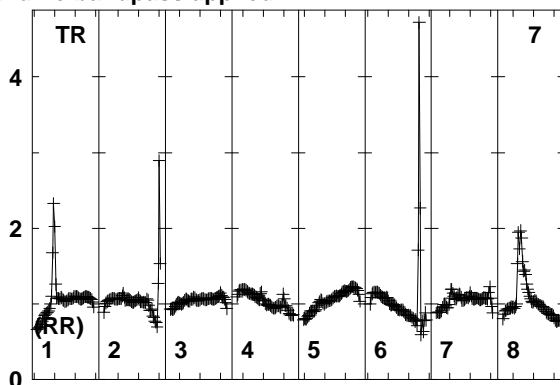
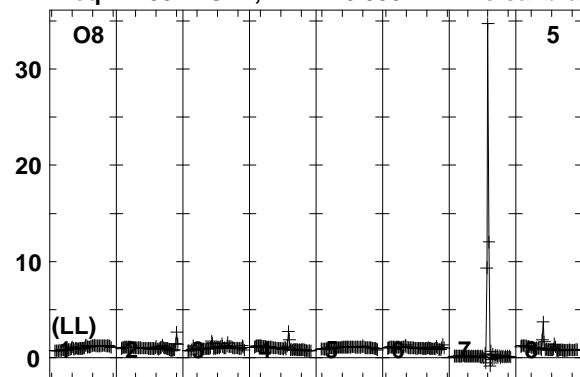

Lower frame: Real Jy
Total-power spectrum Antenna: O8 (05)
Timerange: 00/09:20:01 to 00/09:22:39

Plot file version 702 created 04-NOV-2019 14:14:57

W2246-0526 EY034.UVDATA.1

Freq = 1.5947 GHz, Bw = 16.000 MH No calibration applied and no bandpass applied

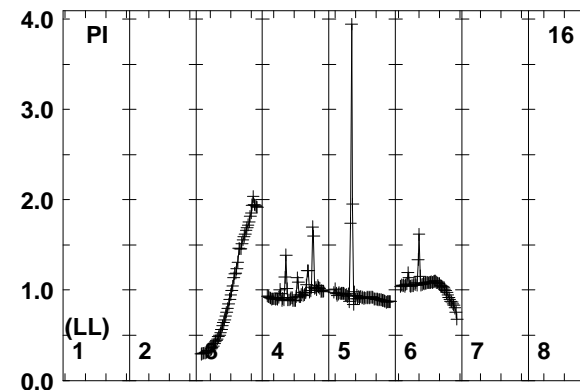
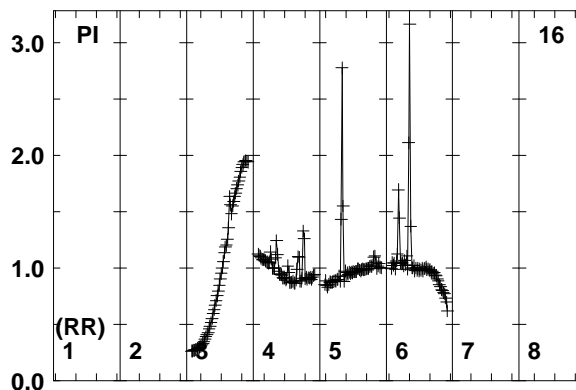
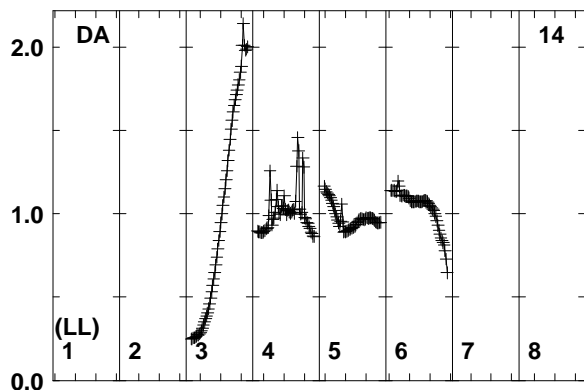
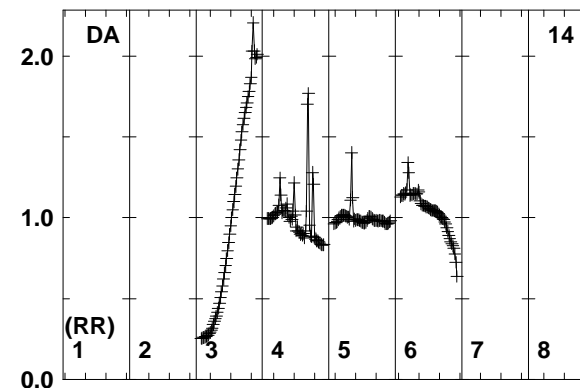
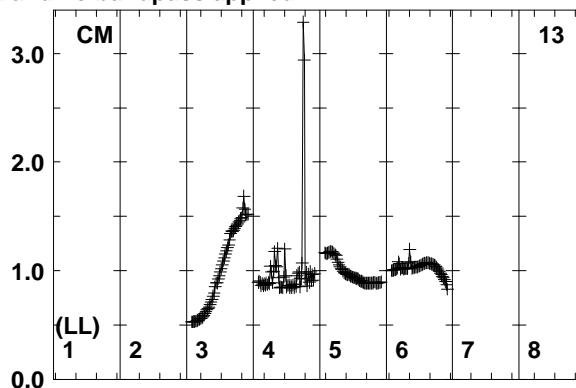
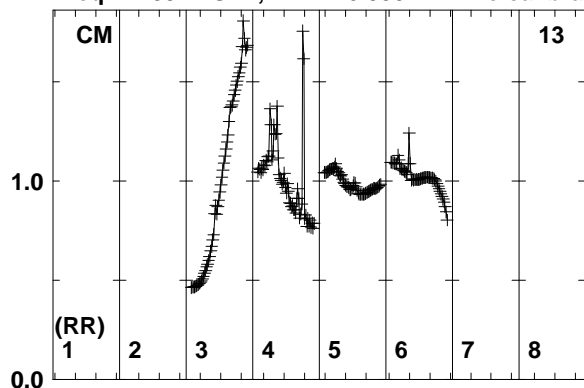

Lower frame: Real Jy
Total-power spectrum Antenna: CM (13)
Timerange: 00/09:20:01 to 00/09:22:39

Plot file version 703 created 04-NOV-2019 14:14:57

J2248-0541 EY034.UVDATA.1

Freq = 1.5947 GHz, Bw = 16.000 MH No calibration applied and no bandpass applied

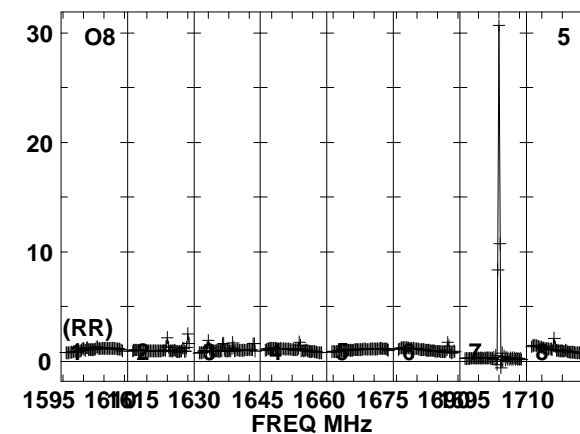
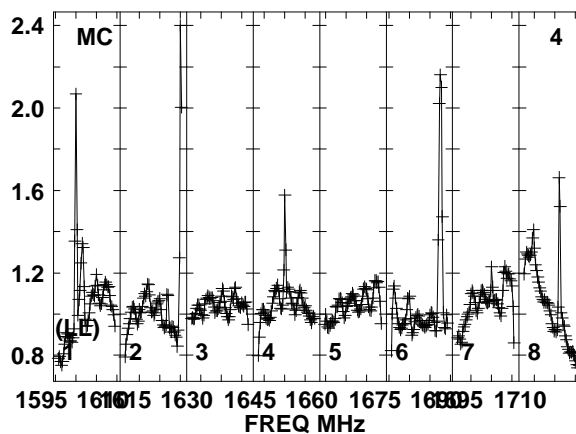
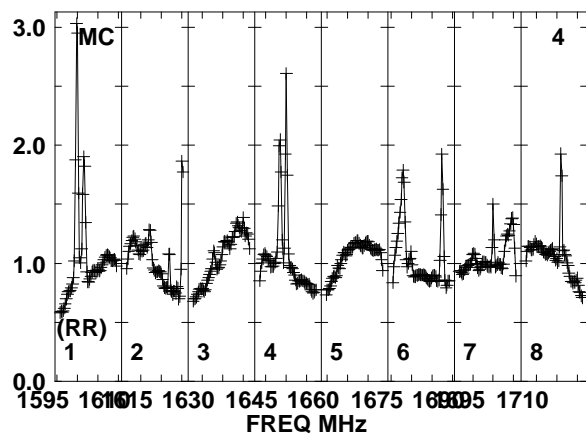
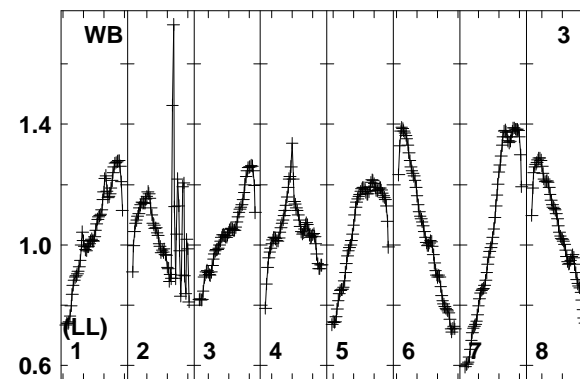
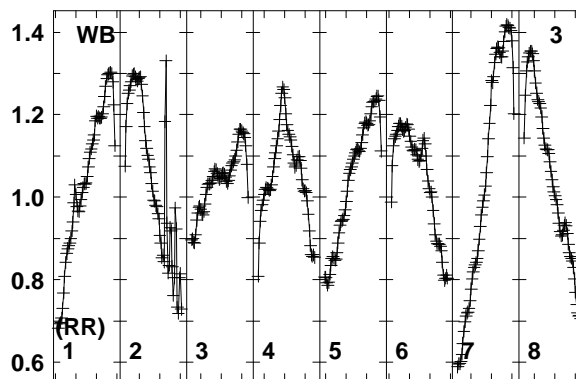
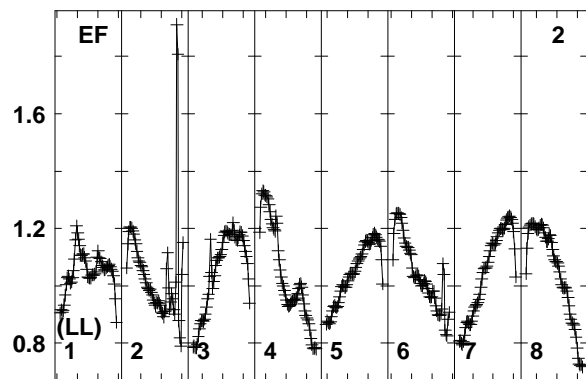
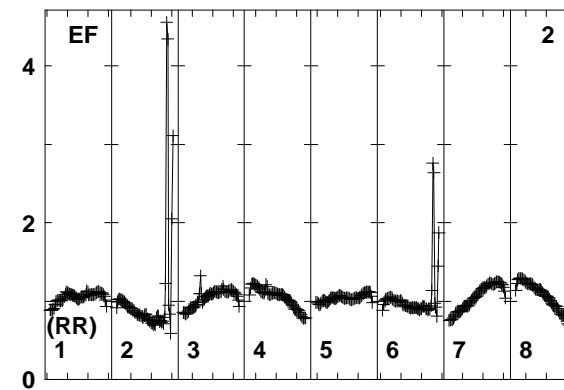
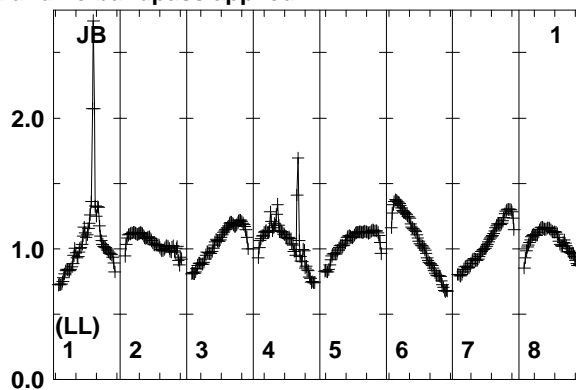
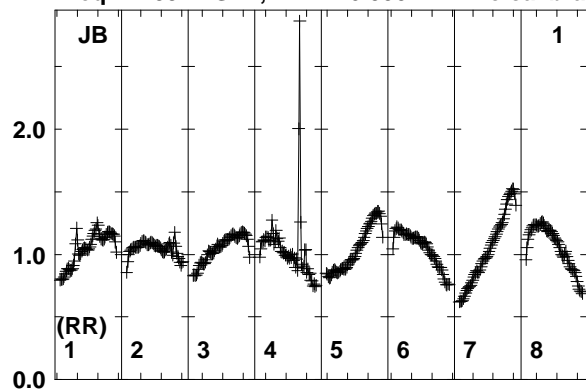

Lower frame: Real Jy
Total-power spectrum Antenna: JB (01)
Timerange: 00/09:22:56 to 00/09:23:54

Plot file version 704 created 04-NOV-2019 14:14:57

J2248-0541 EY034.UVDATA.1

Freq = 1.5947 GHz, Bw = 16.000 MH No calibration applied and no bandpass applied

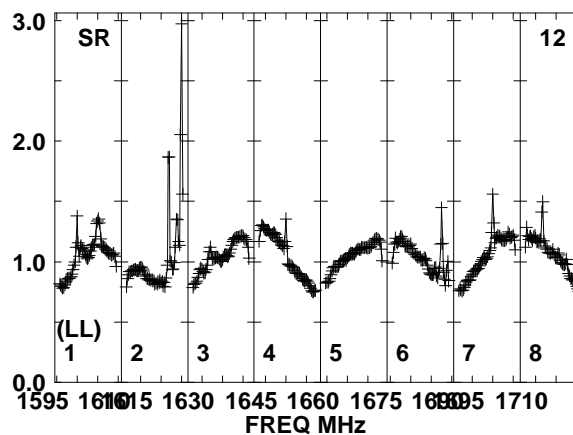
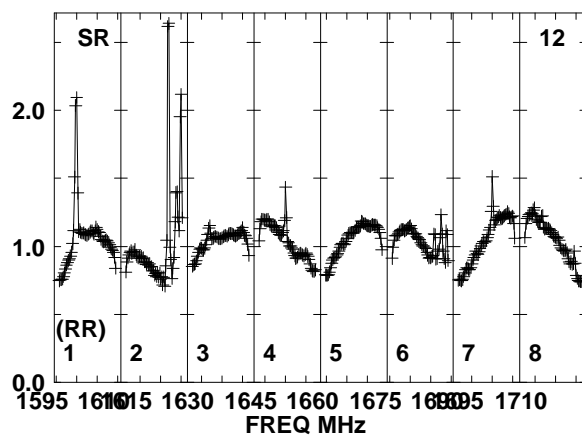
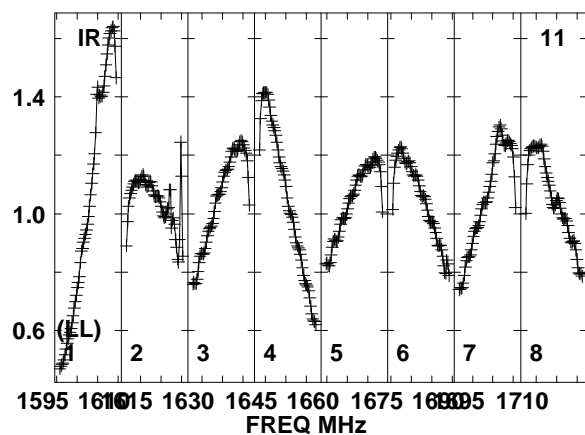
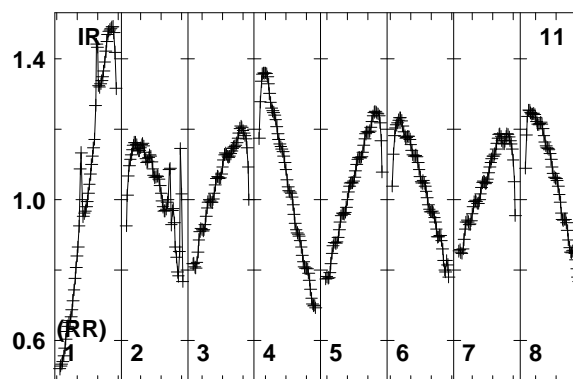
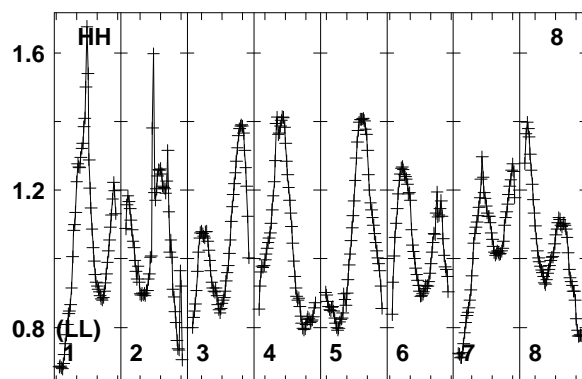
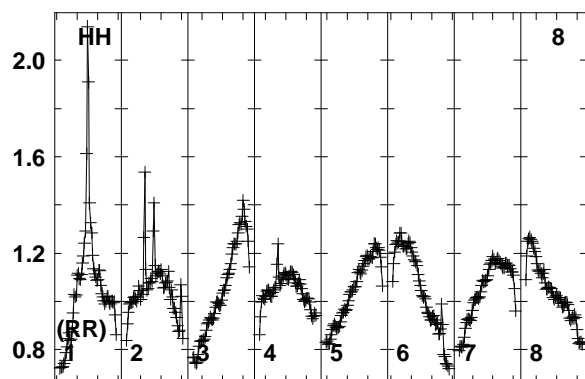
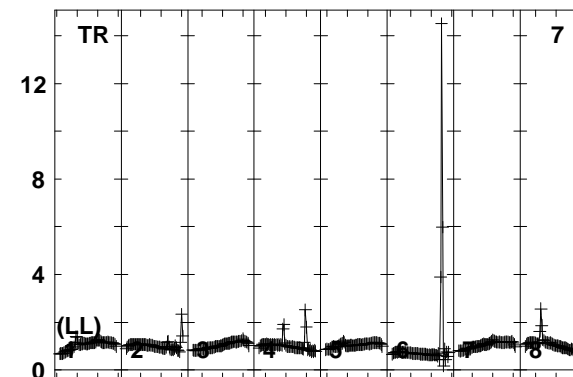
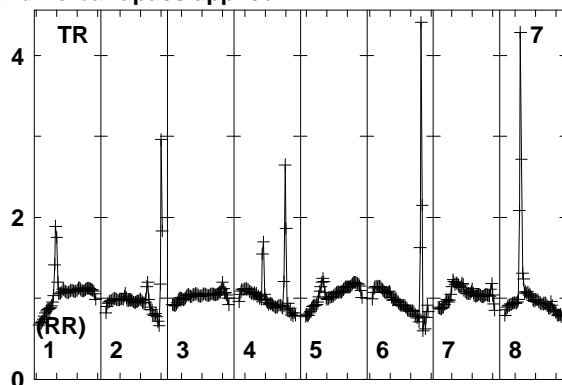
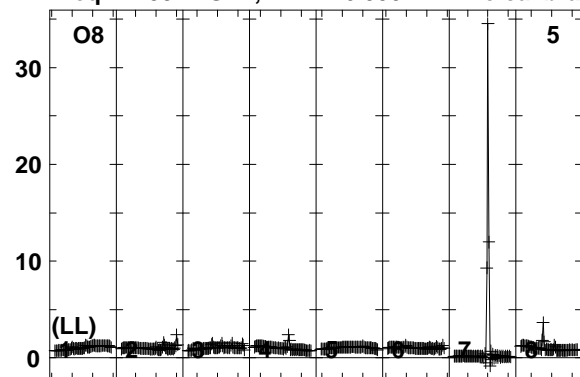

Lower frame: Real Jy
Total-power spectrum Antenna: O8 (05)
Timerange: 00/09:22:56 to 00/09:23:54

Plot file version 705 created 04-NOV-2019 14:14:57

J2248-0541 EY034.UVDATA.1

Freq = 1.5947 GHz, Bw = 16.000 MH No calibration applied and no bandpass applied

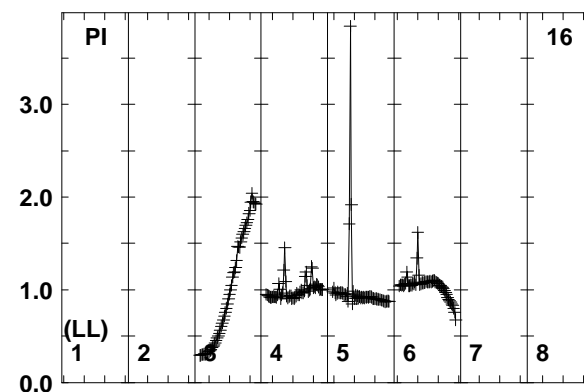
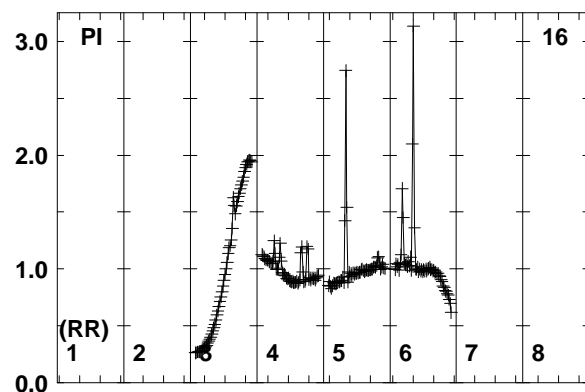
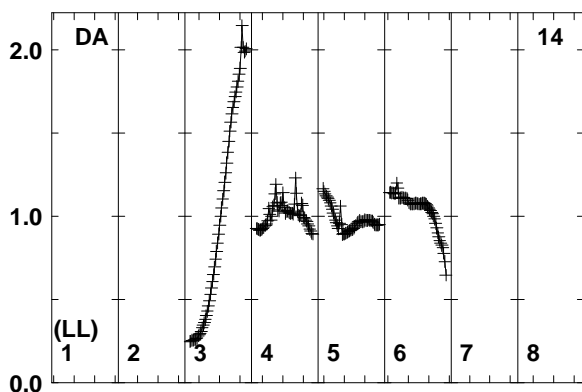
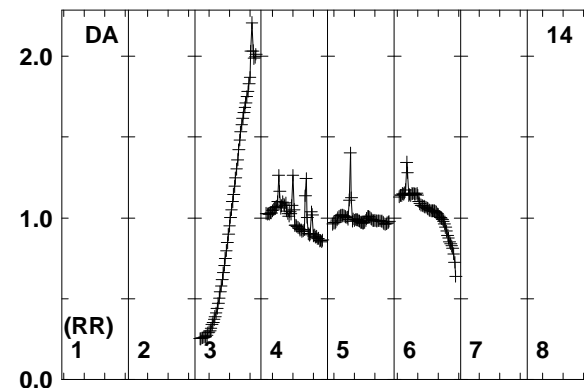
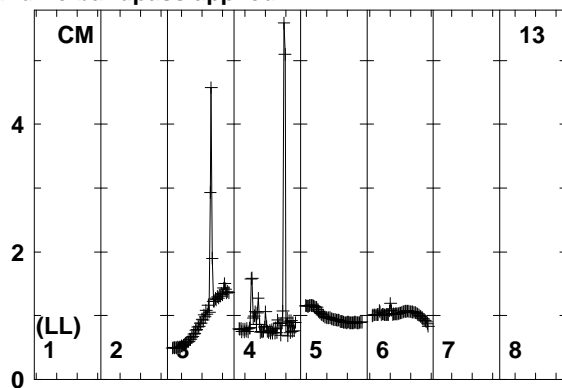
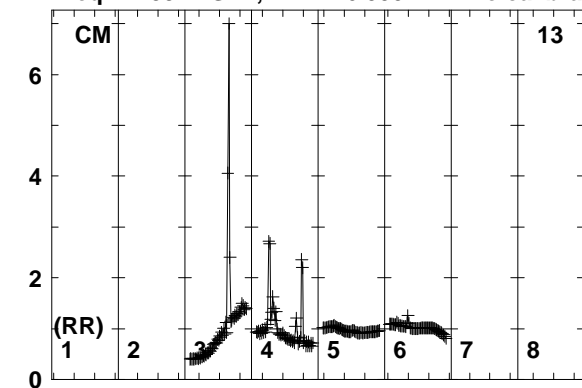

Lower frame: Real Jy
Total-power spectrum Antenna: CM (13)
Timerange: 00/09:22:56 to 00/09:23:54

Plot file version 706 created 04-NOV-2019 14:14:58

W2246-0526 EY034.UVDATA.1

Freq = 1.5947 GHz, Bw = 16.000 MH No calibration applied and no bandpass applied

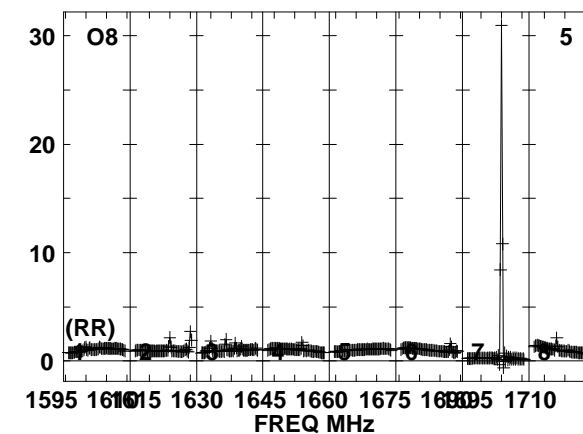
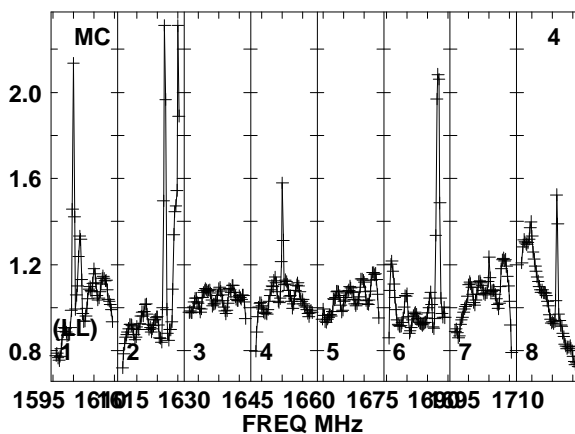
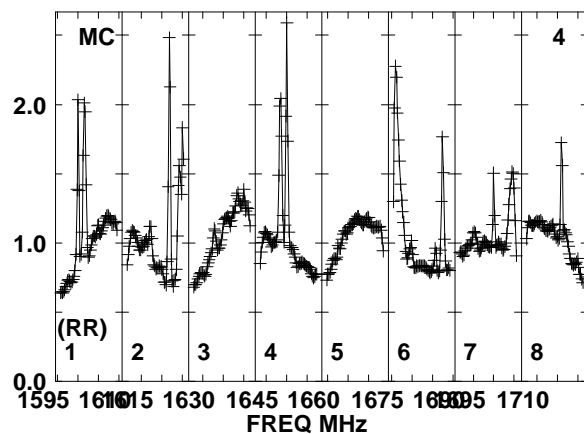
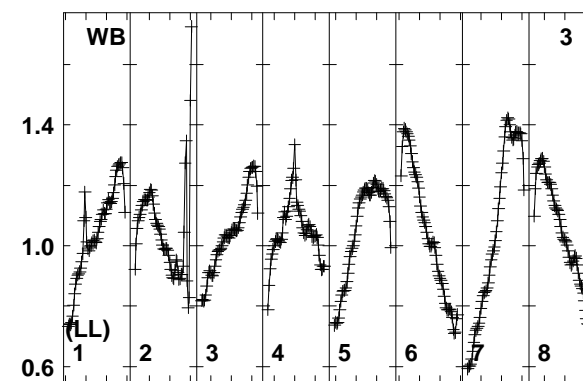
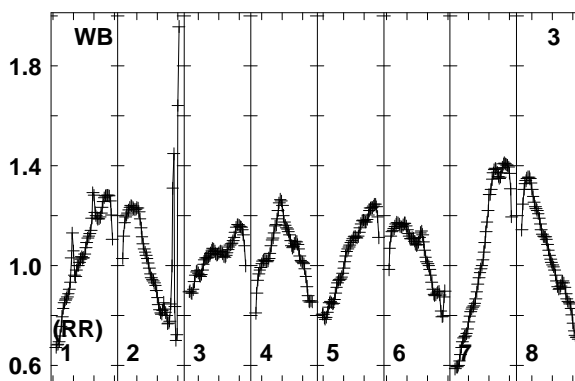
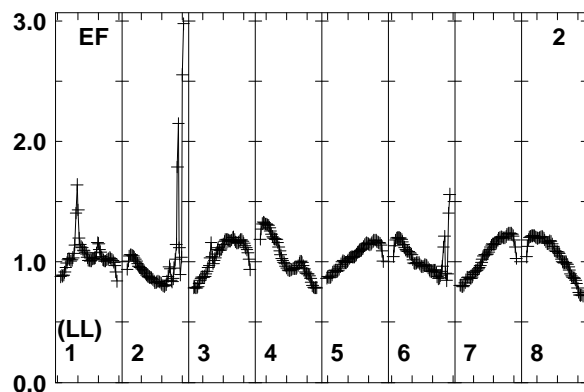
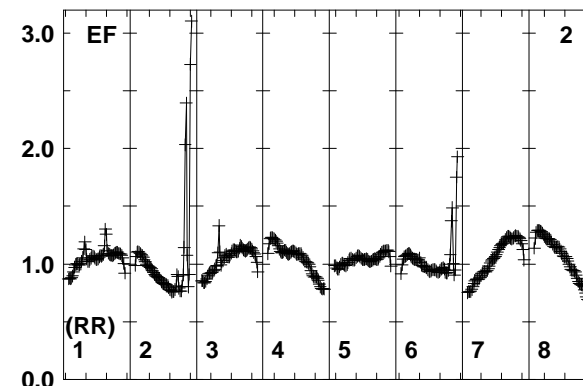
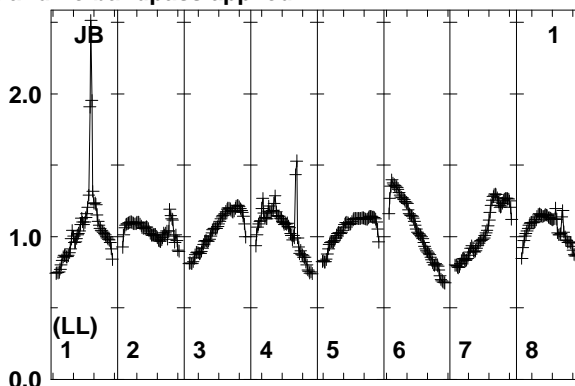
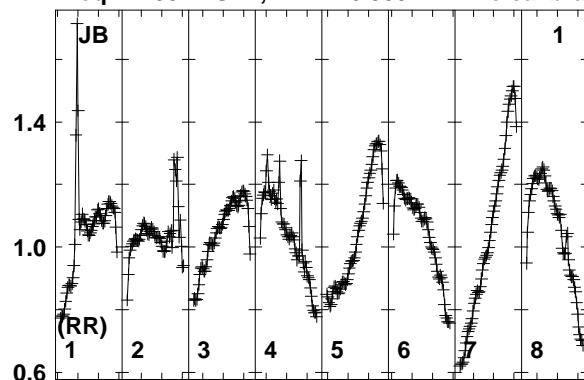

Lower frame: Real Jy
Total-power spectrum Antenna: JB (01)
Timerange: 00/09:23:56 to 00/09:26:34

Plot file version 707 created 04-NOV-2019 14:14:58

W2246-0526 EY034.UVDATA.1

Freq = 1.5947 GHz, Bw = 16.000 MH No calibration applied and no bandpass applied

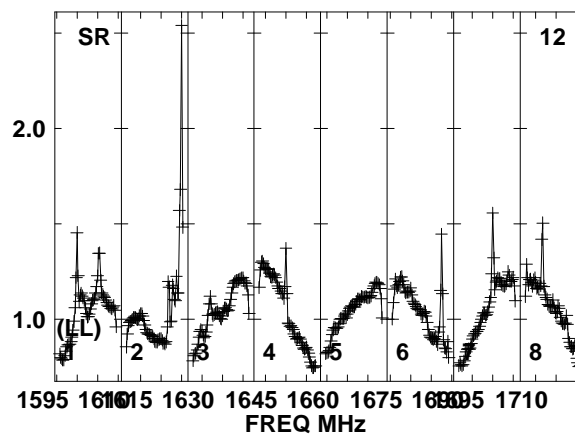
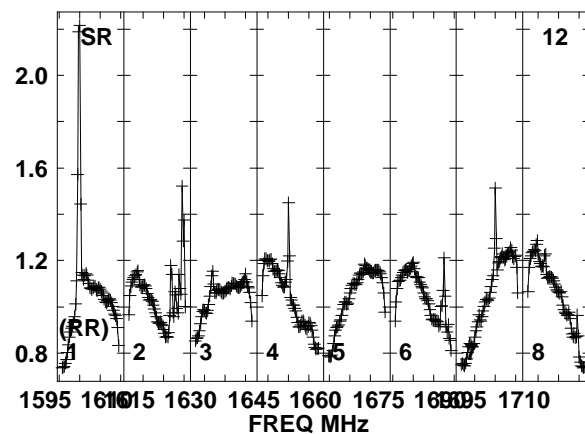
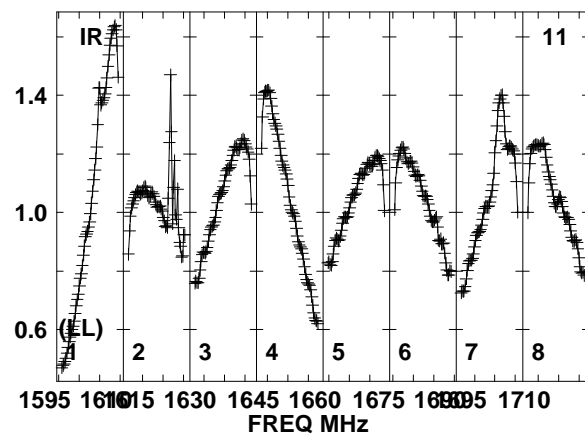
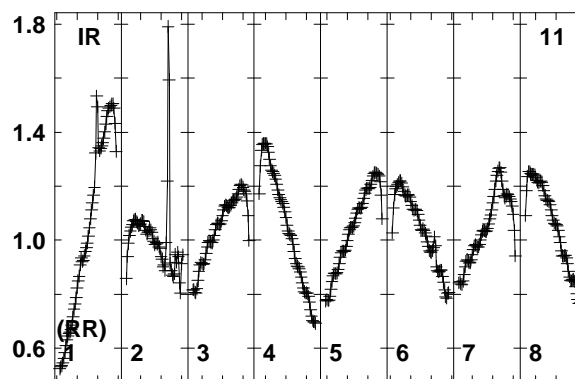
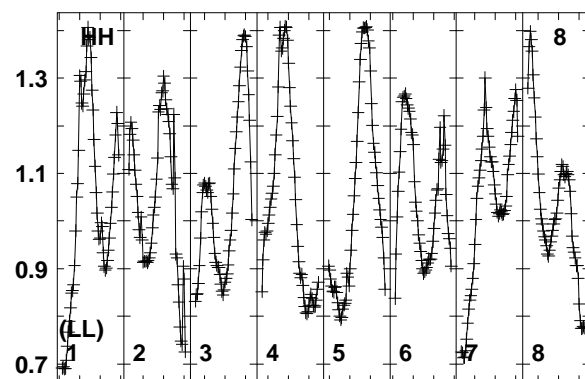
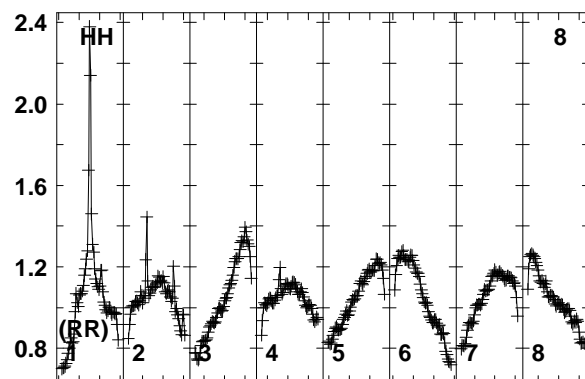
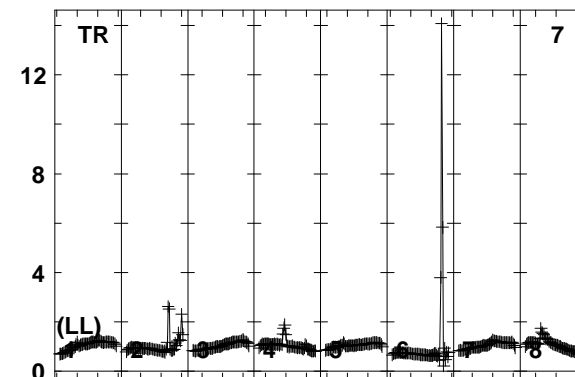
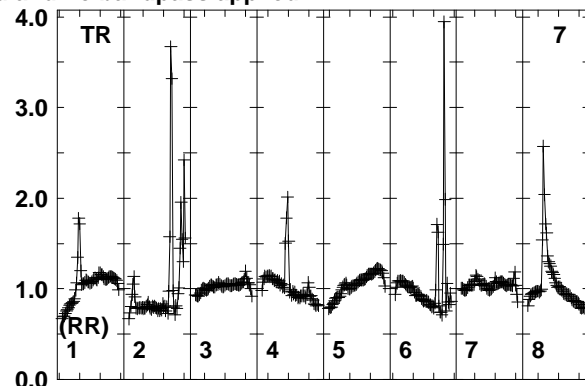
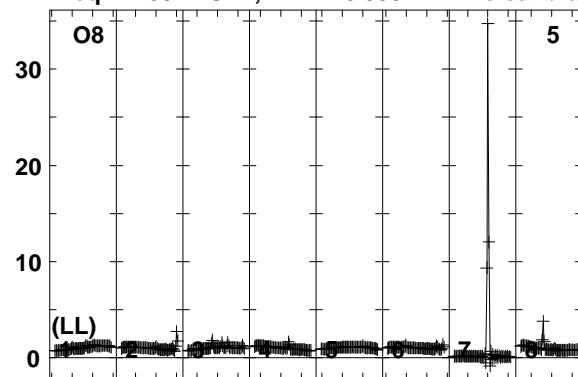

Lower frame: Real Jy
Total-power spectrum Antenna: O8 (05)
Timerange: 00/09:23:56 to 00/09:26:34

Plot file version 708 created 04-NOV-2019 14:14:58

W2246-0526 EY034.UVDATA.1

Freq = 1.5947 GHz, Bw = 16.000 MH No calibration applied and no bandpass applied

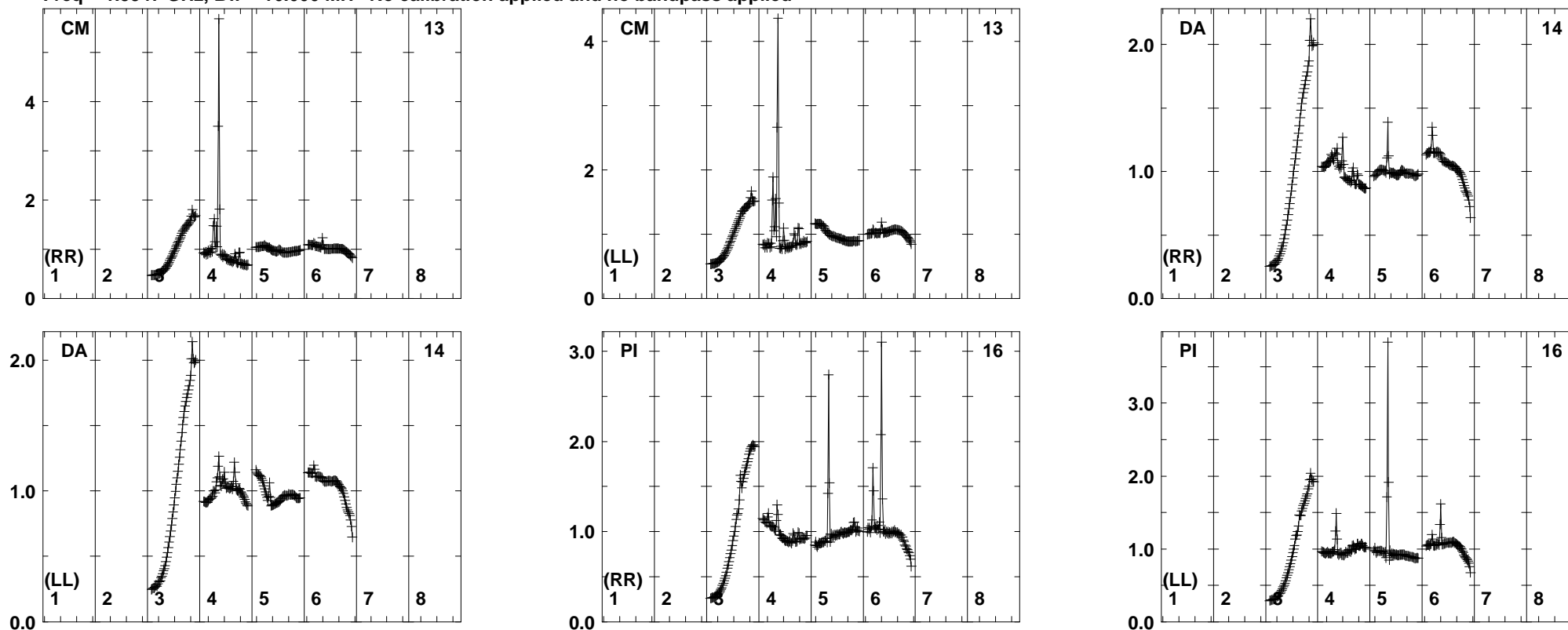

Lower frame: Real Jy
Total-power spectrum Antenna: CM (13)
Timerange: 00/09:23:56 to 00/09:26:34

Plot file version 709 created 04-NOV-2019 14:14:58

J2248-0541 EY034.UVDATA.1

Freq = 1.5947 GHz, Bw = 16.000 MH No calibration applied and no bandpass applied

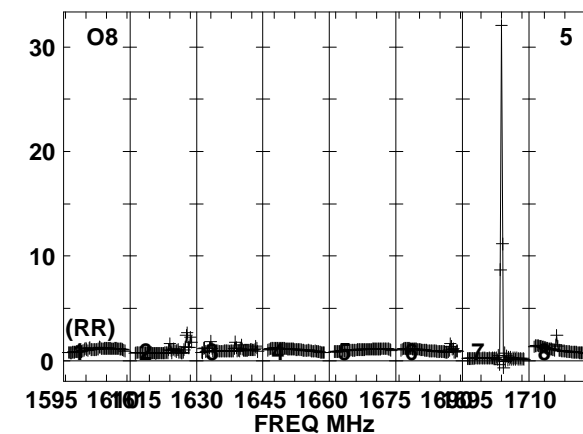
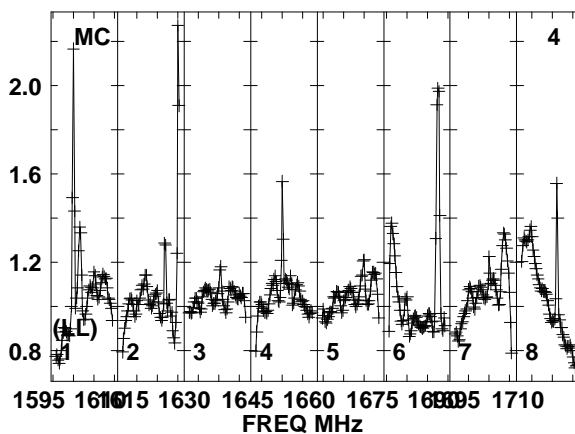
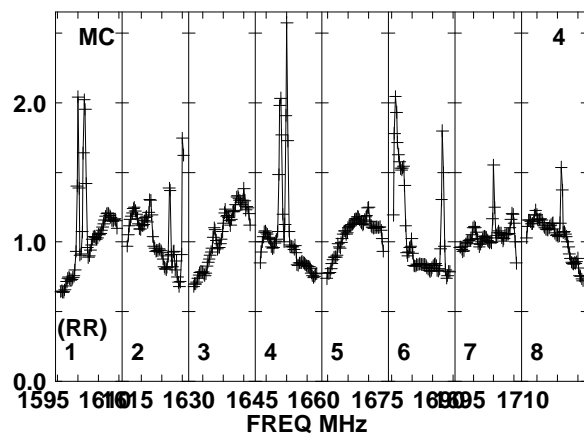
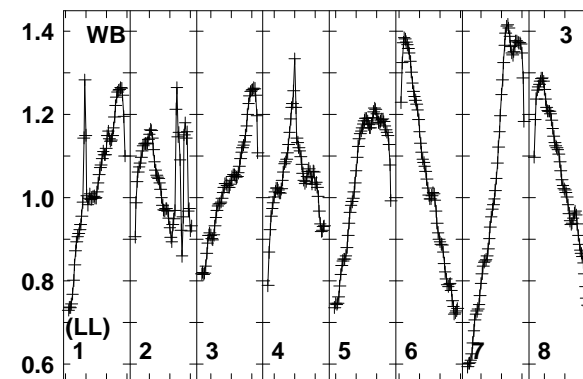
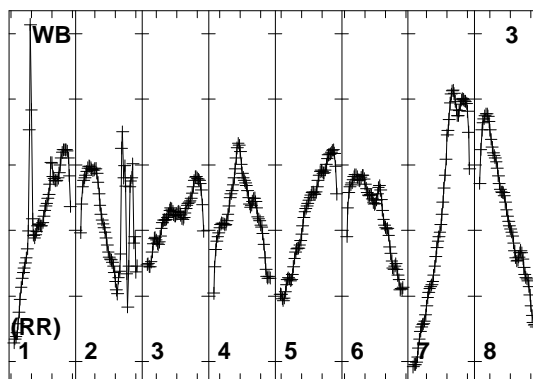
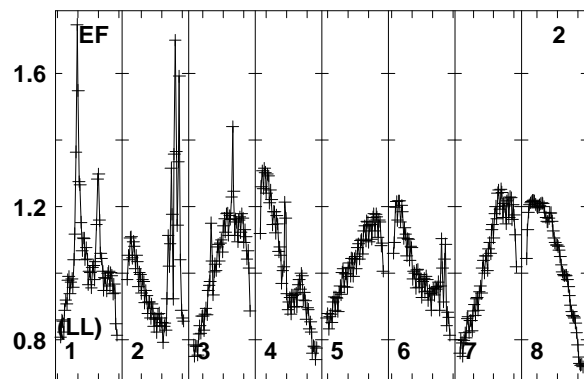
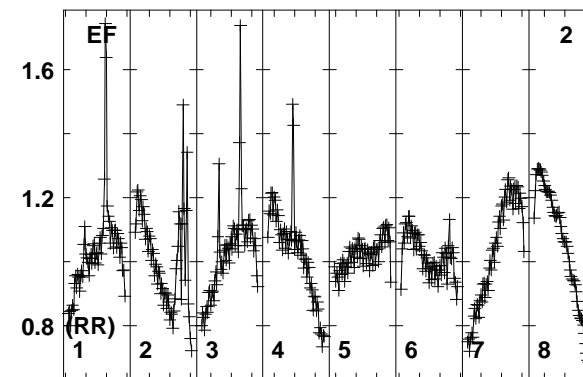
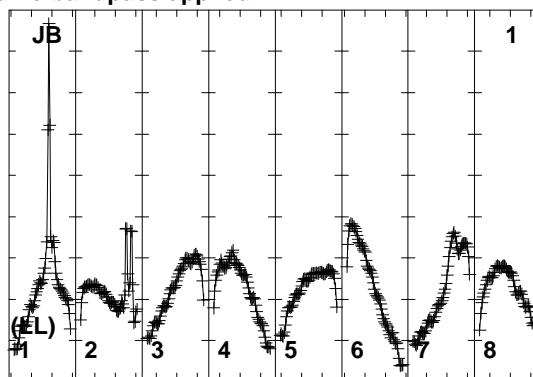
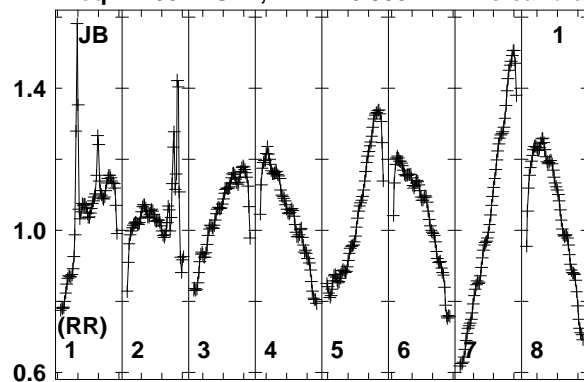

Lower frame: Real Jy
Total-power spectrum Antenna: JB (01)
Timerange: 00/09:26:51 to 00/09:27:49

Plot file version 710 created 04-NOV-2019 14:14:58

J2248-0541 EY034.UVDATA.1

Freq = 1.5947 GHz, Bw = 16.000 MH No calibration applied and no bandpass applied

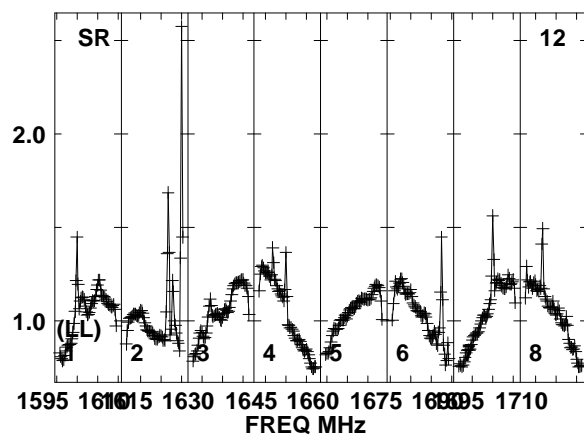
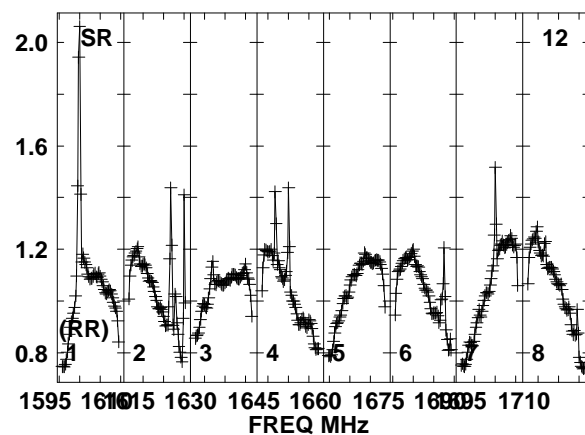
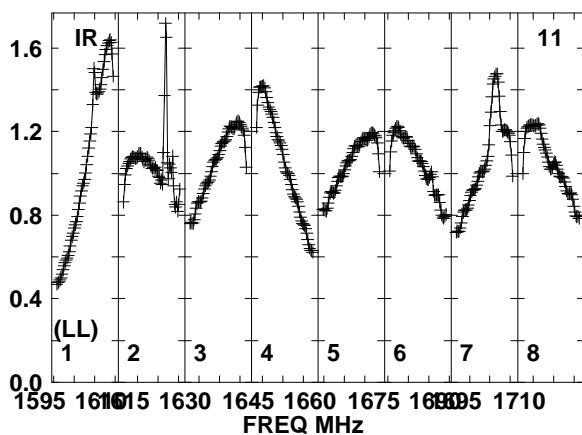
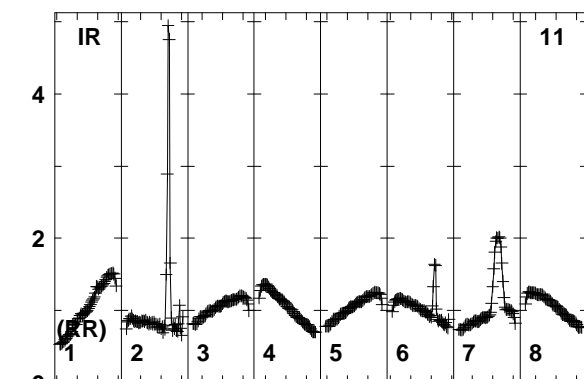
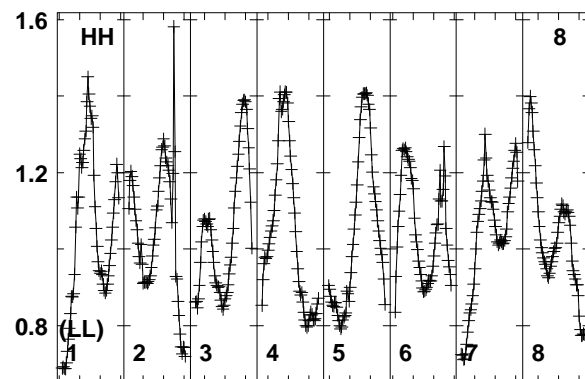
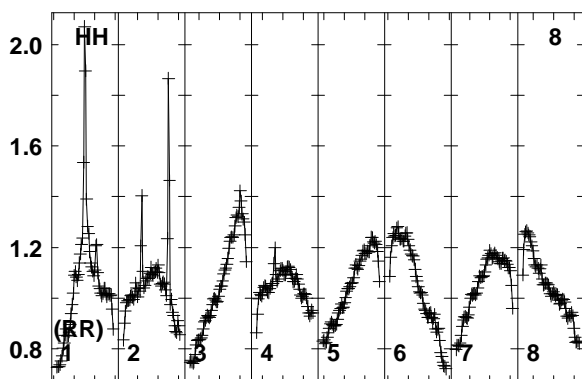
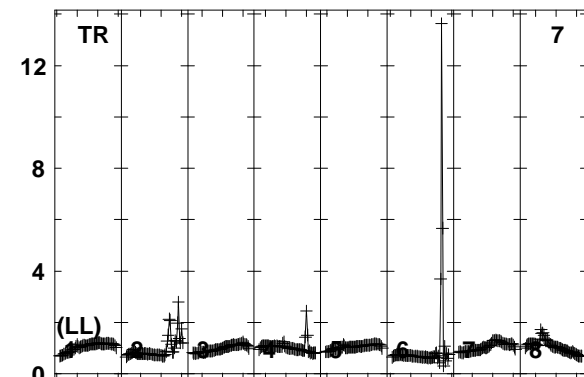
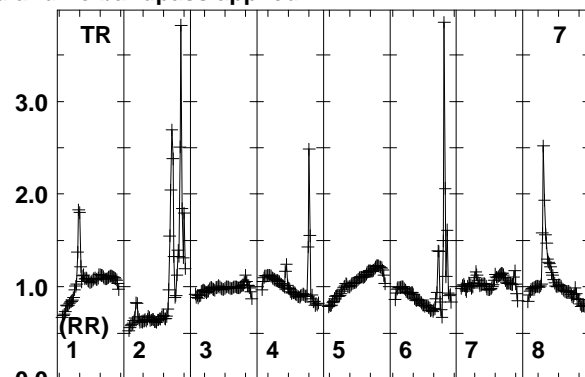
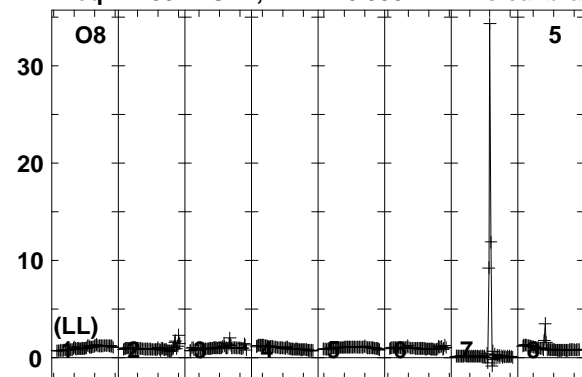

Lower frame: Real Jy
Total-power spectrum Antenna: O8 (05)
Timerange: 00/09:26:51 to 00/09:27:49

Plot file version 711 created 04-NOV-2019 14:14:58

J2248-0541 EY034.UVDATA.1

Freq = 1.5947 GHz, Bw = 16.000 MH No calibration applied and no bandpass applied

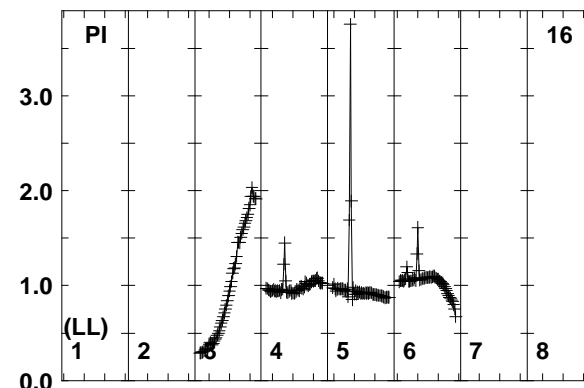
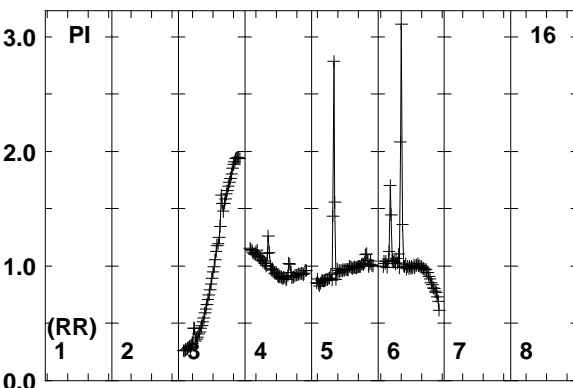
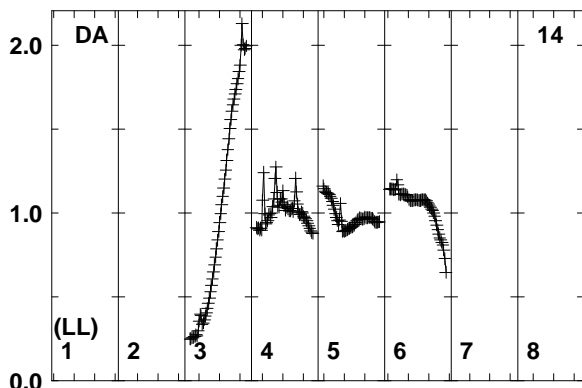
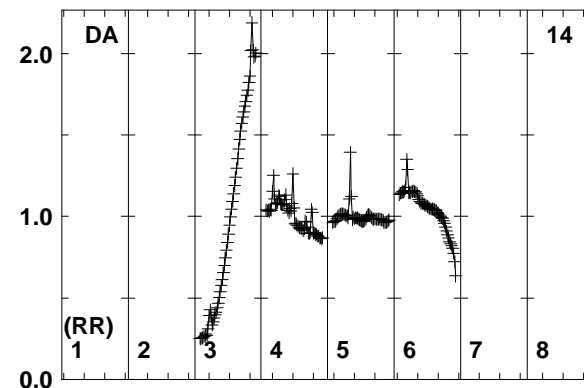
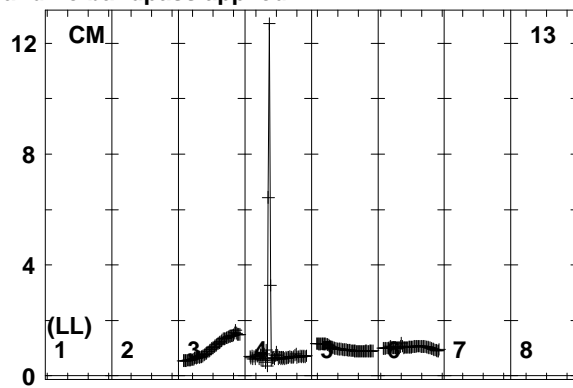
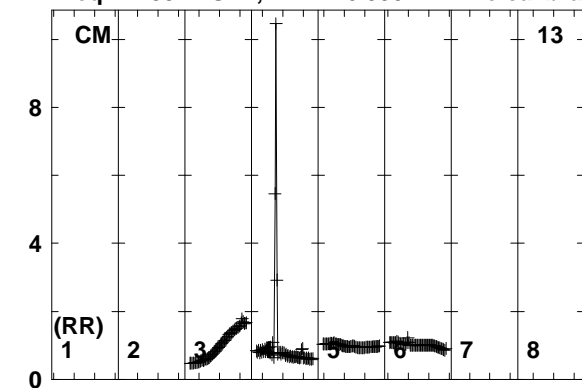

Lower frame: Real Jy
Total-power spectrum Antenna: CM (13)
Timerange: 00/09:26:51 to 00/09:27:49

Plot file version 712 created 04-NOV-2019 14:14:58

W2246-0526 EY034.UVDATA.1

Freq = 1.5947 GHz, Bw = 16.000 MH No calibration applied and no bandpass applied

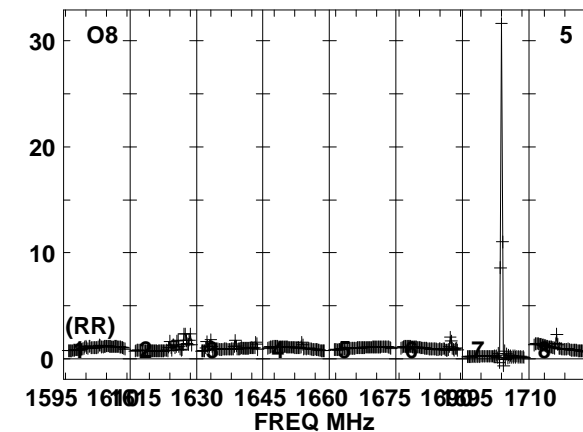
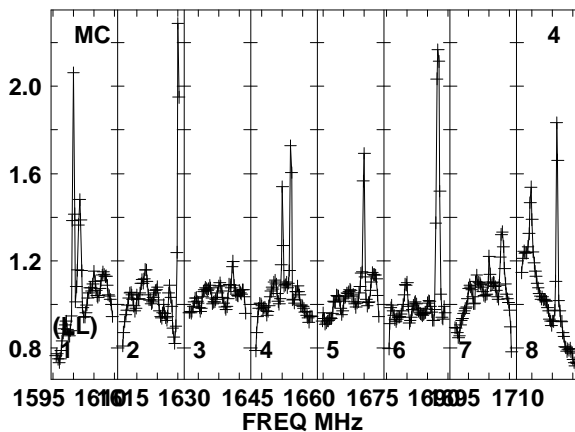
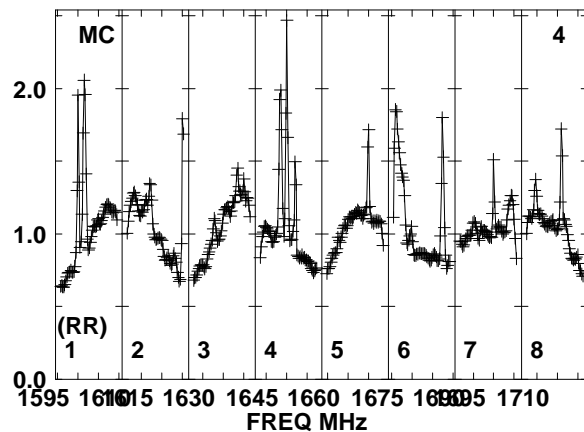
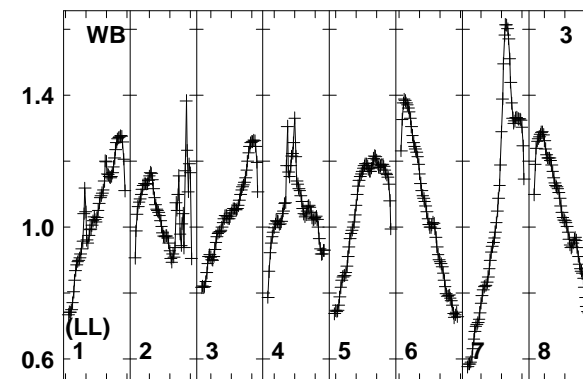
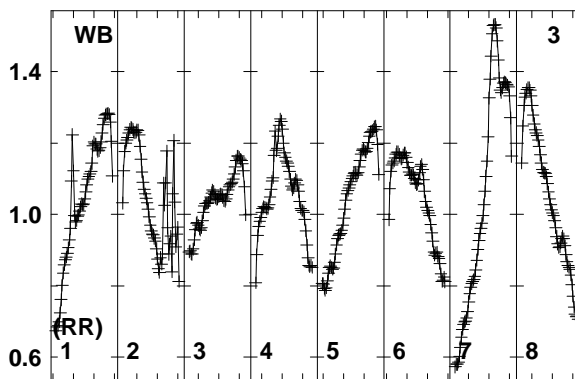
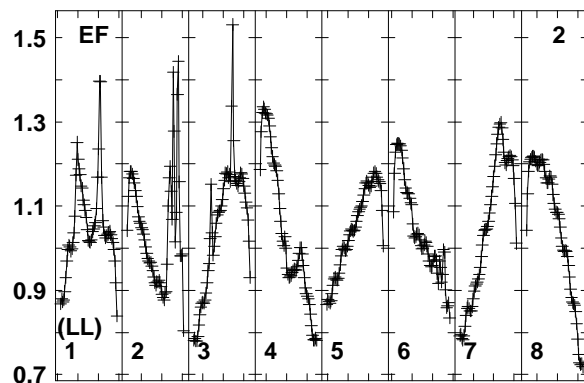
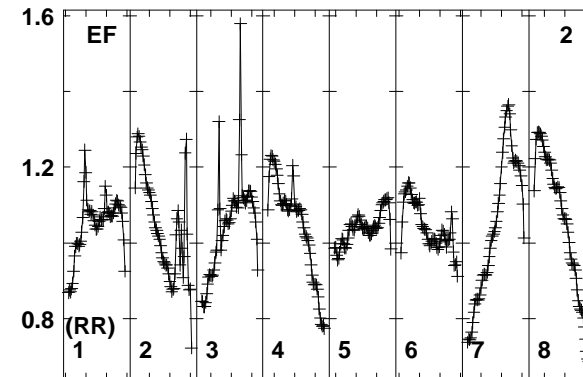
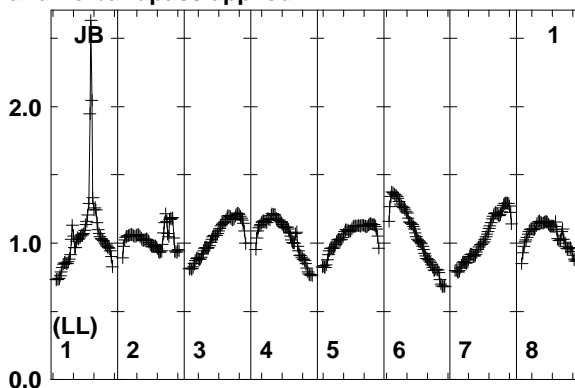
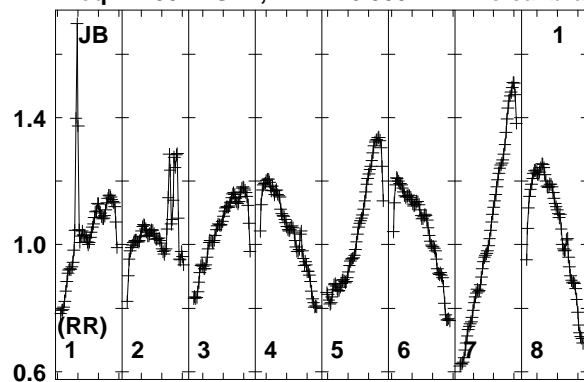

Lower frame: Real Jy
Total-power spectrum Antenna: JB (01)
Timerange: 00/09:27:51 to 00/09:30:29

Plot file version 713 created 04-NOV-2019 14:14:58

W2246-0526 EY034.UVDATA.1

Freq = 1.5947 GHz, Bw = 16.000 MH No calibration applied and no bandpass applied

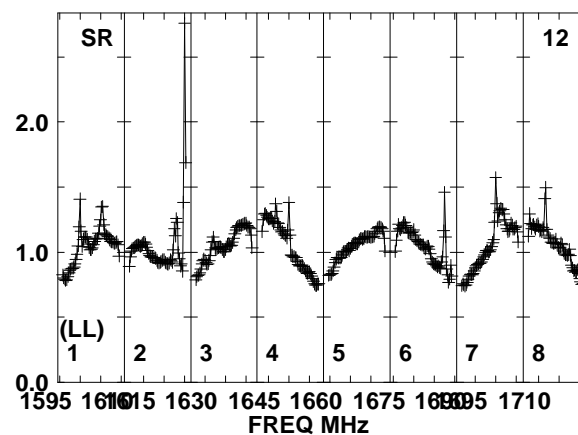
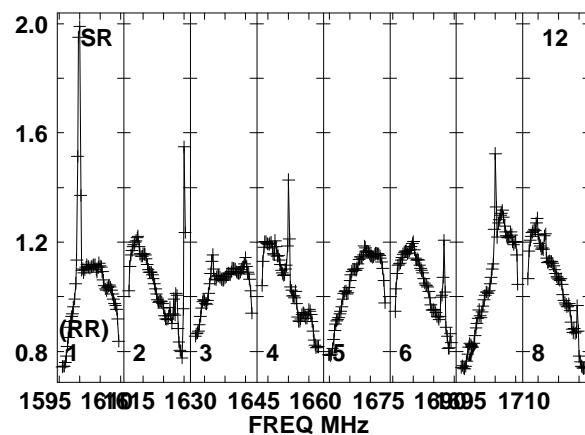
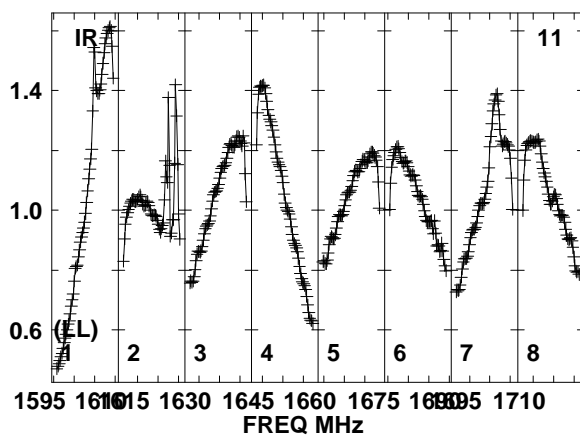
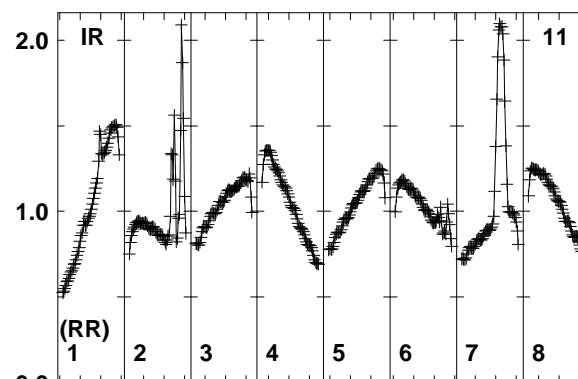
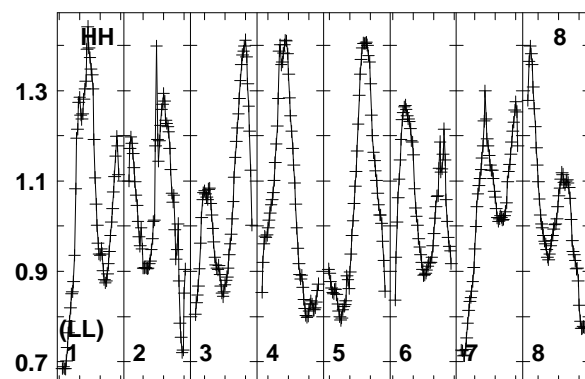
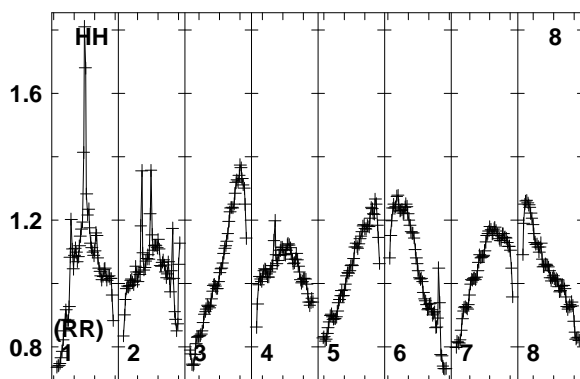
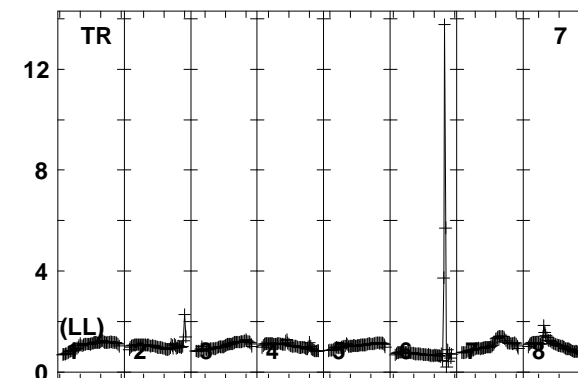
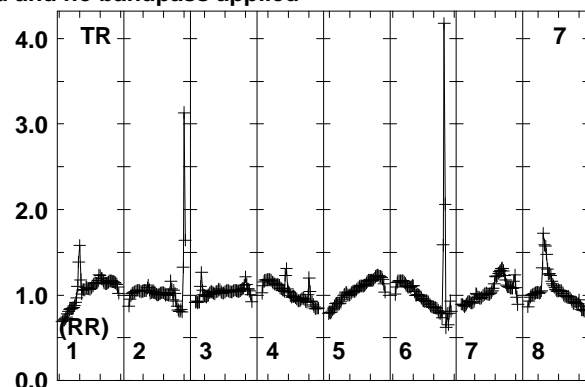
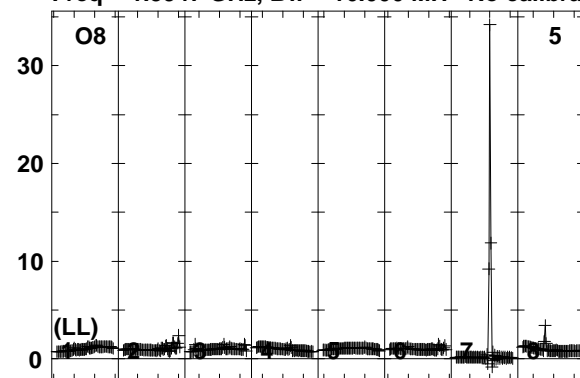

Lower frame: Real Jy
Total-power spectrum Antenna: O8 (05)
Timerange: 00/09:27:51 to 00/09:30:29

Plot file version 714 created 04-NOV-2019 14:14:58

W2246-0526 EY034.UVDATA.1

Freq = 1.5947 GHz, Bw = 16.000 MH No calibration applied and no bandpass applied

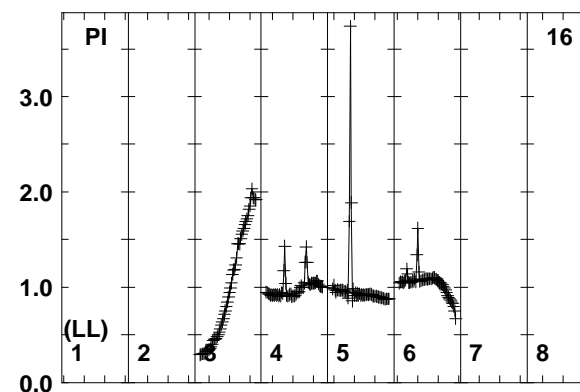
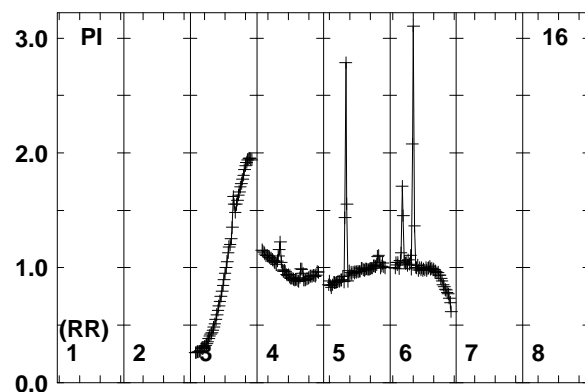
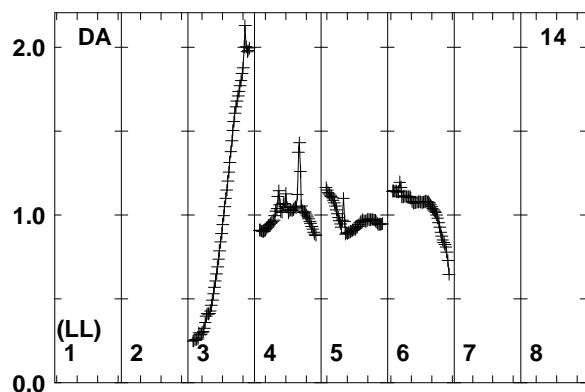
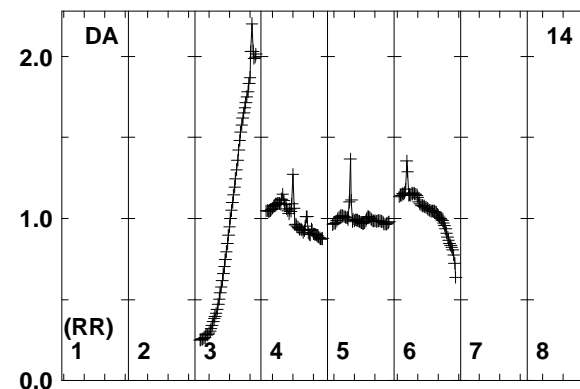
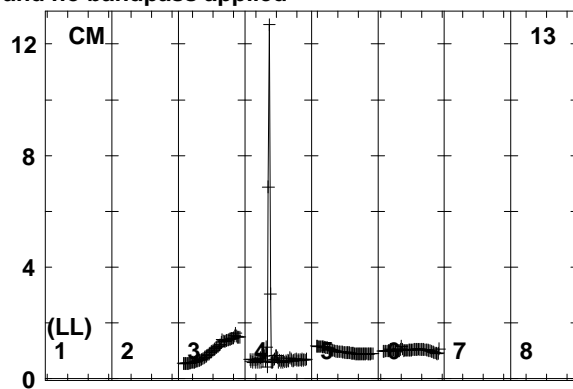
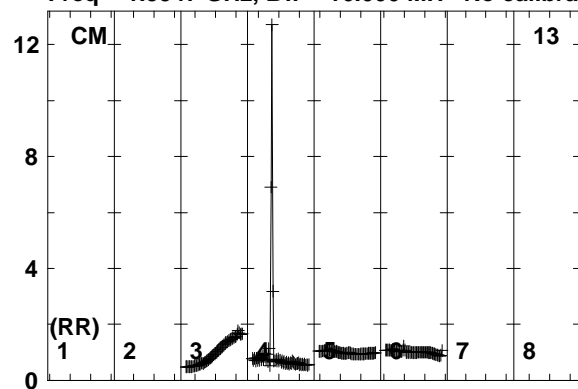

Lower frame: Real Jy
Total-power spectrum Antenna: CM (13)
Timerange: 00/09:27:51 to 00/09:30:29

Plot file version 715 created 04-NOV-2019 14:14:58

J2248-0541 EY034.UVDATA.1

Freq = 1.5947 GHz, Bw = 16.000 MH No calibration applied and no bandpass applied

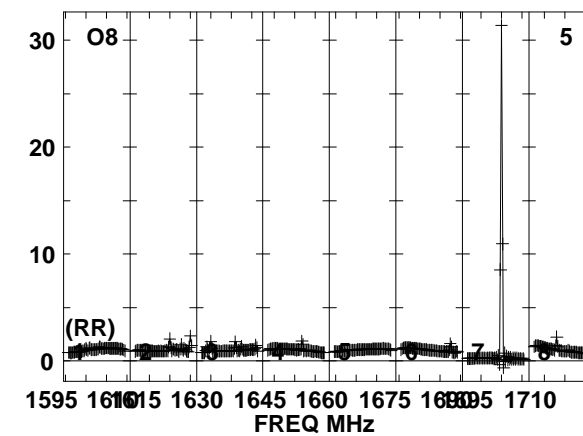
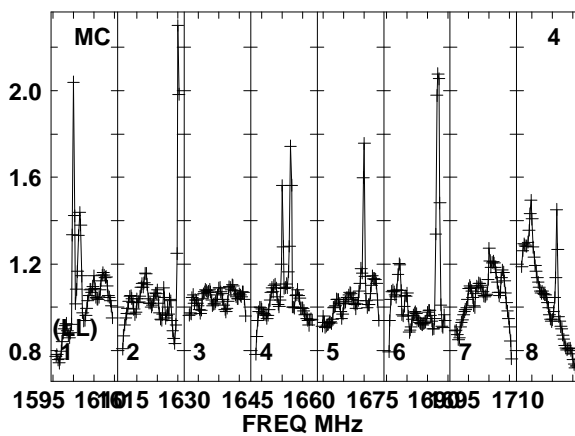
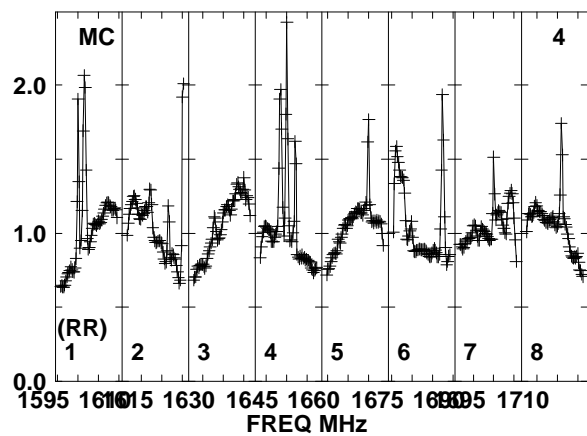
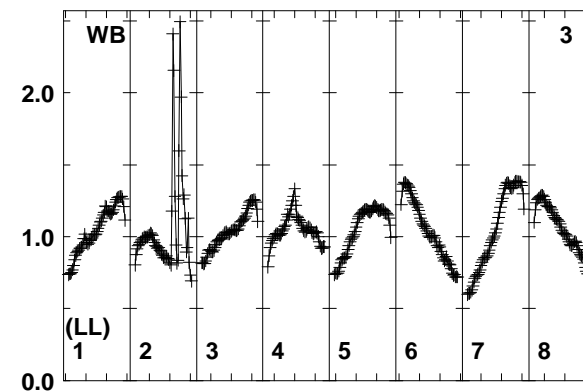
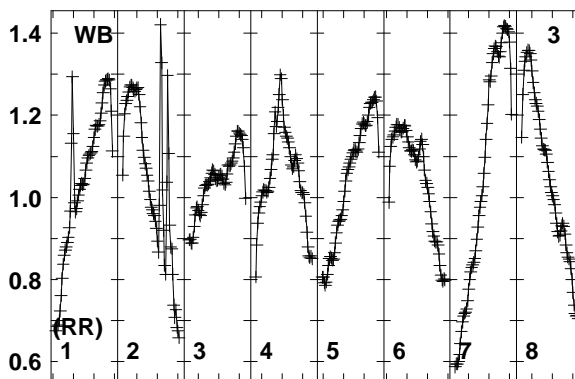
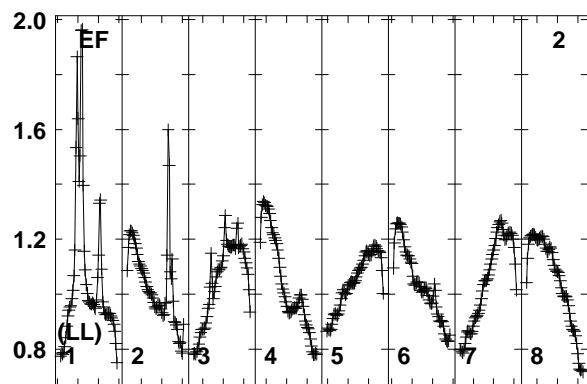
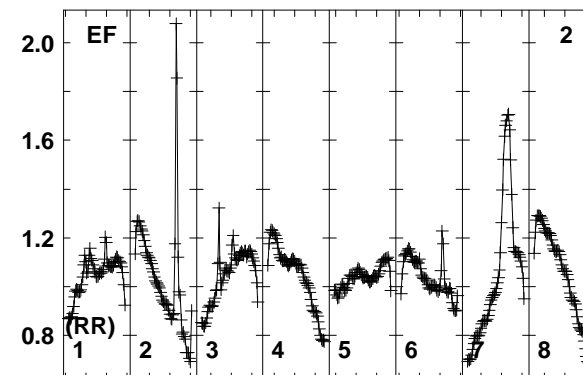
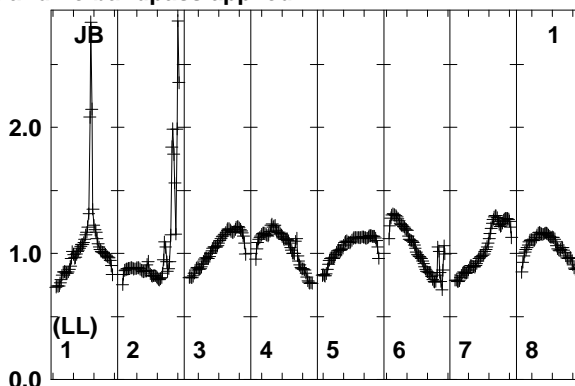
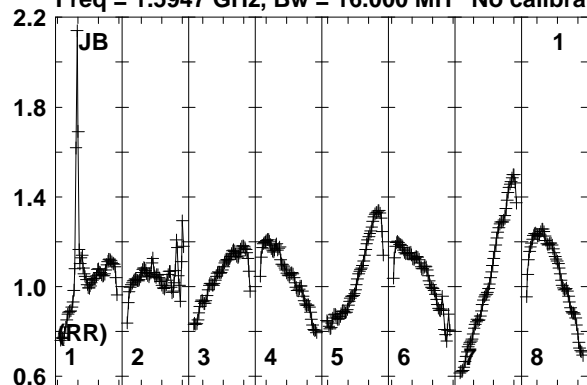

Lower frame: Real Jy
Total-power spectrum Antenna: JB (01)
Timerange: 00/09:31:06 to 00/09:32:04

Plot file version 716 created 04-NOV-2019 14:14:58

J2248-0541 EY034.UVDATA.1

Freq = 1.5947 GHz, Bw = 16.000 MH No calibration applied and no bandpass applied

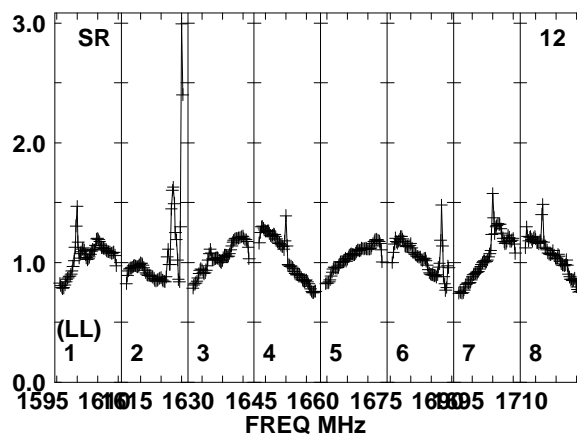
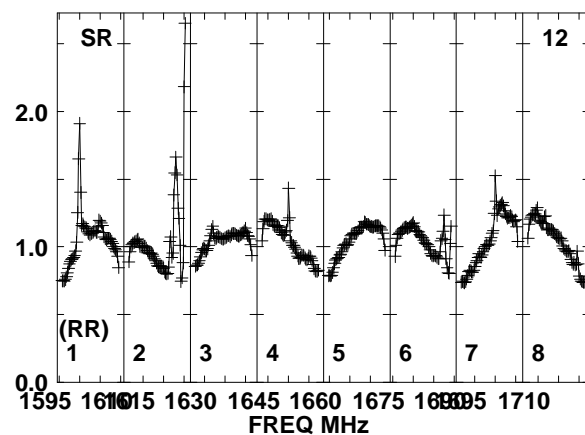
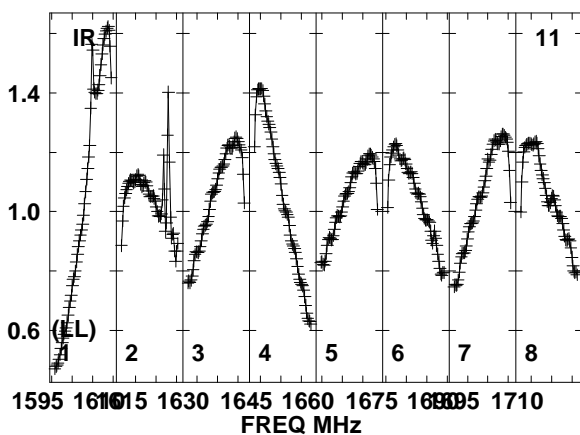
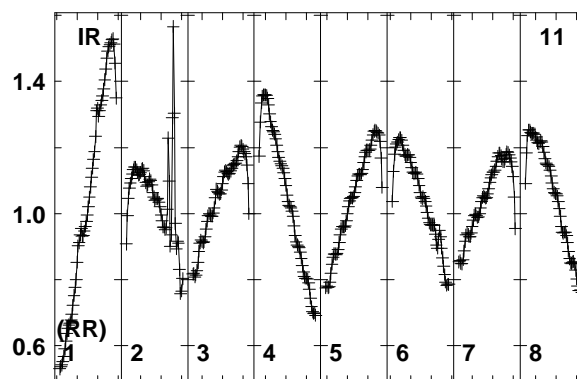
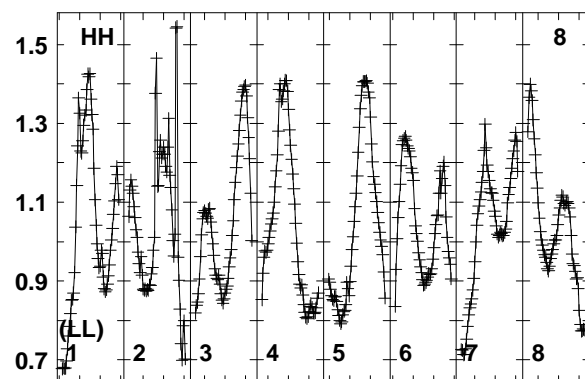
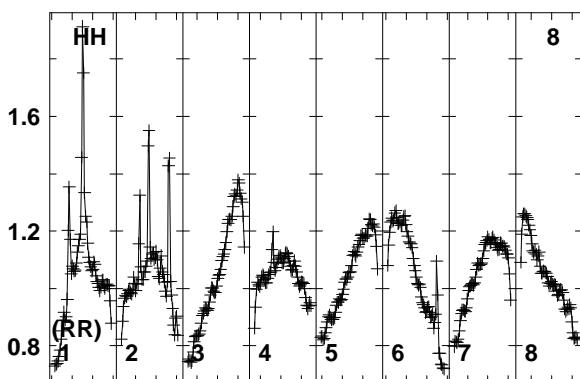
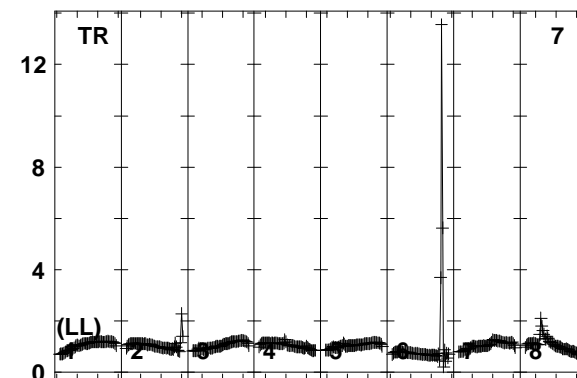
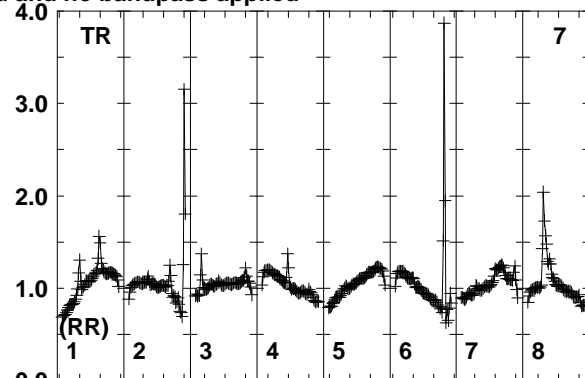
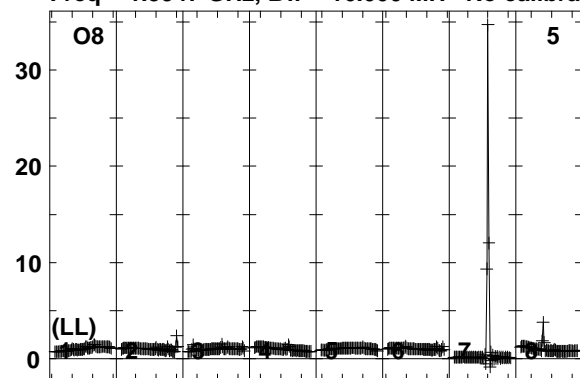

Lower frame: Real Jy
Total-power spectrum Antenna: O8 (05)
Timerange: 00/09:31:06 to 00/09:32:04

Plot file version 717 created 04-NOV-2019 14:14:59

J2248-0541 EY034.UVDATA.1

Freq = 1.5947 GHz, Bw = 16.000 MH No calibration applied and no bandpass applied

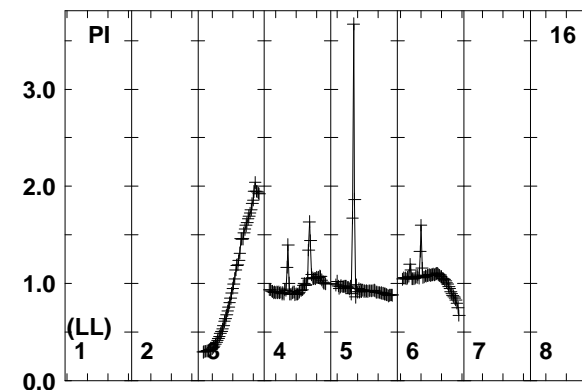
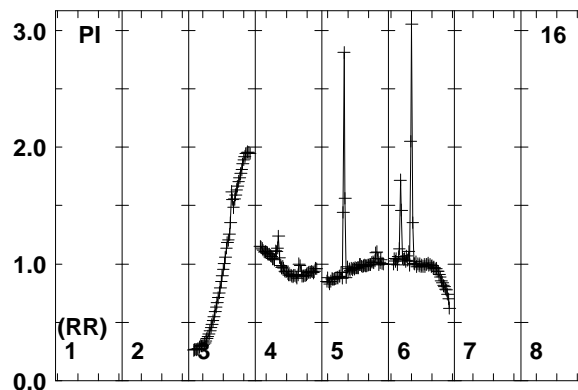
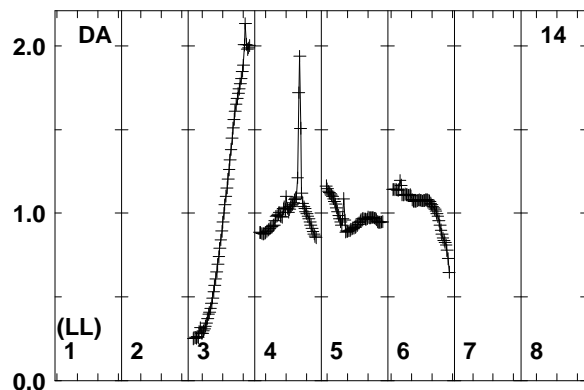
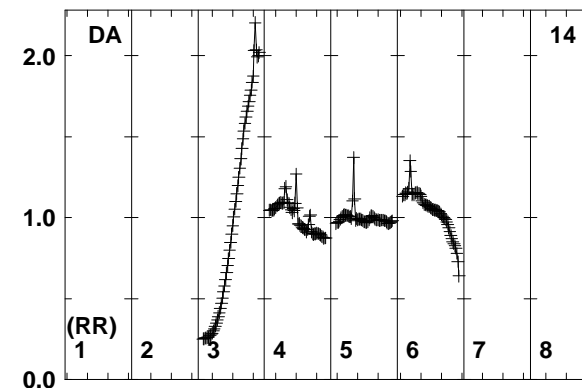
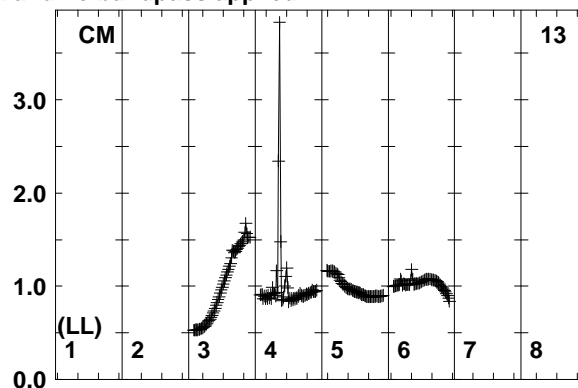
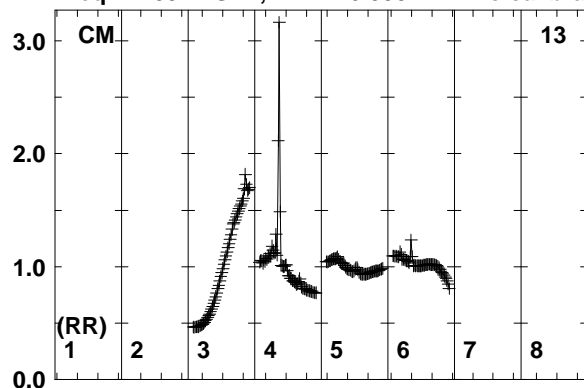

Lower frame: Real Jy
Total-power spectrum Antenna: CM (13)
Timerange: 00/09:31:06 to 00/09:32:04

Plot file version 718 created 04-NOV-2019 14:14:59

W2246-0526 EY034.UVDATA.1

Freq = 1.5947 GHz, Bw = 16.000 MH No calibration applied and no bandpass applied

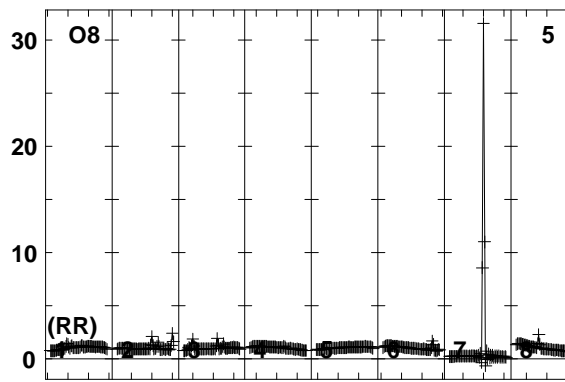
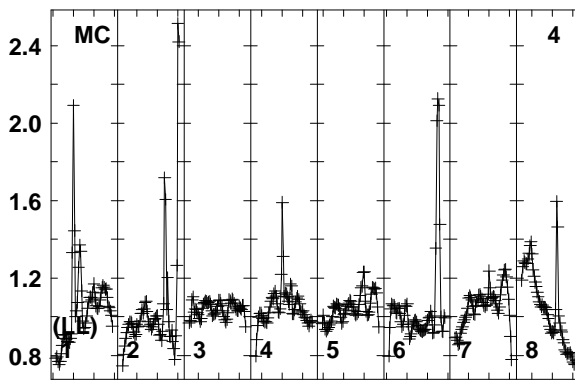
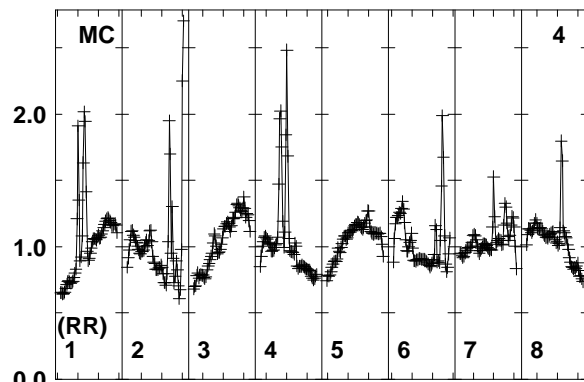
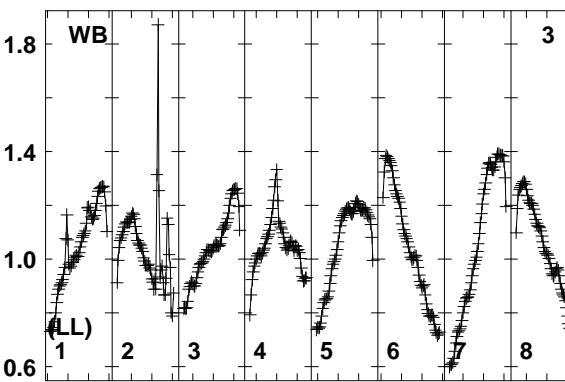
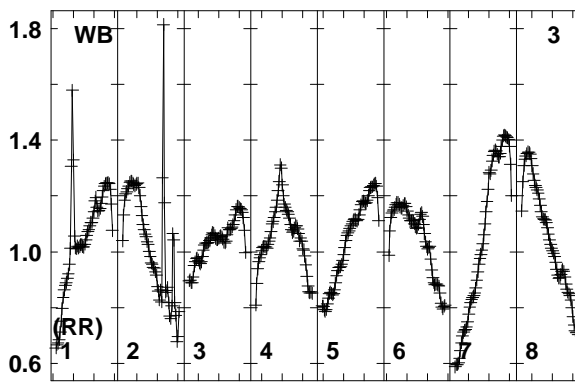
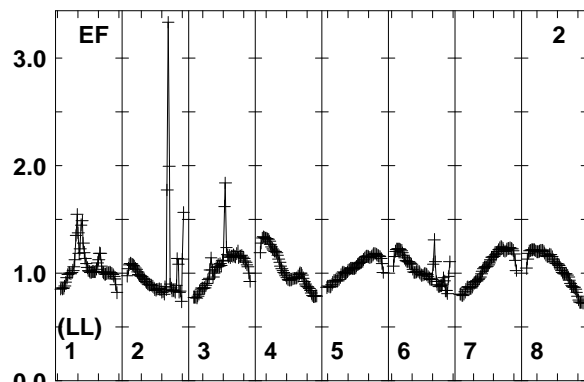
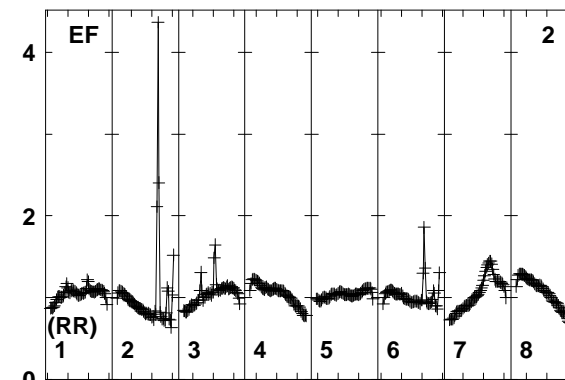
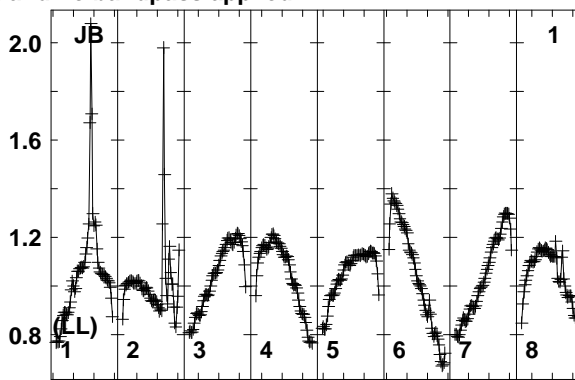
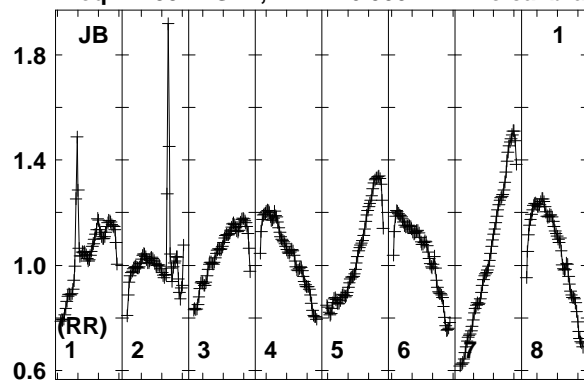

1595 1610 1630 1645 1660 1675 1690 1710
FREQ MHz

1595 1610 1630 1645 1660 1675 1690 1710
FREQ MHz

1595 1610 1630 1645 1660 1675 1690 1710
FREQ MHz

Lower frame: Real Jy
Total-power spectrum Antenna: JB (01)
Timerange: 00/09:32:06 to 00/09:34:44

Plot file version 719 created 04-NOV-2019 14:14:59

W2246-0526 EY034.UVDATA.1

Freq = 1.5947 GHz, Bw = 16.000 MH No calibration applied and no bandpass applied

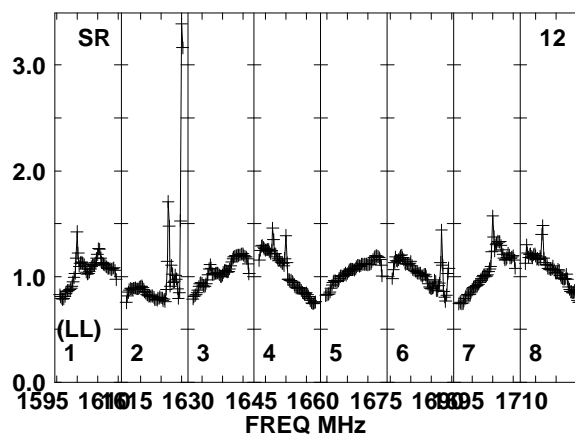
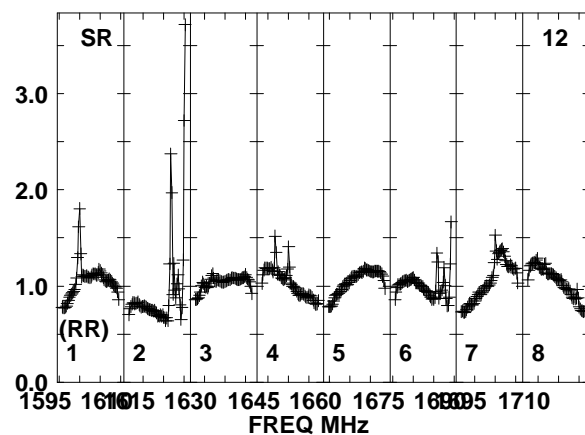
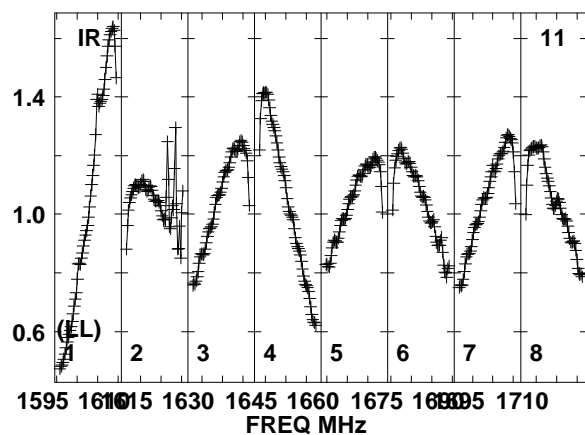
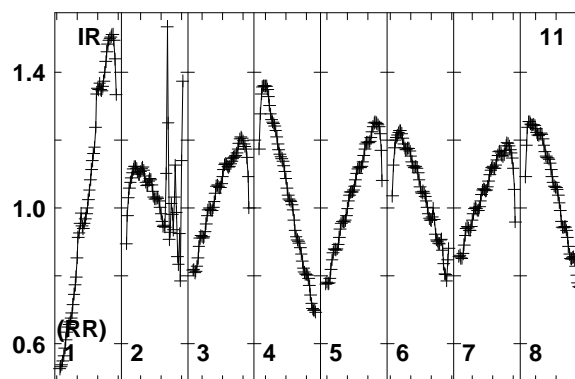
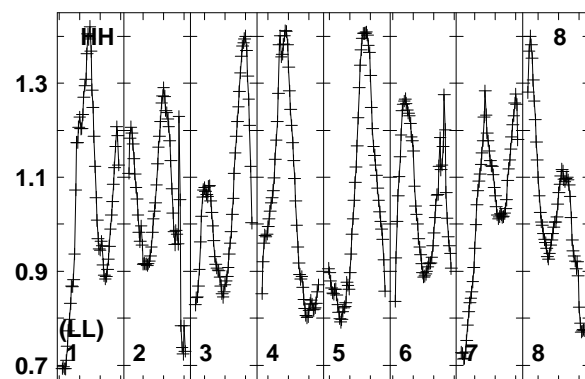
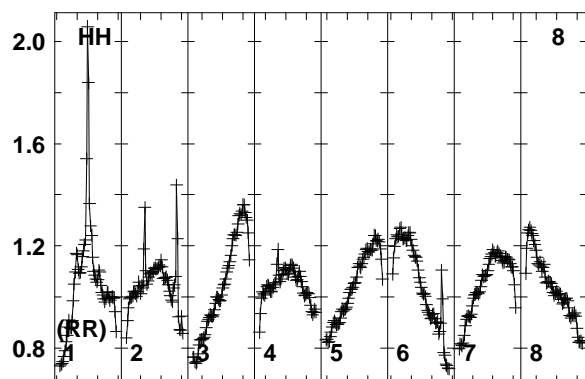
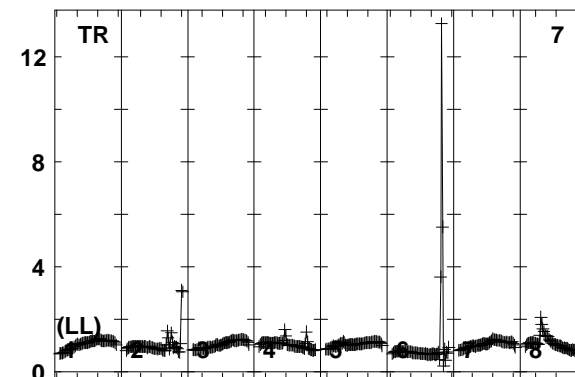
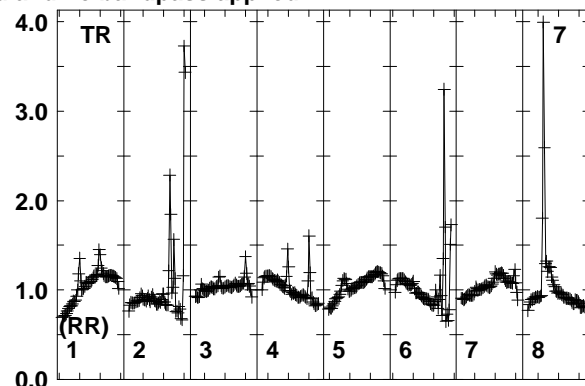
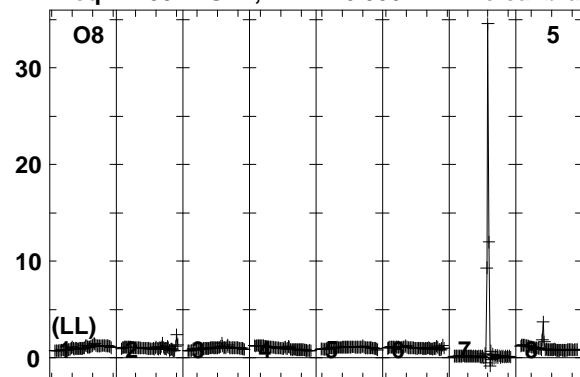

Lower frame: Real Jy
Total-power spectrum Antenna: O8 (05)
Timerange: 00/09:32:06 to 00/09:34:44

Plot file version 720 created 04-NOV-2019 14:14:59

W2246-0526 EY034.UVDATA.1

Freq = 1.5947 GHz, Bw = 16.000 MH No calibration applied and no bandpass applied

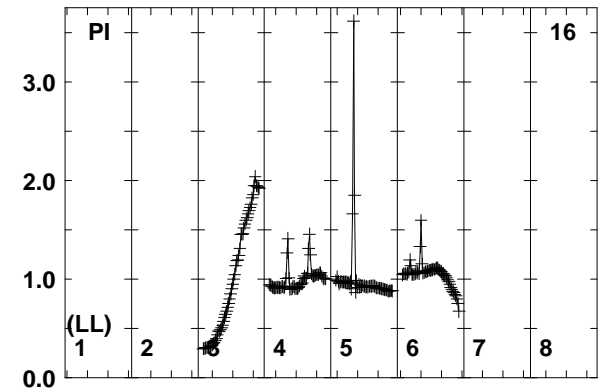
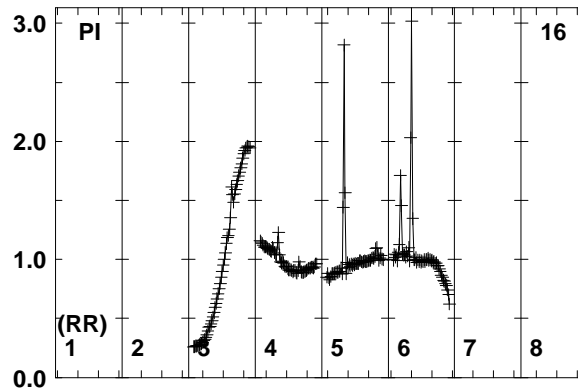
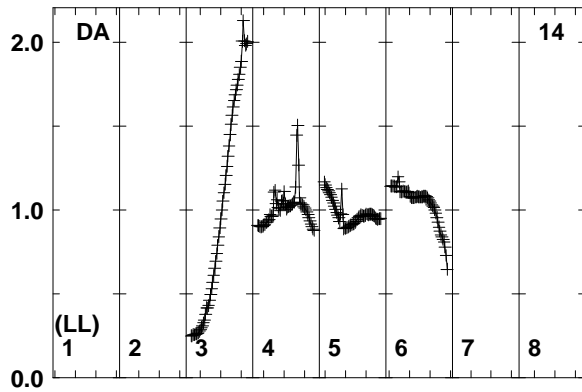
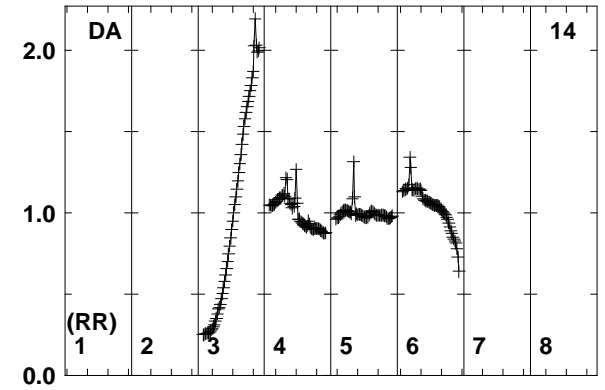
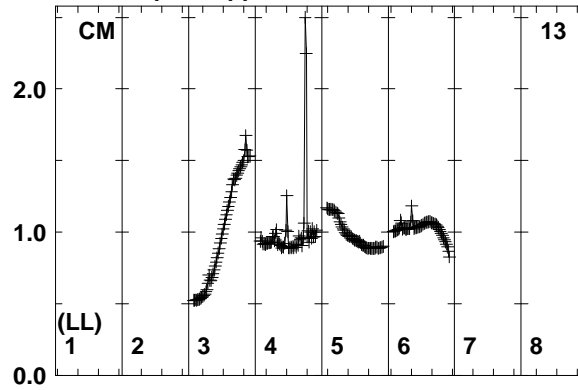
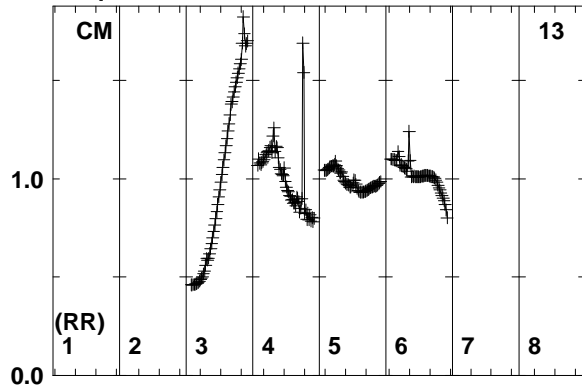

Lower frame: Real Jy
Total-power spectrum Antenna: CM (13)
Timerange: 00/09:32:06 to 00/09:34:44

Plot file version 721 created 04-NOV-2019 14:14:59

J2248-0541 EY034.UVDATA.1

Freq = 1.5947 GHz, Bw = 16.000 MH No calibration applied and no bandpass applied

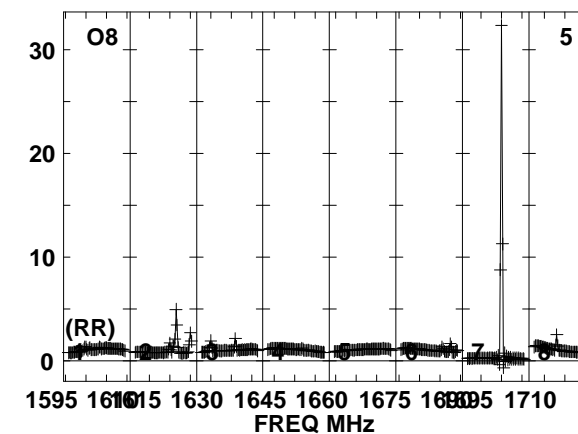
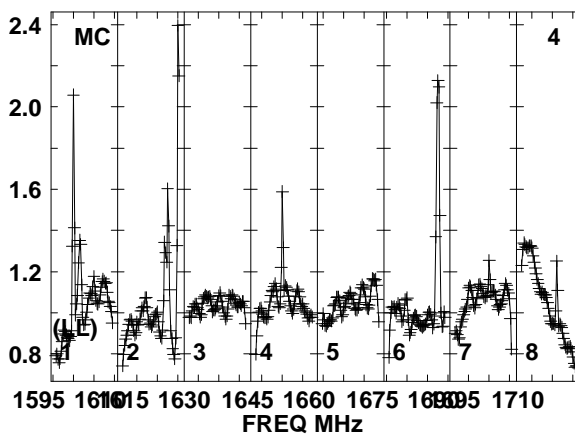
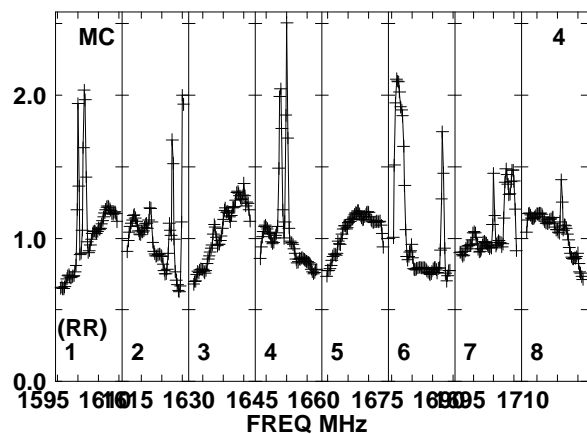
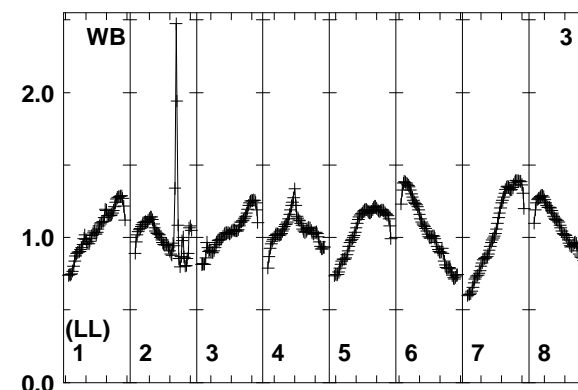
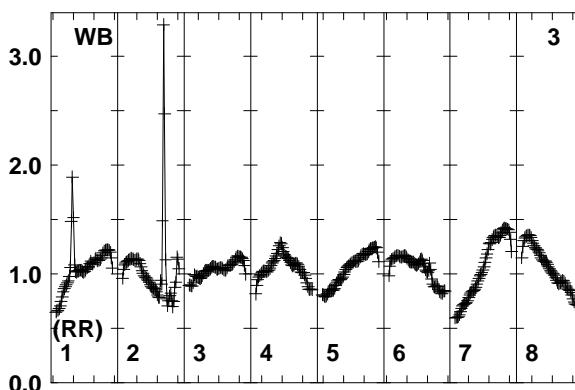
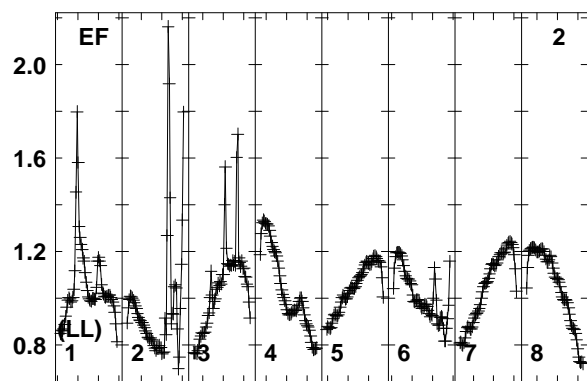
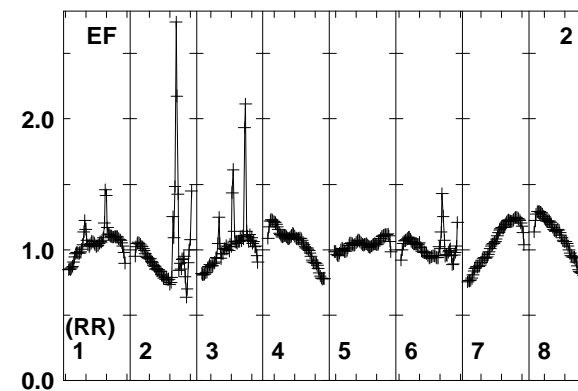
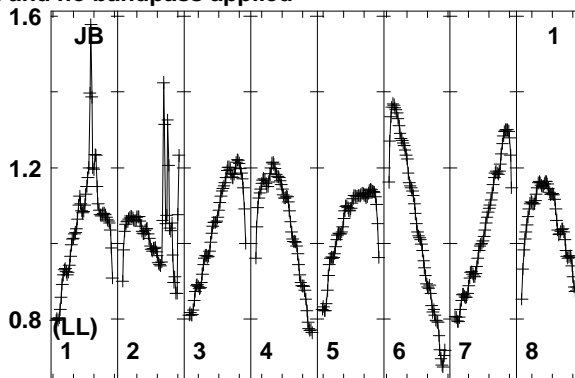
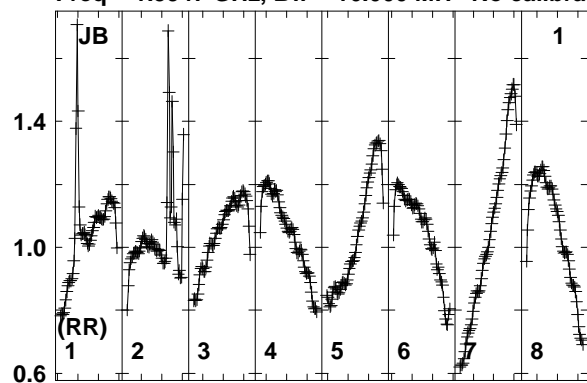

Lower frame: Real Jy
Total-power spectrum Antenna: JB (01)
Timerange: 00/09:35:01 to 00/09:35:59

Plot file version 722 created 04-NOV-2019 14:14:59

J2248-0541 EY034.UVDATA.1

Freq = 1.5947 GHz, Bw = 16.000 MH No calibration applied and no bandpass applied

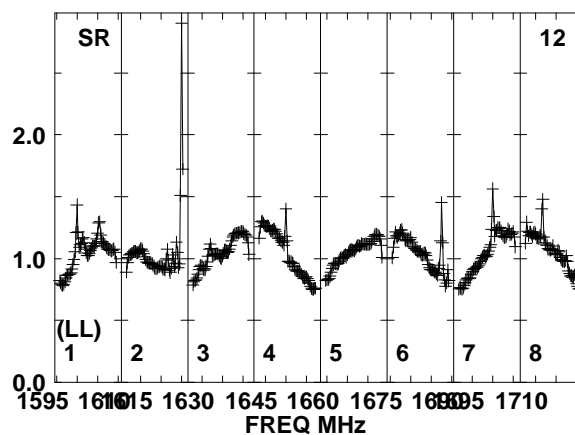
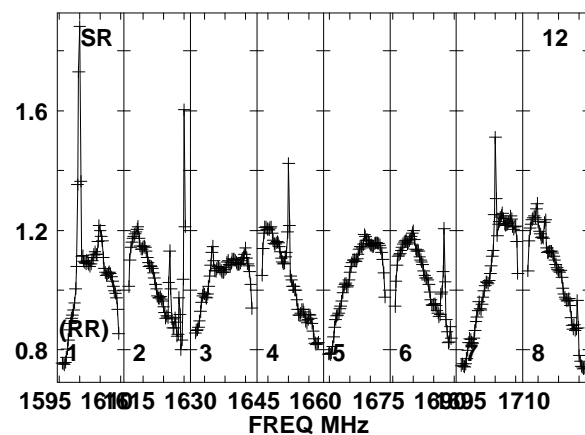
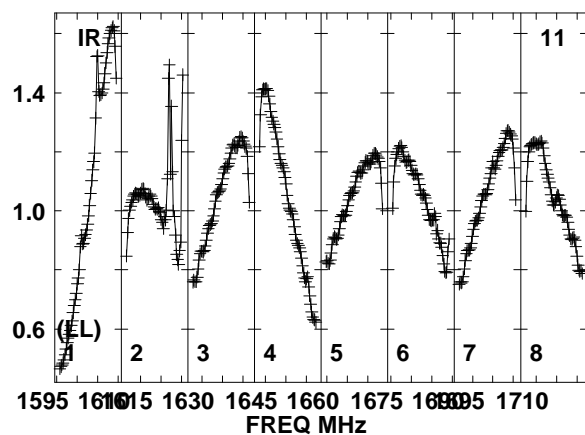
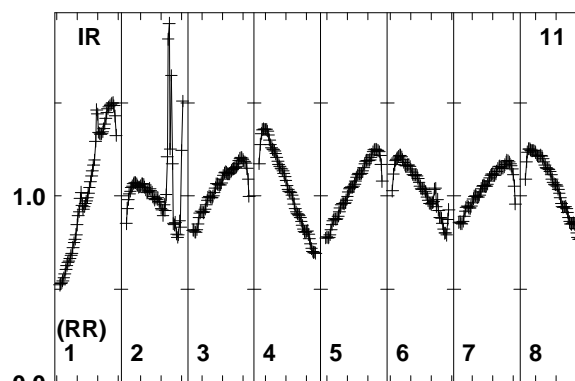
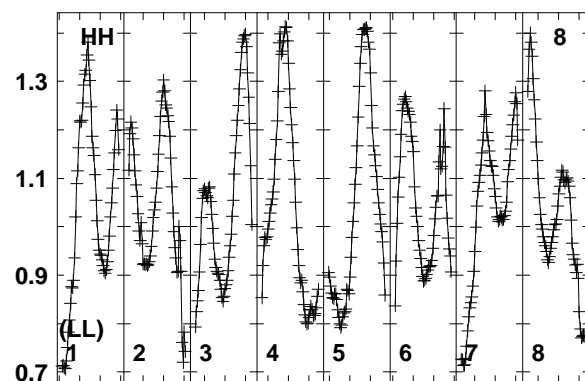
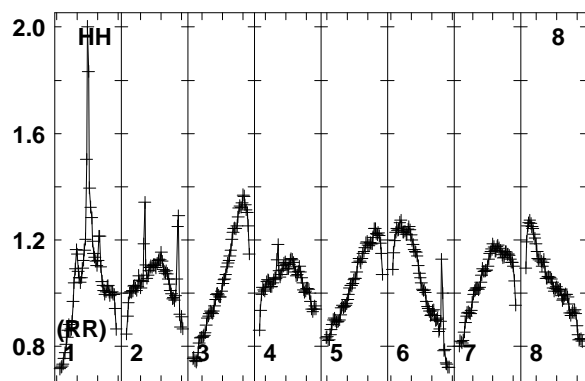
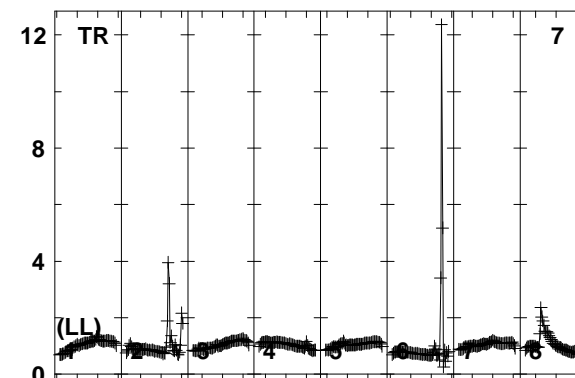
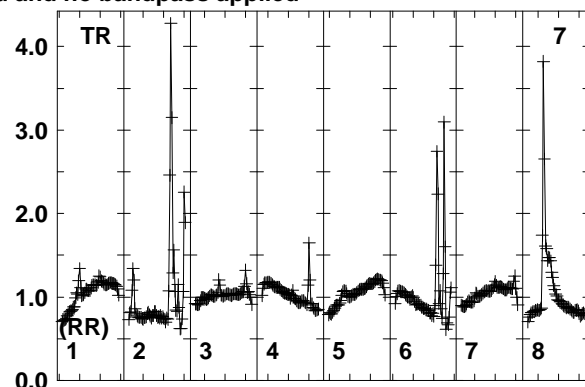
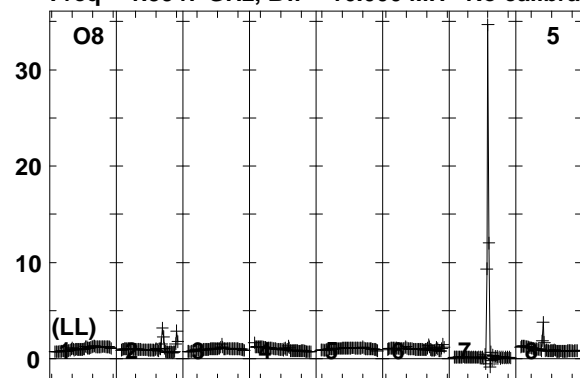

Lower frame: Real Jy
Total-power spectrum Antenna: O8 (05)
Timerange: 00/09:35:01 to 00/09:35:59

Plot file version 723 created 04-NOV-2019 14:14:59

J2248-0541 EY034.UVDATA.1

Freq = 1.5947 GHz, Bw = 16.000 MH No calibration applied and no bandpass applied

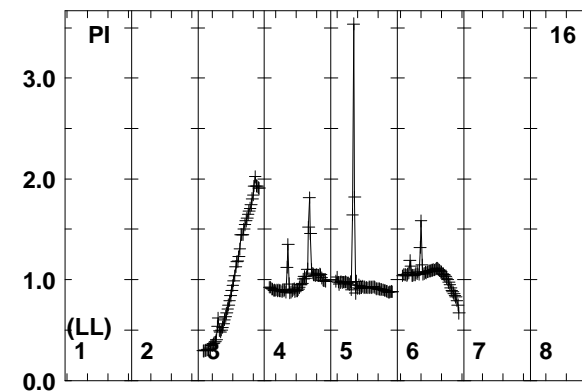
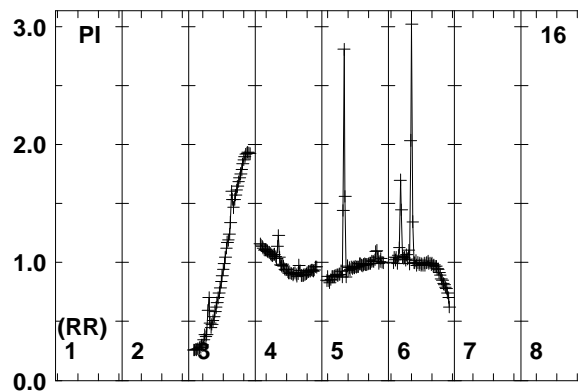
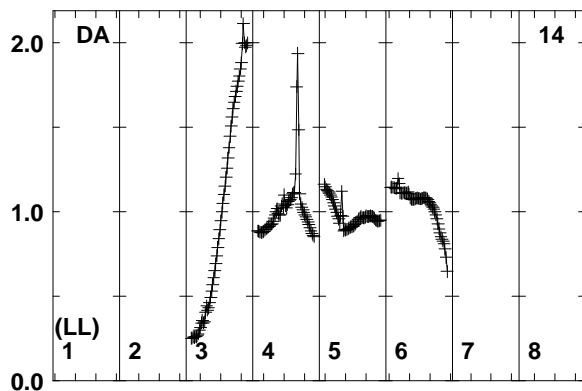
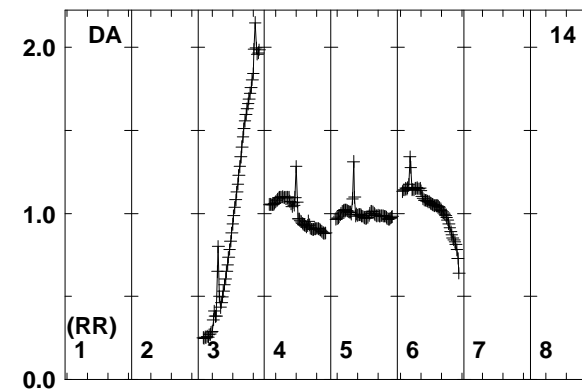
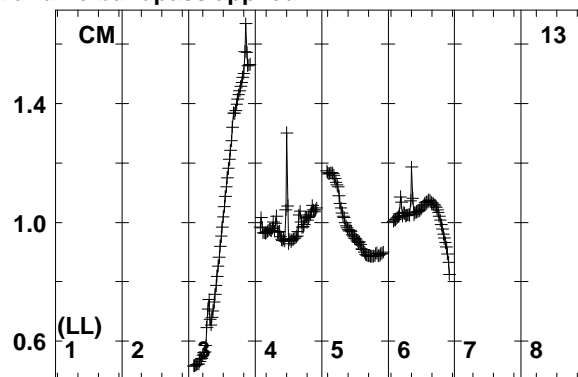
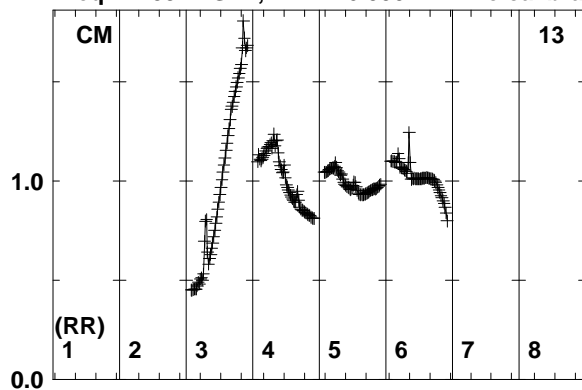

Lower frame: Real Jy
Total-power spectrum Antenna: CM (13)
Timerange: 00/09:35:01 to 00/09:35:59

Plot file version 724 created 04-NOV-2019 14:14:59

J2245-0755 EY034.UVDATA.1

Freq = 1.5947 GHz, Bw = 16.000 MH No calibration applied and no bandpass applied

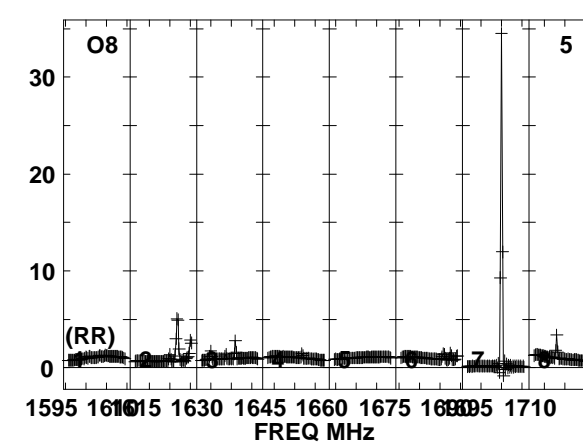
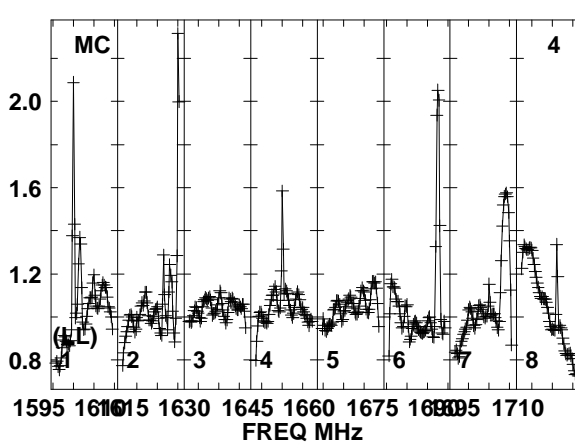
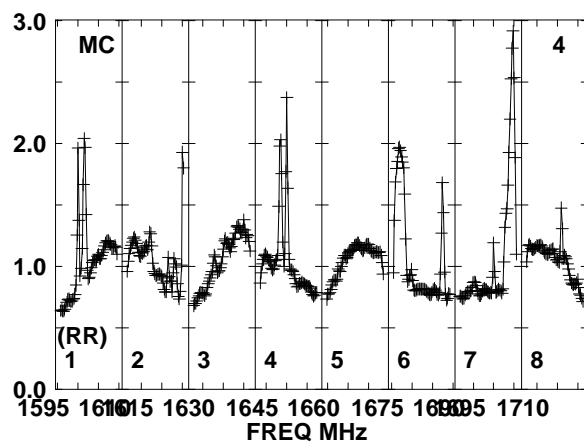
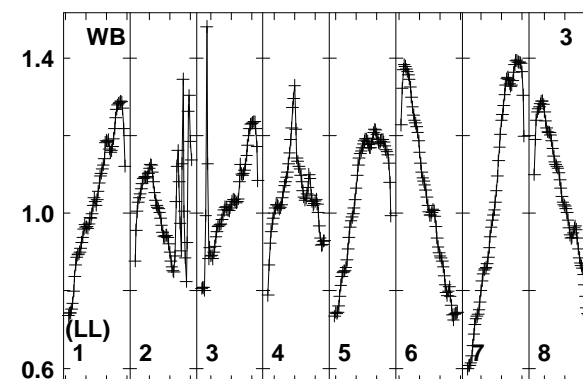
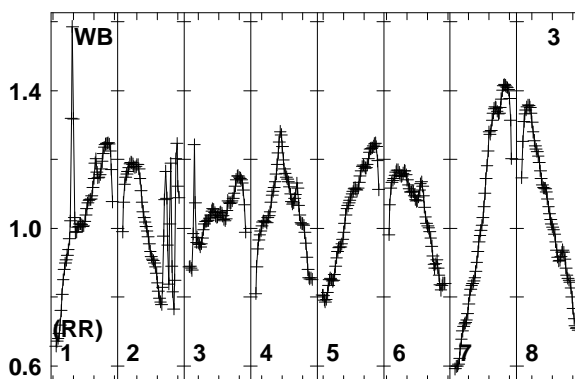
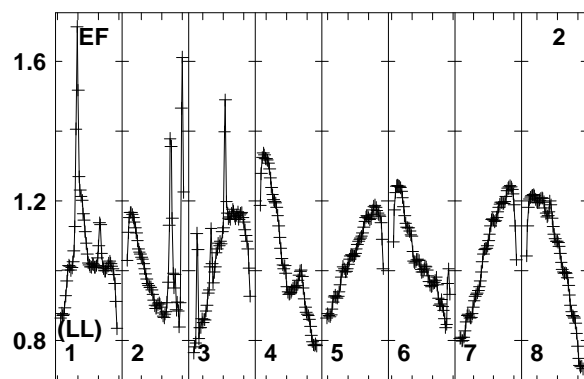
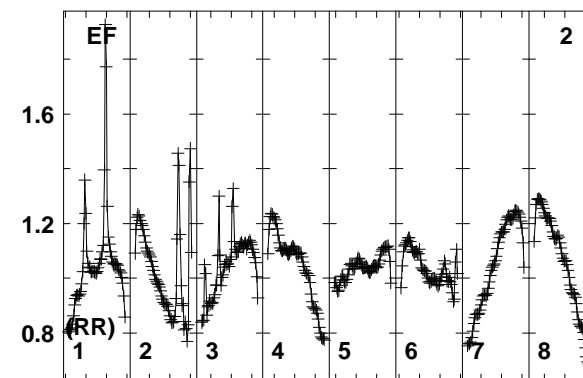
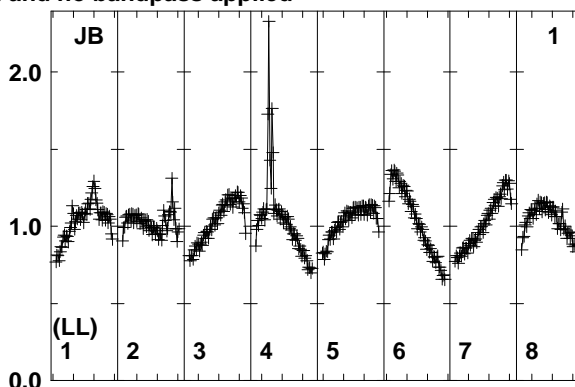
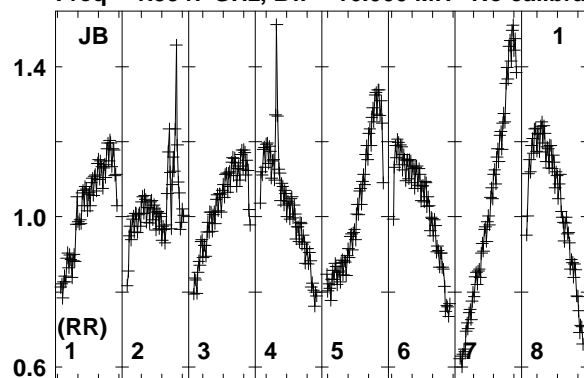

Lower frame: Real Jy
Total-power spectrum Antenna: JB (01)
Timerange: 00/09:36:16 to 00/09:37:14

Plot file version 725 created 04-NOV-2019 14:14:59

J2245-0755 EY034.UVDATA.1

Freq = 1.5947 GHz, Bw = 16.000 MH No calibration applied and no bandpass applied

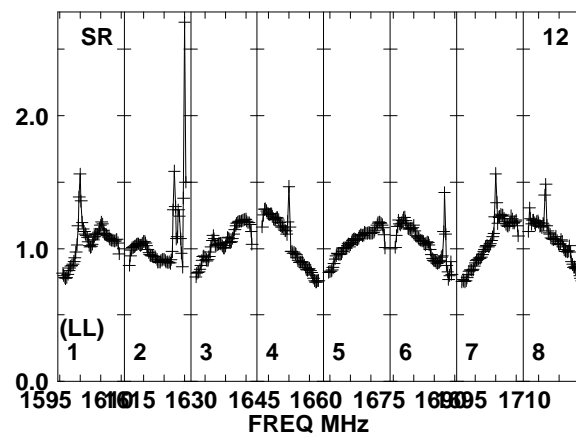
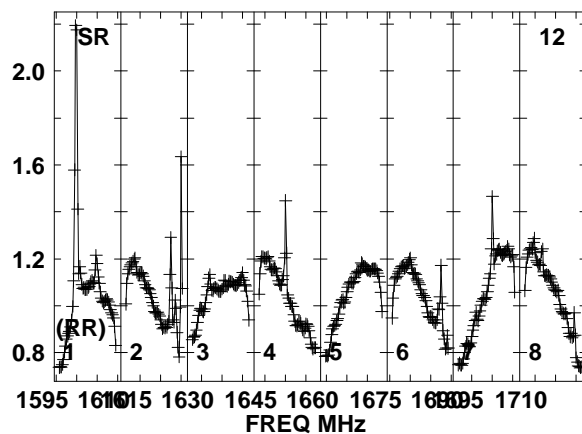
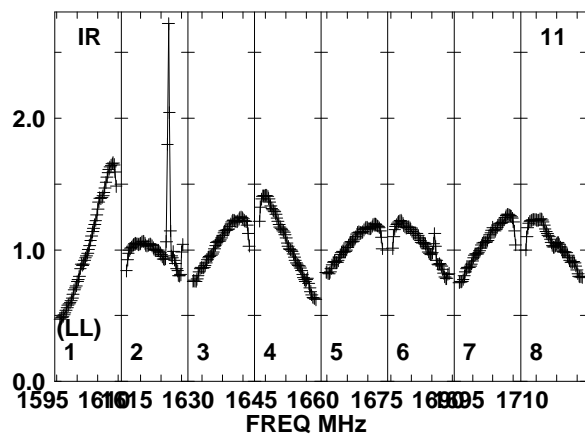
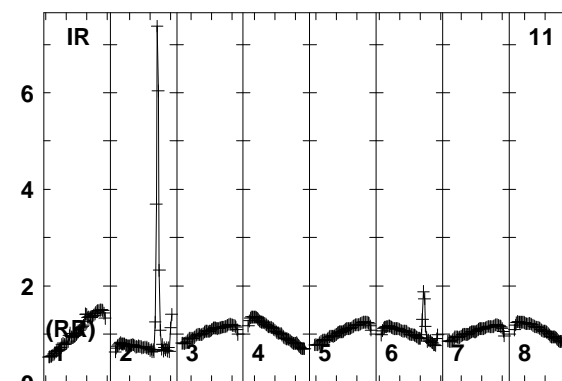
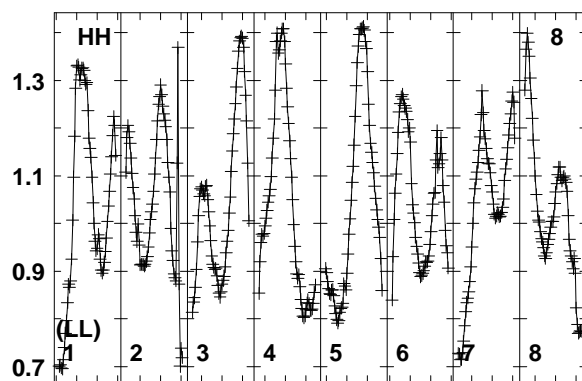
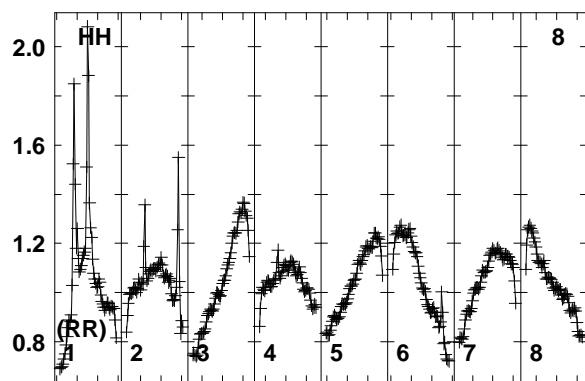
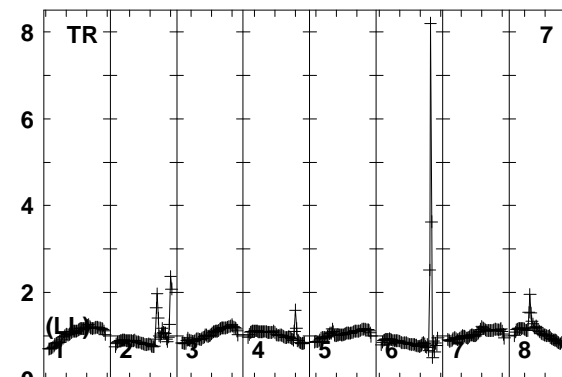
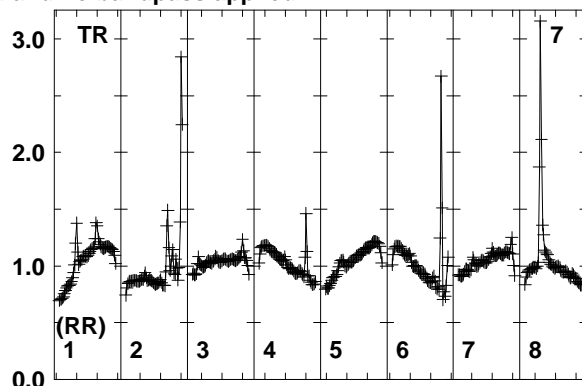
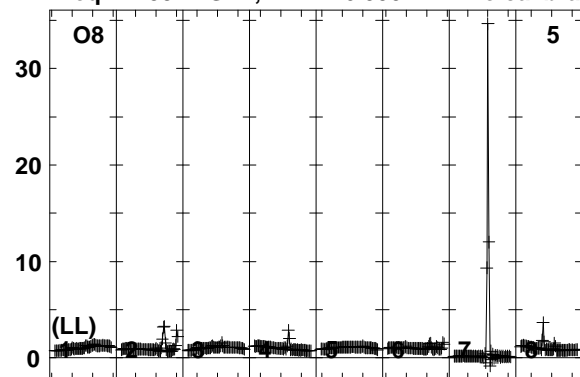

Lower frame: Real Jy
Total-power spectrum Antenna: O8 (05)
Timerange: 00/09:36:16 to 00/09:37:14

Plot file version 726 created 04-NOV-2019 14:14:59

J2245-0755 EY034.UVDATA.1

Freq = 1.5947 GHz, Bw = 16.000 MH No calibration applied and no bandpass applied

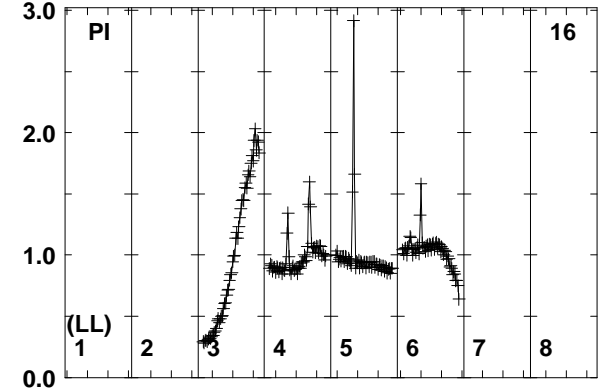
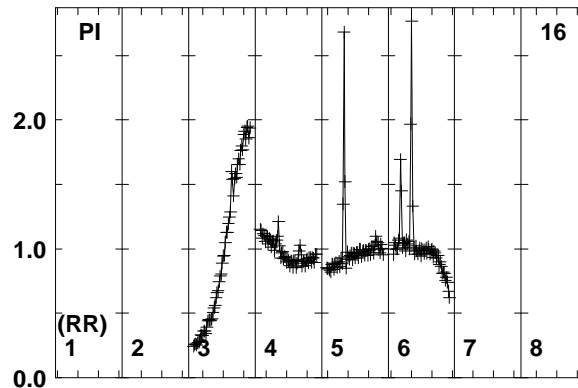
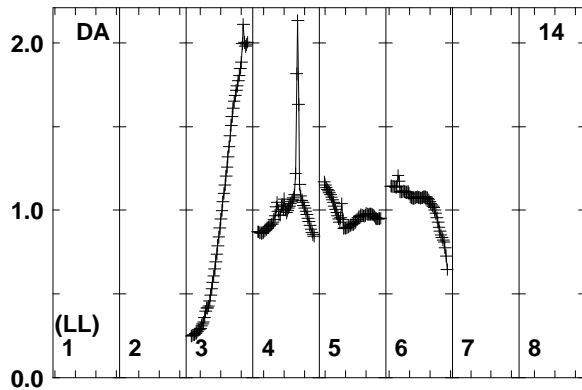
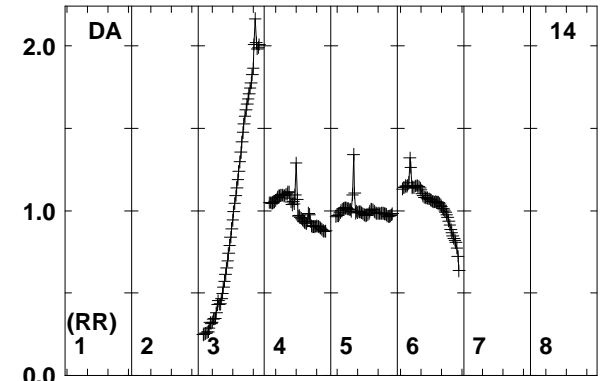
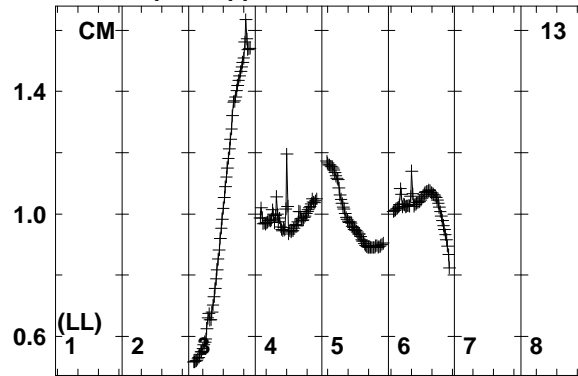
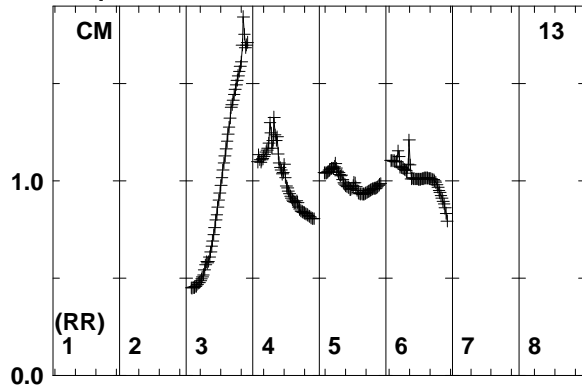

Lower frame: Real Jy
Total-power spectrum Antenna: CM (13)
Timerange: 00/09:36:16 to 00/09:37:14

Plot file version 727 created 04-NOV-2019 14:14:59

J2248-0541 EY034.UVDATA.1

Freq = 1.5947 GHz, Bw = 16.000 MH No calibration applied and no bandpass applied

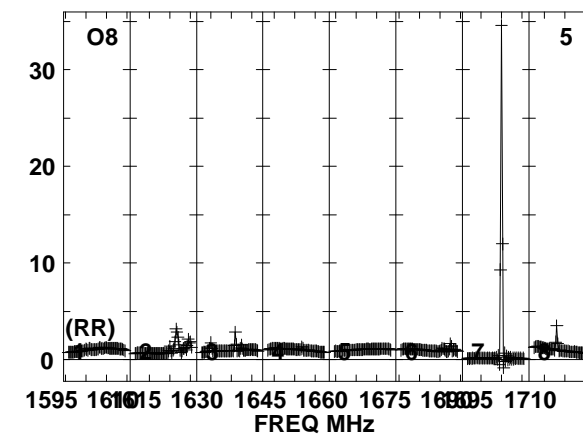
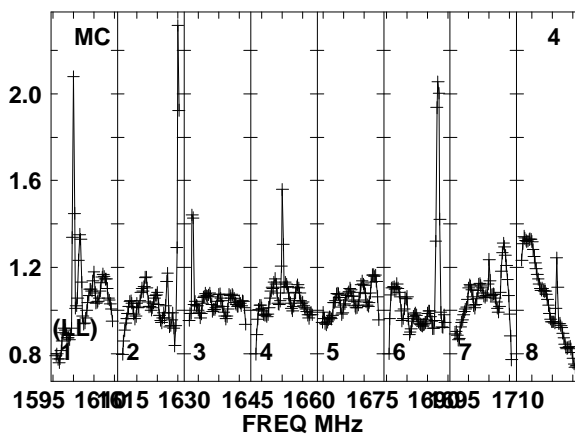
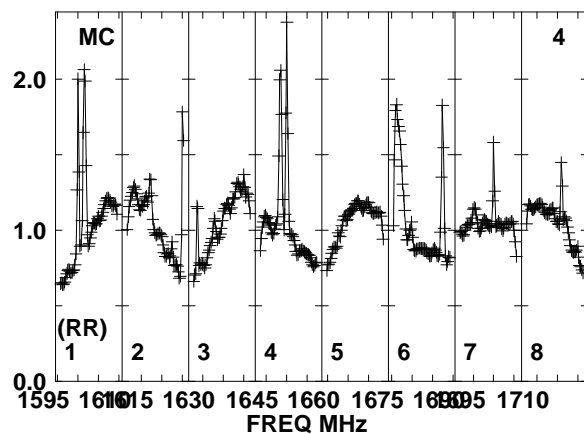
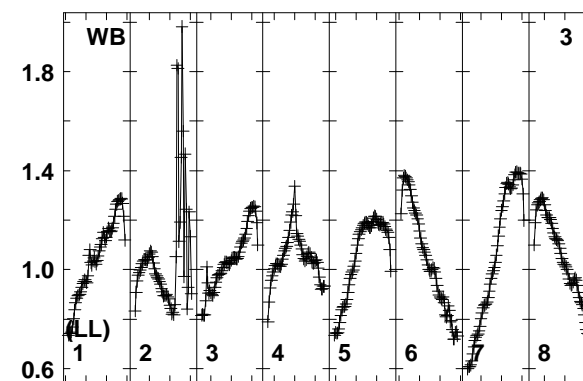
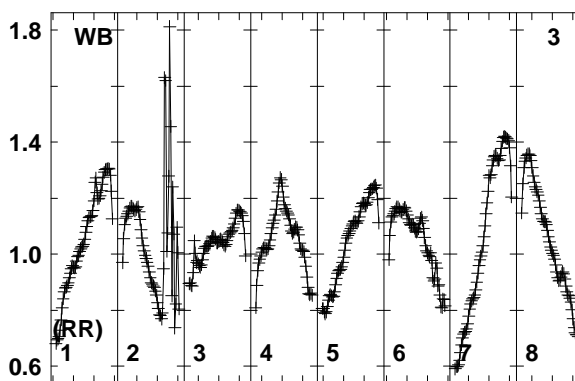
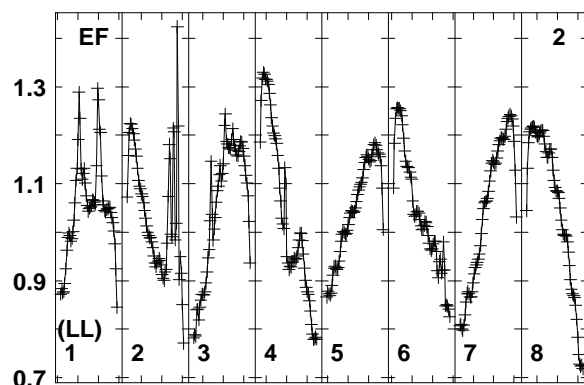
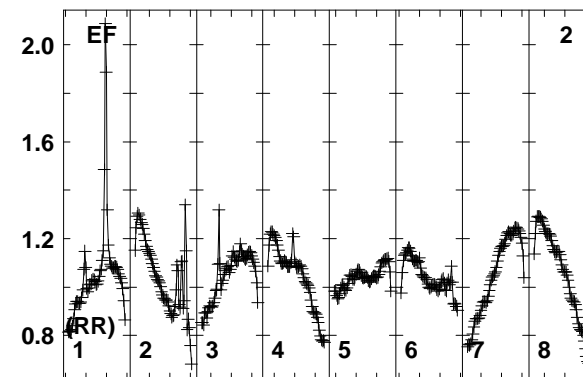
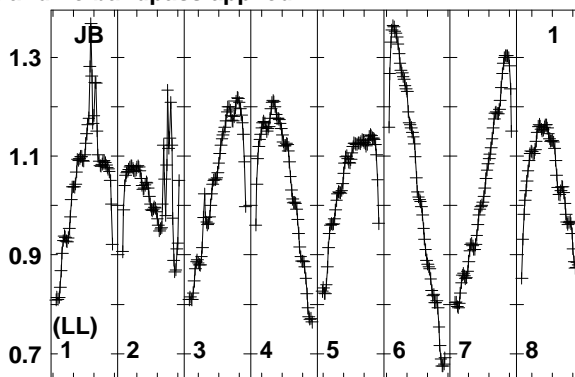
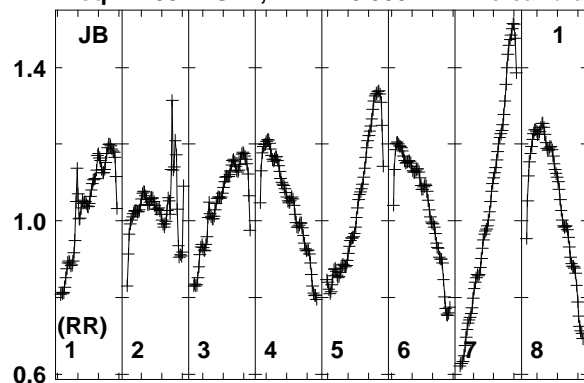

Lower frame: Real Jy
Total-power spectrum Antenna: JB (01)
Timerange: 00/09:38:01 to 00/09:38:59

Plot file version 728 created 04-NOV-2019 14:14:59

J2248-0541 EY034.UVDATA.1

Freq = 1.5947 GHz, Bw = 16.000 MH No calibration applied and no bandpass applied

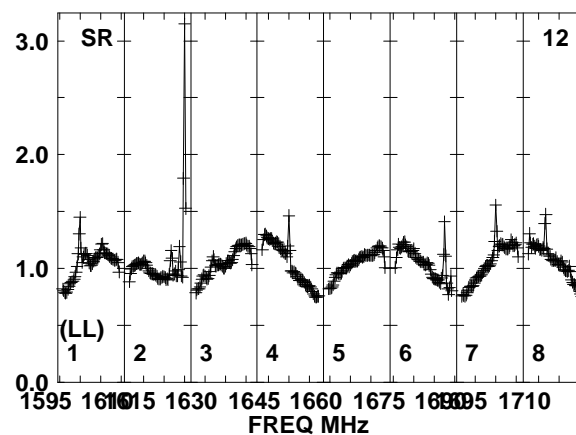
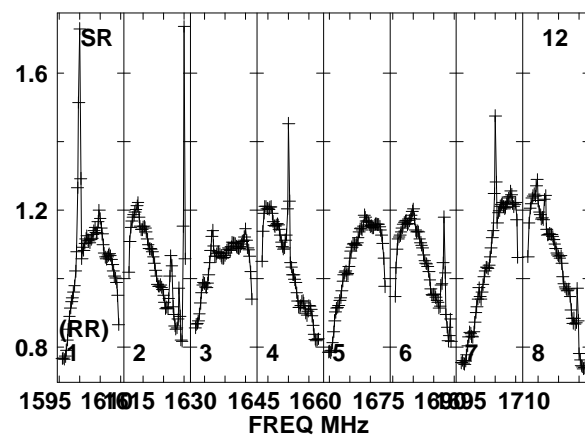
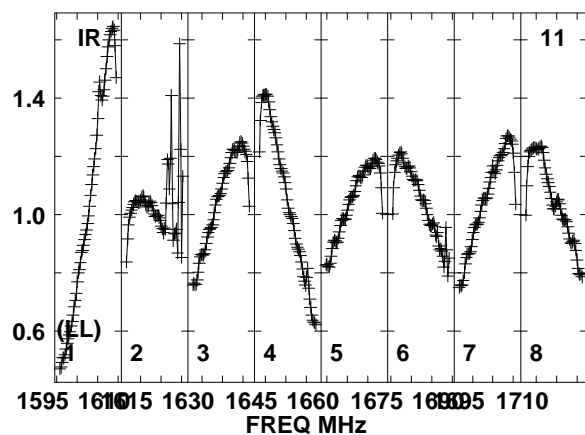
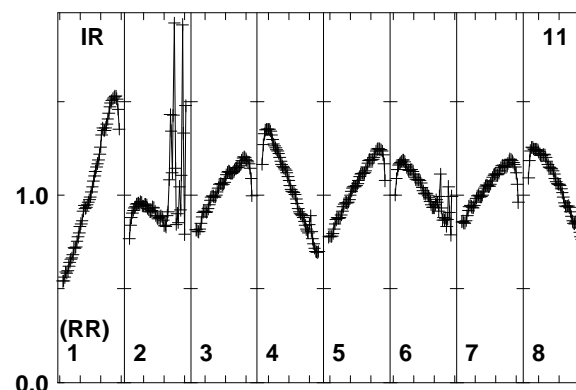
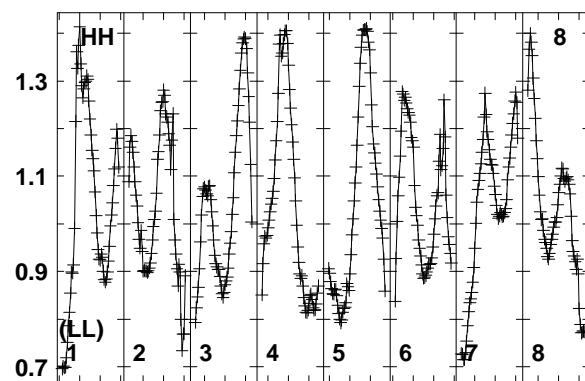
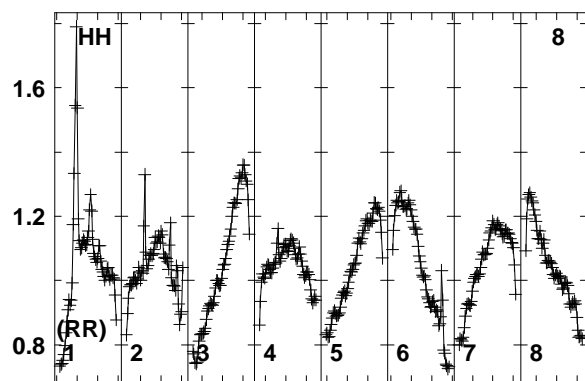
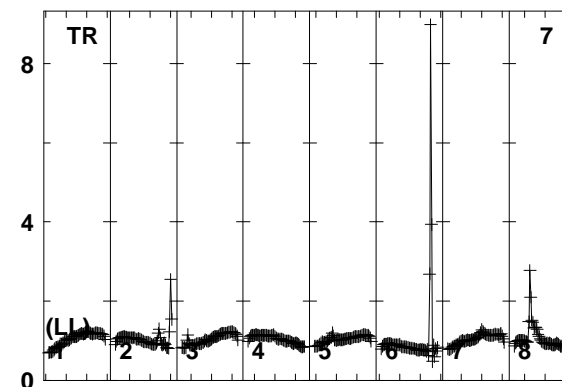
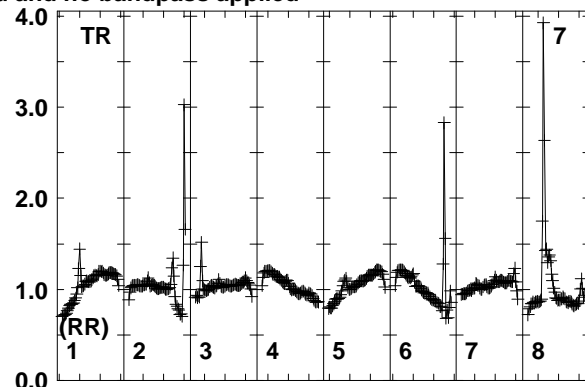
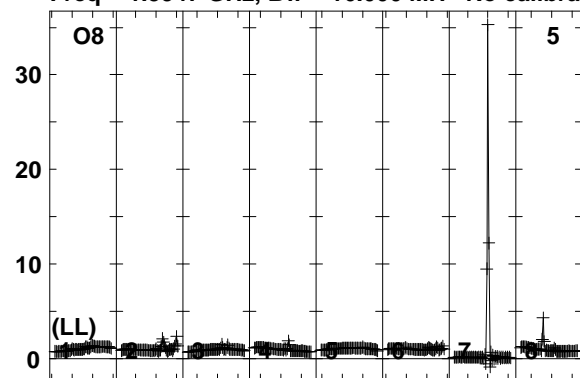

Lower frame: Real Jy
Total-power spectrum Antenna: O8 (05)
Timerange: 00/09:38:01 to 00/09:38:59

Plot file version 729 created 04-NOV-2019 14:14:59

J2248-0541 EY034.UVDATA.1

Freq = 1.5947 GHz, Bw = 16.000 MH No calibration applied and no bandpass applied

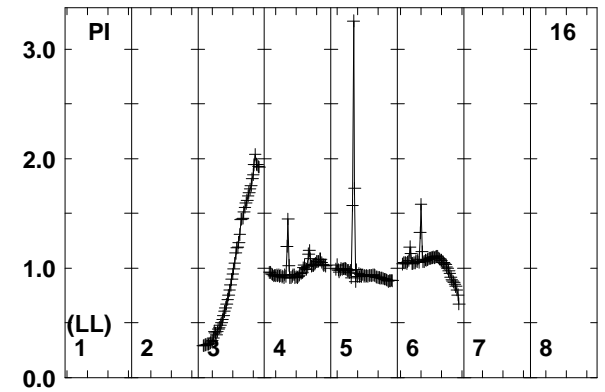
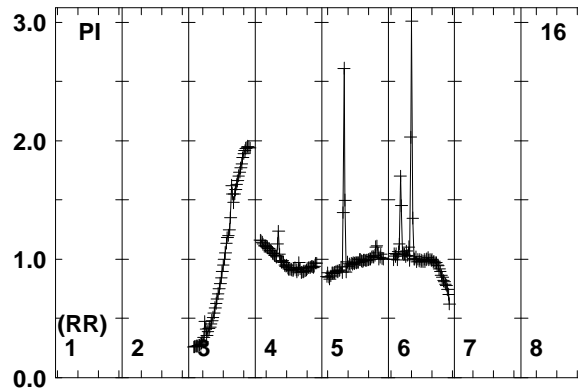
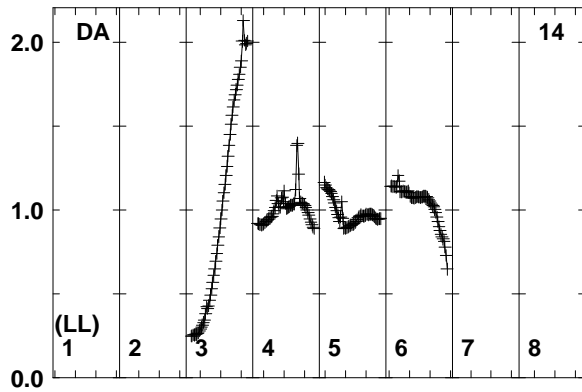
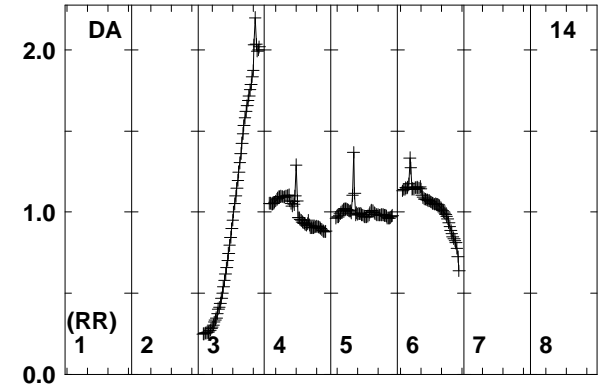
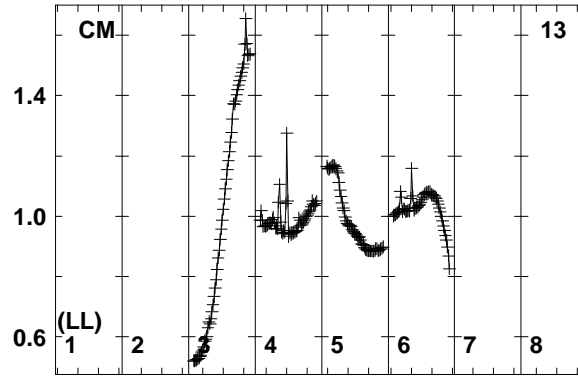
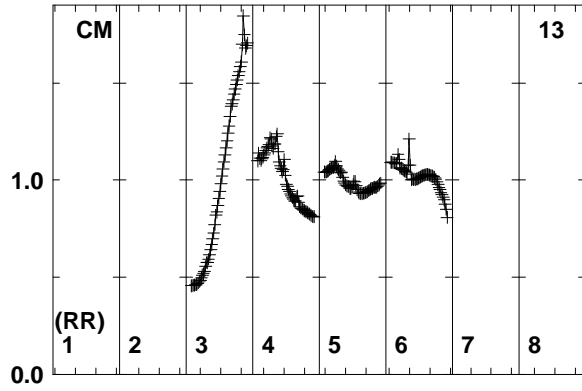

Lower frame: Real Jy
Total-power spectrum Antenna: CM (13)
Timerange: 00/09:38:01 to 00/09:38:59

Plot file version 730 created 04-NOV-2019 14:14:59

W2246-0526 EY034.UVDATA.1

Freq = 1.5947 GHz, Bw = 16.000 MH No calibration applied and no bandpass applied

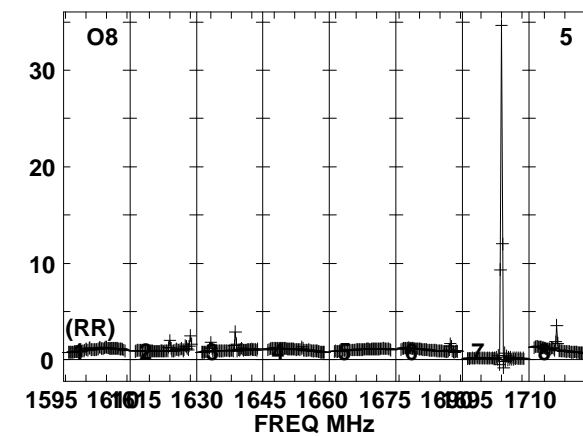
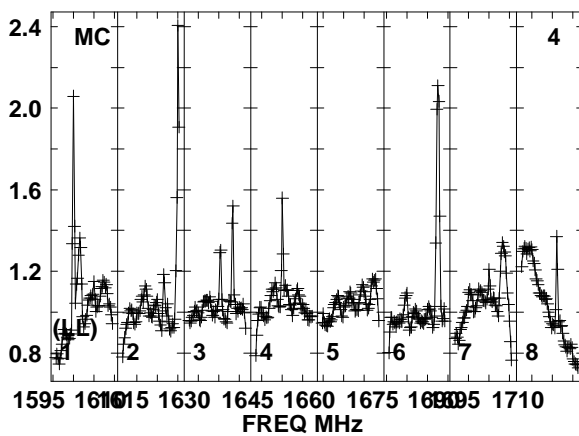
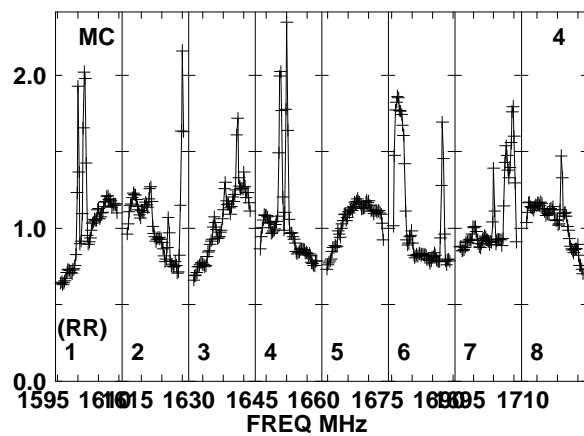
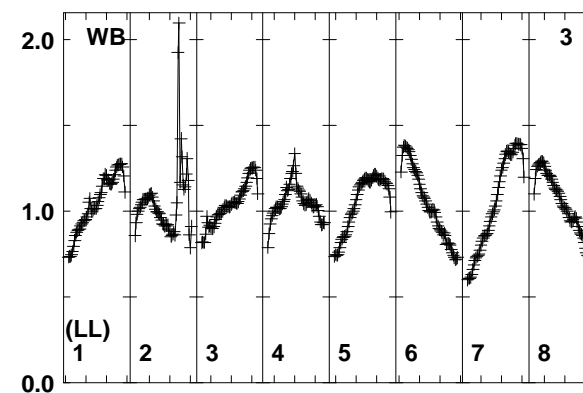
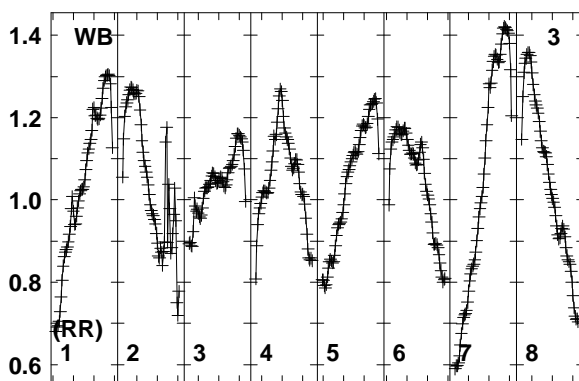
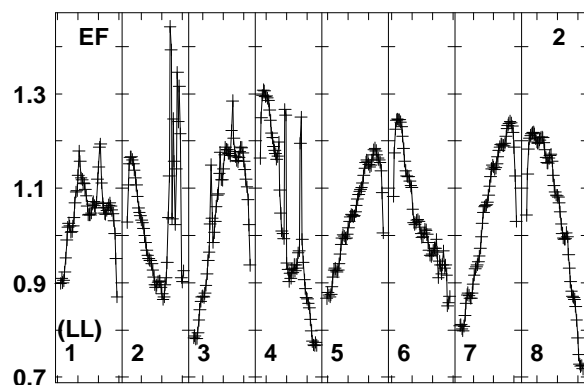
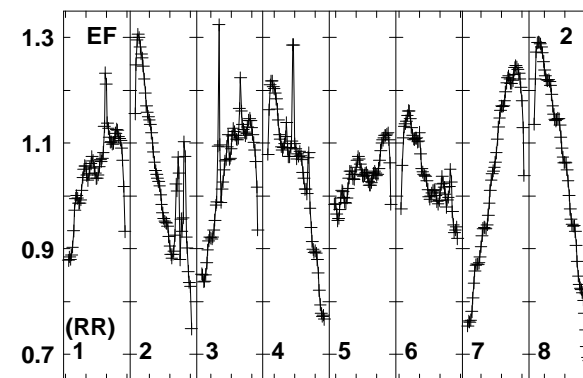
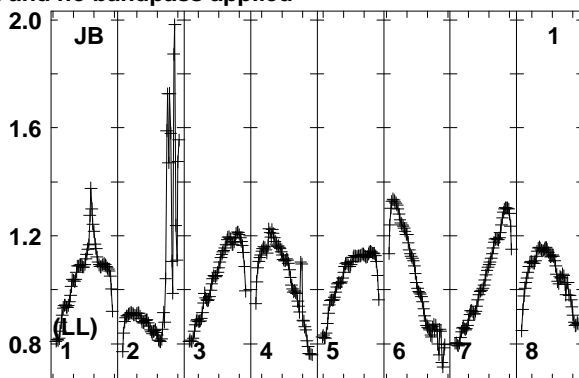
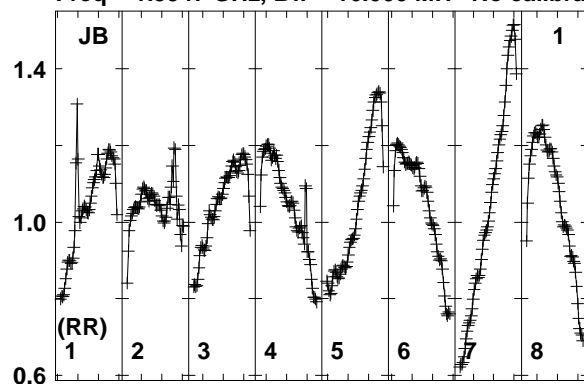

Lower frame: Real Jy
Total-power spectrum Antenna: JB (01)
Timerange: 00/09:39:01 to 00/09:41:29

Plot file version 731 created 04-NOV-2019 14:14:59

W2246-0526 EY034.UVDATA.1

Freq = 1.5947 GHz, Bw = 16.000 MH No calibration applied and no bandpass applied

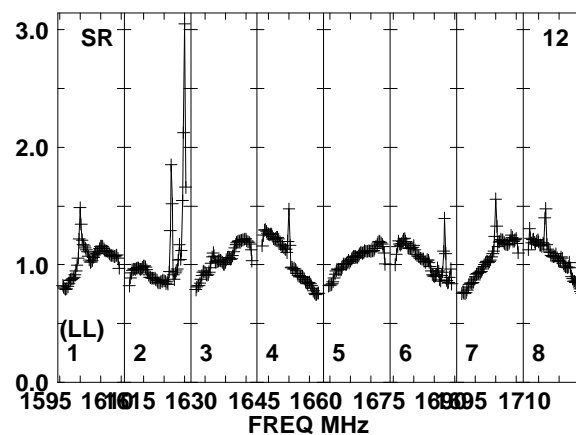
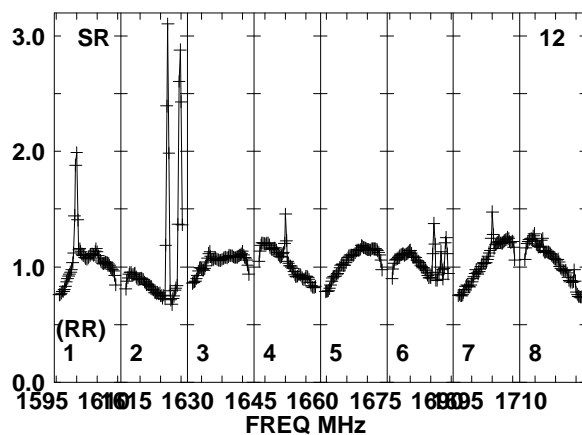
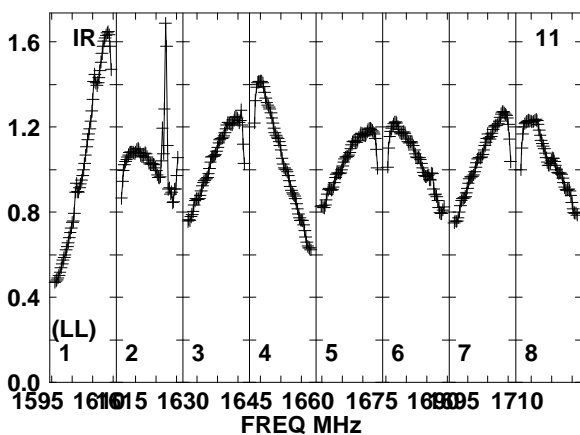
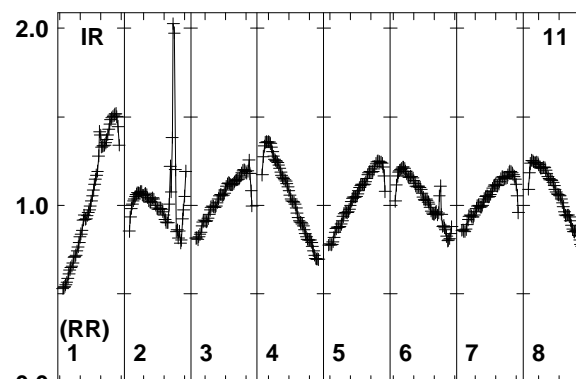
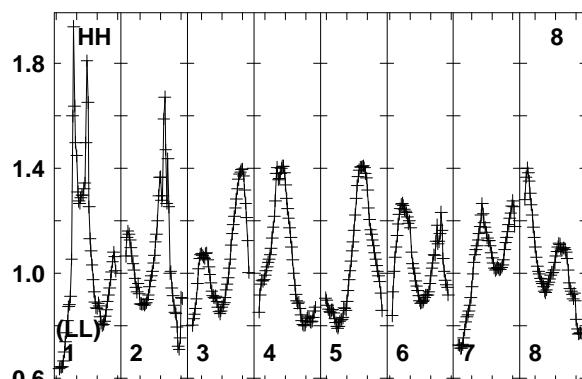
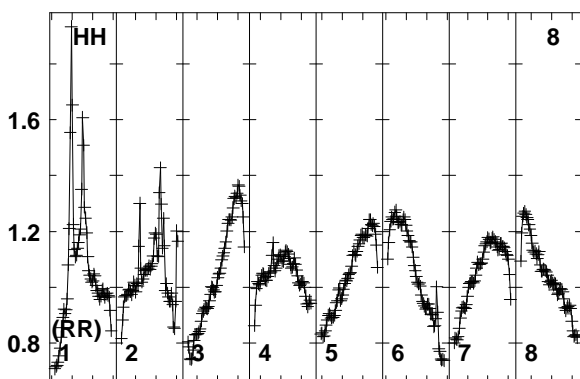
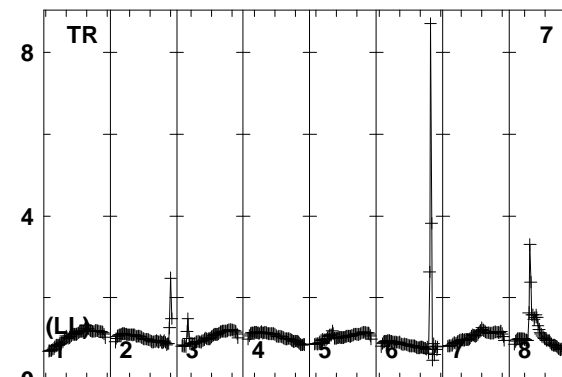
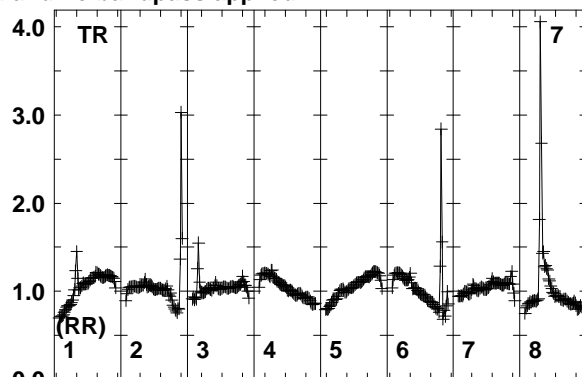
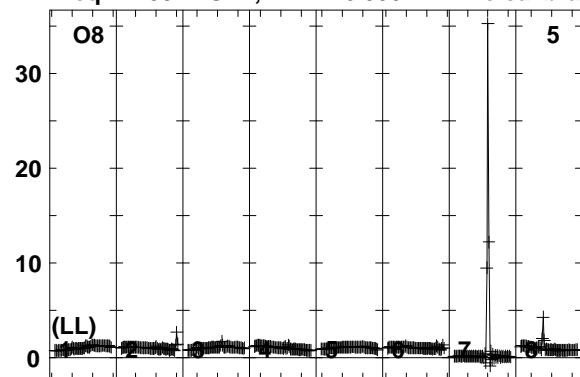

Lower frame: Real Jy
Total-power spectrum Antenna: O8 (05)
Timerange: 00/09:39:01 to 00/09:41:29

Plot file version 732 created 04-NOV-2019 14:15:00

W2246-0526 EY034.UVDATA.1

Freq = 1.5947 GHz, Bw = 16.000 MH No calibration applied and no bandpass applied

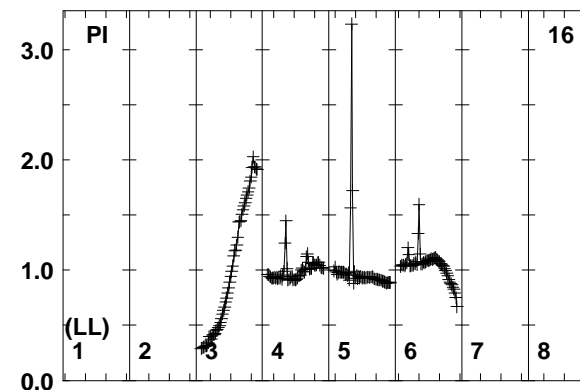
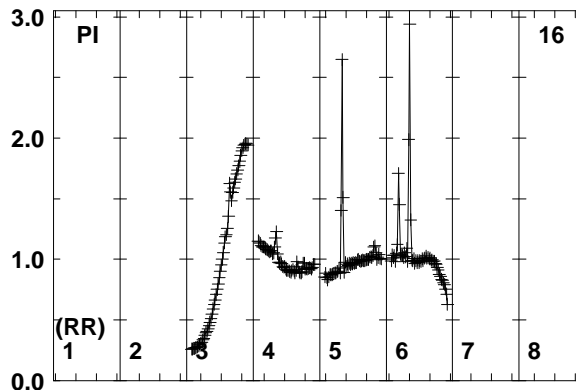
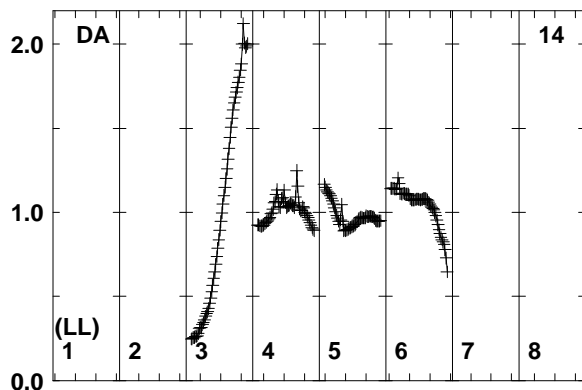
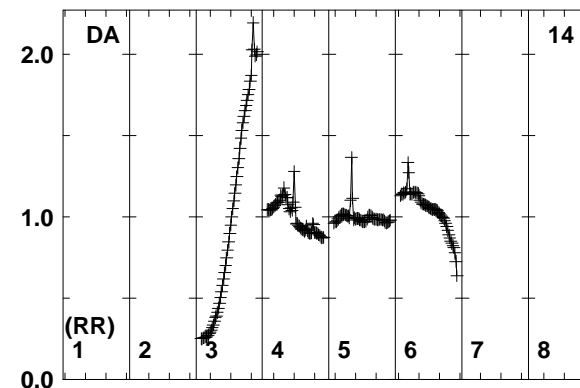
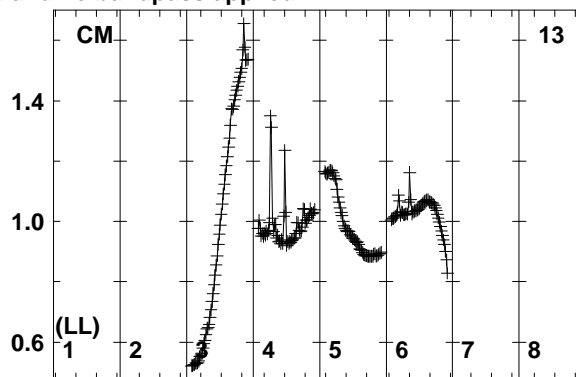
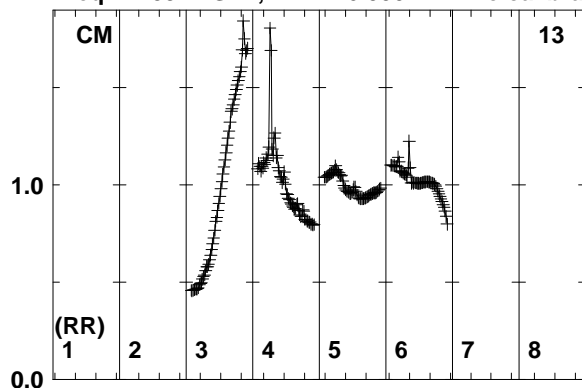

Lower frame: Real Jy
Total-power spectrum Antenna: CM (13)
Timerange: 00/09:39:01 to 00/09:41:29

Plot file version 733 created 04-NOV-2019 14:15:00

J2248-0541 EY034.UVDATA.1

Freq = 1.5947 GHz, Bw = 16.000 MH No calibration applied and no bandpass applied

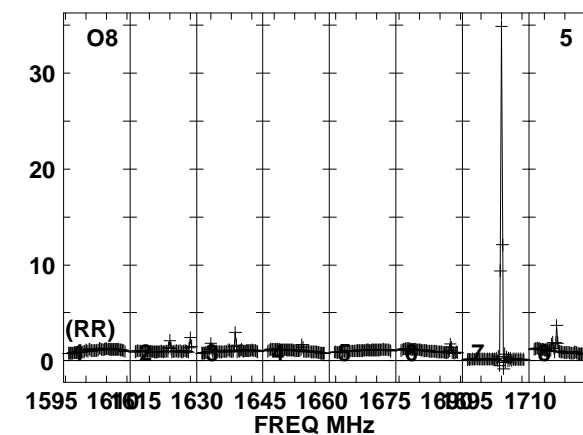
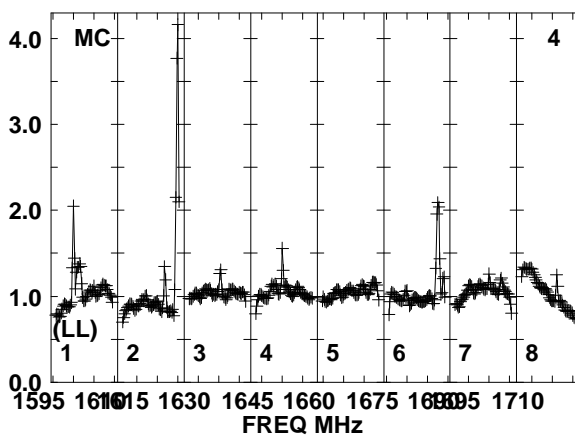
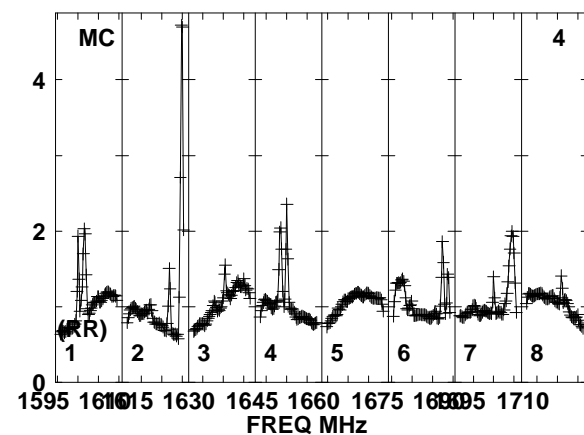
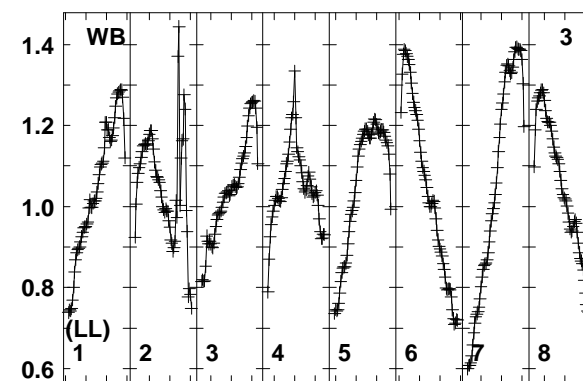
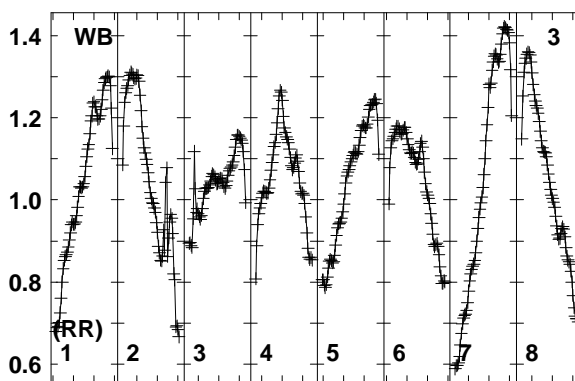
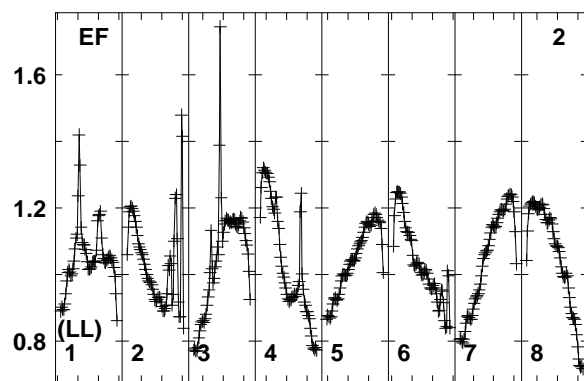
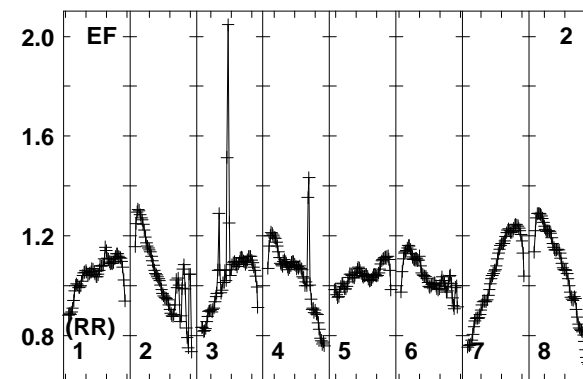
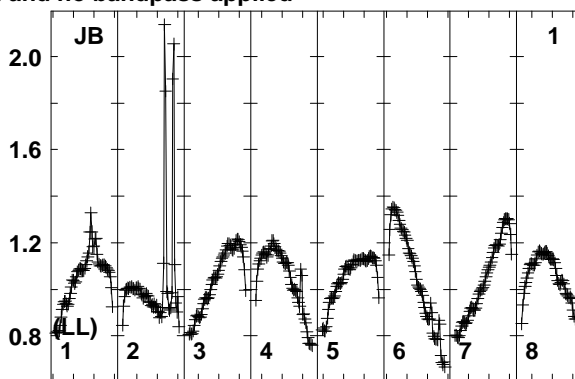
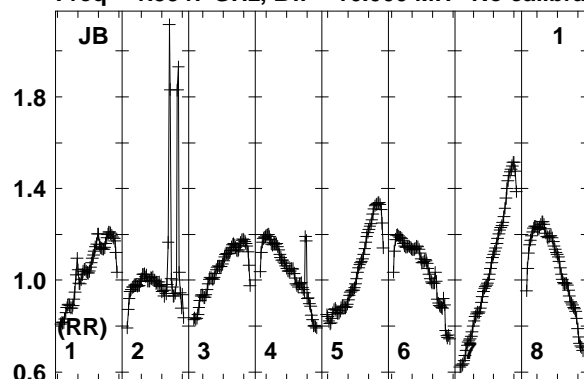

Lower frame: Real Jy
Total-power spectrum Antenna: JB (01)
Timerange: 00/09:41:46 to 00/09:42:44

Plot file version 734 created 04-NOV-2019 14:15:00

J2248-0541 EY034.UVDATA.1

Freq = 1.5947 GHz, Bw = 16.000 MH No calibration applied and no bandpass applied

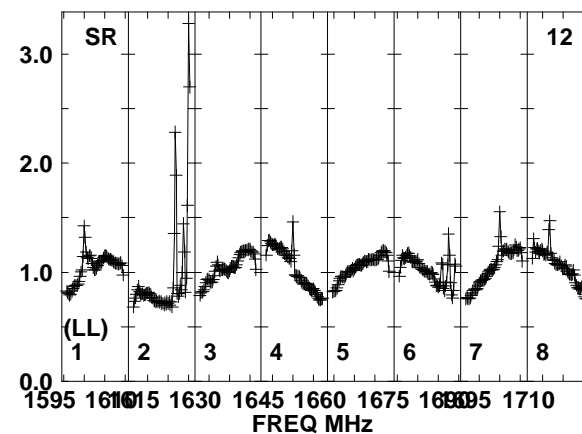
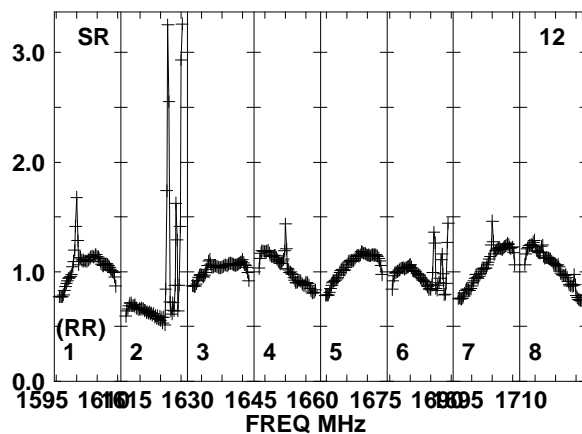
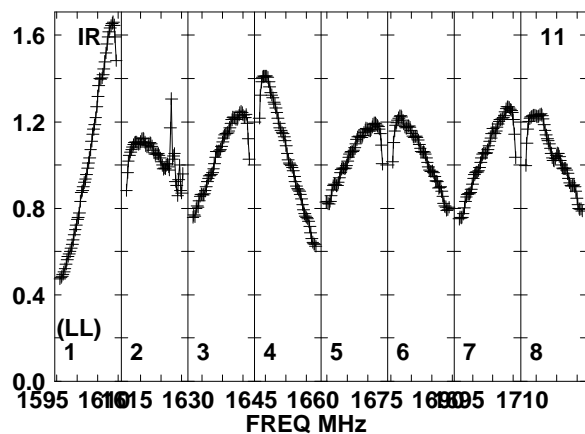
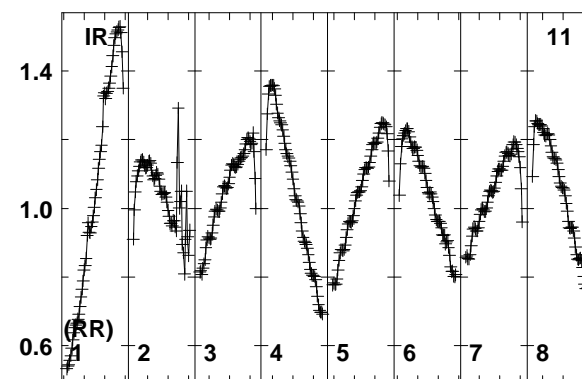
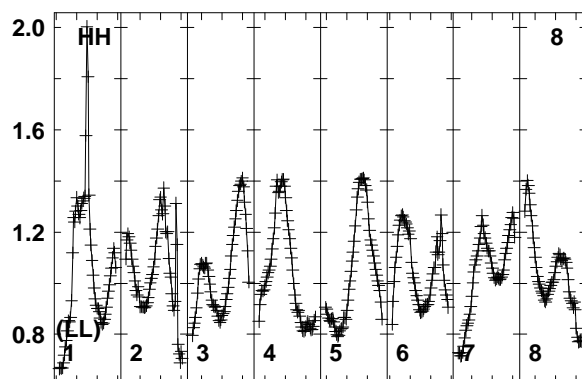
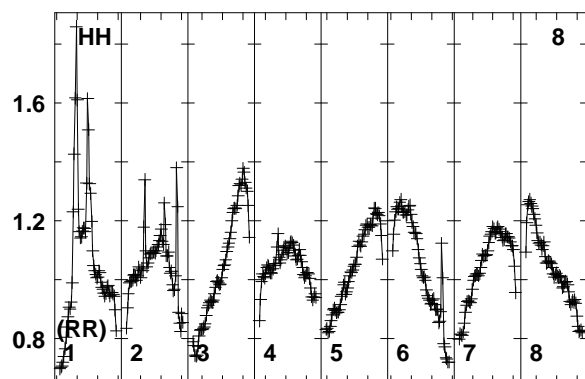
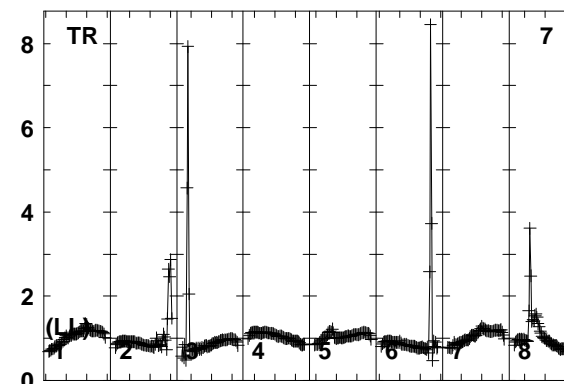
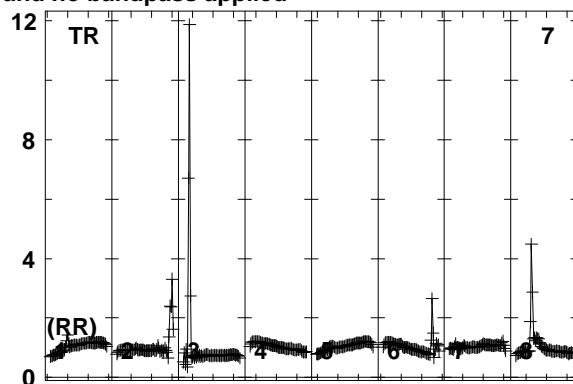
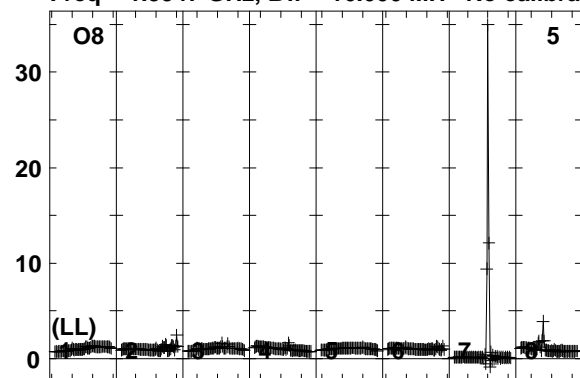

Lower frame: Real Jy
Total-power spectrum Antenna: O8 (05)
Timerange: 00/09:41:46 to 00/09:42:44

Plot file version 735 created 04-NOV-2019 14:15:00

J2248-0541 EY034.UVDATA.1

Freq = 1.5947 GHz, Bw = 16.000 MH No calibration applied and no bandpass applied

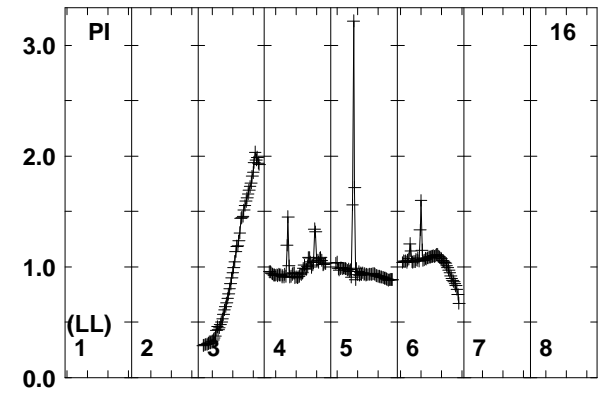
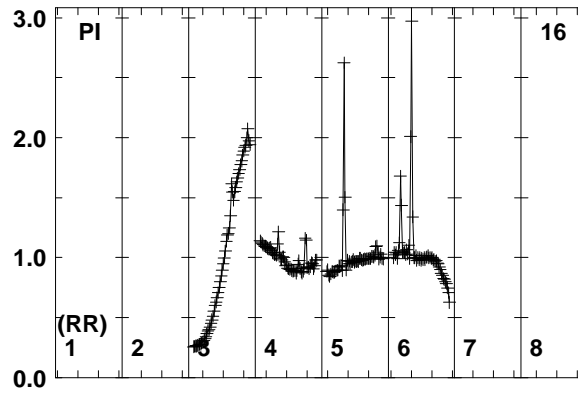
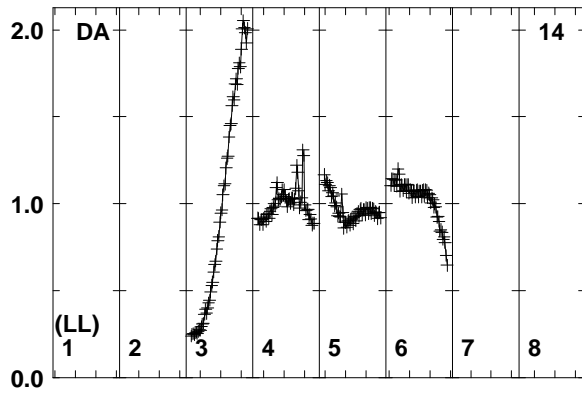
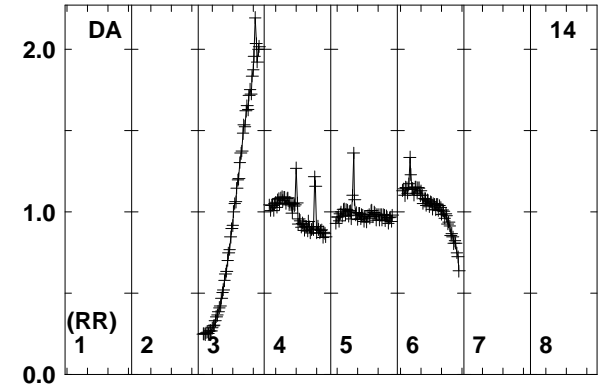
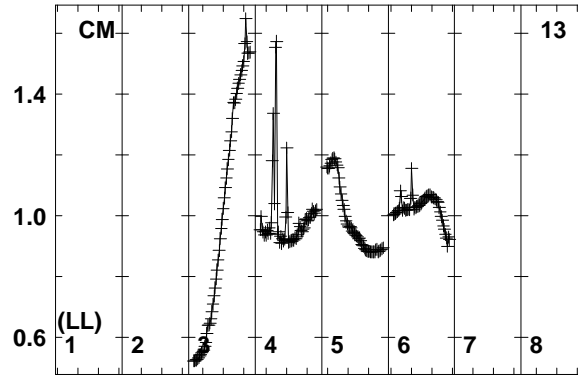
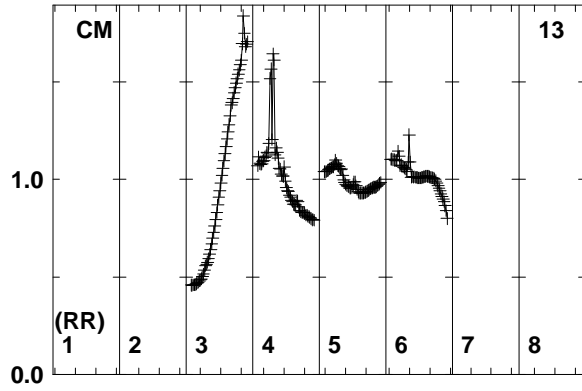

Lower frame: Real Jy
Total-power spectrum Antenna: CM (13)
Timerange: 00/09:41:46 to 00/09:42:44

Plot file version 736 created 04-NOV-2019 14:15:00

W2246-0526 EY034.UVDATA.1

Freq = 1.5947 GHz, Bw = 16.000 MH No calibration applied and no bandpass applied

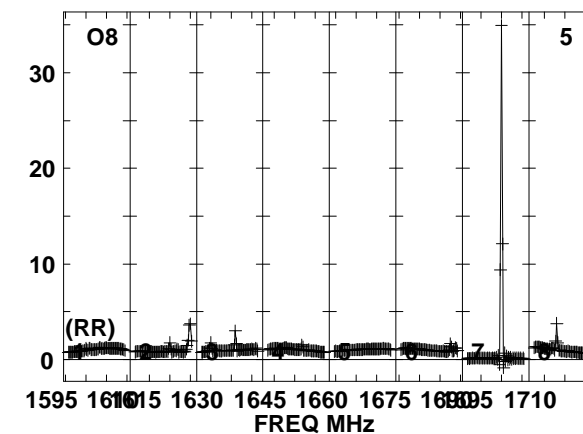
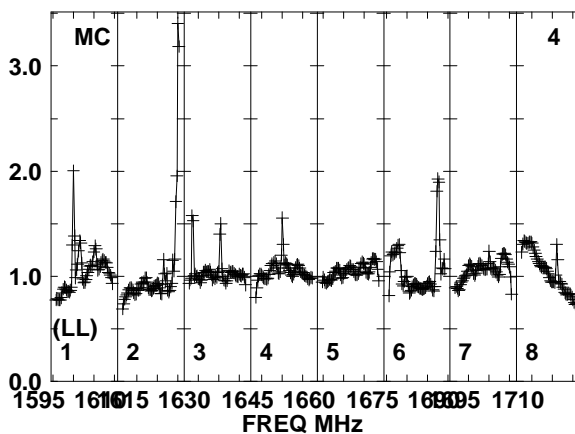
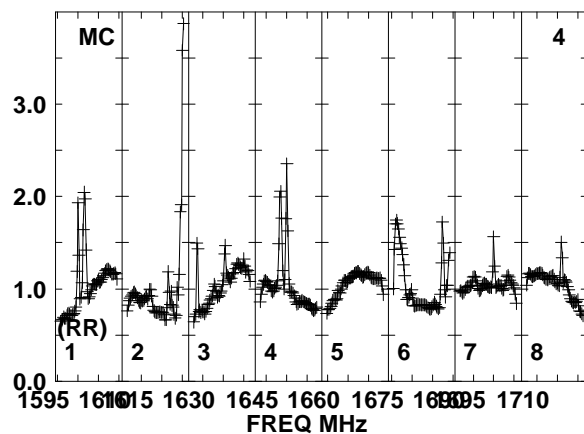
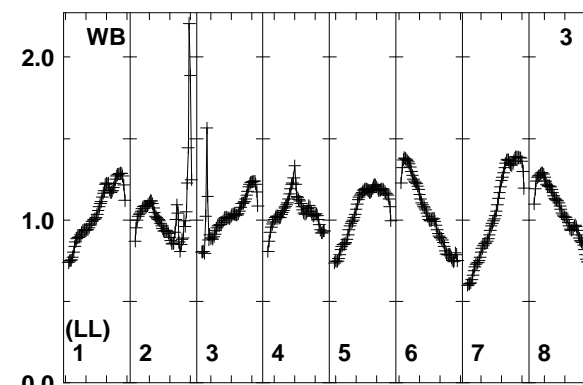
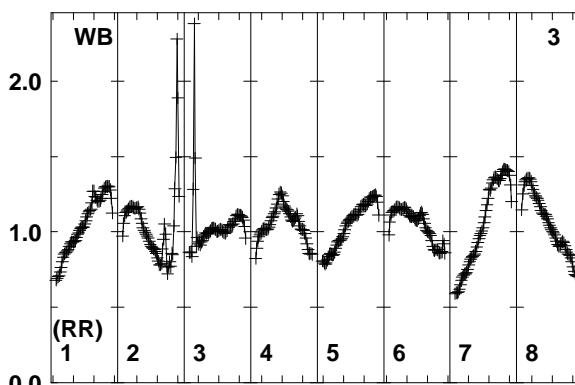
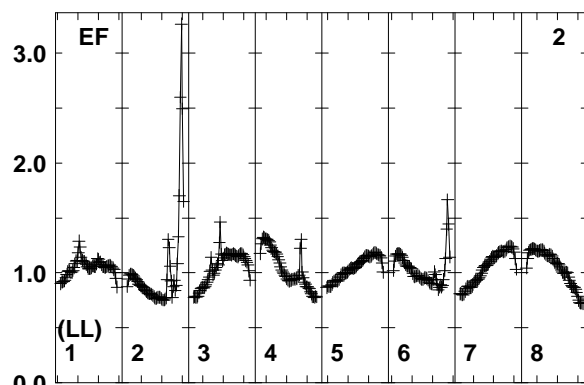
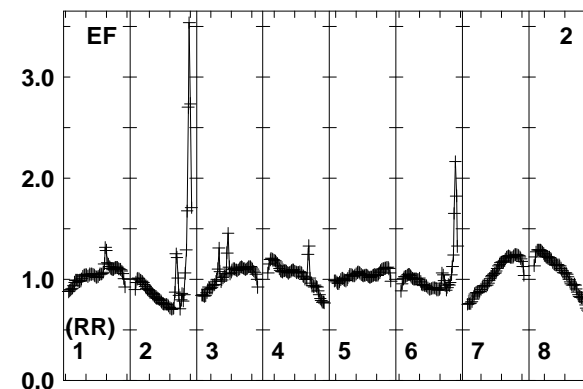
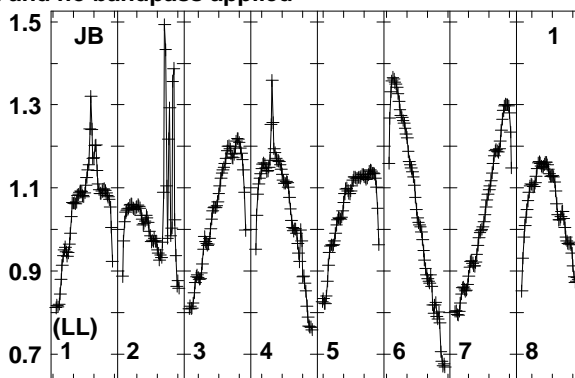
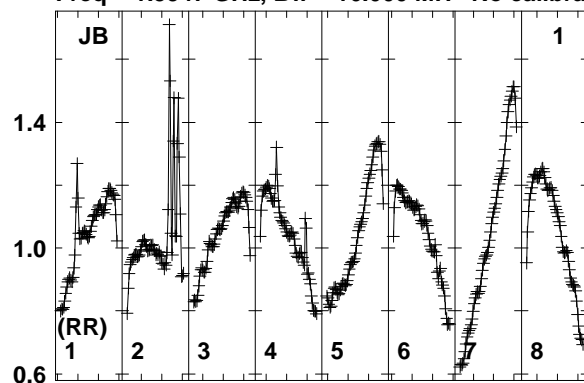

Lower frame: Real Jy
Total-power spectrum Antenna: JB (01)
Timerange: 00/09:42:46 to 00/09:45:24

Plot file version 737 created 04-NOV-2019 14:15:00

W2246-0526 EY034.UVDATA.1

Freq = 1.5947 GHz, Bw = 16.000 MH No calibration applied and no bandpass applied

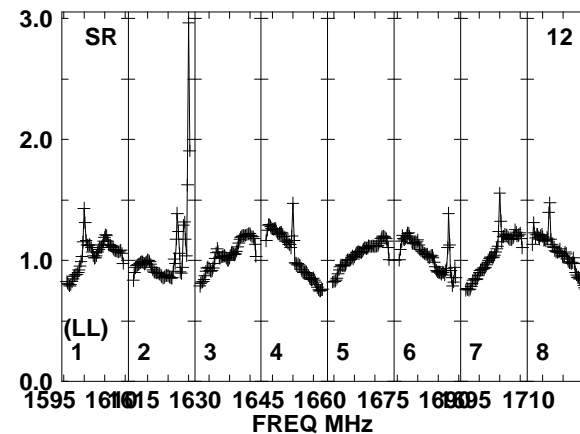
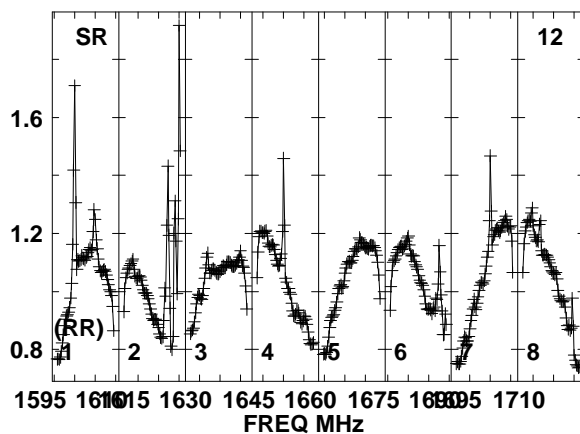
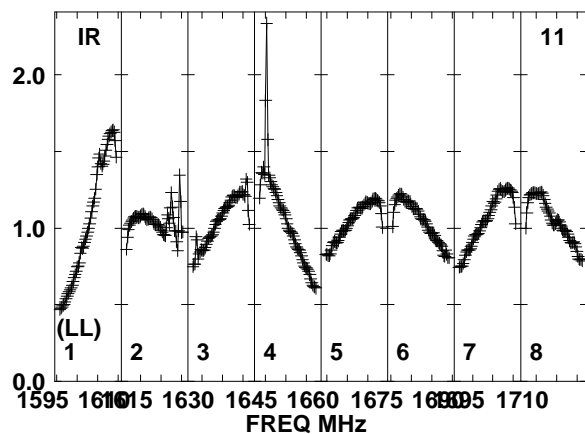
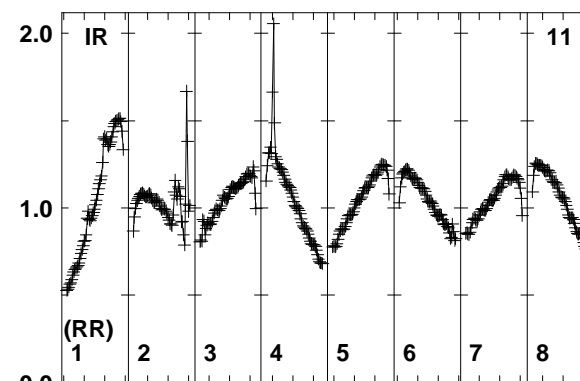
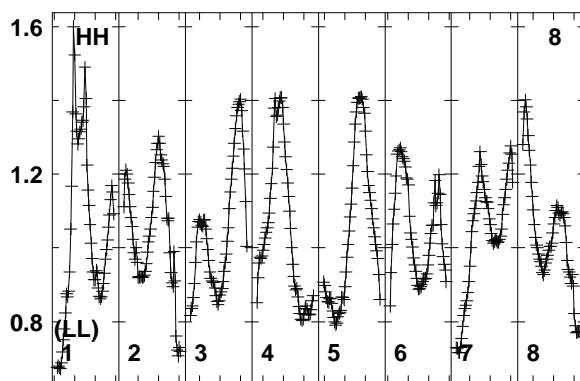
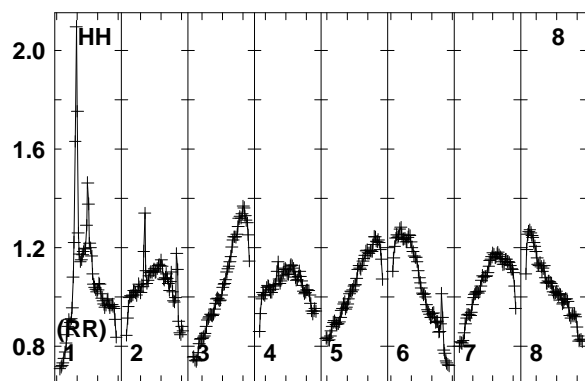
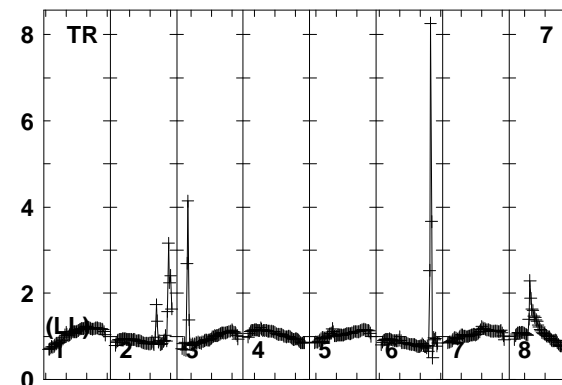
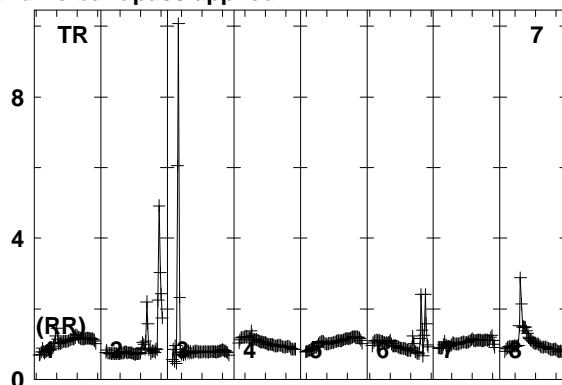
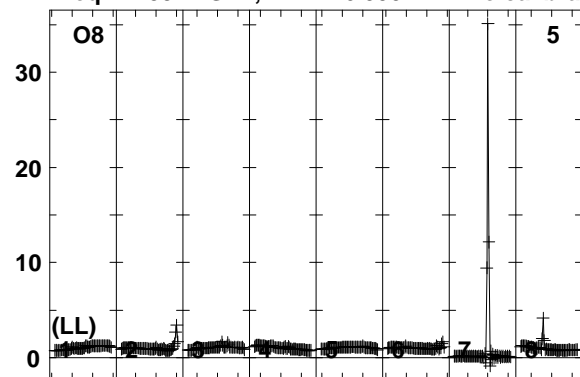

Lower frame: Real Jy
Total-power spectrum Antenna: O8 (05)
Timerange: 00/09:42:46 to 00/09:45:24

Plot file version 738 created 04-NOV-2019 14:15:00

W2246-0526 EY034.UVDATA.1

Freq = 1.5947 GHz, Bw = 16.000 MH No calibration applied and no bandpass applied

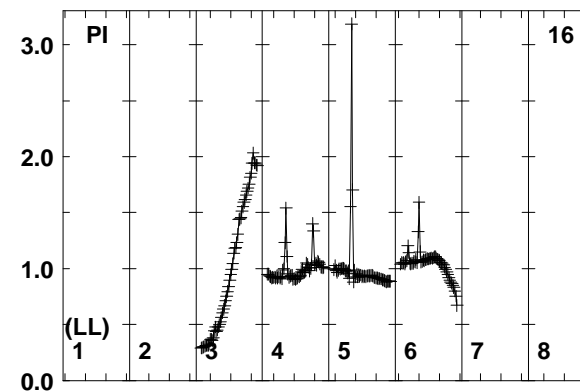
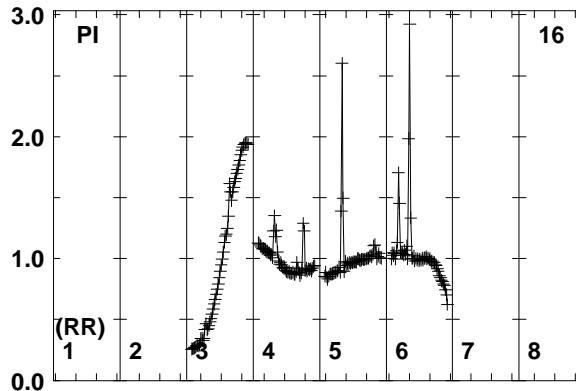
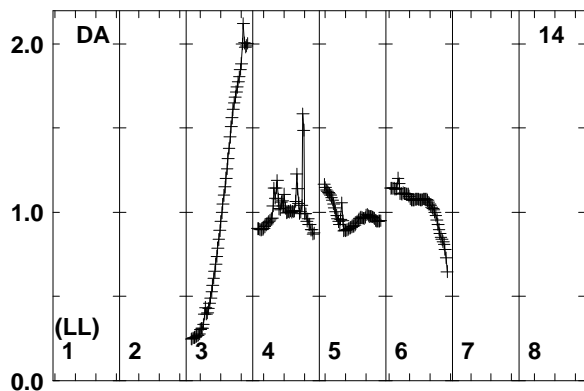
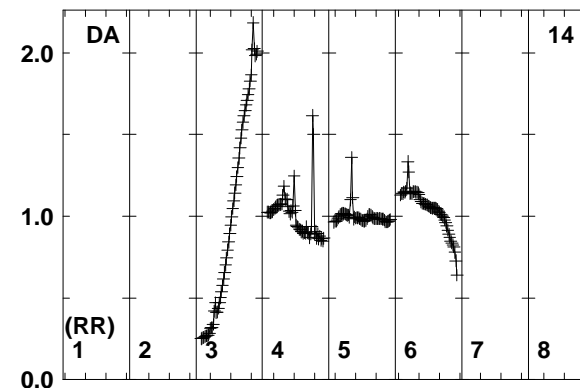
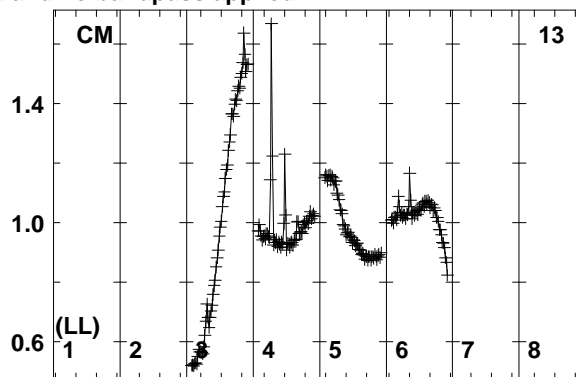
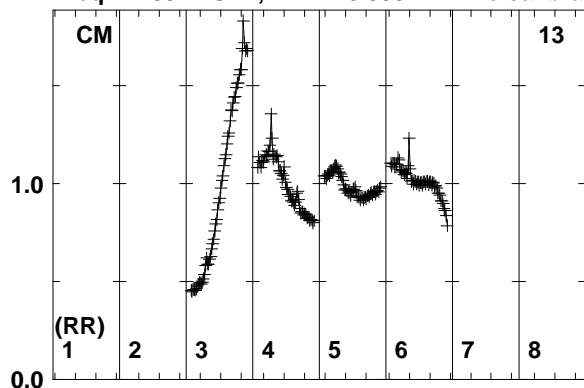

Lower frame: Real Jy
Total-power spectrum Antenna: CM (13)
Timerange: 00/09:42:46 to 00/09:45:24

Plot file version 739 created 04-NOV-2019 14:15:00

J2248-0541 EY034.UVDATA.1

Freq = 1.5947 GHz, Bw = 16.000 MH No calibration applied and no bandpass applied

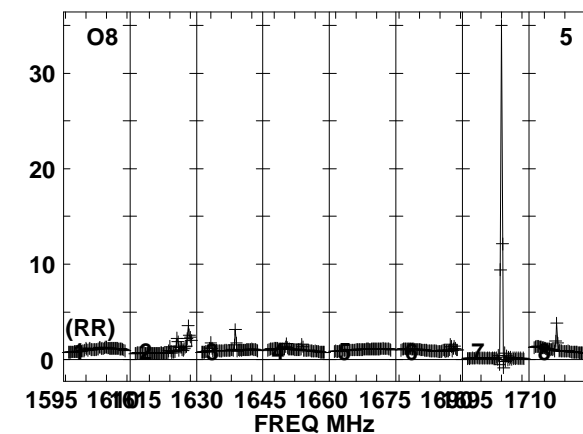
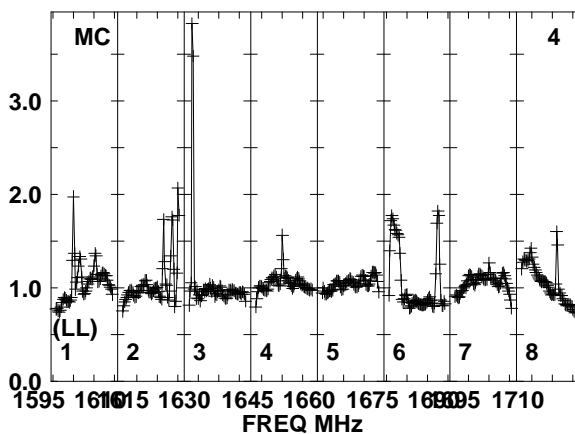
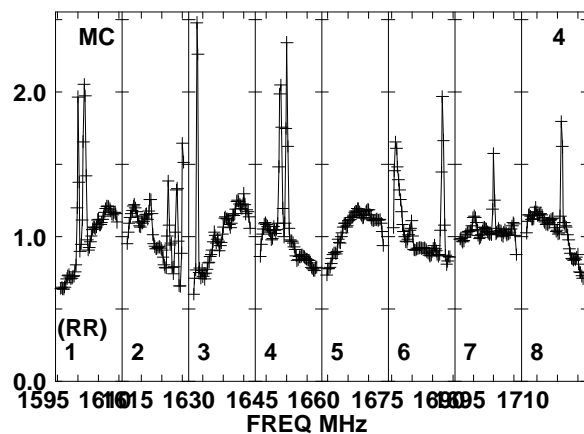
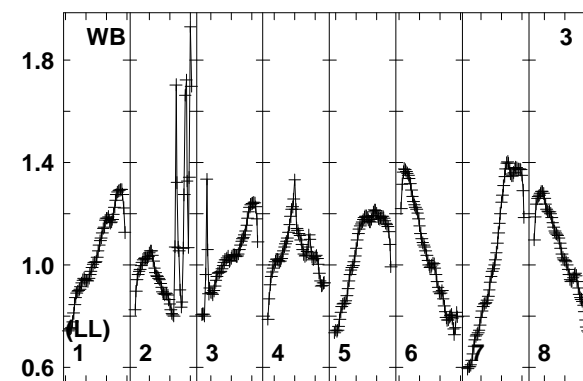
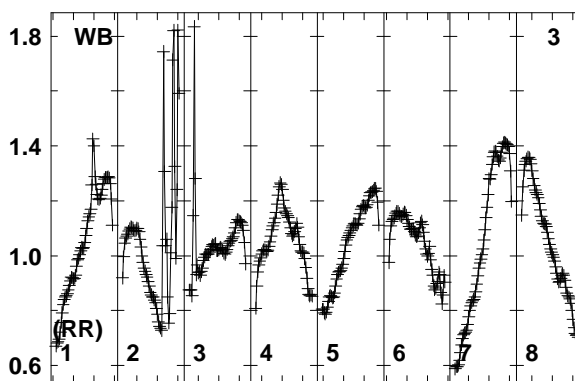
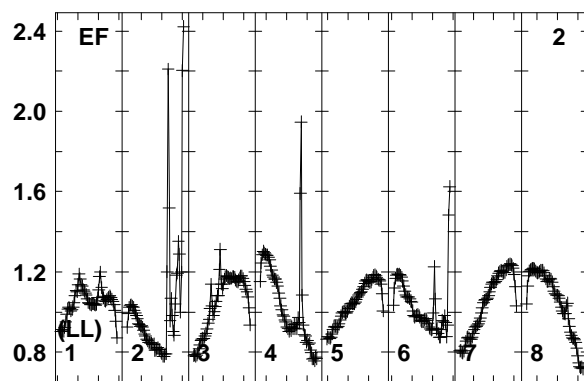
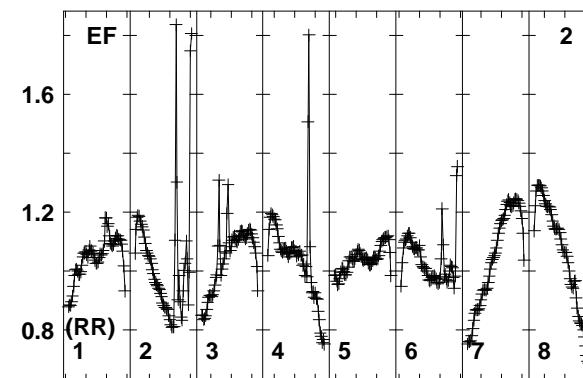
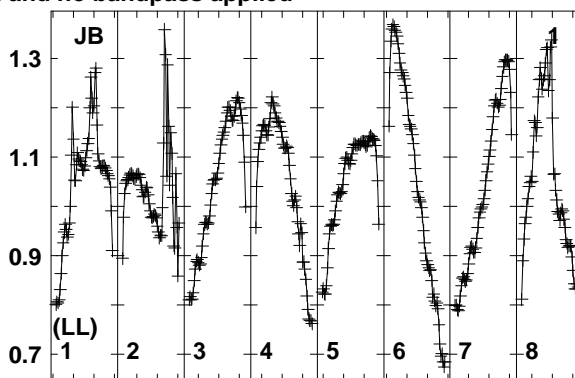
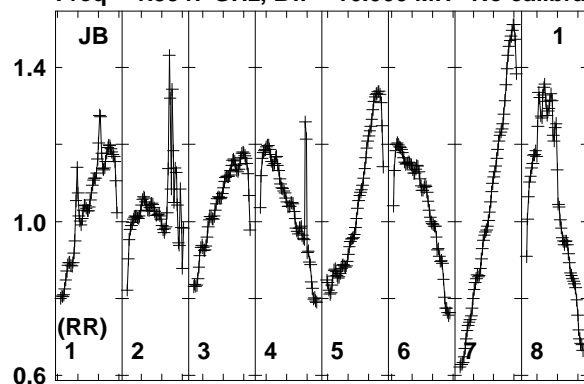

Lower frame: Real Jy
Total-power spectrum Antenna: JB (01)
Timerange: 00/09:45:41 to 00/09:46:39

Plot file version 740 created 04-NOV-2019 14:15:00

J2248-0541 EY034.UVDATA.1

Freq = 1.5947 GHz, Bw = 16.000 MH No calibration applied and no bandpass applied

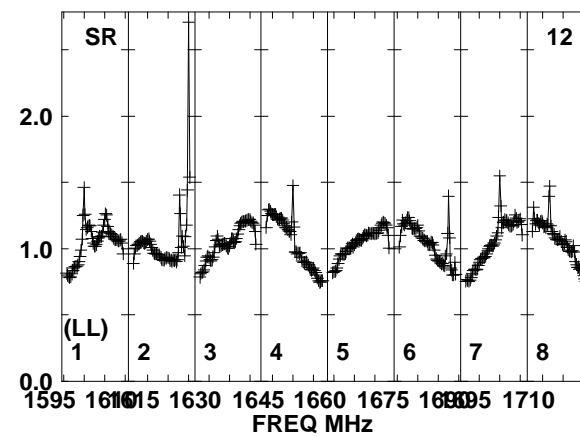
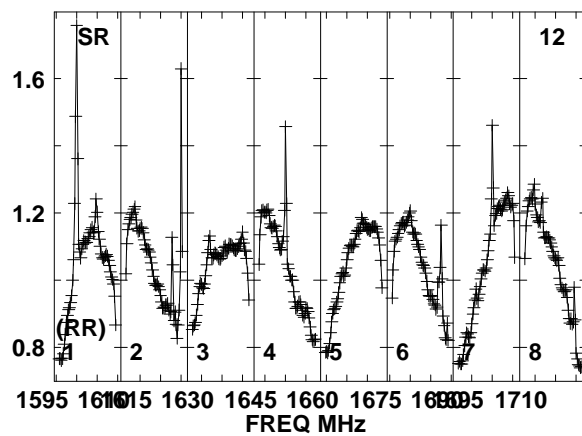
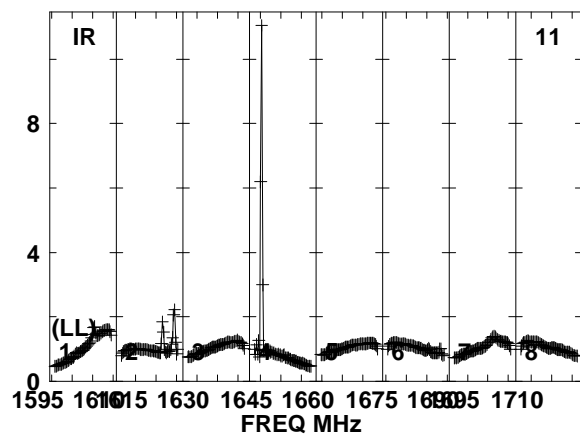
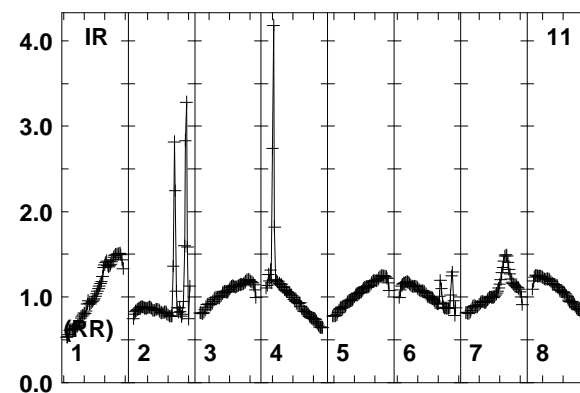
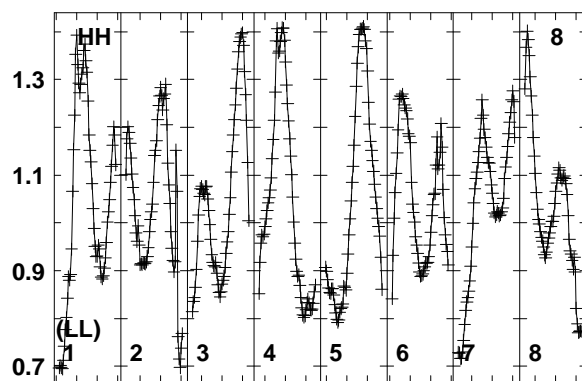
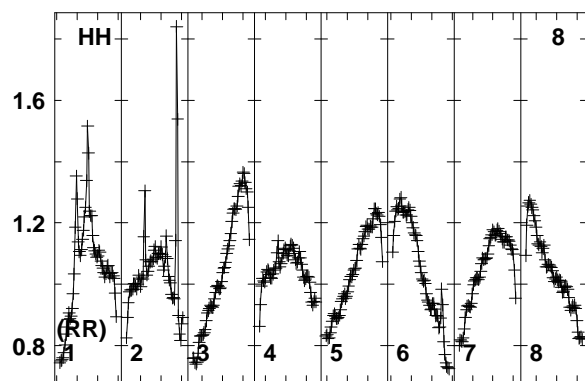
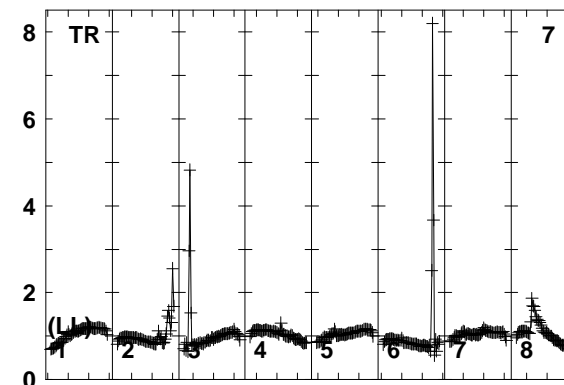
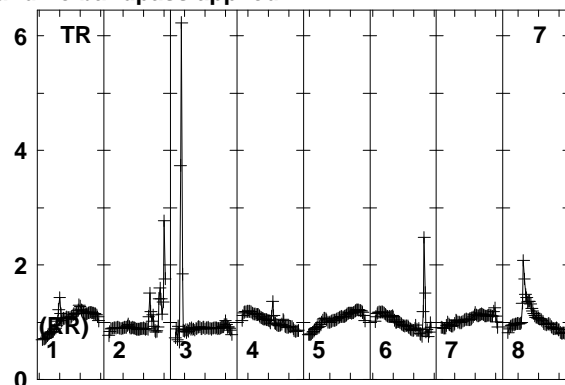
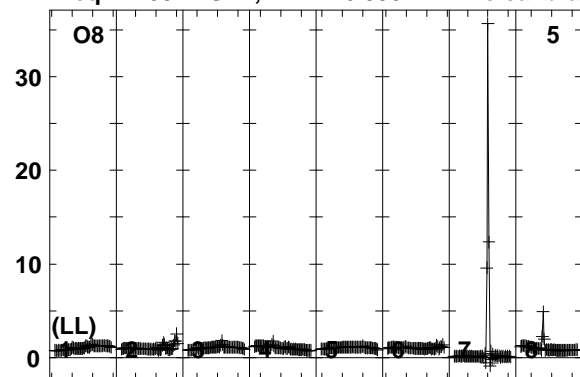

Lower frame: Real Jy
Total-power spectrum Antenna: O8 (05)
Timerange: 00/09:45:41 to 00/09:46:39

Plot file version 741 created 04-NOV-2019 14:15:00

J2248-0541 EY034.UVDATA.1

Freq = 1.5947 GHz, Bw = 16.000 MH No calibration applied and no bandpass applied

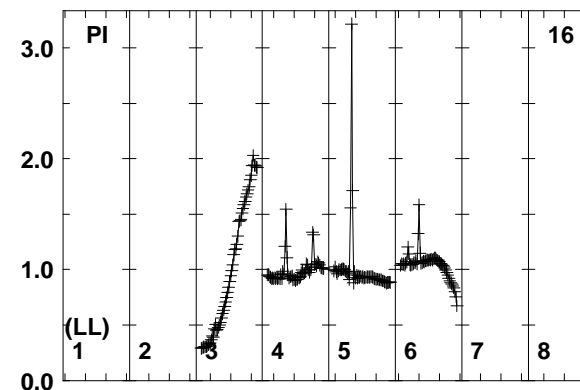
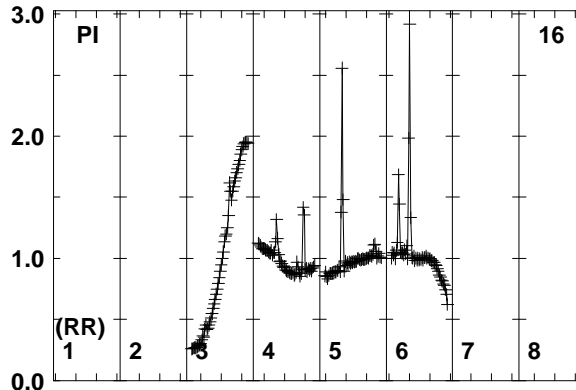
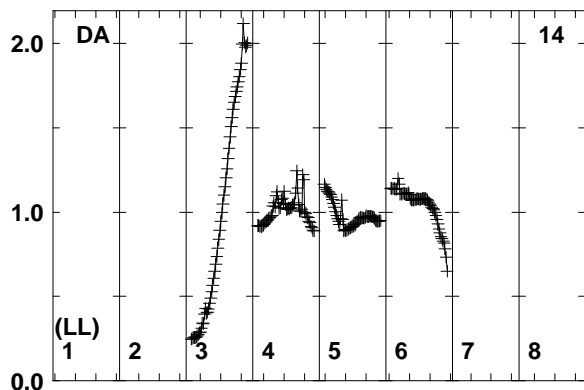
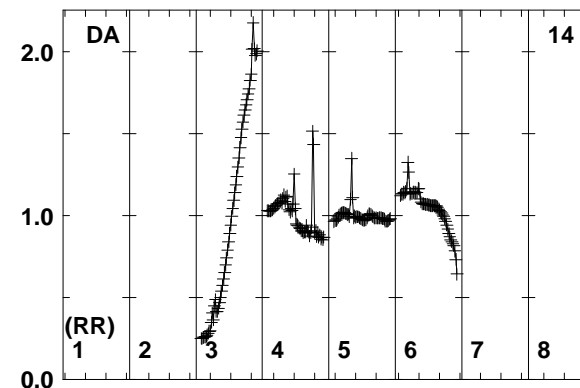
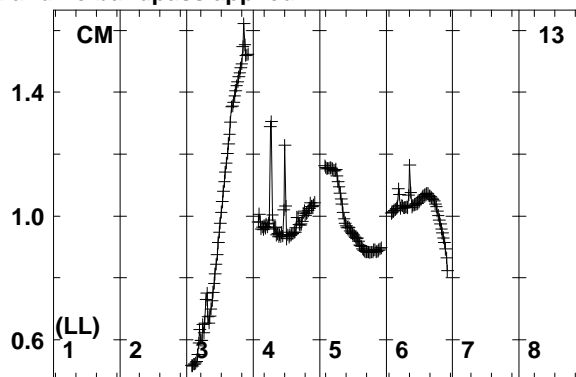
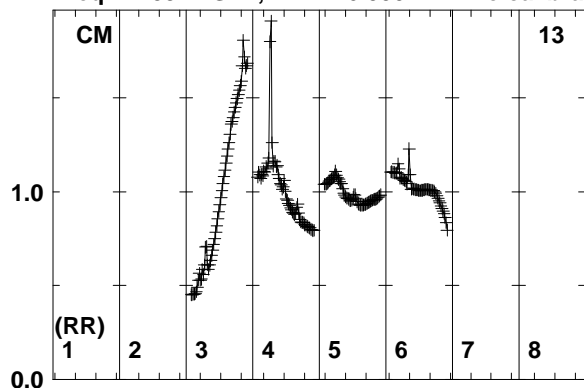

Lower frame: Real Jy
Total-power spectrum Antenna: CM (13)
Timerange: 00/09:45:41 to 00/09:46:39

Plot file version 742 created 04-NOV-2019 14:15:00
 W2246-0526 EY034.UVDATA.1
 Freq = 1.5947 GHz, Bw = 16.000 MH No calibration applied and no bandpass applied

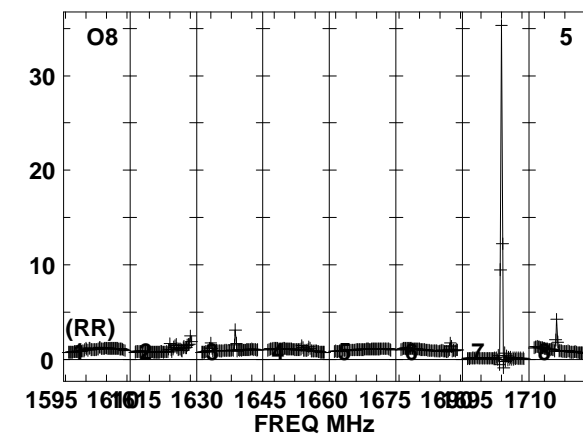
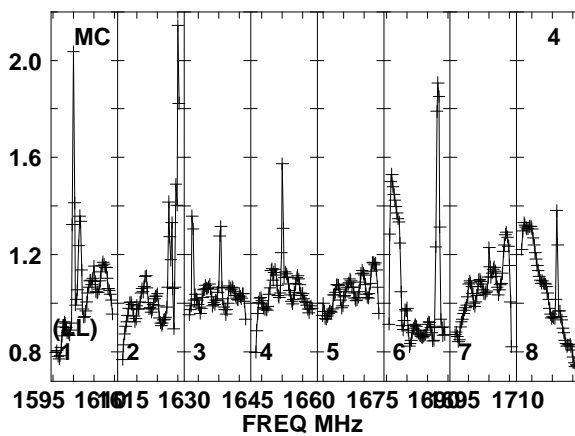
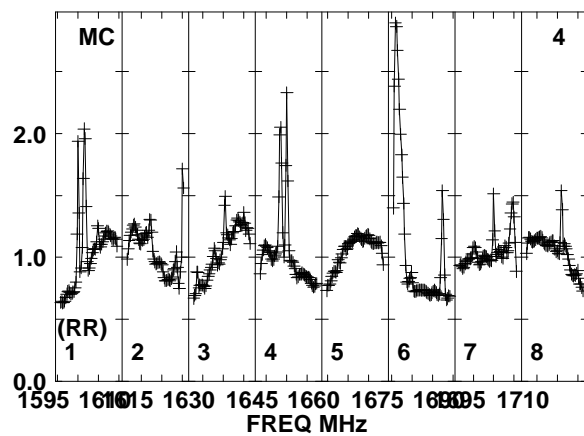
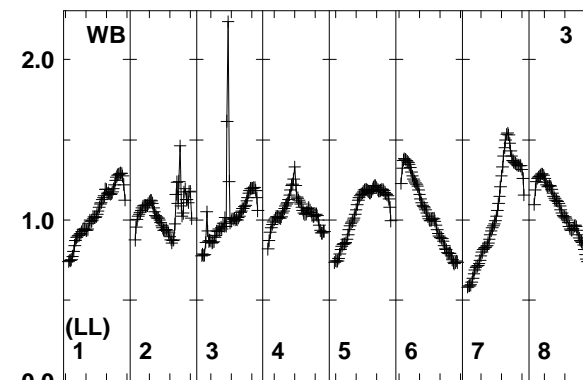
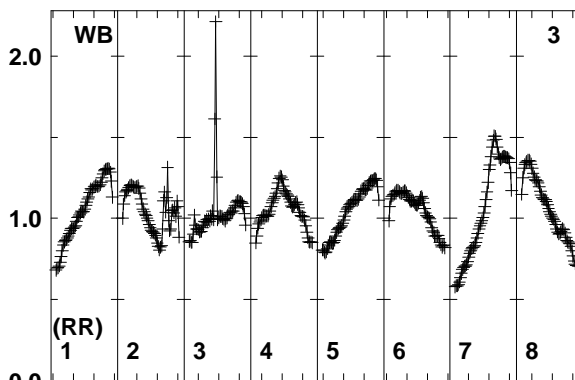
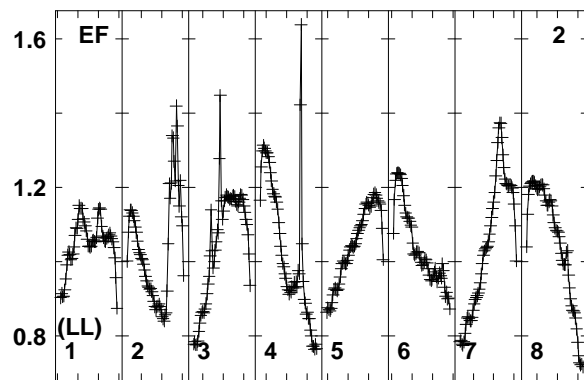
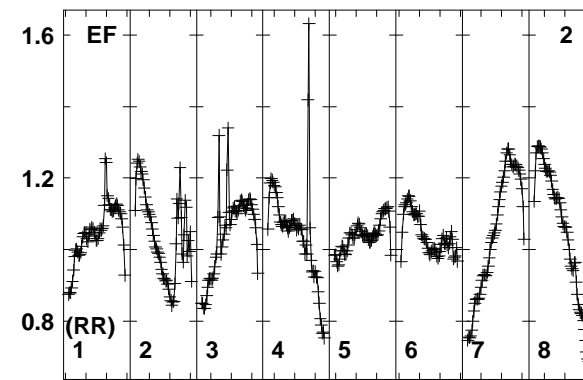
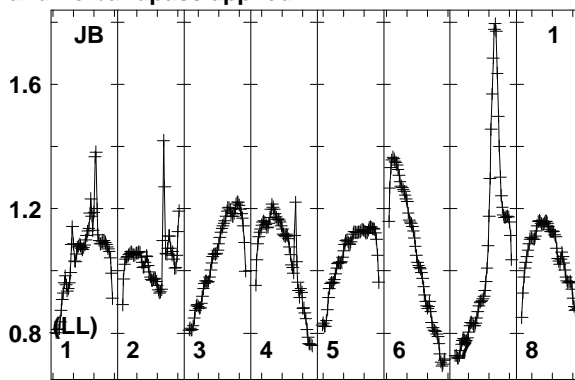
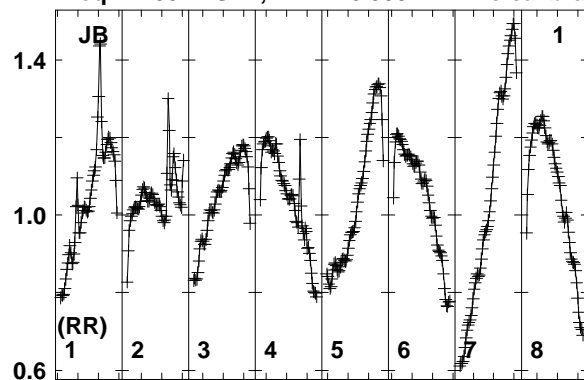

Lower frame: Real Jy
 Total-power spectrum Antenna: JB (01)
 Timerange: 00/09:46:41 to 00/09:49:19

Plot file version 743 created 04-NOV-2019 14:15:01

W2246-0526 EY034.UVDATA.1

Freq = 1.5947 GHz, Bw = 16.000 MH No calibration applied and no bandpass applied

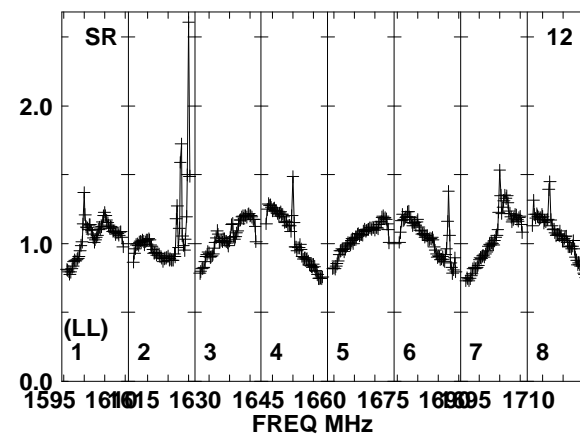
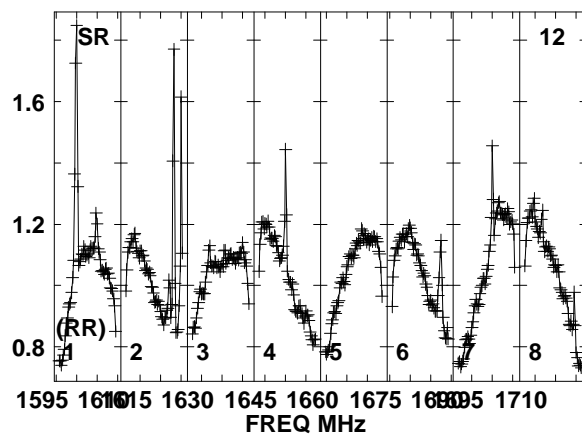
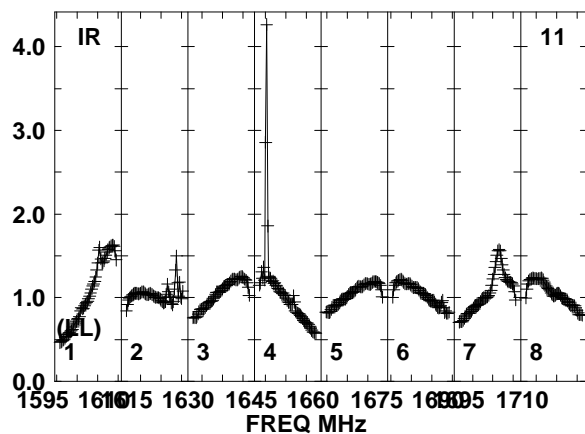
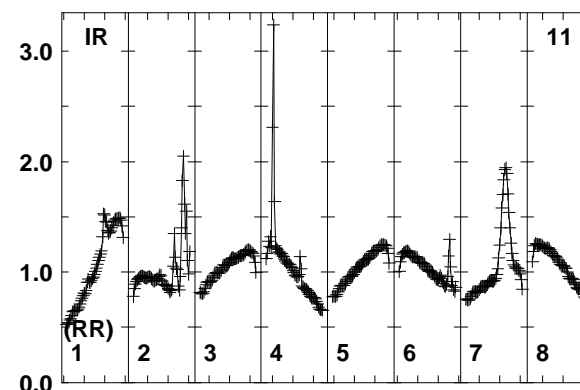
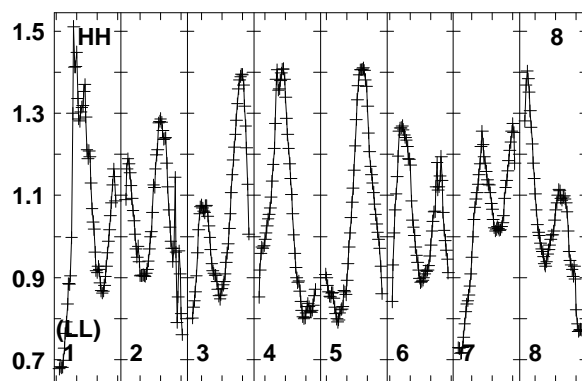
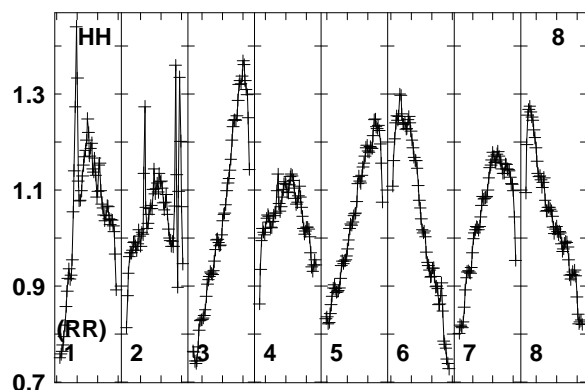
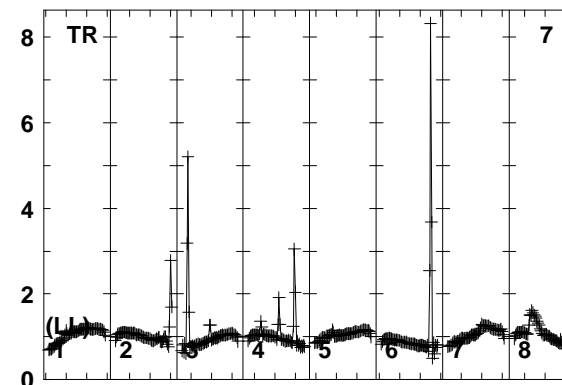
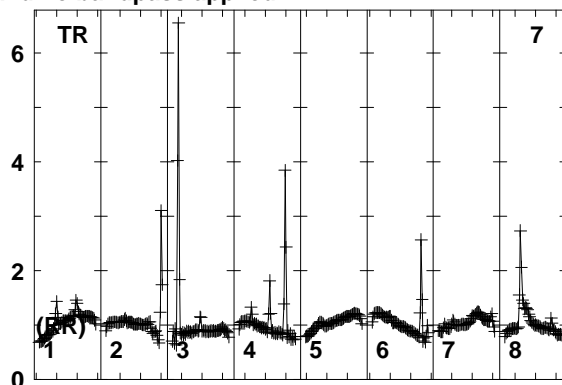
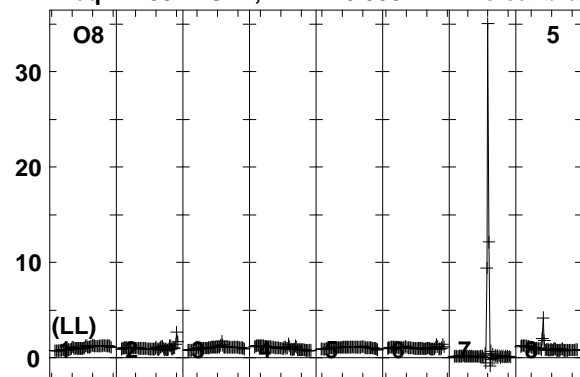

Lower frame: Real Jy
Total-power spectrum Antenna: O8 (05)
Timerange: 00/09:46:41 to 00/09:49:19

Plot file version 744 created 04-NOV-2019 14:15:01

W2246-0526 EY034.UVDATA.1

Freq = 1.5947 GHz, Bw = 16.000 MH No calibration applied and no bandpass applied

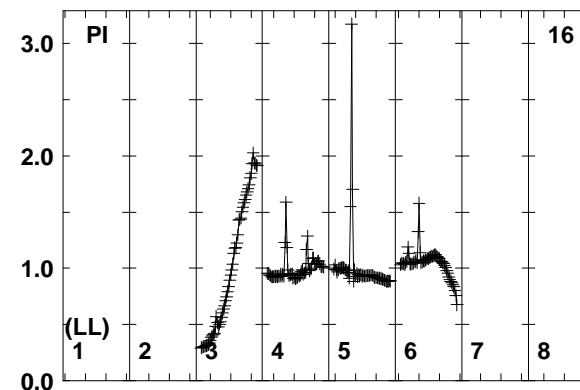
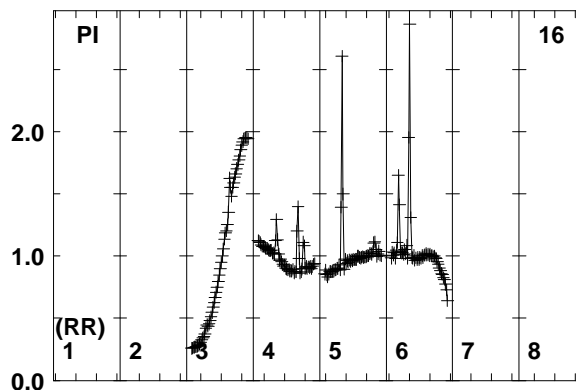
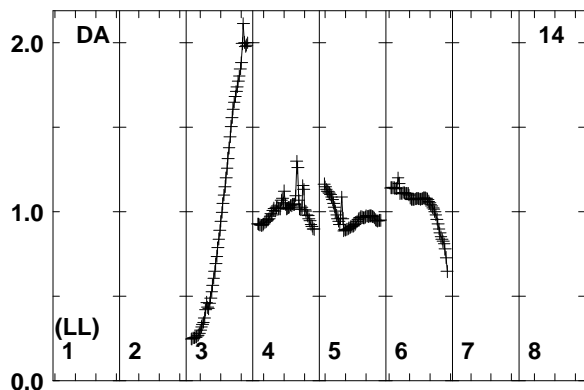
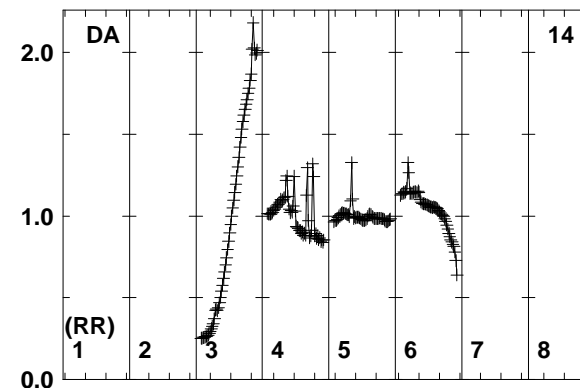
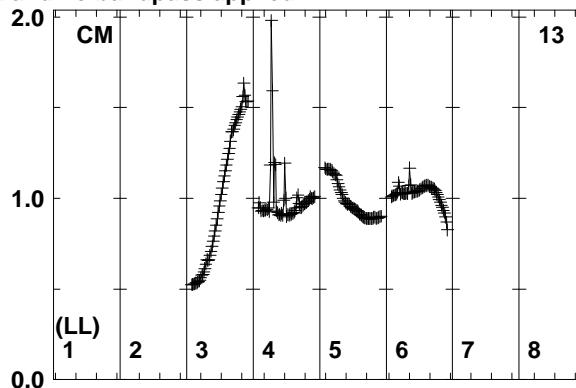
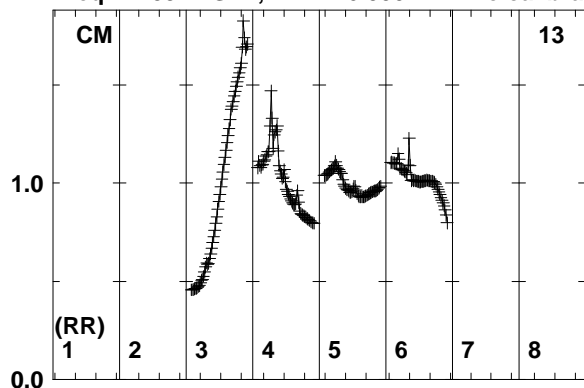

Lower frame: Real Jy
Total-power spectrum Antenna: CM (13)
Timerange: 00/09:46:41 to 00/09:49:19

Plot file version 745 created 04-NOV-2019 14:15:01

J2248-0541 EY034.UVDATA.1

Freq = 1.5947 GHz, Bw = 16.000 MH No calibration applied and no bandpass applied

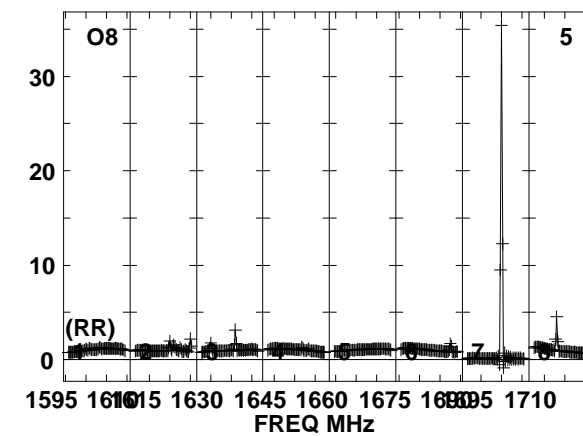
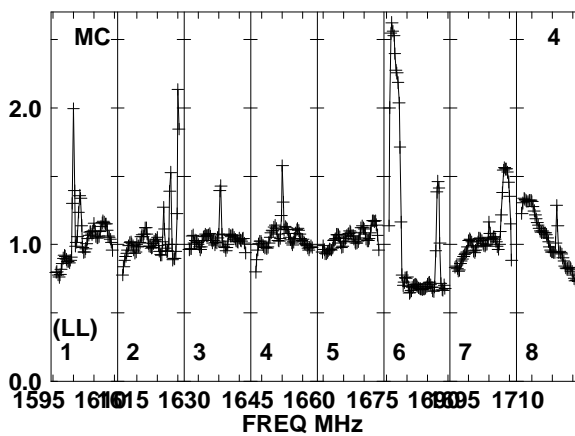
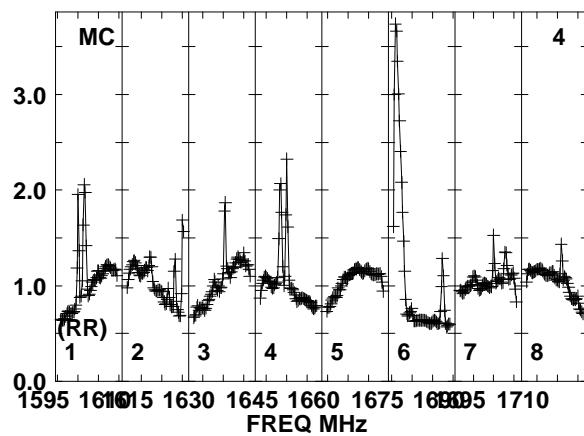
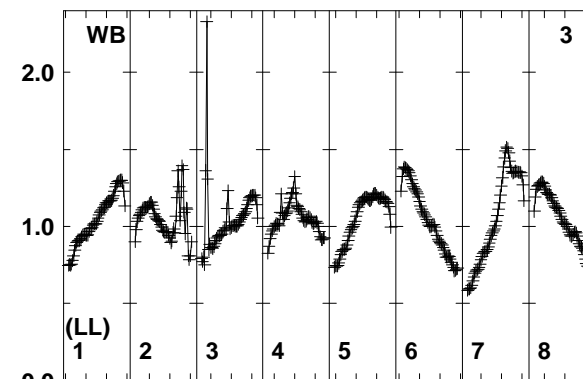
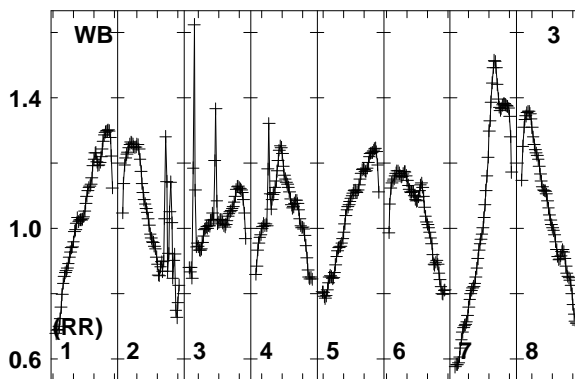
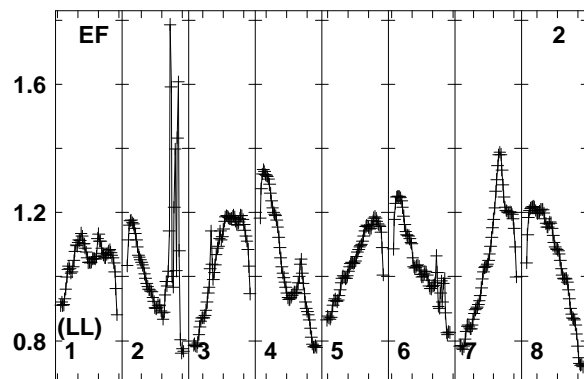
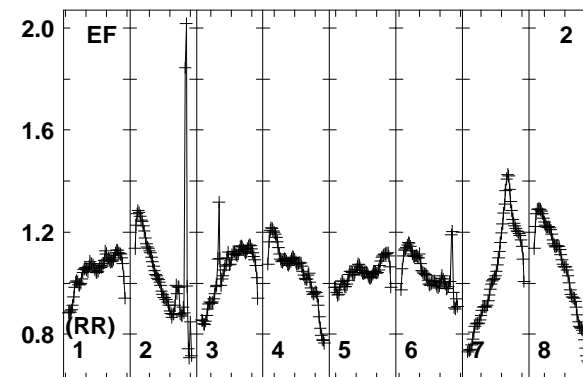
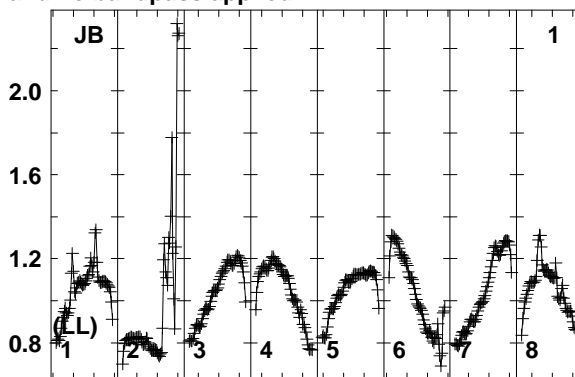
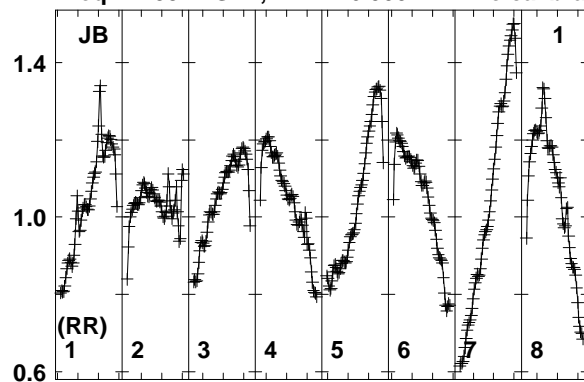

Lower frame: Real Jy
Total-power spectrum Antenna: JB (01)
Timerange: 00/09:49:36 to 00/09:50:34

Plot file version 746 created 04-NOV-2019 14:15:01

J2248-0541 EY034.UVDATA.1

Freq = 1.5947 GHz, Bw = 16.000 MH No calibration applied and no bandpass applied

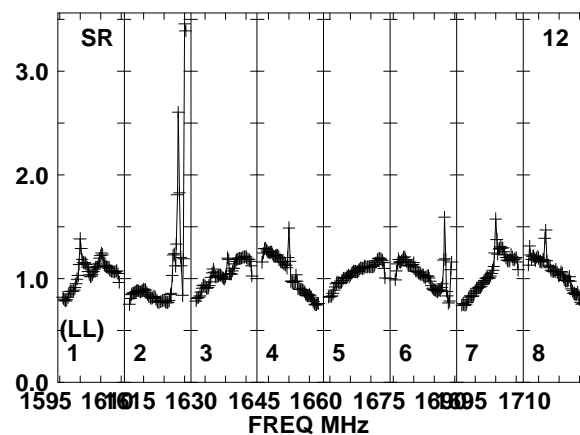
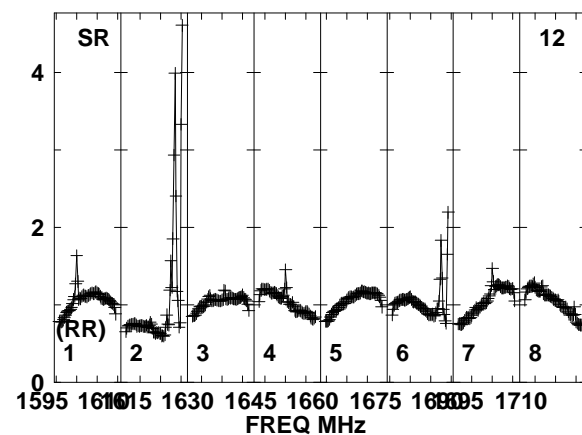
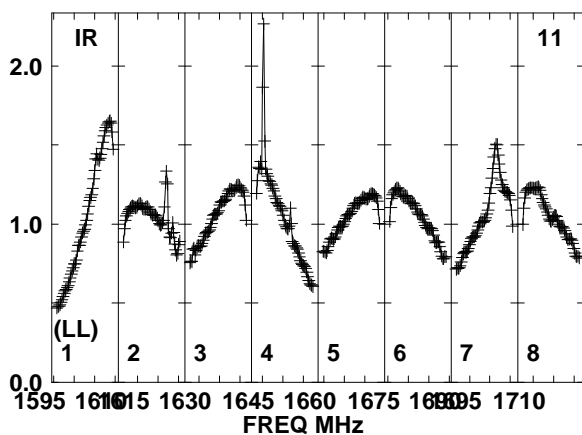
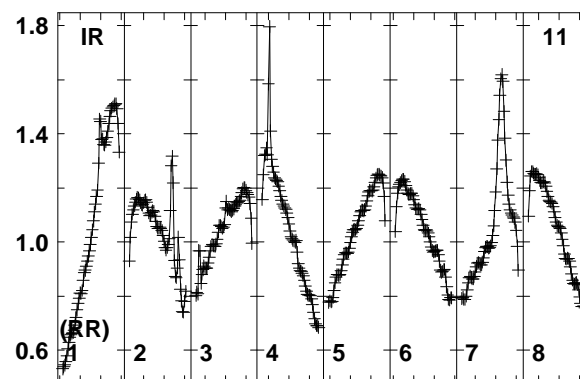
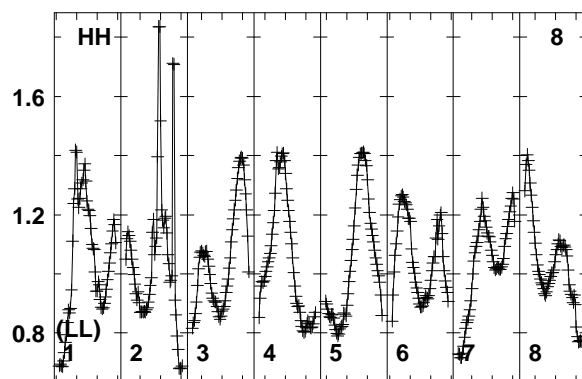
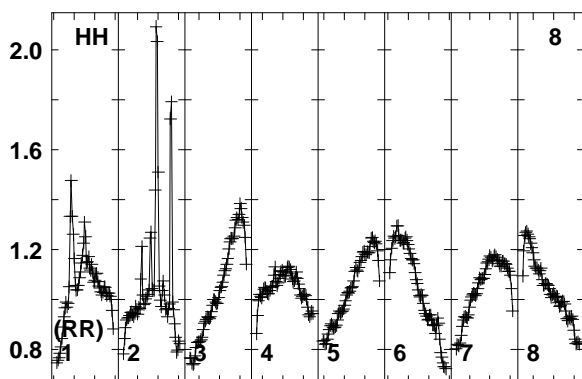
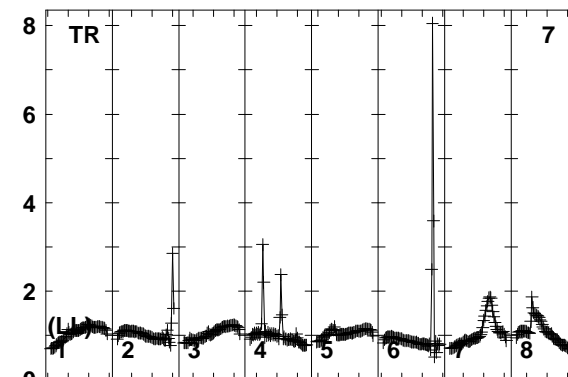
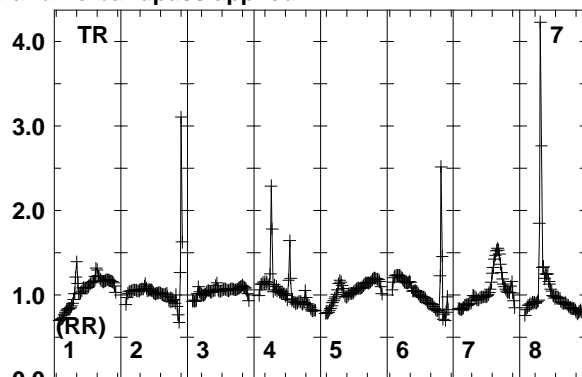
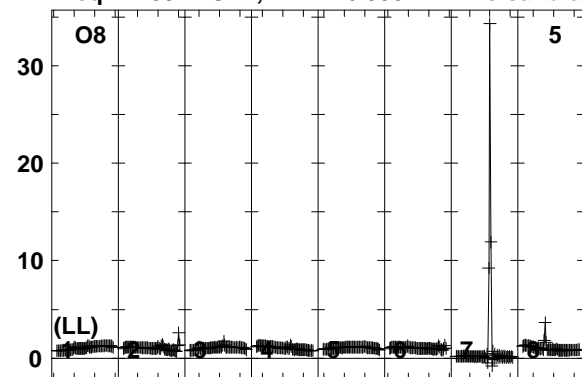

Lower frame: Real Jy
Total-power spectrum Antenna: O8 (05)
Timerange: 00/09:49:36 to 00/09:50:34

Plot file version 747 created 04-NOV-2019 14:15:01

J2248-0541 EY034.UVDATA.1

Freq = 1.5947 GHz, Bw = 16.000 MH No calibration applied and no bandpass applied

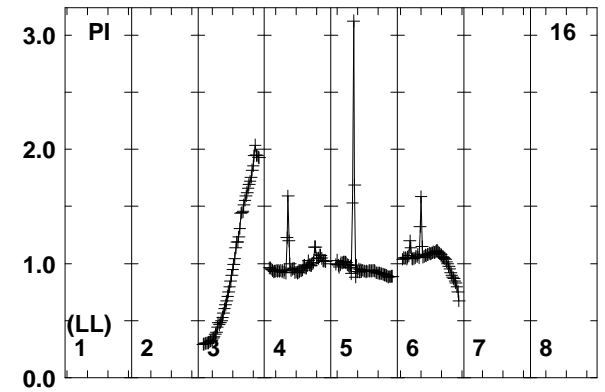
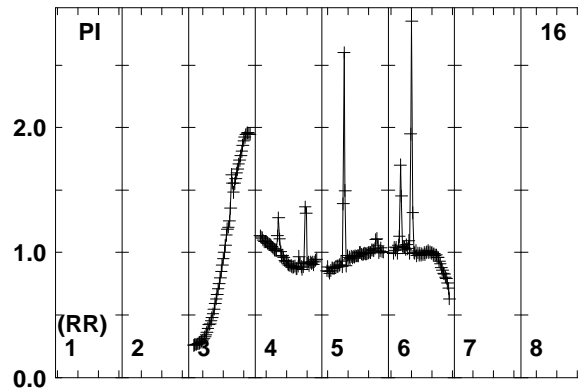
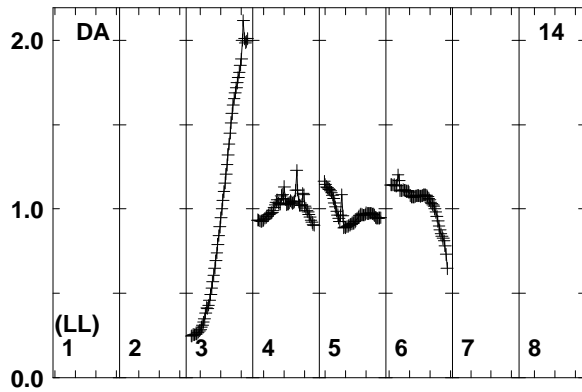
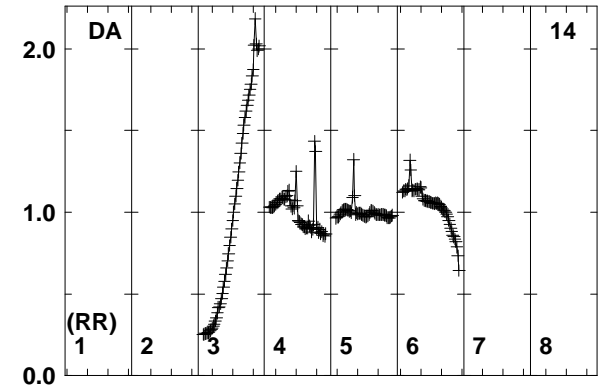
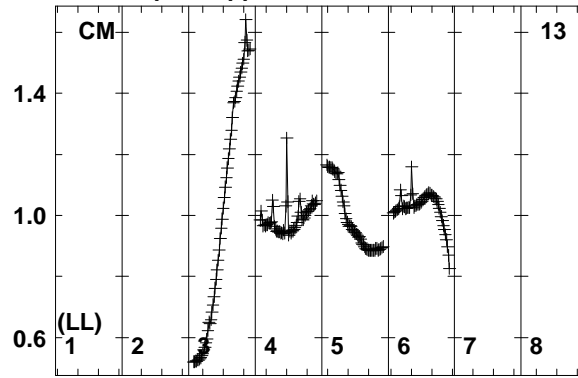
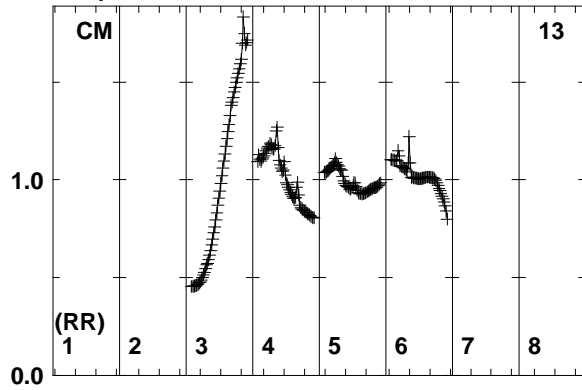

Lower frame: Real Jy
Total-power spectrum Antenna: CM (13)
Timerange: 00/09:49:36 to 00/09:50:34

Plot file version 748 created 04-NOV-2019 14:15:01

W2246-0526 EY034.UVDATA.1

Freq = 1.5947 GHz, Bw = 16.000 MH No calibration applied and no bandpass applied

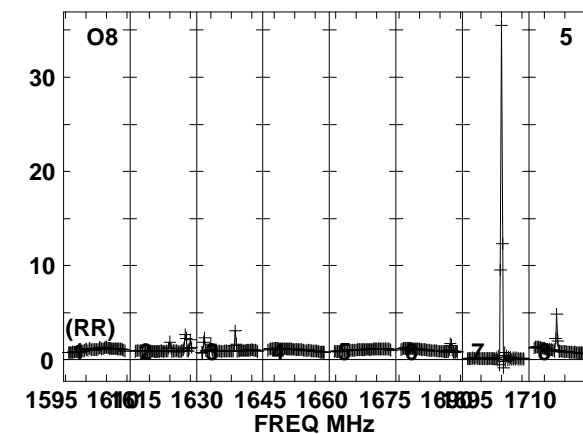
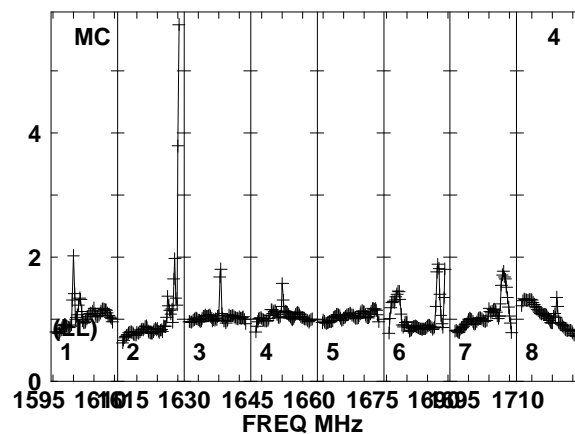
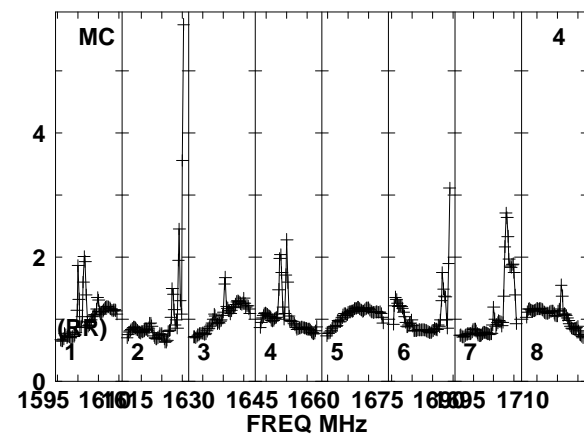
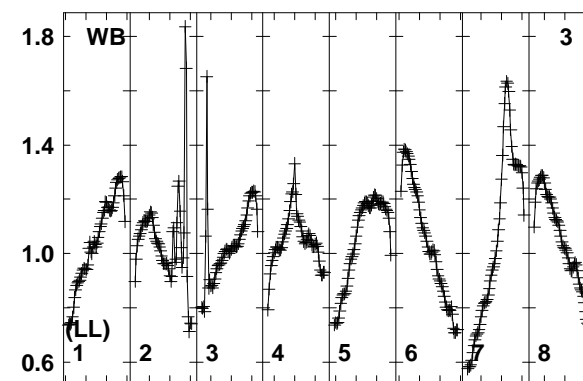
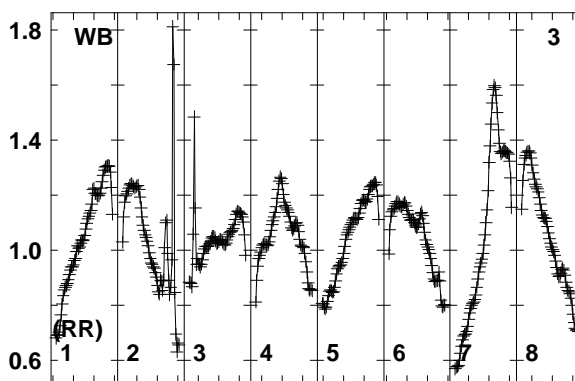
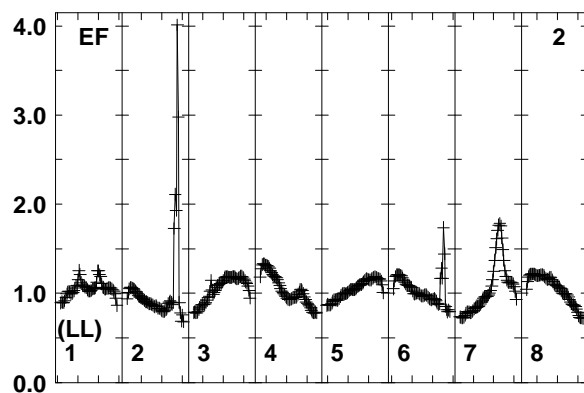
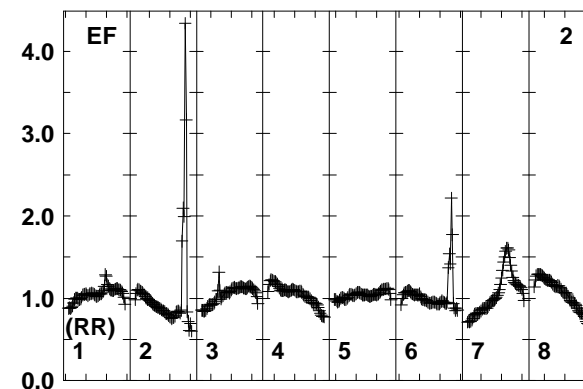
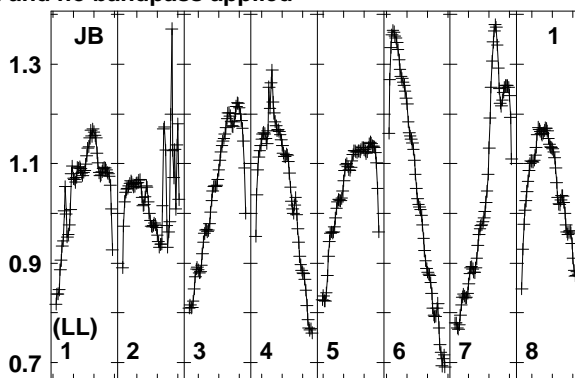
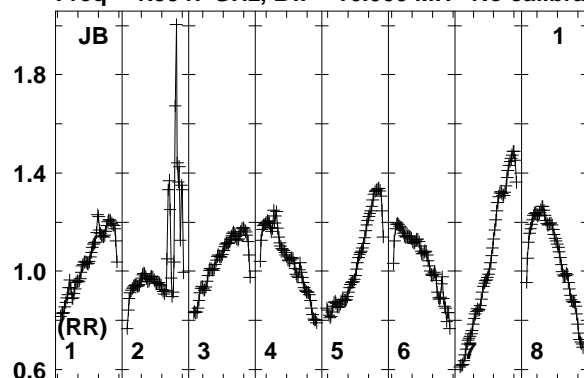

Lower frame: Real Jy
Total-power spectrum Antenna: JB (01)
Timerange: 00/09:50:36 to 00/09:53:14

Plot file version 749 created 04-NOV-2019 14:15:01

W2246-0526 EY034.UVDATA.1

Freq = 1.5947 GHz, Bw = 16.000 MH No calibration applied and no bandpass applied

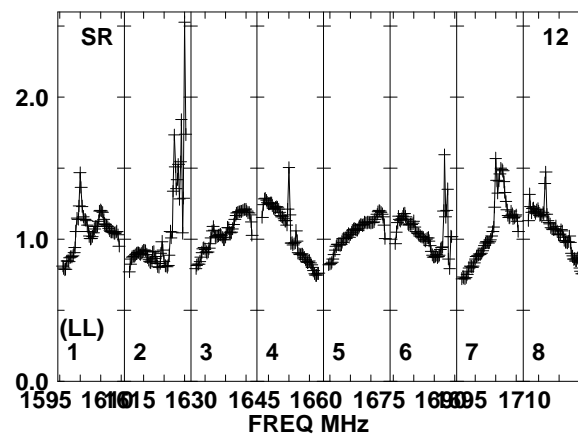
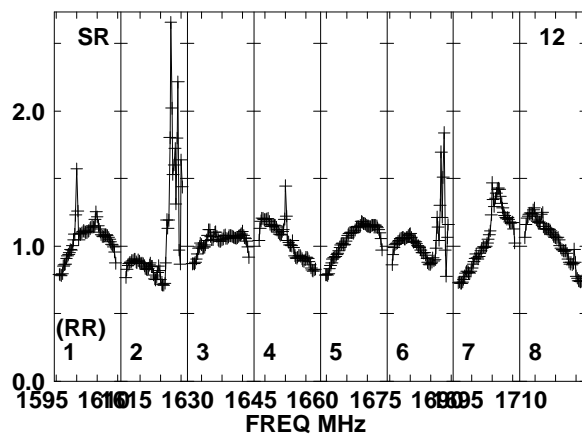
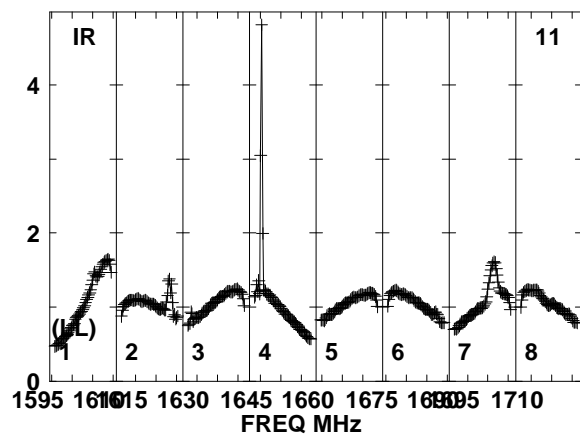
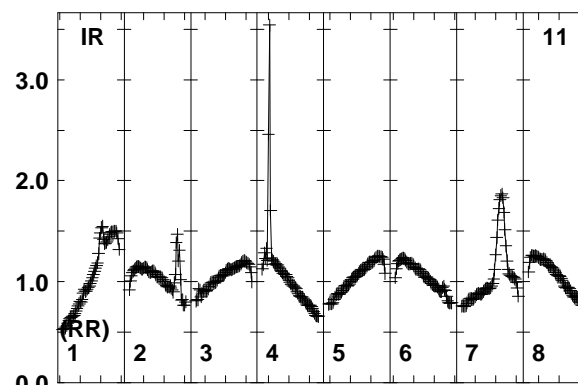
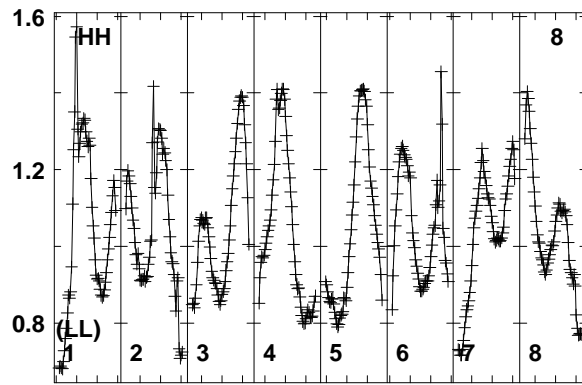
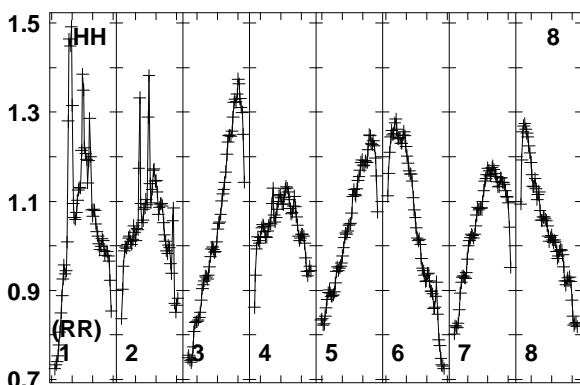
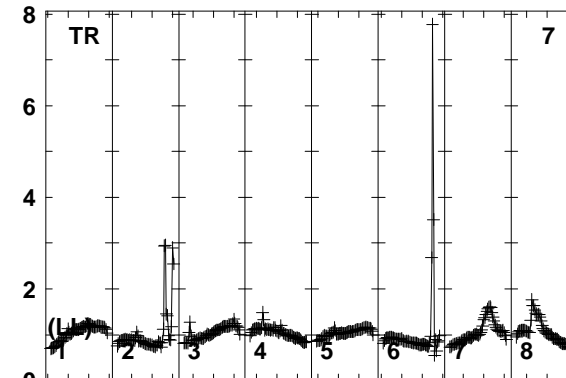
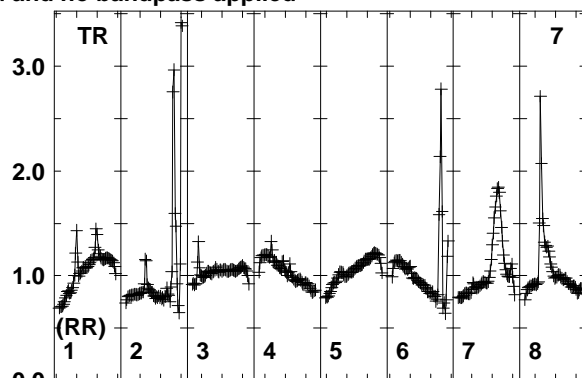
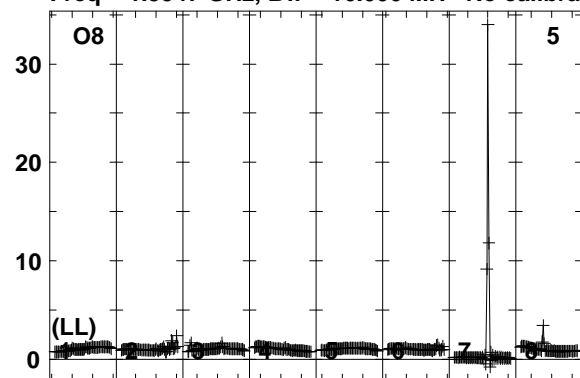

Lower frame: Real Jy
Total-power spectrum Antenna: O8 (05)
Timerange: 00/09:50:36 to 00/09:53:14

Plot file version 750 created 04-NOV-2019 14:15:01

W2246-0526 EY034.UVDATA.1

Freq = 1.5947 GHz, Bw = 16.000 MH No calibration applied and no bandpass applied

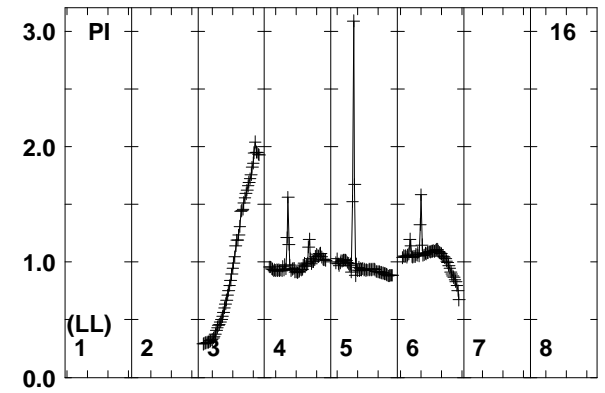
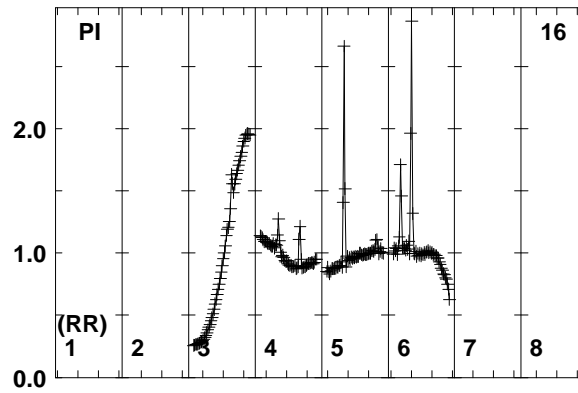
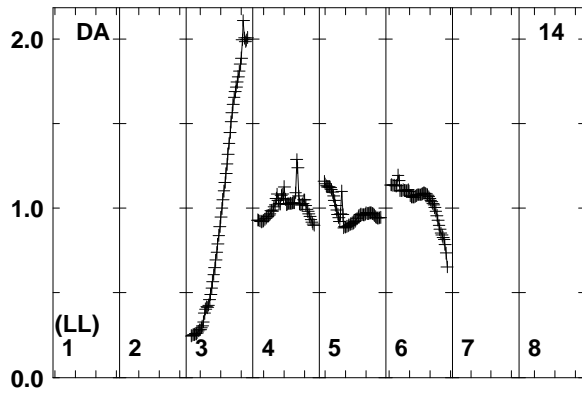
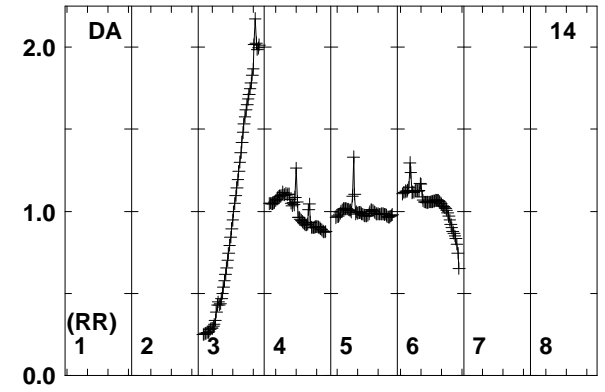
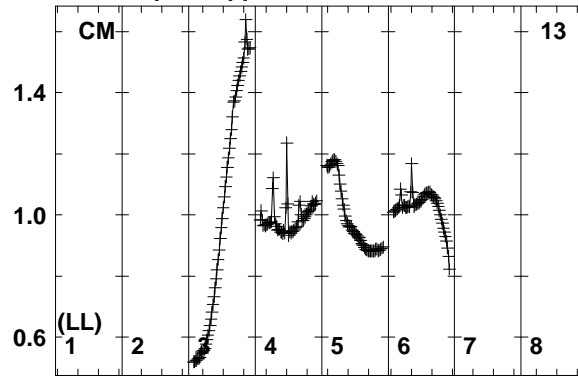
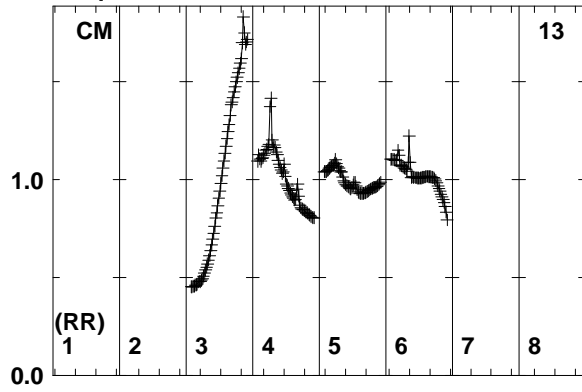

Lower frame: Real Jy
Total-power spectrum Antenna: CM (13)
Timerange: 00/09:50:36 to 00/09:53:14

Plot file version 751 created 04-NOV-2019 14:15:01

J2248-0541 EY034.UVDATA.1

Freq = 1.5947 GHz, Bw = 16.000 MH No calibration applied and no bandpass applied

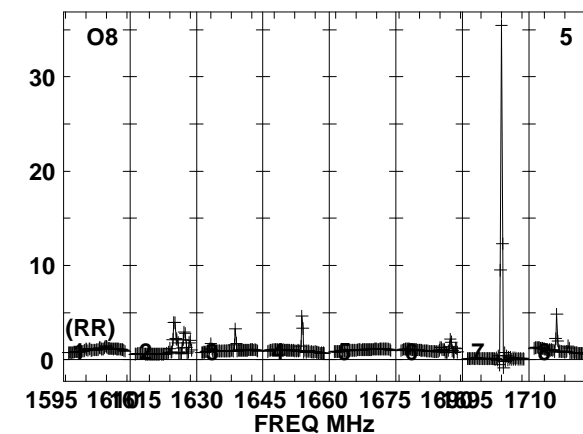
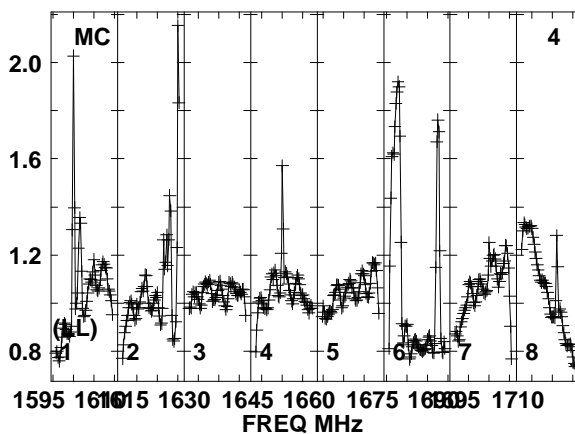
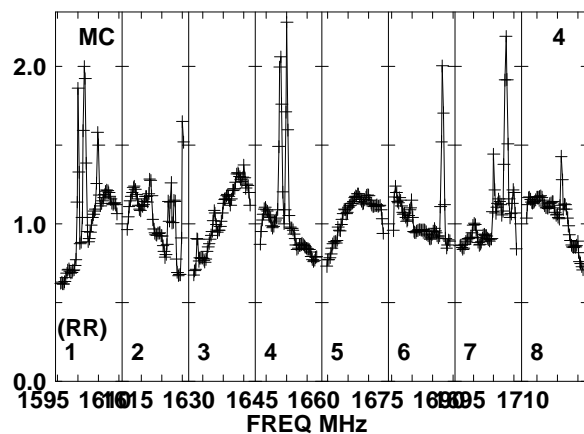
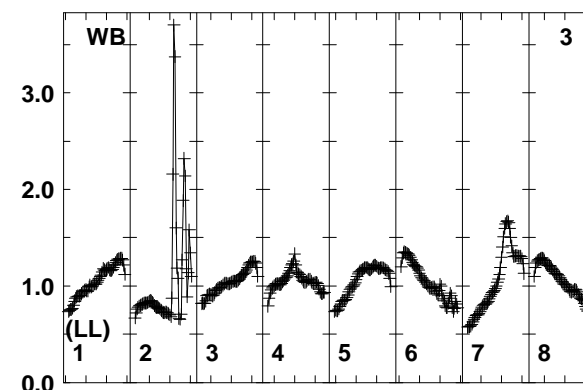
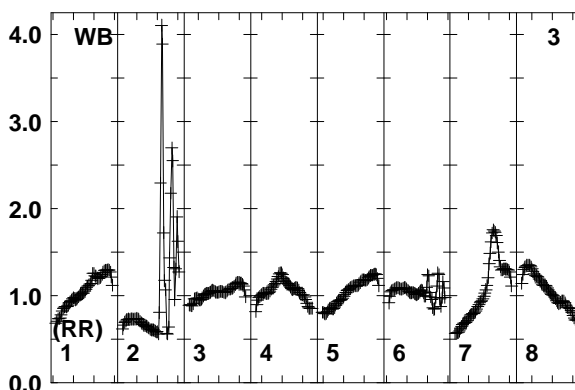
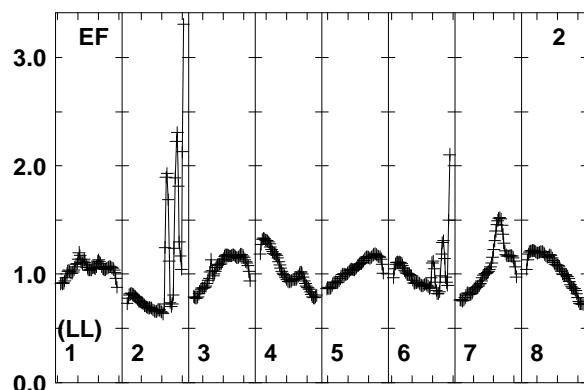
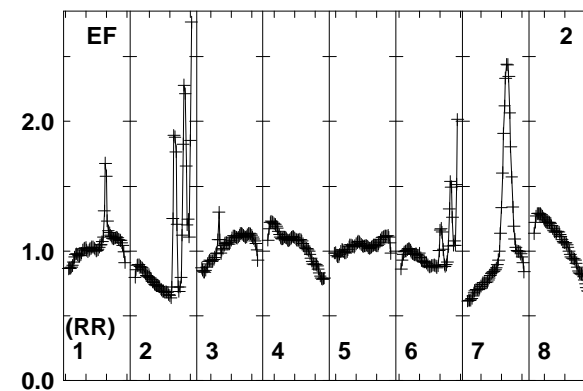
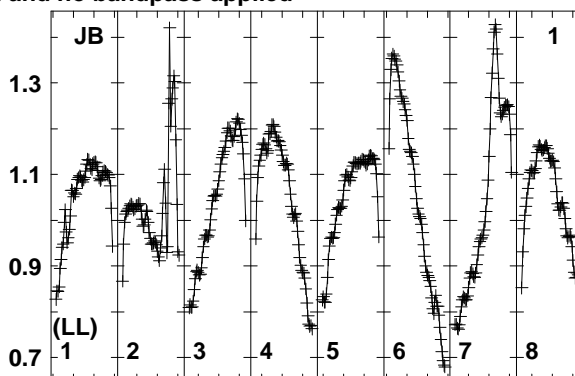
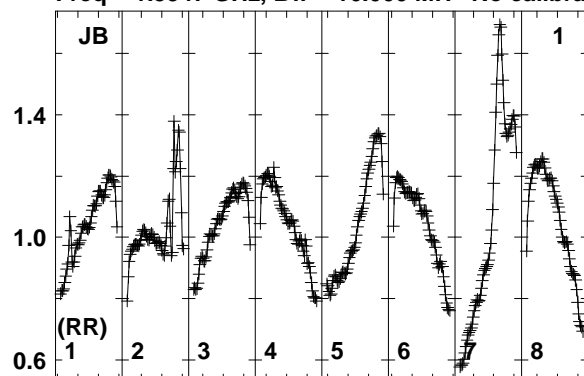

Lower frame: Real Jy
Total-power spectrum Antenna: JB (01)
Timerange: 00/09:53:51 to 00/09:54:49

Plot file version 752 created 04-NOV-2019 14:15:01

J2248-0541 EY034.UVDATA.1

Freq = 1.5947 GHz, Bw = 16.000 MH No calibration applied and no bandpass applied

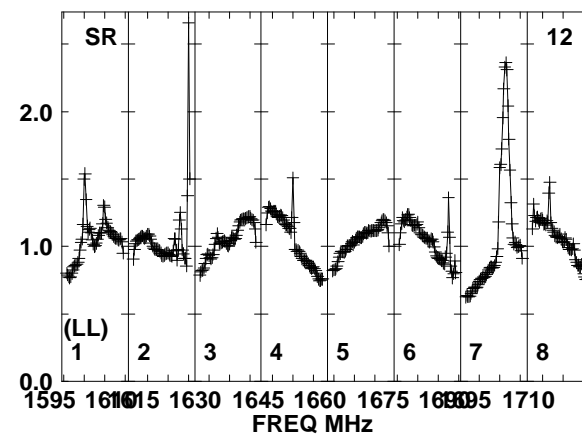
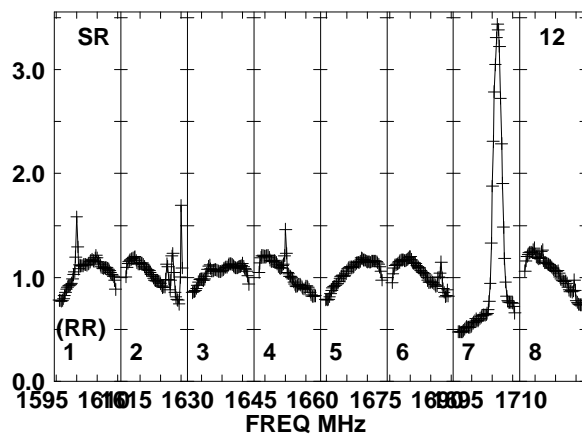
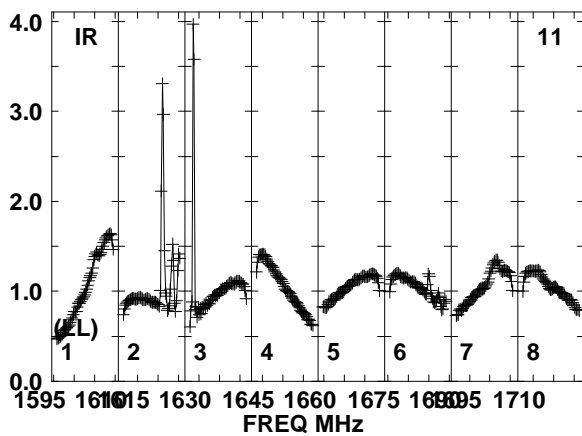
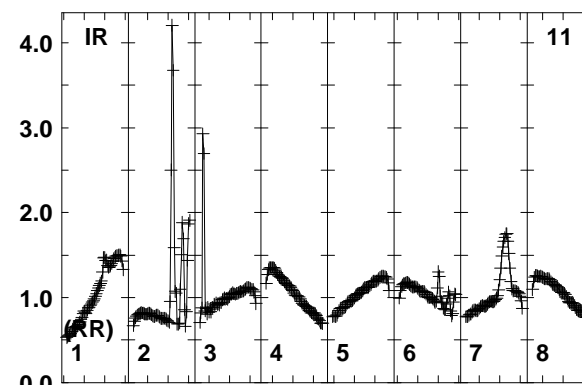
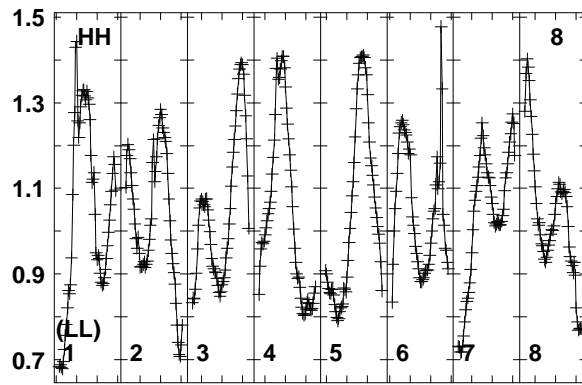
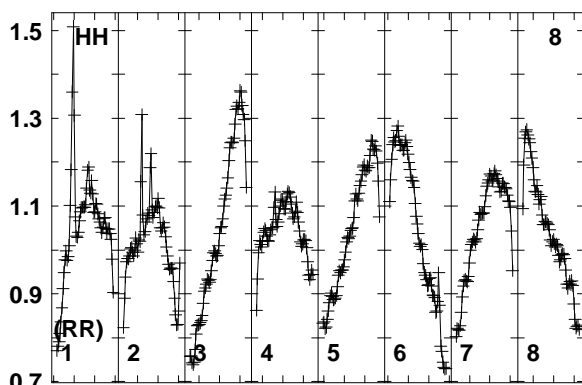
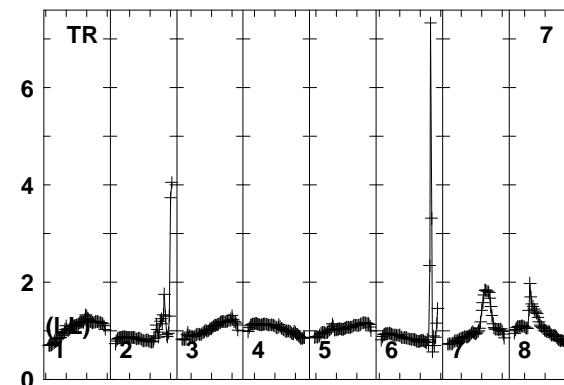
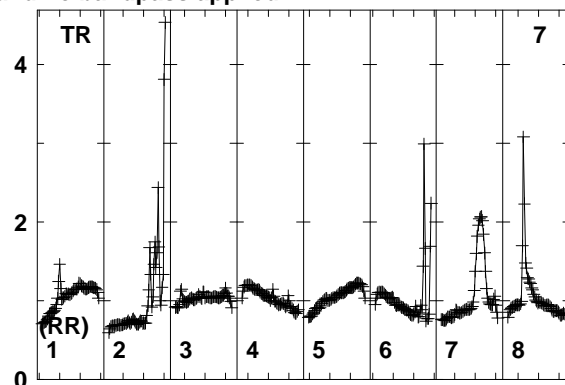
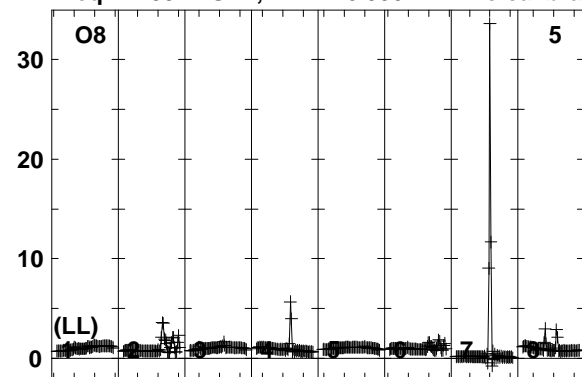

Lower frame: Real Jy
Total-power spectrum Antenna: O8 (05)
Timerange: 00/09:53:51 to 00/09:54:49

Plot file version 753 created 04-NOV-2019 14:15:01

J2248-0541 EY034.UVDATA.1

Freq = 1.5947 GHz, Bw = 16.000 MH No calibration applied and no bandpass applied

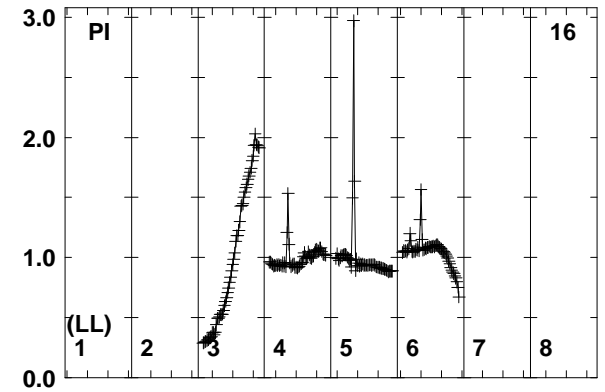
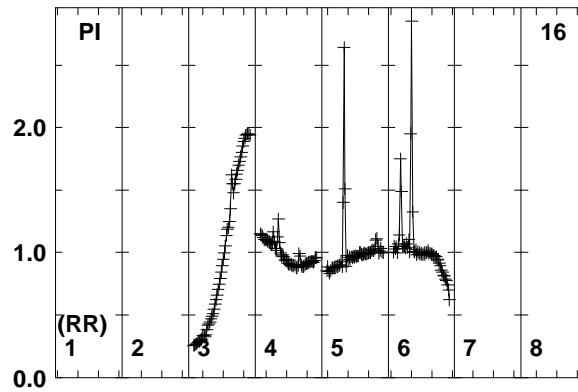
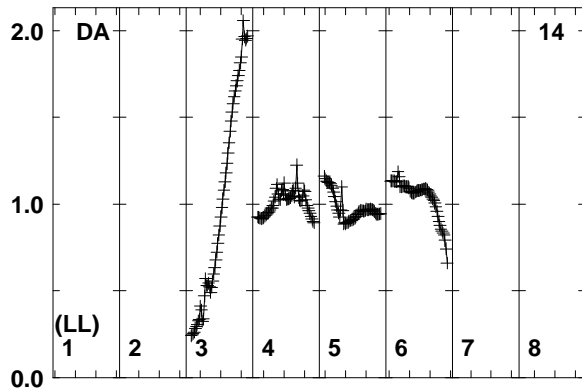
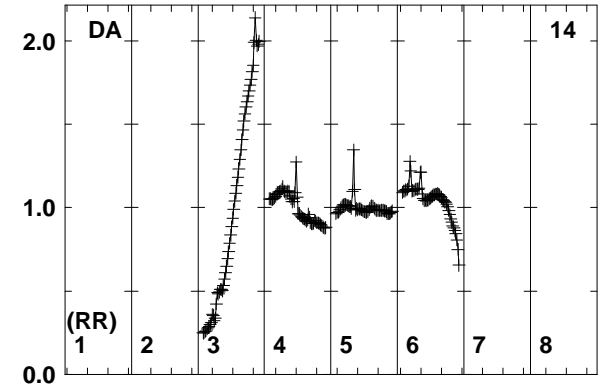
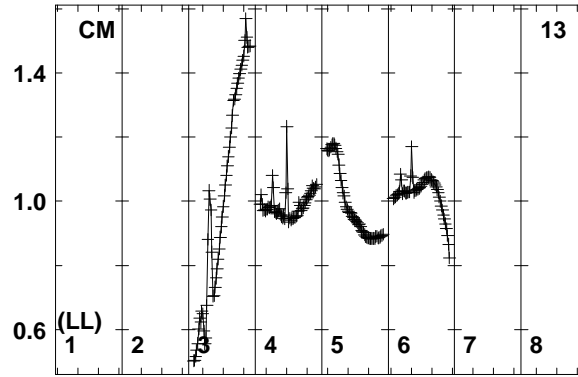
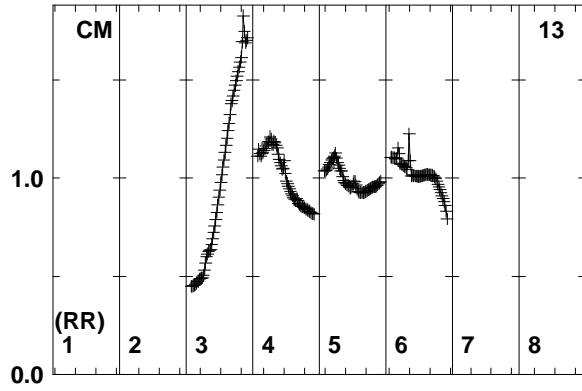

Lower frame: Real Jy
Total-power spectrum Antenna: CM (13)
Timerange: 00/09:53:51 to 00/09:54:49

Plot file version 754 created 04-NOV-2019 14:15:01

W2246-0526 EY034.UVDATA.1

Freq = 1.5947 GHz, Bw = 16.000 MH No calibration applied and no bandpass applied

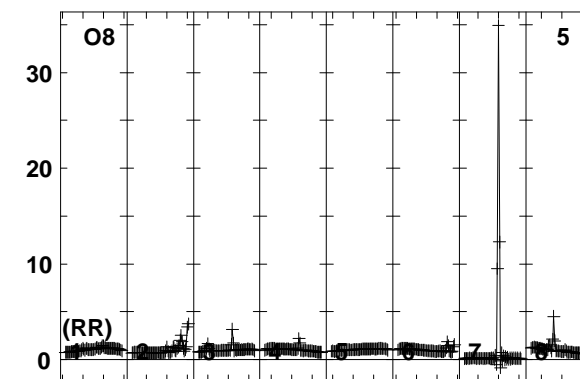
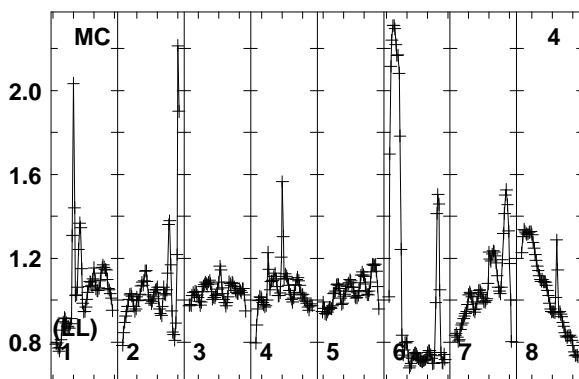
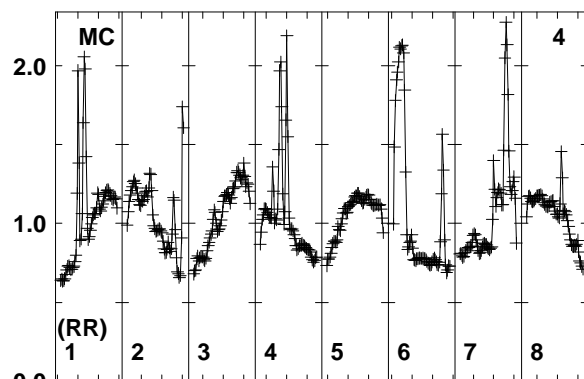
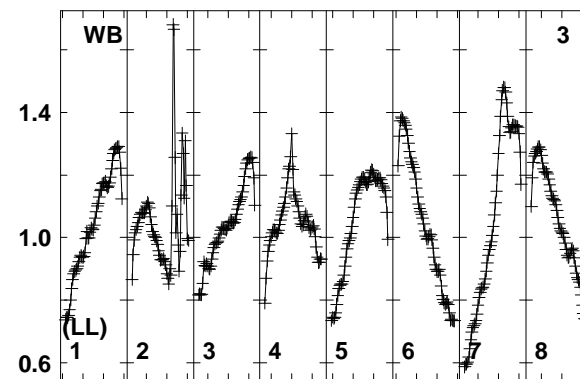
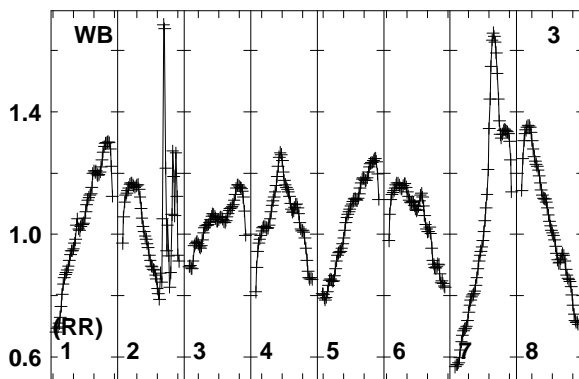
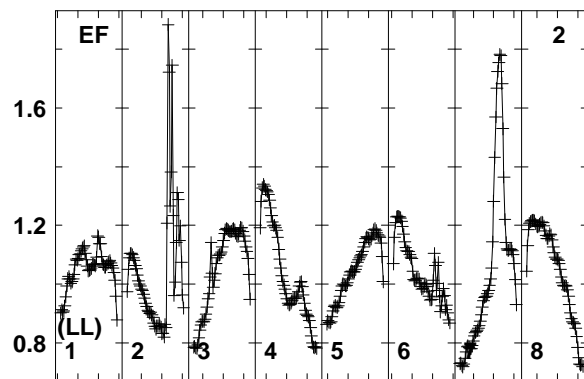
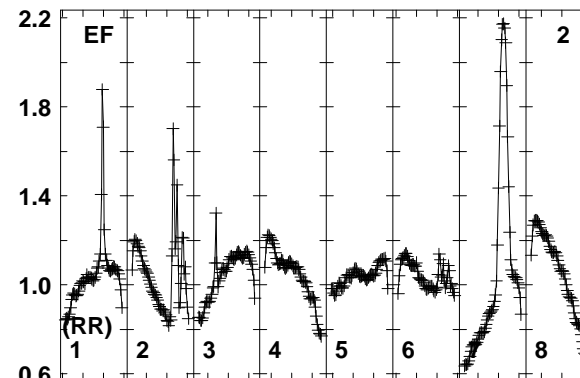
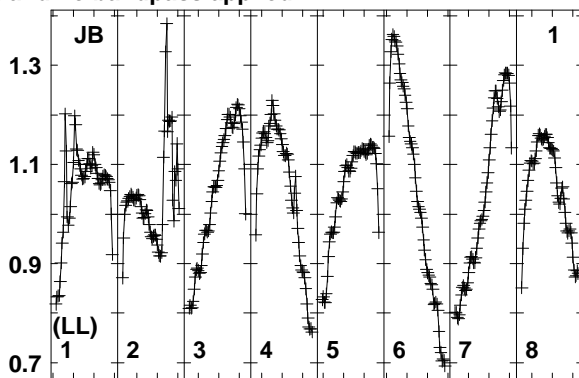
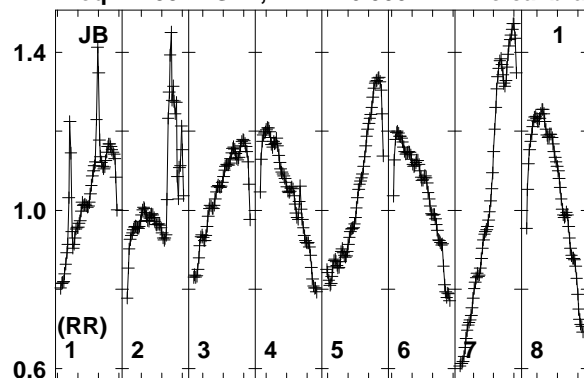

Lower frame: Real Jy
Total-power spectrum Antenna: JB (01)
Timerange: 00/09:54:51 to 00/09:57:29

Plot file version 755 created 04-NOV-2019 14:15:02

W2246-0526 EY034.UVDATA.1

Freq = 1.5947 GHz, Bw = 16.000 MH No calibration applied and no bandpass applied

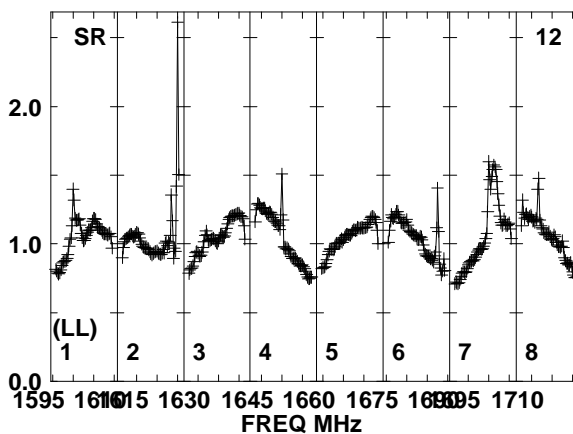
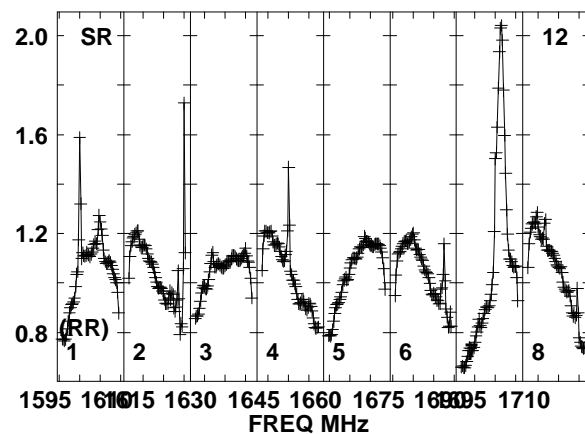
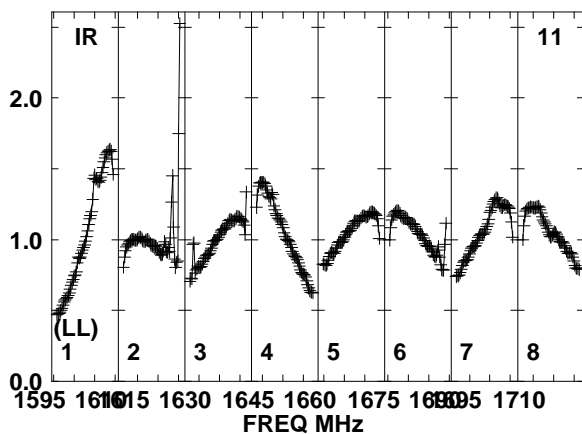
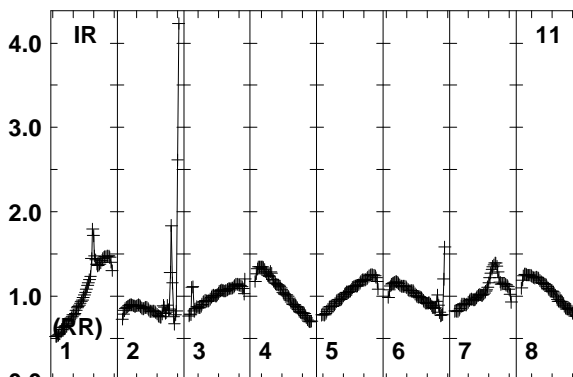
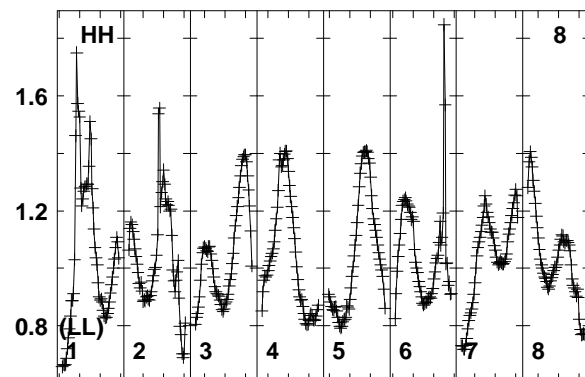
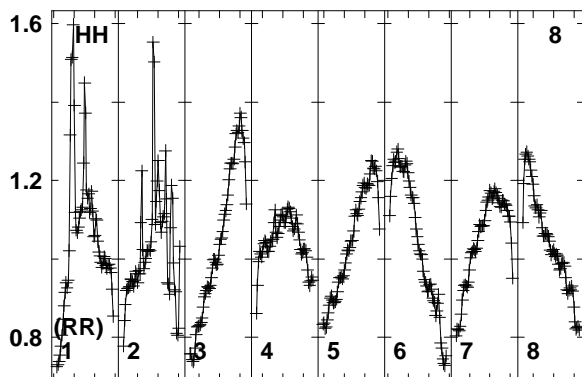
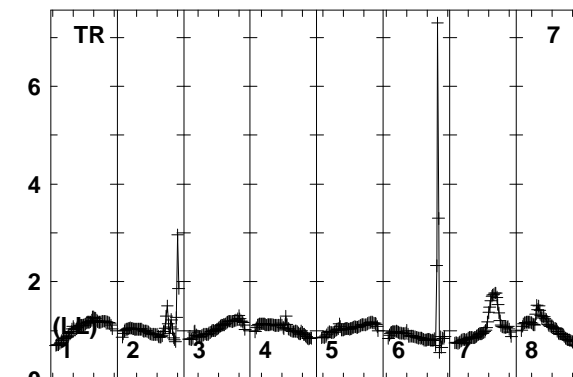
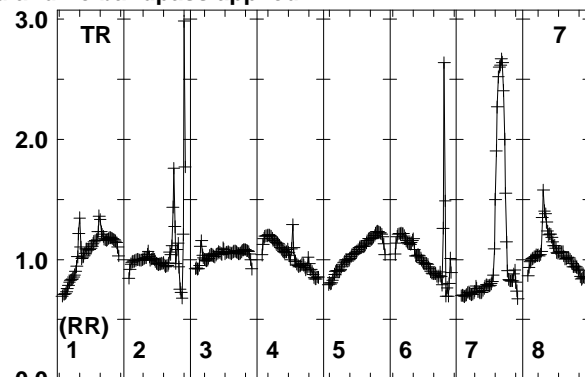
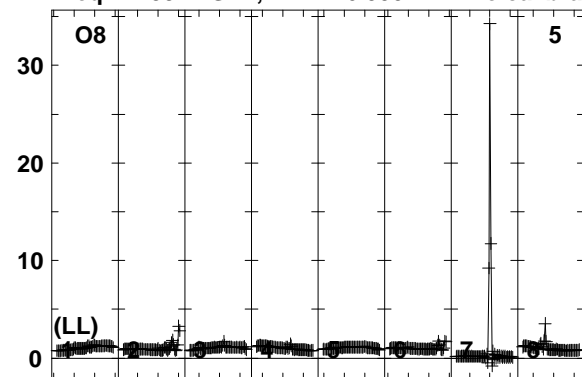

Lower frame: Real Jy
Total-power spectrum Antenna: O8 (05)
Timerange: 00/09:54:51 to 00/09:57:29

Plot file version 756 created 04-NOV-2019 14:15:02

W2246-0526 EY034.UVDATA.1

Freq = 1.5947 GHz, Bw = 16.000 MH No calibration applied and no bandpass applied

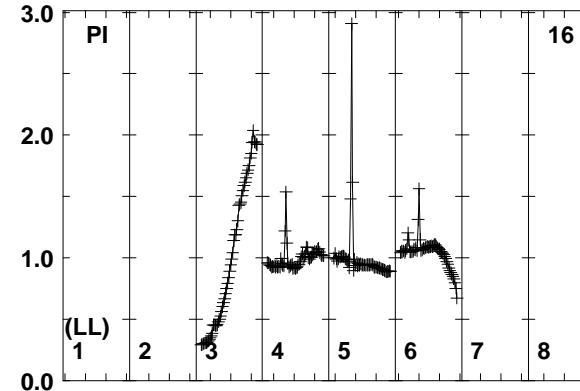
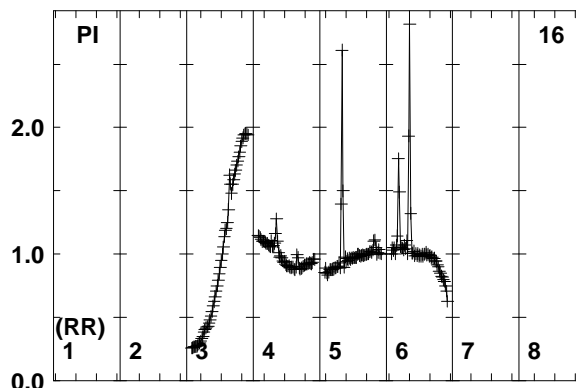
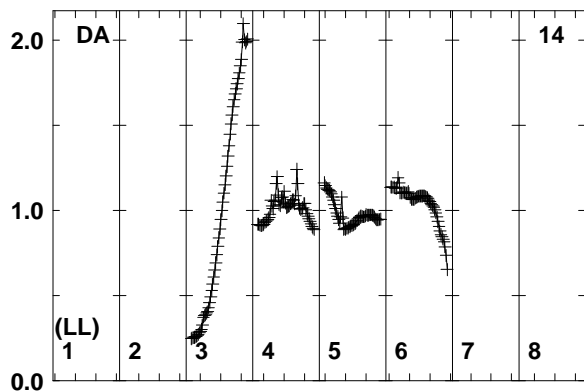
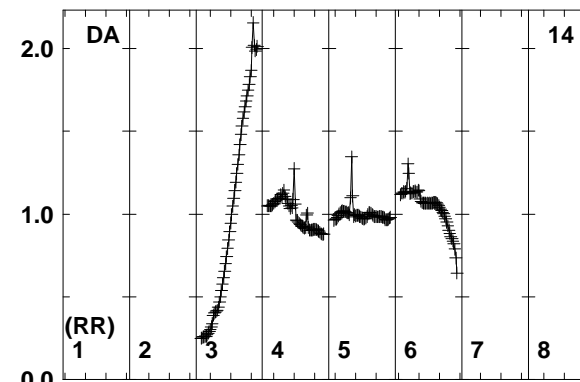
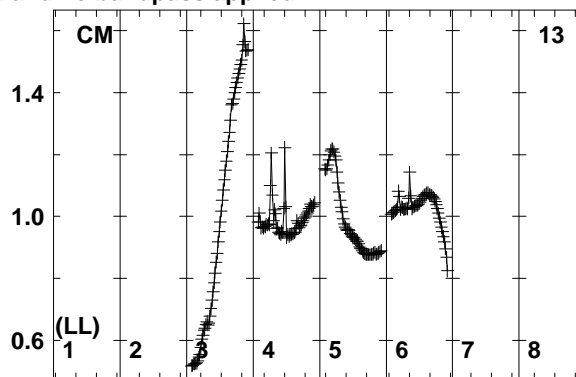
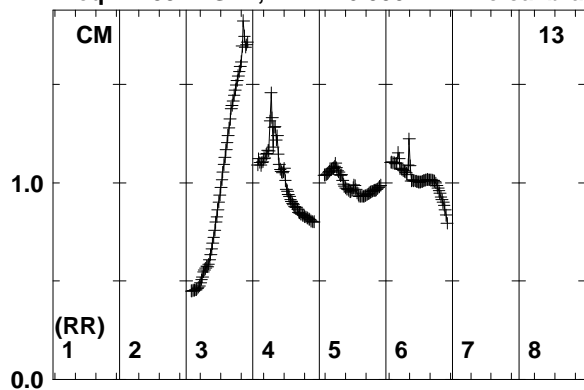

Lower frame: Real Jy
Total-power spectrum Antenna: CM (13)
Timerange: 00/09:54:51 to 00/09:57:29

Plot file version 757 created 04-NOV-2019 14:15:02

J2248-0541 EY034.UVDATA.1

Freq = 1.5947 GHz, Bw = 16.000 MH No calibration applied and no bandpass applied

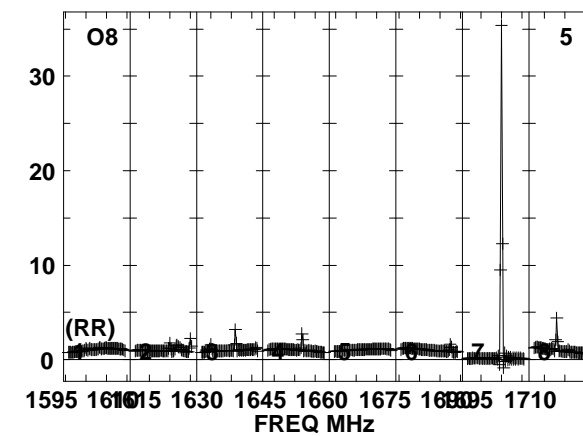
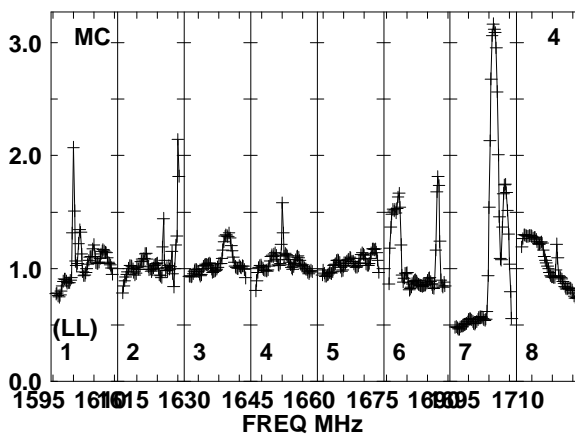
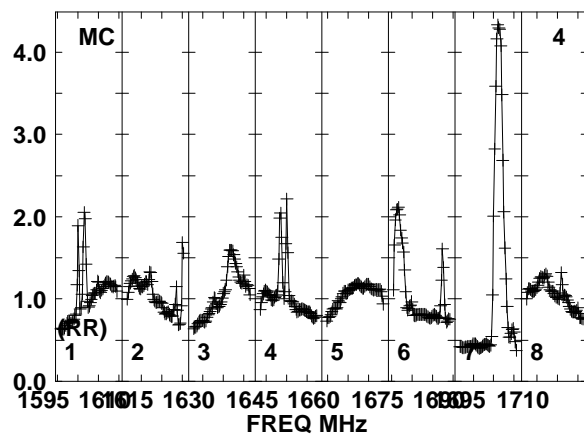
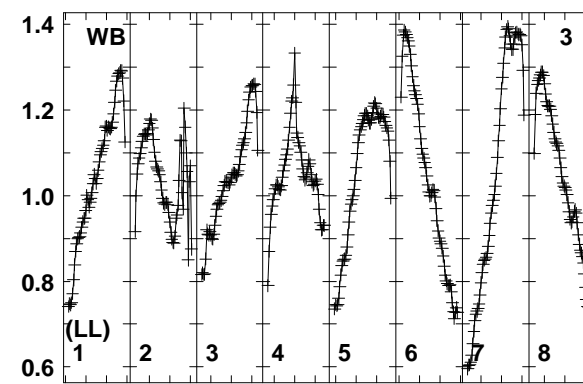
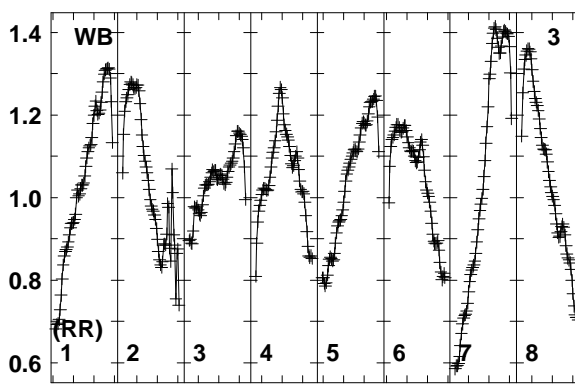
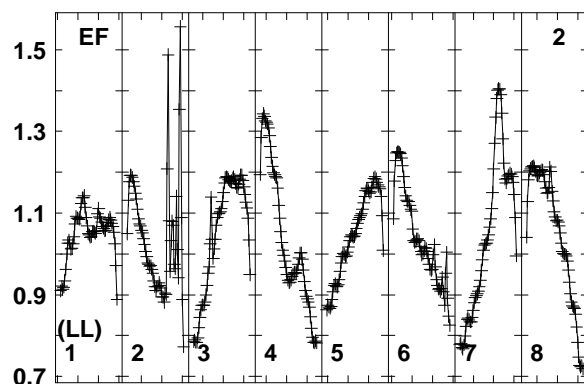
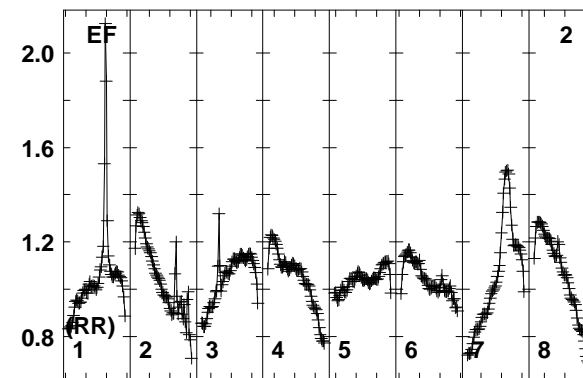
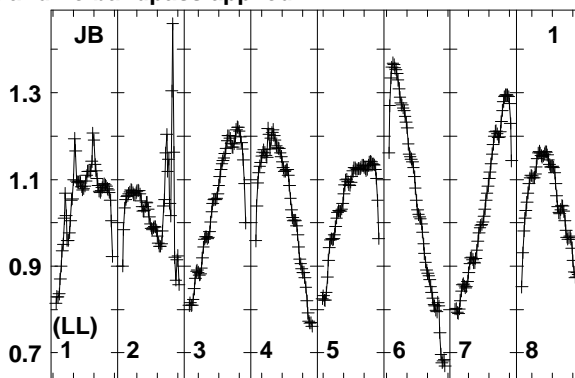
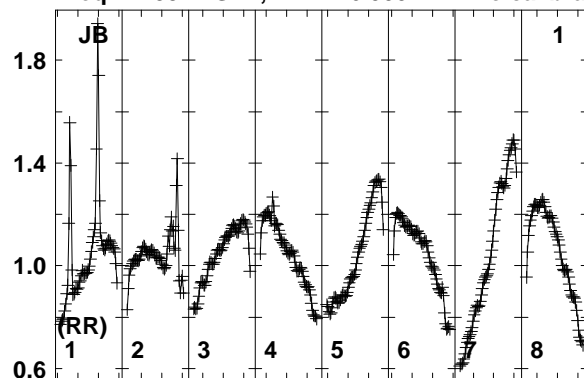

Lower frame: Real Jy
Total-power spectrum Antenna: JB (01)
Timerange: 00/09:57:46 to 00/09:58:44

Plot file version 758 created 04-NOV-2019 14:15:02

J2248-0541 EY034.UVDATA.1

Freq = 1.5947 GHz, Bw = 16.000 MH No calibration applied and no bandpass applied

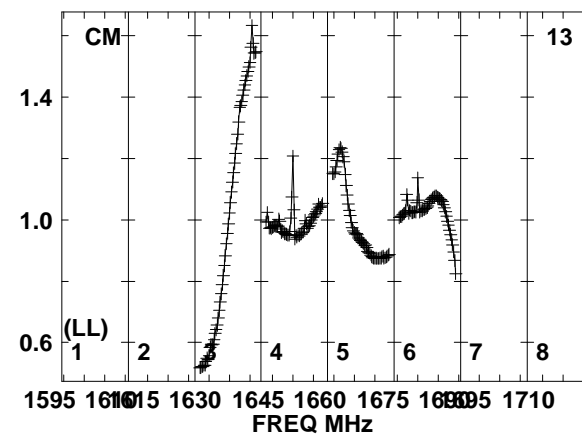
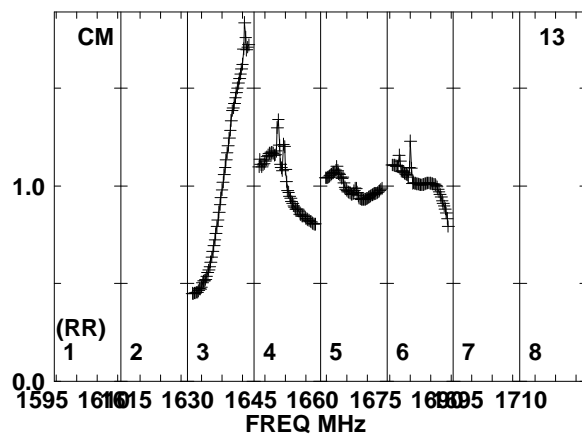
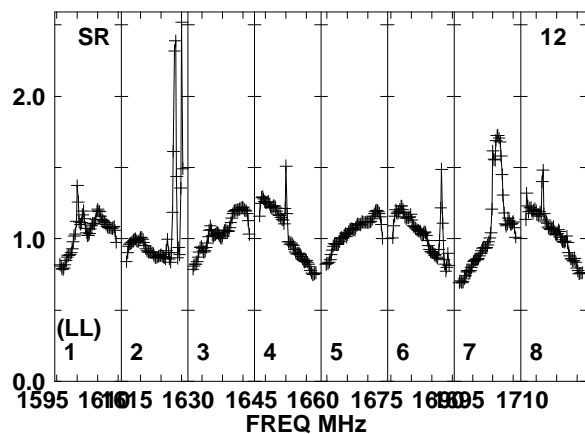
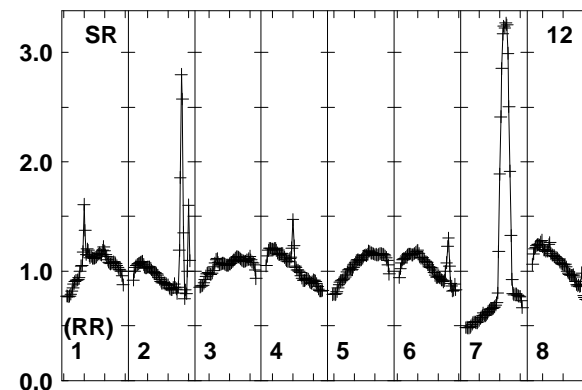
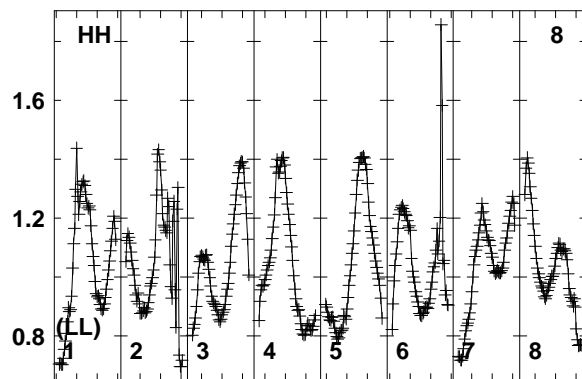
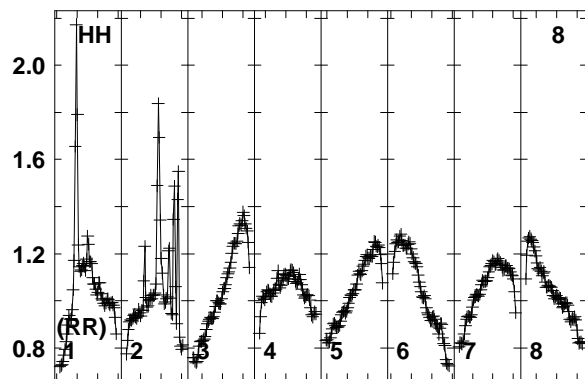
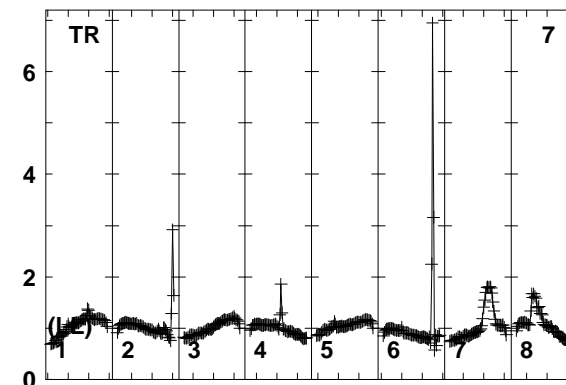
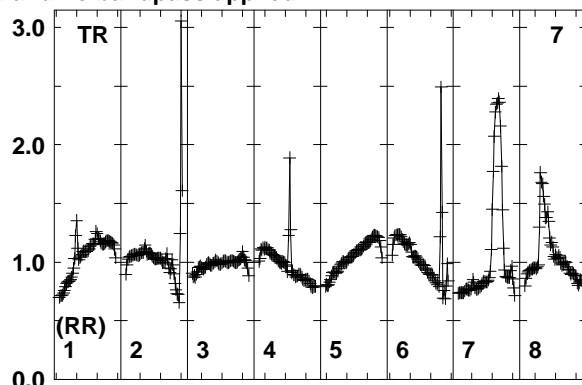
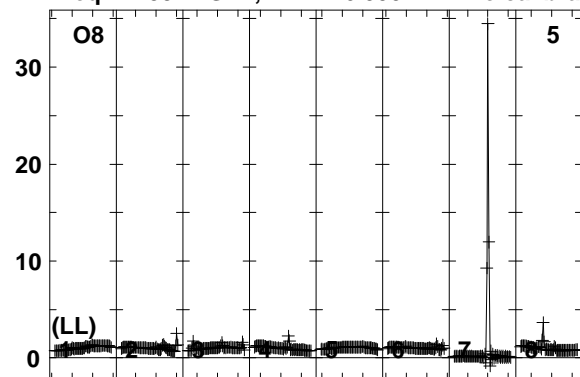

Lower frame: Real Jy
Total-power spectrum Antenna: O8 (05)
Timerange: 00/09:57:46 to 00/09:58:44

Plot file version 759 created 04-NOV-2019 14:15:02

J2248-0541 EY034.UVDATA.1

Freq = 1.5947 GHz, Bw = 16.000 MH No calibration applied and no bandpass applied

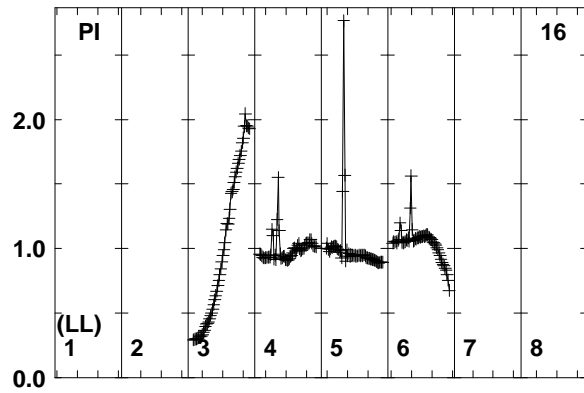
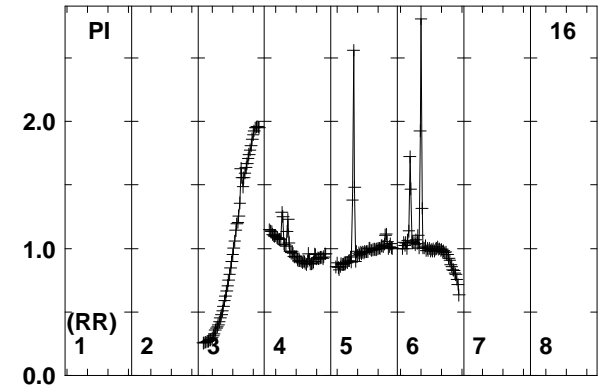
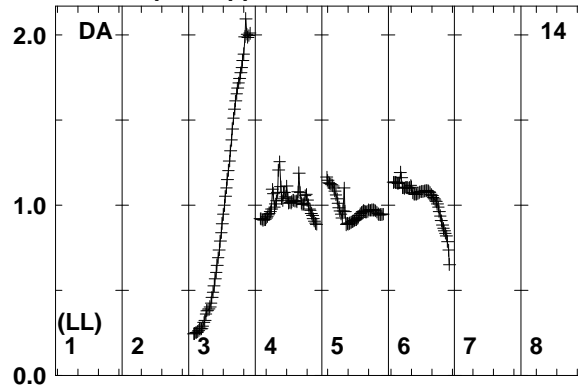
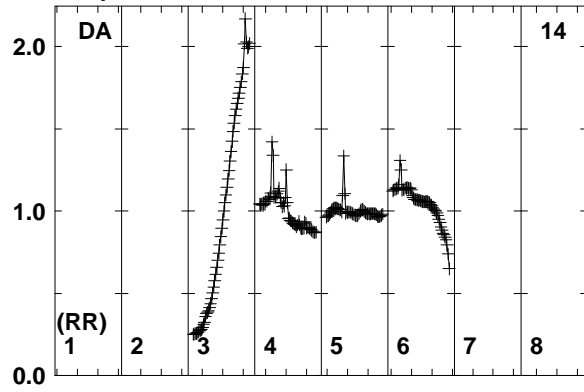

Lower frame: Real Jy
Total-power spectrum Antenna: DA (14)
Timerange: 00/09:57:46 to 00/09:58:44

Plot file version 760 created 04-NOV-2019 14:15:02

J2245-0755 EY034.UVDATA.1

Freq = 1.5947 GHz, Bw = 16.000 MH No calibration applied and no bandpass applied

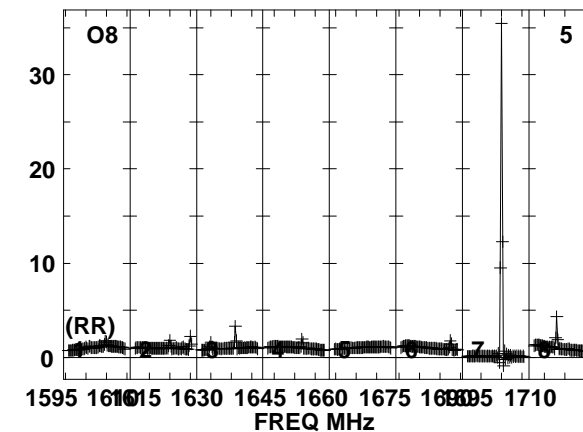
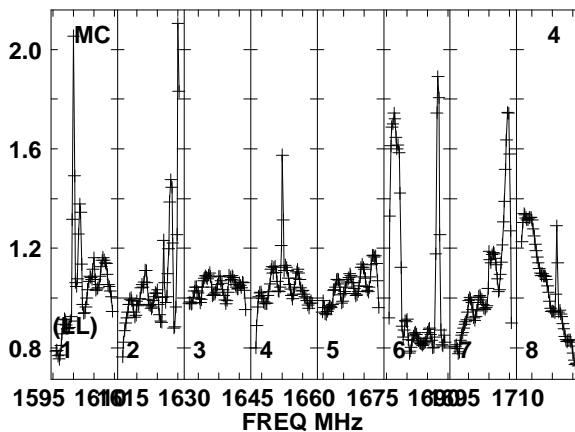
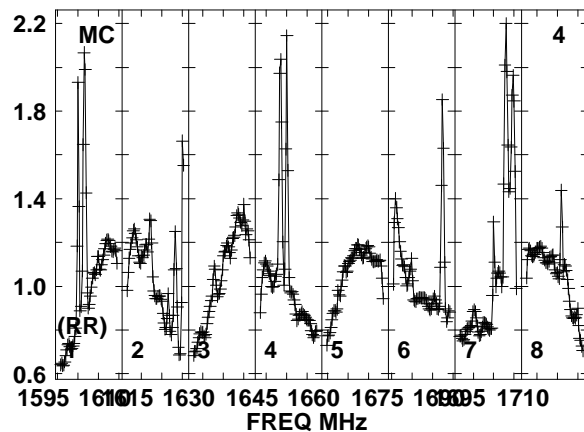
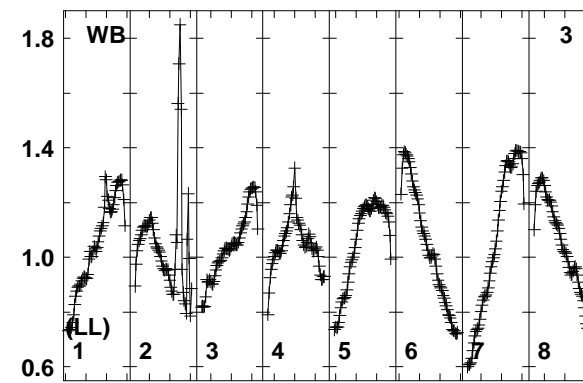
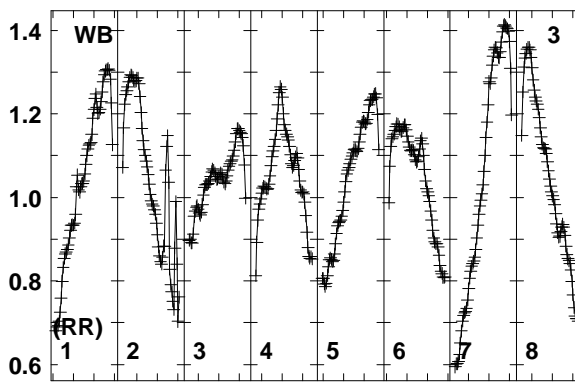
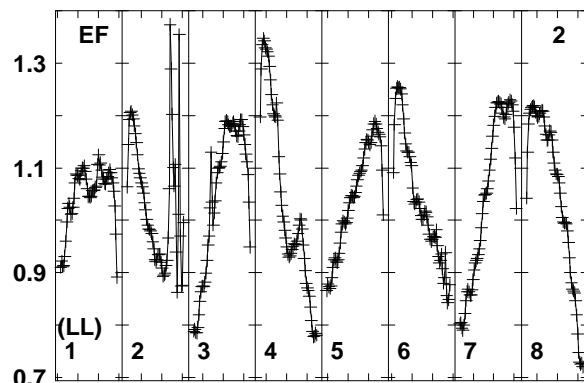
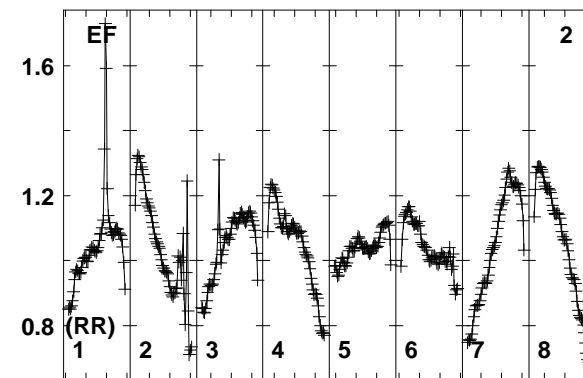
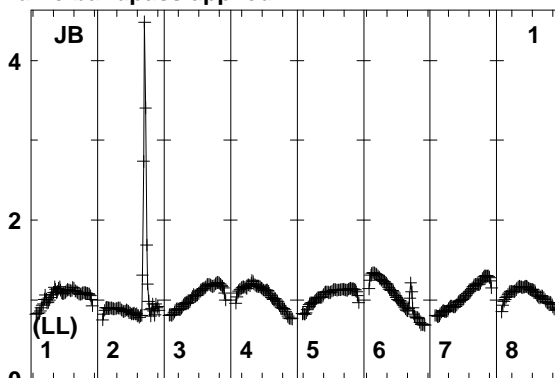
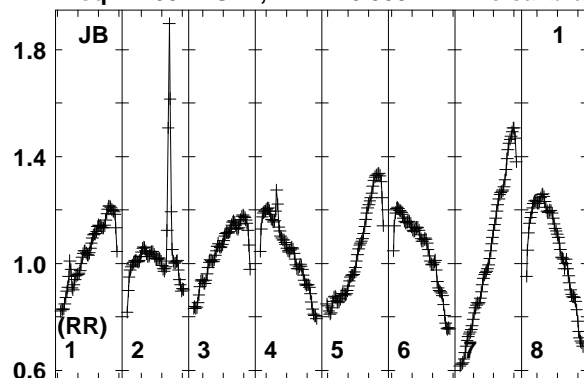

Lower frame: Real Jy
Total-power spectrum Antenna: JB (01)
Timerange: 00/09:59:01 to 00/09:59:59

Plot file version 761 created 04-NOV-2019 14:15:02

J2245-0755 EY034.UVDATA.1

Freq = 1.5947 GHz, Bw = 16.000 MH No calibration applied and no bandpass applied

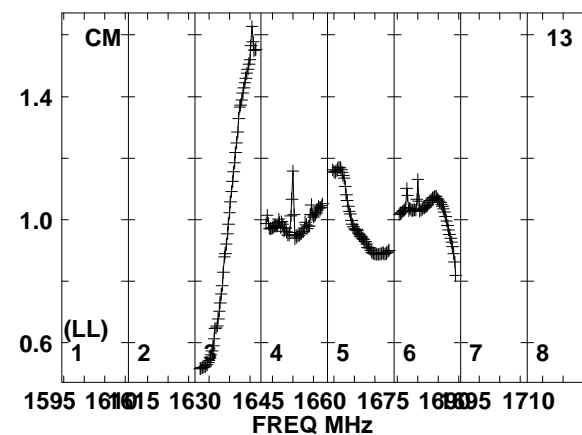
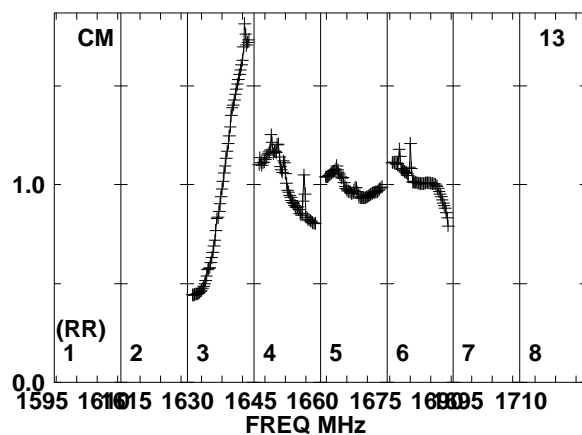
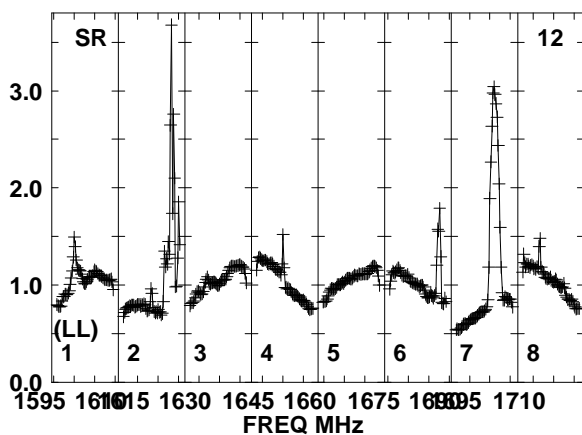
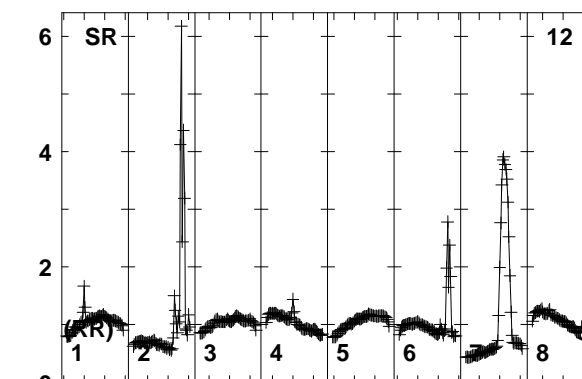
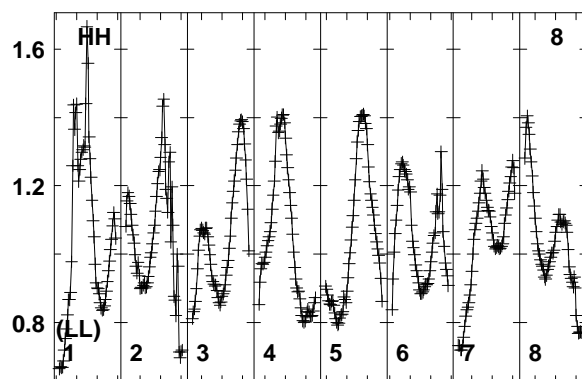
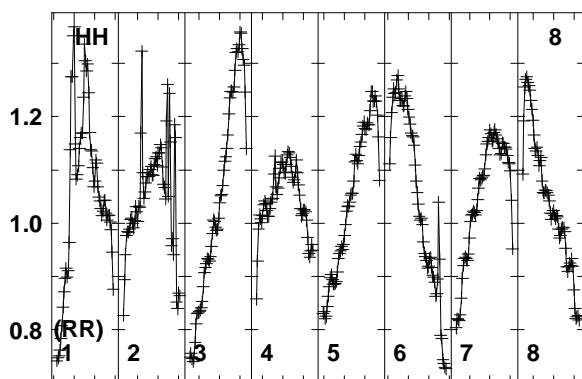
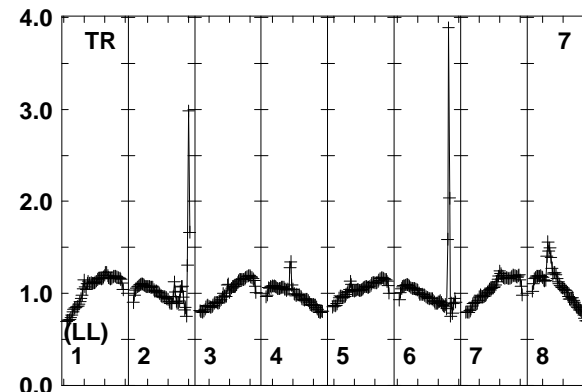
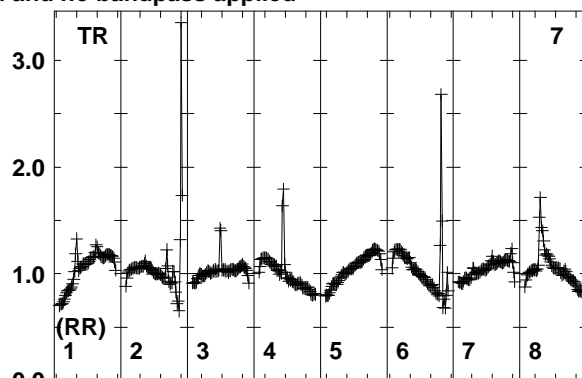
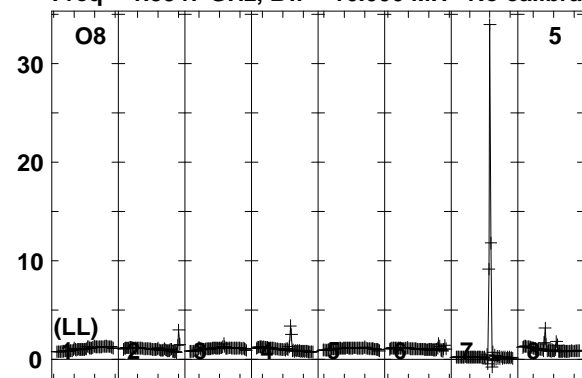

Lower frame: Real Jy
Total-power spectrum Antenna: O8 (05)
Timerange: 00/09:59:01 to 00/09:59:59

Plot file version 762 created 04-NOV-2019 14:15:02

J2245-0755 EY034.UVDATA.1

Freq = 1.5947 GHz, Bw = 16.000 MH No calibration applied and no bandpass applied

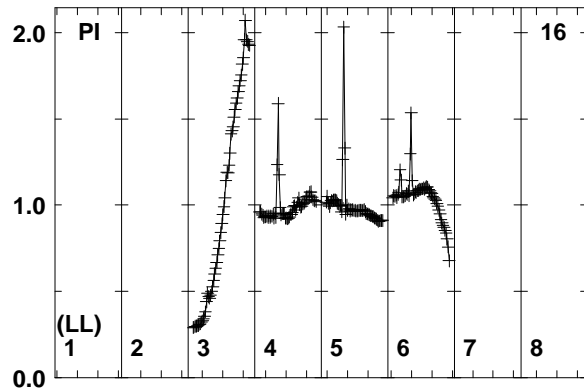
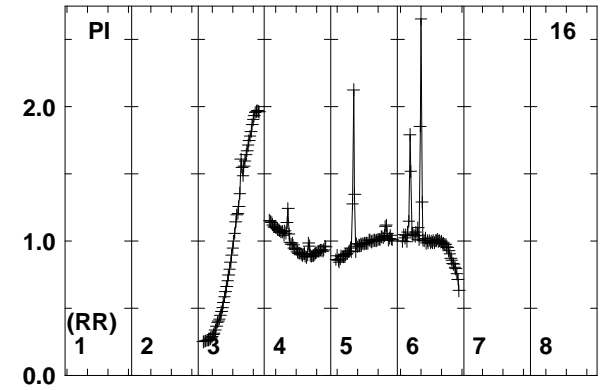
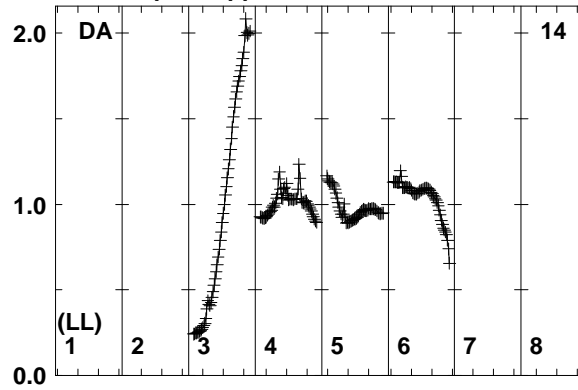
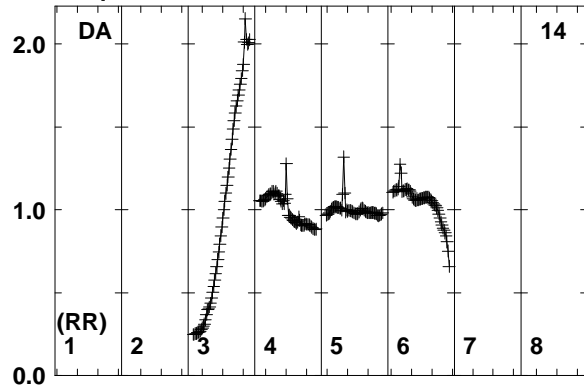

Lower frame: Real Jy
Total-power spectrum Antenna: DA (14)
Timerange: 00/09:59:01 to 00/09:59:59