

Plot file version 1 created 06-JAN-2009 10:57:02

J1642+39 EZ018B.UVDATA.1

Freq = 1.6270 GHz, Bw = 8.000 MH No calibration applied and no bandpass applied

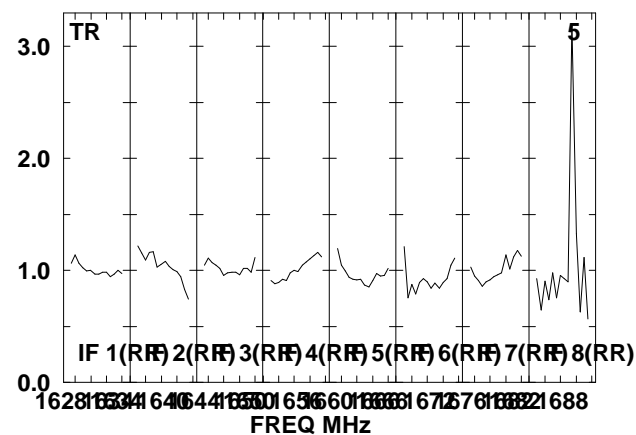
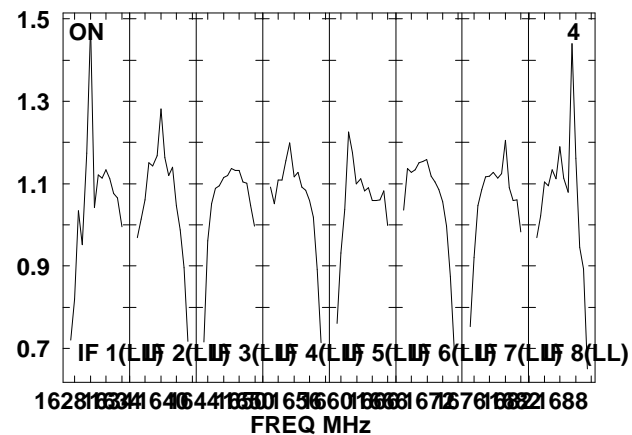
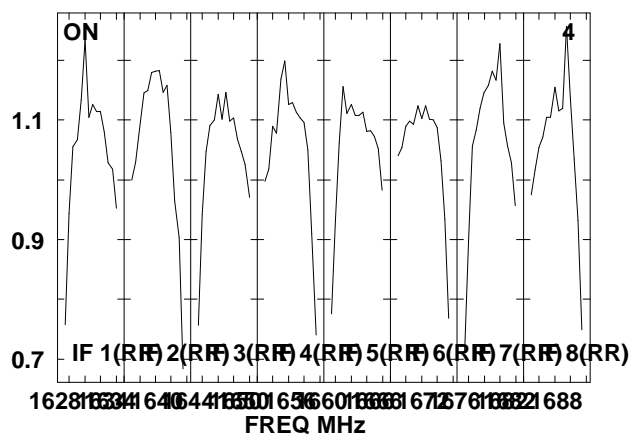
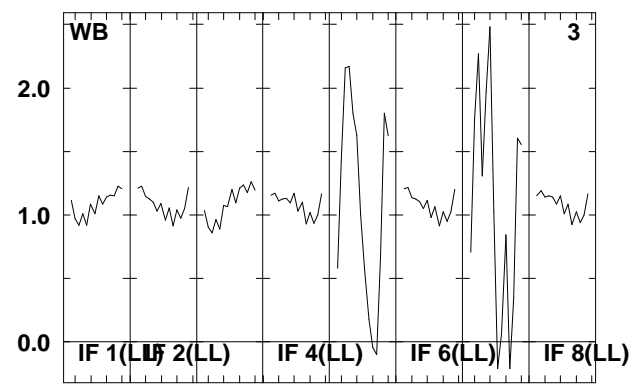
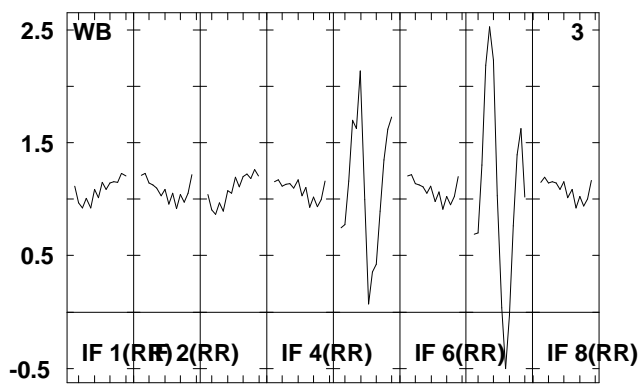
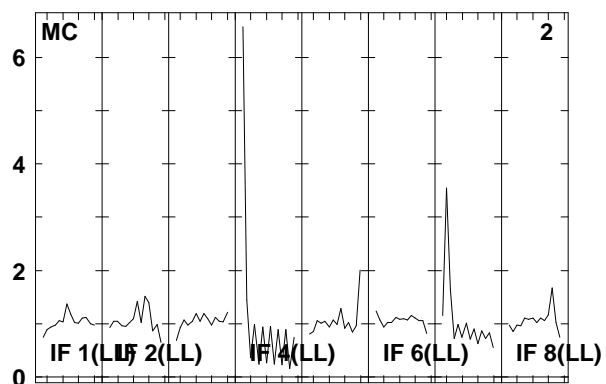
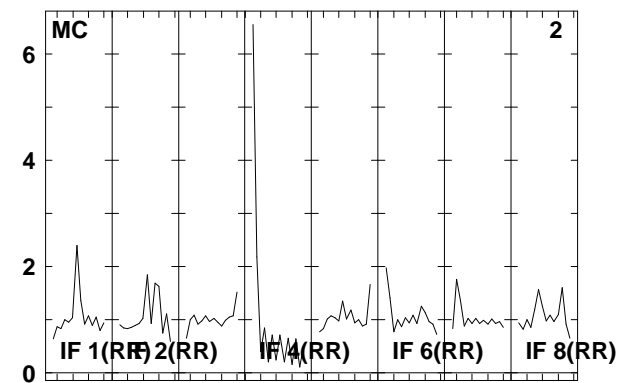
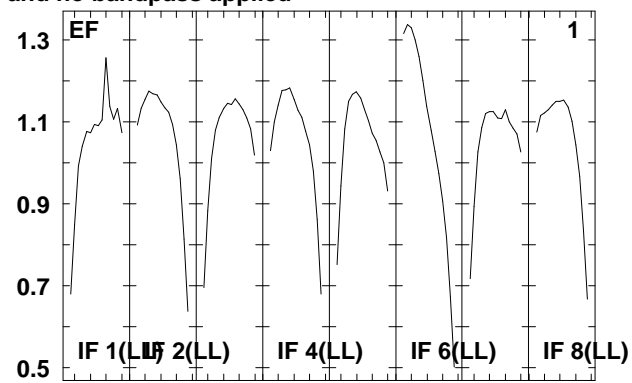
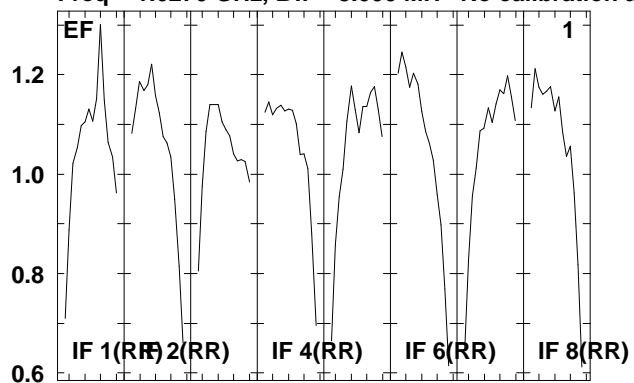

Lower frame: Real Jy  
Total-power spectrum Antenna: \*  
Timerange: 00/09:00:03 to 00/09:03:59

Plot file version 2 created 06-JAN-2009 10:57:02

J1642+39 EZ018B.UVDATA.1

Freq = 1.6270 GHz, Bw = 8.000 MH No calibration applied and no bandpass applied

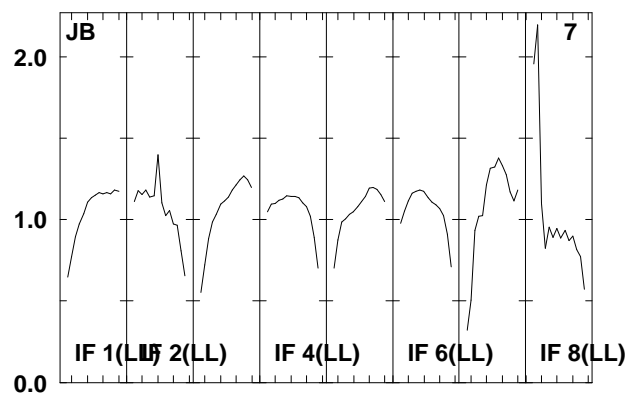
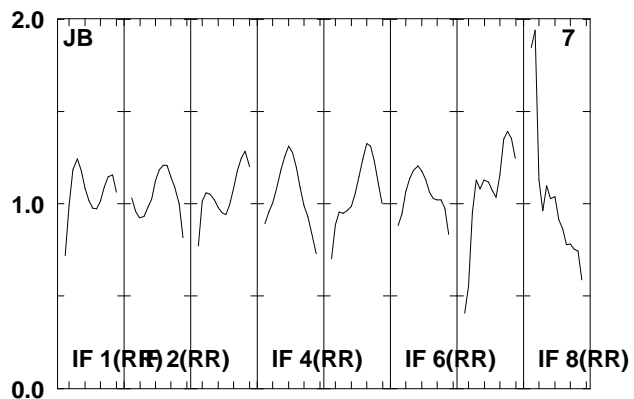
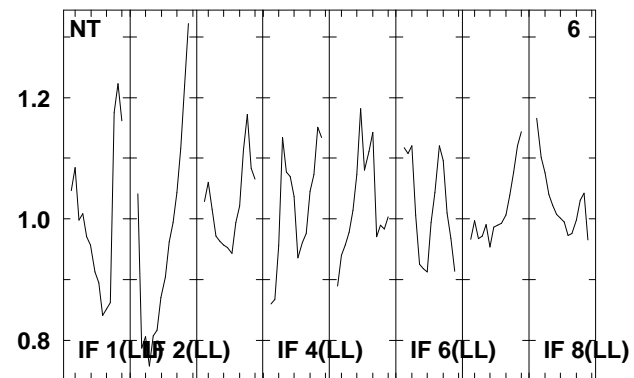
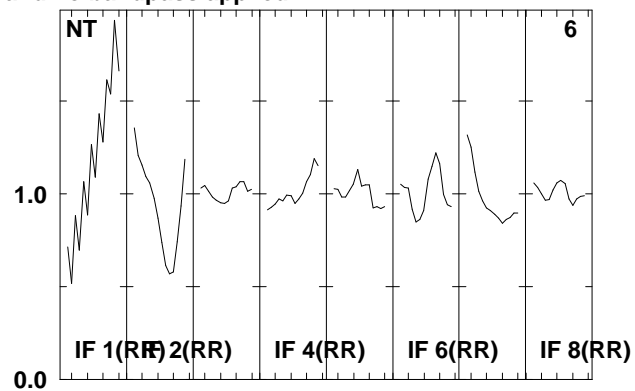
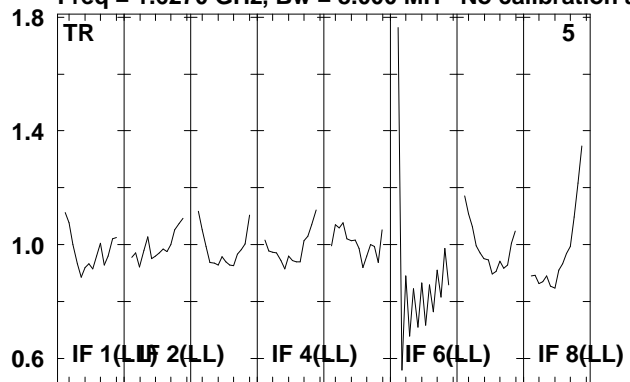

Lower frame: Real Jy  
Total-power spectrum Antenna: \*  
Timerange: 00/09:00:03 to 00/09:03:59

Plot file version 3 created 06-JAN-2009 10:57:03

J1510-05 EZ018B.UVDATA.1

Freq = 1.6270 GHz, Bw = 8.000 MH No calibration applied and no bandpass applied

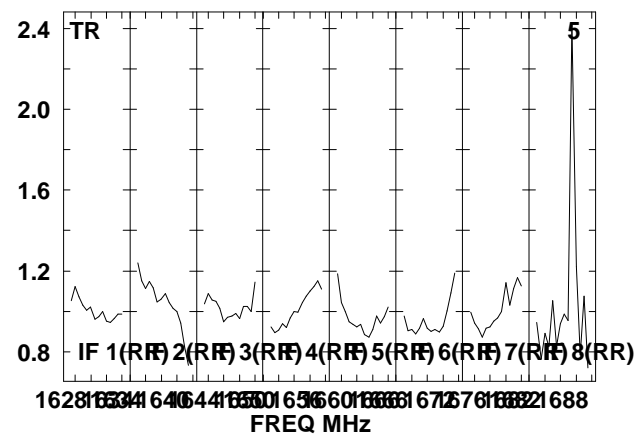
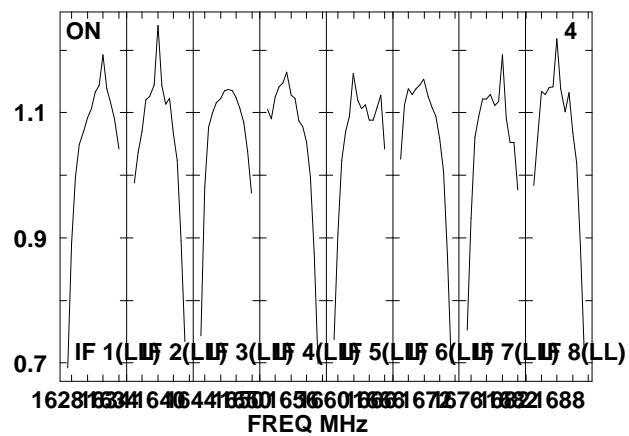
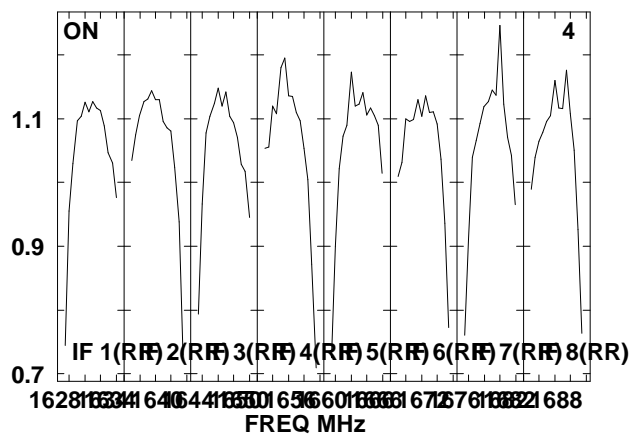
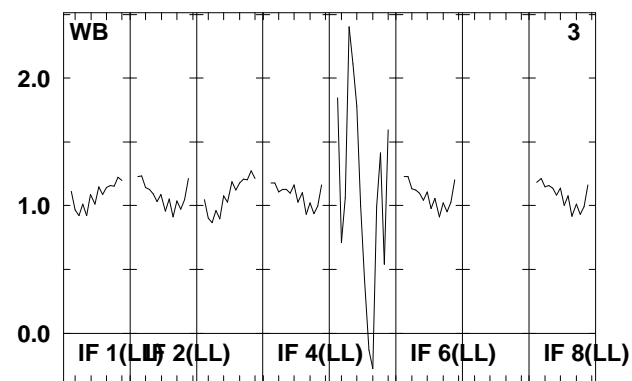
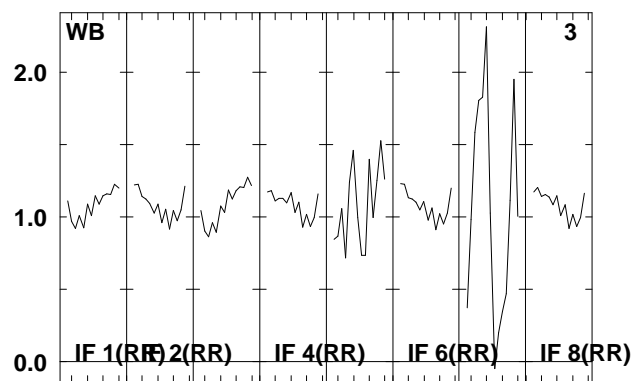
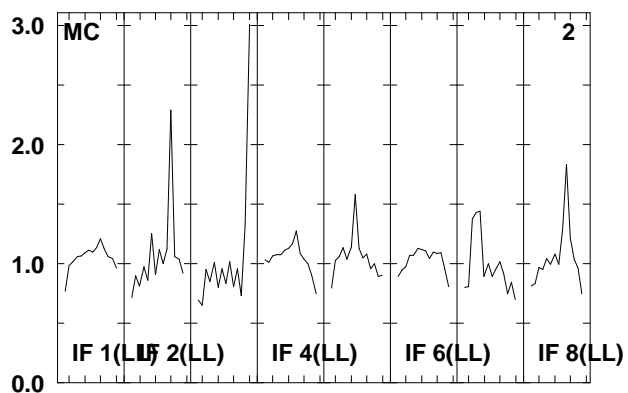
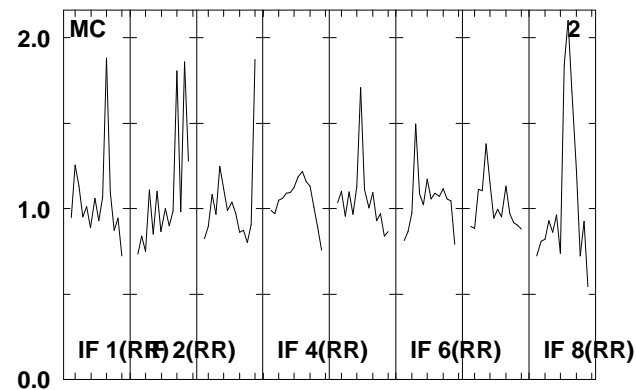
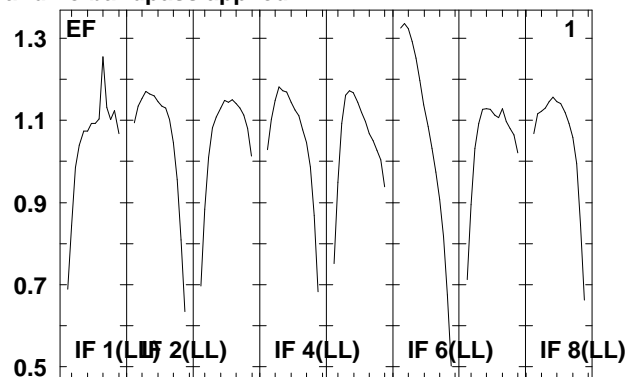
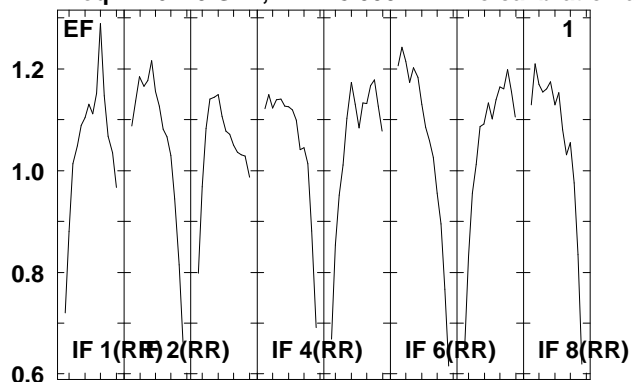

Lower frame: Real Jy

Total-power spectrum Antenna: \*

Timerange: 00/09:05:25 to 00/09:07:59

Plot file version 4 created 06-JAN-2009 10:57:03

J1510-05 EZ018B.UVDATA.1

Freq = 1.6270 GHz, Bw = 8.000 MH No calibration applied and no bandpass applied

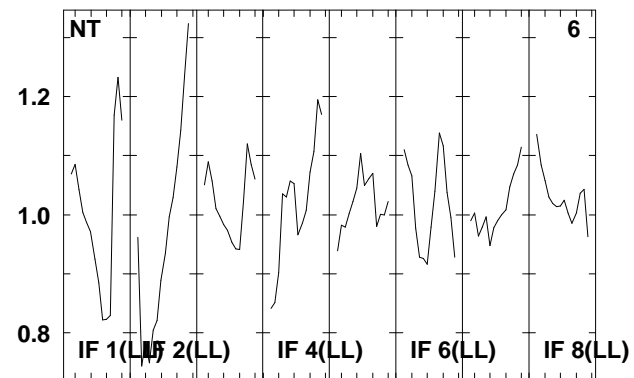
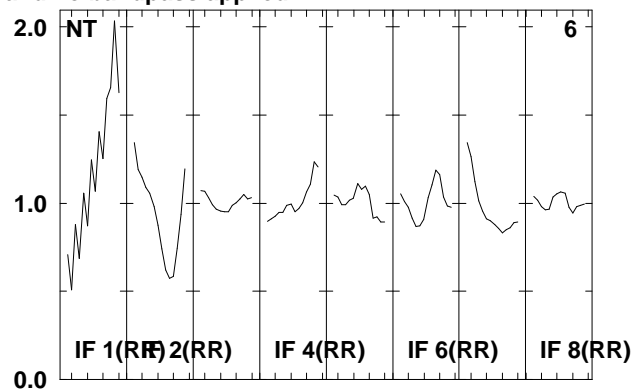
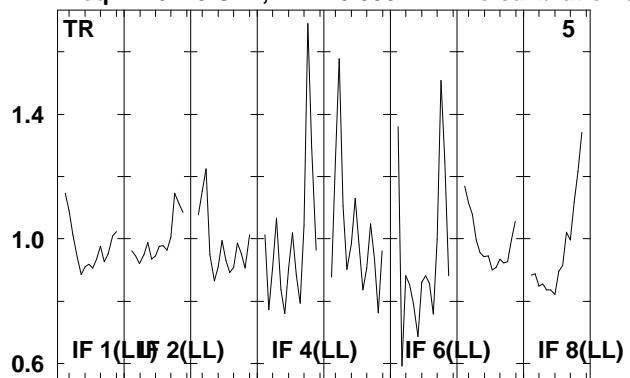

Lower frame: Real Jy  
Total-power spectrum Antenna: \*  
Timerange: 00/09:05:25 to 00/09:07:59

Plot file version 5 created 06-JAN-2009 10:57:03

J150407 EZ018B.UVDATA.1

Freq = 1.6270 GHz, Bw = 8.000 MH No calibration applied and no bandpass applied

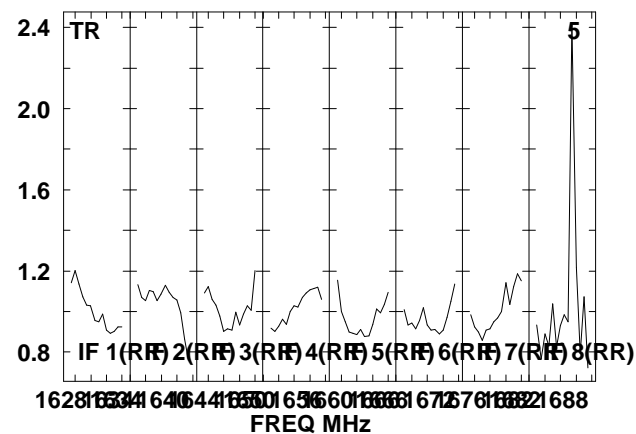
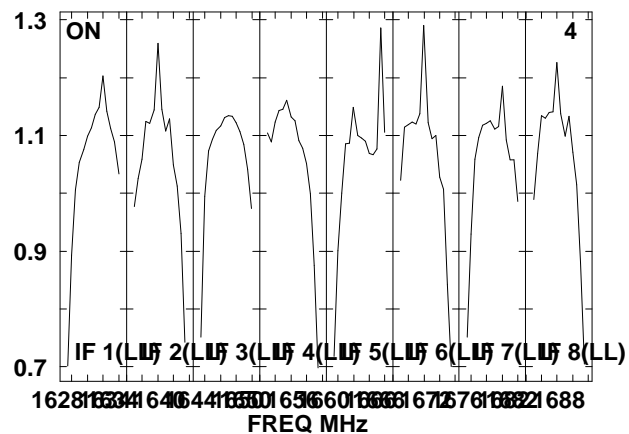
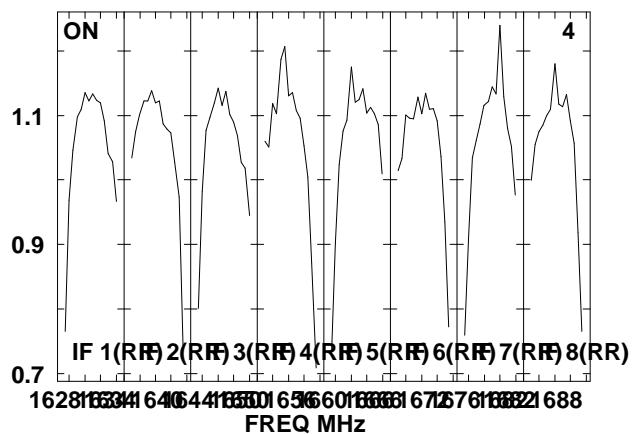
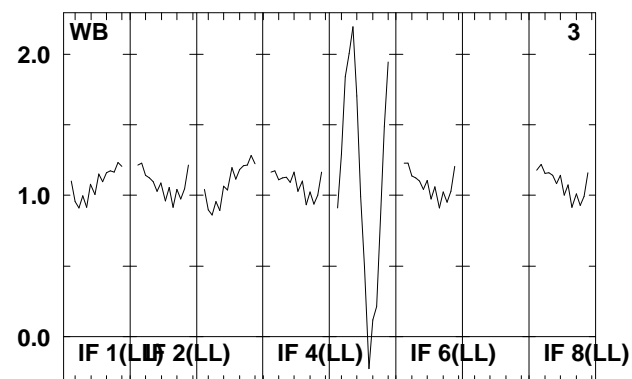
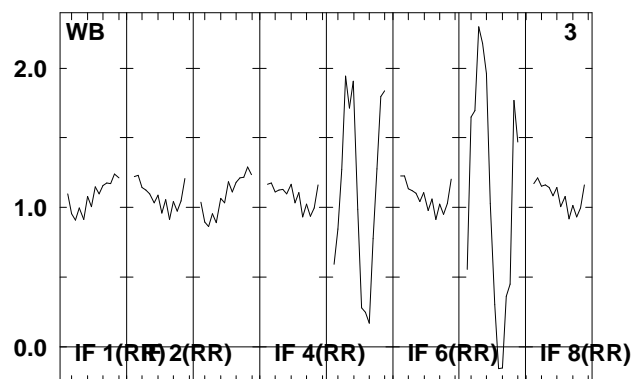
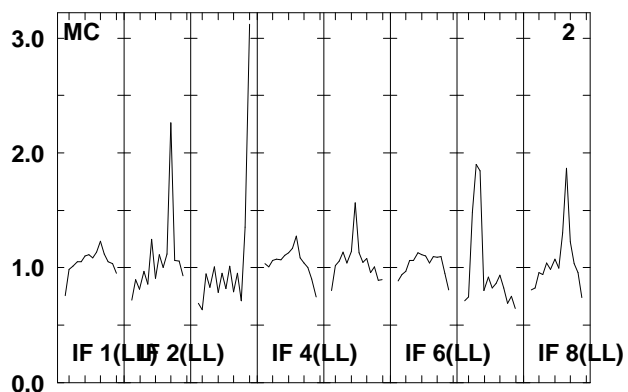
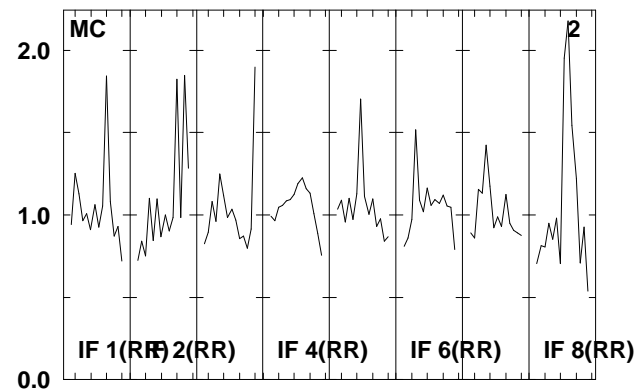
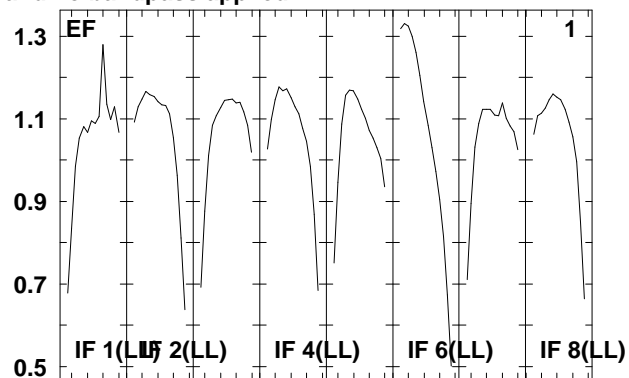
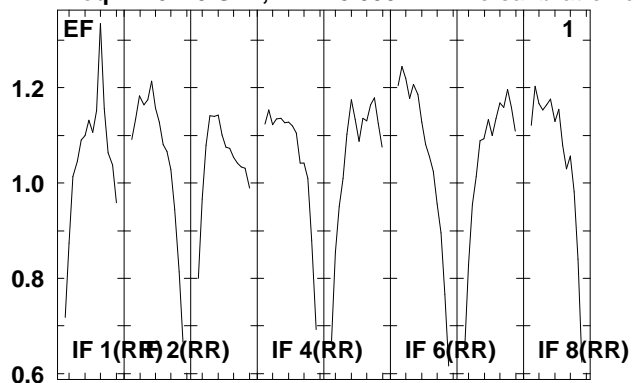

Lower frame: Real Jy

Total-power spectrum Antenna: \*

Timerange: 00/09:08:01 to 00/09:12:01

Plot file version 6 created 06-JAN-2009 10:57:04

J150407 EZ018B.UVDATA.1

Freq = 1.6270 GHz, Bw = 8.000 MH No calibration applied and no bandpass applied

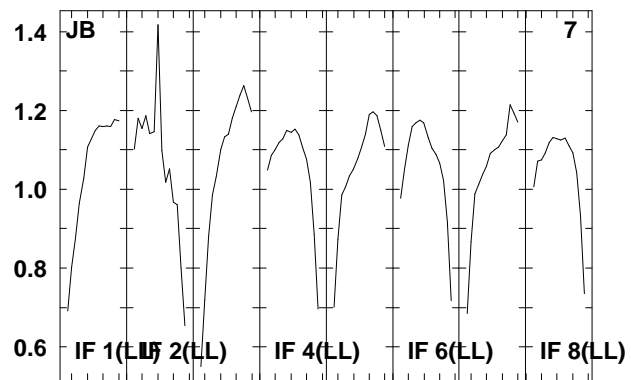
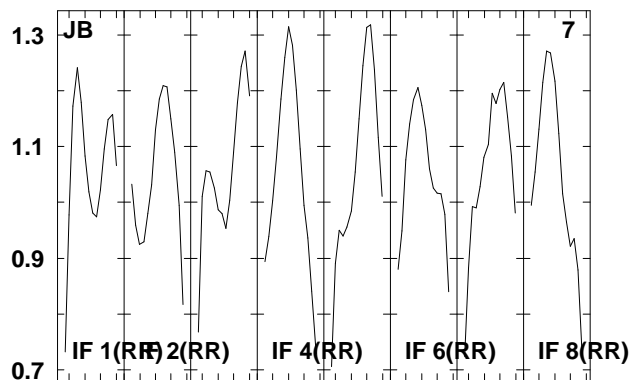
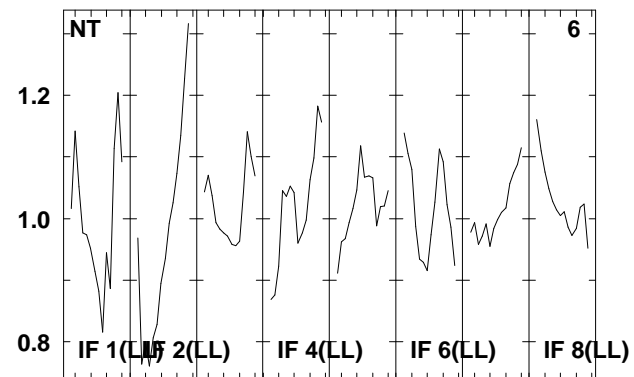
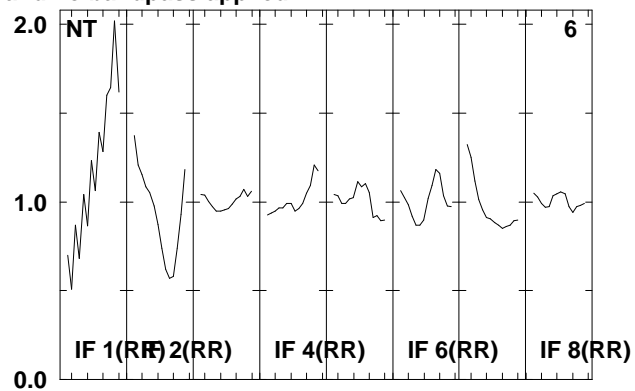
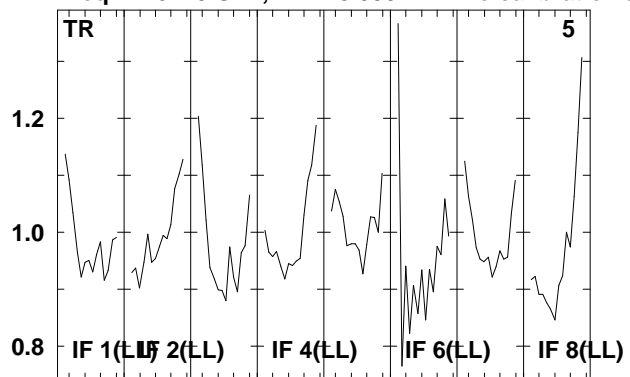

Lower frame: Real Jy  
Total-power spectrum Antenna: \*  
Timerange: 00/09:08:01 to 00/09:12:01

Plot file version 7 created 06-JAN-2009 10:57:04

J1510-05 EZ018B.UVDATA.1

Freq = 1.6270 GHz, Bw = 8.000 MH No calibration applied and no bandpass applied

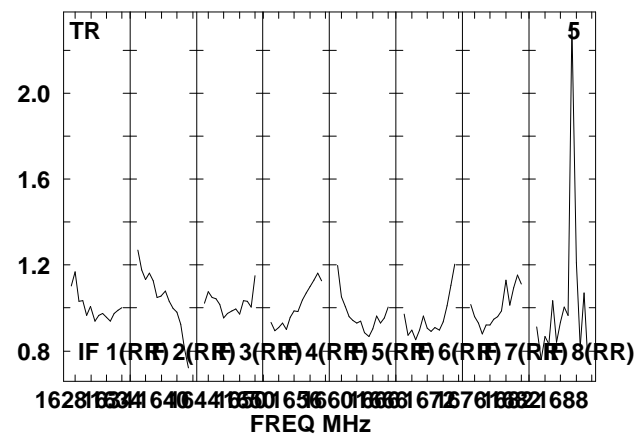
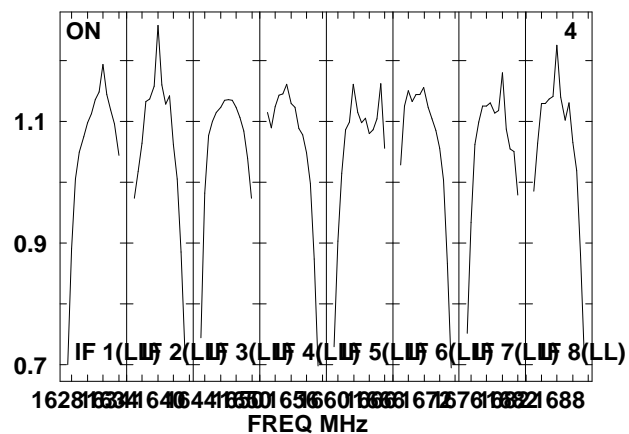
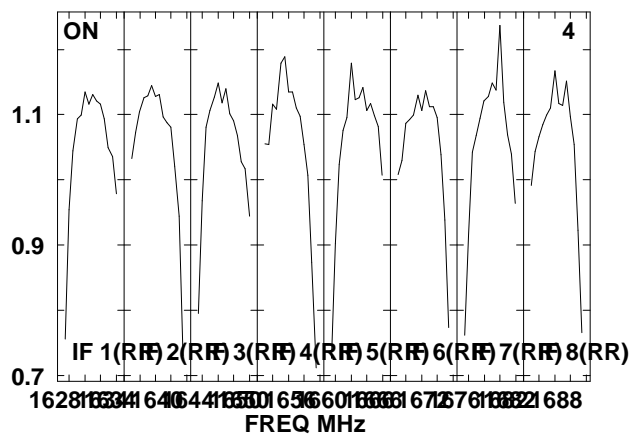
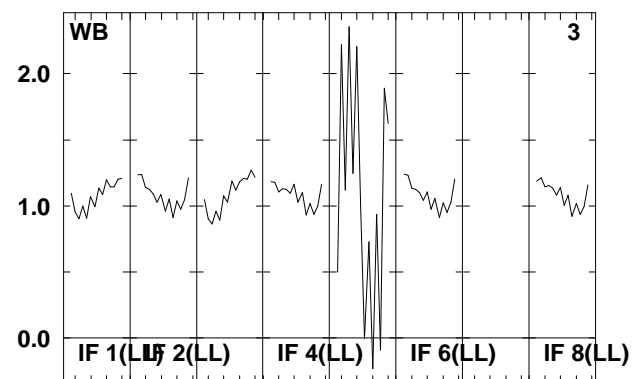
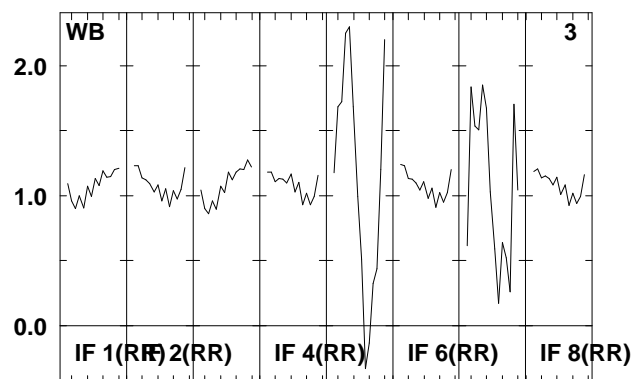
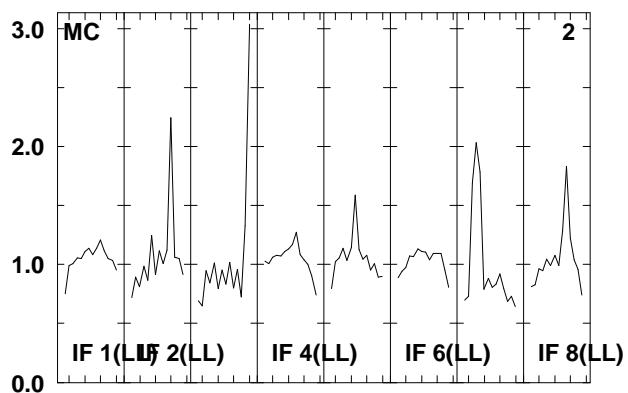
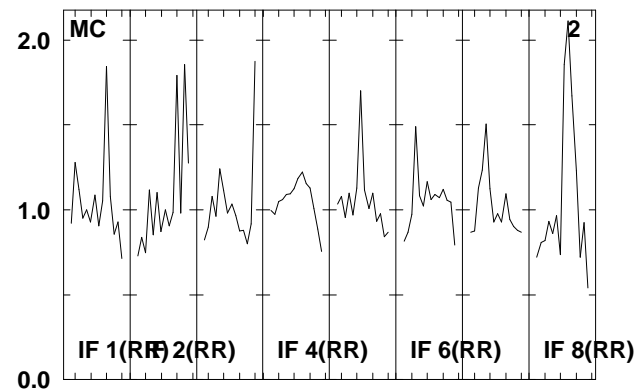
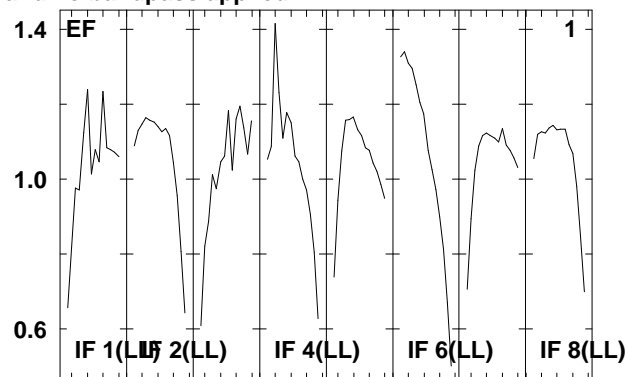
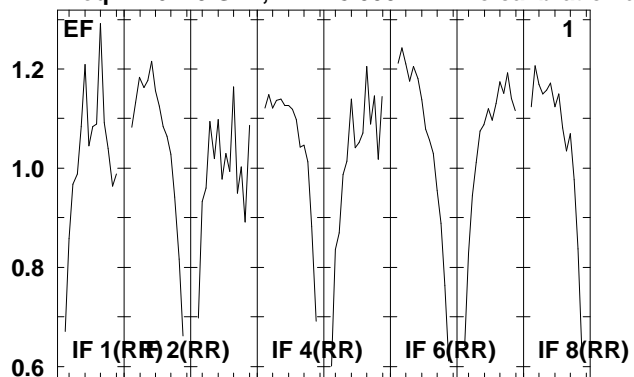

Lower frame: Real Jy

Total-power spectrum Antenna: \*

Timerange: 00/09:12:03 to 00/09:14:09

Plot file version 8 created 06-JAN-2009 10:57:04

J1510-05 EZ018B.UVDATA.1

Freq = 1.6270 GHz, Bw = 8.000 MH No calibration applied and no bandpass applied

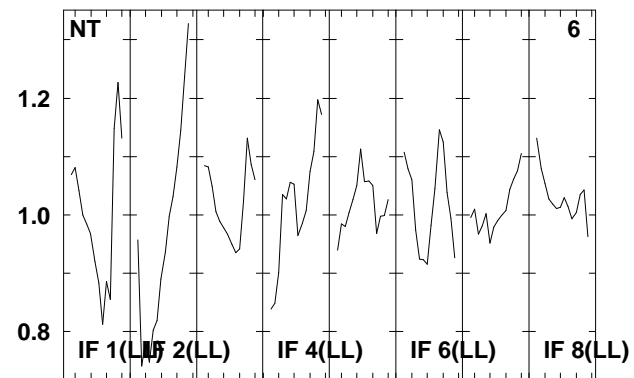
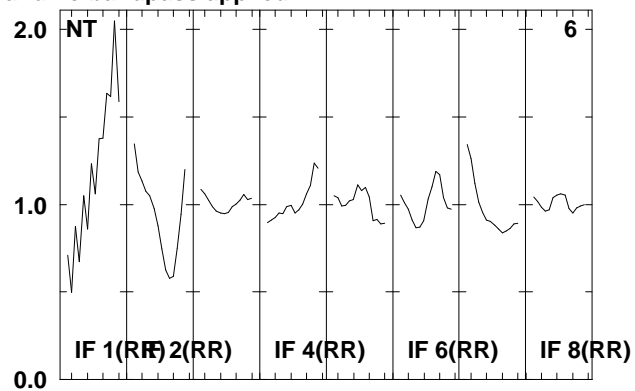
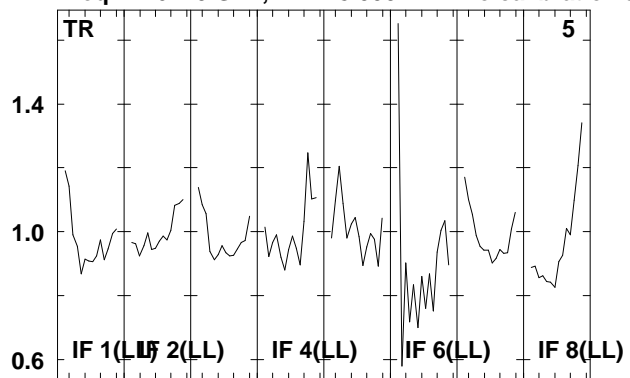

Lower frame: Real Jy  
Total-power spectrum Antenna: \*  
Timerange: 00/09:12:03 to 00/09:14:09



Plot file version 9 created 06-JAN-2009 10:57:05

J150407 EZ018B.UVDATA.1

Freq = 1.6270 GHz, Bw = 8.000 MH No calibration applied and no bandpass applied

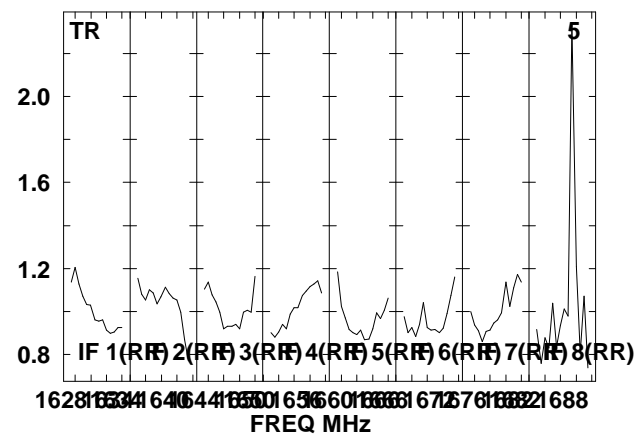
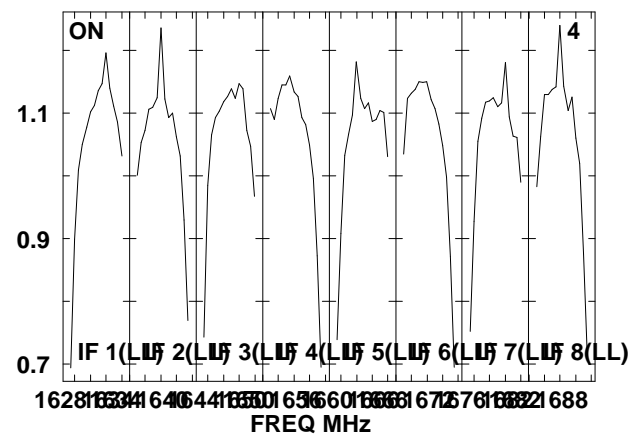
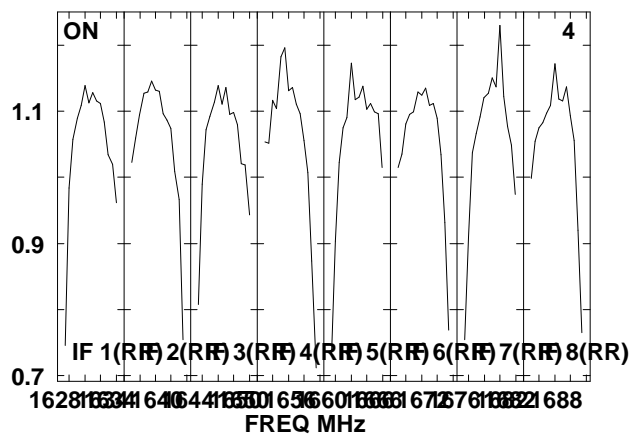
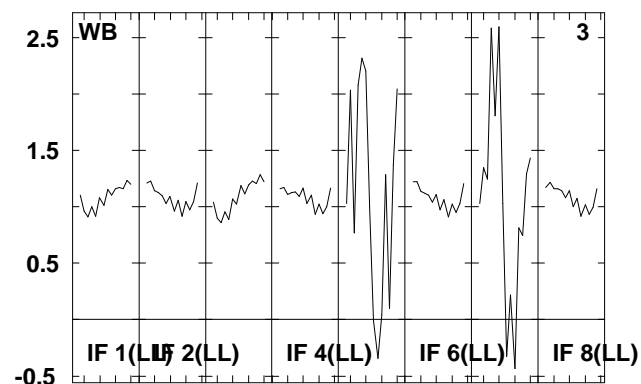
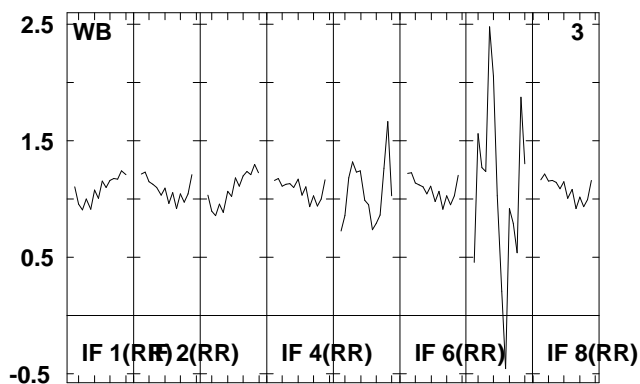
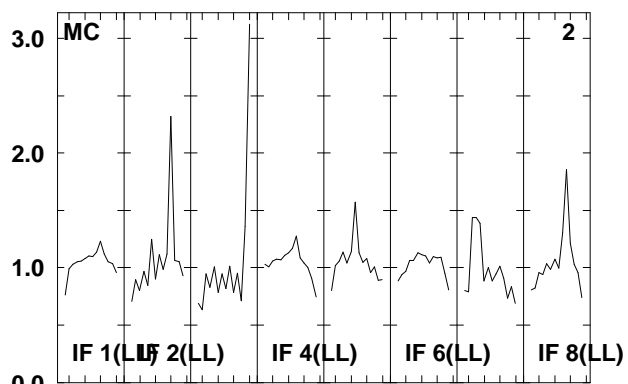
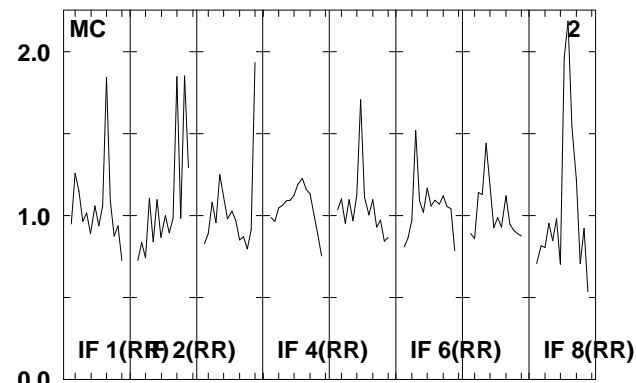
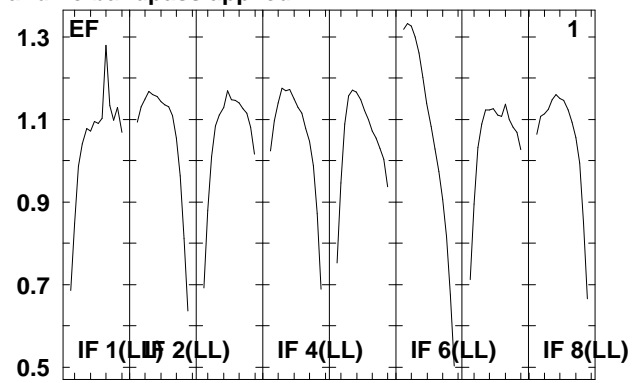
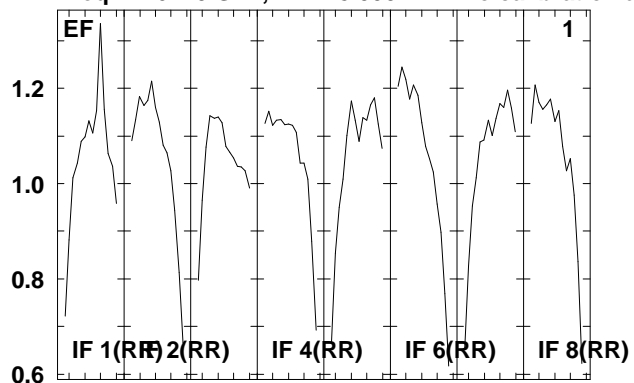

Lower frame: Real Jy  
Total-power spectrum Antenna: \*  
Timerange: 00/09:15:03 to 00/09:18:59

Plot file version 10 created 06-JAN-2009 10:57:05

J150407 EZ018B.UVDATA.1

Freq = 1.6270 GHz, Bw = 8.000 MH No calibration applied and no bandpass applied

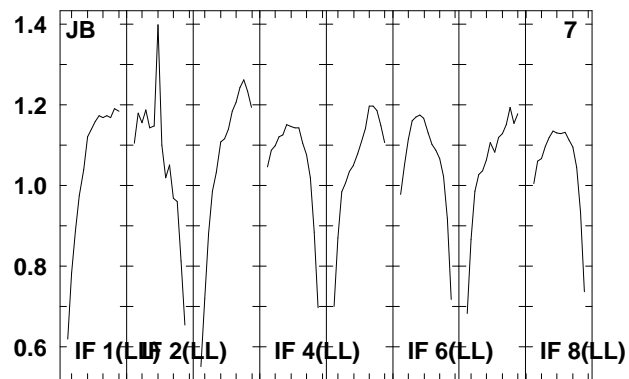
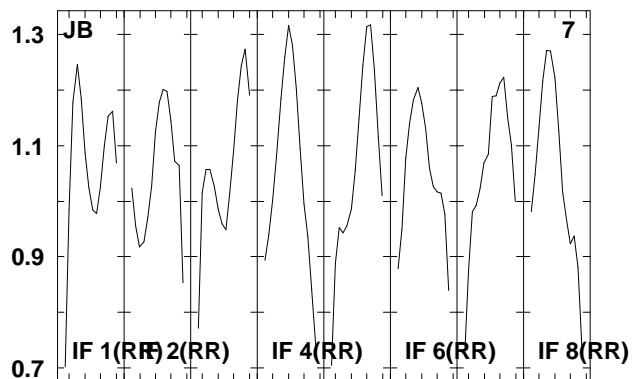
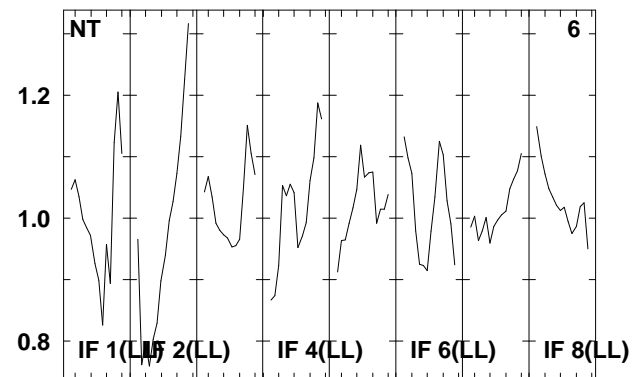
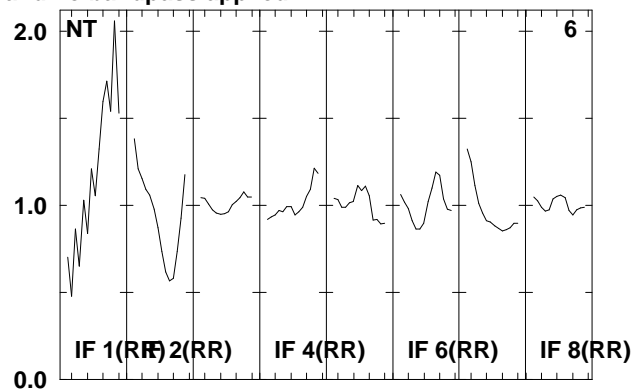
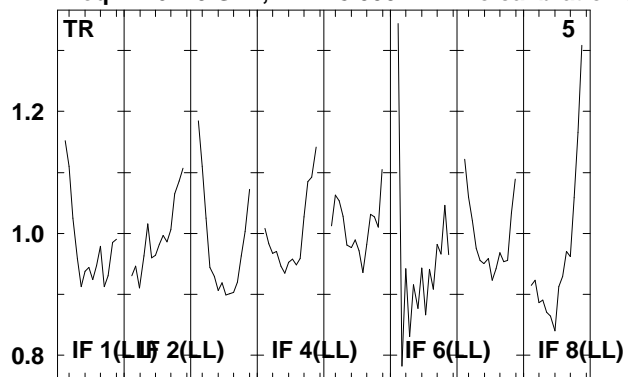

Lower frame: Real Jy  
Total-power spectrum Antenna: \*  
Timerange: 00/09:15:03 to 00/09:18:59

Plot file version 11 created 06-JAN-2009 10:57:05  
 J1510-05 EZ018B.UVDATA.1  
 Freq = 1.6270 GHz, Bw = 8.000 MH No calibration applied and no bandpass applied

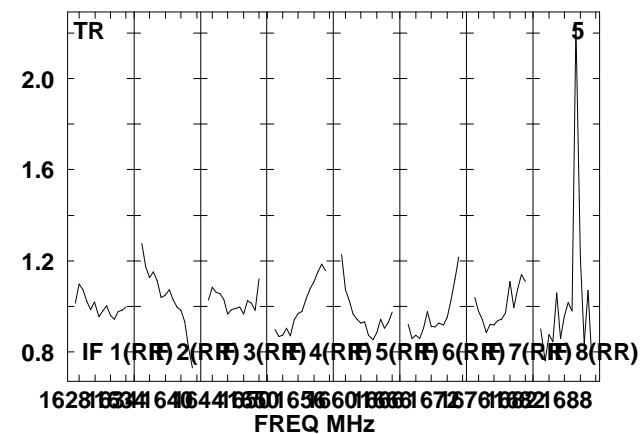
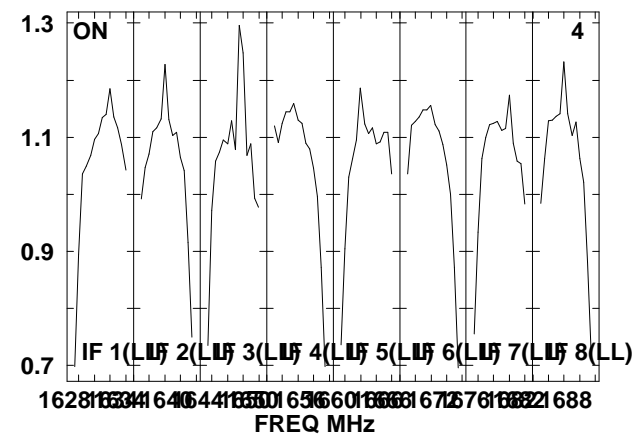
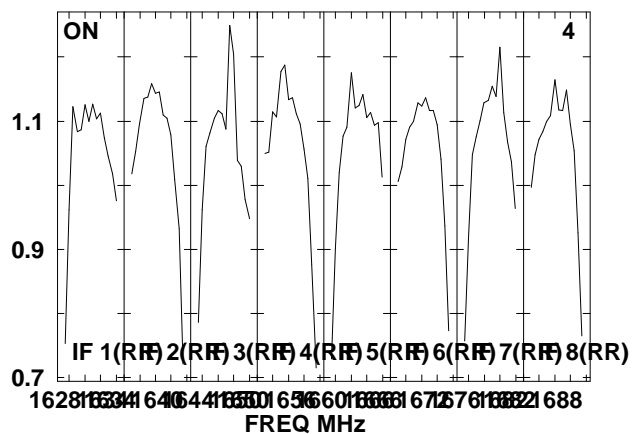
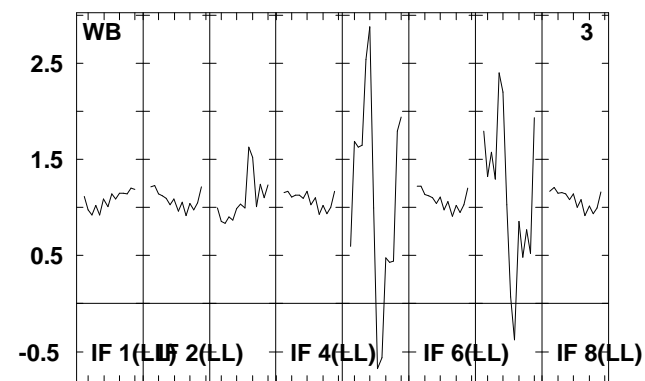
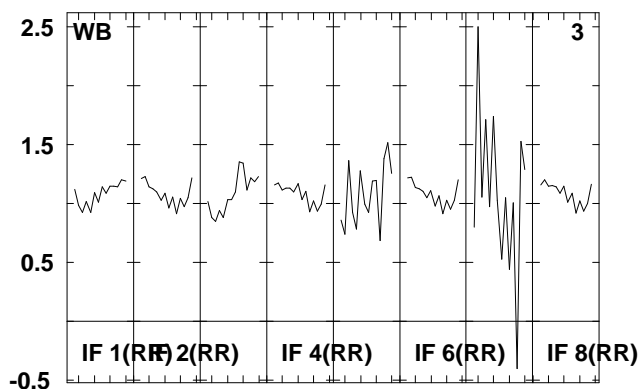
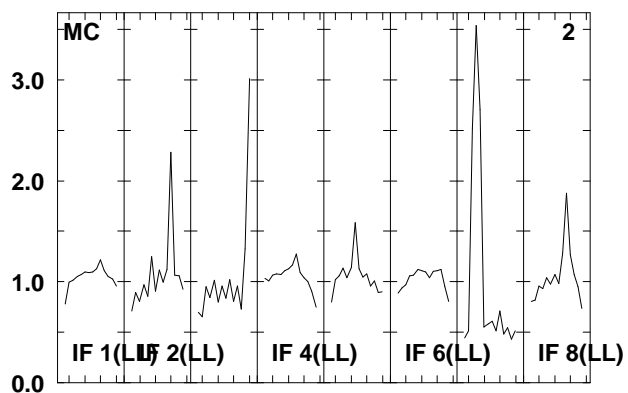
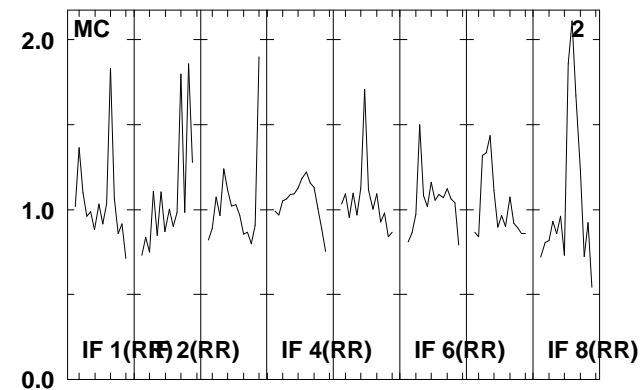
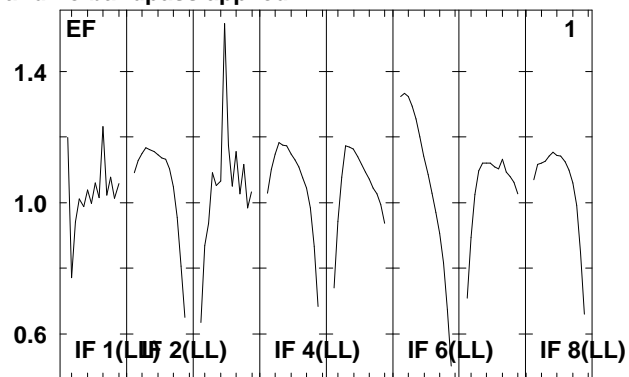
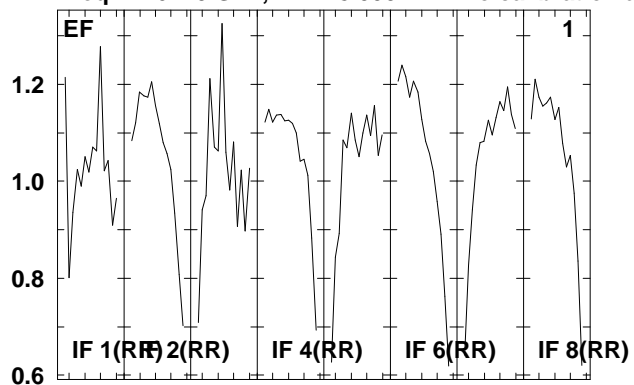

Lower frame: Real Jy  
 Total-power spectrum Antenna: \*  
 Timerange: 00/09:20:03 to 00/09:23:01

Plot file version 12 created 06-JAN-2009 10:57:06

J1510-05 EZ018B.UVDATA.1

Freq = 1.6270 GHz, Bw = 8.000 MH No calibration applied and no bandpass applied

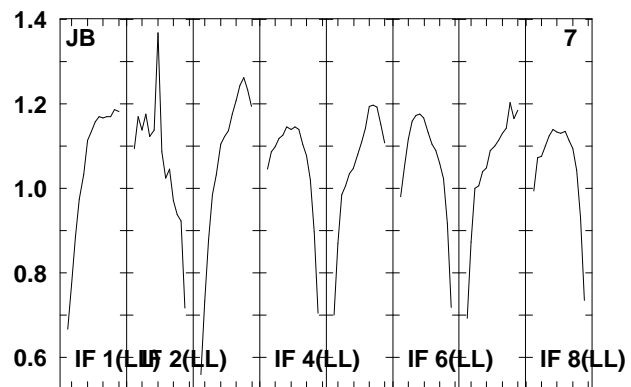
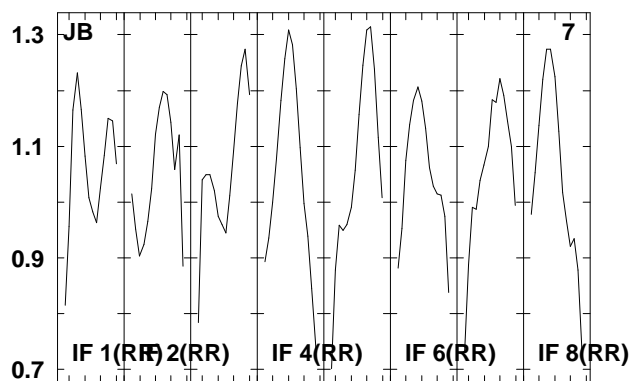
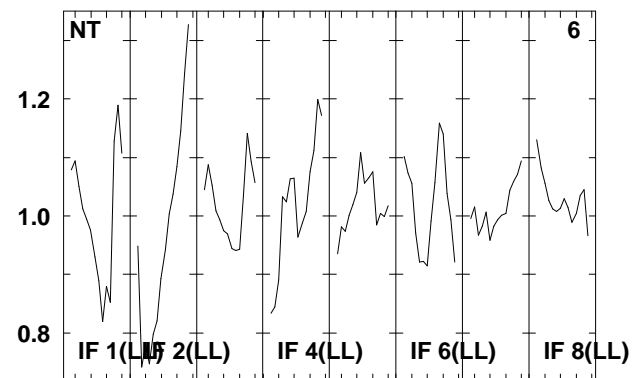
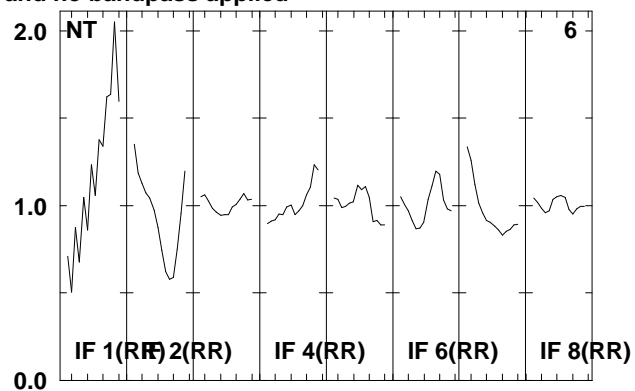
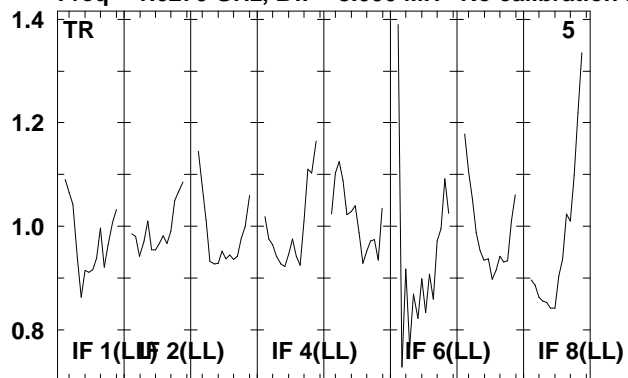

Lower frame: Real Jy  
Total-power spectrum Antenna: \*  
Timerange: 00/09:20:03 to 00/09:23:01

Plot file version 13 created 06-JAN-2009 10:57:06

J150407 EZ018B.UVDATA.1

Freq = 1.6270 GHz, Bw = 8.000 MH No calibration applied and no bandpass applied

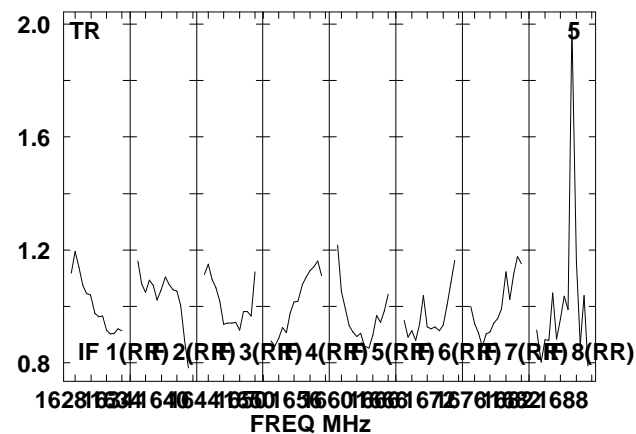
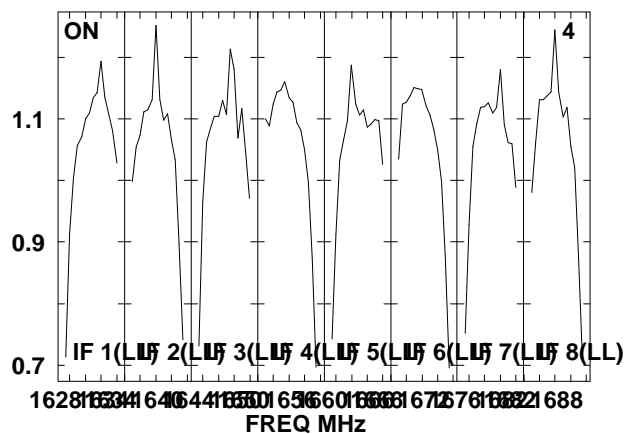
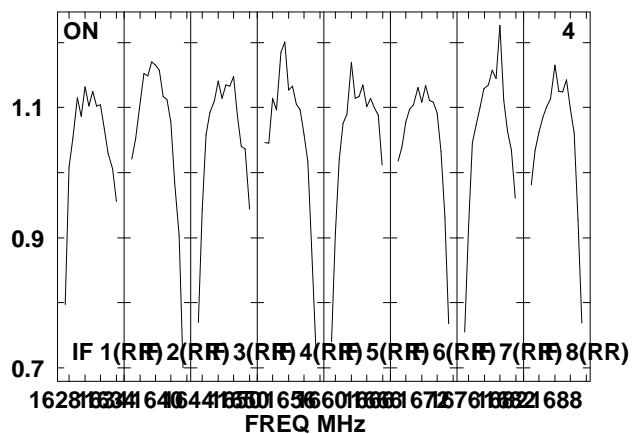
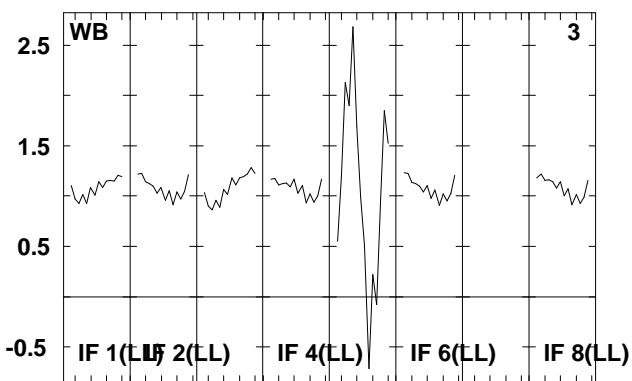
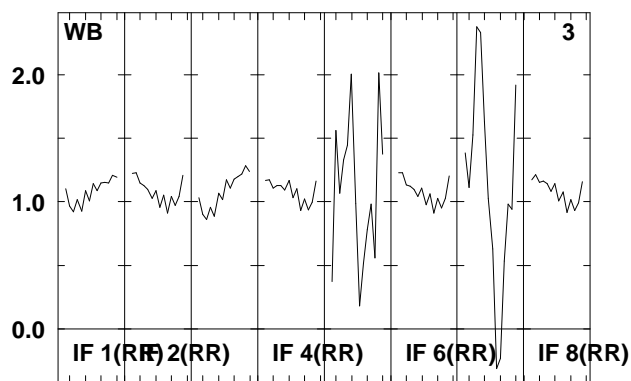
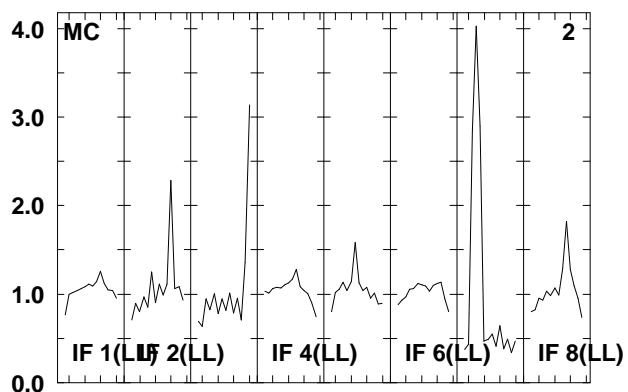
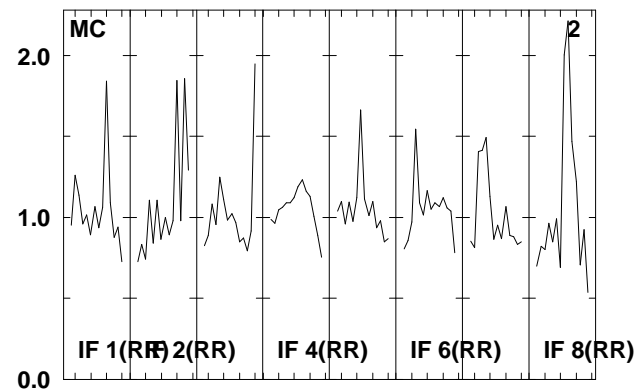
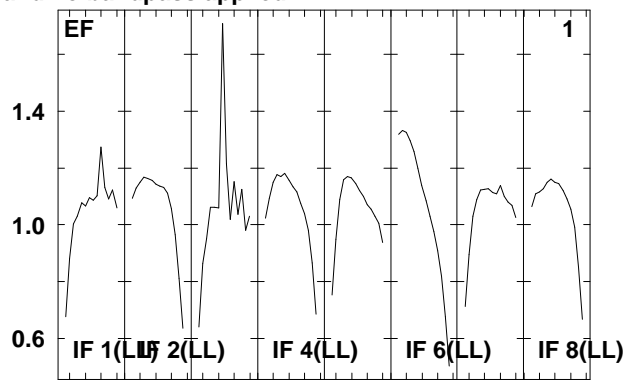
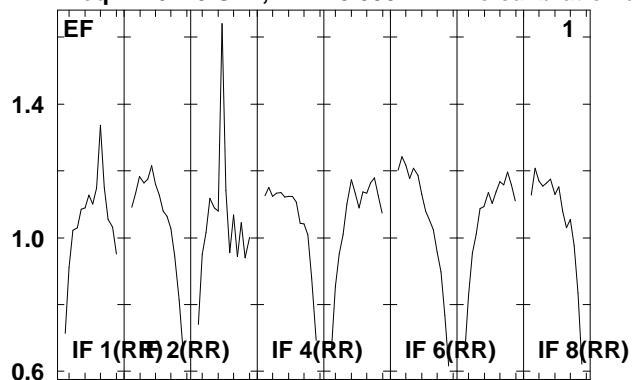

Lower frame: Real Jy

Total-power spectrum Antenna: \*

Timerange: 00/09:23:03 to 00/09:26:59

Plot file version 14 created 06-JAN-2009 10:57:06

J150407 EZ018B.UVDATA.1

Freq = 1.6270 GHz, Bw = 8.000 MH No calibration applied and no bandpass applied

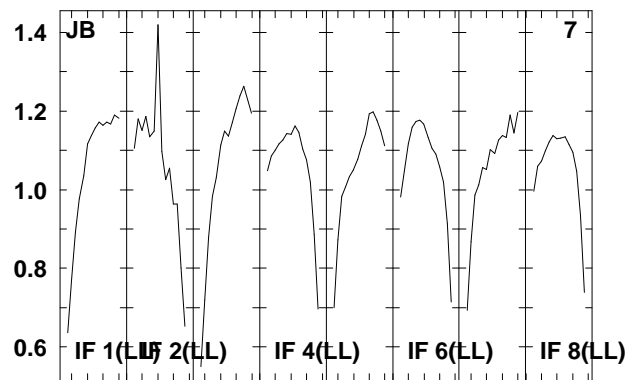
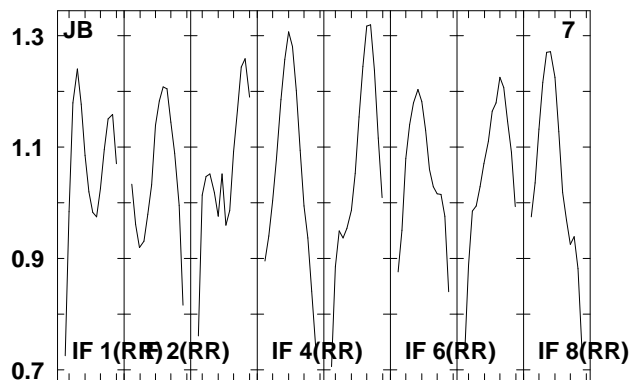
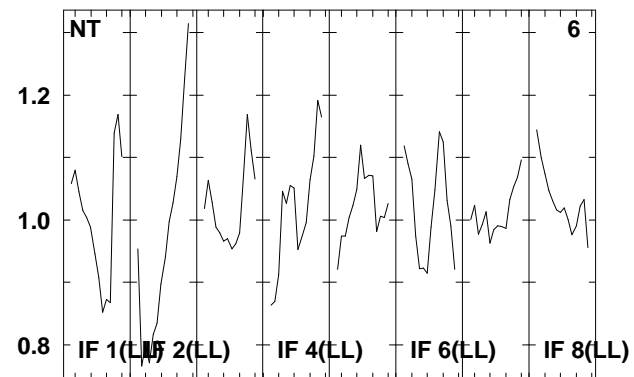
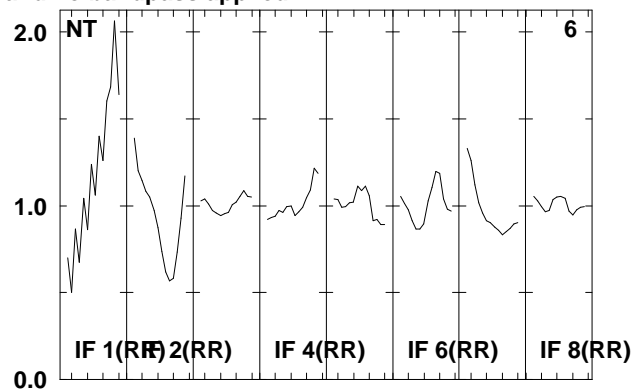
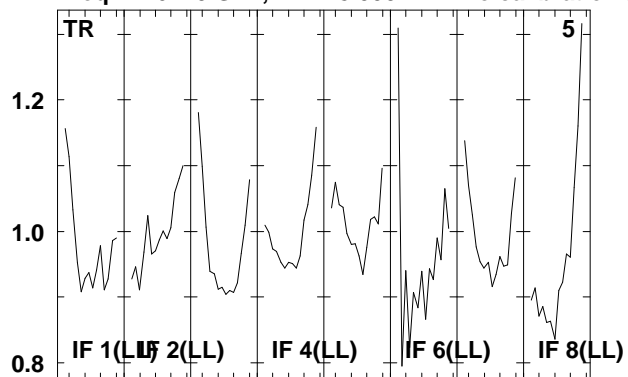

Lower frame: Real Jy  
Total-power spectrum Antenna: \*  
Timerange: 00/09:23:03 to 00/09:26:59

Plot file version 15 created 06-JAN-2009 10:57:07

J1510-05 EZ018B.UVDATA.1

Freq = 1.6270 GHz, Bw = 8.000 MH No calibration applied and no bandpass applied

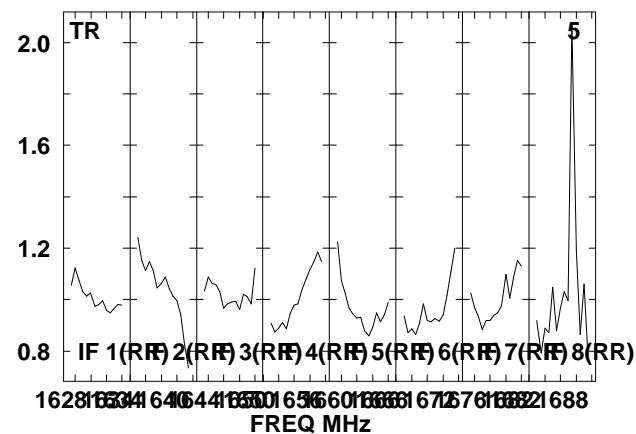
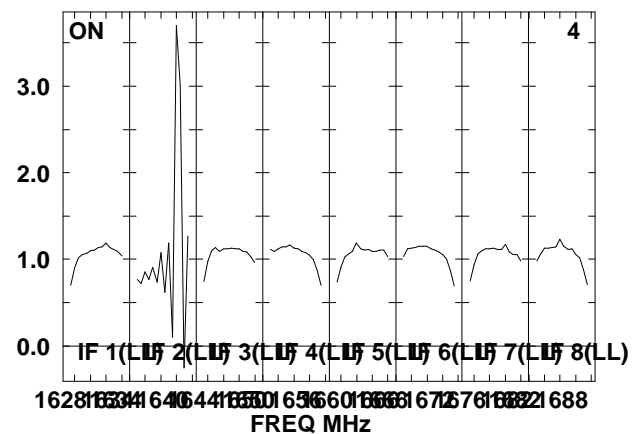
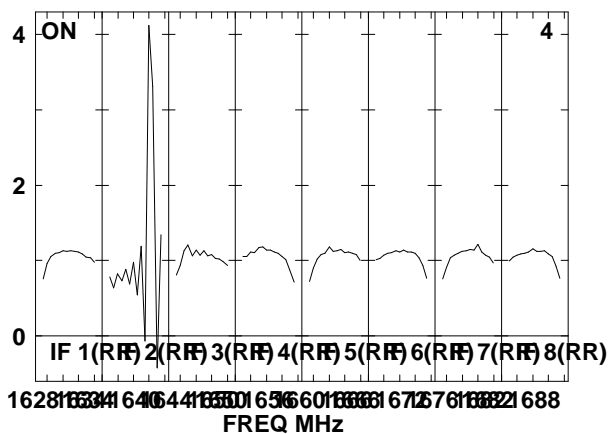
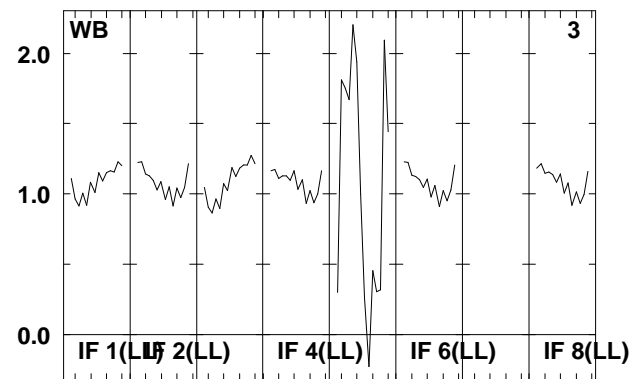
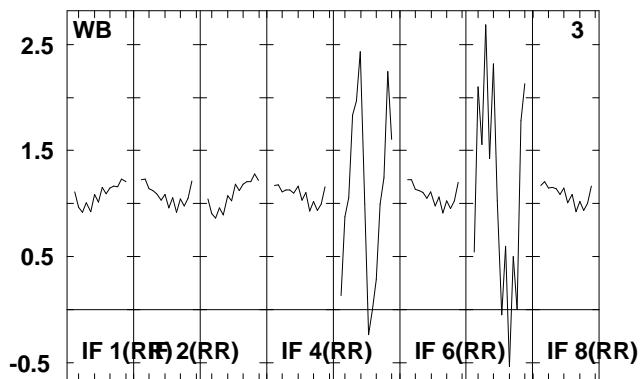
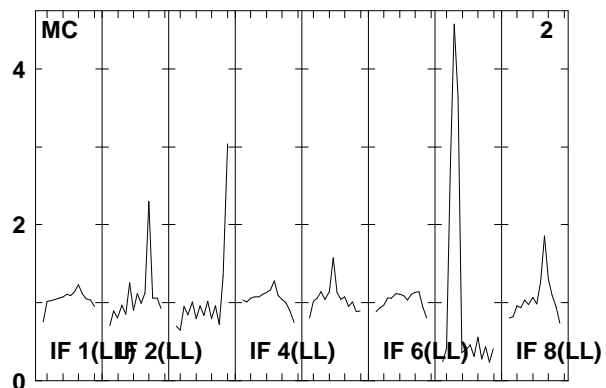
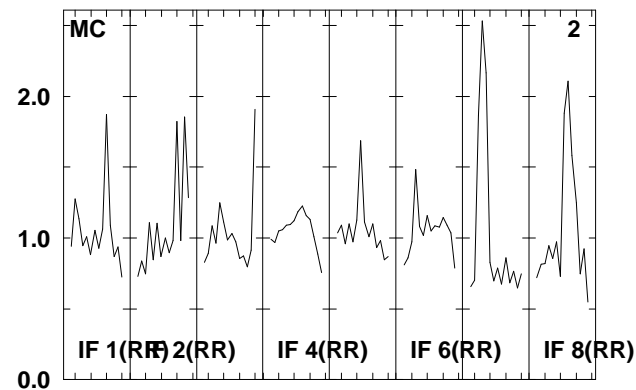
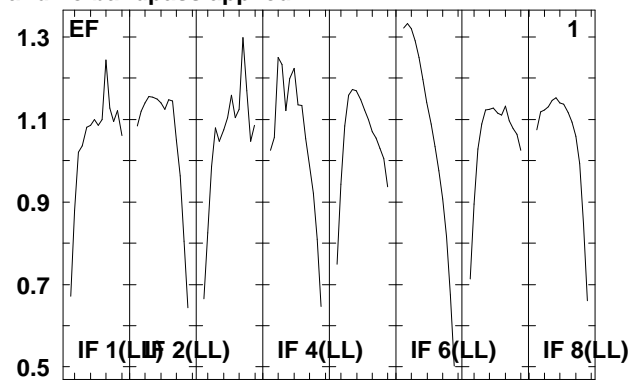
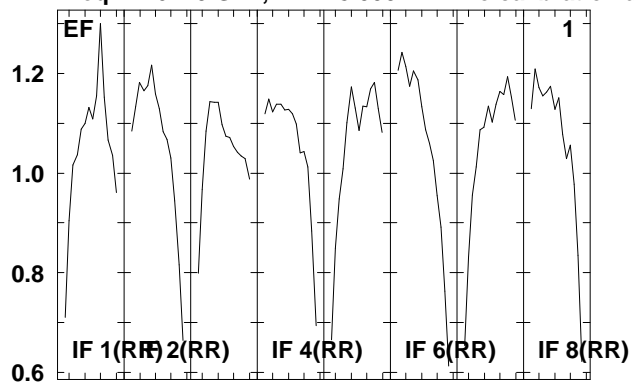

Lower frame: Real Jy  
Total-power spectrum Antenna: \*  
Timerange: 00/09:27:01 to 00/09:30:01

Plot file version 16 created 06-JAN-2009 10:57:07

J1510-05 EZ018B.UVDATA.1

Freq = 1.6270 GHz, Bw = 8.000 MH No calibration applied and no bandpass applied

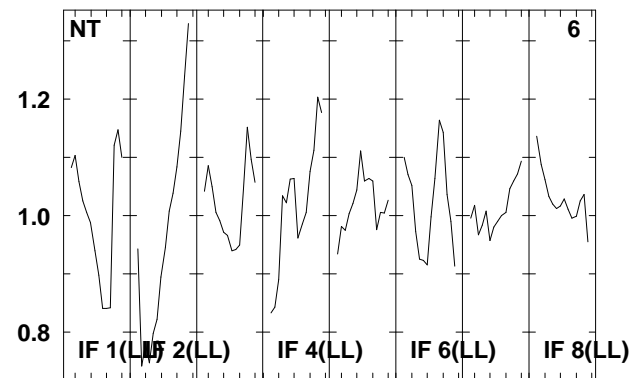
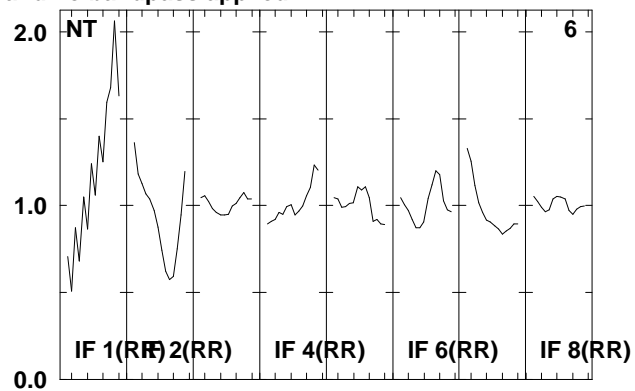
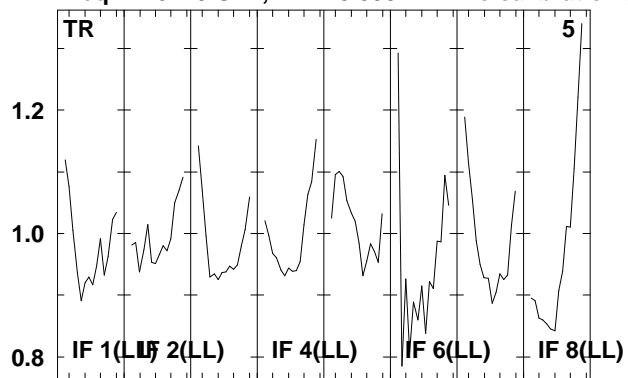

Lower frame: Real Jy  
Total-power spectrum Antenna: \*  
Timerange: 00/09:27:01 to 00/09:30:01



Plot file version 17 created 06-JAN-2009 10:57:07

J150407 EZ018B.UVDATA.1

Freq = 1.6270 GHz, Bw = 8.000 MH No calibration applied and no bandpass applied

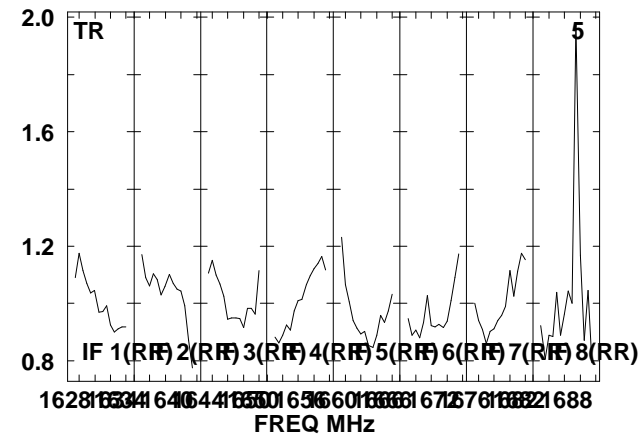
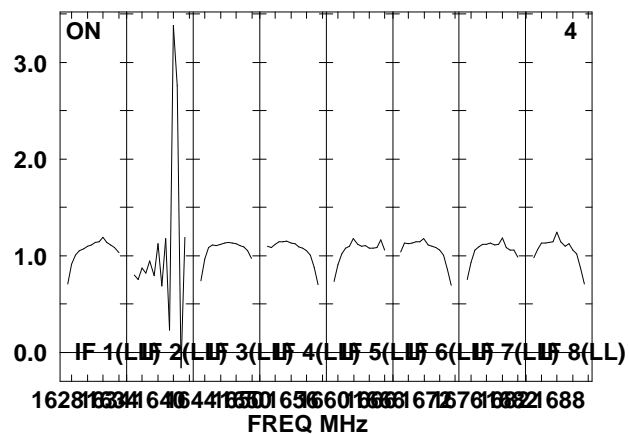
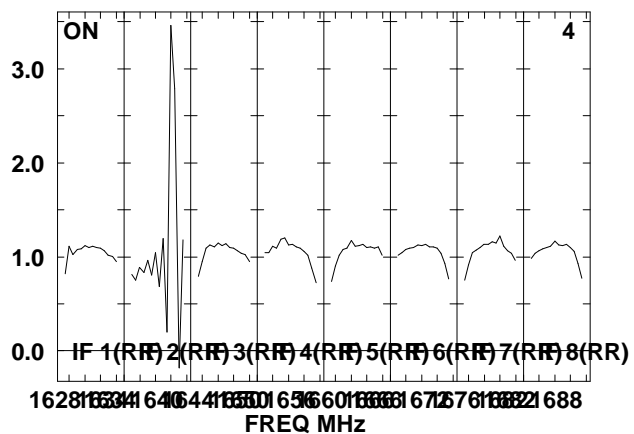
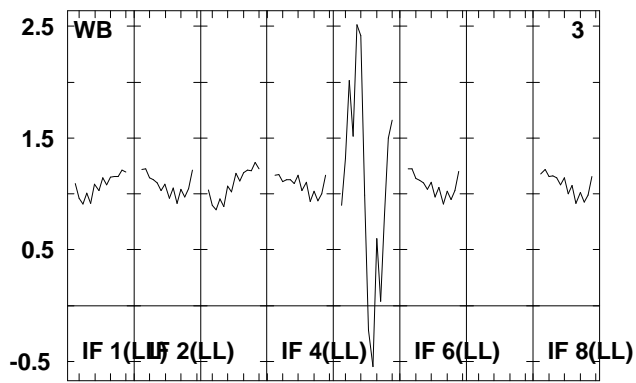
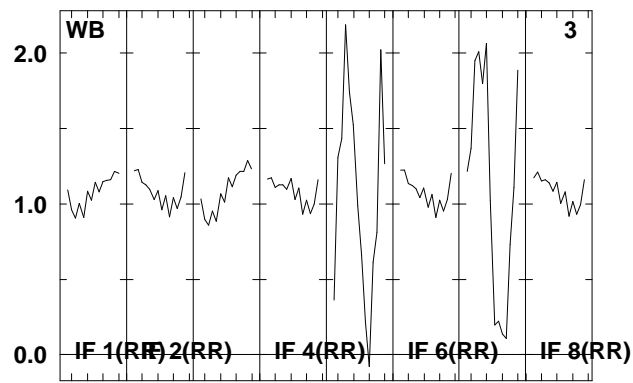
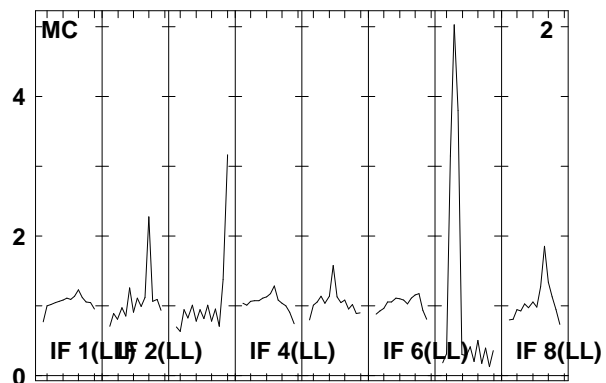
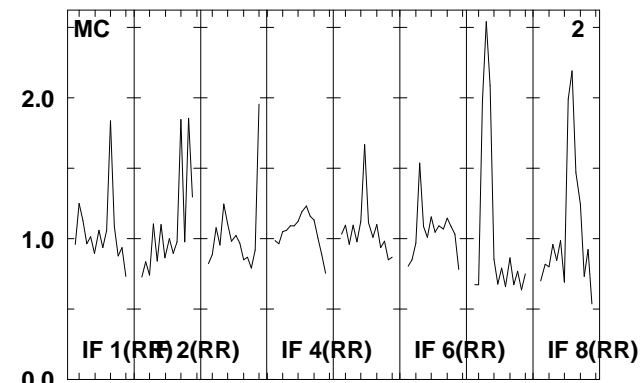
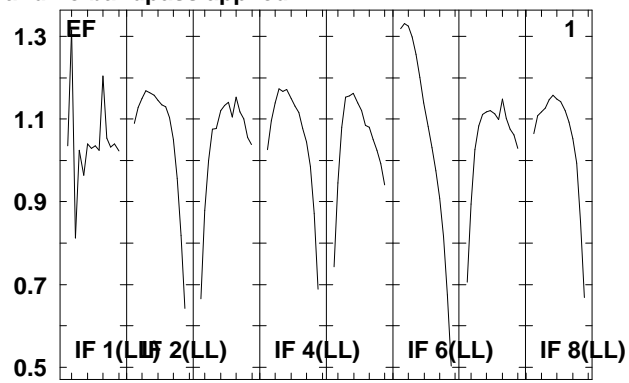
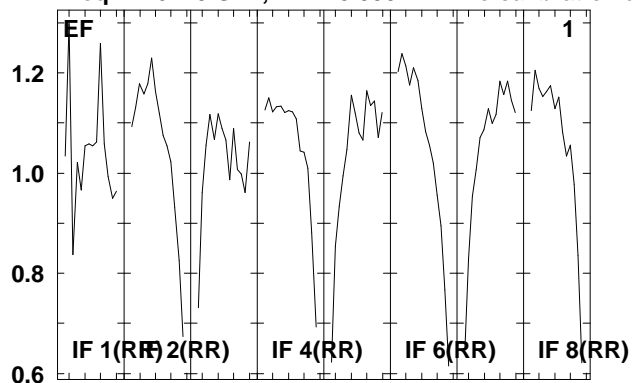

Lower frame: Real Jy

Total-power spectrum Antenna: \*

Timerange: 00/09:30:03 to 00/09:33:59

Plot file version 18 created 06-JAN-2009 10:57:08

J150407 EZ018B.UVDATA.1

Freq = 1.6270 GHz, Bw = 8.000 MH No calibration applied and no bandpass applied

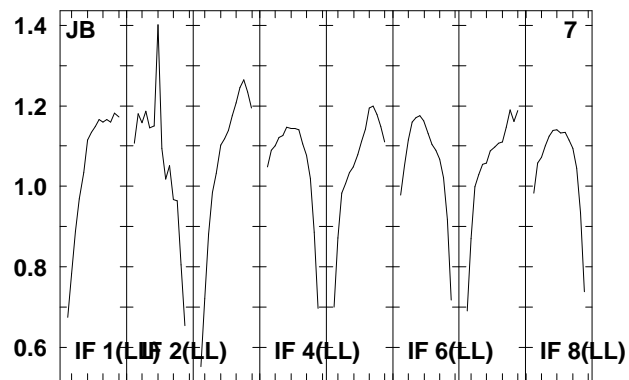
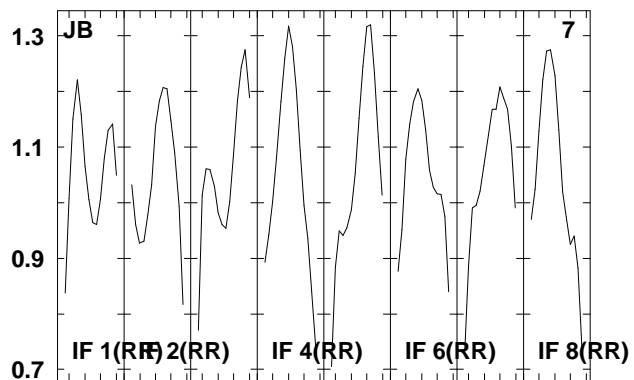
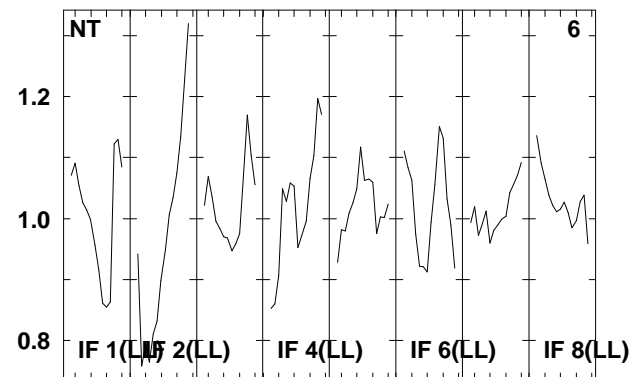
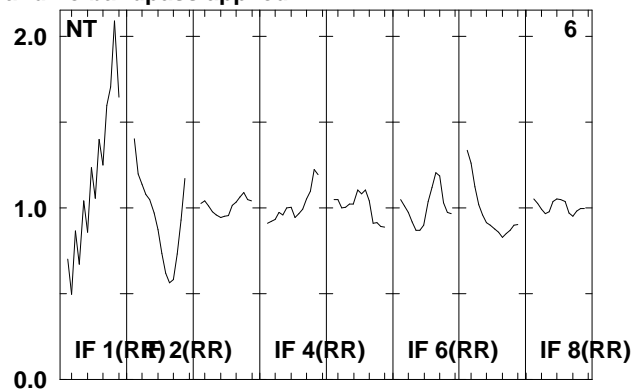
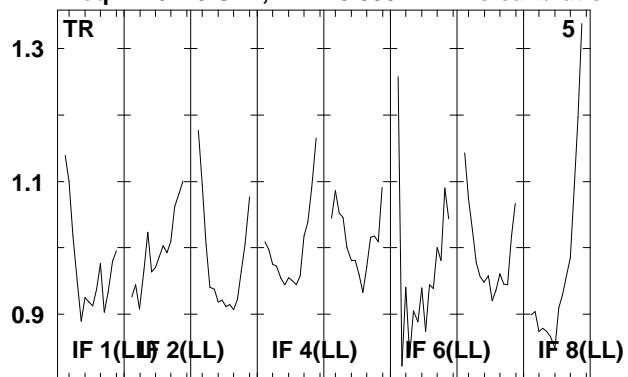

Lower frame: Real Jy  
Total-power spectrum Antenna: \*  
Timerange: 00/09:30:03 to 00/09:33:59

Plot file version 19 created 06-JAN-2009 10:57:08

J1510-05 EZ018B.UVDATA.1

Freq = 1.6270 GHz, Bw = 8.000 MH No calibration applied and no bandpass applied

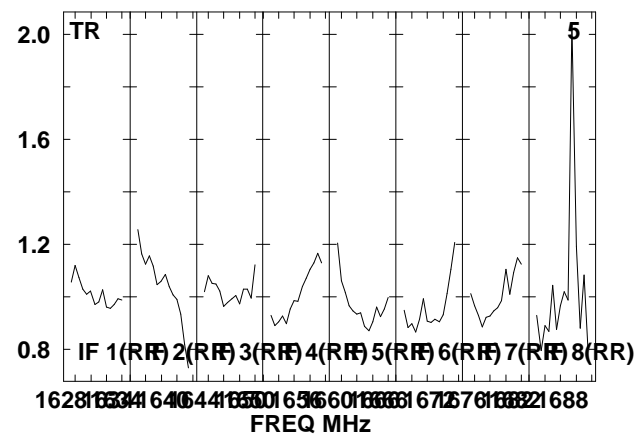
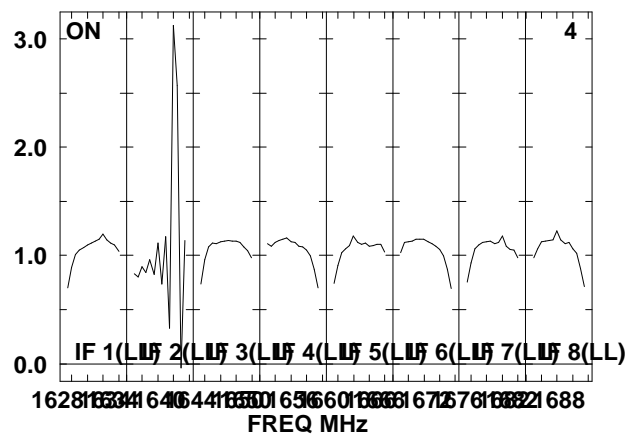
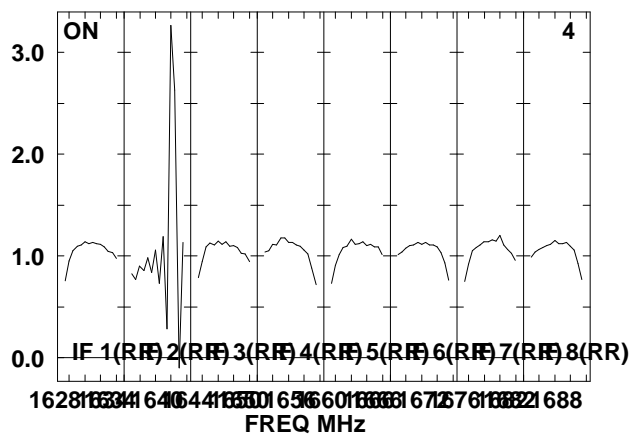
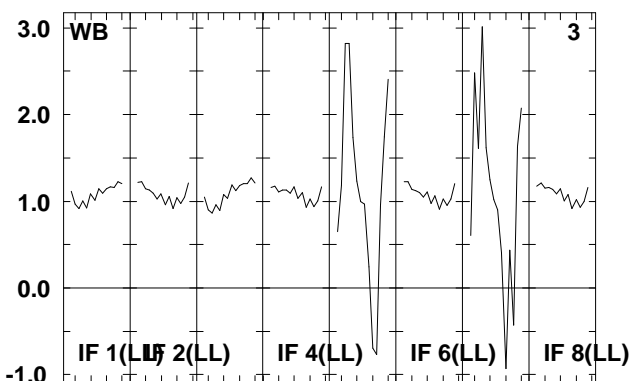
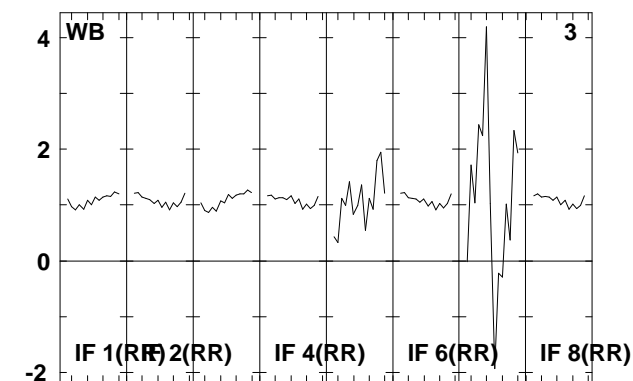
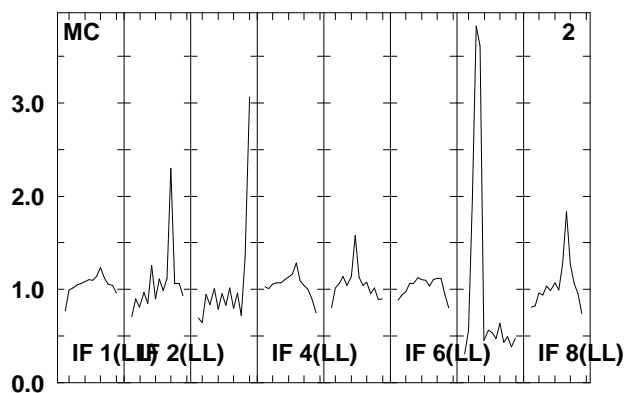
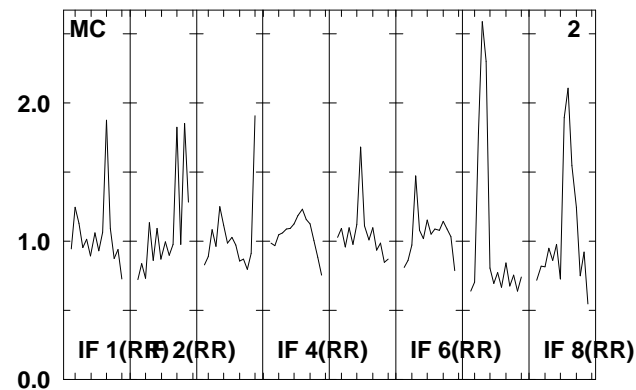
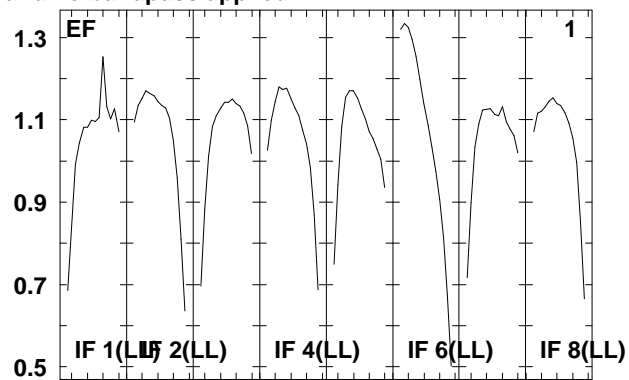
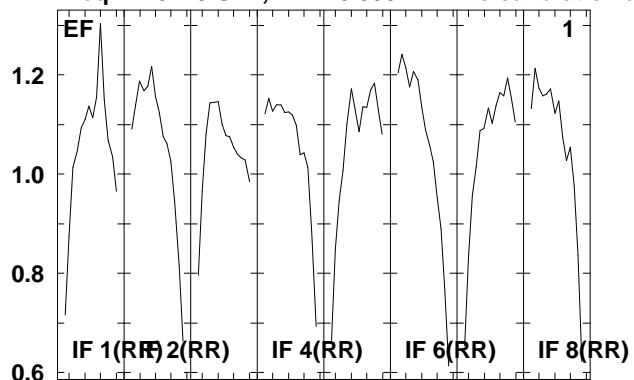

Lower frame: Real Jy  
Total-power spectrum Antenna: \*  
Timerange: 00/09:35:03 to 00/09:38:01

Plot file version 20 created 06-JAN-2009 10:57:09

J1510-05 EZ018B.UVDATA.1

Freq = 1.6270 GHz, Bw = 8.000 MH No calibration applied and no bandpass applied

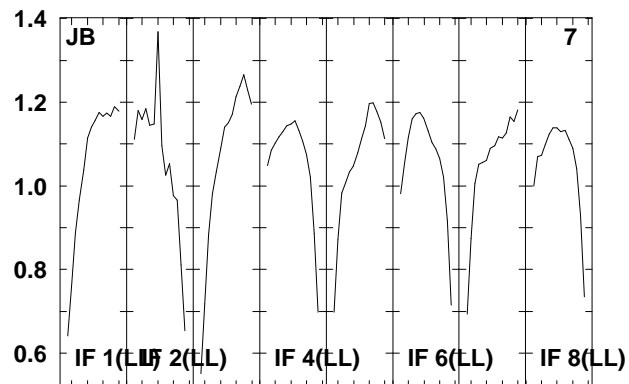
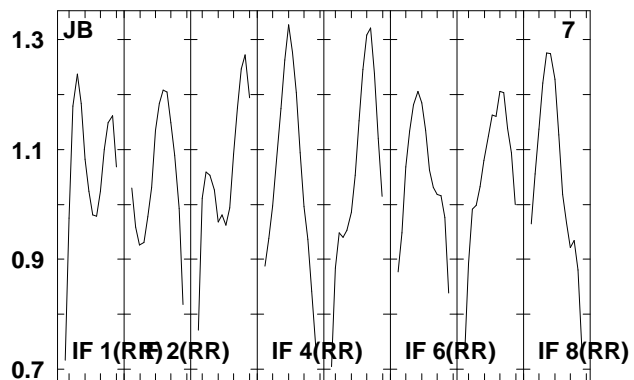
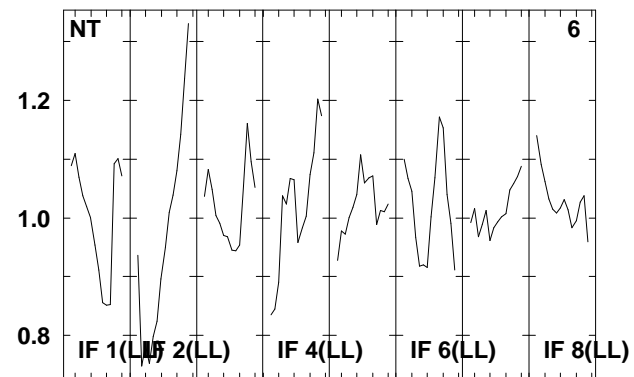
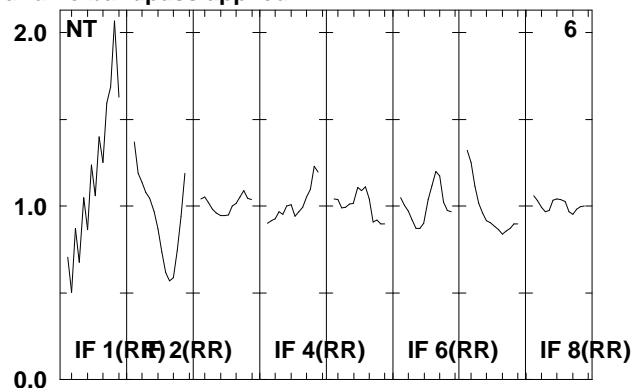
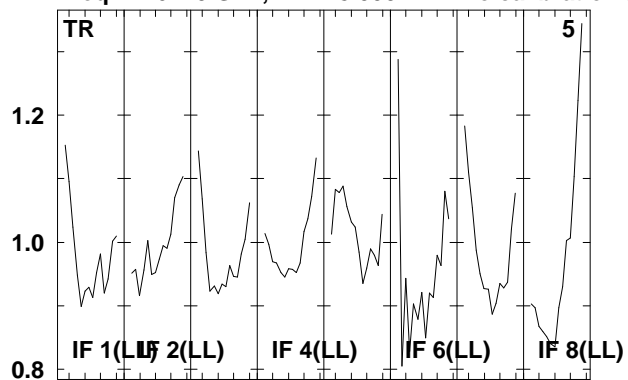

Lower frame: Real Jy  
Total-power spectrum Antenna: \*  
Timerange: 00/09:35:03 to 00/09:38:01

Plot file version 21 created 06-JAN-2009 10:57:09

J150407 EZ018B.UVDATA.1

Freq = 1.6270 GHz, Bw = 8.000 MH No calibration applied and no bandpass applied

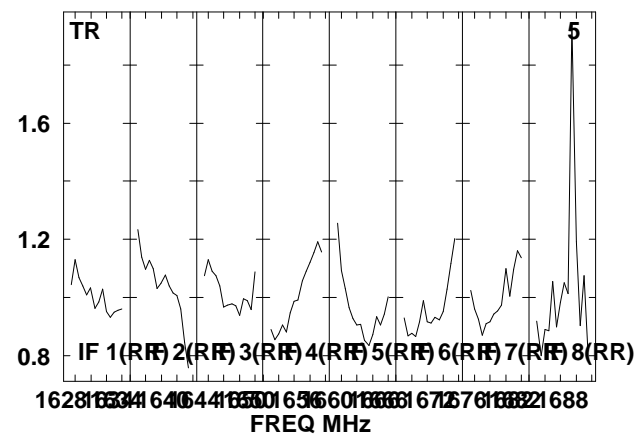
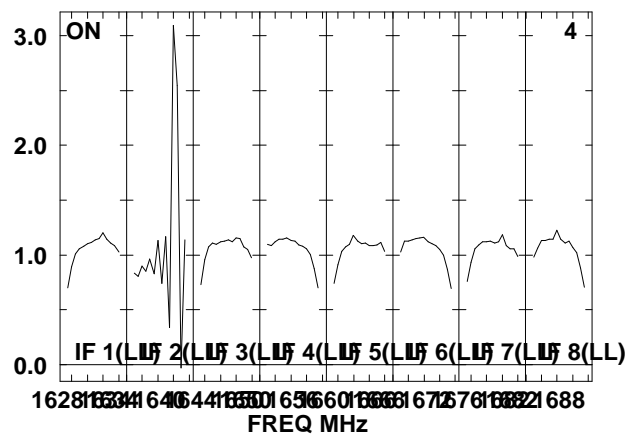
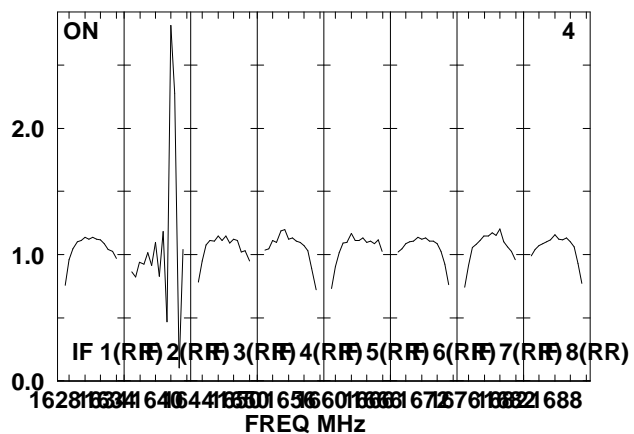
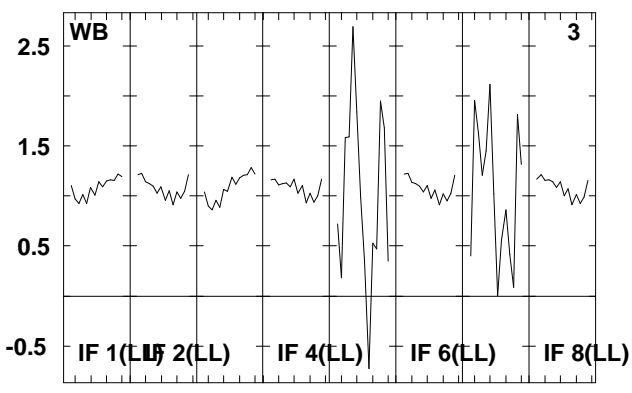
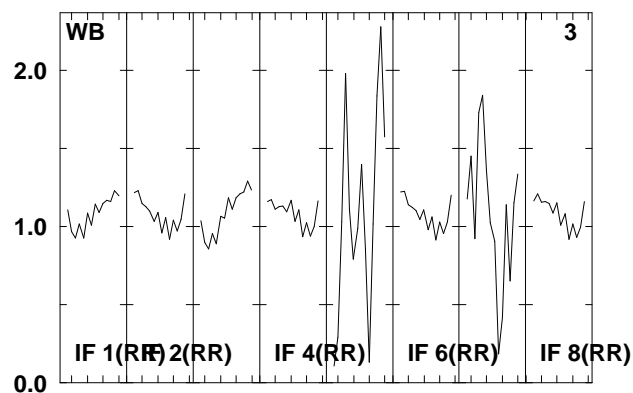
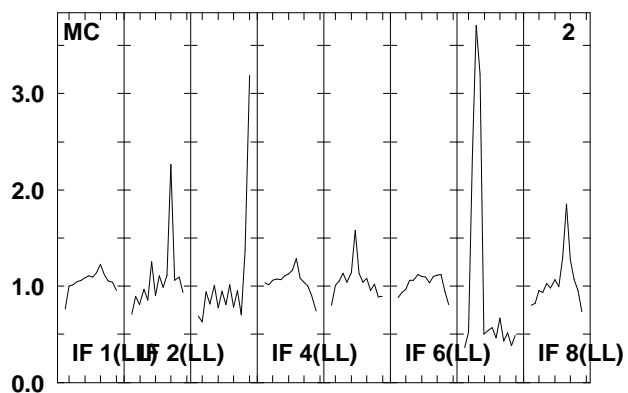
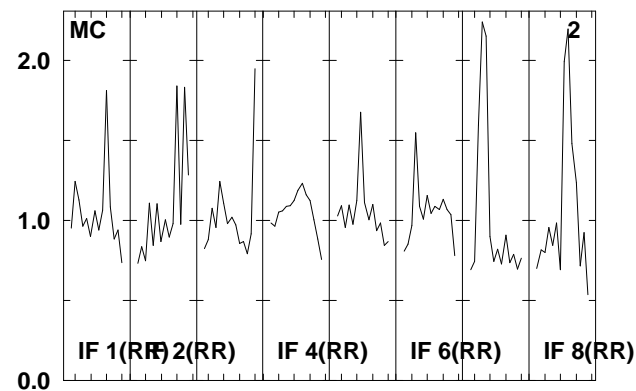
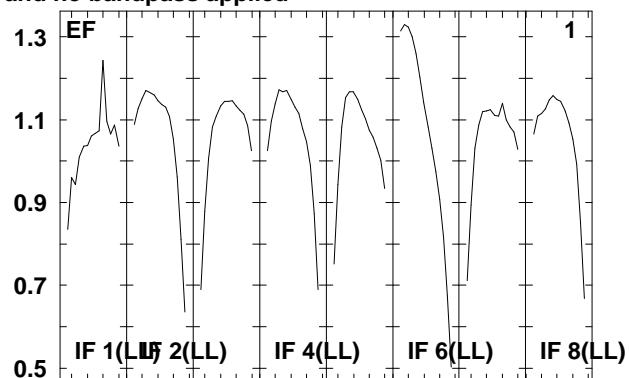
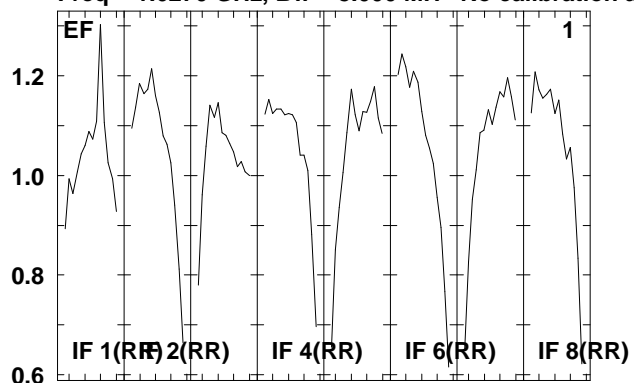

Lower frame: Real Jy

Total-power spectrum Antenna: \*

Timerange: 00/09:38:03 to 00/09:41:59

Plot file version 22 created 06-JAN-2009 10:57:10

J150407 EZ018B.UVDATA.1

Freq = 1.6270 GHz, Bw = 8.000 MH No calibration applied and no bandpass applied

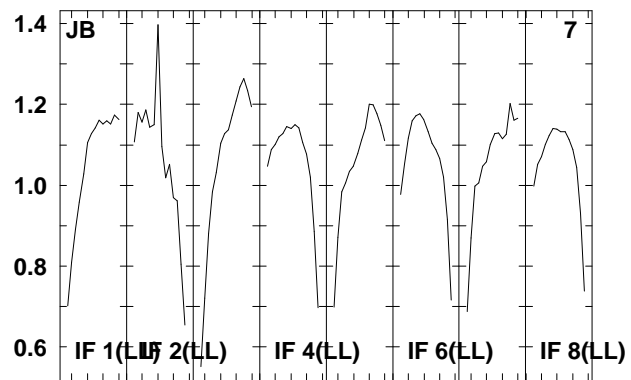
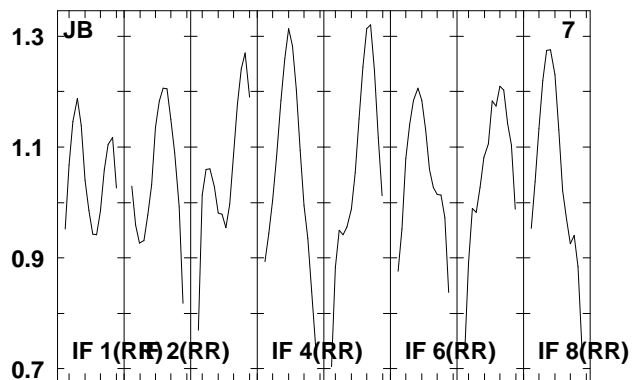
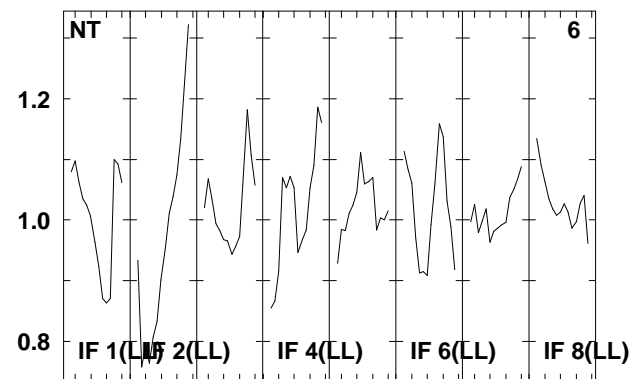
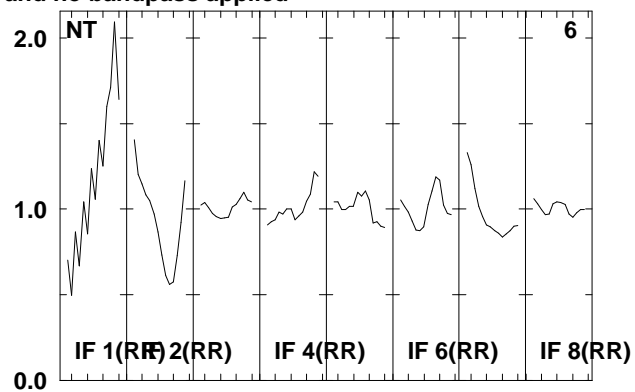
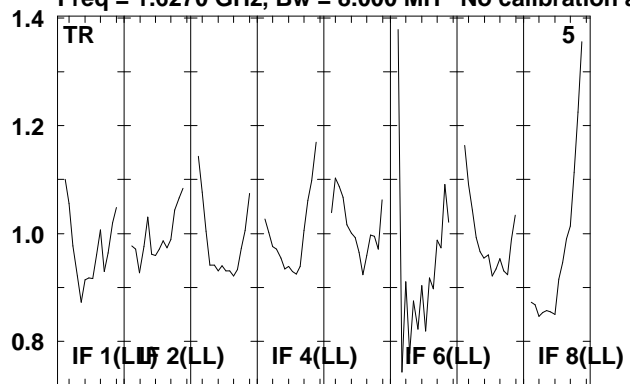

Lower frame: Real Jy  
Total-power spectrum Antenna: \*  
Timerange: 00/09:38:03 to 00/09:41:59

Plot file version 23 created 06-JAN-2009 10:57:10

J1510-05 EZ018B.UVDATA.1

Freq = 1.6270 GHz, Bw = 8.000 MH No calibration applied and no bandpass applied

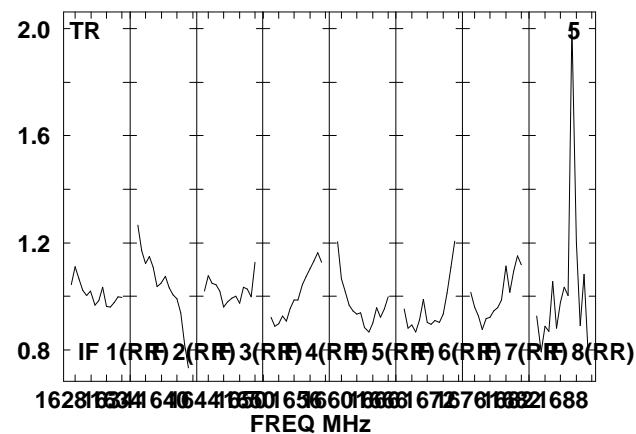
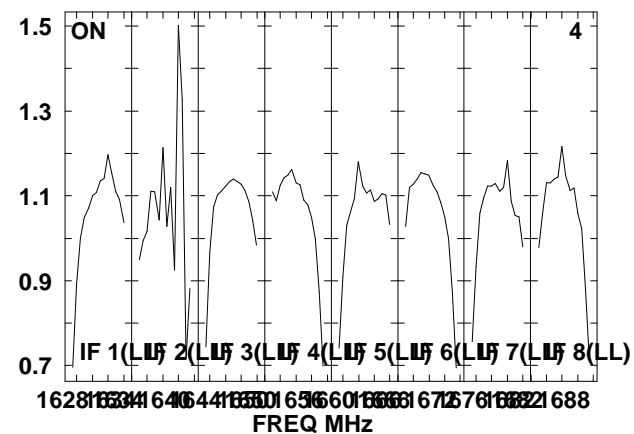
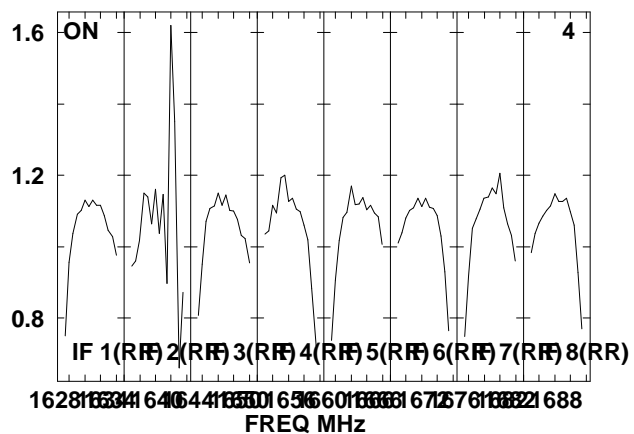
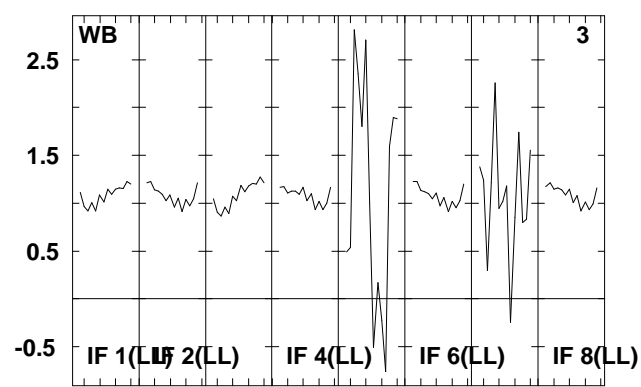
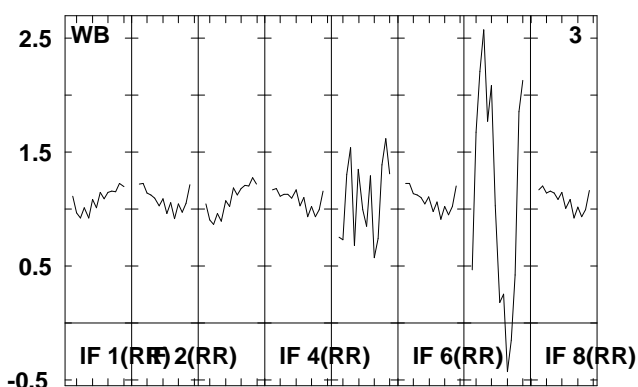
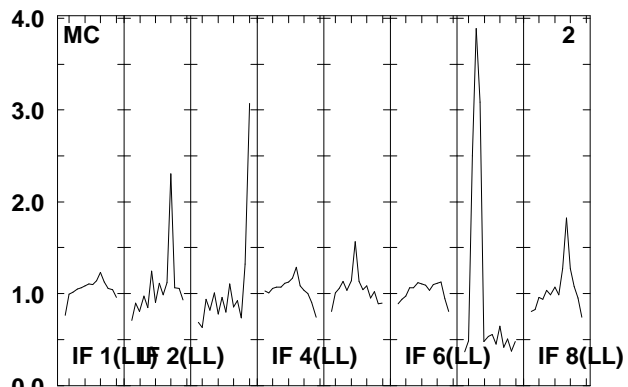
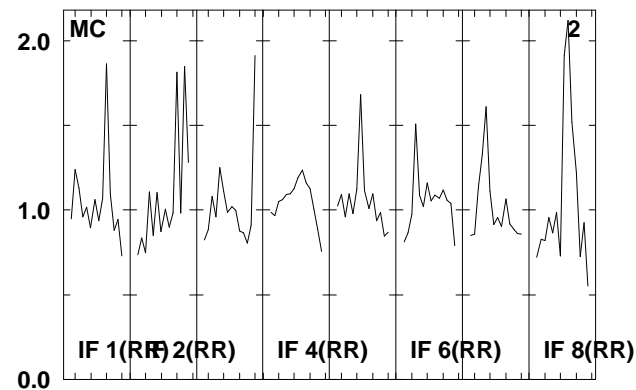
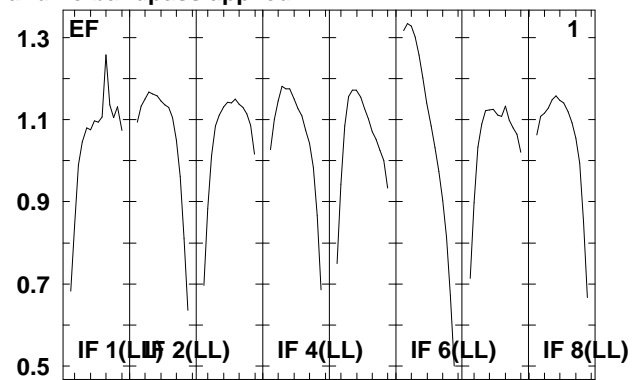
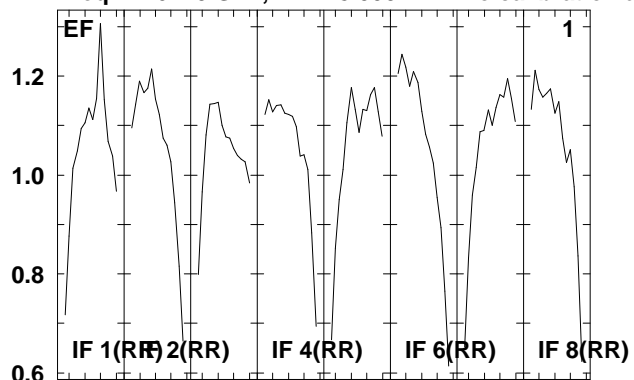

Lower frame: Real Jy  
Total-power spectrum Antenna: \*  
Timerange: 00/09:42:01 to 00/09:45:01

Plot file version 24 created 06-JAN-2009 10:57:10

J1510-05 EZ018B.UVDATA.1

Freq = 1.6270 GHz, Bw = 8.000 MH No calibration applied and no bandpass applied

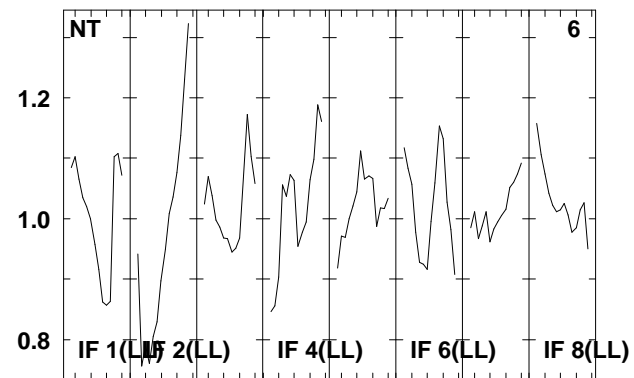
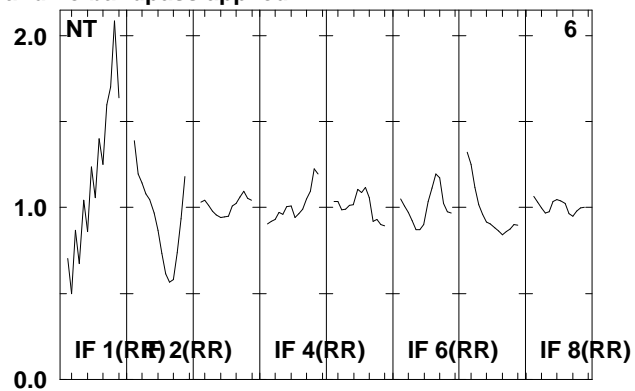
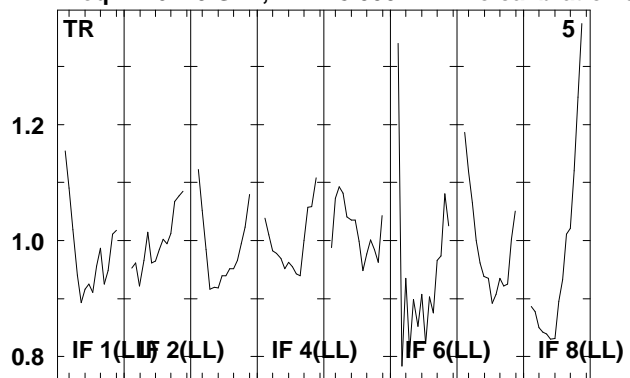

Lower frame: Real Jy  
Total-power spectrum Antenna: \*  
Timerange: 00/09:42:01 to 00/09:45:01



Plot file version 25 created 06-JAN-2009 10:57:11

J150407 EZ018B.UVDATA.1

Freq = 1.6270 GHz, Bw = 8.000 MH No calibration applied and no bandpass applied

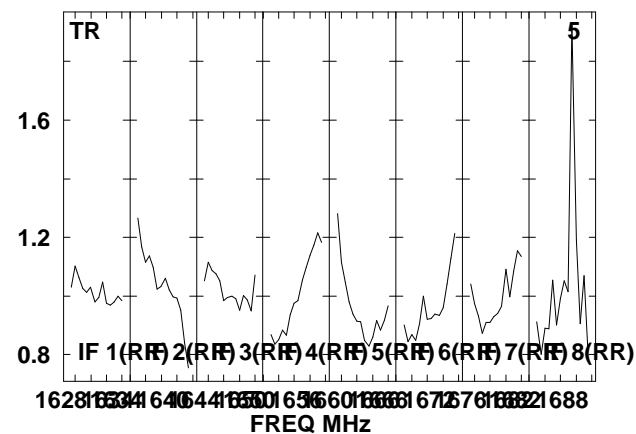
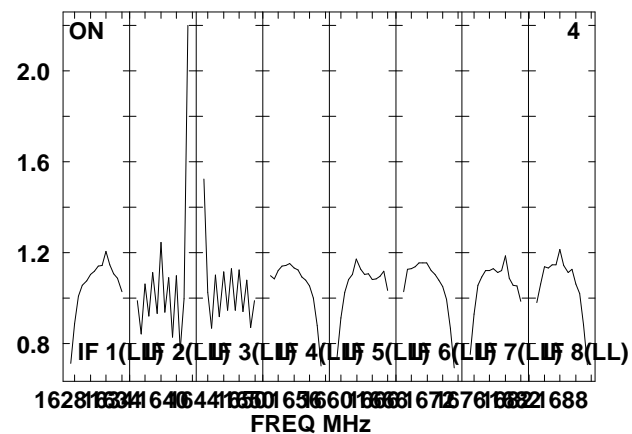
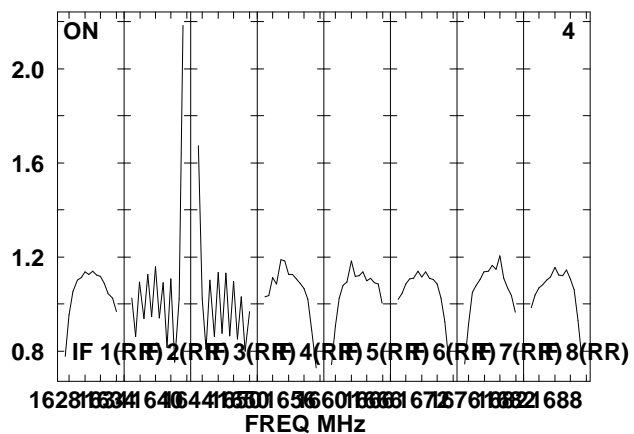
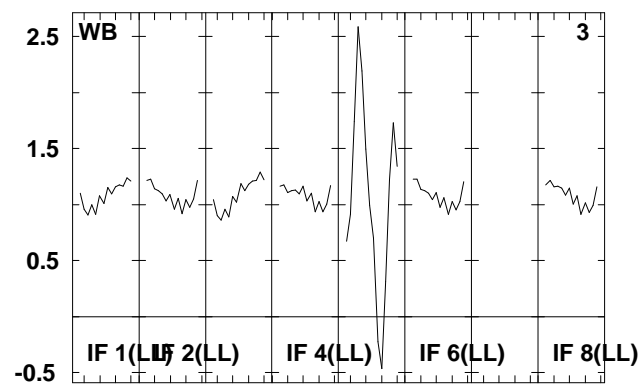
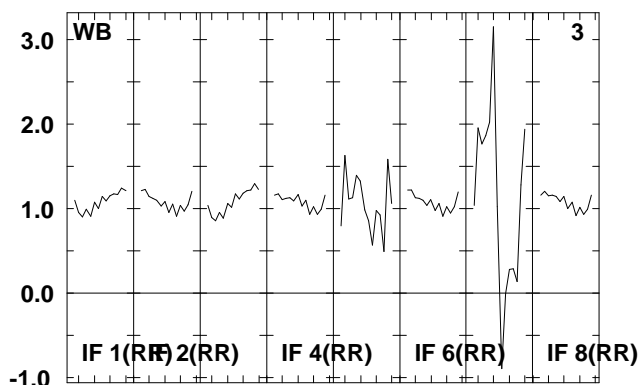
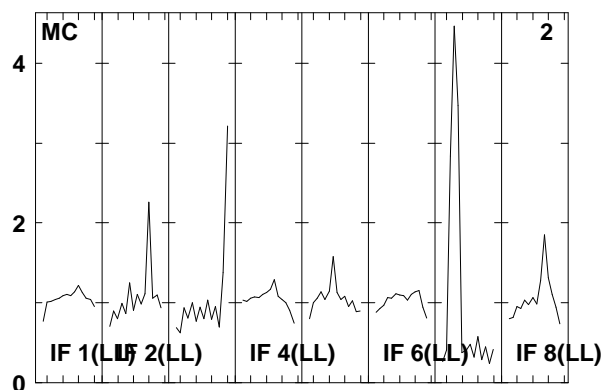
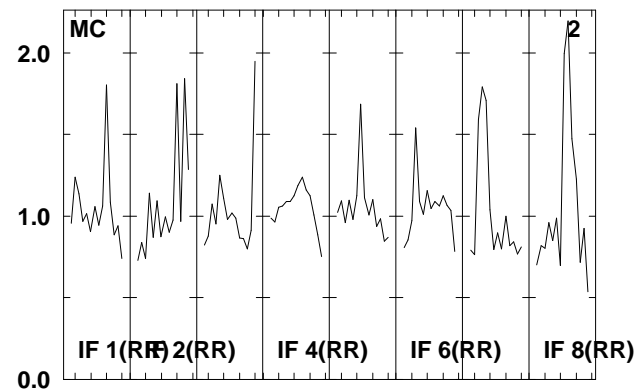
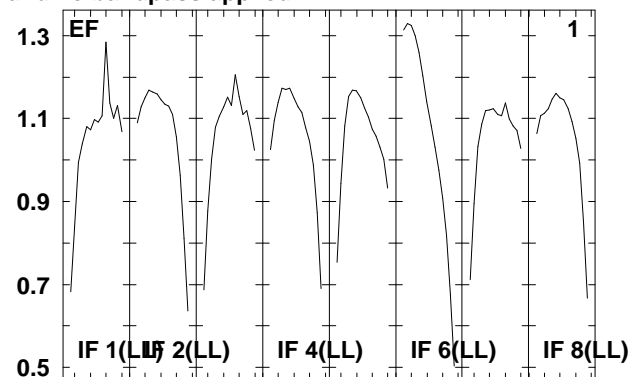
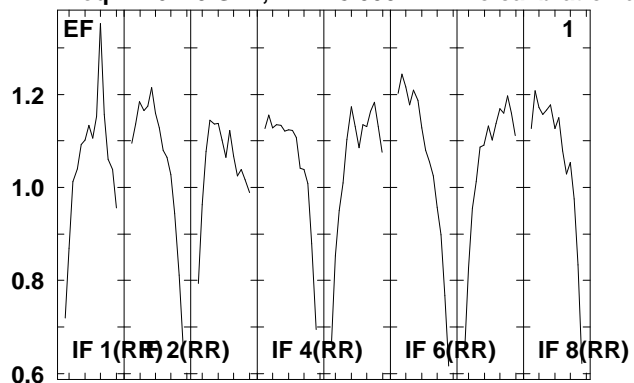

Lower frame: Real Jy

Total-power spectrum Antenna: \*

Timerange: 00/09:45:03 to 00/09:48:21

Plot file version 26 created 06-JAN-2009 10:57:11

J150407 EZ018B.UVDATA.1

Freq = 1.6270 GHz, Bw = 8.000 MH No calibration applied and no bandpass applied

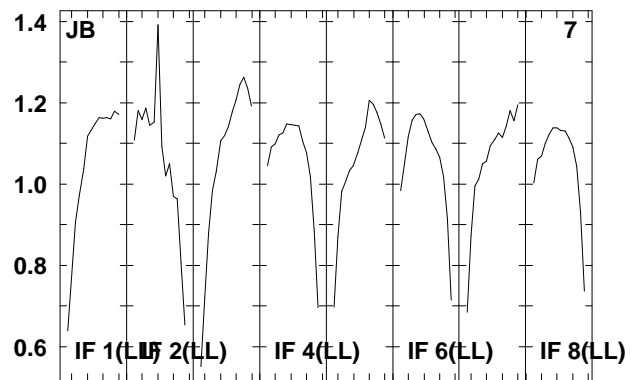
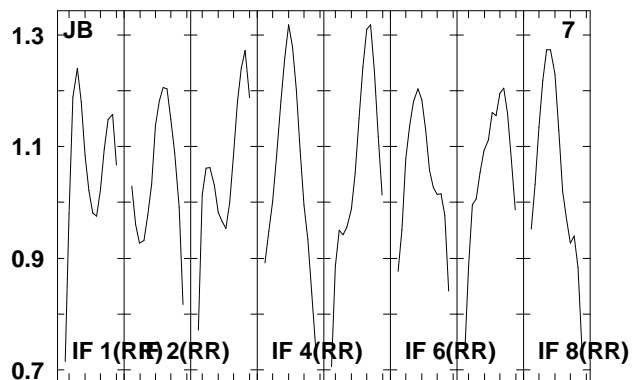
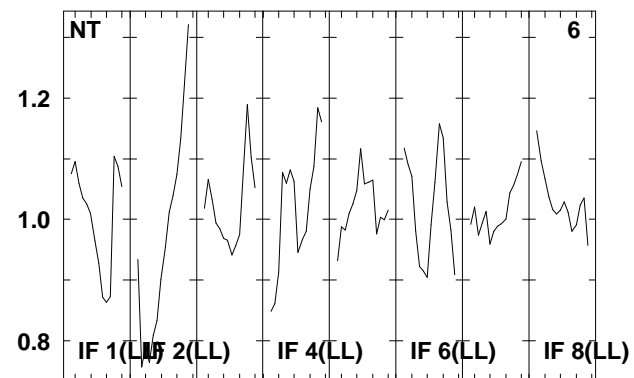
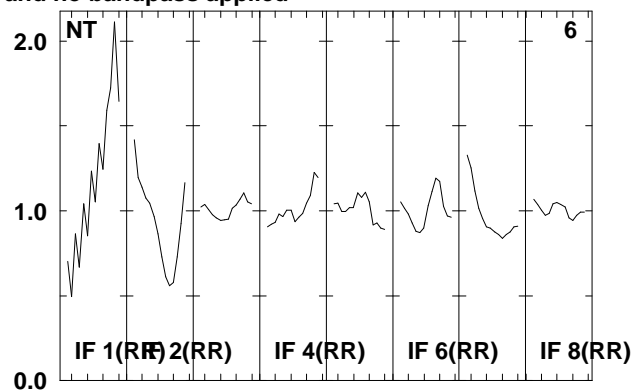
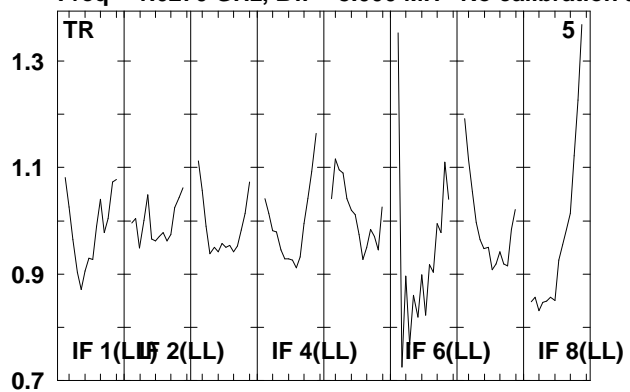

Lower frame: Real Jy  
Total-power spectrum Antenna: \*  
Timerange: 00/09:45:03 to 00/09:48:21

Plot file version 27 created 06-JAN-2009 10:57:11

J1510-05 EZ018B.UVDATA.1

Freq = 1.6270 GHz, Bw = 8.000 MH No calibration applied and no bandpass applied

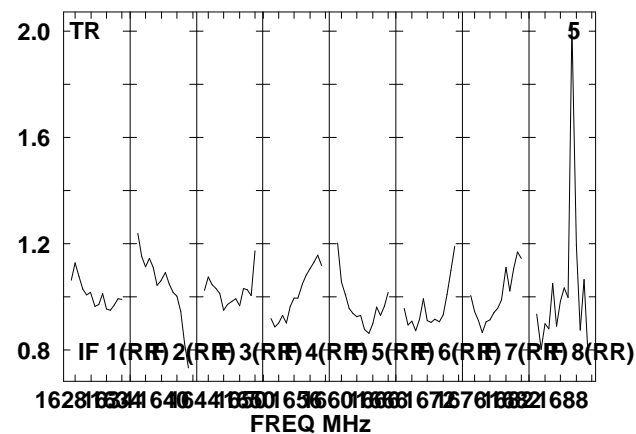
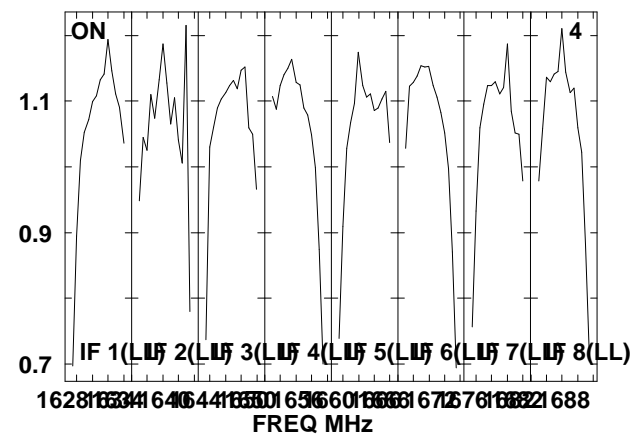
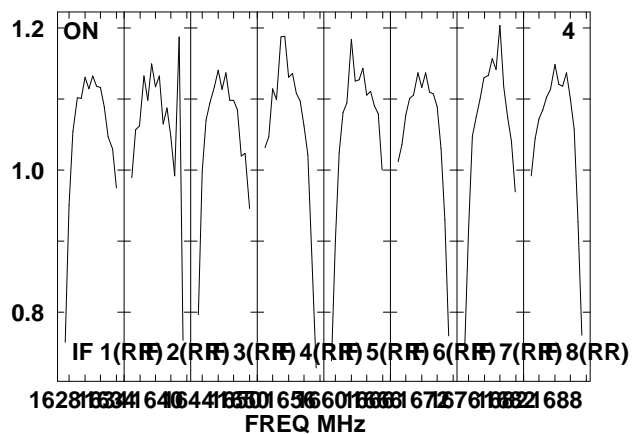
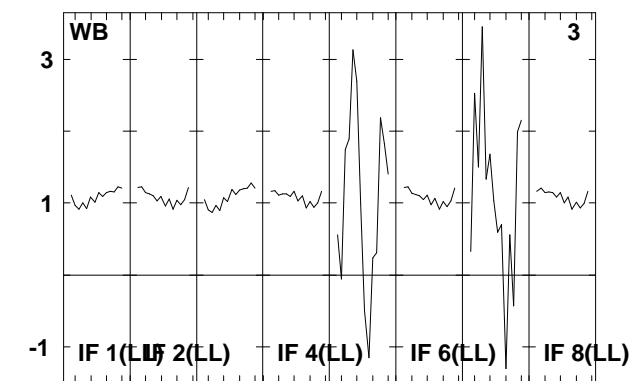
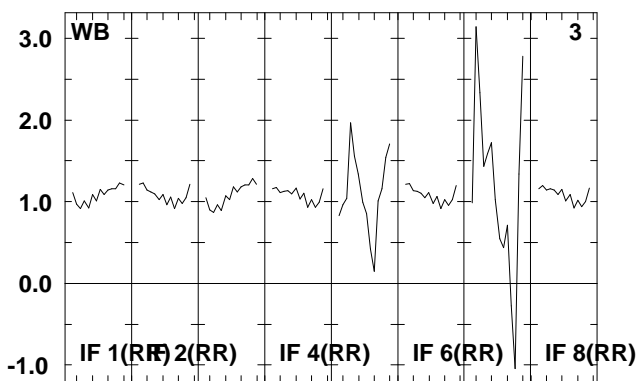
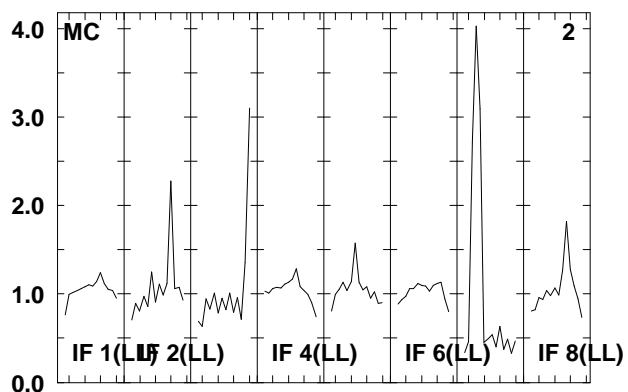
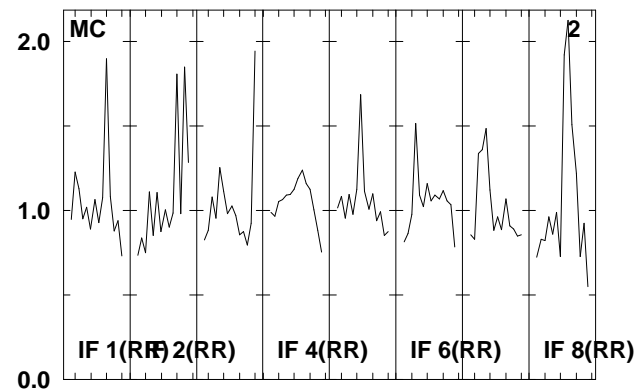
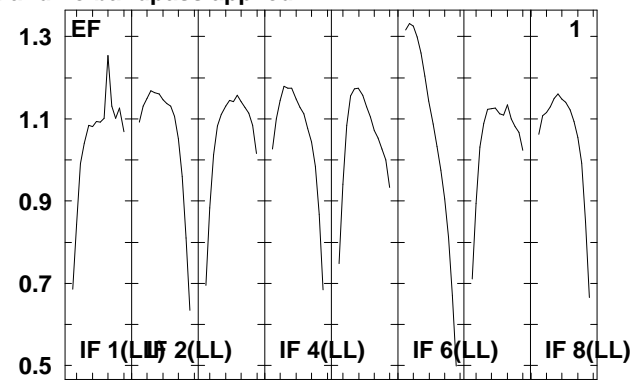
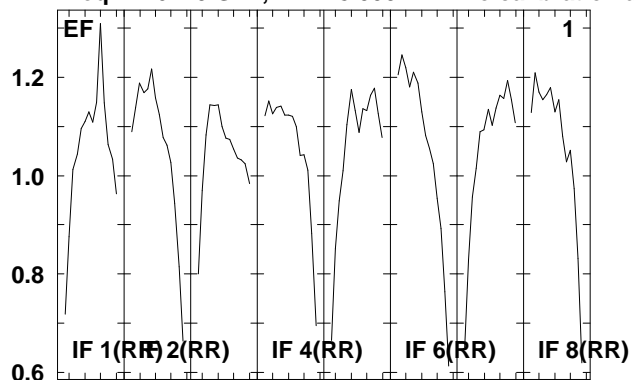

Lower frame: Real Jy

Total-power spectrum Antenna: \*

Timerange: 00/09:50:03 to 00/09:52:59

Plot file version 28 created 06-JAN-2009 10:57:12

J1510-05 EZ018B.UVDATA.1

Freq = 1.6270 GHz, Bw = 8.000 MH No calibration applied and no bandpass applied

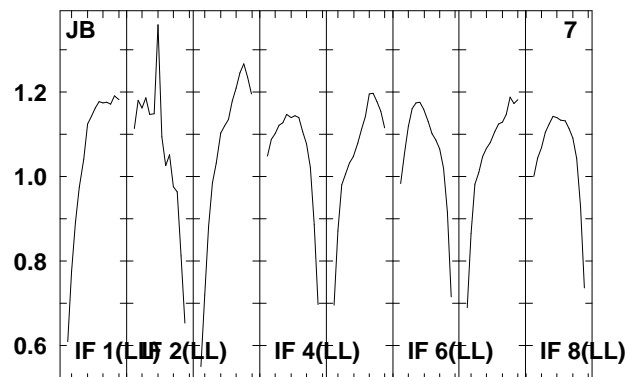
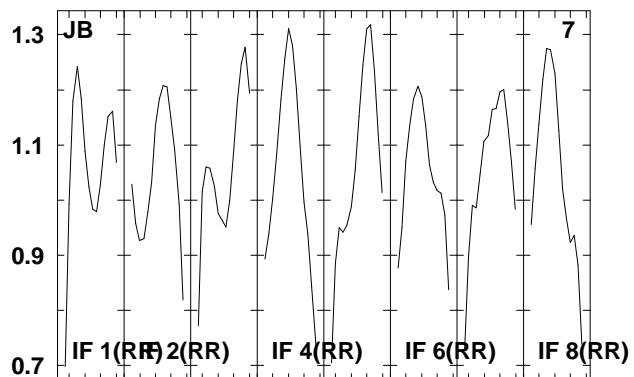
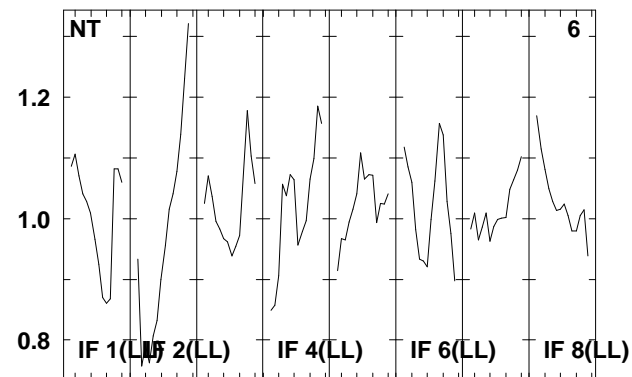
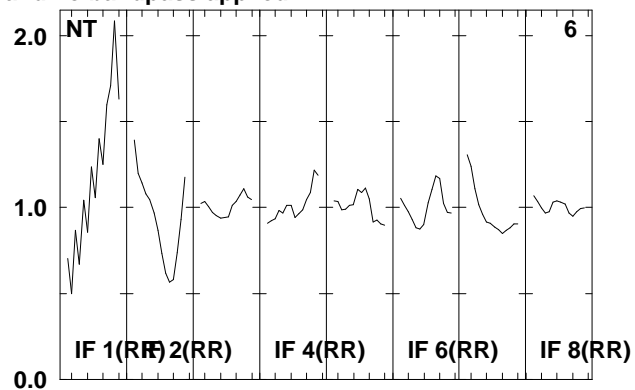
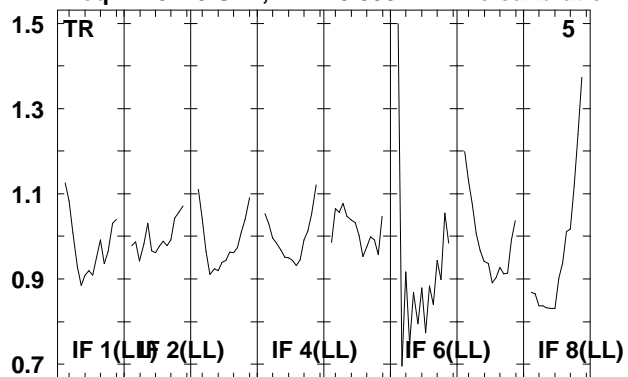

Lower frame: Real Jy  
Total-power spectrum Antenna: \*  
Timerange: 00/09:50:03 to 00/09:52:59

Plot file version 29 created 06-JAN-2009 10:57:12

J150407 EZ018B.UVDATA.1

Freq = 1.6270 GHz, Bw = 8.000 MH No calibration applied and no bandpass applied

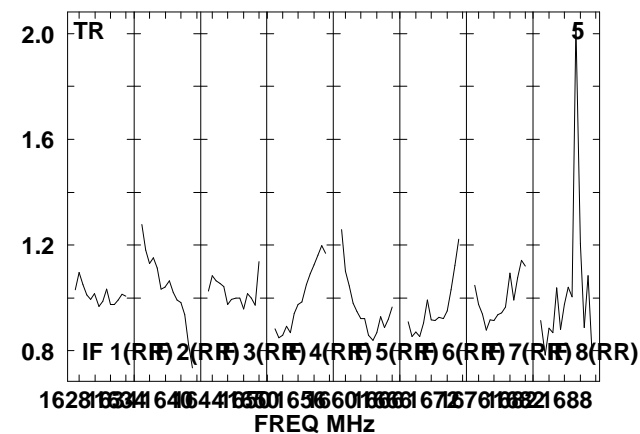
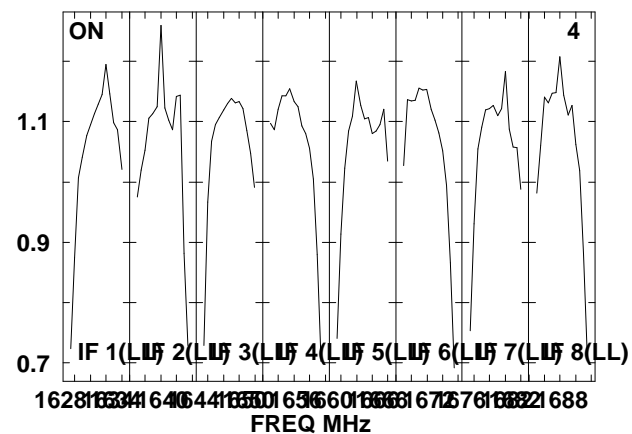
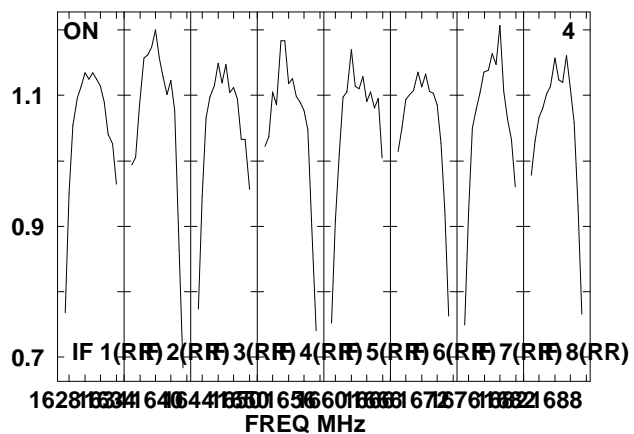
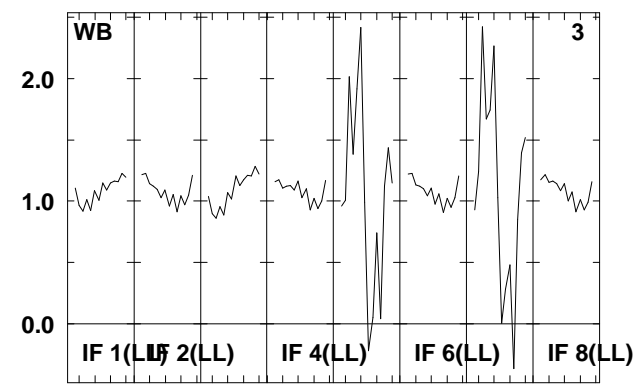
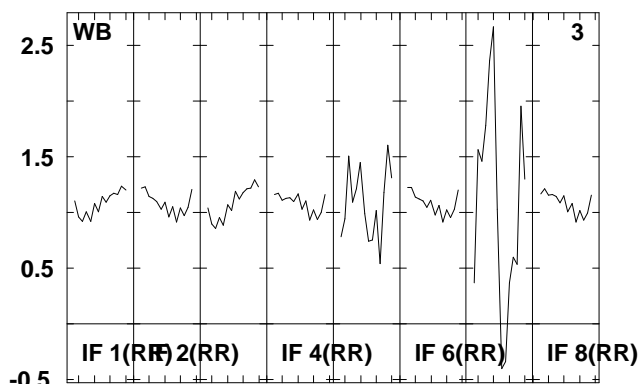
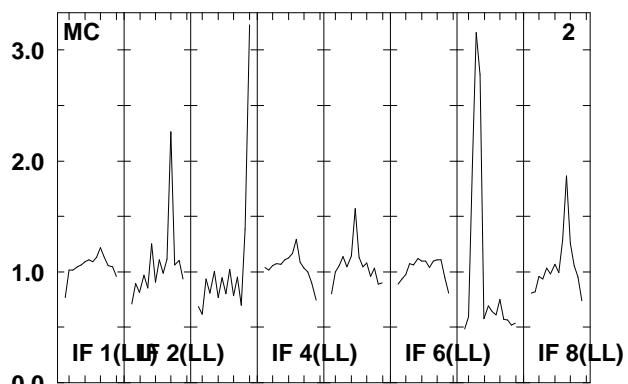
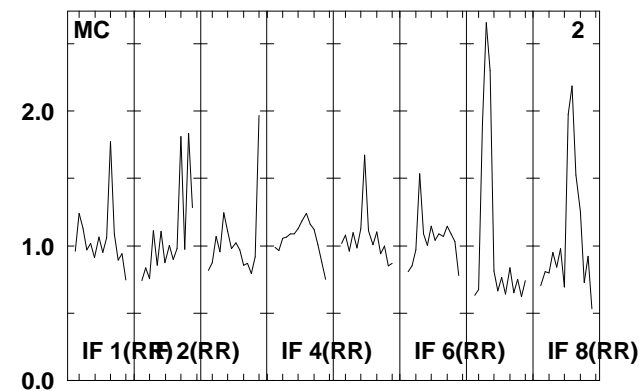
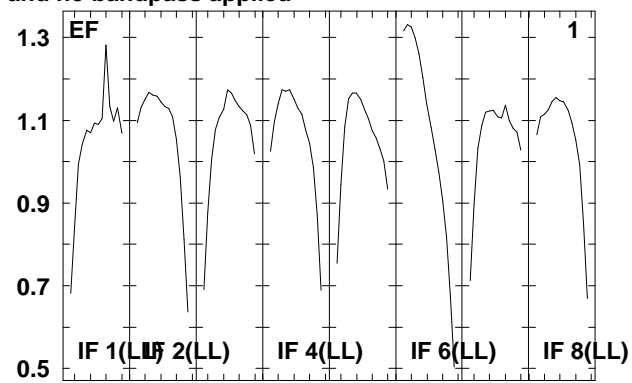
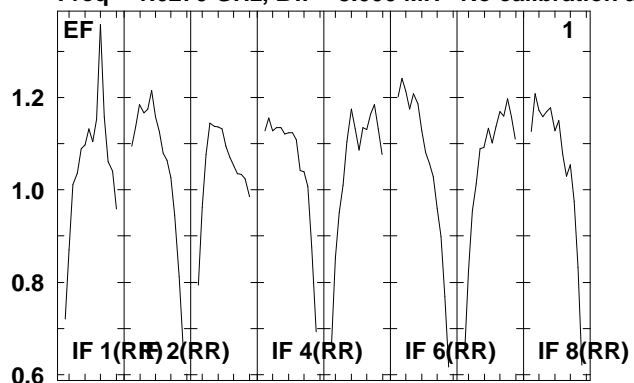

Lower frame: Real Jy  
Total-power spectrum Antenna: \*  
Timerange: 00/09:53:01 to 00/09:57:01

Plot file version 30 created 06-JAN-2009 10:57:12

J150407 EZ018B.UVDATA.1

Freq = 1.6270 GHz, Bw = 8.000 MH No calibration applied and no bandpass applied

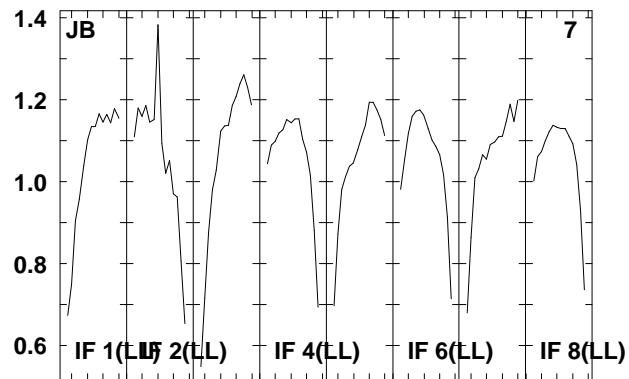
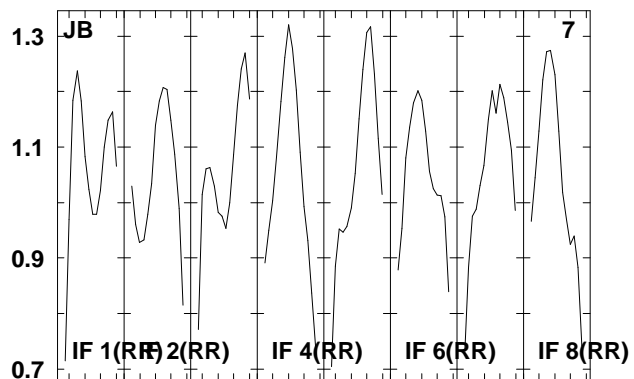
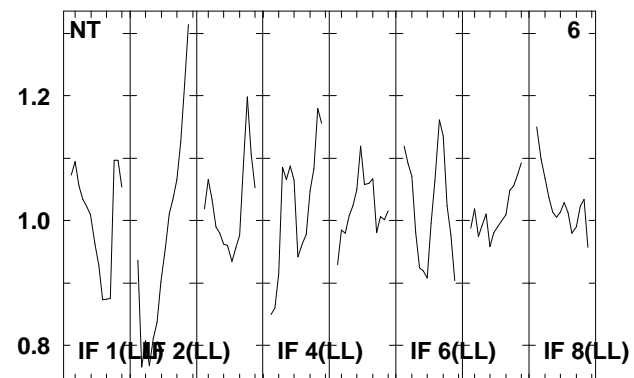
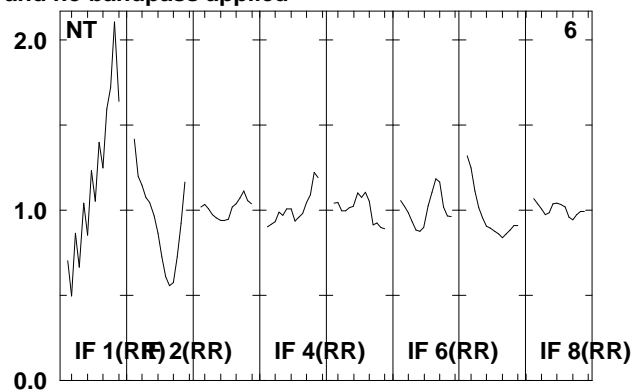
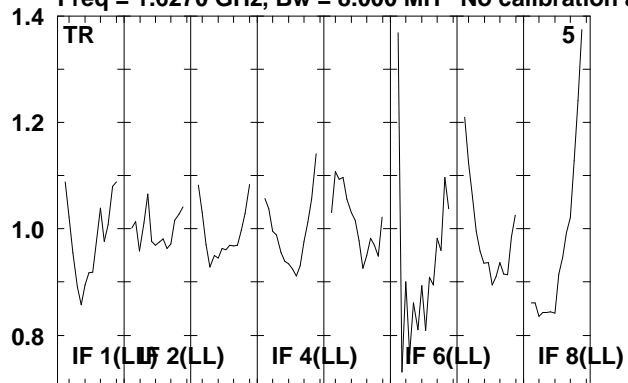

Lower frame: Real Jy  
Total-power spectrum Antenna: \*  
Timerange: 00/09:53:01 to 00/09:57:01

Plot file version 31 created 06-JAN-2009 10:57:13

J1510-05 EZ018B.UVDATA.1

Freq = 1.6270 GHz, Bw = 8.000 MH No calibration applied and no bandpass applied

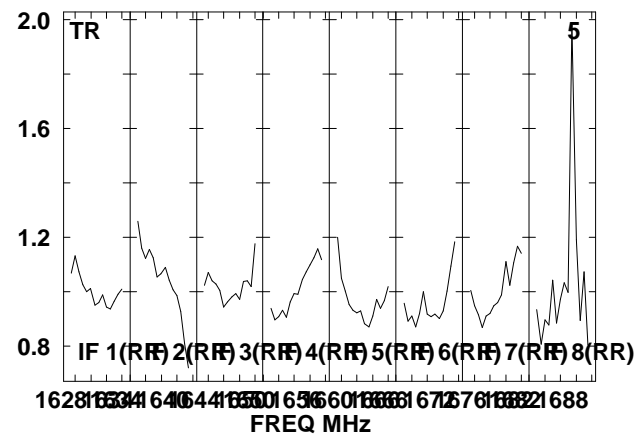
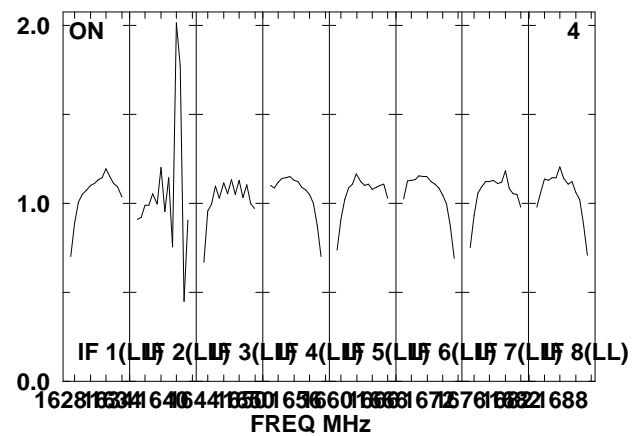
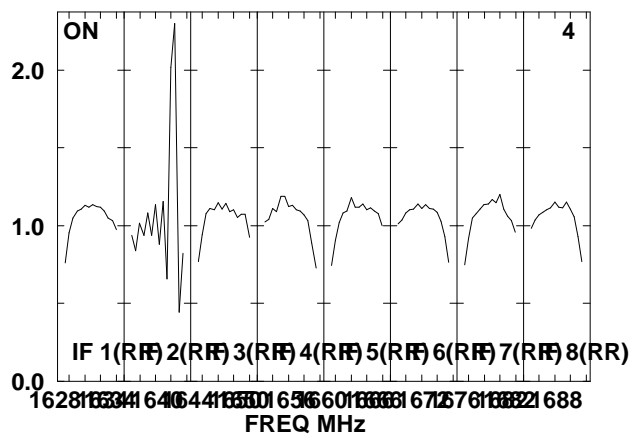
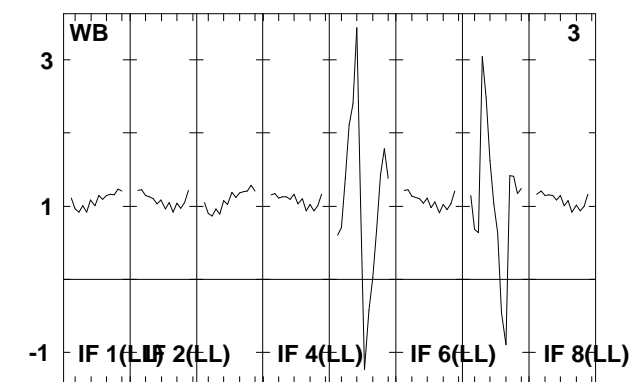
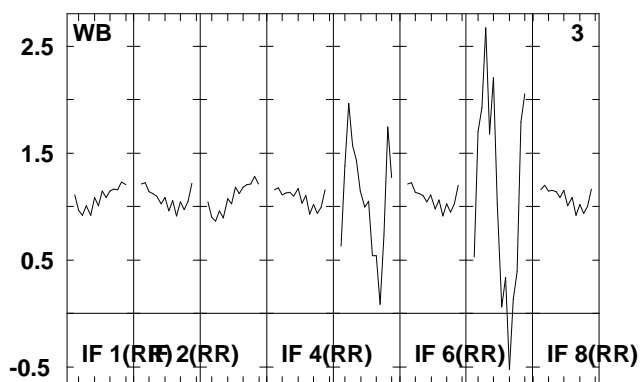
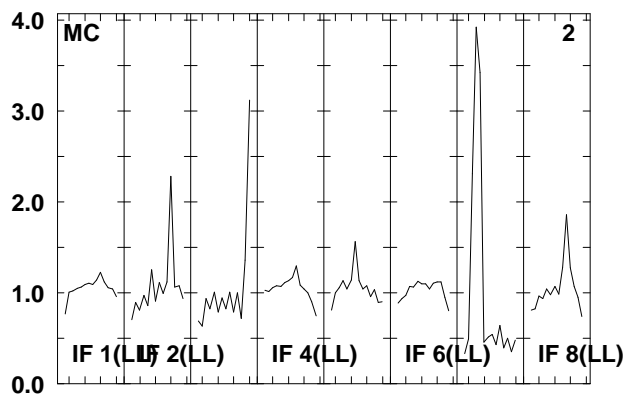
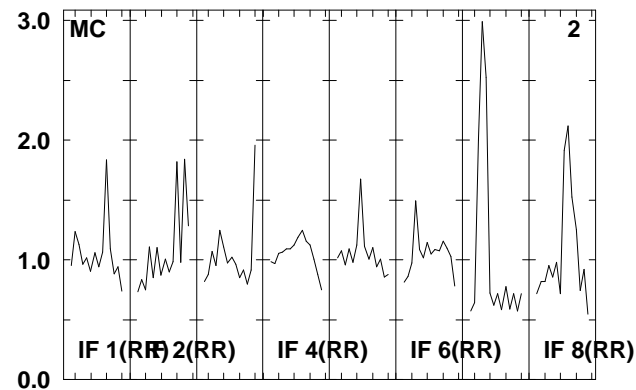
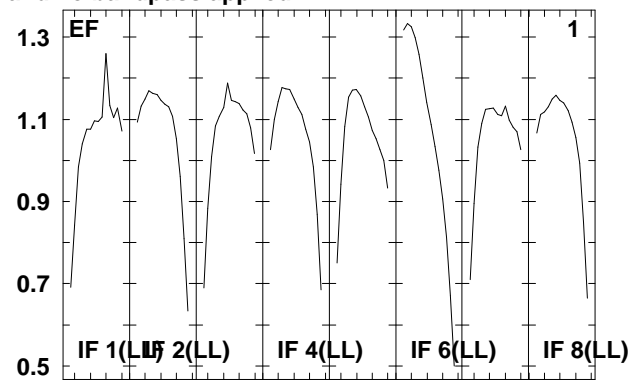
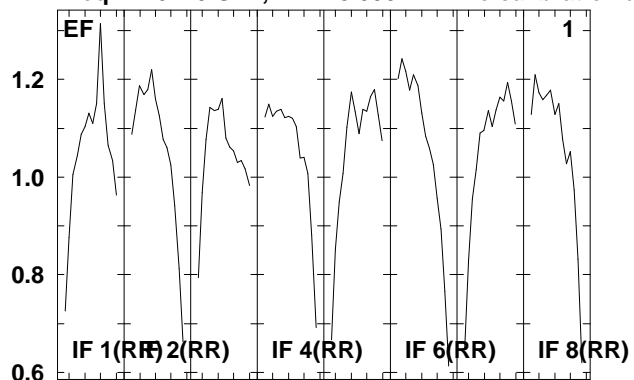

Lower frame: Real Jy  
Total-power spectrum Antenna: \*  
Timerange: 00/09:57:03 to 00/10:00:01

Plot file version 32 created 06-JAN-2009 10:57:13

J1510-05 EZ018B.UVDATA.1

Freq = 1.6270 GHz, Bw = 8.000 MH No calibration applied and no bandpass applied

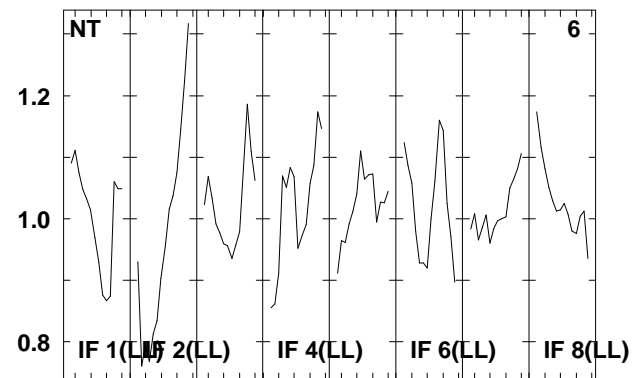
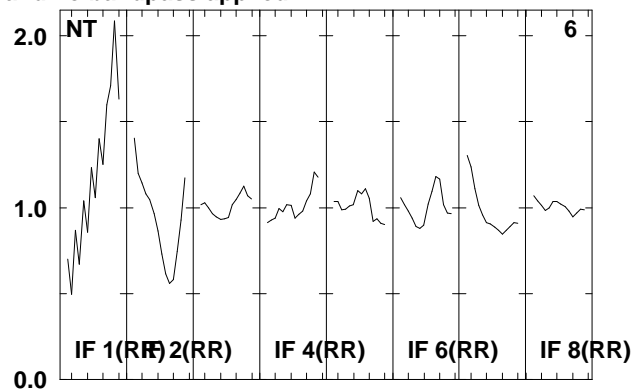
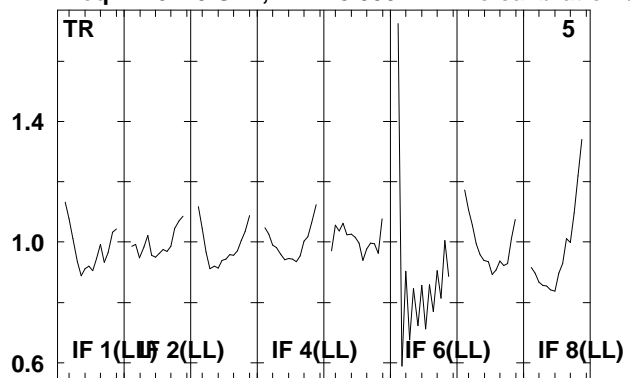

Lower frame: Real Jy  
Total-power spectrum Antenna: \*  
Timerange: 00/09:57:03 to 00/10:00:01



Plot file version 33 created 06-JAN-2009 10:57:13

J150407 EZ018B.UVDATA.1

Freq = 1.6270 GHz, Bw = 8.000 MH No calibration applied and no bandpass applied

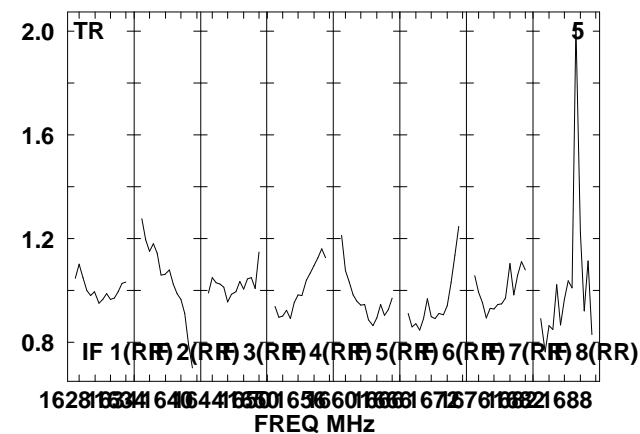
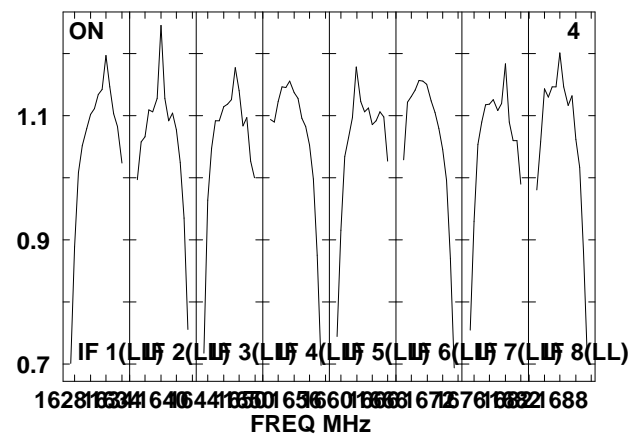
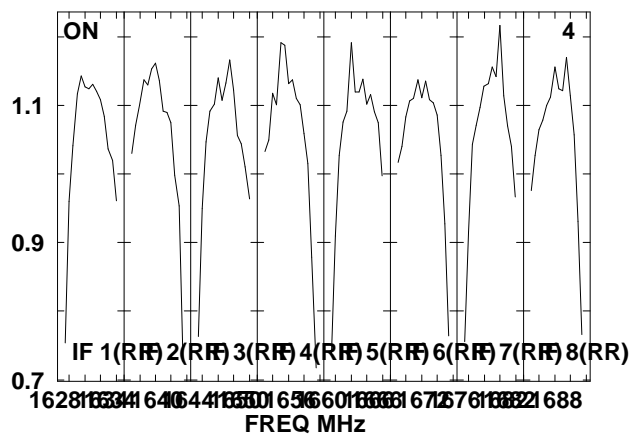
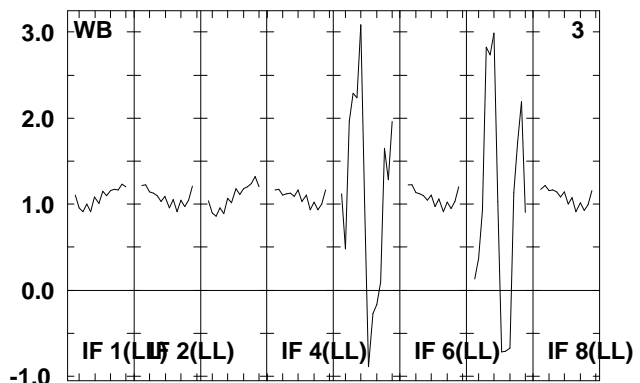
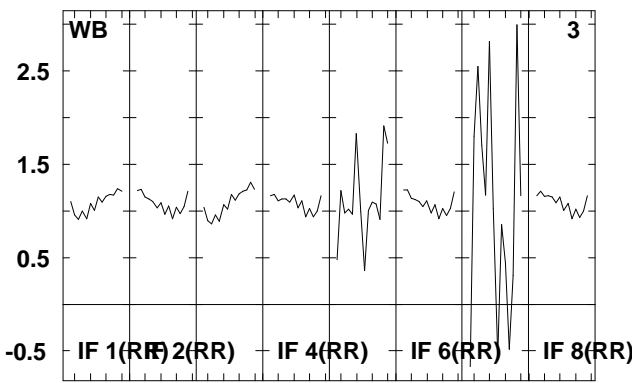
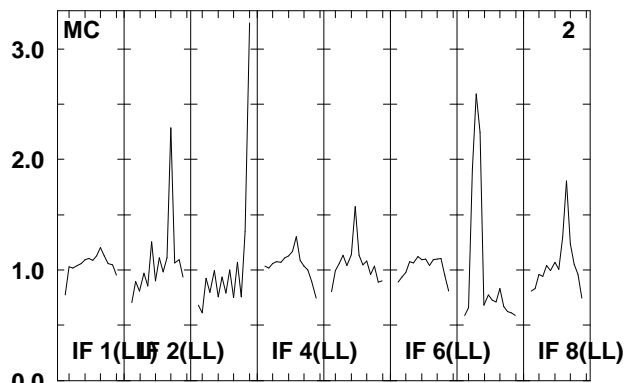
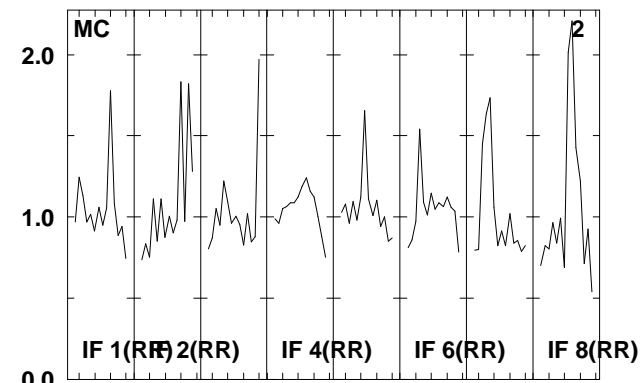
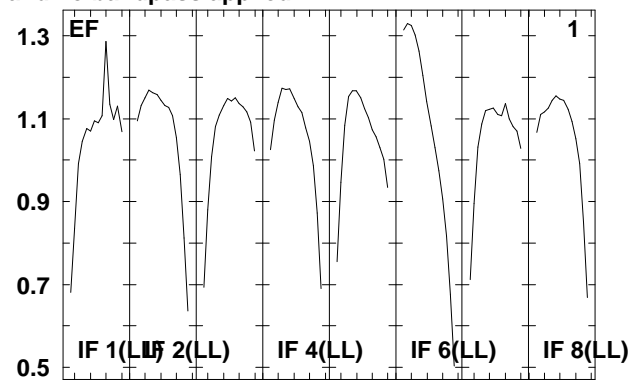
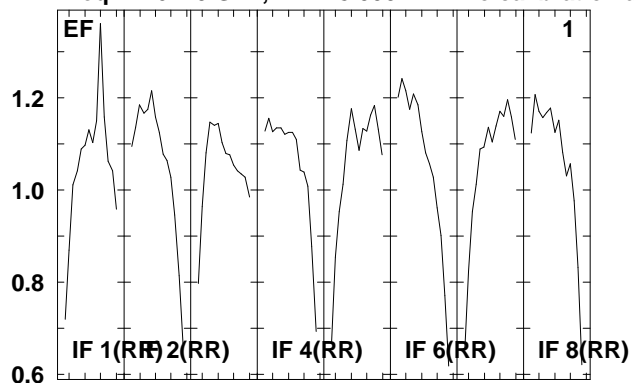

Lower frame: Real Jy  
Total-power spectrum Antenna: \*  
Timerange: 00/10/00:03 to 00/10/03:59

Plot file version 34 created 06-JAN-2009 10:57:14

J150407 EZ018B.UVDATA.1

Freq = 1.6270 GHz, Bw = 8.000 MH No calibration applied and no bandpass applied

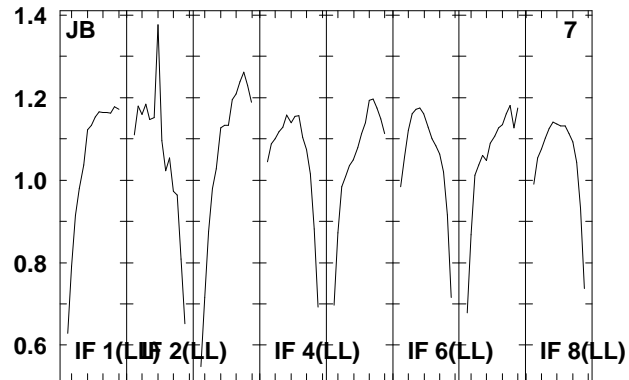
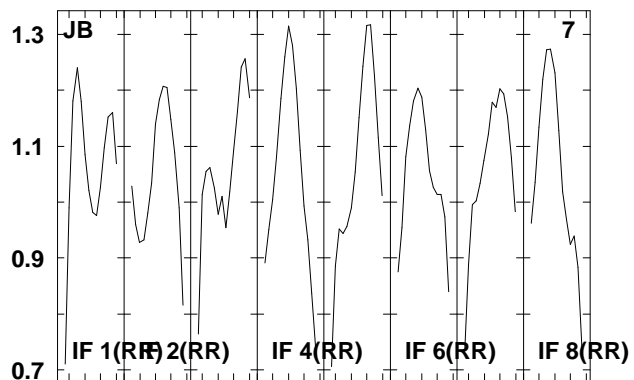
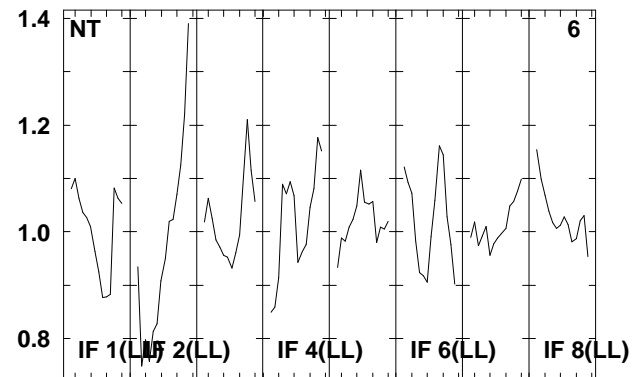
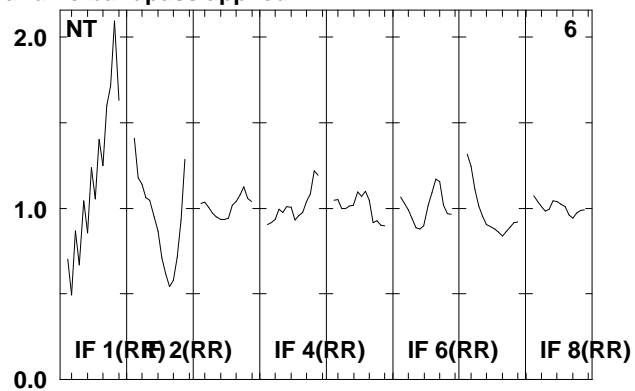
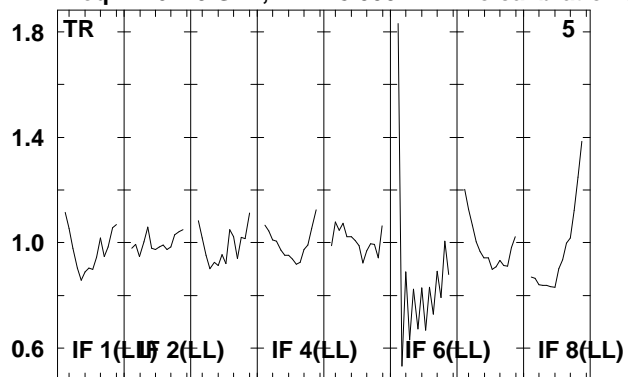

Lower frame: Real Jy  
Total-power spectrum Antenna: \*  
Timerange: 00/10:00:03 to 00/10:03:59

Plot file version 35 created 06-JAN-2009 10:57:14

J1510-05 EZ018B.UVDATA.1

Freq = 1.6270 GHz, Bw = 8.000 MH No calibration applied and no bandpass applied

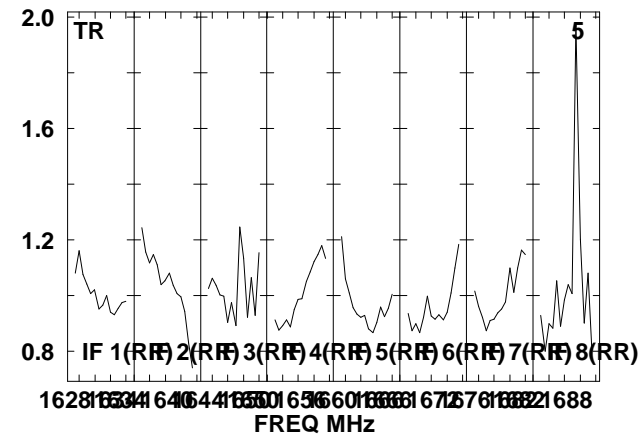
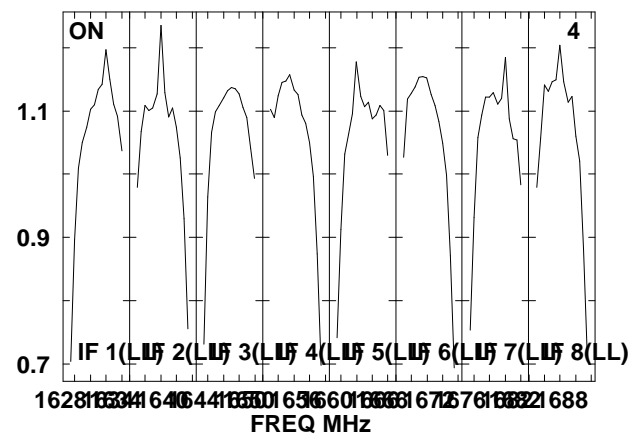
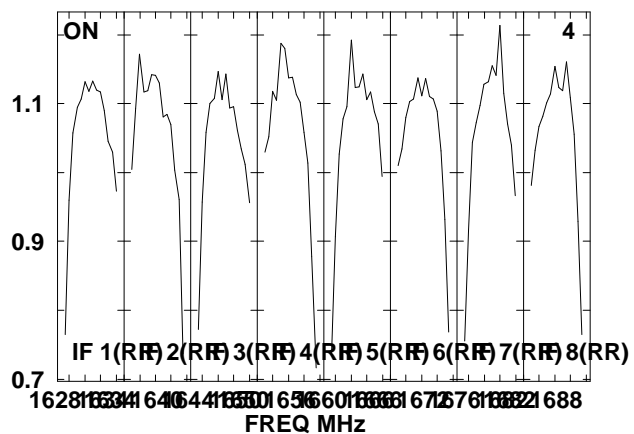
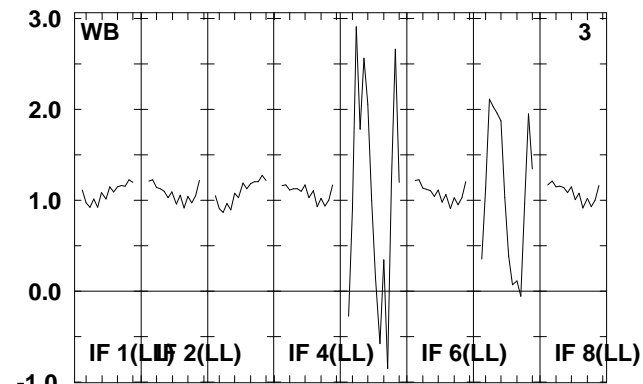
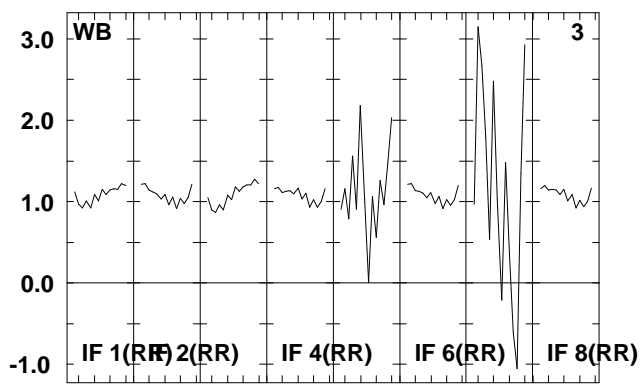
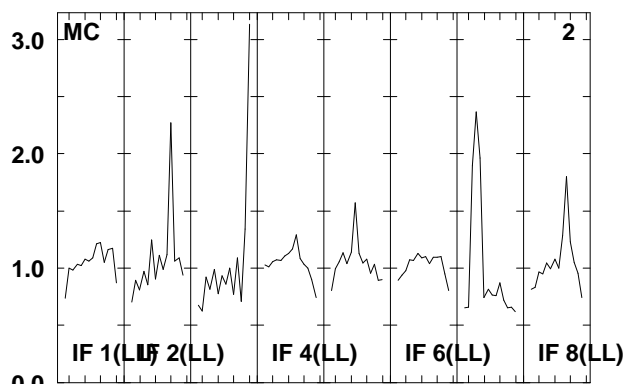
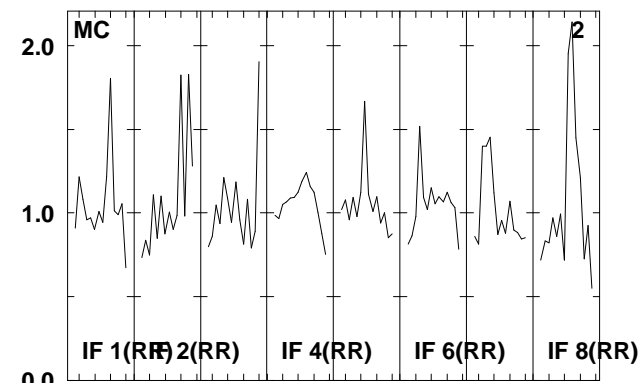
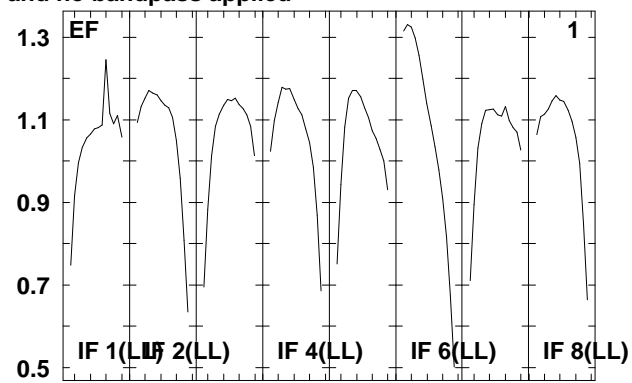
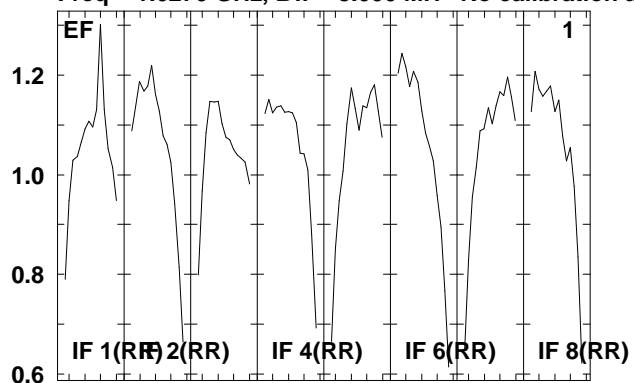

Lower frame: Real Jy  
Total-power spectrum Antenna: \*  
Timerange: 00/10:05:03 to 00/10:08:01

Plot file version 36 created 06-JAN-2009 10:57:15

J1510-05 EZ018B.UVDATA.1

Freq = 1.6270 GHz, Bw = 8.000 MH No calibration applied and no bandpass applied

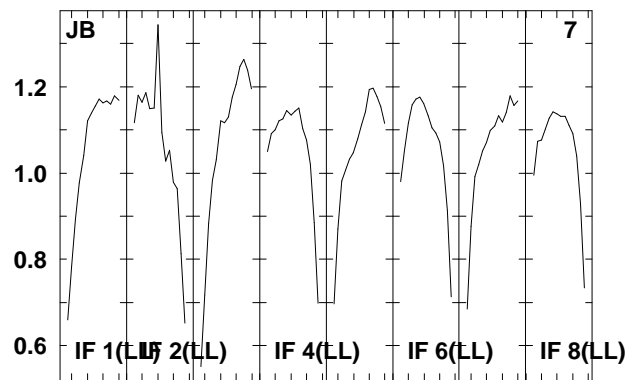
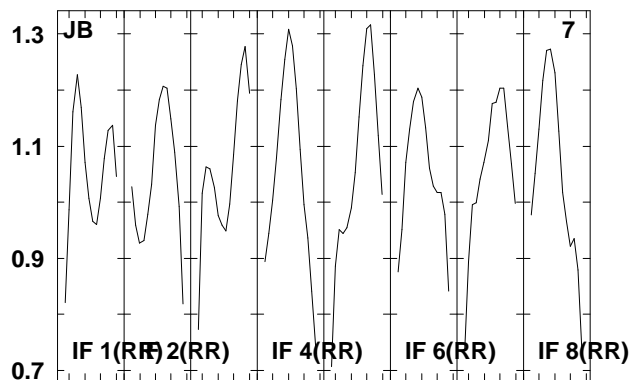
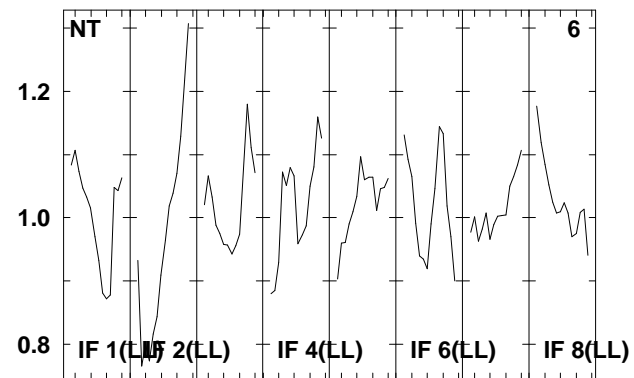
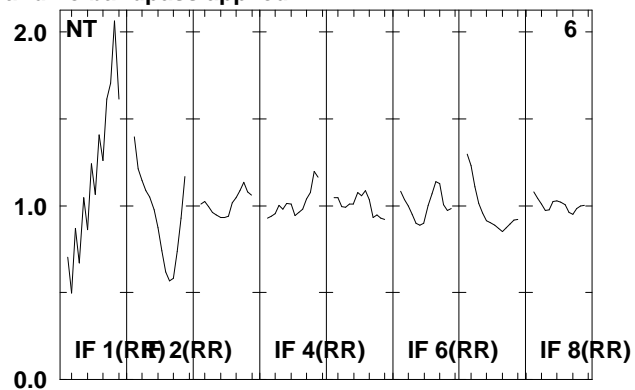
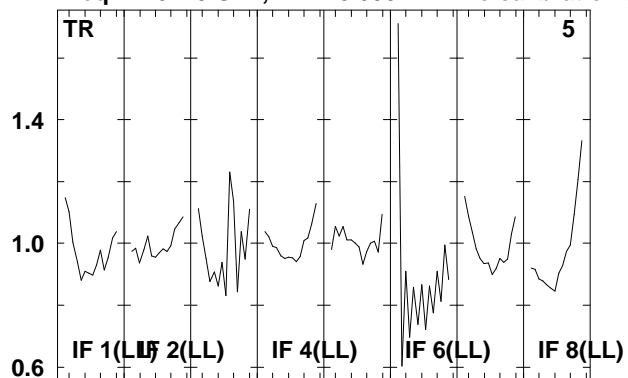

Lower frame: Real Jy  
Total-power spectrum Antenna: \*  
Timerange: 00/10:05:03 to 00/10:08:01

Plot file version 37 created 06-JAN-2009 10:57:15

J150407 EZ018B.UVDATA.1

Freq = 1.6270 GHz, Bw = 8.000 MH No calibration applied and no bandpass applied

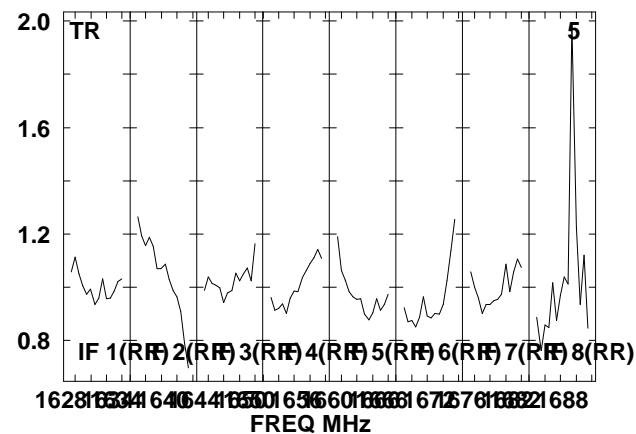
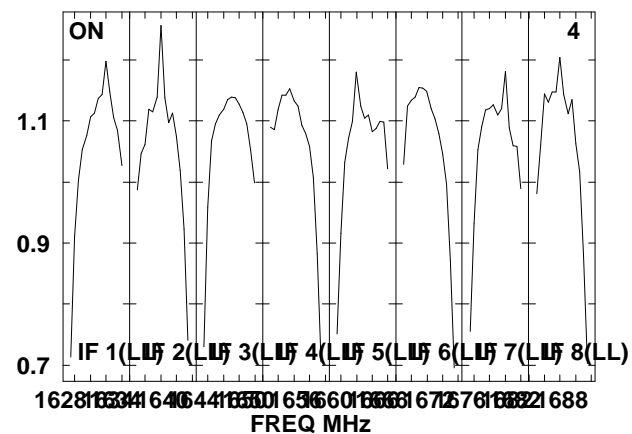
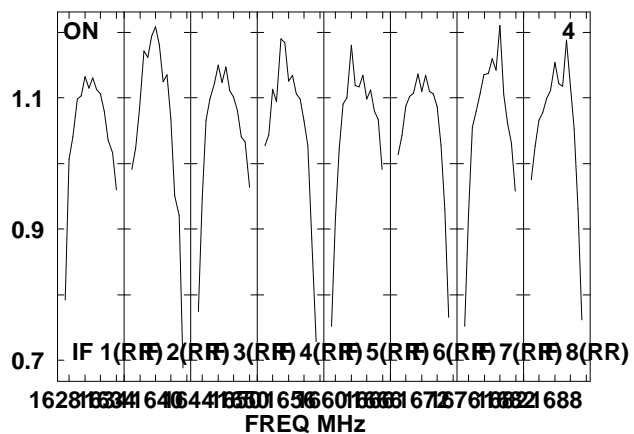
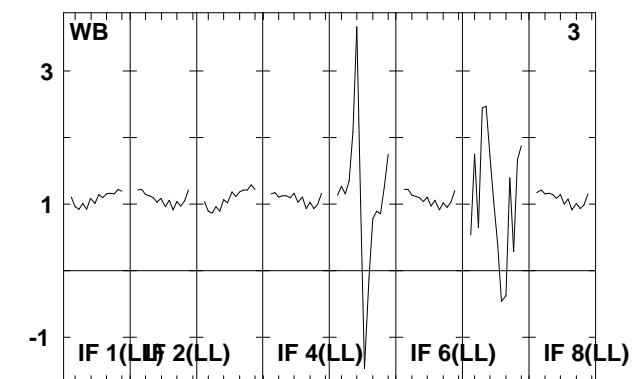
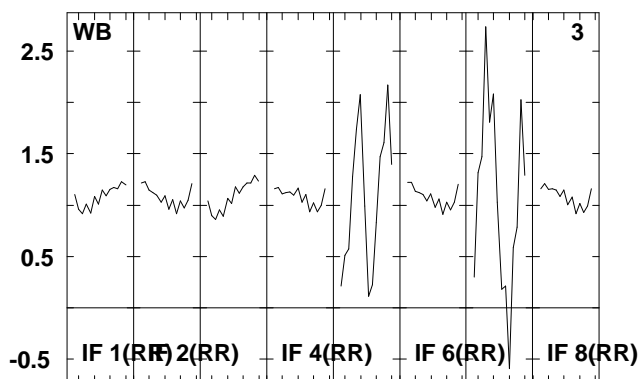
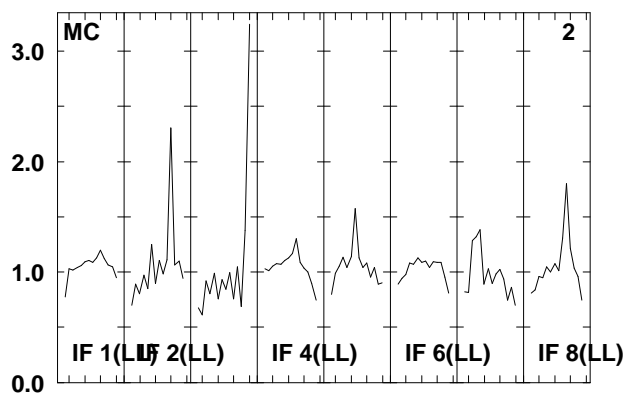
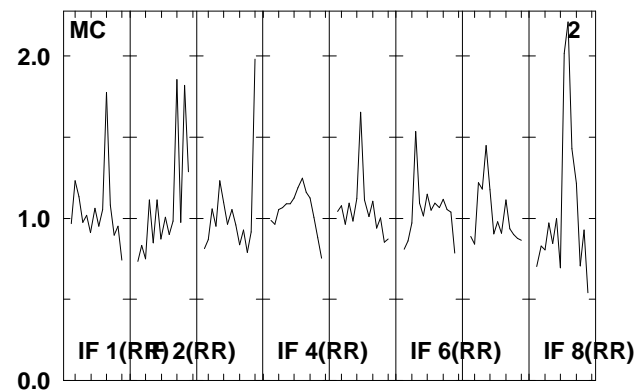
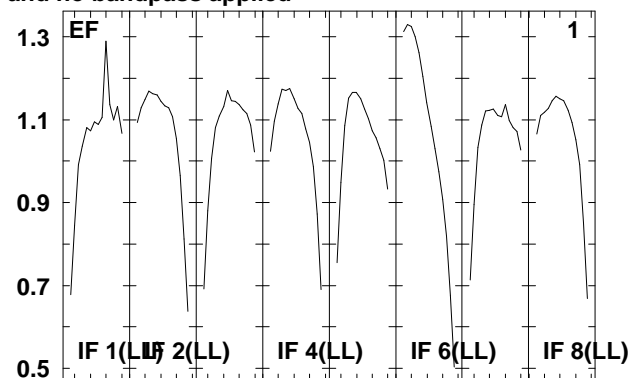
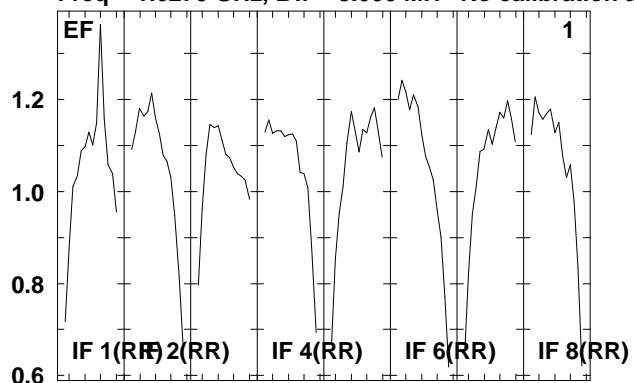

Lower frame: Real Jy

Total-power spectrum Antenna: \*

Timerange: 00/10:08:03 to 00/10:11:59

Plot file version 38 created 06-JAN-2009 10:57:16

J150407 EZ018B.UVDATA.1

Freq = 1.6270 GHz, Bw = 8.000 MH No calibration applied and no bandpass applied

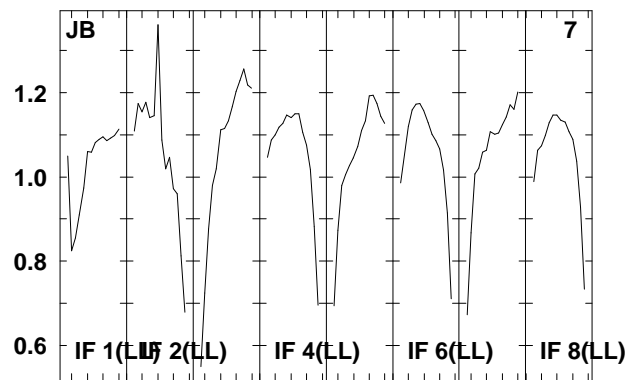
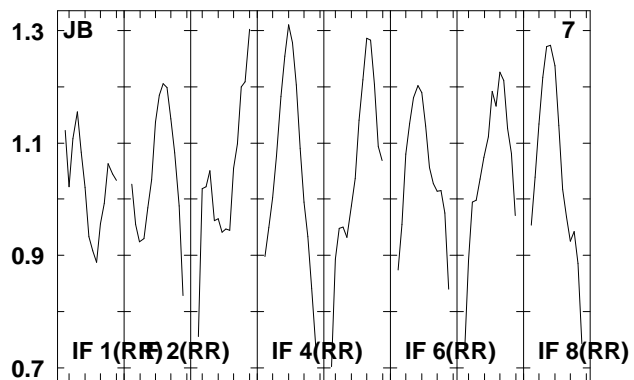
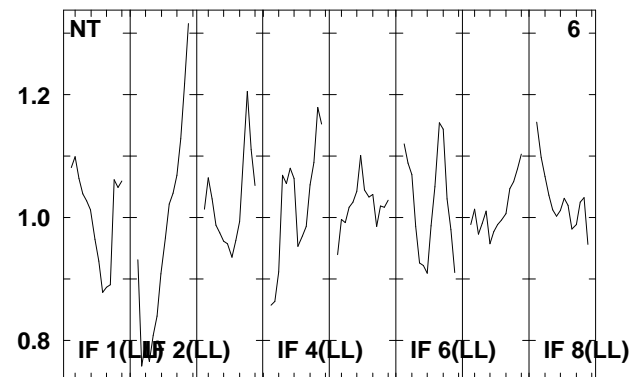
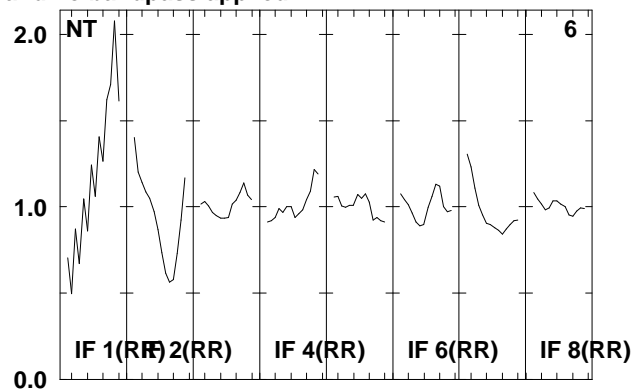
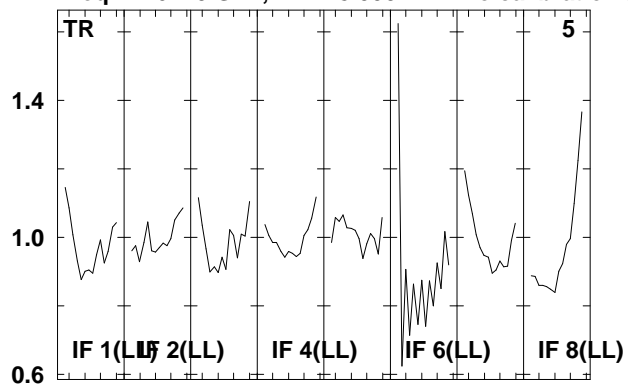

Lower frame: Real Jy  
Total-power spectrum Antenna: \*  
Timerange: 00/10:08:03 to 00/10:11:59

Plot file version 39 created 06-JAN-2009 10:57:16

J1510-05 EZ018B.UVDATA.1

Freq = 1.6270 GHz, Bw = 8.000 MH No calibration applied and no bandpass applied

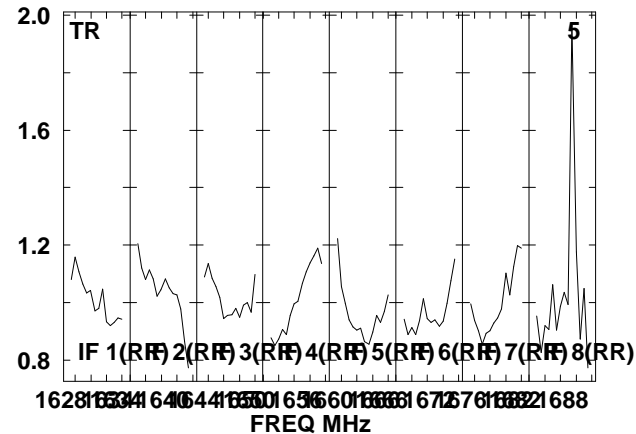
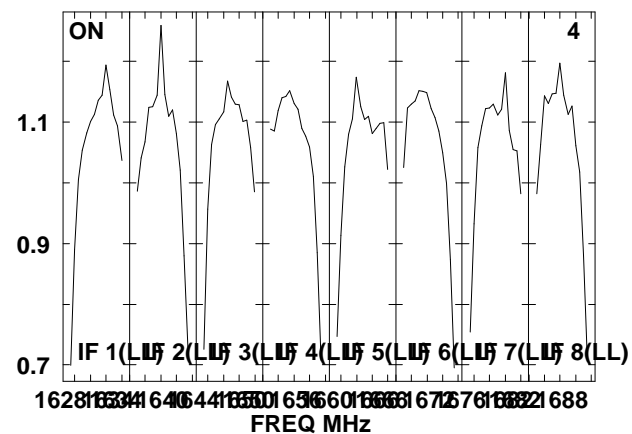
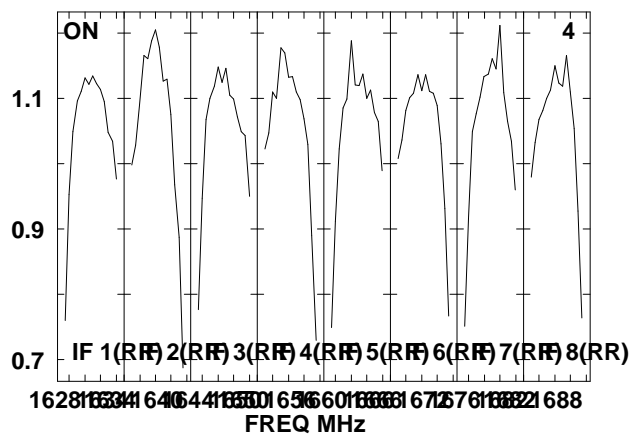
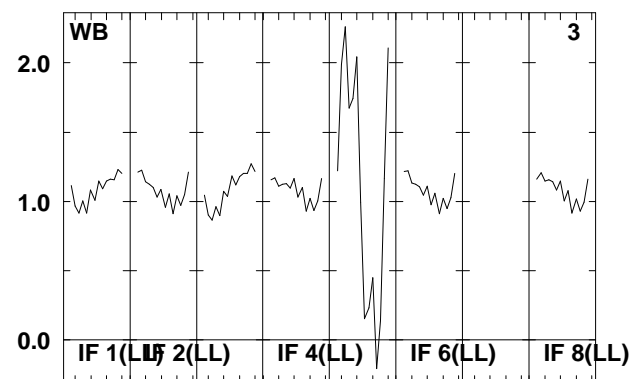
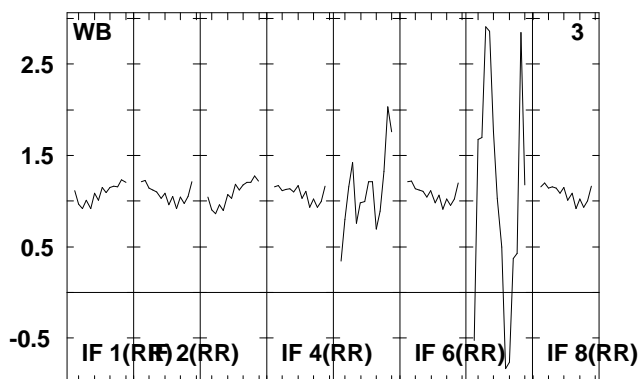
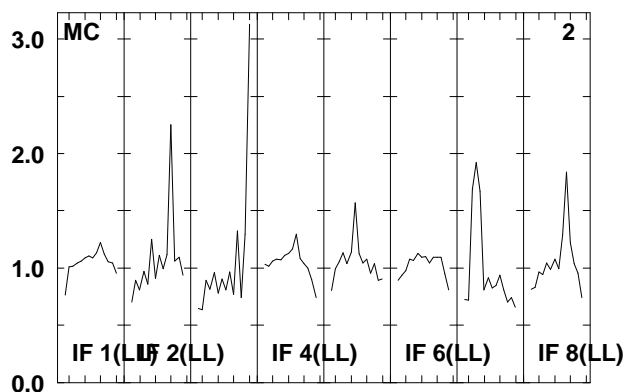
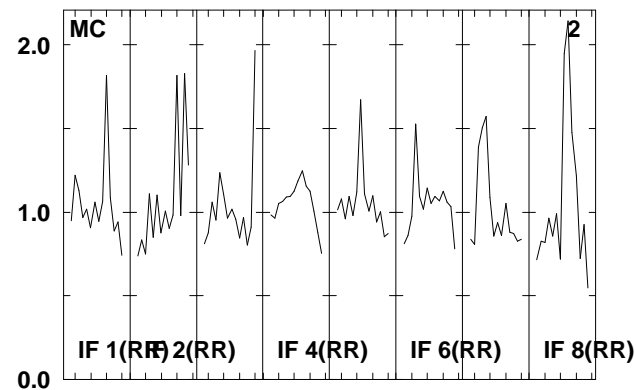
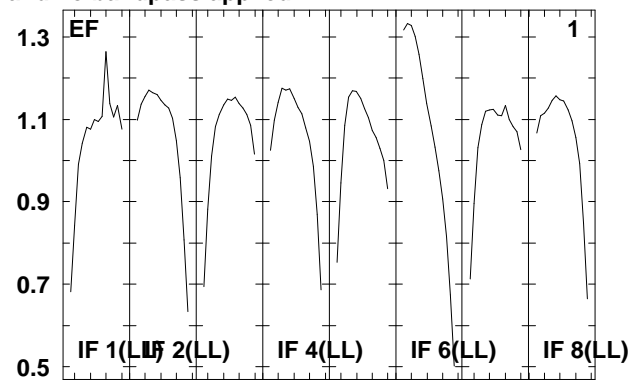
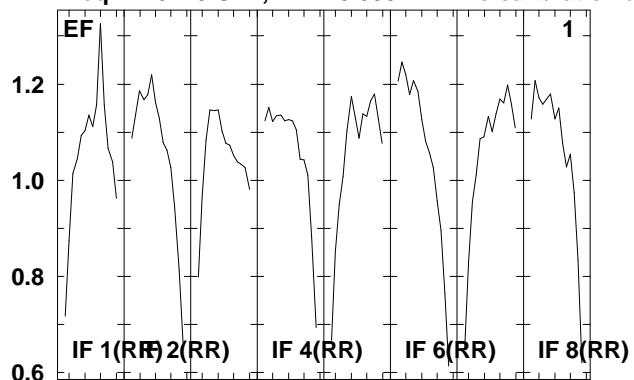

Lower frame: Real Jy  
Total-power spectrum Antenna: \*  
Timerange: 00/10:12:01 to 00/10:15:01

Plot file version 40 created 06-JAN-2009 10:57:16

J1510-05 EZ018B.UVDATA.1

Freq = 1.6270 GHz, Bw = 8.000 MH No calibration applied and no bandpass applied

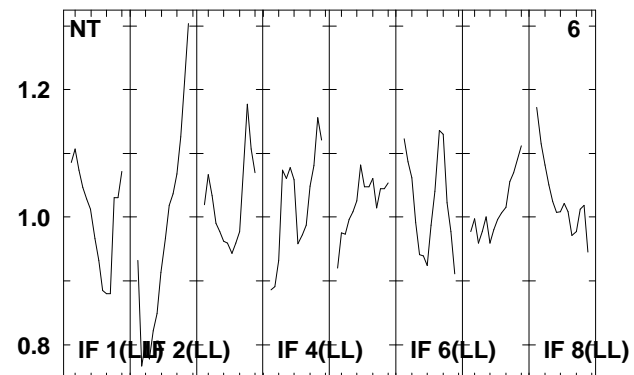
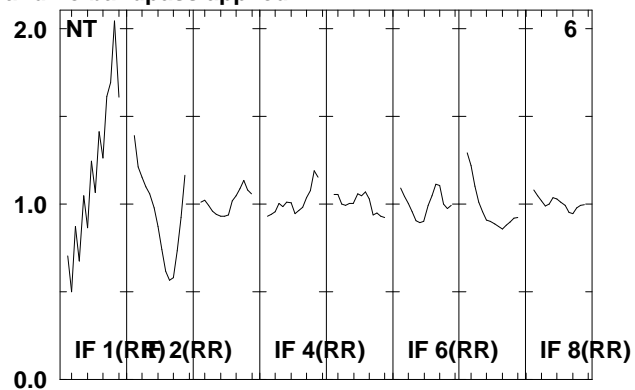
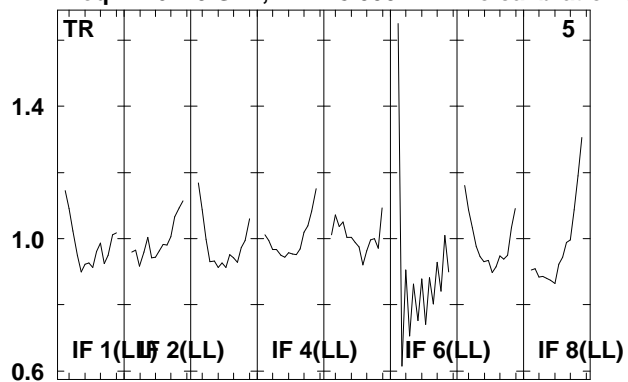

Lower frame: Real Jy  
Total-power spectrum Antenna: \*  
Timerange: 00/10:12:01 to 00/10:15:01



Plot file version 41 created 06-JAN-2009 10:57:17

J150407 EZ018B.UVDATA.1

Freq = 1.6270 GHz, Bw = 8.000 MH No calibration applied and no bandpass applied

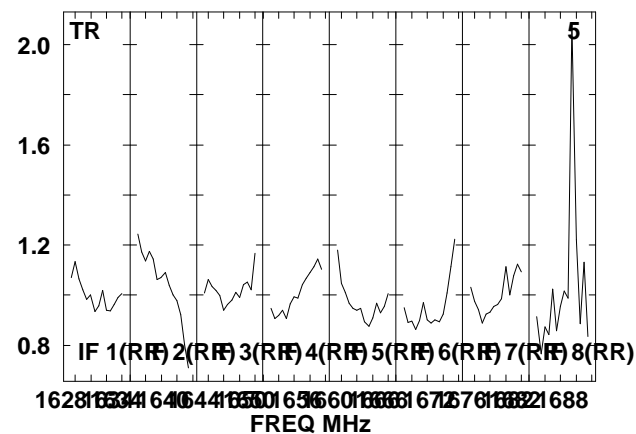
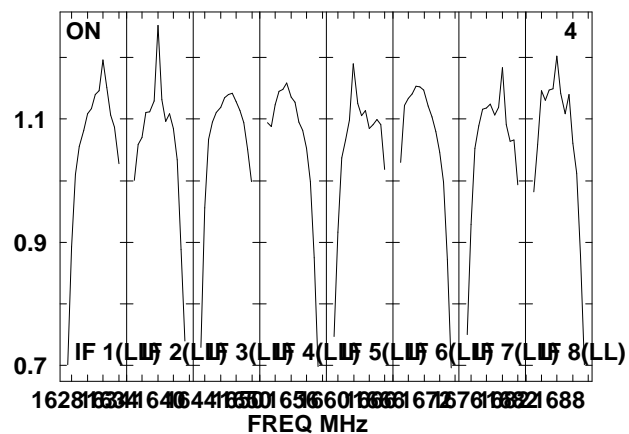
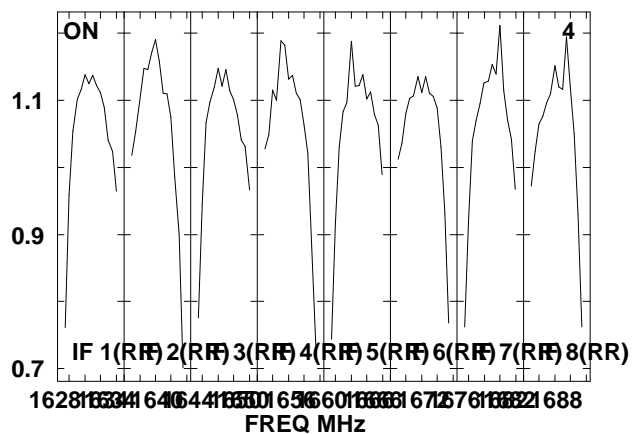
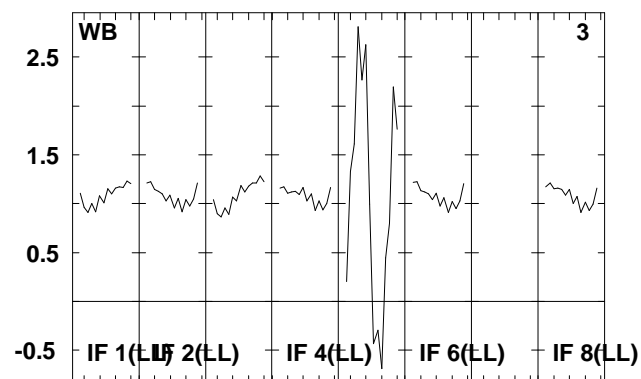
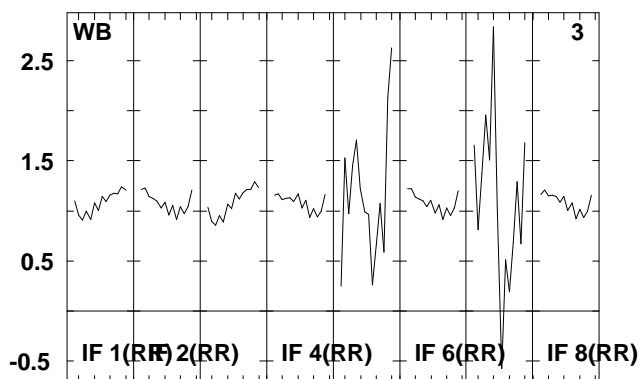
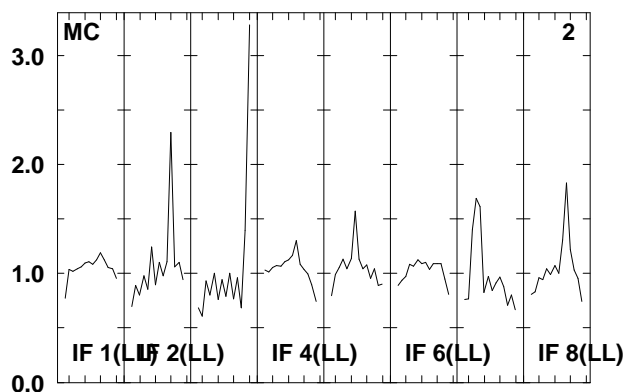
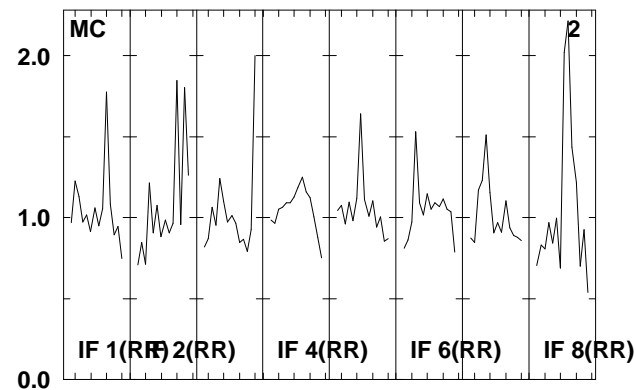
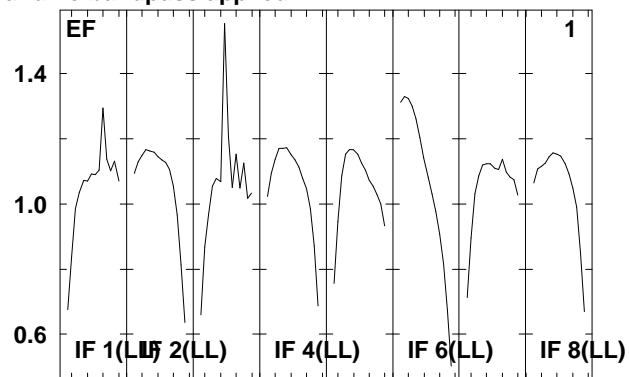
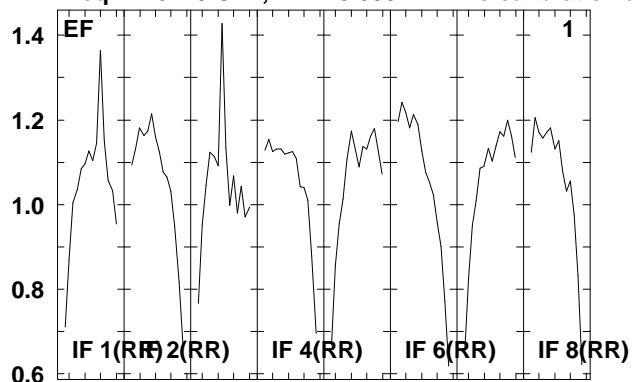

Lower frame: Real Jy

Total-power spectrum Antenna: \*

Timerange: 00/10:15:03 to 00/10:18:59

Plot file version 42 created 06-JAN-2009 10:57:17

J150407 EZ018B.UVDATA.1

Freq = 1.6270 GHz, Bw = 8.000 MH No calibration applied and no bandpass applied

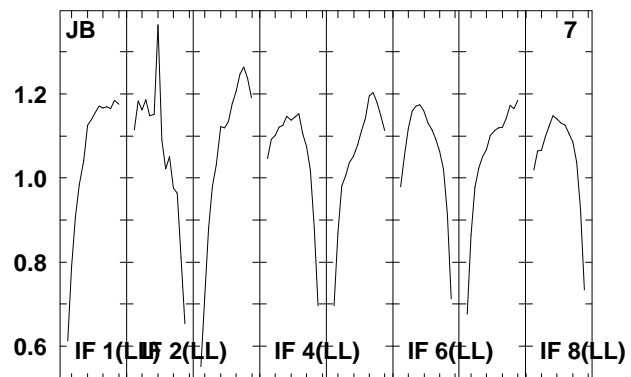
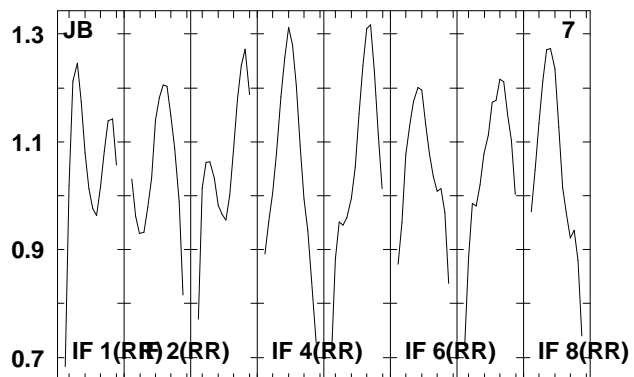
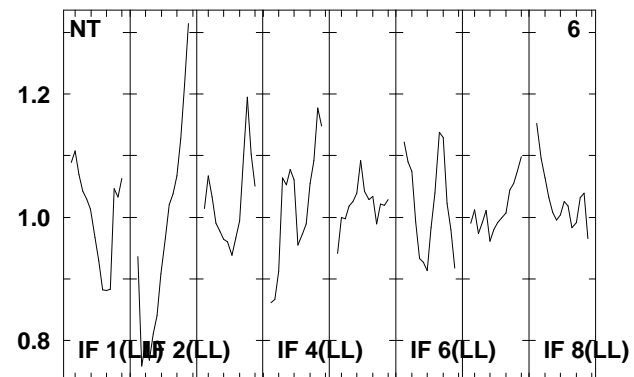
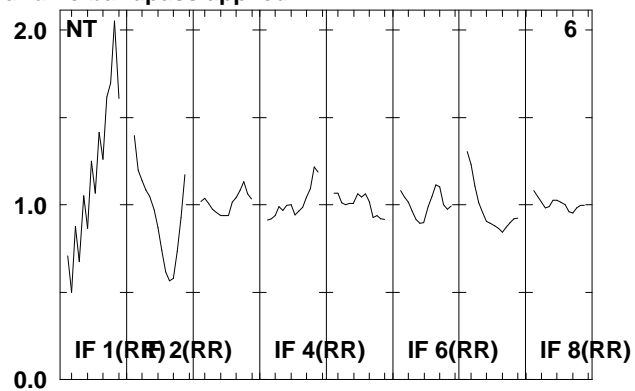
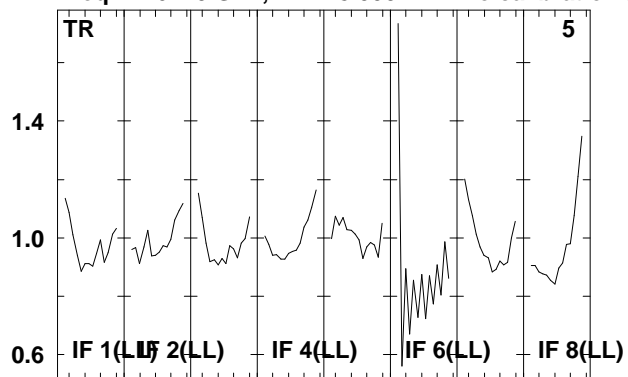

Lower frame: Real Jy  
Total-power spectrum Antenna: \*  
Timerange: 00/10:15:03 to 00/10:18:59

Plot file version 43 created 06-JAN-2009 10:57:17

J1510-05 EZ018B.UVDATA.1

Freq = 1.6270 GHz, Bw = 8.000 MH No calibration applied and no bandpass applied

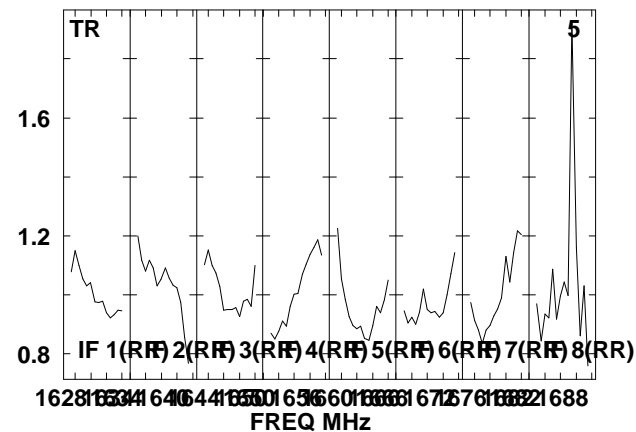
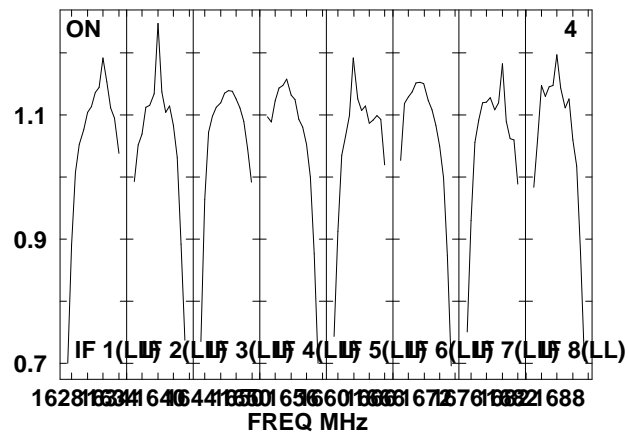
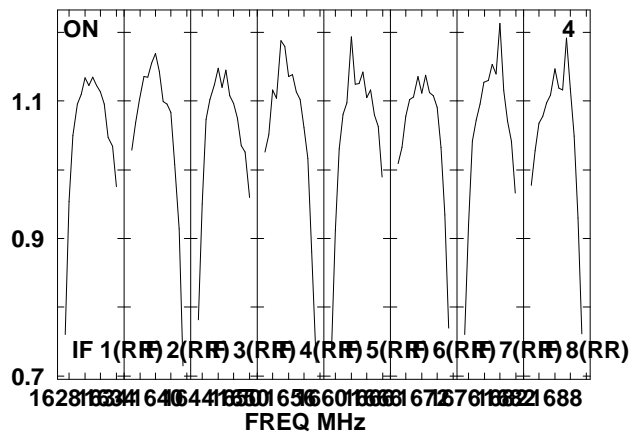
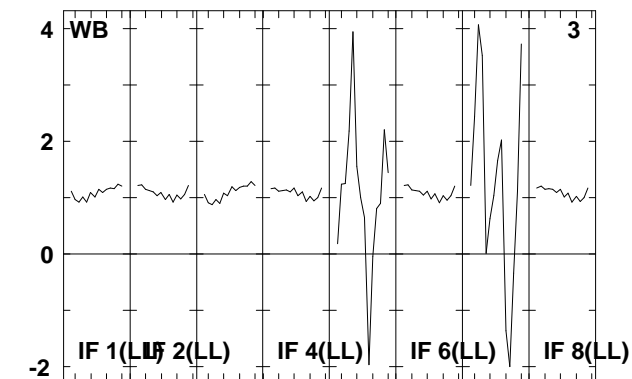
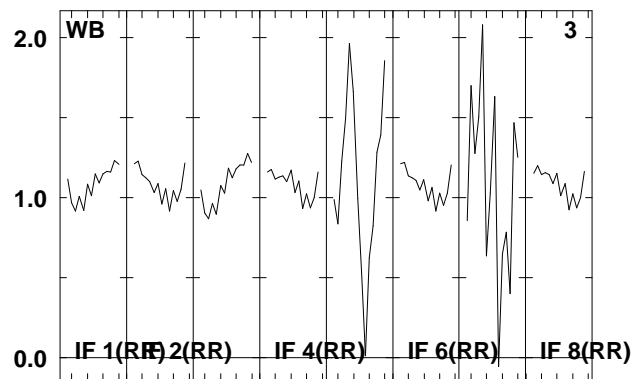
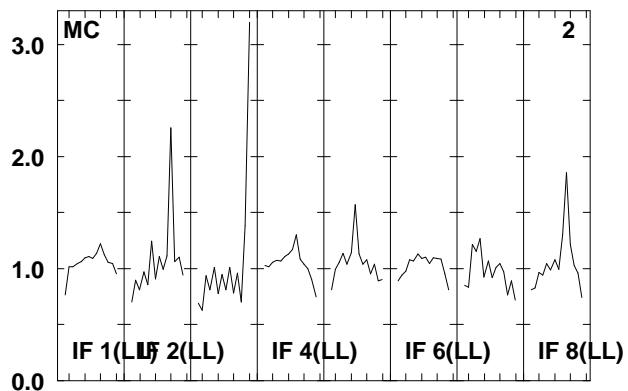
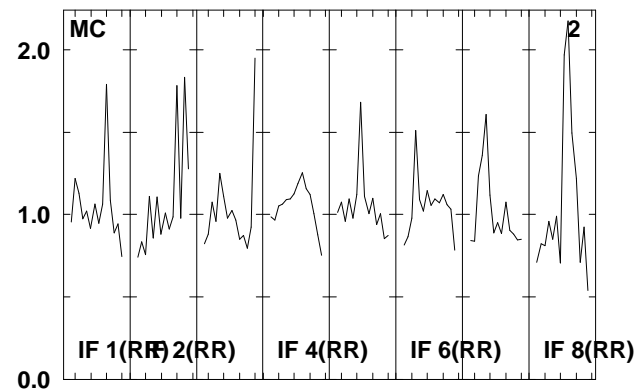
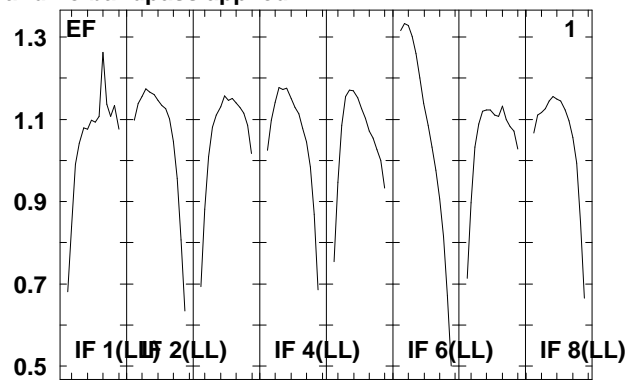
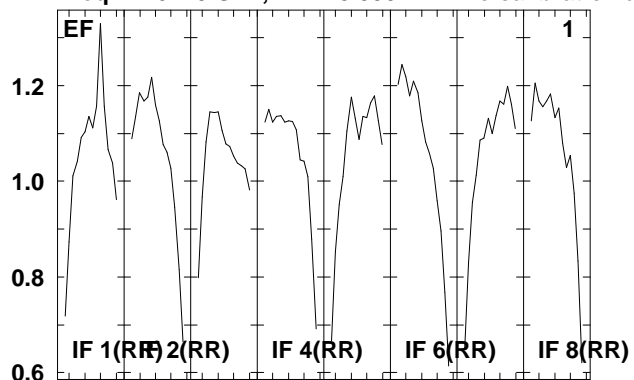

Lower frame: Real Jy

Total-power spectrum Antenna: \*

Timerange: 00/10:20:03 to 00/10:23:01

Plot file version 44 created 06-JAN-2009 10:57:18

J1510-05 EZ018B.UVDATA.1

Freq = 1.6270 GHz, Bw = 8.000 MH No calibration applied and no bandpass applied

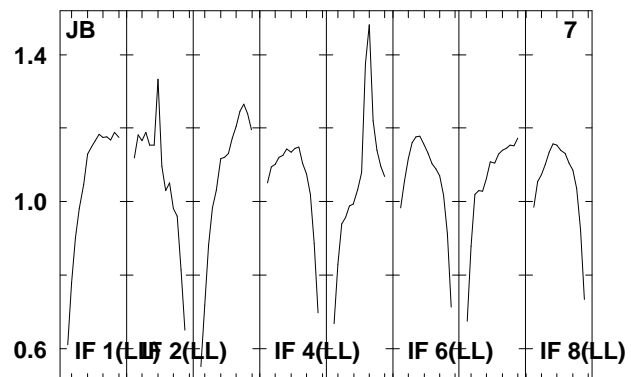
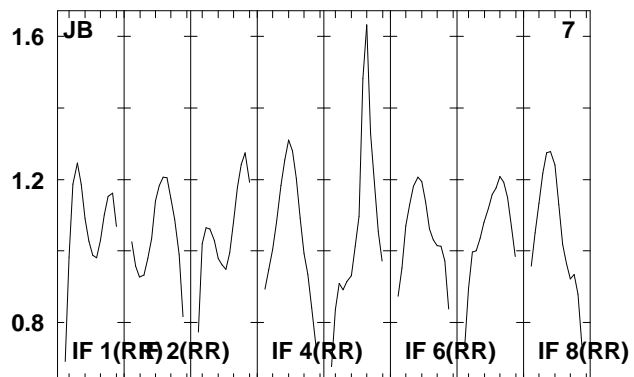
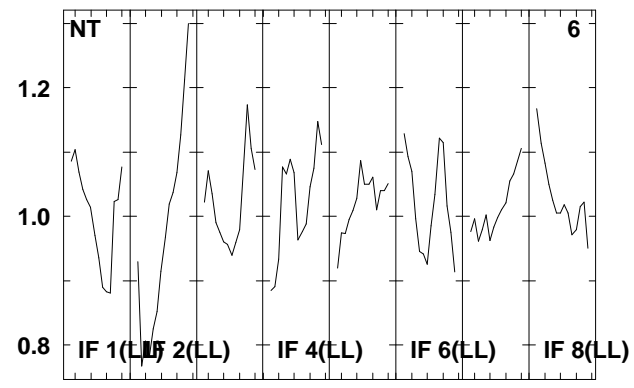
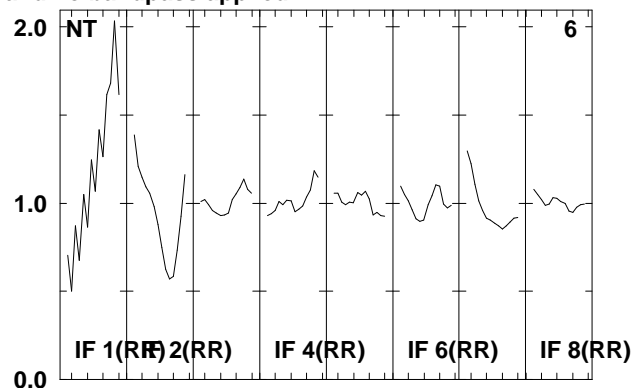
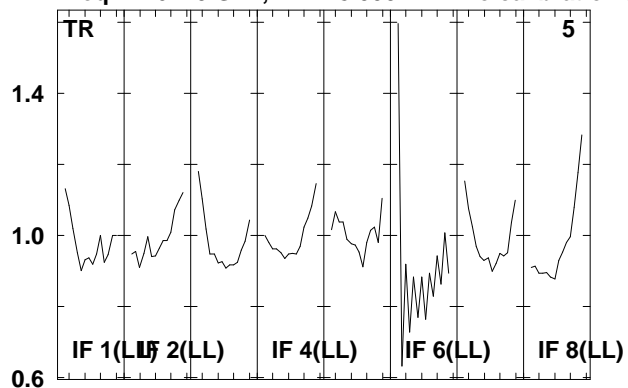

Lower frame: Real Jy  
Total-power spectrum Antenna: \*  
Timerange: 00/10:20:03 to 00/10:23:01

Plot file version 45 created 06-JAN-2009 10:57:18

J150407 EZ018B.UVDATA.1

Freq = 1.6270 GHz, Bw = 8.000 MH No calibration applied and no bandpass applied

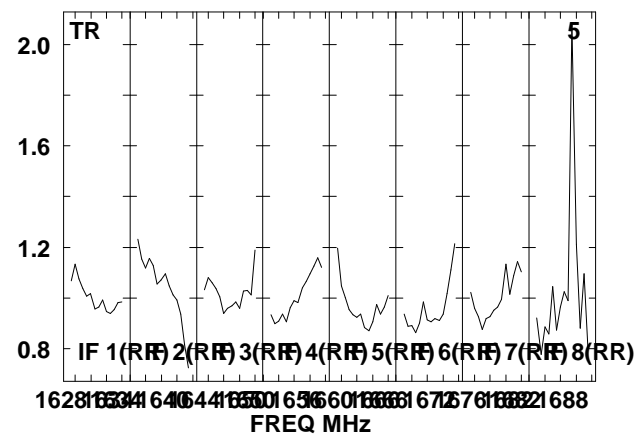
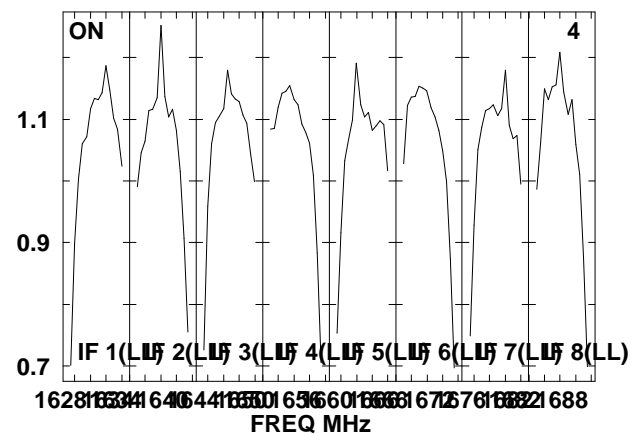
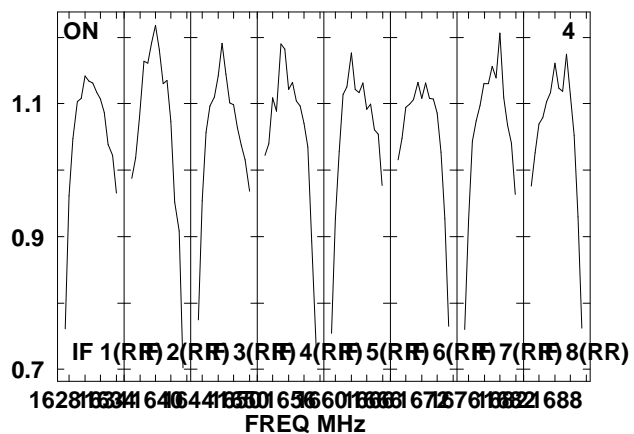
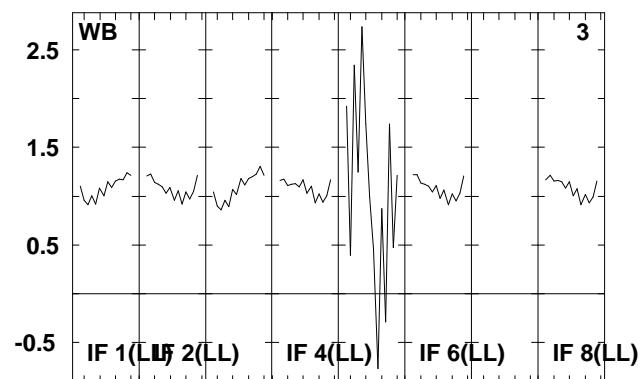
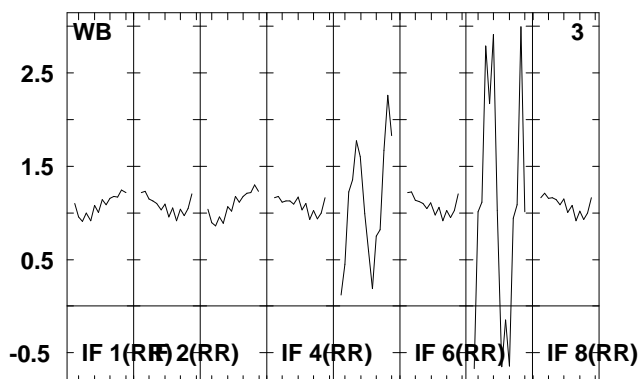
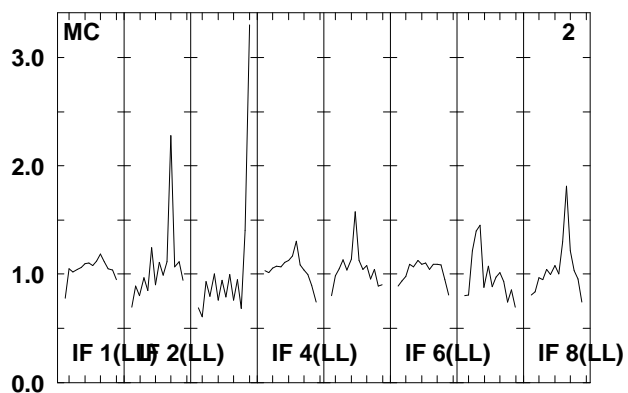
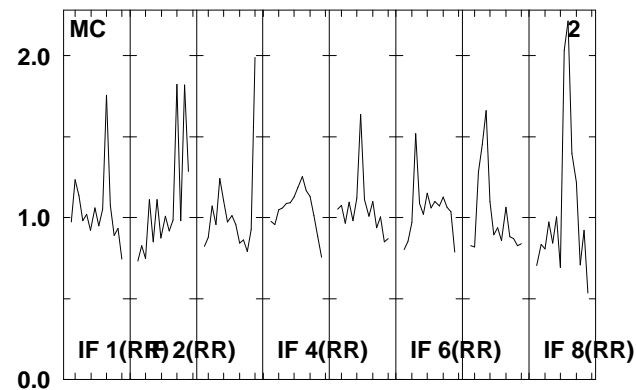
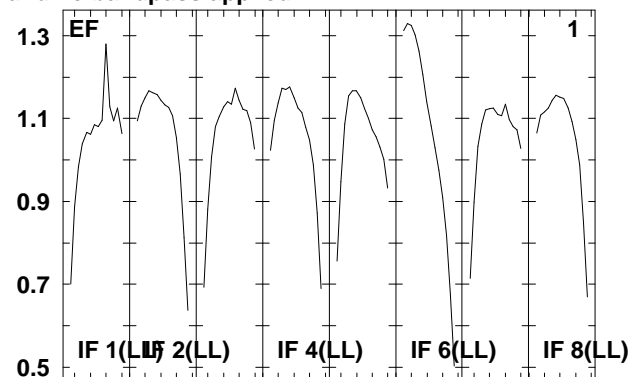
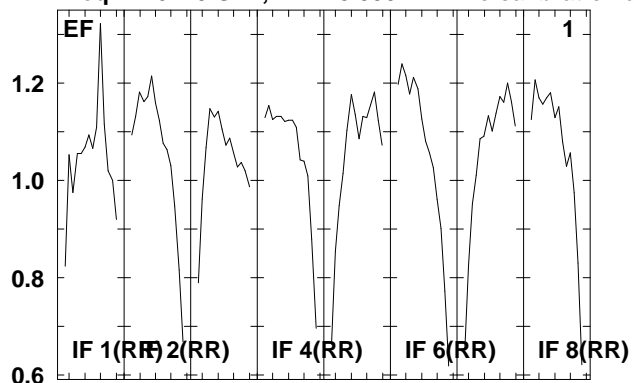

Lower frame: Real Jy

Total-power spectrum Antenna: \*

Timerange: 00/10:23:03 to 00/10:26:59

Plot file version 46 created 06-JAN-2009 10:57:18

J150407 EZ018B.UVDATA.1

Freq = 1.6270 GHz, Bw = 8.000 MH No calibration applied and no bandpass applied

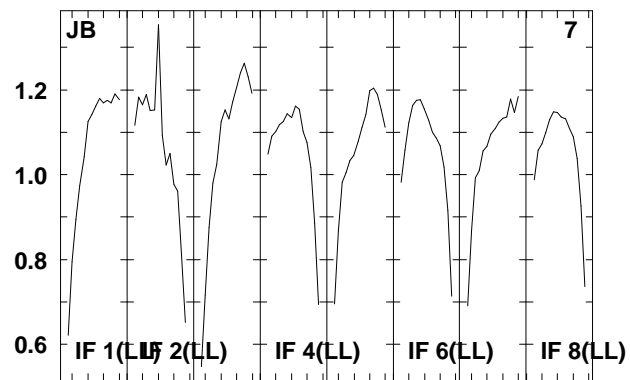
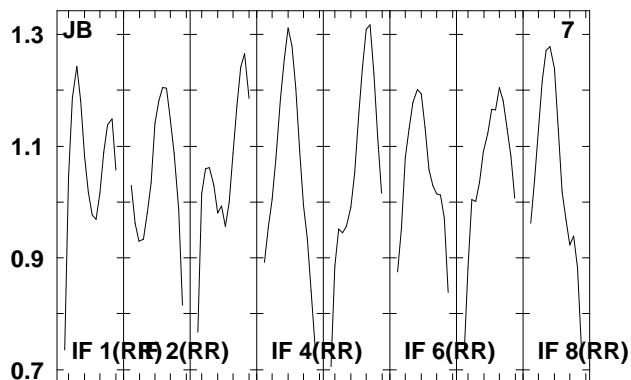
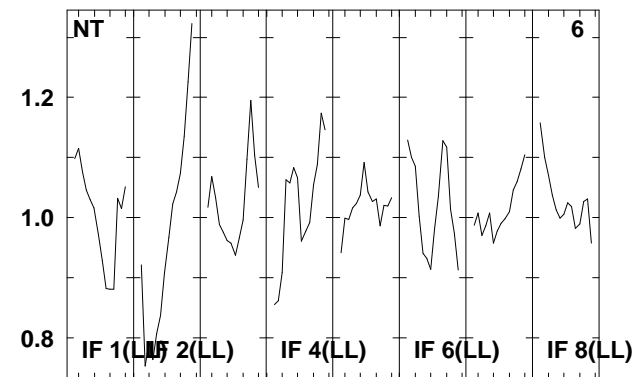
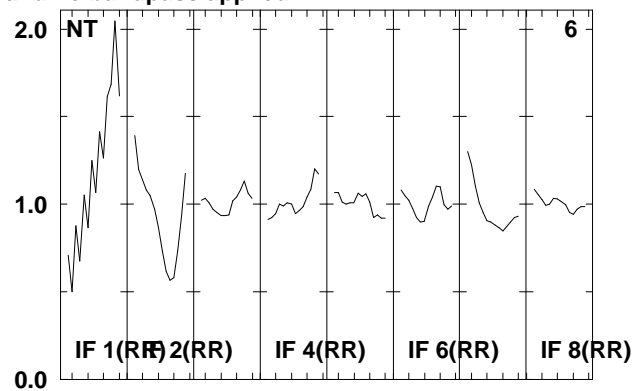
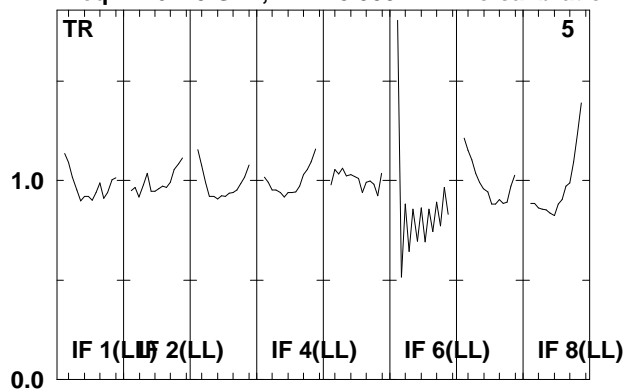

Lower frame: Real Jy  
Total-power spectrum Antenna: \*  
Timerange: 00/10:23:03 to 00/10:26:59

Plot file version 47 created 06-JAN-2009 10:57:19

J1510-05 EZ018B.UVDATA.1

Freq = 1.6270 GHz, Bw = 8.000 MH No calibration applied and no bandpass applied

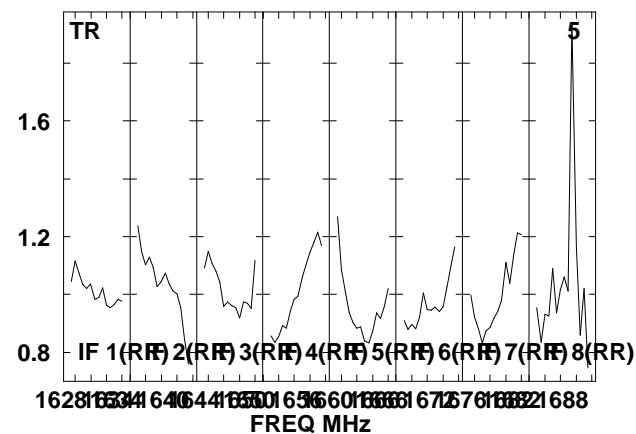
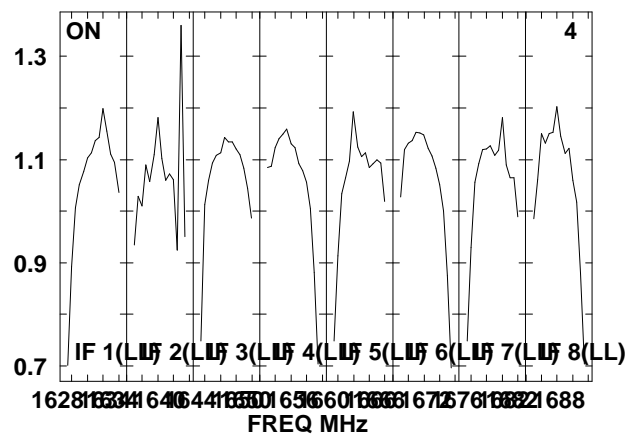
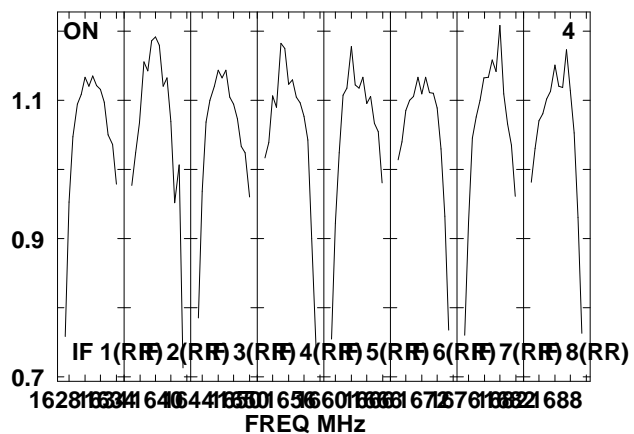
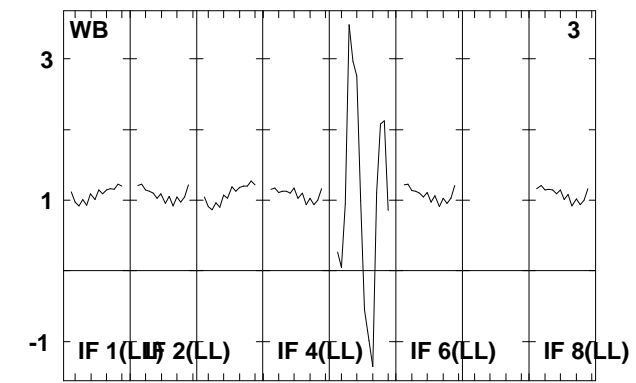
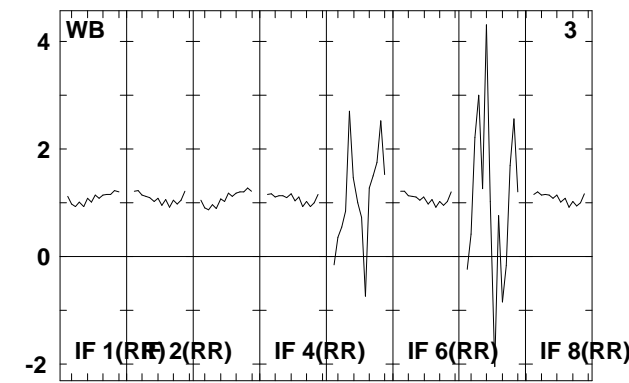
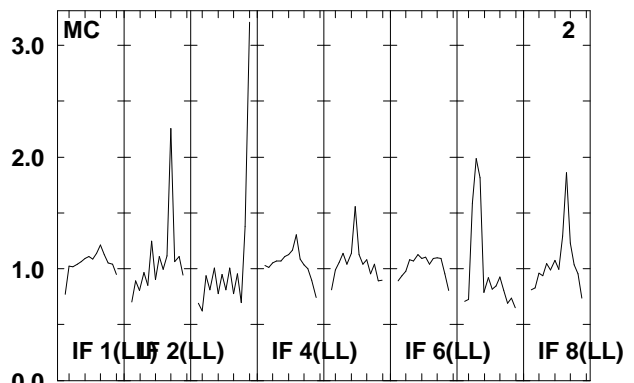
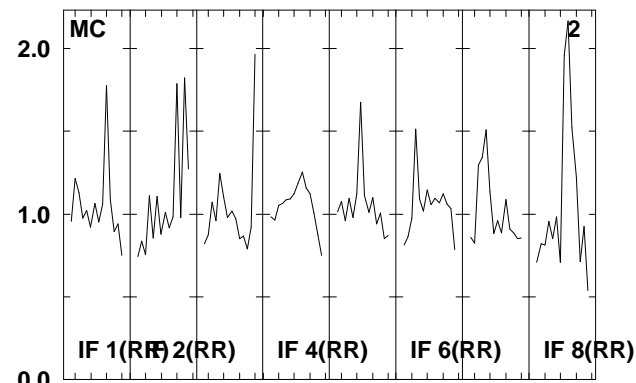
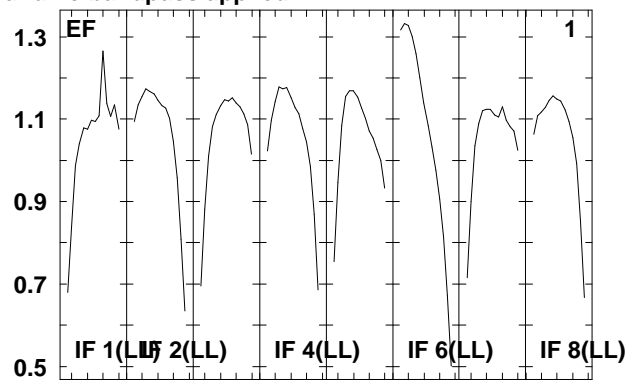
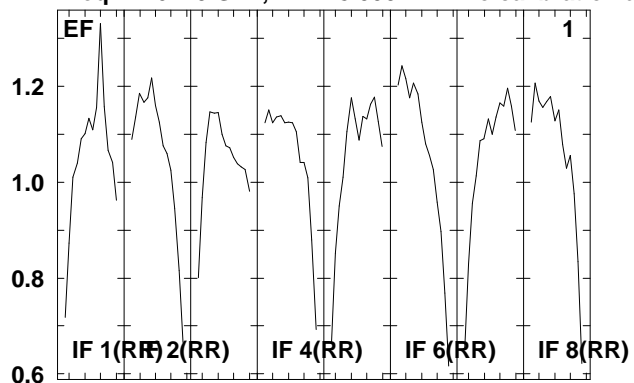

Lower frame: Real Jy  
Total-power spectrum Antenna: \*  
Timerange: 00/10:27:01 to 00/10:30:01

Plot file version 48 created 06-JAN-2009 10:57:19

J1510-05 EZ018B.UVDATA.1

Freq = 1.6270 GHz, Bw = 8.000 MH No calibration applied and no bandpass applied

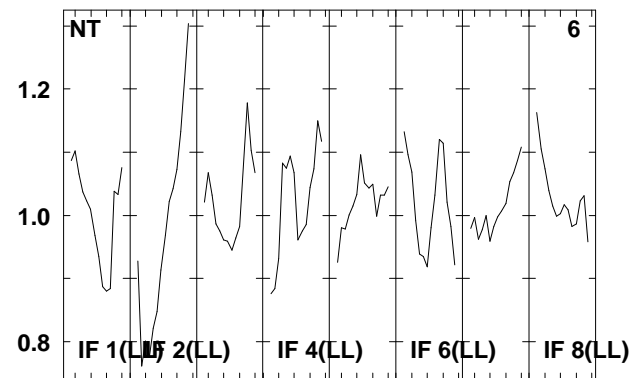
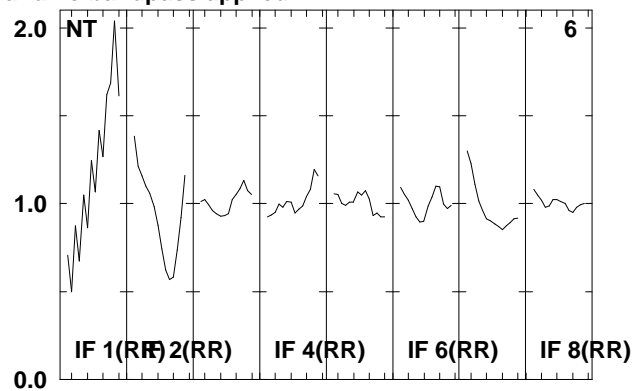
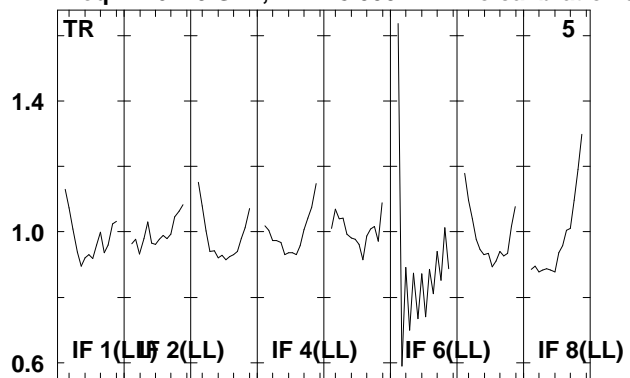

Lower frame: Real Jy  
Total-power spectrum Antenna: \*  
Timerange: 00/10:27:01 to 00/10:30:01



Plot file version 49 created 06-JAN-2009 10:57:20

J150407 EZ018B.UVDATA.1

Freq = 1.6270 GHz, Bw = 8.000 MH No calibration applied and no bandpass applied

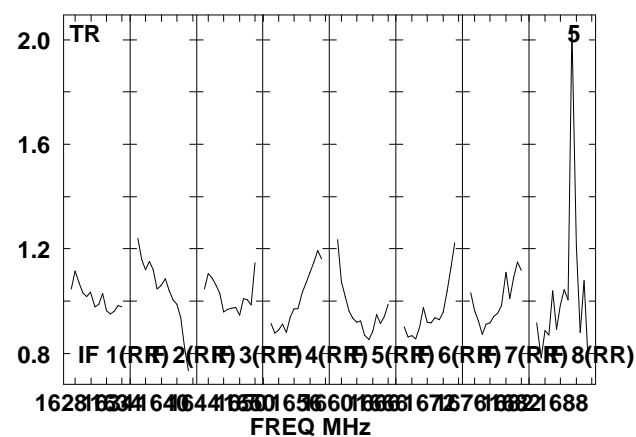
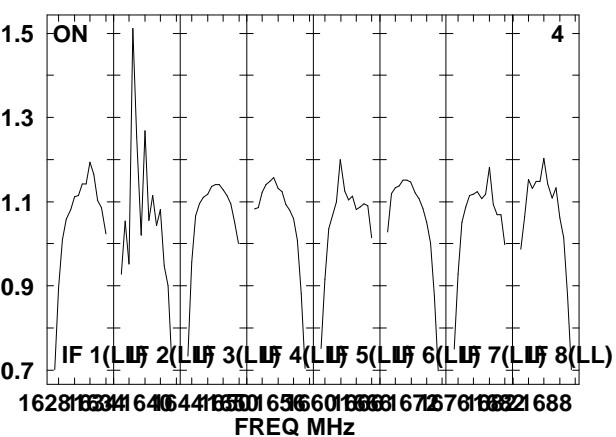
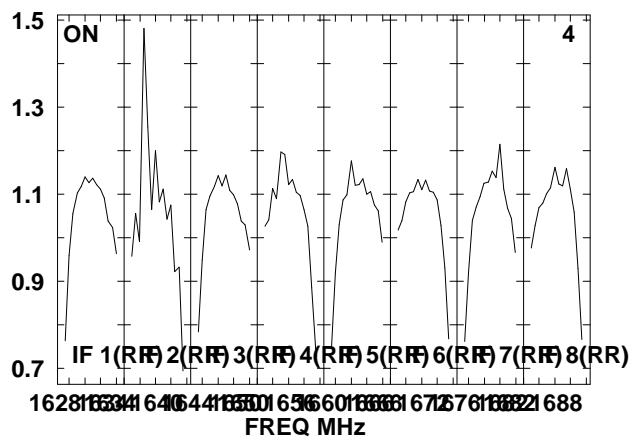
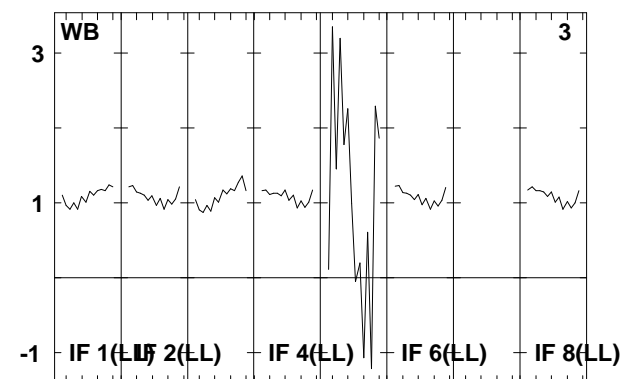
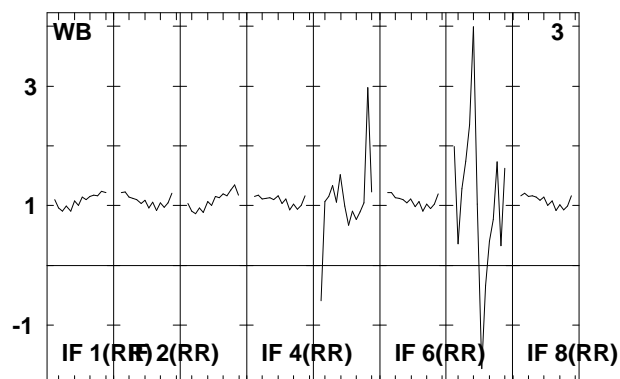
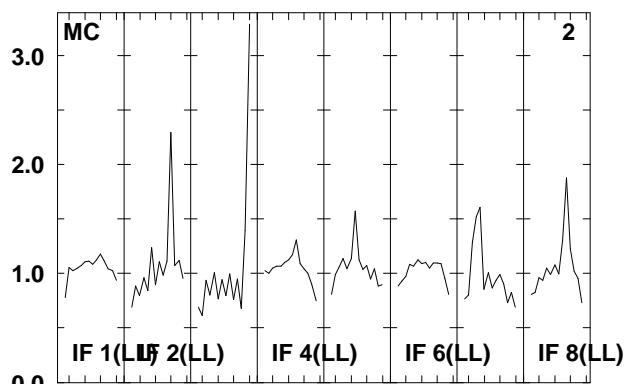
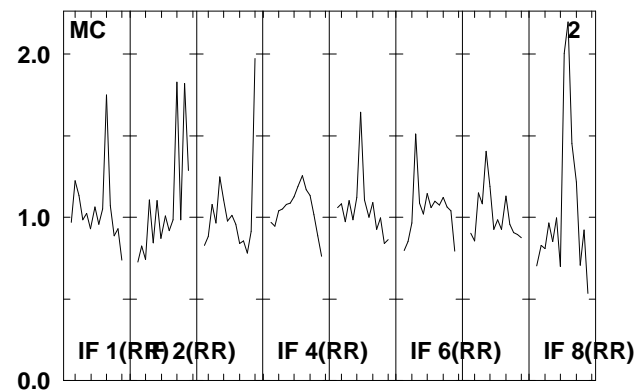
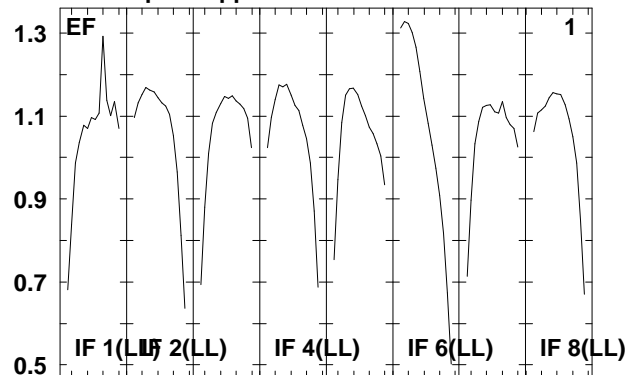
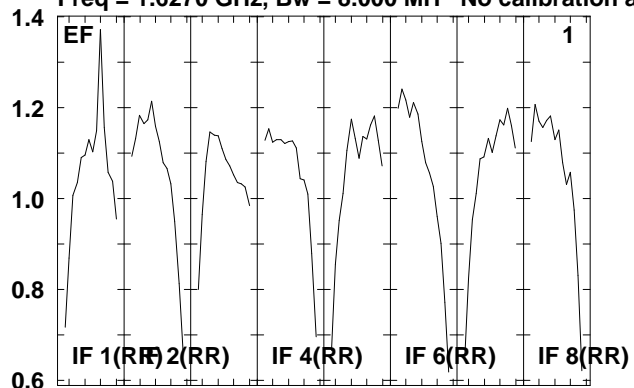

Lower frame: Real Jy  
Total-power spectrum Antenna: \*  
Timerange: 00/10:30:03 to 00/10:33:57

Plot file version 50 created 06-JAN-2009 10:57:20

J150407 EZ018B.UVDATA.1

Freq = 1.6270 GHz, Bw = 8.000 MH No calibration applied and no bandpass applied

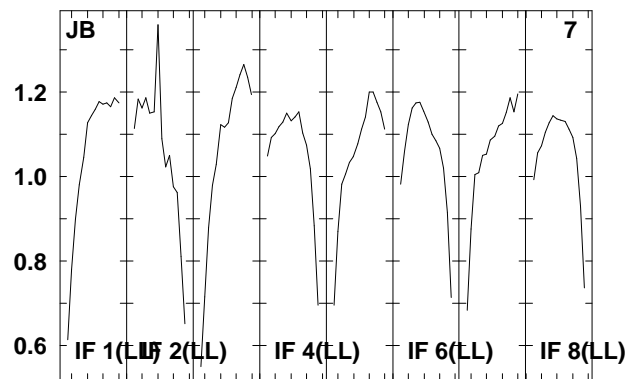
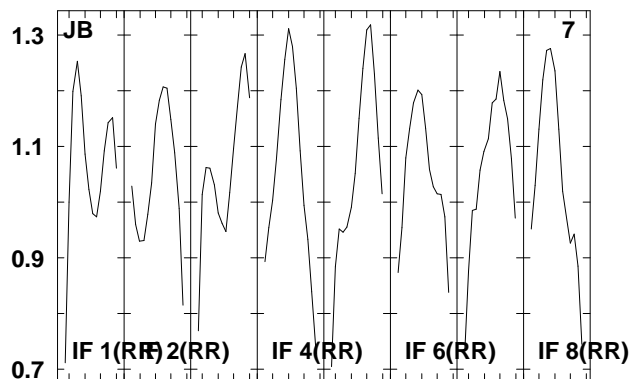
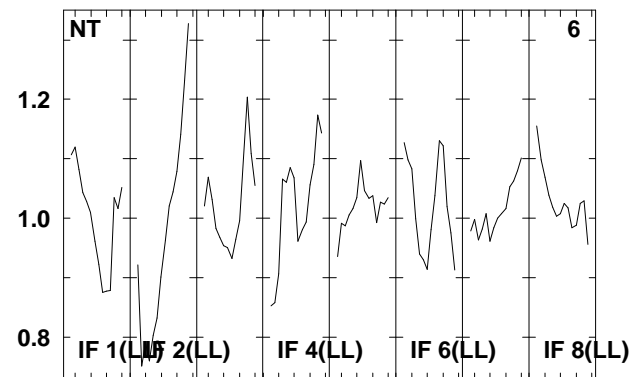
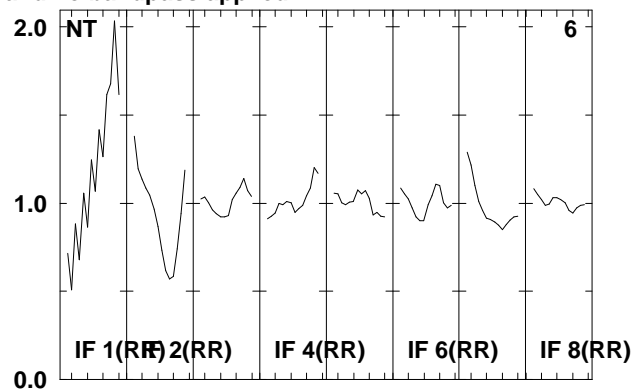
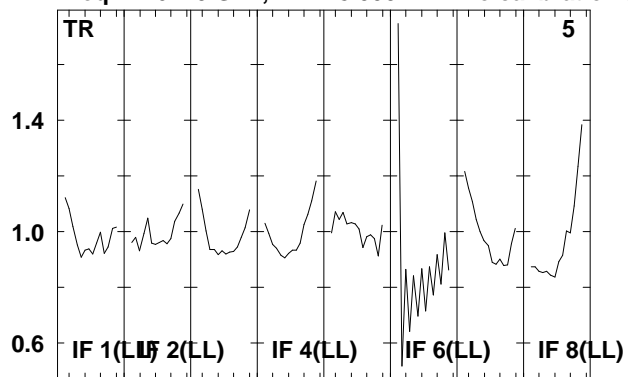

Lower frame: Real Jy  
Total-power spectrum Antenna: \*  
Timerange: 00/10:30:03 to 00/10:33:57

Plot file version 51 created 06-JAN-2009 10:57:20

J1510-05 EZ018B.UVDATA.1

Freq = 1.6270 GHz, Bw = 8.000 MH No calibration applied and no bandpass applied

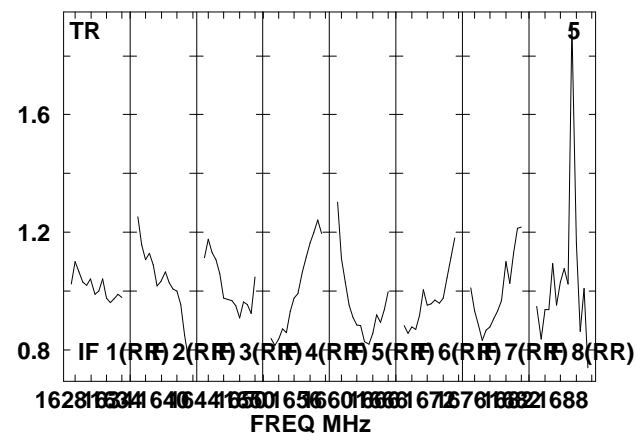
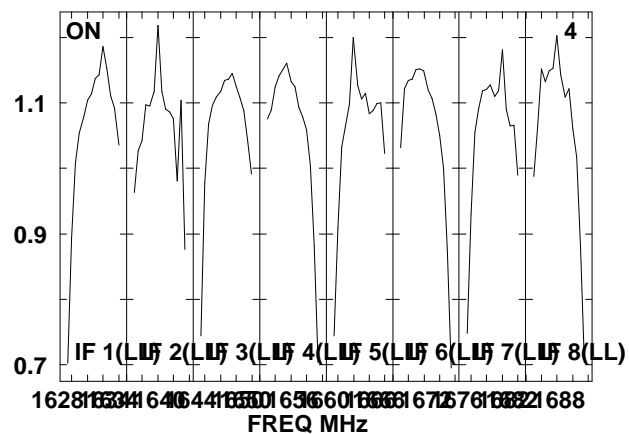
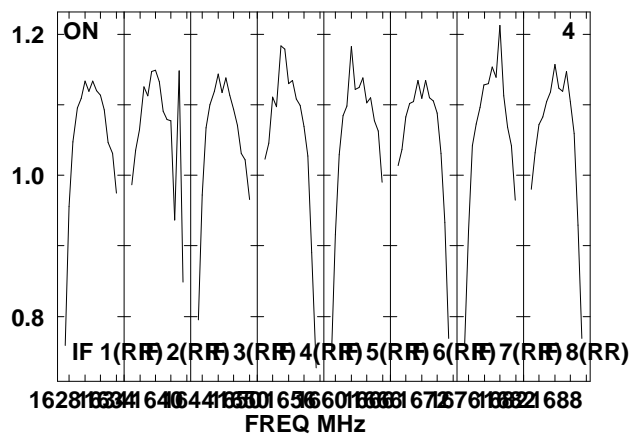
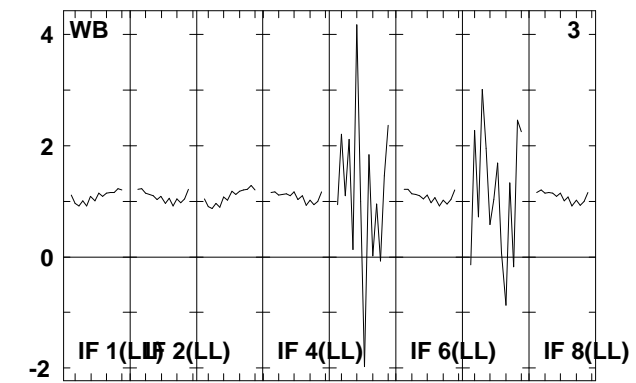
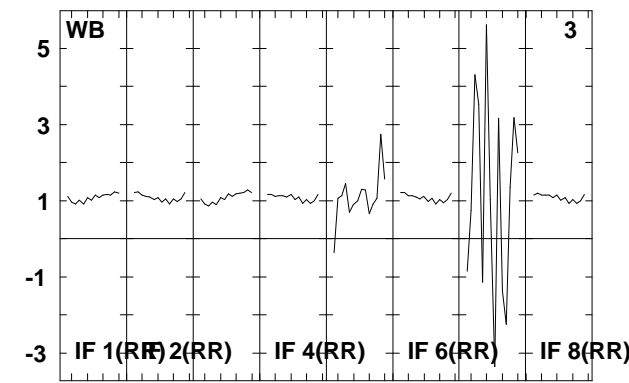
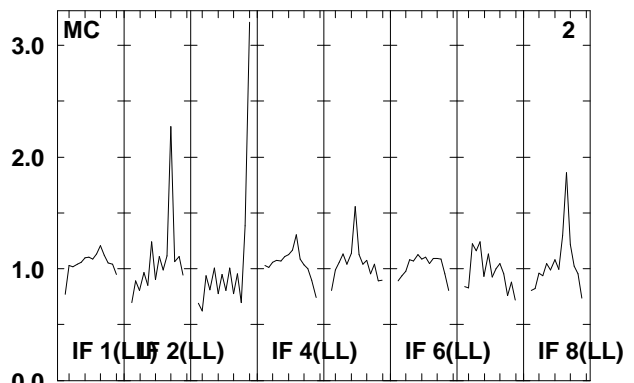
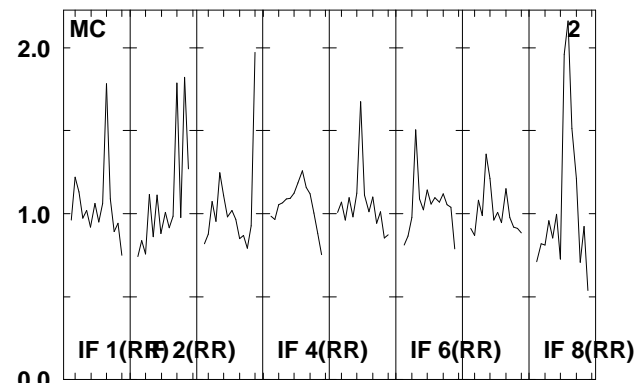
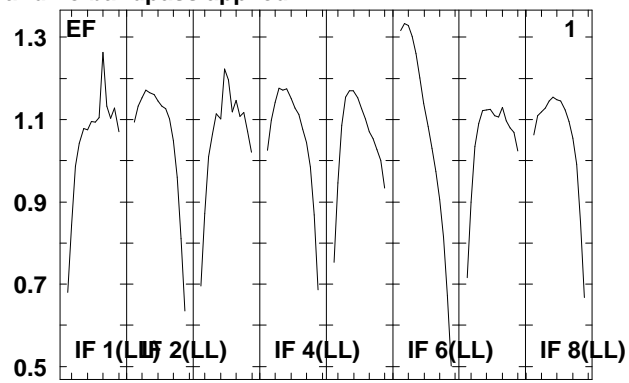
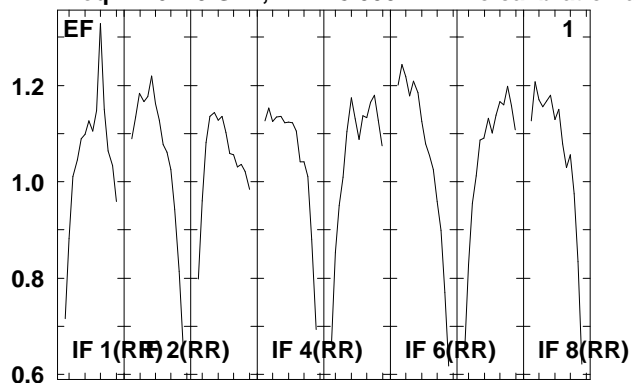

Lower frame: Real Jy  
Total-power spectrum Antenna: \*  
Timerange: 00/10:35:03 to 00/10:37:59

Plot file version 52 created 06-JAN-2009 10:57:21

J1510-05 EZ018B.UVDATA.1

Freq = 1.6270 GHz, Bw = 8.000 MH No calibration applied and no bandpass applied

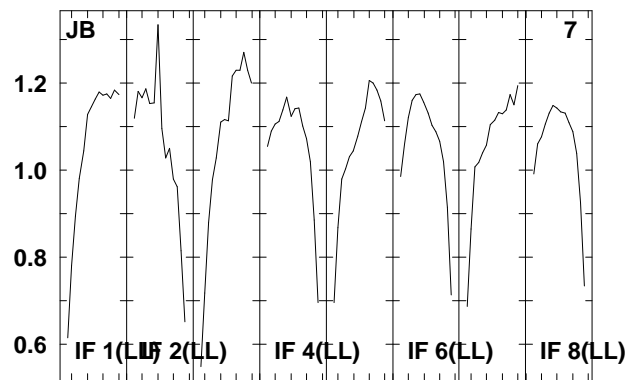
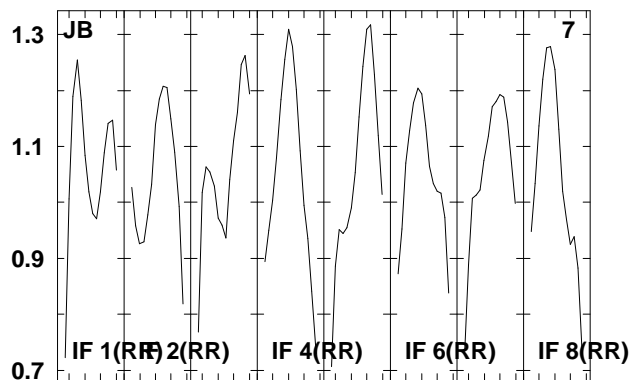
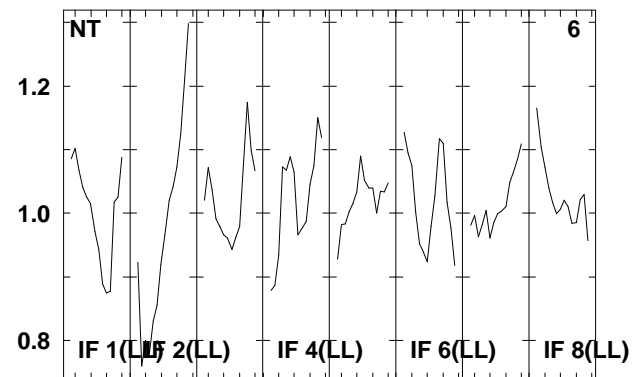
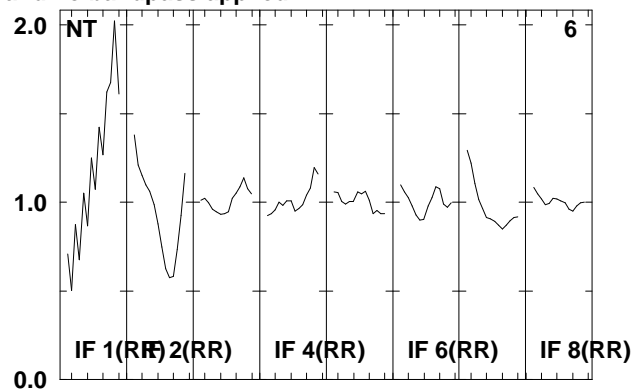
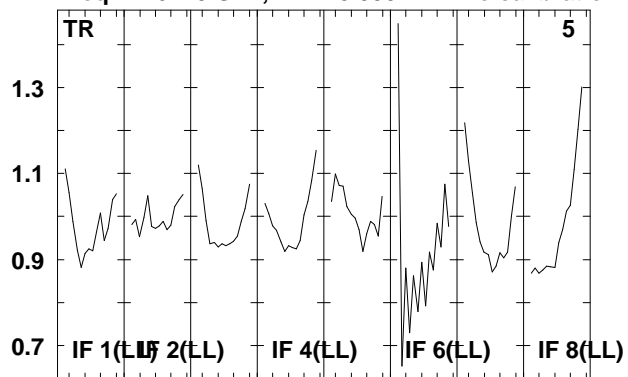

Lower frame: Real Jy  
Total-power spectrum Antenna: \*  
Timerange: 00/10:35:03 to 00/10:37:59

Plot file version 53 created 06-JAN-2009 10:57:21

J150407 EZ018B.UVDATA.1

Freq = 1.6270 GHz, Bw = 8.000 MH No calibration applied and no bandpass applied

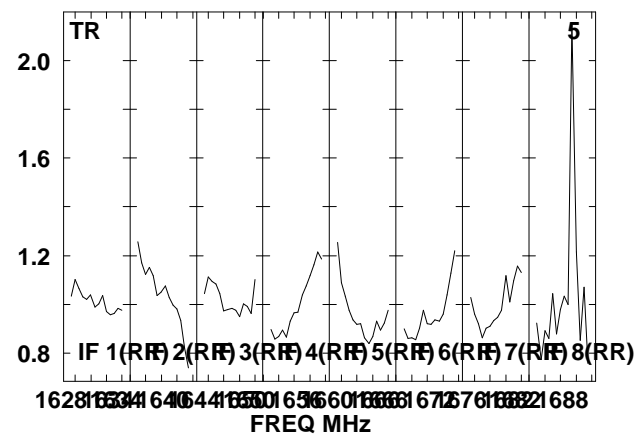
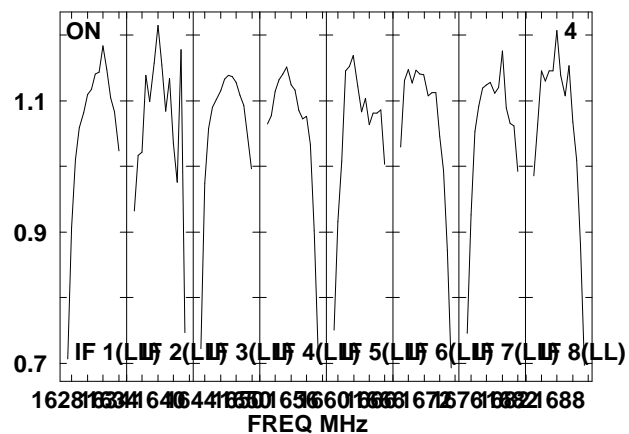
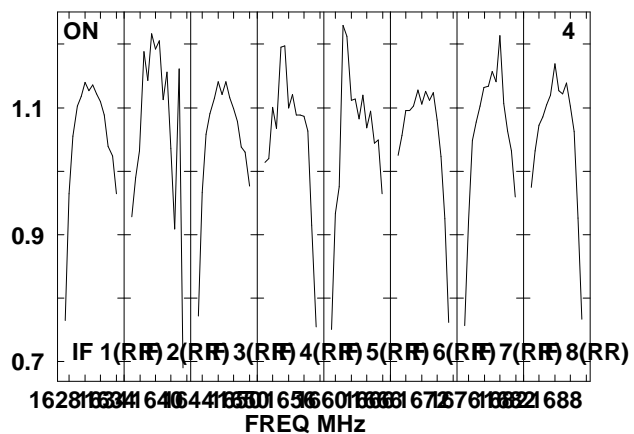
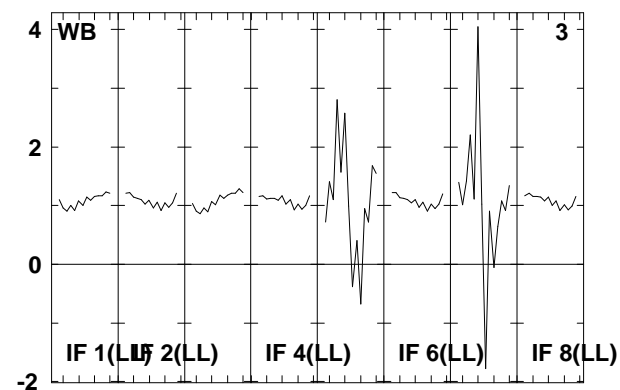
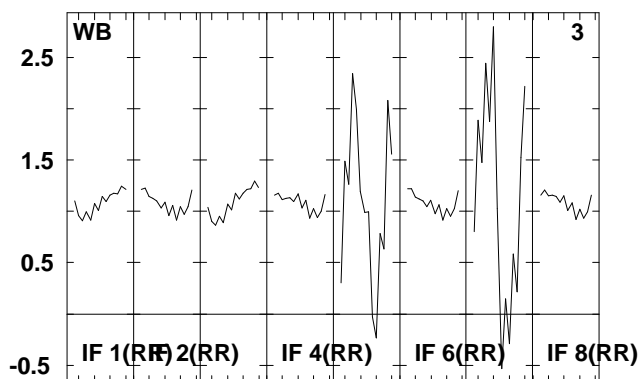
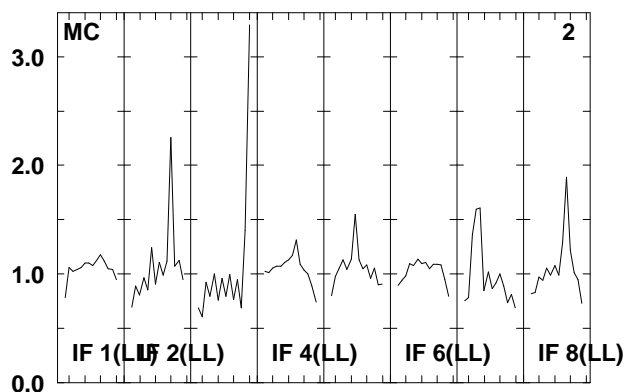
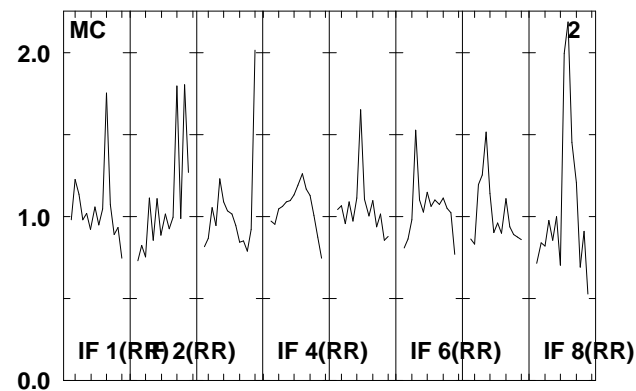
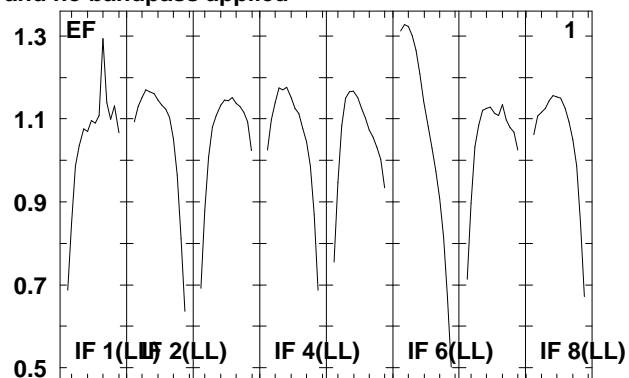
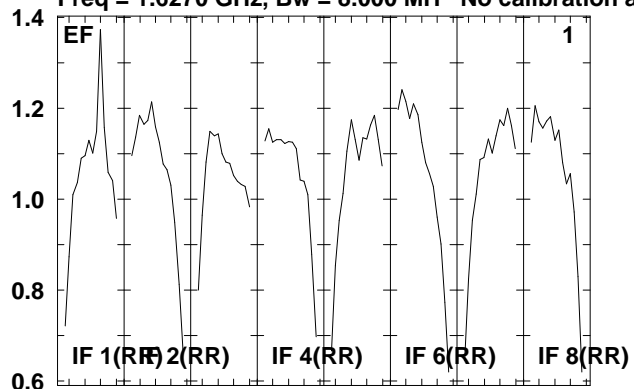

Lower frame: Real Jy  
Total-power spectrum Antenna: \*  
Timerange: 00/10:38:01 to 00/10:42:01

Plot file version 54 created 06-JAN-2009 10:57:22

J150407 EZ018B.UVDATA.1

Freq = 1.6270 GHz, Bw = 8.000 MH No calibration applied and no bandpass applied

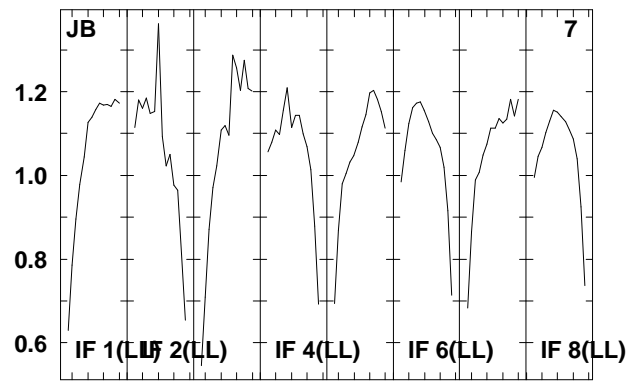
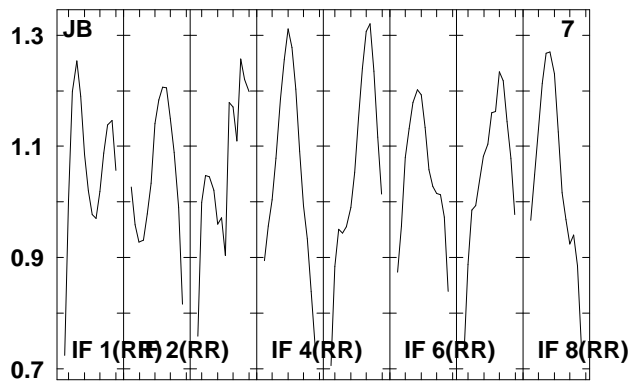
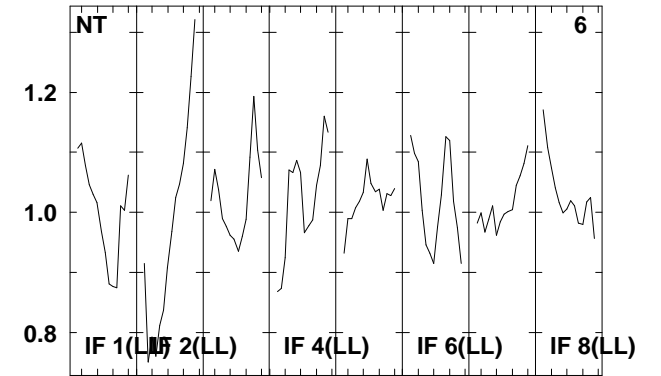
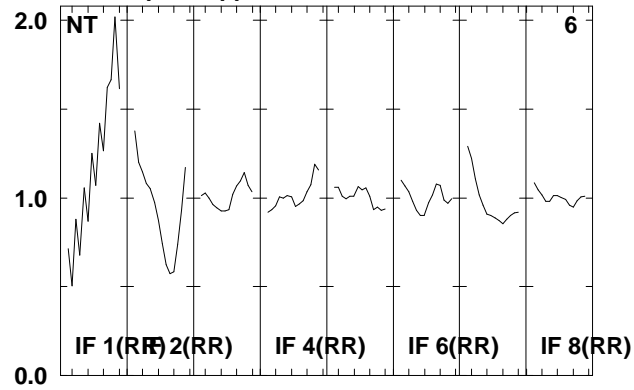
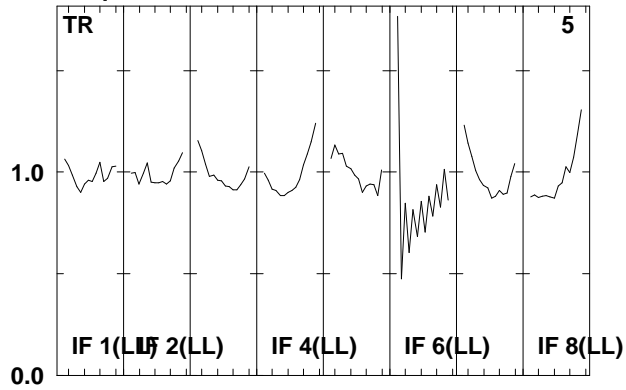

Lower frame: Real Jy  
Total-power spectrum Antenna: \*  
Timerange: 00/10:38:01 to 00/10:42:01

Plot file version 55 created 06-JAN-2009 10:57:22

J1510-05 EZ018B.UVDATA.1

Freq = 1.6270 GHz, Bw = 8.000 MH No calibration applied and no bandpass applied

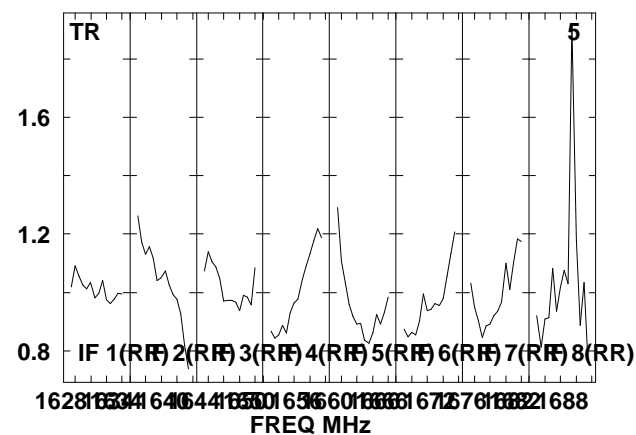
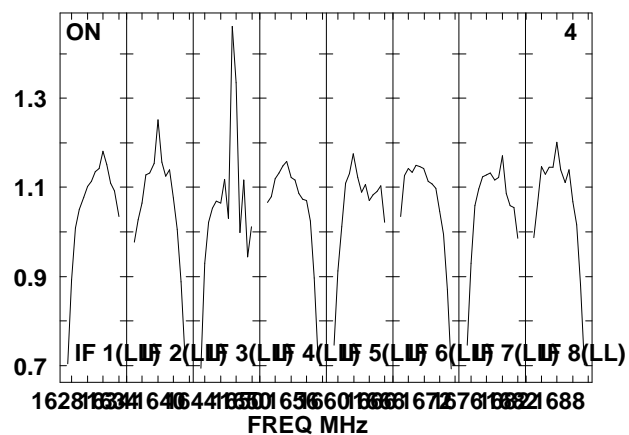
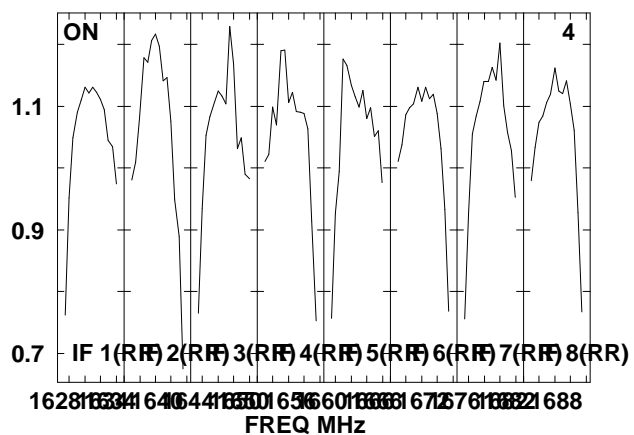
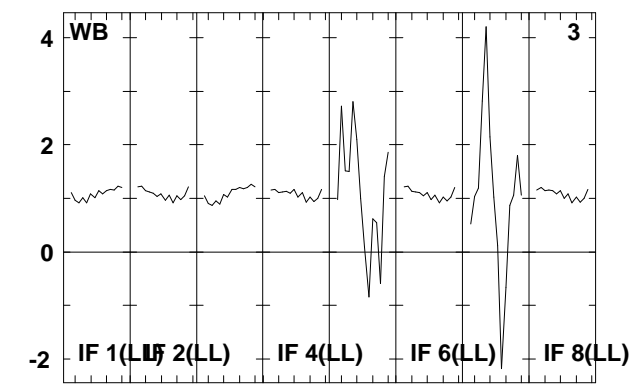
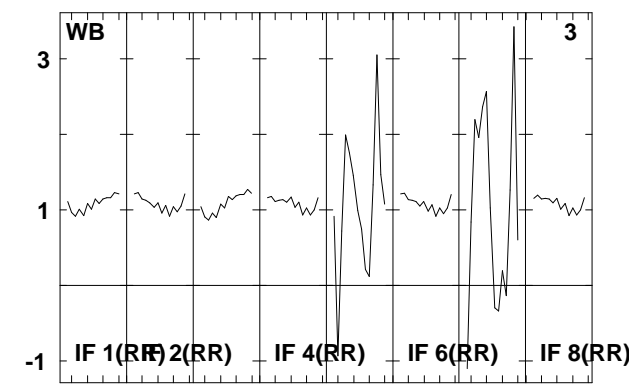
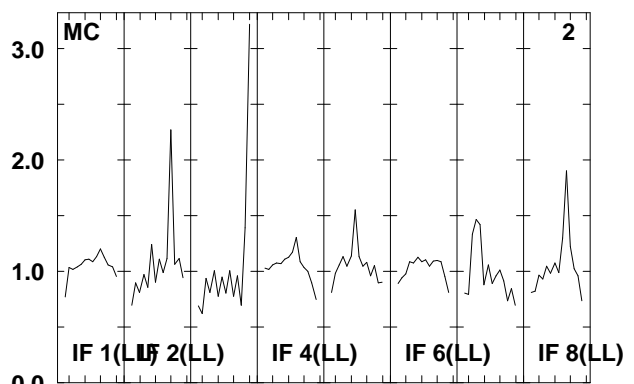
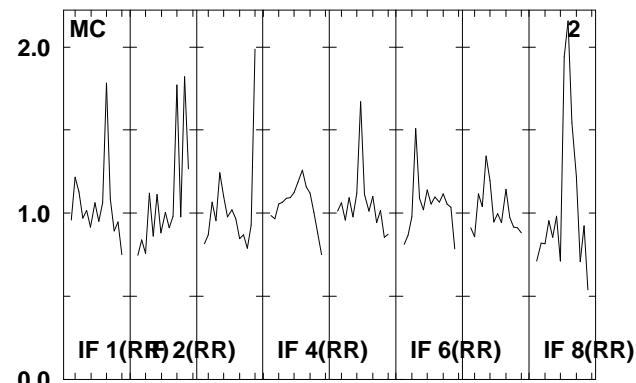
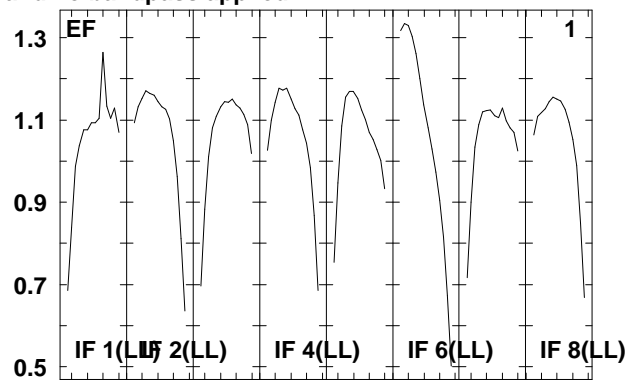
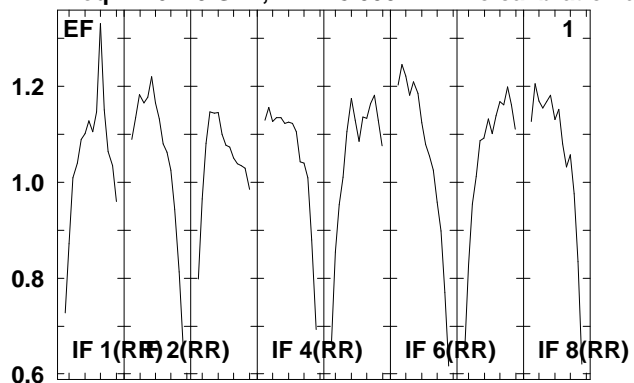

Lower frame: Real Jy  
Total-power spectrum Antenna: \*  
Timerange: 00/10:42:03 to 00/10:45:01

Plot file version 56 created 06-JAN-2009 10:57:22

J1510-05 EZ018B.UVDATA.1

Freq = 1.6270 GHz, Bw = 8.000 MH No calibration applied and no bandpass applied

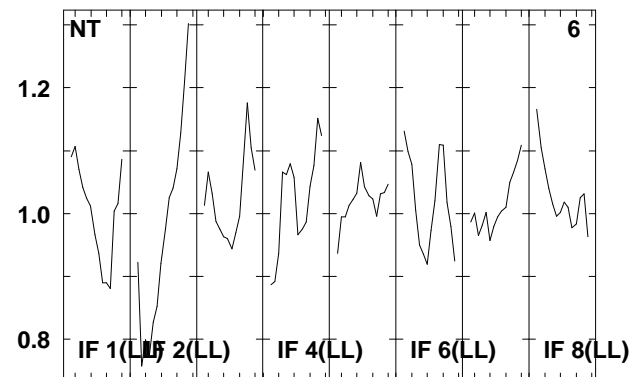
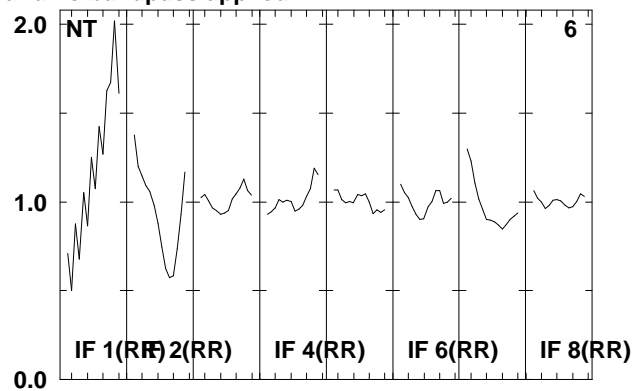
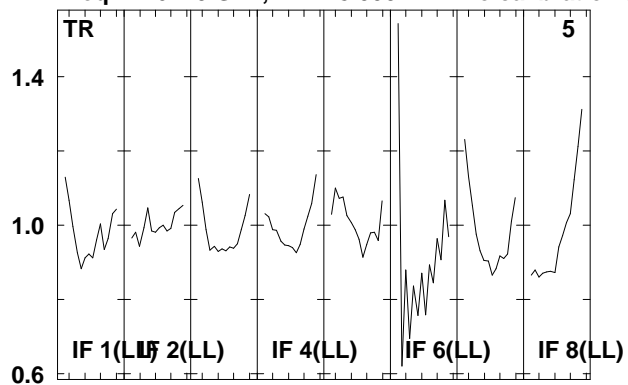

Lower frame: Real Jy  
Total-power spectrum Antenna: \*  
Timerange: 00/10:42:03 to 00/10:45:01



Plot file version 57 created 06-JAN-2009 10:57:23

J150407 EZ018B.UVDATA.1

Freq = 1.6270 GHz, Bw = 8.000 MH No calibration applied and no bandpass applied

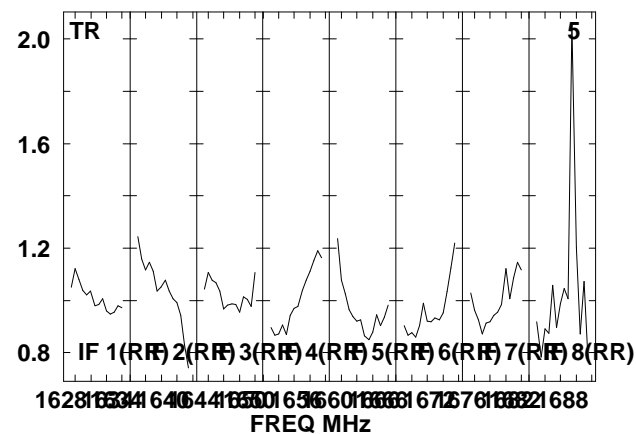
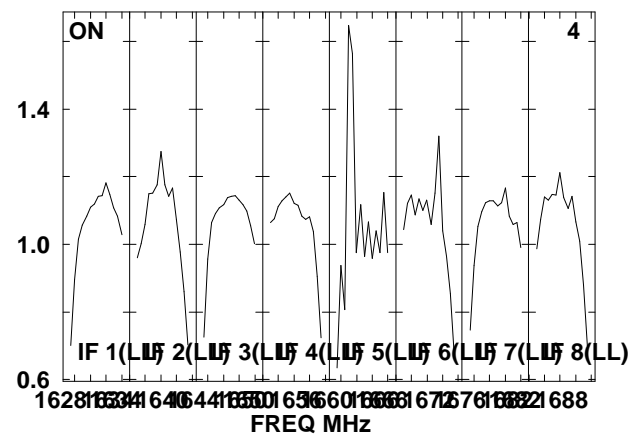
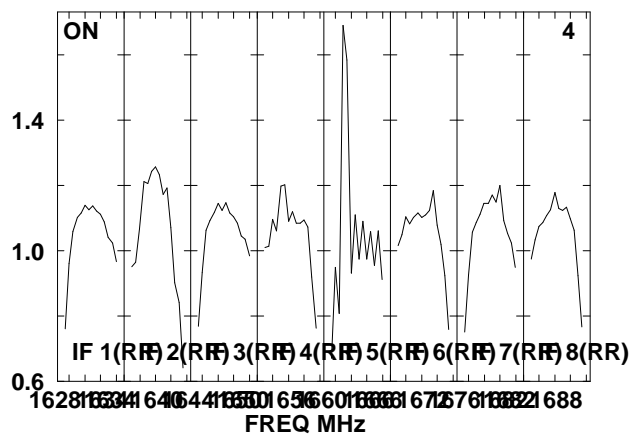
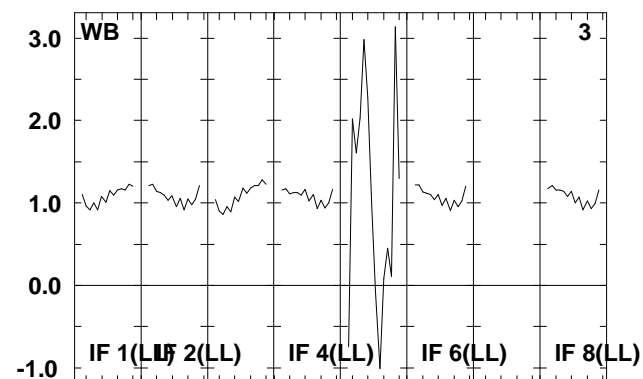
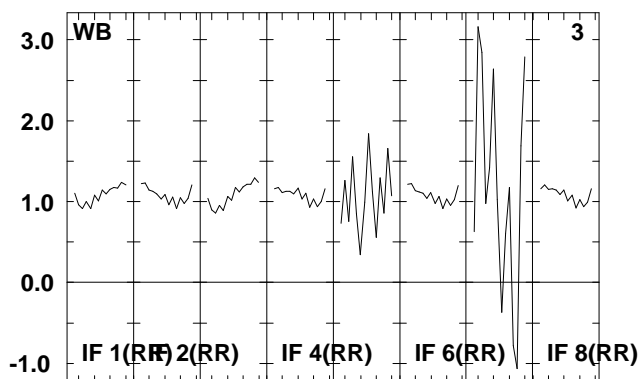
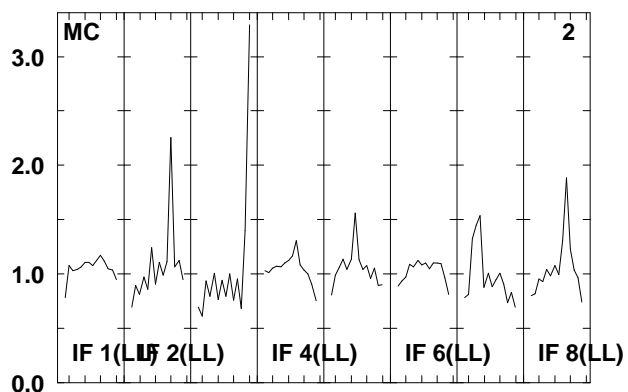
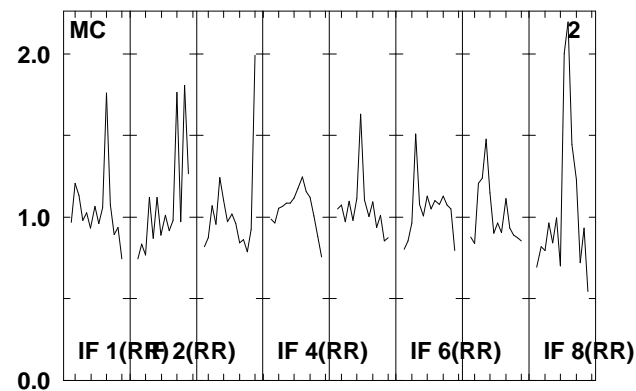
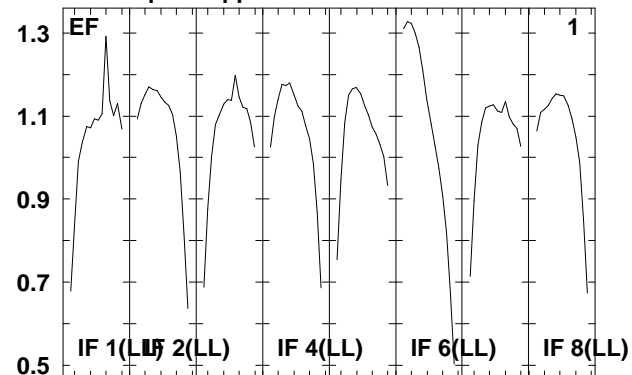
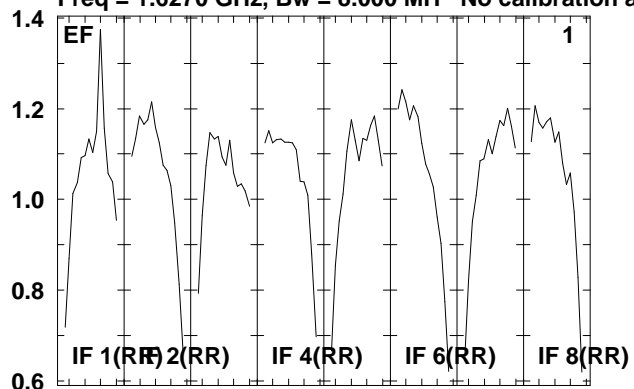

Lower frame: Real Jy  
Total-power spectrum Antenna: \*  
Timerange: 00/10:45:03 to 00/10:48:59

Plot file version 58 created 06-JAN-2009 10:57:23

J150407 EZ018B.UVDATA.1

Freq = 1.6270 GHz, Bw = 8.000 MH No calibration applied and no bandpass applied

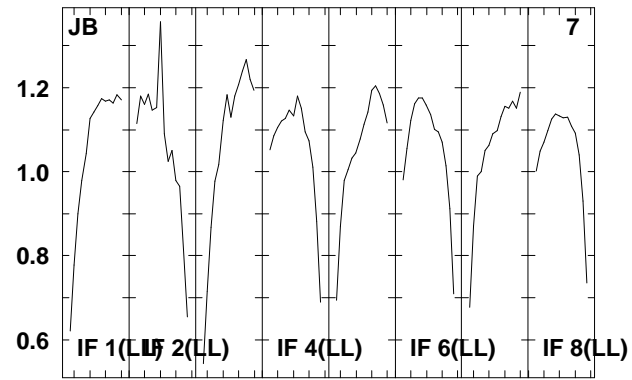
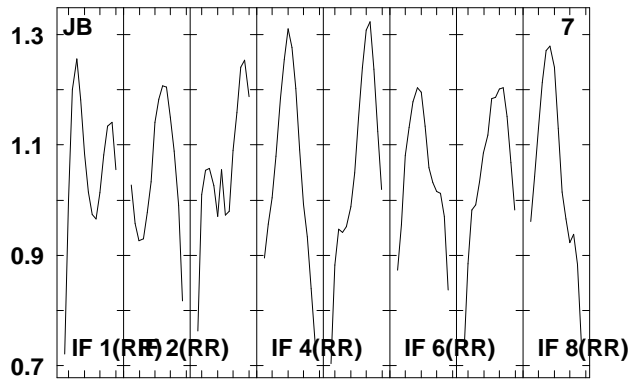
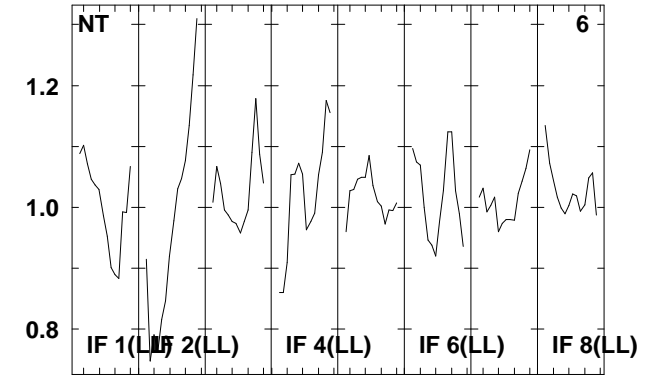
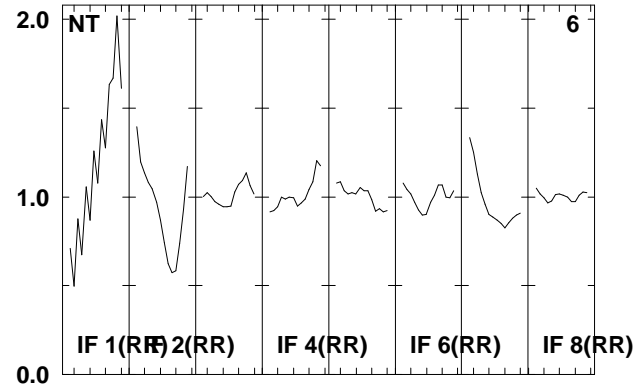
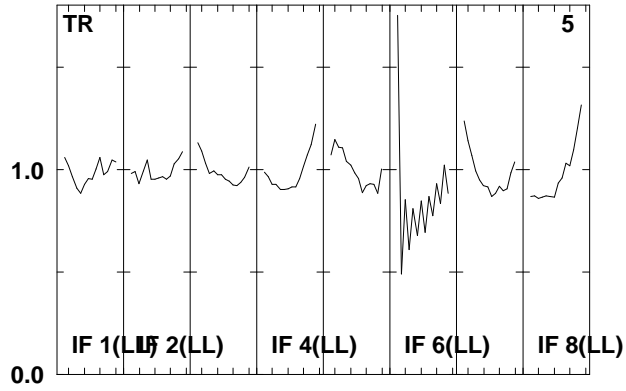

Lower frame: Real Jy  
Total-power spectrum Antenna: \*  
Timerange: 00/10:45:03 to 00/10:48:59

Plot file version 59 created 06-JAN-2009 10:57:23

J1510-05 EZ018B.UVDATA.1

Freq = 1.6270 GHz, Bw = 8.000 MH No calibration applied and no bandpass applied

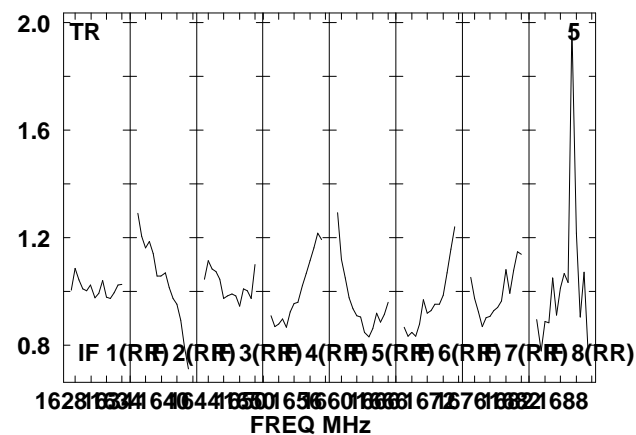
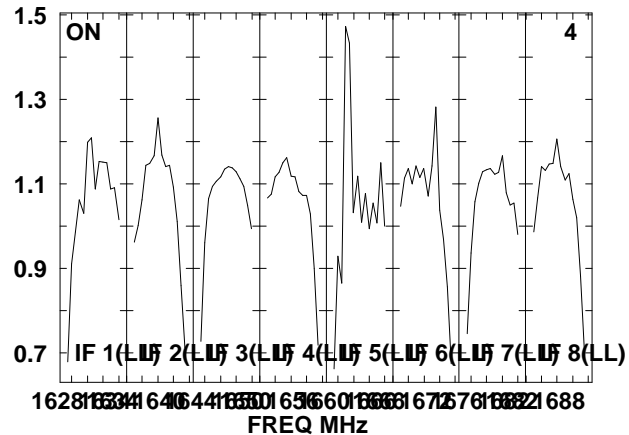
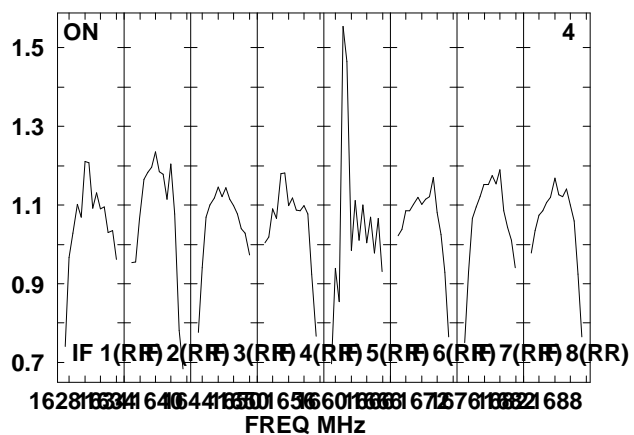
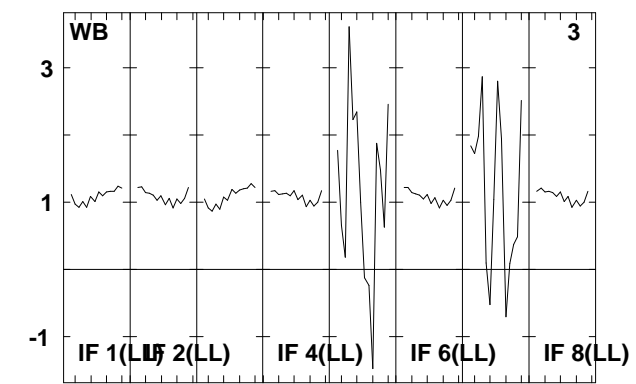
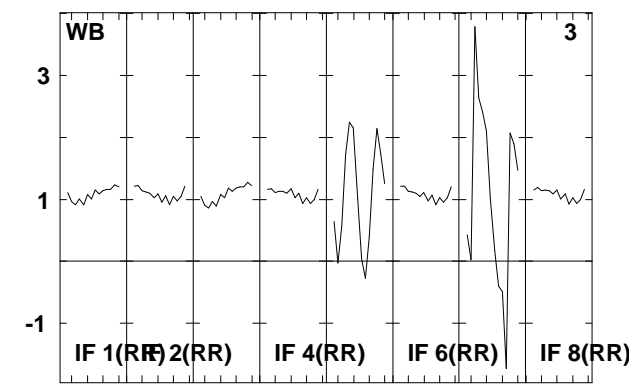
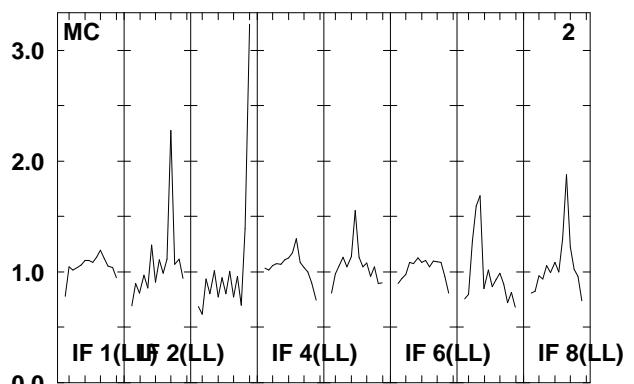
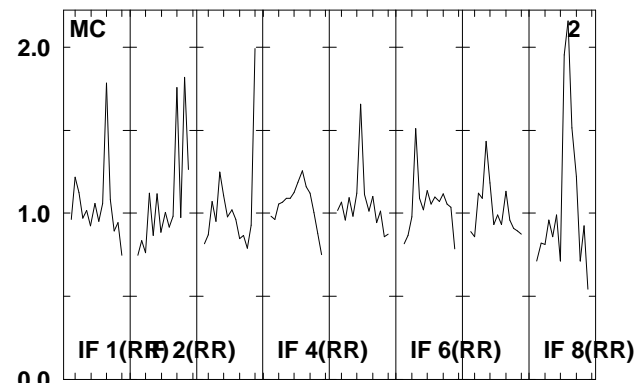
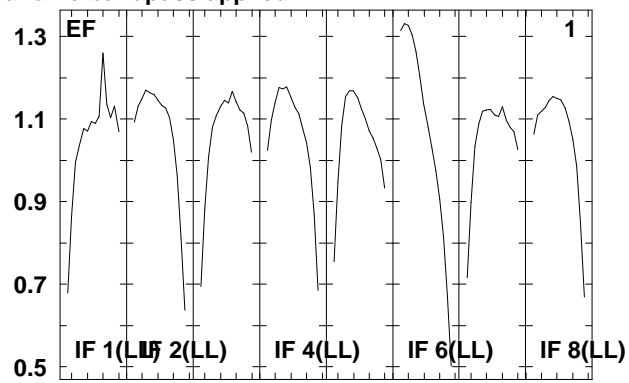
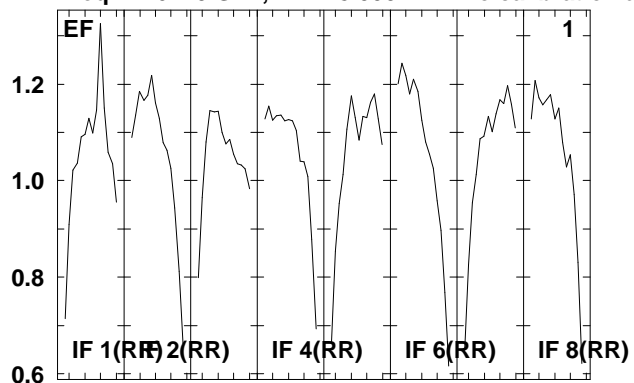

Lower frame: Real Jy  
Total-power spectrum Antenna: \*  
Timerange: 00/10:50:03 to 00/10:53:01

Plot file version 60 created 06-JAN-2009 10:57:24

J1510-05 EZ018B.UVDATA.1

Freq = 1.6270 GHz, Bw = 8.000 MH No calibration applied and no bandpass applied

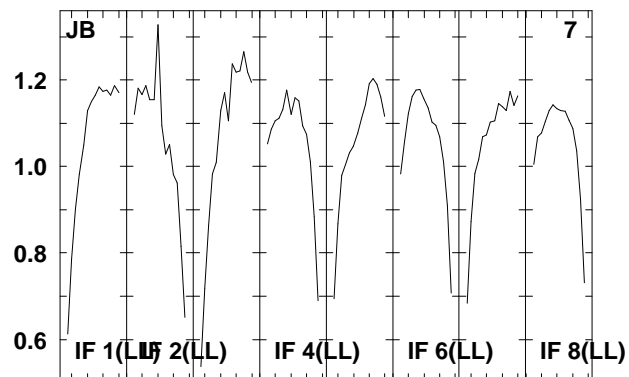
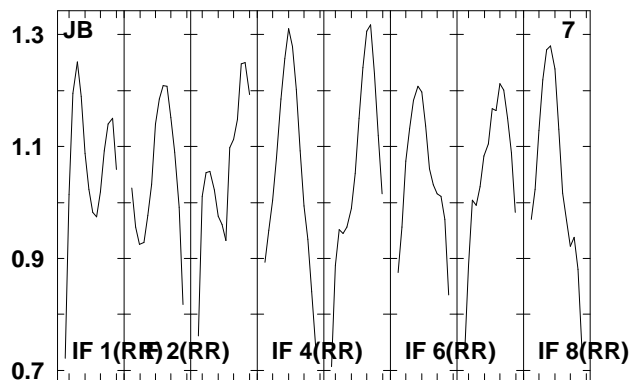
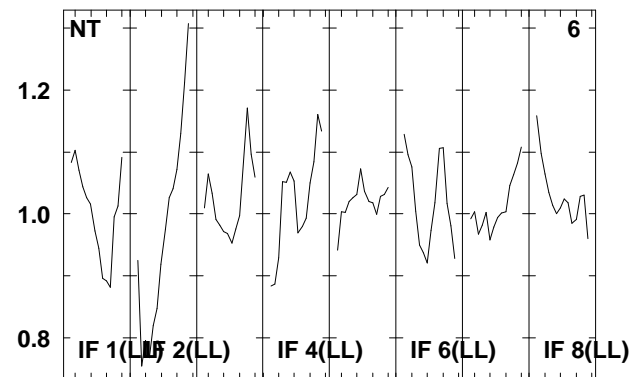
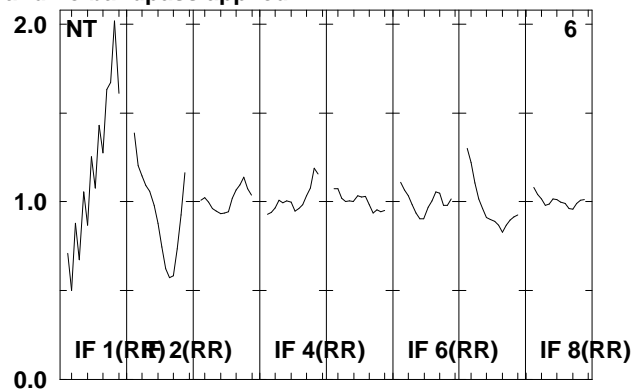
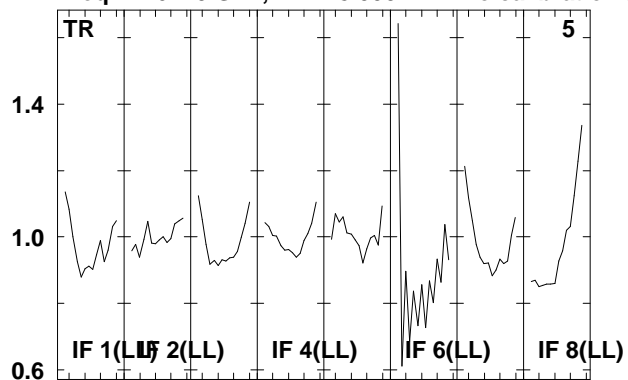

Lower frame: Real Jy  
Total-power spectrum Antenna: \*  
Timerange: 00/10:50:03 to 00/10:53:01

Plot file version 61 created 06-JAN-2009 10:57:24

J150407 EZ018B.UVDATA.1

Freq = 1.6270 GHz, Bw = 8.000 MH No calibration applied and no bandpass applied

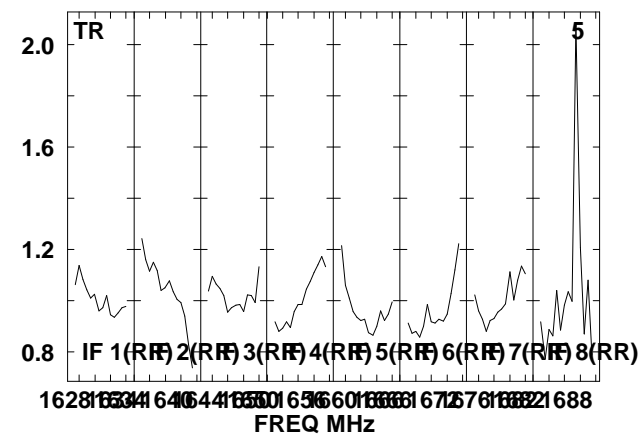
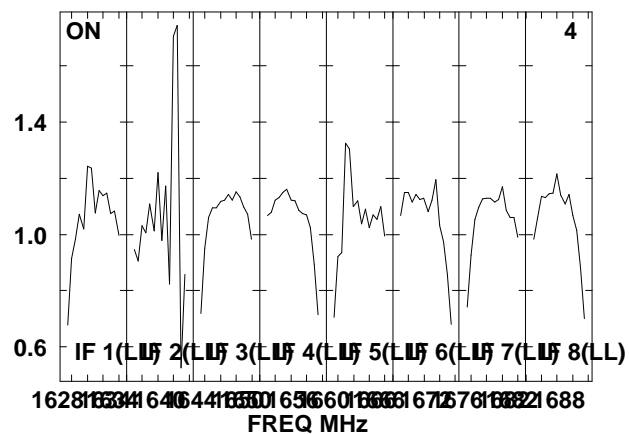
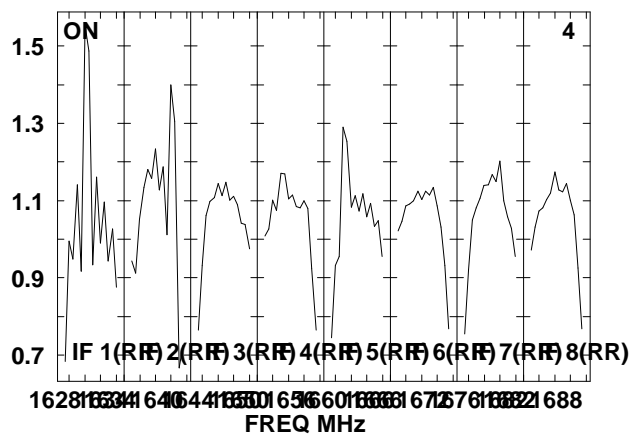
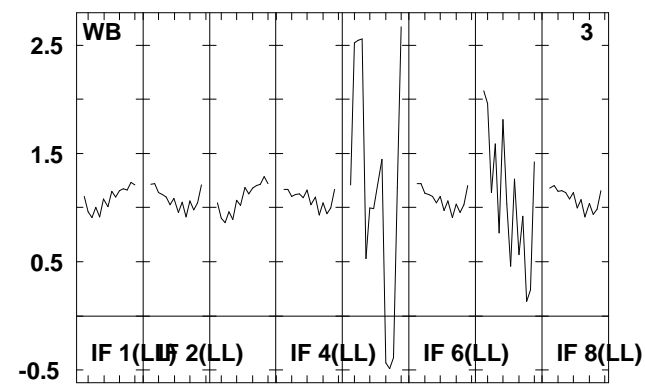
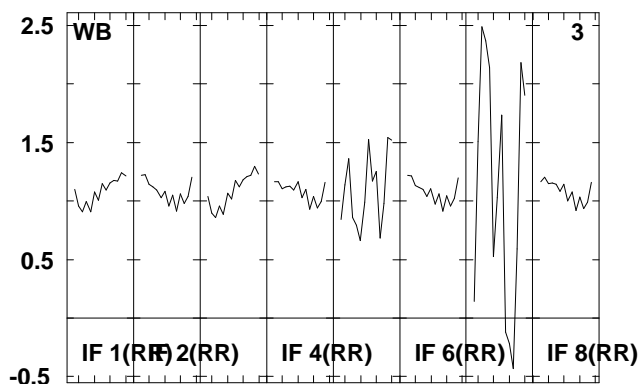
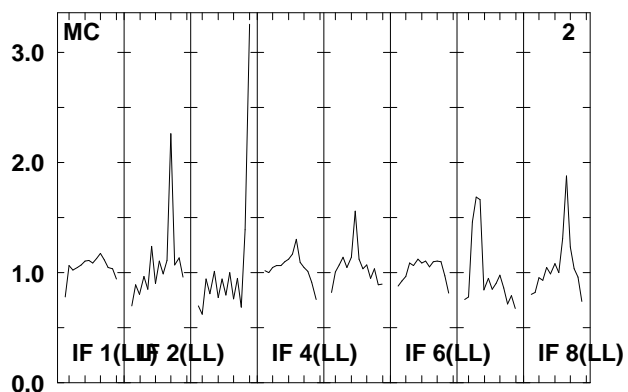
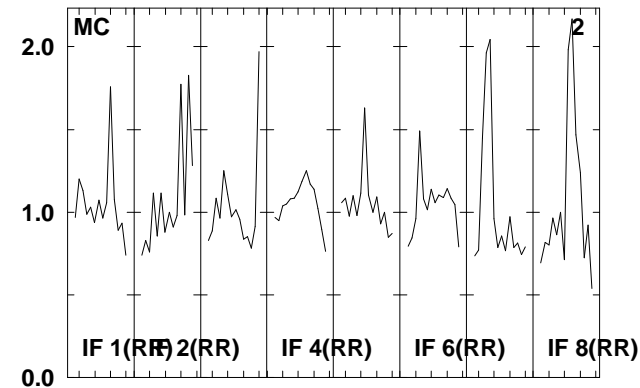
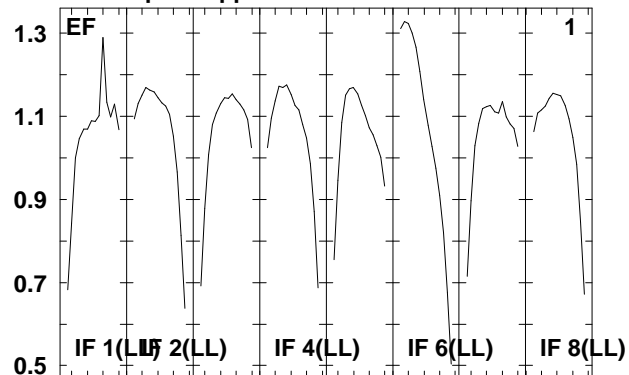
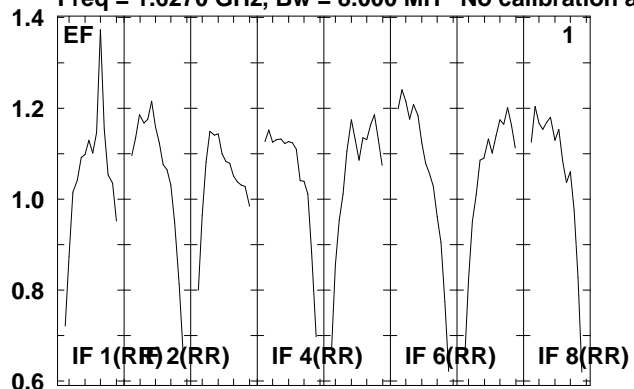

Lower frame: Real Jy  
Total-power spectrum Antenna: \*  
Timerange: 00/10:53:03 to 00/10:56:59

Plot file version 62 created 06-JAN-2009 10:57:25

J150407 EZ018B.UVDATA.1

Freq = 1.6270 GHz, Bw = 8.000 MH No calibration applied and no bandpass applied

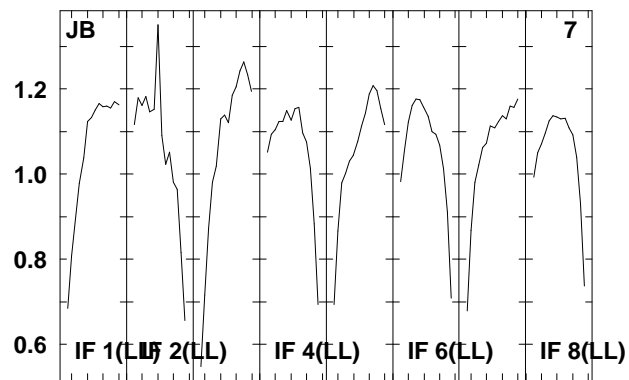
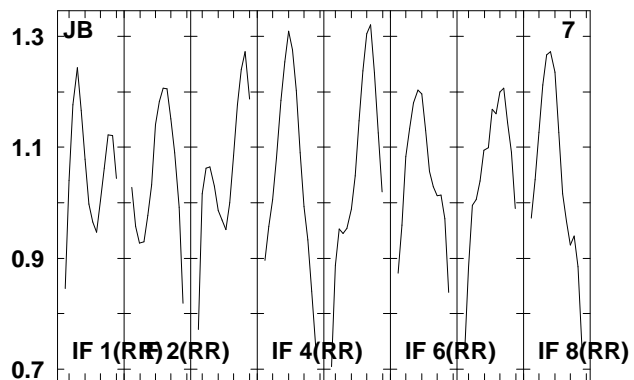
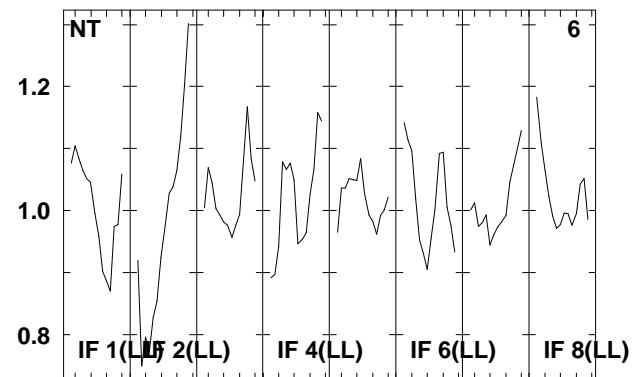
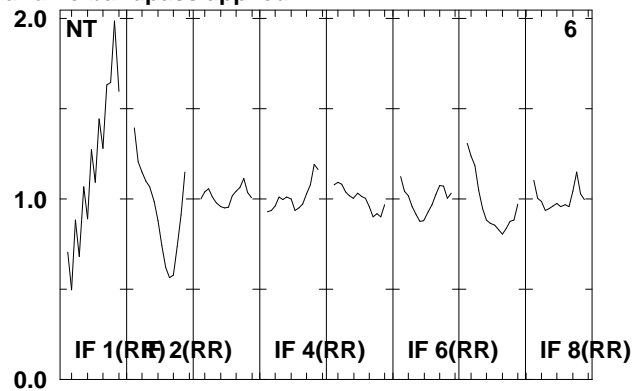
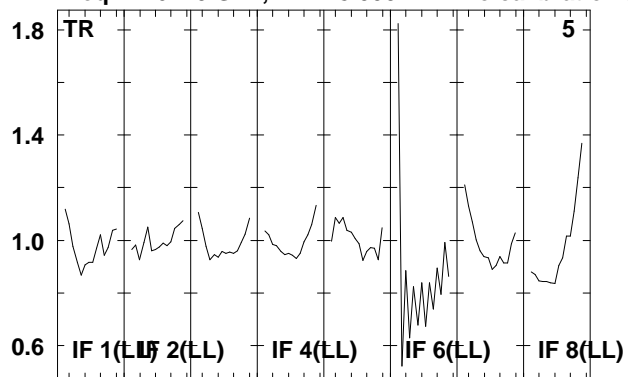

Lower frame: Real Jy  
Total-power spectrum Antenna: \*  
Timerange: 00/10:53:03 to 00/10:56:59

Plot file version 63 created 06-JAN-2009 10:57:25

J1510-05 EZ018B.UVDATA.1

Freq = 1.6270 GHz, Bw = 8.000 MH No calibration applied and no bandpass applied

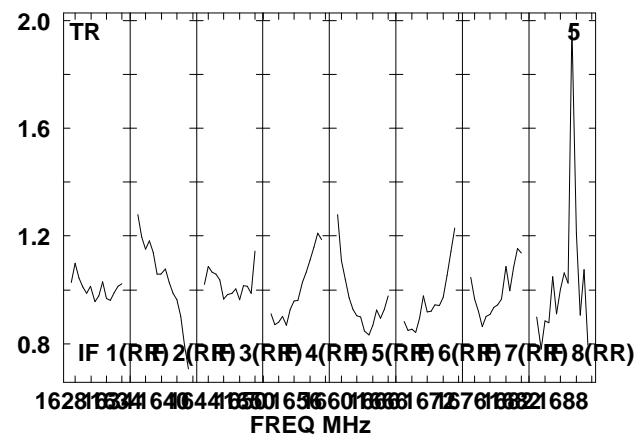
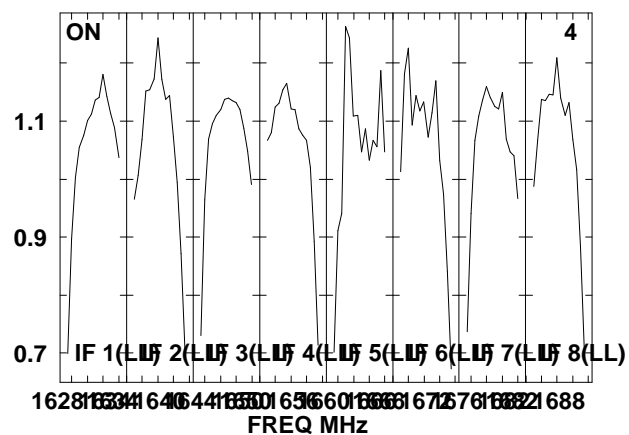
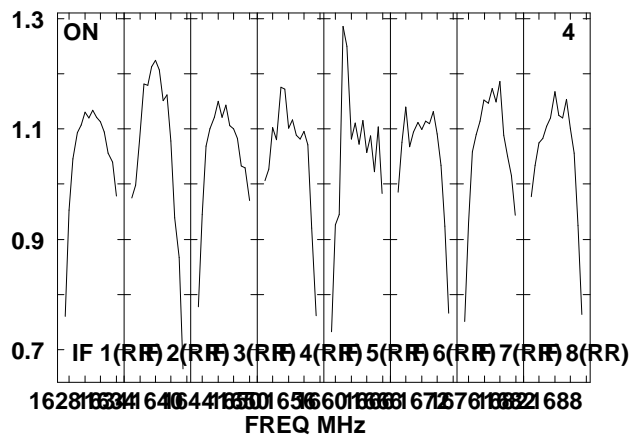
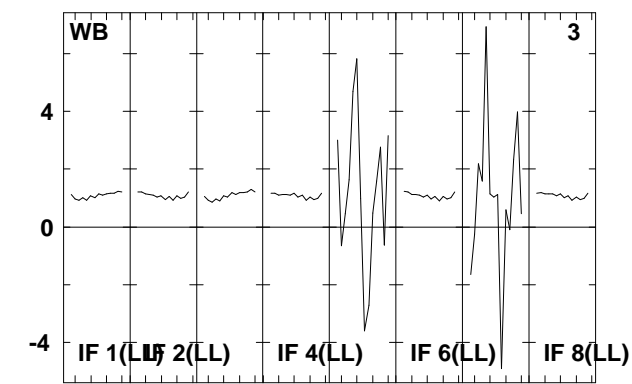
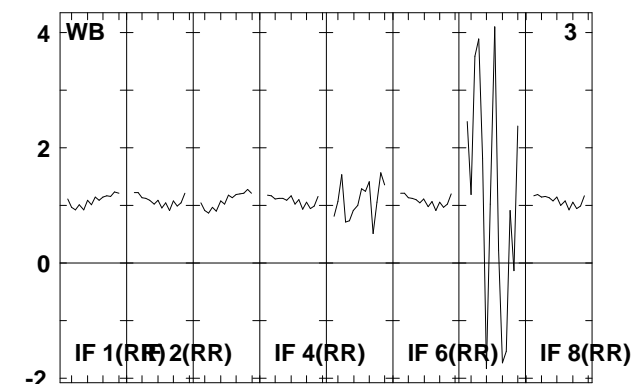
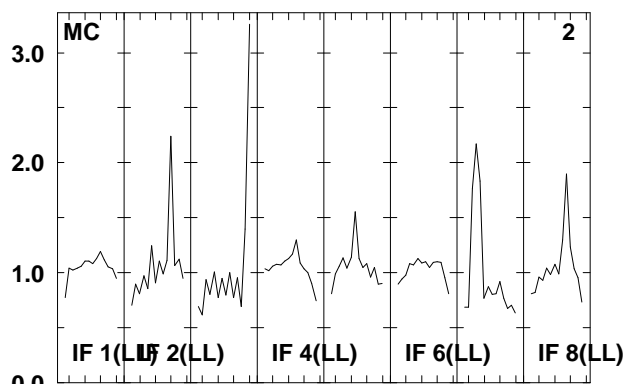
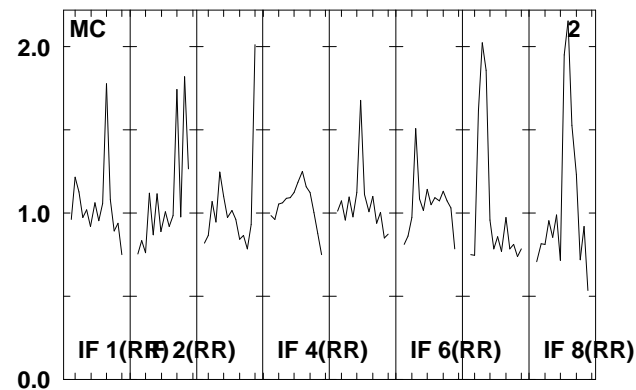
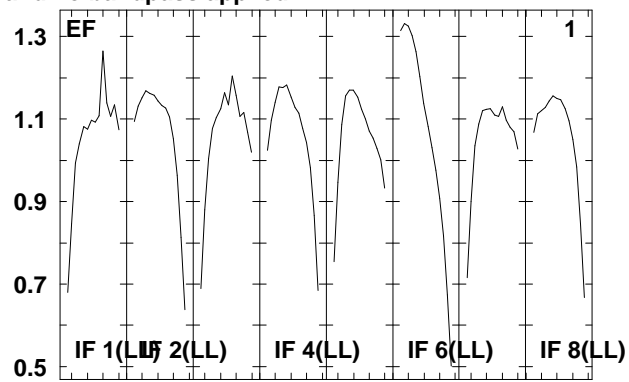
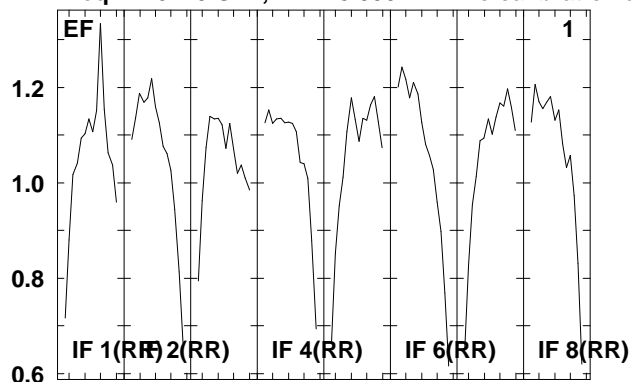

Lower frame: Real Jy  
Total-power spectrum Antenna: \*  
Timerange: 00/10:57:01 to 00/11:00:01

Plot file version 64 created 06-JAN-2009 10:57:25

J1510-05 EZ018B.UVDATA.1

Freq = 1.6270 GHz, Bw = 8.000 MH No calibration applied and no bandpass applied

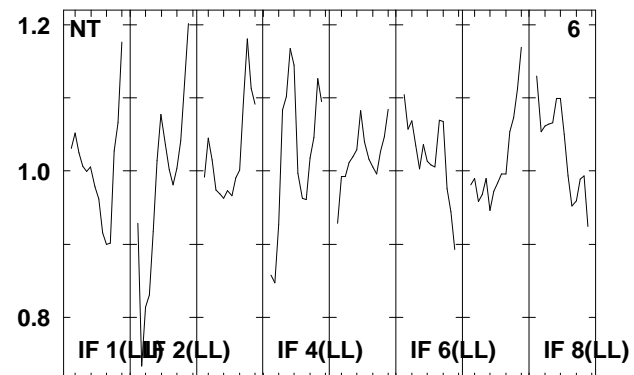
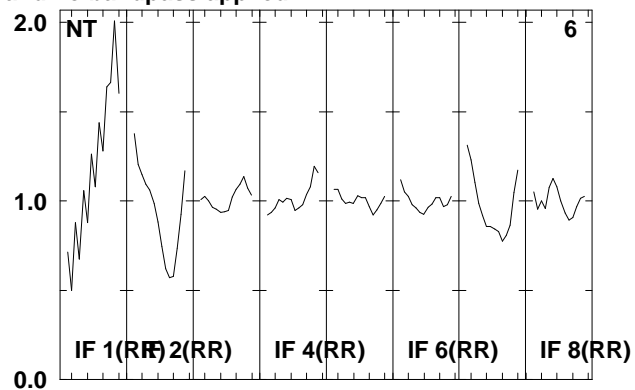
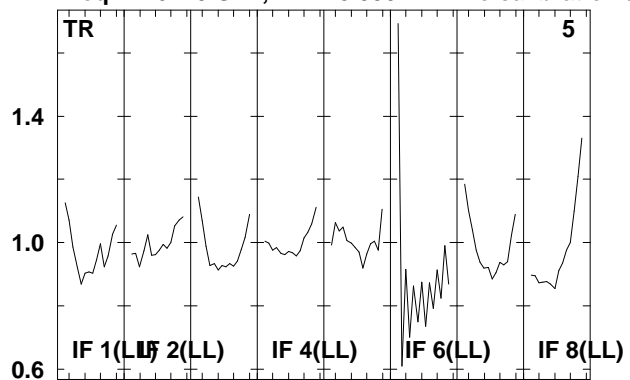

Lower frame: Real Jy  
Total-power spectrum Antenna: \*  
Timerange: 00/10:57:01 to 00/11:00:01



Plot file version 65 created 06-JAN-2009 10:57:26

J150407 EZ018B.UVDATA.1

Freq = 1.6270 GHz, Bw = 8.000 MH No calibration applied and no bandpass applied

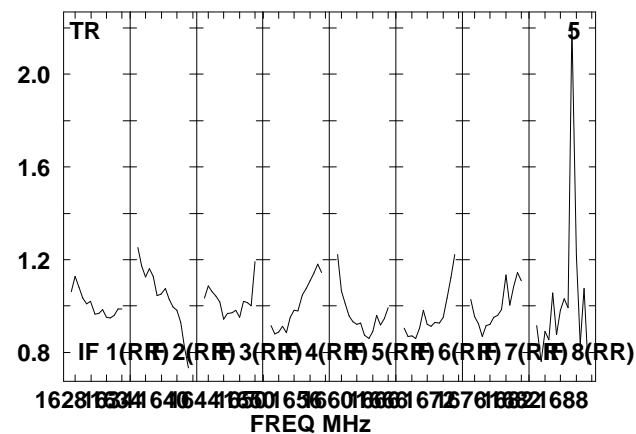
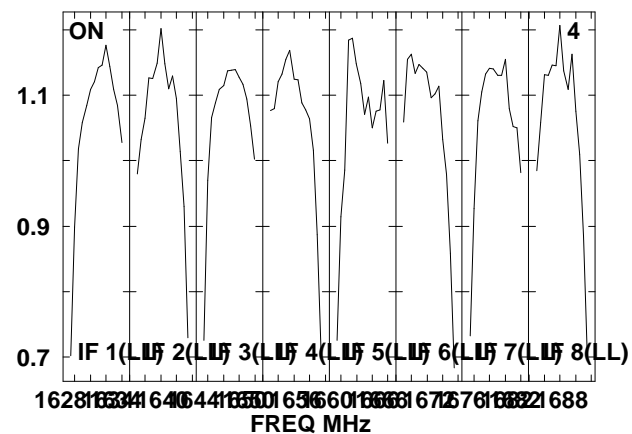
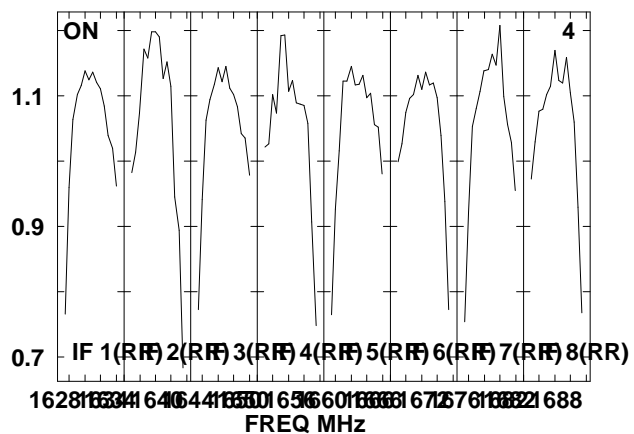
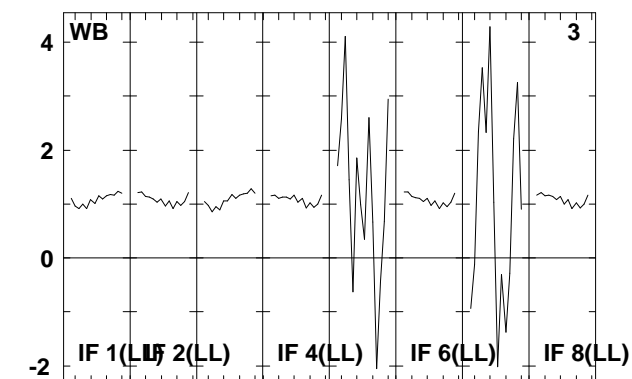
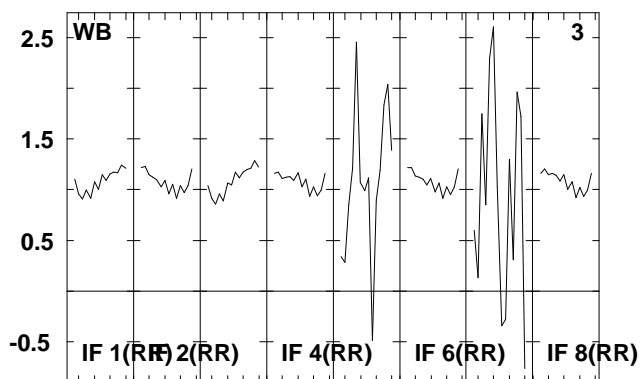
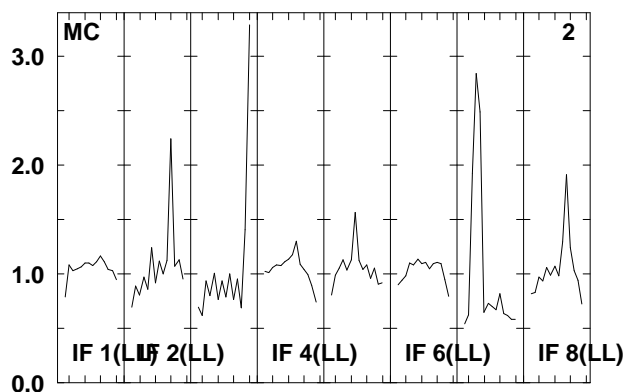
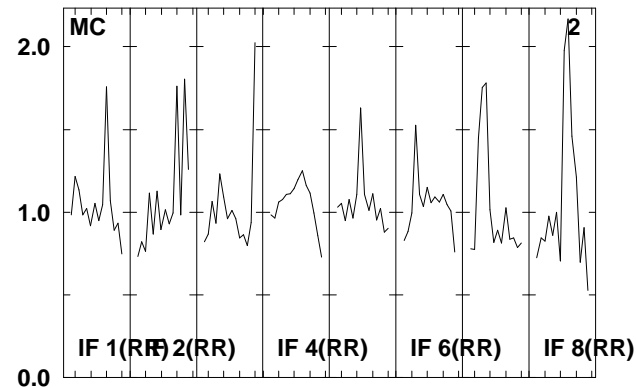
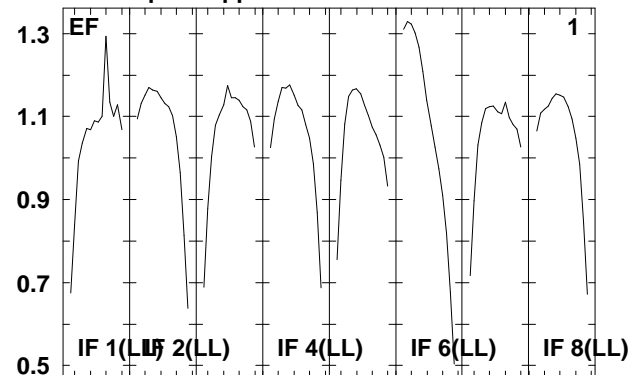
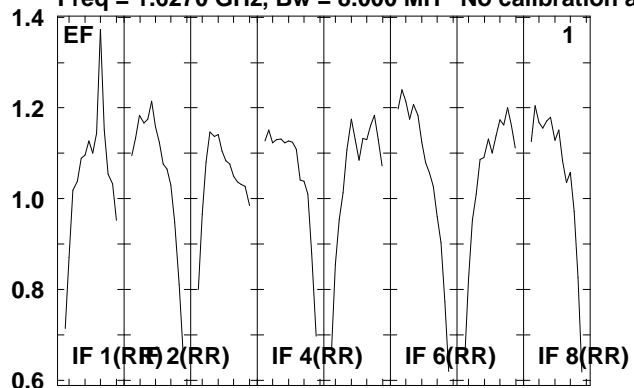

Lower frame: Real Jy  
Total-power spectrum Antenna: \*  
Timerange: 00/11:00:03 to 00/11:03:59

Plot file version 66 created 06-JAN-2009 10:57:26

J150407 EZ018B.UVDATA.1

Freq = 1.6270 GHz, Bw = 8.000 MH No calibration applied and no bandpass applied

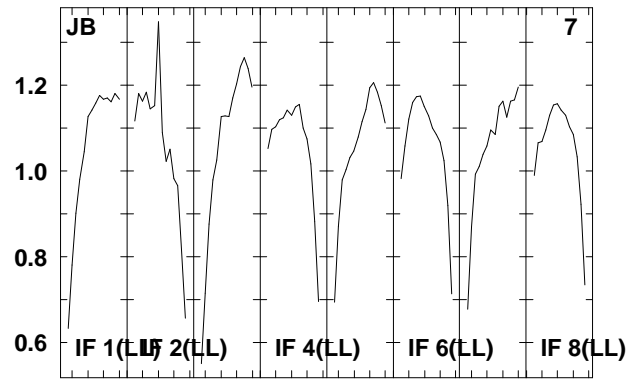
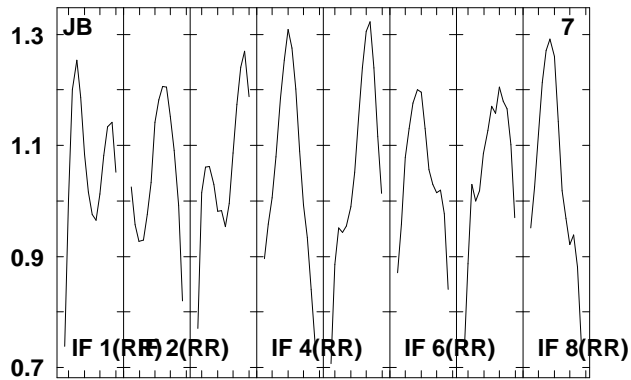
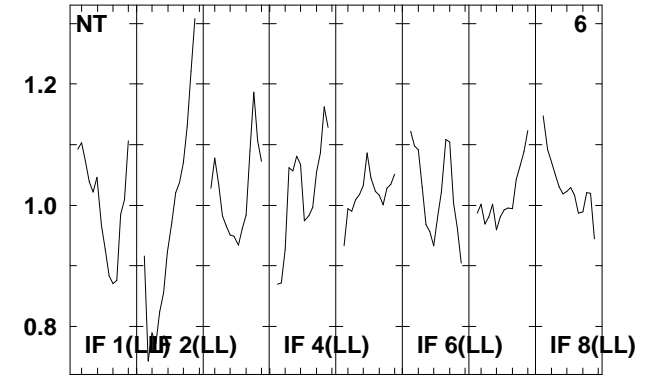
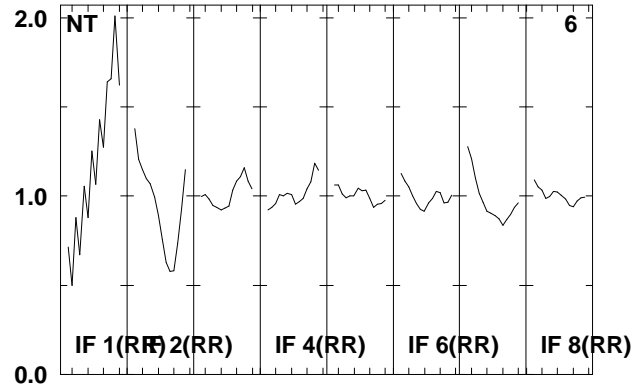
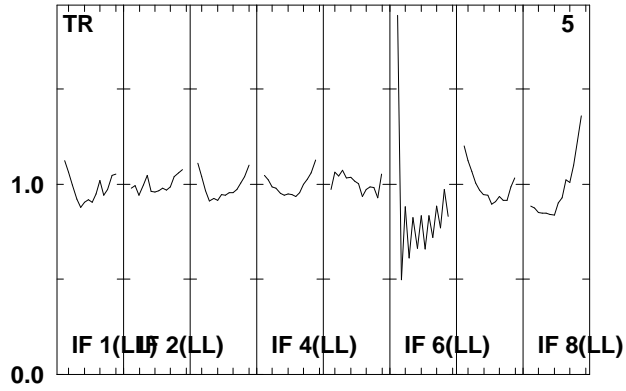

Lower frame: Real Jy  
Total-power spectrum Antenna: \*  
Timerange: 00/11:00:03 to 00/11:03:59

Plot file version 67 created 06-JAN-2009 10:57:26

J1510-05 EZ018B.UVDATA.1

Freq = 1.6270 GHz, Bw = 8.000 MH No calibration applied and no bandpass applied

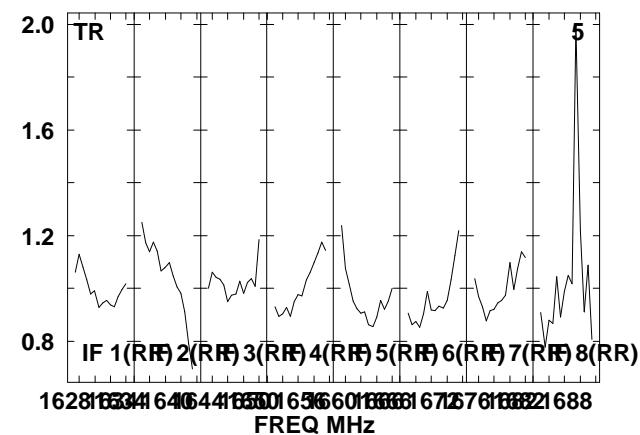
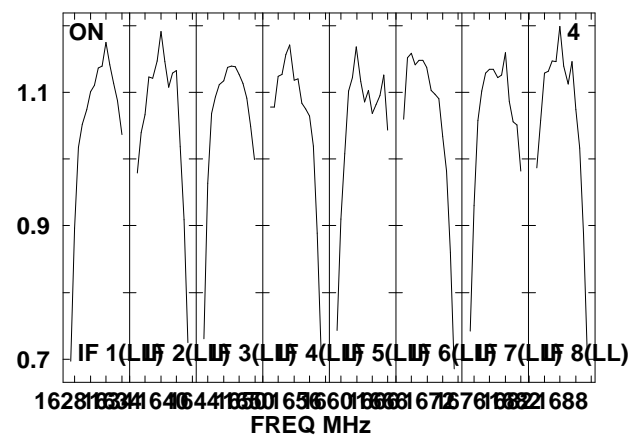
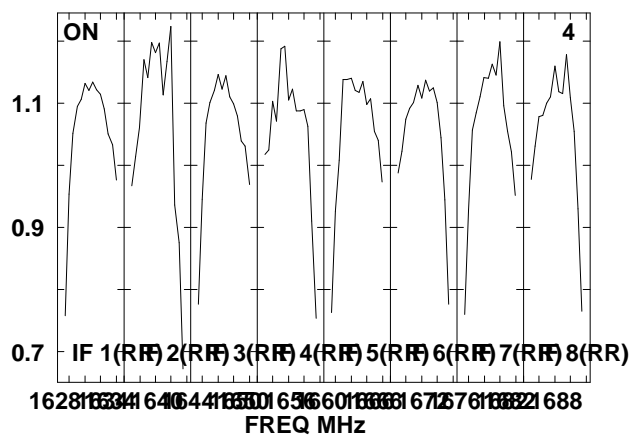
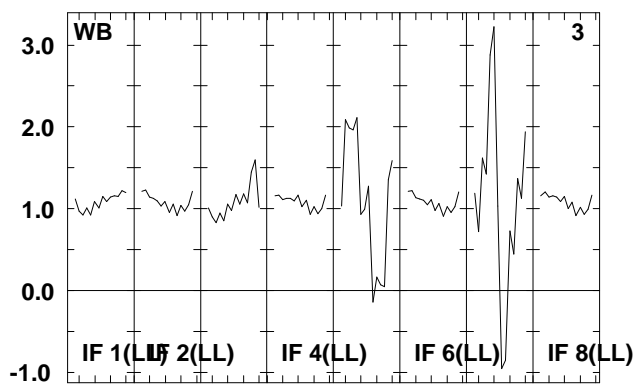
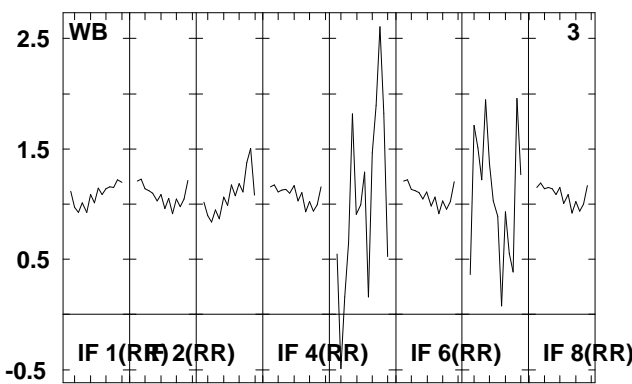
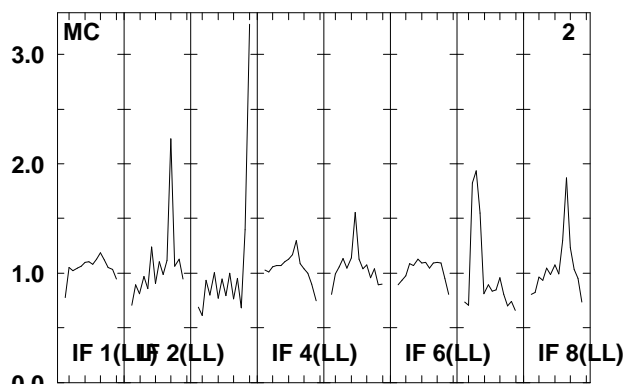
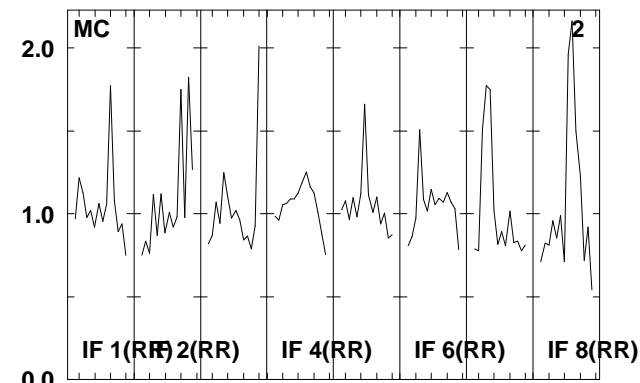
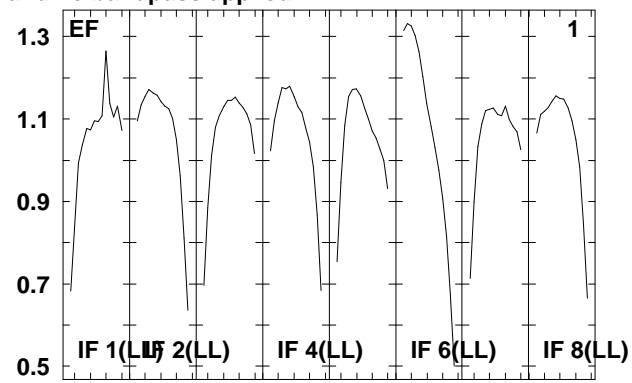
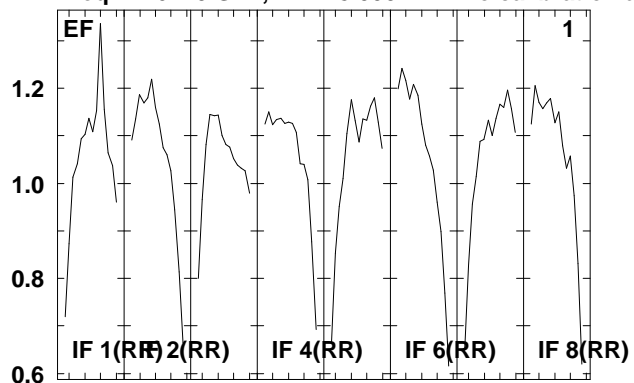

Lower frame: Real Jy  
Total-power spectrum Antenna: \*  
Timerange: 00/11:05:03 to 00/11:08:01

Plot file version 68 created 06-JAN-2009 10:57:27

J1510-05 EZ018B.UVDATA.1

Freq = 1.6270 GHz, Bw = 8.000 MH No calibration applied and no bandpass applied

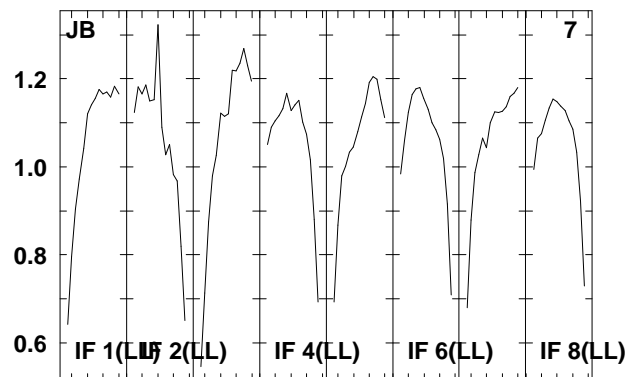
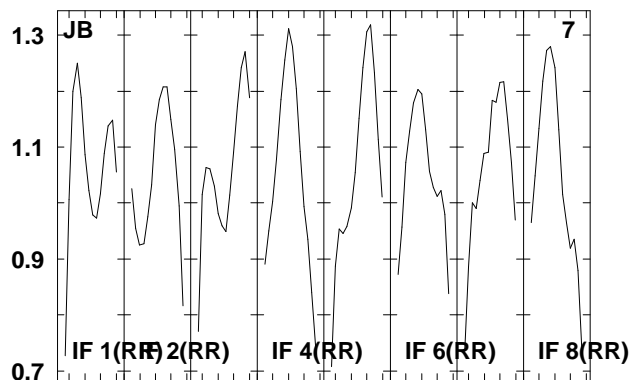
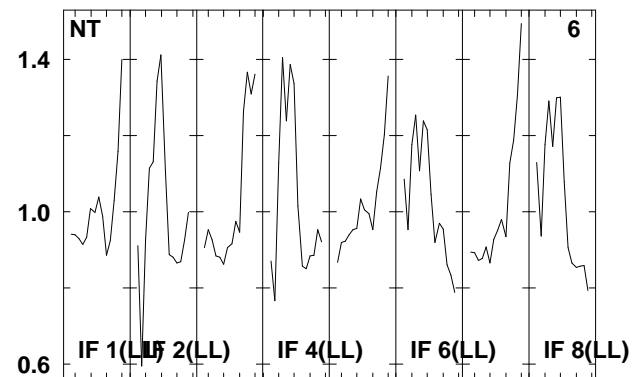
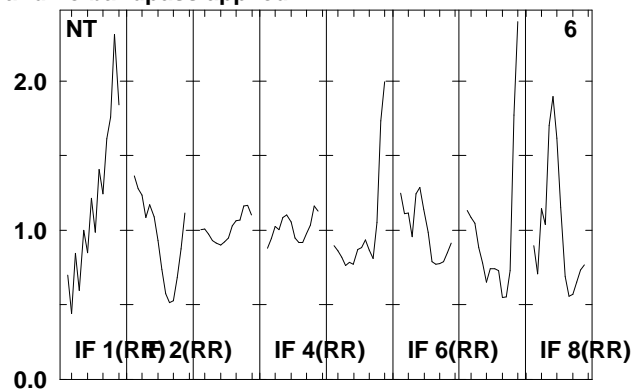
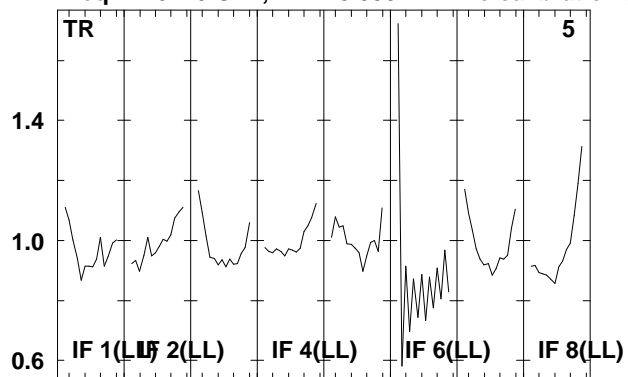

Lower frame: Real Jy  
Total-power spectrum Antenna: \*  
Timerange: 00/11:05:03 to 00/11:08:01

Plot file version 69 created 06-JAN-2009 10:57:27

J150407 EZ018B.UVDATA.1

Freq = 1.6270 GHz, Bw = 8.000 MH No calibration applied and no bandpass applied

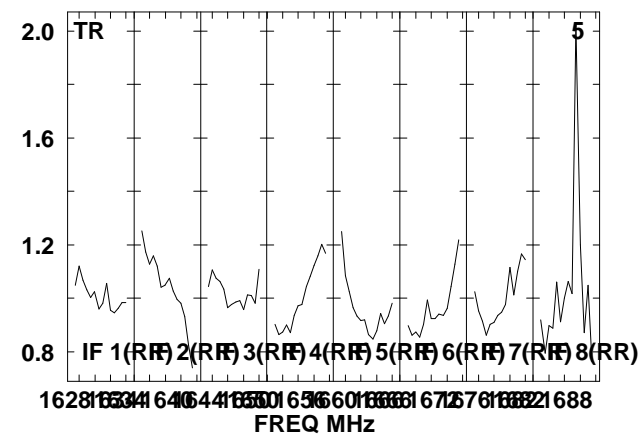
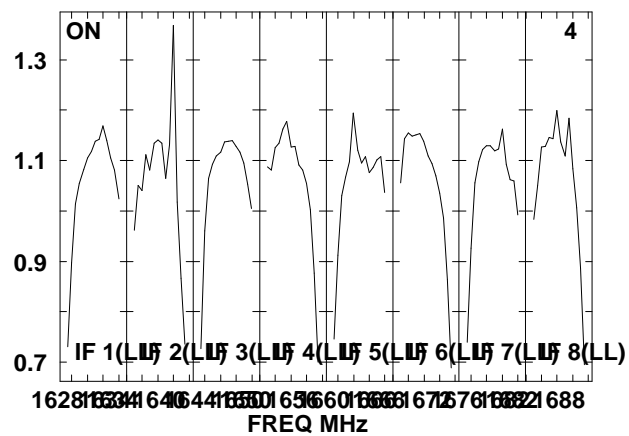
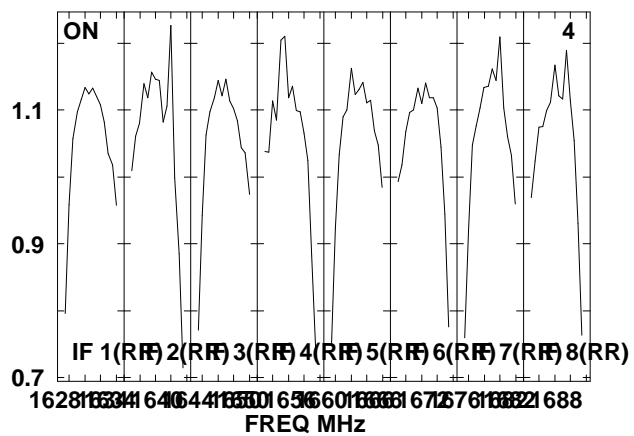
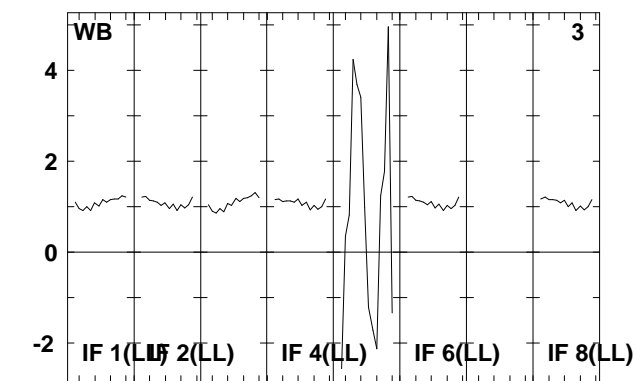
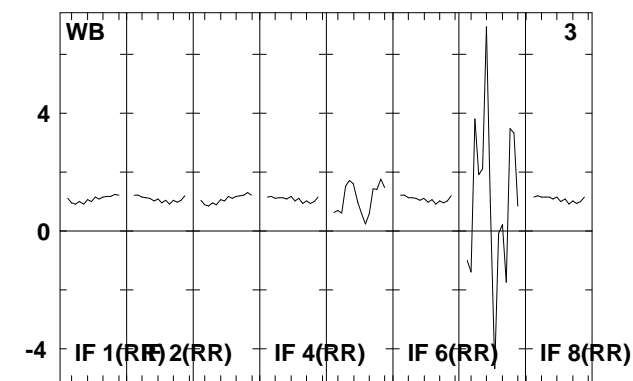
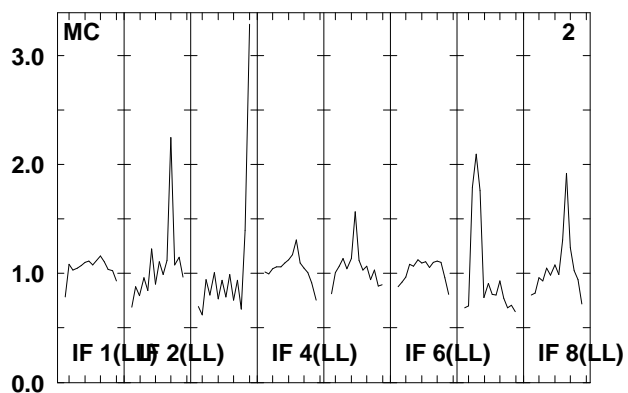
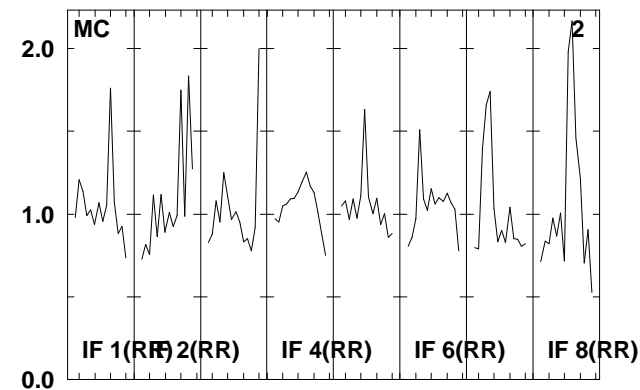
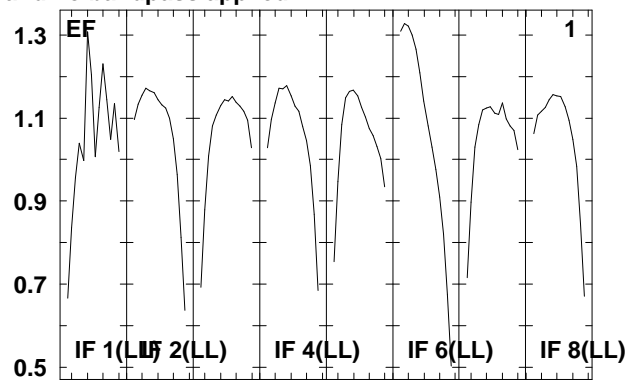
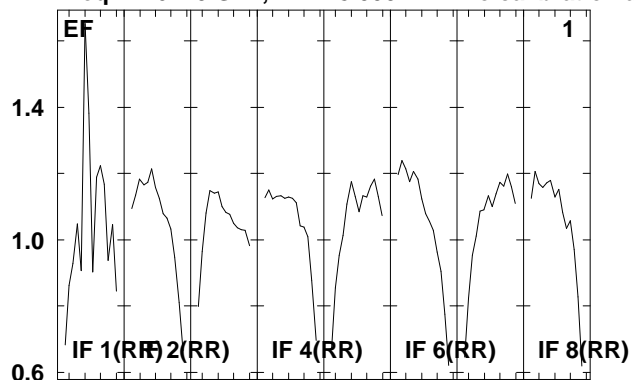

Lower frame: Real Jy  
Total-power spectrum Antenna: \*  
Timerange: 00/11:08:03 to 00/11:11:59

Plot file version 70 created 06-JAN-2009 10:57:28

J150407 EZ018B.UVDATA.1

Freq = 1.6270 GHz, Bw = 8.000 MH No calibration applied and no bandpass applied

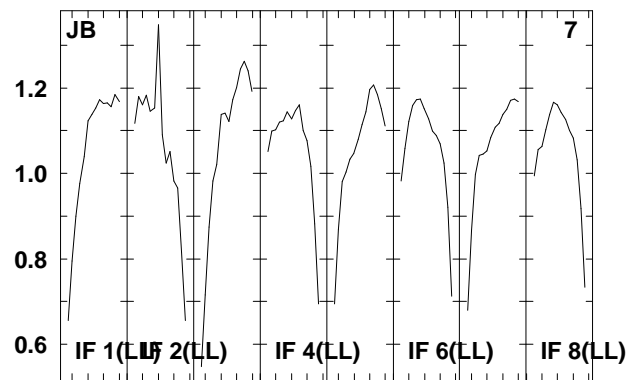
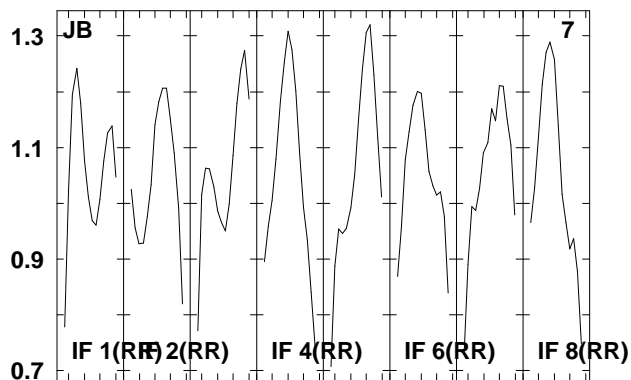
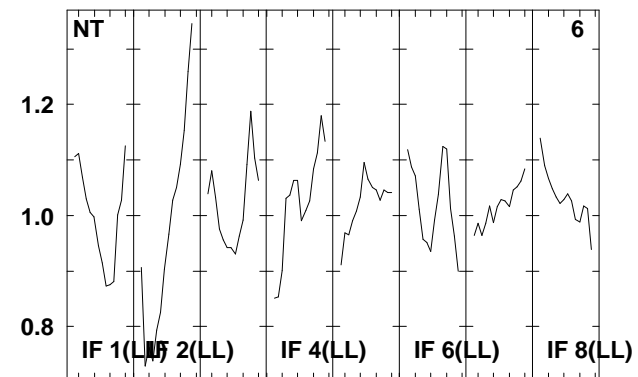
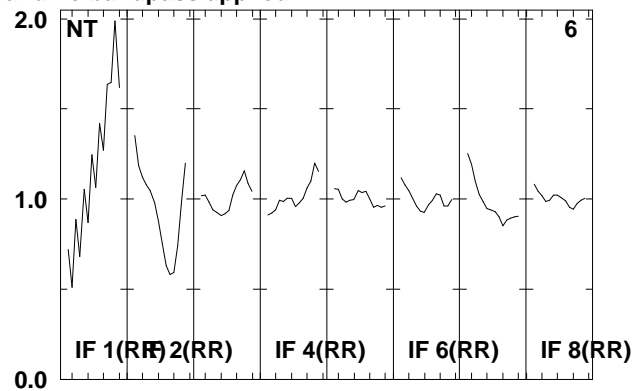
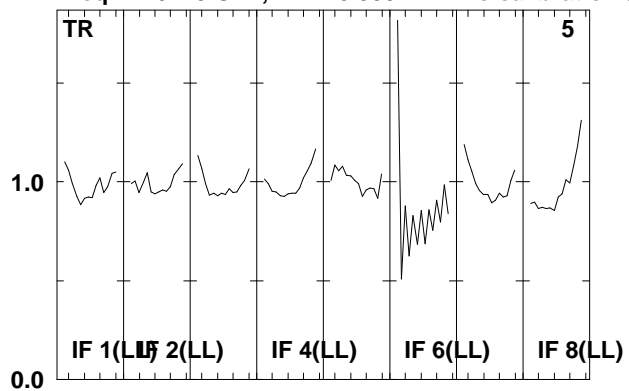

Lower frame: Real Jy  
Total-power spectrum Antenna: \*  
Timerange: 00/11:08:03 to 00/11:11:59

Plot file version 71 created 06-JAN-2009 10:57:28

J1510-05 EZ018B.UVDATA.1

Freq = 1.6270 GHz, Bw = 8.000 MH No calibration applied and no bandpass applied

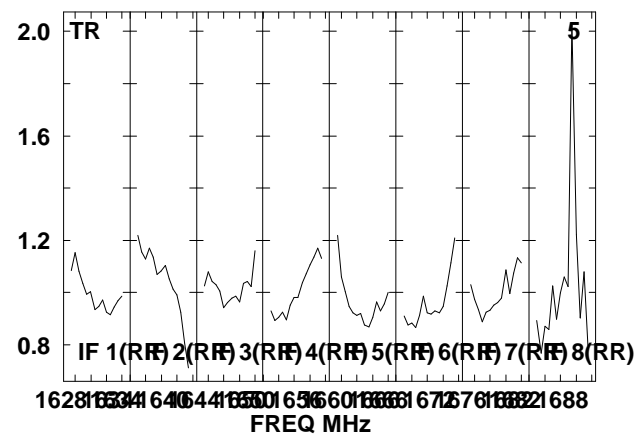
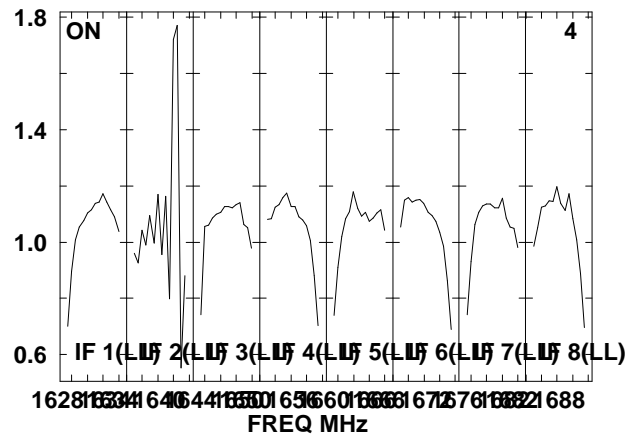
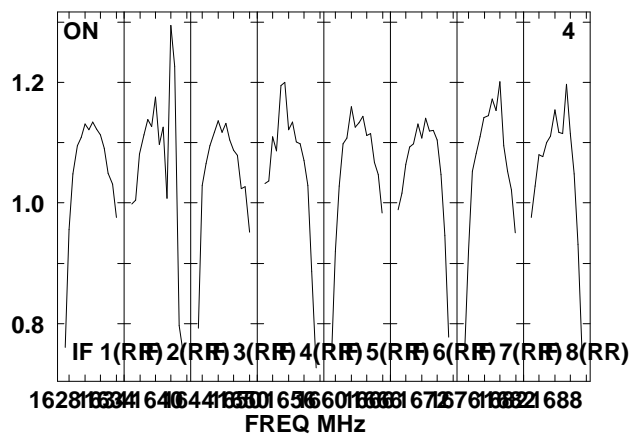
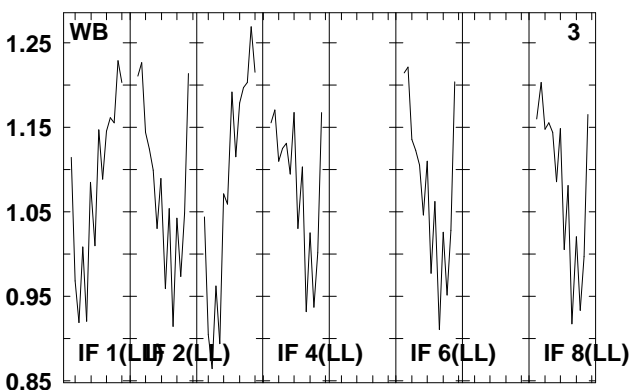
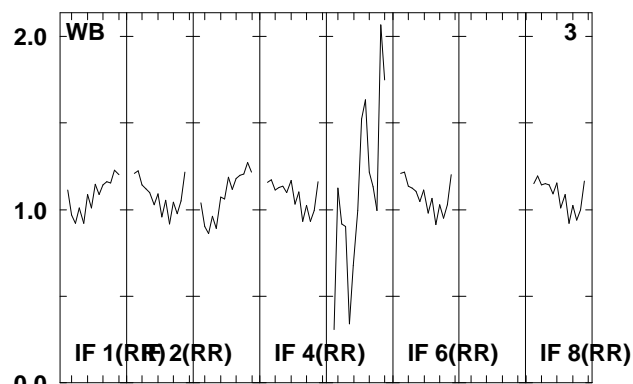
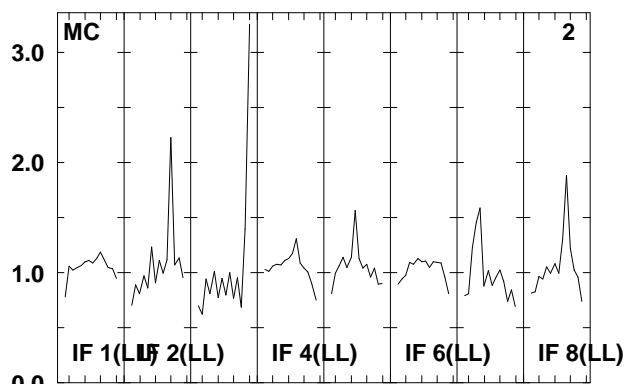
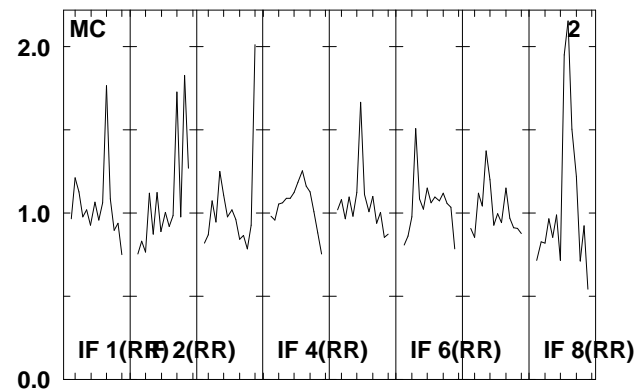
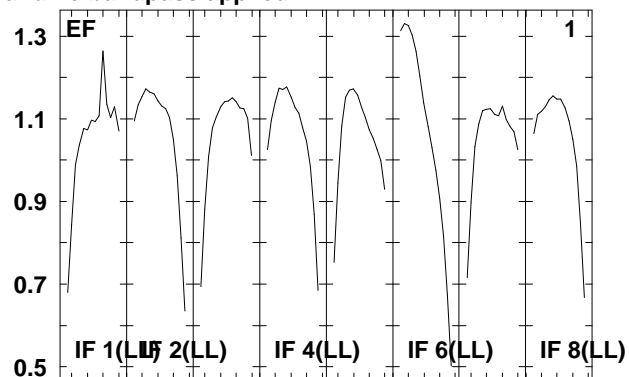
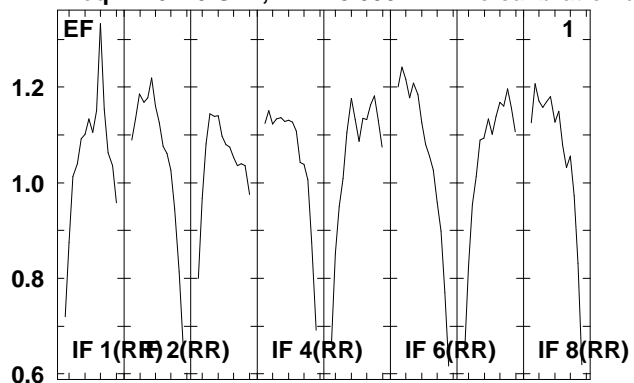

Lower frame: Real Jy  
Total-power spectrum Antenna: \*  
Timerange: 00/11:12:01 to 00/11:15:01

Plot file version 72 created 06-JAN-2009 10:57:28

J1510-05 EZ018B.UVDATA.1

Freq = 1.6270 GHz, Bw = 8.000 MH No calibration applied and no bandpass applied

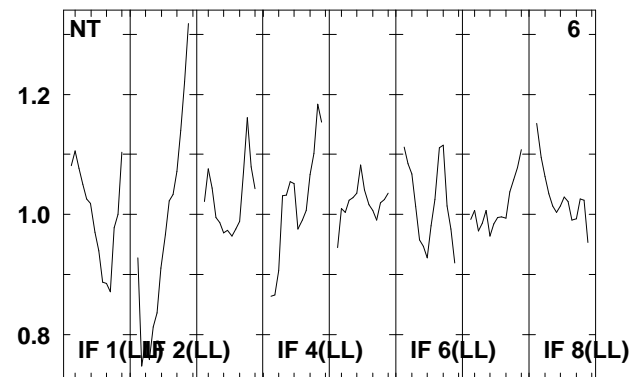
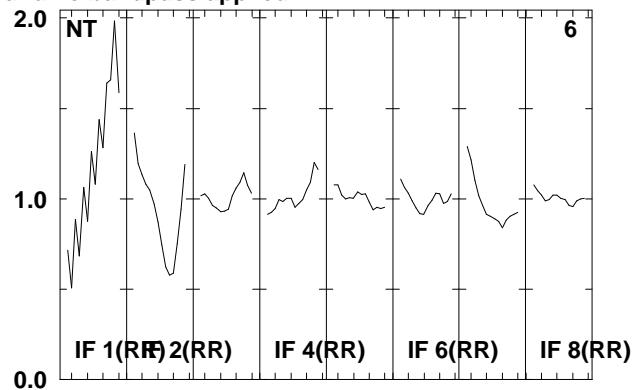
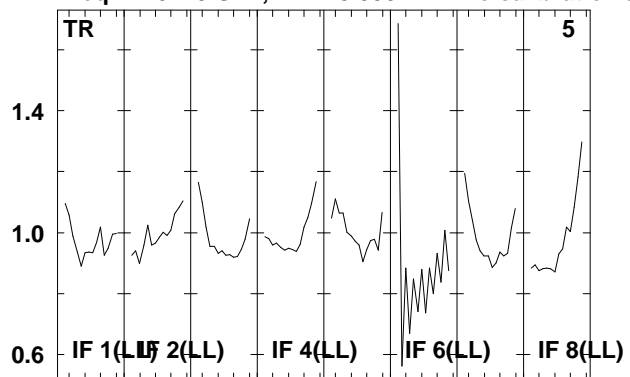

Lower frame: Real Jy  
Total-power spectrum Antenna: \*  
Timerange: 00/11:12:01 to 00/11:15:01



Plot file version 73 created 06-JAN-2009 10:57:29

J150407 EZ018B.UVDATA.1

Freq = 1.6270 GHz, Bw = 8.000 MH No calibration applied and no bandpass applied

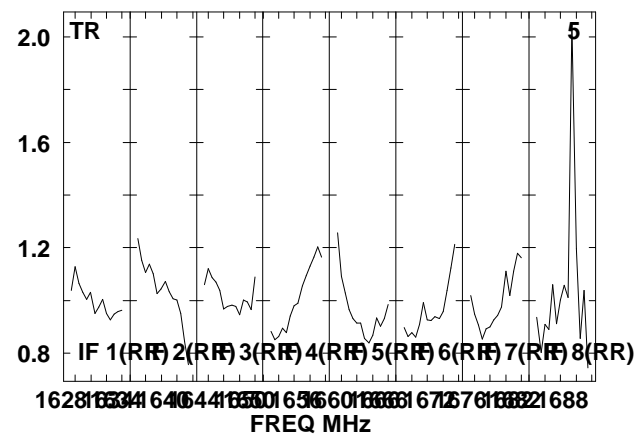
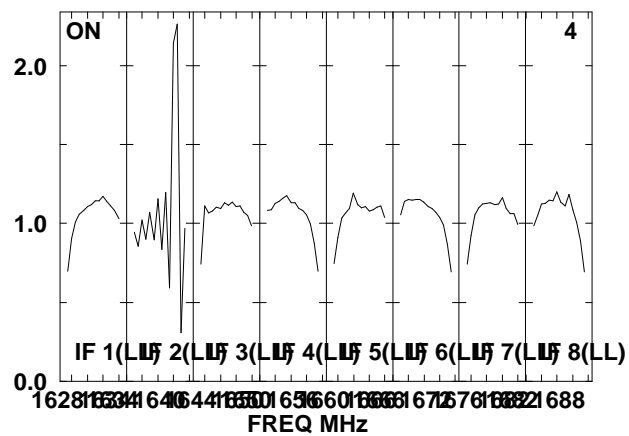
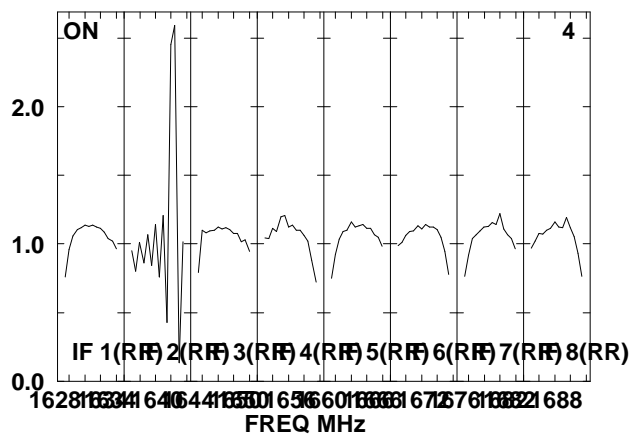
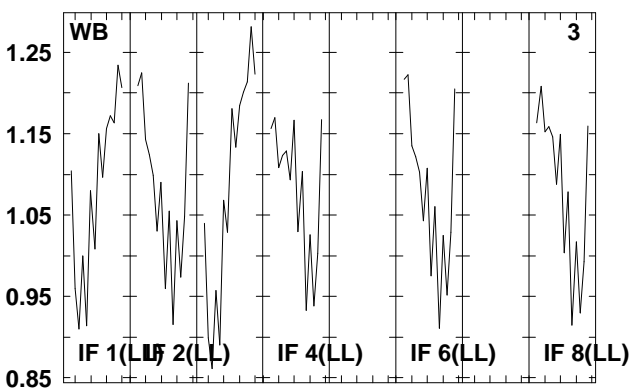
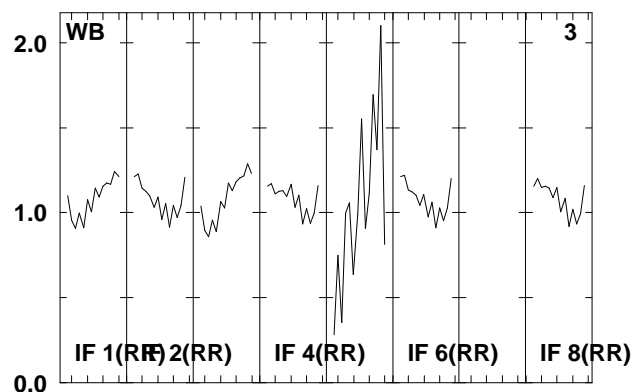
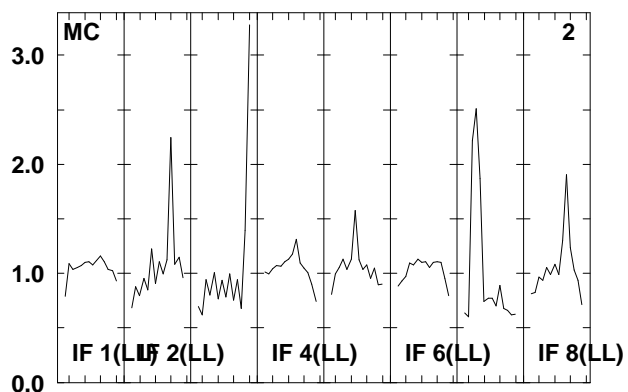
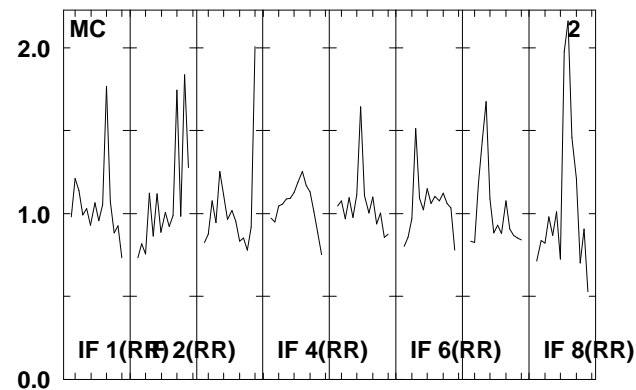
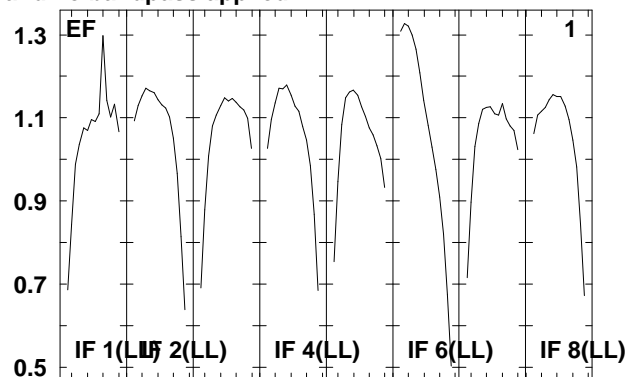
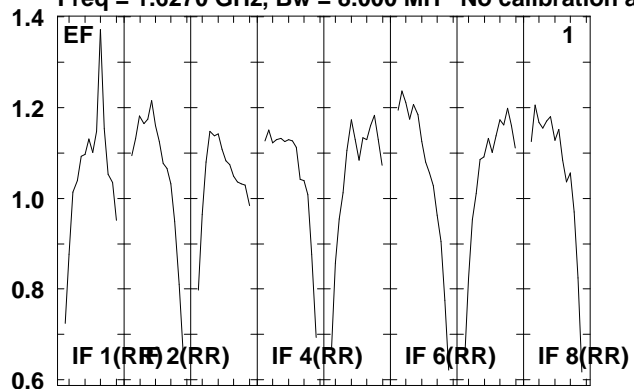

Lower frame: Real Jy

Total-power spectrum Antenna: \*

Timerange: 00/11:15:03 to 00/11:18:59

Plot file version 74 created 06-JAN-2009 10:57:29

J150407 EZ018B.UVDATA.1

Freq = 1.6270 GHz, Bw = 8.000 MH No calibration applied and no bandpass applied

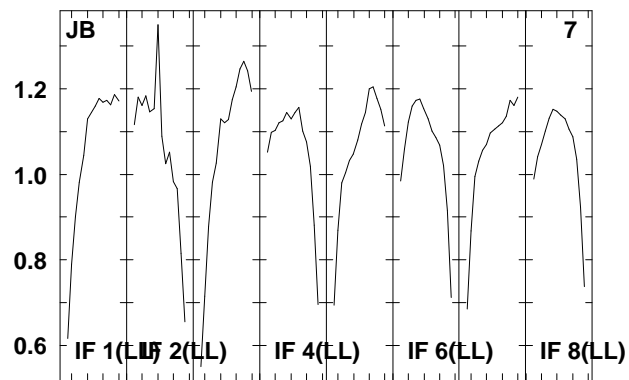
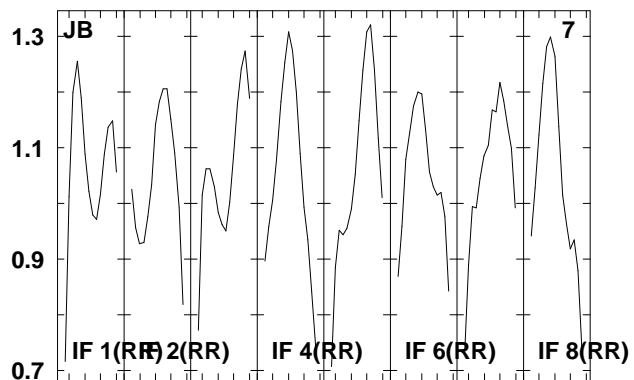
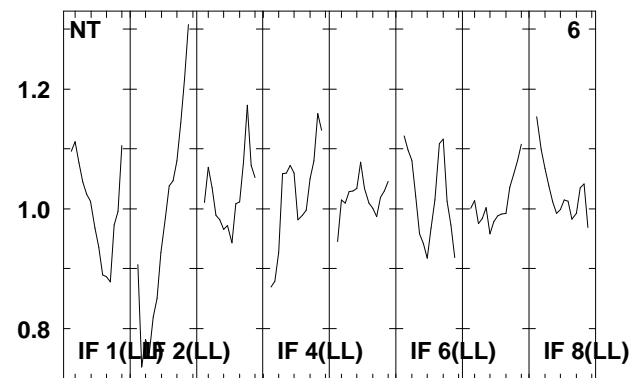
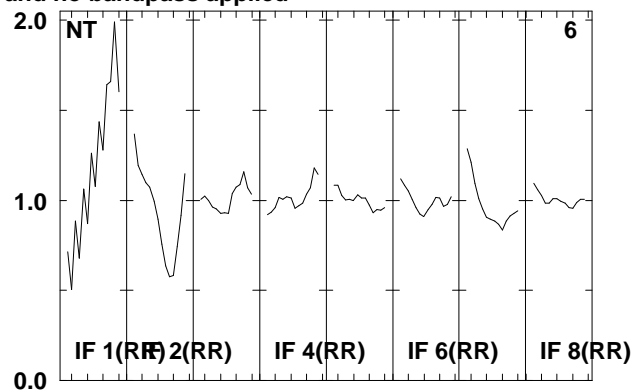
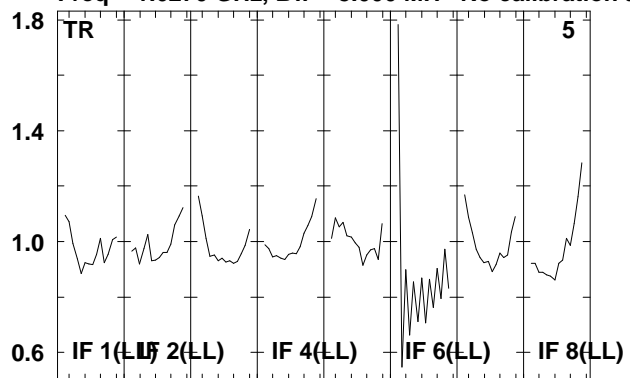

Lower frame: Real Jy  
Total-power spectrum Antenna: \*  
Timerange: 00/11:15:03 to 00/11:18:59

Plot file version 75 created 06-JAN-2009 10:57:30

J1510-05 EZ018B.UVDATA.1

Freq = 1.6270 GHz, Bw = 8.000 MH No calibration applied and no bandpass applied

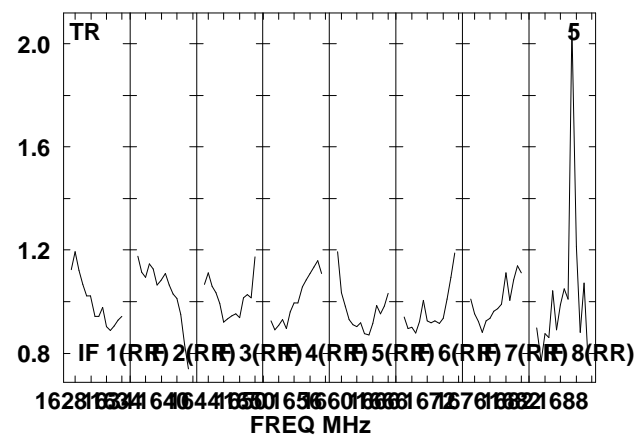
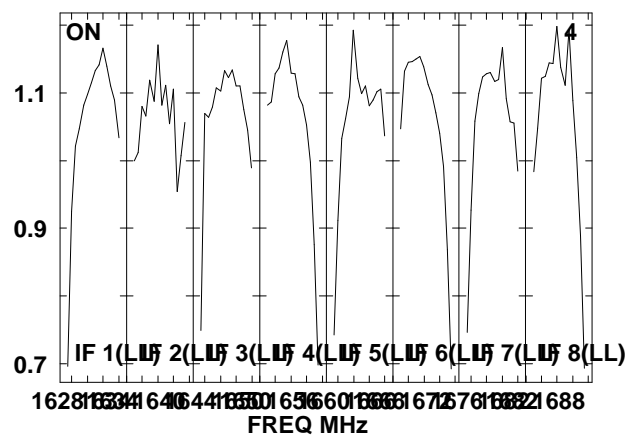
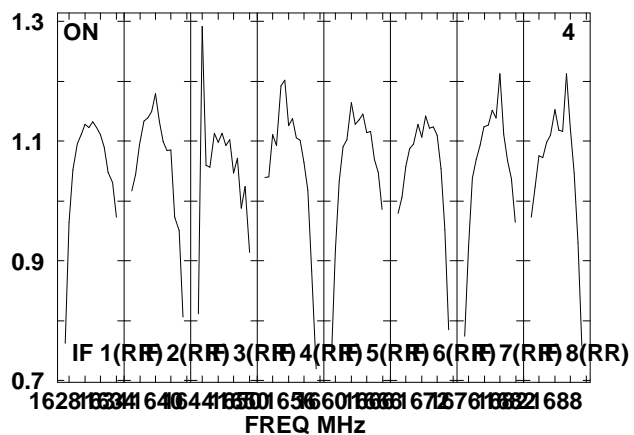
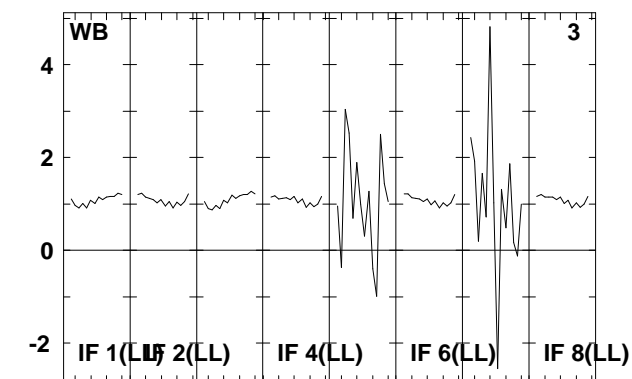
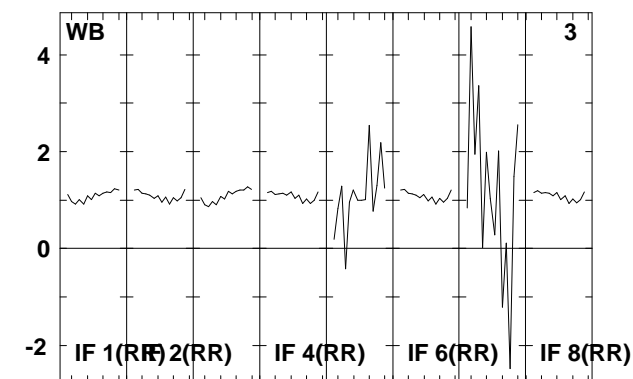
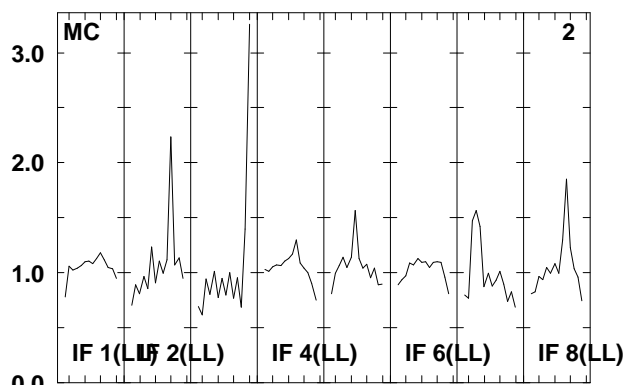
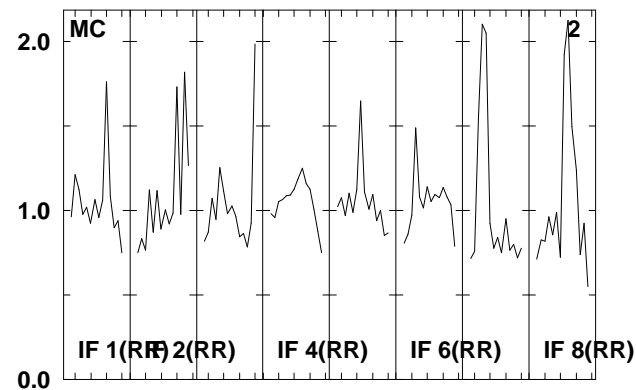
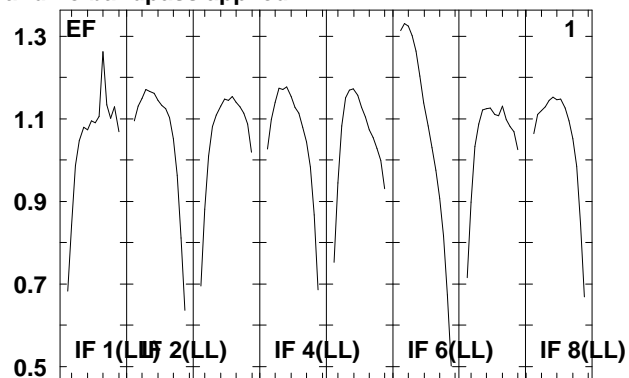
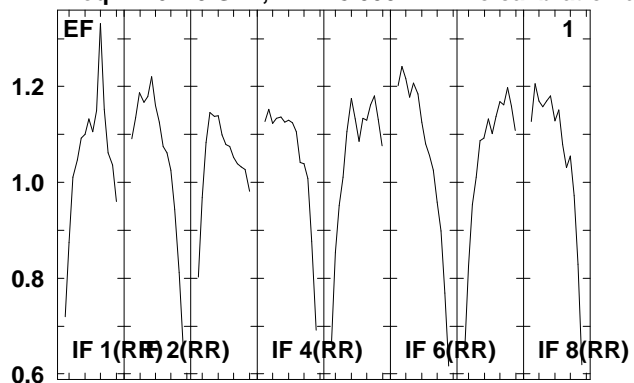

Lower frame: Real Jy  
Total-power spectrum Antenna: \*  
Timerange: 00/11:20:03 to 00/11:22:59

Plot file version 76 created 06-JAN-2009 10:57:30

J1510-05 EZ018B.UVDATA.1

Freq = 1.6270 GHz, Bw = 8.000 MH No calibration applied and no bandpass applied

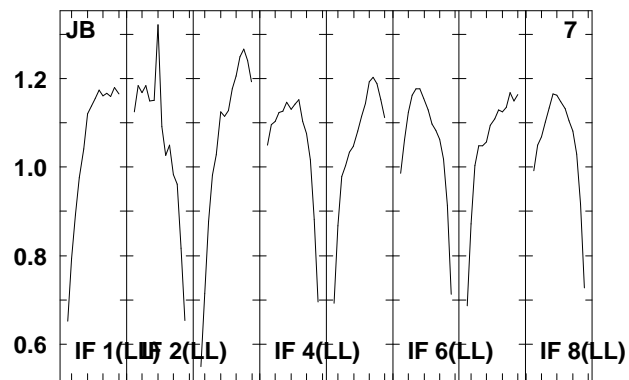
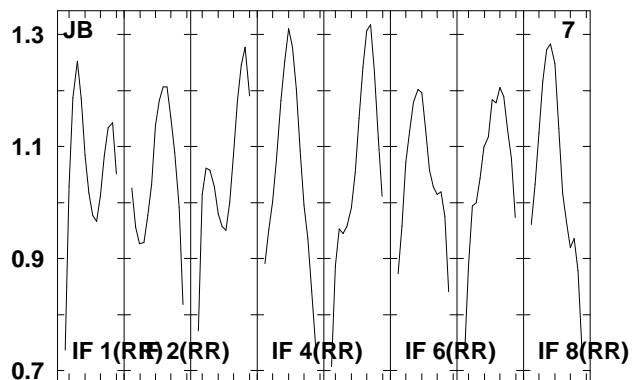
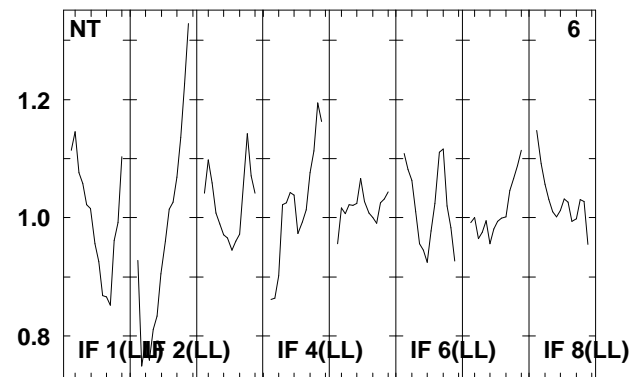
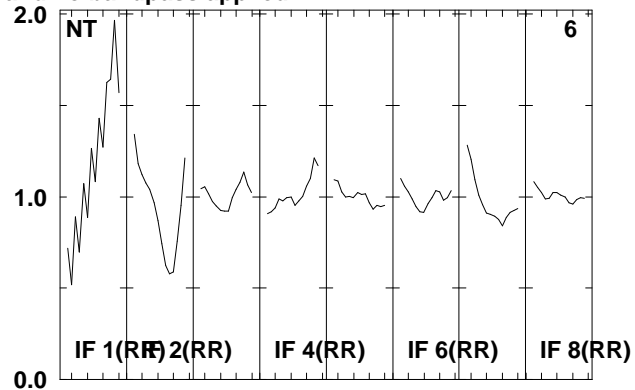
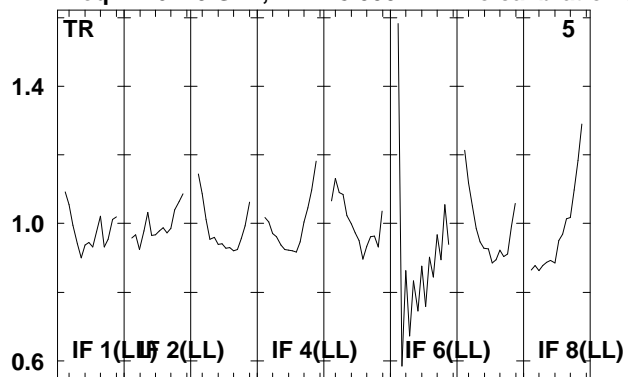

Lower frame: Real Jy  
Total-power spectrum Antenna: \*  
Timerange: 00/11:20:03 to 00/11:22:59

Plot file version 77 created 06-JAN-2009 10:57:30

J150407 EZ018B.UVDATA.1

Freq = 1.6270 GHz, Bw = 8.000 MH No calibration applied and no bandpass applied

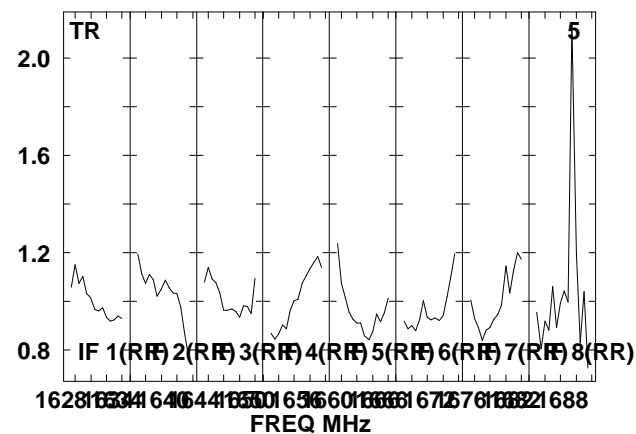
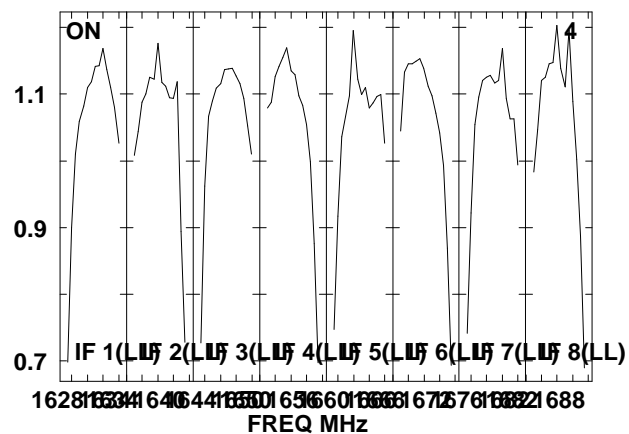
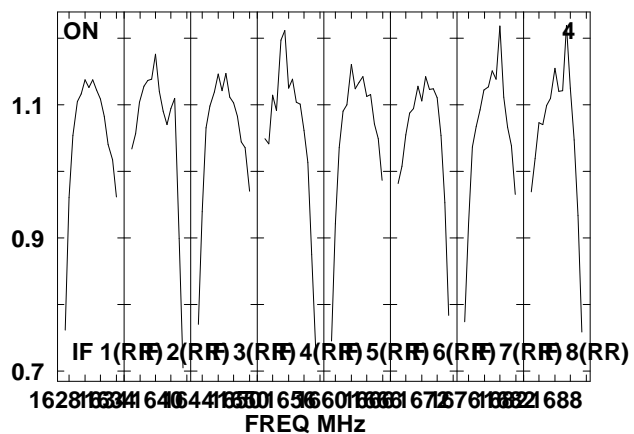
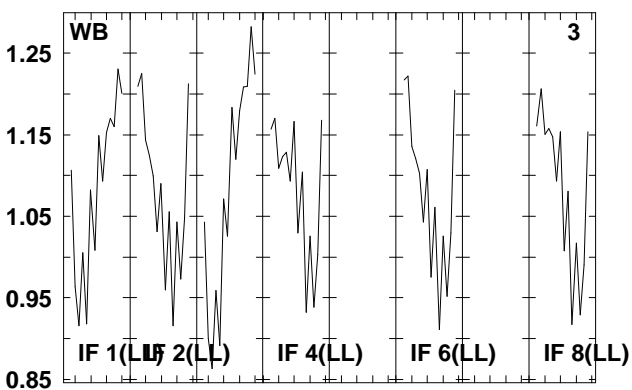
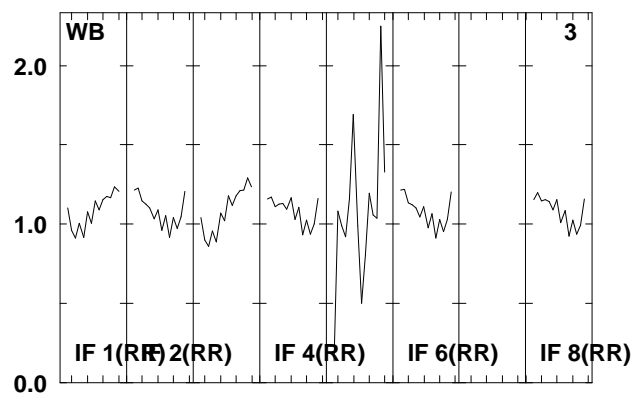
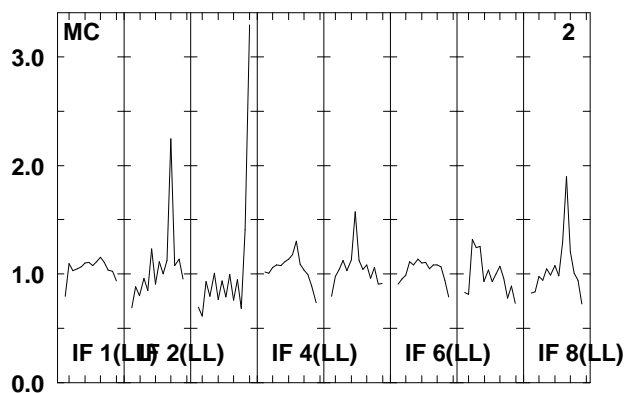
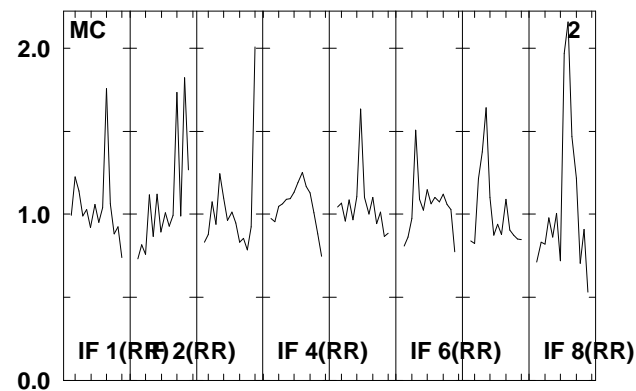
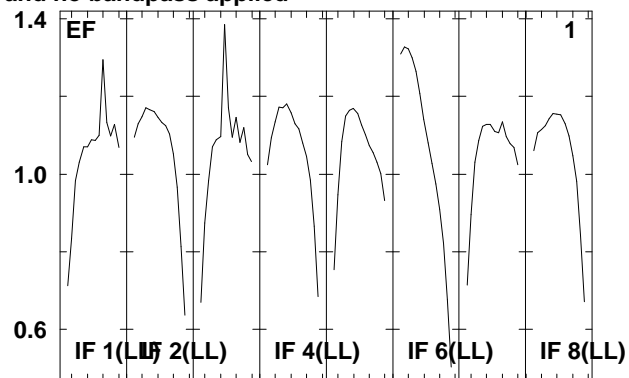
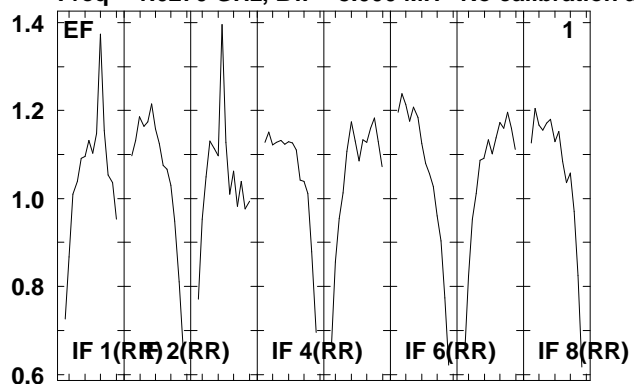

Lower frame: Real Jy  
Total-power spectrum Antenna: \*  
Timerange: 00/11:23:01 to 00/11:27:01

Plot file version 78 created 06-JAN-2009 10:57:31

J150407 EZ018B.UVDATA.1

Freq = 1.6270 GHz, Bw = 8.000 MH No calibration applied and no bandpass applied

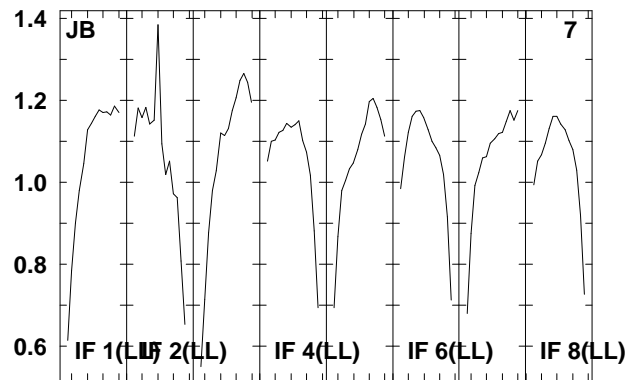
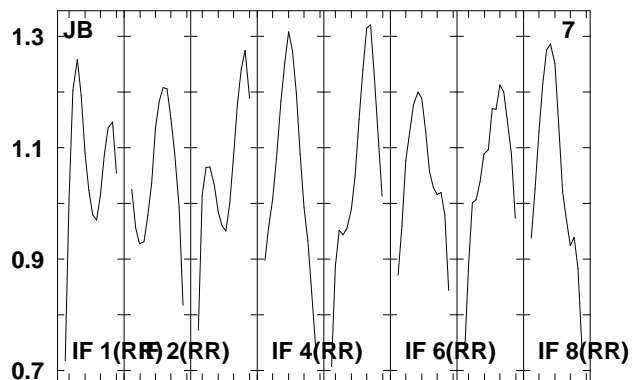
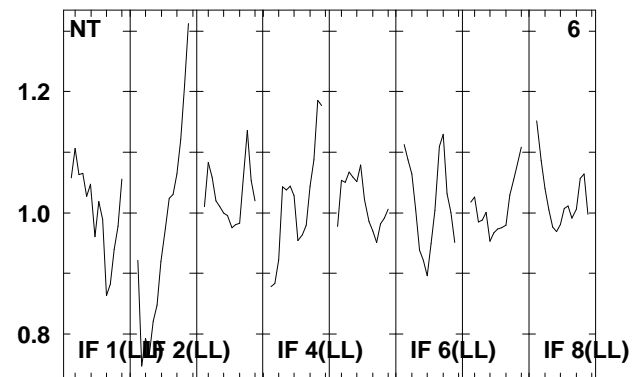
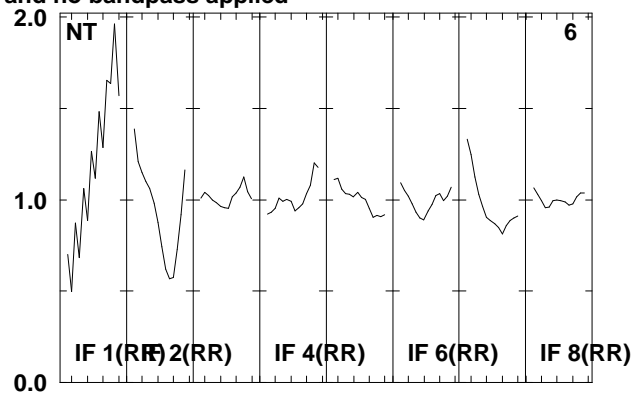
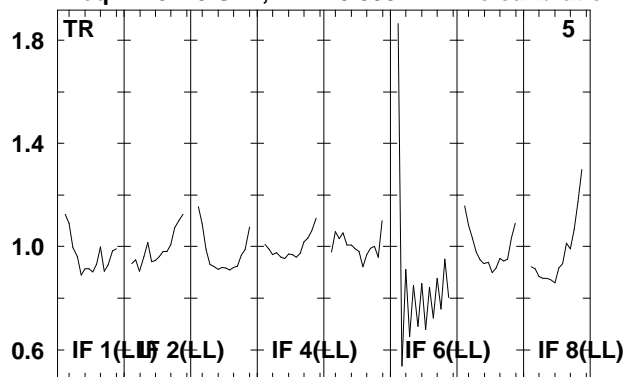

Lower frame: Real Jy  
Total-power spectrum Antenna: \*  
Timerange: 00/11:23:01 to 00/11:27:01

Plot file version 79 created 06-JAN-2009 10:57:31

J1510-05 EZ018B.UVDATA.1

Freq = 1.6270 GHz, Bw = 8.000 MH No calibration applied and no bandpass applied

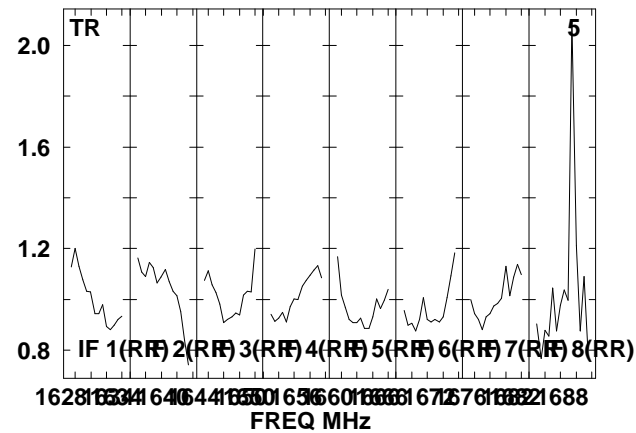
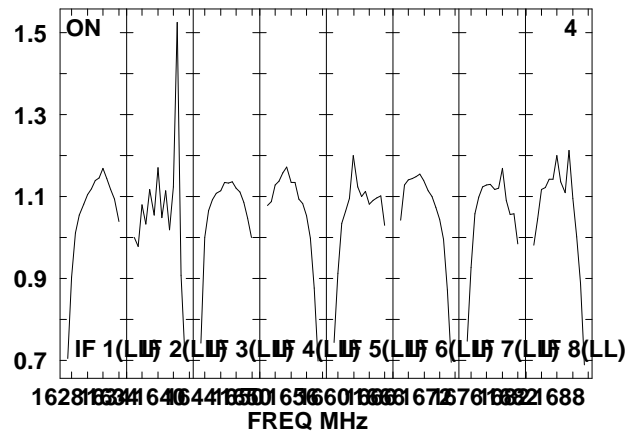
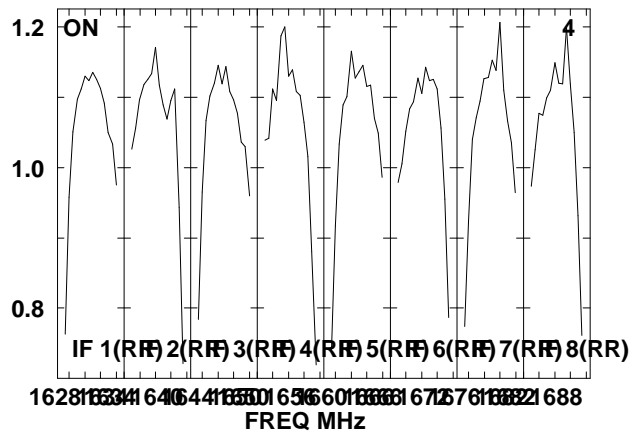
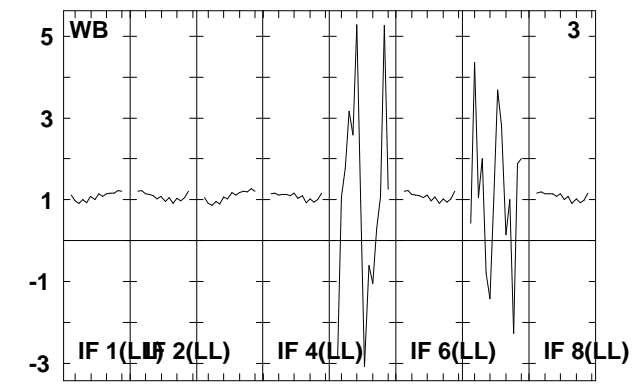
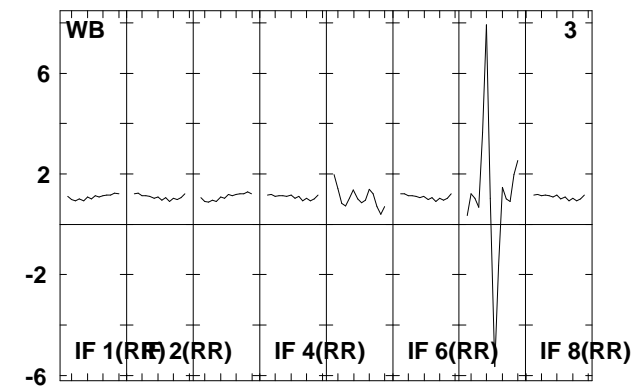
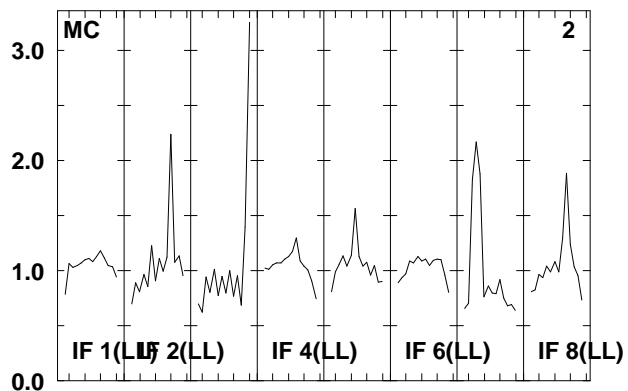
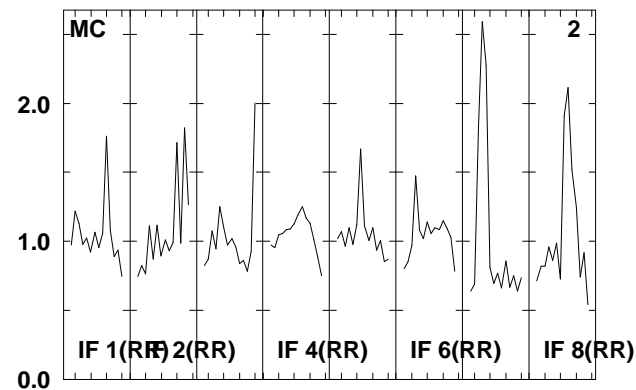
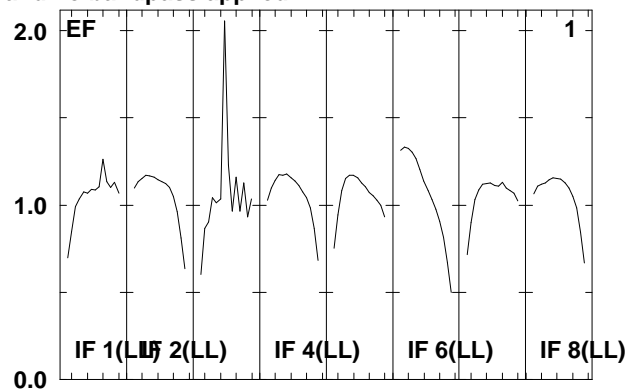
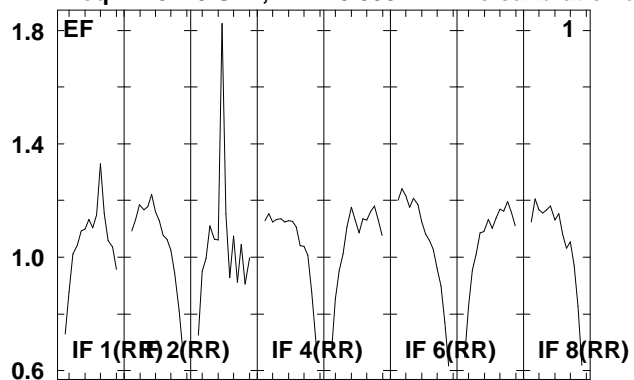

Lower frame: Real Jy

Total-power spectrum Antenna: \*

Timerange: 00/11:27:03 to 00/11:30:01

Plot file version 80 created 06-JAN-2009 10:57:31

J1510-05 EZ018B.UVDATA.1

Freq = 1.6270 GHz, Bw = 8.000 MH No calibration applied and no bandpass applied

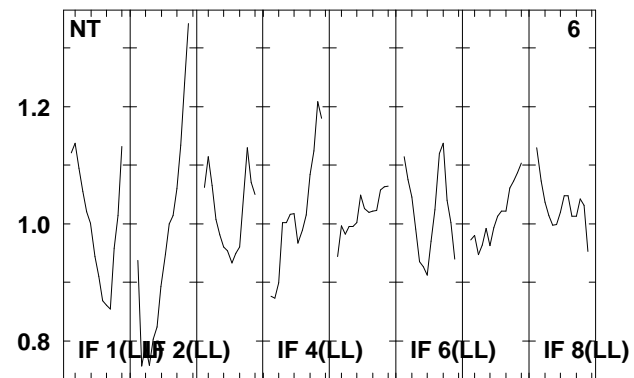
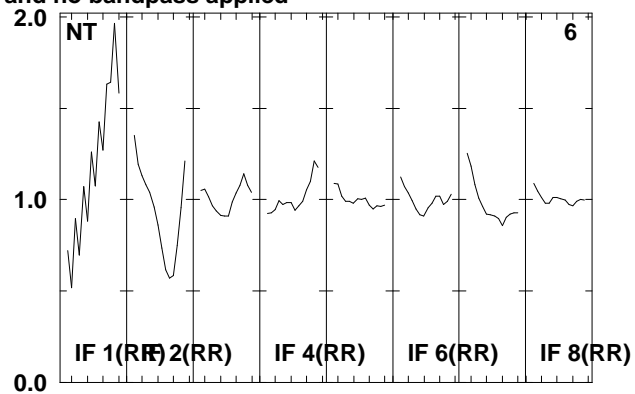
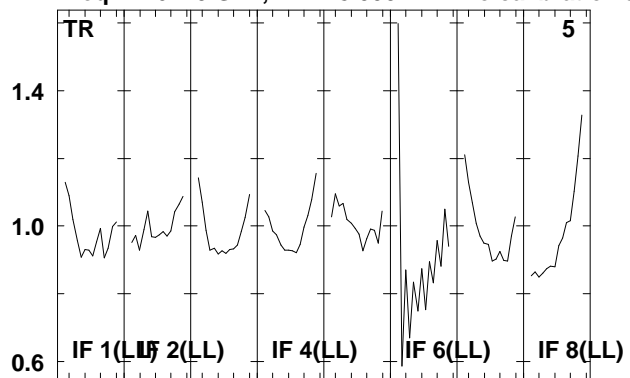

Lower frame: Real Jy  
Total-power spectrum Antenna: \*  
Timerange: 00/11:27:03 to 00/11:30:01



Plot file version 81 created 06-JAN-2009 10:57:32

J150407 EZ018B.UVDATA.1

Freq = 1.6270 GHz, Bw = 8.000 MH No calibration applied and no bandpass applied

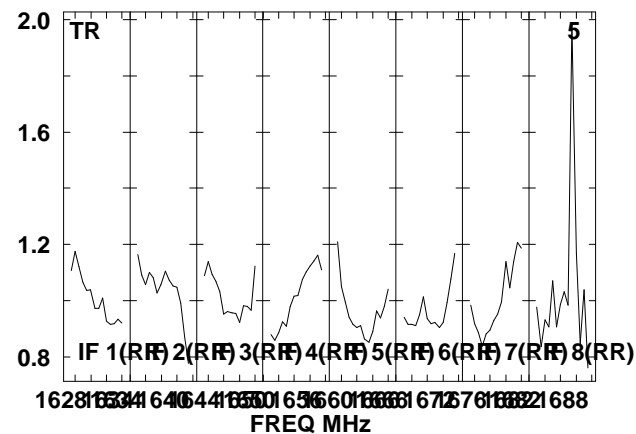
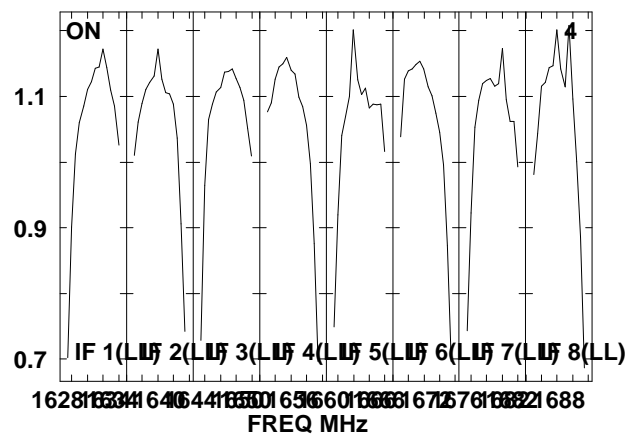
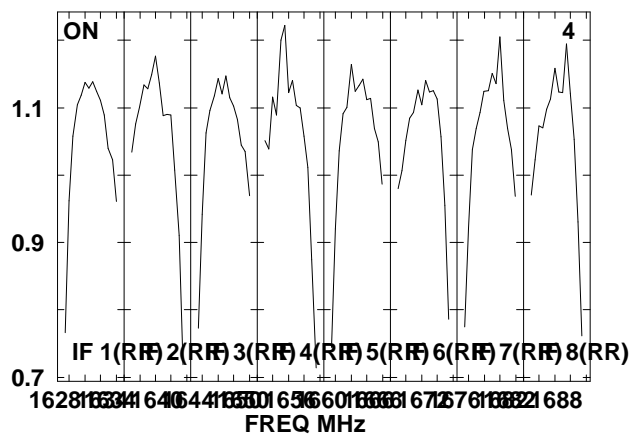
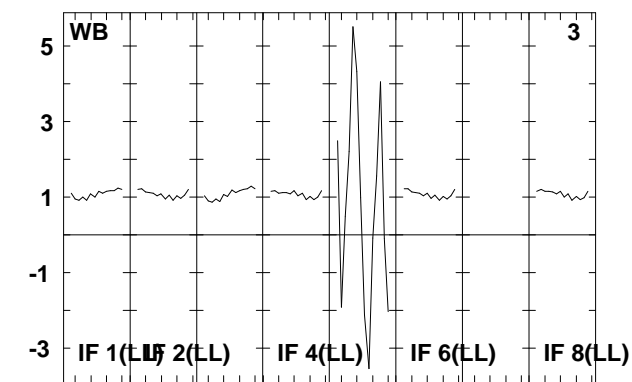
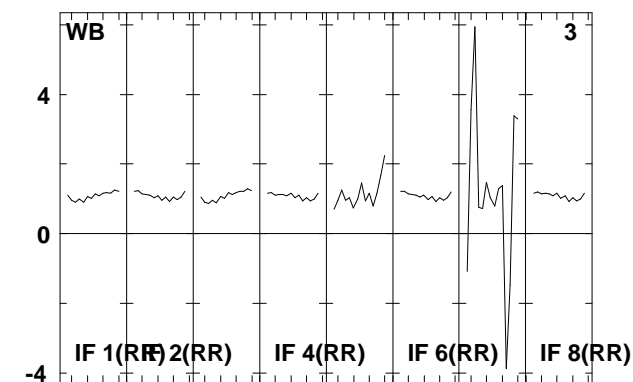
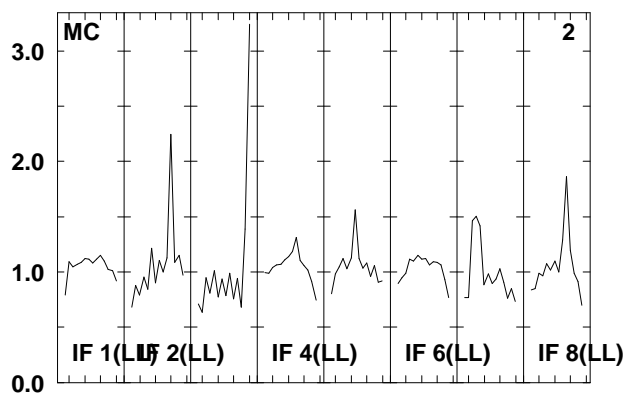
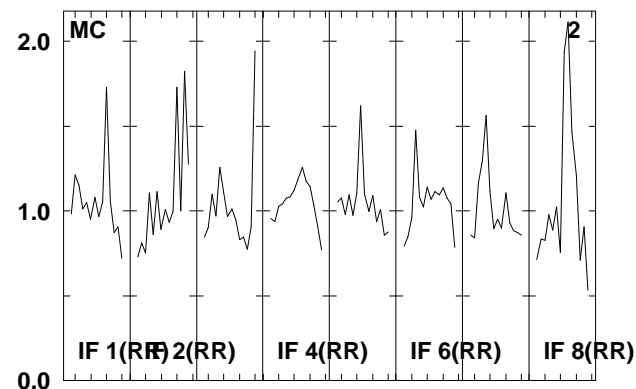
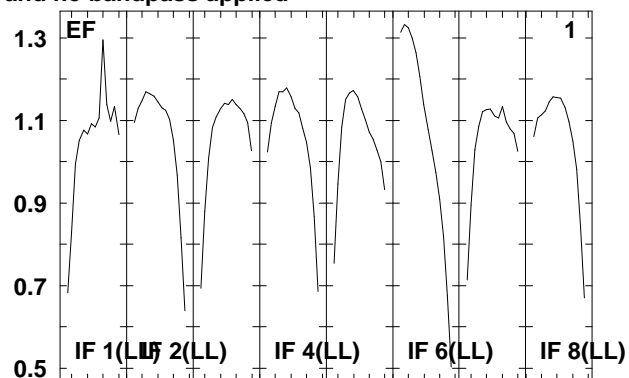
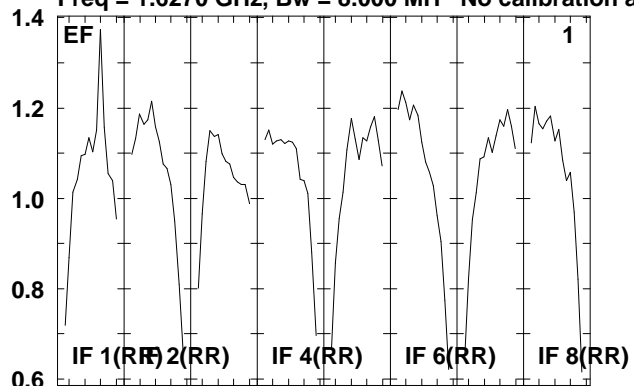

Lower frame: Real Jy  
Total-power spectrum Antenna: \*  
Timerange: 00/11:30:03 to 00/11:33:59

Plot file version 82 created 06-JAN-2009 10:57:32

J150407 EZ018B.UVDATA.1

Freq = 1.6270 GHz, Bw = 8.000 MH No calibration applied and no bandpass applied

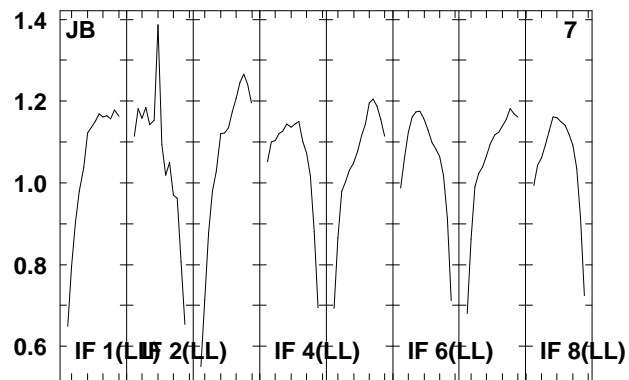
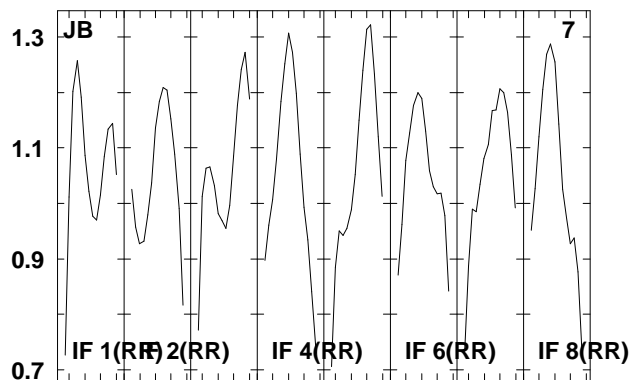
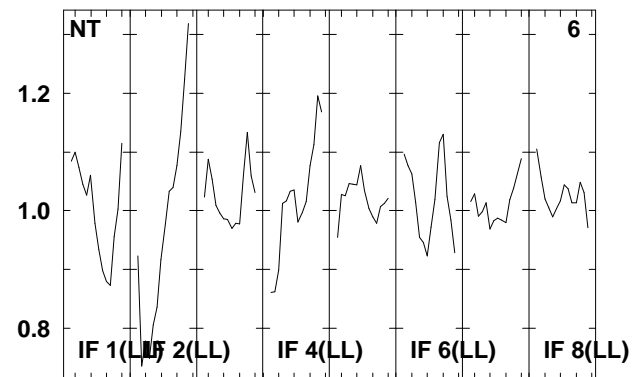
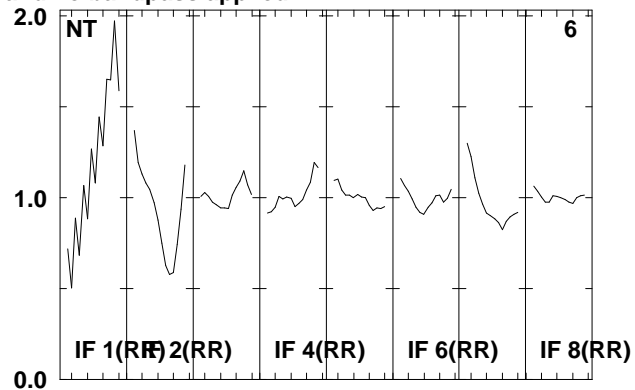
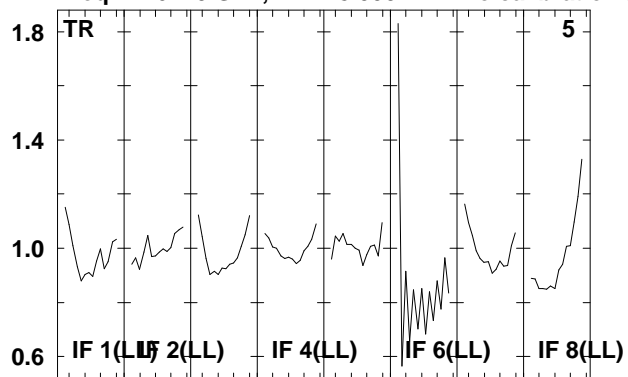

Lower frame: Real Jy  
Total-power spectrum Antenna: \*  
Timerange: 00/11:30:03 to 00/11:33:59

Plot file version 83 created 06-JAN-2009 10:57:32

J1510-05 EZ018B.UVDATA.1

Freq = 1.6270 GHz, Bw = 8.000 MH No calibration applied and no bandpass applied

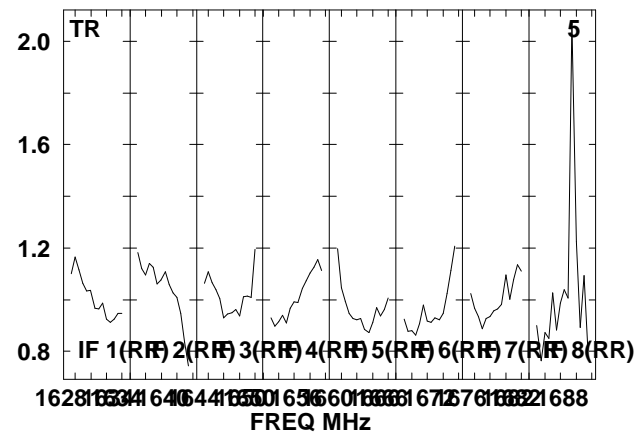
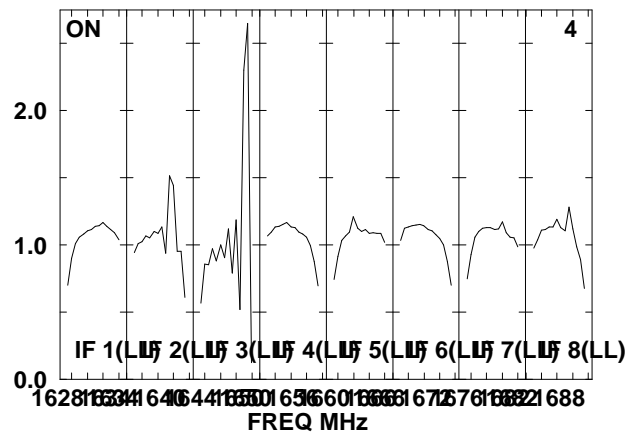
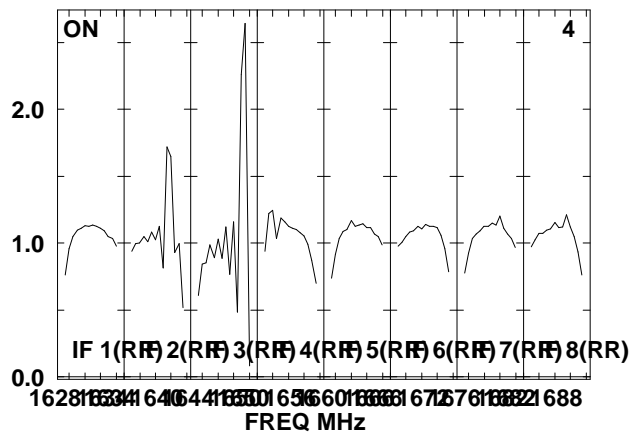
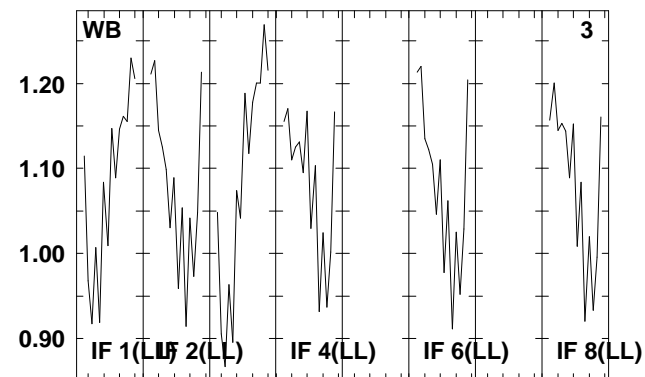
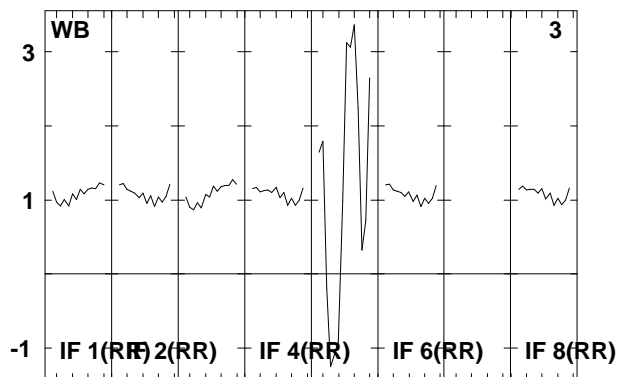
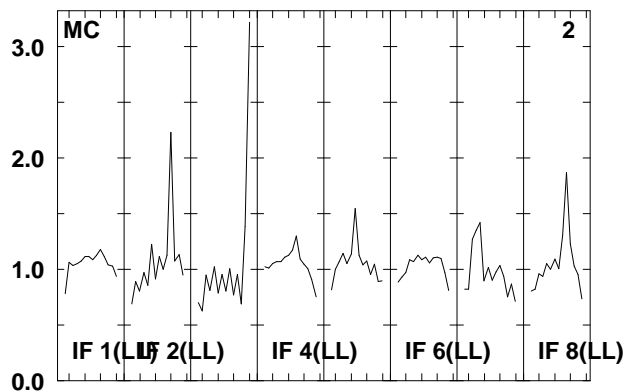
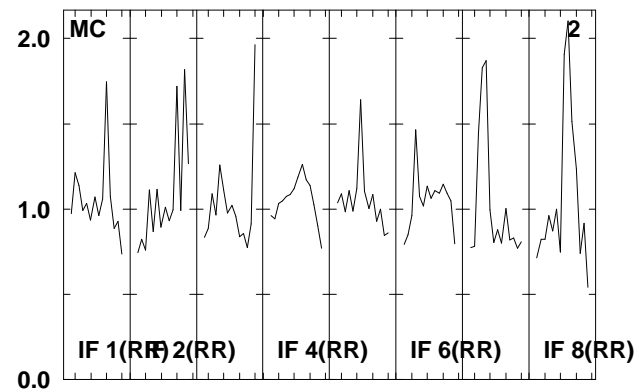
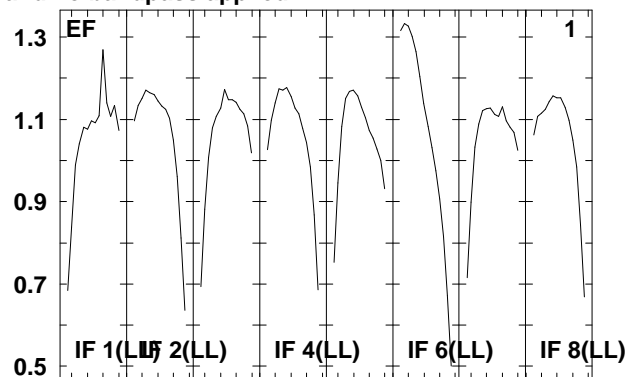
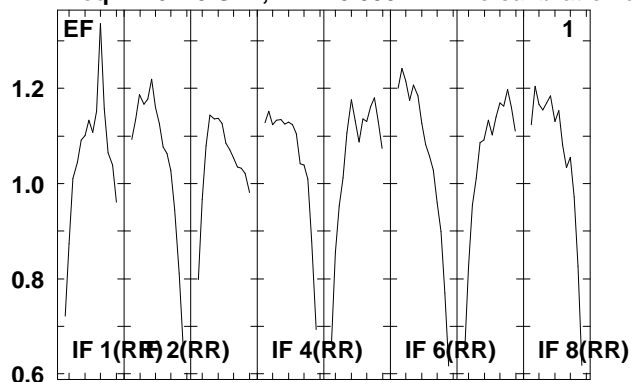

Lower frame: Real Jy  
Total-power spectrum Antenna: \*  
Timerange: 00/11:35:03 to 00/11:38:01

Plot file version 84 created 06-JAN-2009 10:57:33

J1510-05 EZ018B.UVDATA.1

Freq = 1.6270 GHz, Bw = 8.000 MH No calibration applied and no bandpass applied

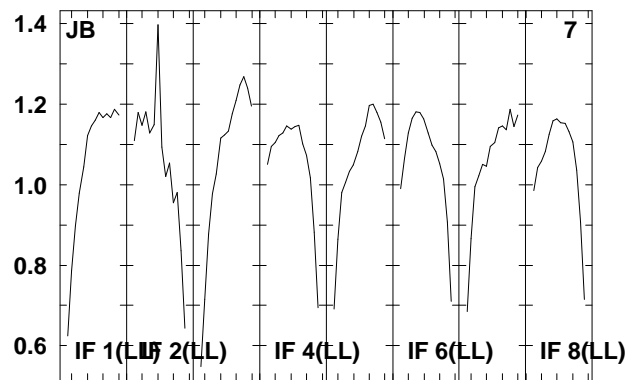
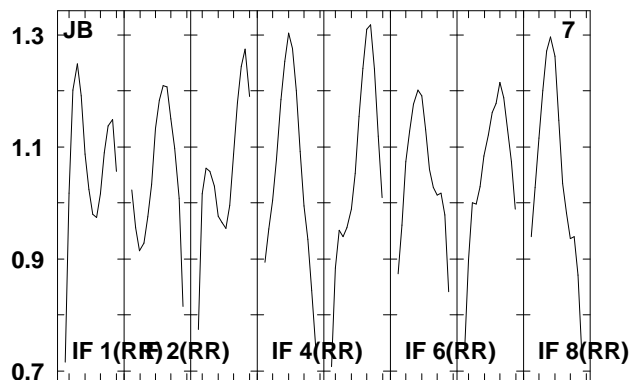
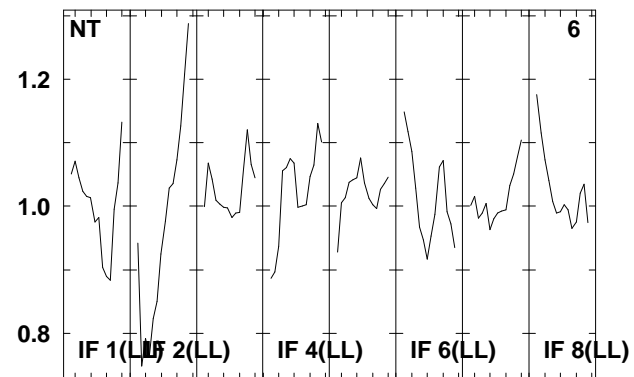
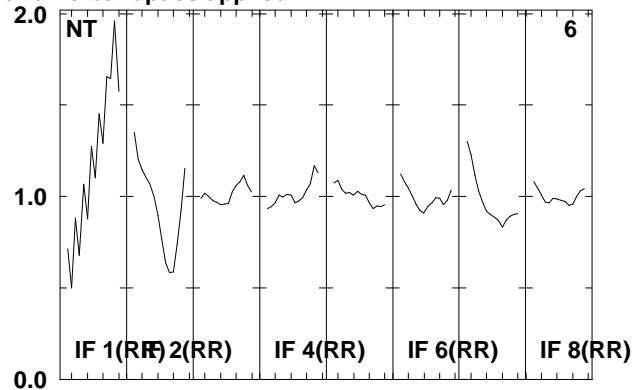
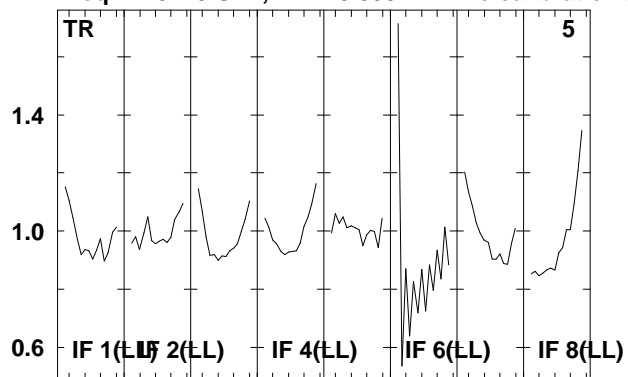

Lower frame: Real Jy  
Total-power spectrum Antenna: \*  
Timerange: 00/11:35:03 to 00/11:38:01

Plot file version 85 created 06-JAN-2009 10:57:33

J150407 EZ018B.UVDATA.1

Freq = 1.6270 GHz, Bw = 8.000 MH No calibration applied and no bandpass applied

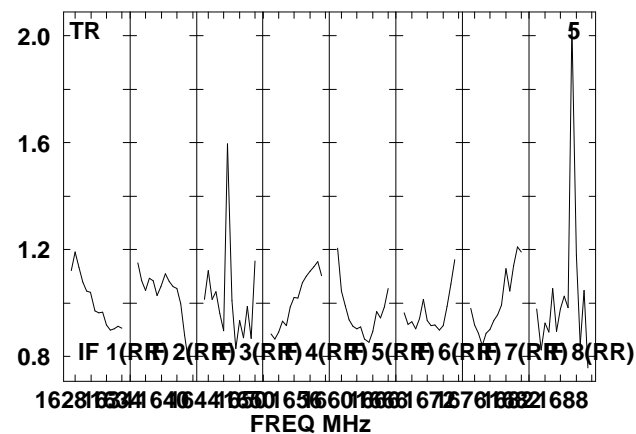
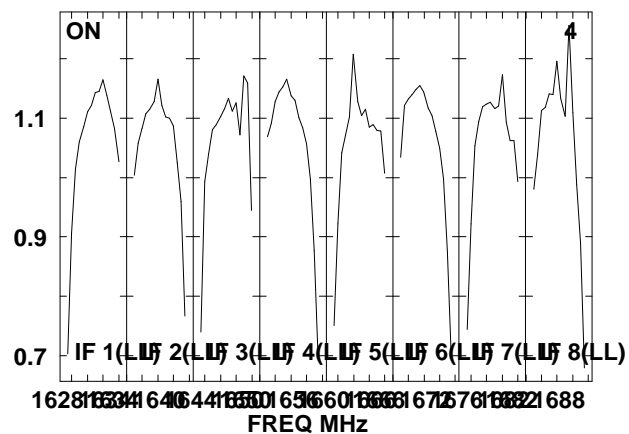
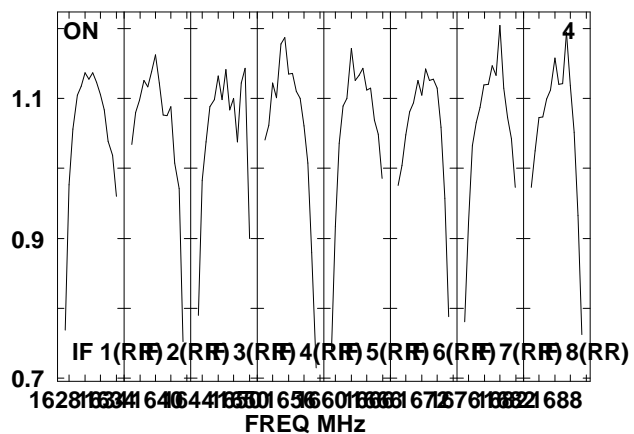
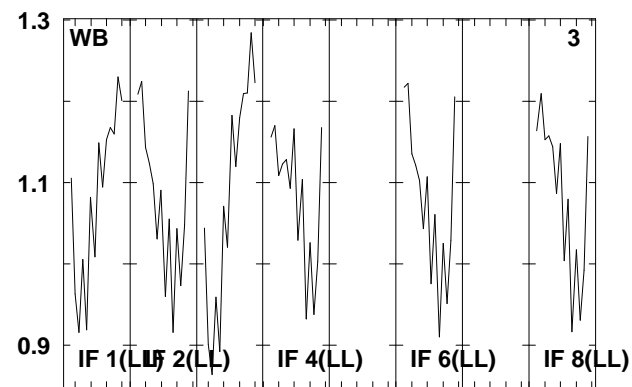
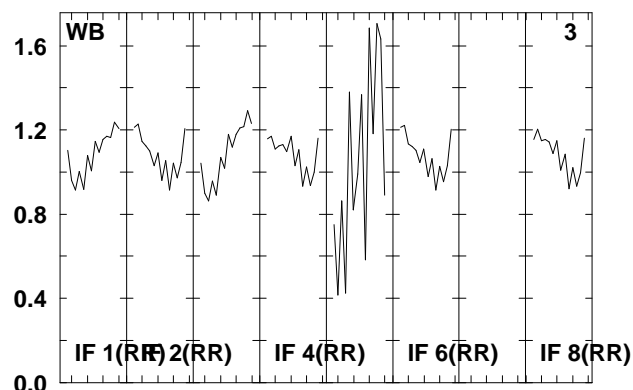
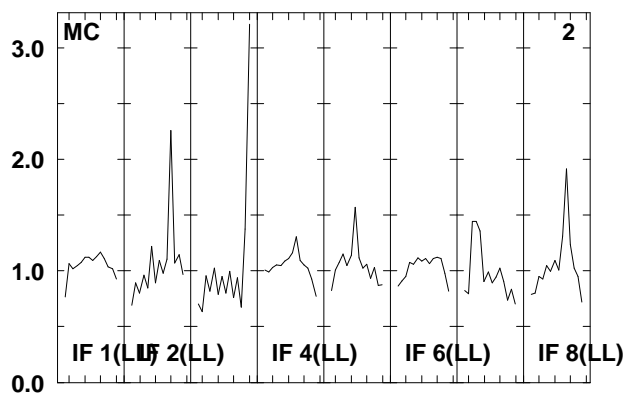
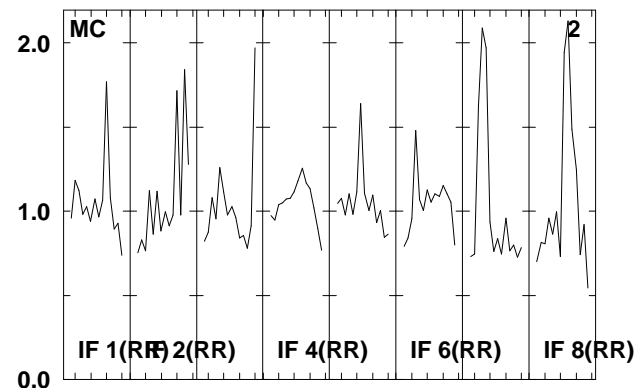
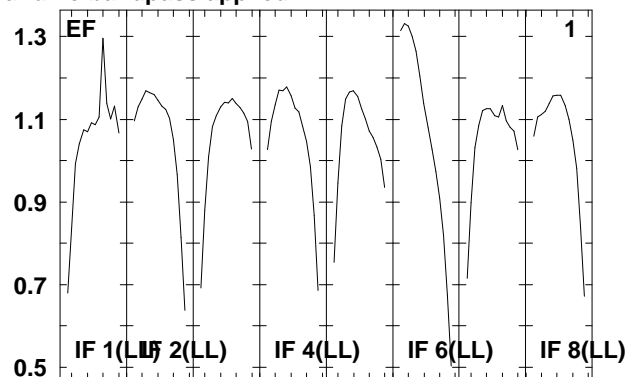
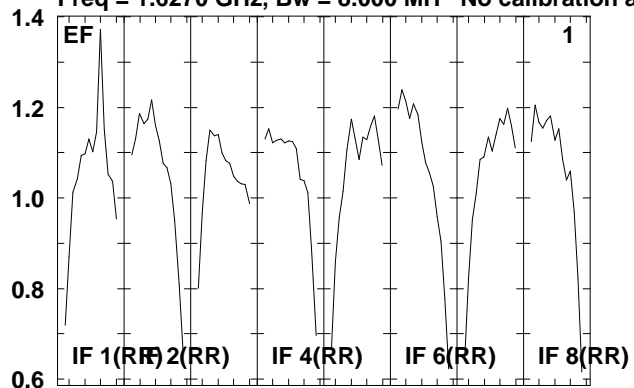

Lower frame: Real Jy  
Total-power spectrum Antenna: \*  
Timerange: 00/11:38:03 to 00/11:41:57

Plot file version 86 created 06-JAN-2009 10:57:34

J150407 EZ018B.UVDATA.1

Freq = 1.6270 GHz, Bw = 8.000 MH No calibration applied and no bandpass applied

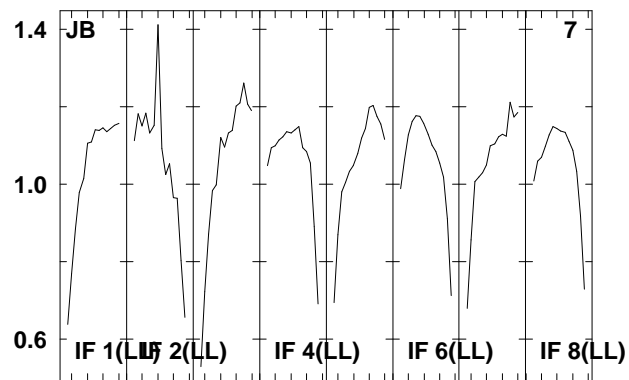
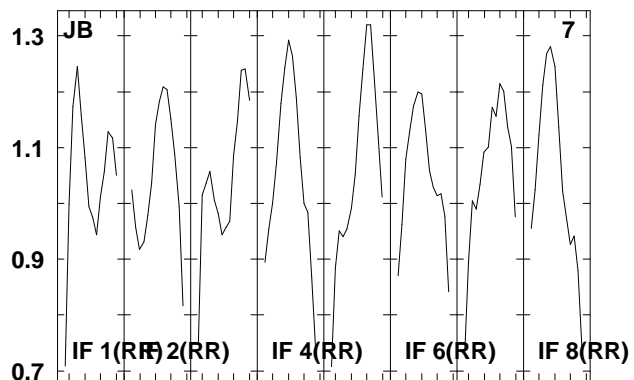
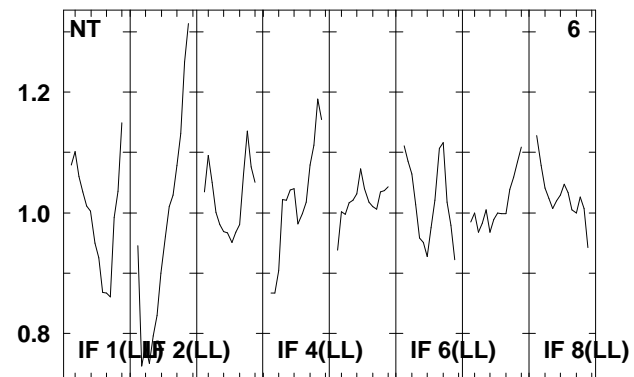
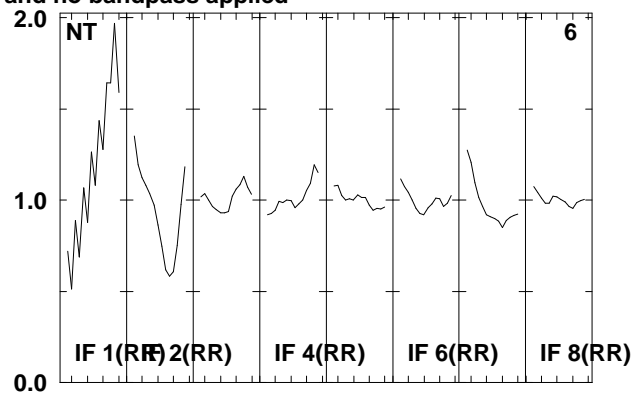
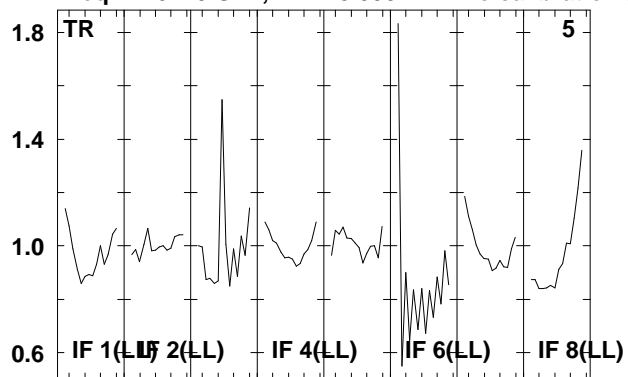

Lower frame: Real Jy  
Total-power spectrum Antenna: \*  
Timerange: 00/11:38:03 to 00/11:41:57

Plot file version 87 created 06-JAN-2009 10:57:34

J1510-05 EZ018B.UVDATA.1

Freq = 1.6270 GHz, Bw = 8.000 MH No calibration applied and no bandpass applied

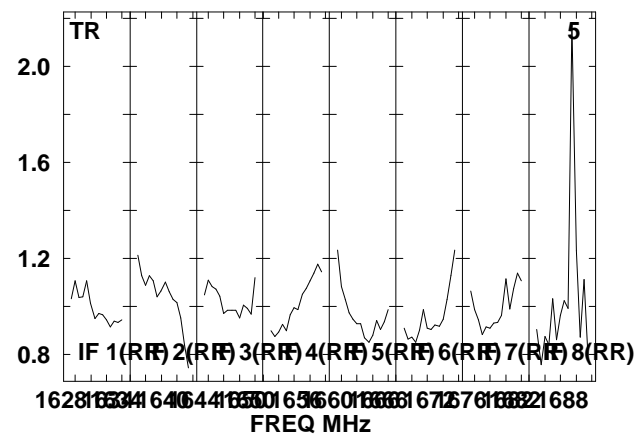
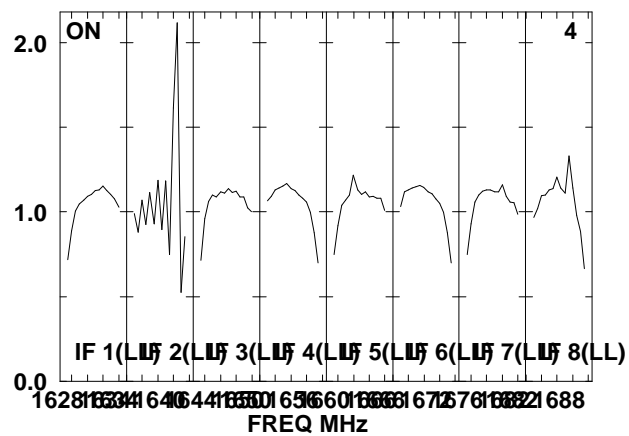
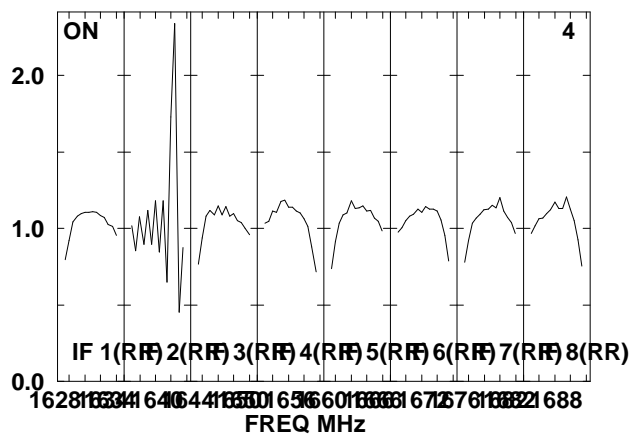
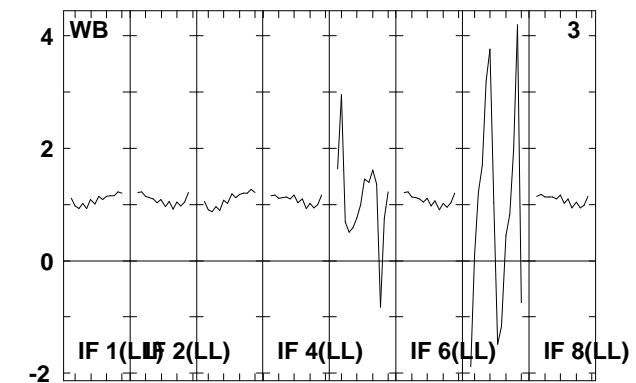
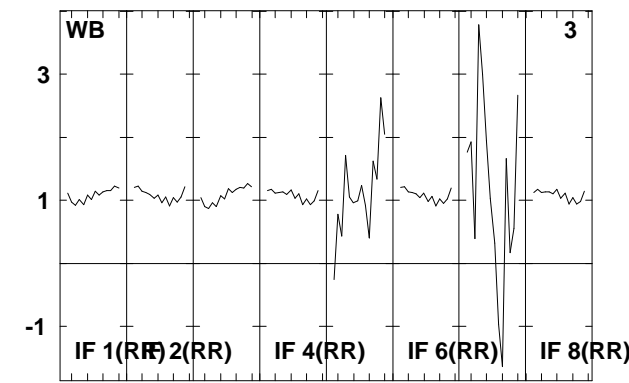
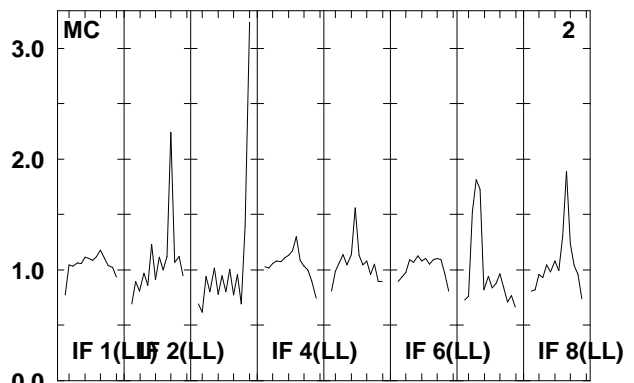
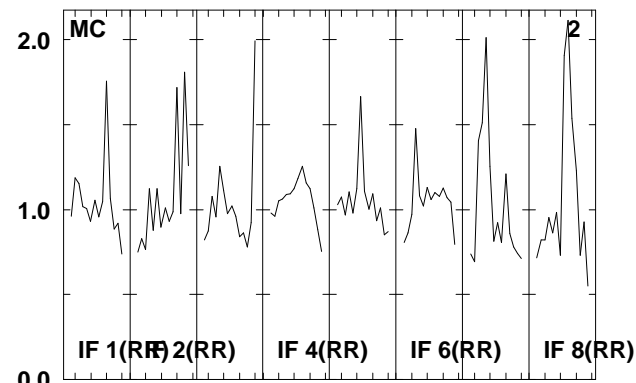
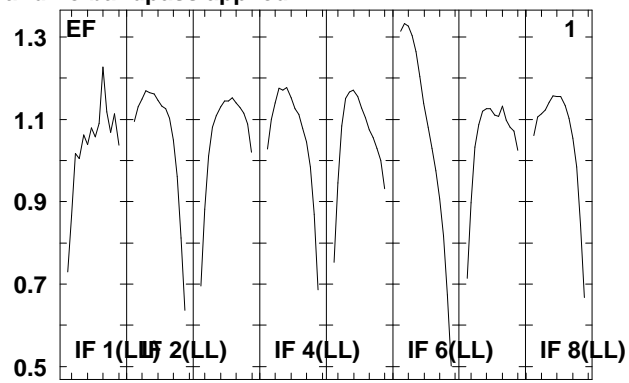
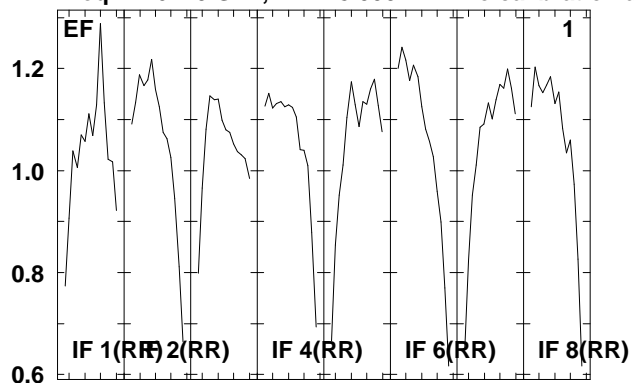

Lower frame: Real Jy  
Total-power spectrum Antenna: \*  
Timerange: 00/11:42:09 to 00/11:44:57

Plot file version 88 created 06-JAN-2009 10:57:34

J1510-05 EZ018B.UVDATA.1

Freq = 1.6270 GHz, Bw = 8.000 MH No calibration applied and no bandpass applied

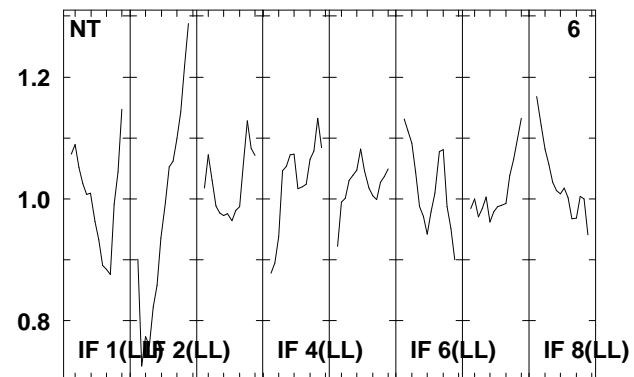
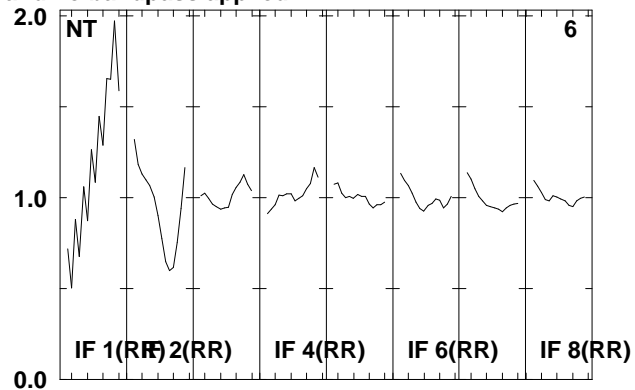
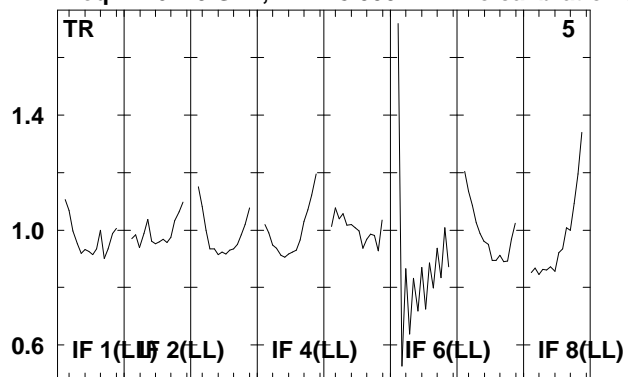

Lower frame: Real Jy  
Total-power spectrum Antenna: \*  
Timerange: 00/11:42:09 to 00/11:44:57



Plot file version 89 created 06-JAN-2009 10:57:35

J150407 EZ018B.UVDATA.1

Freq = 1.6270 GHz, Bw = 8.000 MH No calibration applied and no bandpass applied

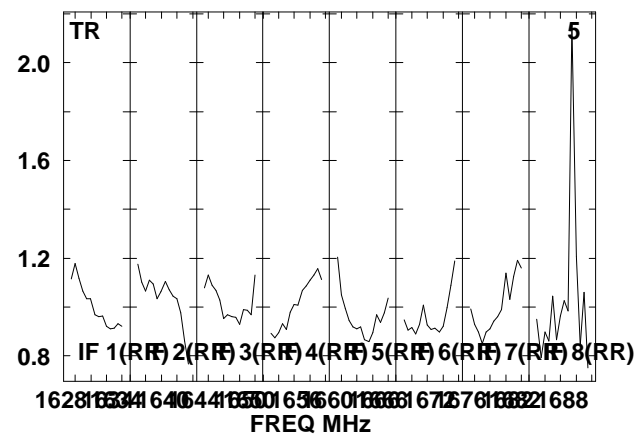
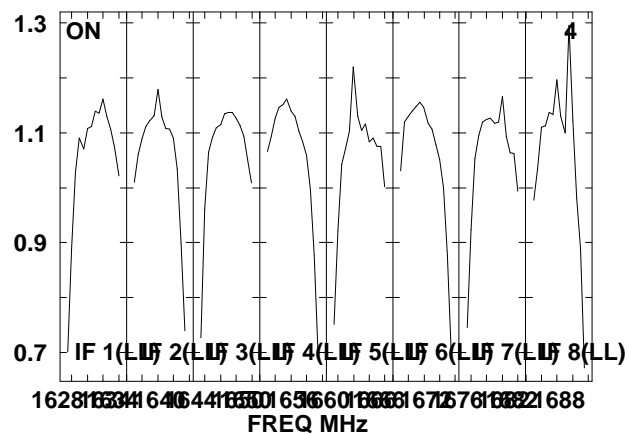
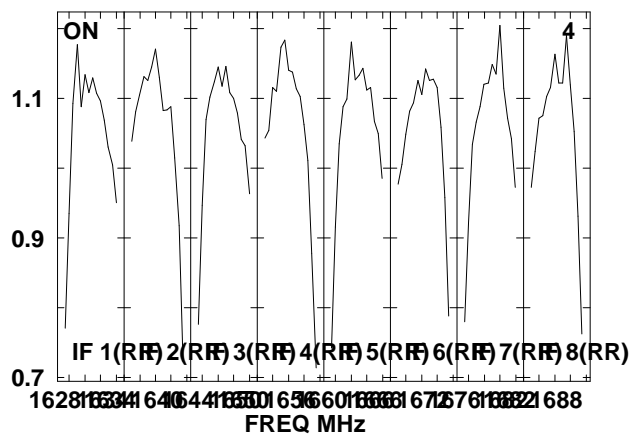
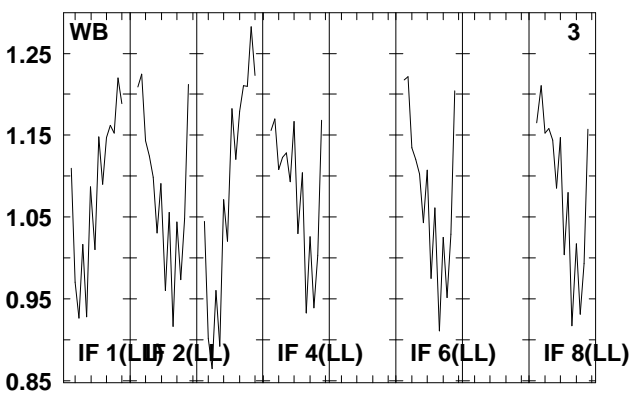
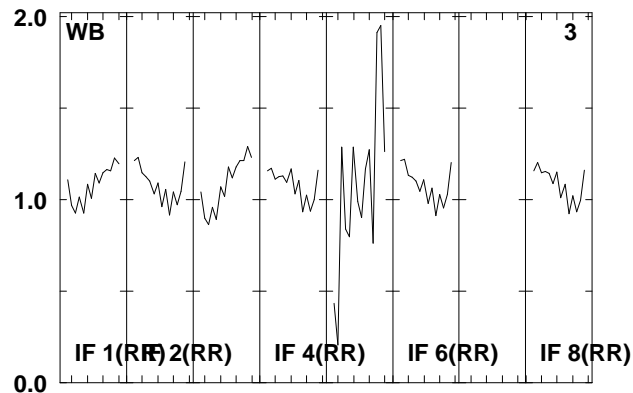
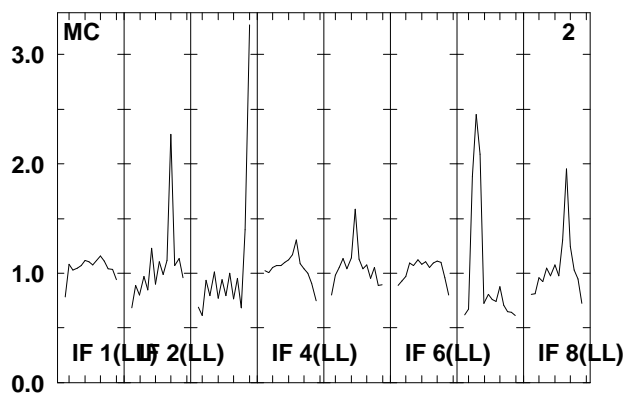
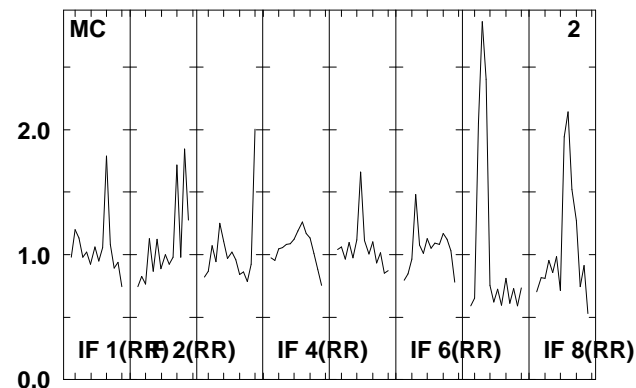
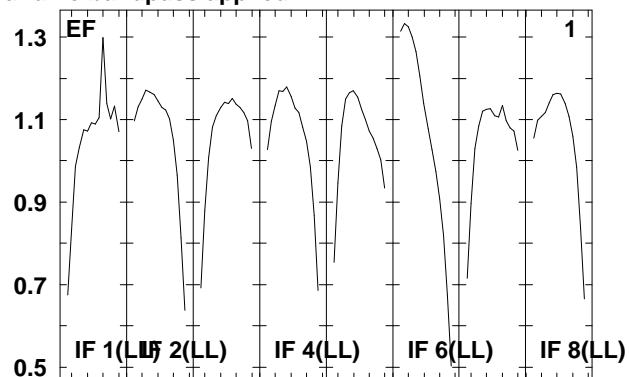
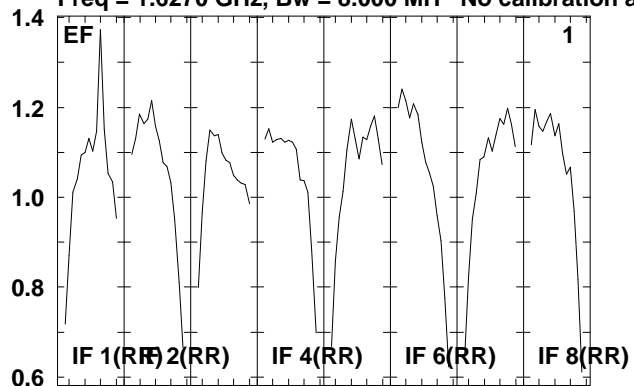

Lower frame: Real Jy  
Total-power spectrum Antenna: \*  
Timerange: 00/11:45:04 to 00/11:49:00

Plot file version 90 created 06-JAN-2009 10:57:35

J150407 EZ018B.UVDATA.1

Freq = 1.6270 GHz, Bw = 8.000 MH No calibration applied and no bandpass applied

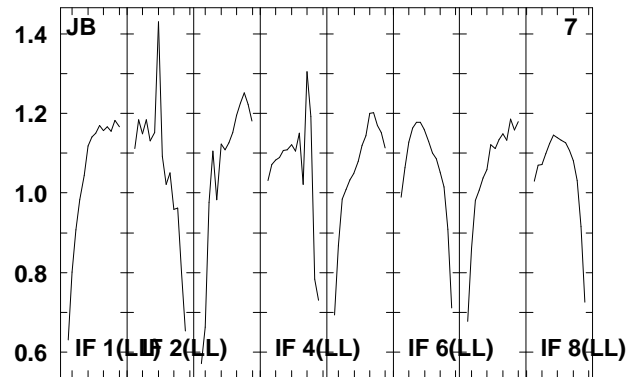
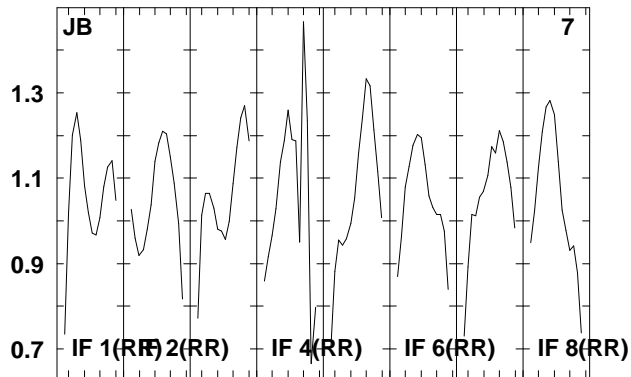
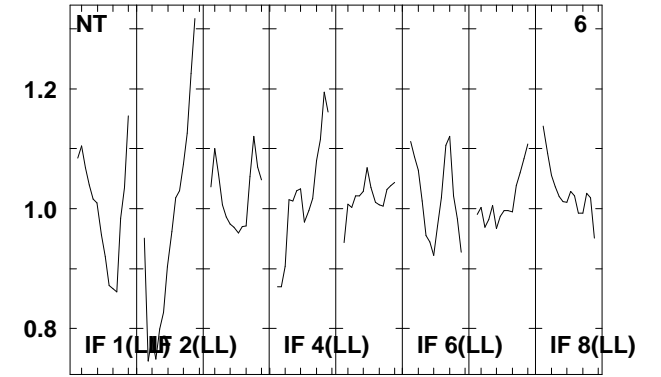
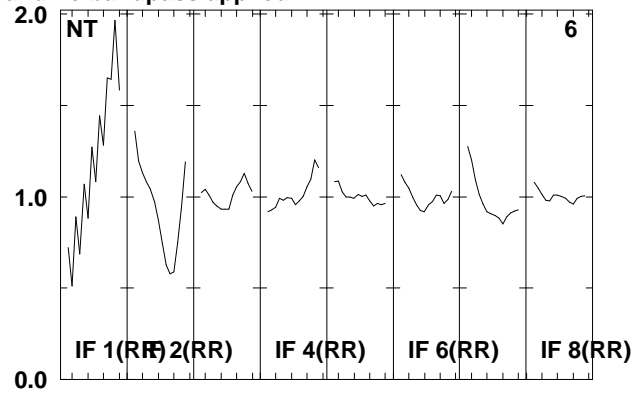
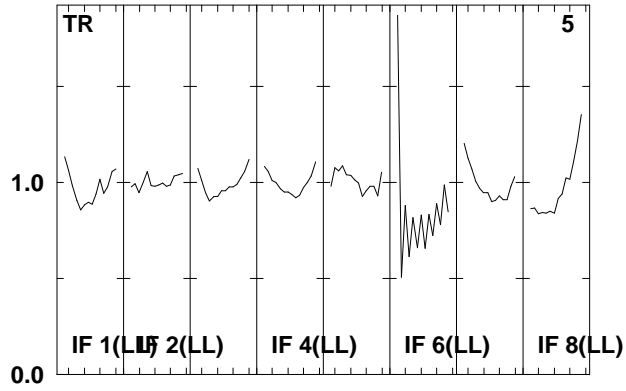

Lower frame: Real Jy  
Total-power spectrum Antenna: \*  
Timerange: 00/11:45:04 to 00/11:49:00

Plot file version 91 created 06-JAN-2009 10:57:35

J1510-05 EZ018B.UVDATA.1

Freq = 1.6270 GHz, Bw = 8.000 MH No calibration applied and no bandpass applied

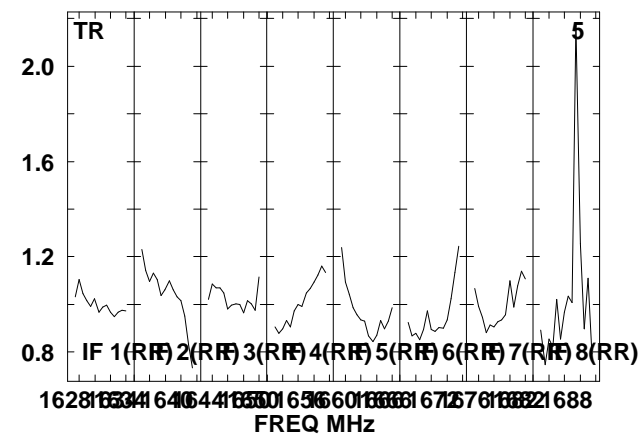
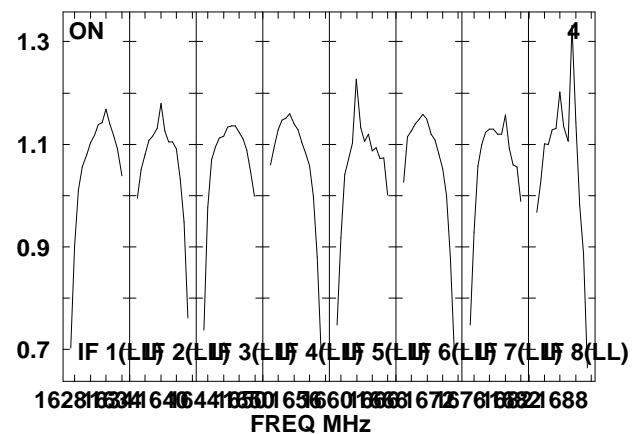
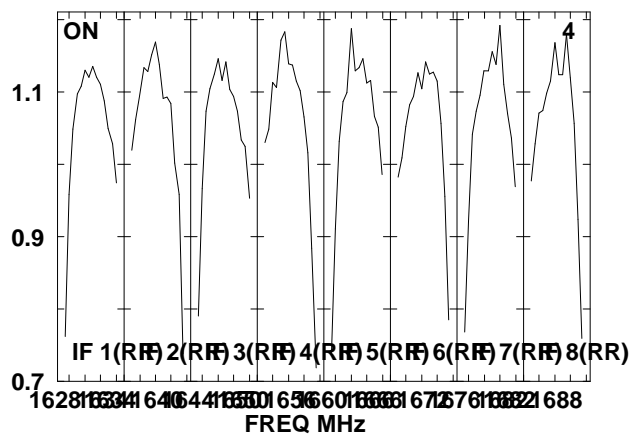
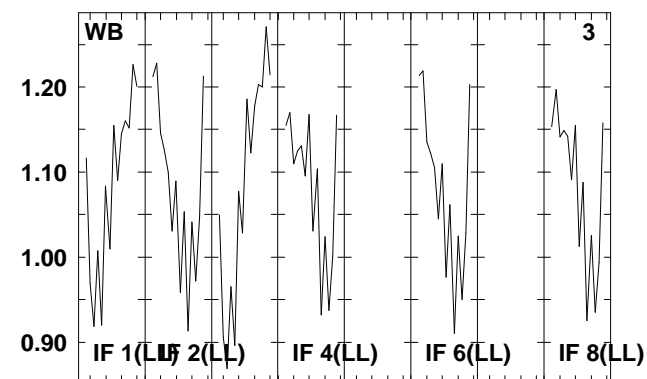
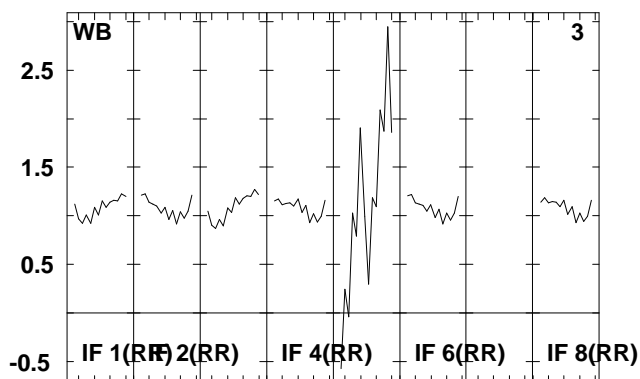
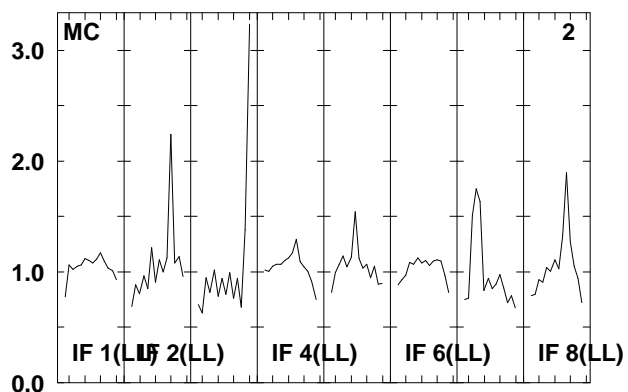
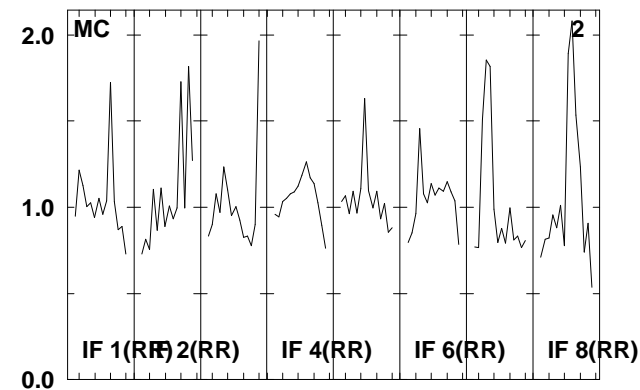
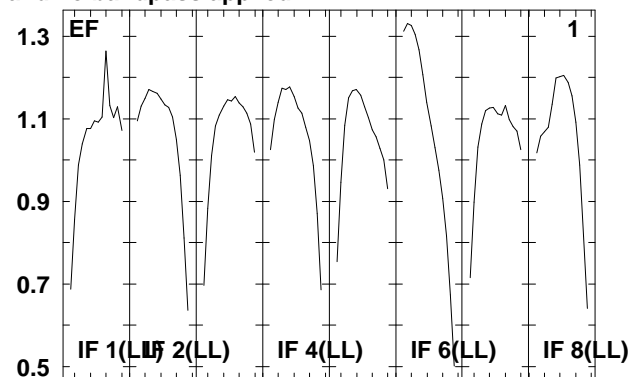
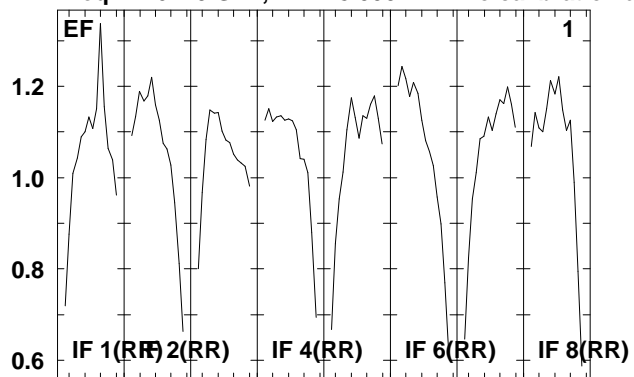

Lower frame: Real Jy  
Total-power spectrum Antenna: \*  
Timerange: 00/11:50:02 to 00/11:53:00

Plot file version 92 created 06-JAN-2009 10:57:36

J1510-05 EZ018B.UVDATA.1

Freq = 1.6270 GHz, Bw = 8.000 MH No calibration applied and no bandpass applied

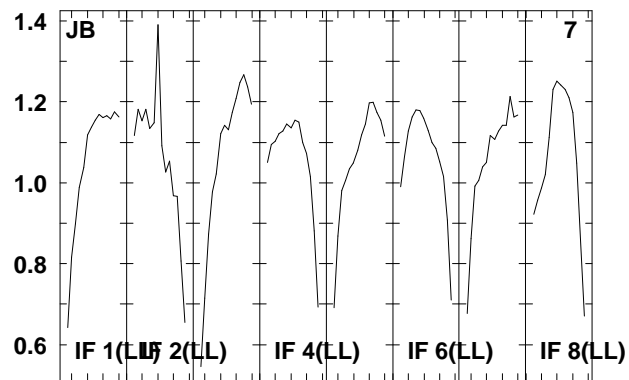
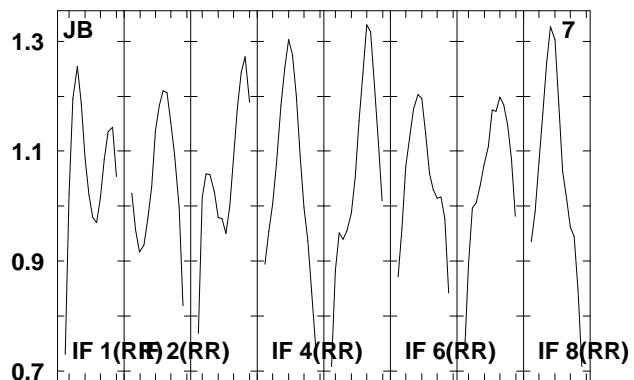
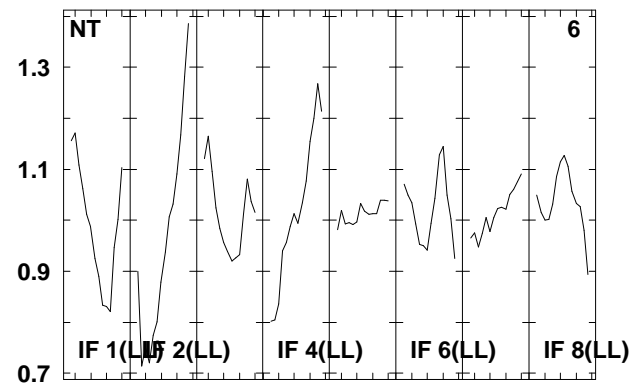
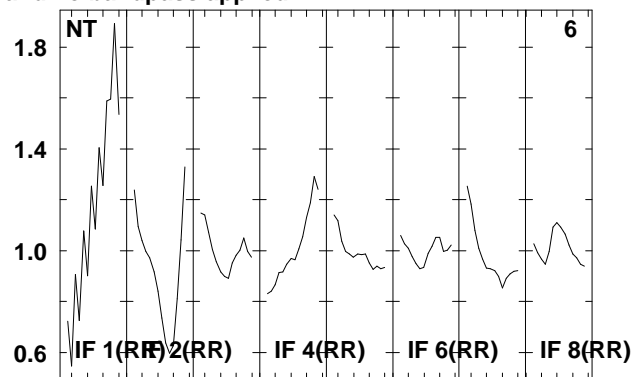
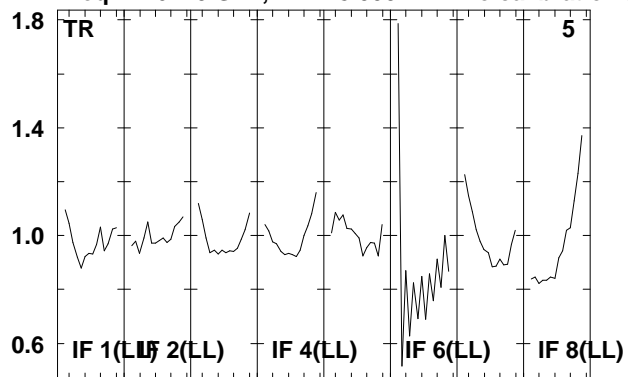

Lower frame: Real Jy  
Total-power spectrum Antenna: \*  
Timerange: 00/11:50:02 to 00/11:53:00

Plot file version 93 created 06-JAN-2009 10:57:36

J150407 EZ018B.UVDATA.1

Freq = 1.6270 GHz, Bw = 8.000 MH No calibration applied and no bandpass applied

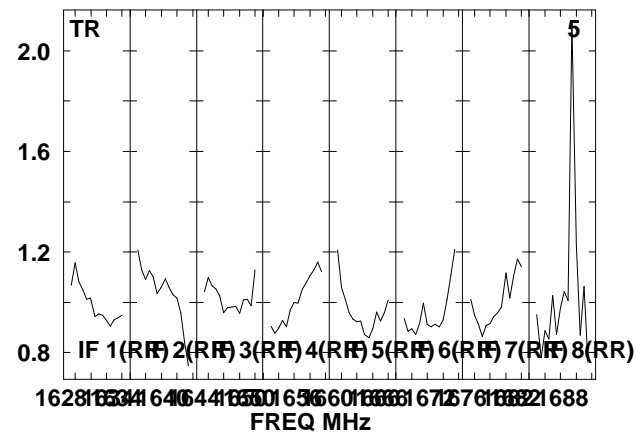
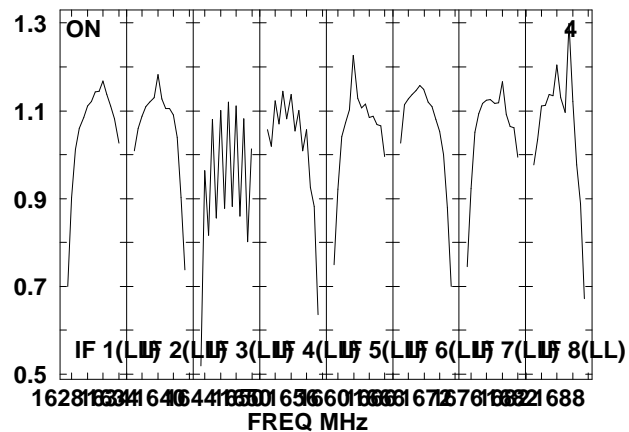
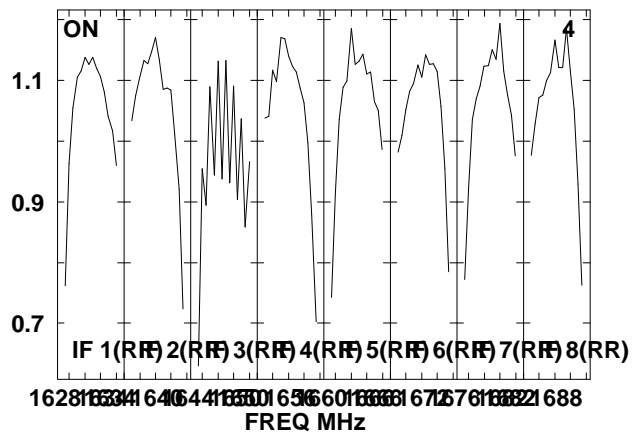
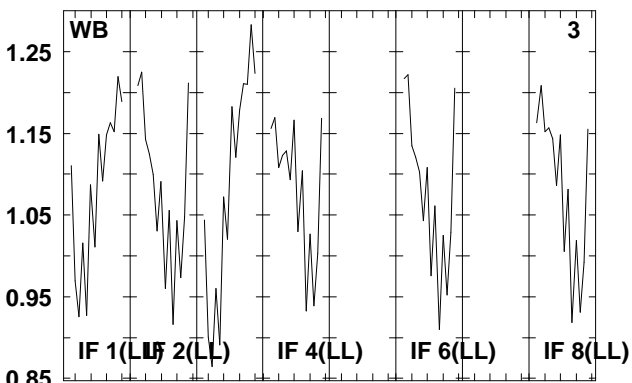
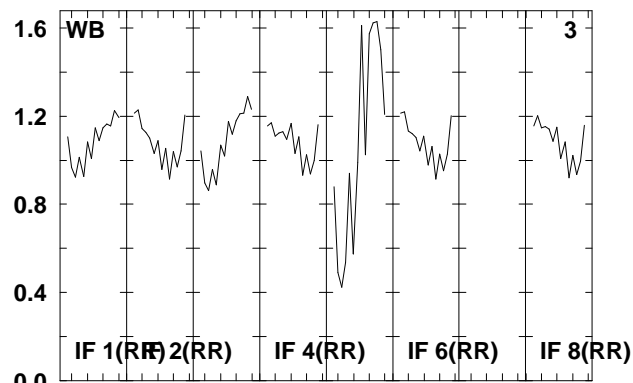
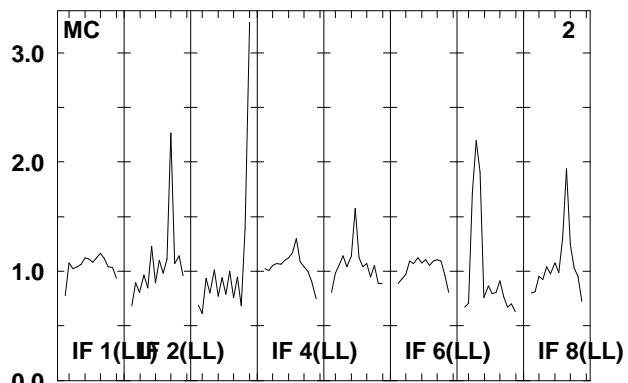
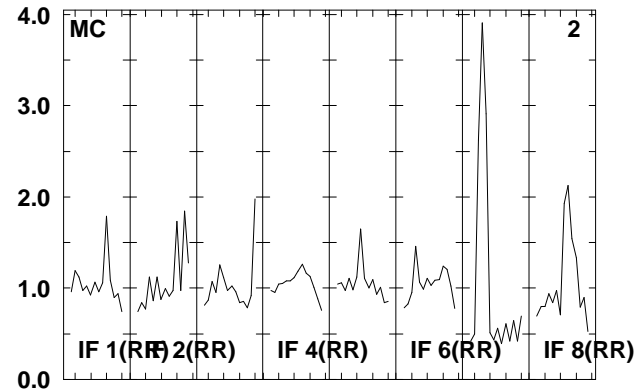
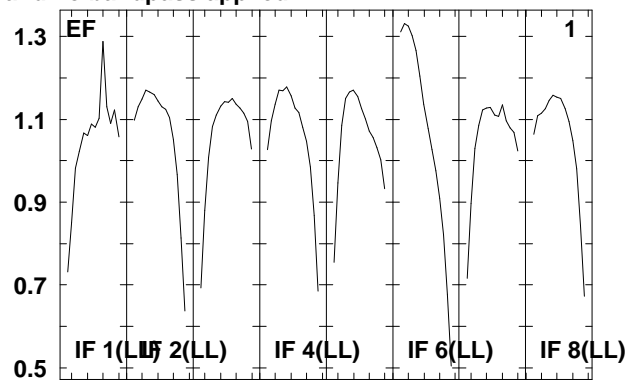
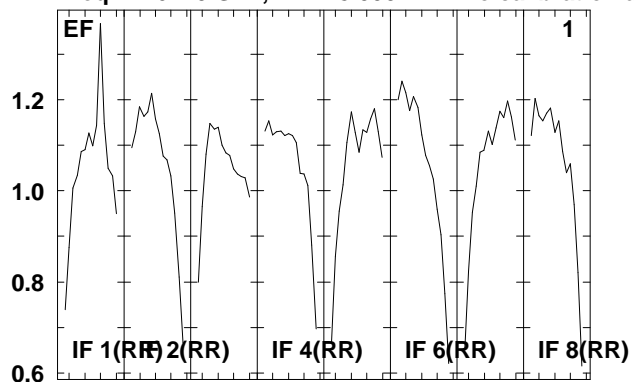

Lower frame: Real Jy  
Total-power spectrum Antenna: \*  
Timerange: 00/11:53:02 to 00/11:57:00

Plot file version 94 created 06-JAN-2009 10:57:36

J150407 EZ018B.UVDATA.1

Freq = 1.6270 GHz, Bw = 8.000 MH No calibration applied and no bandpass applied

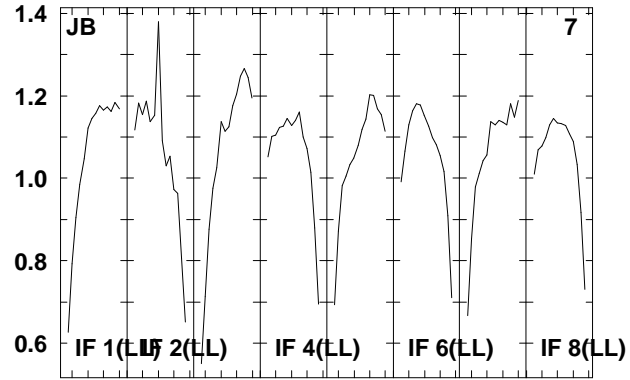
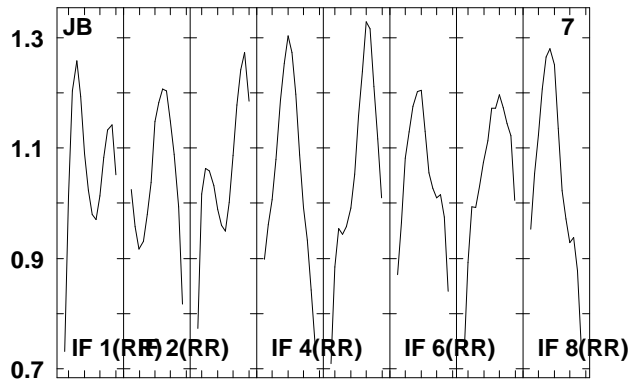
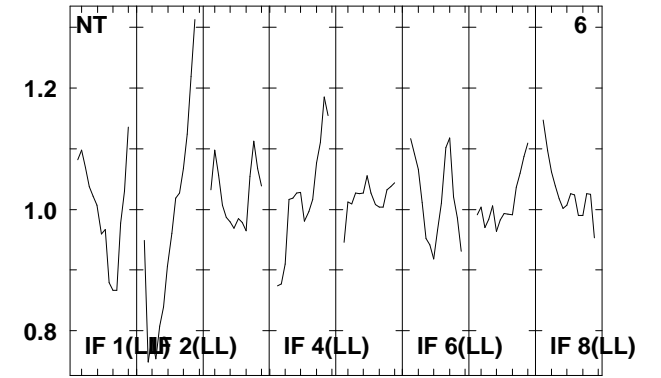
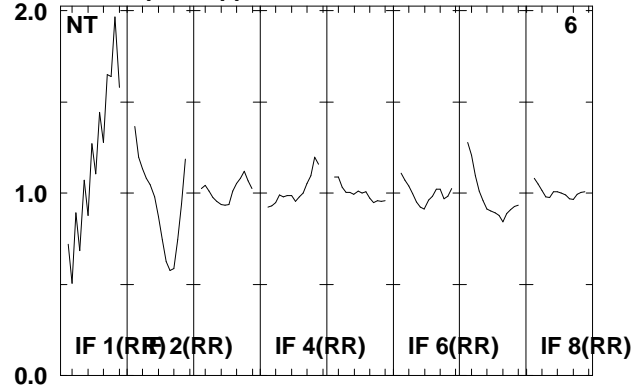
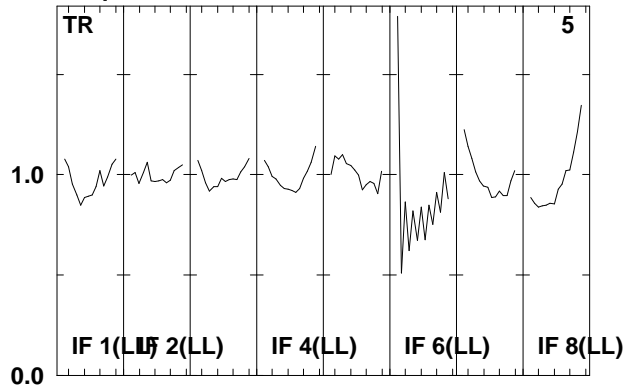

Lower frame: Real Jy  
Total-power spectrum Antenna: \*  
Timerange: 00/11:53:02 to 00/11:57:00

Plot file version 95 created 06-JAN-2009 10:57:37

J1510-05 EZ018B.UVDATA.1

Freq = 1.6270 GHz, Bw = 8.000 MH No calibration applied and no bandpass applied

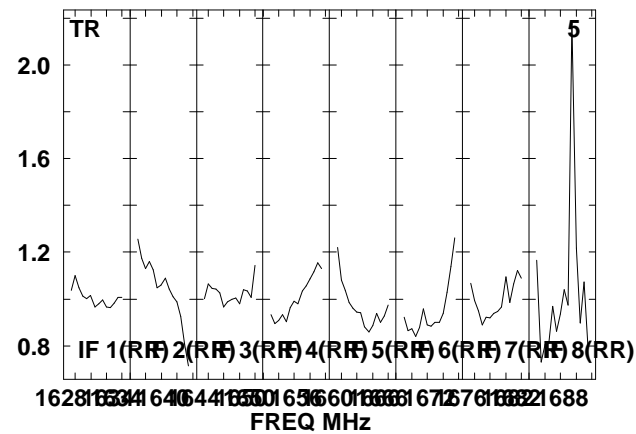
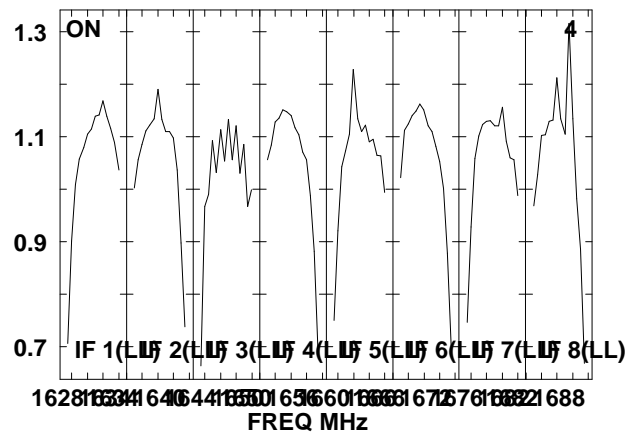
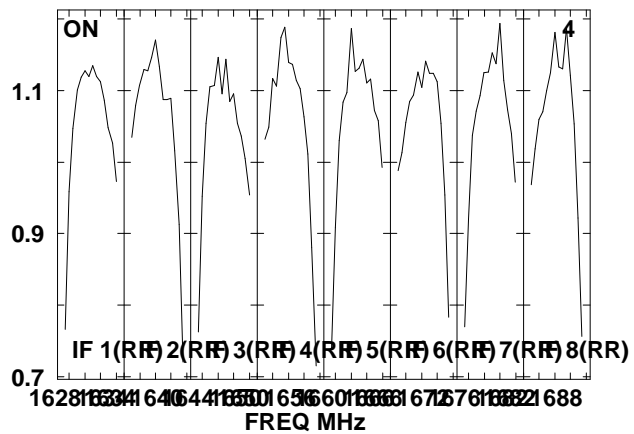
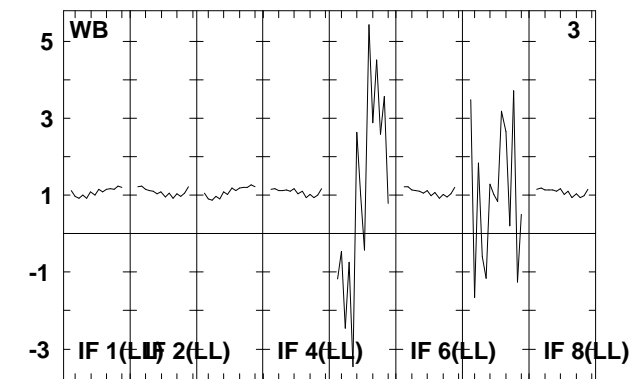
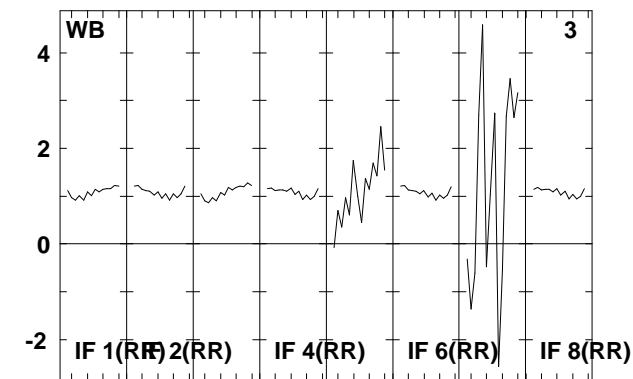
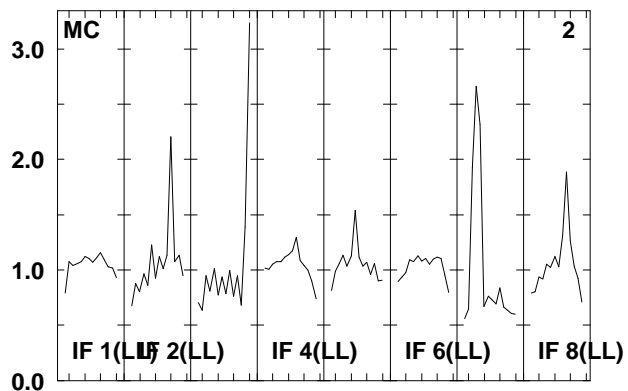
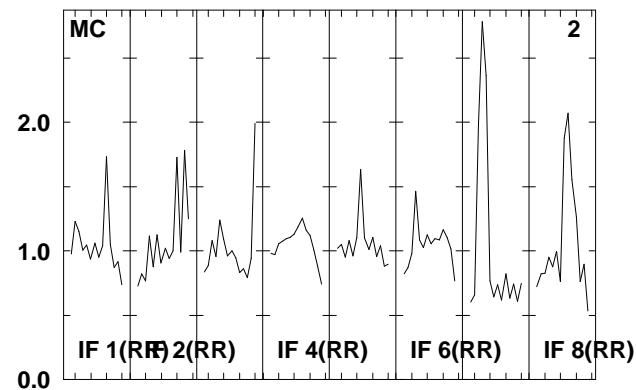
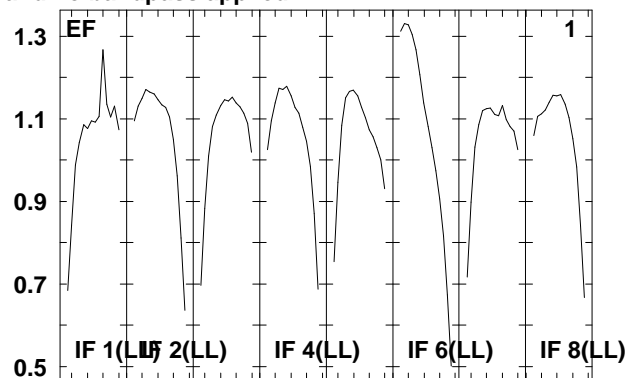
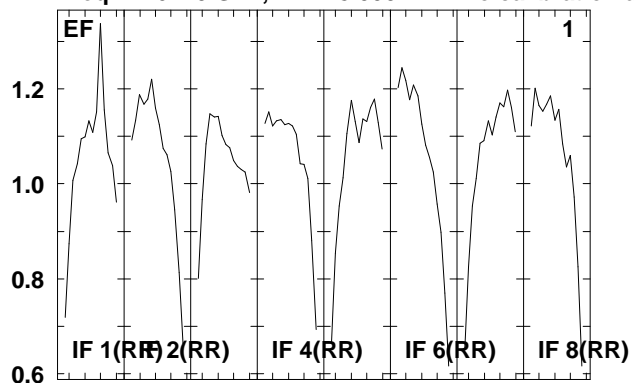

Lower frame: Real Jy  
Total-power spectrum Antenna: \*  
Timerange: 00/11:57:02 to 00/12:00:00

Plot file version 96 created 06-JAN-2009 10:57:37

J1510-05 EZ018B.UVDATA.1

Freq = 1.6270 GHz, Bw = 8.000 MH No calibration applied and no bandpass applied

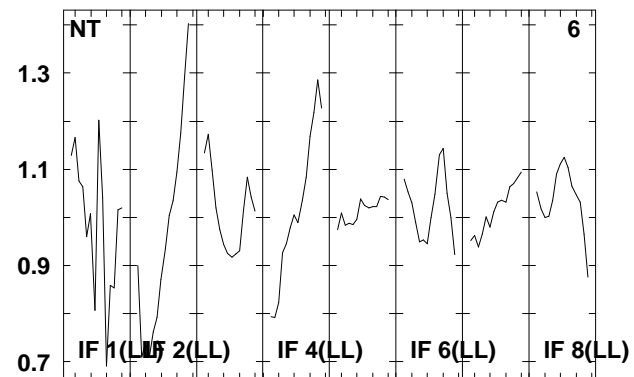
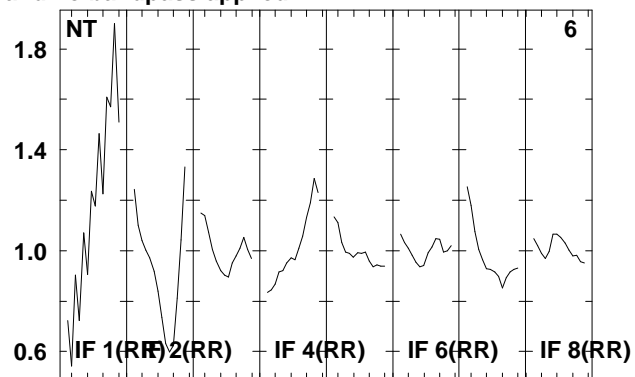
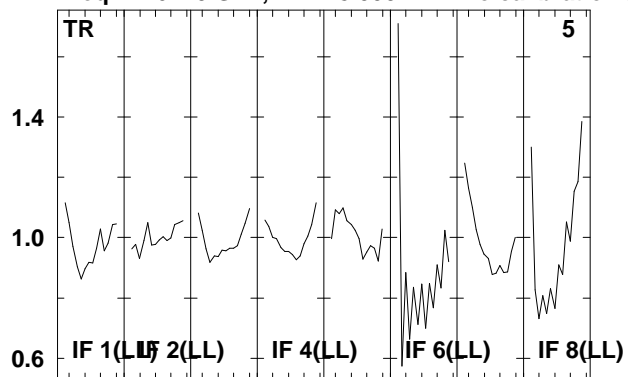

Lower frame: Real Jy  
Total-power spectrum Antenna: \*  
Timerange: 00/11:57:02 to 00/12:00:00



Plot file version 97 created 06-JAN-2009 10:57:37

J150407 EZ018B.UVDATA.1

Freq = 1.6270 GHz, Bw = 8.000 MH No calibration applied and no bandpass applied

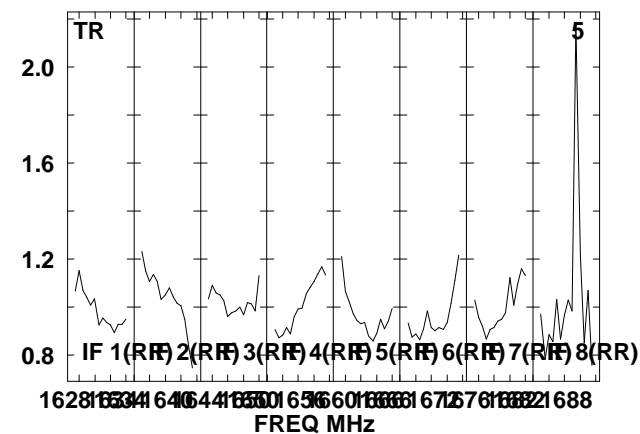
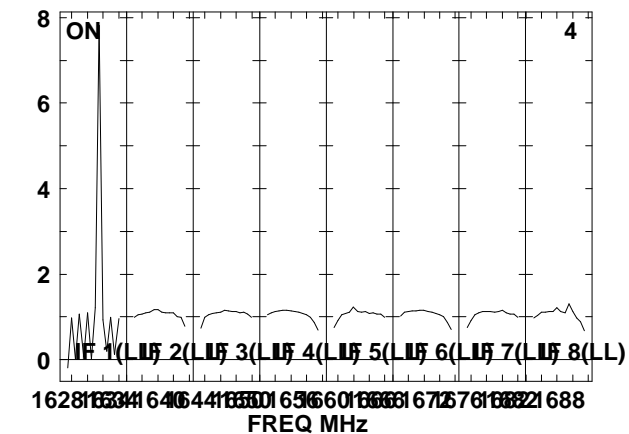
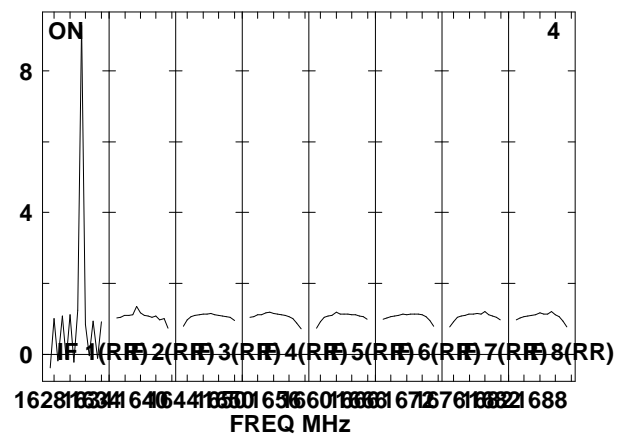
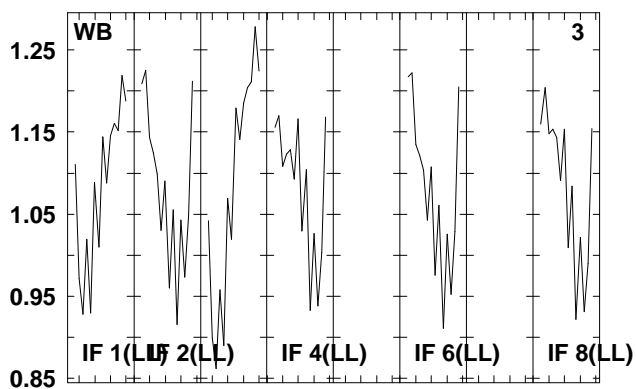
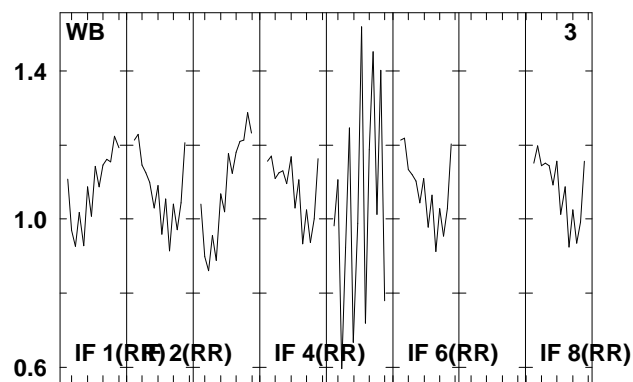
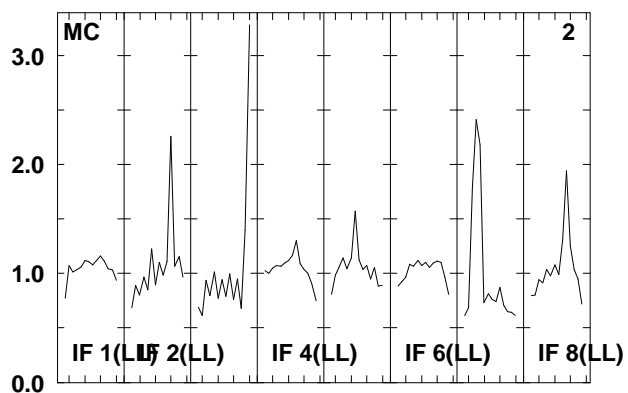
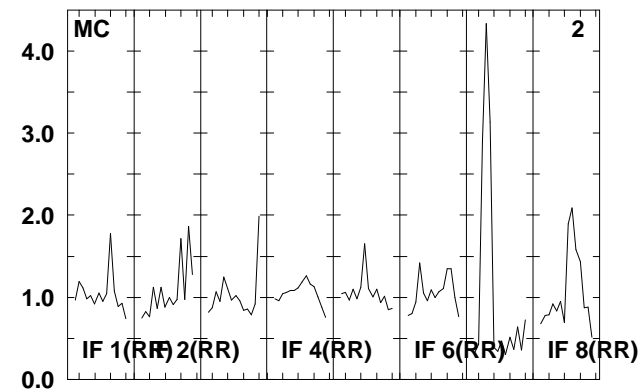
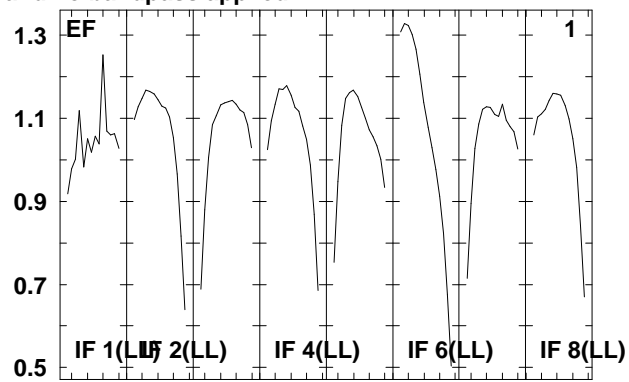
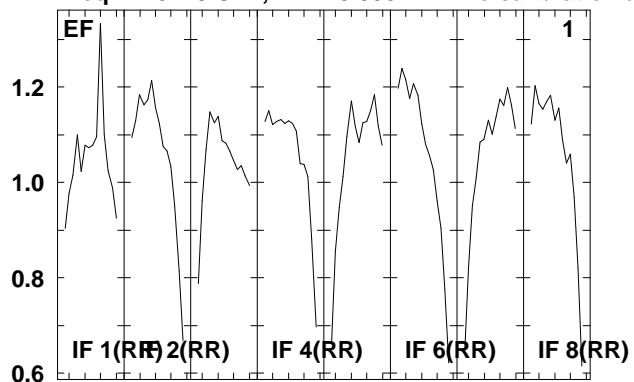

Lower frame: Real Jy  
Total-power spectrum Antenna: \*  
Timerange: 00/12:00:02 to 00/12:03:58

Plot file version 98 created 06-JAN-2009 10:57:38

J150407 EZ018B.UVDATA.1

Freq = 1.6270 GHz, Bw = 8.000 MH No calibration applied and no bandpass applied

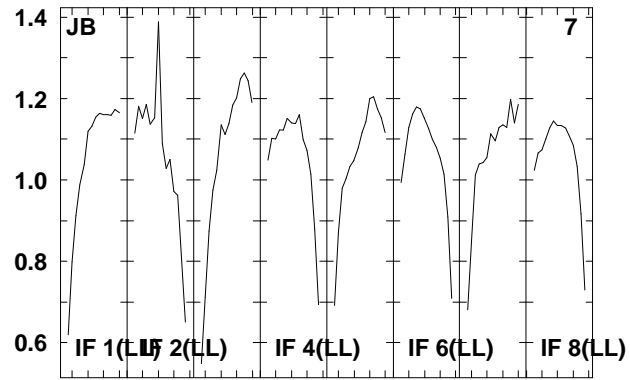
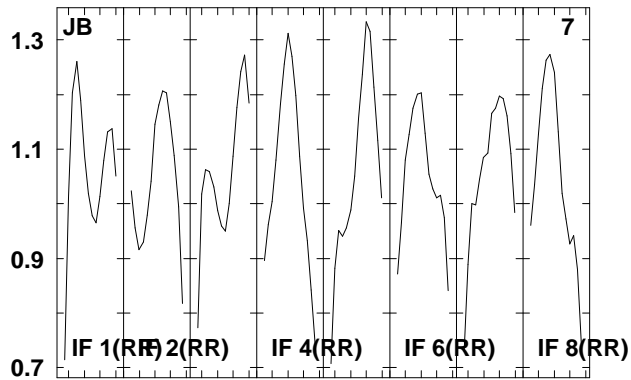
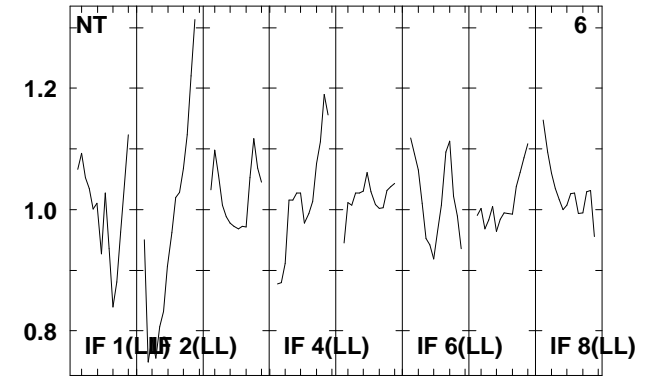
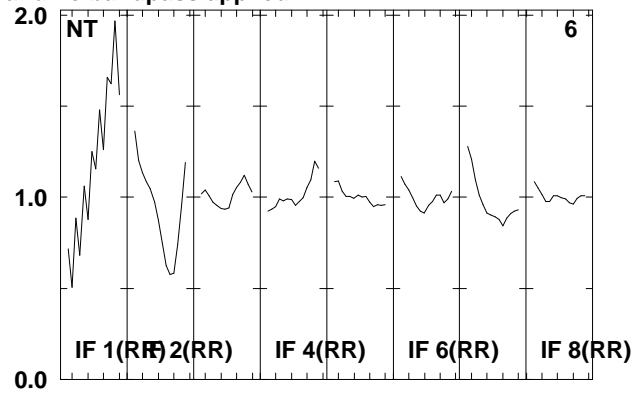
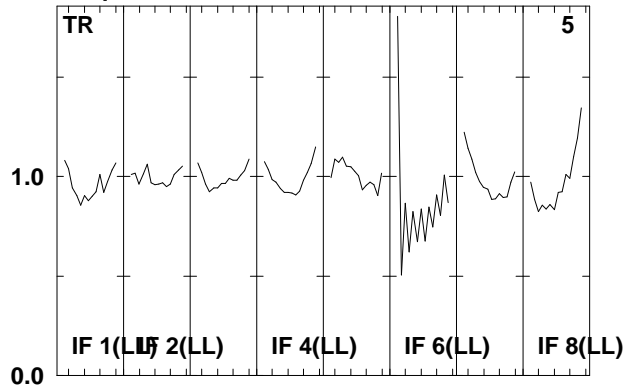

Lower frame: Real Jy  
Total-power spectrum Antenna: \*  
Timerange: 00/12:00:02 to 00/12:03:58

Plot file version 99 created 06-JAN-2009 10:57:38

J1510-05 EZ018B.UVDATA.1

Freq = 1.6270 GHz, Bw = 8.000 MH No calibration applied and no bandpass applied

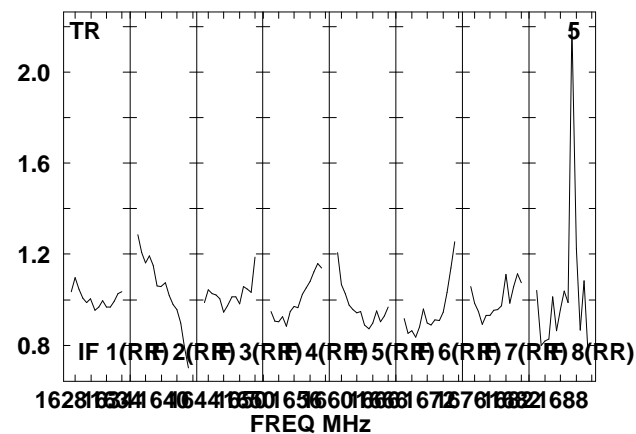
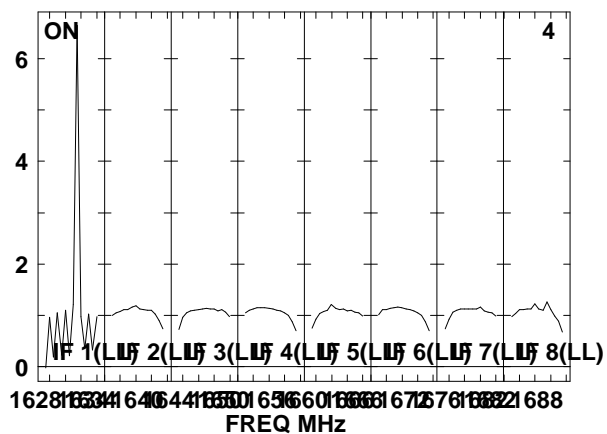
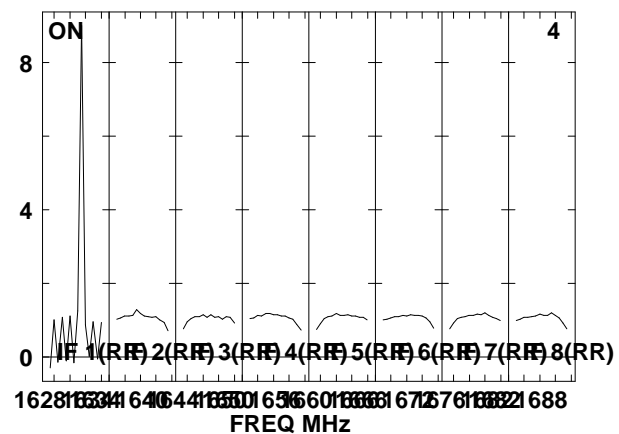
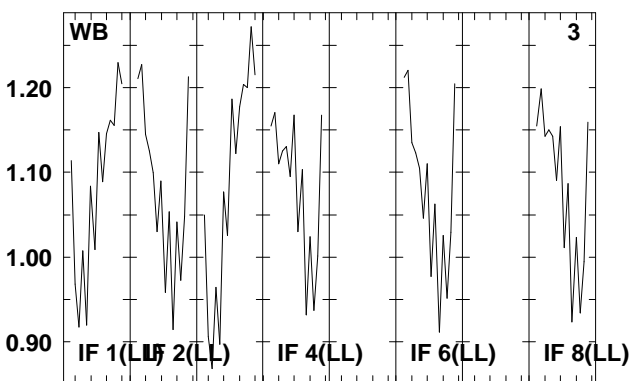
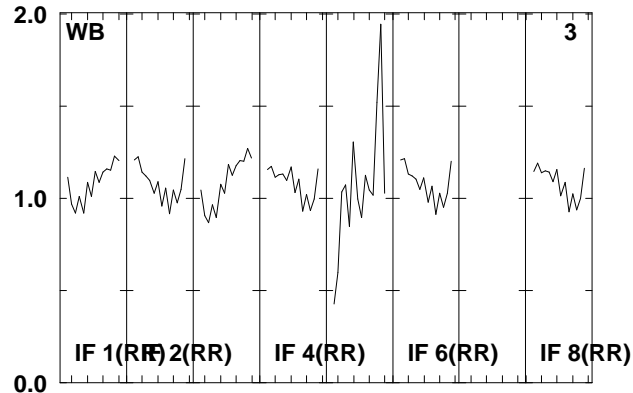
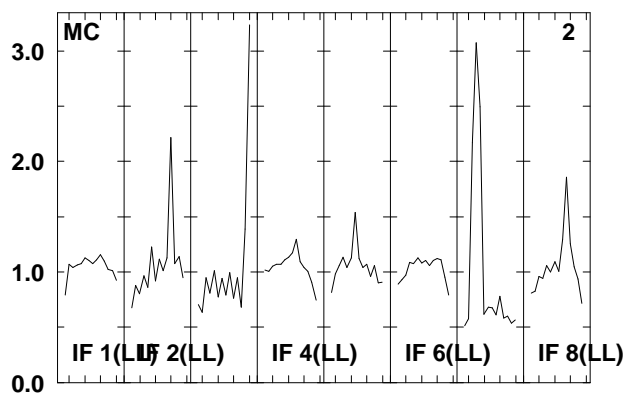
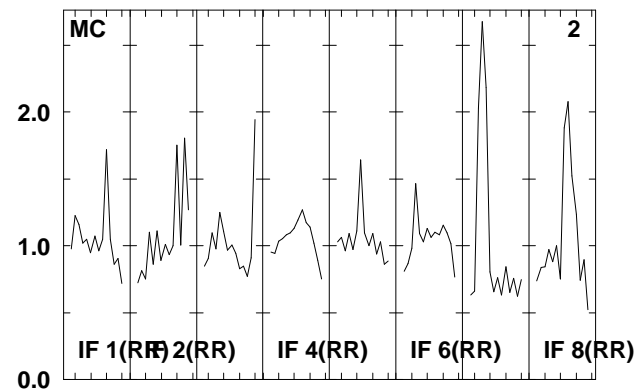
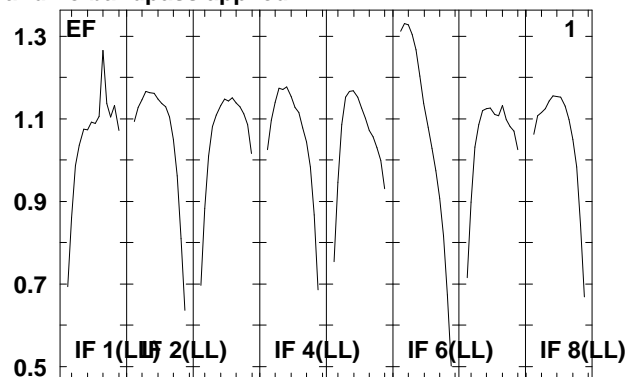
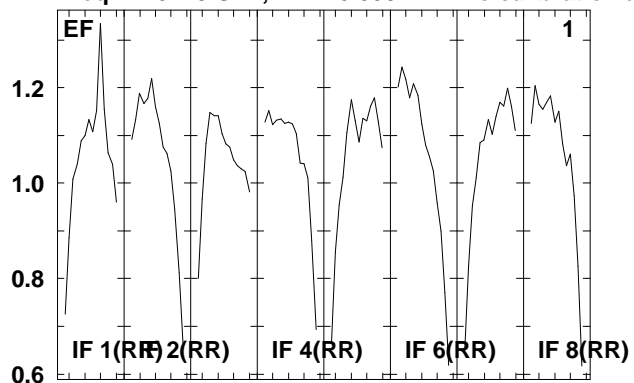

Lower frame: Real Jy  
Total-power spectrum Antenna: \*  
Timerange: 00/12:05:02 to 00/12:08:00

Plot file version 100 created 06-JAN-2009 10:57:39

J1510-05 EZ018B.UVDATA.1

Freq = 1.6270 GHz, Bw = 8.000 MH No calibration applied and no bandpass applied

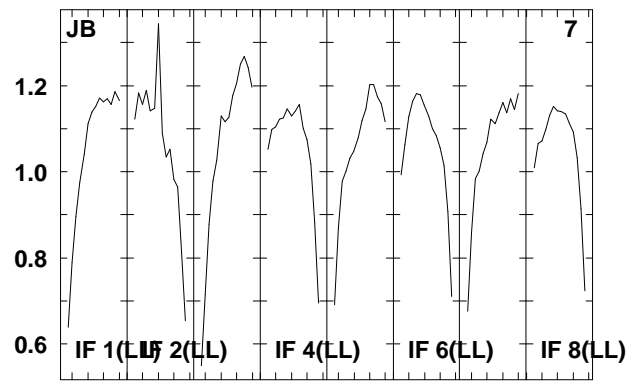
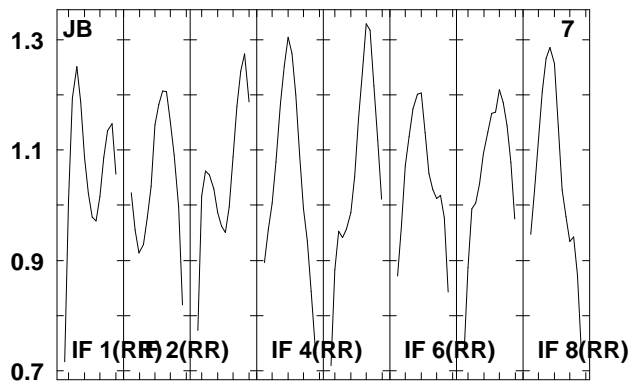
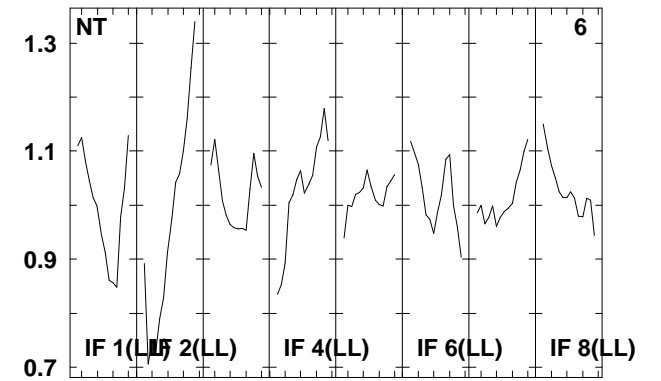
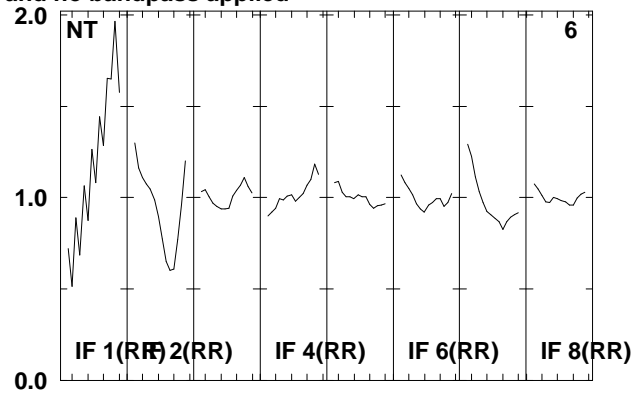
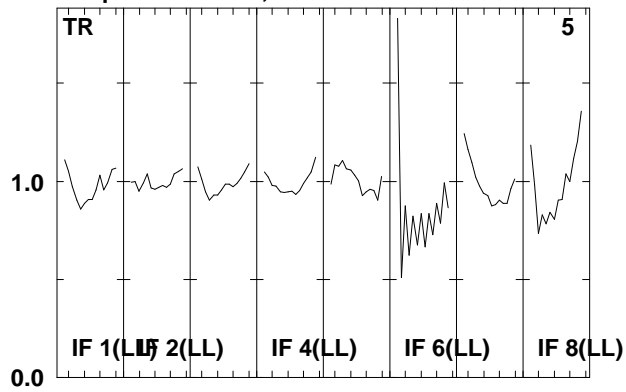

Lower frame: Real Jy  
Total-power spectrum Antenna: \*  
Timerange: 00/12:05:02 to 00/12:08:00

Plot file version 101 created 06-JAN-2009 10:57:39

J150407 EZ018B.UVDATA.1

Freq = 1.6270 GHz, Bw = 8.000 MH No calibration applied and no bandpass applied

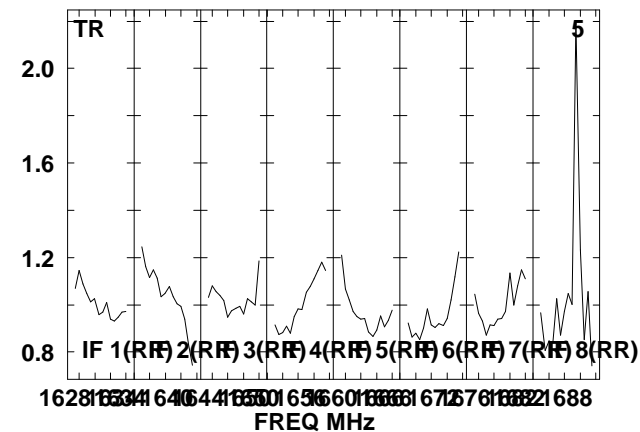
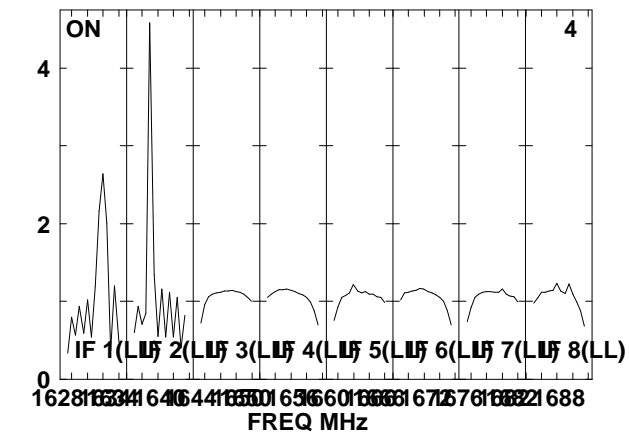
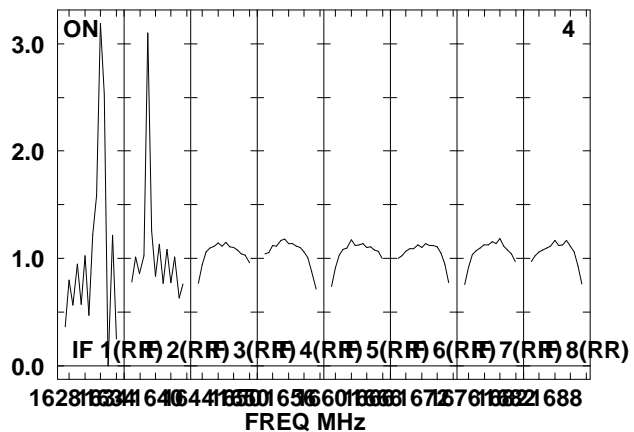
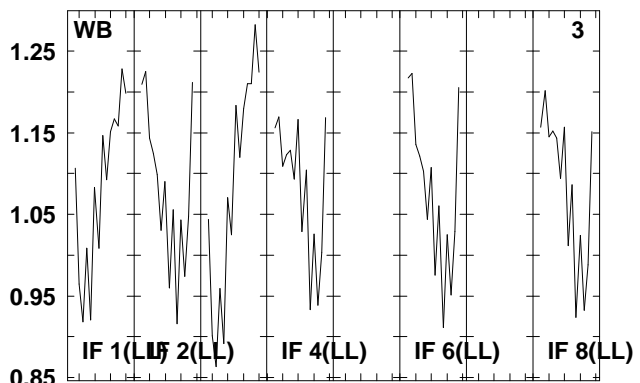
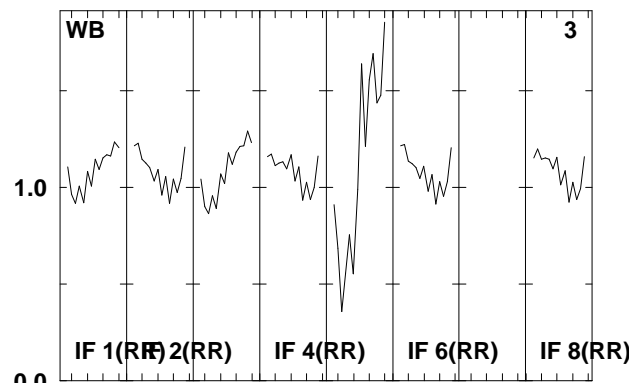
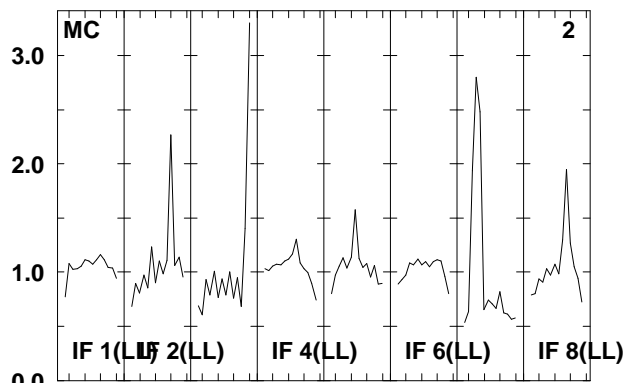
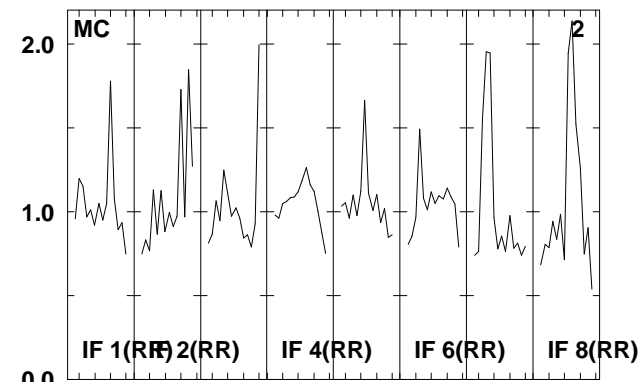
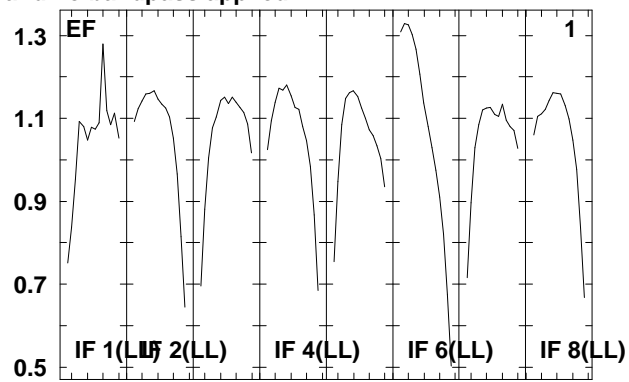
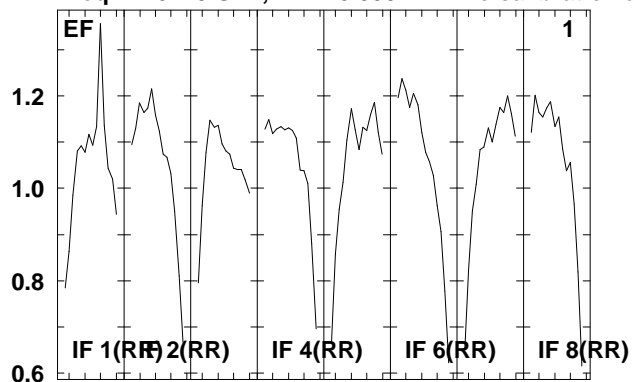

Lower frame: Real Jy  
Total-power spectrum Antenna: \*  
Timerange: 00/12:08:02 to 00/12:12:00

Plot file version 102 created 06-JAN-2009 10:57:40

J150407 EZ018B.UVDATA.1

Freq = 1.6270 GHz, Bw = 8.000 MH No calibration applied and no bandpass applied

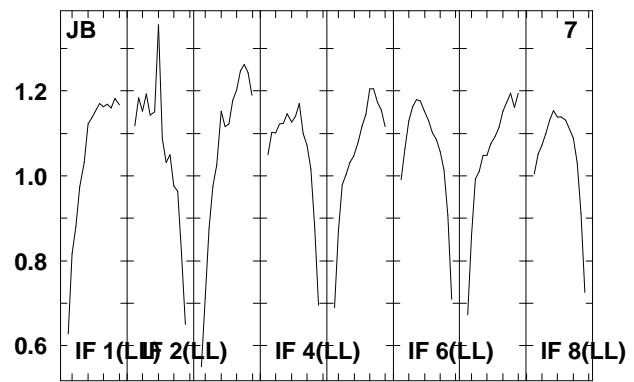
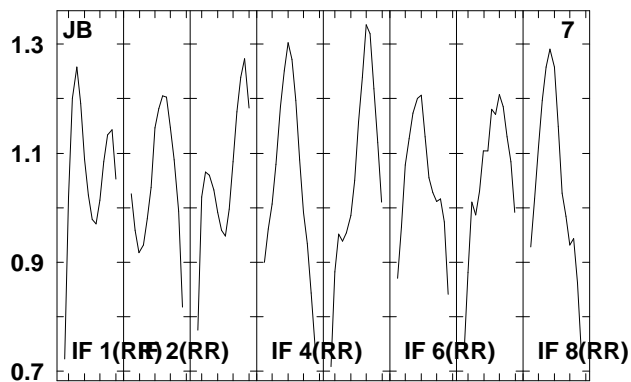
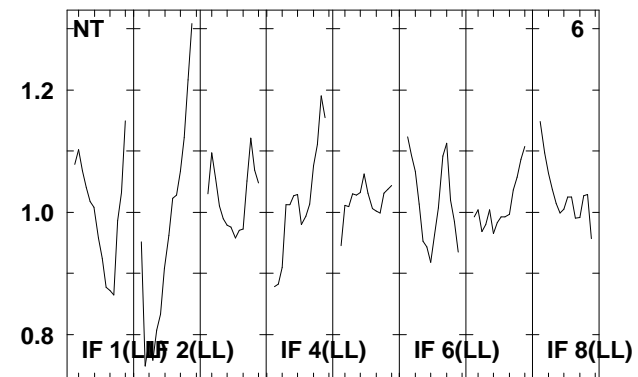
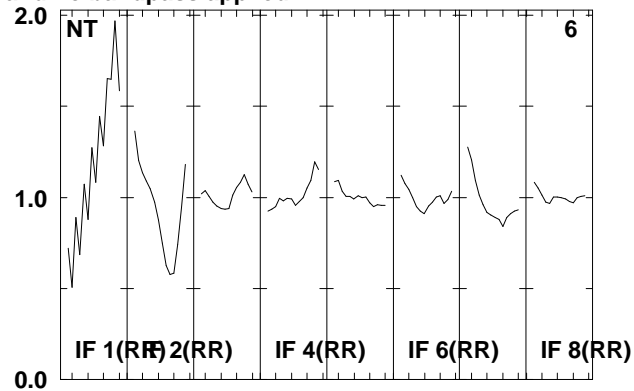
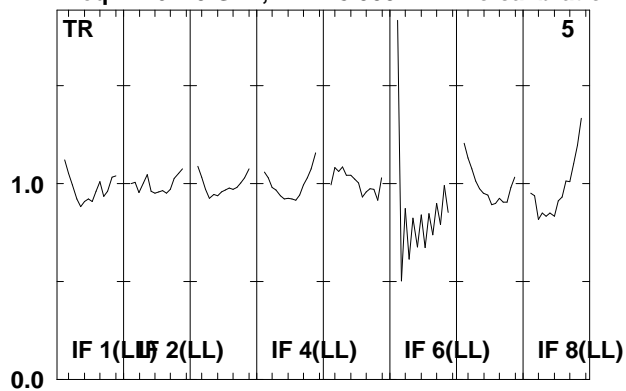

Lower frame: Real Jy  
Total-power spectrum Antenna: \*  
Timerange: 00/12:08:02 to 00/12:12:00

Plot file version 103 created 06-JAN-2009 10:57:40

J1510-05 EZ018B.UVDATA.1

Freq = 1.6270 GHz, Bw = 8.000 MH No calibration applied and no bandpass applied

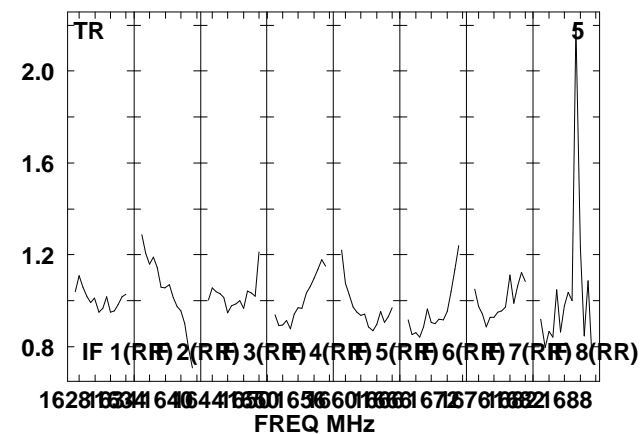
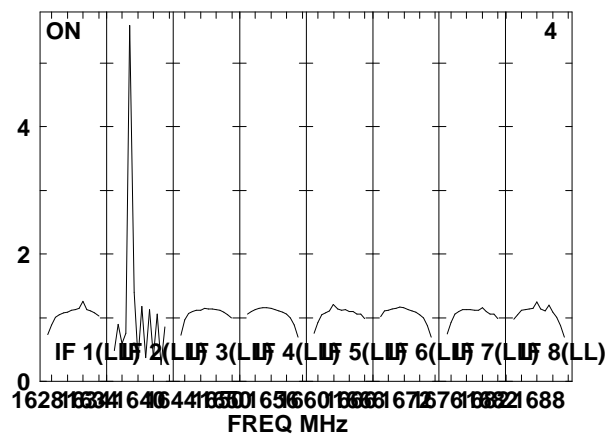
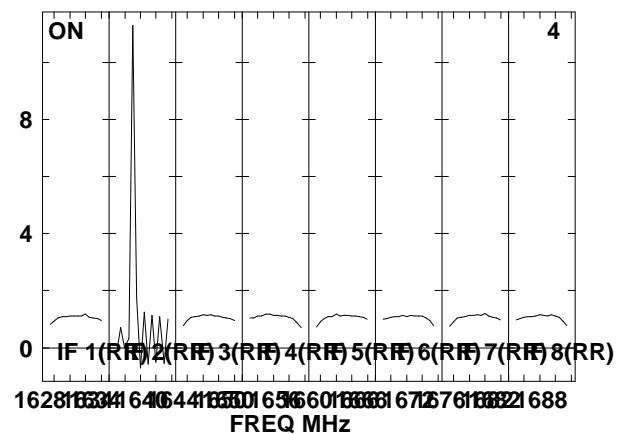
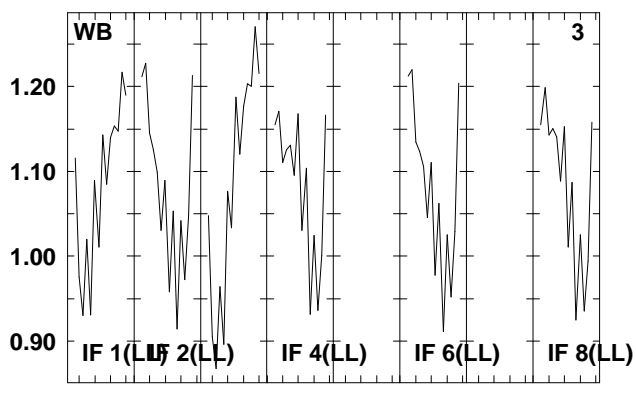
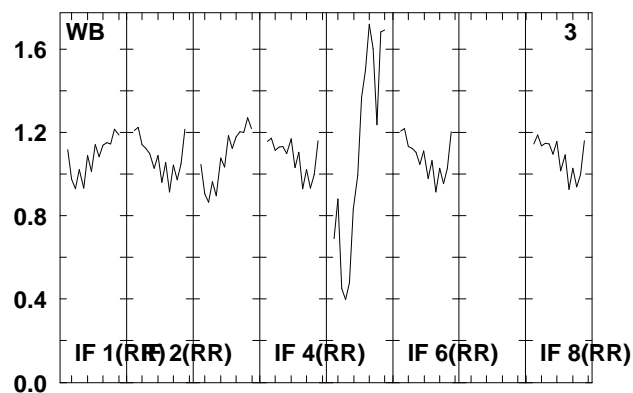
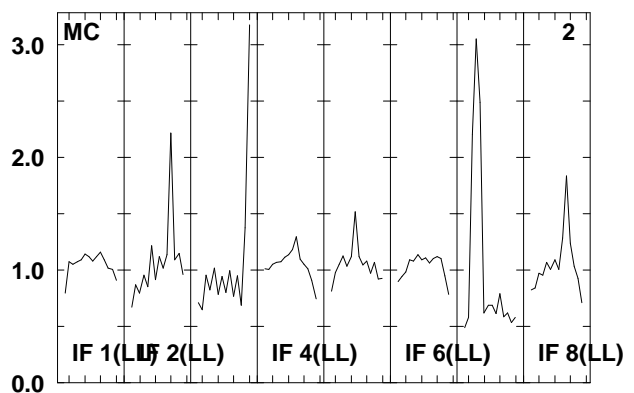
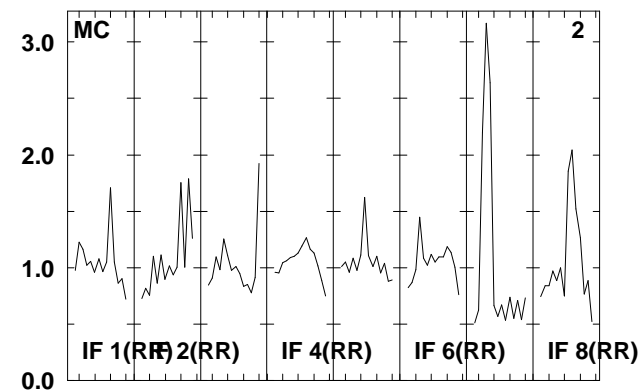
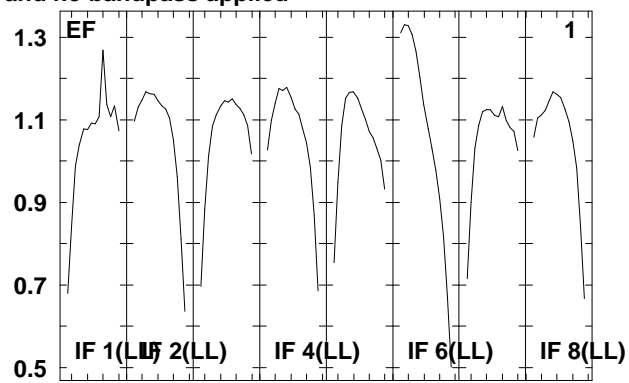
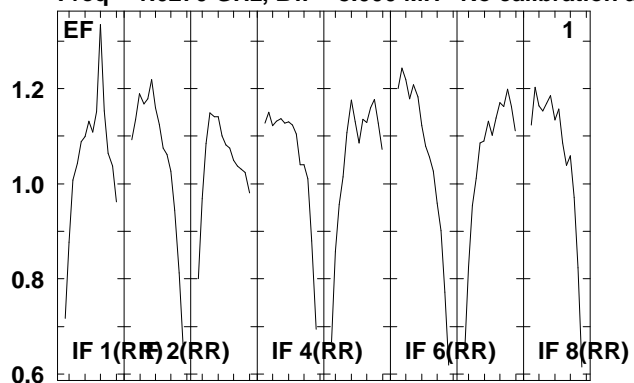

Lower frame: Real Jy  
Total-power spectrum Antenna: \*  
Timerange: 00/12:12:02 to 00/12:15:00

Plot file version 104 created 06-JAN-2009 10:57:40

J1510-05 EZ018B.UVDATA.1

Freq = 1.6270 GHz, Bw = 8.000 MH No calibration applied and no bandpass applied

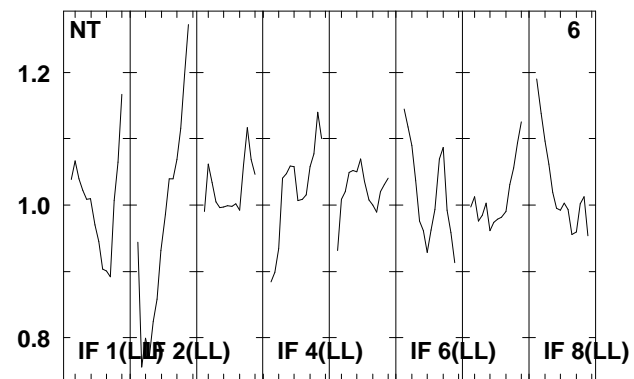
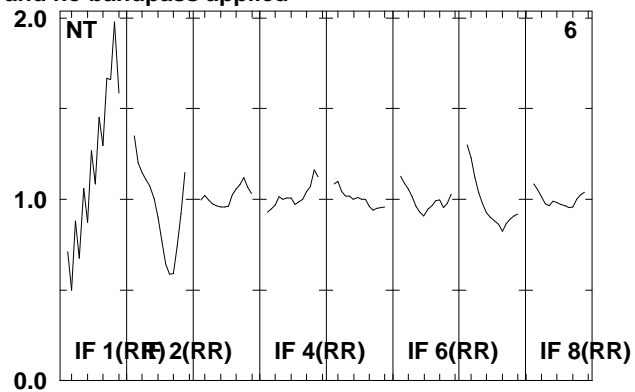
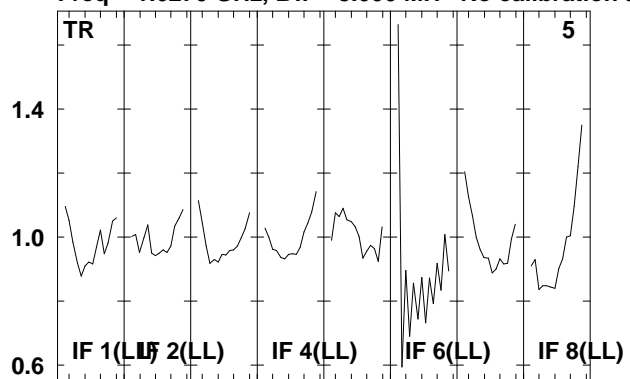

Lower frame: Real Jy  
Total-power spectrum Antenna: \*  
Timerange: 00/12:12:02 to 00/12:15:00



Plot file version 105 created 06-JAN-2009 10:57:41

J150407 EZ018B.UVDATA.1

Freq = 1.6270 GHz, Bw = 8.000 MH No calibration applied and no bandpass applied

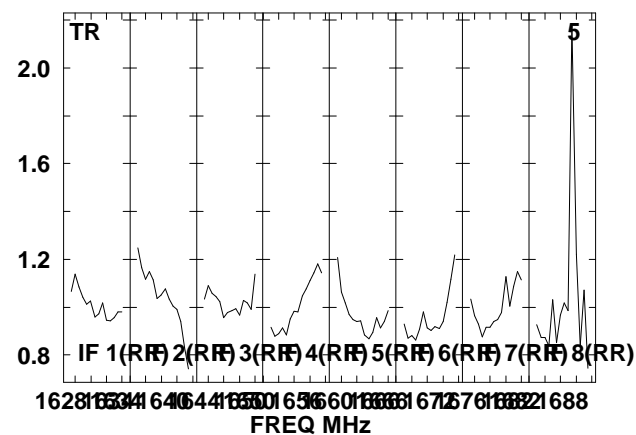
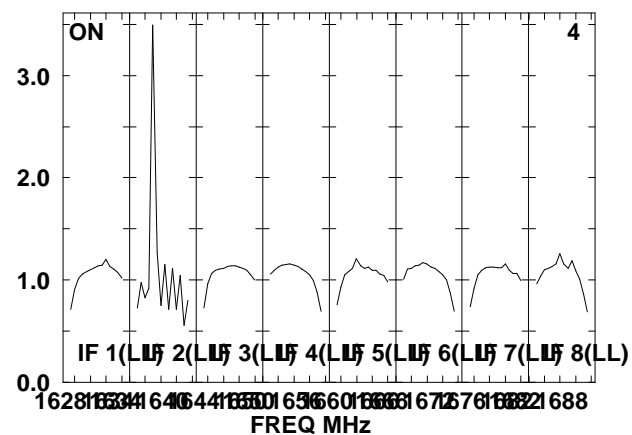
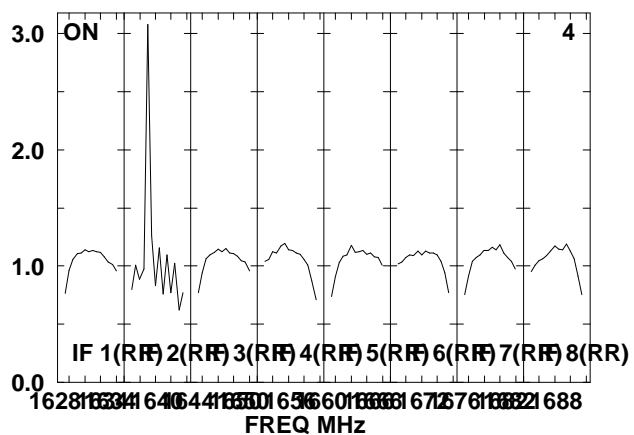
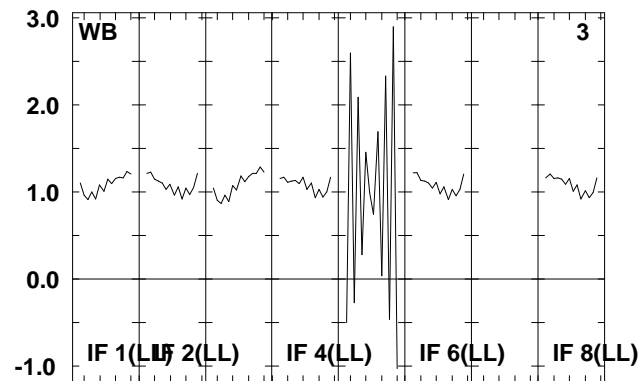
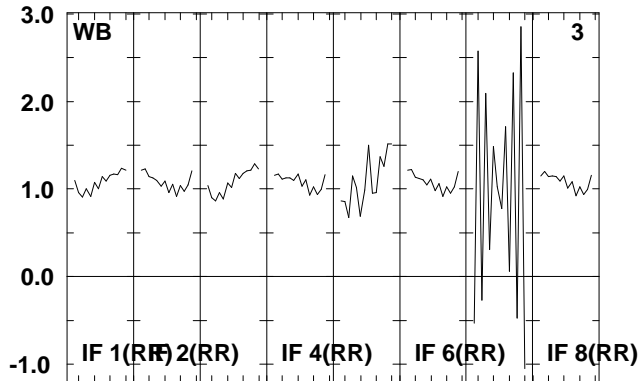
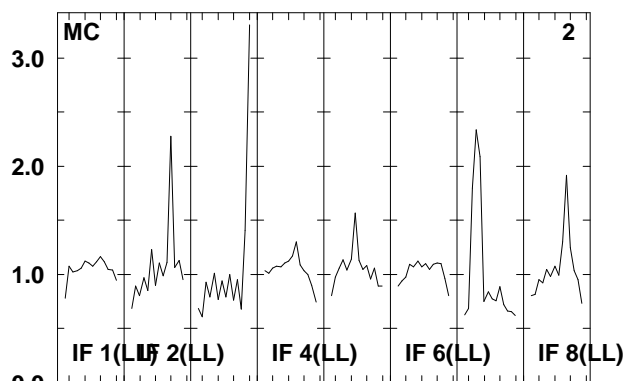
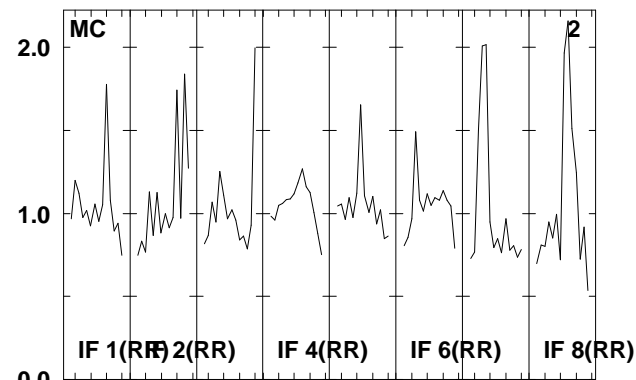
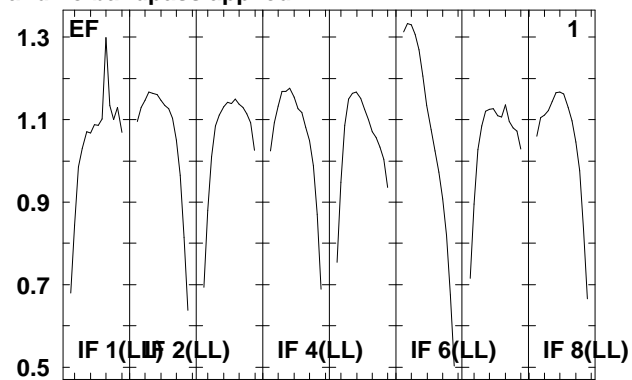
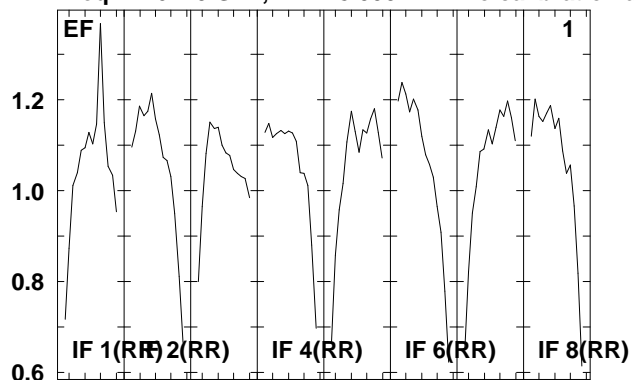

Lower frame: Real Jy  
Total-power spectrum Antenna: \*  
Timerange: 00/12:15:02 to 00/12:18:58

Plot file version 106 created 06-JAN-2009 10:57:41

J150407 EZ018B.UVDATA.1

Freq = 1.6270 GHz, Bw = 8.000 MH No calibration applied and no bandpass applied

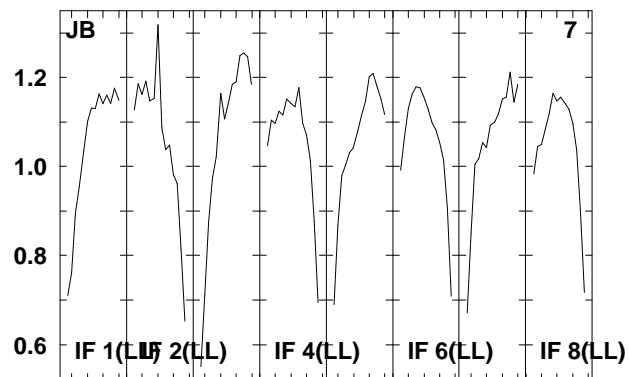
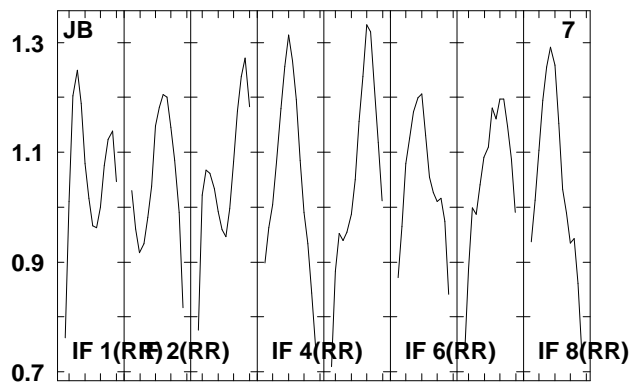
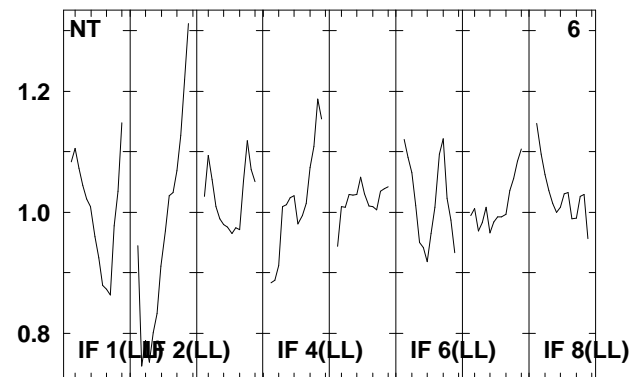
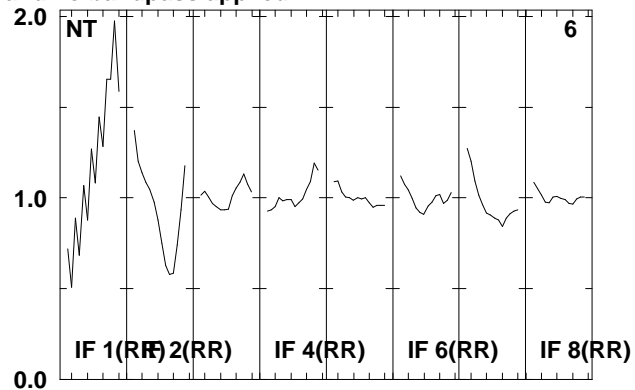
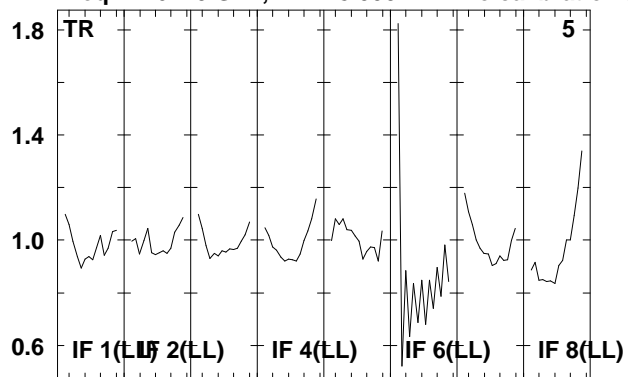

Lower frame: Real Jy  
Total-power spectrum Antenna: \*  
Timerange: 00/12:15:02 to 00/12:18:58

Plot file version 107 created 06-JAN-2009 10:57:41

J1510-05 EZ018B.UVDATA.1

Freq = 1.6270 GHz, Bw = 8.000 MH No calibration applied and no bandpass applied

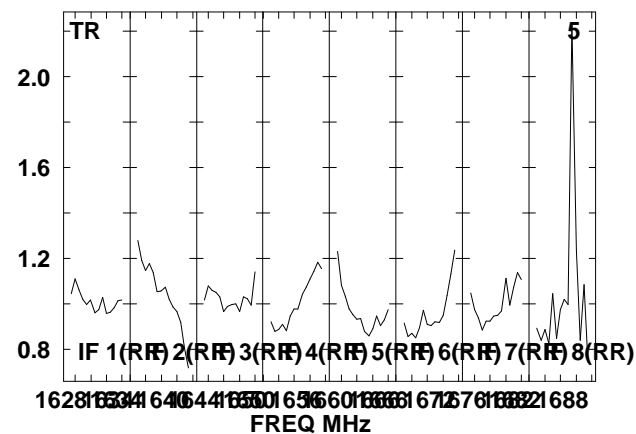
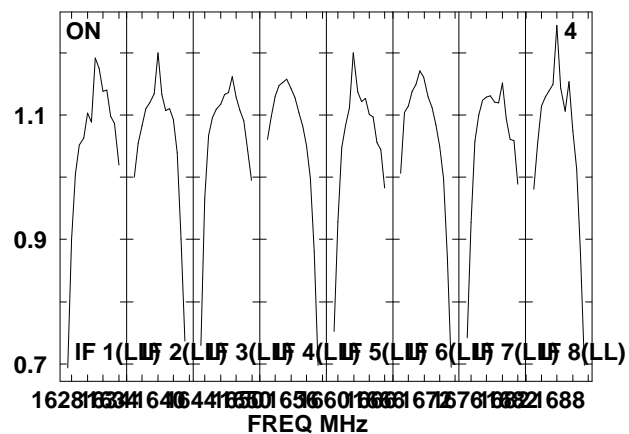
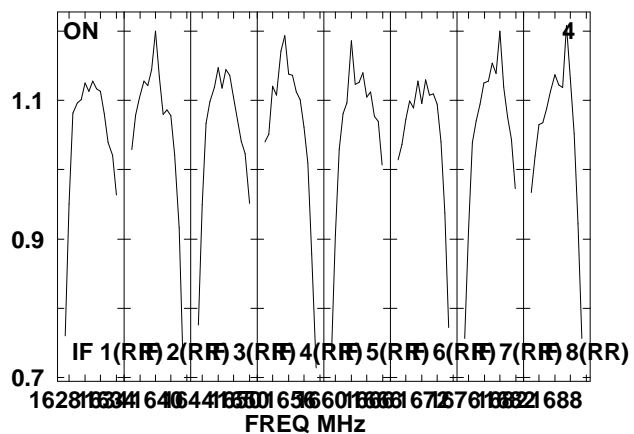
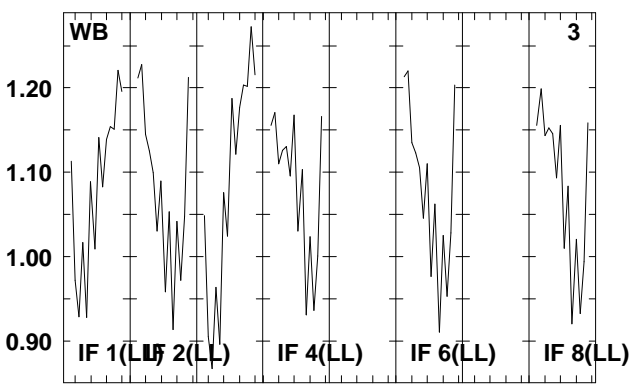
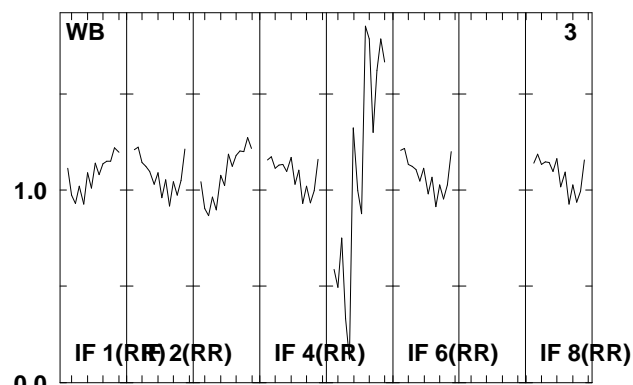
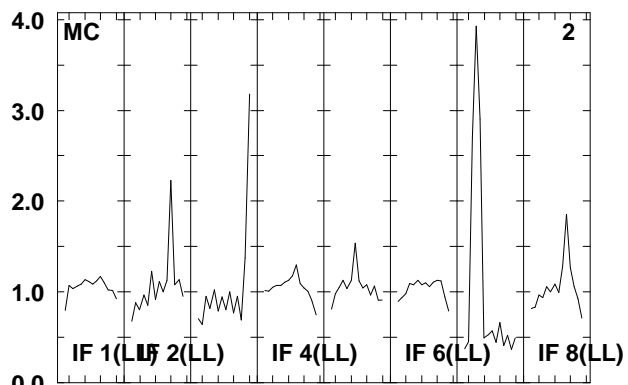
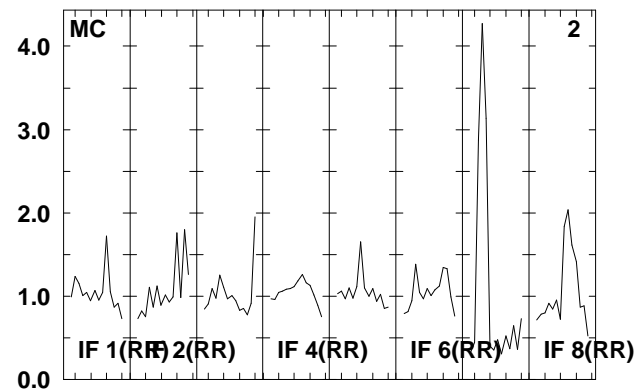
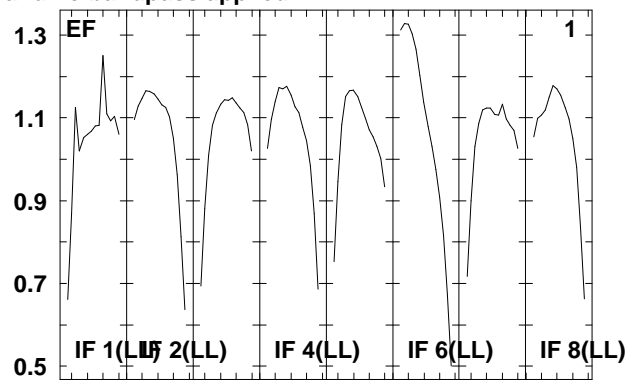
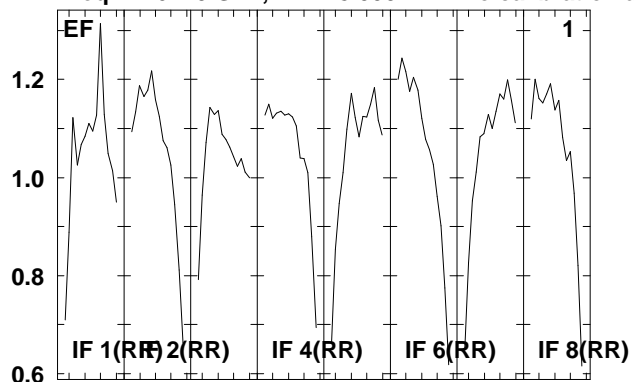

Lower frame: Real Jy  
Total-power spectrum Antenna: \*  
Timerange: 00/12:20:02 to 00/12:23:00

Plot file version 108 created 06-JAN-2009 10:57:42

J1510-05 EZ018B.UVDATA.1

Freq = 1.6270 GHz, Bw = 8.000 MH No calibration applied and no bandpass applied

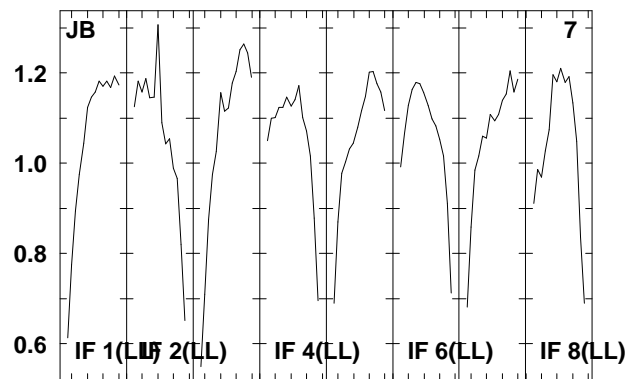
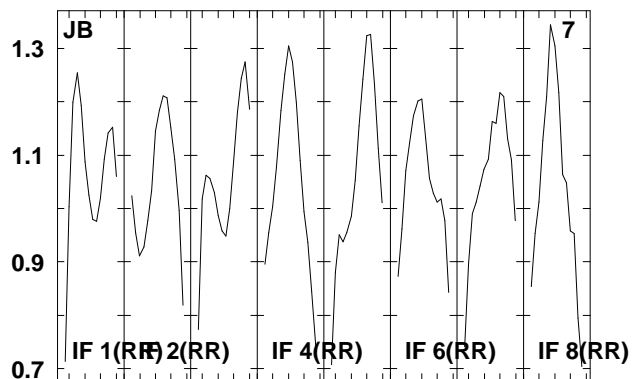
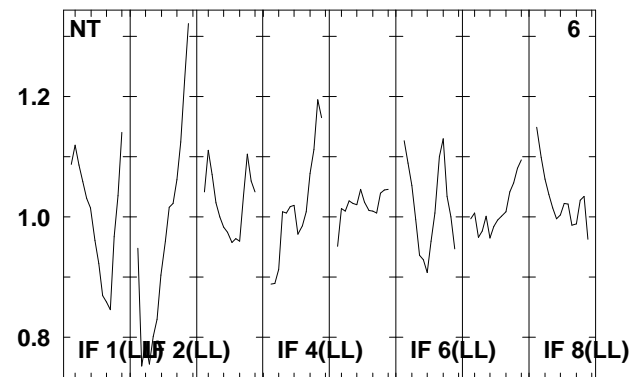
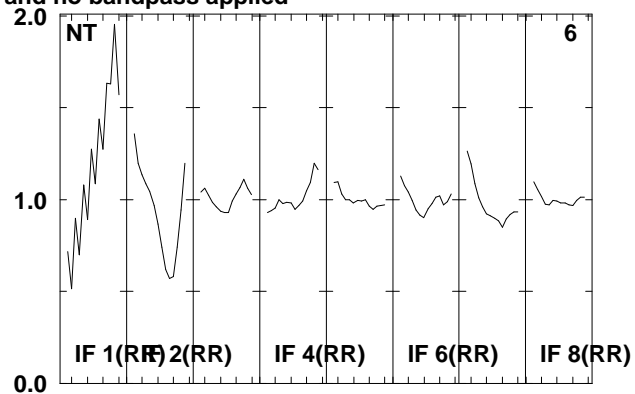
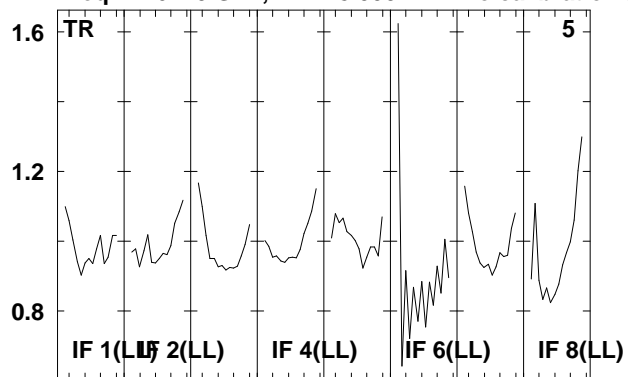

Lower frame: Real Jy  
Total-power spectrum Antenna: \*  
Timerange: 00/12:20:02 to 00/12:23:00

Plot file version 109 created 06-JAN-2009 10:57:42

J150407 EZ018B.UVDATA.1

Freq = 1.6270 GHz, Bw = 8.000 MH No calibration applied and no bandpass applied

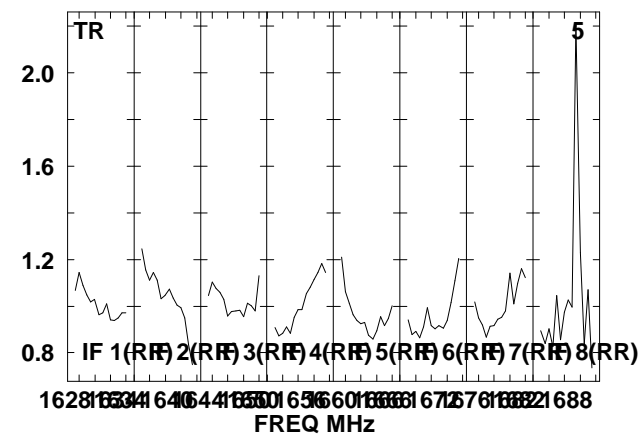
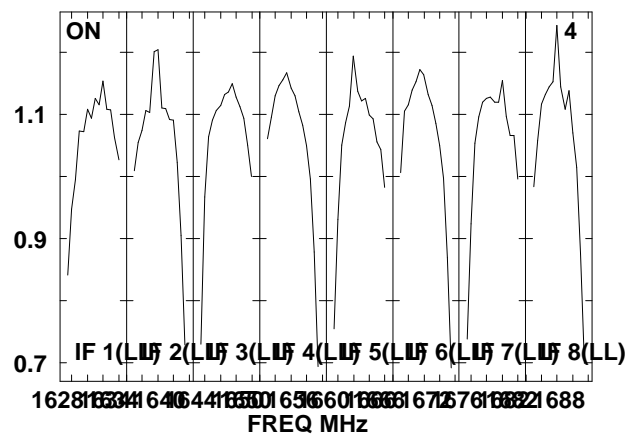
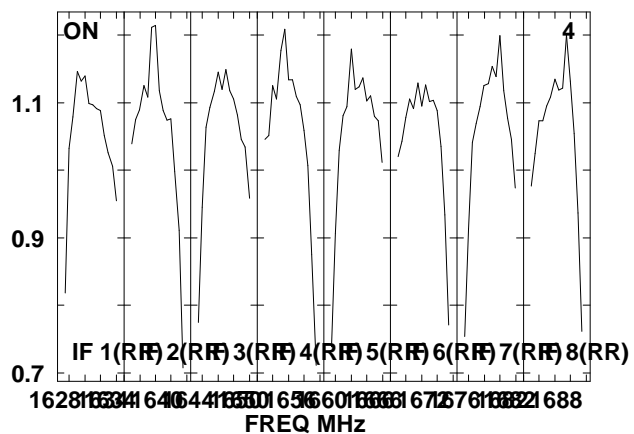
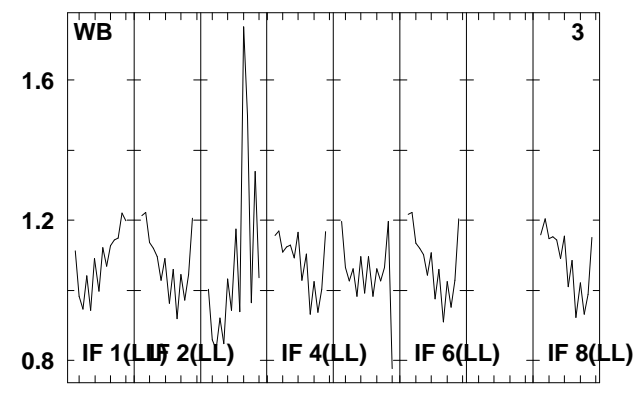
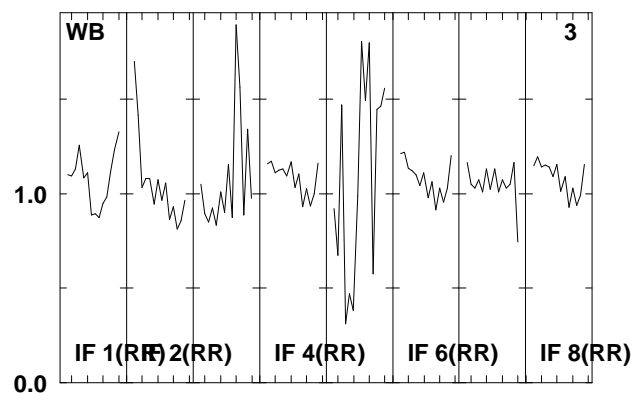
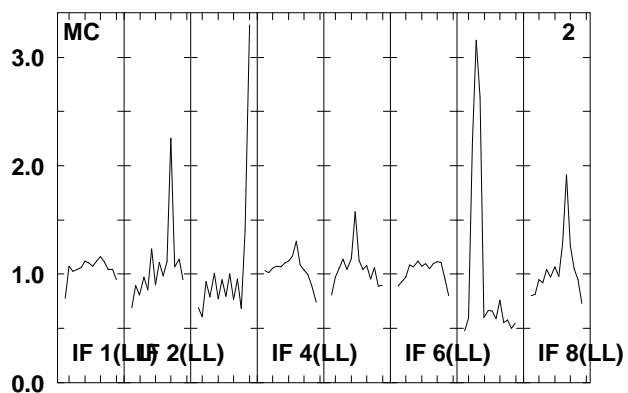
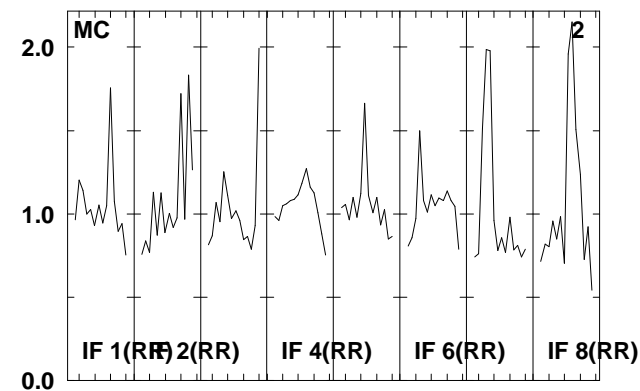
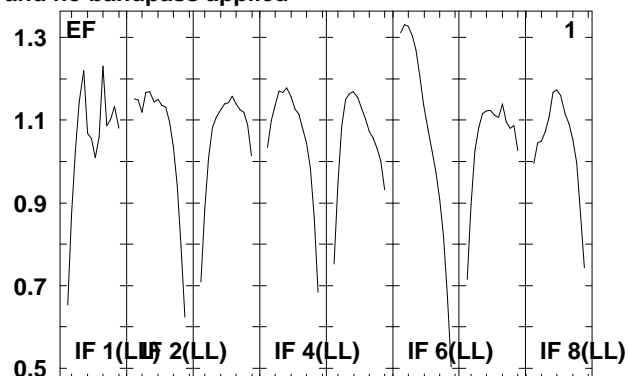
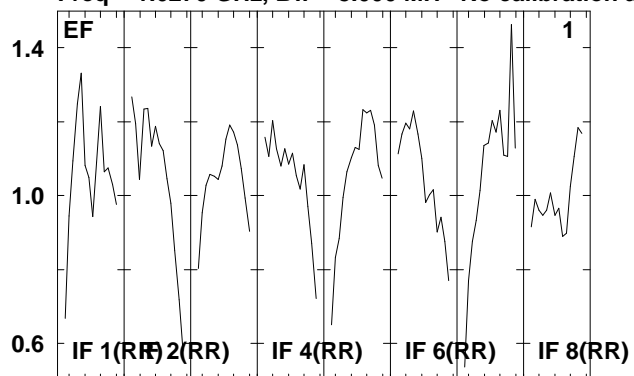

Lower frame: Real Jy  
Total-power spectrum Antenna: \*  
Timerange: 00/12:23:08 to 00/12:27:00

Plot file version 110 created 06-JAN-2009 10:57:43

J150407 EZ018B.UVDATA.1

Freq = 1.6270 GHz, Bw = 8.000 MH No calibration applied and no bandpass applied

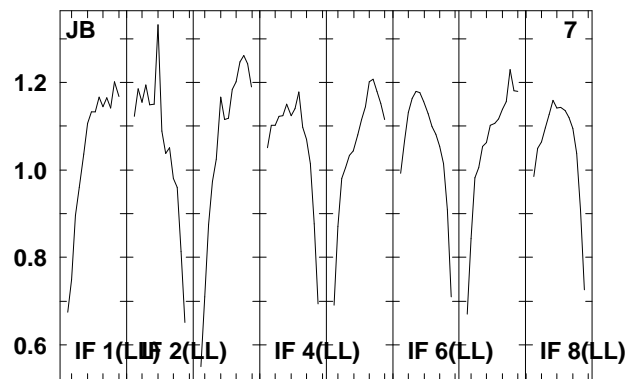
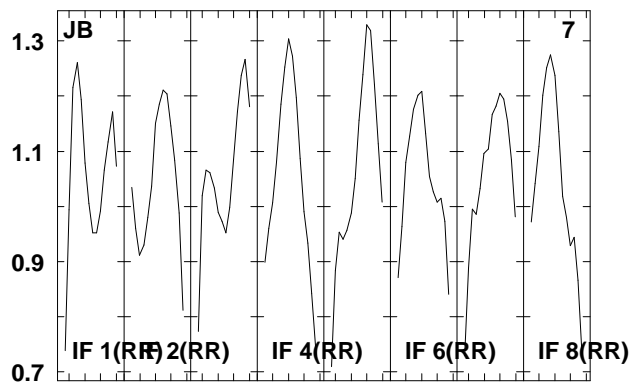
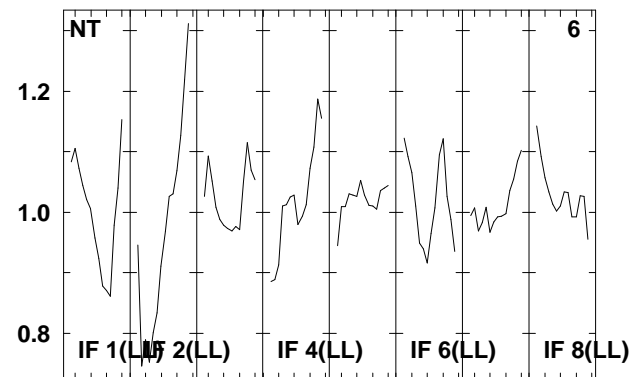
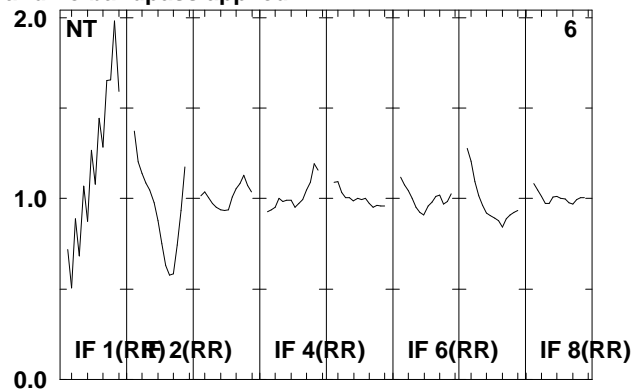
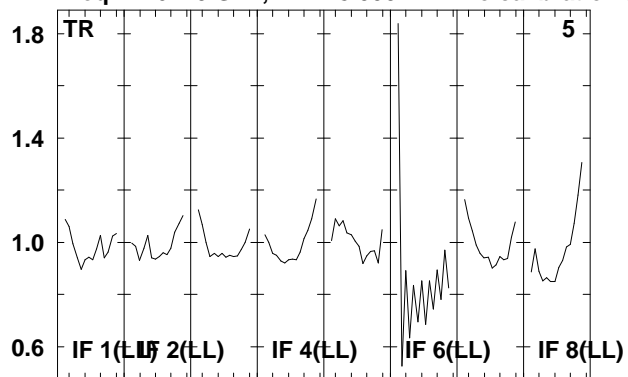

Lower frame: Real Jy  
Total-power spectrum Antenna: \*  
Timerange: 00/12:23:08 to 00/12:27:00

Plot file version 111 created 06-JAN-2009 10:57:43

J1510-05 EZ018B.UVDATA.1

Freq = 1.6270 GHz, Bw = 8.000 MH No calibration applied and no bandpass applied

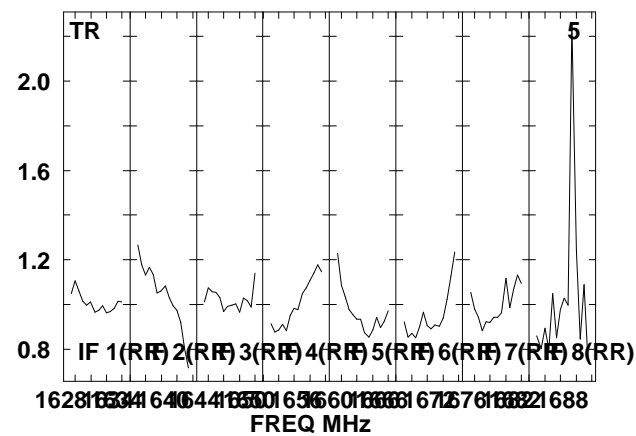
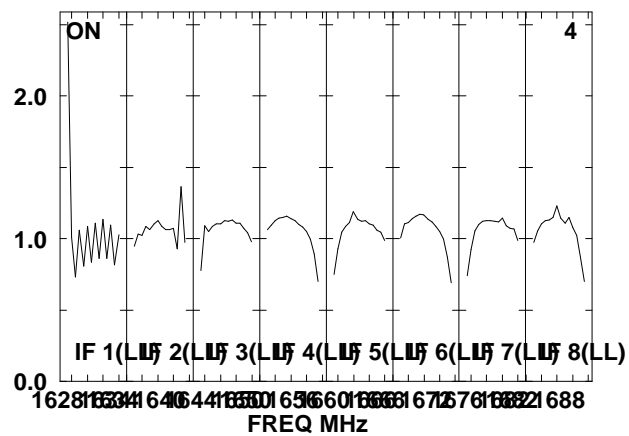
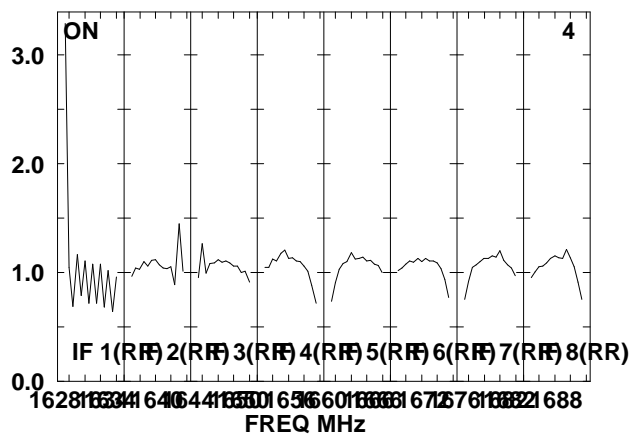
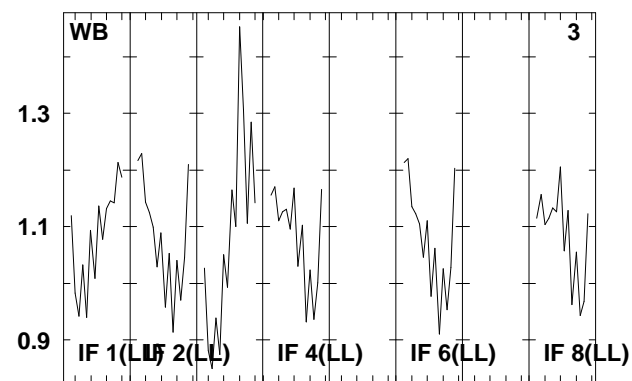
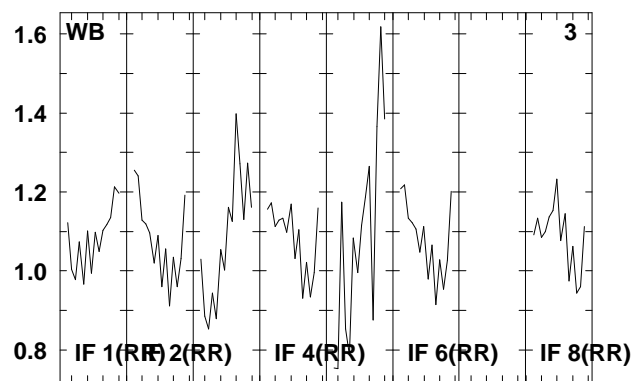
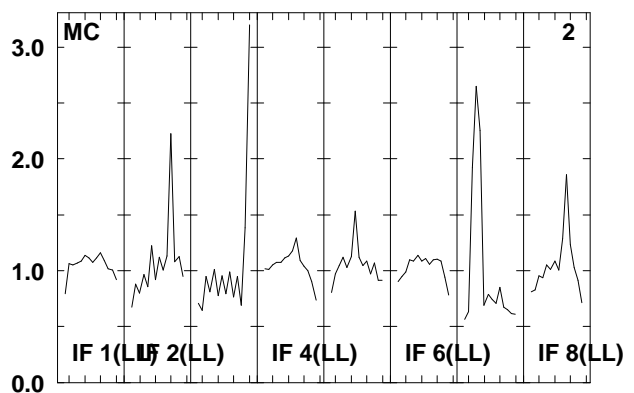
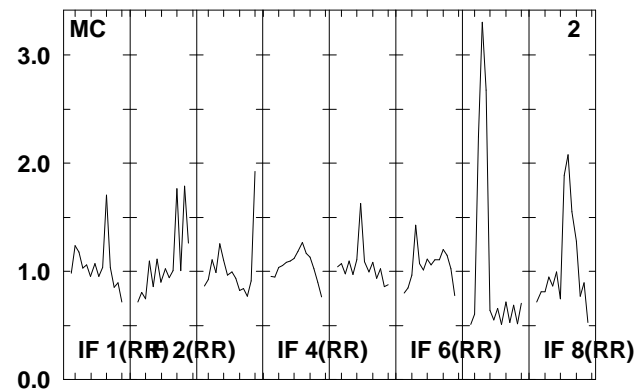
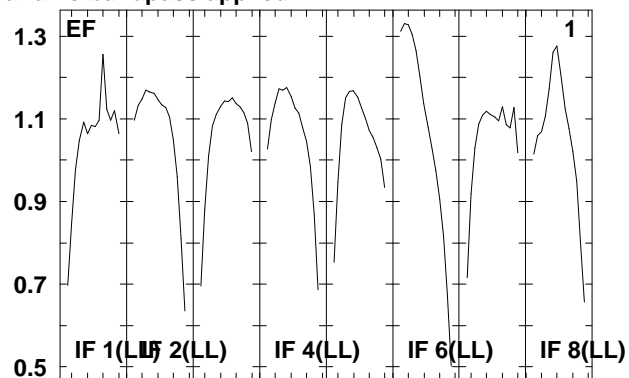
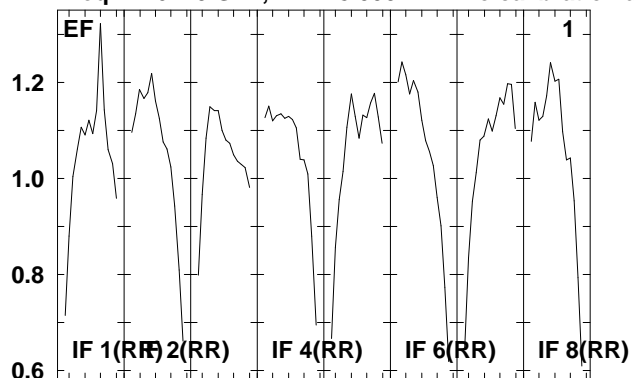

Lower frame: Real Jy  
Total-power spectrum Antenna: \*  
Timerange: 00/12:27:02 to 00/12:30:00

Plot file version 112 created 06-JAN-2009 10:57:43

J1510-05 EZ018B.UVDATA.1

Freq = 1.6270 GHz, Bw = 8.000 MH No calibration applied and no bandpass applied

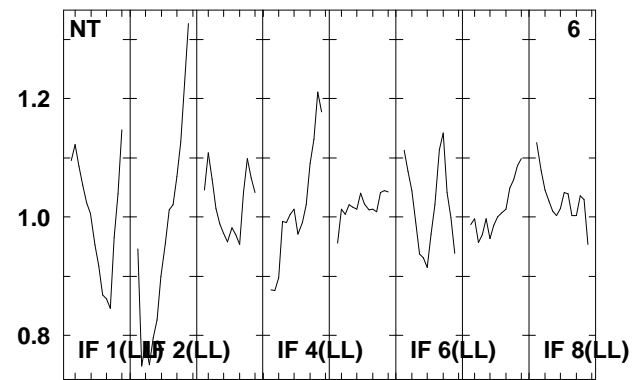
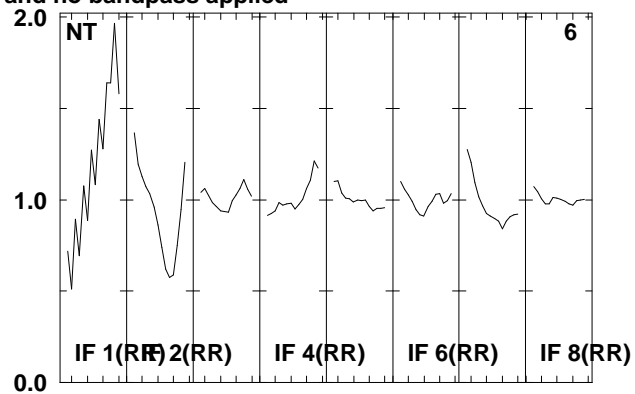
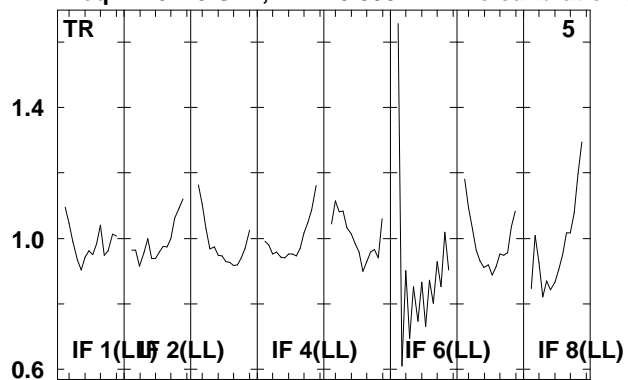

Lower frame: Real Jy  
Total-power spectrum Antenna: \*  
Timerange: 00/12:27:02 to 00/12:30:00



Plot file version 113 created 06-JAN-2009 10:57:44

J150407 EZ018B.UVDATA.1

Freq = 1.6270 GHz, Bw = 8.000 MH No calibration applied and no bandpass applied

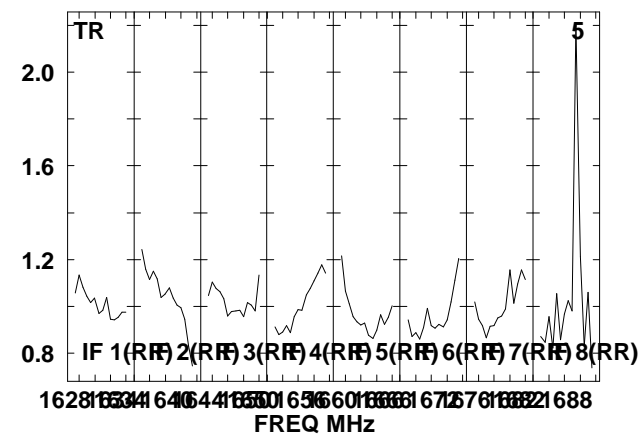
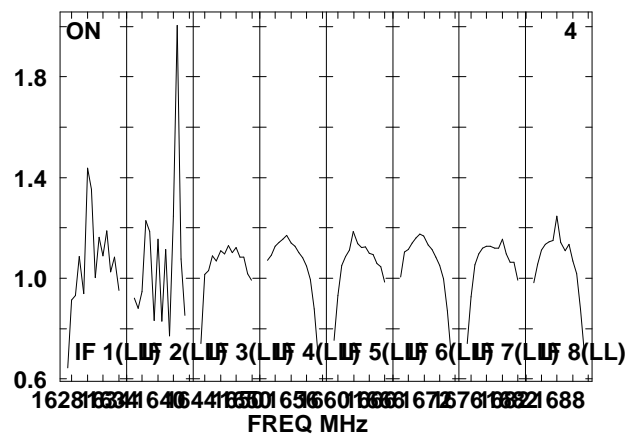
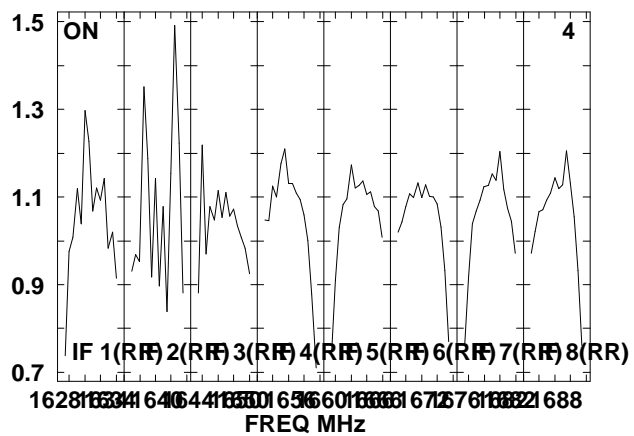
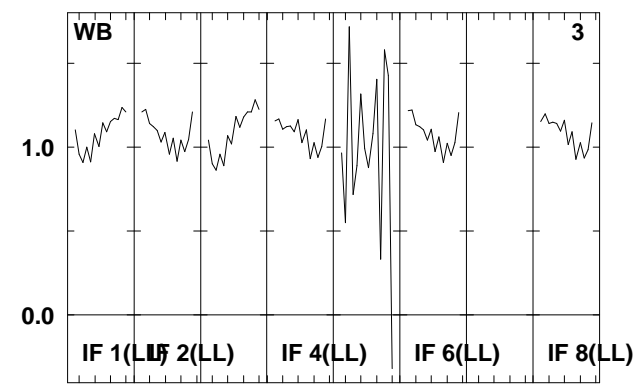
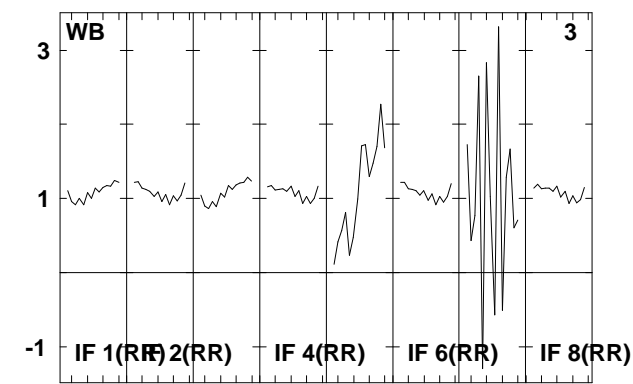
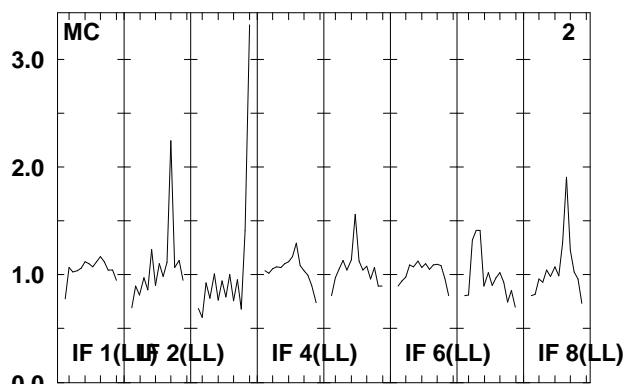
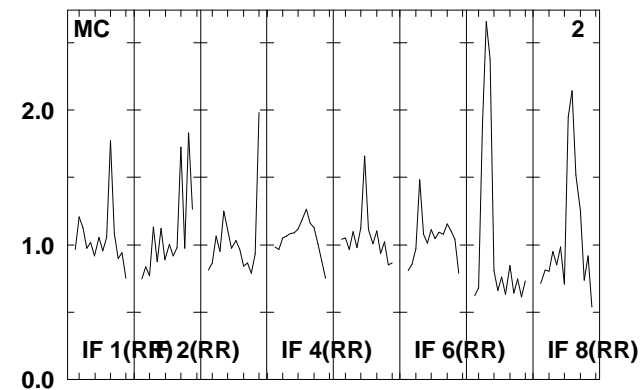
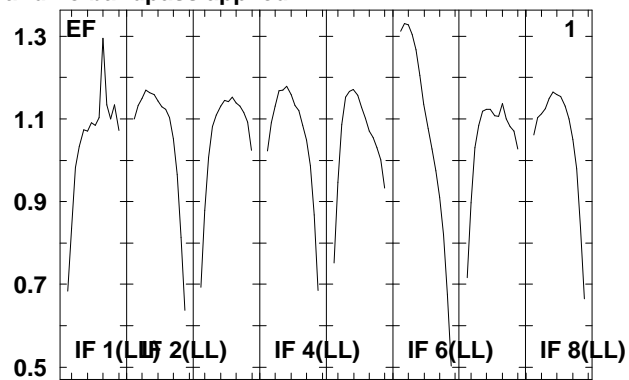
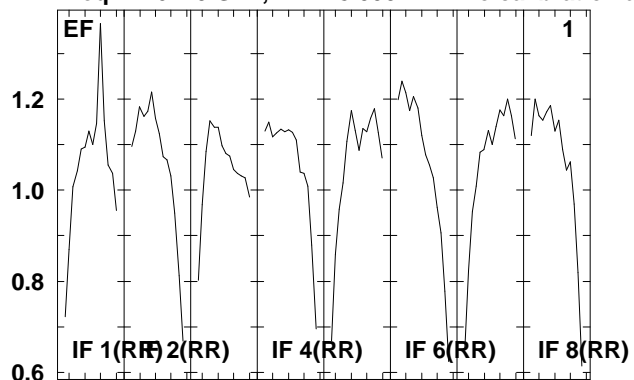

Lower frame: Real Jy  
Total-power spectrum Antenna: \*  
Timerange: 00/12:30:02 to 00/12:34:00

Plot file version 114 created 06-JAN-2009 10:57:44

J150407 EZ018B.UVDATA.1

Freq = 1.6270 GHz, Bw = 8.000 MH No calibration applied and no bandpass applied

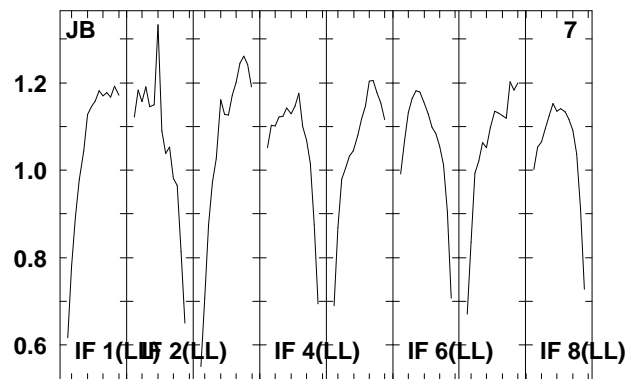
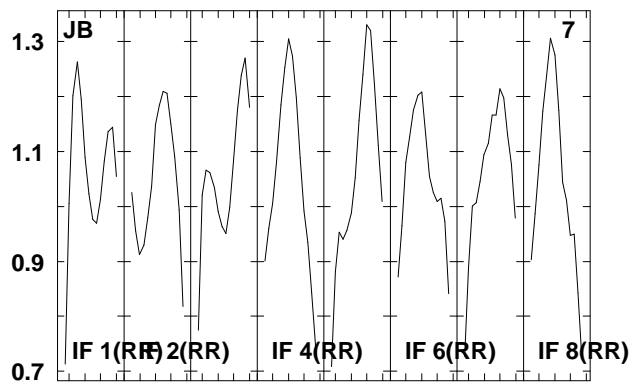
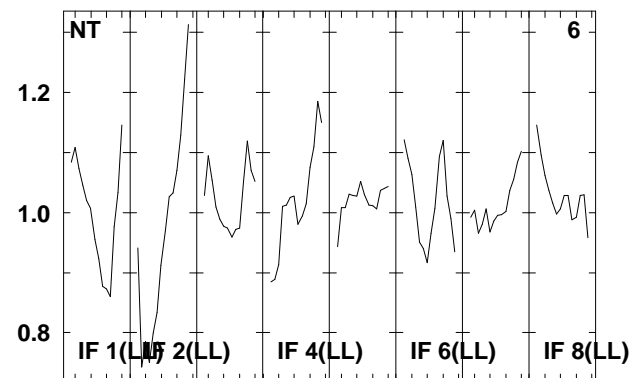
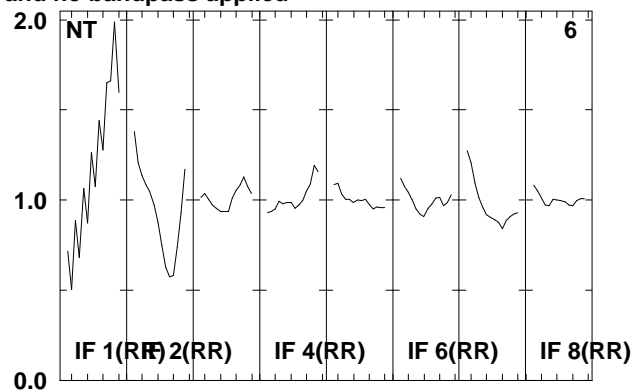
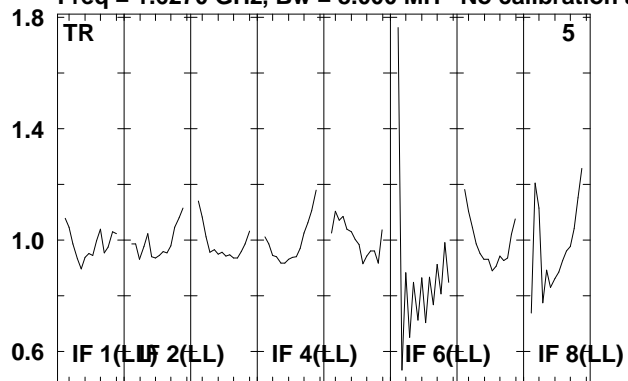

Lower frame: Real Jy  
Total-power spectrum Antenna: \*  
Timerange: 00/12:30:02 to 00/12:34:00

Plot file version 115 created 06-JAN-2009 10:57:45

J1642+39 EZ018B.UVDATA.1

Freq = 1.6270 GHz, Bw = 8.000 MH No calibration applied and no bandpass applied

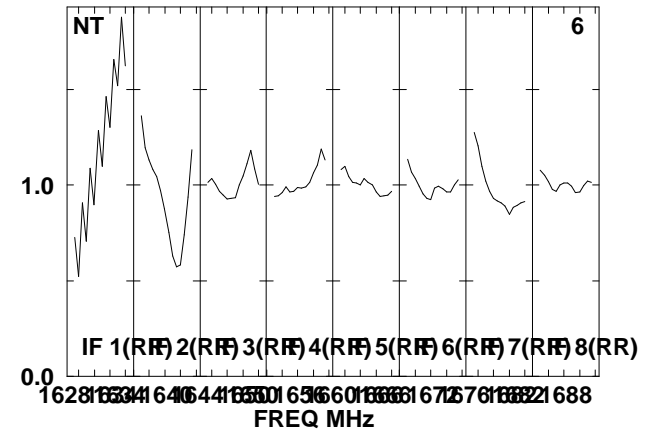
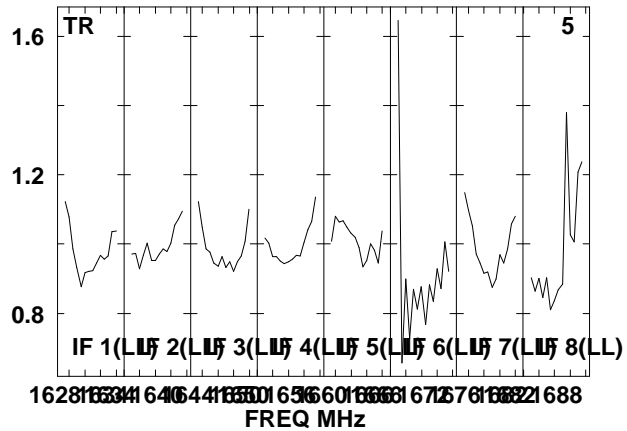
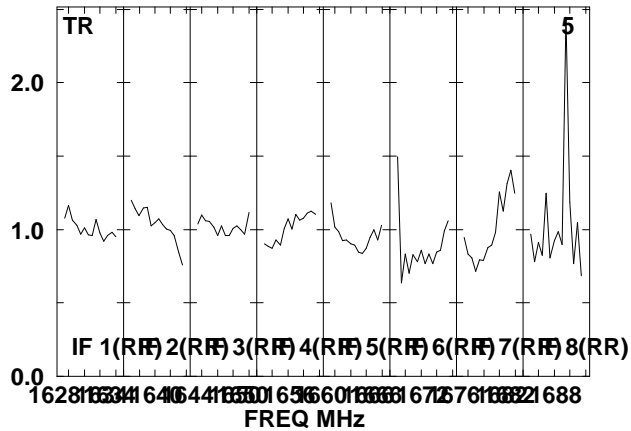
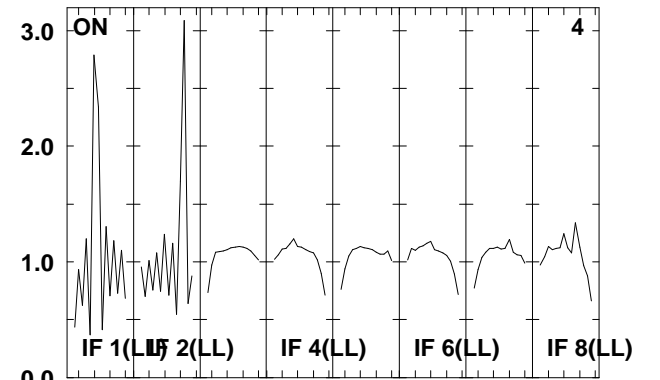
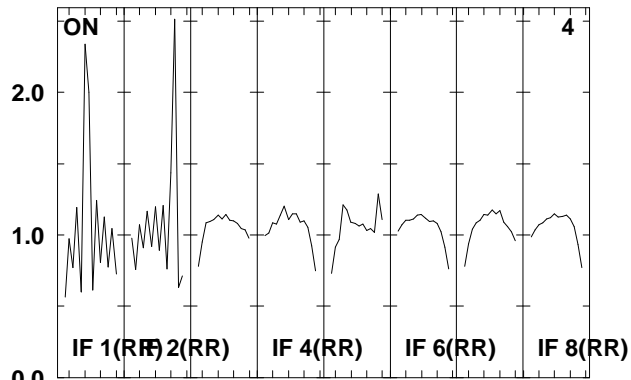
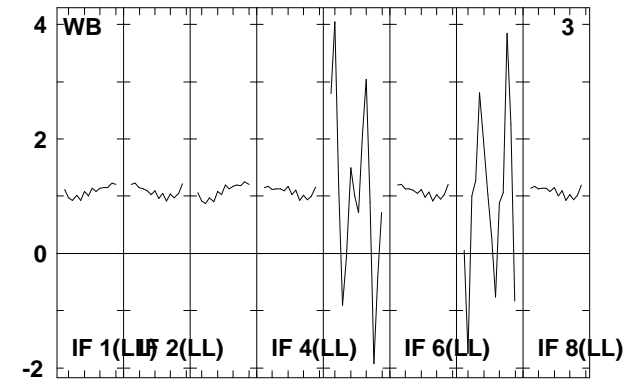
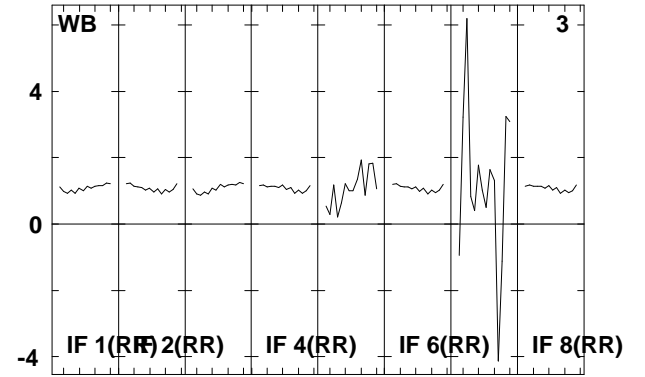
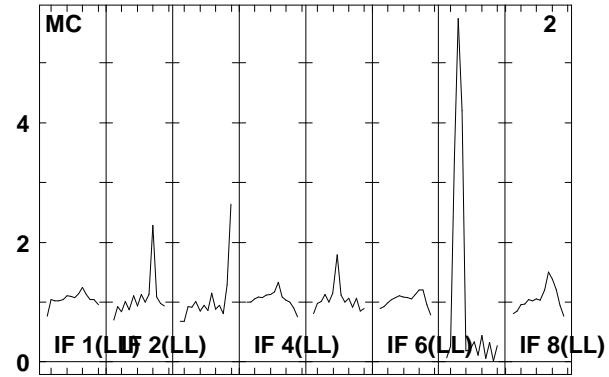
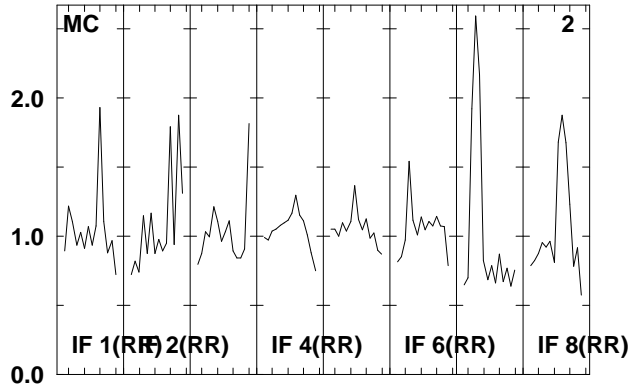

Lower frame: Real Jy  
Total-power spectrum Antenna: \*  
Timerange: 00/12:39:02 to 00/12:44:00

Plot file version 116 created 06-JAN-2009 10:57:45

J1642+39 EZ018B.UVDATA.1

Freq = 1.6270 GHz, Bw = 8.000 MH No calibration applied and no bandpass applied

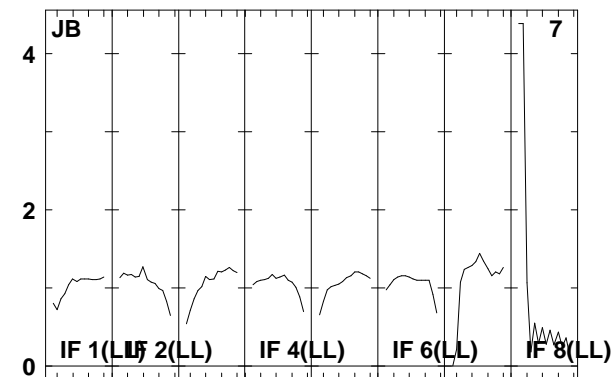
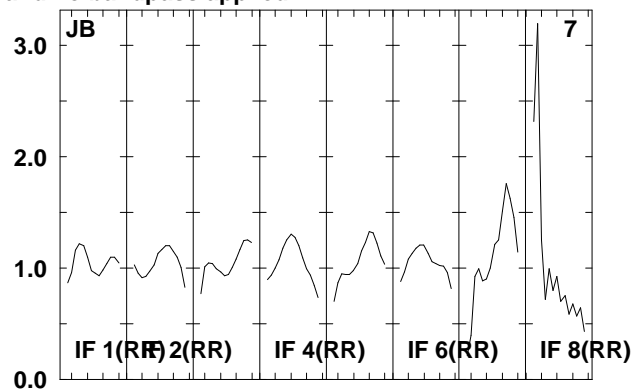
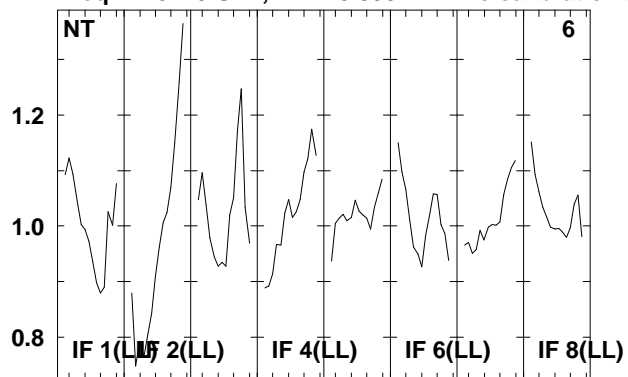

Lower frame: Real Jy  
Total-power spectrum Antenna: \*  
Timerange: 00/12:39:02 to 00/12:44:00

Plot file version 117 created 06-JAN-2009 10:57:45

J1510-05 EZ018B.UVDATA.1

Freq = 1.6270 GHz, Bw = 8.000 MH No calibration applied and no bandpass applied

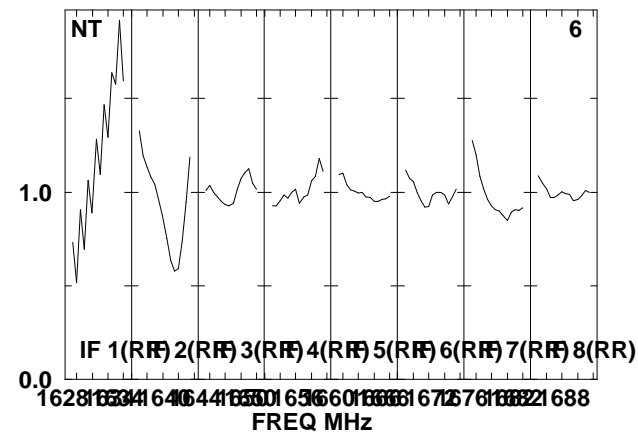
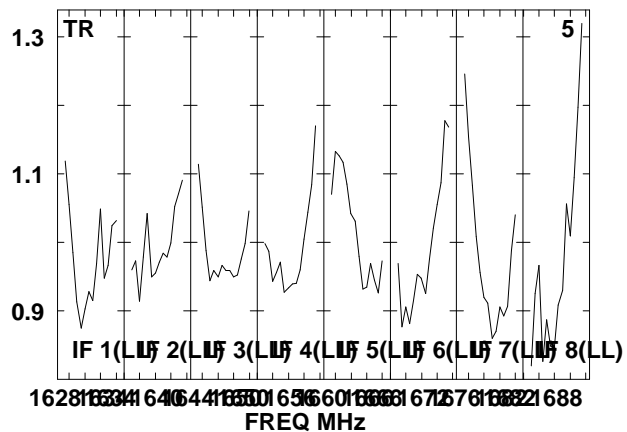
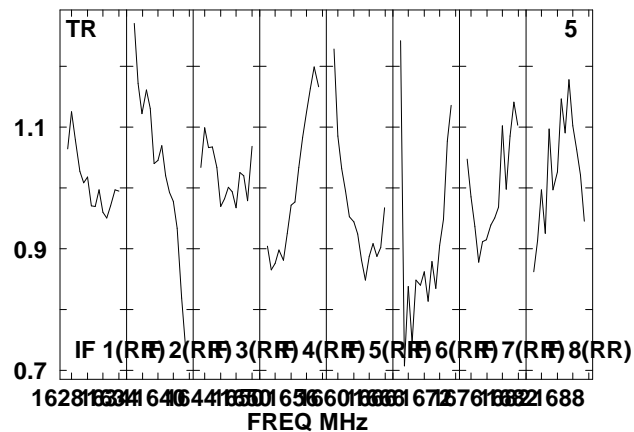
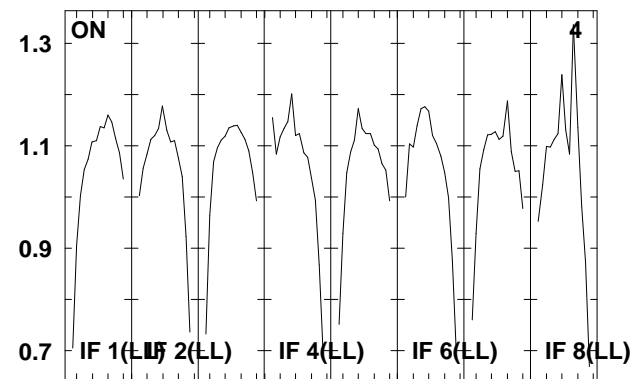
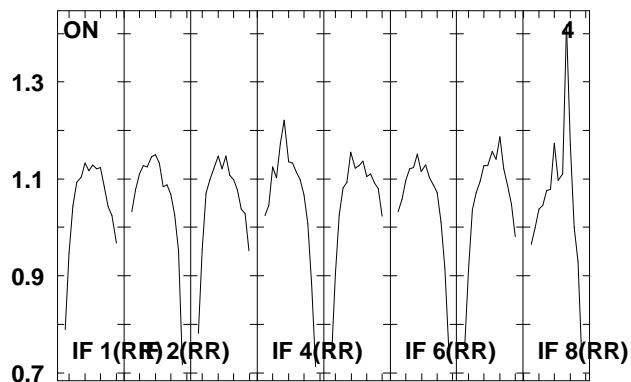
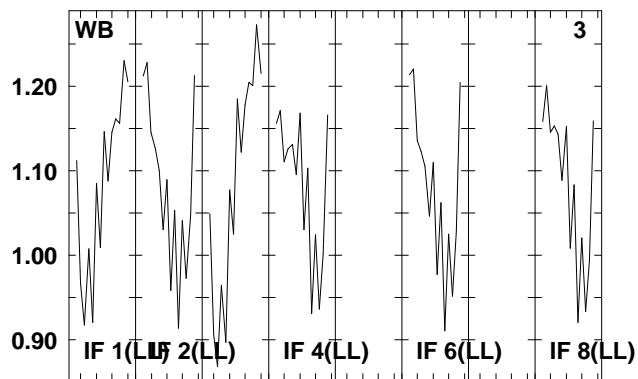
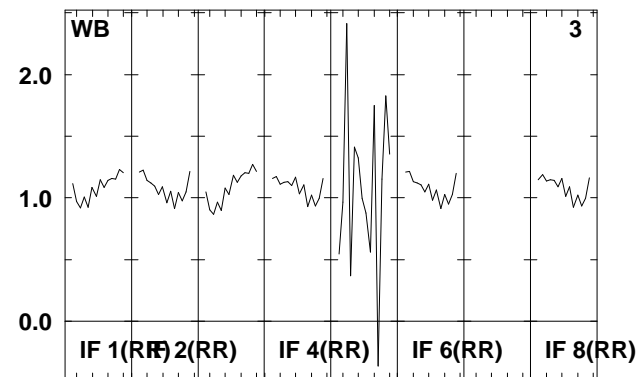
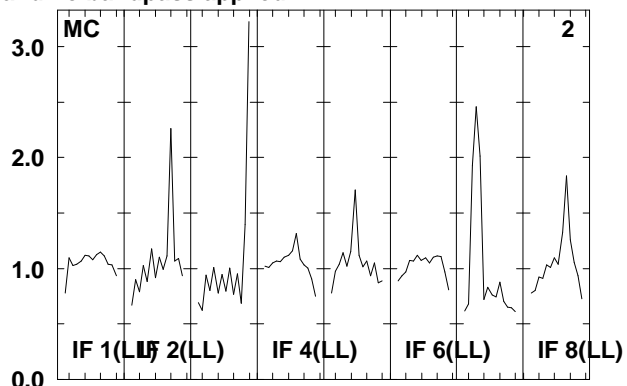
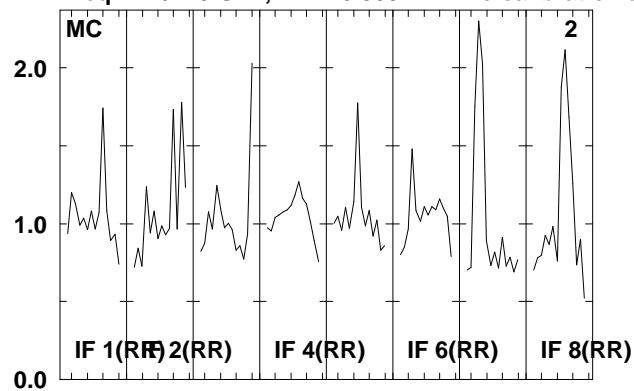

Lower frame: Real Jy

Total-power spectrum Antenna: \*

Timerange: 00/12:45:42 to 00/12:48:00

Plot file version 118 created 06-JAN-2009 10:57:46  
J1510-05 EZ018B.UVDATA.1  
Freq = 1.6270 GHz, Bw = 8.000 MH No calibration applied and no bandpass applied

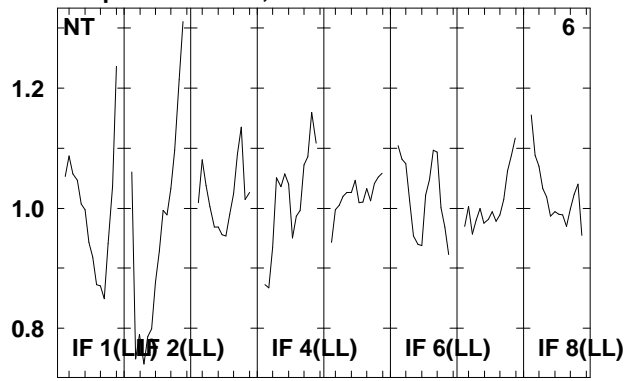

Lower frame: Real Jy  
Total-power spectrum Antenna: \*  
Timerange: 00/12:45:42 to 00/12:48:00

Plot file version 119 created 06-JAN-2009 10:57:46

J150407 EZ018B.UVDATA.1

Freq = 1.6270 GHz, Bw = 8.000 MH No calibration applied and no bandpass applied

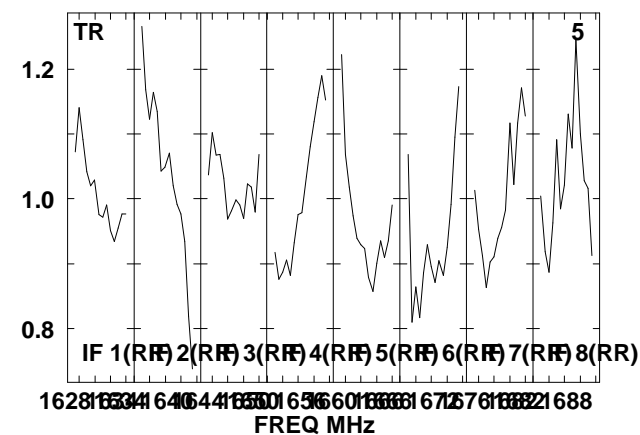
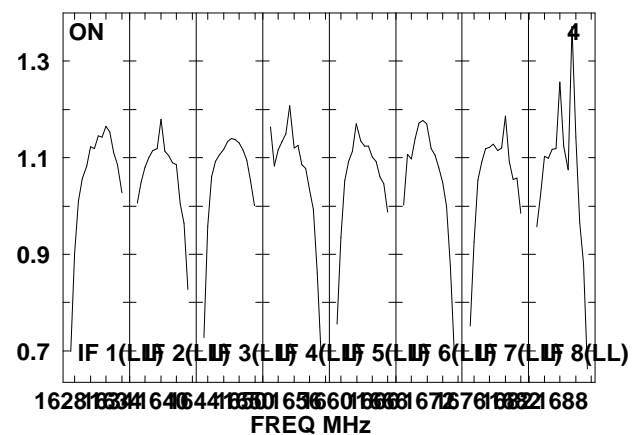
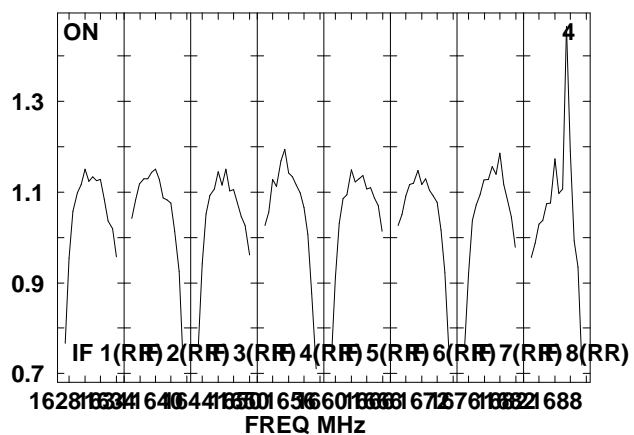
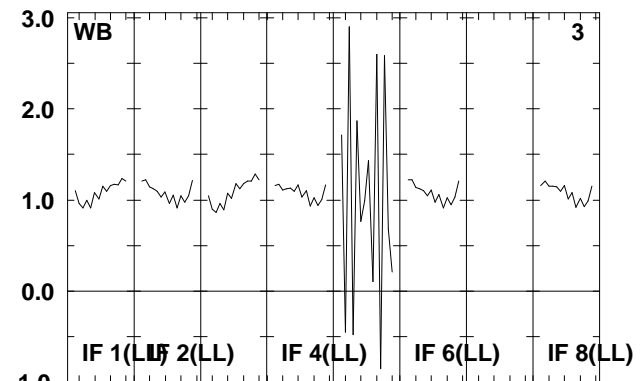
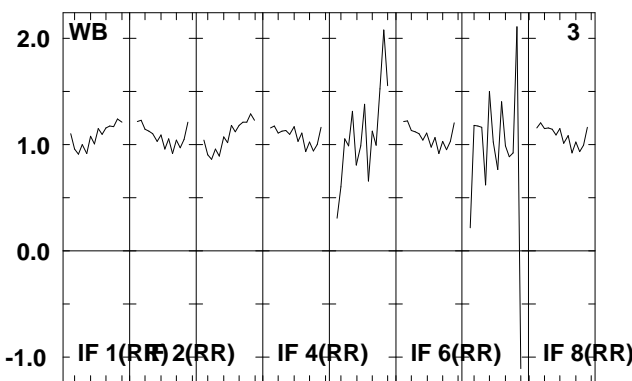
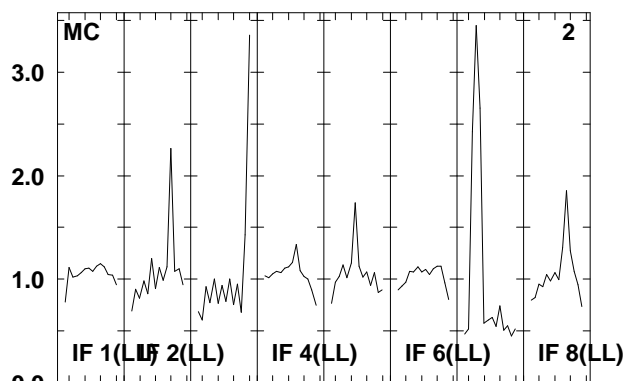
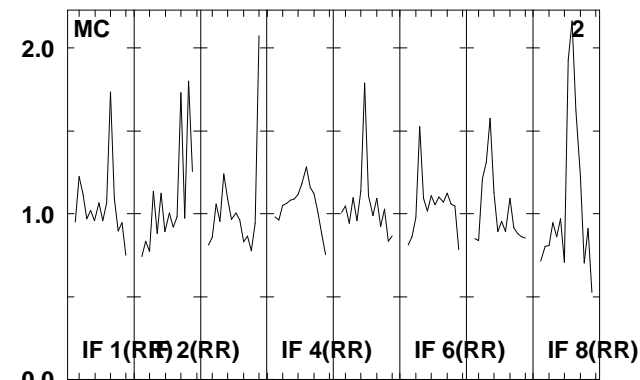
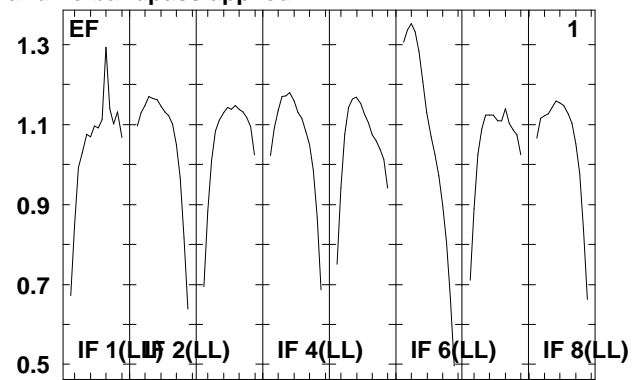
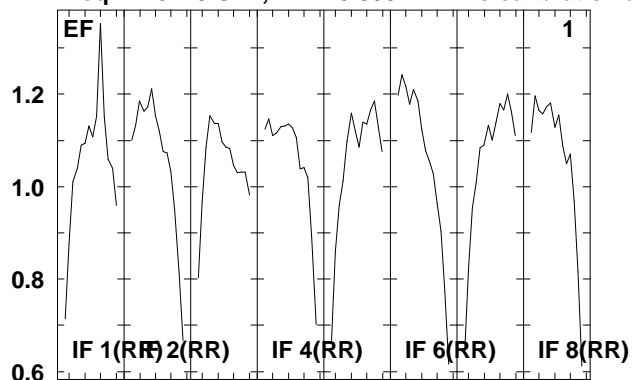

Lower frame: Real Jy  
Total-power spectrum Antenna: \*  
Timerange: 00/12:48:02 to 00/12:52:00

Plot file version 120 created 06-JAN-2009 10:57:46

J150407 EZ018B.UVDATA.1

Freq = 1.6270 GHz, Bw = 8.000 MH No calibration applied and no bandpass applied

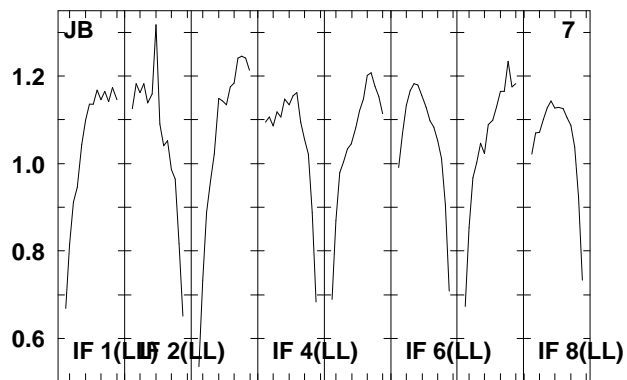
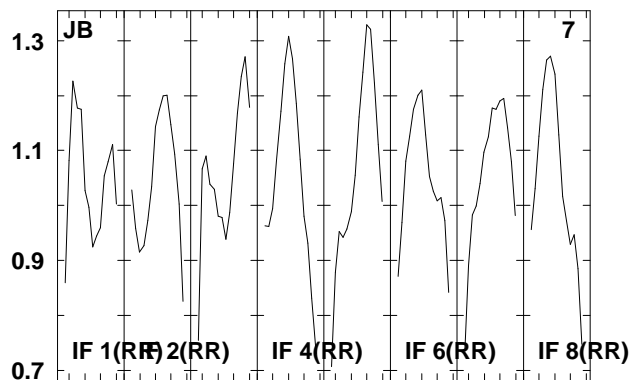
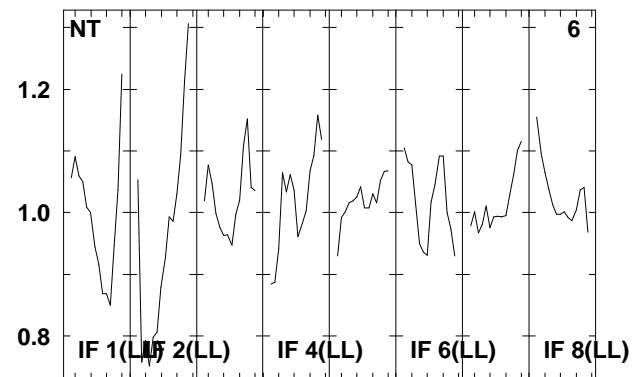
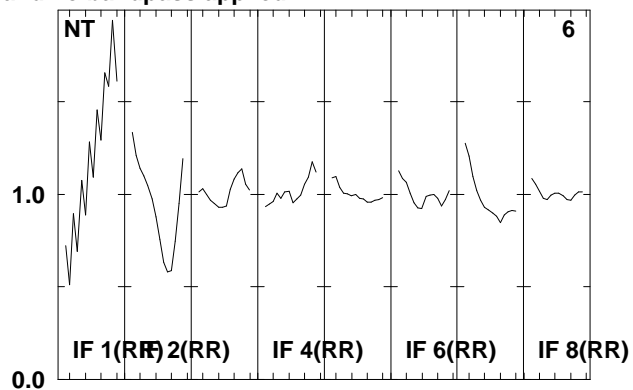
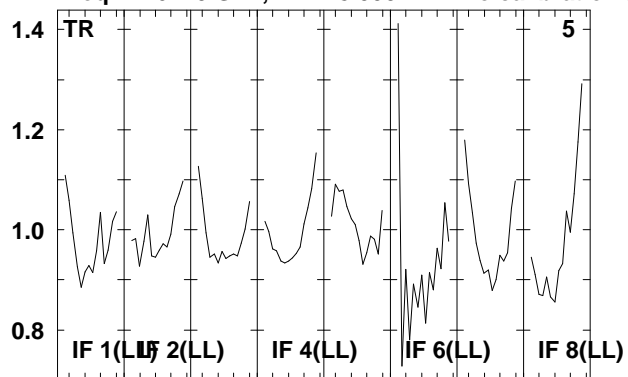

Lower frame: Real Jy  
Total-power spectrum Antenna: \*  
Timerange: 00/12:48:02 to 00/12:52:00



Plot file version 121 created 06-JAN-2009 10:57:47

J1510-05 EZ018B.UVDATA.1

Freq = 1.6270 GHz, Bw = 8.000 MH No calibration applied and no bandpass applied

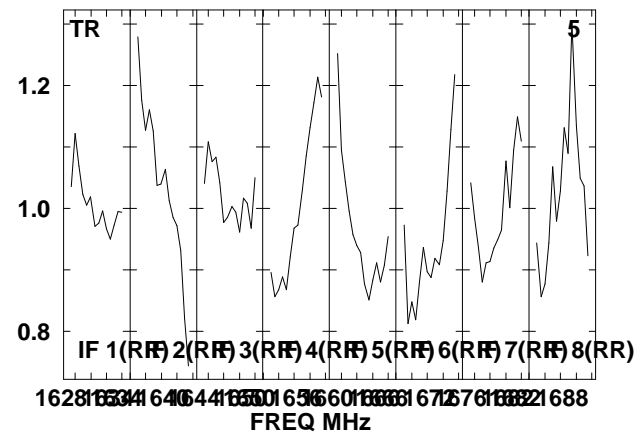
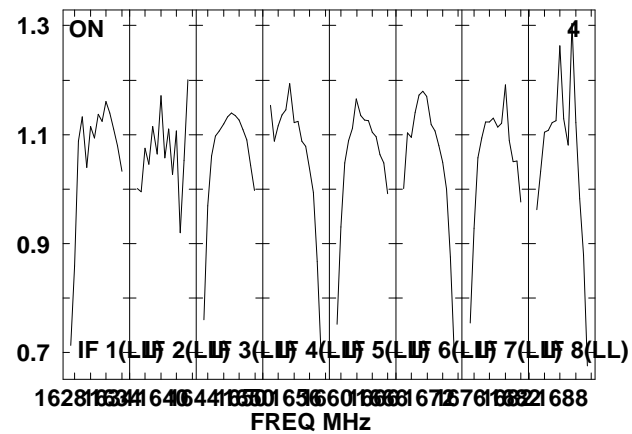
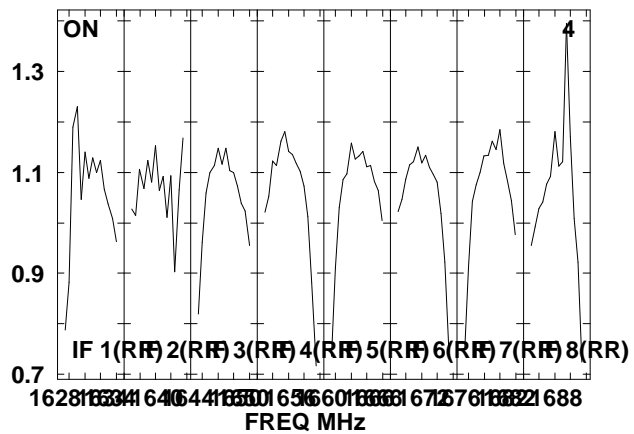
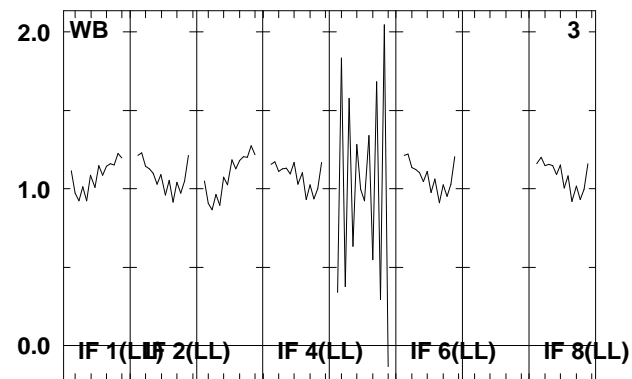
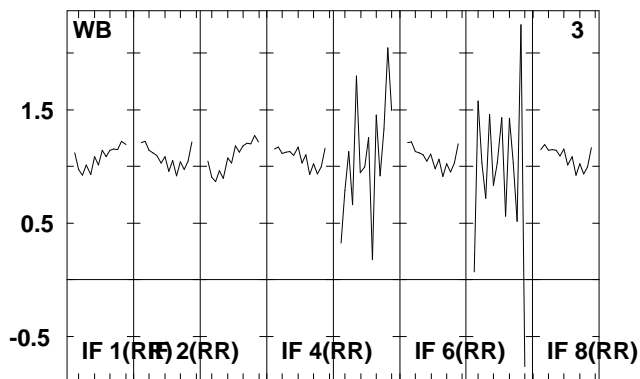
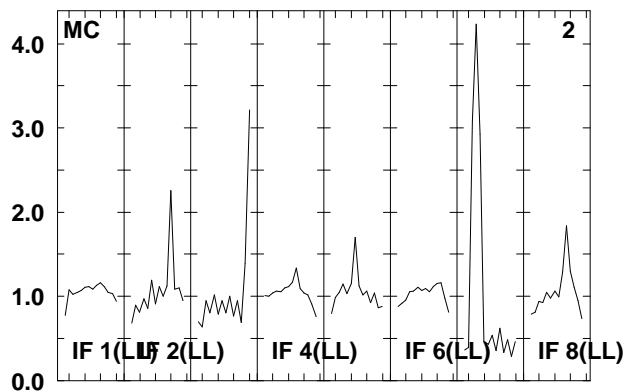
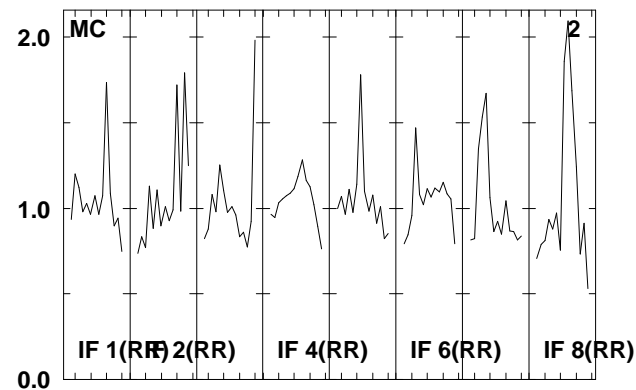
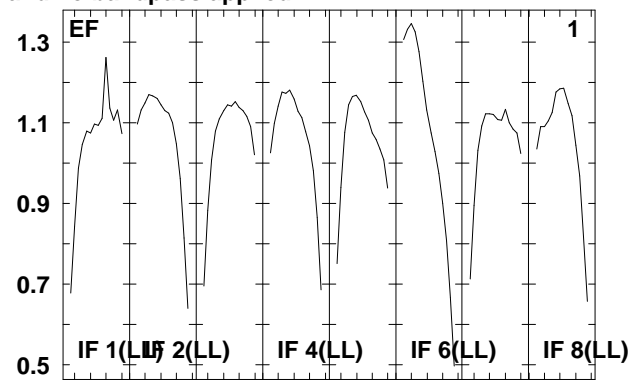
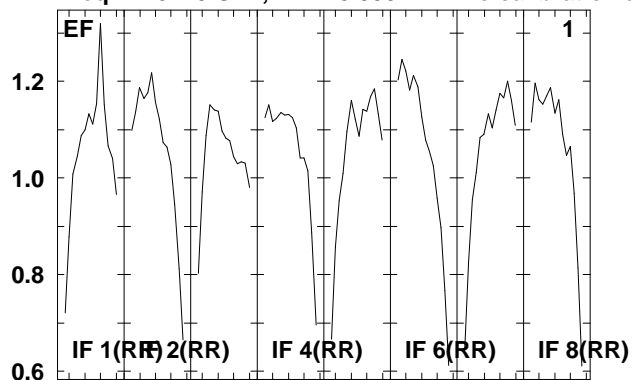

Lower frame: Real Jy  
Total-power spectrum Antenna: \*  
Timerange: 00/12:52:02 to 00/12:55:00

Plot file version 122 created 06-JAN-2009 10:57:47

J1510-05 EZ018B.UVDATA.1

Freq = 1.6270 GHz, Bw = 8.000 MH No calibration applied and no bandpass applied

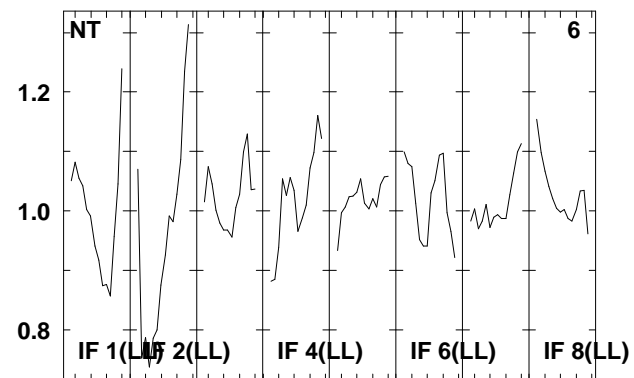
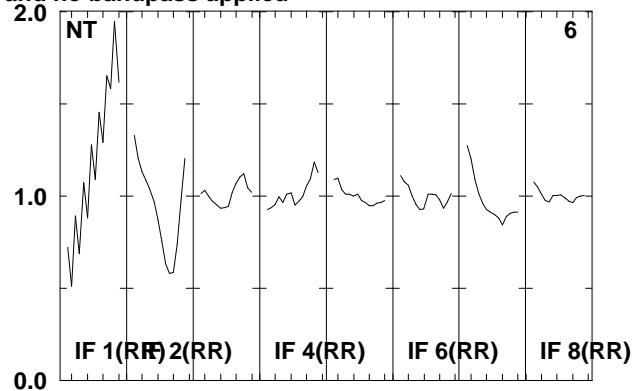
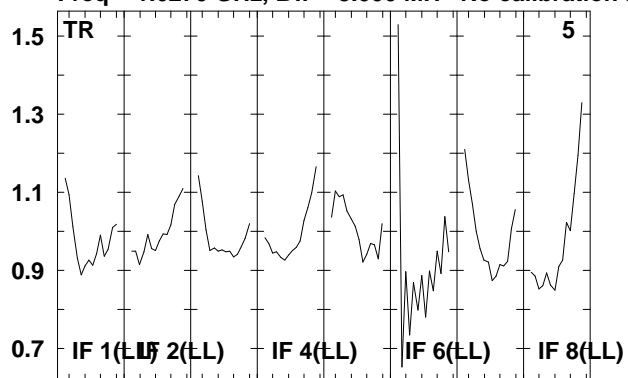

Lower frame: Real Jy  
Total-power spectrum Antenna: \*  
Timerange: 00/12:52:02 to 00/12:55:00

Plot file version 123 created 06-JAN-2009 10:57:47

J150407 EZ018B.UVDATA.1

Freq = 1.6270 GHz, Bw = 8.000 MH No calibration applied and no bandpass applied

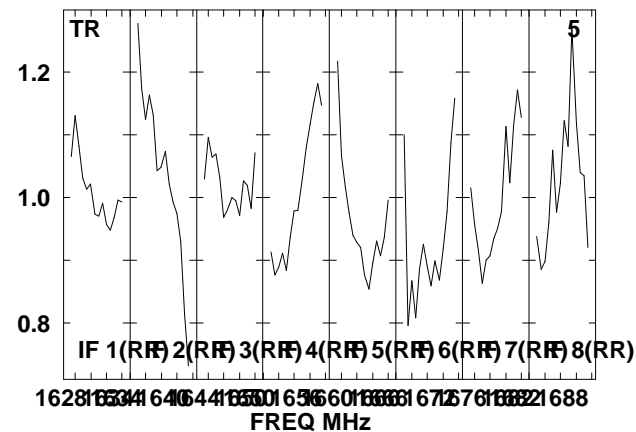
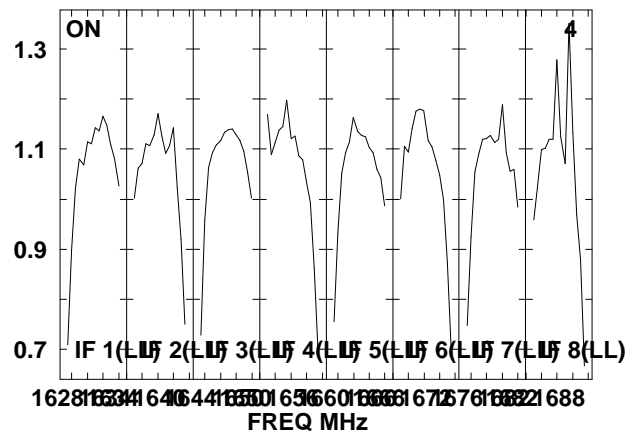
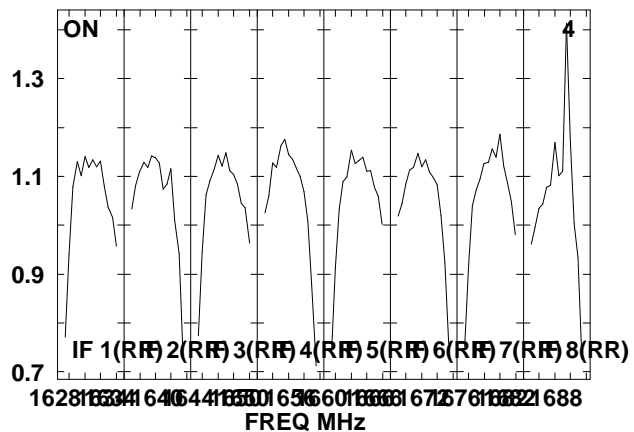
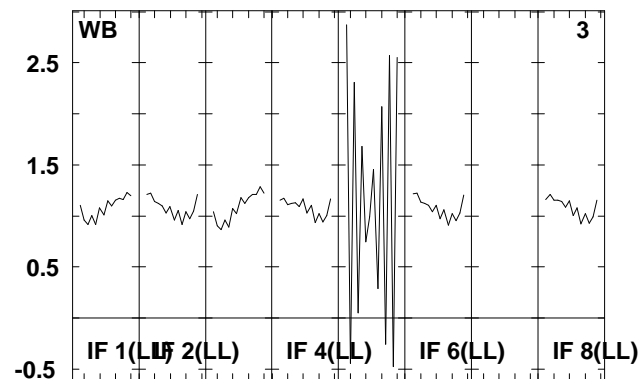
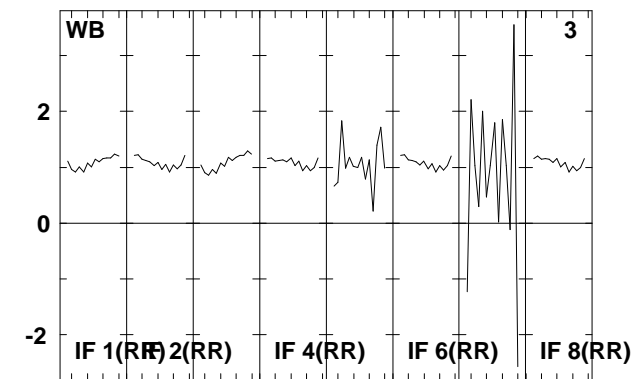
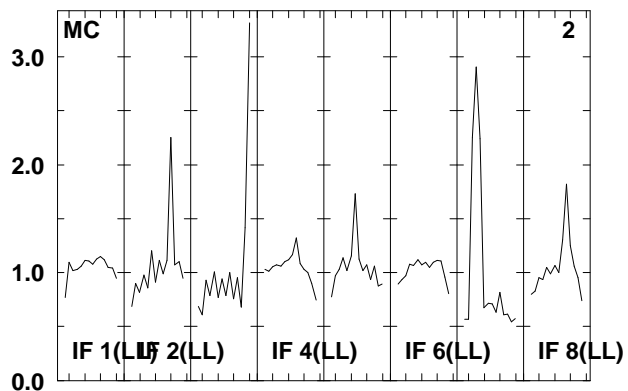
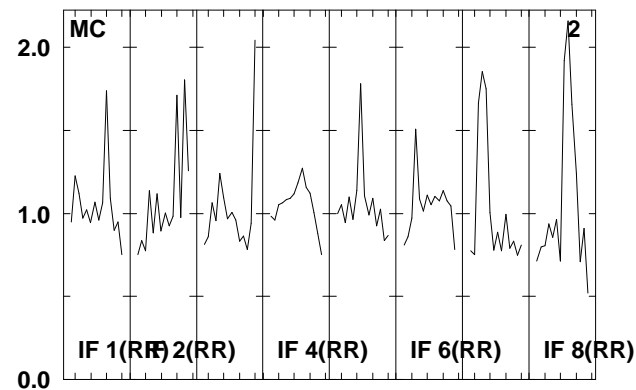
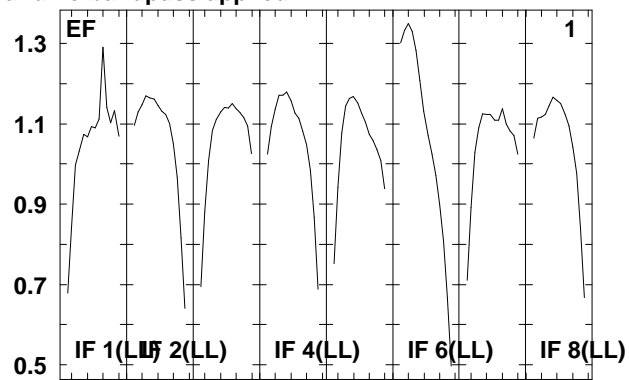
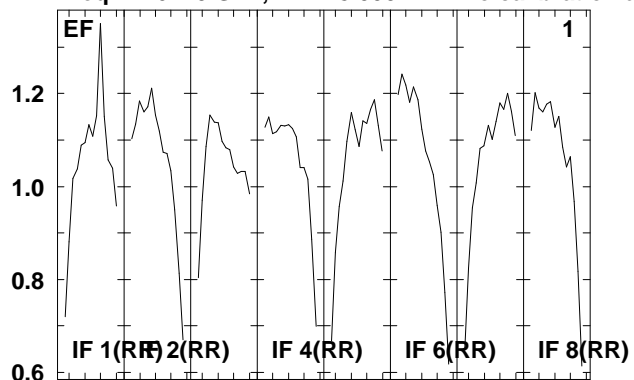

Lower frame: Real Jy  
Total-power spectrum Antenna: \*  
Timerange: 00/12:55:02 to 00/12:58:58

Plot file version 124 created 06-JAN-2009 10:57:48

J150407 EZ018B.UVDATA.1

Freq = 1.6270 GHz, Bw = 8.000 MH No calibration applied and no bandpass applied

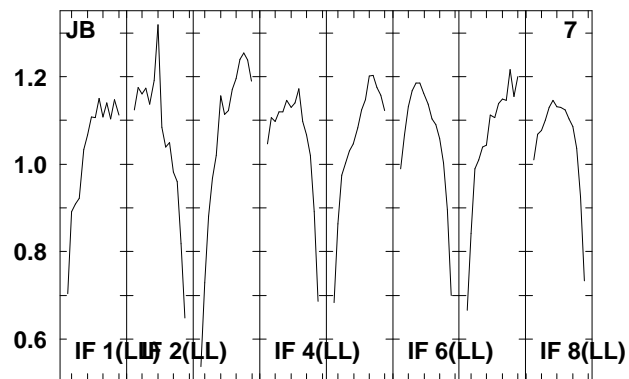
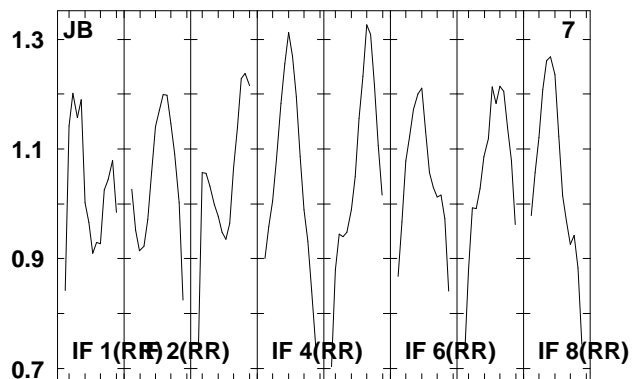
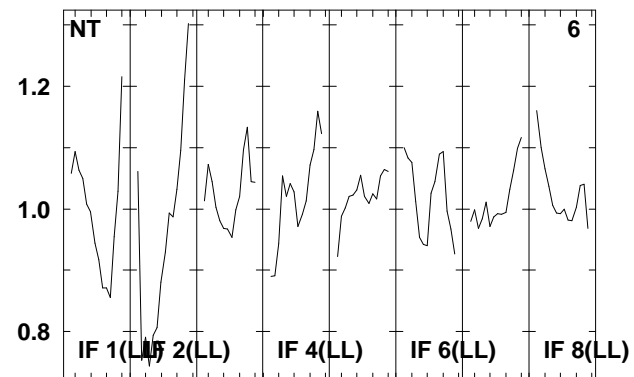
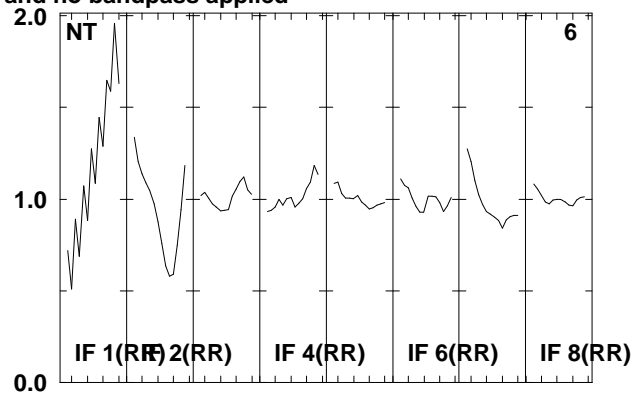
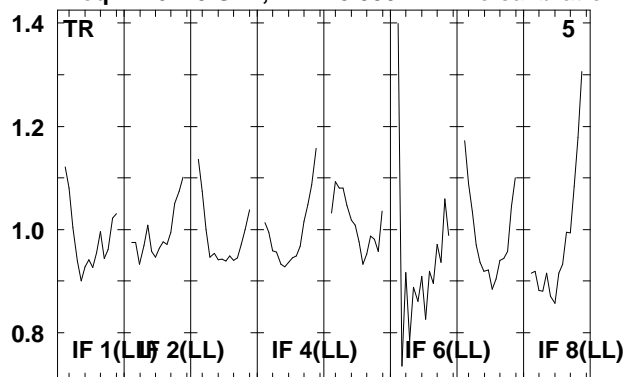

Lower frame: Real Jy  
Total-power spectrum Antenna: \*  
Timerange: 00/12:55:02 to 00/12:58:58

Plot file version 125 created 06-JAN-2009 10:57:48

J1510-05 EZ018B.UVDATA.1

Freq = 1.6270 GHz, Bw = 8.000 MH No calibration applied and no bandpass applied

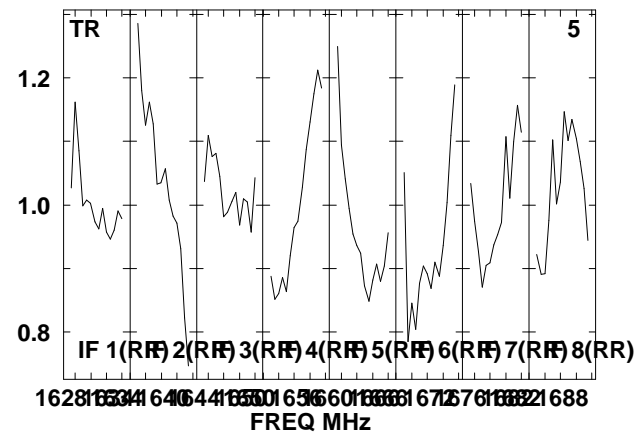
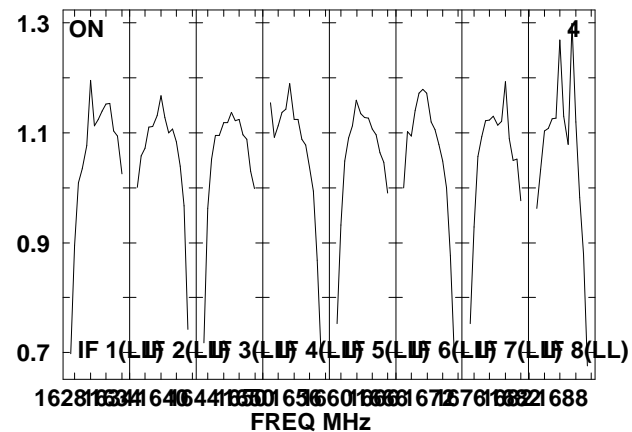
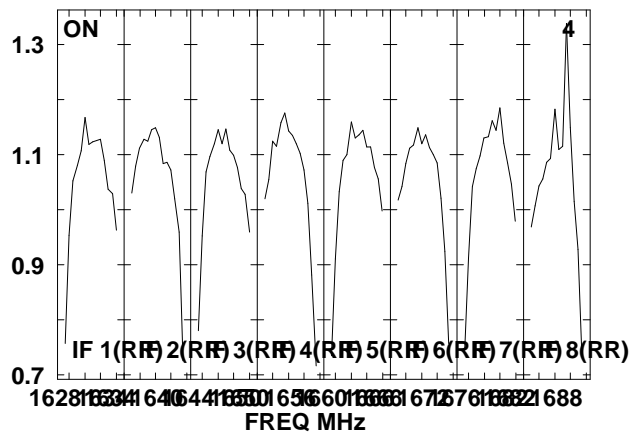
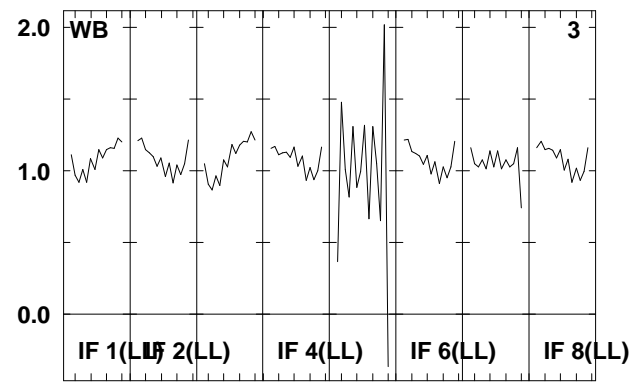
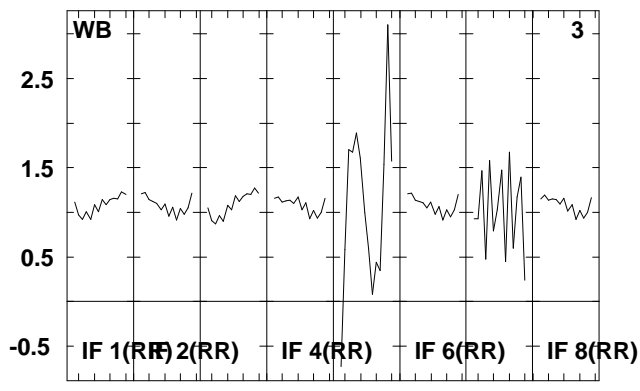
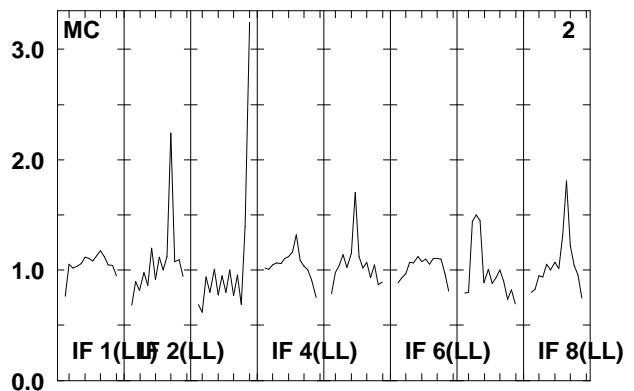
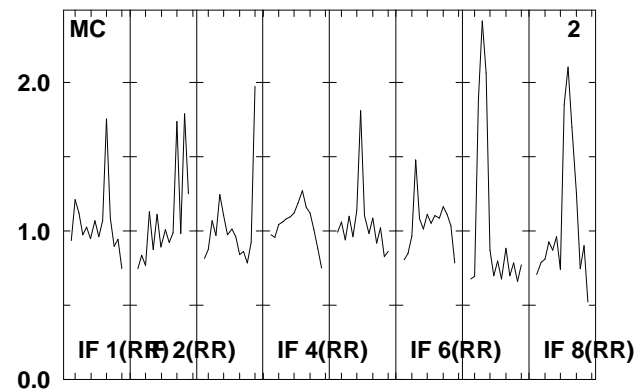
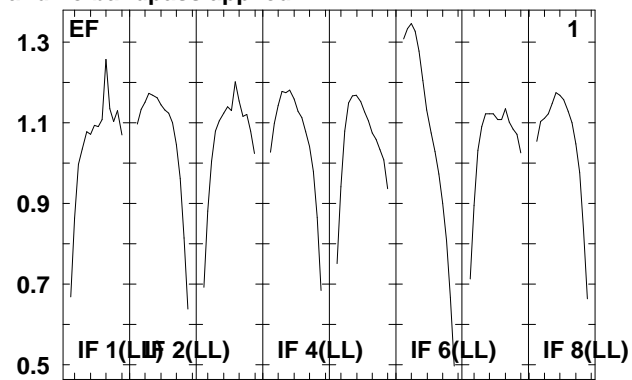
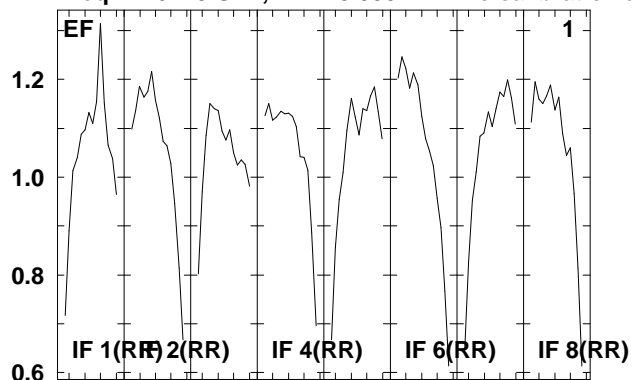

Lower frame: Real Jy

Total-power spectrum Antenna: \*

Timerange: 00/13:00:02 to 00/13:03:00

Plot file version 126 created 06-JAN-2009 10:57:48

J1510-05 EZ018B.UVDATA.1

Freq = 1.6270 GHz, Bw = 8.000 MH No calibration applied and no bandpass applied

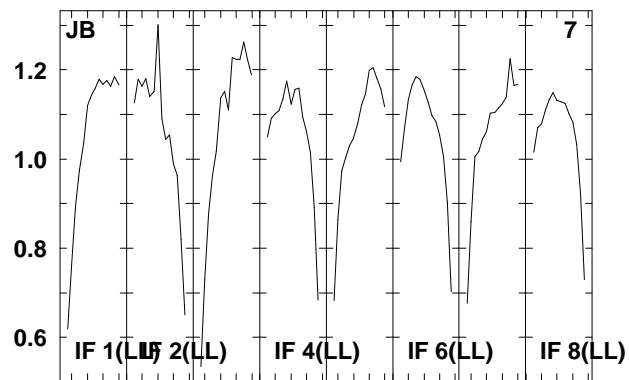
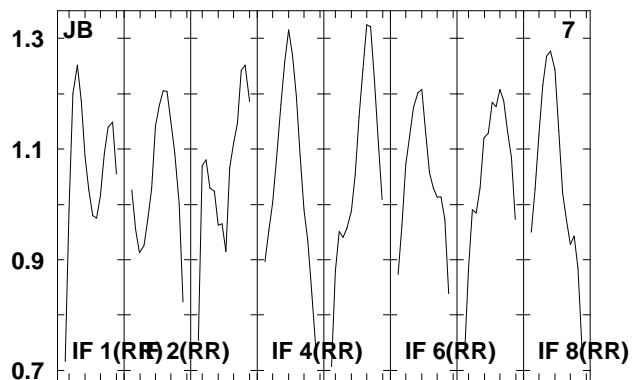
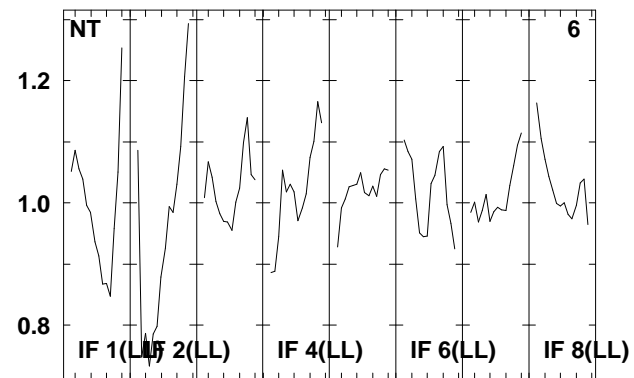
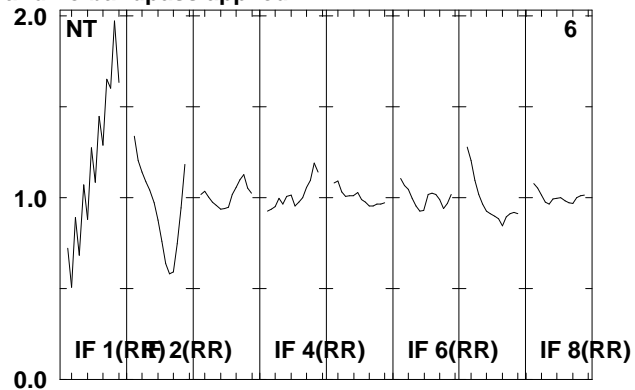
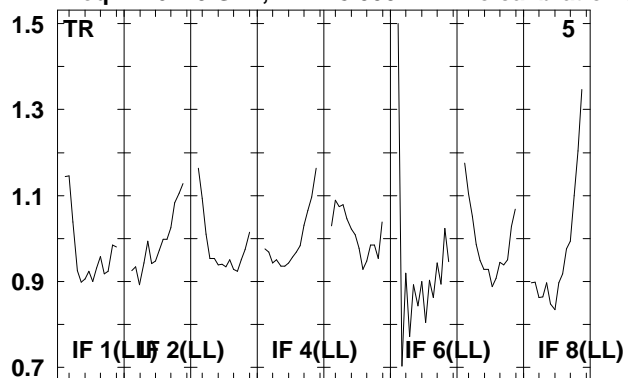

Lower frame: Real Jy  
Total-power spectrum Antenna: \*  
Timerange: 00/13:00:02 to 00/13:03:00

Plot file version 127 created 06-JAN-2009 10:57:49

J150407 EZ018B.UVDATA.1

Freq = 1.6270 GHz, Bw = 8.000 MH No calibration applied and no bandpass applied

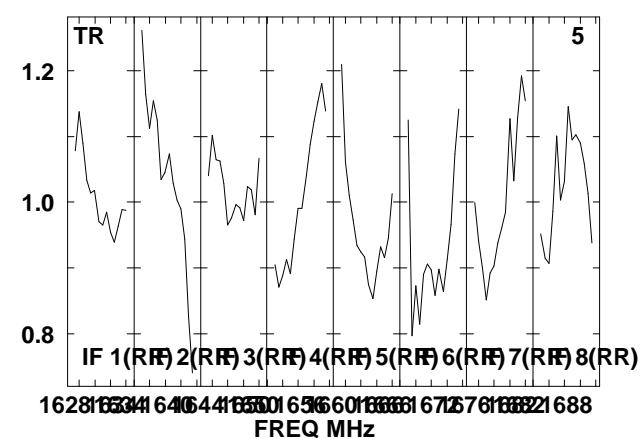
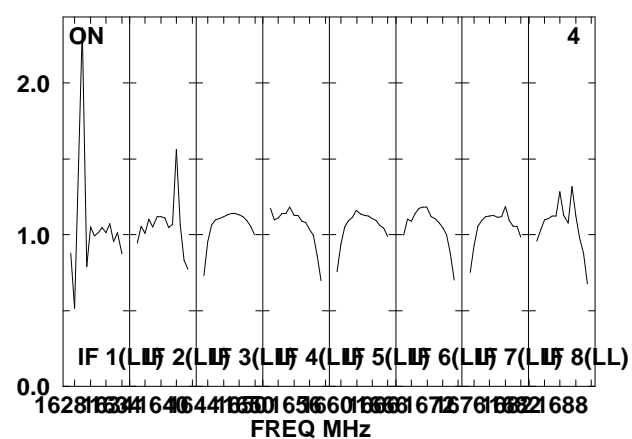
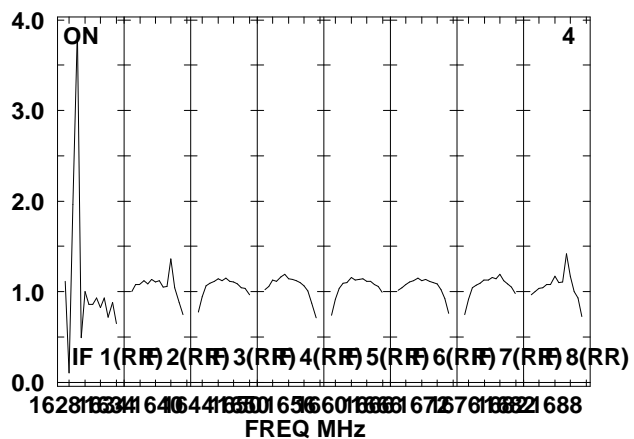
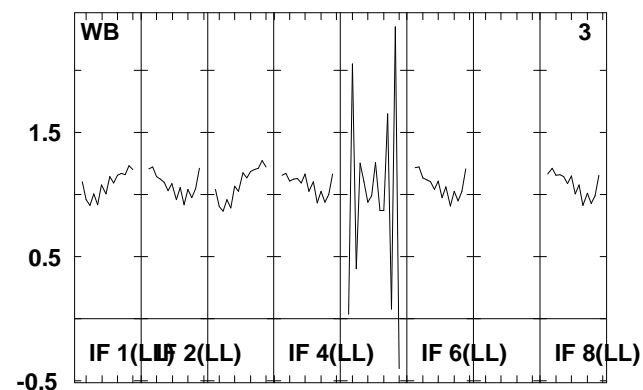
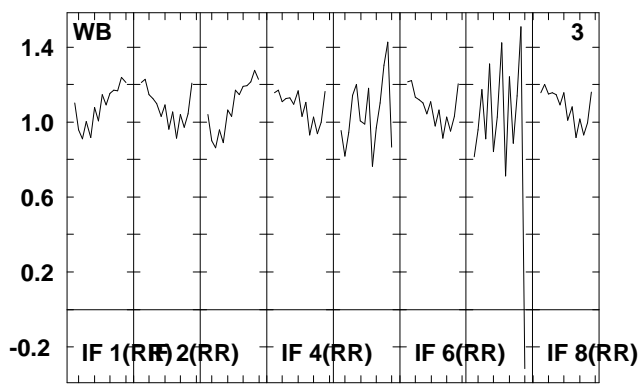
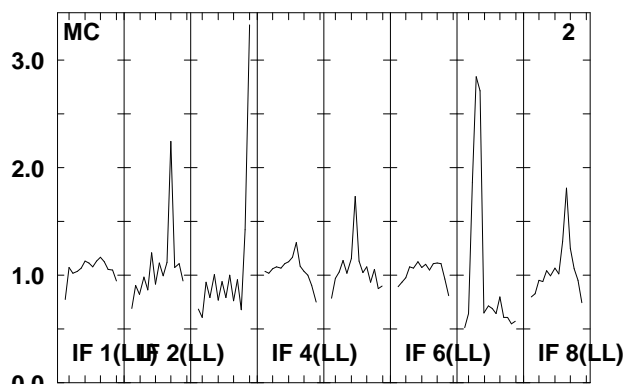
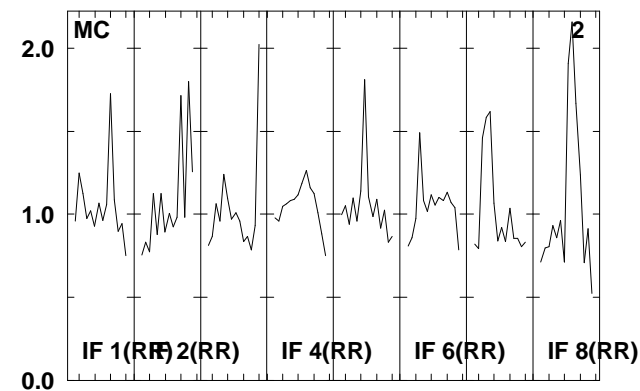
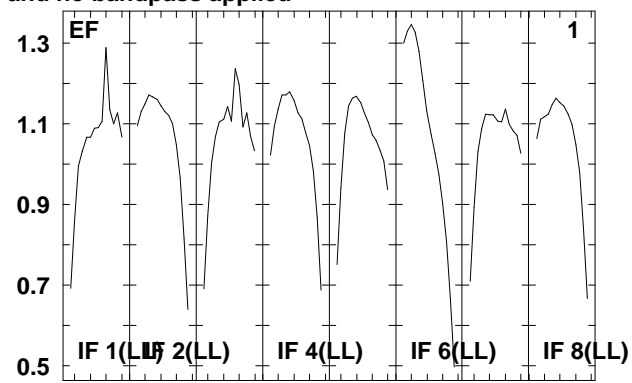
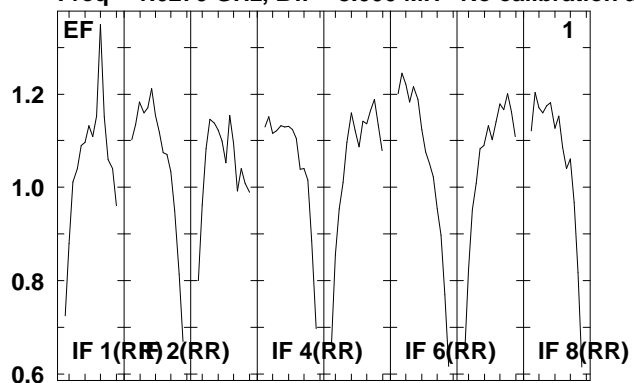

Lower frame: Real Jy  
Total-power spectrum Antenna: \*  
Timerange: 00/13:03:02 to 00/13:07:00

Plot file version 128 created 06-JAN-2009 10:57:49

J150407 EZ018B.UVDATA.1

Freq = 1.6270 GHz, Bw = 8.000 MH No calibration applied and no bandpass applied

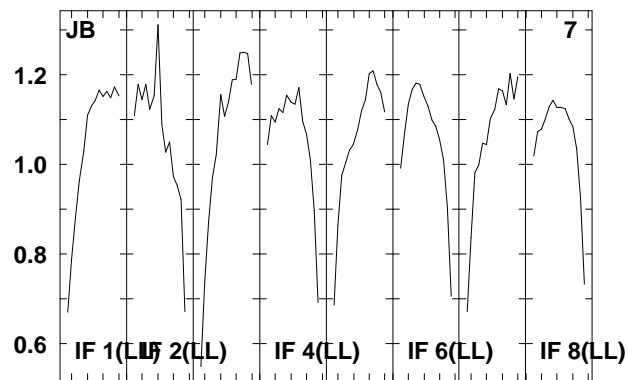
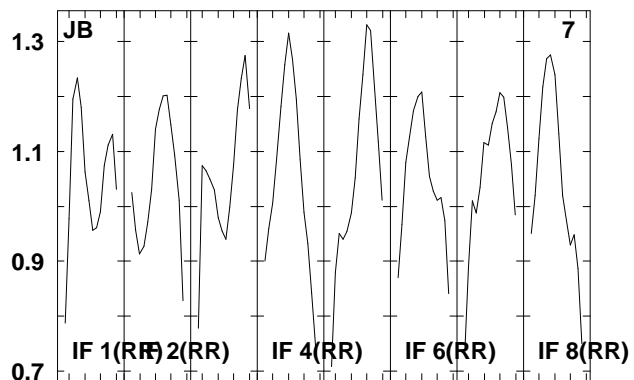
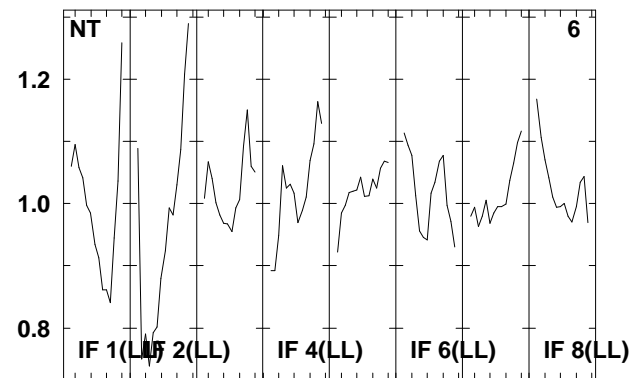
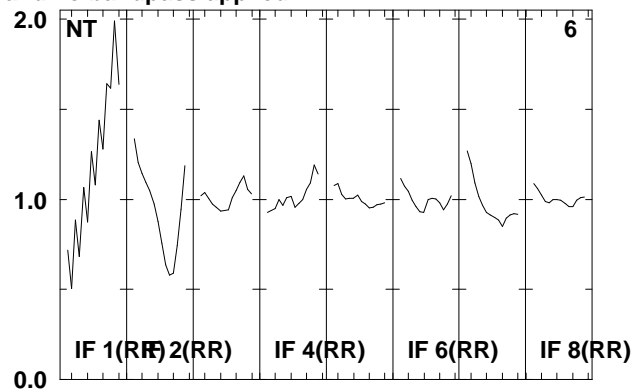
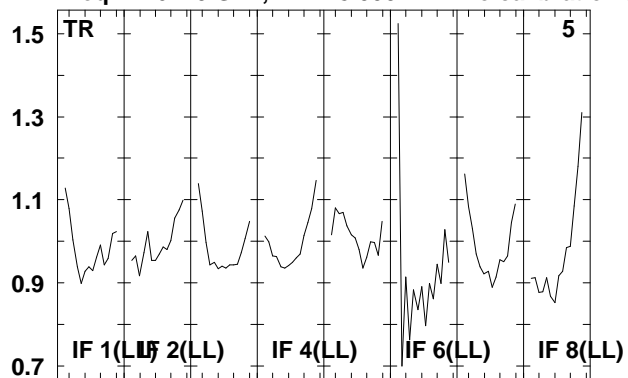

Lower frame: Real Jy  
Total-power spectrum Antenna: \*  
Timerange: 00/13:03:02 to 00/13:07:00



Plot file version 129 created 06-JAN-2009 10:57:50

J1510-05 EZ018B.UVDATA.1

Freq = 1.6270 GHz, Bw = 8.000 MH No calibration applied and no bandpass applied

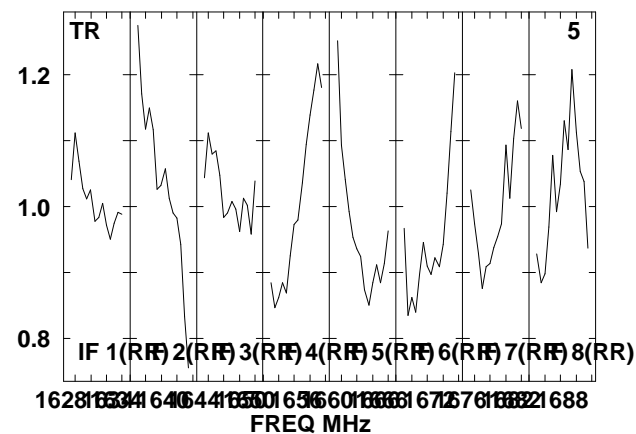
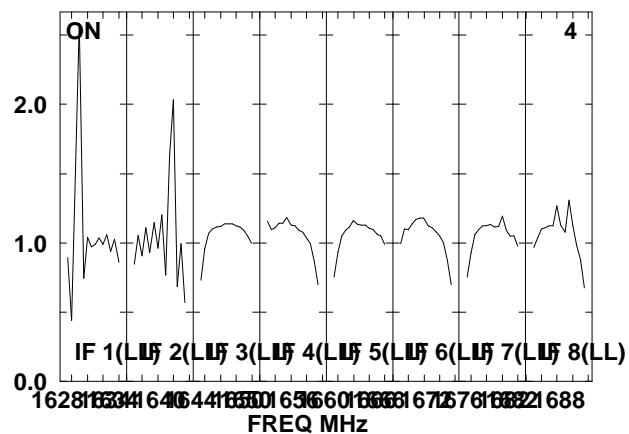
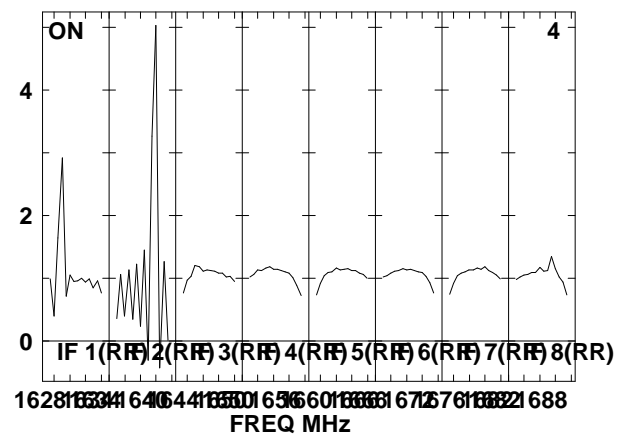
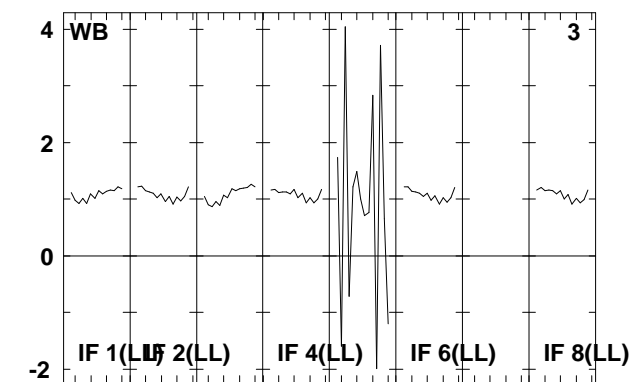
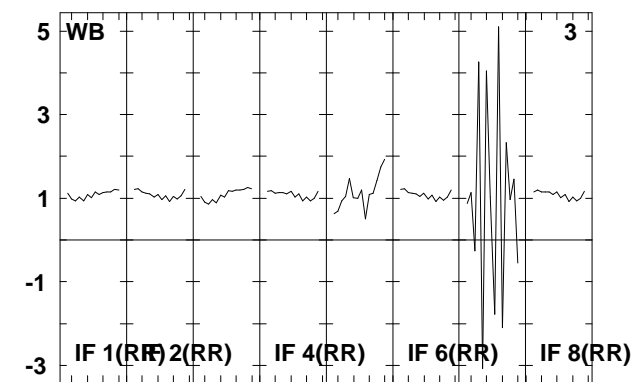
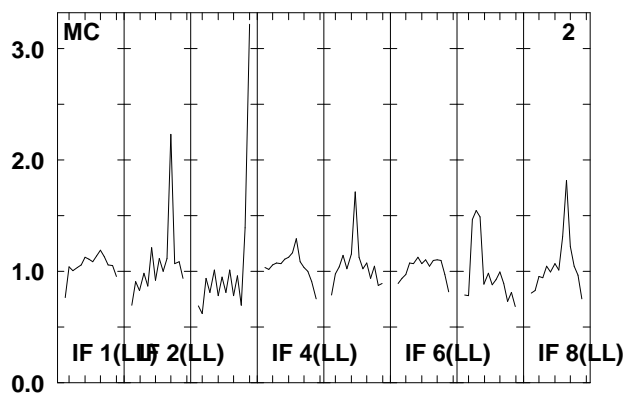
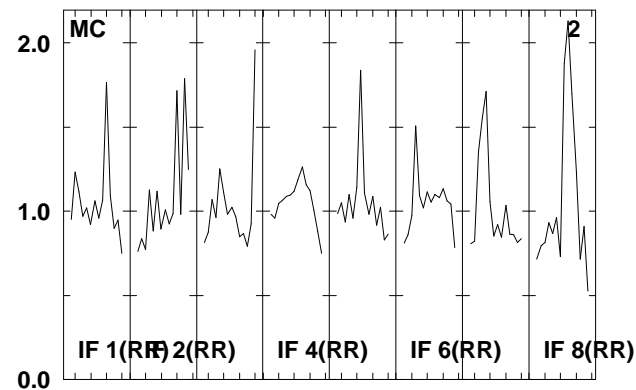
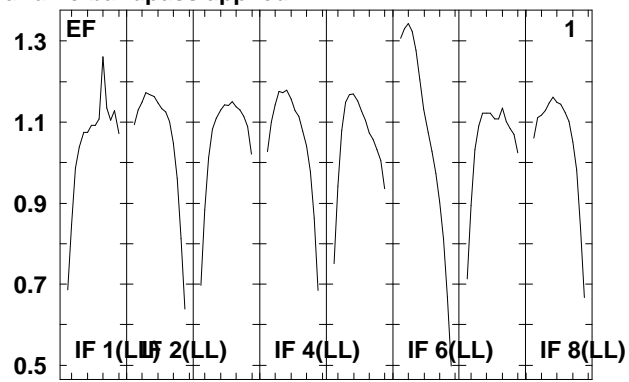
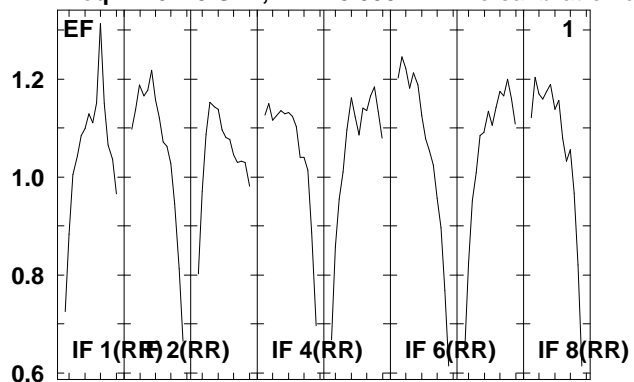

Lower frame: Real Jy

Total-power spectrum Antenna: \*

Timerange: 00/13:07:02 to 00/13:10:00

Plot file version 130 created 06-JAN-2009 10:57:50

J1510-05 EZ018B.UVDATA.1

Freq = 1.6270 GHz, Bw = 8.000 MH No calibration applied and no bandpass applied

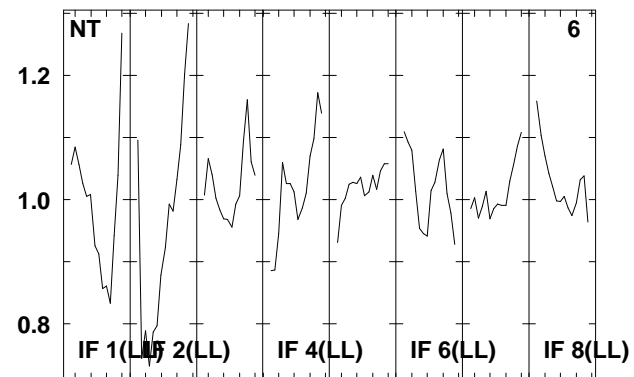
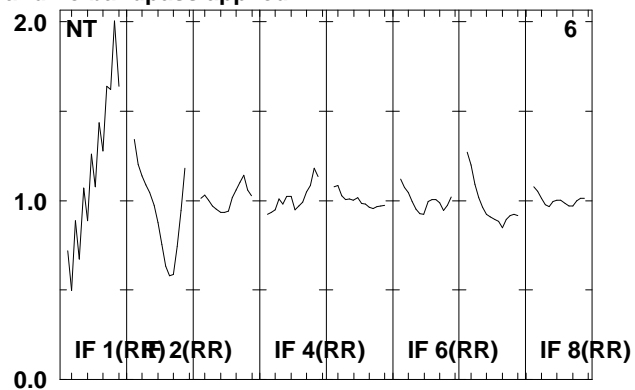
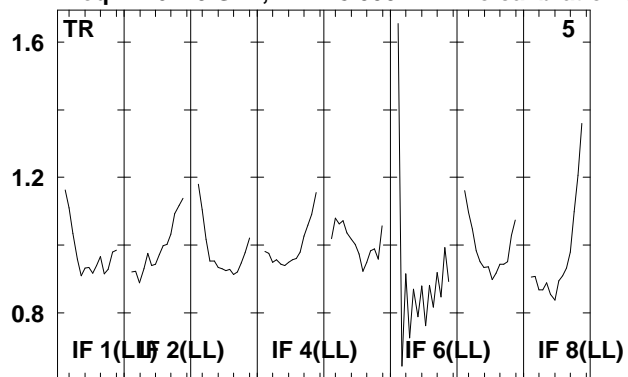

Lower frame: Real Jy  
Total-power spectrum Antenna: \*  
Timerange: 00/13:07:02 to 00/13:10:00

Plot file version 131 created 06-JAN-2009 10:57:50

J150407 EZ018B.UVDATA.1

Freq = 1.6270 GHz, Bw = 8.000 MH No calibration applied and no bandpass applied

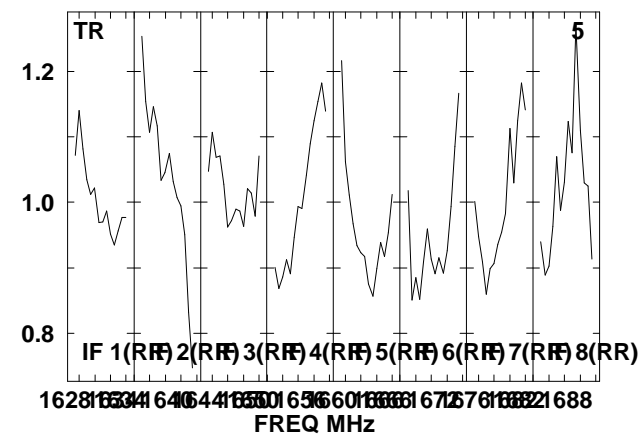
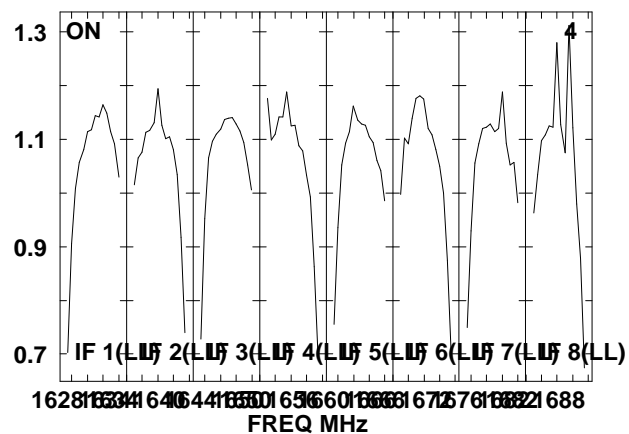
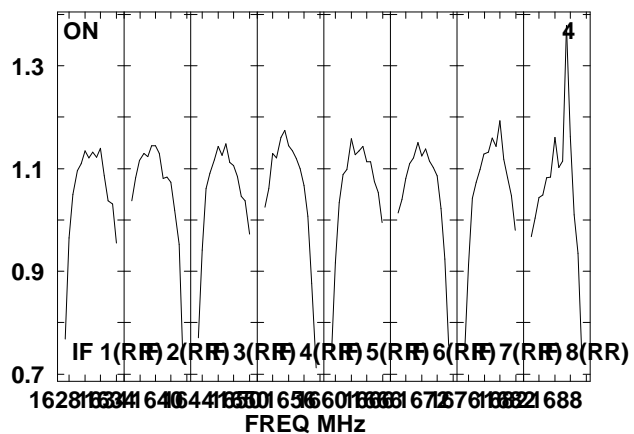
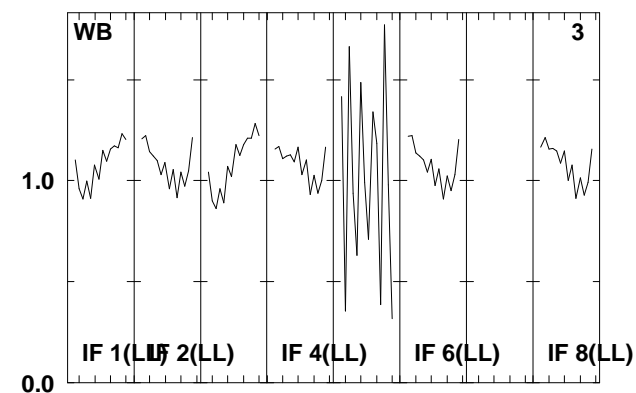
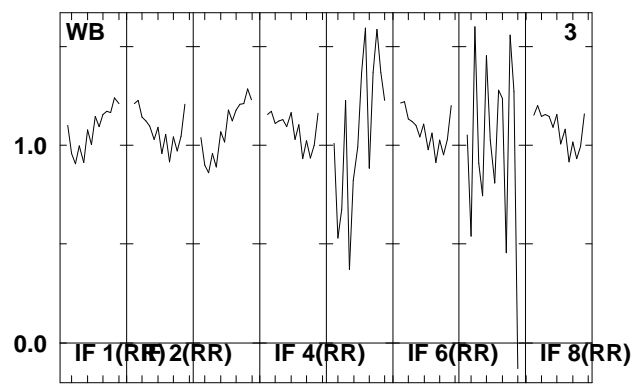
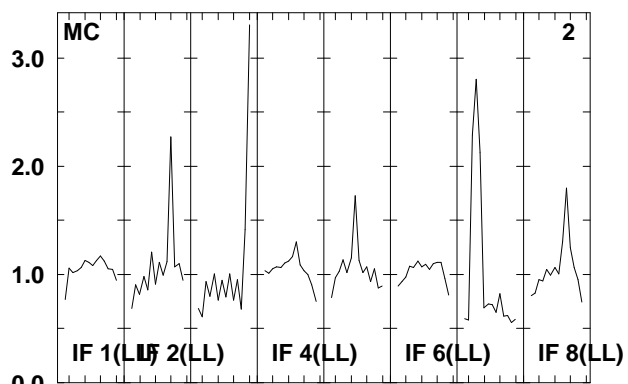
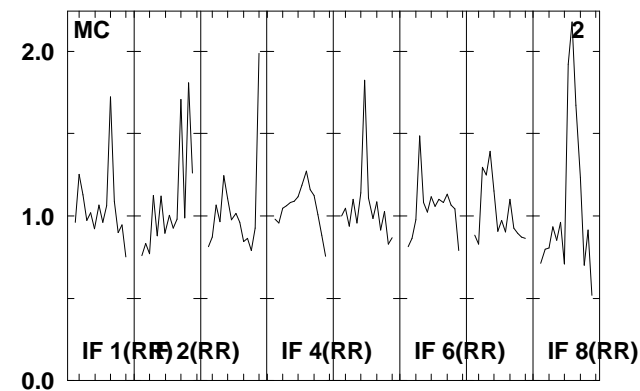
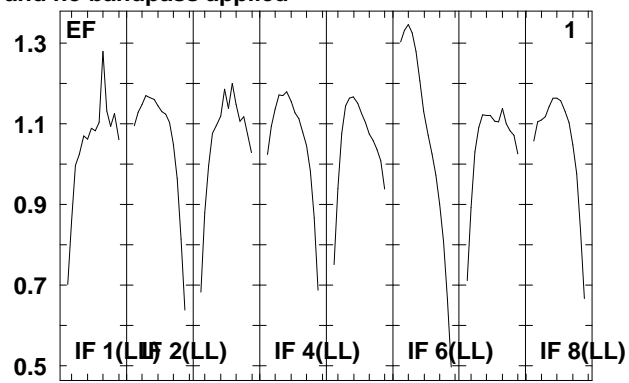
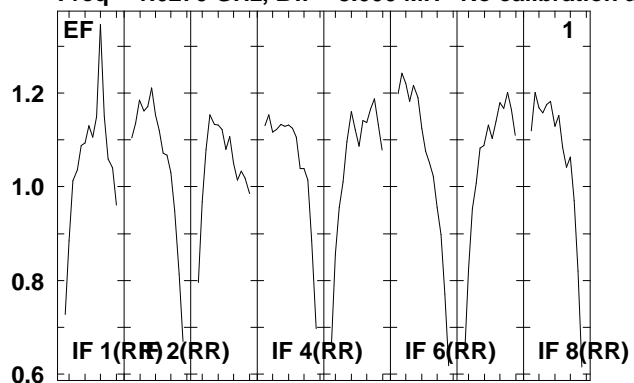

Lower frame: Real Jy  
Total-power spectrum Antenna: \*  
Timerange: 00/13:10:02 to 00/13:13:58

Plot file version 132 created 06-JAN-2009 10:57:51

J150407 EZ018B.UVDATA.1

Freq = 1.6270 GHz, Bw = 8.000 MH No calibration applied and no bandpass applied

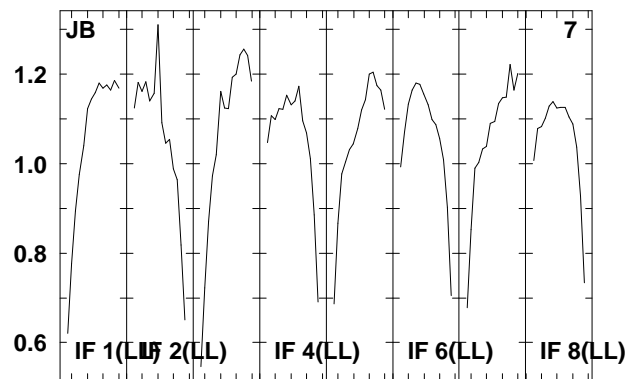
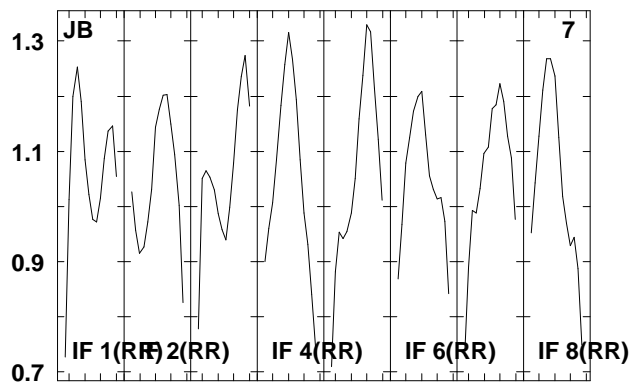
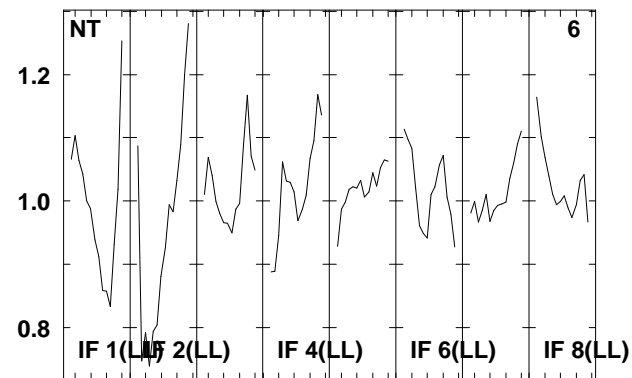
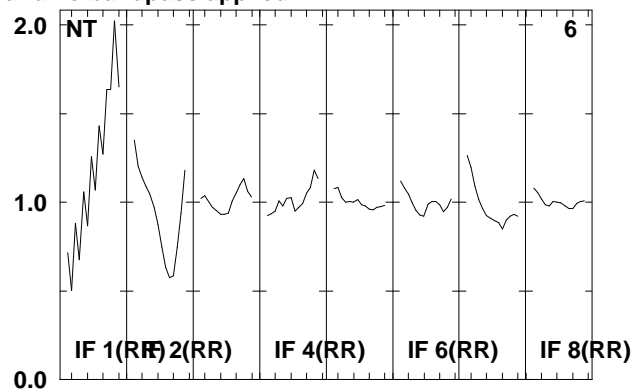
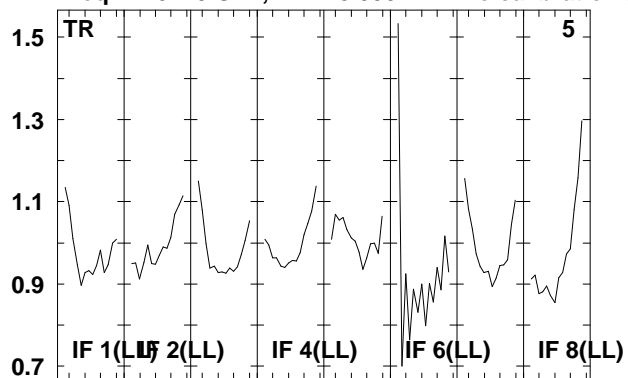

Lower frame: Real Jy  
Total-power spectrum Antenna: \*  
Timerange: 00/13:10:02 to 00/13:13:58

Plot file version 133 created 06-JAN-2009 10:57:51

J1510-05 EZ018B.UVDATA.1

Freq = 1.6270 GHz, Bw = 8.000 MH No calibration applied and no bandpass applied

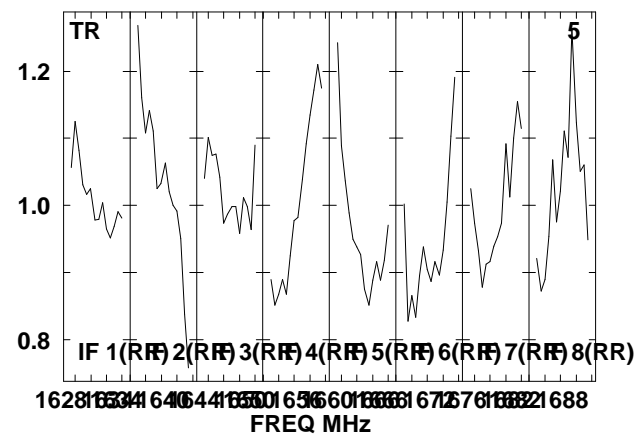
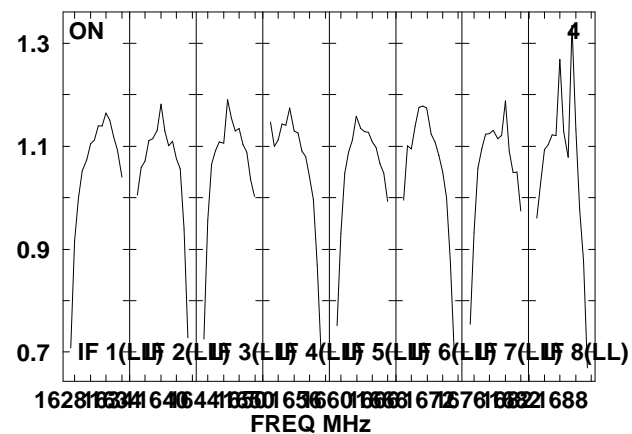
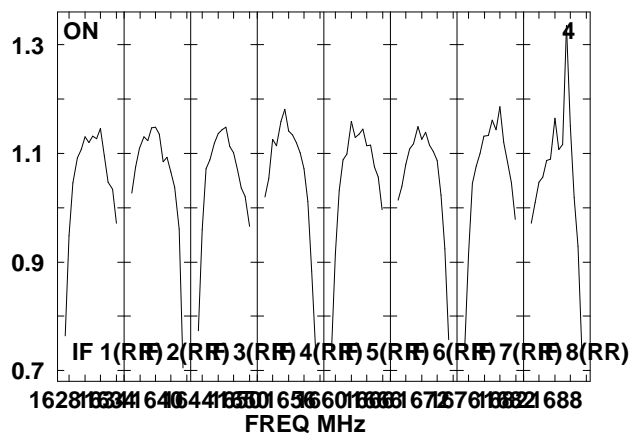
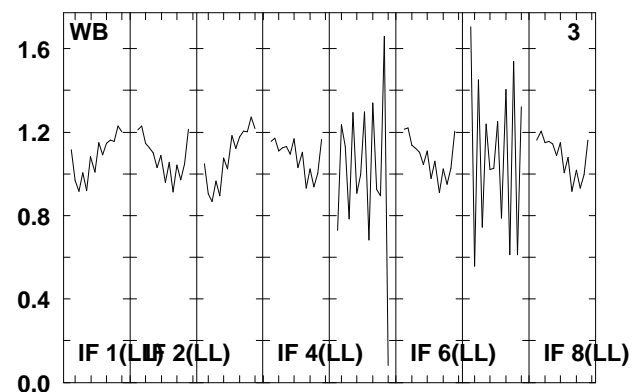
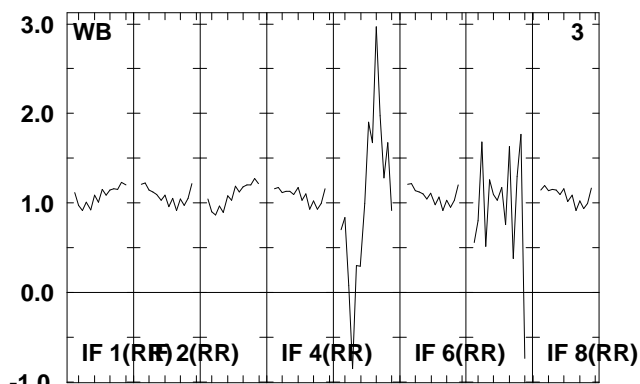
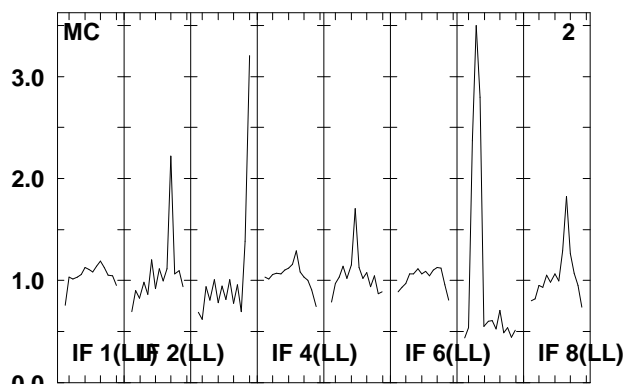
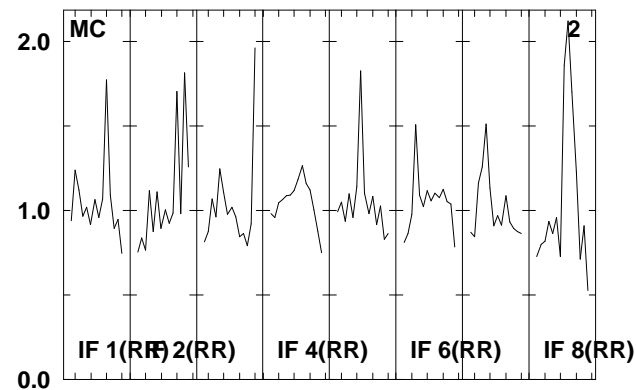
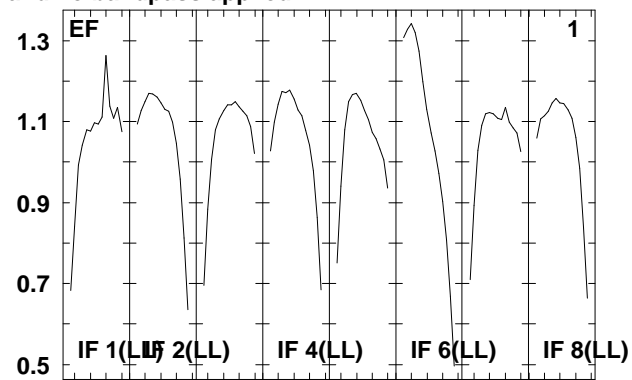
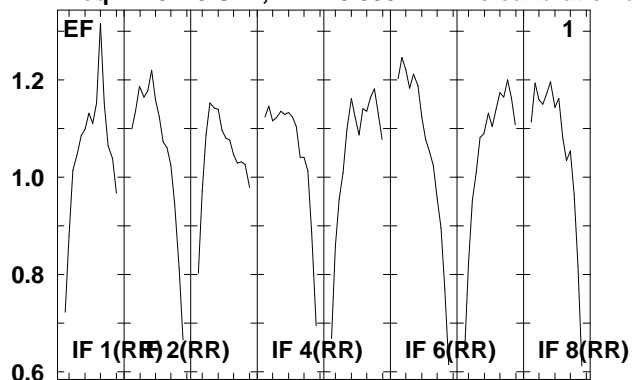

Lower frame: Real Jy

Total-power spectrum Antenna: \*

Timerange: 00/13:15:02 to 00/13:18:00

Plot file version 134 created 06-JAN-2009 10:57:51

J1510-05 EZ018B.UVDATA.1

Freq = 1.6270 GHz, Bw = 8.000 MH No calibration applied and no bandpass applied

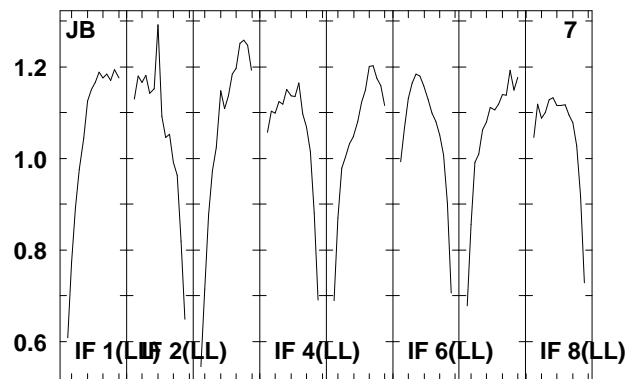
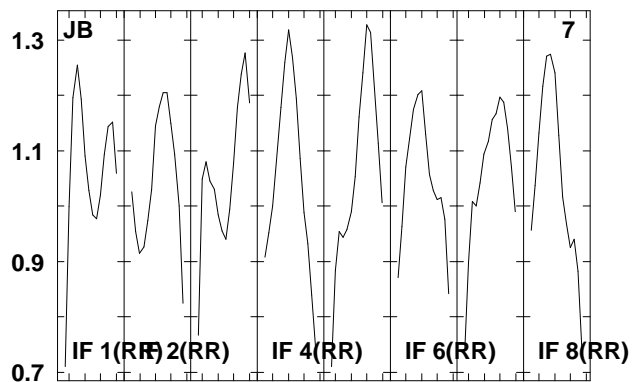
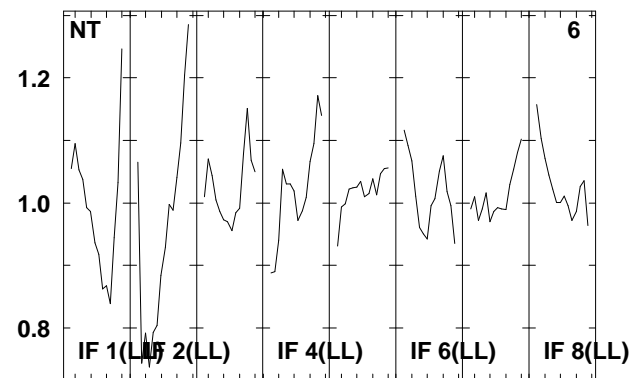
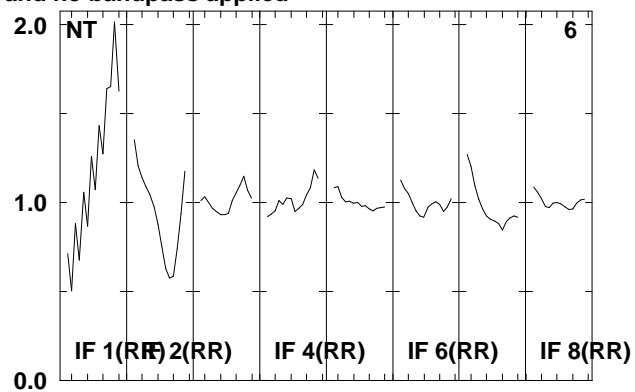
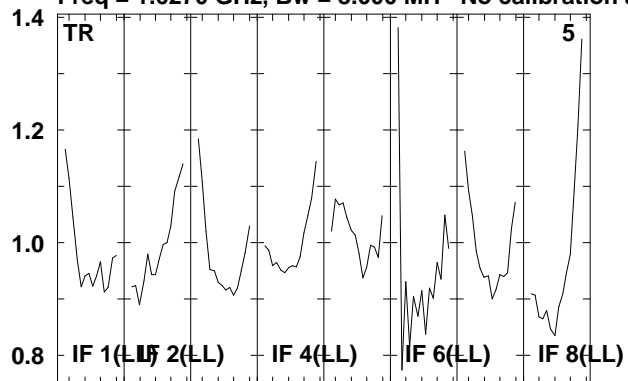

Lower frame: Real Jy  
Total-power spectrum Antenna: \*  
Timerange: 00/13:15:02 to 00/13:18:00

Plot file version 135 created 06-JAN-2009 10:57:52

J150407 EZ018B.UVDATA.1

Freq = 1.6270 GHz, Bw = 8.000 MH No calibration applied and no bandpass applied

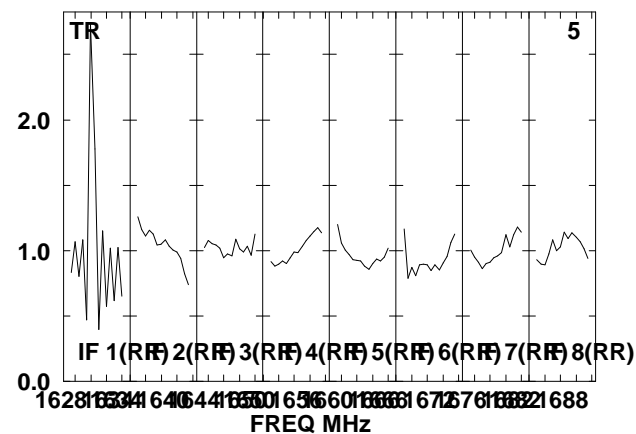
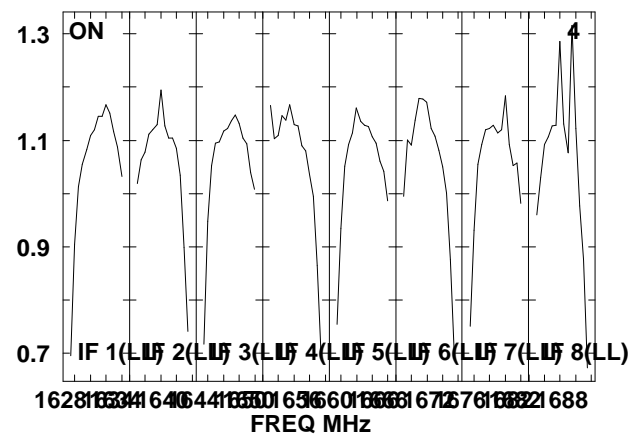
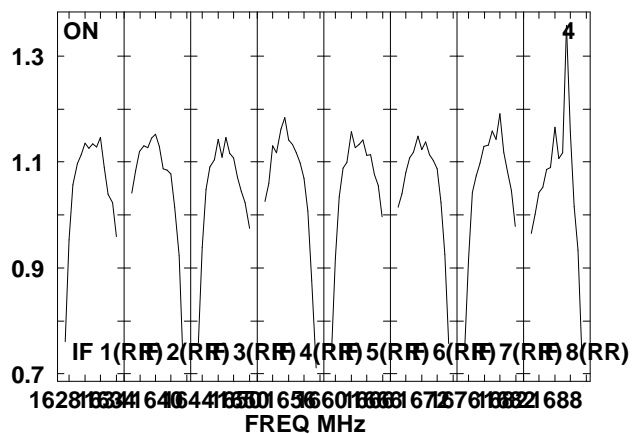
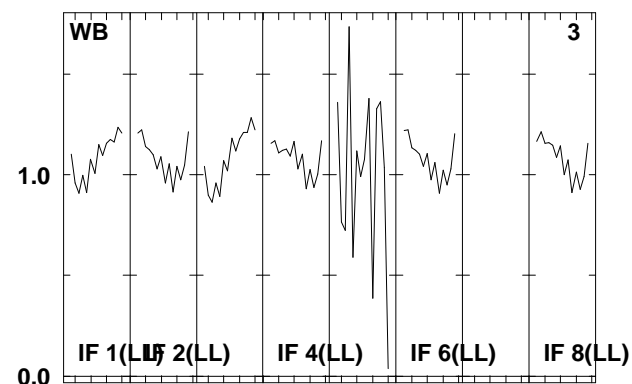
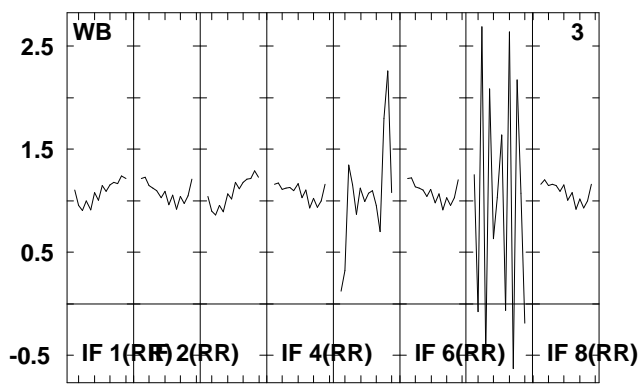
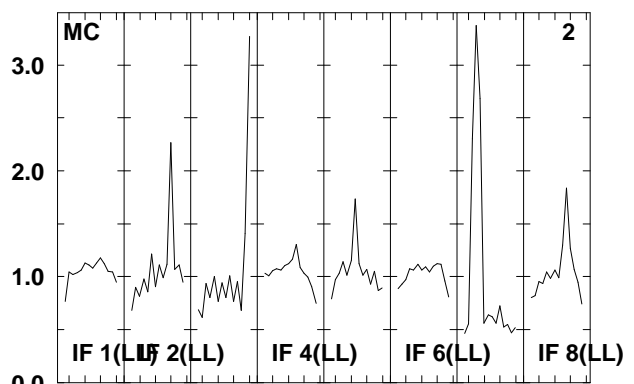
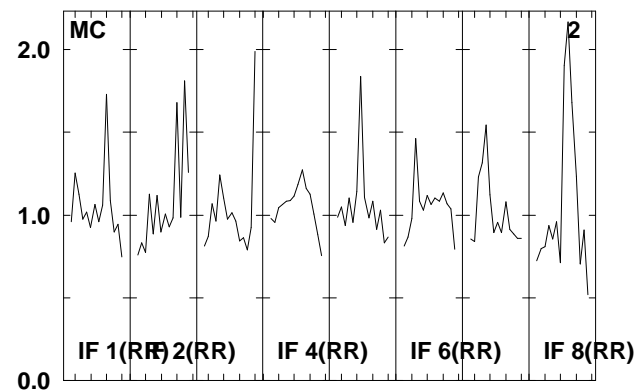
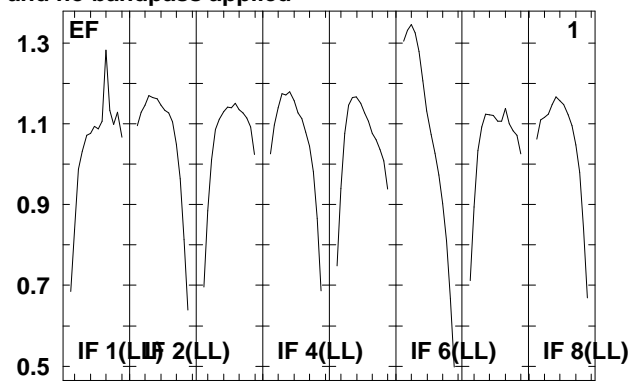
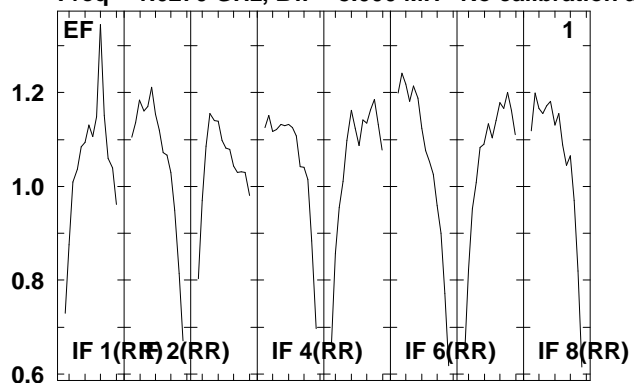

Lower frame: Real Jy  
Total-power spectrum Antenna: \*  
Timerange: 00/13:18:02 to 00/13:21:56

Plot file version 136 created 06-JAN-2009 10:57:52

J150407 EZ018B.UVDATA.1

Freq = 1.6270 GHz, Bw = 8.000 MH No calibration applied and no bandpass applied

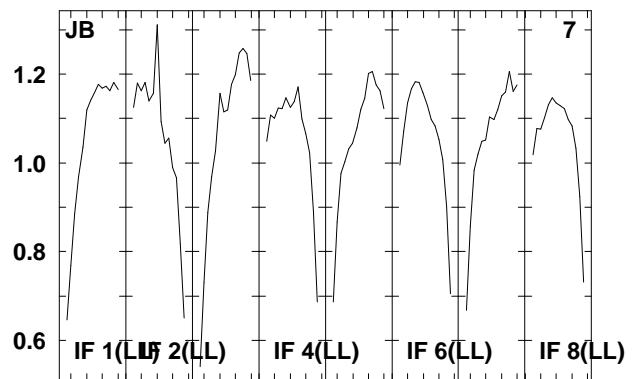
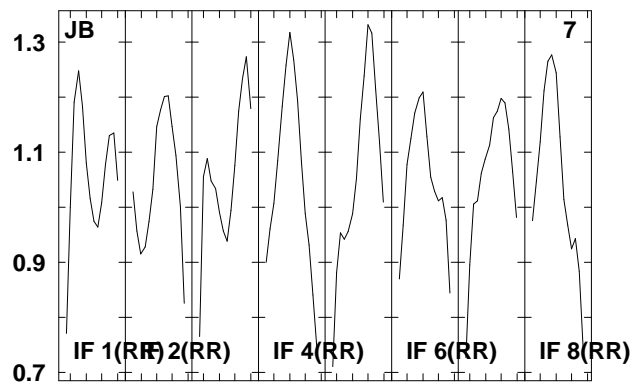
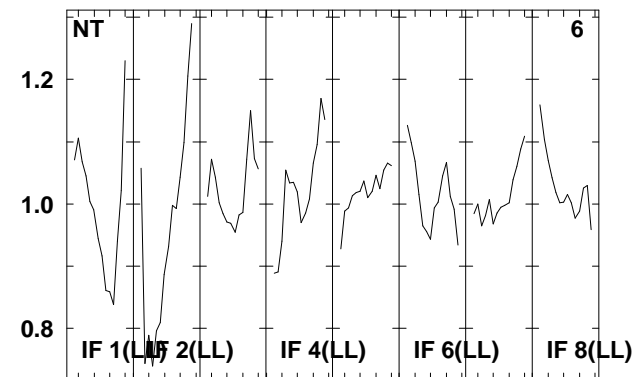
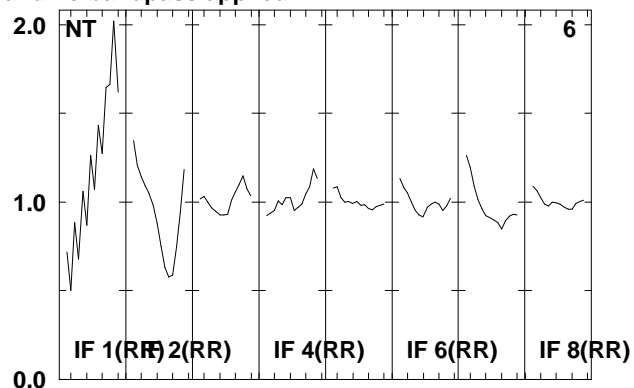
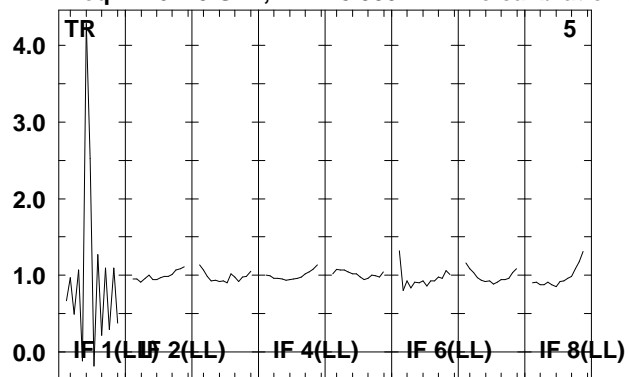

Lower frame: Real Jy  
Total-power spectrum Antenna: \*  
Timerange: 00/13:18:02 to 00/13:21:56



Plot file version 137 created 06-JAN-2009 10:57:53

J1510-05 EZ018B.UVDATA.1

Freq = 1.6270 GHz, Bw = 8.000 MH No calibration applied and no bandpass applied

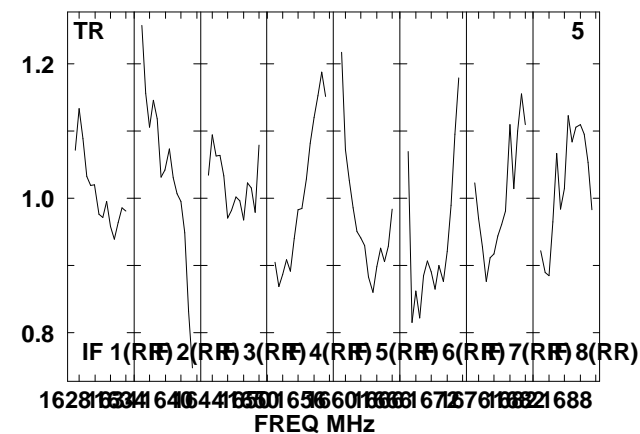
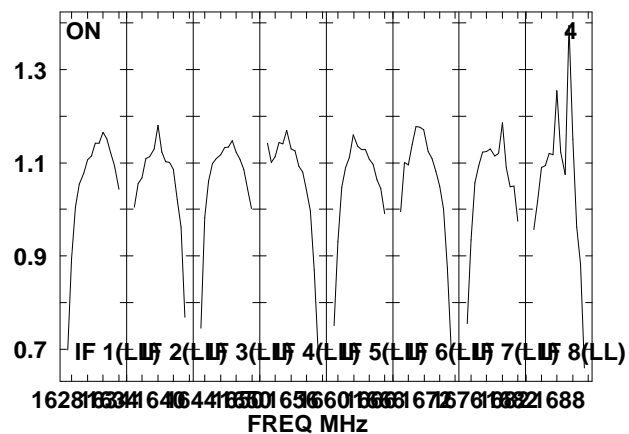
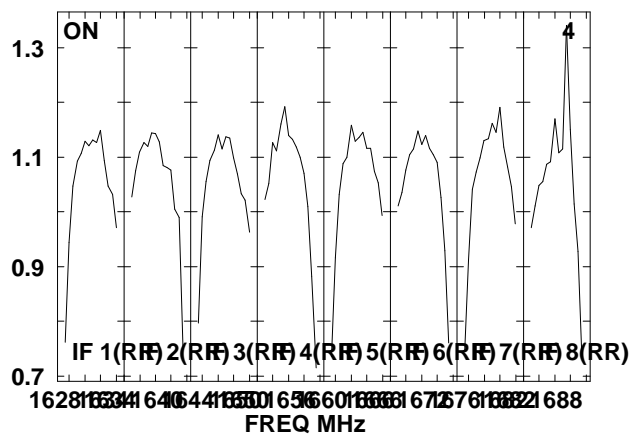
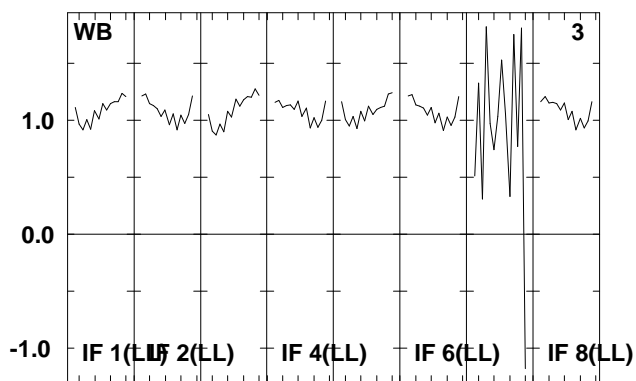
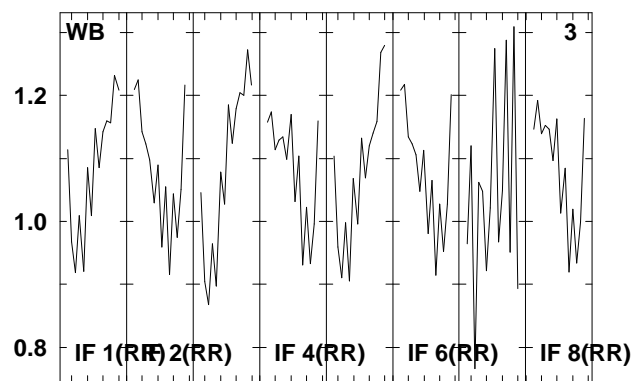
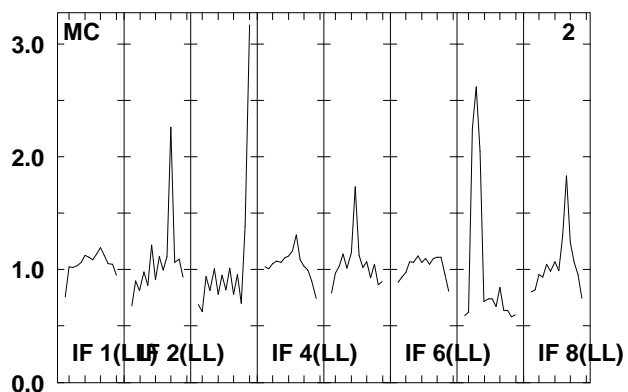
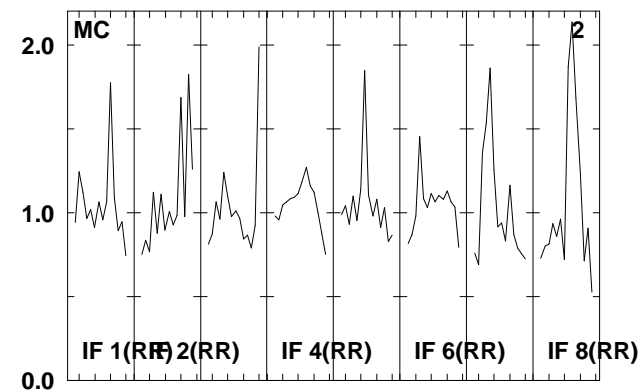
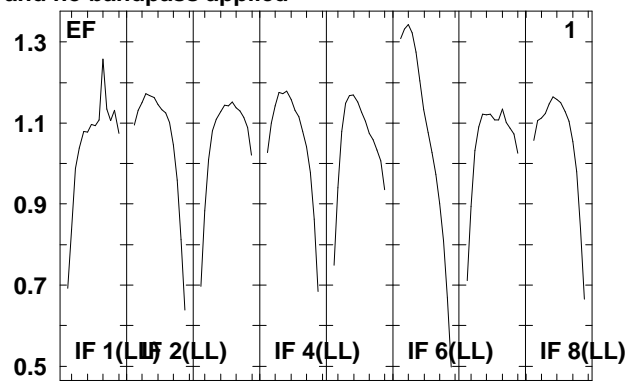
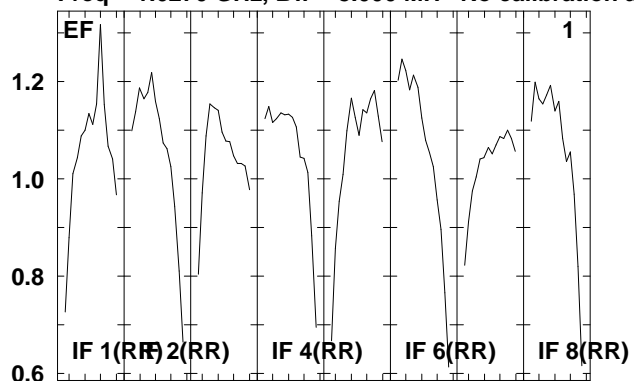

Lower frame: Real Jy  
Total-power spectrum Antenna: \*  
Timerange: 00/13:22:08 to 00/13:24:56

Plot file version 138 created 06-JAN-2009 10:57:53

J1510-05 EZ018B.UVDATA.1

Freq = 1.6270 GHz, Bw = 8.000 MH No calibration applied and no bandpass applied

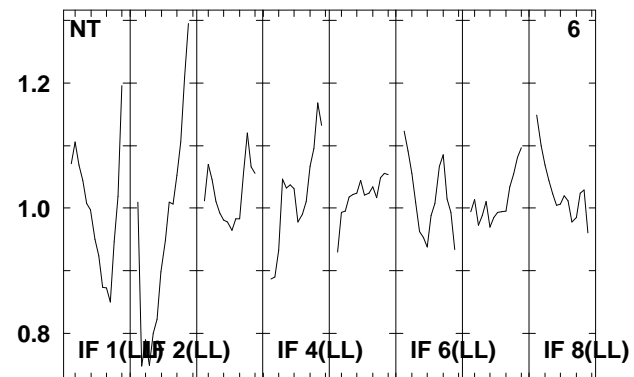
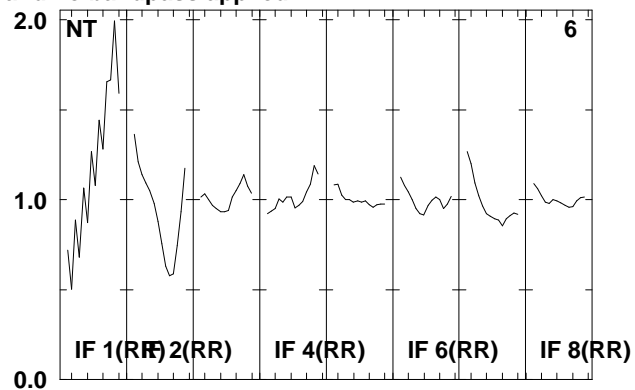
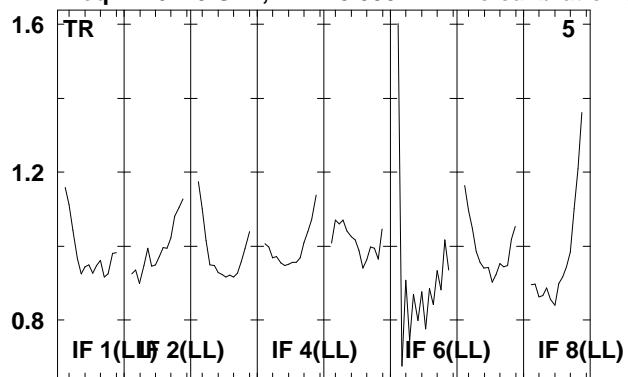

Lower frame: Real Jy  
Total-power spectrum Antenna: \*  
Timerange: 00/13:22:08 to 00/13:24:56

Plot file version 139 created 06-JAN-2009 10:57:53

J150407 EZ018B.UVDATA.1

Freq = 1.6270 GHz, Bw = 8.000 MH No calibration applied and no bandpass applied

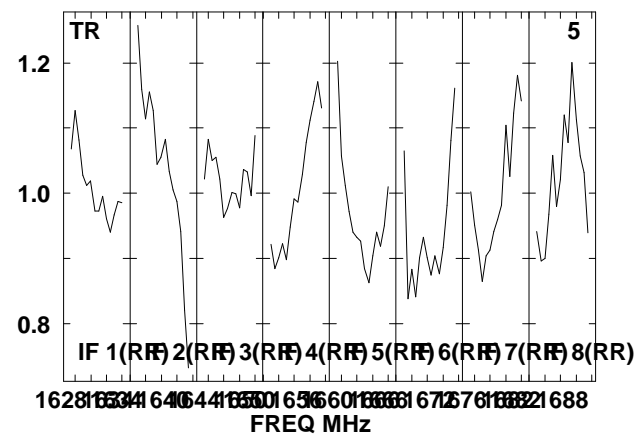
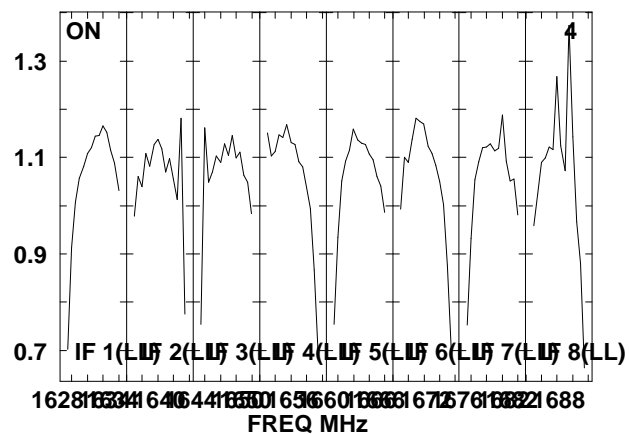
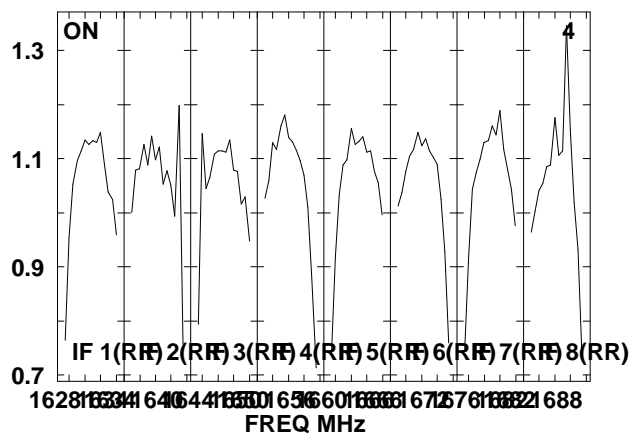
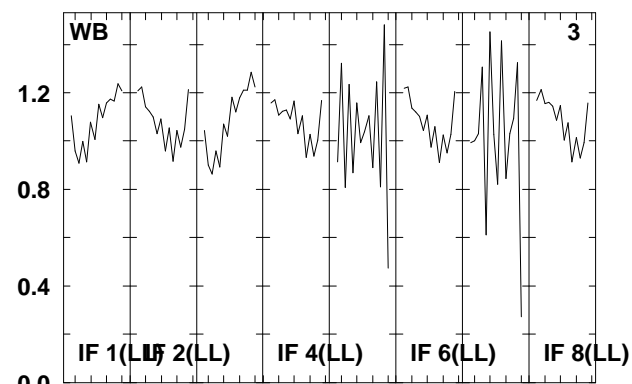
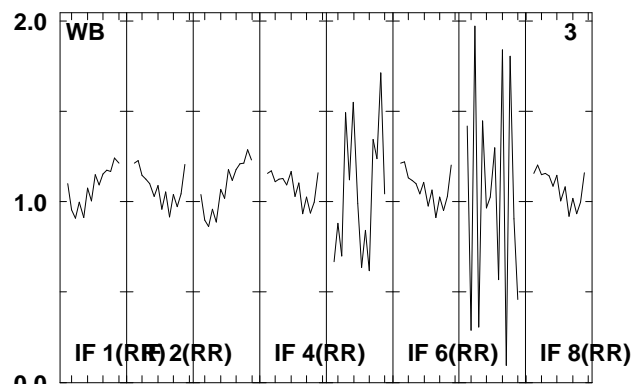
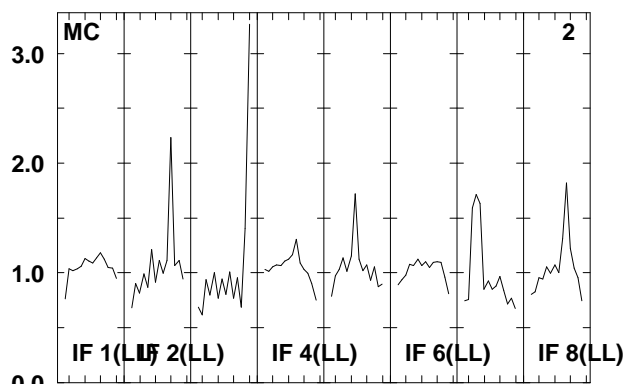
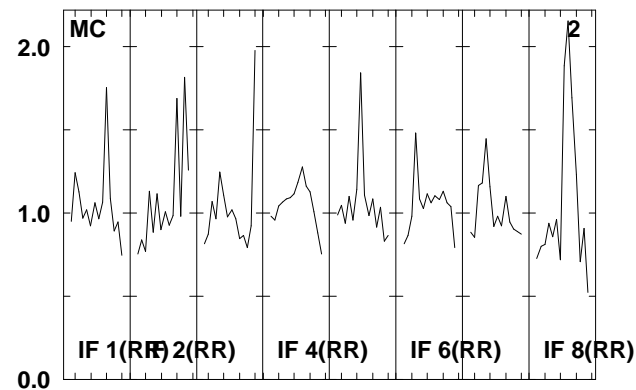
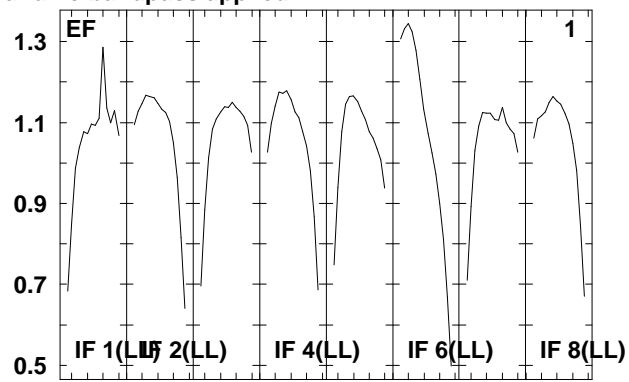
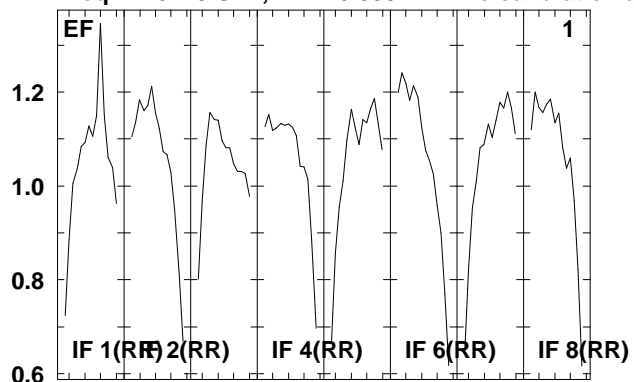

Lower frame: Real Jy  
Total-power spectrum Antenna: \*  
Timerange: 00/13:25:02 to 00/13:29:00

Plot file version 140 created 06-JAN-2009 10:57:54

J150407 EZ018B.UVDATA.1

Freq = 1.6270 GHz, Bw = 8.000 MH No calibration applied and no bandpass applied

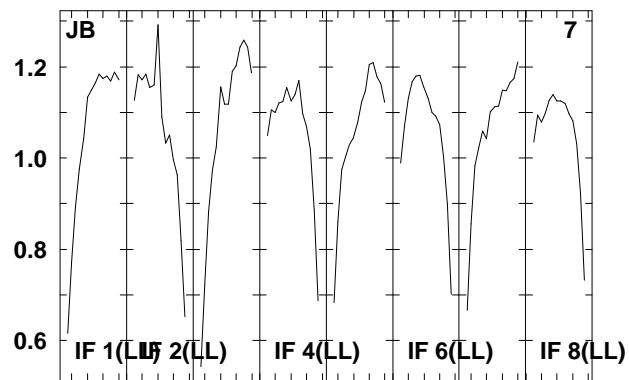
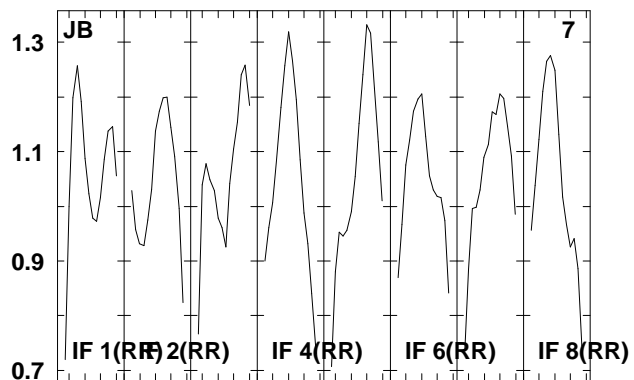
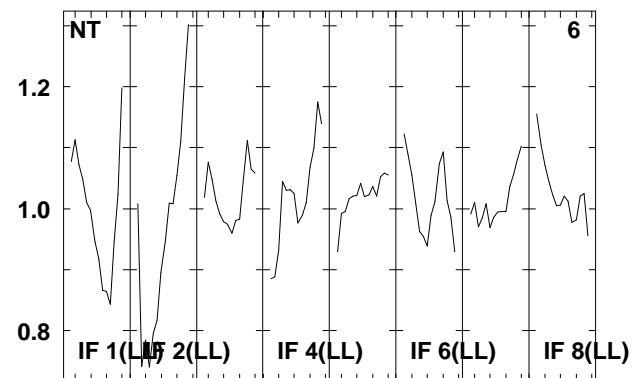
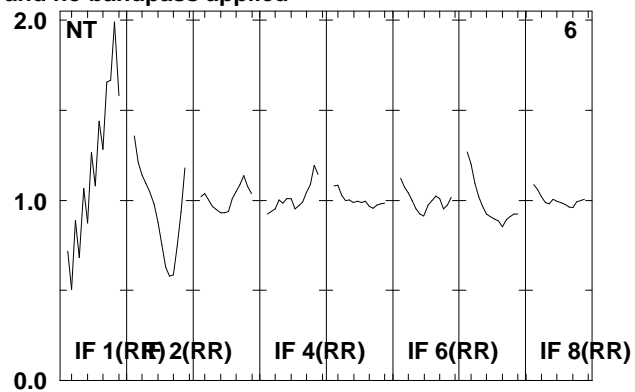
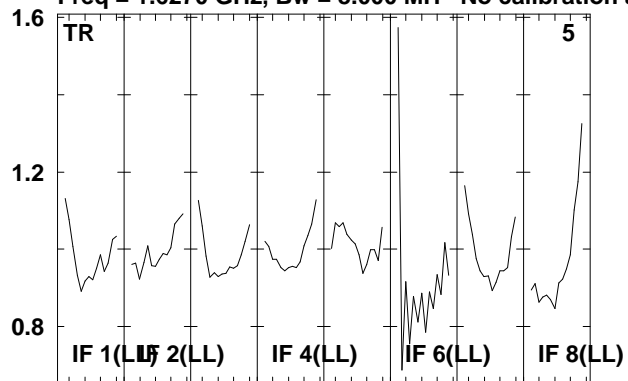

Lower frame: Real Jy  
Total-power spectrum Antenna: \*  
Timerange: 00/13:25:02 to 00/13:29:00

Plot file version 141 created 06-JAN-2009 10:57:54

J1510-05 EZ018B.UVDATA.1

Freq = 1.6270 GHz, Bw = 8.000 MH No calibration applied and no bandpass applied

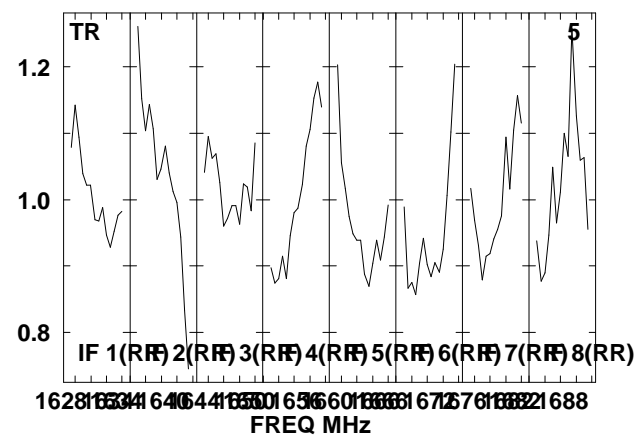
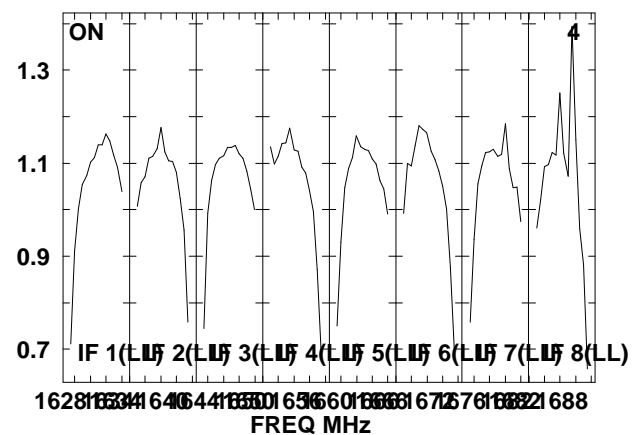
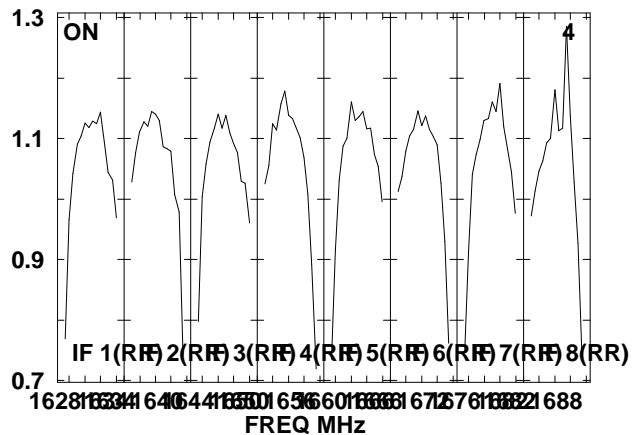
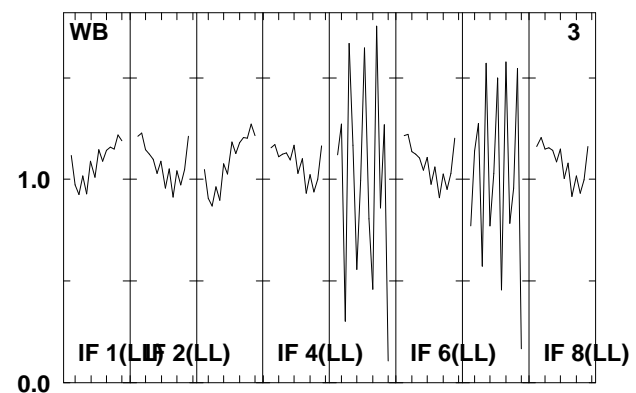
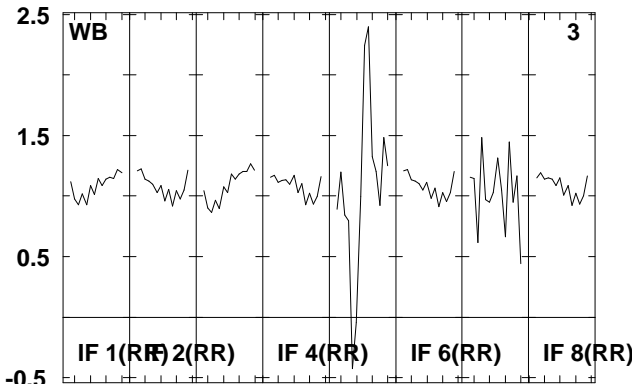
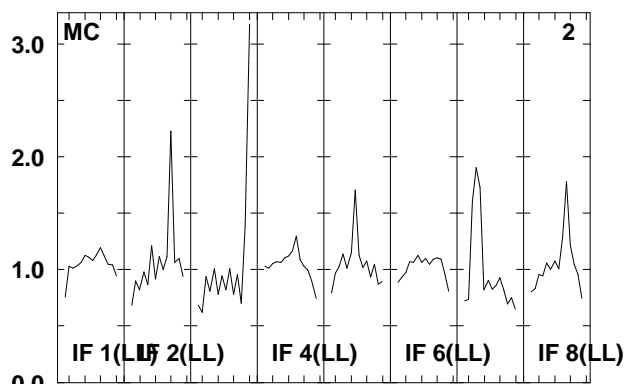
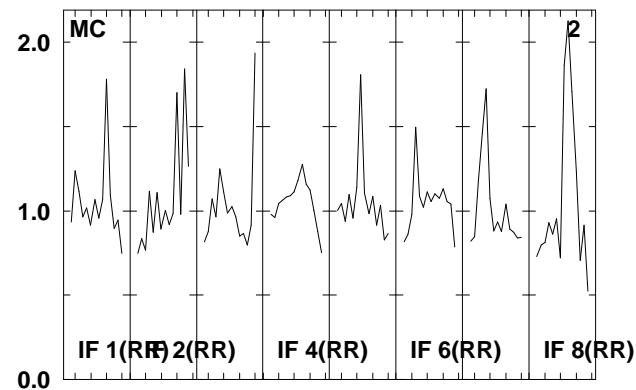
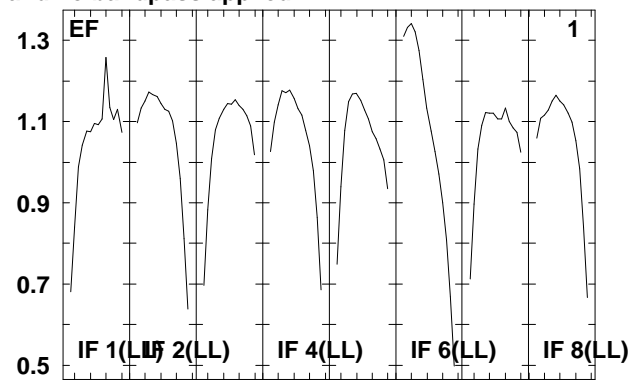
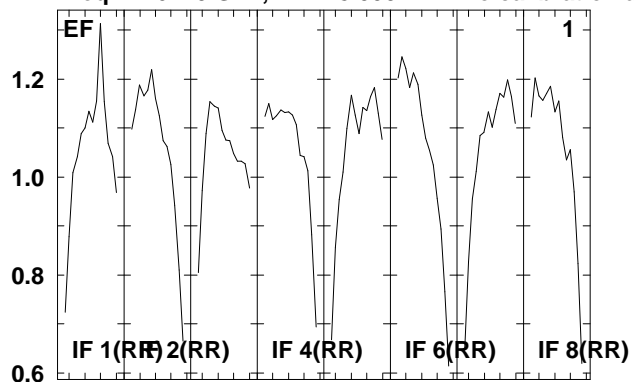

Lower frame: Real Jy  
Total-power spectrum Antenna: \*  
Timerange: 00/13:30:02 to 00/13:33:00

Plot file version 142 created 06-JAN-2009 10:57:55

J1510-05 EZ018B.UVDATA.1

Freq = 1.6270 GHz, Bw = 8.000 MH No calibration applied and no bandpass applied

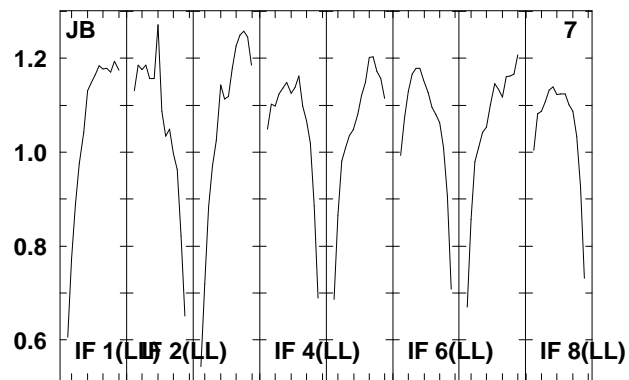
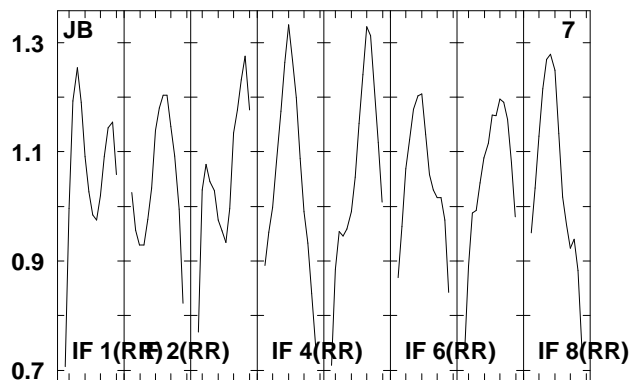
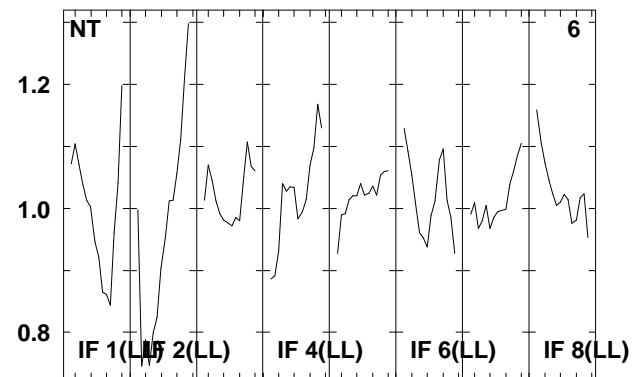
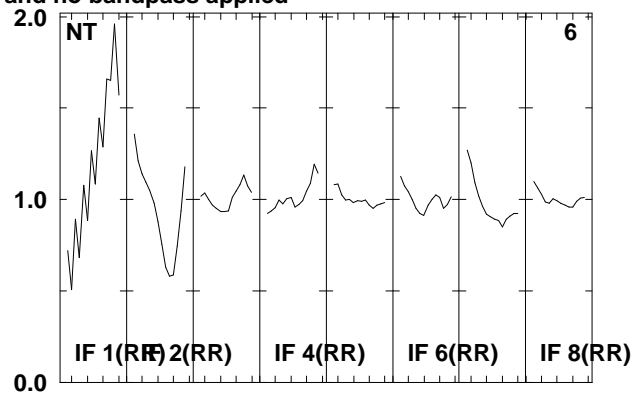
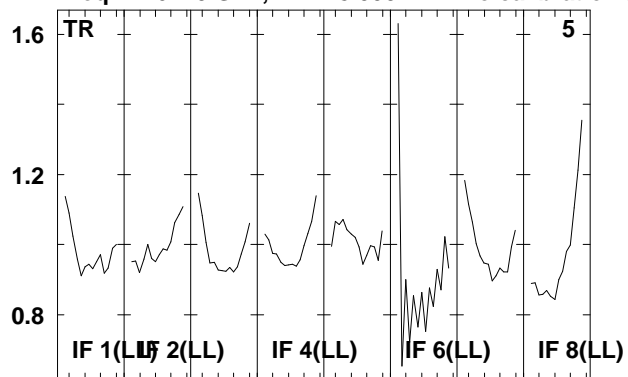

Lower frame: Real Jy  
Total-power spectrum Antenna: \*  
Timerange: 00/13:30:02 to 00/13:33:00

Plot file version 143 created 06-JAN-2009 10:57:55

J150407 EZ018B.UVDATA.1

Freq = 1.6270 GHz, Bw = 8.000 MH No calibration applied and no bandpass applied

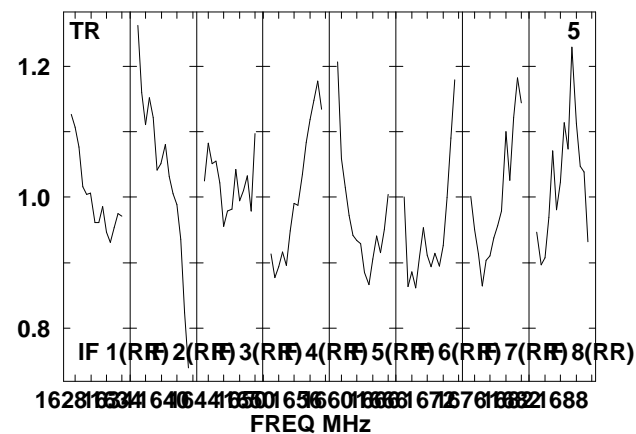
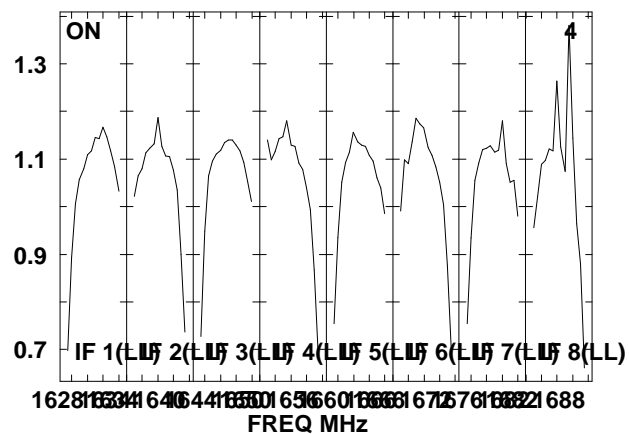
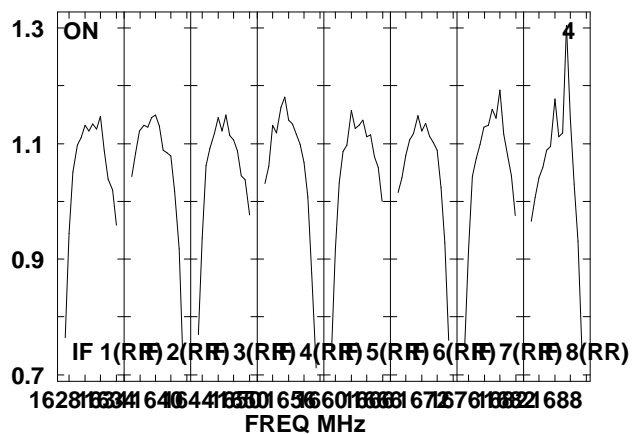
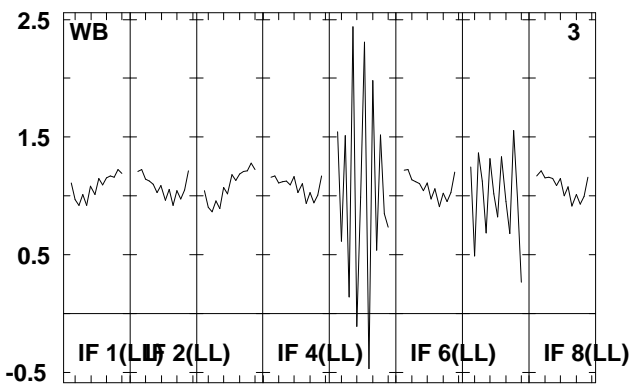
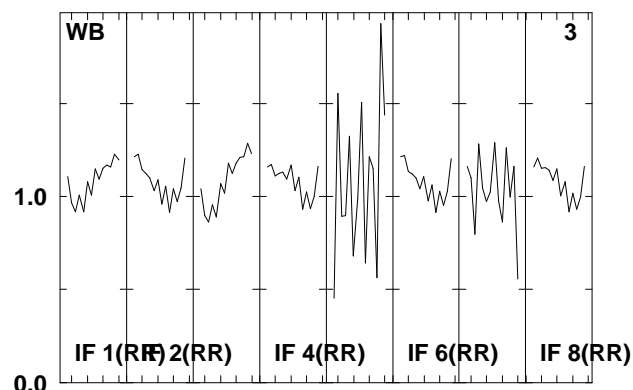
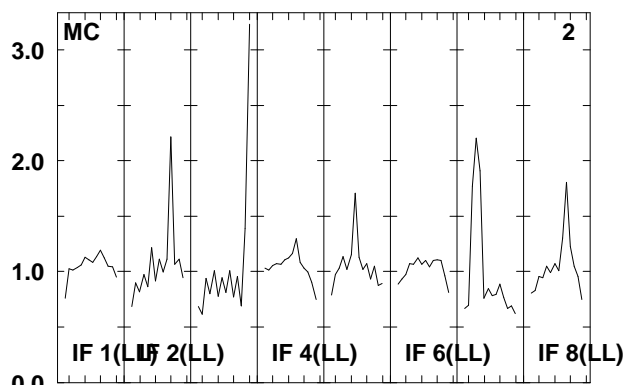
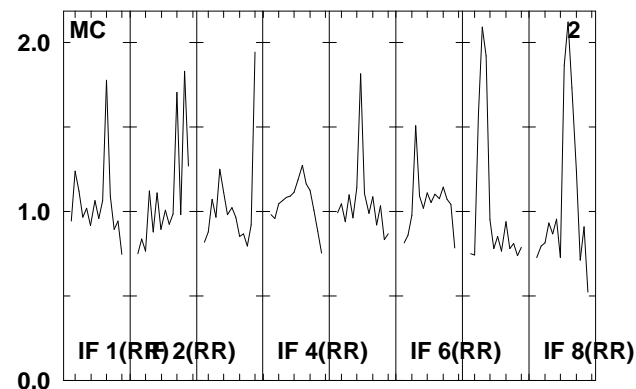
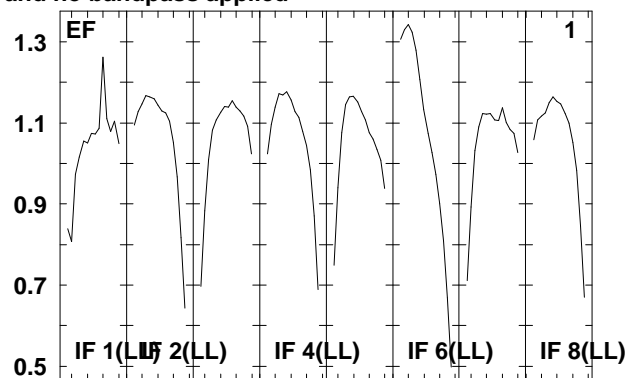
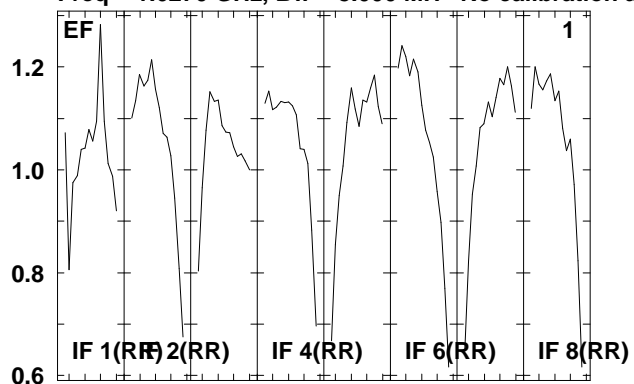

Lower frame: Real Jy

Total-power spectrum Antenna: \*

Timerange: 00/13:33:02 to 00/13:37:00

Plot file version 144 created 06-JAN-2009 10:57:55

J150407 EZ018B.UVDATA.1

Freq = 1.6270 GHz, Bw = 8.000 MH No calibration applied and no bandpass applied

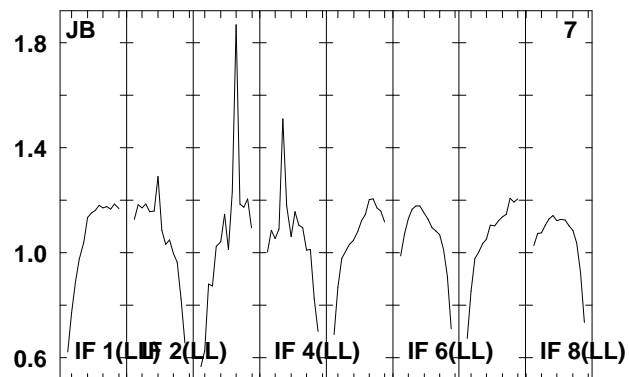
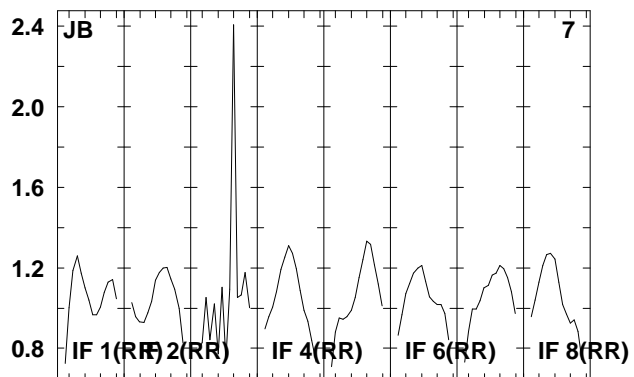
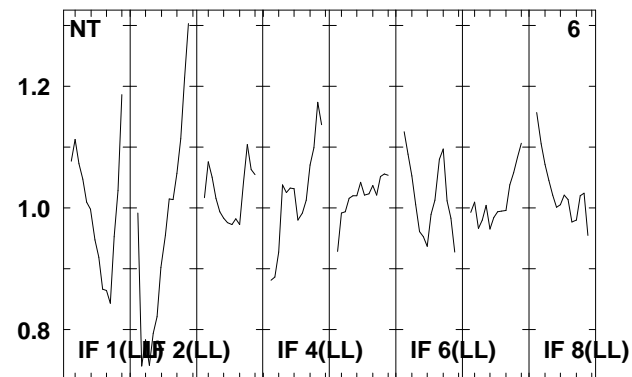
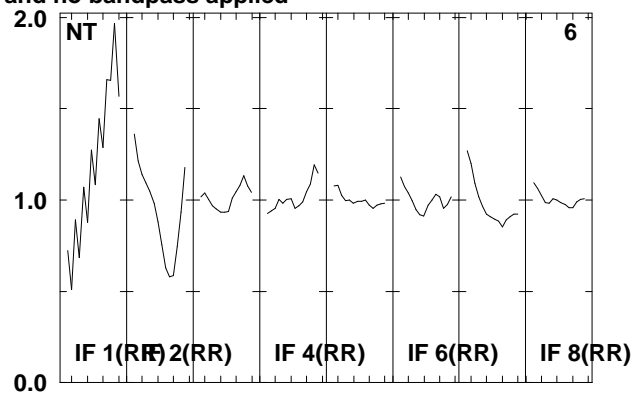
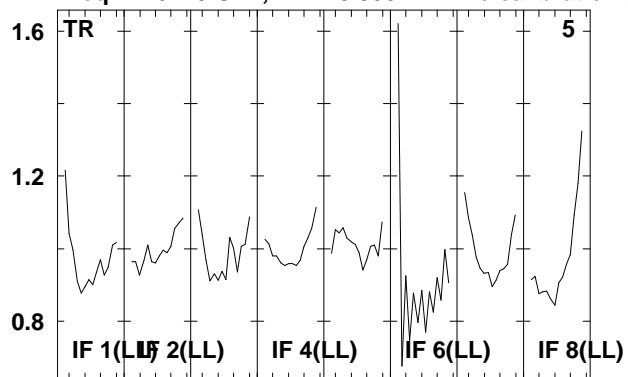

Lower frame: Real Jy  
Total-power spectrum Antenna: \*  
Timerange: 00/13:33:02 to 00/13:37:00



Plot file version 145 created 06-JAN-2009 10:57:56

J1510-05 EZ018B.UVDATA.1

Freq = 1.6270 GHz, Bw = 8.000 MH No calibration applied and no bandpass applied

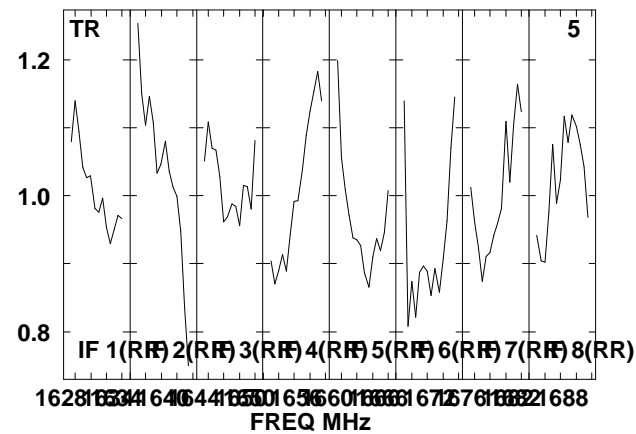
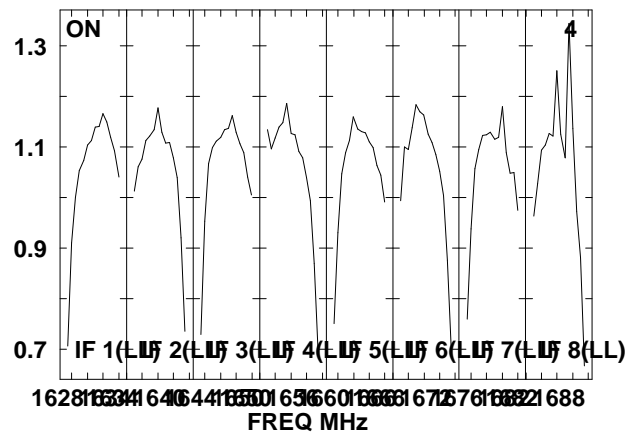
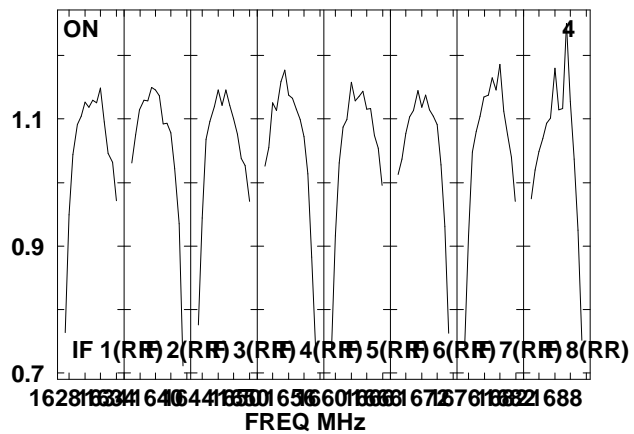
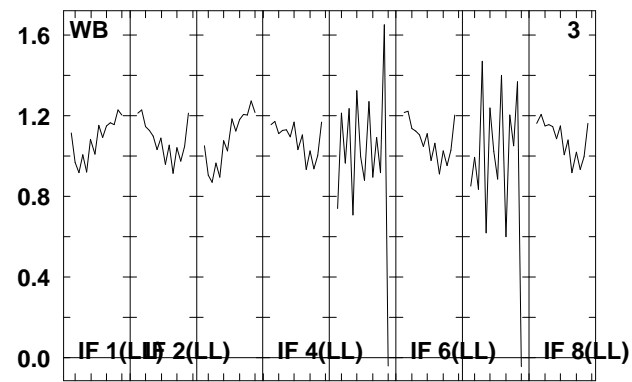
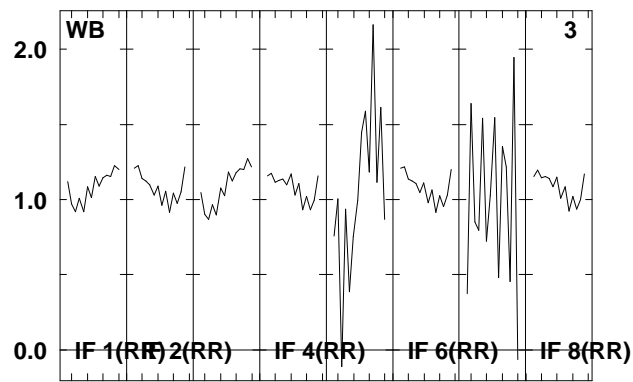
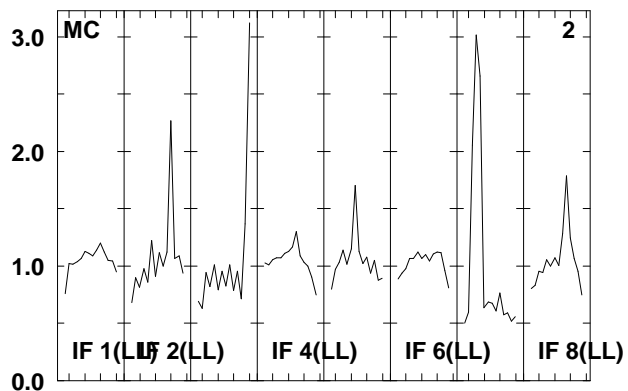
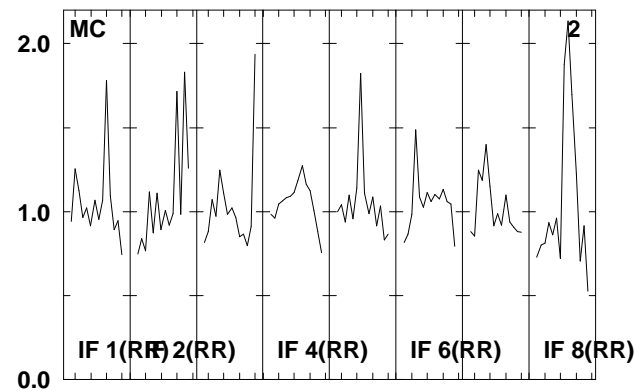
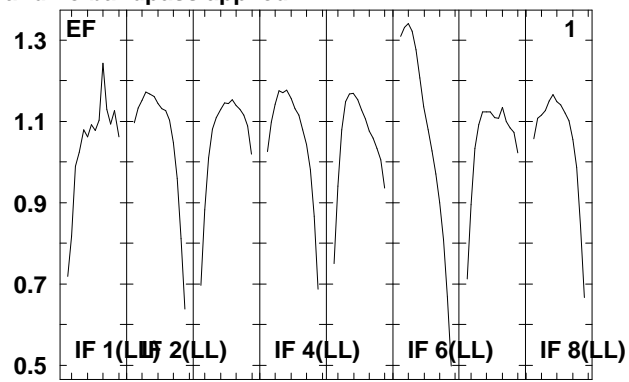
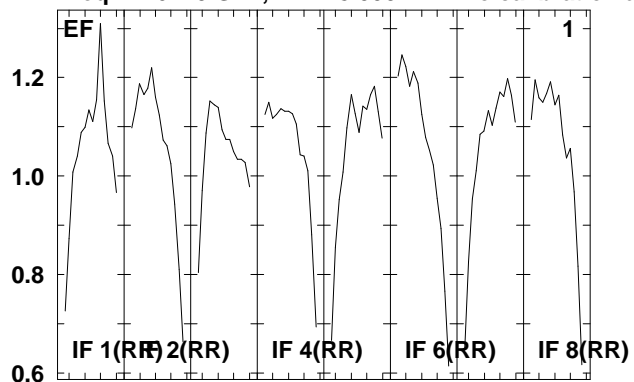

Lower frame: Real Jy

Total-power spectrum Antenna: \*

Timerange: 00/13:37:02 to 00/13:40:00

Plot file version 146 created 06-JAN-2009 10:57:56

J1510-05 EZ018B.UVDATA.1

Freq = 1.6270 GHz, Bw = 8.000 MH No calibration applied and no bandpass applied

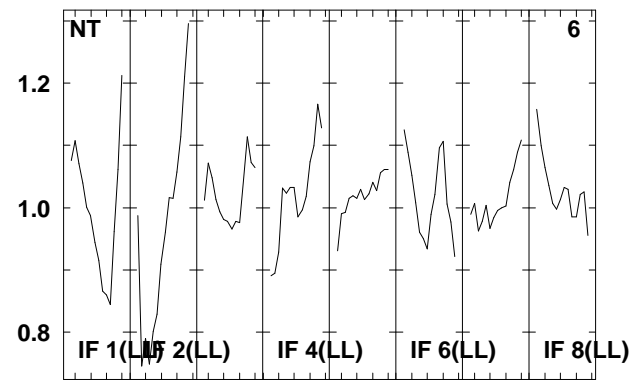
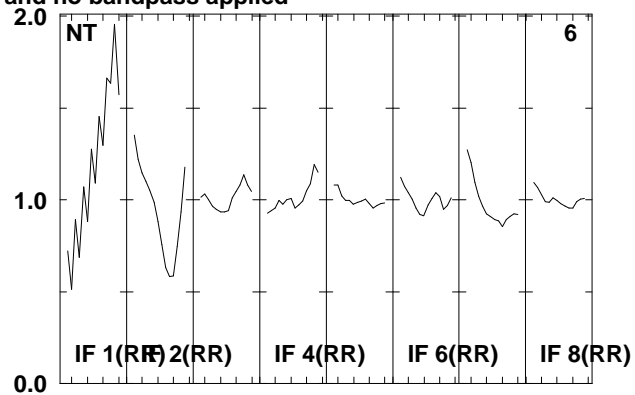
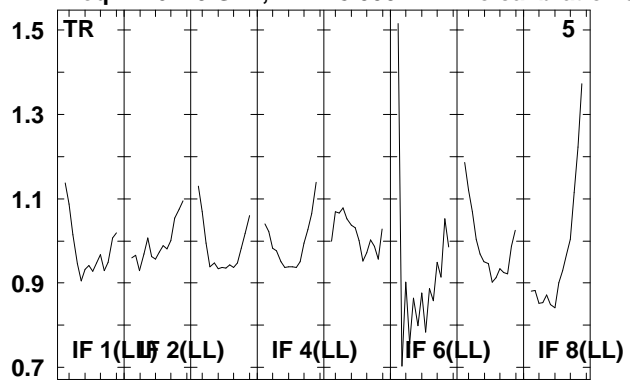

Lower frame: Real Jy  
Total-power spectrum Antenna: \*  
Timerange: 00/13:37:02 to 00/13:40:00

Plot file version 147 created 06-JAN-2009 10:57:56

J150407 EZ018B.UVDATA.1

Freq = 1.6270 GHz, Bw = 8.000 MH No calibration applied and no bandpass applied

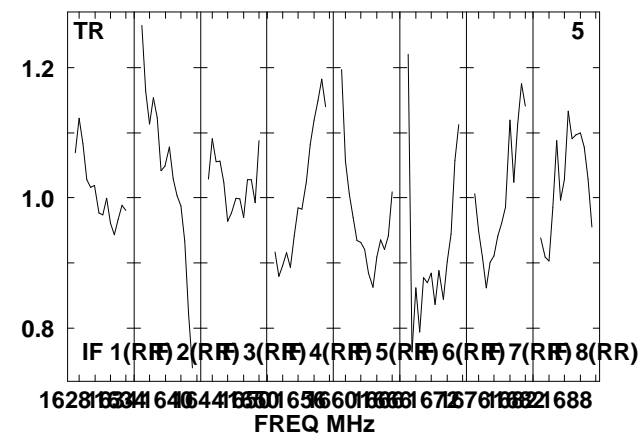
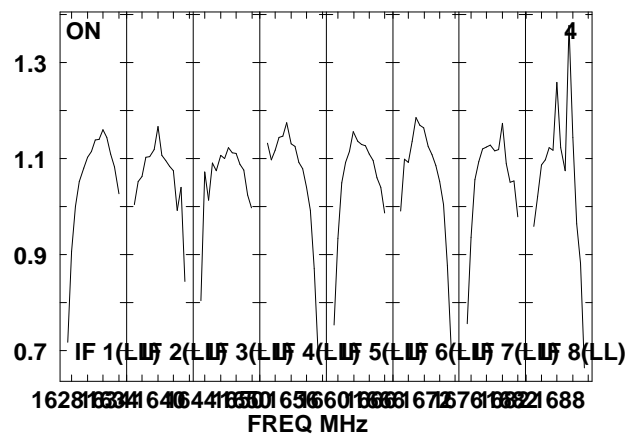
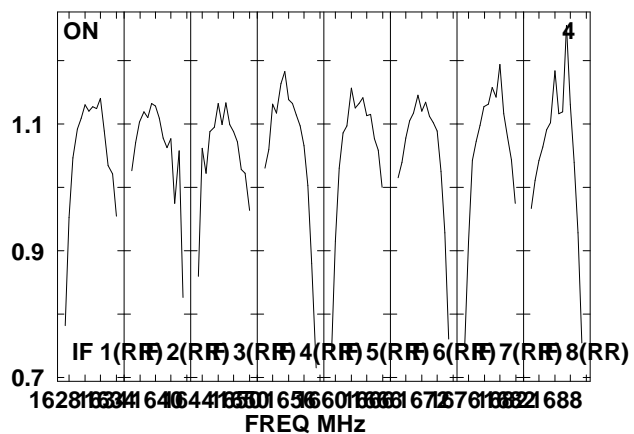
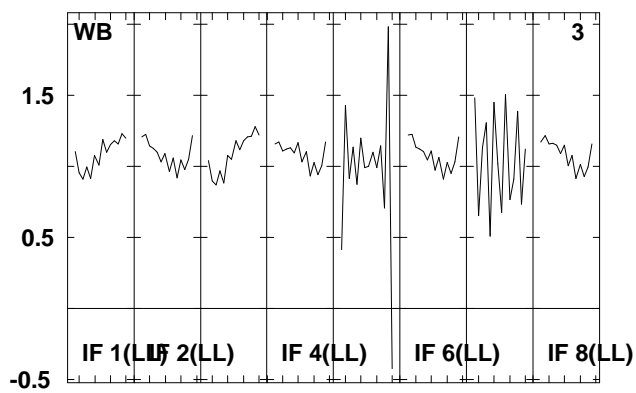
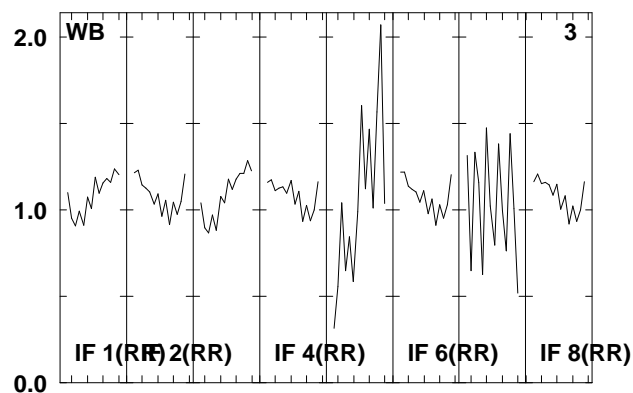
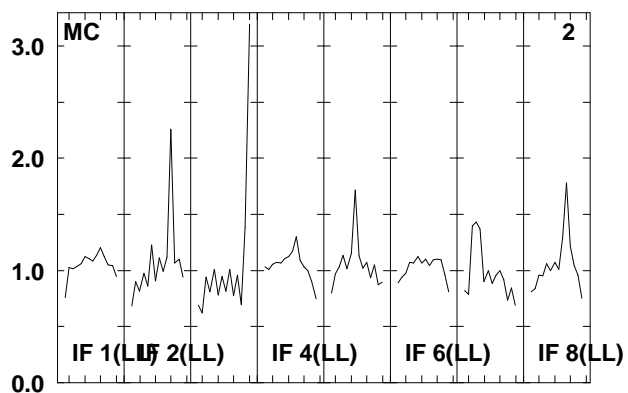
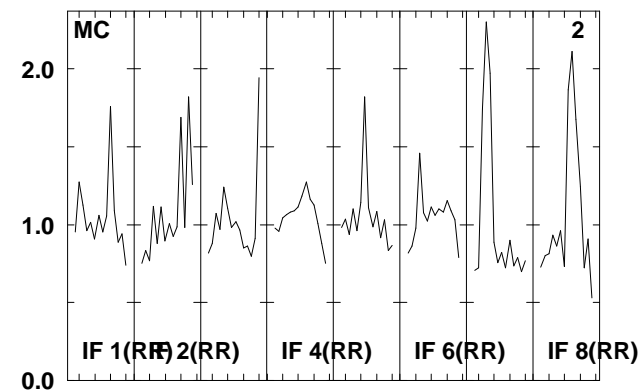
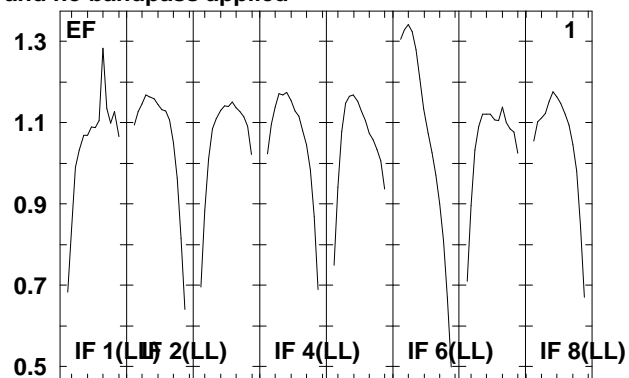
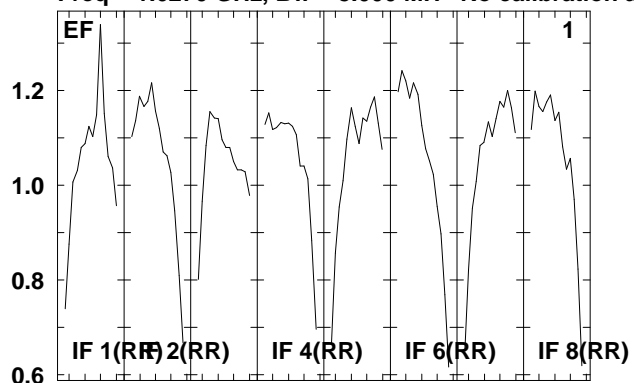

Lower frame: Real Jy

Total-power spectrum Antenna: \*

Timerange: 00/13:40:02 to 00/13:43:56

Plot file version 148 created 06-JAN-2009 10:57:57

J150407 EZ018B.UVDATA.1

Freq = 1.6270 GHz, Bw = 8.000 MH No calibration applied and no bandpass applied

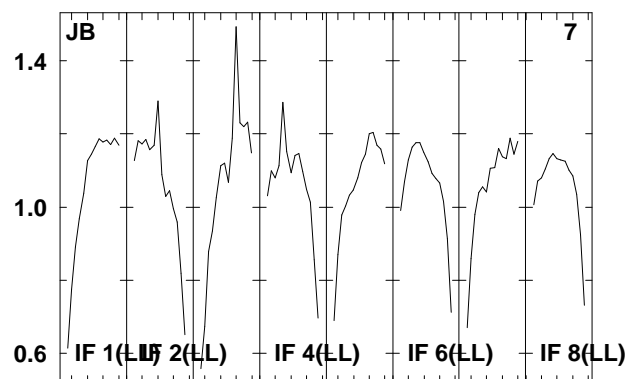
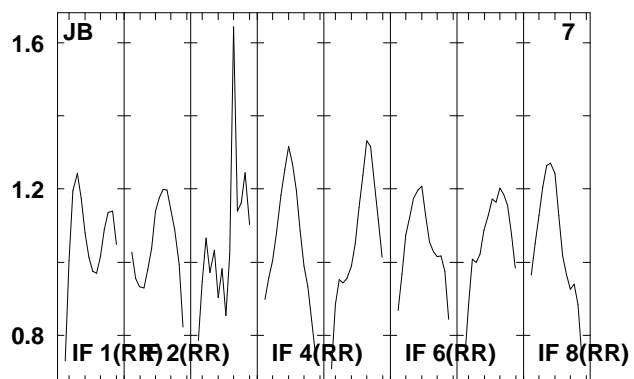
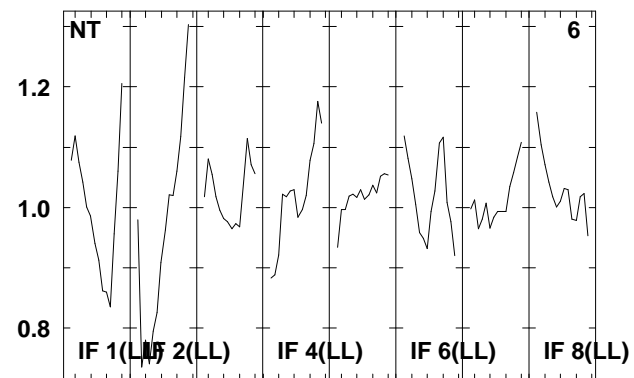
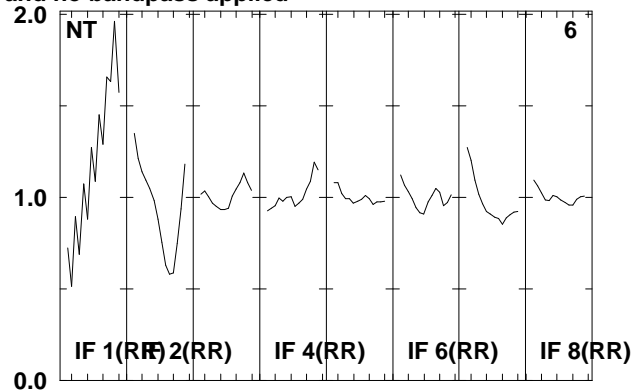
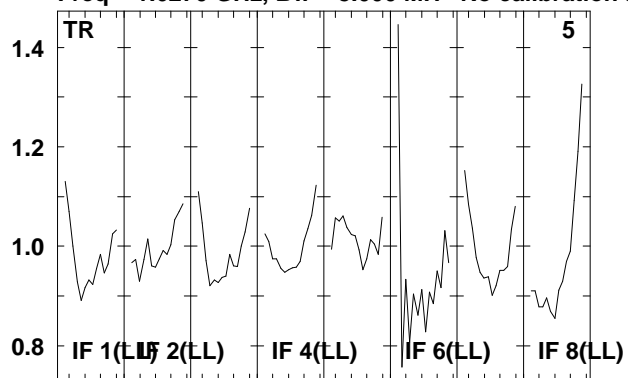

Lower frame: Real Jy  
Total-power spectrum Antenna: \*  
Timerange: 00/13:40:02 to 00/13:43:56

Plot file version 149 created 06-JAN-2009 10:57:57

J1510-05 EZ018B.UVDATA.1

Freq = 1.6270 GHz, Bw = 8.000 MH No calibration applied and no bandpass applied

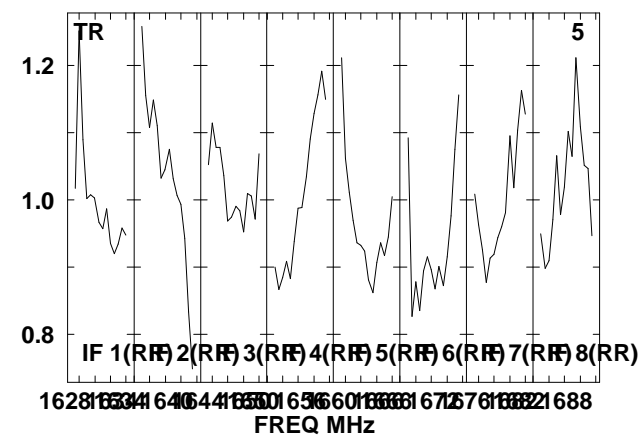
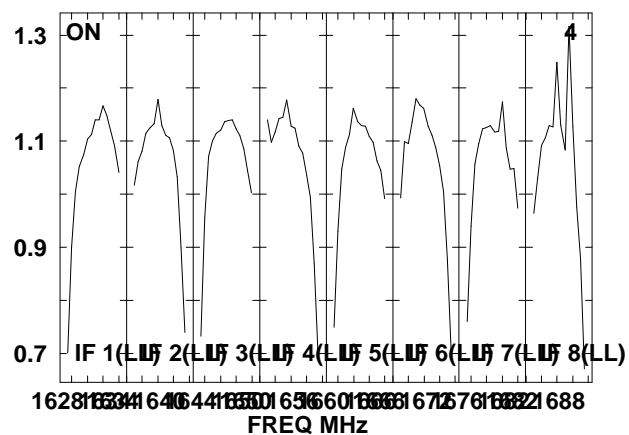
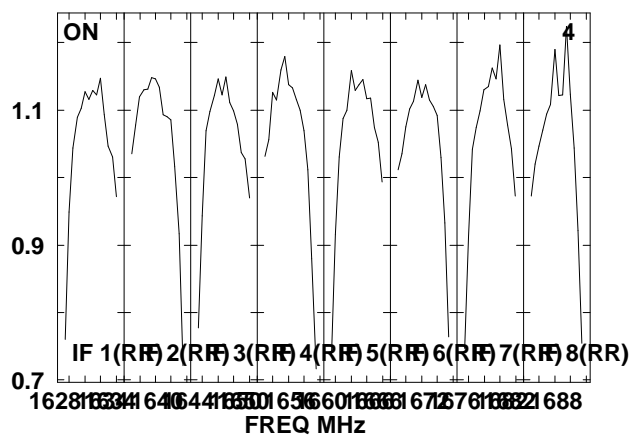
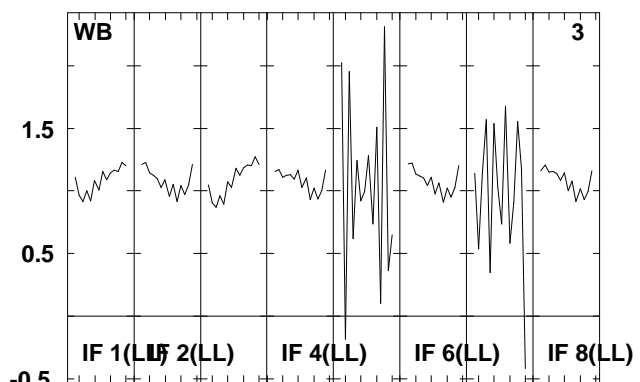
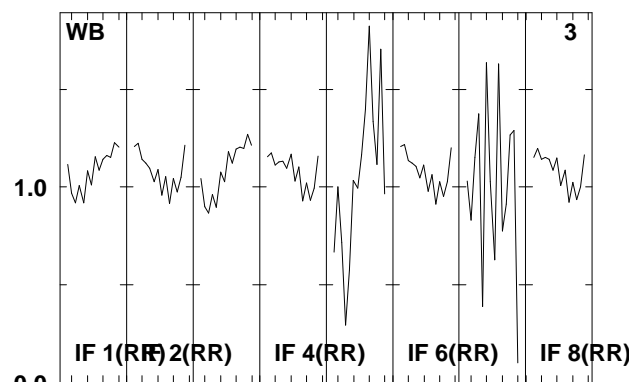
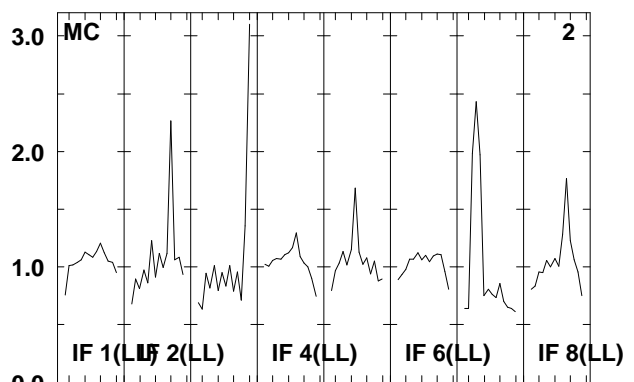
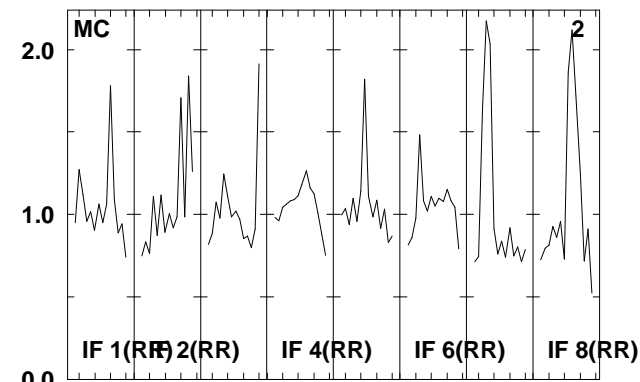
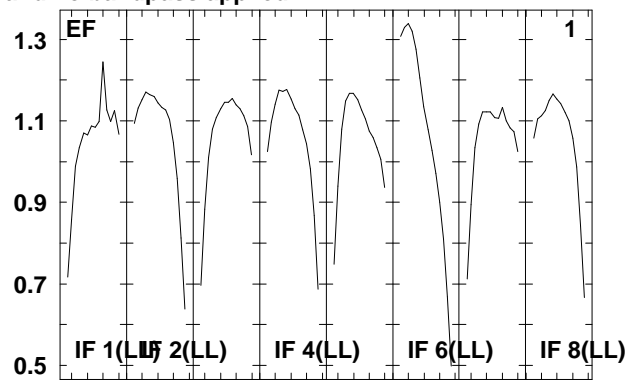
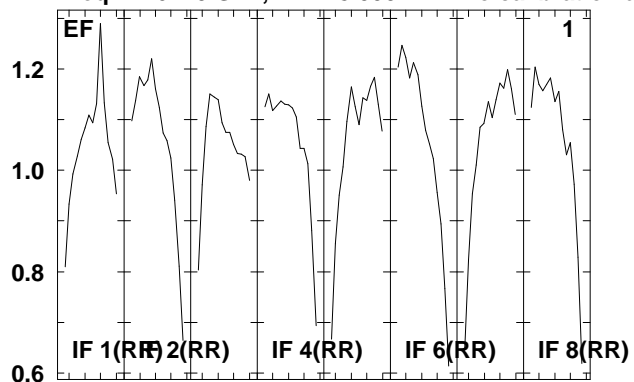

Lower frame: Real Jy  
Total-power spectrum Antenna: \*  
Timerange: 00/13:45:02 to 00/13:48:00

Plot file version 150 created 06-JAN-2009 10:57:58

J1510-05 EZ018B.UVDATA.1

Freq = 1.6270 GHz, Bw = 8.000 MH No calibration applied and no bandpass applied

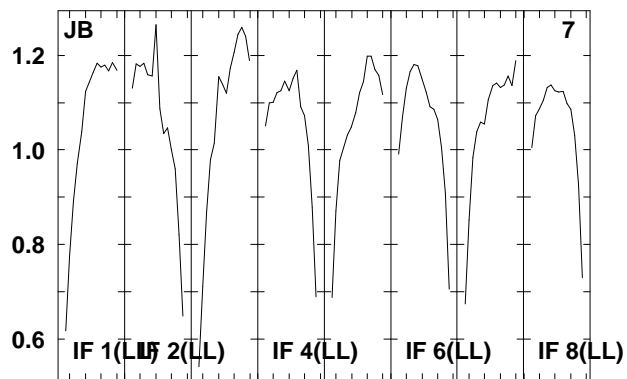
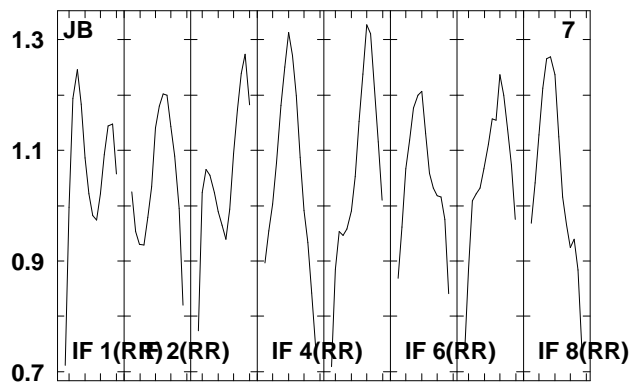
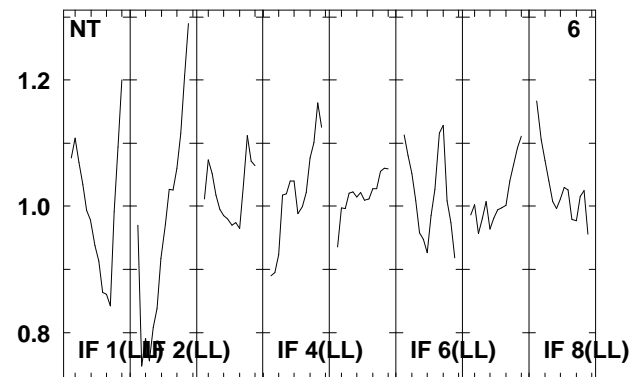
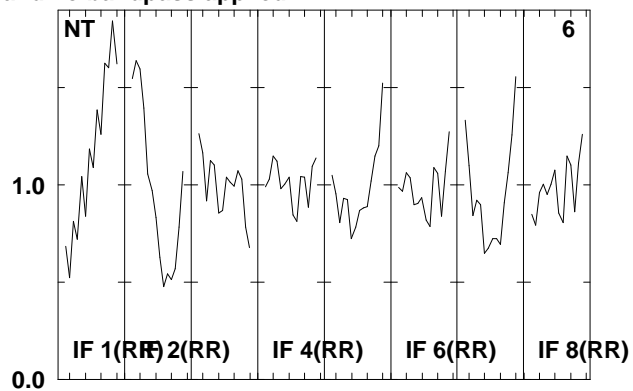
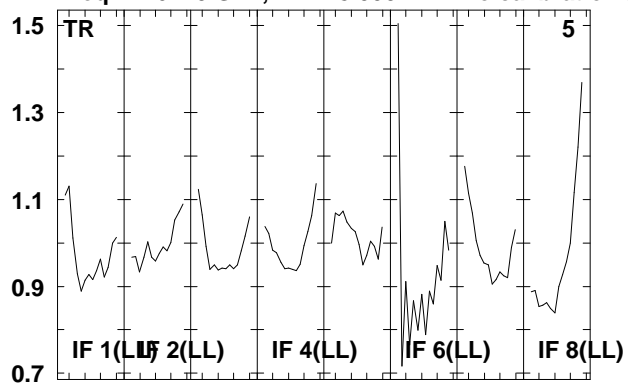

Lower frame: Real Jy  
Total-power spectrum Antenna: \*  
Timerange: 00/13:45:02 to 00/13:48:00

Plot file version 151 created 06-JAN-2009 10:57:58

J150407 EZ018B.UVDATA.1

Freq = 1.6270 GHz, Bw = 8.000 MH No calibration applied and no bandpass applied

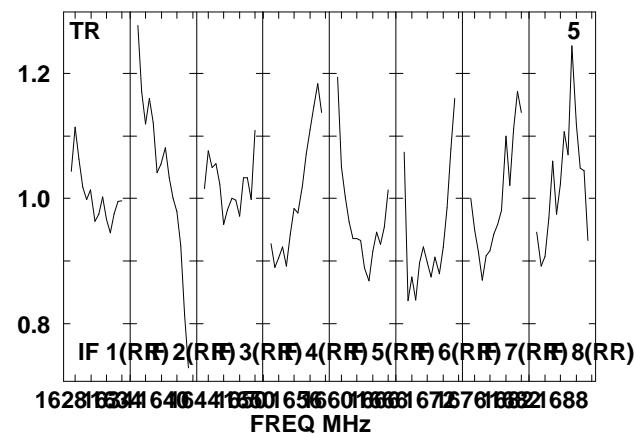
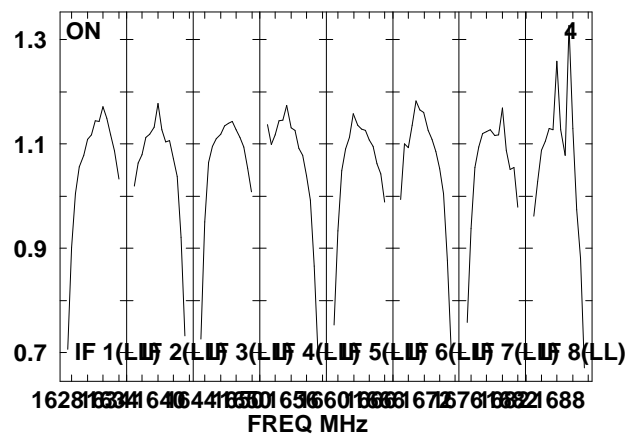
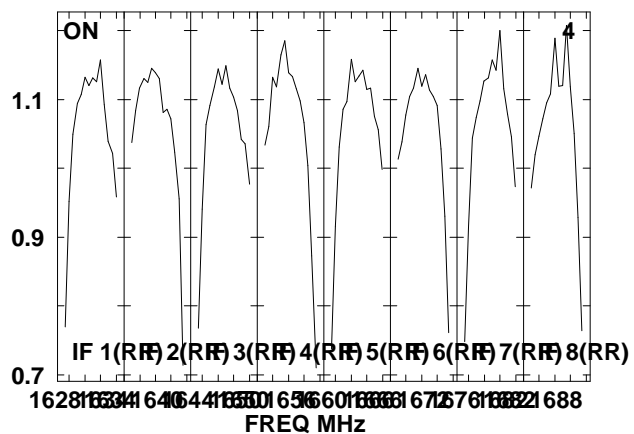
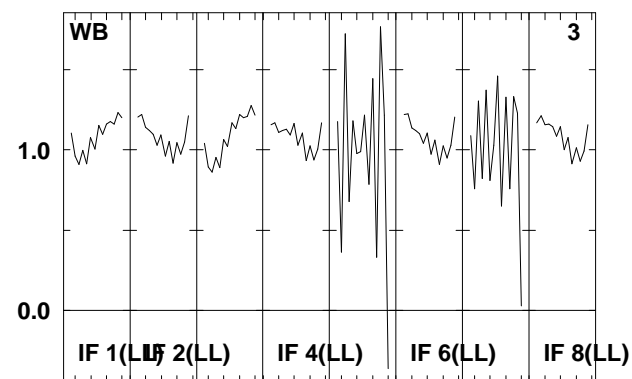
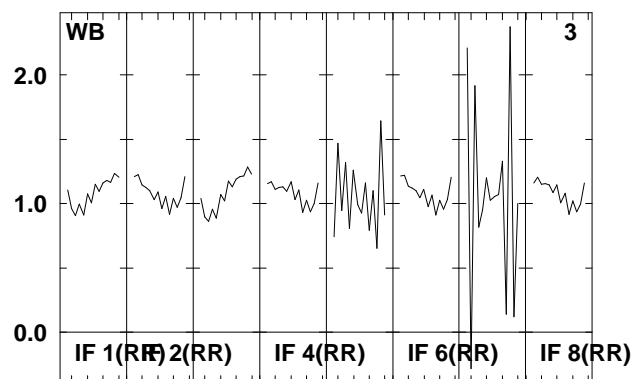
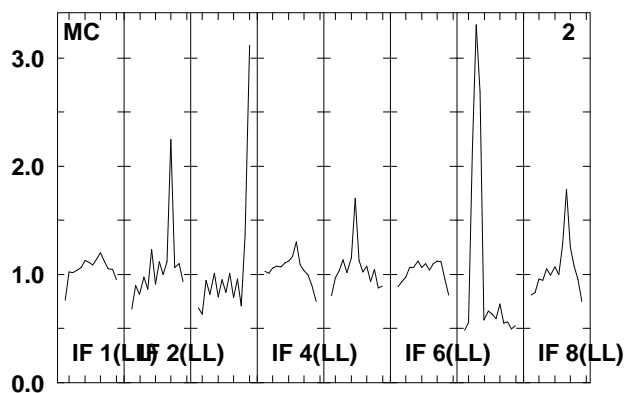
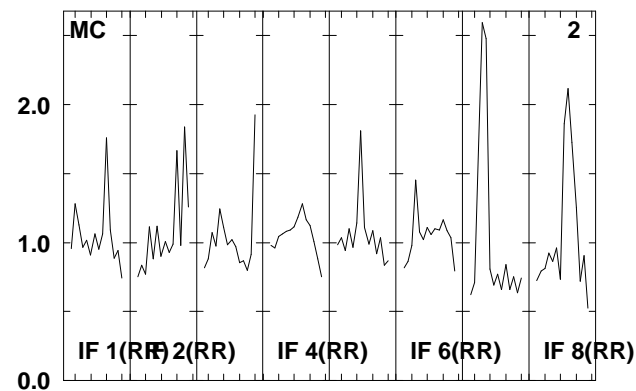
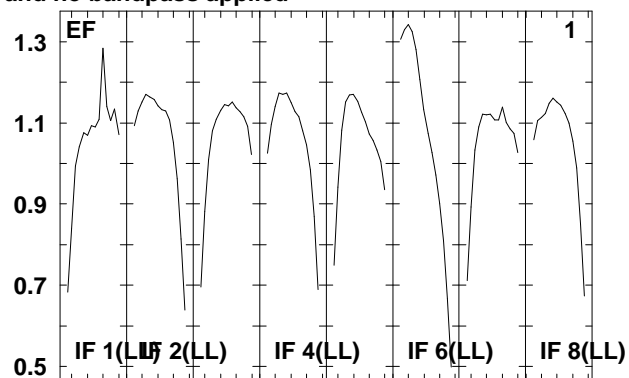
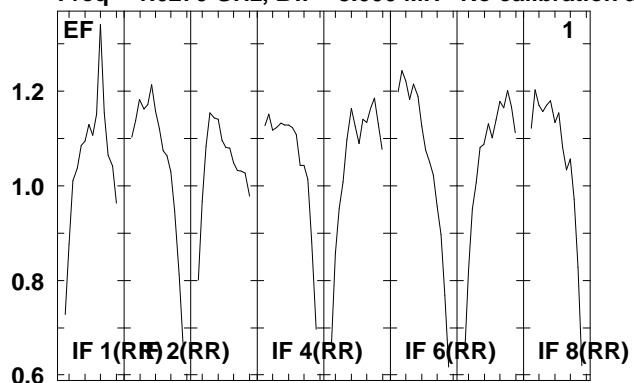

Lower frame: Real Jy

Total-power spectrum Antenna: \*

Timerange: 00/13:48:02 to 00/13:52:00

Plot file version 152 created 06-JAN-2009 10:57:59

J150407 EZ018B.UVDATA.1

Freq = 1.6270 GHz, Bw = 8.000 MH No calibration applied and no bandpass applied

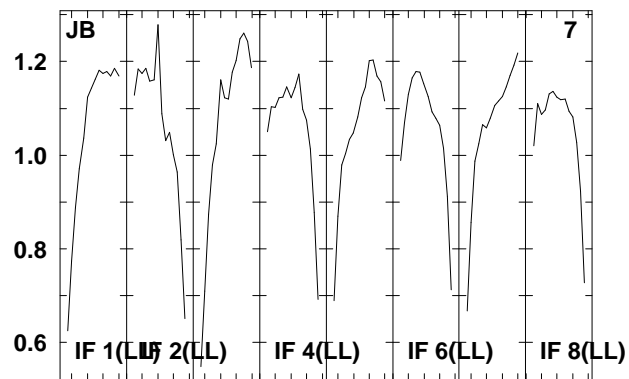
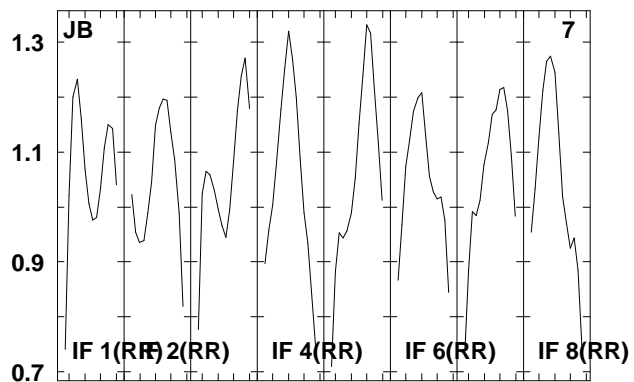
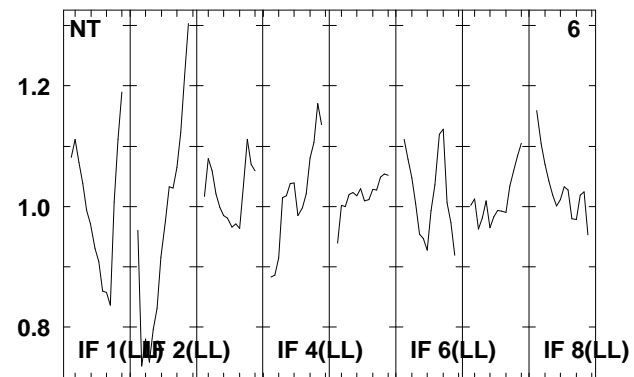
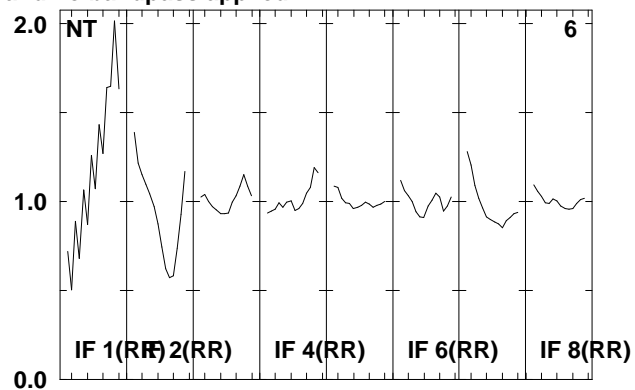
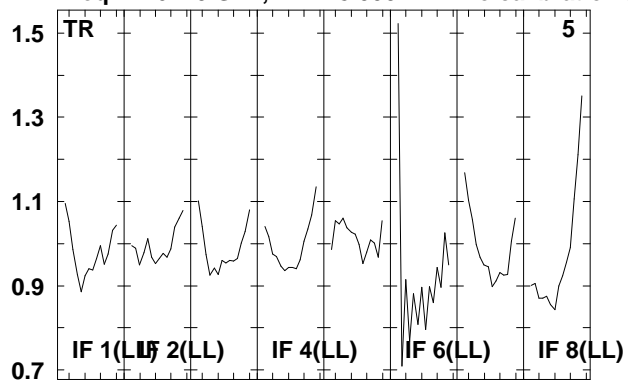

Lower frame: Real Jy  
Total-power spectrum Antenna: \*  
Timerange: 00/13:48:02 to 00/13:52:00



Plot file version 153 created 06-JAN-2009 10:57:59

J1510-05 EZ018B.UVDATA.1

Freq = 1.6270 GHz, Bw = 8.000 MH No calibration applied and no bandpass applied

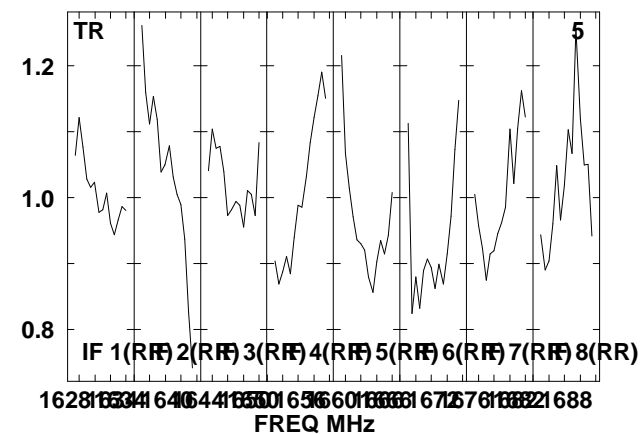
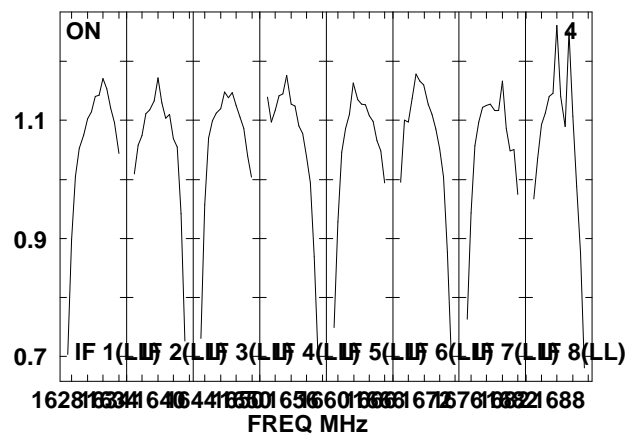
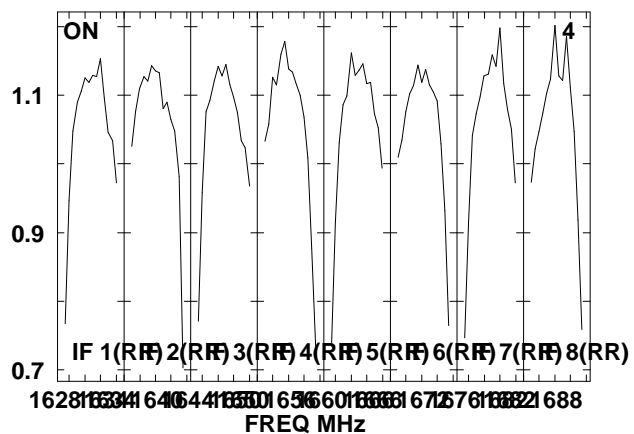
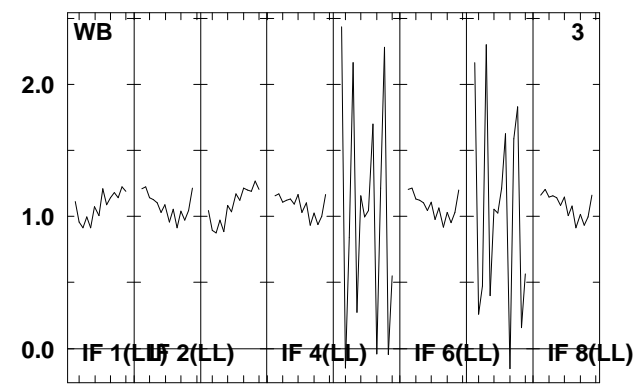
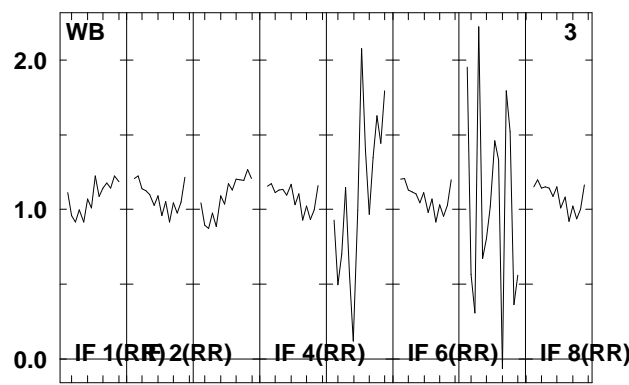
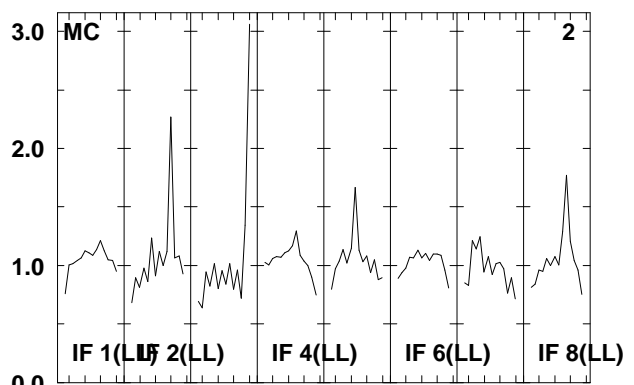
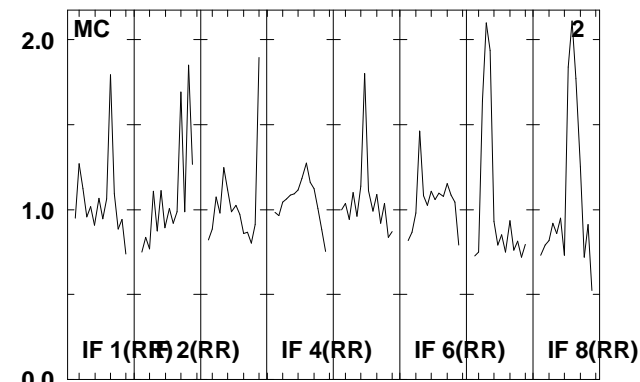
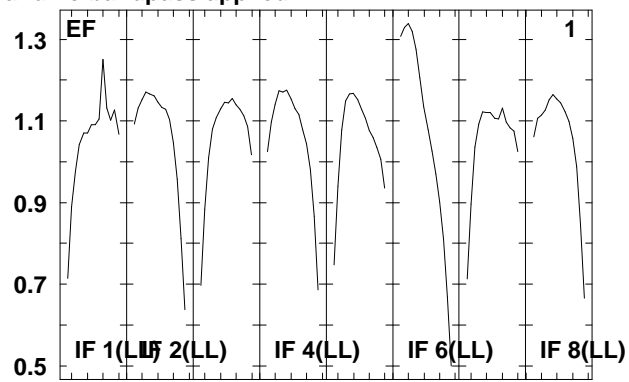
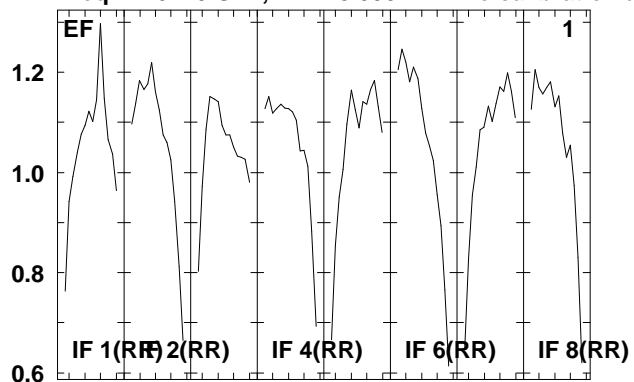

Lower frame: Real Jy  
Total-power spectrum Antenna: \*  
Timerange: 00/13:52:02 to 00/13:55:00

Plot file version 154 created 06-JAN-2009 10:57:59

J1510-05 EZ018B.UVDATA.1

Freq = 1.6270 GHz, Bw = 8.000 MH No calibration applied and no bandpass applied

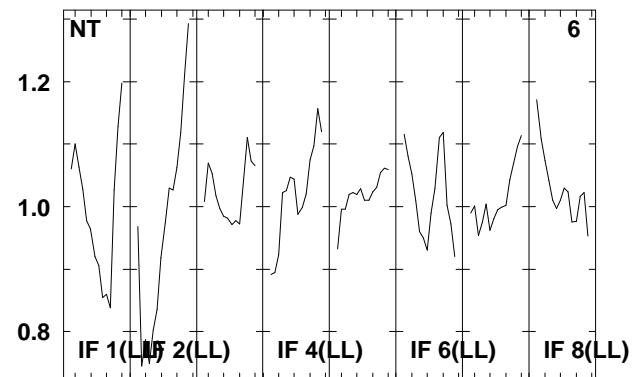
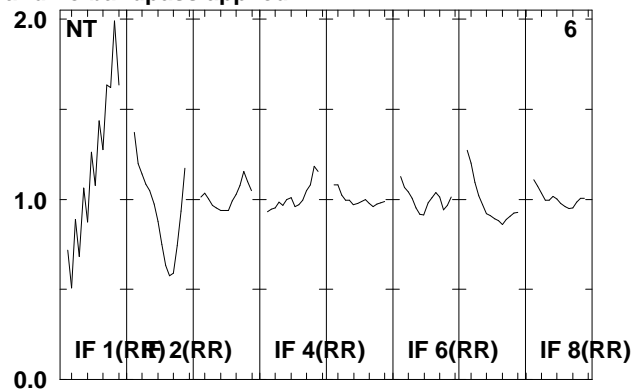
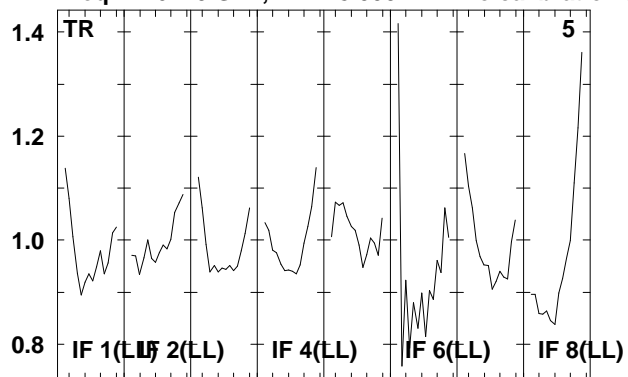

Lower frame: Real Jy  
Total-power spectrum Antenna: \*  
Timerange: 00/13:52:02 to 00/13:55:00

Plot file version 155 created 06-JAN-2009 10:58:00

J150407 EZ018B.UVDATA.1

Freq = 1.6270 GHz, Bw = 8.000 MH No calibration applied and no bandpass applied

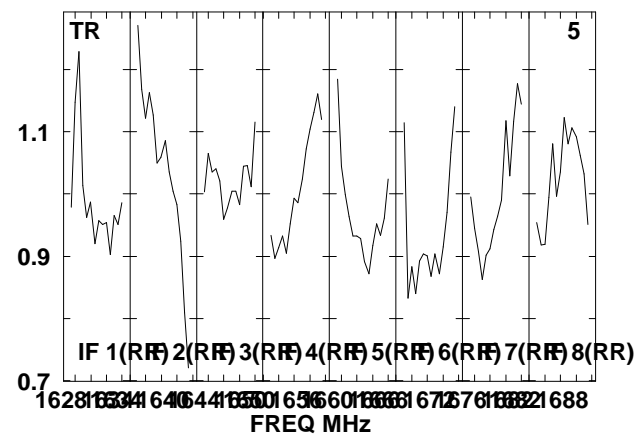
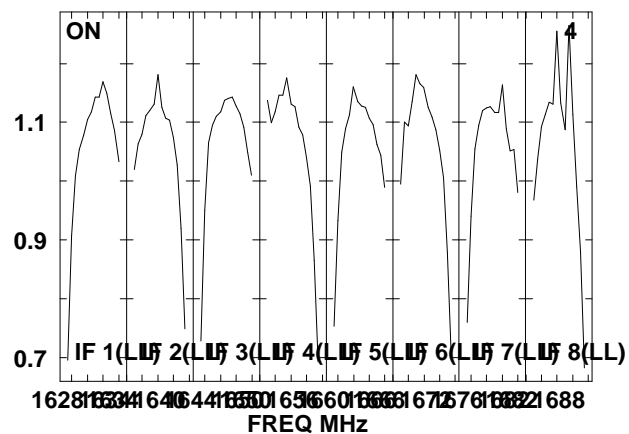
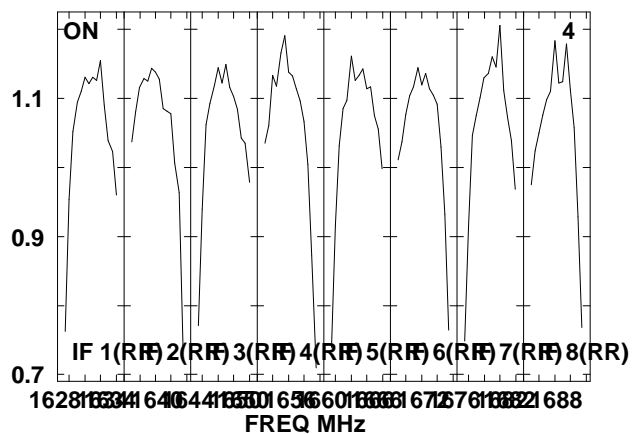
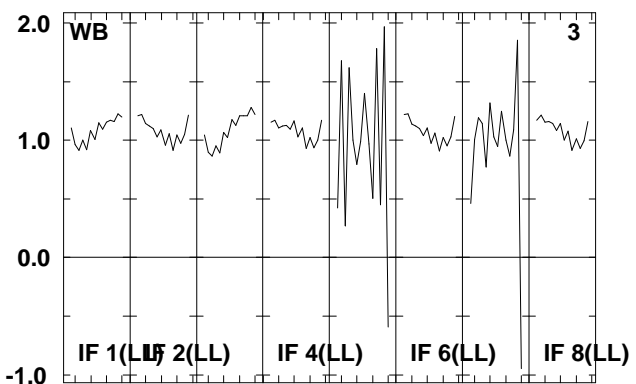
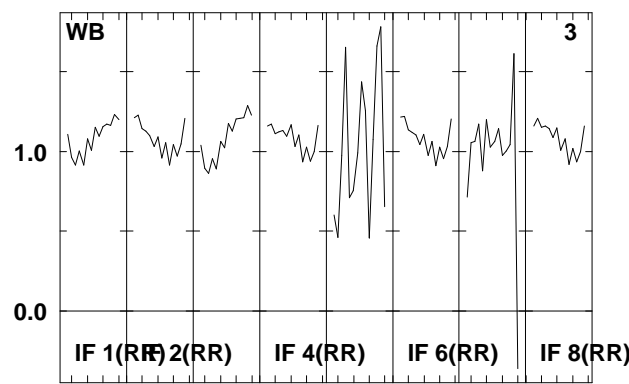
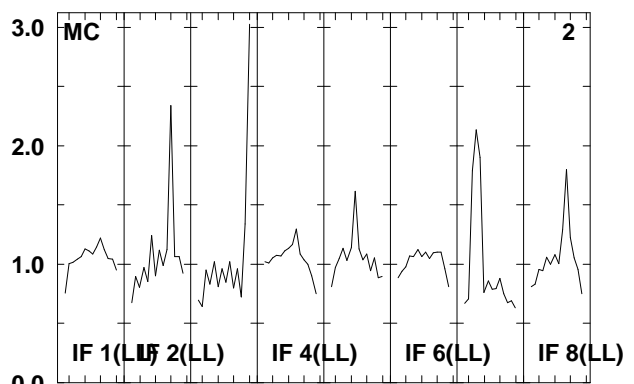
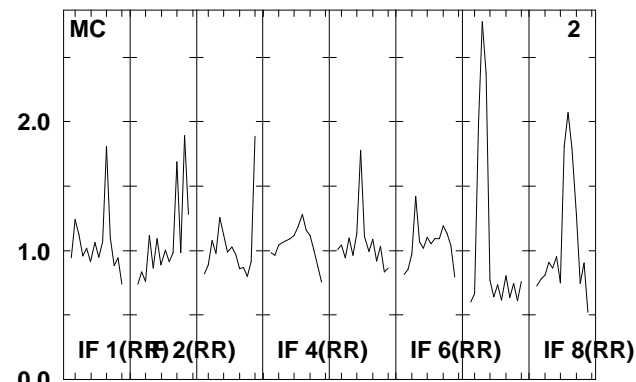
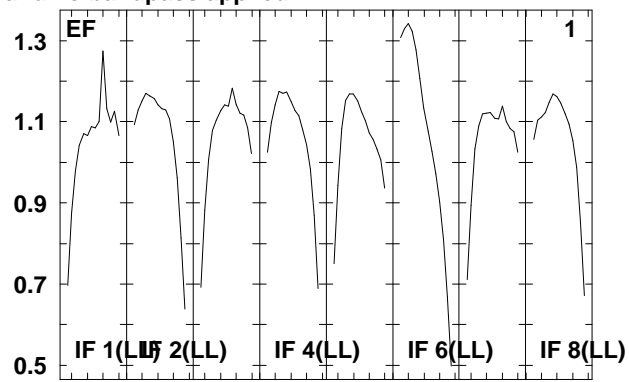
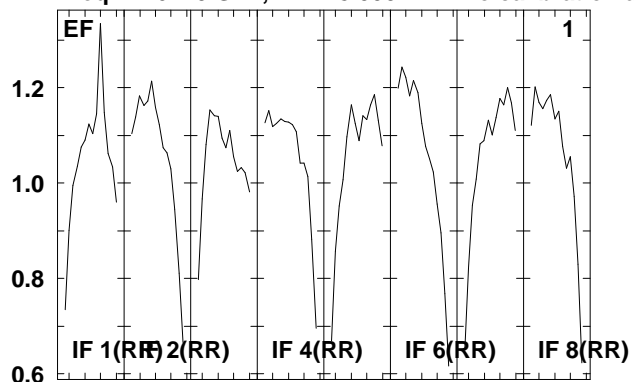

Lower frame: Real Jy  
Total-power spectrum Antenna: \*  
Timerange: 00/13:55:02 to 00/13:58:58

Plot file version 156 created 06-JAN-2009 10:58:00

J150407 EZ018B.UVDATA.1

Freq = 1.6270 GHz, Bw = 8.000 MH No calibration applied and no bandpass applied

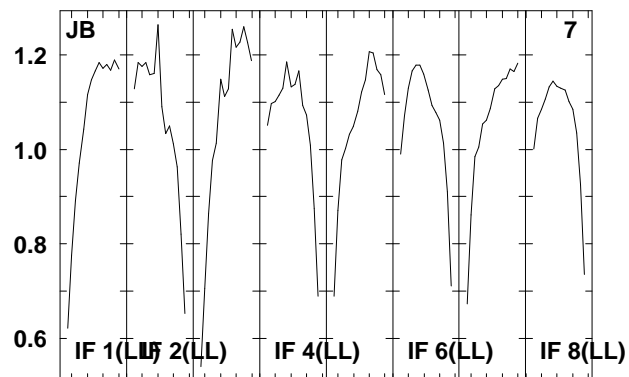
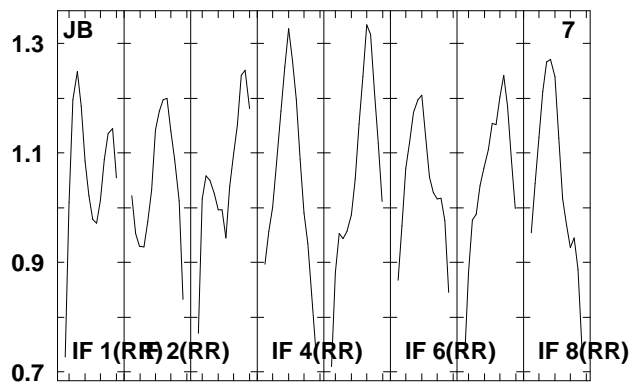
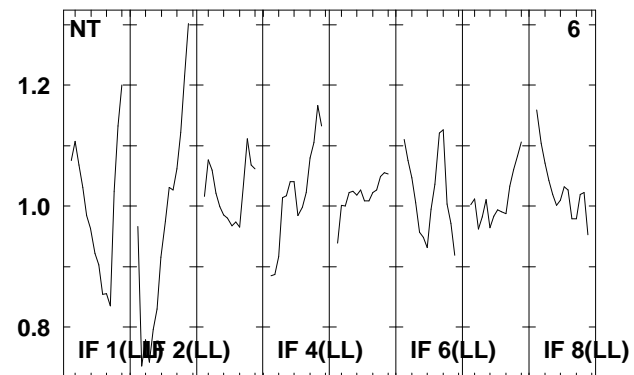
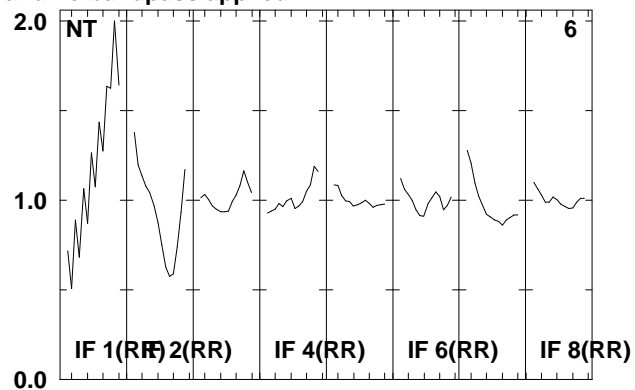
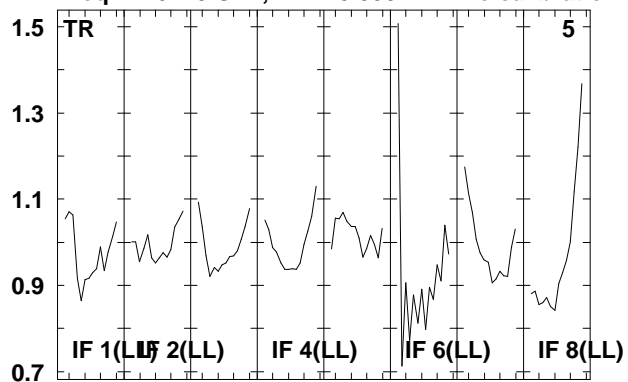

Lower frame: Real Jy  
Total-power spectrum Antenna: \*  
Timerange: 00/13:55:02 to 00/13:58:58

Plot file version 157 created 06-JAN-2009 10:58:01

J1510-05 EZ018B.UVDATA.1

Freq = 1.6270 GHz, Bw = 8.000 MH No calibration applied and no bandpass applied

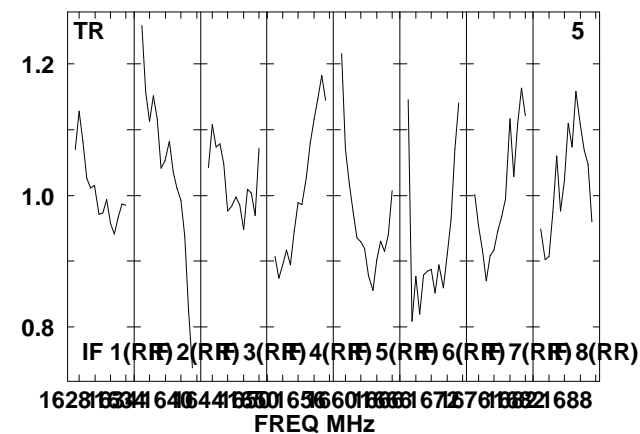
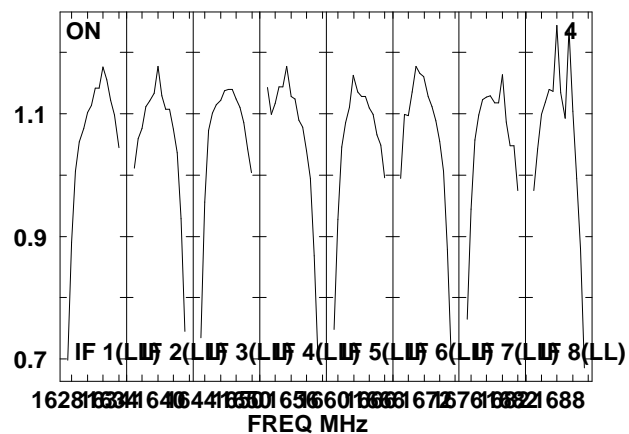
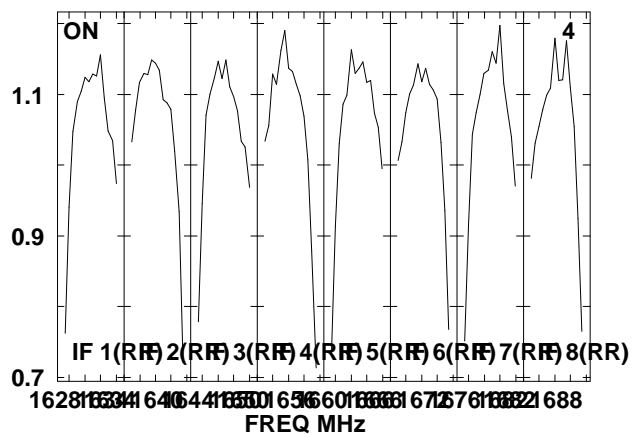
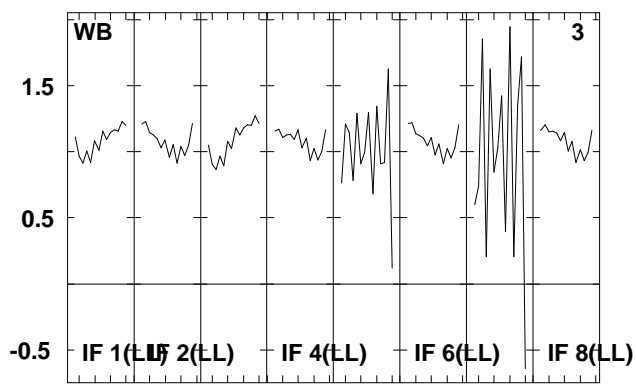
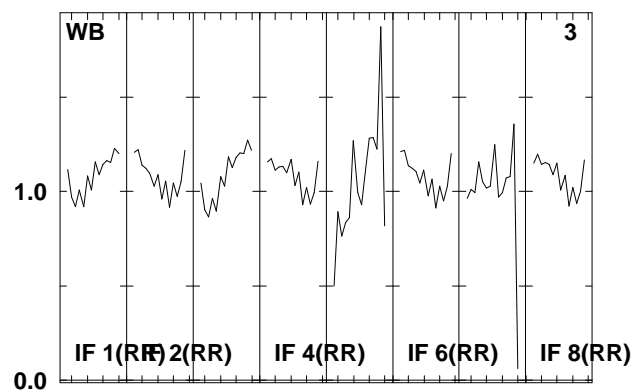
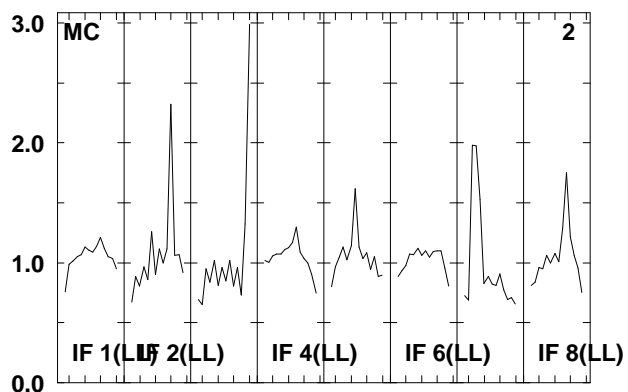
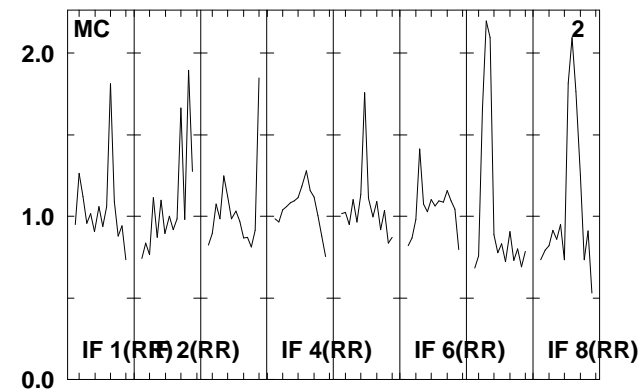
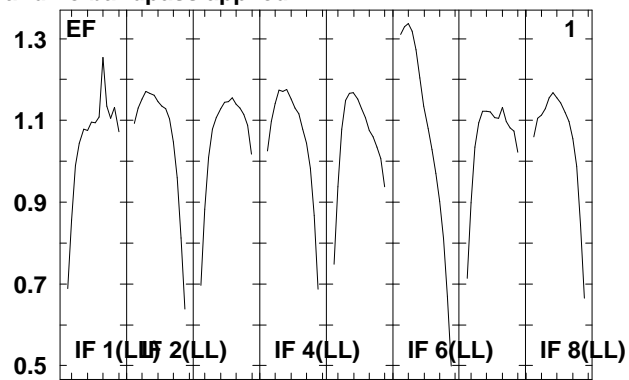
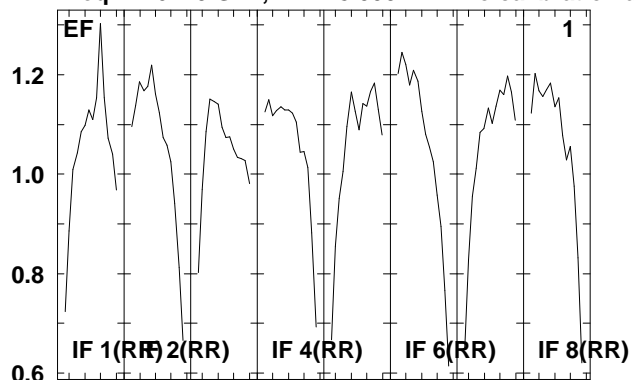

Lower frame: Real Jy

Total-power spectrum Antenna: \*

Timerange: 00/14:00:02 to 00/14:03:00

Plot file version 158 created 06-JAN-2009 10:58:01

J1510-05 EZ018B.UVDATA.1

Freq = 1.6270 GHz, Bw = 8.000 MH No calibration applied and no bandpass applied

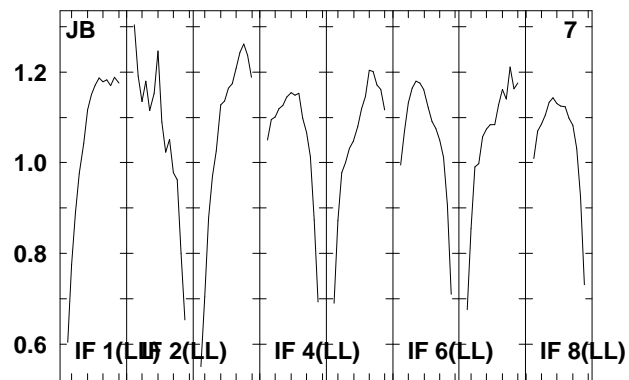
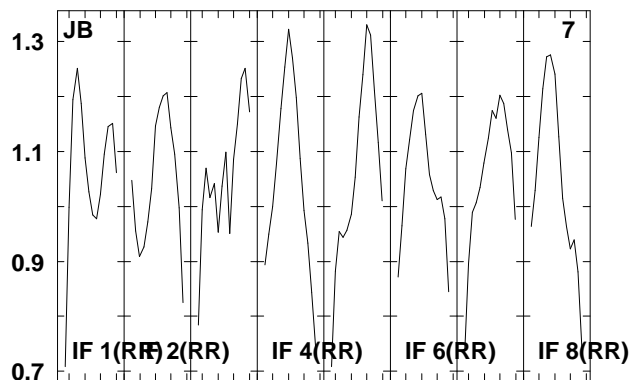
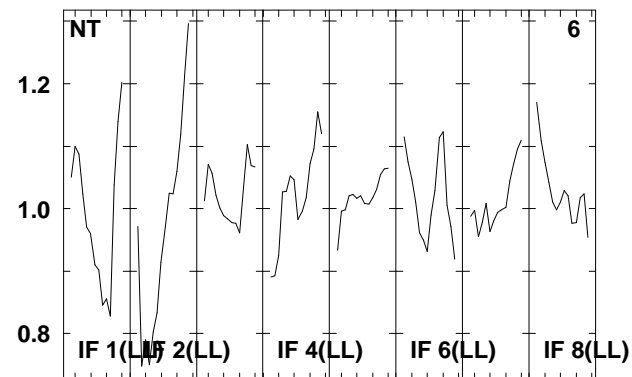
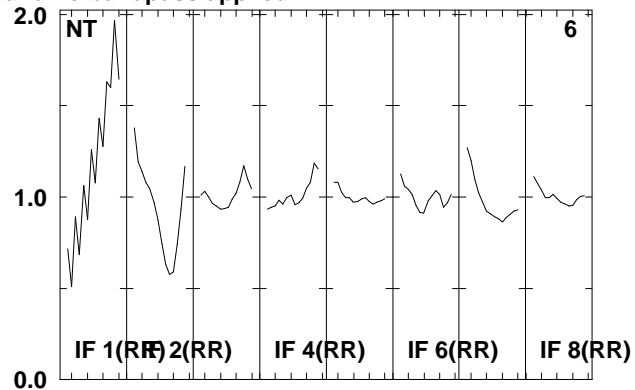
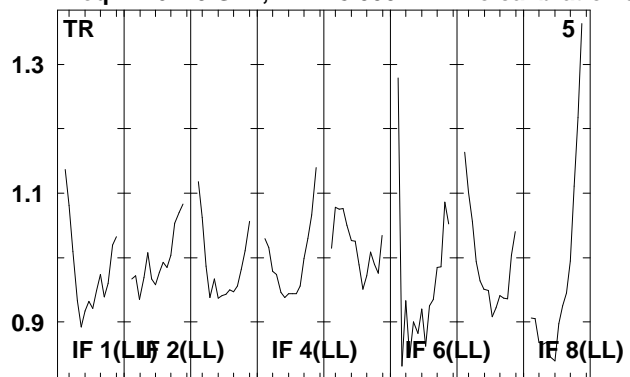

Lower frame: Real Jy  
Total-power spectrum Antenna: \*  
Timerange: 00/14:00:02 to 00/14:03:00

Plot file version 159 created 06-JAN-2009 10:58:01

J150407 EZ018B.UVDATA.1

Freq = 1.6270 GHz, Bw = 8.000 MH No calibration applied and no bandpass applied

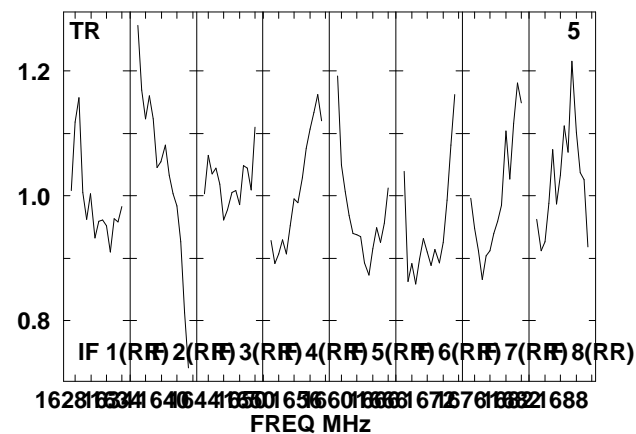
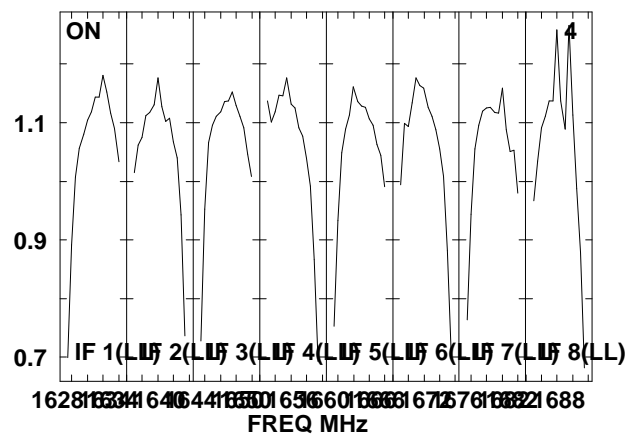
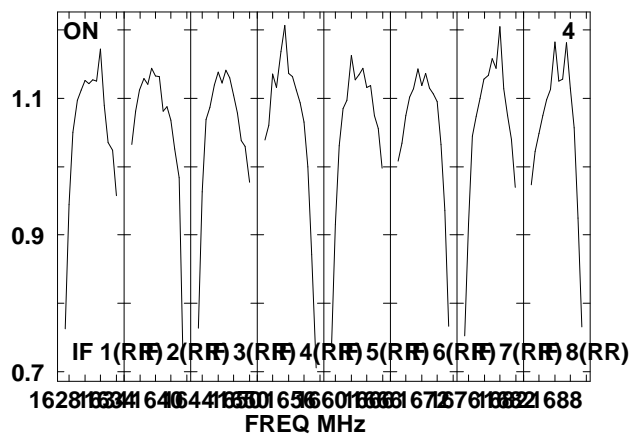
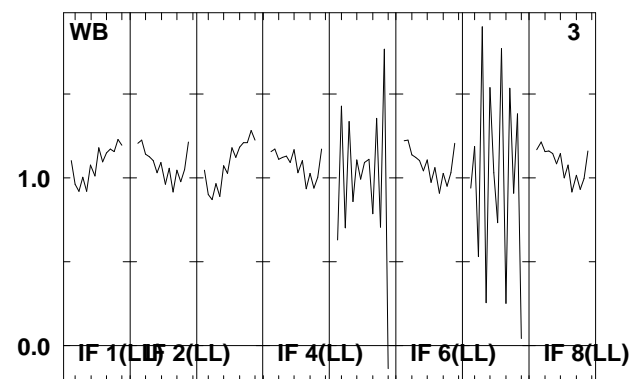
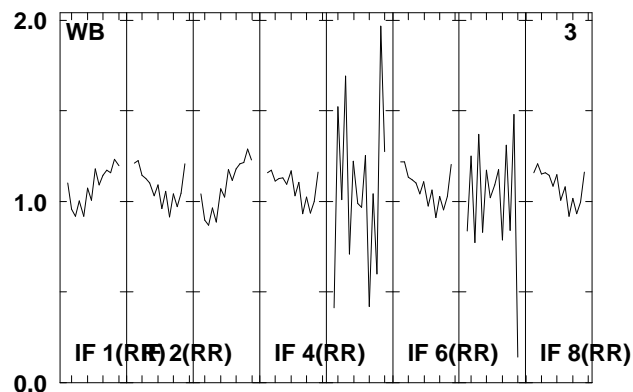
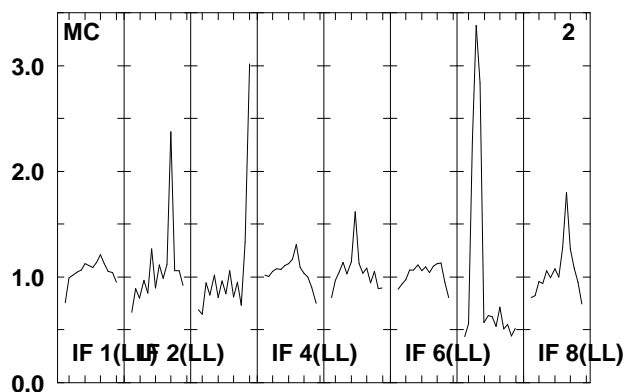
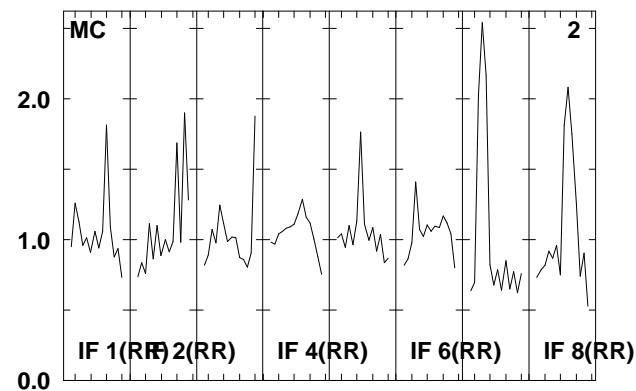
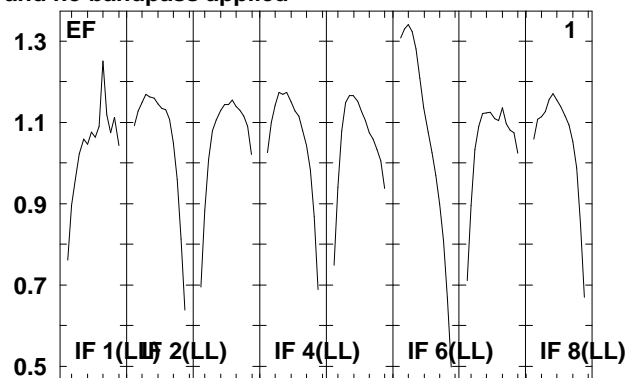
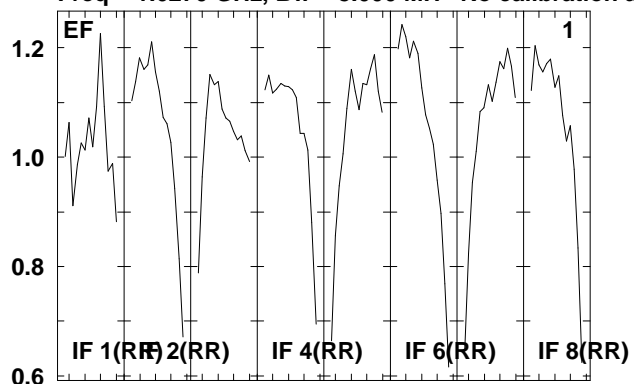

Lower frame: Real Jy

Total-power spectrum Antenna: \*

Timerange: 00/14:03:02 to 00/14:07:00

Plot file version 160 created 06-JAN-2009 10:58:02

J150407 EZ018B.UVDATA.1

Freq = 1.6270 GHz, Bw = 8.000 MH No calibration applied and no bandpass applied

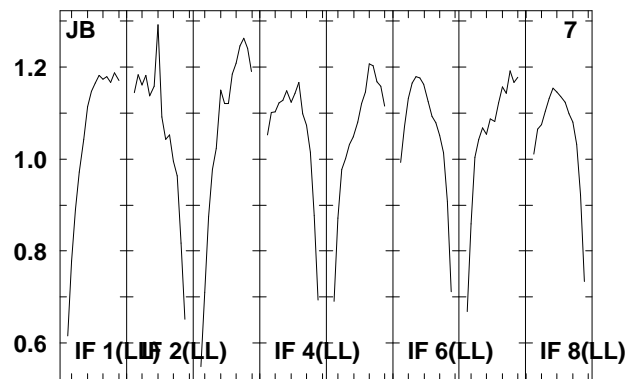
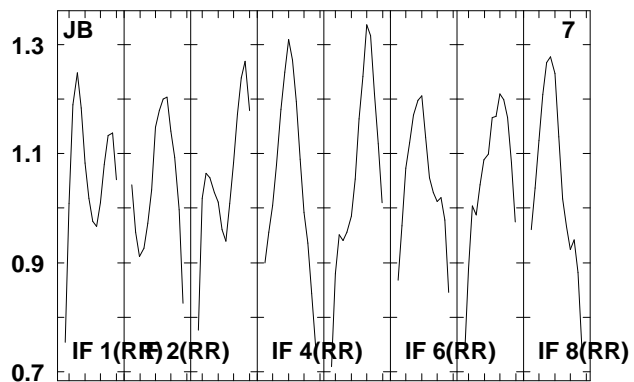
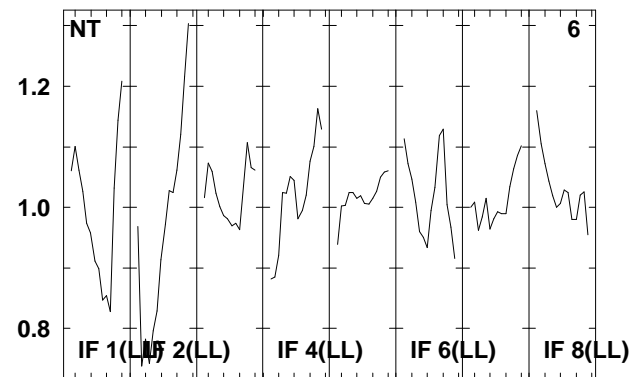
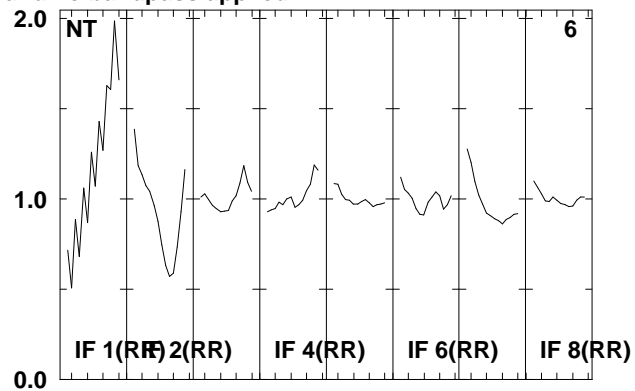
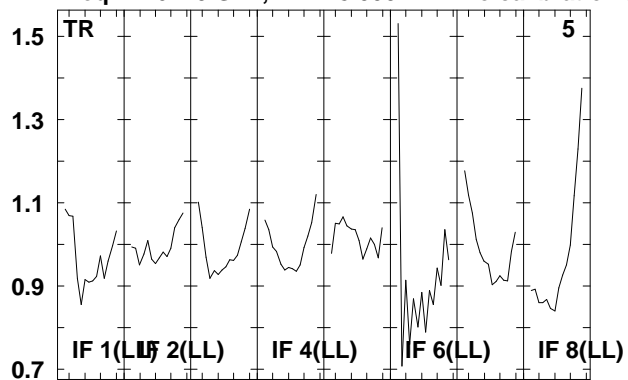

Lower frame: Real Jy  
Total-power spectrum Antenna: \*  
Timerange: 00/14:03:02 to 00/14:07:00



Plot file version 161 created 06-JAN-2009 10:58:02

J1510-05 EZ018B.UVDATA.1

Freq = 1.6270 GHz, Bw = 8.000 MH No calibration applied and no bandpass applied

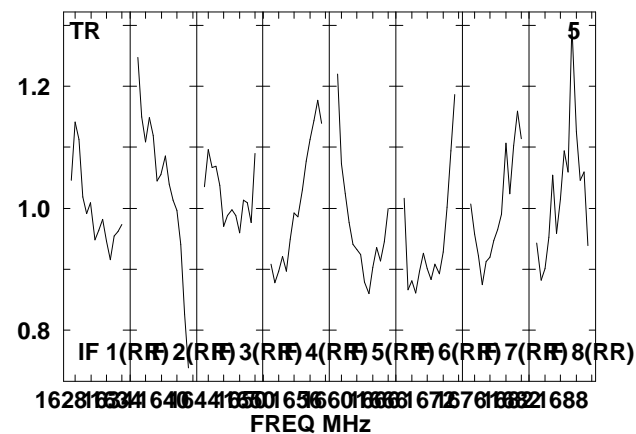
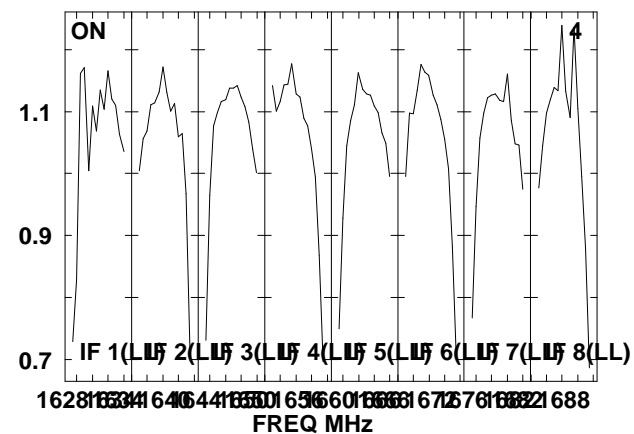
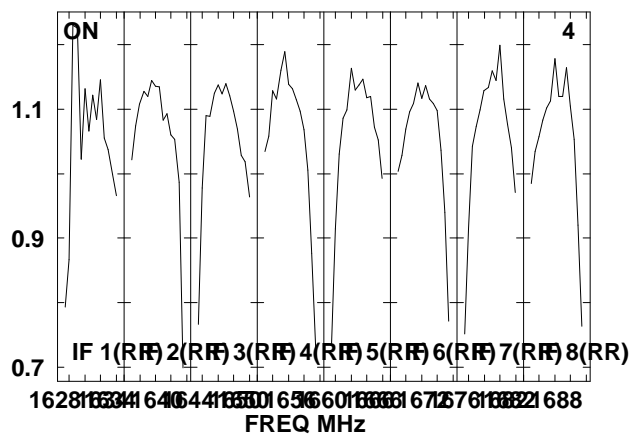
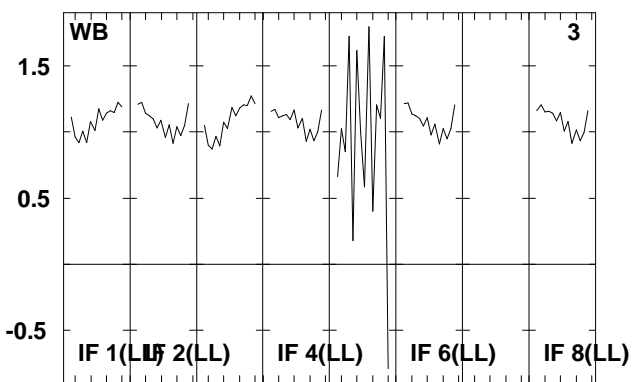
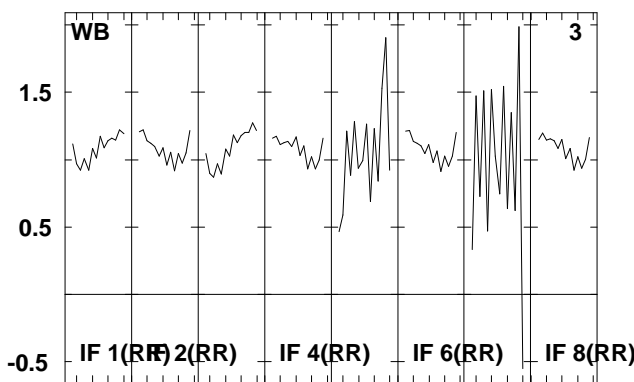
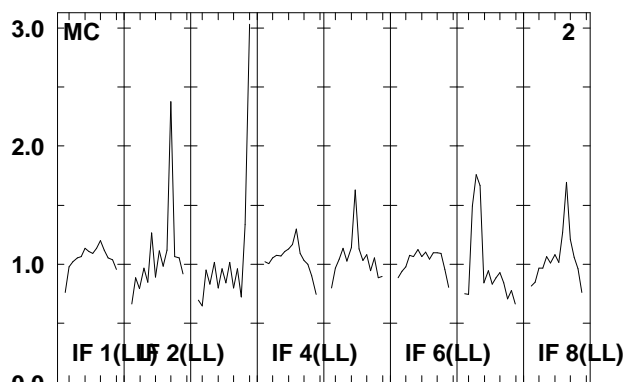
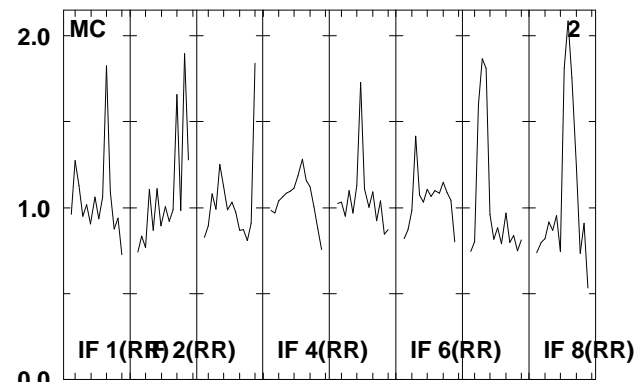
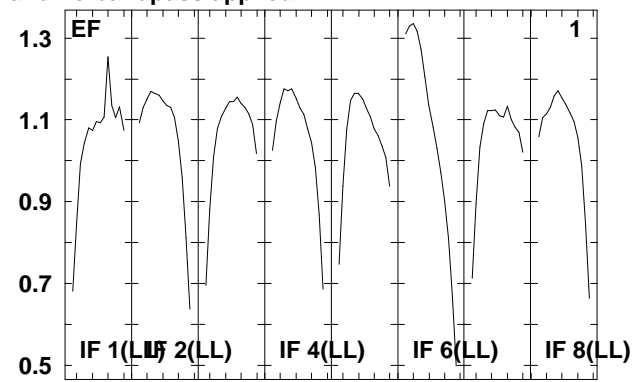
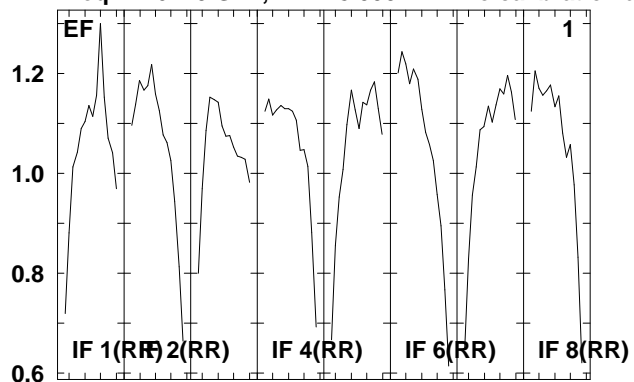

Lower frame: Real Jy  
Total-power spectrum Antenna: \*  
Timerange: 00/14:07:02 to 00/14:10:00

Plot file version 162 created 06-JAN-2009 10:58:03

J1510-05 EZ018B.UVDATA.1

Freq = 1.6270 GHz, Bw = 8.000 MH No calibration applied and no bandpass applied

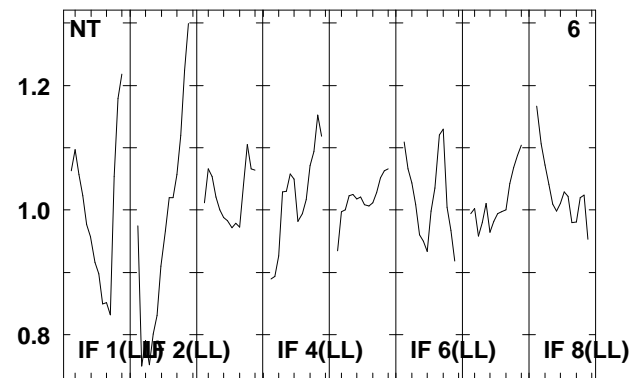
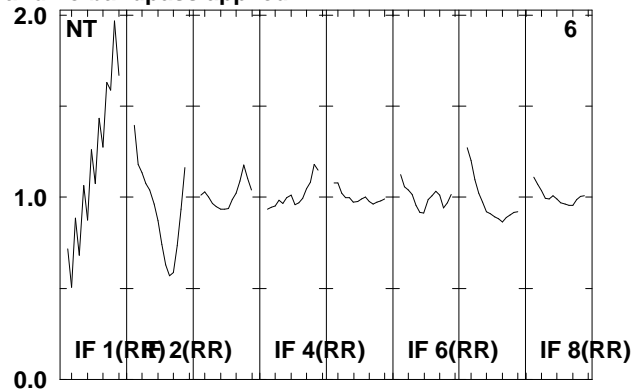
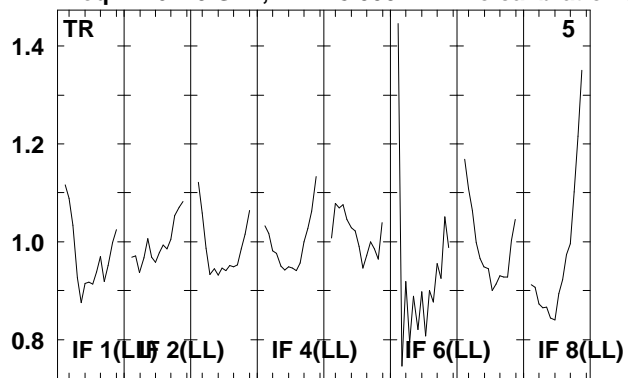

Lower frame: Real Jy  
Total-power spectrum Antenna: \*  
Timerange: 00/14:07:02 to 00/14:10:00

Plot file version 163 created 06-JAN-2009 10:58:03

J150407 EZ018B.UVDATA.1

Freq = 1.6270 GHz, Bw = 8.000 MH No calibration applied and no bandpass applied

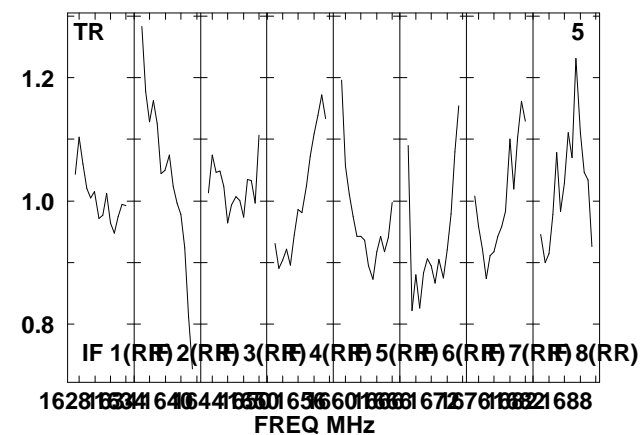
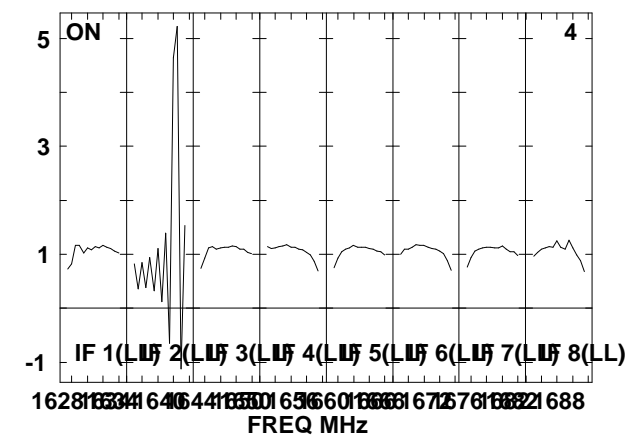
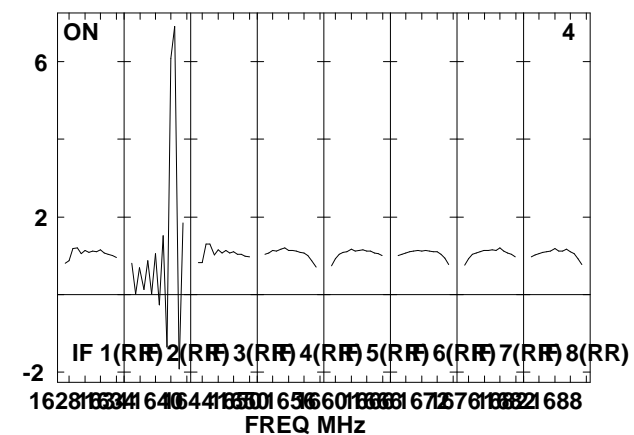
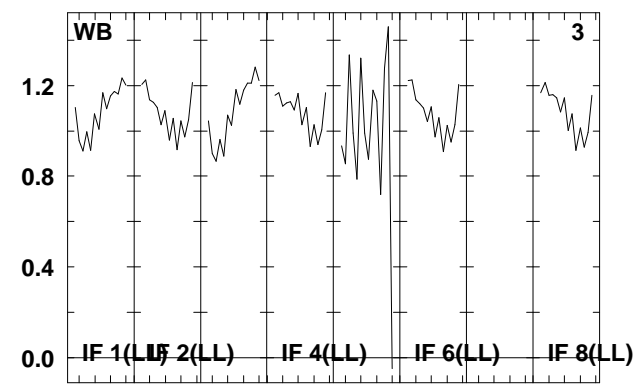
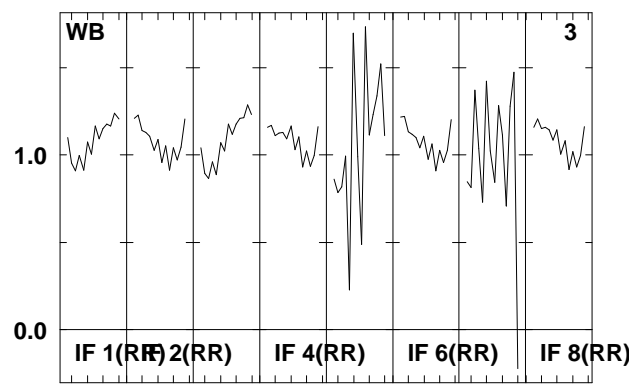
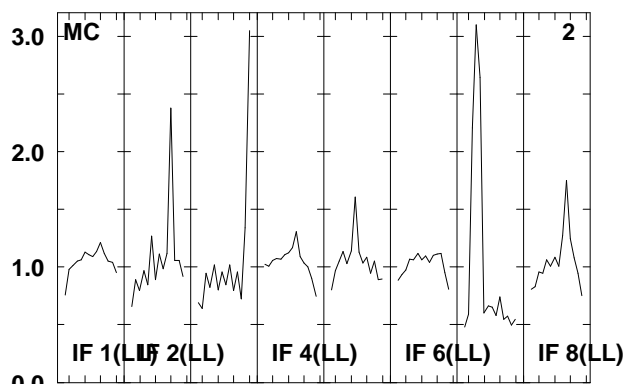
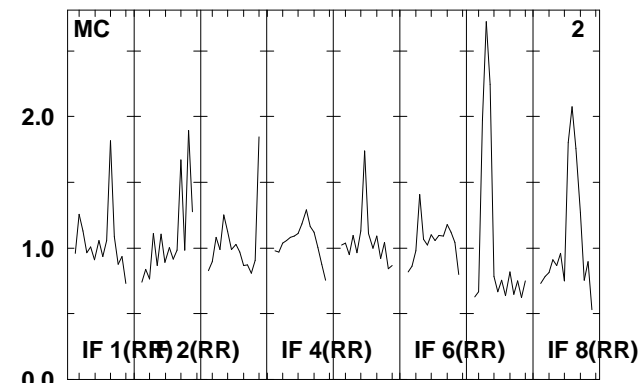
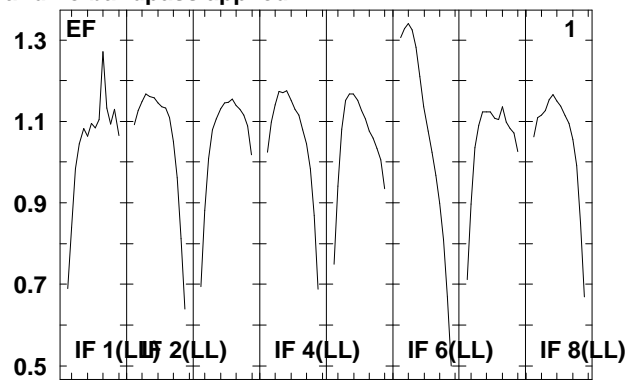
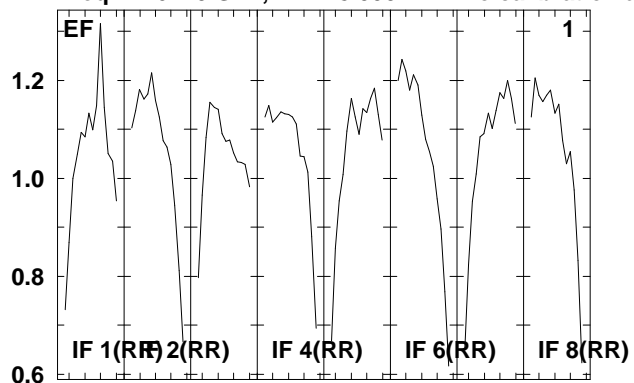

Lower frame: Real Jy  
Total-power spectrum Antenna: \*  
Timerange: 00/14:10:02 to 00/14:14:00

Plot file version 164 created 06-JAN-2009 10:58:03

J150407 EZ018B.UVDATA.1

Freq = 1.6270 GHz, Bw = 8.000 MH No calibration applied and no bandpass applied

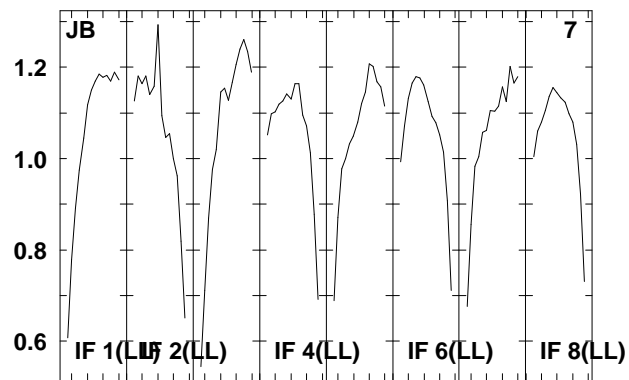
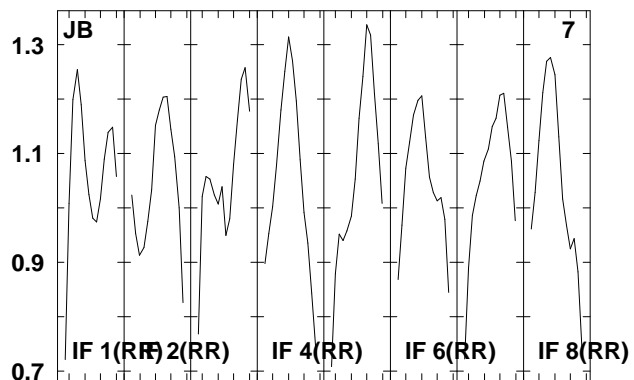
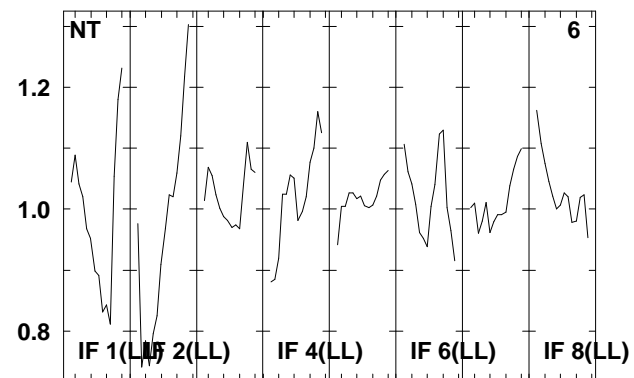
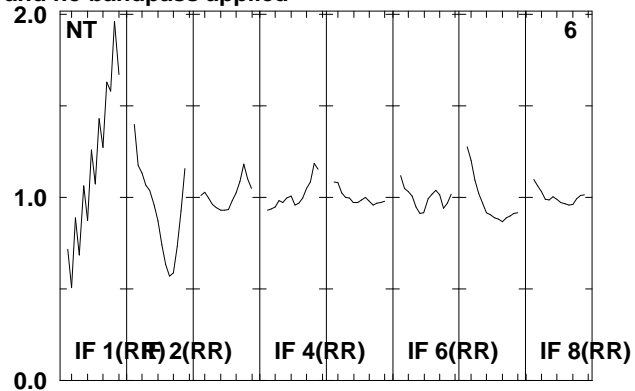
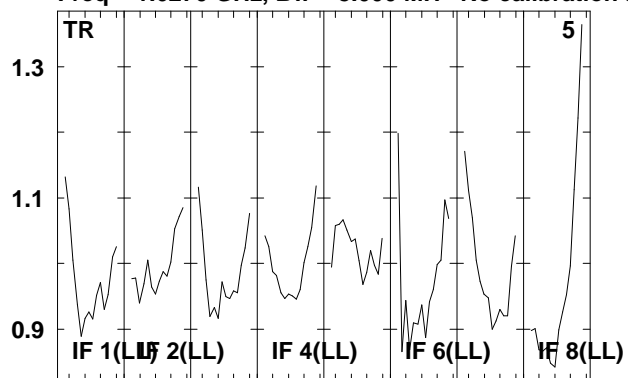

Lower frame: Real Jy  
Total-power spectrum Antenna: \*  
Timerange: 00/14:10:02 to 00/14:14:00

Plot file version 165 created 06-JAN-2009 10:58:04

J1510-05 EZ018B.UVDATA.1

Freq = 1.6270 GHz, Bw = 8.000 MH No calibration applied and no bandpass applied

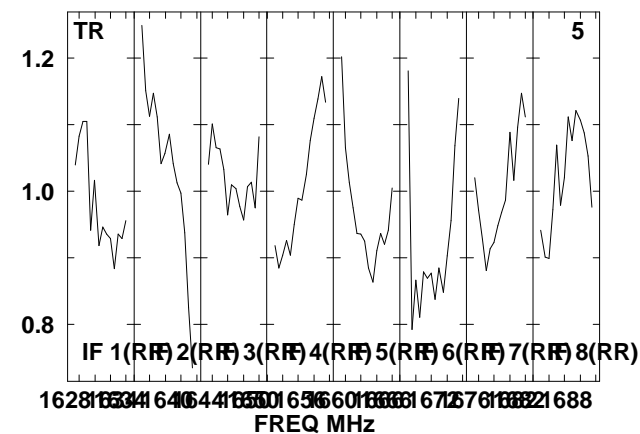
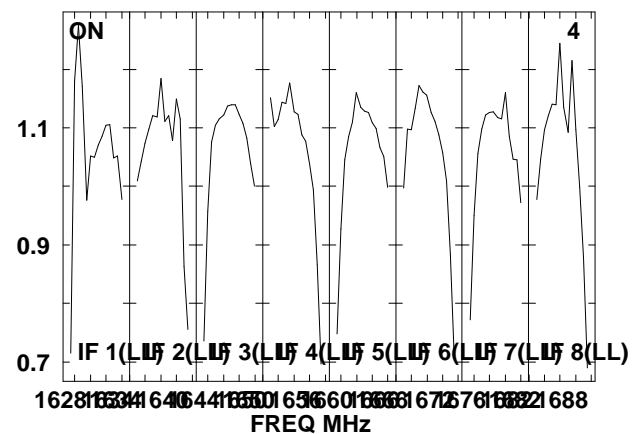
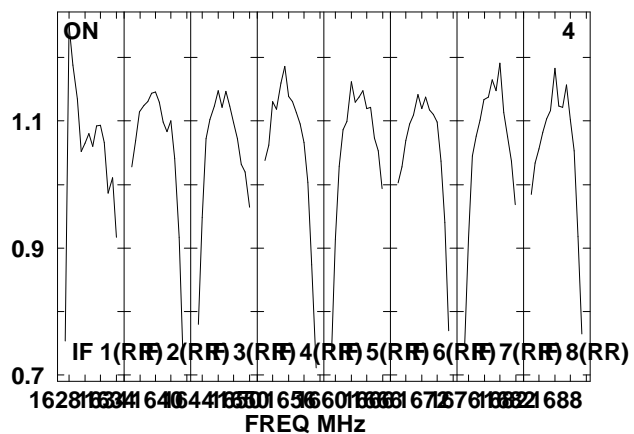
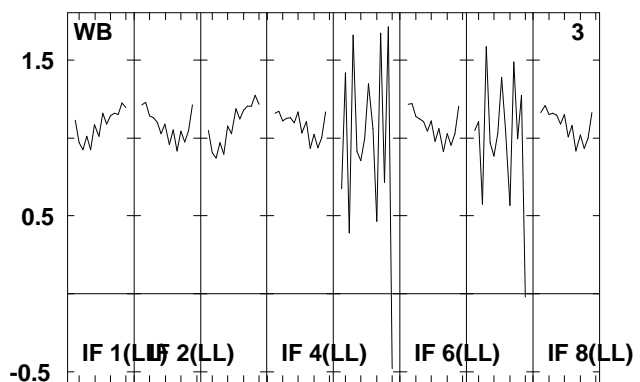
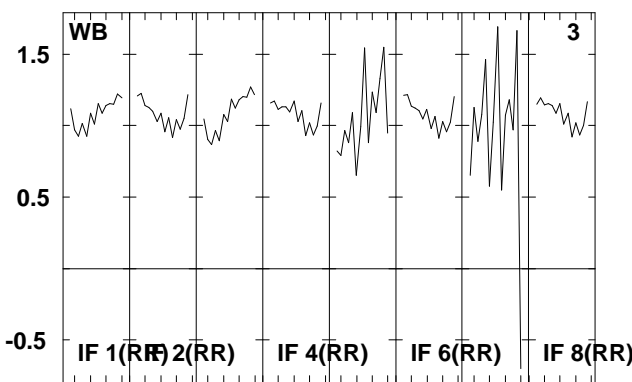
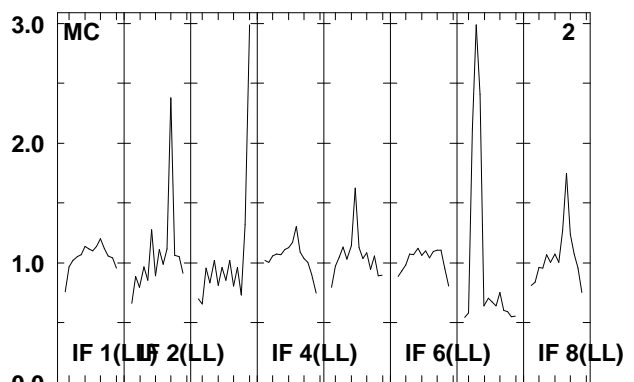
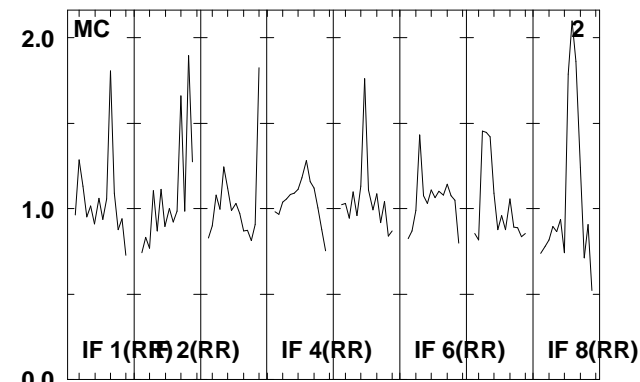
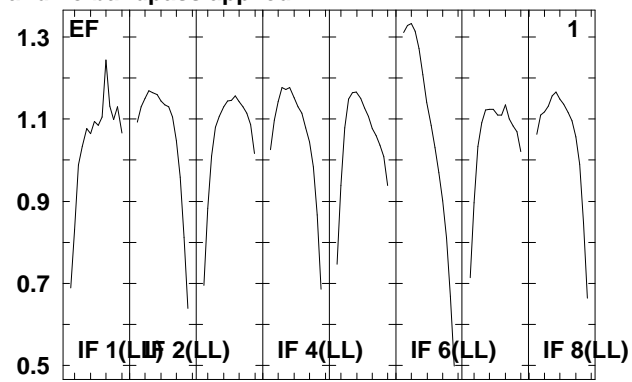
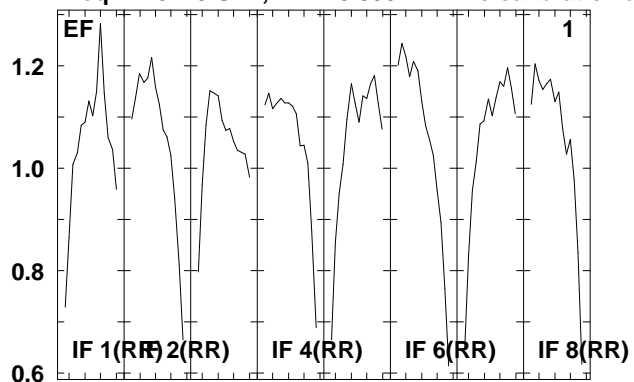

Lower frame: Real Jy  
Total-power spectrum Antenna: \*  
Timerange: 00/14:15:02 to 00/14:18:00

Plot file version 166 created 06-JAN-2009 10:58:04

J1510-05 EZ018B.UVDATA.1

Freq = 1.6270 GHz, Bw = 8.000 MH No calibration applied and no bandpass applied

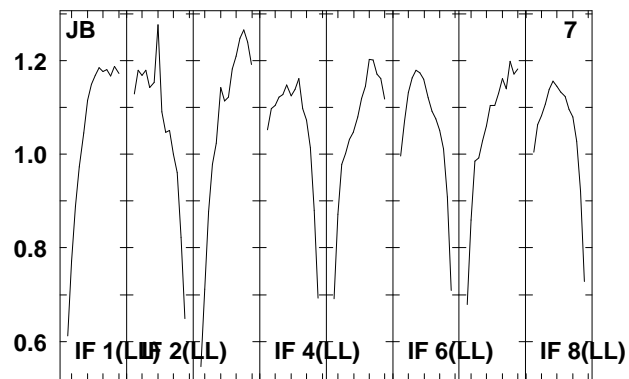
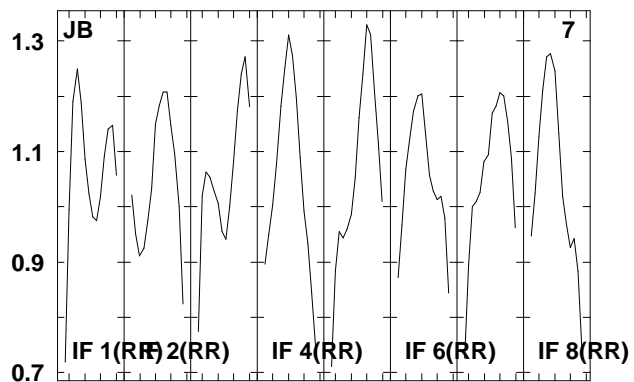
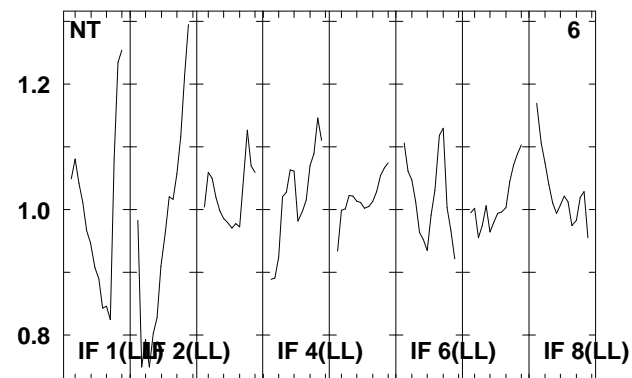
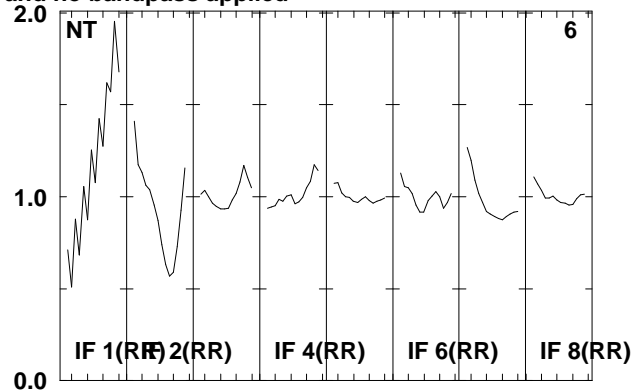
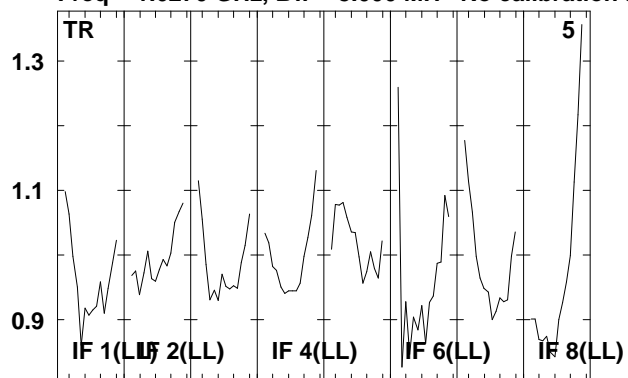

Lower frame: Real Jy  
Total-power spectrum Antenna: \*  
Timerange: 00/14:15:02 to 00/14:18:00

Plot file version 167 created 06-JAN-2009 10:58:05

J150407 EZ018B.UVDATA.1

Freq = 1.6270 GHz, Bw = 8.000 MH No calibration applied and no bandpass applied

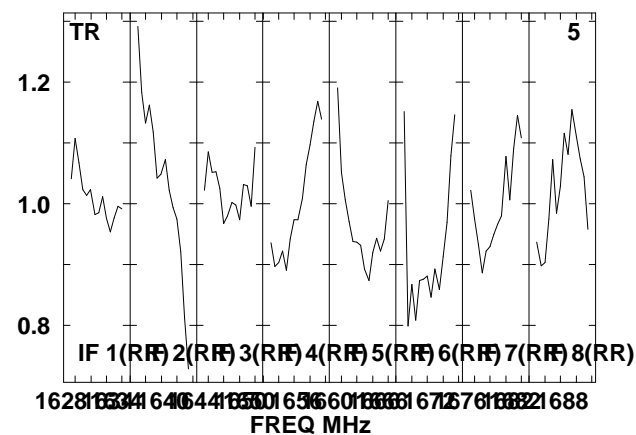
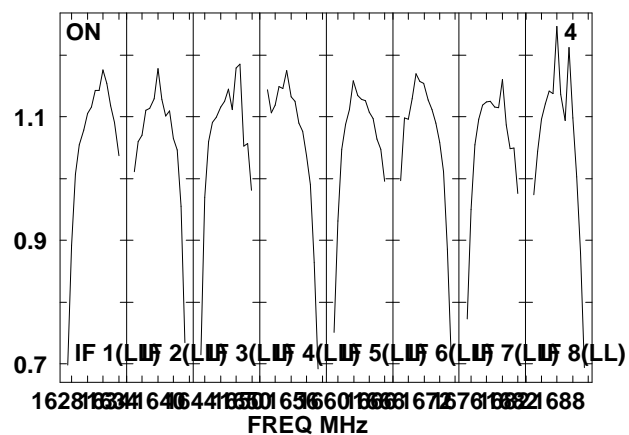
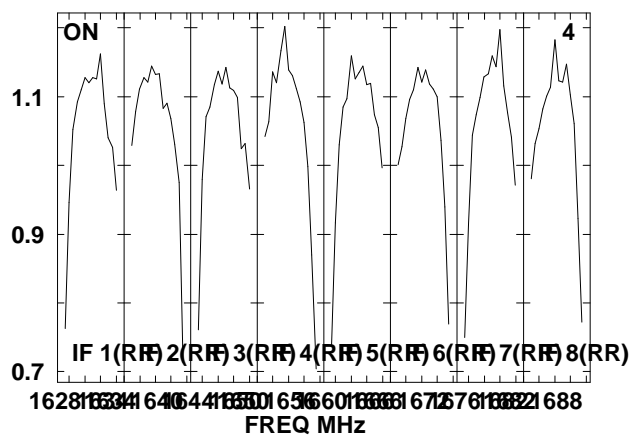
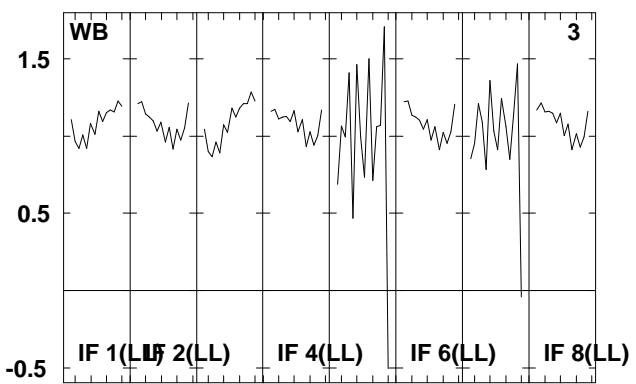
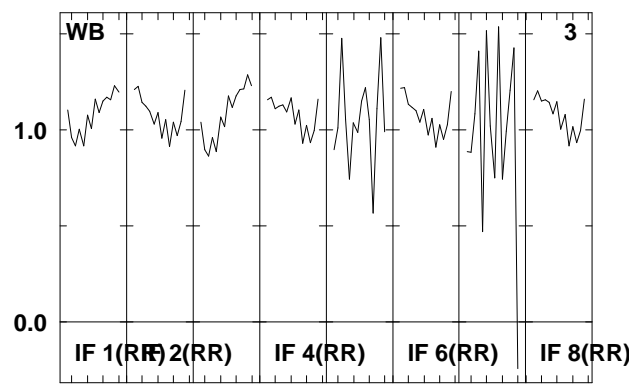
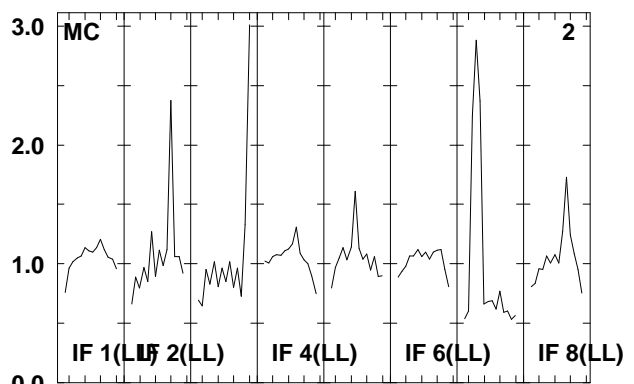
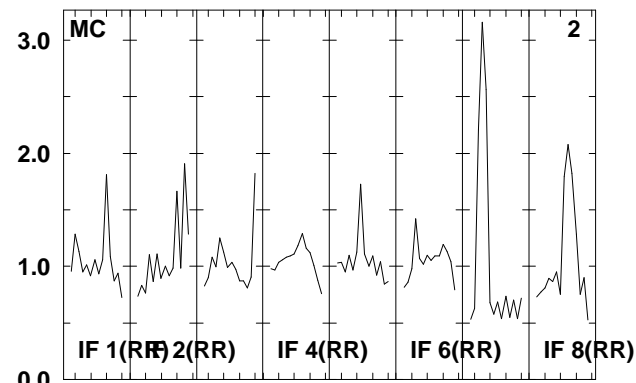
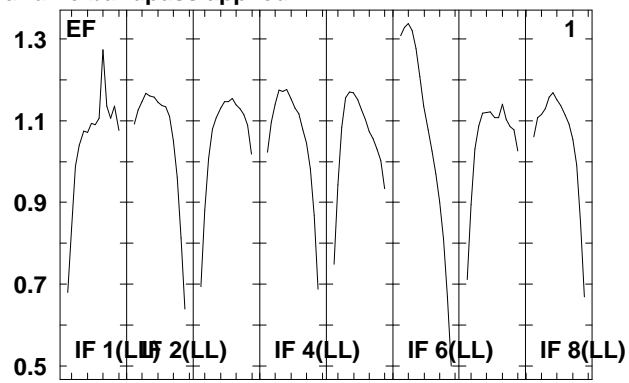
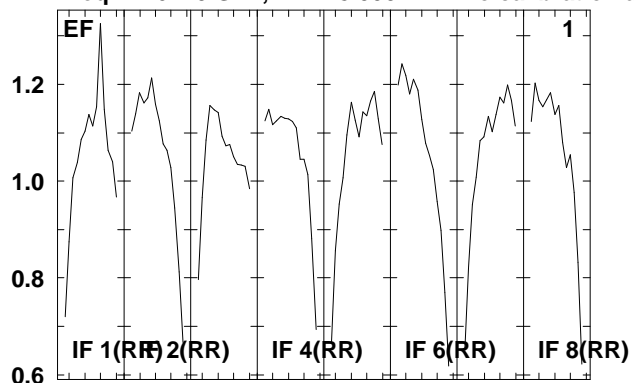

Lower frame: Real Jy  
Total-power spectrum Antenna: \*  
Timerange: 00/14:18:02 to 00/14:22:00

Plot file version 168 created 06-JAN-2009 10:58:05

J150407 EZ018B.UVDATA.1

Freq = 1.6270 GHz, Bw = 8.000 MH No calibration applied and no bandpass applied

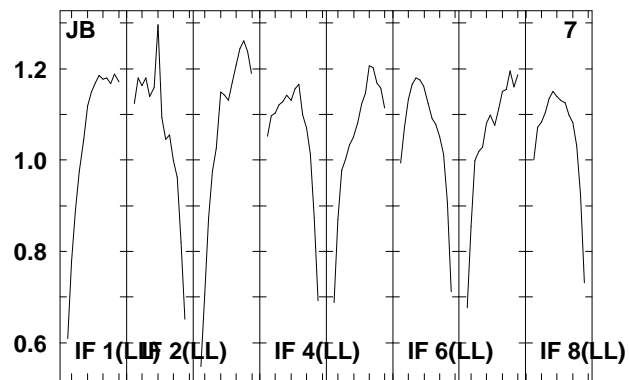
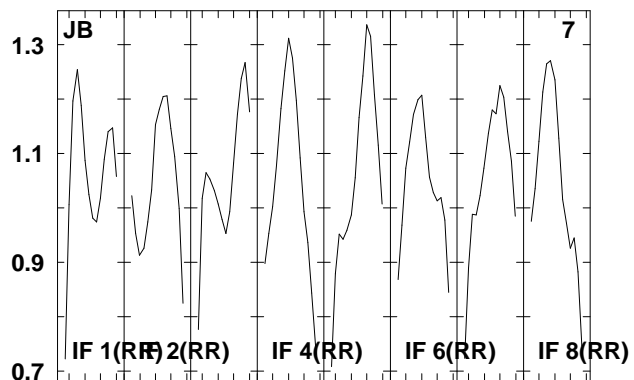
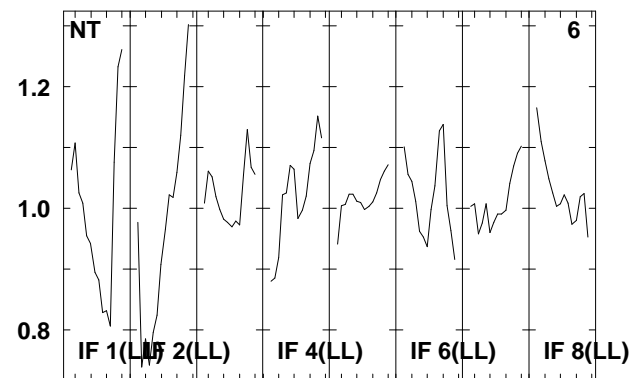
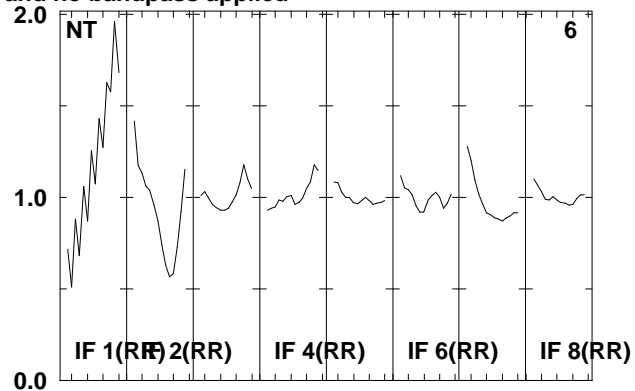
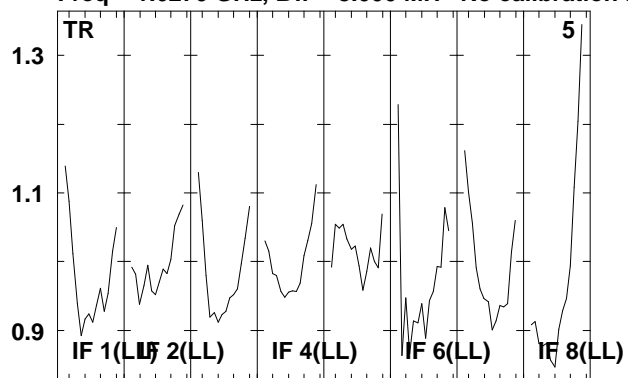

Lower frame: Real Jy  
Total-power spectrum Antenna: \*  
Timerange: 00/14:18:02 to 00/14:22:00



Plot file version 169 created 06-JAN-2009 10:58:06

J1510-05 EZ018B.UVDATA.1

Freq = 1.6270 GHz, Bw = 8.000 MH No calibration applied and no bandpass applied

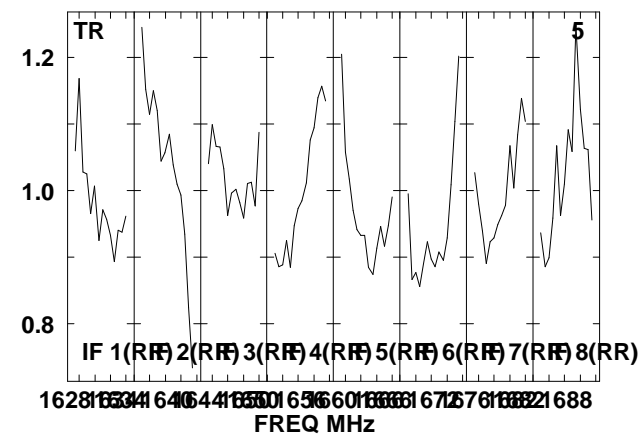
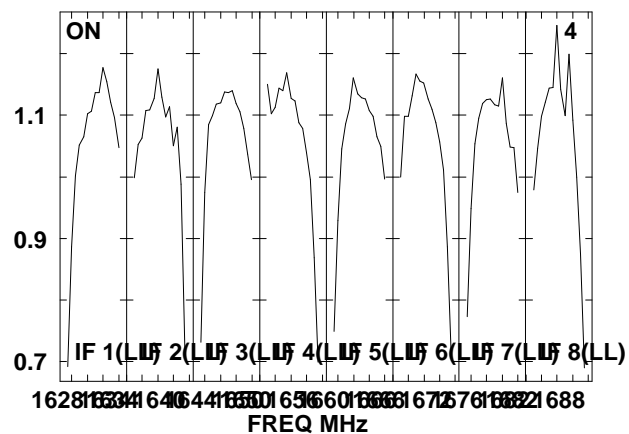
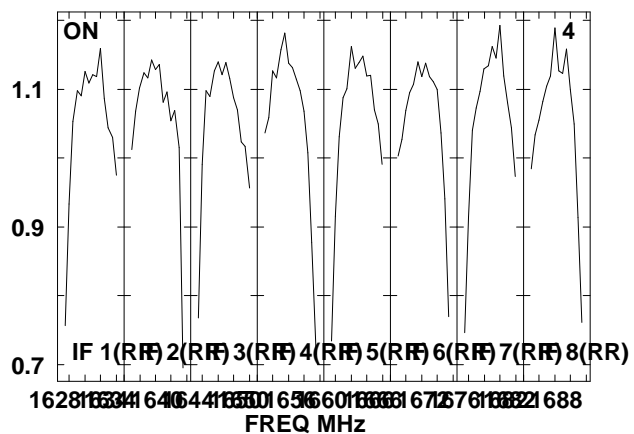
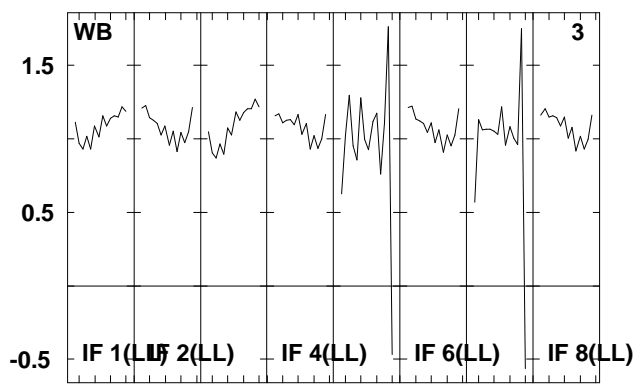
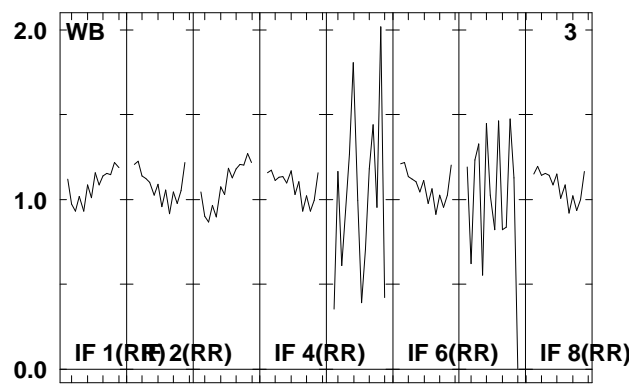
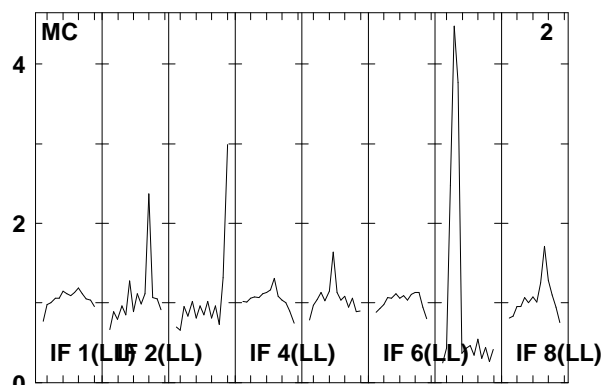
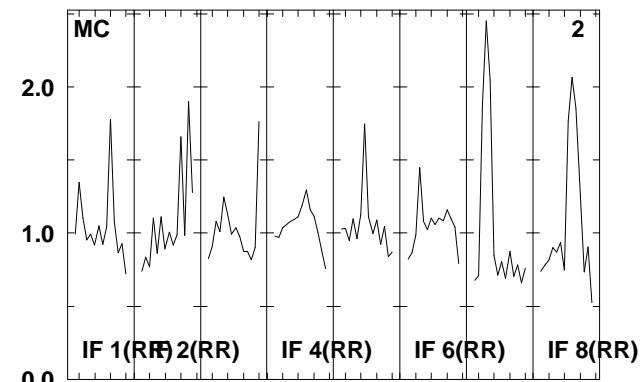
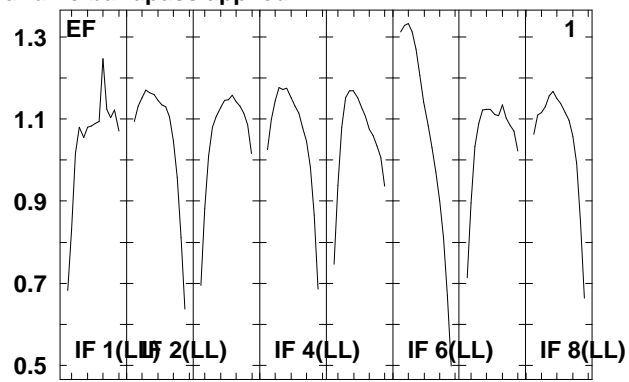
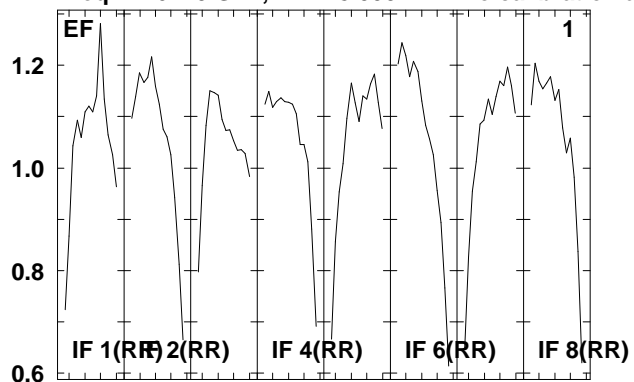

Lower frame: Real Jy  
Total-power spectrum Antenna: \*  
Timerange: 00/14:22:02 to 00/14:25:00

Plot file version 170 created 06-JAN-2009 10:58:06

J1510-05 EZ018B.UVDATA.1

Freq = 1.6270 GHz, Bw = 8.000 MH No calibration applied and no bandpass applied

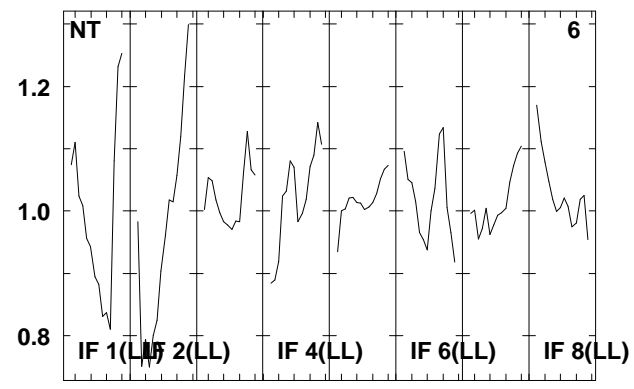
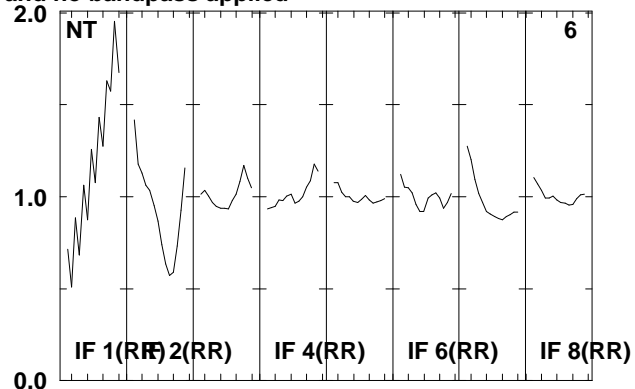
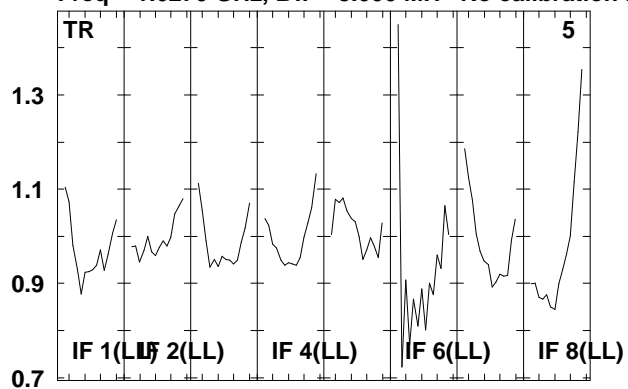

Lower frame: Real Jy  
Total-power spectrum Antenna: \*  
Timerange: 00/14:22:02 to 00/14:25:00

Plot file version 171 created 06-JAN-2009 10:58:06

J150407 EZ018B.UVDATA.1

Freq = 1.6270 GHz, Bw = 8.000 MH No calibration applied and no bandpass applied

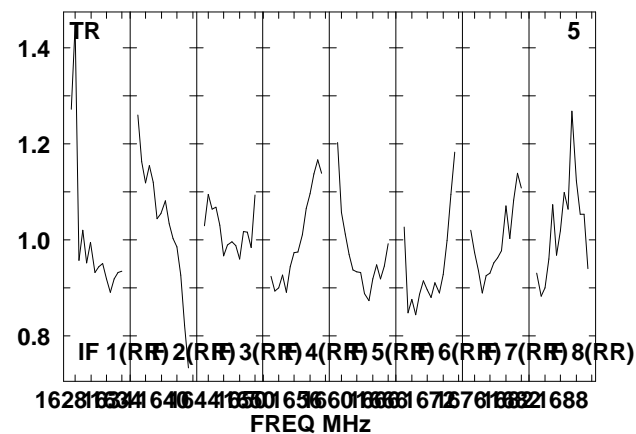
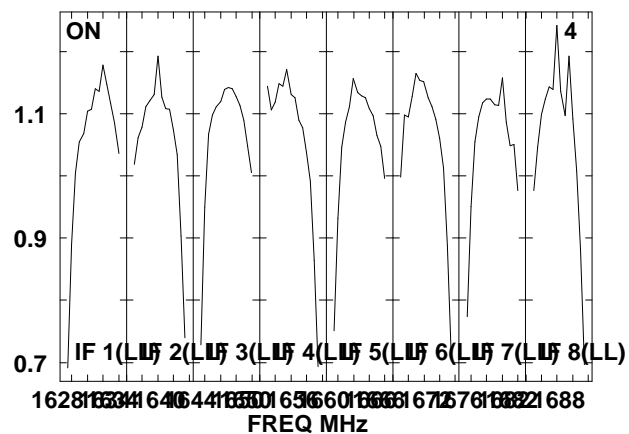
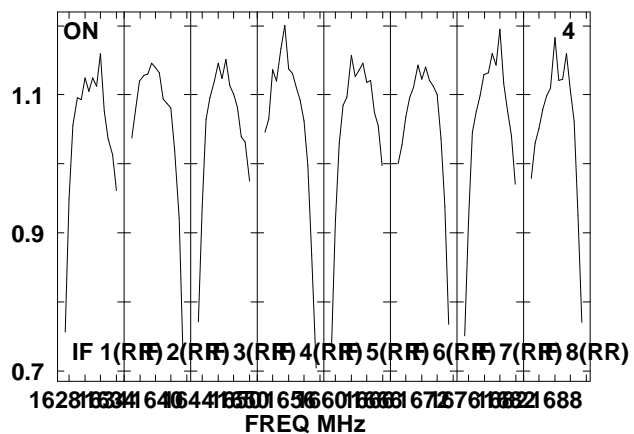
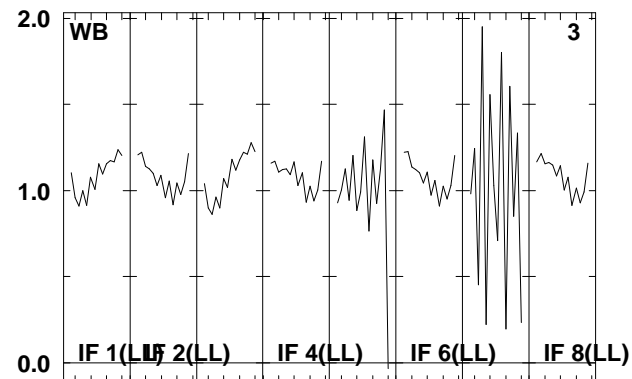
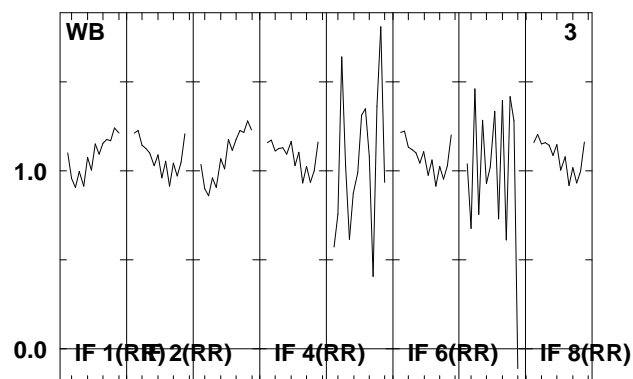
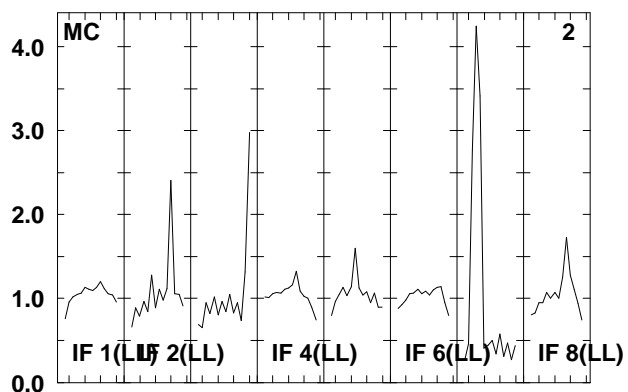
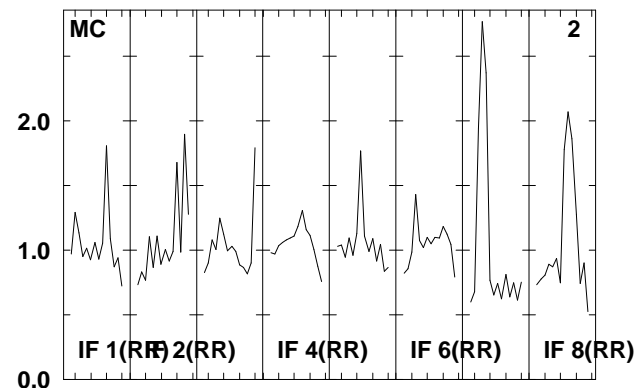
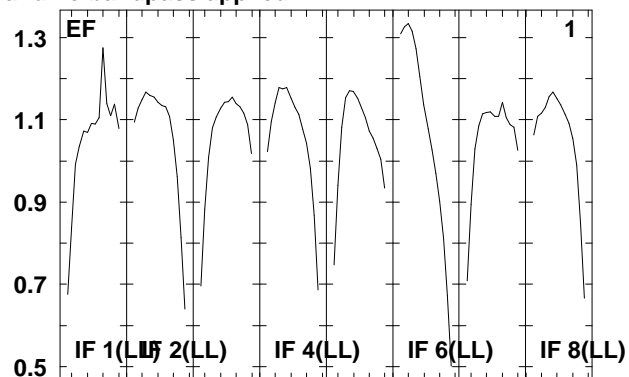
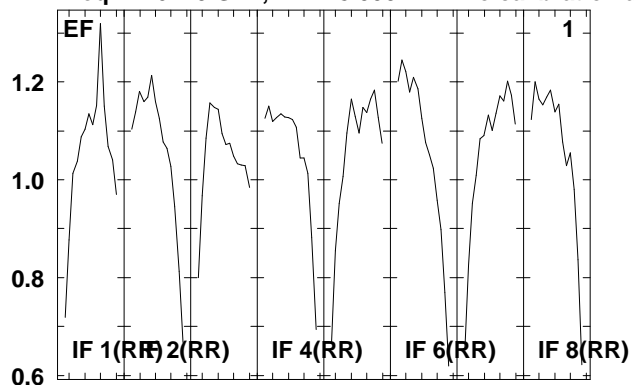

Lower frame: Real Jy

Total-power spectrum Antenna: \*

Timerange: 00/14:25:02 to 00/14:28:58

Plot file version 172 created 06-JAN-2009 10:58:07

J150407 EZ018B.UVDATA.1

Freq = 1.6270 GHz, Bw = 8.000 MH No calibration applied and no bandpass applied

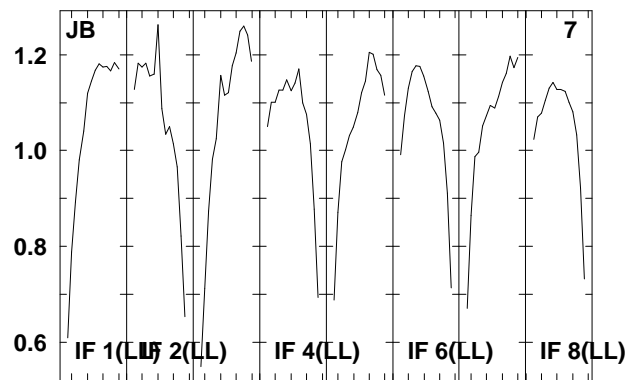
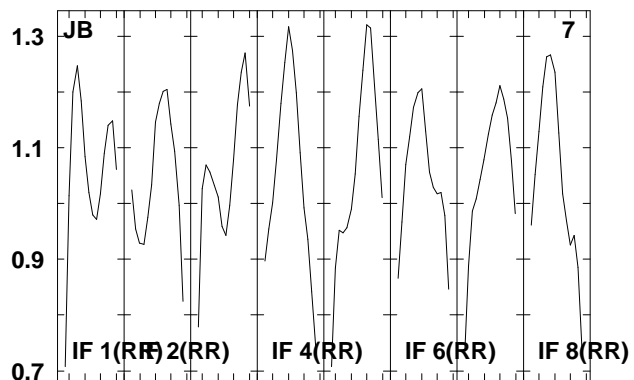
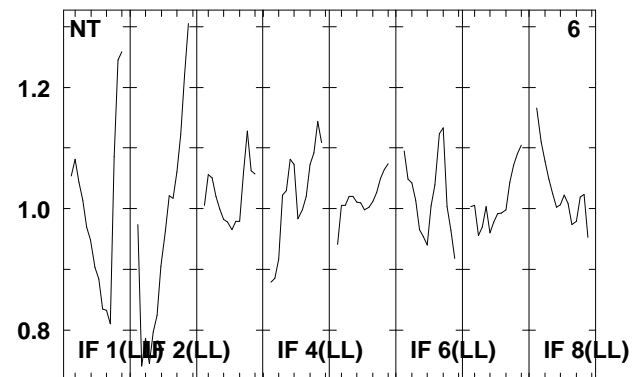
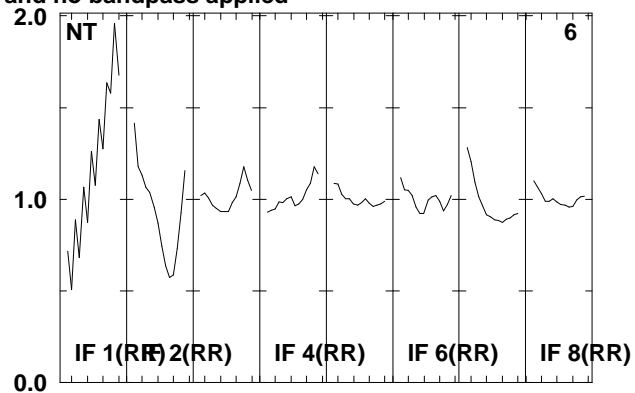
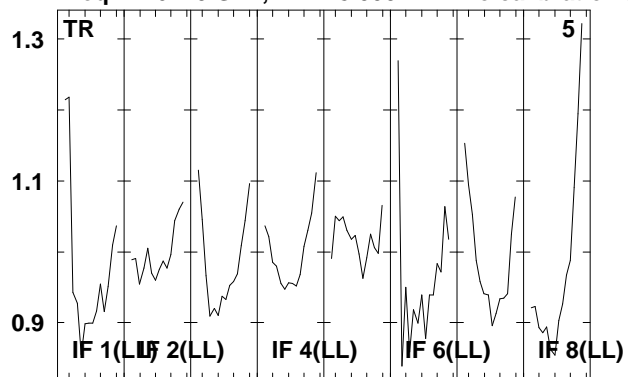

Lower frame: Real Jy  
Total-power spectrum Antenna: \*  
Timerange: 00/14:25:02 to 00/14:28:58

Plot file version 173 created 06-JAN-2009 10:58:07

J1510-05 EZ018B.UVDATA.1

Freq = 1.6270 GHz, Bw = 8.000 MH No calibration applied and no bandpass applied

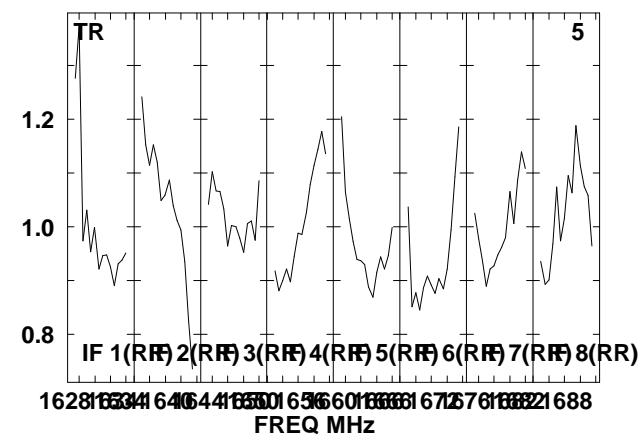
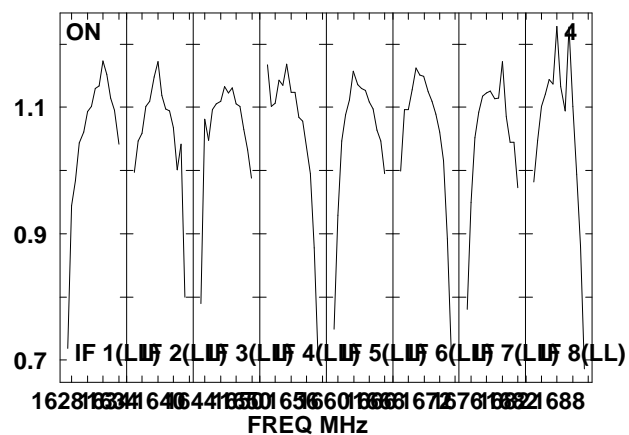
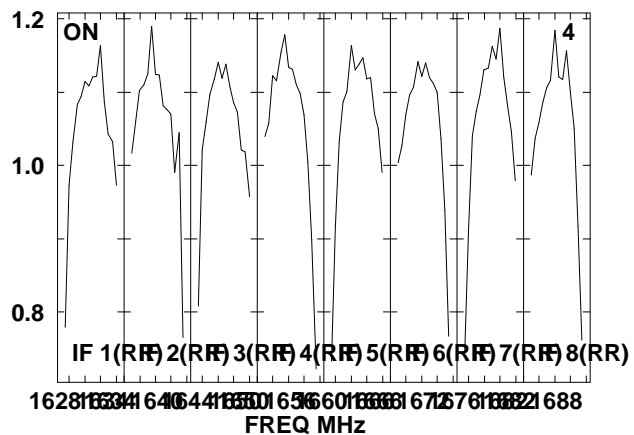
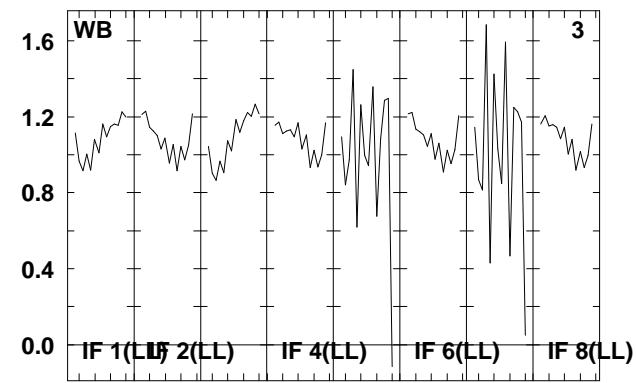
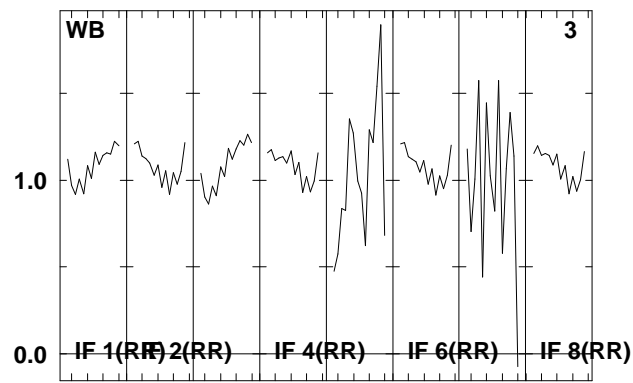
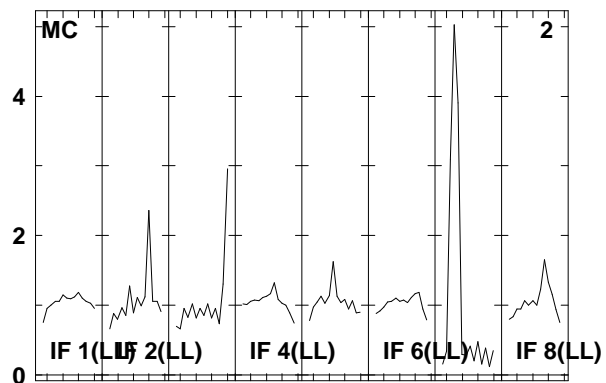
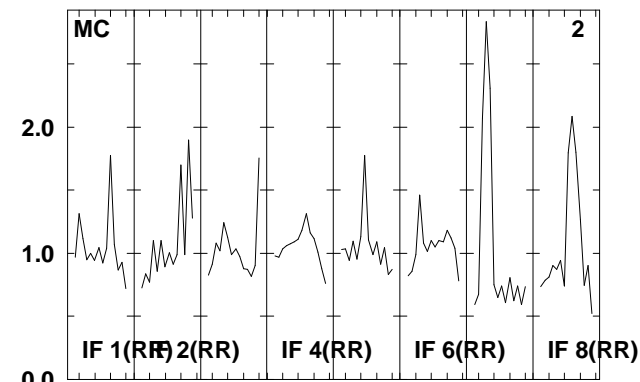
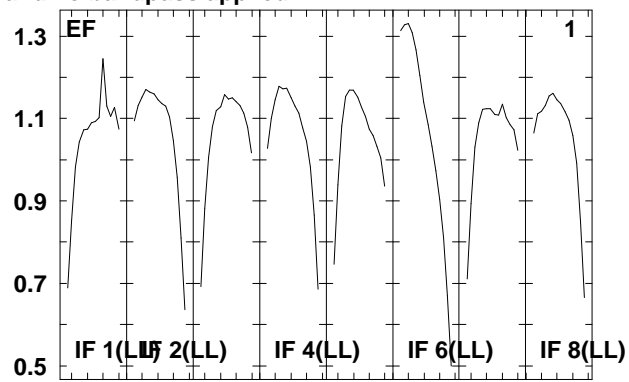
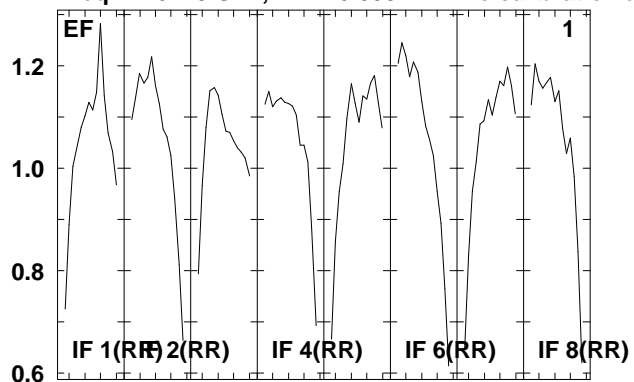

1628 1634 1640 1644 1650 1656 1660 1666 1672 1676 1682 1688  
FREQ MHz

1628 1634 1640 1644 1650 1656 1660 1666 1672 1676 1682 1688  
FREQ MHz

1628 1634 1640 1644 1650 1656 1660 1666 1672 1676 1682 1688  
FREQ MHz

Lower frame: Real Jy  
Total-power spectrum Antenna: \*  
Timerange: 00/14:30:02 to 00/14:33:00

Plot file version 174 created 06-JAN-2009 10:58:07

J1510-05 EZ018B.UVDATA.1

Freq = 1.6270 GHz, Bw = 8.000 MH No calibration applied and no bandpass applied

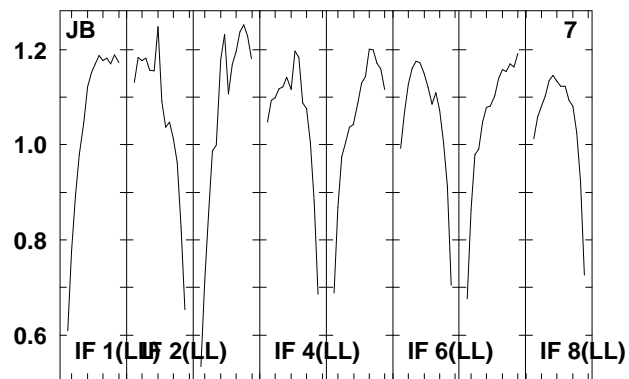
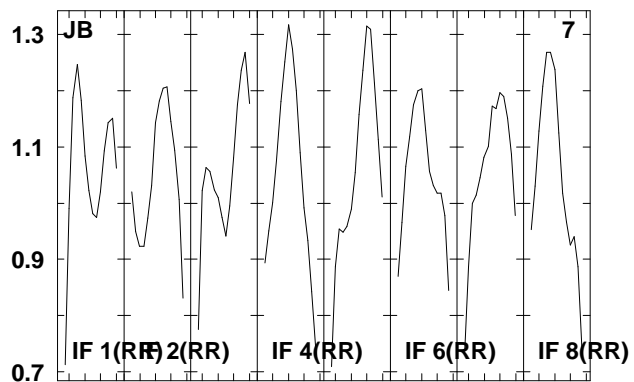
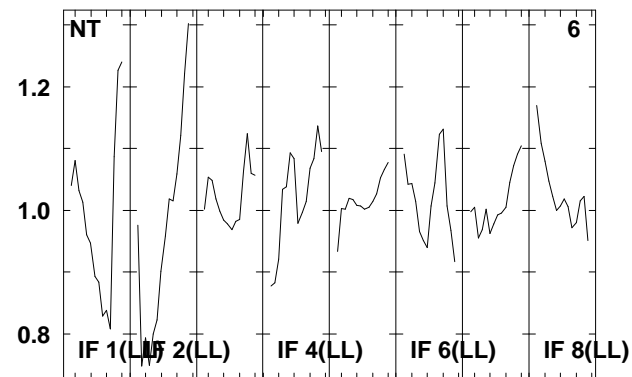
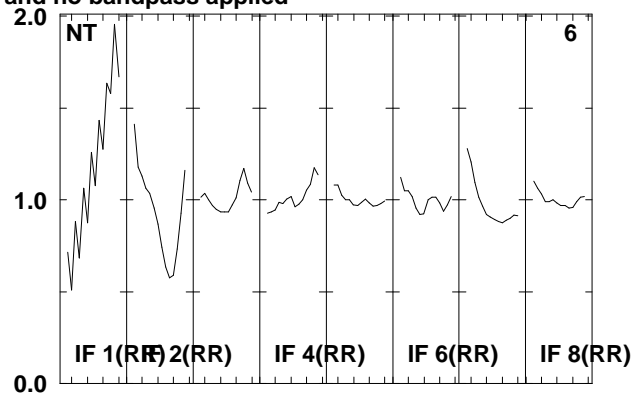
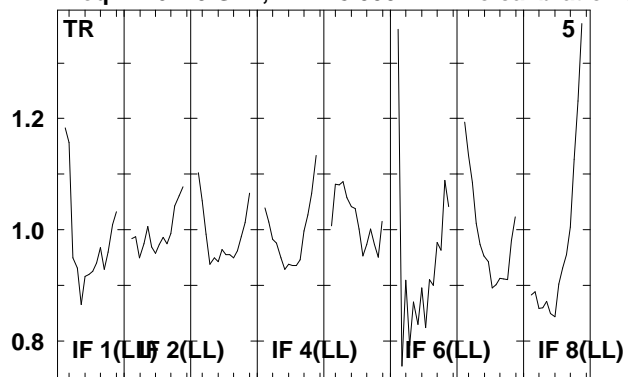

Lower frame: Real Jy  
Total-power spectrum Antenna: \*  
Timerange: 00/14:30:02 to 00/14:33:00

Plot file version 175 created 06-JAN-2009 10:58:08

J150407 EZ018B.UVDATA.1

Freq = 1.6270 GHz, Bw = 8.000 MH No calibration applied and no bandpass applied

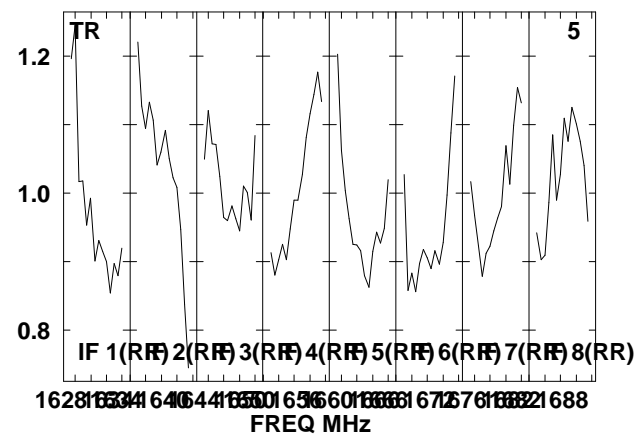
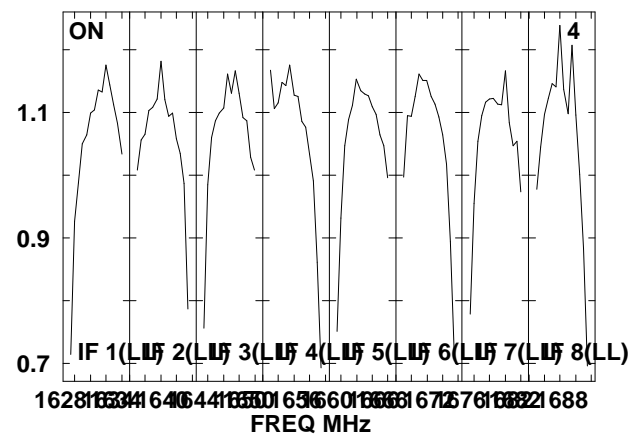
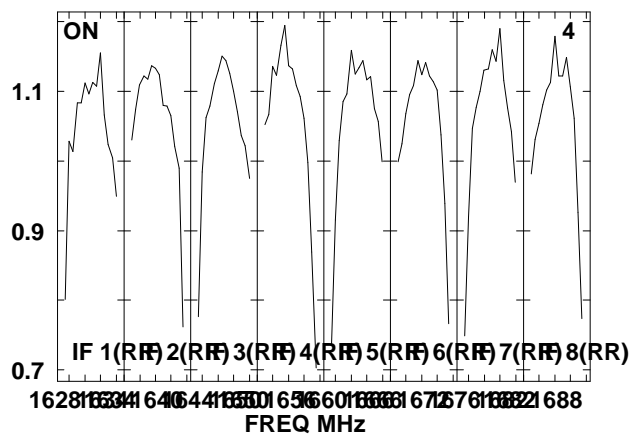
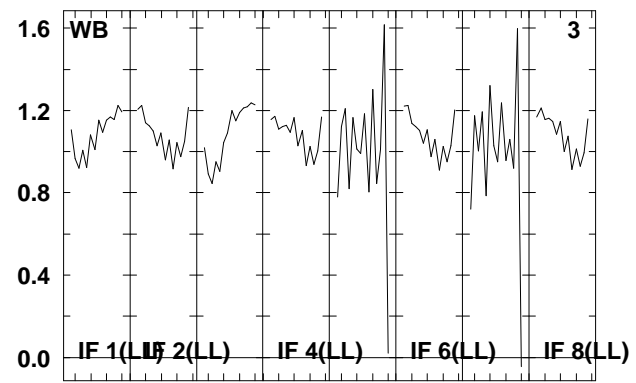
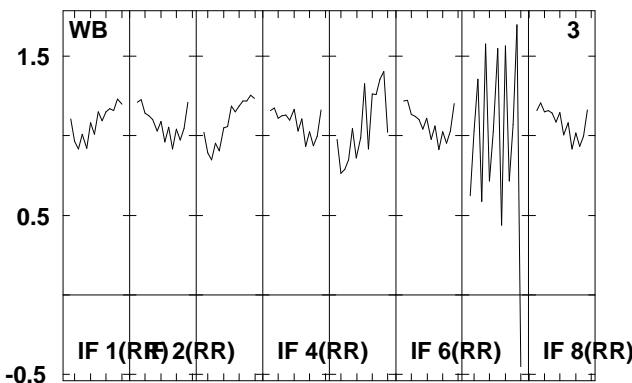
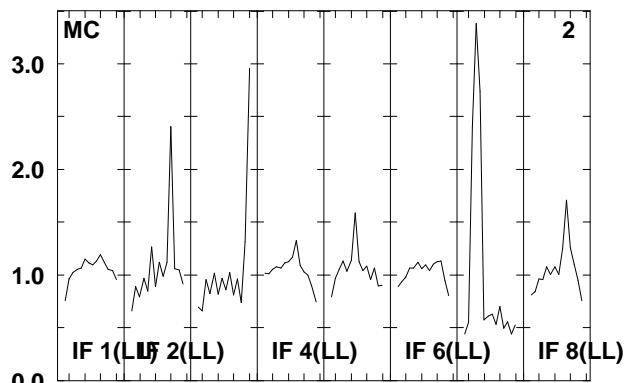
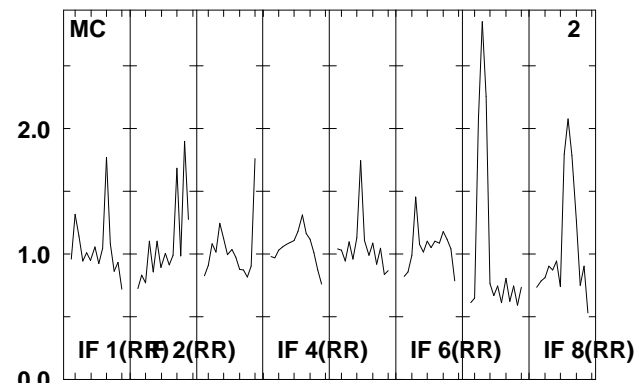
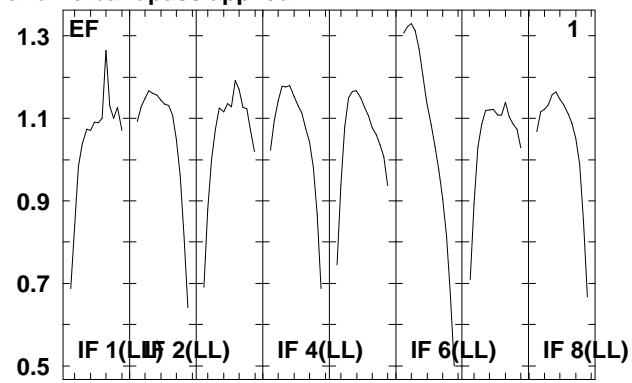
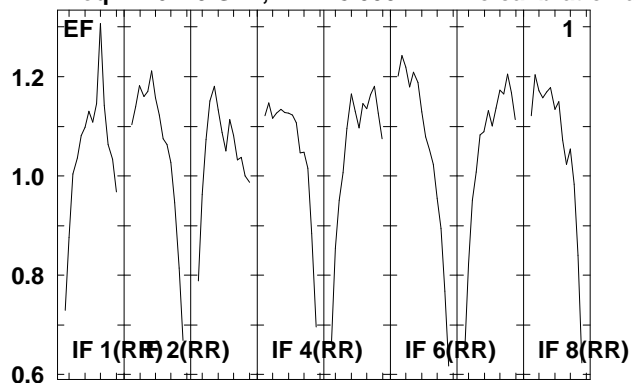

Lower frame: Real Jy  
Total-power spectrum Antenna: \*  
Timerange: 00/14:33:02 to 00/14:37:00

Plot file version 176 created 06-JAN-2009 10:58:08

J150407 EZ018B.UVDATA.1

Freq = 1.6270 GHz, Bw = 8.000 MH No calibration applied and no bandpass applied

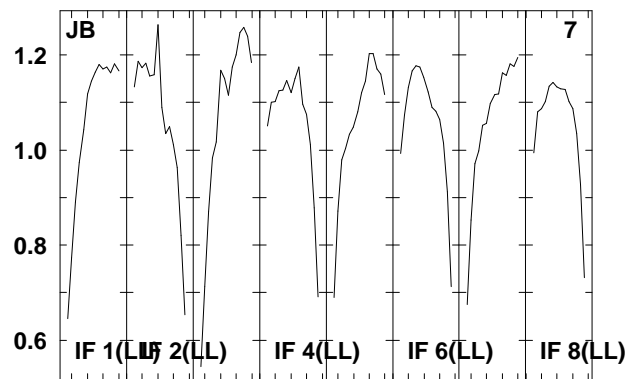
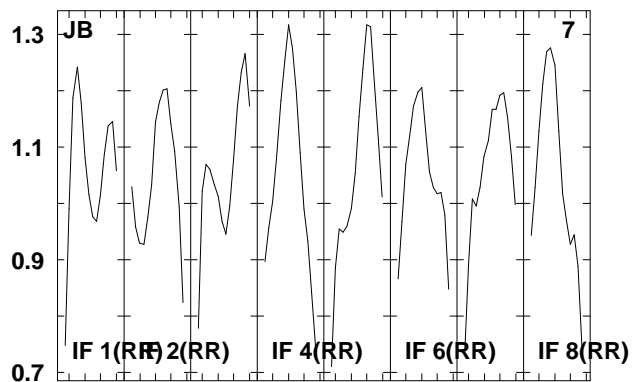
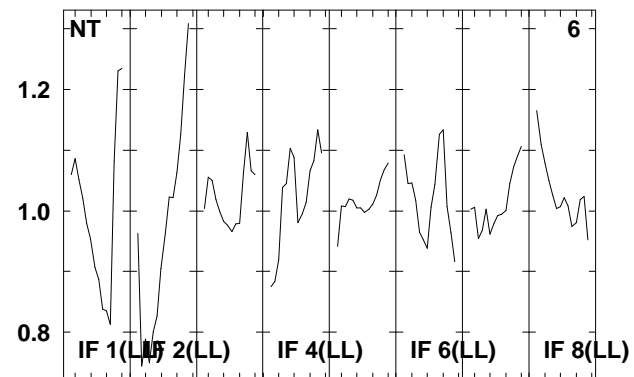
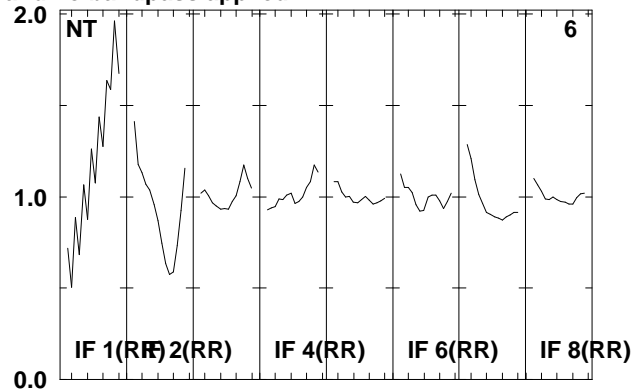
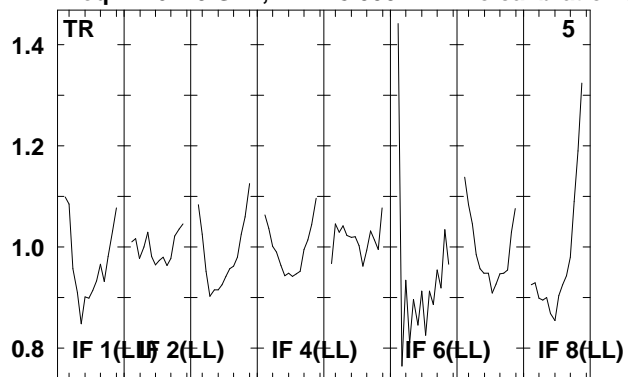

Lower frame: Real Jy  
Total-power spectrum Antenna: \*  
Timerange: 00/14:33:02 to 00/14:37:00



Plot file version 177 created 06-JAN-2009 10:58:08

J1510-05 EZ018B.UVDATA.1

Freq = 1.6270 GHz, Bw = 8.000 MH No calibration applied and no bandpass applied

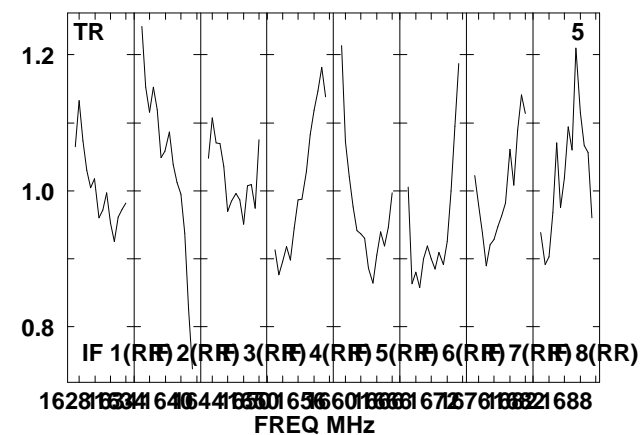
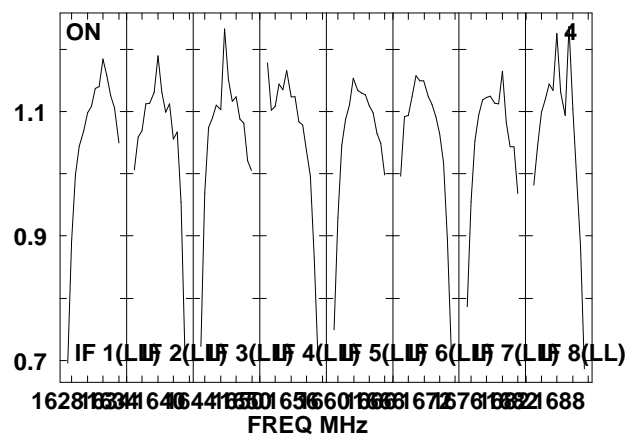
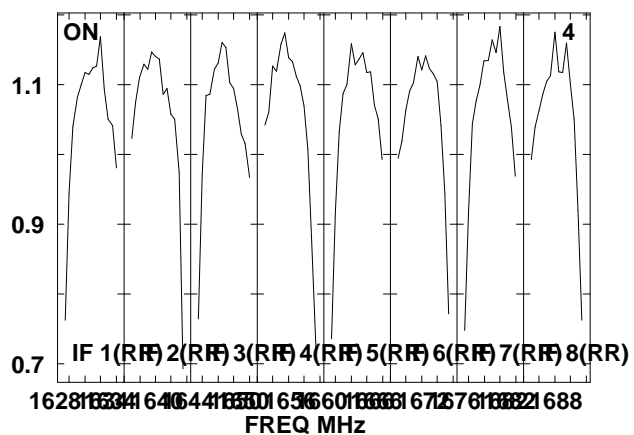
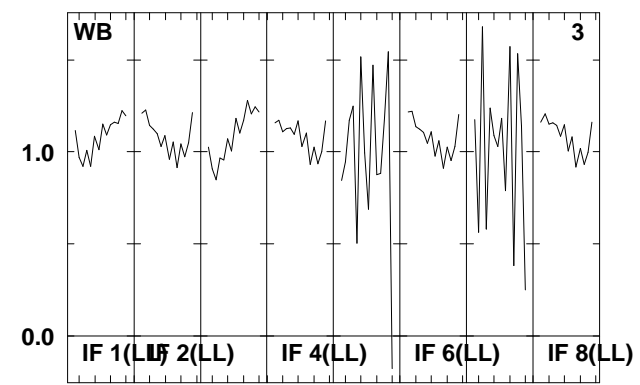
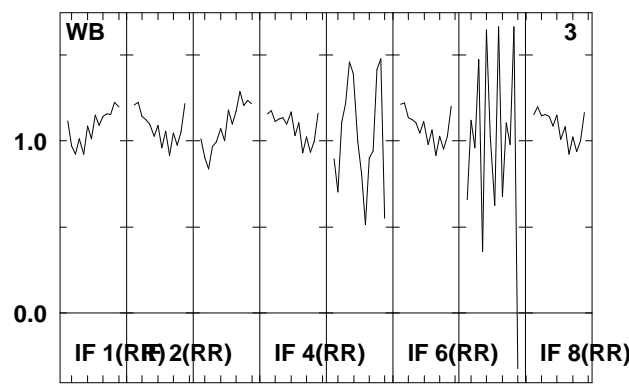
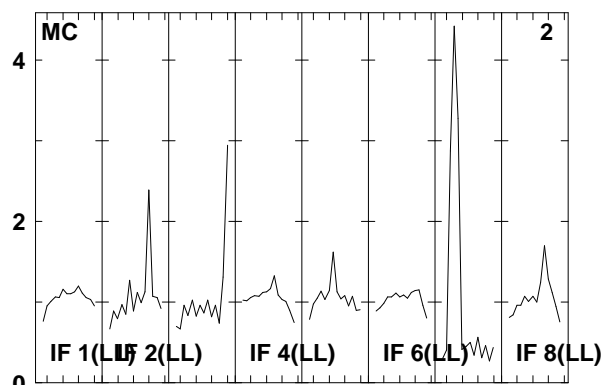
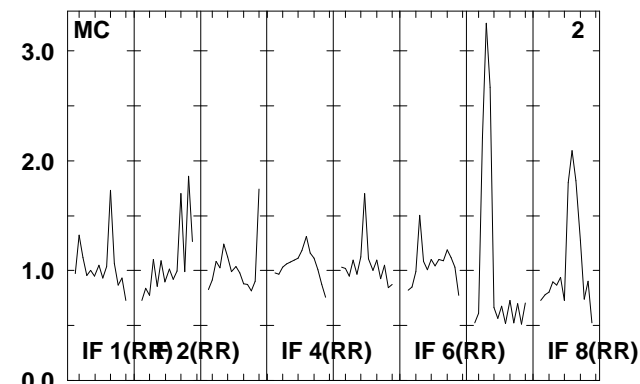
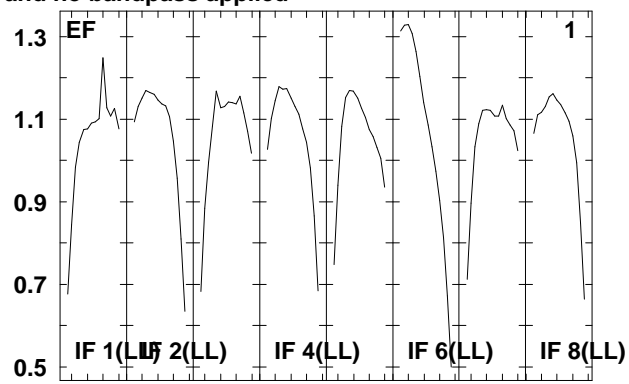
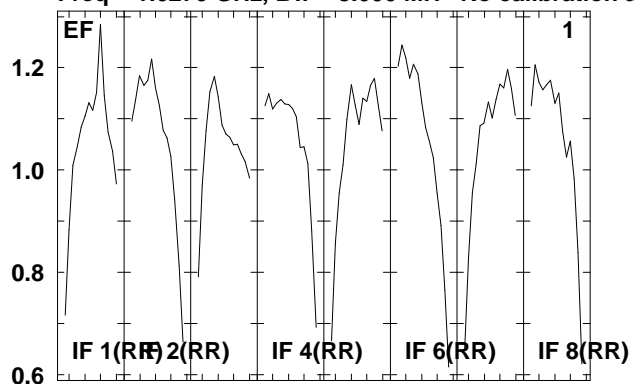

Lower frame: Real Jy  
Total-power spectrum Antenna: \*  
Timerange: 00/14:37:02 to 00/14:40:00

Plot file version 178 created 06-JAN-2009 10:58:09

J1510-05 EZ018B.UVDATA.1

Freq = 1.6270 GHz, Bw = 8.000 MH No calibration applied and no bandpass applied

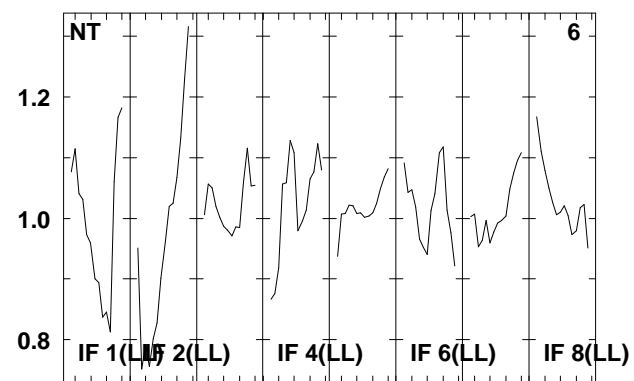
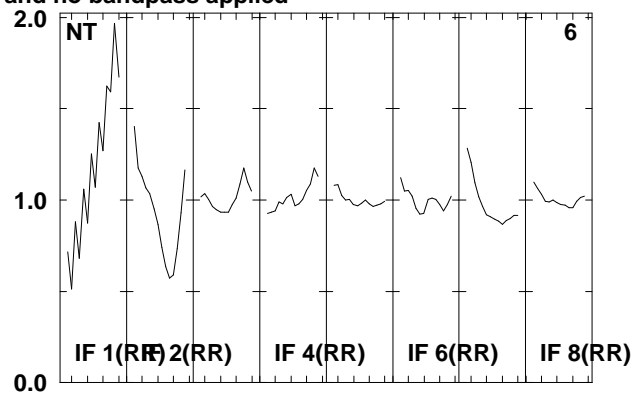
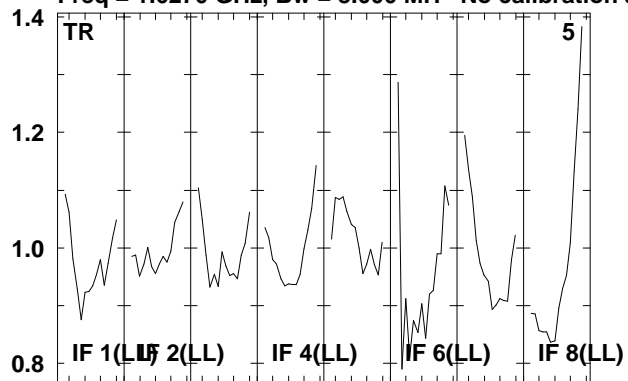

Lower frame: Real Jy  
Total-power spectrum Antenna: \*  
Timerange: 00/14:37:02 to 00/14:40:00

Plot file version 179 created 06-JAN-2009 10:58:10

J150407 EZ018B.UVDATA.1

Freq = 1.6270 GHz, Bw = 8.000 MH No calibration applied and no bandpass applied

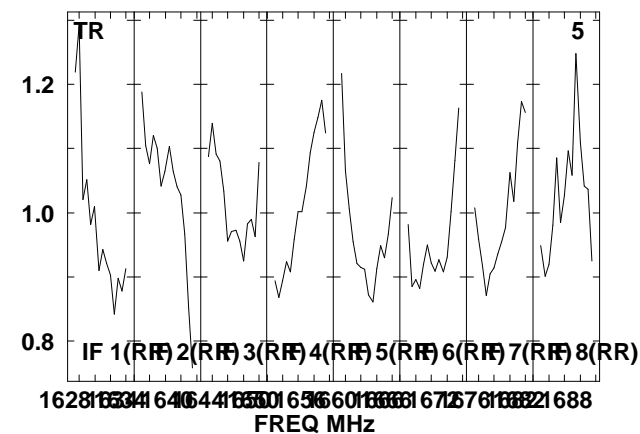
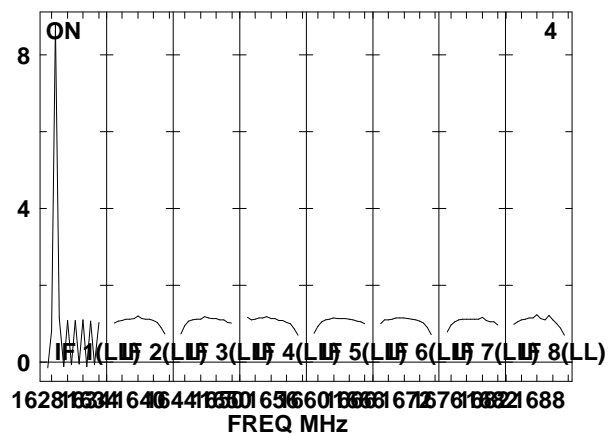
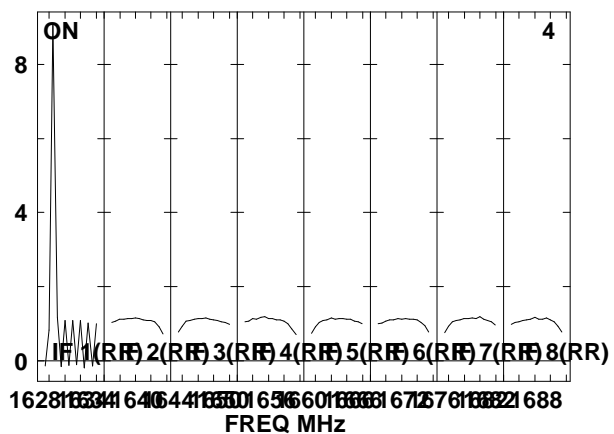
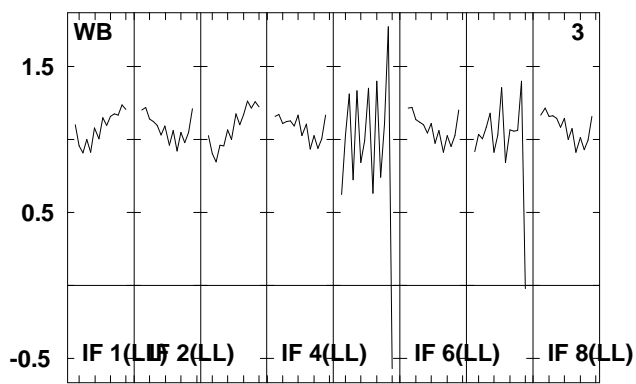
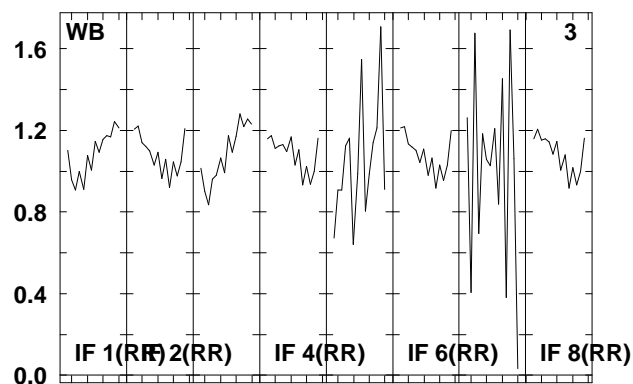
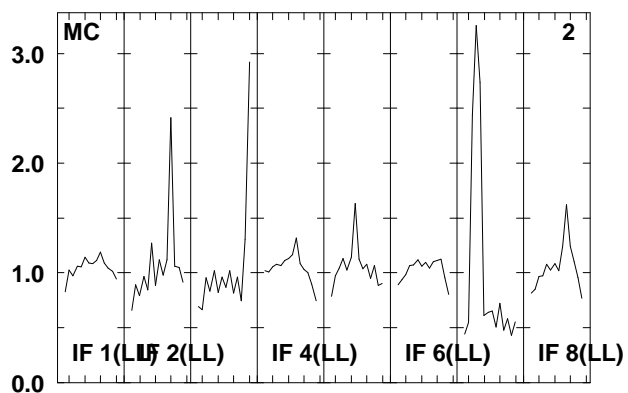
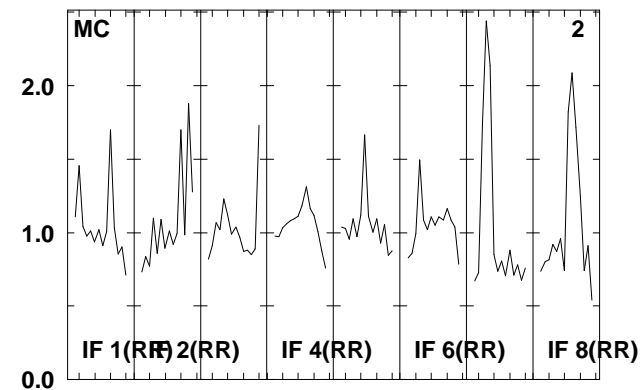
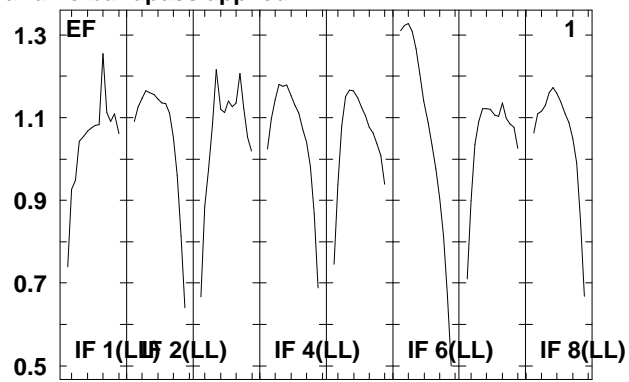
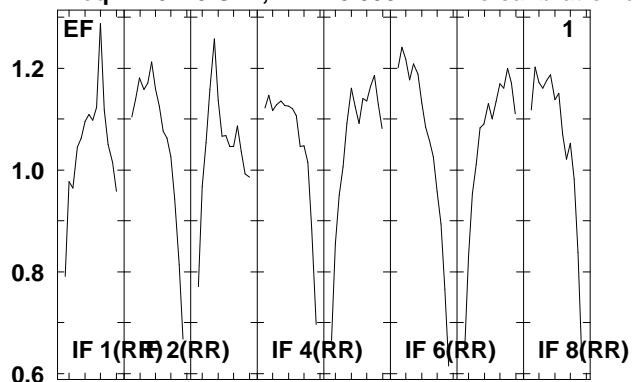

Lower frame: Real Jy

Total-power spectrum Antenna: \*

Timerange: 00/14:40:02 to 00/14:43:56

Plot file version 180 created 06-JAN-2009 10:58:10

J150407 EZ018B.UVDATA.1

Freq = 1.6270 GHz, Bw = 8.000 MH No calibration applied and no bandpass applied

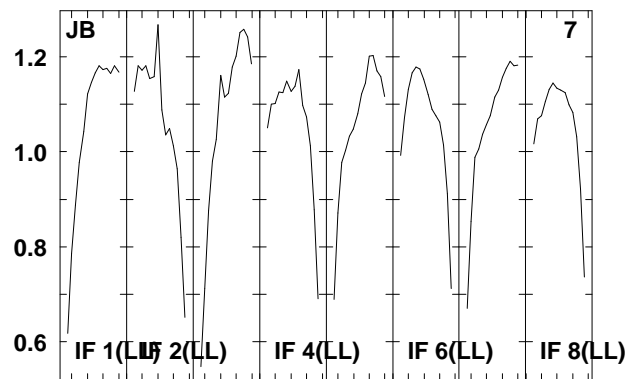
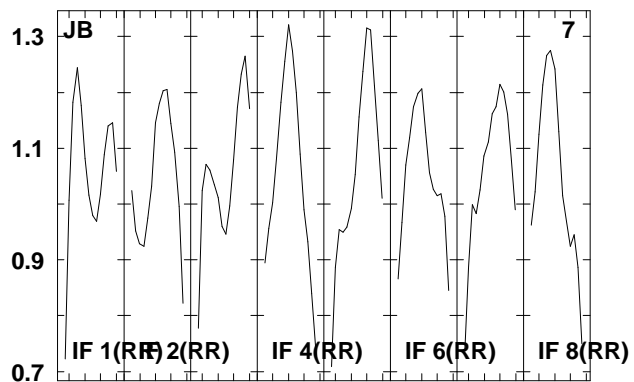
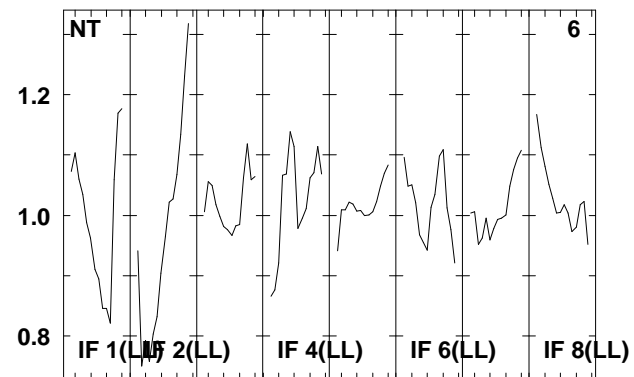
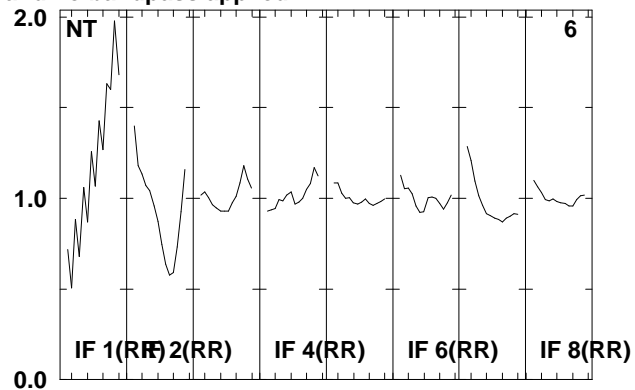
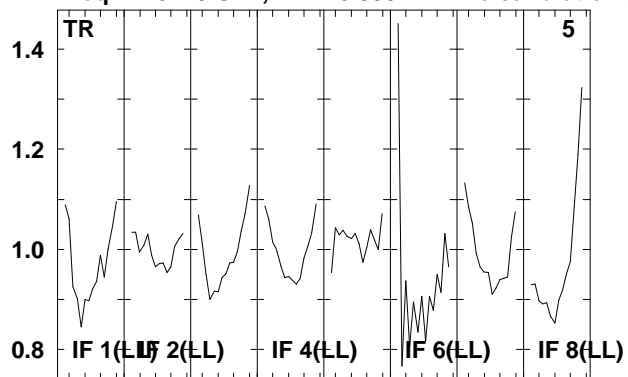

Lower frame: Real Jy  
Total-power spectrum Antenna: \*  
Timerange: 00/14:40:02 to 00/14:43:56

Plot file version 181 created 06-JAN-2009 10:58:11

J1510-05 EZ018B.UVDATA.1

Freq = 1.6270 GHz, Bw = 8.000 MH No calibration applied and no bandpass applied

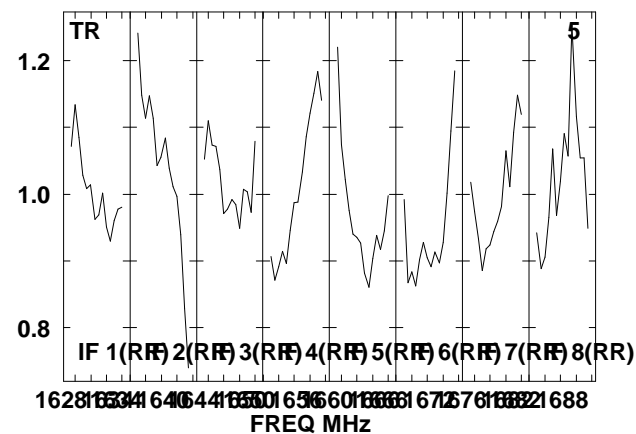
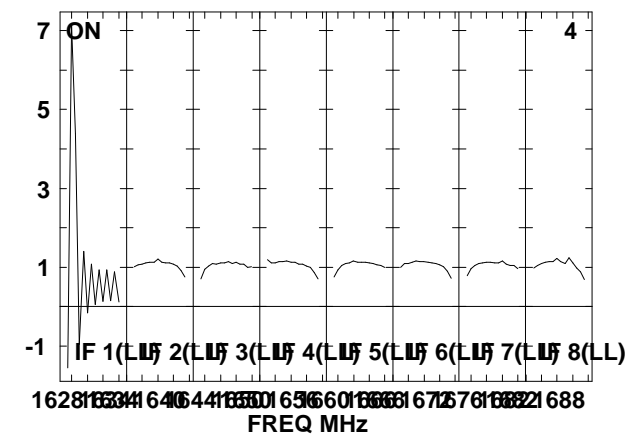
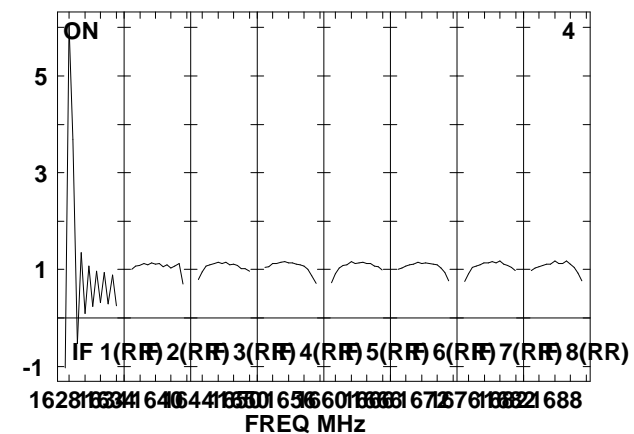
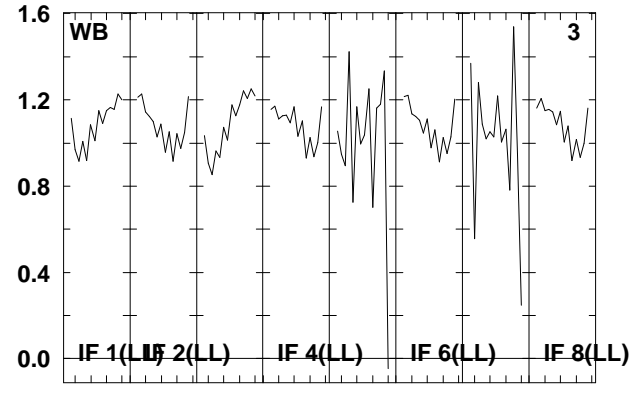
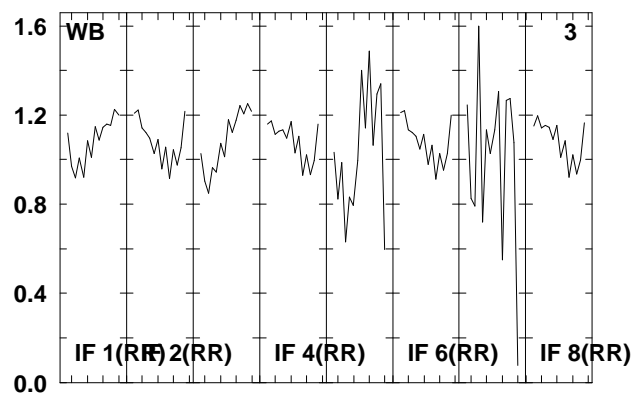
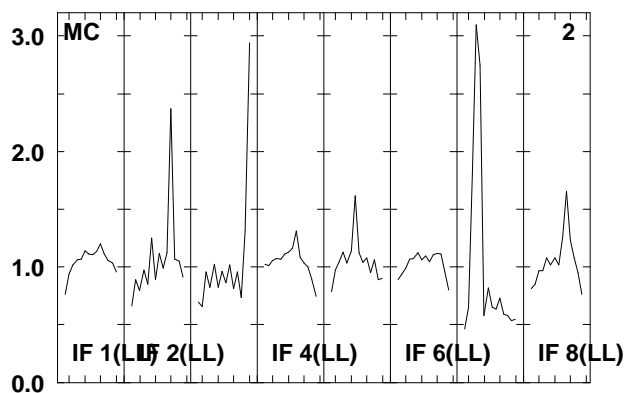
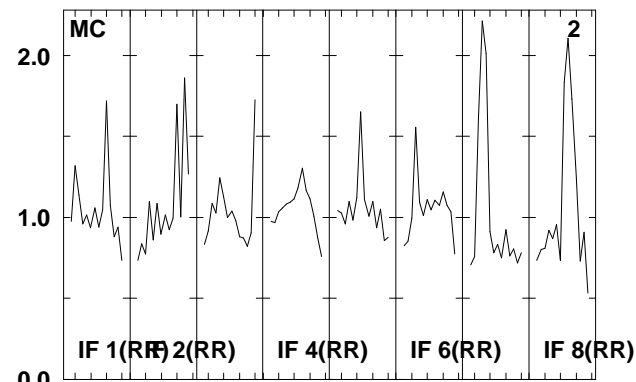
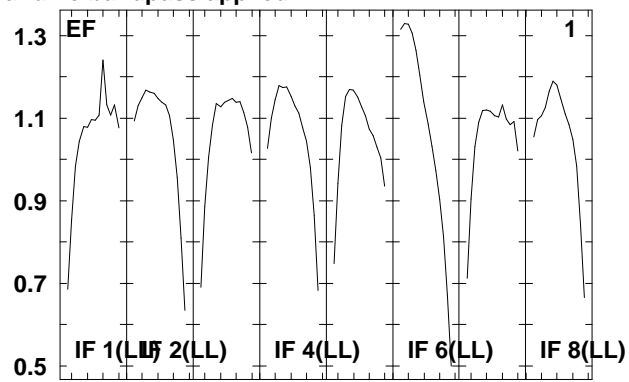
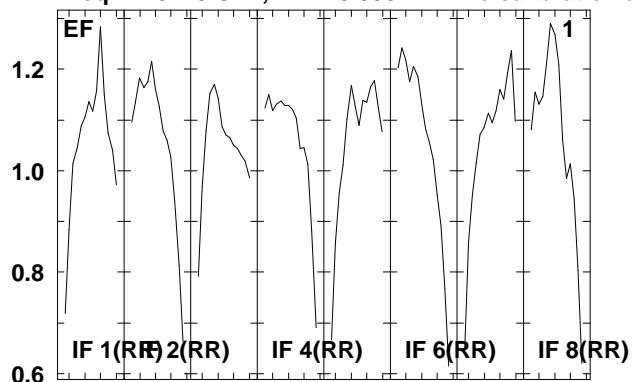

Lower frame: Real Jy  
Total-power spectrum Antenna: \*  
Timerange: 00/14:45:03 to 00/14:48:01

Plot file version 182 created 06-JAN-2009 10:58:11

J1510-05 EZ018B.UVDATA.1

Freq = 1.6270 GHz, Bw = 8.000 MH No calibration applied and no bandpass applied

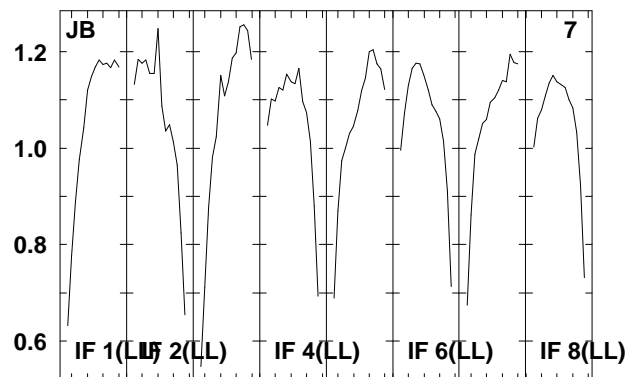
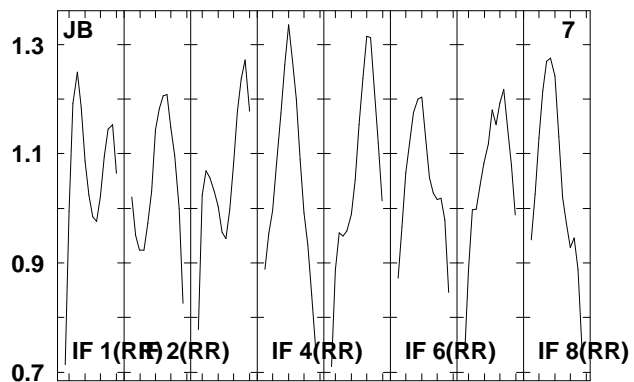
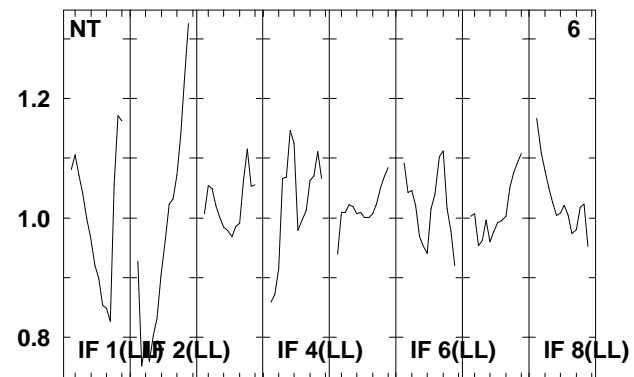
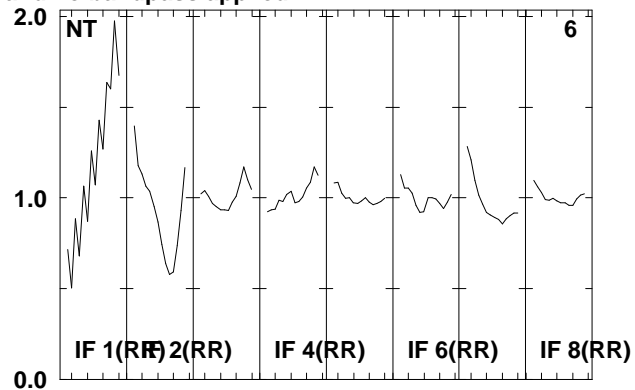
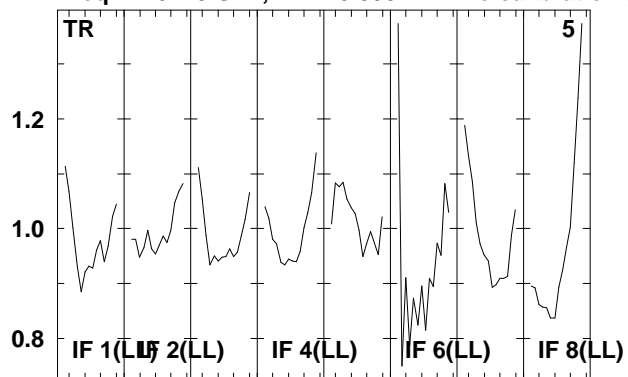

Lower frame: Real Jy  
Total-power spectrum Antenna: \*  
Timerange: 00/14:45:03 to 00/14:48:01

Plot file version 183 created 06-JAN-2009 10:58:11

J150407 EZ018B.UVDATA.1

Freq = 1.6270 GHz, Bw = 8.000 MH No calibration applied and no bandpass applied

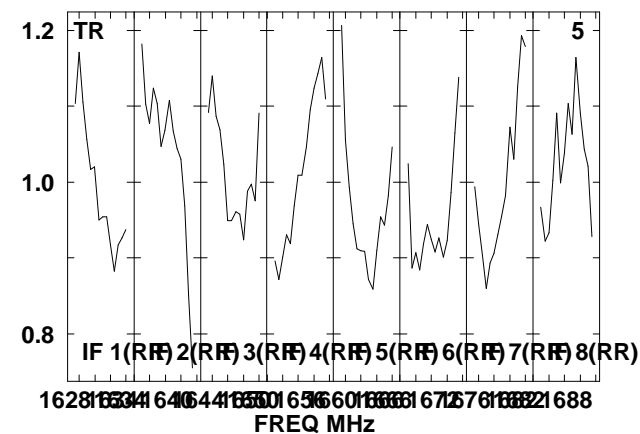
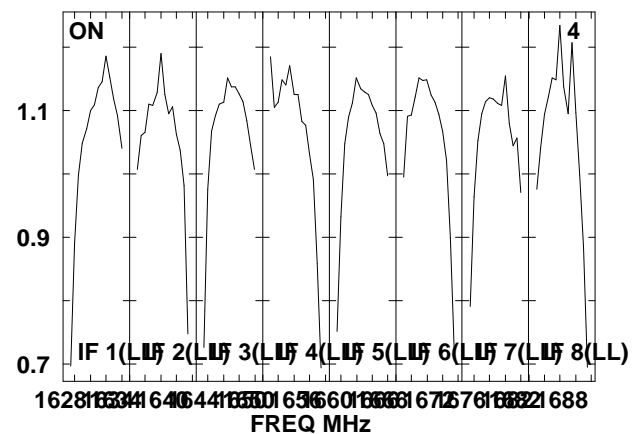
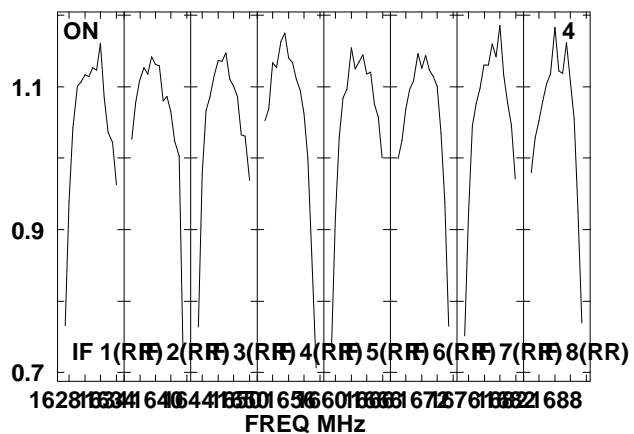
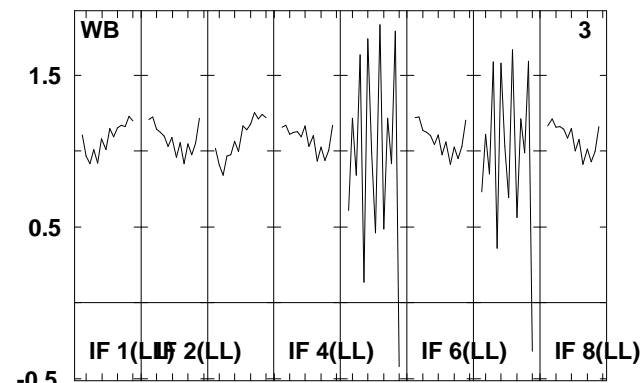
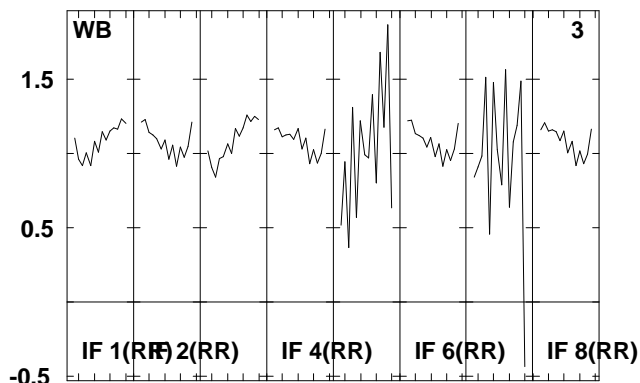
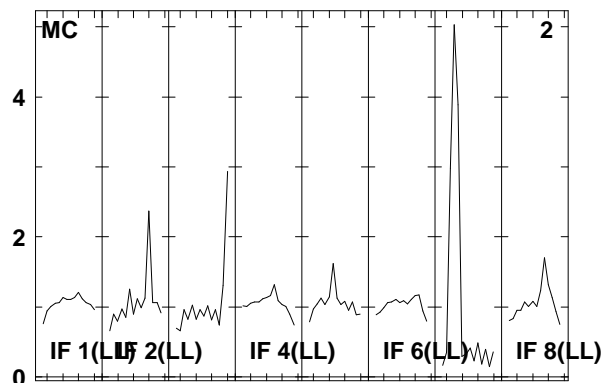
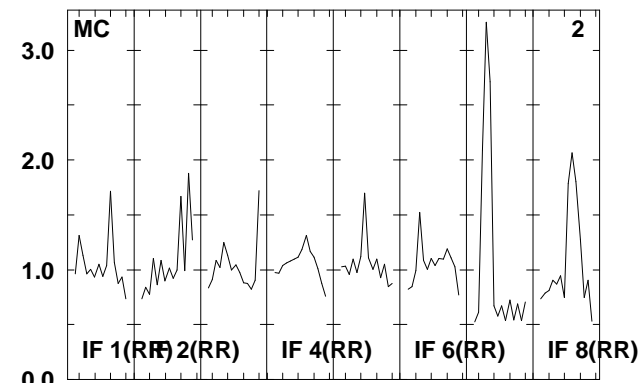
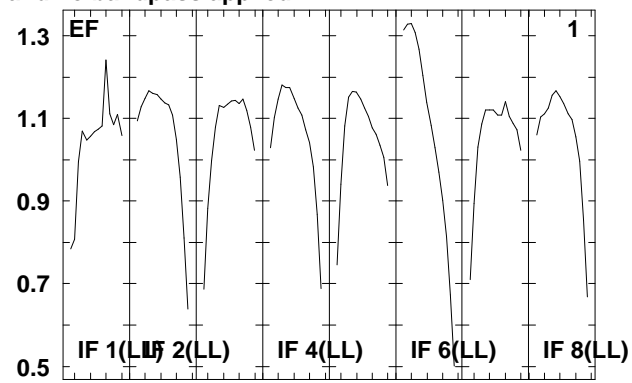
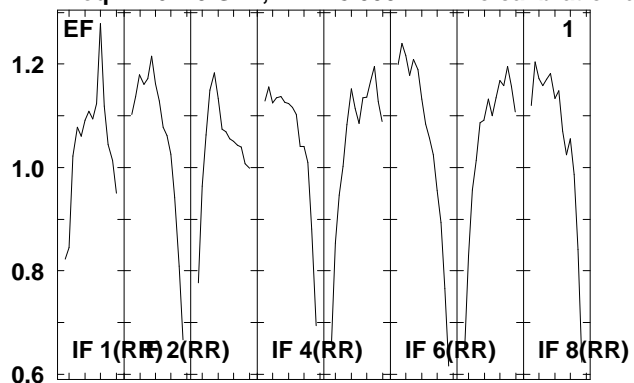

Lower frame: Real Jy  
Total-power spectrum Antenna: \*  
Timerange: 00/14:48:03 to 00/14:52:01

Plot file version 184 created 06-JAN-2009 10:58:12

J150407 EZ018B.UVDATA.1

Freq = 1.6270 GHz, Bw = 8.000 MH No calibration applied and no bandpass applied

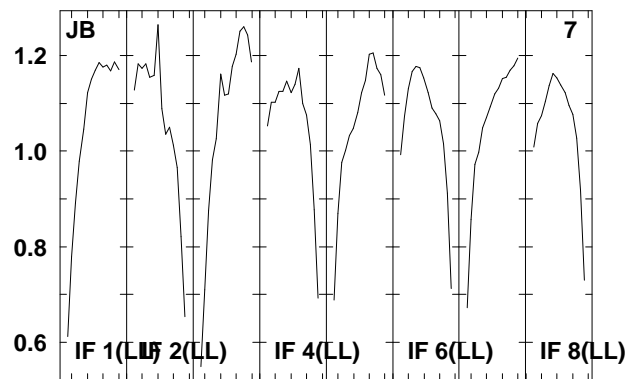
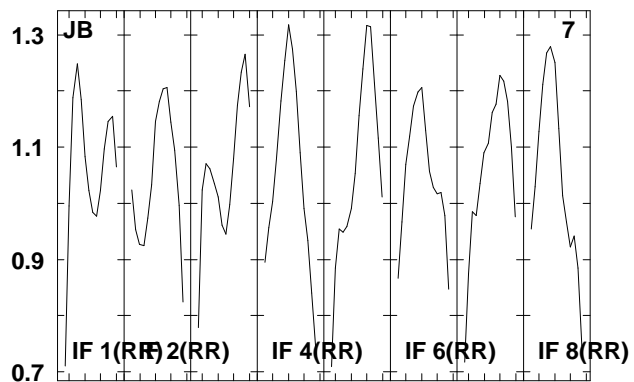
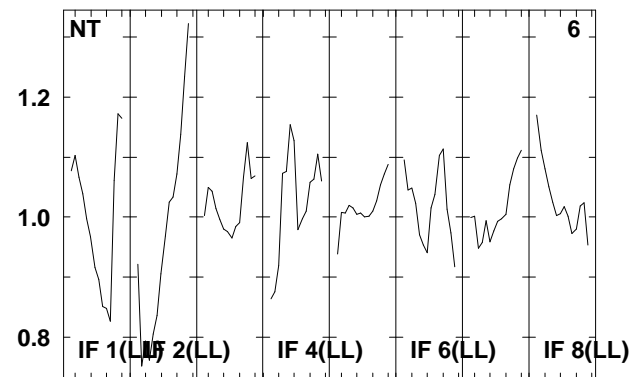
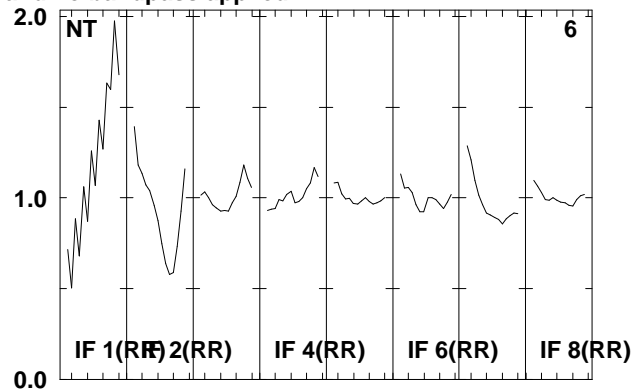
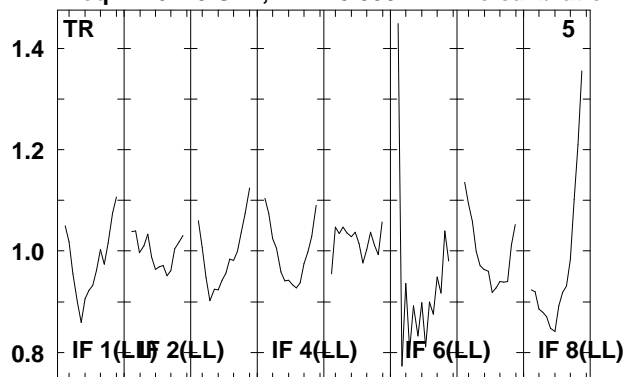

Lower frame: Real Jy  
Total-power spectrum Antenna: \*  
Timerange: 00/14:48:03 to 00/14:52:01



Plot file version 185 created 06-JAN-2009 10:58:12

J1510-05 EZ018B.UVDATA.1

Freq = 1.6270 GHz, Bw = 8.000 MH No calibration applied and no bandpass applied

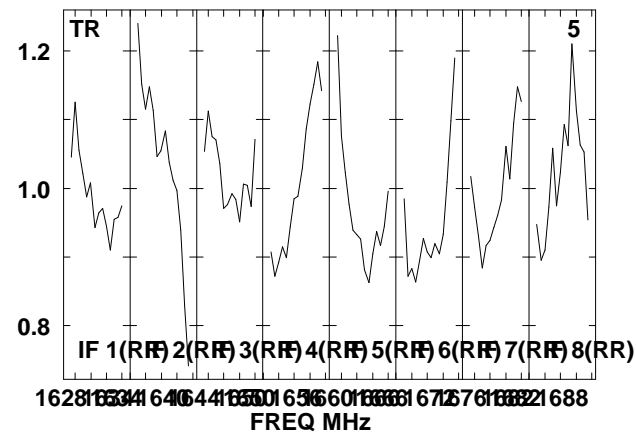
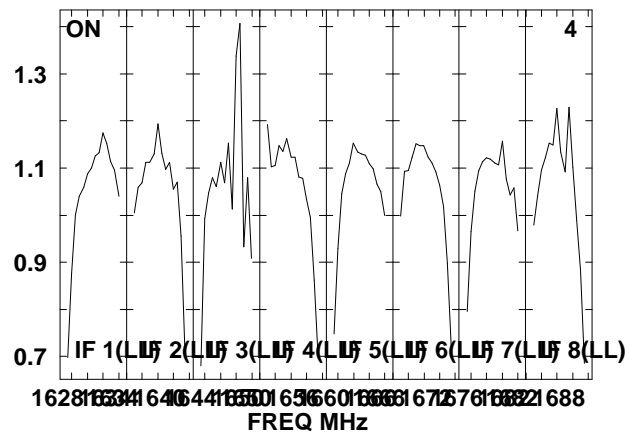
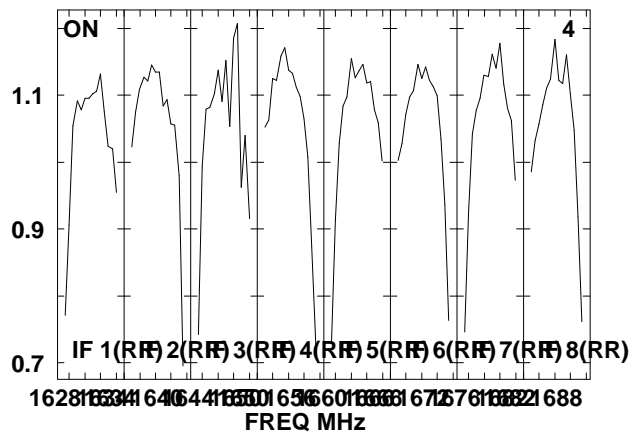
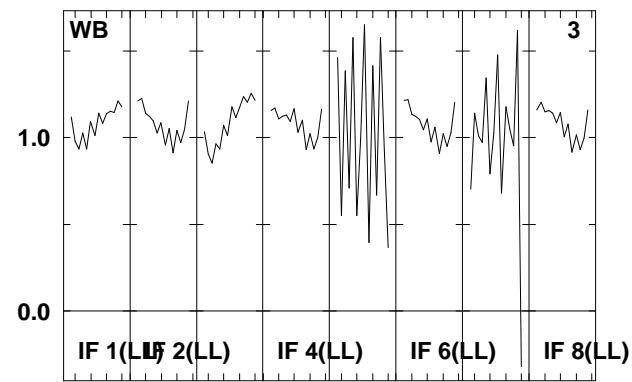
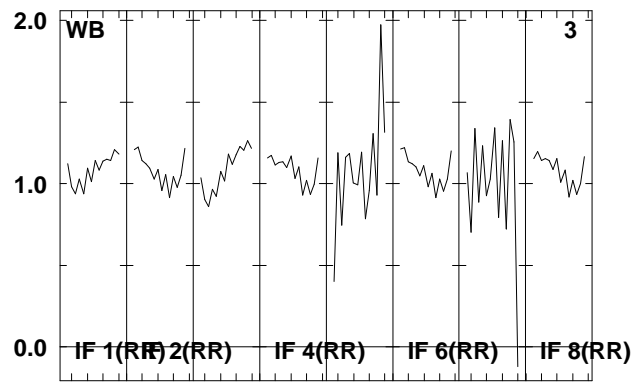
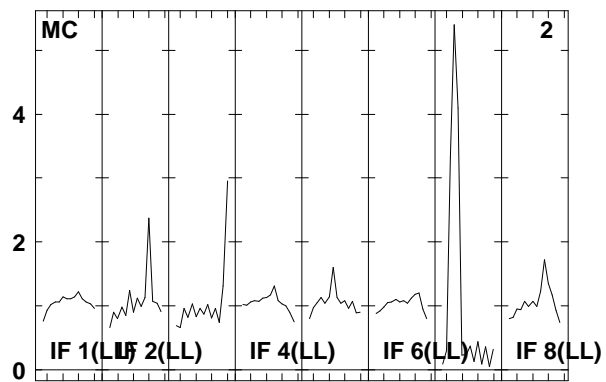
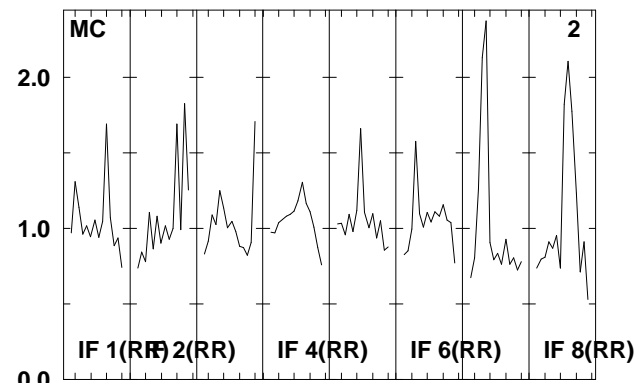
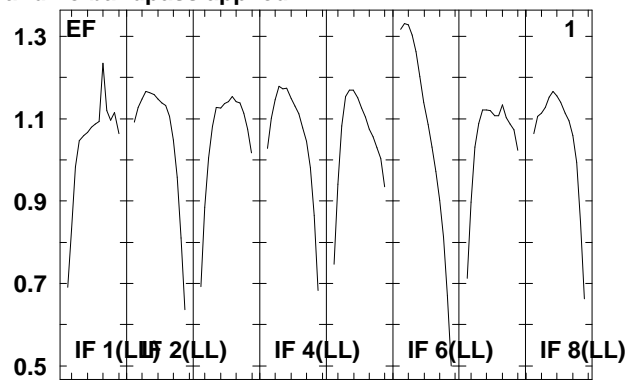
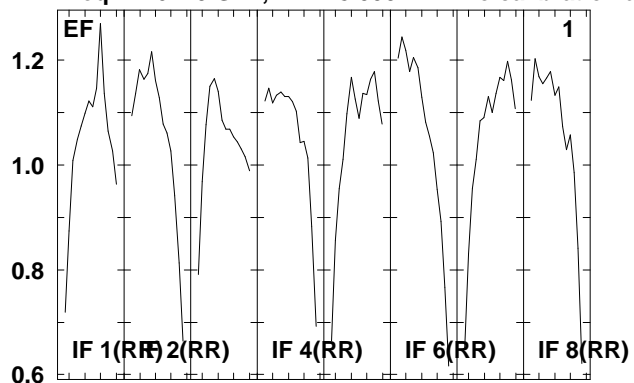

Lower frame: Real Jy  
Total-power spectrum Antenna: \*  
Timerange: 00/14:52:03 to 00/14:54:59

Plot file version 186 created 06-JAN-2009 10:58:12

J1510-05 EZ018B.UVDATA.1

Freq = 1.6270 GHz, Bw = 8.000 MH No calibration applied and no bandpass applied

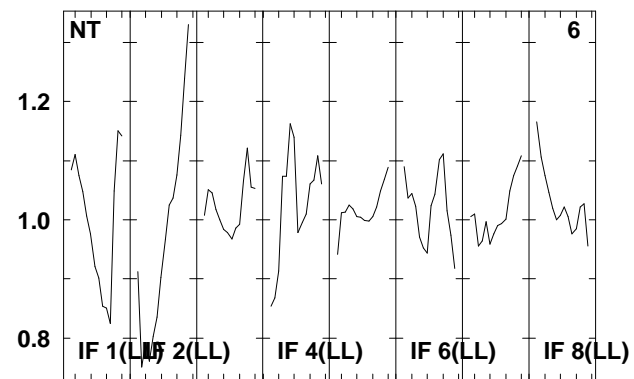
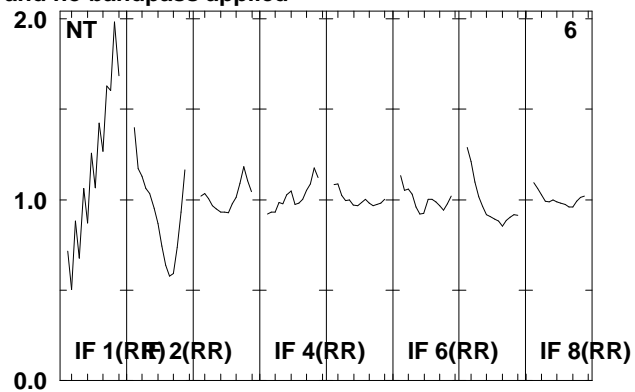
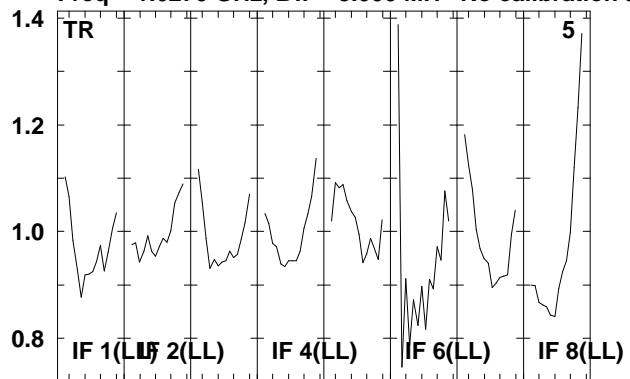

Lower frame: Real Jy  
Total-power spectrum Antenna: \*  
Timerange: 00/14:52:03 to 00/14:54:59

Plot file version 187 created 06-JAN-2009 10:58:13

J150407 EZ018B.UVDATA.1

Freq = 1.6270 GHz, Bw = 8.000 MH No calibration applied and no bandpass applied

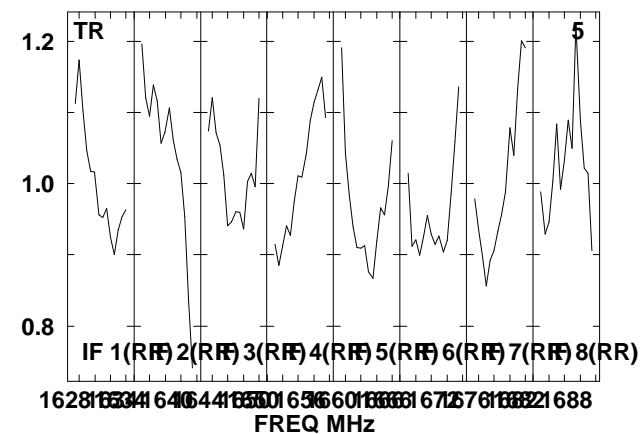
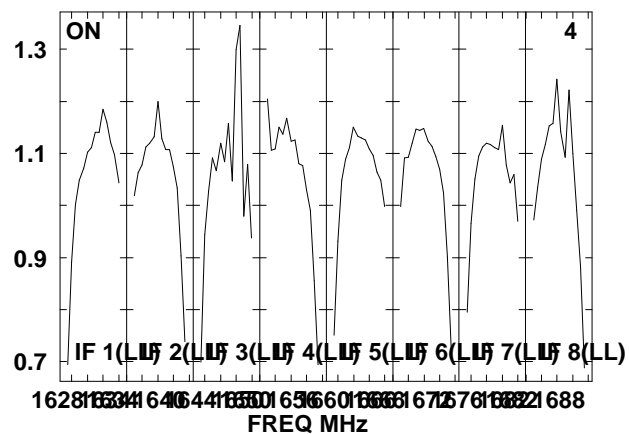
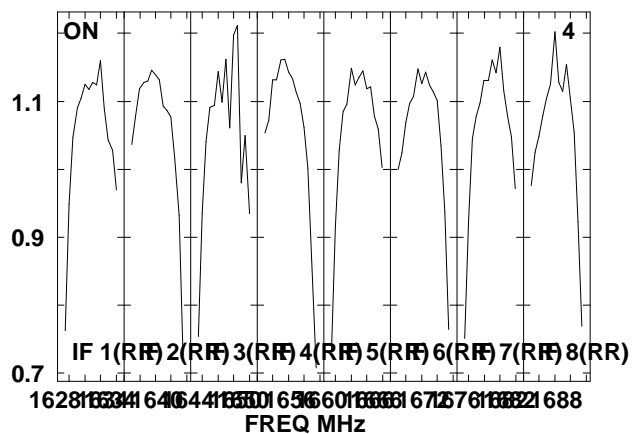
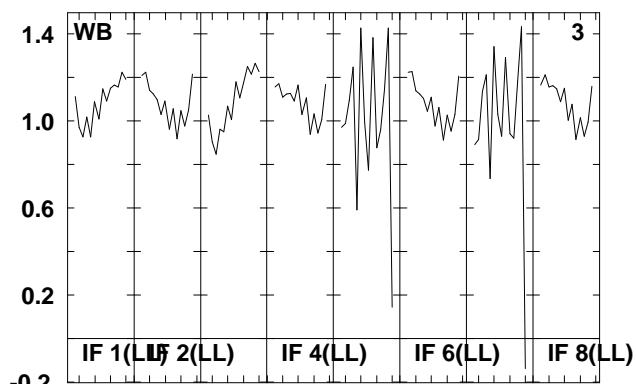
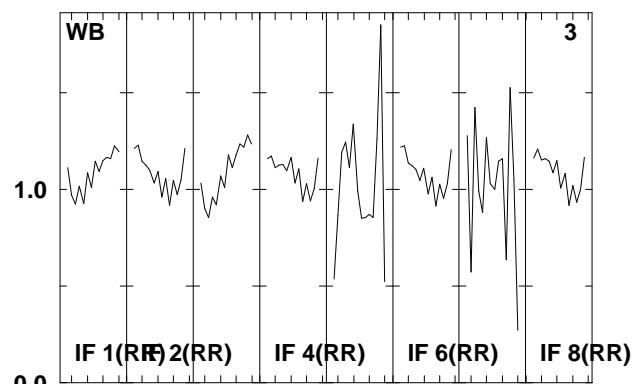
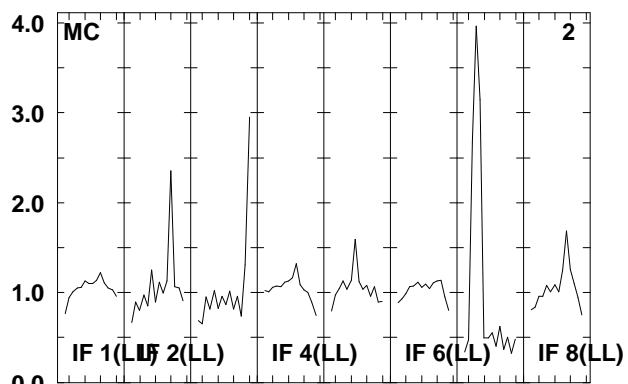
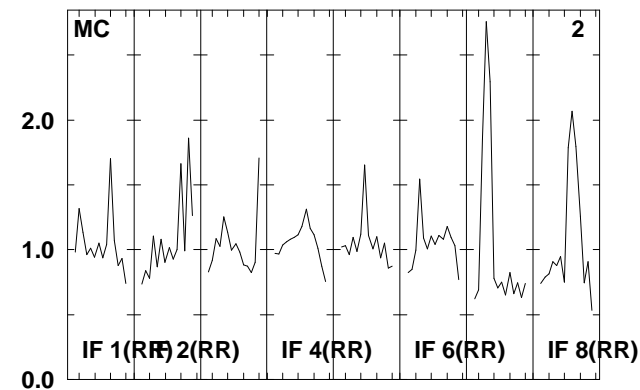
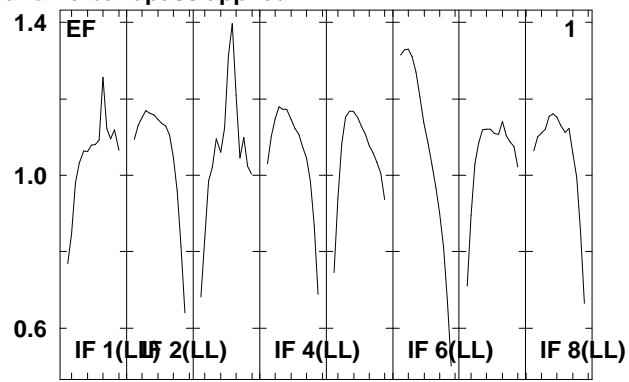
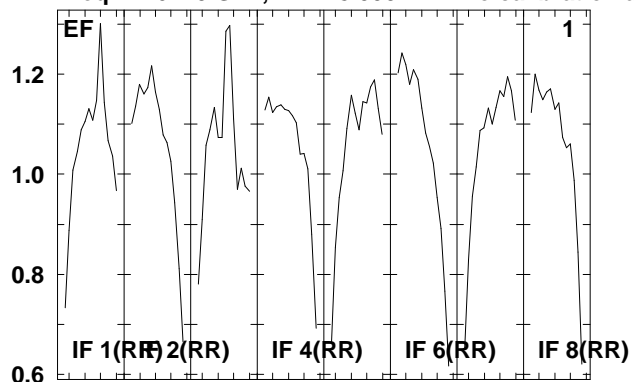

Lower frame: Real Jy  
Total-power spectrum Antenna: \*  
Timerange: 00/14:55:01 to 00/14:58:59

Plot file version 188 created 06-JAN-2009 10:58:13

J150407 EZ018B.UVDATA.1

Freq = 1.6270 GHz, Bw = 8.000 MH No calibration applied and no bandpass applied

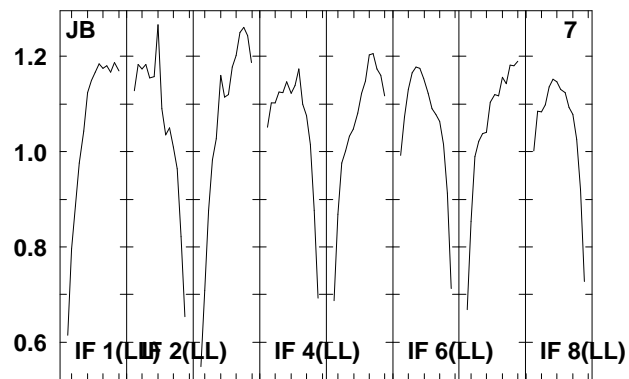
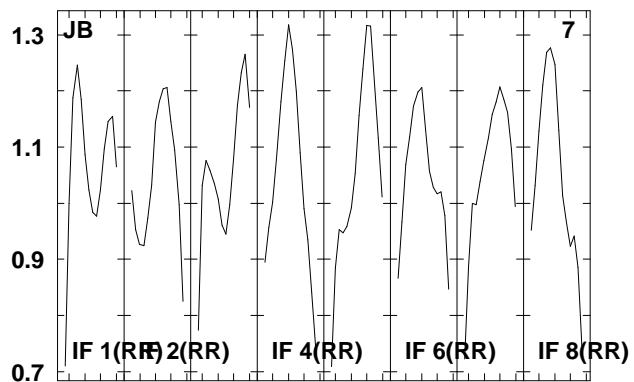
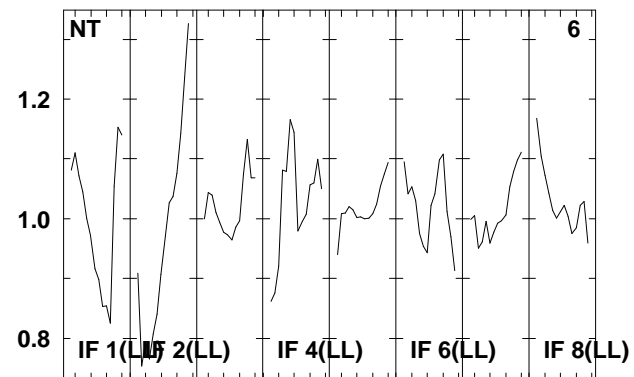
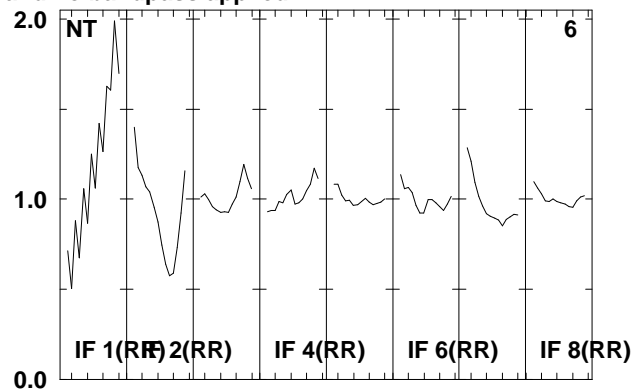
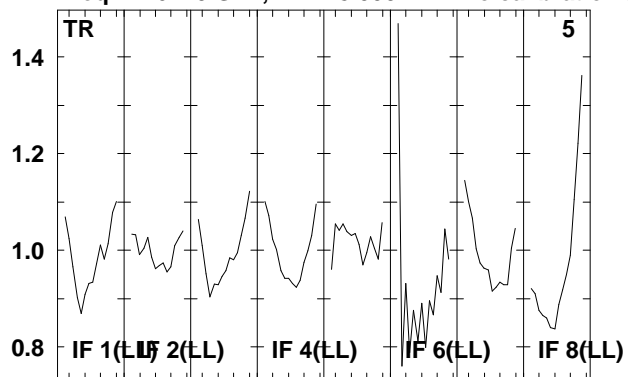

Lower frame: Real Jy  
Total-power spectrum Antenna: \*  
Timerange: 00/14:55:01 to 00/14:58:59

Plot file version 189 created 06-JAN-2009 10:58:14

J1510-05 EZ018B.UVDATA.1

Freq = 1.6270 GHz, Bw = 8.000 MH No calibration applied and no bandpass applied

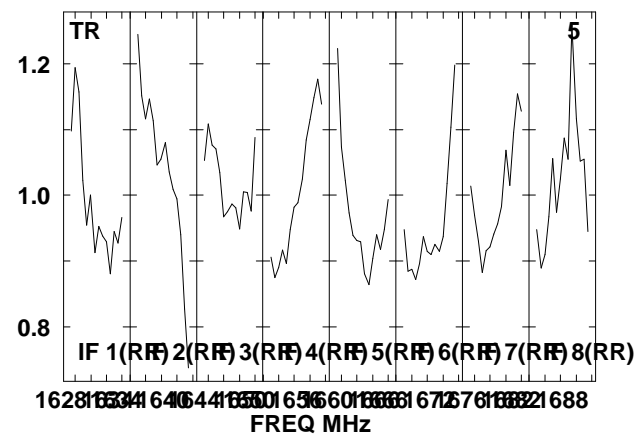
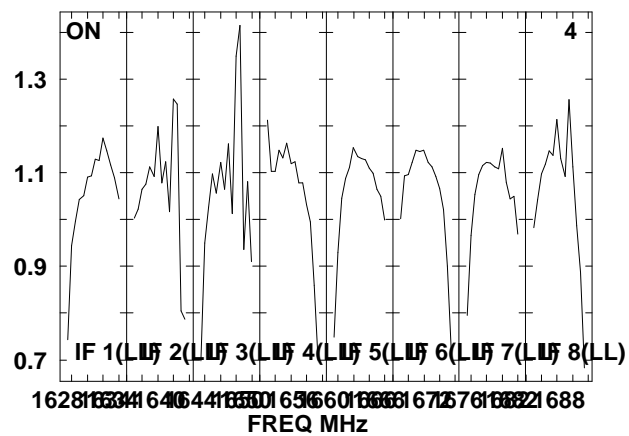
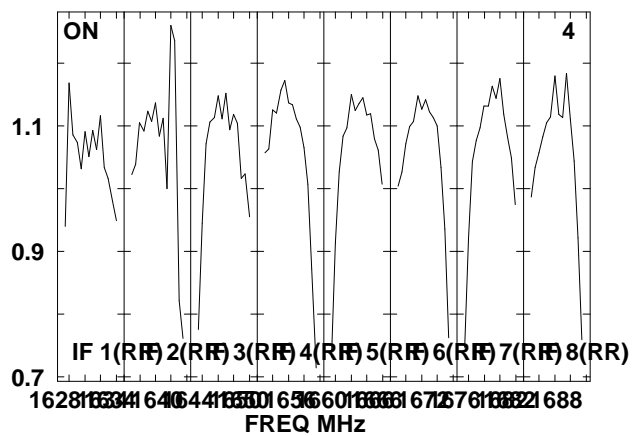
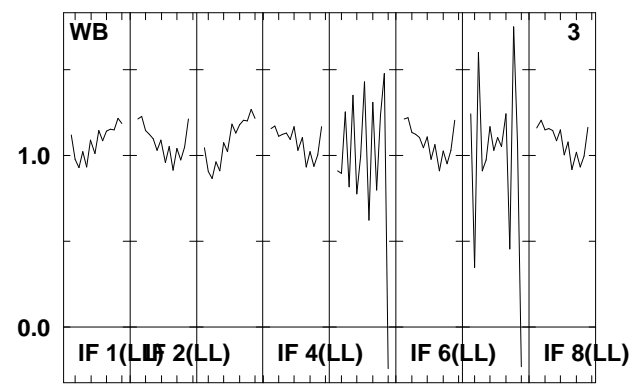
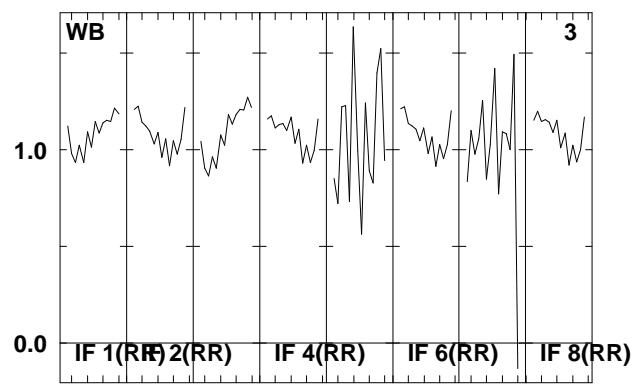
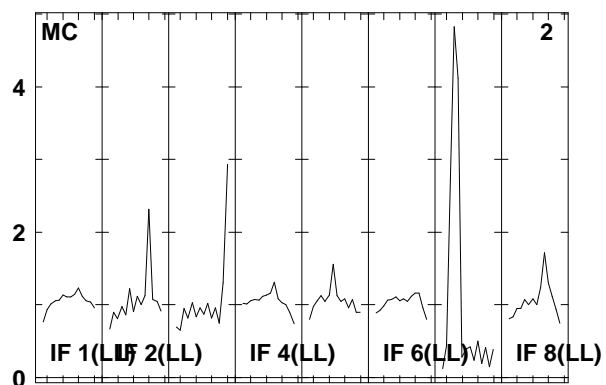
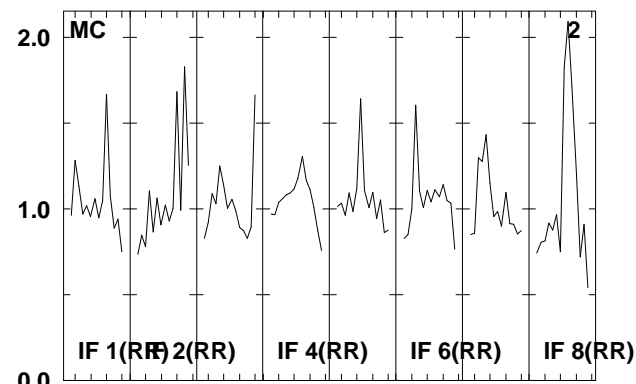
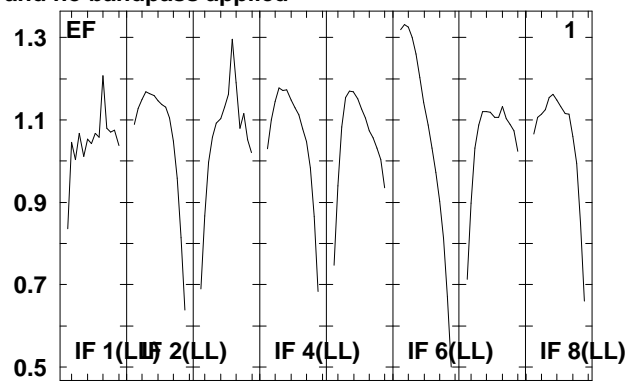
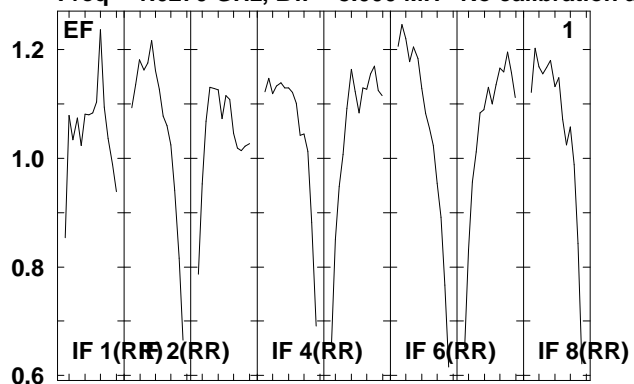

Lower frame: Real Jy  
Total-power spectrum Antenna: \*  
Timerange: 00/15:00:03 to 00/15:03:01

Plot file version 190 created 06-JAN-2009 10:58:14

J1510-05 EZ018B.UVDATA.1

Freq = 1.6270 GHz, Bw = 8.000 MH No calibration applied and no bandpass applied

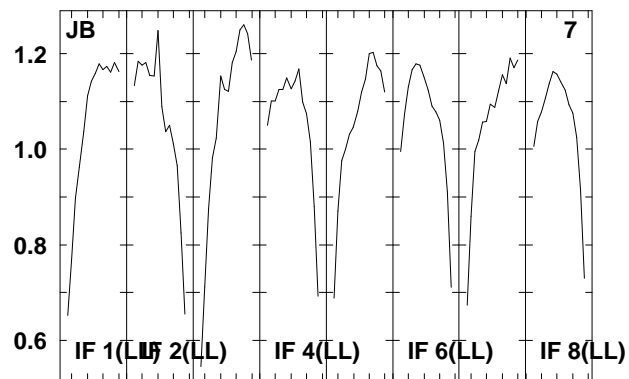
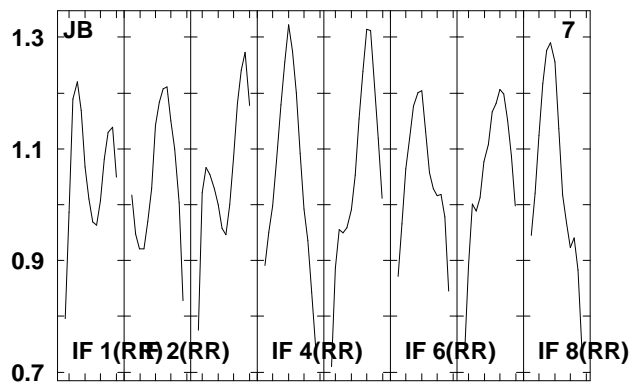
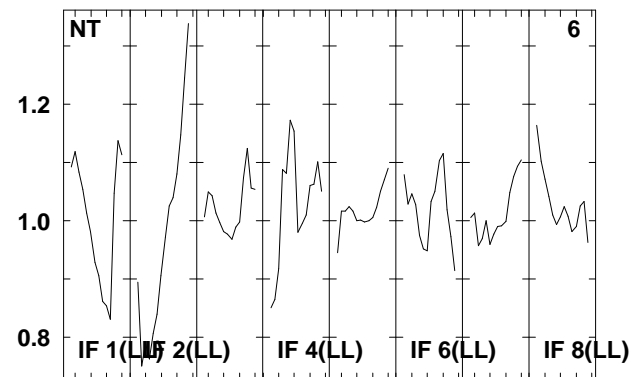
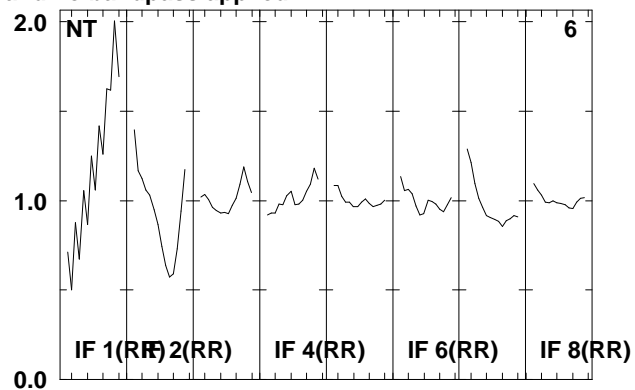
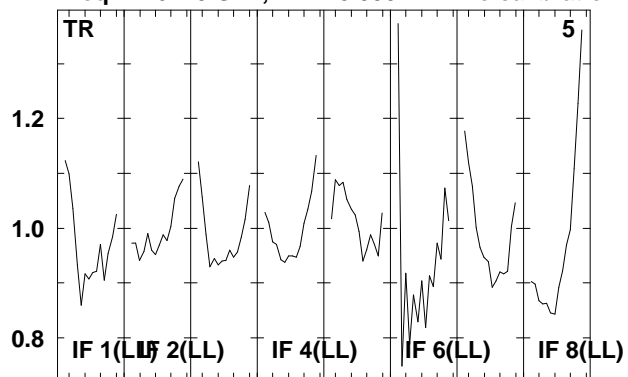

Lower frame: Real Jy  
Total-power spectrum Antenna: \*  
Timerange: 00/15:00:03 to 00/15:03:01

Plot file version 191 created 06-JAN-2009 10:58:14

J150407 EZ018B.UVDATA.1

Freq = 1.6270 GHz, Bw = 8.000 MH No calibration applied and no bandpass applied

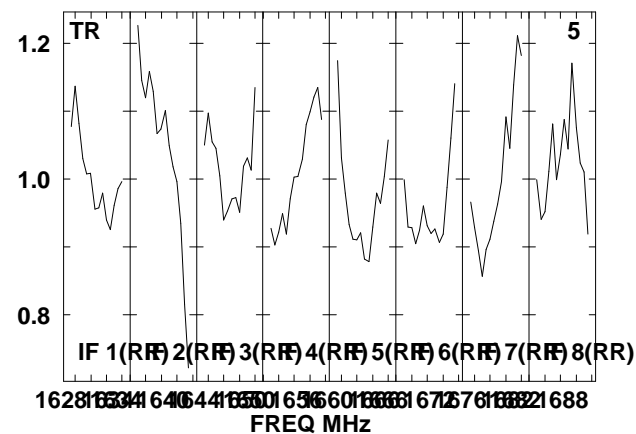
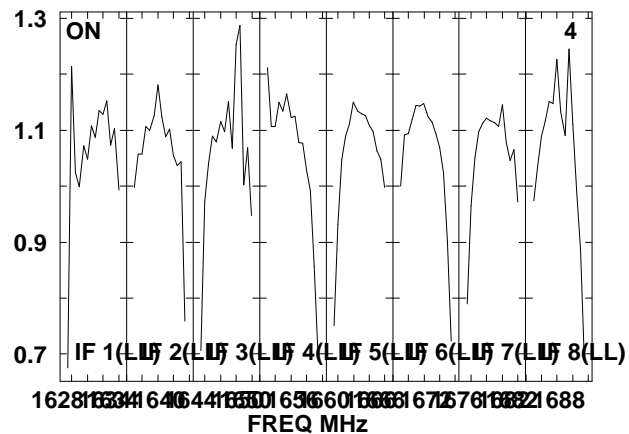
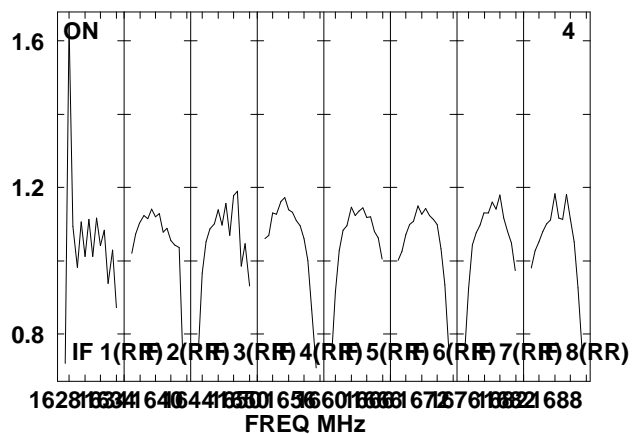
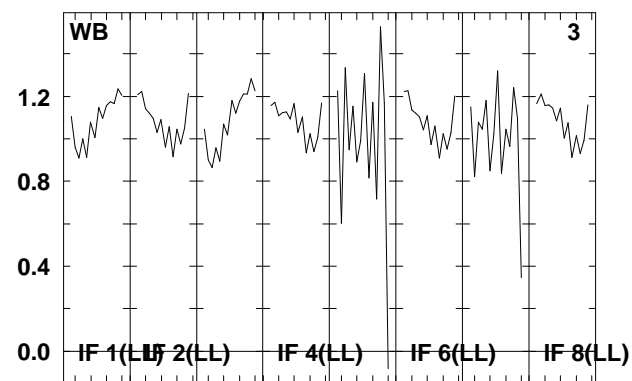
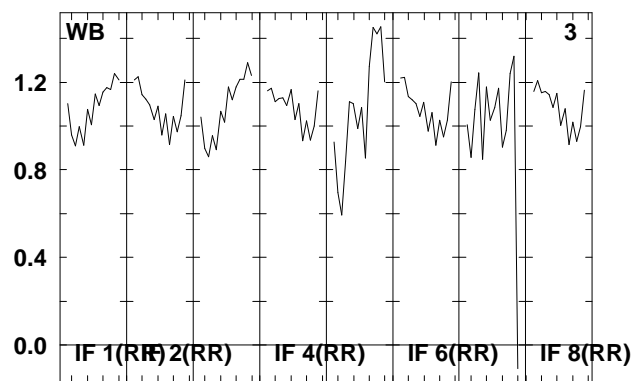
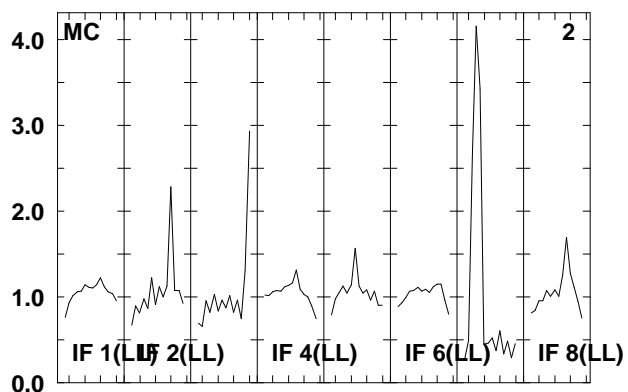
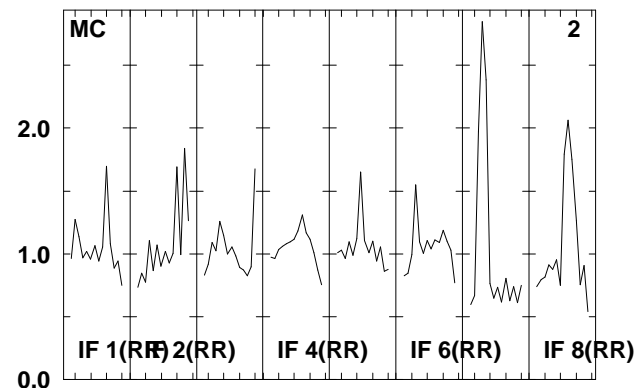
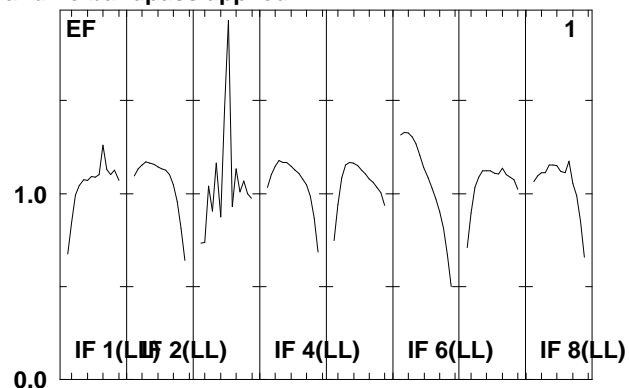
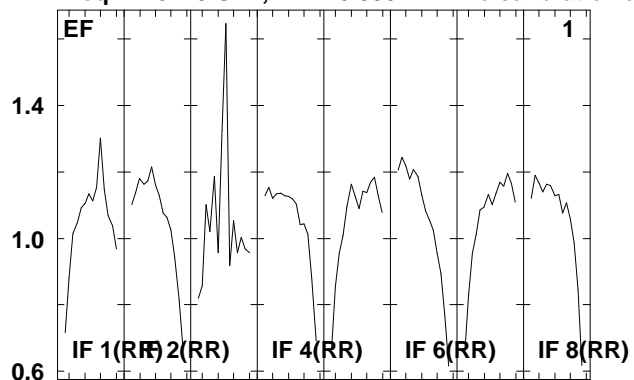

Lower frame: Real Jy

Total-power spectrum Antenna: \*

Timerange: 00/15:03:03 to 00/15:06:59

Plot file version 192 created 06-JAN-2009 10:58:15

J150407 EZ018B.UVDATA.1

Freq = 1.6270 GHz, Bw = 8.000 MH No calibration applied and no bandpass applied

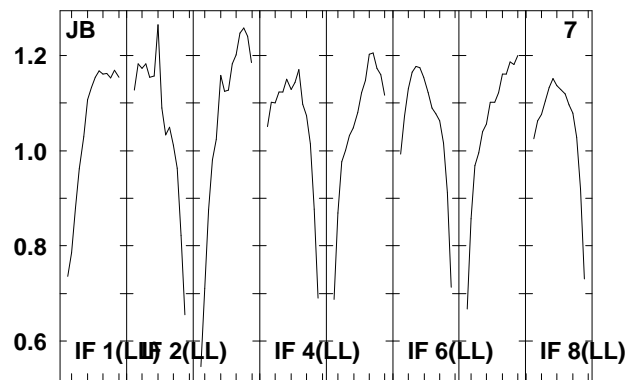
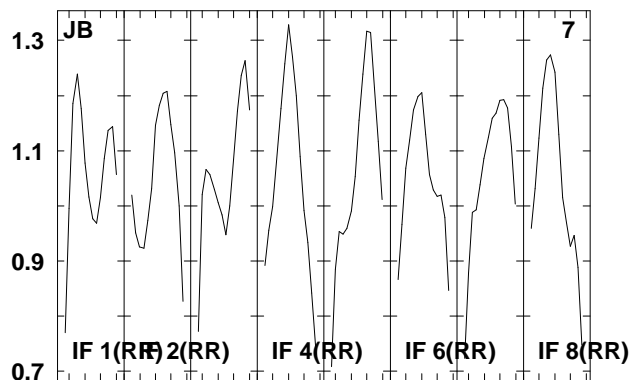
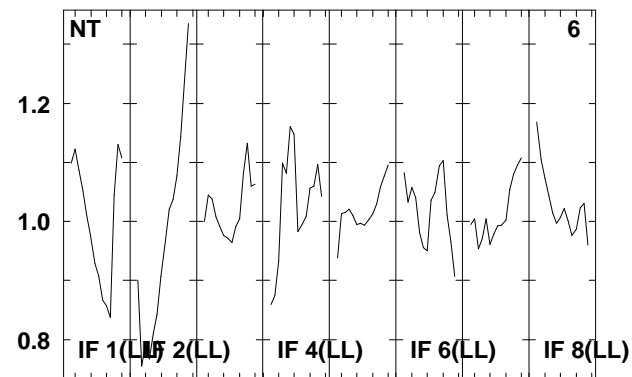
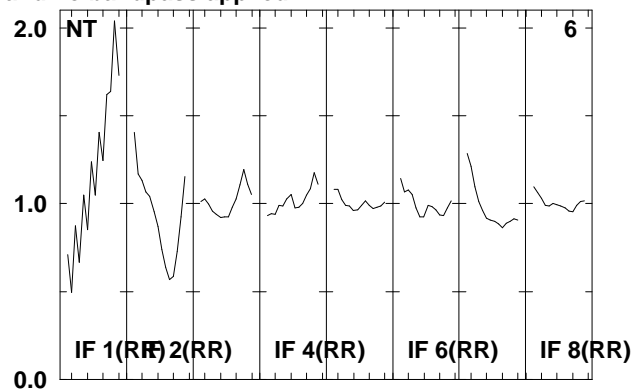
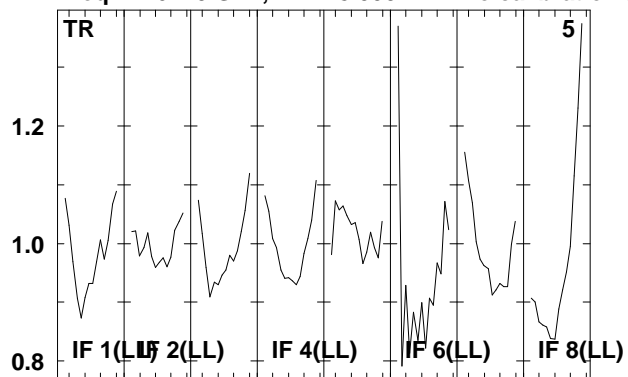

Lower frame: Real Jy  
Total-power spectrum Antenna: \*  
Timerange: 00/15:03:03 to 00/15:06:59



Plot file version 193 created 06-JAN-2009 10:58:15

J1510-05 EZ018B.UVDATA.1

Freq = 1.6270 GHz, Bw = 8.000 MH No calibration applied and no bandpass applied

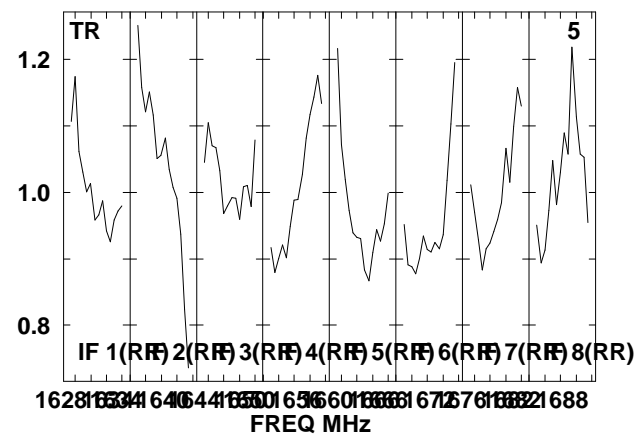
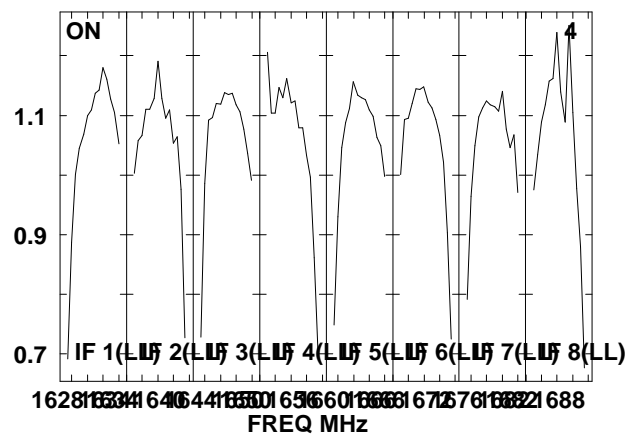
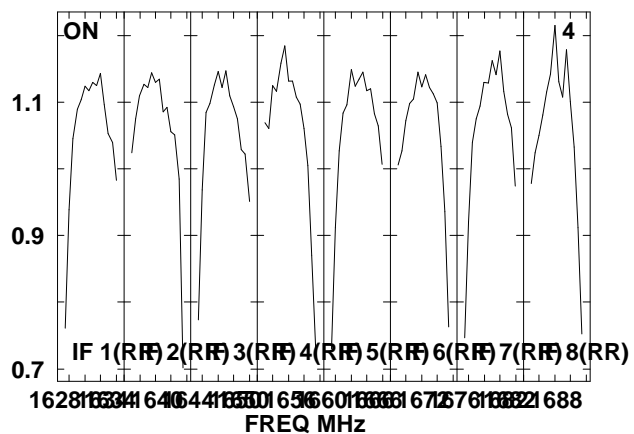
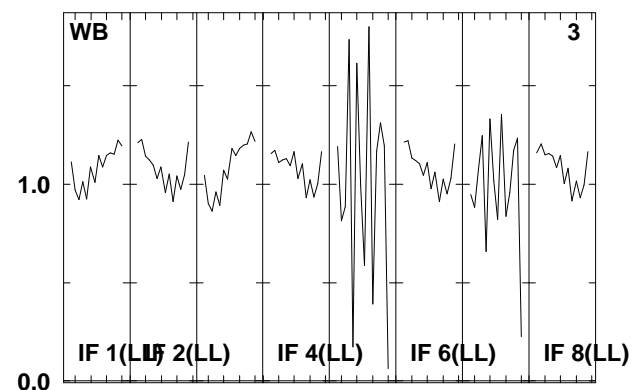
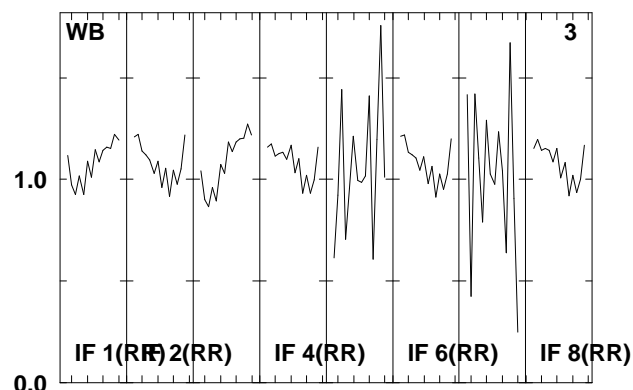
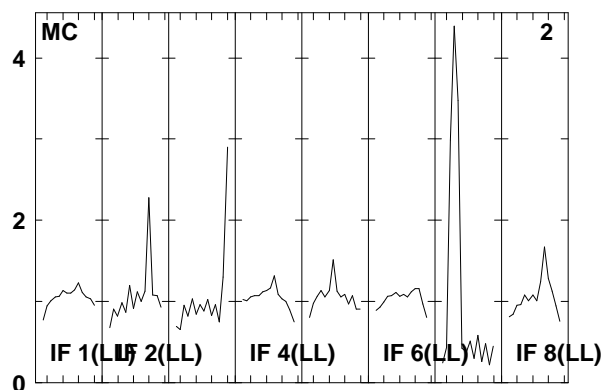
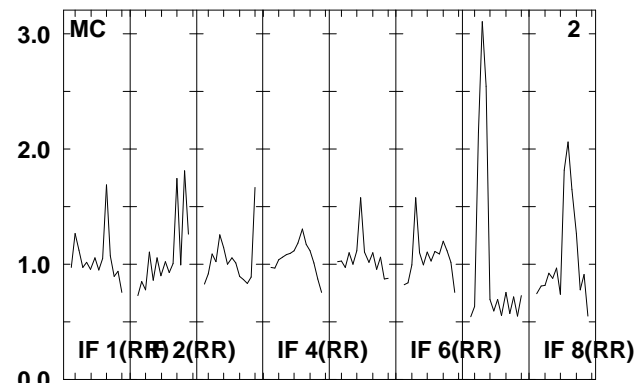
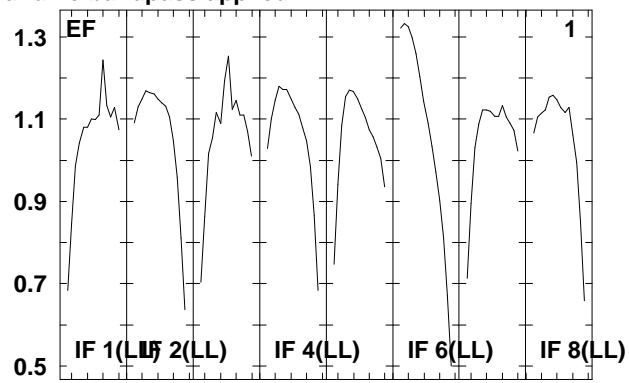
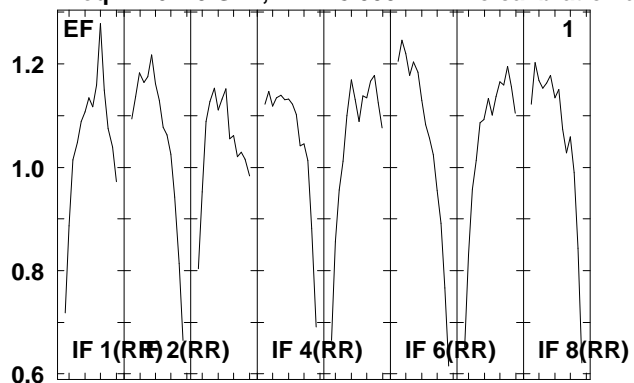

Lower frame: Real Jy  
Total-power spectrum Antenna: \*  
Timerange: 00/15:07:01 to 00/15:10:01

Plot file version 194 created 06-JAN-2009 10:58:16

J1510-05 EZ018B.UVDATA.1

Freq = 1.6270 GHz, Bw = 8.000 MH No calibration applied and no bandpass applied

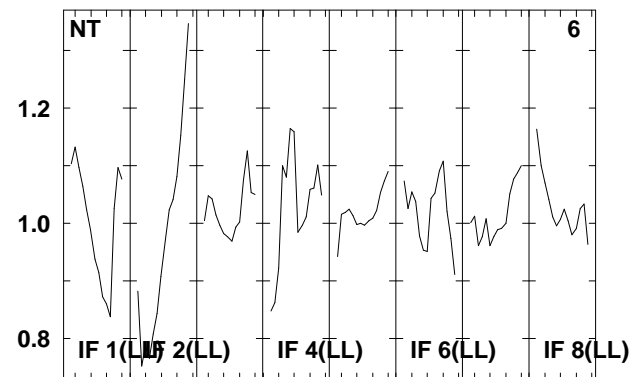
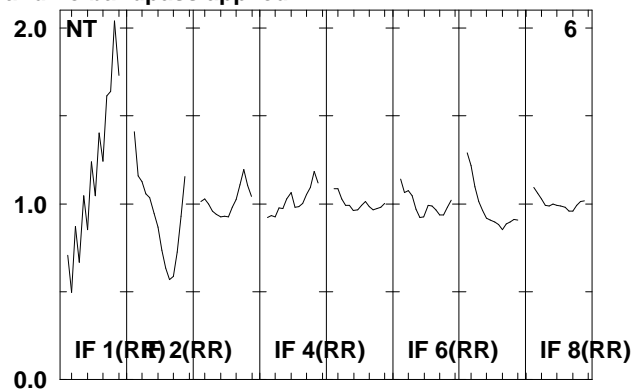
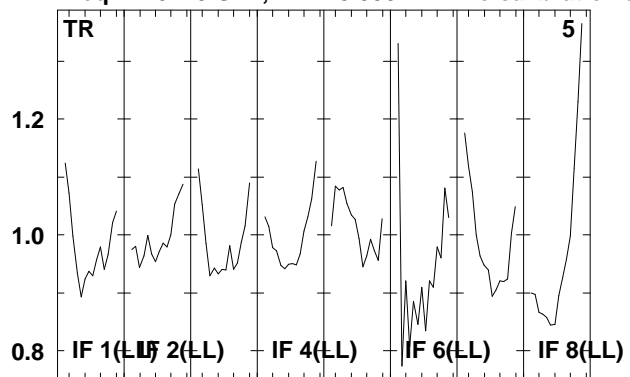

Lower frame: Real Jy  
Total-power spectrum Antenna: \*  
Timerange: 00/15:07:01 to 00/15:10:01

Plot file version 195 created 06-JAN-2009 10:58:16

J150407 EZ018B.UVDATA.1

Freq = 1.6270 GHz, Bw = 8.000 MH No calibration applied and no bandpass applied

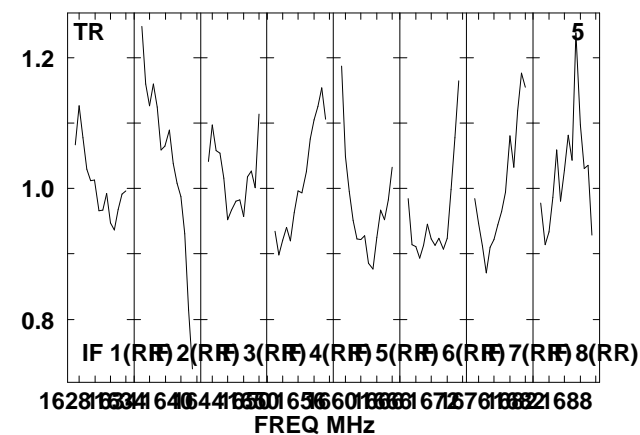
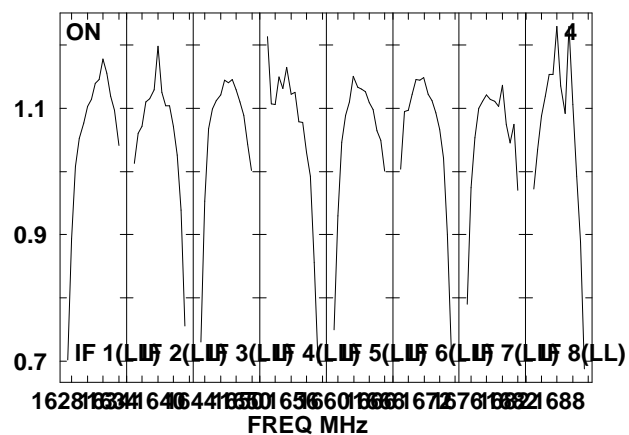
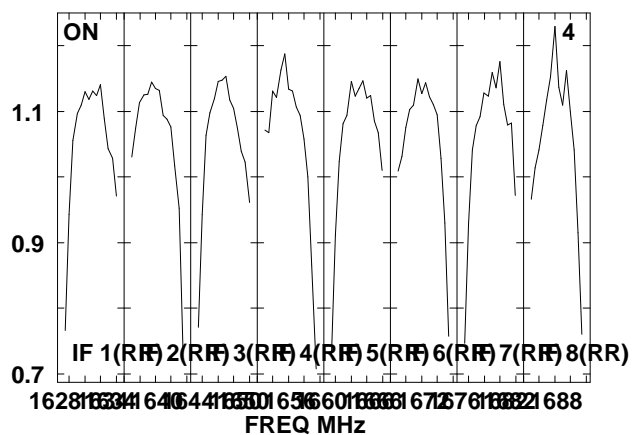
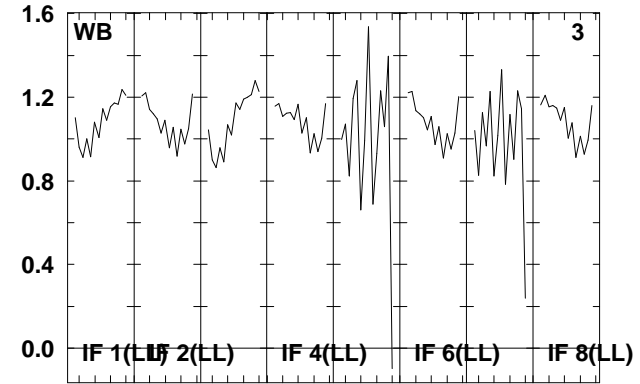
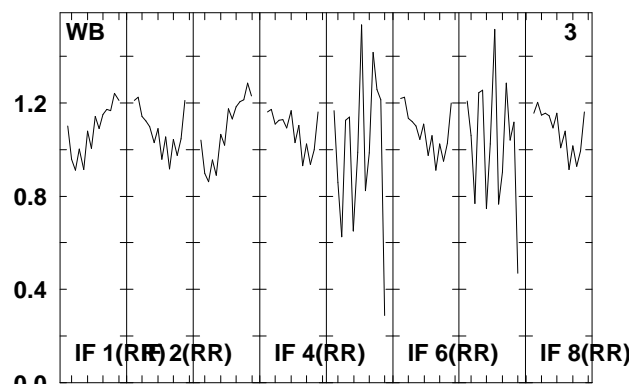
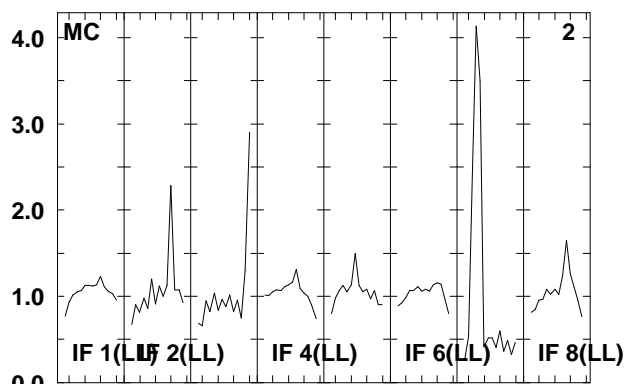
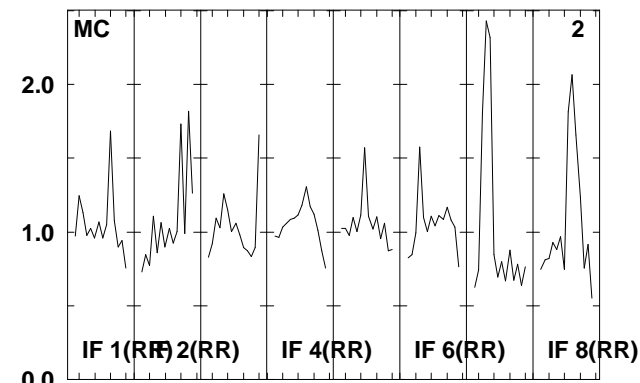
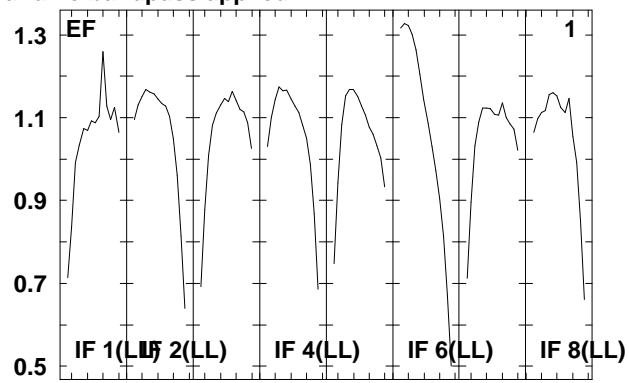
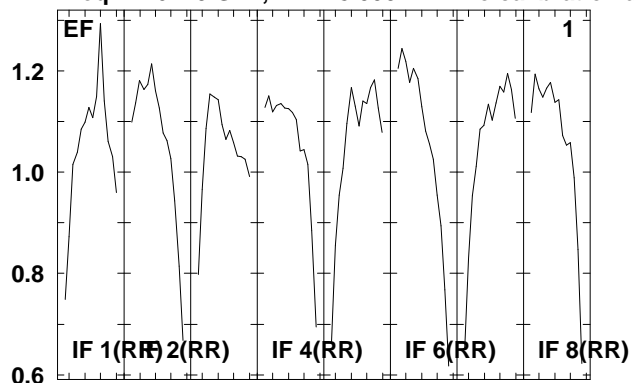

Lower frame: Real Jy  
Total-power spectrum Antenna: \*  
Timerange: 00/15:10:03 to 00/15:13:59

Plot file version 196 created 06-JAN-2009 10:58:16

J150407 EZ018B.UVDATA.1

Freq = 1.6270 GHz, Bw = 8.000 MH No calibration applied and no bandpass applied

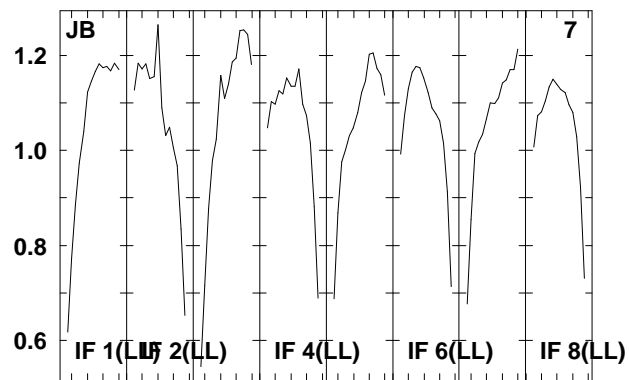
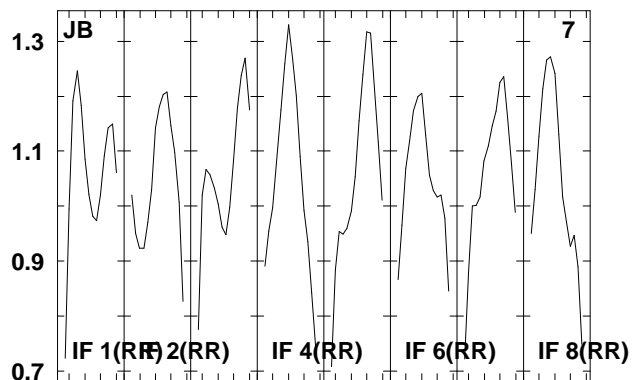
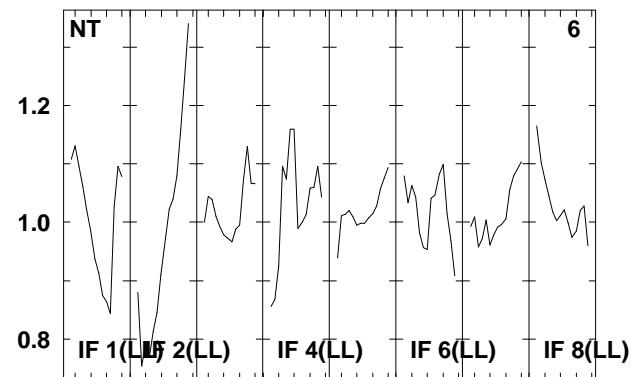
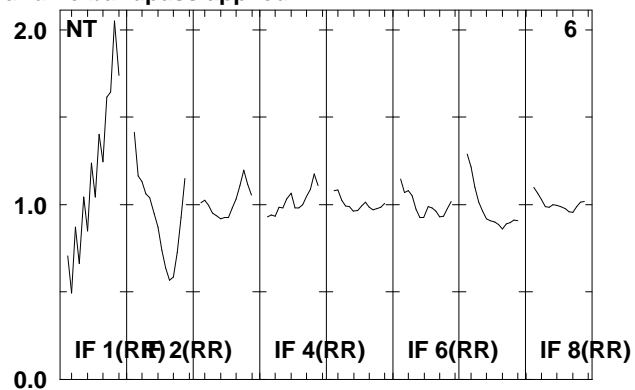
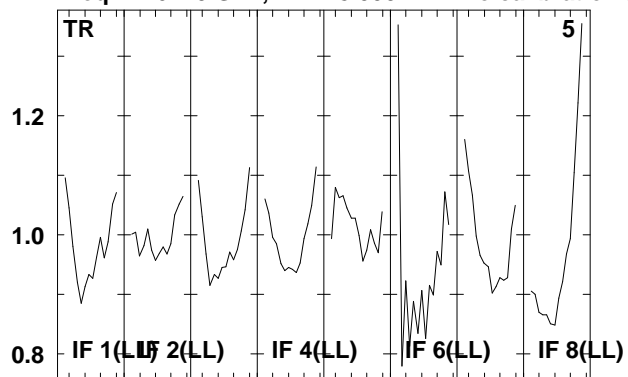

Lower frame: Real Jy  
Total-power spectrum Antenna: \*  
Timerange: 00/15:10:03 to 00/15:13:59

Plot file version 197 created 06-JAN-2009 10:58:17

J1510-05 EZ018B.UVDATA.1

Freq = 1.6270 GHz, Bw = 8.000 MH No calibration applied and no bandpass applied

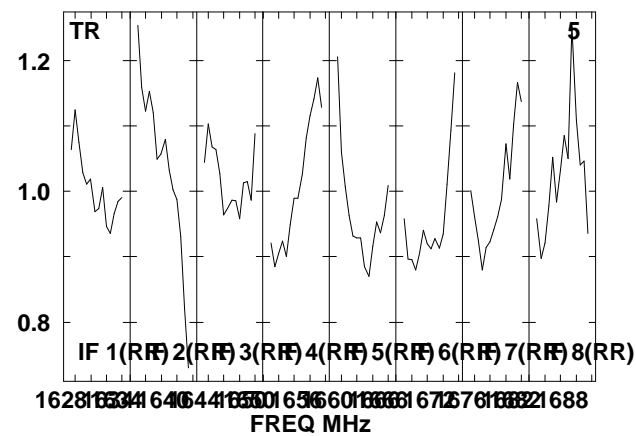
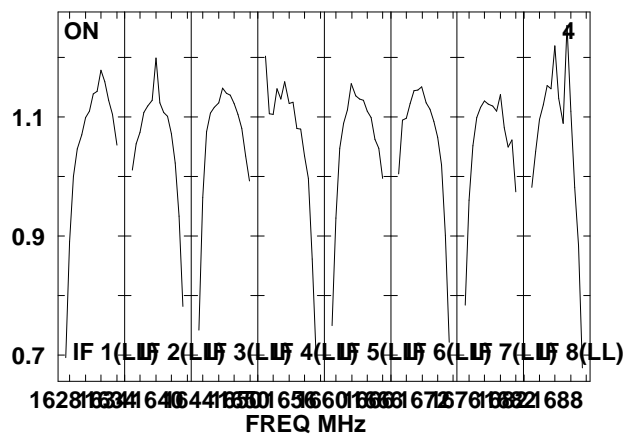
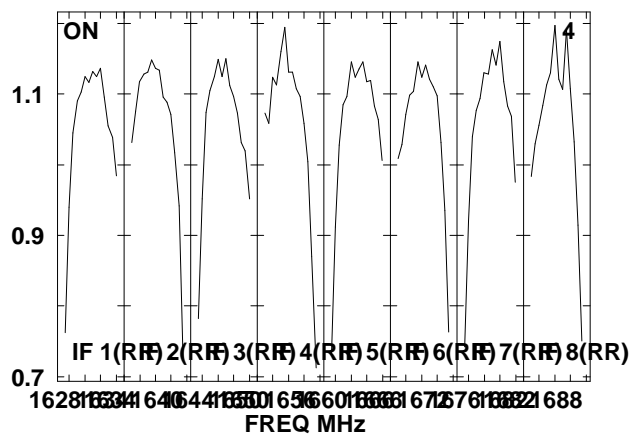
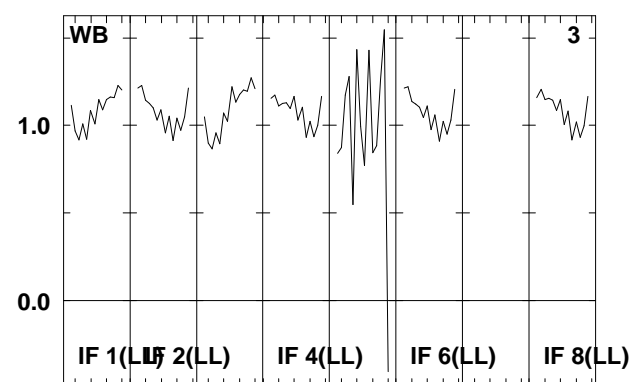
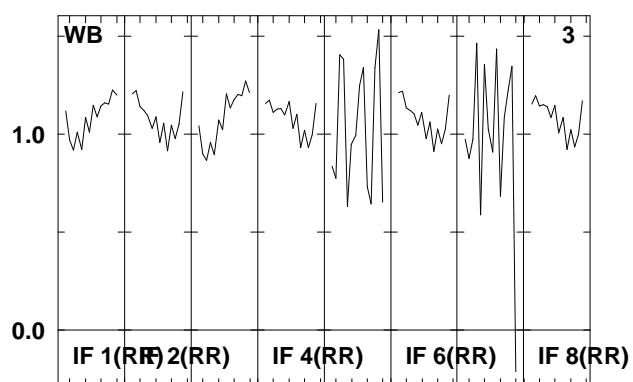
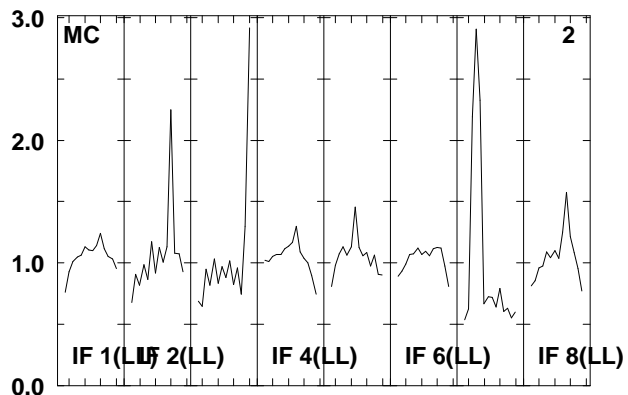
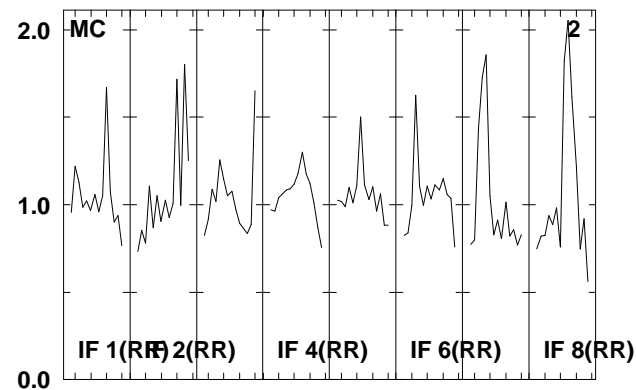
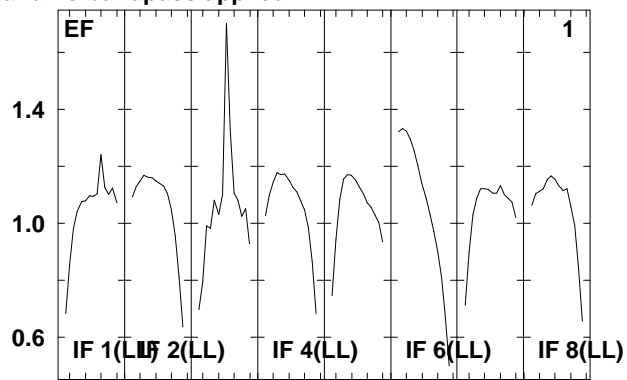
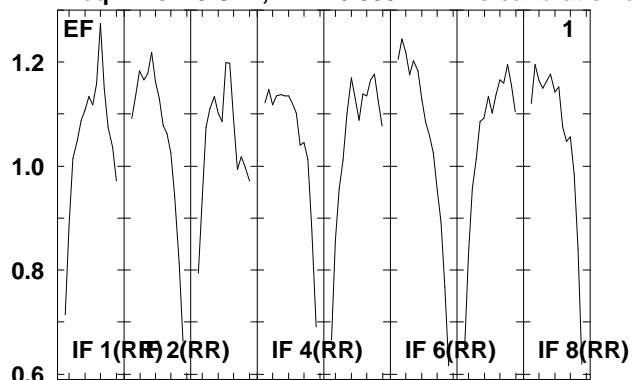

Lower frame: Real Jy  
Total-power spectrum Antenna: \*  
Timerange: 00/15:15:03 to 00/15:18:01

Plot file version 198 created 06-JAN-2009 10:58:17

J1510-05 EZ018B.UVDATA.1

Freq = 1.6270 GHz, Bw = 8.000 MH No calibration applied and no bandpass applied

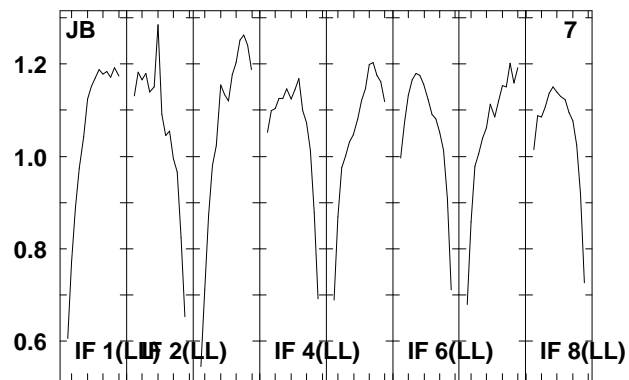
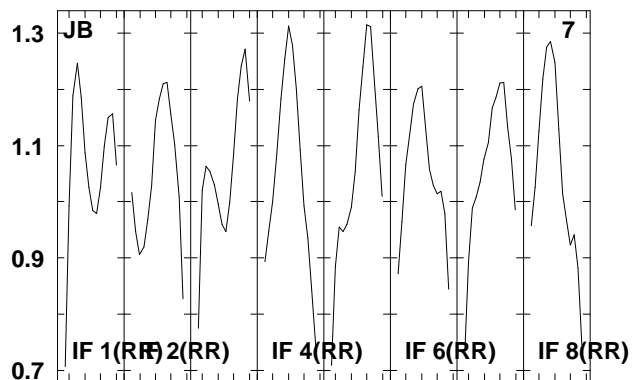
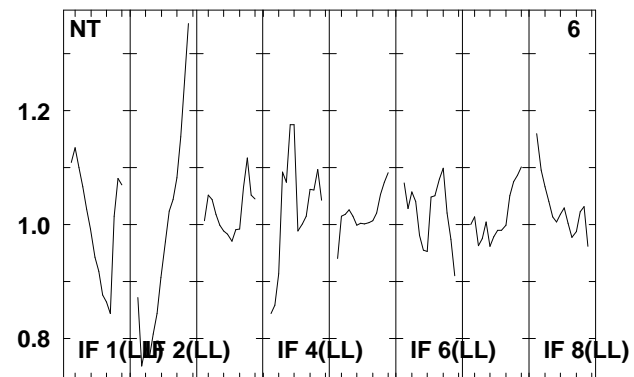
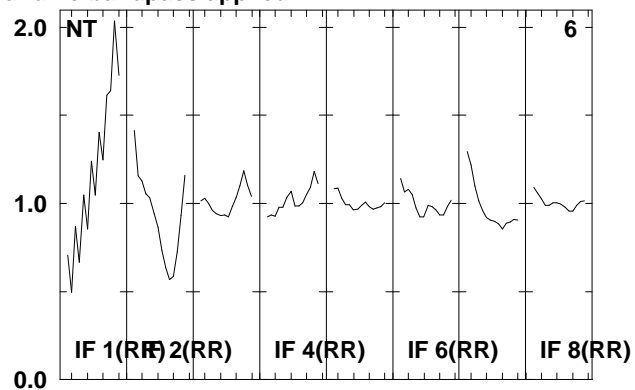
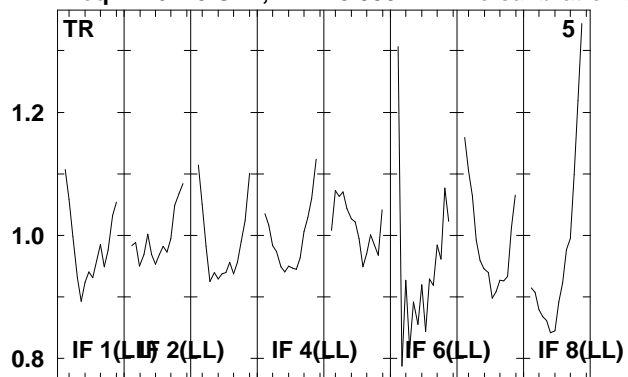

Lower frame: Real Jy  
Total-power spectrum Antenna: \*  
Timerange: 00/15:15:03 to 00/15:18:01

Plot file version 199 created 06-JAN-2009 10:58:17

J150407 EZ018B.UVDATA.1

Freq = 1.6270 GHz, Bw = 8.000 MH No calibration applied and no bandpass applied

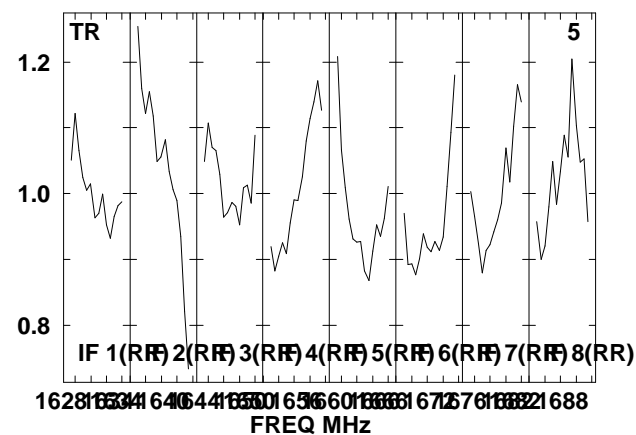
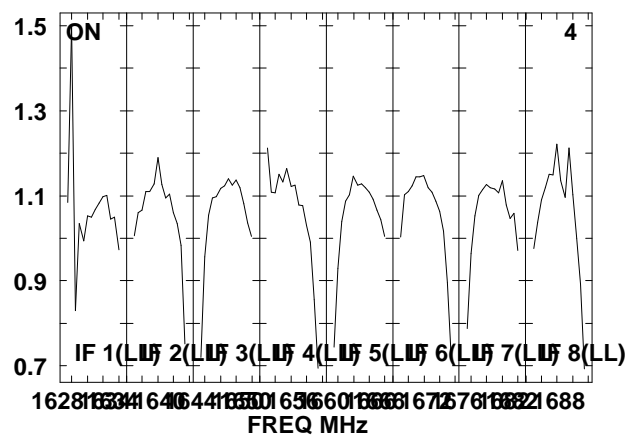
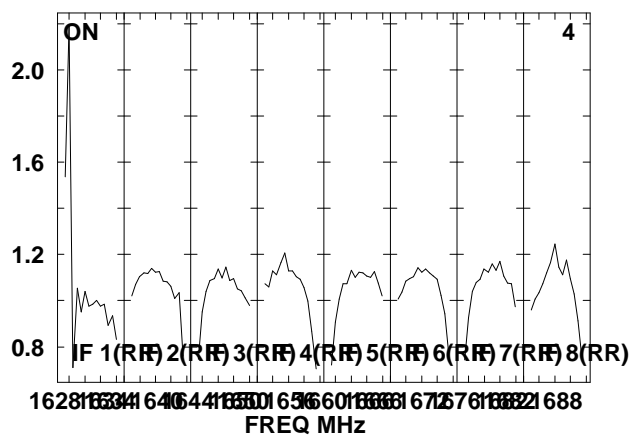
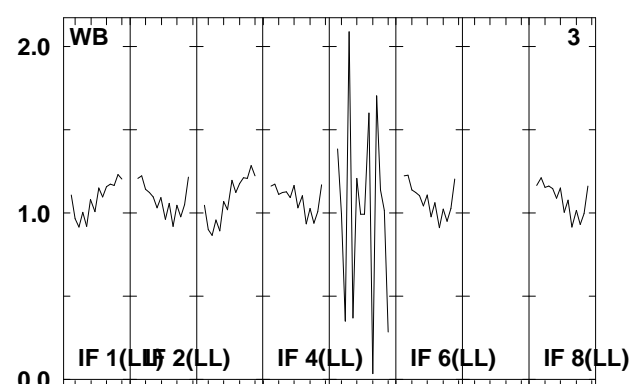
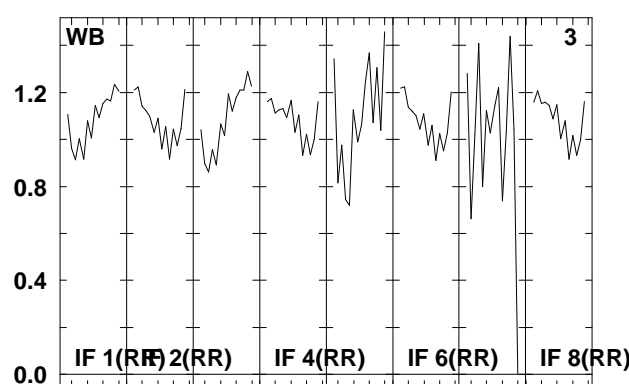
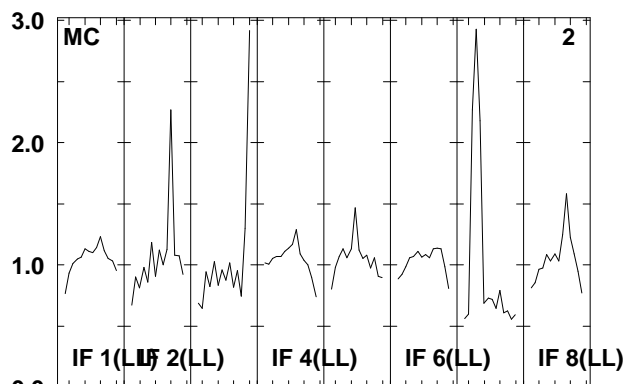
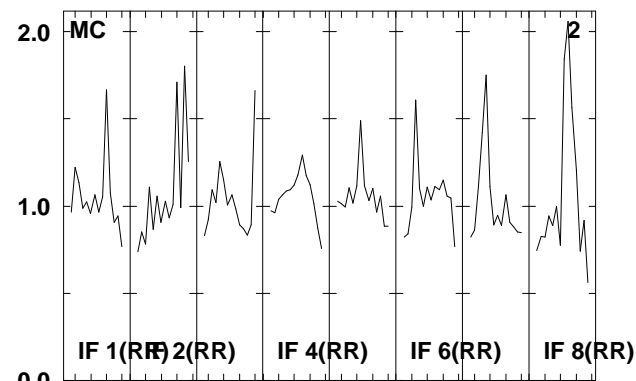
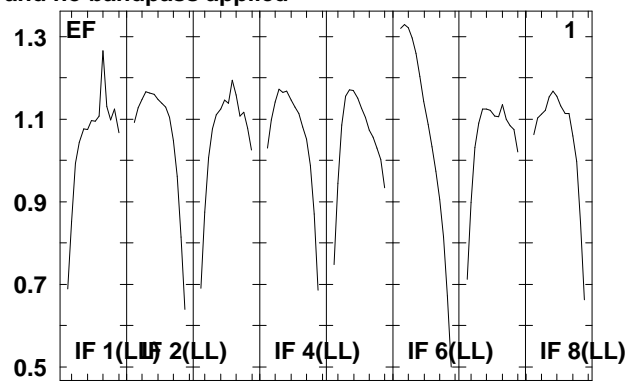
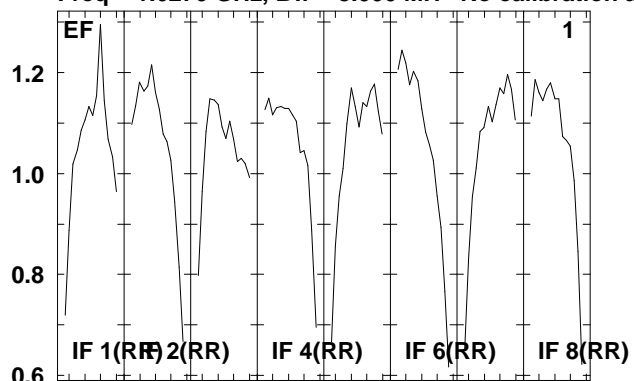

Lower frame: Real Jy  
Total-power spectrum Antenna: \*  
Timerange: 00/15:18:03 to 00/15:21:59

Plot file version 200 created 06-JAN-2009 10:58:18

J150407 EZ018B.UVDATA.1

Freq = 1.6270 GHz, Bw = 8.000 MH No calibration applied and no bandpass applied

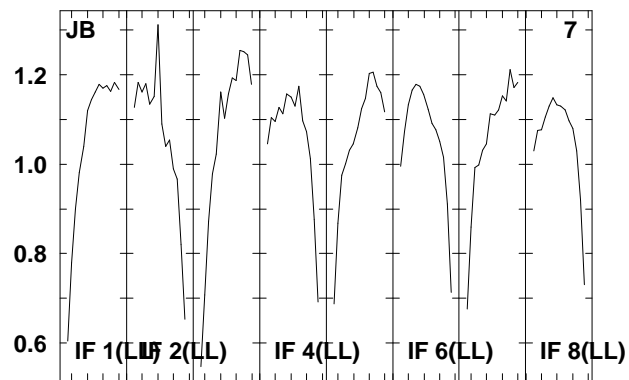
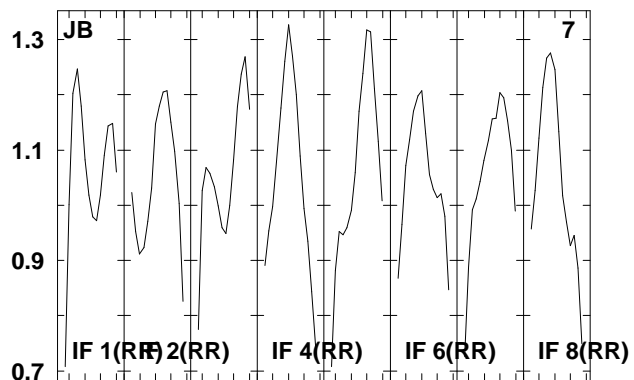
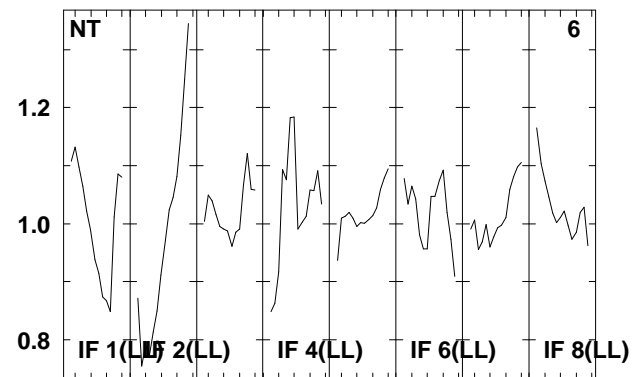
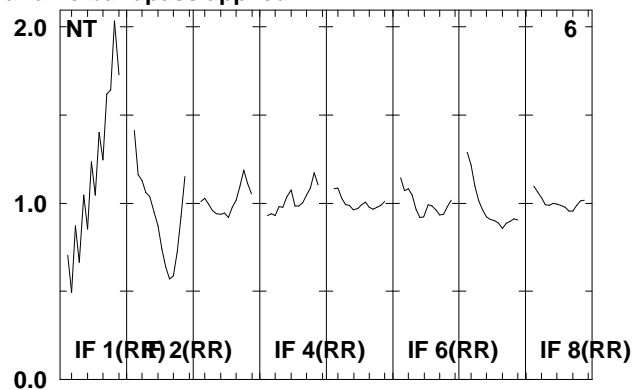
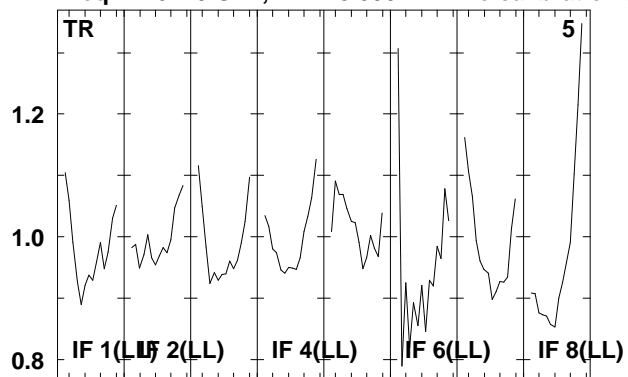

Lower frame: Real Jy  
Total-power spectrum Antenna: \*  
Timerange: 00/15:18:03 to 00/15:21:59



Plot file version 201 created 06-JAN-2009 10:58:18

J1510-05 EZ018B.UVDATA.1

Freq = 1.6270 GHz, Bw = 8.000 MH No calibration applied and no bandpass applied

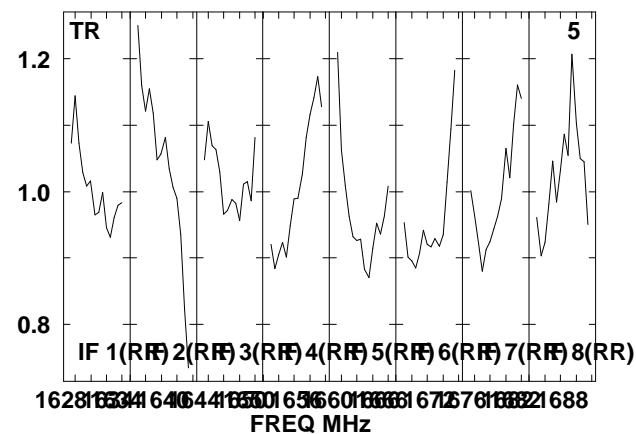
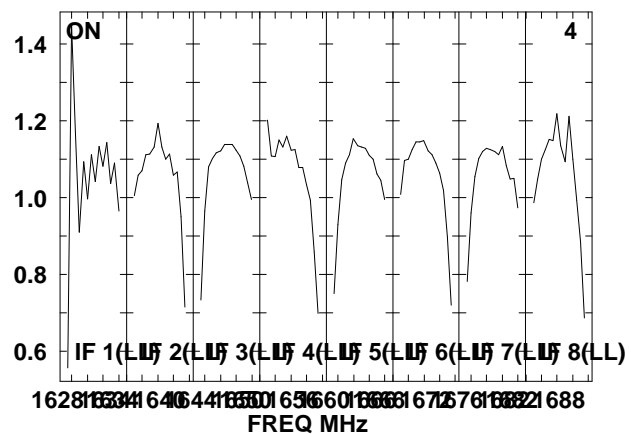
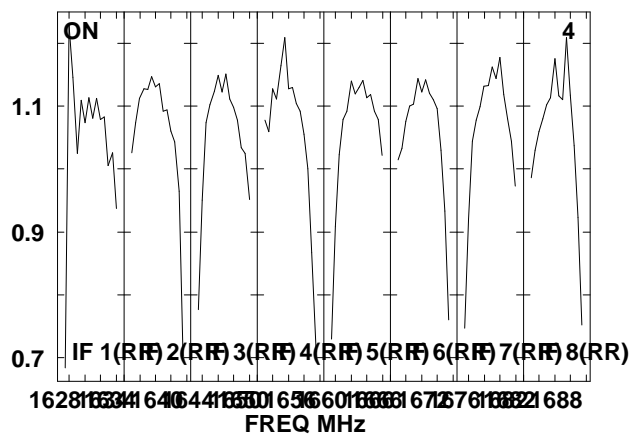
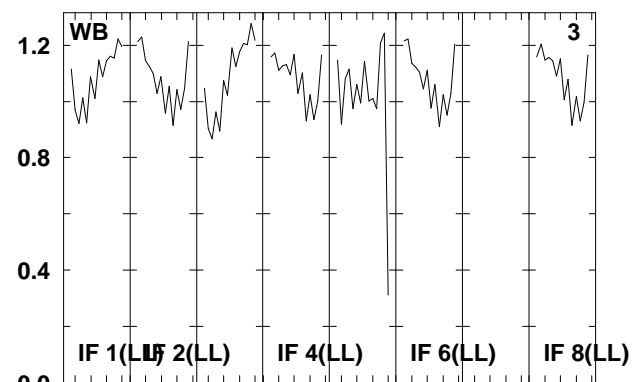
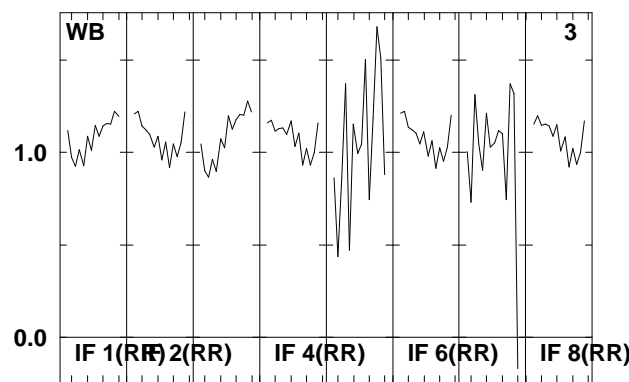
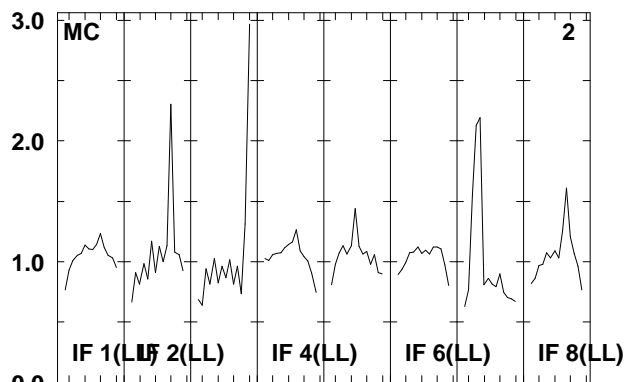
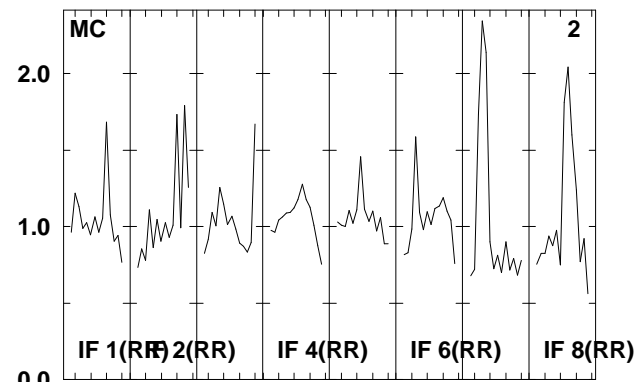
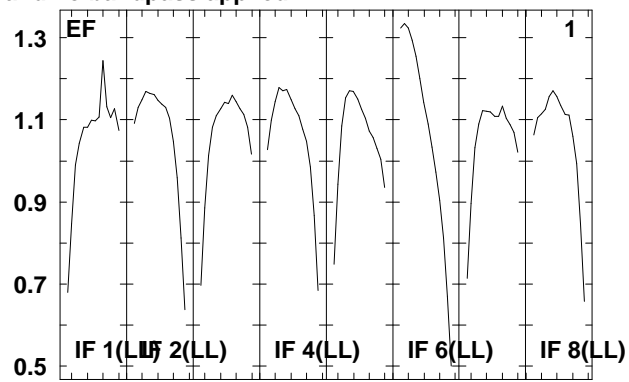
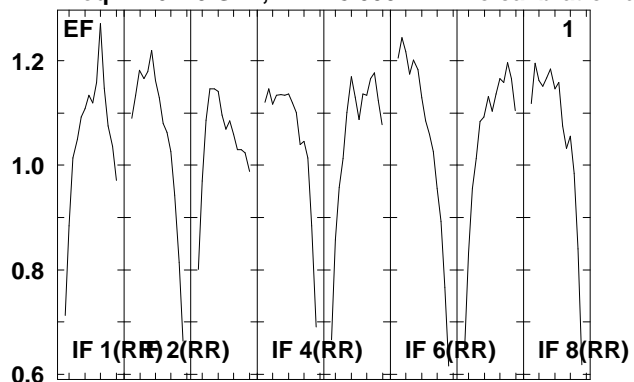

1628 1634 1640 1644 1650 1656 1660 1666 1672 1676 1682 1688  
FREQ MHz

1628 1634 1640 1644 1650 1656 1660 1666 1672 1676 1682 1688  
FREQ MHz

1628 1634 1640 1644 1650 1656 1660 1666 1672 1676 1682 1688  
FREQ MHz

Lower frame: Real Jy  
Total-power spectrum Antenna: \*  
Timerange: 00/15:22:01 to 00/15:25:01

Plot file version 202 created 06-JAN-2009 10:58:18

J1510-05 EZ018B.UVDATA.1

Freq = 1.6270 GHz, Bw = 8.000 MH No calibration applied and no bandpass applied

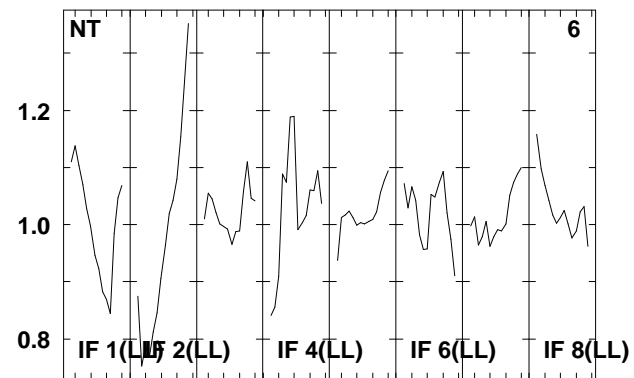
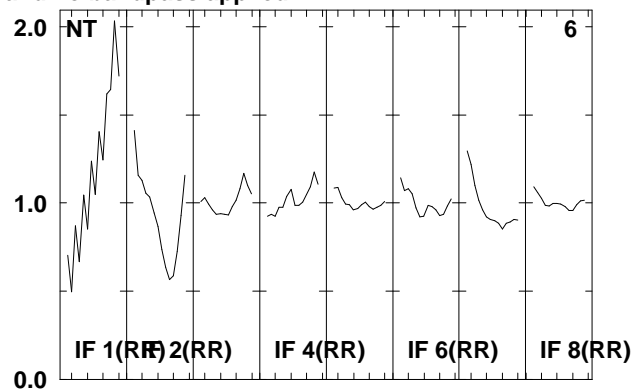
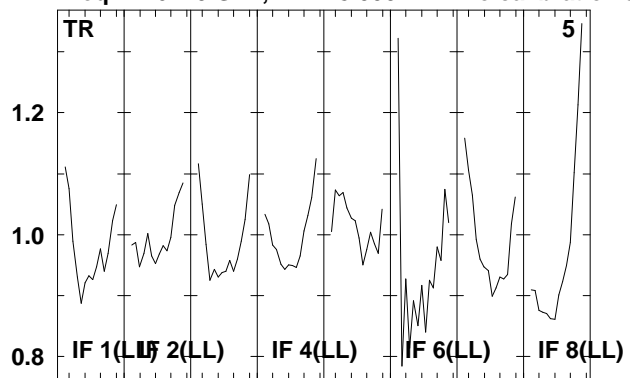

Lower frame: Real Jy  
Total-power spectrum Antenna: \*  
Timerange: 00/15:22:01 to 00/15:25:01

Plot file version 203 created 06-JAN-2009 10:58:19

J150407 EZ018B.UVDATA.1

Freq = 1.6270 GHz, Bw = 8.000 MH No calibration applied and no bandpass applied

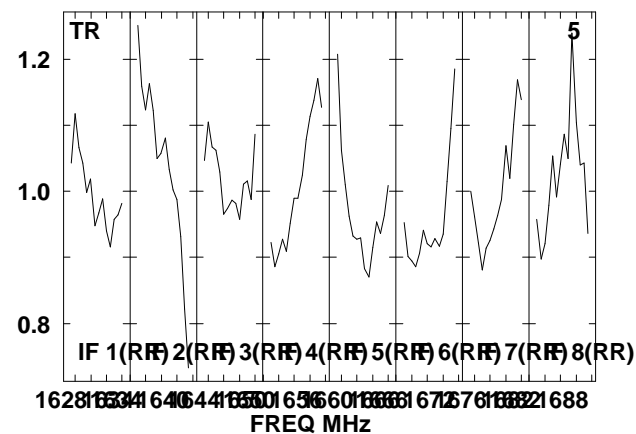
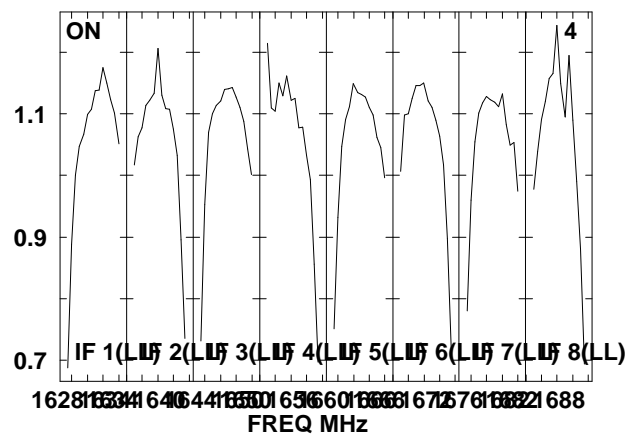
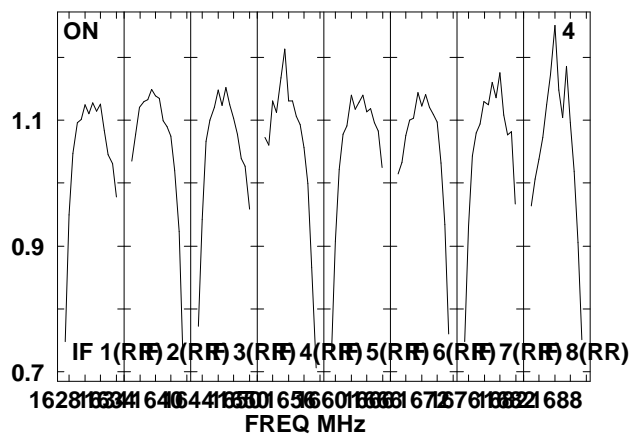
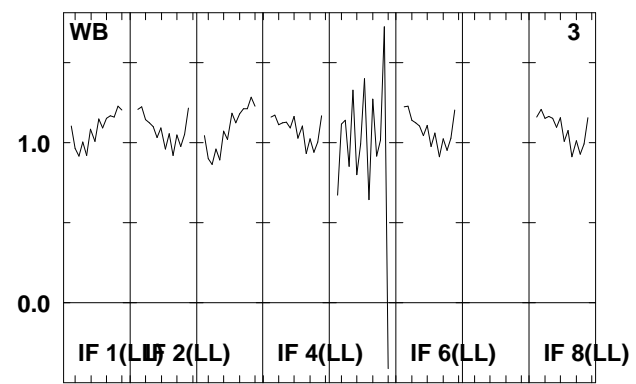
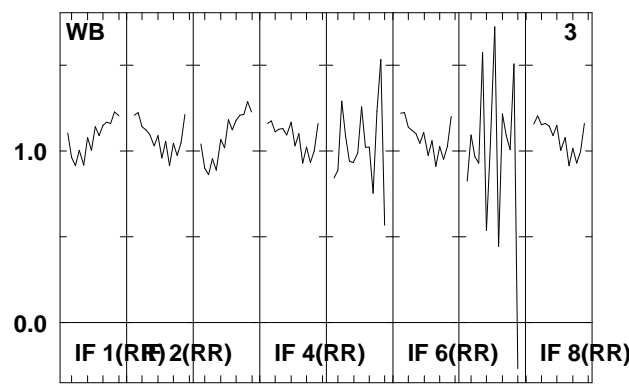
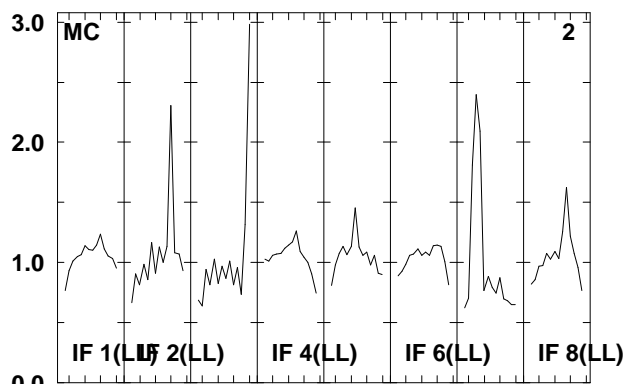
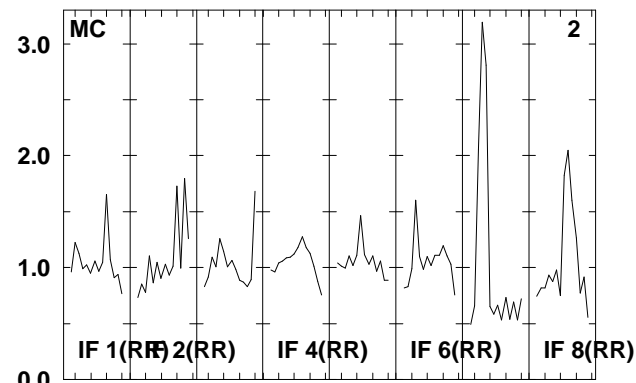
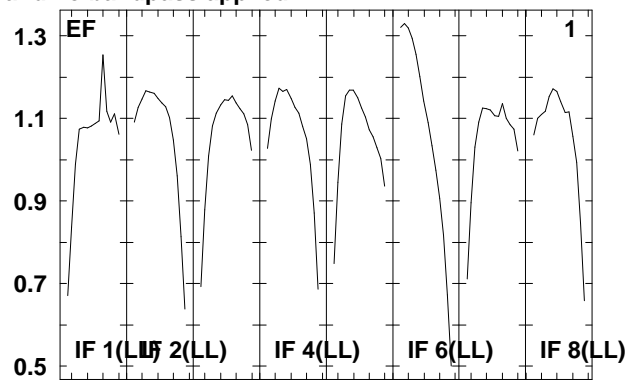
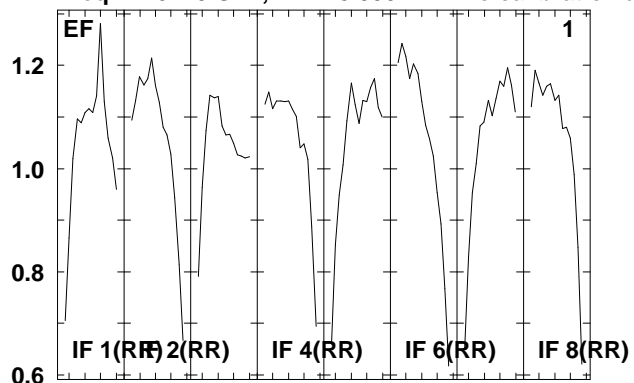

Lower frame: Real Jy  
Total-power spectrum Antenna: \*  
Timerange: 00/15:25:03 to 00/15:28:59

Plot file version 204 created 06-JAN-2009 10:58:19

J150407 EZ018B.UVDATA.1

Freq = 1.6270 GHz, Bw = 8.000 MH No calibration applied and no bandpass applied

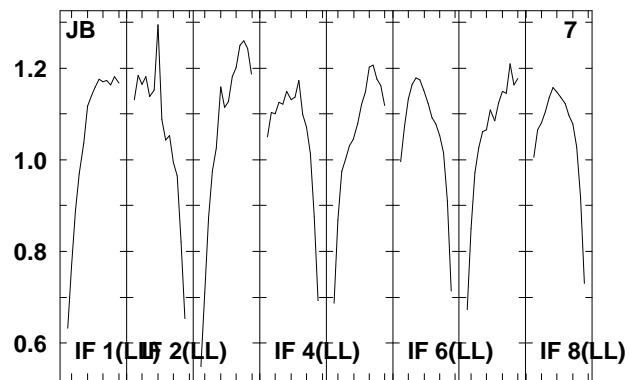
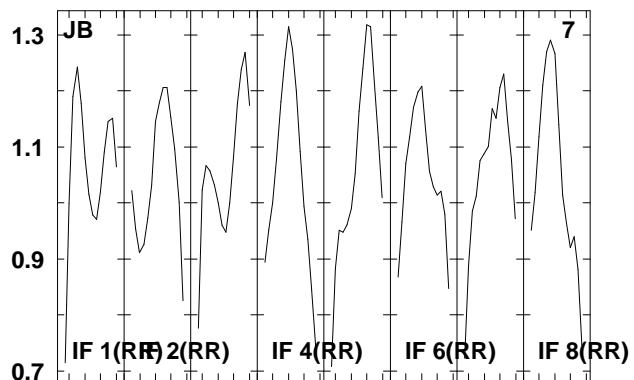
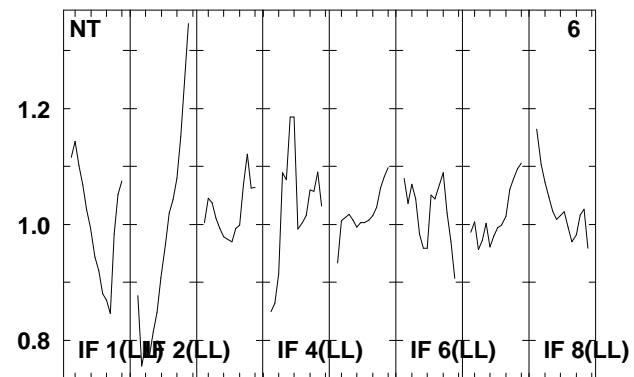
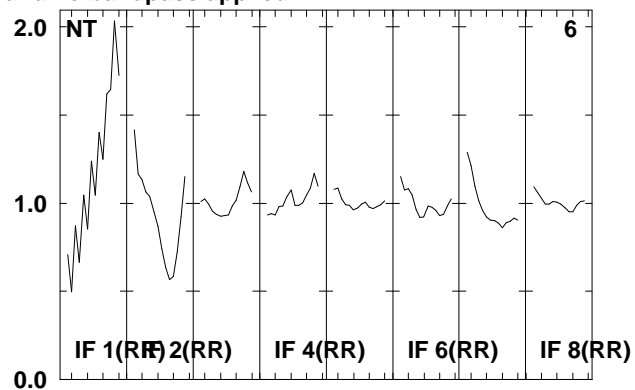
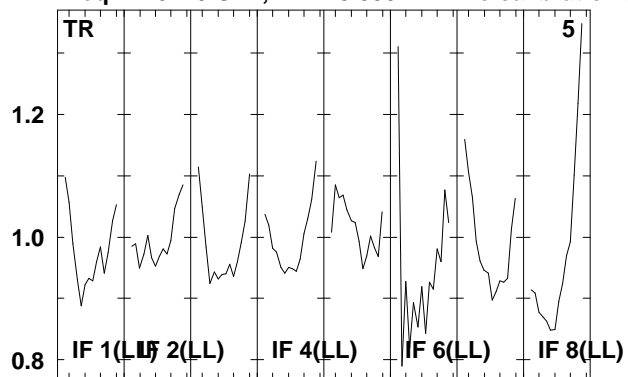

Lower frame: Real Jy  
Total-power spectrum Antenna: \*  
Timerange: 00/15:25:03 to 00/15:28:59

Plot file version 205 created 06-JAN-2009 10:58:20

J1510-05 EZ018B.UVDATA.1

Freq = 1.6270 GHz, Bw = 8.000 MH No calibration applied and no bandpass applied

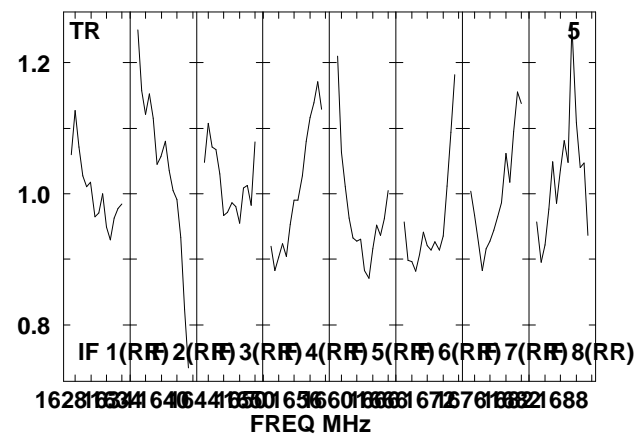
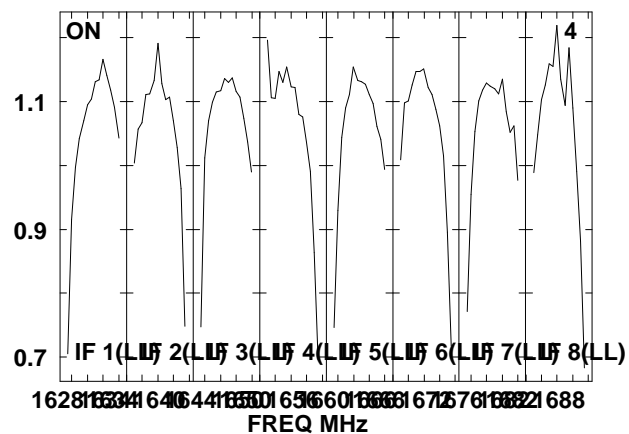
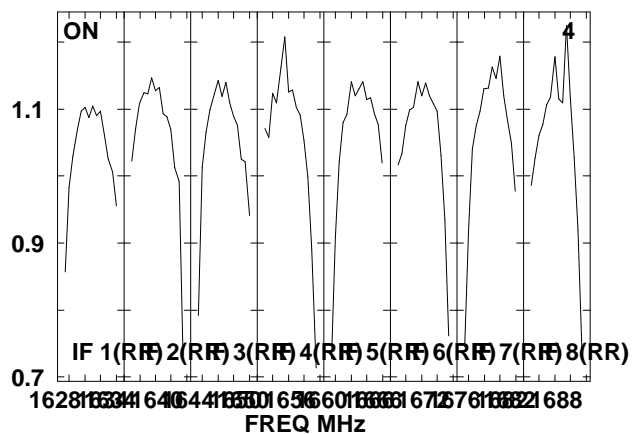
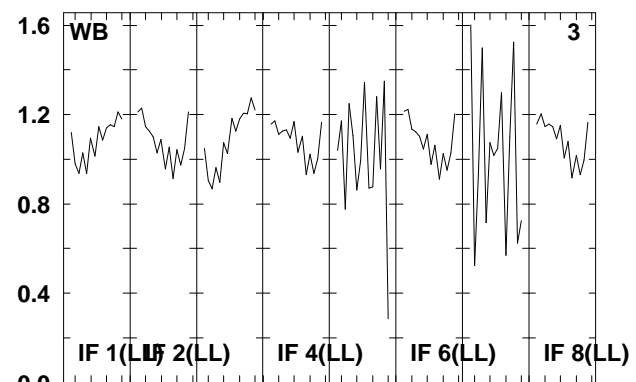
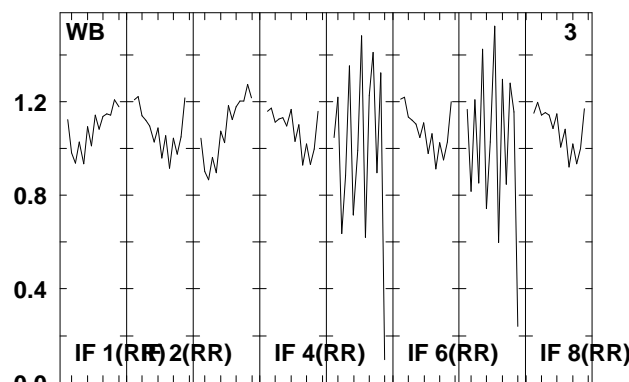
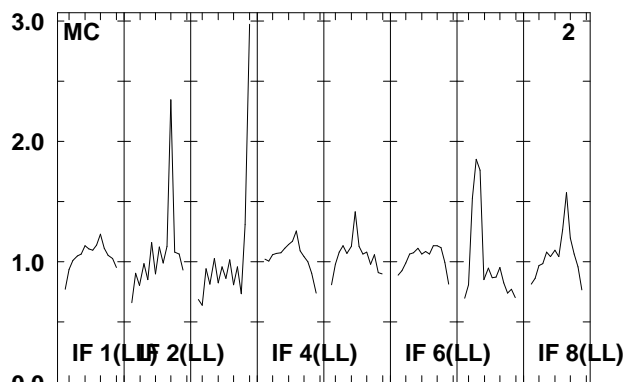
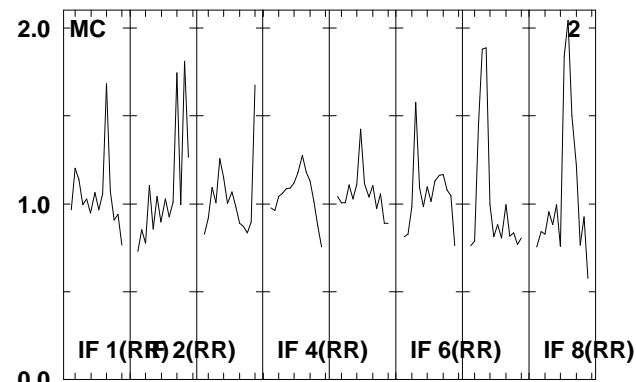
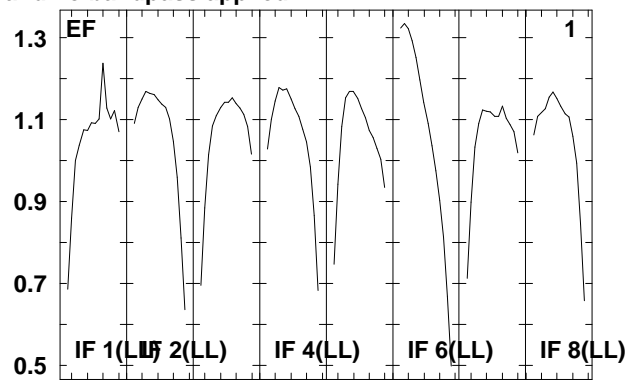
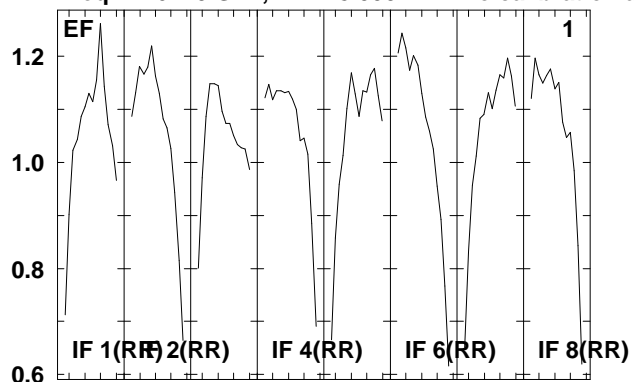

Lower frame: Real Jy  
Total-power spectrum Antenna: \*  
Timerange: 00/15:30:03 to 00/15:33:01

Plot file version 206 created 06-JAN-2009 10:58:20

J1510-05 EZ018B.UVDATA.1

Freq = 1.6270 GHz, Bw = 8.000 MH No calibration applied and no bandpass applied

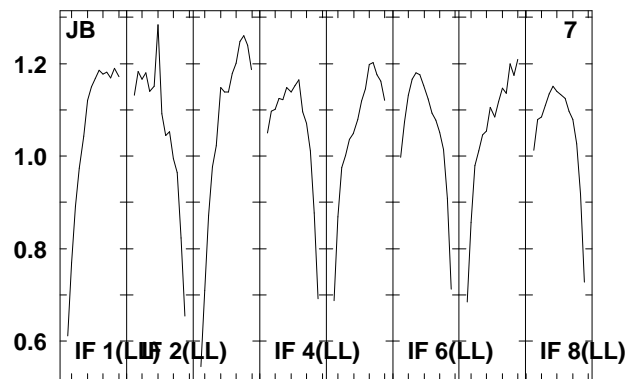
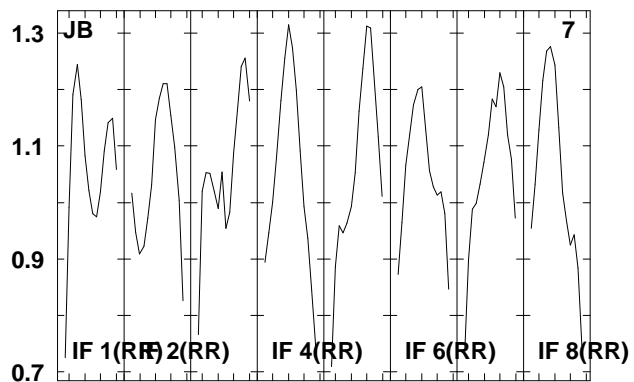
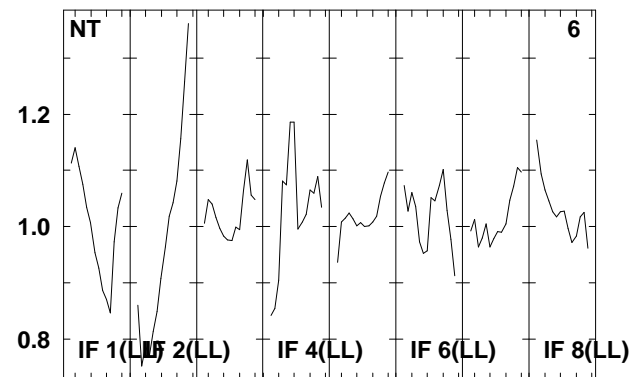
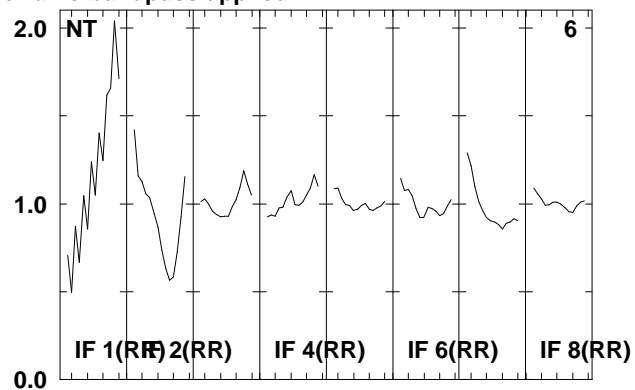
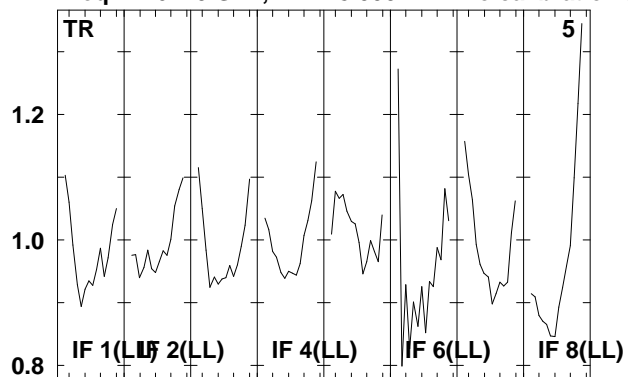

Lower frame: Real Jy  
Total-power spectrum Antenna: \*  
Timerange: 00/15:30:03 to 00/15:33:01

Plot file version 207 created 06-JAN-2009 10:58:20

J150407 EZ018B.UVDATA.1

Freq = 1.6270 GHz, Bw = 8.000 MH No calibration applied and no bandpass applied

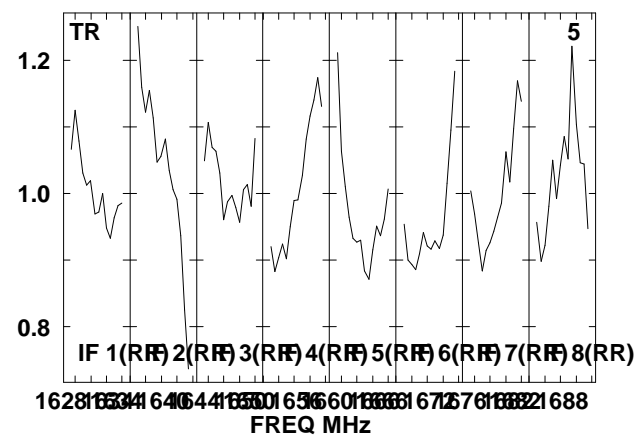
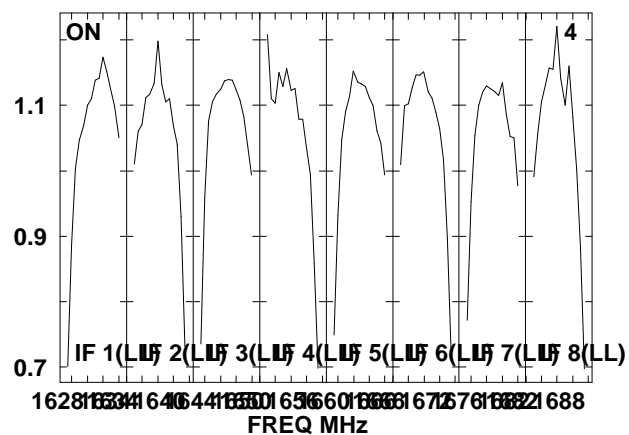
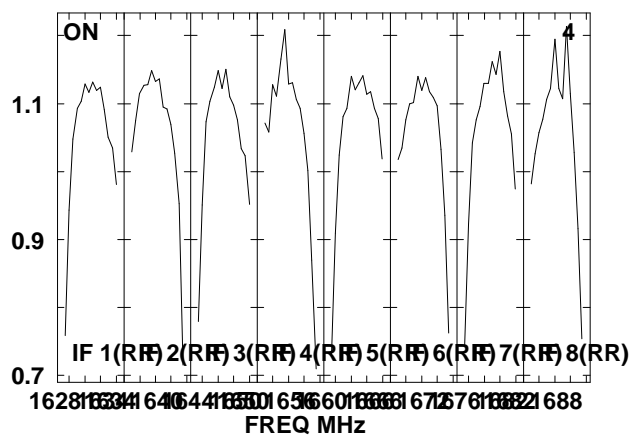
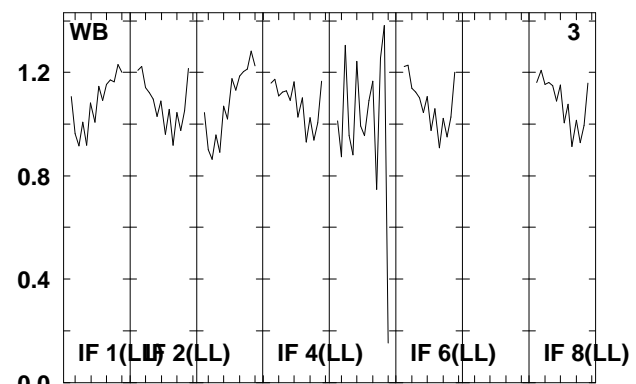
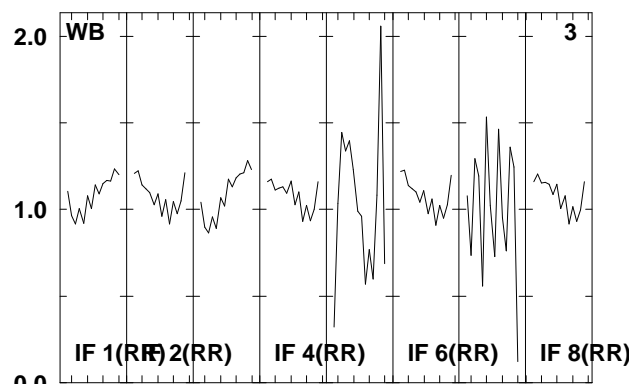
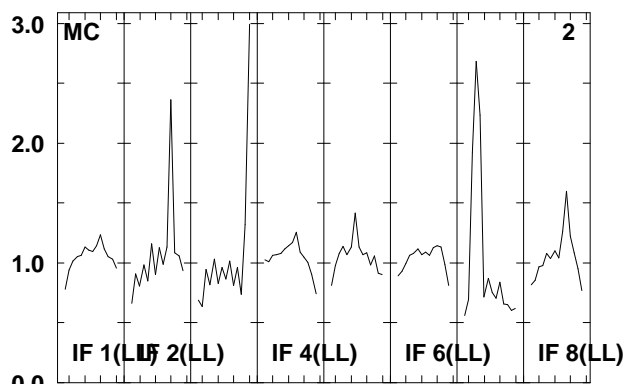
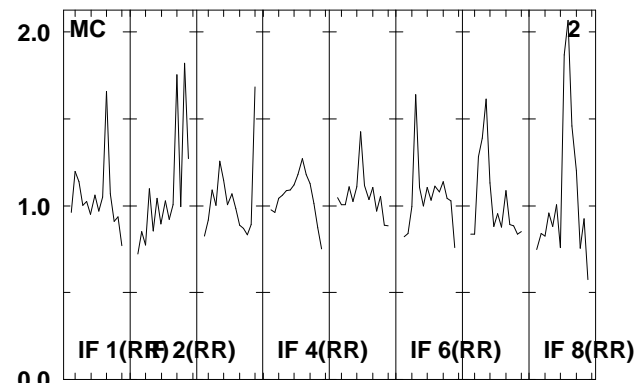
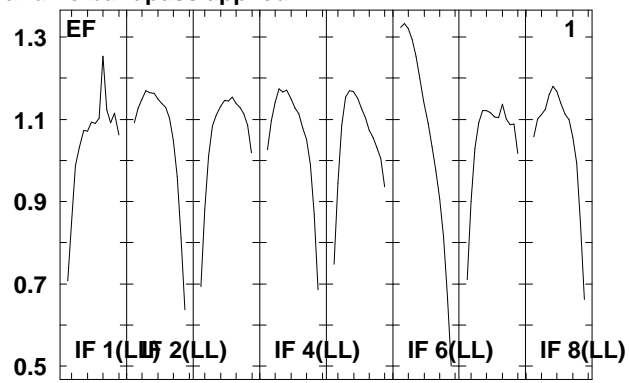
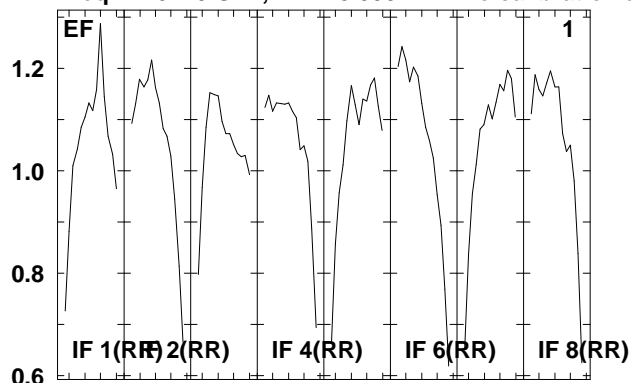

Lower frame: Real Jy  
Total-power spectrum Antenna: \*  
Timerange: 00/15:33:03 to 00/15:37:01

Plot file version 208 created 06-JAN-2009 10:58:21

J150407 EZ018B.UVDATA.1

Freq = 1.6270 GHz, Bw = 8.000 MH No calibration applied and no bandpass applied

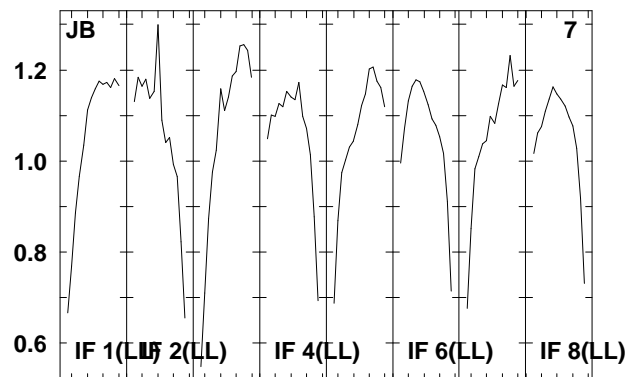
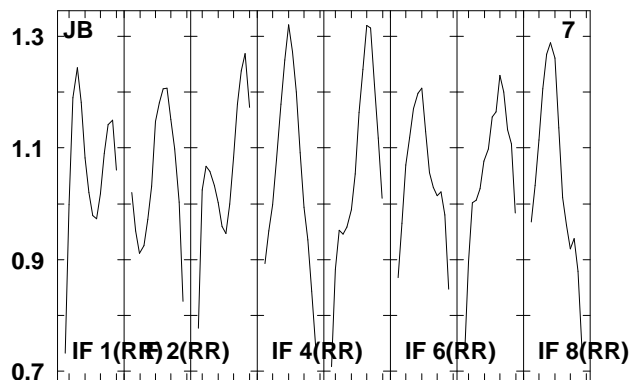
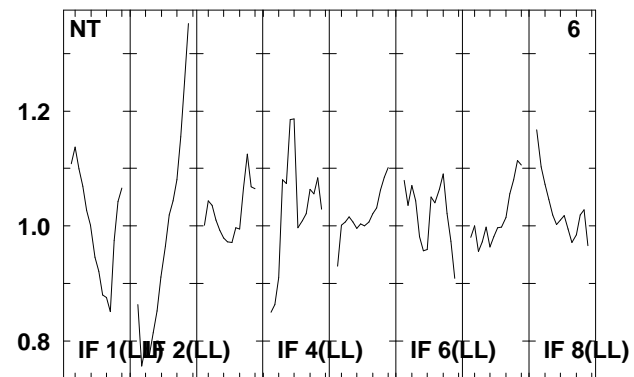
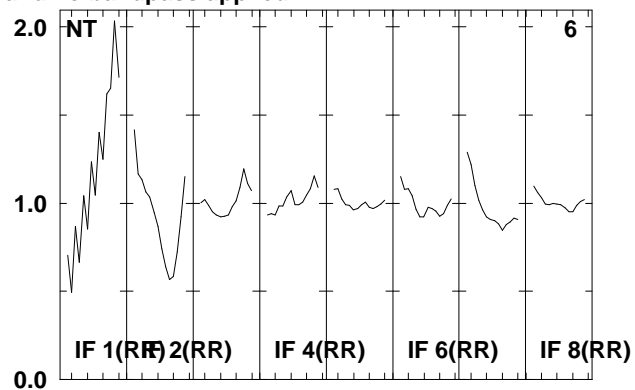
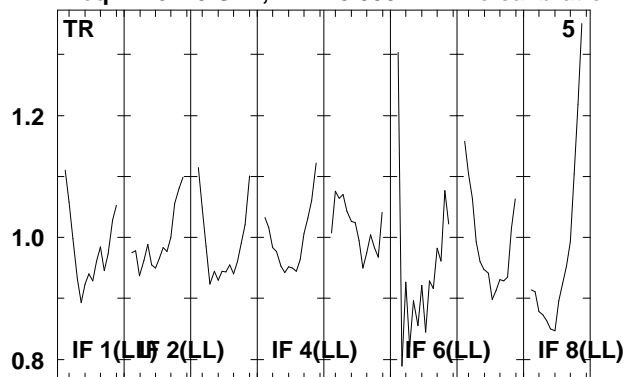

Lower frame: Real Jy  
Total-power spectrum Antenna: \*  
Timerange: 00/15:33:03 to 00/15:37:01



Plot file version 209 created 06-JAN-2009 10:58:21

J1510-05 EZ018B.UVDATA.1

Freq = 1.6270 GHz, Bw = 8.000 MH No calibration applied and no bandpass applied

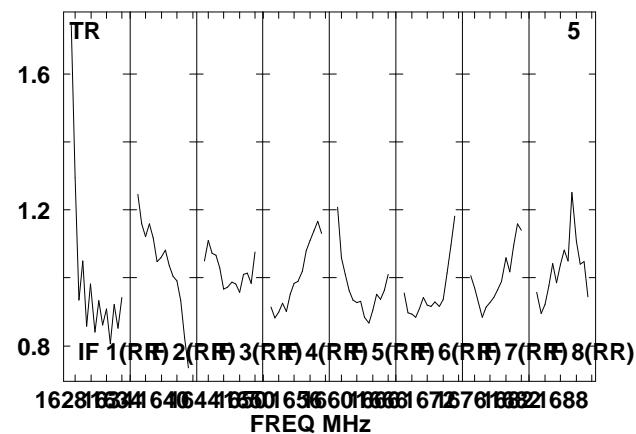
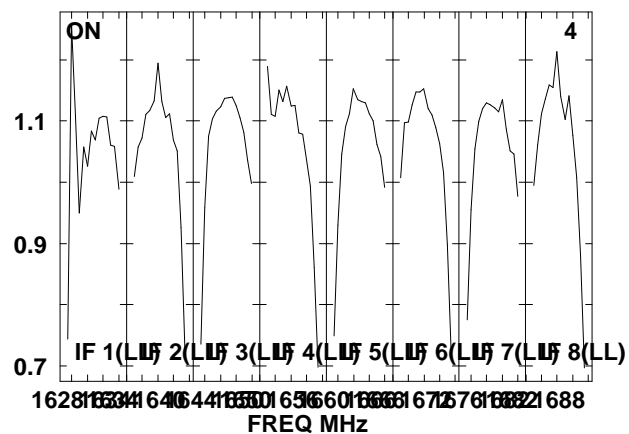
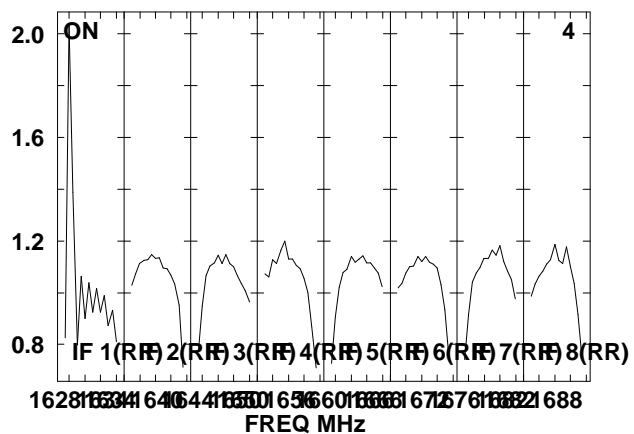
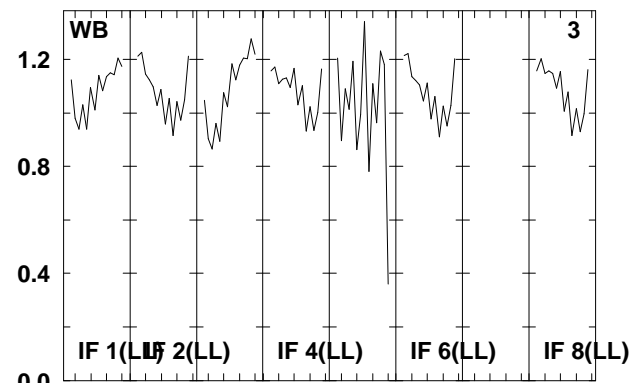
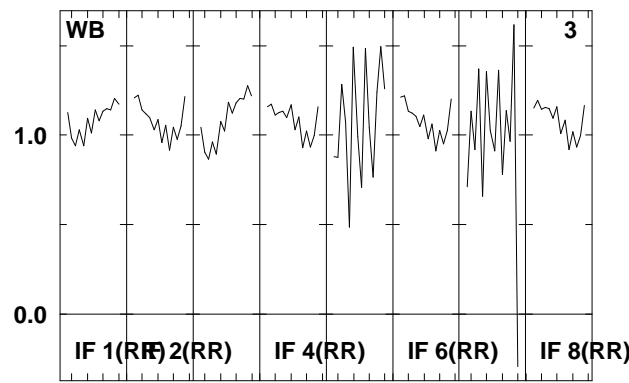
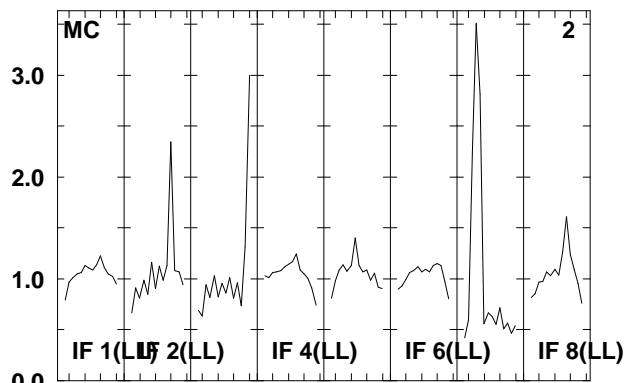
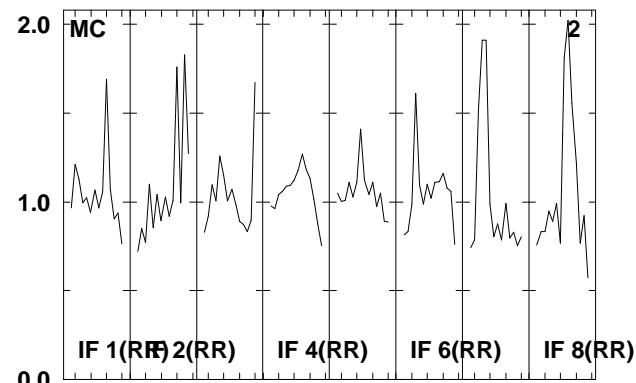
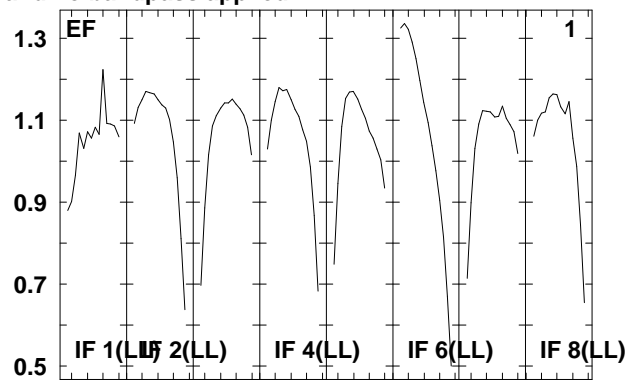
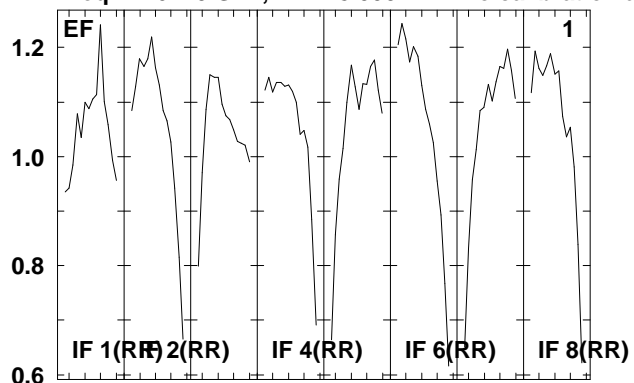

Lower frame: Real Jy  
Total-power spectrum Antenna: \*  
Timerange: 00/15:37:03 to 00/15:39:59

Plot file version 210 created 06-JAN-2009 10:58:21

J1510-05 EZ018B.UVDATA.1

Freq = 1.6270 GHz, Bw = 8.000 MH No calibration applied and no bandpass applied

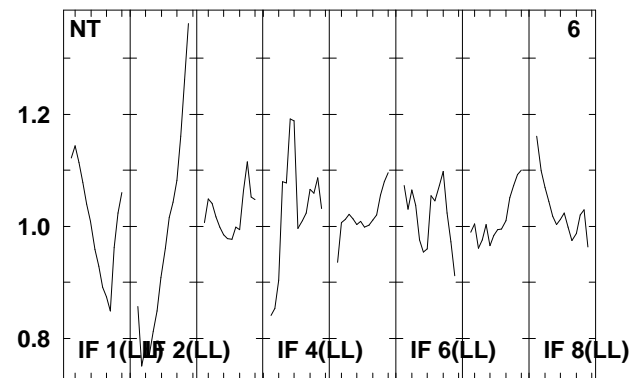
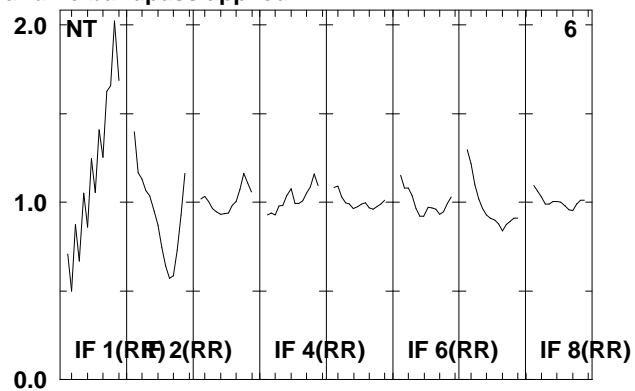
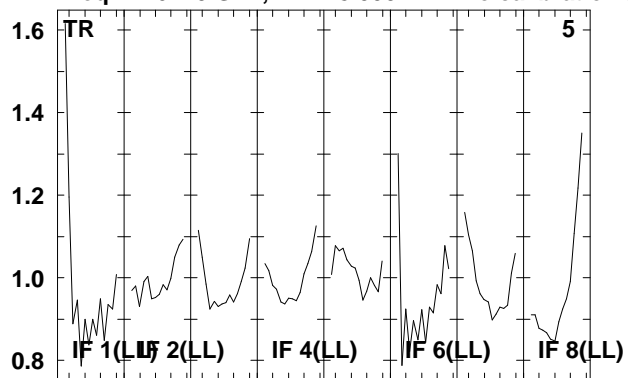

Lower frame: Real Jy  
Total-power spectrum Antenna: \*  
Timerange: 00/15:37:03 to 00/15:39:59

Plot file version 211 created 06-JAN-2009 10:58:22

J150407 EZ018B.UVDATA.1

Freq = 1.6270 GHz, Bw = 8.000 MH No calibration applied and no bandpass applied

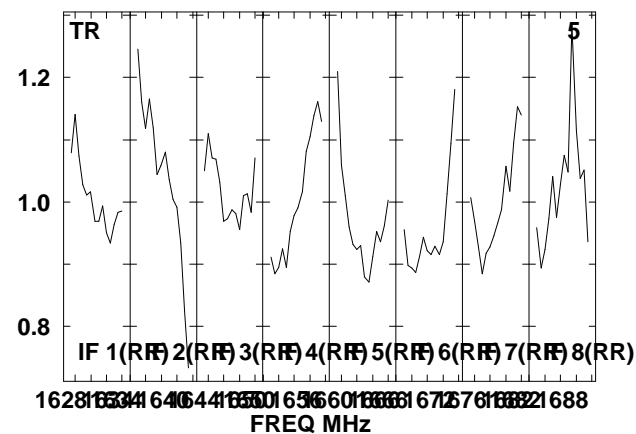
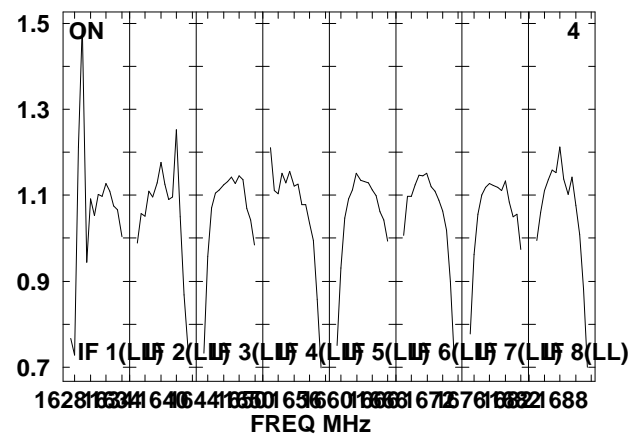
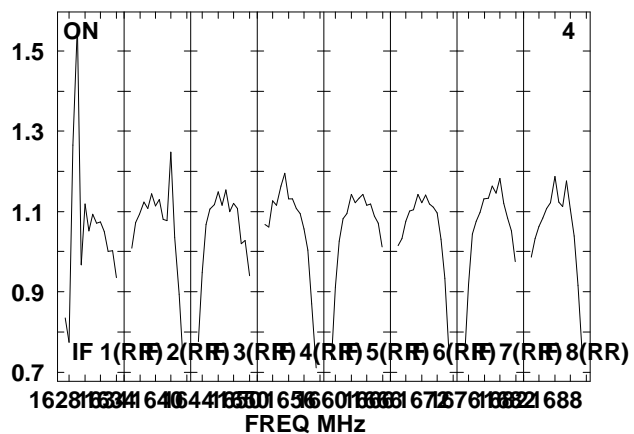
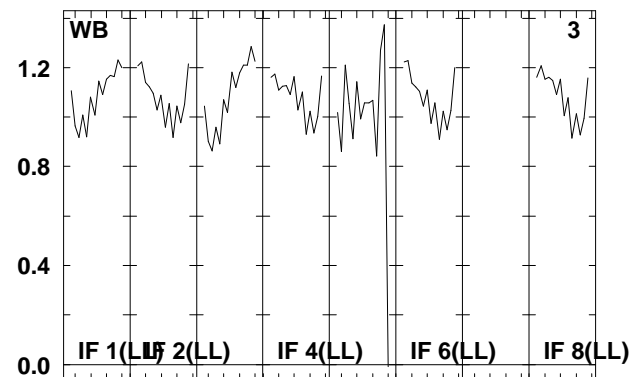
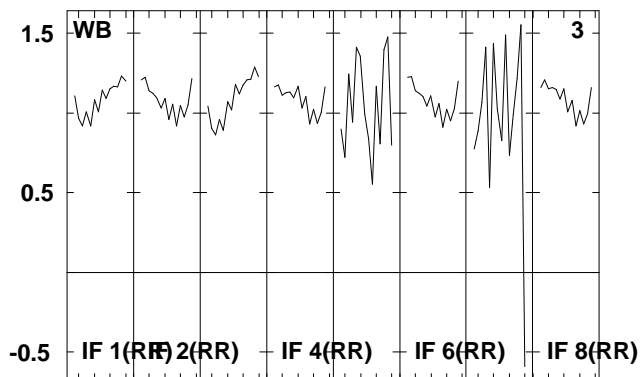
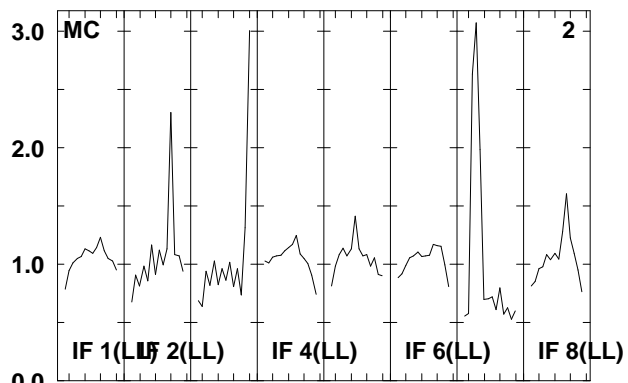
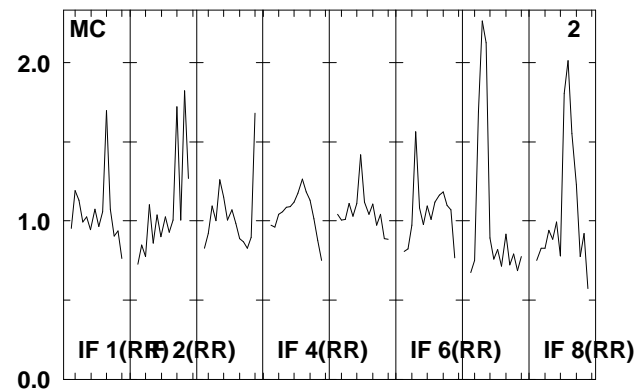
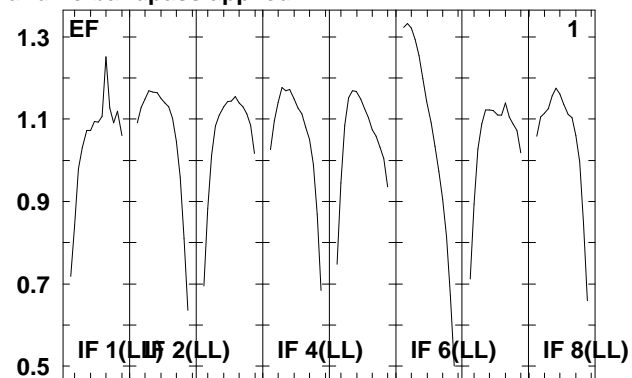
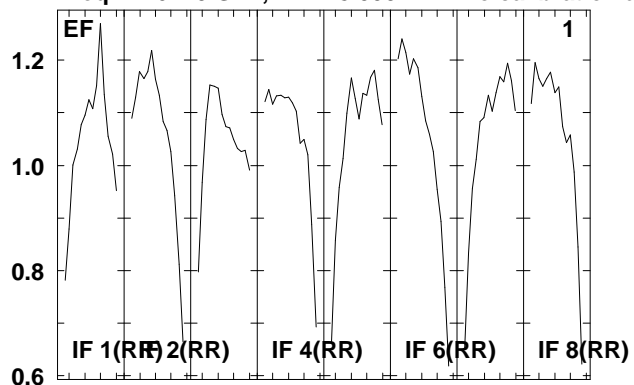

Lower frame: Real Jy  
Total-power spectrum Antenna: \*  
Timerange: 00/15:40:01 to 00/15:43:59

Plot file version 212 created 06-JAN-2009 10:58:22

J150407 EZ018B.UVDATA.1

Freq = 1.6270 GHz, Bw = 8.000 MH No calibration applied and no bandpass applied

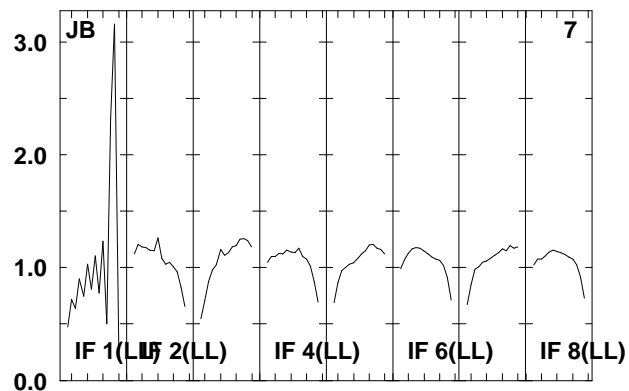
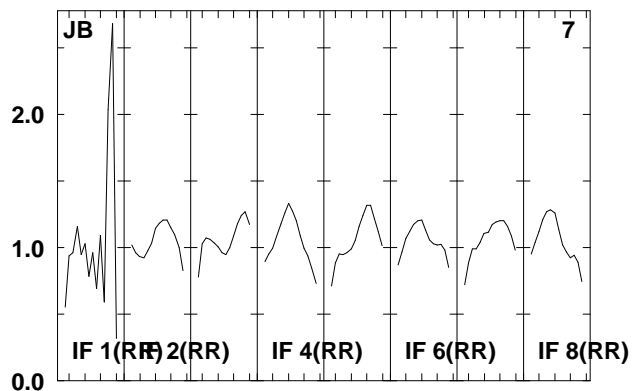
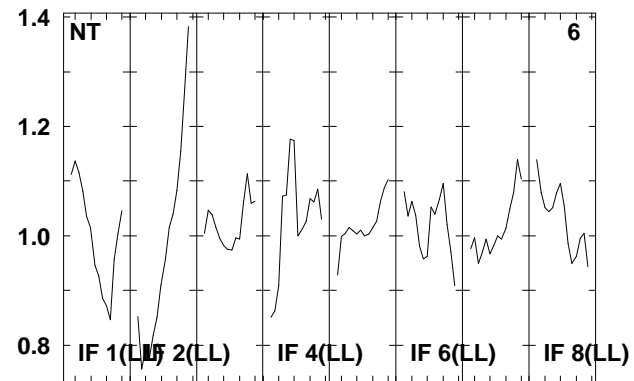
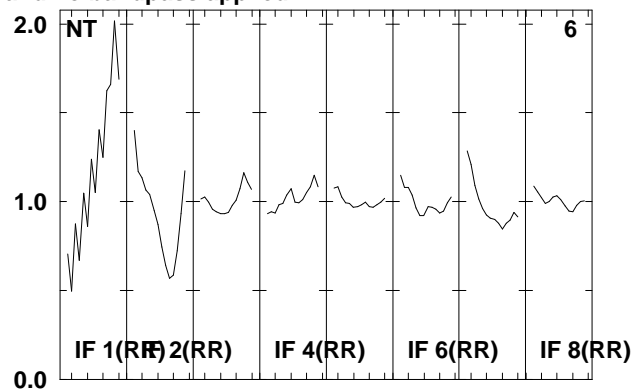
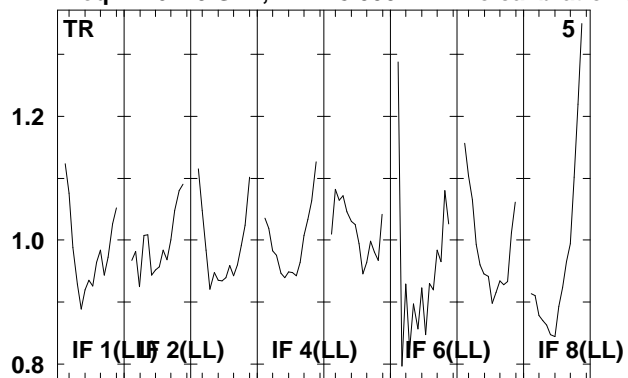

Lower frame: Real Jy  
Total-power spectrum Antenna: \*  
Timerange: 00/15:40:01 to 00/15:43:59

Plot file version 213 created 06-JAN-2009 10:58:23

J1510-05 EZ018B.UVDATA.1

Freq = 1.6270 GHz, Bw = 8.000 MH No calibration applied and no bandpass applied

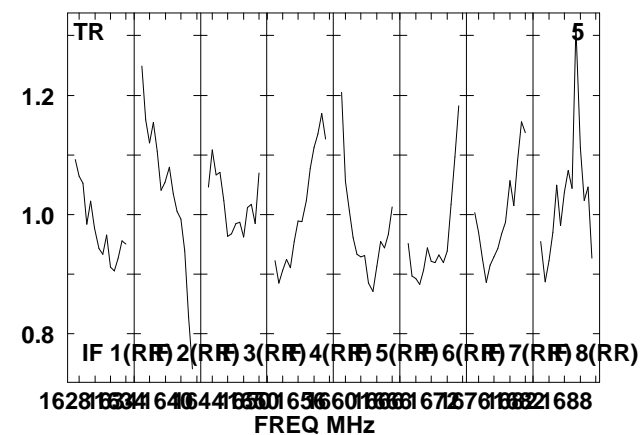
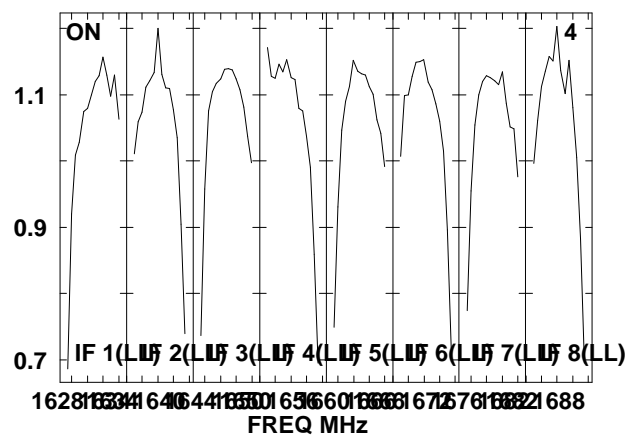
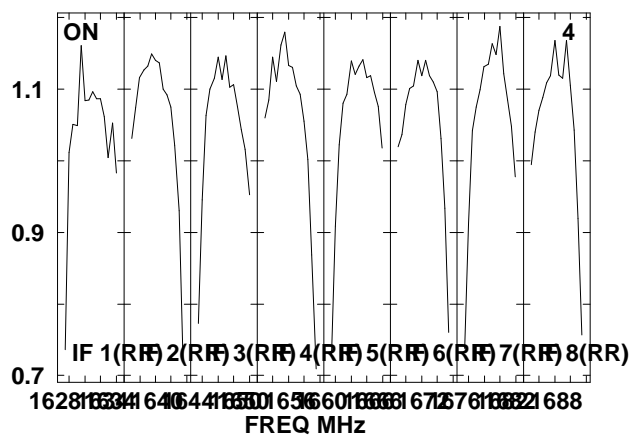
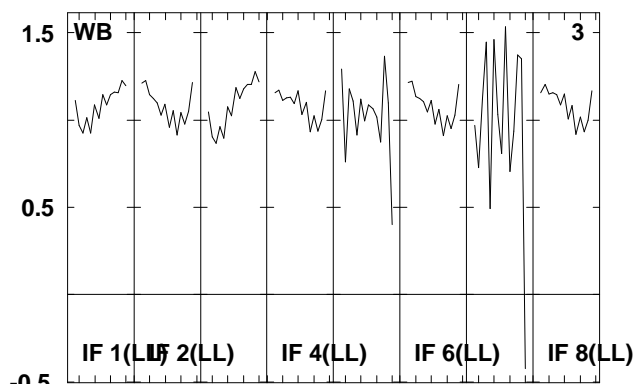
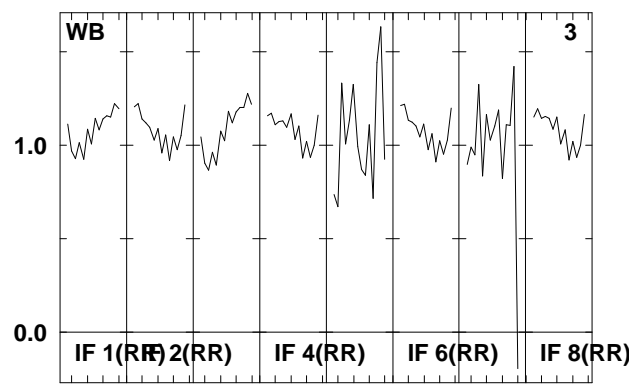
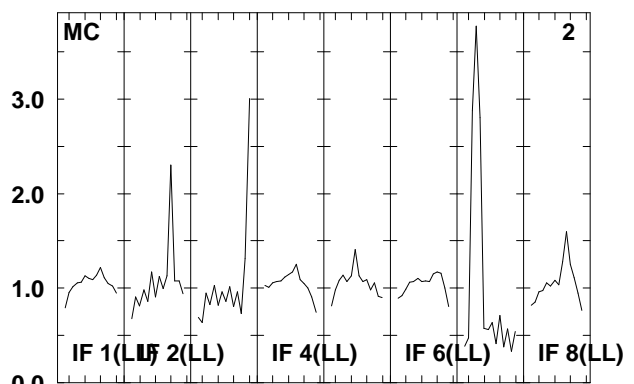
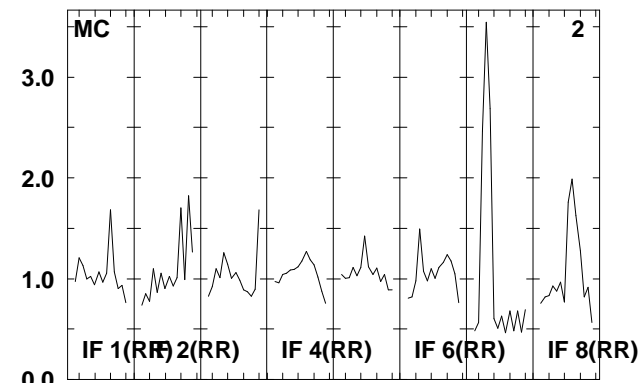
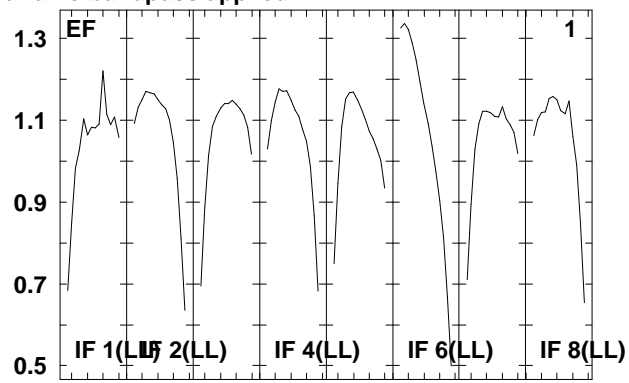
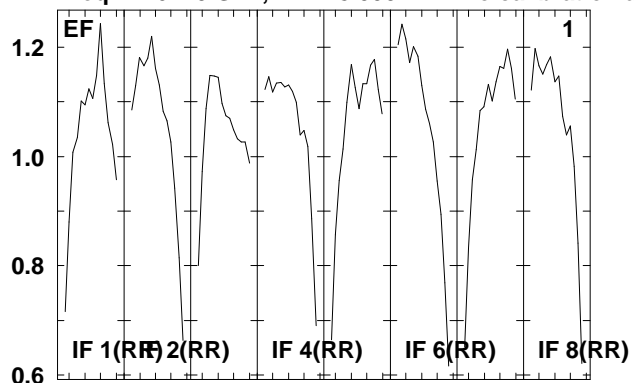

Lower frame: Real Jy  
Total-power spectrum Antenna: \*  
Timerange: 00/15:45:03 to 00/15:48:01

Plot file version 214 created 06-JAN-2009 10:58:23

J1510-05 EZ018B.UVDATA.1

Freq = 1.6270 GHz, Bw = 8.000 MH No calibration applied and no bandpass applied

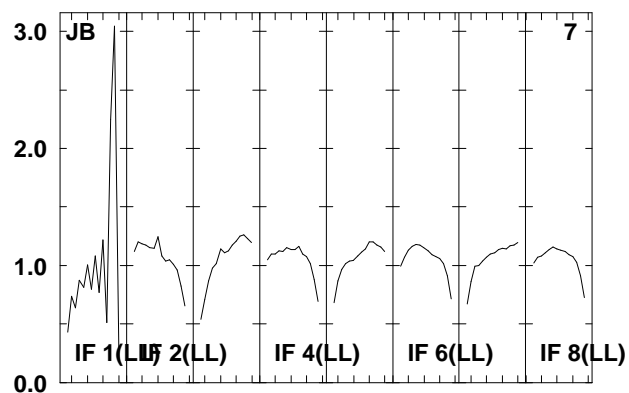
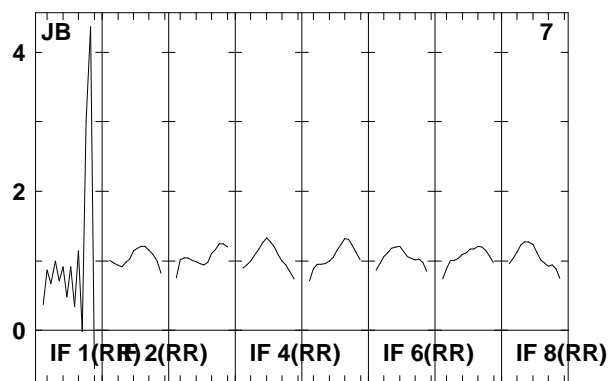
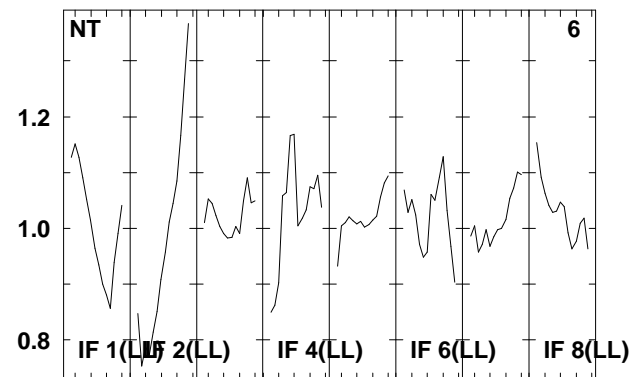
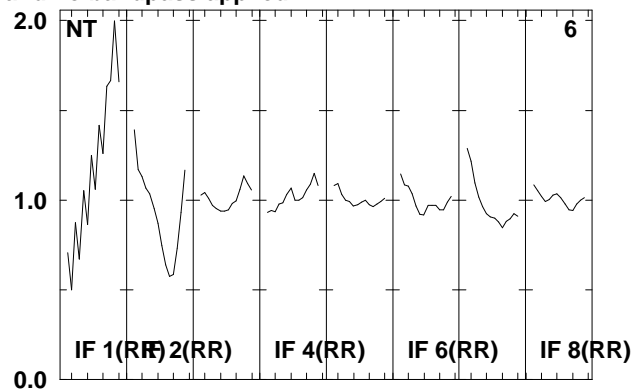
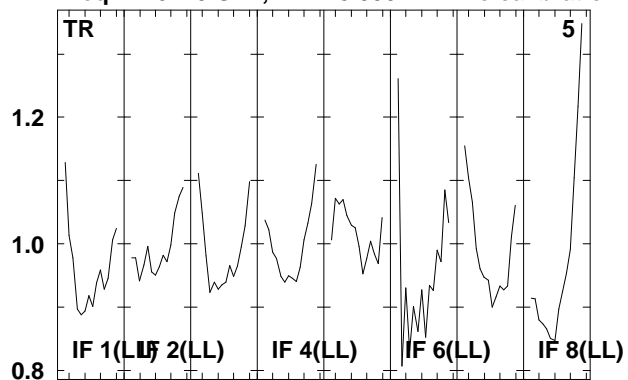

Lower frame: Real Jy  
Total-power spectrum Antenna: \*  
Timerange: 00/15:45:03 to 00/15:48:01

Plot file version 215 created 06-JAN-2009 10:58:23

J150407 EZ018B.UVDATA.1

Freq = 1.6270 GHz, Bw = 8.000 MH No calibration applied and no bandpass applied

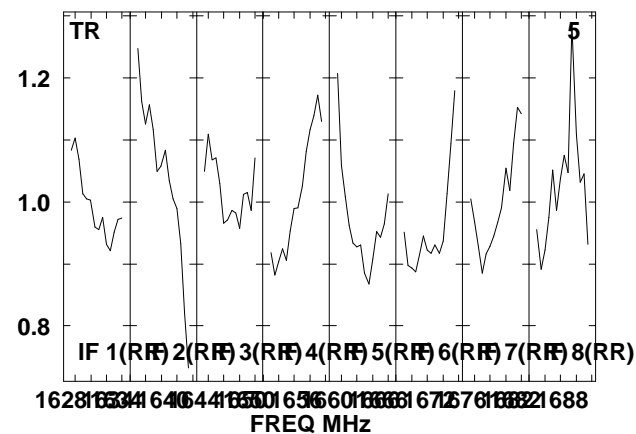
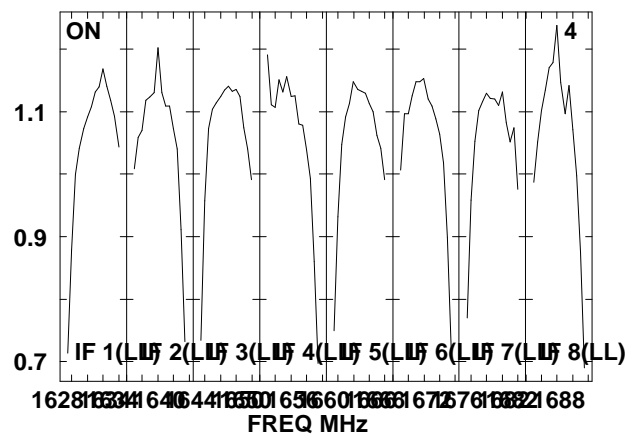
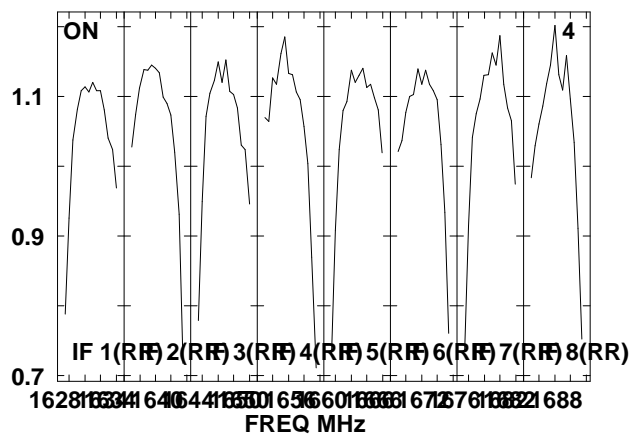
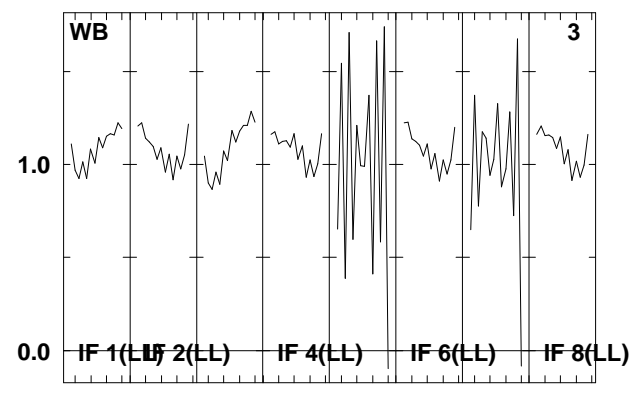
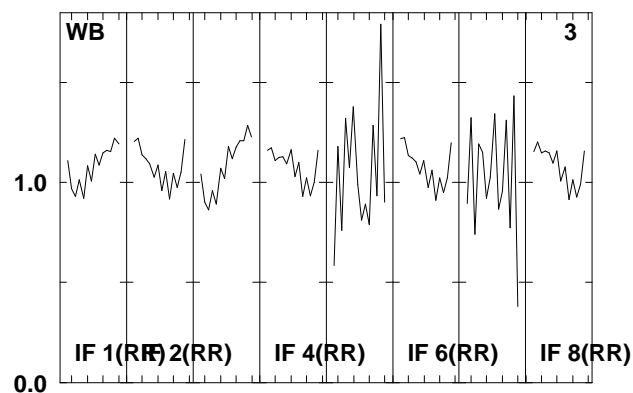
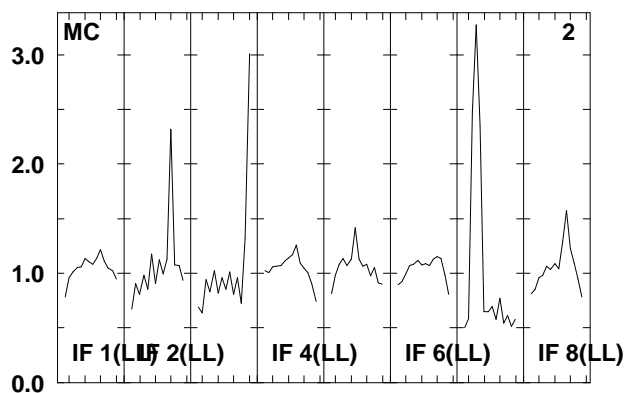
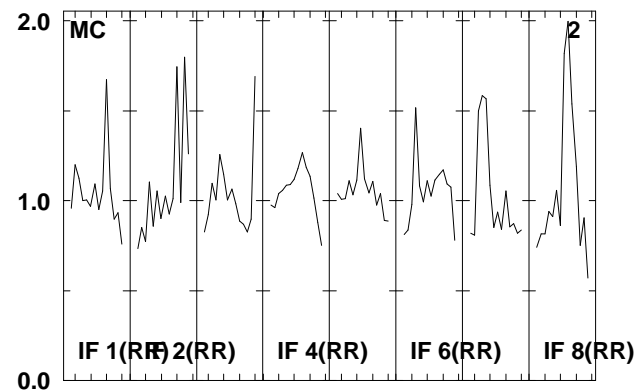
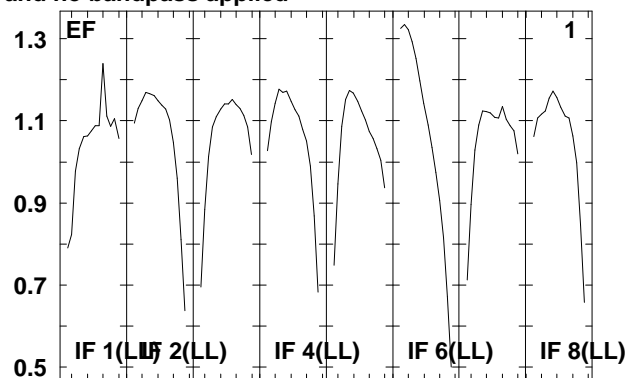
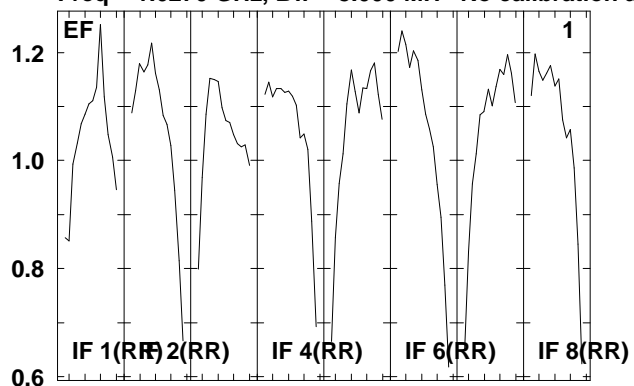

Lower frame: Real Jy

Total-power spectrum Antenna: \*

Timerange: 00/15:48:03 to 00/15:51:59

Plot file version 216 created 06-JAN-2009 10:58:24

J150407 EZ018B.UVDATA.1

Freq = 1.6270 GHz, Bw = 8.000 MH No calibration applied and no bandpass applied

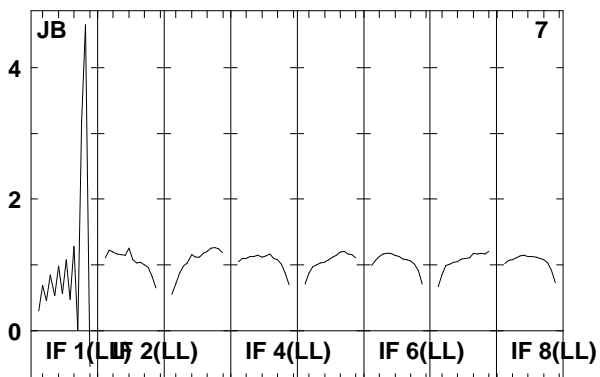
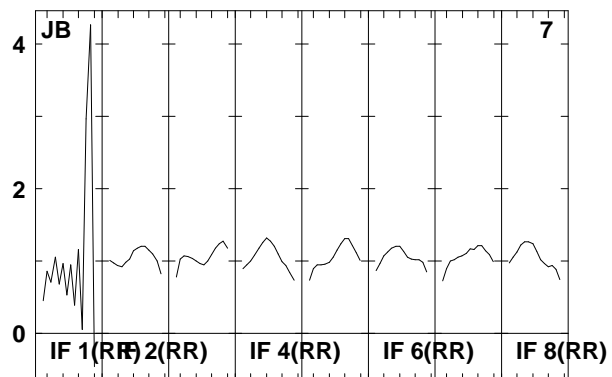
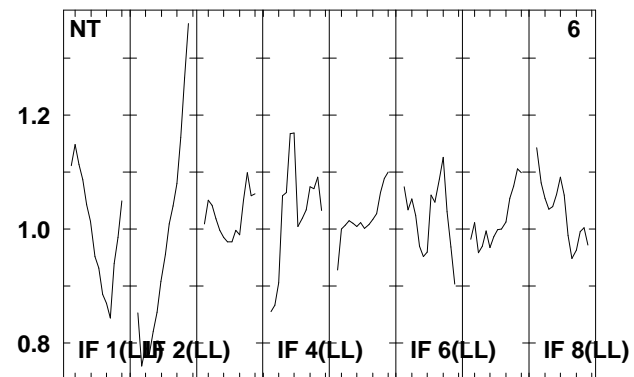
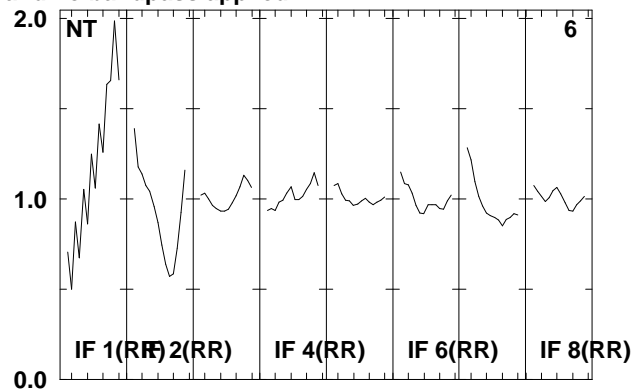
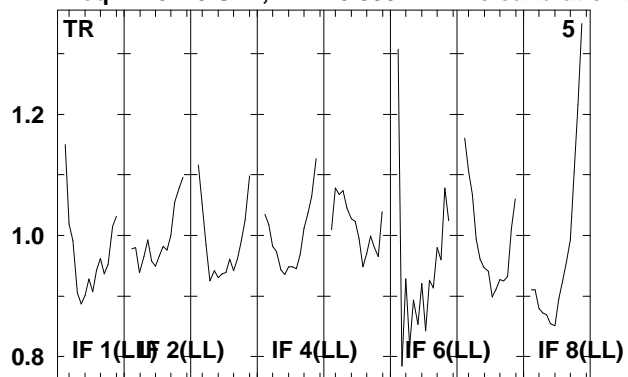

Lower frame: Real Jy  
Total-power spectrum Antenna: \*  
Timerange: 00/15:48:03 to 00/15:51:59



Plot file version 217 created 06-JAN-2009 10:58:24

J1510-05 EZ018B.UVDATA.1

Freq = 1.6270 GHz, Bw = 8.000 MH No calibration applied and no bandpass applied

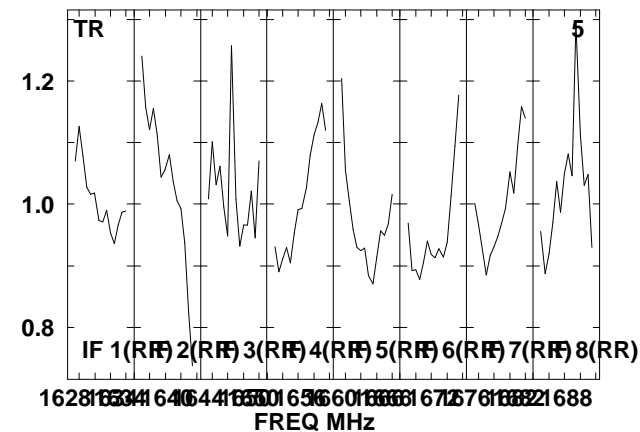
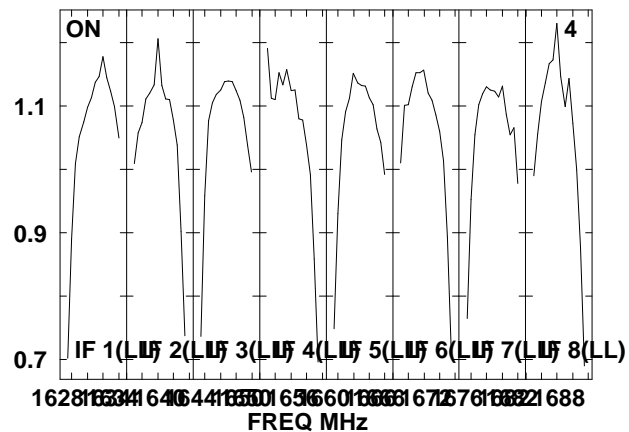
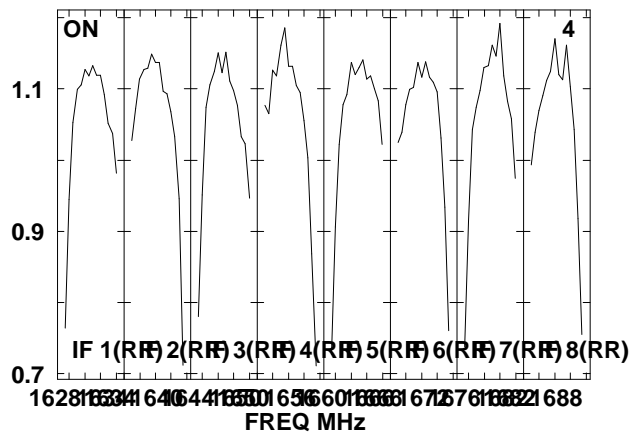
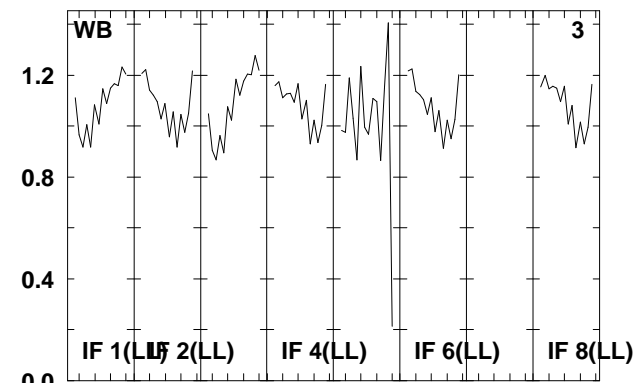
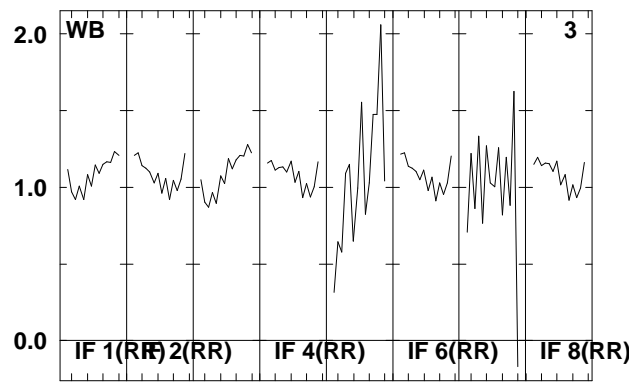
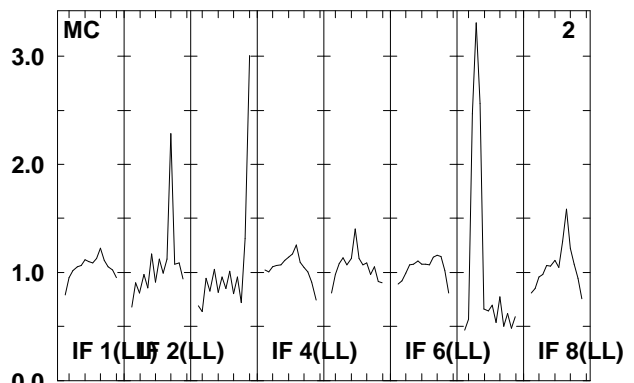
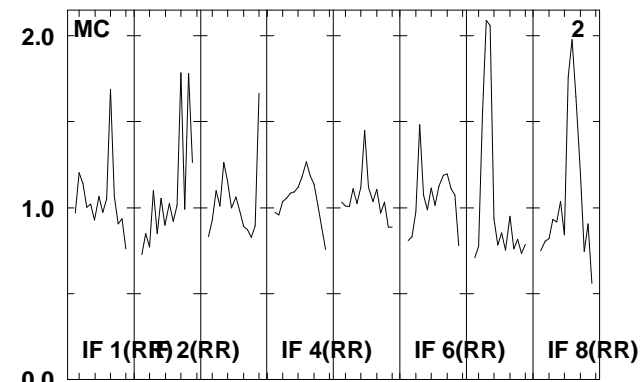
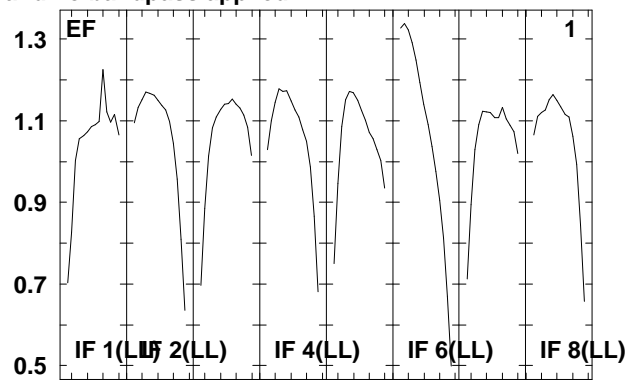
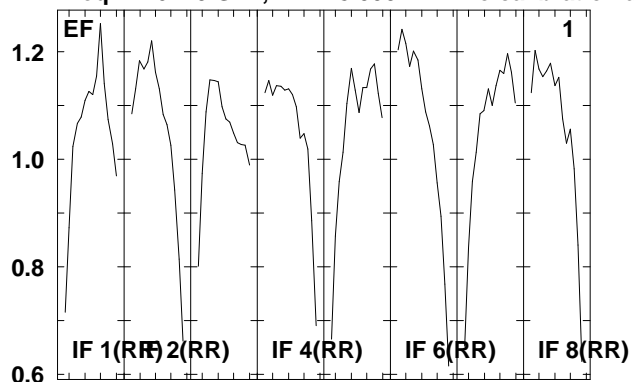

Lower frame: Real Jy  
Total-power spectrum Antenna: \*  
Timerange: 00/15:52:01 to 00/15:55:01

Plot file version 218 created 06-JAN-2009 10:58:25

J1510-05 EZ018B.UVDATA.1

Freq = 1.6270 GHz, Bw = 8.000 MH No calibration applied and no bandpass applied

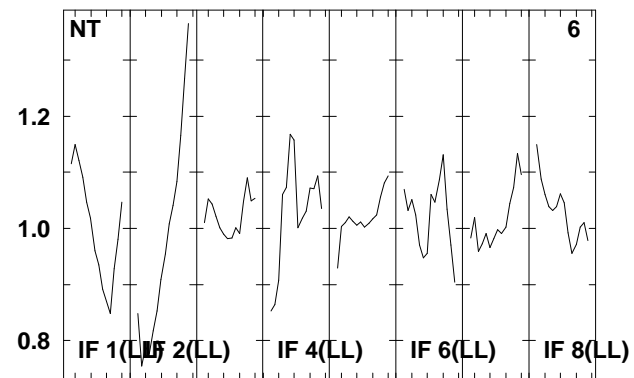
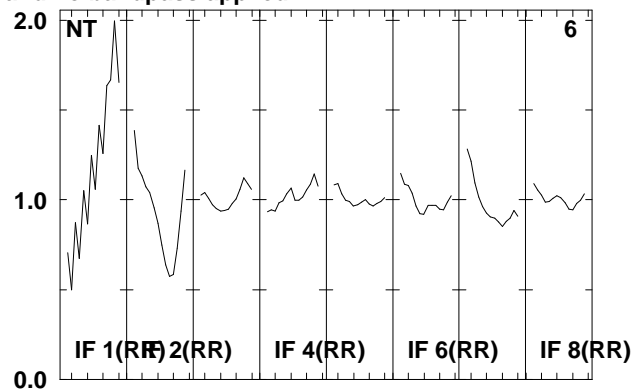
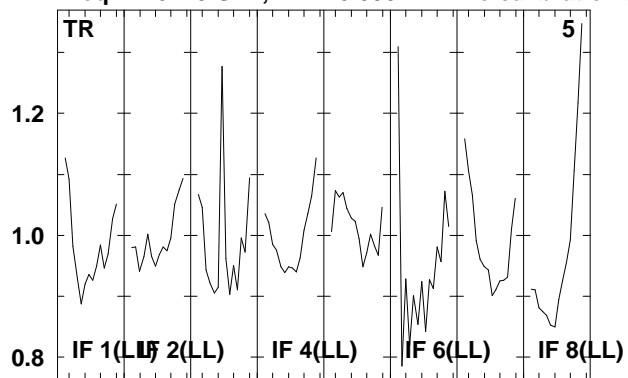

Lower frame: Real Jy  
Total-power spectrum Antenna: \*  
Timerange: 00/15:52:01 to 00/15:55:01

Plot file version 219 created 06-JAN-2009 10:58:25

J150407 EZ018B.UVDATA.1

Freq = 1.6270 GHz, Bw = 8.000 MH No calibration applied and no bandpass applied

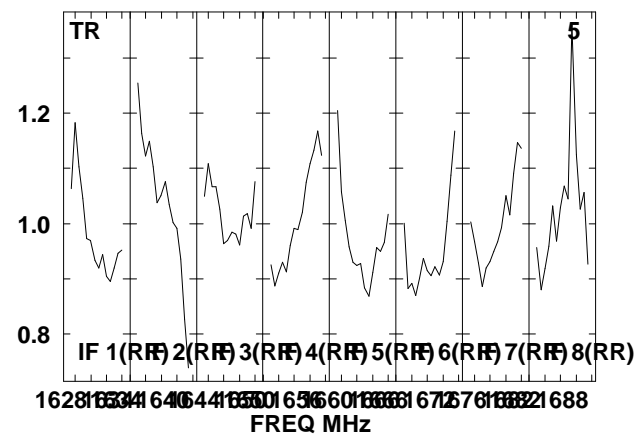
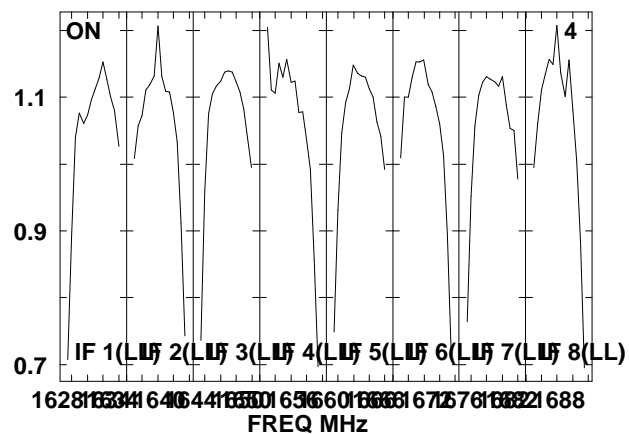
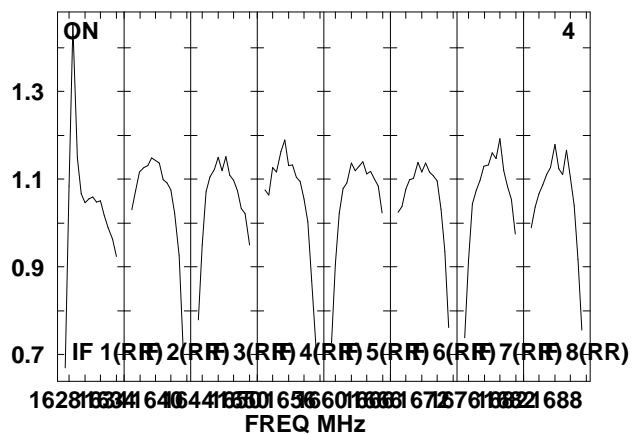
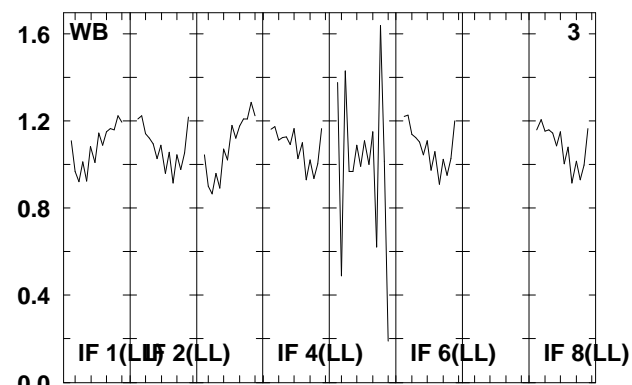
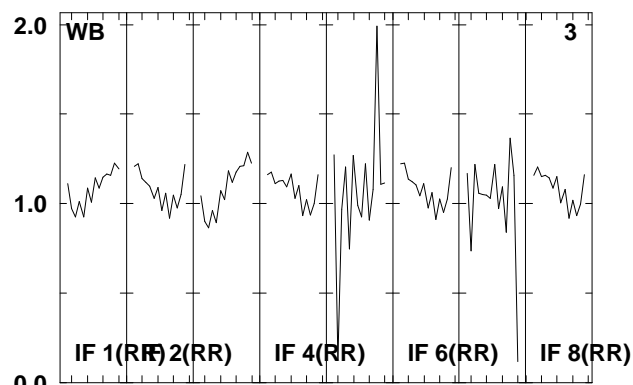
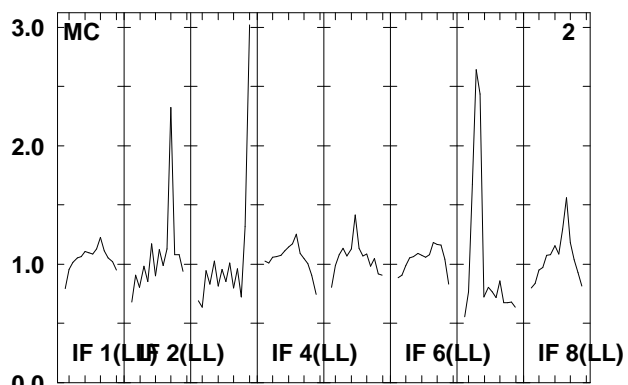
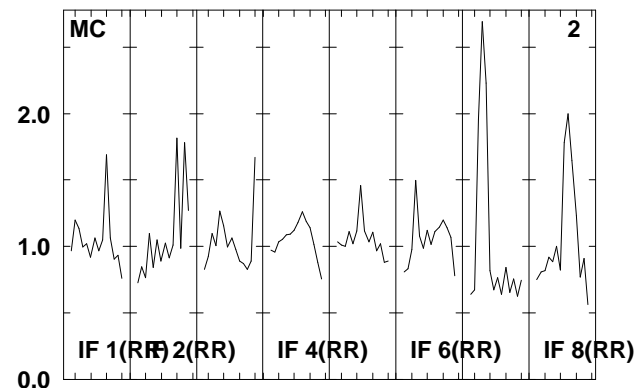
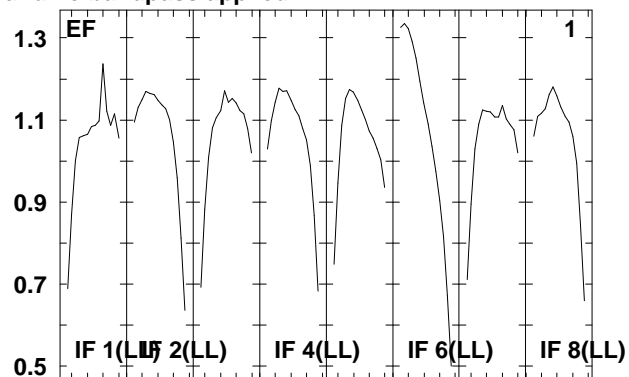
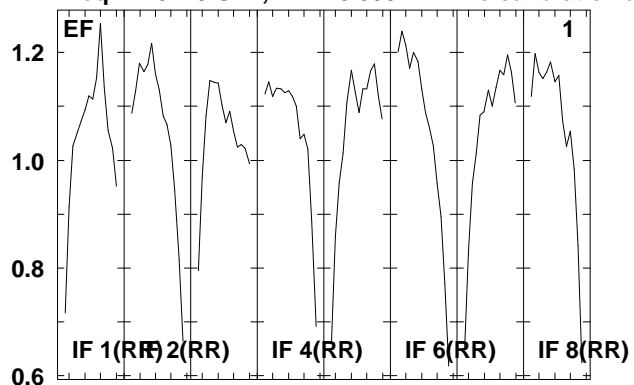

Lower frame: Real Jy

Total-power spectrum Antenna: \*

Timerange: 00/15:55:03 to 00/15:58:59

Plot file version 220 created 06-JAN-2009 10:58:25

J150407 EZ018B.UVDATA.1

Freq = 1.6270 GHz, Bw = 8.000 MH No calibration applied and no bandpass applied

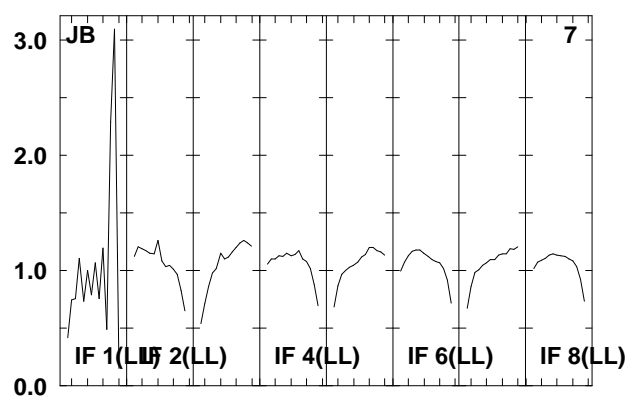
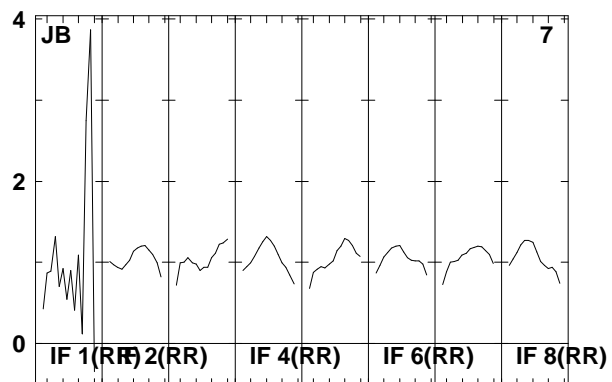
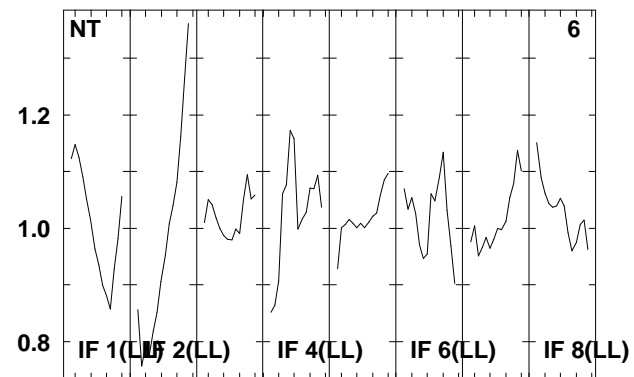
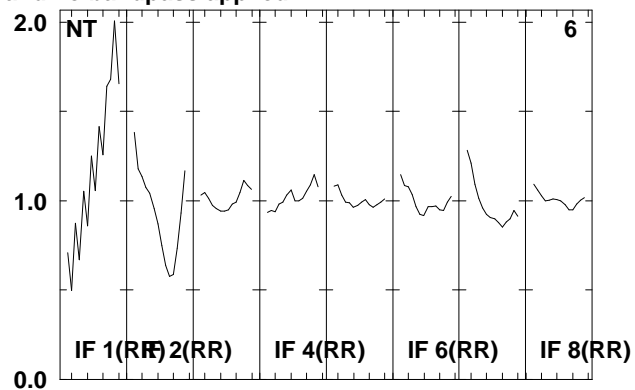
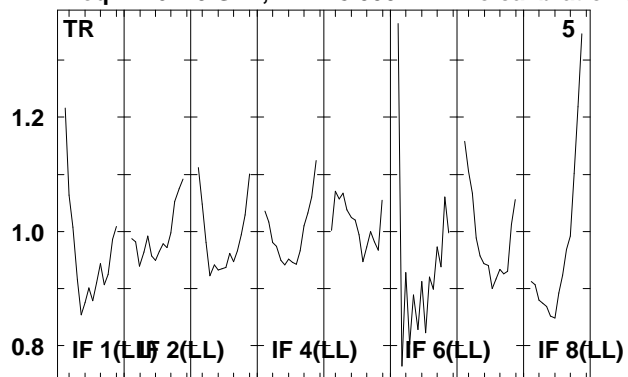

Lower frame: Real Jy  
Total-power spectrum Antenna: \*  
Timerange: 00/15:55:03 to 00/15:58:59

Plot file version 221 created 06-JAN-2009 10:58:26

J1510-05 EZ018B.UVDATA.1

Freq = 1.6270 GHz, Bw = 8.000 MH No calibration applied and no bandpass applied

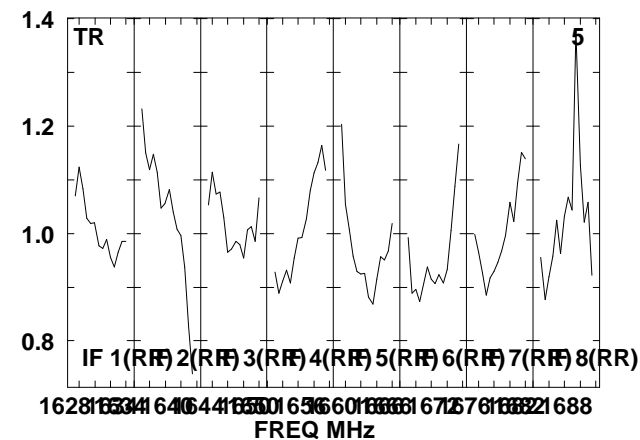
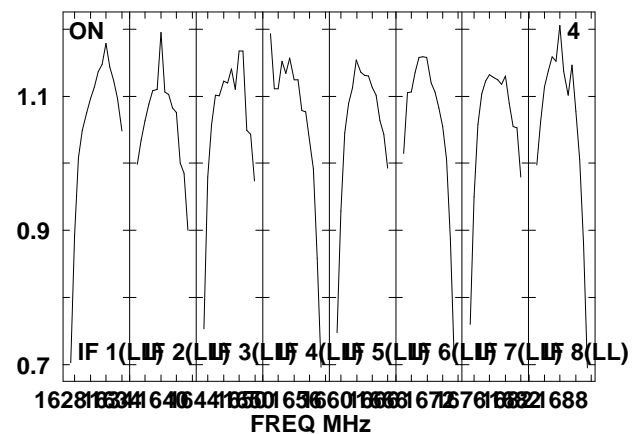
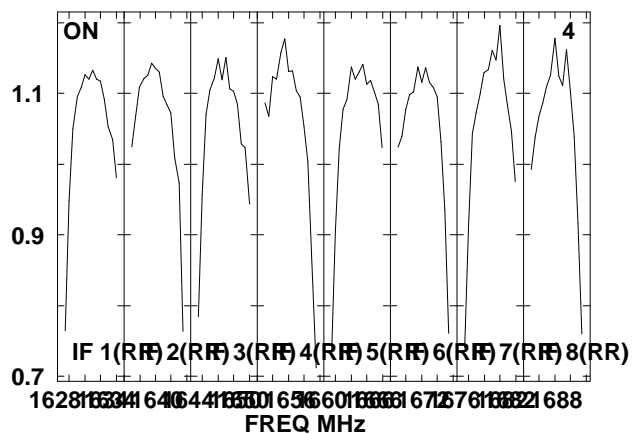
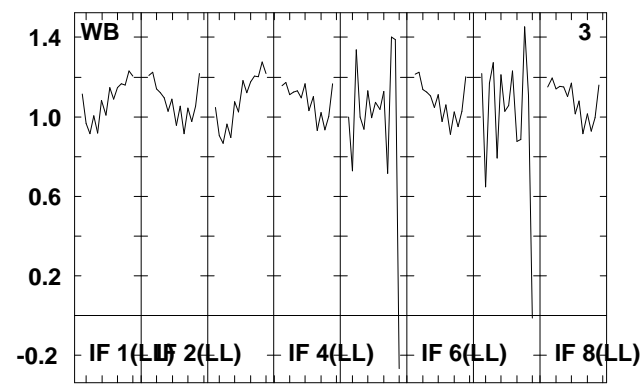
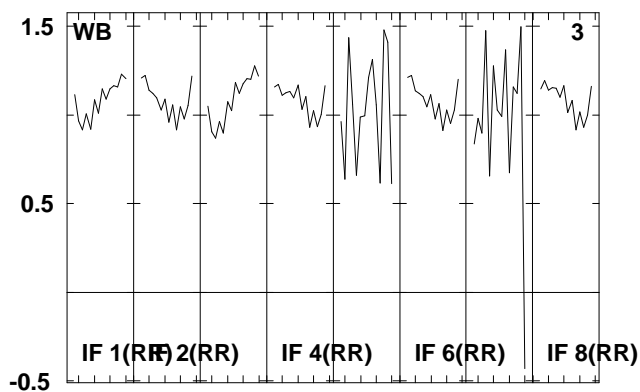
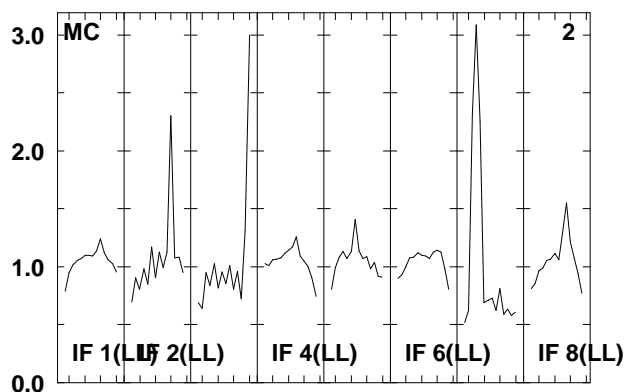
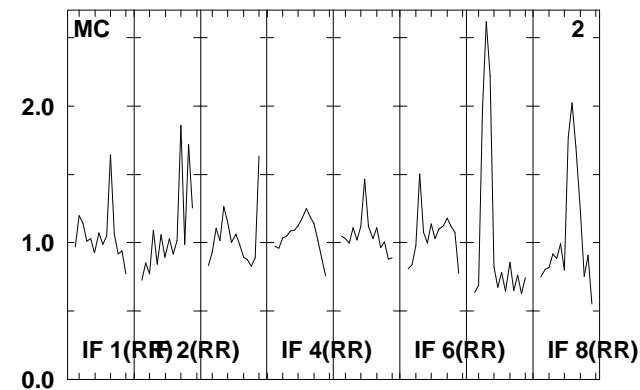
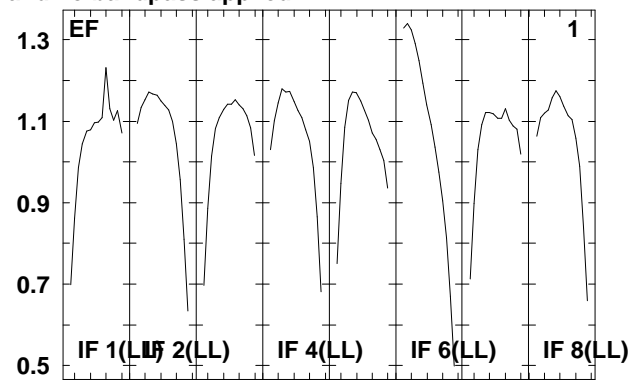
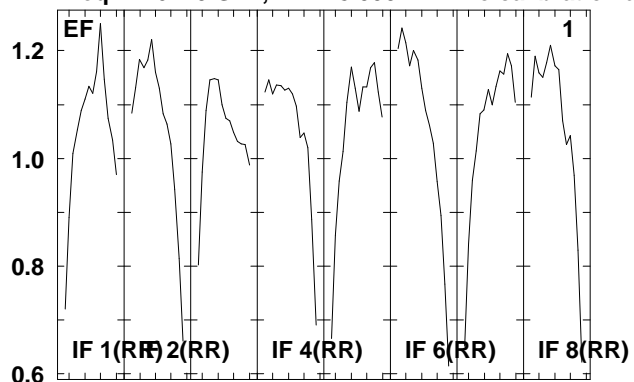

Lower frame: Real Jy  
Total-power spectrum Antenna: \*  
Timerange: 00/16:00:03 to 00/16:03:01

Plot file version 222 created 06-JAN-2009 10:58:26

J1510-05 EZ018B.UVDATA.1

Freq = 1.6270 GHz, Bw = 8.000 MH No calibration applied and no bandpass applied

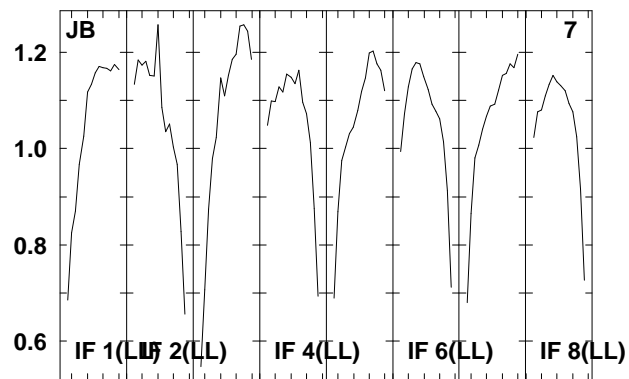
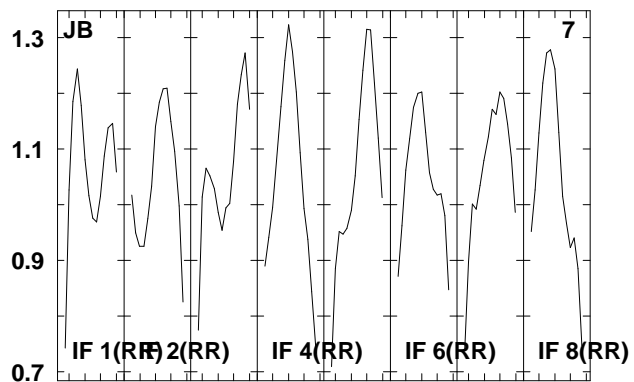
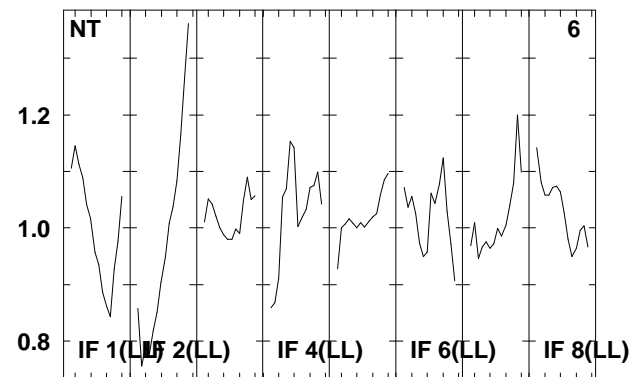
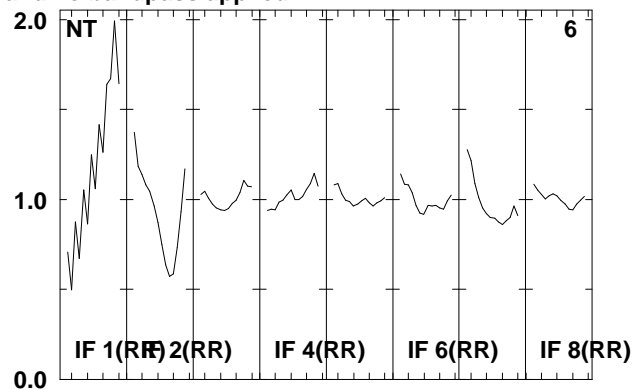
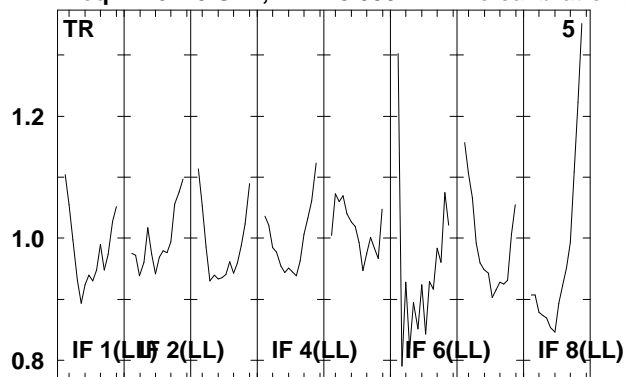

Lower frame: Real Jy  
Total-power spectrum Antenna: \*  
Timerange: 00/16:00:03 to 00/16:03:01

Plot file version 223 created 06-JAN-2009 10:58:26

J150407 EZ018B.UVDATA.1

Freq = 1.6270 GHz, Bw = 8.000 MH No calibration applied and no bandpass applied

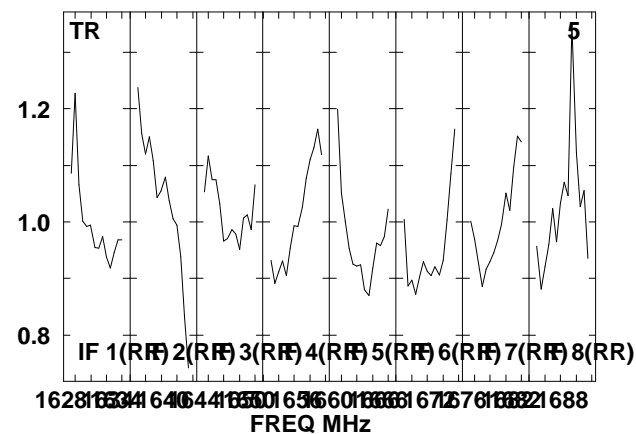
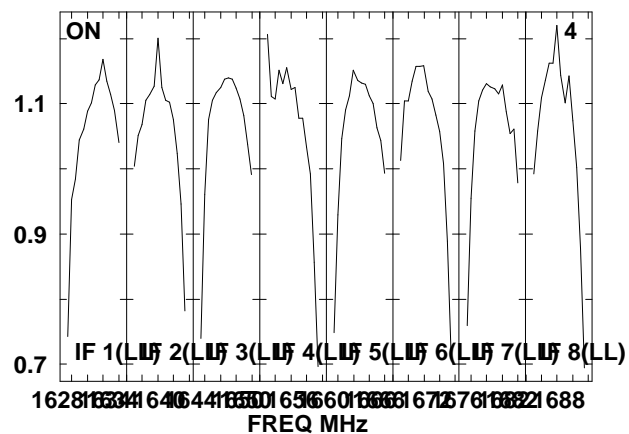
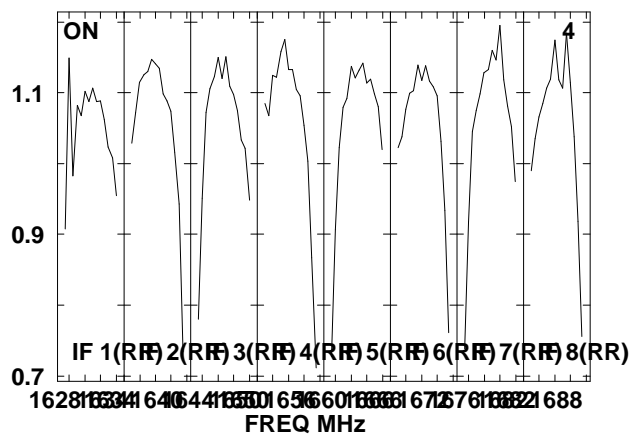
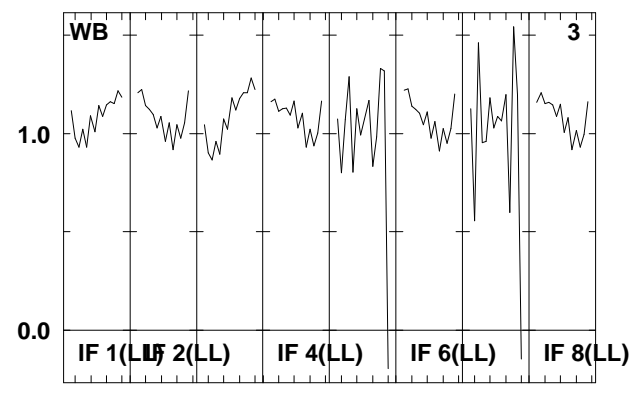
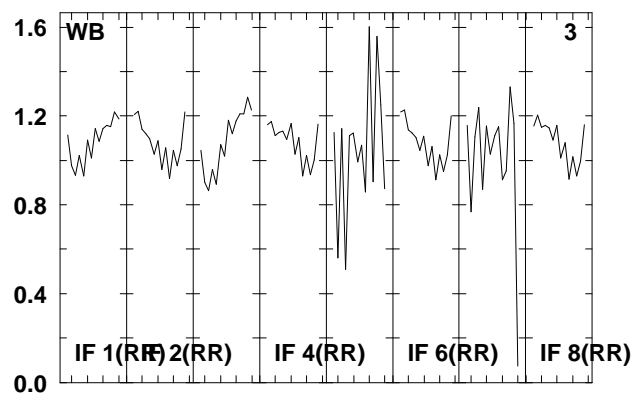
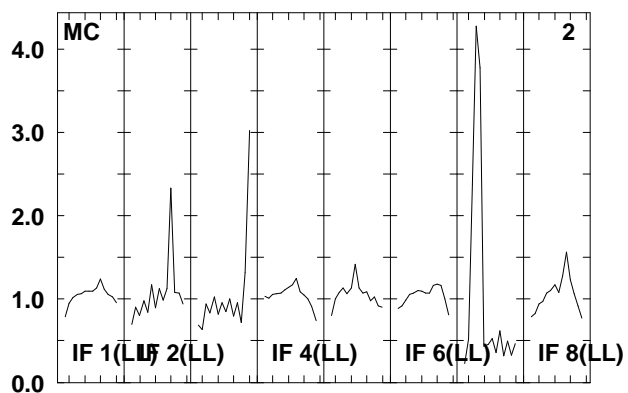
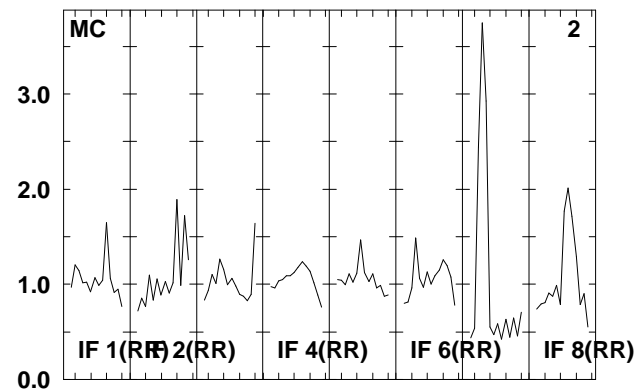
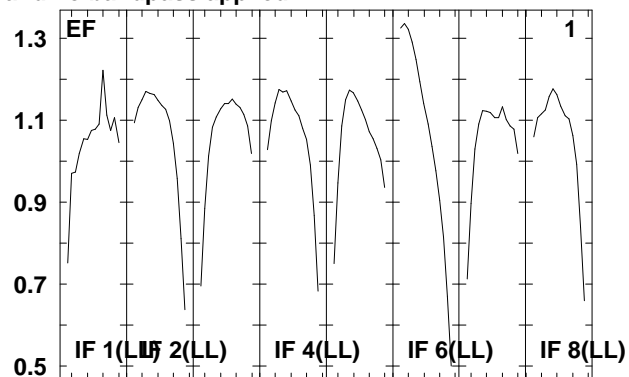
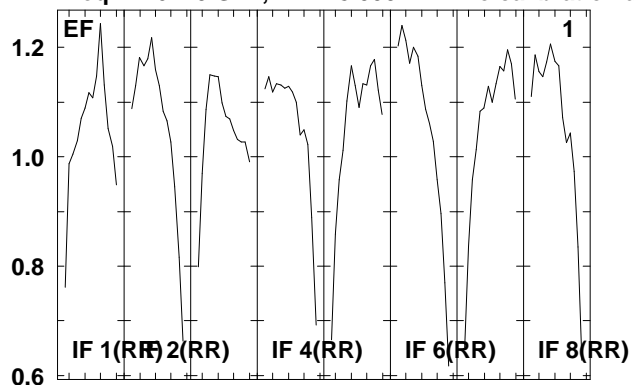

Lower frame: Real Jy  
Total-power spectrum Antenna: \*  
Timerange: 00/16:03:03 to 00/16:06:59

Plot file version 224 created 06-JAN-2009 10:58:27

J150407 EZ018B.UVDATA.1

Freq = 1.6270 GHz, Bw = 8.000 MH No calibration applied and no bandpass applied

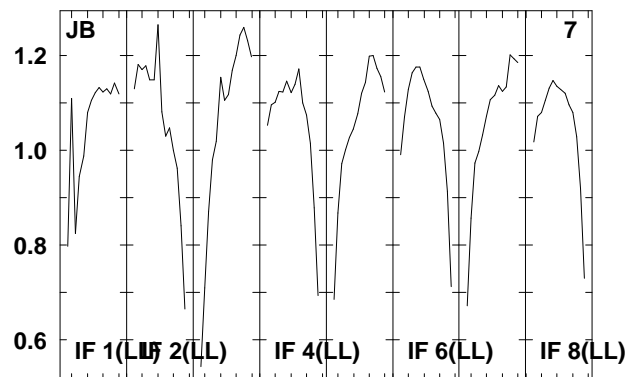
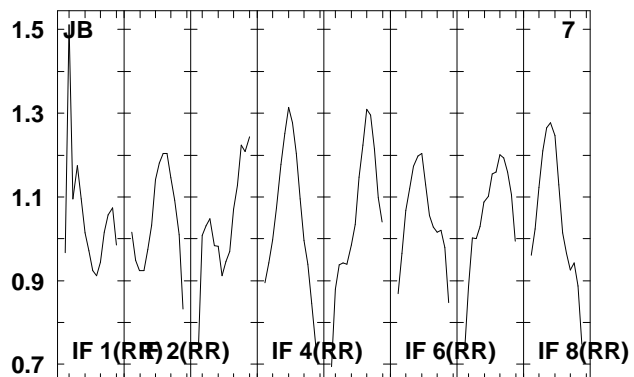
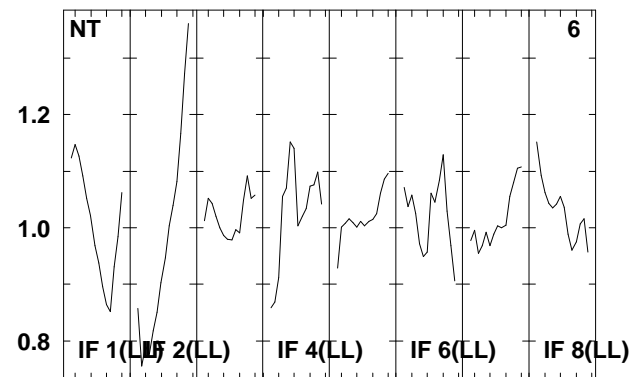
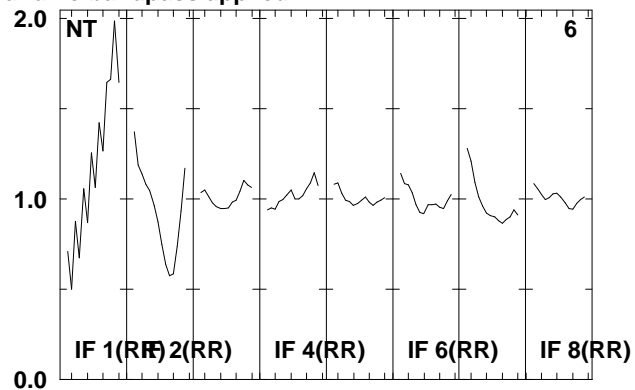
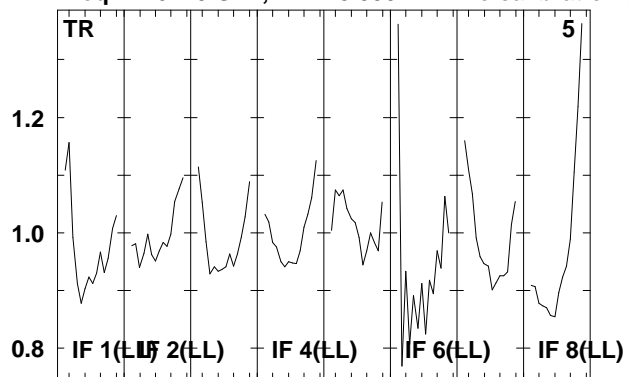

Lower frame: Real Jy  
Total-power spectrum Antenna: \*  
Timerange: 00/16:03:03 to 00/16:06:59



Plot file version 225 created 06-JAN-2009 10:58:27

J1510-05 EZ018B.UVDATA.1

Freq = 1.6270 GHz, Bw = 8.000 MH No calibration applied and no bandpass applied

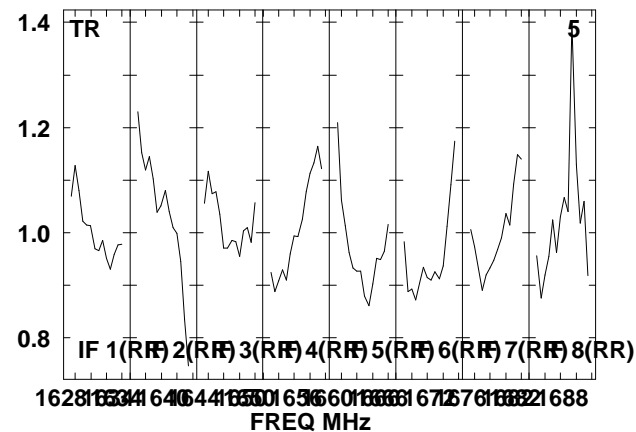
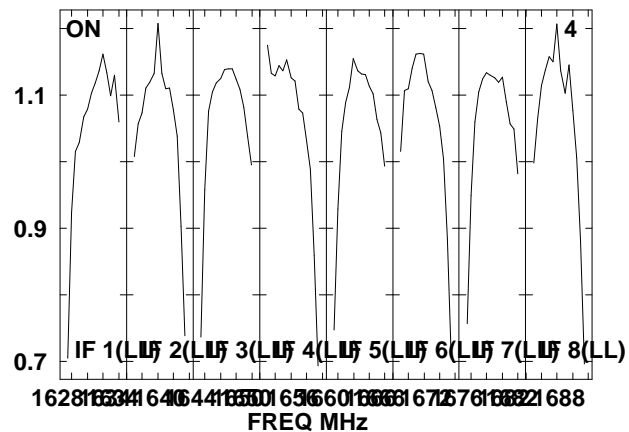
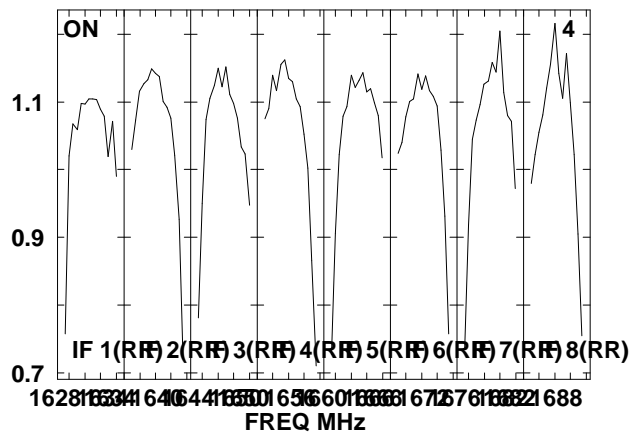
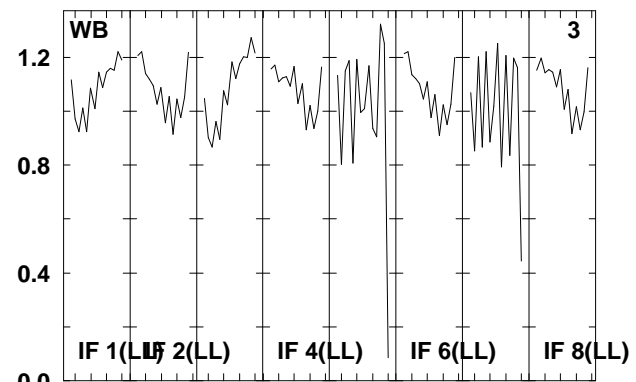
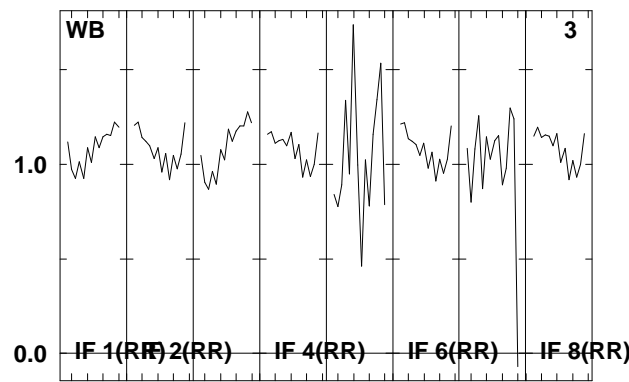
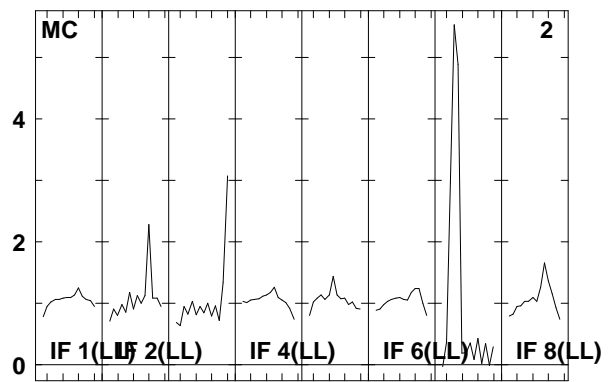
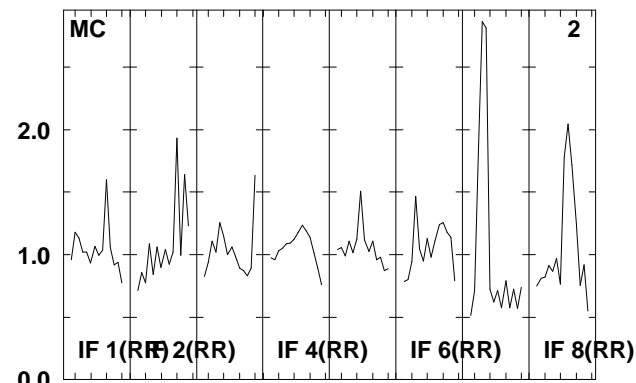
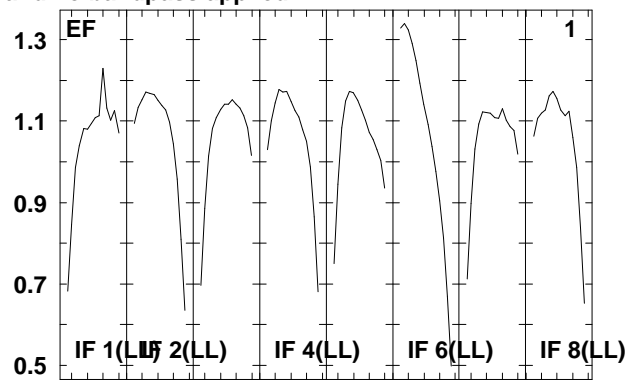
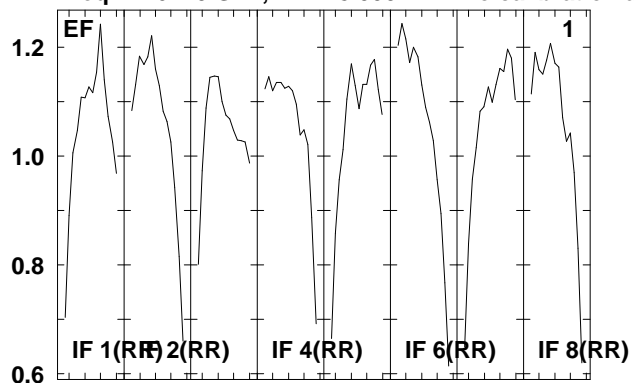

Lower frame: Real Jy  
Total-power spectrum Antenna: \*  
Timerange: 00/16:07:01 to 00/16:10:01

Plot file version 226 created 06-JAN-2009 10:58:28

J1510-05 EZ018B.UVDATA.1

Freq = 1.6270 GHz, Bw = 8.000 MH No calibration applied and no bandpass applied

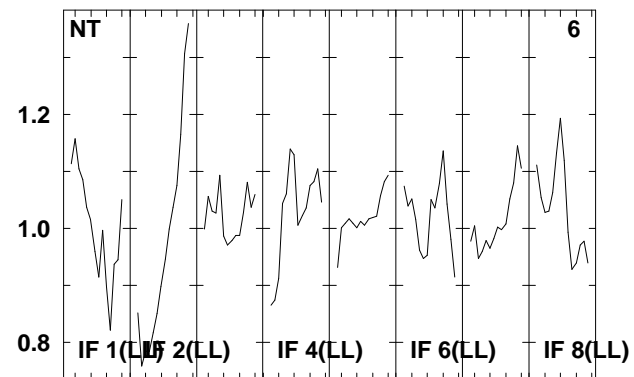
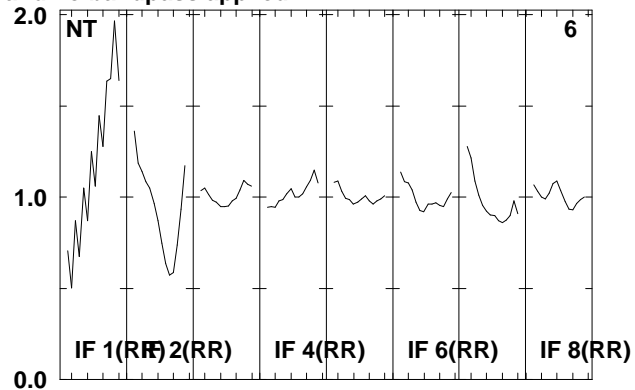
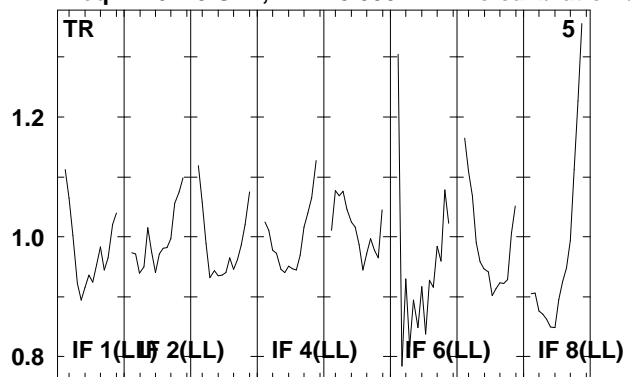

Lower frame: Real Jy  
Total-power spectrum Antenna: \*  
Timerange: 00/16:07:01 to 00/16:10:01

Plot file version 227 created 06-JAN-2009 10:58:28

J150407 EZ018B.UVDATA.1

Freq = 1.6270 GHz, Bw = 8.000 MH No calibration applied and no bandpass applied

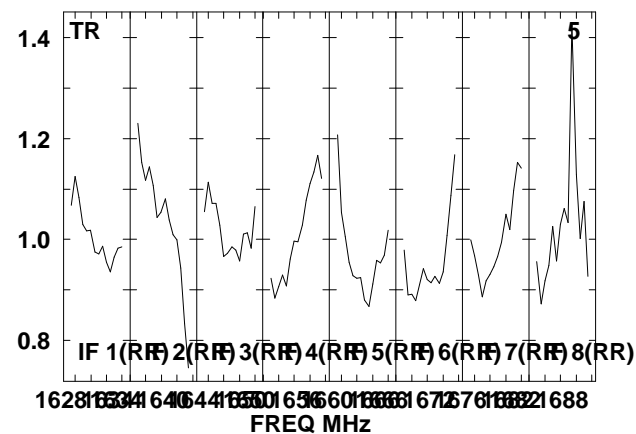
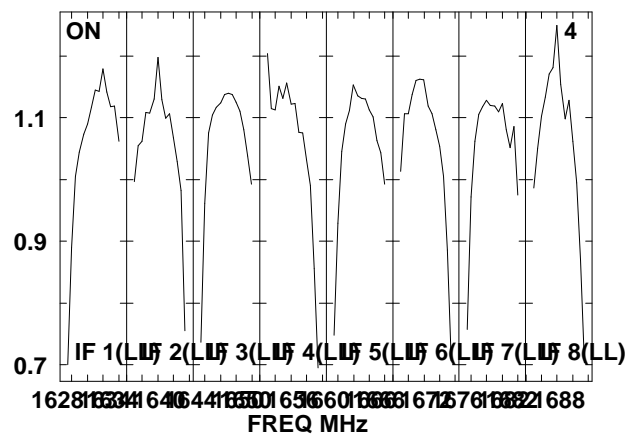
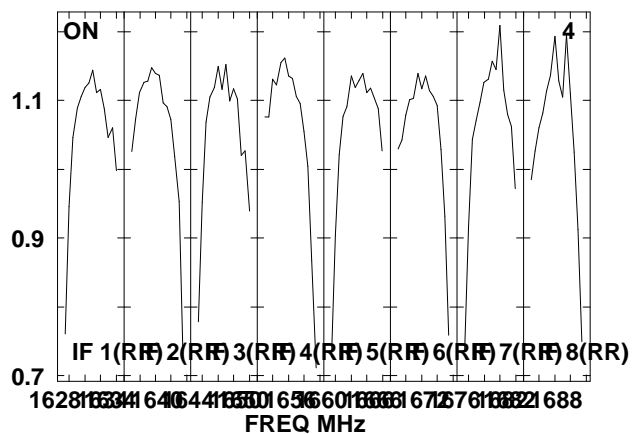
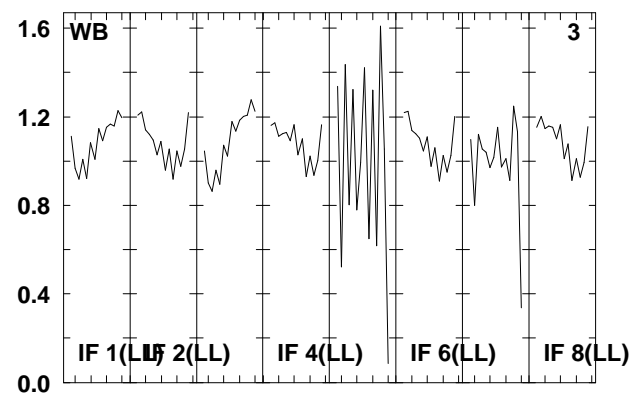
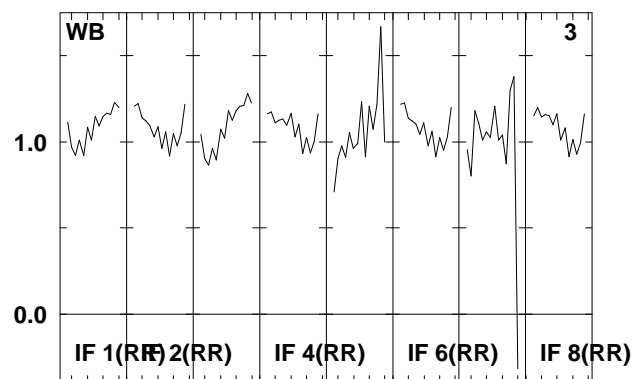
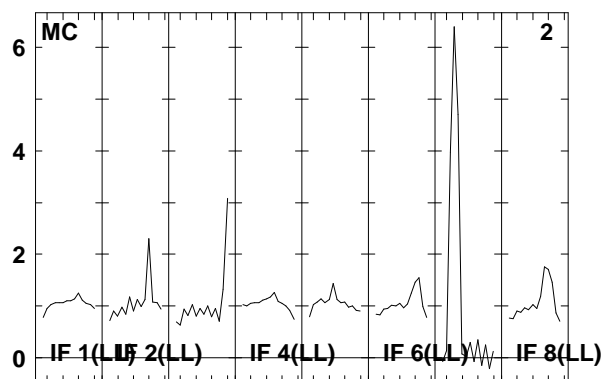
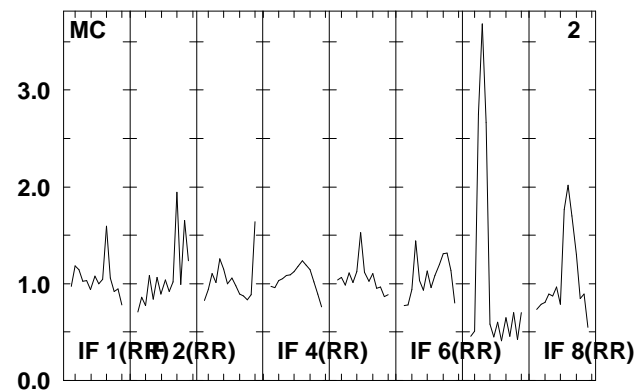
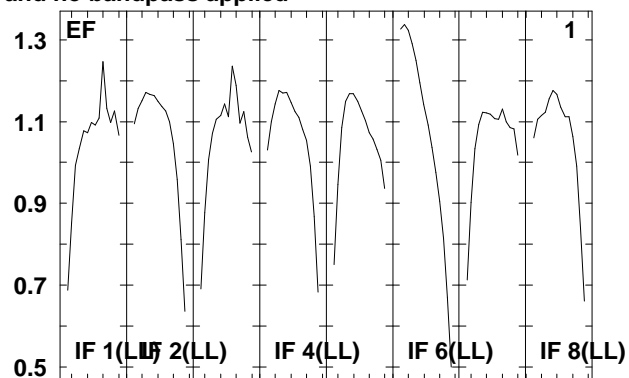
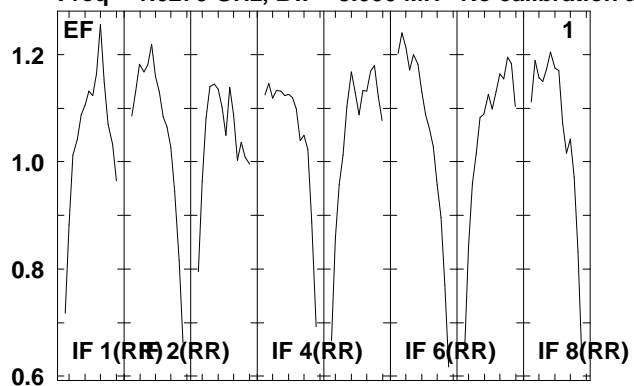

Lower frame: Real Jy  
Total-power spectrum Antenna: \*  
Timerange: 00/16:10:03 to 00/16:13:59

Plot file version 228 created 06-JAN-2009 10:58:28

J150407 EZ018B.UVDATA.1

Freq = 1.6270 GHz, Bw = 8.000 MH No calibration applied and no bandpass applied

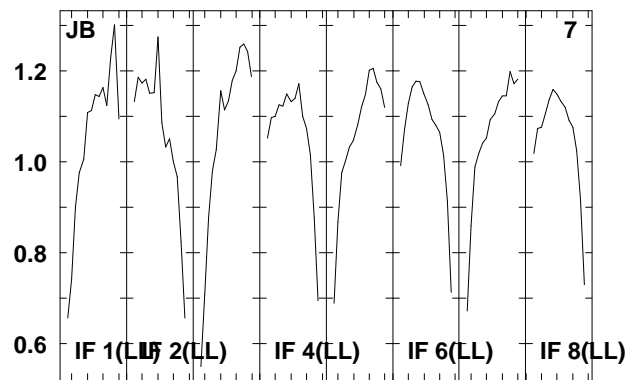
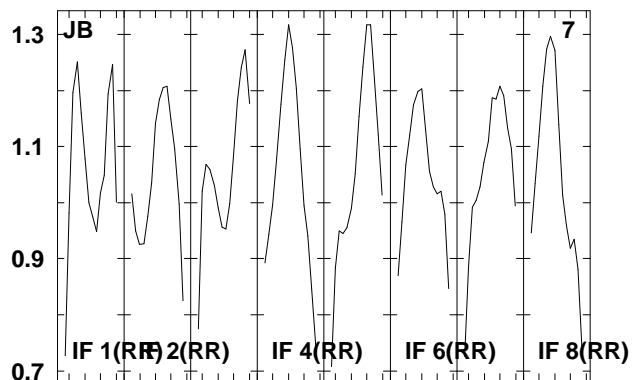
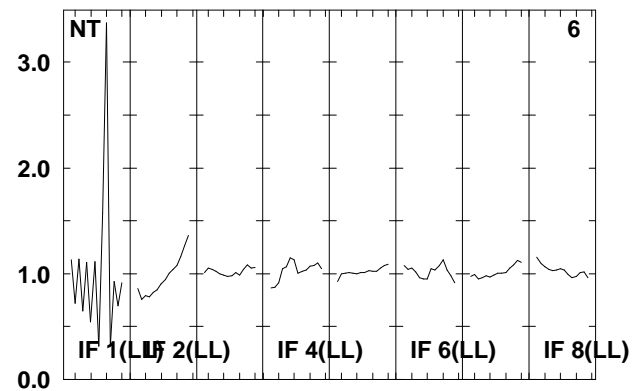
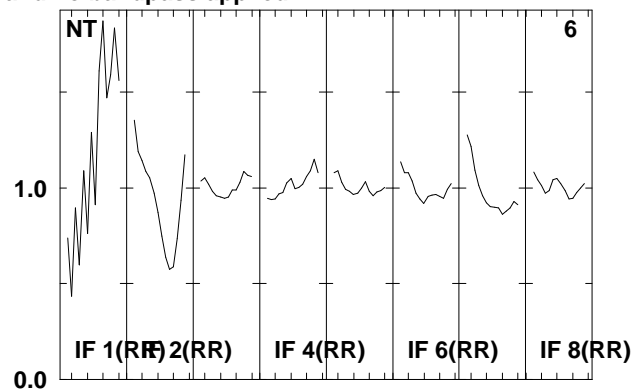
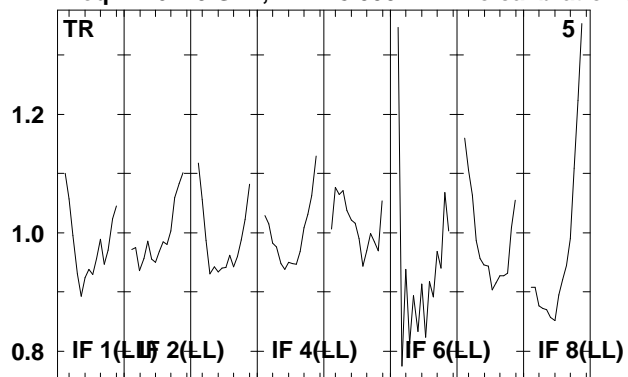

Lower frame: Real Jy  
Total-power spectrum Antenna: \*  
Timerange: 00/16:10:03 to 00/16:13:59

Plot file version 229 created 06-JAN-2009 10:58:29

J1510-05 EZ018B.UVDATA.1

Freq = 1.6270 GHz, Bw = 8.000 MH No calibration applied and no bandpass applied

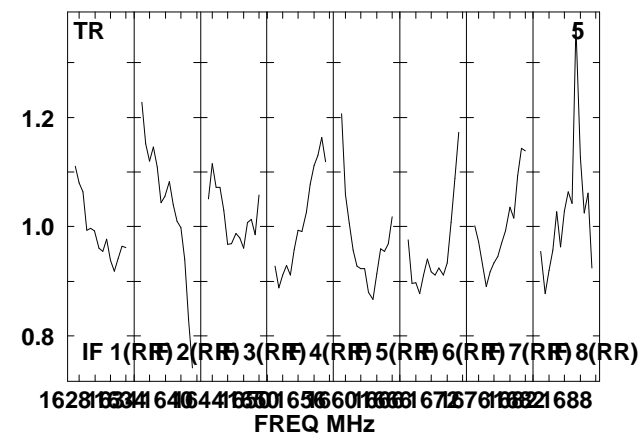
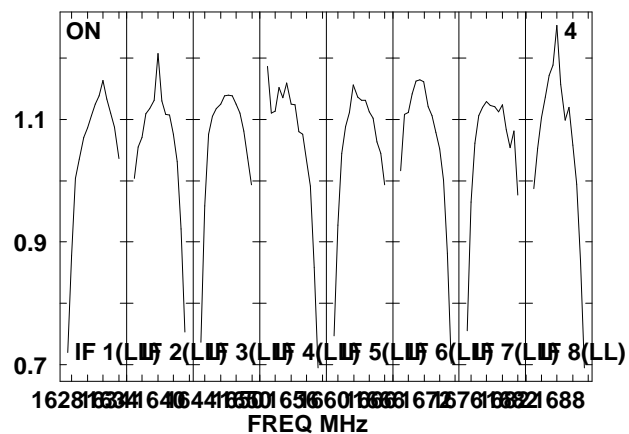
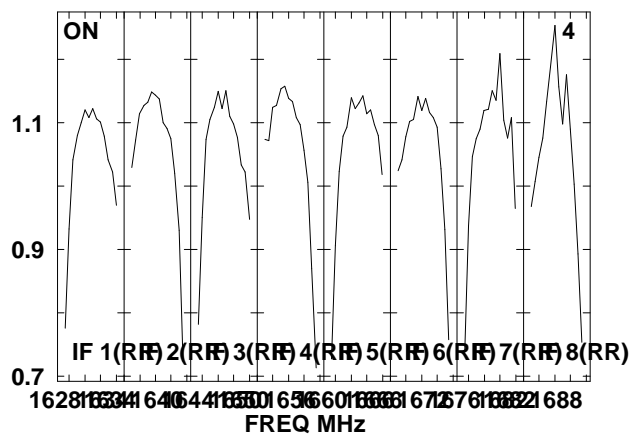
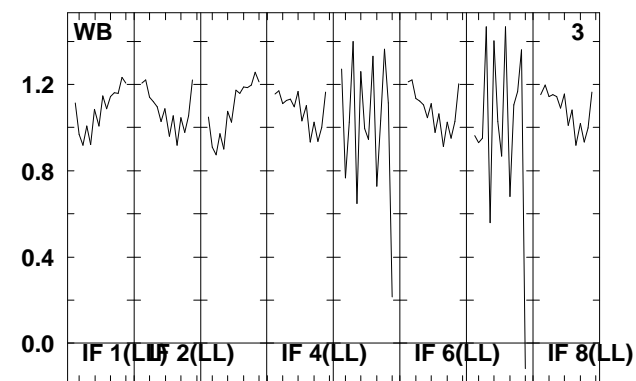
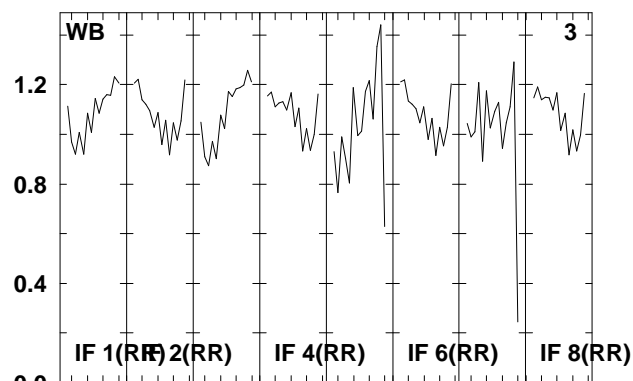
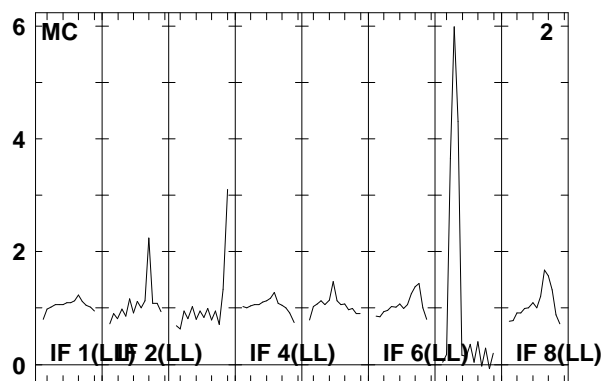
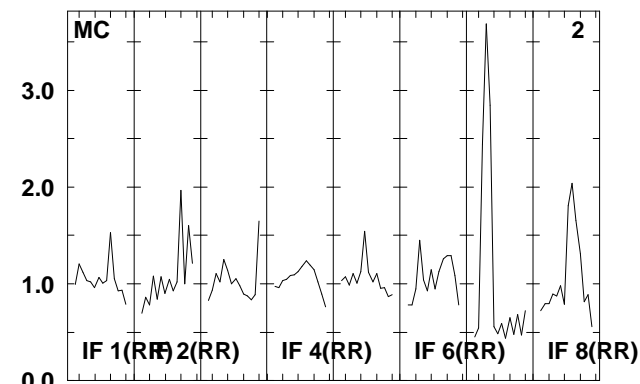
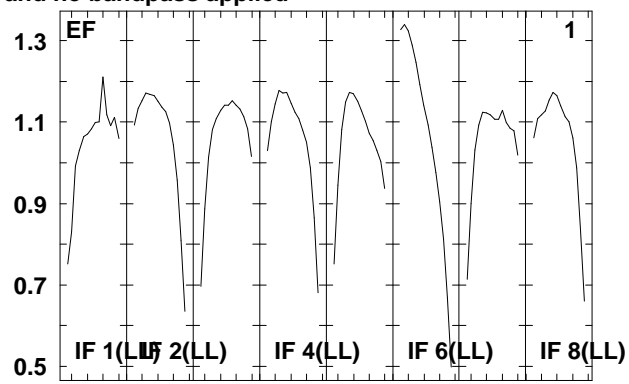
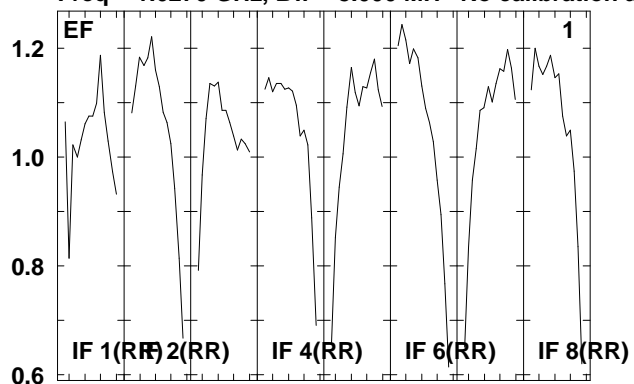

Lower frame: Real Jy  
Total-power spectrum Antenna: \*  
Timerange: 00/16:15:03 to 00/16:18:01

Plot file version 230 created 06-JAN-2009 10:58:29

J1510-05 EZ018B.UVDATA.1

Freq = 1.6270 GHz, Bw = 8.000 MH No calibration applied and no bandpass applied

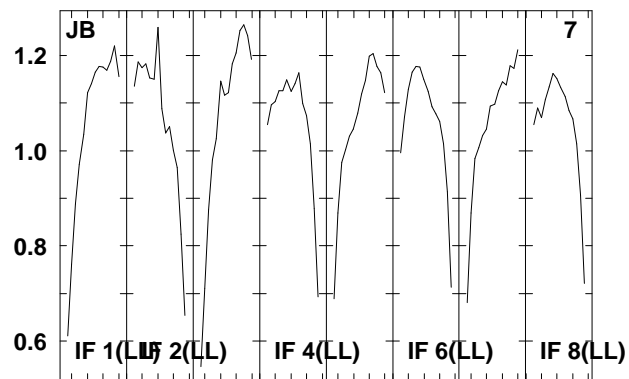
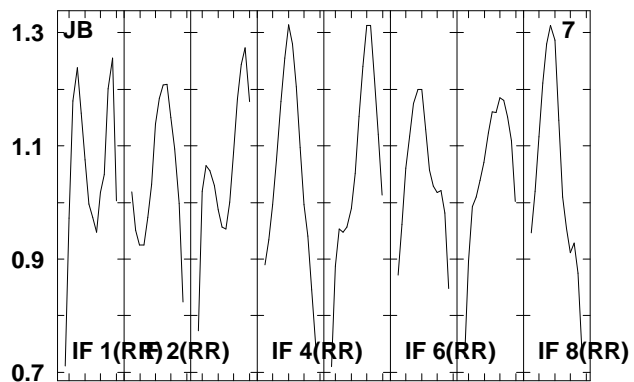
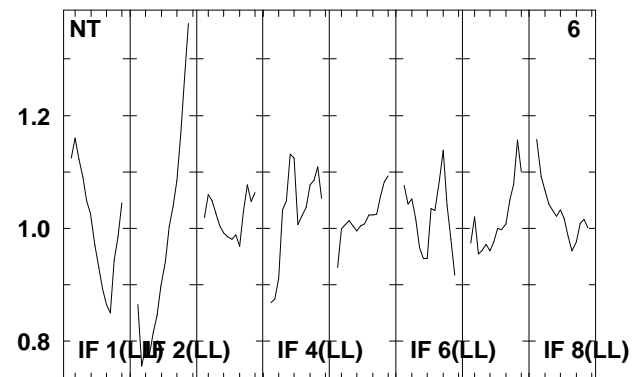
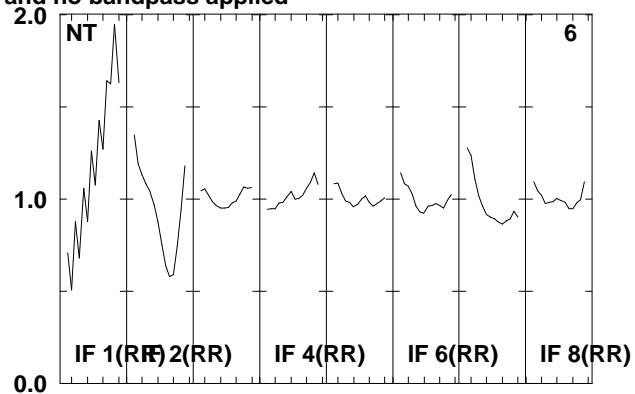
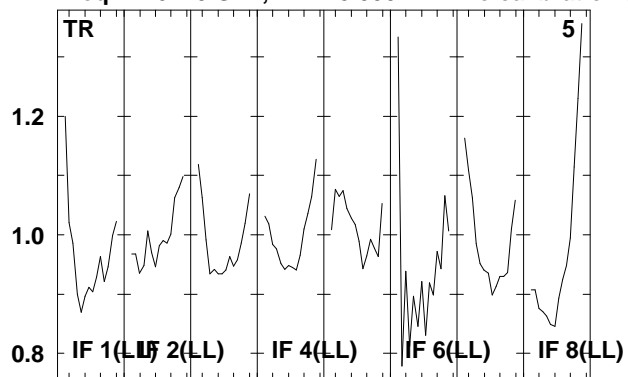

Lower frame: Real Jy  
Total-power spectrum Antenna: \*  
Timerange: 00/16:15:03 to 00/16:18:01

Plot file version 231 created 06-JAN-2009 10:58:30

J150407 EZ018B.UVDATA.1

Freq = 1.6270 GHz, Bw = 8.000 MH No calibration applied and no bandpass applied

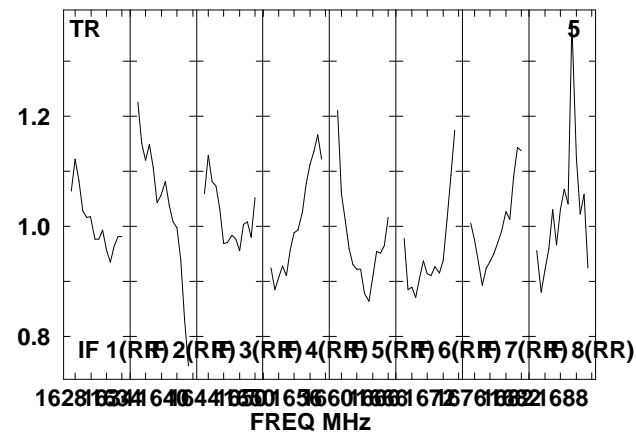
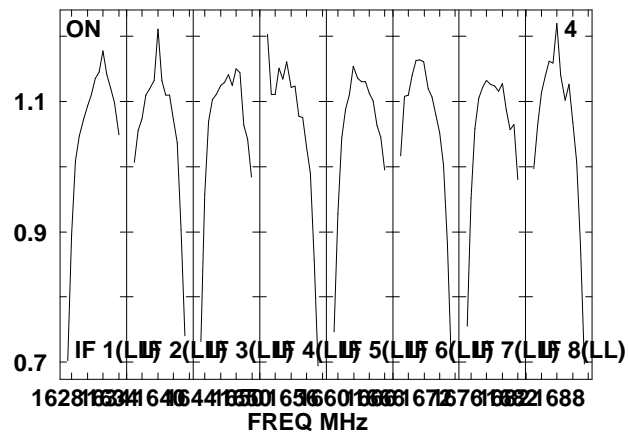
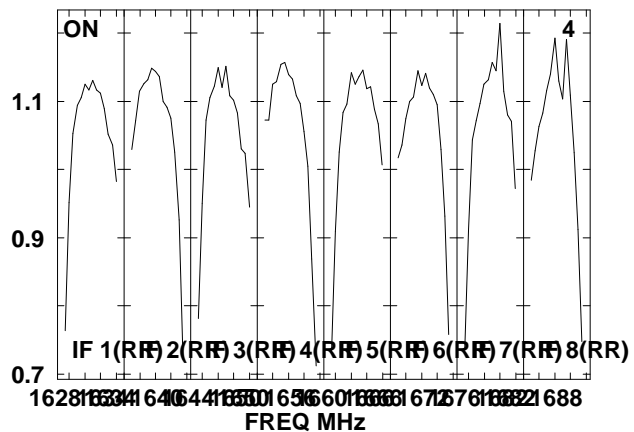
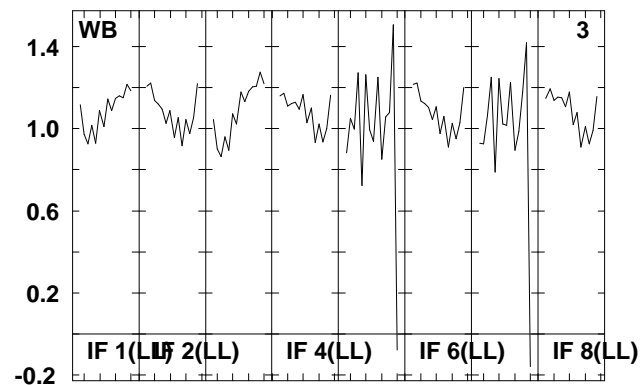
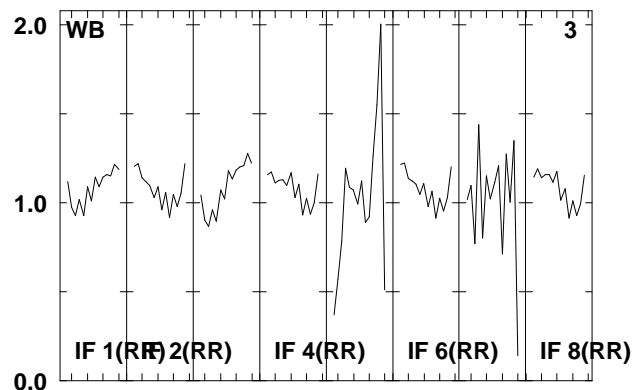
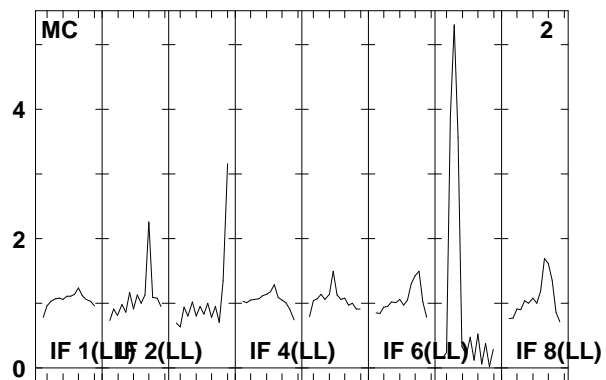
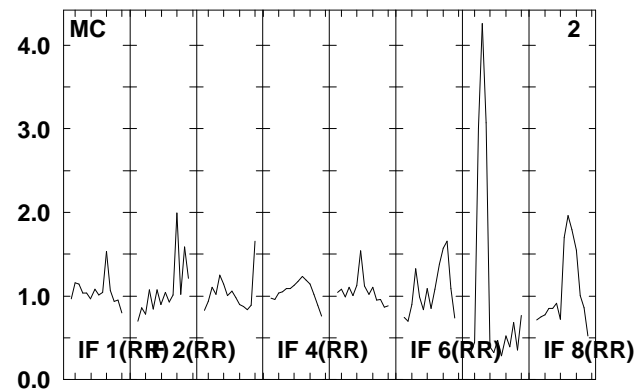
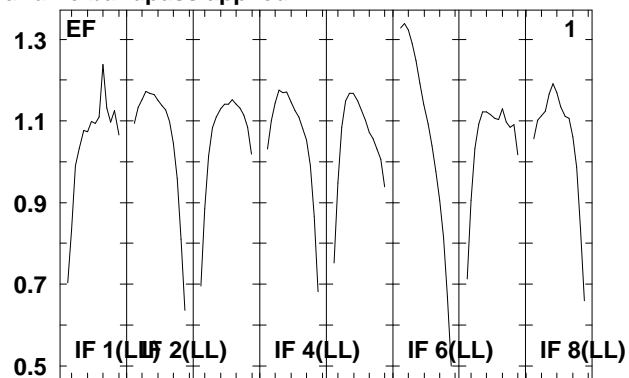
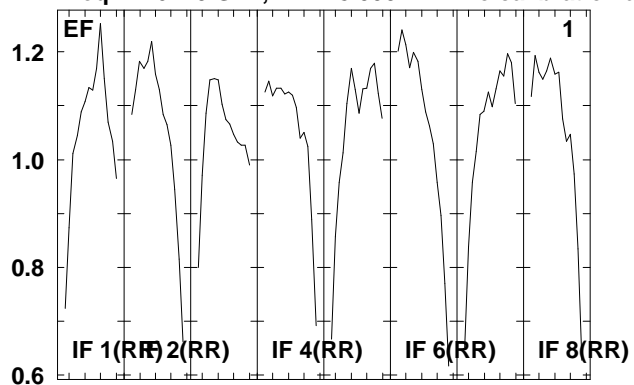

Lower frame: Real Jy  
Total-power spectrum Antenna: \*  
Timerange: 00/16:18:03 to 00/16:22:01

Plot file version 232 created 06-JAN-2009 10:58:30

J150407 EZ018B.UVDATA.1

Freq = 1.6270 GHz, Bw = 8.000 MH No calibration applied and no bandpass applied

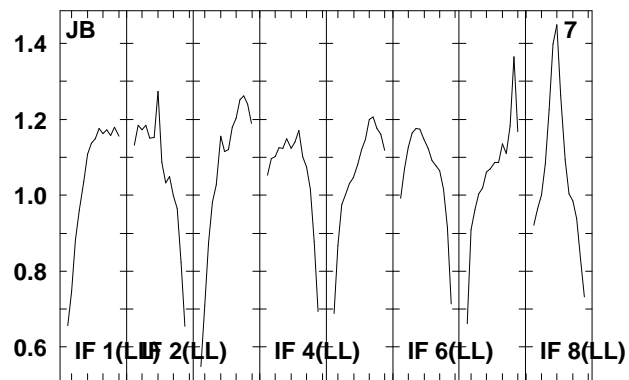
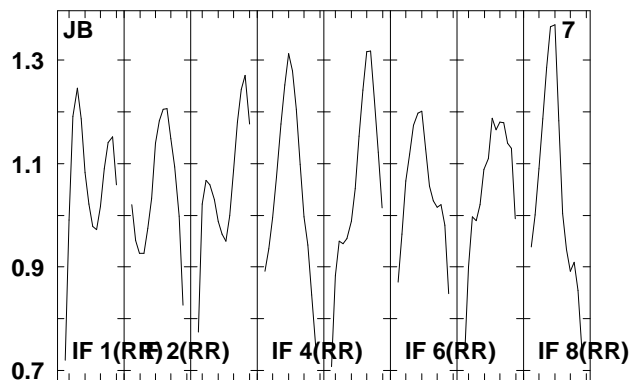
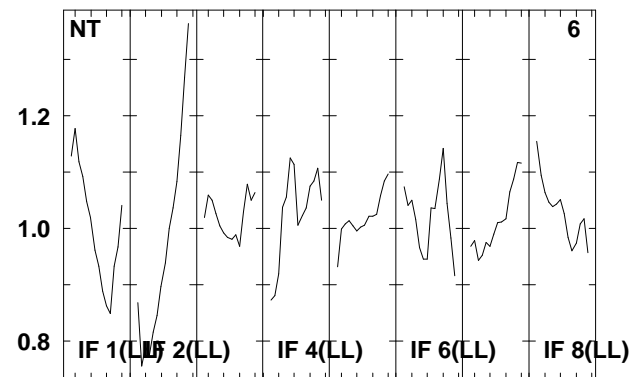
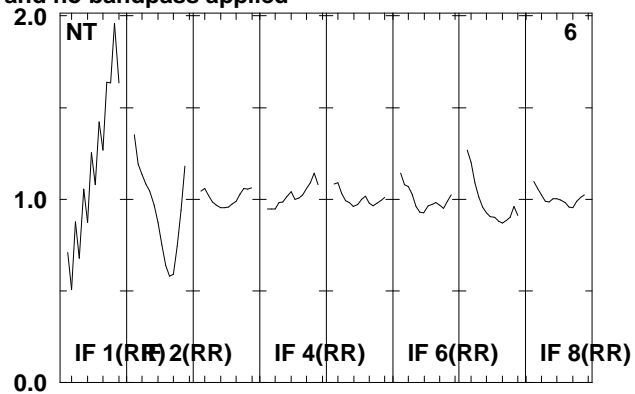
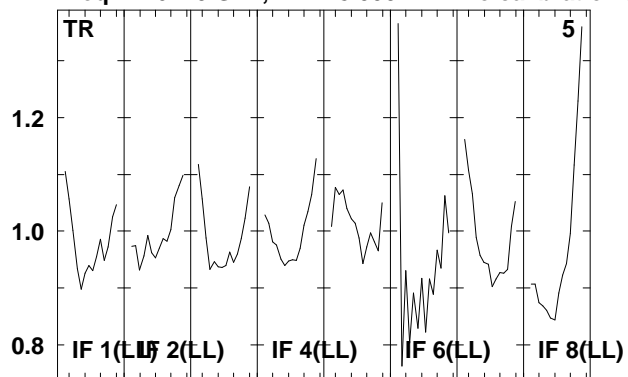

Lower frame: Real Jy  
Total-power spectrum Antenna: \*  
Timerange: 00/16:18:03 to 00/16:22:01



Plot file version 233 created 06-JAN-2009 10:58:30

J1510-05 EZ018B.UVDATA.1

Freq = 1.6270 GHz, Bw = 8.000 MH No calibration applied and no bandpass applied

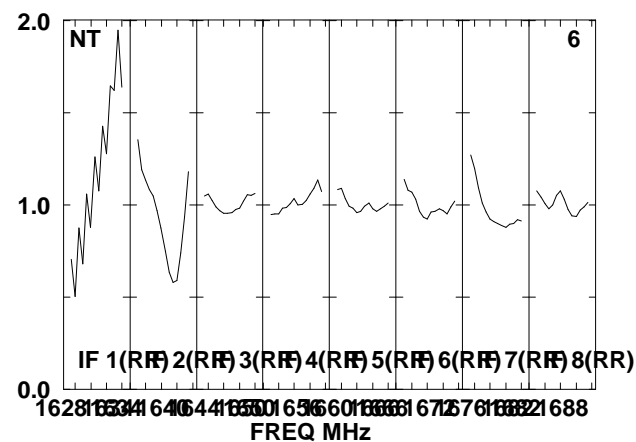
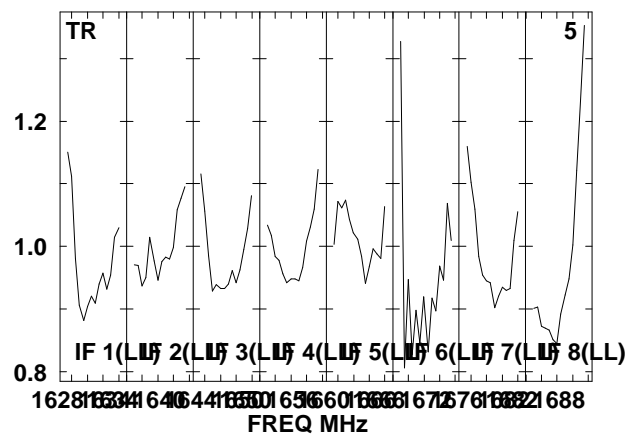
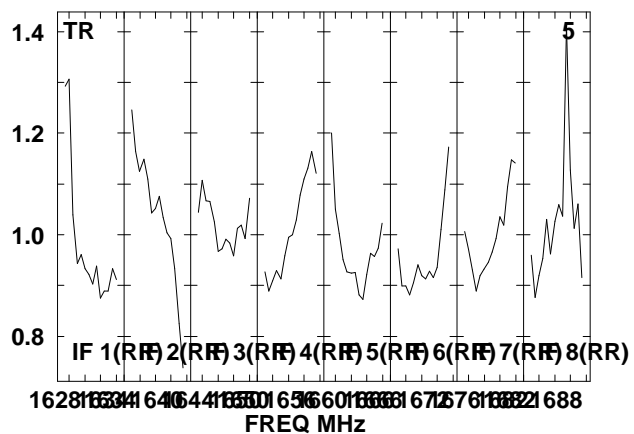
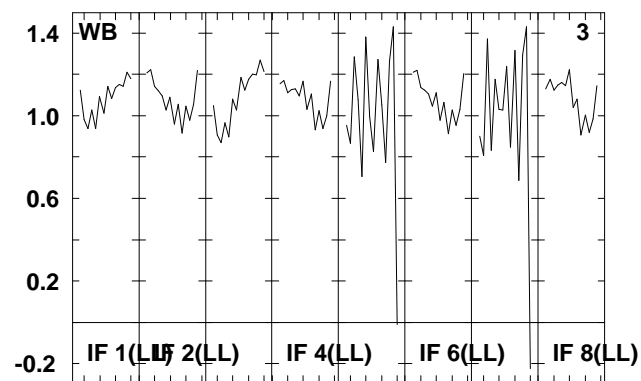
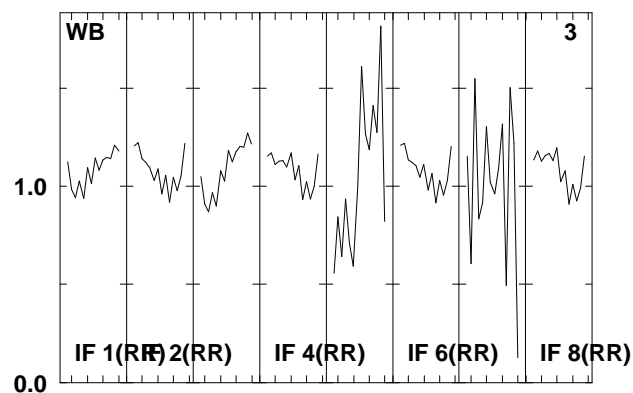
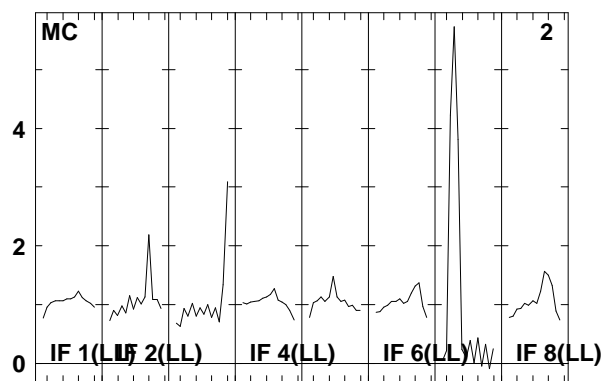
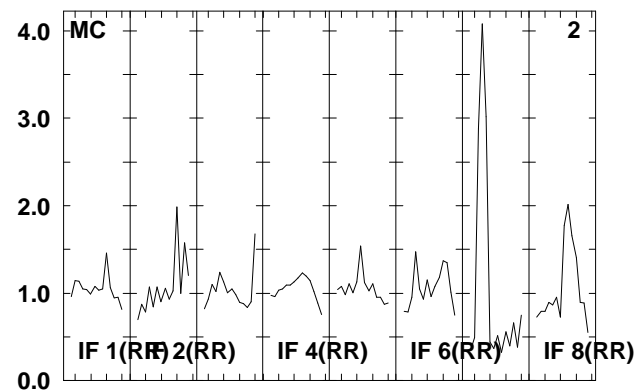
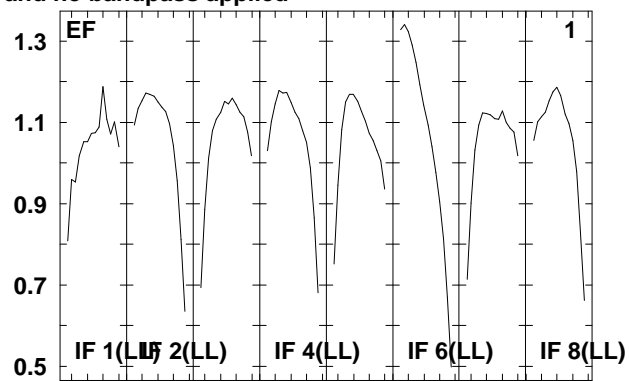
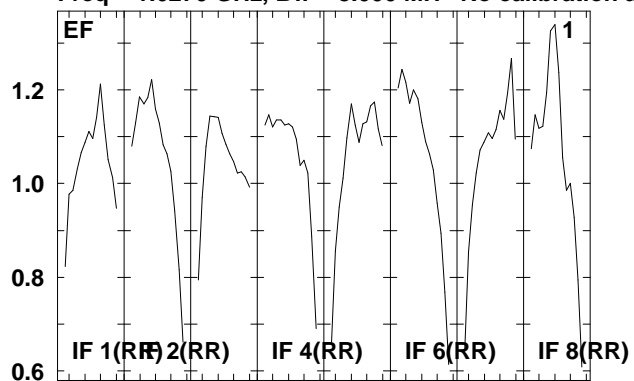

Lower frame: Real Jy  
Total-power spectrum Antenna: \*  
Timerange: 00/16:22:03 to 00/16:24:59

Plot file version 234 created 06-JAN-2009 10:58:31  
J1510-05 EZ018B.UVDATA.1  
Freq = 1.6270 GHz, Bw = 8.000 MH No calibration applied and no bandpass applied

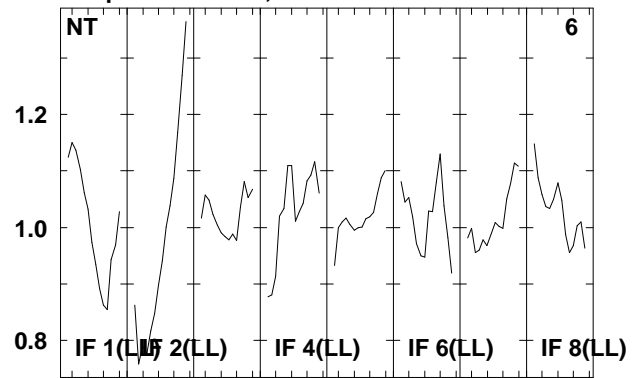

Lower frame: Real Jy  
Total-power spectrum Antenna: \*  
Timerange: 00/16:22:03 to 00/16:24:59

Plot file version 235 created 06-JAN-2009 10:58:31

J150407 EZ018B.UVDATA.1

Freq = 1.6270 GHz, Bw = 8.000 MH No calibration applied and no bandpass applied

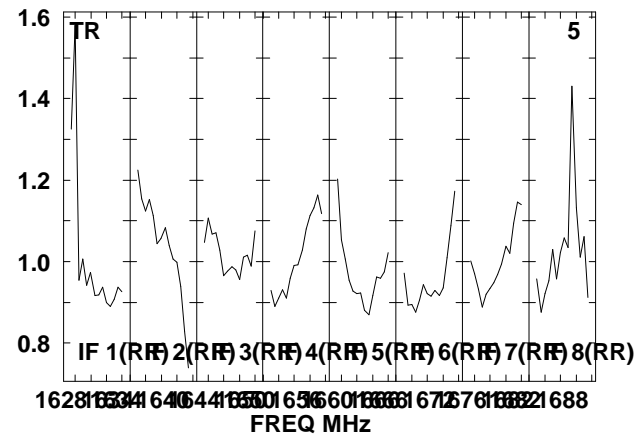
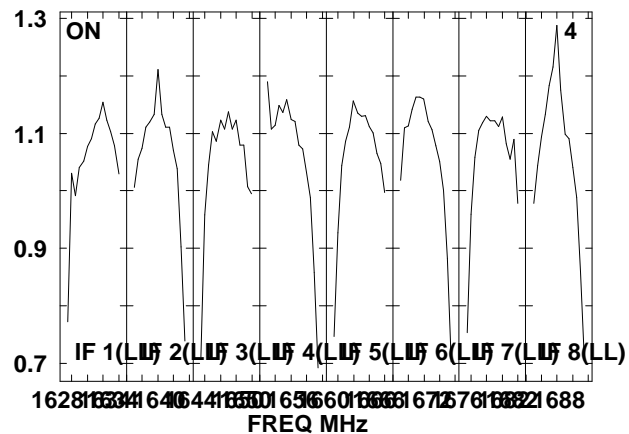
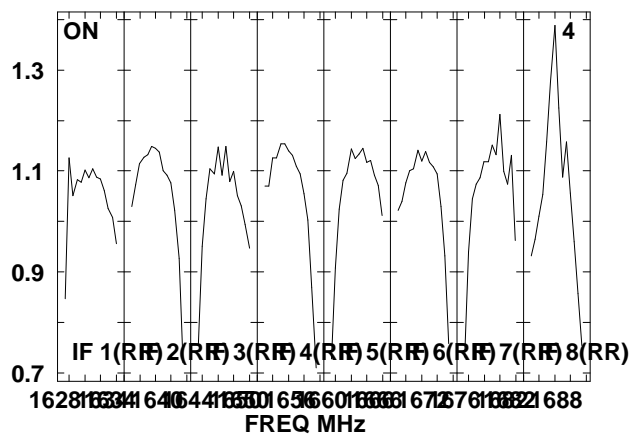
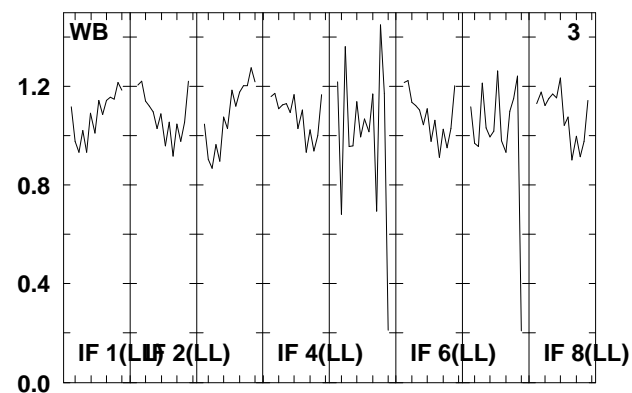
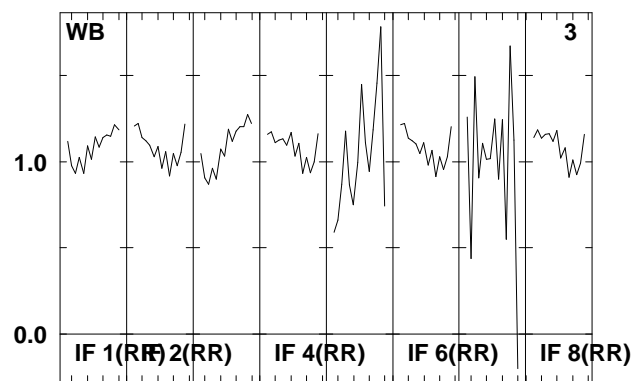
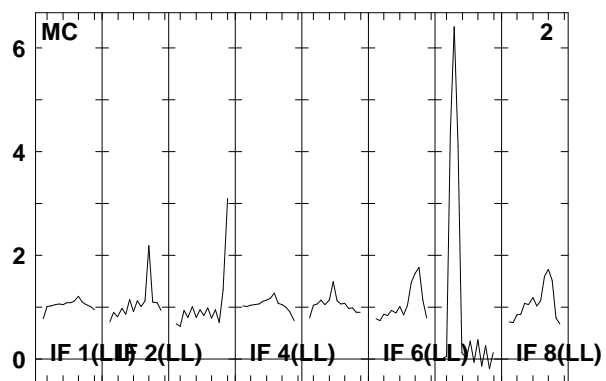
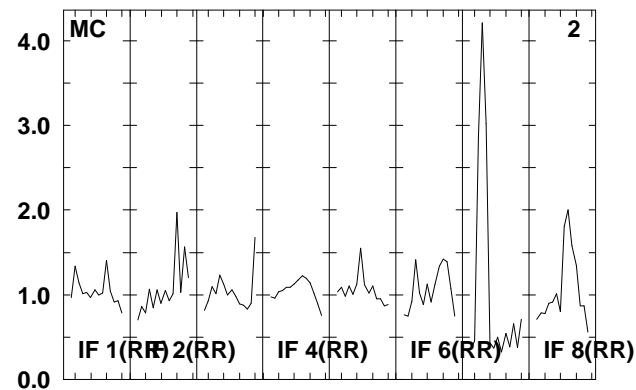
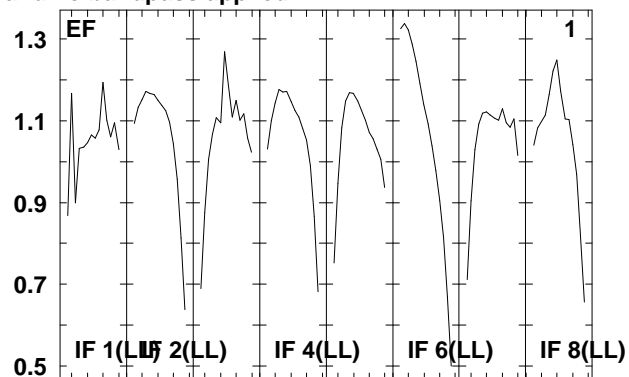
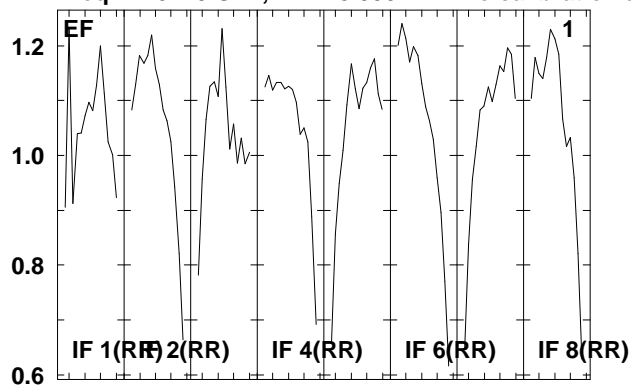

Lower frame: Real Jy  
Total-power spectrum Antenna: \*  
Timerange: 00/16:25:01 to 00/16:28:57

Plot file version 236 created 06-JAN-2009 10:58:31

J150407 EZ018B.UVDATA.1

Freq = 1.6270 GHz, Bw = 8.000 MH No calibration applied and no bandpass applied

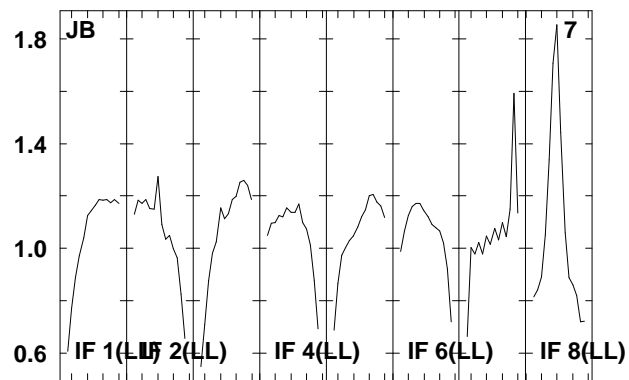
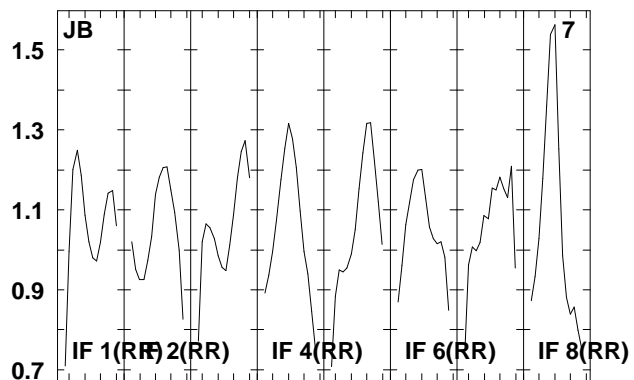
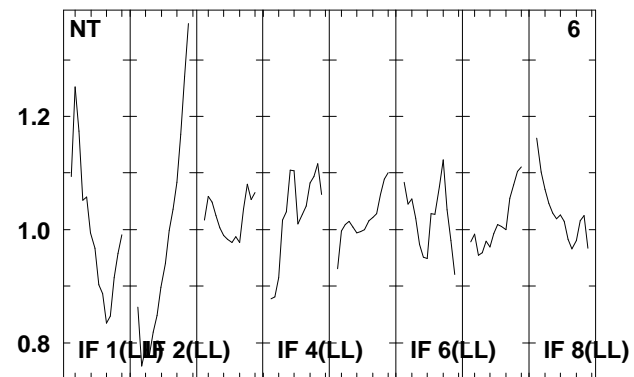
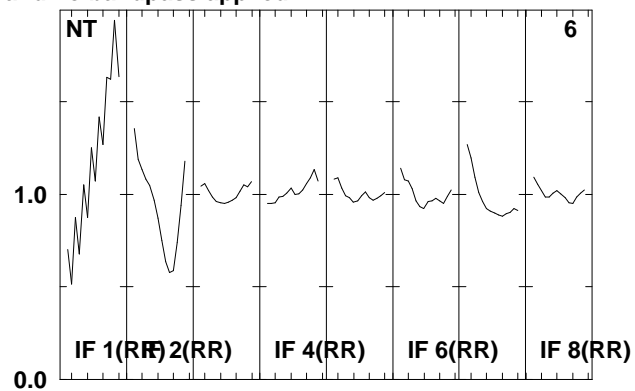
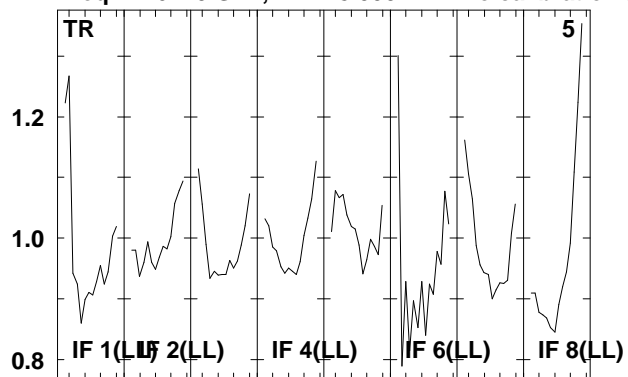

Lower frame: Real Jy  
Total-power spectrum Antenna: \*  
Timerange: 00/16:25:01 to 00/16:28:57