

Plot file version 1 created 26-JUL-2013 10:17:22
 4C39.25 EZ024 1.UVDATA.1
 Freq = 22.1720 GHz, Bw = 16.000 MH Calibrated with CL # 3 and BP # 1 (BP mode 1)

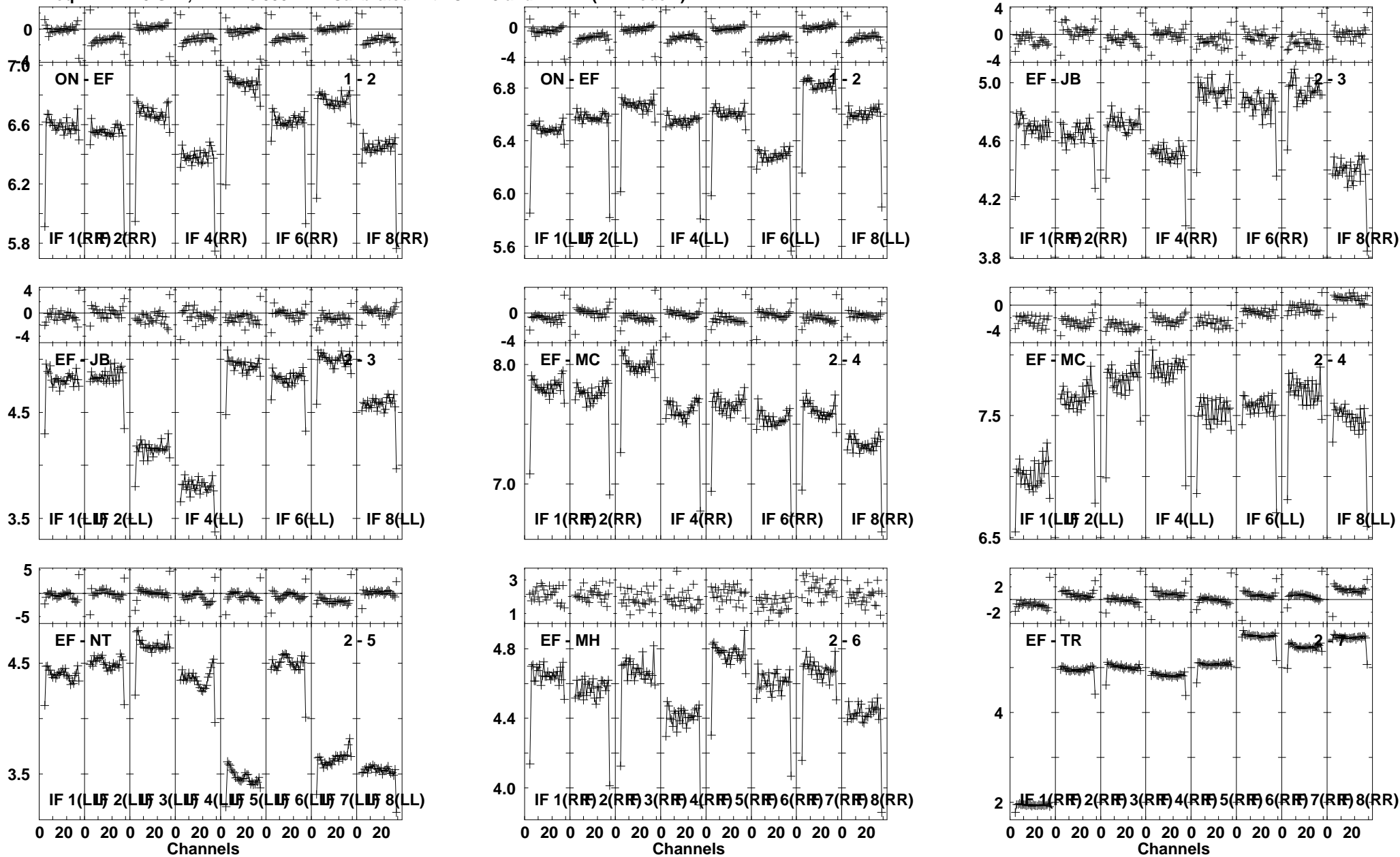

Lower frame: Ampl Jy Top frame: Phas deg
 Vector averaged cross-power spectrum Several baselines displayed
 Timerange: 00/18:00:31 to 00/18:09:58

Plot file version 2 created 26-JUL-2013 10:17:27

4C39.25 EZ024 1.UVDATA.1

Freq = 22.1720 GHz, Bw = 16.000 MH Calibrated with CL # 3 and BP # 1 (BP mode 1)

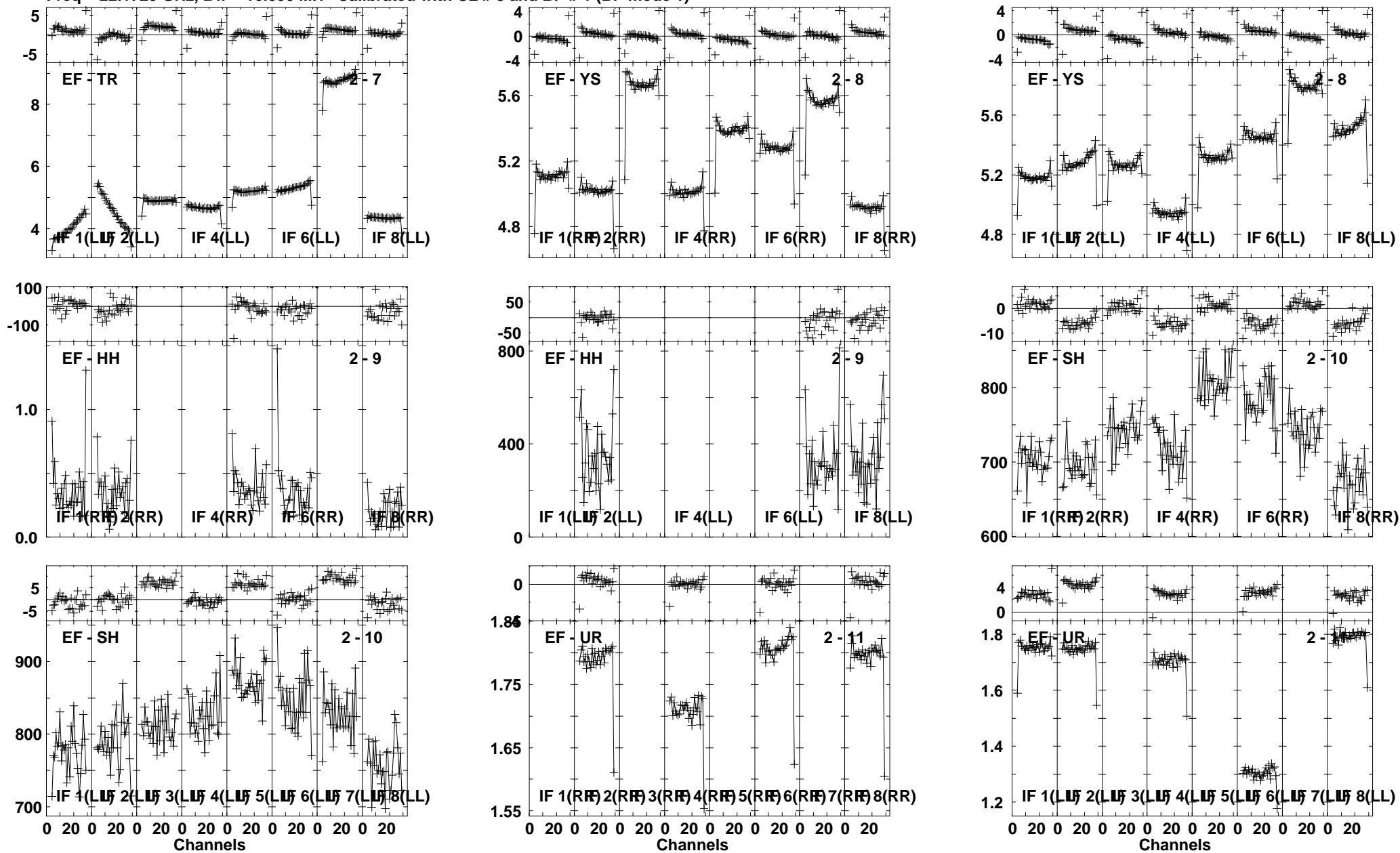

Lower frame: Ampl Jy Top frame: Phas deg
Vector averaged cross-power spectrum Several baselines displayed
Timerange: 00/18:00:31 to 00/18:09:58

Plot file version 3 created 26-JUL-2013 10:17:35
 B1152+199A EZ024 1.UVDATA.1
 Freq = 22.1720 GHz, Bw = 16.000 MH Calibrated with CL # 3 and BP # 1 (BP mode 1)

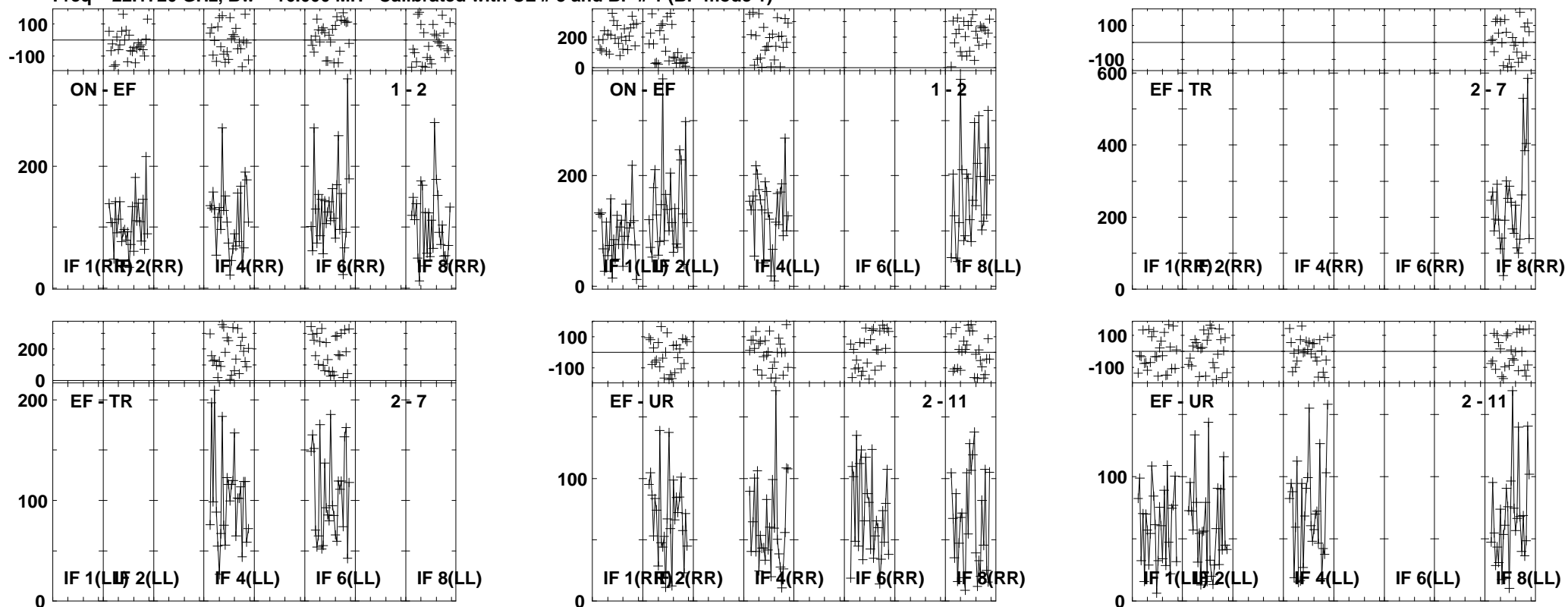

Lower frame: Milli Ampl Jy Top frame: Phas deg
 Vector averaged cross-power spectrum Several baselines displayed
 Timerange: 00:18:16:17 to 00:18:18:15

Plot file version 4 created 26-JUL-2013 10:17:37

B1152+199A EZ024 1.UVDATA.1

Freq = 22.1720 GHz, Bw = 16.000 MH Calibrated with CL # 3 and BP # 1 (BP mode 1)

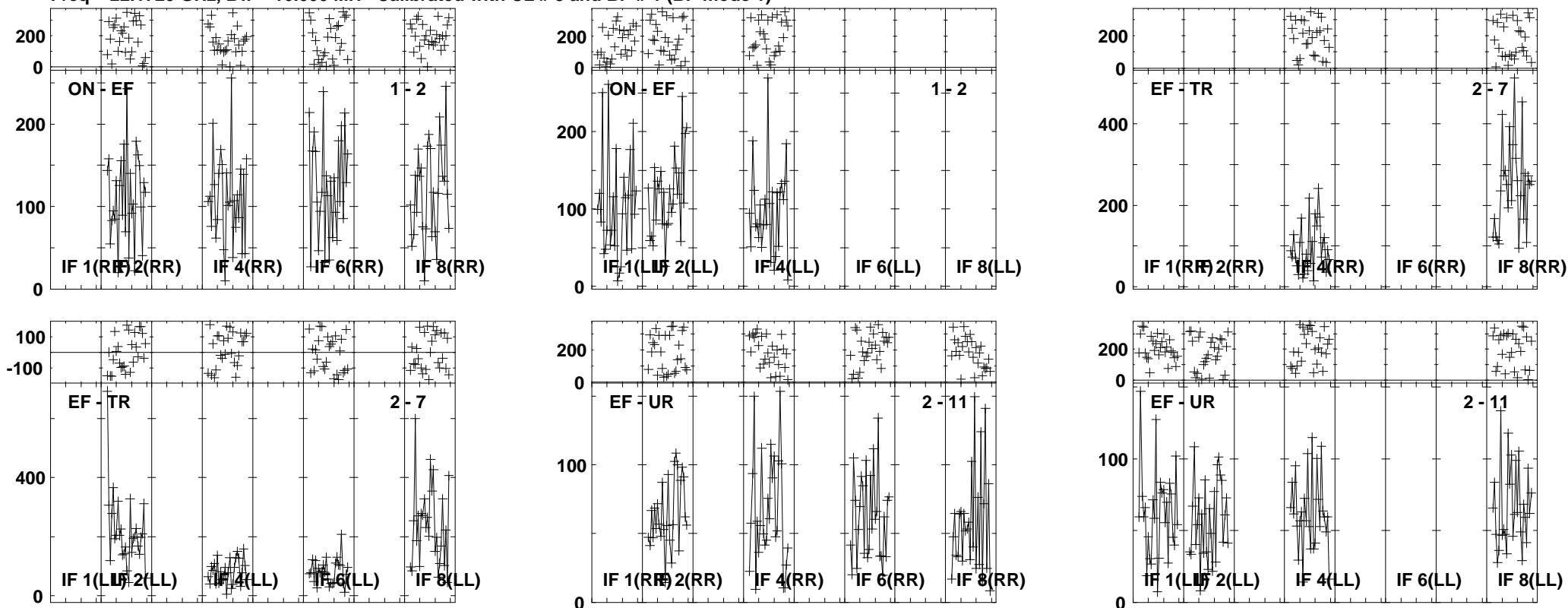

Lower frame: Milli Ampl Jy Top frame: Phas deg
Vector averaged cross-power spectrum Several baselines displayed
Timerange: 00/18:20:06 to 00/18:22:04

Plot file version 5 created 26-JUL-2013 10:17:39
 B1152+199A EZ024 1.UVDATA.1
 Freq = 22.1720 GHz, Bw = 16.000 MH Calibrated with CL # 3 and BP # 1 (BP mode 1)

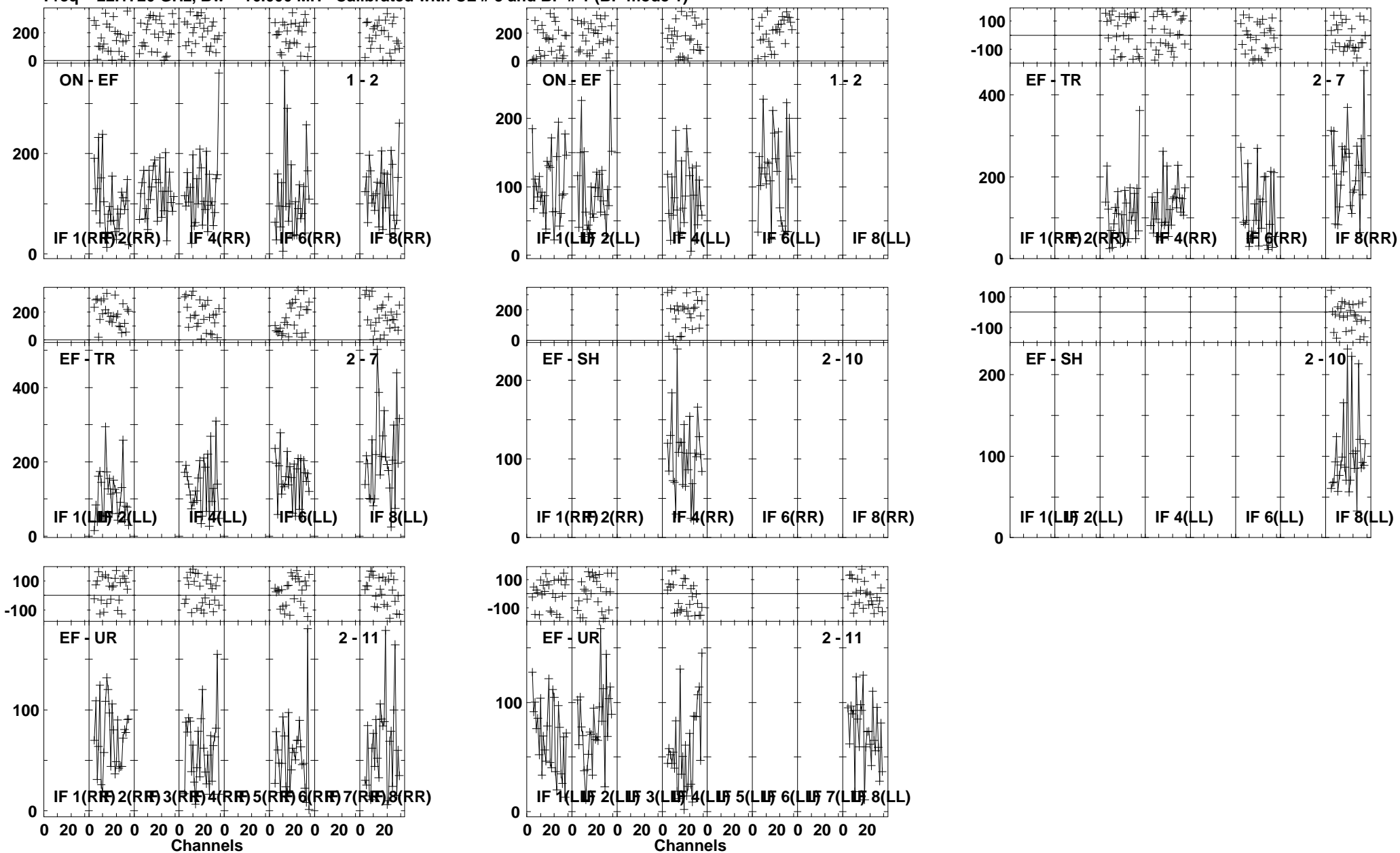

Lower frame: Milli Ampl Jy Top frame: Phas deg
 Vector averaged cross-power spectrum Several baselines displayed
 Timerange: 00/18:23:55 to 00/18:25:53

Plot file version 6 created 26-JUL-2013 10:17:41

J1125+2610 EZ24 1.UVDATA.1

Freq = 22.1720 GHz, Bw = 16.000 MH Calibrated with CL # 3 and BP # 1 (BP mode 1)

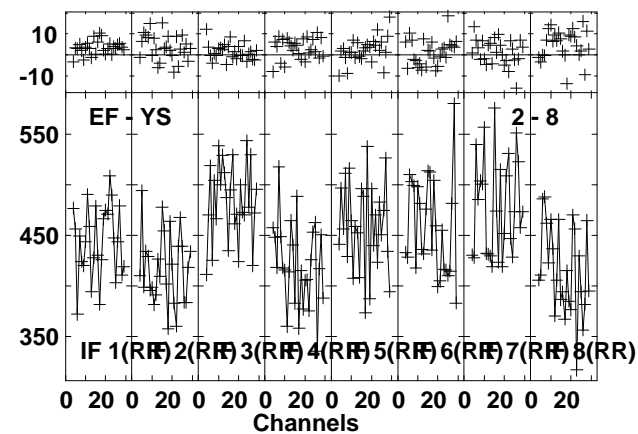
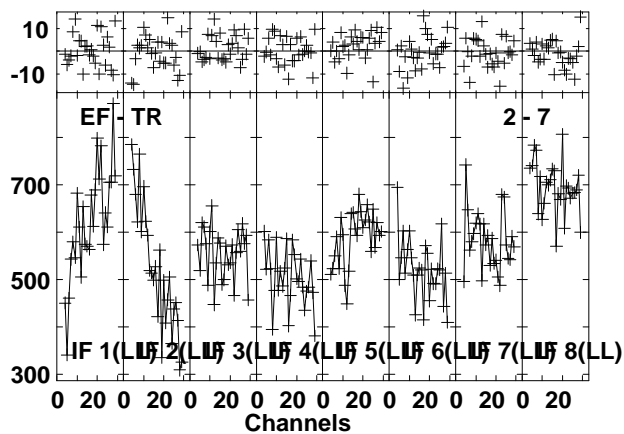
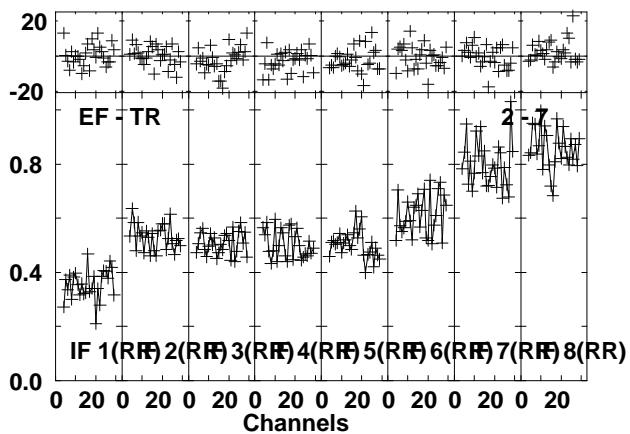
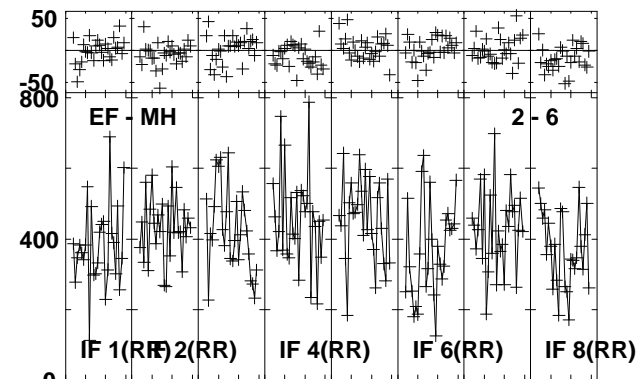
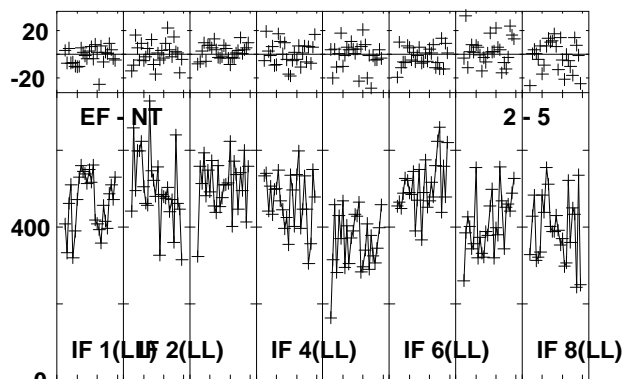
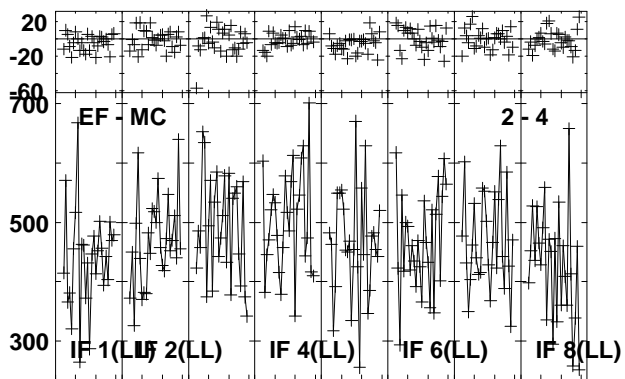
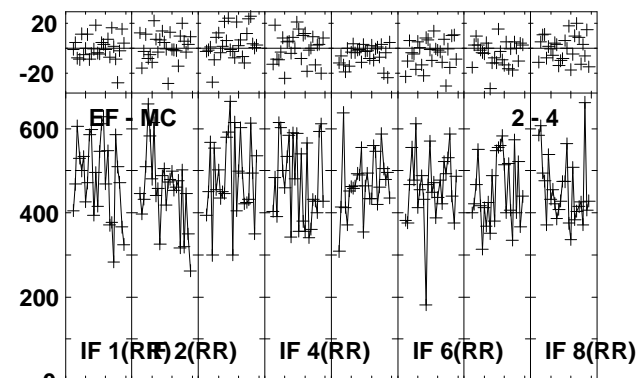
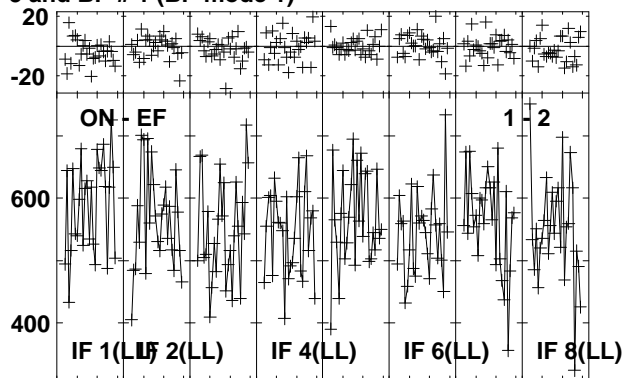
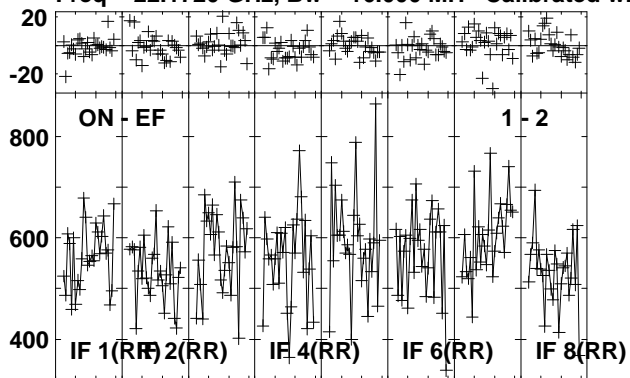

Lower frame: Milli Ampl Jy Top frame: Phas deg
Vector averaged cross-power spectrum Several baselines displayed
Timerange: 00/18:28:33 to 00/18:30:15

Plot file version 7 created 26-JUL-2013 10:17:42
 J1125+2610 EZ024 1.UVDATA.1
 Freq = 22.1720 GHz, Bw = 16.000 MH Calibrated with CL # 3 and BP # 1 (BP mode 1)

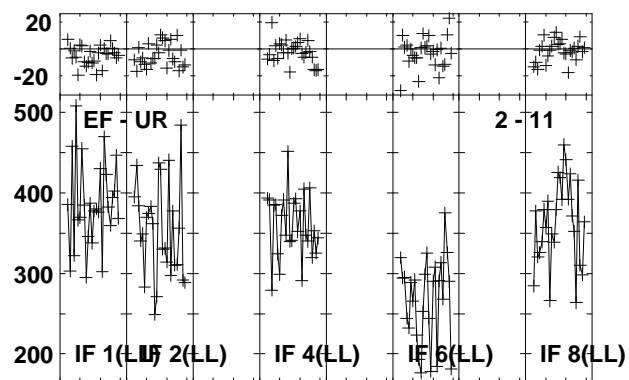
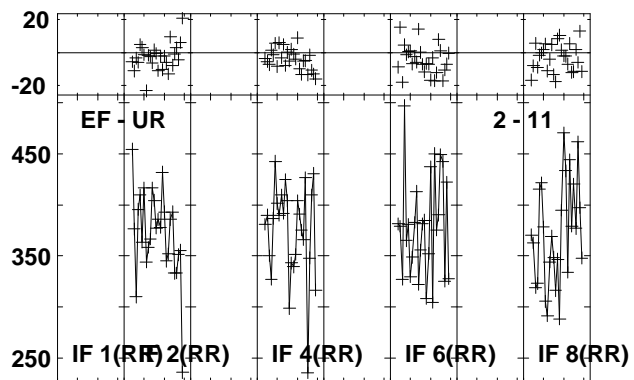
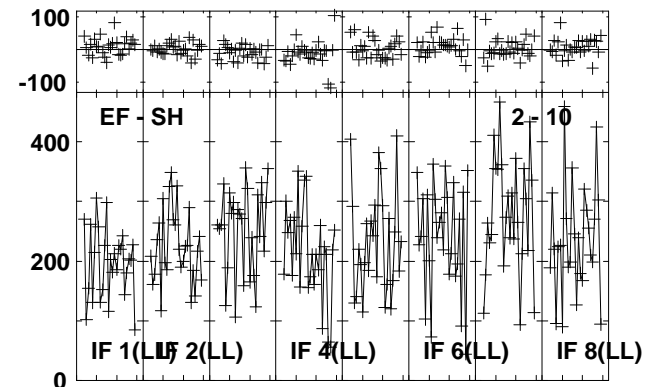
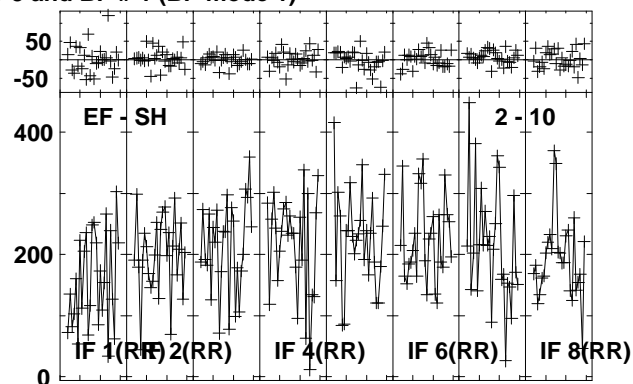
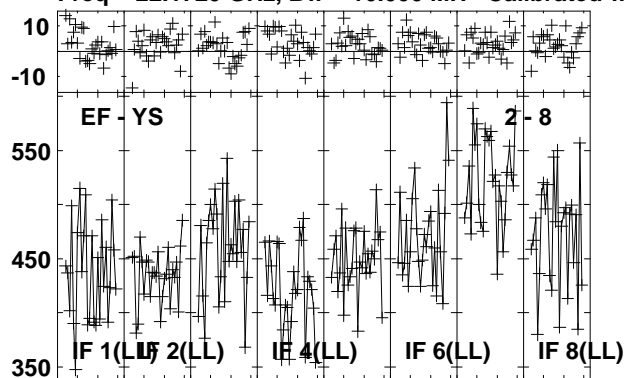

Lower frame: Milli Ampl Jy Top frame: Phas deg
 Vector averaged cross-power spectrum Several baselines displayed
 Timerange: 00/18:28:33 to 00/18:30:15

Plot file version 8 created 26-JUL-2013 10:17:43

B1152+199A EZ024 1.UVDATA.1

Freq = 22.1720 GHz, Bw = 16.000 MH Calibrated with CL # 3 and BP # 1 (BP mode 1)

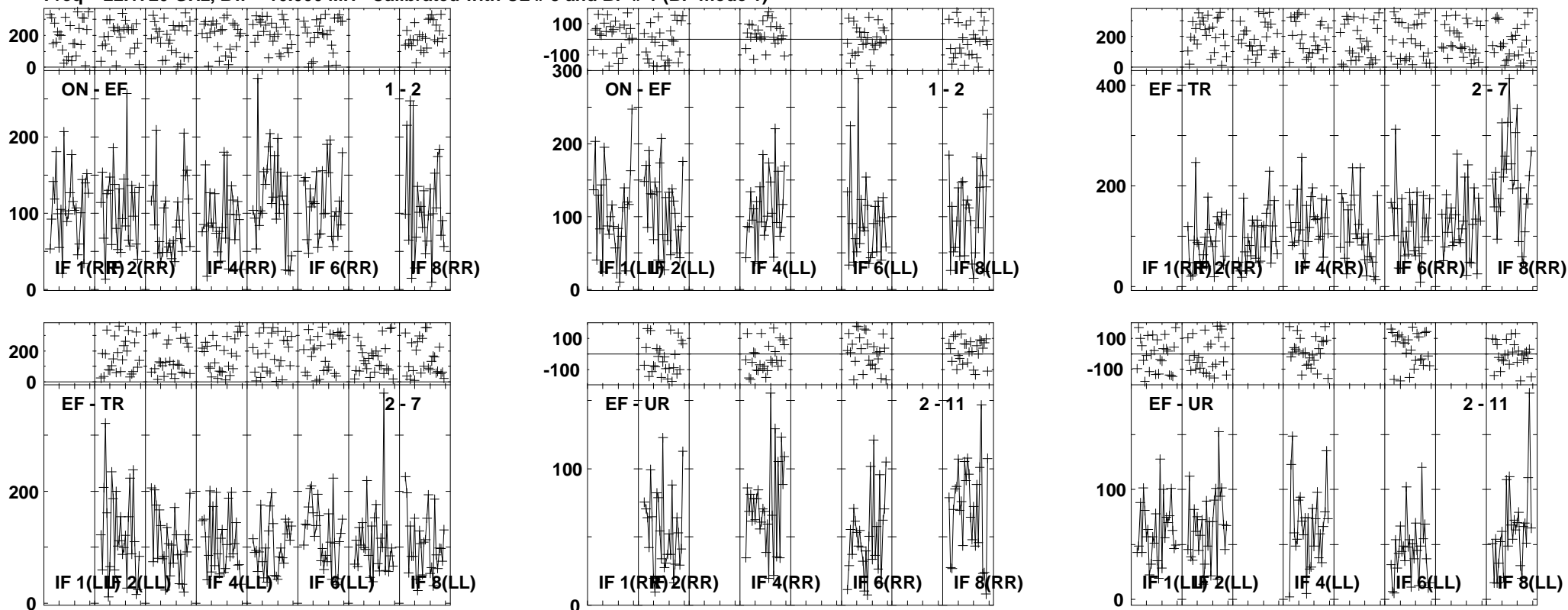

Lower frame: Milli Ampl Jy Top frame: Phas deg
Vector averaged cross-power spectrum Several baselines displayed
Timerange: 00/18:32:41 to 00/18:34:39

Plot file version 9 created 26-JUL-2013 10:17:45
 J1157 EZ024 1.UVDATA.1
 Freq = 22.1720 GHz, Bw = 16.000 MH Calibrated with CL # 3 and BP # 1 (BP mode 1)

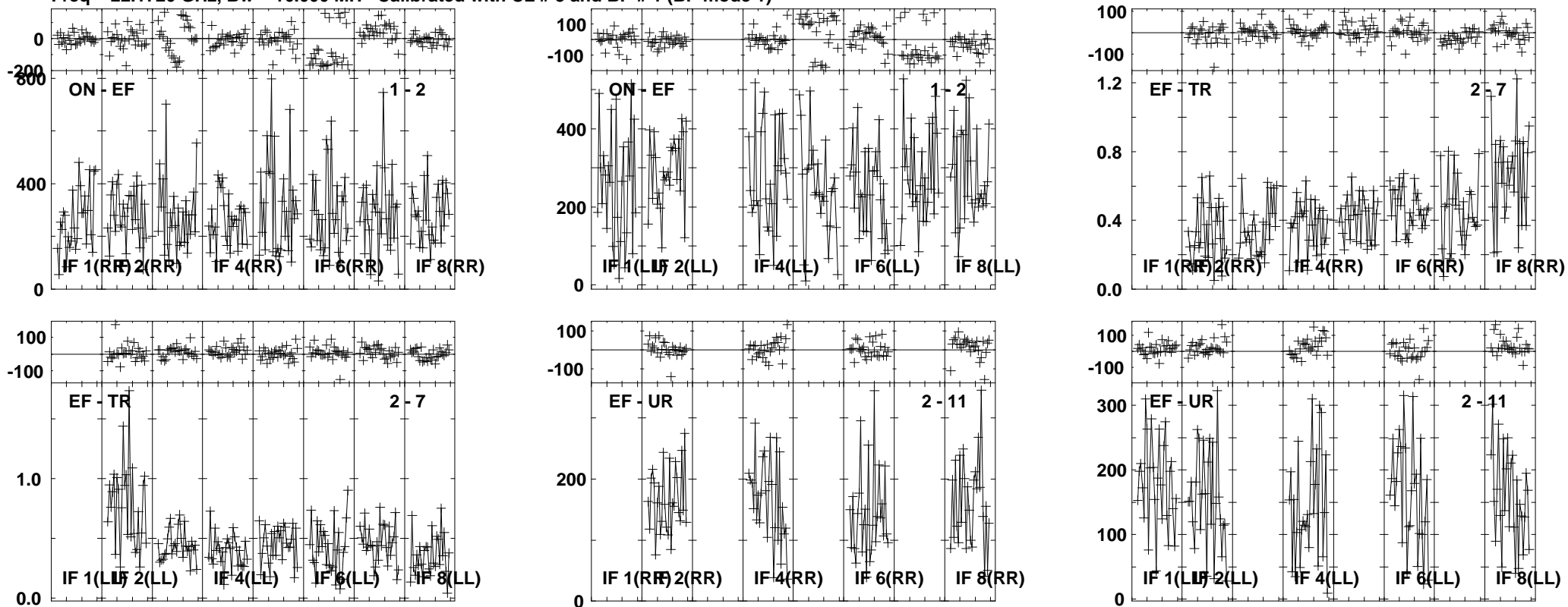

Lower frame: Milli Ampl Jy Top frame: Phas deg
 Vector averaged cross-power spectrum Several baselines displayed
 Timerange: 00:18:35:06 to 00:18:36:04

Plot file version 10 created 26-JUL-2013 10:17:46
 B1152+199A EZ024 1.UVDATA.1
 Freq = 22.1720 GHz, Bw = 16.000 MH Calibrated with CL # 3 and BP # 1 (BP mode 1)

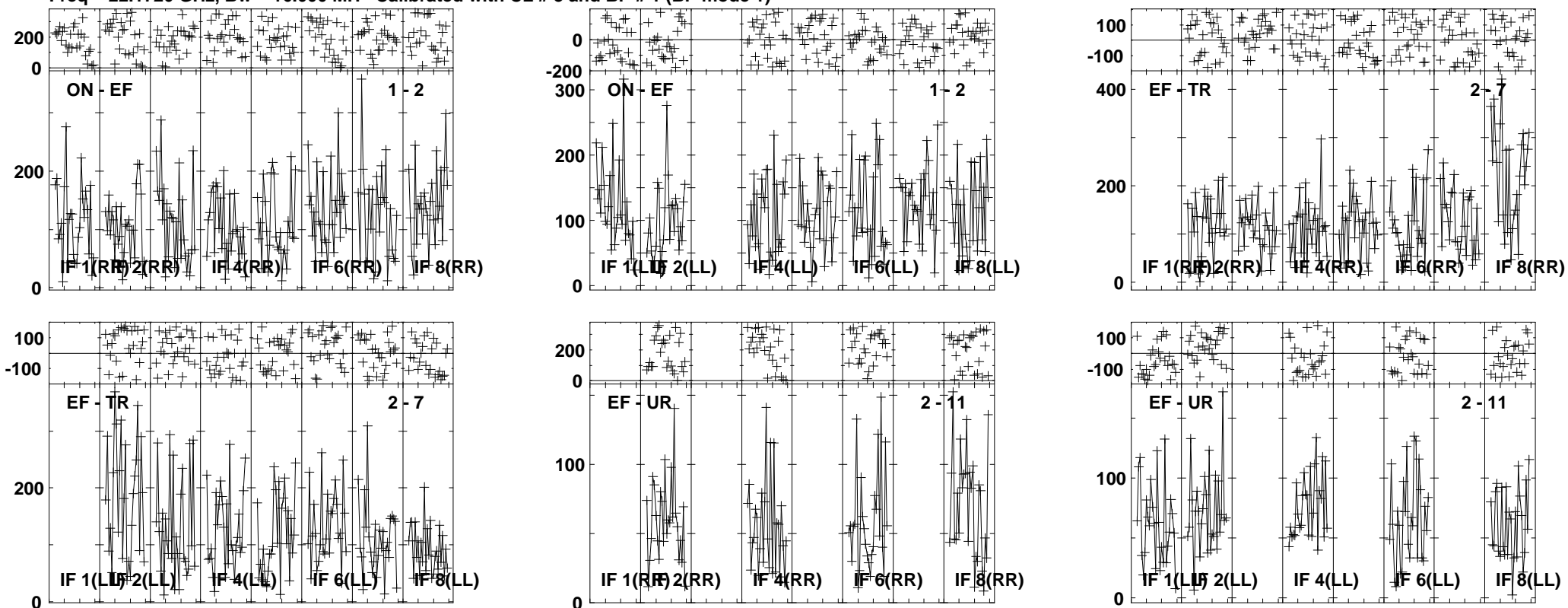

Lower frame: Milli Ampl Jy Top frame: Phas deg
 Vector averaged cross-power spectrum Several baselines displayed
 Timerange: 00/18:36:30 to 00/18:38:28

Plot file version 11 created 26-JUL-2013 10:17:47

J1157 EZ024 1.UVDATA.1

Freq = 22.1720 GHz, Bw = 16.000 MH Calibrated with CL # 3 and BP # 1 (BP mode 1)

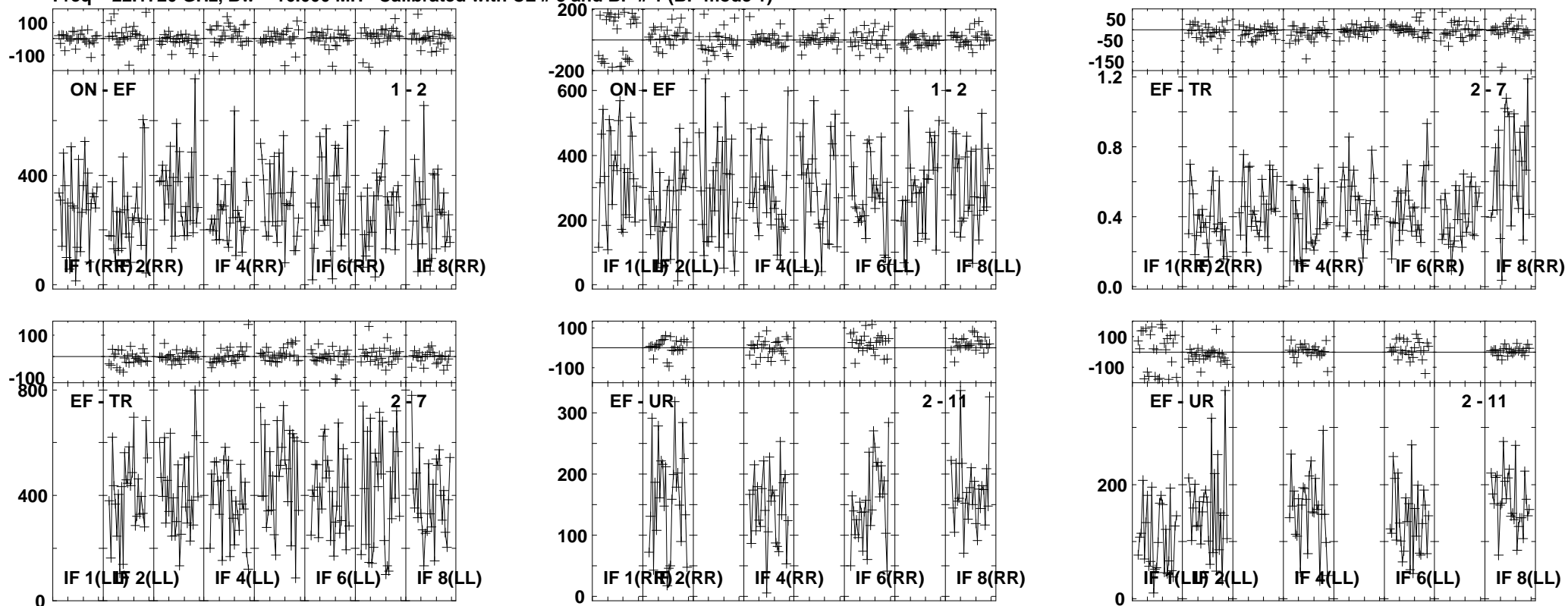

Lower frame: Milli Ampl Jy Top frame: Phas deg
Vector averaged cross-power spectrum Several baselines displayed
Timerange: 00:18:38:55 to 00:18:39:53

Plot file version 12 created 26-JUL-2013 10:17:48
 B1152+199A EZ024 1.UVDATA.1
 Freq = 22.1720 GHz, Bw = 16.000 MH Calibrated with CL # 3 and BP # 1 (BP mode 1)

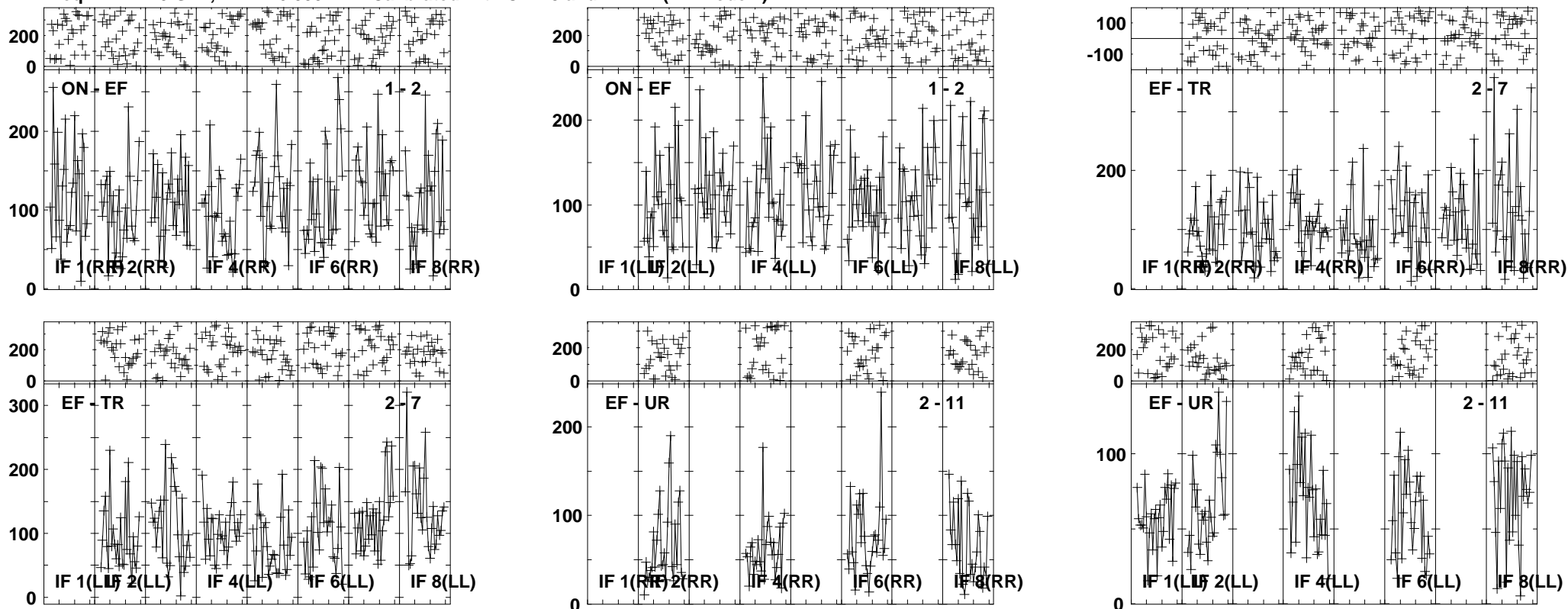

Lower frame: Milli Ampl Jy Top frame: Phas deg
 Vector averaged cross-power spectrum Several baselines displayed
 Timerange: 00/18:40:19 to 00/18:42:17

Plot file version 13 created 26-JUL-2013 10:17:50
 J1157 EZ024 1.UVDATA.1
 Freq = 22.1720 GHz, Bw = 16.000 MH Calibrated with CL # 3 and BP # 1 (BP mode 1)

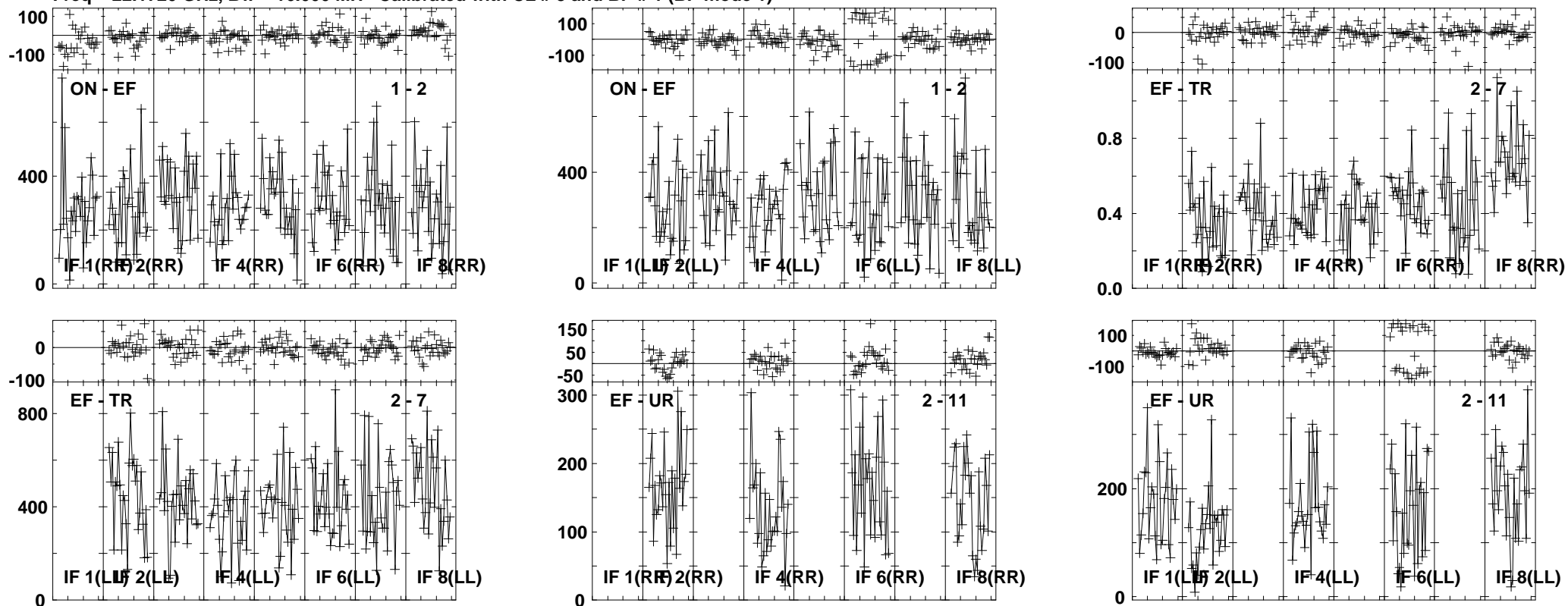

Lower frame: Milli Ampl Jy Top frame: Phas deg
 Vector averaged cross-power spectrum Several baselines displayed
 Timerange: 00/18:42:43 to 00/18:43:41

Plot file version 14 created 26-JUL-2013 10:17:50

J1125+2610 EZ24 1.UVDATA.1

Freq = 22.1720 GHz, Bw = 16.000 MH Calibrated with CL # 3 and BP # 1 (BP mode 1)

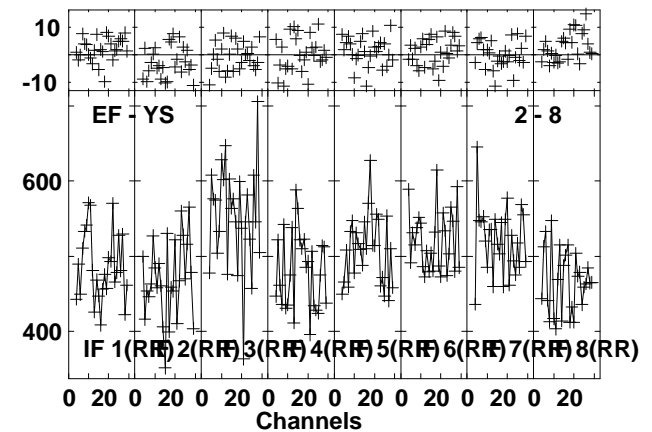
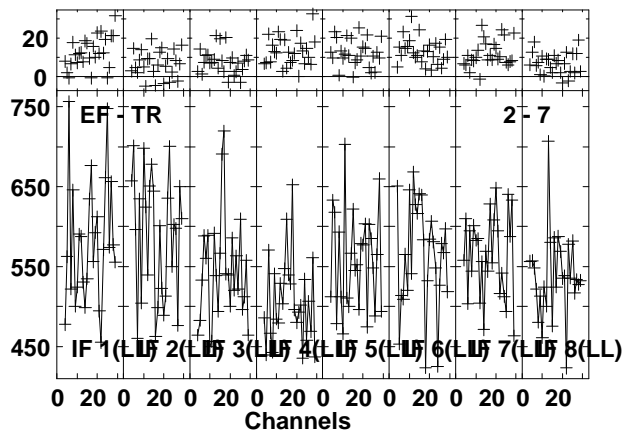
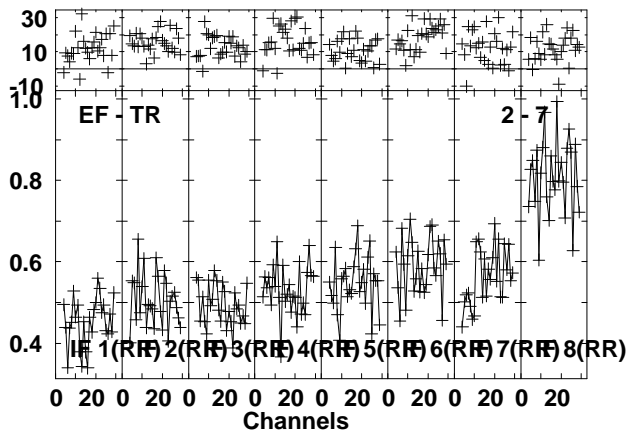
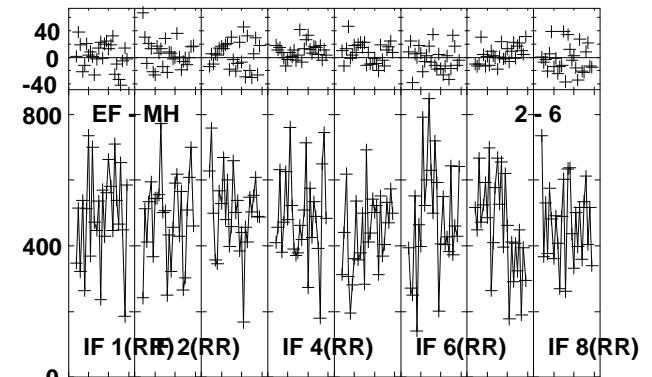
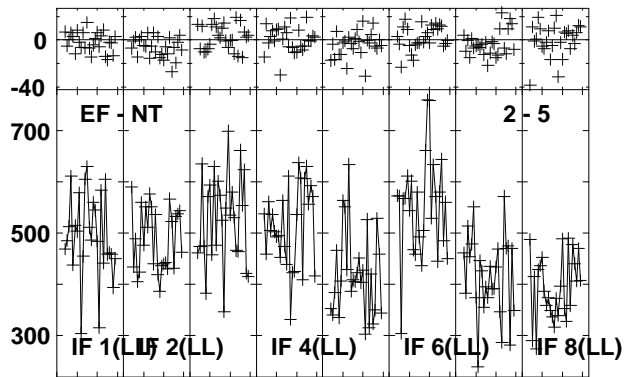
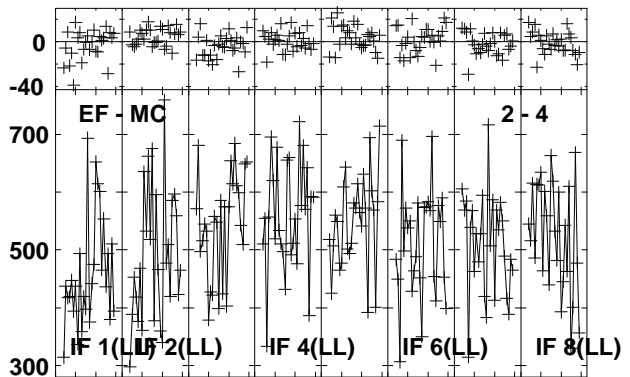
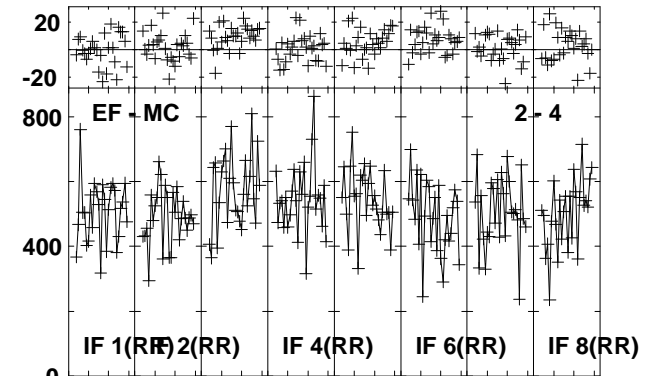
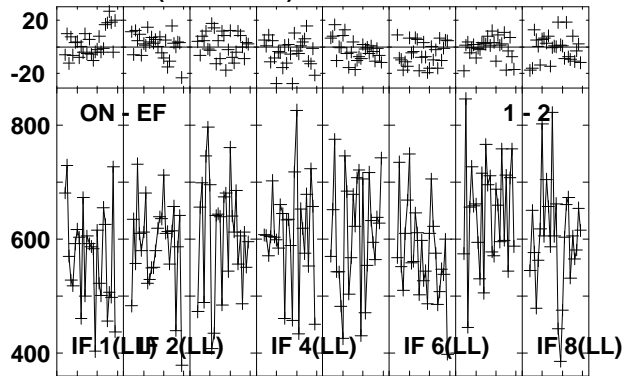
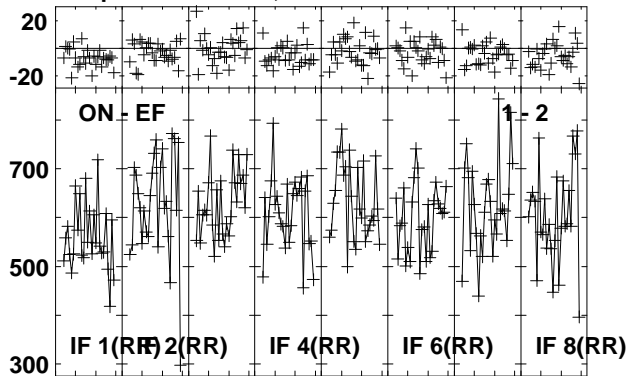

Lower frame: Milli Ampl Jy Top frame: Phas deg
Vector averaged cross-power spectrum Several baselines displayed
Timerange: 00/18:45:08 to 00/18:46:50

Plot file version 15 created 26-JUL-2013 10:17:51
 J1125+2610 EZ024 1.UVDATA.1
 Freq = 22.1720 GHz, Bw = 16.000 MH Calibrated with CL # 3 and BP # 1 (BP mode 1)

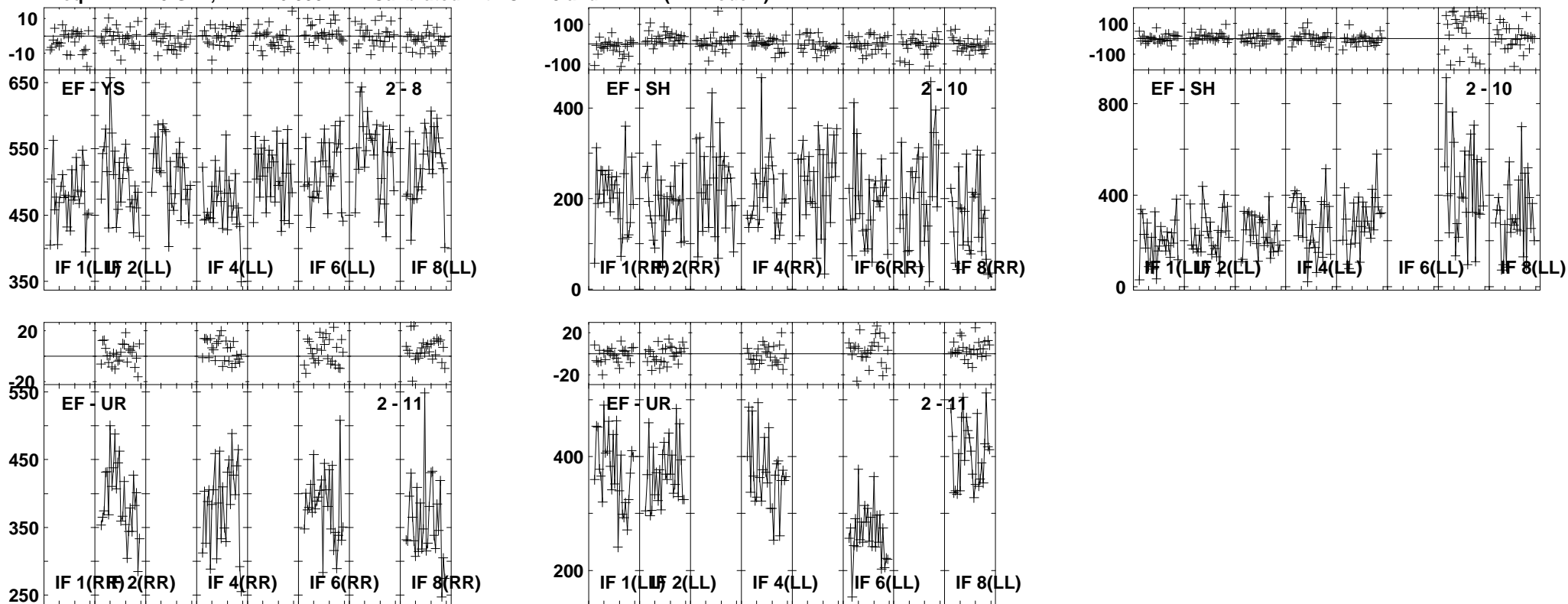

Lower frame: Milli Ampl Jy Top frame: Phas deg
 Vector averaged cross-power spectrum Several baselines displayed
 Timerange: 00/18:45:08 to 00/18:46:50

Plot file version 16 created 26-JUL-2013 10:17:52
 J1157 EZ024 1.UVDATA.1
 Freq = 22.1720 GHz, Bw = 16.000 MH Calibrated with CL # 3 and BP # 1 (BP mode 1)

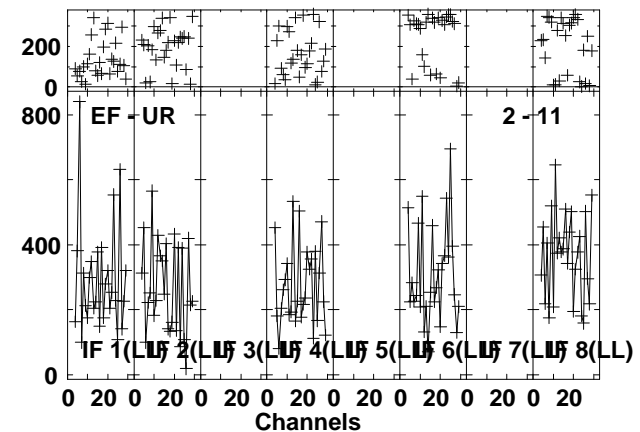
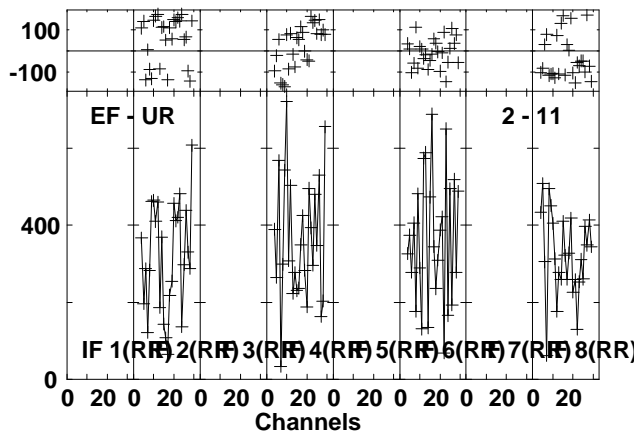
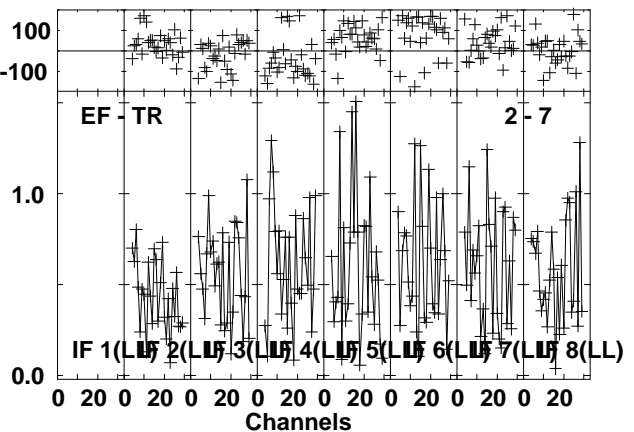
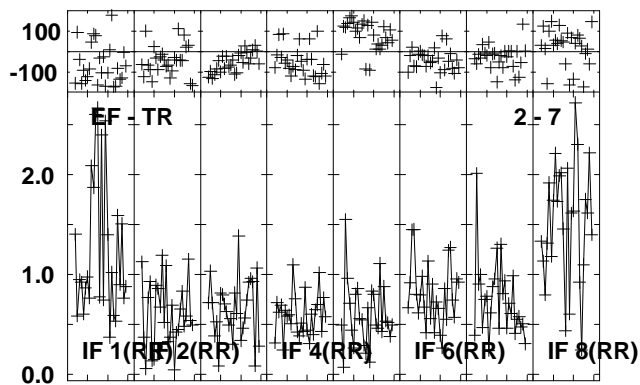
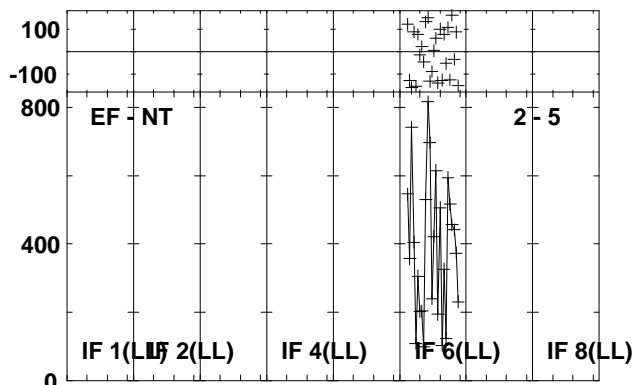
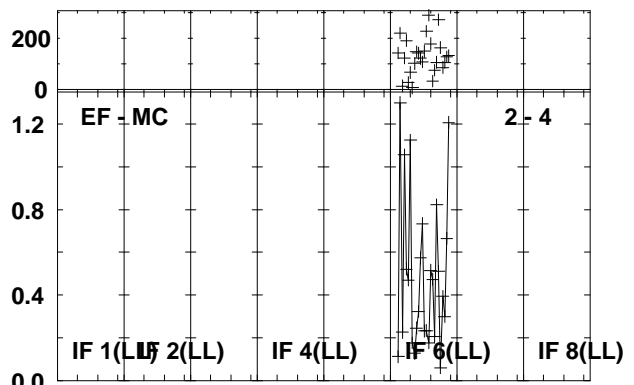
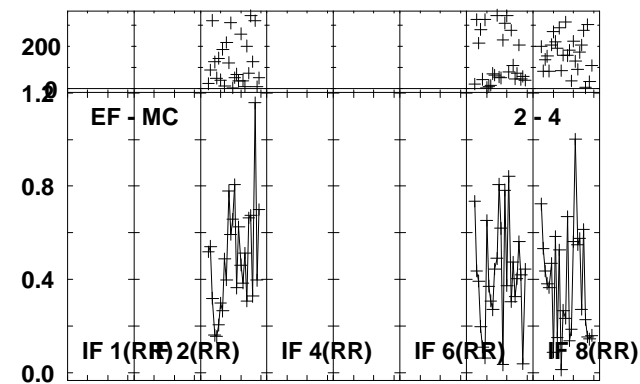
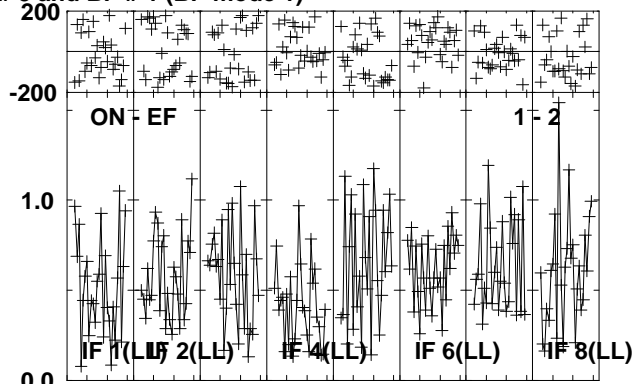
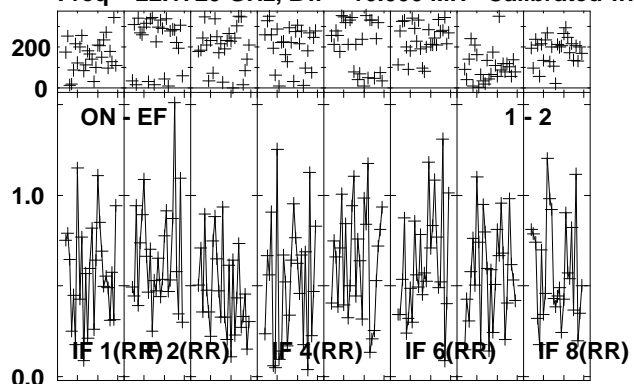

Lower frame: Ampl Jy Top frame: Phas deg
 Vector averaged cross-power spectrum Several baselines displayed
 Timerange: 00:18:48:07 to 00:18:48:49

Plot file version 17 created 26-JUL-2013 10:17:53
 B1152+199A EZ024 1.UVDATA.1
 Freq = 22.1720 GHz, Bw = 16.000 MH Calibrated with CL # 3 and BP # 1 (BP mode 1)

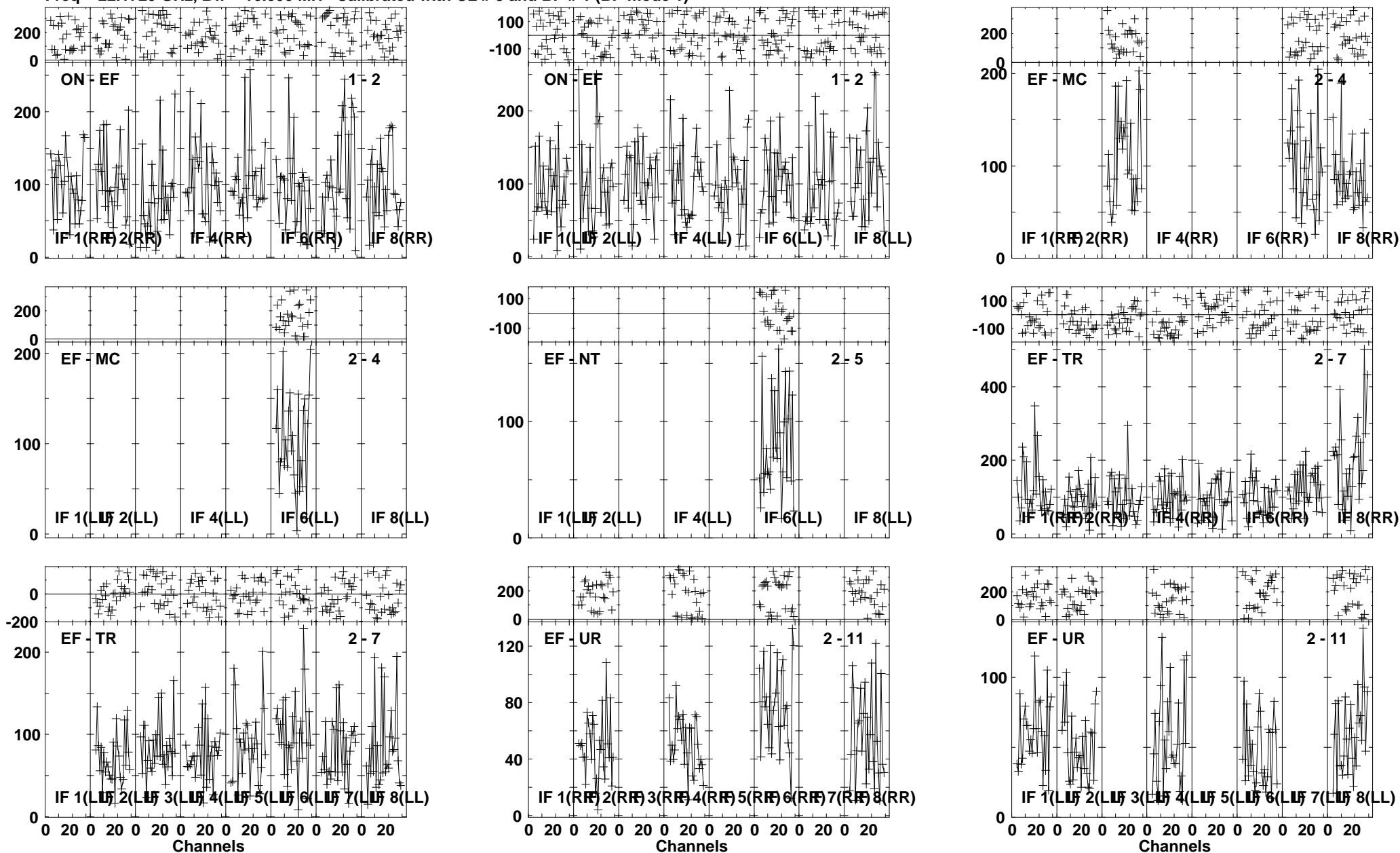

Lower frame: Milli Ampl Jy Top frame: Phas deg
 Vector averaged cross-power spectrum Several baselines displayed
 Timerange: 00/18:49:24 to 00/18:51:22

Plot file version 18 created 26-JUL-2013 10:17:54

J1157 EZ024 1.UVDATA.1

Freq = 22.1720 GHz, Bw = 16.000 MH Calibrated with CL # 3 and BP # 1 (BP mode 1)

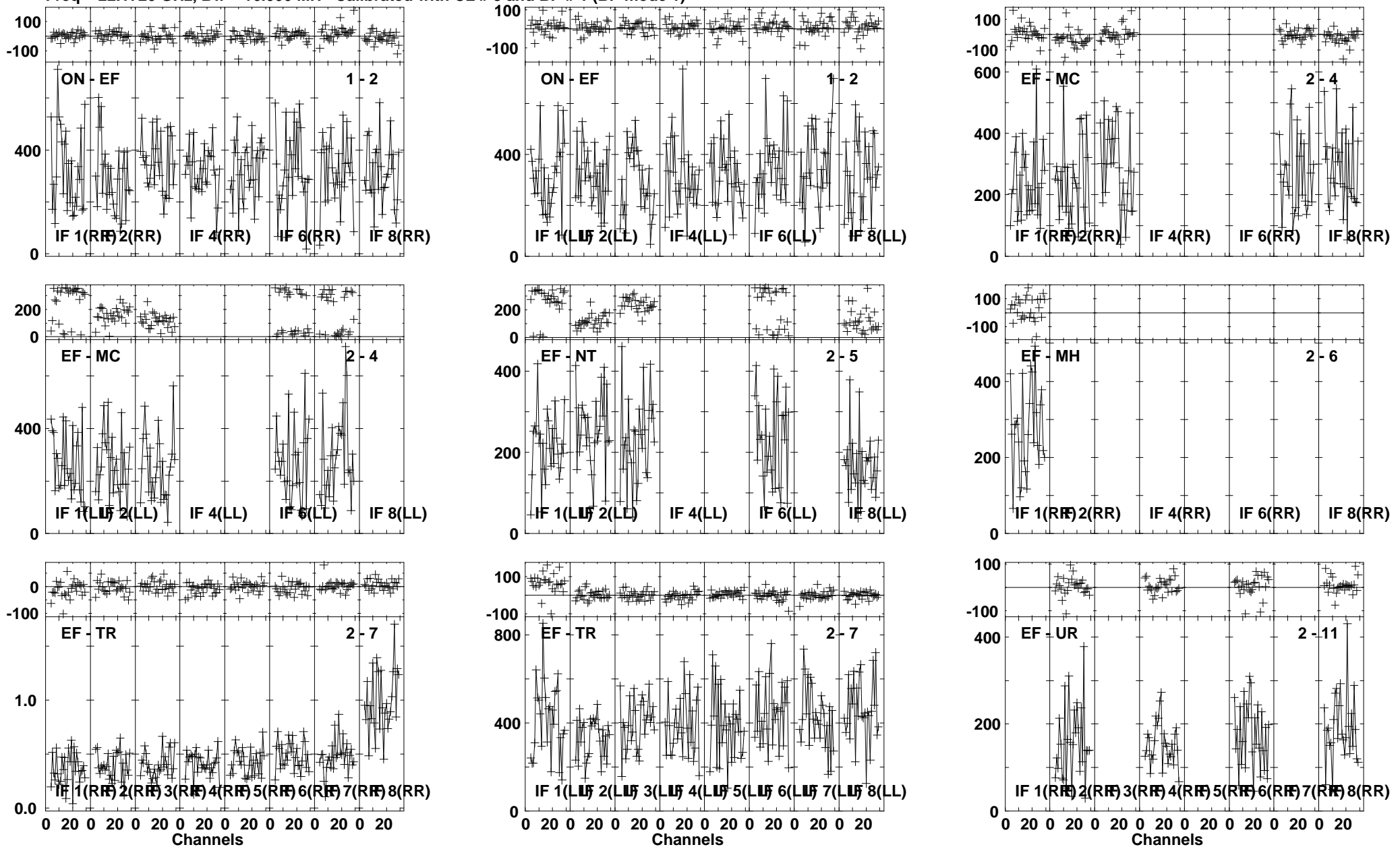

Lower frame: Milli Ampl Jy Top frame: Phas deg
Vector averaged cross-power spectrum Several baselines displayed
Timerange: 00/18:51:48 to 00/18:52:46

Plot file version 19 created 26-JUL-2013 10:17:55
J1157 EZ024 1.UVDATA.1
Freq = 22.1720 GHz, Bw = 16.000 MH Calibrated with CL # 3 and BP # 1 (BP mode 1)

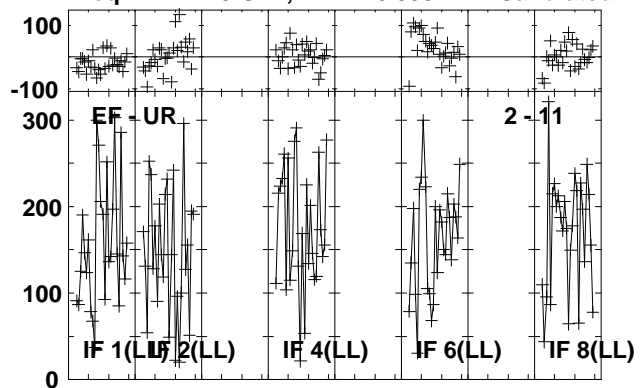

Lower frame: Milli Ampl Jy Top frame: Phas deg
Vector averaged cross-power spectrum Several baselines displayed
Timerange: 00/18:51:48 to 00/18:52:46

Plot file version 20 created 26-JUL-2013 10:17:56

B1152+199A EZ024 1.UVDATA.1

Freq = 22.1720 GHz, Bw = 16.000 MH Calibrated with CL # 3 and BP # 1 (BP mode 1)

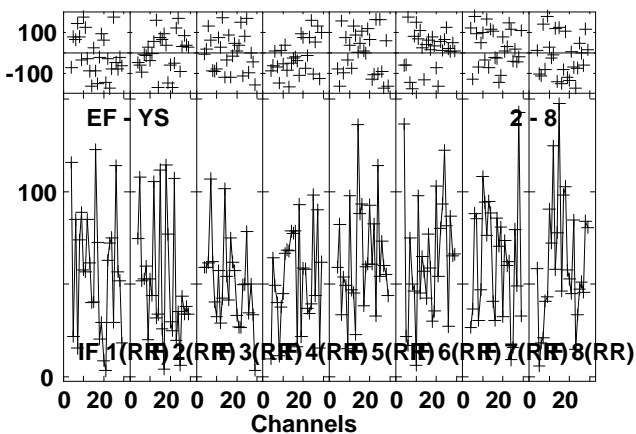
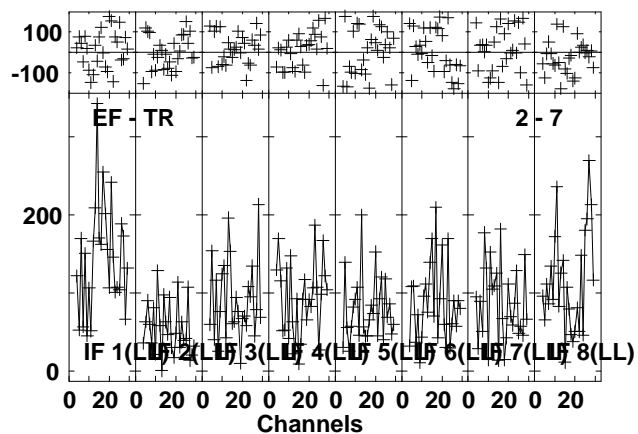
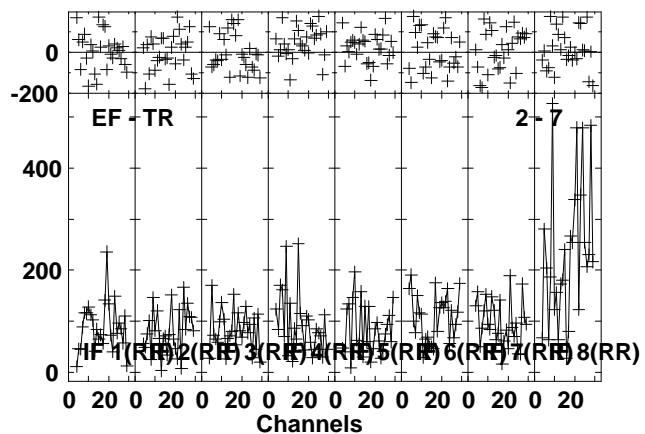
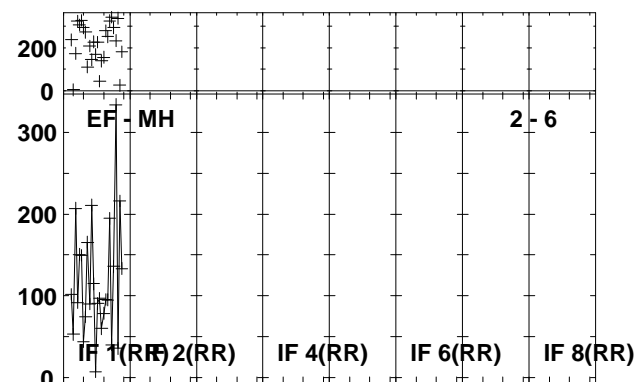
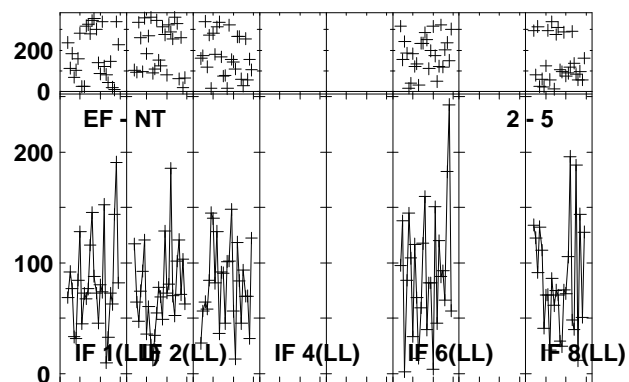
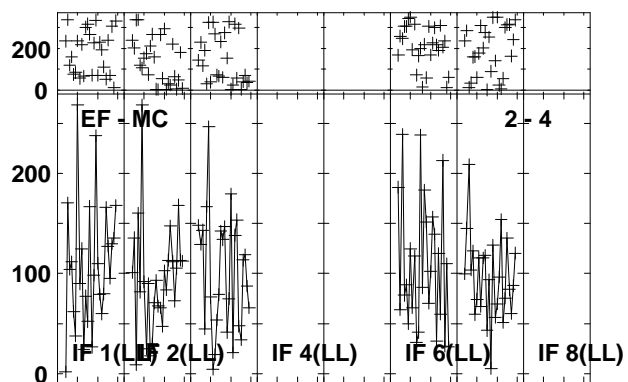
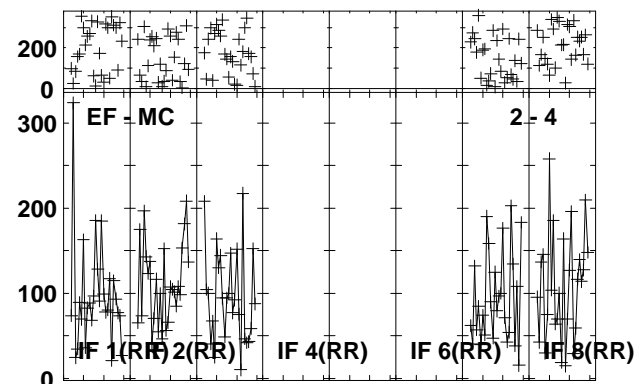
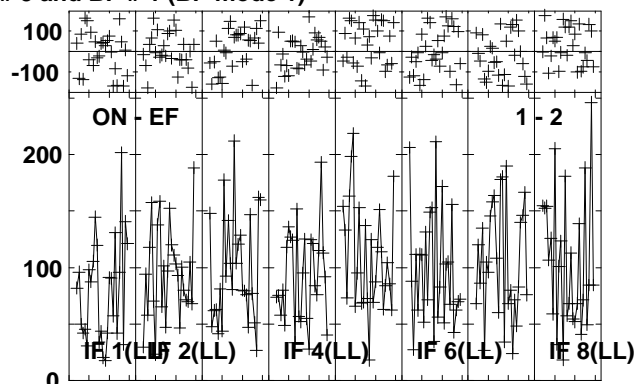
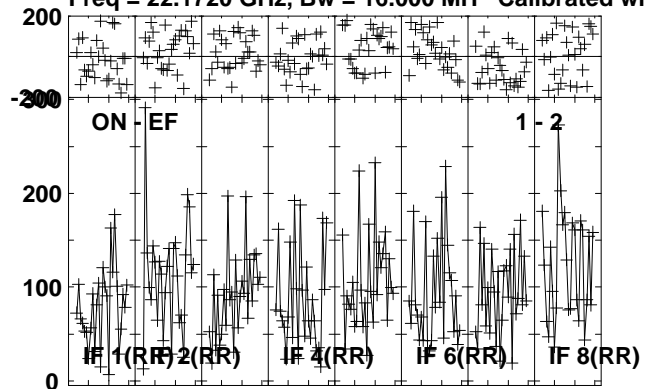

Lower frame: Milli Ampl Jy Top frame: Phas deg
Vector averaged cross-power spectrum Several baselines displayed
Timerange: 00:18:53:20 to 00:18:55:18

Plot file version 21 created 26-JUL-2013 10:17:57
 B1152+199A EZ024 1.UVDATA.1
 Freq = 22.1720 GHz, Bw = 16.000 MH Calibrated with CL # 3 and BP # 1 (BP mode 1)

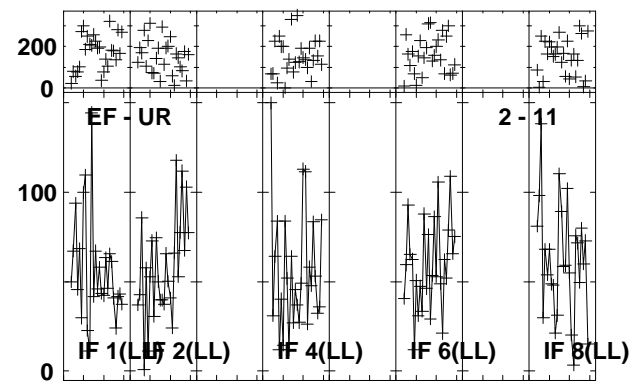
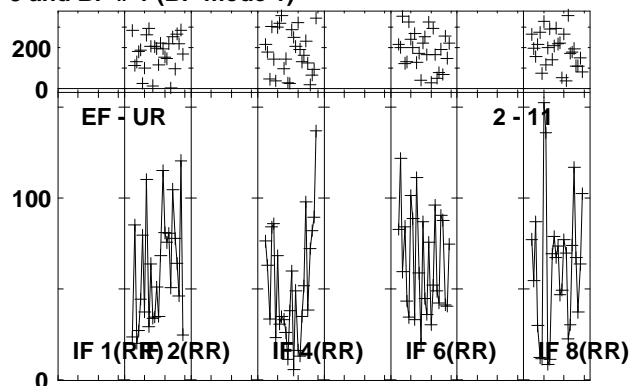
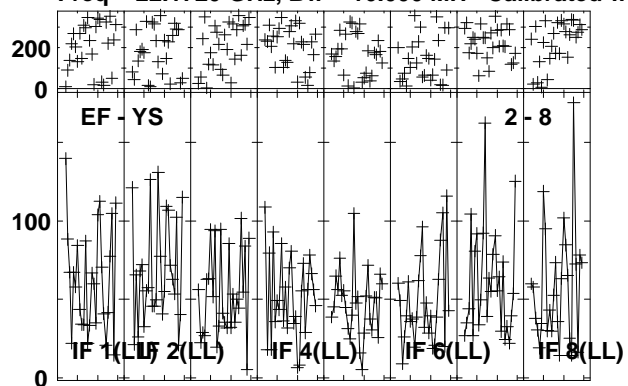

Lower frame: Milli Ampl Jy Top frame: Phas deg
 Vector averaged cross-power spectrum Several baselines displayed
 Timerange: 00/18:53:20 to 00/18:55:18

Plot file version 22 created 26-JUL-2013 10:17:58

J1157 EZ024 1.UVDATA.1

Freq = 22.1720 GHz, Bw = 16.000 MH Calibrated with CL # 3 and BP # 1 (BP mode 1)

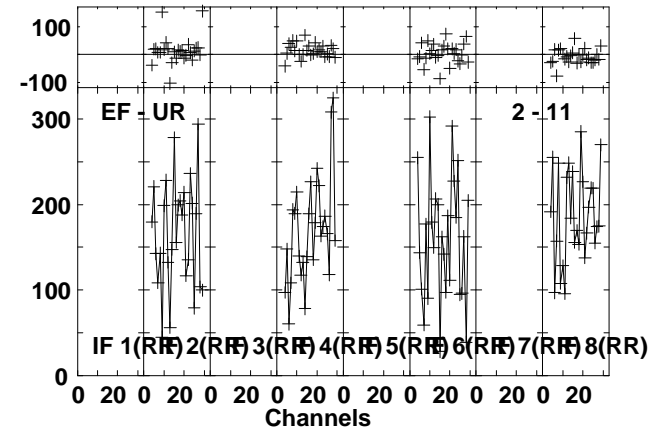
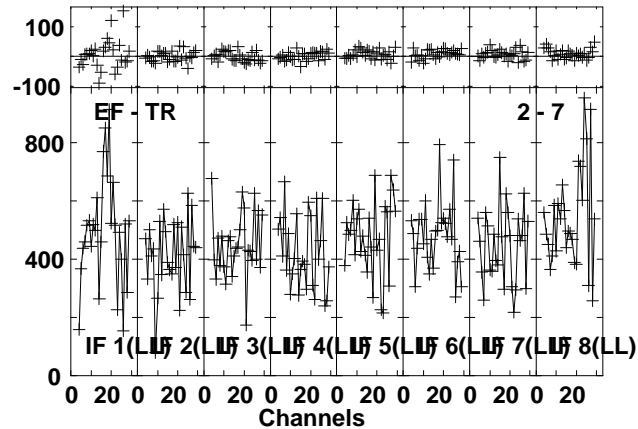
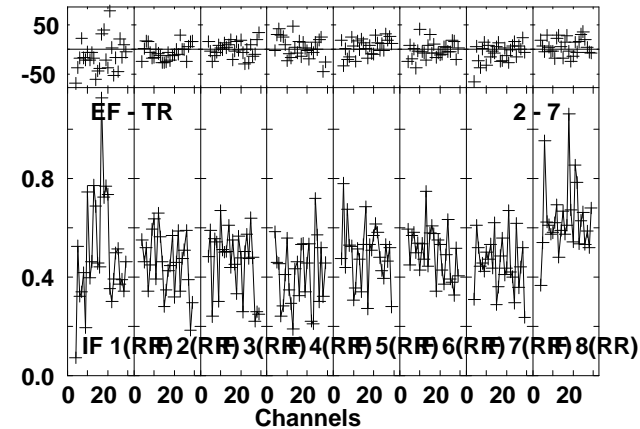
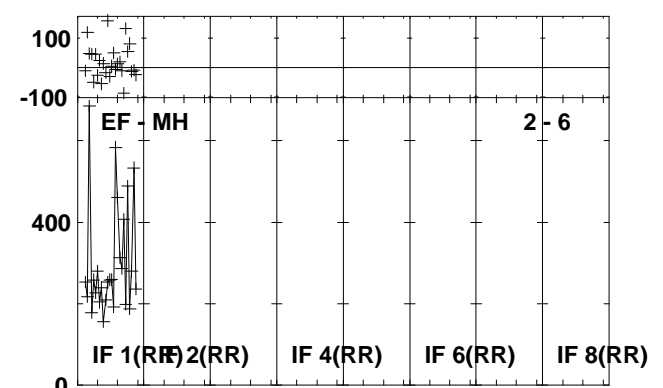
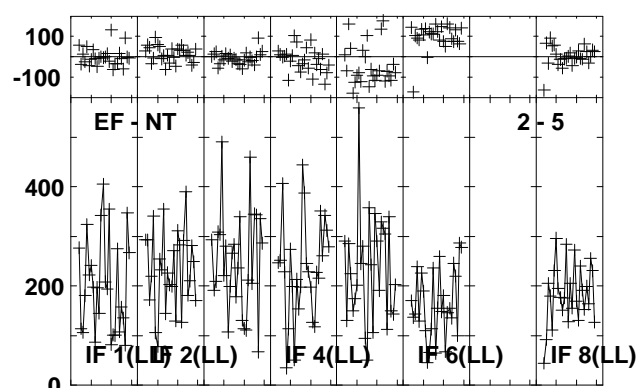
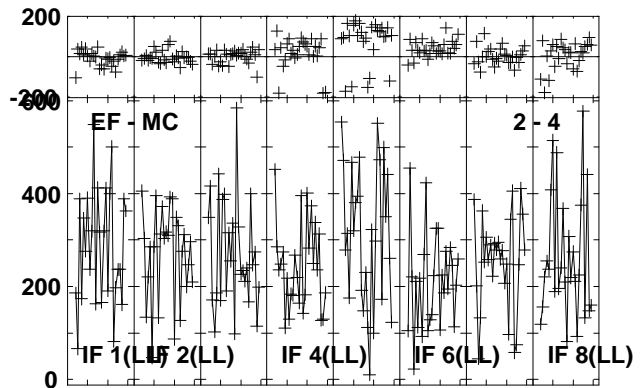
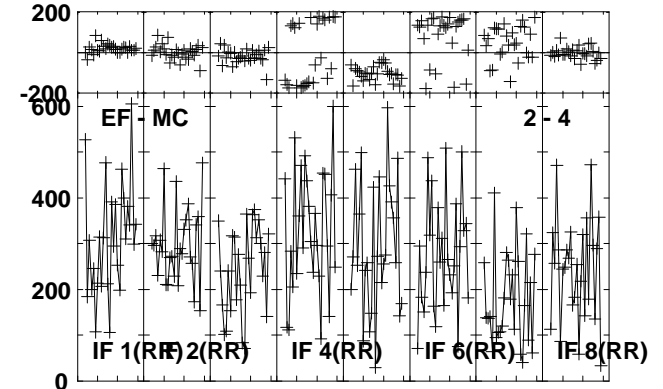
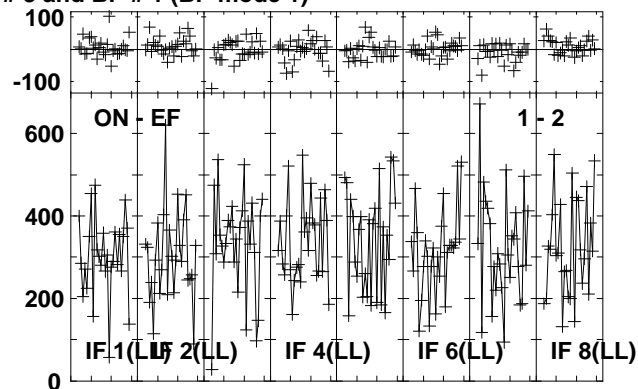
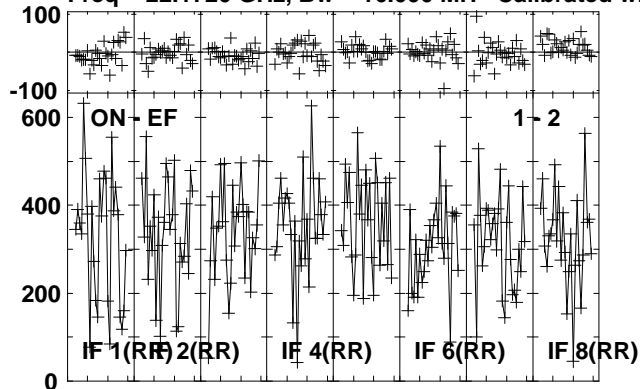

Lower frame: Milli Ampl Jy Top frame: Phas deg
Vector averaged cross-power spectrum Several baselines displayed
Timerange: 00/18:55:53 to 00/18:56:51

Plot file version 23 created 26-JUL-2013 10:17:58
J1157 EZ024 1.UVDATA.1
Freq = 22.1720 GHz, Bw = 16.000 MH Calibrated with CL # 3 and BP # 1 (BP mode 1)

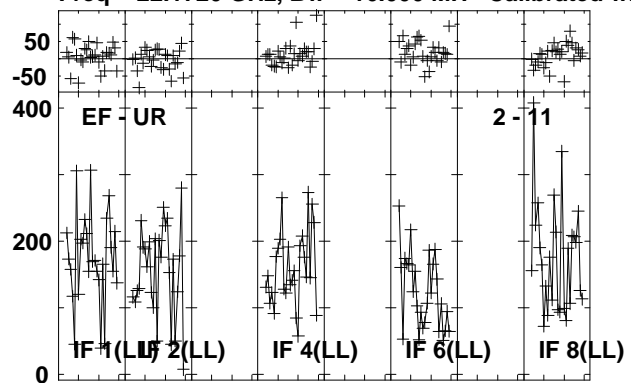

Lower frame: Milli Ampl Jy Top frame: Phas deg
Vector averaged cross-power spectrum Several baselines displayed
Timerange: 00/18:55:53 to 00/18:56:51

Plot file version 24 created 26-JUL-2013 10:17:59
 B1152+199A EZ24 1.UVDATA.1
 Freq = 22.1720 GHz, Bw = 16.000 MH Calibrated with CL # 3 and BP # 1 (BP mode 1)

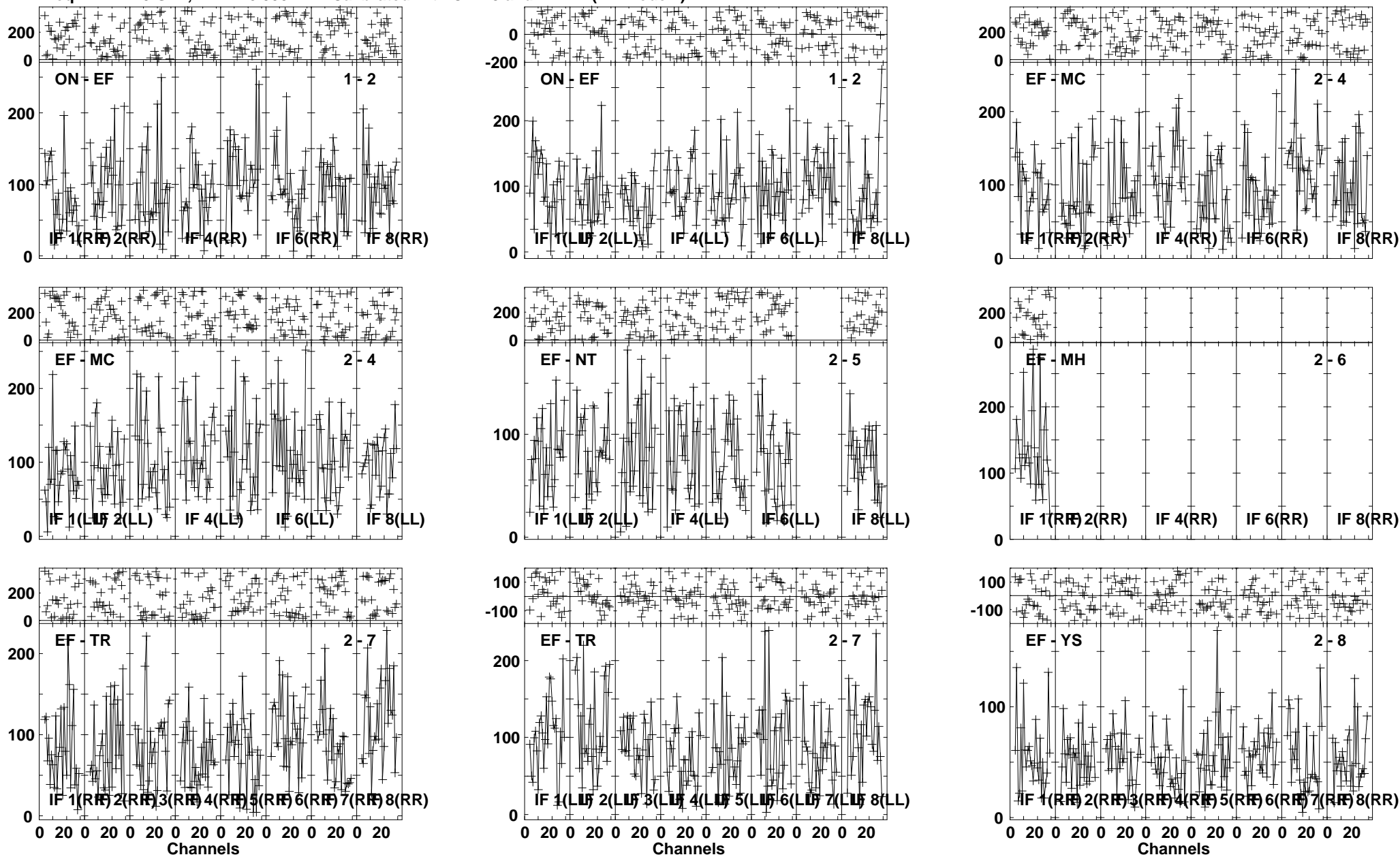

Lower frame: Milli Ampl Jy Top frame: Phas deg
 Vector averaged cross-power spectrum Several baselines displayed
 Timerange: 00/18:57:26 to 00/18:59:24

Plot file version 25 created 26-JUL-2013 10:18:00
 B1152+199A EZ024 1.UVDATA.1
 Freq = 22.1720 GHz, Bw = 16.000 MH Calibrated with CL # 3 and BP # 1 (BP mode 1)

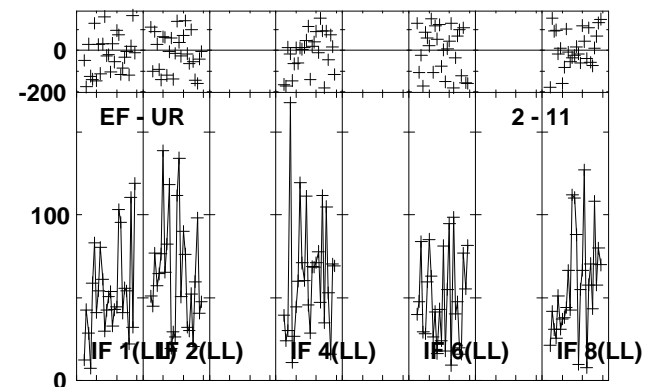
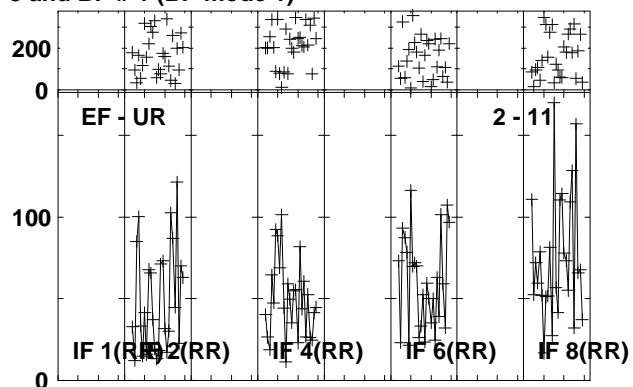
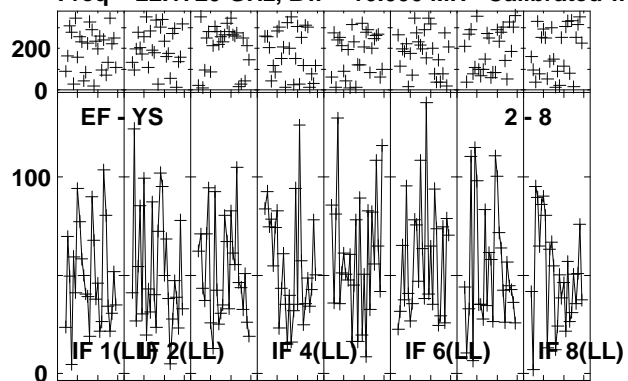

Lower frame: Milli Ampl Jy Top frame: Phas deg
 Vector averaged cross-power spectrum Several baselines displayed
 Timerange: 00/18:57:26 to 00/18:59:24

Plot file version 26 created 26-JUL-2013 10:18:01

J1157 EZ024 1.UVDATA.1

Freq = 22.1720 GHz, Bw = 16.000 MH Calibrated with CL # 3 and BP # 1 (BP mode 1)

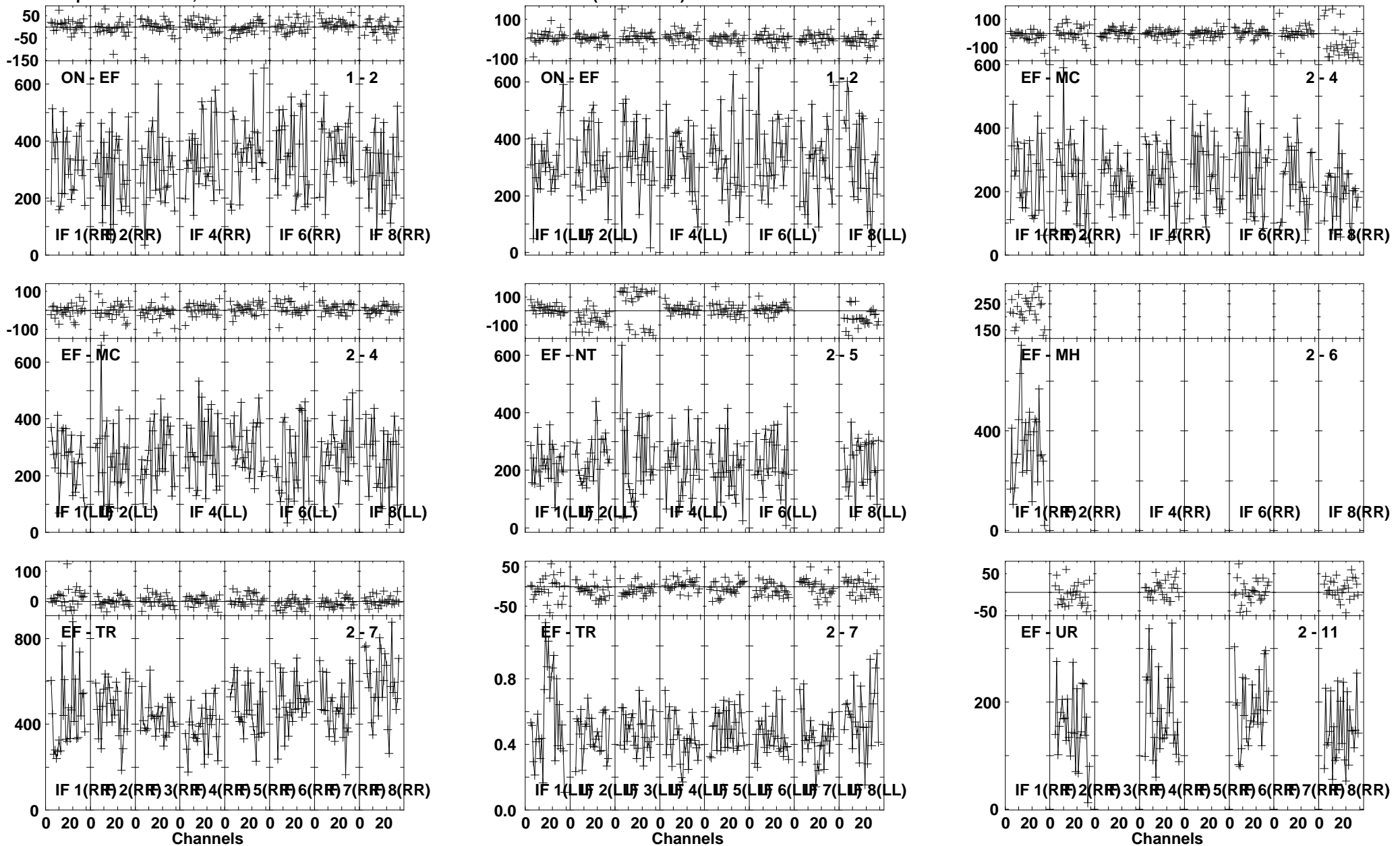

Lower frame: Milli Ampl Jy Top frame: Phas deg
Vector averaged cross-power spectrum Several baselines displayed
Timerange: 00:18:59:59 to 00:19:00:57

Plot file version 27 created 26-JUL-2013 10:18:02
J1157 EZ024 1.UVDATA.1
Freq = 22.1720 GHz, Bw = 16.000 MH Calibrated with CL # 3 and BP # 1 (BP mode 1)

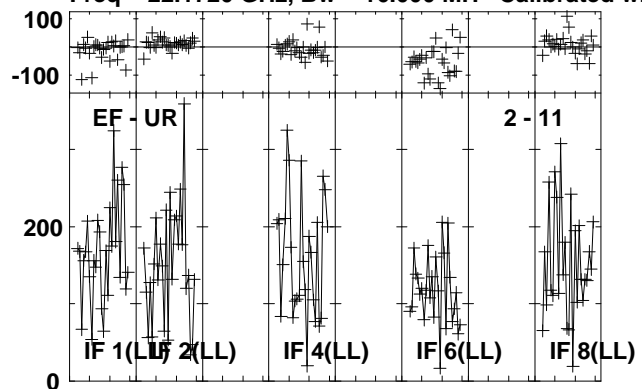

Lower frame: Milli Ampl Jy Top frame: Phas deg
Vector averaged cross-power spectrum Several baselines displayed
Timerange: 00/18:59:59 to 00/19:00:57

Plot file version 28 created 26-JUL-2013 10:18:02

J1125+2610 EZ24 1.UVDATA.1

Freq = 22.1720 GHz, Bw = 16.000 MH Calibrated with CL # 3 and BP # 1 (BP mode 1)

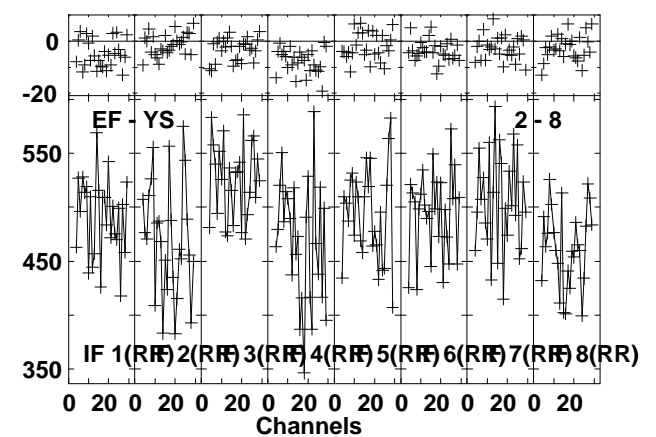
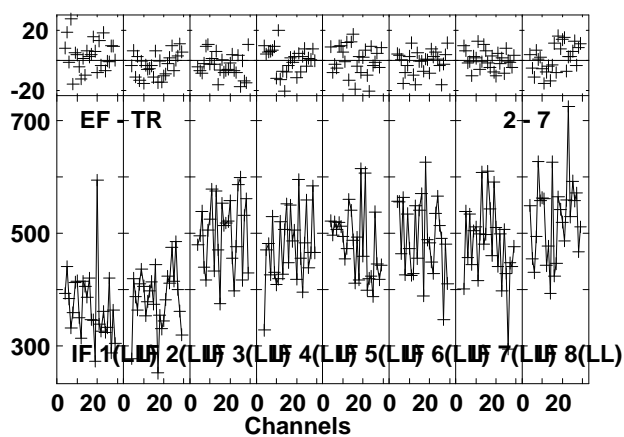
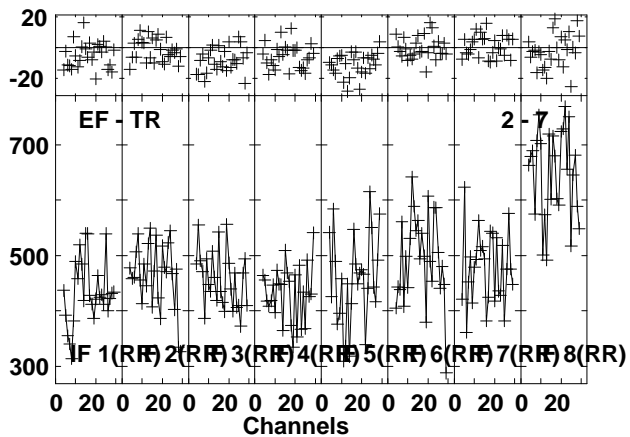
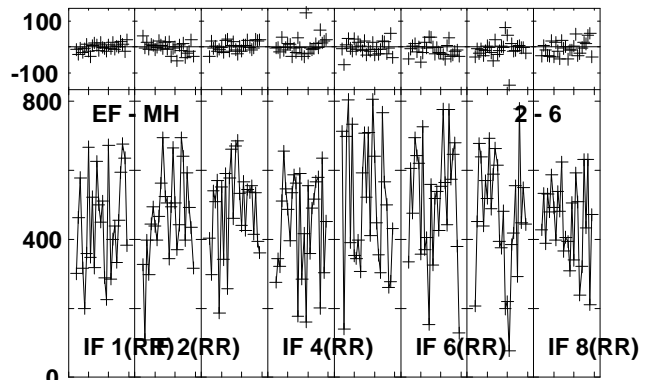
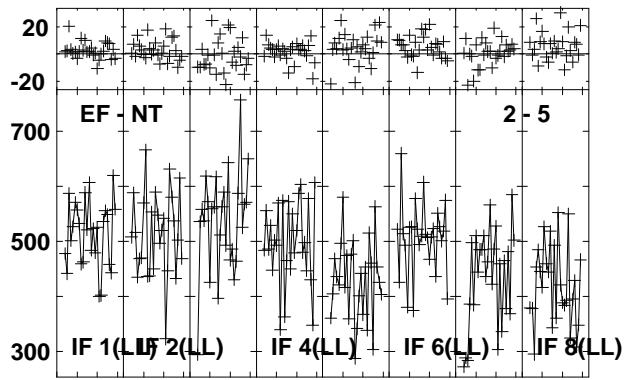
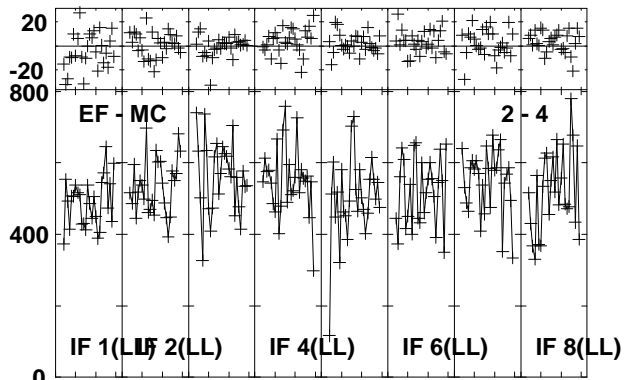
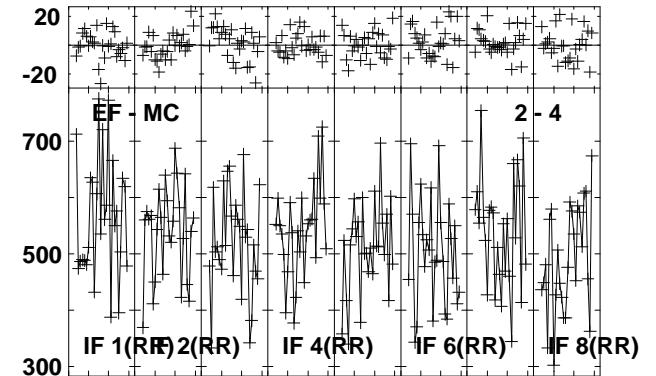
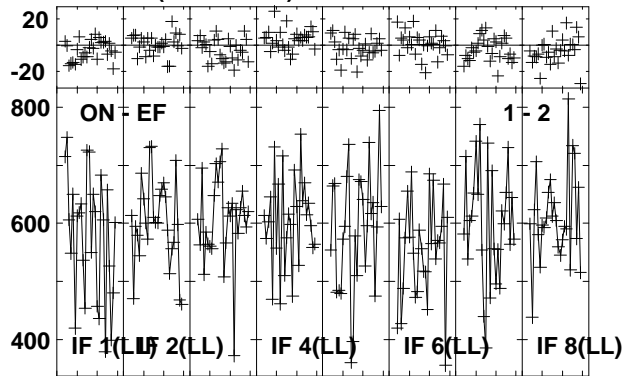
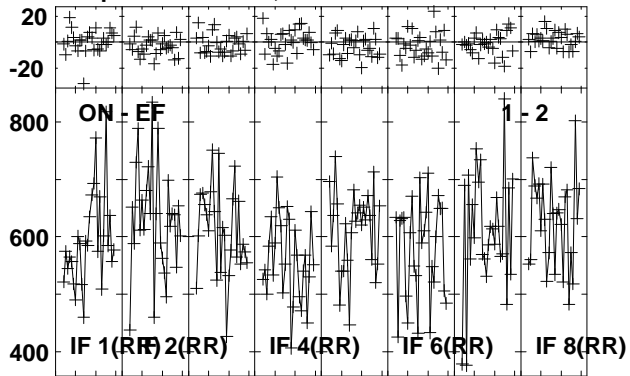

Lower frame: Milli Ampl Jy Top frame: Phas deg
Vector averaged cross-power spectrum Several baselines displayed
Timerange: 00/19:02:25 to 00/19:04:07

Plot file version 29 created 26-JUL-2013 10:18:03
 J1125+2610 EZ024 1.UVDATA.1
 Freq = 22.1720 GHz, Bw = 16.000 MH Calibrated with CL # 3 and BP # 1 (BP mode 1)

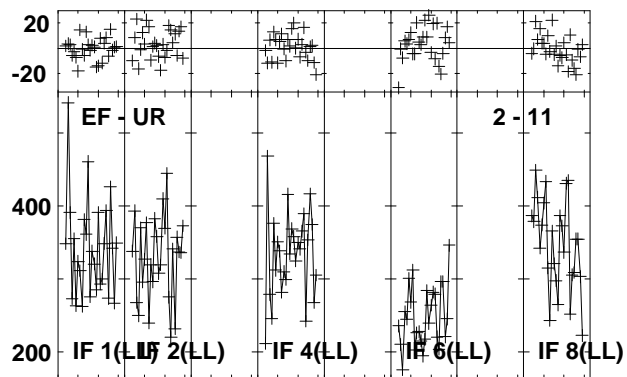
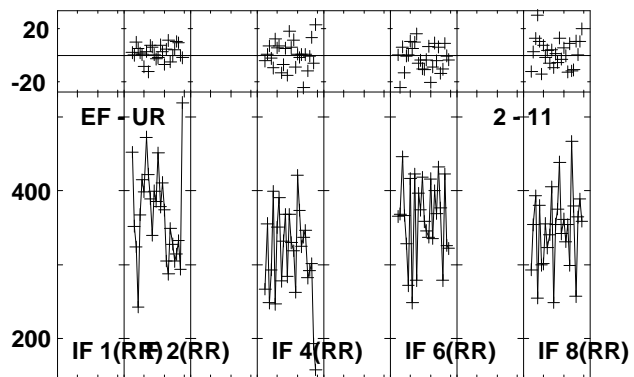
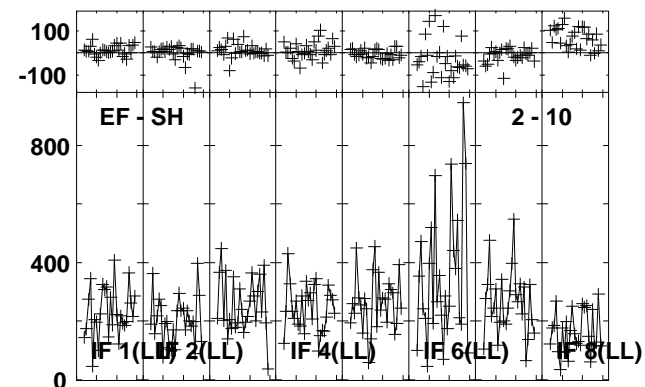
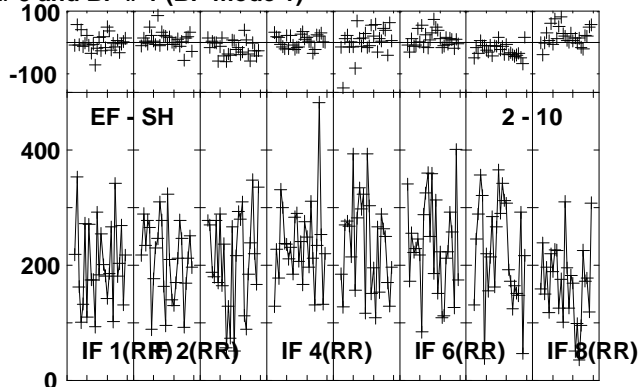
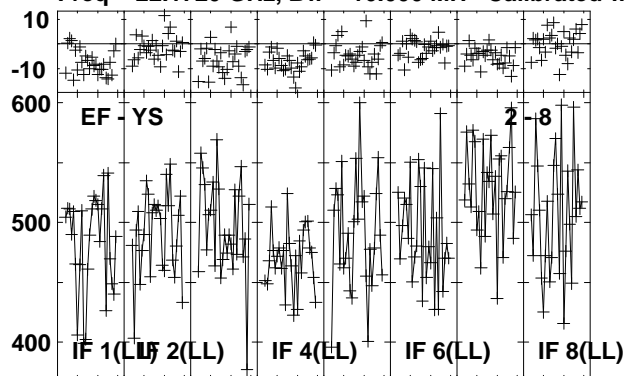

Lower frame: Milli Ampl Jy Top frame: Phas deg
 Vector averaged cross-power spectrum Several baselines displayed
 Timerange: 00/19:02:25 to 00/19:04:07

Plot file version 30 created 26-JUL-2013 10:18:04

J1157 EZ024 1.UVDATA.1

Freq = 22.1720 GHz, Bw = 16.000 MH Calibrated with CL # 3 and BP # 1 (BP mode 1)

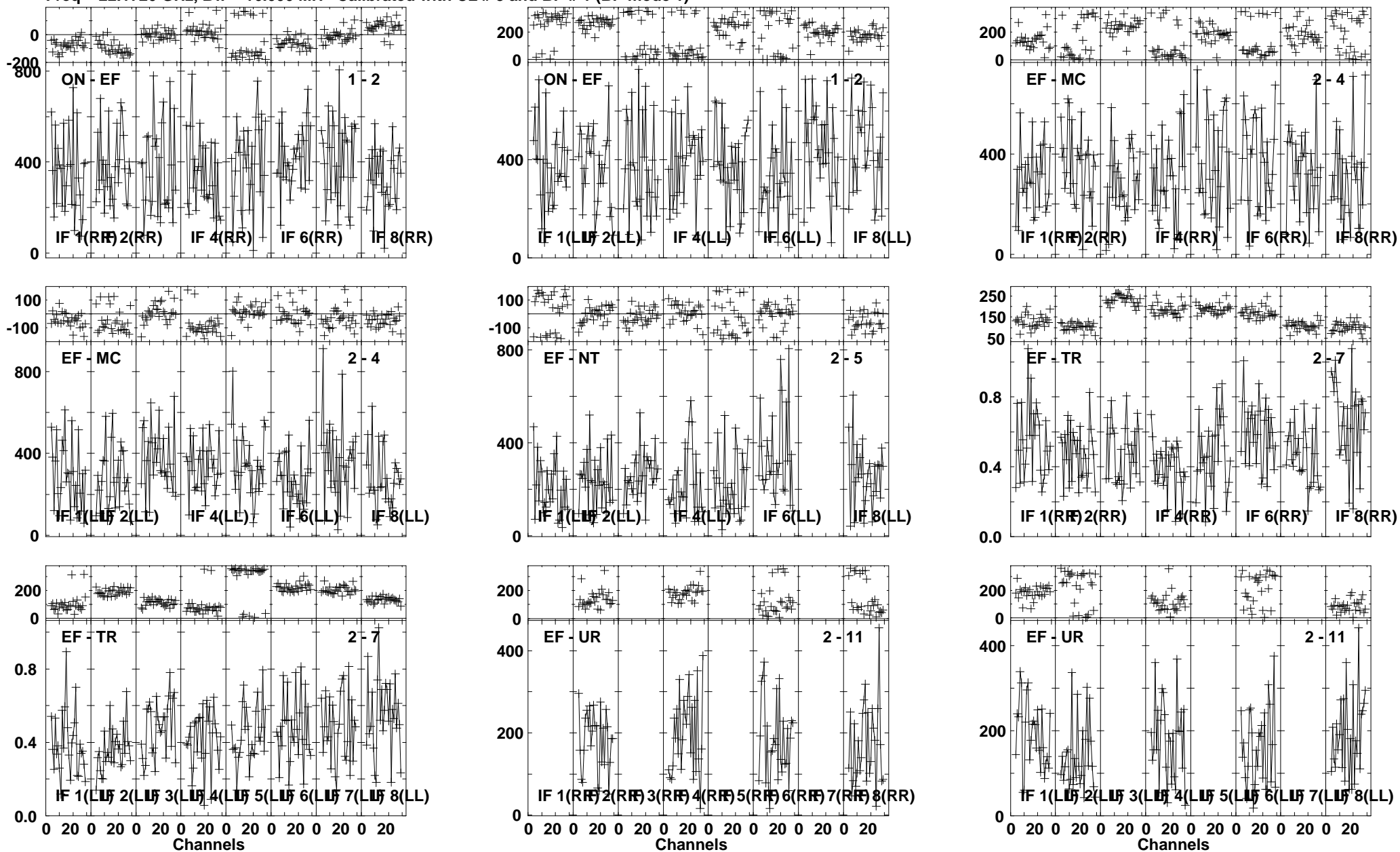

Lower frame: Milli Ampl Jy Top frame: Phas deg
Vector averaged cross-power spectrum Several baselines displayed
Timerange: 00:19:05:33 to 00:19:06:15

Plot file version 31 created 26-JUL-2013 10:18:05
 B1152+199A EZ24 1.UVDATA.1
 Freq = 22.1720 GHz, Bw = 16.000 MH Calibrated with CL # 3 and BP # 1 (BP mode 1)

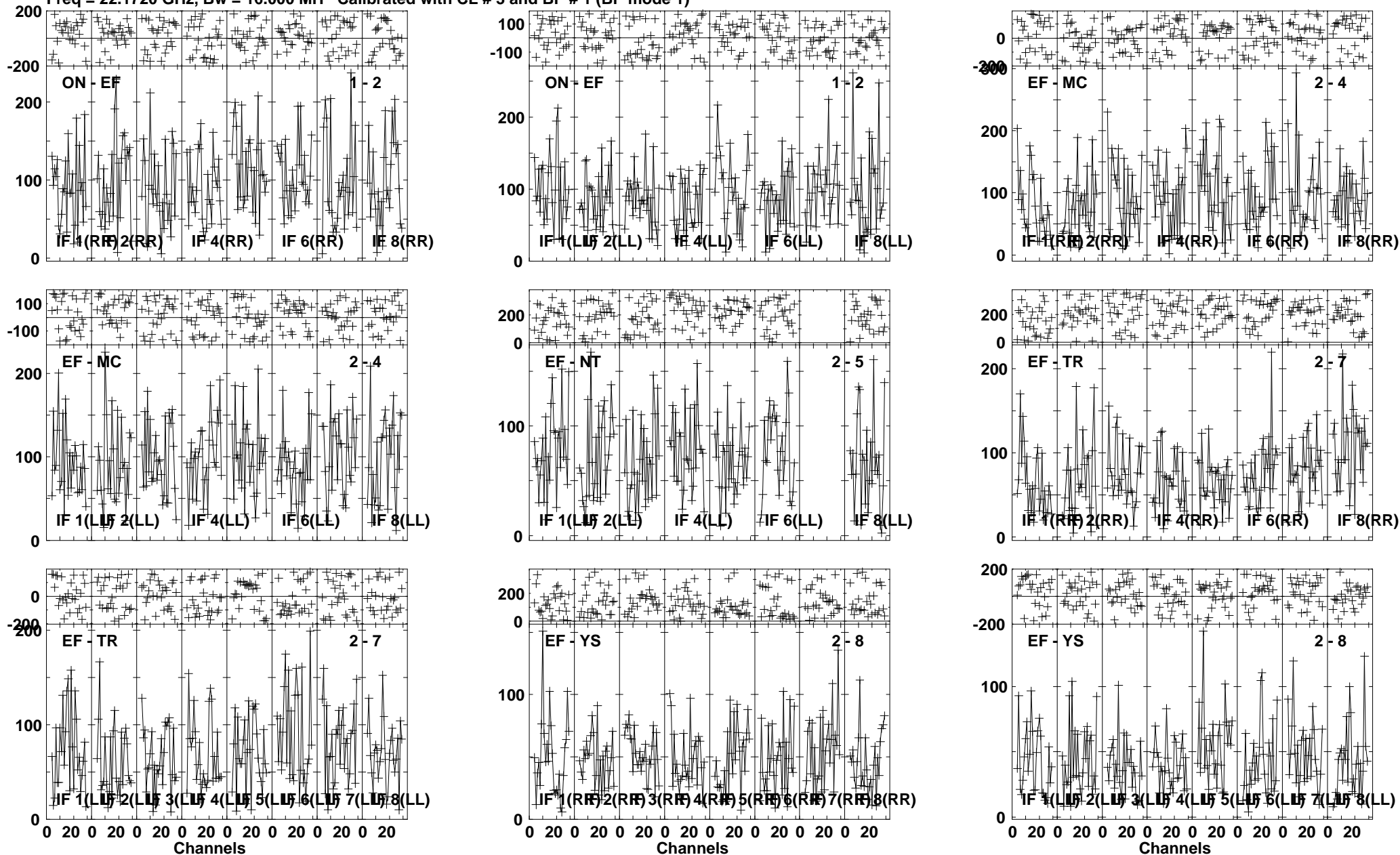

Lower frame: Milli Ampl Jy Top frame: Phas deg
 Vector averaged cross-power spectrum Several baselines displayed
 Timerange: 00/19:06:51 to 00/19:08:49

Plot file version 32 created 26-JUL-2013 10:18:07

B1152+199A EZ024 1.UVDATA.1

Freq = 22.1720 GHz, Bw = 16.000 MH Calibrated with CL # 3 and BP # 1 (BP mode 1)

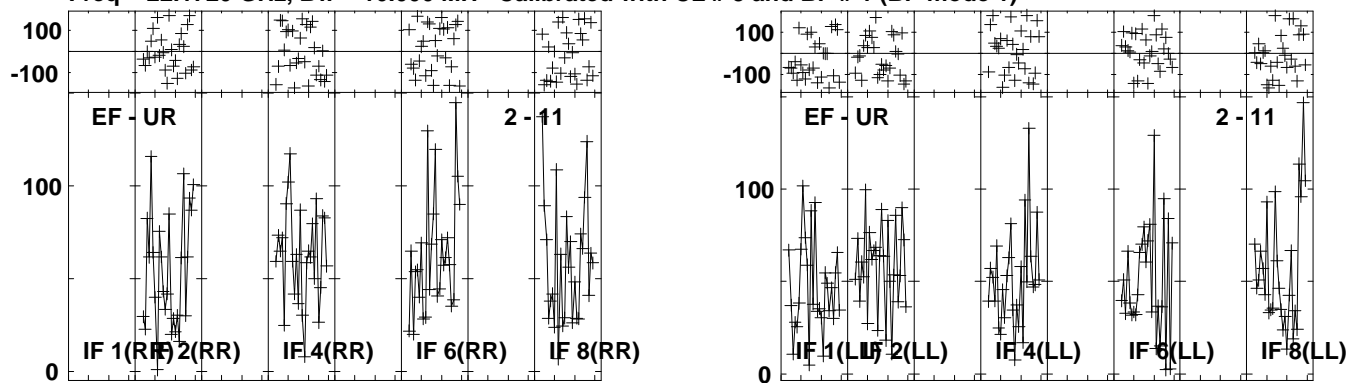

Lower frame: Milli Ampl Jy Top frame: Phas deg
Vector averaged cross-power spectrum Several baselines displayed
Timerange: 00/19:06:51 to 00/19:08:49

Plot file version 33 created 26-JUL-2013 10:18:07

J1157 EZ024 1.UVDATA.1

Freq = 22.1720 GHz, Bw = 16.000 MH Calibrated with CL # 3 and BP # 1 (BP mode 1)

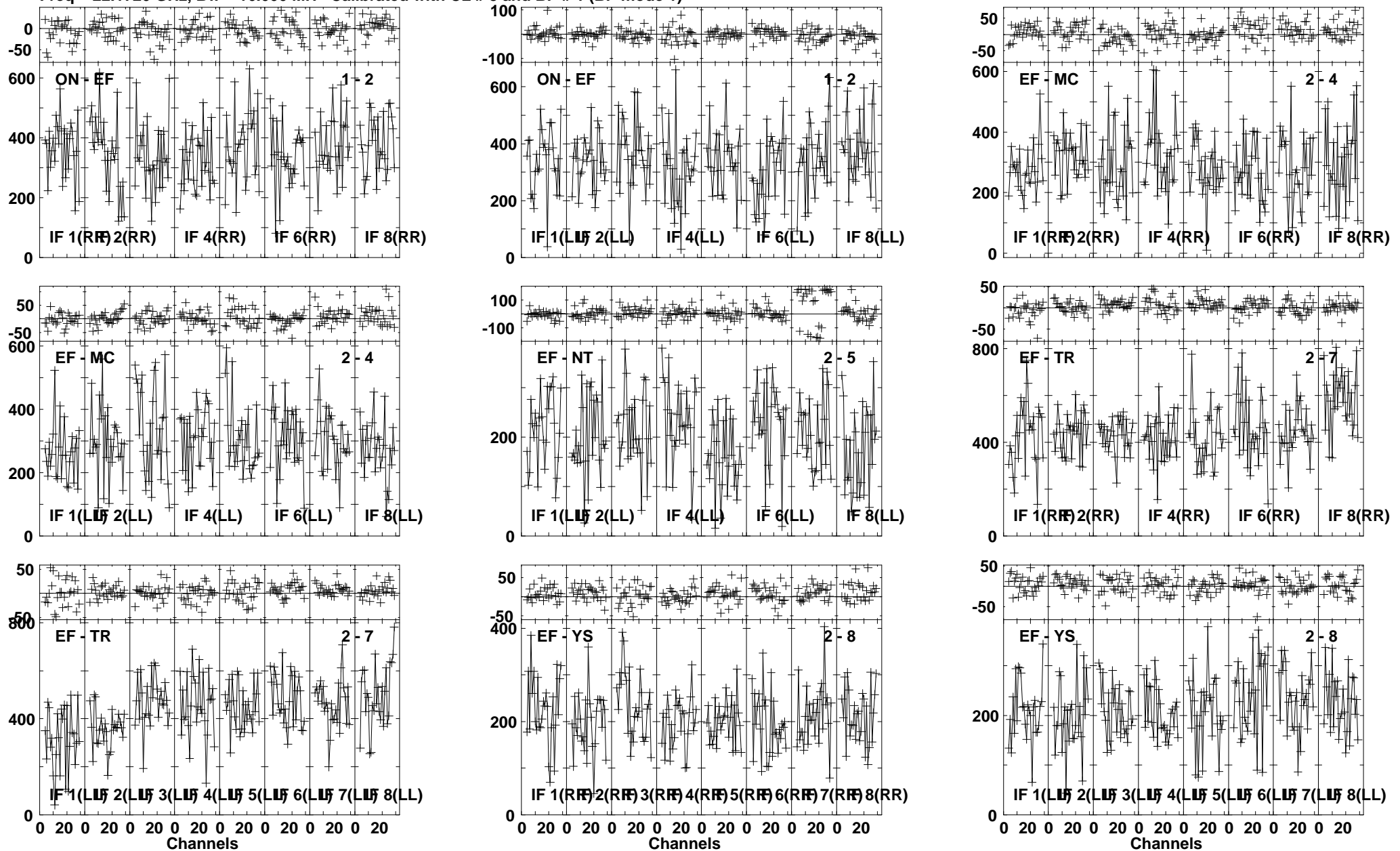

Lower frame: Milli Ampl Jy Top frame: Phas deg
Vector averaged cross-power spectrum Several baselines displayed
Timerange: 00/19:09:24 to 00/19:10:22

Plot file version 34 created 26-JUL-2013 10:18:08
 J1157 EZ024 1.UVDATA.1
 Freq = 22.1720 GHz, Bw = 16.000 MH Calibrated with CL # 3 and BP # 1 (BP mode 1)

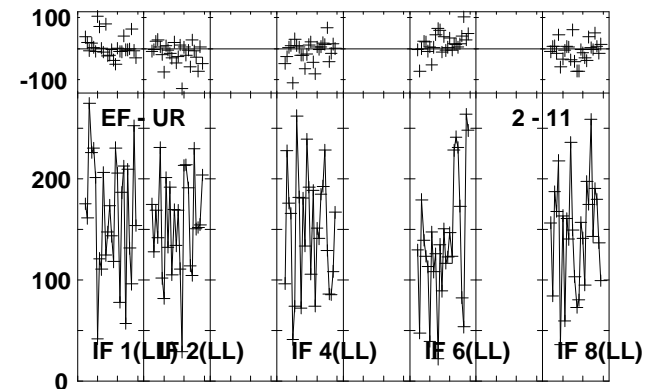
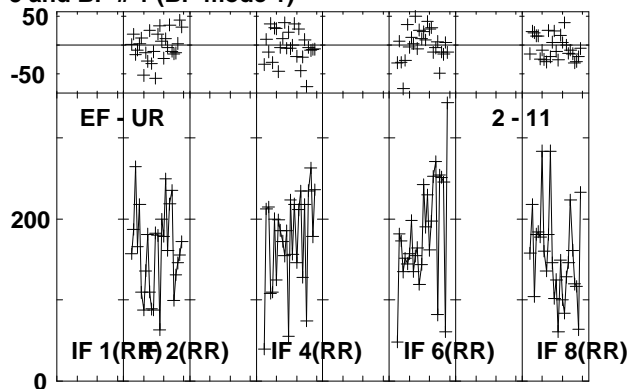
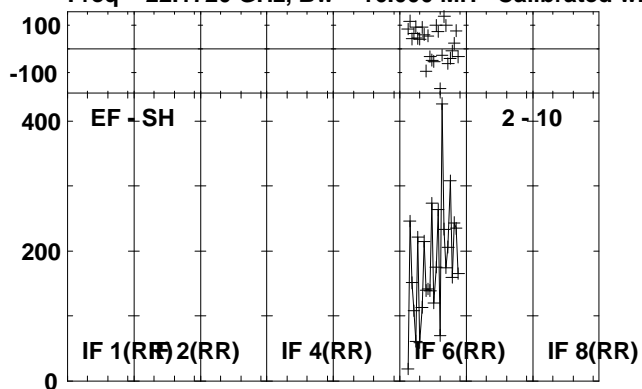

Lower frame: Milli Ampl Jy Top frame: Phas deg
 Vector averaged cross-power spectrum Several baselines displayed
 Timerange: 00/19:09:24 to 00/19:10:22

Plot file version 35 created 26-JUL-2013 10:18:09

B1152+199A EZ024 1.UVDATA.1

Freq = 22.1720 GHz, Bw = 16.000 MH Calibrated with CL # 3 and BP # 1 (BP mode 1)

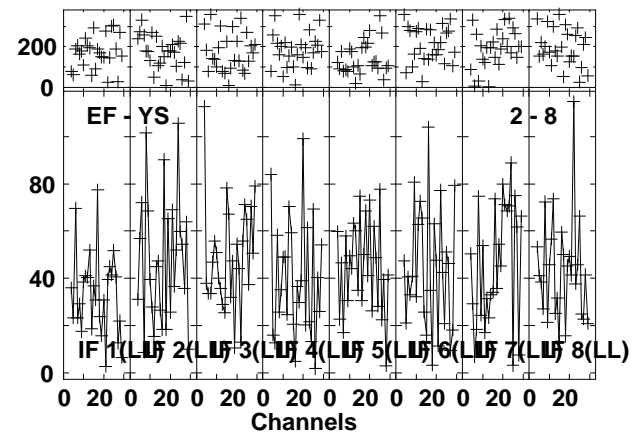
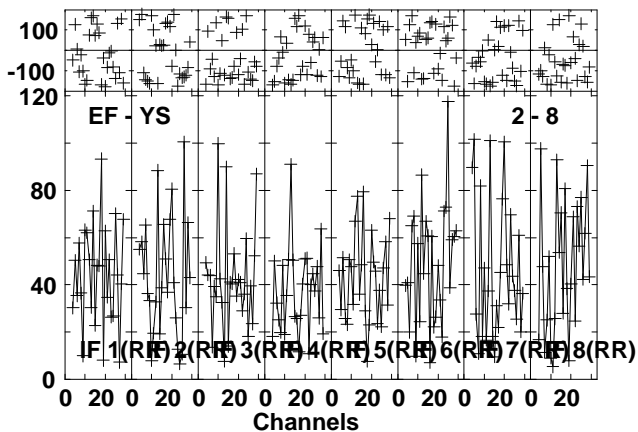
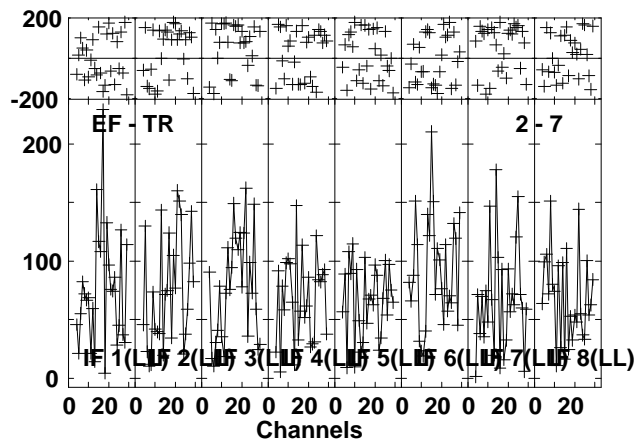
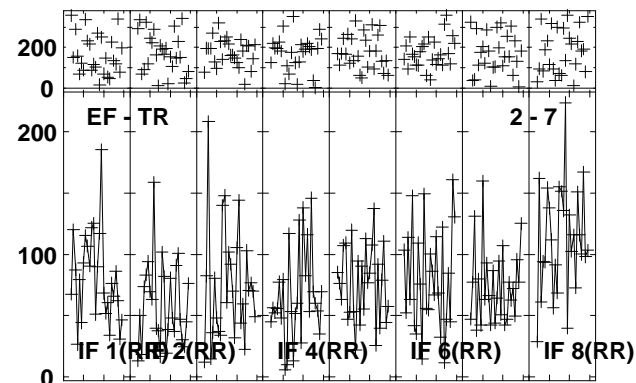
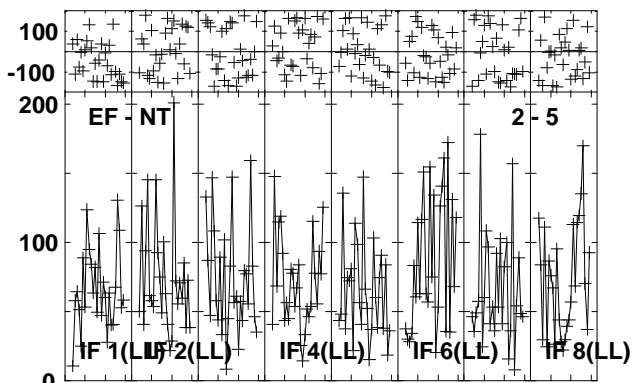
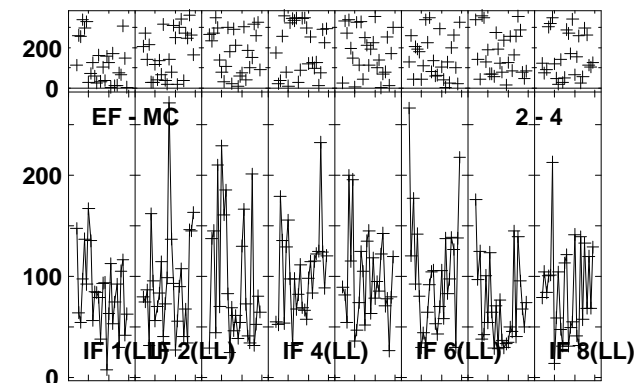
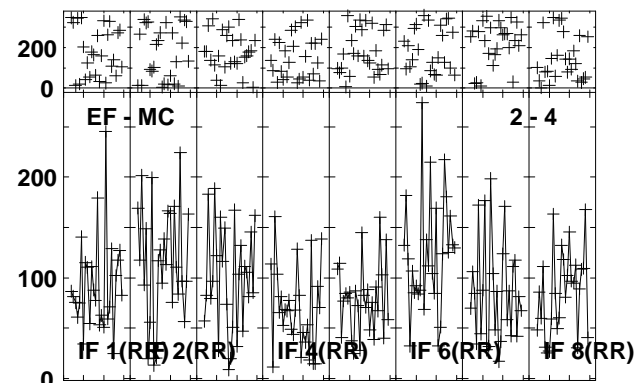
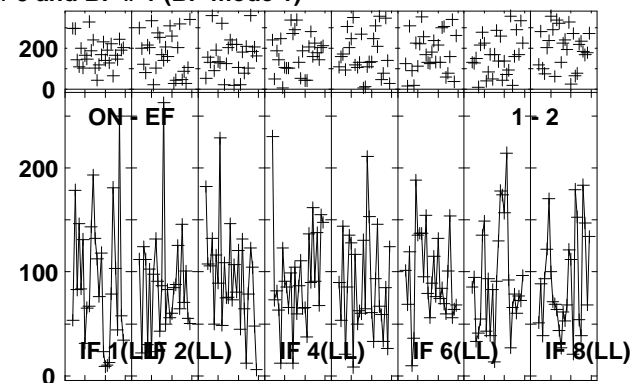
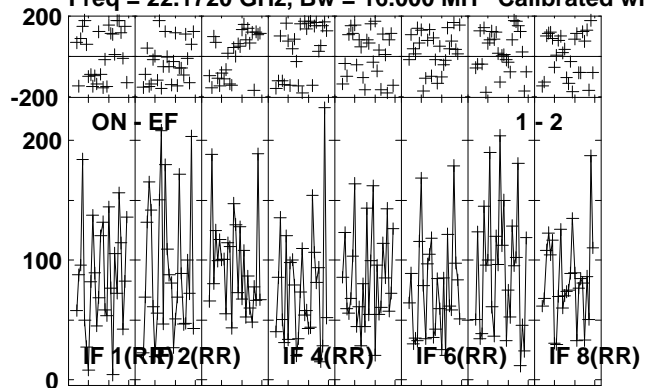

Lower frame: Milli Ampl Jy Top frame: Phas deg
Vector averaged cross-power spectrum Several baselines displayed
Timerange: 00/19:10:57 to 00/19:12:55

Plot file version 36 created 26-JUL-2013 10:18:10
 B1152+199A EZ024 1.UVDATA.1
 Freq = 22.1720 GHz, Bw = 16.000 MH Calibrated with CL # 3 and BP # 1 (BP mode 1)

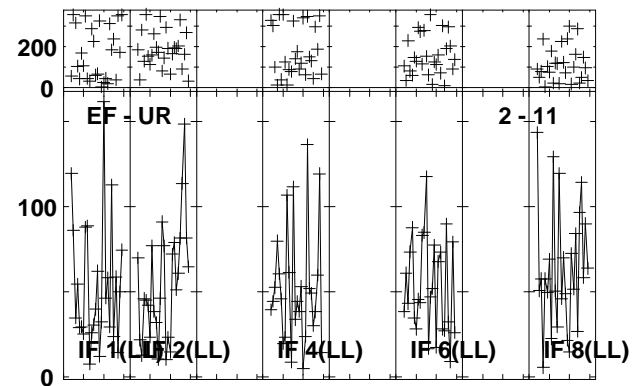
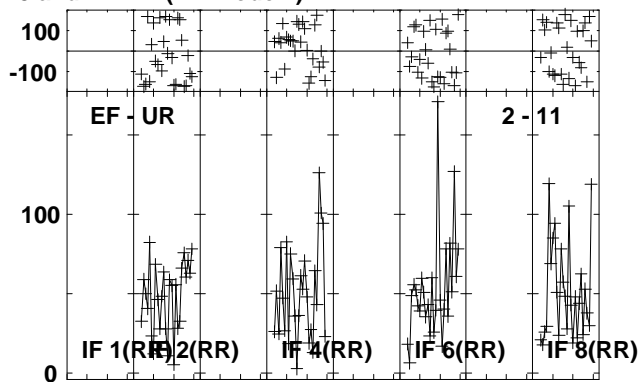
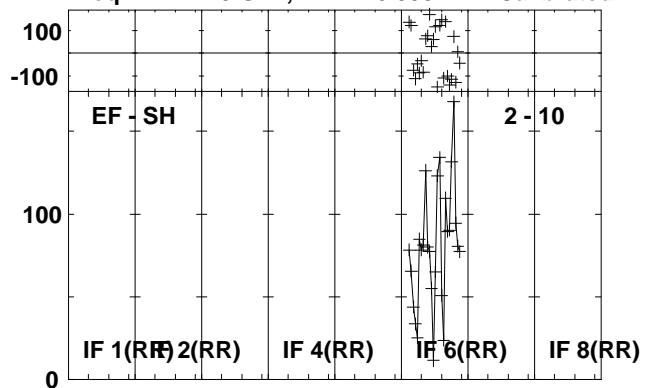

Lower frame: Milli Ampl Jy Top frame: Phas deg
 Vector averaged cross-power spectrum Several baselines displayed
 Timerange: 00/19:10:57 to 00/19:12:55

Plot file version 37 created 26-JUL-2013 10:18:11

J1157 EZ024 1.UVDATA.1

Freq = 22.1720 GHz, Bw = 16.000 MH Calibrated with CL # 3 and BP # 1 (BP mode 1)

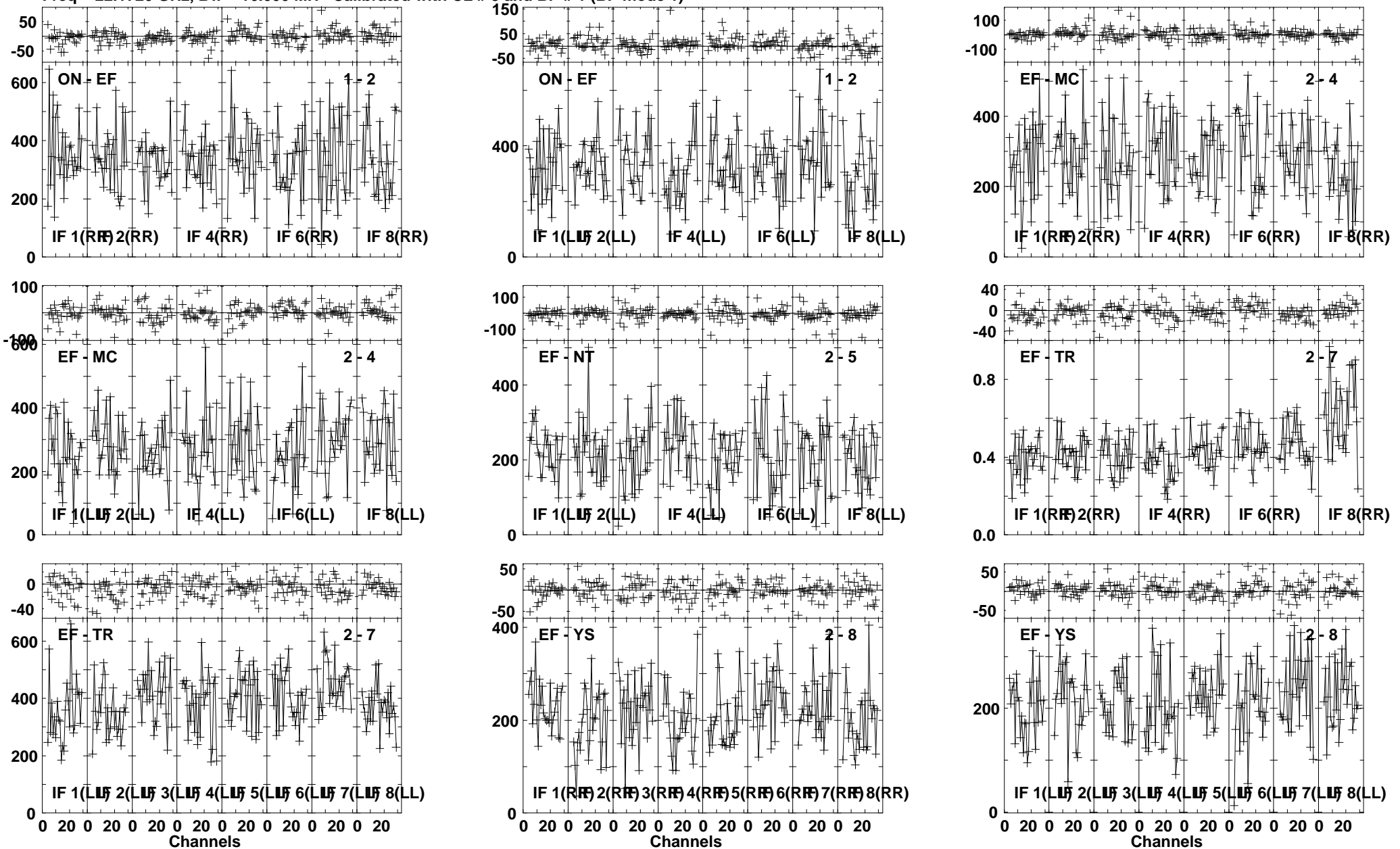

Lower frame: Milli Ampl Jy Top frame: Phas deg
Vector averaged cross-power spectrum Several baselines displayed
Timerange: 00/19:13:30 to 00/19:14:28

Plot file version 38 created 26-JUL-2013 10:18:12
J1157 EZ024 1.UVDATA.1
Freq = 22.1720 GHz, Bw = 16.000 MH Calibrated with CL # 3 and BP # 1 (BP mode 1)

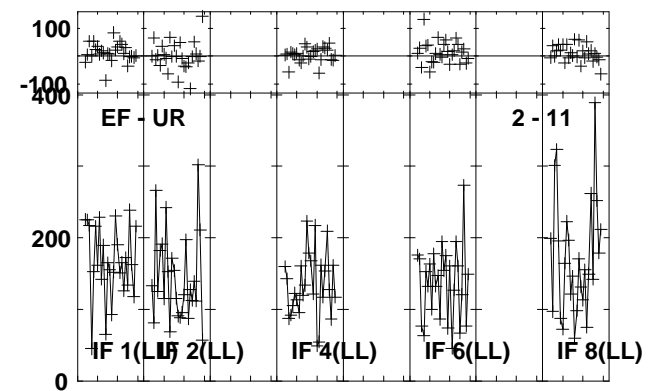
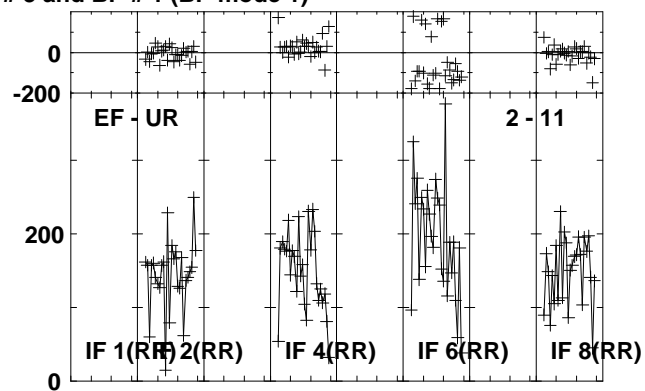
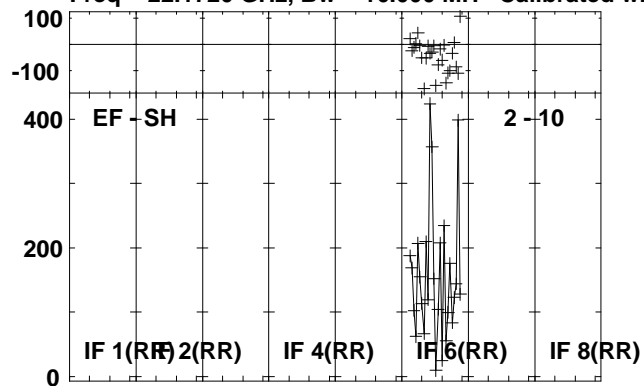

Lower frame: Milli Ampl Jy Top frame: Phas deg
Vector averaged cross-power spectrum Several baselines displayed
Timerange: 00/19:13:30 to 00/19:14:28

Plot file version 39 created 26-JUL-2013 10:18:12
 B1152+199A EZ24 1.UVDATA.1
 Freq = 22.1720 GHz, Bw = 16.000 MH Calibrated with CL # 3 and BP # 1 (BP mode 1)

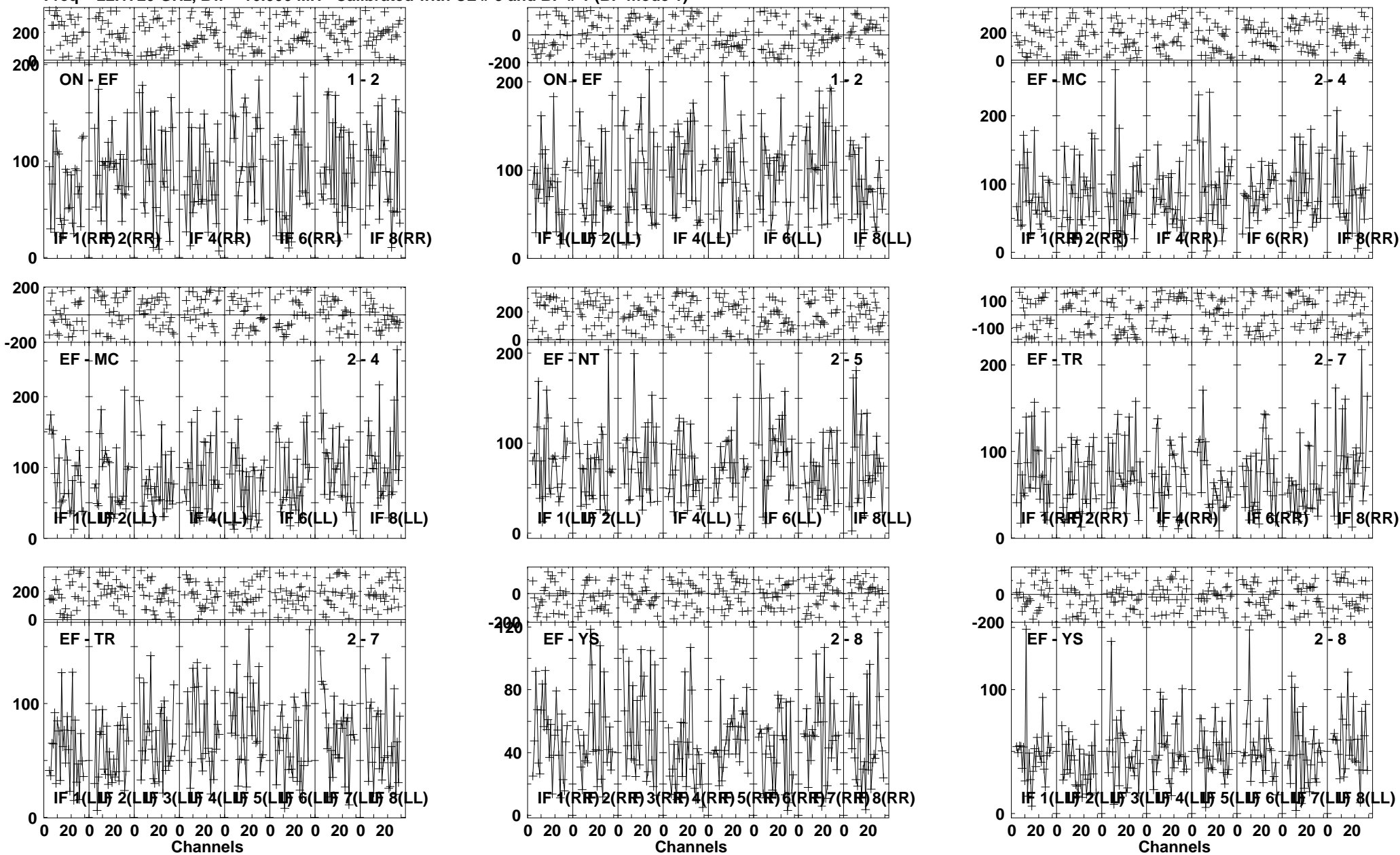

Lower frame: Milli Ampl Jy Top frame: Phas deg
 Vector averaged cross-power spectrum Several baselines displayed
 Timerange: 00/19:15:04 to 00/19:17:02

Plot file version 40 created 26-JUL-2013 10:18:14
 B1152+199A EZ024 1.UVDATA.1
 Freq = 22.1720 GHz, Bw = 16.000 MH Calibrated with CL # 3 and BP # 1 (BP mode 1)

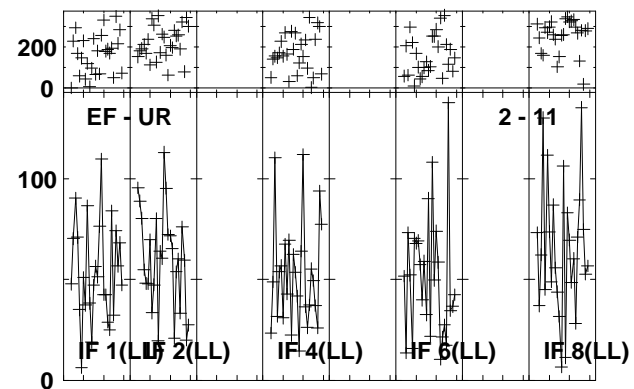
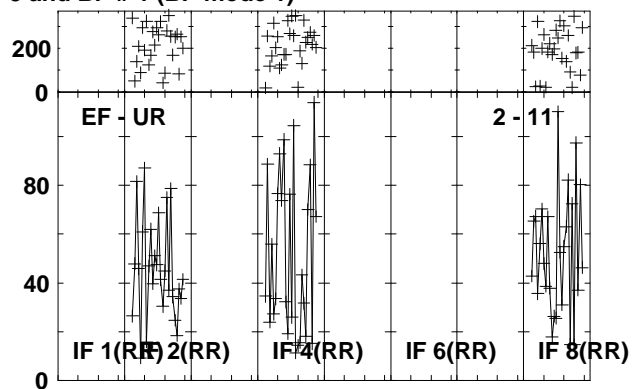
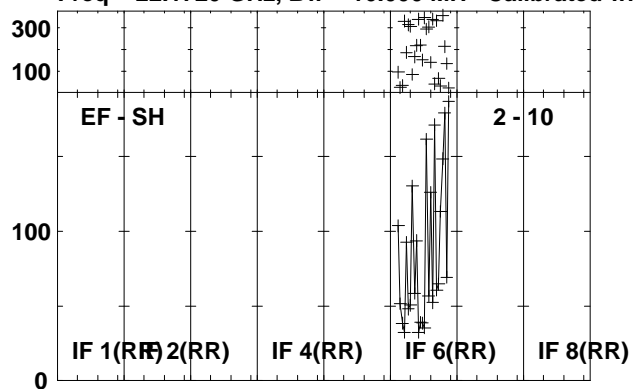

Lower frame: Milli Ampl Jy Top frame: Phas deg
 Vector averaged cross-power spectrum Several baselines displayed
 Timerange: 00/19:15:04 to 00/19:17:02

Plot file version 41 created 26-JUL-2013 10:18:15
 J1157 EZ024 1.UVDATA.1
 Freq = 22.1720 GHz, Bw = 16.000 MH Calibrated with CL # 3 and BP # 1 (BP mode 1)

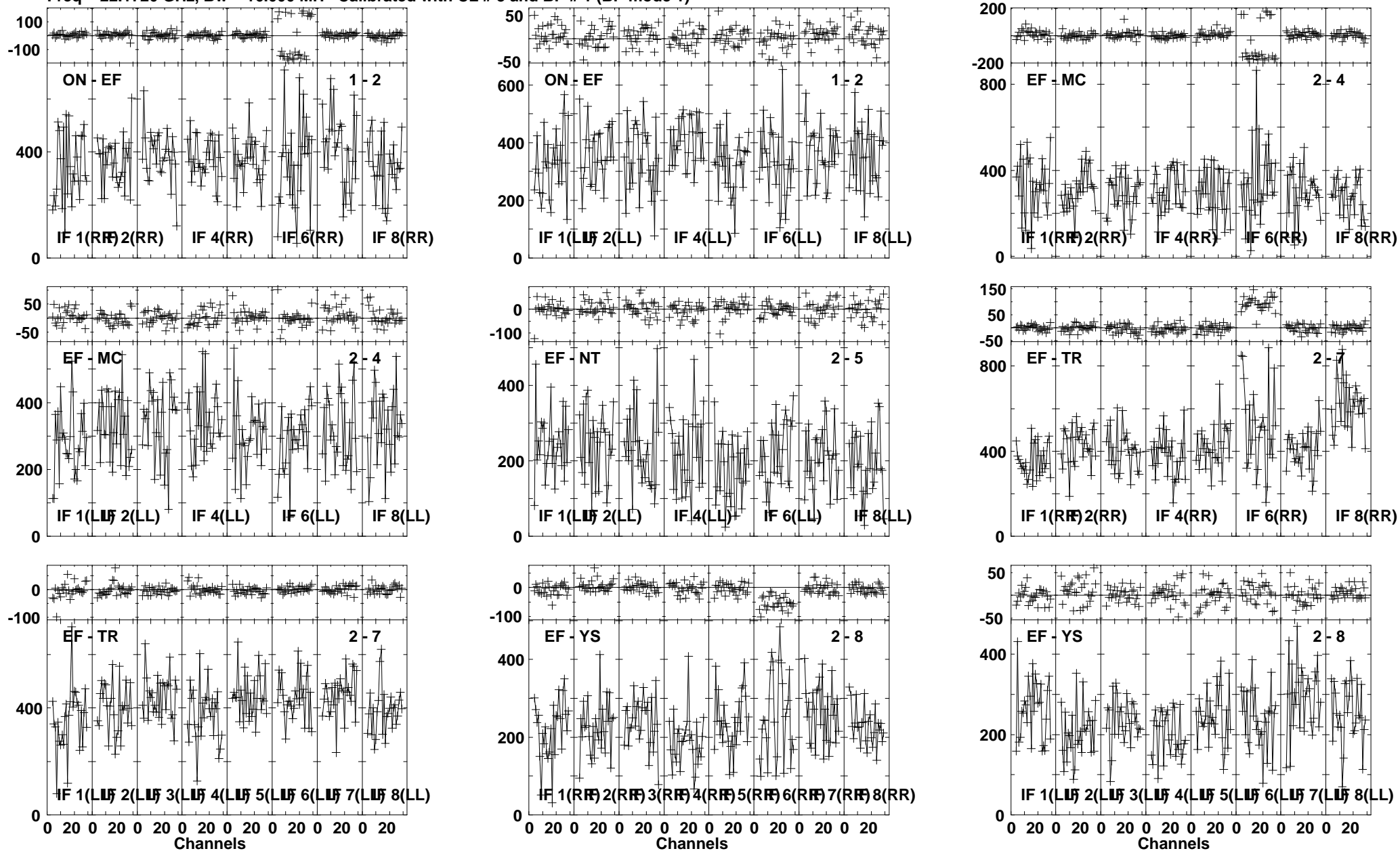

Lower frame: Milli Ampl Jy Top frame: Phas deg
 Vector averaged cross-power spectrum Several baselines displayed
 Timerange: 00/19:17:37 to 00/19:18:35

Plot file version 42 created 26-JUL-2013 10:18:16
 J1157 EZ024 1.UVDATA.1
 Freq = 22.1720 GHz, Bw = 16.000 MH Calibrated with CL # 3 and BP # 1 (BP mode 1)

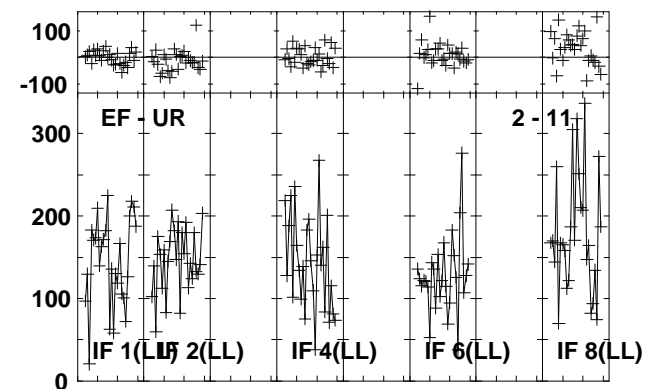
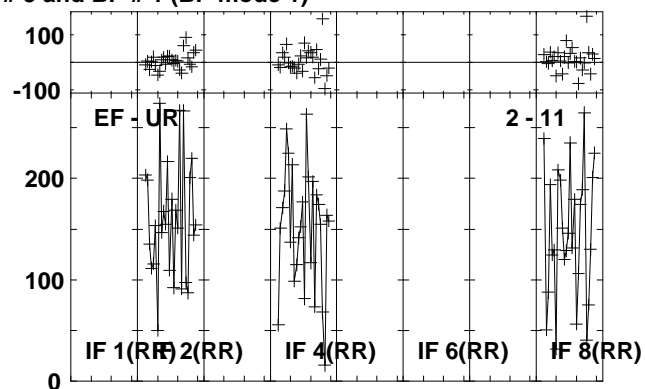
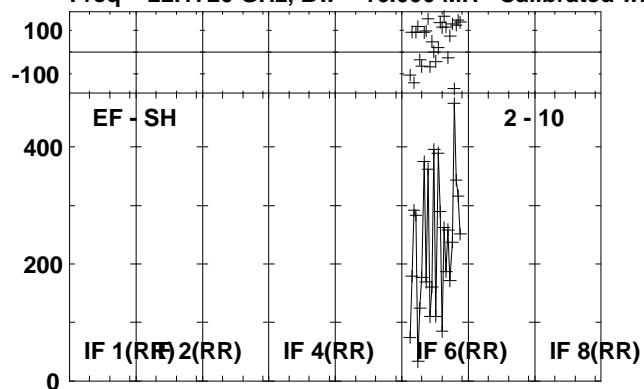

Lower frame: Milli Ampl Jy Top frame: Phas deg
 Vector averaged cross-power spectrum Several baselines displayed
 Timerange: 00/19:17:37 to 00/19:18:35

Plot file version 43 created 26-JUL-2013 10:18:16
 J1125+2610 EZ024 1.UVDATA.1
 Freq = 22.1720 GHz, Bw = 16.000 MH Calibrated with CL # 3 and BP # 1 (BP mode 1)

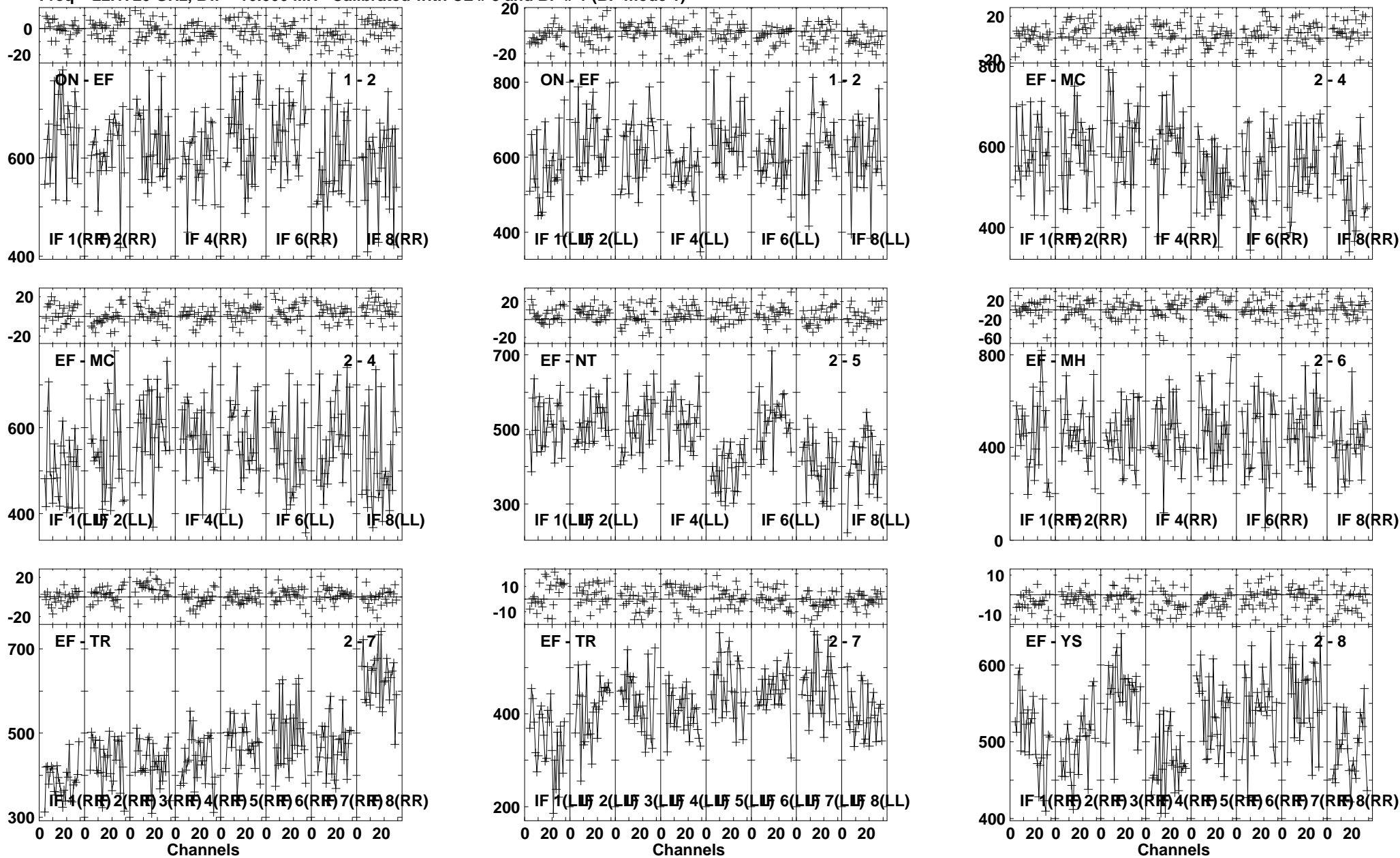

Lower frame: Milli Ampl Jy Top frame: Phas deg
 Vector averaged cross-power spectrum Several baselines displayed
 Timerange: 00/19:20:02 to 00/19:21:44

Plot file version 44 created 26-JUL-2013 10:18:17

J1125+2610 EZ024 1.UVDATA.1

Freq = 22.1720 GHz, Bw = 16.000 MH Calibrated with CL # 3 and BP # 1 (BP mode 1)

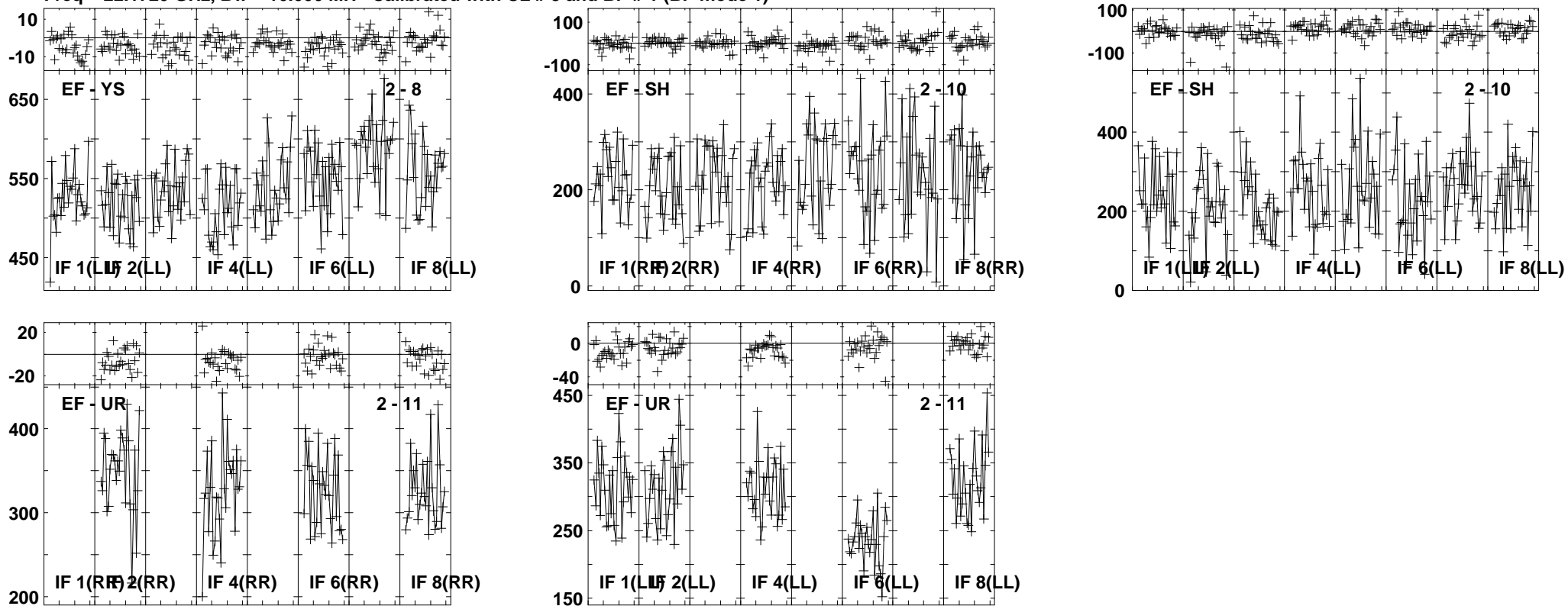

Lower frame: Milli Ampl Jy Top frame: Phas deg
Vector averaged cross-power spectrum Several baselines displayed
Timerange: 00/19:20:02 to 00/19:21:44

Plot file version 45 created 26-JUL-2013 10:18:18
 J1157 EZ024 1.UVDATA.1
 Freq = 22.1720 GHz, Bw = 16.000 MH Calibrated with CL # 3 and BP # 1 (BP mode 1)

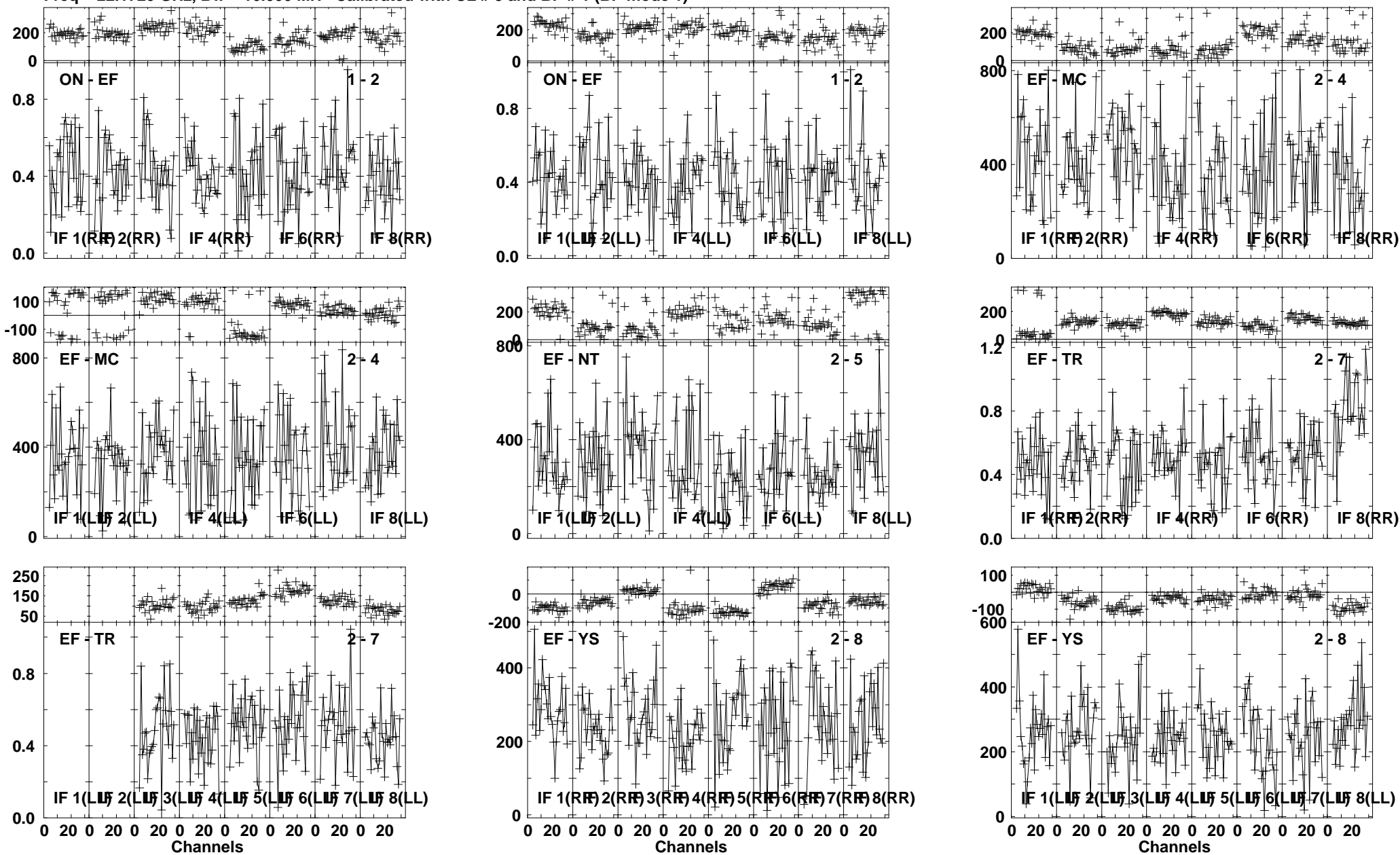

Lower frame: Ampl Jy Top frame: Phas deg
 Vector averaged cross-power spectrum Several baselines displayed
 Timerange: 00/19:23:10 to 00/19:23:52

Plot file version 46 created 26-JUL-2013 10:18:18

J1157 EZ024 1.UVDATA.1

Freq = 22.1720 GHz, Bw = 16.000 MH Calibrated with CL # 3 and BP # 1 (BP mode 1)

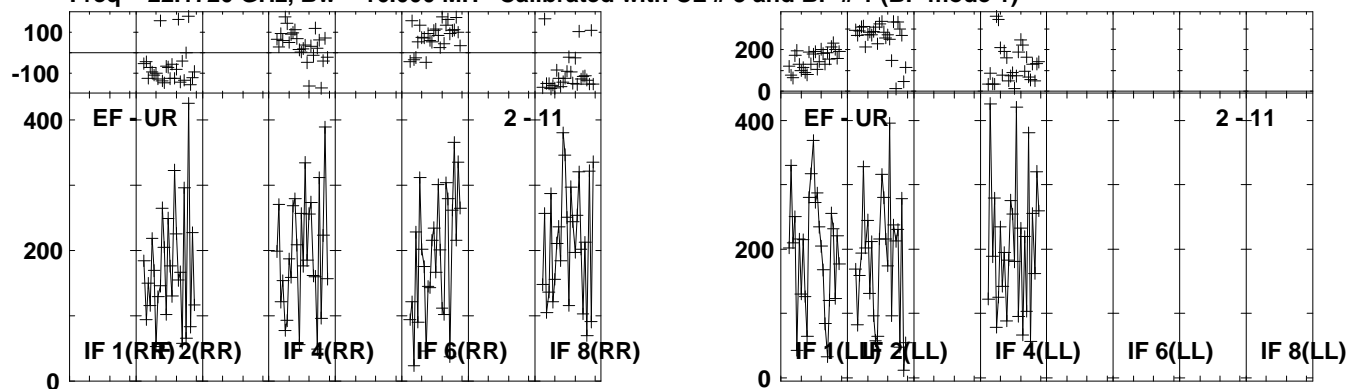

Lower frame: Milli Ampl Jy Top frame: Phas deg
Vector averaged cross-power spectrum Several baselines displayed
Timerange: 00/19:23:10 to 00/19:23:52

Plot file version 47 created 26-JUL-2013 10:18:19
 B1152+199A EZ024 1.UVDATA.1
 Freq = 22.1720 GHz, Bw = 16.000 MH Calibrated with CL # 3 and BP # 1 (BP mode 1)

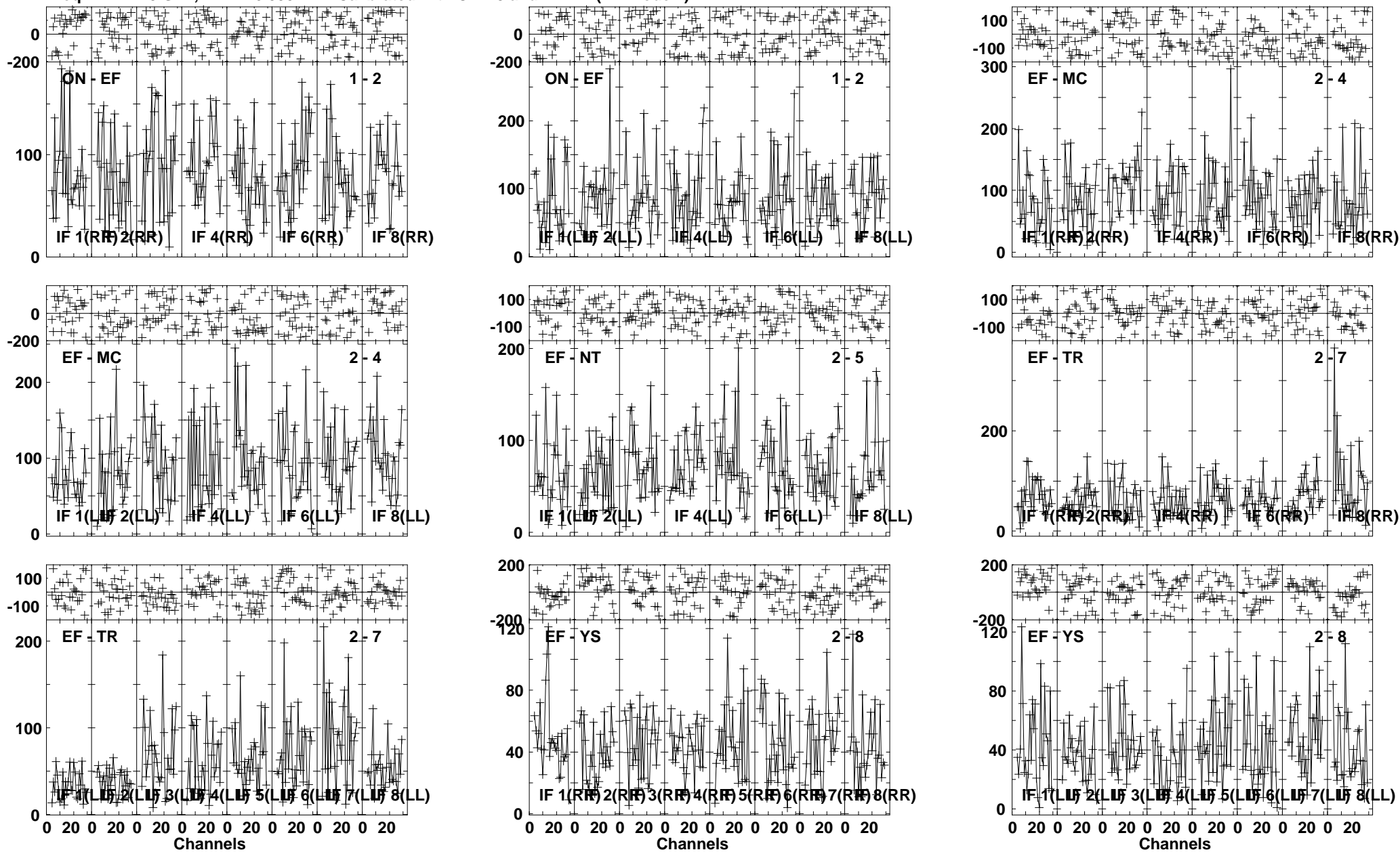

Lower frame: Milli Ampl Jy Top frame: Phas deg
 Vector averaged cross-power spectrum Several baselines displayed
 Timerange: 00/19:24:28 to 00/19:26:26

Plot file version 48 created 26-JUL-2013 10:18:20

B1152+199A EZ024 1.UVDATA.1

Freq = 22.1720 GHz, Bw = 16.000 MH Calibrated with CL # 3 and BP # 1 (BP mode 1)

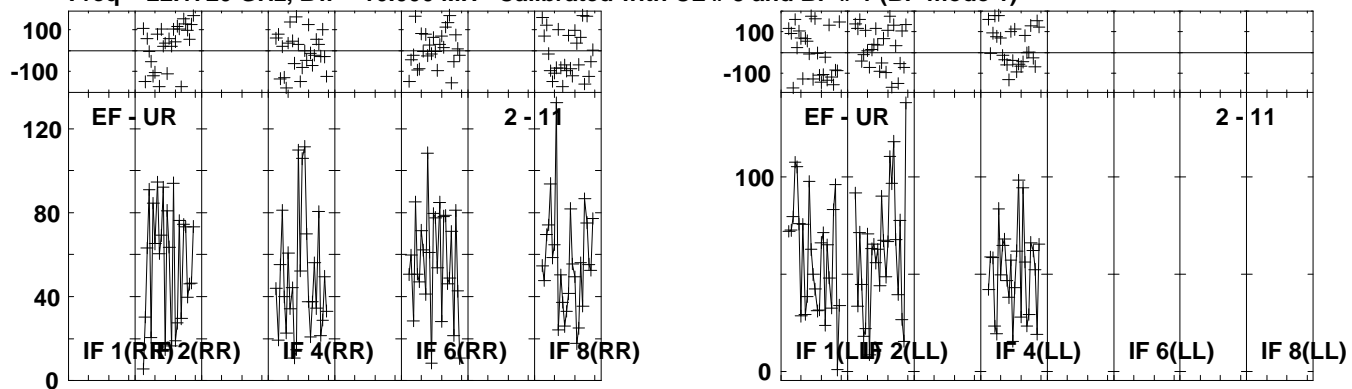

Lower frame: Milli Ampl Jy Top frame: Phas deg
Vector averaged cross-power spectrum Several baselines displayed
Timerange: 00/19:24:28 to 00/19:26:26

Plot file version 49 created 26-JUL-2013 10:18:21

J1157 EZ024 1.UVDATA.1

Freq = 22.1720 GHz, Bw = 16.000 MH Calibrated with CL # 3 and BP # 1 (BP mode 1)

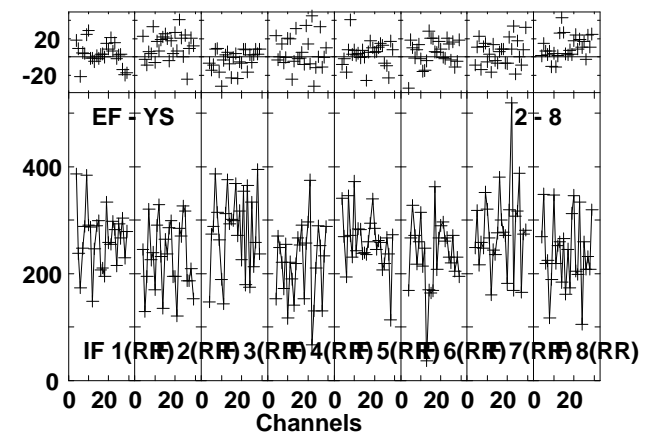
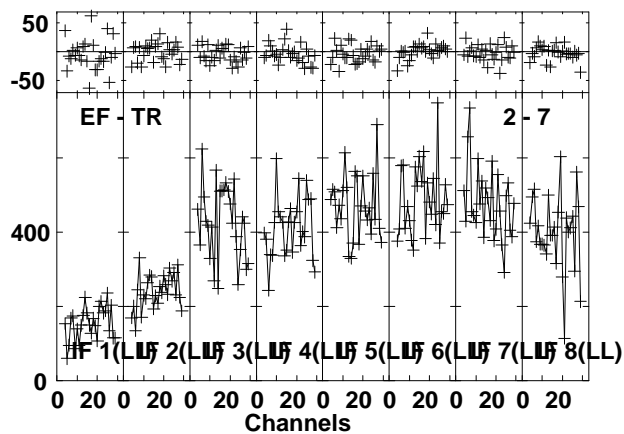
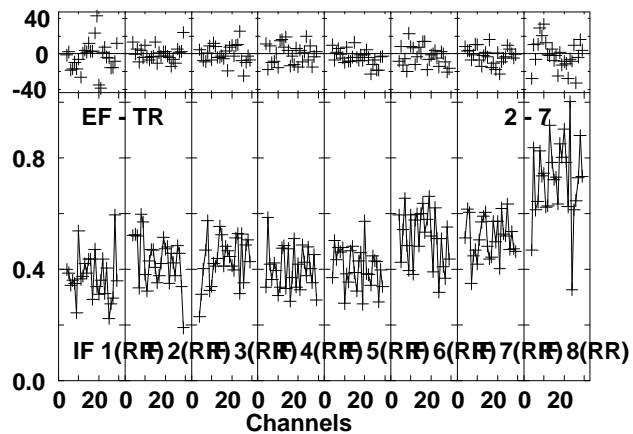
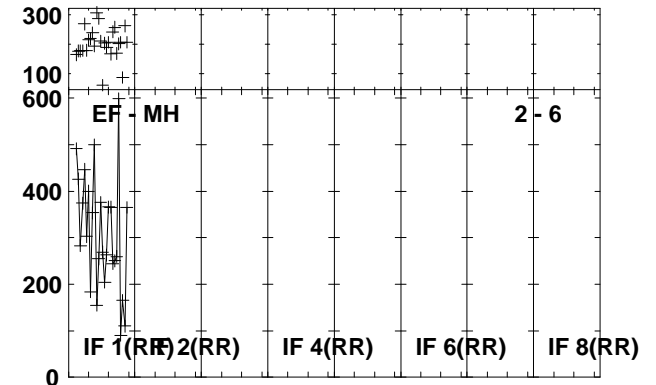
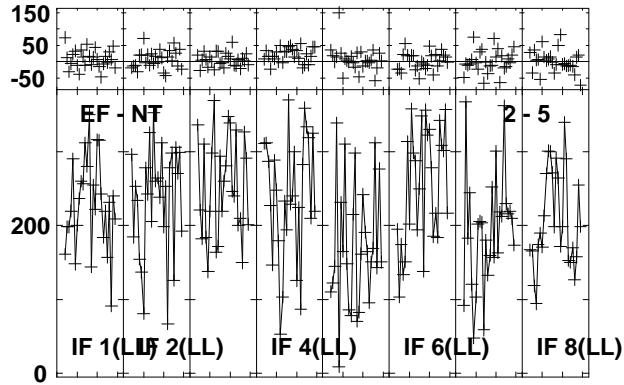
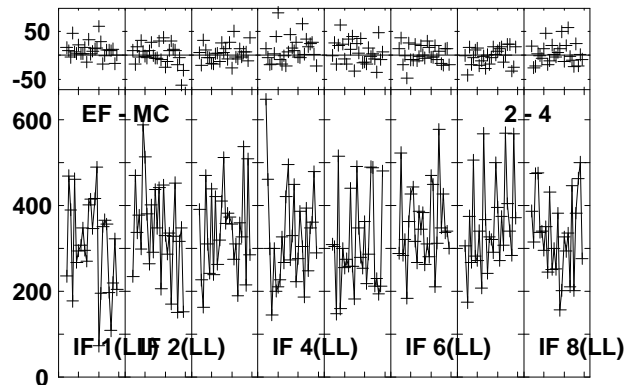
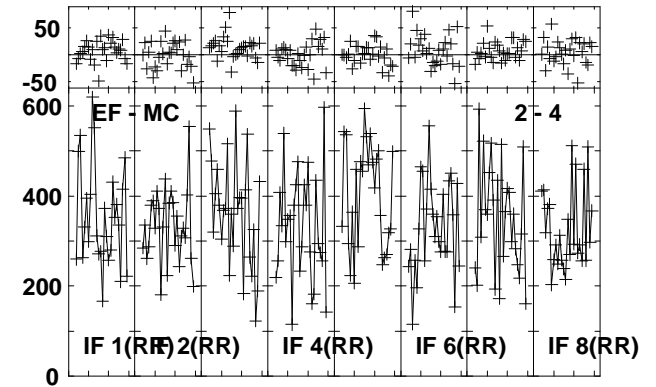
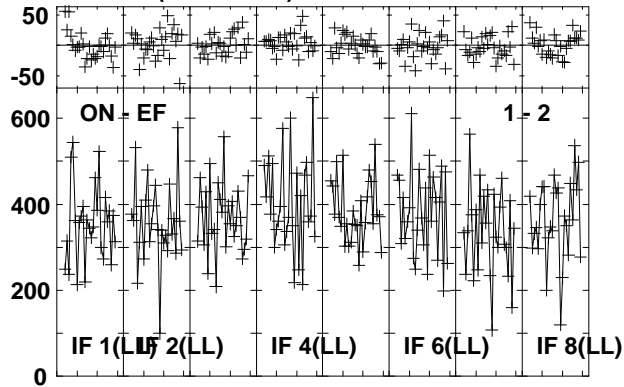
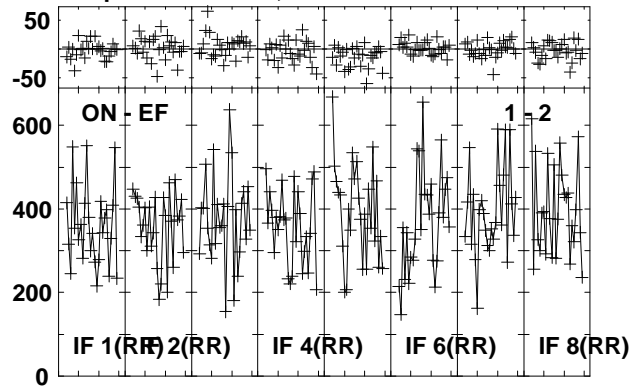

Lower frame: Milli Ampl Jy Top frame: Phas deg
Vector averaged cross-power spectrum Several baselines displayed
Timerange: 00:19:27:02 to 00:19:28:00

Plot file version 50 created 26-JUL-2013 10:18:21

J1157 EZ024 1.UVDATA.1

Freq = 22.1720 GHz, Bw = 16.000 MH Calibrated with CL # 3 and BP # 1 (BP mode 1)

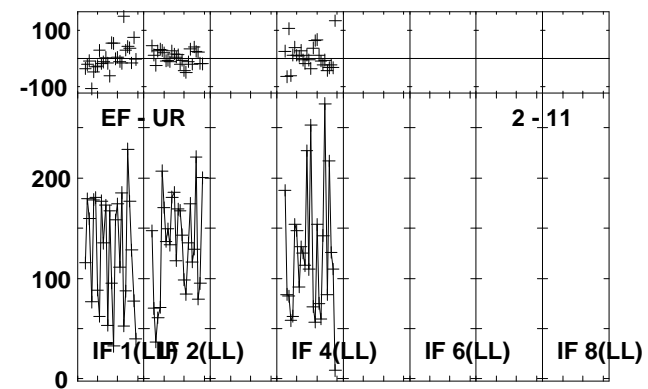
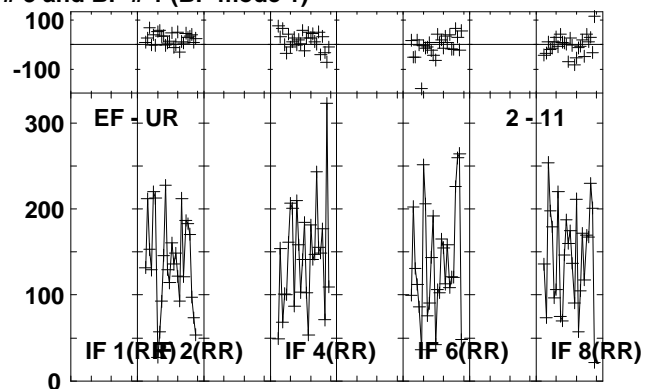
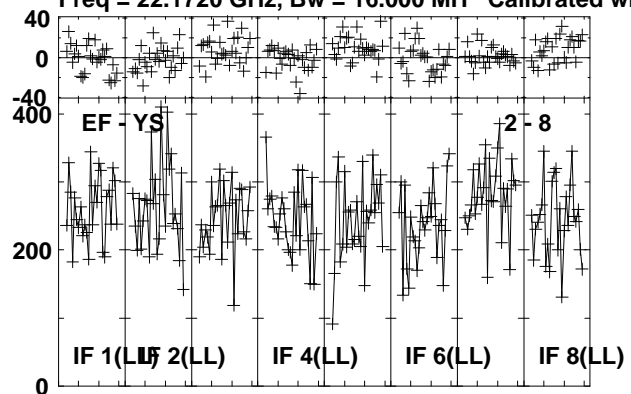

Lower frame: Milli Ampl Jy Top frame: Phas deg
Vector averaged cross-power spectrum Several baselines displayed
Timerange: 00:19:27:02 to 00:19:28:00

Plot file version 51 created 26-JUL-2013 10:18:22
 B1152+199A EZ24 1.UVDATA.1
 Freq = 22.1720 GHz, Bw = 16.000 MH Calibrated with CL # 3 and BP # 1 (BP mode 1)

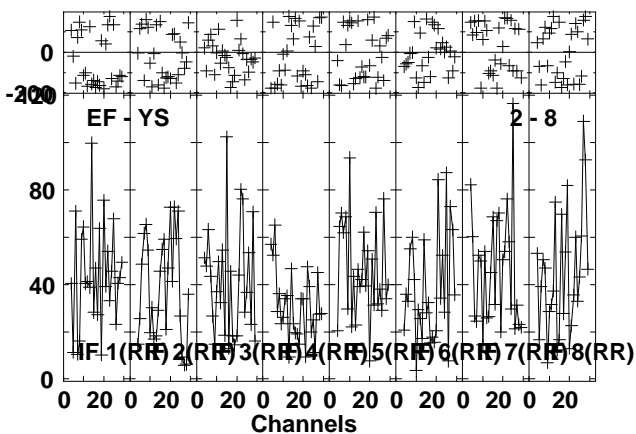
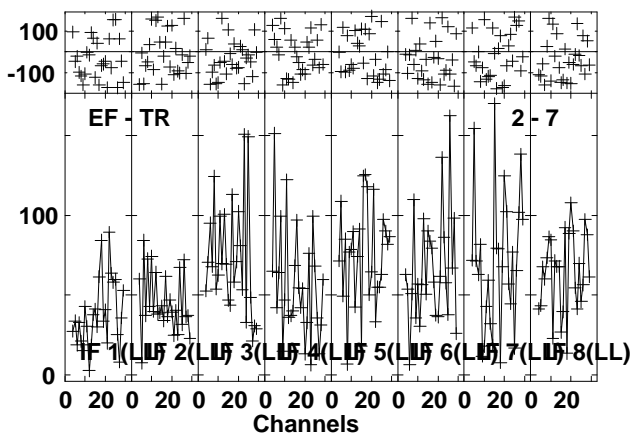
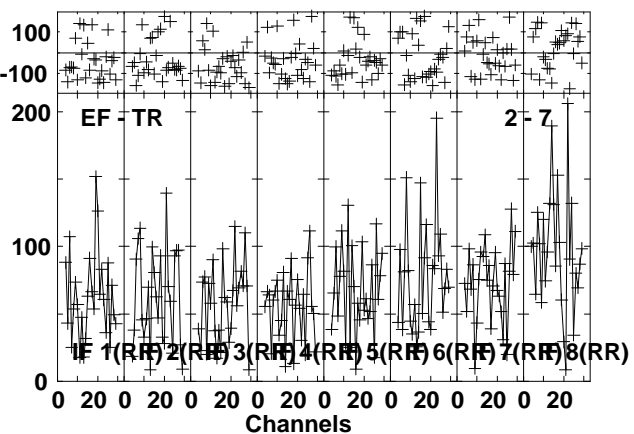
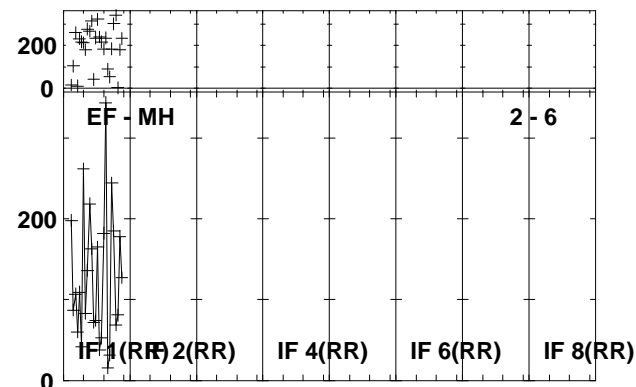
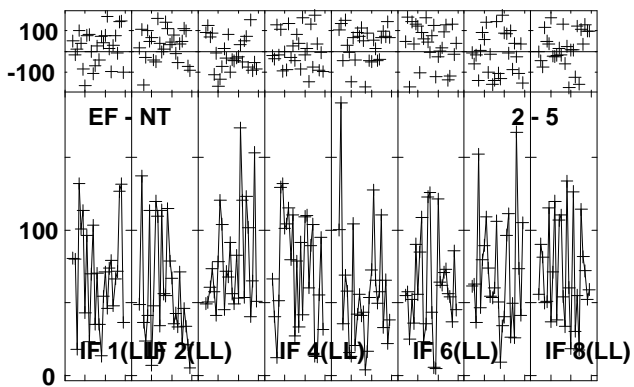
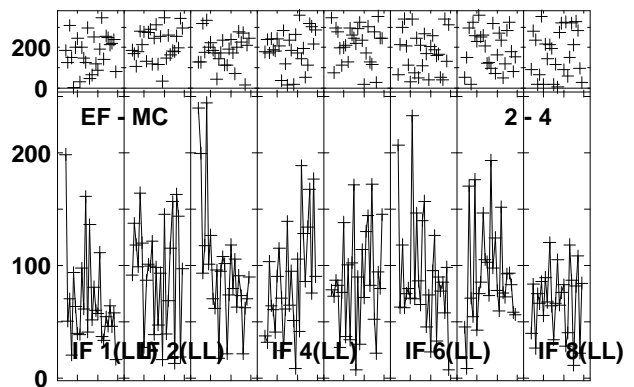
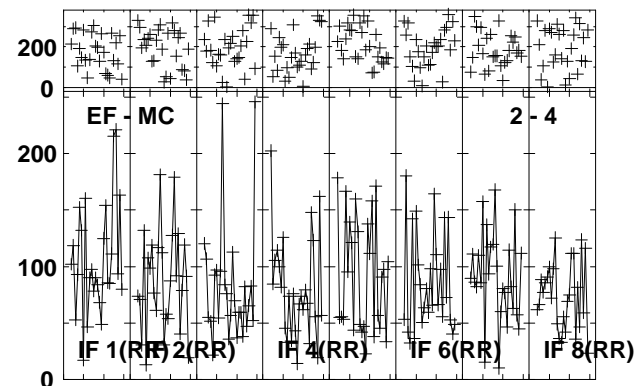
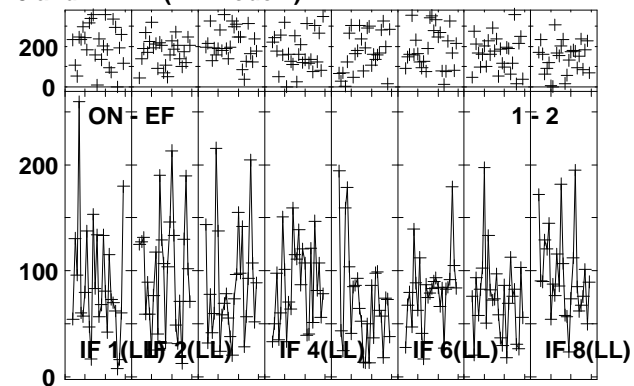
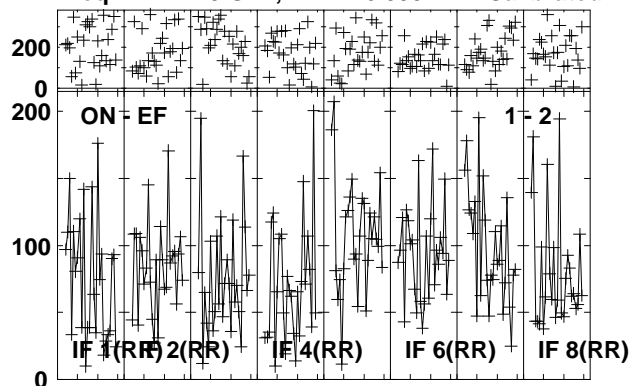

Lower frame: Milli Ampl Jy Top frame: Phas deg
 Vector averaged cross-power spectrum Several baselines displayed
 Timerange: 00/19:28:35 to 00/19:30:33

Plot file version 52 created 26-JUL-2013 10:18:23
 B1152+199A EZ024 1.UVDATA.1
 Freq = 22.1720 GHz, Bw = 16.000 MH Calibrated with CL # 3 and BP # 1 (BP mode 1)

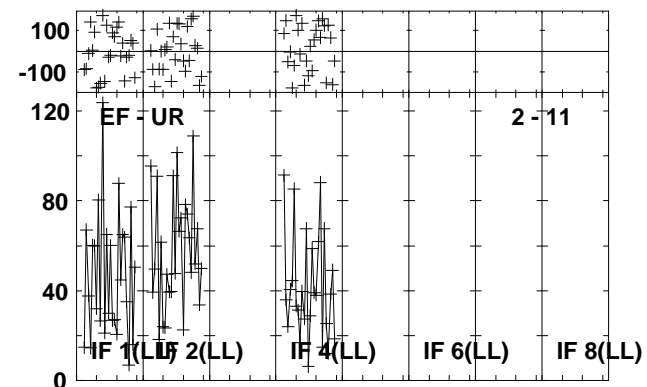
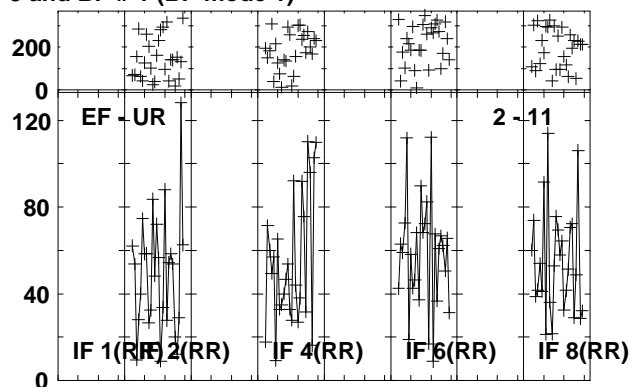
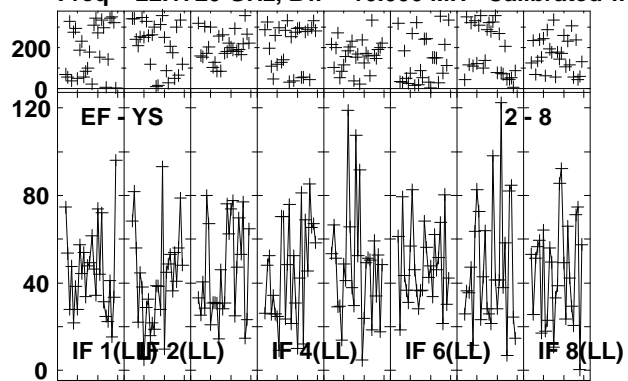

Lower frame: Milli Ampl Jy Top frame: Phas deg
 Vector averaged cross-power spectrum Several baselines displayed
 Timerange: 00/19:28:35 to 00/19:30:33

Plot file version 53 created 26-JUL-2013 10:18:25

J1157 EZ024 1.UVDATA.1

Freq = 22.1720 GHz, Bw = 16.000 MH Calibrated with CL # 3 and BP # 1 (BP mode 1)

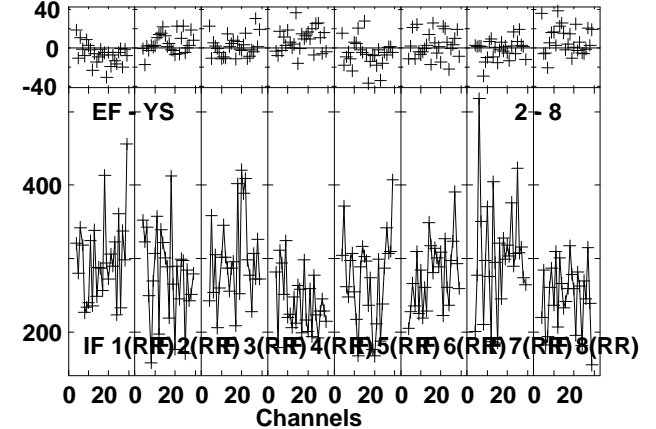
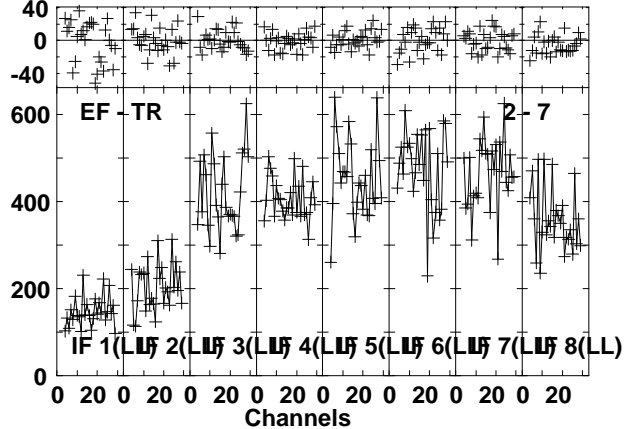
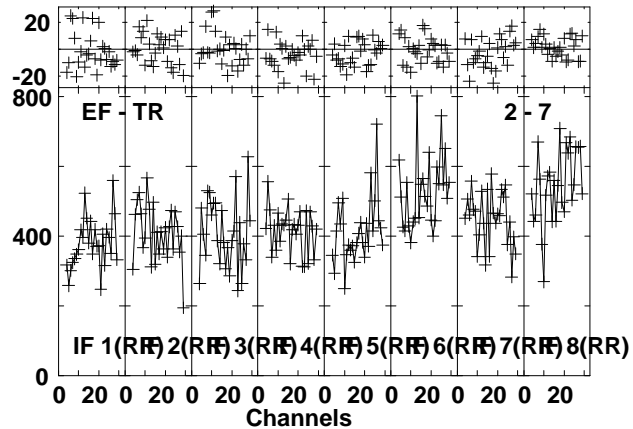
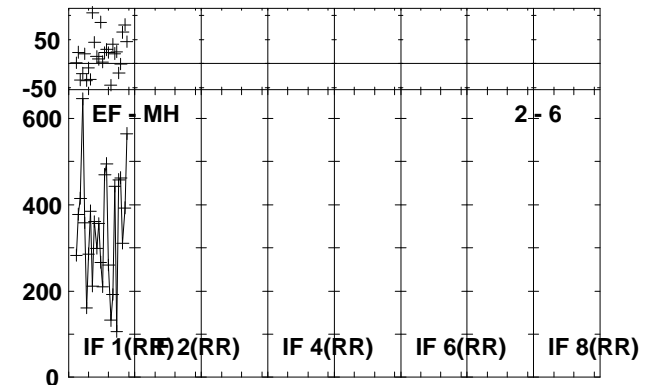
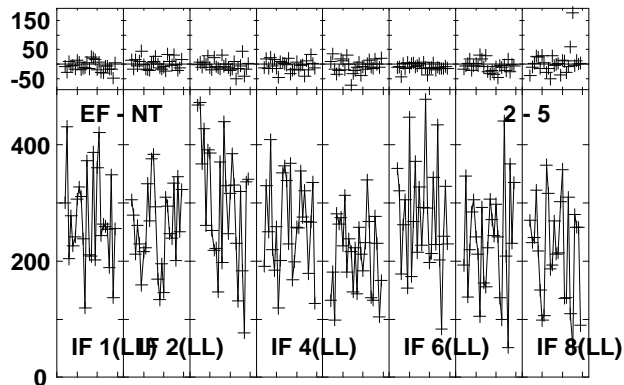
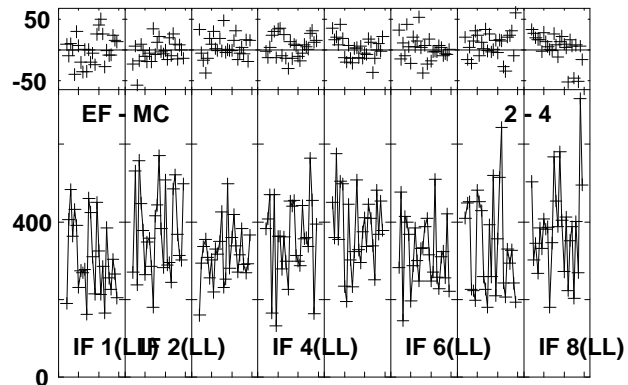
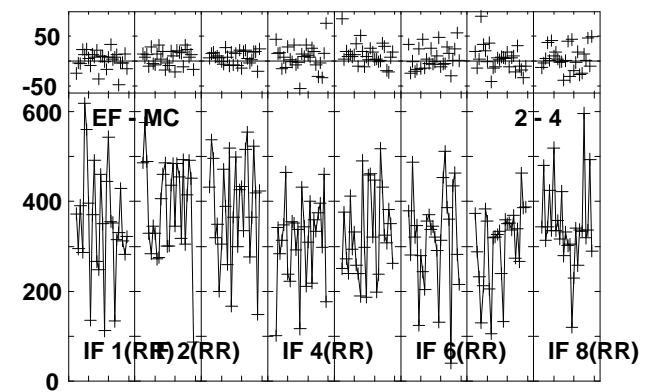
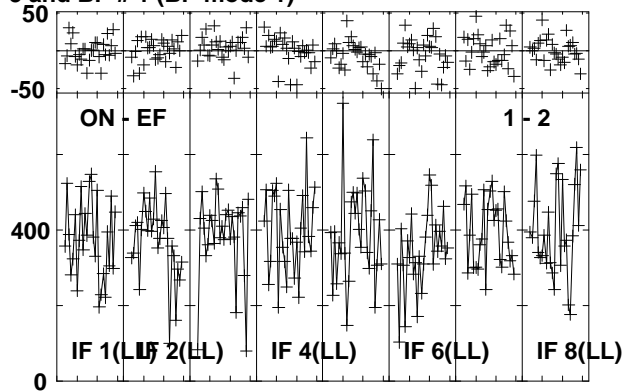
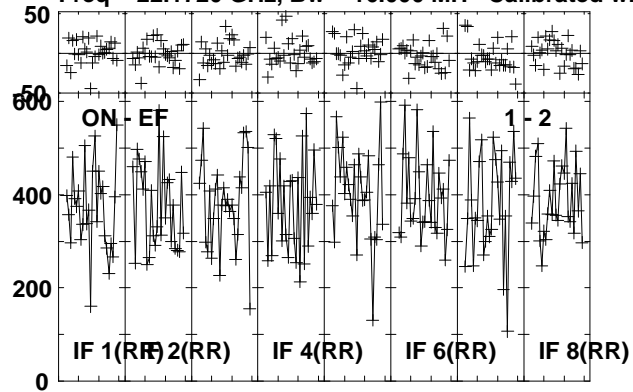

Lower frame: Milli Ampl Jy Top frame: Phas deg
Vector averaged cross-power spectrum Several baselines displayed
Timerange: 00/19:31:08 to 00/19:32:06

Plot file version 54 created 26-JUL-2013 10:18:25

J1157 EZ024 1.UVDATA.1

Freq = 22.1720 GHz, Bw = 16.000 MH Calibrated with CL # 3 and BP # 1 (BP mode 1)

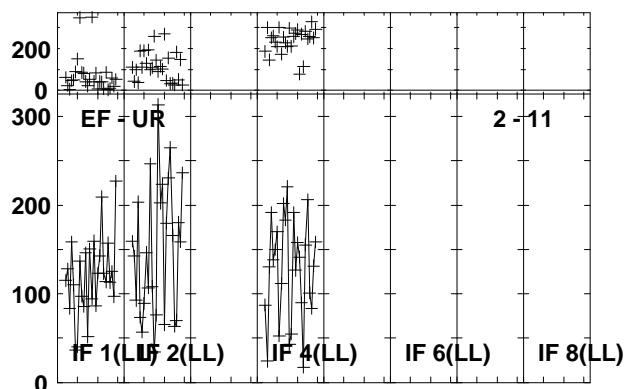
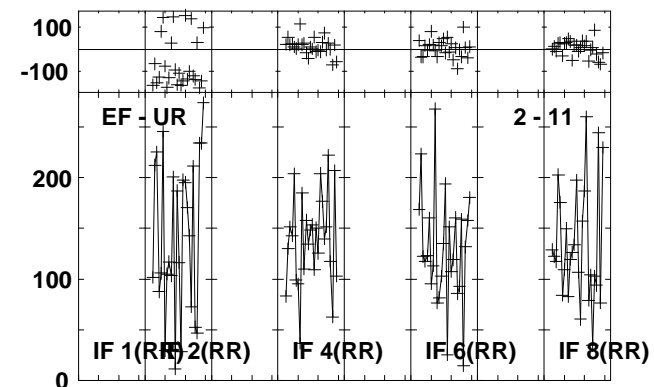
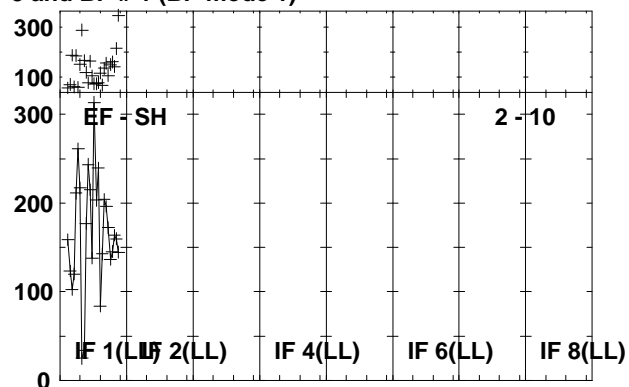
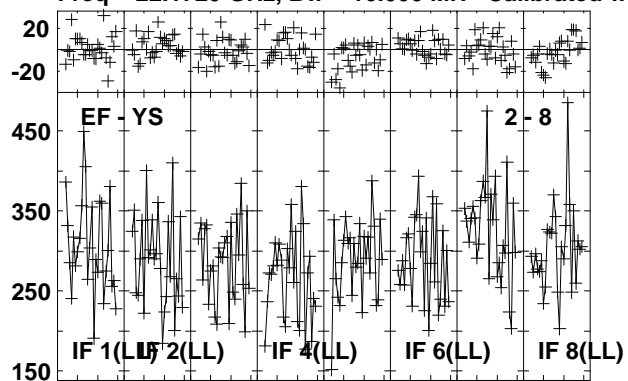

Lower frame: Milli Ampl Jy Top frame: Phas deg
Vector averaged cross-power spectrum Several baselines displayed
Timerange: 00/19:31:08 to 00/19:32:06

Plot file version 55 created 26-JUL-2013 10:18:26
 B1152+199A EZ24 1.UVDATA.1
 Freq = 22.1720 GHz, Bw = 16.000 MH Calibrated with CL # 3 and BP # 1 (BP mode 1)

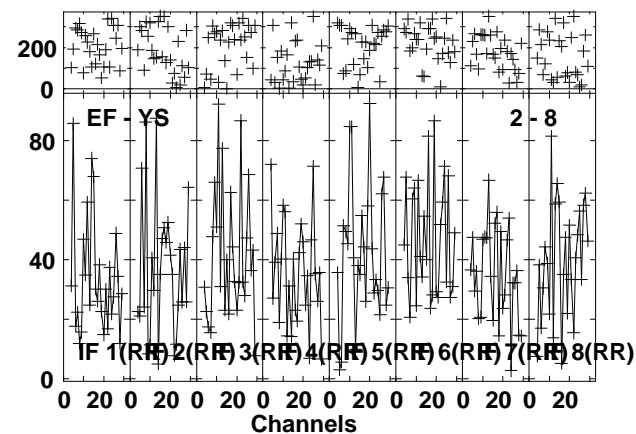
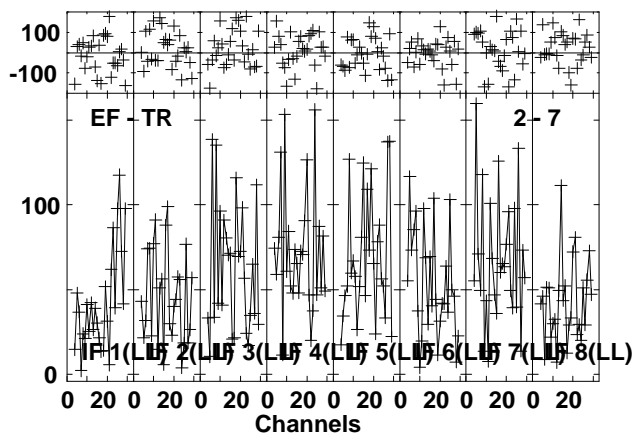
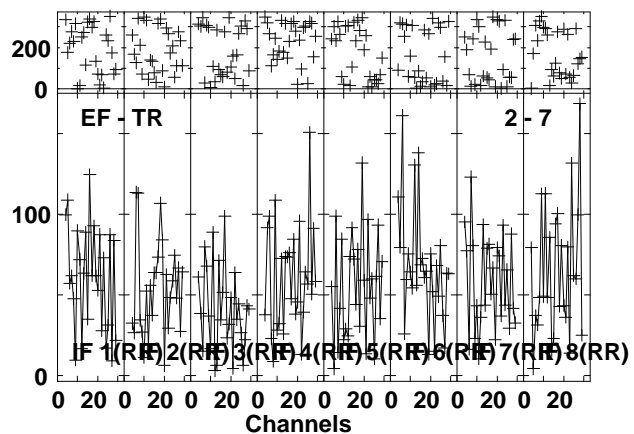
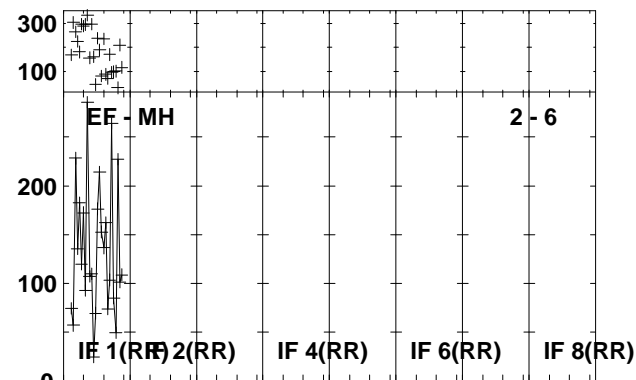
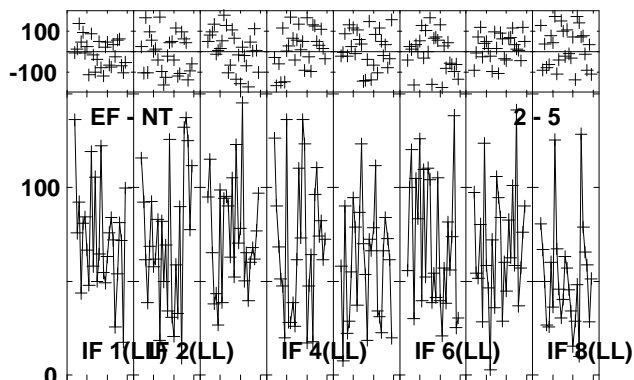
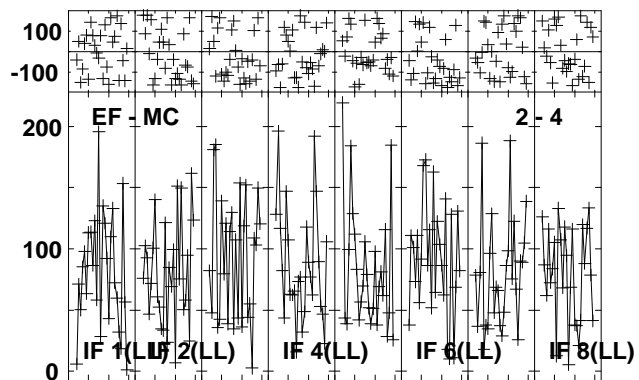
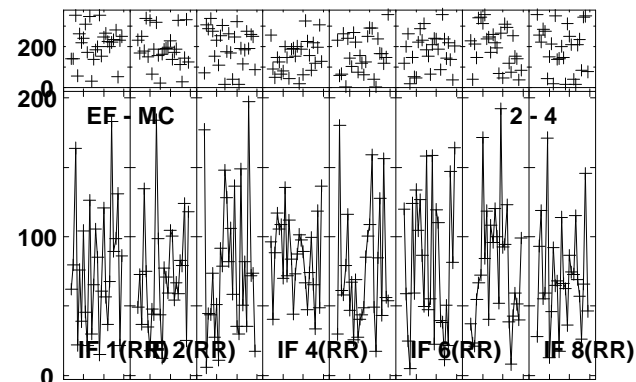
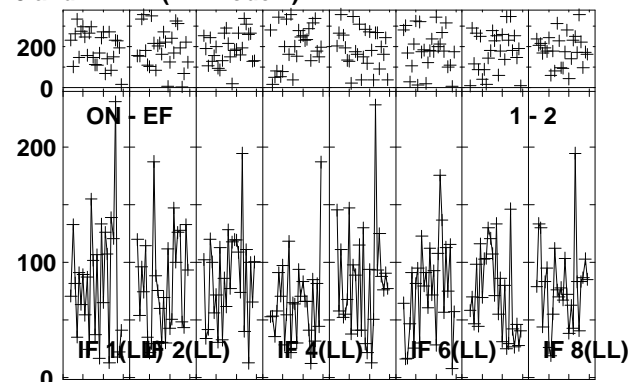
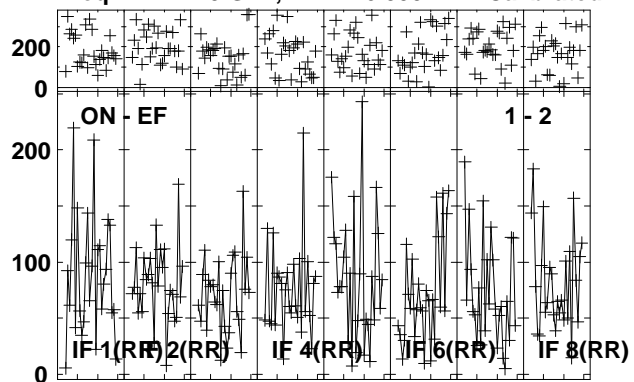

Lower frame: Milli Ampl Jy Top frame: Phas deg
 Vector averaged cross-power spectrum Several baselines displayed
 Timerange: 00/19:32:41 to 00/19:34:39

Plot file version 56 created 26-JUL-2013 10:18:27

B1152+199A EZ024 1.UVDATA.1

Freq = 22.1720 GHz, Bw = 16.000 MH Calibrated with CL # 3 and BP # 1 (BP mode 1)

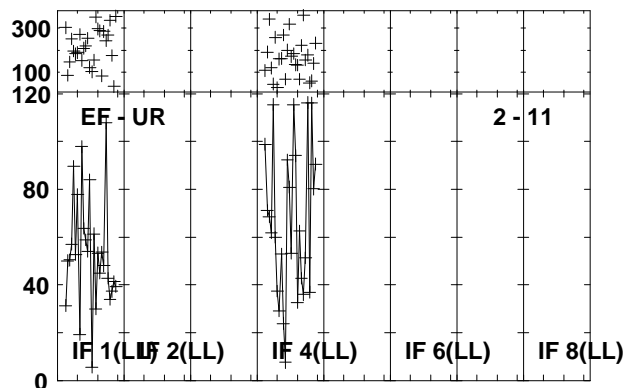
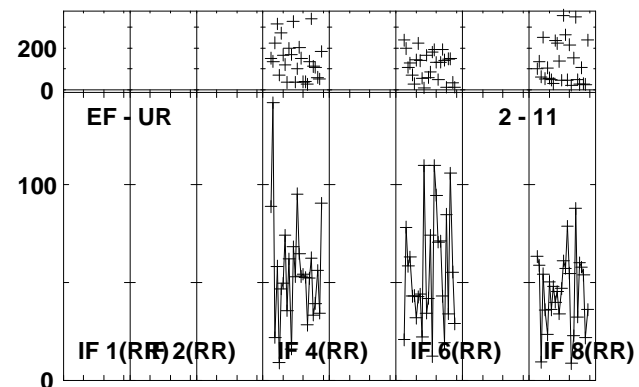
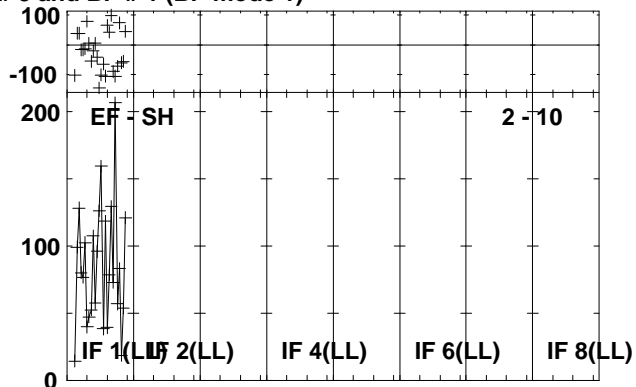
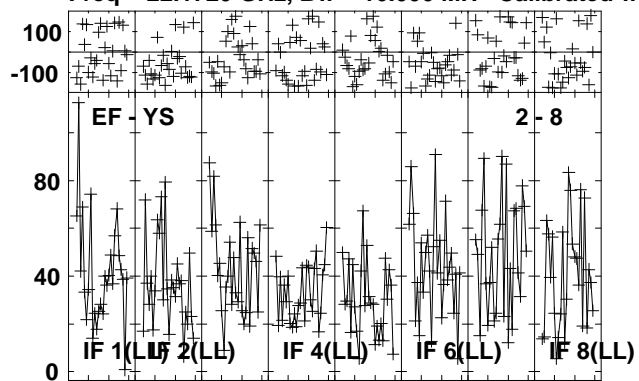

Lower frame: Milli Ampl Jy Top frame: Phas deg
Vector averaged cross-power spectrum Several baselines displayed
Timerange: 00/19:32:41 to 00/19:34:39

Plot file version 57 created 26-JUL-2013 10:18:29

J1157 EZ024 1.UVDATA.1

Freq = 22.1720 GHz, Bw = 16.000 MH Calibrated with CL # 3 and BP # 1 (BP mode 1)

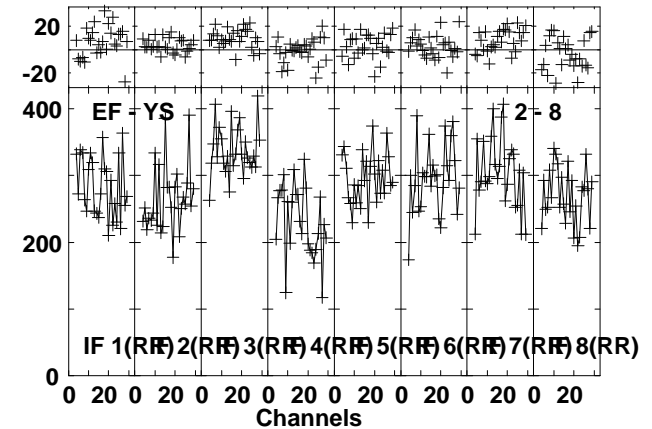
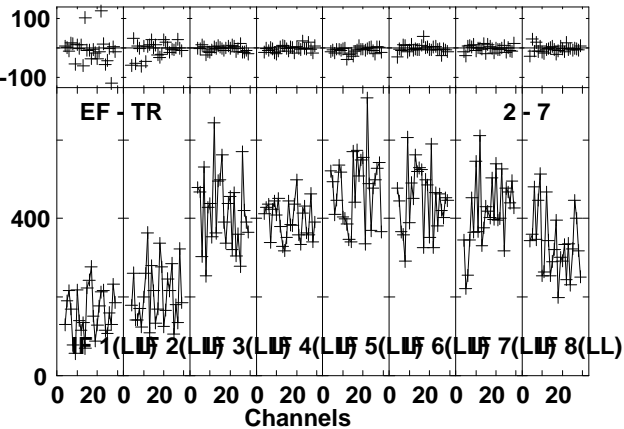
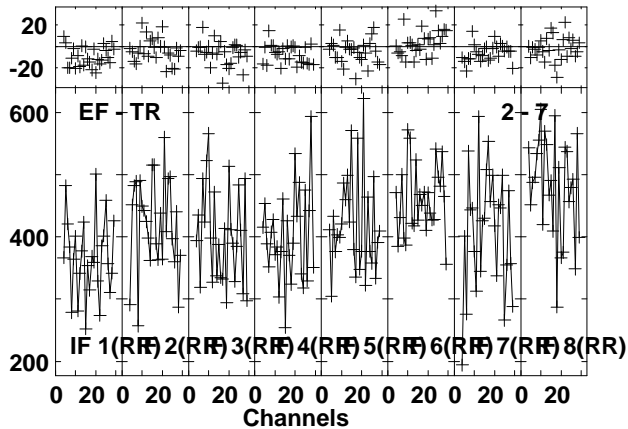
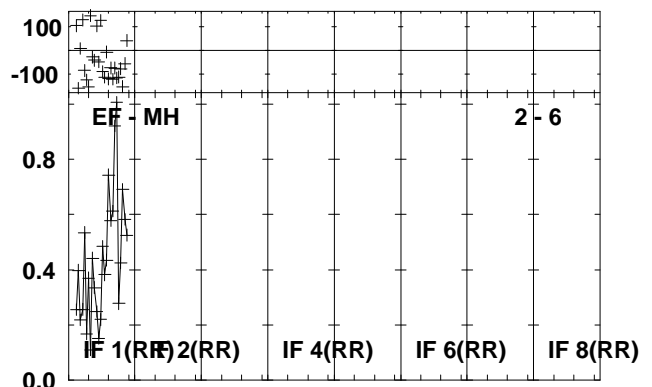
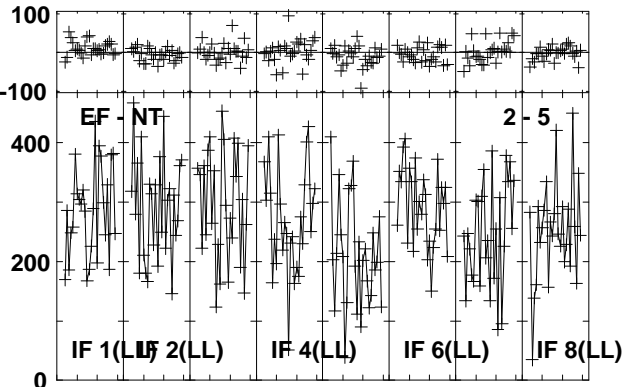
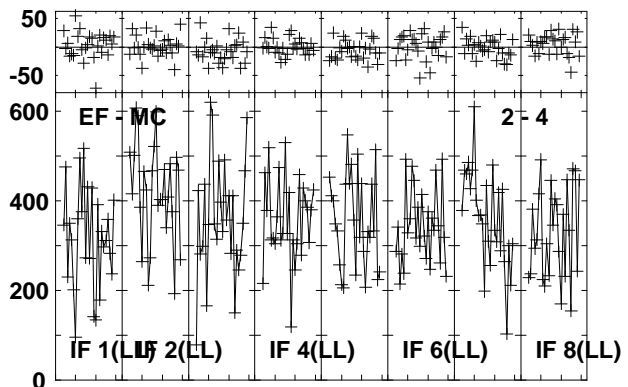
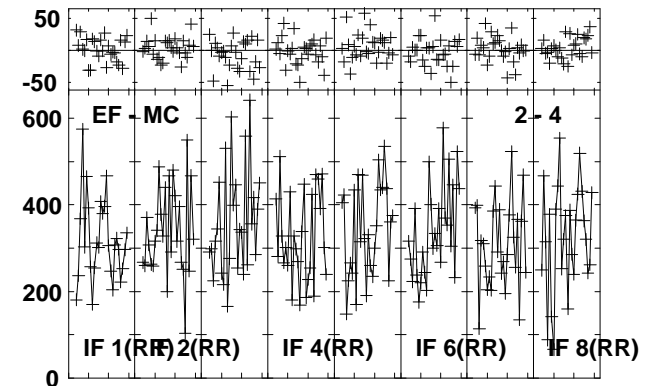
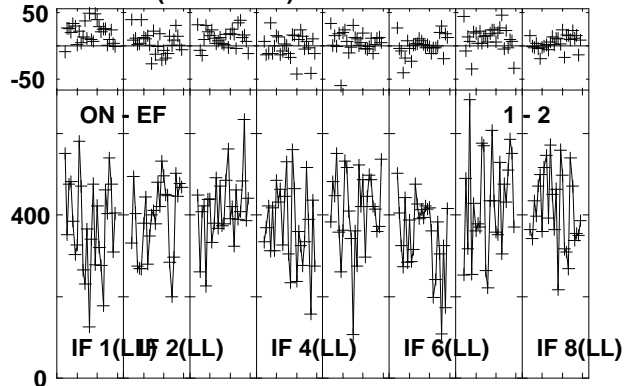
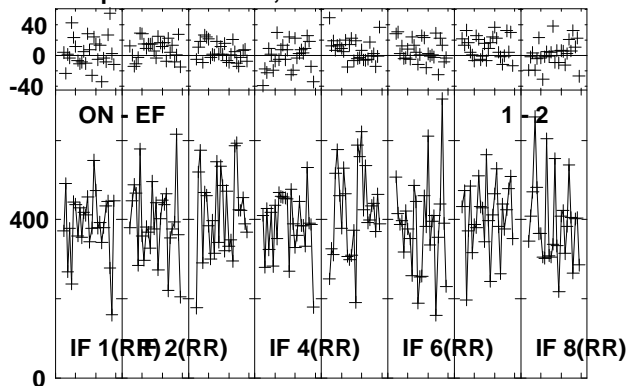

Lower frame: Milli Ampl Jy Top frame: Phas deg
Vector averaged cross-power spectrum Several baselines displayed
Timerange: 00/19:35:14 to 00/19:36:12

Plot file version 58 created 26-JUL-2013 10:18:29
 J1157 EZ024 1.UVDATA.1
 Freq = 22.1720 GHz, Bw = 16.000 MH Calibrated with CL # 3 and BP # 1 (BP mode 1)

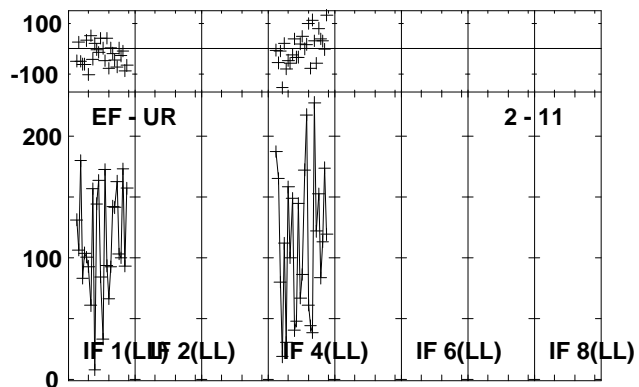
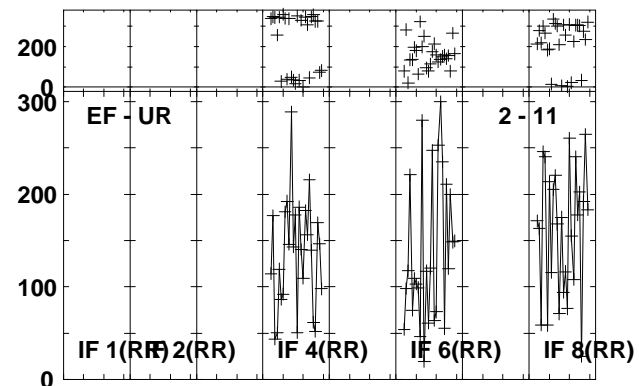
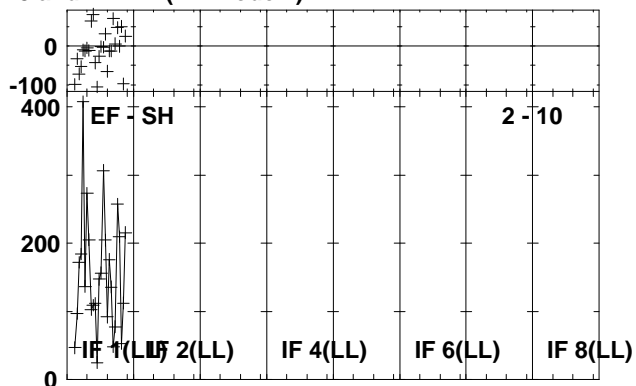
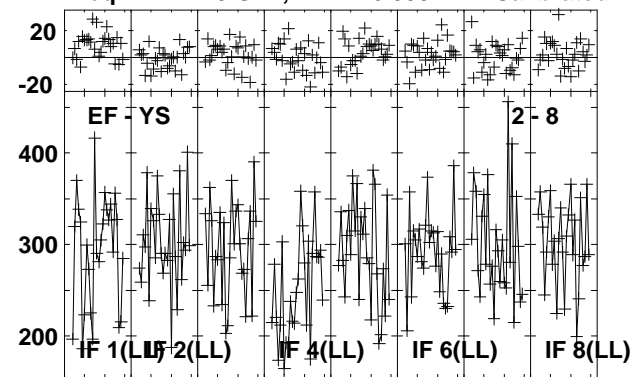

Lower frame: Milli Ampl Jy Top frame: Phas deg
 Vector averaged cross-power spectrum Several baselines displayed
 Timerange: 00/19:35:14 to 00/19:36:12

Plot file version 59 created 26-JUL-2013 10:18:30
 B1152+199A EZ024 1.UVDATA.1
 Freq = 22.1720 GHz, Bw = 16.000 MH Calibrated with CL # 3 and BP # 1 (BP mode 1)

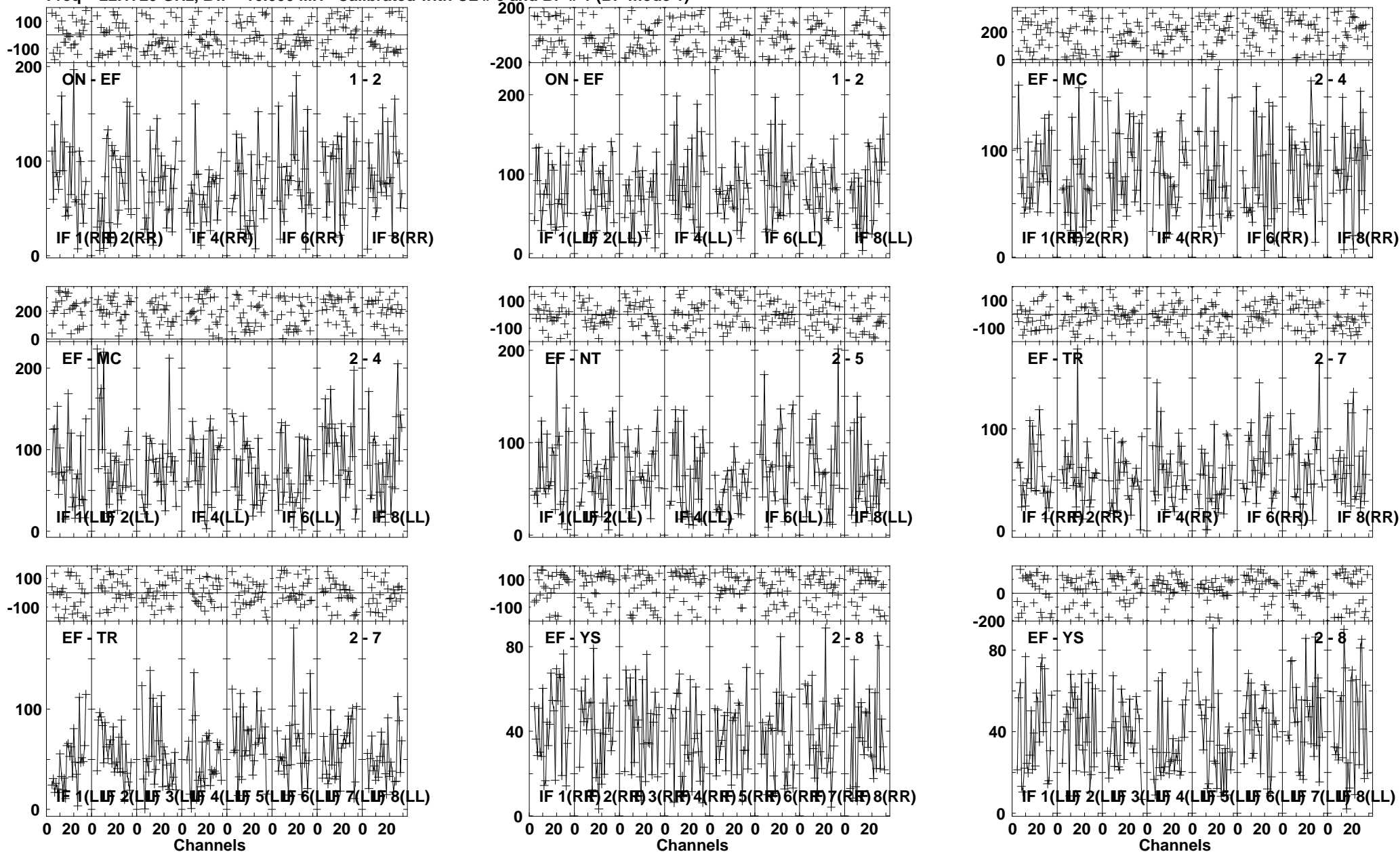

Lower frame: Milli Ampl Jy Top frame: Phas deg
 Vector averaged cross-power spectrum Several baselines displayed
 Timerange: 00/19:36:47 to 00/19:38:45

Plot file version 60 created 26-JUL-2013 10:18:32

B1152+199A EZ024 1.UVDATA.1

Freq = 22.1720 GHz, Bw = 16.000 MH Calibrated with CL # 3 and BP # 1 (BP mode 1)

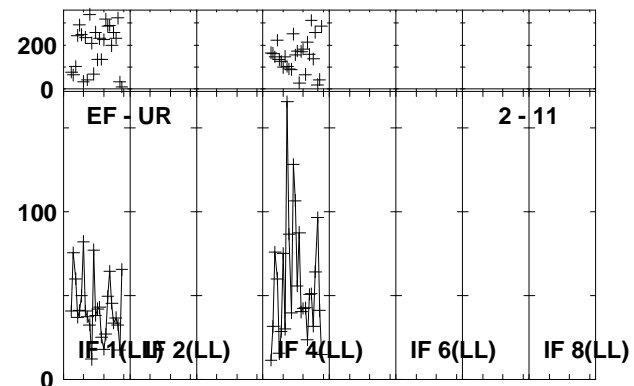
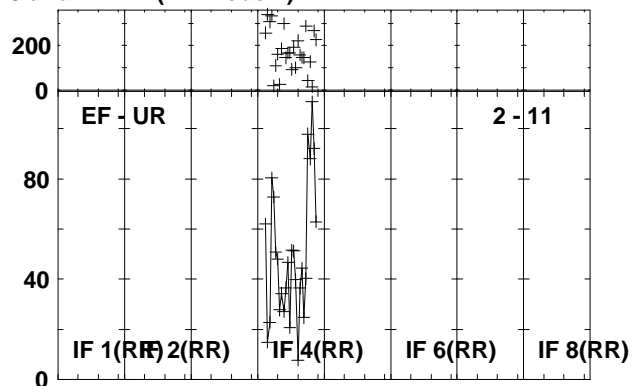
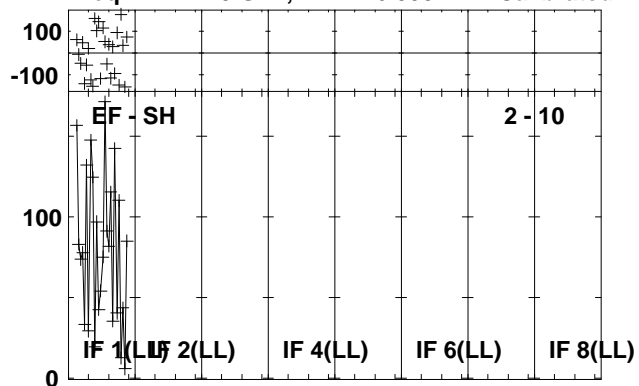

Lower frame: Milli Ampl Jy Top frame: Phas deg
Vector averaged cross-power spectrum Several baselines displayed
Timerange: 00/19:36:47 to 00/19:38:45

Plot file version 61 created 26-JUL-2013 10:18:33

J1125+2610 EZ024 1.UVDATA.1

Freq = 22.1720 GHz, Bw = 16.000 MH Calibrated with CL # 3 and BP # 1 (BP mode 1)

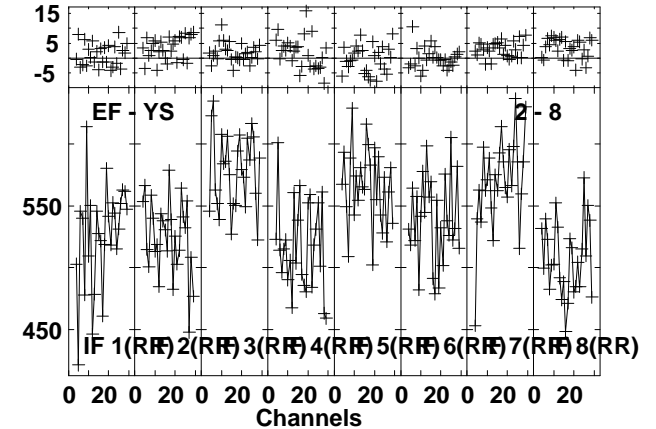
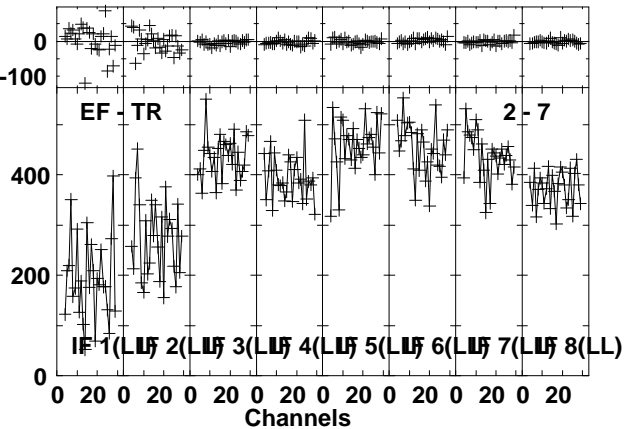
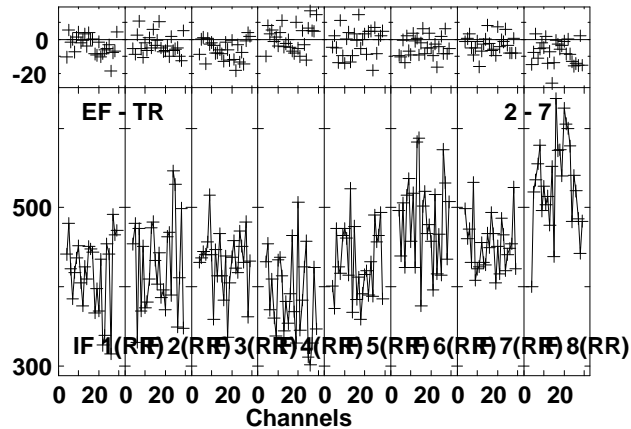
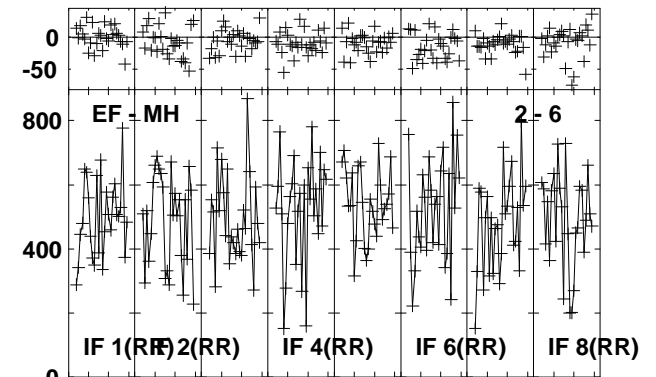
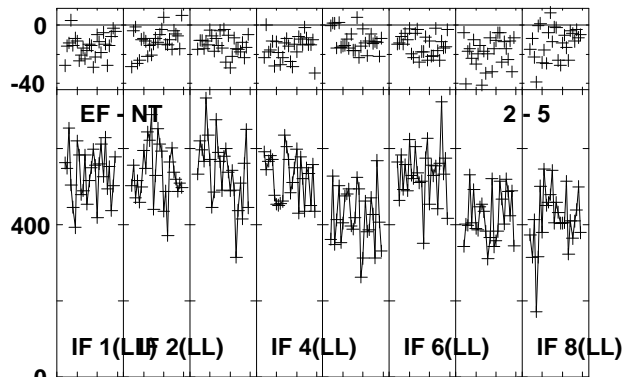
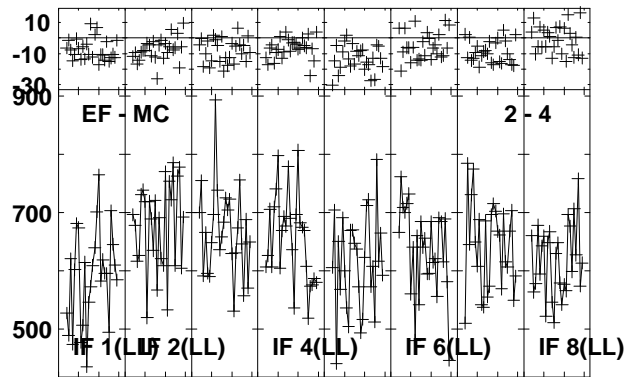
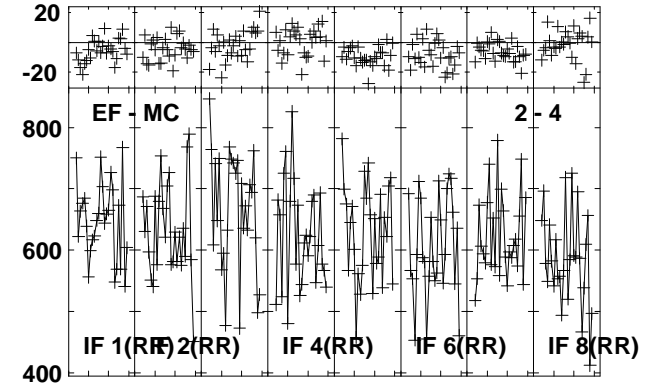
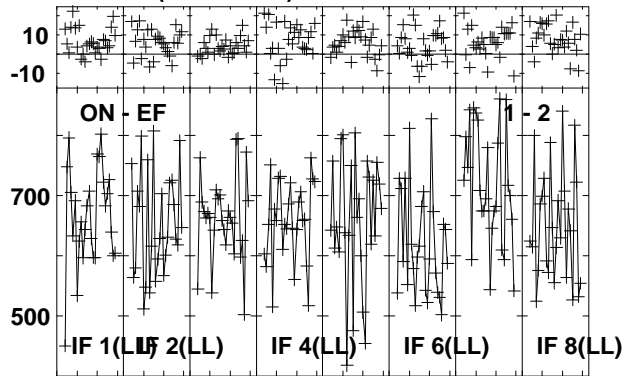
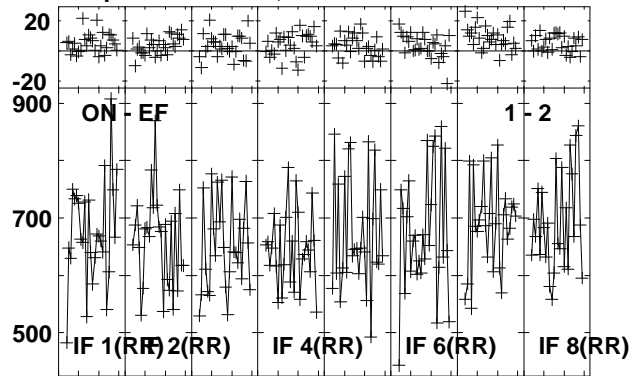

Lower frame: Milli Ampl Jy Top frame: Phas deg
Vector averaged cross-power spectrum Several baselines displayed
Timerange: 00:19:40:01 to 00:19:41:13

Plot file version 62 created 26-JUL-2013 10:18:33
 J1125+2610 EZ024 1.UVDATA.1
 Freq = 22.1720 GHz, Bw = 16.000 MH Calibrated with CL # 3 and BP # 1 (BP mode 1)

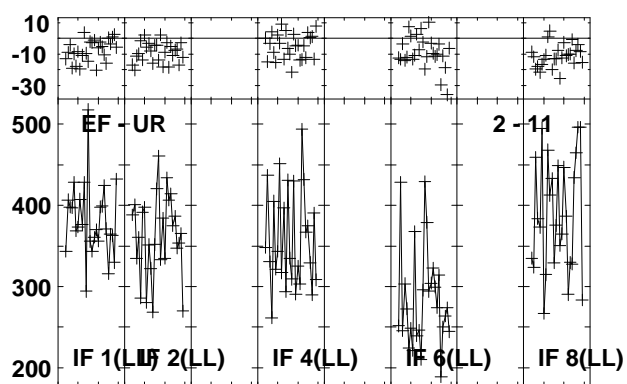
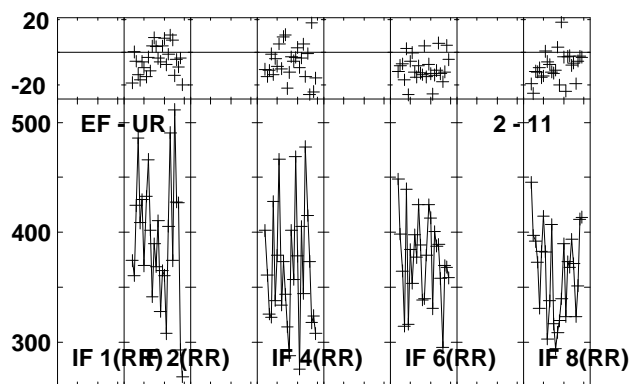
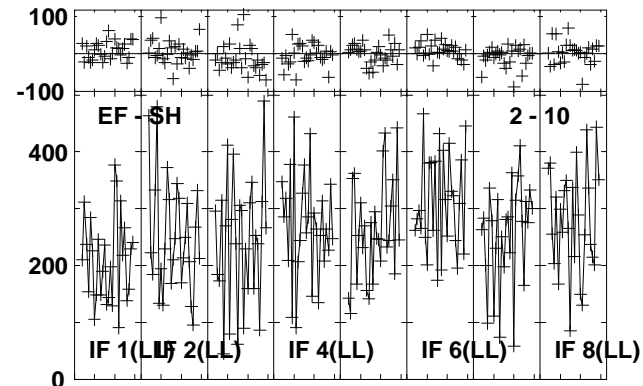
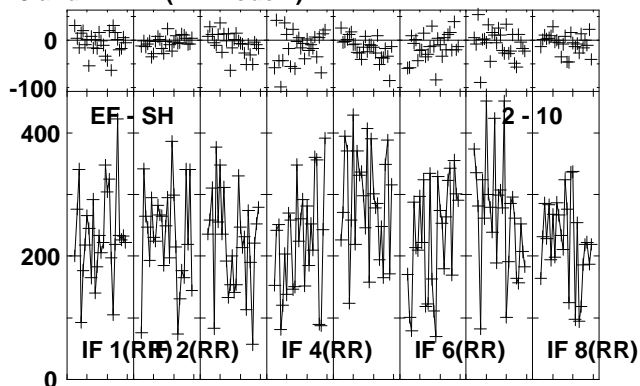
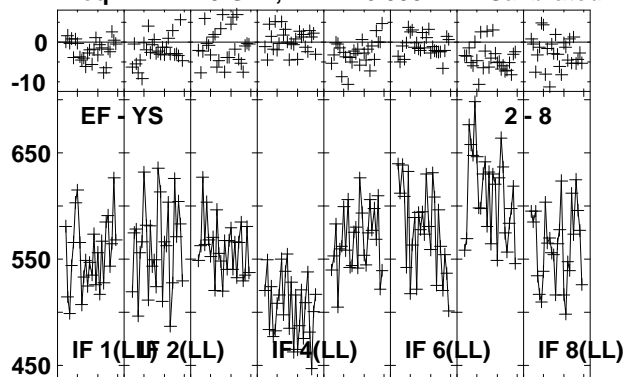

Lower frame: Milli Ampl Jy Top frame: Phas deg
 Vector averaged cross-power spectrum Several baselines displayed
 Timerange: 00/19:40:01 to 00/19:41:13

Plot file version 63 created 26-JUL-2013 10:18:34

J1157 EZ024 1.UVDATA.1

Freq = 22.1720 GHz, Bw = 16.000 MH Calibrated with CL # 3 and BP # 1 (BP mode 1)

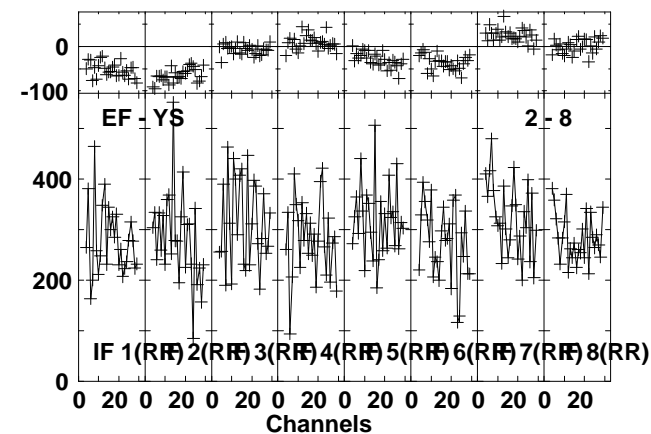
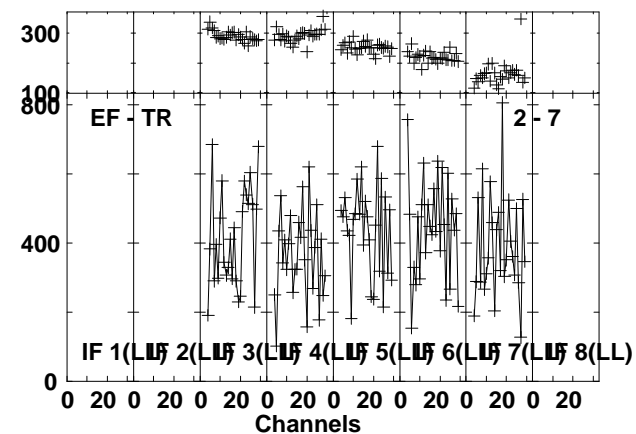
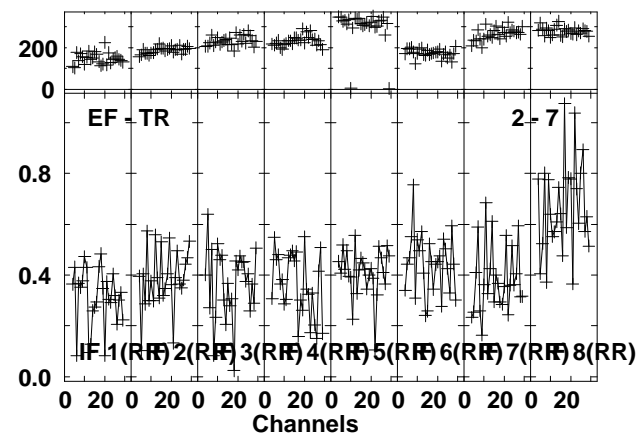
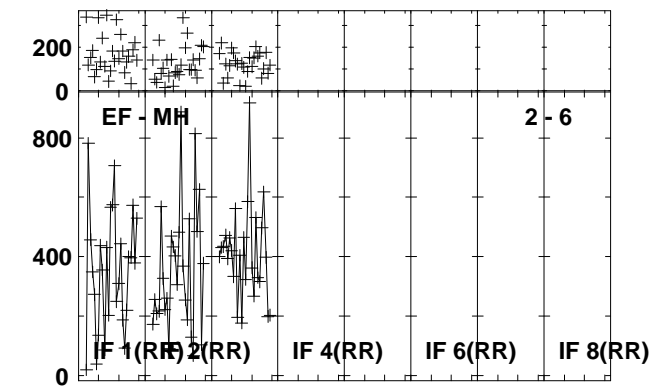
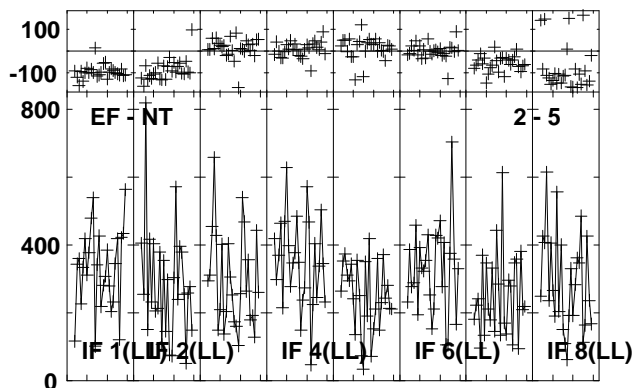
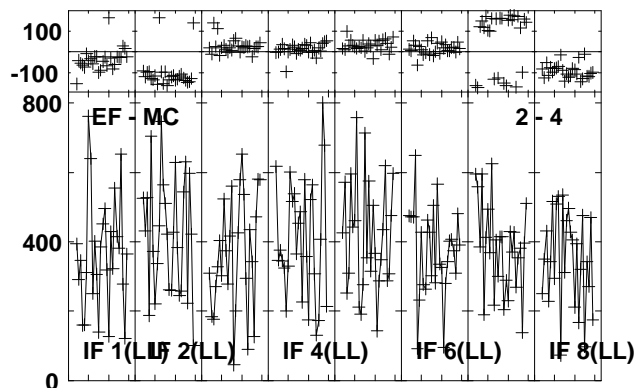
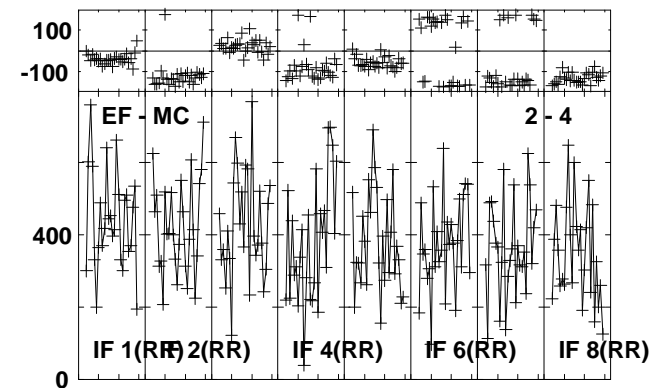
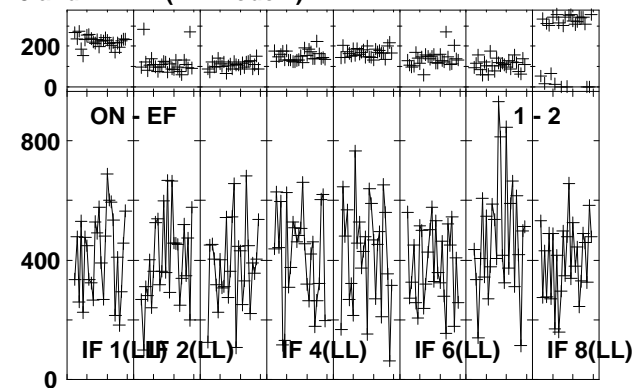
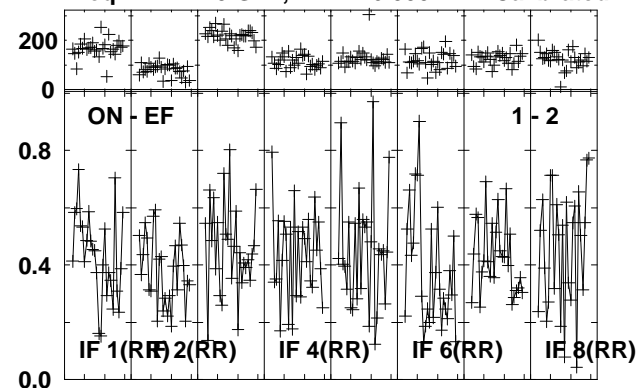

Lower frame: Ampl Jy Top frame: Phas deg
Vector averaged cross-power spectrum Several baselines displayed
Timerange: 00/19:42:40 to 00/19:43:22

Plot file version 64 created 26-JUL-2013 10:18:35
 J1157 EZ024 1.UVDATA.1
 Freq = 22.1720 GHz, Bw = 16.000 MH Calibrated with CL # 3 and BP # 1 (BP mode 1)

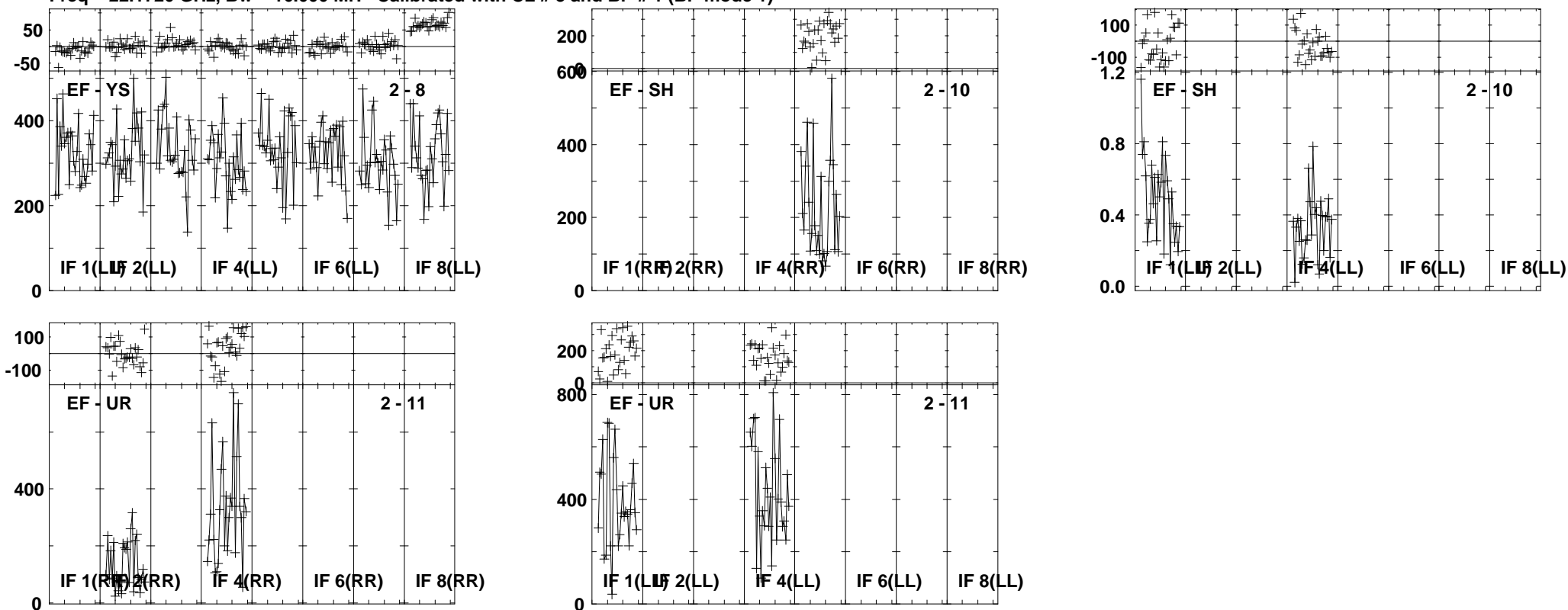

Lower frame: Milli Ampl Jy Top frame: Phas deg
 Vector averaged cross-power spectrum Several baselines displayed
 Timerange: 00:19:42:40 to 00:19:43:22

Plot file version 65 created 26-JUL-2013 10:18:35
 B1152+199A EZ024 1.UVDATA.1
 Freq = 22.1720 GHz, Bw = 16.000 MH Calibrated with CL # 3 and BP # 1 (BP mode 1)

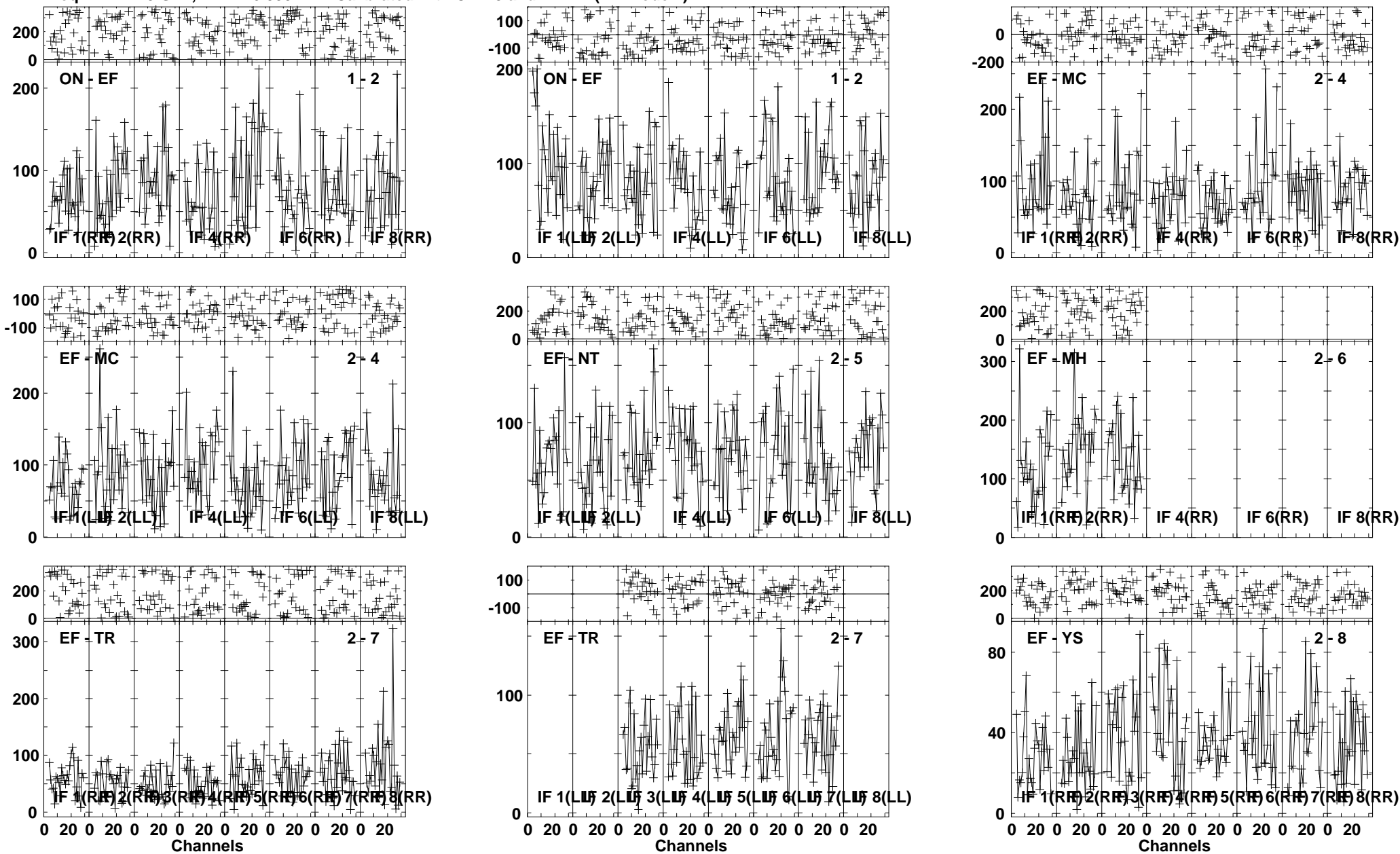

Lower frame: Milli Ampl Jy Top frame: Phas deg
 Vector averaged cross-power spectrum Several baselines displayed
 Timerange: 00/19:43:58 to 00/19:45:56

Plot file version 66 created 26-JUL-2013 10:18:37
 B1152+199A EZ024 1.UVDATA.1
 Freq = 22.1720 GHz, Bw = 16.000 MH Calibrated with CL # 3 and BP # 1 (BP mode 1)

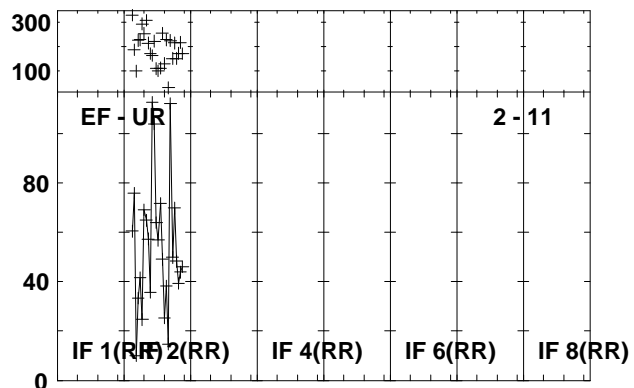
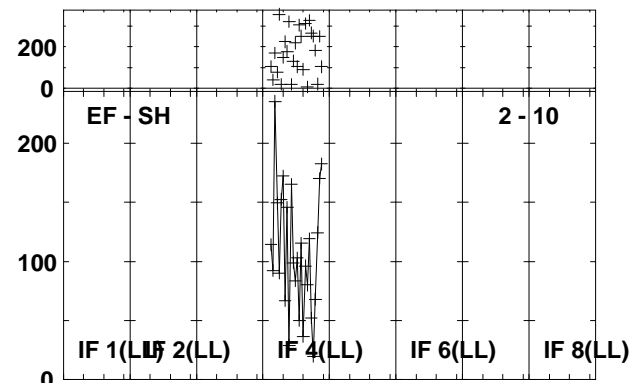
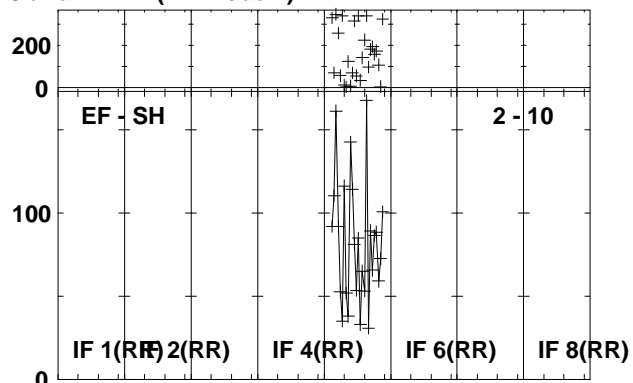
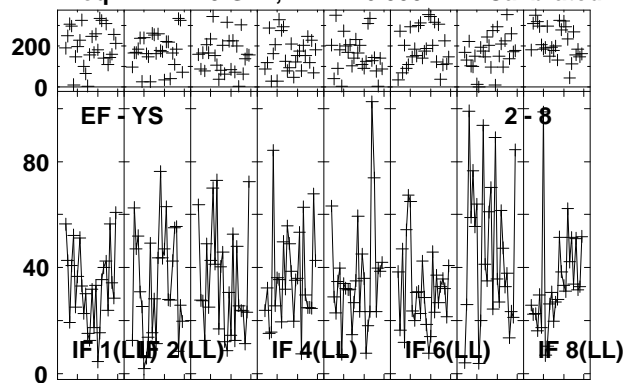

Lower frame: Milli Ampl Jy Top frame: Phas deg
 Vector averaged cross-power spectrum Several baselines displayed
 Timerange: 00/19:43:58 to 00/19:45:56

Plot file version 67 created 26-JUL-2013 10:18:38

J1157 EZ024 1.UVDATA.1

Freq = 22.1720 GHz, Bw = 16.000 MH Calibrated with CL # 3 and BP # 1 (BP mode 1)

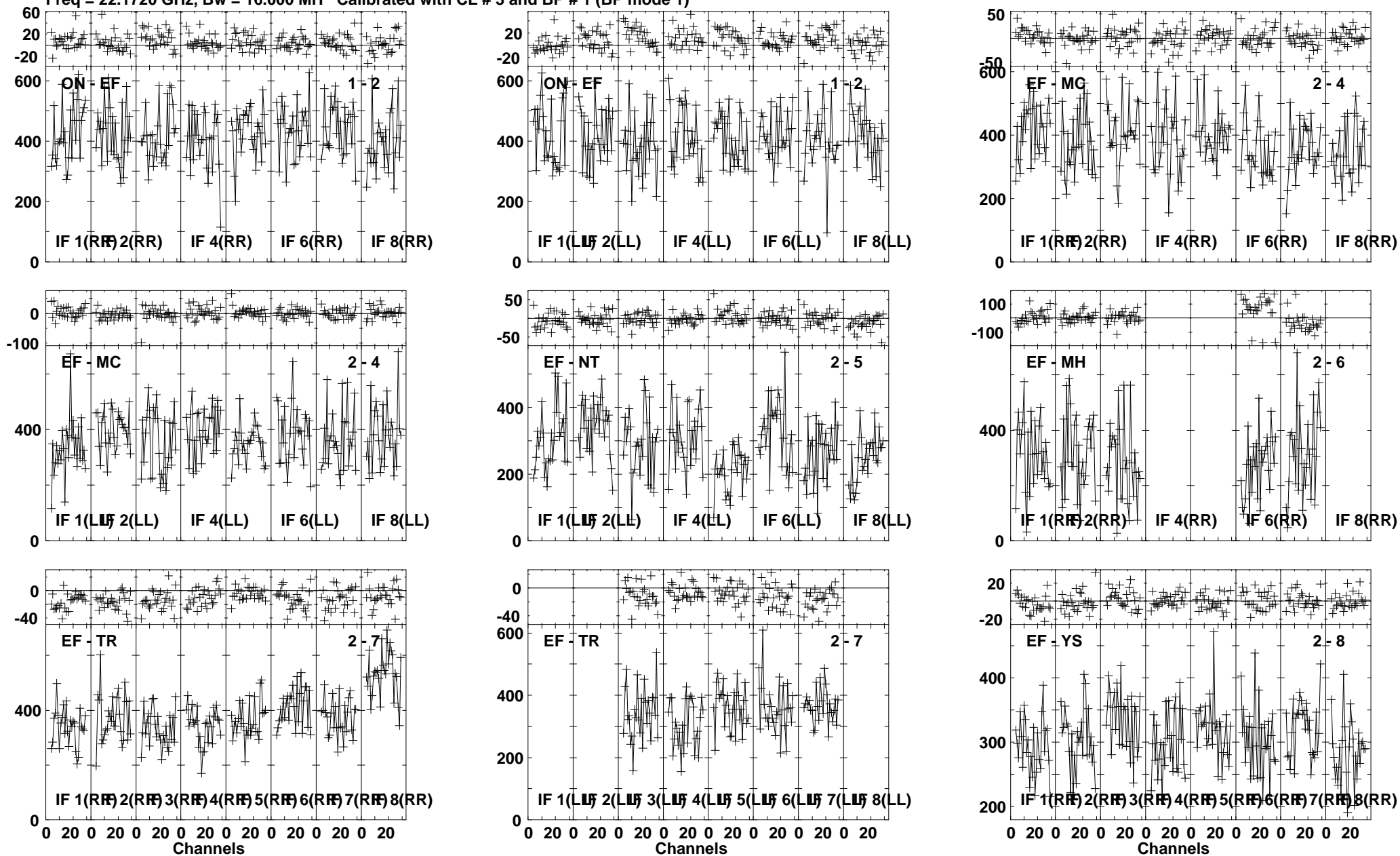

Lower frame: Milli Ampl Jy Top frame: Phas deg
Vector averaged cross-power spectrum Several baselines displayed
Timerange: 00:19:46:31 to 00:19:47:29

Plot file version 68 created 26-JUL-2013 10:18:39

J1157 EZ024 1.UVDATA.1

Freq = 22.1720 GHz, Bw = 16.000 MH Calibrated with CL # 3 and BP # 1 (BP mode 1)

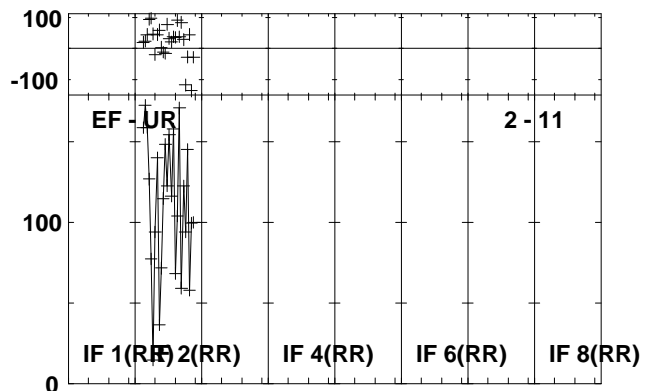
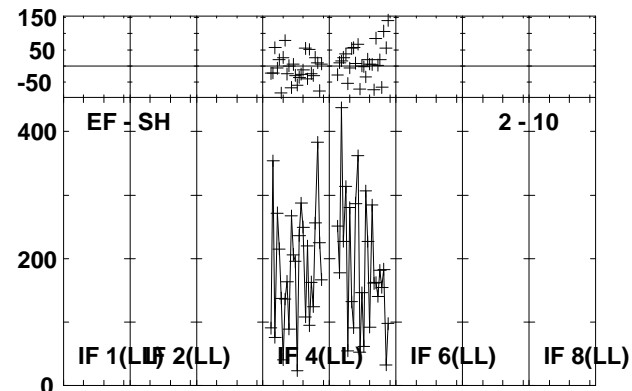
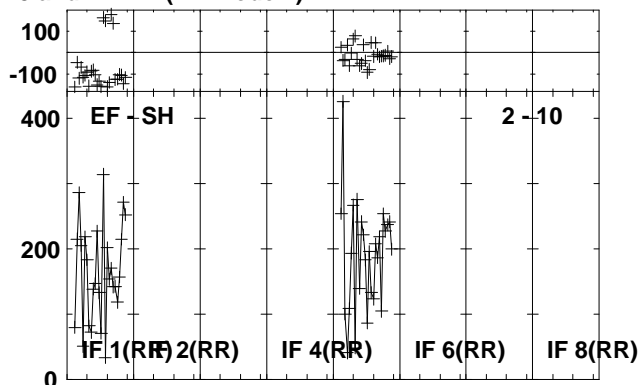
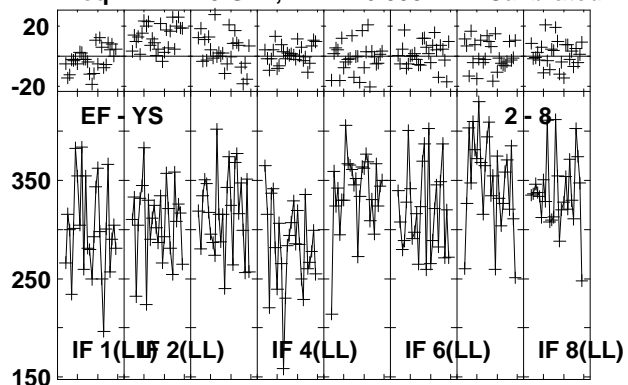

Lower frame: Milli Ampl Jy Top frame: Phas deg
Vector averaged cross-power spectrum Several baselines displayed
Timerange: 00/19:46:31 to 00/19:47:29

Plot file version 69 created 26-JUL-2013 10:18:39
 B1152+199A EZ024 1.UVDATA.1
 Freq = 22.1720 GHz, Bw = 16.000 MH Calibrated with CL # 3 and BP # 1 (BP mode 1)

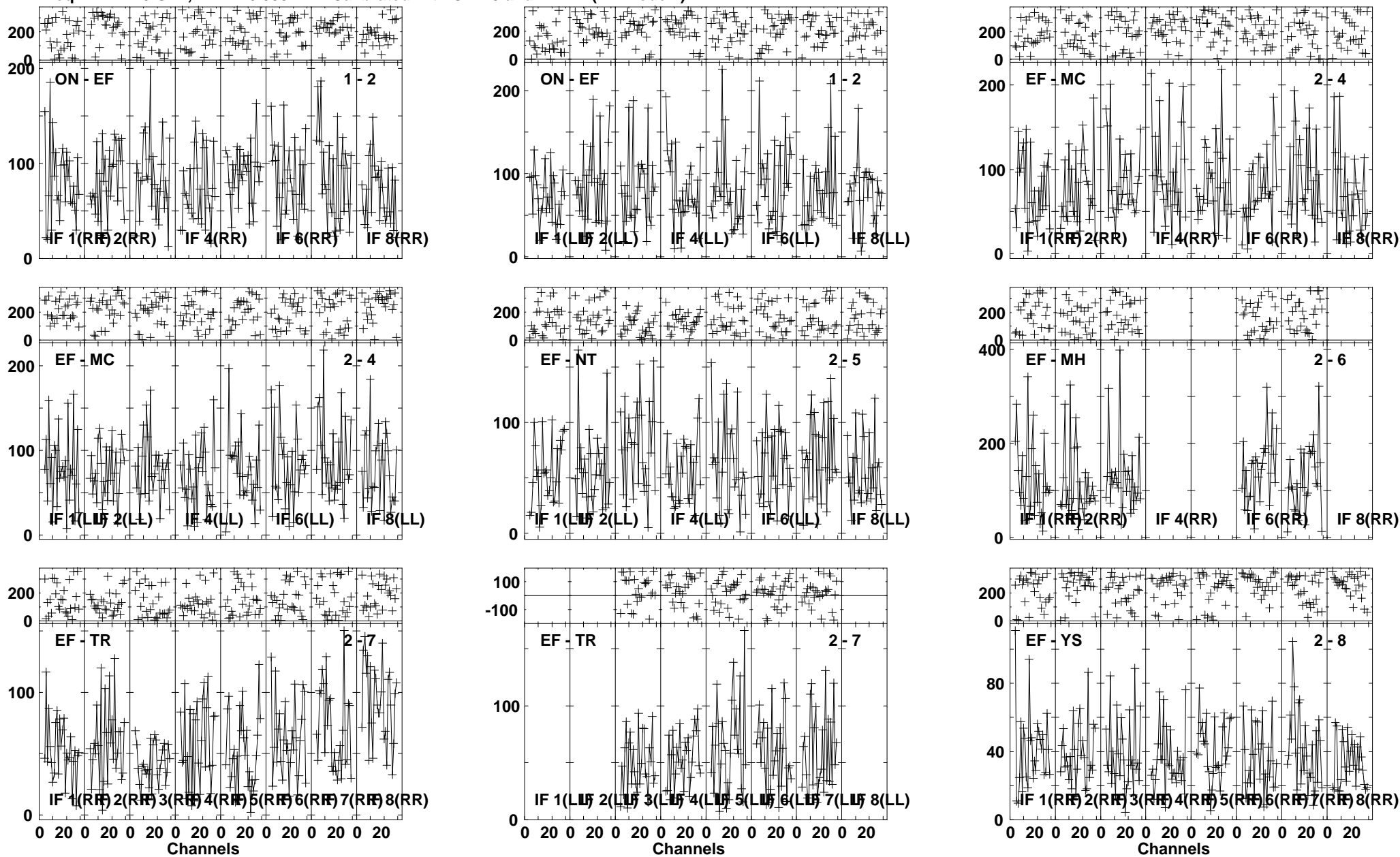

Lower frame: Milli Ampl Jy Top frame: Phas deg
 Vector averaged cross-power spectrum Several baselines displayed
 Timerange: 00/19:48:04 to 00/19:50:02

Plot file version 70 created 26-JUL-2013 10:18:41
 B1152+199A EZ024 1.UVDATA.1
 Freq = 22.1720 GHz, Bw = 16.000 MH Calibrated with CL # 3 and BP # 1 (BP mode 1)

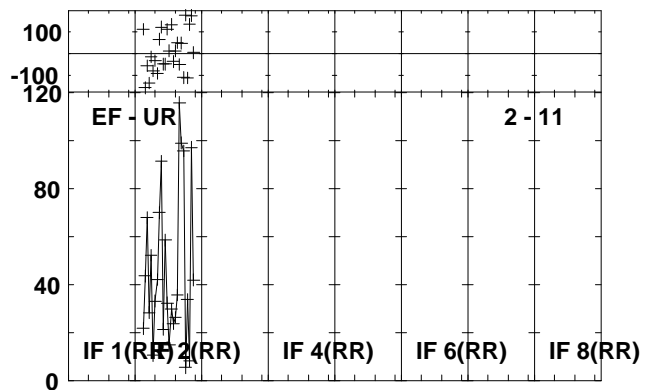
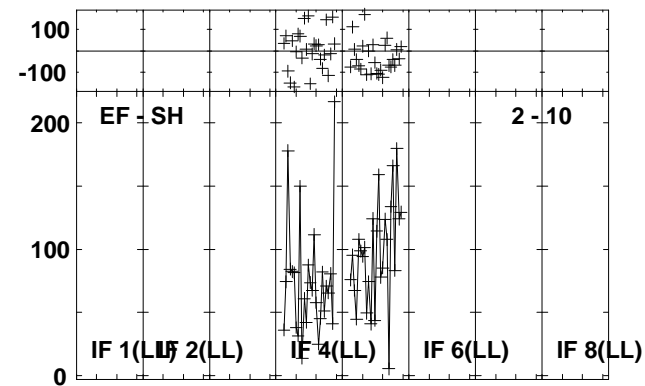
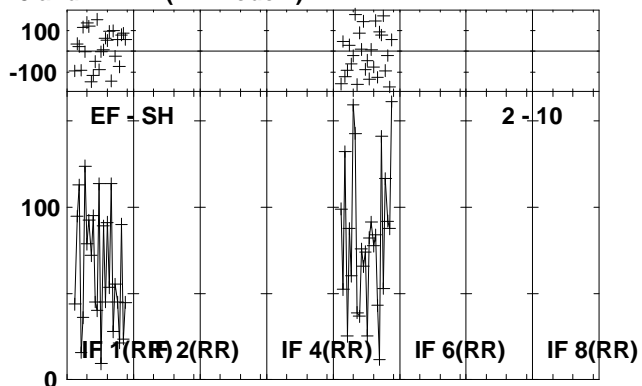
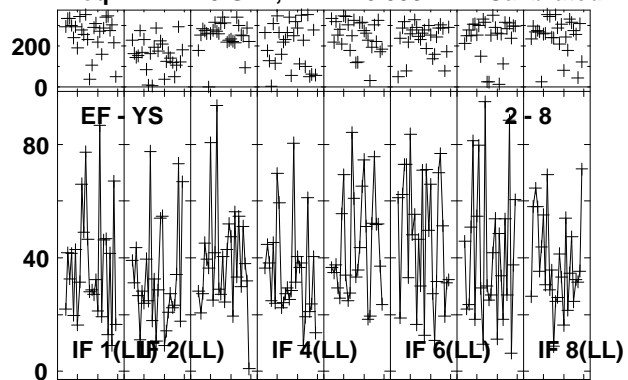

Lower frame: Milli Ampl Jy Top frame: Phas deg
 Vector averaged cross-power spectrum Several baselines displayed
 Timerange: 00/19:48:04 to 00/19:50:02

Plot file version 71 created 26-JUL-2013 10:18:42

J1157 EZ024 1.UVDATA.1

Freq = 22.1720 GHz, Bw = 16.000 MH Calibrated with CL # 3 and BP # 1 (BP mode 1)

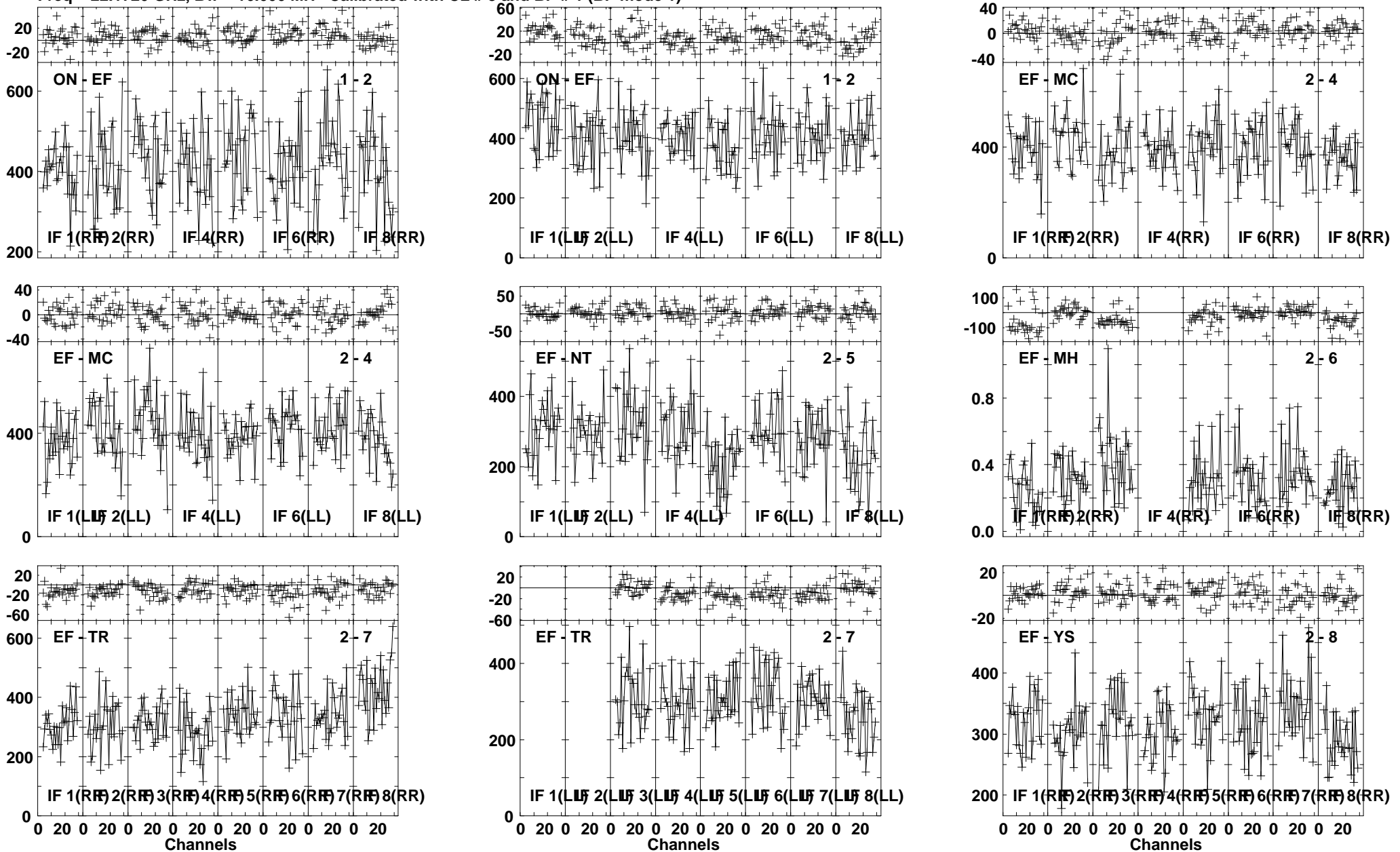

Lower frame: Milli Ampl Jy Top frame: Phas deg
Vector averaged cross-power spectrum Several baselines displayed
Timerange: 00:19:50:37 to 00:19:51:35

Plot file version 72 created 26-JUL-2013 10:18:43

J1157 EZ024 1.UVDATA.1

Freq = 22.1720 GHz, Bw = 16.000 MH Calibrated with CL # 3 and BP # 1 (BP mode 1)

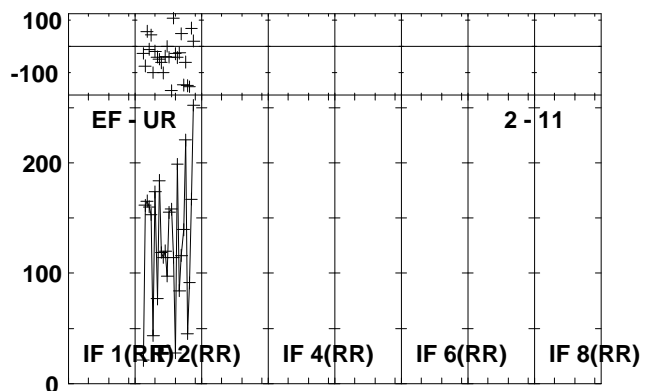
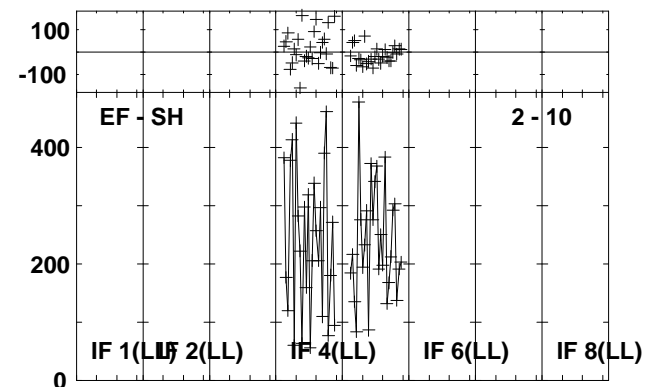
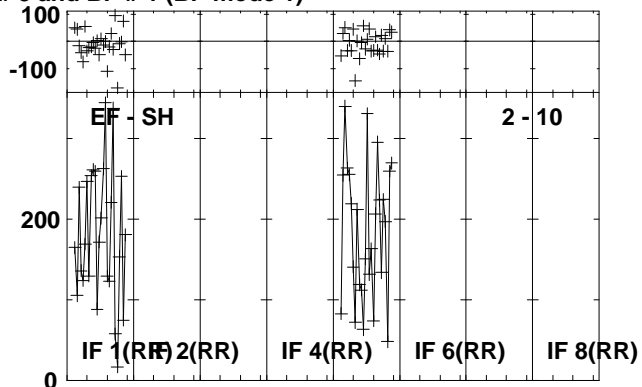
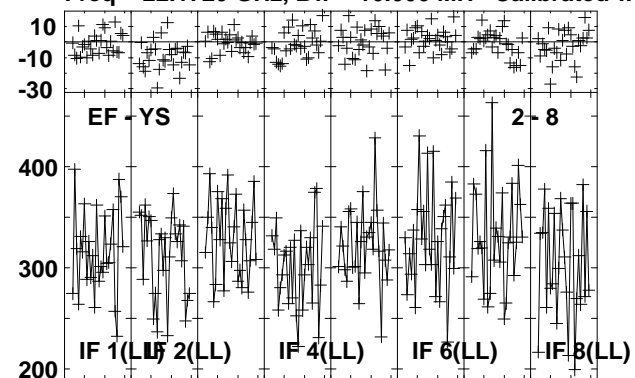

Lower frame: Milli Ampl Jy Top frame: Phas deg
Vector averaged cross-power spectrum Several baselines displayed
Timerange: 00/19:50:37 to 00/19:51:35

Plot file version 73 created 26-JUL-2013 10:18:43
 B1152+199A EZ024 1.UVDATA.1
 Freq = 22.1720 GHz, Bw = 16.000 MH Calibrated with CL # 3 and BP # 1 (BP mode 1)

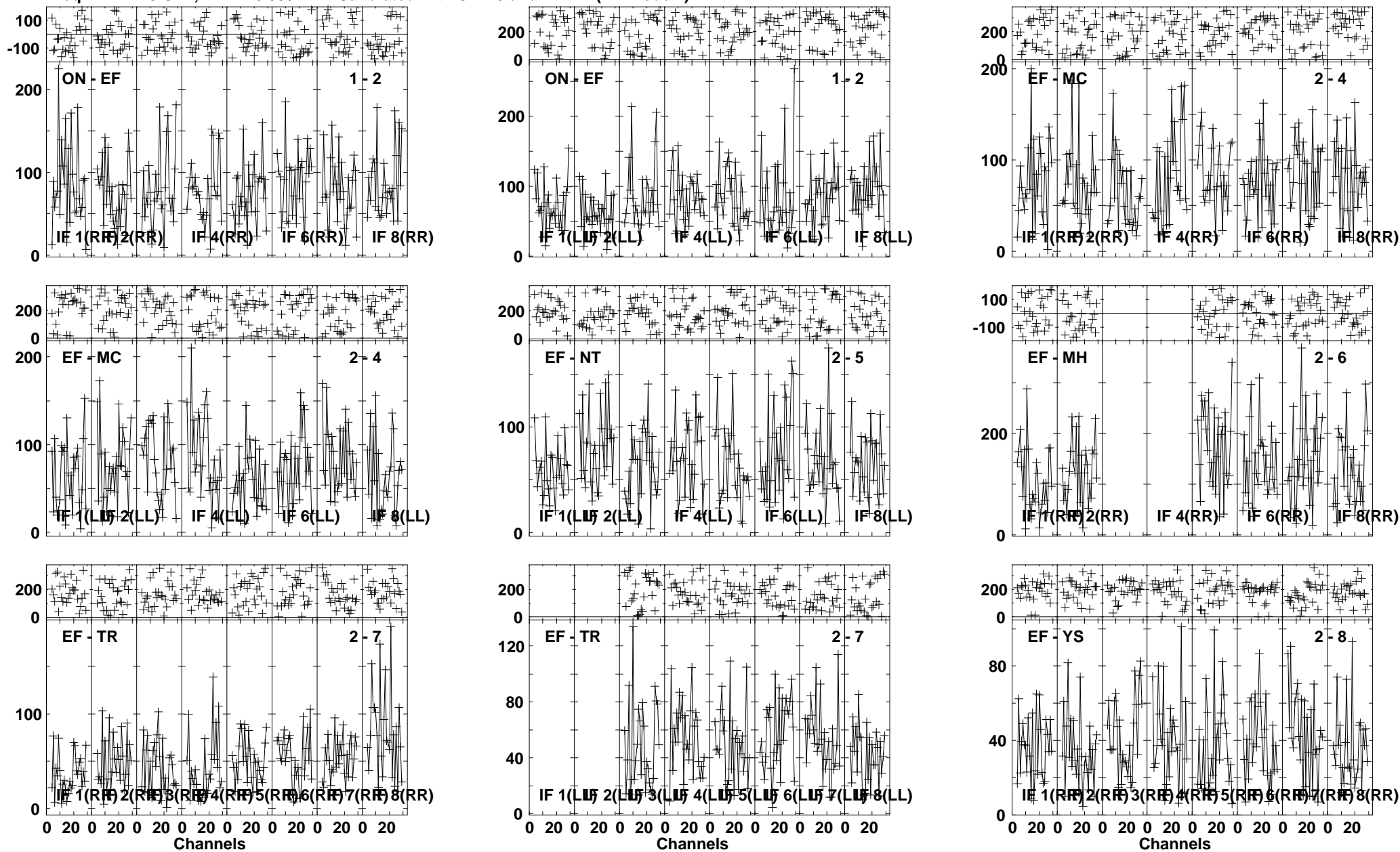

Lower frame: Milli Ampl Jy Top frame: Phas deg
 Vector averaged cross-power spectrum Several baselines displayed
 Timerange: 00/19:52:10 to 00/19:54:08

Plot file version 74 created 26-JUL-2013 10:18:45
 B1152+199A EZ024 1.UVDATA.1
 Freq = 22.1720 GHz, Bw = 16.000 MH Calibrated with CL # 3 and BP # 1 (BP mode 1)

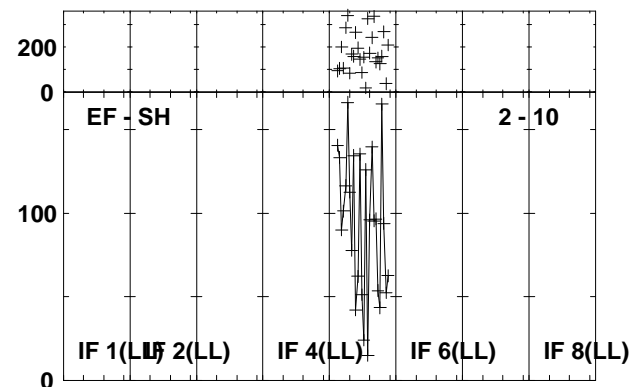
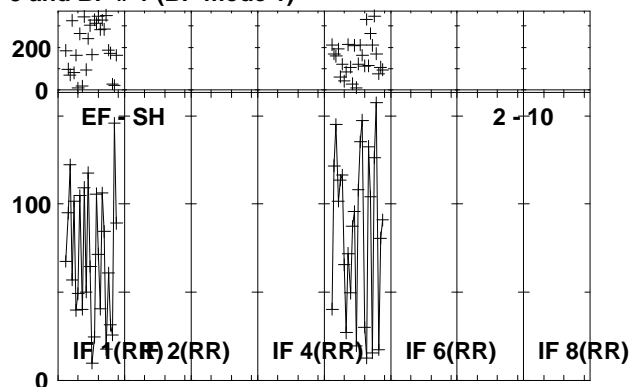
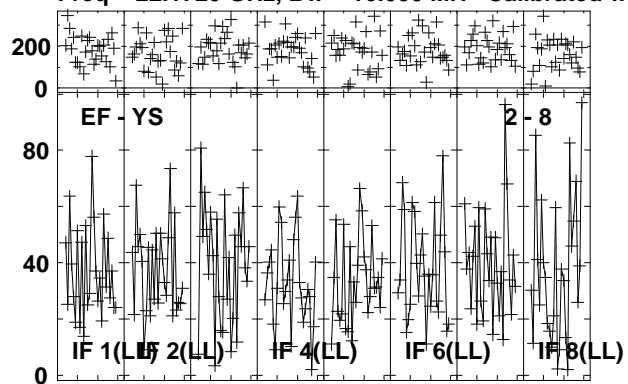

Lower frame: Milli Ampl Jy Top frame: Phas deg
 Vector averaged cross-power spectrum Several baselines displayed
 Timerange: 00/19:52:10 to 00/19:54:08

Plot file version 75 created 26-JUL-2013 10:18:46

J1157 EZ024 1.UVDATA.1

Freq = 22.1720 GHz, Bw = 16.000 MH Calibrated with CL # 3 and BP # 1 (BP mode 1)

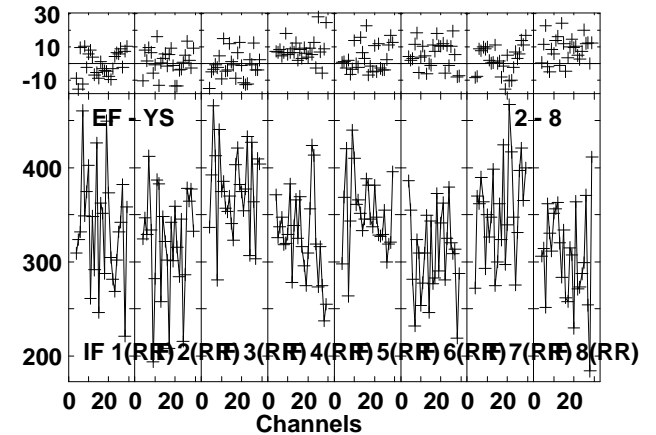
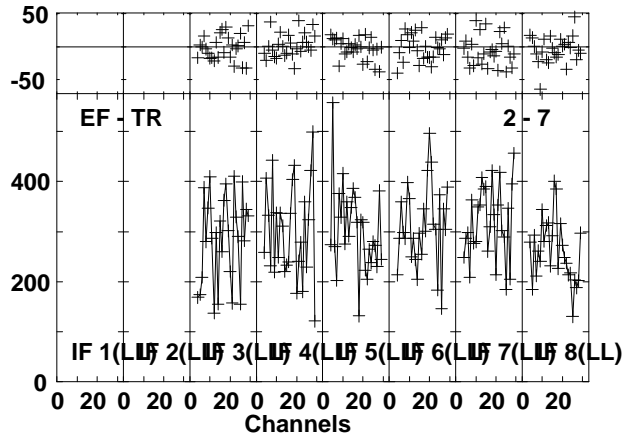
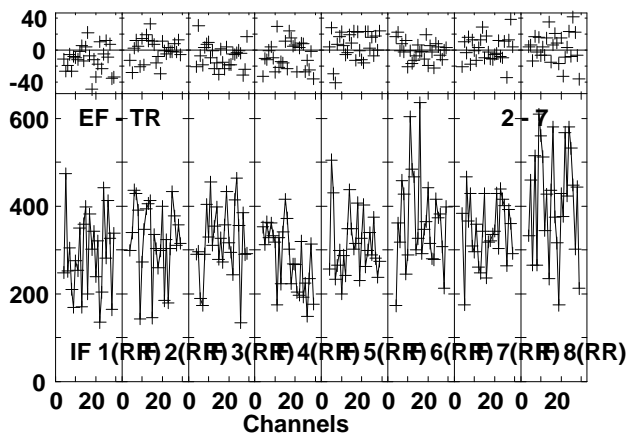
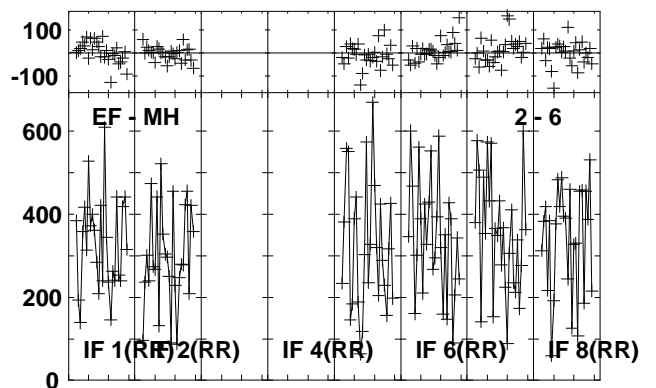
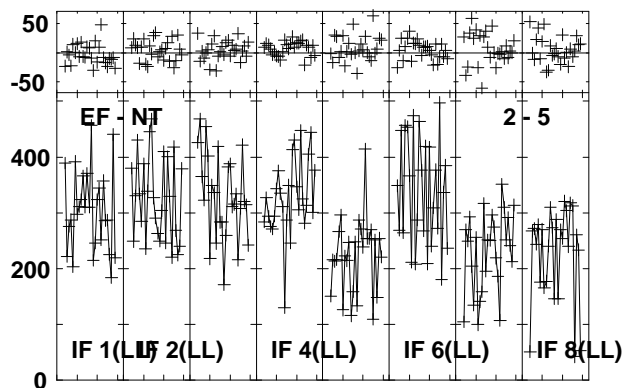
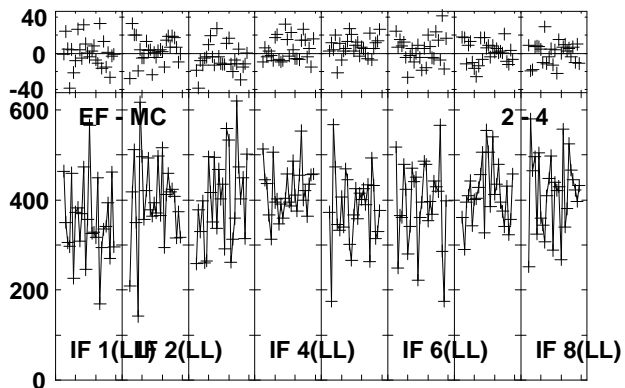
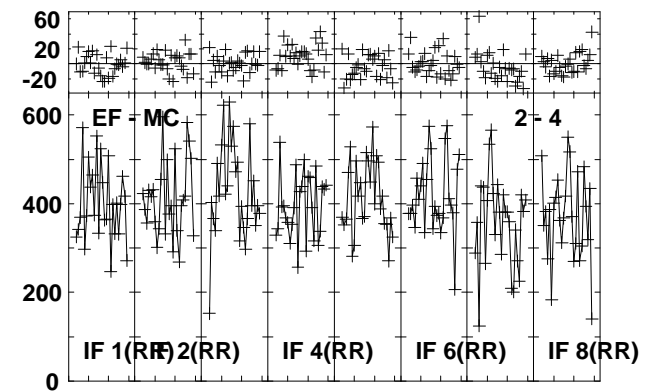
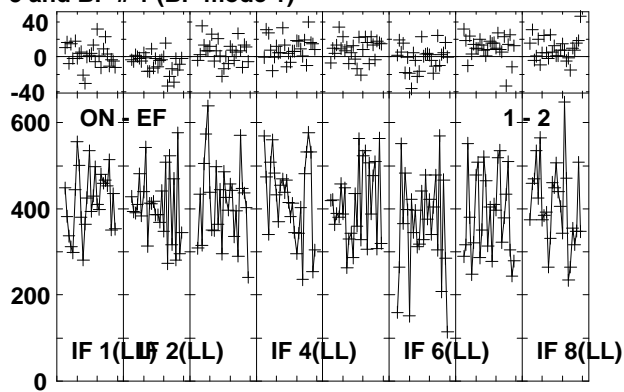
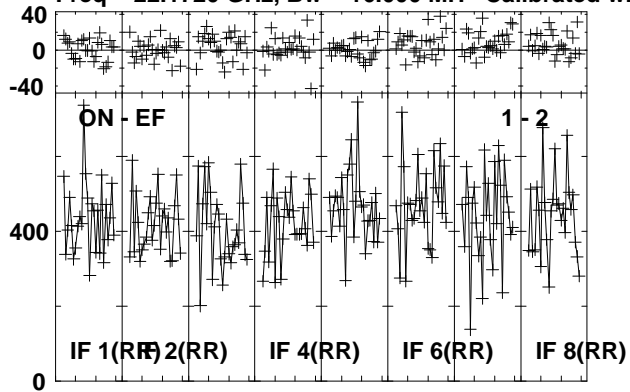

Lower frame: Milli Ampl Jy Top frame: Phas deg
Vector averaged cross-power spectrum Several baselines displayed
Timerange: 00/19:54:43 to 00/19:55:41

Plot file version 76 created 26-JUL-2013 10:18:47

J1157 EZ024 1.UVDATA.1

Freq = 22.1720 GHz, Bw = 16.000 MH Calibrated with CL # 3 and BP # 1 (BP mode 1)

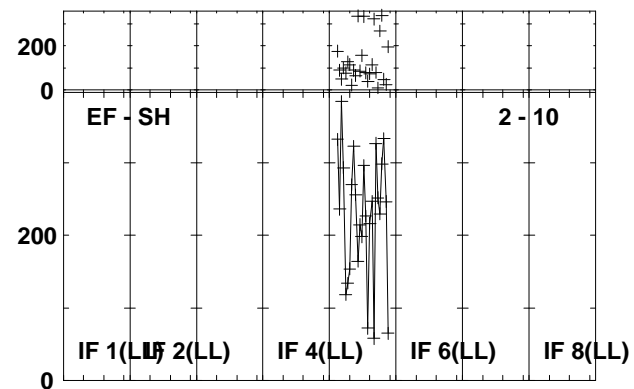
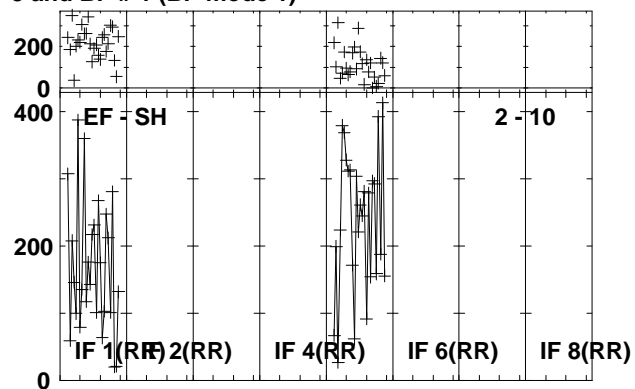
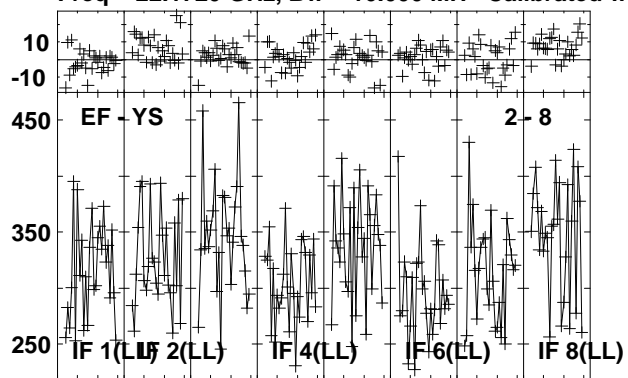

Lower frame: Milli Ampl Jy Top frame: Phas deg
Vector averaged cross-power spectrum Several baselines displayed
Timerange: 00/19:54:43 to 00/19:55:41

Plot file version 77 created 26-JUL-2013 10:18:47
 B1152+199A EZ024 1.UVDATA.1
 Freq = 22.1720 GHz, Bw = 16.000 MH Calibrated with CL # 3 and BP # 1 (BP mode 1)

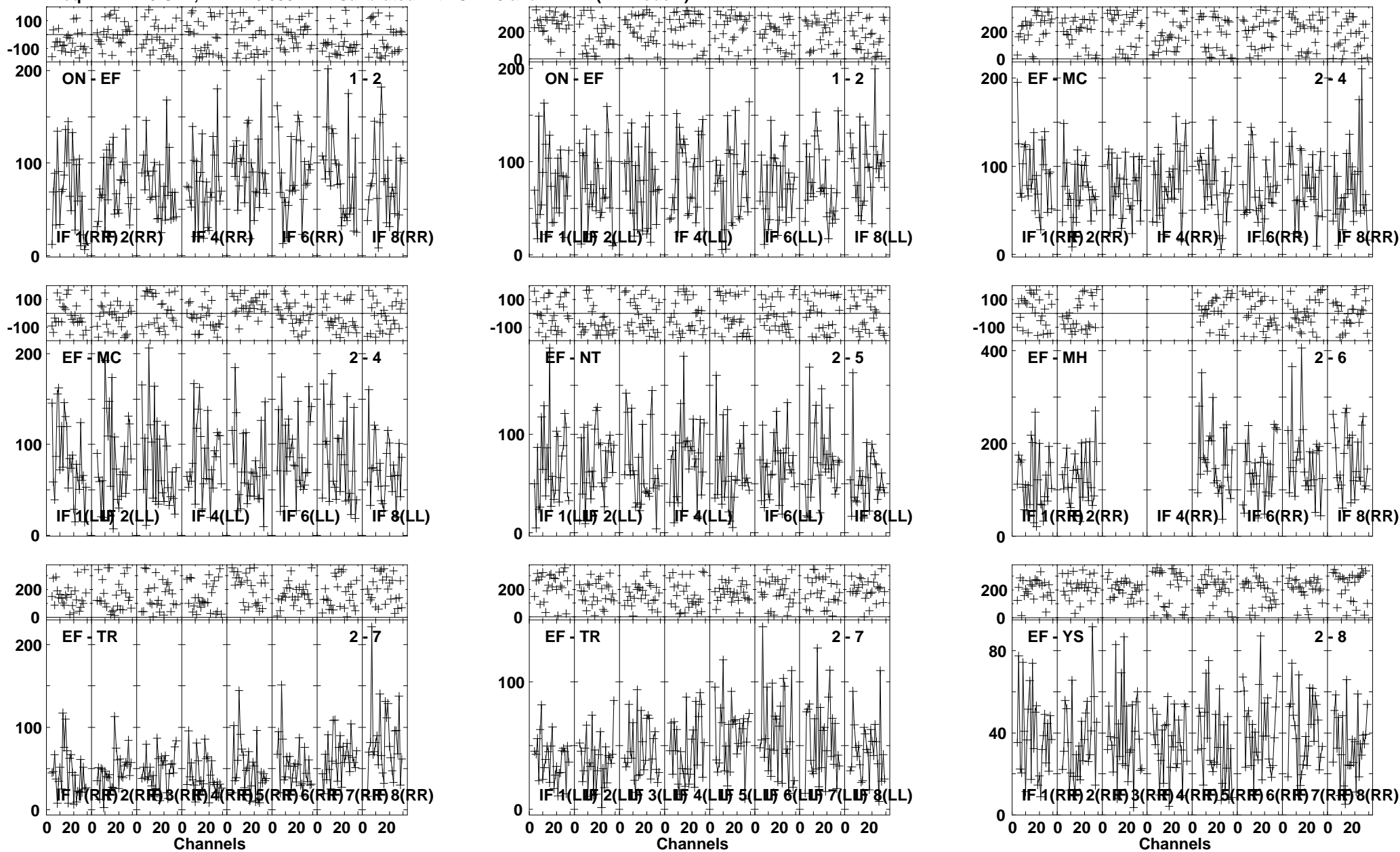

Lower frame: Milli Ampl Jy Top frame: Phas deg
 Vector averaged cross-power spectrum Several baselines displayed
 Timerange: 00/19:56:16 to 00/19:58:14

Plot file version 78 created 26-JUL-2013 10:18:49
B1152+199A EZ024 1.UVDATA.1
Freq = 22.1720 GHz, Bw = 16.000 MH Calibrated with CL # 3 and BP # 1 (BP mode 1)

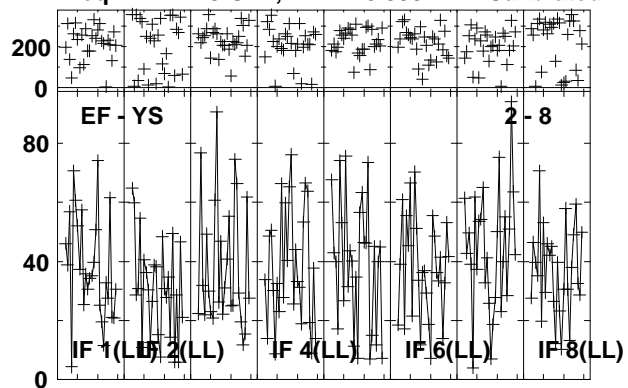

Lower frame: Milli Ampl Jy Top frame: Phas deg
Vector averaged cross-power spectrum Several baselines displayed
Timerange: 00/19:56:16 to 00/19:58:14

Plot file version 79 created 26-JUL-2013 10:18:50
 J1125+2610 EZ024 1.UVDATA.1
 Freq = 22.1720 GHz, Bw = 16.000 MH Calibrated with CL # 3 and BP # 1 (BP mode 1)

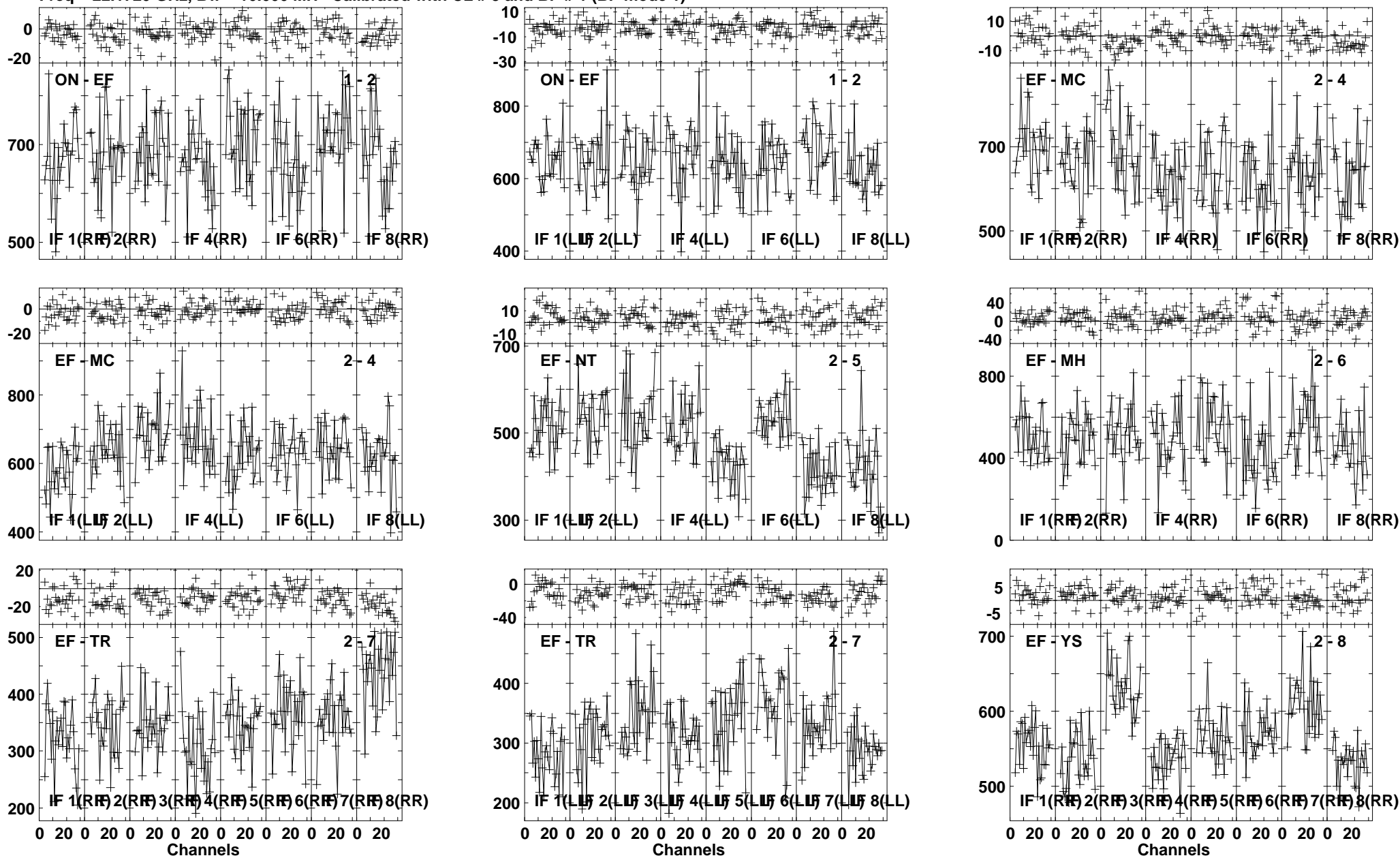

Lower frame: Milli Ampl Jy Top frame: Phas deg
 Vector averaged cross-power spectrum Several baselines displayed
 Timerange: 00/19:59:31 to 00/20:01:13

Plot file version 80 created 26-JUL-2013 10:18:51
 J1125+2610 EZ024 1.UVDATA.1
 Freq = 22.1720 GHz, Bw = 16.000 MH Calibrated with CL # 3 and BP # 1 (BP mode 1)

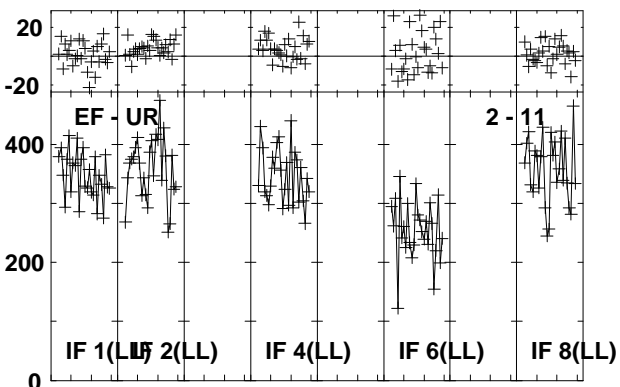
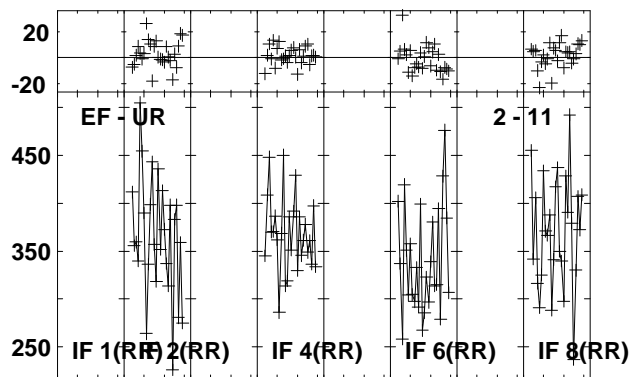
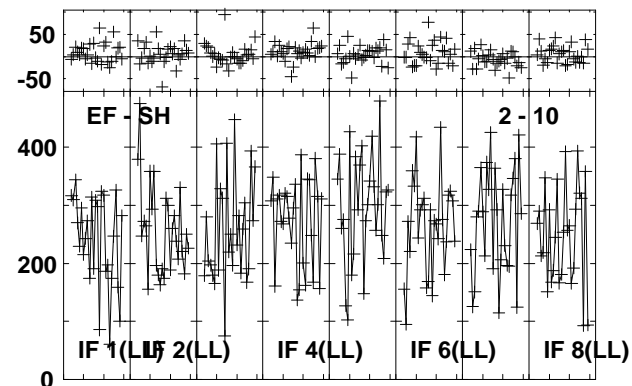
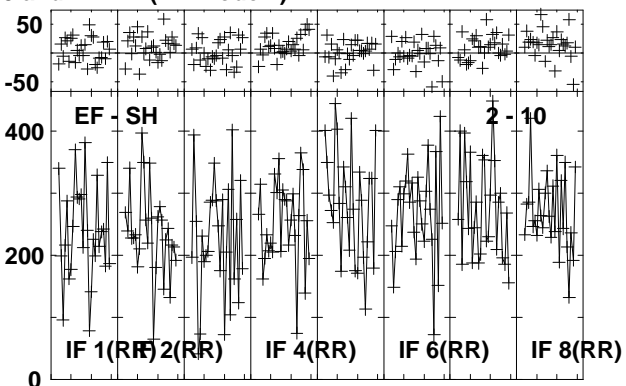
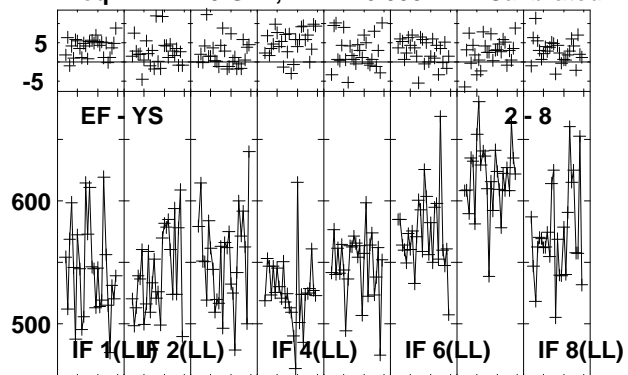

Lower frame: Milli Ampl Jy Top frame: Phas deg
 Vector averaged cross-power spectrum Several baselines displayed
 Timerange: 00/19:59:31 to 00/20:01:13

Plot file version 81 created 26-JUL-2013 10:18:52
 J1157 EZ024 1.UVDATA.1
 Freq = 22.1720 GHz, Bw = 16.000 MH Calibrated with CL # 3 and BP # 1 (BP mode 1)

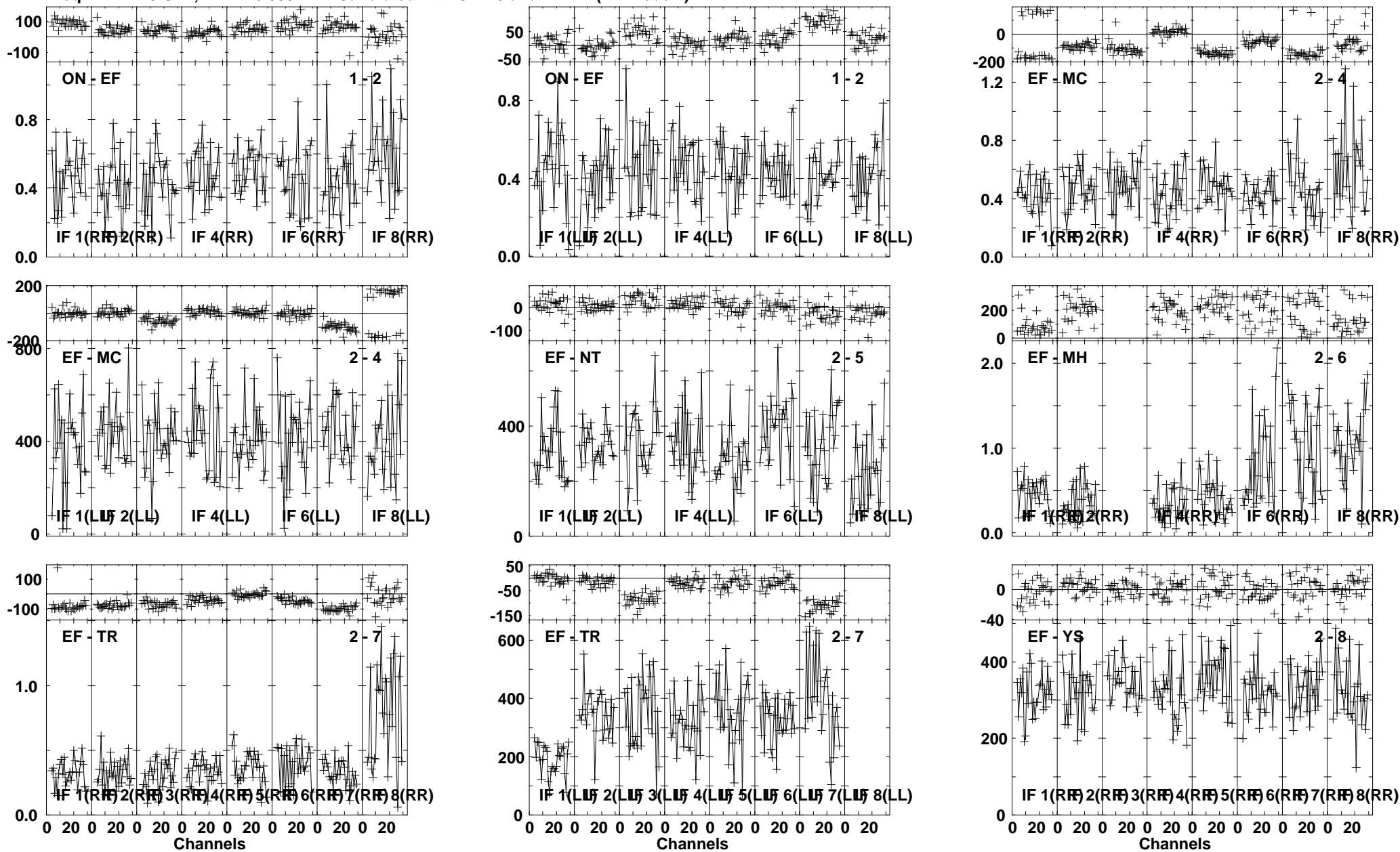

Lower frame: Ampl Jy Top frame: Phas deg
 Vector averaged cross-power spectrum Several baselines displayed
 Timerange: 00/20:02:40 to 00/20:03:22

Plot file version 82 created 26-JUL-2013 10:18:52
 J1157 EZ024 1.UVDATA.1
 Freq = 22.1720 GHz, Bw = 16.000 MH Calibrated with CL # 3 and BP # 1 (BP mode 1)

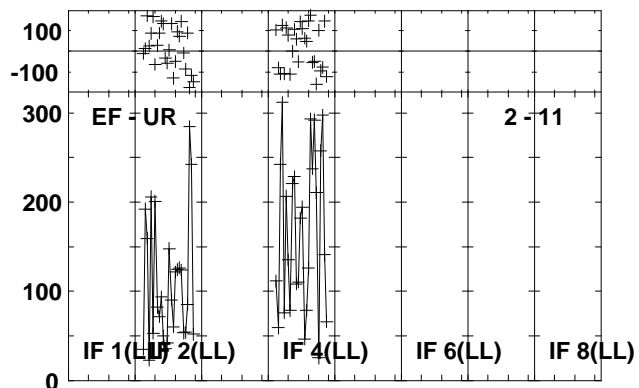
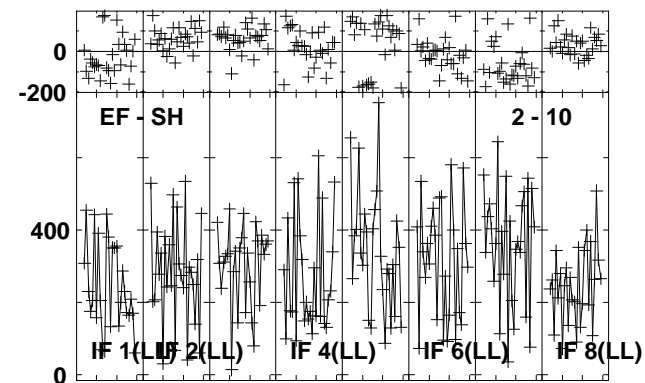
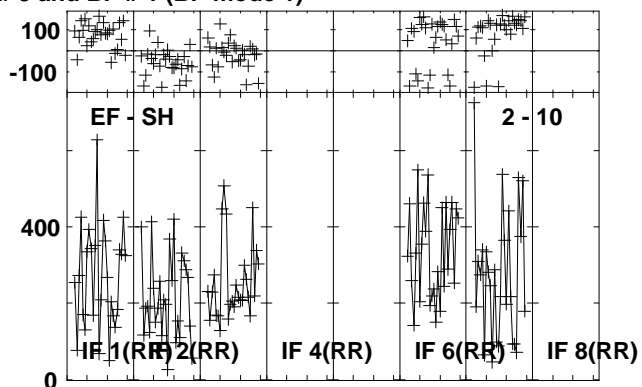
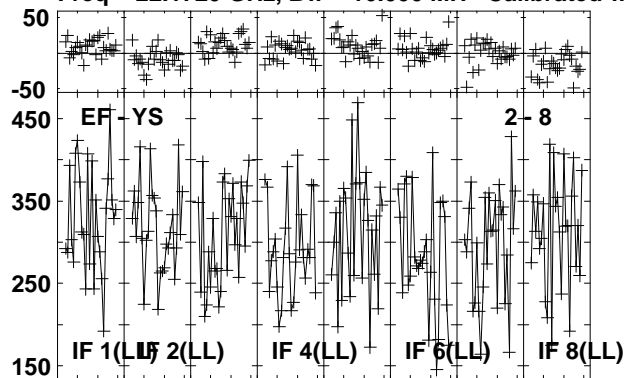

Lower frame: Milli Ampl Jy Top frame: Phas deg
 Vector averaged cross-power spectrum Several baselines displayed
 Timerange: 00/20:02:40 to 00/20:03:22

Plot file version 83 created 26-JUL-2013 10:18:53
 B1152+199A EZ024 1.UVDATA.1
 Freq = 22.1720 GHz, Bw = 16.000 MH Calibrated with CL # 3 and BP # 1 (BP mode 1)

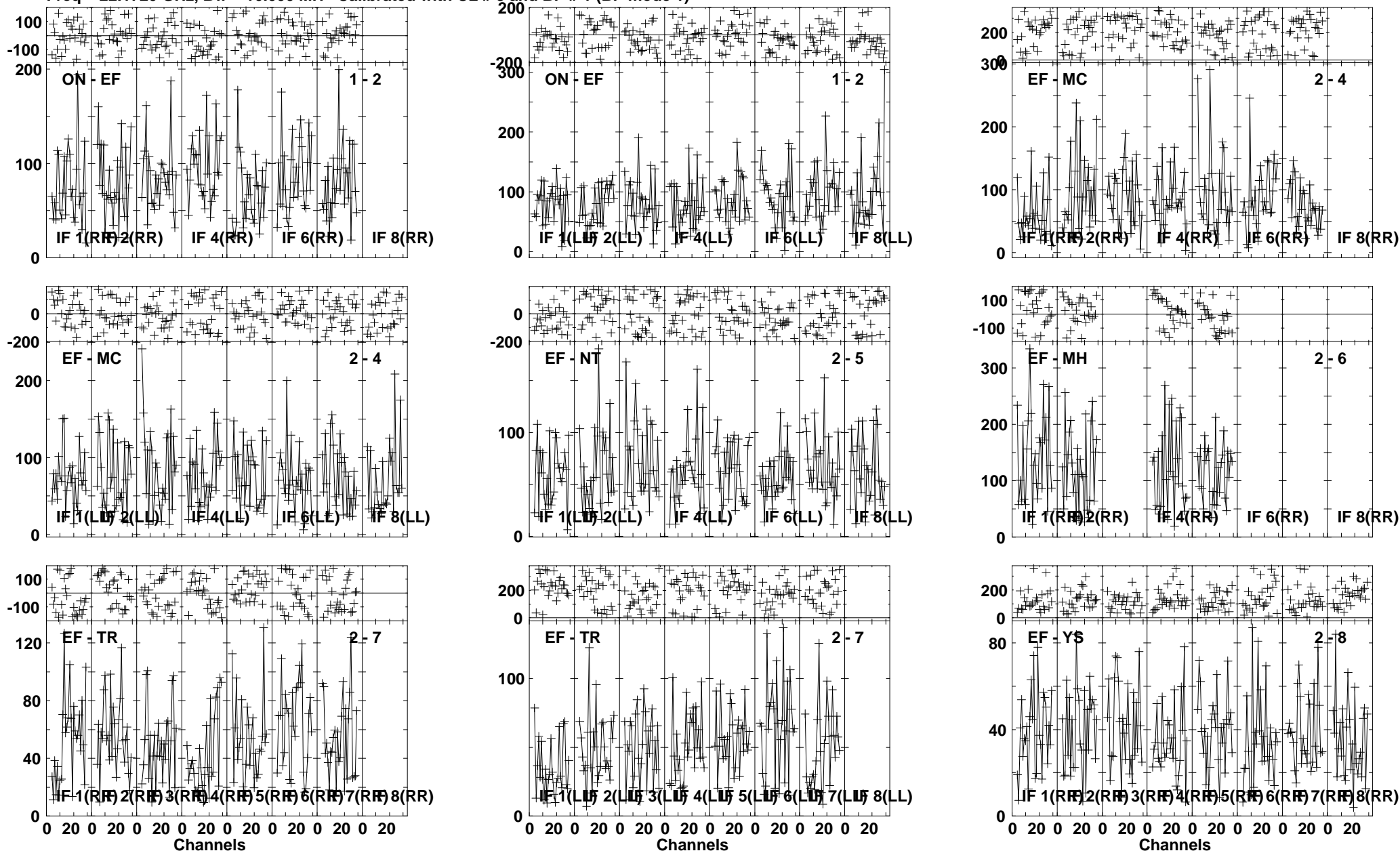

Lower frame: Milli Ampl Jy Top frame: Phas deg
 Vector averaged cross-power spectrum Several baselines displayed
 Timerange: 00/20:03:58 to 00/20:05:56

Plot file version 84 created 26-JUL-2013 10:18:54

B1152+199A EZ024 1.UVDATA.1

Freq = 22.1720 GHz, Bw = 16.000 MH Calibrated with CL # 3 and BP # 1 (BP mode 1)

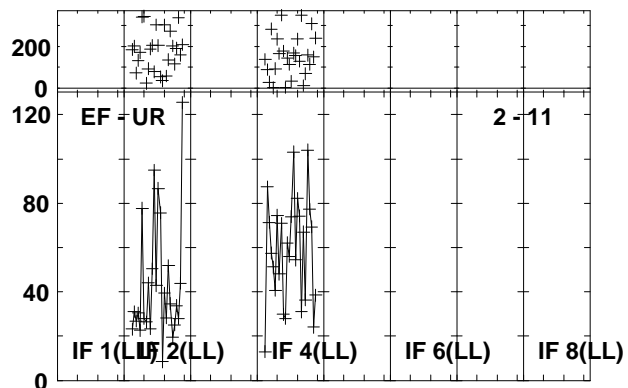
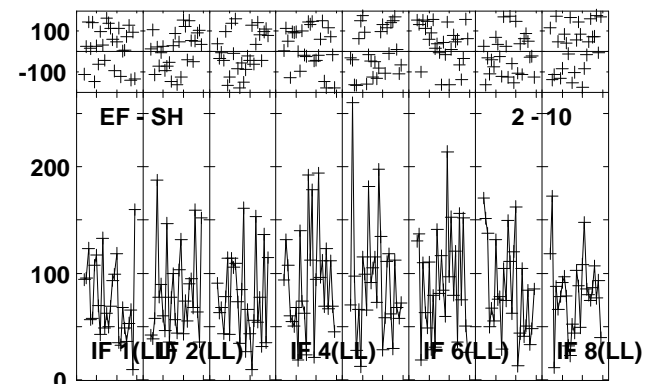
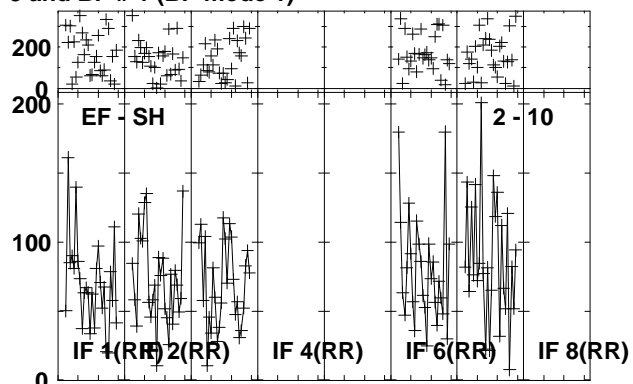
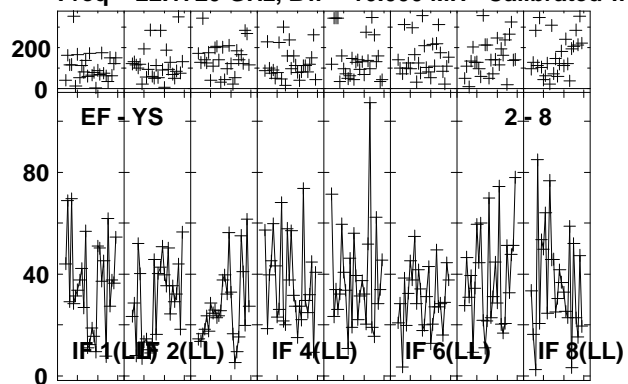

Lower frame: Milli Ampl Jy Top frame: Phas deg
Vector averaged cross-power spectrum Several baselines displayed
Timerange: 00/20:03:58 to 00/20:05:56

Plot file version 85 created 26-JUL-2013 10:18:56

J1157 EZ024 1.UVDATA.1

Freq = 22.1720 GHz, Bw = 16.000 MH Calibrated with CL # 3 and BP # 1 (BP mode 1)

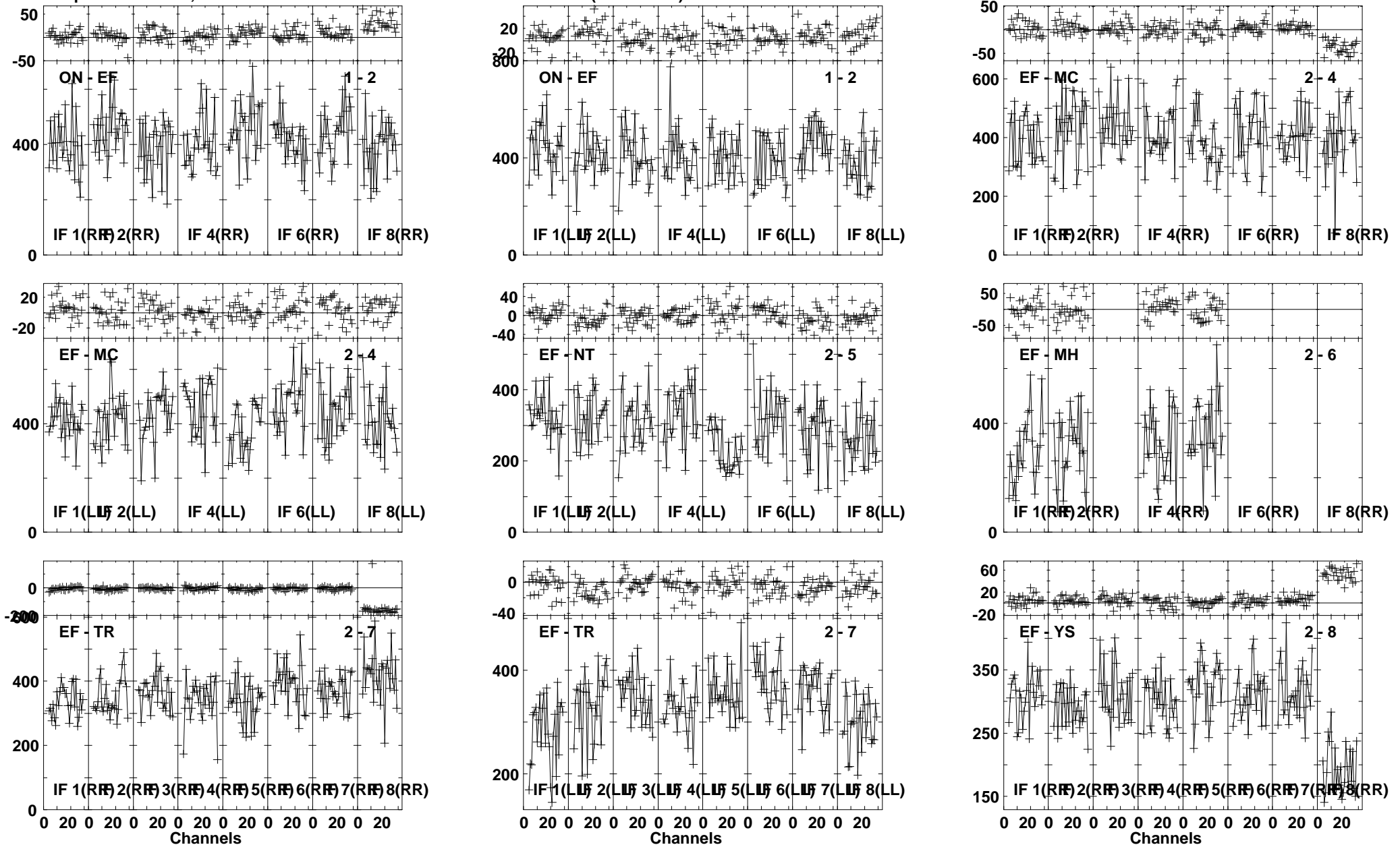

Lower frame: Milli Ampl Jy Top frame: Phas deg
Vector averaged cross-power spectrum Several baselines displayed
Timerange: 00/20:06:31 to 00/20:07:29

Plot file version 86 created 26-JUL-2013 10:18:57
 J1157 EZ024 1.UVDATA.1
 Freq = 22.1720 GHz, Bw = 16.000 MH Calibrated with CL # 3 and BP # 1 (BP mode 1)

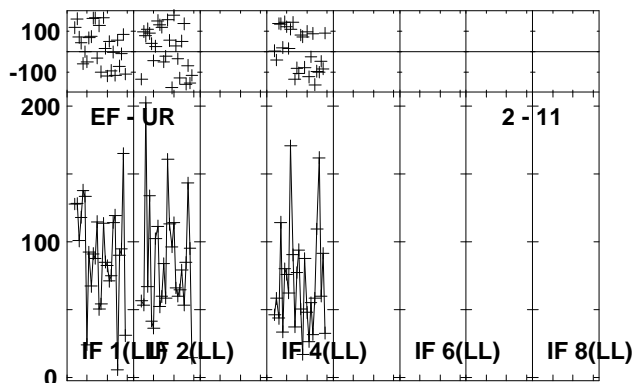
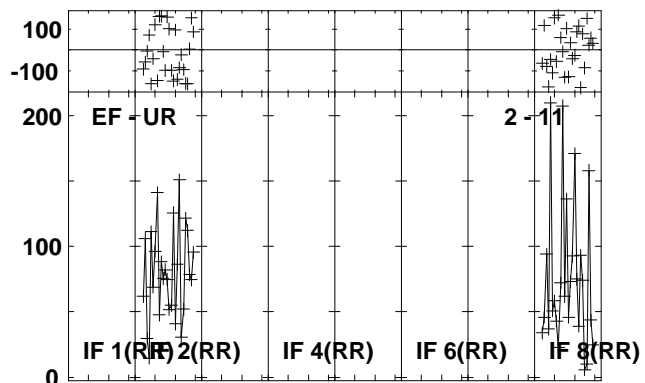
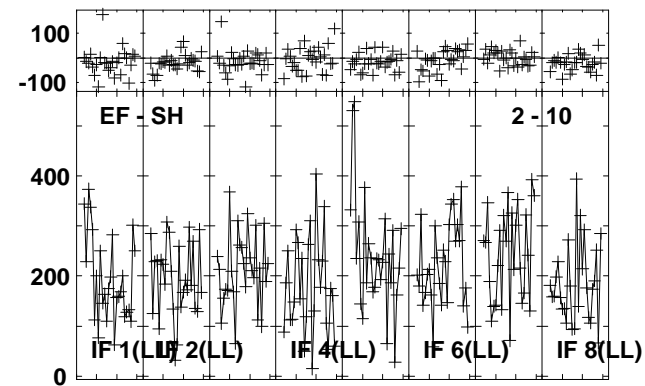
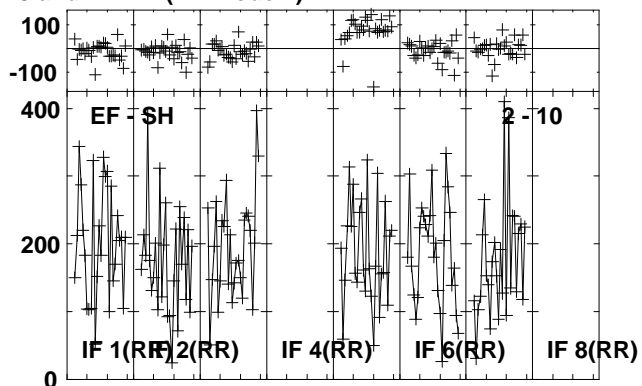
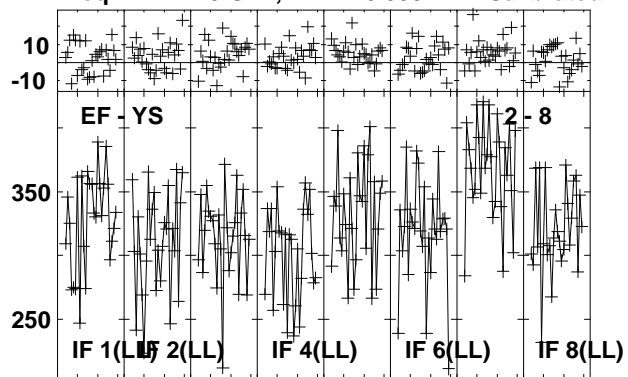

Lower frame: Milli Ampl Jy Top frame: Phas deg
 Vector averaged cross-power spectrum Several baselines displayed
 Timerange: 00/20:06:31 to 00/20:07:29

Plot file version 87 created 26-JUL-2013 10:18:58
 B1152+199A EZ024 1.UVDATA.1
 Freq = 22.1720 GHz, Bw = 16.000 MH Calibrated with CL # 3 and BP # 1 (BP mode 1)

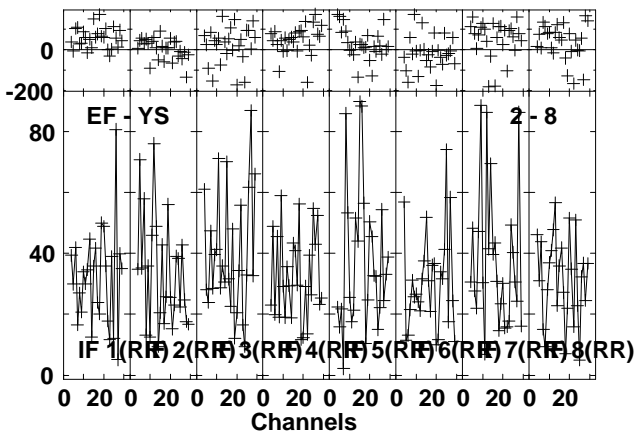
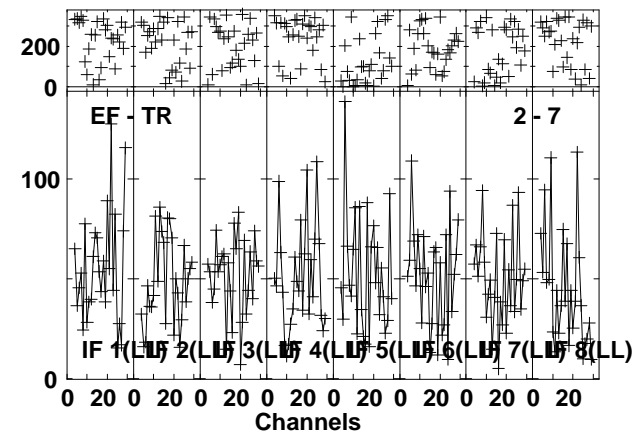
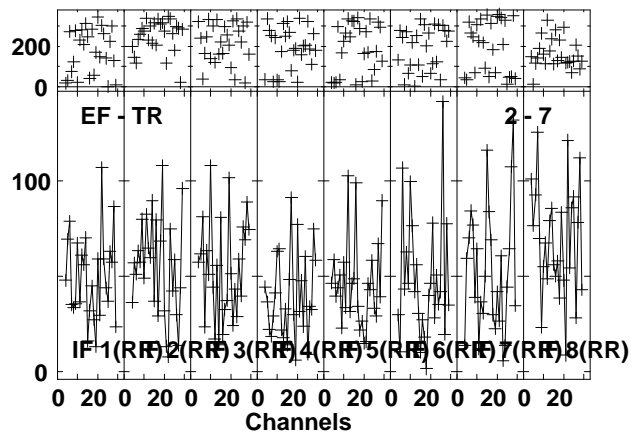
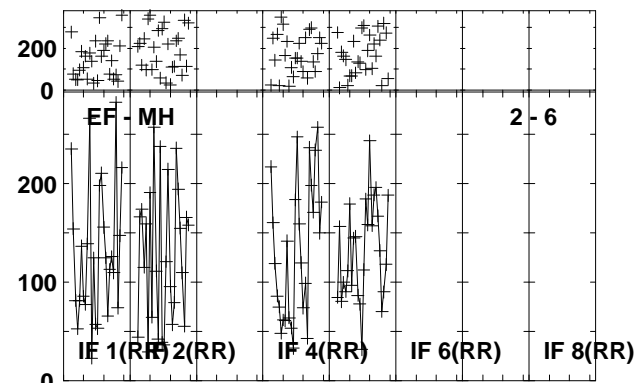
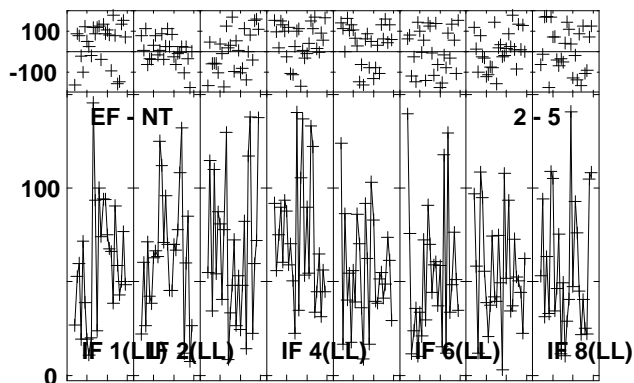
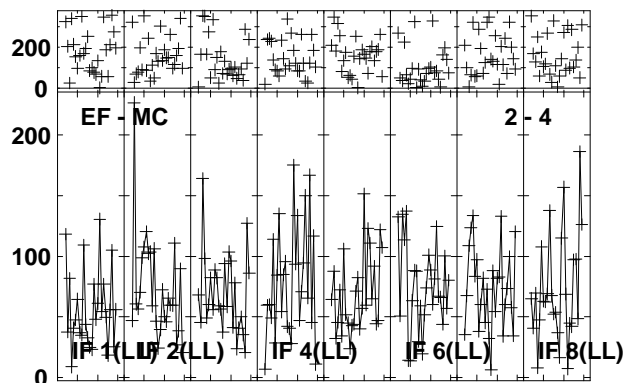
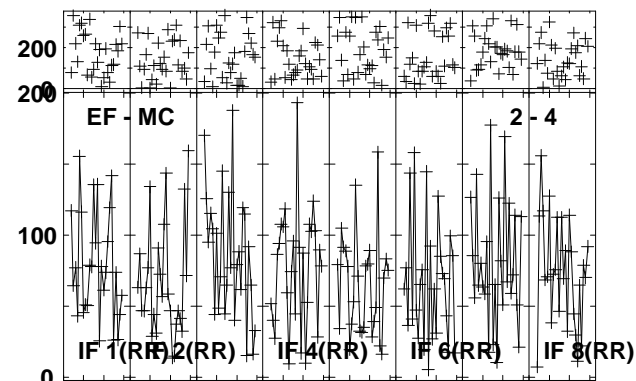
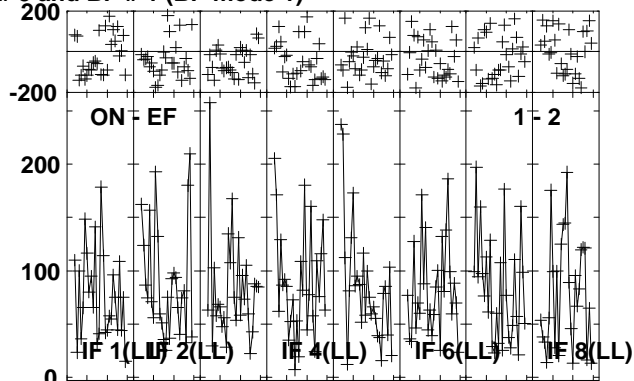
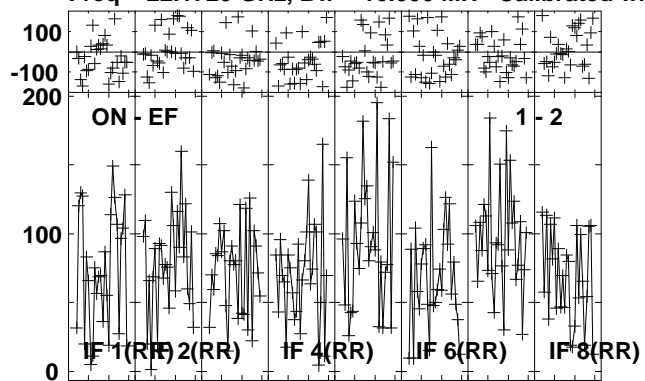

Lower frame: Milli Ampl Jy Top frame: Phas deg
 Vector averaged cross-power spectrum Several baselines displayed
 Timerange: 00/20:08:04 to 00/20:10:02

Plot file version 88 created 26-JUL-2013 10:18:59
 B1152+199A EZ024 1.UVDATA.1
 Freq = 22.1720 GHz, Bw = 16.000 MH Calibrated with CL # 3 and BP # 1 (BP mode 1)

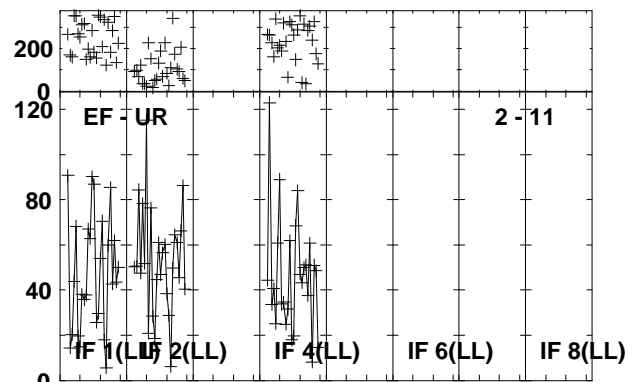
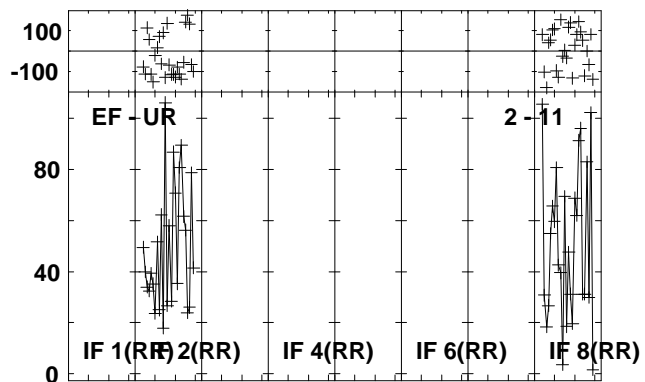
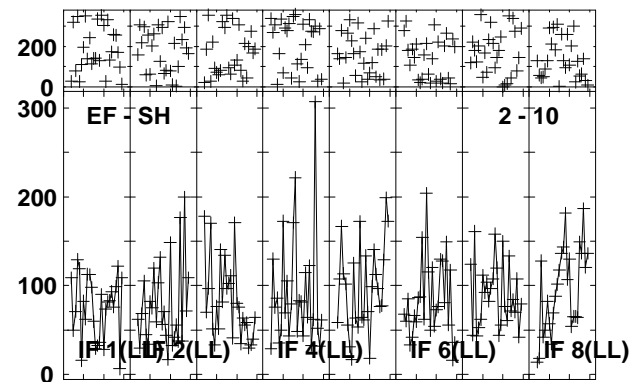
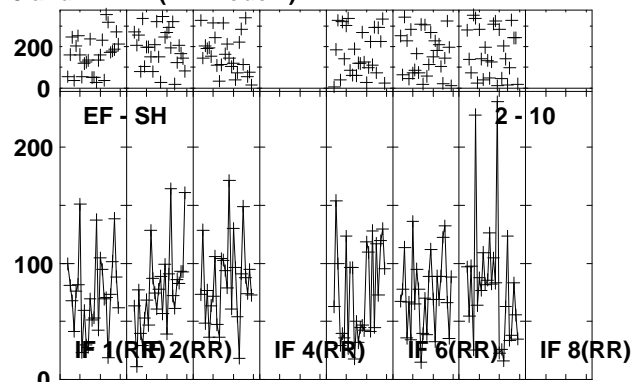
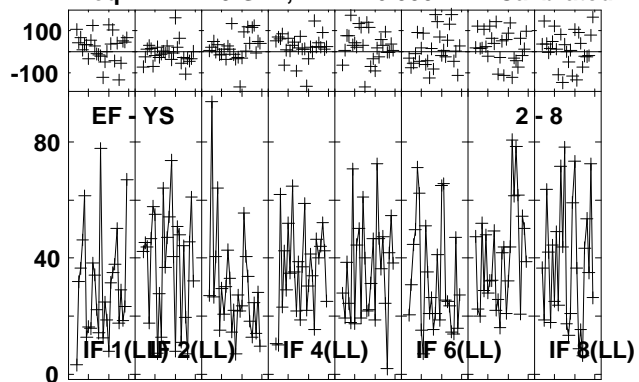

Lower frame: Milli Ampl Jy Top frame: Phas deg
 Vector averaged cross-power spectrum Several baselines displayed
 Timerange: 00/20:08:04 to 00/20:10:02

Plot file version 89 created 26-JUL-2013 10:19:01
 J1125+2610 EZ024 1.UVDATA.1
 Freq = 22.1720 GHz, Bw = 16.000 MH Calibrated with CL # 3 and BP # 1 (BP mode 1)

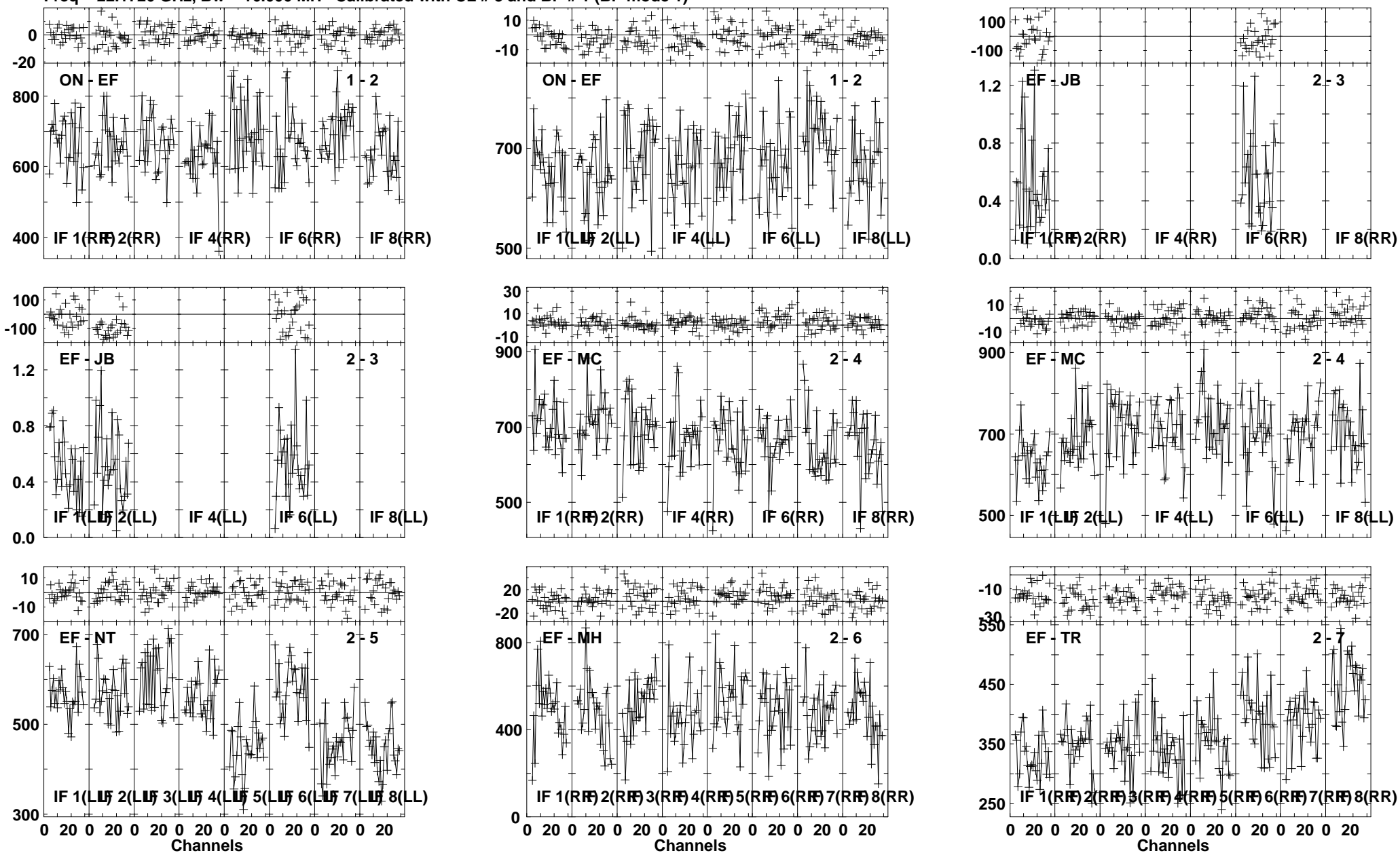

Lower frame: Milli Ampl Jy Top frame: Phas deg
 Vector averaged cross-power spectrum Several baselines displayed
 Timerange: 00/20:11:18 to 00/20:13:00

Plot file version 90 created 26-JUL-2013 10:19:02
 J1125+2610 EZ024 1.UVDATA.1
 Freq = 22.1720 GHz, Bw = 16.000 MH Calibrated with CL # 3 and BP # 1 (BP mode 1)

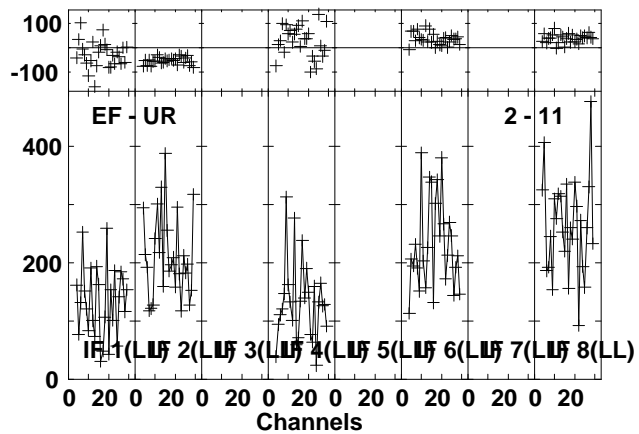
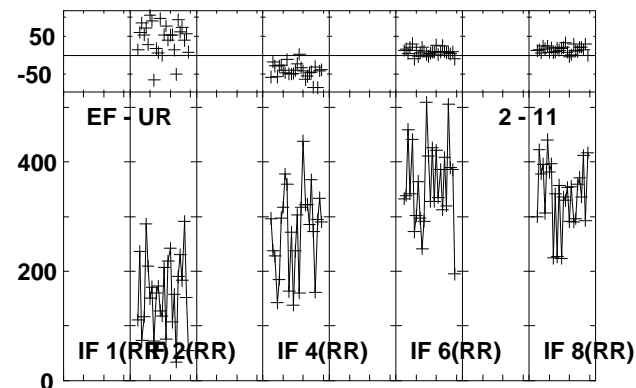
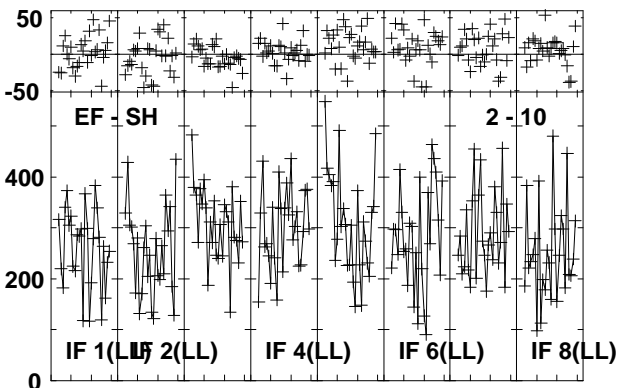
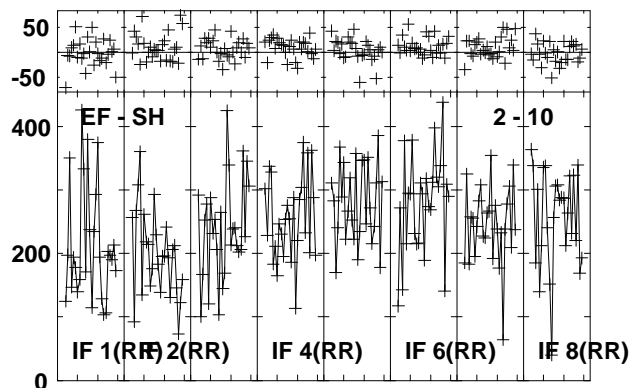
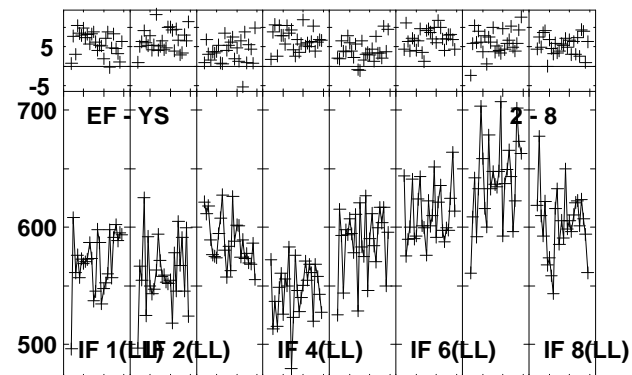
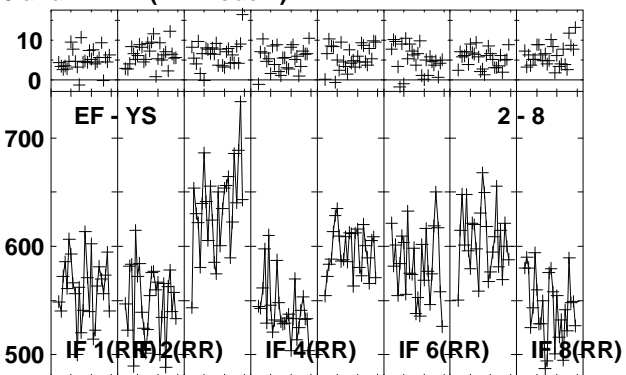
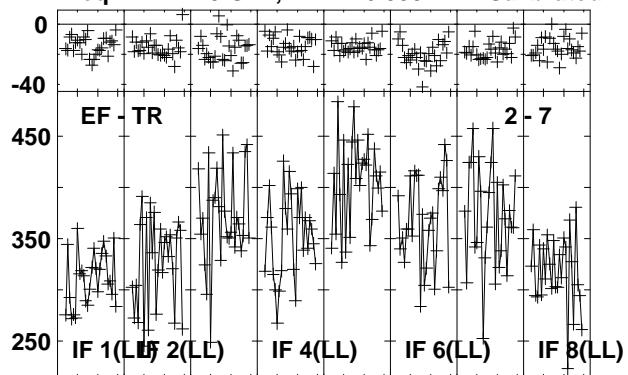

Lower frame: Milli Ampl Jy Top frame: Phas deg
 Vector averaged cross-power spectrum Several baselines displayed
 Timerange: 00/20:11:18 to 00/20:13:00

Plot file version 91 created 26-JUL-2013 10:19:04
 4C39.25 EZ024 1.UVDATA.1
 Freq = 22.1720 GHz, Bw = 16.000 MH Calibrated with CL # 3 and BP # 1 (BP mode 1)

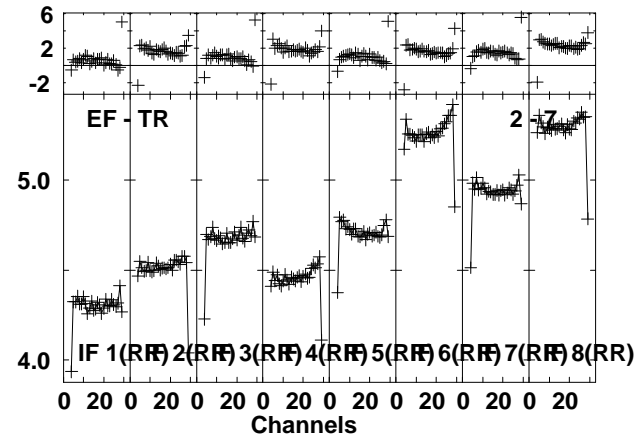
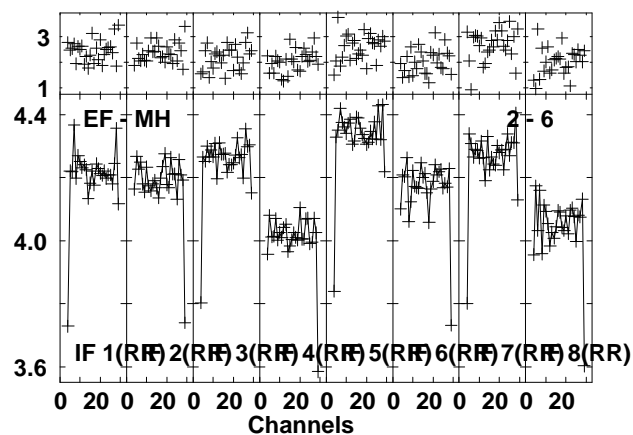
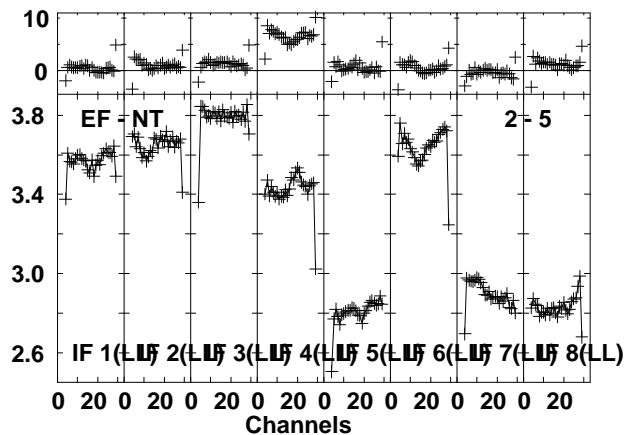
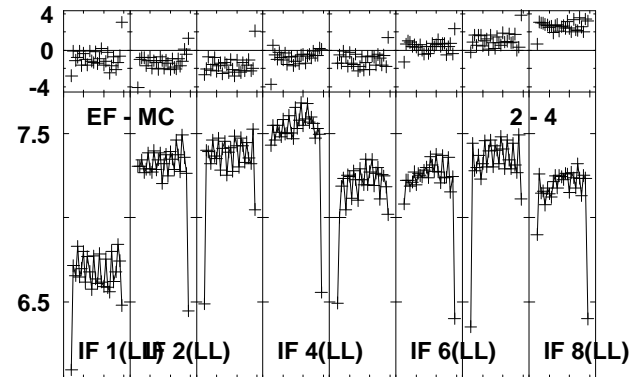
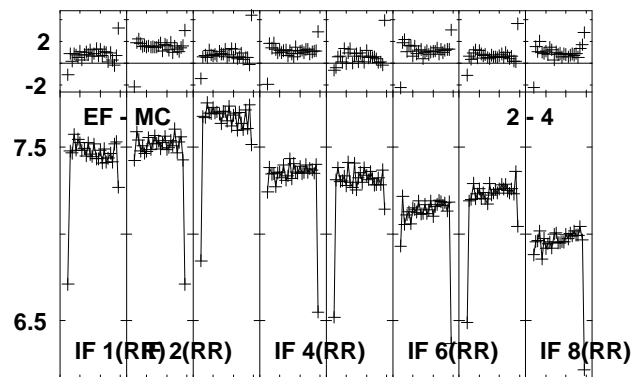
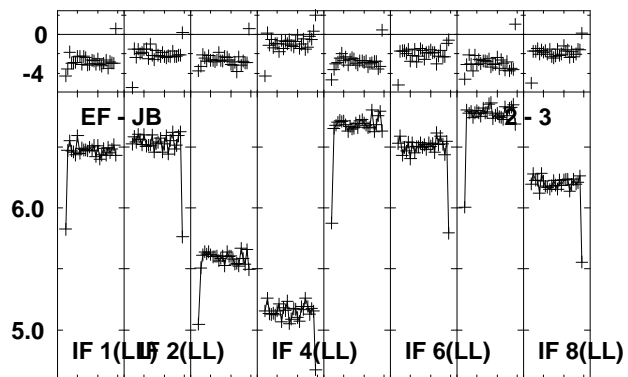
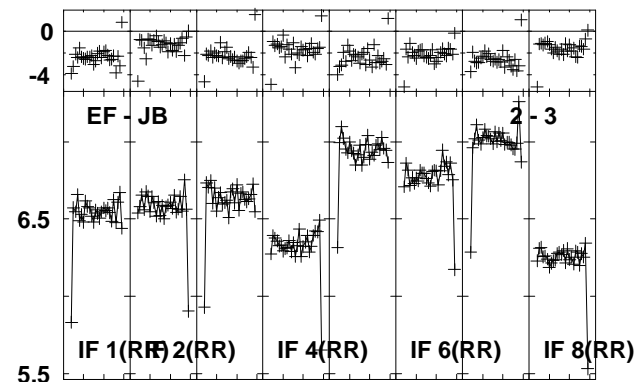
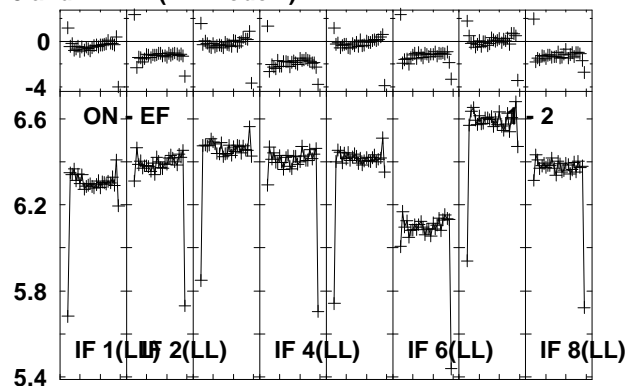
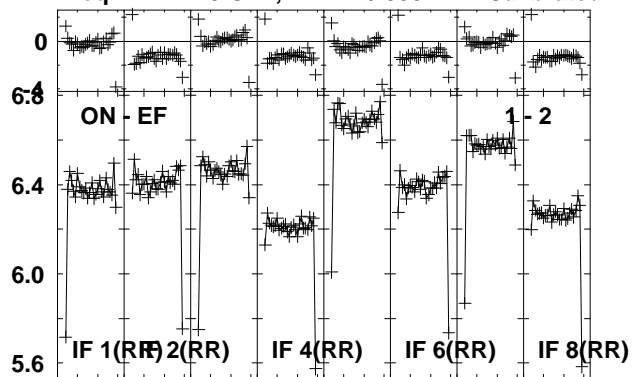

Lower frame: Ampl Jy Top frame: Phas deg
 Vector averaged cross-power spectrum Several baselines displayed
 Timerange: 00/20:15:30 to 00/20:25:12

Plot file version 92 created 26-JUL-2013 10:19:09

4C39.25 EZ024 1.UVDATA.1

Freq = 22.1720 GHz, Bw = 16.000 MH Calibrated with CL # 3 and BP # 1 (BP mode 1)

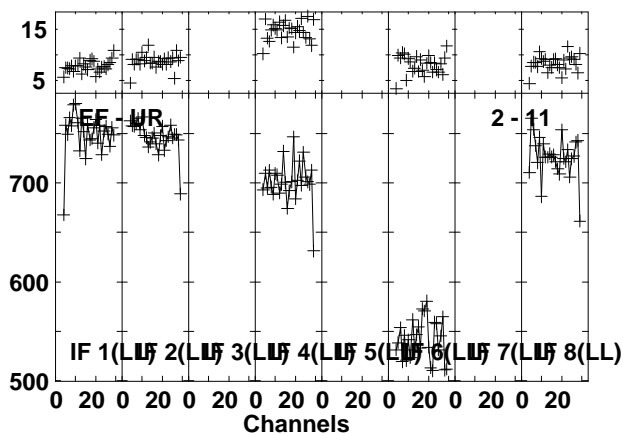
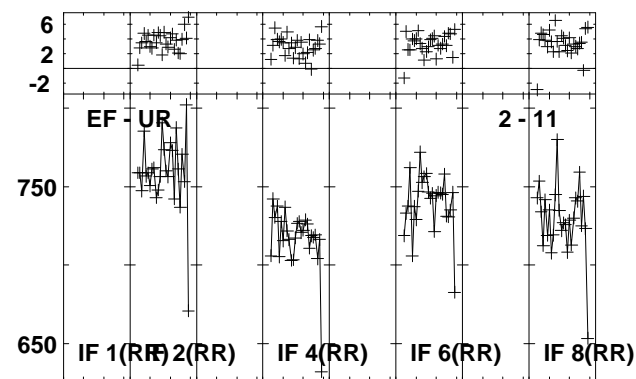
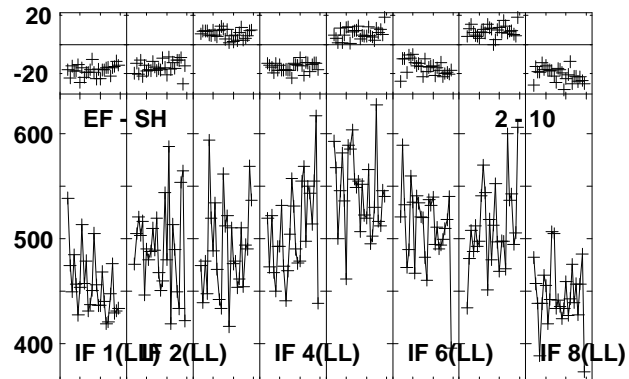
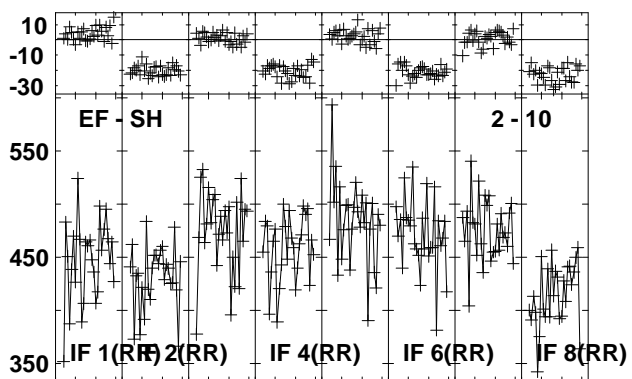
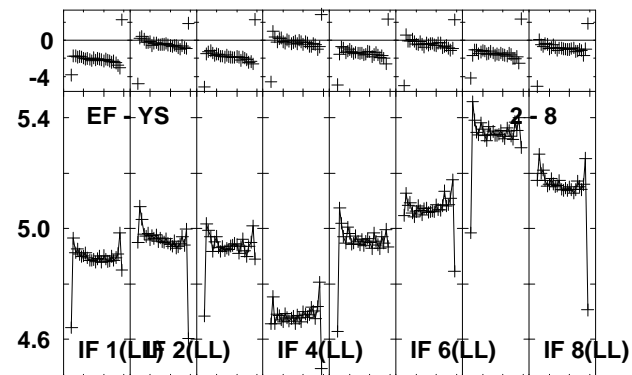
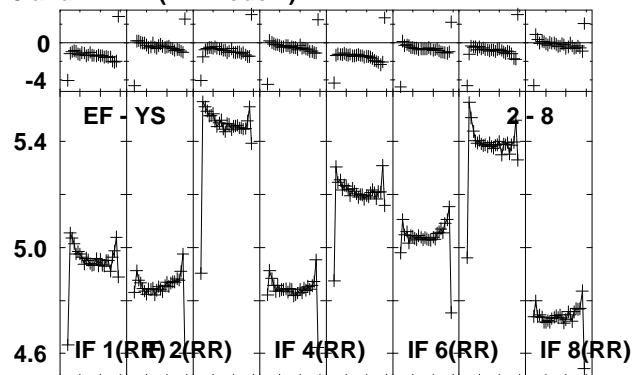
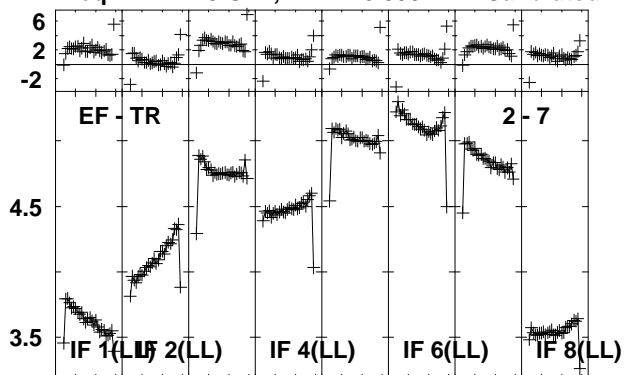

Lower frame: Ampl Jy Top frame: Phas deg
Vector averaged cross-power spectrum Several baselines displayed
Timerange: 00/20:15:30 to 00/20:25:12

Plot file version 93 created 26-JUL-2013 10:19:17

J1157 EZ024 1.UVDATA.1

Freq = 22.1720 GHz, Bw = 16.000 MH Calibrated with CL # 3 and BP # 1 (BP mode 1)

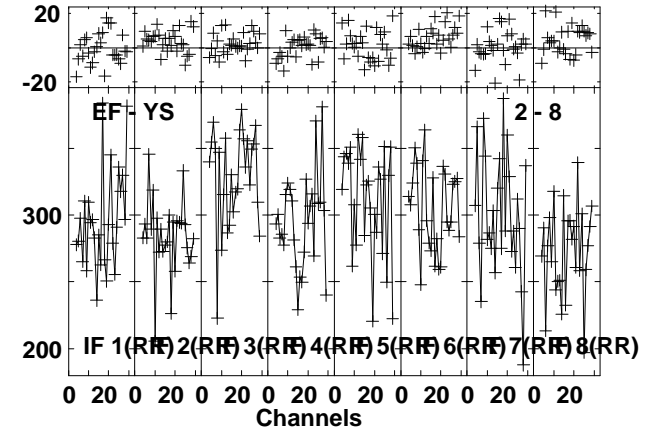
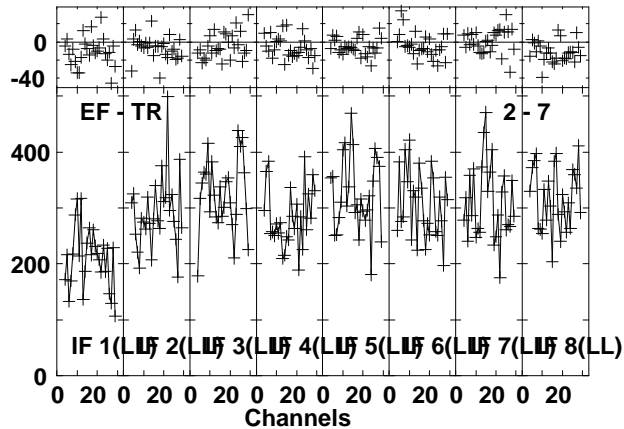
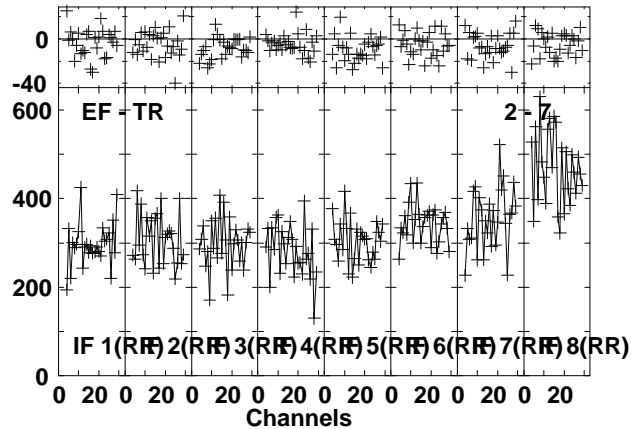
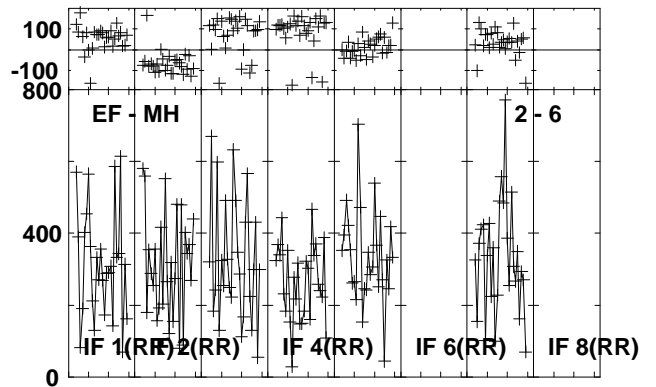
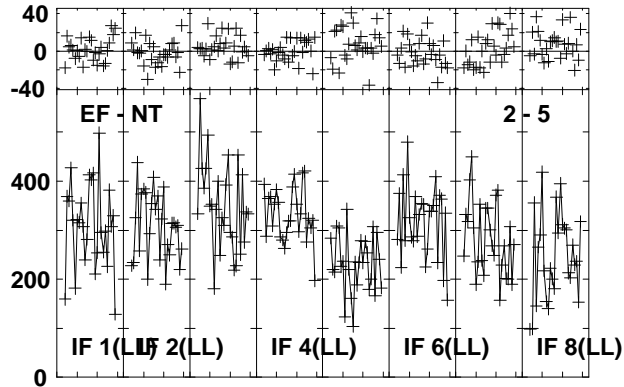
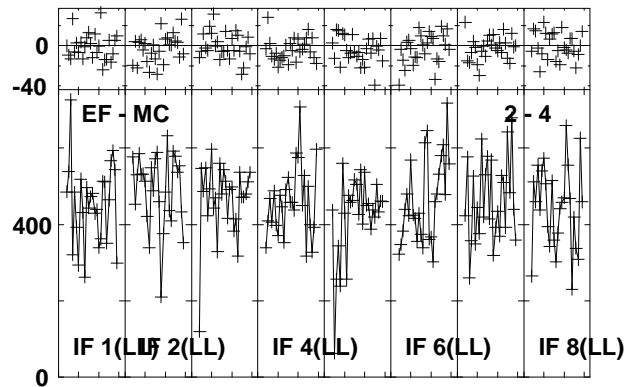
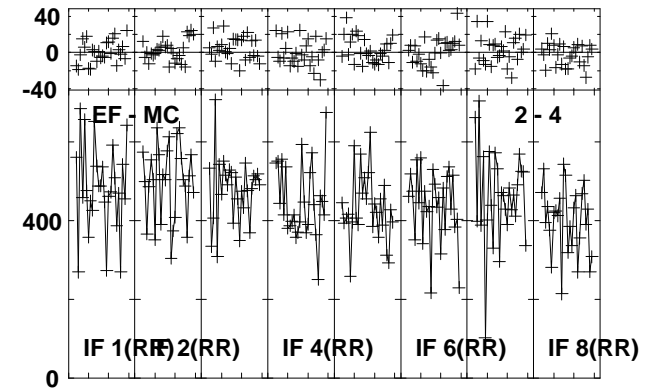
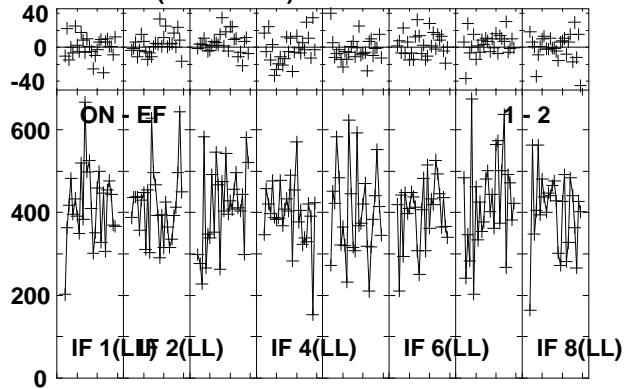
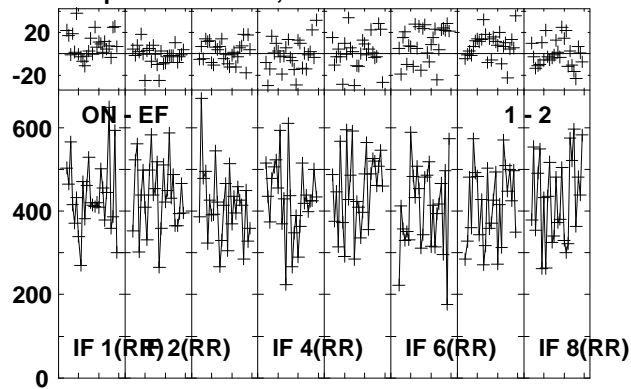

Lower frame: Milli Ampl Jy Top frame: Phas deg
Vector averaged cross-power spectrum Several baselines displayed
Timerange: 00/20:28:26 to 00/20:29:08

Plot file version 94 created 26-JUL-2013 10:19:18
 J1157 EZ024 1.UVDATA.1
 Freq = 22.1720 GHz, Bw = 16.000 MH Calibrated with CL # 3 and BP # 1 (BP mode 1)

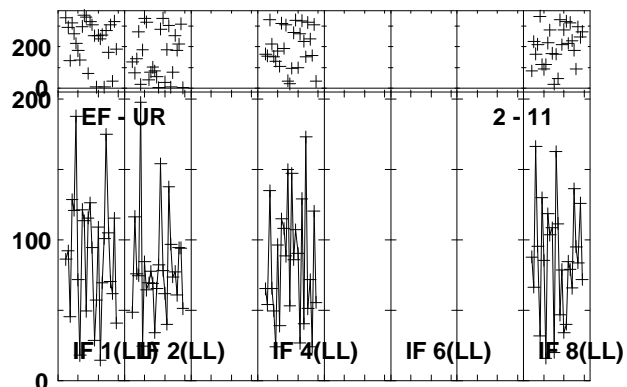
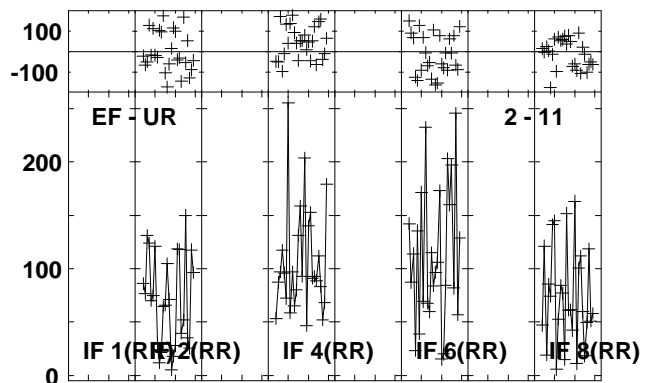
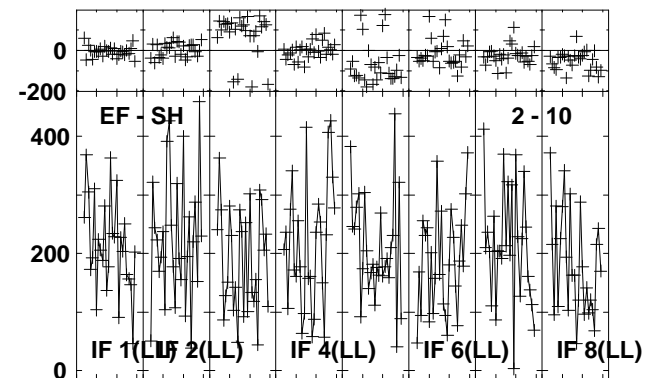
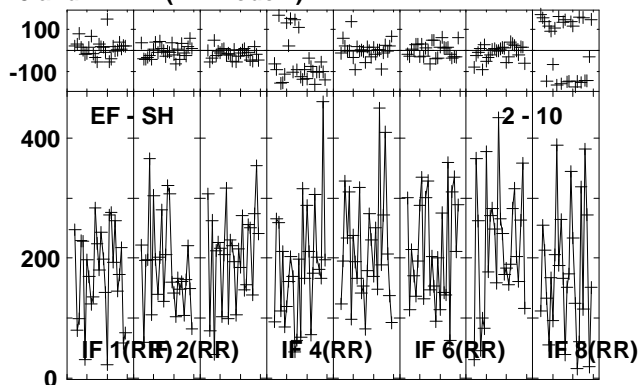
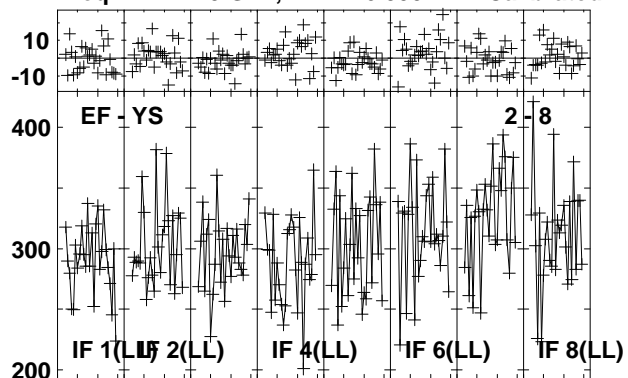

Lower frame: Milli Ampl Jy Top frame: Phas deg
 Vector averaged cross-power spectrum Several baselines displayed
 Timerange: 00/20:28:26 to 00/20:29:08

Plot file version 95 created 26-JUL-2013 10:19:19
 B1152+199A EZ024 1.UVDATA.1
 Freq = 22.1720 GHz, Bw = 16.000 MH Calibrated with CL # 3 and BP # 1 (BP mode 1)

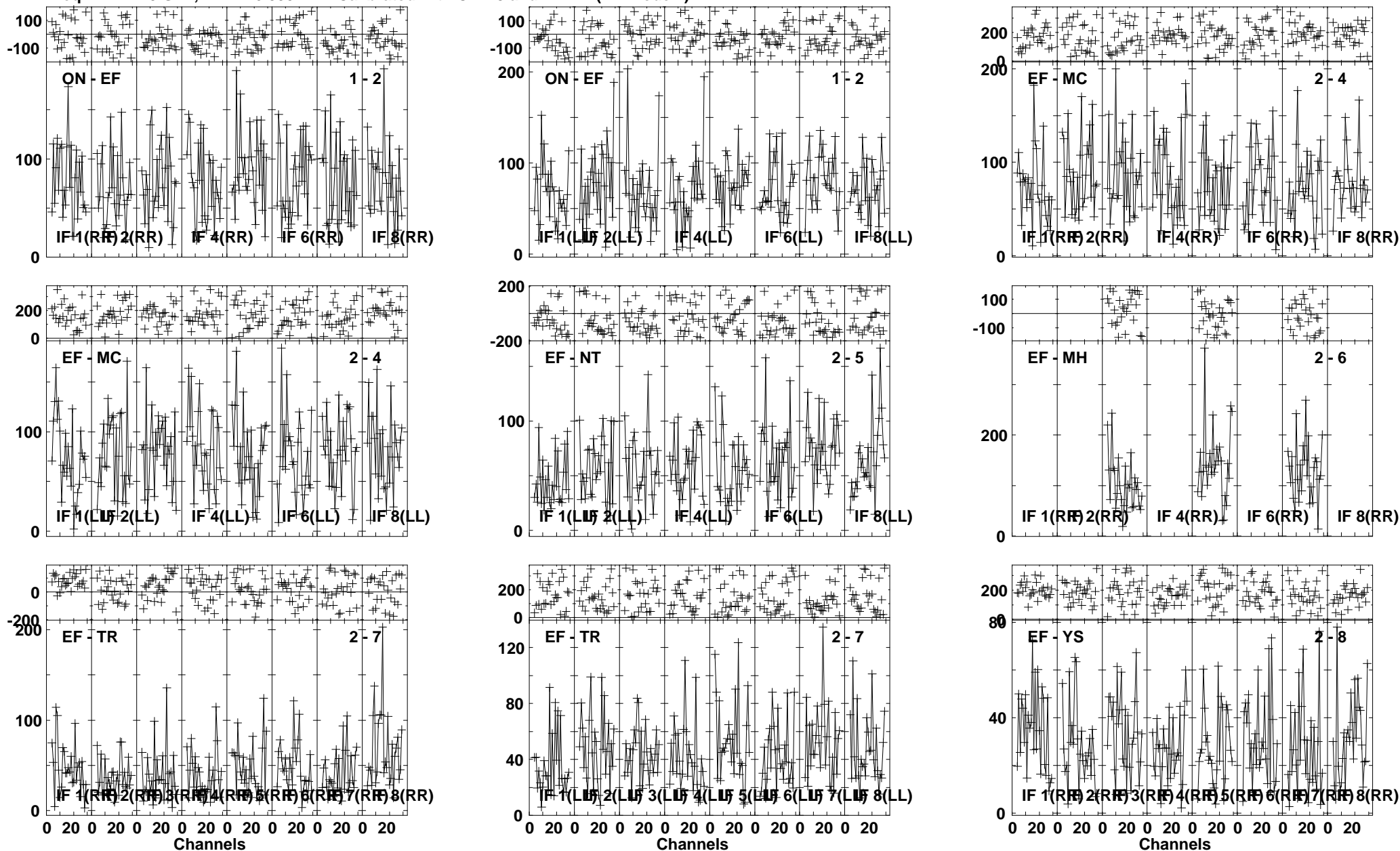

Lower frame: Milli Ampl Jy Top frame: Phas deg
 Vector averaged cross-power spectrum Several baselines displayed
 Timerange: 00/20:29:44 to 00/20:31:42

Plot file version 96 created 26-JUL-2013 10:19:20
 B1152+199A EZ024 1.UVDATA.1
 Freq = 22.1720 GHz, Bw = 16.000 MH Calibrated with CL # 3 and BP # 1 (BP mode 1)

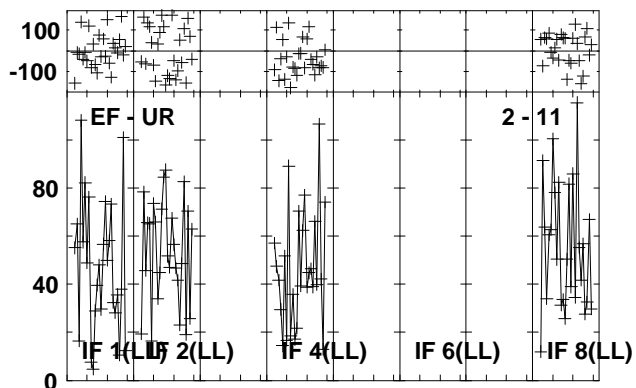
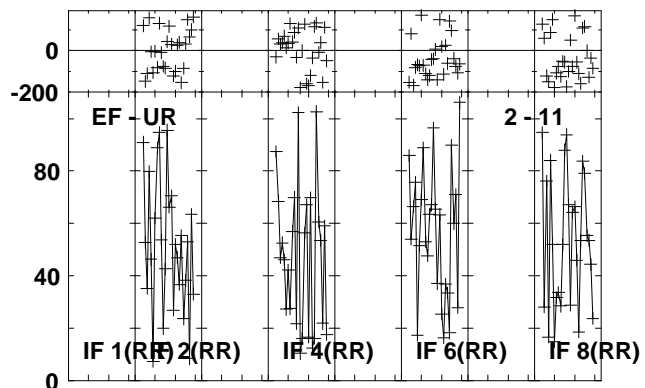
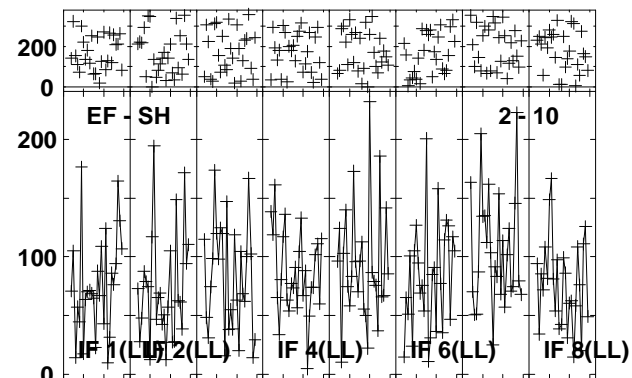
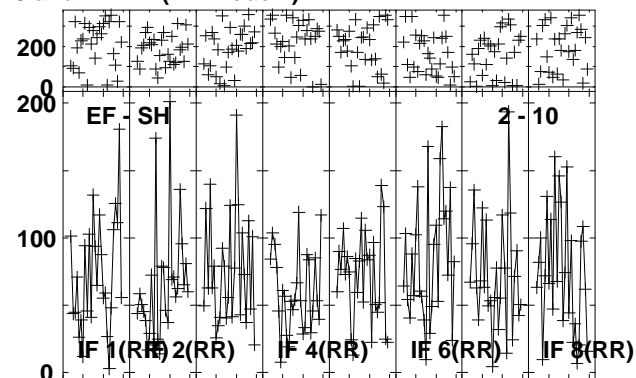
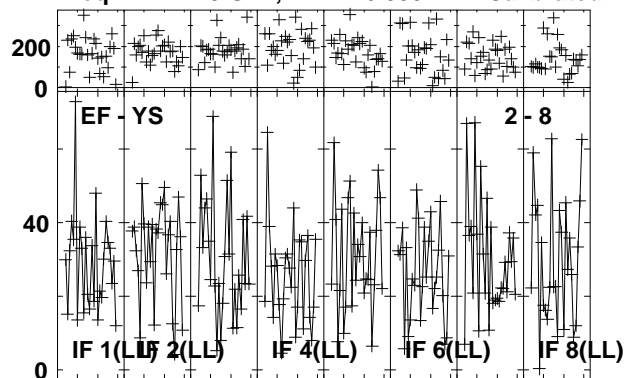

Lower frame: Milli Ampl Jy Top frame: Phas deg
 Vector averaged cross-power spectrum Several baselines displayed
 Timerange: 00/20:29:44 to 00/20:31:42

Plot file version 97 created 26-JUL-2013 10:19:22

J1157 EZ024 1.UVDATA.1

Freq = 22.1720 GHz, Bw = 16.000 MH Calibrated with CL # 3 and BP # 1 (BP mode 1)

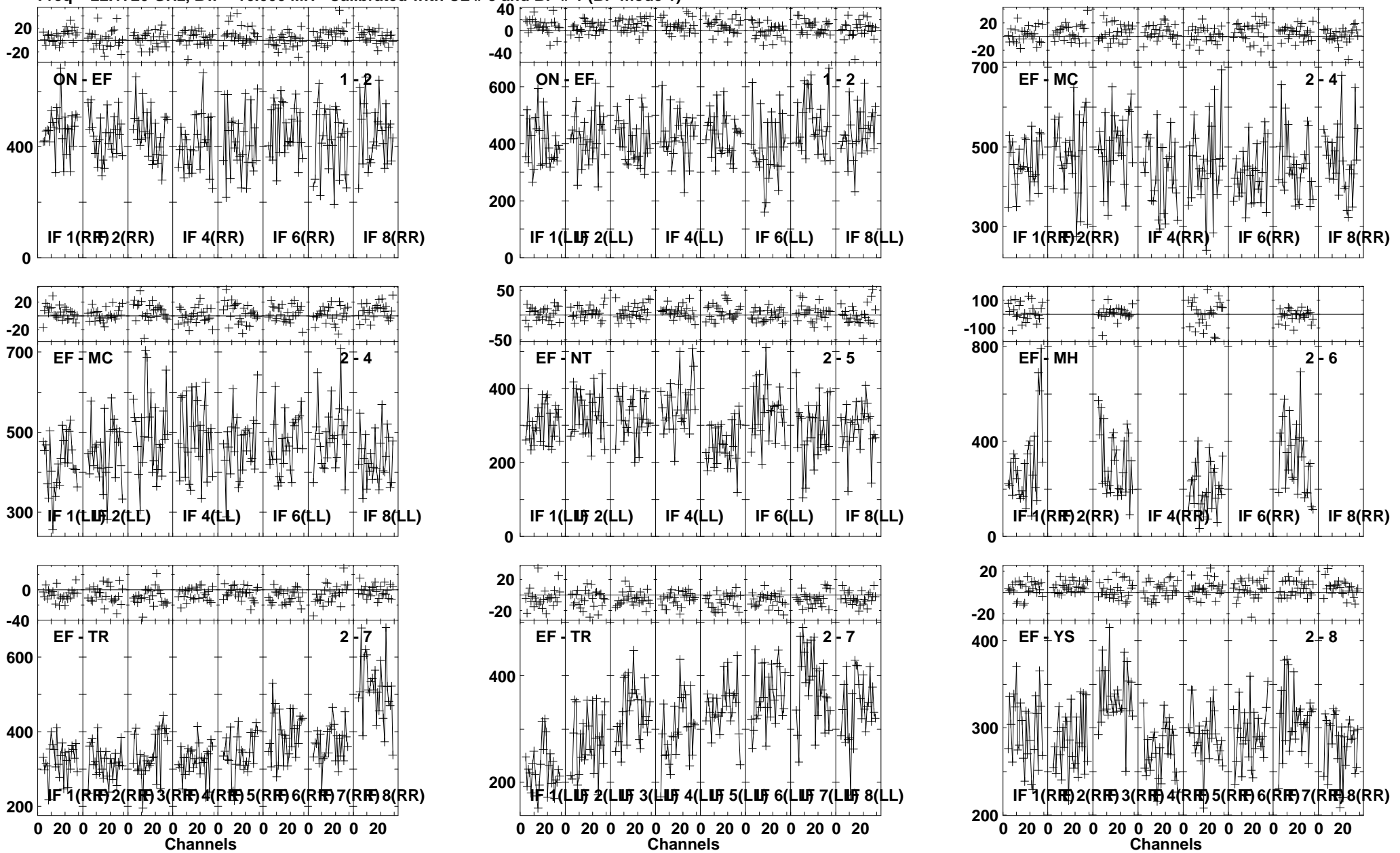

Lower frame: Milli Ampl Jy Top frame: Phas deg
Vector averaged cross-power spectrum Several baselines displayed
Timerange: 00/20:32:17 to 00/20:33:15

Plot file version 98 created 26-JUL-2013 10:19:23
 J1157 EZ024 1.UVDATA.1
 Freq = 22.1720 GHz, Bw = 16.000 MH Calibrated with CL # 3 and BP # 1 (BP mode 1)

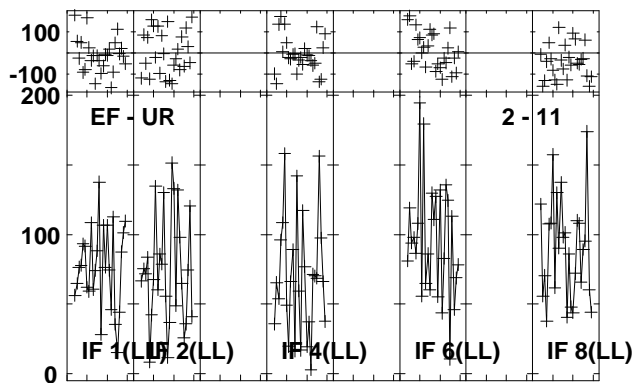
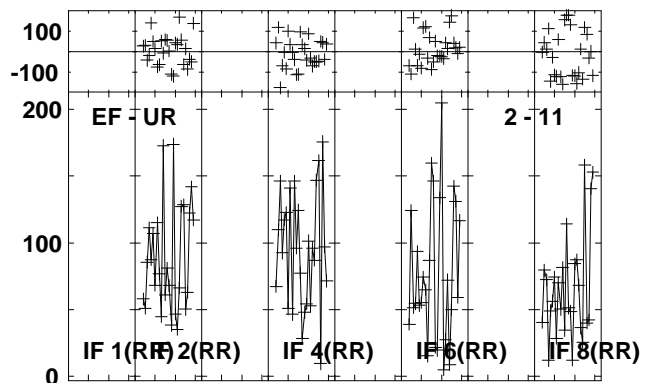
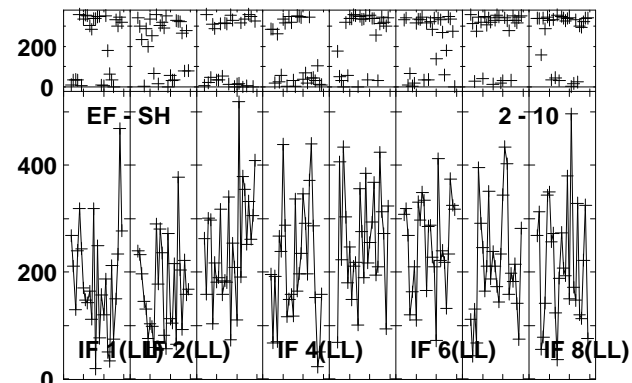
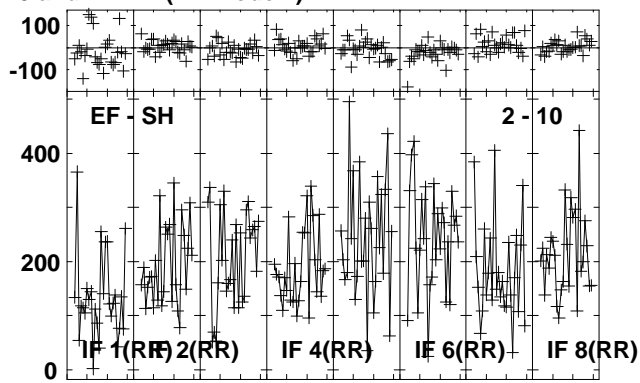
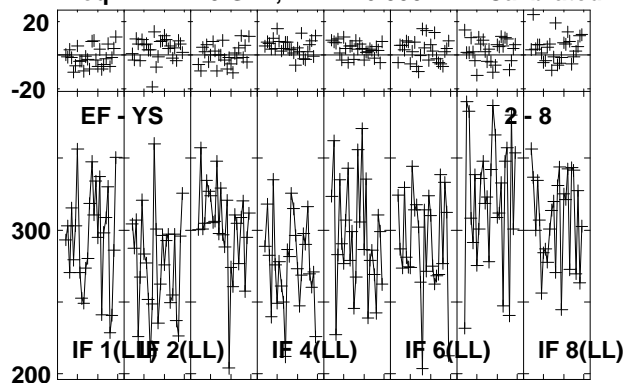

Lower frame: Milli Ampl Jy Top frame: Phas deg
 Vector averaged cross-power spectrum Several baselines displayed
 Timerange: 00/20:32:17 to 00/20:33:15

Plot file version 99 created 26-JUL-2013 10:19:24
 B1152+199A EZ024 1.UVDATA.1
 Freq = 22.1720 GHz, Bw = 16.000 MH Calibrated with CL # 3 and BP # 1 (BP mode 1)

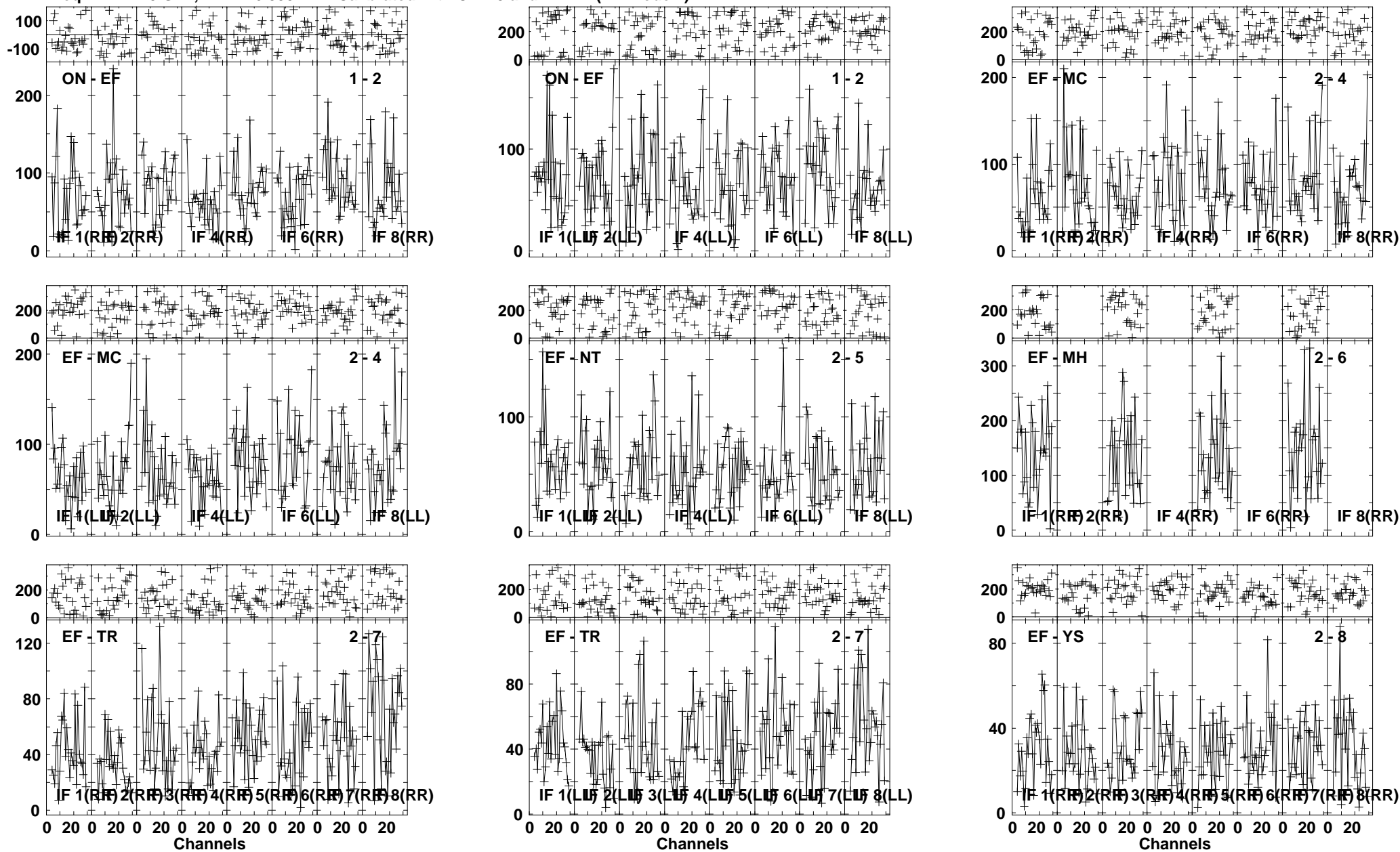

Lower frame: Milli Ampl Jy Top frame: Phas deg
 Vector averaged cross-power spectrum Several baselines displayed
 Timerange: 00/20:33:50 to 00/20:35:48

Plot file version 100 created 26-JUL-2013 10:19:25
 B1152+199A EZ024 1.UVDATA.1
 Freq = 22.1720 GHz, Bw = 16.000 MH Calibrated with CL # 3 and BP # 1 (BP mode 1)

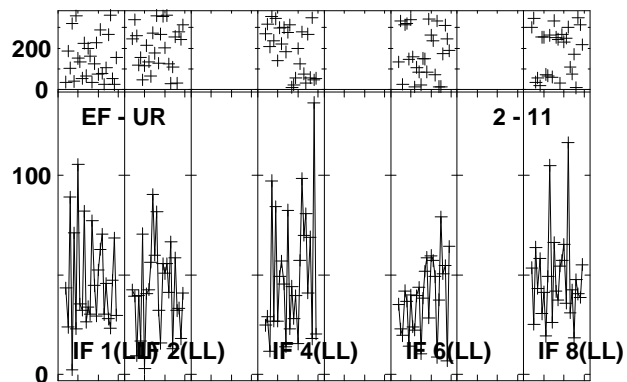
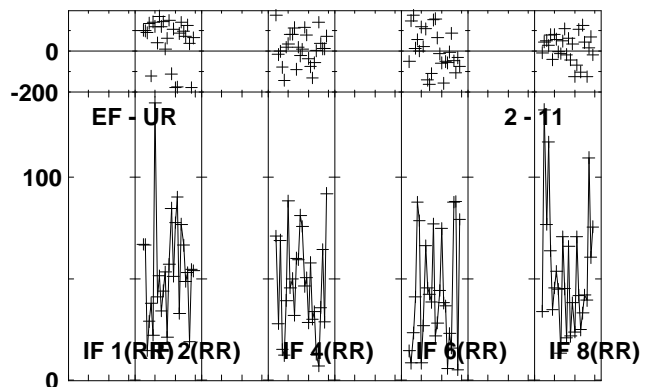
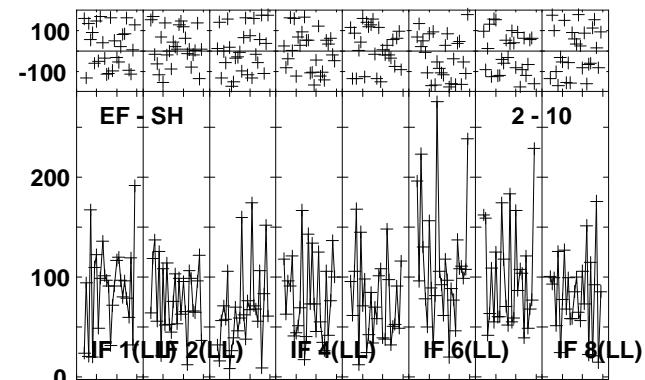
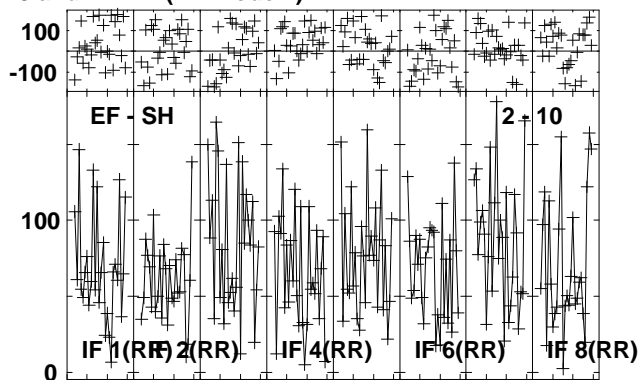
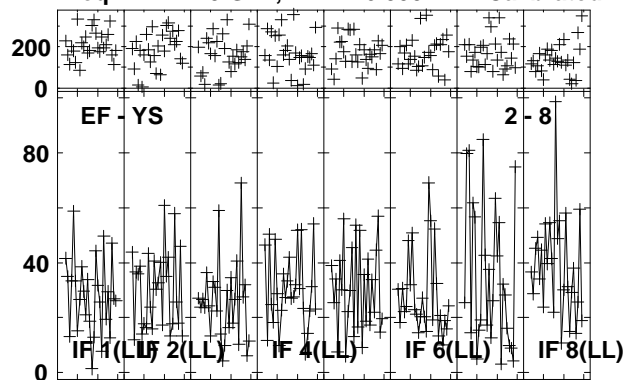

Lower frame: Milli Ampl Jy Top frame: Phas deg
 Vector averaged cross-power spectrum Several baselines displayed
 Timerange: 00/20:33:50 to 00/20:35:48

Plot file version 101 created 26-JUL-2013 10:19:27

J1157 EZ024 1.UVDATA.1

Freq = 22.1720 GHz, Bw = 16.000 MH Calibrated with CL # 3 and BP # 1 (BP mode 1)

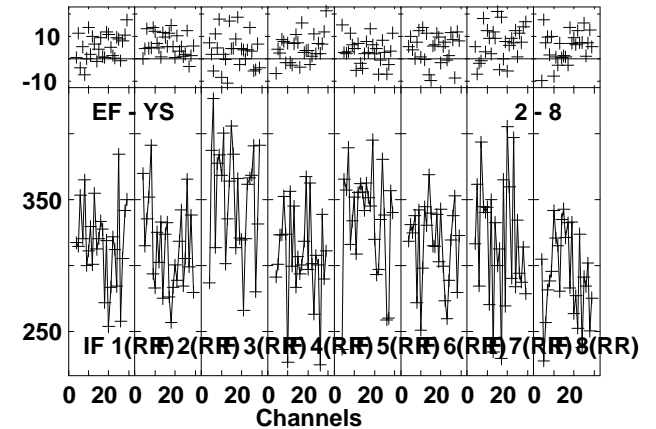
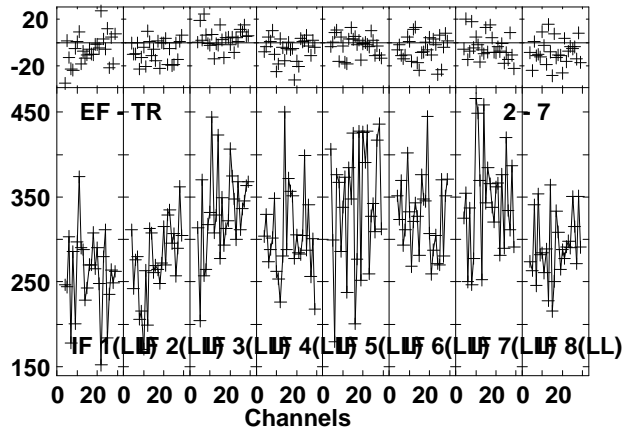
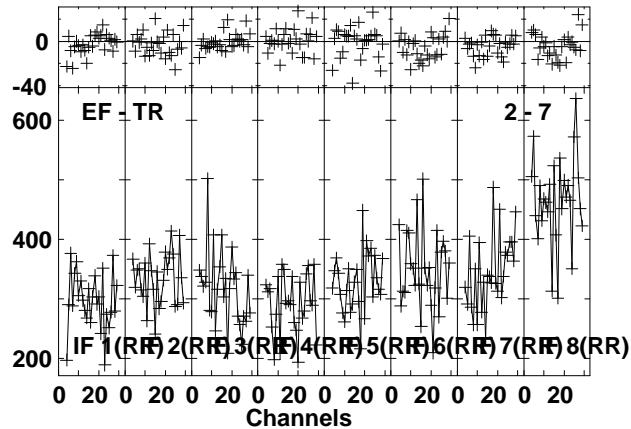
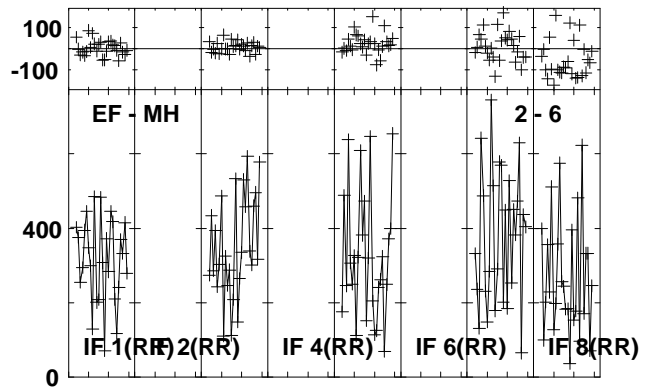
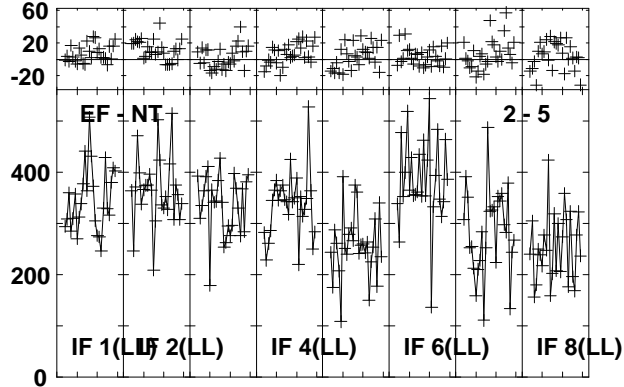
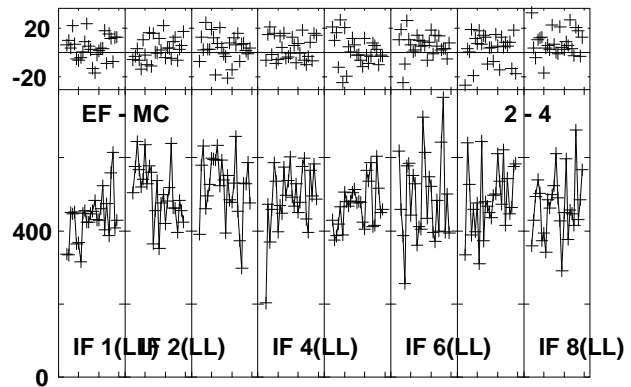
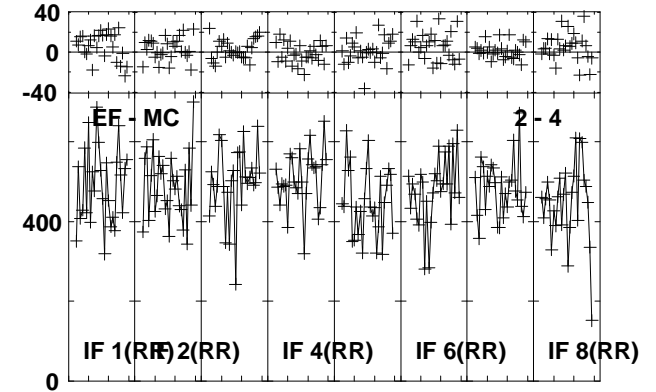
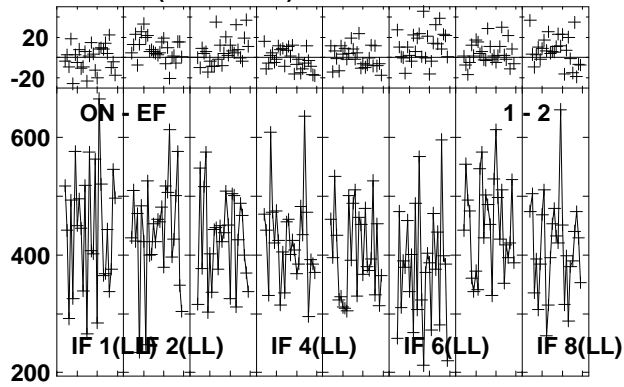
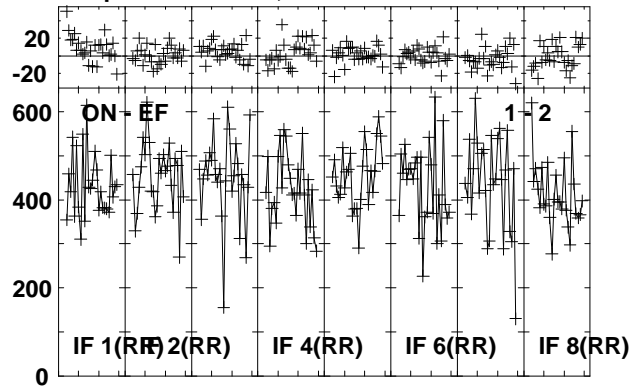

Lower frame: Milli Ampl Jy Top frame: Phas deg
Vector averaged cross-power spectrum Several baselines displayed
Timerange: 00/20:36:23 to 00/20:37:21

Plot file version 102 created 26-JUL-2013 10:19:28
 J1157 EZ024 1.UVDATA.1
 Freq = 22.1720 GHz, Bw = 16.000 MH Calibrated with CL # 3 and BP # 1 (BP mode 1)

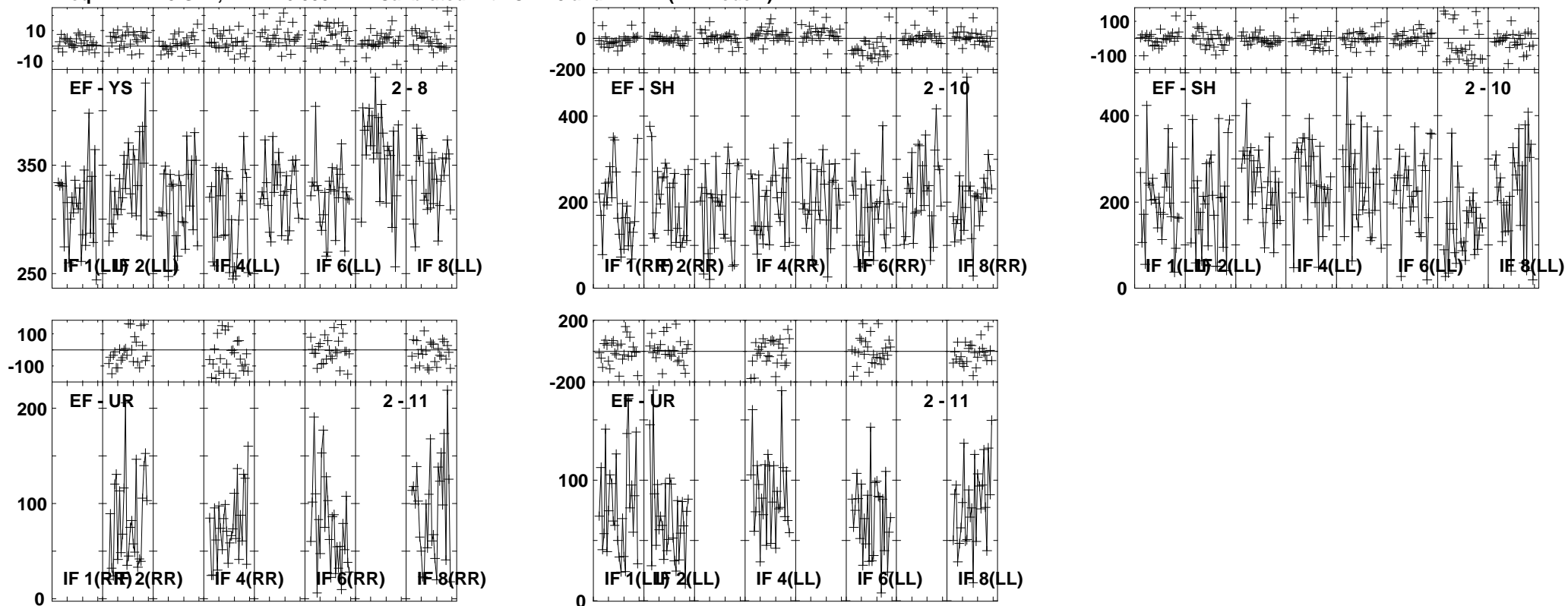

Lower frame: Milli Ampl Jy Top frame: Phas deg
 Vector averaged cross-power spectrum Several baselines displayed
 Timerange: 00/20:36:23 to 00/20:37:21

Plot file version 103 created 26-JUL-2013 10:19:28
 B1152+199A EZ024 1.UVDATA.1
 Freq = 22.1720 GHz, Bw = 16.000 MH Calibrated with CL # 3 and BP # 1 (BP mode 1)

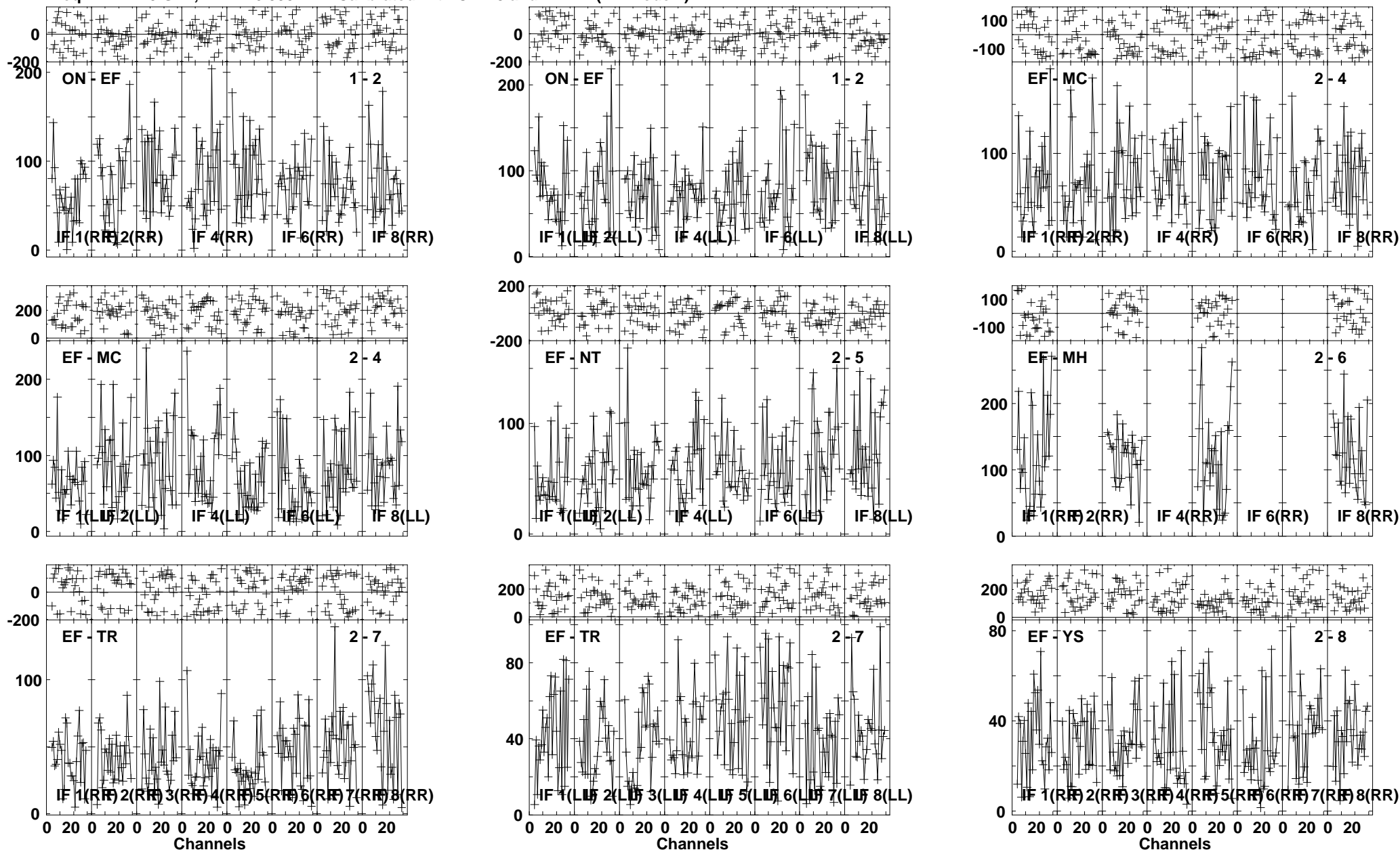

Lower frame: Milli Ampl Jy Top frame: Phas deg
 Vector averaged cross-power spectrum Several baselines displayed
 Timerange: 00/20:37:56 to 00/20:39:54

Plot file version 104 created 26-JUL-2013 10:19:30
 B1152+199A EZ024 1.UVDATA.1
 Freq = 22.1720 GHz, Bw = 16.000 MH Calibrated with CL # 3 and BP # 1 (BP mode 1)

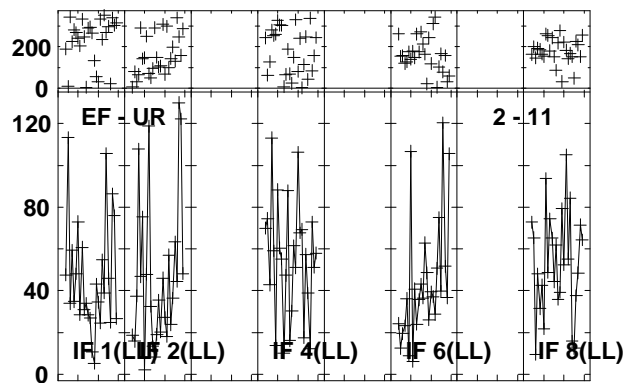
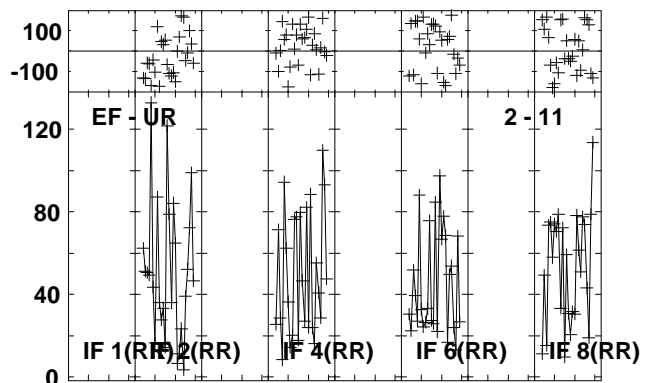
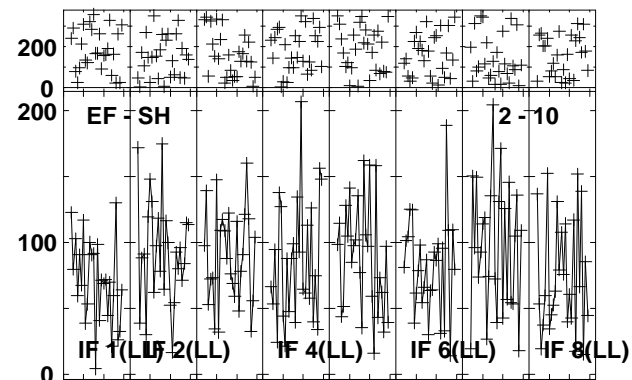
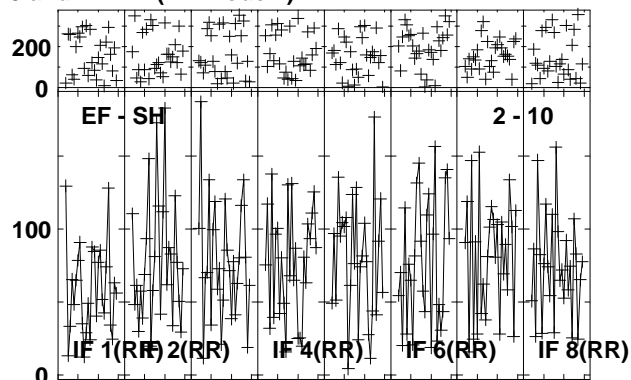
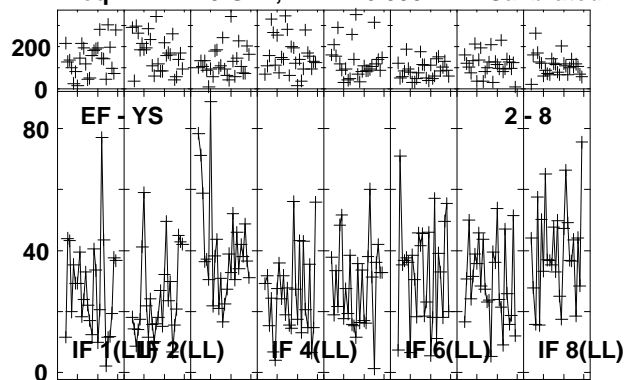

Lower frame: Milli Ampl Jy Top frame: Phas deg
 Vector averaged cross-power spectrum Several baselines displayed
 Timerange: 00/20:37:56 to 00/20:39:54

Plot file version 105 created 26-JUL-2013 10:19:31
 J1157 EZ024 1.UVDATA.1
 Freq = 22.1720 GHz, Bw = 16.000 MH Calibrated with CL # 3 and BP # 1 (BP mode 1)

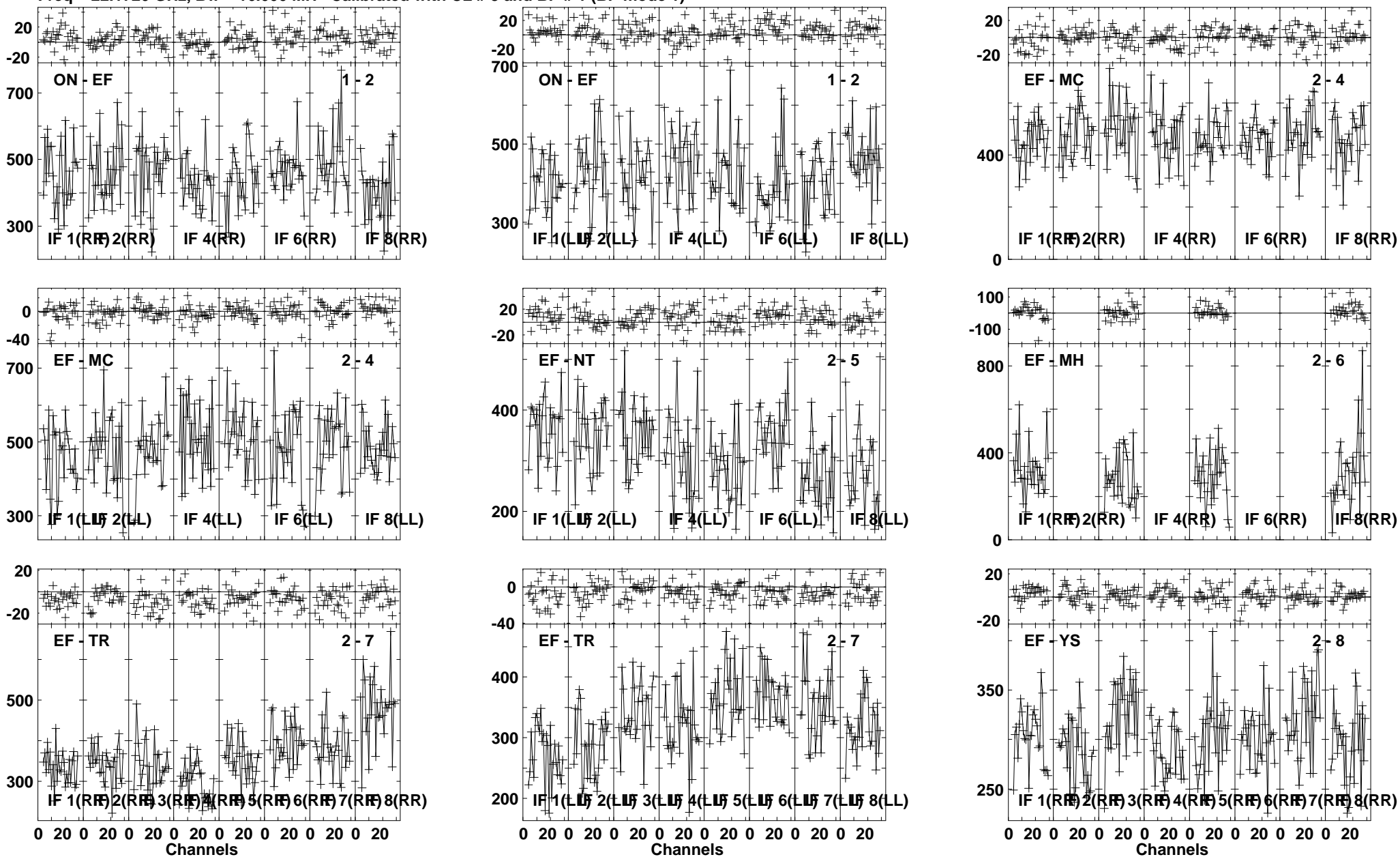

Lower frame: Milli Ampl Jy Top frame: Phas deg
 Vector averaged cross-power spectrum Several baselines displayed
 Timerange: 00:20:40:29 to 00:20:41:27

Plot file version 106 created 26-JUL-2013 10:19:32
 J1157 EZ024 1.UVDATA.1
 Freq = 22.1720 GHz, Bw = 16.000 MH Calibrated with CL # 3 and BP # 1 (BP mode 1)

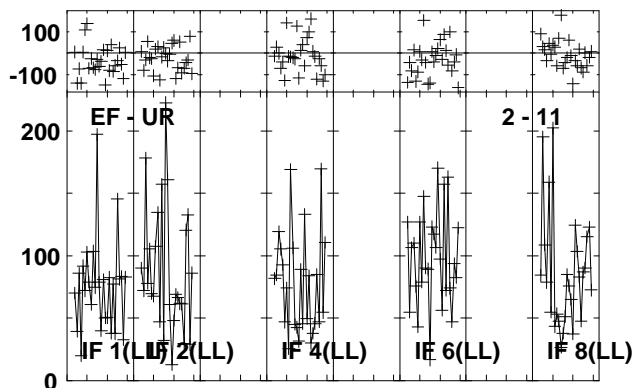
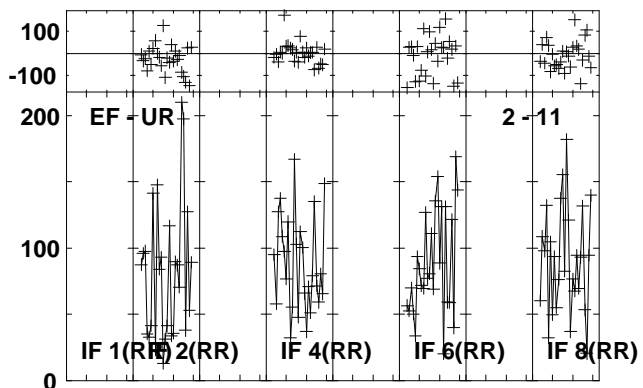
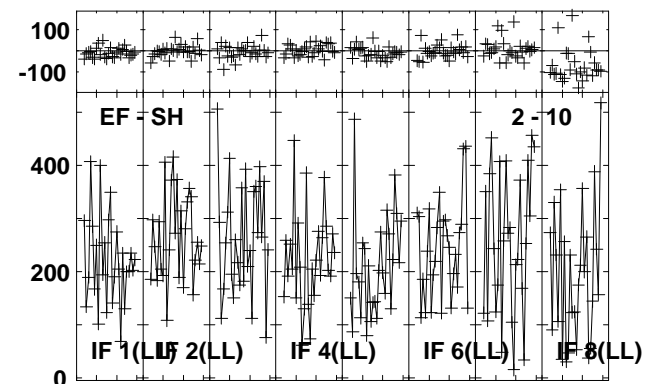
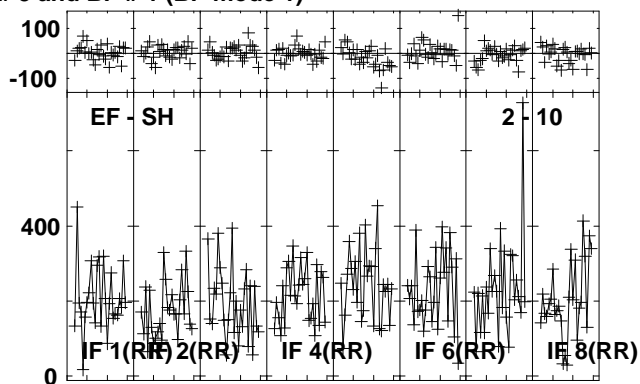
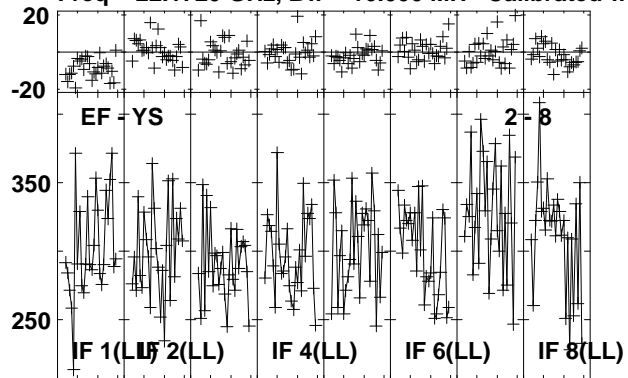

Lower frame: Milli Ampl Jy Top frame: Phas deg
 Vector averaged cross-power spectrum Several baselines displayed
 Timerange: 00/20:40:29 to 00/20:41:27

Plot file version 107 created 26-JUL-2013 10:19:33
 J1125+2610 EZ024 1.UVDATA.1
 Freq = 22.1720 GHz, Bw = 16.000 MH Calibrated with CL # 3 and BP # 1 (BP mode 1)

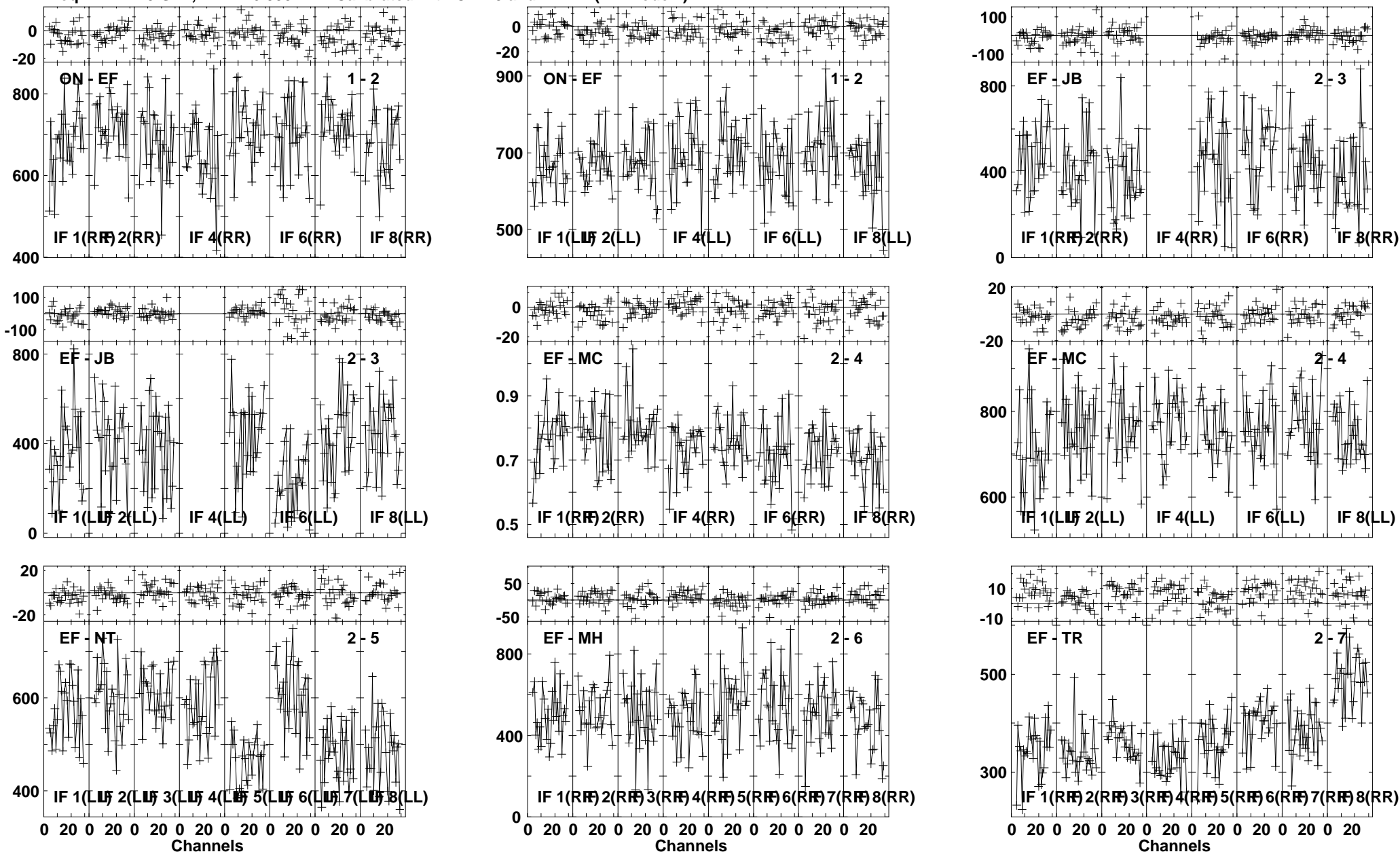

Lower frame: Milli Ampl Jy Top frame: Phas deg
 Vector averaged cross-power spectrum Several baselines displayed
 Timerange: 00/20:42:54 to 00/20:44:36

Plot file version 108 created 26-JUL-2013 10:19:34
 J1125+2610 EZ024 1.UVDATA.1
 Freq = 22.1720 GHz, Bw = 16.000 MH Calibrated with CL # 3 and BP # 1 (BP mode 1)

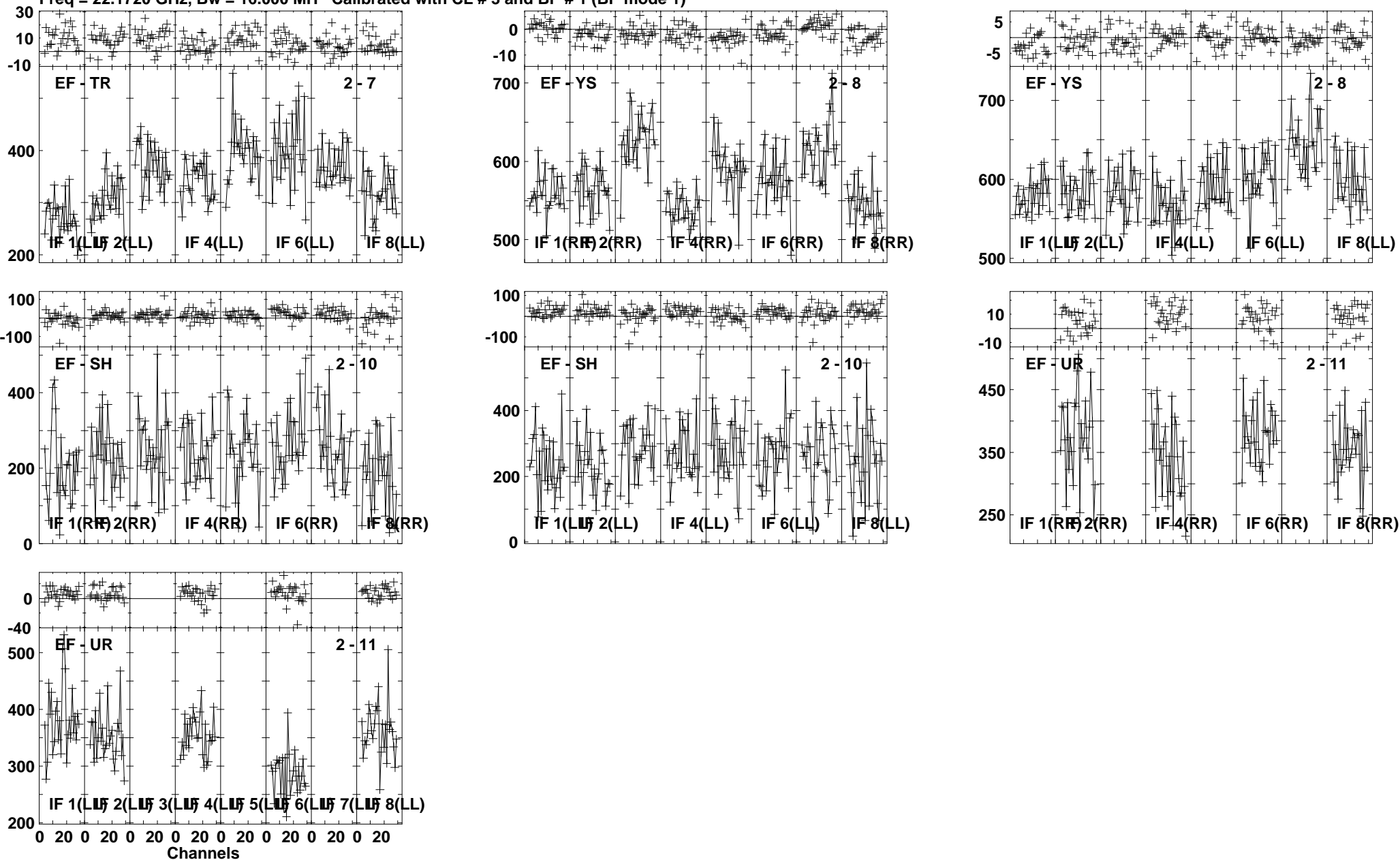

Lower frame: Milli Ampl Jy Top frame: Phas deg
 Vector averaged cross-power spectrum Several baselines displayed
 Timerange: 00/20:42:54 to 00/20:44:36

Plot file version 109 created 26-JUL-2013 10:19:35

J1157 EZ024 1.UVDATA.1

Freq = 22.1720 GHz, Bw = 16.000 MH Calibrated with CL # 3 and BP # 1 (BP mode 1)

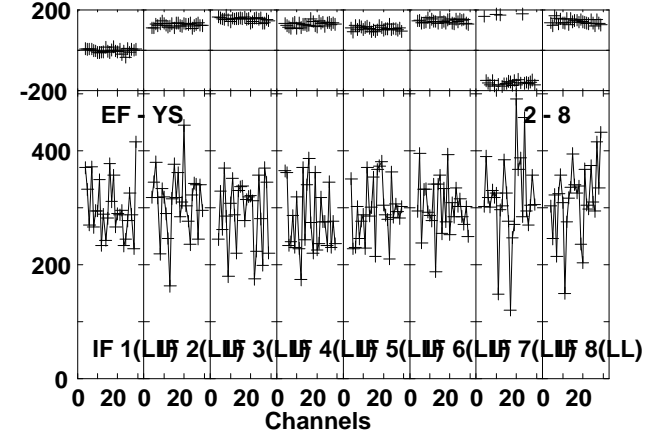
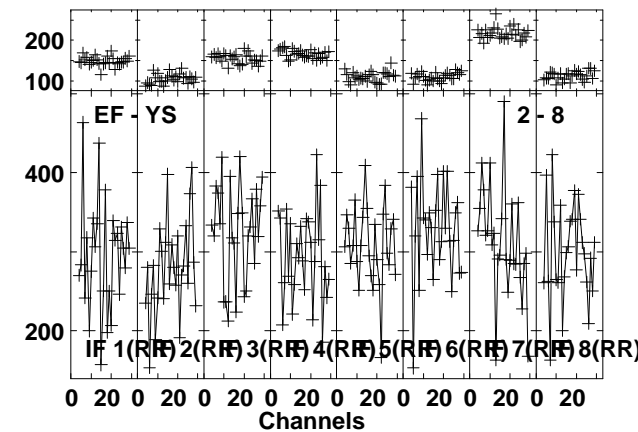
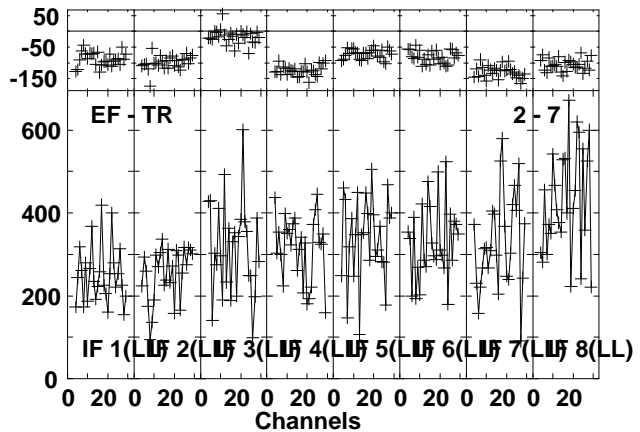
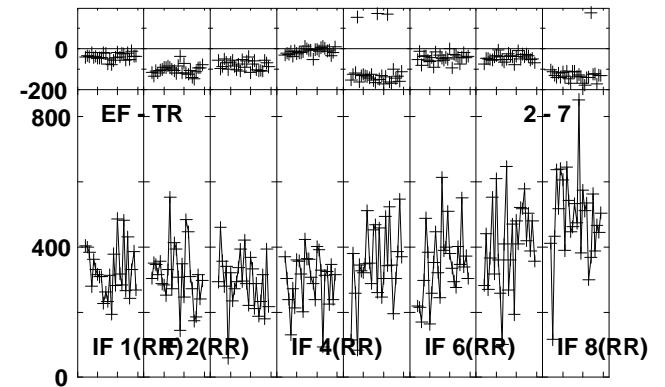
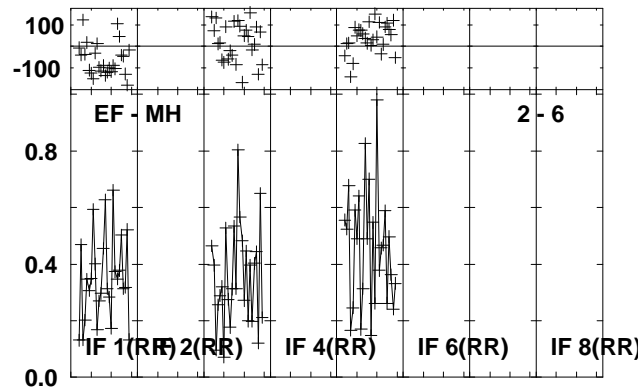
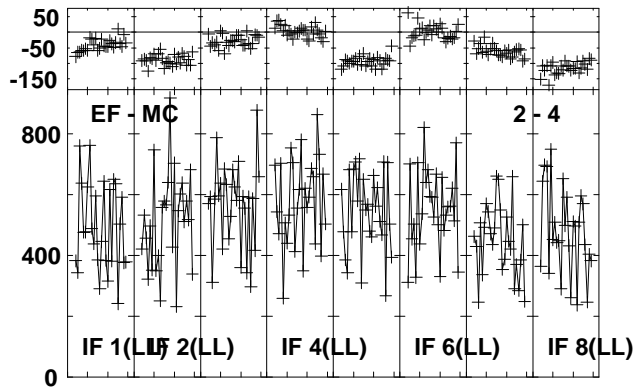
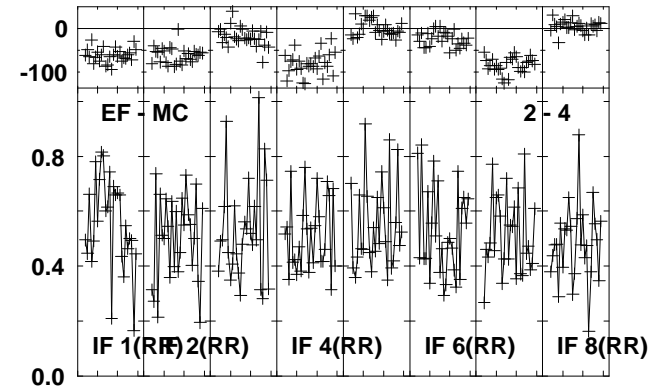
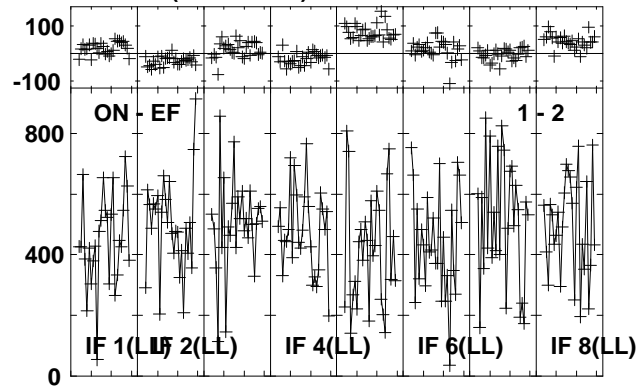
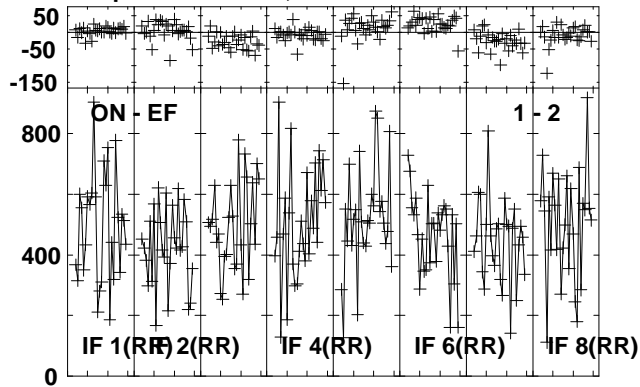

Lower frame: Milli Ampl Jy Top frame: Phas deg
Vector averaged cross-power spectrum Several baselines displayed
Timerange: 00/20:46:03 to 00/20:46:45

Plot file version 110 created 26-JUL-2013 10:19:36

J1157 EZ024 1.UVDATA.1

Freq = 22.1720 GHz, Bw = 16.000 MH Calibrated with CL # 3 and BP # 1 (BP mode 1)

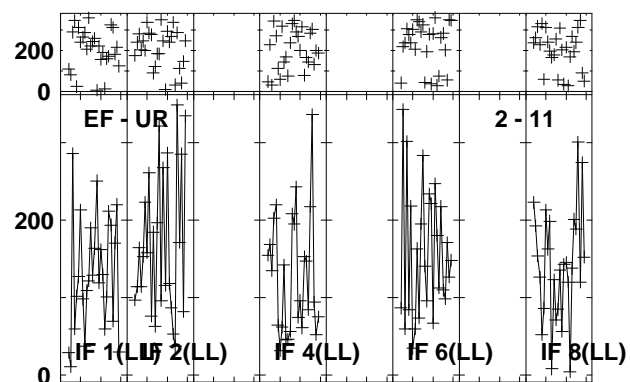
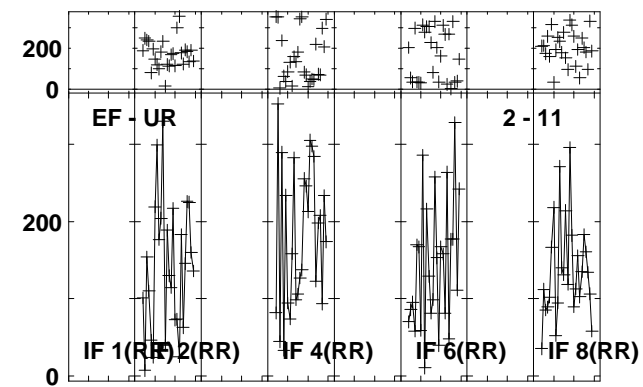
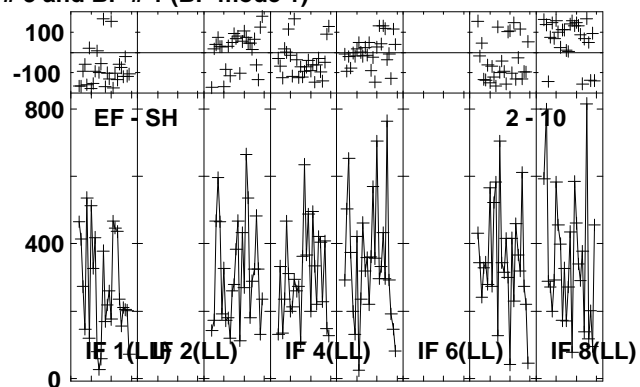
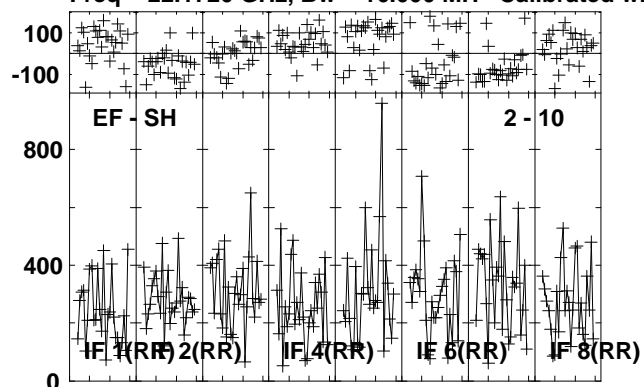

Lower frame: Milli Ampl Jy Top frame: Phas deg
Vector averaged cross-power spectrum Several baselines displayed
Timerange: 00/20:46:03 to 00/20:46:45

Plot file version 111 created 26-JUL-2013 10:19:36
 B1152+199A EZ24 1.UVDATA.1
 Freq = 22.1720 GHz, Bw = 16.000 MH Calibrated with CL # 3 and BP # 1 (BP mode 1)

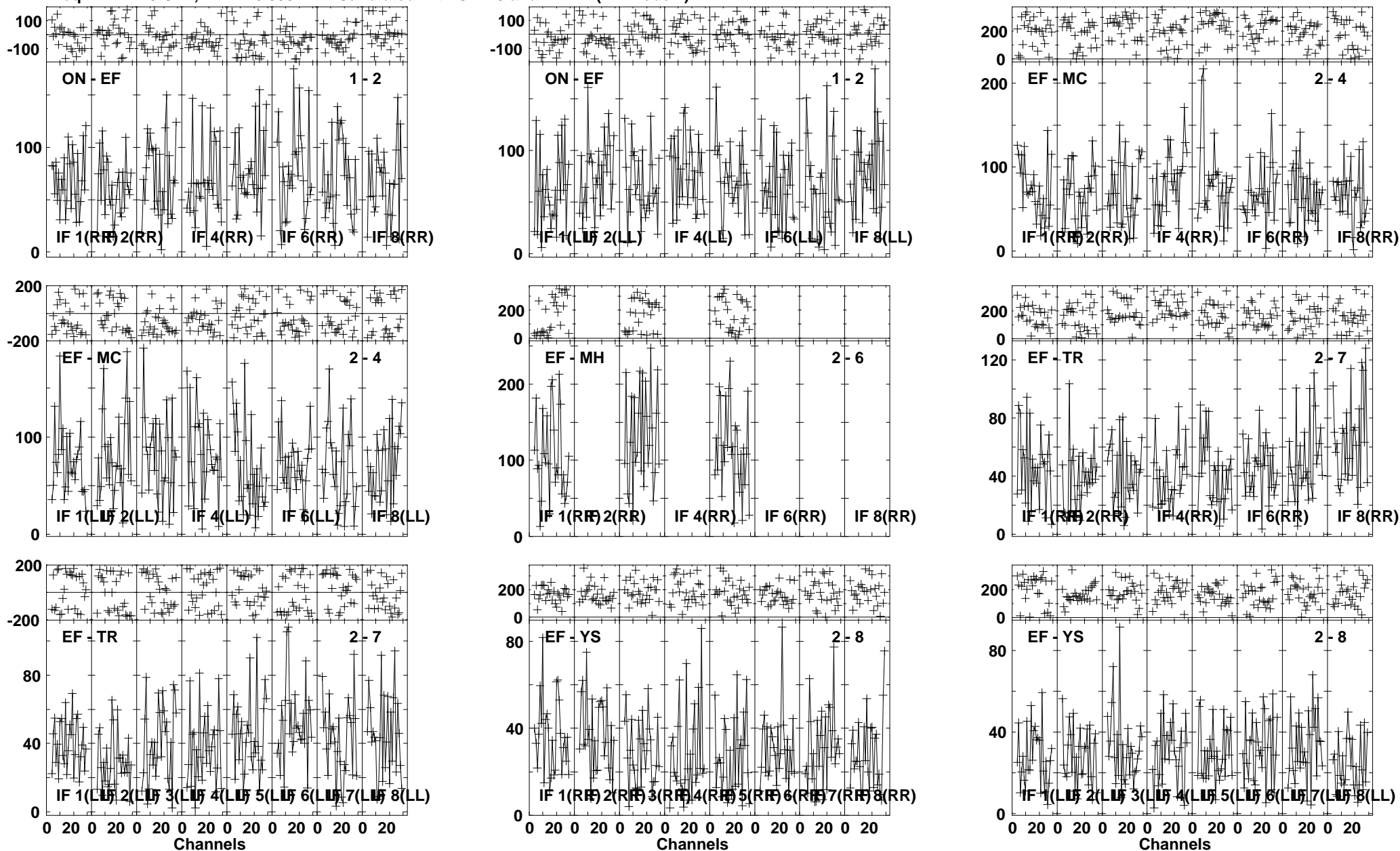

Lower frame: Milli Ampl Jy Top frame: Phas deg
 Vector averaged cross-power spectrum Several baselines displayed
 Timerange: 00/20:47:21 to 00/20:49:19

Plot file version 112 created 26-JUL-2013 10:19:38
 B1152+199A EZ024 1.UVDATA.1
 Freq = 22.1720 GHz, Bw = 16.000 MH Calibrated with CL # 3 and BP # 1 (BP mode 1)

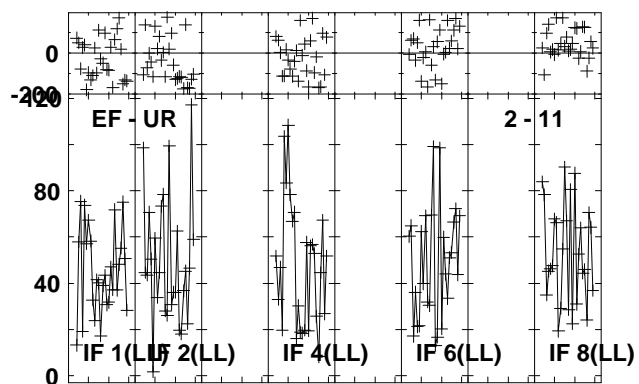
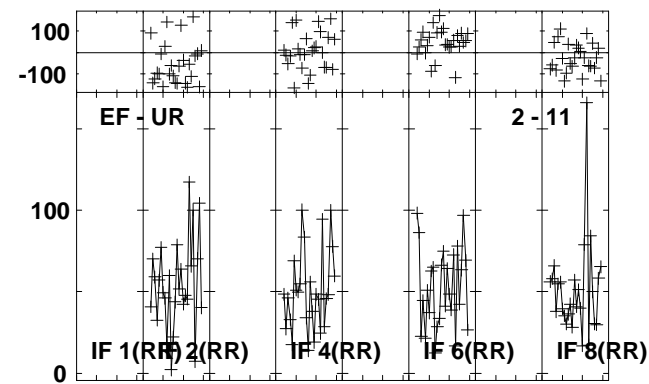
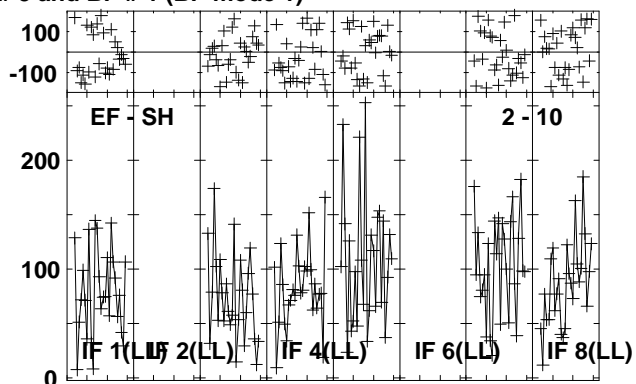
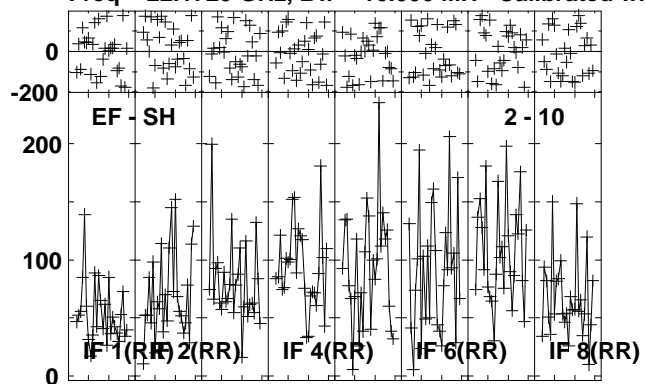

Lower frame: Milli Ampl Jy Top frame: Phas deg
 Vector averaged cross-power spectrum Several baselines displayed
 Timerange: 00/20:47:21 to 00/20:49:19

Plot file version 113 created 26-JUL-2013 10:19:39

J1157 EZ024 1.UVDATA.1

Freq = 22.1720 GHz, Bw = 16.000 MH Calibrated with CL # 3 and BP # 1 (BP mode 1)

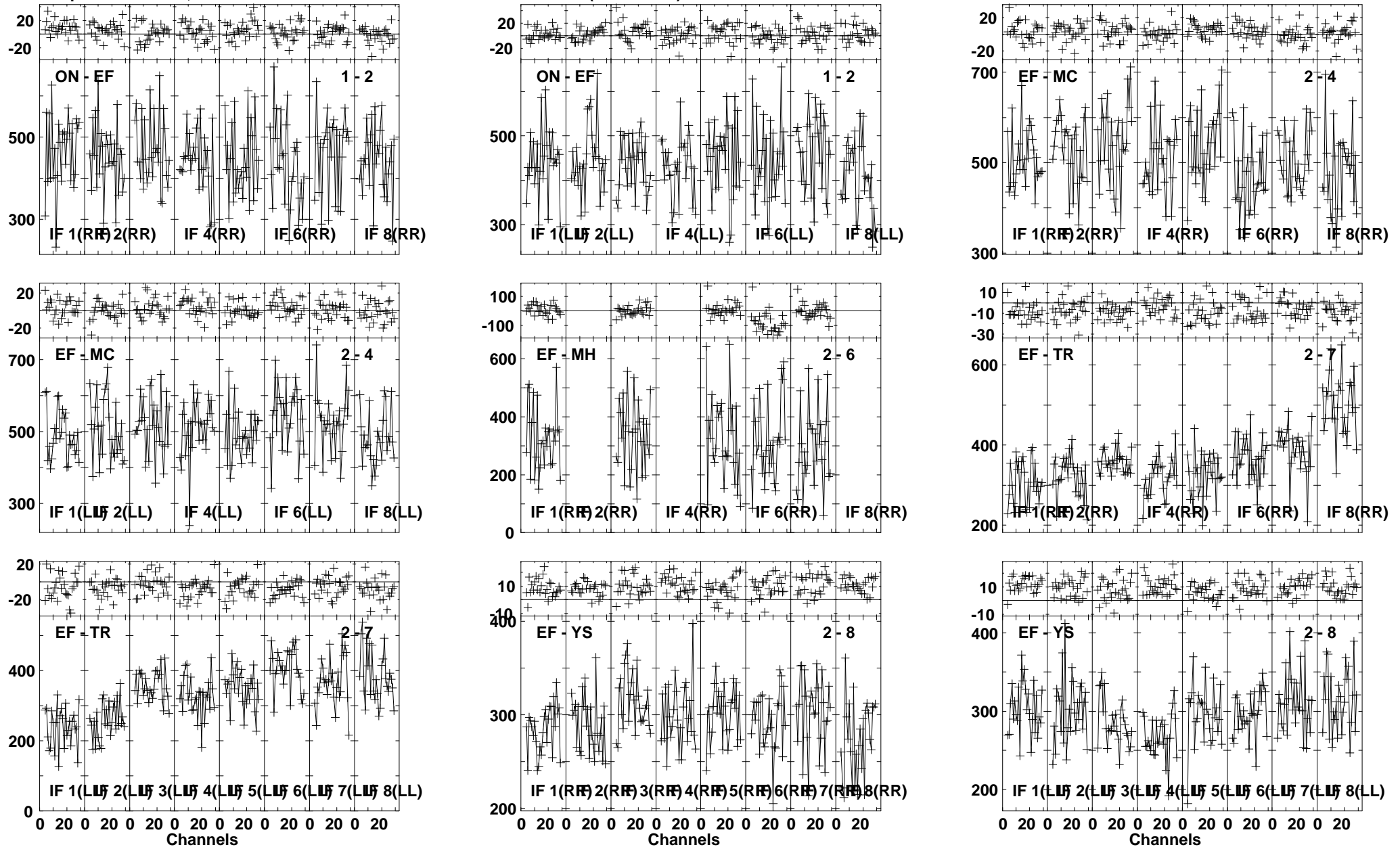

Lower frame: Milli Ampl Jy Top frame: Phas deg
Vector averaged cross-power spectrum Several baselines displayed
Timerange: 00:20:49:54 to 00:20:50:52

Plot file version 114 created 26-JUL-2013 10:19:40

J1157 EZ024 1.UVDATA.1

Freq = 22.1720 GHz, Bw = 16.000 MH Calibrated with CL # 3 and BP # 1 (BP mode 1)

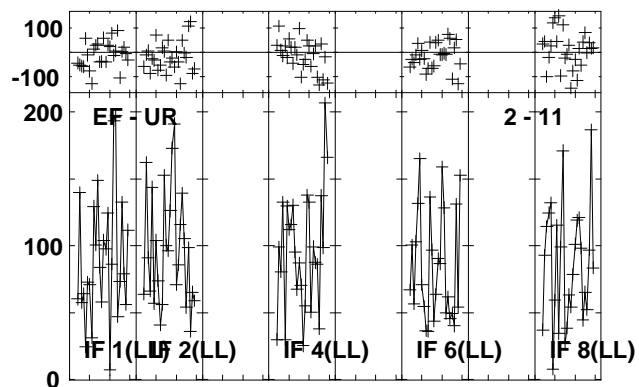
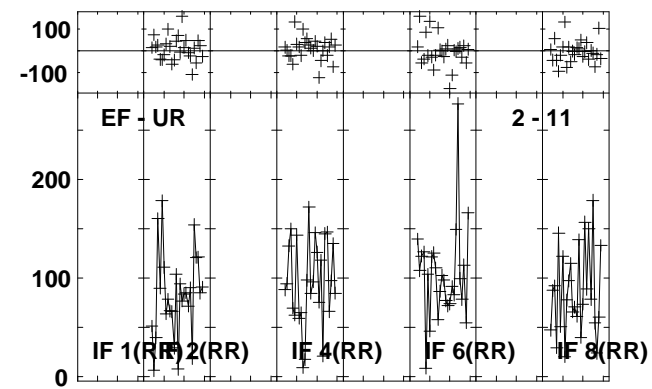
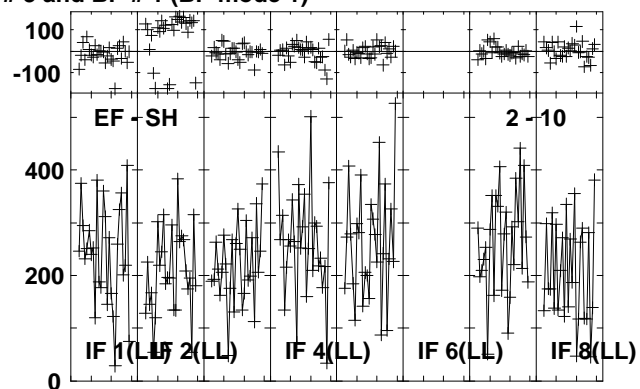
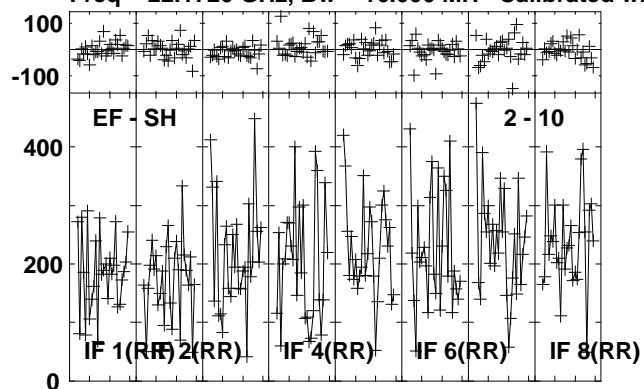

Lower frame: Milli Ampl Jy Top frame: Phas deg
Vector averaged cross-power spectrum Several baselines displayed
Timerange: 00/20:49:54 to 00/20:50:52

Plot file version 115 created 26-JUL-2013 10:19:40
 B1152+199A EZ024 1.UVDATA.1
 Freq = 22.1720 GHz, Bw = 16.000 MH Calibrated with CL # 3 and BP # 1 (BP mode 1)

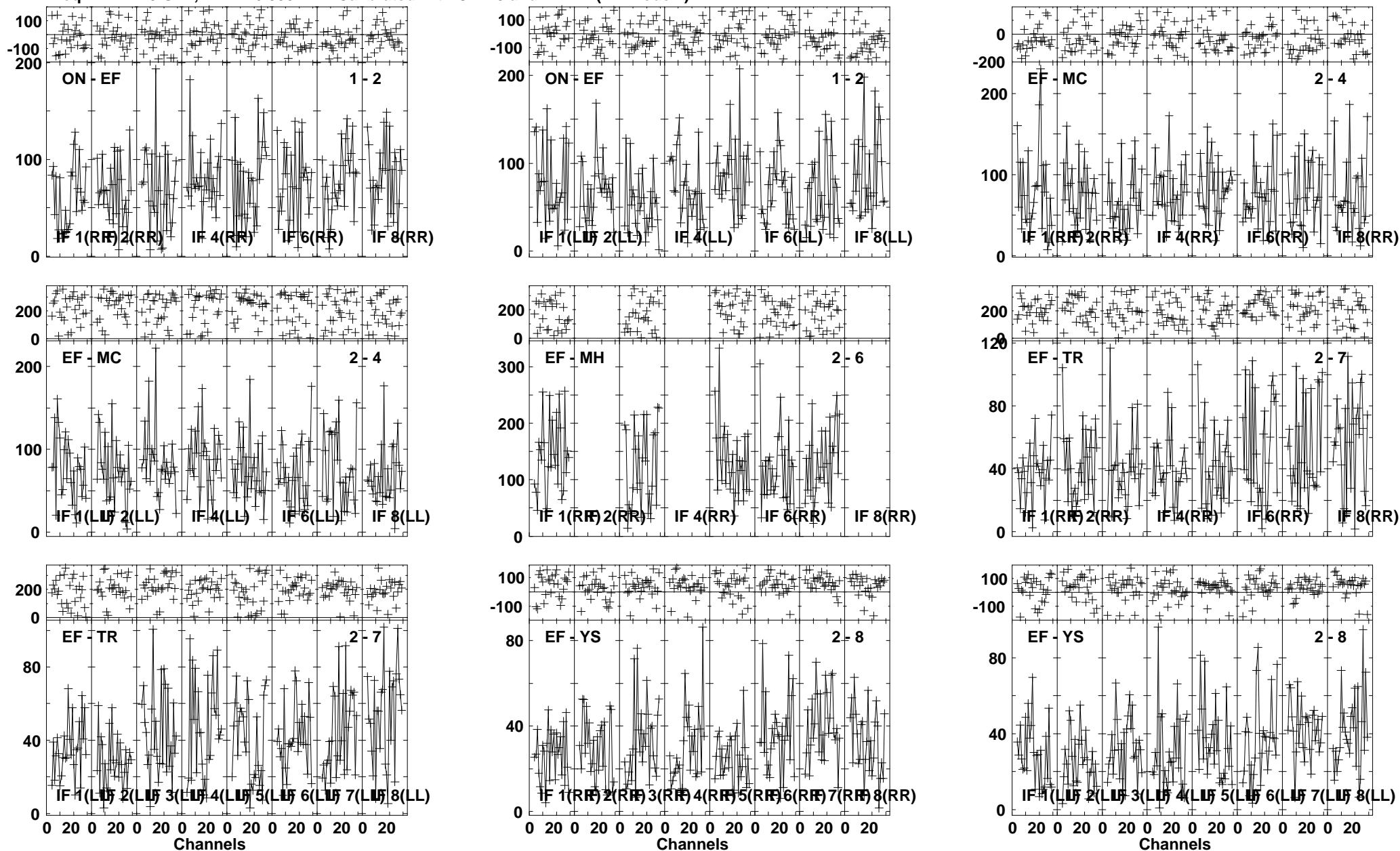

Lower frame: Milli Ampl Jy Top frame: Phas deg
 Vector averaged cross-power spectrum Several baselines displayed
 Timerange: 00/20:51:27 to 00/20:53:25

Plot file version 116 created 26-JUL-2013 10:19:42
 B1152+199A EZ24 1.UVDATA.1
 Freq = 22.1720 GHz, Bw = 16.000 MH Calibrated with CL # 3 and BP # 1 (BP mode 1)

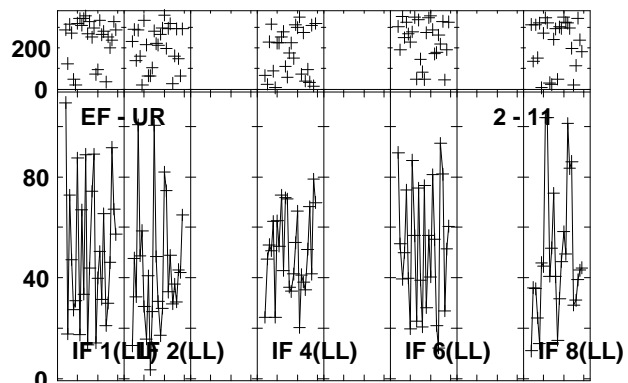
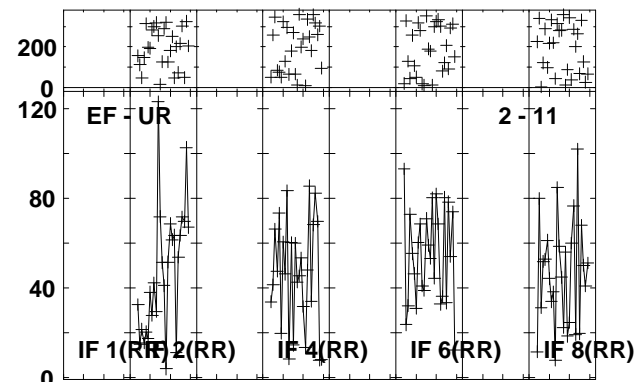
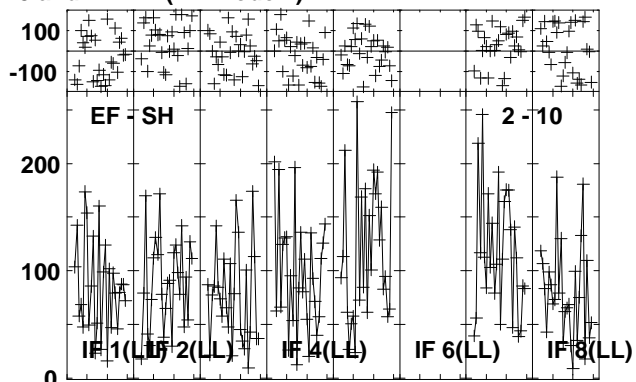
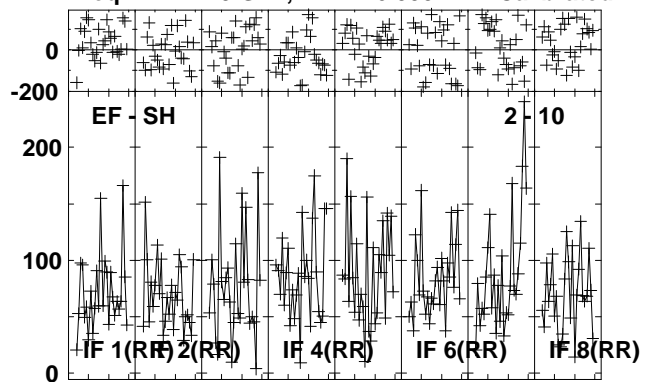

Lower frame: Milli Ampl Jy Top frame: Phas deg
 Vector averaged cross-power spectrum Several baselines displayed
 Timerange: 00/20:51:27 to 00/20:53:25

Plot file version 117 created 26-JUL-2013 10:19:43

J1157 EZ024 1.UVDATA.1

Freq = 22.1720 GHz, Bw = 16.000 MH Calibrated with CL # 3 and BP # 1 (BP mode 1)

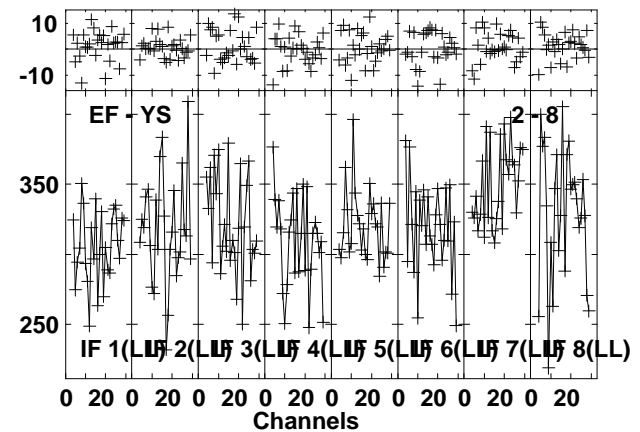
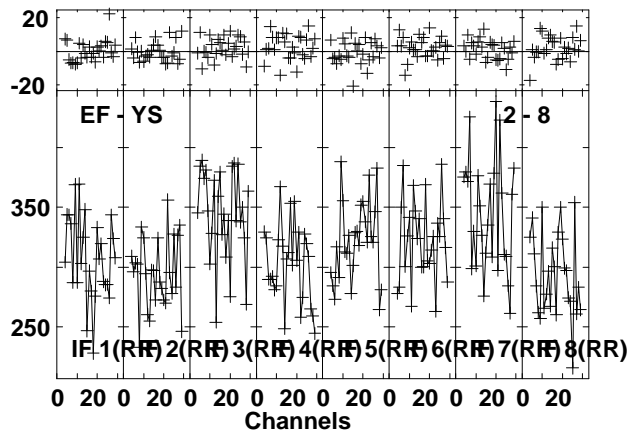
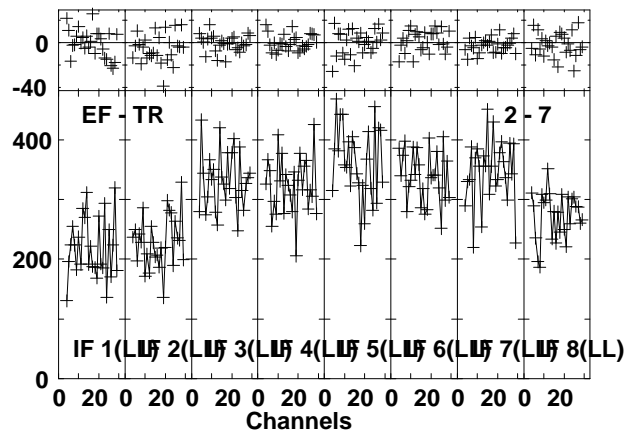
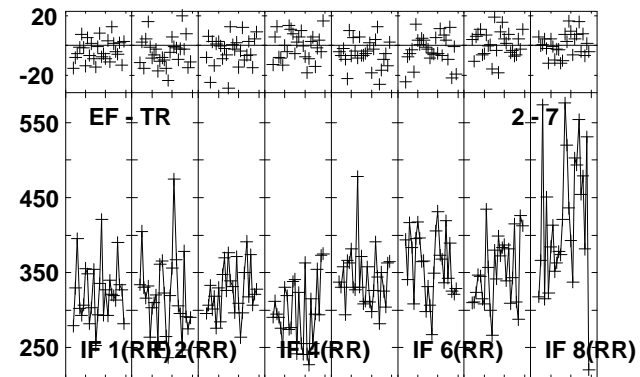
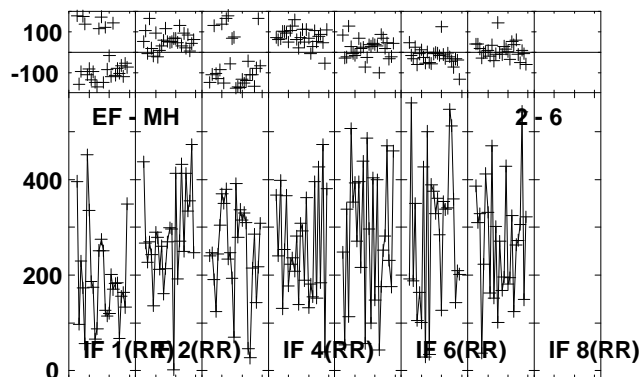
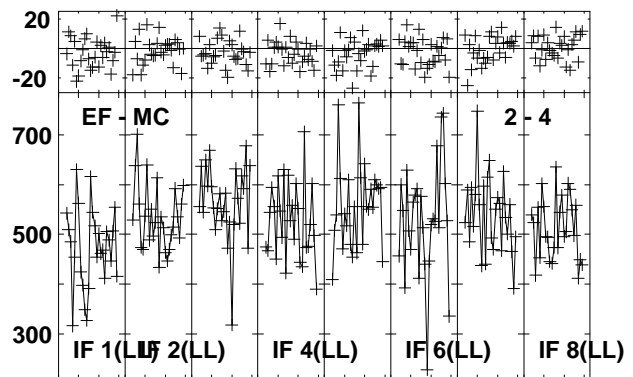
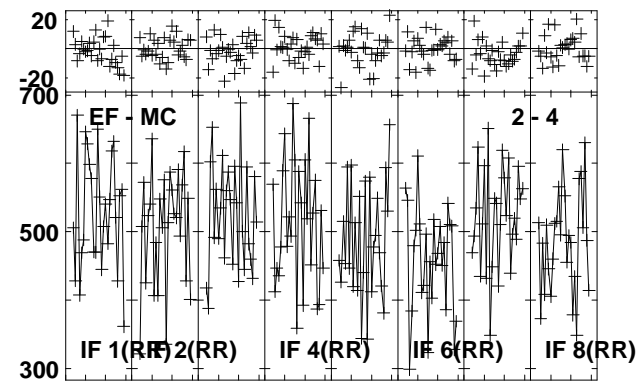
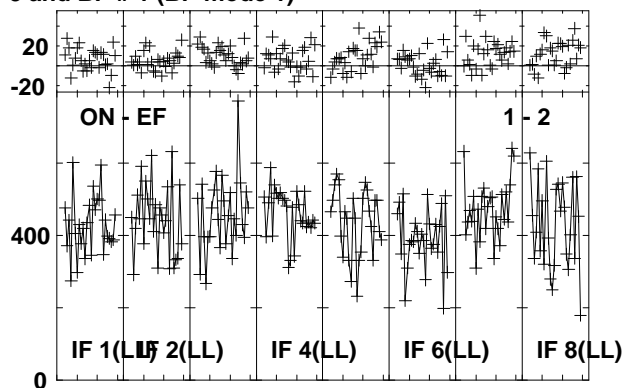
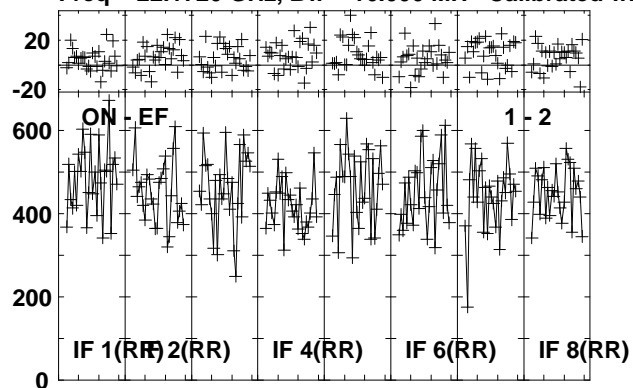

Lower frame: Milli Ampl Jy Top frame: Phas deg
Vector averaged cross-power spectrum Several baselines displayed
Timerange: 00/20:54:00 to 00/20:54:58

Plot file version 118 created 26-JUL-2013 10:19:44

J1157 EZ024 1.UVDATA.1

Freq = 22.1720 GHz, Bw = 16.000 MH Calibrated with CL # 3 and BP # 1 (BP mode 1)

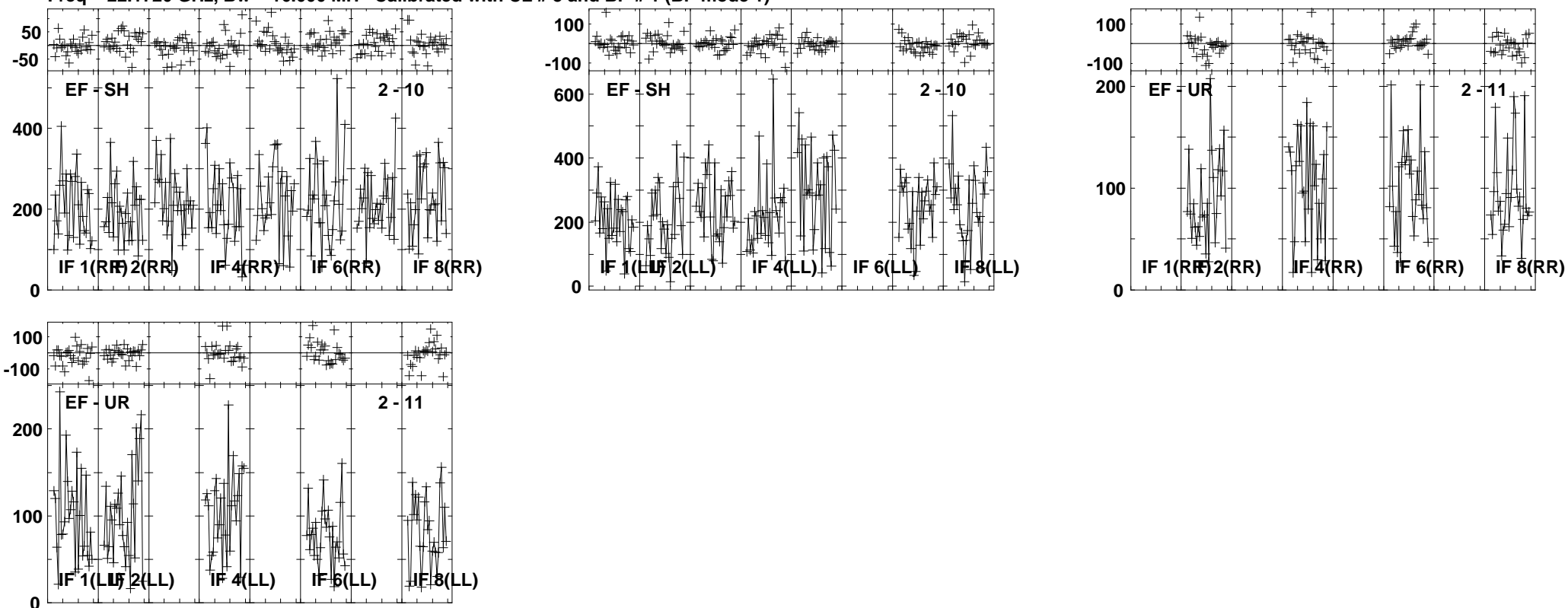

Lower frame: Milli Ampl Jy Top frame: Phas deg
Vector averaged cross-power spectrum Several baselines displayed
Timerange: 00/20:54:00 to 00/20:54:58

Plot file version 119 created 26-JUL-2013 10:19:45
 B1152+199A EZ024 1.UVDATA.1
 Freq = 22.1720 GHz, Bw = 16.000 MH Calibrated with CL # 3 and BP # 1 (BP mode 1)

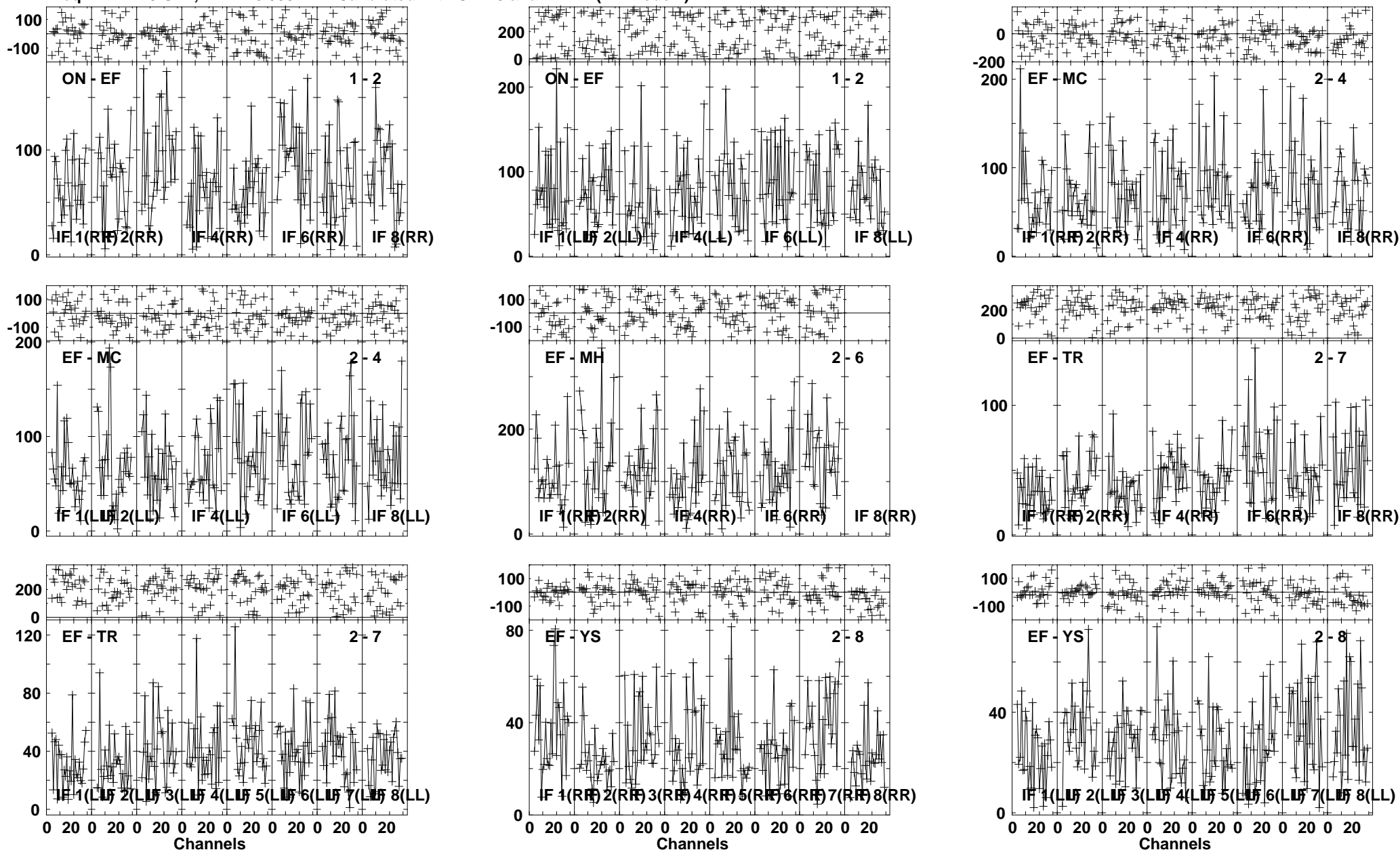

Lower frame: Milli Ampl Jy Top frame: Phas deg
 Vector averaged cross-power spectrum Several baselines displayed
 Timerange: 00/20:55:33 to 00/20:57:31

Plot file version 120 created 26-JUL-2013 10:19:47
 B1152+199A EZ024 1.UVDATA.1
 Freq = 22.1720 GHz, Bw = 16.000 MH Calibrated with CL # 3 and BP # 1 (BP mode 1)

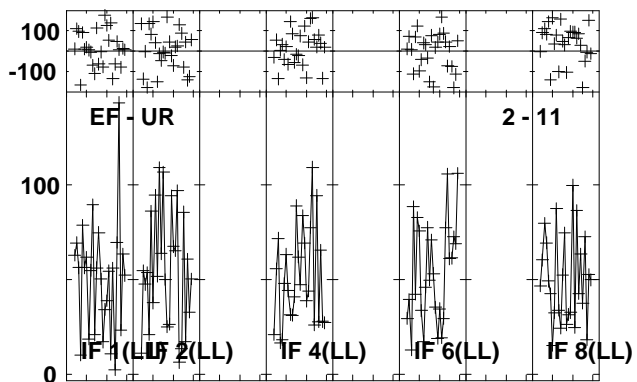
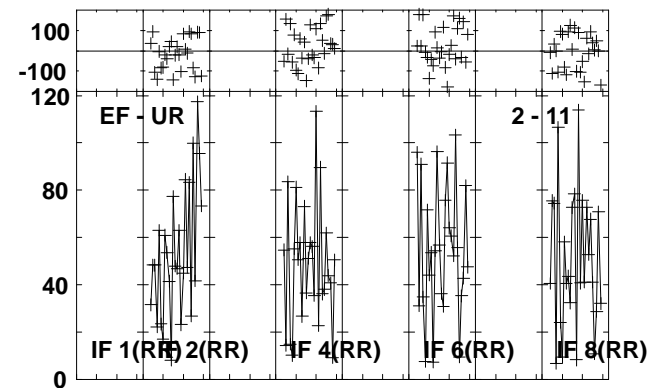
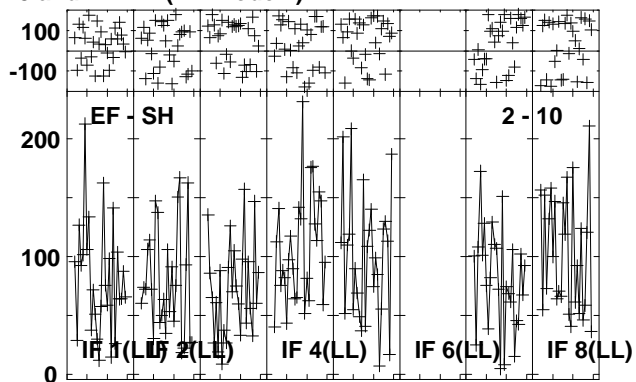
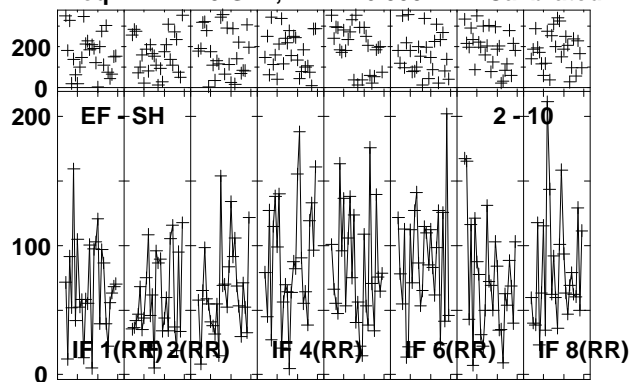

Lower frame: Milli Ampl Jy Top frame: Phas deg
 Vector averaged cross-power spectrum Several baselines displayed
 Timerange: 00/20:55:33 to 00/20:57:31

Plot file version 121 created 26-JUL-2013 10:19:48

J1157 EZ024 1.UVDATA.1

Freq = 22.1720 GHz, Bw = 16.000 MH Calibrated with CL # 3 and BP # 1 (BP mode 1)

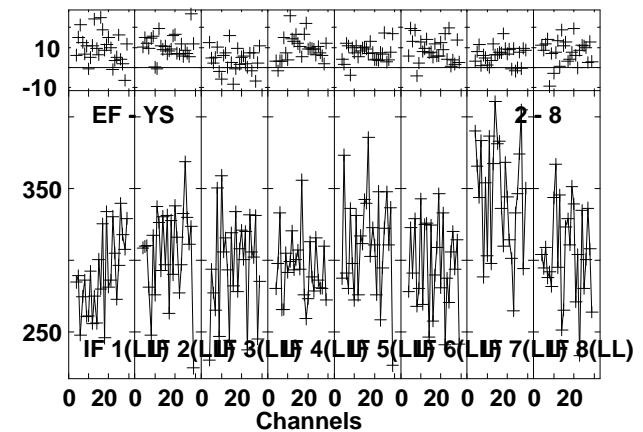
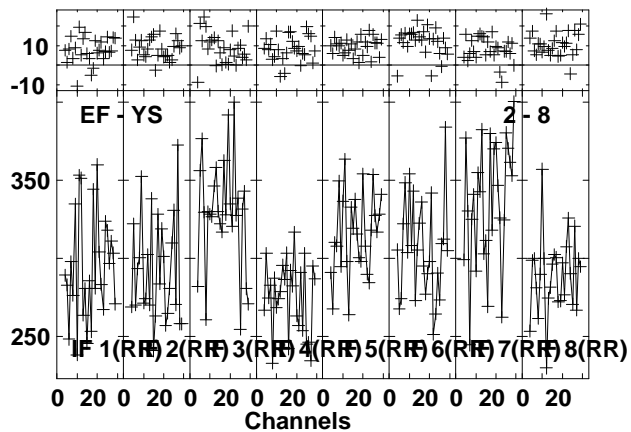
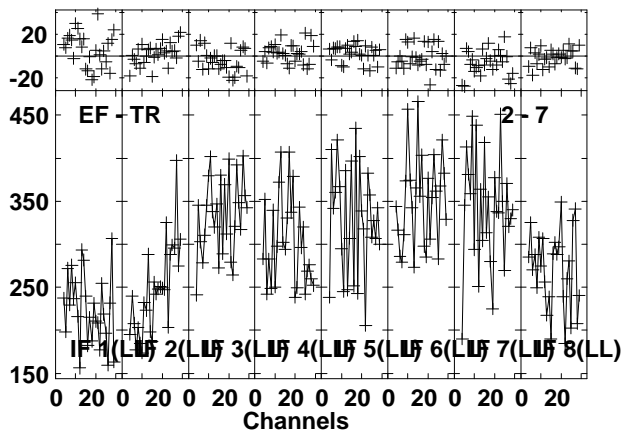
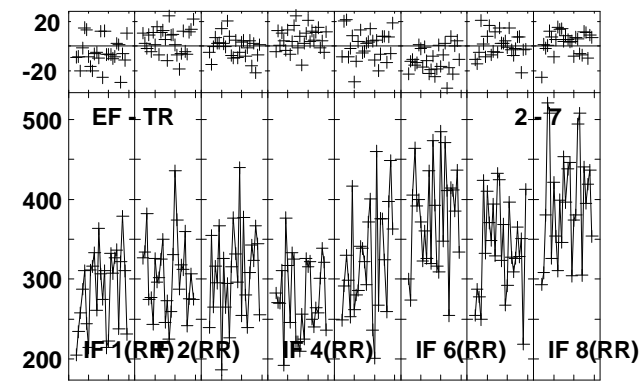
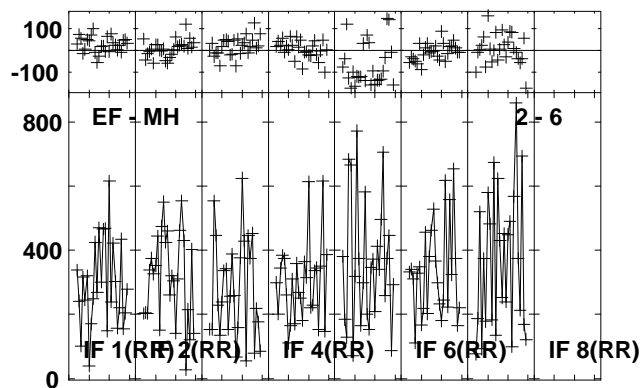
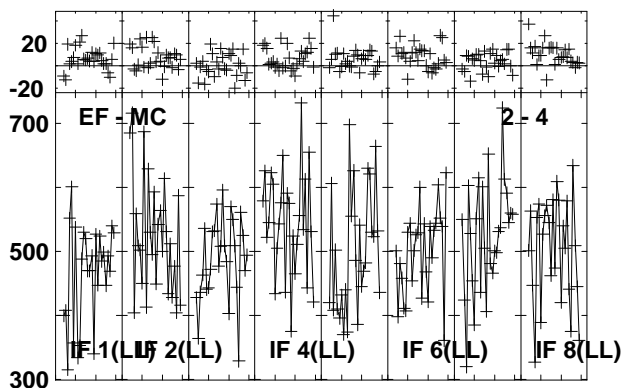
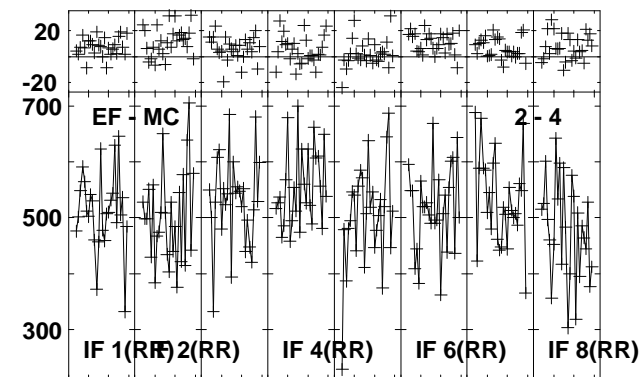
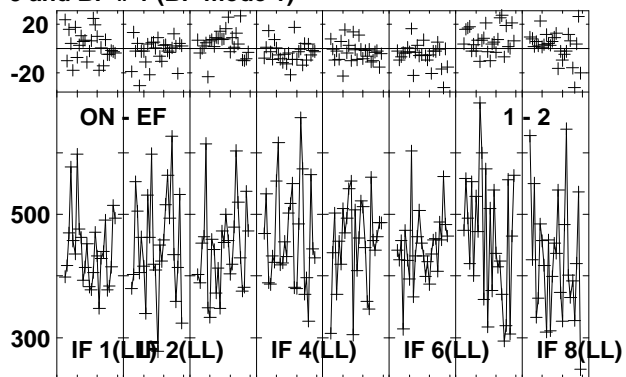
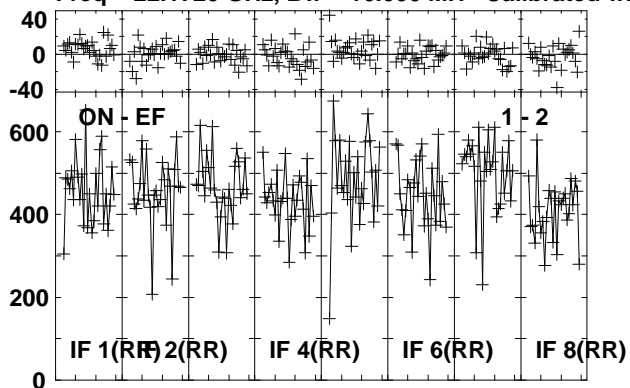

Lower frame: Milli Ampl Jy Top frame: Phas deg
Vector averaged cross-power spectrum Several baselines displayed
Timerange: 00/20:58:06 to 00/20:59:04

Plot file version 122 created 26-JUL-2013 10:19:49

J1157 EZ024 1.UVDATA.1

Freq = 22.1720 GHz, Bw = 16.000 MH Calibrated with CL # 3 and BP # 1 (BP mode 1)

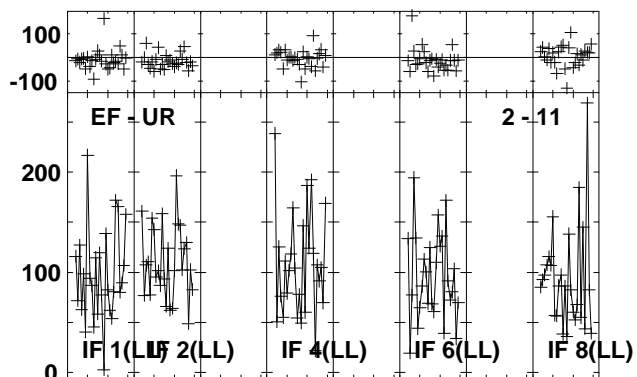
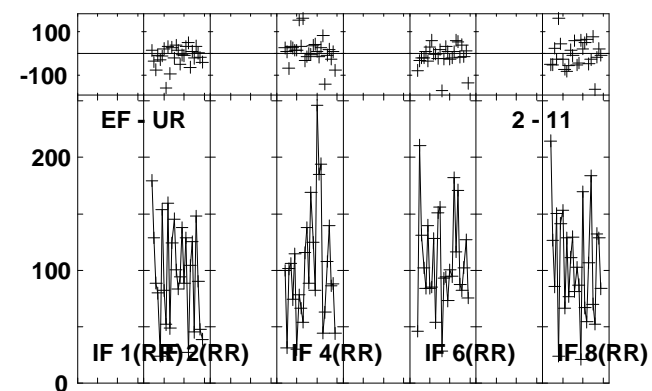
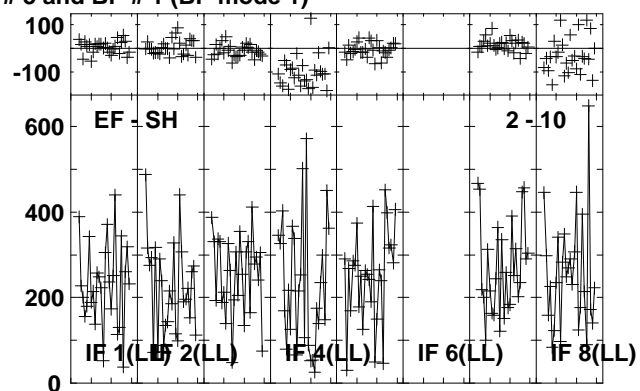
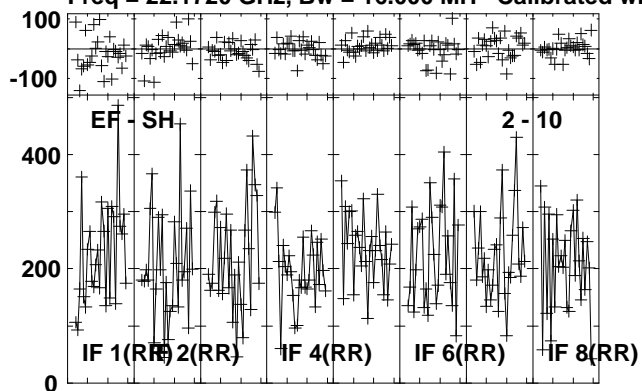

Lower frame: Milli Ampl Jy Top frame: Phas deg
Vector averaged cross-power spectrum Several baselines displayed
Timerange: 00/20:58:06 to 00/20:59:04

Plot file version 123 created 26-JUL-2013 10:19:49
 J1125+2610 EZ024 1.UVDATA.1
 Freq = 22.1720 GHz, Bw = 16.000 MH Calibrated with CL # 3 and BP # 1 (BP mode 1)

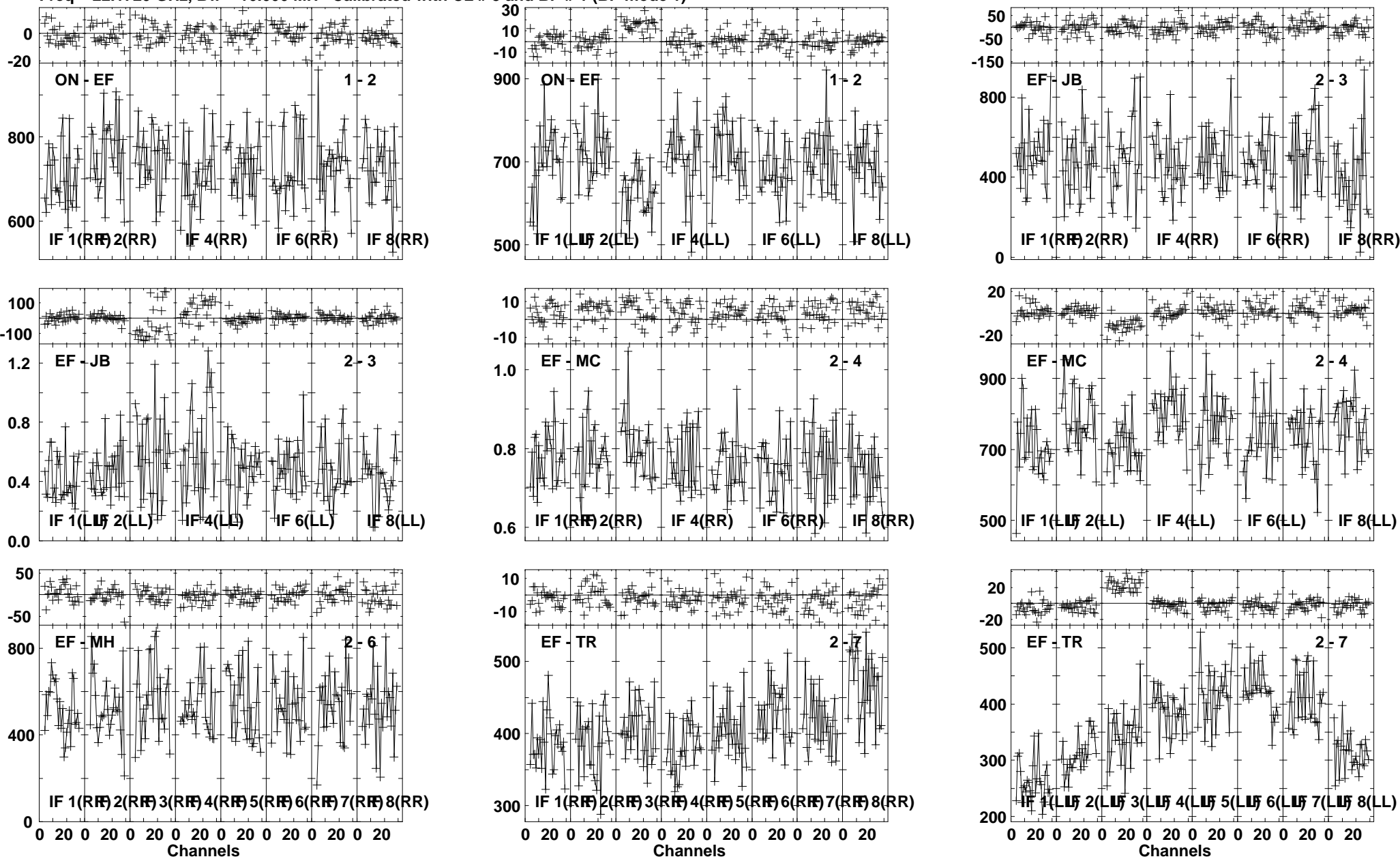

Lower frame: Milli Ampl Jy Top frame: Phas deg
 Vector averaged cross-power spectrum Several baselines displayed
 Timerange: 00/21:00:31 to 00/21:02:13

Plot file version 124 created 26-JUL-2013 10:19:50
 J1125+2610 EZ024 1.UVDATA.1
 Freq = 22.1720 GHz, Bw = 16.000 MH Calibrated with CL # 3 and BP # 1 (BP mode 1)

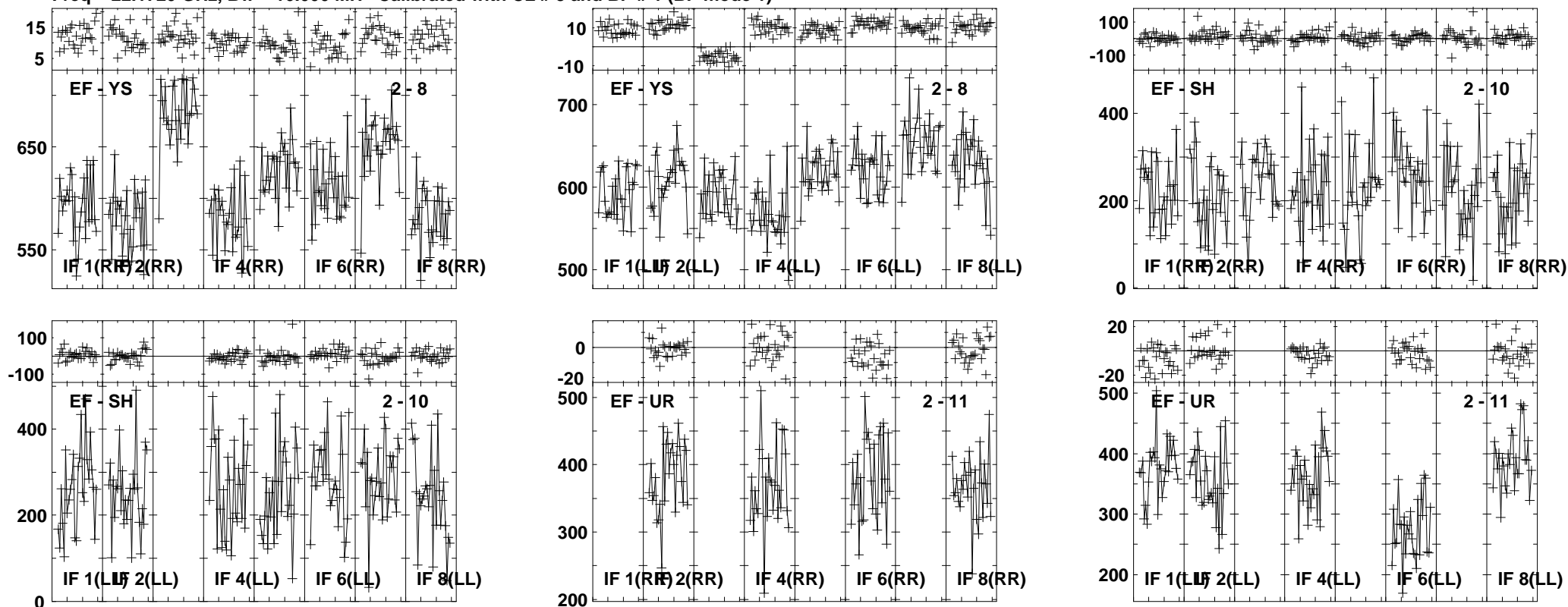

Lower frame: Milli Ampl Jy Top frame: Phas deg
 Vector averaged cross-power spectrum Several baselines displayed
 Timerange: 00/21:00:31 to 00/21:02:13

Plot file version 125 created 26-JUL-2013 10:19:59
 B1152+199A EZ024 1.UVDATA.1
 Freq = 22.1720 GHz, Bw = 16.000 MH Calibrated with CL # 3 and BP # 1 (BP mode 1)

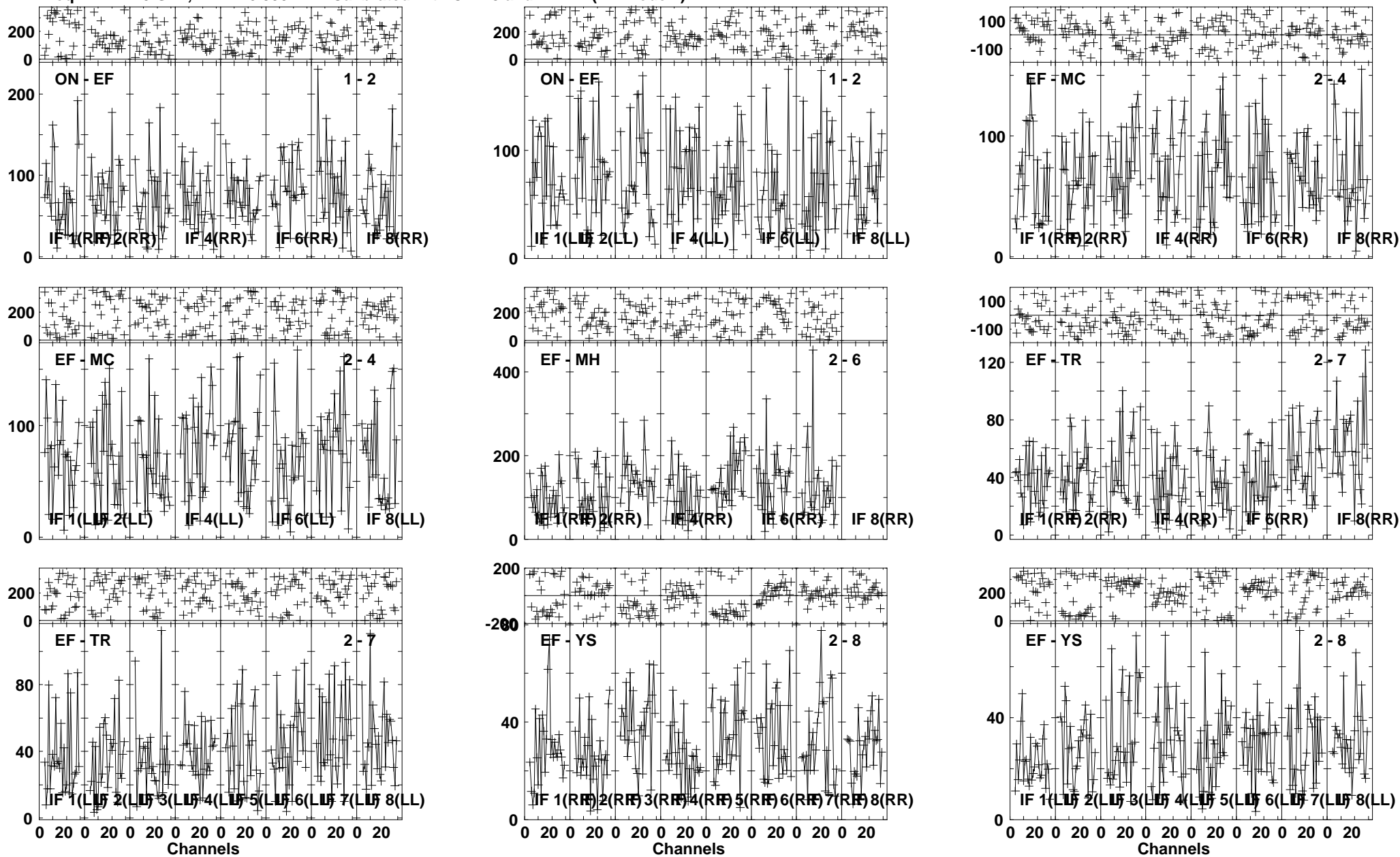

Lower frame: Milli Ampl Jy Top frame: Phas deg
 Vector averaged cross-power spectrum Several baselines displayed
 Timerange: 00/21:13:00 to 00/21:14:58

Plot file version 126 created 26-JUL-2013 10:20:01
 B1152+199A EZ024 1.UVDATA.1
 Freq = 22.1720 GHz, Bw = 16.000 MH Calibrated with CL # 3 and BP # 1 (BP mode 1)

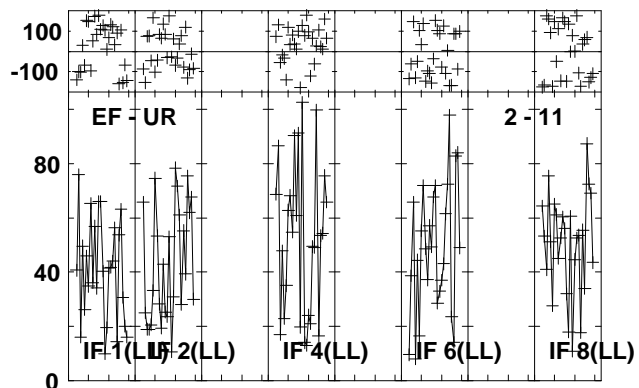
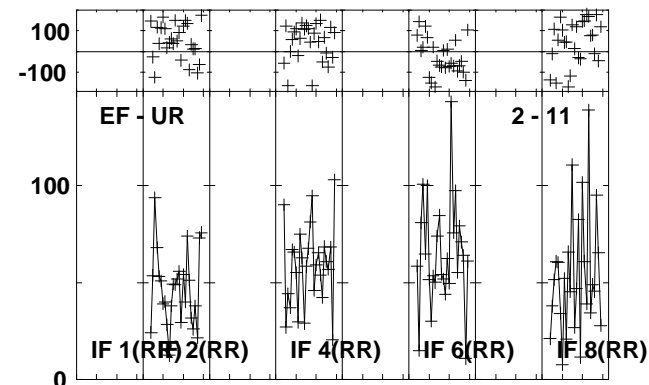
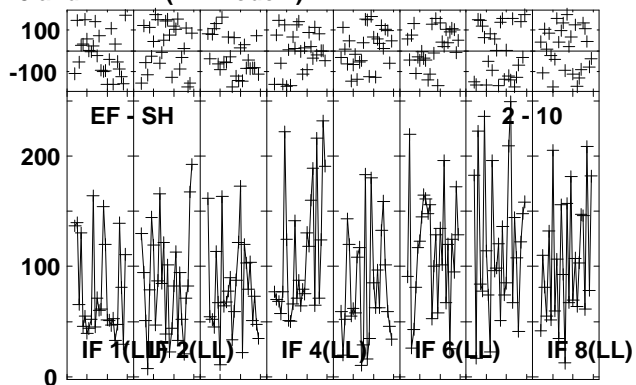
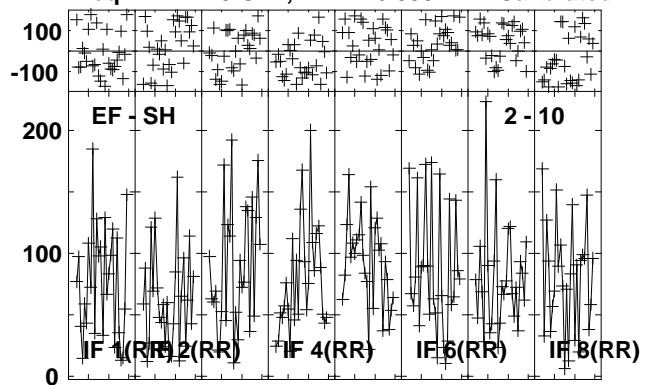

Lower frame: Milli Ampl Jy Top frame: Phas deg
 Vector averaged cross-power spectrum Several baselines displayed
 Timerange: 00/21:13:00 to 00/21:14:58

Plot file version 127 created 26-JUL-2013 10:20:02
 J1157 EZ024 1.UVDATA.1
 Freq = 22.1720 GHz, Bw = 16.000 MH Calibrated with CL # 3 and BP # 1 (BP mode 1)

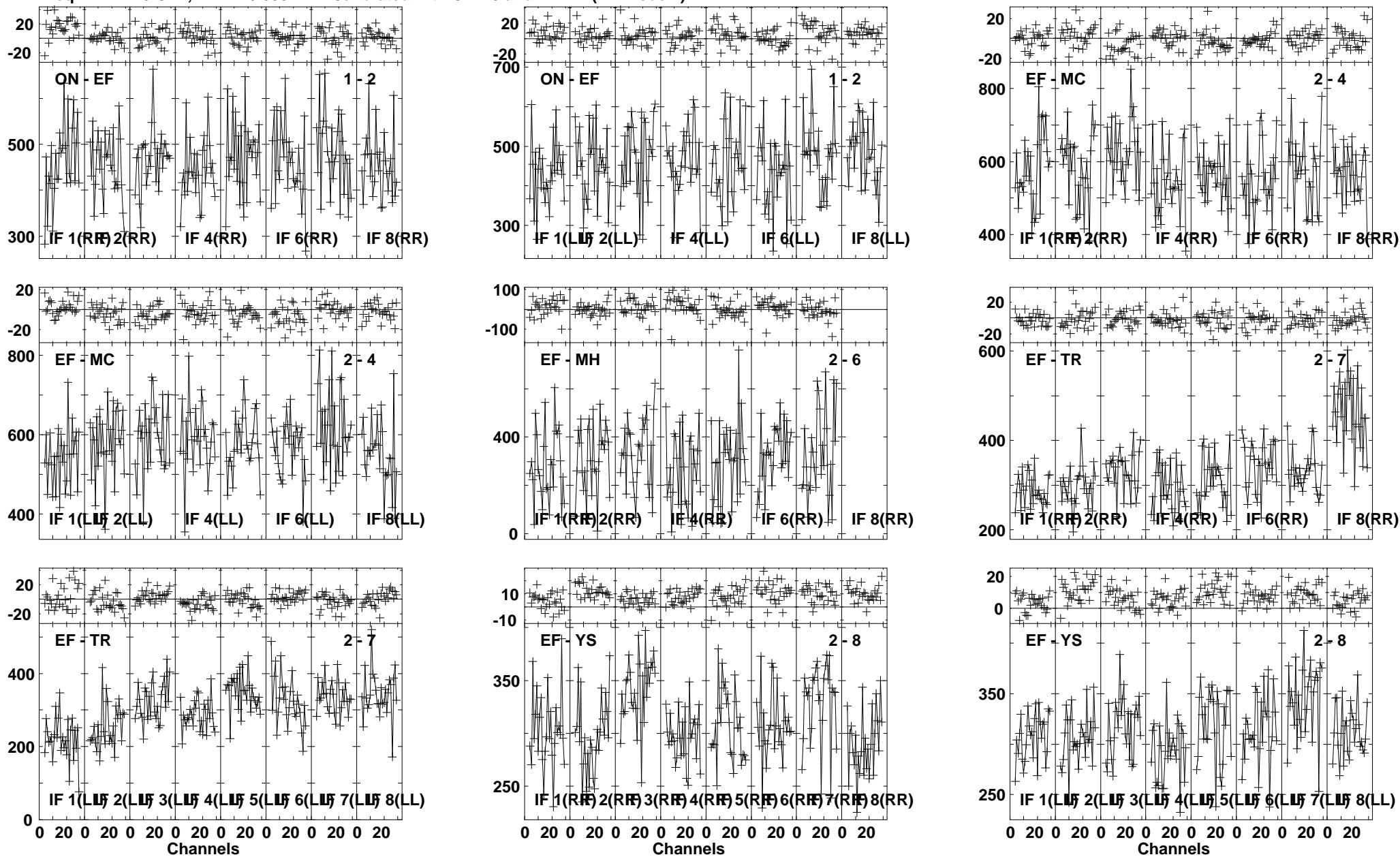

Lower frame: Milli Ampl Jy Top frame: Phas deg
 Vector averaged cross-power spectrum Several baselines displayed
 Timerange: 00/21:15:33 to 00/21:16:31

Plot file version 128 created 26-JUL-2013 10:20:03

J1157 EZ024 1.UVDATA.1

Freq = 22.1720 GHz, Bw = 16.000 MH Calibrated with CL # 3 and BP # 1 (BP mode 1)

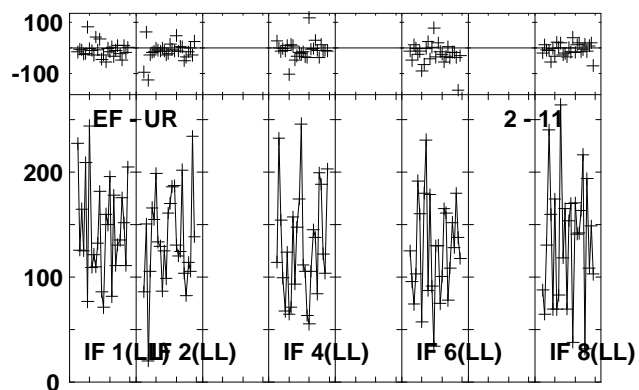
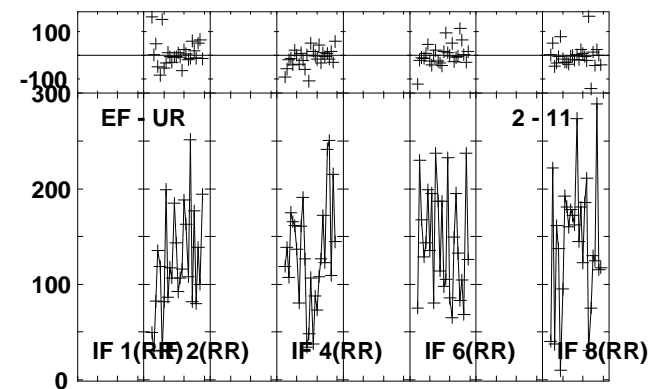
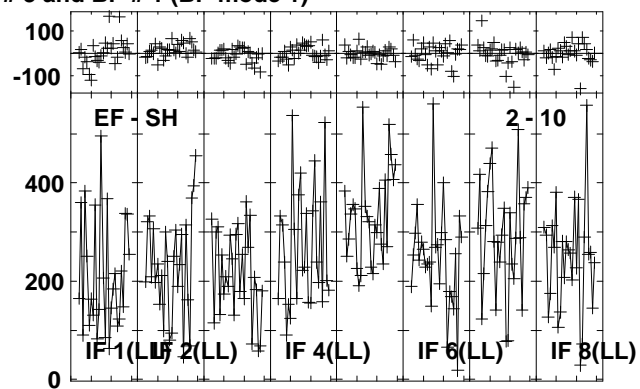
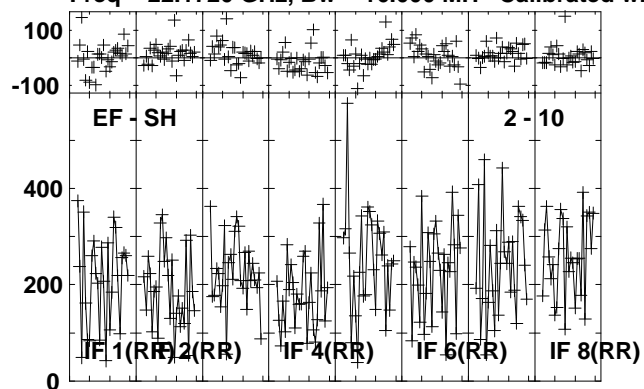

Lower frame: Milli Ampl Jy Top frame: Phas deg
Vector averaged cross-power spectrum Several baselines displayed
Timerange: 00/21:15:33 to 00/21:16:31

Plot file version 129 created 26-JUL-2013 10:20:04
 B1152+199A EZ024 1.UVDATA.1
 Freq = 22.1720 GHz, Bw = 16.000 MH Calibrated with CL # 3 and BP # 1 (BP mode 1)

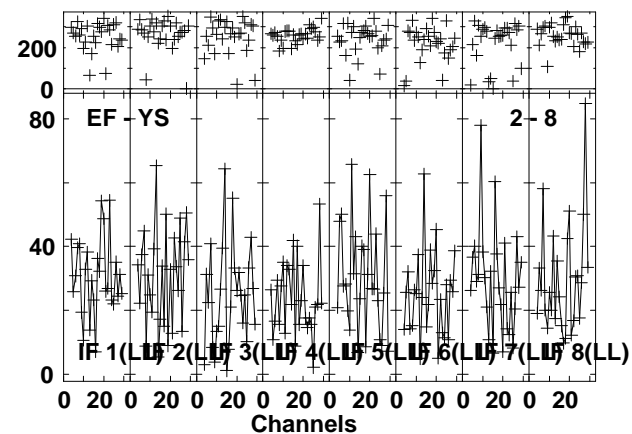
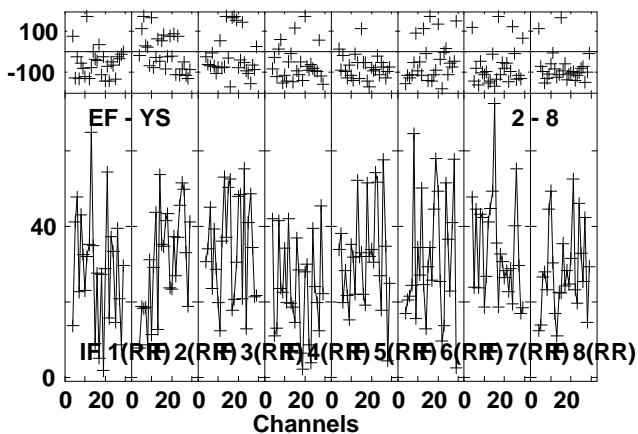
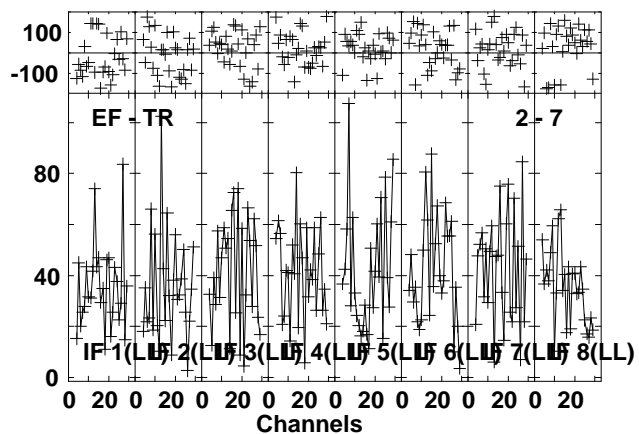
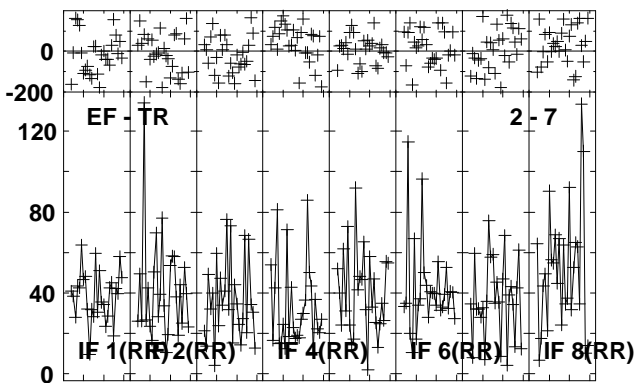
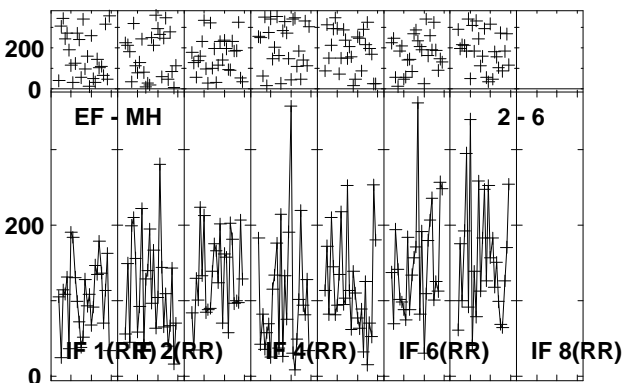
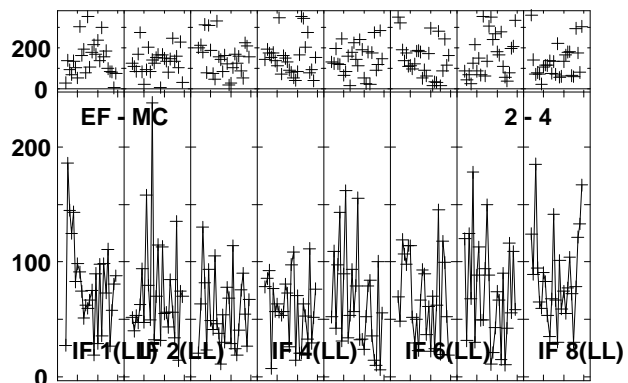
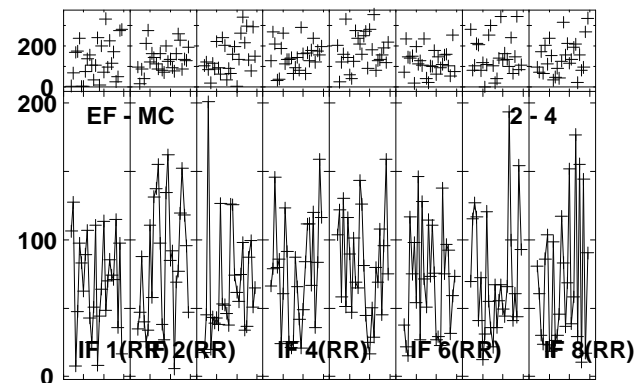
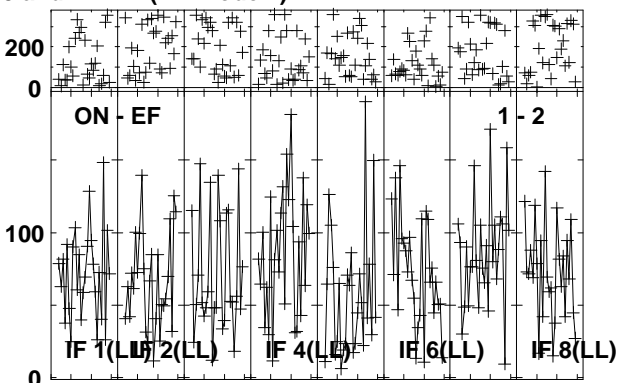
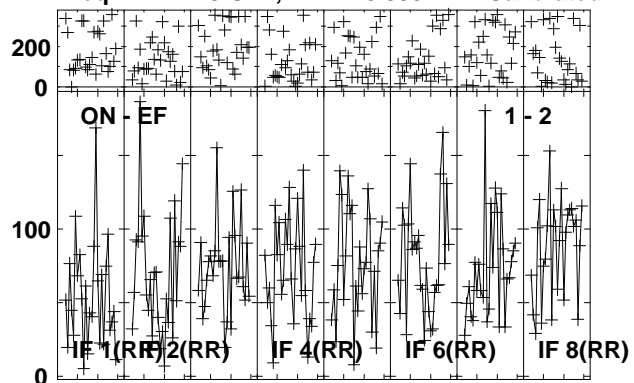

Lower frame: Milli Ampl Jy Top frame: Phas deg
 Vector averaged cross-power spectrum Several baselines displayed
 Timerange: 00/21:17:06 to 00/21:19:04

Plot file version 130 created 26-JUL-2013 10:20:06
 B1152+199A EZ024 1.UVDATA.1
 Freq = 22.1720 GHz, Bw = 16.000 MH Calibrated with CL # 3 and BP # 1 (BP mode 1)

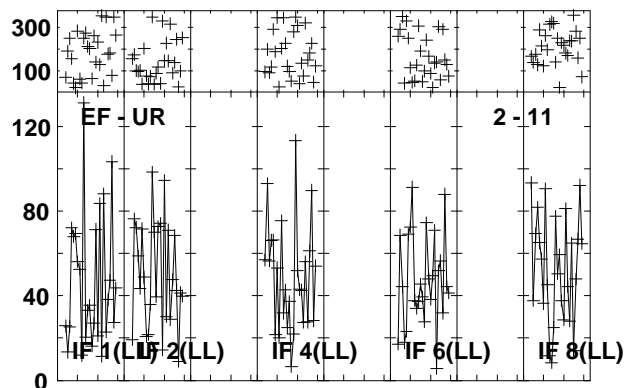
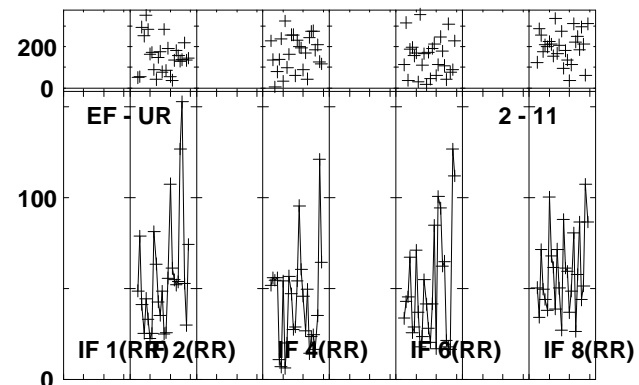
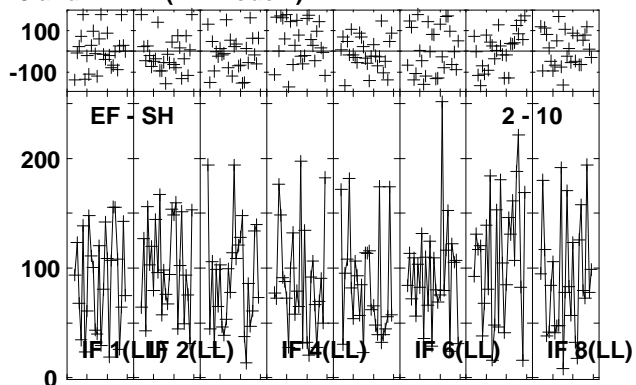
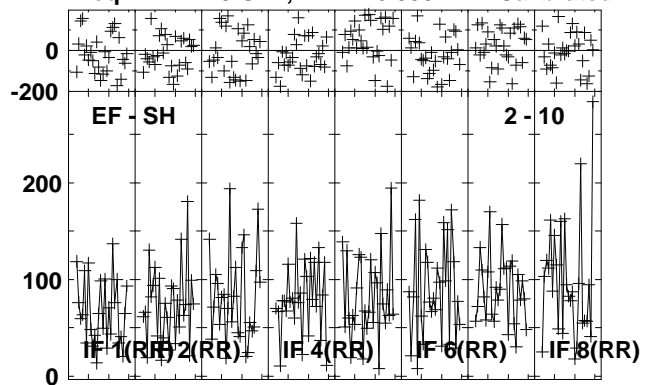

Lower frame: Milli Ampl Jy Top frame: Phas deg
 Vector averaged cross-power spectrum Several baselines displayed
 Timerange: 00/21:17:06 to 00/21:19:04

Plot file version 131 created 26-JUL-2013 10:20:07
 J1157 EZ024 1.UVDATA.1
 Freq = 22.1720 GHz, Bw = 16.000 MH Calibrated with CL # 3 and BP # 1 (BP mode 1)

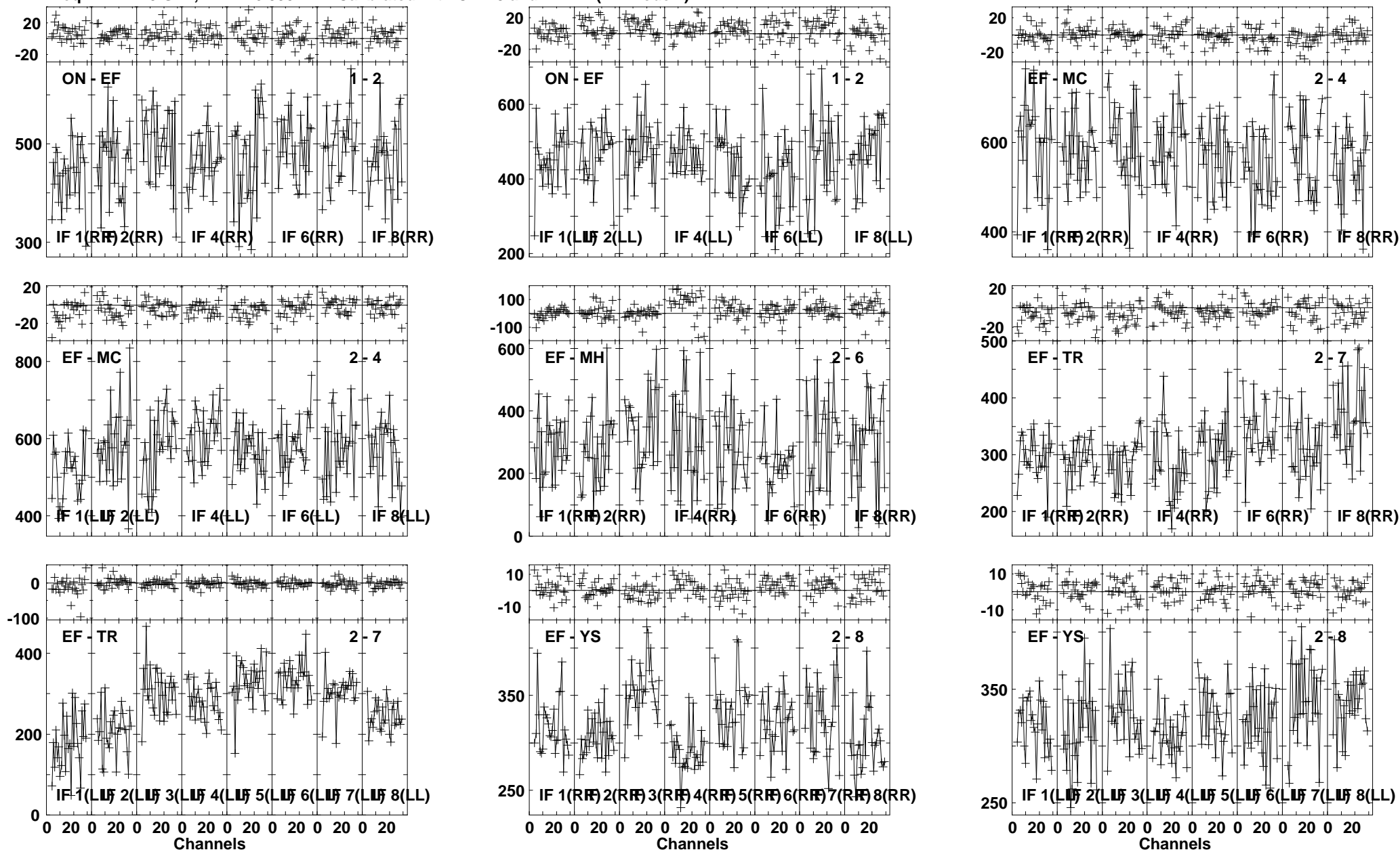

Lower frame: Milli Ampl Jy Top frame: Phas deg
 Vector averaged cross-power spectrum Several baselines displayed
 Timerange: 00/21:19:39 to 00/21:20:37

Plot file version 132 created 26-JUL-2013 10:20:08

J1157 EZ024 1.UVDATA.1

Freq = 22.1720 GHz, Bw = 16.000 MH Calibrated with CL # 3 and BP # 1 (BP mode 1)

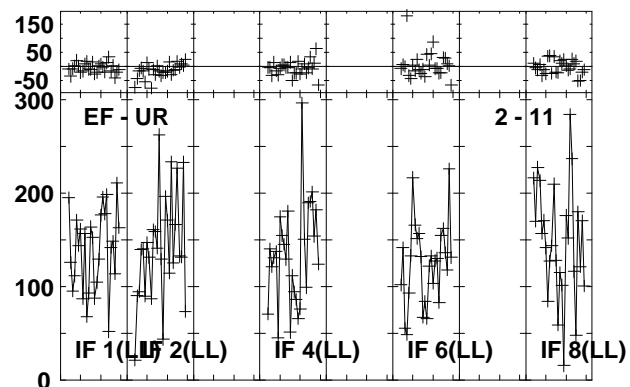
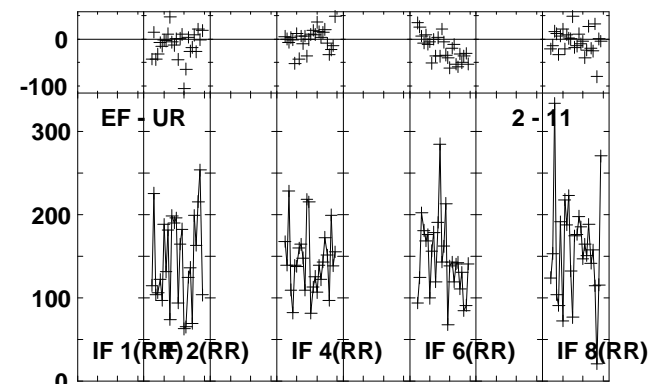
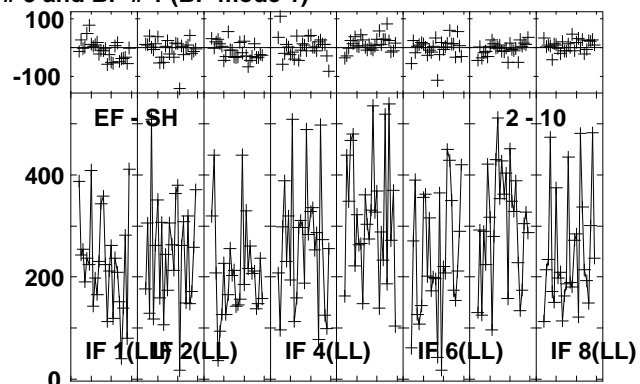
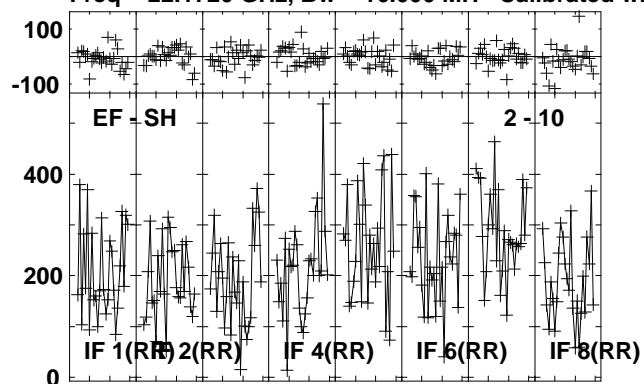

Lower frame: Milli Ampl Jy Top frame: Phas deg
Vector averaged cross-power spectrum Several baselines displayed
Timerange: 00/21:19:39 to 00/21:20:37

Plot file version 133 created 26-JUL-2013 10:20:09
 B1152+199A EZ024 1.UVDATA.1
 Freq = 22.1720 GHz, Bw = 16.000 MH Calibrated with CL # 3 and BP # 1 (BP mode 1)

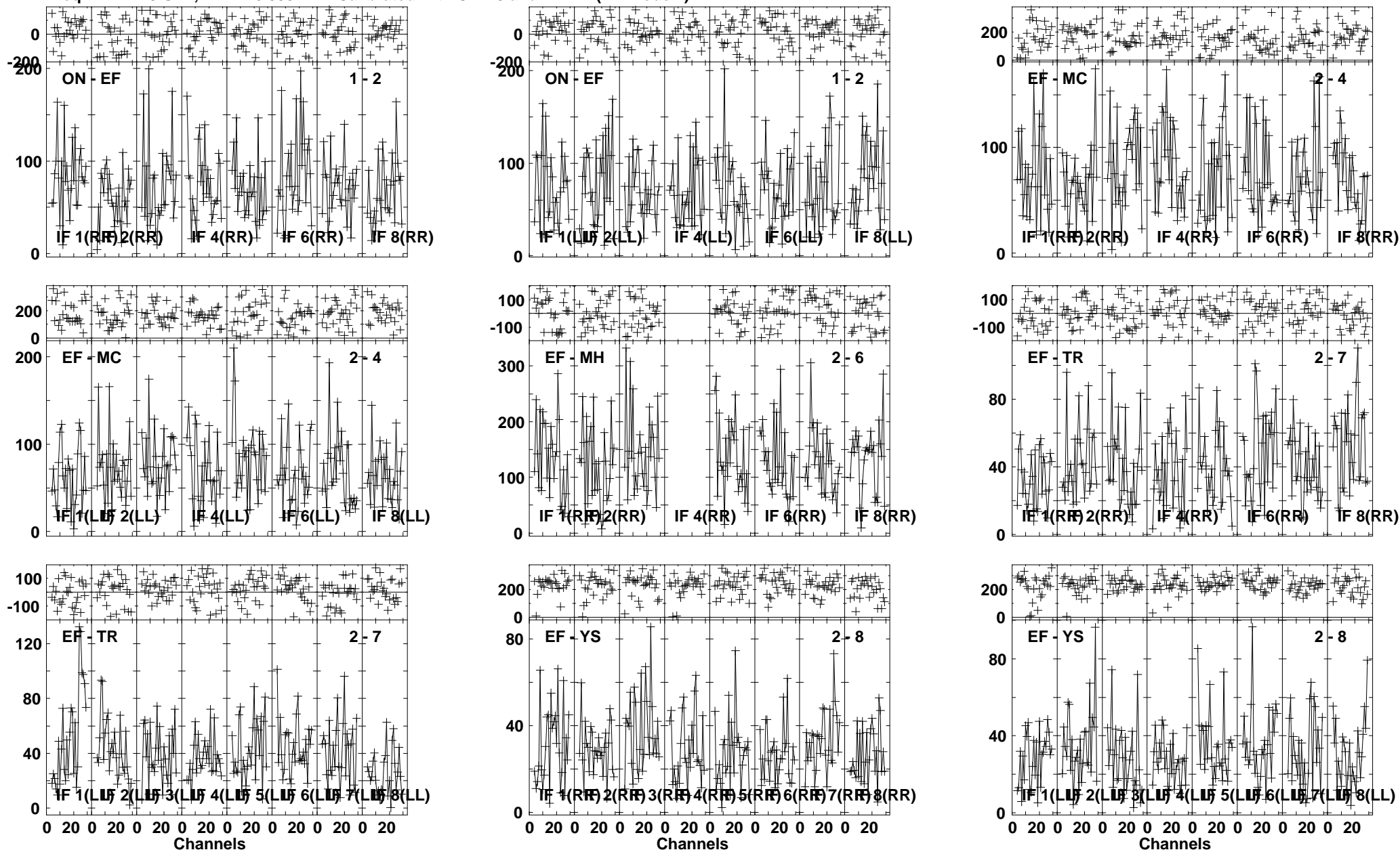

Lower frame: Milli Ampl Jy Top frame: Phas deg
 Vector averaged cross-power spectrum Several baselines displayed
 Timerange: 00/21:21:12 to 00/21:23:10

Plot file version 134 created 26-JUL-2013 10:20:11
 B1152+199A EZ024 1.UVDATA.1
 Freq = 22.1720 GHz, Bw = 16.000 MH Calibrated with CL # 3 and BP # 1 (BP mode 1)

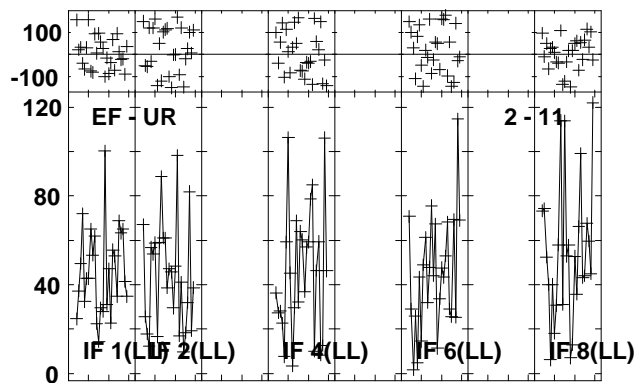
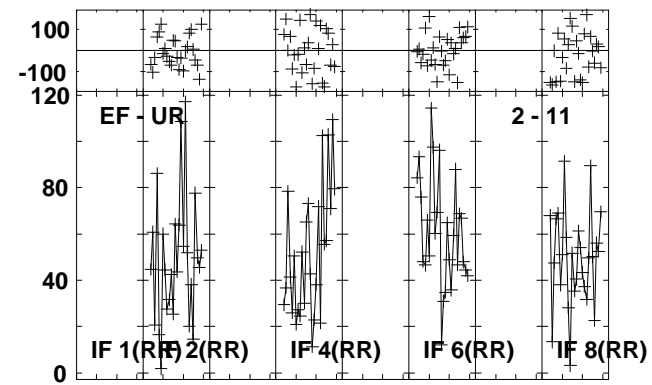
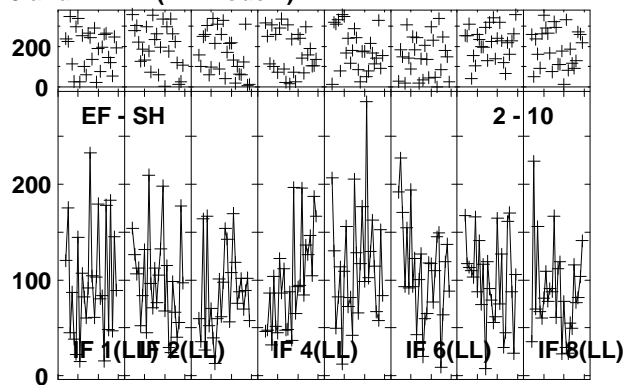
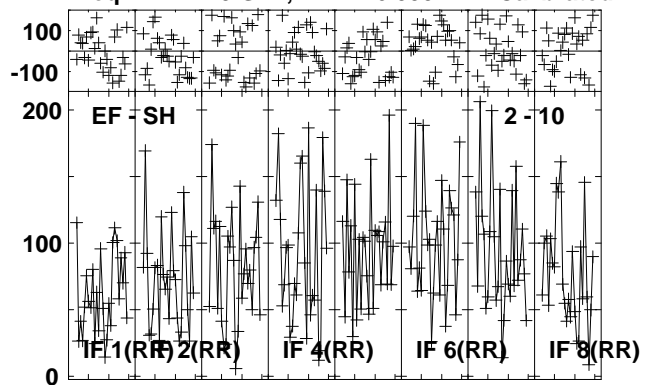

Lower frame: Milli Ampl Jy Top frame: Phas deg
 Vector averaged cross-power spectrum Several baselines displayed
 Timerange: 00/21:21:12 to 00/21:23:10

Plot file version 135 created 26-JUL-2013 10:20:12

J1157 EZ024 1.UVDATA.1

Freq = 22.1720 GHz, Bw = 16.000 MH Calibrated with CL # 3 and BP # 1 (BP mode 1)

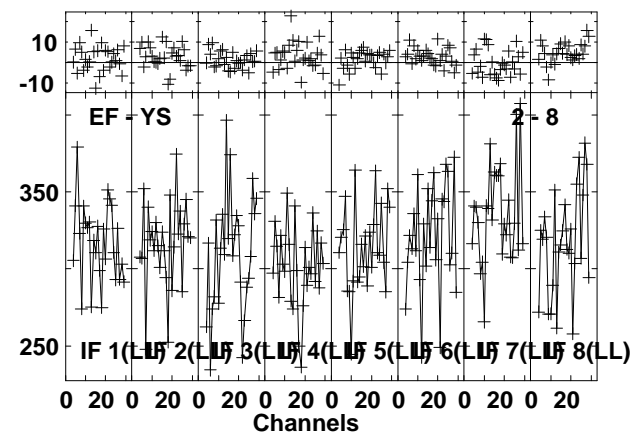
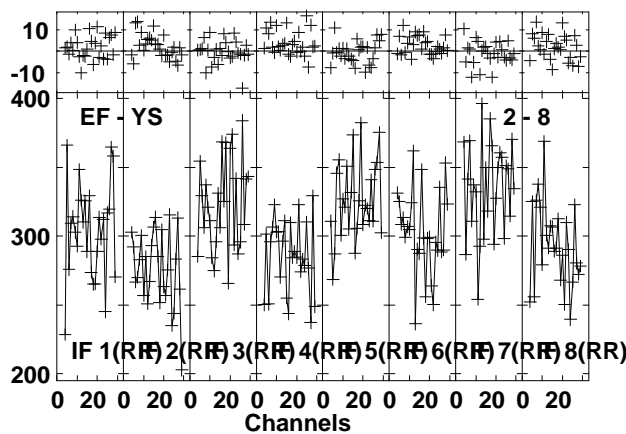
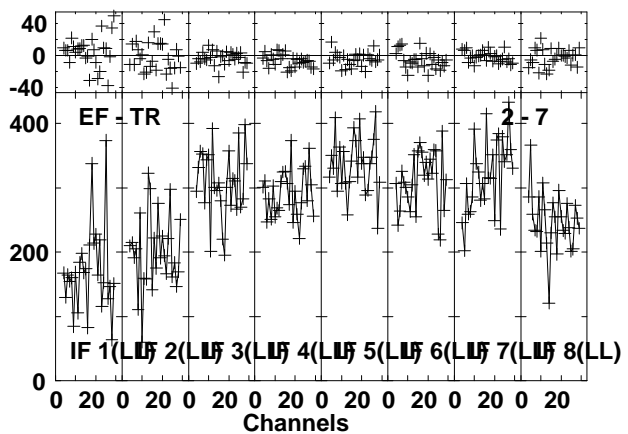
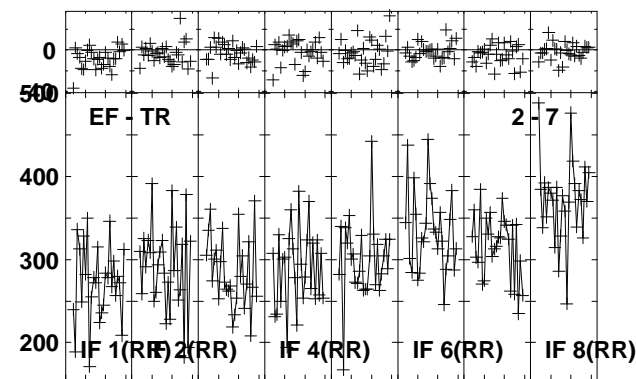
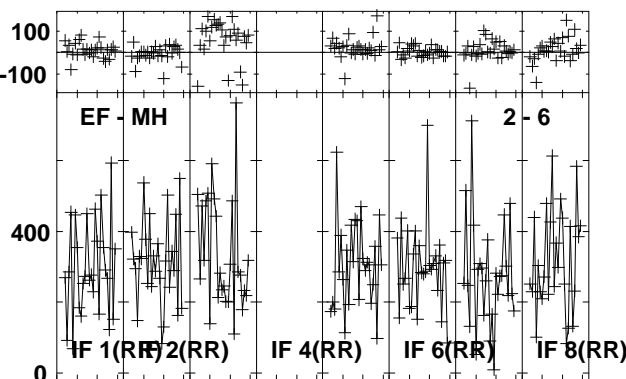
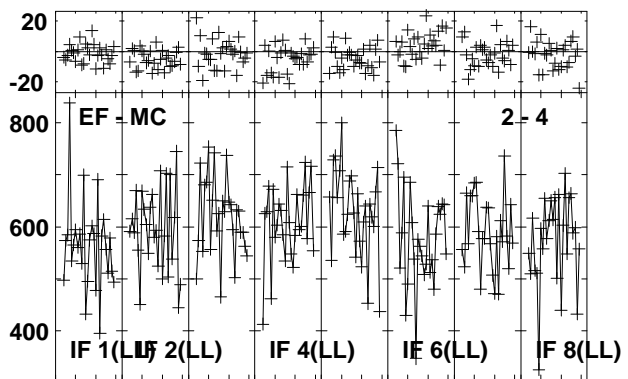
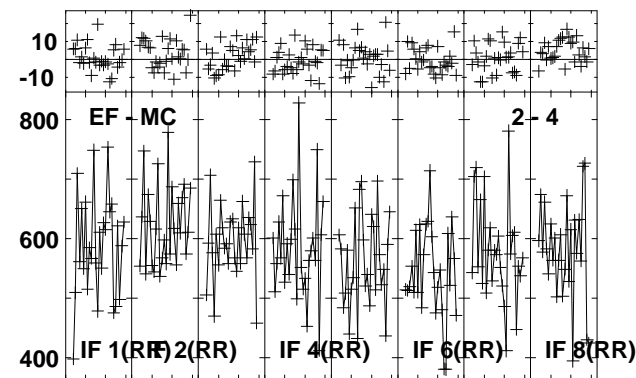
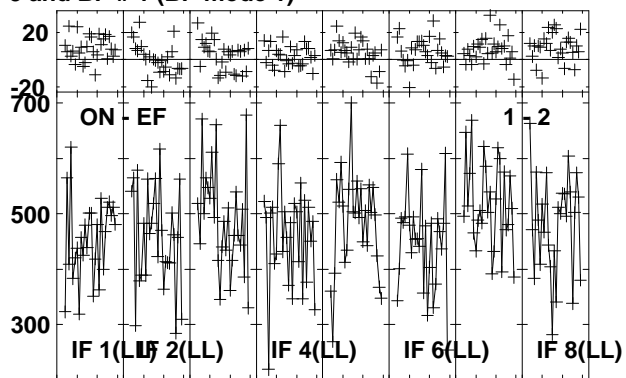
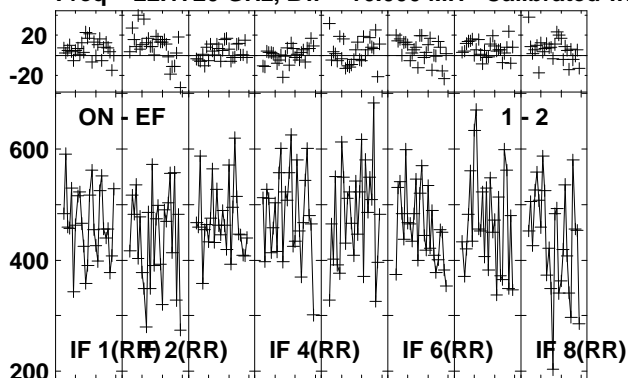

Lower frame: Milli Ampl Jy Top frame: Phas deg
Vector averaged cross-power spectrum Several baselines displayed
Timerange: 00/21:23:45 to 00/21:24:43

Plot file version 136 created 26-JUL-2013 10:20:13
 J1157 EZ024 1.UVDATA.1
 Freq = 22.1720 GHz, Bw = 16.000 MH Calibrated with CL # 3 and BP # 1 (BP mode 1)

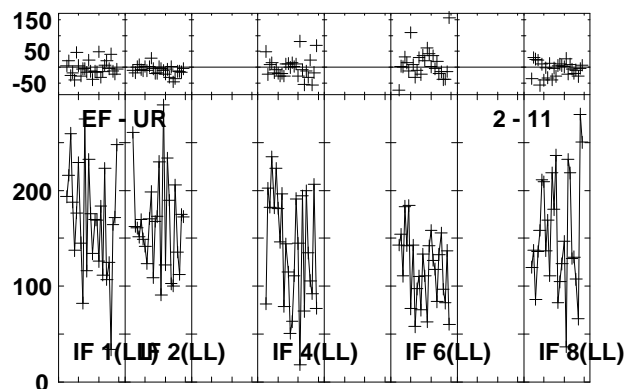
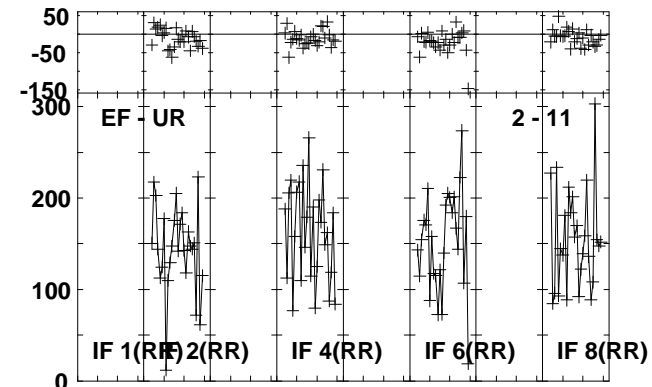
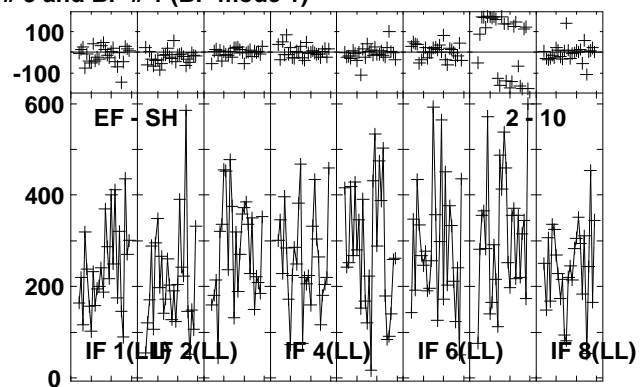
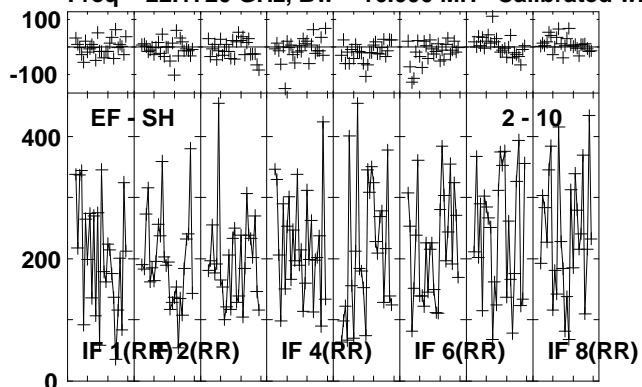

Lower frame: Milli Ampl Jy Top frame: Phas deg
 Vector averaged cross-power spectrum Several baselines displayed
 Timerange: 00/21:23:45 to 00/21:24:43

Plot file version 137 created 26-JUL-2013 10:20:13
 J1125+2610 EZ024 1.UVDATA.1
 Freq = 22.1720 GHz, Bw = 16.000 MH Calibrated with CL # 3 and BP # 1 (BP mode 1)

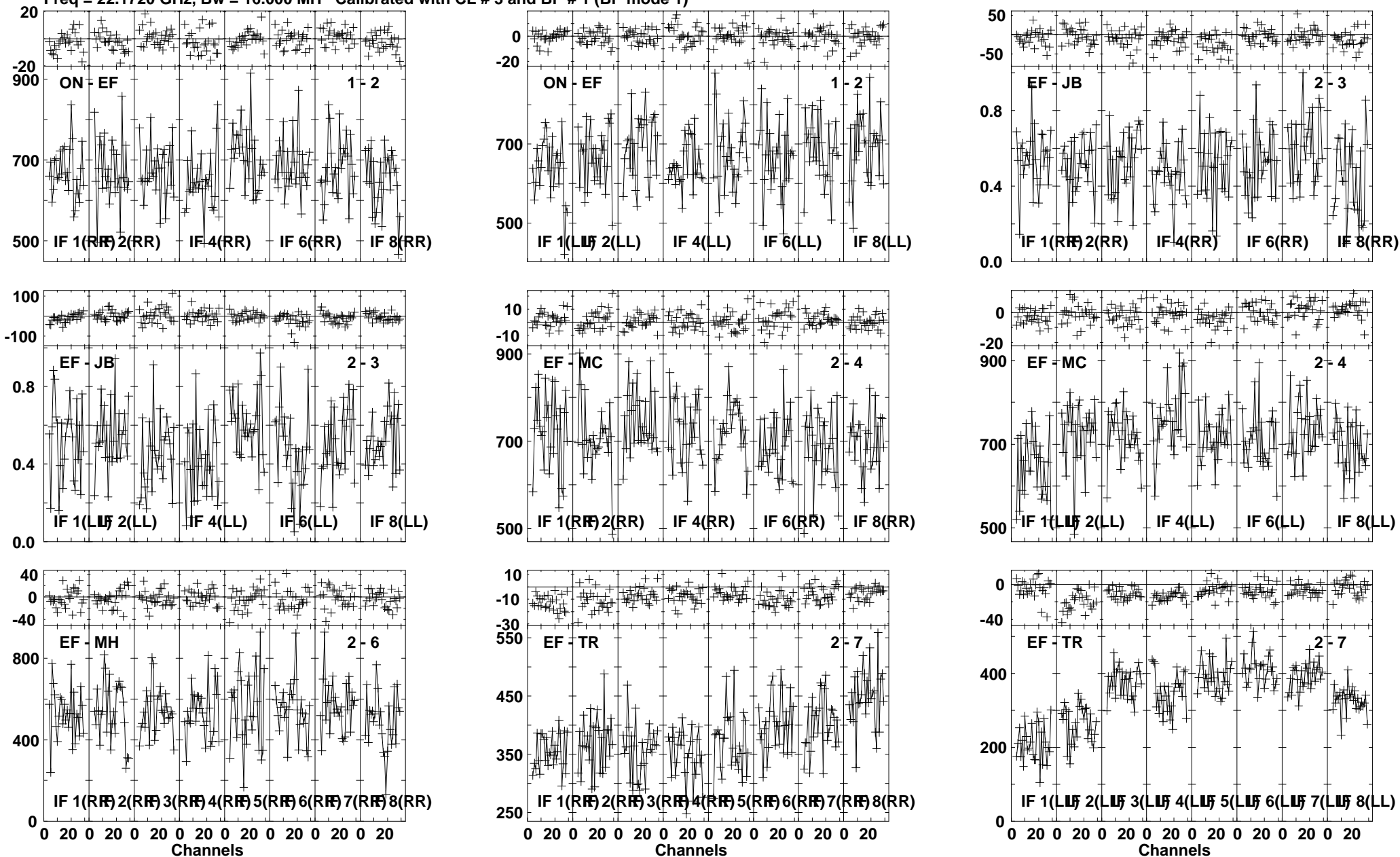

Lower frame: Milli Ampl Jy Top frame: Phas deg
 Vector averaged cross-power spectrum Several baselines displayed
 Timerange: 00/21:26:10 to 00/21:27:52

Plot file version 138 created 26-JUL-2013 10:20:14
 J1125+2610 EZ024 1.UVDATA.1
 Freq = 22.1720 GHz, Bw = 16.000 MH Calibrated with CL # 3 and BP # 1 (BP mode 1)

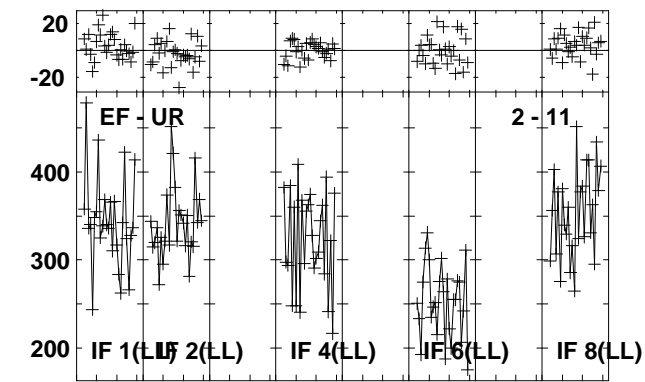
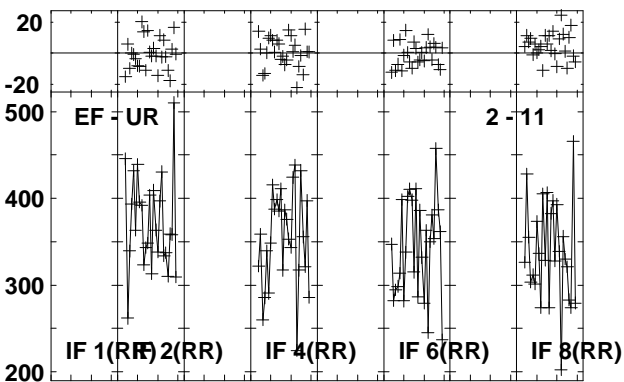
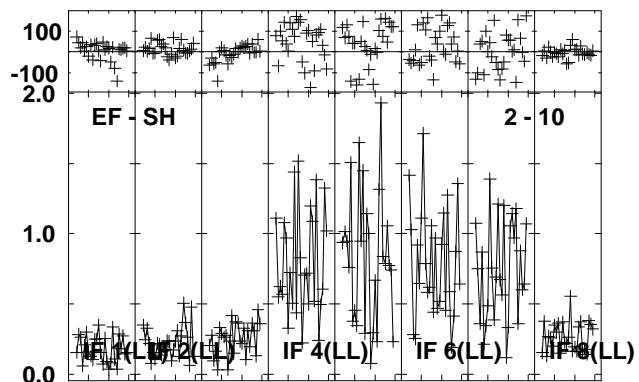
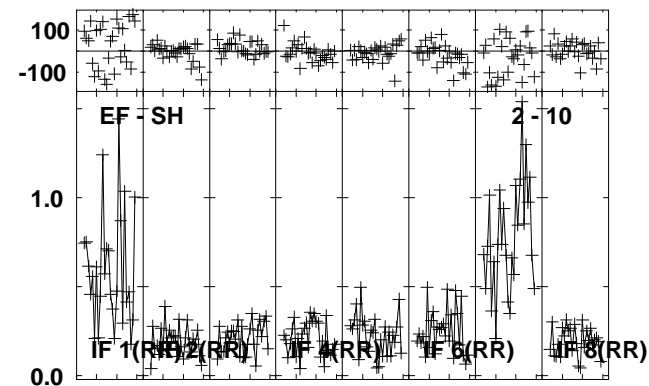
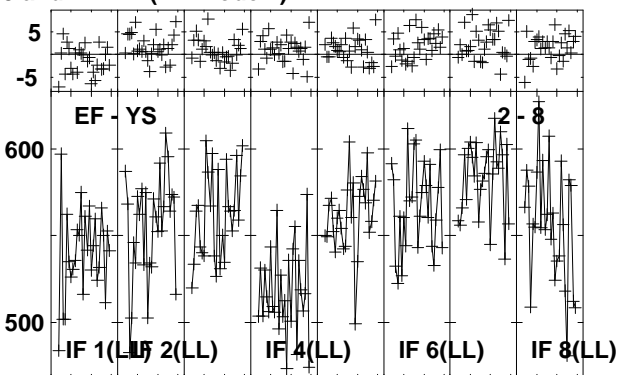
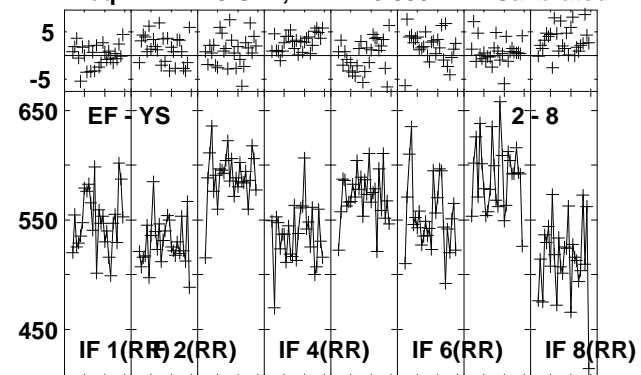

Lower frame: Milli Ampl Jy Top frame: Phas deg
 Vector averaged cross-power spectrum Several baselines displayed
 Timerange: 00/21:26:10 to 00/21:27:52

Plot file version 139 created 26-JUL-2013 10:20:15
 J1157 EZ024 1.UVDATA.1
 Freq = 22.1720 GHz, Bw = 16.000 MH Calibrated with CL # 3 and BP # 1 (BP mode 1)

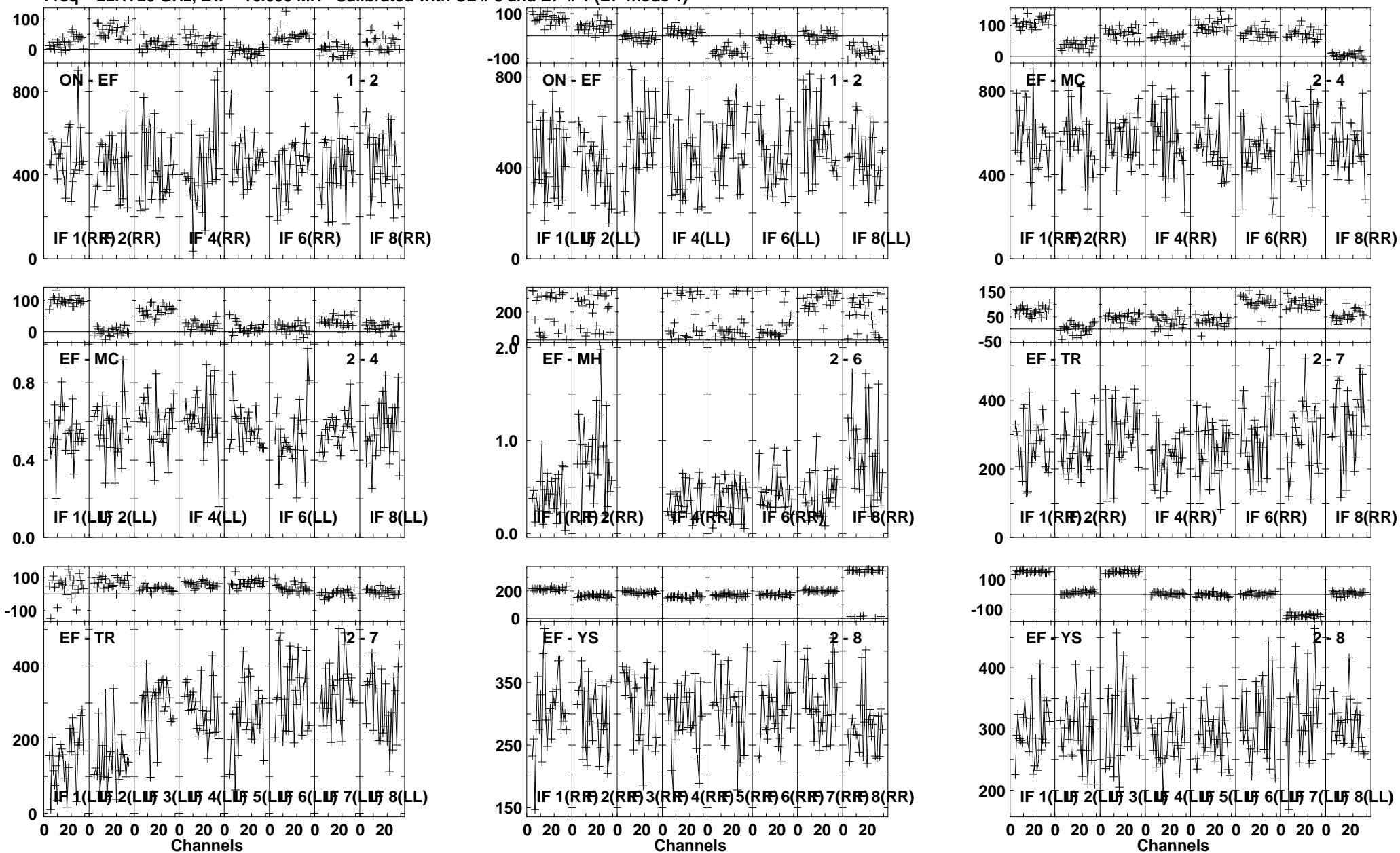

Lower frame: Milli Ampl Jy Top frame: Phas deg
 Vector averaged cross-power spectrum Several baselines displayed
 Timerange: 00/21:29:19 to 00/21:30:01

Plot file version 140 created 26-JUL-2013 10:20:16
 J1157 EZ2024 1.UVDATA.1
 Freq = 22.1720 GHz, Bw = 16.000 MH Calibrated with CL # 3 and BP # 1 (BP mode 1)

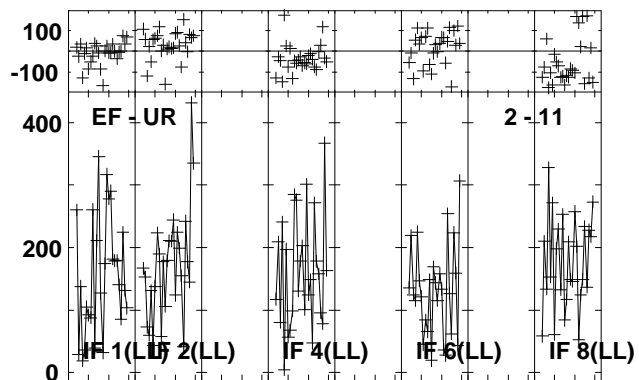
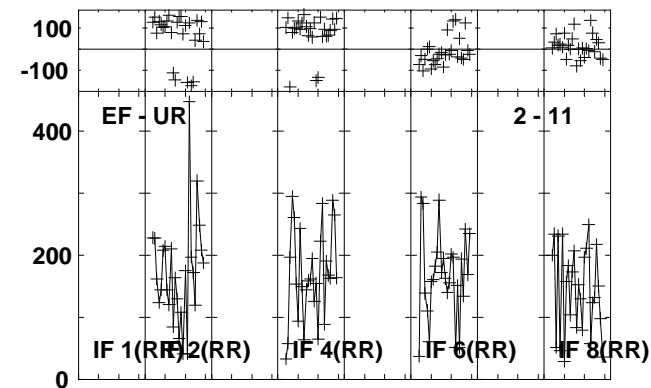
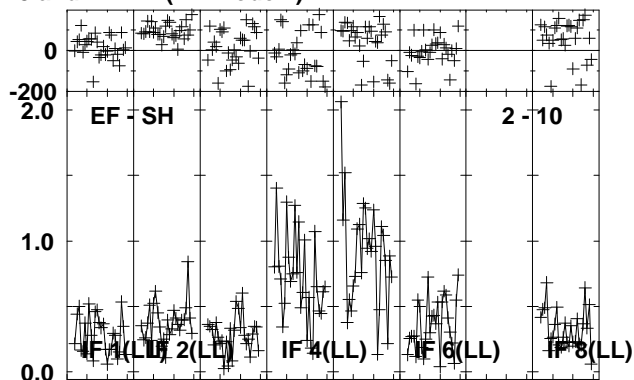
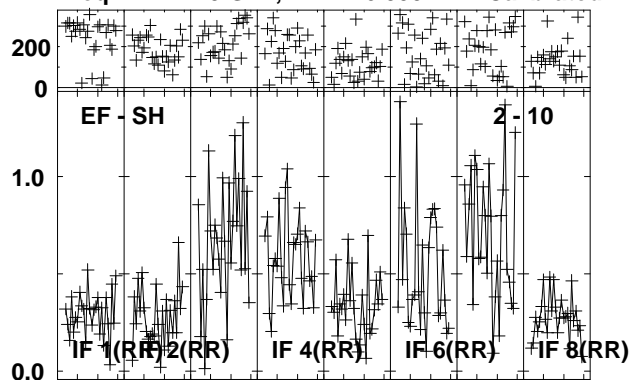

Lower frame: Ampl Jy Top frame: Phas deg
 Vector averaged cross-power spectrum Several baselines displayed
 Timerange: 00/21:29:19 to 00/21:30:01

Plot file version 141 created 26-JUL-2013 10:20:16
 B1152+199A EZ024 1.UVDATA.1
 Freq = 22.1720 GHz, Bw = 16.000 MH Calibrated with CL # 3 and BP # 1 (BP mode 1)

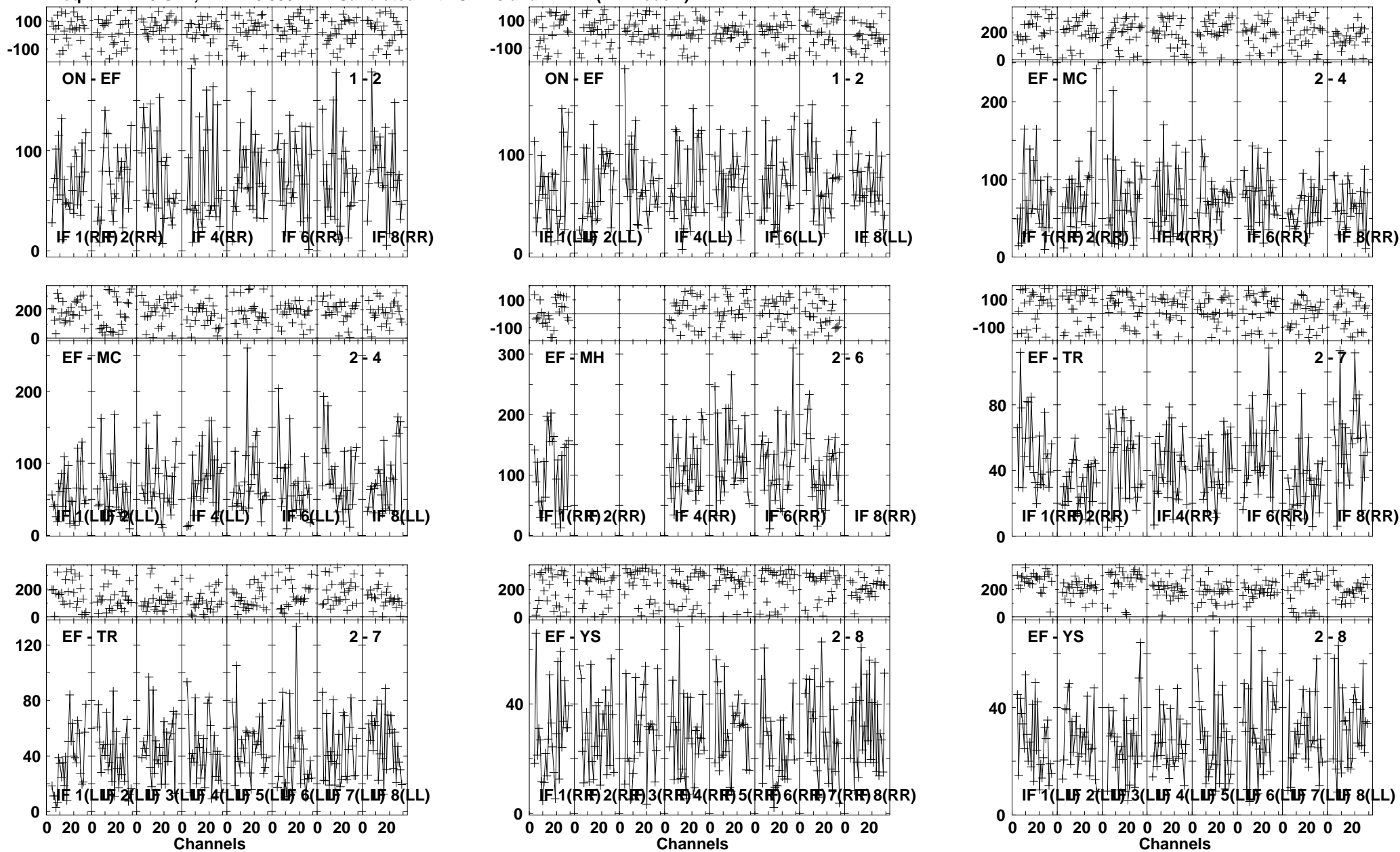

Lower frame: Milli Ampl Jy Top frame: Phas deg
 Vector averaged cross-power spectrum Several baselines displayed
 Timerange: 00/21:30:37 to 00/21:32:35

Plot file version 142 created 26-JUL-2013 10:20:18
 B1152+199A EZ024 1.UVDATA.1
 Freq = 22.1720 GHz, Bw = 16.000 MH Calibrated with CL # 3 and BP # 1 (BP mode 1)

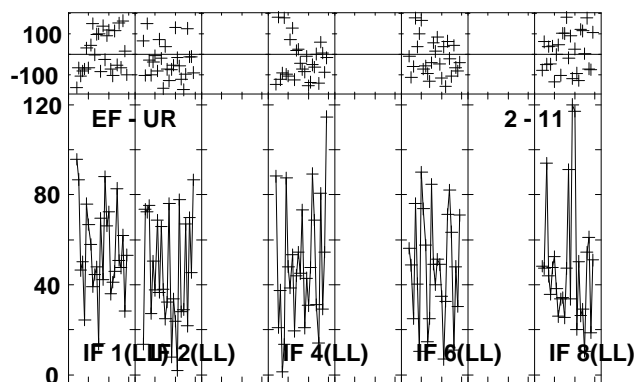
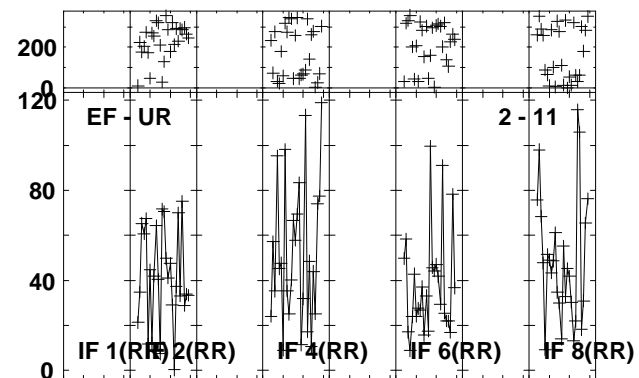
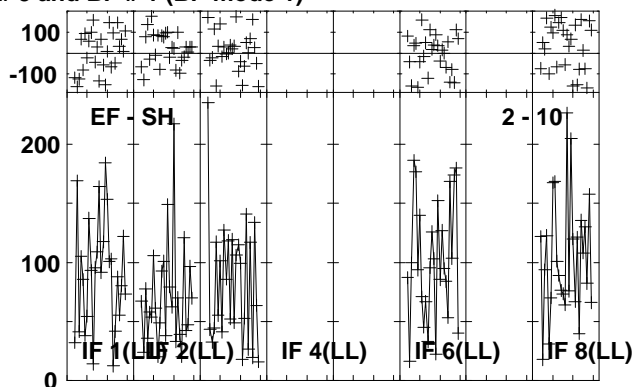
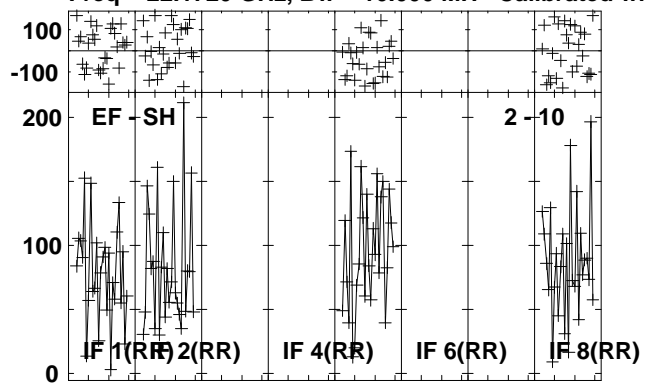

Lower frame: Milli Ampl Jy Top frame: Phas deg
 Vector averaged cross-power spectrum Several baselines displayed
 Timerange: 00/21:30:37 to 00/21:32:35

Plot file version 143 created 26-JUL-2013 10:20:19

J1157 EZ024 1.UVDATA.1

Freq = 22.1720 GHz, Bw = 16.000 MH Calibrated with CL # 3 and BP # 1 (BP mode 1)

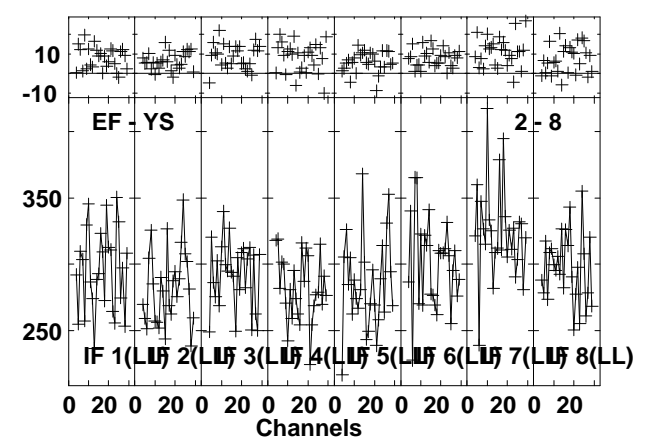
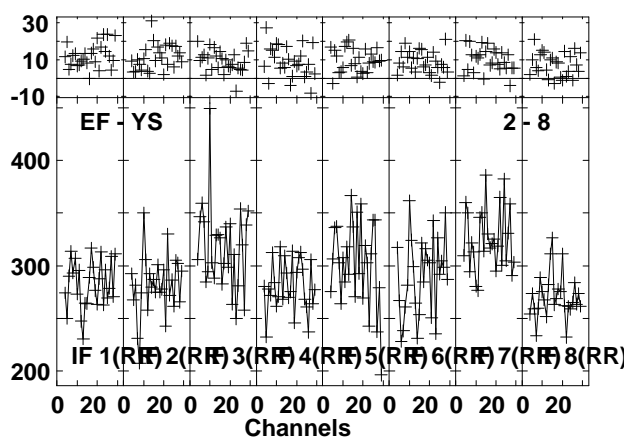
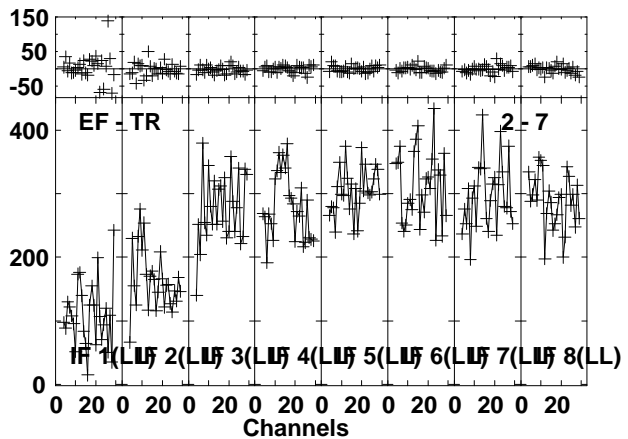
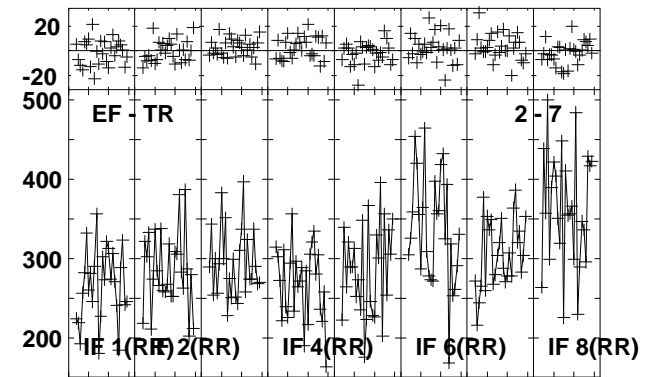
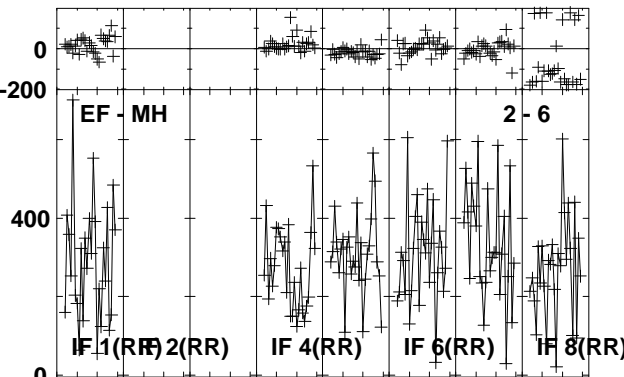
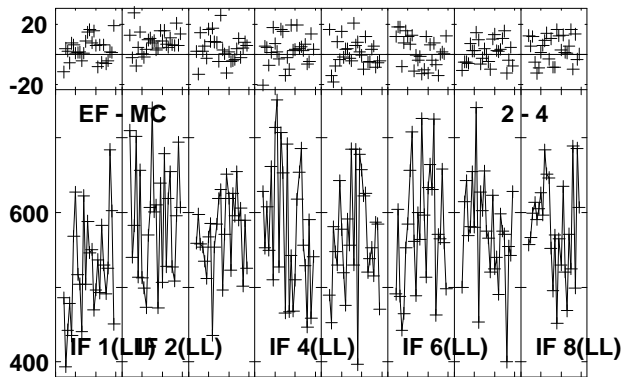
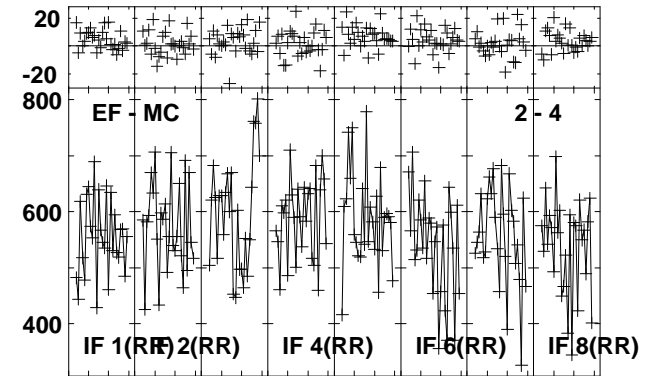
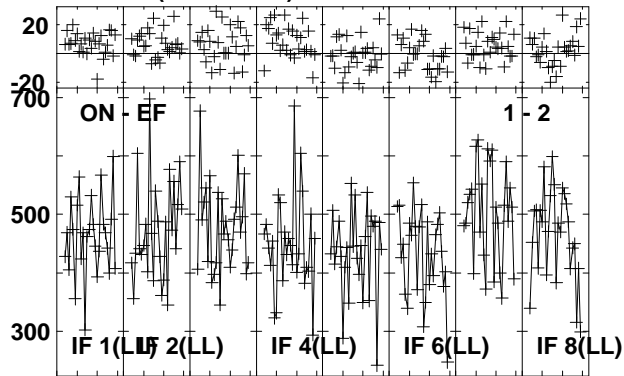
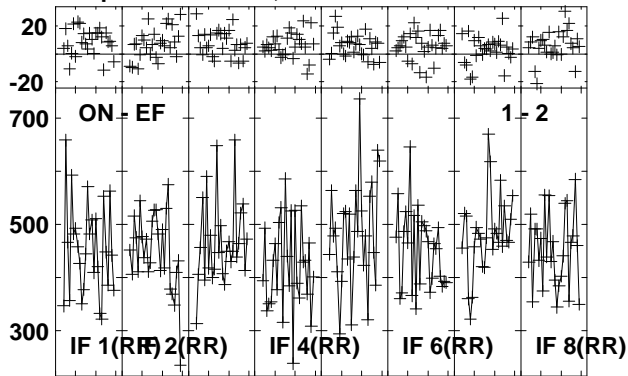

Lower frame: Milli Ampl Jy Top frame: Phas deg
Vector averaged cross-power spectrum Several baselines displayed
Timerange: 00/21:33:10 to 00/21:34:08

Plot file version 144 created 26-JUL-2013 10:20:20

J1157 EZ024 1.UVDATA.1

Freq = 22.1720 GHz, Bw = 16.000 MH Calibrated with CL # 3 and BP # 1 (BP mode 1)

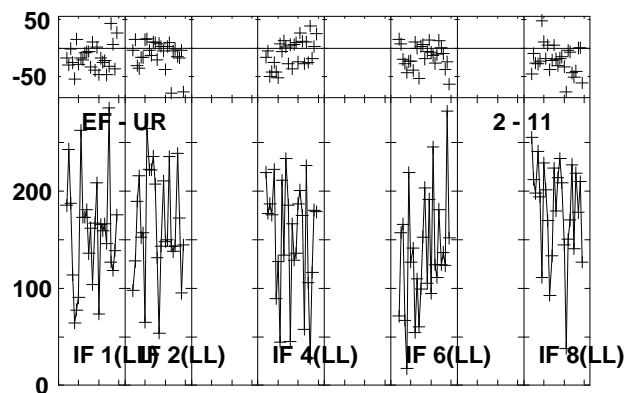
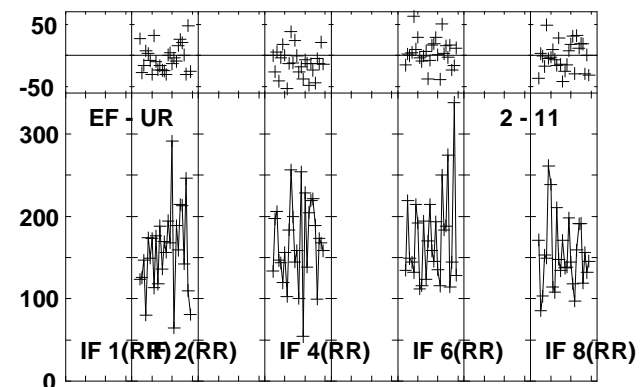
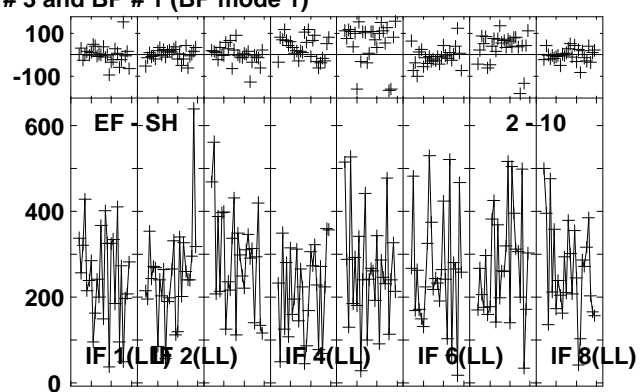
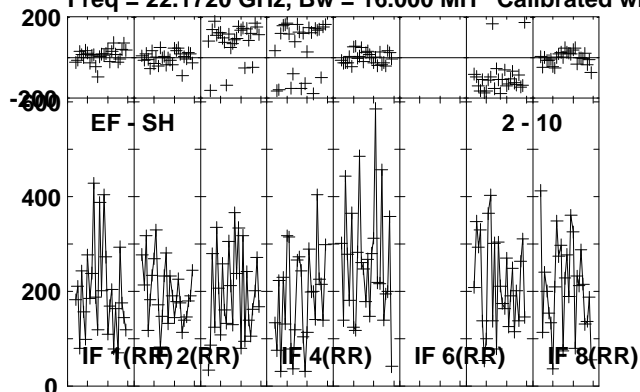

Lower frame: Milli Ampl Jy Top frame: Phas deg
Vector averaged cross-power spectrum Several baselines displayed
Timerange: 00/21:33:10 to 00/21:34:08

Plot file version 145 created 26-JUL-2013 10:20:21
 B1152+199A EZ024 1.UVDATA.1
 Freq = 22.1720 GHz, Bw = 16.000 MH Calibrated with CL # 3 and BP # 1 (BP mode 1)

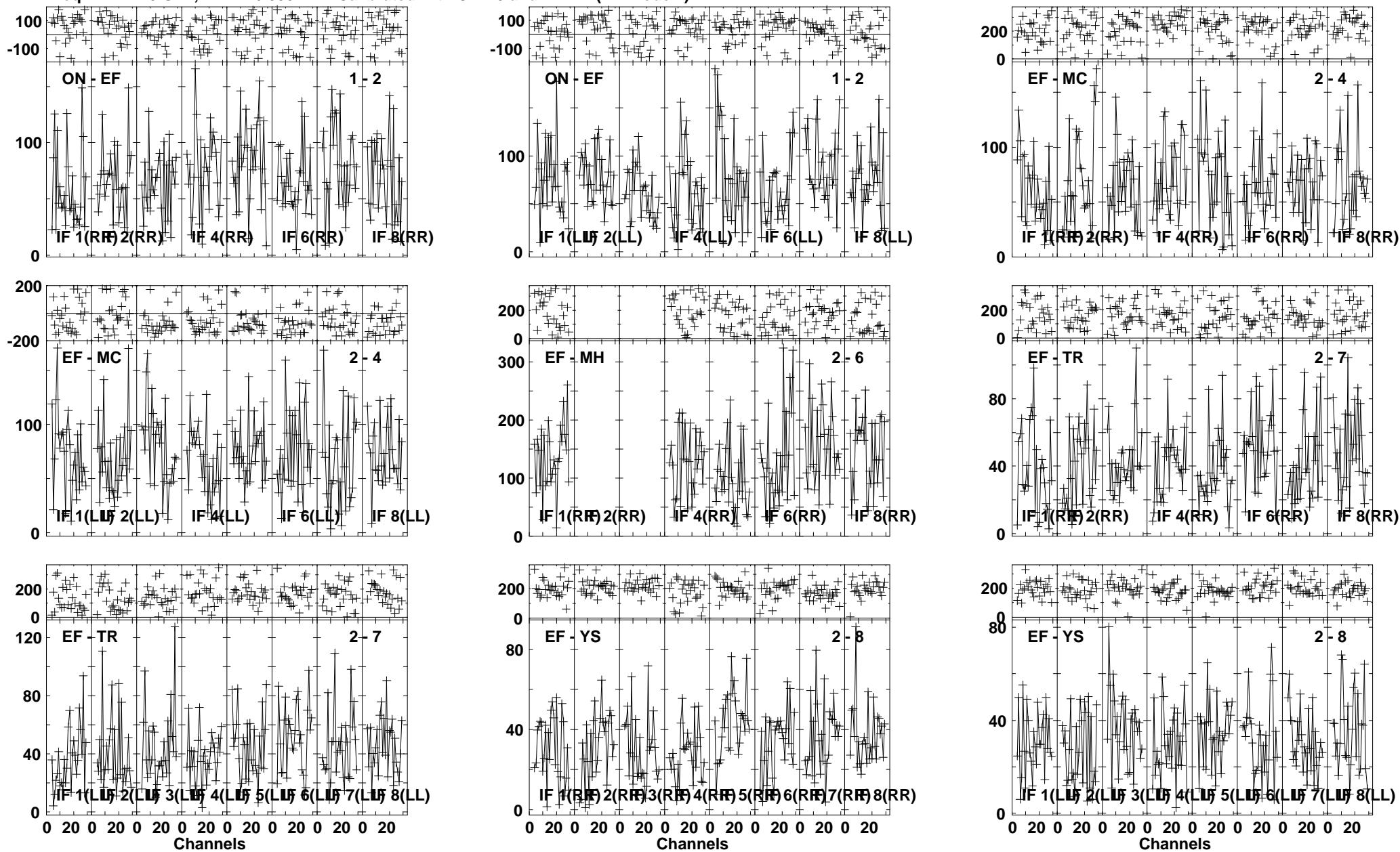

Lower frame: Milli Ampl Jy Top frame: Phas deg
 Vector averaged cross-power spectrum Several baselines displayed
 Timerange: 00/21:34:43 to 00/21:36:41

Plot file version 146 created 26-JUL-2013 10:20:22
 B1152+199A EZ024 1.UVDATA.1
 Freq = 22.1720 GHz, Bw = 16.000 MH Calibrated with CL # 3 and BP # 1 (BP mode 1)

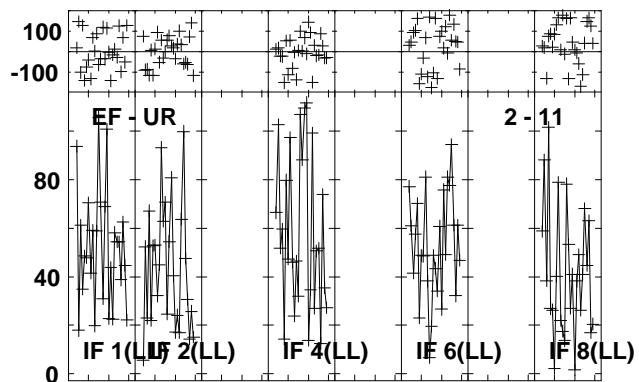
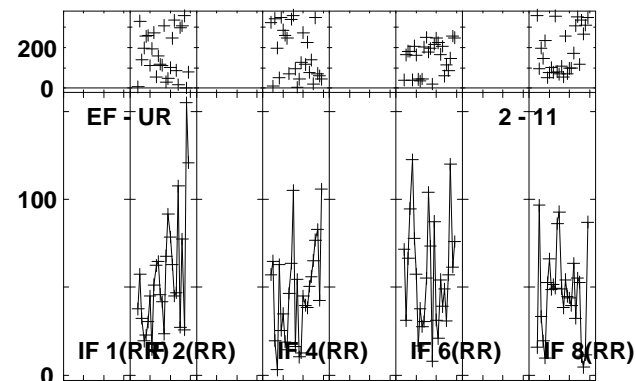
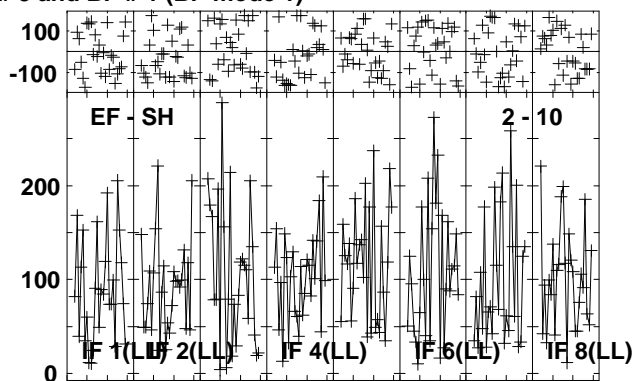
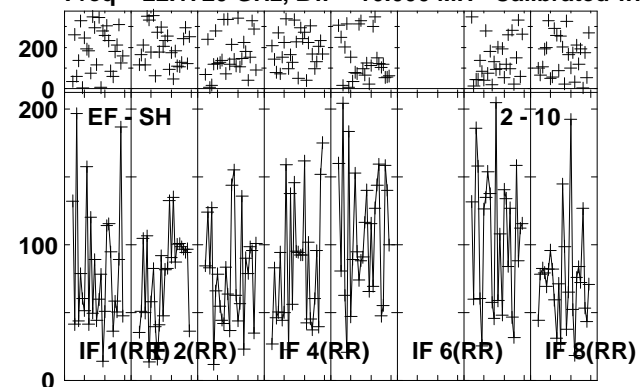

Lower frame: Milli Ampl Jy Top frame: Phas deg
 Vector averaged cross-power spectrum Several baselines displayed
 Timerange: 00/21:34:43 to 00/21:36:41

Plot file version 147 created 26-JUL-2013 10:20:23
 J1157 EZ024 1.UVDATA.1
 Freq = 22.1720 GHz, Bw = 16.000 MH Calibrated with CL # 3 and BP # 1 (BP mode 1)

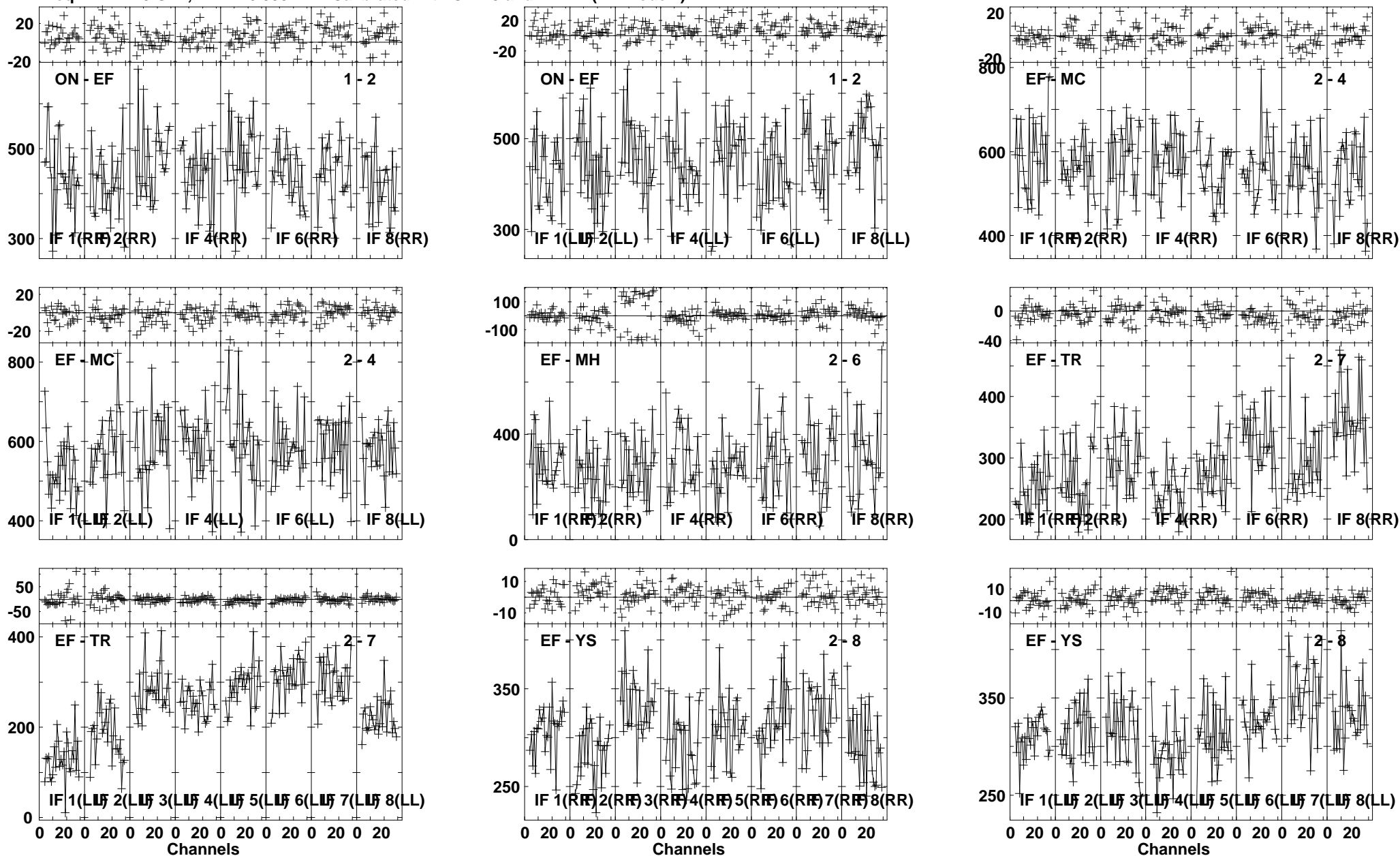

Lower frame: Milli Ampl Jy Top frame: Phas deg
 Vector averaged cross-power spectrum Several baselines displayed
 Timerange: 00/21:37:17 to 00/21:38:15

Plot file version 148 created 26-JUL-2013 10:20:24

J1157 EZ024 1.UVDATA.1

Freq = 22.1720 GHz, Bw = 16.000 MH Calibrated with CL # 3 and BP # 1 (BP mode 1)

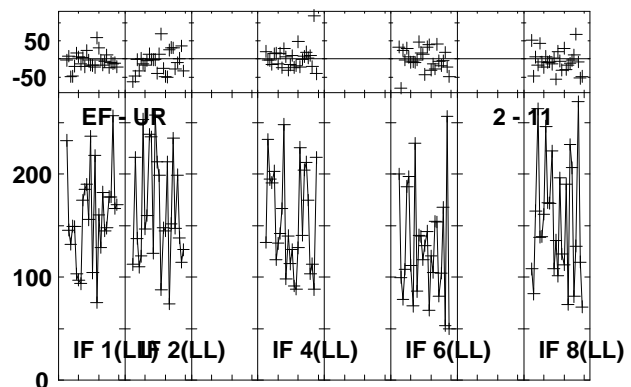
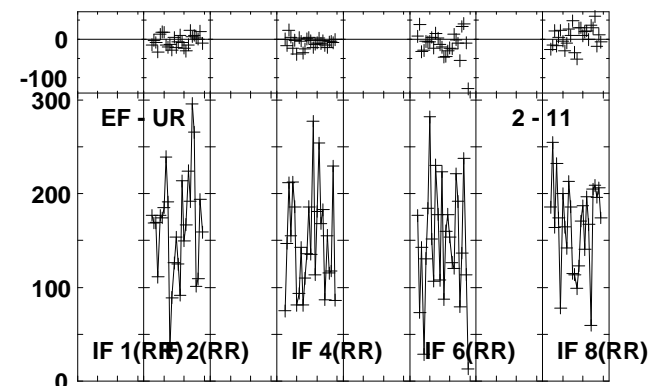
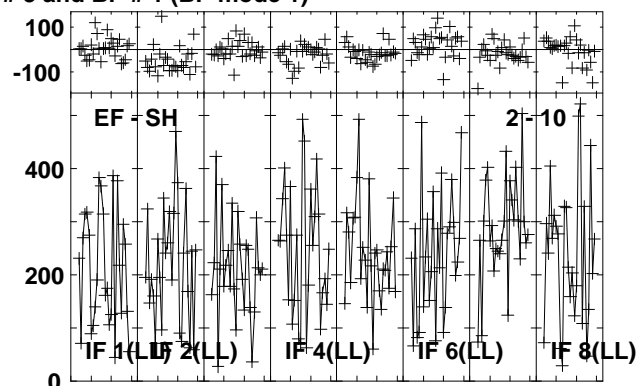
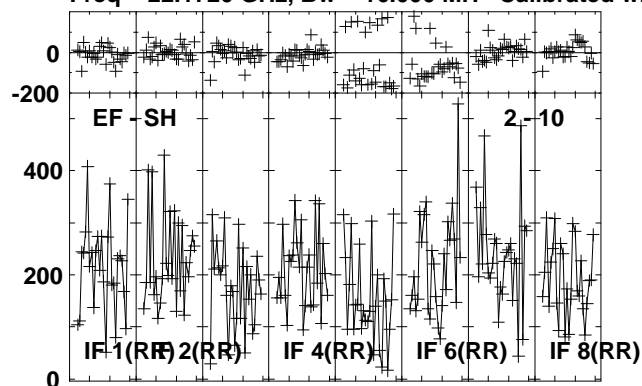

Lower frame: Milli Ampl Jy Top frame: Phas deg
Vector averaged cross-power spectrum Several baselines displayed
Timerange: 00/21:37:17 to 00/21:38:15

Plot file version 149 created 26-JUL-2013 10:20:25
 B1152+199A EZ024 1.UVDATA.1
 Freq = 22.1720 GHz, Bw = 16.000 MH Calibrated with CL # 3 and BP # 1 (BP mode 1)

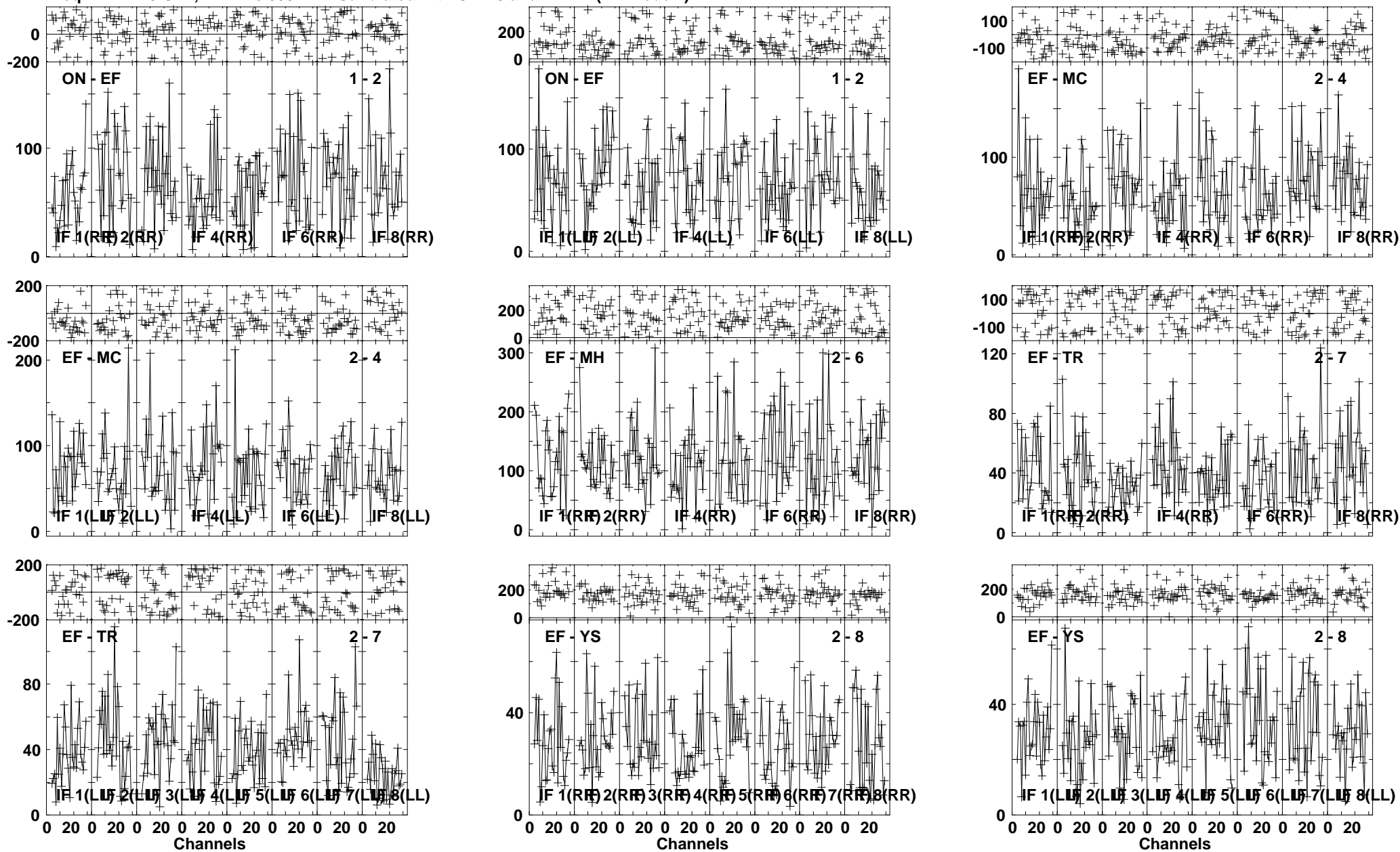

Lower frame: Milli Ampl Jy Top frame: Phas deg
 Vector averaged cross-power spectrum Several baselines displayed
 Timerange: 00/21:38:50 to 00/21:40:48

Plot file version 150 created 26-JUL-2013 10:20:27

B1152+199A EZ024 1.UVDATA.1

Freq = 22.1720 GHz, Bw = 16.000 MH Calibrated with CL # 3 and BP # 1 (BP mode 1)

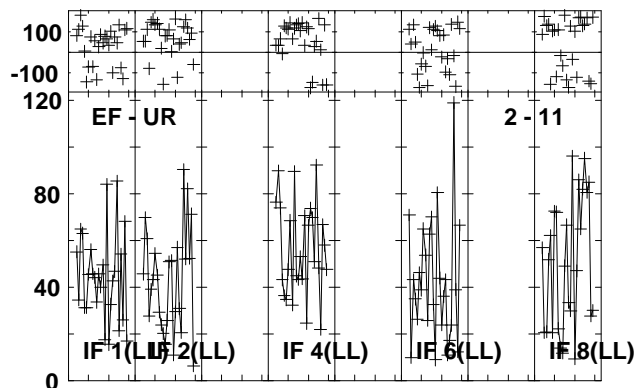
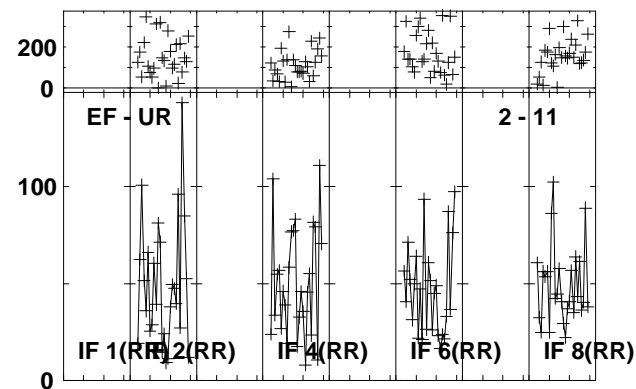
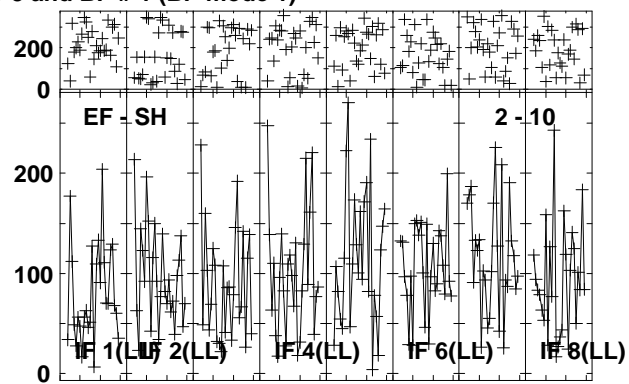
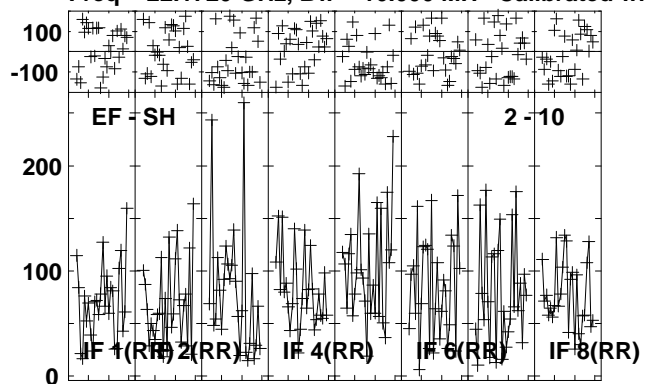

Lower frame: Milli Ampl Jy Top frame: Phas deg
Vector averaged cross-power spectrum Several baselines displayed
Timerange: 00/21:38:50 to 00/21:40:48

Plot file version 151 created 26-JUL-2013 10:20:28

J1157 EZ024 1.UVDATA.1

Freq = 22.1720 GHz, Bw = 16.000 MH Calibrated with CL # 3 and BP # 1 (BP mode 1)

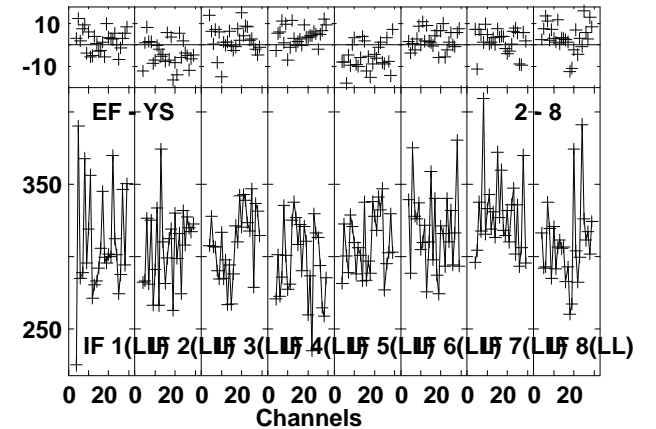
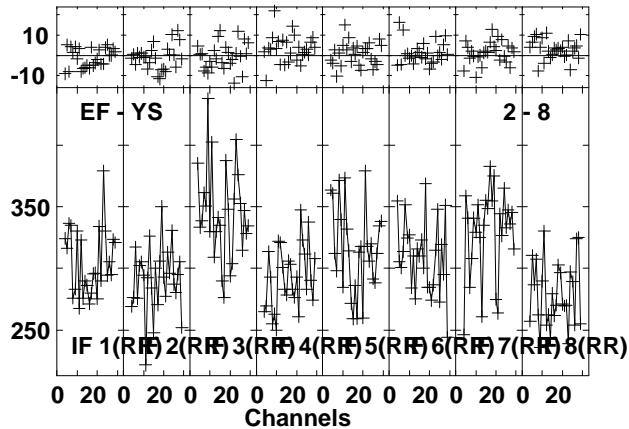
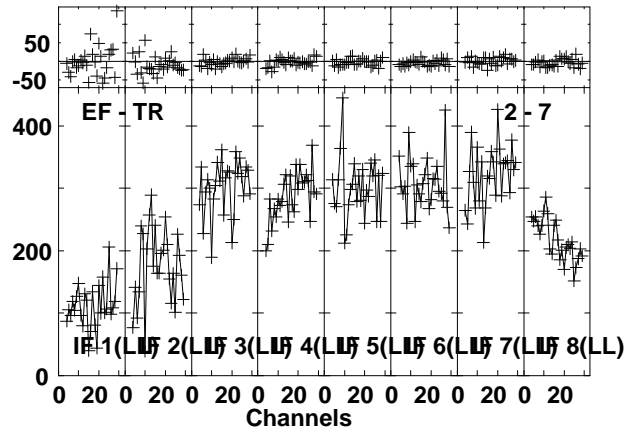
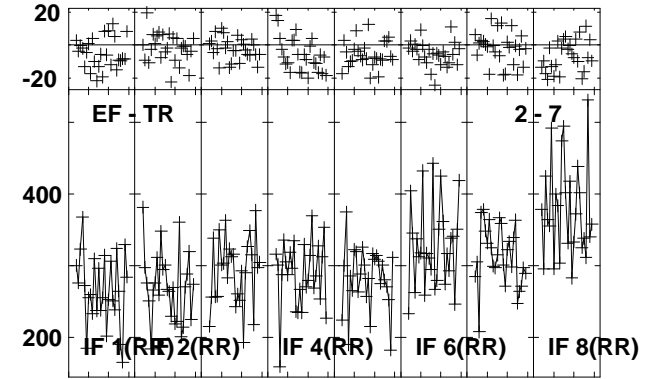
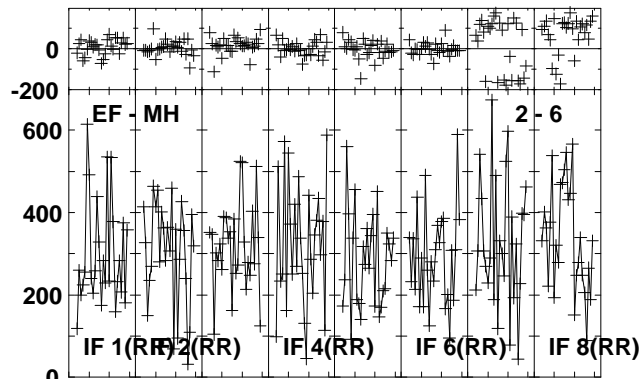
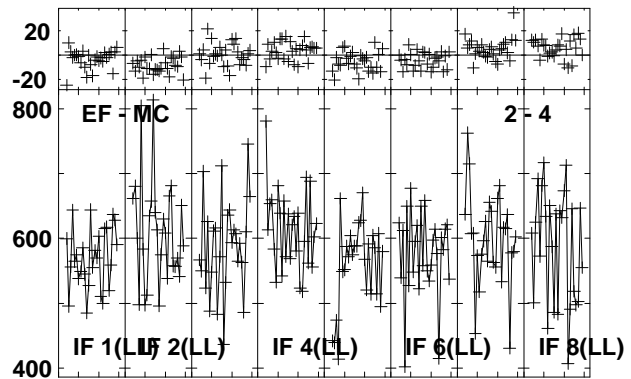
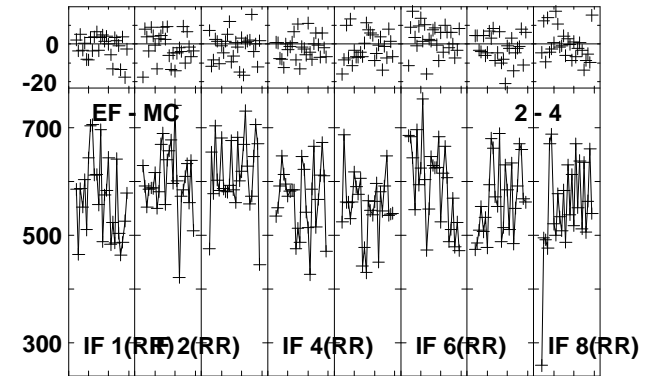
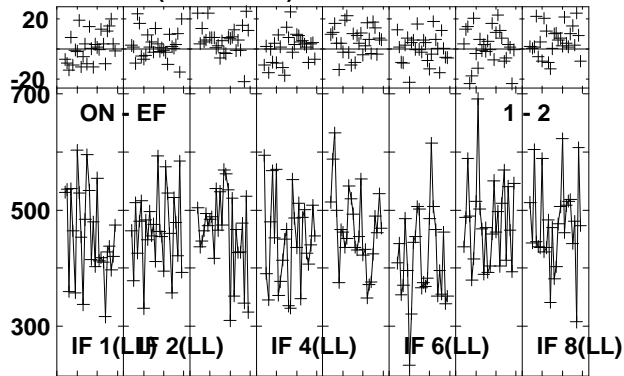
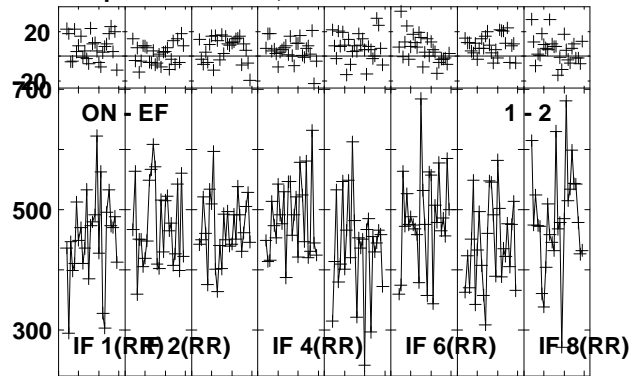

Lower frame: Milli Ampl Jy Top frame: Phas deg
Vector averaged cross-power spectrum Several baselines displayed
Timerange: 00/21:41:23 to 00/21:42:21

Plot file version 152 created 26-JUL-2013 10:20:29
 J1157 EZ024 1.UVDATA.1
 Freq = 22.1720 GHz, Bw = 16.000 MH Calibrated with CL # 3 and BP # 1 (BP mode 1)

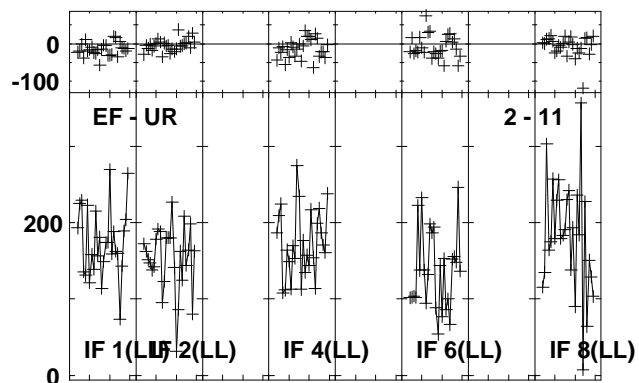
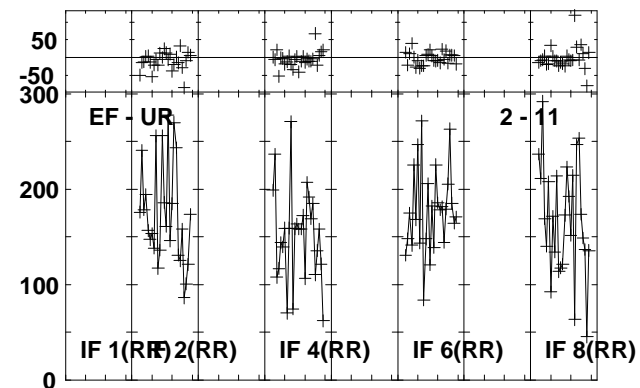
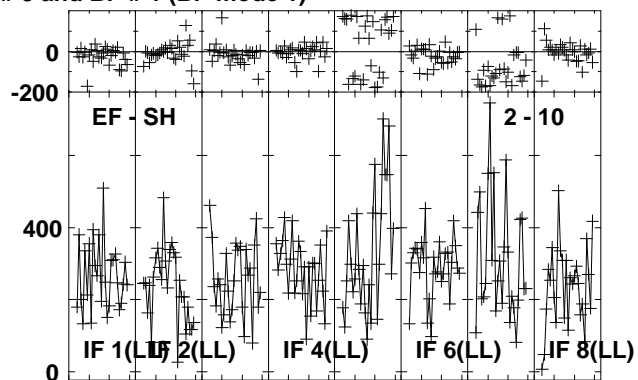
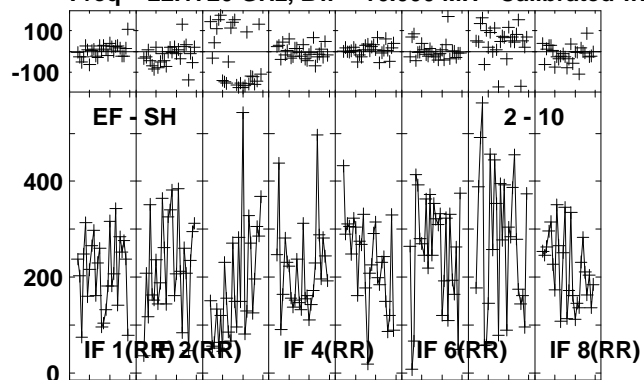

Lower frame: Milli Ampl Jy Top frame: Phas deg
 Vector averaged cross-power spectrum Several baselines displayed
 Timerange: 00/21:41:23 to 00/21:42:21

Plot file version 153 created 26-JUL-2013 10:20:29
 J1125+2610 EZ024 1.UVDATA.1
 Freq = 22.1720 GHz, Bw = 16.000 MH Calibrated with CL # 3 and BP # 1 (BP mode 1)

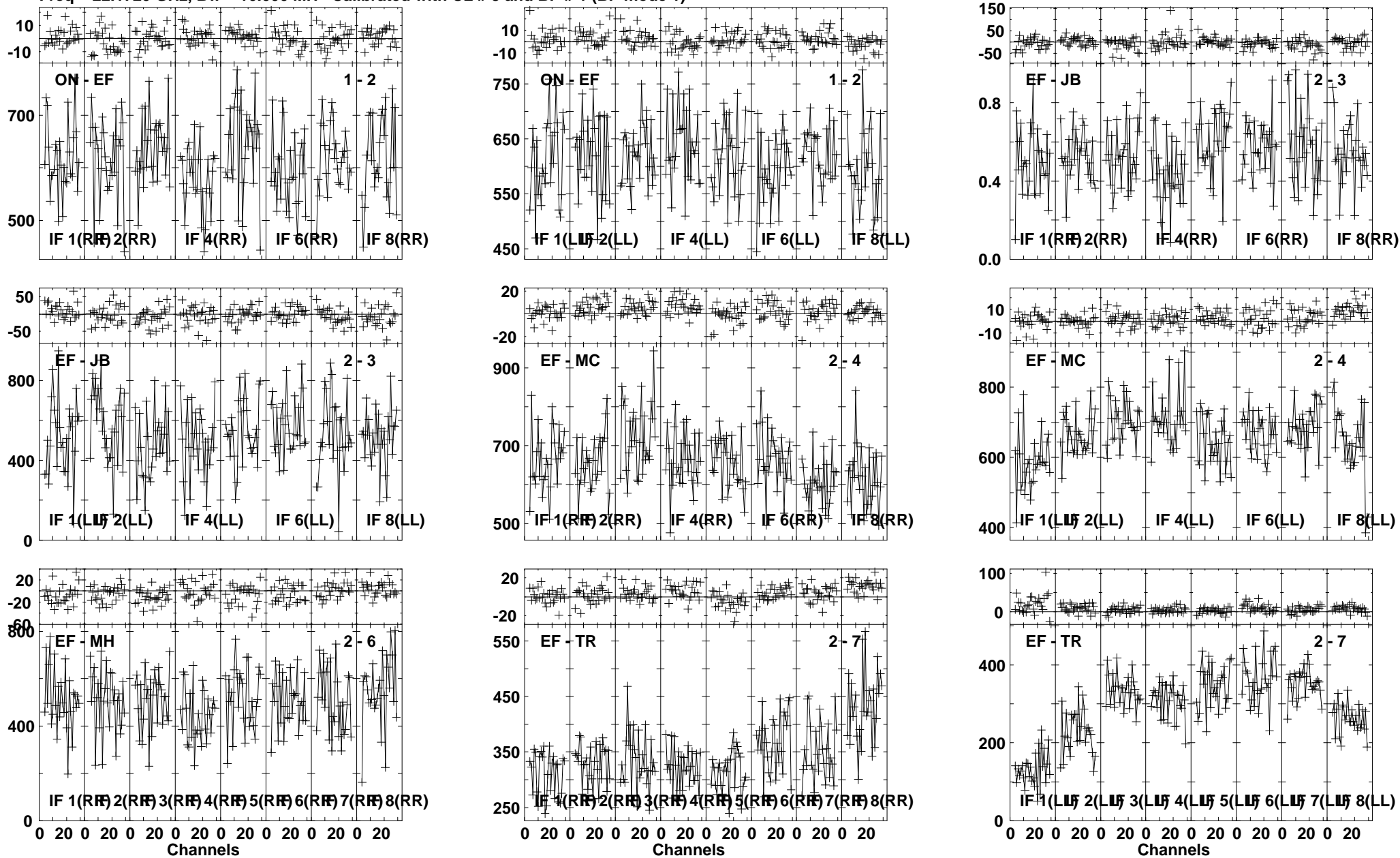

Lower frame: Milli Ampl Jy Top frame: Phas deg
 Vector averaged cross-power spectrum Several baselines displayed
 Timerange: 00/21:43:48 to 00/21:45:30

Plot file version 154 created 26-JUL-2013 10:20:30
 J1125+2610 EZ024 1.UVDATA.1
 Freq = 22.1720 GHz, Bw = 16.000 MH Calibrated with CL # 3 and BP # 1 (BP mode 1)

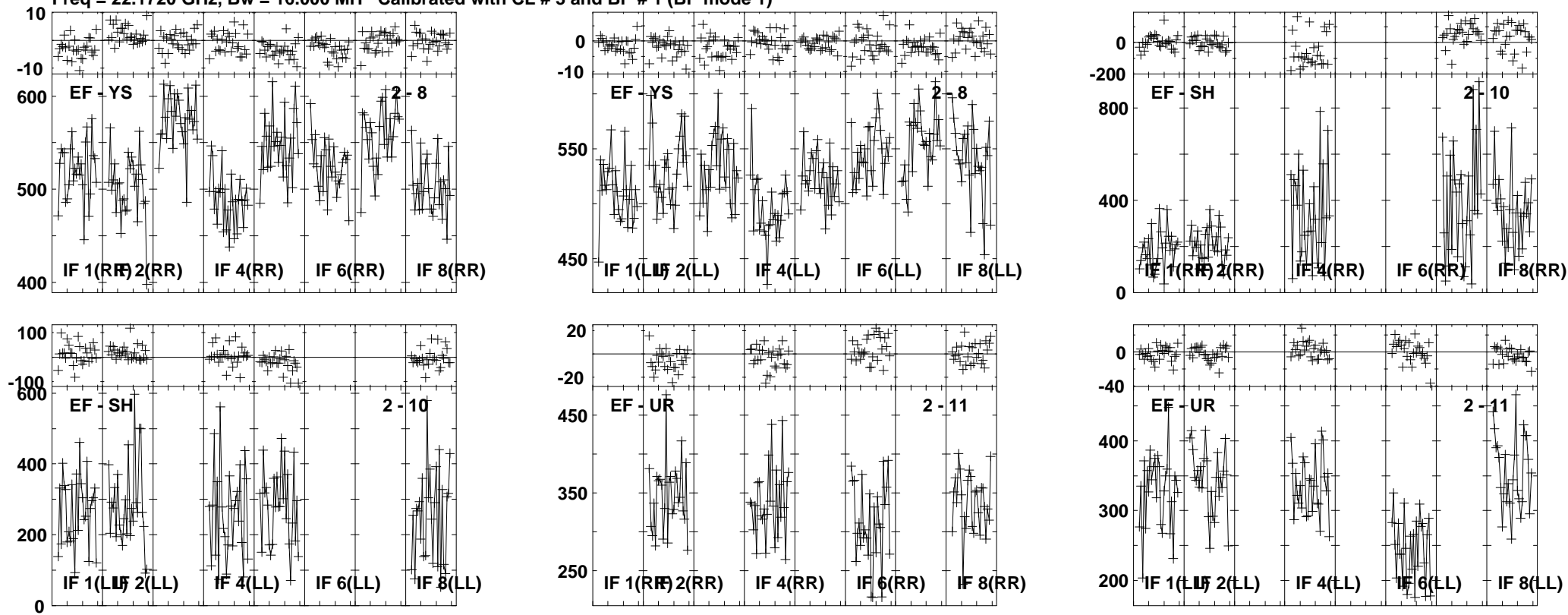

Lower frame: Milli Ampl Jy Top frame: Phas deg
 Vector averaged cross-power spectrum Several baselines displayed
 Timerange: 00/21:43:48 to 00/21:45:30

Plot file version 155 created 26-JUL-2013 10:20:31

J1157 EZ024 1.UVDATA.1

Freq = 22.1720 GHz, Bw = 16.000 MH Calibrated with CL # 3 and BP # 1 (BP mode 1)

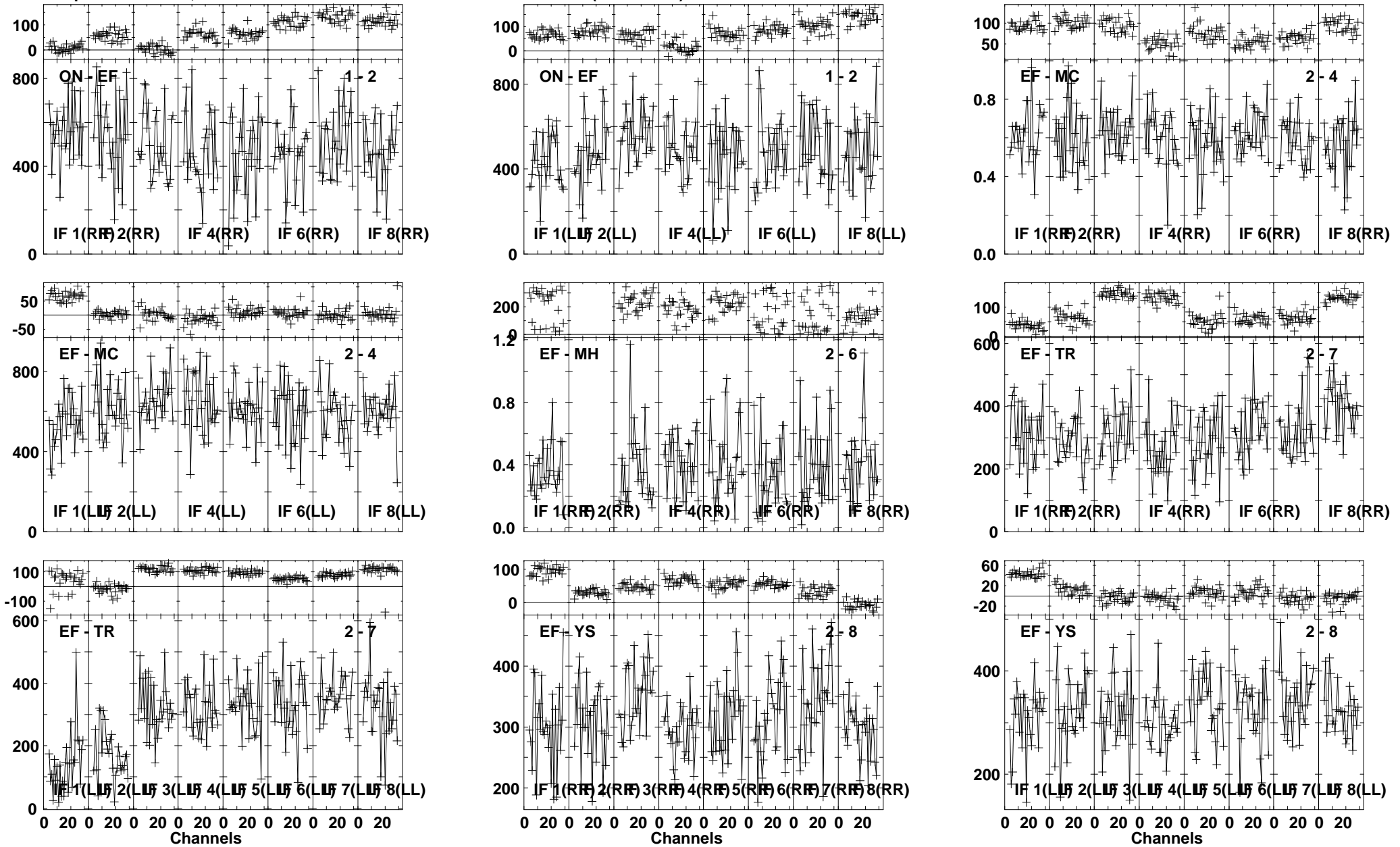

Lower frame: Milli Ampl Jy Top frame: Phas deg
Vector averaged cross-power spectrum Several baselines displayed
Timerange: 00/21:46:57 to 00/21:47:39

Plot file version 156 created 26-JUL-2013 10:20:32
 J1157 EZ024 1.UVDATA.1
 Freq = 22.1720 GHz, Bw = 16.000 MH Calibrated with CL # 3 and BP # 1 (BP mode 1)

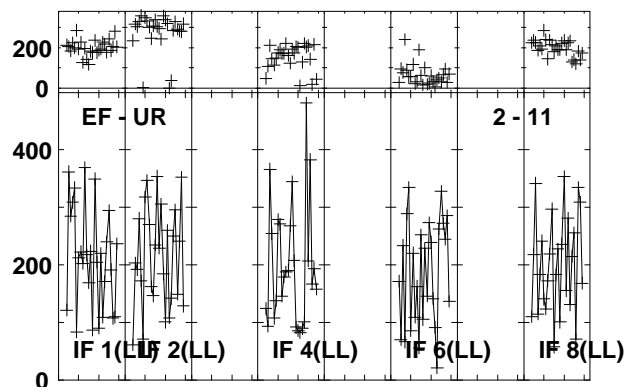
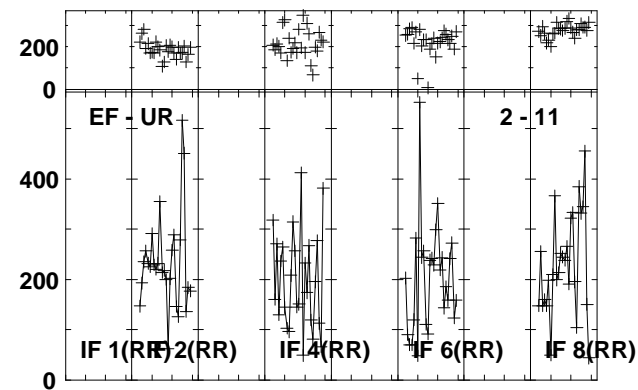
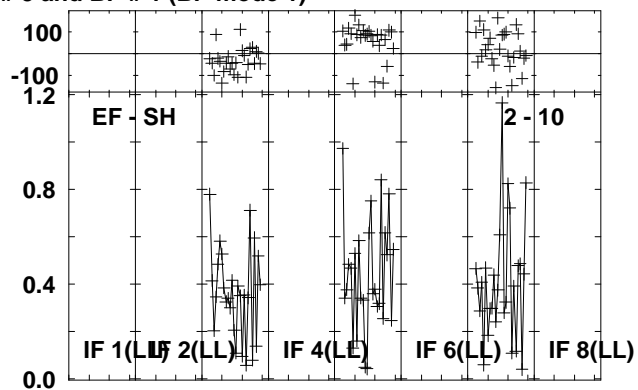
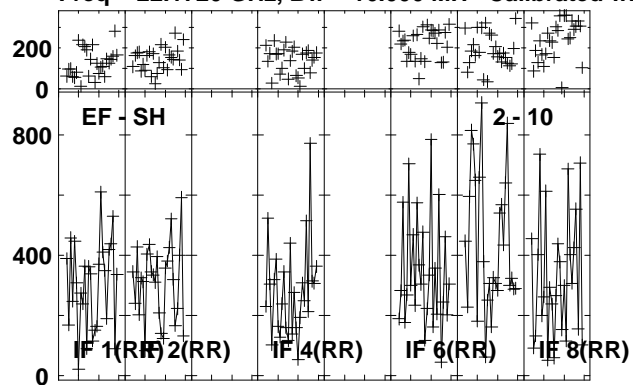

Lower frame: Milli Ampl Jy Top frame: Phas deg
 Vector averaged cross-power spectrum Several baselines displayed
 Timerange: 00/21:46:57 to 00/21:47:39

Plot file version 157 created 26-JUL-2013 10:20:33
 B1152+199A EZ024 1.UVDATA.1
 Freq = 22.1720 GHz, Bw = 16.000 MH Calibrated with CL # 3 and BP # 1 (BP mode 1)

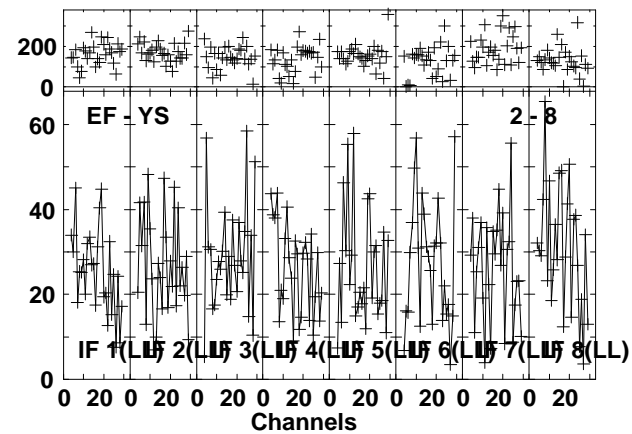
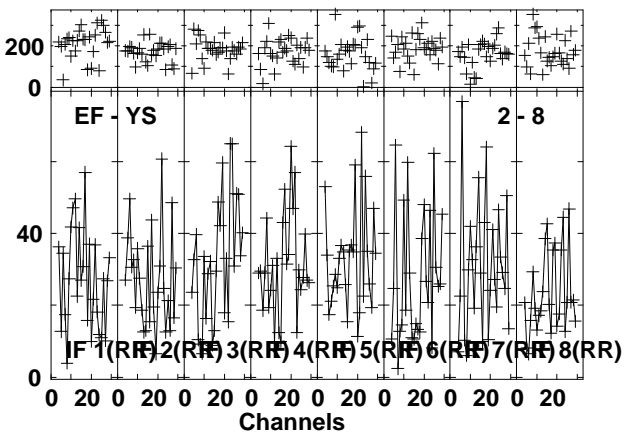
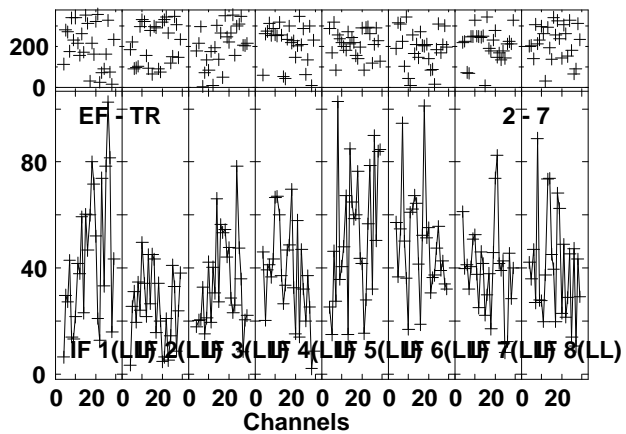
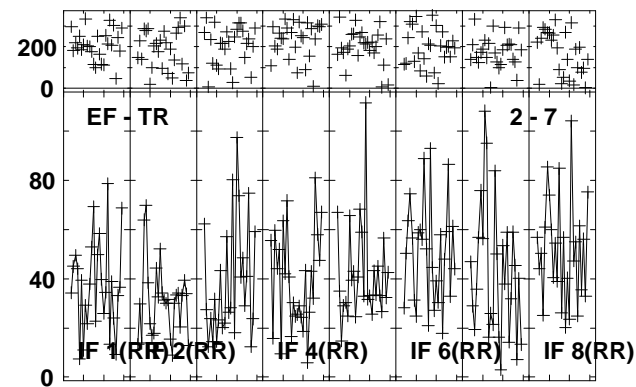
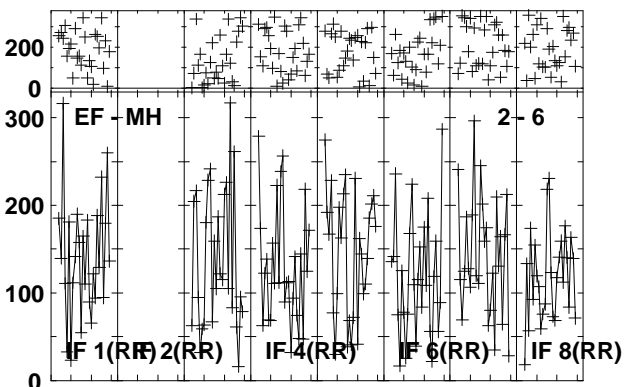
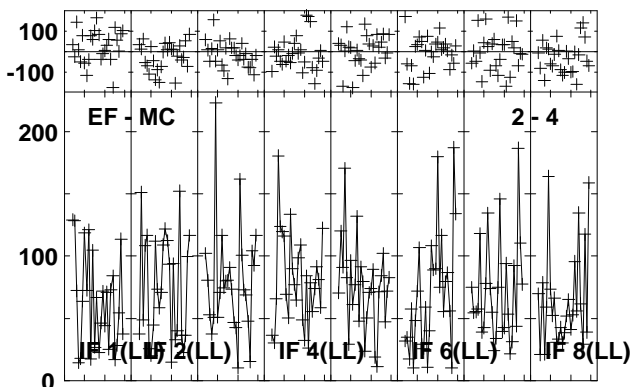
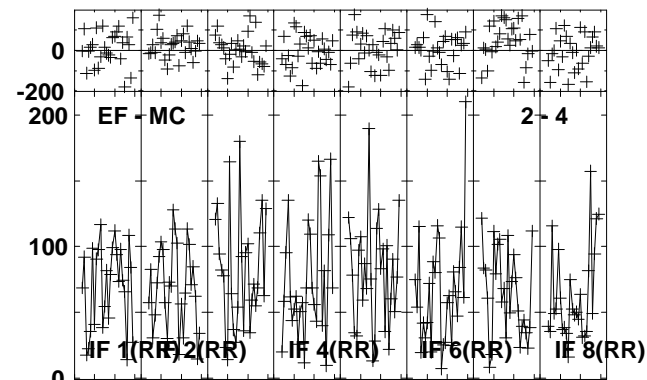
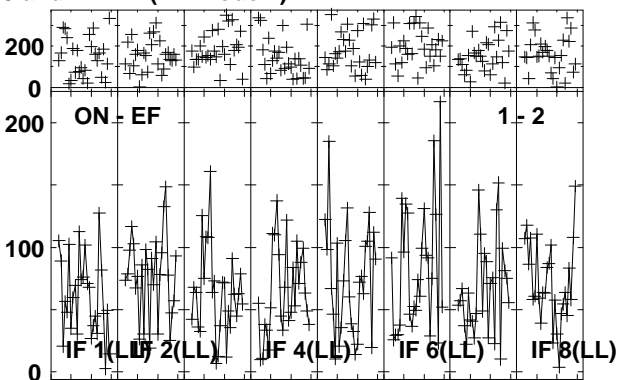
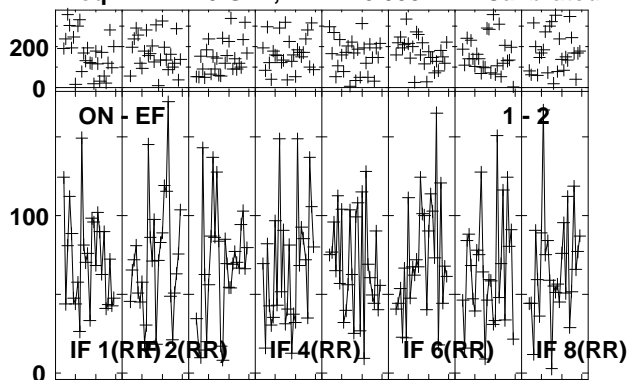

Lower frame: Milli Ampl Jy Top frame: Phas deg
 Vector averaged cross-power spectrum Several baselines displayed
 Timerange: 00/21:48:15 to 00/21:50:13

Plot file version 158 created 26-JUL-2013 10:20:35

B1152+199A EZ024 1.UVDATA.1

Freq = 22.1720 GHz, Bw = 16.000 MH Calibrated with CL # 3 and BP # 1 (BP mode 1)

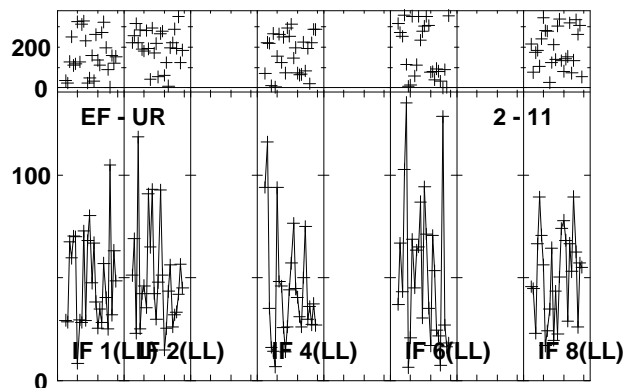
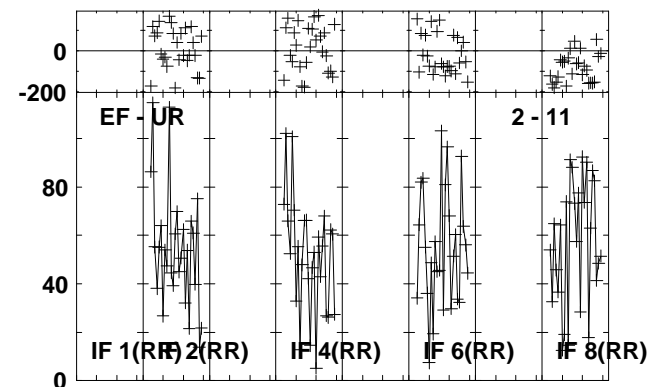
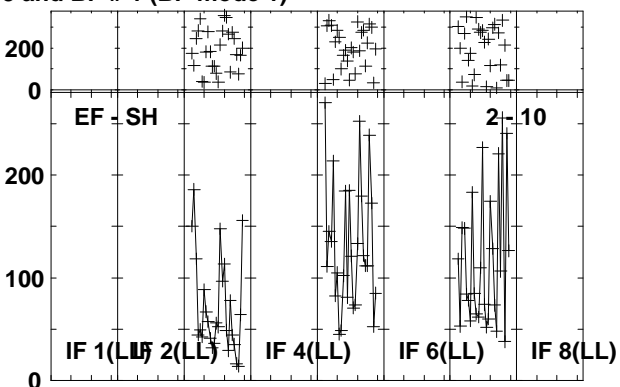
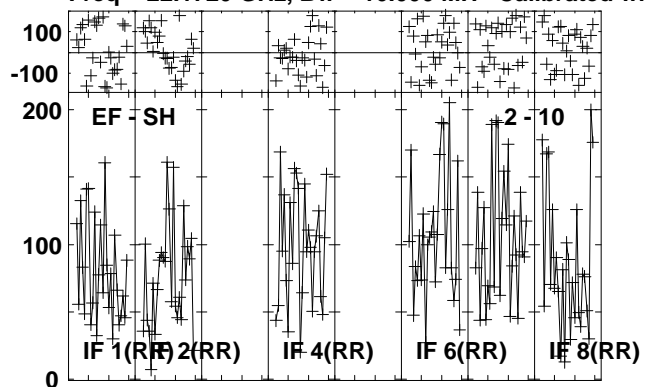

Lower frame: Milli Ampl Jy Top frame: Phas deg
Vector averaged cross-power spectrum Several baselines displayed
Timerange: 00/21:48:15 to 00/21:50:13

Plot file version 159 created 26-JUL-2013 10:20:36
 J1157 EZ024 1.UVDATA.1
 Freq = 22.1720 GHz, Bw = 16.000 MH Calibrated with CL # 3 and BP # 1 (BP mode 1)

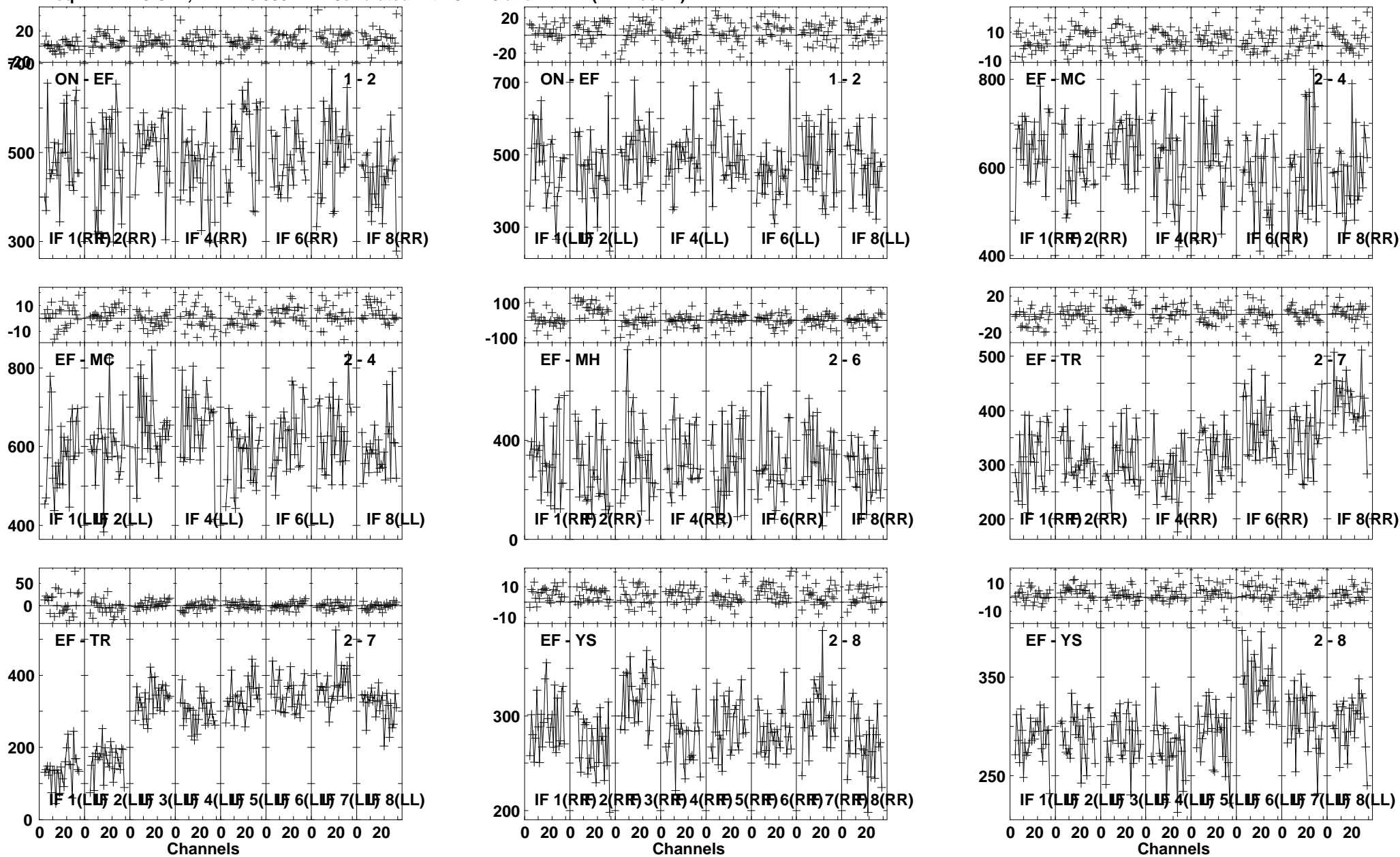

Lower frame: Milli Ampl Jy Top frame: Phas deg
 Vector averaged cross-power spectrum Several baselines displayed
 Timerange: 00/21:50:48 to 00/21:51:46

Plot file version 160 created 26-JUL-2013 10:20:37

J1157 EZ024 1.UVDATA.1

Freq = 22.1720 GHz, Bw = 16.000 MH Calibrated with CL # 3 and BP # 1 (BP mode 1)

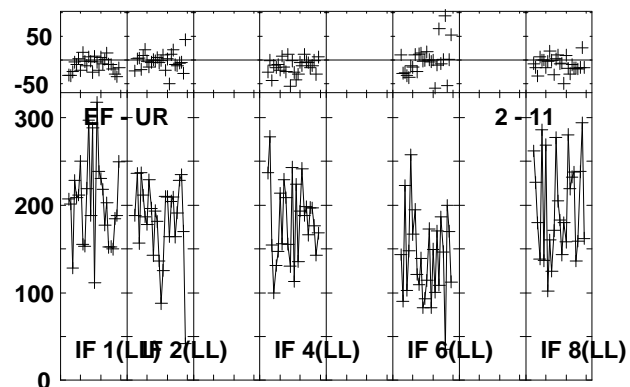
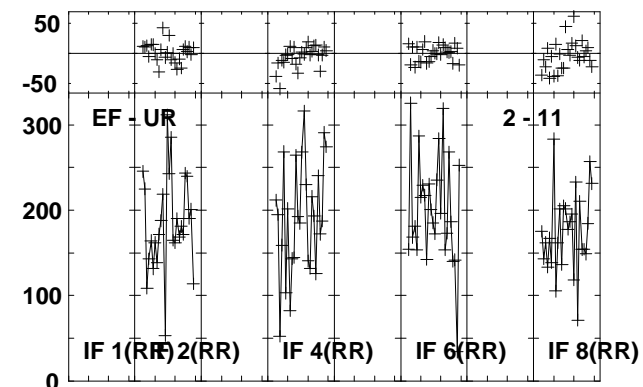
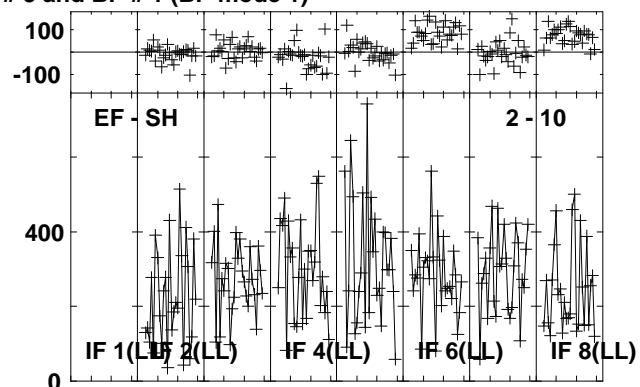
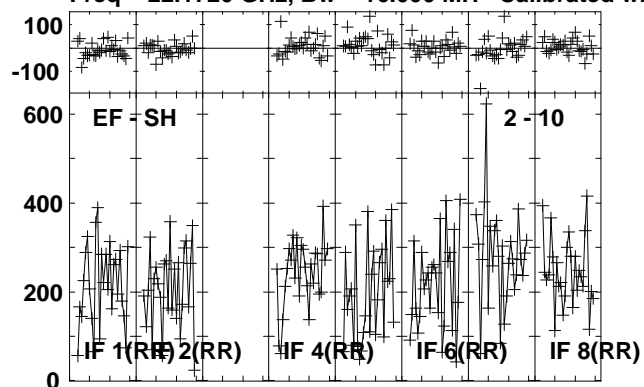

Lower frame: Milli Ampl Jy Top frame: Phas deg
Vector averaged cross-power spectrum Several baselines displayed
Timerange: 00/21:50:48 to 00/21:51:46

Plot file version 161 created 26-JUL-2013 10:20:38
 B1152+199A EZ024 1.UVDATA.1
 Freq = 22.1720 GHz, Bw = 16.000 MH Calibrated with CL # 3 and BP # 1 (BP mode 1)

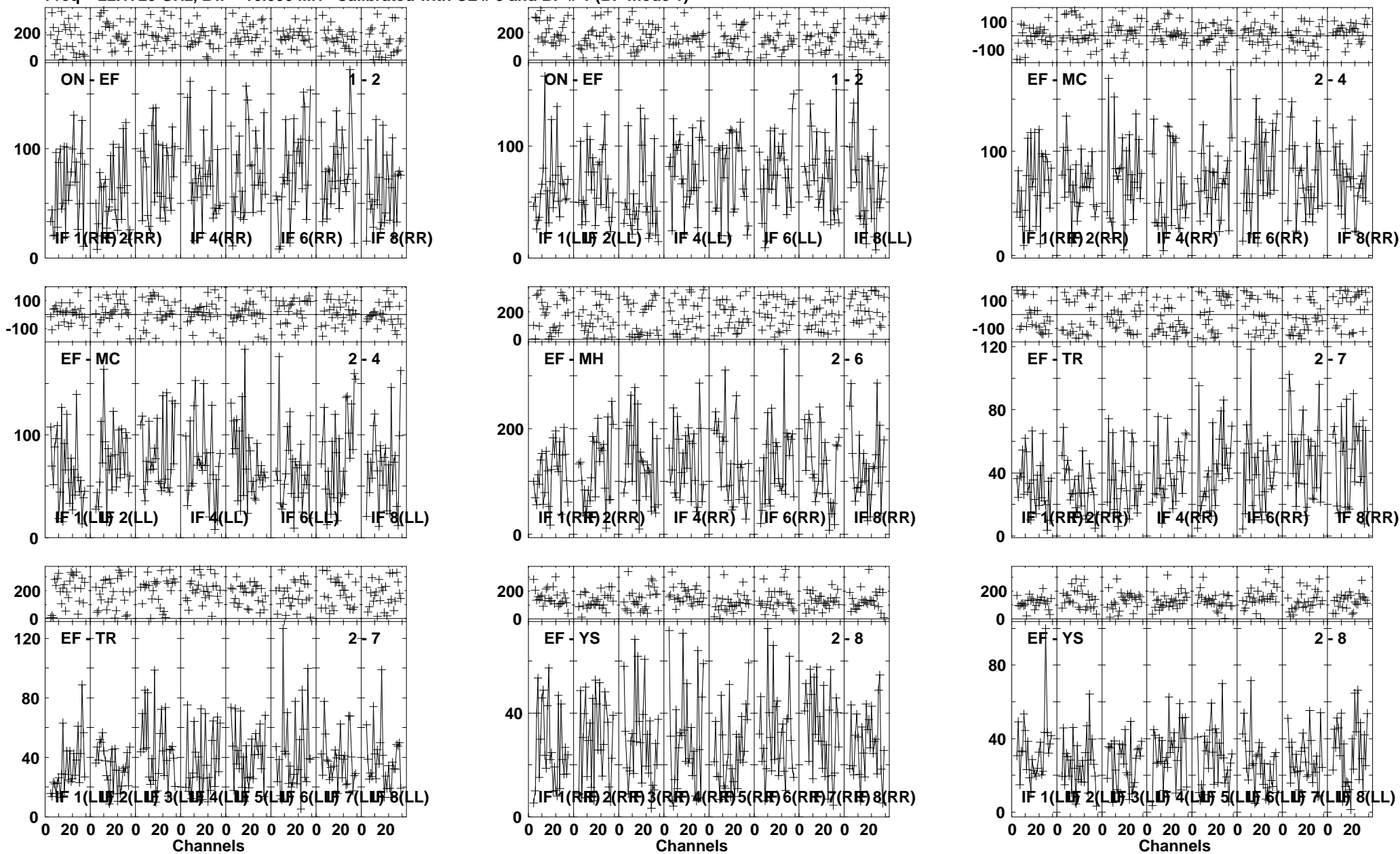

Lower frame: Milli Ampl Jy Top frame: Phas deg
 Vector averaged cross-power spectrum Several baselines displayed
 Timerange: 00/21:52:21 to 00/21:54:19

Plot file version 162 created 26-JUL-2013 10:20:39
 B1152+199A EZ024 1.UVDATA.1
 Freq = 22.1720 GHz, Bw = 16.000 MH Calibrated with CL # 3 and BP # 1 (BP mode 1)

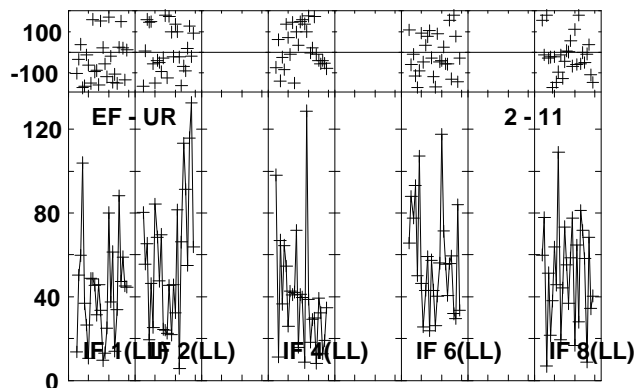
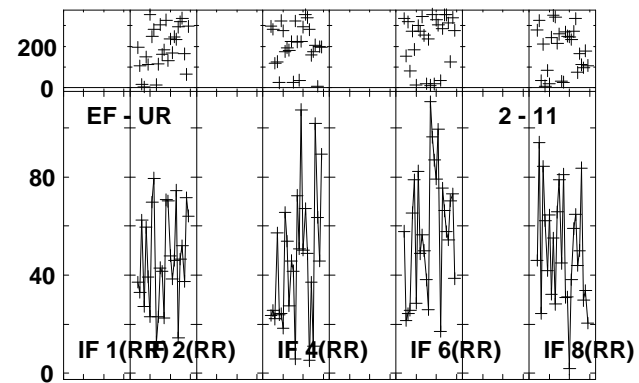
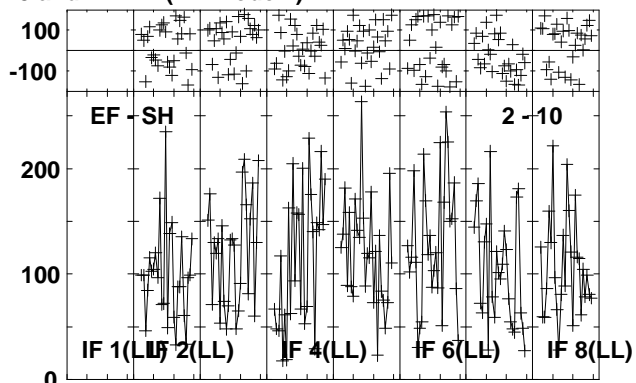
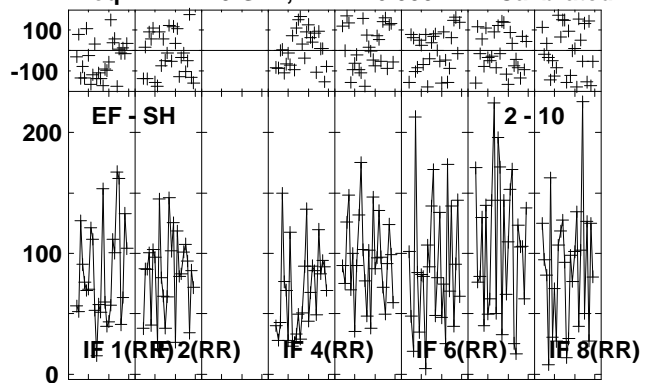

Lower frame: Milli Ampl Jy Top frame: Phas deg
 Vector averaged cross-power spectrum Several baselines displayed
 Timerange: 00/21:52:21 to 00/21:54:19

Plot file version 163 created 26-JUL-2013 10:20:40

J1157 EZ024 1.UVDATA.1

Freq = 22.1720 GHz, Bw = 16.000 MH Calibrated with CL # 3 and BP # 1 (BP mode 1)

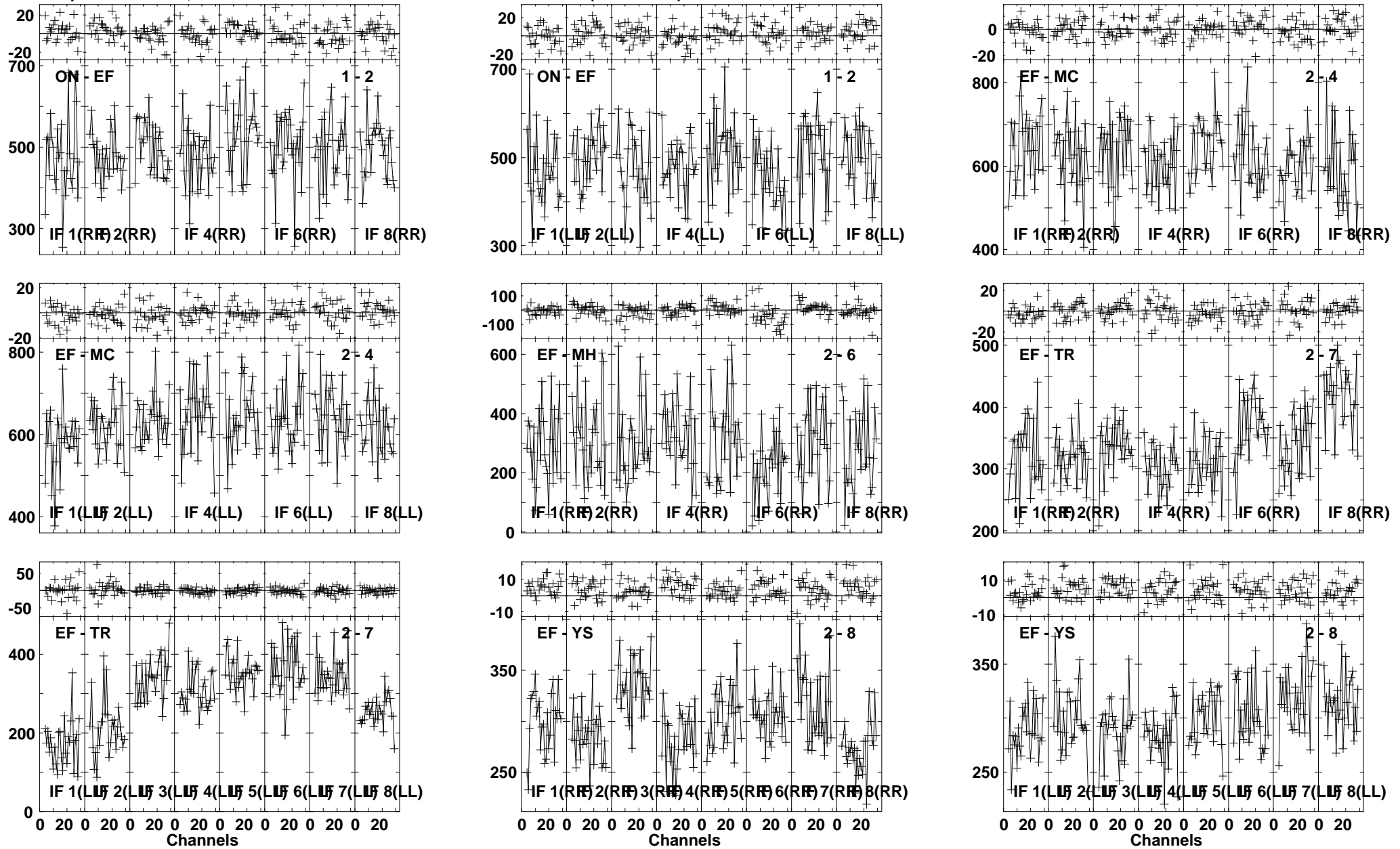

Lower frame: Milli Ampl Jy Top frame: Phas deg
Vector averaged cross-power spectrum Several baselines displayed
Timerange: 00/21:54:54 to 00/21:55:52

Plot file version 164 created 26-JUL-2013 10:20:41
 J1157 EZ024 1.UVDATA.1
 Freq = 22.1720 GHz, Bw = 16.000 MH Calibrated with CL # 3 and BP # 1 (BP mode 1)

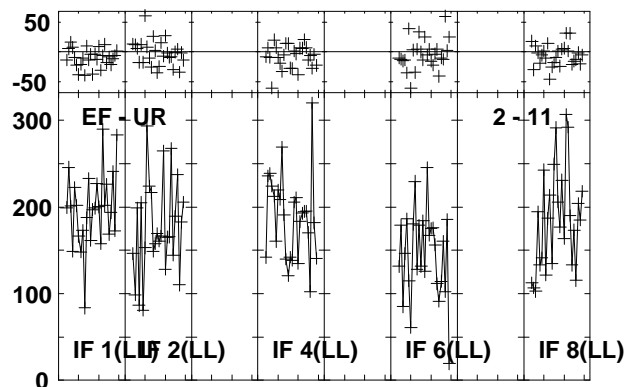
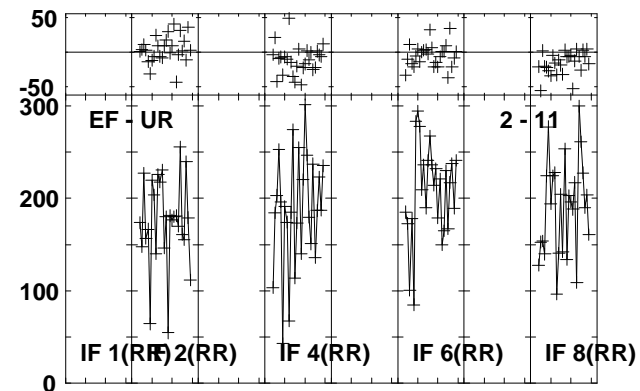
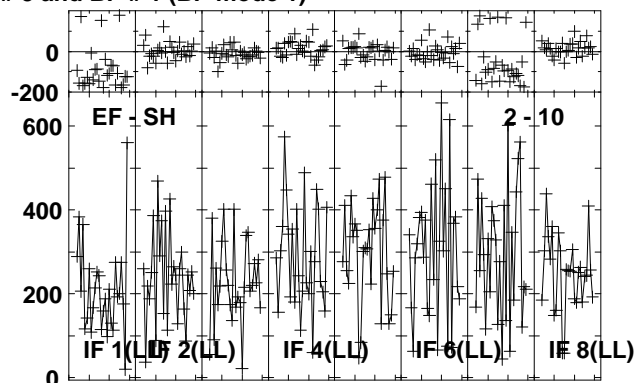
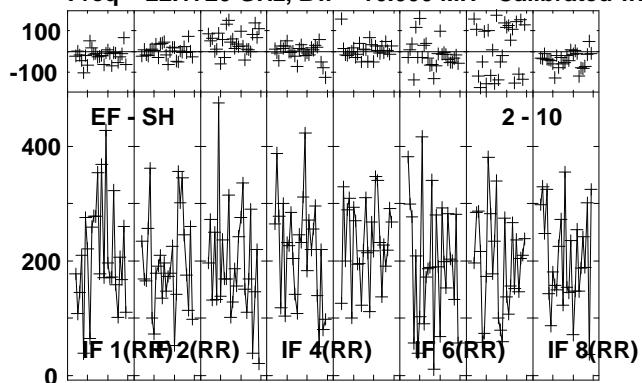

Lower frame: Milli Ampl Jy Top frame: Phas deg
 Vector averaged cross-power spectrum Several baselines displayed
 Timerange: 00/21:54:54 to 00/21:55:52

Plot file version 165 created 26-JUL-2013 10:20:42
 B1152+199A EZ024 1.UVDATA.1
 Freq = 22.1720 GHz, Bw = 16.000 MH Calibrated with CL # 3 and BP # 1 (BP mode 1)

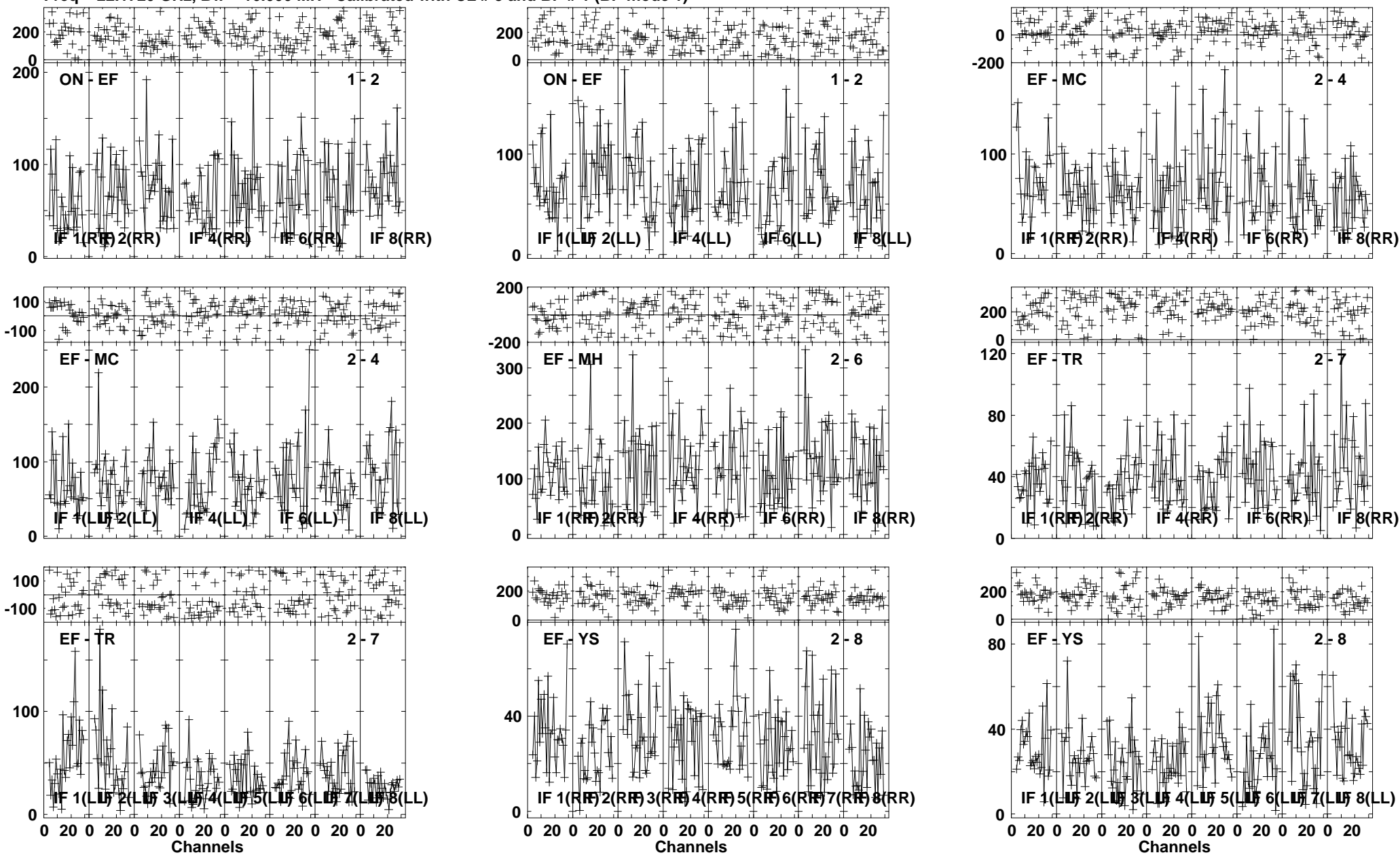

Lower frame: Milli Ampl Jy Top frame: Phas deg
 Vector averaged cross-power spectrum Several baselines displayed
 Timerange: 00/21:56:27 to 00/21:58:25

Plot file version 166 created 26-JUL-2013 10:20:44
 B1152+199A EZ024 1.UVDATA.1
 Freq = 22.1720 GHz, Bw = 16.000 MH Calibrated with CL # 3 and BP # 1 (BP mode 1)

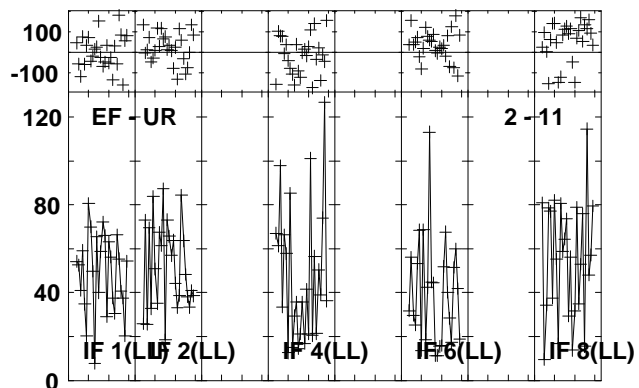
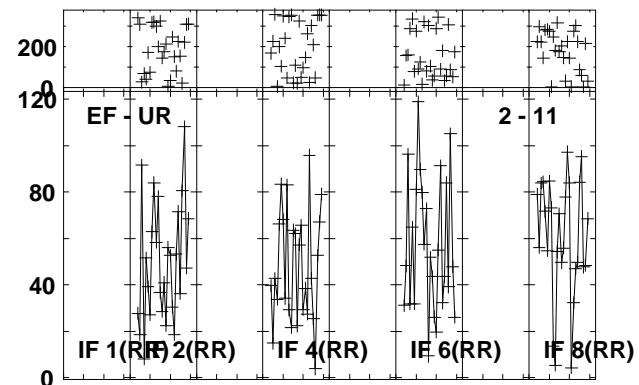
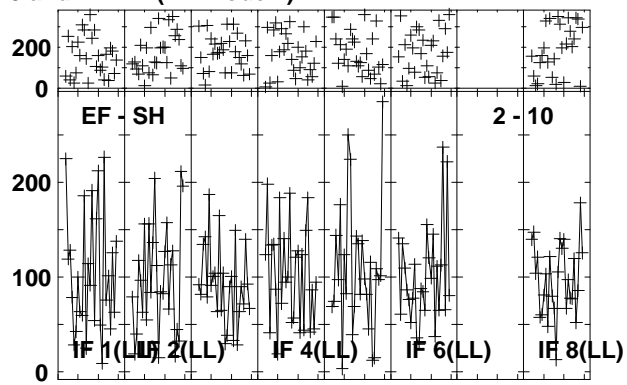
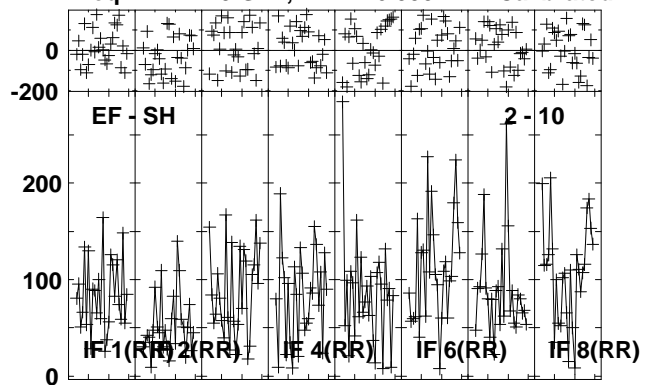

Lower frame: Milli Ampl Jy Top frame: Phas deg
 Vector averaged cross-power spectrum Several baselines displayed
 Timerange: 00/21:56:27 to 00/21:58:25

Plot file version 167 created 26-JUL-2013 10:20:45
 J1157 EZ024 1.UVDATA.1
 Freq = 22.1720 GHz, Bw = 16.000 MH Calibrated with CL # 3 and BP # 1 (BP mode 1)

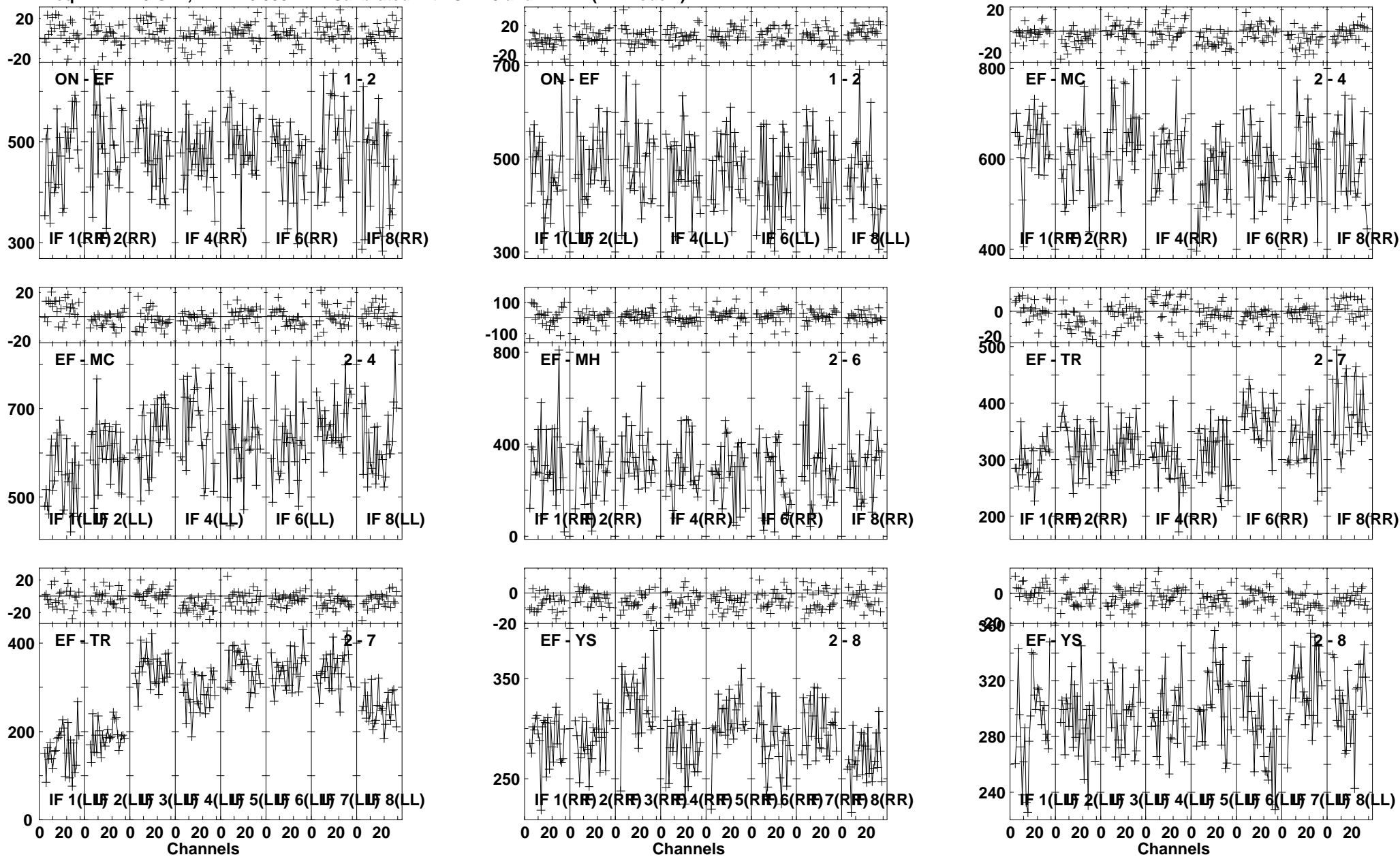

Lower frame: Milli Ampl Jy Top frame: Phas deg
 Vector averaged cross-power spectrum Several baselines displayed
 Timerange: 00/21:59:00 to 00/21:59:58

Plot file version 168 created 26-JUL-2013 10:20:46

J1157 EZ024 1.UVDATA.1

Freq = 22.1720 GHz, Bw = 16.000 MH Calibrated with CL # 3 and BP # 1 (BP mode 1)

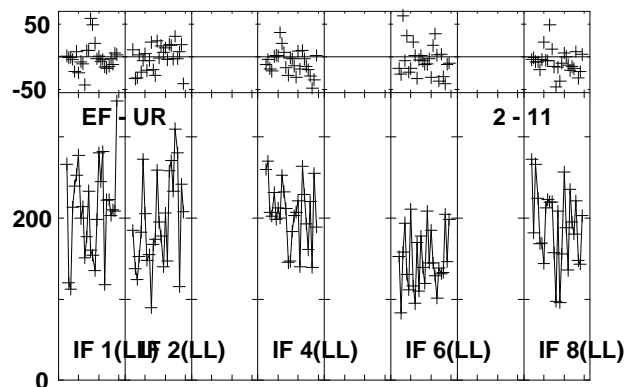
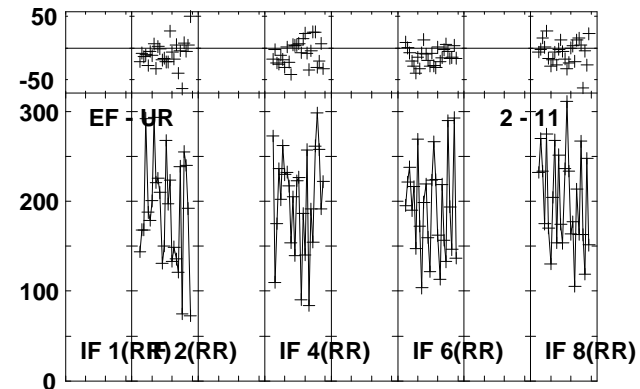
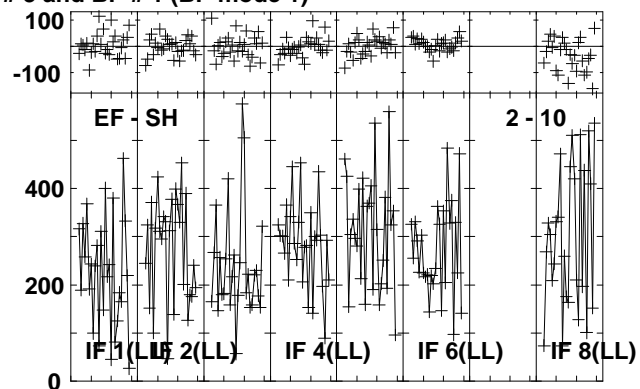
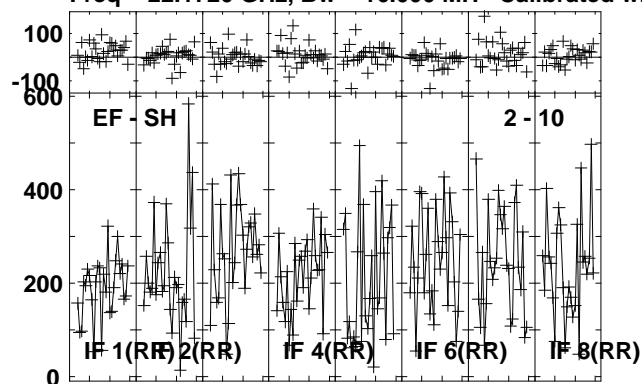

Lower frame: Milli Ampl Jy Top frame: Phas deg
Vector averaged cross-power spectrum Several baselines displayed
Timerange: 00/21:59:00 to 00/21:59:58

Plot file version 169 created 26-JUL-2013 10:20:46
 J1125+2610 EZ024 1.UVDATA.1
 Freq = 22.1720 GHz, Bw = 16.000 MH Calibrated with CL # 3 and BP # 1 (BP mode 1)

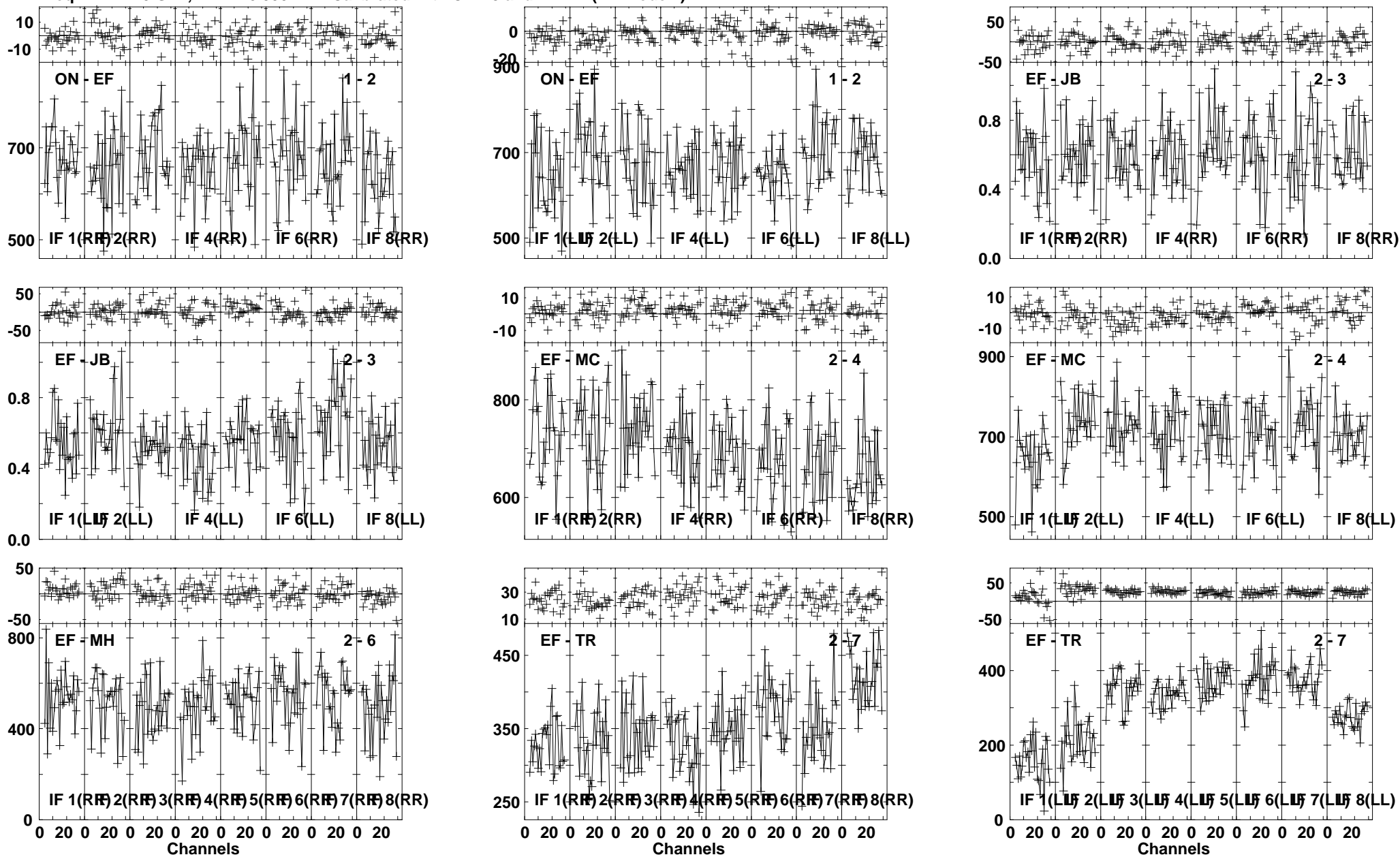

Lower frame: Milli Ampl Jy Top frame: Phas deg
 Vector averaged cross-power spectrum Several baselines displayed
 Timerange: 00/22:01:25 to 00/22:03:07

Plot file version 170 created 26-JUL-2013 10:20:48
 J1125+2610 EZ024 1.UVDATA.1
 Freq = 22.1720 GHz, Bw = 16.000 MH Calibrated with CL # 3 and BP # 1 (BP mode 1)

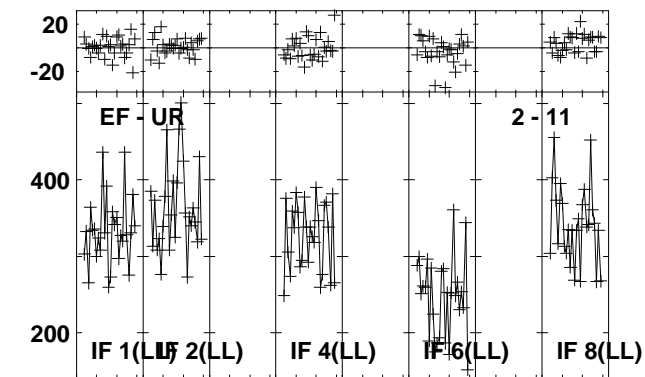
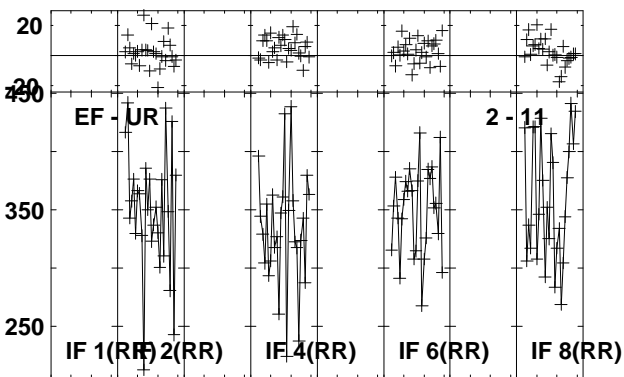
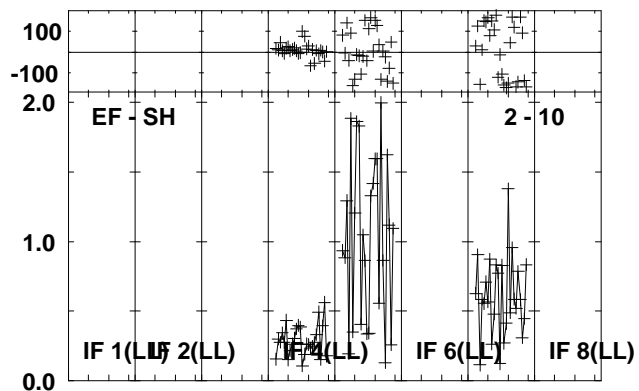
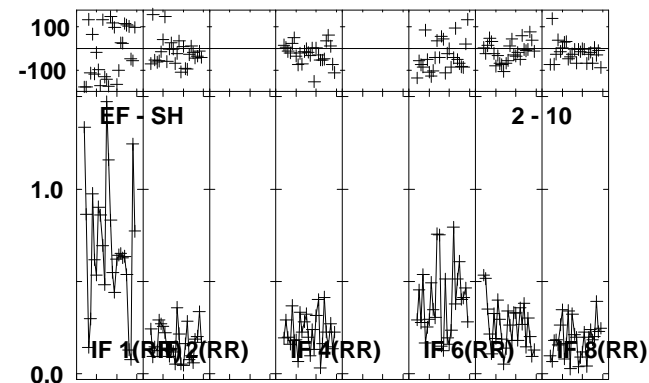
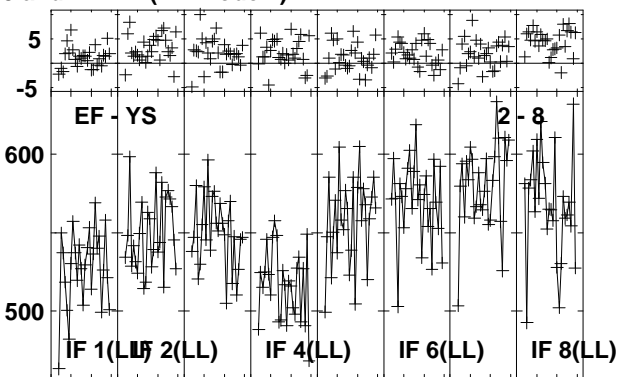
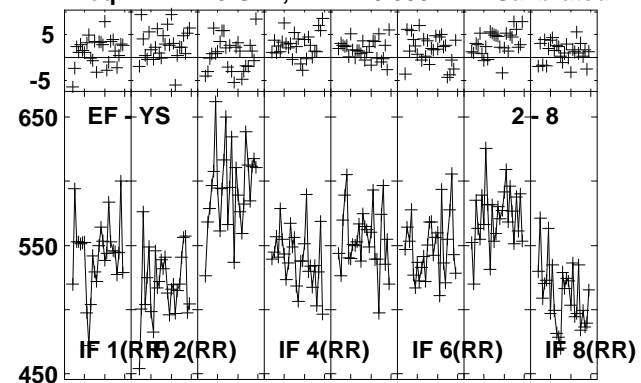

Lower frame: Milli Ampl Jy Top frame: Phas deg
 Vector averaged cross-power spectrum Several baselines displayed
 Timerange: 00/22:01:25 to 00/22:03:07

Plot file version 171 created 26-JUL-2013 10:20:49
 J1157 EZ024 1.UVDATA.1
 Freq = 22.1720 GHz, Bw = 16.000 MH Calibrated with CL # 3 and BP # 1 (BP mode 1)

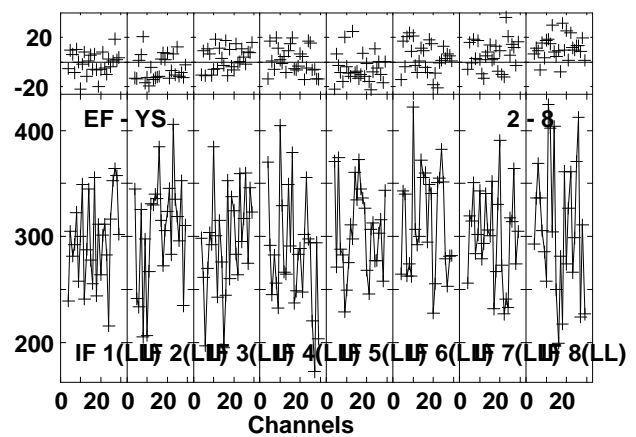
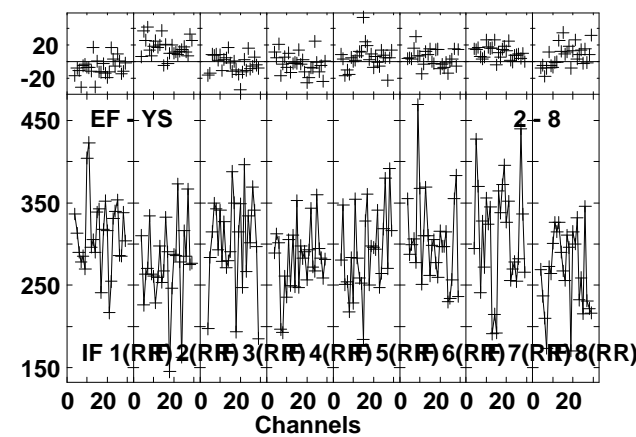
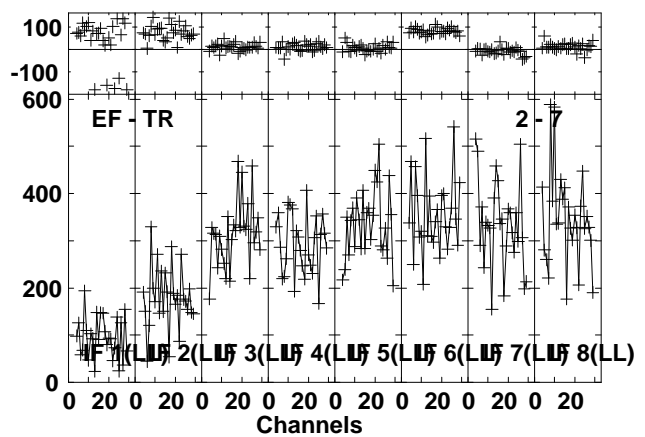
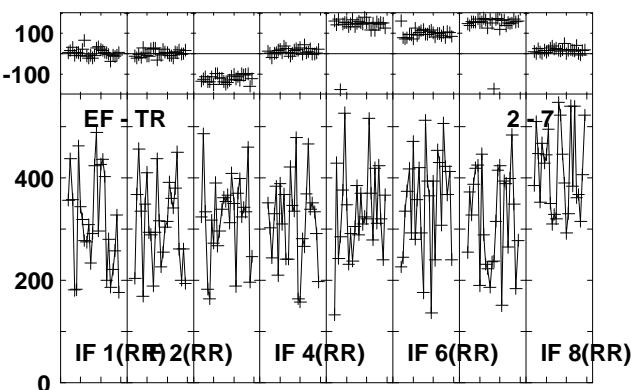
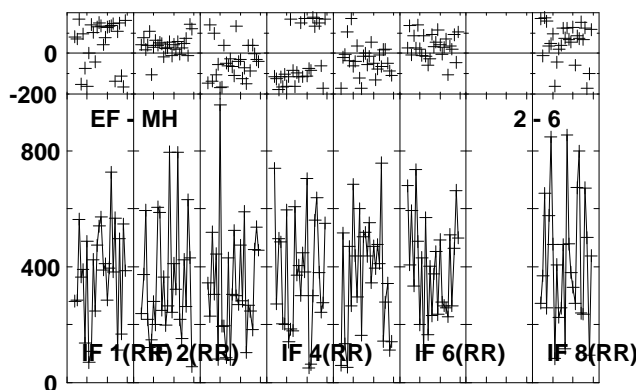
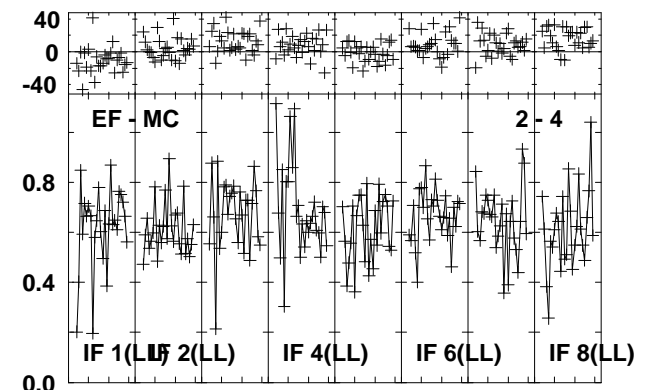
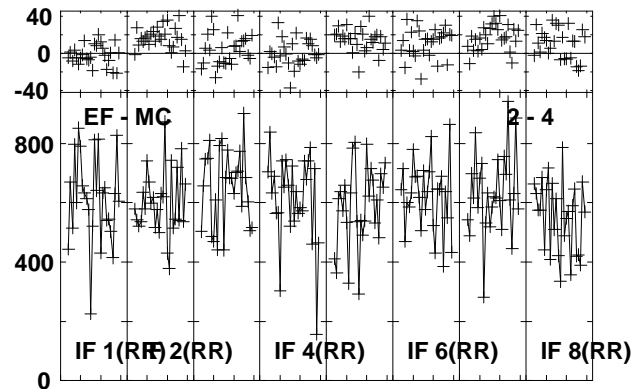
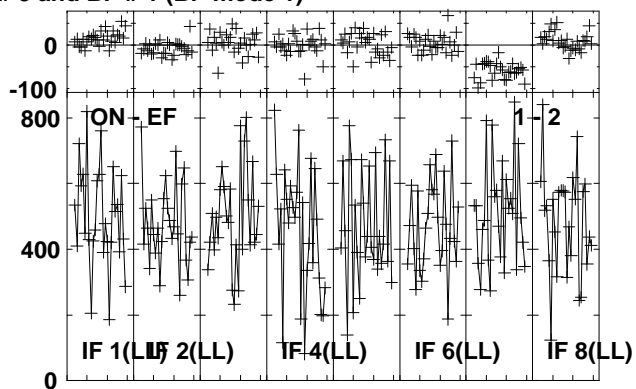
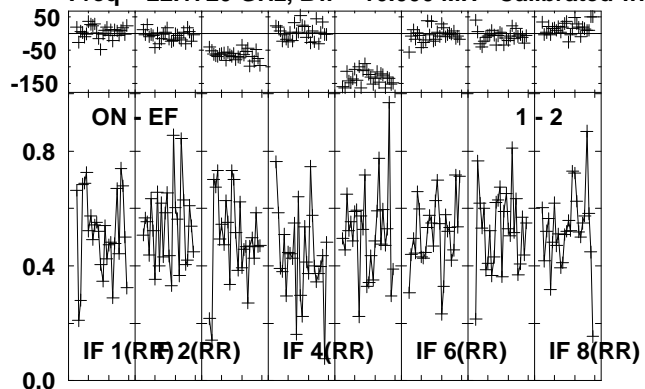

Lower frame: Ampl Jy Top frame: Phas deg
 Vector averaged cross-power spectrum Several baselines displayed
 Timerange: 00/22:04:34 to 00/22:05:16

Plot file version 172 created 26-JUL-2013 10:20:49
 J1157 EZ024 1.UVDATA.1
 Freq = 22.1720 GHz, Bw = 16.000 MH Calibrated with CL # 3 and BP # 1 (BP mode 1)

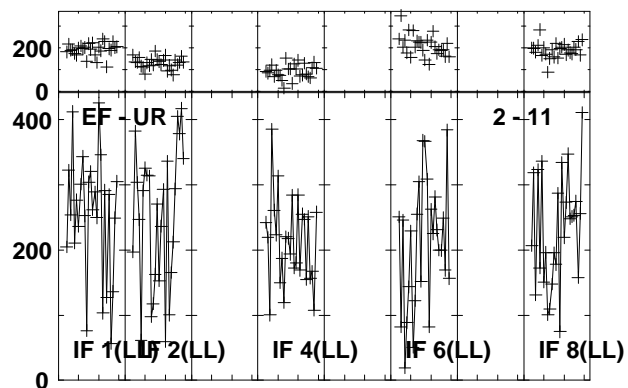
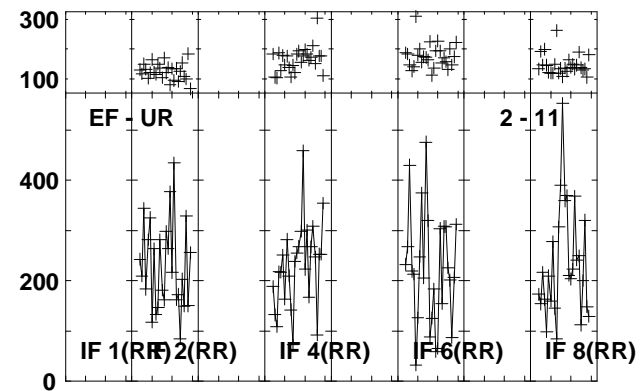
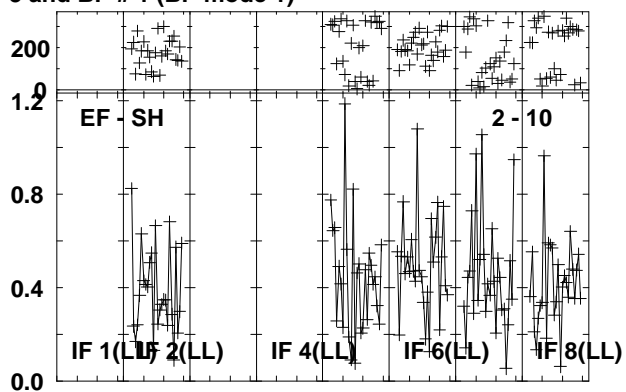
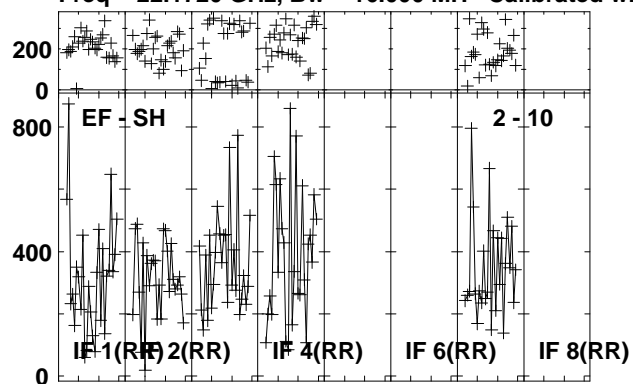

Lower frame: Milli Ampl Jy Top frame: Phas deg
 Vector averaged cross-power spectrum Several baselines displayed
 Timerange: 00/22:04:34 to 00/22:05:16

Plot file version 173 created 26-JUL-2013 10:20:50
 B1152+199A EZ024 1.UVDATA.1
 Freq = 22.1720 GHz, Bw = 16.000 MH Calibrated with CL # 3 and BP # 1 (BP mode 1)

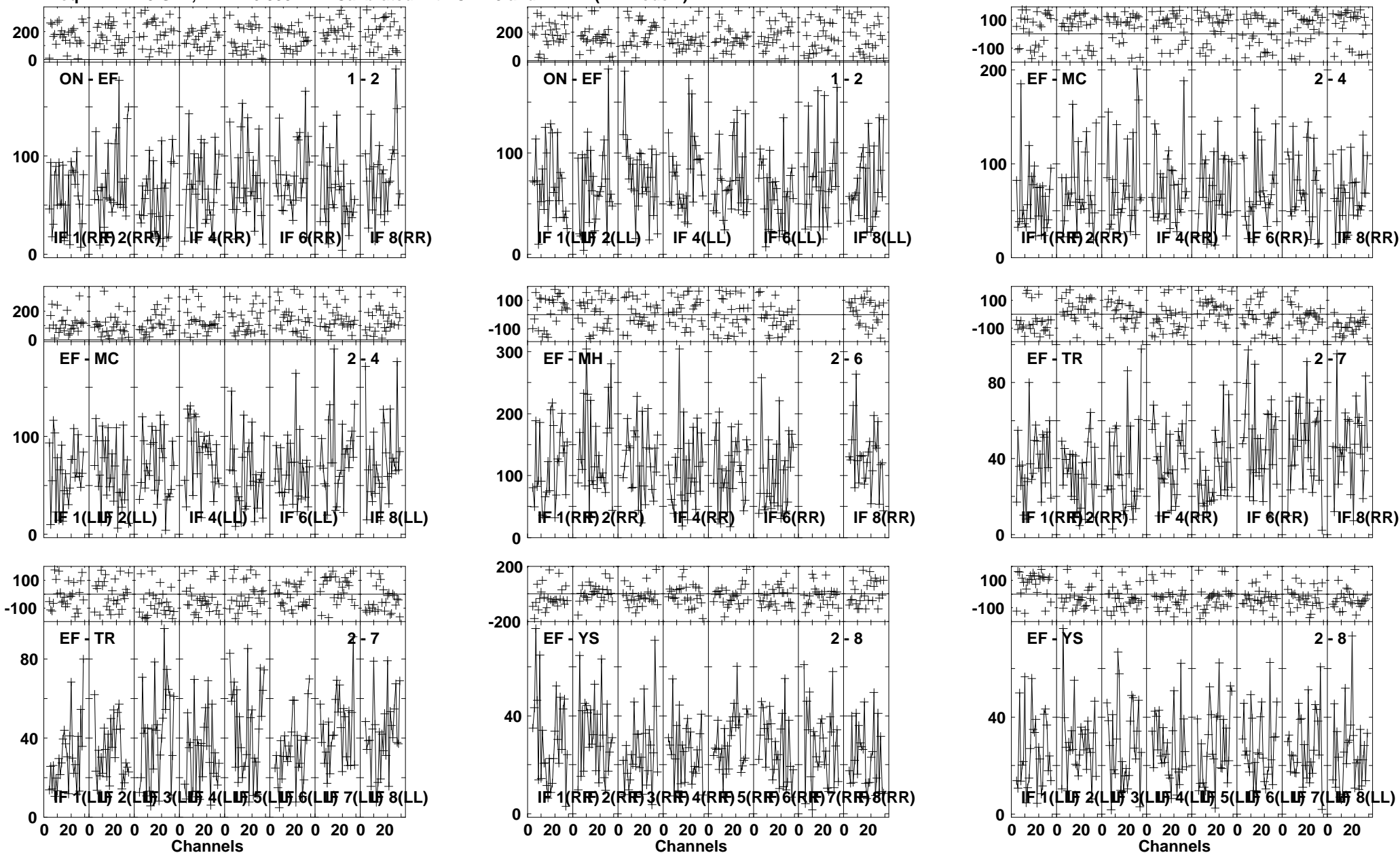

Lower frame: Milli Ampl Jy Top frame: Phas deg
 Vector averaged cross-power spectrum Several baselines displayed
 Timerange: 00/22:05:52 to 00/22:07:50

Plot file version 174 created 26-JUL-2013 10:20:52
 B1152+199A EZ024 1.UVDATA.1
 Freq = 22.1720 GHz, Bw = 16.000 MH Calibrated with CL # 3 and BP # 1 (BP mode 1)

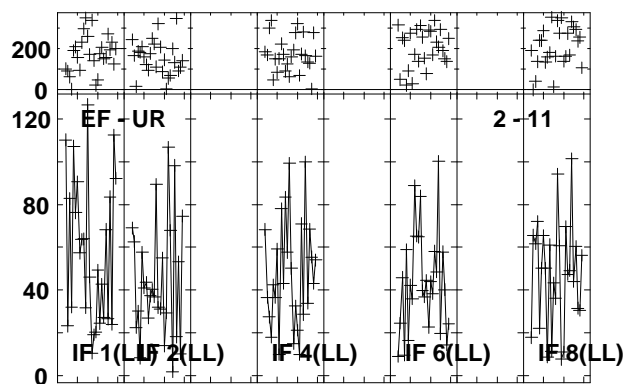
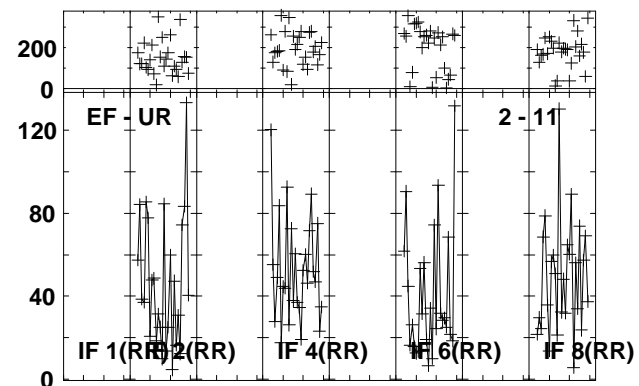
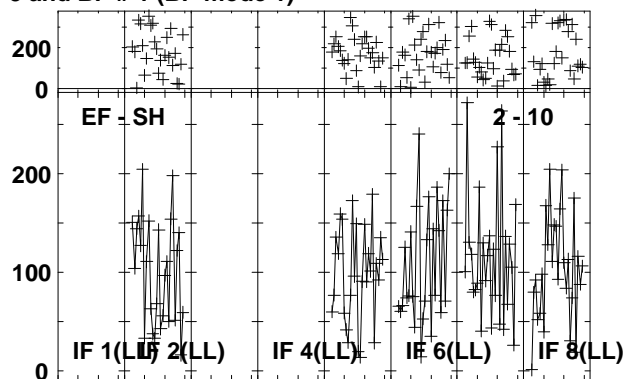
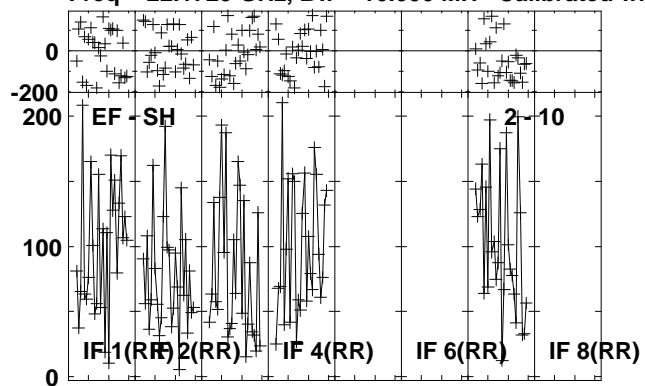

Lower frame: Milli Ampl Jy Top frame: Phas deg
 Vector averaged cross-power spectrum Several baselines displayed
 Timerange: 00/22:05:52 to 00/22:07:50

Plot file version 175 created 26-JUL-2013 10:20:53

J1157 EZ024 1.UVDATA.1

Freq = 22.1720 GHz, Bw = 16.000 MH Calibrated with CL # 3 and BP # 1 (BP mode 1)

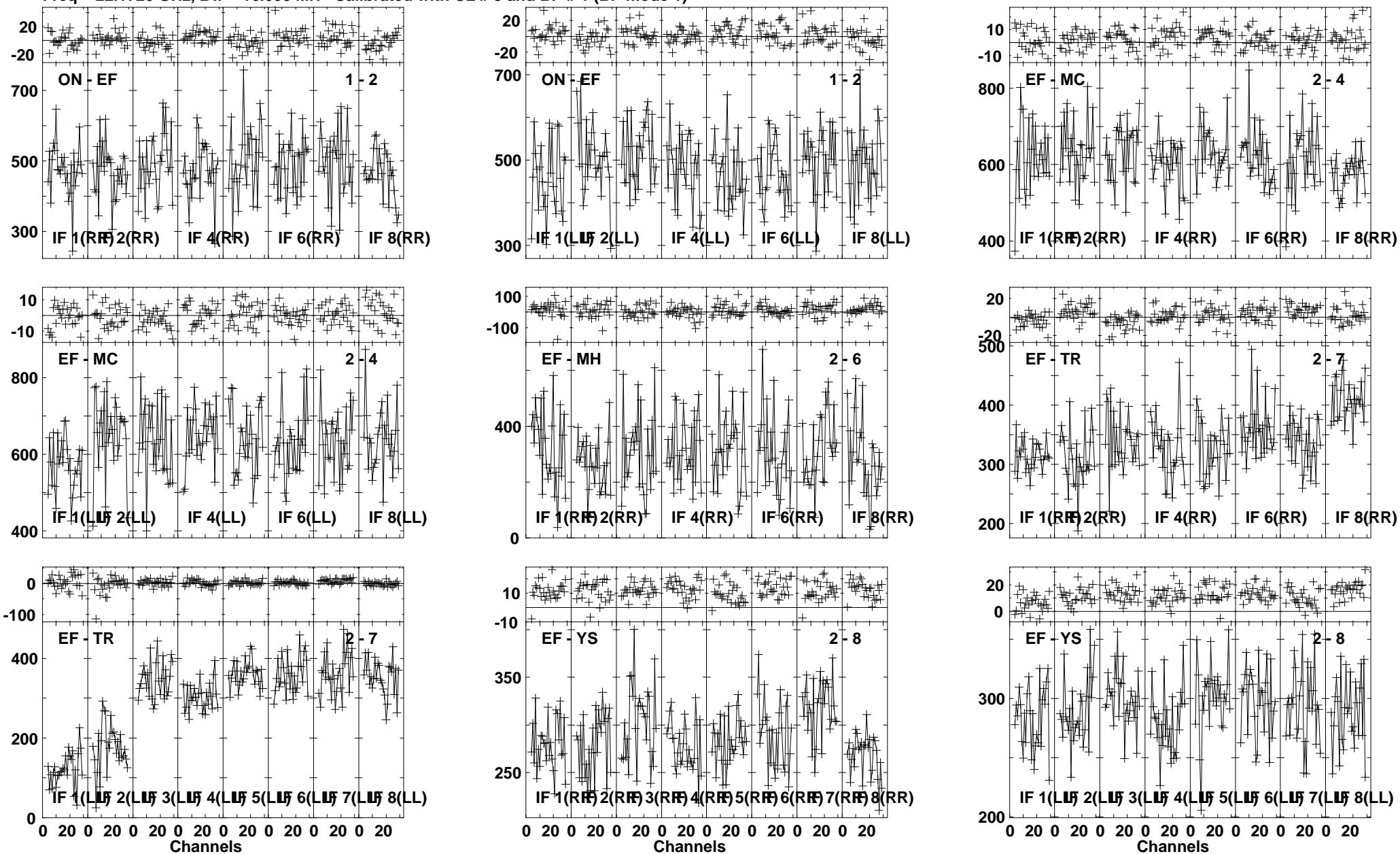

Lower frame: Milli Ampl Jy Top frame: Phas deg
Vector averaged cross-power spectrum Several baselines displayed
Timerange: 00/22:08:25 to 00/22:09:23

Plot file version 176 created 26-JUL-2013 10:20:54

J1157 EZ024 1.UVDATA.1

Freq = 22.1720 GHz, Bw = 16.000 MH Calibrated with CL # 3 and BP # 1 (BP mode 1)

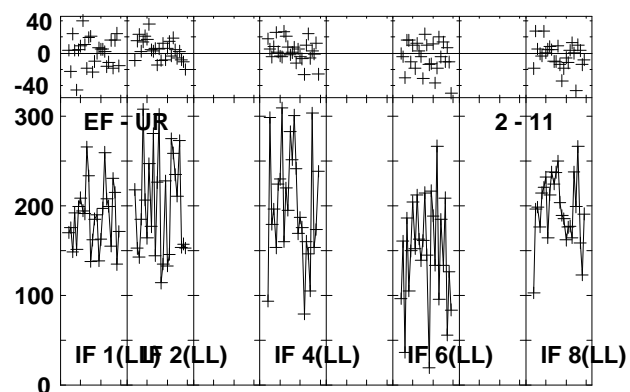
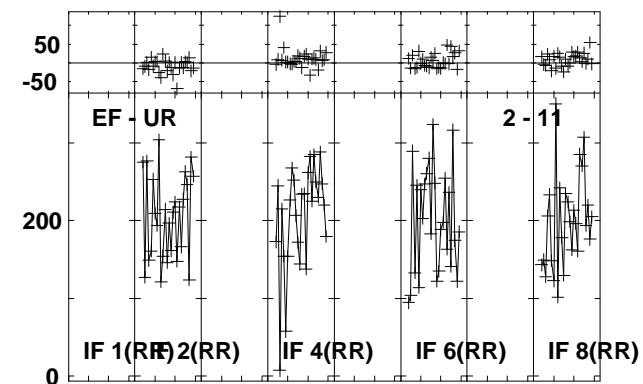
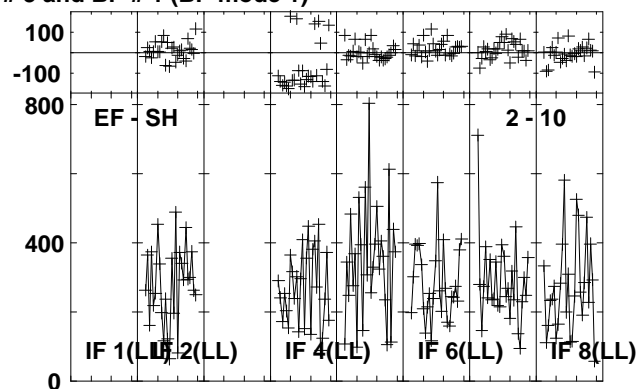
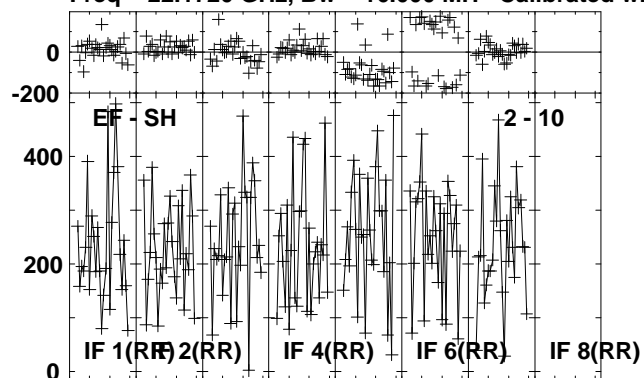

Lower frame: Milli Ampl Jy Top frame: Phas deg
Vector averaged cross-power spectrum Several baselines displayed
Timerange: 00/22:08:25 to 00/22:09:23

Plot file version 177 created 26-JUL-2013 10:20:55

B1152+199A EZ024 1.UVDATA.1

Freq = 22.1720 GHz, Bw = 16.000 MH Calibrated with CL # 3 and BP # 1 (BP mode 1)

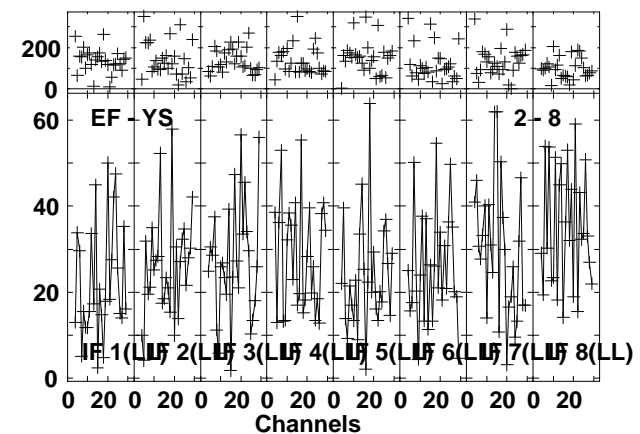
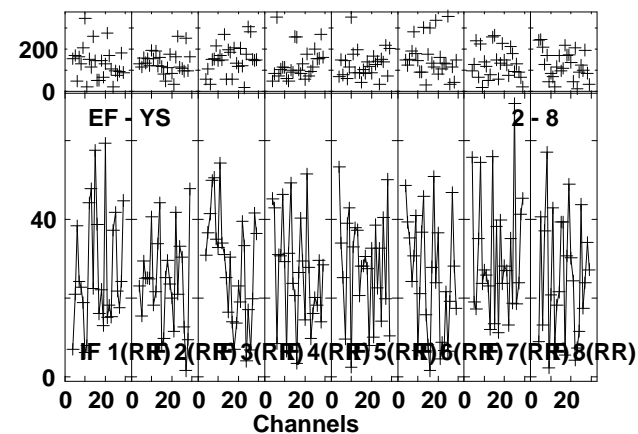
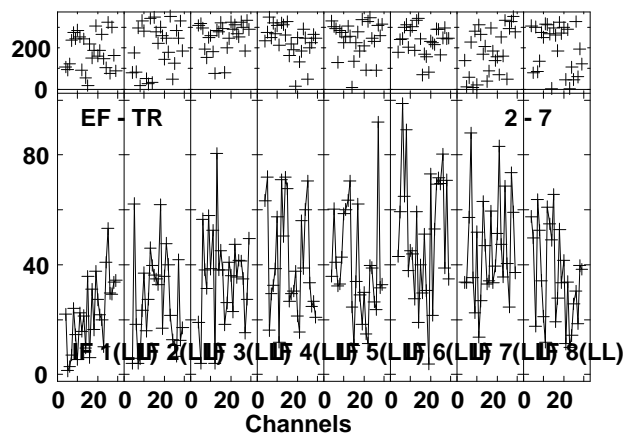
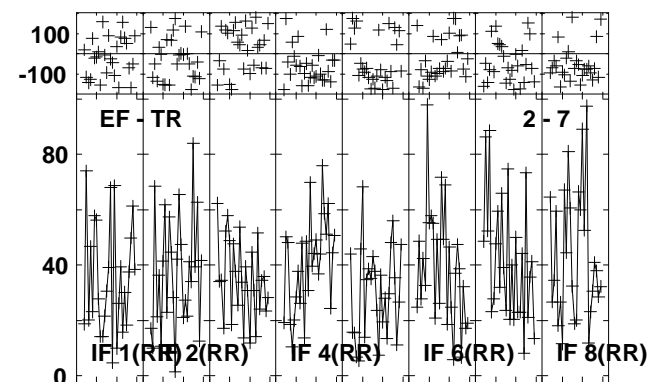
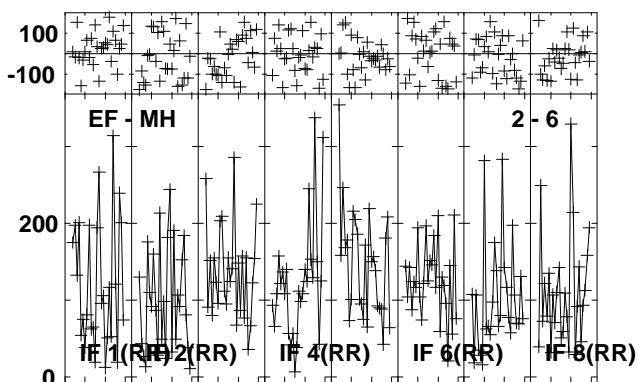
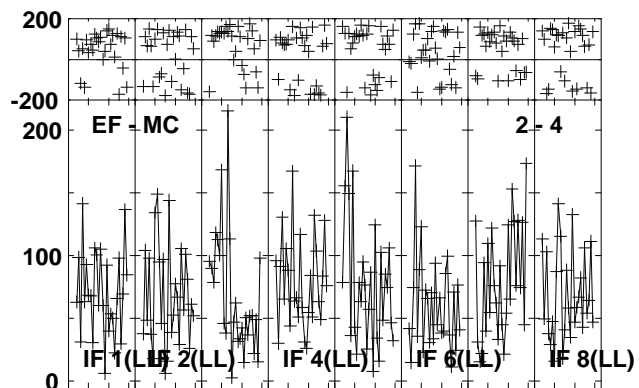
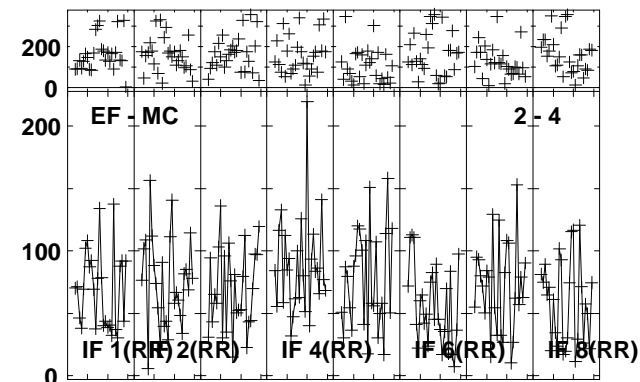
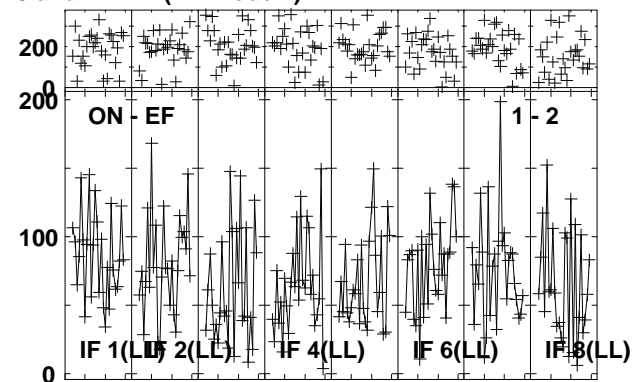
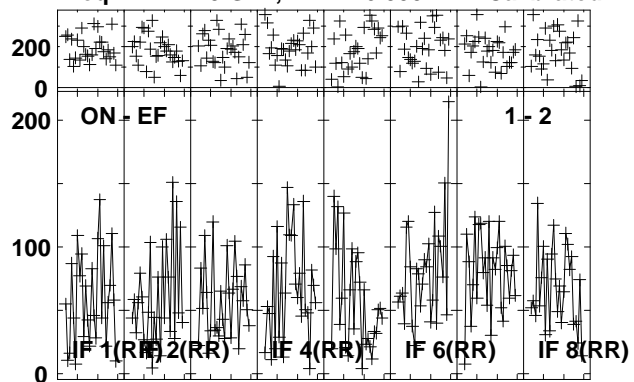

Lower frame: Milli Ampl Jy Top frame: Phas deg
Vector averaged cross-power spectrum Several baselines displayed
Timerange: 00/22:09:58 to 00/22:11:56

Plot file version 178 created 26-JUL-2013 10:20:57

B1152+199A EZ024 1.UVDATA.1

Freq = 22.1720 GHz, Bw = 16.000 MH Calibrated with CL # 3 and BP # 1 (BP mode 1)

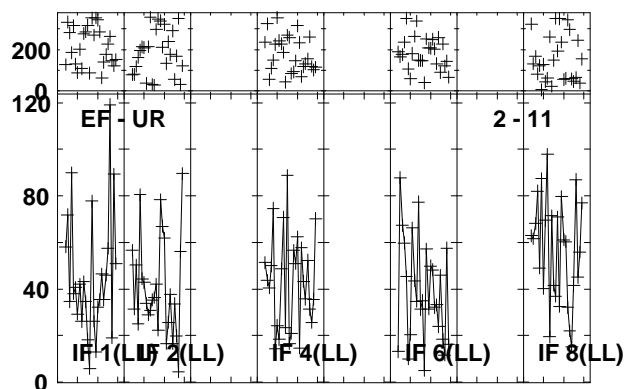
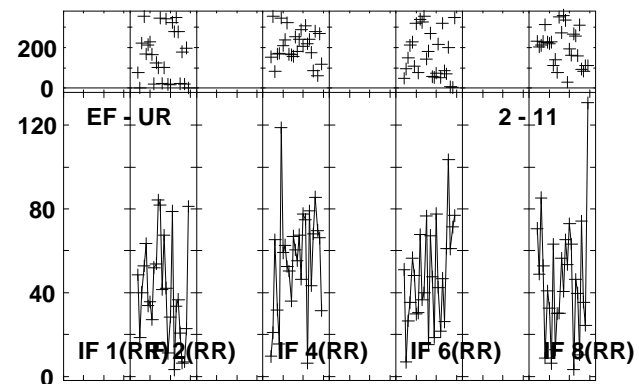
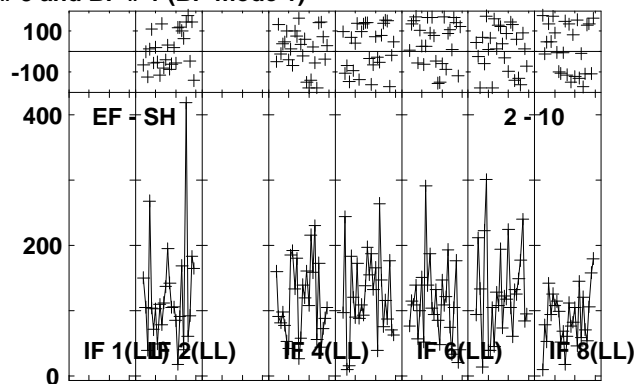
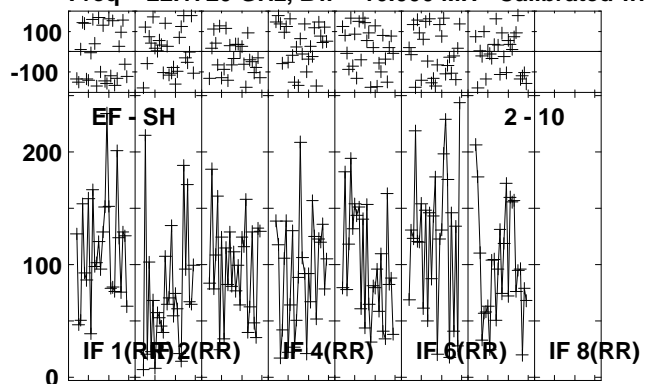

Lower frame: Milli Ampl Jy Top frame: Phas deg
Vector averaged cross-power spectrum Several baselines displayed
Timerange: 00/22:09:58 to 00/22:11:56

Plot file version 179 created 26-JUL-2013 10:20:58

J1157 EZ024 1.UVDATA.1

Freq = 22.1720 GHz, Bw = 16.000 MH Calibrated with CL # 3 and BP # 1 (BP mode 1)

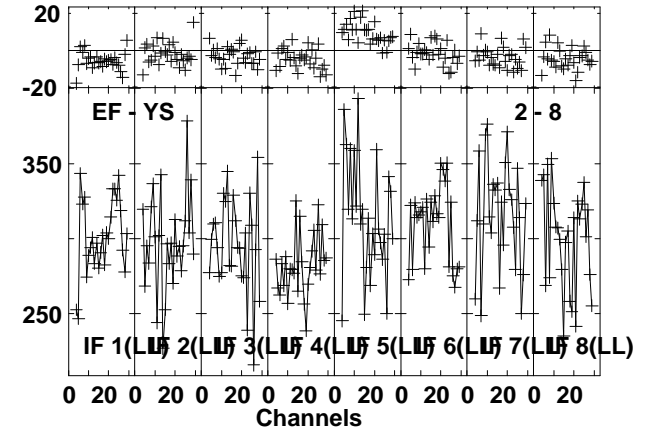
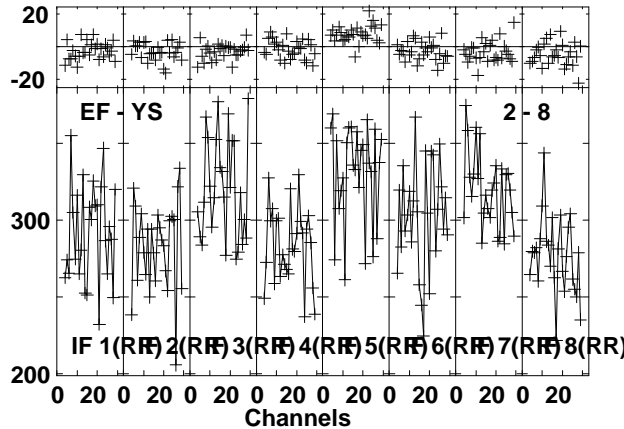
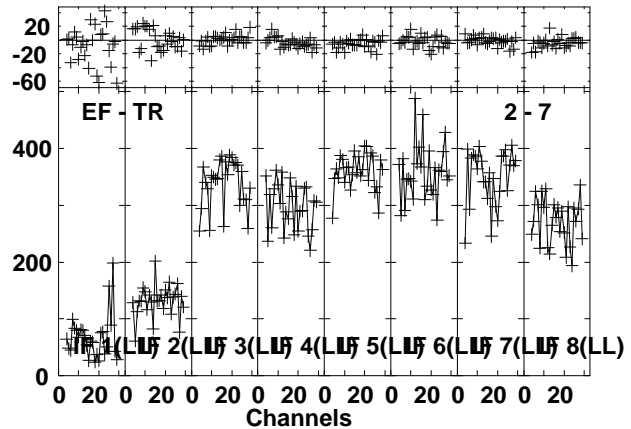
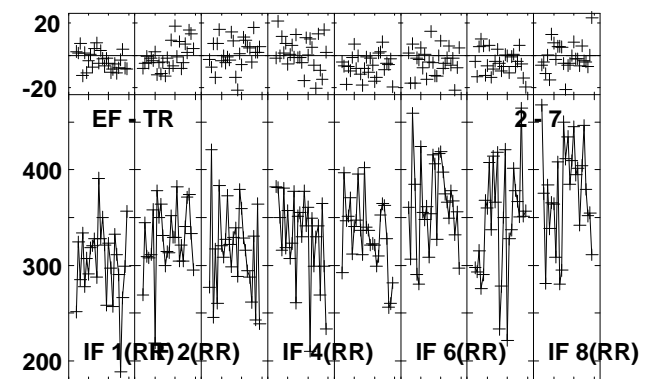
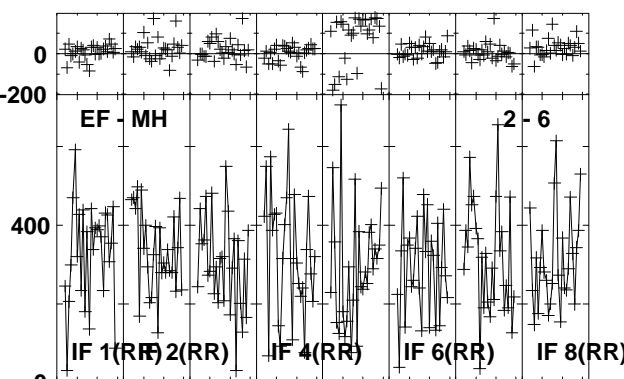
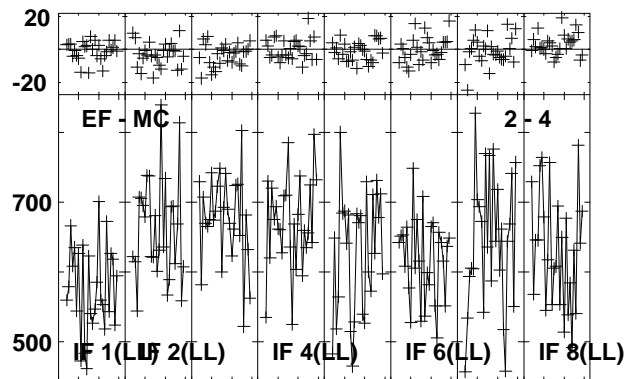
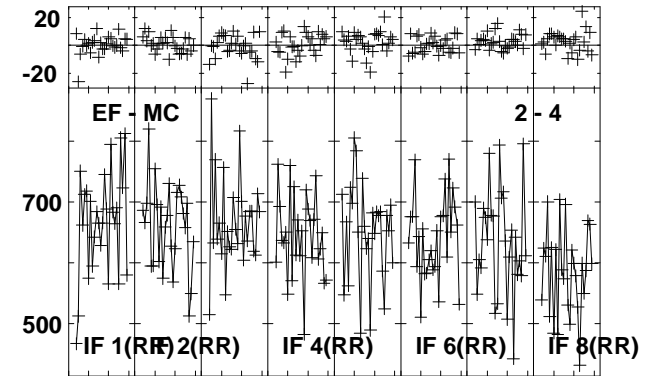
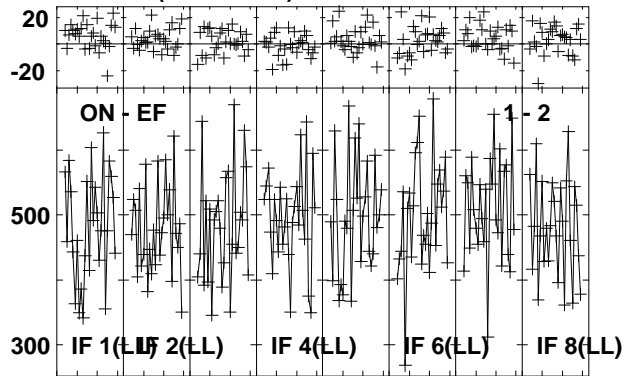
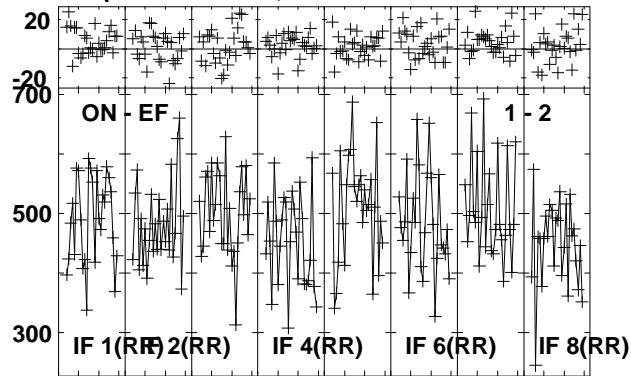

Lower frame: Milli Ampl Jy Top frame: Phas deg
Vector averaged cross-power spectrum Several baselines displayed
Timerange: 00/22:12:31 to 00/22:13:29

Plot file version 180 created 26-JUL-2013 10:20:59

J1157 EZ024 1.UVDATA.1

Freq = 22.1720 GHz, Bw = 16.000 MH Calibrated with CL # 3 and BP # 1 (BP mode 1)

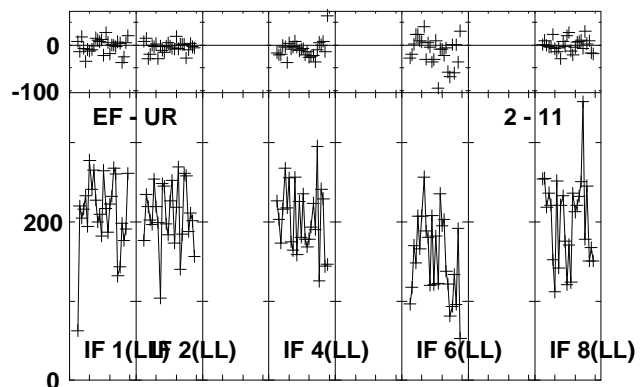
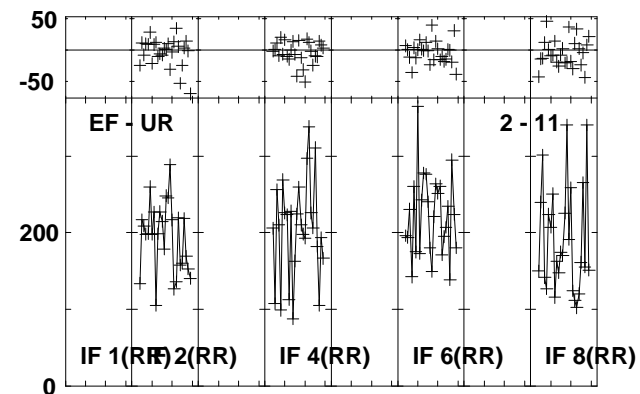
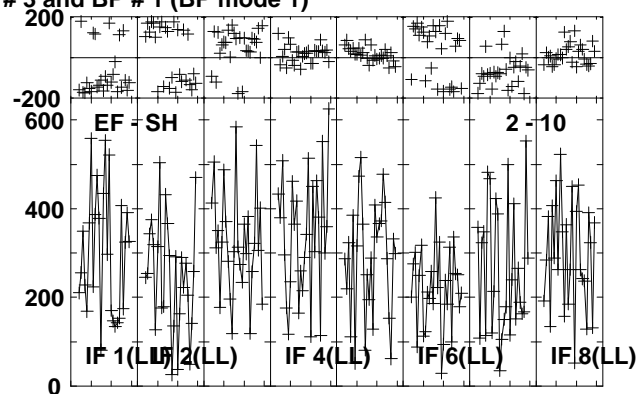
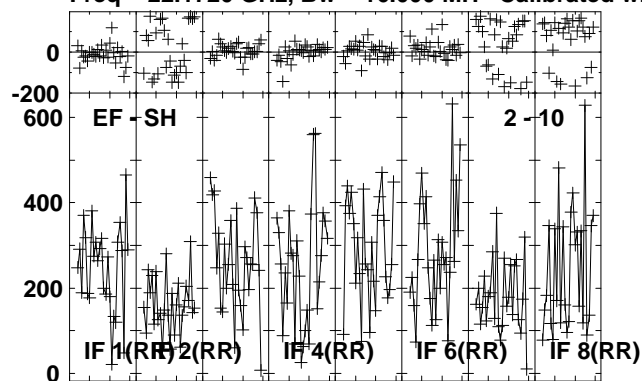

Lower frame: Milli Ampl Jy Top frame: Phas deg
Vector averaged cross-power spectrum Several baselines displayed
Timerange: 00/22:12:31 to 00/22:13:29

Plot file version 181 created 26-JUL-2013 10:20:59
 B1152+199A EZ024 1.UVDATA.1
 Freq = 22.1720 GHz, Bw = 16.000 MH Calibrated with CL # 3 and BP # 1 (BP mode 1)

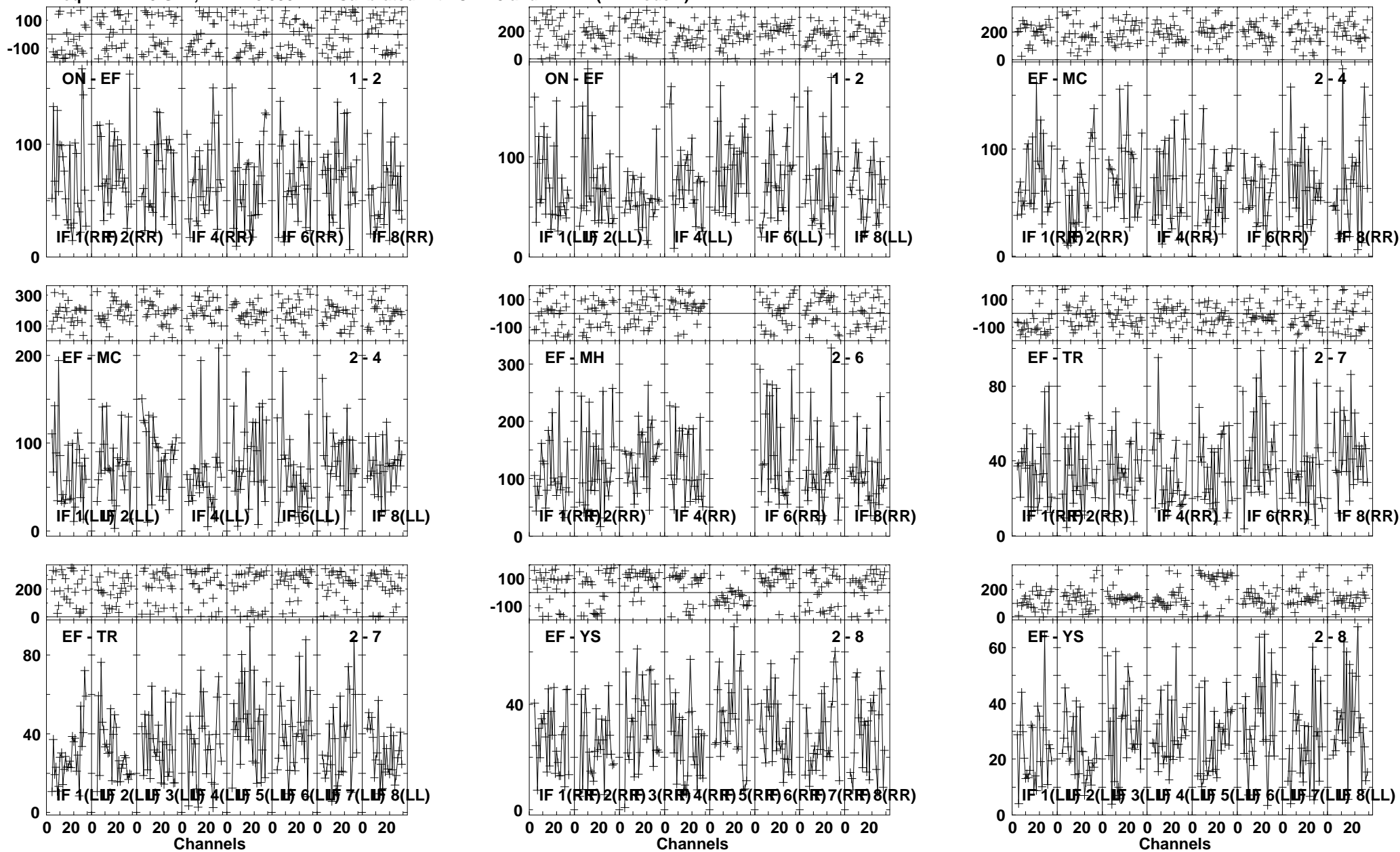

Lower frame: Milli Ampl Jy Top frame: Phas deg
 Vector averaged cross-power spectrum Several baselines displayed
 Timerange: 00/22:14:04 to 00/22:16:02

Plot file version 182 created 26-JUL-2013 10:21:01
 B1152+199A EZ024 1.UVDATA.1
 Freq = 22.1720 GHz, Bw = 16.000 MH Calibrated with CL # 3 and BP # 1 (BP mode 1)

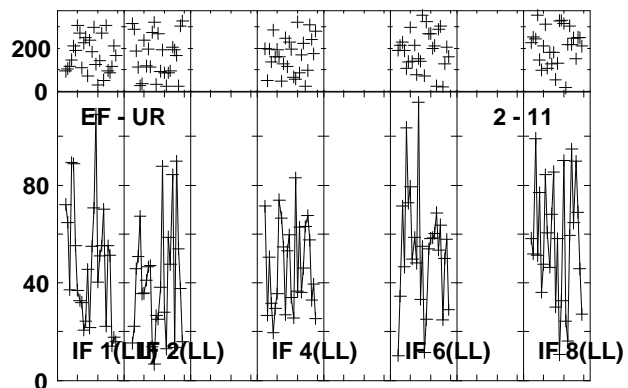
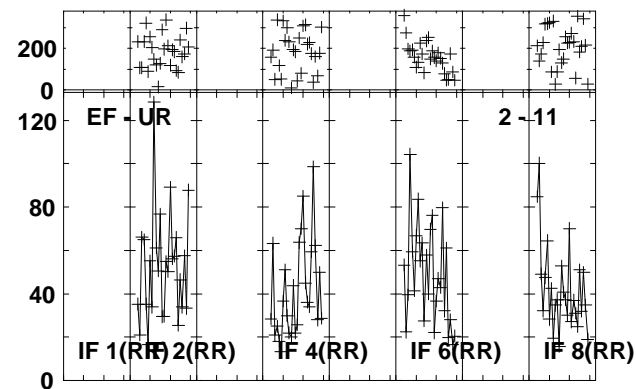
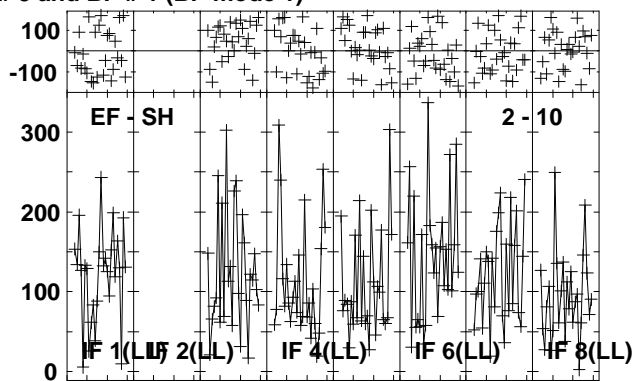
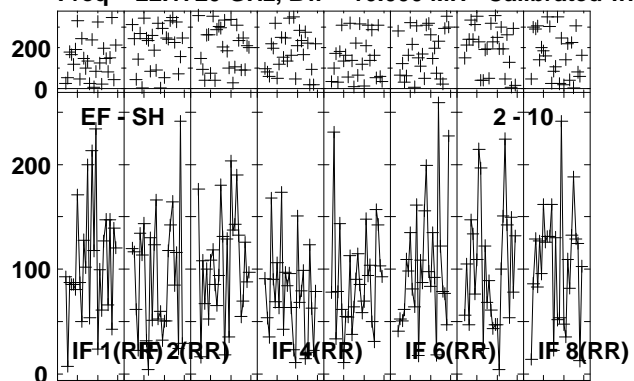

Lower frame: Milli Ampl Jy Top frame: Phas deg
 Vector averaged cross-power spectrum Several baselines displayed
 Timerange: 00/22:14:04 to 00/22:16:02

Plot file version 183 created 26-JUL-2013 10:21:02
 J1157 EZ024 1.UVDATA.1
 Freq = 22.1720 GHz, Bw = 16.000 MH Calibrated with CL # 3 and BP # 1 (BP mode 1)

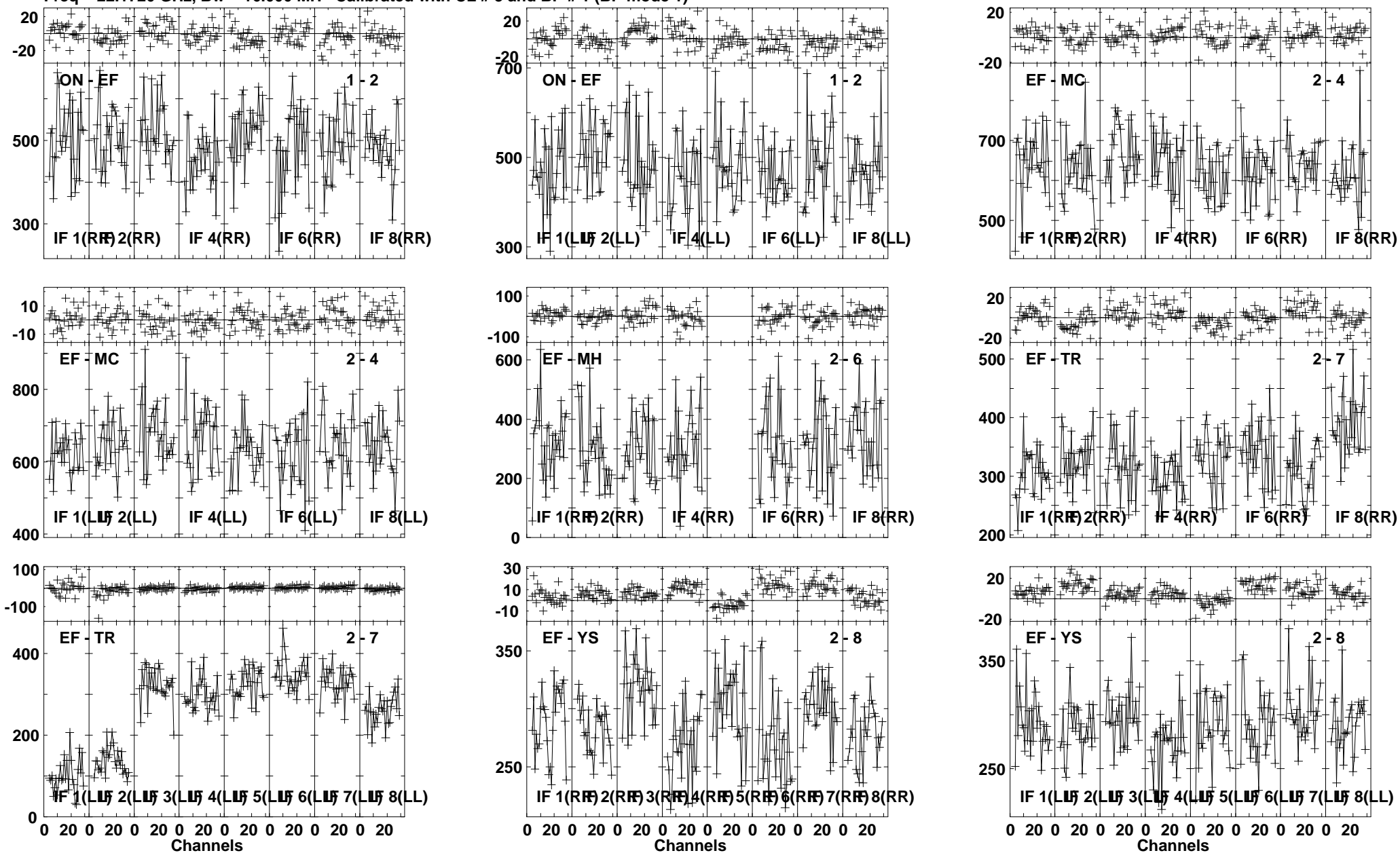

Lower frame: Milli Ampl Jy Top frame: Phas deg
 Vector averaged cross-power spectrum Several baselines displayed
 Timerange: 00/22:16:37 to 00/22:17:35

Plot file version 184 created 26-JUL-2013 10:21:03

J1157 EZ024 1.UVDATA.1

Freq = 22.1720 GHz, Bw = 16.000 MH Calibrated with CL # 3 and BP # 1 (BP mode 1)

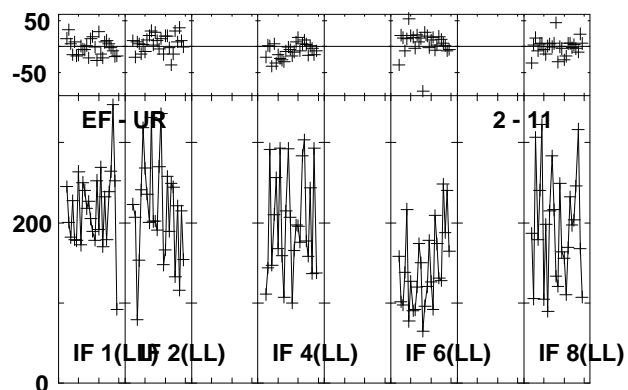
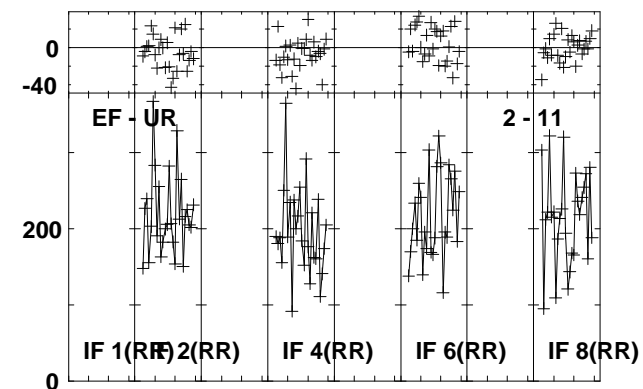
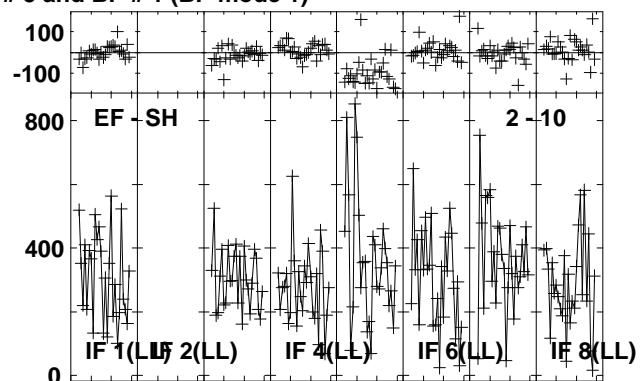
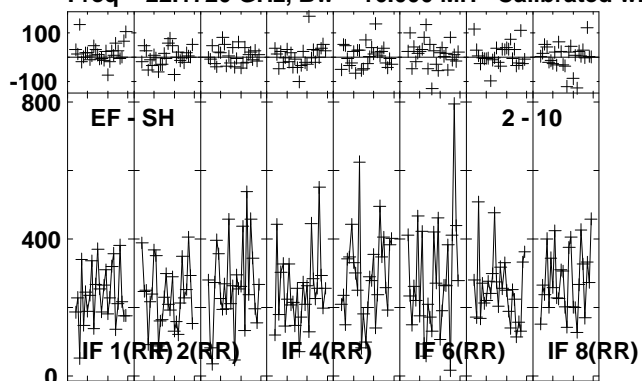

Lower frame: Milli Ampl Jy Top frame: Phas deg
Vector averaged cross-power spectrum Several baselines displayed
Timerange: 00/22:16:37 to 00/22:17:35

Plot file version 185 created 26-JUL-2013 10:21:04
 J1125+2610 EZ024 1.UVDATA.1
 Freq = 22.1720 GHz, Bw = 16.000 MH Calibrated with CL # 3 and BP # 1 (BP mode 1)

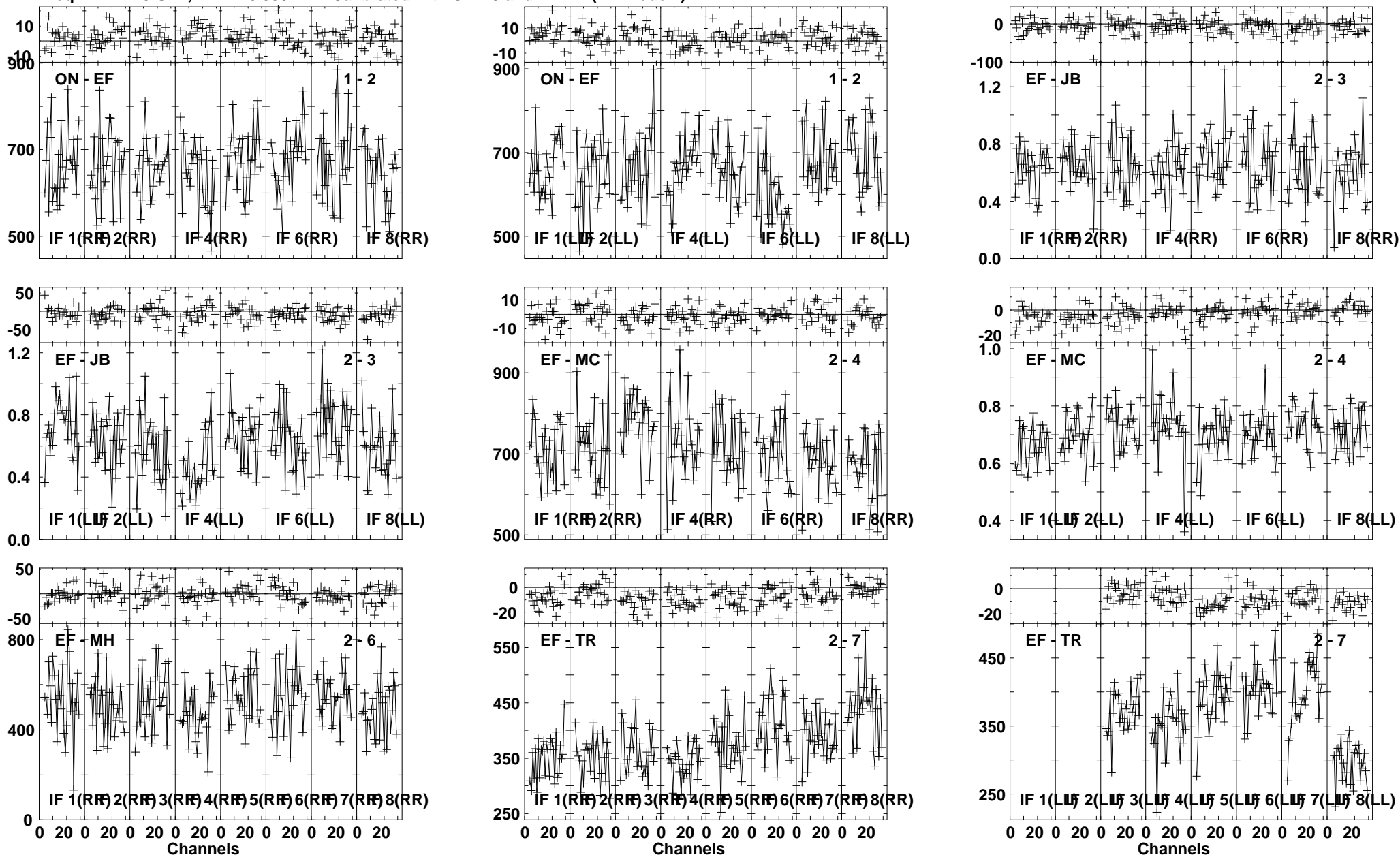

Lower frame: Milli Ampl Jy Top frame: Phas deg
 Vector averaged cross-power spectrum Several baselines displayed
 Timerange: 00/22:19:03 to 00/22:20:45

Plot file version 186 created 26-JUL-2013 10:21:05
 J1125+2610 EZ024 1.UVDATA.1
 Freq = 22.1720 GHz, Bw = 16.000 MH Calibrated with CL # 3 and BP # 1 (BP mode 1)

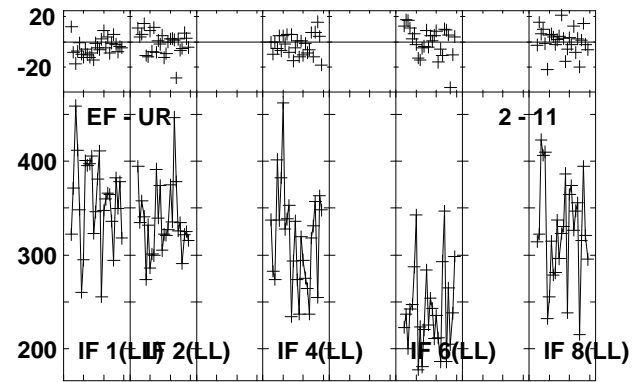
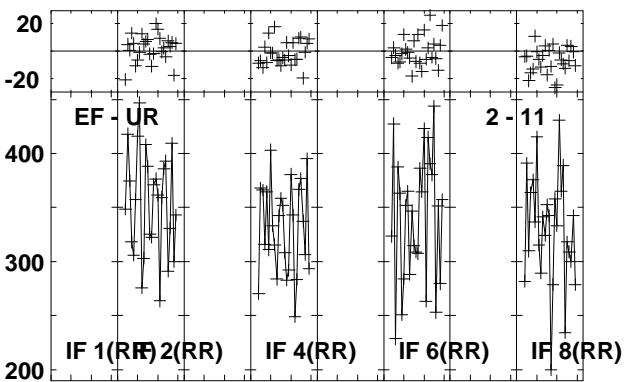
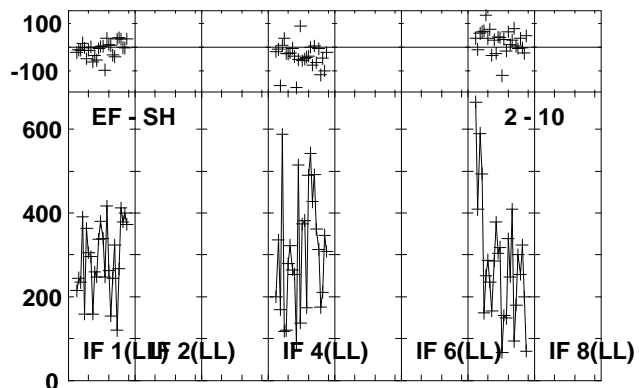
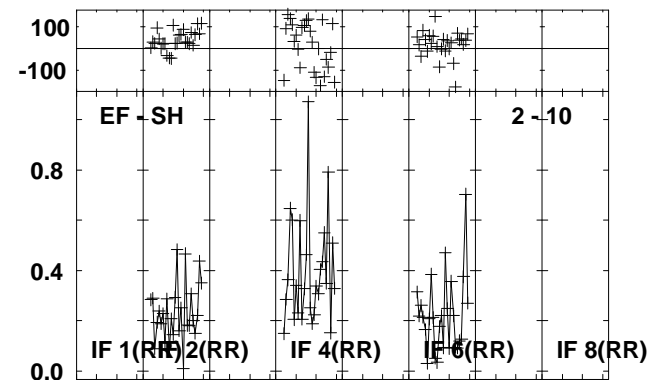
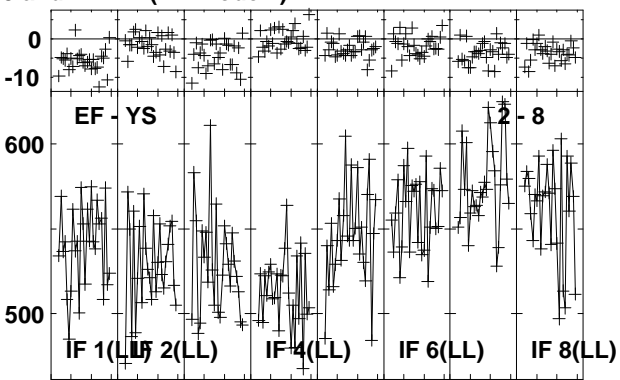
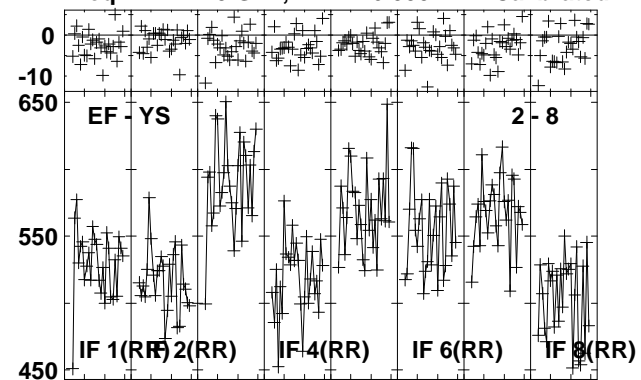

Lower frame: Milli Ampl Jy Top frame: Phas deg
 Vector averaged cross-power spectrum Several baselines displayed
 Timerange: 00/22:19:03 to 00/22:20:45

Plot file version 187 created 26-JUL-2013 10:21:06

J1157 EZ024 1.UVDATA.1

Freq = 22.1720 GHz, Bw = 16.000 MH Calibrated with CL # 3 and BP # 1 (BP mode 1)

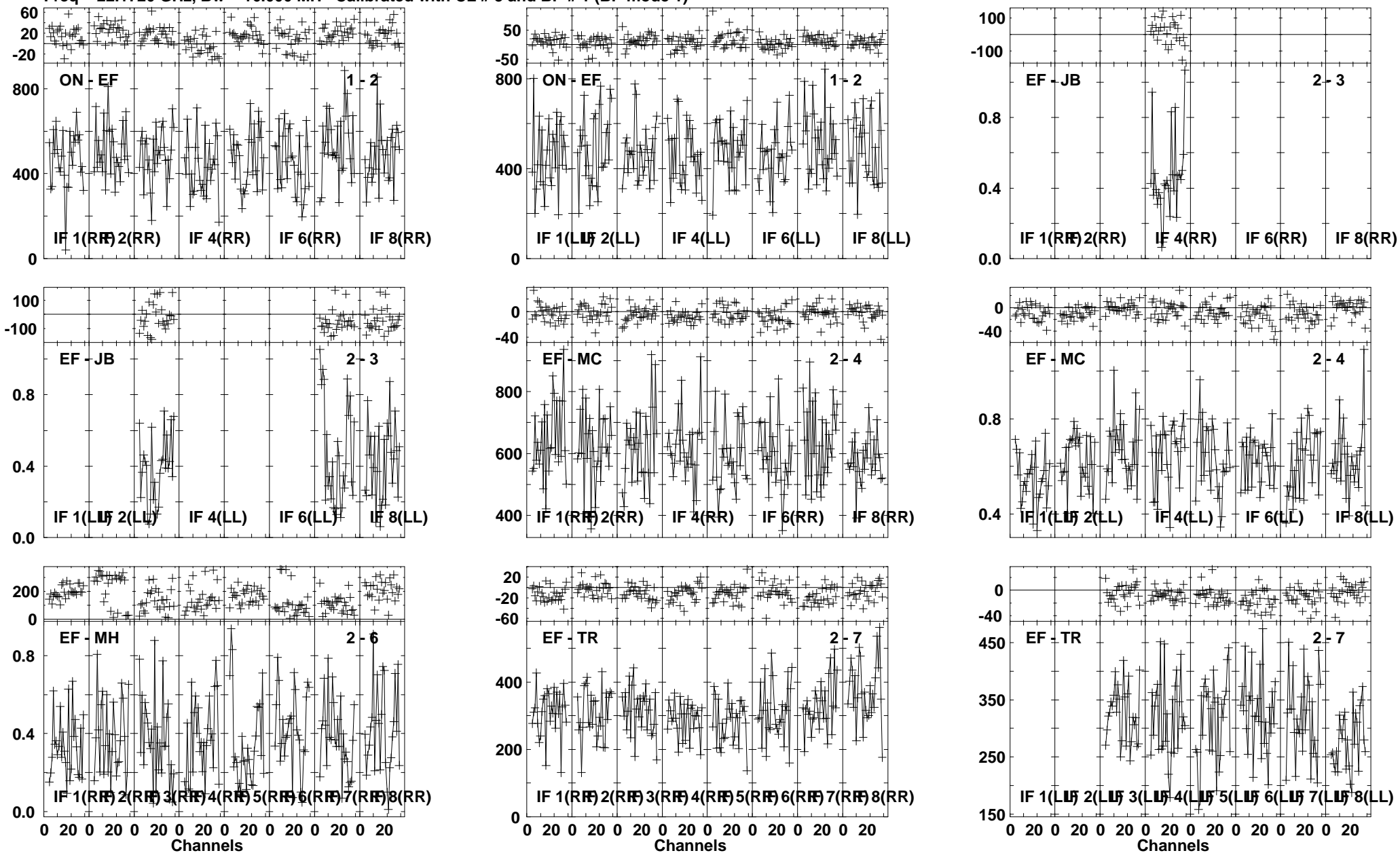

Lower frame: Milli Ampl Jy Top frame: Phas deg
Vector averaged cross-power spectrum Several baselines displayed
Timerange: 00/22:22:12 to 00/22:22:54

Plot file version 188 created 26-JUL-2013 10:21:07
 J1157 EZ024 1.UVDATA.1
 Freq = 22.1720 GHz, Bw = 16.000 MH Calibrated with CL # 3 and BP # 1 (BP mode 1)

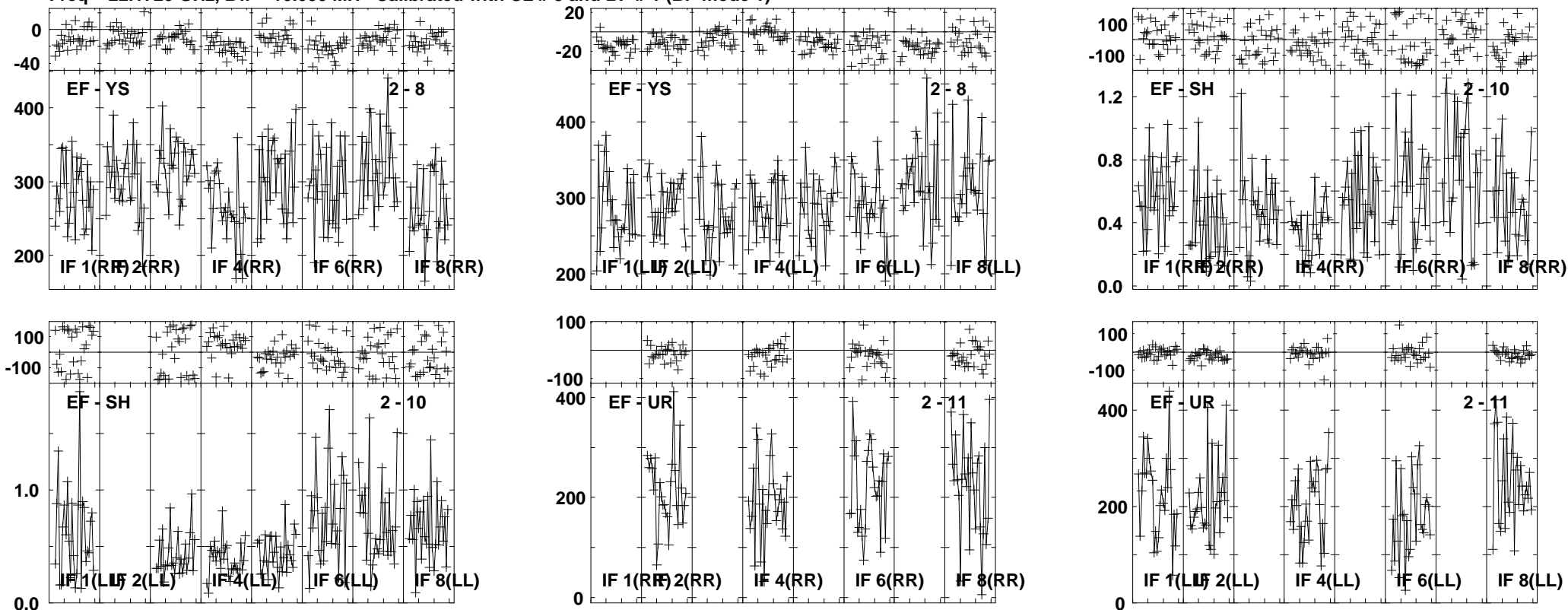

Lower frame: Milli Ampl Jy Top frame: Phas deg
 Vector averaged cross-power spectrum Several baselines displayed
 Timerange: 00/22:22:12 to 00/22:22:54

Plot file version 189 created 26-JUL-2013 10:21:07
 B1152+199A EZ024 1.UVDATA.1
 Freq = 22.1720 GHz, Bw = 16.000 MH Calibrated with CL # 3 and BP # 1 (BP mode 1)

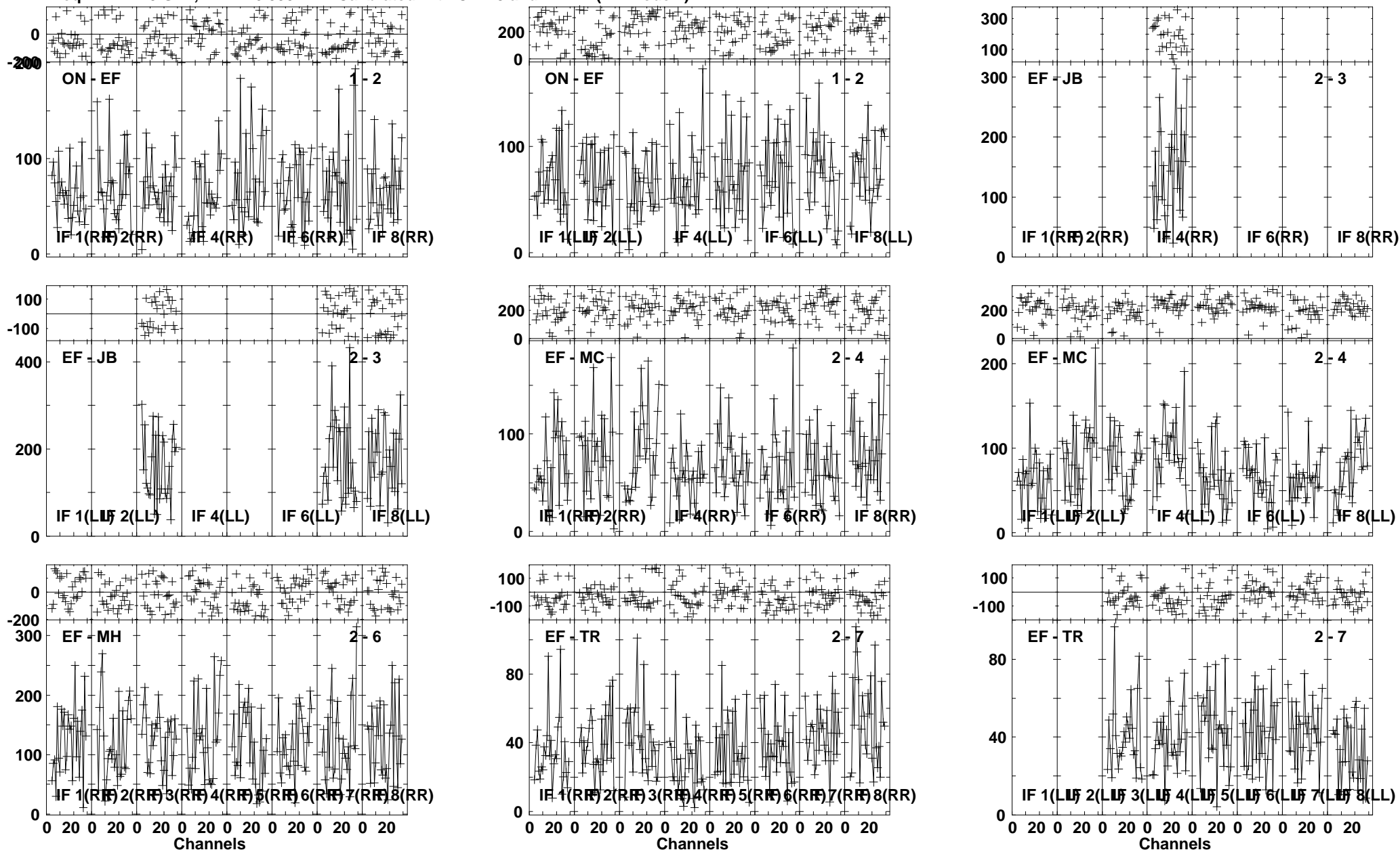

Lower frame: Milli Ampl Jy Top frame: Phas deg
 Vector averaged cross-power spectrum Several baselines displayed
 Timerange: 00/22:23:30 to 00/22:25:28

Plot file version 190 created 26-JUL-2013 10:21:09
 B1152+199A EZ024 1.UVDATA.1
 Freq = 22.1720 GHz, Bw = 16.000 MH Calibrated with CL # 3 and BP # 1 (BP mode 1)

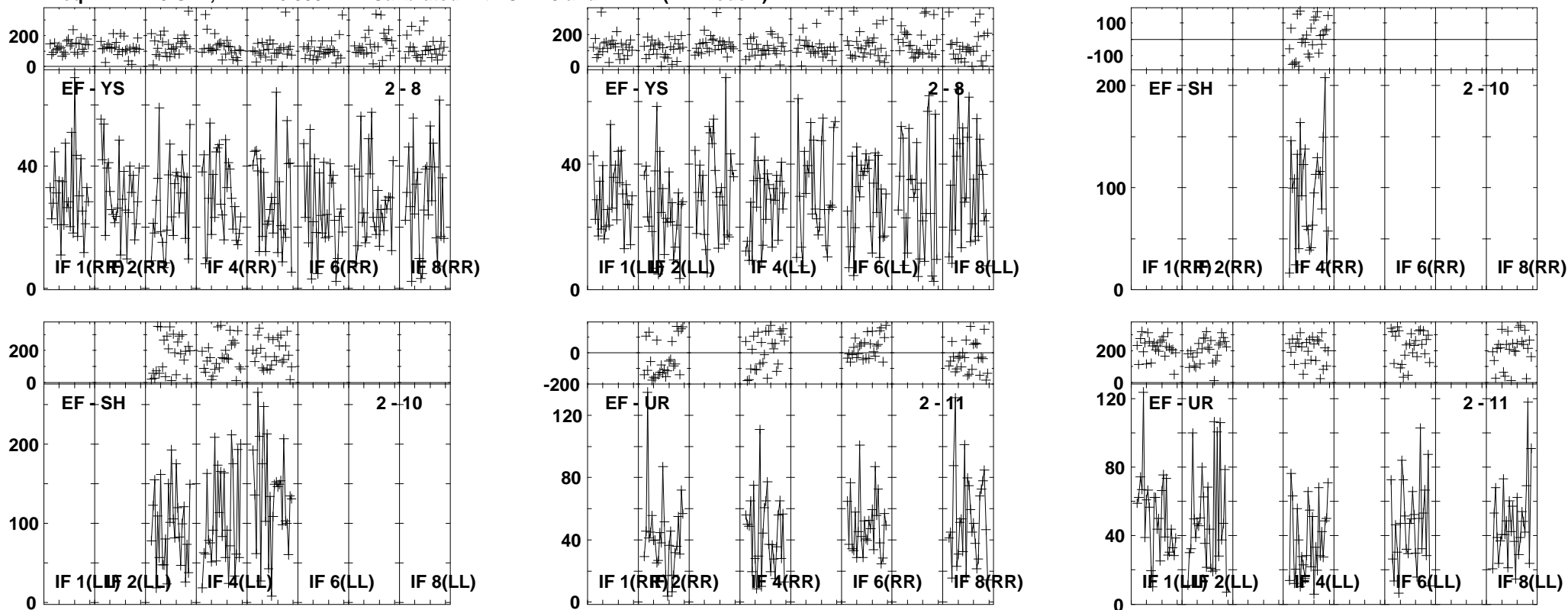

Lower frame: Milli Ampl Jy Top frame: Phas deg
 Vector averaged cross-power spectrum Several baselines displayed
 Timerange: 00/22:23:30 to 00/22:25:28

Plot file version 191 created 26-JUL-2013 10:21:10
 J1157 EZ024 1.UVDATA.1
 Freq = 22.1720 GHz, Bw = 16.000 MH Calibrated with CL # 3 and BP # 1 (BP mode 1)

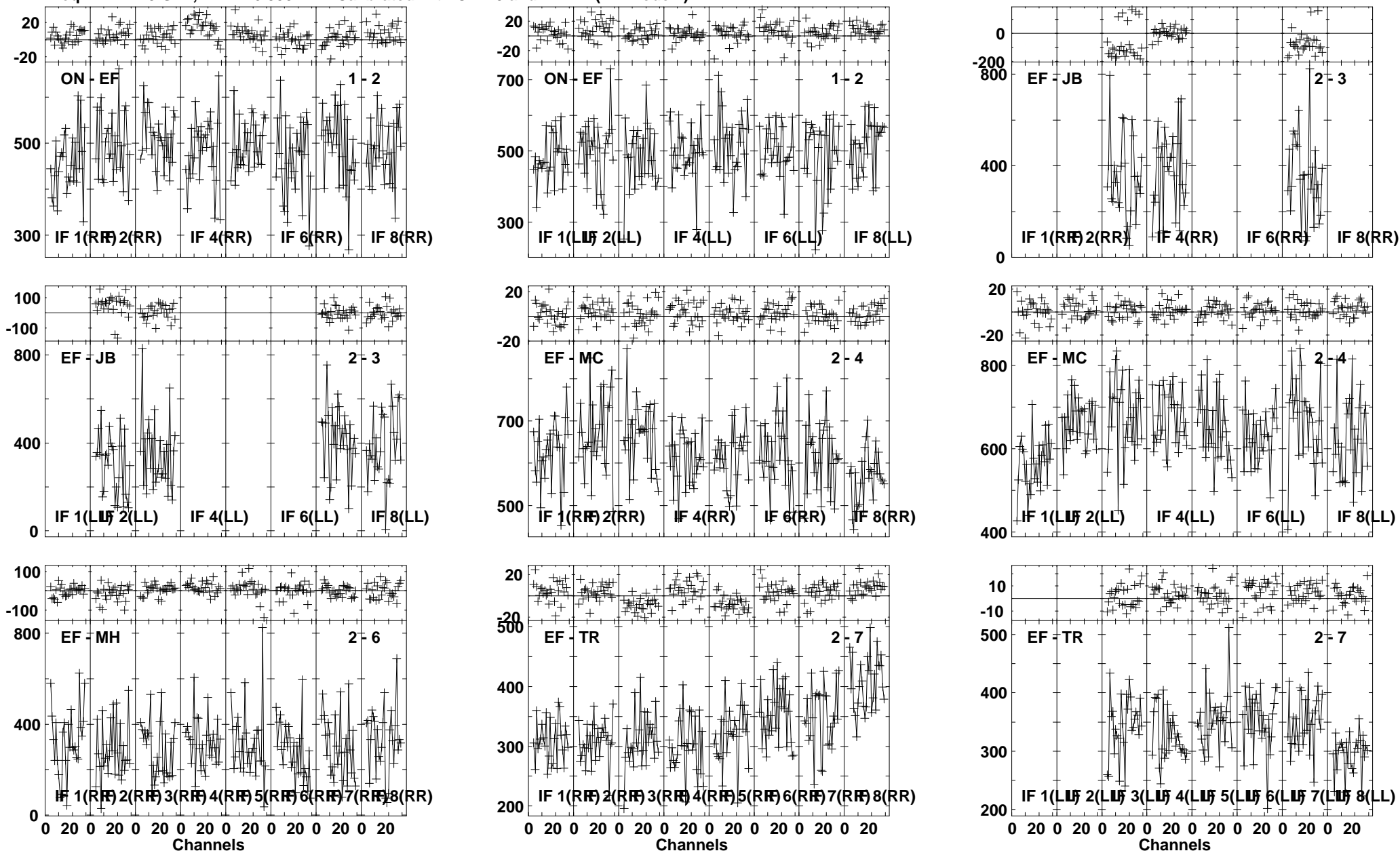

Lower frame: Milli Ampl Jy Top frame: Phas deg
 Vector averaged cross-power spectrum Several baselines displayed
 Timerange: 00:22:26:03 to 00:22:27:01

Plot file version 192 created 26-JUL-2013 10:21:11
 J1157 EZ024 1.UVDATA.1
 Freq = 22.1720 GHz, Bw = 16.000 MH Calibrated with CL # 3 and BP # 1 (BP mode 1)

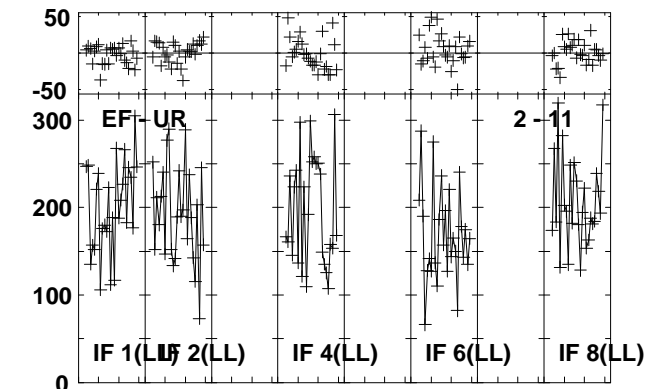
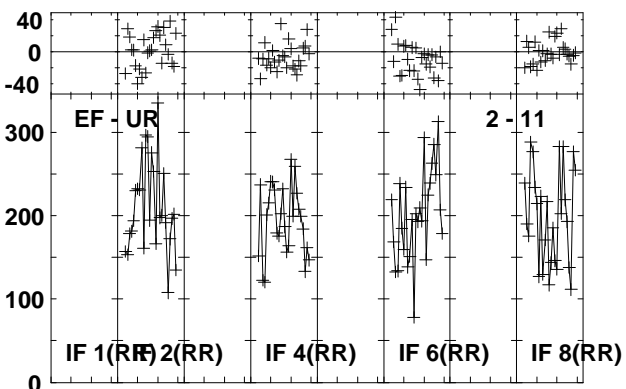
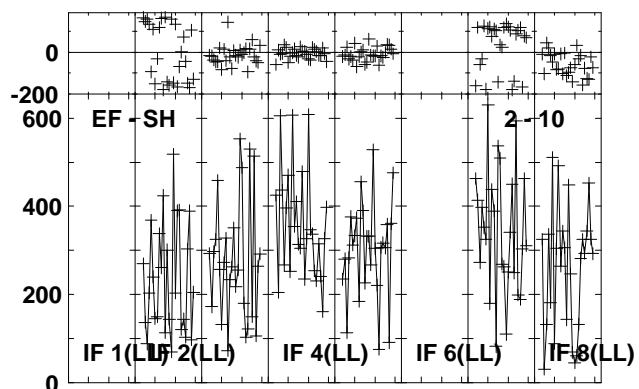
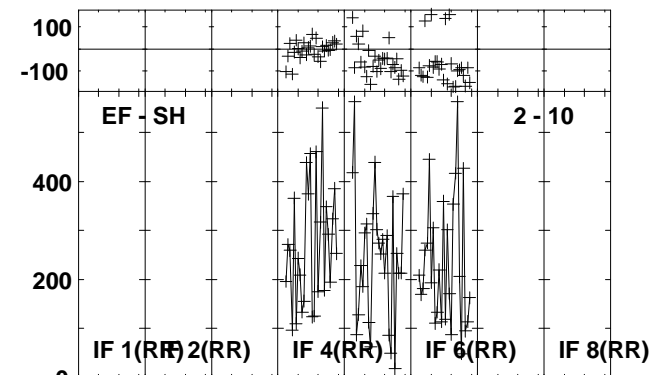
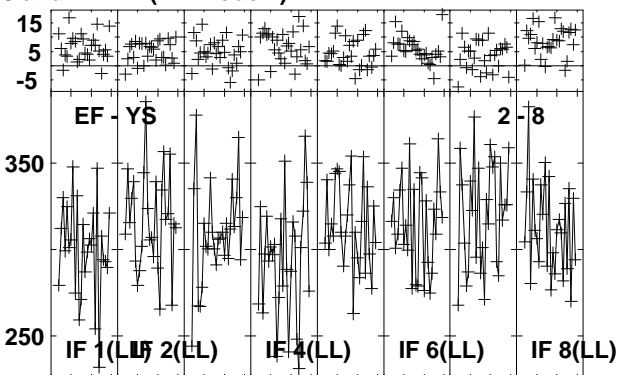
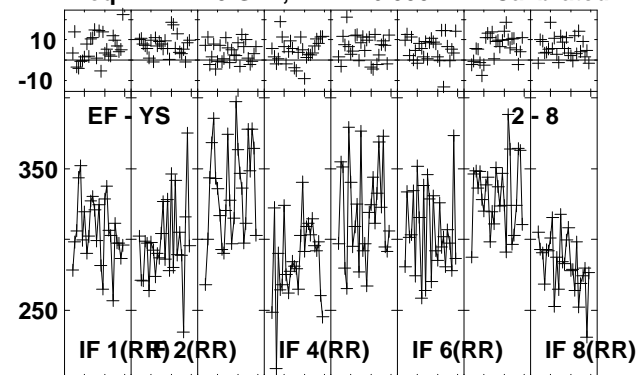

Lower frame: Milli Ampl Jy Top frame: Phas deg
 Vector averaged cross-power spectrum Several baselines displayed
 Timerange: 00/22:26:03 to 00/22:27:01

Plot file version 193 created 26-JUL-2013 10:21:12
 B1152+199A EZ024 1.UVDATA.1
 Freq = 22.1720 GHz, Bw = 16.000 MH Calibrated with CL # 3 and BP # 1 (BP mode 1)

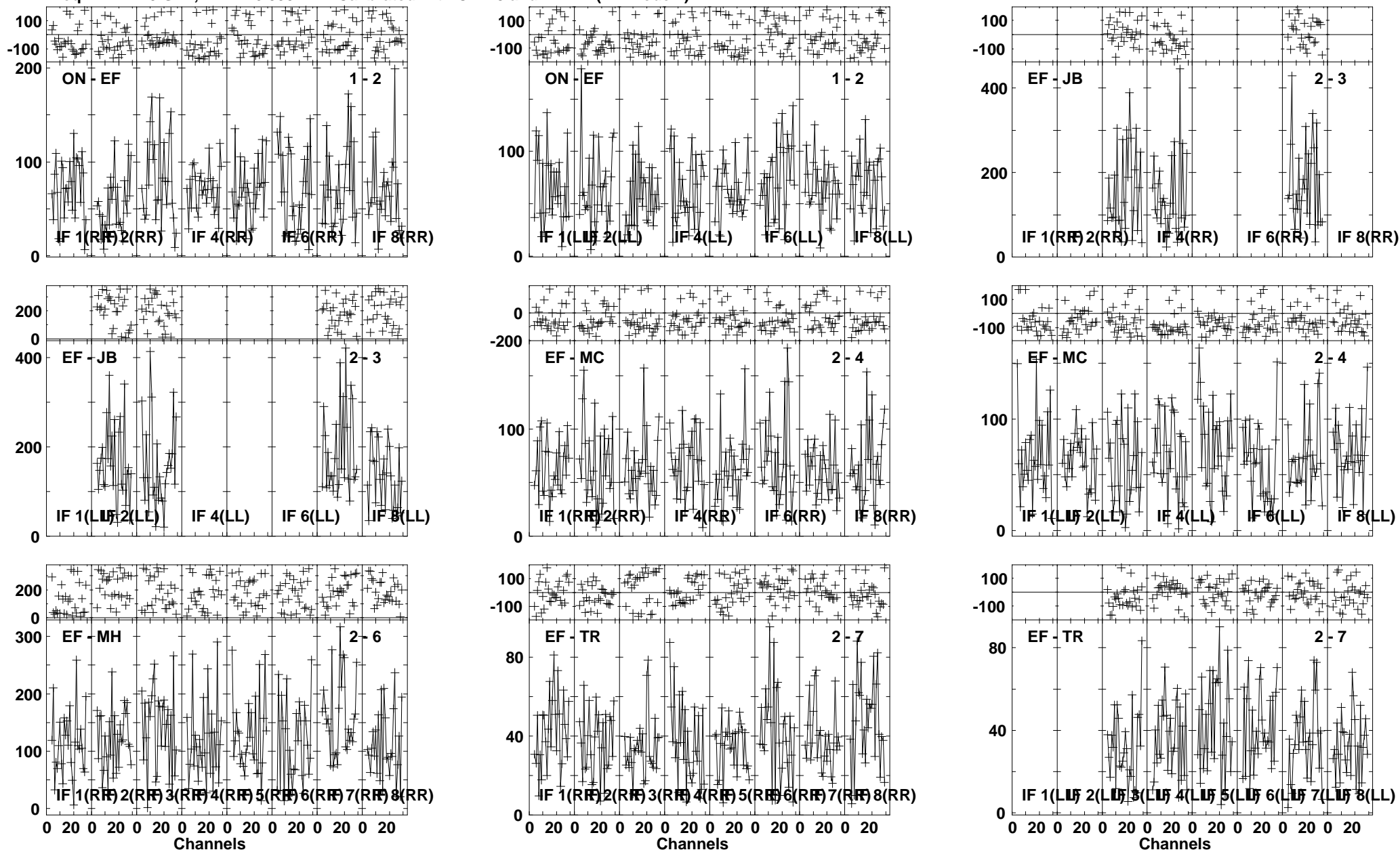

Lower frame: Milli Ampl Jy Top frame: Phas deg
 Vector averaged cross-power spectrum Several baselines displayed
 Timerange: 00/22:27:36 to 00/22:29:34

Plot file version 194 created 26-JUL-2013 10:21:14
 B1152+199A EZ024 1.UVDATA.1
 Freq = 22.1720 GHz, Bw = 16.000 MH Calibrated with CL # 3 and BP # 1 (BP mode 1)

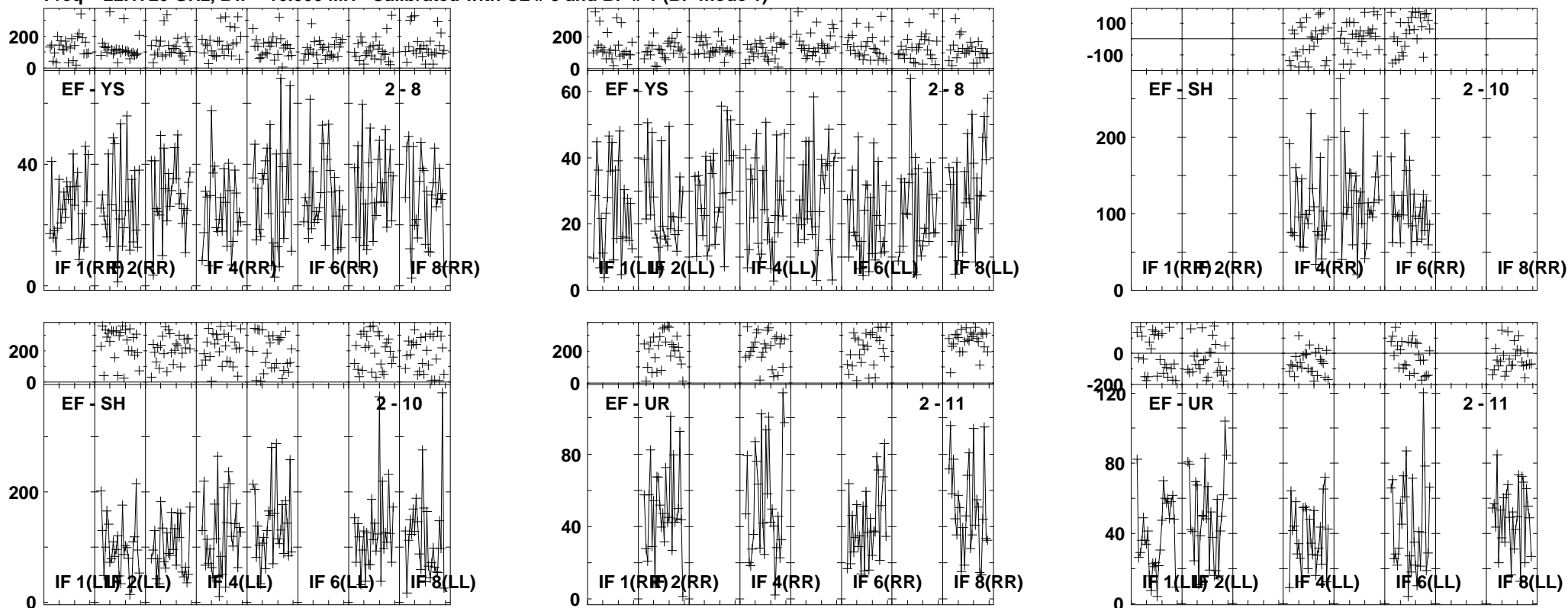

Lower frame: Milli Ampl Jy Top frame: Phas deg
 Vector averaged cross-power spectrum Several baselines displayed
 Timerange: 00/22:27:36 to 00/22:29:34

Plot file version 195 created 26-JUL-2013 10:21:15
 J1157 EZ024 1.UVDATA.1
 Freq = 22.1720 GHz, Bw = 16.000 MH Calibrated with CL # 3 and BP # 1 (BP mode 1)

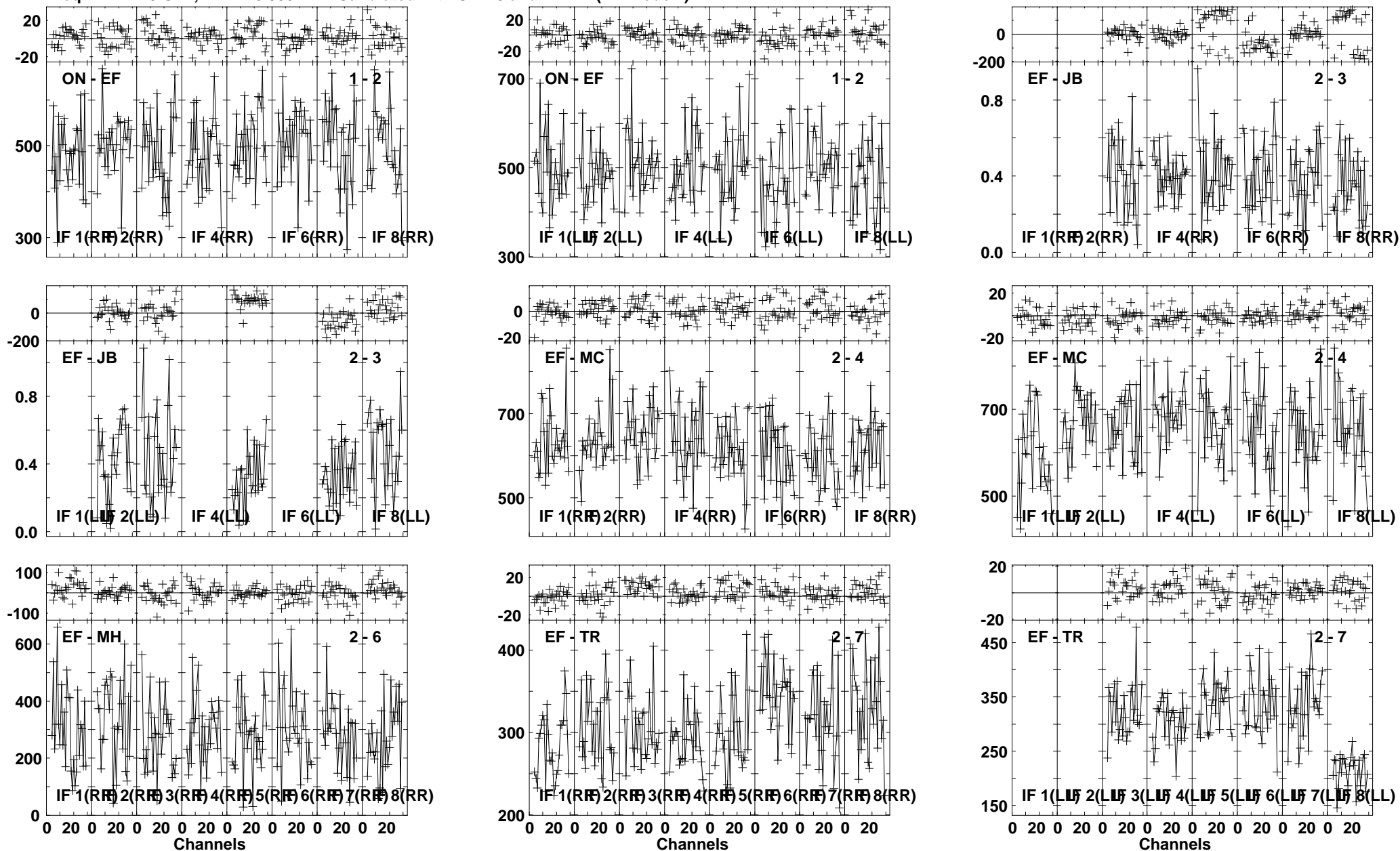

Lower frame: Milli Ampl Jy Top frame: Phas deg
 Vector averaged cross-power spectrum Several baselines displayed
 Timerange: 00/22:30:09 to 00/22:31:07

Plot file version 196 created 26-JUL-2013 10:21:16
 J1157 EZ024 1.UVDATA.1
 Freq = 22.1720 GHz, Bw = 16.000 MH Calibrated with CL # 3 and BP # 1 (BP mode 1)

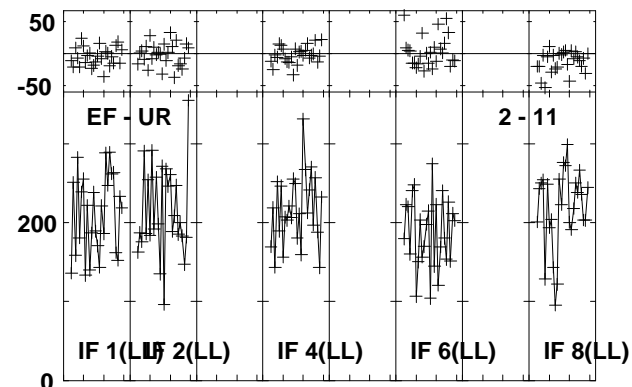
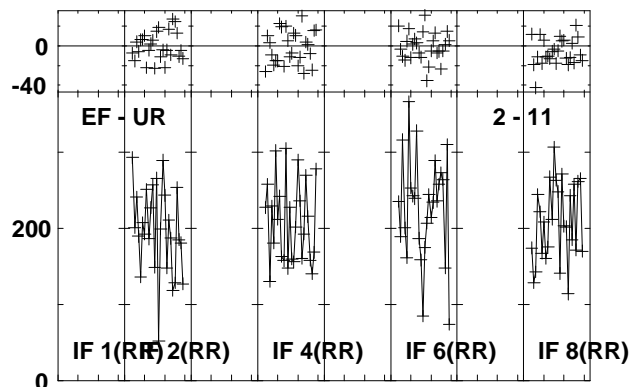
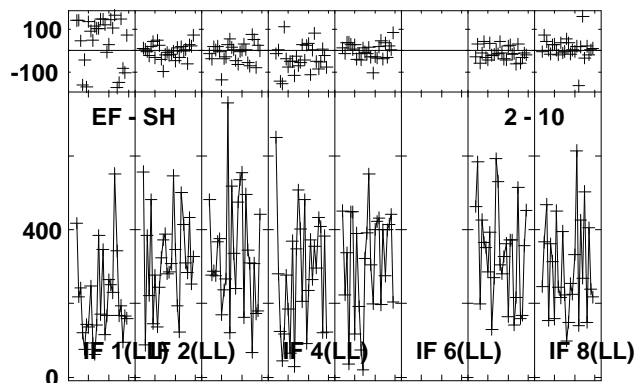
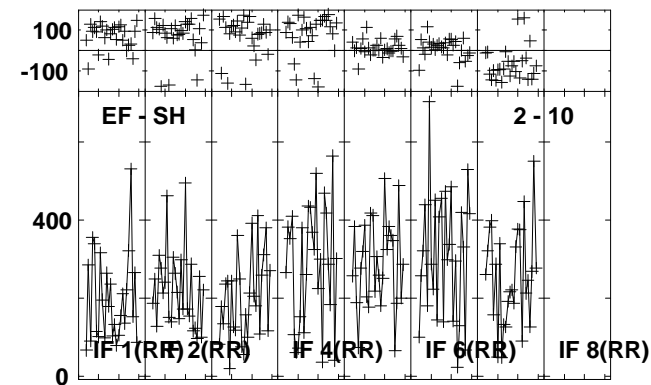
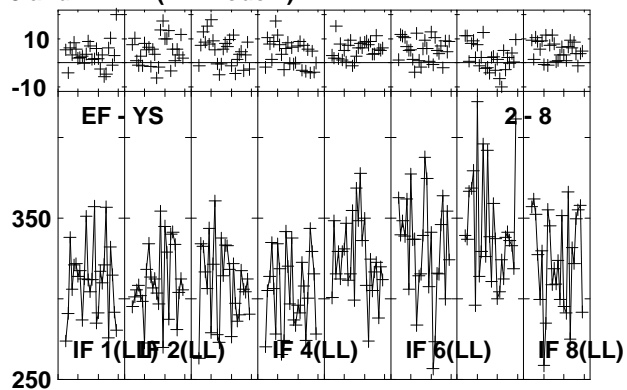
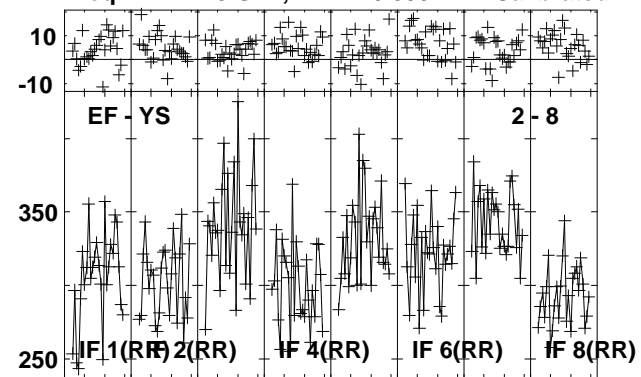

Lower frame: Milli Ampl Jy Top frame: Phas deg
 Vector averaged cross-power spectrum Several baselines displayed
 Timerange: 00:22:30:09 to 00:22:31:07

Plot file version 197 created 26-JUL-2013 10:21:17
 B1152+199A EZ024 1.UVDATA.1
 Freq = 22.1720 GHz, Bw = 16.000 MH Calibrated with CL # 3 and BP # 1 (BP mode 1)

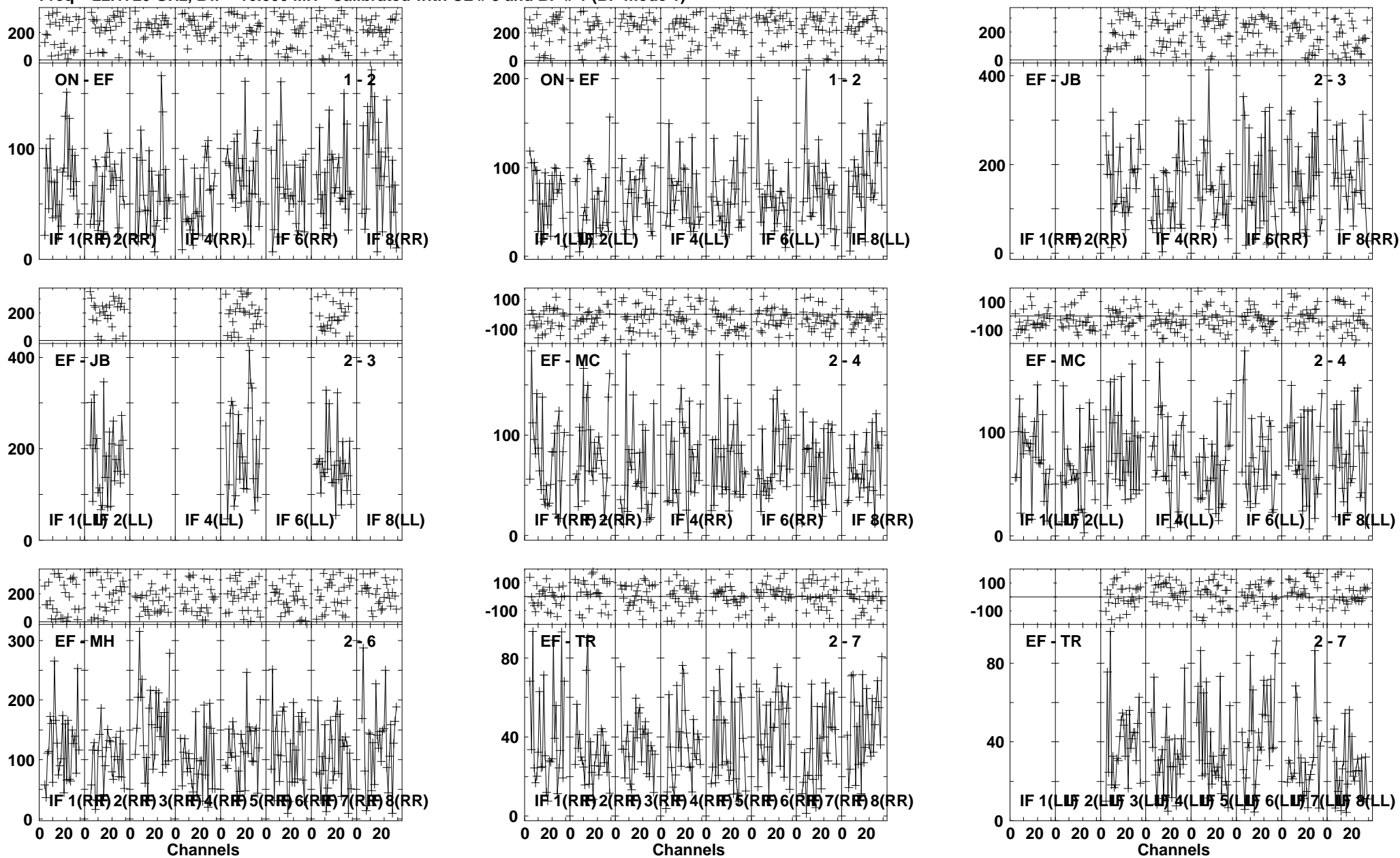

Lower frame: Milli Ampl Jy Top frame: Phas deg
 Vector averaged cross-power spectrum Several baselines displayed
 Timerange: 00/22:31:42 to 00/22:33:40

Plot file version 198 created 26-JUL-2013 10:21:19
 B1152+199A EZ024 1.UVDATA.1
 Freq = 22.1720 GHz, Bw = 16.000 MH Calibrated with CL # 3 and BP # 1 (BP mode 1)

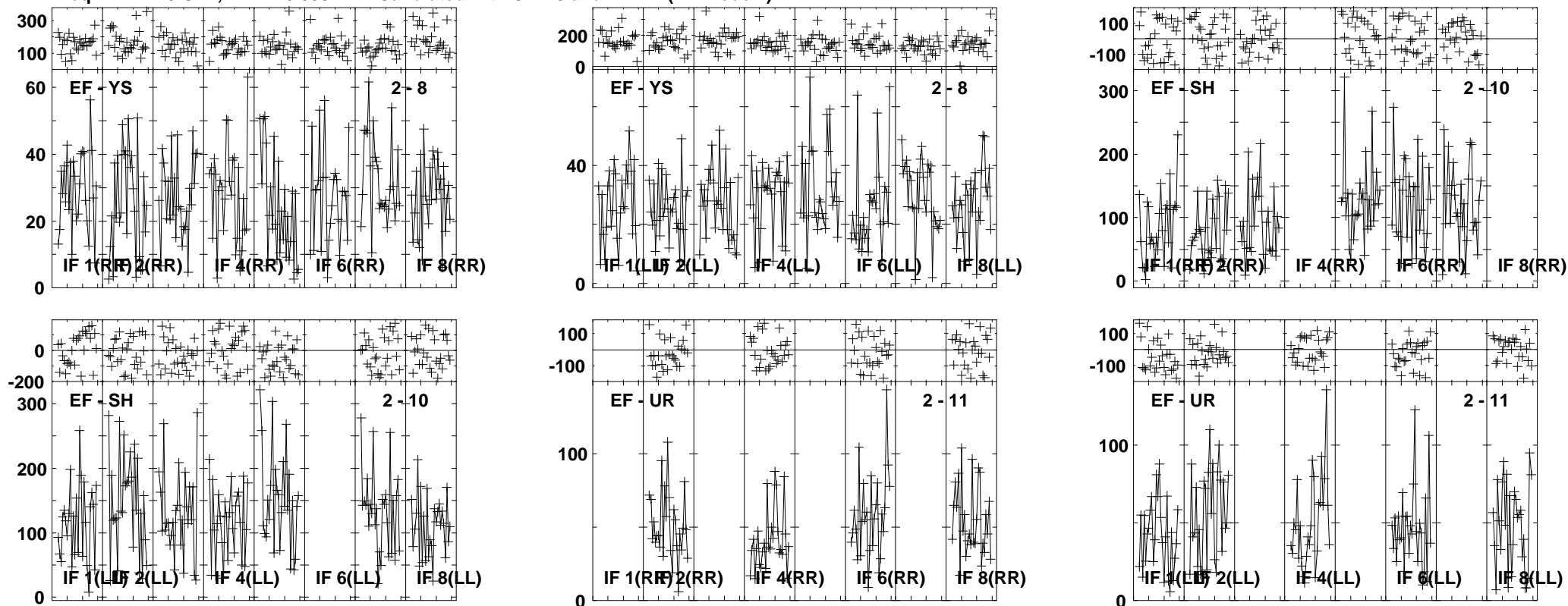

Lower frame: Milli Ampl Jy Top frame: Phas deg
 Vector averaged cross-power spectrum Several baselines displayed
 Timerange: 00/22:31:42 to 00/22:33:40

Plot file version 199 created 26-JUL-2013 10:21:20
 J1157 EZ024 1.UVDATA.1
 Freq = 22.1720 GHz, Bw = 16.000 MH Calibrated with CL # 3 and BP # 1 (BP mode 1)

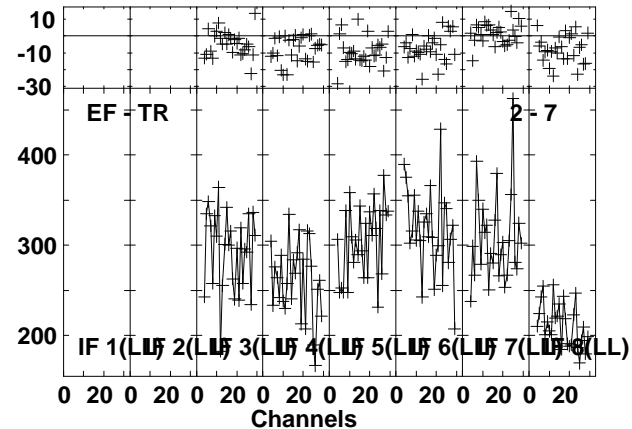
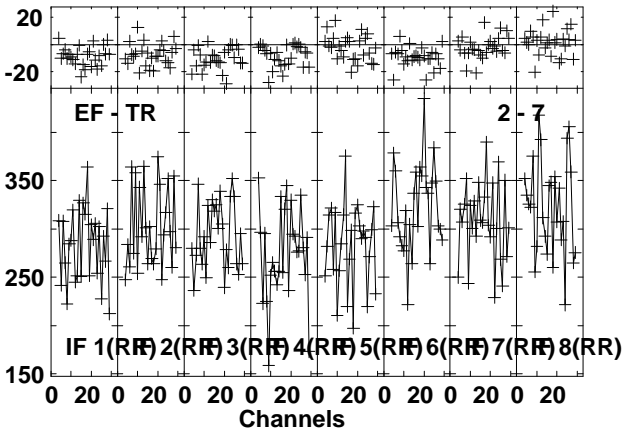
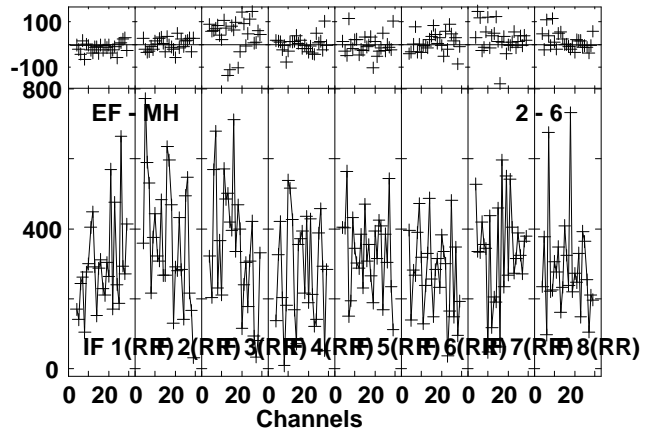
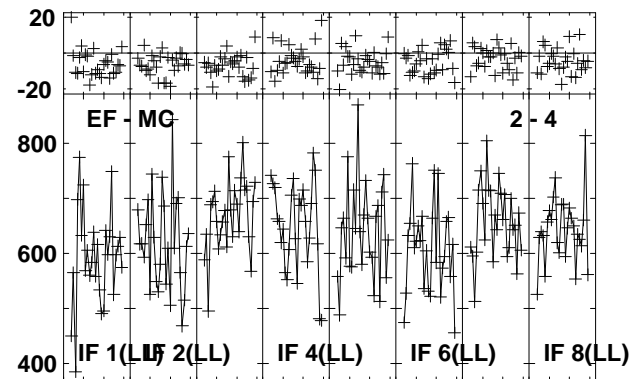
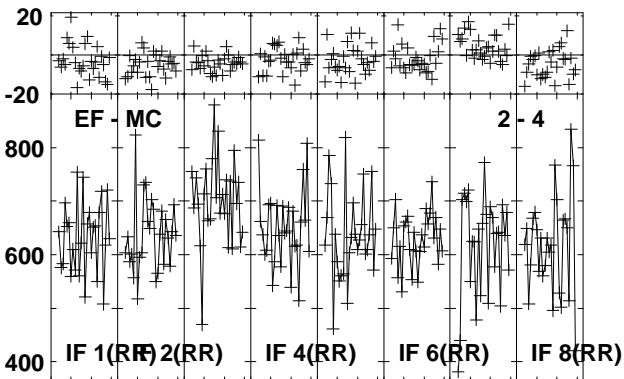
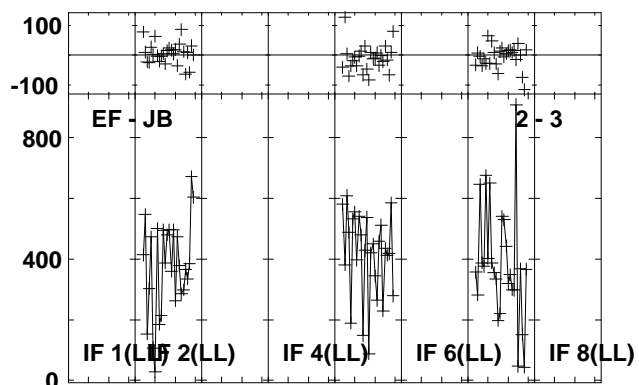
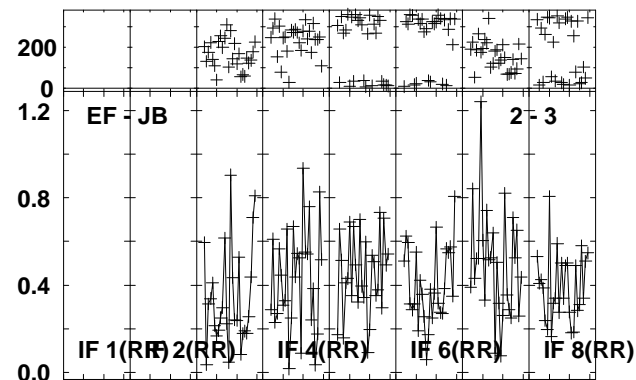
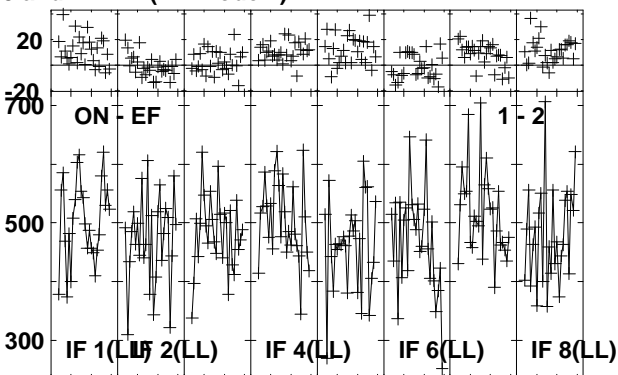
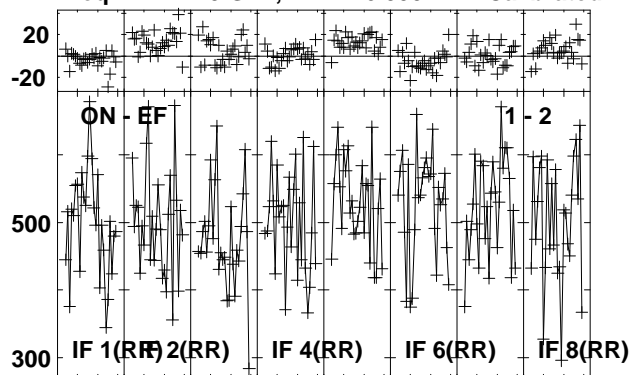

Lower frame: Milli Ampl Jy Top frame: Phas deg
 Vector averaged cross-power spectrum Several baselines displayed
 Timerange: 00/22:34:15 to 00/22:35:13

Plot file version 200 created 26-JUL-2013 10:21:21

J1157 EZ024 1.UVDATA.1

Freq = 22.1720 GHz, Bw = 16.000 MH Calibrated with CL # 3 and BP # 1 (BP mode 1)

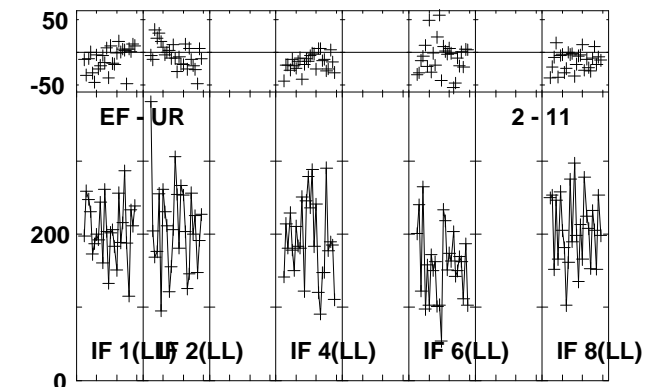
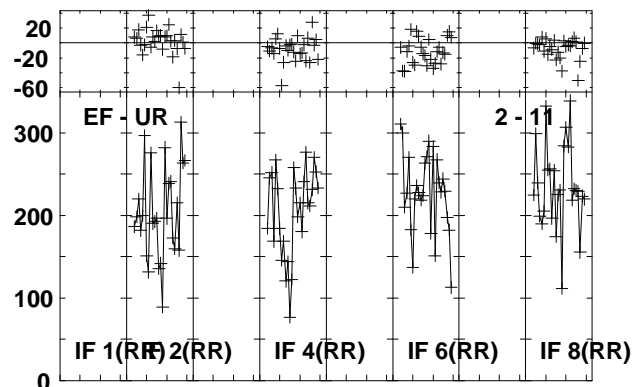
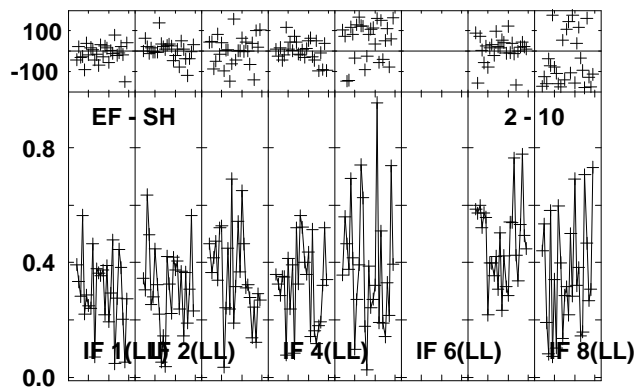
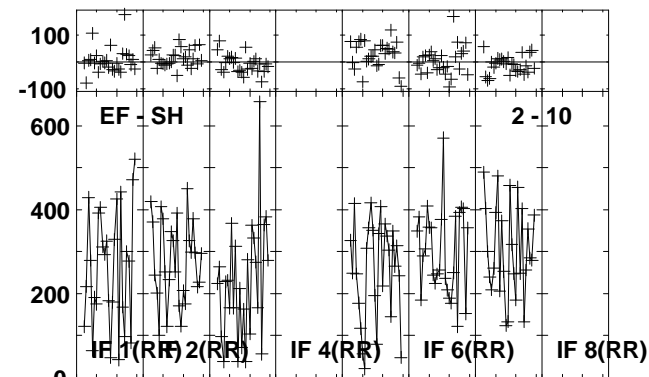
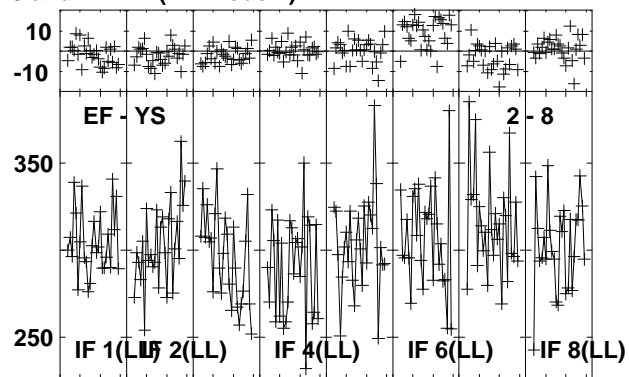
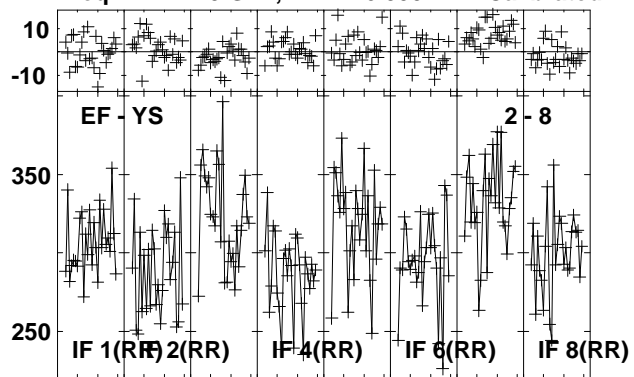

Lower frame: Milli Ampl Jy Top frame: Phas deg
Vector averaged cross-power spectrum Several baselines displayed
Timerange: 00/22:34:15 to 00/22:35:13

Plot file version 201 created 26-JUL-2013 10:21:22
 J1125+2610 EZ024 1.UVDATA.1
 Freq = 22.1720 GHz, Bw = 16.000 MH Calibrated with CL # 3 and BP # 1 (BP mode 1)

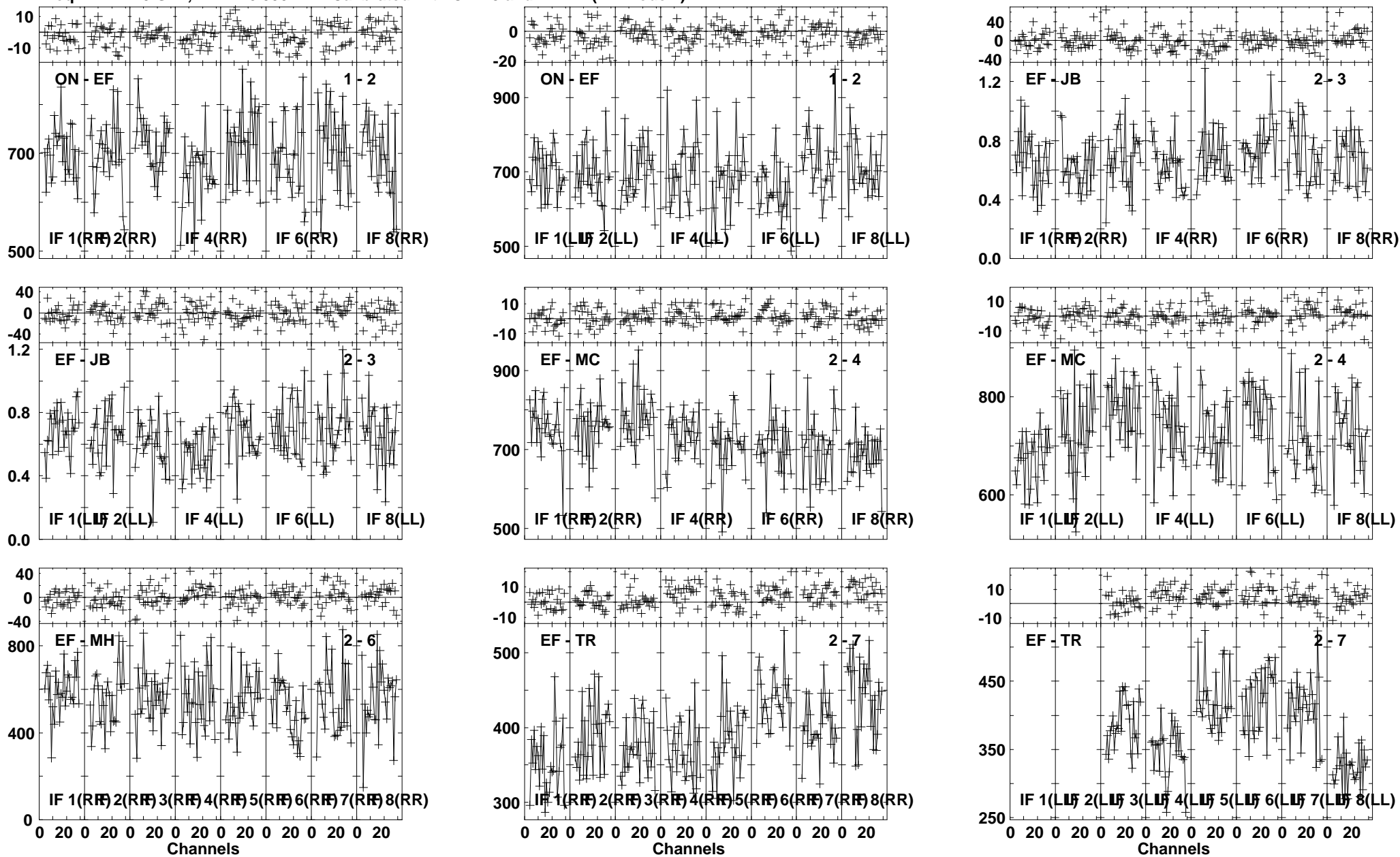

Lower frame: Milli Ampl Jy Top frame: Phas deg
 Vector averaged cross-power spectrum Several baselines displayed
 Timerange: 00/22:36:40 to 00/22:38:22

Plot file version 202 created 26-JUL-2013 10:21:23
 J1125+2610 EZ024 1.UVDATA.1
 Freq = 22.1720 GHz, Bw = 16.000 MH Calibrated with CL # 3 and BP # 1 (BP mode 1)

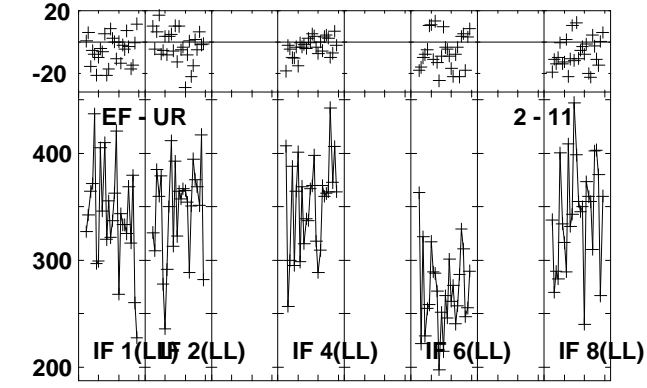
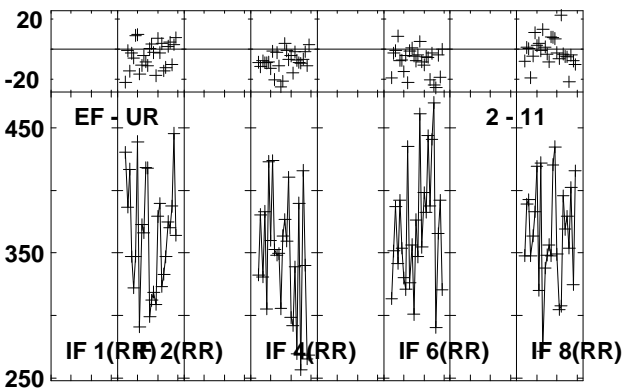
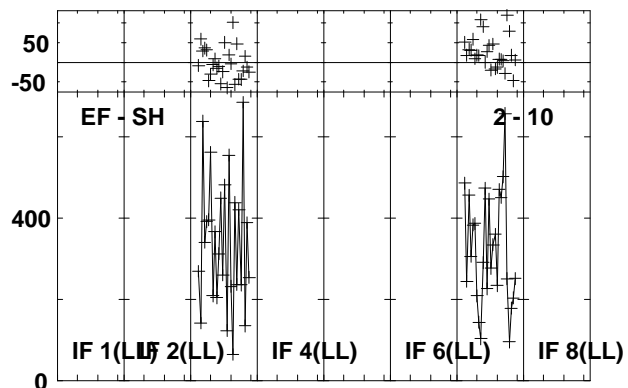
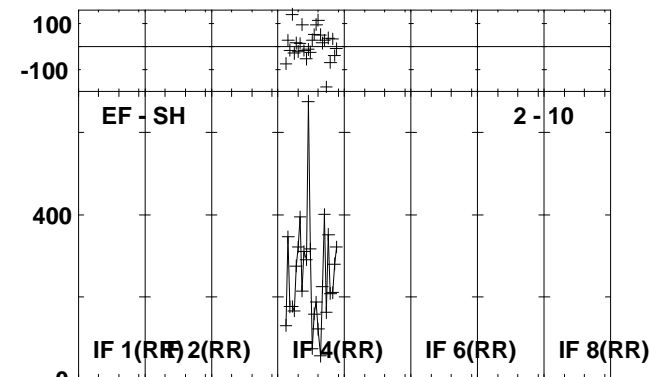
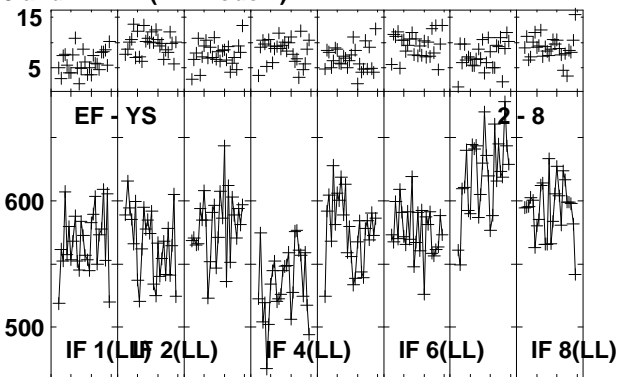
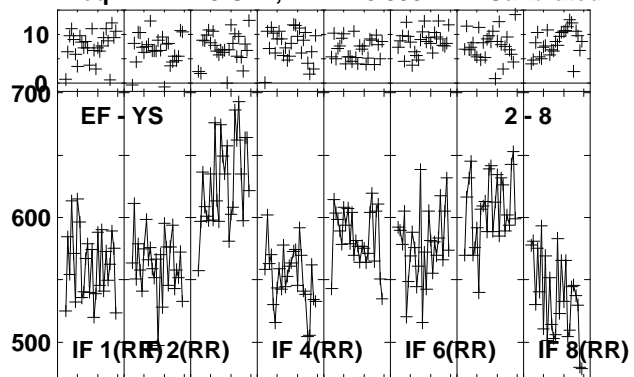

Lower frame: Milli Ampl Jy Top frame: Phas deg
 Vector averaged cross-power spectrum Several baselines displayed
 Timerange: 00/22:36:40 to 00/22:38:22

Plot file version 203 created 26-JUL-2013 10:21:24

J1157 EZ024 1.UVDATA.1

Freq = 22.1720 GHz, Bw = 16.000 MH Calibrated with CL # 3 and BP # 1 (BP mode 1)

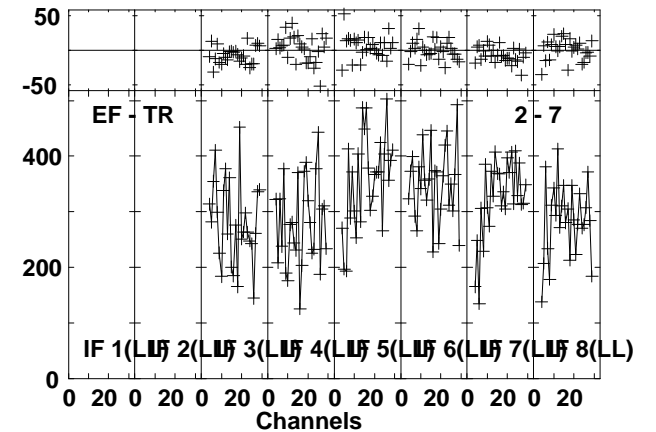
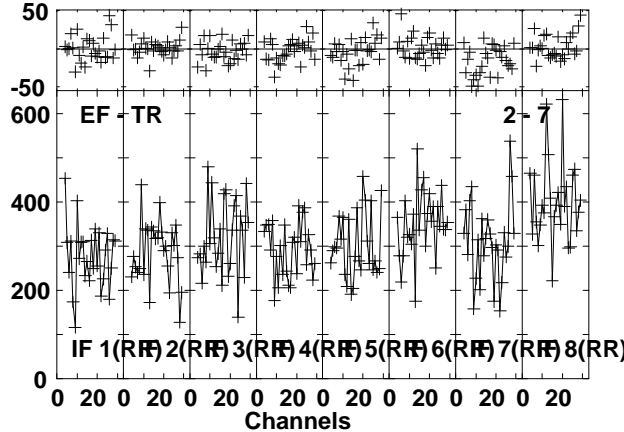
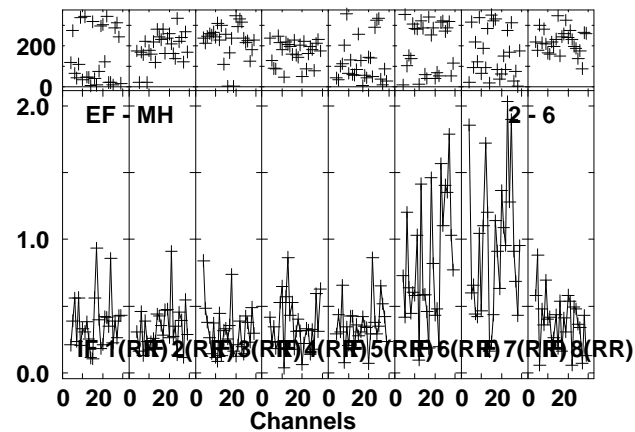
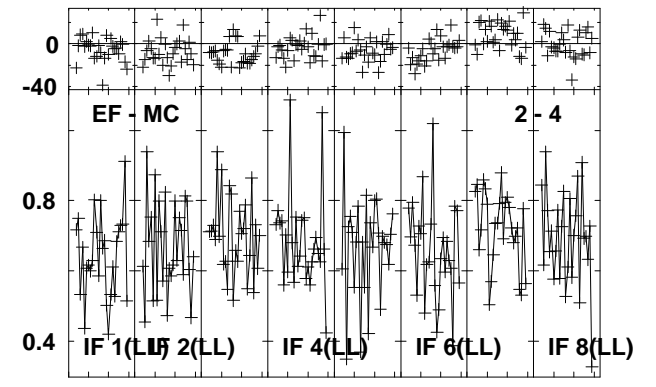
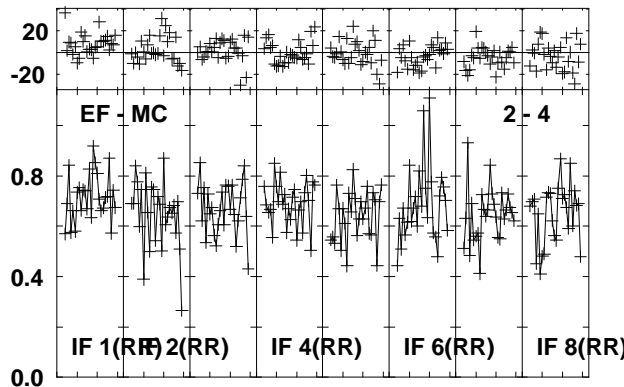
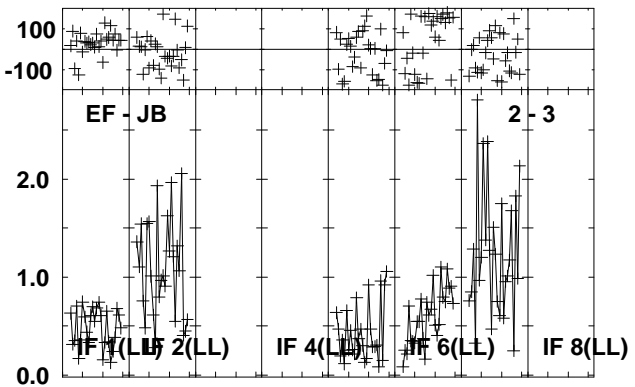
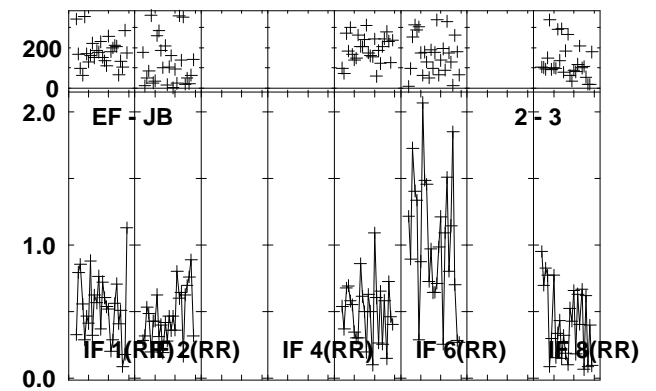
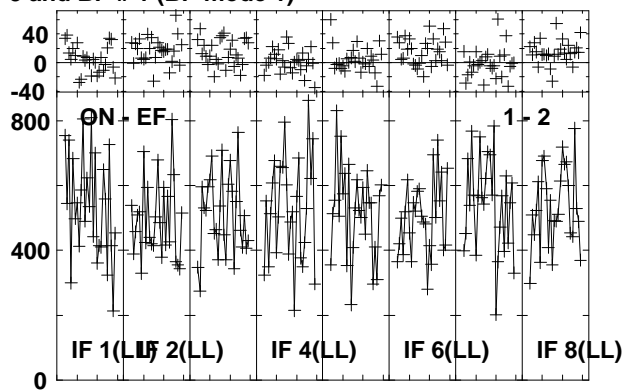
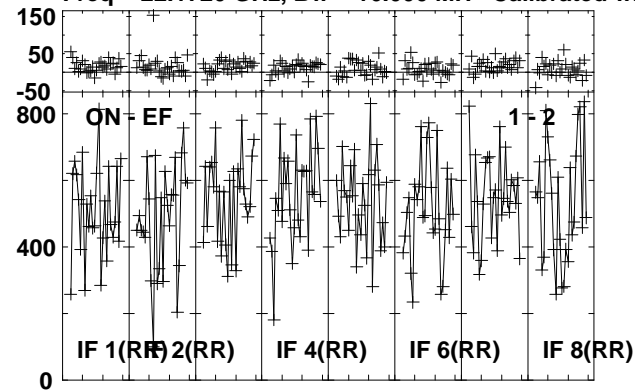

Lower frame: Milli Ampl Jy Top frame: Phas deg
Vector averaged cross-power spectrum Several baselines displayed
Timerange: 00/22:39:49 to 00/22:40:31

Plot file version 204 created 26-JUL-2013 10:21:24
 J1157 EZ024 1.UVDATA.1
 Freq = 22.1720 GHz, Bw = 16.000 MH Calibrated with CL # 3 and BP # 1 (BP mode 1)

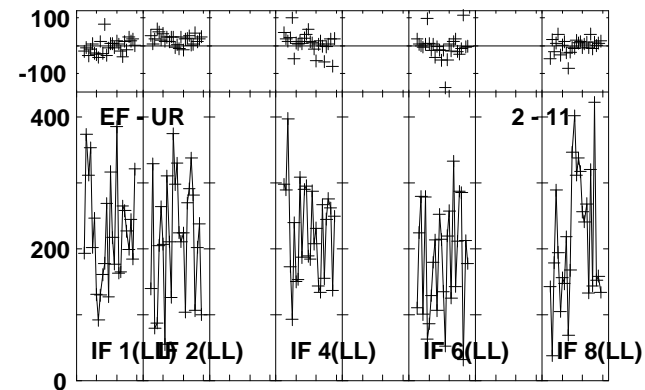
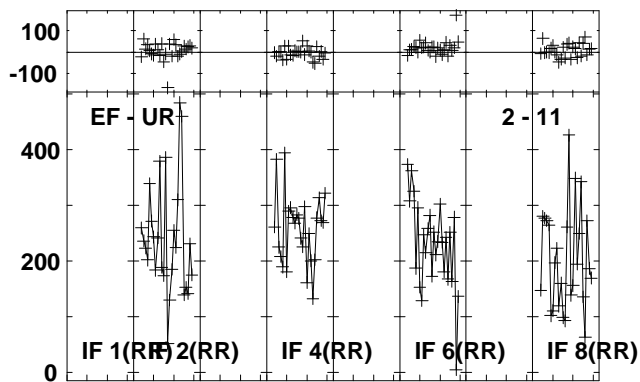
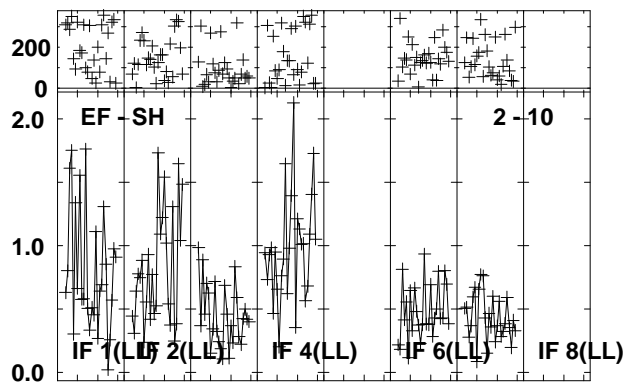
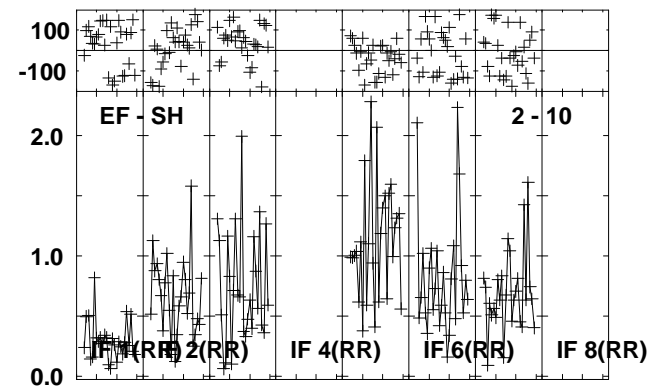
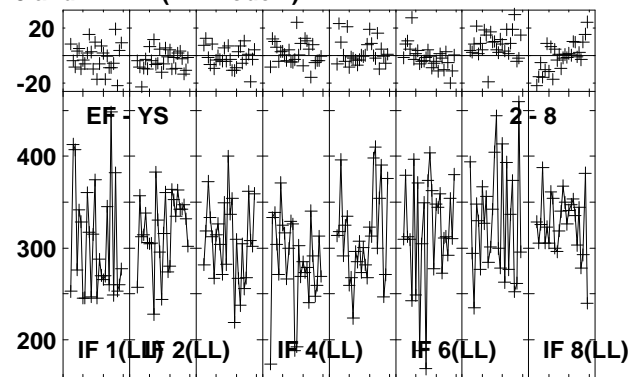
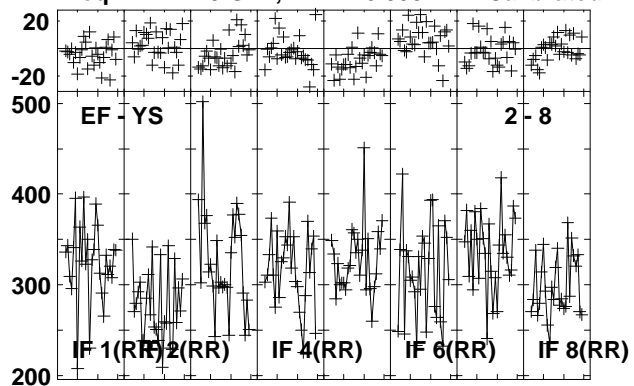

Lower frame: Milli Ampl Jy Top frame: Phas deg
 Vector averaged cross-power spectrum Several baselines displayed
 Timerange: 00/22:39:49 to 00/22:40:31

Plot file version 205 created 26-JUL-2013 10:21:25
 B1152+199A EZ24 1.UVDATA.1
 Freq = 22.1720 GHz, Bw = 16.000 MH Calibrated with CL # 3 and BP # 1 (BP mode 1)

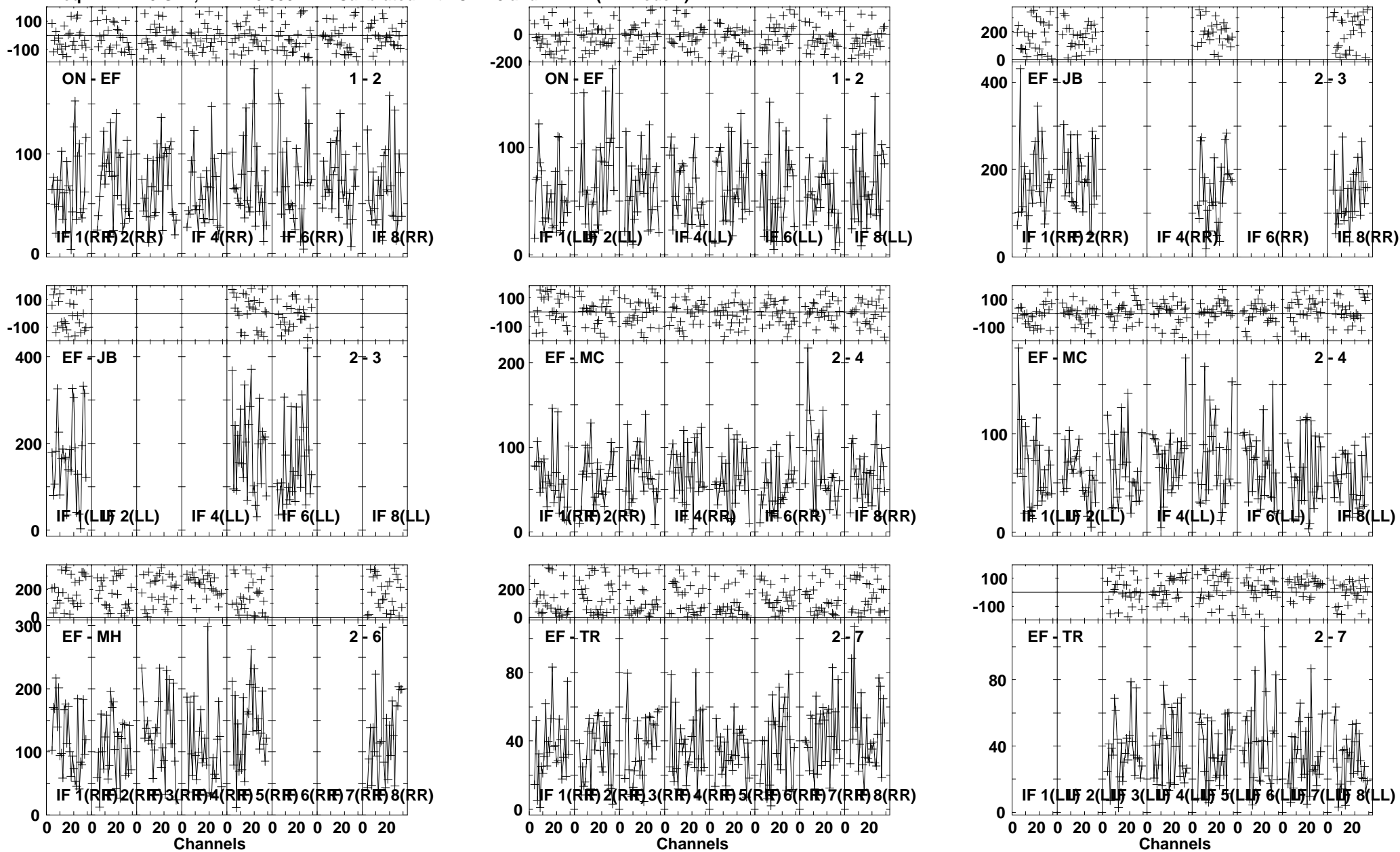

Lower frame: Milli Ampl Jy Top frame: Phas deg
 Vector averaged cross-power spectrum Several baselines displayed
 Timerange: 00/22:41:07 to 00/22:43:05

Plot file version 206 created 26-JUL-2013 10:21:27
 B1152+199A EZ024 1.UVDATA.1
 Freq = 22.1720 GHz, Bw = 16.000 MH Calibrated with CL # 3 and BP # 1 (BP mode 1)

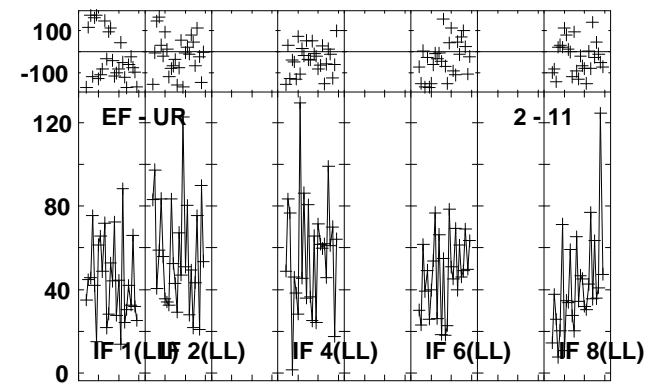
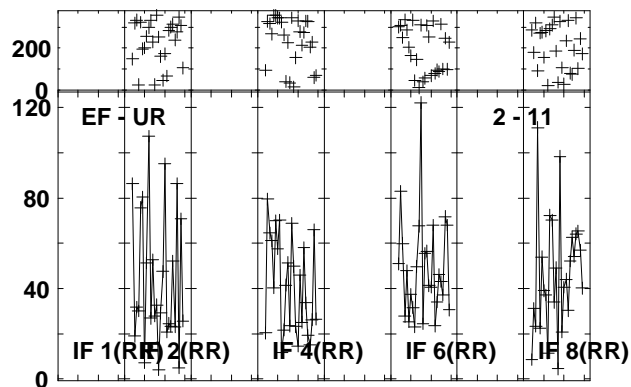
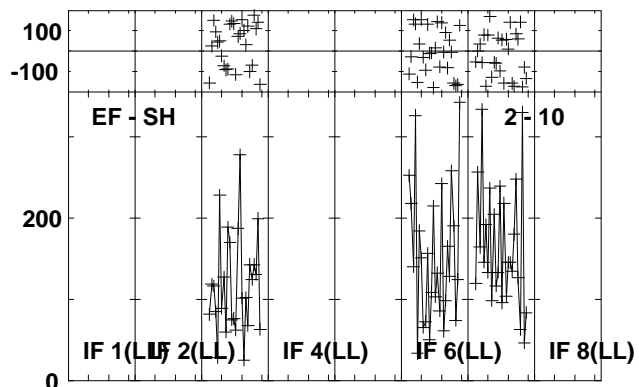
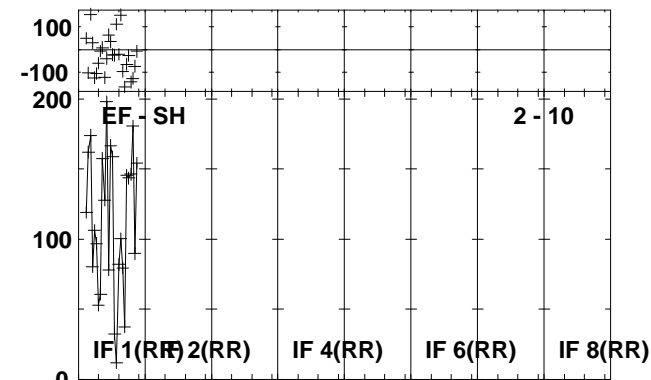
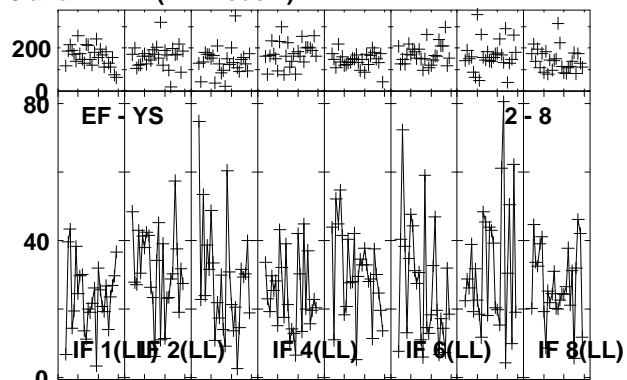
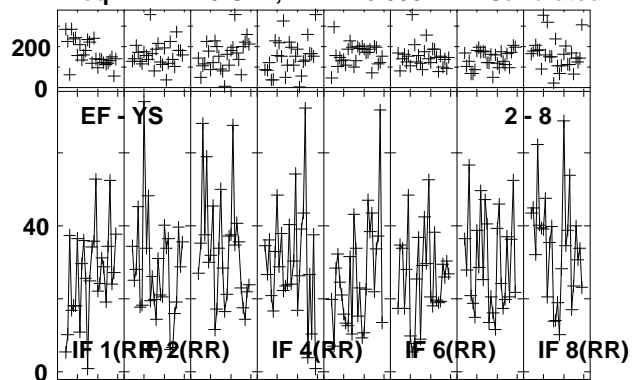

Lower frame: Milli Ampl Jy Top frame: Phas deg
 Vector averaged cross-power spectrum Several baselines displayed
 Timerange: 00/22:41:07 to 00/22:43:05

Plot file version 207 created 26-JUL-2013 10:21:29
 J1157 EZ024 1.UVDATA.1
 Freq = 22.1720 GHz, Bw = 16.000 MH Calibrated with CL # 3 and BP # 1 (BP mode 1)

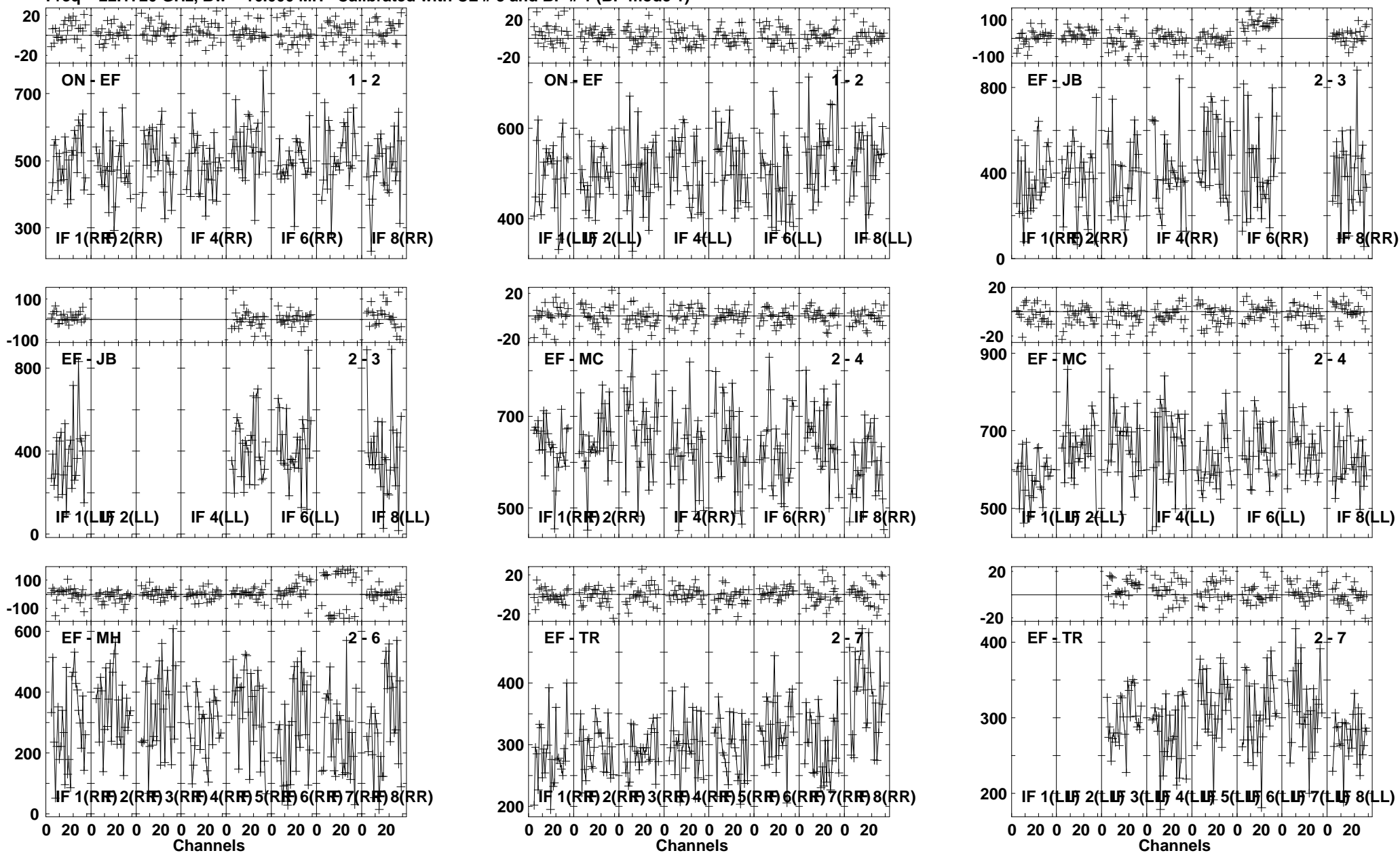

Lower frame: Milli Ampl Jy Top frame: Phas deg
 Vector averaged cross-power spectrum Several baselines displayed
 Timerange: 00/22:43:40 to 00/22:44:38

Plot file version 208 created 26-JUL-2013 10:21:29
 J1157 EZ024 1.UVDATA.1
 Freq = 22.1720 GHz, Bw = 16.000 MH Calibrated with CL # 3 and BP # 1 (BP mode 1)

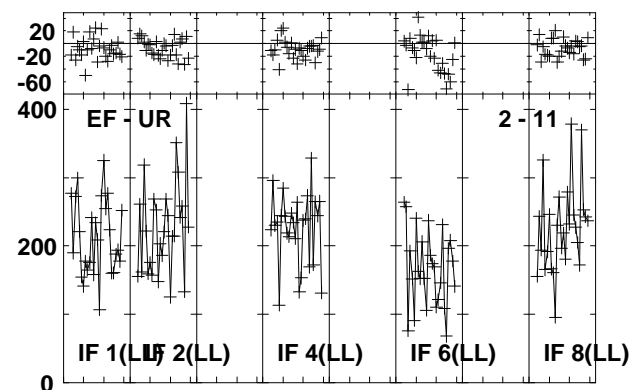
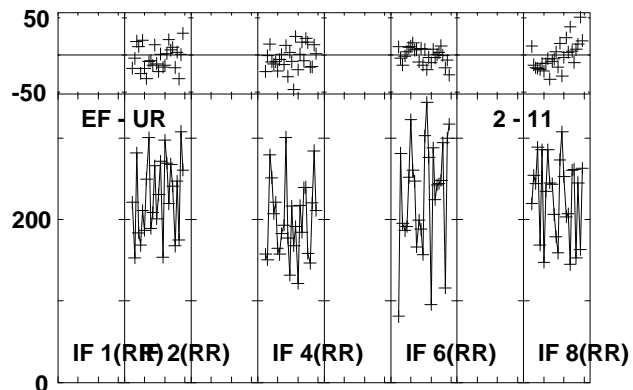
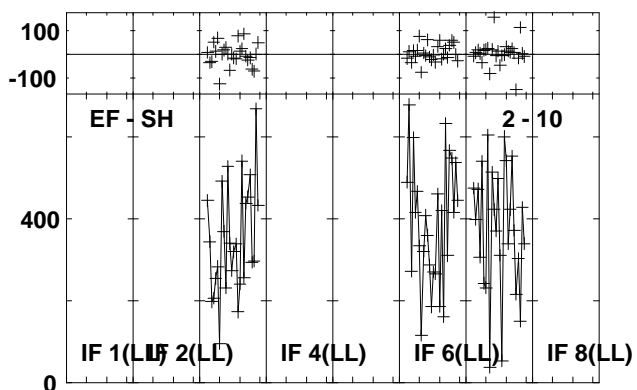
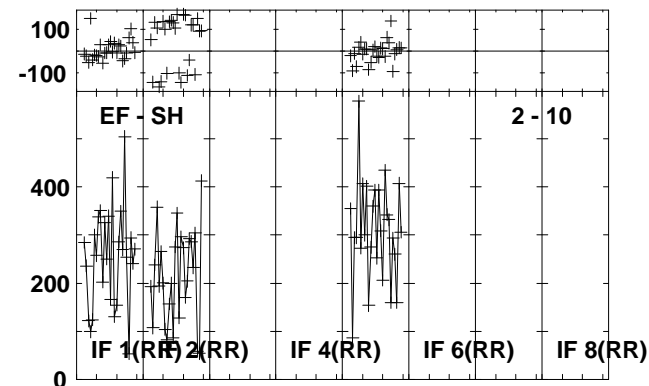
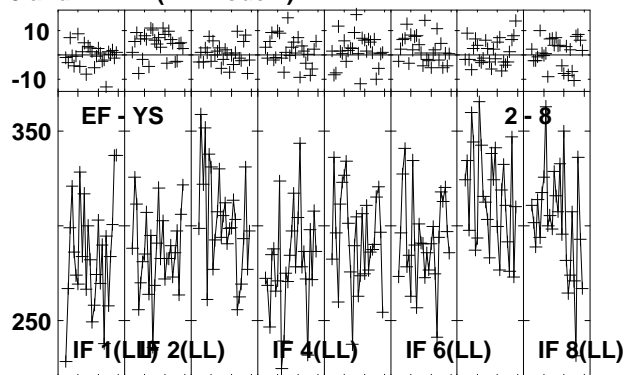
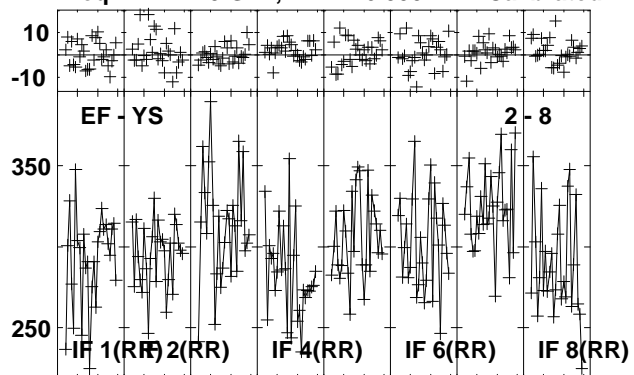

Lower frame: Milli Ampl Jy Top frame: Phas deg
 Vector averaged cross-power spectrum Several baselines displayed
 Timerange: 00/22:43:40 to 00/22:44:38

Plot file version 209 created 26-JUL-2013 10:21:30
 B1152+199A EZ24 1.UVDATA.1
 Freq = 22.1720 GHz, Bw = 16.000 MH Calibrated with CL # 3 and BP # 1 (BP mode 1)

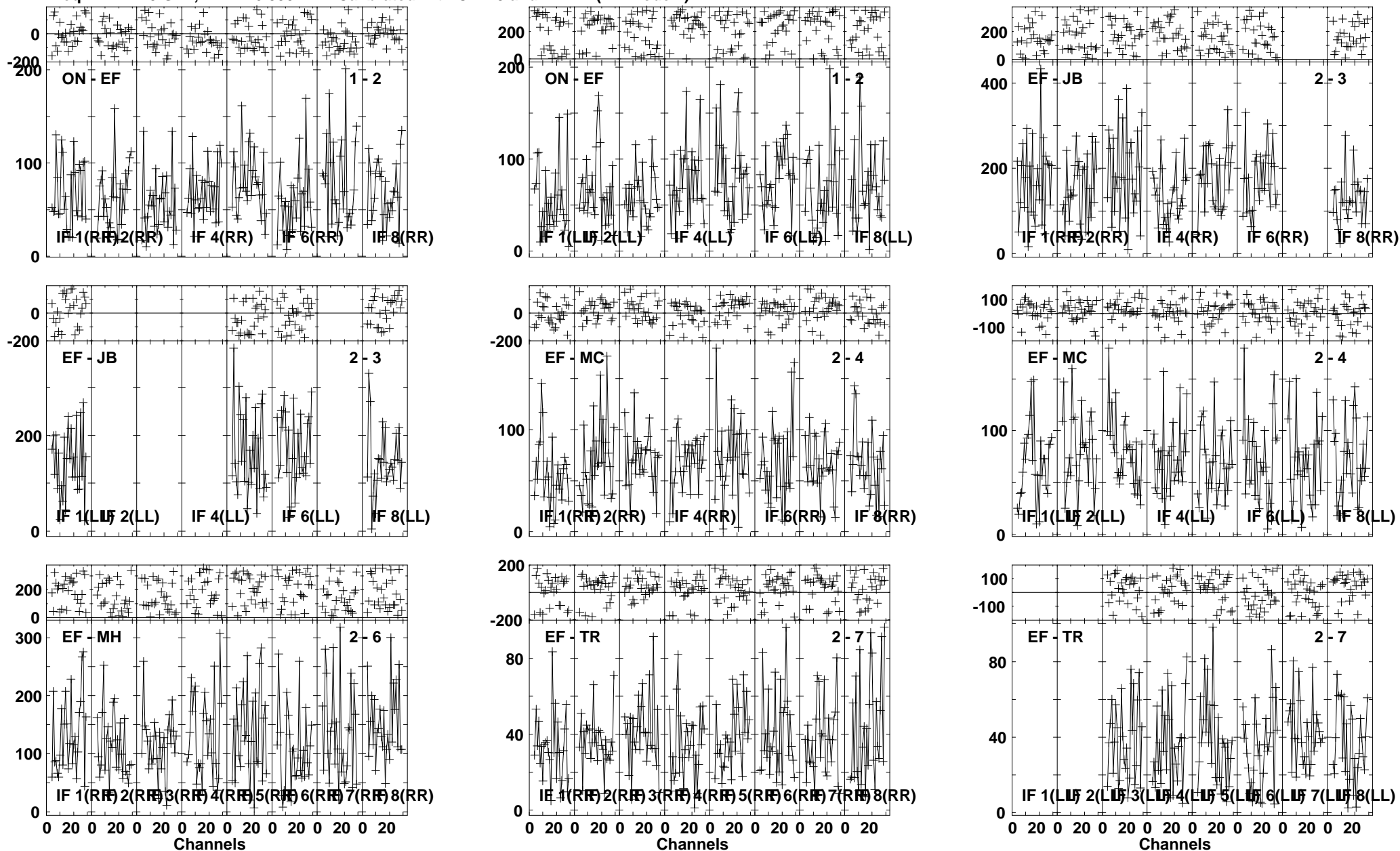

Lower frame: Milli Ampl Jy Top frame: Phas deg
 Vector averaged cross-power spectrum Several baselines displayed
 Timerange: 00/22:45:13 to 00/22:47:11

Plot file version 210 created 26-JUL-2013 10:21:32
 B1152+199A EZ024 1.UVDATA.1
 Freq = 22.1720 GHz, Bw = 16.000 MH Calibrated with CL # 3 and BP # 1 (BP mode 1)

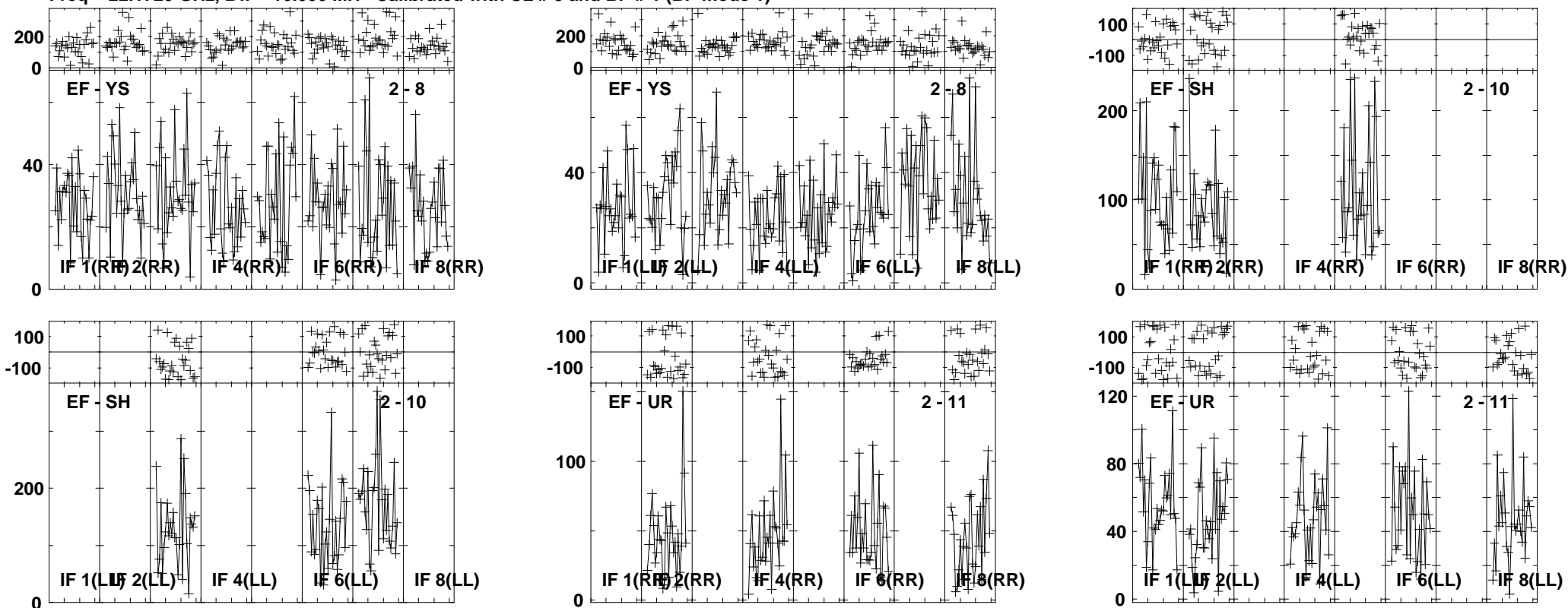

Lower frame: Milli Ampl Jy Top frame: Phas deg
 Vector averaged cross-power spectrum Several baselines displayed
 Timerange: 00/22:45:13 to 00/22:47:11

Plot file version 211 created 26-JUL-2013 10:21:33

J1157 EZ024 1.UVDATA.1

Freq = 22.1720 GHz, Bw = 16.000 MH Calibrated with CL # 3 and BP # 1 (BP mode 1)

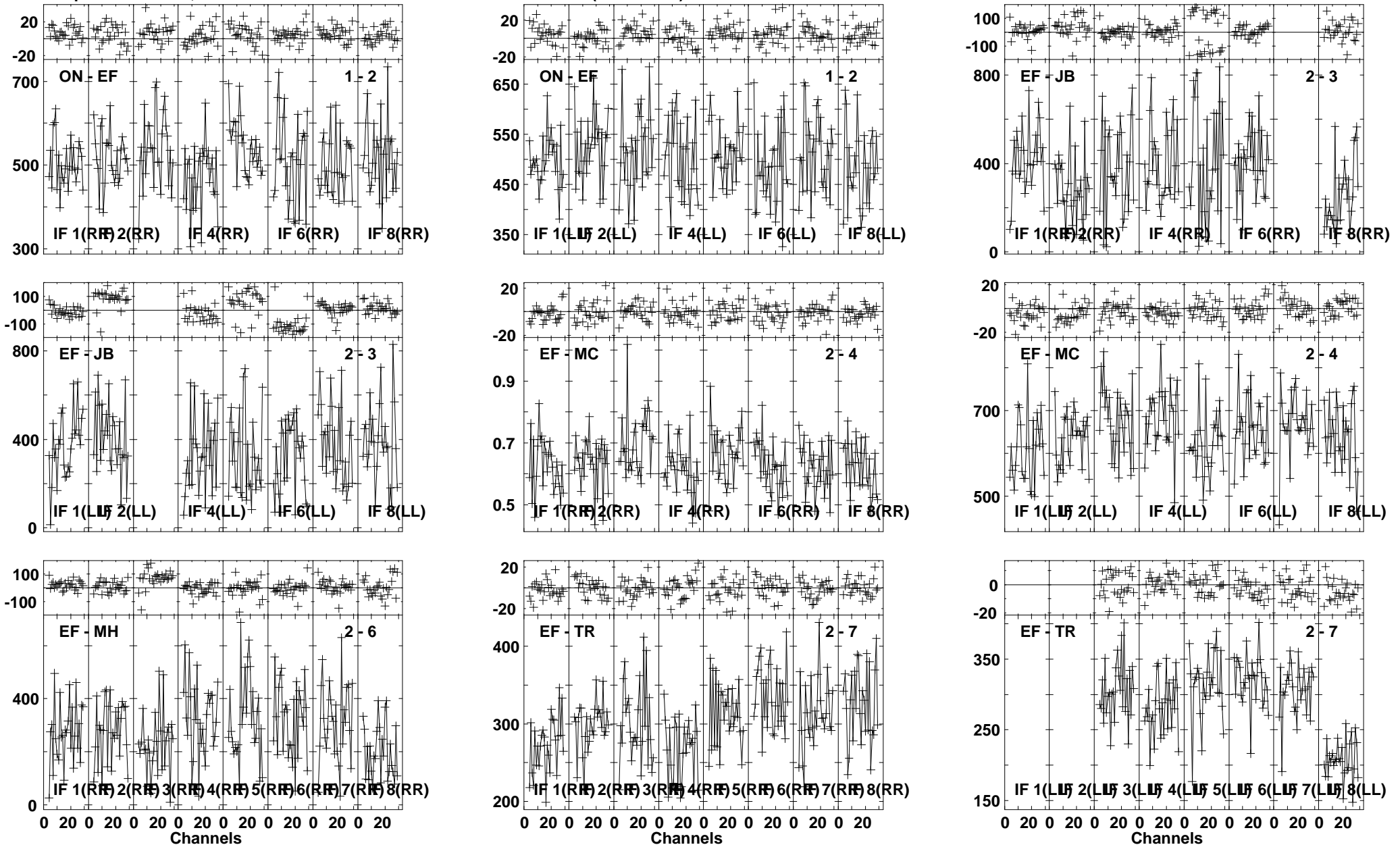

Lower frame: Milli Ampl Jy Top frame: Phas deg
Vector averaged cross-power spectrum Several baselines displayed
Timerange: 00/22:47:46 to 00/22:48:44

Plot file version 212 created 26-JUL-2013 10:21:34
 J1157 EZ024 1.UVDATA.1
 Freq = 22.1720 GHz, Bw = 16.000 MH Calibrated with CL # 3 and BP # 1 (BP mode 1)

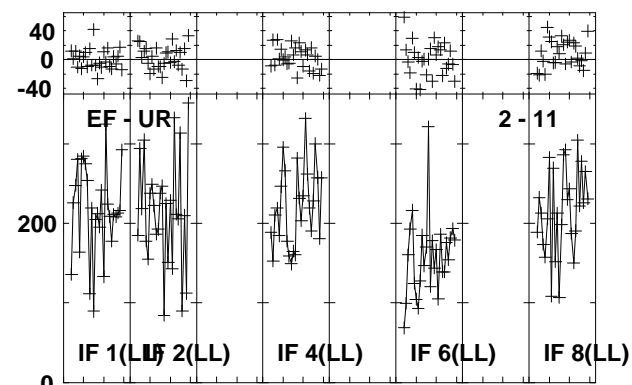
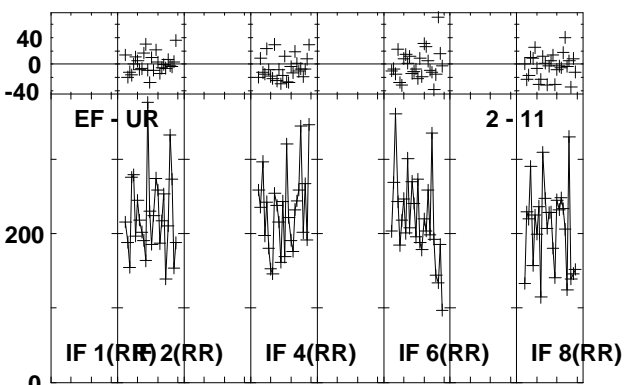
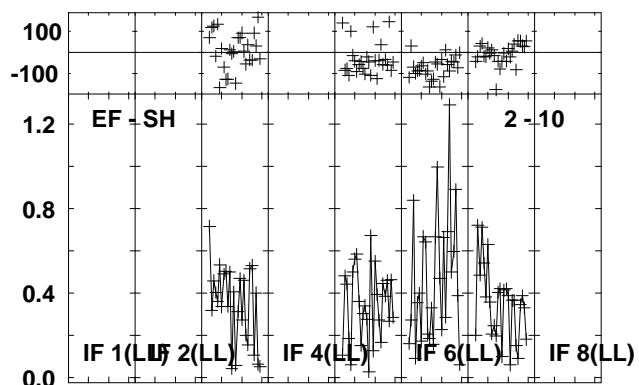
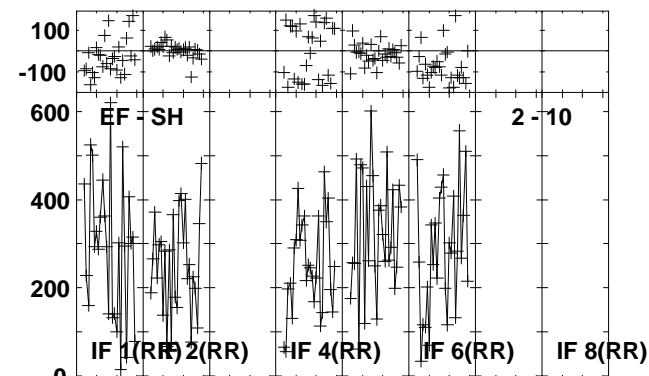
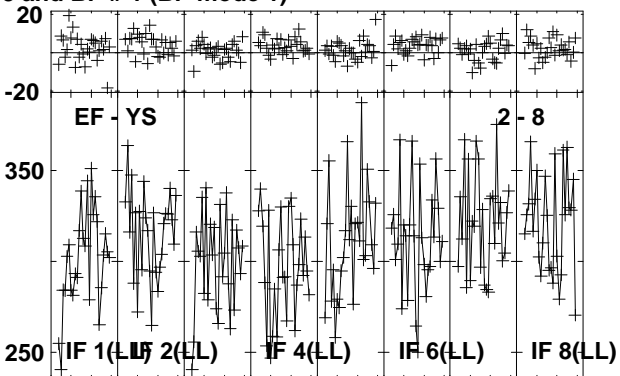
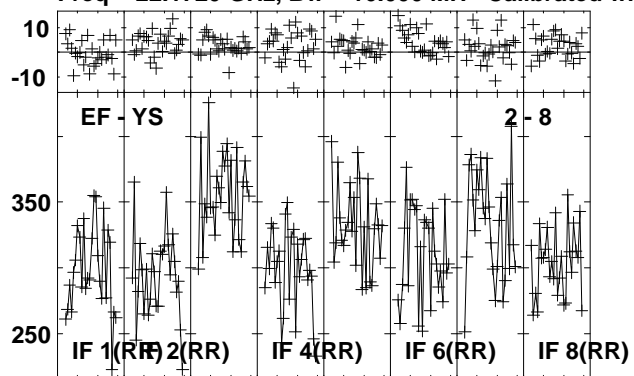

Lower frame: Milli Ampl Jy Top frame: Phas deg
 Vector averaged cross-power spectrum Several baselines displayed
 Timerange: 00/22:47:46 to 00/22:48:44

Plot file version 213 created 26-JUL-2013 10:21:35
 B1152+199A EZ24 1.UVDATA.1
 Freq = 22.1720 GHz, Bw = 16.000 MH Calibrated with CL # 3 and BP # 1 (BP mode 1)

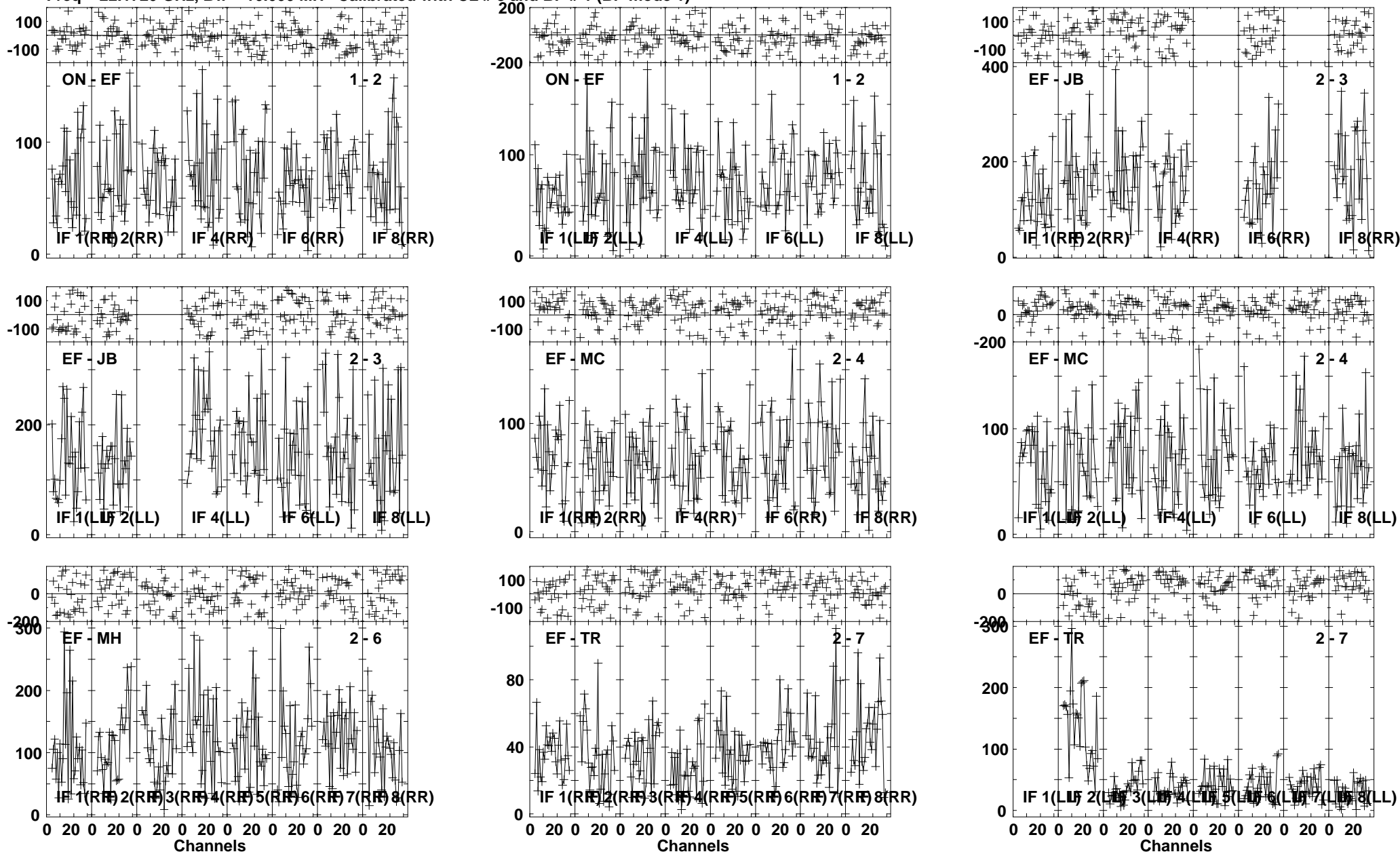

Lower frame: Milli Ampl Jy Top frame: Phas deg
 Vector averaged cross-power spectrum Several baselines displayed
 Timerange: 00/22:49:19 to 00/22:51:17

Plot file version 214 created 26-JUL-2013 10:21:37
 B1152+199A EZ024 1.UVDATA.1
 Freq = 22.1720 GHz, Bw = 16.000 MH Calibrated with CL # 3 and BP # 1 (BP mode 1)

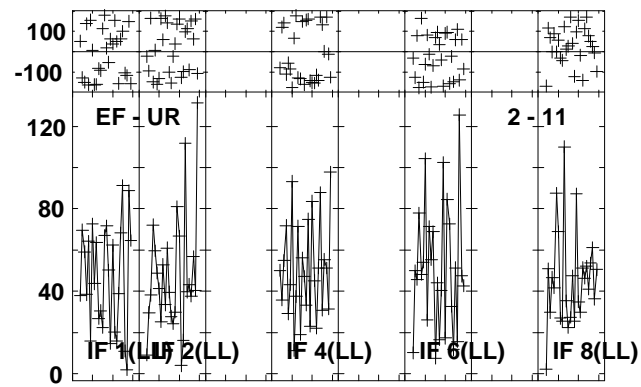
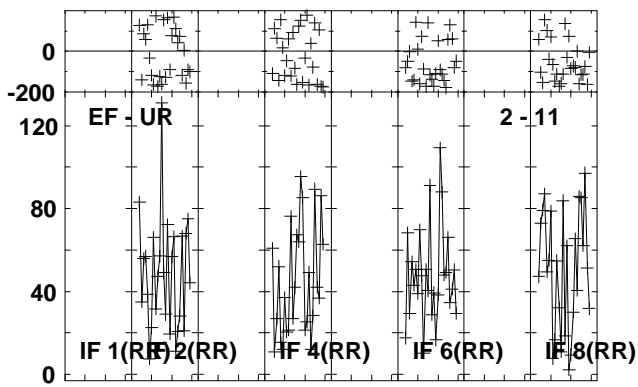
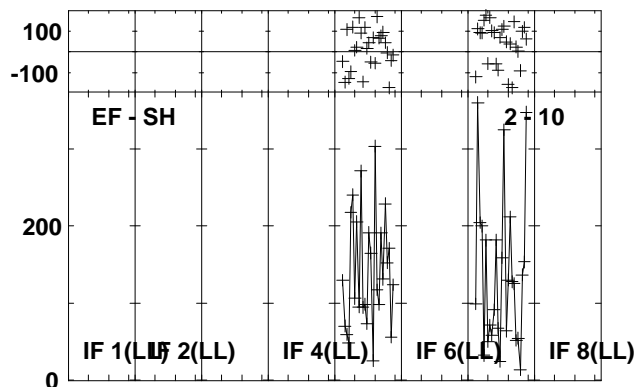
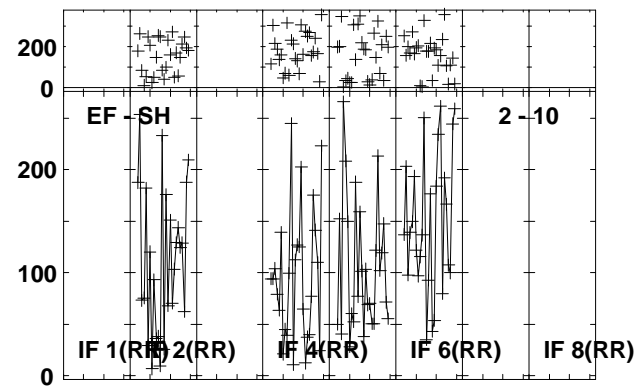
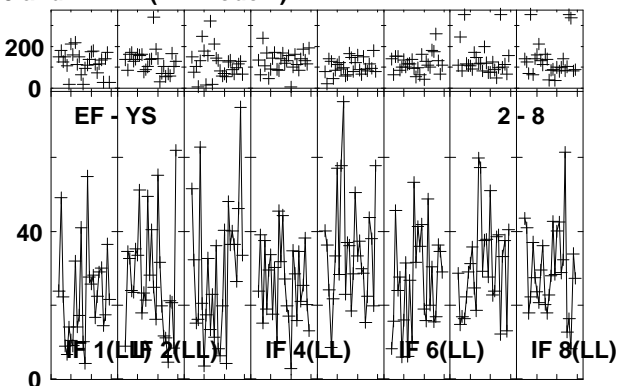
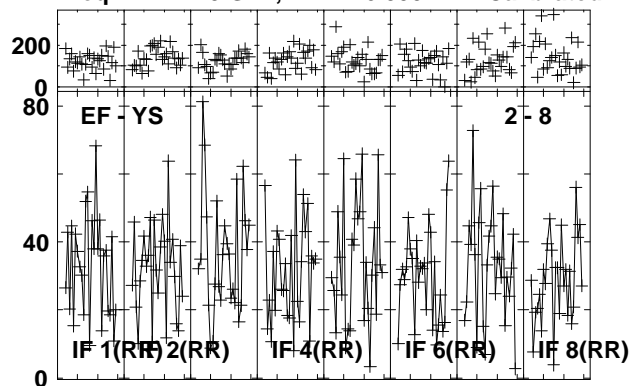

Lower frame: Milli Ampl Jy Top frame: Phas deg
 Vector averaged cross-power spectrum Several baselines displayed
 Timerange: 00/22:49:19 to 00/22:51:17

Plot file version 215 created 26-JUL-2013 10:21:38
 J1157 EZ024 1.UVDATA.1
 Freq = 22.1720 GHz, Bw = 16.000 MH Calibrated with CL # 3 and BP # 1 (BP mode 1)

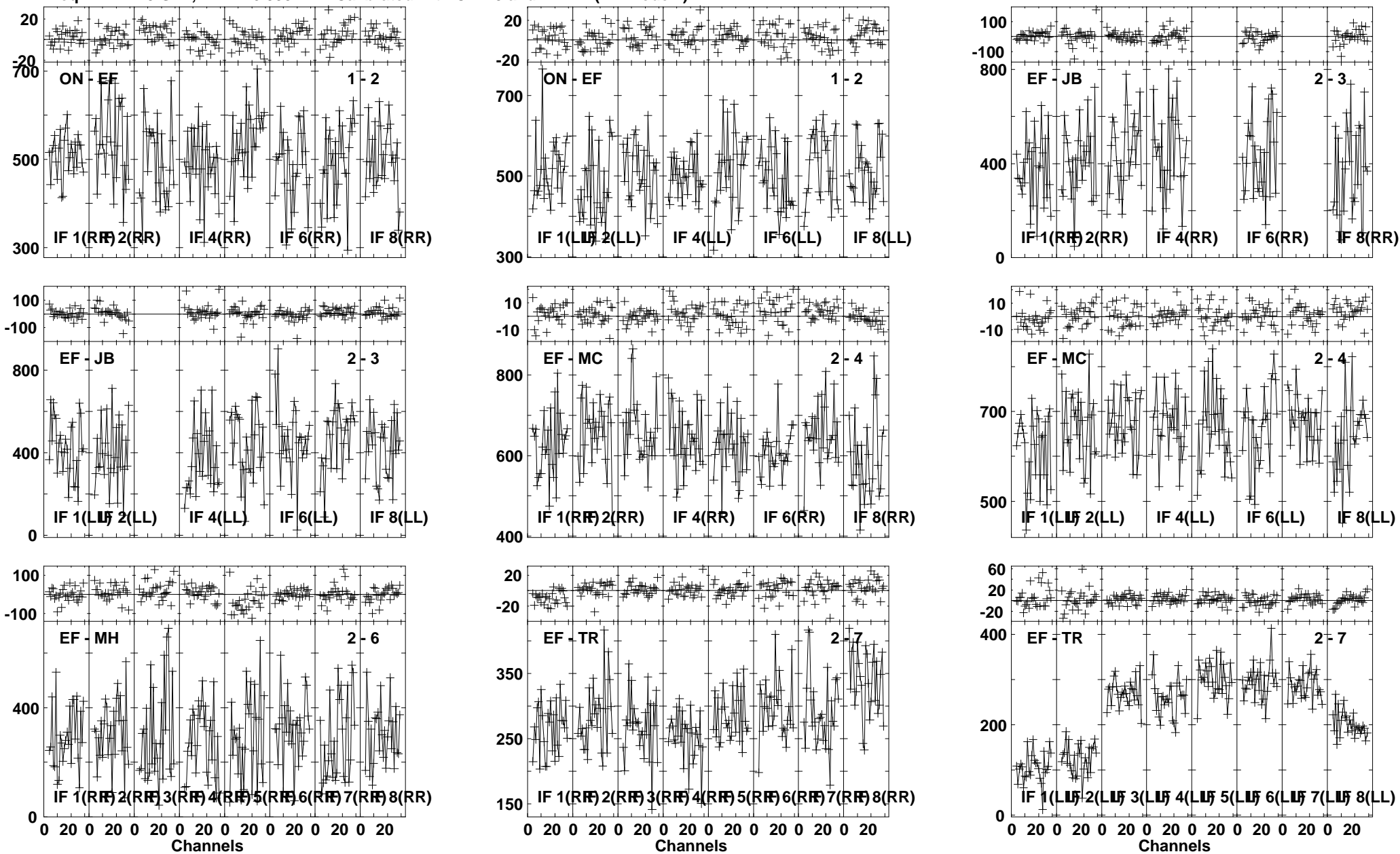

Lower frame: Milli Ampl Jy Top frame: Phas deg
 Vector averaged cross-power spectrum Several baselines displayed
 Timerange: 00/22:51:52 to 00/22:52:50

Plot file version 216 created 26-JUL-2013 10:21:39
 J1157 EZ024 1.UVDATA.1
 Freq = 22.1720 GHz, Bw = 16.000 MH Calibrated with CL # 3 and BP # 1 (BP mode 1)

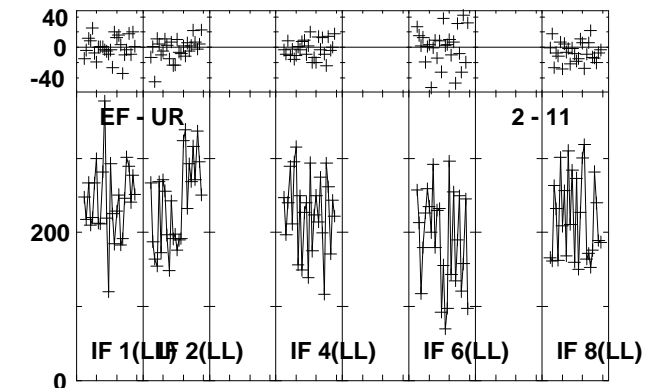
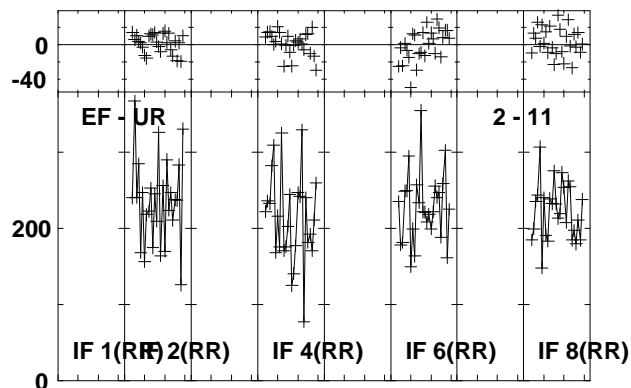
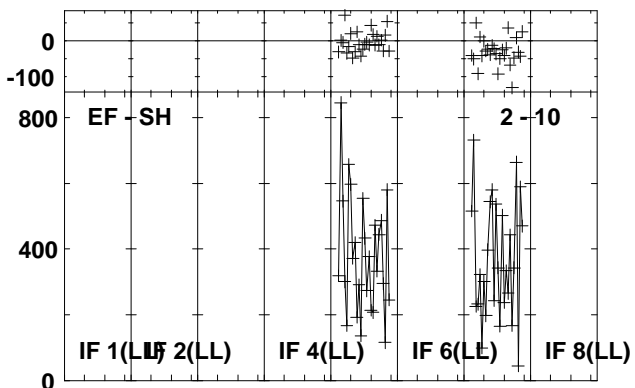
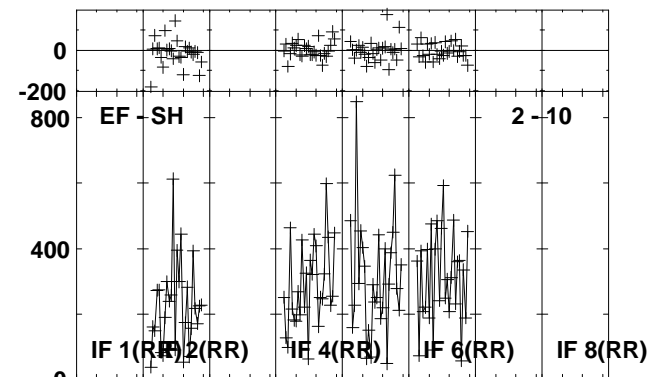
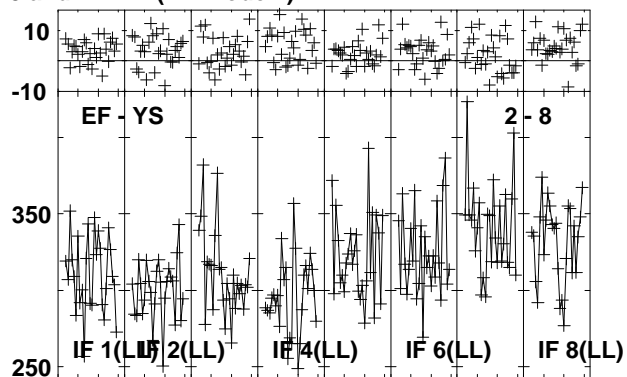
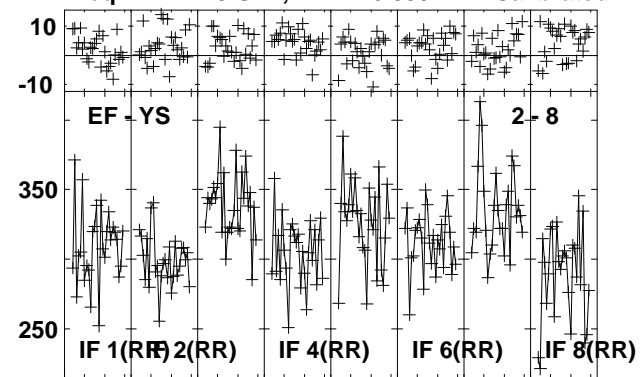

Lower frame: Milli Ampl Jy Top frame: Phas deg
 Vector averaged cross-power spectrum Several baselines displayed
 Timerange: 00/22:51:52 to 00/22:52:50

Plot file version 217 created 26-JUL-2013 10:21:40
 J1125+2610 EZ024 1.UVDATA.1
 Freq = 22.1720 GHz, Bw = 16.000 MH Calibrated with CL # 3 and BP # 1 (BP mode 1)

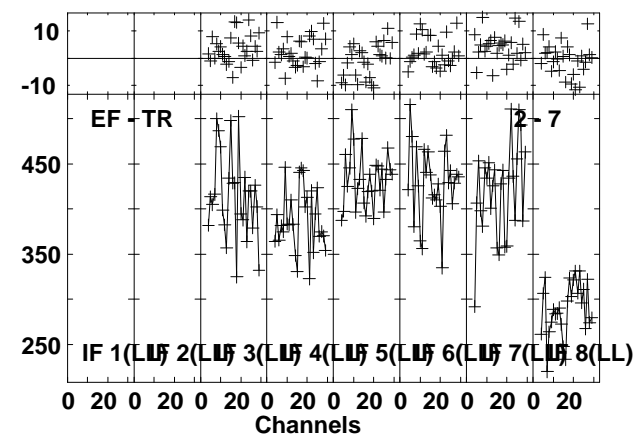
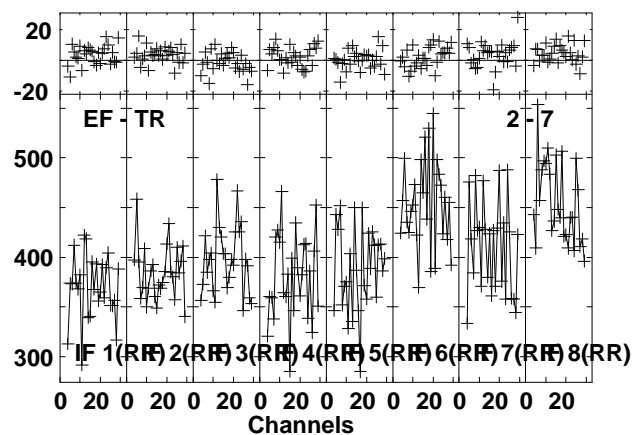
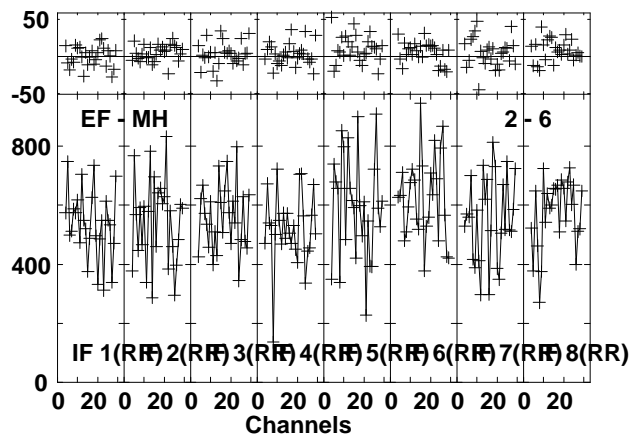
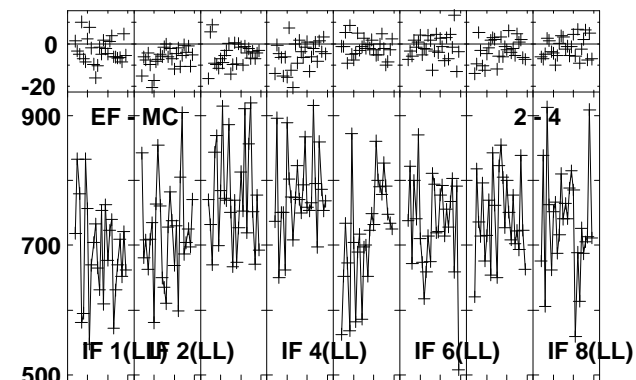
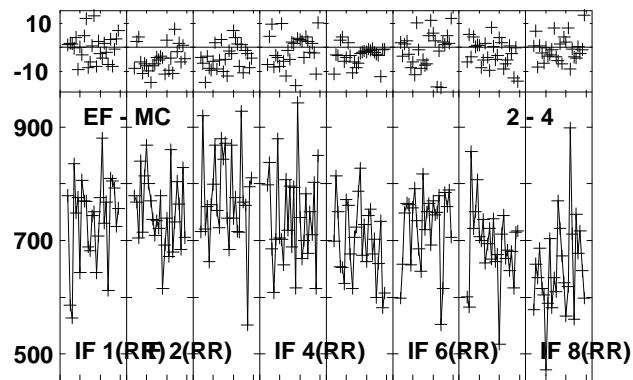
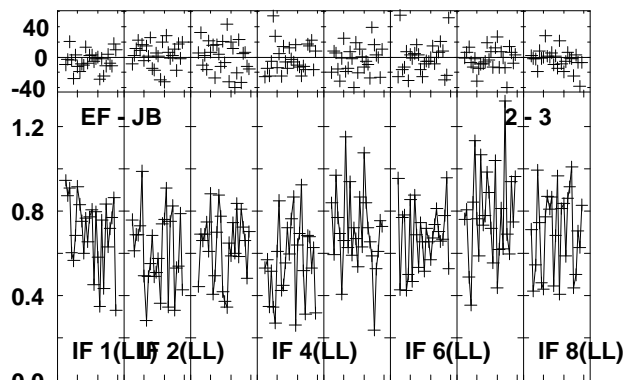
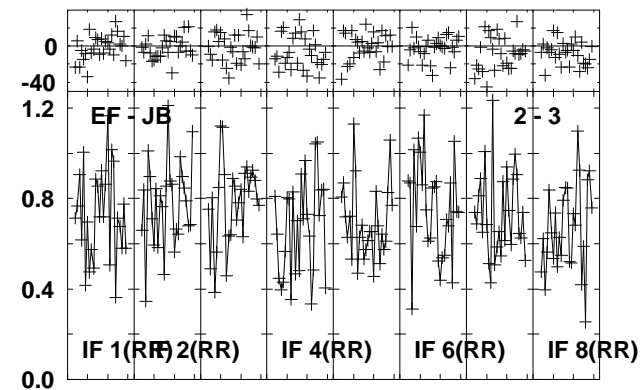
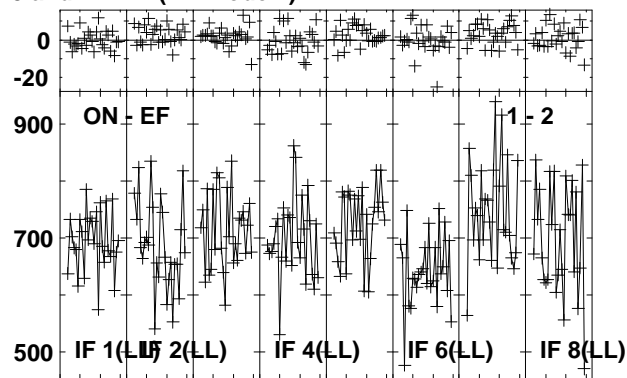
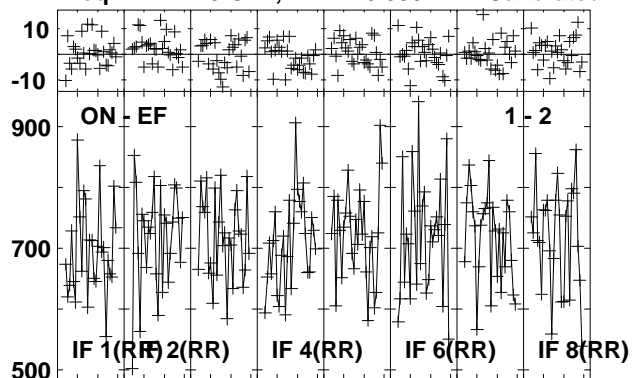

Lower frame: Milli Ampl Jy Top frame: Phas deg
 Vector averaged cross-power spectrum Several baselines displayed
 Timerange: 00/22:54:17 to 00/22:55:59

Plot file version 218 created 26-JUL-2013 10:21:41

J1125+2610 EZ024 1.UVDATA.1

Freq = 22.1720 GHz, Bw = 16.000 MH Calibrated with CL # 3 and BP # 1 (BP mode 1)

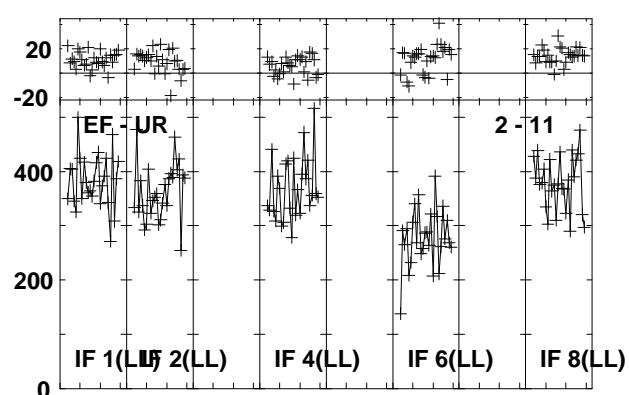
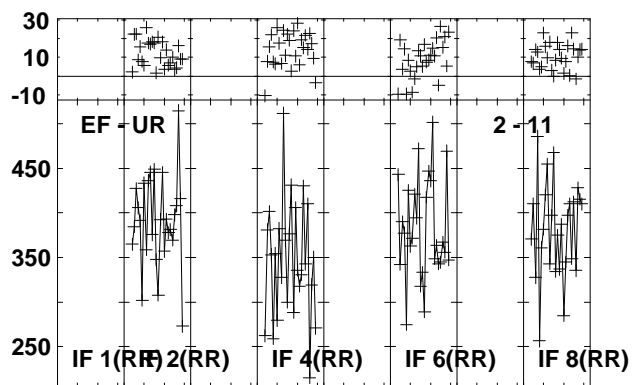
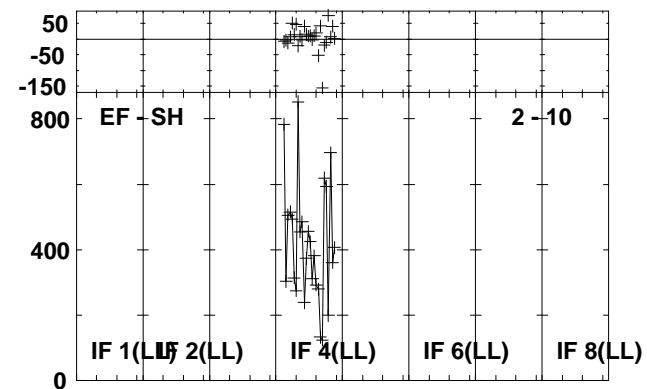
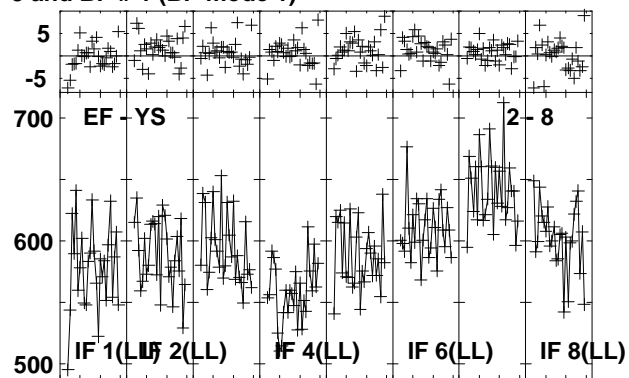
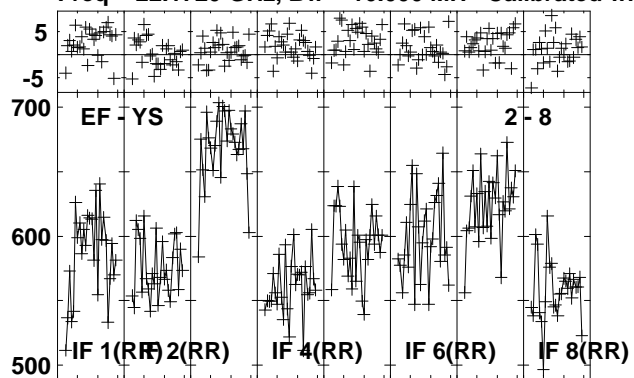

Lower frame: Milli Ampl Jy Top frame: Phas deg
Vector averaged cross-power spectrum Several baselines displayed
Timerange: 00:22:54:17 to 00:22:55:59

Plot file version 219 created 26-JUL-2013 10:21:50

J1157 EZ024 1.UVDATA.1

Freq = 22.1720 GHz, Bw = 16.000 MH Calibrated with CL # 3 and BP # 1 (BP mode 1)

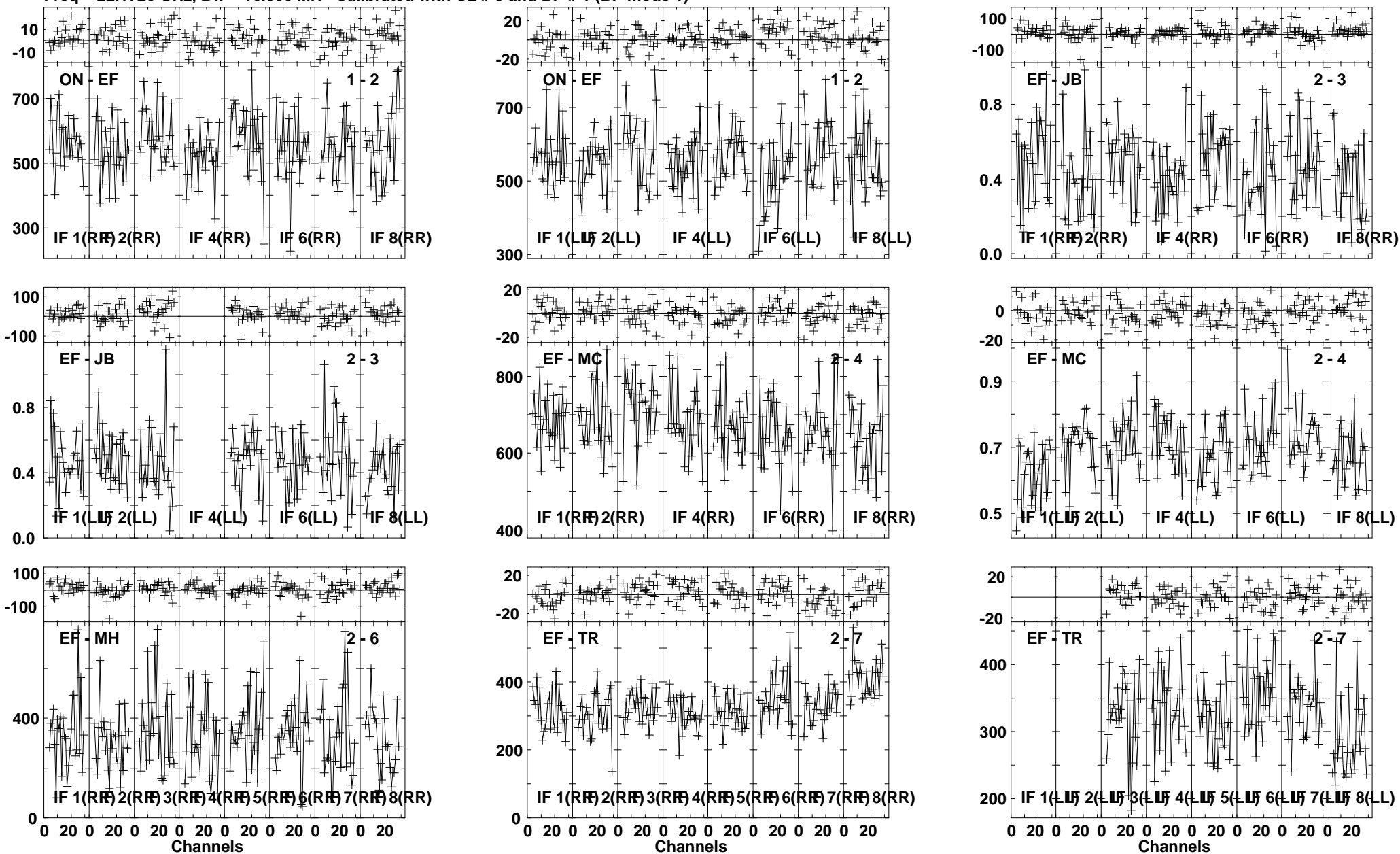

Lower frame: Milli Ampl Jy Top frame: Phas deg
Vector averaged cross-power spectrum Several baselines displayed
Timerange: 00/23:05:26 to 00/23:06:08

Plot file version 220 created 26-JUL-2013 10:21:51
 J1157 EZ024 1.UVDATA.1
 Freq = 22.1720 GHz, Bw = 16.000 MH Calibrated with CL # 3 and BP # 1 (BP mode 1)

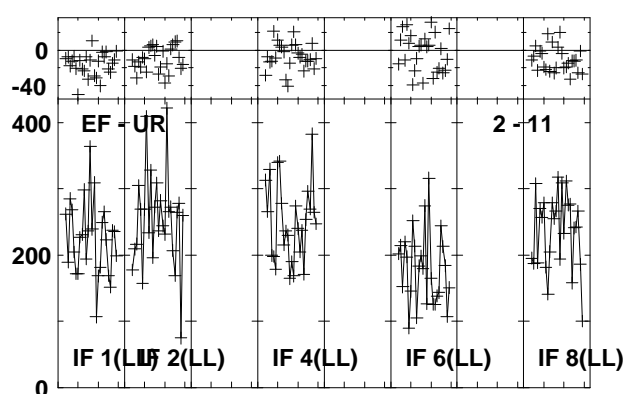
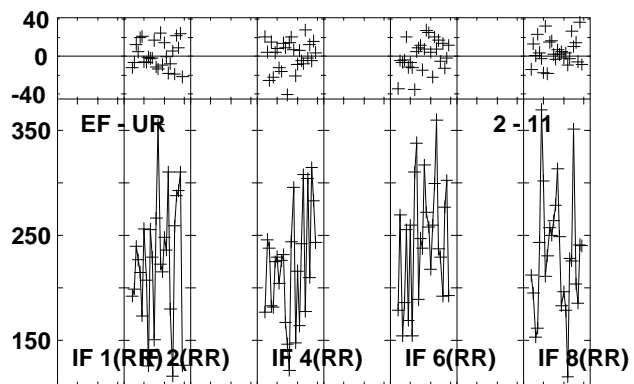
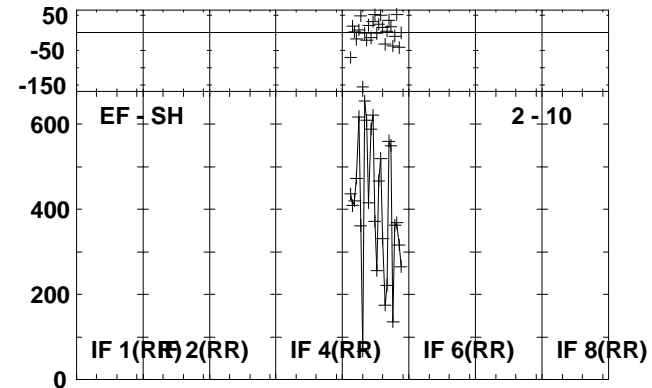
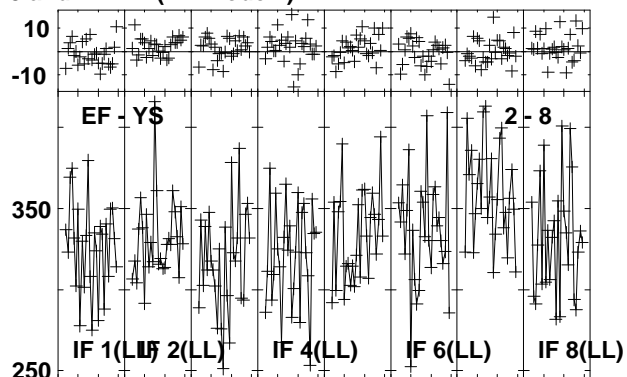
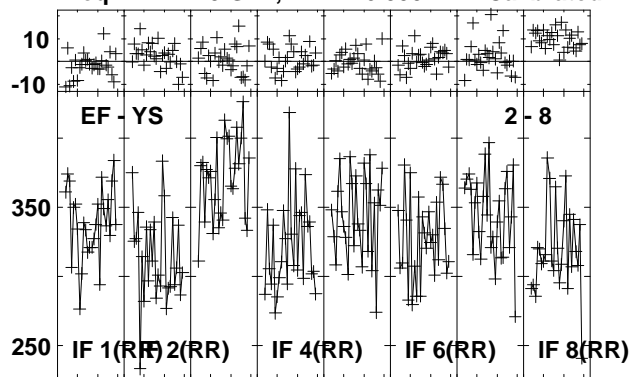

Lower frame: Milli Ampl Jy Top frame: Phas deg
 Vector averaged cross-power spectrum Several baselines displayed
 Timerange: 00/23:05:26 to 00/23:06:08

Plot file version 221 created 26-JUL-2013 10:21:52
 B1152+199A EZ24 1.UVDATA.1
 Freq = 22.1720 GHz, Bw = 16.000 MH Calibrated with CL # 3 and BP # 1 (BP mode 1)

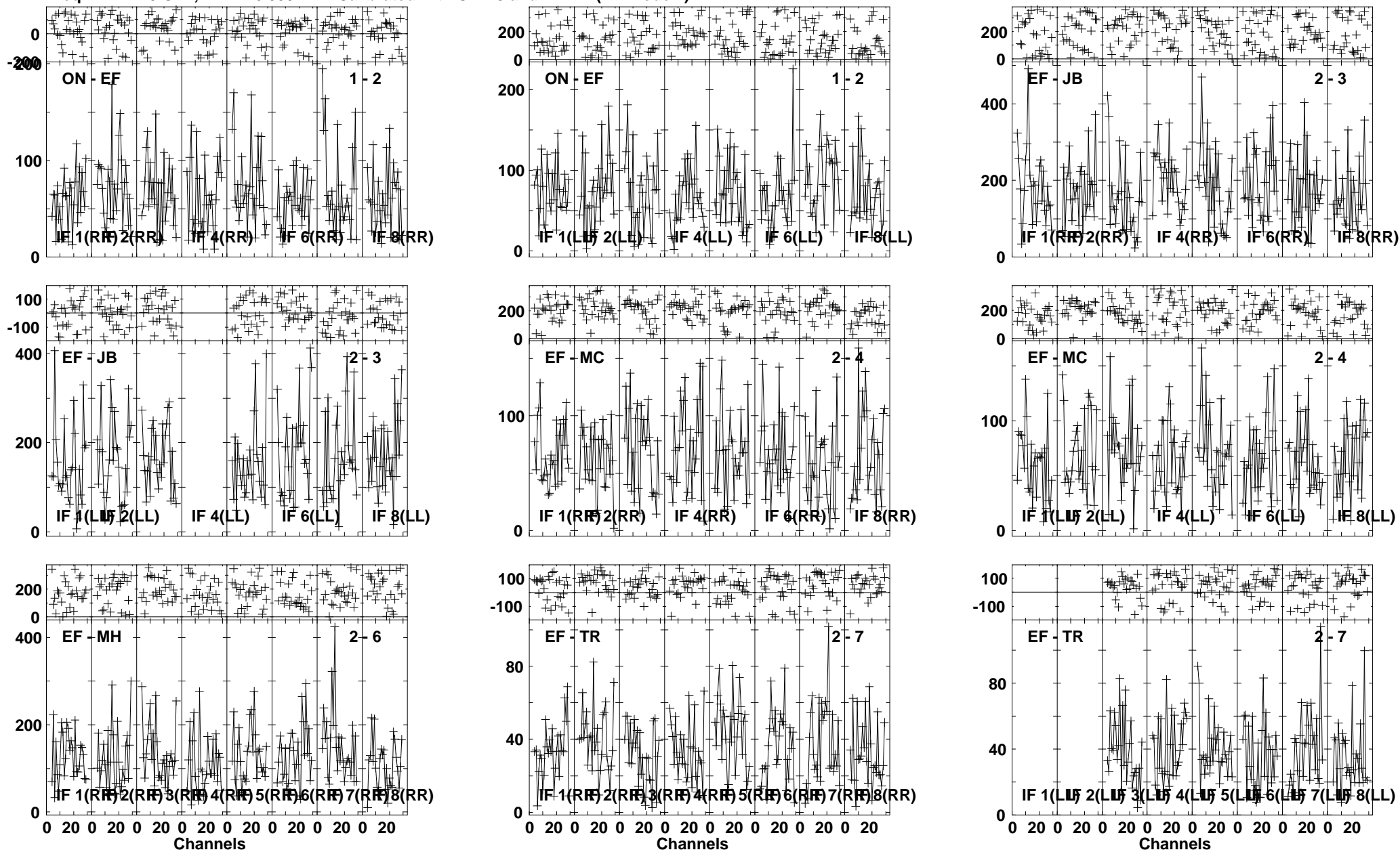

Lower frame: Milli Ampl Jy Top frame: Phas deg
 Vector averaged cross-power spectrum Several baselines displayed
 Timerange: 00/23:06:44 to 00/23:08:42

Plot file version 222 created 26-JUL-2013 10:21:53
 B1152+199A EZ024 1.UVDATA.1
 Freq = 22.1720 GHz, Bw = 16.000 MH Calibrated with CL # 3 and BP # 1 (BP mode 1)

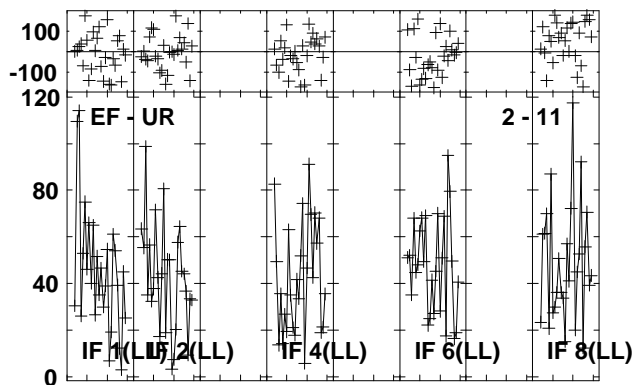
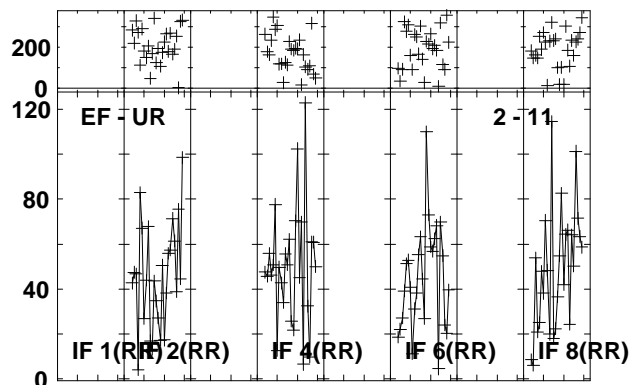
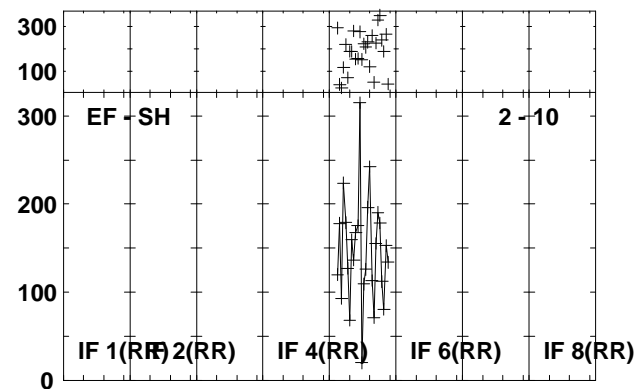
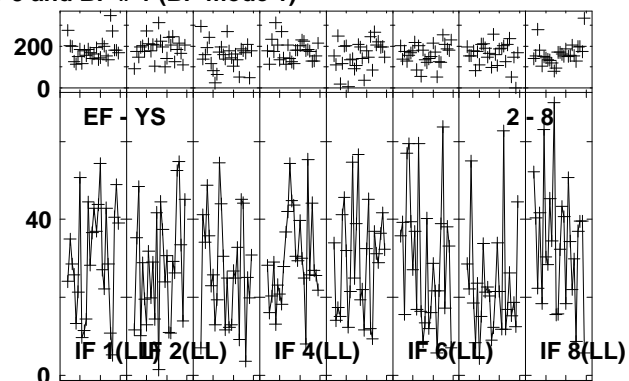
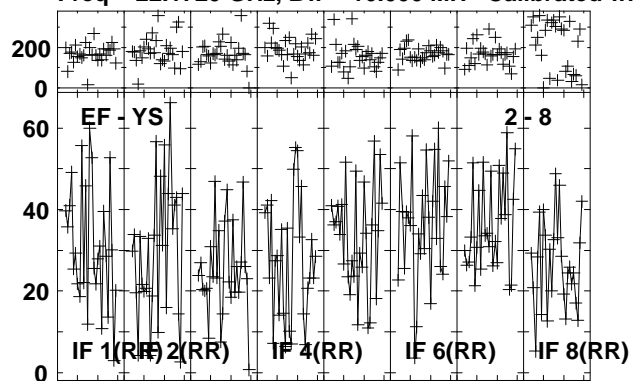

Lower frame: Milli Ampl Jy Top frame: Phas deg
 Vector averaged cross-power spectrum Several baselines displayed
 Timerange: 00/23:06:44 to 00/23:08:42

Plot file version 223 created 26-JUL-2013 10:21:55

J1157 EZ024 1.UVDATA.1

Freq = 22.1720 GHz, Bw = 16.000 MH Calibrated with CL # 3 and BP # 1 (BP mode 1)

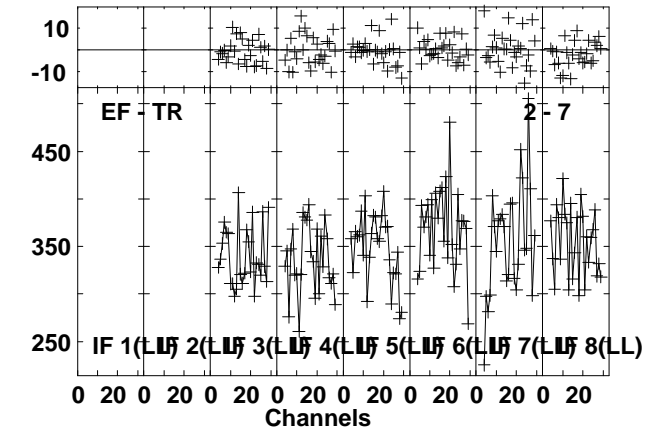
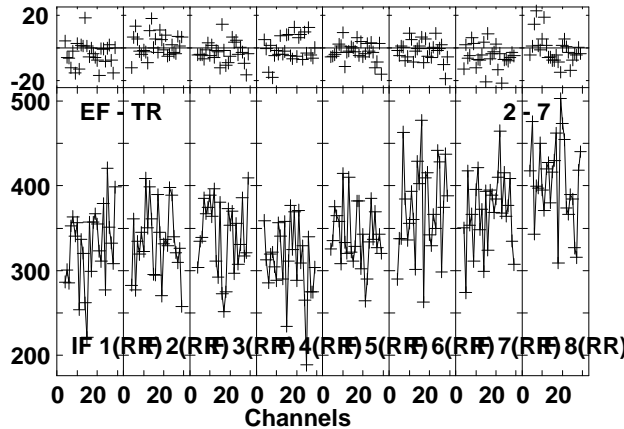
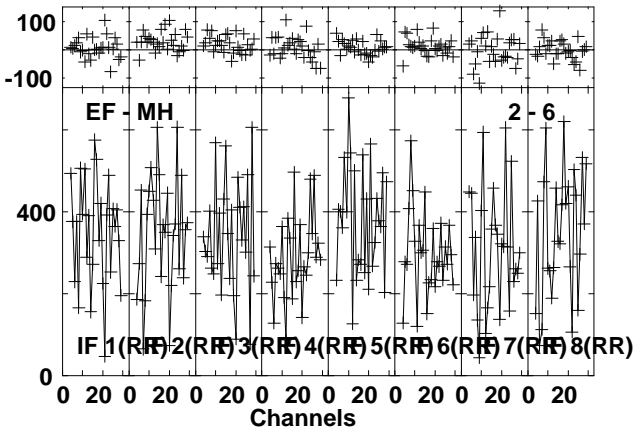
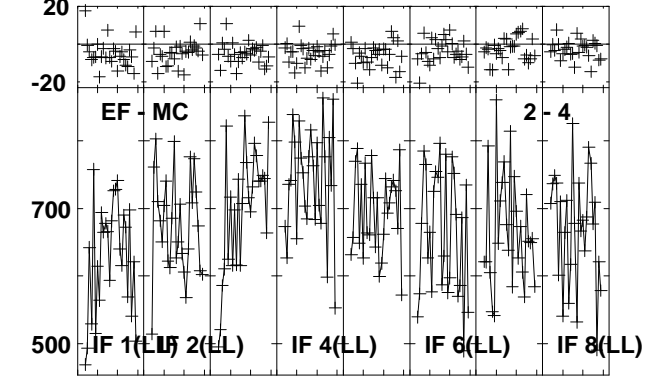
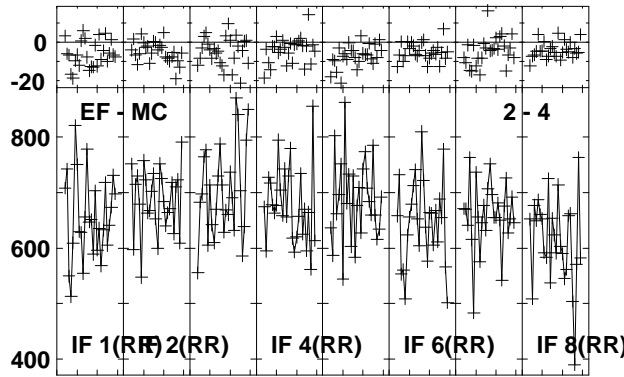
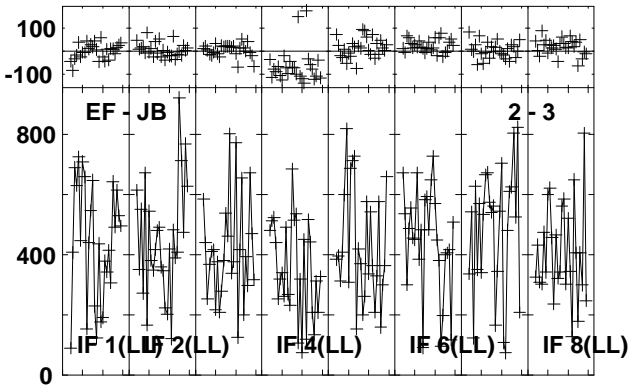
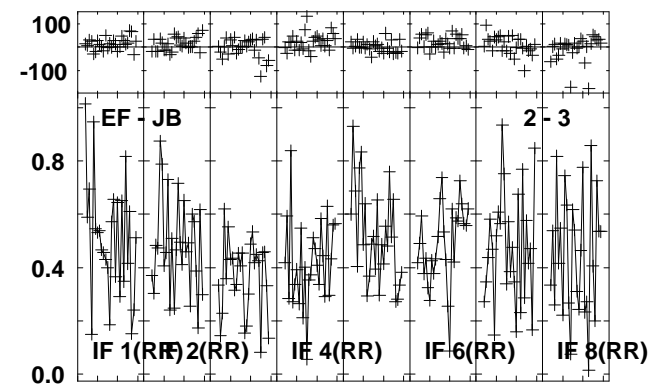
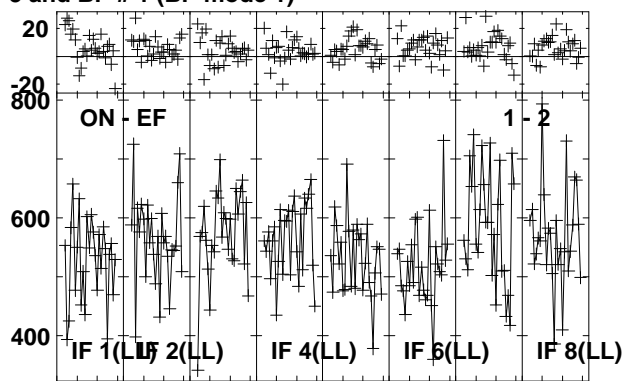
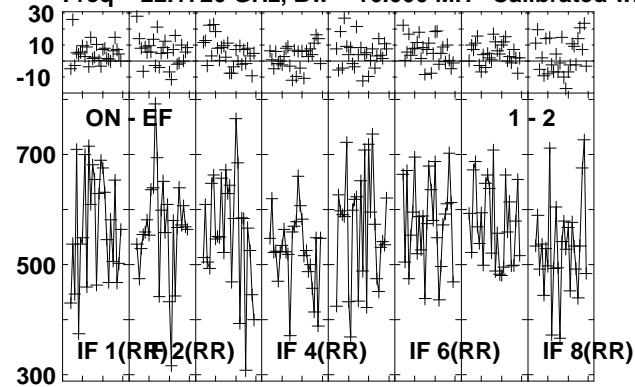

Lower frame: Milli Ampl Jy Top frame: Phas deg
Vector averaged cross-power spectrum Several baselines displayed
Timerange: 00/23:09:17 to 00/23:10:15

Plot file version 224 created 26-JUL-2013 10:21:56
 J1157 EZ024 1.UVDATA.1
 Freq = 22.1720 GHz, Bw = 16.000 MH Calibrated with CL # 3 and BP # 1 (BP mode 1)

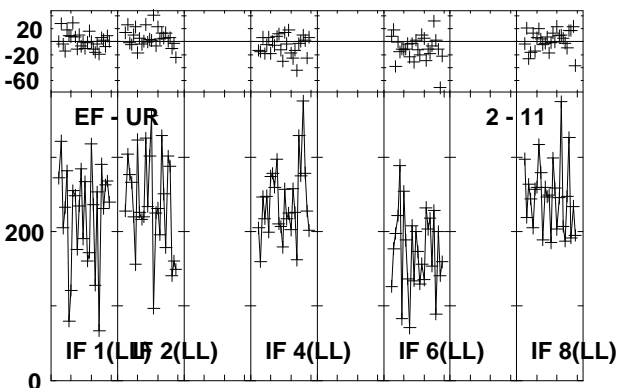
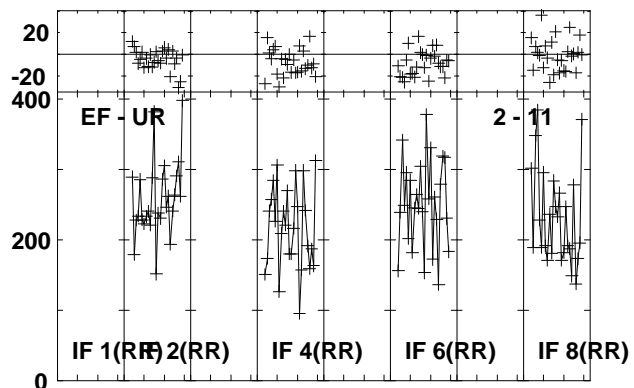
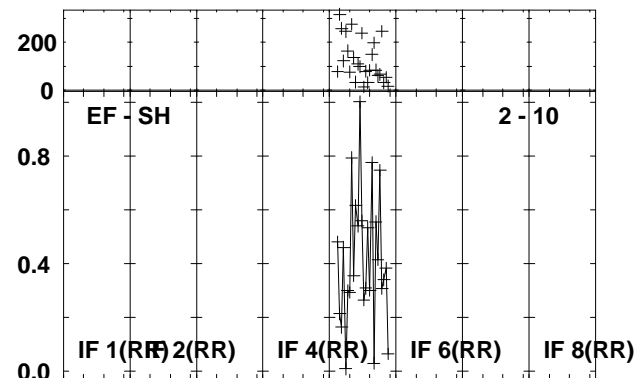
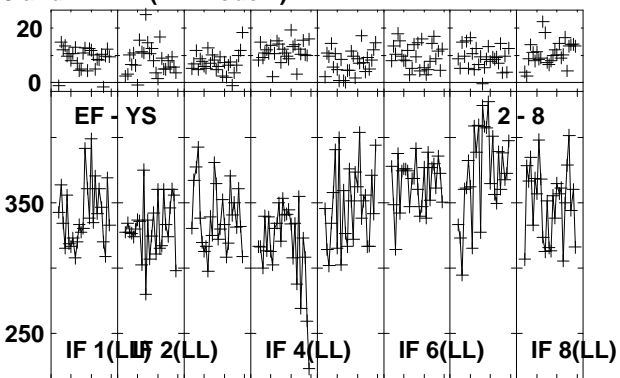
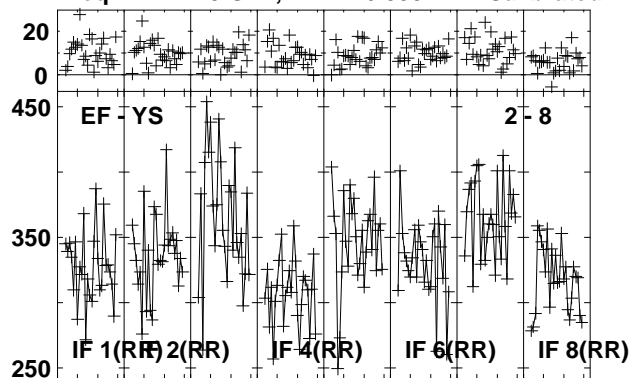

Lower frame: Milli Ampl Jy Top frame: Phas deg
 Vector averaged cross-power spectrum Several baselines displayed
 Timerange: 00/23:09:17 to 00/23:10:15

Plot file version 225 created 26-JUL-2013 10:21:57
 B1152+199A EZ024 1.UVDATA.1
 Freq = 22.1720 GHz, Bw = 16.000 MH Calibrated with CL # 3 and BP # 1 (BP mode 1)

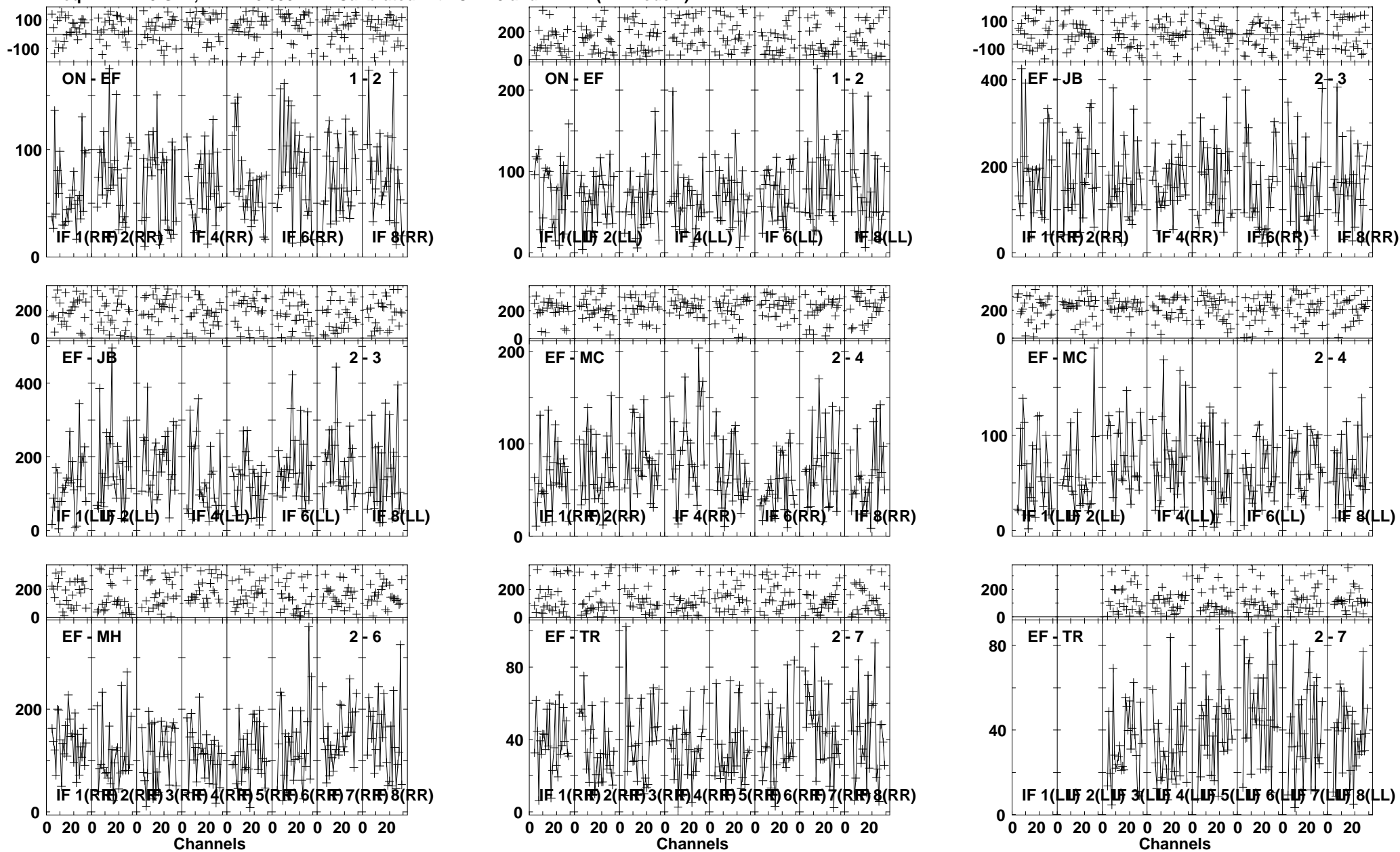

Lower frame: Milli Ampl Jy Top frame: Phas deg
 Vector averaged cross-power spectrum Several baselines displayed
 Timerange: 00/23:10:50 to 00/23:12:48

Plot file version 226 created 26-JUL-2013 10:21:58
 B1152+199A EZ024 1.UVDATA.1
 Freq = 22.1720 GHz, Bw = 16.000 MH Calibrated with CL # 3 and BP # 1 (BP mode 1)

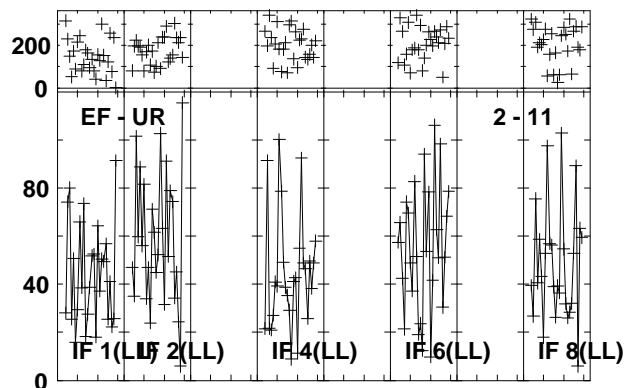
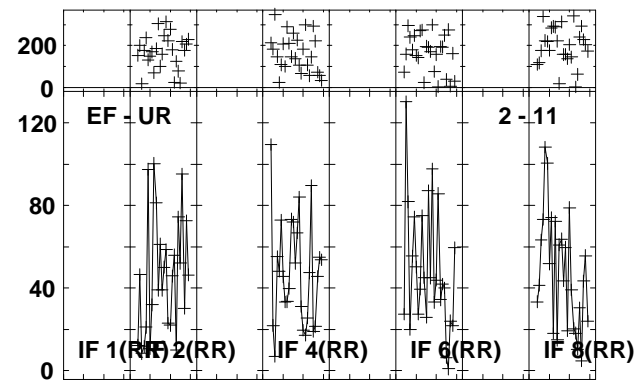
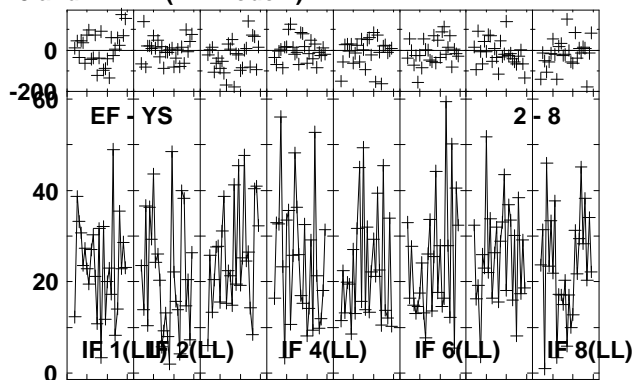
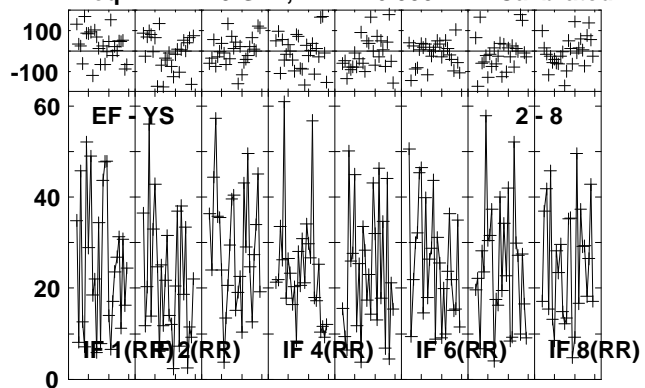

Lower frame: Milli Ampl Jy Top frame: Phas deg
 Vector averaged cross-power spectrum Several baselines displayed
 Timerange: 00/23:10:50 to 00/23:12:48

Plot file version 227 created 26-JUL-2013 10:22:00
 J1157 EZ024 1.UVDATA.1
 Freq = 22.1720 GHz, Bw = 16.000 MH Calibrated with CL # 3 and BP # 1 (BP mode 1)

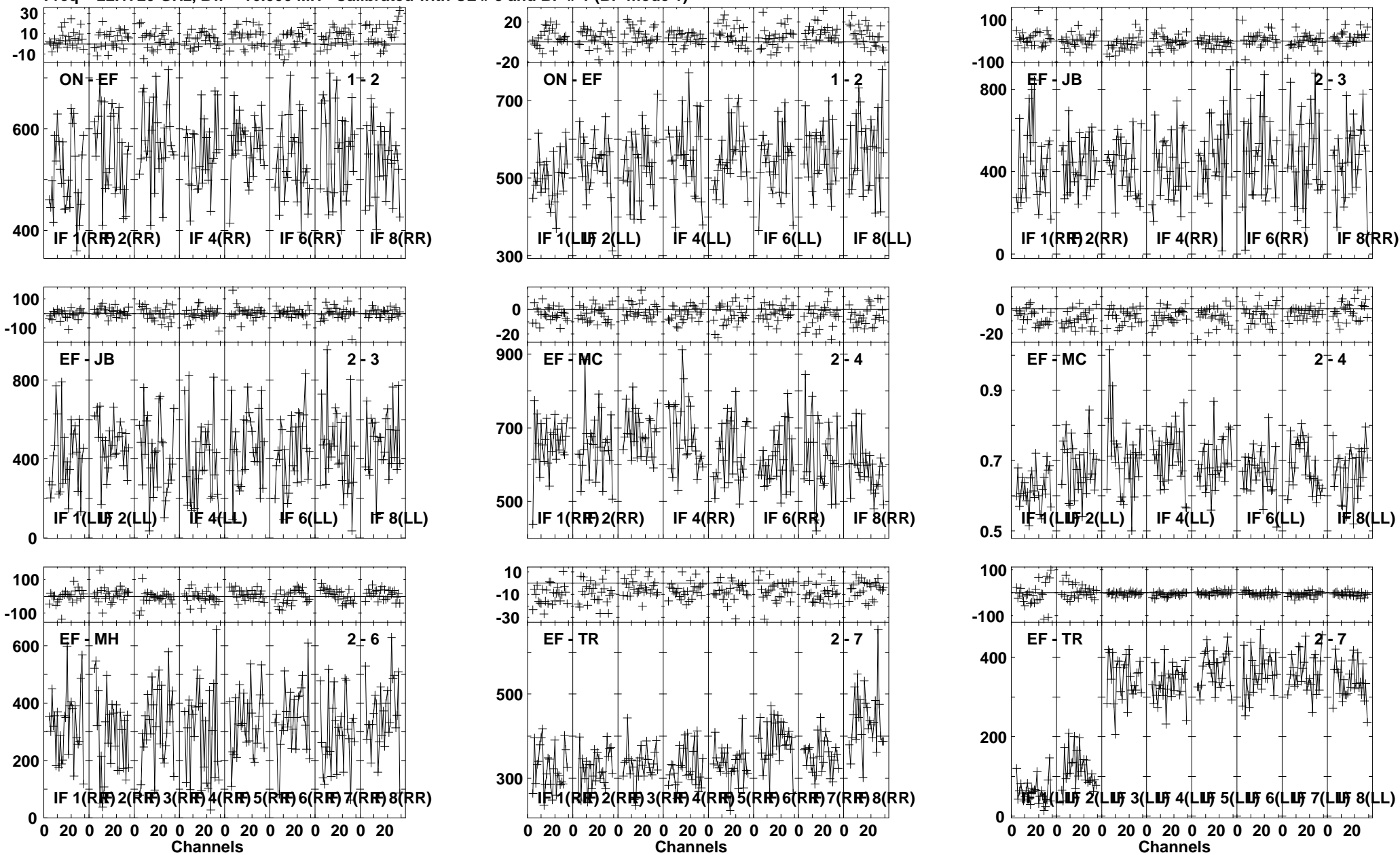

Lower frame: Milli Ampl Jy Top frame: Phas deg
 Vector averaged cross-power spectrum Several baselines displayed
 Timerange: 00/23:13:23 to 00/23:14:21

Plot file version 228 created 26-JUL-2013 10:22:01
 J1157 EZ024 1.UVDATA.1
 Freq = 22.1720 GHz, Bw = 16.000 MH Calibrated with CL # 3 and BP # 1 (BP mode 1)

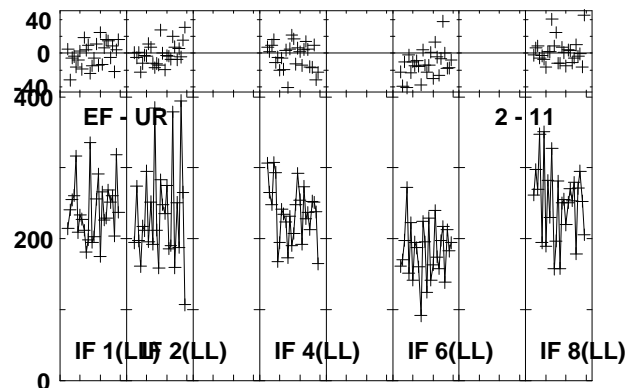
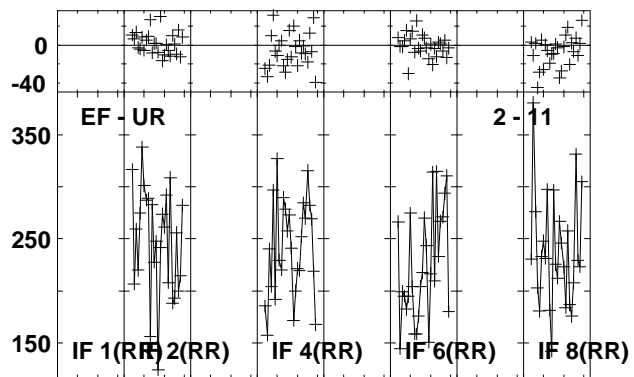
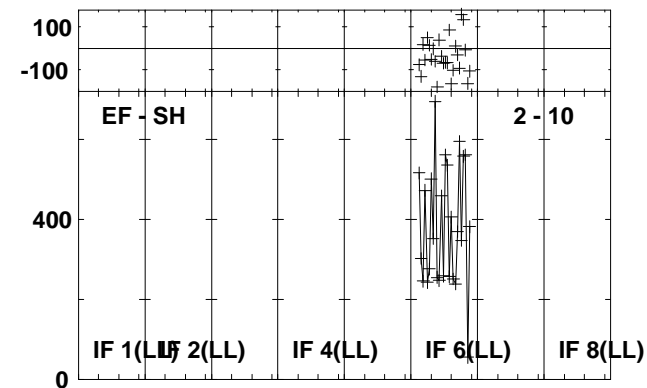
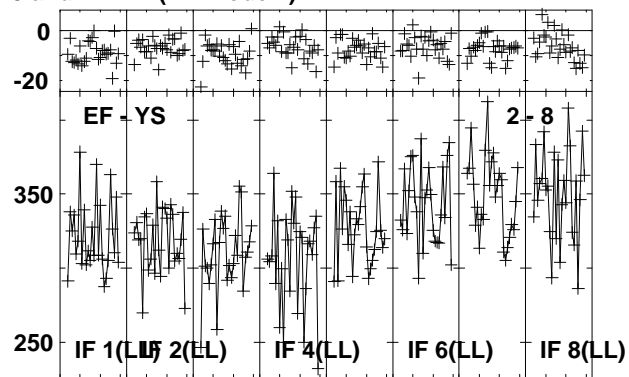
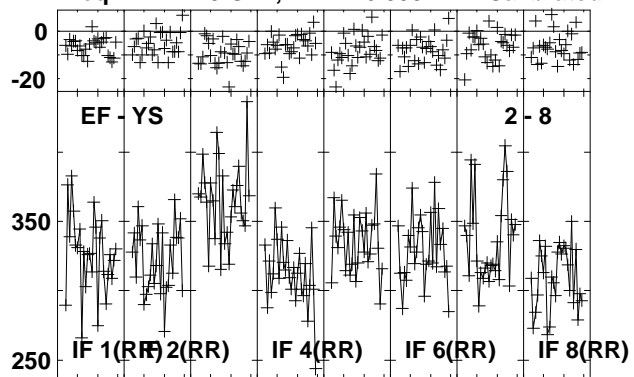

Lower frame: Milli Ampl Jy Top frame: Phas deg
 Vector averaged cross-power spectrum Several baselines displayed
 Timerange: 00/23:13:23 to 00/23:14:21

Plot file version 229 created 26-JUL-2013 10:22:02
 B1152+199A EZ024 1.UVDATA.1
 Freq = 22.1720 GHz, Bw = 16.000 MH Calibrated with CL # 3 and BP # 1 (BP mode 1)

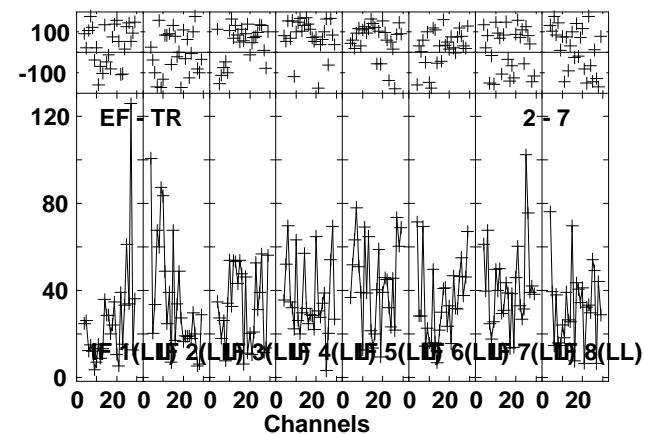
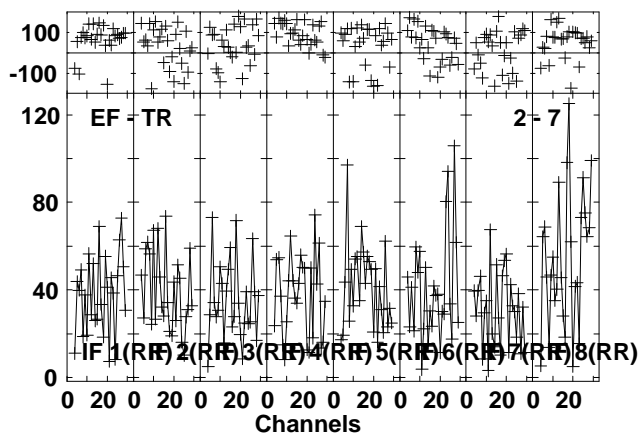
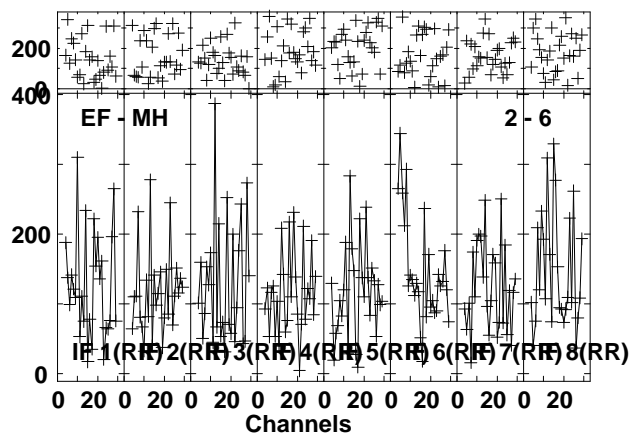
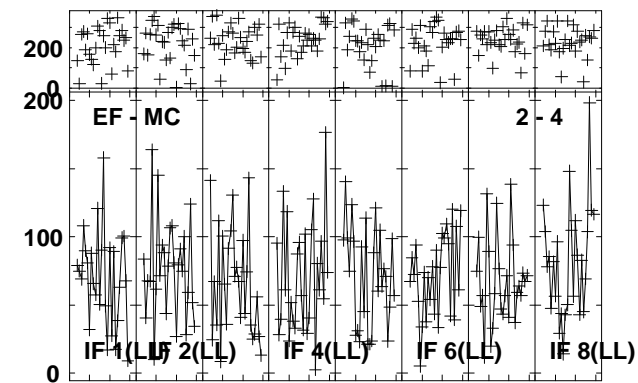
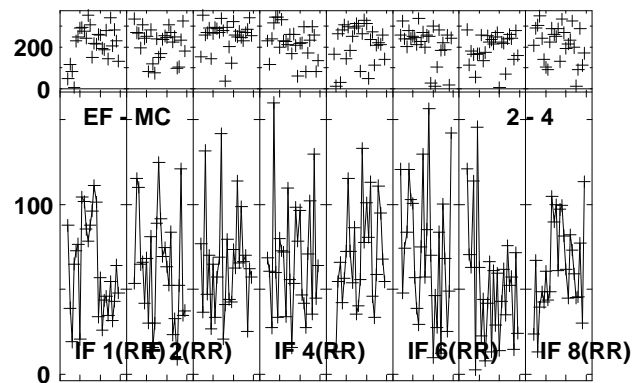
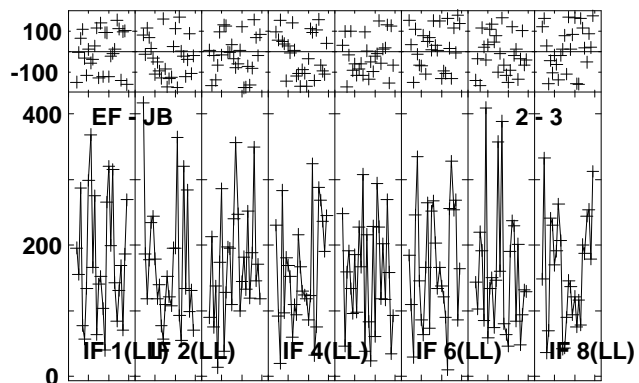
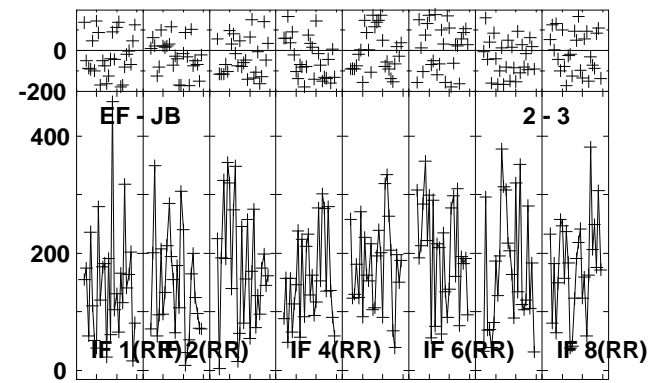
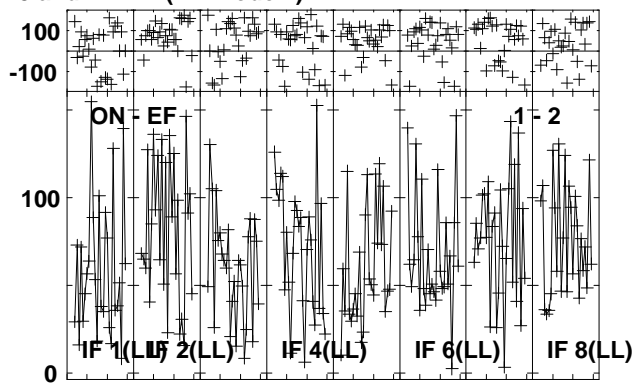
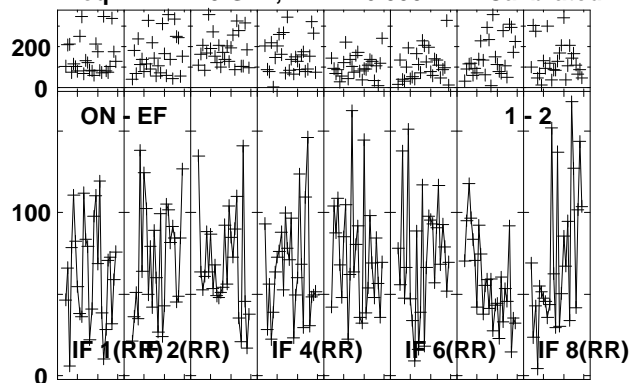

Lower frame: Milli Ampl Jy Top frame: Phas deg
 Vector averaged cross-power spectrum Several baselines displayed
 Timerange: 00/23:14:57 to 00/23:16:55

Plot file version 230 created 26-JUL-2013 10:22:03
 B1152+199A EZ024 1.UVDATA.1
 Freq = 22.1720 GHz, Bw = 16.000 MH Calibrated with CL # 3 and BP # 1 (BP mode 1)

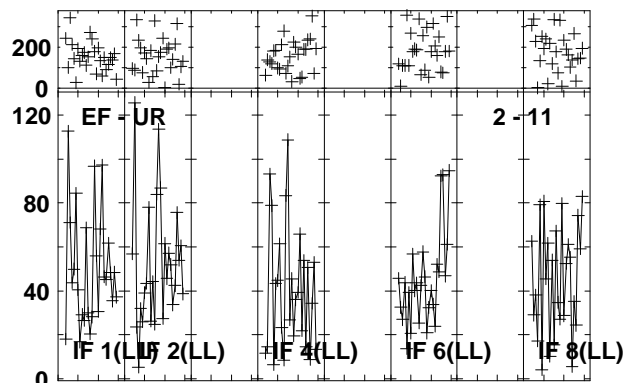
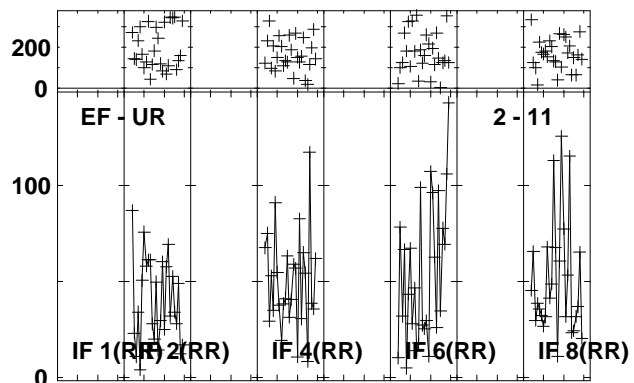
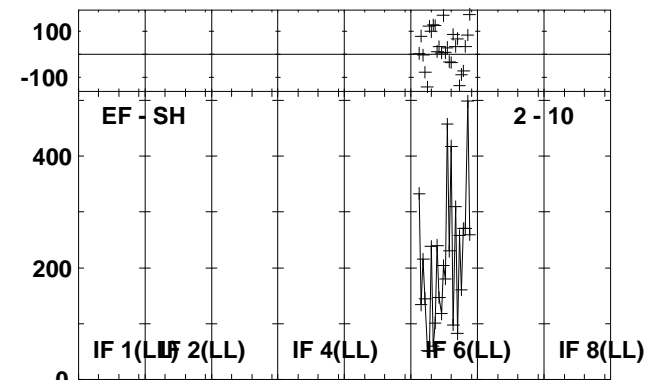
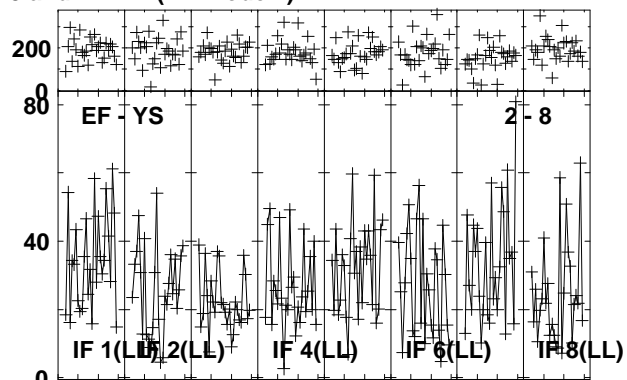
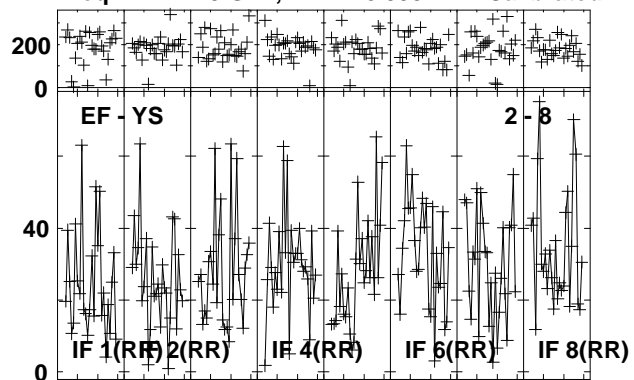

Lower frame: Milli Ampl Jy Top frame: Phas deg
 Vector averaged cross-power spectrum Several baselines displayed
 Timerange: 00/23:14:57 to 00/23:16:55

Plot file version 231 created 26-JUL-2013 10:22:05
 J1157 EZ024 1.UVDATA.1
 Freq = 22.1720 GHz, Bw = 16.000 MH Calibrated with CL # 3 and BP # 1 (BP mode 1)

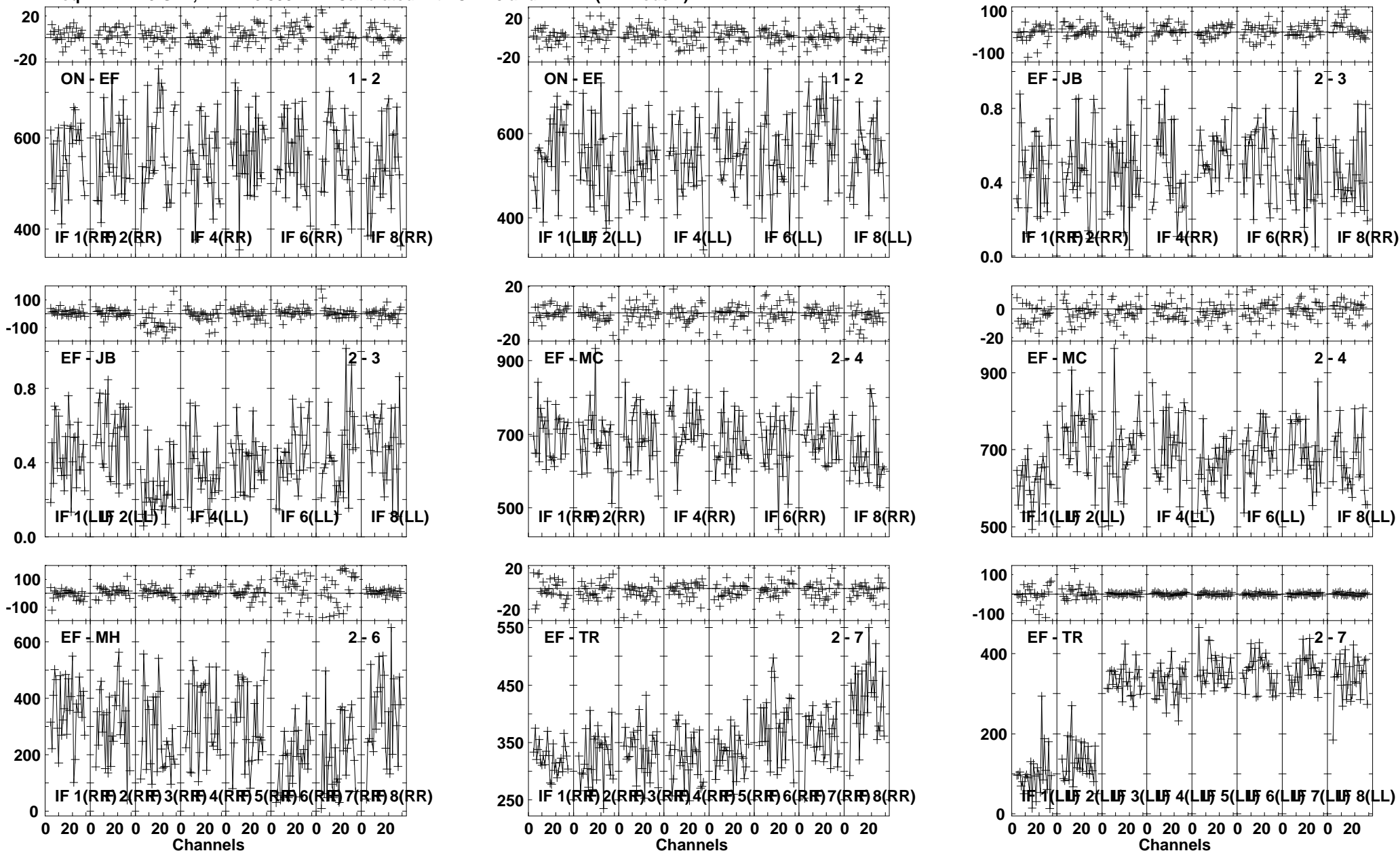

Lower frame: Milli Ampl Jy Top frame: Phas deg
 Vector averaged cross-power spectrum Several baselines displayed
 Timerange: 00/23:17:30 to 00/23:18:28

Plot file version 232 created 26-JUL-2013 10:22:06
 J1157 EZ024 1.UVDATA.1
 Freq = 22.1720 GHz, Bw = 16.000 MH Calibrated with CL # 3 and BP # 1 (BP mode 1)

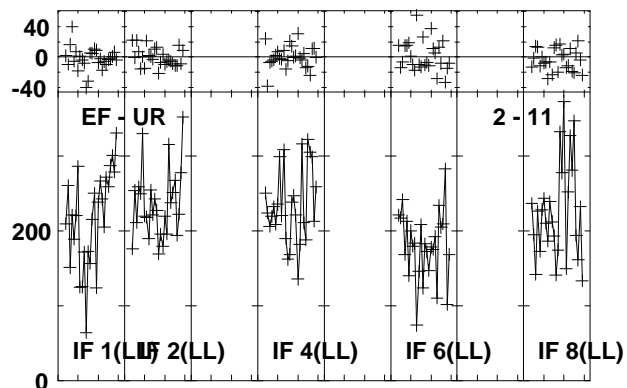
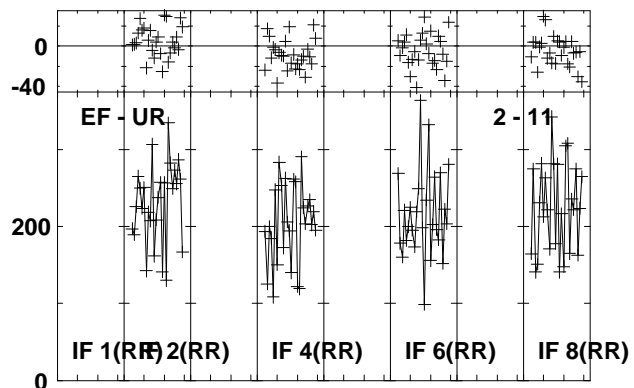
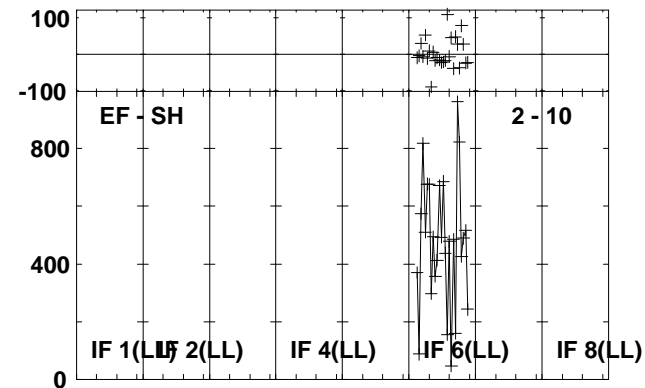
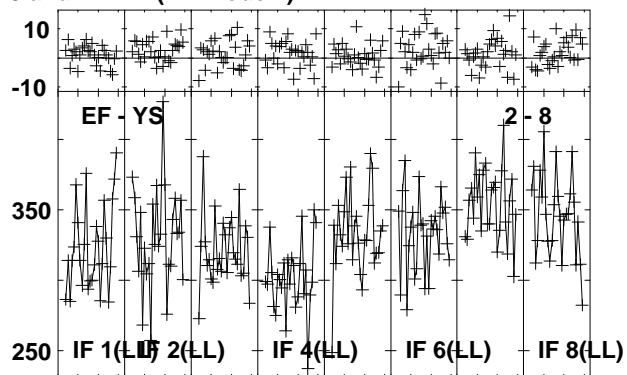
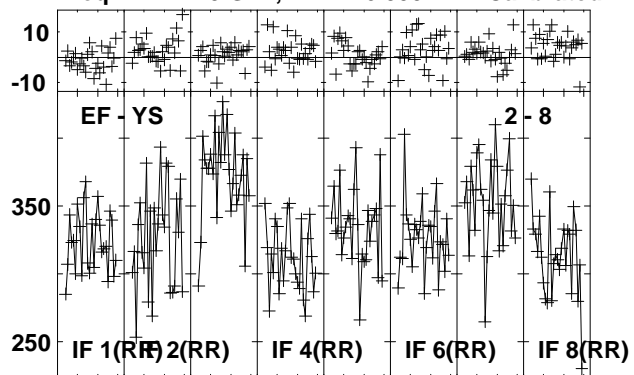

Lower frame: Milli Ampl Jy Top frame: Phas deg
 Vector averaged cross-power spectrum Several baselines displayed
 Timerange: 00/23:17:30 to 00/23:18:28

Plot file version 233 created 26-JUL-2013 10:22:06
 J1157 EZ024 1.UVDATA.1
 Freq = 22.1720 GHz, Bw = 16.000 MH Calibrated with CL # 3 and BP # 1 (BP mode 1)

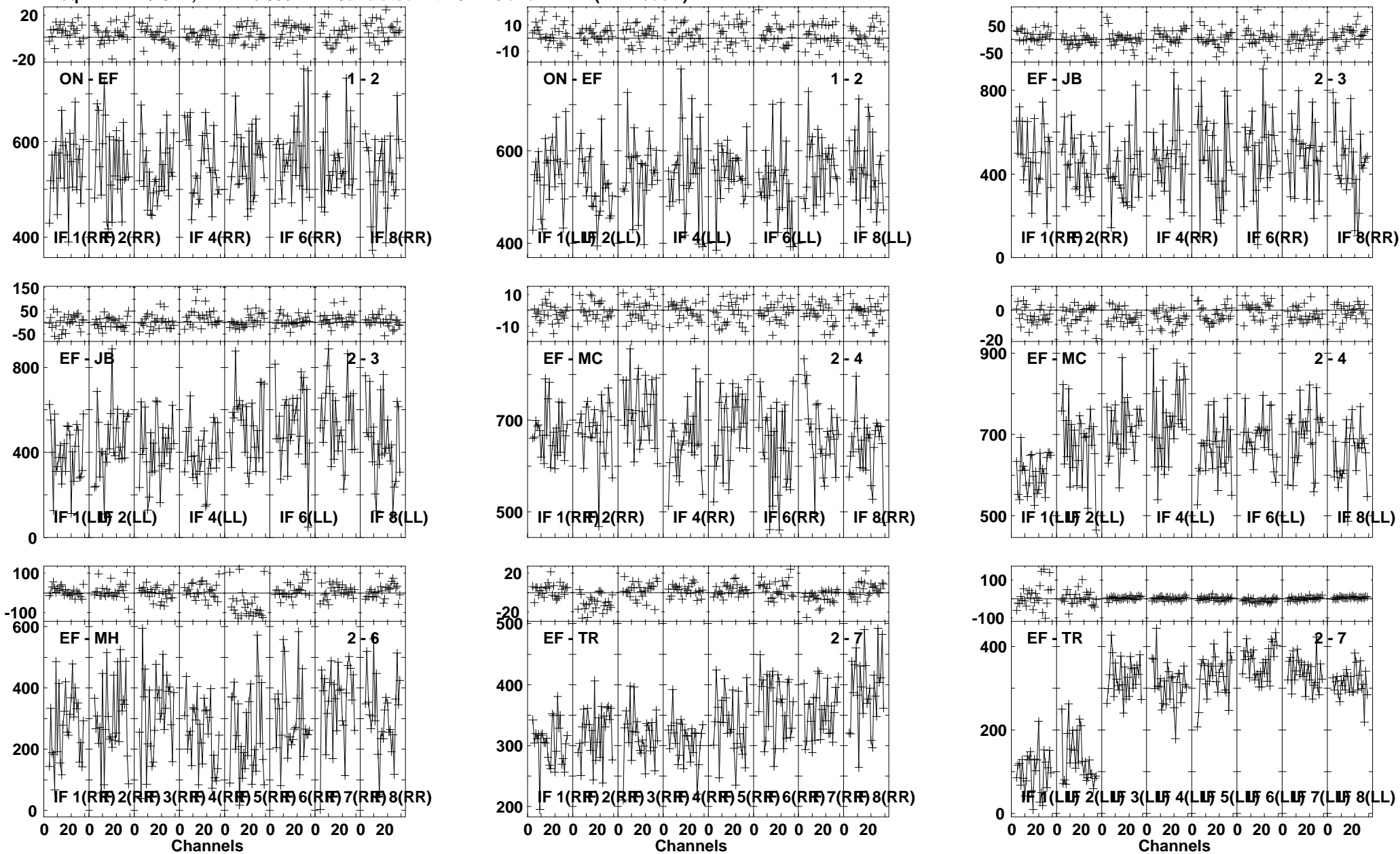

Lower frame: Milli Ampl Jy Top frame: Phas deg
 Vector averaged cross-power spectrum Several baselines displayed
 Timerange: 00/23:18:50 to 00/23:19:48

Plot file version 234 created 26-JUL-2013 10:22:07
 J1157 EZ024 1.UVDATA.1
 Freq = 22.1720 GHz, Bw = 16.000 MH Calibrated with CL # 3 and BP # 1 (BP mode 1)

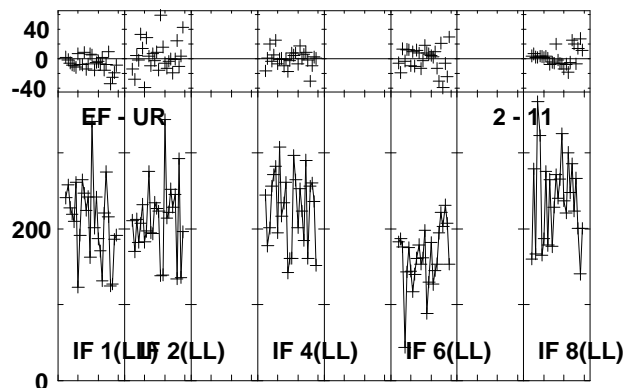
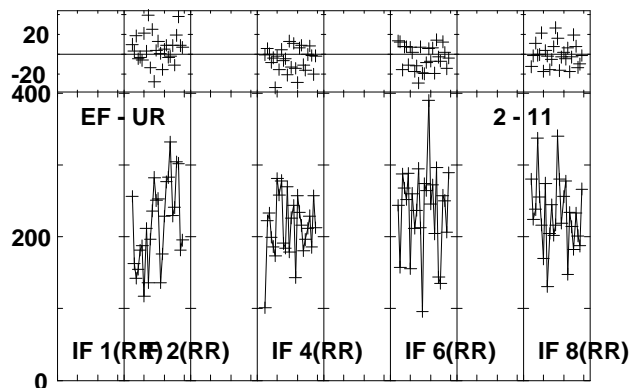
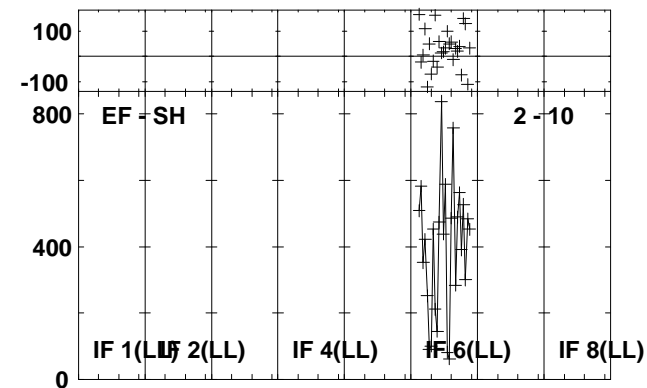
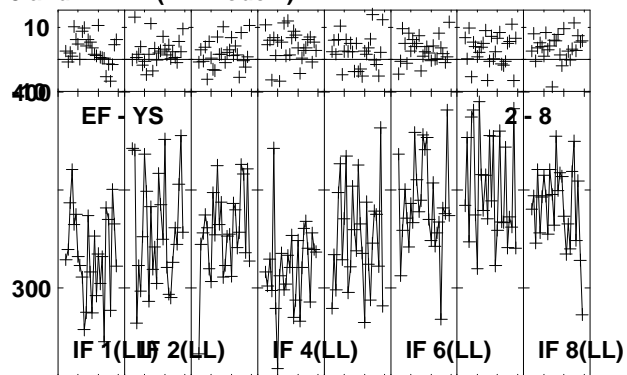
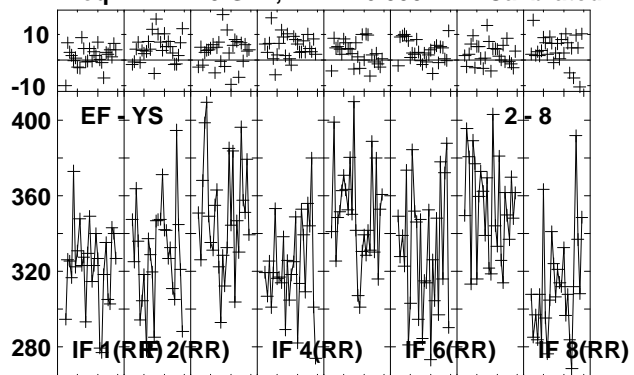

Lower frame: Milli Ampl Jy Top frame: Phas deg
 Vector averaged cross-power spectrum Several baselines displayed
 Timerange: 00/23:18:50 to 00/23:19:48

Plot file version 235 created 26-JUL-2013 10:22:08
 J1125+2610 EZ024 1.UVDATA.1
 Freq = 22.1720 GHz, Bw = 16.000 MH Calibrated with CL # 3 and BP # 1 (BP mode 1)

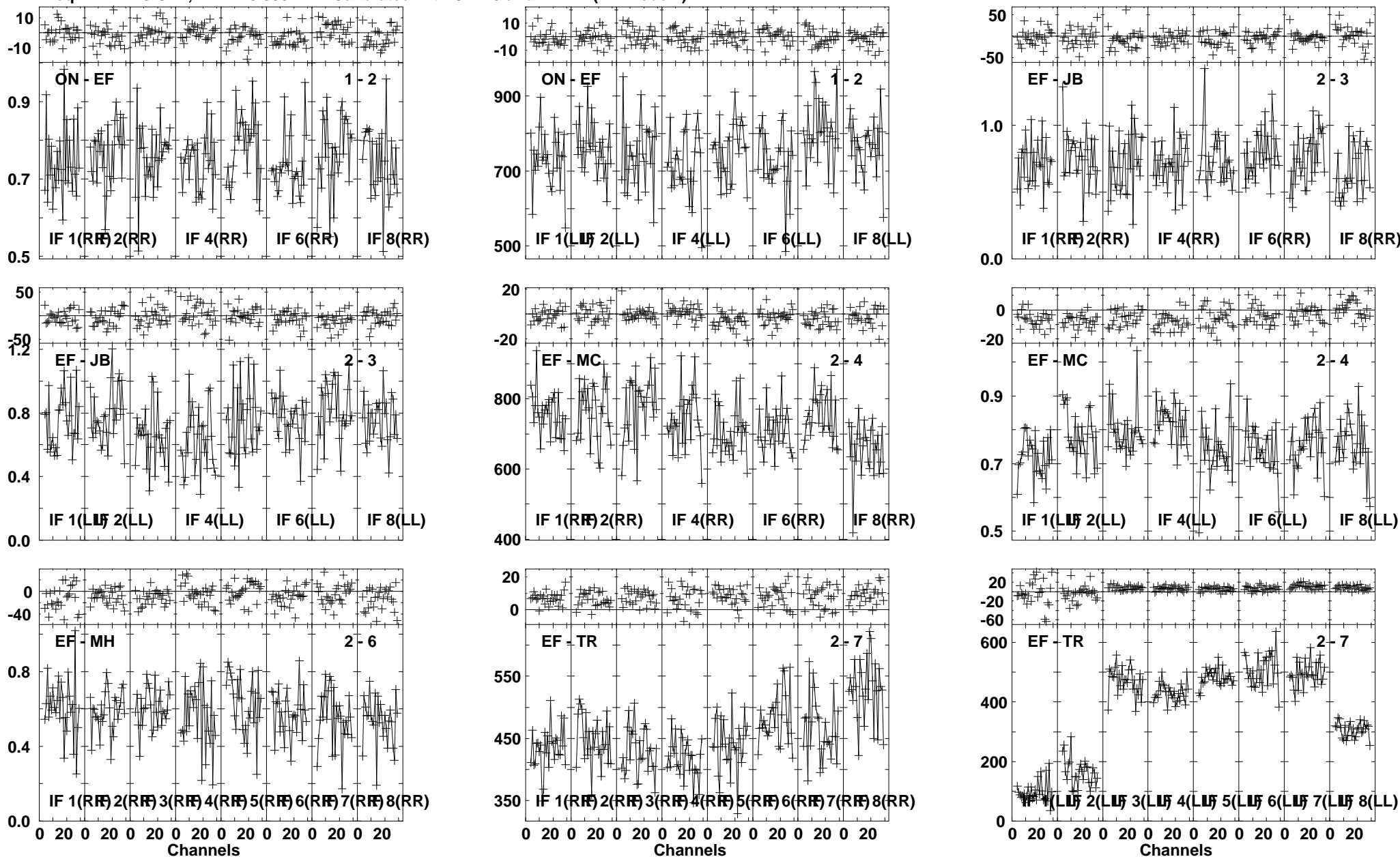

Lower frame: Ampl Jy Top frame: Phas deg
 Vector averaged cross-power spectrum Several baselines displayed
 Timerange: 00/23:21:14 to 00/23:22:26

Plot file version 236 created 26-JUL-2013 10:22:09
 J1125+2610 EZ024 1.UVDATA.1
 Freq = 22.1720 GHz, Bw = 16.000 MH Calibrated with CL # 3 and BP # 1 (BP mode 1)

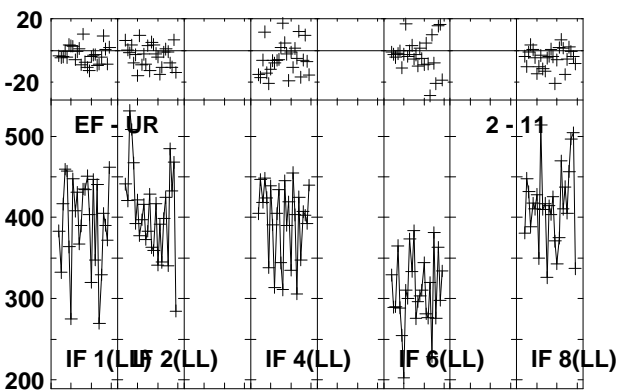
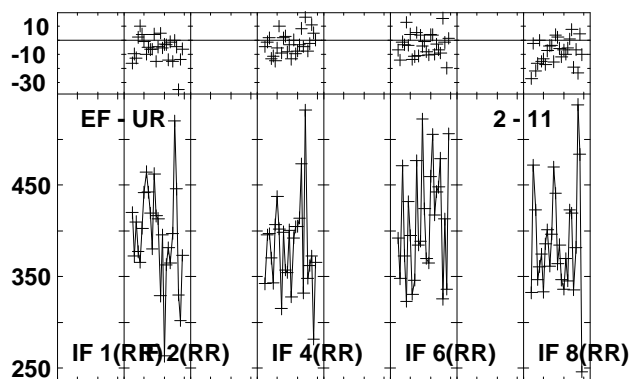
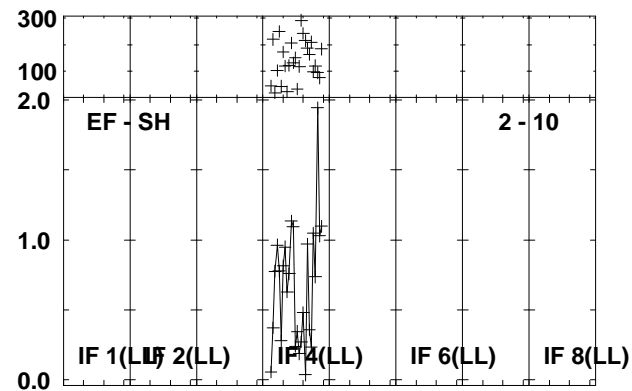
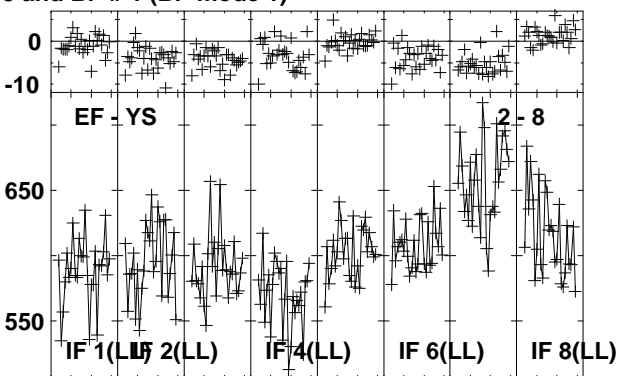
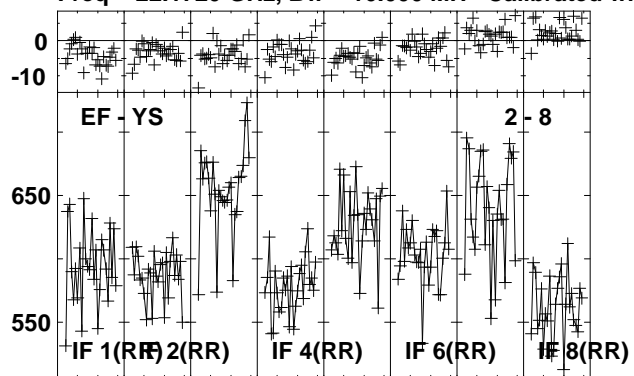

Lower frame: Milli Ampl Jy Top frame: Phas deg
 Vector averaged cross-power spectrum Several baselines displayed
 Timerange: 00/23:21:14 to 00/23:22:26

Plot file version 237 created 26-JUL-2013 10:22:10

J1157 EZ024 1.UVDATA.1

Freq = 22.1720 GHz, Bw = 16.000 MH Calibrated with CL # 3 and BP # 1 (BP mode 1)

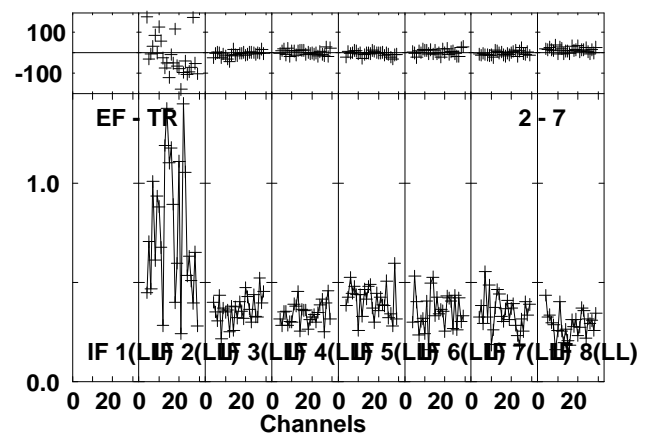
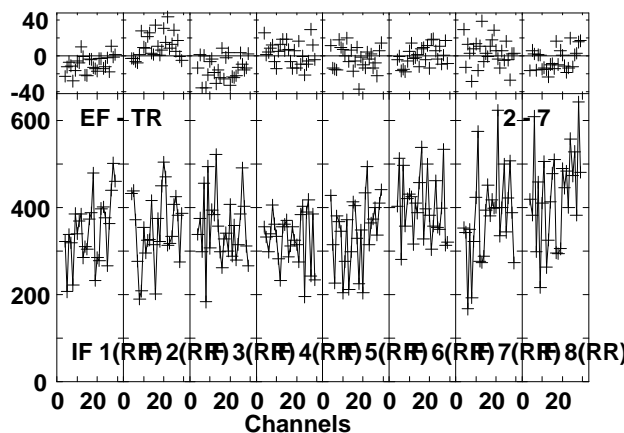
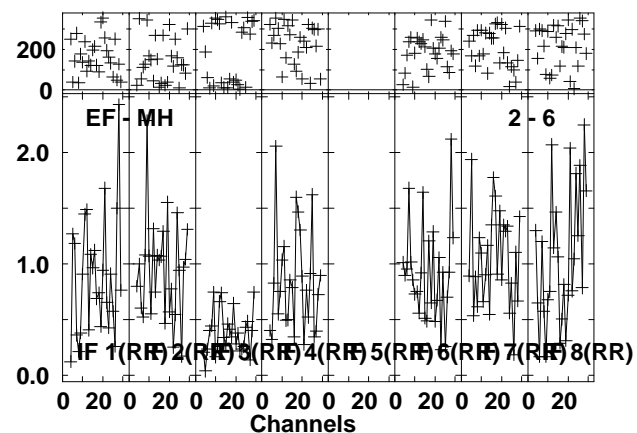
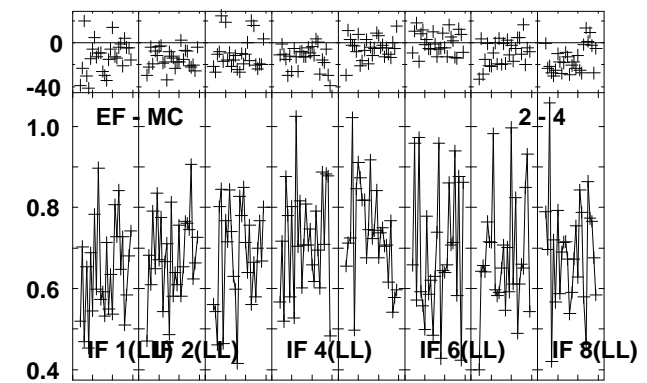
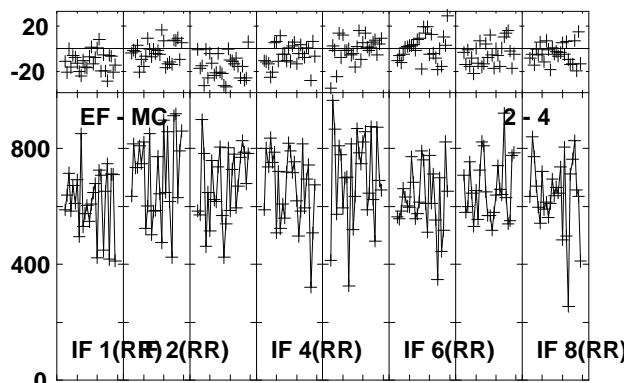
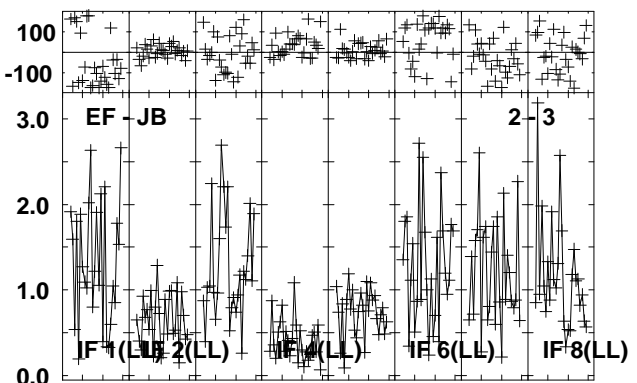
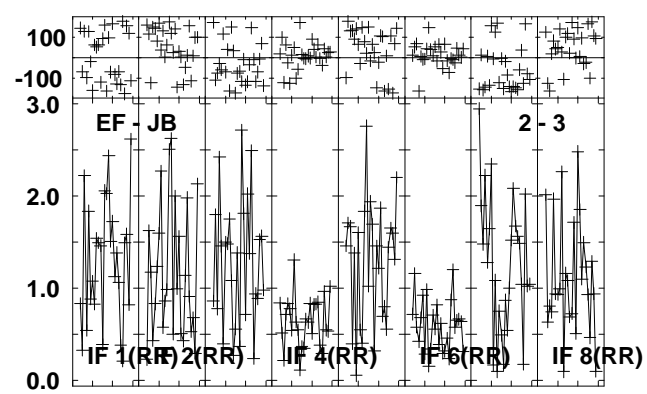
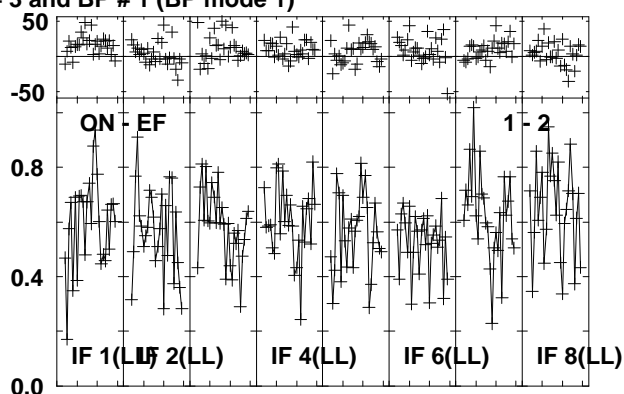
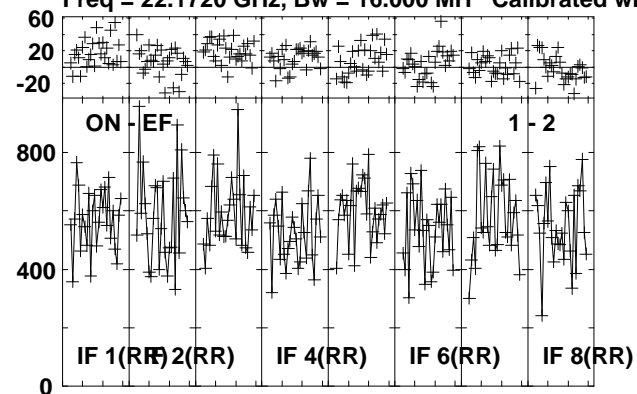

Lower frame: Milli Ampl Jy Top frame: Phas deg
Vector averaged cross-power spectrum Several baselines displayed
Timerange: 00/23:23:51 to 00/23:24:33

Plot file version 238 created 26-JUL-2013 10:22:11

J1157 EZ024 1.UVDATA.1

Freq = 22.1720 GHz, Bw = 16.000 MH Calibrated with CL # 3 and BP # 1 (BP mode 1)

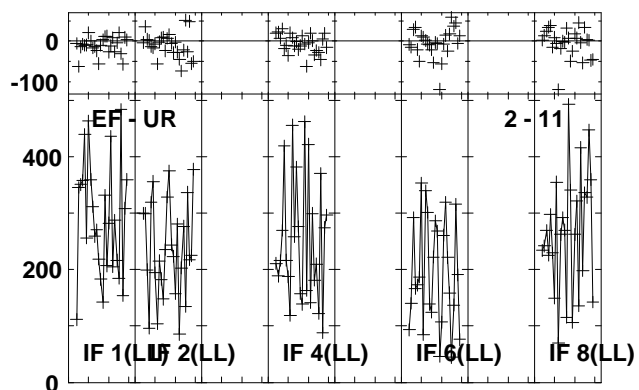
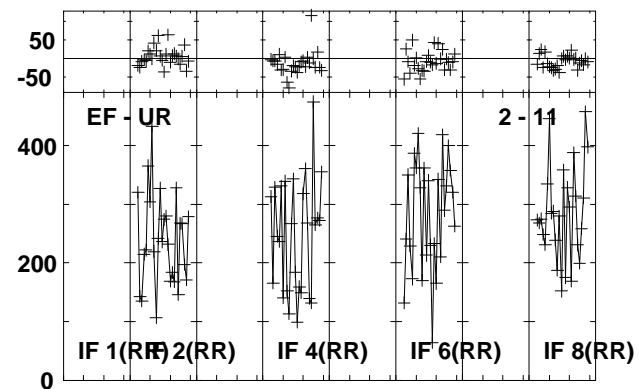
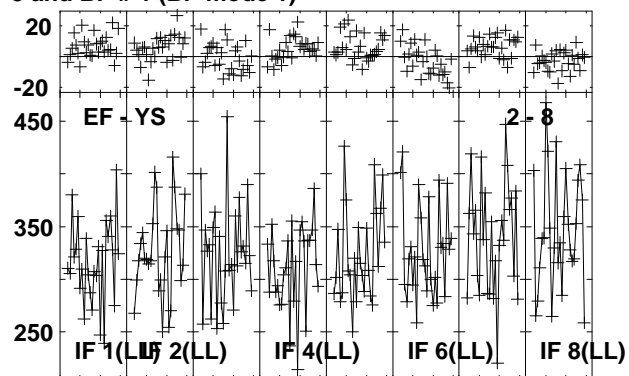
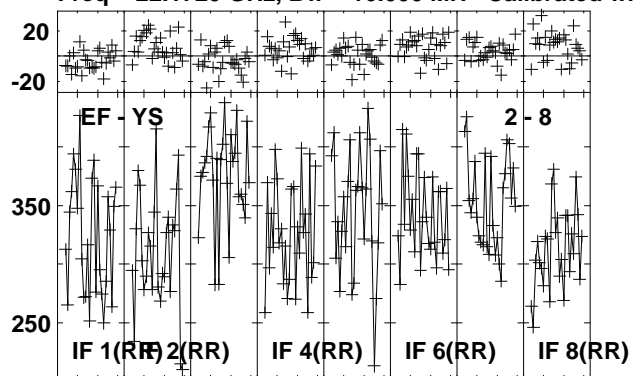

Lower frame: Milli Ampl Jy Top frame: Phas deg
Vector averaged cross-power spectrum Several baselines displayed
Timerange: 00/23:23:51 to 00/23:24:33

Plot file version 239 created 26-JUL-2013 10:22:11
 B1152+199A EZ024 1.UVDATA.1
 Freq = 22.1720 GHz, Bw = 16.000 MH Calibrated with CL # 3 and BP # 1 (BP mode 1)

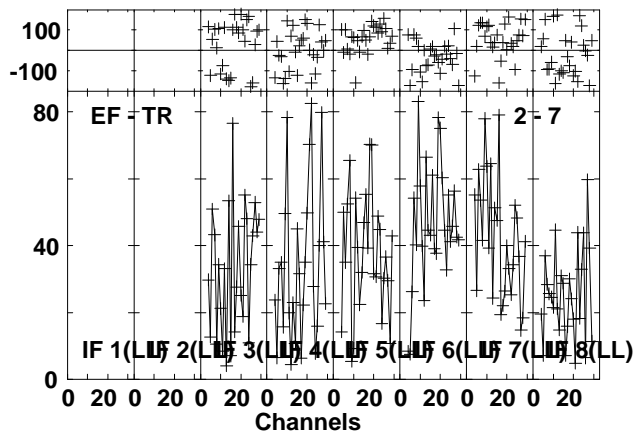
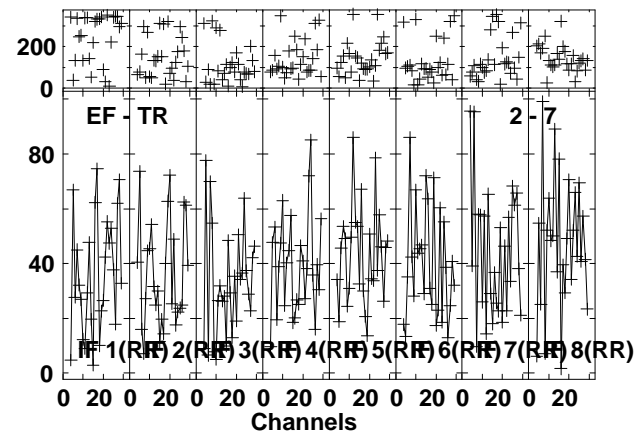
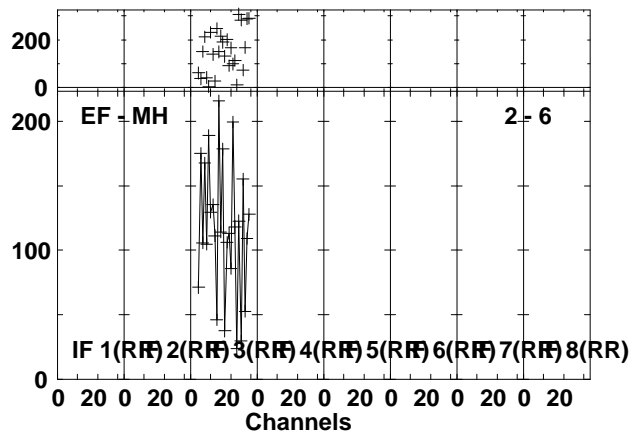
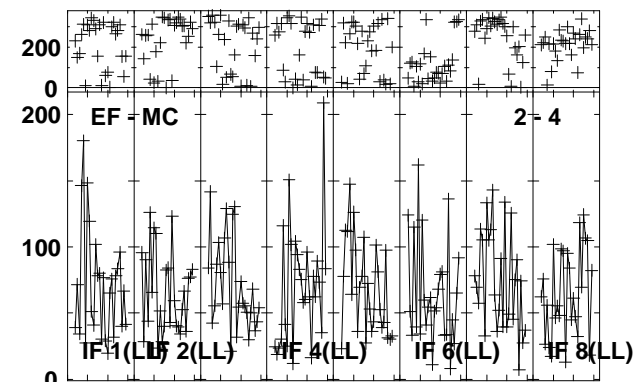
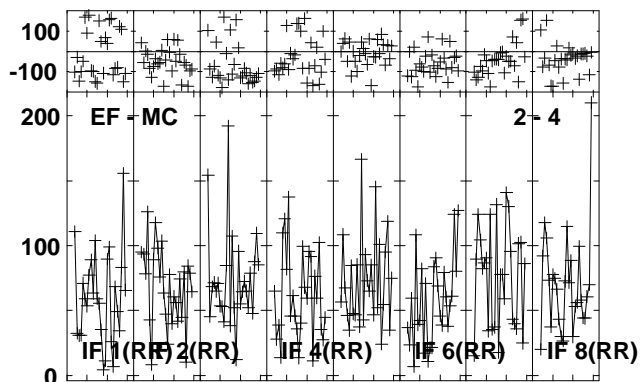
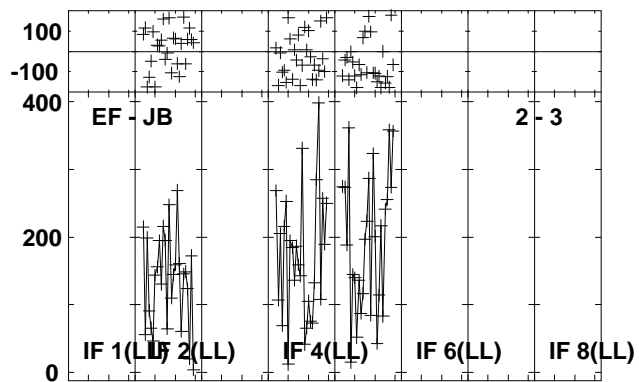
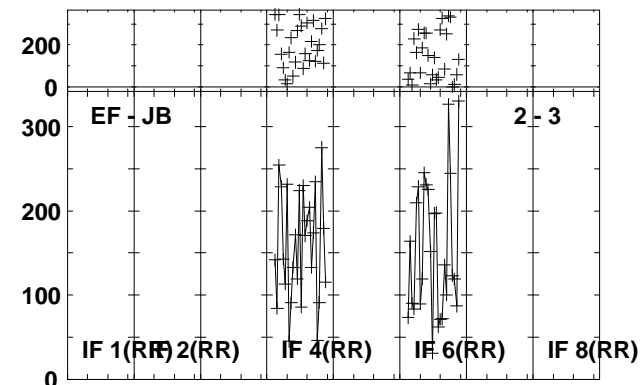
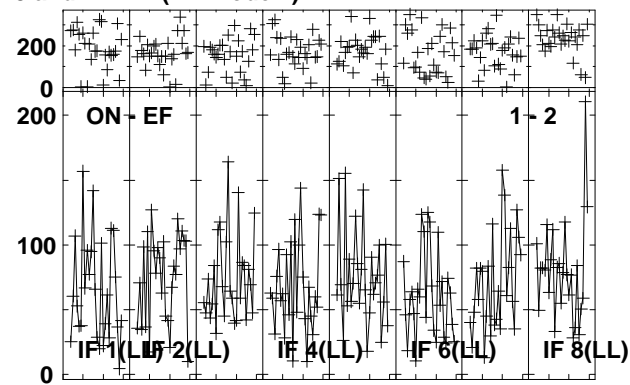
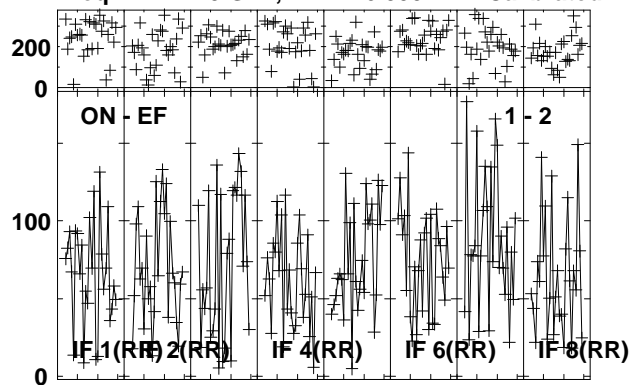

Lower frame: Milli Ampl Jy Top frame: Phas deg
 Vector averaged cross-power spectrum Several baselines displayed
 Timerange: 00/23:25:10 to 00/23:27:08

Plot file version 240 created 26-JUL-2013 10:22:13
 B1152+199A EZ024 1.UVDATA.1
 Freq = 22.1720 GHz, Bw = 16.000 MH Calibrated with CL # 3 and BP # 1 (BP mode 1)

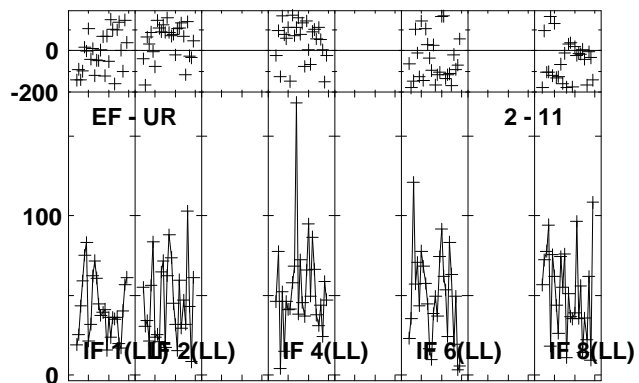
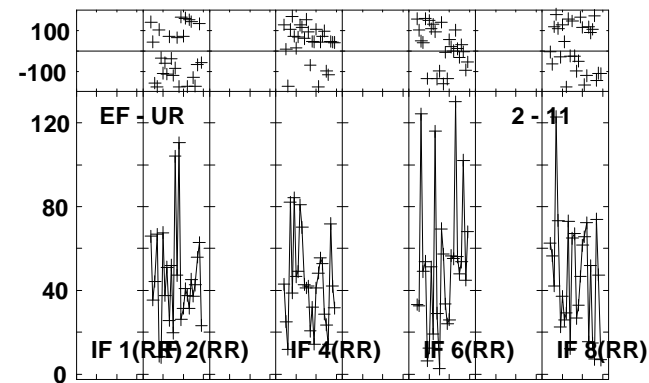
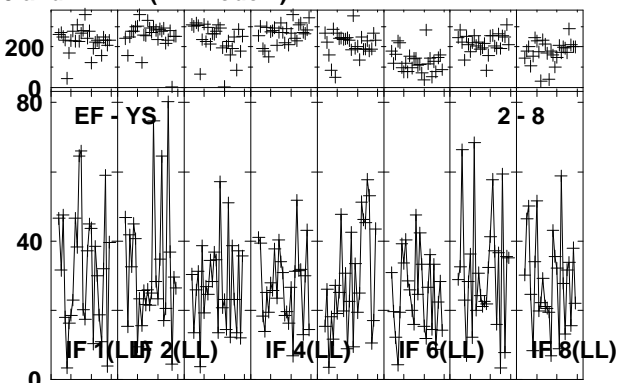
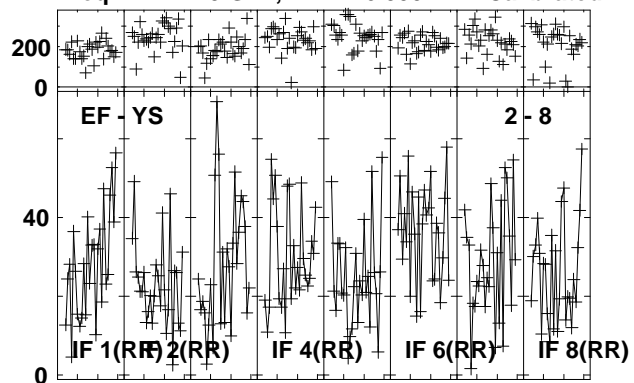

Lower frame: Milli Ampl Jy Top frame: Phas deg
 Vector averaged cross-power spectrum Several baselines displayed
 Timerange: 00/23:25:10 to 00/23:27:08

Plot file version 241 created 26-JUL-2013 10:22:14
 J1157 EZ024 1.UVDATA.1
 Freq = 22.1720 GHz, Bw = 16.000 MH Calibrated with CL # 3 and BP # 1 (BP mode 1)

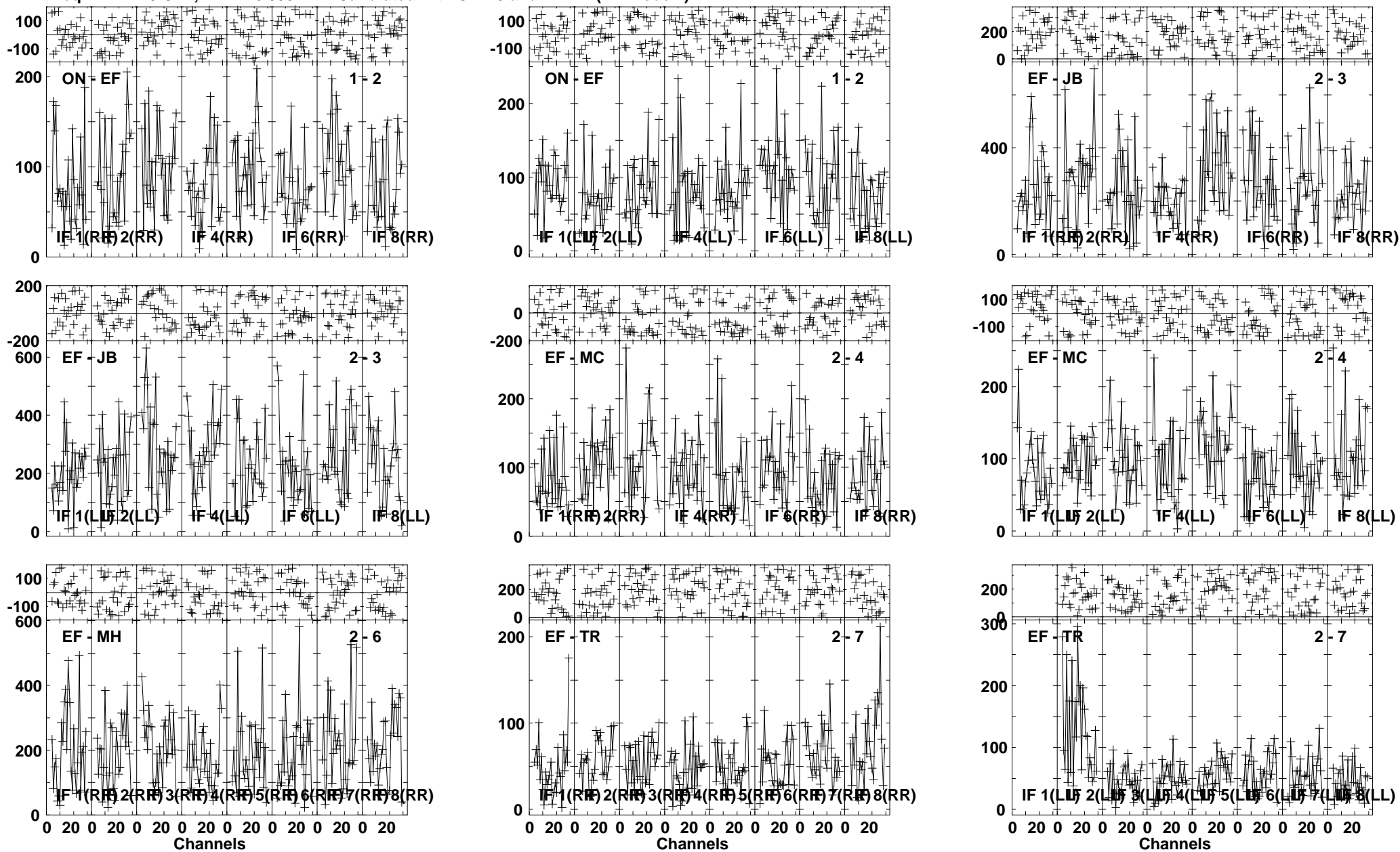

Lower frame: Milli Ampl Jy Top frame: Phas deg
 Vector averaged cross-power spectrum Several baselines displayed
 Timerange: 00/23:27:43 to 00/23:28:41

Plot file version 242 created 26-JUL-2013 10:22:15
 J1157 EZ024 1.UVDATA.1
 Freq = 22.1720 GHz, Bw = 16.000 MH Calibrated with CL # 3 and BP # 1 (BP mode 1)

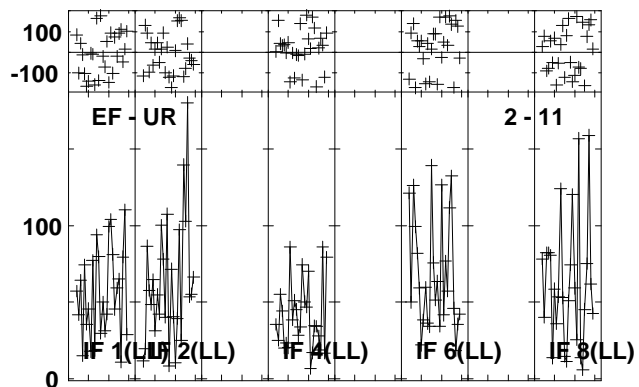
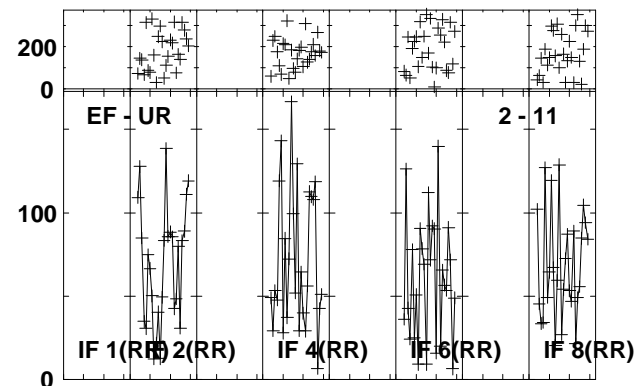
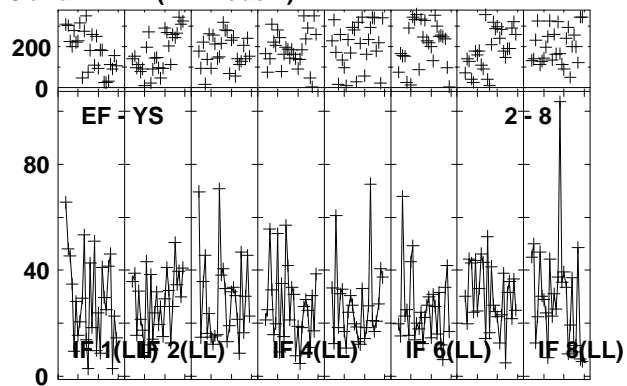
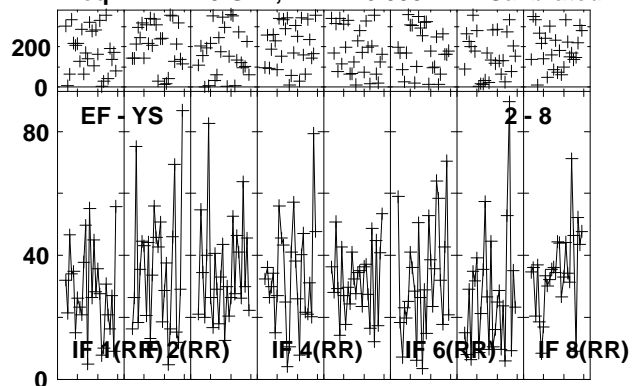

Lower frame: Milli Ampl Jy Top frame: Phas deg
 Vector averaged cross-power spectrum Several baselines displayed
 Timerange: 00/23:27:43 to 00/23:28:41

Plot file version 243 created 26-JUL-2013 10:22:16
 B1152+199A EZ024 1.UVDATA.1
 Freq = 22.1720 GHz, Bw = 16.000 MH Calibrated with CL # 3 and BP # 1 (BP mode 1)

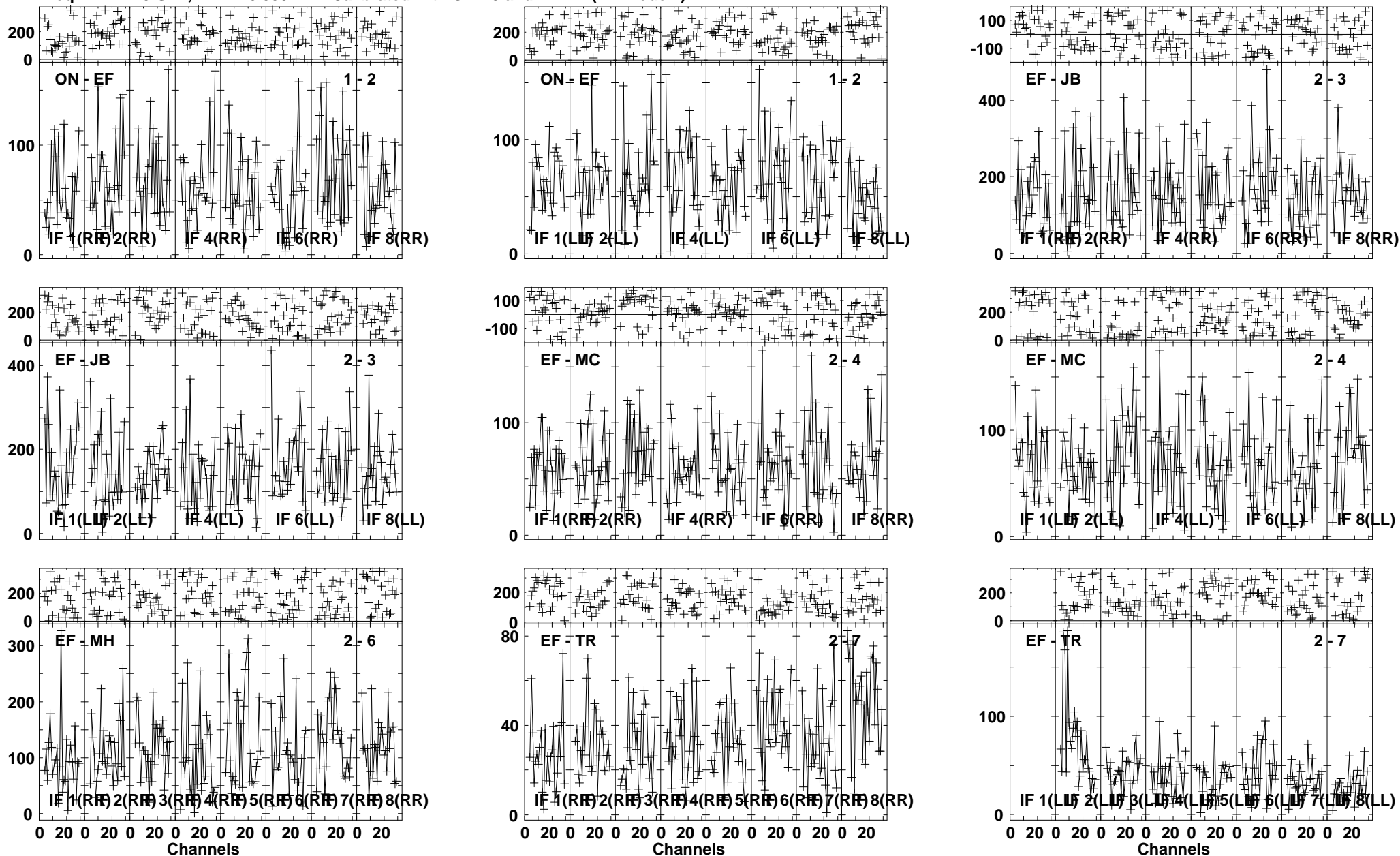

Lower frame: Milli Ampl Jy Top frame: Phas deg
 Vector averaged cross-power spectrum Several baselines displayed
 Timerange: 00/23:29:17 to 00/23:31:15

Plot file version 244 created 26-JUL-2013 10:22:17
 B1152+199A EZ024 1.UVDATA.1
 Freq = 22.1720 GHz, Bw = 16.000 MH Calibrated with CL # 3 and BP # 1 (BP mode 1)

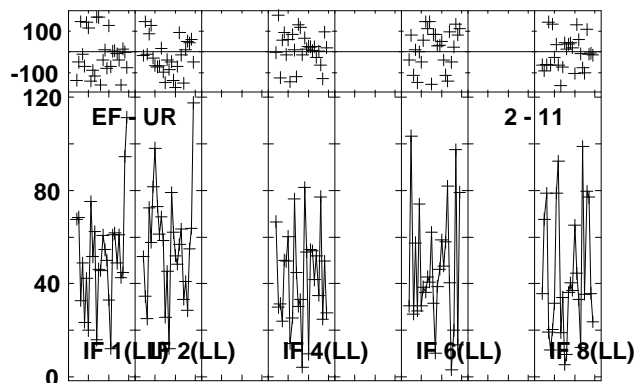
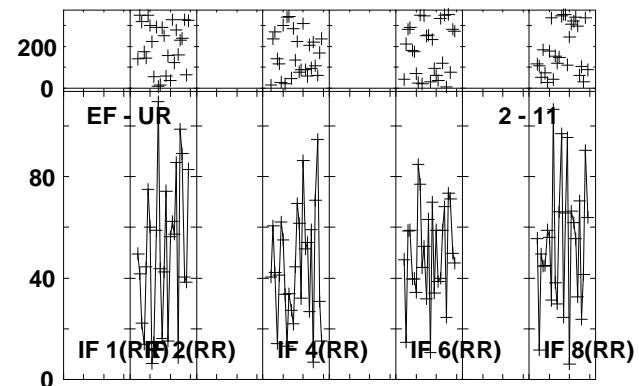
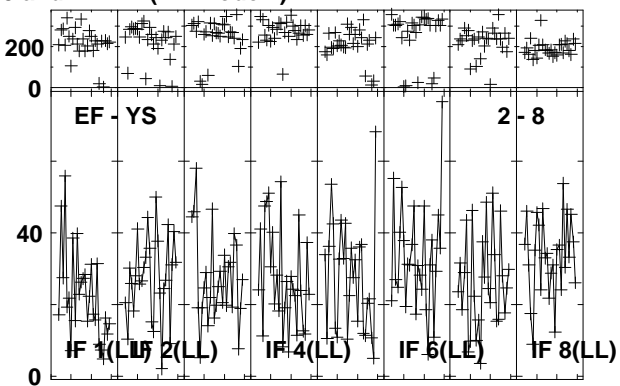
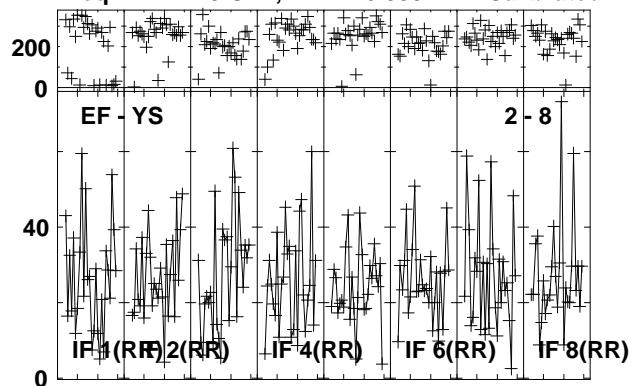

Lower frame: Milli Ampl Jy Top frame: Phas deg
 Vector averaged cross-power spectrum Several baselines displayed
 Timerange: 00/23:29:17 to 00/23:31:15

Plot file version 245 created 26-JUL-2013 10:22:19
 J1157 EZ024 1.UVDATA.1
 Freq = 22.1720 GHz, Bw = 16.000 MH Calibrated with CL # 3 and BP # 1 (BP mode 1)

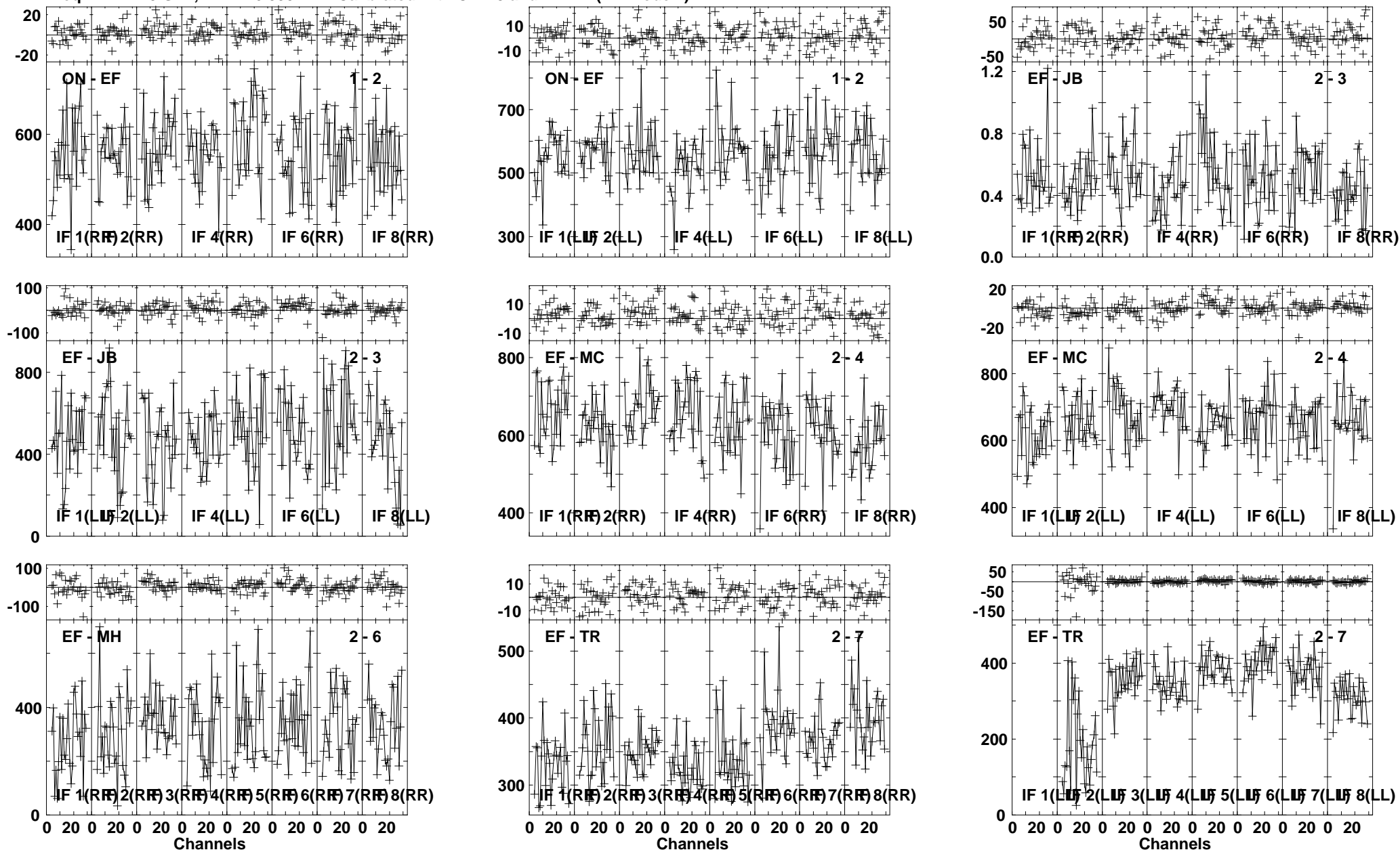

Lower frame: Milli Ampl Jy Top frame: Phas deg
 Vector averaged cross-power spectrum Several baselines displayed
 Timerange: 00/23:31:50 to 00/23:32:48

Plot file version 246 created 26-JUL-2013 10:22:20

J1157 EZ024 1.UVDATA.1

Freq = 22.1720 GHz, Bw = 16.000 MH Calibrated with CL # 3 and BP # 1 (BP mode 1)

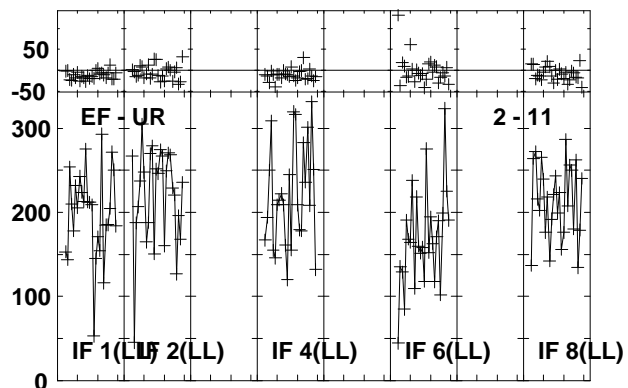
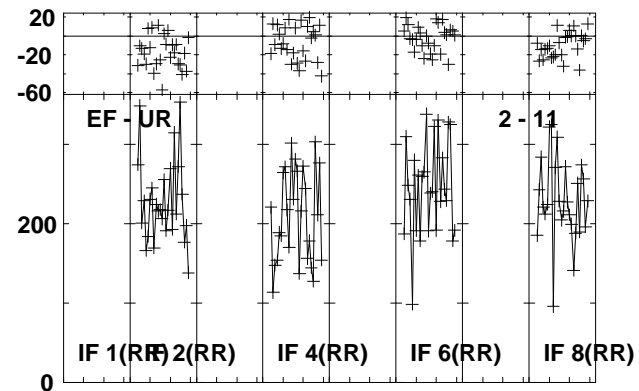
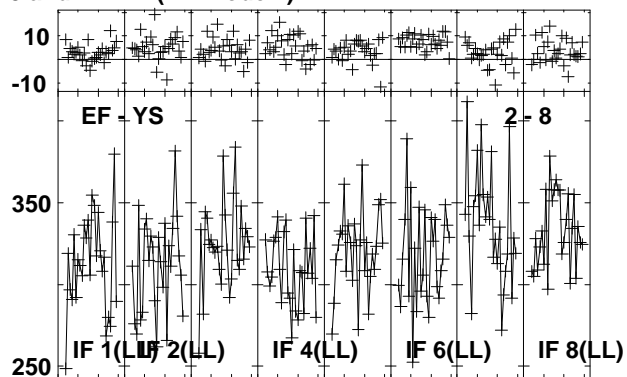
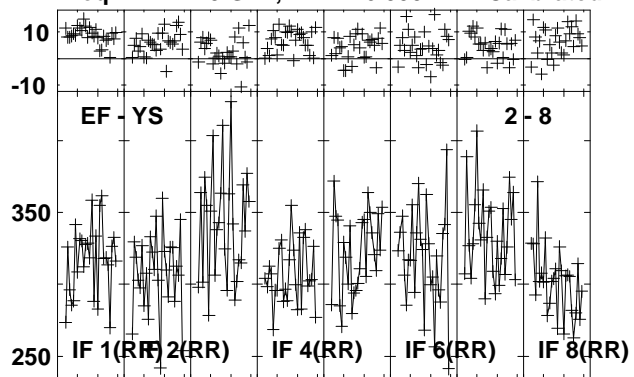

Lower frame: Milli Ampl Jy Top frame: Phas deg
Vector averaged cross-power spectrum Several baselines displayed
Timerange: 00/23:31:50 to 00/23:32:48

Plot file version 247 created 26-JUL-2013 10:22:21
 B1152+199A EZ024 1.UVDATA.1
 Freq = 22.1720 GHz, Bw = 16.000 MH Calibrated with CL # 3 and BP # 1 (BP mode 1)

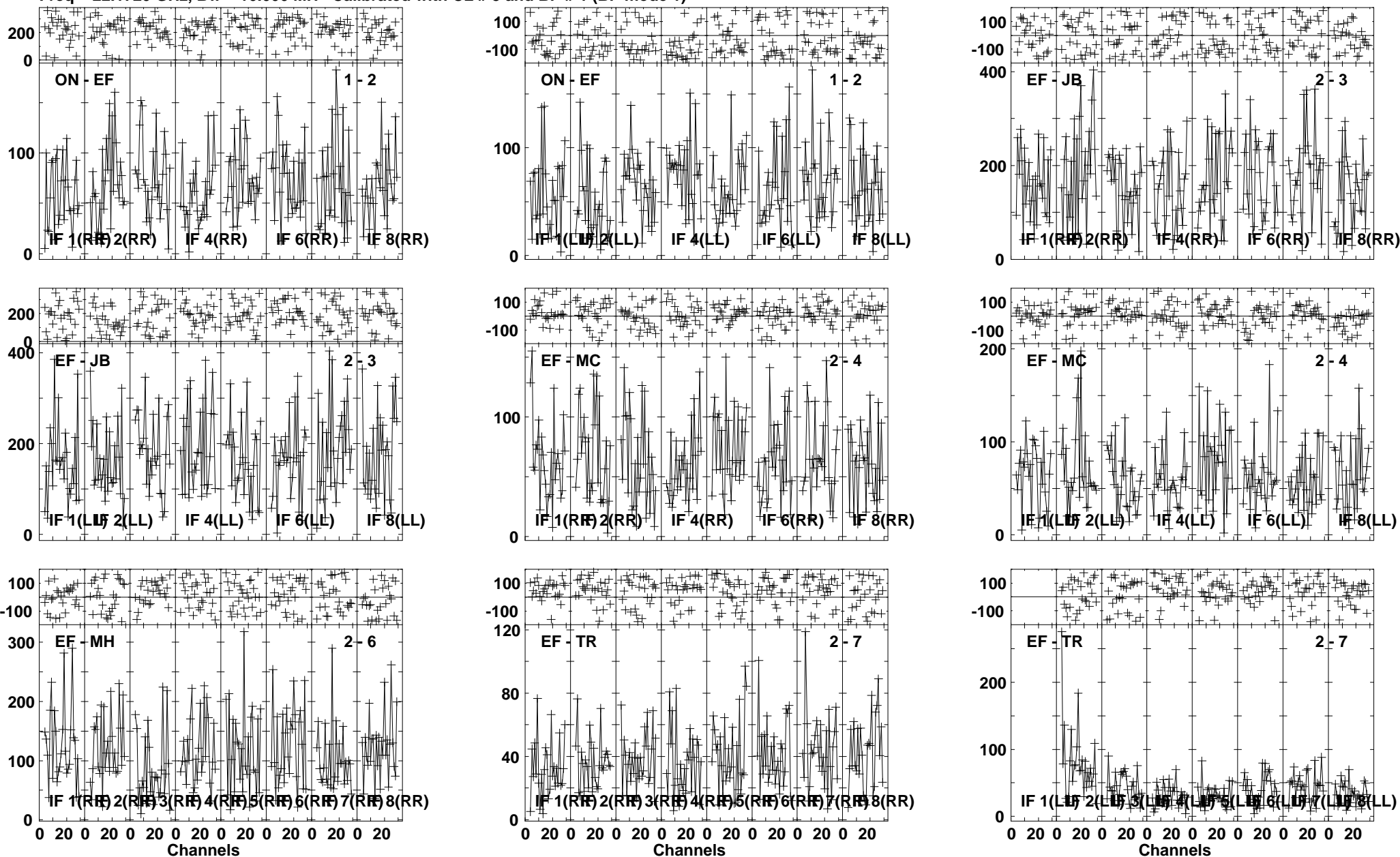

Lower frame: Milli Ampl Jy Top frame: Phas deg
 Vector averaged cross-power spectrum Several baselines displayed
 Timerange: 00/23:33:24 to 00/23:35:22

Plot file version 248 created 26-JUL-2013 10:22:22

B1152+199A EZ024 1.UVDATA.1

Freq = 22.1720 GHz, Bw = 16.000 MH Calibrated with CL # 3 and BP # 1 (BP mode 1)

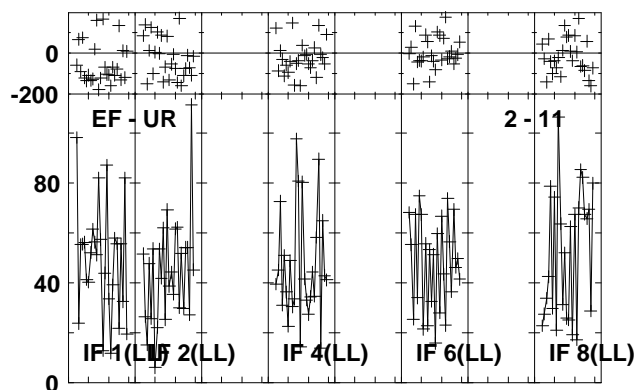
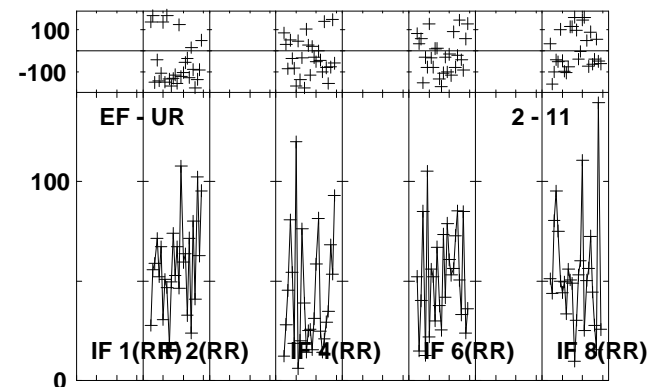
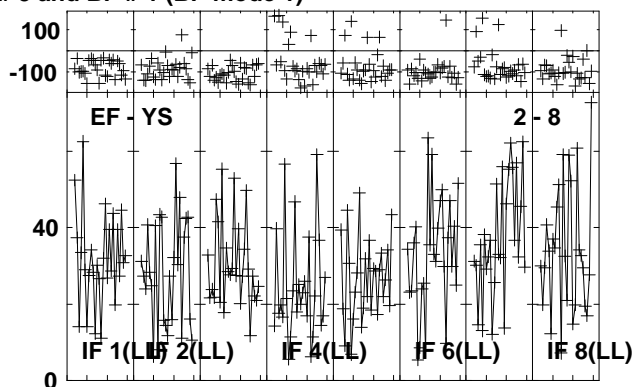
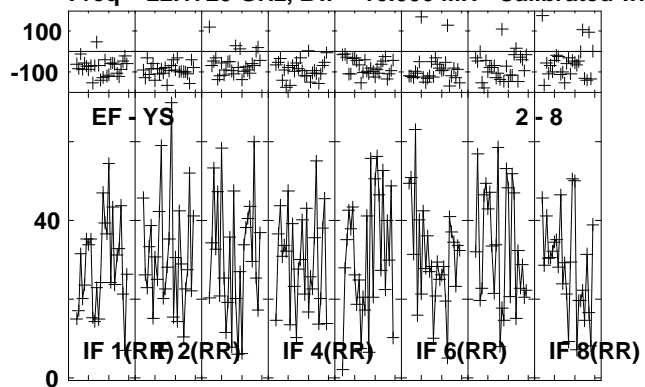

Lower frame: Milli Ampl Jy Top frame: Phas deg
Vector averaged cross-power spectrum Several baselines displayed
Timerange: 00/23:33:24 to 00/23:35:22

Plot file version 249 created 26-JUL-2013 10:22:24

J1157 EZ024 1.UVDATA.1

Freq = 22.1720 GHz, Bw = 16.000 MH Calibrated with CL # 3 and BP # 1 (BP mode 1)

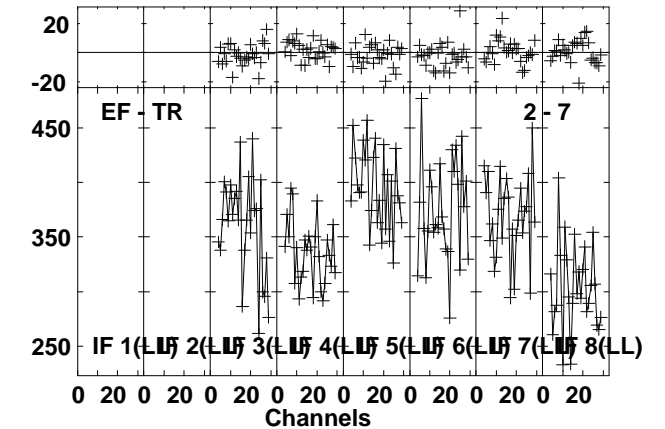
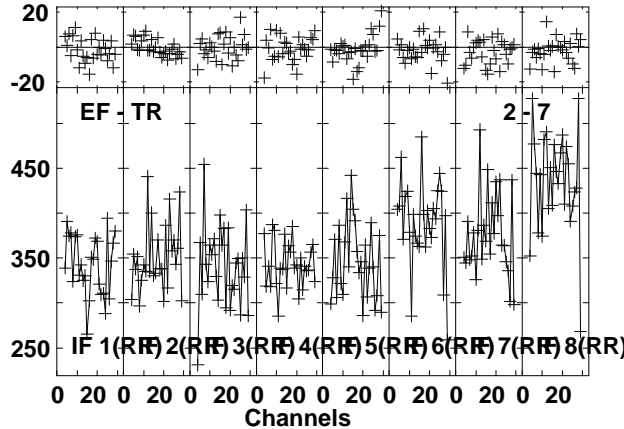
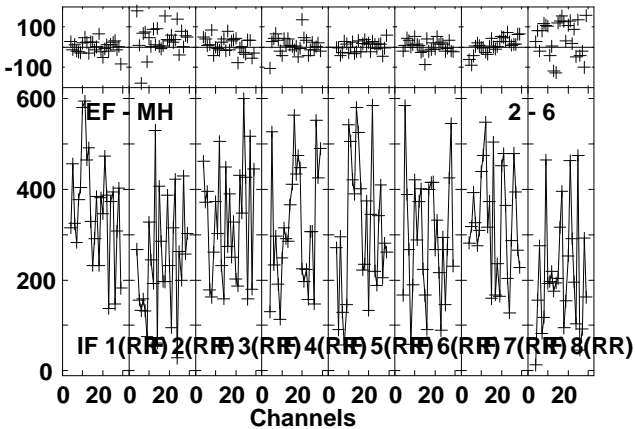
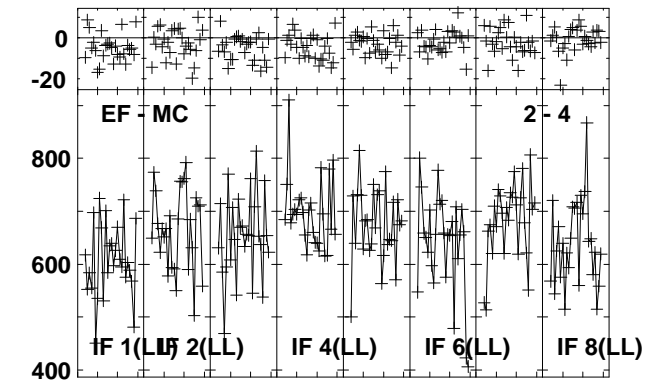
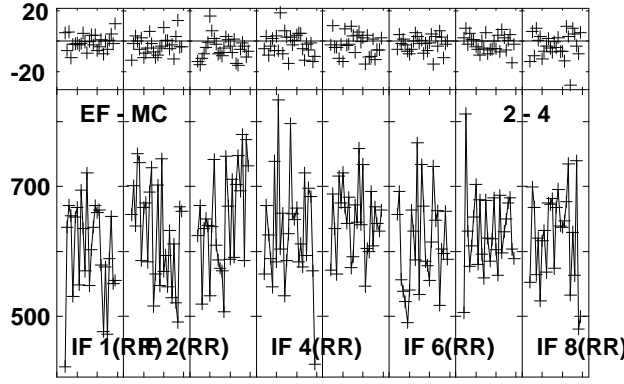
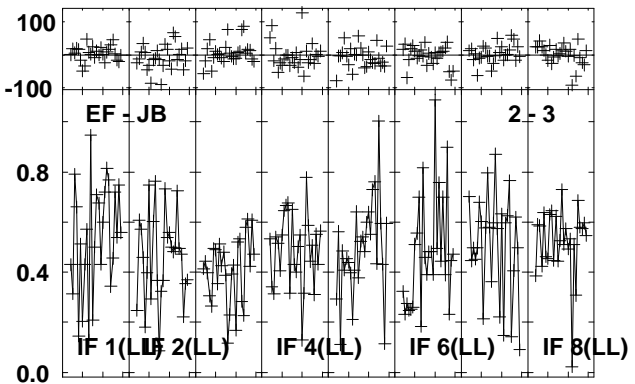
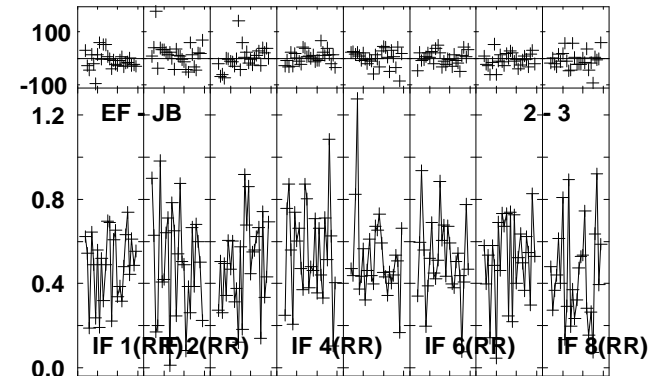
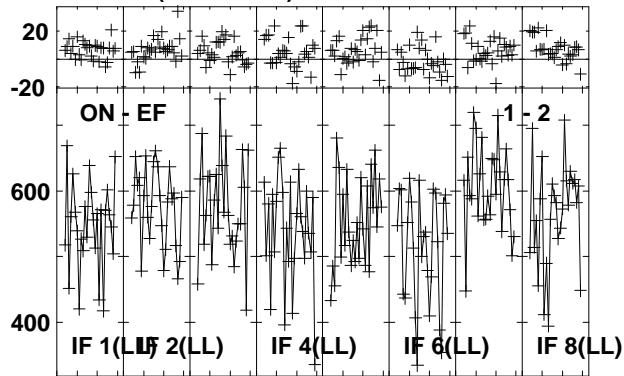
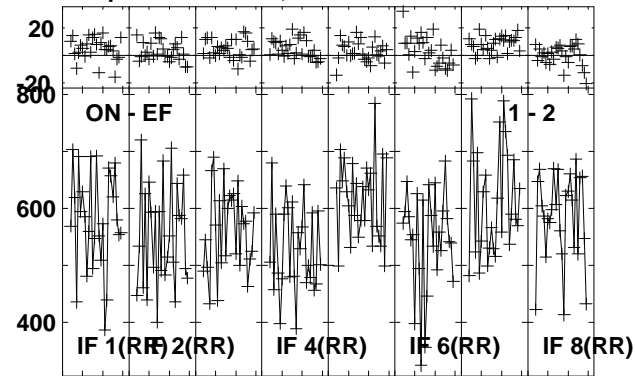

Lower frame: Milli Ampl Jy Top frame: Phas deg
Vector averaged cross-power spectrum Several baselines displayed
Timerange: 00/23:35:57 to 00/23:36:55

Plot file version 250 created 26-JUL-2013 10:22:25
 J1157 EZ024 1.UVDATA.1
 Freq = 22.1720 GHz, Bw = 16.000 MH Calibrated with CL # 3 and BP # 1 (BP mode 1)

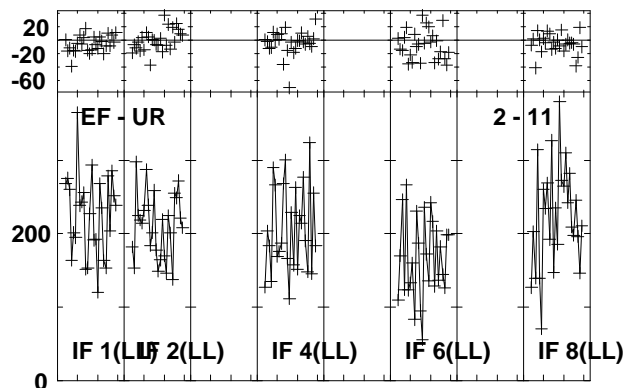
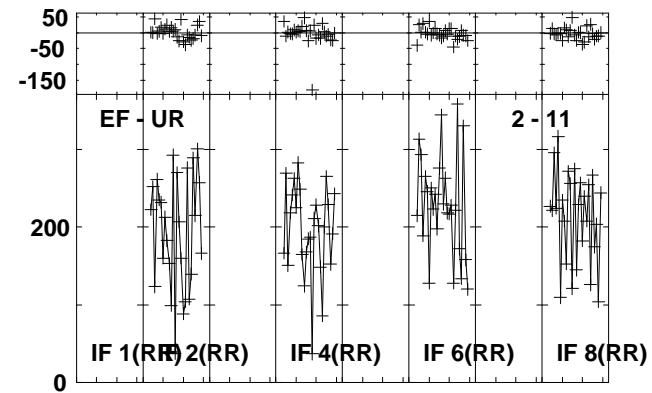
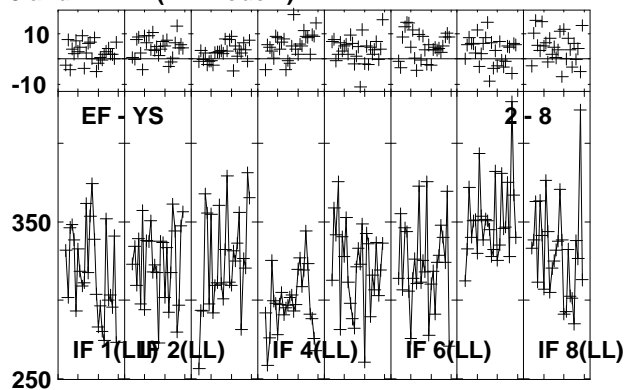
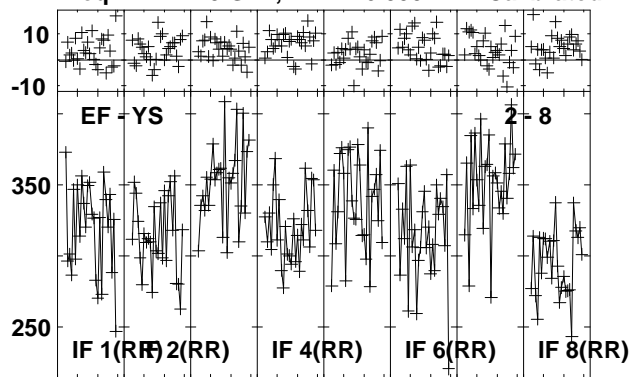

Lower frame: Milli Ampl Jy Top frame: Phas deg
 Vector averaged cross-power spectrum Several baselines displayed
 Timerange: 00/23:35:57 to 00/23:36:55

Plot file version 251 created 26-JUL-2013 10:22:26
 J1157 EZ024 1.UVDATA.1
 Freq = 22.1720 GHz, Bw = 16.000 MH Calibrated with CL # 3 and BP # 1 (BP mode 1)

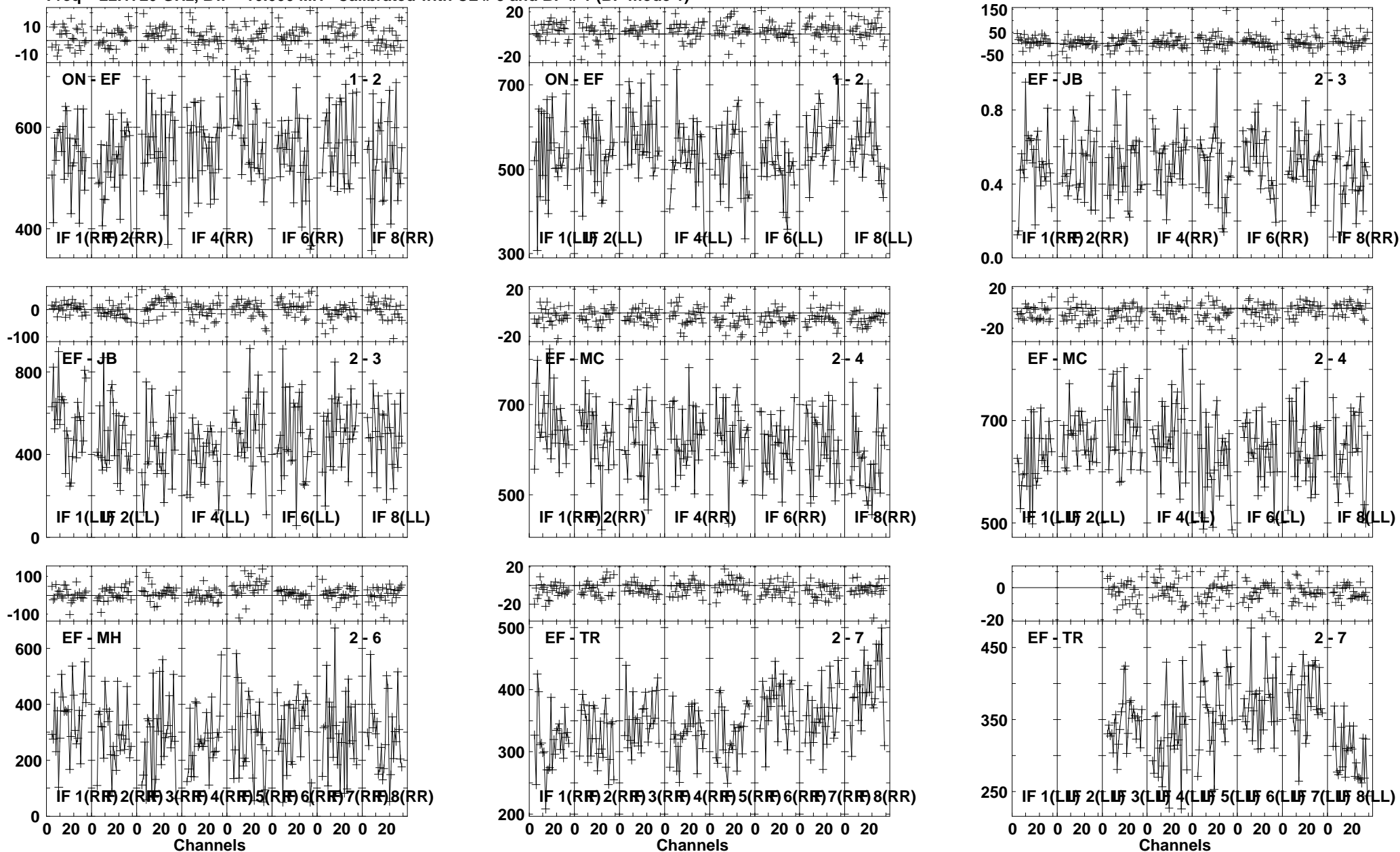

Lower frame: Milli Ampl Jy Top frame: Phas deg
 Vector averaged cross-power spectrum Several baselines displayed
 Timerange: 00/23:37:17 to 00/23:38:15

Plot file version 252 created 26-JUL-2013 10:22:26
 J1157 EZ024 1.UVDATA.1
 Freq = 22.1720 GHz, Bw = 16.000 MH Calibrated with CL # 3 and BP # 1 (BP mode 1)

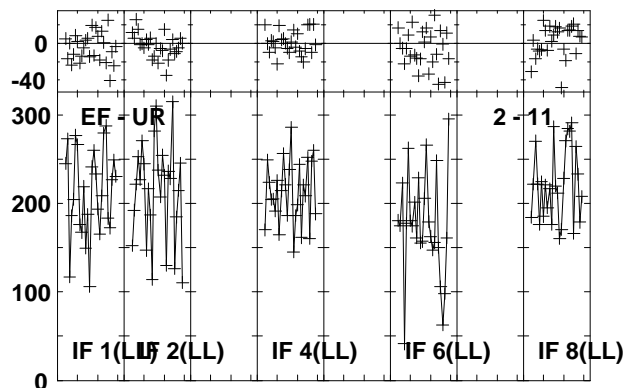
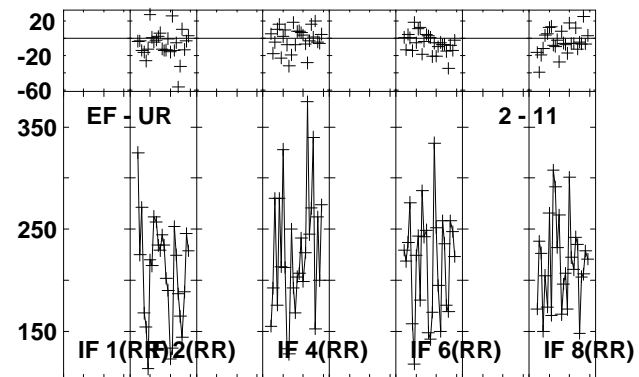
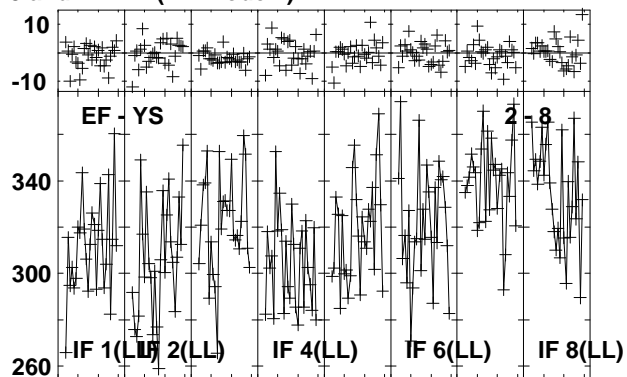
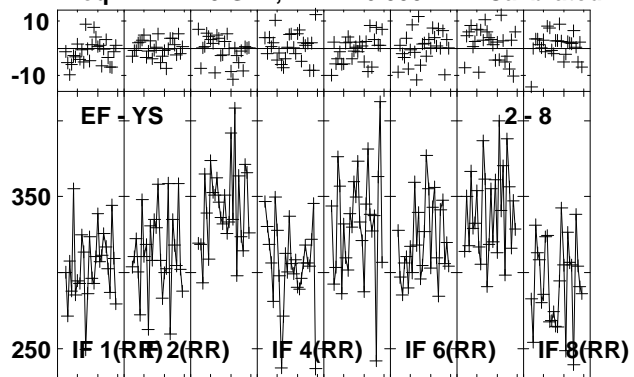

Lower frame: Milli Ampl Jy Top frame: Phas deg
 Vector averaged cross-power spectrum Several baselines displayed
 Timerange: 00/23:37:17 to 00/23:38:15

Plot file version 253 created 26-JUL-2013 10:22:27
 J1125+2610 EZ024 1.UVDATA.1
 Freq = 22.1720 GHz, Bw = 16.000 MH Calibrated with CL # 3 and BP # 1 (BP mode 1)

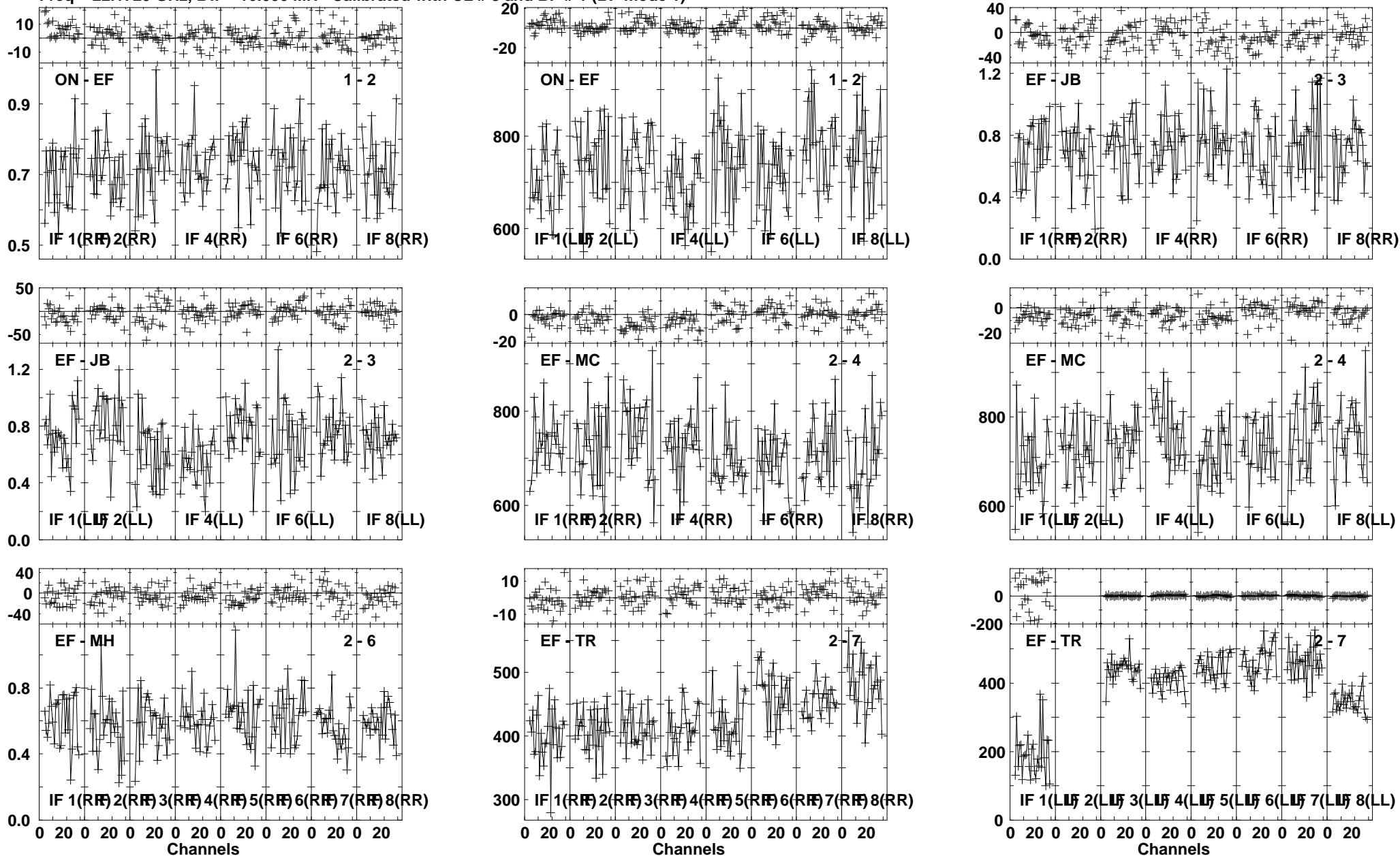

Lower frame: Ampl Jy Top frame: Phas deg
 Vector averaged cross-power spectrum Several baselines displayed
 Timerange: 00/23:39:39 to 00/23:40:51

Plot file version 254 created 26-JUL-2013 10:22:29

J1125+2610 EZ024 1.UVDATA.1

Freq = 22.1720 GHz, Bw = 16.000 MH Calibrated with CL # 3 and BP # 1 (BP mode 1)

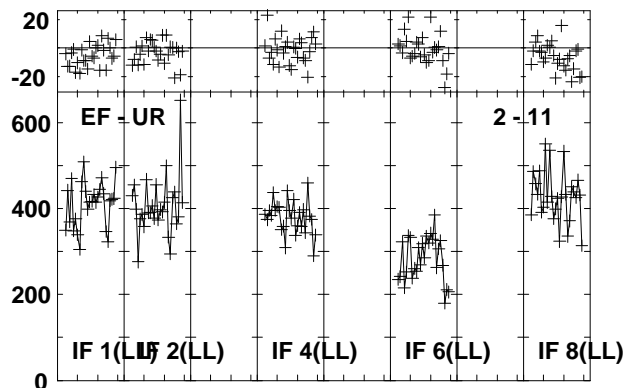
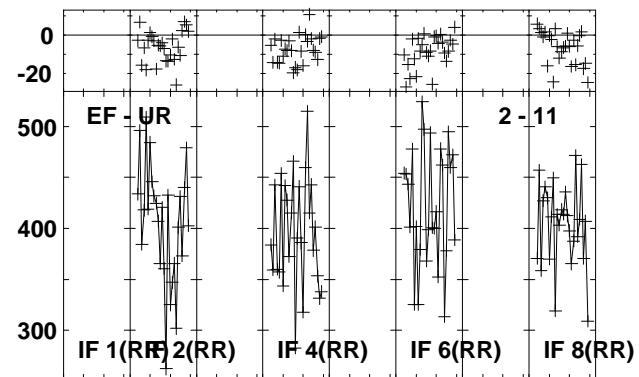
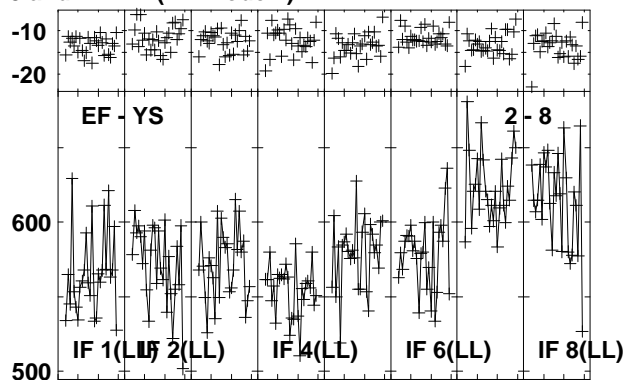
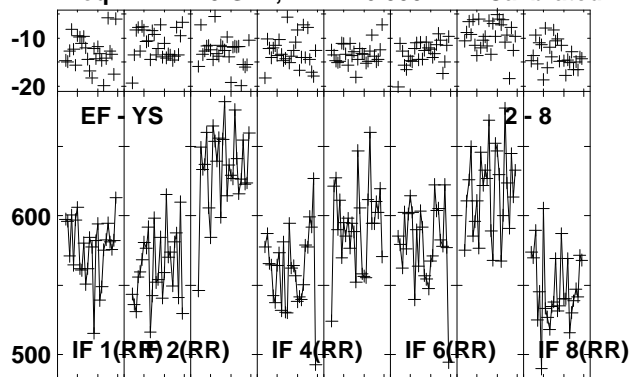

Lower frame: Milli Ampl Jy Top frame: Phas deg
Vector averaged cross-power spectrum Several baselines displayed
Timerange: 00/23:39:39 to 00/23:40:51

Plot file version 255 created 26-JUL-2013 10:22:30

J1157 EZ024 1.UVDATA.1

Freq = 22.1720 GHz, Bw = 16.000 MH Calibrated with CL # 3 and BP # 1 (BP mode 1)

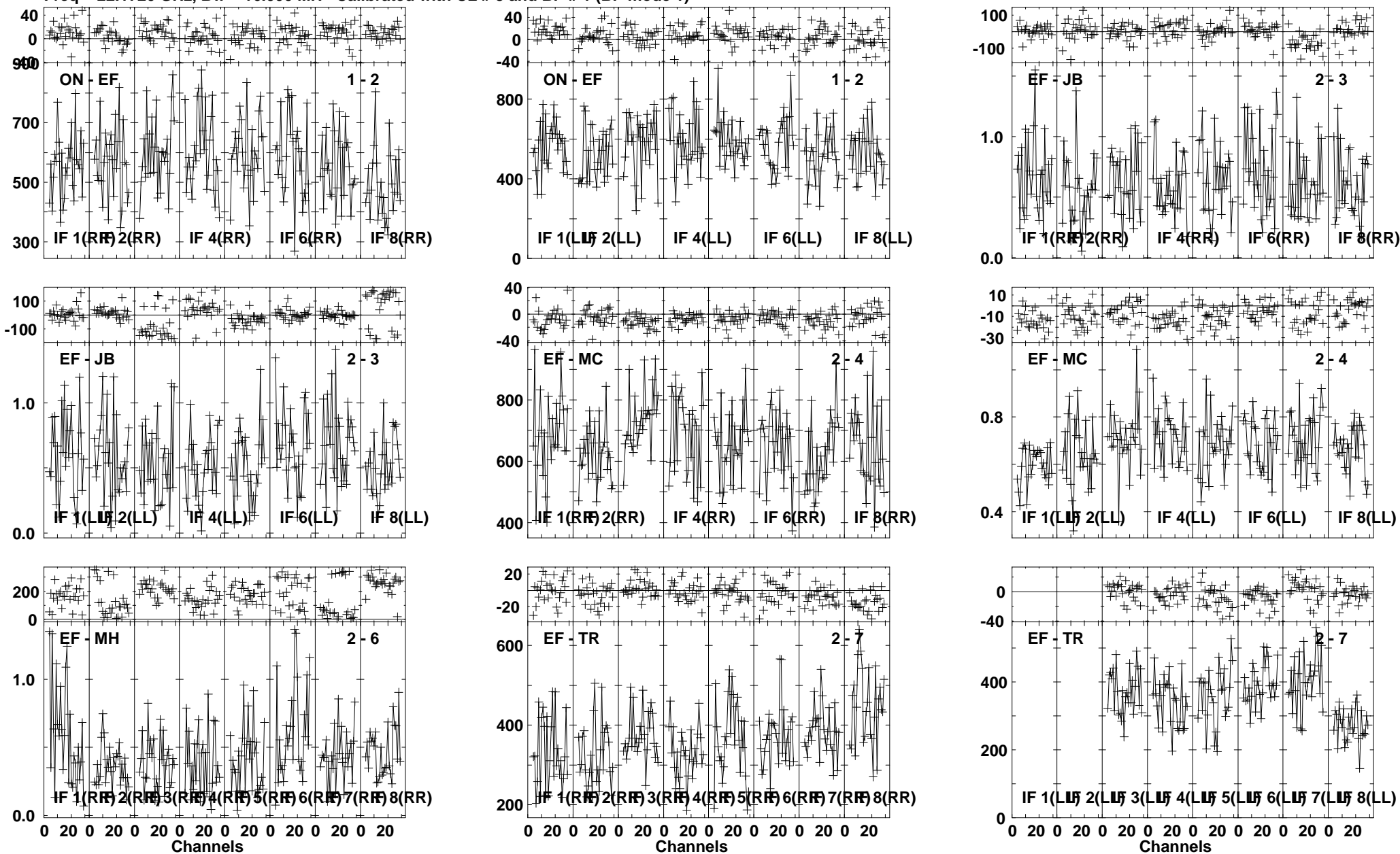

Lower frame: Milli Ampl Jy Top frame: Phas deg
Vector averaged cross-power spectrum Several baselines displayed
Timerange: 00/23:42:16 to 00/23:42:58

Plot file version 256 created 26-JUL-2013 10:22:31
 J1157 EZ024 1.UVDATA.1
 Freq = 22.1720 GHz, Bw = 16.000 MH Calibrated with CL # 3 and BP # 1 (BP mode 1)

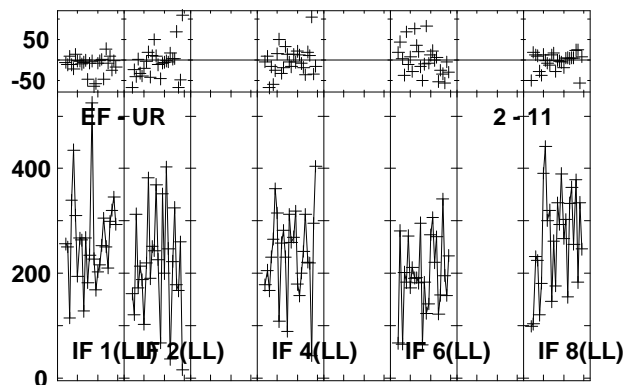
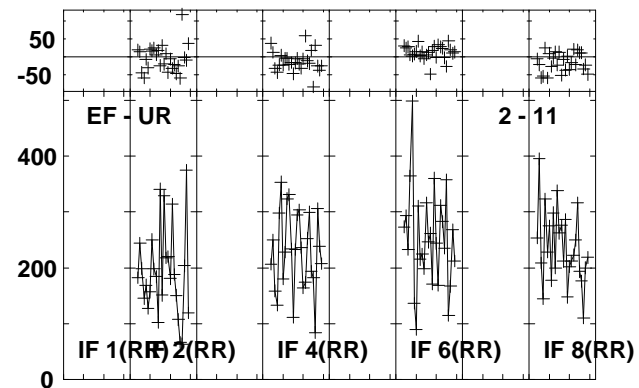
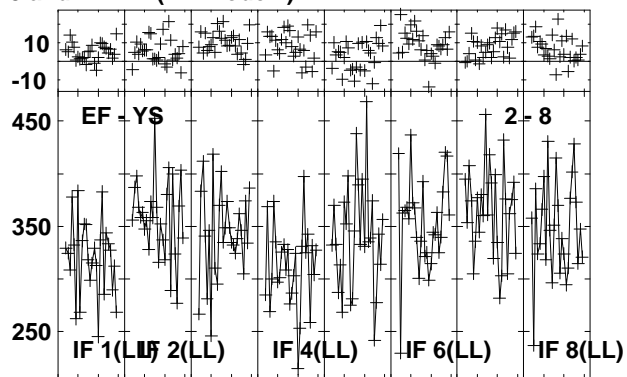
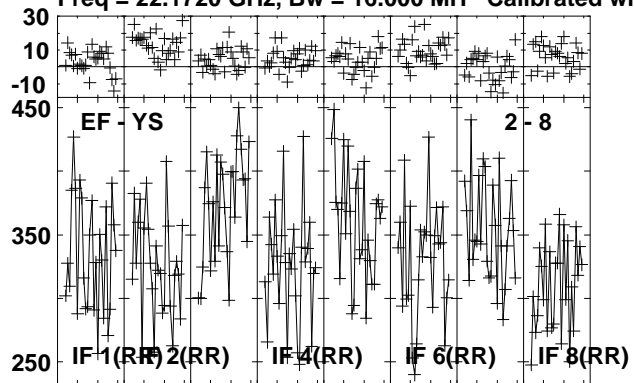

Lower frame: Milli Ampl Jy Top frame: Phas deg
 Vector averaged cross-power spectrum Several baselines displayed
 Timerange: 00/23:42:16 to 00/23:42:58

Plot file version 257 created 26-JUL-2013 10:22:32
 B1152+199A EZ024 1.UVDATA.1
 Freq = 22.1720 GHz, Bw = 16.000 MH Calibrated with CL # 3 and BP # 1 (BP mode 1)

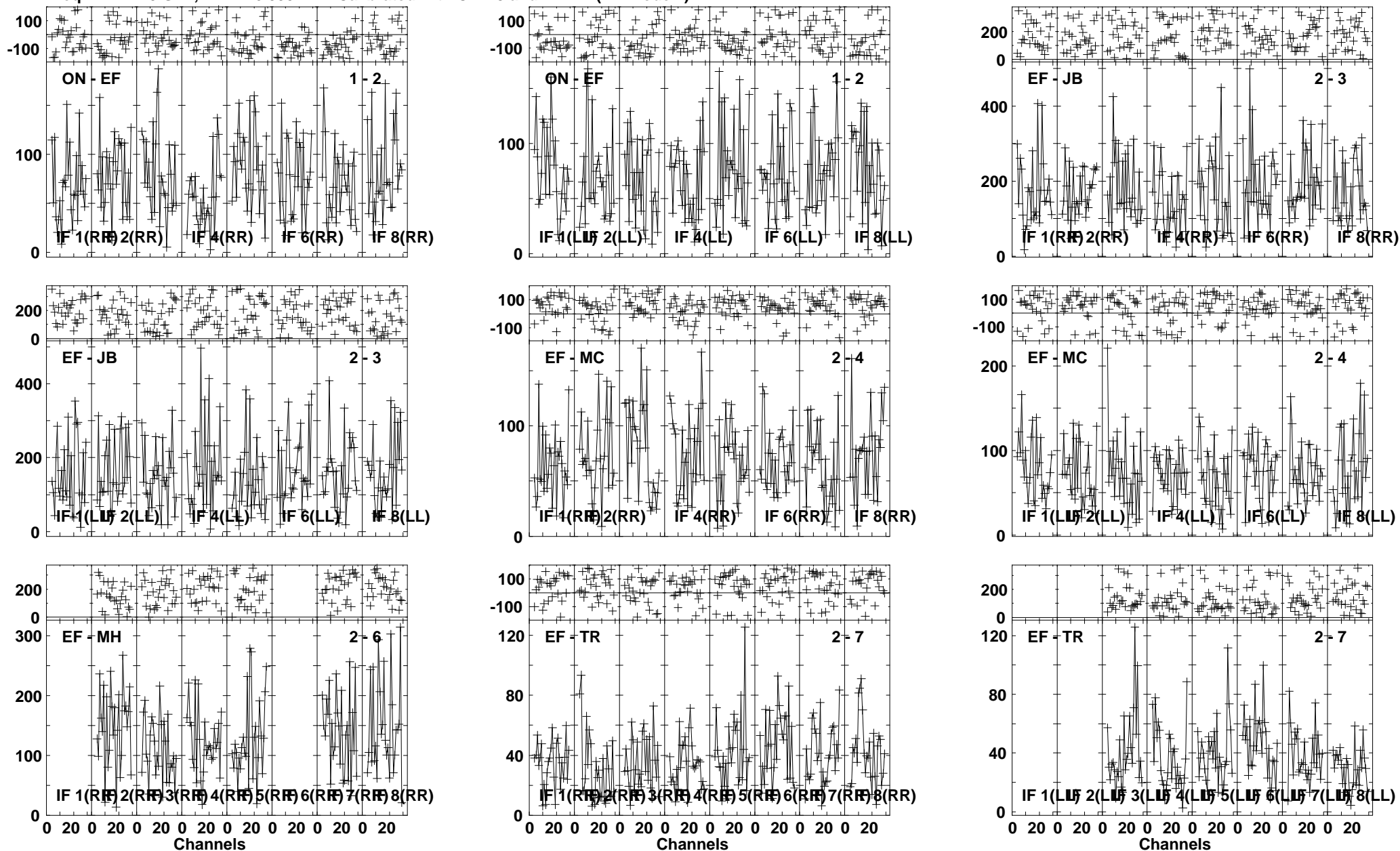

Lower frame: Milli Ampl Jy Top frame: Phas deg
 Vector averaged cross-power spectrum Several baselines displayed
 Timerange: 00/23:43:35 to 00/23:45:33

Plot file version 258 created 26-JUL-2013 10:22:34
 B1152+199A EZ024 1.UVDATA.1
 Freq = 22.1720 GHz, Bw = 16.000 MH Calibrated with CL # 3 and BP # 1 (BP mode 1)

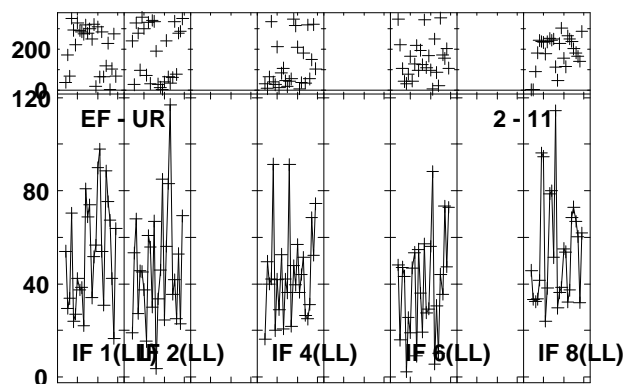
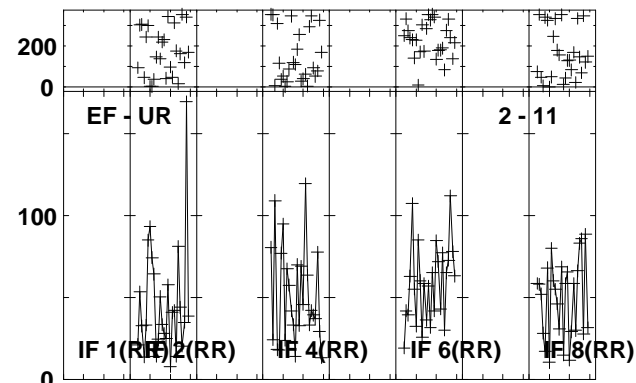
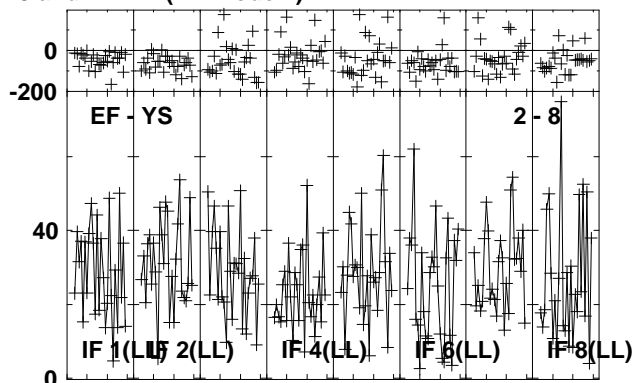
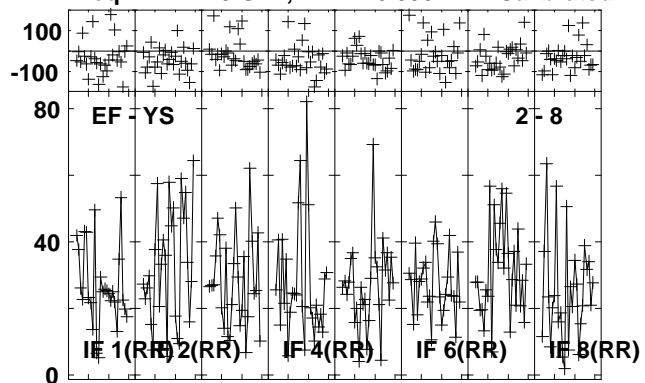

Lower frame: Milli Ampl Jy Top frame: Phas deg
 Vector averaged cross-power spectrum Several baselines displayed
 Timerange: 00/23:43:35 to 00/23:45:33

Plot file version 259 created 26-JUL-2013 10:22:36

J1157 EZ024 1.UVDATA.1

Freq = 22.1720 GHz, Bw = 16.000 MH Calibrated with CL # 3 and BP # 1 (BP mode 1)

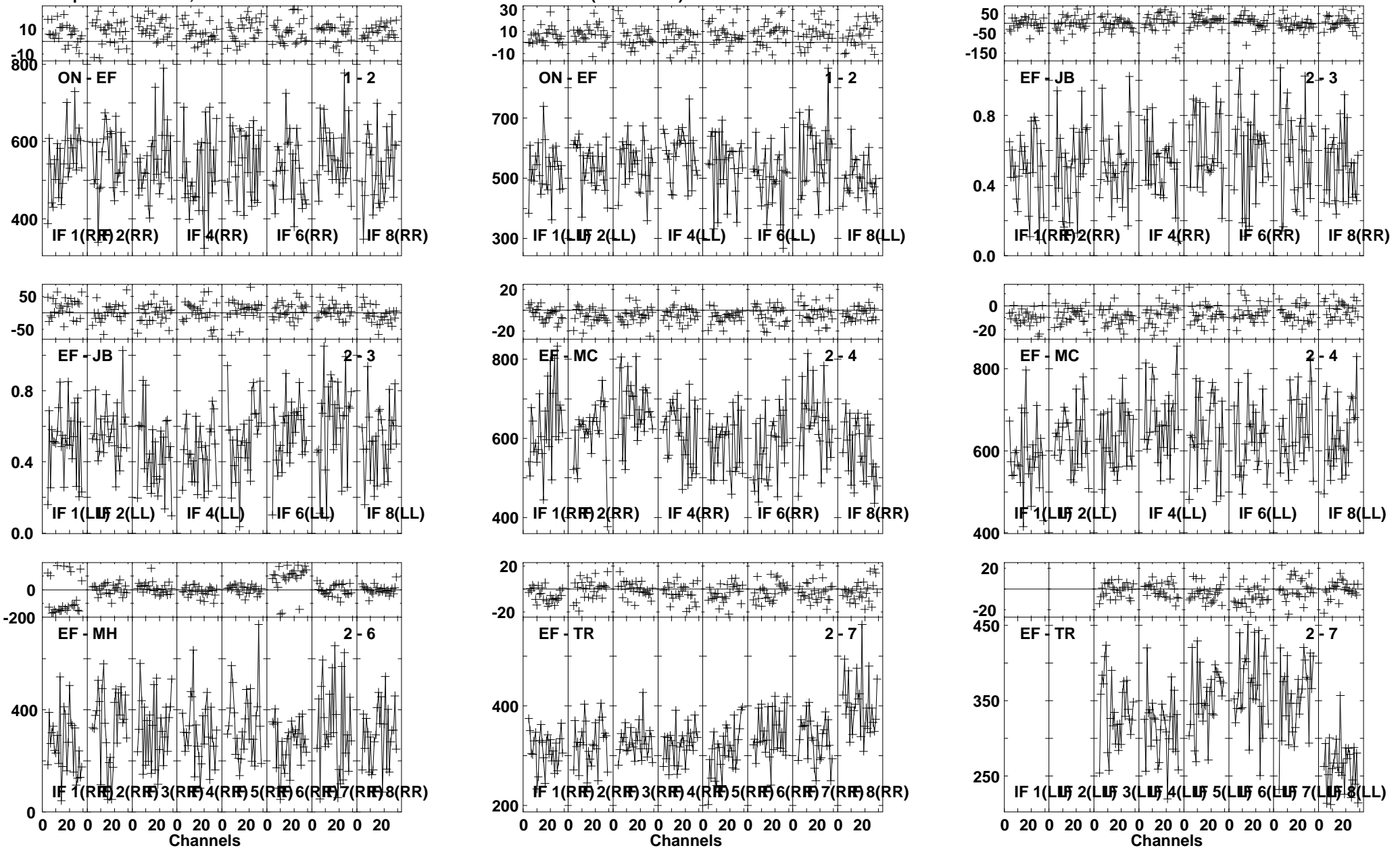

Lower frame: Milli Ampl Jy Top frame: Phas deg
Vector averaged cross-power spectrum Several baselines displayed
Timerange: 00/23:46:08 to 00/23:47:06

Plot file version 260 created 26-JUL-2013 10:22:37
 J1157 EZ024 1.UVDATA.1
 Freq = 22.1720 GHz, Bw = 16.000 MH Calibrated with CL # 3 and BP # 1 (BP mode 1)

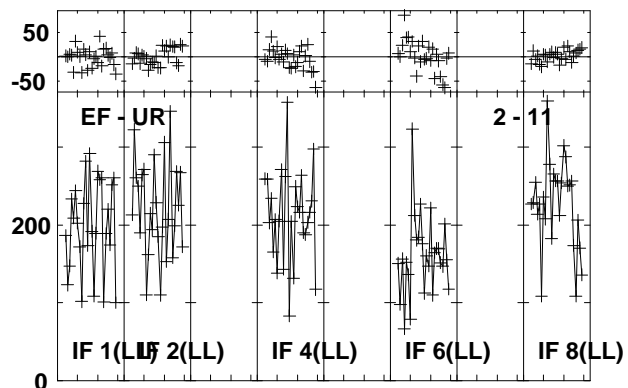
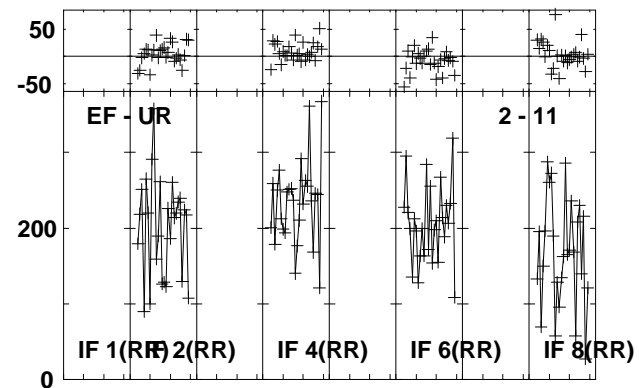
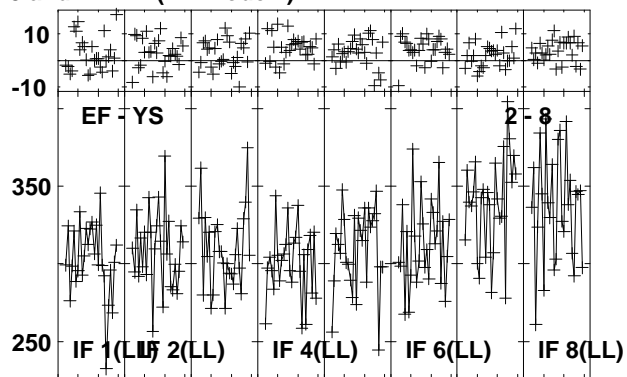
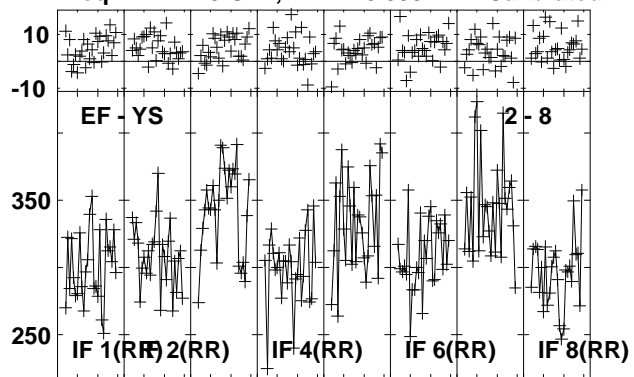

Lower frame: Milli Ampl Jy Top frame: Phas deg
 Vector averaged cross-power spectrum Several baselines displayed
 Timerange: 00/23:46:08 to 00/23:47:06

Plot file version 261 created 26-JUL-2013 10:22:39
 B1152+199A EZ024 1.UVDATA.1
 Freq = 22.1720 GHz, Bw = 16.000 MH Calibrated with CL # 3 and BP # 1 (BP mode 1)

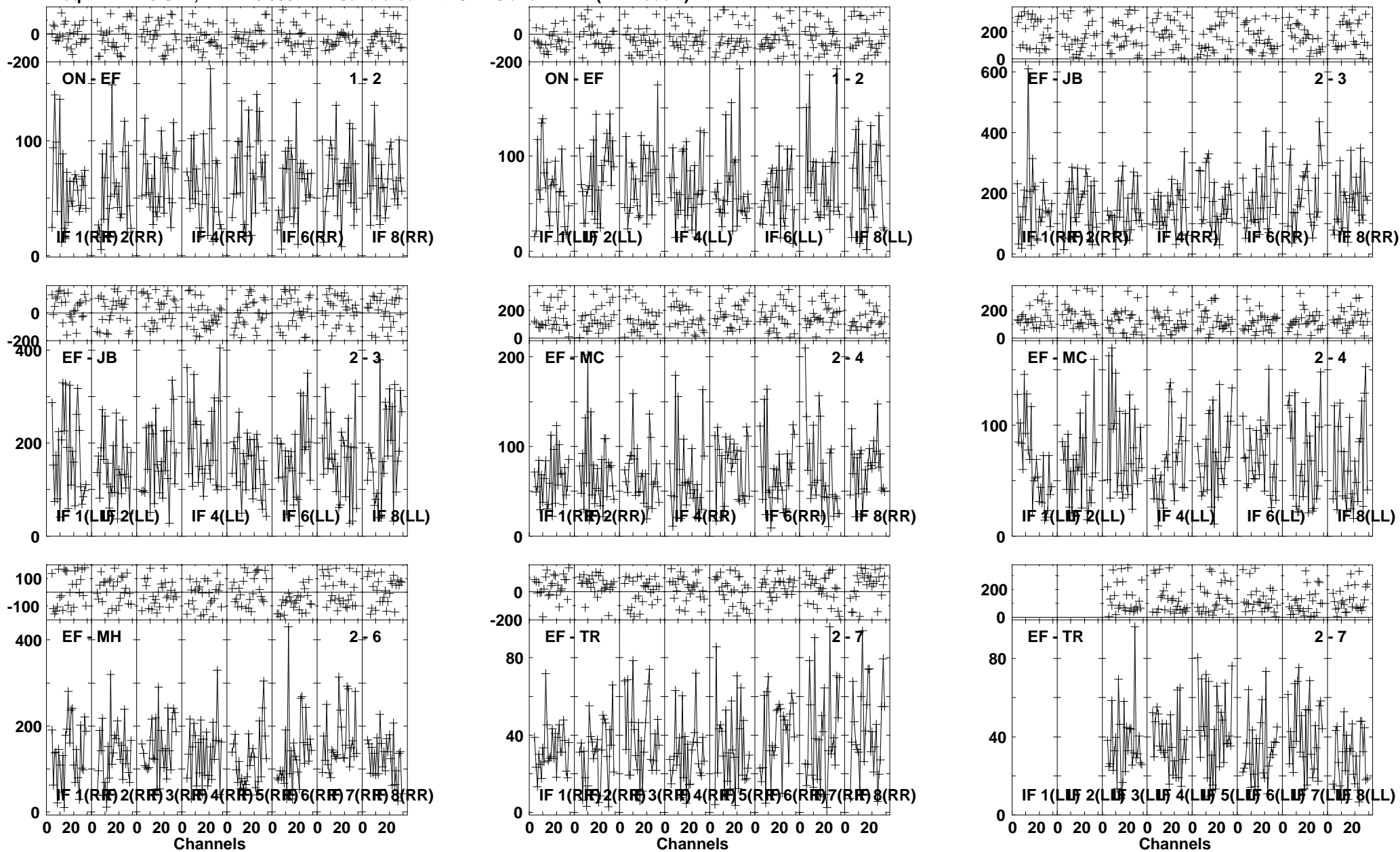

Lower frame: Milli Ampl Jy Top frame: Phas deg
 Vector averaged cross-power spectrum Several baselines displayed
 Timerange: 00/23:47:42 to 00/23:49:40

Plot file version 262 created 26-JUL-2013 10:22:41
 B1152+199A EZ024 1.UVDATA.1
 Freq = 22.1720 GHz, Bw = 16.000 MH Calibrated with CL # 3 and BP # 1 (BP mode 1)

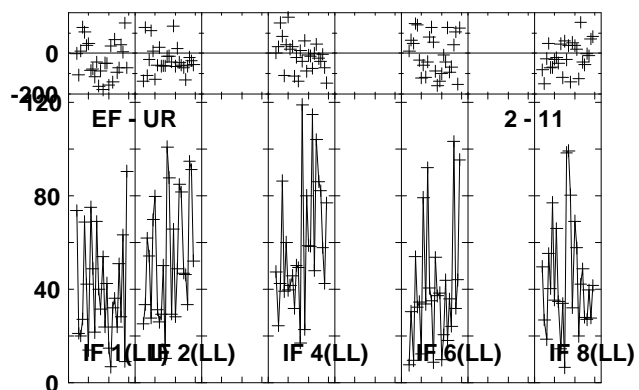
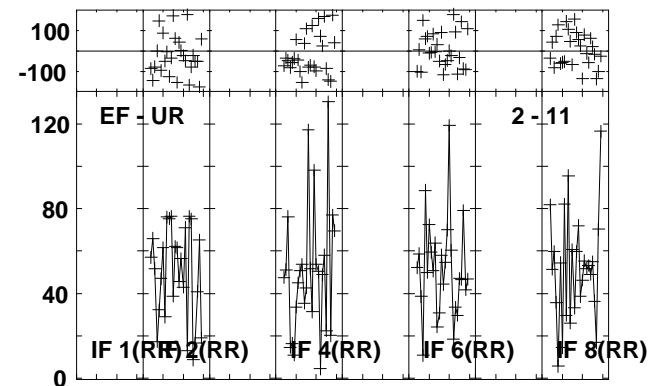
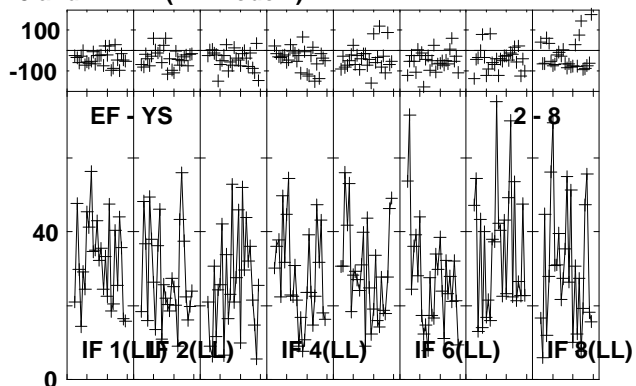
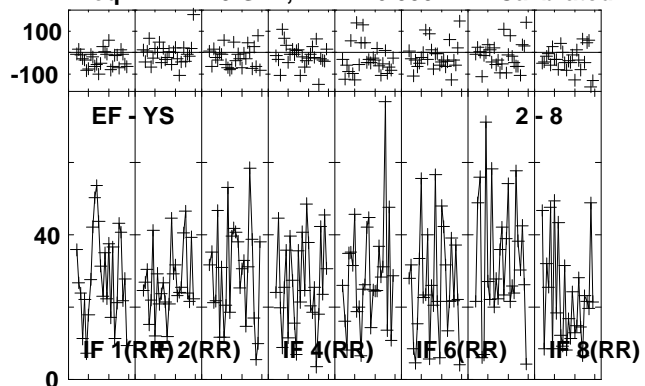

Lower frame: Milli Ampl Jy Top frame: Phas deg
 Vector averaged cross-power spectrum Several baselines displayed
 Timerange: 00/23:47:42 to 00/23:49:40

Plot file version 263 created 26-JUL-2013 10:22:43

J1157 EZ024 1.UVDATA.1

Freq = 22.1720 GHz, Bw = 16.000 MH Calibrated with CL # 3 and BP # 1 (BP mode 1)

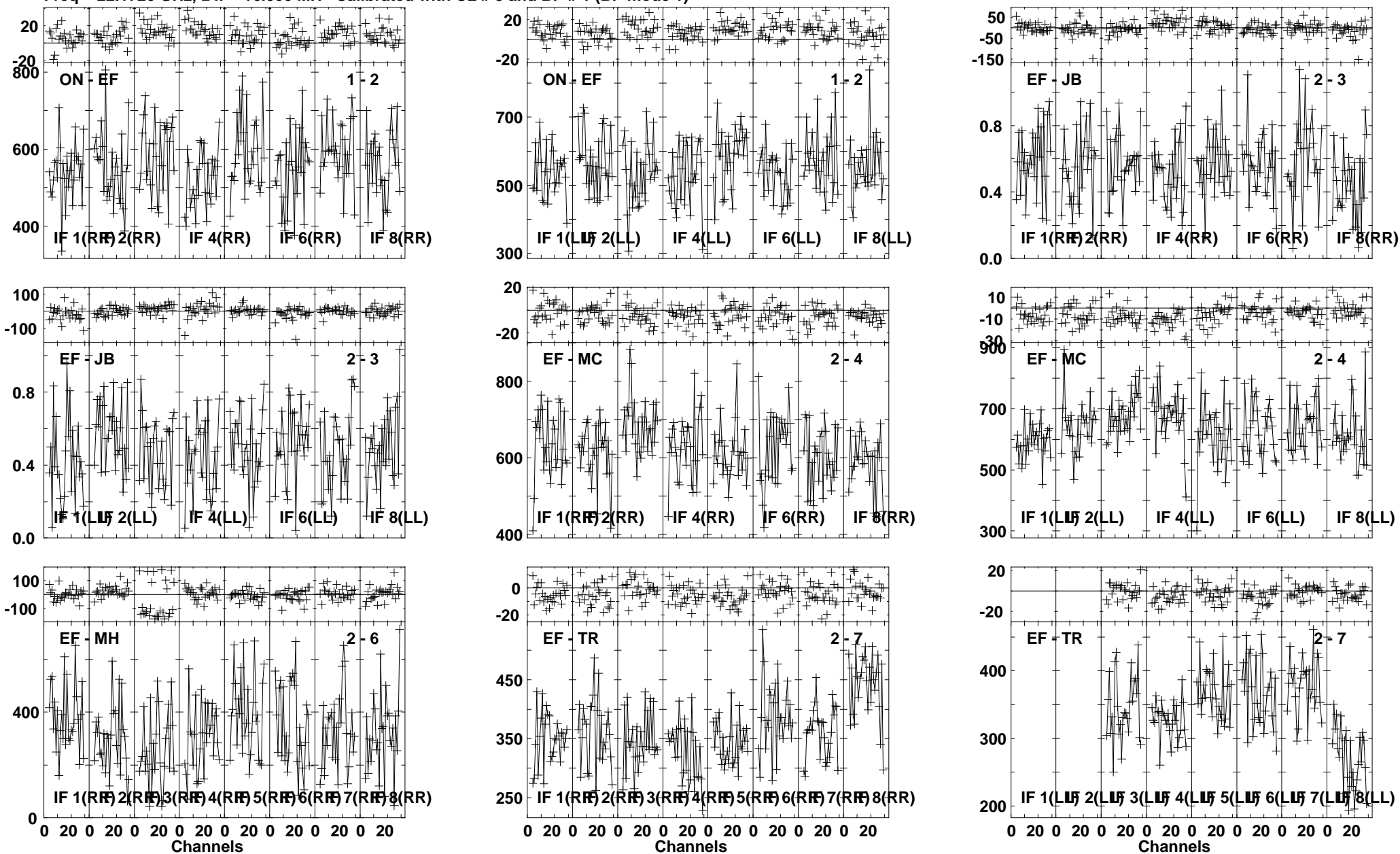

Lower frame: Milli Ampl Jy Top frame: Phas deg
Vector averaged cross-power spectrum Several baselines displayed
Timerange: 00/23:50:15 to 00/23:51:13

Plot file version 264 created 26-JUL-2013 10:22:44
 J1157 EZ024 1.UVDATA.1
 Freq = 22.1720 GHz, Bw = 16.000 MH Calibrated with CL # 3 and BP # 1 (BP mode 1)

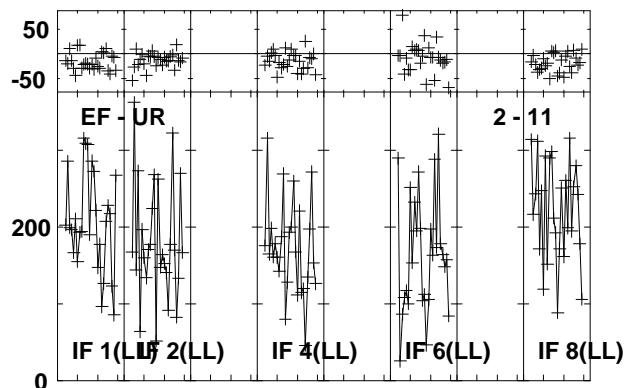
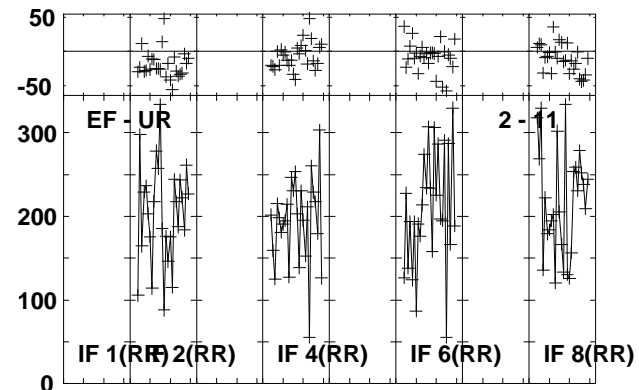
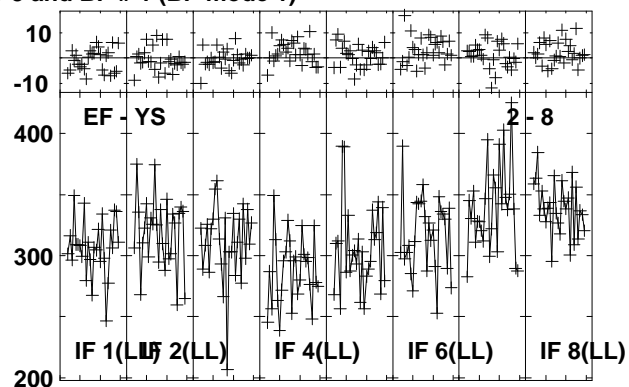
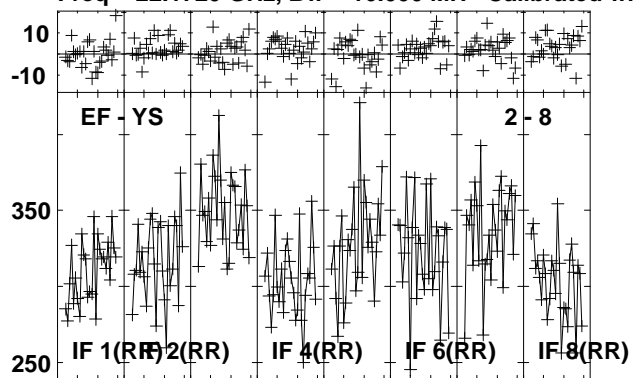

Lower frame: Milli Ampl Jy Top frame: Phas deg
 Vector averaged cross-power spectrum Several baselines displayed
 Timerange: 00/23:50:15 to 00/23:51:13

Plot file version 265 created 26-JUL-2013 10:22:45
 B1152+199A EZ024 1.UVDATA.1
 Freq = 22.1720 GHz, Bw = 16.000 MH Calibrated with CL # 3 and BP # 1 (BP mode 1)

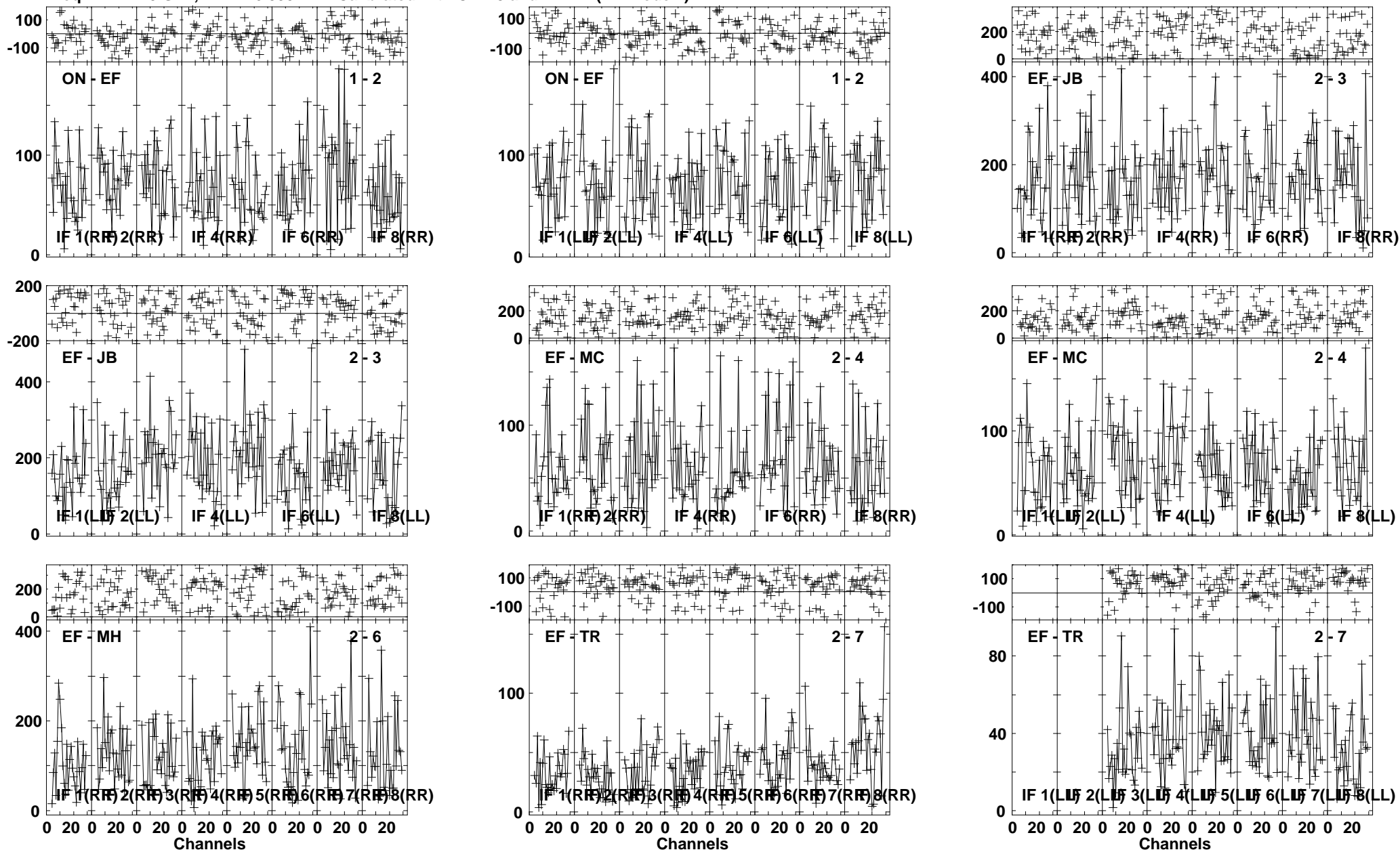

Lower frame: Milli Ampl Jy Top frame: Phas deg
 Vector averaged cross-power spectrum Several baselines displayed
 Timerange: 00/23:51:49 to 00/23:53:47

Plot file version 266 created 26-JUL-2013 10:22:47

B1152+199A EZ024 1.UVDATA.1

Freq = 22.1720 GHz, Bw = 16.000 MH Calibrated with CL # 3 and BP # 1 (BP mode 1)

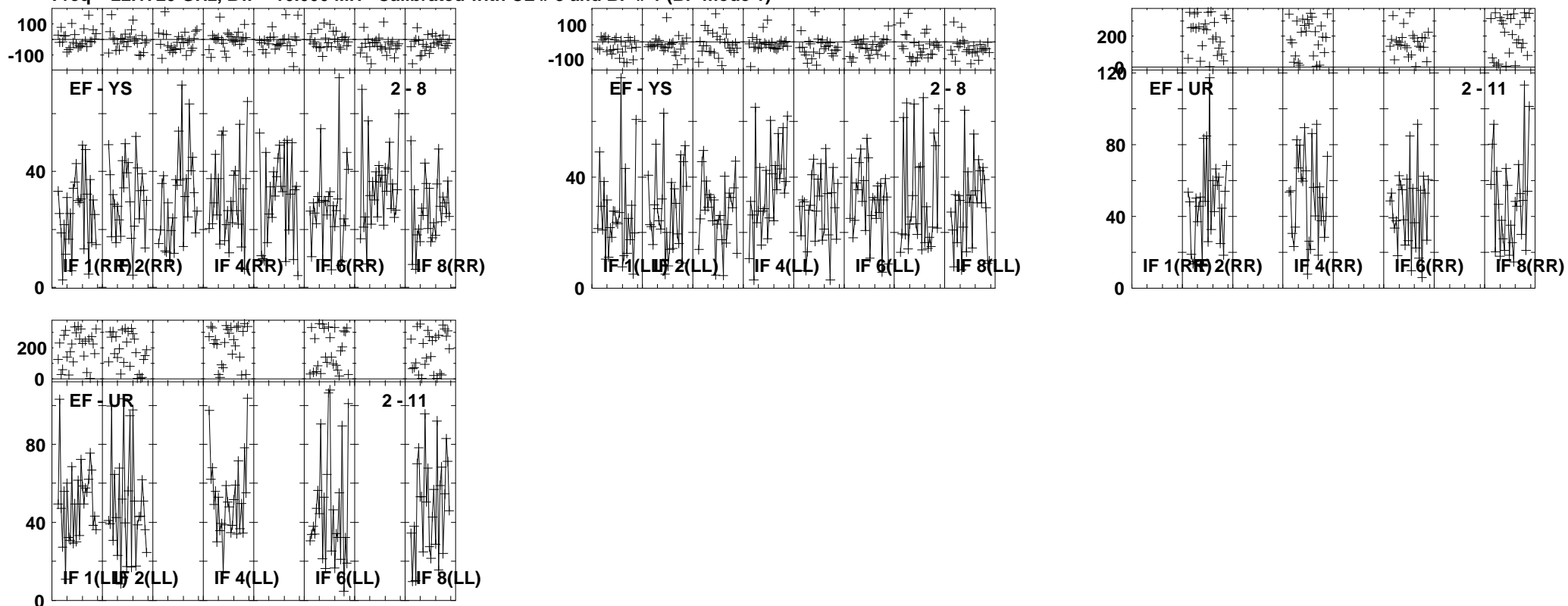

Lower frame: Milli Ampl Jy Top frame: Phas deg
Vector averaged cross-power spectrum Several baselines displayed
Timerange: 00/23:51:49 to 00/23:53:47

Plot file version 267 created 26-JUL-2013 10:22:49
 J1157 EZ024 1.UVDATA.1
 Freq = 22.1720 GHz, Bw = 16.000 MH Calibrated with CL # 3 and BP # 1 (BP mode 1)

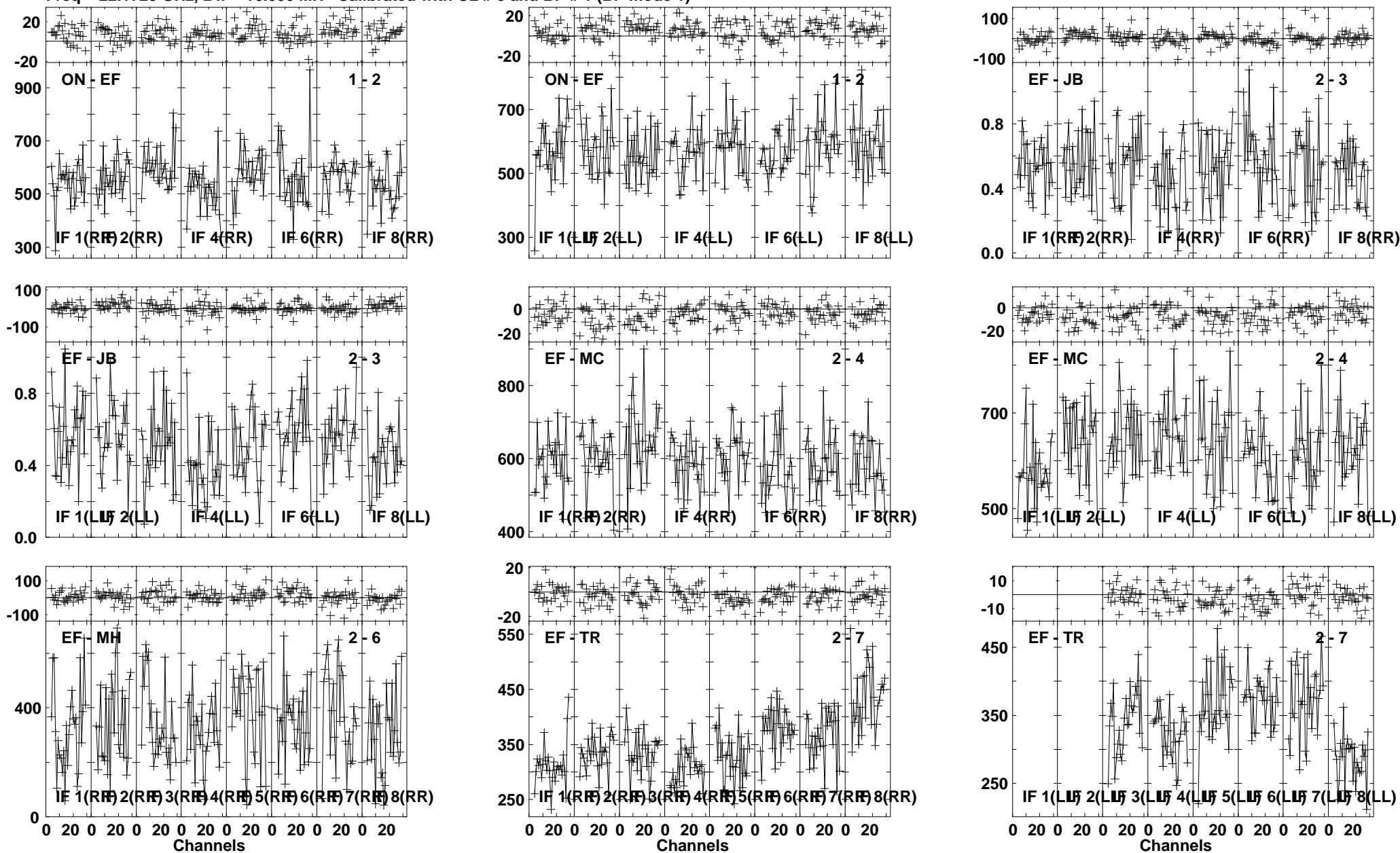

Lower frame: Milli Ampl Jy Top frame: Phas deg
 Vector averaged cross-power spectrum Several baselines displayed
 Timerange: 00/23:54:23 to 00/23:55:21

Plot file version 268 created 26-JUL-2013 10:22:50

J1157 EZ024 1.UVDATA.1

Freq = 22.1720 GHz, Bw = 16.000 MH Calibrated with CL # 3 and BP # 1 (BP mode 1)

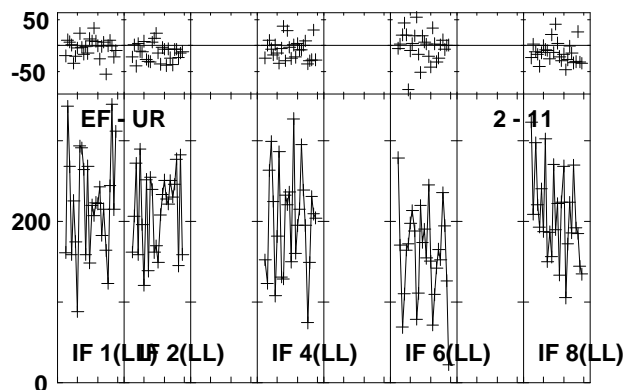
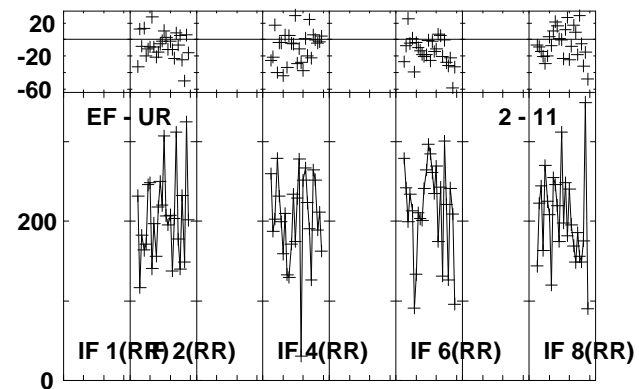
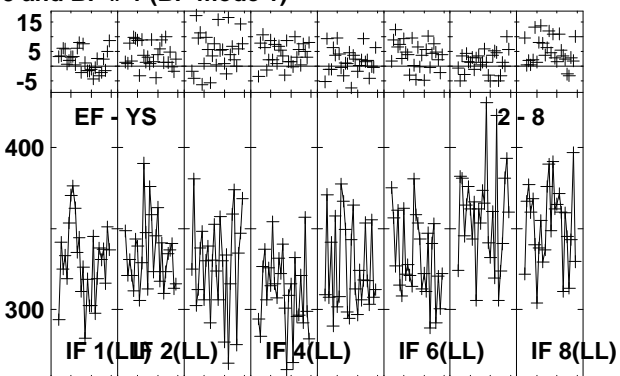
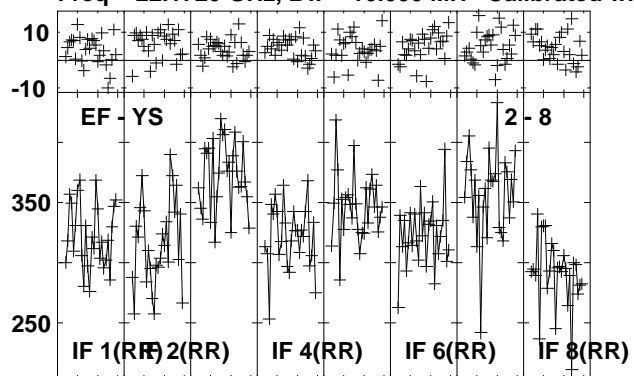

Lower frame: Milli Ampl Jy Top frame: Phas deg
Vector averaged cross-power spectrum Several baselines displayed
Timerange: 00/23:54:23 to 00/23:55:21

Plot file version 269 created 26-JUL-2013 10:22:51
 J1157 EZ024 1.UVDATA.1
 Freq = 22.1720 GHz, Bw = 16.000 MH Calibrated with CL # 3 and BP # 1 (BP mode 1)

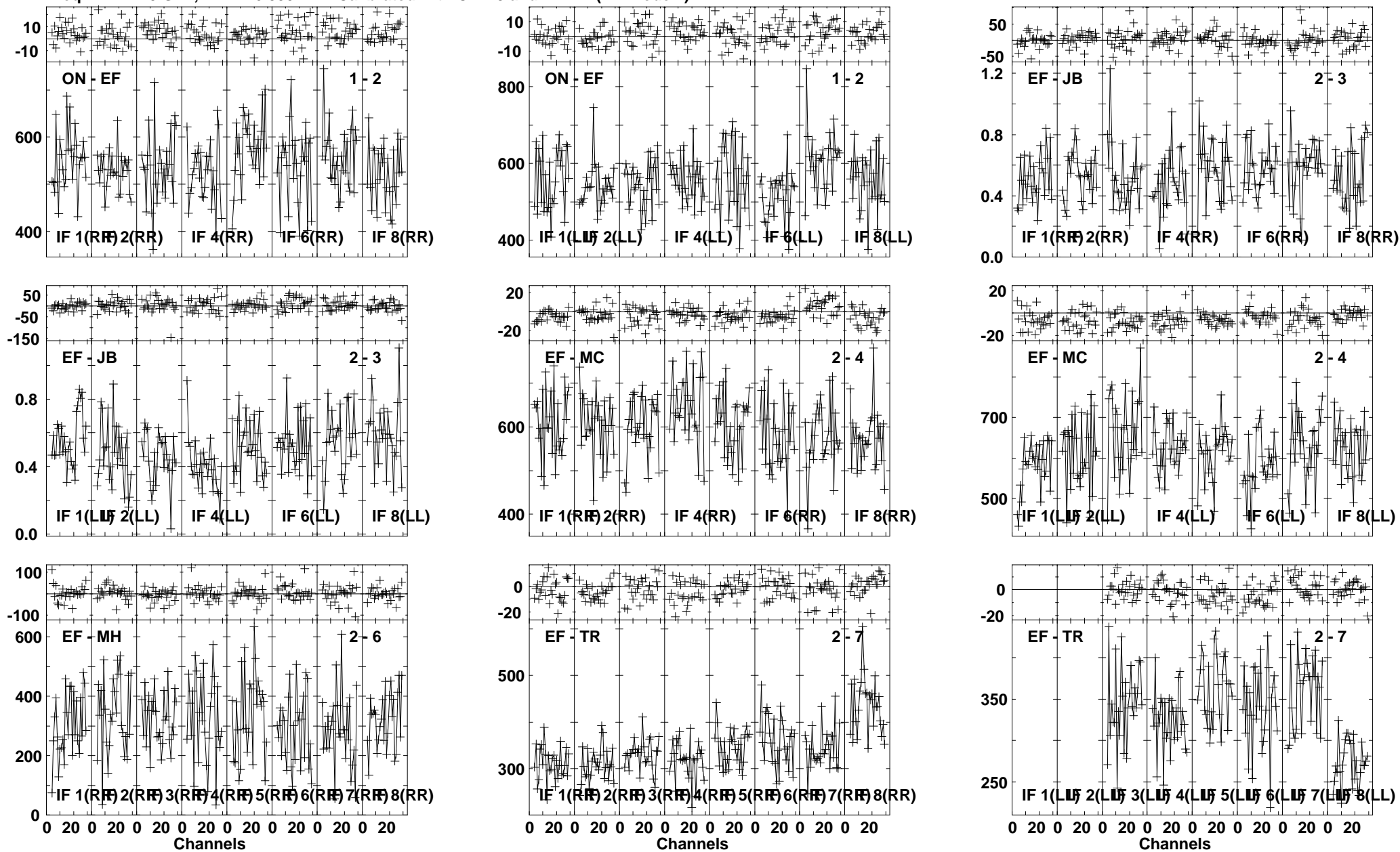

Lower frame: Milli Ampl Jy Top frame: Phas deg
 Vector averaged cross-power spectrum Several baselines displayed
 Timerange: 00/23:55:43 to 00/23:56:41

Plot file version 270 created 26-JUL-2013 10:22:52
 J1157 EZ024 1.UVDATA.1
 Freq = 22.1720 GHz, Bw = 16.000 MH Calibrated with CL # 3 and BP # 1 (BP mode 1)

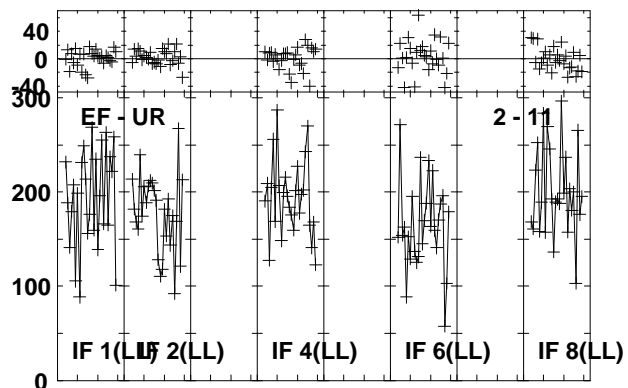
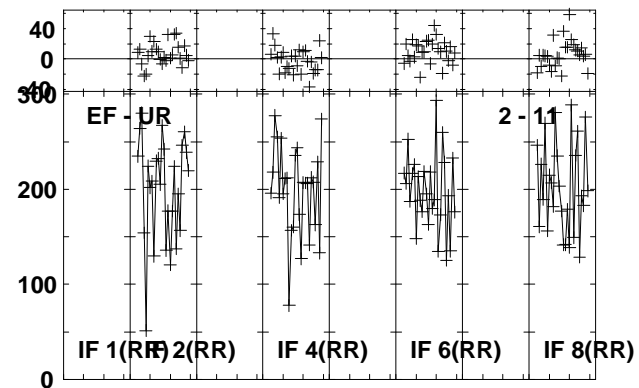
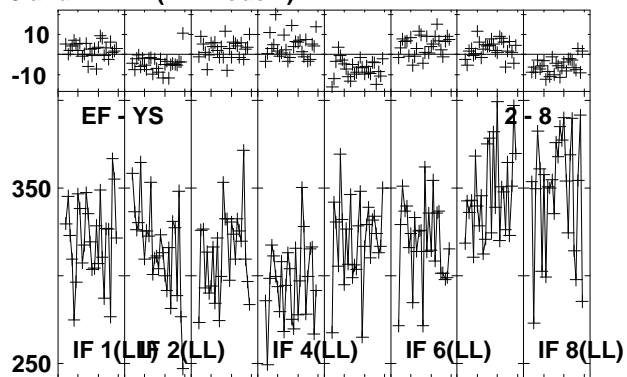
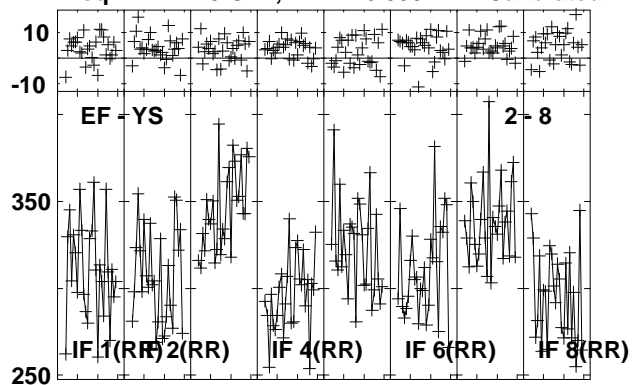

Lower frame: Milli Ampl Jy Top frame: Phas deg
 Vector averaged cross-power spectrum Several baselines displayed
 Timerange: 00/23:55:43 to 00/23:56:41

Plot file version 271 created 26-JUL-2013 10:22:53
 J1125+2610 EZ024 1.UVDATA.1
 Freq = 22.1720 GHz, Bw = 16.000 MH Calibrated with CL # 3 and BP # 1 (BP mode 1)

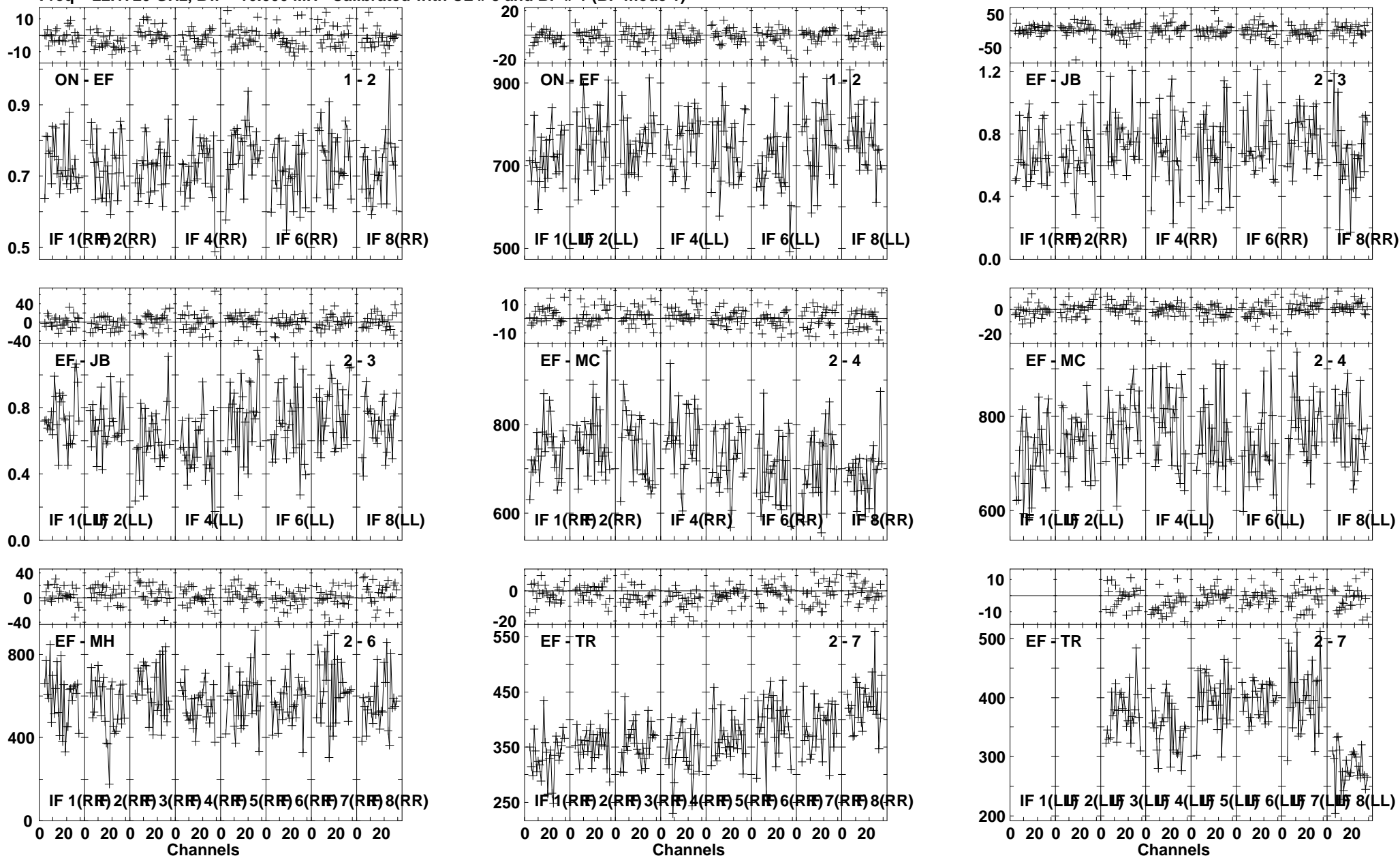

Lower frame: Ampl Jy Top frame: Phas deg
 Vector averaged cross-power spectrum Several baselines displayed
 Timerange: 00/23:58:04 to 00/23:59:46

Plot file version 272 created 26-JUL-2013 10:22:55
 J1125+2610 EZ024 1.UVDATA.1
 Freq = 22.1720 GHz, Bw = 16.000 MH Calibrated with CL # 3 and BP # 1 (BP mode 1)

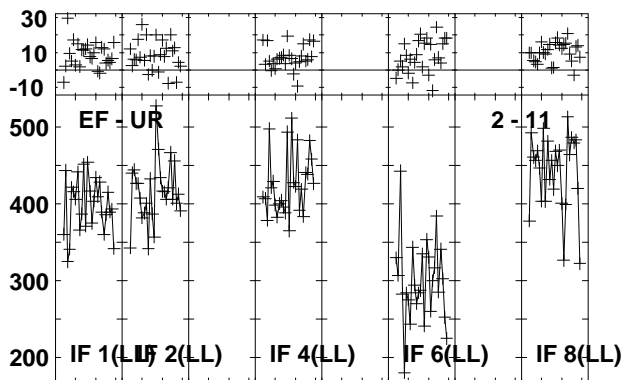
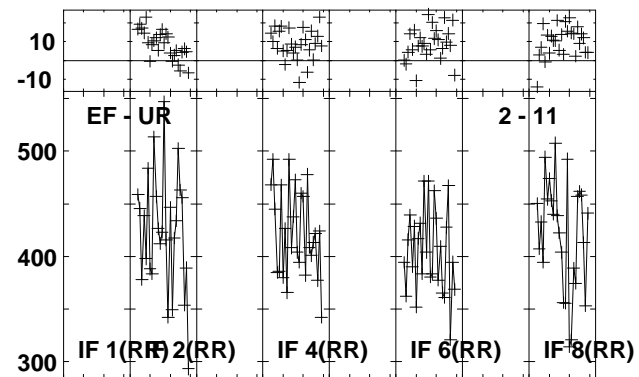
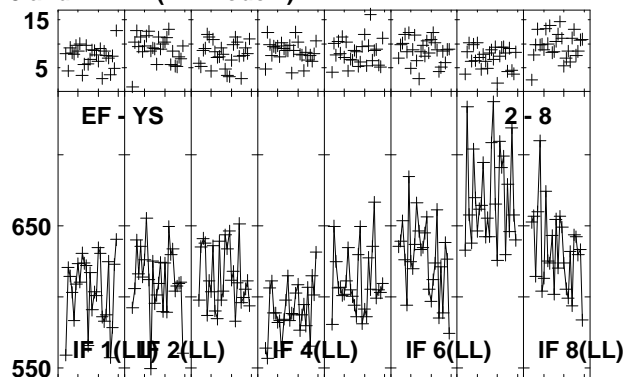
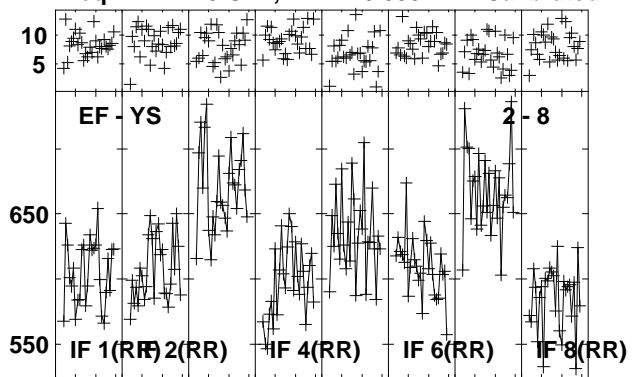

Lower frame: Milli Ampl Jy Top frame: Phas deg
 Vector averaged cross-power spectrum Several baselines displayed
 Timerange: 00/23:58:04 to 00/23:59:46

Plot file version 273 created 26-JUL-2013 10:22:56

J1157 EZ024 1.UVDATA.1

Freq = 22.1720 GHz, Bw = 16.000 MH Calibrated with CL # 3 and BP # 1 (BP mode 1)

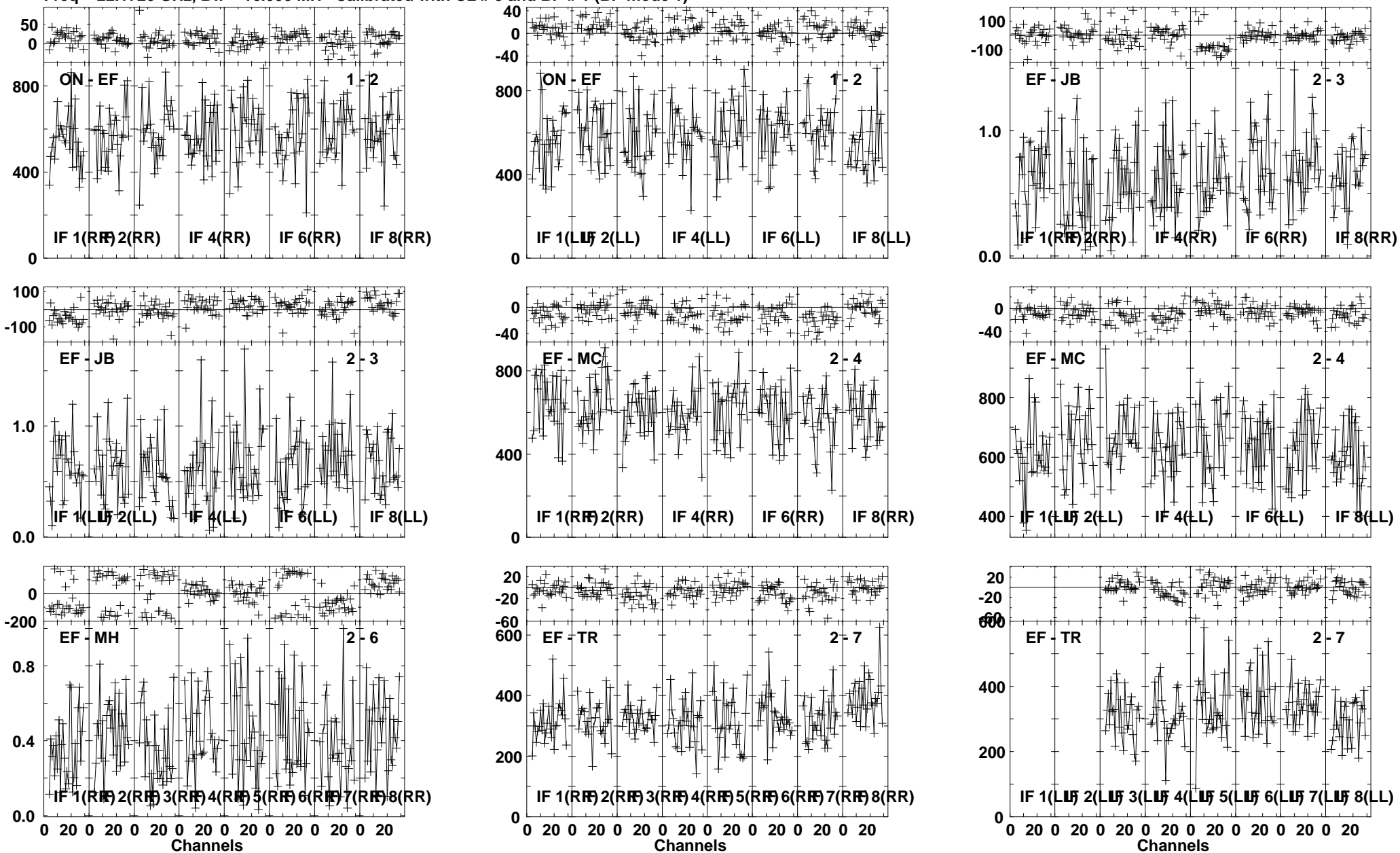

Lower frame: Milli Ampl Jy Top frame: Phas deg
Vector averaged cross-power spectrum Several baselines displayed
Timerange: 01/00:01:09 to 01/00:01:51

Plot file version 274 created 26-JUL-2013 10:22:57

J1157 EZ024 1.UVDATA.1

Freq = 22.1720 GHz, Bw = 16.000 MH Calibrated with CL # 3 and BP # 1 (BP mode 1)

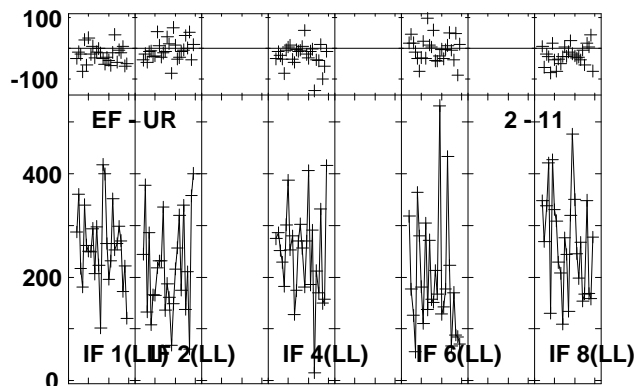
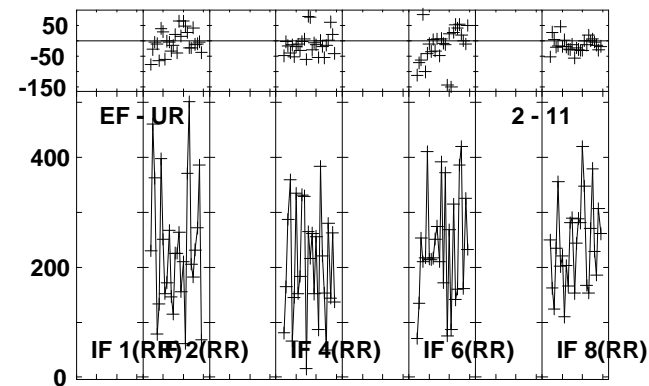
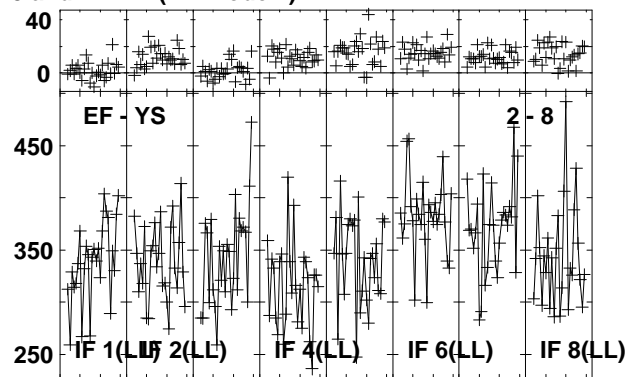
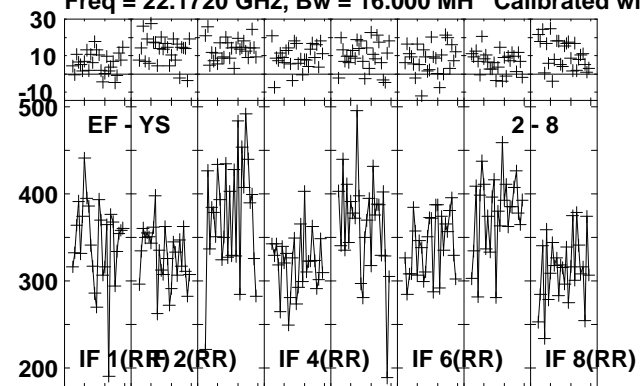

Lower frame: Milli Ampl Jy Top frame: Phas deg
Vector averaged cross-power spectrum Several baselines displayed
Timerange: 01/00:01:09 to 01/00:01:51

Plot file version 275 created 26-JUL-2013 10:22:58
 B1152+199A EZ024 1.UVDATA.1
 Freq = 22.1720 GHz, Bw = 16.000 MH Calibrated with CL # 3 and BP # 1 (BP mode 1)

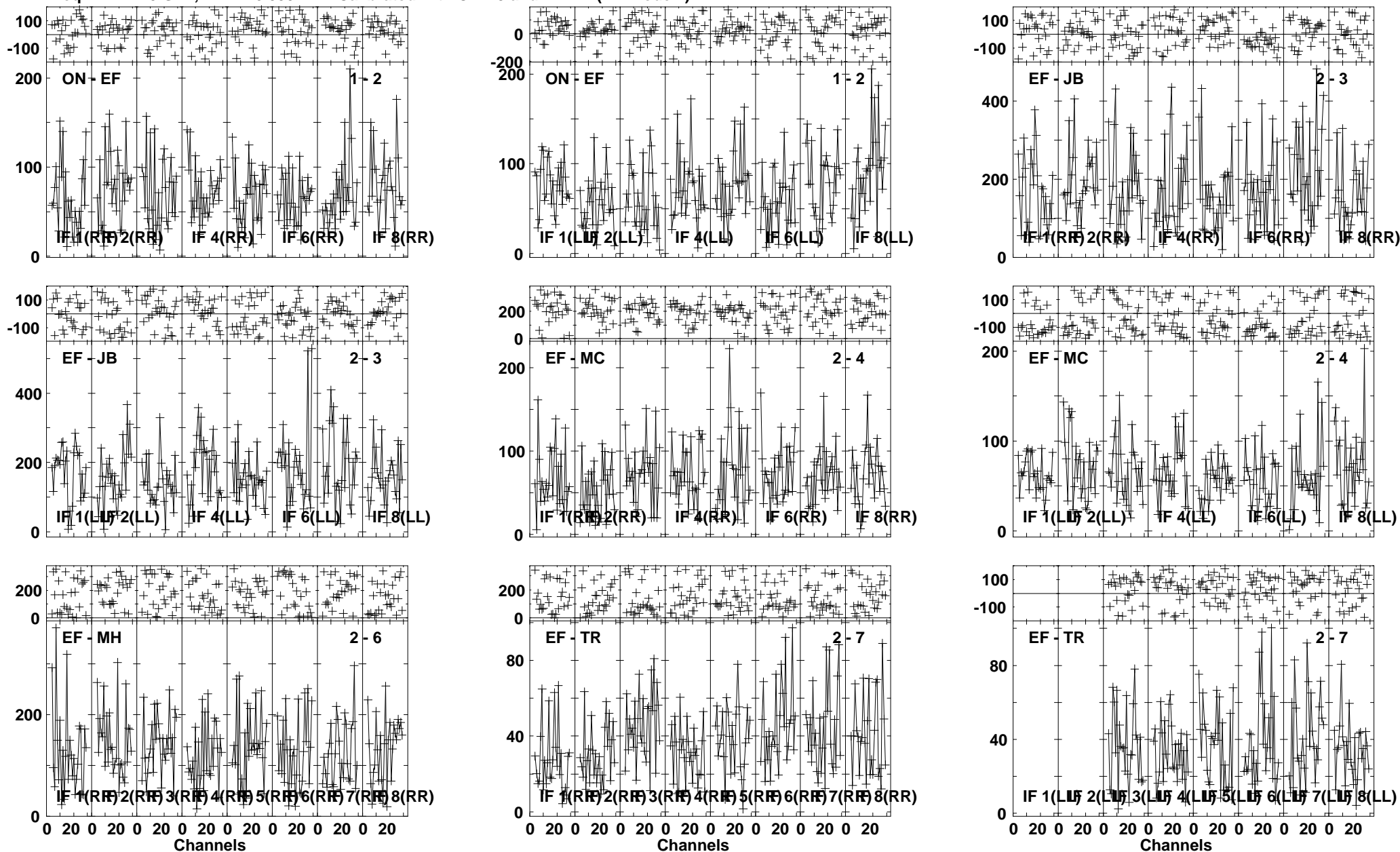

Lower frame: Milli Ampl Jy Top frame: Phas deg
 Vector averaged cross-power spectrum Several baselines displayed
 Timerange: 01/00:02:27 to 01/00:04:25

Plot file version 276 created 26-JUL-2013 10:23:00
 B1152+199A EZ024 1.UVDATA.1
 Freq = 22.1720 GHz, Bw = 16.000 MH Calibrated with CL # 3 and BP # 1 (BP mode 1)

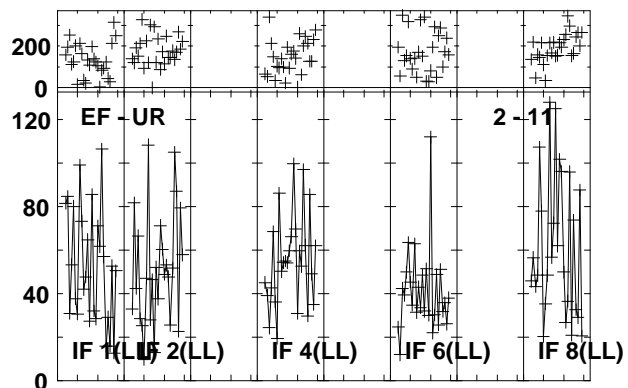
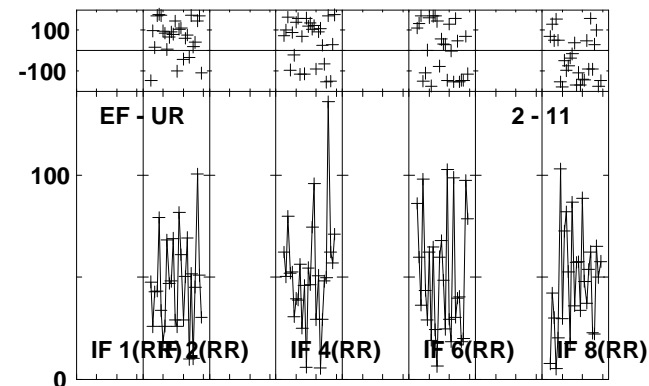
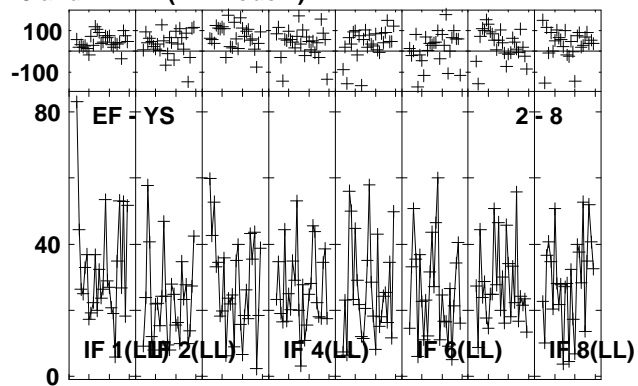
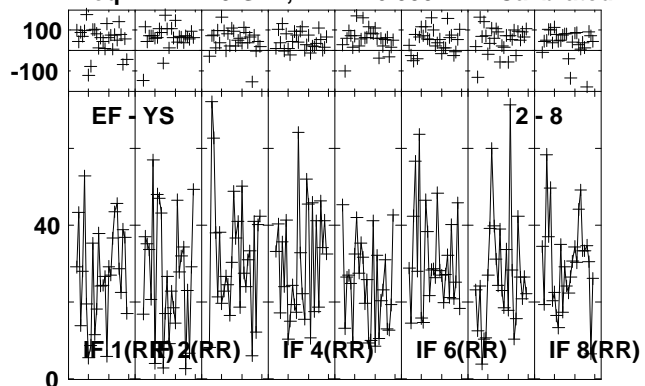

Lower frame: Milli Ampl Jy Top frame: Phas deg
 Vector averaged cross-power spectrum Several baselines displayed
 Timerange: 01/00:02:27 to 01/00:04:25

Plot file version 277 created 26-JUL-2013 10:23:02

J1157 EZ024 1.UVDATA.1

Freq = 22.1720 GHz, Bw = 16.000 MH Calibrated with CL # 3 and BP # 1 (BP mode 1)

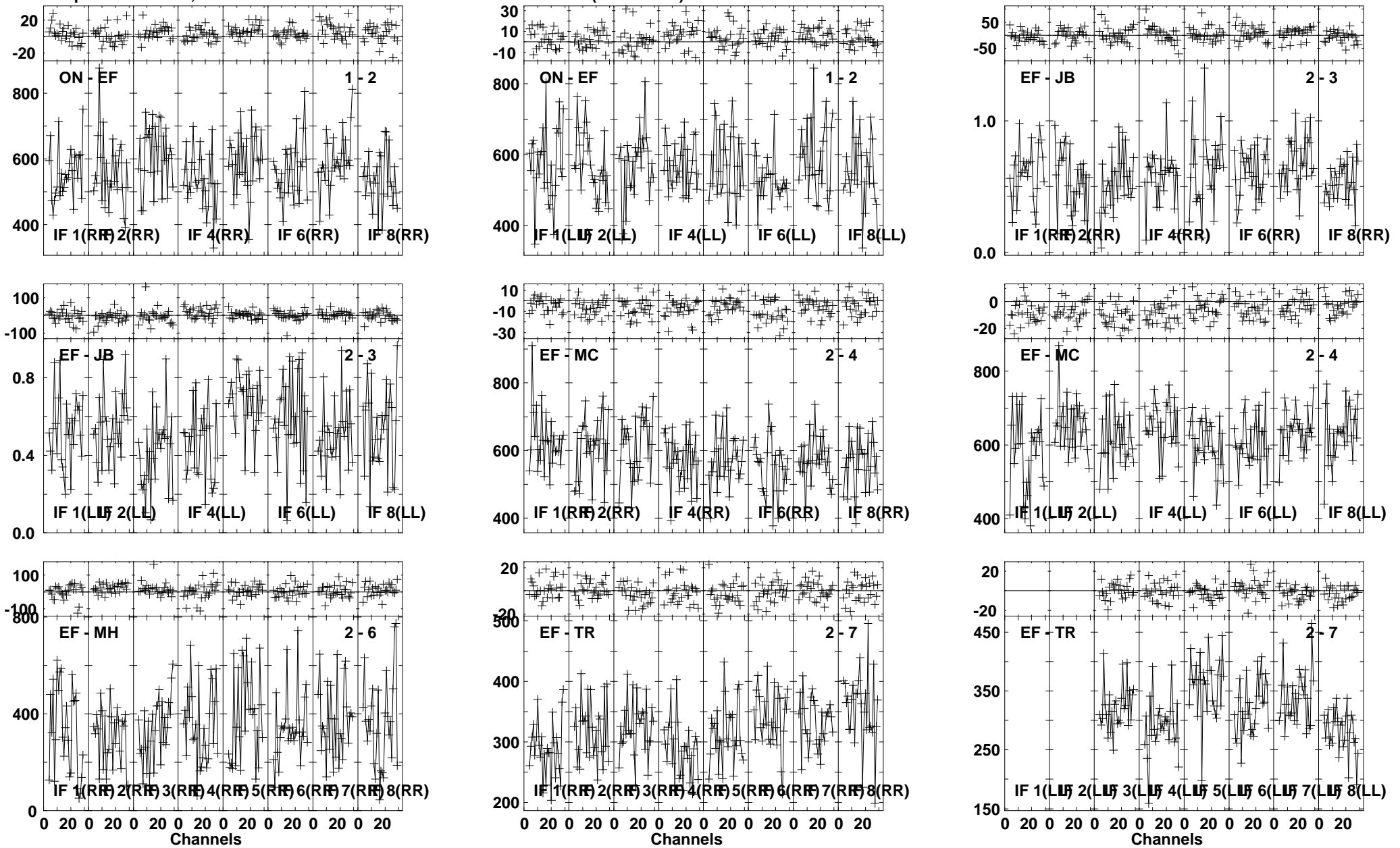

Lower frame: Milli Ampl Jy Top frame: Phas deg
Vector averaged cross-power spectrum Several baselines displayed
Timerange: 01/00:05:01 to 01/00:05:59

Plot file version 278 created 26-JUL-2013 10:23:03
 J1157 EZ024 1.UVDATA.1
 Freq = 22.1720 GHz, Bw = 16.000 MH Calibrated with CL # 3 and BP # 1 (BP mode 1)

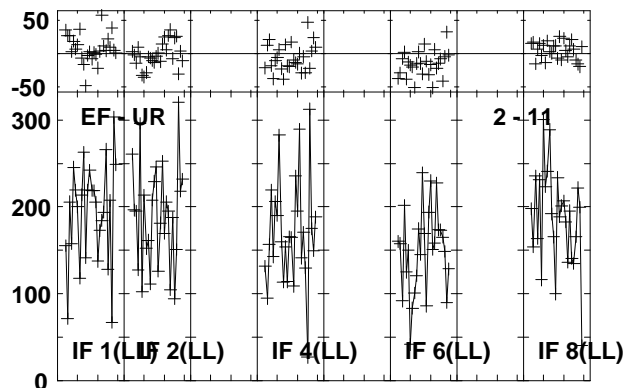
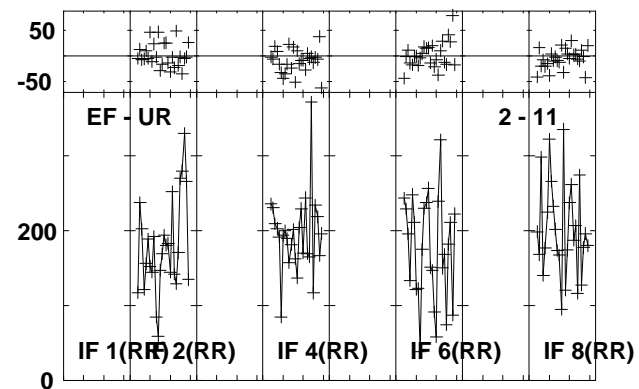
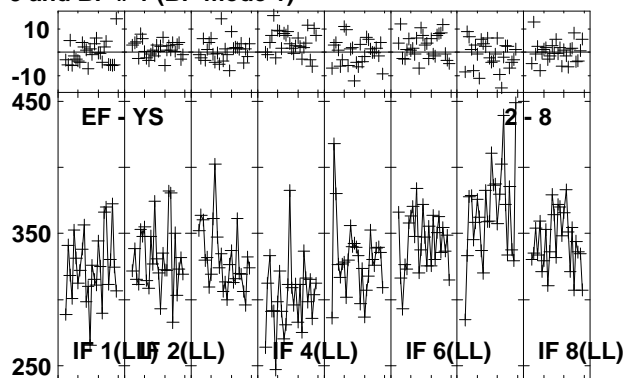
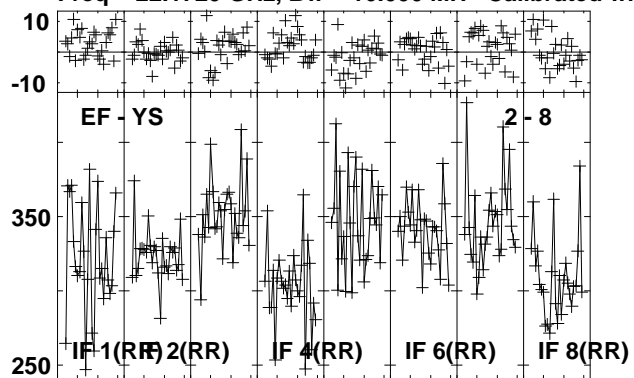

Lower frame: Milli Ampl Jy Top frame: Phas deg
 Vector averaged cross-power spectrum Several baselines displayed
 Timerange: 01/00:05:01 to 01/00:05:59

Plot file version 279 created 26-JUL-2013 10:23:04
 B1152+199A EZ024 1.UVDATA.1
 Freq = 22.1720 GHz, Bw = 16.000 MH Calibrated with CL # 3 and BP # 1 (BP mode 1)

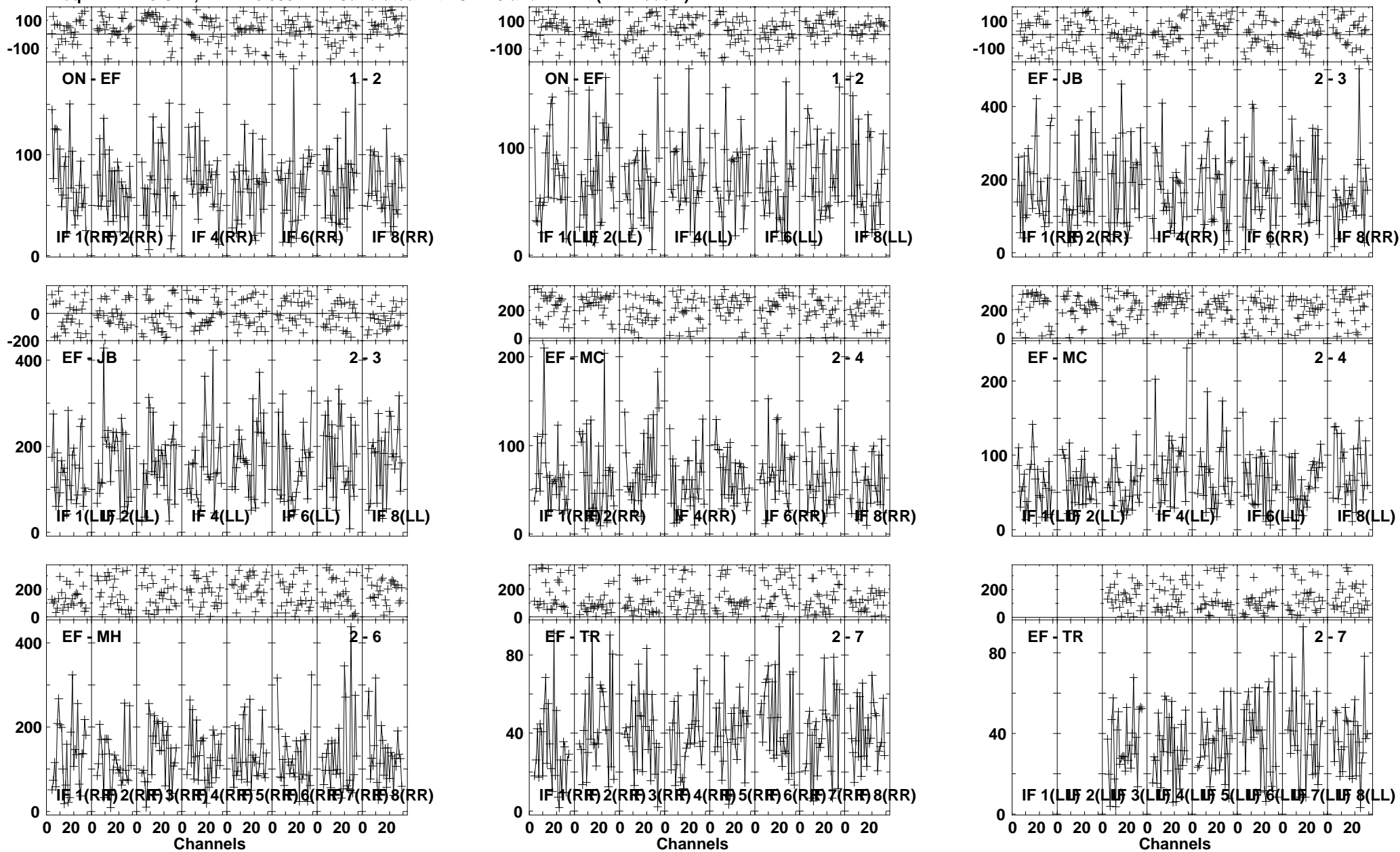

Lower frame: Milli Ampl Jy Top frame: Phas deg
 Vector averaged cross-power spectrum Several baselines displayed
 Timerange: 01/00:06:35 to 01/00:08:33

Plot file version 280 created 26-JUL-2013 10:23:06
 B1152+199A EZ024 1.UVDATA.1
 Freq = 22.1720 GHz, Bw = 16.000 MH Calibrated with CL # 3 and BP # 1 (BP mode 1)

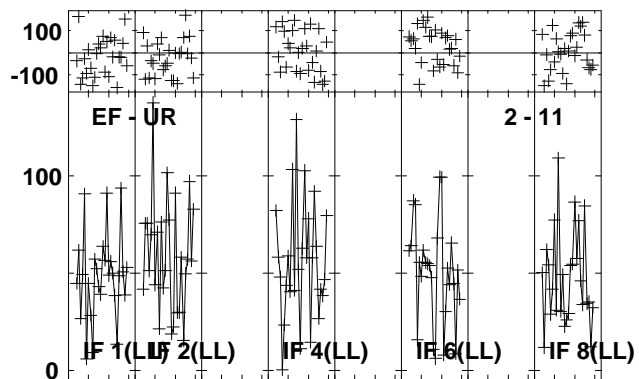
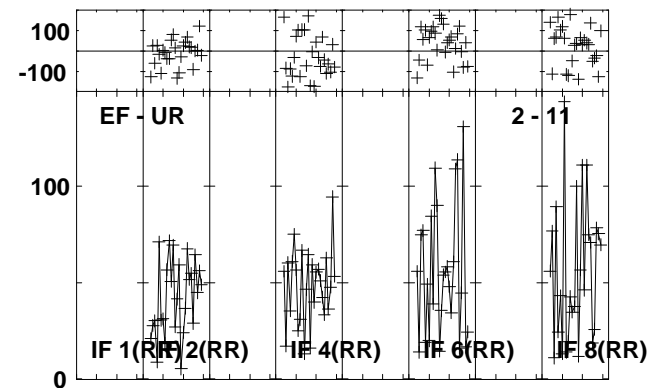
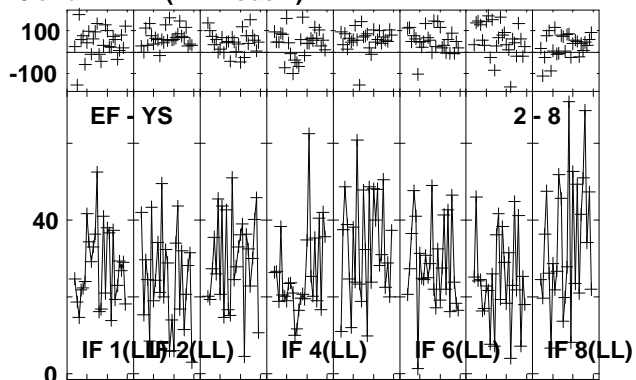
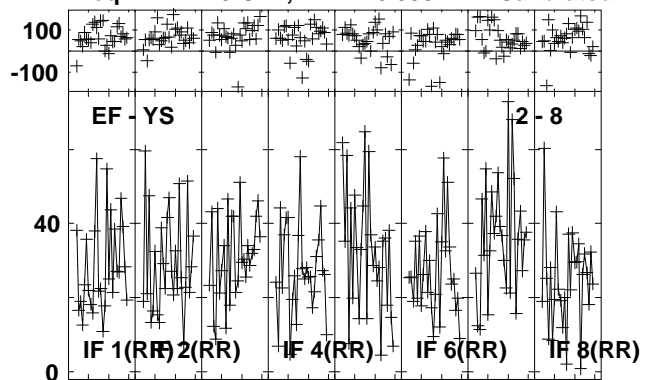

Lower frame: Milli Ampl Jy Top frame: Phas deg
 Vector averaged cross-power spectrum Several baselines displayed
 Timerange: 01/00:06:35 to 01/00:08:33

Plot file version 281 created 26-JUL-2013 10:23:08

J1157 EZ024 1.UVDATA.1

Freq = 22.1720 GHz, Bw = 16.000 MH Calibrated with CL # 3 and BP # 1 (BP mode 1)

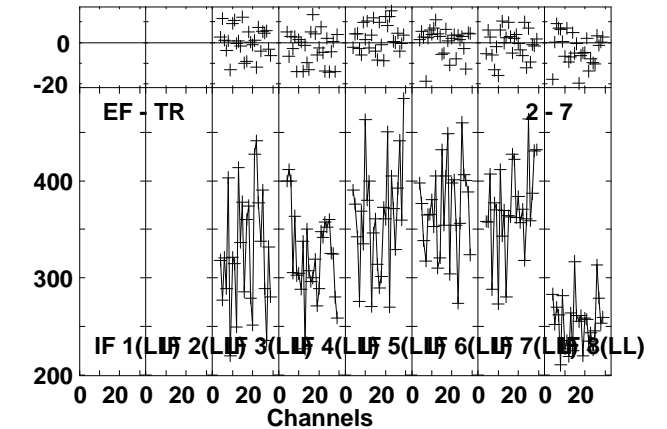
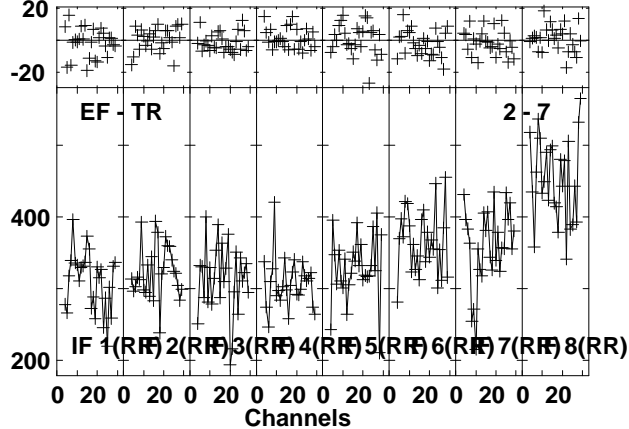
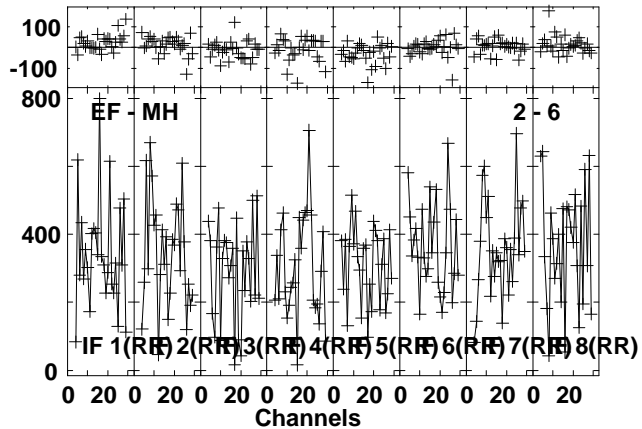
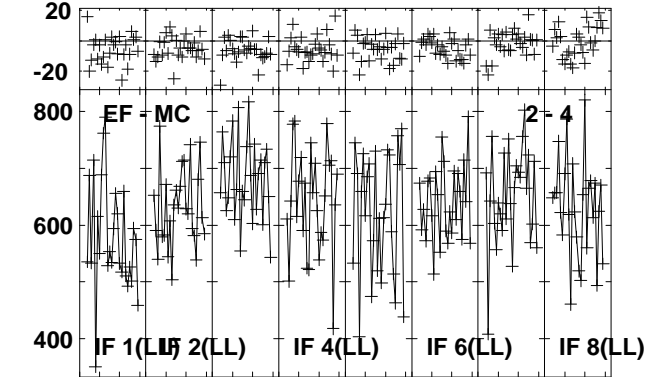
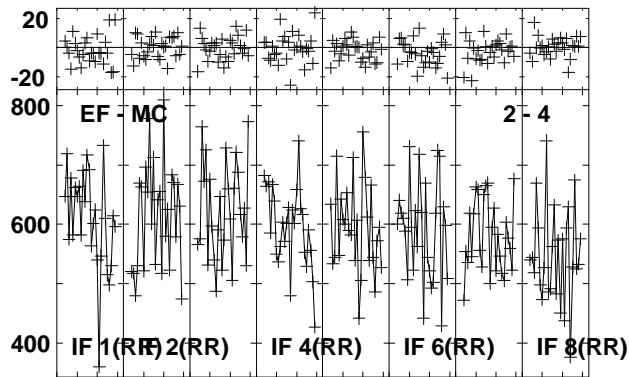
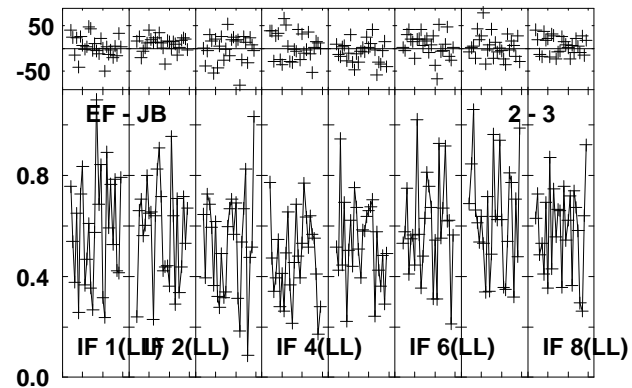
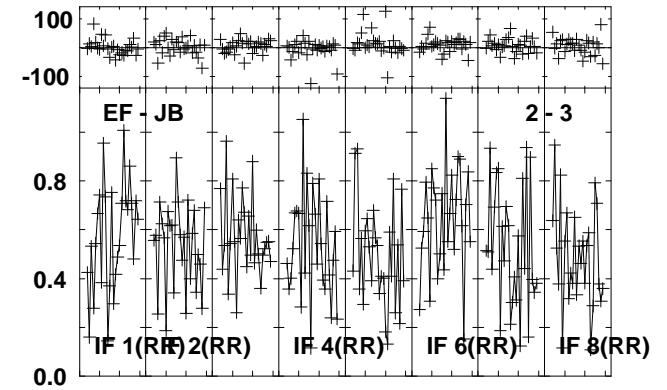
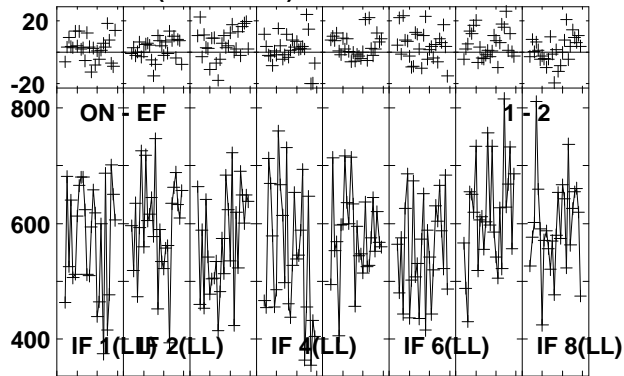
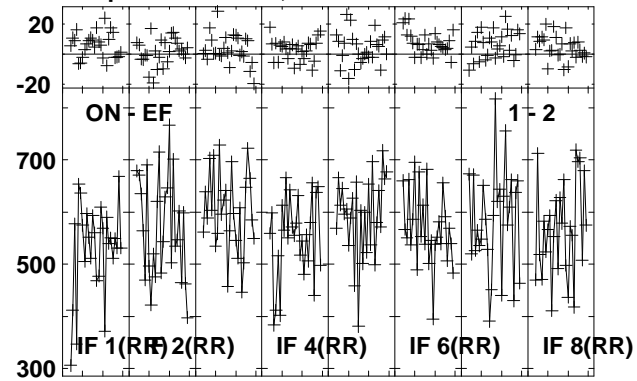

Lower frame: Milli Ampl Jy Top frame: Phas deg
Vector averaged cross-power spectrum Several baselines displayed
Timerange: 01/00:09:08 to 01/00:10:06

Plot file version 282 created 26-JUL-2013 10:23:09
 J1157 EZ024 1.UVDATA.1
 Freq = 22.1720 GHz, Bw = 16.000 MH Calibrated with CL # 3 and BP # 1 (BP mode 1)

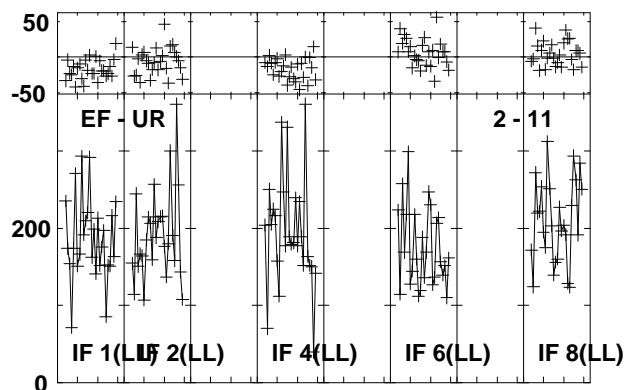
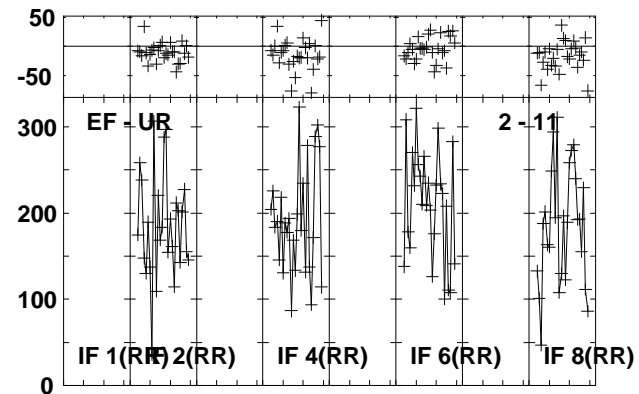
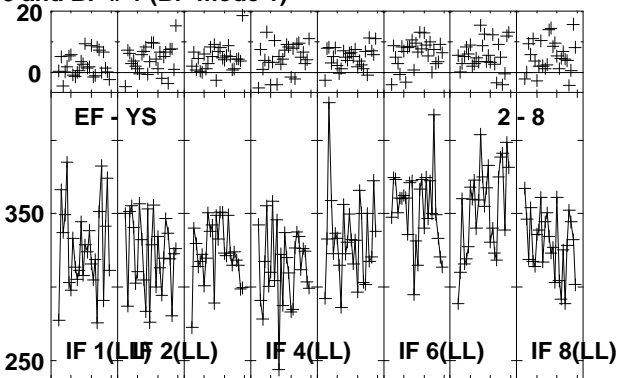
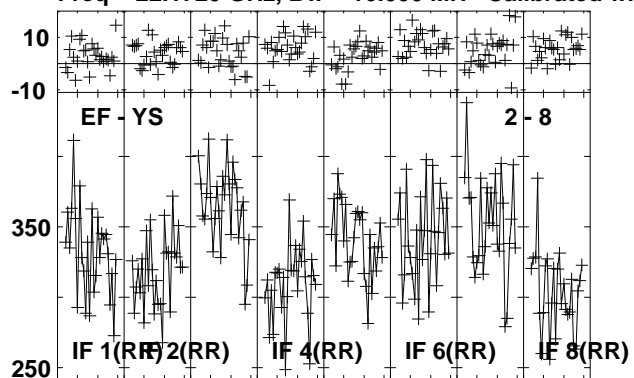

Lower frame: Milli Ampl Jy Top frame: Phas deg
 Vector averaged cross-power spectrum Several baselines displayed
 Timerange: 01/00:09:08 to 01/00:10:06

Plot file version 283 created 26-JUL-2013 10:23:11
 B1152+199A EZ24 1.UVDATA.1
 Freq = 22.1720 GHz, Bw = 16.000 MH Calibrated with CL # 3 and BP # 1 (BP mode 1)

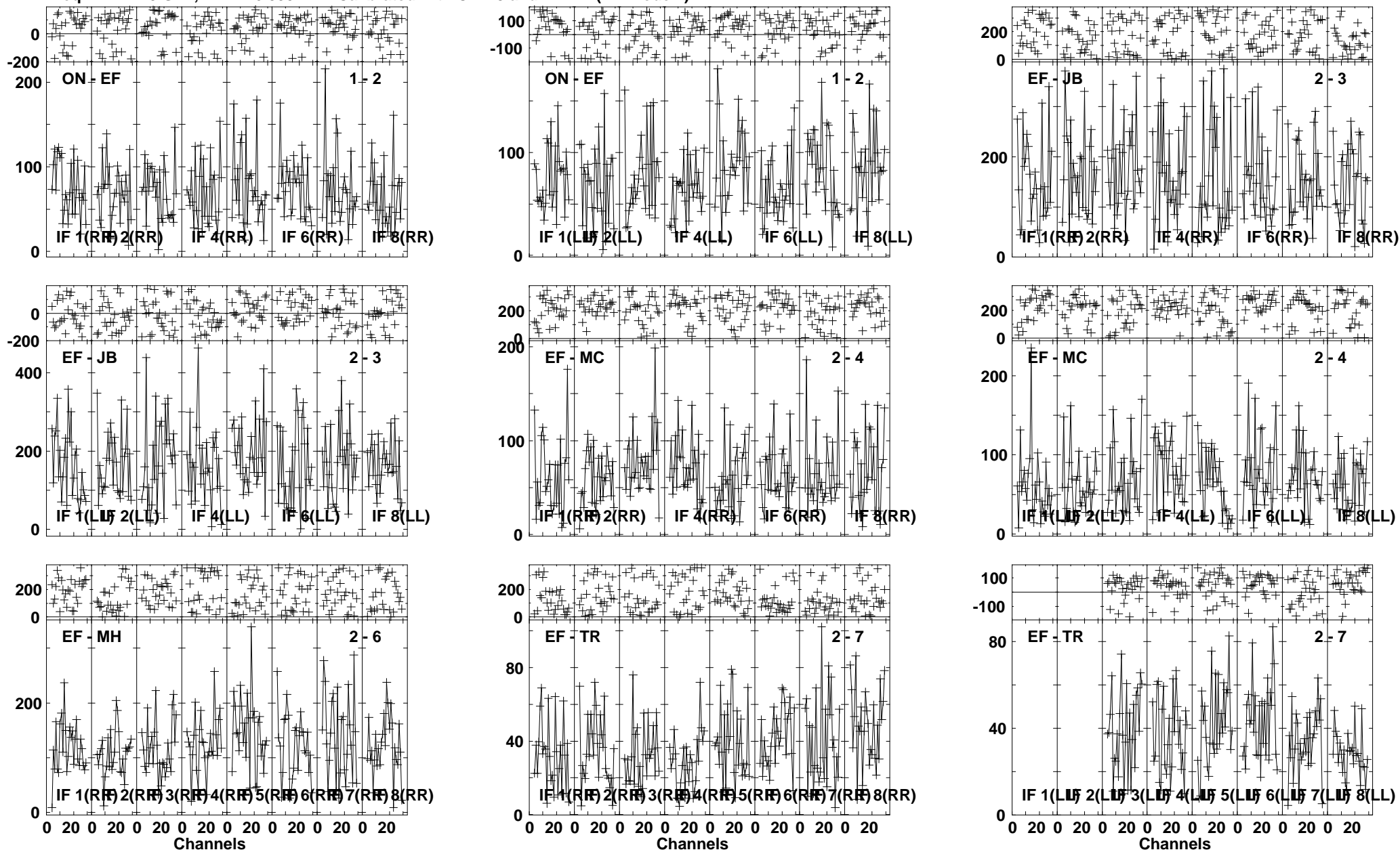

Lower frame: Milli Ampl Jy Top frame: Phas deg
 Vector averaged cross-power spectrum Several baselines displayed
 Timerange: 01/00:10:42 to 01/00:12:40

Plot file version 284 created 26-JUL-2013 10:23:12
 B1152+199A EZ024 1.UVDATA.1
 Freq = 22.1720 GHz, Bw = 16.000 MH Calibrated with CL # 3 and BP # 1 (BP mode 1)

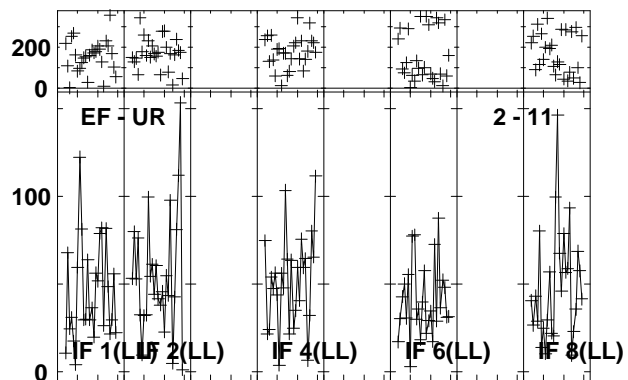
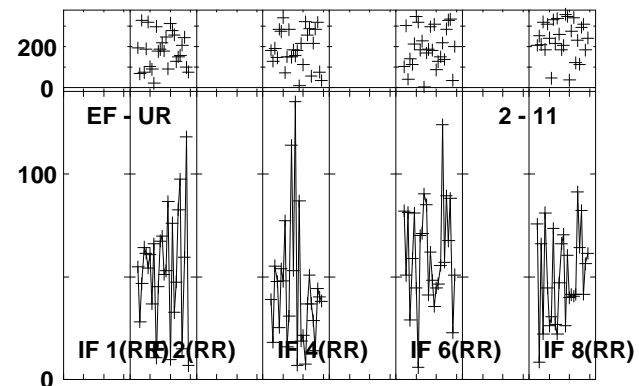
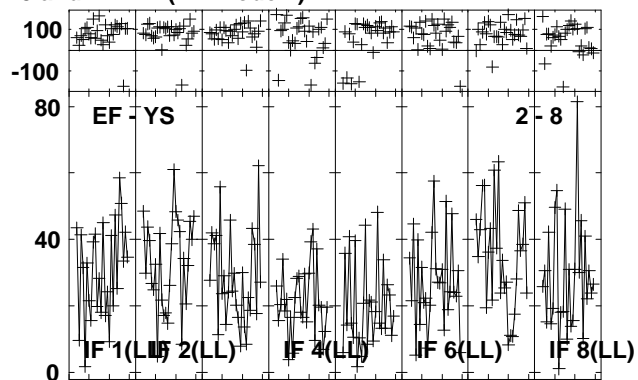
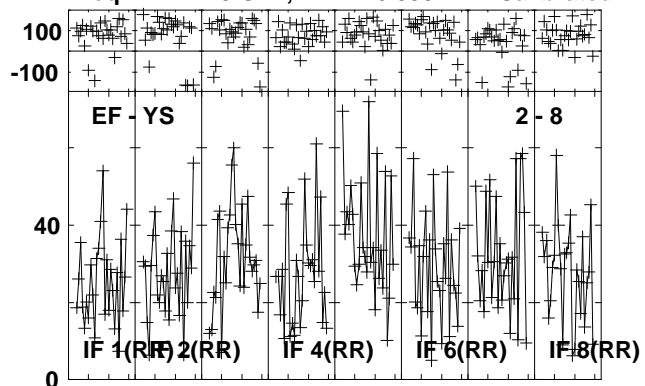

Lower frame: Milli Ampl Jy Top frame: Phas deg
 Vector averaged cross-power spectrum Several baselines displayed
 Timerange: 01/00:10:42 to 01/00:12:40

Plot file version 285 created 26-JUL-2013 10:23:14

J1157 EZ024 1.UVDATA.1

Freq = 22.1720 GHz, Bw = 16.000 MH Calibrated with CL # 3 and BP # 1 (BP mode 1)

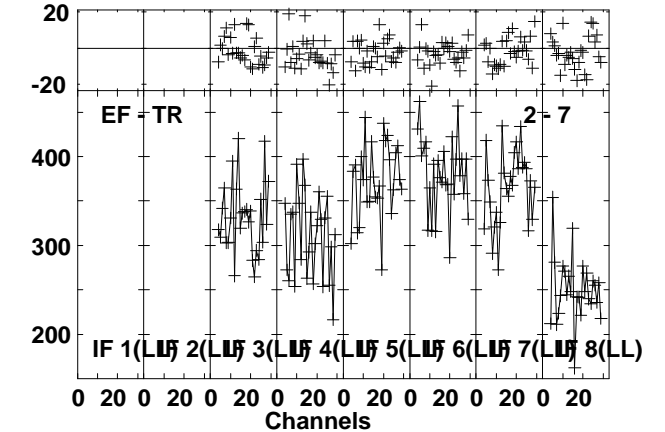
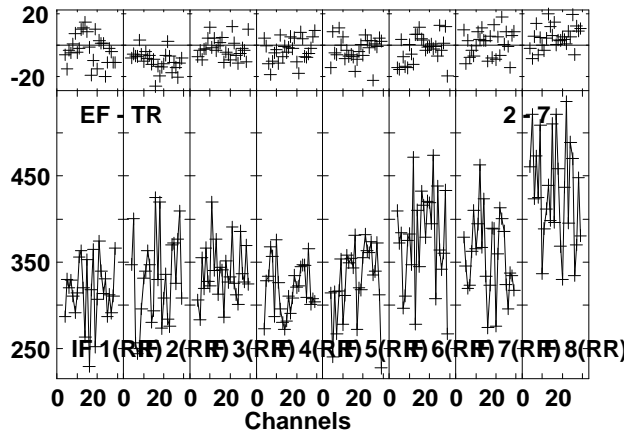
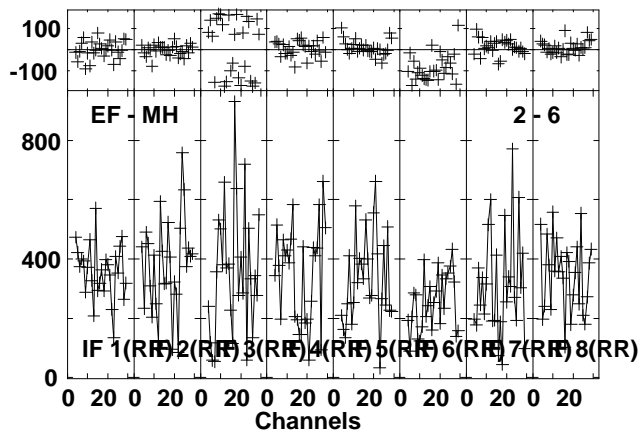
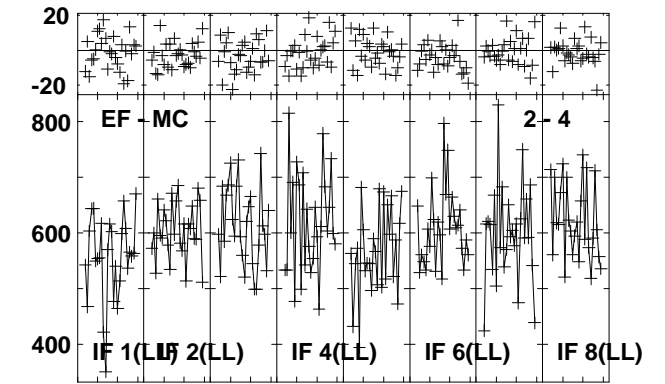
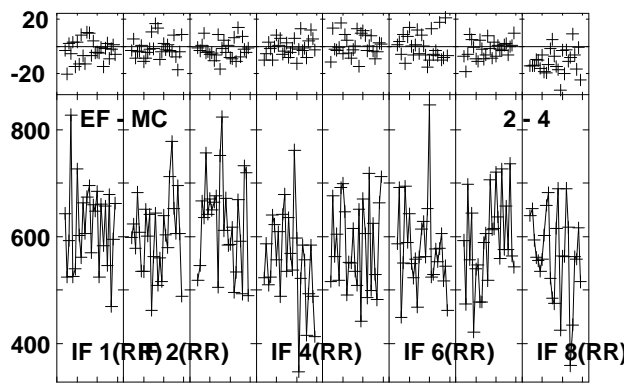
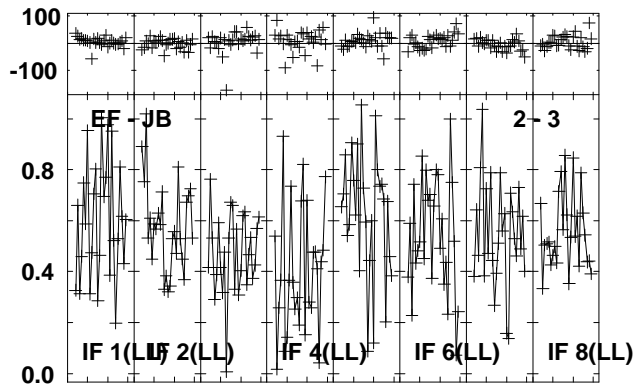
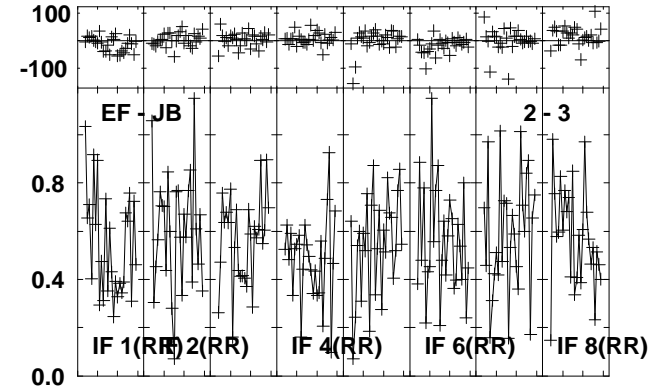
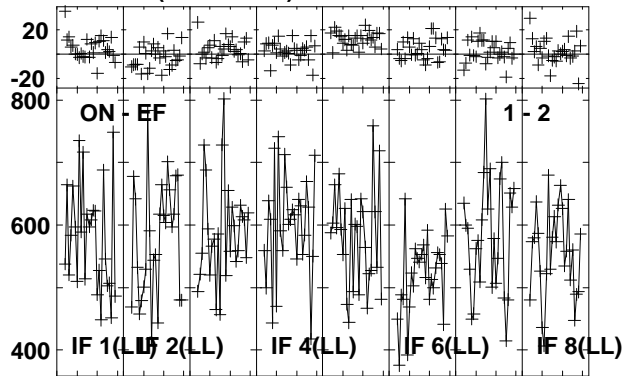
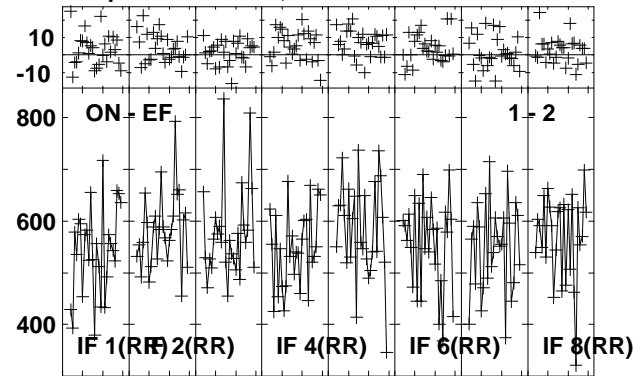

Lower frame: Milli Ampl Jy Top frame: Phas deg
Vector averaged cross-power spectrum Several baselines displayed
Timerange: 01/00:13:16 to 01/00:14:14

Plot file version 286 created 26-JUL-2013 10:23:15
 J1157 EZ024 1.UVDATA.1
 Freq = 22.1720 GHz, Bw = 16.000 MH Calibrated with CL # 3 and BP # 1 (BP mode 1)

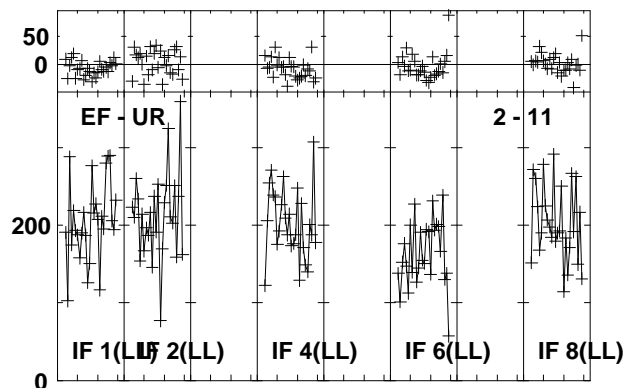
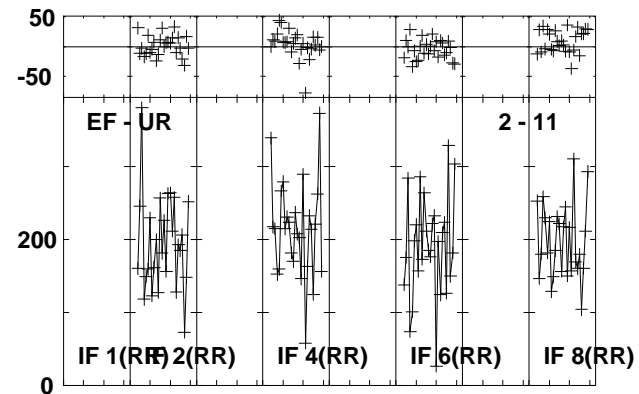
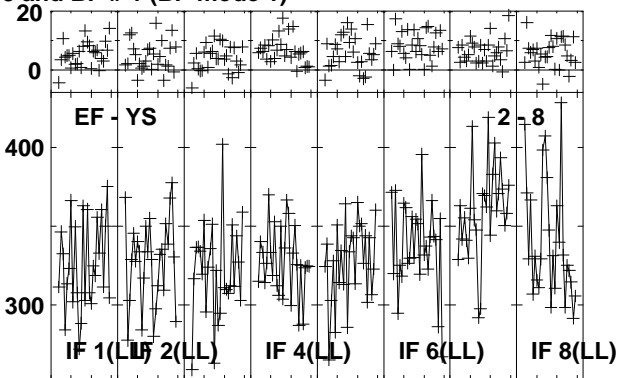
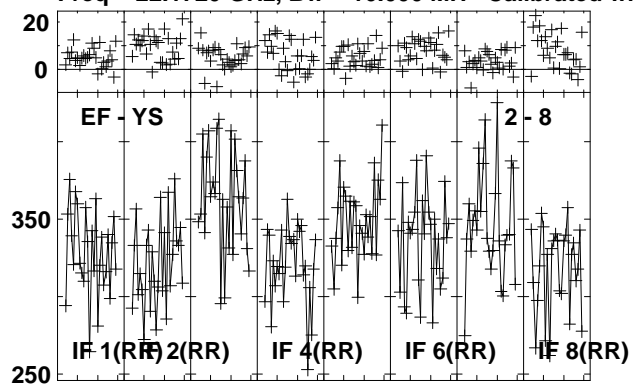

Lower frame: Milli Ampl Jy Top frame: Phas deg
 Vector averaged cross-power spectrum Several baselines displayed
 Timerange: 01/00:13:16 to 01/00:14:14

Plot file version 287 created 26-JUL-2013 10:23:16
 J1125+2610 EZ024 1.UVDATA.1
 Freq = 22.1720 GHz, Bw = 16.000 MH Calibrated with CL # 3 and BP # 1 (BP mode 1)

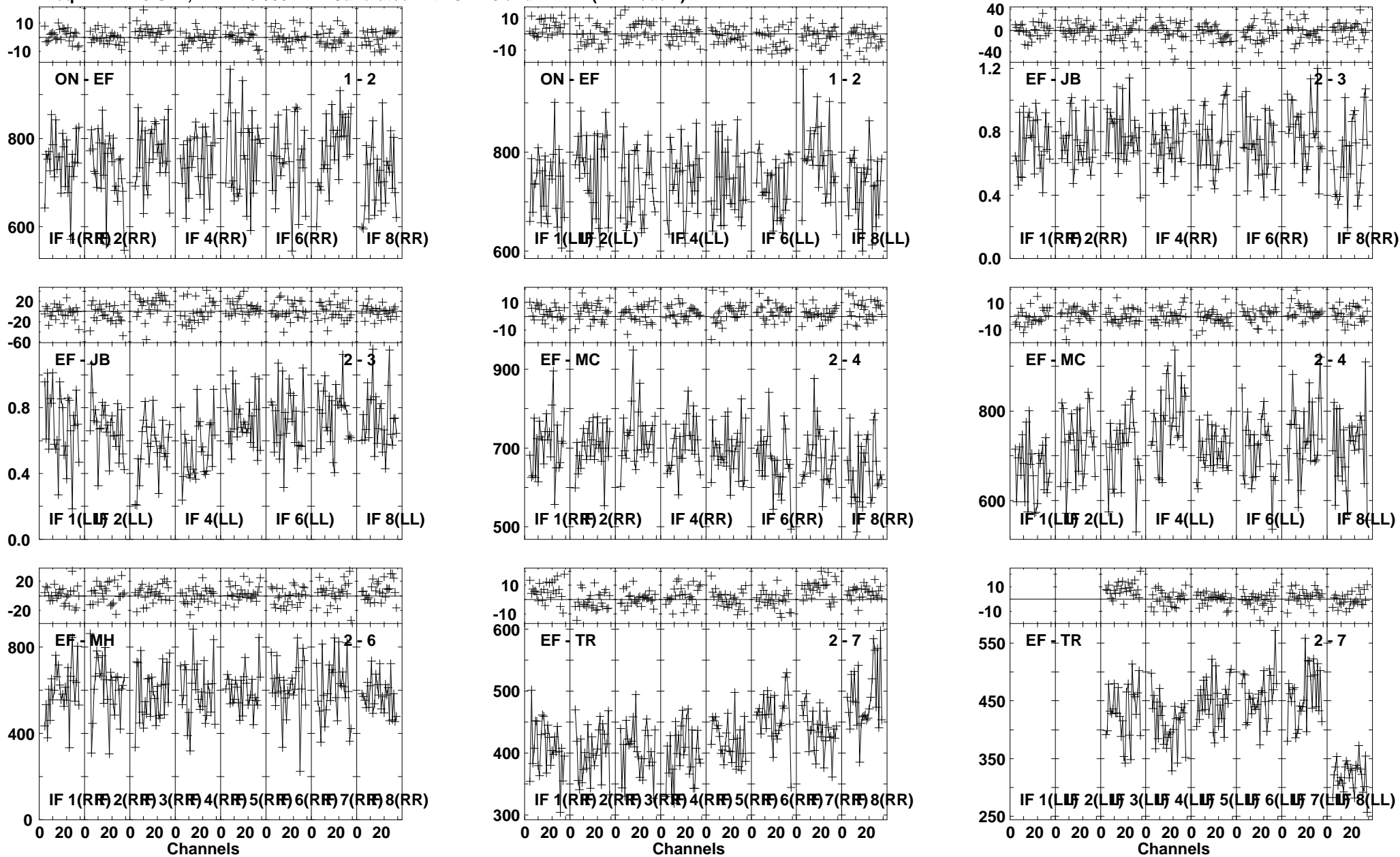

Lower frame: Milli Ampl Jy Top frame: Phas deg
 Vector averaged cross-power spectrum Several baselines displayed
 Timerange: 01/00:15:35 to 01/00:17:17

Plot file version 288 created 26-JUL-2013 10:23:17
 J1125+2610 EZ024 1.UVDATA.1
 Freq = 22.1720 GHz, Bw = 16.000 MH Calibrated with CL # 3 and BP # 1 (BP mode 1)

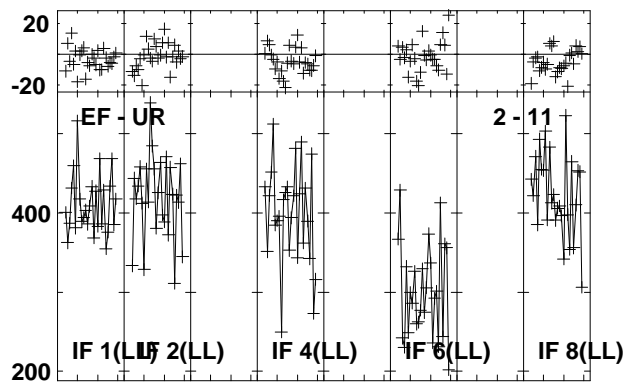
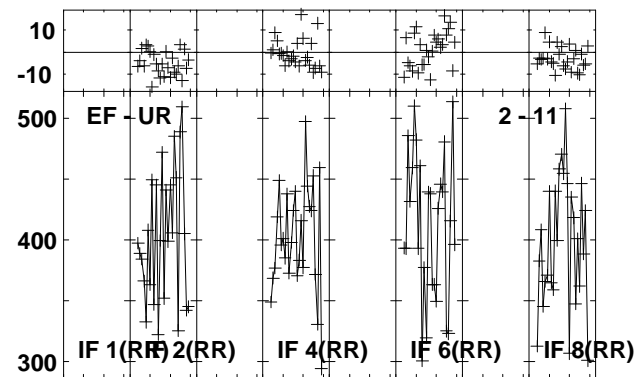
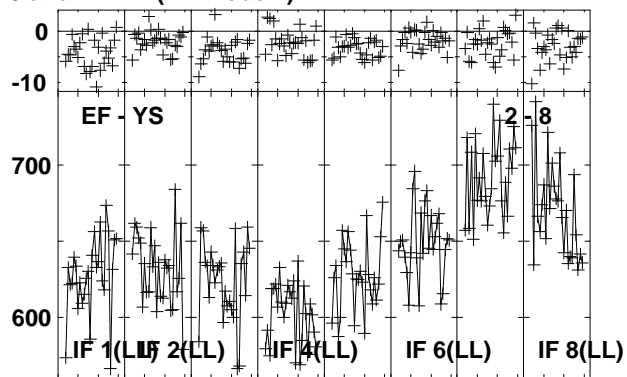
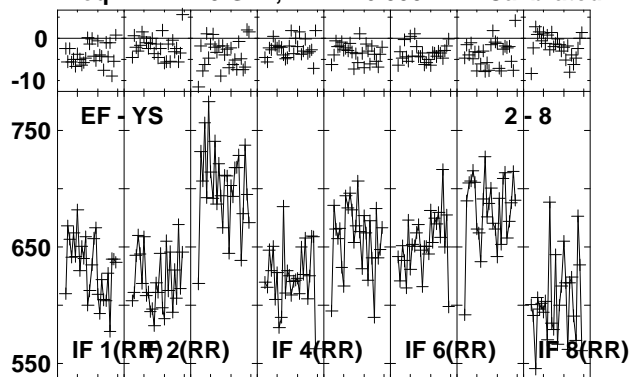

Lower frame: Milli Ampl Jy Top frame: Phas deg
 Vector averaged cross-power spectrum Several baselines displayed
 Timerange: 01/00:15:35 to 01/00:17:17

Plot file version 289 created 26-JUL-2013 10:23:19

J1157 EZ024 1.UVDATA.1

Freq = 22.1720 GHz, Bw = 16.000 MH Calibrated with CL # 3 and BP # 1 (BP mode 1)

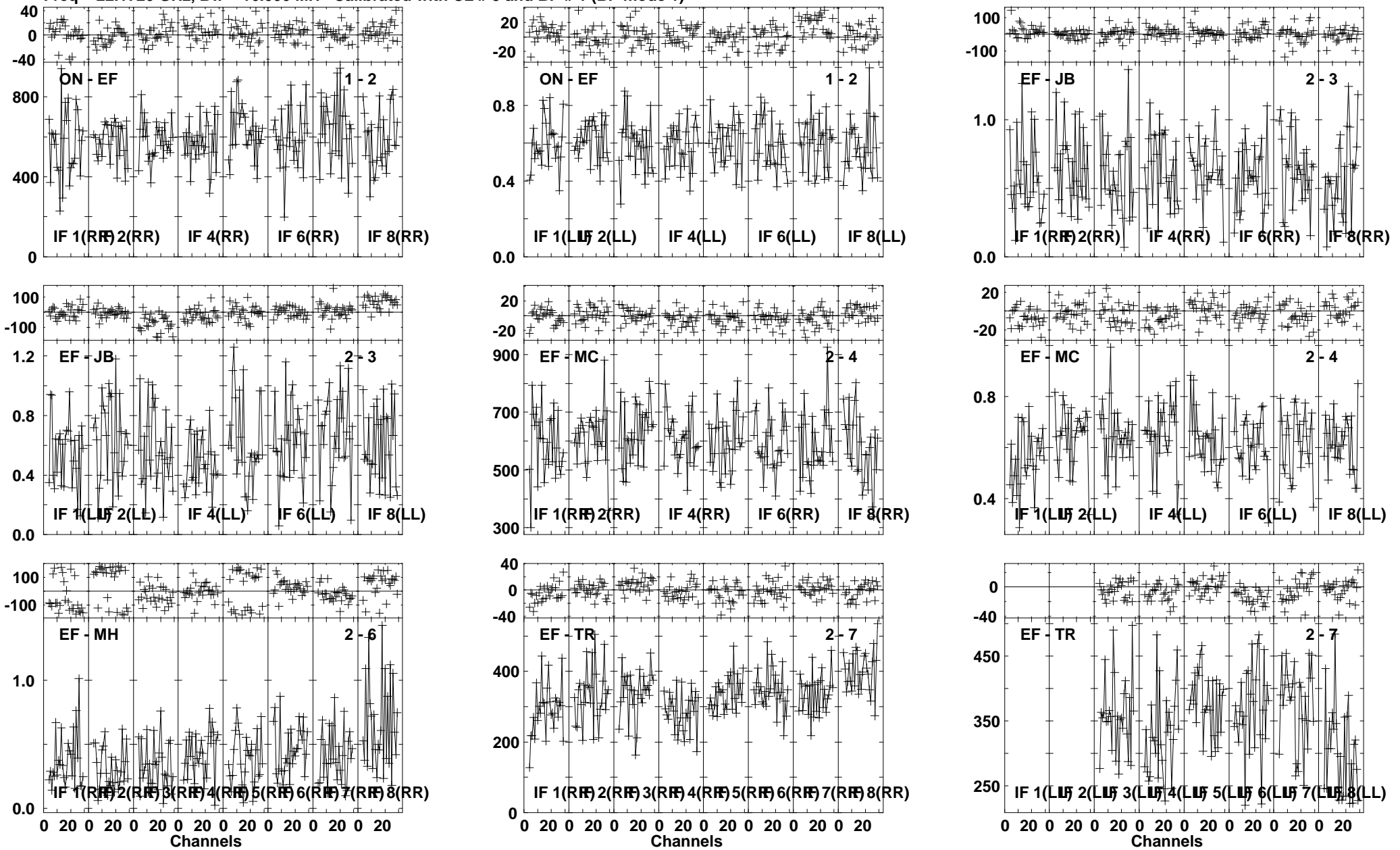

Lower frame: Milli Ampl Jy Top frame: Phas deg
Vector averaged cross-power spectrum Several baselines displayed
Timerange: 01/00:18:38 to 01/00:19:20

Plot file version 290 created 26-JUL-2013 10:23:19
 J1157 EZ024 1.UVDATA.1
 Freq = 22.1720 GHz, Bw = 16.000 MH Calibrated with CL # 3 and BP # 1 (BP mode 1)

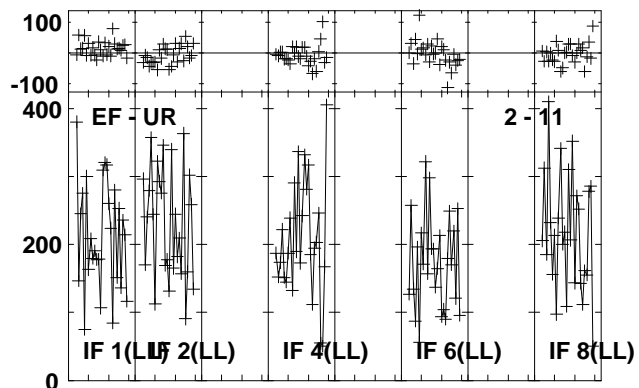
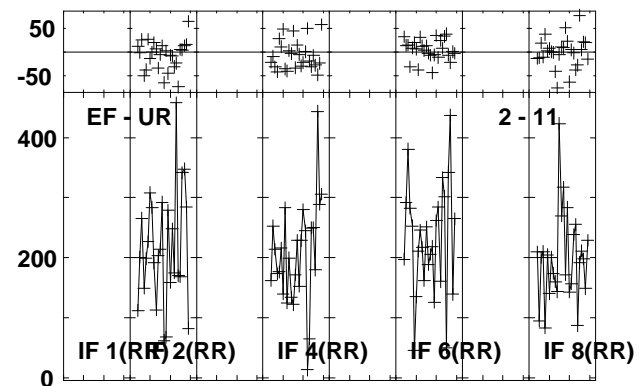
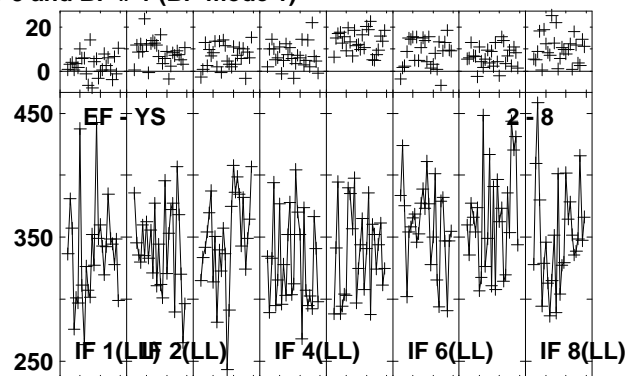
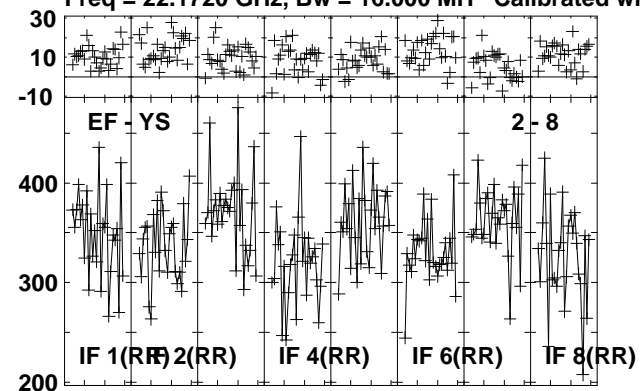

Lower frame: Milli Ampl Jy Top frame: Phas deg
 Vector averaged cross-power spectrum Several baselines displayed
 Timerange: 01/00:18:38 to 01/00:19:20

Plot file version 291 created 26-JUL-2013 10:23:20
 B1152+199A EZ024 1.UVDATA.1
 Freq = 22.1720 GHz, Bw = 16.000 MH Calibrated with CL # 3 and BP # 1 (BP mode 1)

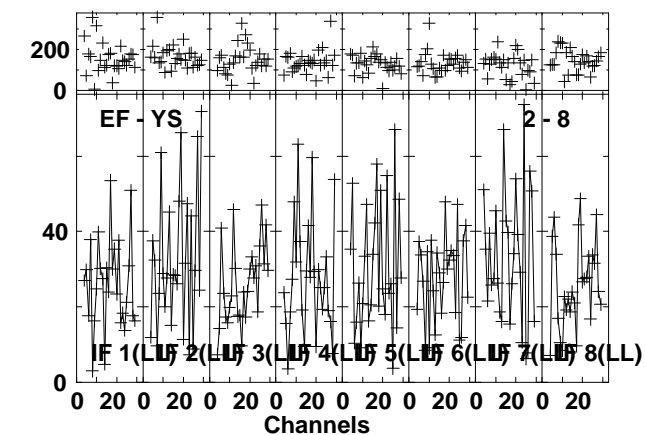
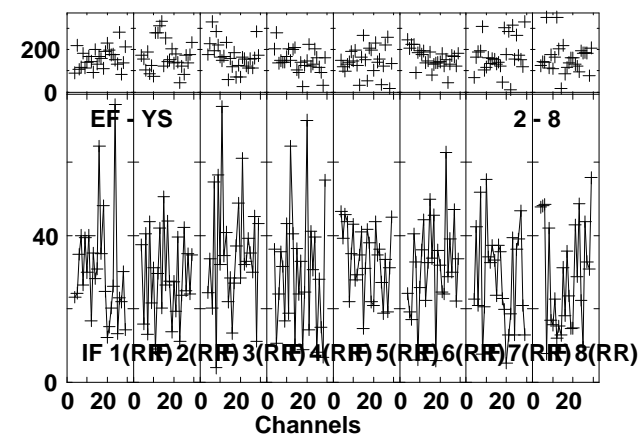
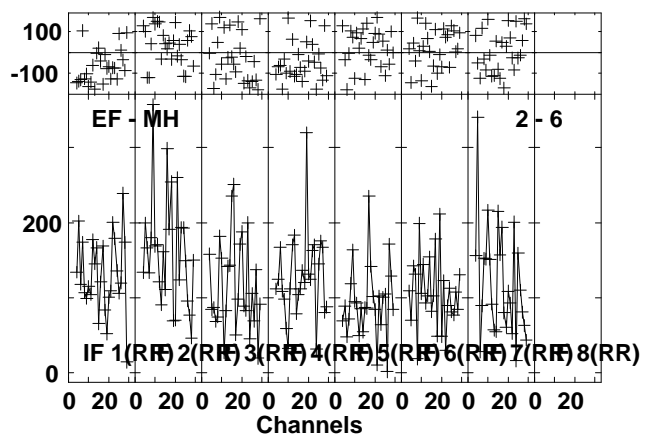
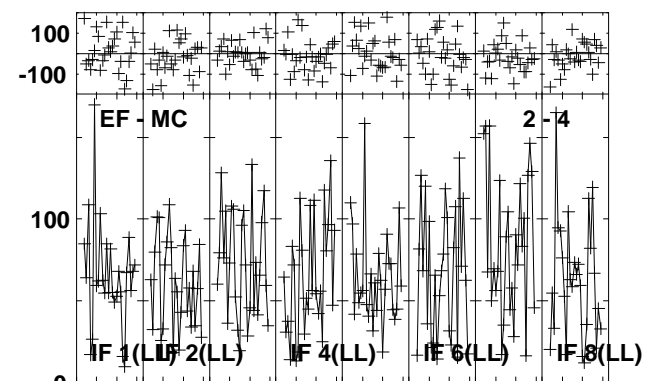
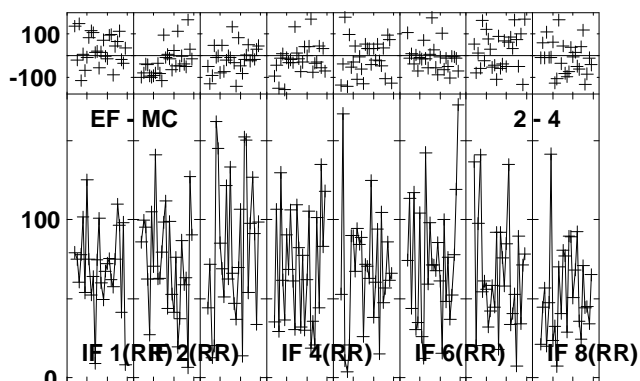
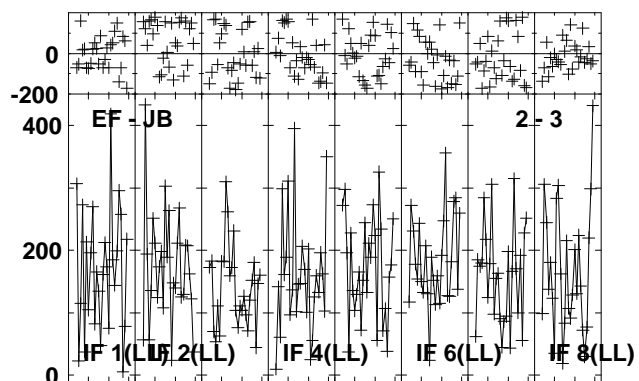
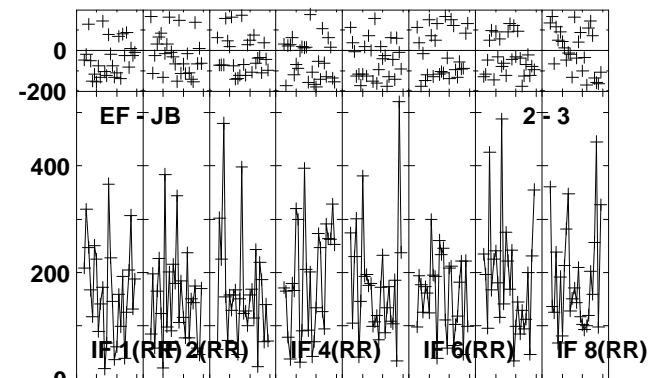
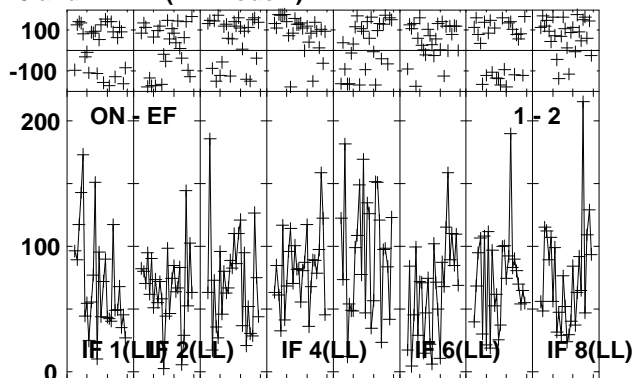
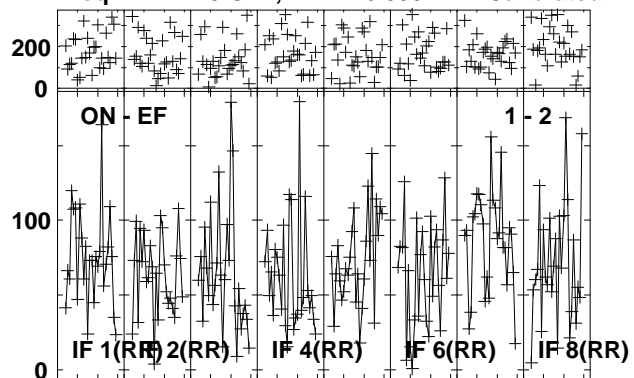

Lower frame: Milli Ampl Jy Top frame: Phas deg
 Vector averaged cross-power spectrum Several baselines displayed
 Timerange: 01/00:19:57 to 01/00:21:55

Plot file version 292 created 26-JUL-2013 10:23:23

B1152+199A EZ024 1.UVDATA.1

Freq = 22.1720 GHz, Bw = 16.000 MH Calibrated with CL # 3 and BP # 1 (BP mode 1)

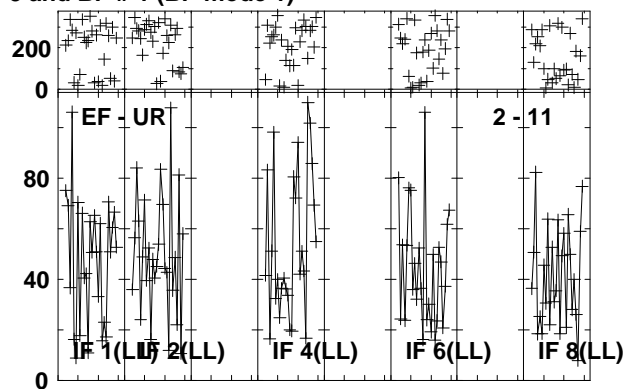
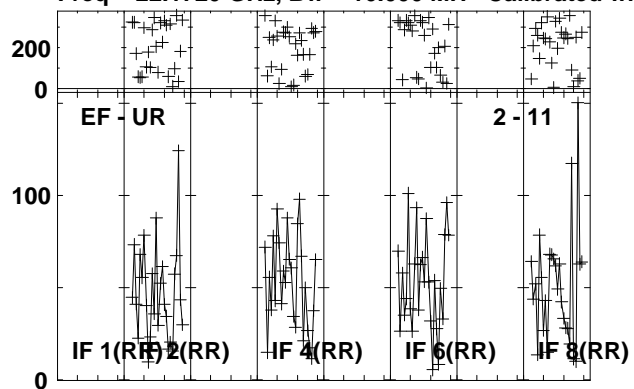

Lower frame: Milli Ampl Jy Top frame: Phas deg
Vector averaged cross-power spectrum Several baselines displayed
Timerange: 01/00:19:57 to 01/00:21:55

Plot file version 293 created 26-JUL-2013 10:23:24

J1157 EZ024 1.UVDATA.1

Freq = 22.1720 GHz, Bw = 16.000 MH Calibrated with CL # 3 and BP # 1 (BP mode 1)

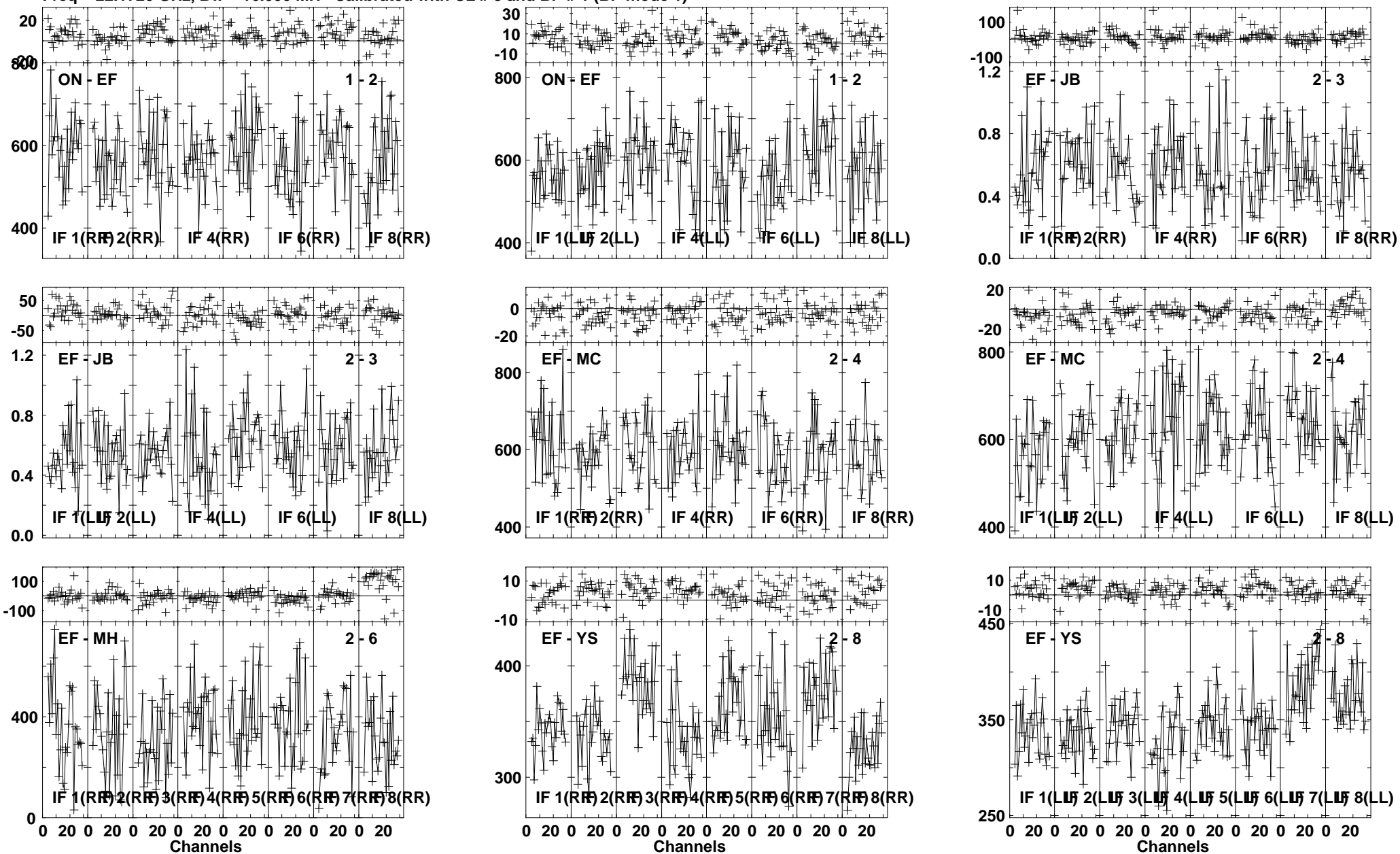

Plot file version 294 created 26-JUL-2013 10:23:25

J1157 EZ024 1.UVDATA.1

Freq = 22.1720 GHz, Bw = 16.000 MH Calibrated with CL # 3 and BP # 1 (BP mode 1)

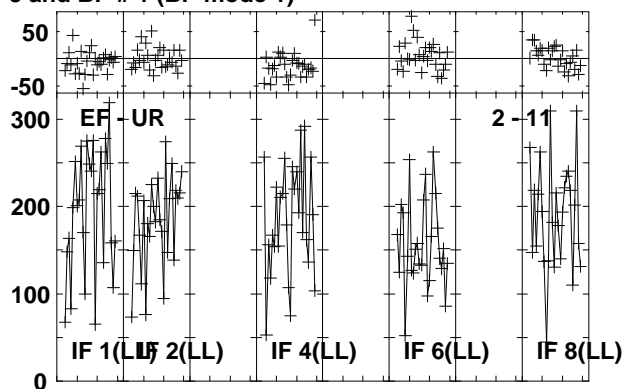
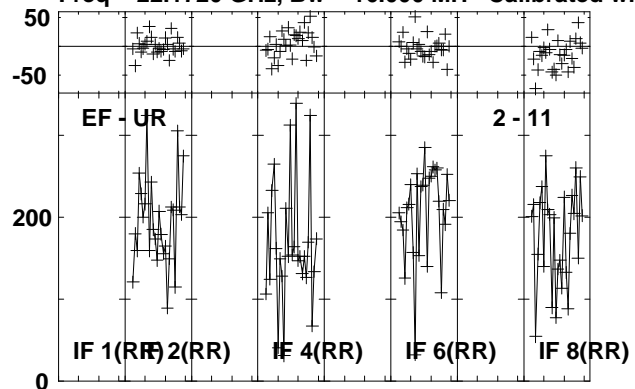

Lower frame: Milli Ampl Jy Top frame: Phas deg
Vector averaged cross-power spectrum Several baselines displayed
Timerange: 01/00:22:30 to 01/00:23:28

Plot file version 295 created 26-JUL-2013 10:23:25

B1152+199A EZ024 1.UVDATA.1

Freq = 22.1720 GHz, Bw = 16.000 MH Calibrated with CL # 3 and BP # 1 (BP mode 1)

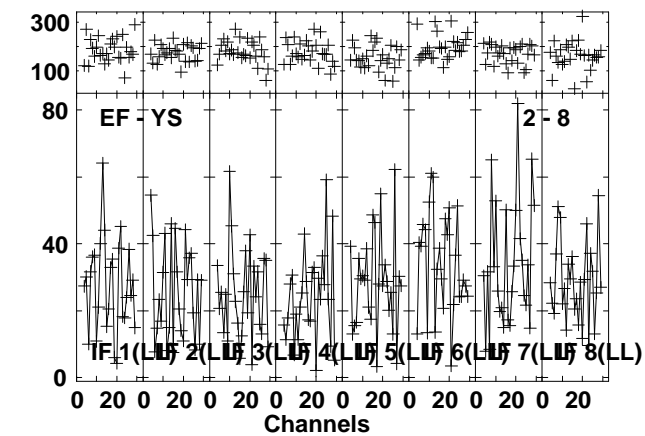
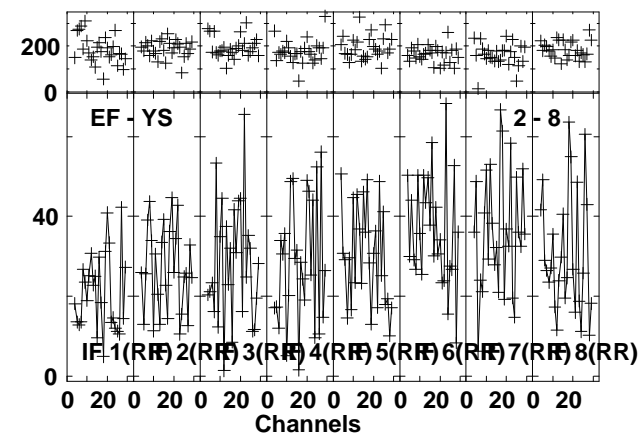
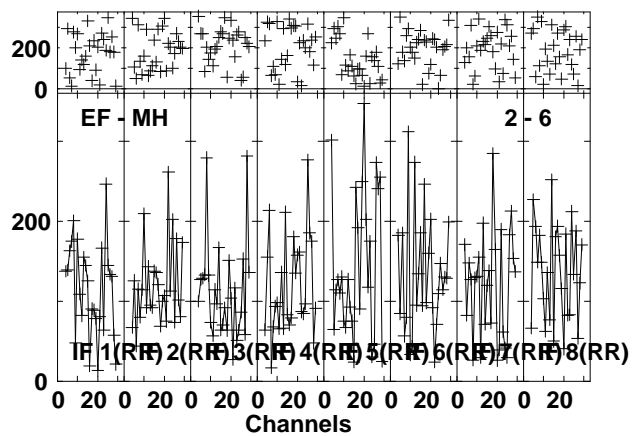
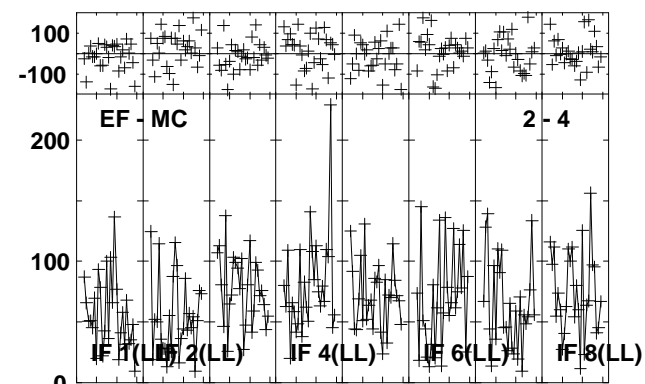
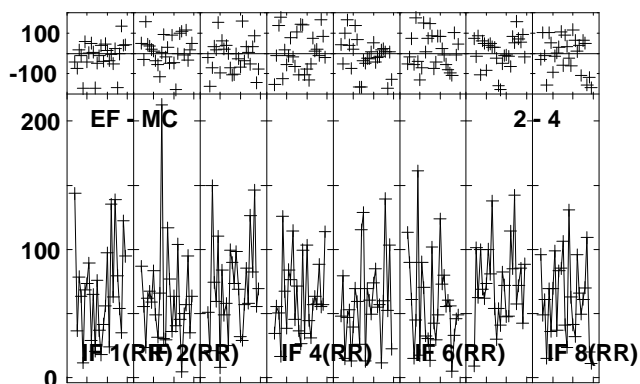
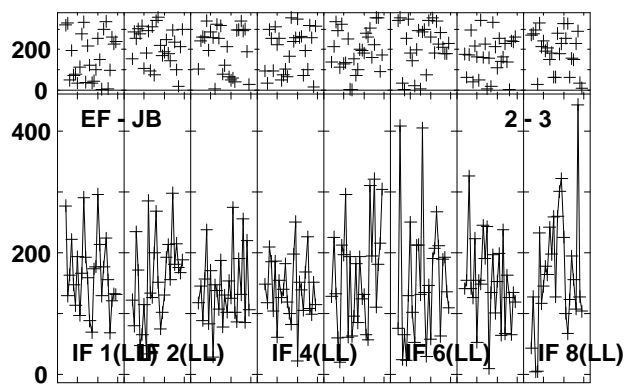
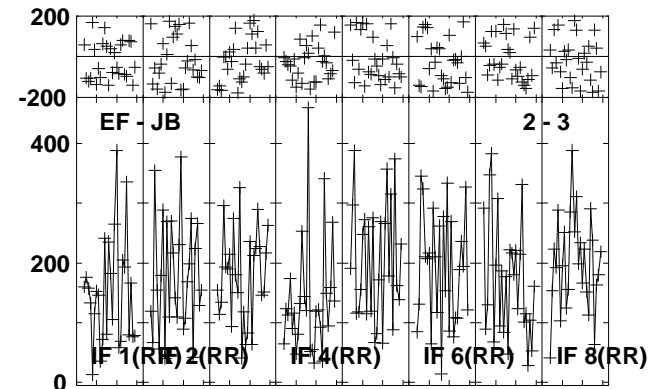
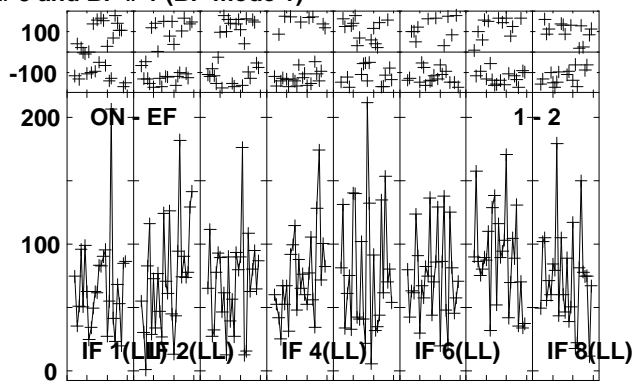
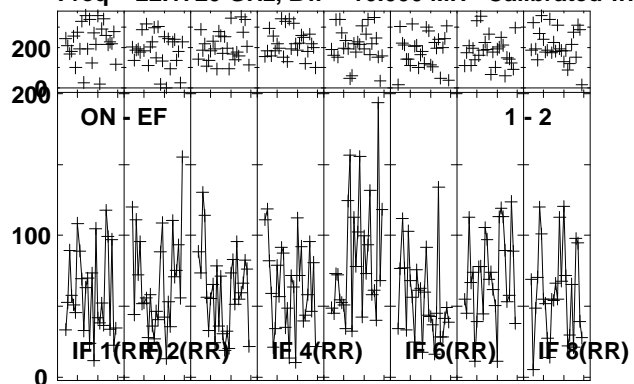

Lower frame: Milli Ampl Jy Top frame: Phas deg
Vector averaged cross-power spectrum Several baselines displayed
Timerange: 01/00:24:04 to 01/00:26:02

Plot file version 296 created 26-JUL-2013 10:23:28

B1152+199A EZ024 1.UVDATA.1

Freq = 22.1720 GHz, Bw = 16.000 MH Calibrated with CL # 3 and BP # 1 (BP mode 1)

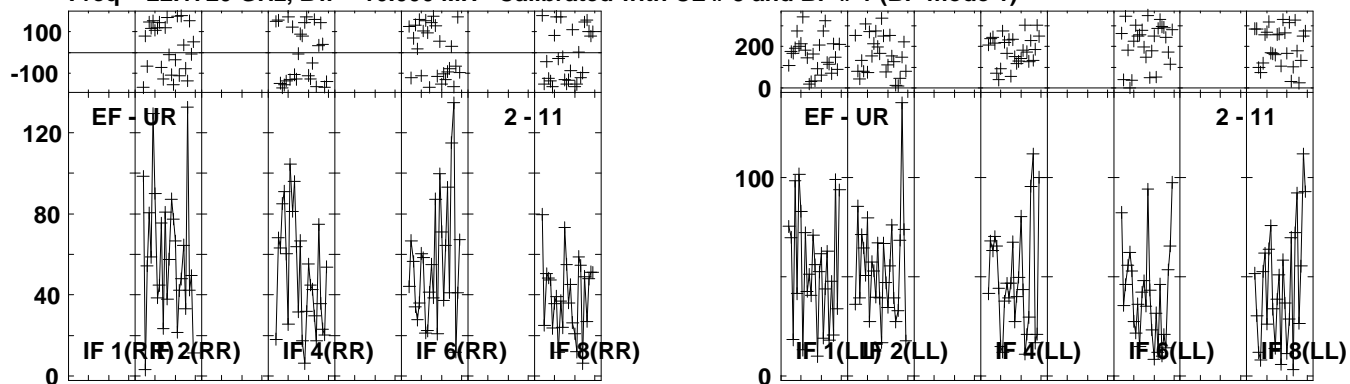

Lower frame: Milli Ampl Jy Top frame: Phas deg
Vector averaged cross-power spectrum Several baselines displayed
Timerange: 01/00:24:04 to 01/00:26:02

Plot file version 297 created 26-JUL-2013 10:23:29

J1157 EZ024 1.UVDATA.1

Freq = 22.1720 GHz, Bw = 16.000 MH Calibrated with CL # 3 and BP # 1 (BP mode 1)

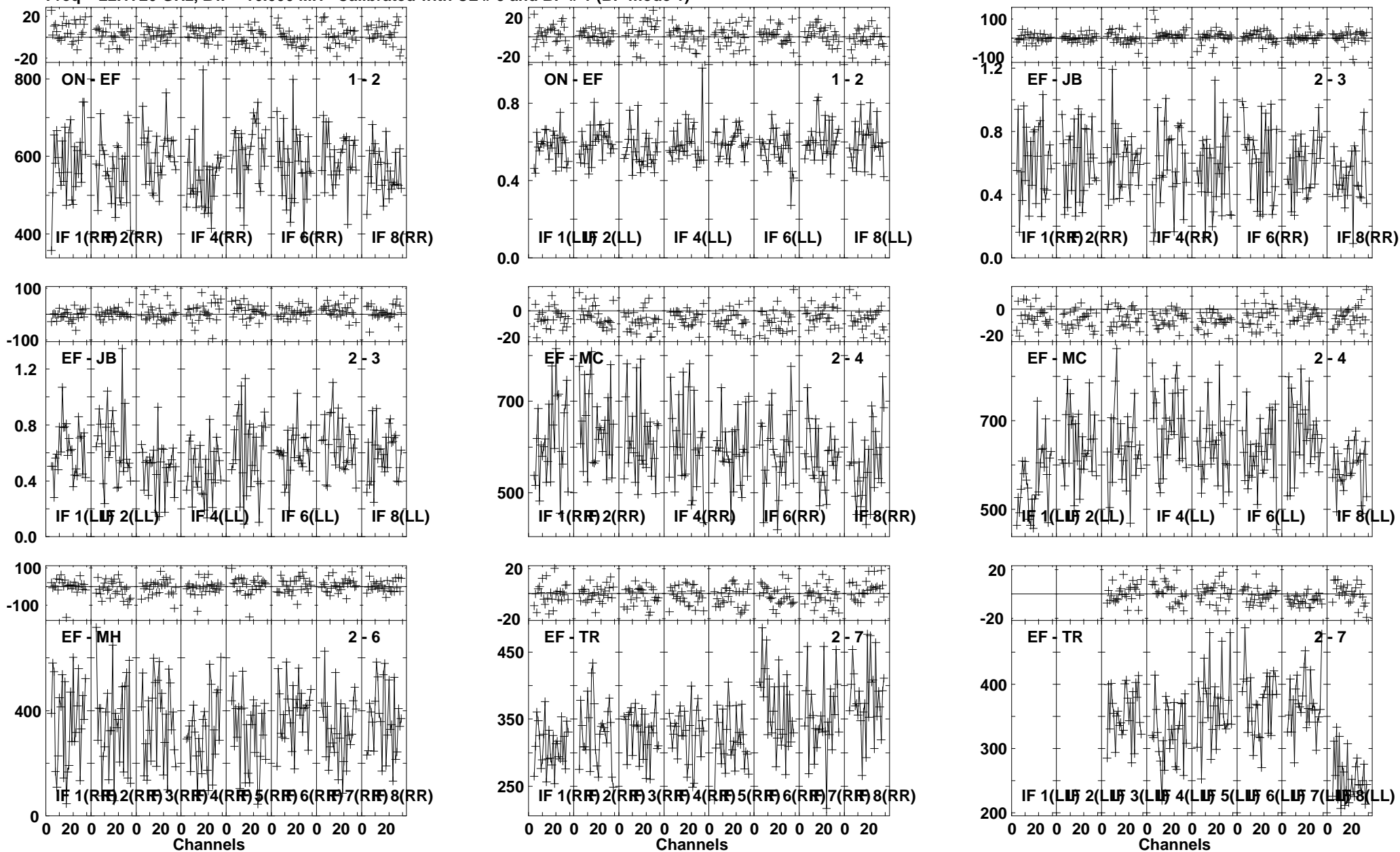

Lower frame: Milli Ampl Jy Top frame: Phas deg
Vector averaged cross-power spectrum Several baselines displayed
Timerange: 01/00:26:38 to 01/00:27:36

Plot file version 298 created 26-JUL-2013 10:23:29
 J1157 EZ024 1.UVDATA.1
 Freq = 22.1720 GHz, Bw = 16.000 MH Calibrated with CL # 3 and BP # 1 (BP mode 1)

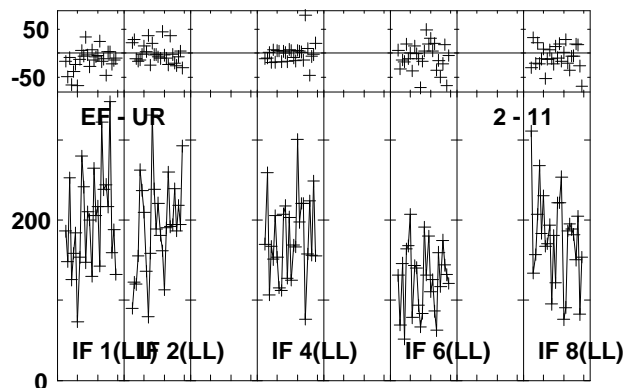
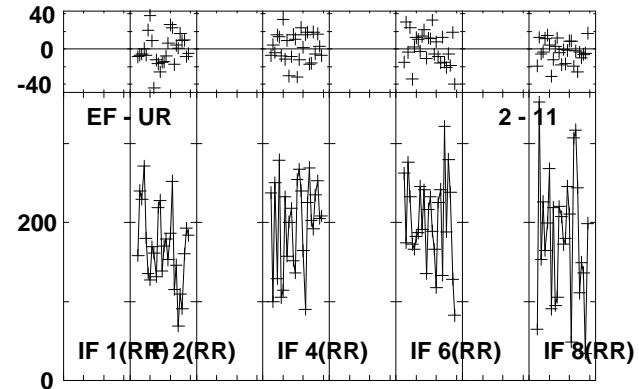
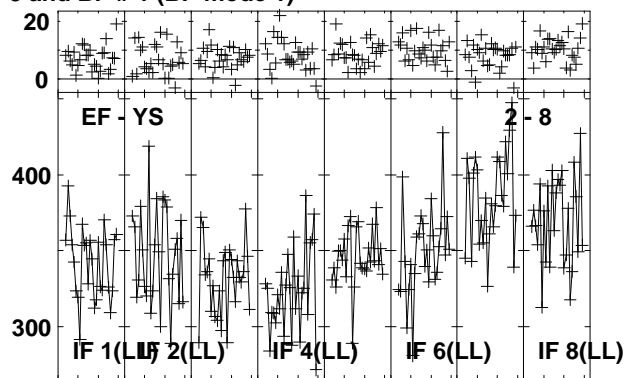
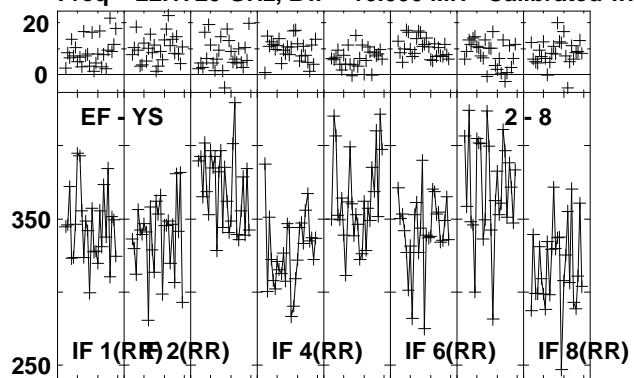

Lower frame: Milli Ampl Jy Top frame: Phas deg
 Vector averaged cross-power spectrum Several baselines displayed
 Timerange: 01/00:26:38 to 01/00:27:36

Plot file version 299 created 26-JUL-2013 10:23:31
 B1152+199A EZ024 1.UVDATA.1
 Freq = 22.1720 GHz, Bw = 16.000 MH Calibrated with CL # 3 and BP # 1 (BP mode 1)

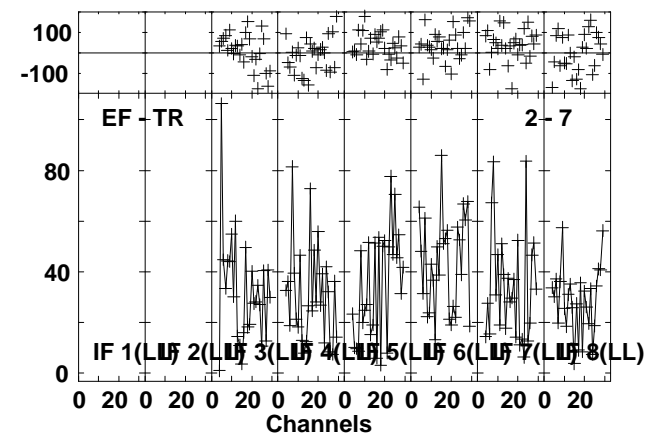
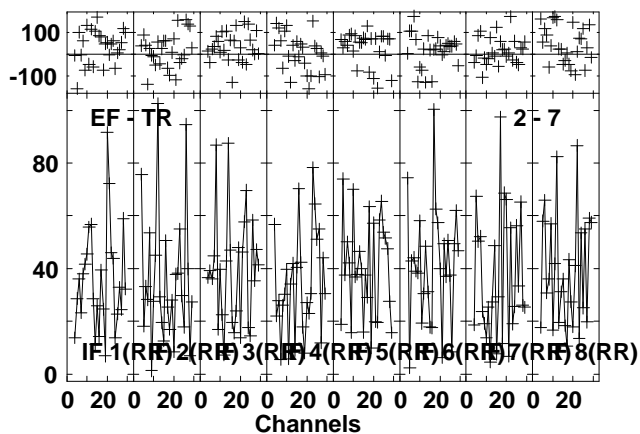
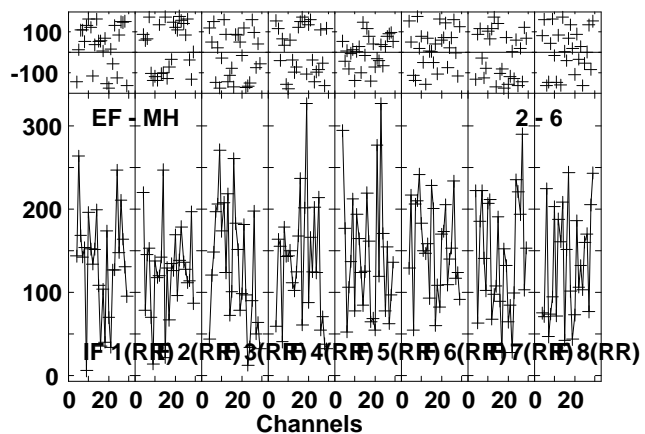
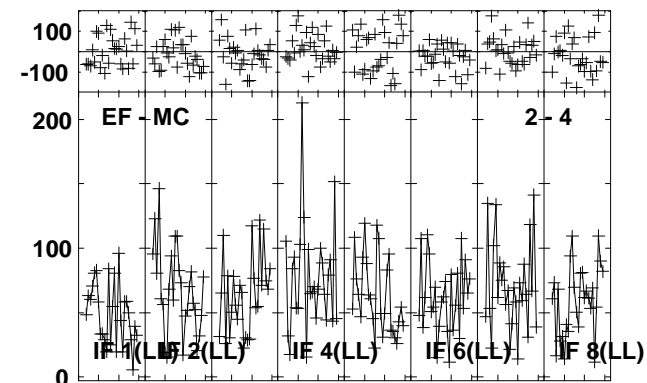
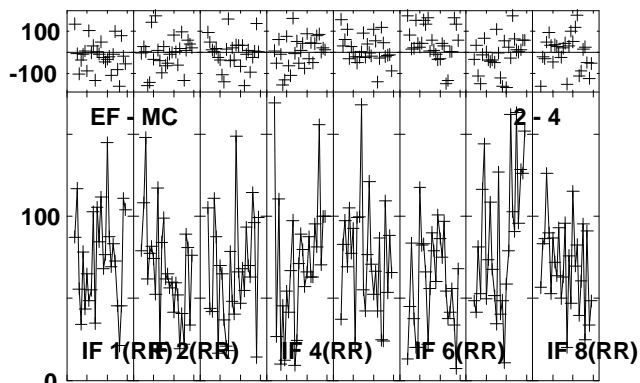
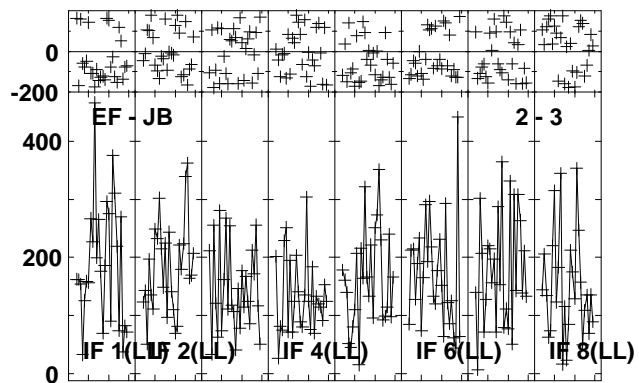
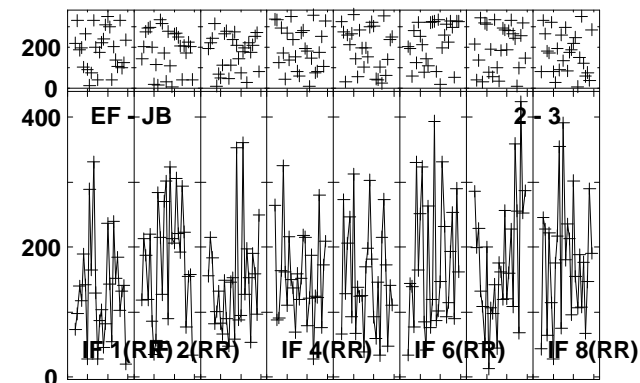
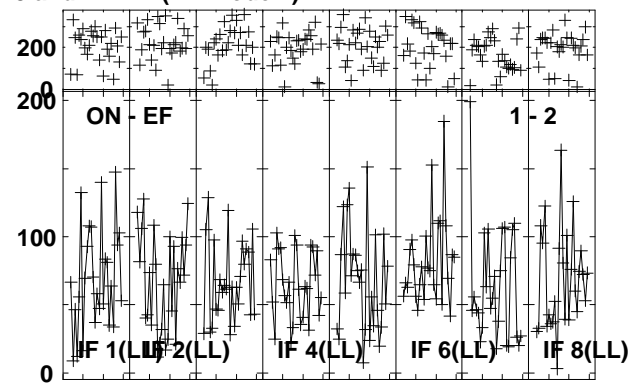
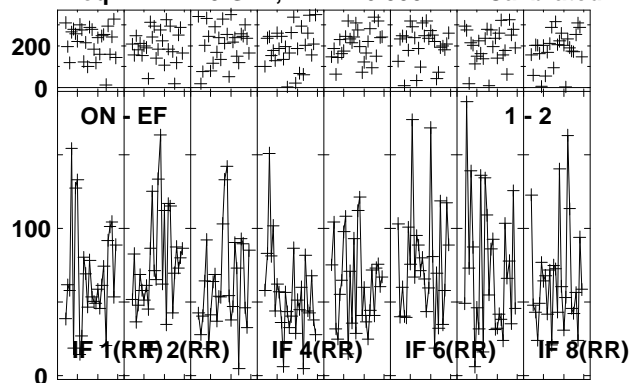

Lower frame: Milli Ampl Jy Top frame: Phas deg
 Vector averaged cross-power spectrum Several baselines displayed
 Timerange: 01/00:28:12 to 01/00:30:10

Plot file version 300 created 26-JUL-2013 10:23:32
 B1152+199A EZ024 1.UVDATA.1
 Freq = 22.1720 GHz, Bw = 16.000 MH Calibrated with CL # 3 and BP # 1 (BP mode 1)

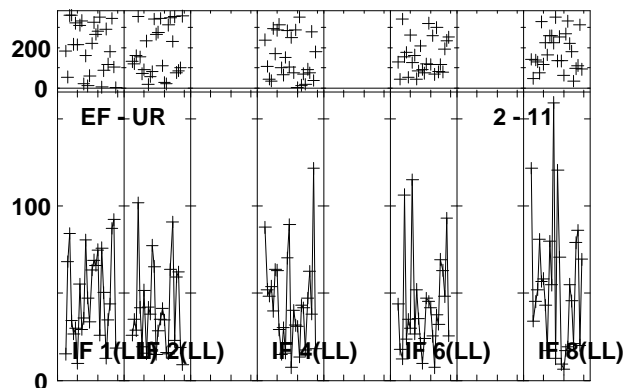
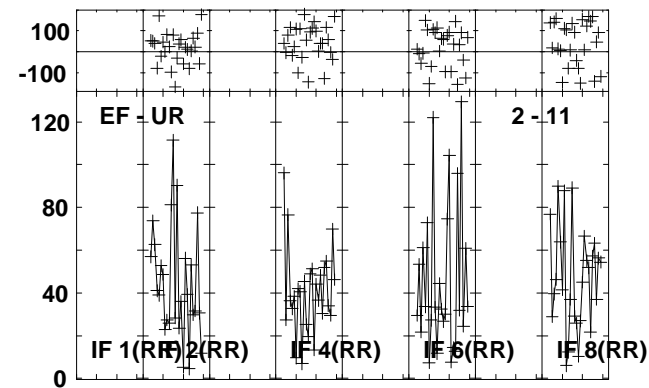
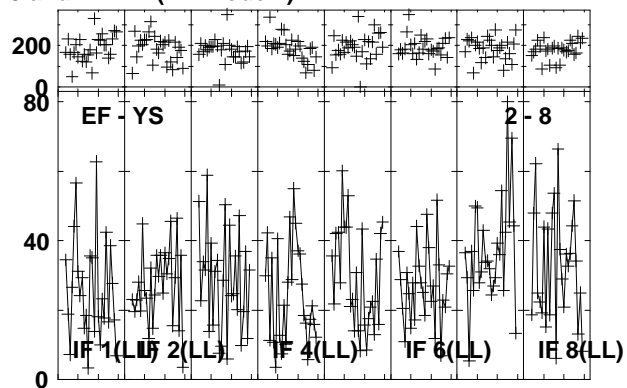
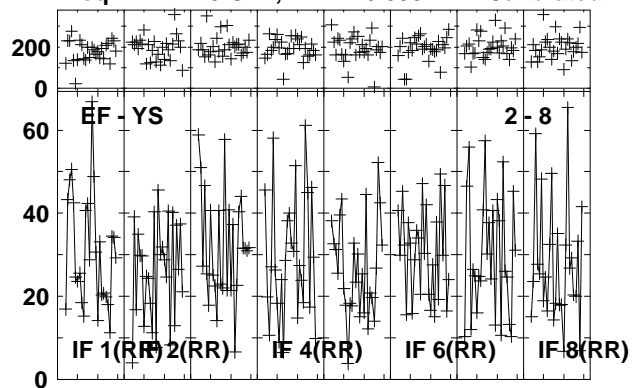

Lower frame: Milli Ampl Jy Top frame: Phas deg
 Vector averaged cross-power spectrum Several baselines displayed
 Timerange: 01/00:28:12 to 01/00:30:10

Plot file version 301 created 26-JUL-2013 10:23:34

J1157 EZ024 1.UVDATA.1

Freq = 22.1720 GHz, Bw = 16.000 MH Calibrated with CL # 3 and BP # 1 (BP mode 1)

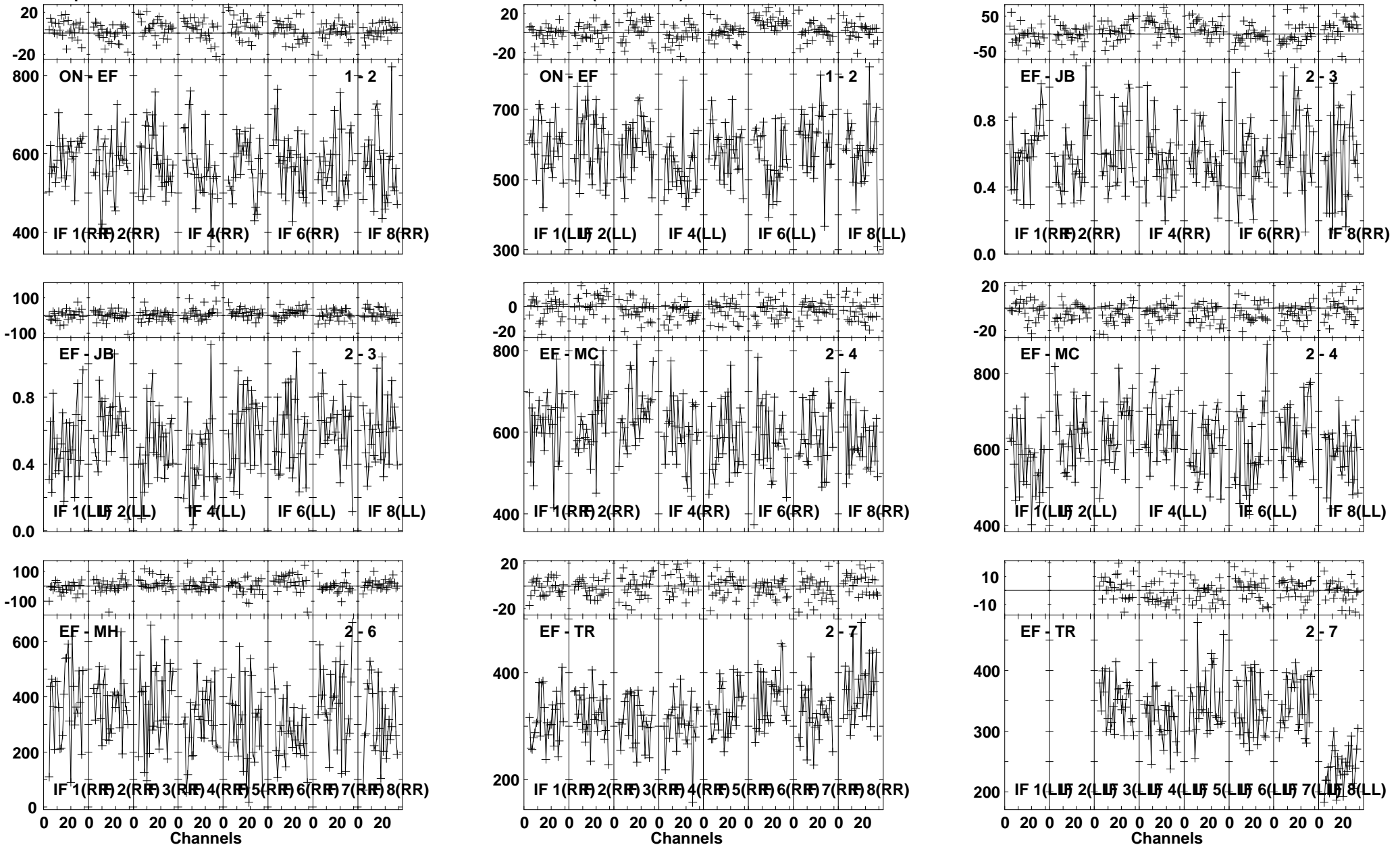

Lower frame: Milli Ampl Jy Top frame: Phas deg
Vector averaged cross-power spectrum Several baselines displayed
Timerange: 01/00:30:45 to 01/00:31:43

Plot file version 302 created 26-JUL-2013 10:23:35
 J1157 EZ024 1.UVDATA.1
 Freq = 22.1720 GHz, Bw = 16.000 MH Calibrated with CL # 3 and BP # 1 (BP mode 1)

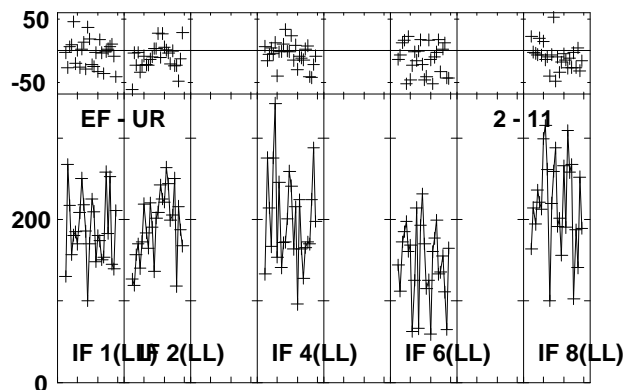
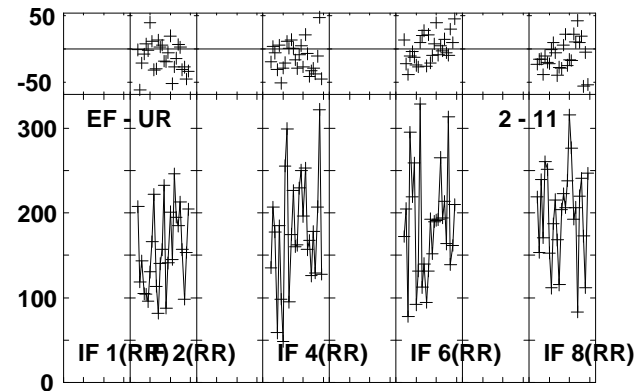
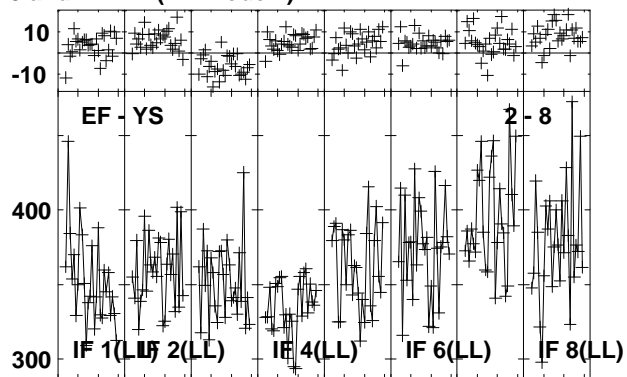
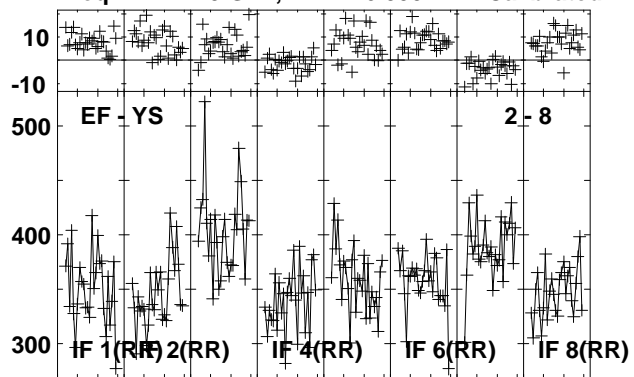

Lower frame: Milli Ampl Jy Top frame: Phas deg
 Vector averaged cross-power spectrum Several baselines displayed
 Timerange: 01/00:30:45 to 01/00:31:43

Plot file version 303 created 26-JUL-2013 10:23:36
 J1125+2610 EZ024 1.UVDATA.1
 Freq = 22.1720 GHz, Bw = 16.000 MH Calibrated with CL # 3 and BP # 1 (BP mode 1)

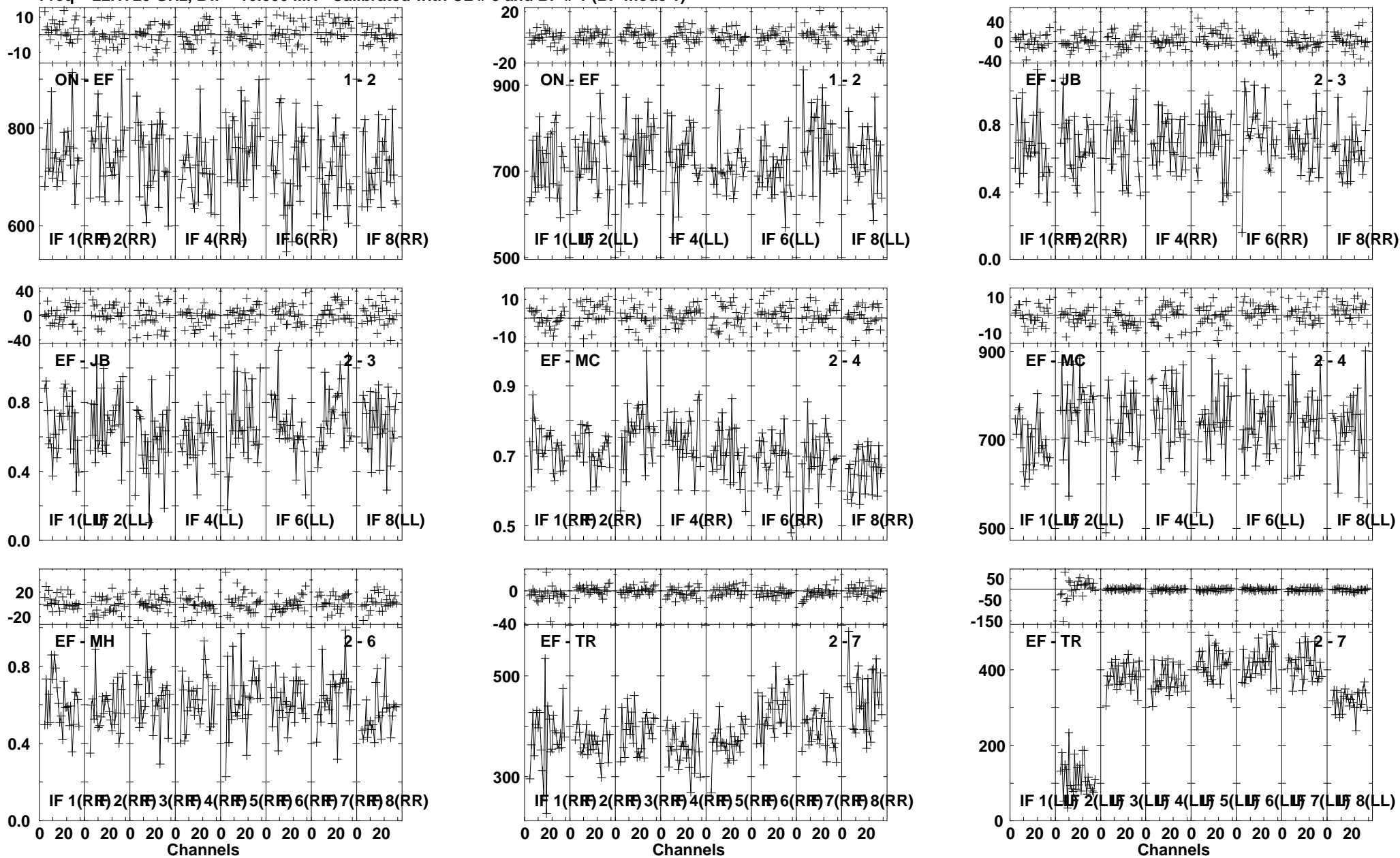

Lower frame: Milli Ampl Jy Top frame: Phas deg
 Vector averaged cross-power spectrum Several baselines displayed
 Timerange: 01/00:33:05 to 01/00:34:47

Plot file version 304 created 26-JUL-2013 10:23:37
 J1125+2610 EZ024 1.UVDATA.1
 Freq = 22.1720 GHz, Bw = 16.000 MH Calibrated with CL # 3 and BP # 1 (BP mode 1)

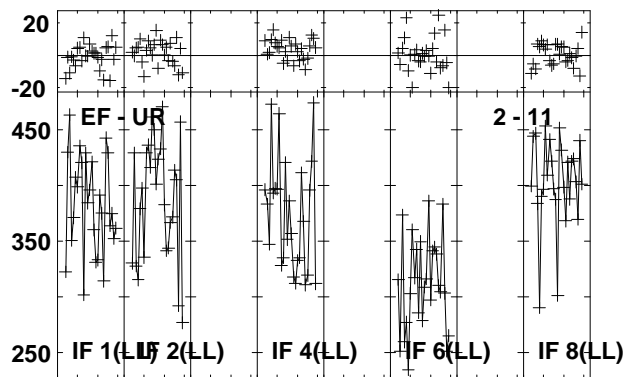
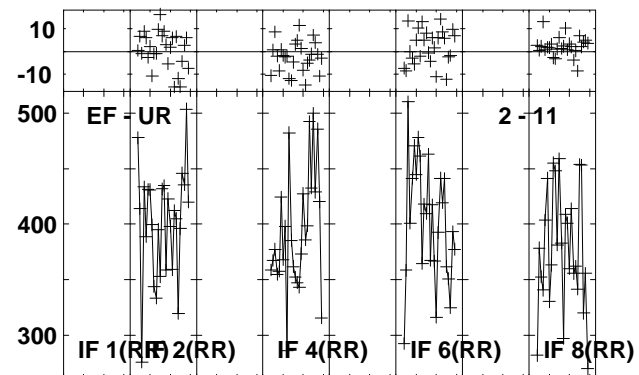
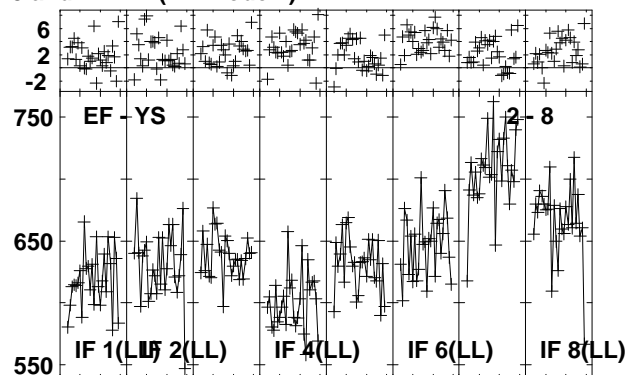
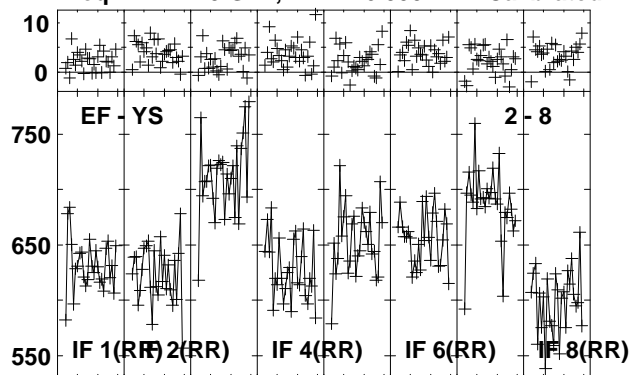

Lower frame: Milli Ampl Jy Top frame: Phas deg
 Vector averaged cross-power spectrum Several baselines displayed
 Timerange: 01/00:33:05 to 01/00:34:47

Plot file version 305 created 26-JUL-2013 10:23:38

J1157 EZ024 1.UVDATA.1

Freq = 22.1720 GHz, Bw = 16.000 MH Calibrated with CL # 3 and BP # 1 (BP mode 1)

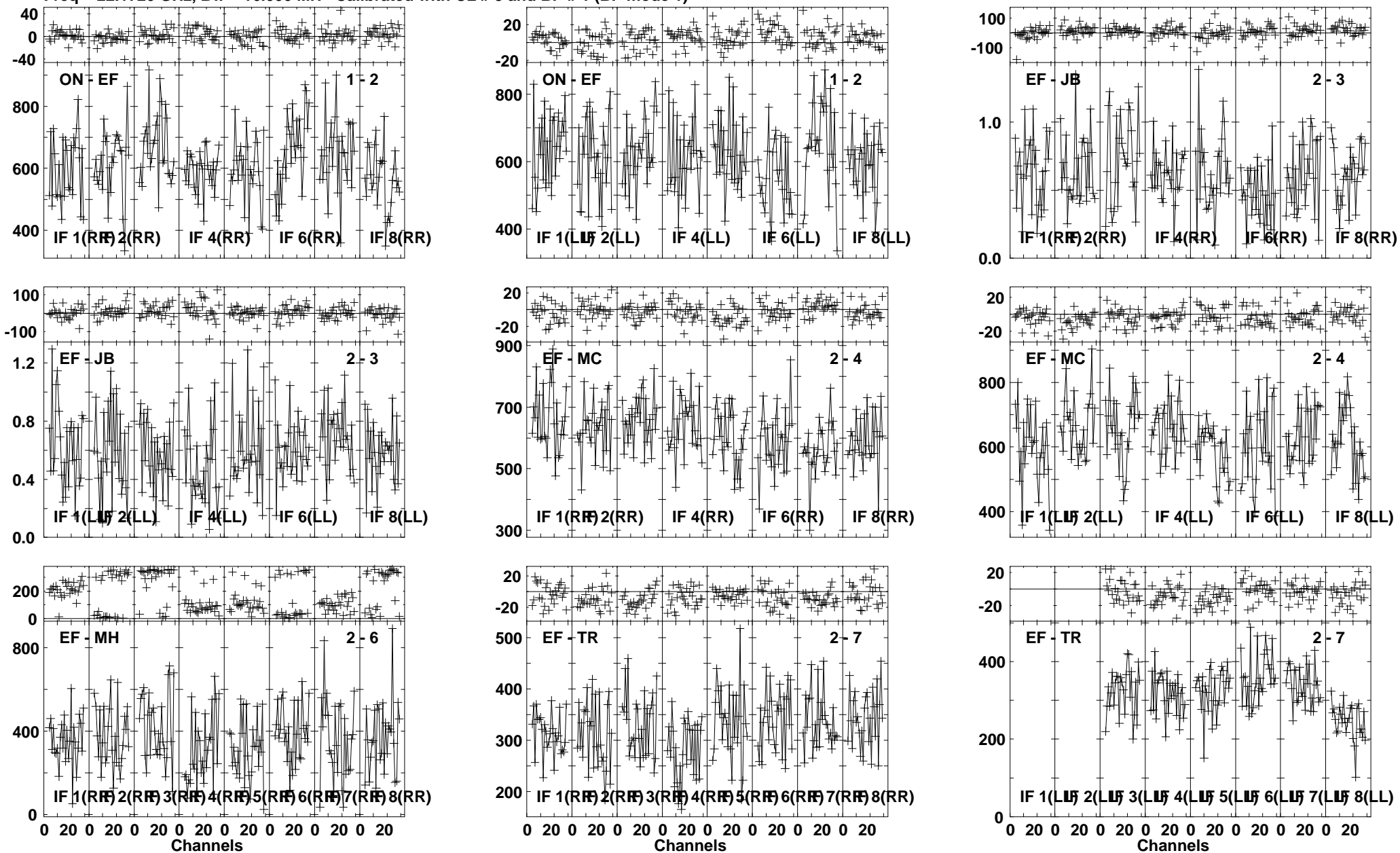

Lower frame: Milli Ampl Jy Top frame: Phas deg
Vector averaged cross-power spectrum Several baselines displayed
Timerange: 01/00:36:08 to 01/00:36:50

Plot file version 306 created 26-JUL-2013 10:23:39
 J1157 EZ024 1.UVDATA.1
 Freq = 22.1720 GHz, Bw = 16.000 MH Calibrated with CL # 3 and BP # 1 (BP mode 1)

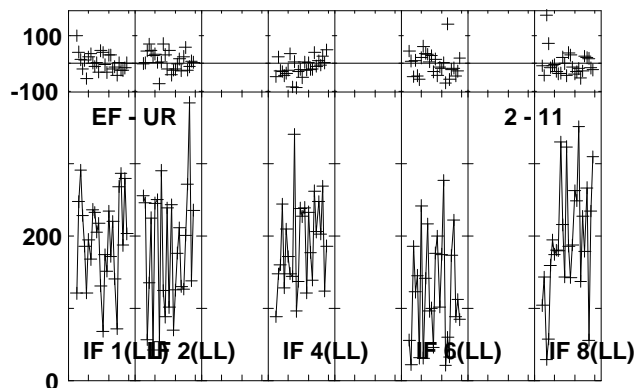
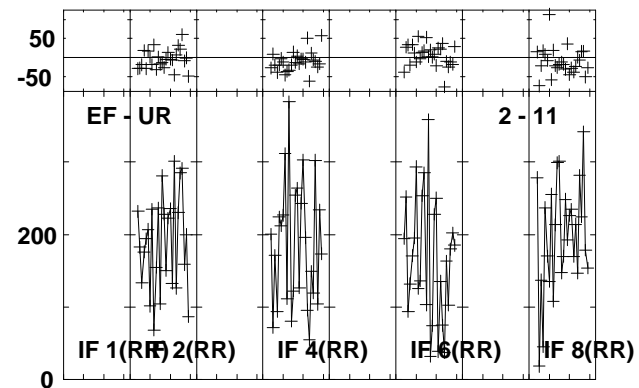
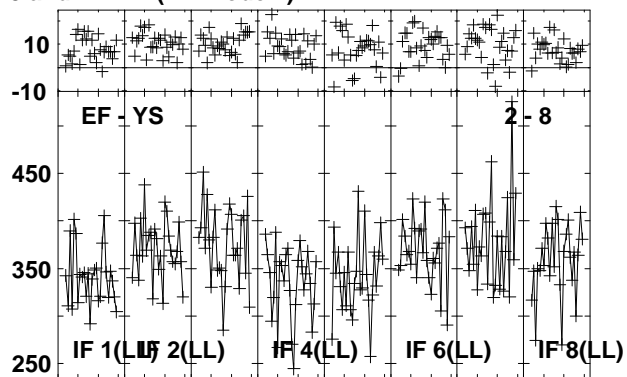
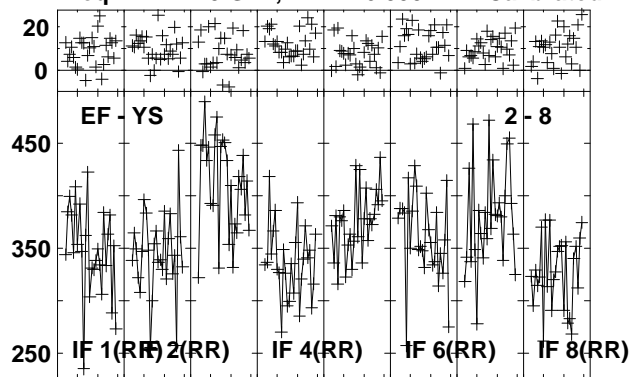

Lower frame: Milli Ampl Jy Top frame: Phas deg
 Vector averaged cross-power spectrum Several baselines displayed
 Timerange: 01/00:36:08 to 01/00:36:50

Plot file version 307 created 26-JUL-2013 10:23:40

B1152+199A EZ024 1.UVDATA.1

Freq = 22.1720 GHz, Bw = 16.000 MH Calibrated with CL # 3 and BP # 1 (BP mode 1)

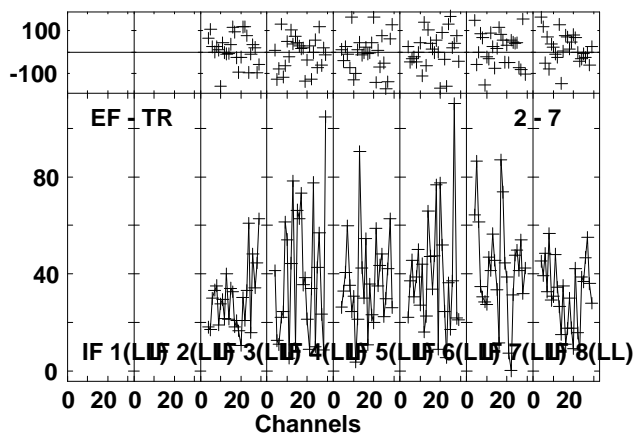
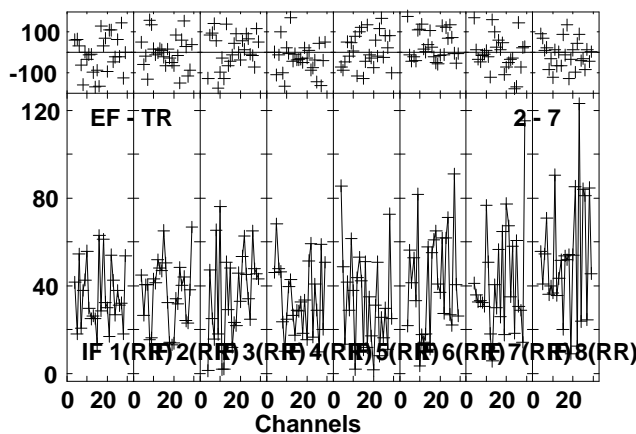
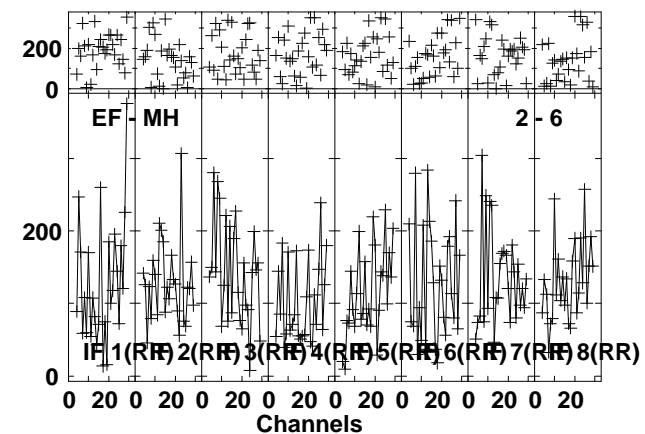
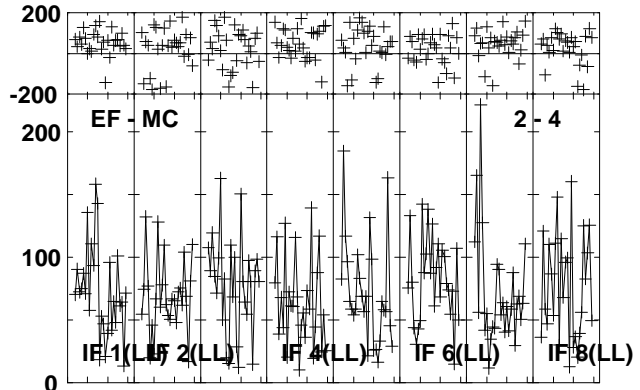
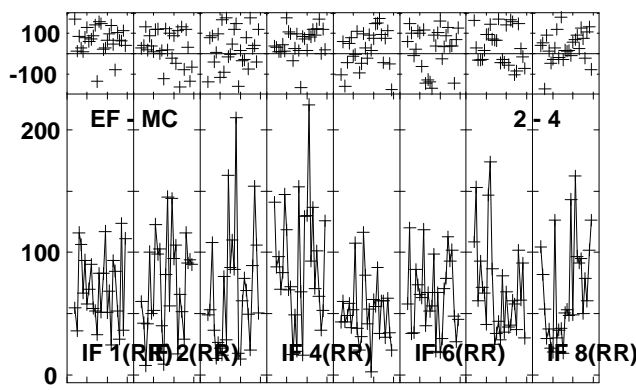
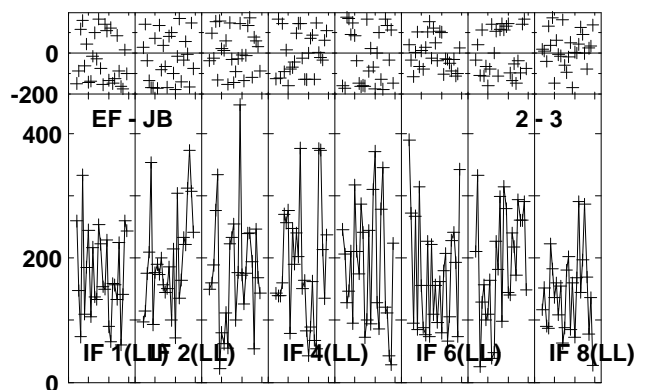
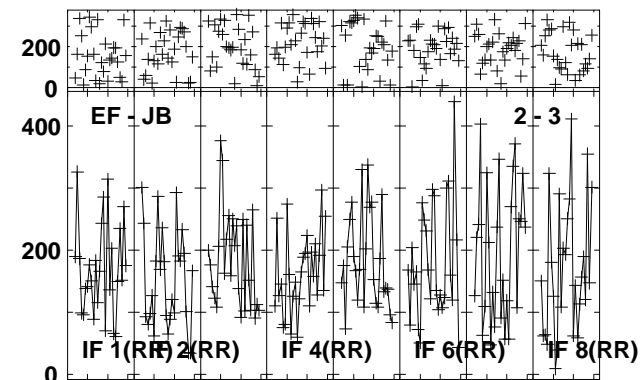
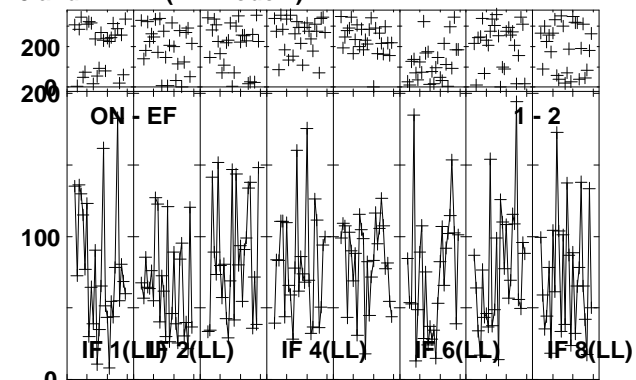
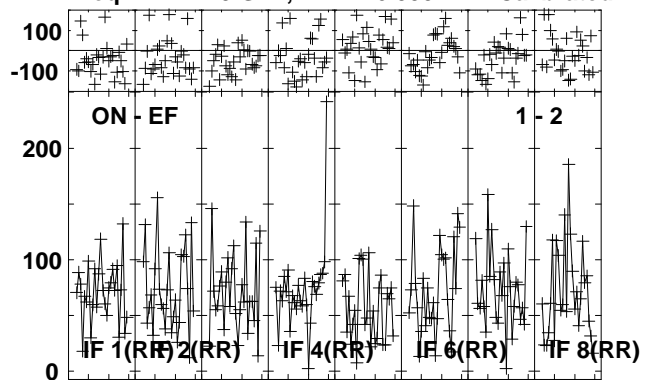

Lower frame: Milli Ampl Jy Top frame: Phas deg
Vector averaged cross-power spectrum Several baselines displayed
Timerange: 01/00:37:27 to 01/00:39:25

Plot file version 308 created 26-JUL-2013 10:23:42
 B1152+199A EZ024 1.UVDATA.1
 Freq = 22.1720 GHz, Bw = 16.000 MH Calibrated with CL # 3 and BP # 1 (BP mode 1)

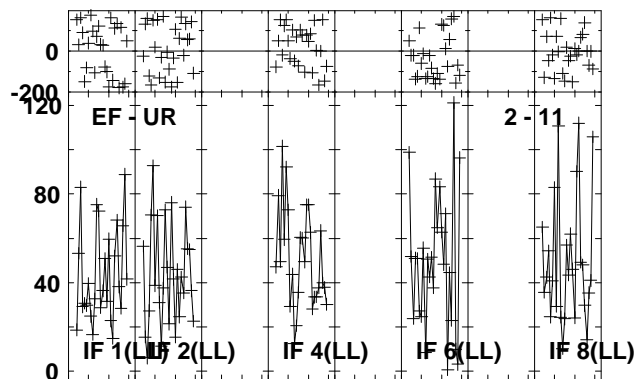
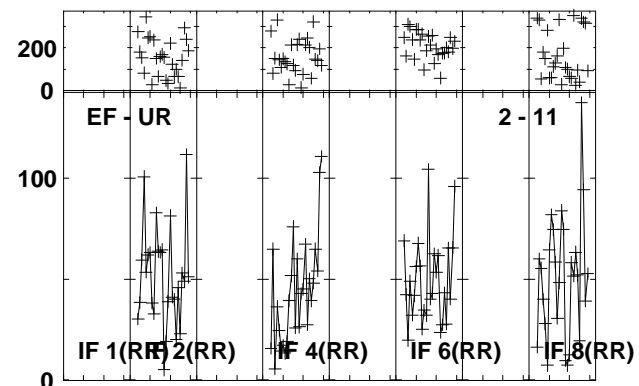
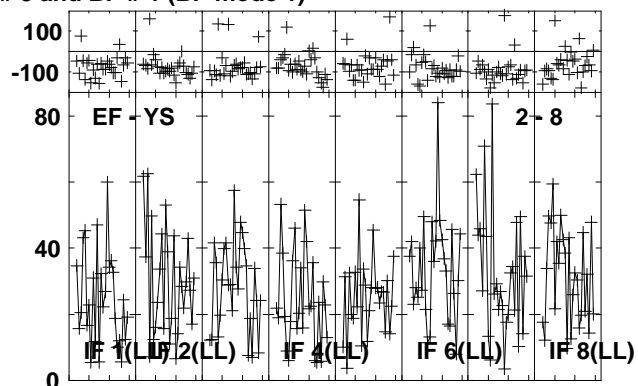
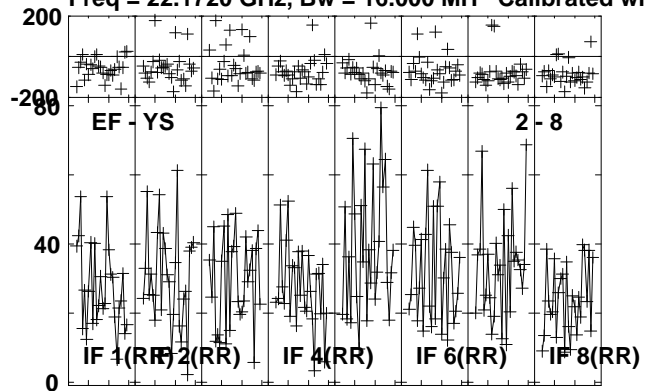

Lower frame: Milli Ampl Jy Top frame: Phas deg
 Vector averaged cross-power spectrum Several baselines displayed
 Timerange: 01/00:37:27 to 01/00:39:25

Plot file version 309 created 26-JUL-2013 10:23:43

J1157 EZ024 1.UVDATA.1

Freq = 22.1720 GHz, Bw = 16.000 MH Calibrated with CL # 3 and BP # 1 (BP mode 1)

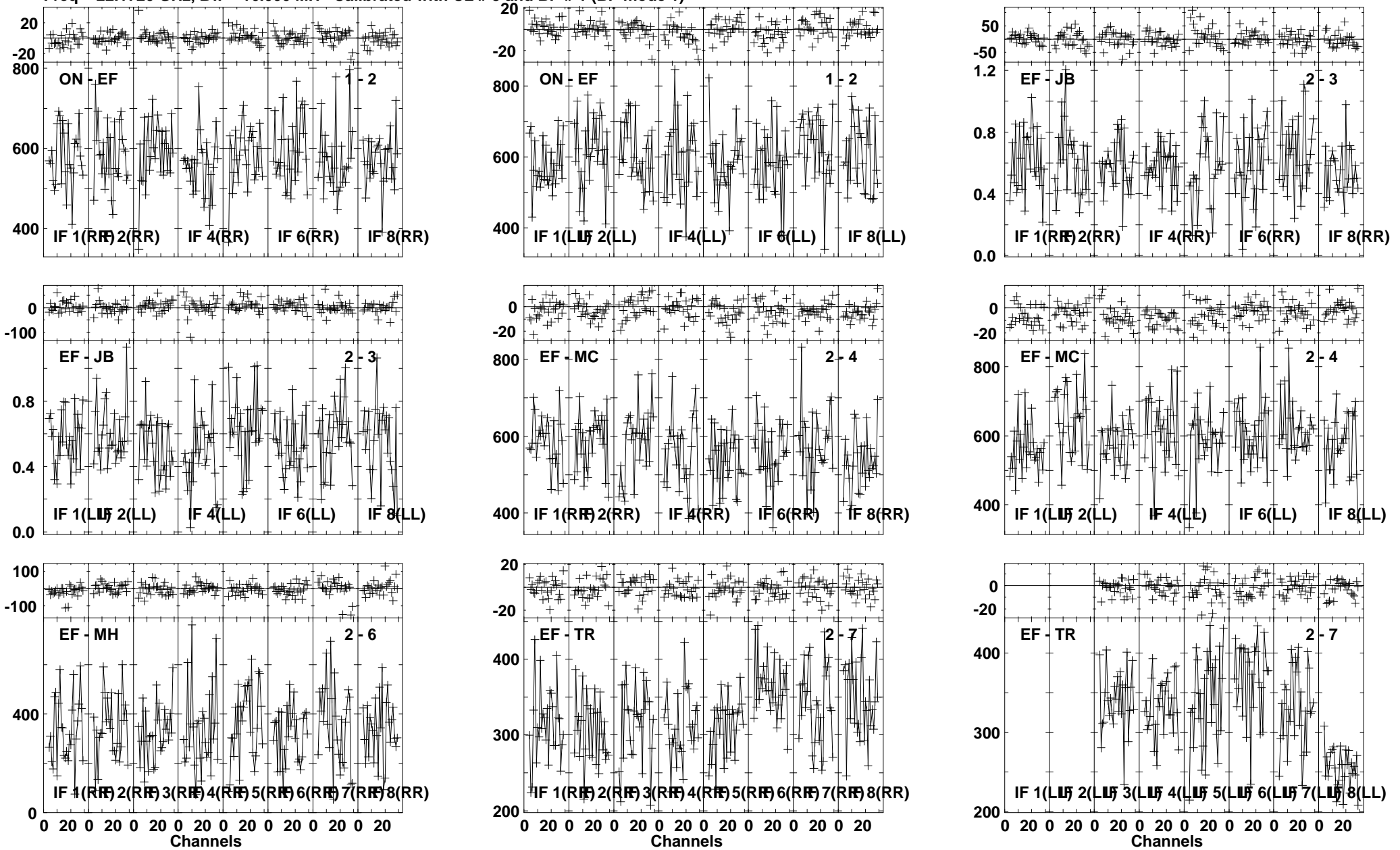

Lower frame: Milli Ampl Jy Top frame: Phas deg
Vector averaged cross-power spectrum Several baselines displayed
Timerange: 01/00:40:01 to 01/00:40:59

Plot file version 310 created 26-JUL-2013 10:23:44
 J1157 EZ024 1.UVDATA.1
 Freq = 22.1720 GHz, Bw = 16.000 MH Calibrated with CL # 3 and BP # 1 (BP mode 1)

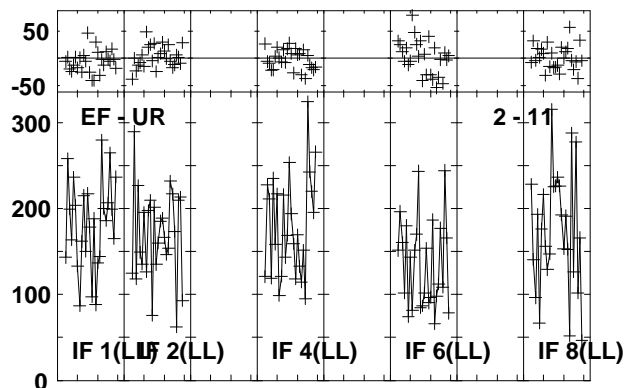
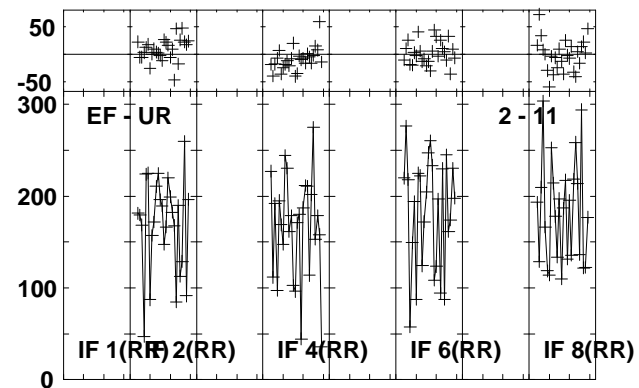
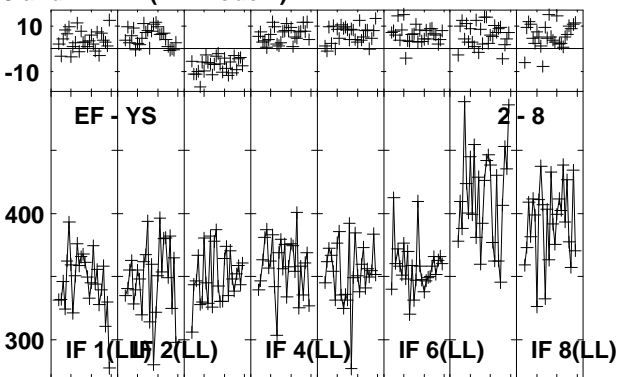
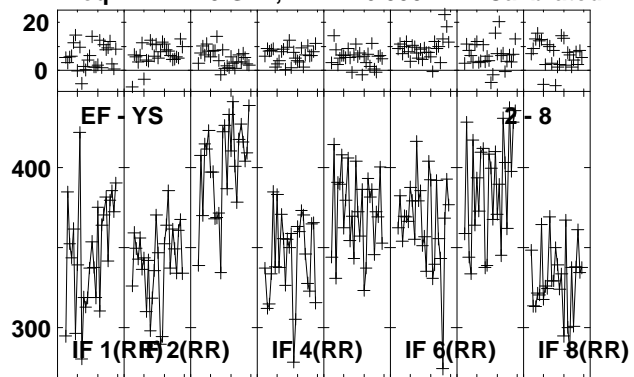

Lower frame: Milli Ampl Jy Top frame: Phas deg
 Vector averaged cross-power spectrum Several baselines displayed
 Timerange: 01/00:40:01 to 01/00:40:59

Plot file version 311 created 26-JUL-2013 10:23:45
 B1152+199A EZ024 1.UVDATA.1
 Freq = 22.1720 GHz, Bw = 16.000 MH Calibrated with CL # 3 and BP # 1 (BP mode 1)

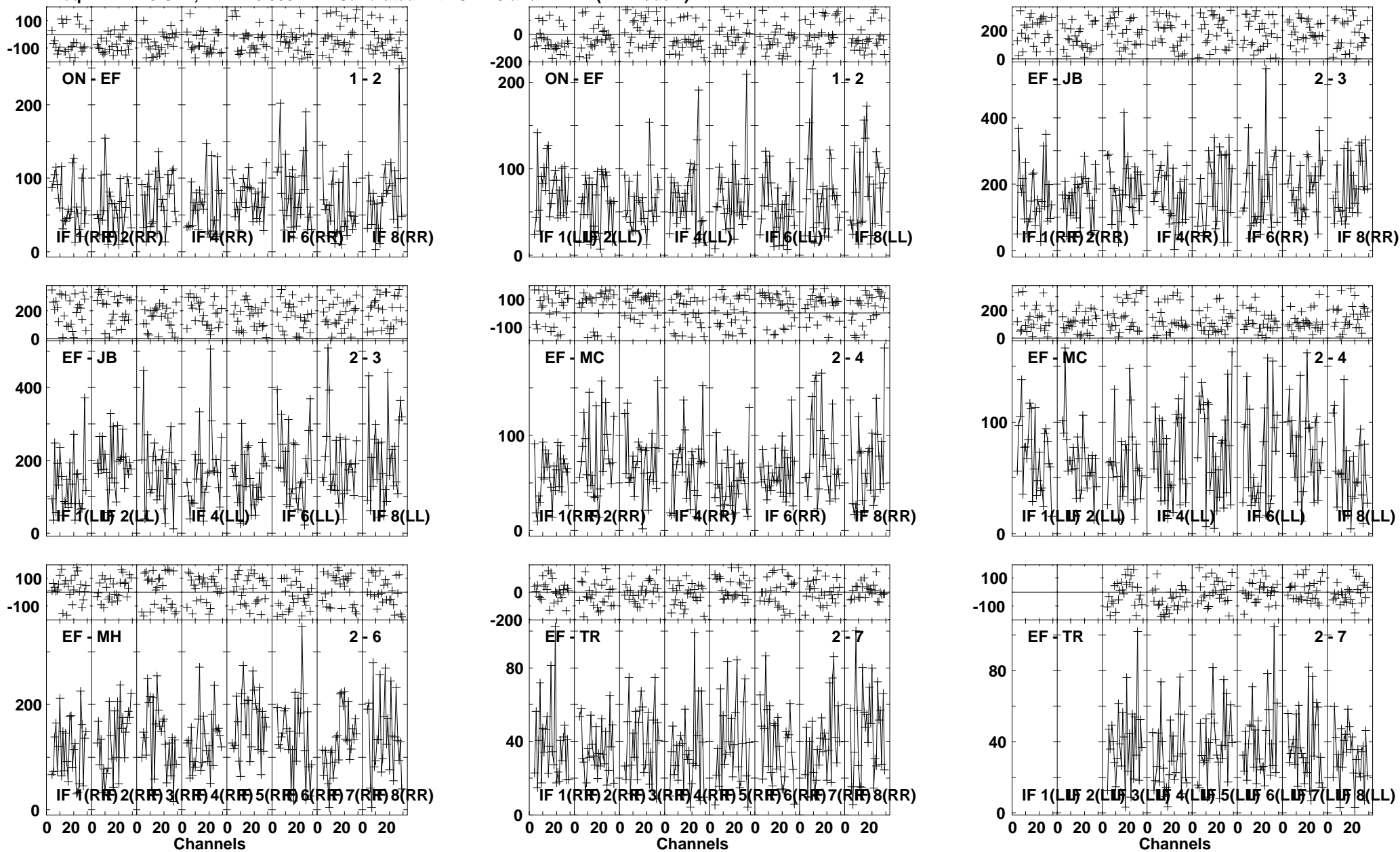

Lower frame: Milli Ampl Jy Top frame: Phas deg
 Vector averaged cross-power spectrum Several baselines displayed
 Timerange: 01/00:41:34 to 01/00:43:32

Plot file version 312 created 26-JUL-2013 10:23:47

B1152+199A EZ024 1.UVDATA.1

Freq = 22.1720 GHz, Bw = 16.000 MH Calibrated with CL # 3 and BP # 1 (BP mode 1)

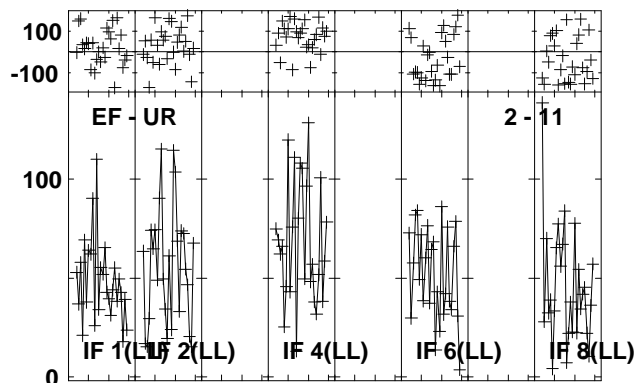
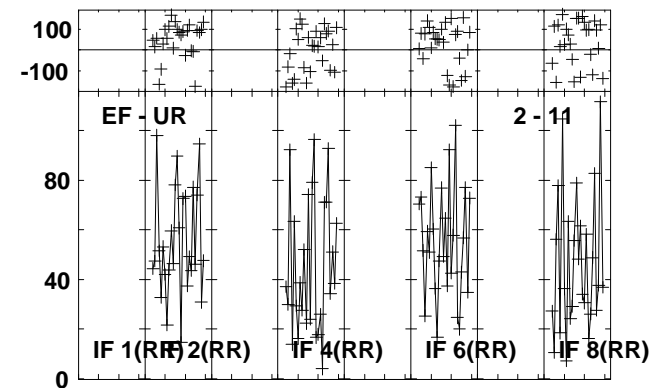
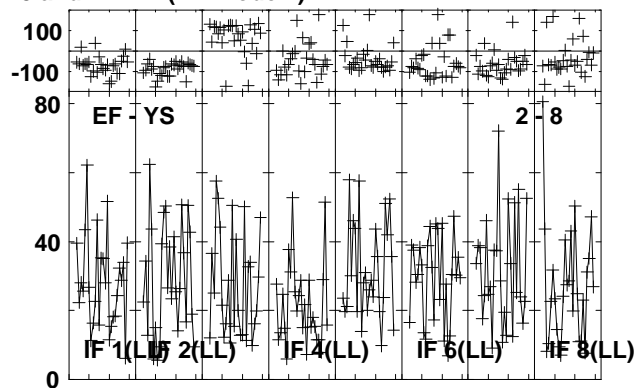
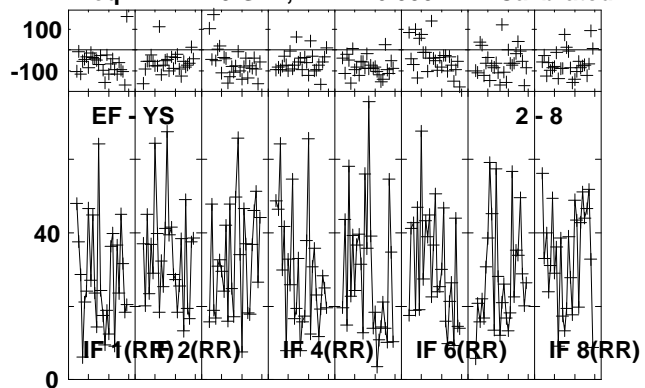

Lower frame: Milli Ampl Jy Top frame: Phas deg
Vector averaged cross-power spectrum Several baselines displayed
Timerange: 01/00:41:34 to 01/00:43:32

Plot file version 313 created 26-JUL-2013 10:23:49

J1157 EZ024 1.UVDATA.1

Freq = 22.1720 GHz, Bw = 16.000 MH Calibrated with CL # 3 and BP # 1 (BP mode 1)

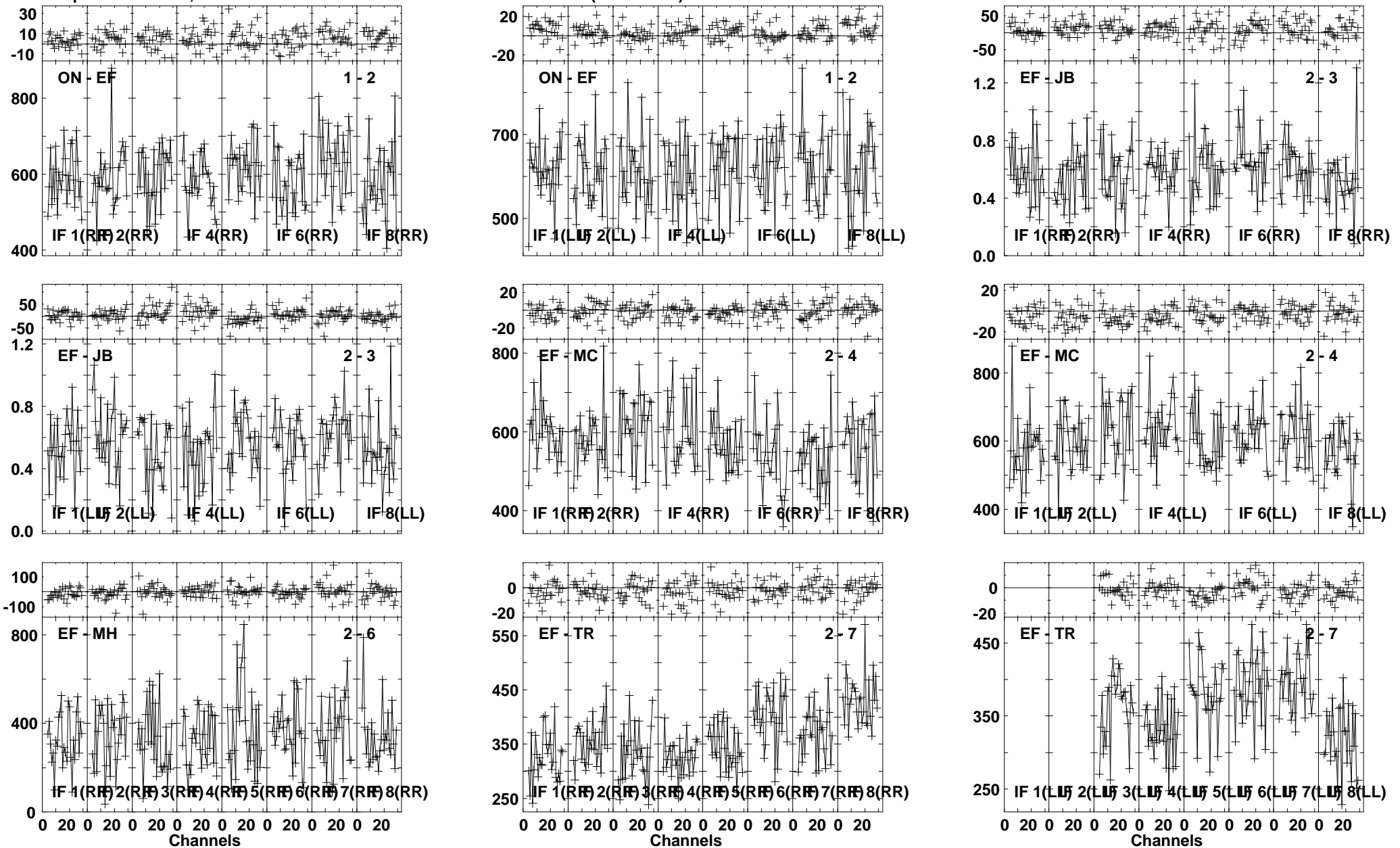

Lower frame: Milli Ampl Jy Top frame: Phas deg
Vector averaged cross-power spectrum Several baselines displayed
Timerange: 01/00:44:08 to 01/00:45:06

Plot file version 314 created 26-JUL-2013 10:23:49
 J1157 EZ024 1.UVDATA.1
 Freq = 22.1720 GHz, Bw = 16.000 MH Calibrated with CL # 3 and BP # 1 (BP mode 1)

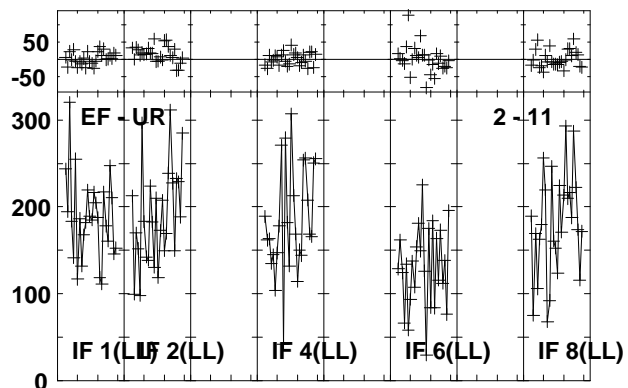
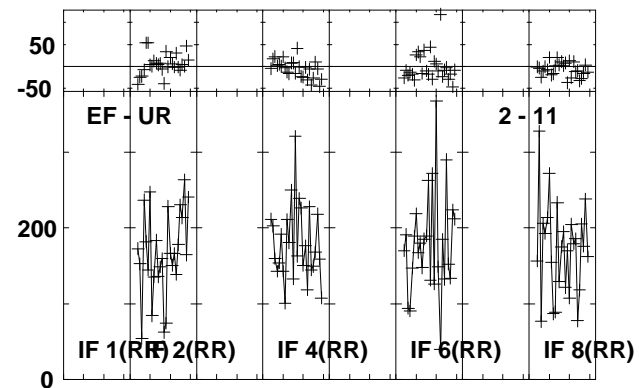
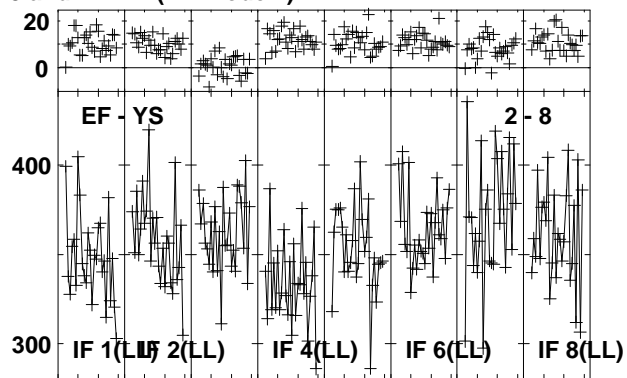
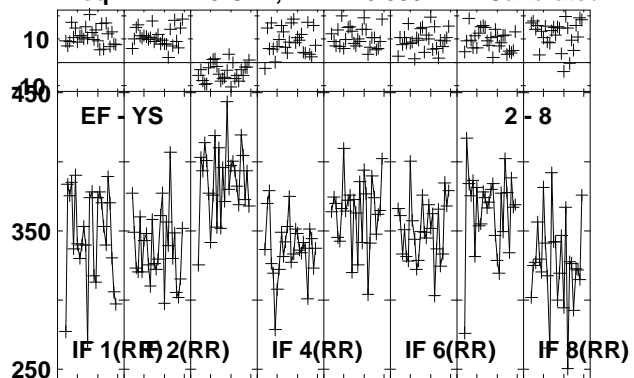

Lower frame: Milli Ampl Jy Top frame: Phas deg
 Vector averaged cross-power spectrum Several baselines displayed
 Timerange: 01/00:44:08 to 01/00:45:06

Plot file version 315 created 26-JUL-2013 10:23:51
 B1152+199A EZ024 1.UVDATA.1
 Freq = 22.1720 GHz, Bw = 16.000 MH Calibrated with CL # 3 and BP # 1 (BP mode 1)

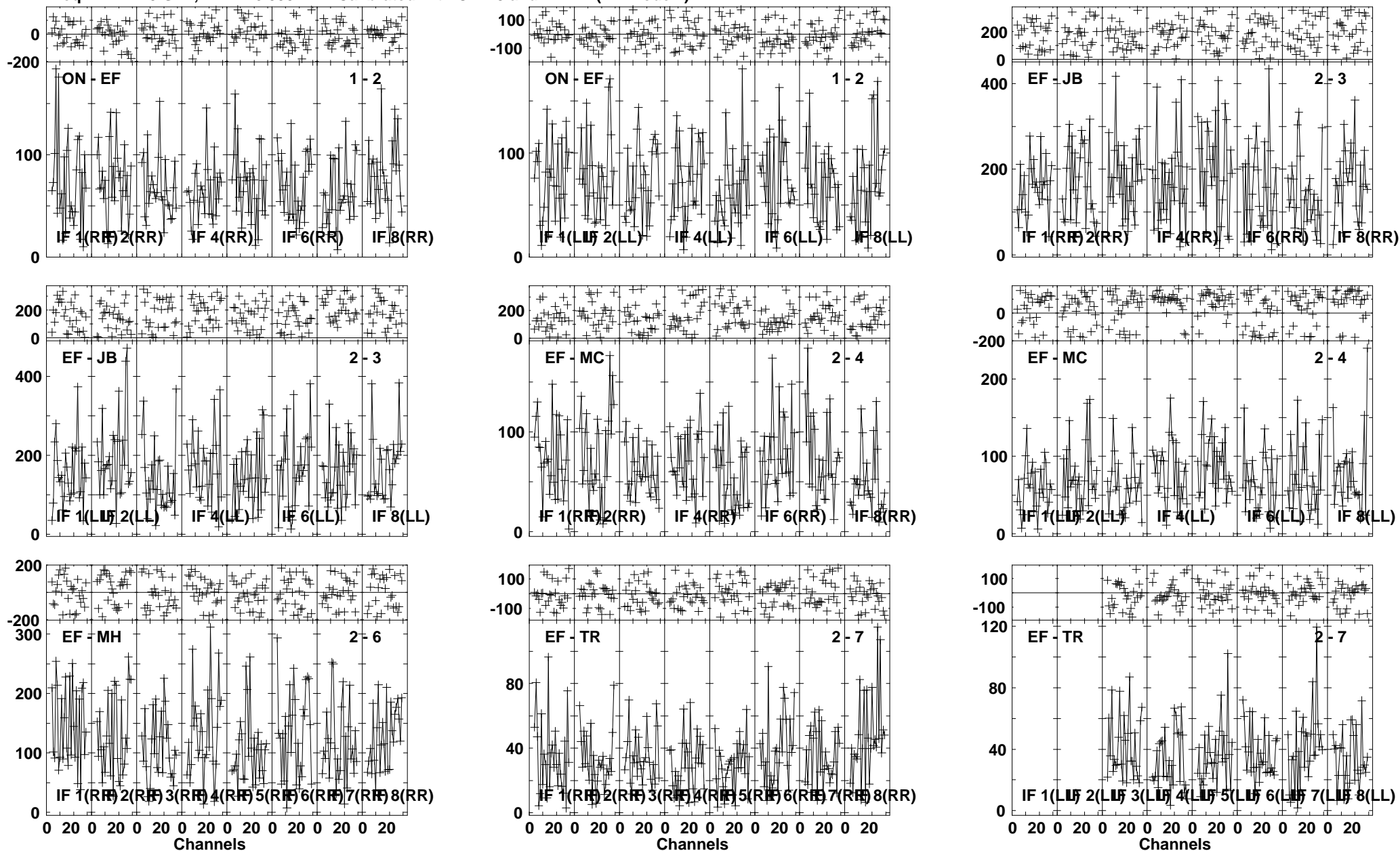

Lower frame: Milli Ampl Jy Top frame: Phas deg
 Vector averaged cross-power spectrum Several baselines displayed
 Timerange: 01/00:45:42 to 01/00:47:40

Plot file version 316 created 26-JUL-2013 10:23:52
 B1152+199A EZ024 1.UVDATA.1
 Freq = 22.1720 GHz, Bw = 16.000 MH Calibrated with CL # 3 and BP # 1 (BP mode 1)

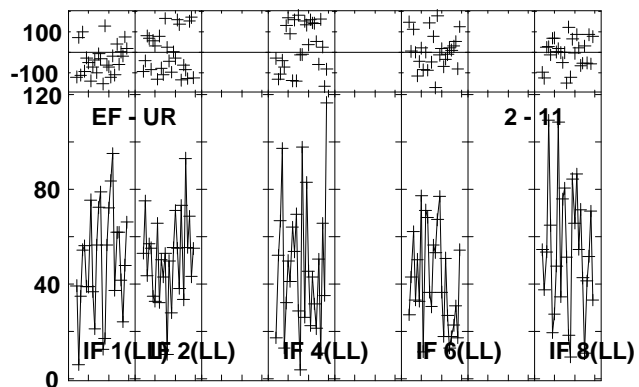
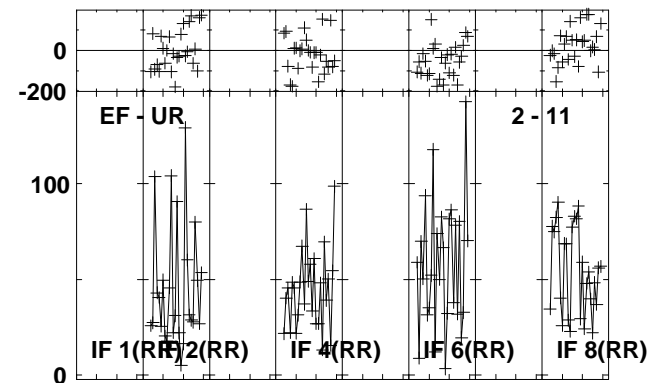
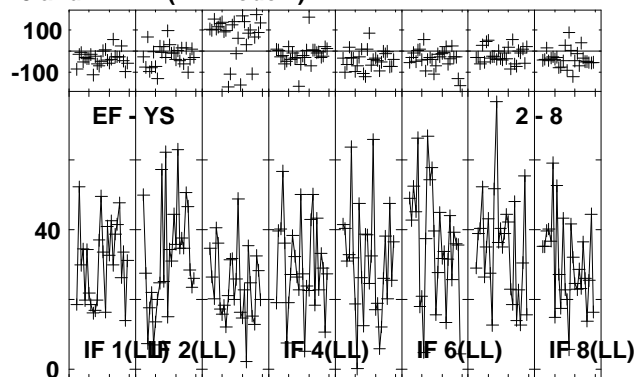
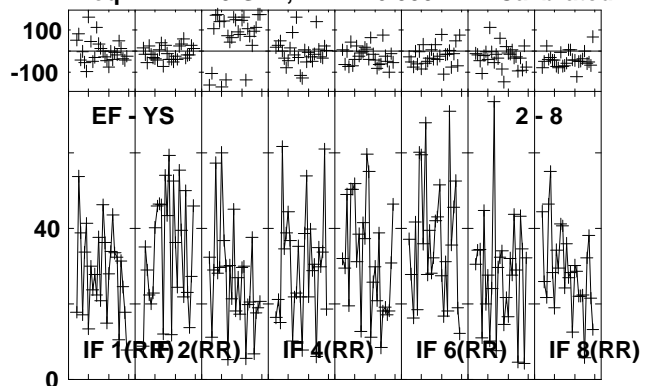

Lower frame: Milli Ampl Jy Top frame: Phas deg
 Vector averaged cross-power spectrum Several baselines displayed
 Timerange: 01/00:45:42 to 01/00:47:40

Plot file version 317 created 26-JUL-2013 10:23:54

J1157 EZ024 1.UVDATA.1

Freq = 22.1720 GHz, Bw = 16.000 MH Calibrated with CL # 3 and BP # 1 (BP mode 1)

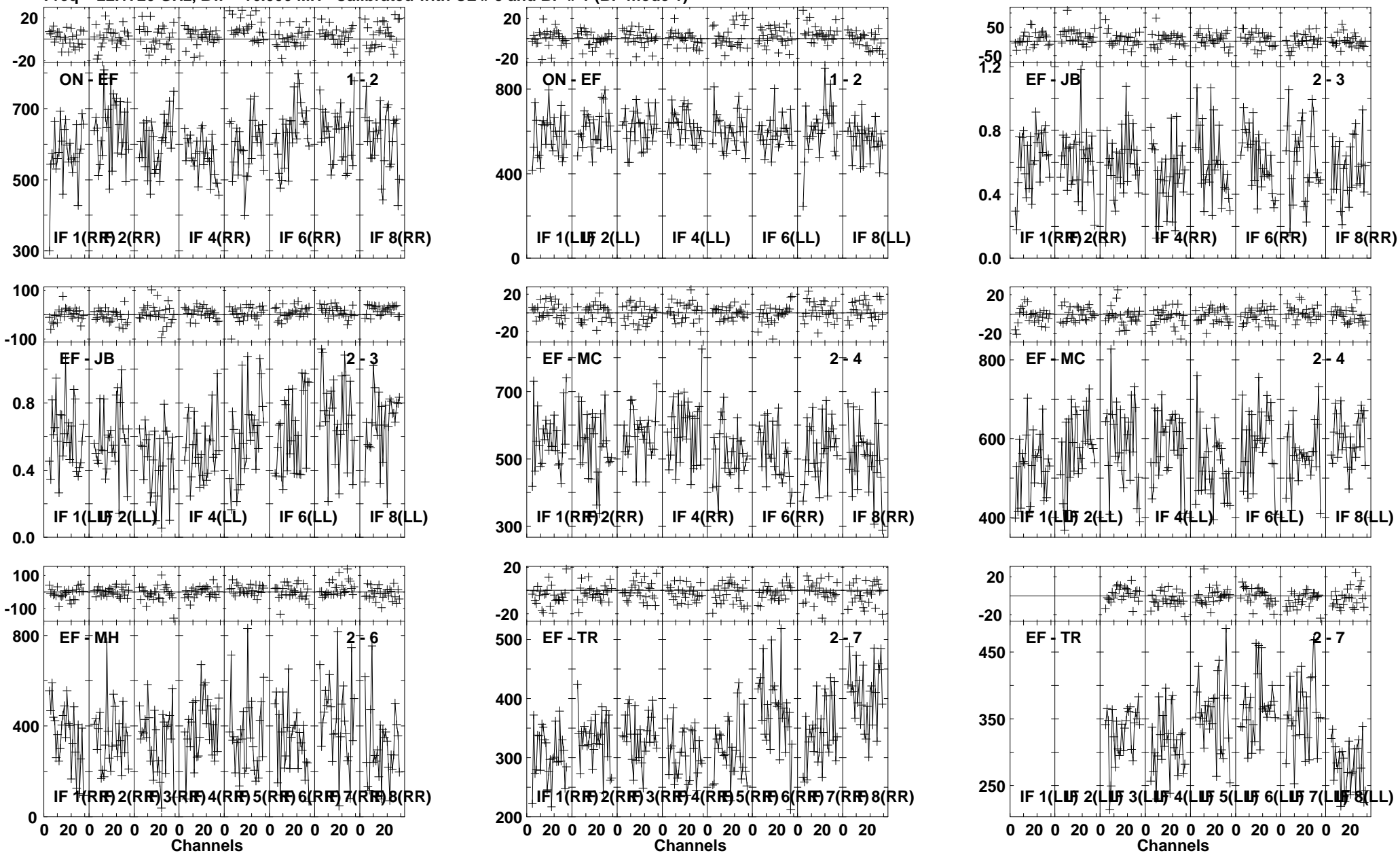

Lower frame: Milli Ampl Jy Top frame: Phas deg
Vector averaged cross-power spectrum Several baselines displayed
Timerange: 01/00:48:15 to 01/00:49:13

Plot file version 318 created 26-JUL-2013 10:23:55
 J1157 EZ024 1.UVDATA.1
 Freq = 22.1720 GHz, Bw = 16.000 MH Calibrated with CL # 3 and BP # 1 (BP mode 1)

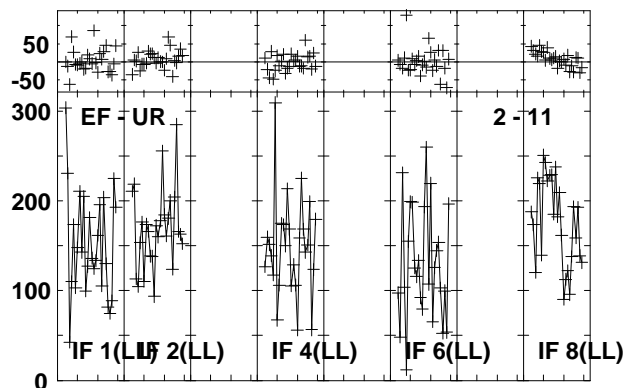
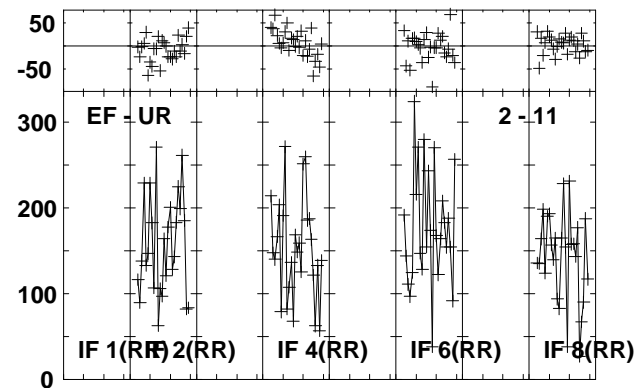
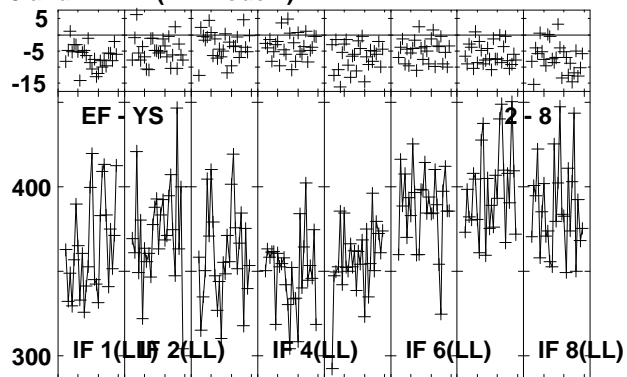
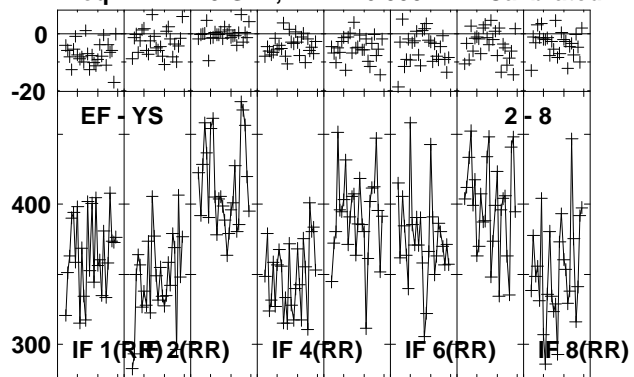

Lower frame: Milli Ampl Jy Top frame: Phas deg
 Vector averaged cross-power spectrum Several baselines displayed
 Timerange: 01/00:48:15 to 01/00:49:13

Plot file version 319 created 26-JUL-2013 10:23:56
 J1125+2610 EZ024 1.UVDATA.1
 Freq = 22.1720 GHz, Bw = 16.000 MH Calibrated with CL # 3 and BP # 1 (BP mode 1)

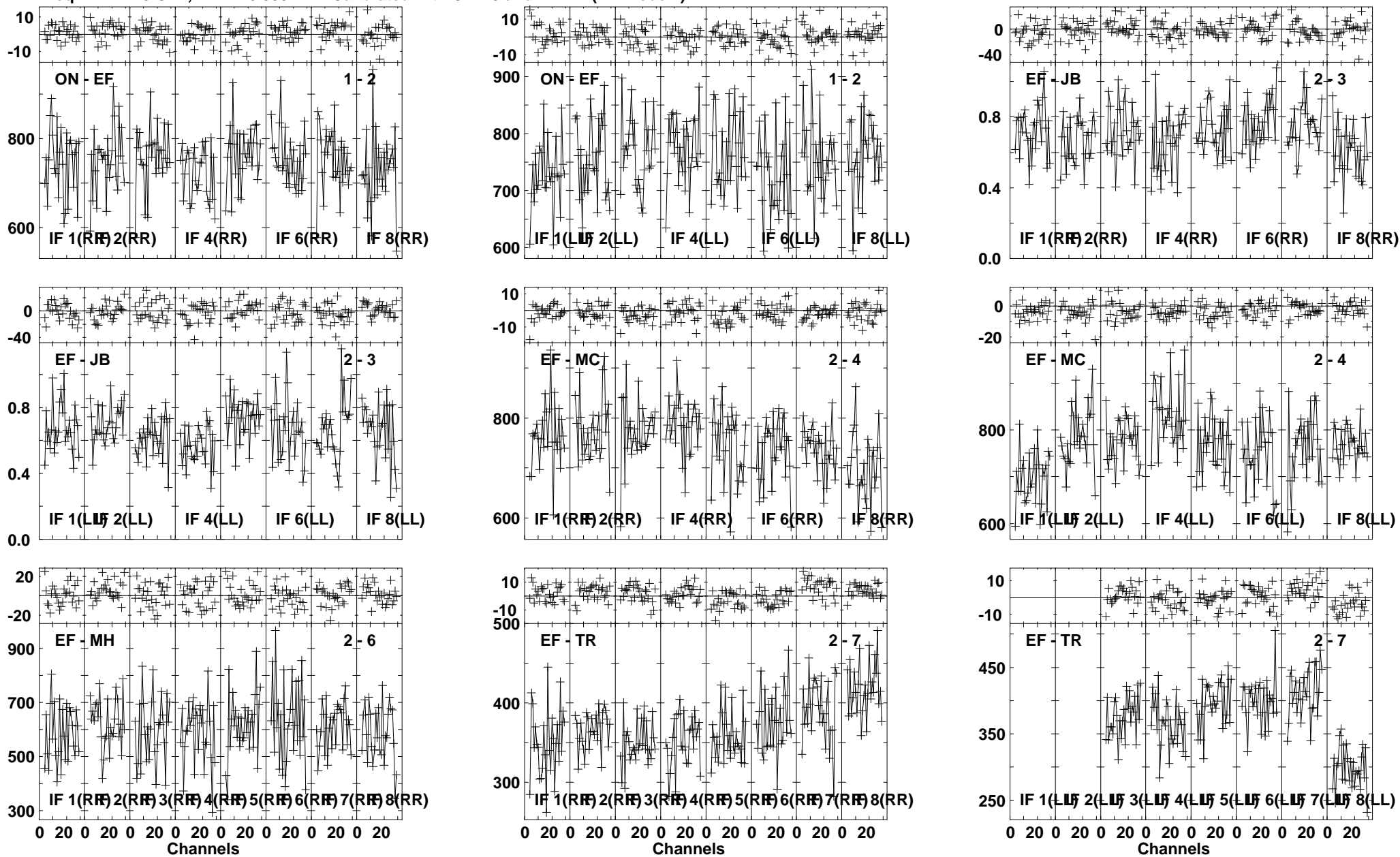

Lower frame: Milli Ampl Jy Top frame: Phas deg
 Vector averaged cross-power spectrum Several baselines displayed
 Timerange: 01/00:50:40 to 01/00:52:22

Plot file version 320 created 26-JUL-2013 10:23:57
 J1125+2610 EZ024 1.UVDATA.1
 Freq = 22.1720 GHz, Bw = 16.000 MH Calibrated with CL # 3 and BP # 1 (BP mode 1)

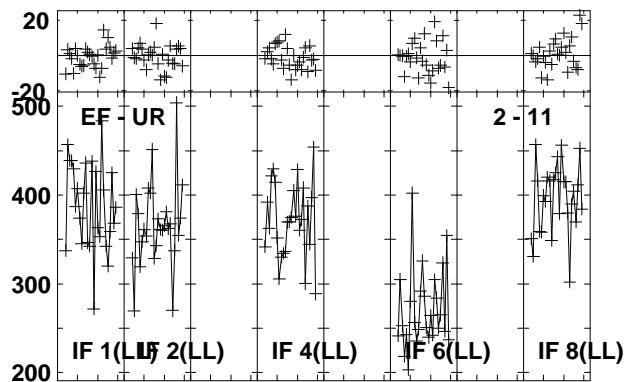
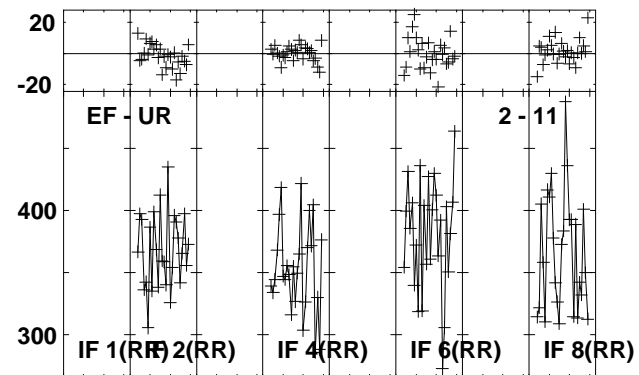
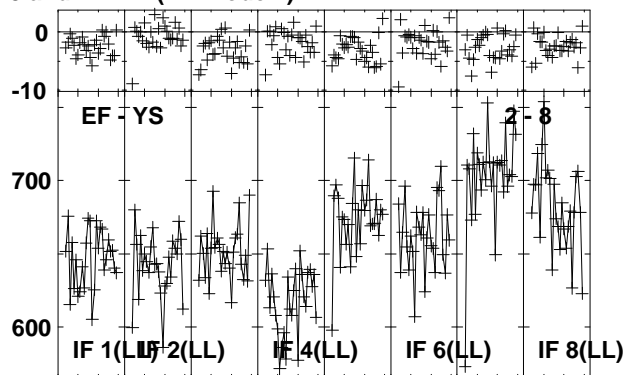
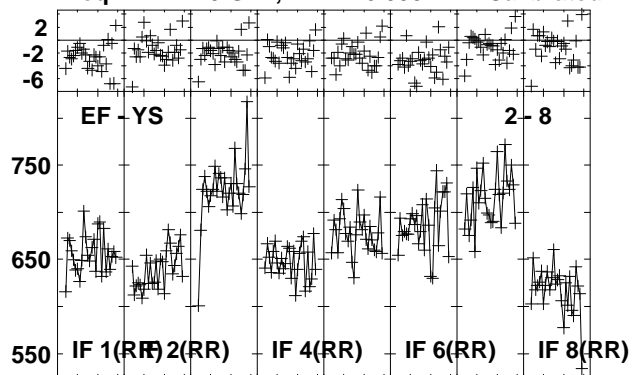

Lower frame: Milli Ampl Jy Top frame: Phas deg
 Vector averaged cross-power spectrum Several baselines displayed
 Timerange: 01/00:50:40 to 01/00:52:22

Plot file version 321 created 26-JUL-2013 10:23:59

J1157 EZ024 1.UVDATA.1

Freq = 22.1720 GHz, Bw = 16.000 MH Calibrated with CL # 3 and BP # 1 (BP mode 1)

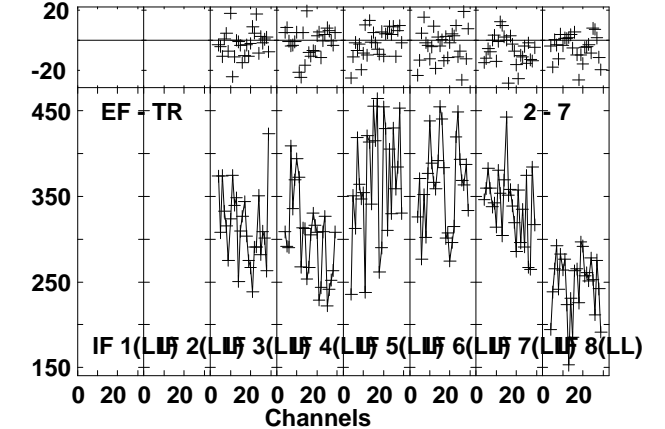
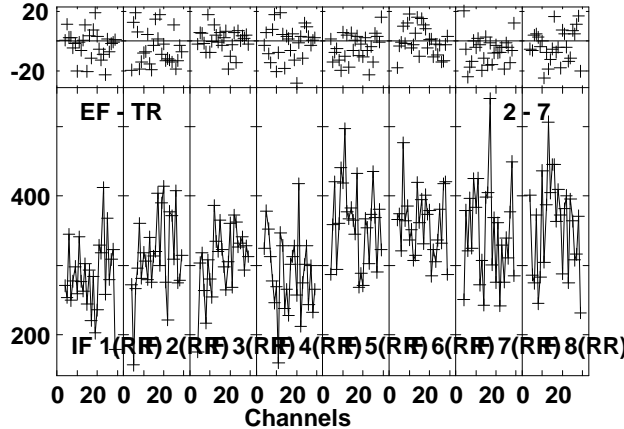
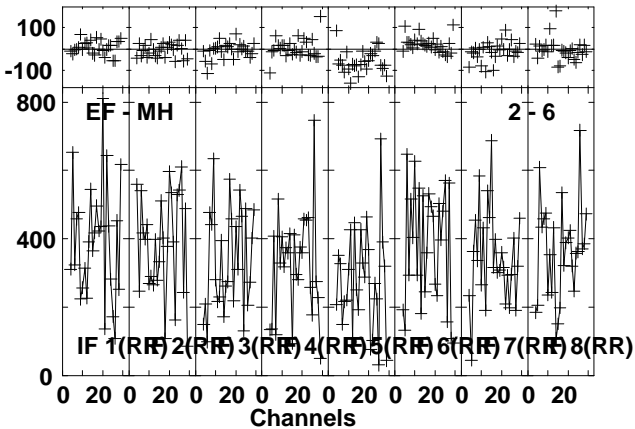
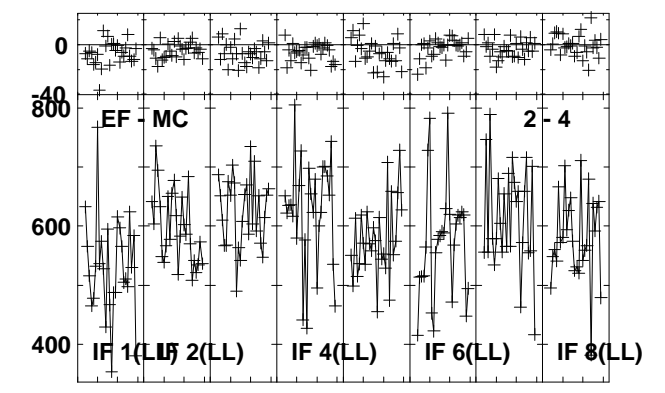
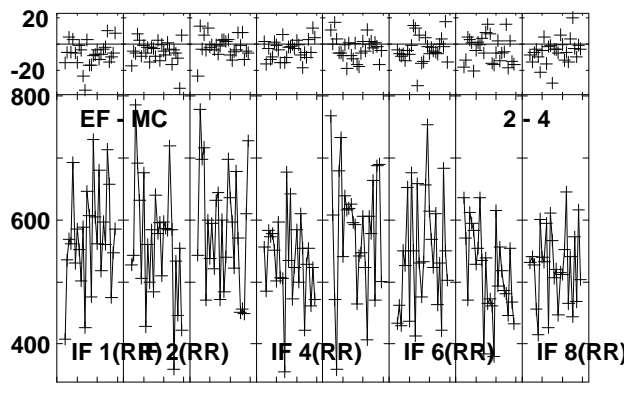
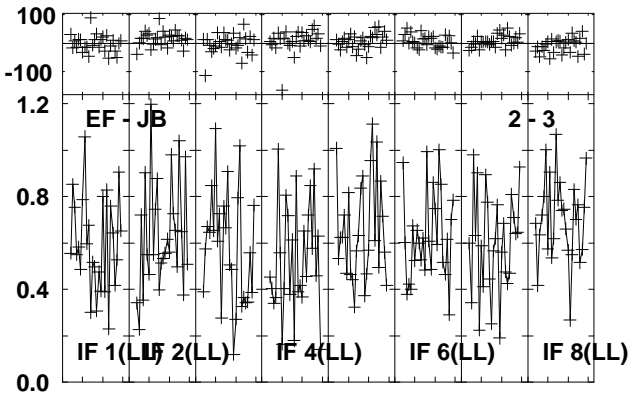
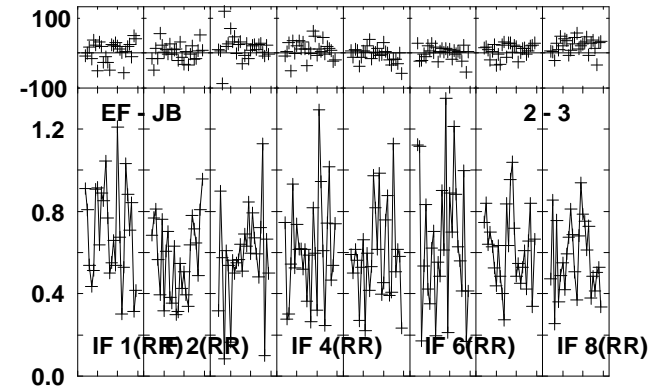
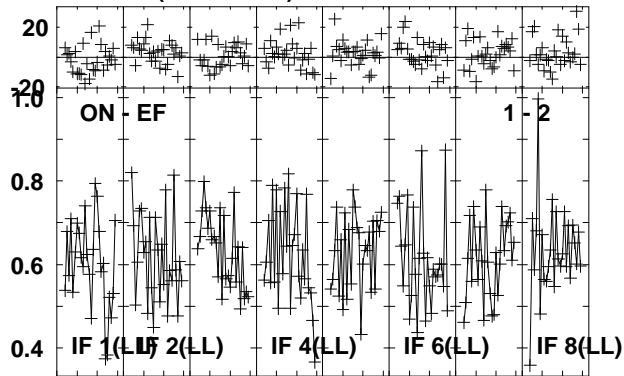
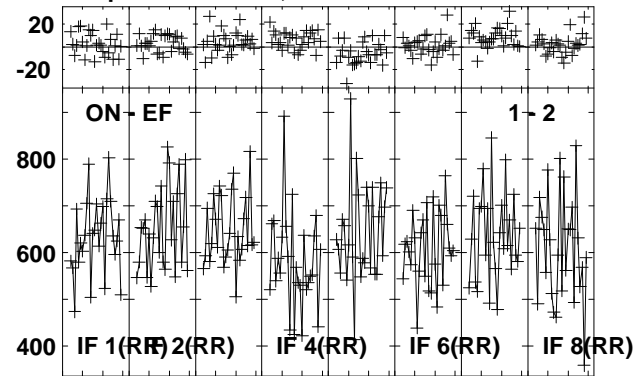

Lower frame: Milli Ampl Jy Top frame: Phas deg
Vector averaged cross-power spectrum Several baselines displayed
Timerange: 01/00:53:48 to 01/00:54:30

Plot file version 322 created 26-JUL-2013 10:23:59
 J1157 EZ024 1.UVDATA.1
 Freq = 22.1720 GHz, Bw = 16.000 MH Calibrated with CL # 3 and BP # 1 (BP mode 1)

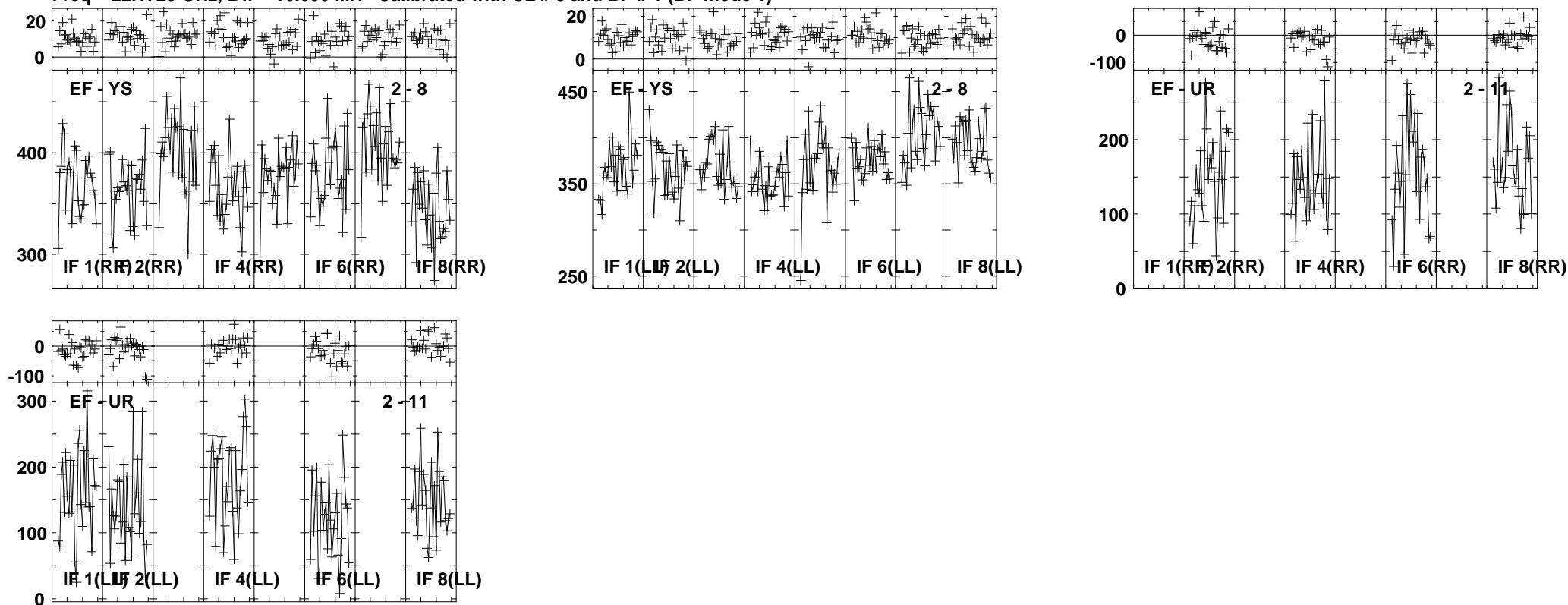

Lower frame: Milli Ampl Jy Top frame: Phas deg
 Vector averaged cross-power spectrum Several baselines displayed
 Timerange: 01/00:53:48 to 01/00:54:30

Plot file version 323 created 26-JUL-2013 10:24:00
 B1152+199A EZ024 1.UVDATA.1
 Freq = 22.1720 GHz, Bw = 16.000 MH Calibrated with CL # 3 and BP # 1 (BP mode 1)

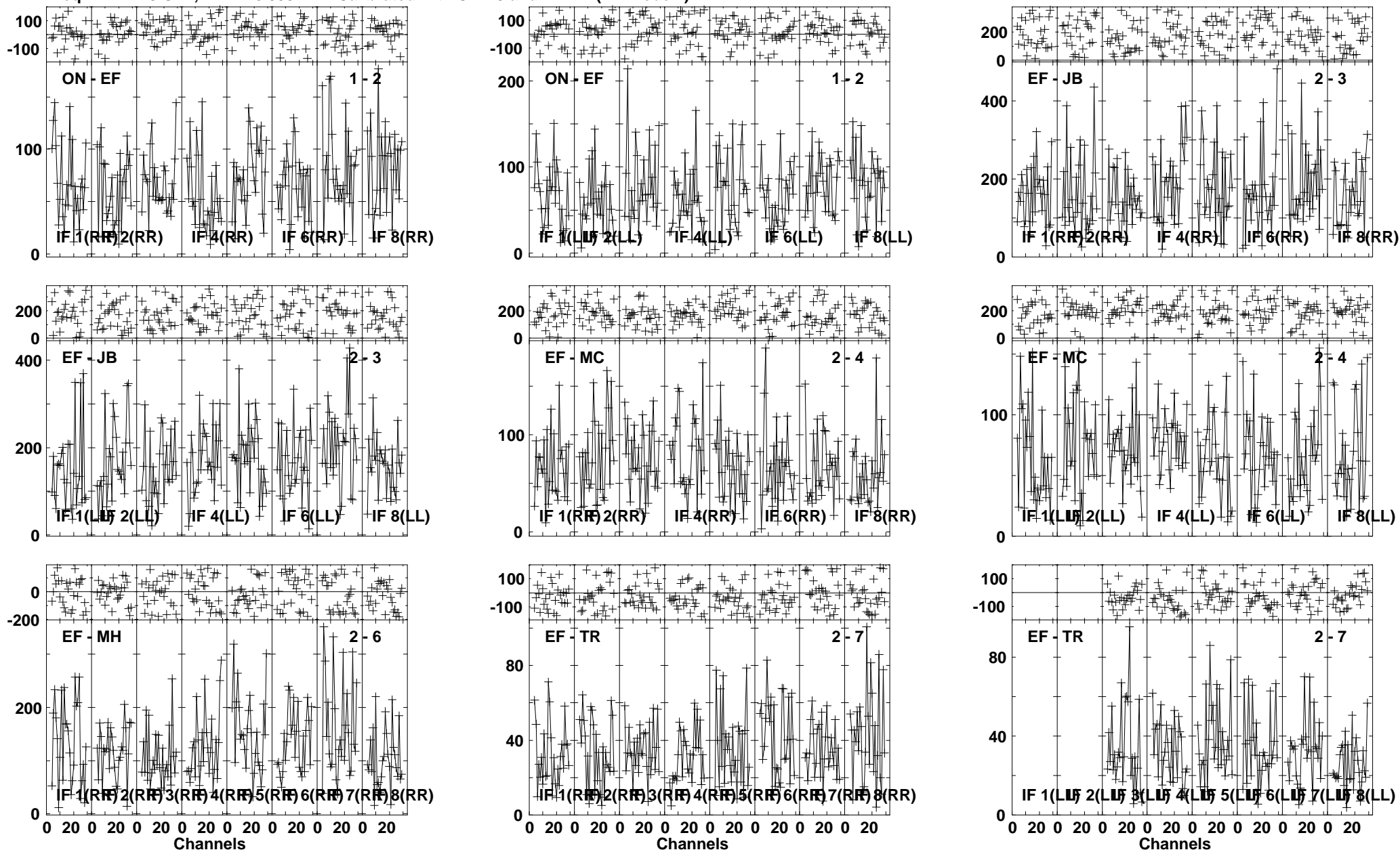

Lower frame: Milli Ampl Jy Top frame: Phas deg
 Vector averaged cross-power spectrum Several baselines displayed
 Timerange: 01/00:55:06 to 01/00:57:04

Plot file version 324 created 26-JUL-2013 10:24:02

B1152+199A EZ024 1.UVDATA.1

Freq = 22.1720 GHz, Bw = 16.000 MH Calibrated with CL # 3 and BP # 1 (BP mode 1)

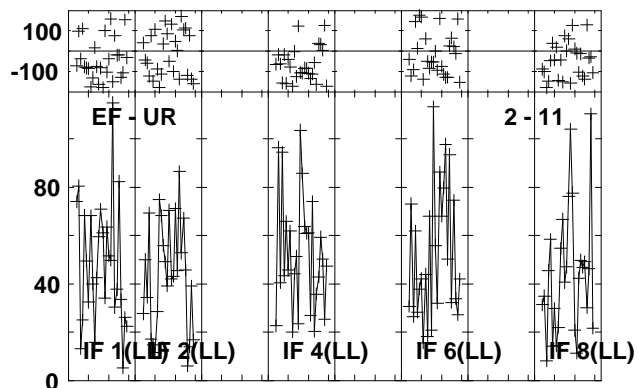
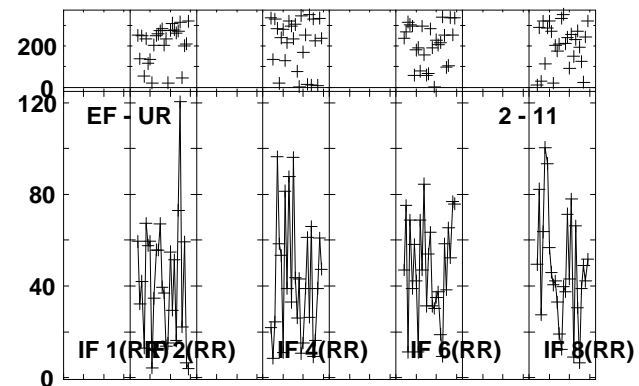
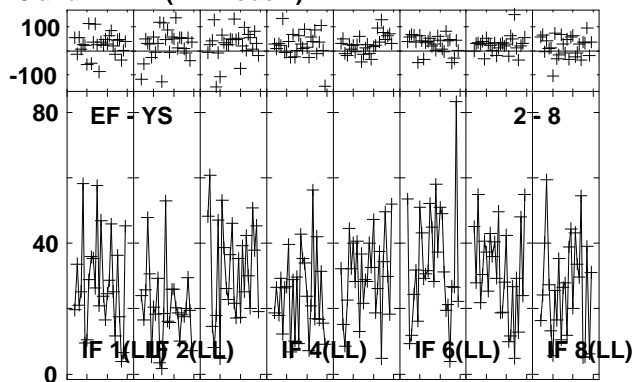
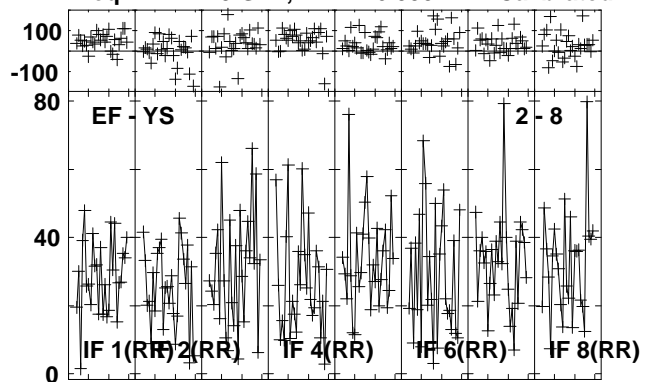

Lower frame: Milli Ampl Jy Top frame: Phas deg
Vector averaged cross-power spectrum Several baselines displayed
Timerange: 01/00:55:06 to 01/00:57:04

Plot file version 325 created 26-JUL-2013 10:24:04

J1157 EZ024 1.UVDATA.1

Freq = 22.1720 GHz, Bw = 16.000 MH Calibrated with CL # 3 and BP # 1 (BP mode 1)

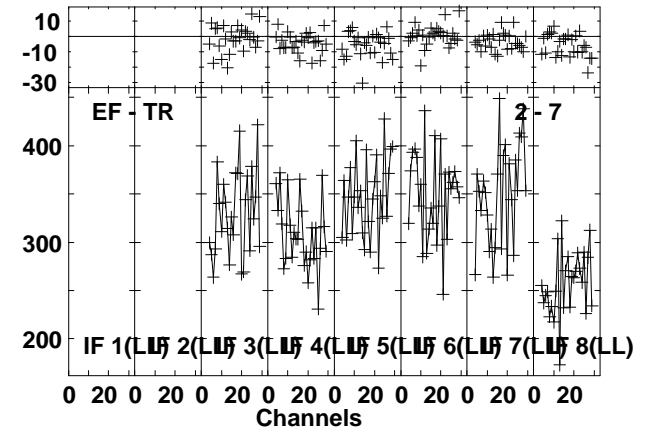
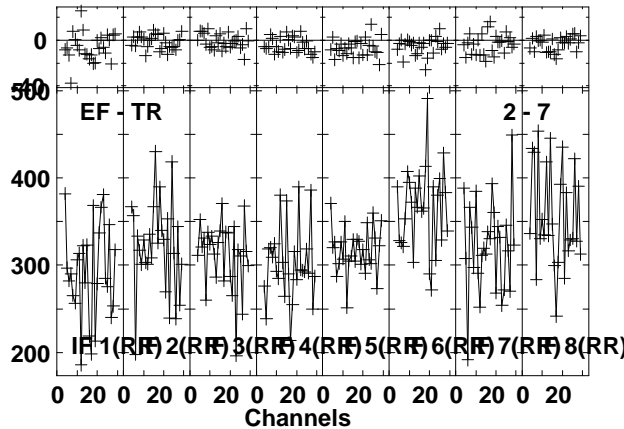
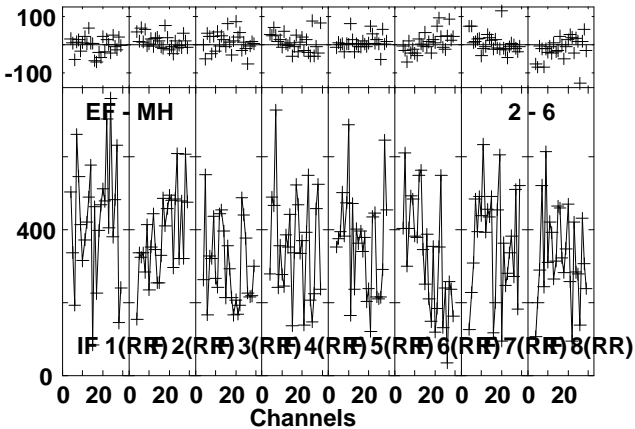
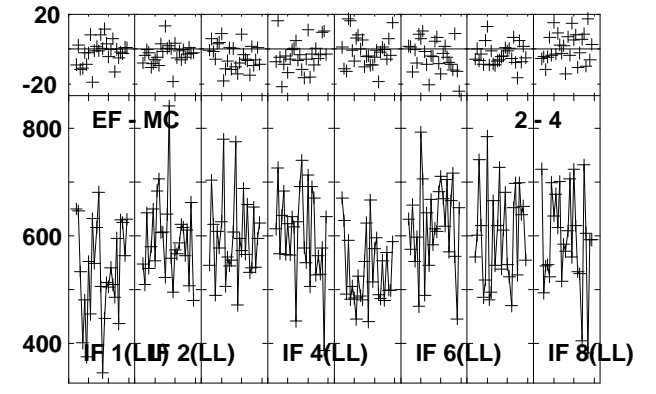
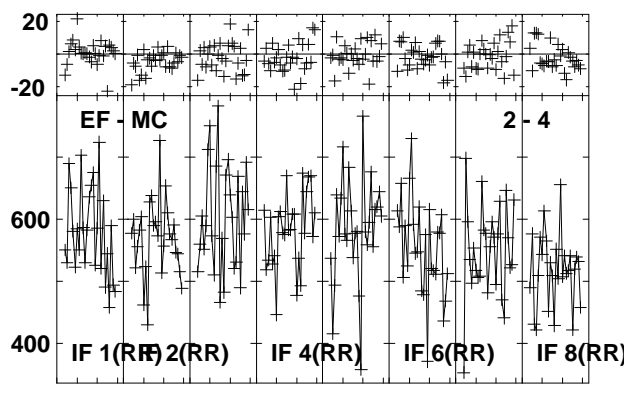
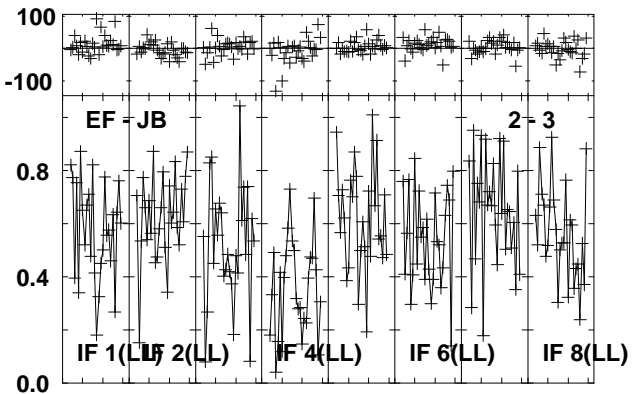
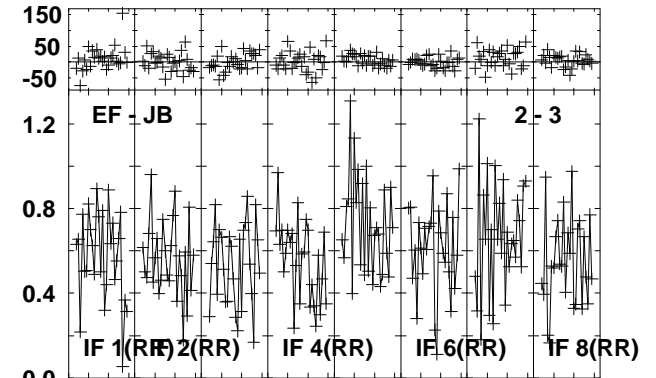
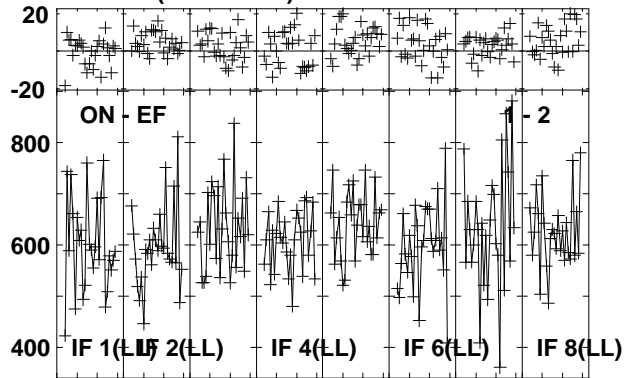
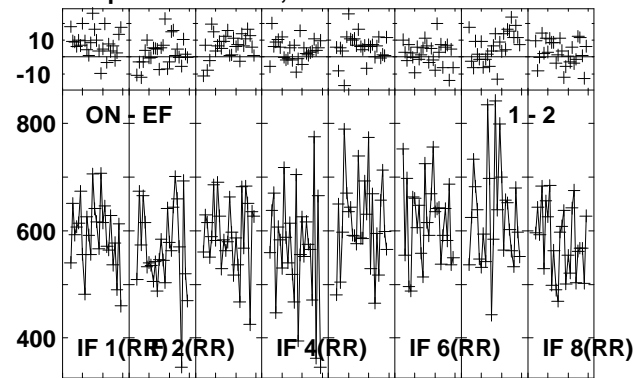

Lower frame: Milli Ampl Jy Top frame: Phas deg
Vector averaged cross-power spectrum Several baselines displayed
Timerange: 01/00:57:40 to 01/00:58:38

Plot file version 326 created 26-JUL-2013 10:24:04

J1157 EZ024 1.UVDATA.1

Freq = 22.1720 GHz, Bw = 16.000 MH Calibrated with CL # 3 and BP # 1 (BP mode 1)

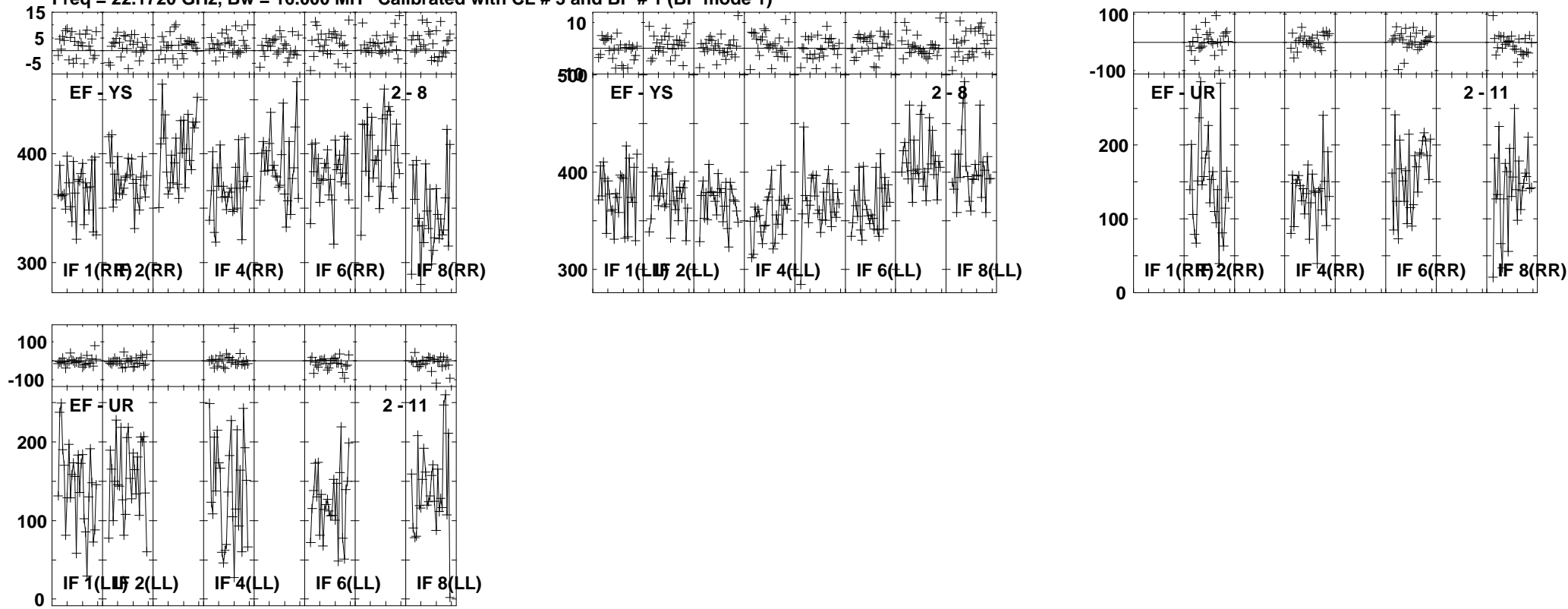

Lower frame: Milli Ampl Jy Top frame: Phas deg
Vector averaged cross-power spectrum Several baselines displayed
Timerange: 01/00:57:40 to 01/00:58:38

Plot file version 327 created 26-JUL-2013 10:24:06
 B1152+199A EZ024 1.UVDATA.1
 Freq = 22.1720 GHz, Bw = 16.000 MH Calibrated with CL # 3 and BP # 1 (BP mode 1)

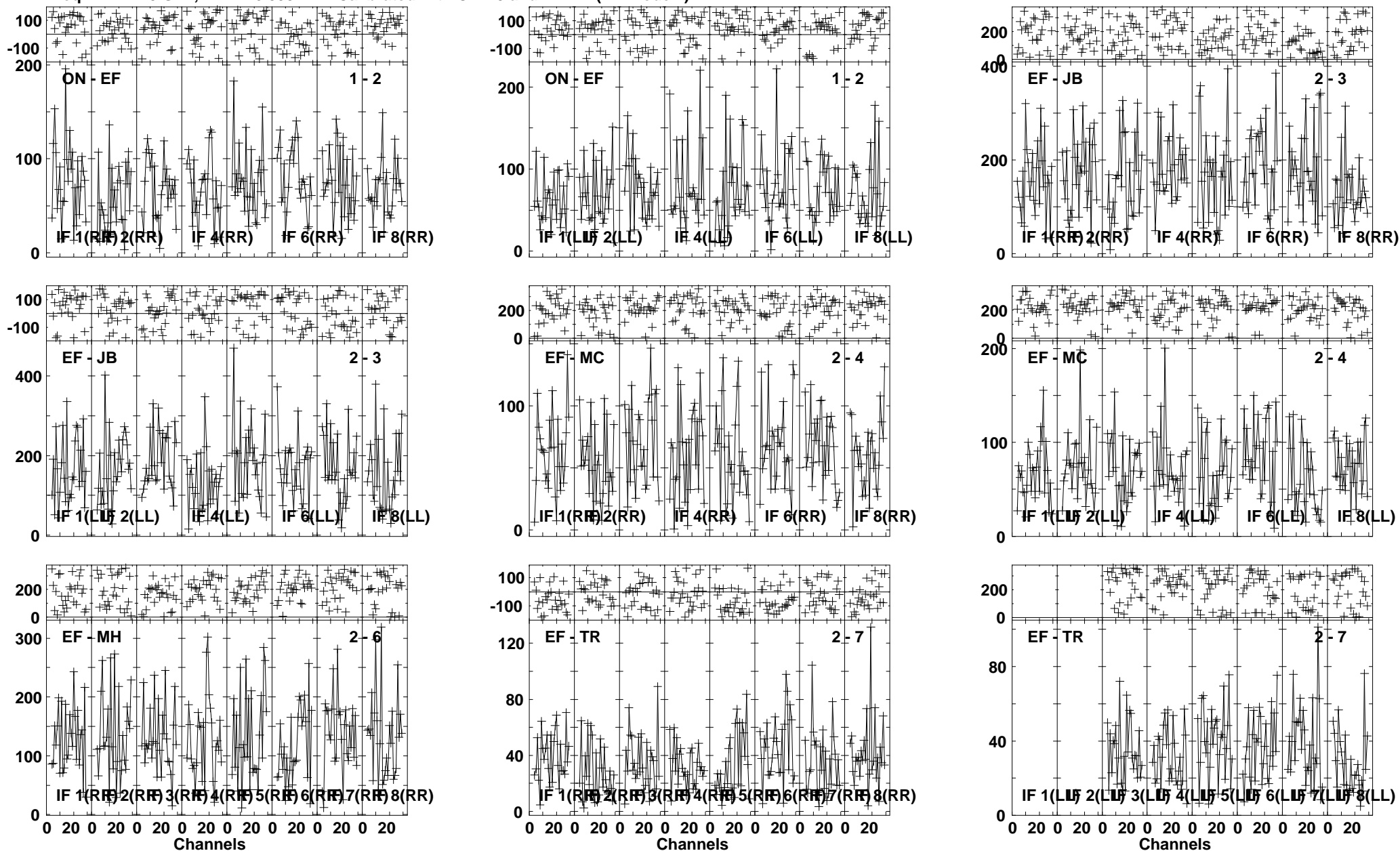

Lower frame: Milli Ampl Jy Top frame: Phas deg
 Vector averaged cross-power spectrum Several baselines displayed
 Timerange: 01/00:59:14 to 01/01:01:12

Plot file version 328 created 26-JUL-2013 10:24:07

B1152+199A EZ024 1.UVDATA.1

Freq = 22.1720 GHz, Bw = 16.000 MH Calibrated with CL # 3 and BP # 1 (BP mode 1)

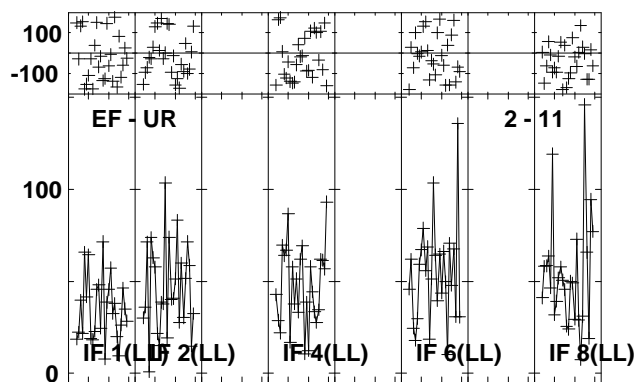
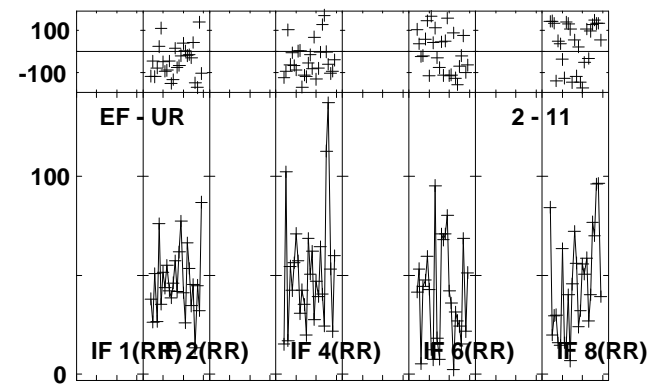
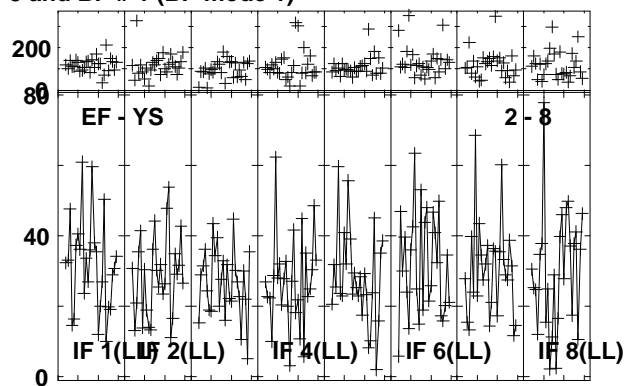
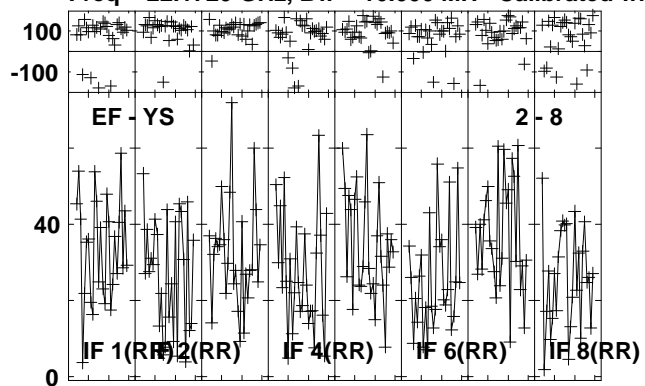

Lower frame: Milli Ampl Jy Top frame: Phas deg
Vector averaged cross-power spectrum Several baselines displayed
Timerange: 01/00:59:14 to 01/01:01:12

Plot file version 329 created 26-JUL-2013 10:24:09

J1157 EZ024 1.UVDATA.1

Freq = 22.1720 GHz, Bw = 16.000 MH Calibrated with CL # 3 and BP # 1 (BP mode 1)

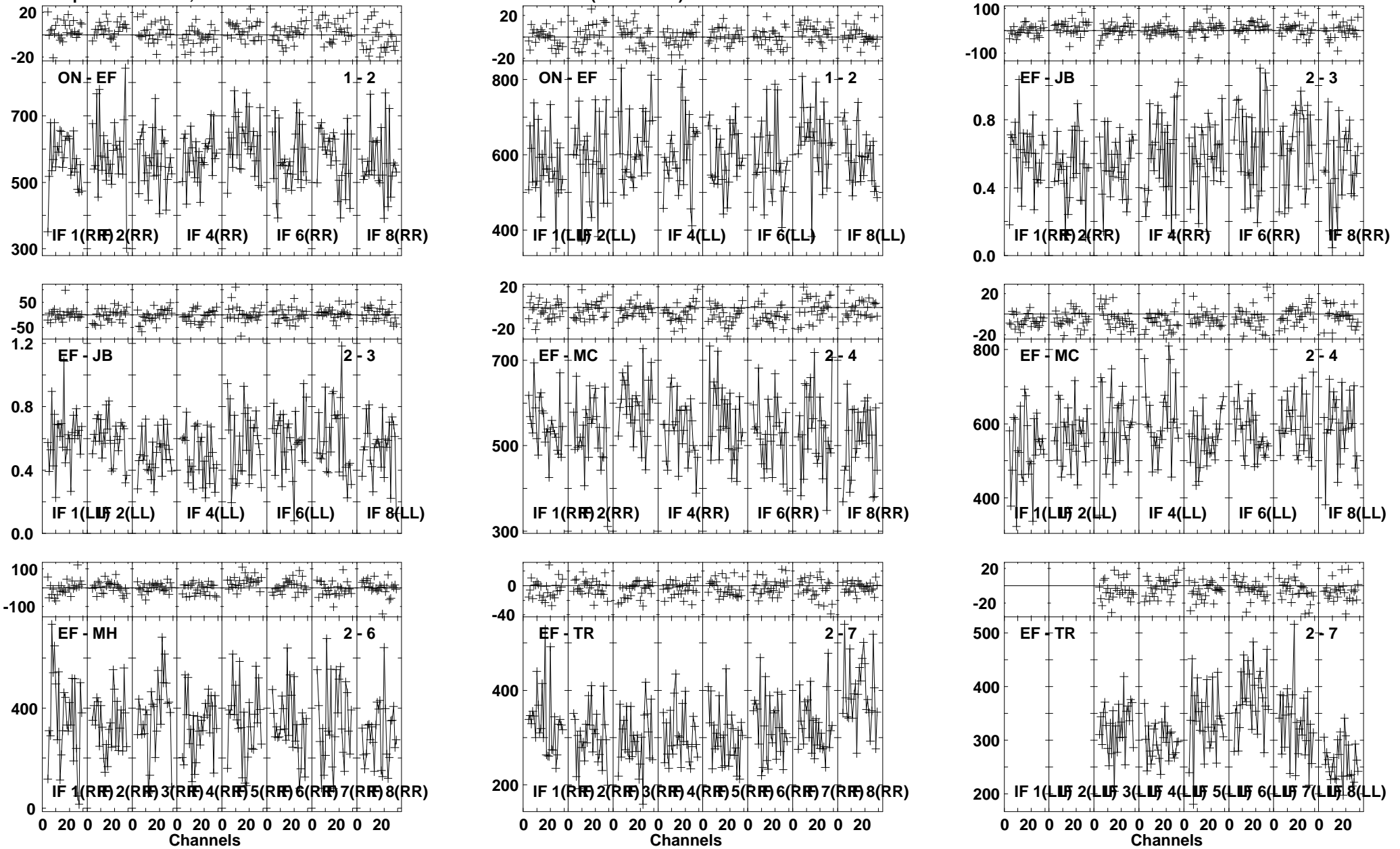

Lower frame: Milli Ampl Jy Top frame: Phas deg
Vector averaged cross-power spectrum Several baselines displayed
Timerange: 01/01:01:47 to 01/01:02:45

Plot file version 330 created 26-JUL-2013 10:24:10
 J1157 EZ024 1.UVDATA.1
 Freq = 22.1720 GHz, Bw = 16.000 MH Calibrated with CL # 3 and BP # 1 (BP mode 1)

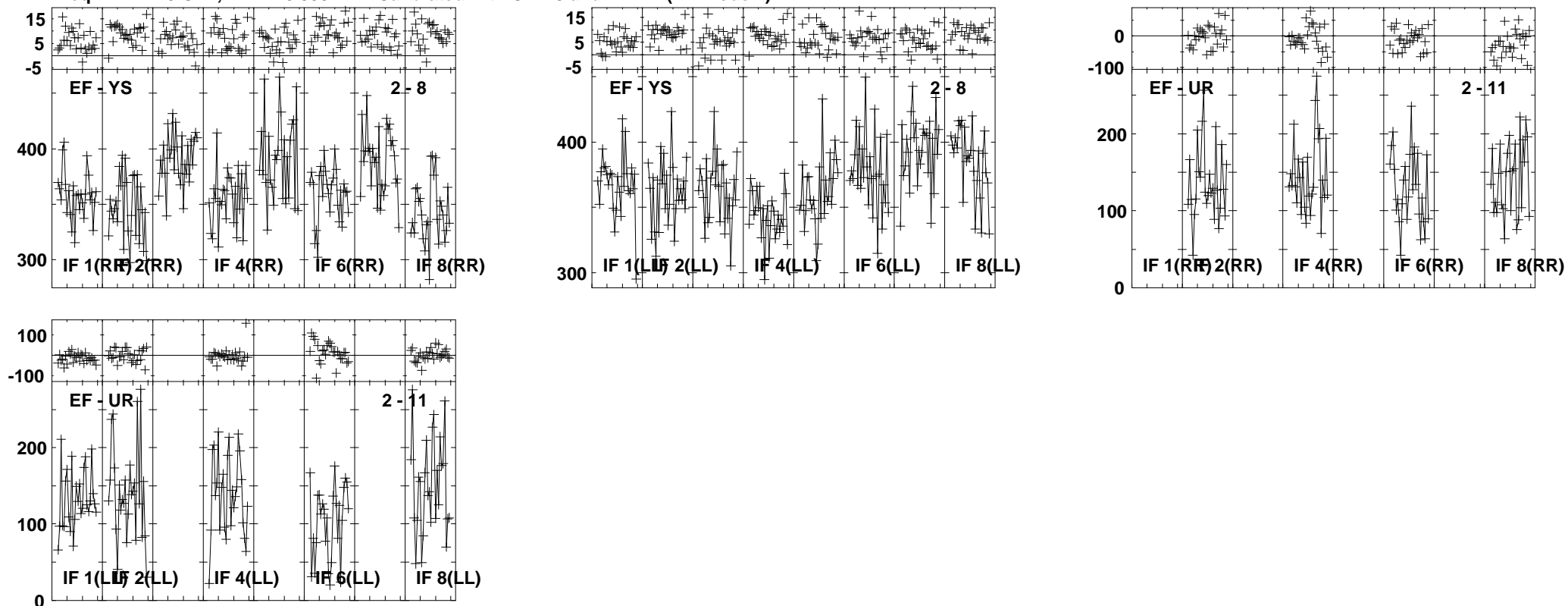

Lower frame: Milli Ampl Jy Top frame: Phas deg
 Vector averaged cross-power spectrum Several baselines displayed
 Timerange: 01/01:01:47 to 01/01:02:45

Plot file version 331 created 26-JUL-2013 10:24:11
 B1152+199A EZ024 1.UVDATA.1
 Freq = 22.1720 GHz, Bw = 16.000 MH Calibrated with CL # 3 and BP # 1 (BP mode 1)

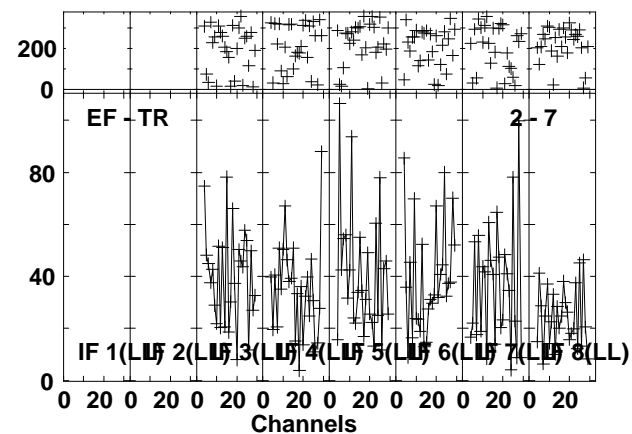
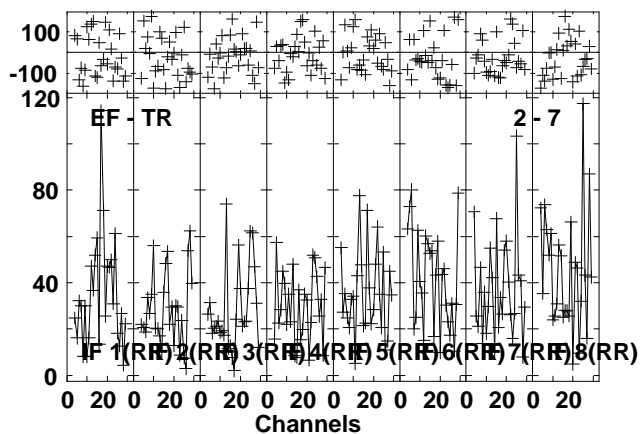
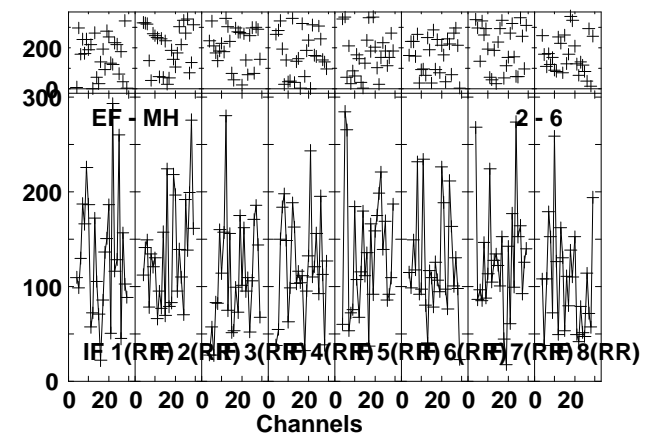
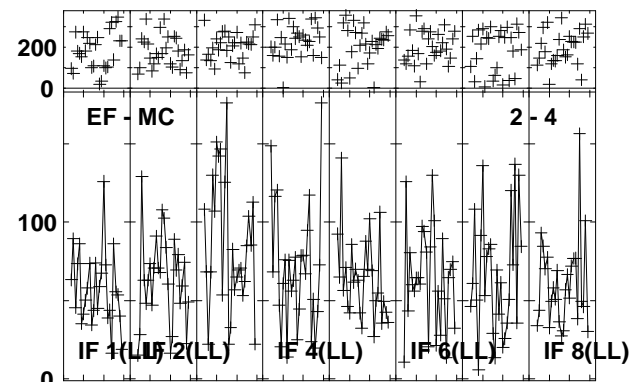
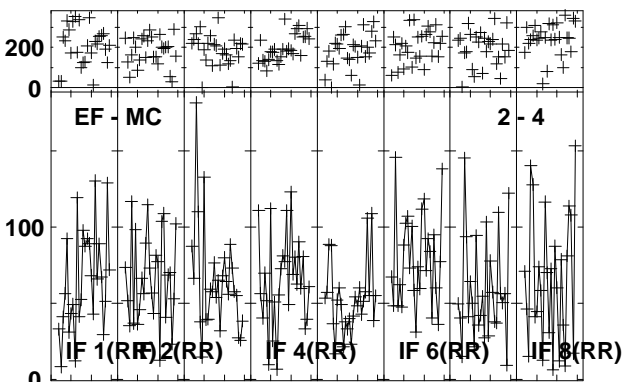
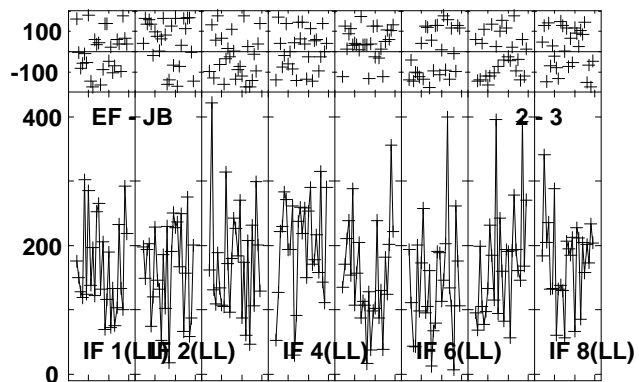
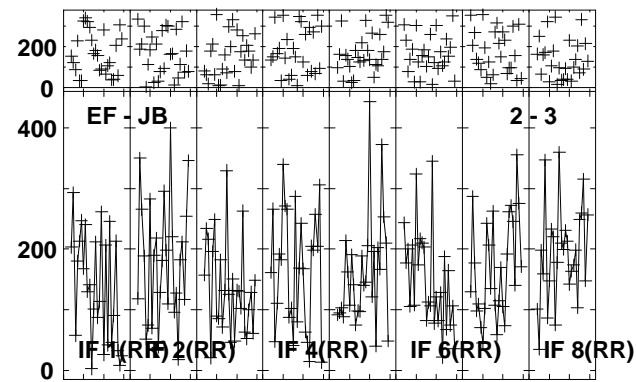
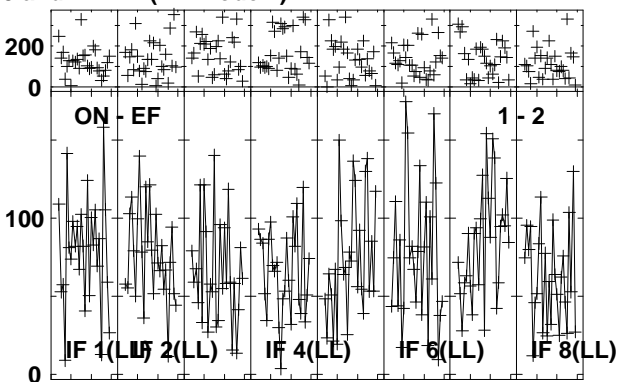
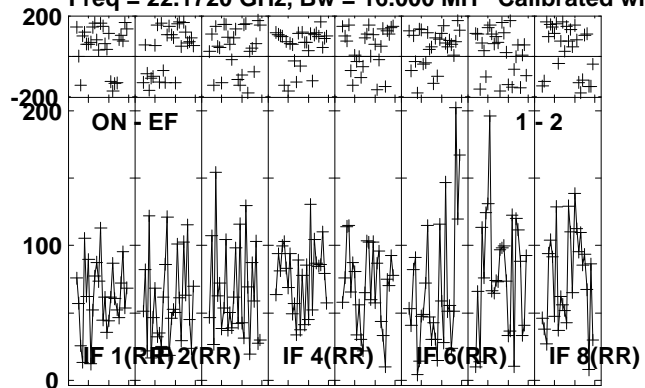

Lower frame: Milli Ampl Jy Top frame: Phas deg
 Vector averaged cross-power spectrum Several baselines displayed
 Timerange: 01/01:03:20 to 01/01:05:18

Plot file version 332 created 26-JUL-2013 10:24:12
 B1152+199A EZ024 1.UVDATA.1
 Freq = 22.1720 GHz, Bw = 16.000 MH Calibrated with CL # 3 and BP # 1 (BP mode 1)

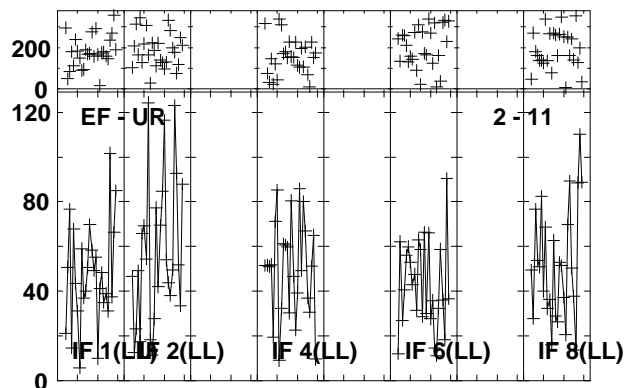
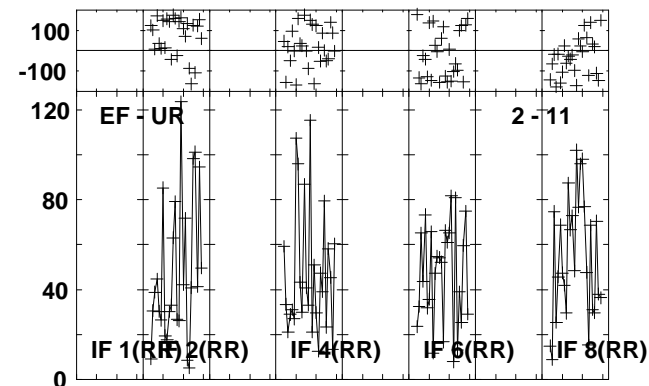
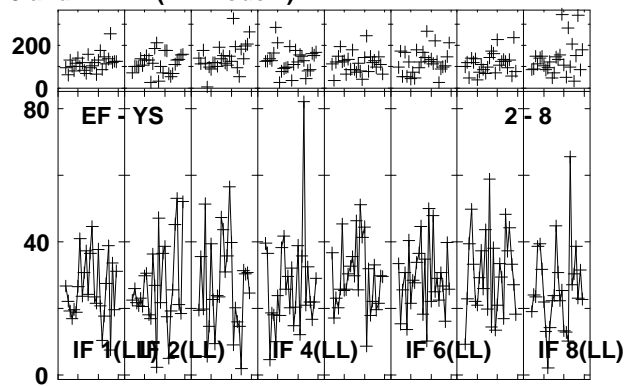
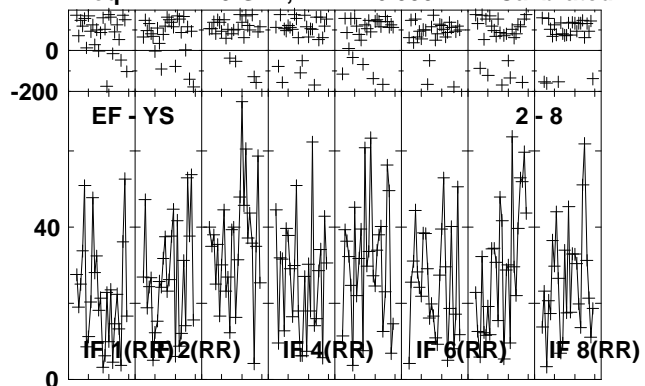

Lower frame: Milli Ampl Jy Top frame: Phas deg
 Vector averaged cross-power spectrum Several baselines displayed
 Timerange: 01/01:03:20 to 01/01:05:18

Plot file version 333 created 26-JUL-2013 10:24:14
 J1157 EZ024 1.UVDATA.1
 Freq = 22.1720 GHz, Bw = 16.000 MH Calibrated with CL # 3 and BP # 1 (BP mode 1)

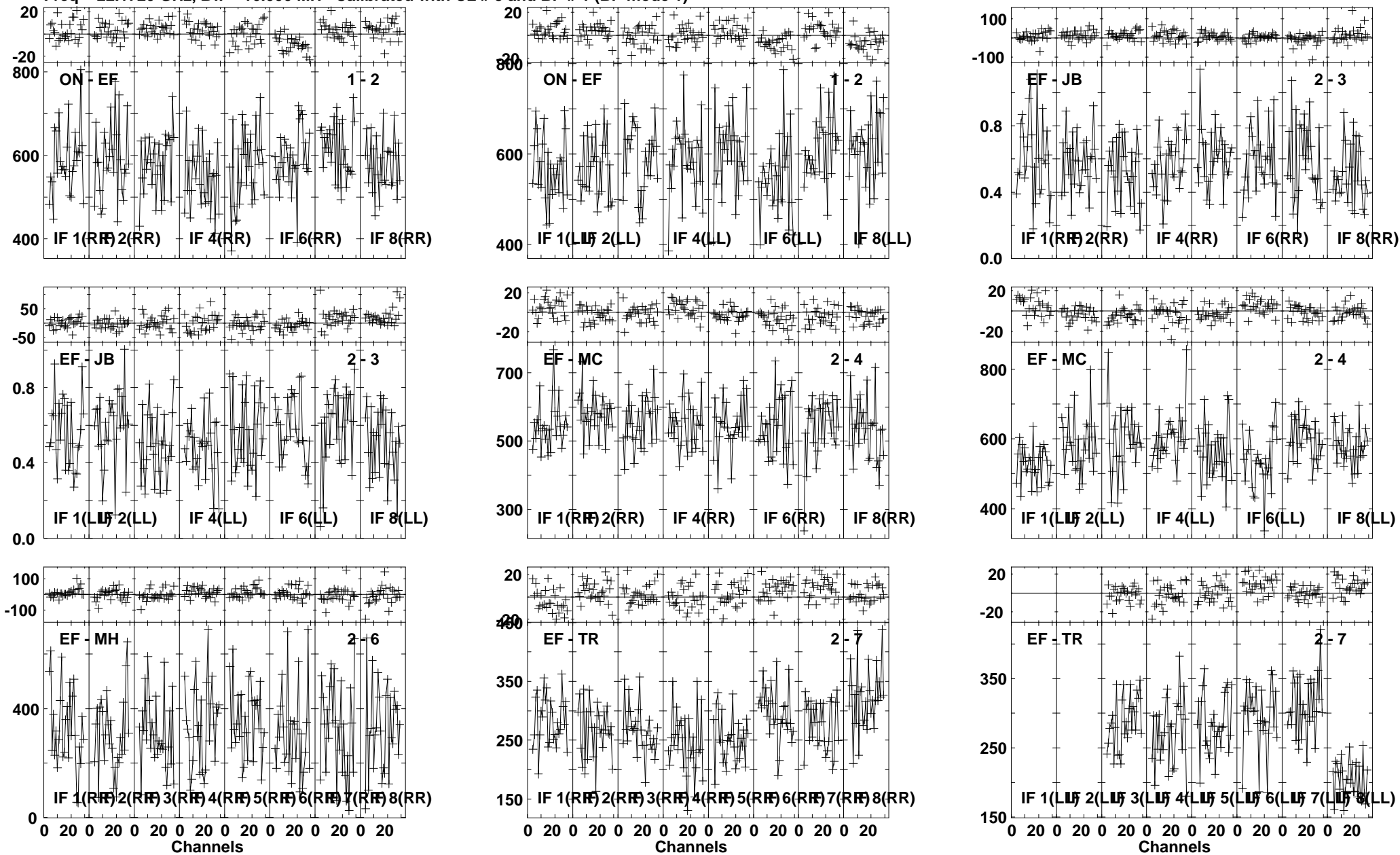

Lower frame: Milli Ampl Jy Top frame: Phas deg
 Vector averaged cross-power spectrum Several baselines displayed
 Timerange: 01/01:05:54 to 01/01:06:52

Plot file version 334 created 26-JUL-2013 10:24:15
 J1157 EZ024 1.UVDATA.1
 Freq = 22.1720 GHz, Bw = 16.000 MH Calibrated with CL # 3 and BP # 1 (BP mode 1)

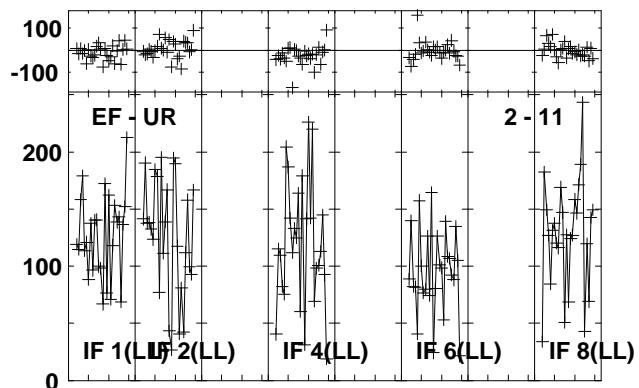
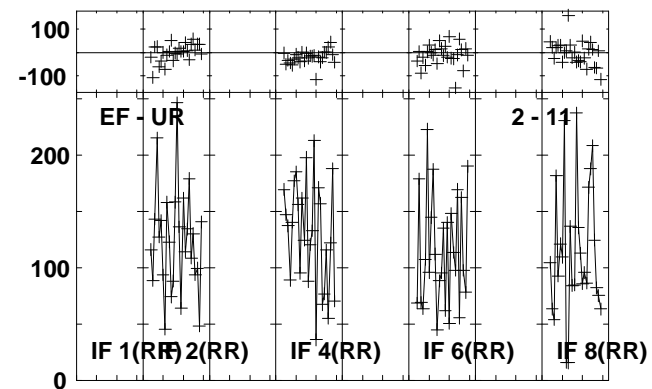
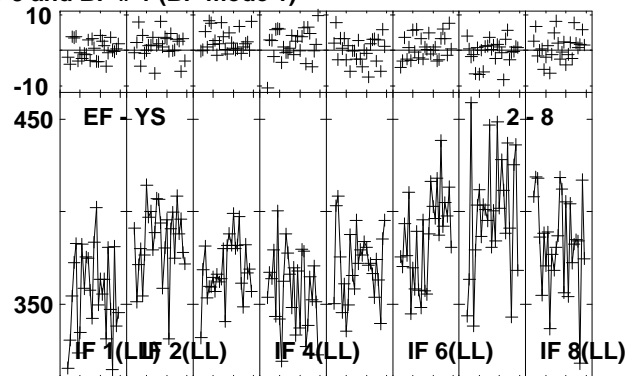
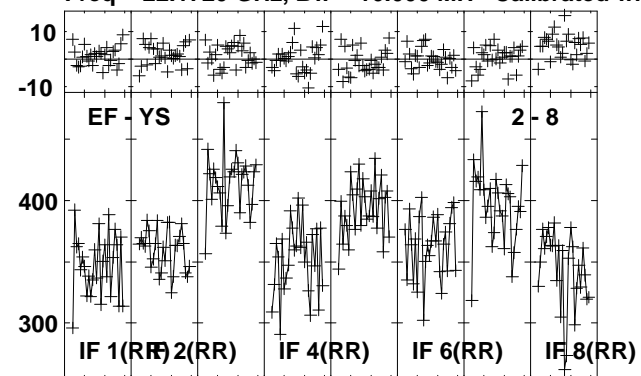

Lower frame: Milli Ampl Jy Top frame: Phas deg
 Vector averaged cross-power spectrum Several baselines displayed
 Timerange: 01/01:05:54 to 01/01:06:52

Plot file version 335 created 26-JUL-2013 10:24:16
 J1125+2610 EZ024 1.UVDATA.1
 Freq = 22.1720 GHz, Bw = 16.000 MH Calibrated with CL # 3 and BP # 1 (BP mode 1)

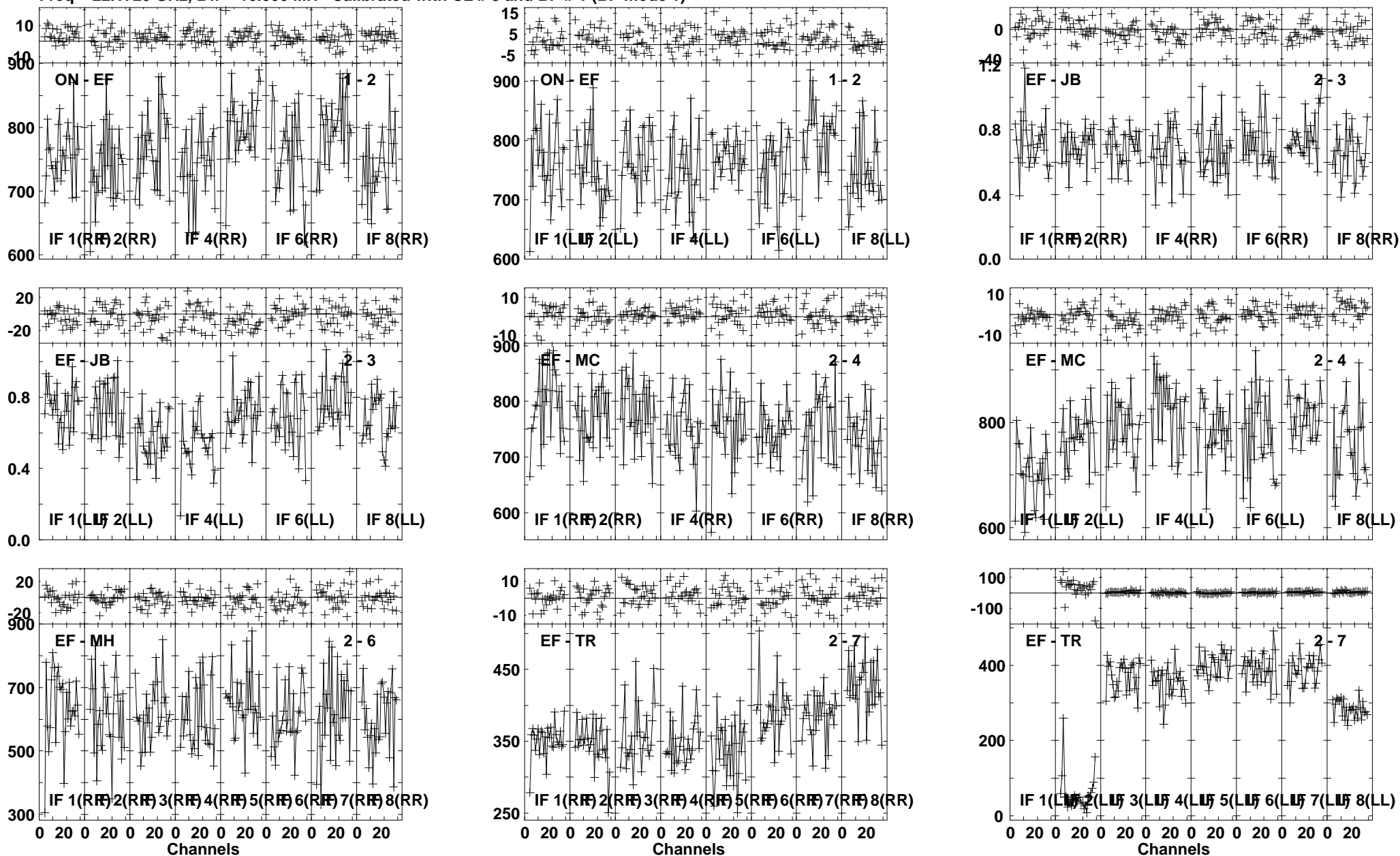

Lower frame: Milli Ampl Jy Top frame: Phas deg
 Vector averaged cross-power spectrum Several baselines displayed
 Timerange: 01/01:08:22 to 01/01:10:04

Plot file version 336 created 26-JUL-2013 10:24:17
 J1125+2610 EZ024 1.UVDATA.1
 Freq = 22.1720 GHz, Bw = 16.000 MH Calibrated with CL # 3 and BP # 1 (BP mode 1)

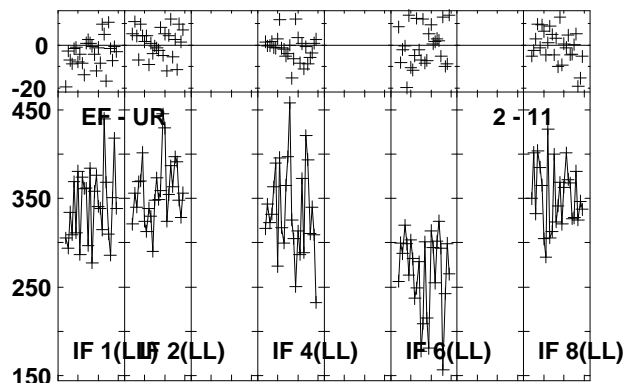
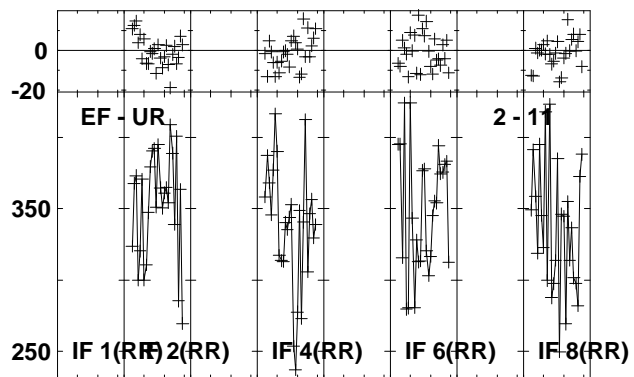
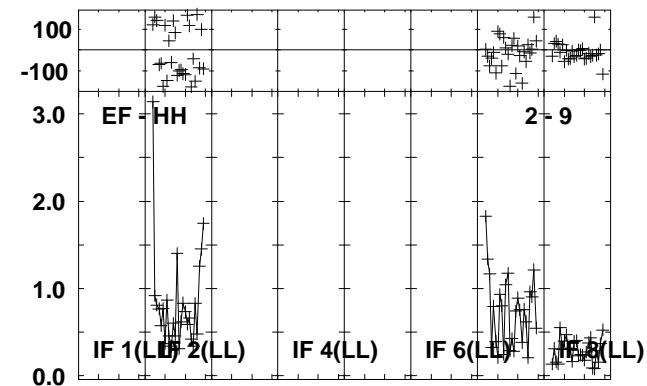
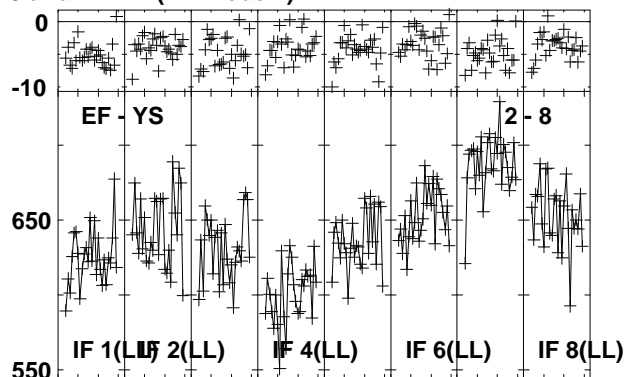
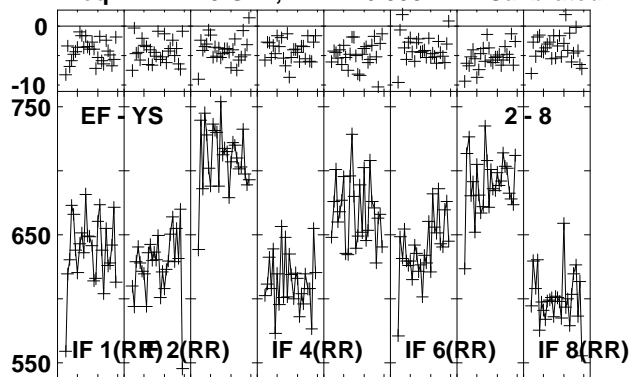

Lower frame: Milli Ampl Jy Top frame: Phas deg
 Vector averaged cross-power spectrum Several baselines displayed
 Timerange: 01/01:08:22 to 01/01:10:04

Plot file version 337 created 26-JUL-2013 10:24:27

J1157 EZ024 1.UVDATA.1

Freq = 22.1720 GHz, Bw = 16.000 MH Calibrated with CL # 3 and BP # 1 (BP mode 1)

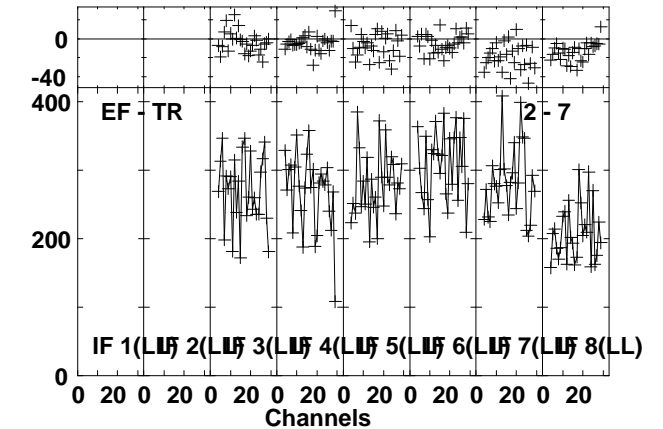
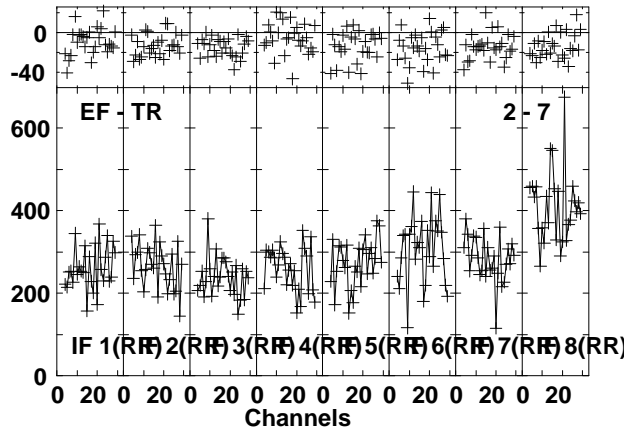
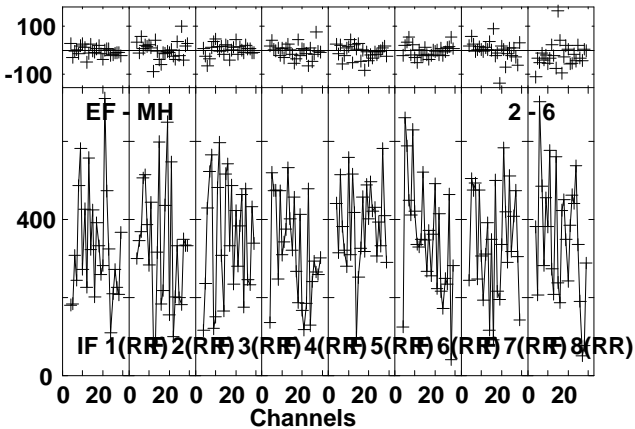
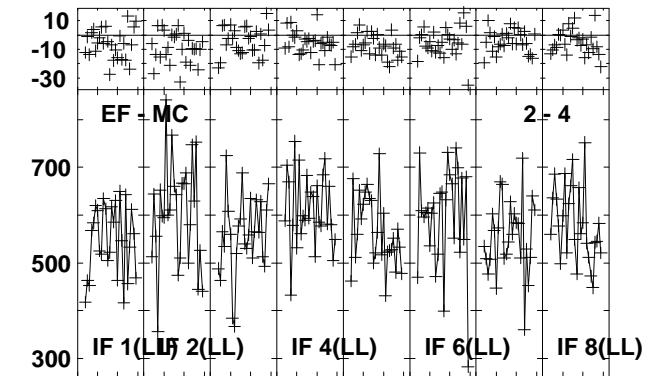
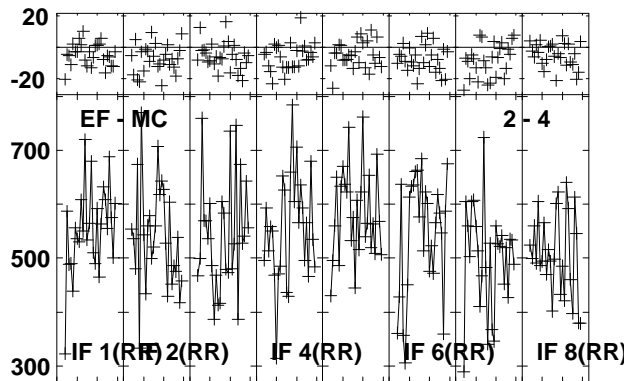
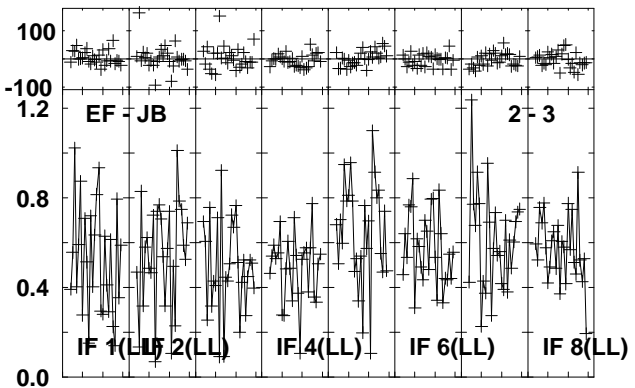
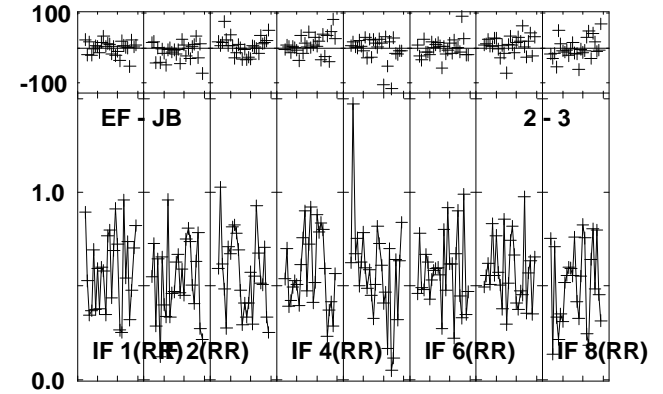
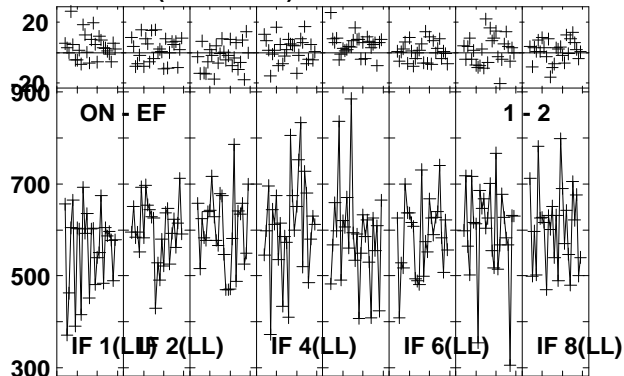
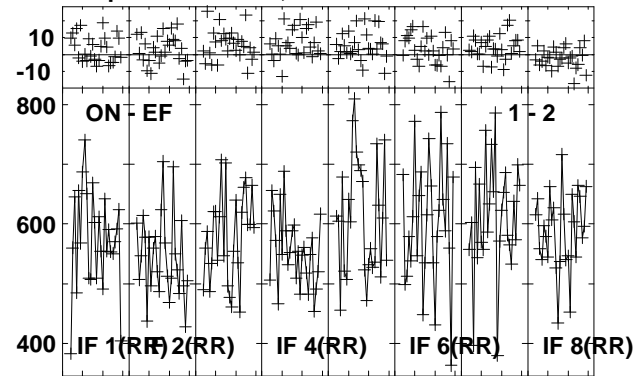

Lower frame: Milli Ampl Jy Top frame: Phas deg
Vector averaged cross-power spectrum Several baselines displayed
Timerange: 01/01:19:36 to 01/01:20:18

Plot file version 338 created 26-JUL-2013 10:24:27
 J1157 EZ024 1.UVDATA.1
 Freq = 22.1720 GHz, Bw = 16.000 MH Calibrated with CL # 3 and BP # 1 (BP mode 1)

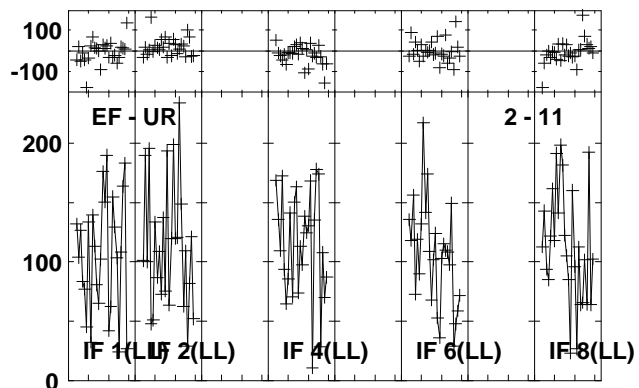
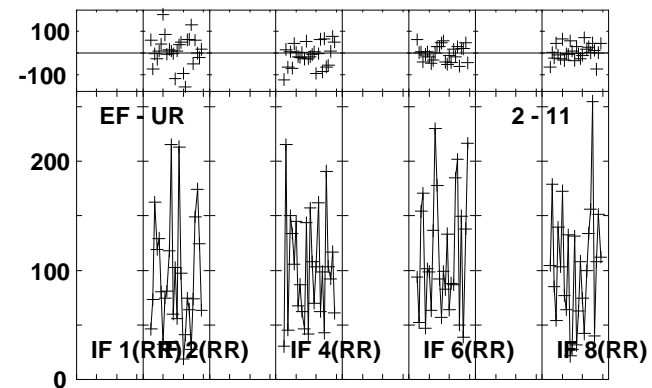
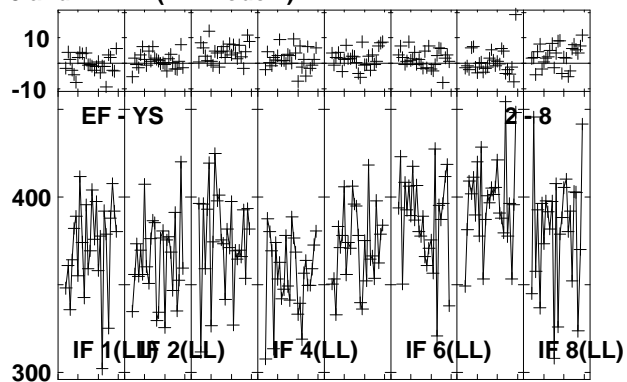
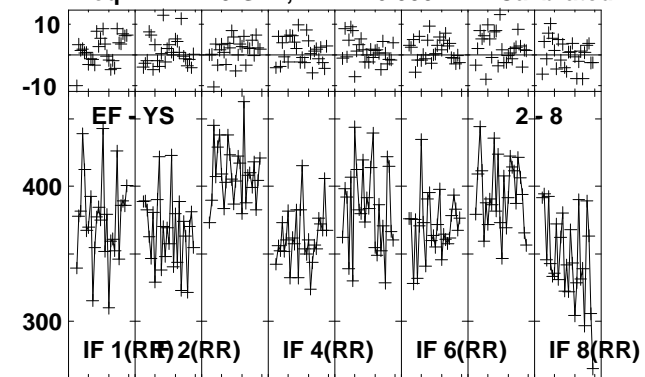

Lower frame: Milli Ampl Jy Top frame: Phas deg
 Vector averaged cross-power spectrum Several baselines displayed
 Timerange: 01/01:19:36 to 01/01:20:18

Plot file version 339 created 26-JUL-2013 10:24:28
 B1152+199A EZ024 1.UVDATA.1
 Freq = 22.1720 GHz, Bw = 16.000 MH Calibrated with CL # 3 and BP # 1 (BP mode 1)

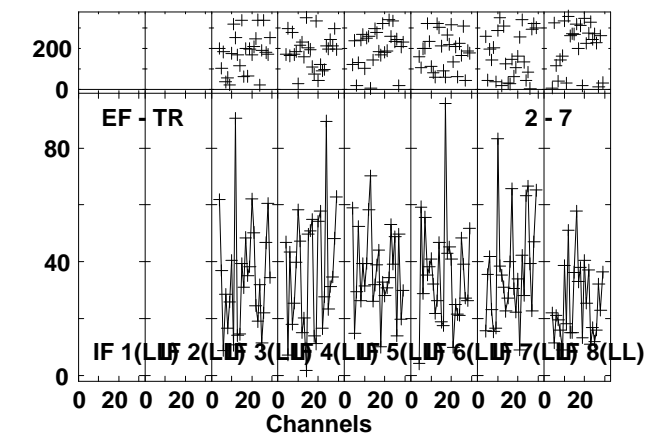
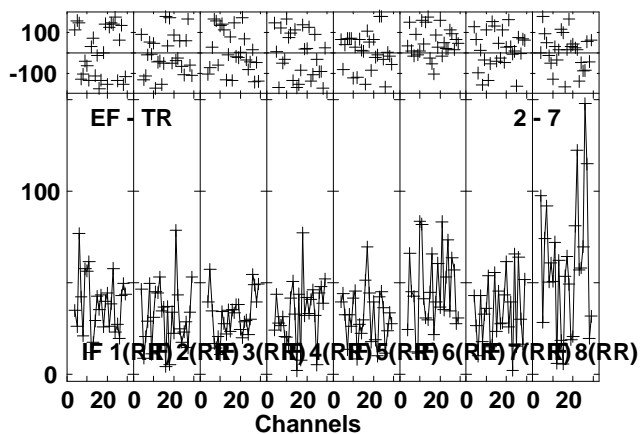
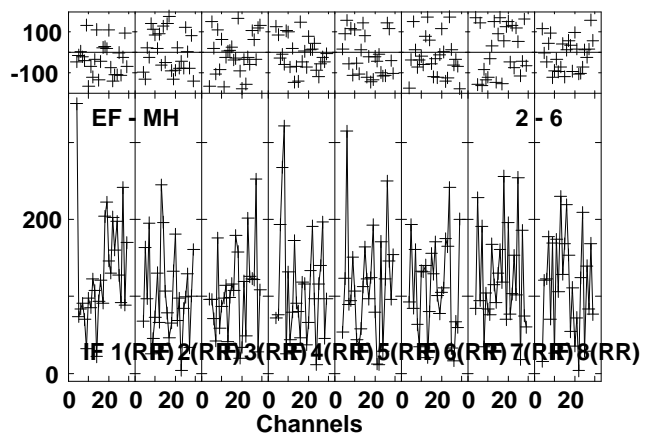
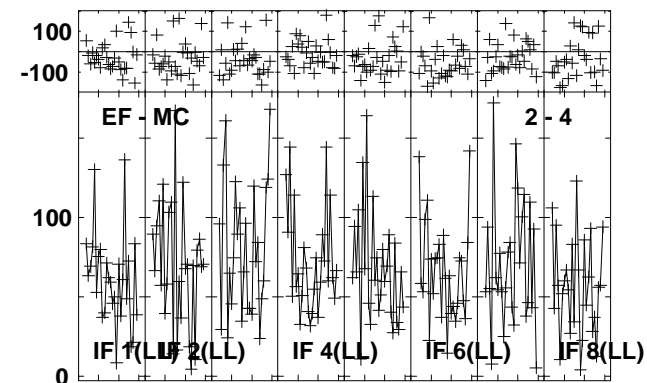
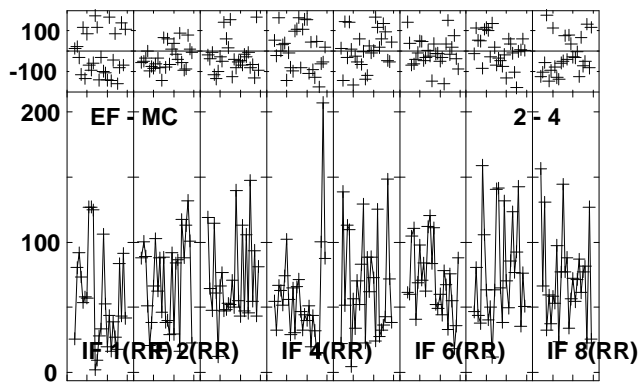
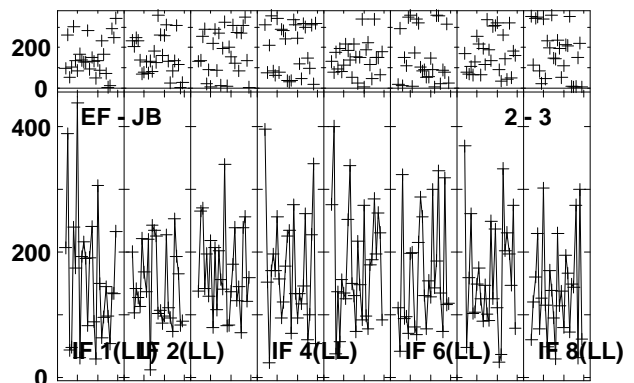
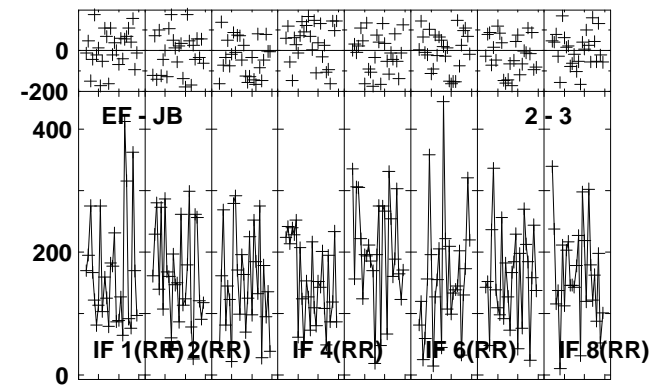
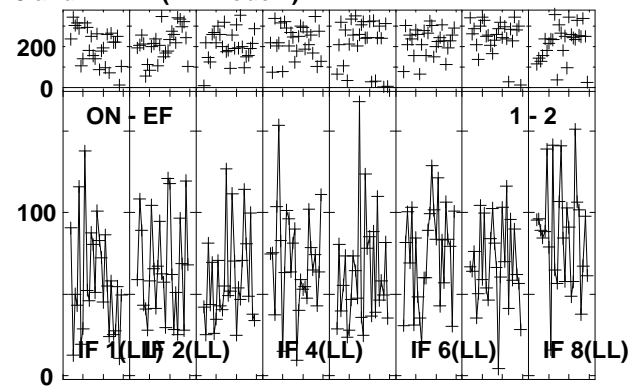
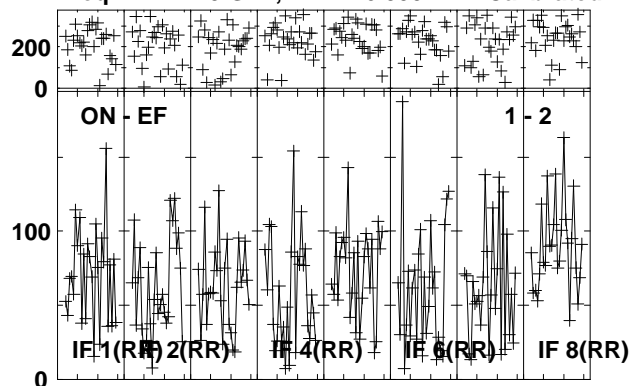

Lower frame: Milli Ampl Jy Top frame: Phas deg
 Vector averaged cross-power spectrum Several baselines displayed
 Timerange: 01/01:20:54 to 01/01:22:52

Plot file version 340 created 26-JUL-2013 10:24:30

B1152+199A EZ024 1.UVDATA.1

Freq = 22.1720 GHz, Bw = 16.000 MH Calibrated with CL # 3 and BP # 1 (BP mode 1)

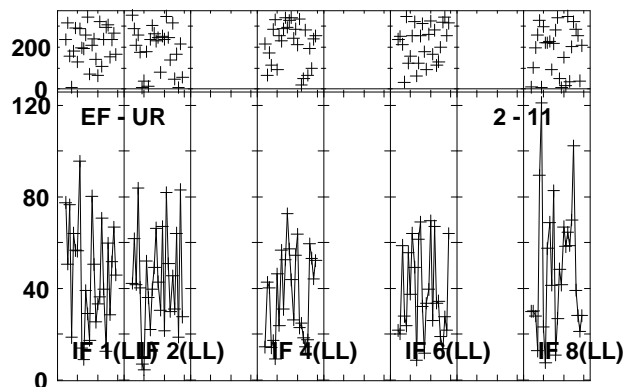
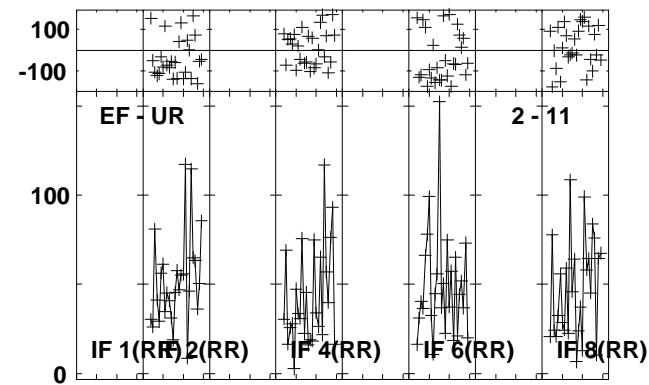
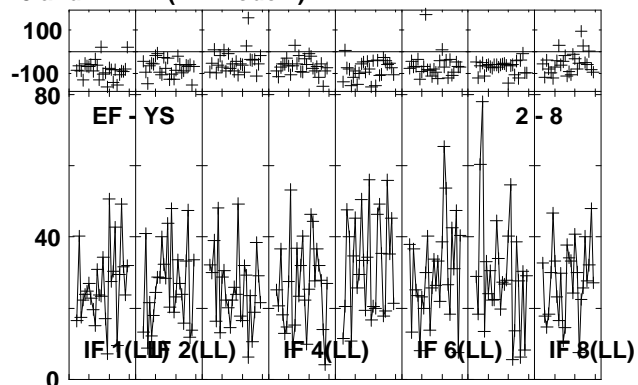
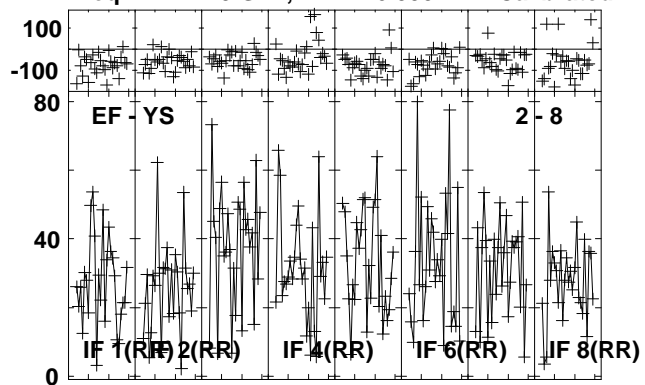

Lower frame: Milli Ampl Jy Top frame: Phas deg
Vector averaged cross-power spectrum Several baselines displayed
Timerange: 01/01:20:54 to 01/01:22:52

Plot file version 341 created 26-JUL-2013 10:24:31
 J1157 EZ024 1.UVDATA.1
 Freq = 22.1720 GHz, Bw = 16.000 MH Calibrated with CL # 3 and BP # 1 (BP mode 1)

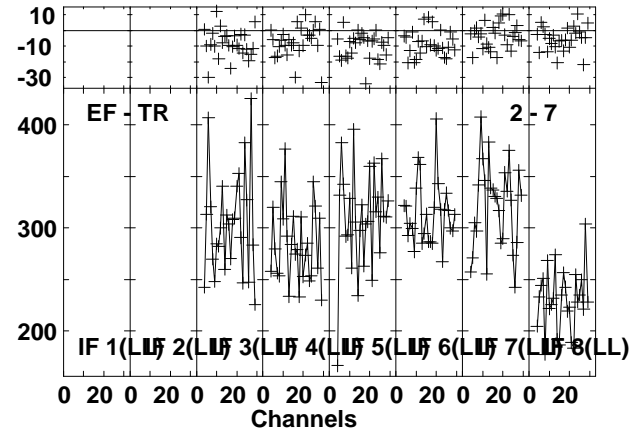
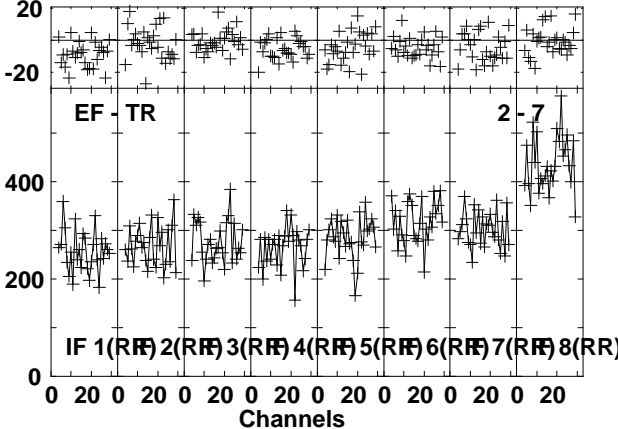
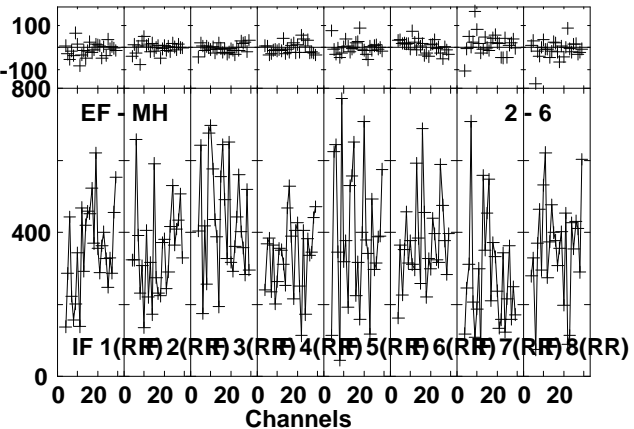
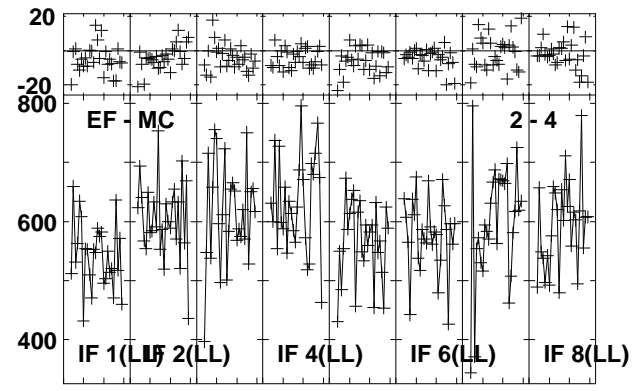
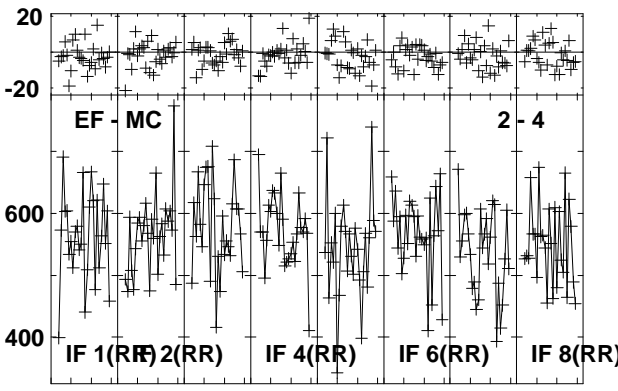
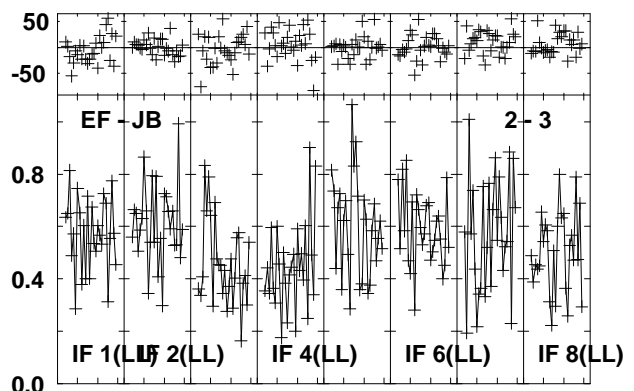
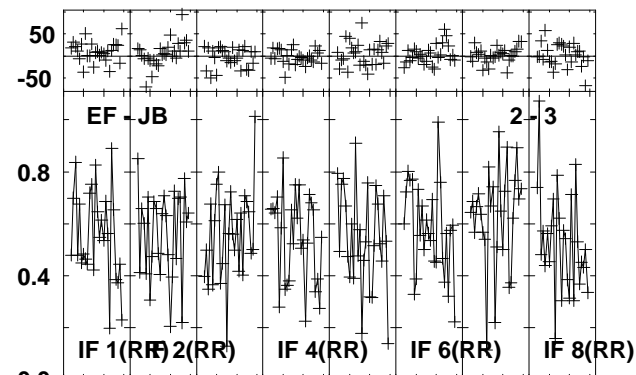
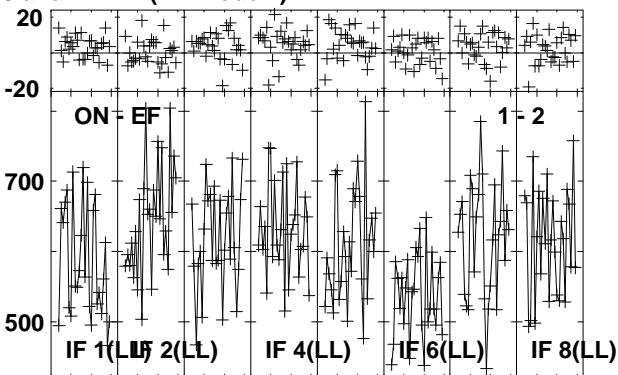
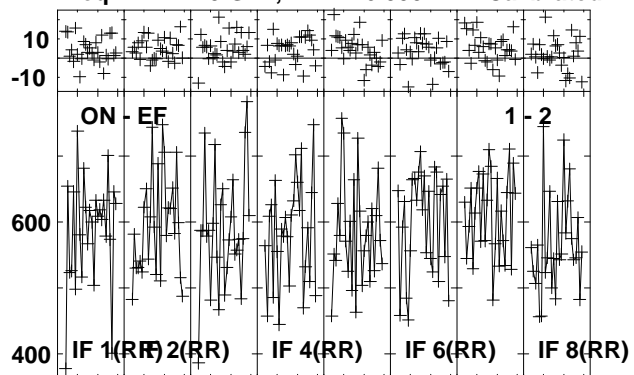

Lower frame: Milli Ampl Jy Top frame: Phas deg
 Vector averaged cross-power spectrum Several baselines displayed
 Timerange: 01/01:23:27 to 01/01:24:25

Plot file version 342 created 26-JUL-2013 10:24:32
 J1157 EZ024 1.UVDATA.1
 Freq = 22.1720 GHz, Bw = 16.000 MH Calibrated with CL # 3 and BP # 1 (BP mode 1)

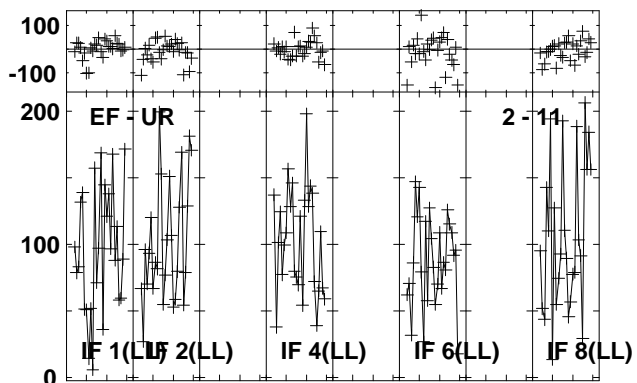
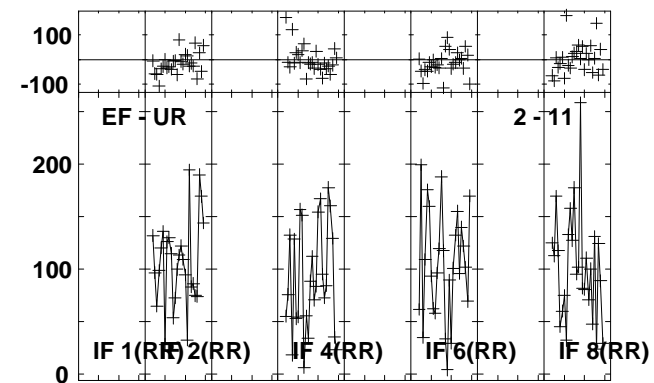
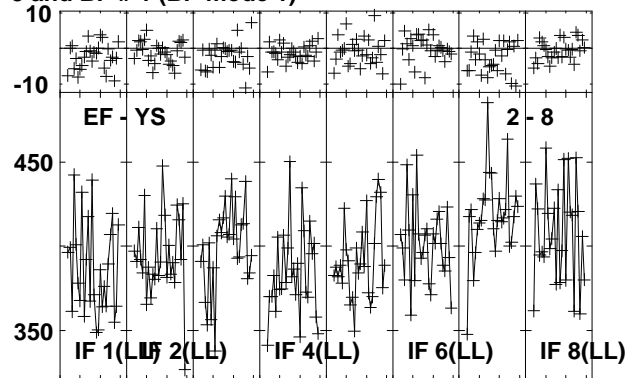
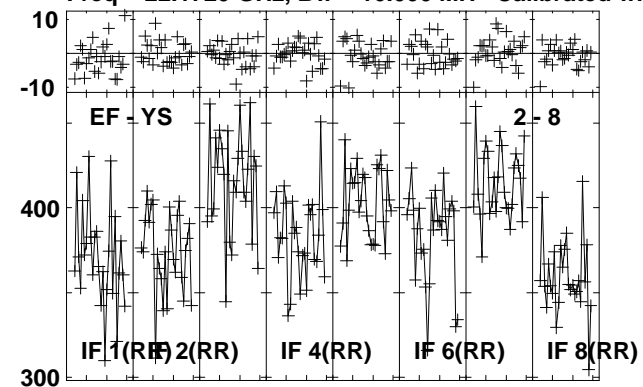

Lower frame: Milli Ampl Jy Top frame: Phas deg
 Vector averaged cross-power spectrum Several baselines displayed
 Timerange: 01/01:23:27 to 01/01:24:25

Plot file version 343 created 26-JUL-2013 10:24:33
 B1152+199A EZ024 1.UVDATA.1
 Freq = 22.1720 GHz, Bw = 16.000 MH Calibrated with CL # 3 and BP # 1 (BP mode 1)

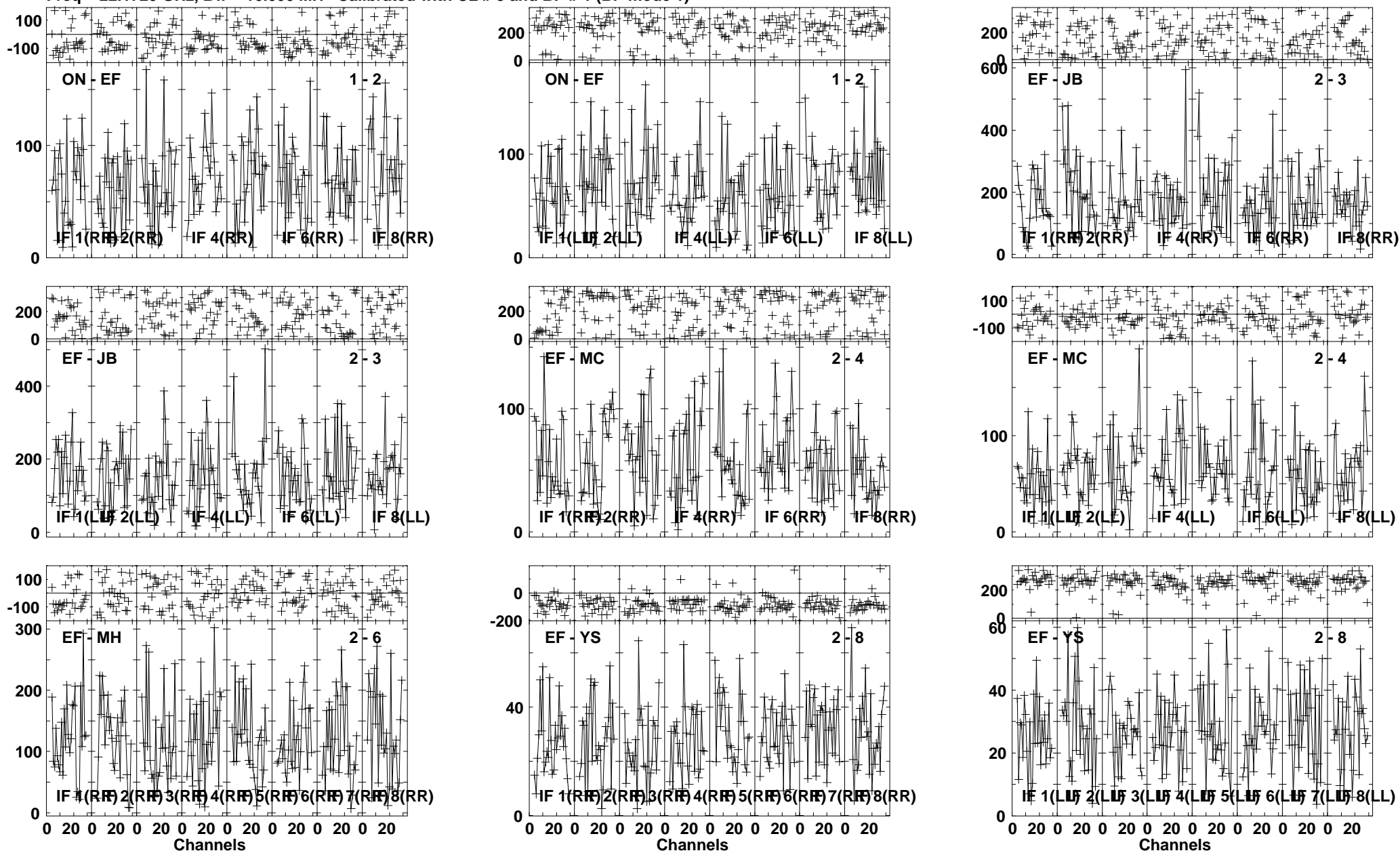

Lower frame: Milli Ampl Jy Top frame: Phas deg
 Vector averaged cross-power spectrum Several baselines displayed
 Timerange: 01/01:25:00 to 01/01:26:58

Plot file version 344 created 26-JUL-2013 10:24:35

B1152+199A EZ024 1.UVDATA.1

Freq = 22.1720 GHz, Bw = 16.000 MH Calibrated with CL # 3 and BP # 1 (BP mode 1)

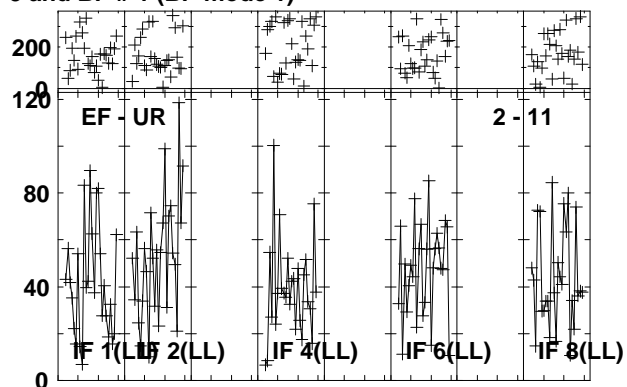
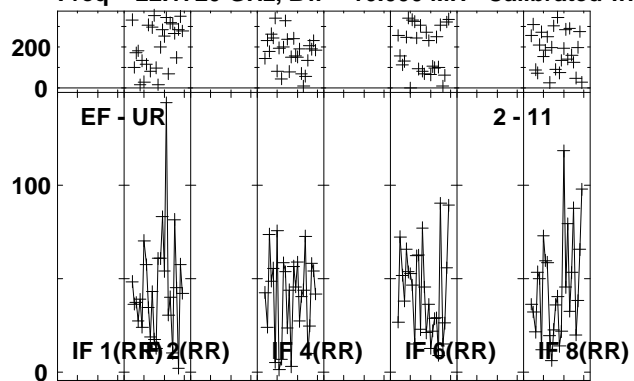

Lower frame: Milli Ampl Jy Top frame: Phas deg
Vector averaged cross-power spectrum Several baselines displayed
Timerange: 01/01:25:00 to 01/01:26:58

Plot file version 345 created 26-JUL-2013 10:24:36

J1157 EZ024 1.UVDATA.1

Freq = 22.1720 GHz, Bw = 16.000 MH Calibrated with CL # 3 and BP # 1 (BP mode 1)

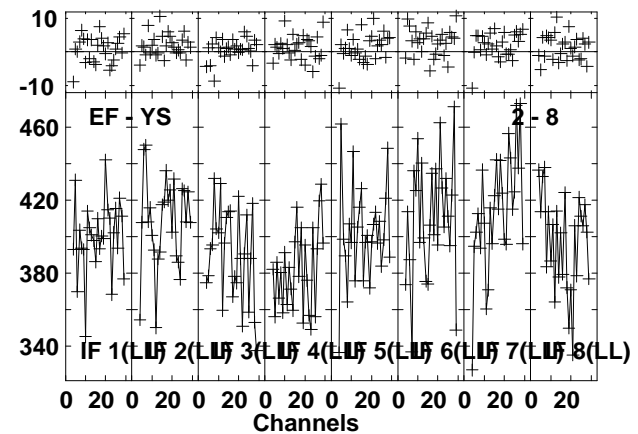
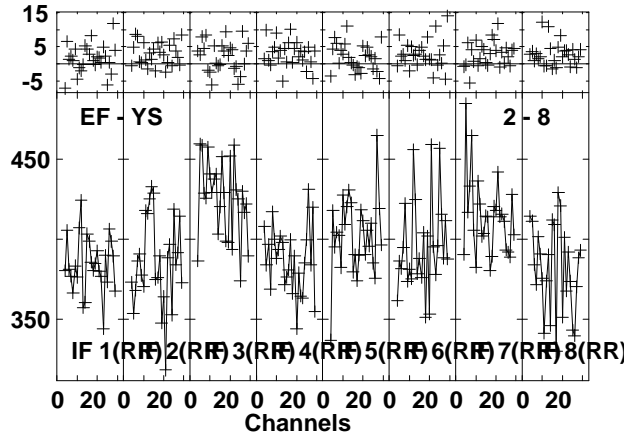
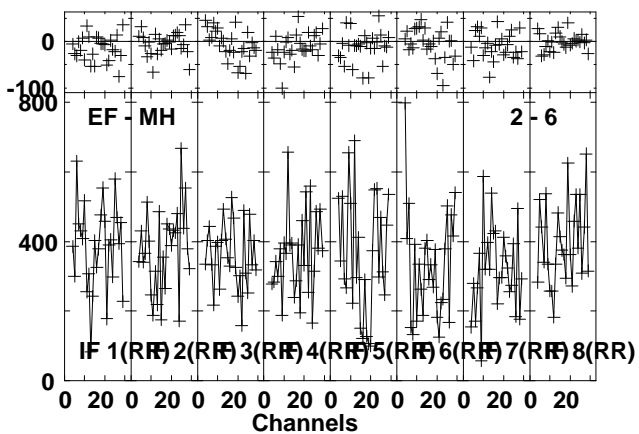
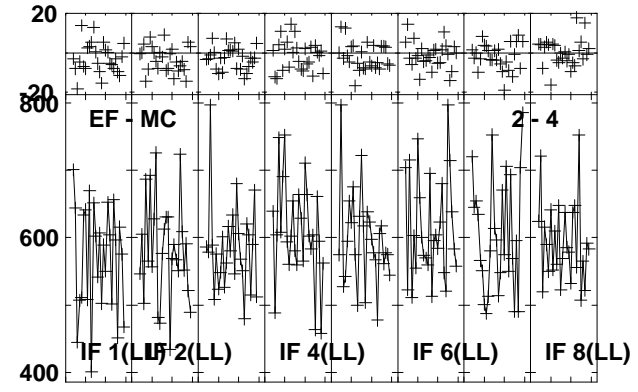
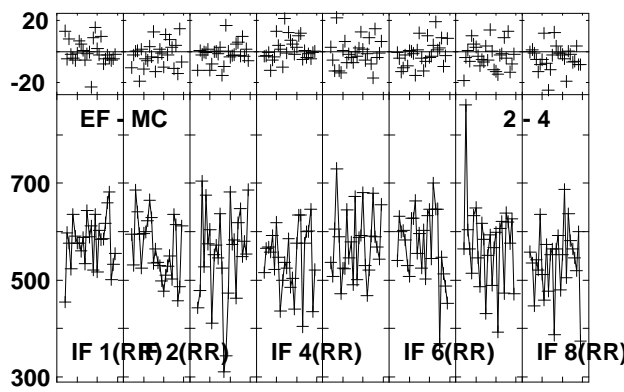
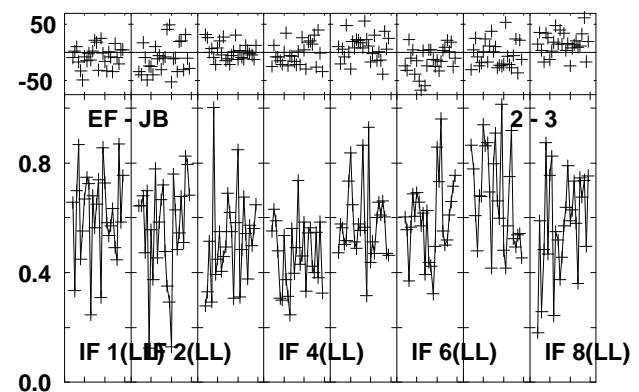
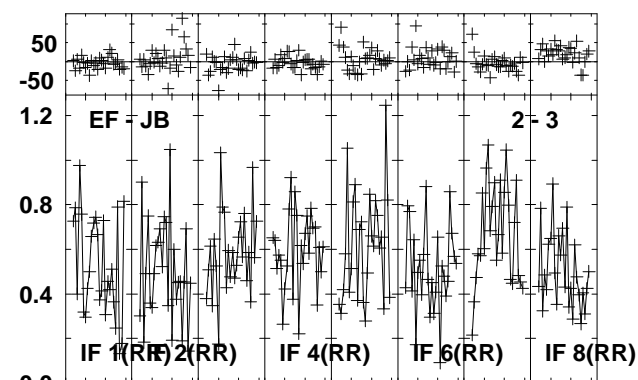
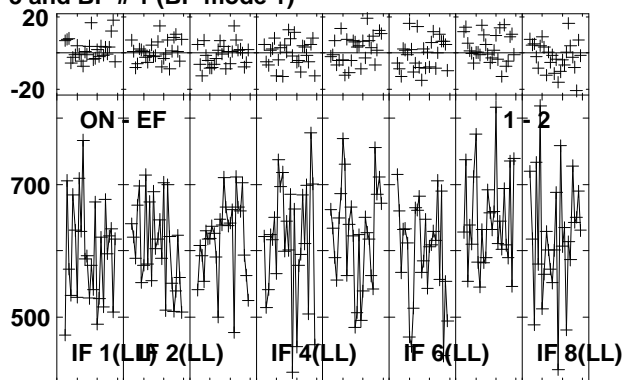
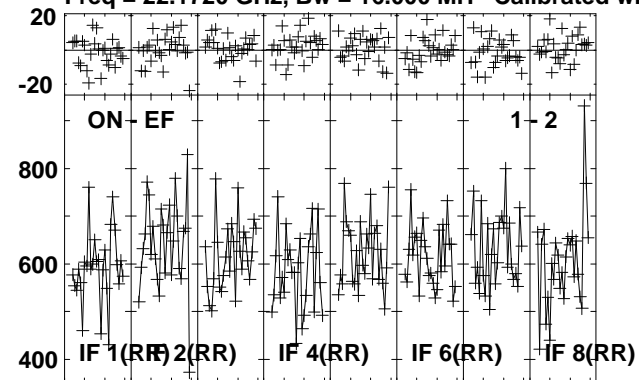

Lower frame: Milli Ampl Jy Top frame: Phas deg
Vector averaged cross-power spectrum Several baselines displayed
Timerange: 01/01:27:33 to 01/01:28:31

Plot file version 346 created 26-JUL-2013 10:24:37

J1157 EZ024 1.UVDATA.1

Freq = 22.1720 GHz, Bw = 16.000 MH Calibrated with CL # 3 and BP # 1 (BP mode 1)

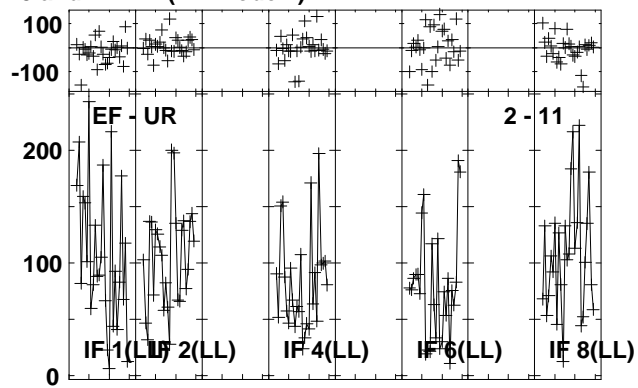
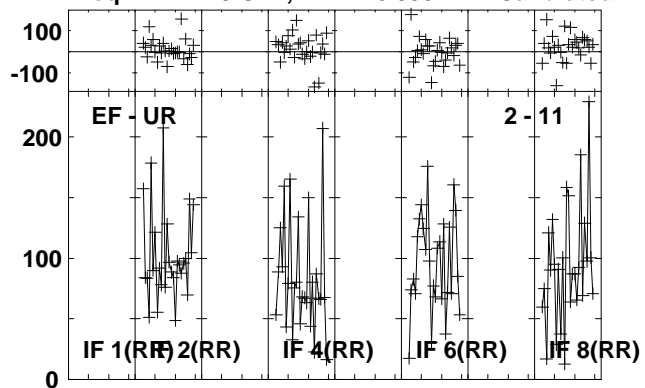

Lower frame: Milli Ampl Jy Top frame: Phas deg
Vector averaged cross-power spectrum Several baselines displayed
Timerange: 01/01:27:33 to 01/01:28:31

Plot file version 347 created 26-JUL-2013 10:24:38
 B1152+199A EZ024 1.UVDATA.1
 Freq = 22.1720 GHz, Bw = 16.000 MH Calibrated with CL # 3 and BP # 1 (BP mode 1)

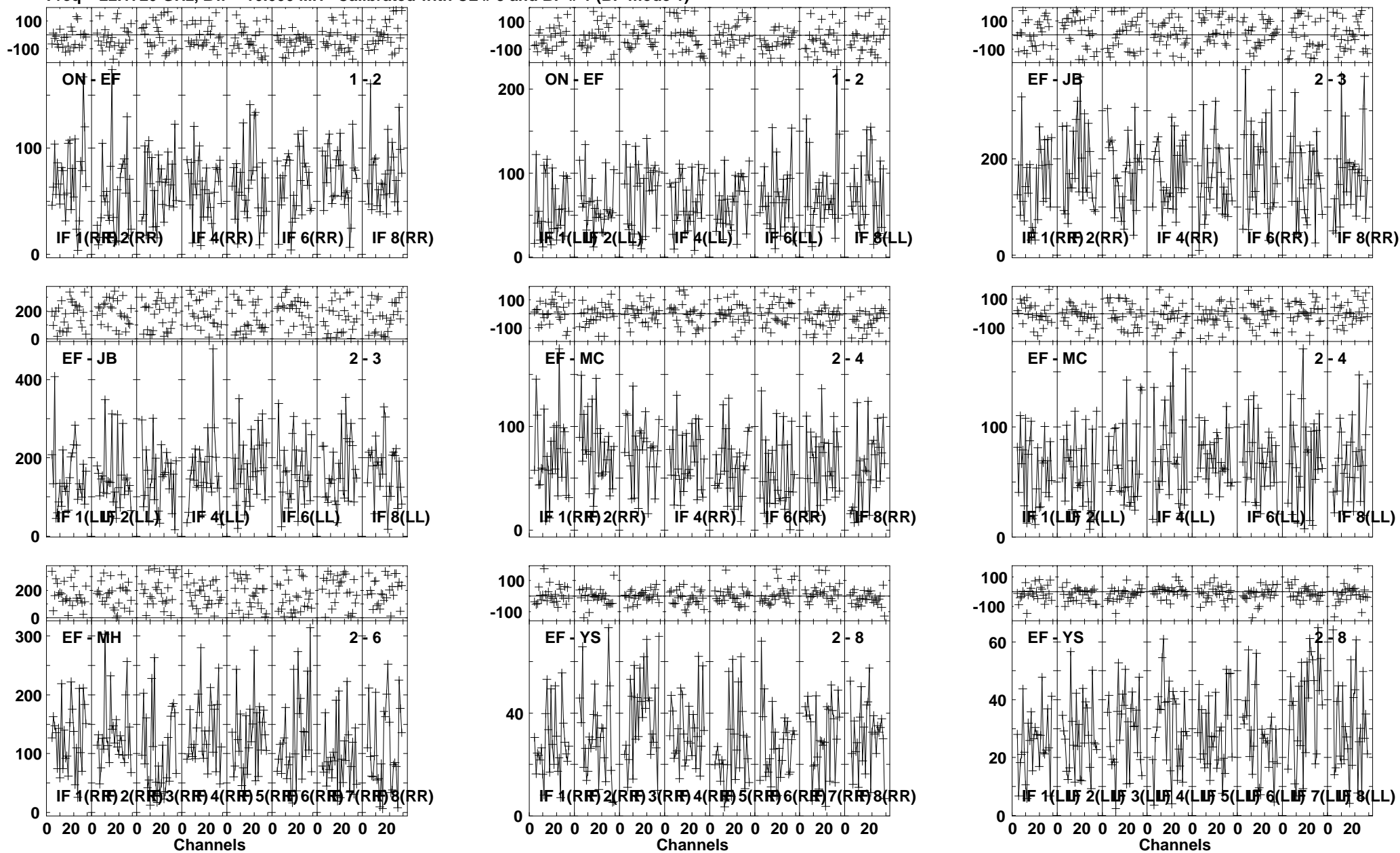

Lower frame: Milli Ampl Jy Top frame: Phas deg
 Vector averaged cross-power spectrum Several baselines displayed
 Timerange: 01/01:29:06 to 01/01:31:04

Plot file version 348 created 26-JUL-2013 10:24:40

B1152+199A EZ024 1.UVDATA.1

Freq = 22.1720 GHz, Bw = 16.000 MH Calibrated with CL # 3 and BP # 1 (BP mode 1)

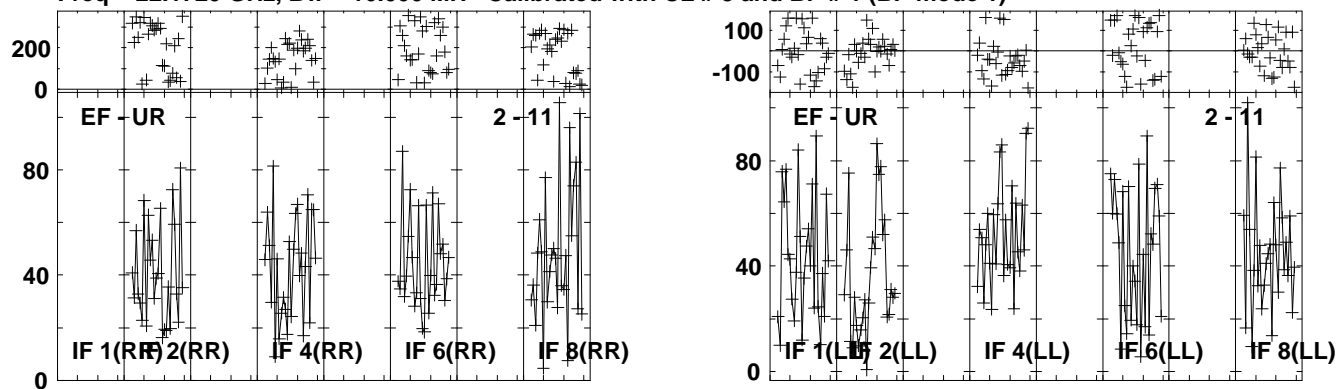

Lower frame: Milli Ampl Jy Top frame: Phas deg
Vector averaged cross-power spectrum Several baselines displayed
Timerange: 01/01:29:06 to 01/01:31:04

Plot file version 349 created 26-JUL-2013 10:24:40
 J1157 EZ024 1.UVDATA.1
 Freq = 22.1720 GHz, Bw = 16.000 MH Calibrated with CL # 3 and BP # 1 (BP mode 1)

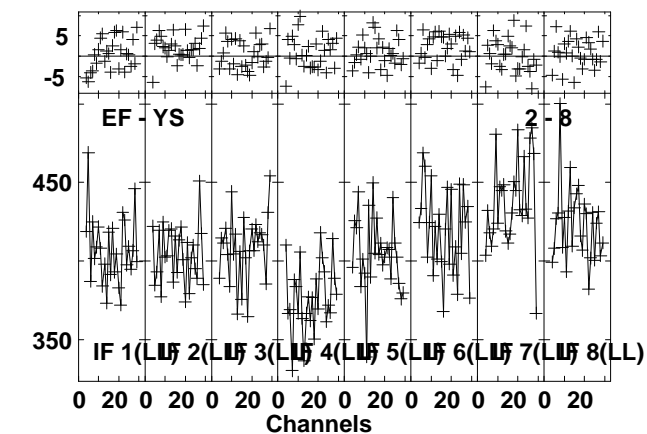
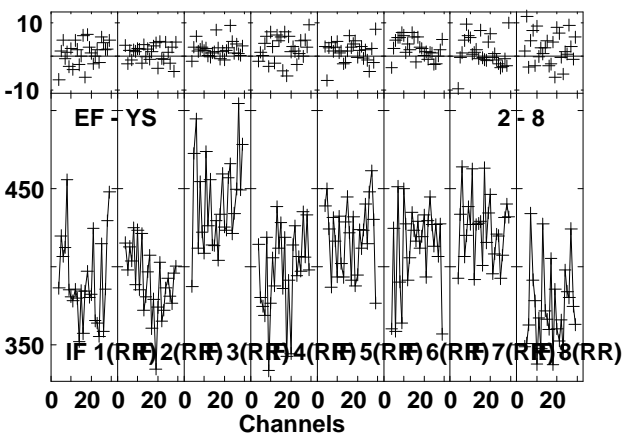
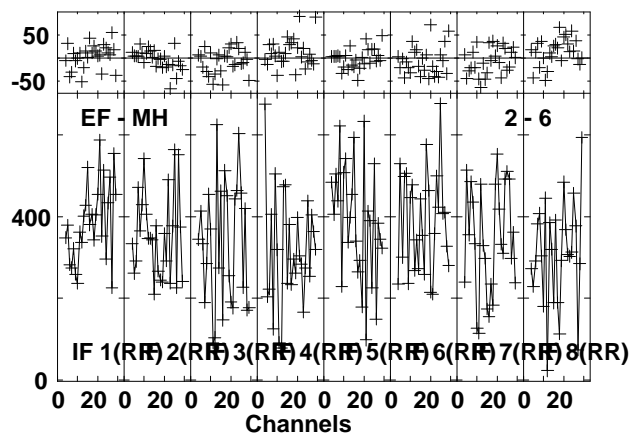
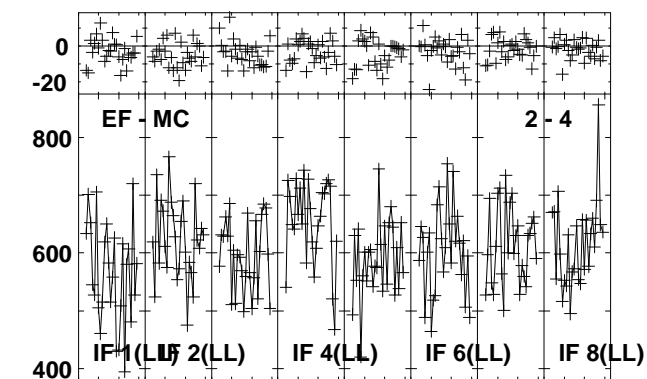
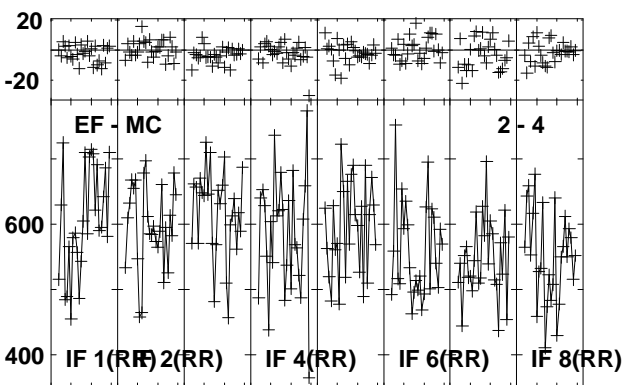
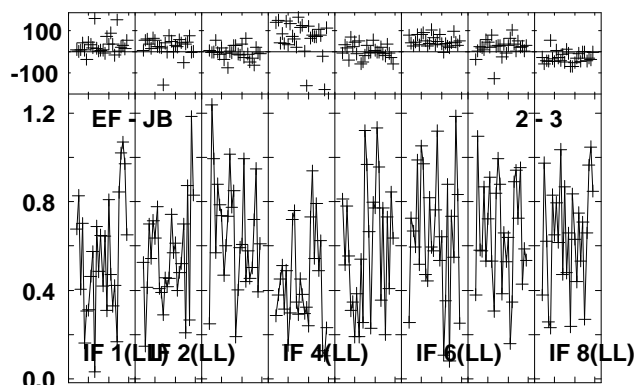
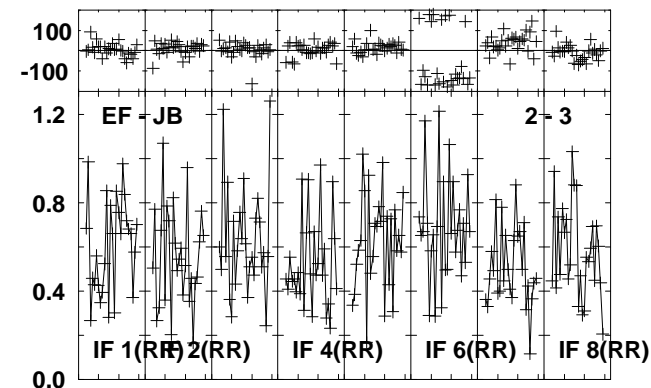
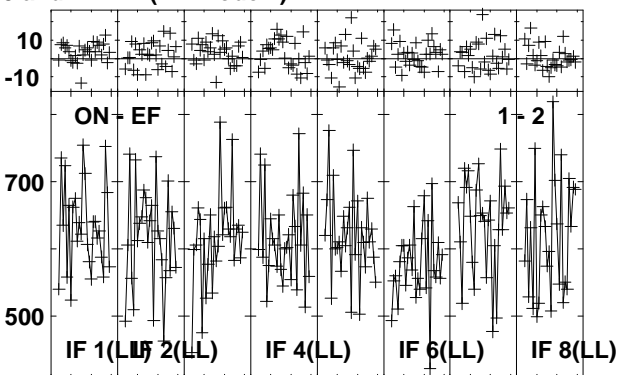
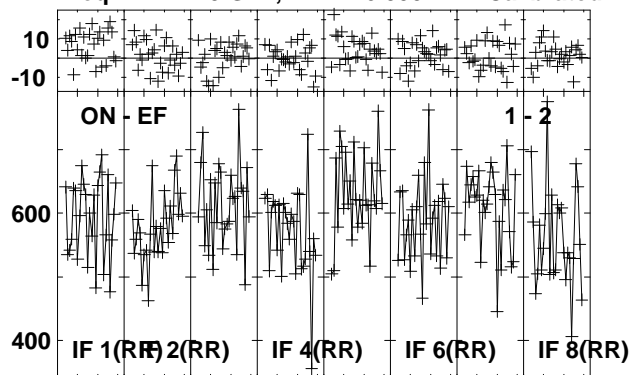

Lower frame: Milli Ampl Jy Top frame: Phas deg
 Vector averaged cross-power spectrum Several baselines displayed
 Timerange: 01/01:31:39 to 01/01:32:37

Plot file version 350 created 26-JUL-2013 10:24:41
J1157 EZ024 1.UVDATA.1
Freq = 22.1720 GHz, Bw = 16.000 MH Calibrated with CL # 3 and BP # 1 (BP mode 1)

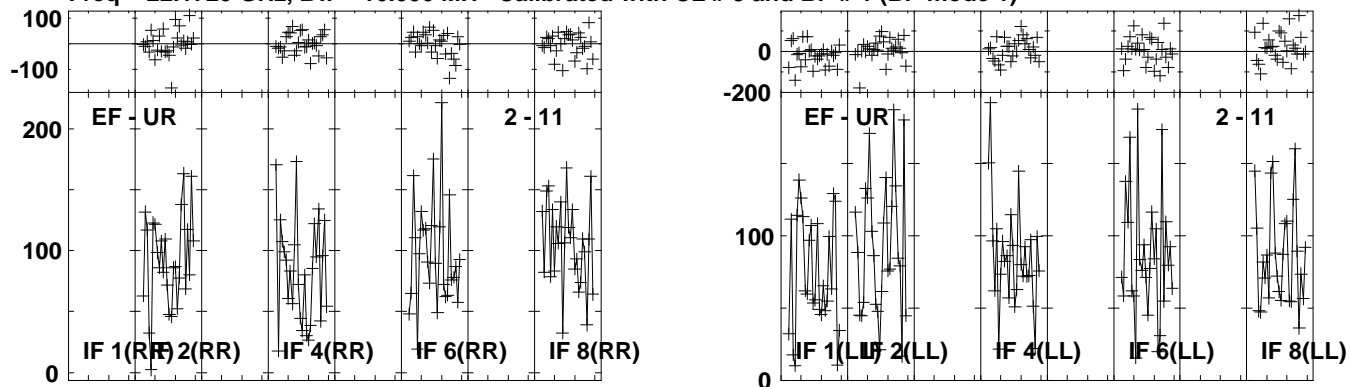

Lower frame: Milli Ampl Jy Top frame: Phas deg
Vector averaged cross-power spectrum Several baselines displayed
Timerange: 01/01:31:39 to 01/01:32:37

Plot file version 351 created 26-JUL-2013 10:24:42
 J1125+2610 EZ024 1.UVDATA.1
 Freq = 22.1720 GHz, Bw = 16.000 MH Calibrated with CL # 3 and BP # 1 (BP mode 1)

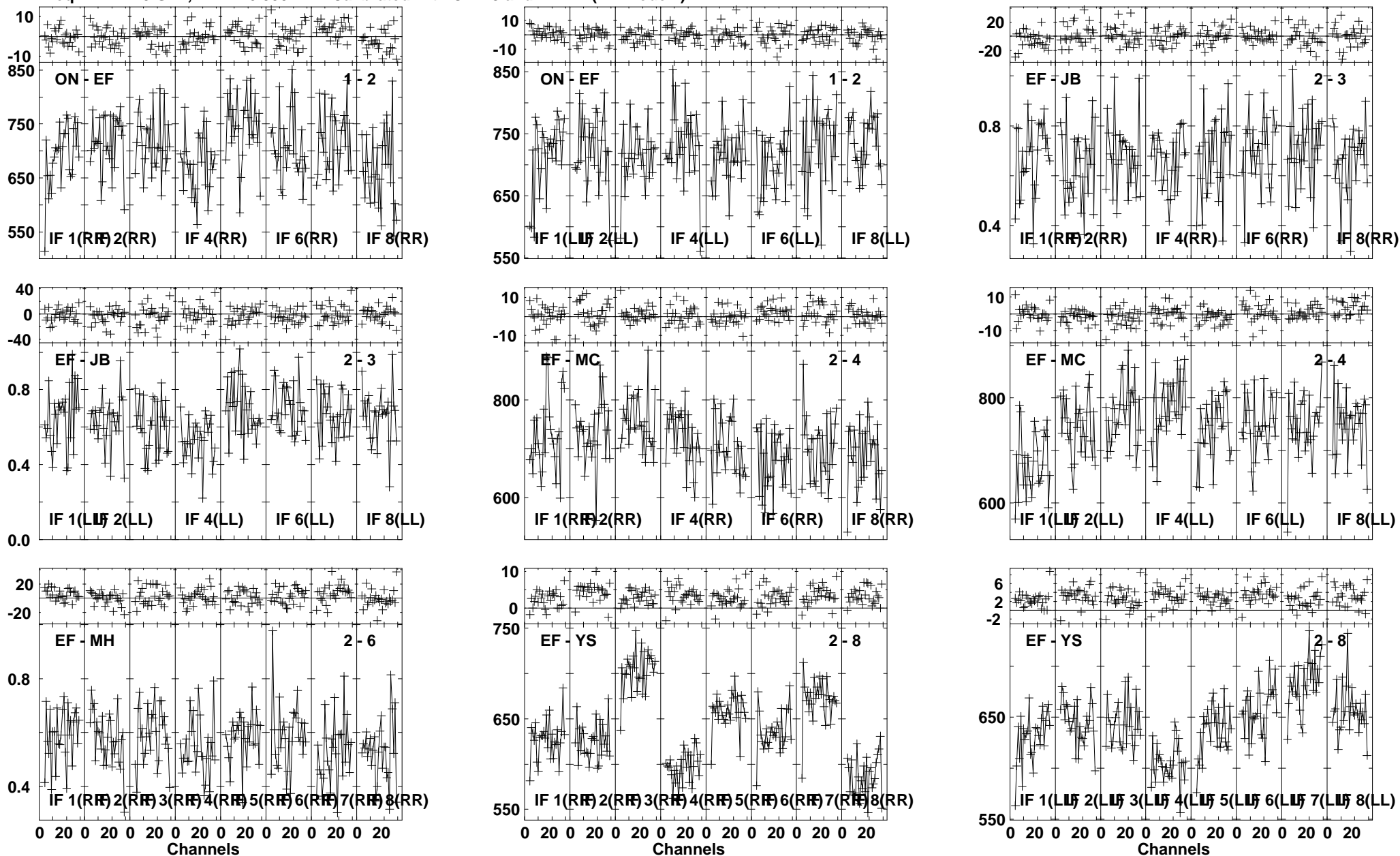

Lower frame: Milli Ampl Jy Top frame: Phas deg
 Vector averaged cross-power spectrum Several baselines displayed
 Timerange: 01/01:34:11 to 01/01:35:53

Plot file version 352 created 26-JUL-2013 10:24:43
 J1125+2610 EZ024 1.UVDATA.1
 Freq = 22.1720 GHz, Bw = 16.000 MH Calibrated with CL # 3 and BP # 1 (BP mode 1)

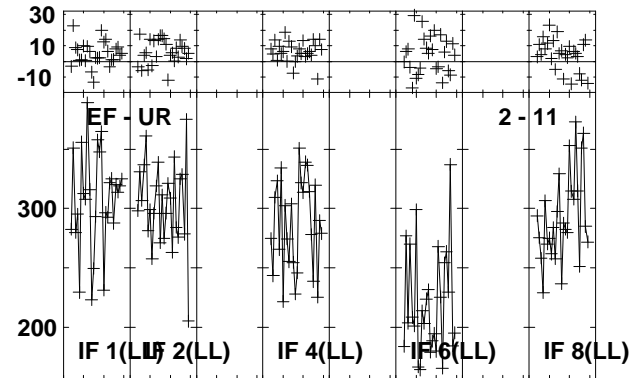
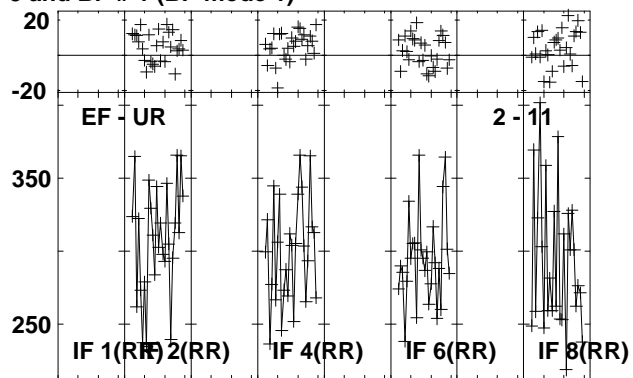
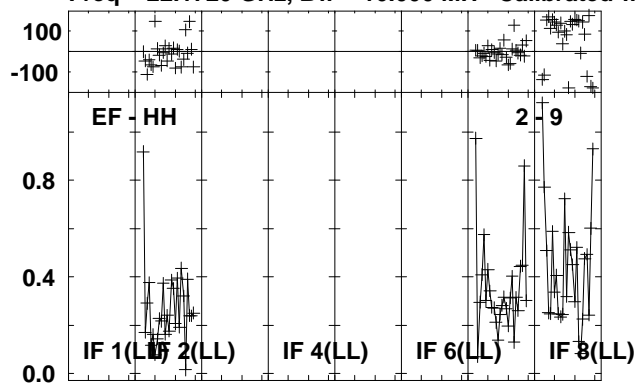

Lower frame: Ampl Jy Top frame: Phas deg
 Vector averaged cross-power spectrum Several baselines displayed
 Timerange: 01/01:34:11 to 01/01:35:53

Plot file version 353 created 26-JUL-2013 10:24:44
 J1157 EZ024 1.UVDATA.1
 Freq = 22.1720 GHz, Bw = 16.000 MH Calibrated with CL # 3 and BP # 1 (BP mode 1)

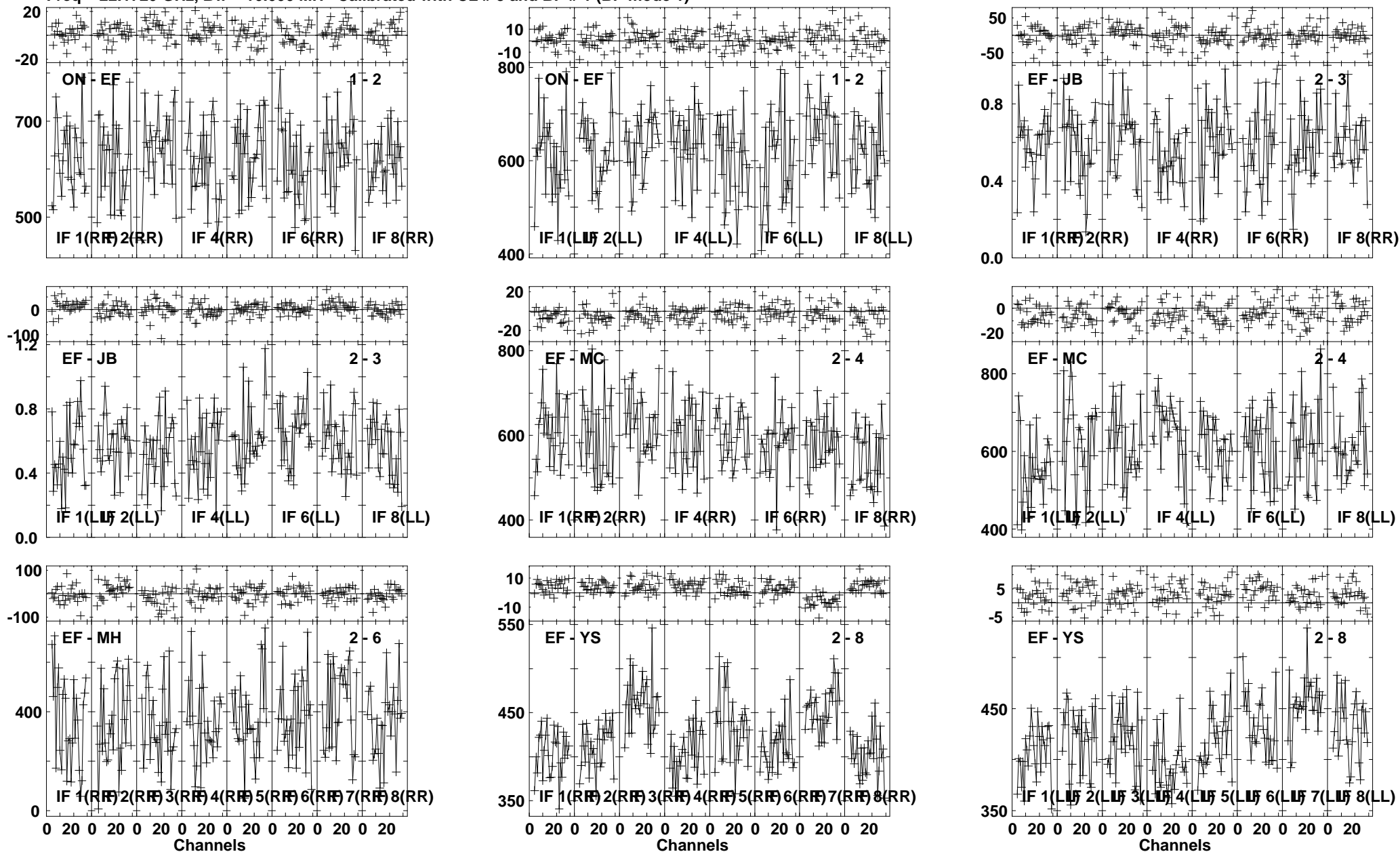

Lower frame: Milli Ampl Jy Top frame: Phas deg
 Vector averaged cross-power spectrum Several baselines displayed
 Timerange: 01/01:37:25 to 01/01:38:07

Plot file version 354 created 26-JUL-2013 10:24:45

J1157 EZ024 1.UVDATA.1

Freq = 22.1720 GHz, Bw = 16.000 MH Calibrated with CL # 3 and BP # 1 (BP mode 1)

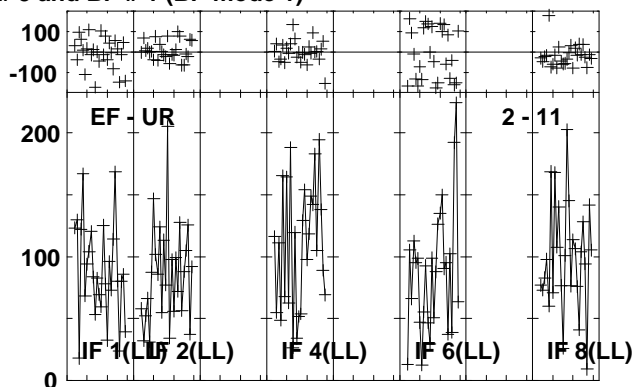
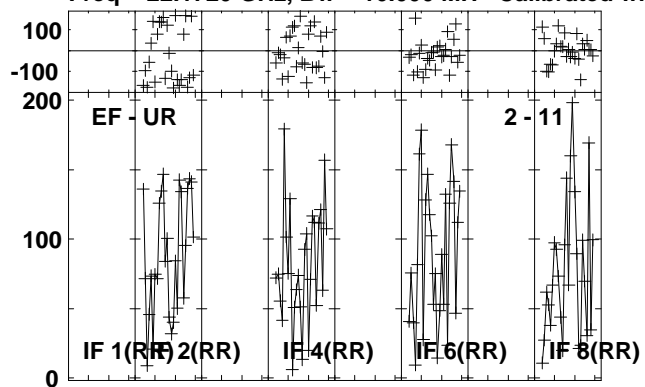

Lower frame: Milli Ampl Jy Top frame: Phas deg
Vector averaged cross-power spectrum Several baselines displayed
Timerange: 01/01:37:25 to 01/01:38:07

Plot file version 355 created 26-JUL-2013 10:24:45
 B1152+199A EZ024 1.UVDATA.1
 Freq = 22.1720 GHz, Bw = 16.000 MH Calibrated with CL # 3 and BP # 1 (BP mode 1)

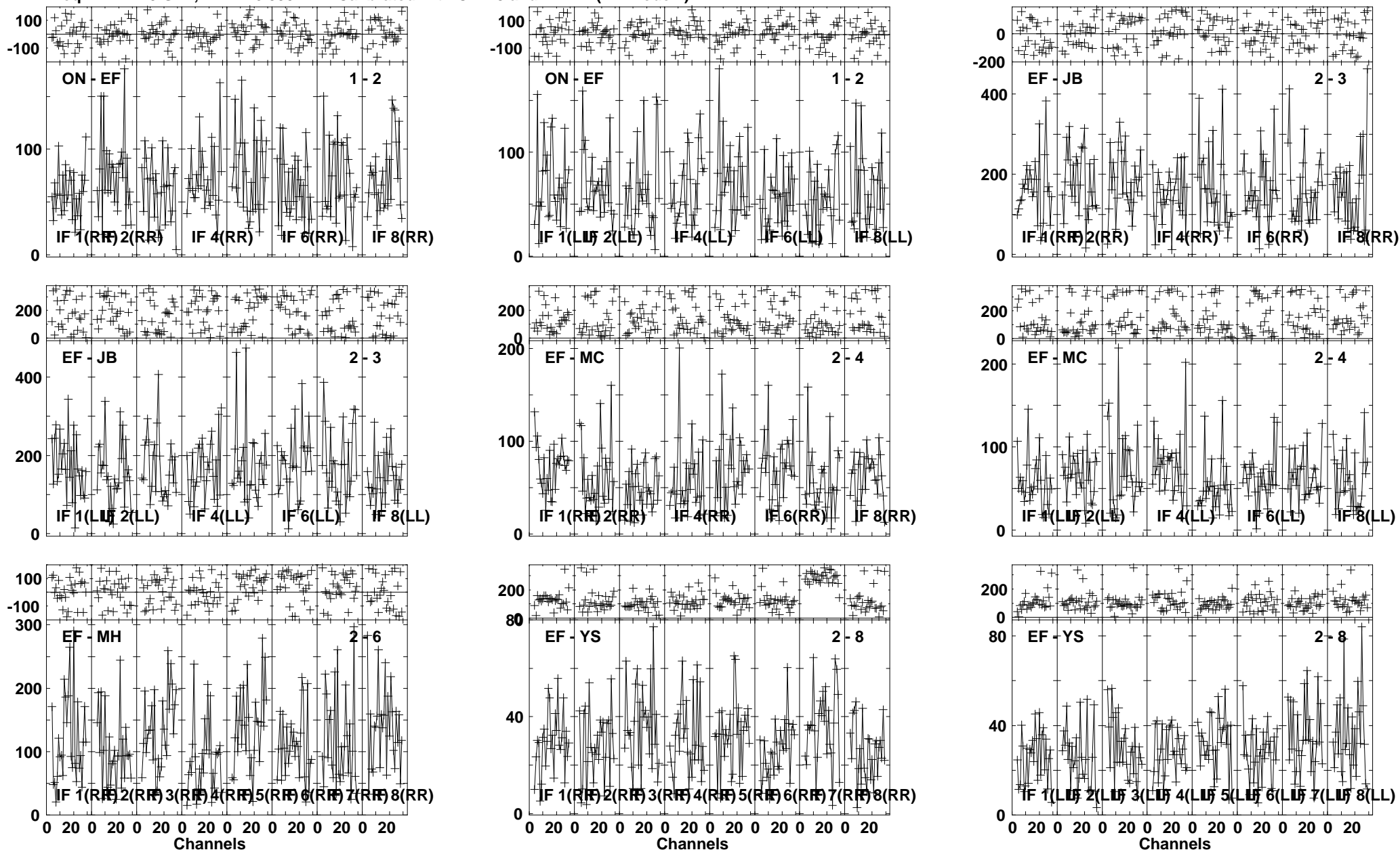

Lower frame: Milli Ampl Jy Top frame: Phas deg
 Vector averaged cross-power spectrum Several baselines displayed
 Timerange: 01/01:38:43 to 01/01:40:41

Plot file version 356 created 26-JUL-2013 10:24:48

B1152+199A EZ024 1.UVDATA.1

Freq = 22.1720 GHz, Bw = 16.000 MH Calibrated with CL # 3 and BP # 1 (BP mode 1)

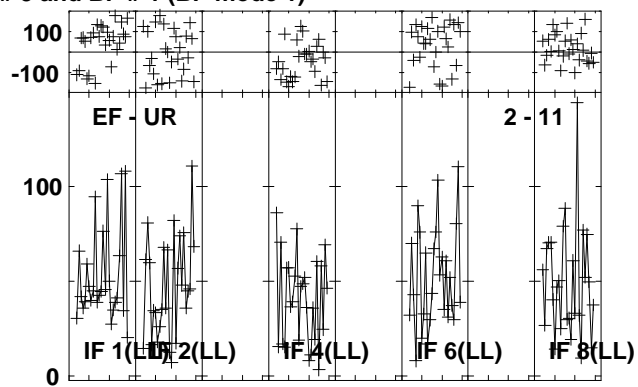
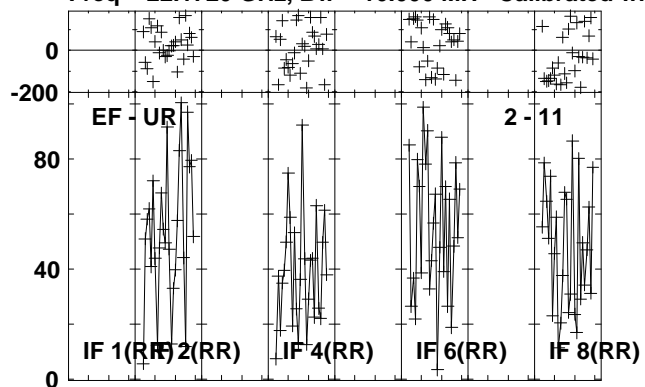

Lower frame: Milli Ampl Jy Top frame: Phas deg
Vector averaged cross-power spectrum Several baselines displayed
Timerange: 01/01:38:43 to 01/01:40:41

Plot file version 357 created 26-JUL-2013 10:24:49
 J1157 EZ024 1.UVDATA.1
 Freq = 22.1720 GHz, Bw = 16.000 MH Calibrated with CL # 3 and BP # 1 (BP mode 1)

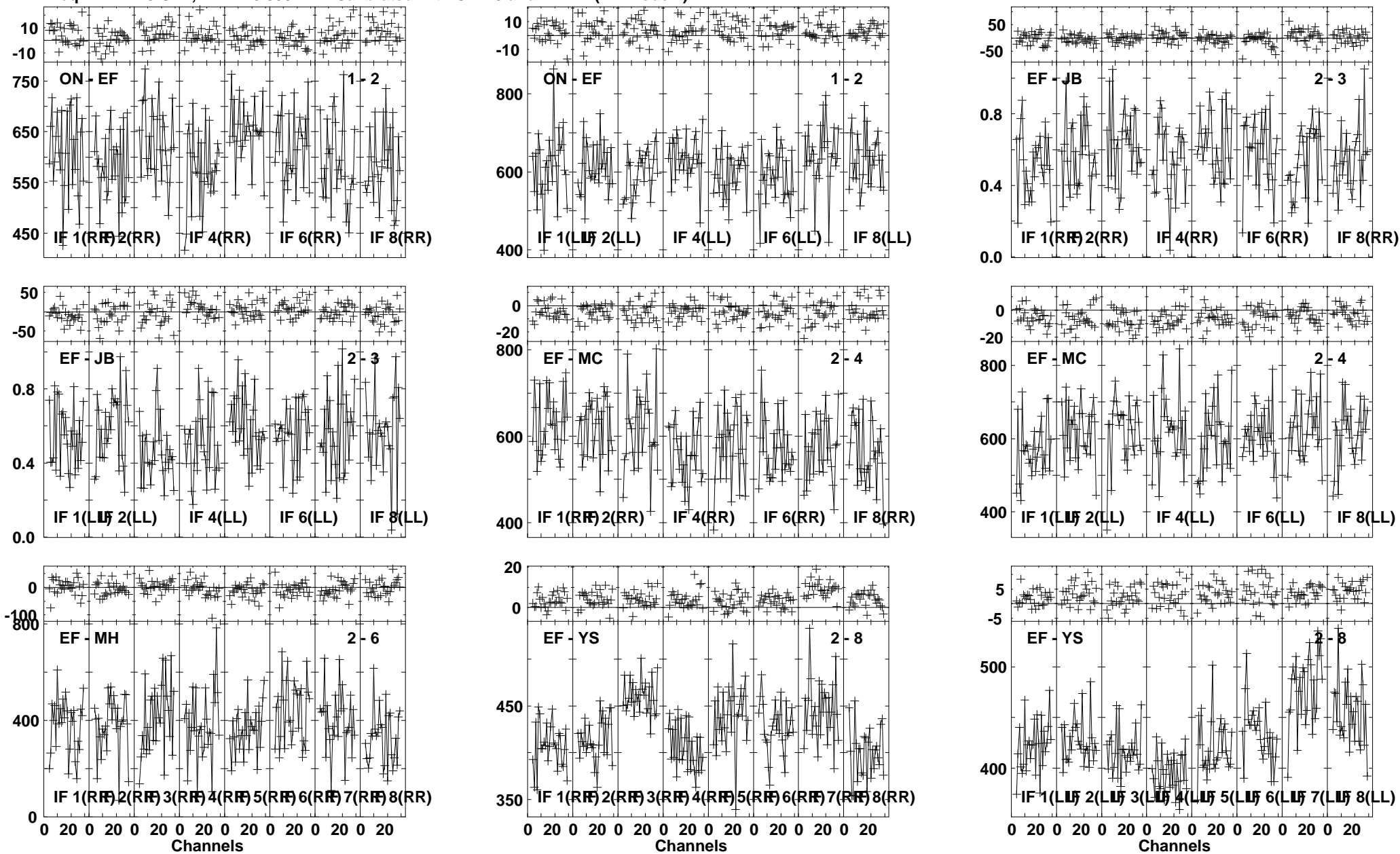

Lower frame: Milli Ampl Jy Top frame: Phas deg
 Vector averaged cross-power spectrum Several baselines displayed
 Timerange: 01/01:41:16 to 01/01:42:14

Plot file version 358 created 26-JUL-2013 10:24:50

J1157 EZ024 1.UVDATA.1

Freq = 22.1720 GHz, Bw = 16.000 MH Calibrated with CL # 3 and BP # 1 (BP mode 1)

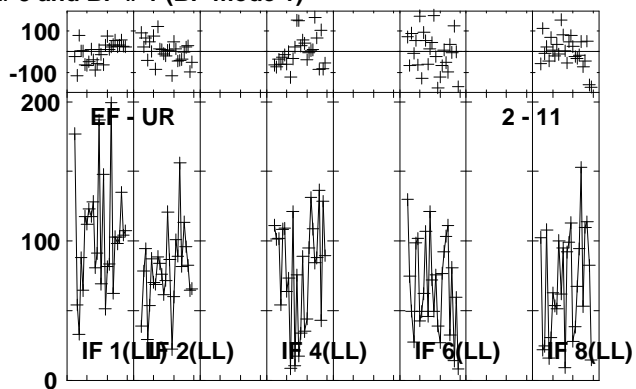
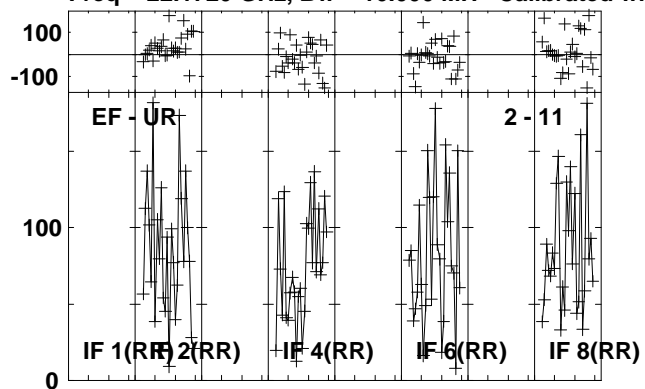

Lower frame: Milli Ampl Jy Top frame: Phas deg
Vector averaged cross-power spectrum Several baselines displayed
Timerange: 01/01:41:16 to 01/01:42:14

Plot file version 359 created 26-JUL-2013 10:24:50
 B1152+199A EZ024 1.UVDATA.1
 Freq = 22.1720 GHz, Bw = 16.000 MH Calibrated with CL # 3 and BP # 1 (BP mode 1)

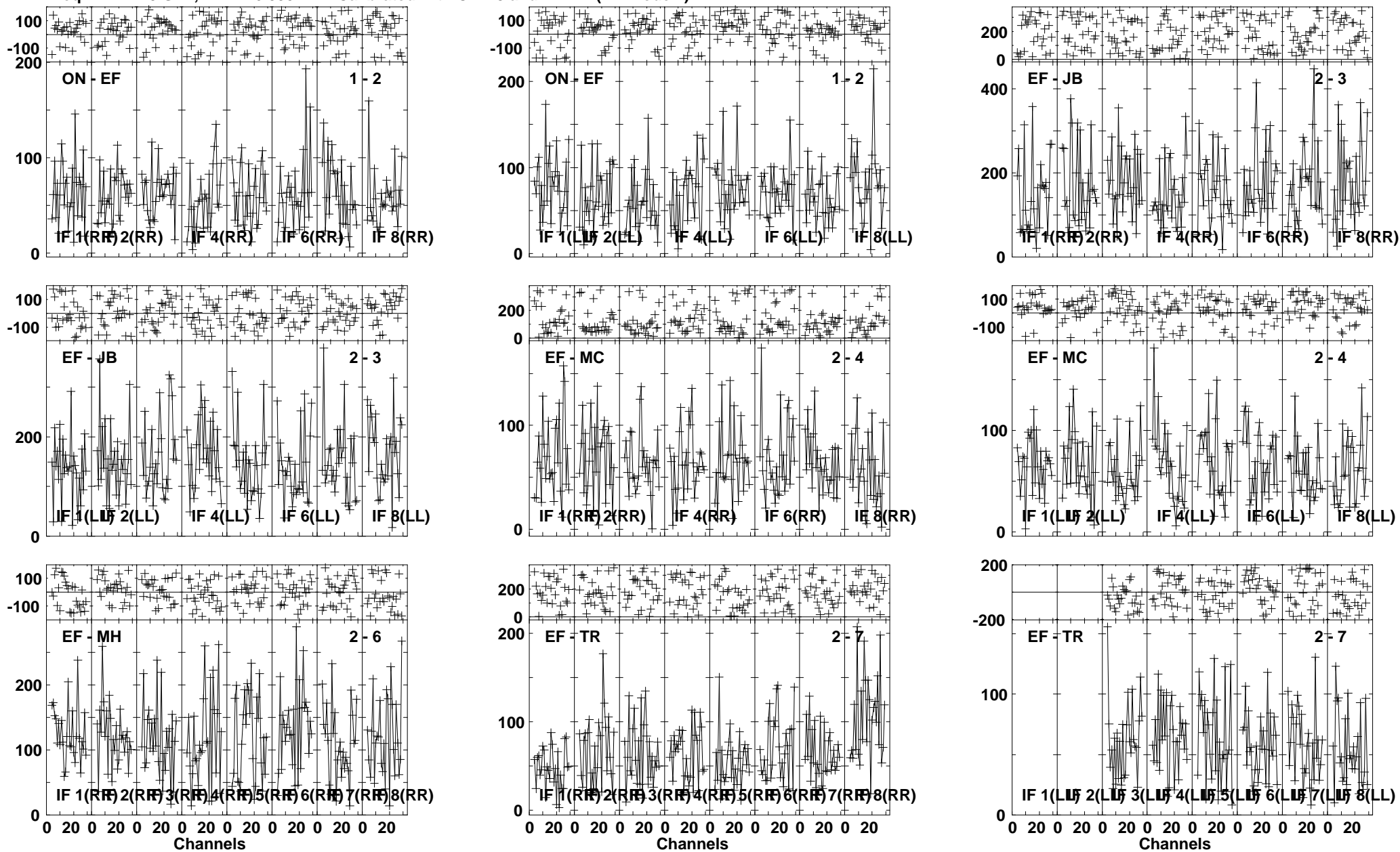

Lower frame: Milli Ampl Jy Top frame: Phas deg
 Vector averaged cross-power spectrum Several baselines displayed
 Timerange: 01/01:42:49 to 01/01:44:47

Plot file version 360 created 26-JUL-2013 10:24:52
 B1152+199A EZ024 1.UVDATA.1
 Freq = 22.1720 GHz, Bw = 16.000 MH Calibrated with CL # 3 and BP # 1 (BP mode 1)

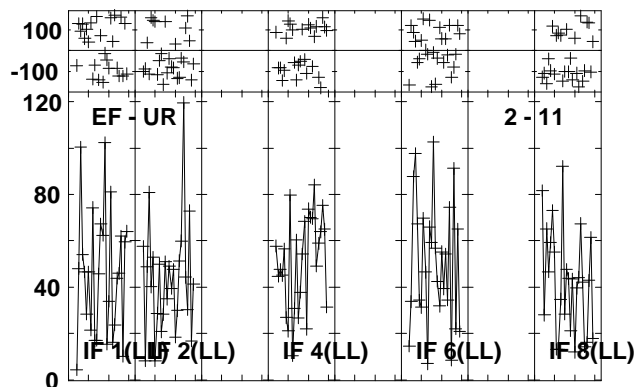
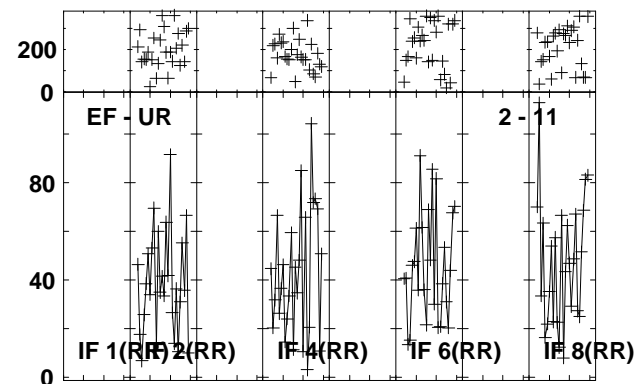
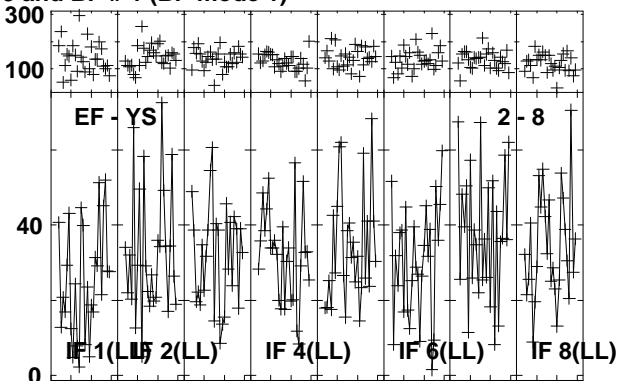
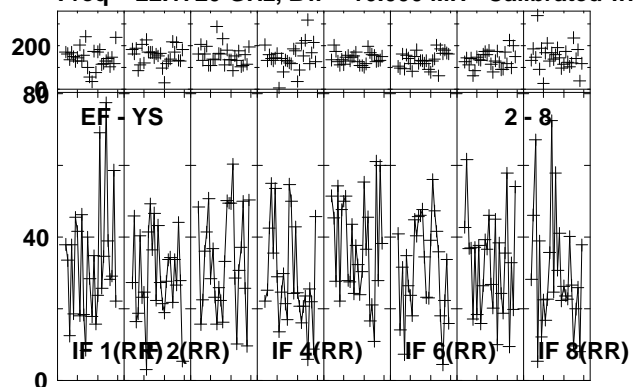

Lower frame: Milli Ampl Jy Top frame: Phas deg
 Vector averaged cross-power spectrum Several baselines displayed
 Timerange: 01/01:42:49 to 01/01:44:47

Plot file version 361 created 26-JUL-2013 10:24:53
 J1157 EZ2024 1.UVDATA.1
 Freq = 22.1720 GHz, Bw = 16.000 MHz Calibrated with CL # 3 and BP # 1 (BP mode 1)

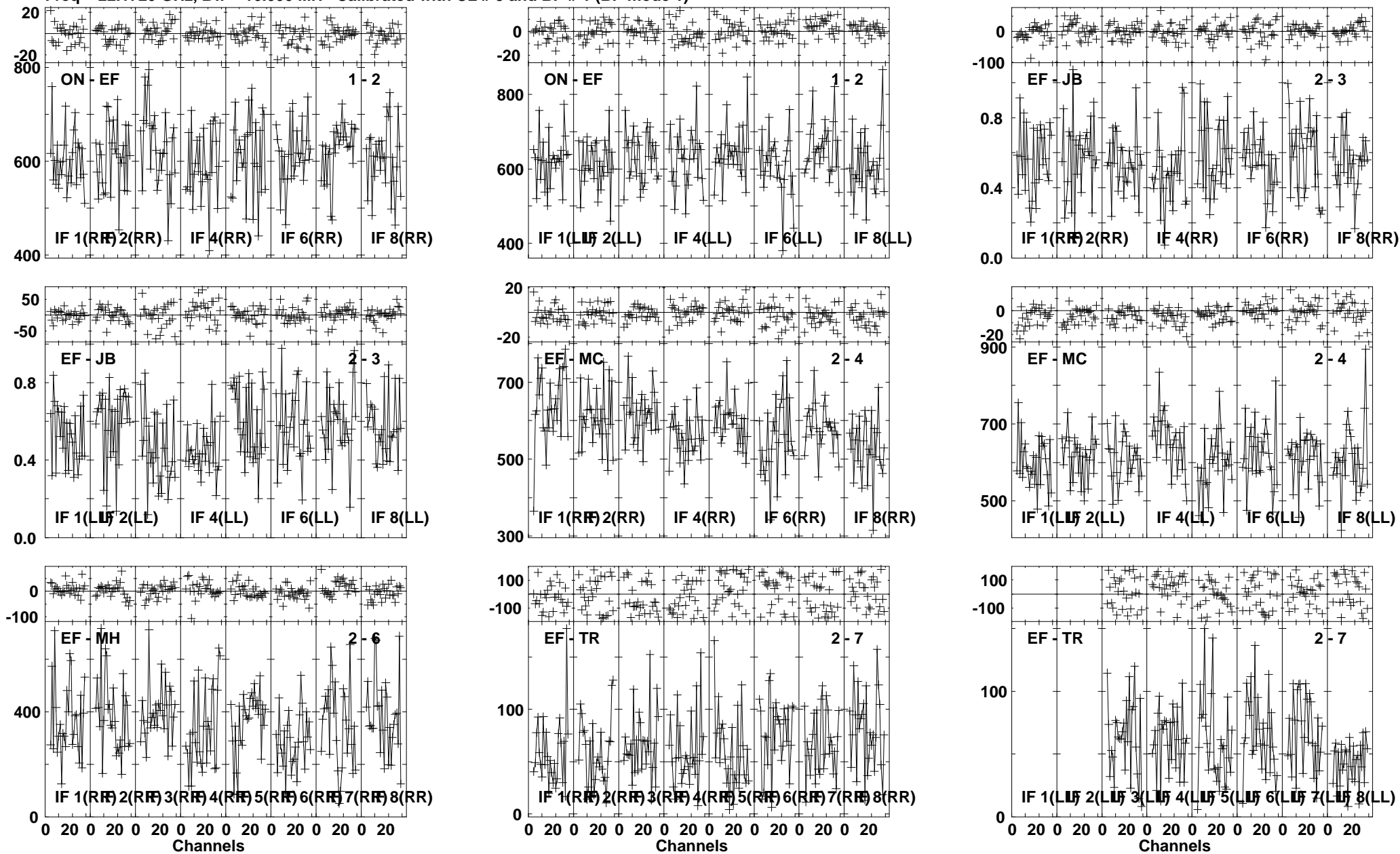

Lower frame: Milli Ampl Jy Top frame: Phas deg
 Vector averaged cross-power spectrum Several baselines displayed
 Timerange: 01/01:45:22 to 01/01:46:20

Plot file version 362 created 26-JUL-2013 10:24:54
 J1157 EZ024 1.UVDATA.1
 Freq = 22.1720 GHz, Bw = 16.000 MH Calibrated with CL # 3 and BP # 1 (BP mode 1)

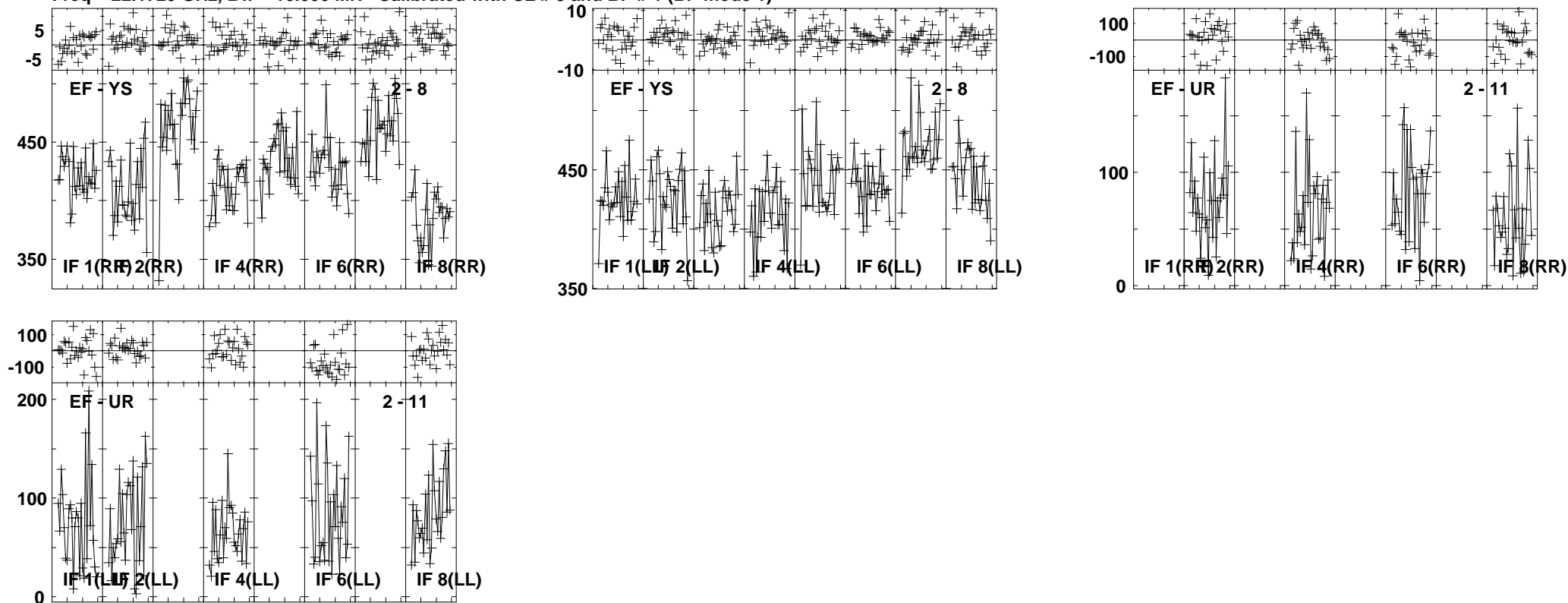

Lower frame: Milli Ampl Jy Top frame: Phas deg
 Vector averaged cross-power spectrum Several baselines displayed
 Timerange: 01/01:45:22 to 01/01:46:20

Plot file version 363 created 26-JUL-2013 10:24:55
 B1152+199A EZ024 1.UVDATA.1
 Freq = 22.1720 GHz, Bw = 16.000 MH Calibrated with CL # 3 and BP # 1 (BP mode 1)

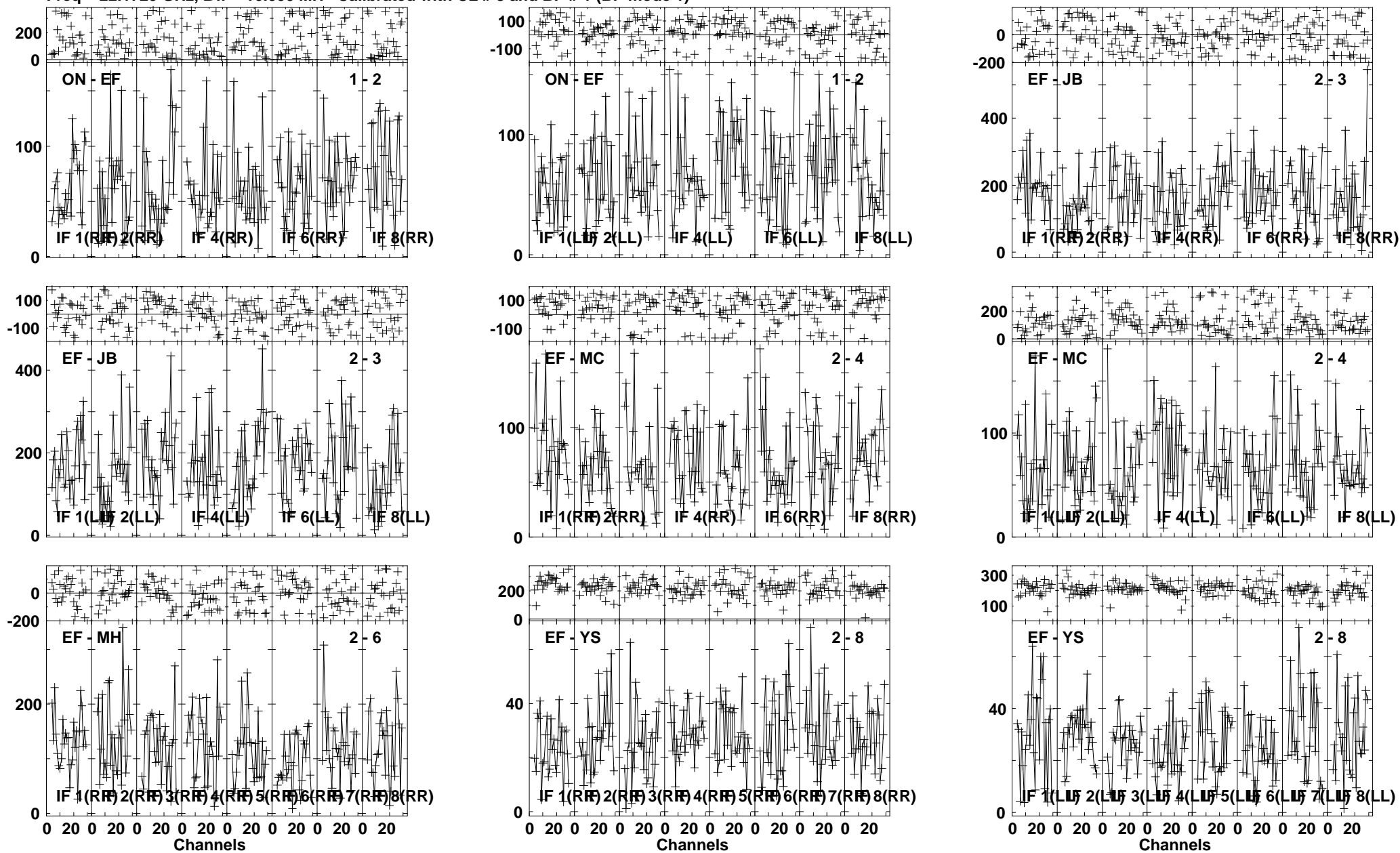

Lower frame: Milli Ampl Jy Top frame: Phas deg
 Vector averaged cross-power spectrum Several baselines displayed
 Timerange: 01/01:46:55 to 01/01:48:53

Plot file version 364 created 26-JUL-2013 10:24:57

B1152+199A EZ024 1.UVDATA.1

Freq = 22.1720 GHz, Bw = 16.000 MH Calibrated with CL # 3 and BP # 1 (BP mode 1)

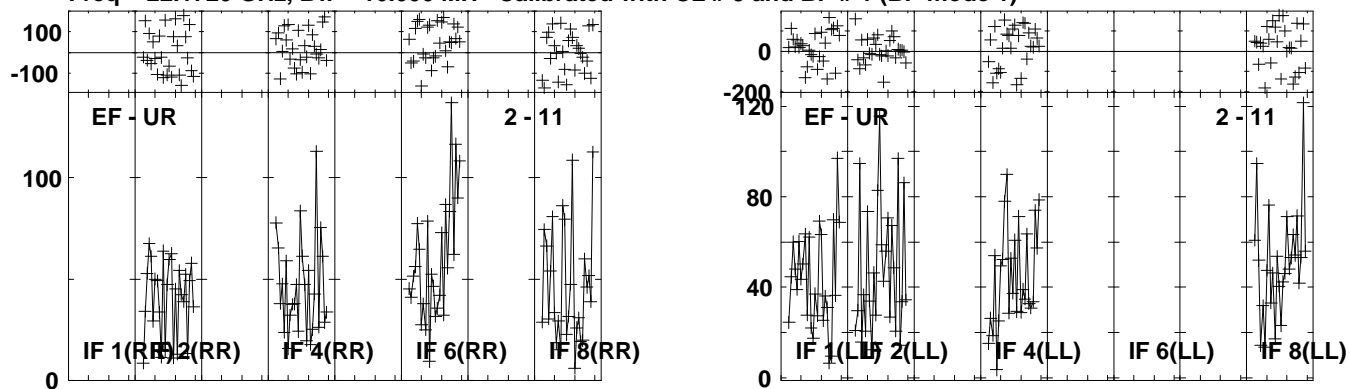

Lower frame: Milli Ampl Jy Top frame: Phas deg
Vector averaged cross-power spectrum Several baselines displayed
Timerange: 01/01:46:55 to 01/01:48:53

Plot file version 365 created 26-JUL-2013 10:24:58
 J1157 EZ204 1.UVDATA.1
 Freq = 22.1720 GHz, Bw = 16.000 MH Calibrated with CL # 3 and BP # 1 (BP mode 1)

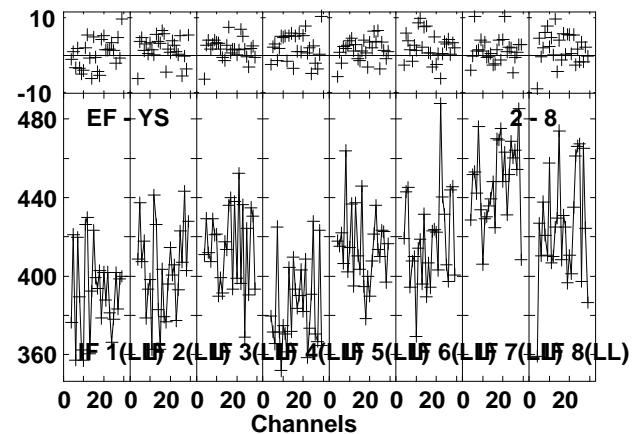
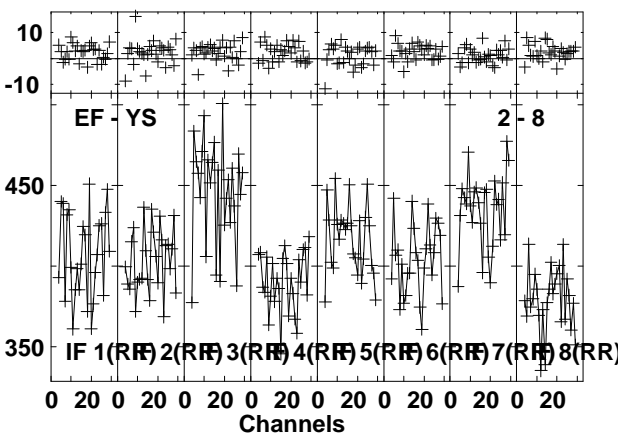
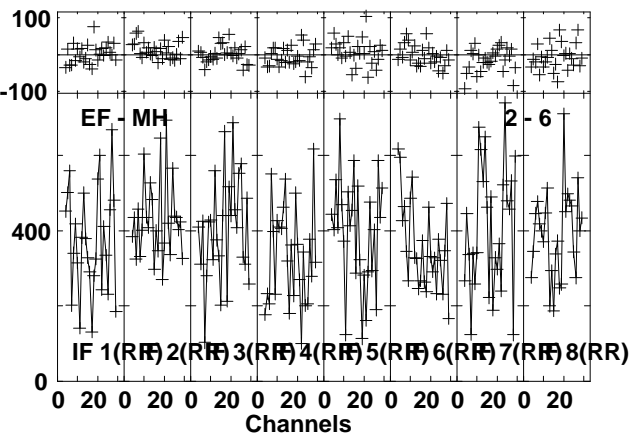
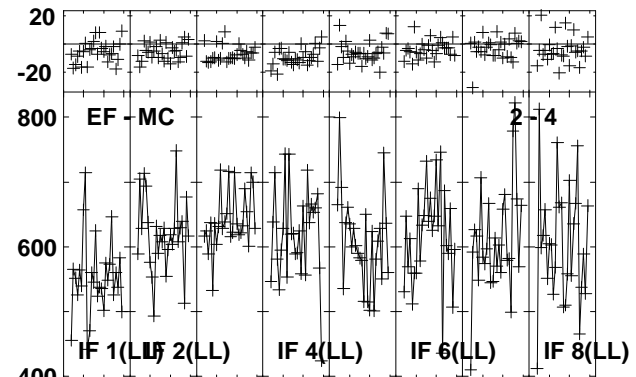
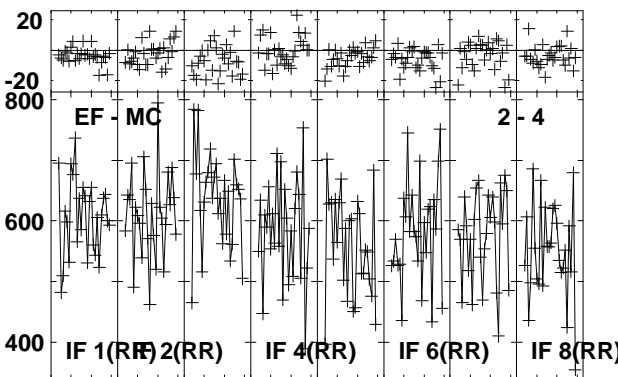
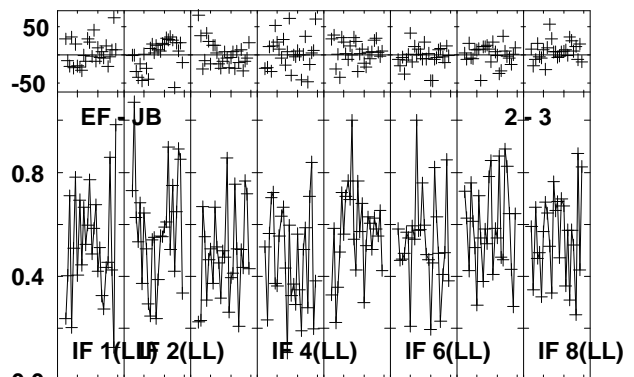
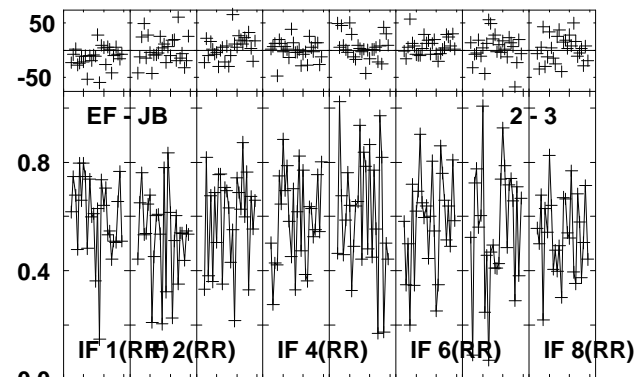
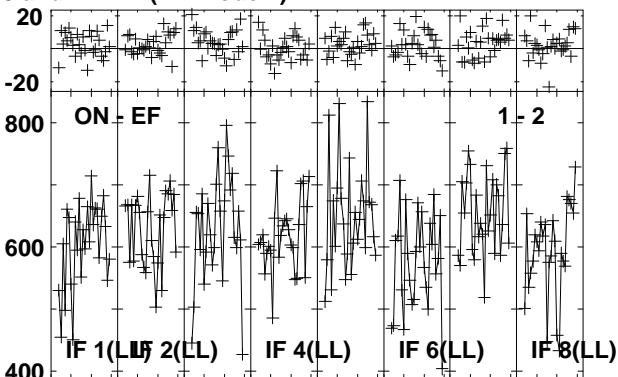
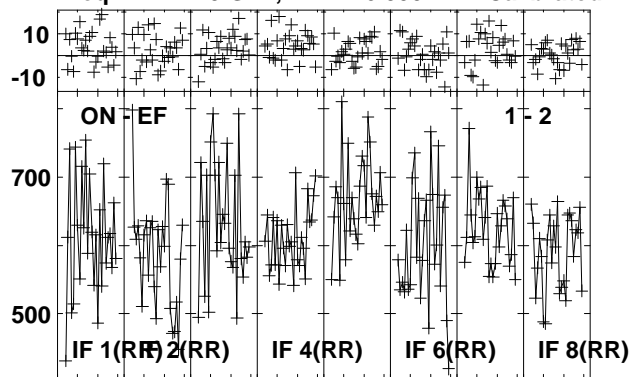

Lower frame: Milli Ampl Jy Top frame: Phas deg
 Vector averaged cross-power spectrum Several baselines displayed
 Timerange: 01/01:49:28 to 01/01:50:26

Plot file version 366 created 26-JUL-2013 10:24:59

J1157 EZ024 1.UVDATA.1

Freq = 22.1720 GHz, Bw = 16.000 MH Calibrated with CL # 3 and BP # 1 (BP mode 1)

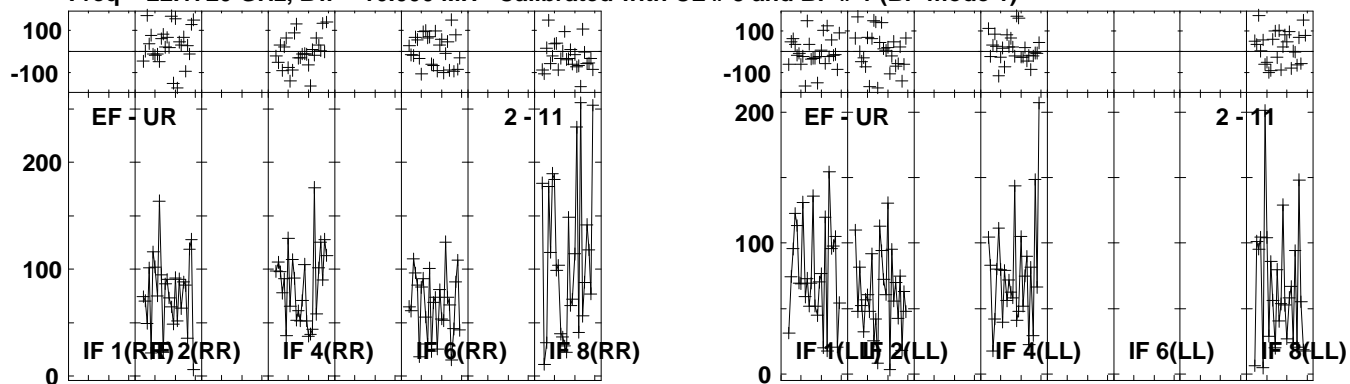

Lower frame: Milli Ampl Jy Top frame: Phas deg
Vector averaged cross-power spectrum Several baselines displayed
Timerange: 01/01:49:28 to 01/01:50:26

Plot file version 367 created 26-JUL-2013 10:25:00
 J1125+2610 EZ024 1.UVDATA.1
 Freq = 22.1720 GHz, Bw = 16.000 MH Calibrated with CL # 3 and BP # 1 (BP mode 1)

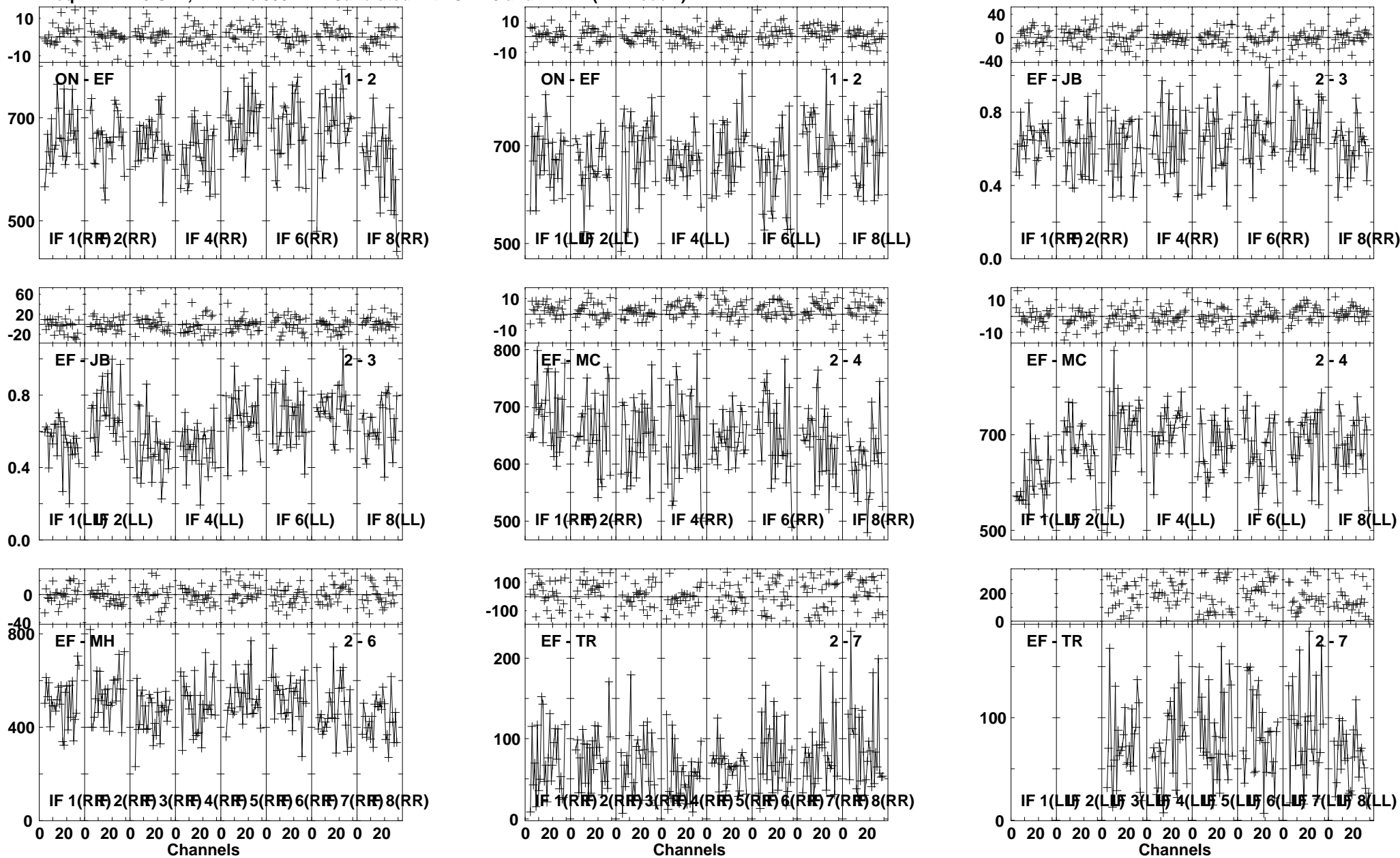

Lower frame: Milli Ampl Jy Top frame: Phas deg
 Vector averaged cross-power spectrum Several baselines displayed
 Timerange: 01/01:52:01 to 01/01:53:43

Plot file version 368 created 26-JUL-2013 10:25:01
 J1125+2610 EZ024 1.UVDATA.1
 Freq = 22.1720 GHz, Bw = 16.000 MH Calibrated with CL # 3 and BP # 1 (BP mode 1)

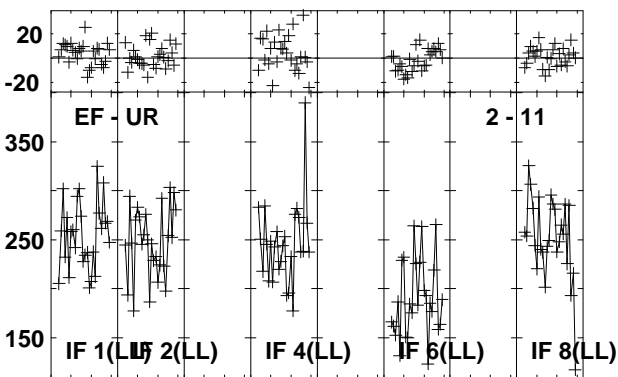
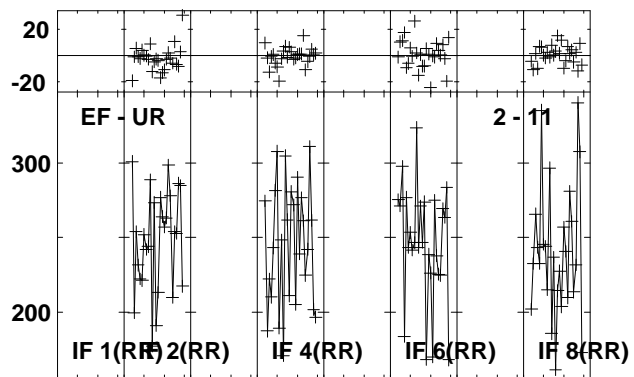
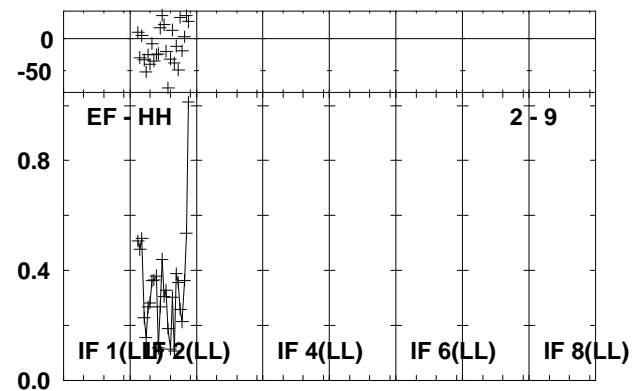
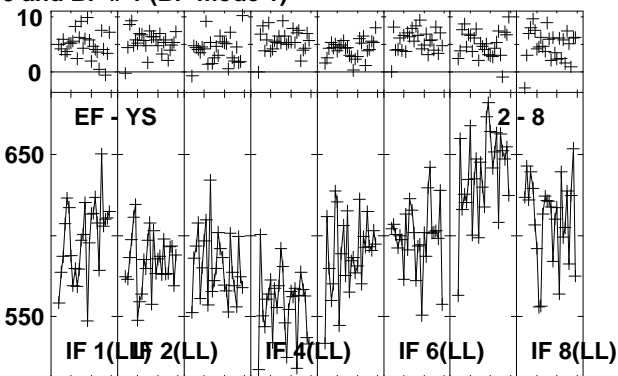
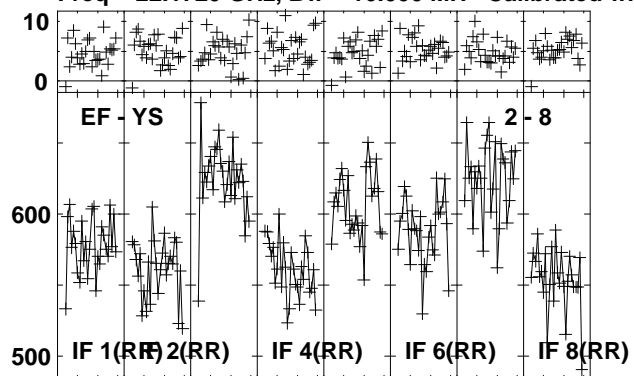

Lower frame: Milli Ampl Jy Top frame: Phas deg
 Vector averaged cross-power spectrum Several baselines displayed
 Timerange: 01/01:52:01 to 01/01:53:43

Plot file version 369 created 26-JUL-2013 10:25:02

J1157 EZ024 1.UVDATA.1

Freq = 22.1720 GHz, Bw = 16.000 MH Calibrated with CL # 3 and BP # 1 (BP mode 1)

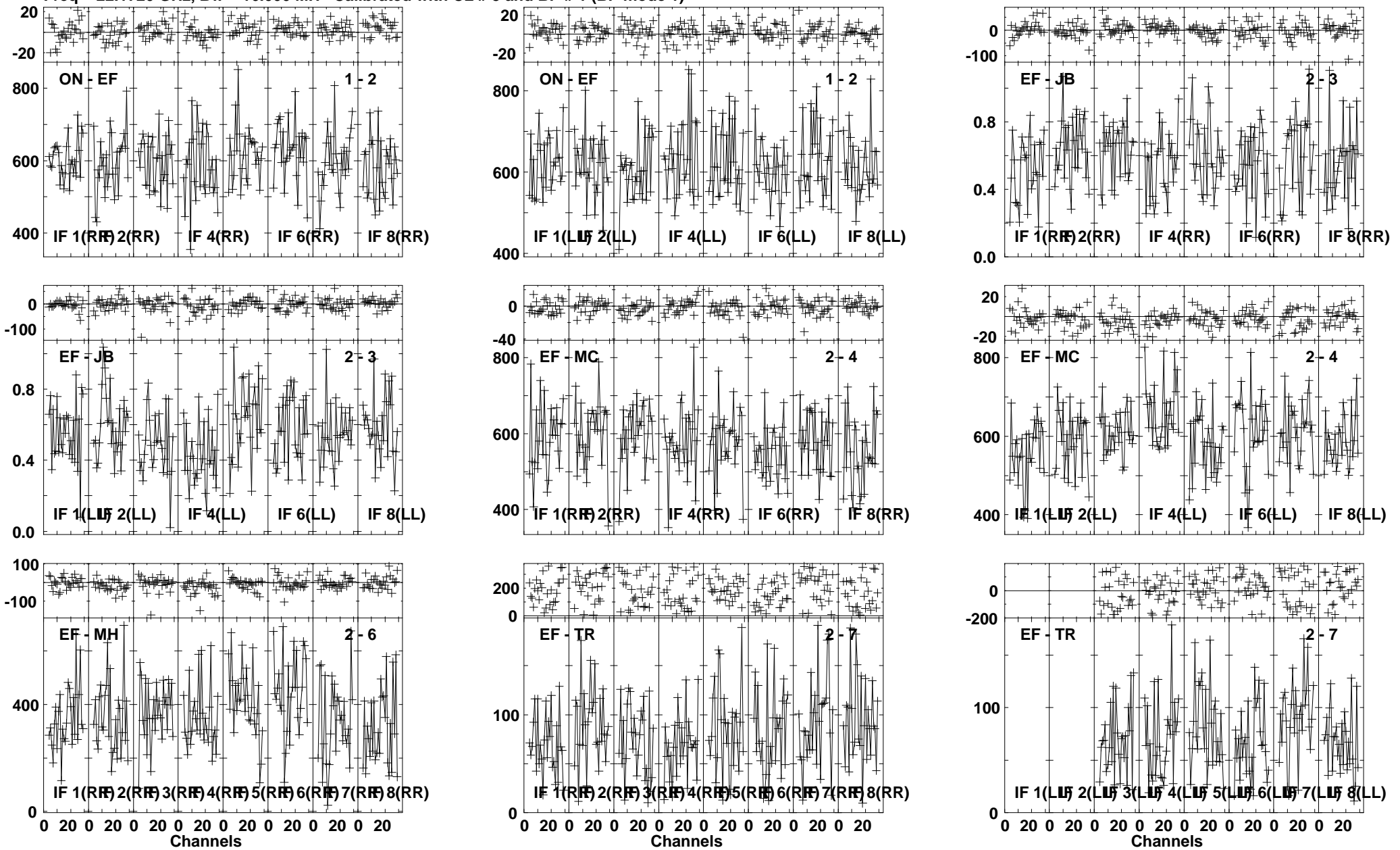

Lower frame: Milli Ampl Jy Top frame: Phas deg
Vector averaged cross-power spectrum Several baselines displayed
Timerange: 01/01:55:16 to 01/01:55:58

Plot file version 370 created 26-JUL-2013 10:25:03
 J1157 EZ024 1.UVDATA.1
 Freq = 22.1720 GHz, Bw = 16.000 MH Calibrated with CL # 3 and BP # 1 (BP mode 1)

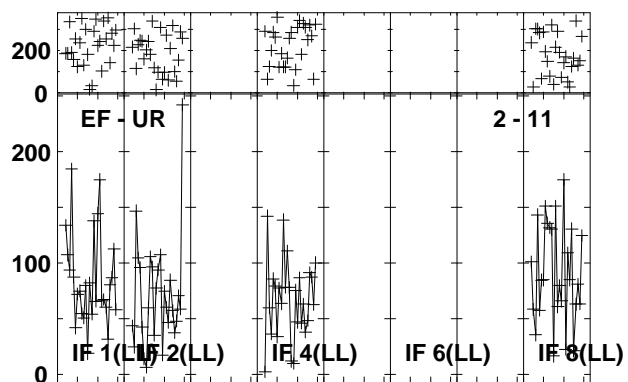
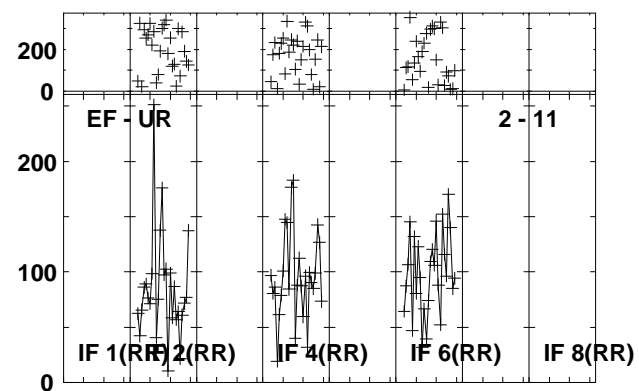
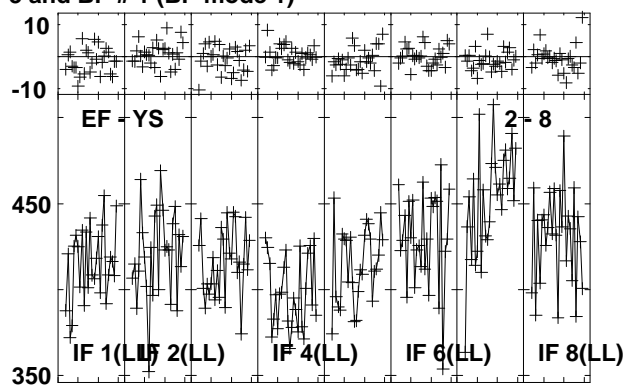
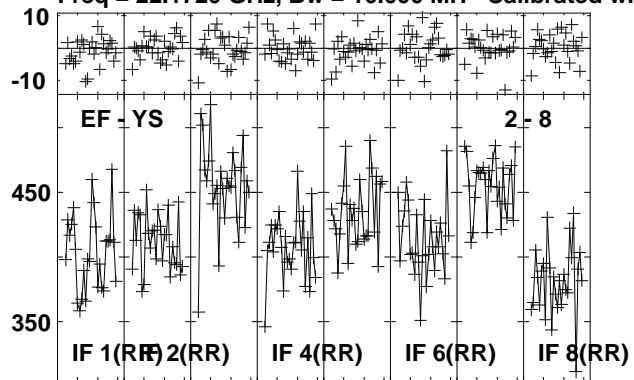

Lower frame: Milli Ampl Jy Top frame: Phas deg
 Vector averaged cross-power spectrum Several baselines displayed
 Timerange: 01/01:55:16 to 01/01:55:58

Plot file version 371 created 26-JUL-2013 10:25:04
 B1152+199A EZ24 1.UVDATA.1
 Freq = 22.1720 GHz, Bw = 16.000 MH Calibrated with CL # 3 and BP # 1 (BP mode 1)

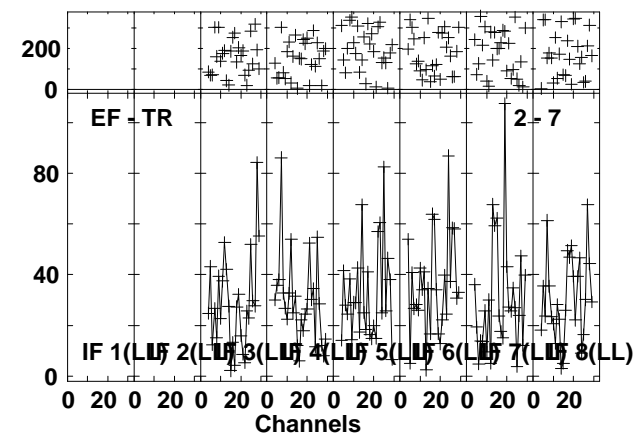
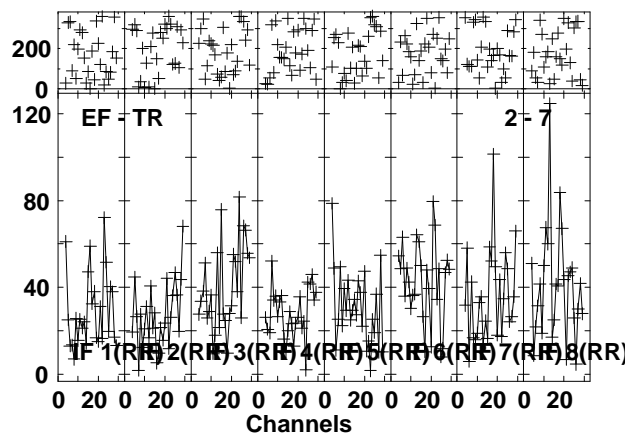
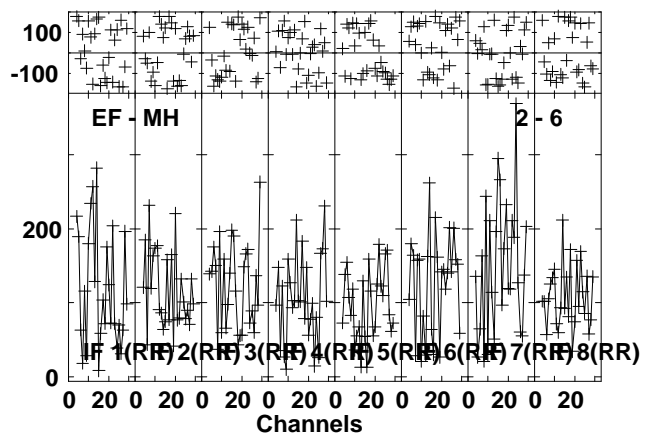
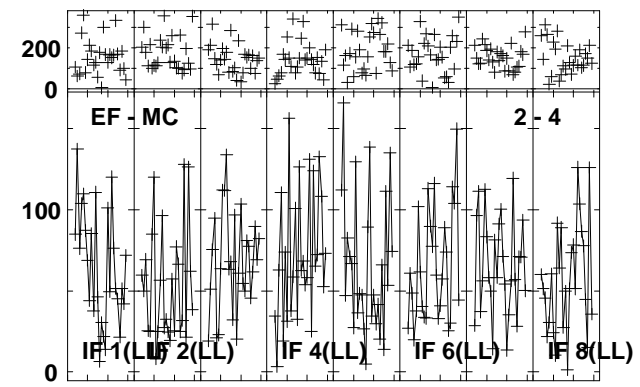
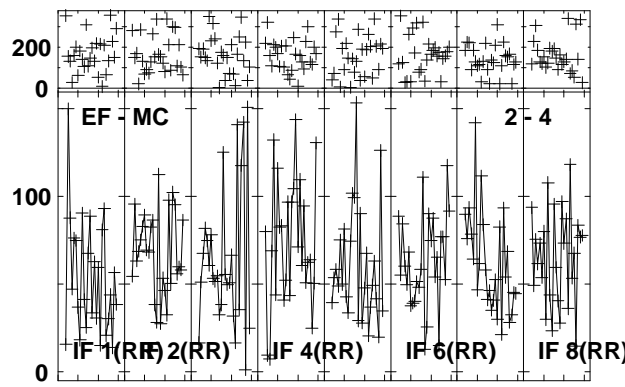
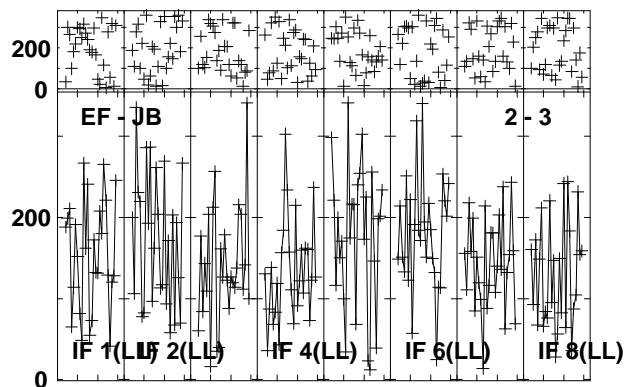
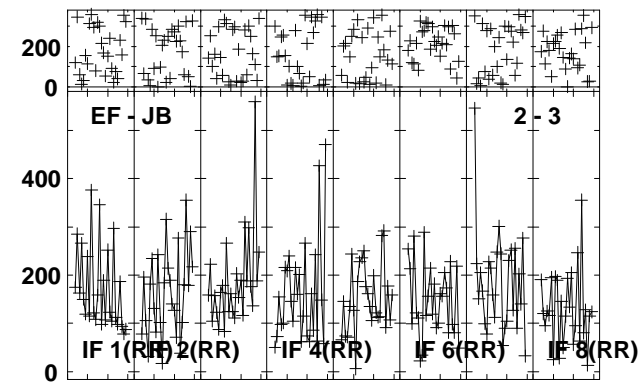
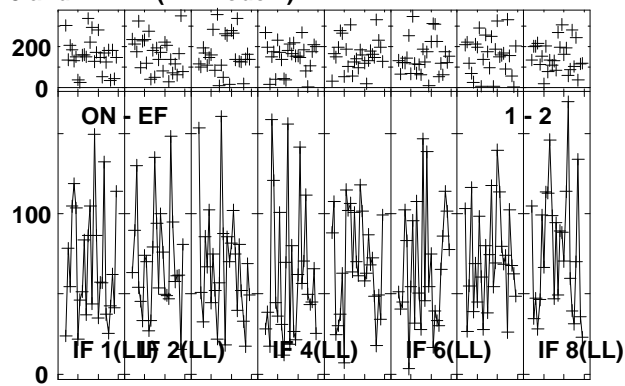
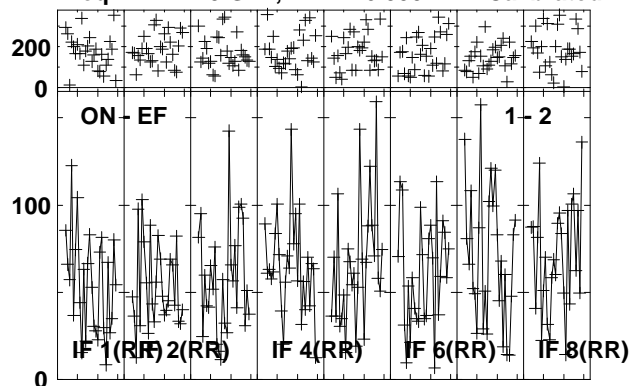

Lower frame: Milli Ampl Jy Top frame: Phas deg
 Vector averaged cross-power spectrum Several baselines displayed
 Timerange: 01/01:56:34 to 01/01:58:32

Plot file version 372 created 26-JUL-2013 10:25:05
 B1152+199A EZ024 1.UVDATA.1
 Freq = 22.1720 GHz, Bw = 16.000 MH Calibrated with CL # 3 and BP # 1 (BP mode 1)

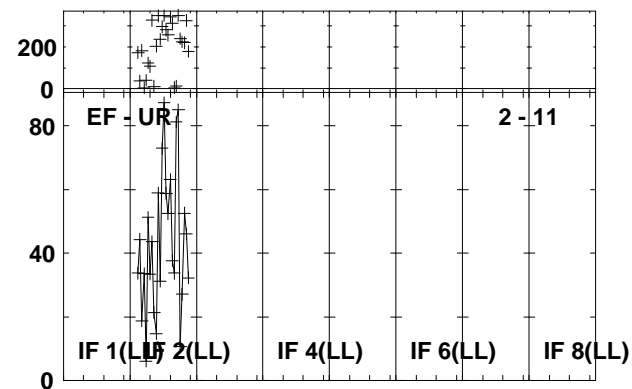
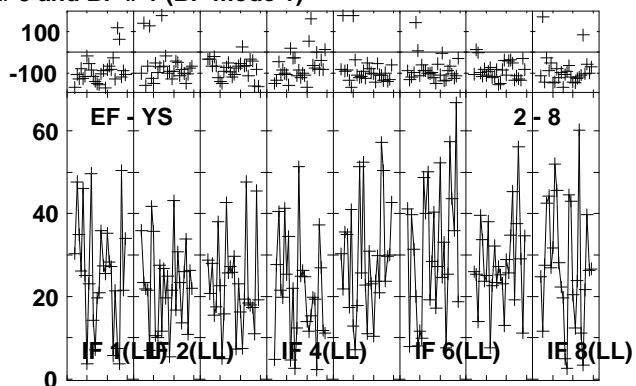
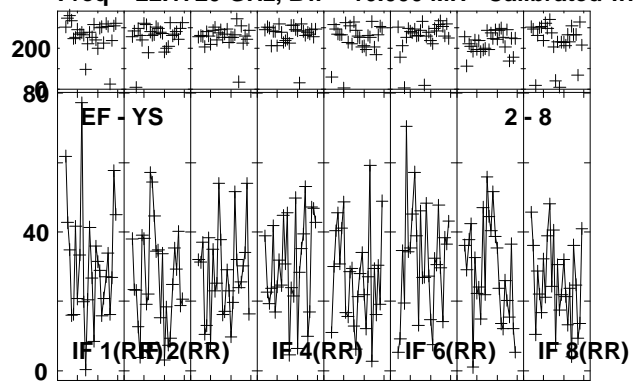

Lower frame: Milli Ampl Jy Top frame: Phas deg
 Vector averaged cross-power spectrum Several baselines displayed
 Timerange: 01/01:56:34 to 01/01:58:32

Plot file version 373 created 26-JUL-2013 10:25:07
 J1157 EZ024 1.UVDATA.1
 Freq = 22.1720 GHz, Bw = 16.000 MH Calibrated with CL # 3 and BP # 1 (BP mode 1)

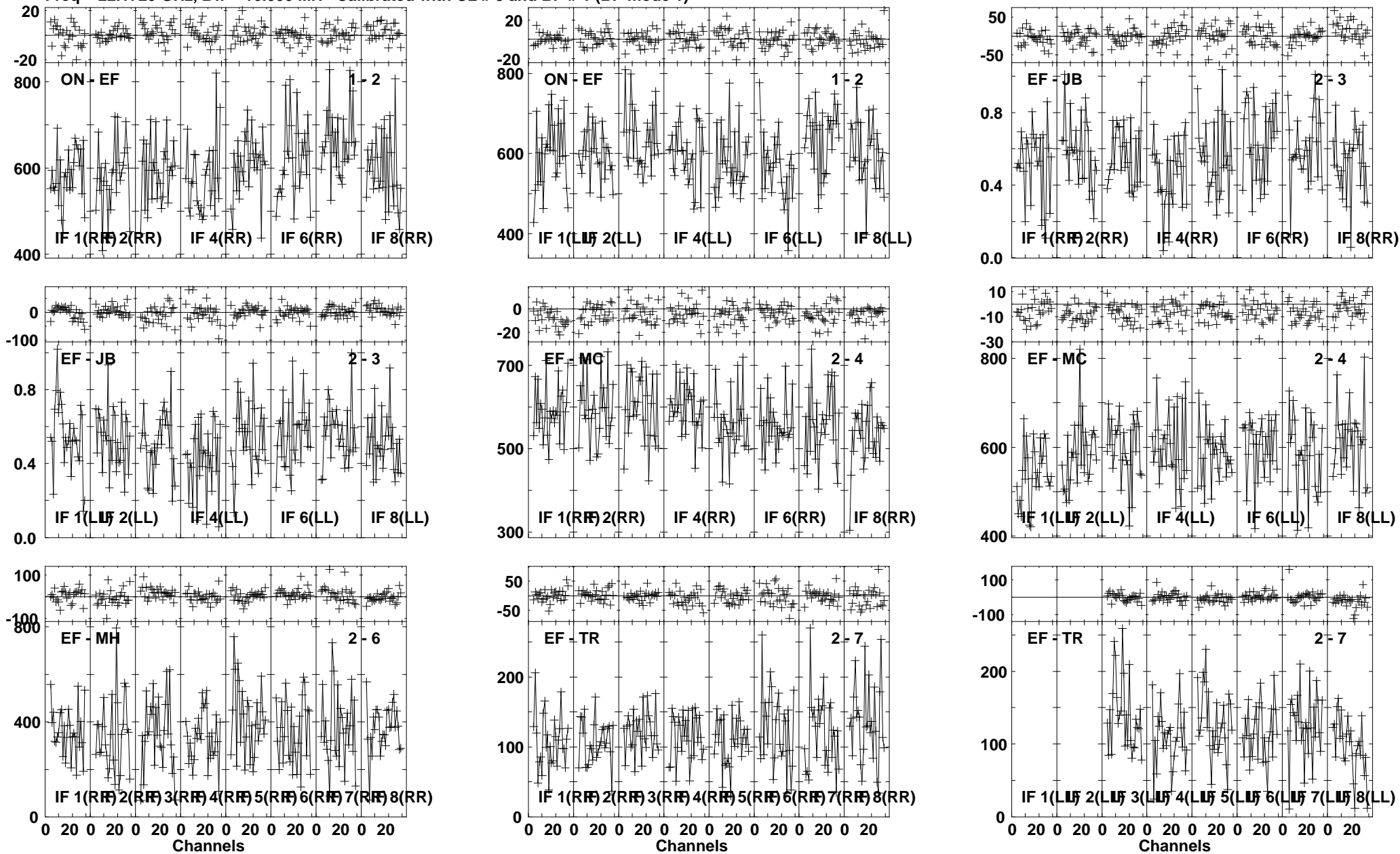

Lower frame: Milli Ampl Jy Top frame: Phas deg
 Vector averaged cross-power spectrum Several baselines displayed
 Timerange: 01/01:59:07 to 01/02:00:05

Plot file version 374 created 26-JUL-2013 10:25:08

J1157 EZ024 1.UVDATA.1

Freq = 22.1720 GHz, Bw = 16.000 MH Calibrated with CL # 3 and BP # 1 (BP mode 1)

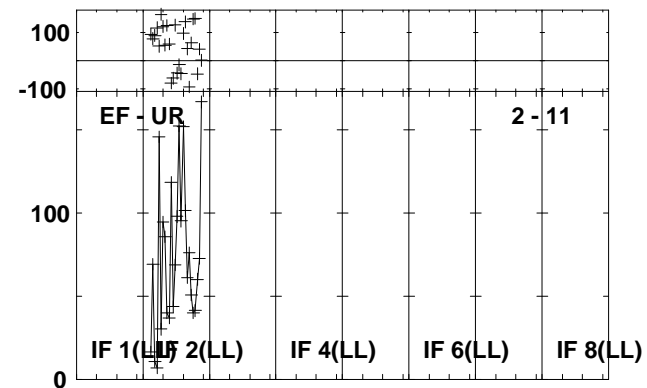
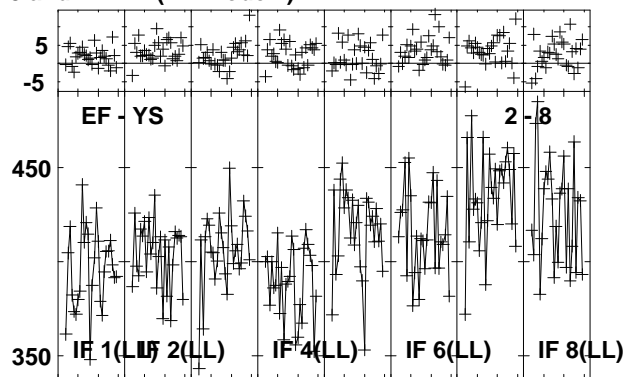
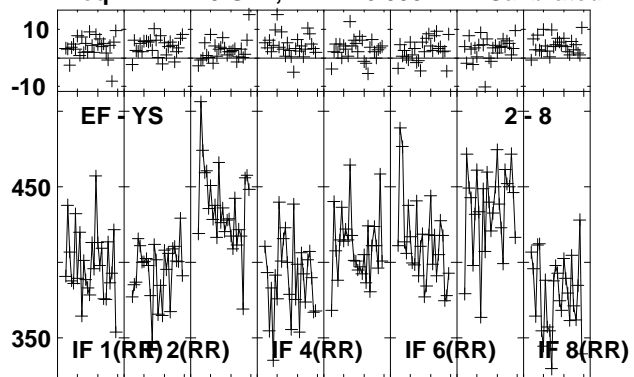

Lower frame: Milli Ampl Jy Top frame: Phas deg
Vector averaged cross-power spectrum Several baselines displayed
Timerange: 01/01:59:07 to 01/02:00:05

Plot file version 375 created 26-JUL-2013 10:25:09
 B1152+199A EZ024 1.UVDATA.1
 Freq = 22.1720 GHz, Bw = 16.000 MH Calibrated with CL # 3 and BP # 1 (BP mode 1)

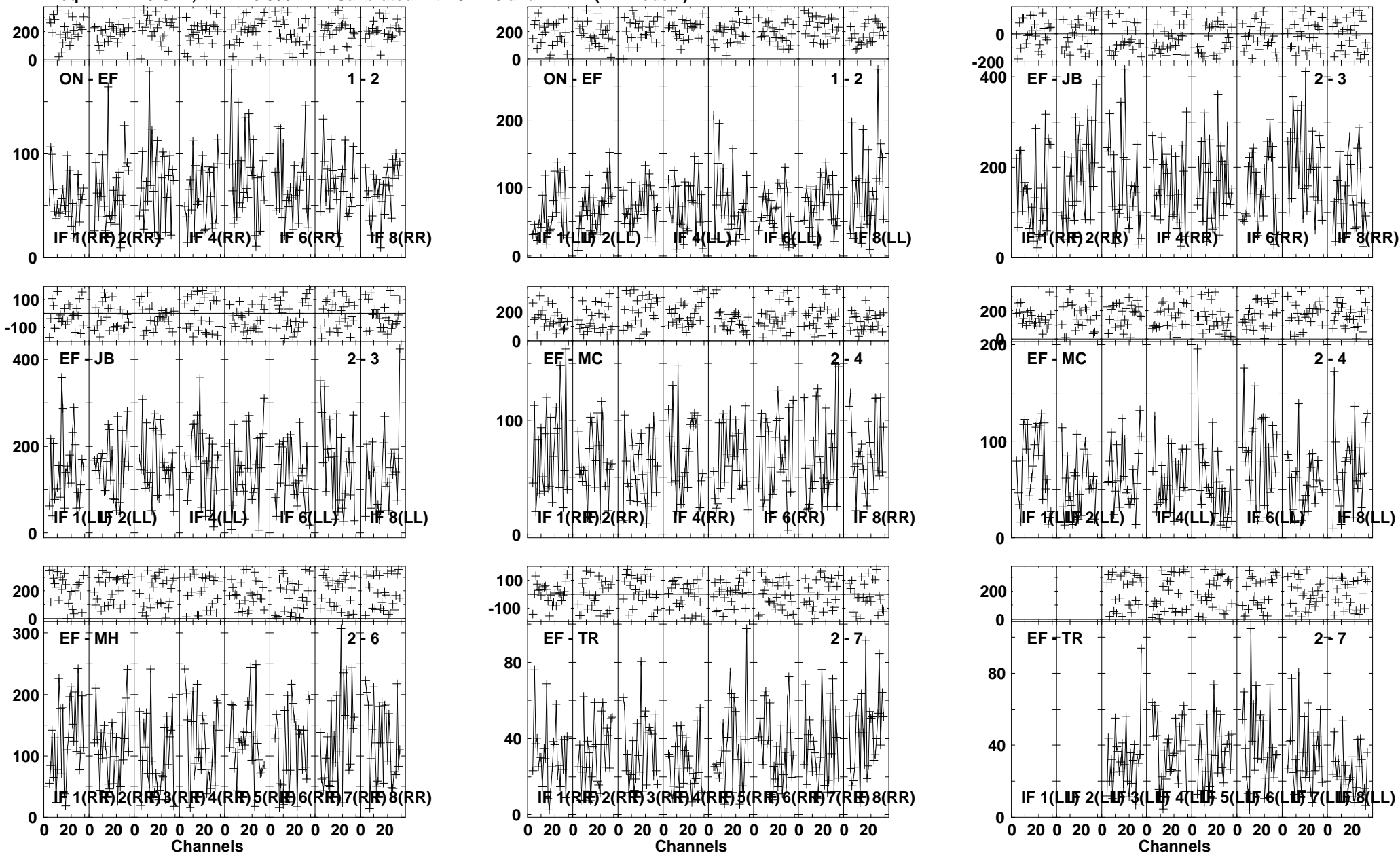

Lower frame: Milli Ampl Jy Top frame: Phas deg
 Vector averaged cross-power spectrum Several baselines displayed
 Timerange: 01/02:00:40 to 01/02:02:38

Plot file version 376 created 26-JUL-2013 10:25:10

B1152+199A EZ024 1.UVDATA.1

Freq = 22.1720 GHz, Bw = 16.000 MH Calibrated with CL # 3 and BP # 1 (BP mode 1)

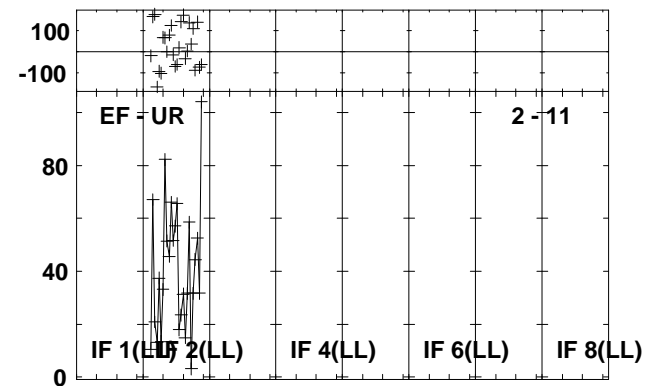
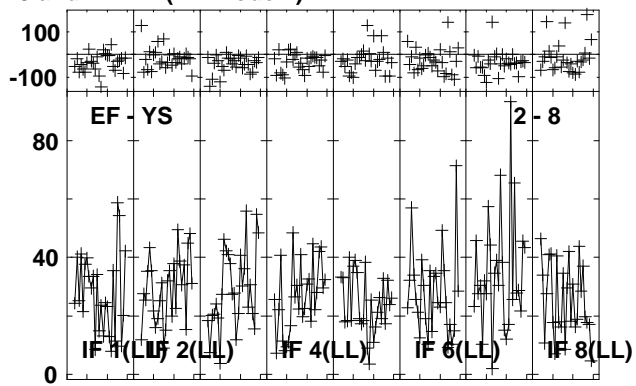
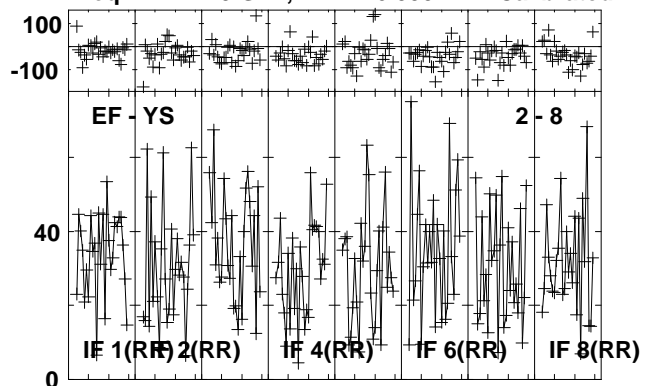

Lower frame: Milli Ampl Jy Top frame: Phas deg
Vector averaged cross-power spectrum Several baselines displayed
Timerange: 01/02:00:40 to 01/02:02:38

Plot file version 377 created 26-JUL-2013 10:25:12
 J1157 EZ024 1.UVDATA.1
 Freq = 22.1720 GHz, Bw = 16.000 MH Calibrated with CL # 3 and BP # 1 (BP mode 1)

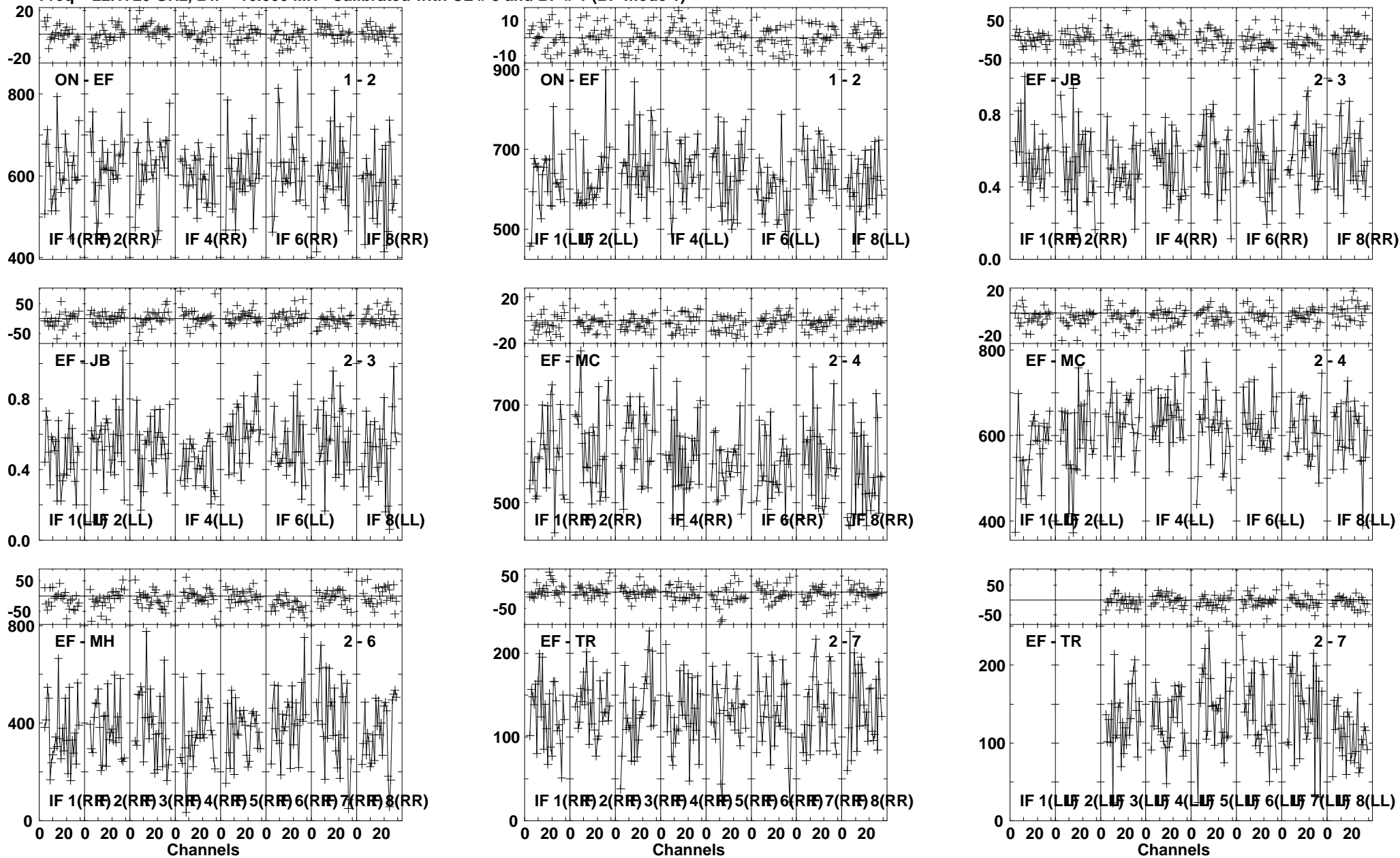

Lower frame: Milli Ampl Jy Top frame: Phas deg
 Vector averaged cross-power spectrum Several baselines displayed
 Timerange: 01/02:03:13 to 01/02:04:11

Plot file version 378 created 26-JUL-2013 10:25:13

J1157 EZ024 1.UVDATA.1

Freq = 22.1720 GHz, Bw = 16.000 MH Calibrated with CL # 3 and BP # 1 (BP mode 1)

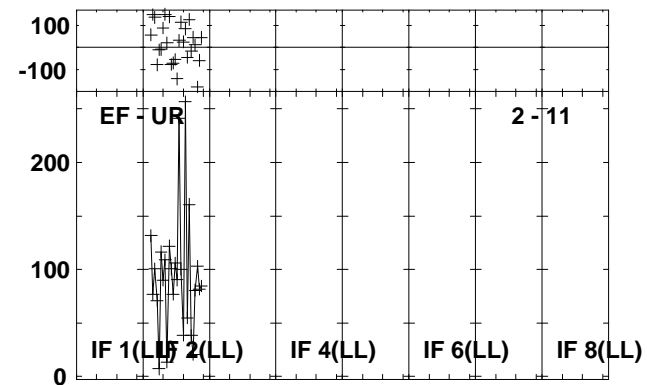
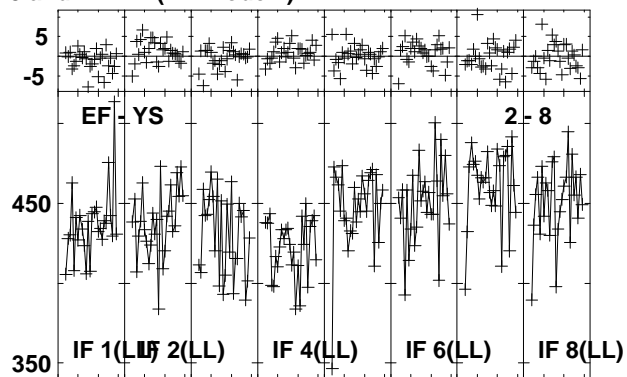
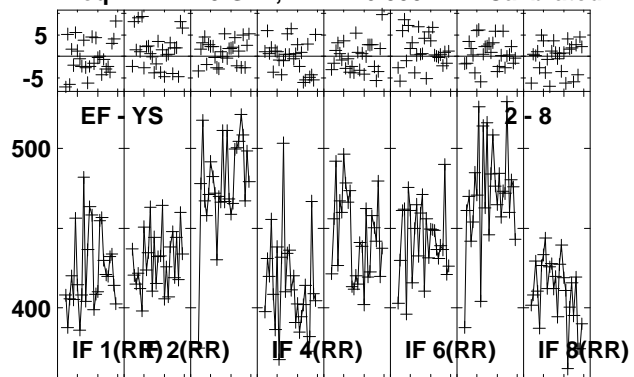

Lower frame: Milli Ampl Jy Top frame: Phas deg
Vector averaged cross-power spectrum Several baselines displayed
Timerange: 01/02:03:13 to 01/02:04:11

Plot file version 379 created 26-JUL-2013 10:25:14
 B1152+199A EZ024 1.UVDATA.1
 Freq = 22.1720 GHz, Bw = 16.000 MH Calibrated with CL # 3 and BP # 1 (BP mode 1)

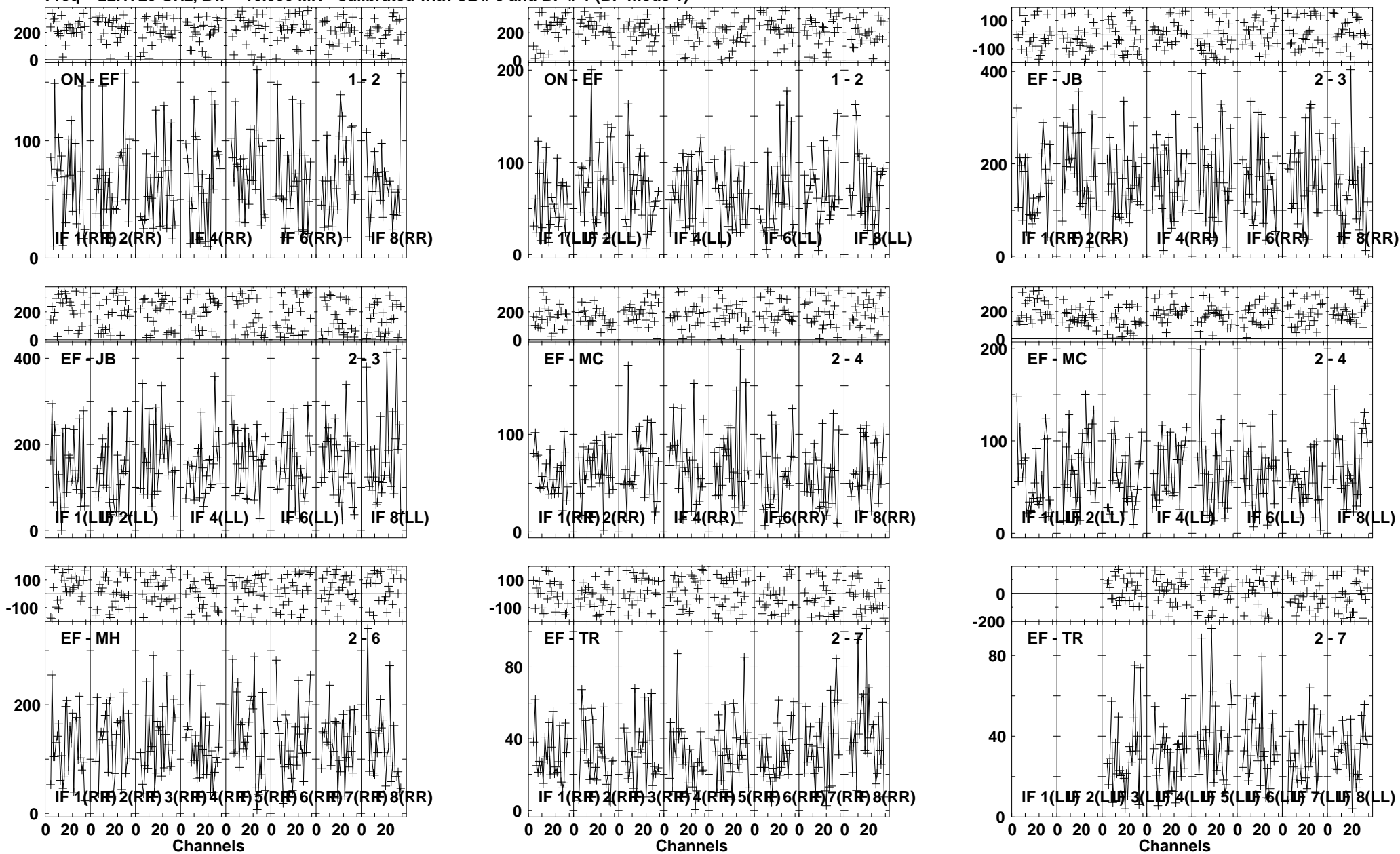

Lower frame: Milli Ampl Jy Top frame: Phas deg
 Vector averaged cross-power spectrum Several baselines displayed
 Timerange: 01/02:04:46 to 01/02:06:44

Plot file version 380 created 26-JUL-2013 10:25:15

B1152+199A EZ024 1.UVDATA.1

Freq = 22.1720 GHz, Bw = 16.000 MH Calibrated with CL # 3 and BP # 1 (BP mode 1)

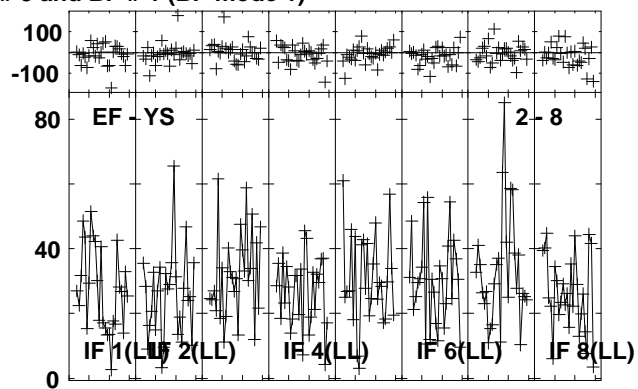
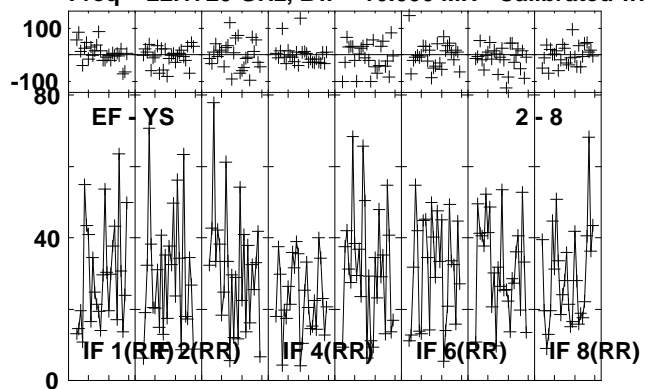

Lower frame: Milli Ampl Jy Top frame: Phas deg
Vector averaged cross-power spectrum Several baselines displayed
Timerange: 01/02:04:46 to 01/02:06:44

Plot file version 381 created 26-JUL-2013 10:25:17

J1157 EZ024 1.UVDATA.1

Freq = 22.1720 GHz, Bw = 16.000 MH Calibrated with CL # 3 and BP # 1 (BP mode 1)

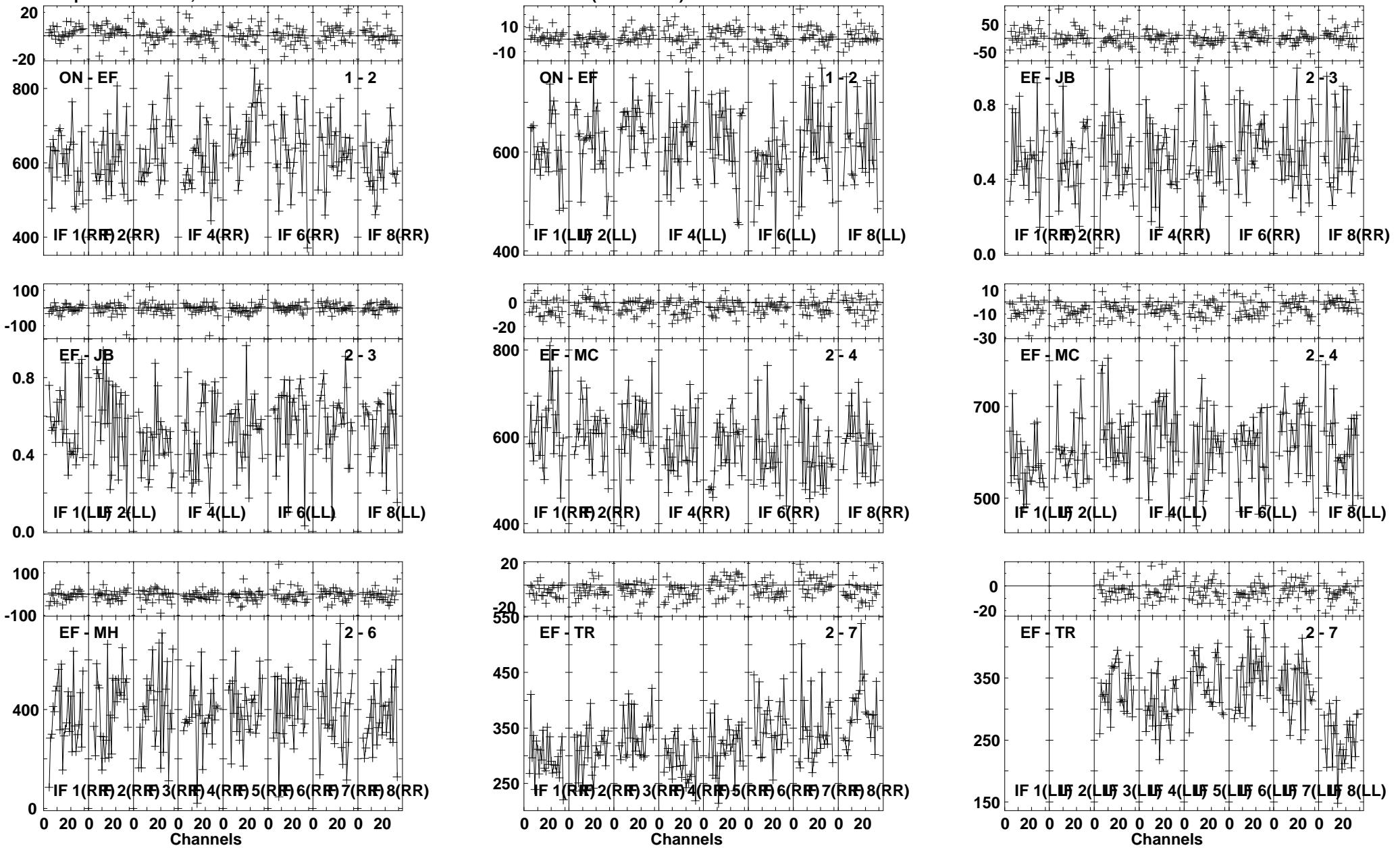

Plot file version 382 created 26-JUL-2013 10:25:18

J1157 EZ024 1.UVDATA.1

Freq = 22.1720 GHz, Bw = 16.000 MH Calibrated with CL # 3 and BP # 1 (BP mode 1)

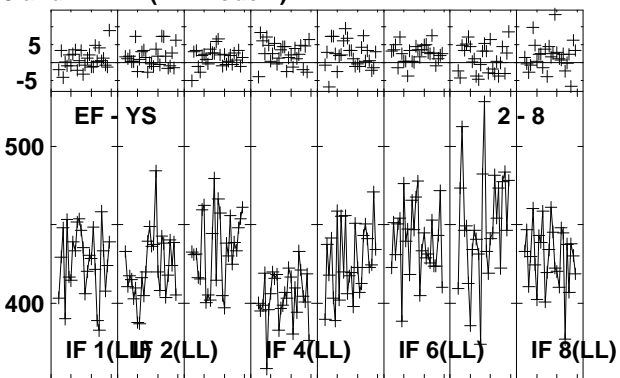
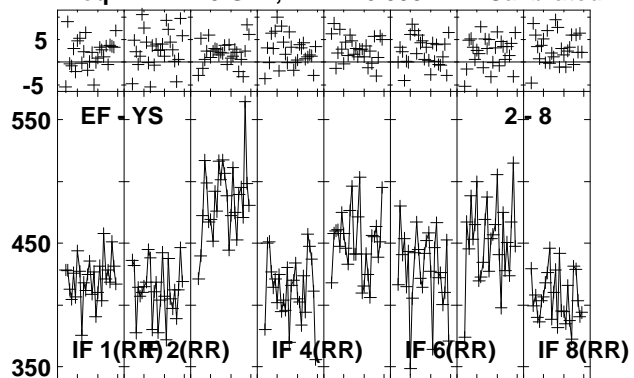

Lower frame: Milli Ampl Jy Top frame: Phas deg
Vector averaged cross-power spectrum Several baselines displayed
Timerange: 01/02:07:19 to 01/02:08:17

Plot file version 383 created 26-JUL-2013 10:25:19
 J1125+2610 EZ024 1.UVDATA.1
 Freq = 22.1720 GHz, Bw = 16.000 MH Calibrated with CL # 3 and BP # 1 (BP mode 1)

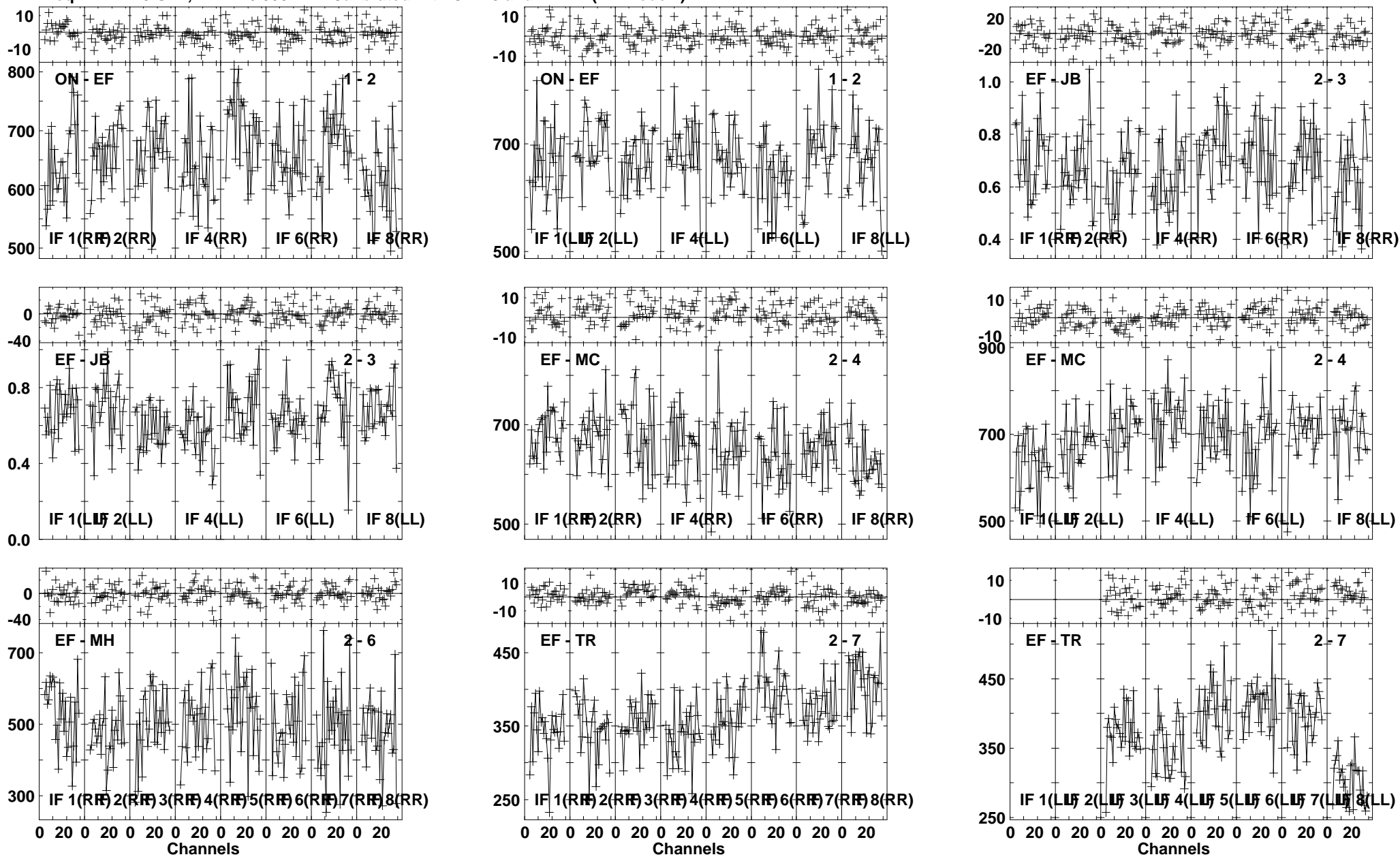

Lower frame: Milli Ampl Jy Top frame: Phas deg
 Vector averaged cross-power spectrum Several baselines displayed
 Timerange: 01/02:09:51 to 01/02:11:33

Plot file version 384 created 26-JUL-2013 10:25:20
 J1125+2610 EZ024 1.UVDATA.1
 Freq = 22.1720 GHz, Bw = 16.000 MH Calibrated with CL # 3 and BP # 1 (BP mode 1)

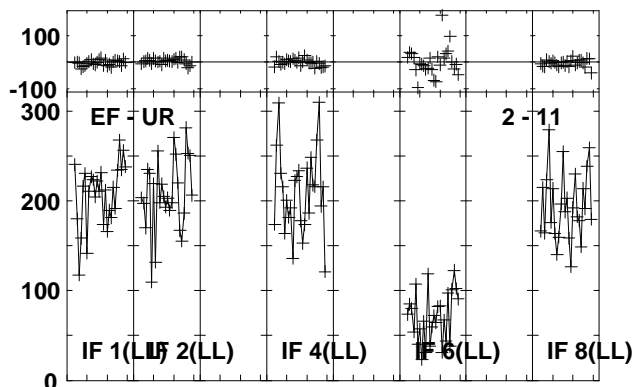
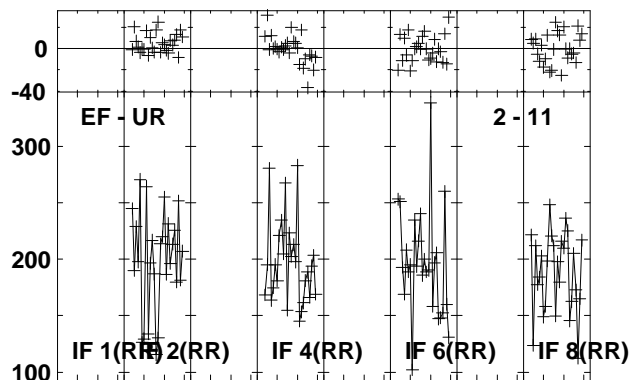
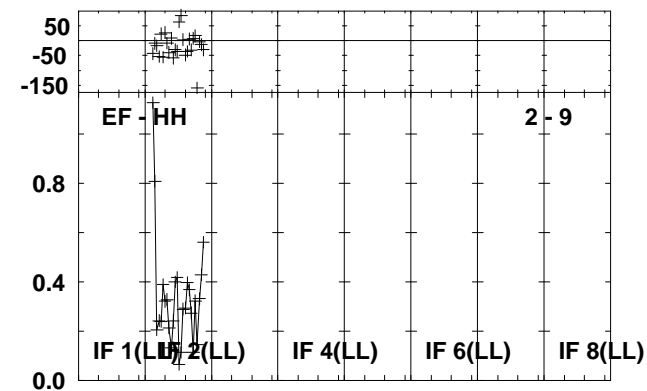
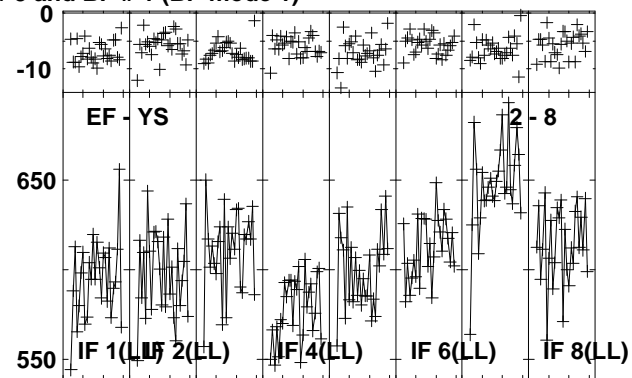
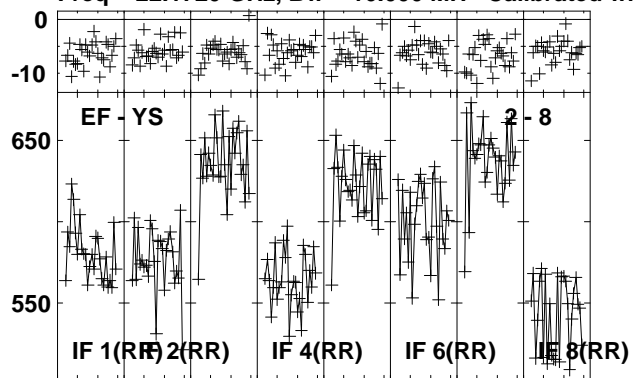

Lower frame: Milli Ampl Jy Top frame: Phas deg
 Vector averaged cross-power spectrum Several baselines displayed
 Timerange: 01/02:09:51 to 01/02:11:33

Plot file version 385 created 26-JUL-2013 10:25:21
 J1157 EZ204 1.UVDATA.1
 Freq = 22.1720 GHz, Bw = 16.000 MH Calibrated with CL # 3 and BP # 1 (BP mode 1)

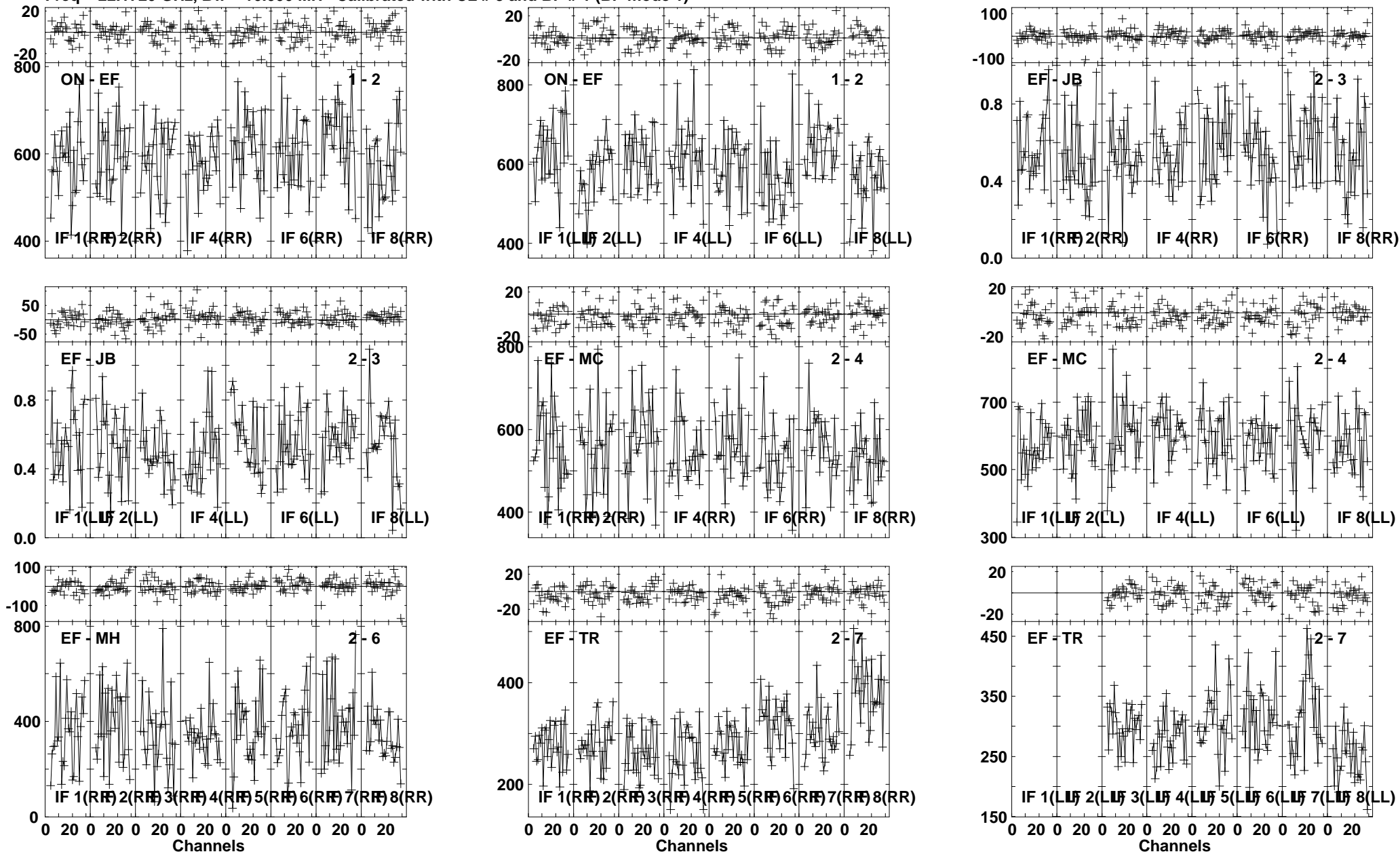

Lower frame: Milli Ampl Jy Top frame: Phas deg
 Vector averaged cross-power spectrum Several baselines displayed
 Timerange: 01/02:13:06 to 01/02:13:48

Plot file version 386 created 26-JUL-2013 10:25:22

J1157 EZ024 1.UVDATA.1

Freq = 22.1720 GHz, Bw = 16.000 MH Calibrated with CL # 3 and BP # 1 (BP mode 1)

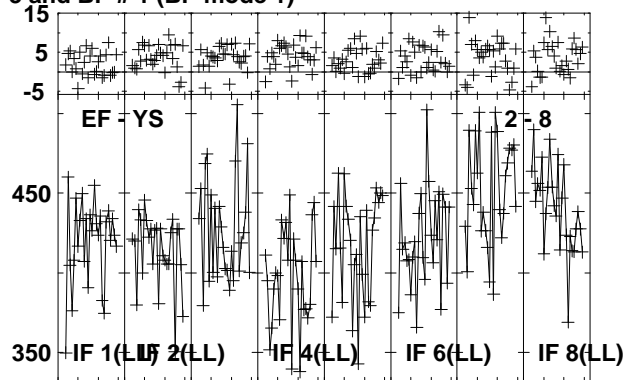
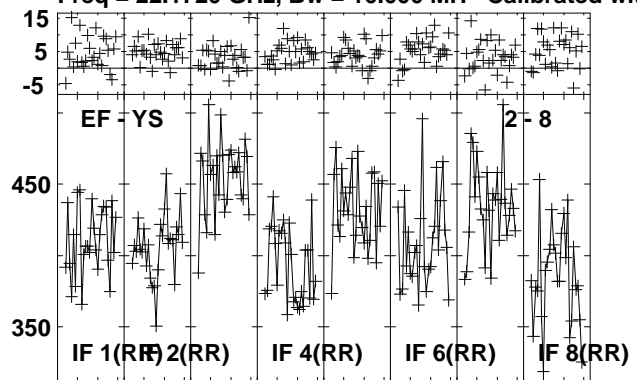

Lower frame: Milli Ampl Jy Top frame: Phas deg
Vector averaged cross-power spectrum Several baselines displayed
Timerange: 01/02:13:06 to 01/02:13:48

Plot file version 387 created 26-JUL-2013 10:25:23
 B1152+199A EZ024 1.UVDATA.1
 Freq = 22.1720 GHz, Bw = 16.000 MH Calibrated with CL # 3 and BP # 1 (BP mode 1)

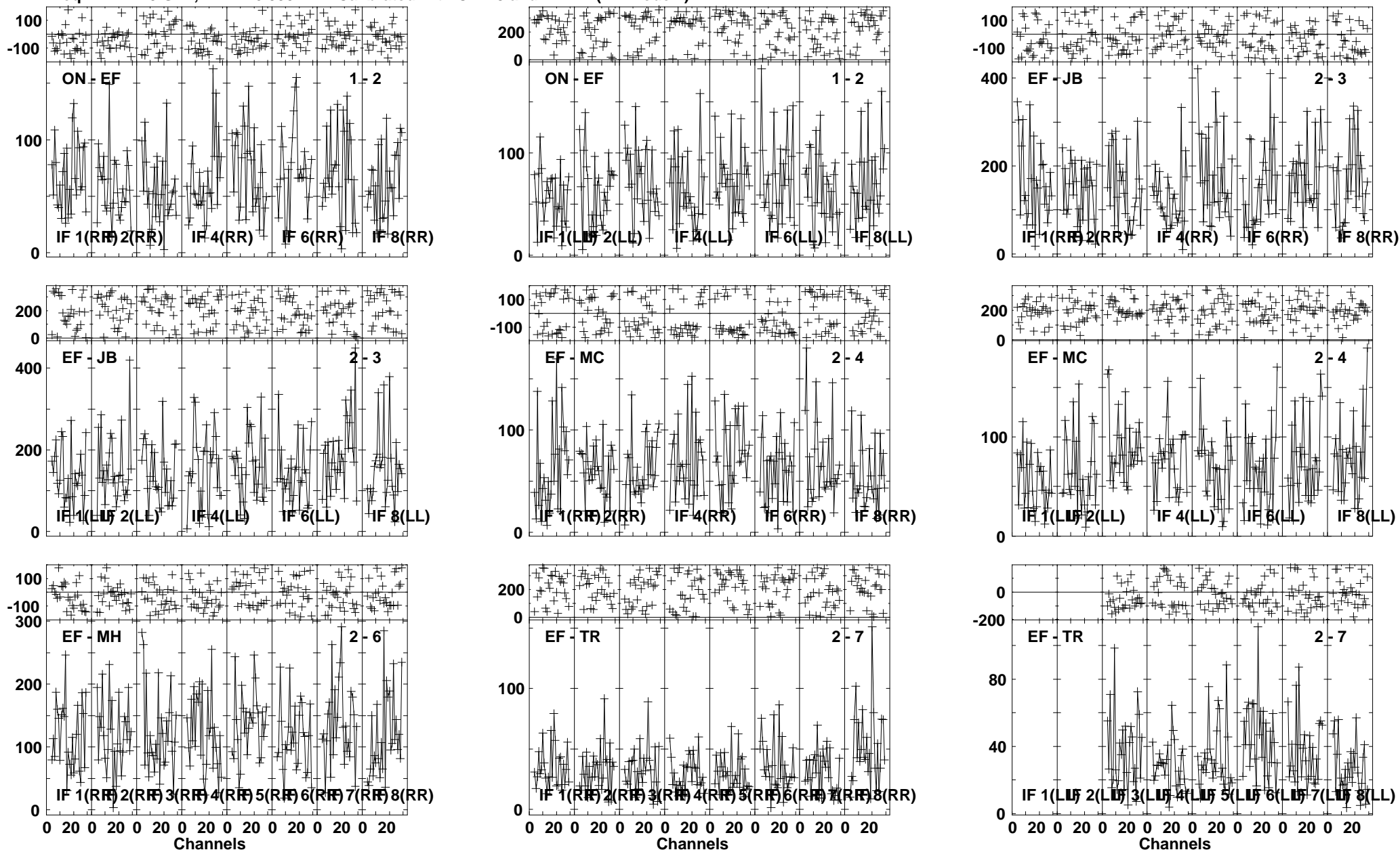

Lower frame: Milli Ampl Jy Top frame: Phas deg
 Vector averaged cross-power spectrum Several baselines displayed
 Timerange: 01/02:14:24 to 01/02:16:22

Plot file version 388 created 26-JUL-2013 10:25:24

B1152+199A EZ024 1.UVDATA.1

Freq = 22.1720 GHz, Bw = 16.000 MH Calibrated with CL # 3 and BP # 1 (BP mode 1)

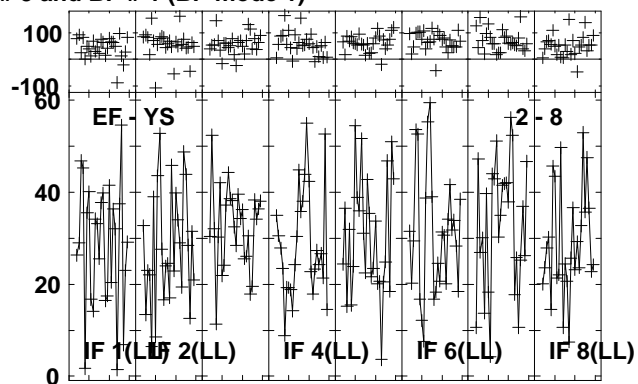
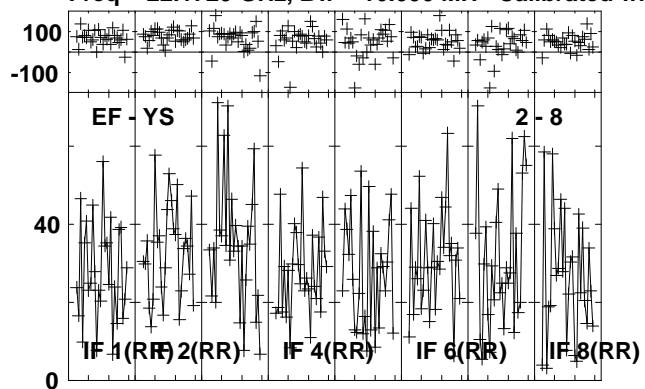

Lower frame: Milli Ampl Jy Top frame: Phas deg
Vector averaged cross-power spectrum Several baselines displayed
Timerange: 01/02:14:24 to 01/02:16:22

Plot file version 389 created 26-JUL-2013 10:25:26
 J1157 EZ024 1.UVDATA.1
 Freq = 22.1720 GHz, Bw = 16.000 MH Calibrated with CL # 3 and BP # 1 (BP mode 1)

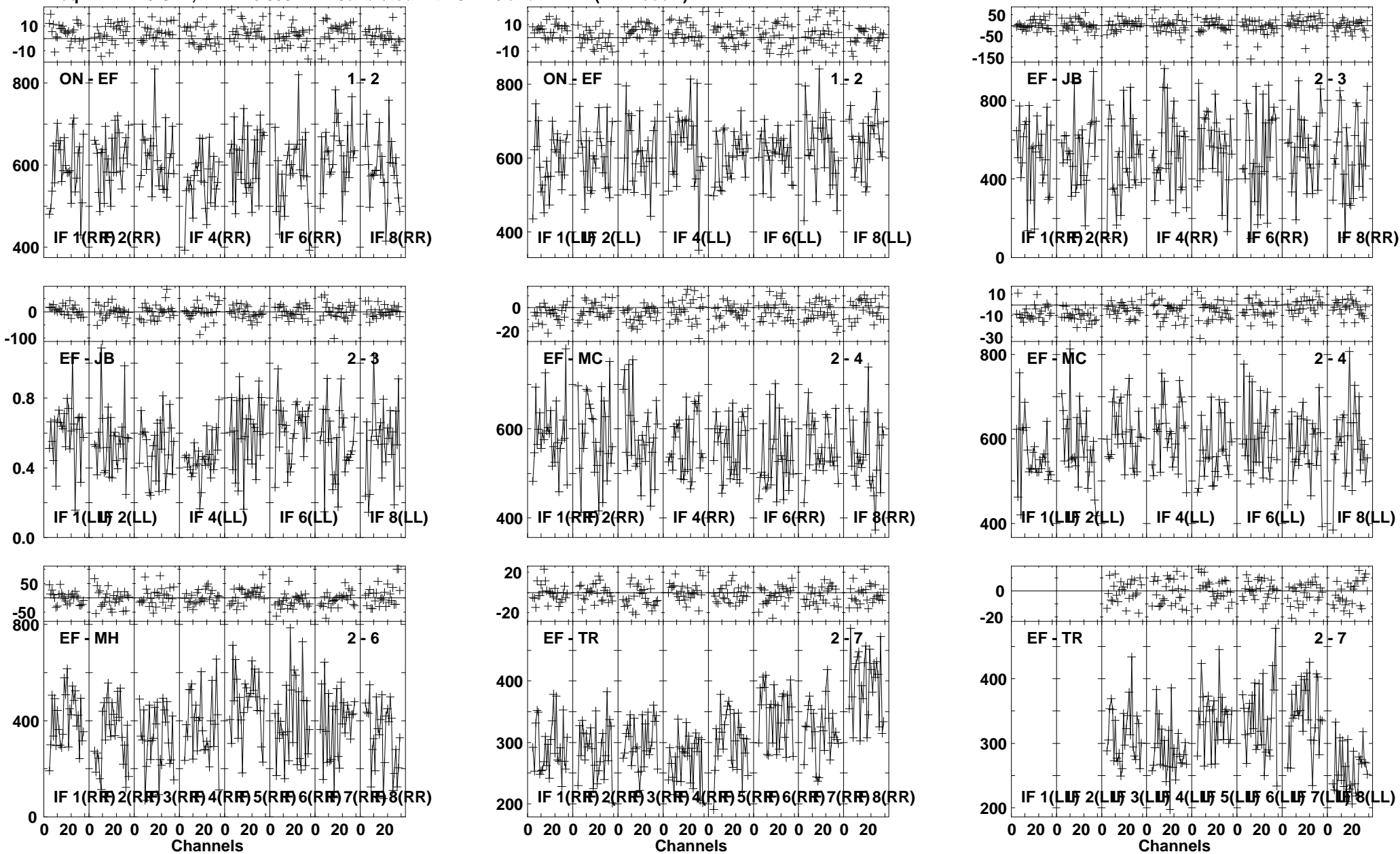

Lower frame: Milli Ampl Jy Top frame: Phas deg
 Vector averaged cross-power spectrum Several baselines displayed
 Timerange: 01/02:16:57 to 01/02:17:55

Plot file version 390 created 26-JUL-2013 10:25:26

J1157 EZ024 1.UVDATA.1

Freq = 22.1720 GHz, Bw = 16.000 MH Calibrated with CL # 3 and BP # 1 (BP mode 1)

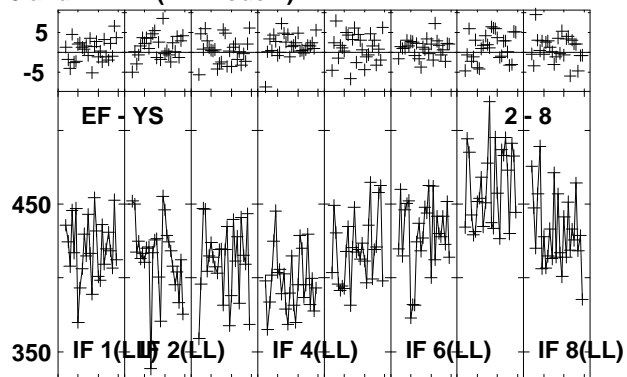
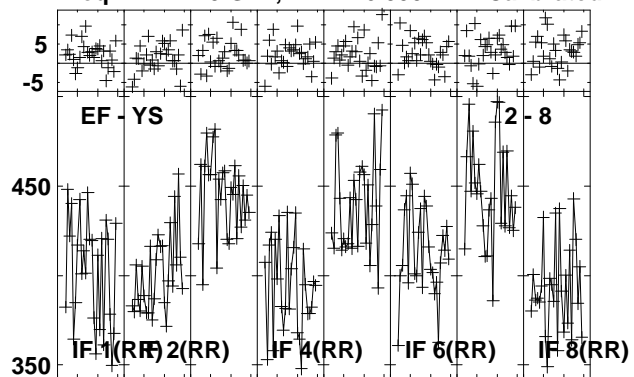

Lower frame: Milli Ampl Jy Top frame: Phas deg
Vector averaged cross-power spectrum Several baselines displayed
Timerange: 01/02:16:57 to 01/02:17:55

Plot file version 391 created 26-JUL-2013 10:25:27
 B1152+199A EZ024 1.UVDATA.1
 Freq = 22.1720 GHz, Bw = 16.000 MH Calibrated with CL # 3 and BP # 1 (BP mode 1)

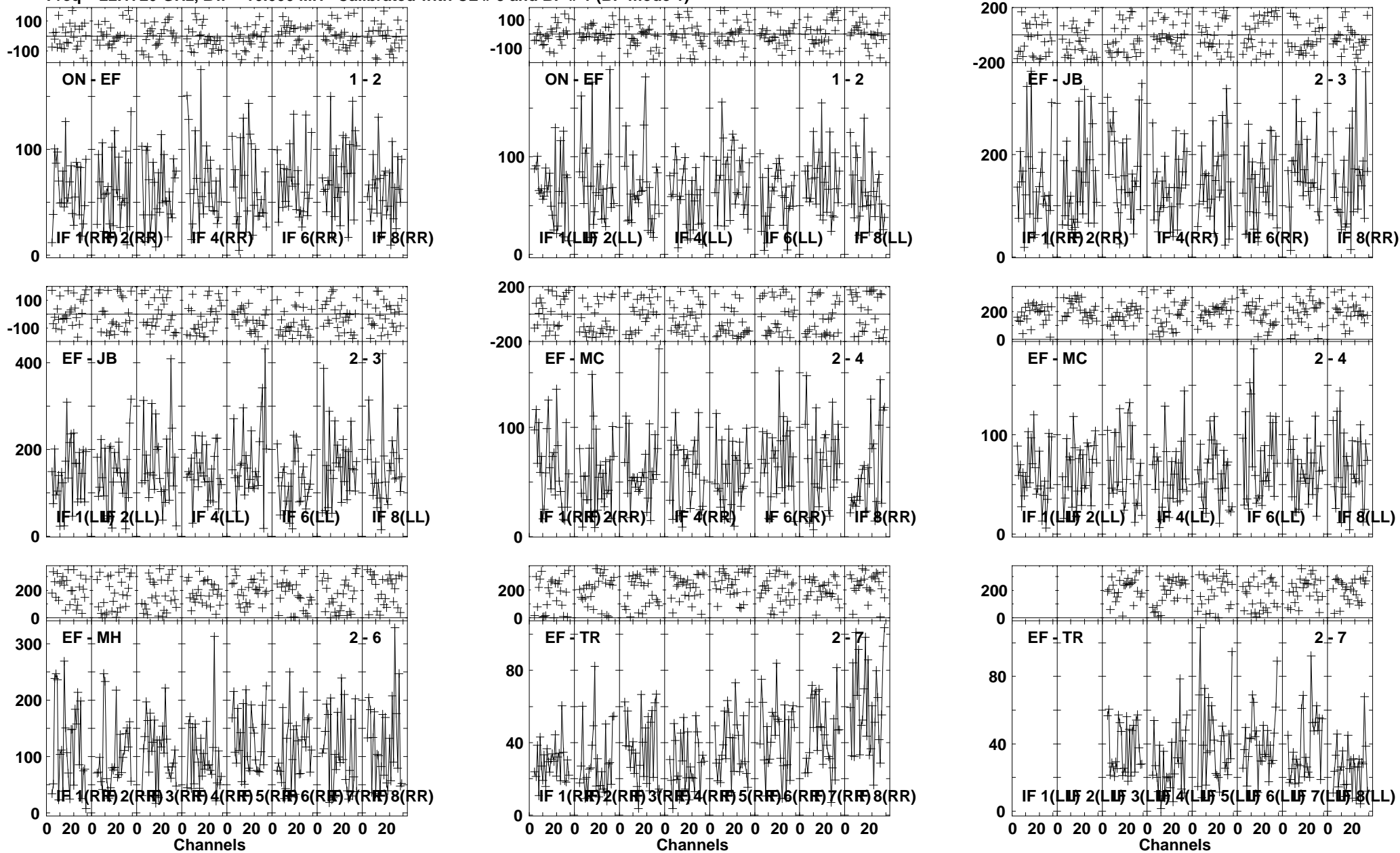

Lower frame: Milli Ampl Jy Top frame: Phas deg
 Vector averaged cross-power spectrum Several baselines displayed
 Timerange: 01/02:18:30 to 01/02:20:28

Plot file version 392 created 26-JUL-2013 10:25:29

B1152+199A EZ204 1.UVDATA.1

Freq = 22.1720 GHz, Bw = 16.000 MH Calibrated with CL # 3 and BP # 1 (BP mode 1)

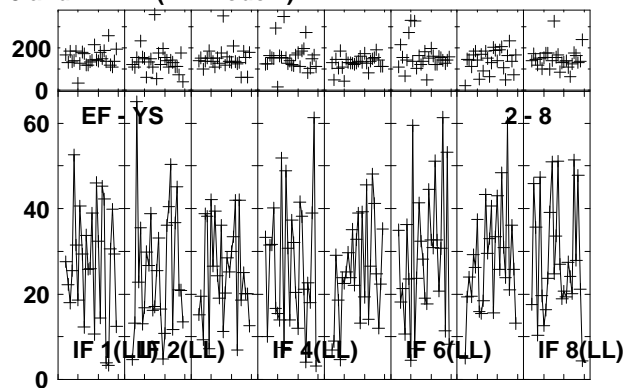
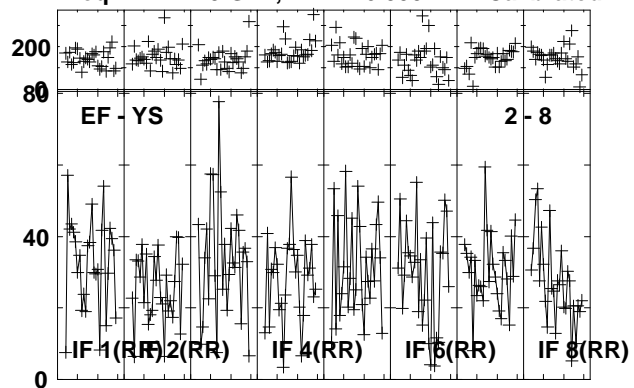

Lower frame: Milli Ampl Jy Top frame: Phas deg
Vector averaged cross-power spectrum Several baselines displayed
Timerange: 01/02:18:30 to 01/02:20:28

Plot file version 393 created 26-JUL-2013 10:25:30
 J1157 EZ024 1.UVDATA.1
 Freq = 22.1720 GHz, Bw = 16.000 MH Calibrated with CL # 3 and BP # 1 (BP mode 1)

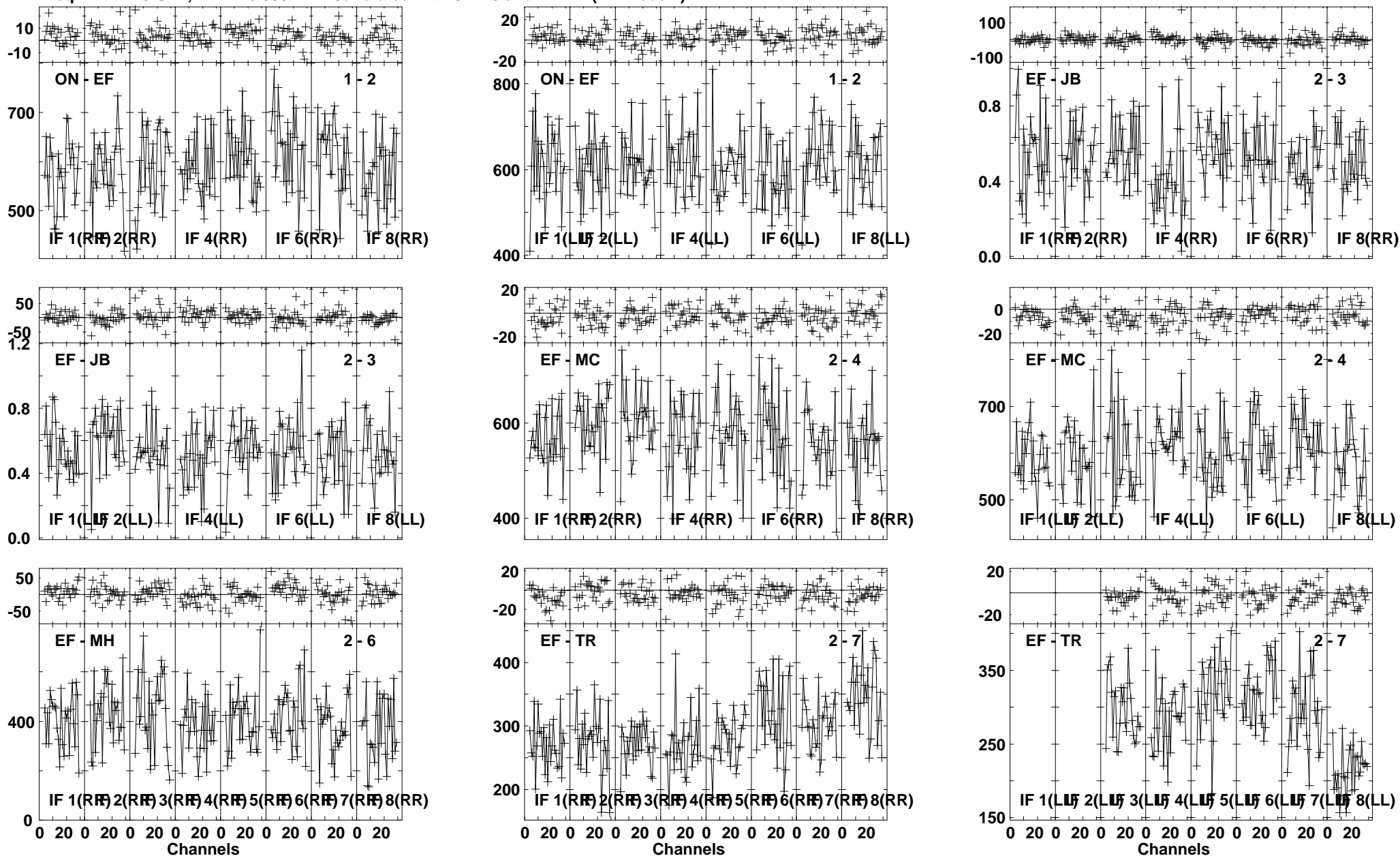

Lower frame: Milli Ampl Jy Top frame: Phas deg
 Vector averaged cross-power spectrum Several baselines displayed
 Timerange: 01/02:21:03 to 01/02:22:01

Plot file version 394 created 26-JUL-2013 10:25:31

J1157 EZ024 1.UVDATA.1

Freq = 22.1720 GHz, Bw = 16.000 MH Calibrated with CL # 3 and BP # 1 (BP mode 1)

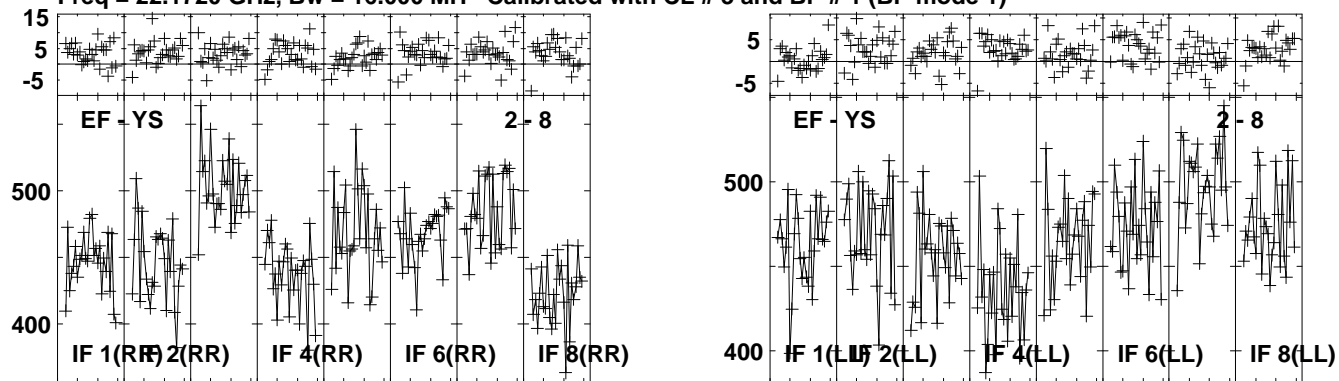

Lower frame: Milli Ampl Jy Top frame: Phas deg
Vector averaged cross-power spectrum Several baselines displayed
Timerange: 01/02:21:03 to 01/02:22:01

Plot file version 395 created 26-JUL-2013 10:25:32
 B1152+199A EZ024 1.UVDATA.1
 Freq = 22.1720 GHz, Bw = 16.000 MH Calibrated with CL # 3 and BP # 1 (BP mode 1)

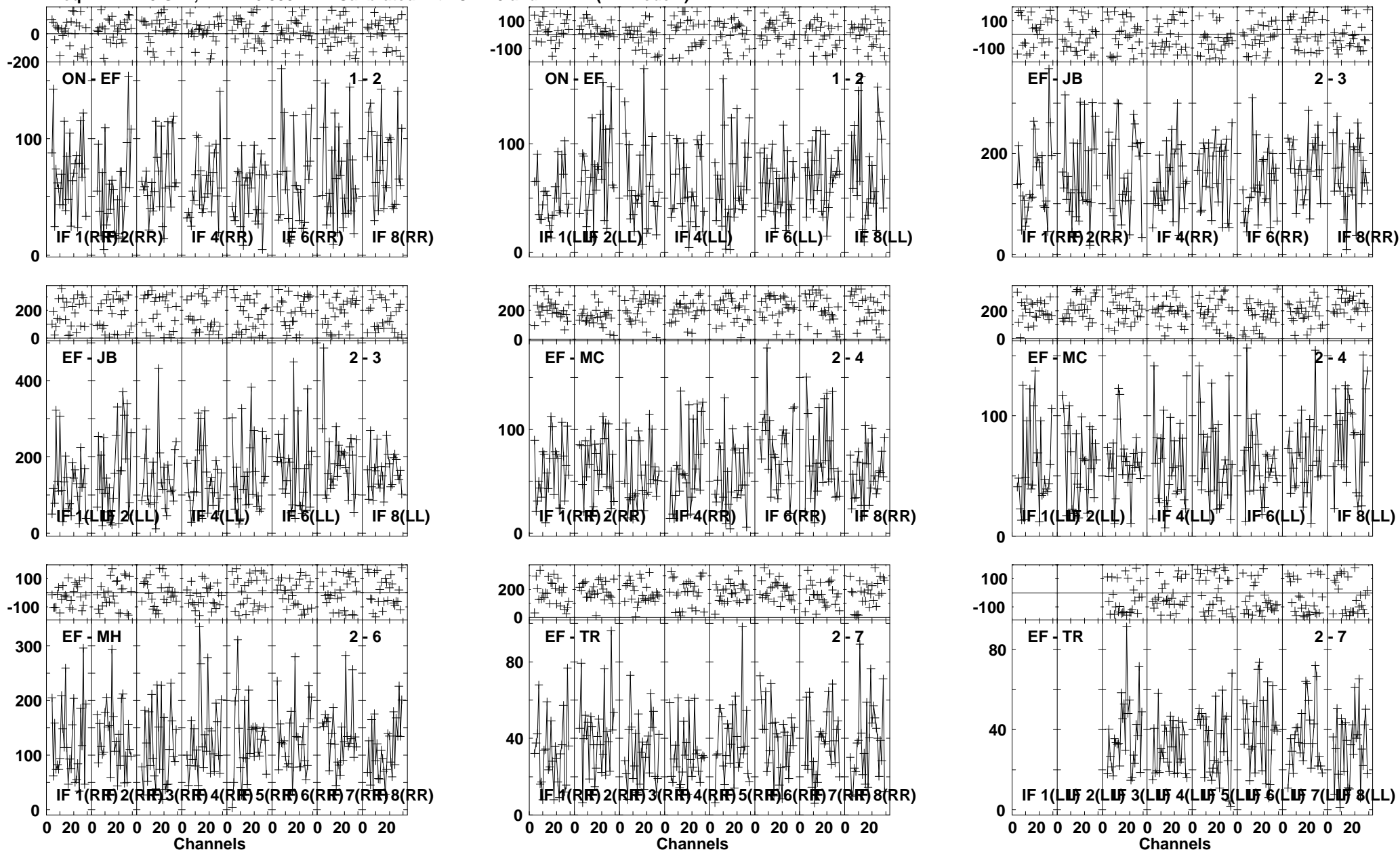

Lower frame: Milli Ampl Jy Top frame: Phas deg
 Vector averaged cross-power spectrum Several baselines displayed
 Timerange: 01/02:22:36 to 01/02:24:34

Plot file version 396 created 26-JUL-2013 10:25:33

B1152+199A EZ024 1.UVDATA.1

Freq = 22.1720 GHz, Bw = 16.000 MH Calibrated with CL # 3 and BP # 1 (BP mode 1)

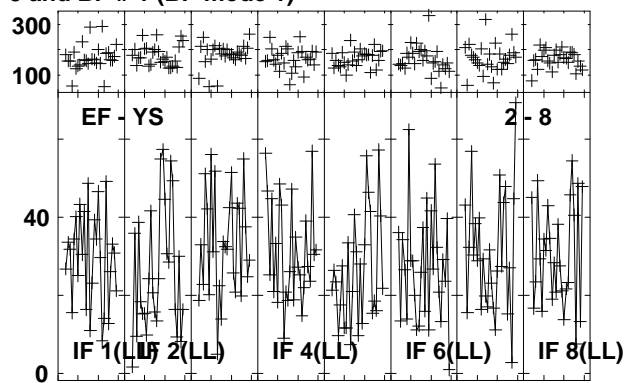
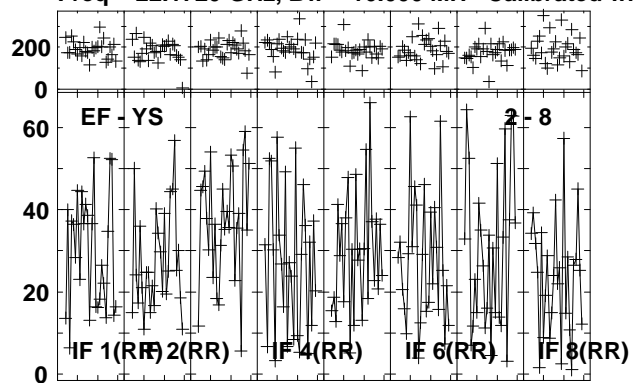

Lower frame: Milli Ampl Jy Top frame: Phas deg
Vector averaged cross-power spectrum Several baselines displayed
Timerange: 01/02:22:36 to 01/02:24:34

Plot file version 397 created 26-JUL-2013 10:25:35
 J1157 EZ2024 1.UVDATA.1
 Freq = 22.1720 GHz, Bw = 16.000 MH Calibrated with CL # 3 and BP # 1 (BP mode 1)

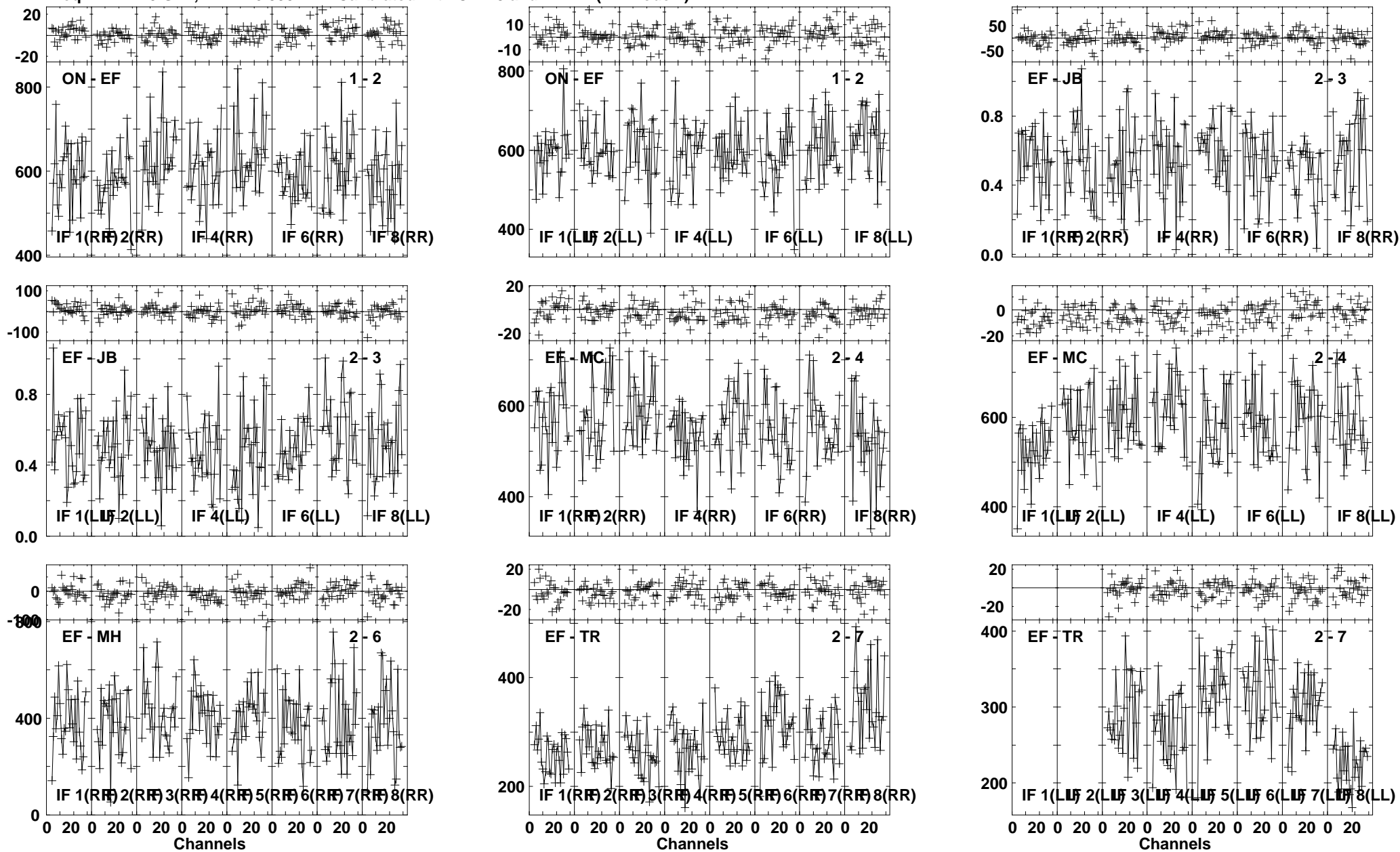

Lower frame: Milli Ampl Jy Top frame: Phas deg
 Vector averaged cross-power spectrum Several baselines displayed
 Timerange: 01/02:25:09 to 01/02:26:07

Plot file version 398 created 26-JUL-2013 10:25:35

J1157 EZ024 1.UVDATA.1

Freq = 22.1720 GHz, Bw = 16.000 MH Calibrated with CL # 3 and BP # 1 (BP mode 1)

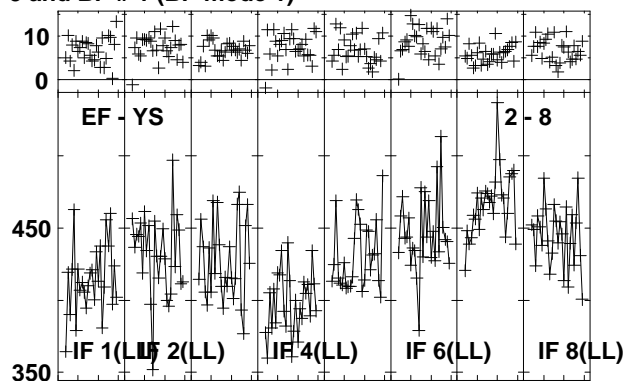
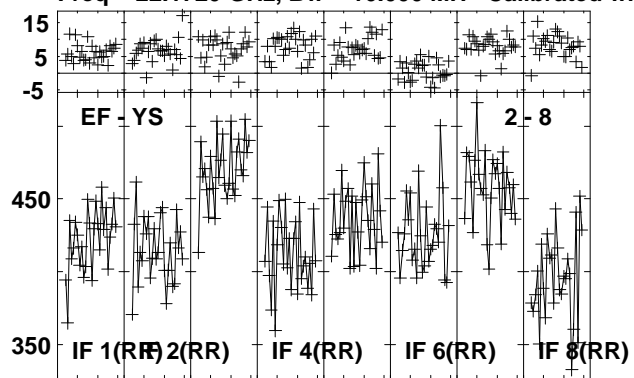

Lower frame: Milli Ampl Jy Top frame: Phas deg
Vector averaged cross-power spectrum Several baselines displayed
Timerange: 01/02:25:09 to 01/02:26:07

Plot file version 399 created 26-JUL-2013 10:25:36
 J1125+2610 EZ024 1.UVDATA.1
 Freq = 22.1720 GHz, Bw = 16.000 MH Calibrated with CL # 3 and BP # 1 (BP mode 1)

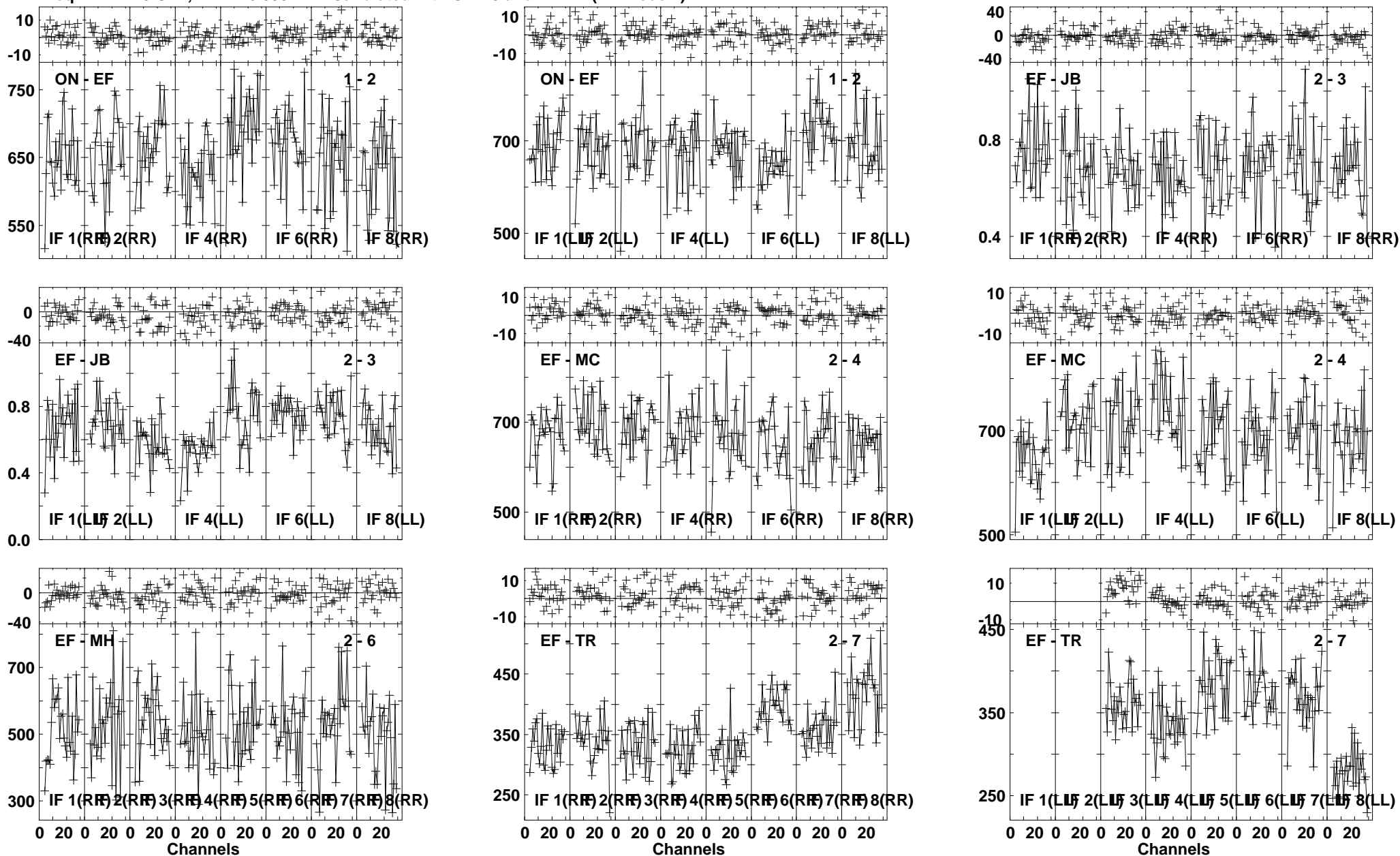

Lower frame: Milli Ampl Jy Top frame: Phas deg
 Vector averaged cross-power spectrum Several baselines displayed
 Timerange: 01/02:27:41 to 01/02:29:23

Plot file version 400 created 26-JUL-2013 10:25:37

J1125+2610 EZ024 1.UVDATA.1

Freq = 22.1720 GHz, Bw = 16.000 MH Calibrated with CL # 3 and BP # 1 (BP mode 1)

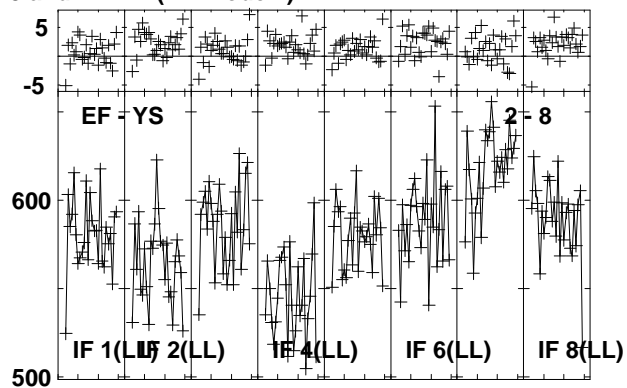
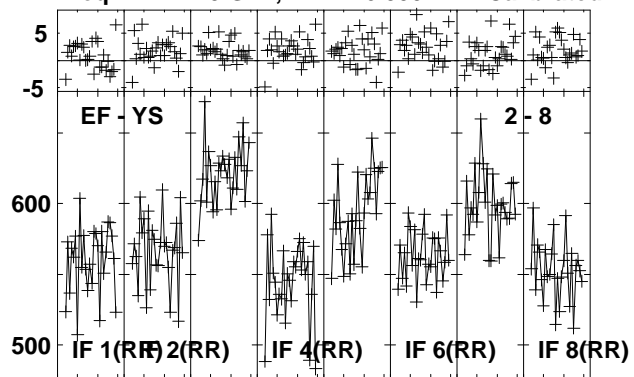

Lower frame: Milli Ampl Jy Top frame: Phas deg
Vector averaged cross-power spectrum Several baselines displayed
Timerange: 01/02:27:41 to 01/02:29:23

Plot file version 401 created 26-JUL-2013 10:25:38

J1157 EZ024 1.UVDATA.1

Freq = 22.1720 GHz, Bw = 16.000 MH Calibrated with CL # 3 and BP # 1 (BP mode 1)

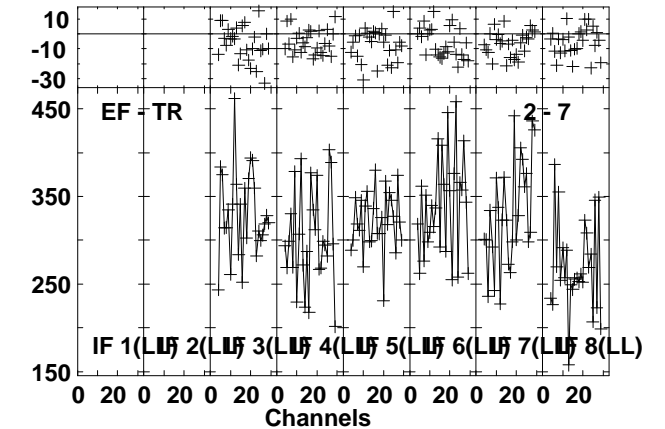
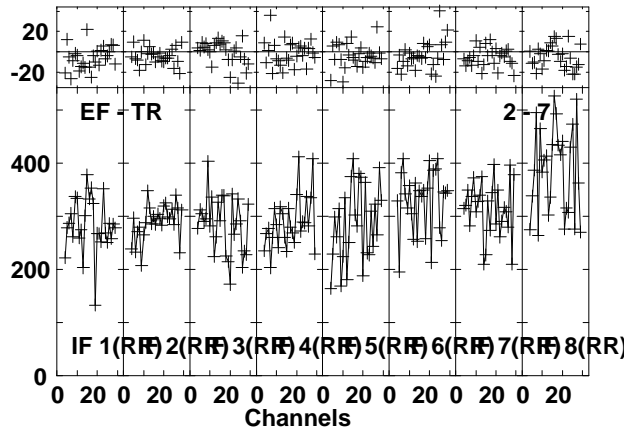
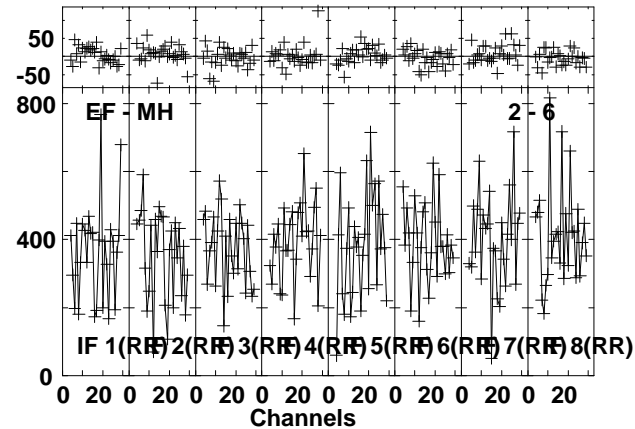
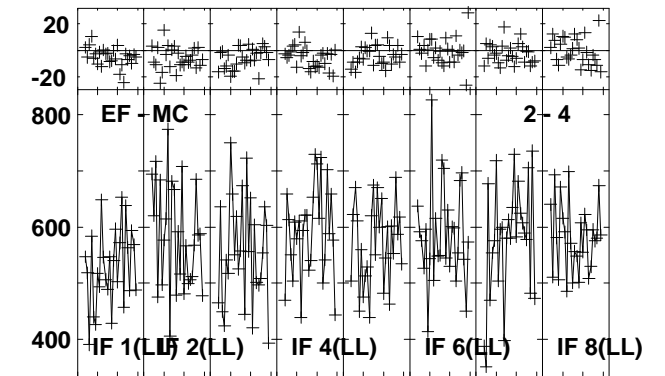
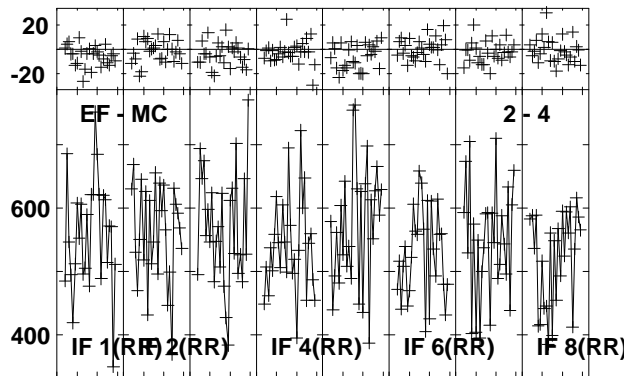
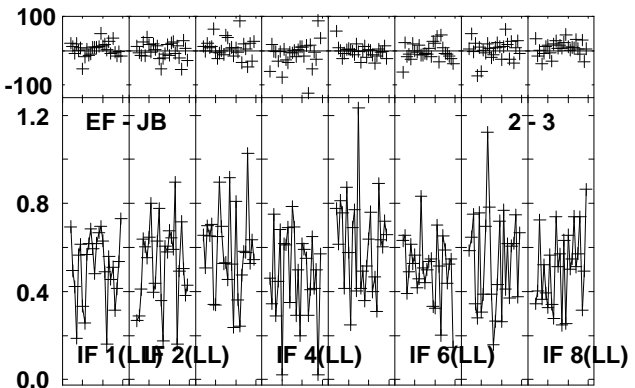
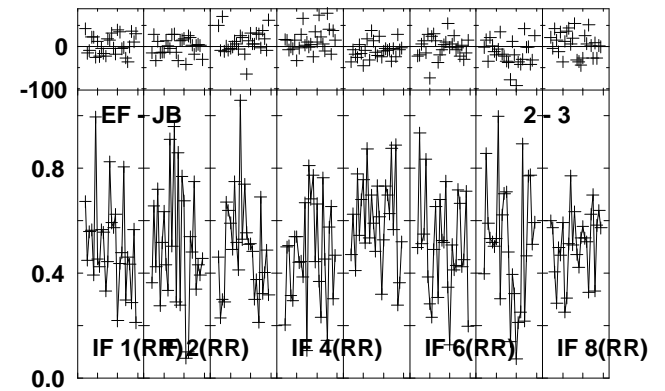
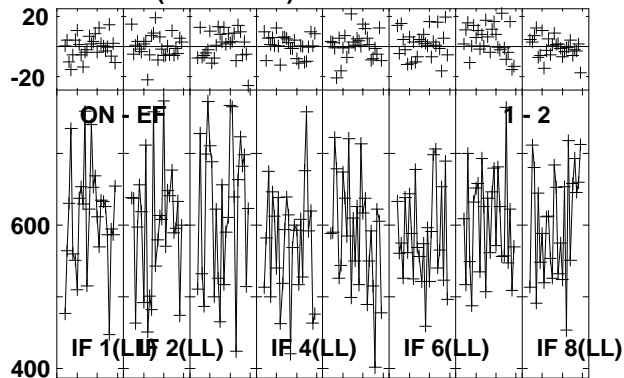
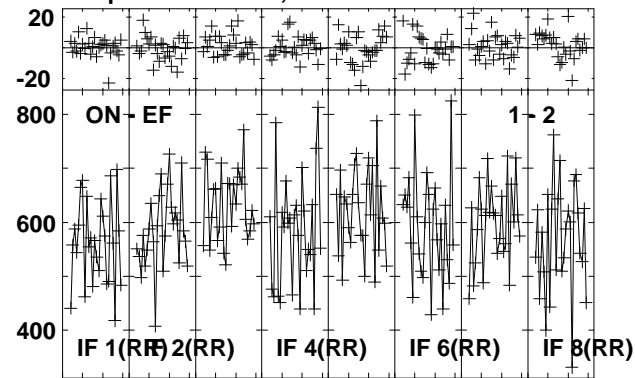

Lower frame: Milli Ampl Jy Top frame: Phas deg
Vector averaged cross-power spectrum Several baselines displayed
Timerange: 01/02:30:56 to 01/02:31:38

Plot file version 402 created 26-JUL-2013 10:25:39

J1157 EZ024 1.UVDATA.1

Freq = 22.1720 GHz, Bw = 16.000 MH Calibrated with CL # 3 and BP # 1 (BP mode 1)

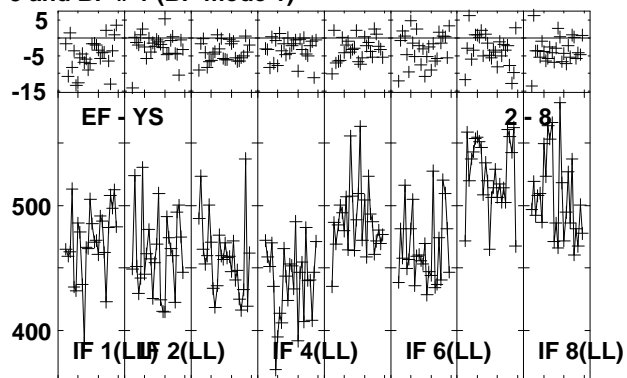
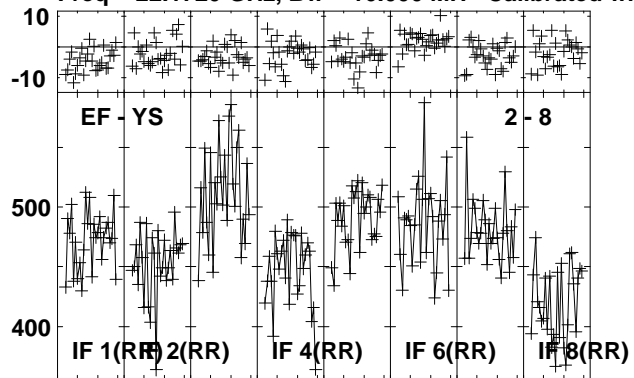

Lower frame: Milli Ampl Jy Top frame: Phas deg
Vector averaged cross-power spectrum Several baselines displayed
Timerange: 01/02:30:56 to 01/02:31:38

Plot file version 403 created 26-JUL-2013 10:25:40
 B1152+199A EZ024 1.UVDATA.1
 Freq = 22.1720 GHz, Bw = 16.000 MH Calibrated with CL # 3 and BP # 1 (BP mode 1)

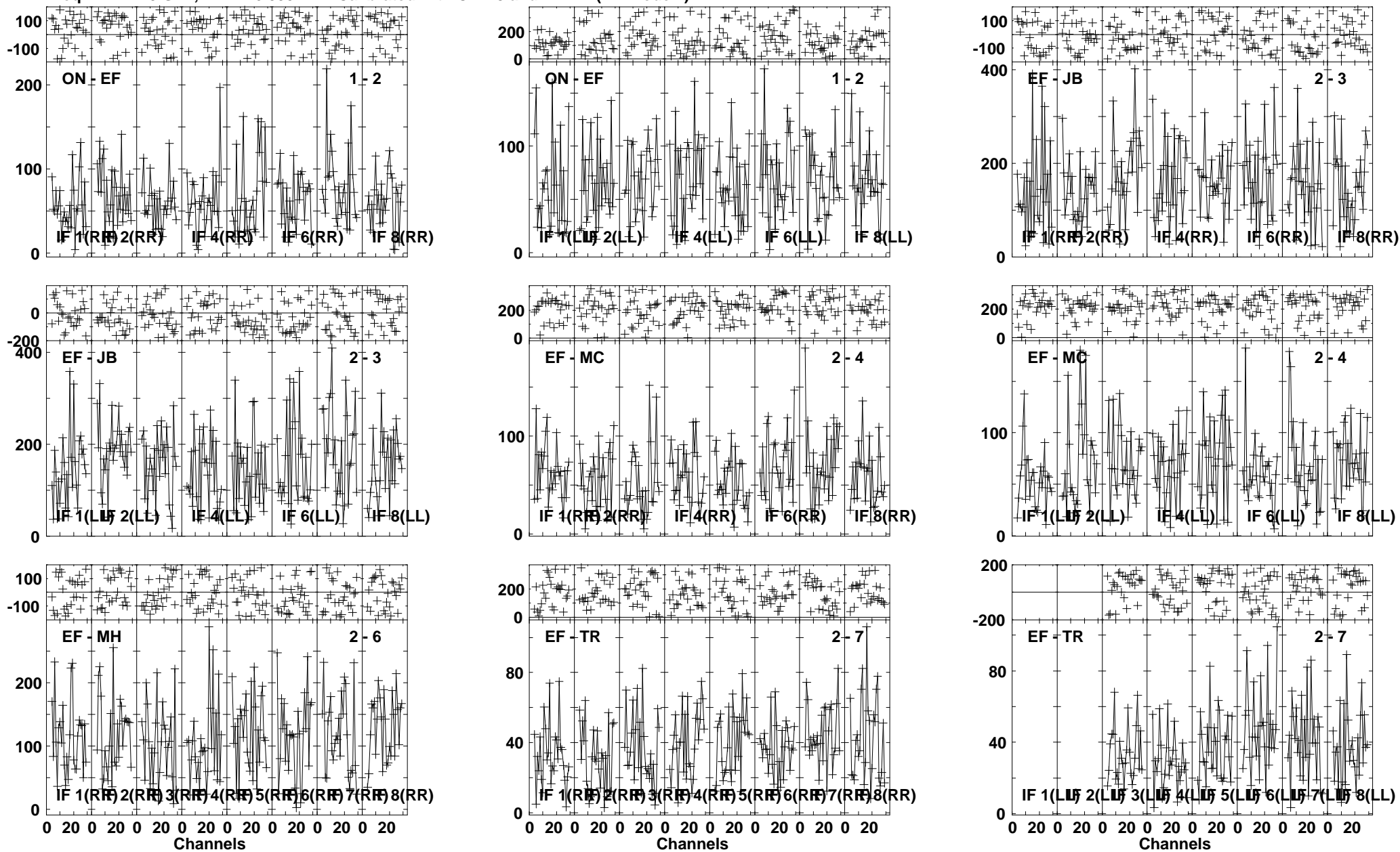

Lower frame: Milli Ampl Jy Top frame: Phas deg
 Vector averaged cross-power spectrum Several baselines displayed
 Timerange: 01/02:32:14 to 01/02:34:12

Plot file version 404 created 26-JUL-2013 10:25:41

B1152+199A EZ024 1.UVDATA.1

Freq = 22.1720 GHz, Bw = 16.000 MH Calibrated with CL # 3 and BP # 1 (BP mode 1)

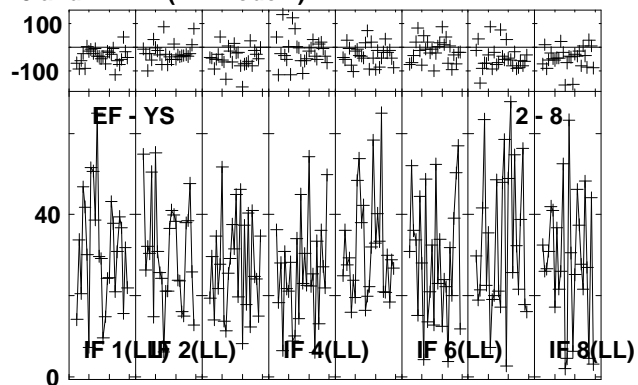
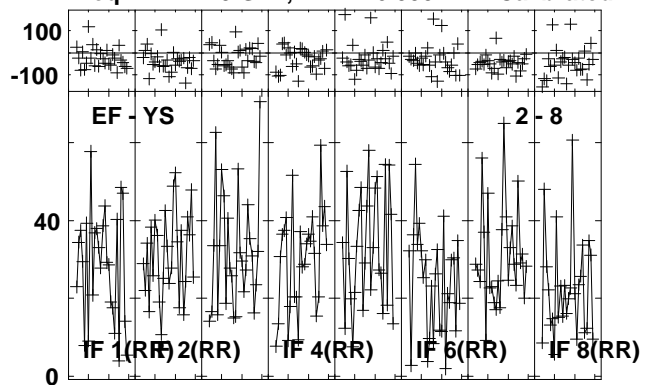

Lower frame: Milli Ampl Jy Top frame: Phas deg
Vector averaged cross-power spectrum Several baselines displayed
Timerange: 01/02:32:14 to 01/02:34:12

Plot file version 405 created 26-JUL-2013 10:25:42
 J1157 EZ2024 1.UVDATA.1
 Freq = 22.1720 GHz, Bw = 16.000 MH Calibrated with CL # 3 and BP # 1 (BP mode 1)

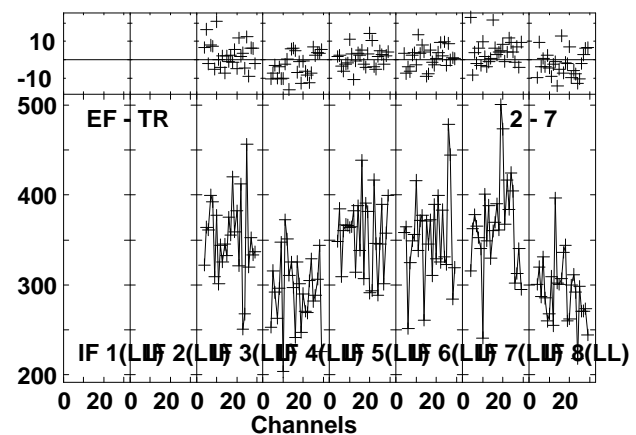
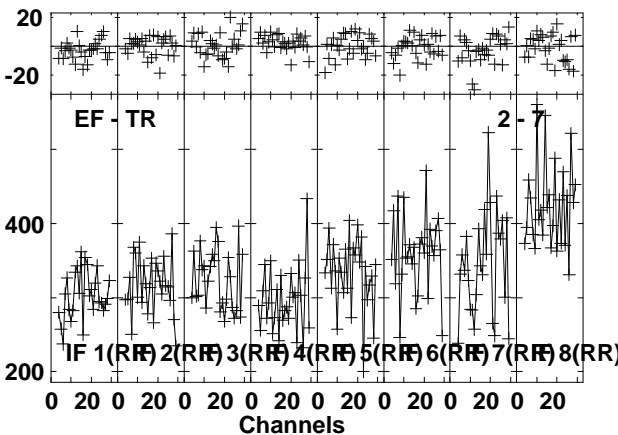
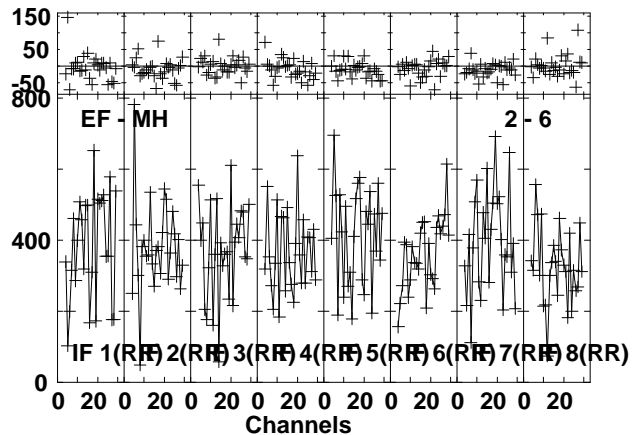
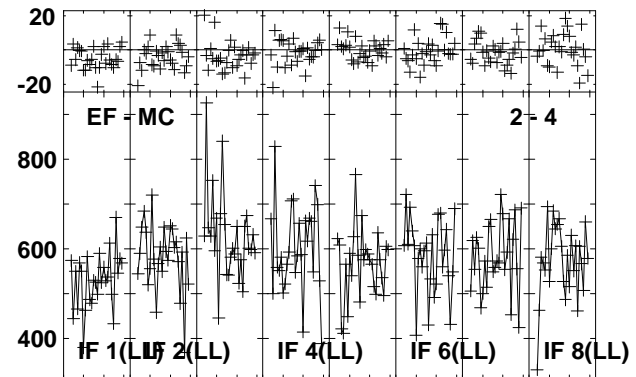
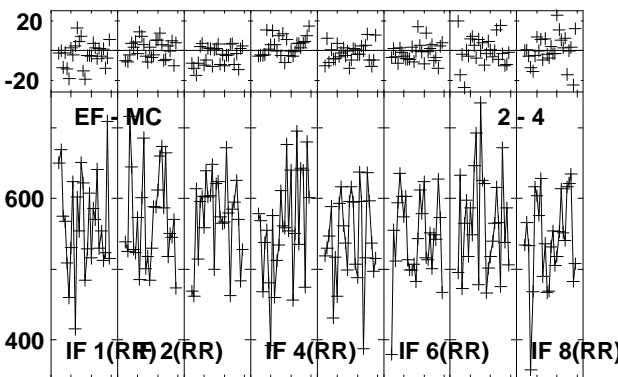
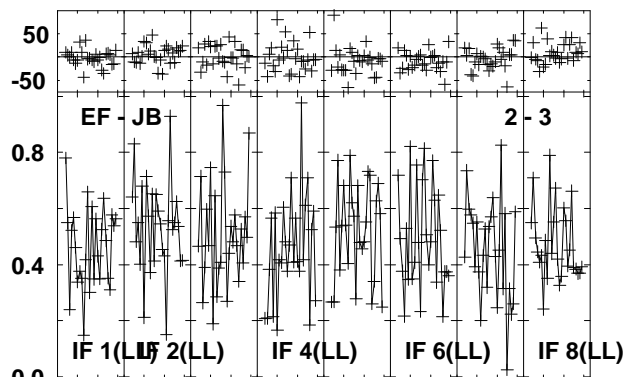
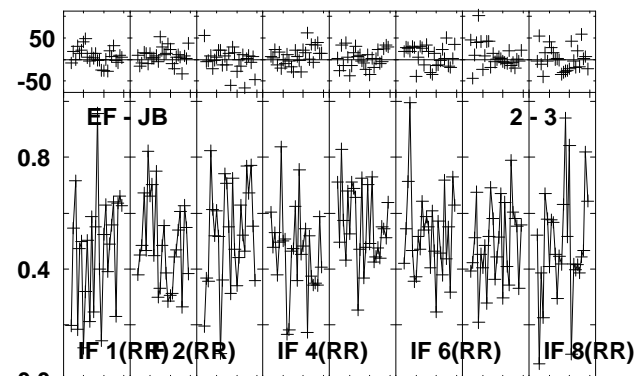
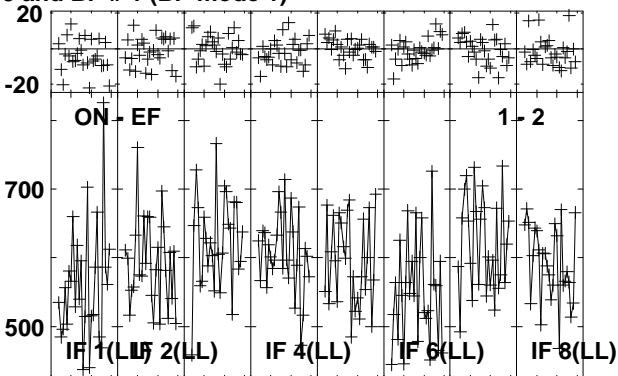
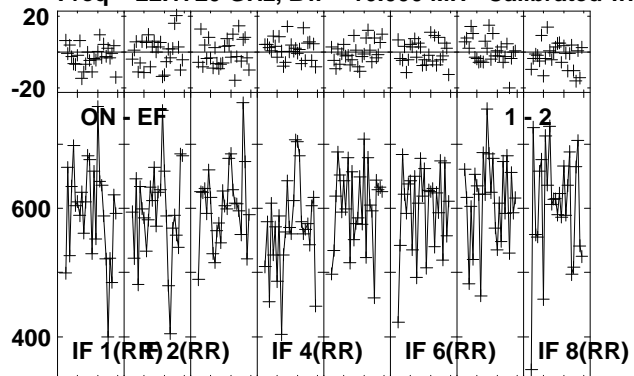

Lower frame: Milli Ampl Jy Top frame: Phas deg
 Vector averaged cross-power spectrum Several baselines displayed
 Timerange: 01/02:34:47 to 01/02:35:45

Plot file version 406 created 26-JUL-2013 10:25:43

J1157 EZ024 1.UVDATA.1

Freq = 22.1720 GHz, Bw = 16.000 MH Calibrated with CL # 3 and BP # 1 (BP mode 1)

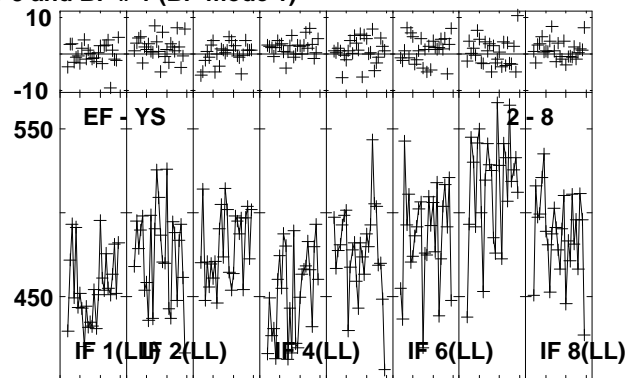
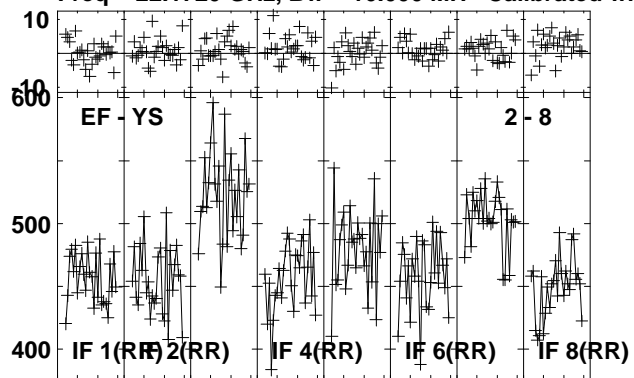

Lower frame: Milli Ampl Jy Top frame: Phas deg
Vector averaged cross-power spectrum Several baselines displayed
Timerange: 01/02:34:47 to 01/02:35:45

Plot file version 407 created 26-JUL-2013 10:25:44
 B1152+199A EZ024 1.UVDATA.1
 Freq = 22.1720 GHz, Bw = 16.000 MH Calibrated with CL # 3 and BP # 1 (BP mode 1)

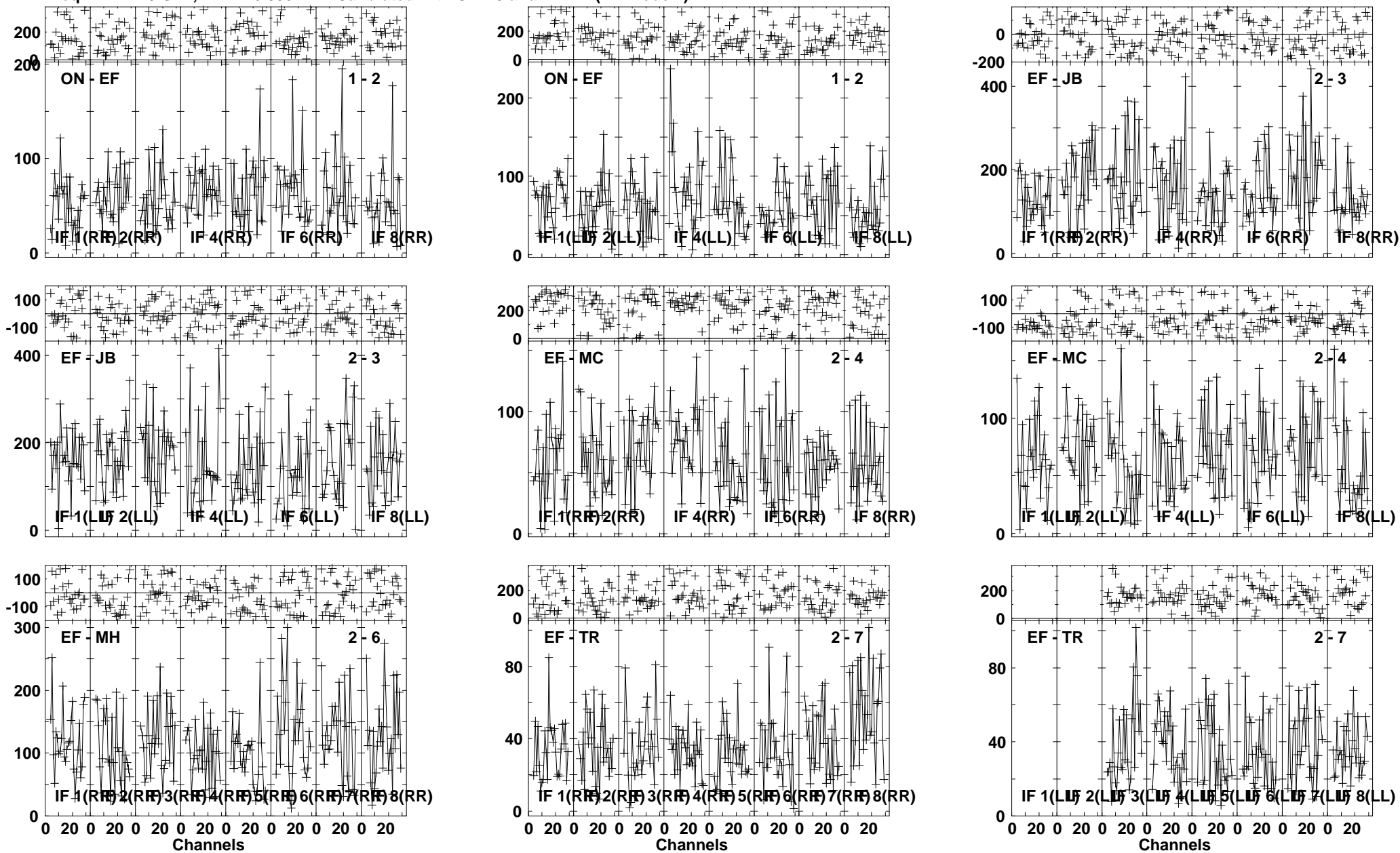

Lower frame: Milli Ampl Jy Top frame: Phas deg
 Vector averaged cross-power spectrum Several baselines displayed
 Timerange: 01/02:36:21 to 01/02:38:19

Plot file version 408 created 26-JUL-2013 10:25:45

B1152+199A EZ024 1.UVDATA.1

Freq = 22.1720 GHz, Bw = 16.000 MH Calibrated with CL # 3 and BP # 1 (BP mode 1)

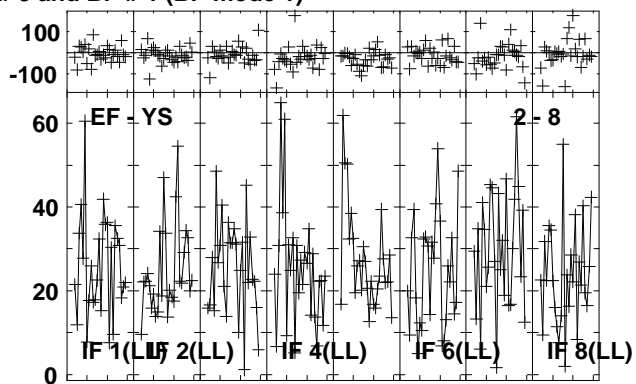
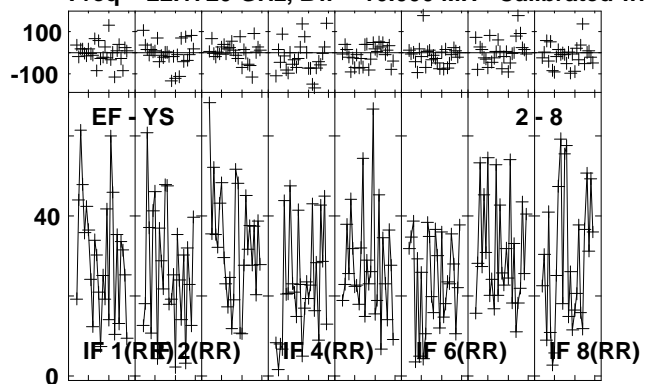

Lower frame: Milli Ampl Jy Top frame: Phas deg
Vector averaged cross-power spectrum Several baselines displayed
Timerange: 01/02:36:21 to 01/02:38:19

Plot file version 409 created 26-JUL-2013 10:25:46
 J1157 EZ024 1.UVDATA.1
 Freq = 22.1720 GHz, Bw = 16.000 MH Calibrated with CL # 3 and BP # 1 (BP mode 1)

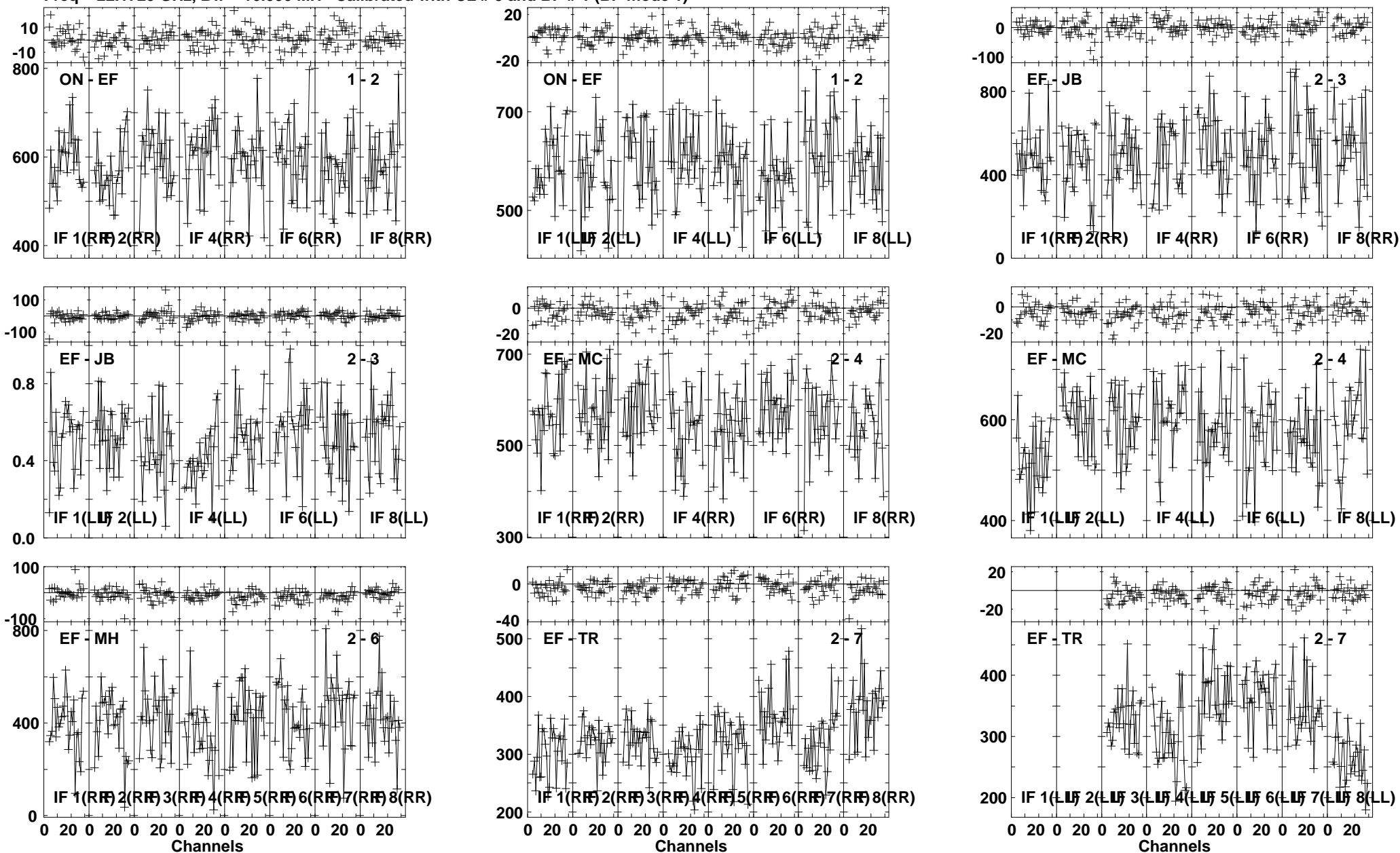

Lower frame: Milli Ampl Jy Top frame: Phas deg
 Vector averaged cross-power spectrum Several baselines displayed
 Timerange: 01/02:38:54 to 01/02:39:52

Plot file version 410 created 26-JUL-2013 10:25:47

J1157 EZ024 1.UVDATA.1

Freq = 22.1720 GHz, Bw = 16.000 MH Calibrated with CL # 3 and BP # 1 (BP mode 1)

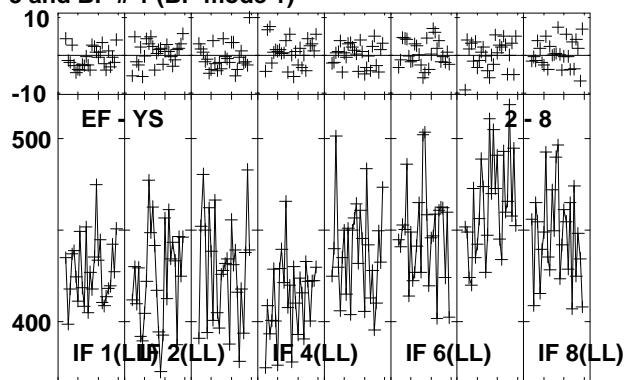
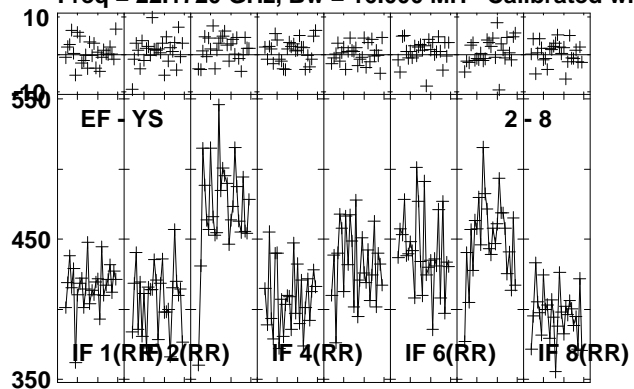

Lower frame: Milli Ampl Jy Top frame: Phas deg
Vector averaged cross-power spectrum Several baselines displayed
Timerange: 01/02:38:54 to 01/02:39:52

Plot file version 411 created 26-JUL-2013 10:25:48
 B1152+199A EZ024 1.UVDATA.1
 Freq = 22.1720 GHz, Bw = 16.000 MH Calibrated with CL # 3 and BP # 1 (BP mode 1)

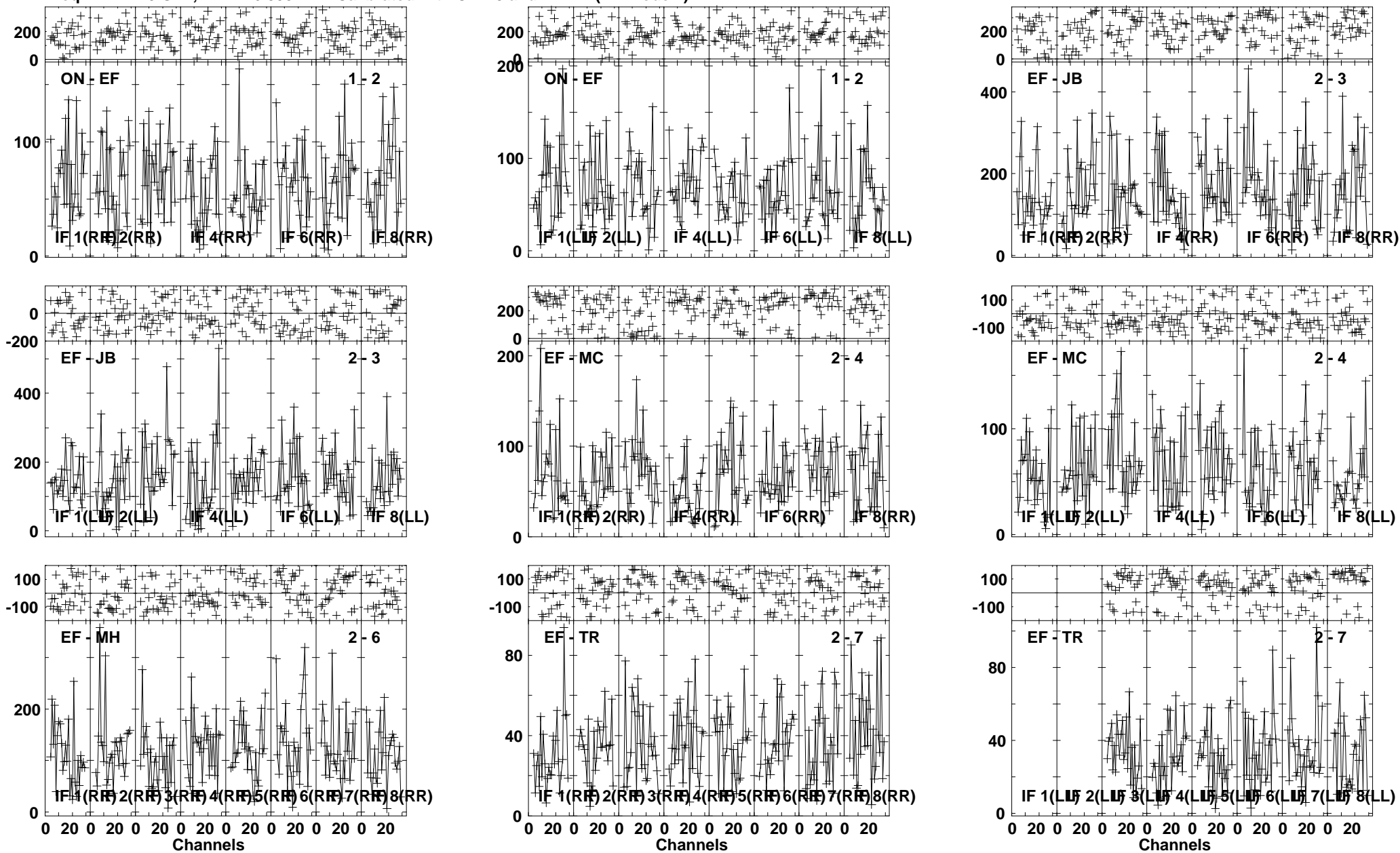

Lower frame: Milli Ampl Jy Top frame: Phas deg
 Vector averaged cross-power spectrum Several baselines displayed
 Timerange: 01/02:40:27 to 01/02:42:25

Plot file version 412 created 26-JUL-2013 10:25:49

B1152+199A EZ024 1.UVDATA.1

Freq = 22.1720 GHz, Bw = 16.000 MH Calibrated with CL # 3 and BP # 1 (BP mode 1)

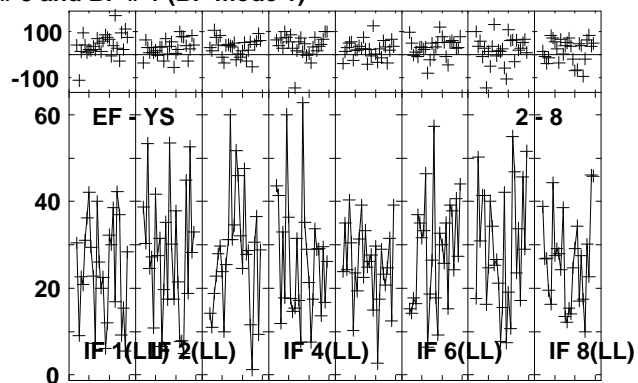
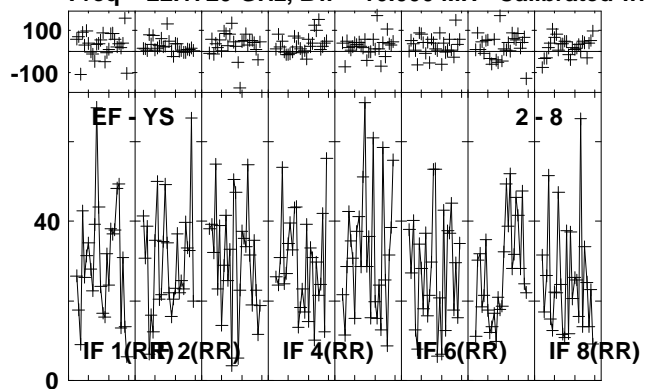

Lower frame: Milli Ampl Jy Top frame: Phas deg
Vector averaged cross-power spectrum Several baselines displayed
Timerange: 01/02:40:27 to 01/02:42:25

Plot file version 413 created 26-JUL-2013 10:25:51
 J1157 EZ024 1.UVDATA.1
 Freq = 22.1720 GHz, Bw = 16.000 MH Calibrated with CL # 3 and BP # 1 (BP mode 1)

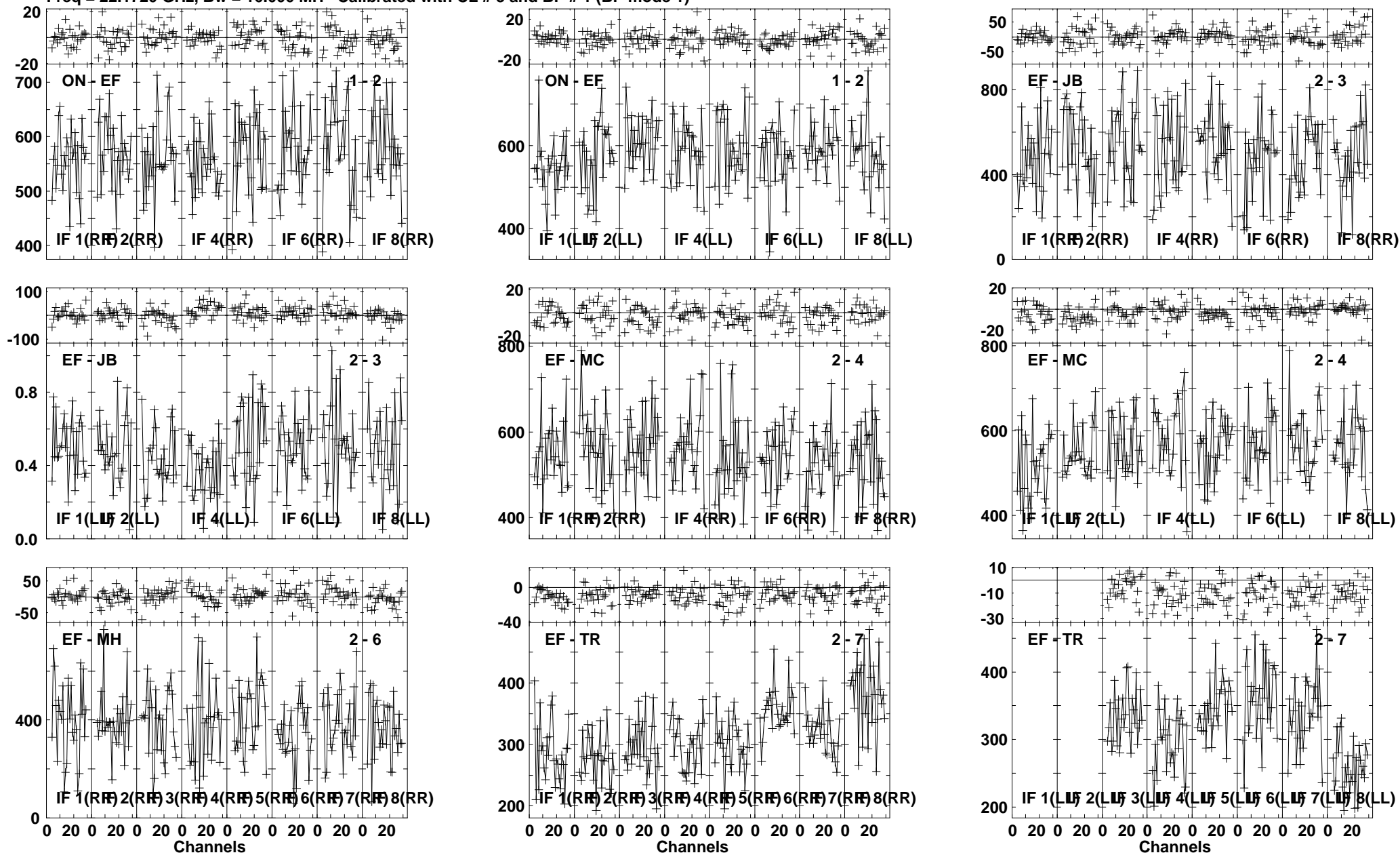

Lower frame: Milli Ampl Jy Top frame: Phas deg
 Vector averaged cross-power spectrum Several baselines displayed
 Timerange: 01/02:43:01 to 01/02:43:59

Plot file version 414 created 26-JUL-2013 10:25:51

J1157 EZ024 1.UVDATA.1

Freq = 22.1720 GHz, Bw = 16.000 MH Calibrated with CL # 3 and BP # 1 (BP mode 1)

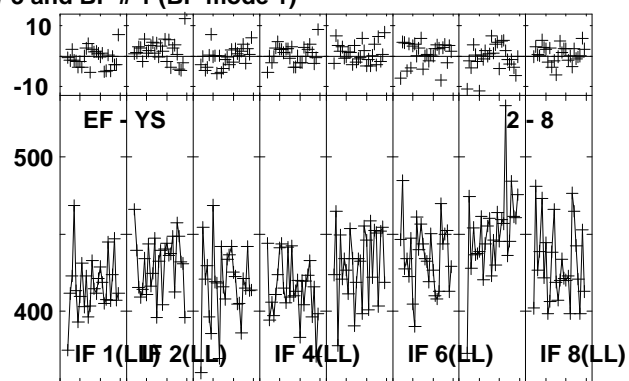
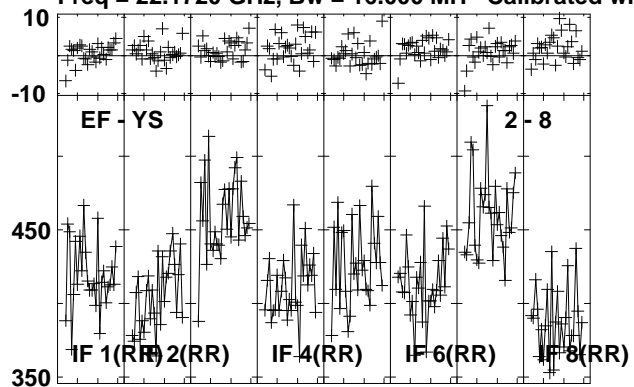

Lower frame: Milli Ampl Jy Top frame: Phas deg
Vector averaged cross-power spectrum Several baselines displayed
Timerange: 01/02:43:01 to 01/02:43:59

Plot file version 415 created 26-JUL-2013 10:25:52
 J1125+2610 EZ024 1.UVDATA.1
 Freq = 22.1720 GHz, Bw = 16.000 MH Calibrated with CL # 3 and BP # 1 (BP mode 1)

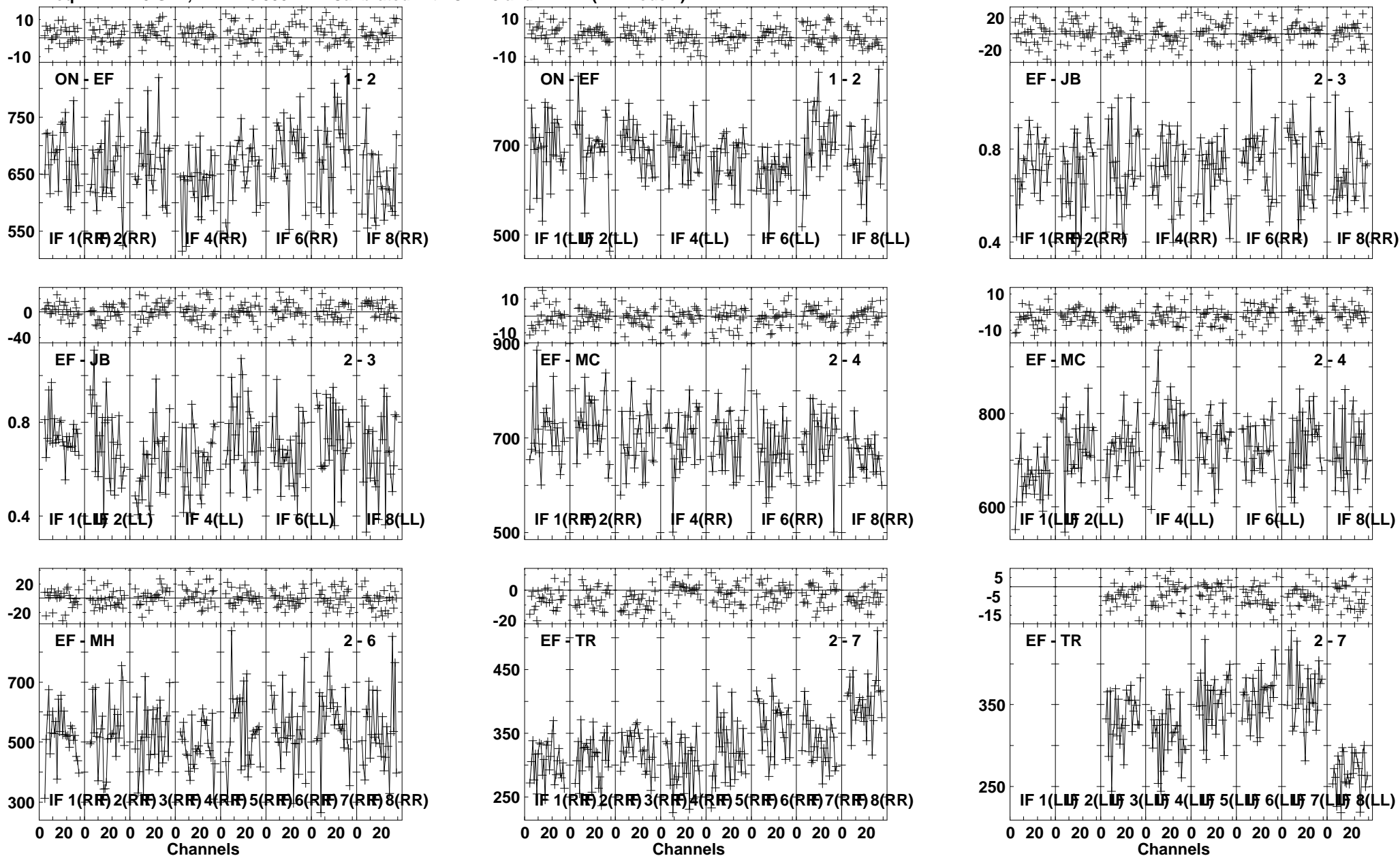

Lower frame: Milli Ampl Jy Top frame: Phas deg
 Vector averaged cross-power spectrum Several baselines displayed
 Timerange: 01/02:45:33 to 01/02:47:15

Plot file version 416 created 26-JUL-2013 10:25:53

J1125+2610 EZ024 1.UVDATA.1

Freq = 22.1720 GHz, Bw = 16.000 MH Calibrated with CL # 3 and BP # 1 (BP mode 1)

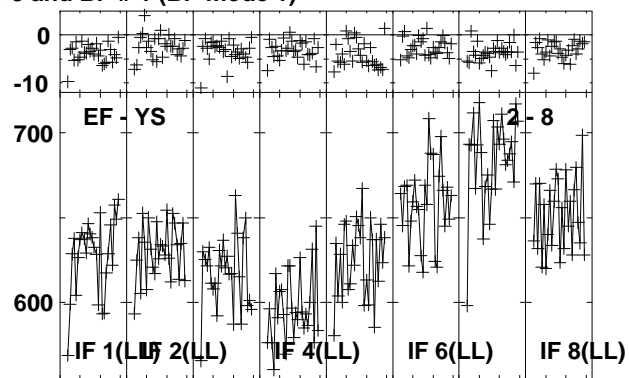
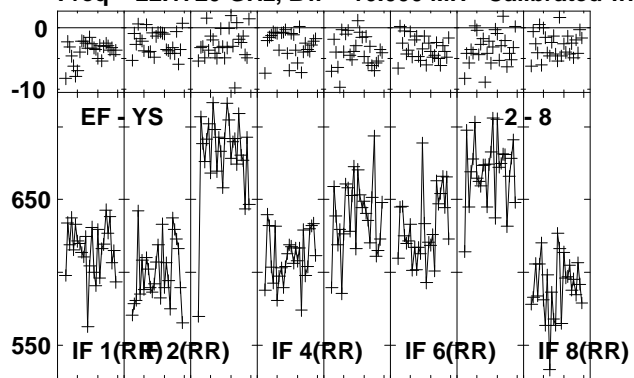

Lower frame: Milli Ampl Jy Top frame: Phas deg
Vector averaged cross-power spectrum Several baselines displayed
Timerange: 01/02:45:33 to 01/02:47:15

Plot file version 417 created 26-JUL-2013 10:25:54

J1157 EZ024 1.UVDATA.1

Freq = 22.1720 GHz, Bw = 16.000 MH Calibrated with CL # 3 and BP # 1 (BP mode 1)

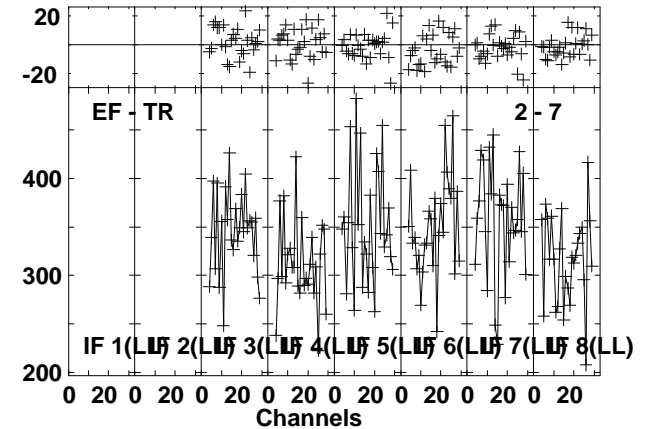
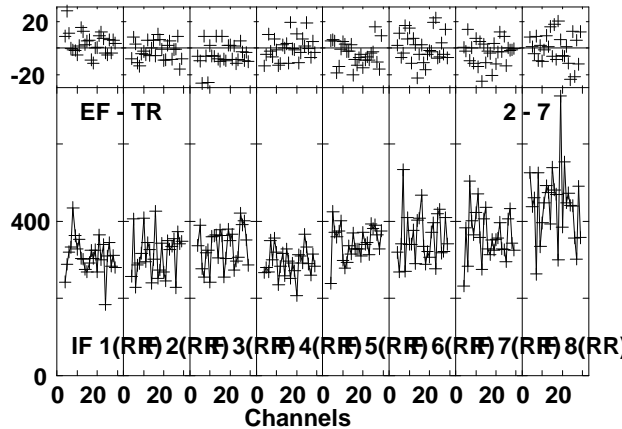
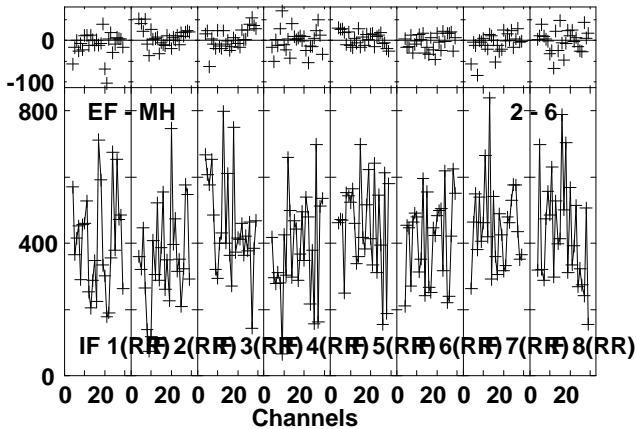
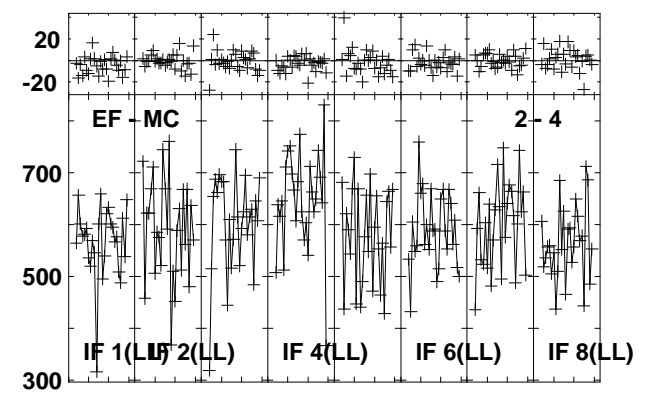
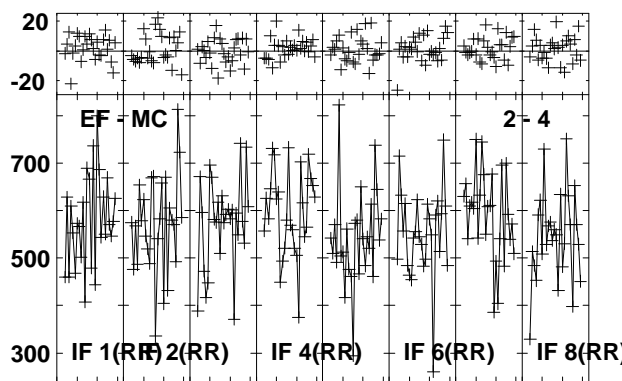
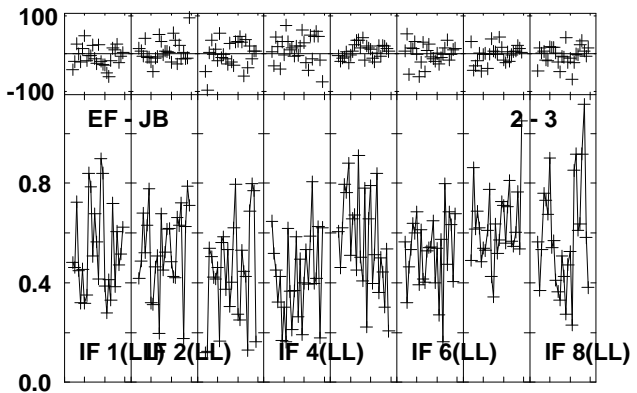
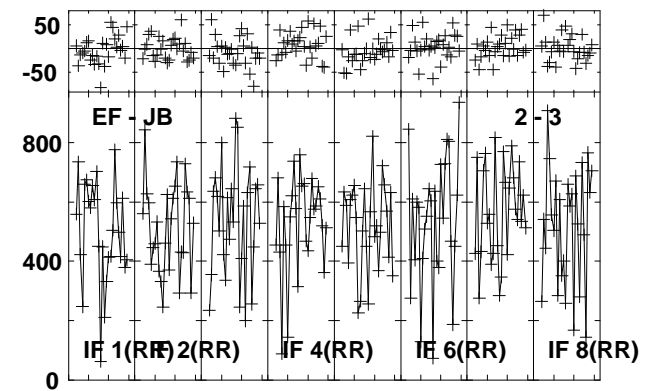
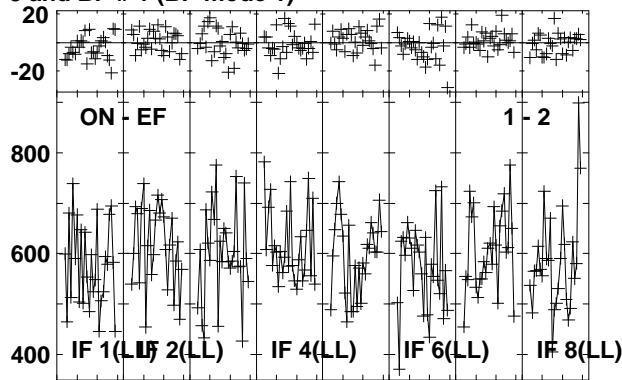
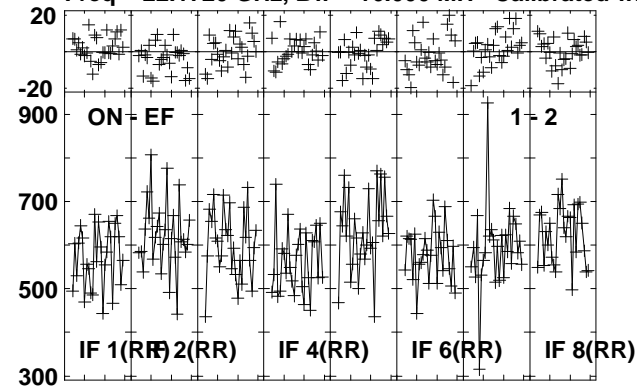

Lower frame: Milli Ampl Jy Top frame: Phas deg
Vector averaged cross-power spectrum Several baselines displayed
Timerange: 01/02:48:48 to 01/02:49:30

Plot file version 418 created 26-JUL-2013 10:25:55

J1157 EZ024 1.UVDATA.1

Freq = 22.1720 GHz, Bw = 16.000 MH Calibrated with CL # 3 and BP # 1 (BP mode 1)

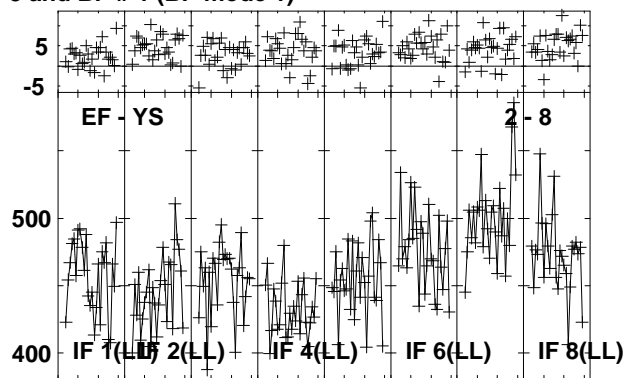
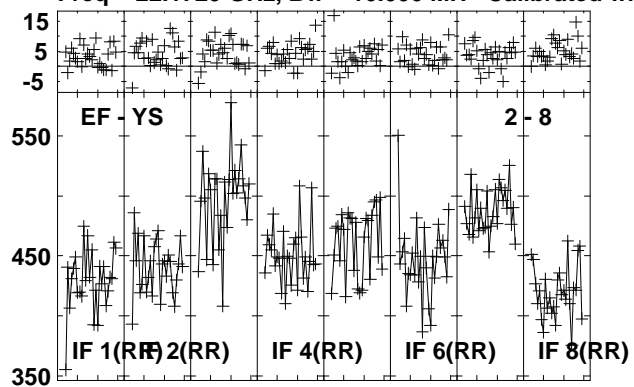

Lower frame: Milli Ampl Jy Top frame: Phas deg
Vector averaged cross-power spectrum Several baselines displayed
Timerange: 01/02:48:48 to 01/02:49:30

Plot file version 419 created 26-JUL-2013 10:25:56
 B1152+199A EZ024 1.UVDATA.1
 Freq = 22.1720 GHz, Bw = 16.000 MH Calibrated with CL # 3 and BP # 1 (BP mode 1)

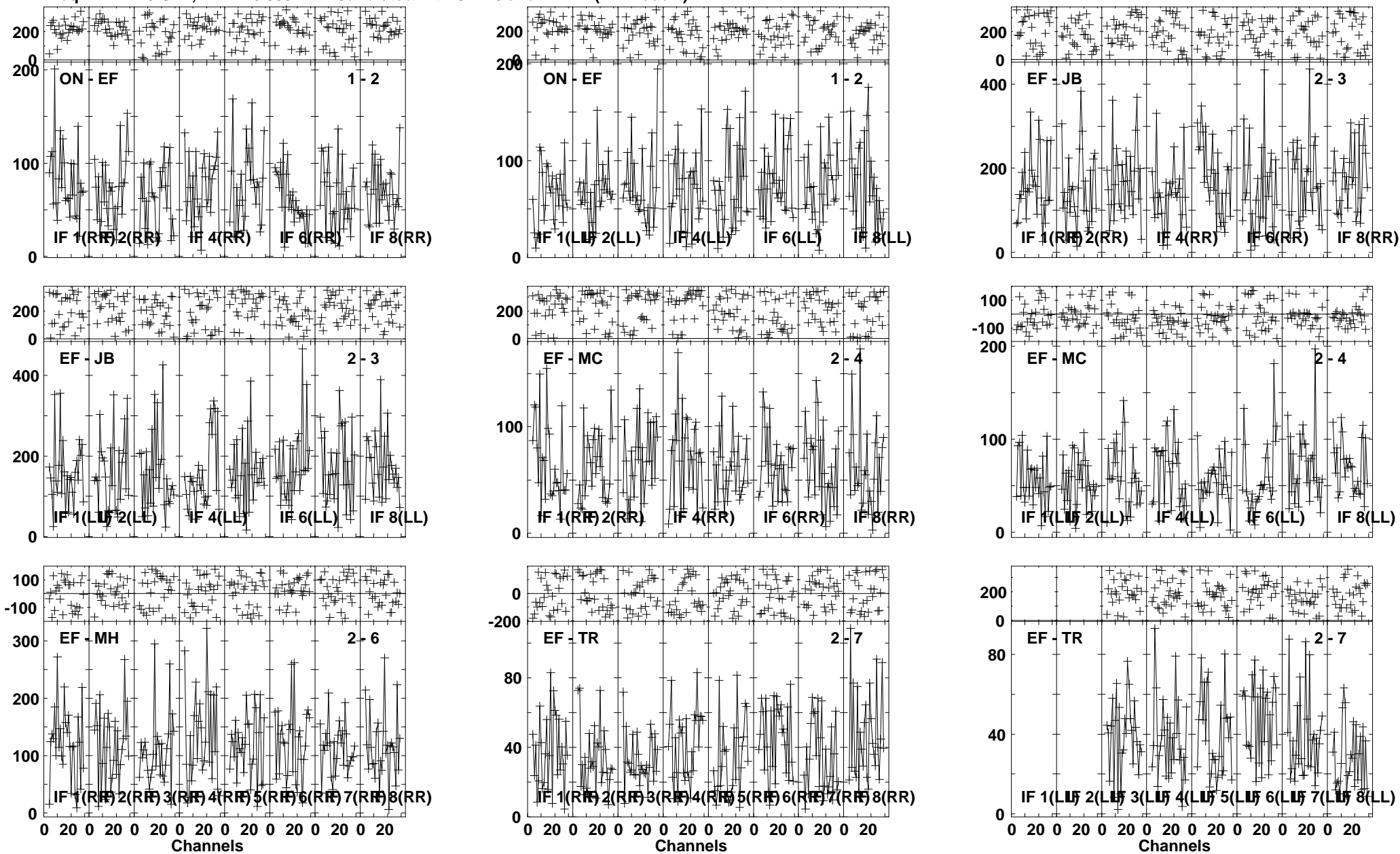

Lower frame: Milli Ampl Jy Top frame: Phas deg
 Vector averaged cross-power spectrum Several baselines displayed
 Timerange: 01/02:50:06 to 01/02:52:04

Plot file version 420 created 26-JUL-2013 10:25:57

B1152+199A EZ024 1.UVDATA.1

Freq = 22.1720 GHz, Bw = 16.000 MH Calibrated with CL # 3 and BP # 1 (BP mode 1)

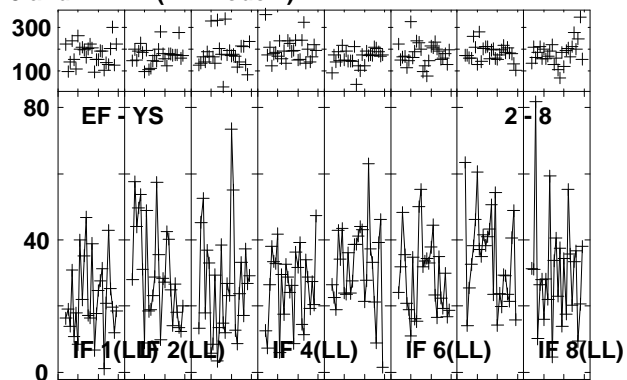
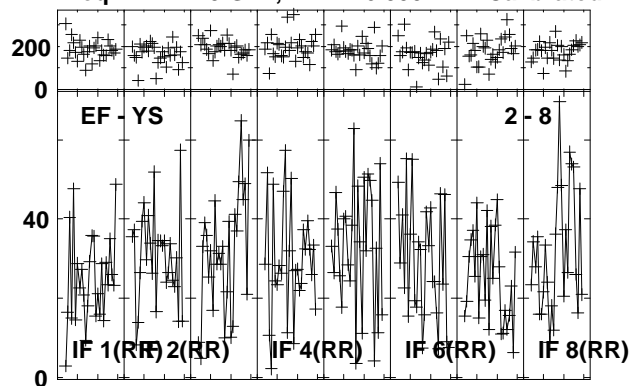

Lower frame: Milli Ampl Jy Top frame: Phas deg
Vector averaged cross-power spectrum Several baselines displayed
Timerange: 01/02:50:06 to 01/02:52:04

Plot file version 421 created 26-JUL-2013 10:25:58

J1157 EZ024 1.UVDATA.1

Freq = 22.1720 GHz, Bw = 16.000 MH Calibrated with CL # 3 and BP # 1 (BP mode 1)

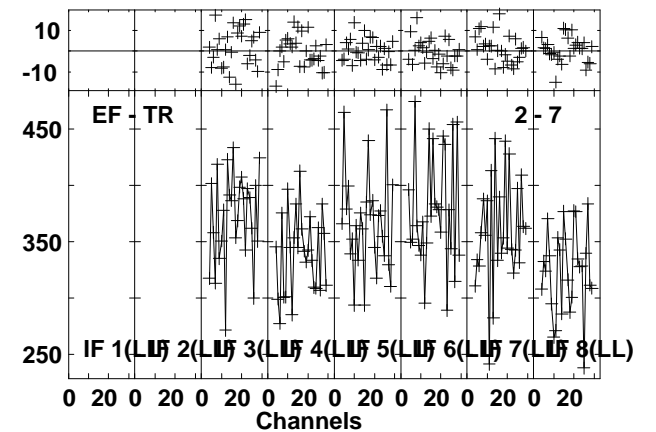
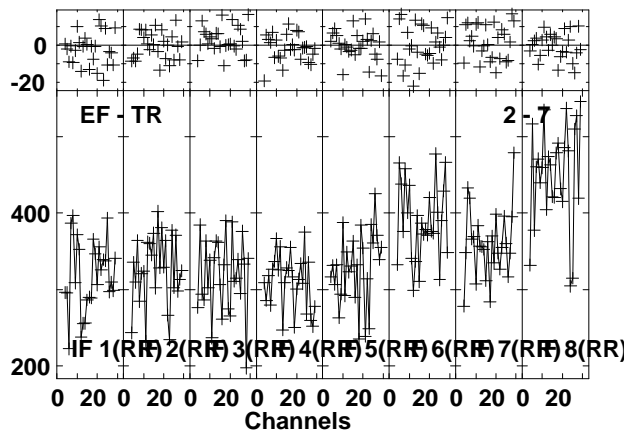
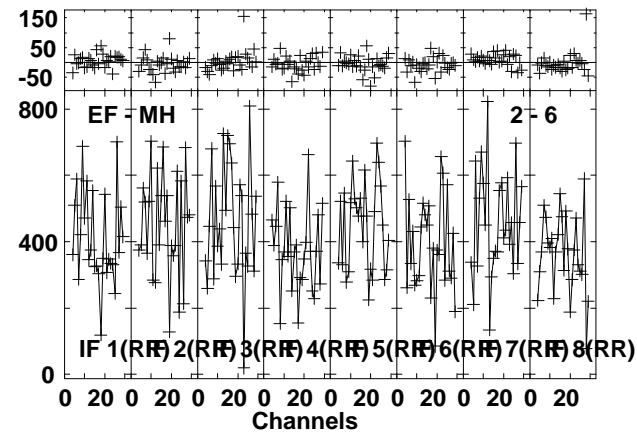
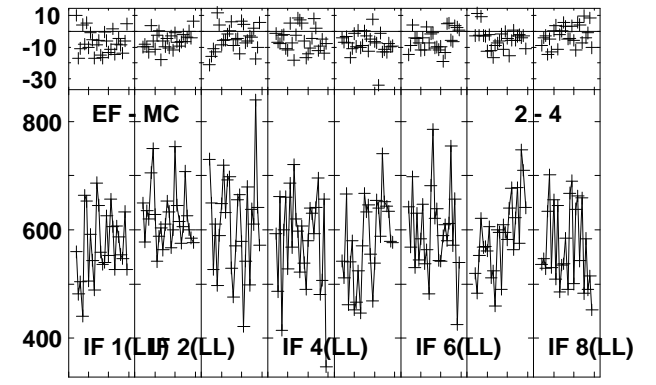
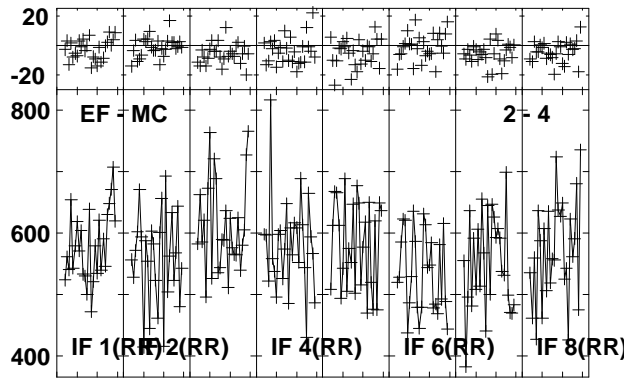
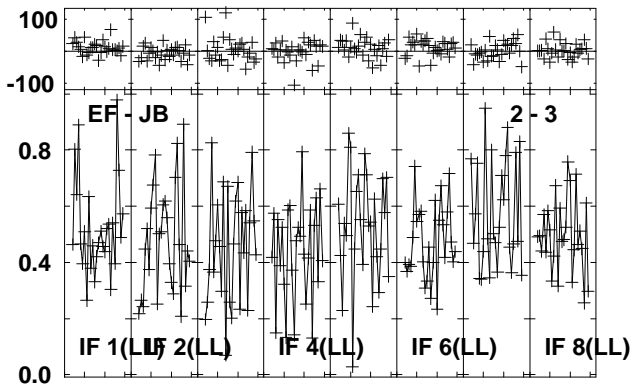
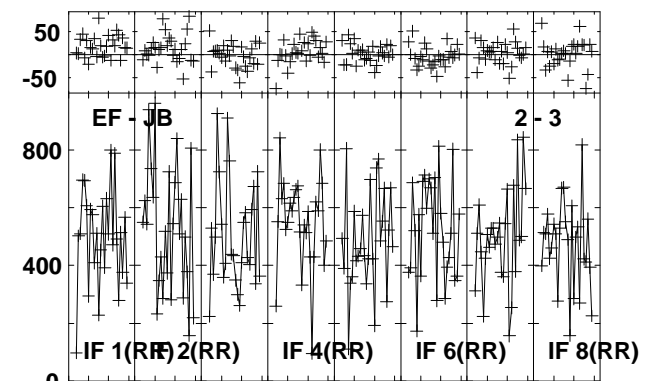
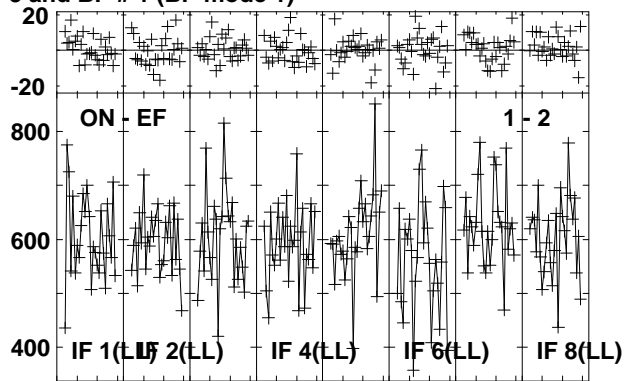
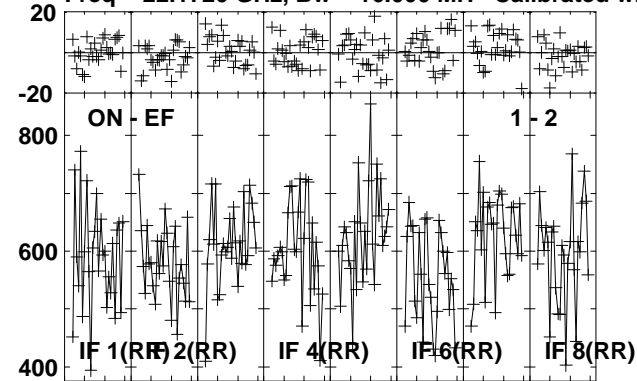

Lower frame: Milli Ampl Jy Top frame: Phas deg
Vector averaged cross-power spectrum Several baselines displayed
Timerange: 01/02:52:39 to 01/02:53:37

Plot file version 422 created 26-JUL-2013 10:25:59

J1157 EZ024 1.UVDATA.1

Freq = 22.1720 GHz, Bw = 16.000 MH Calibrated with CL # 3 and BP # 1 (BP mode 1)

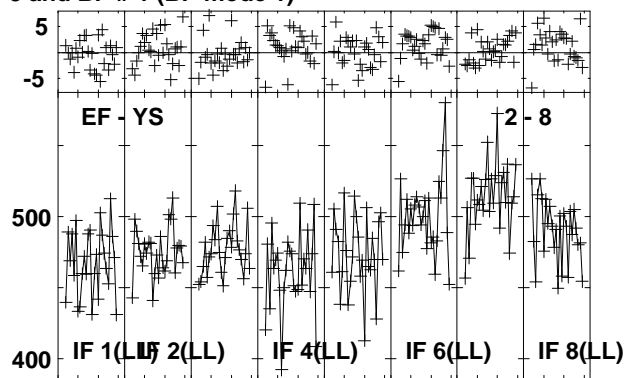
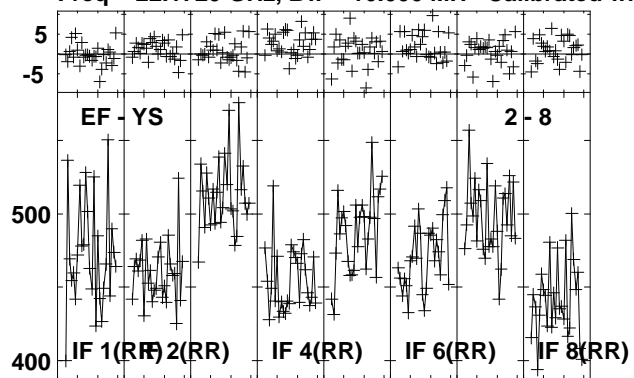

Lower frame: Milli Ampl Jy Top frame: Phas deg
Vector averaged cross-power spectrum Several baselines displayed
Timerange: 01/02:52:39 to 01/02:53:37

Plot file version 423 created 26-JUL-2013 10:26:00
 B1152+199A EZ024 1.UVDATA.1
 Freq = 22.1720 GHz, Bw = 16.000 MH Calibrated with CL # 3 and BP # 1 (BP mode 1)

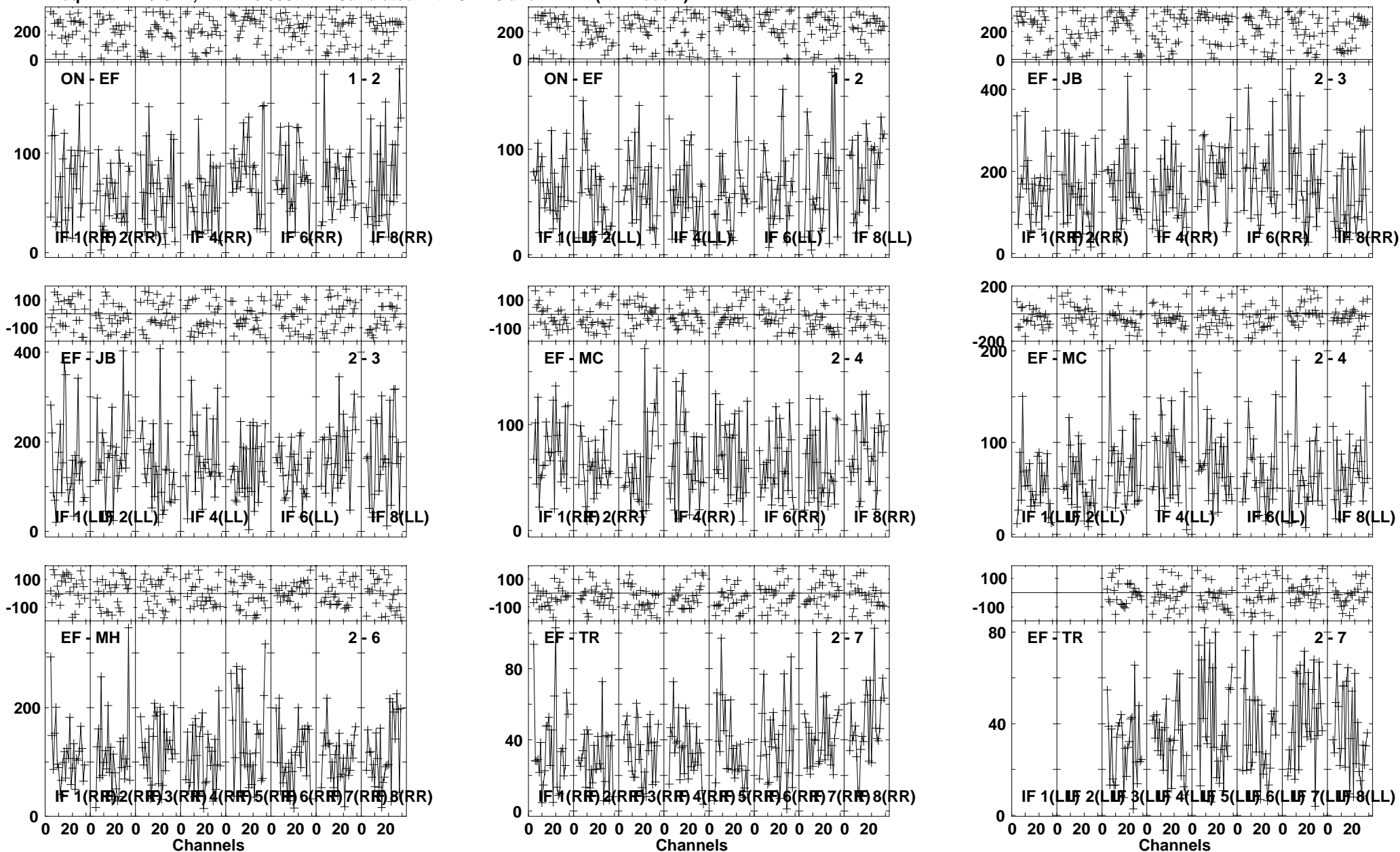

Lower frame: Milli Ampl Jy Top frame: Phas deg
 Vector averaged cross-power spectrum Several baselines displayed
 Timerange: 01/02:54:13 to 01/02:56:11

Plot file version 424 created 26-JUL-2013 10:26:01

B1152+199A EZ024 1.UVDATA.1

Freq = 22.1720 GHz, Bw = 16.000 MH Calibrated with CL # 3 and BP # 1 (BP mode 1)

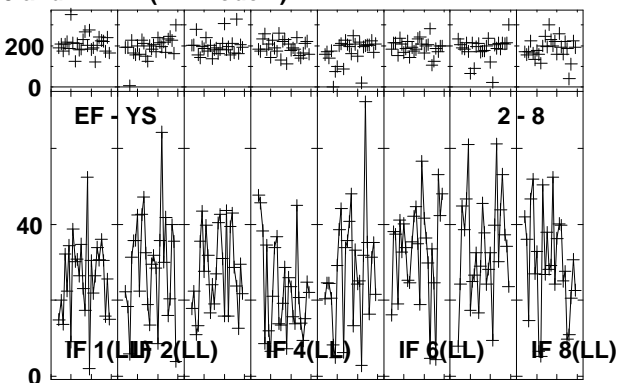
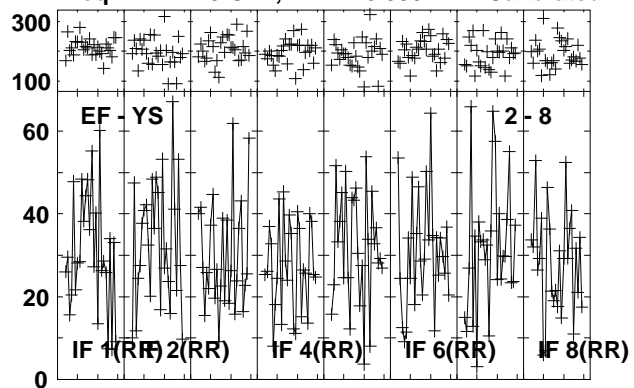

Lower frame: Milli Ampl Jy Top frame: Phas deg
Vector averaged cross-power spectrum Several baselines displayed
Timerange: 01/02:54:13 to 01/02:56:11

Plot file version 425 created 26-JUL-2013 10:26:02
 J1157 EZ024 1.UVDATA.1
 Freq = 22.1720 GHz, Bw = 16.000 MH Calibrated with CL # 3 and BP # 1 (BP mode 1)

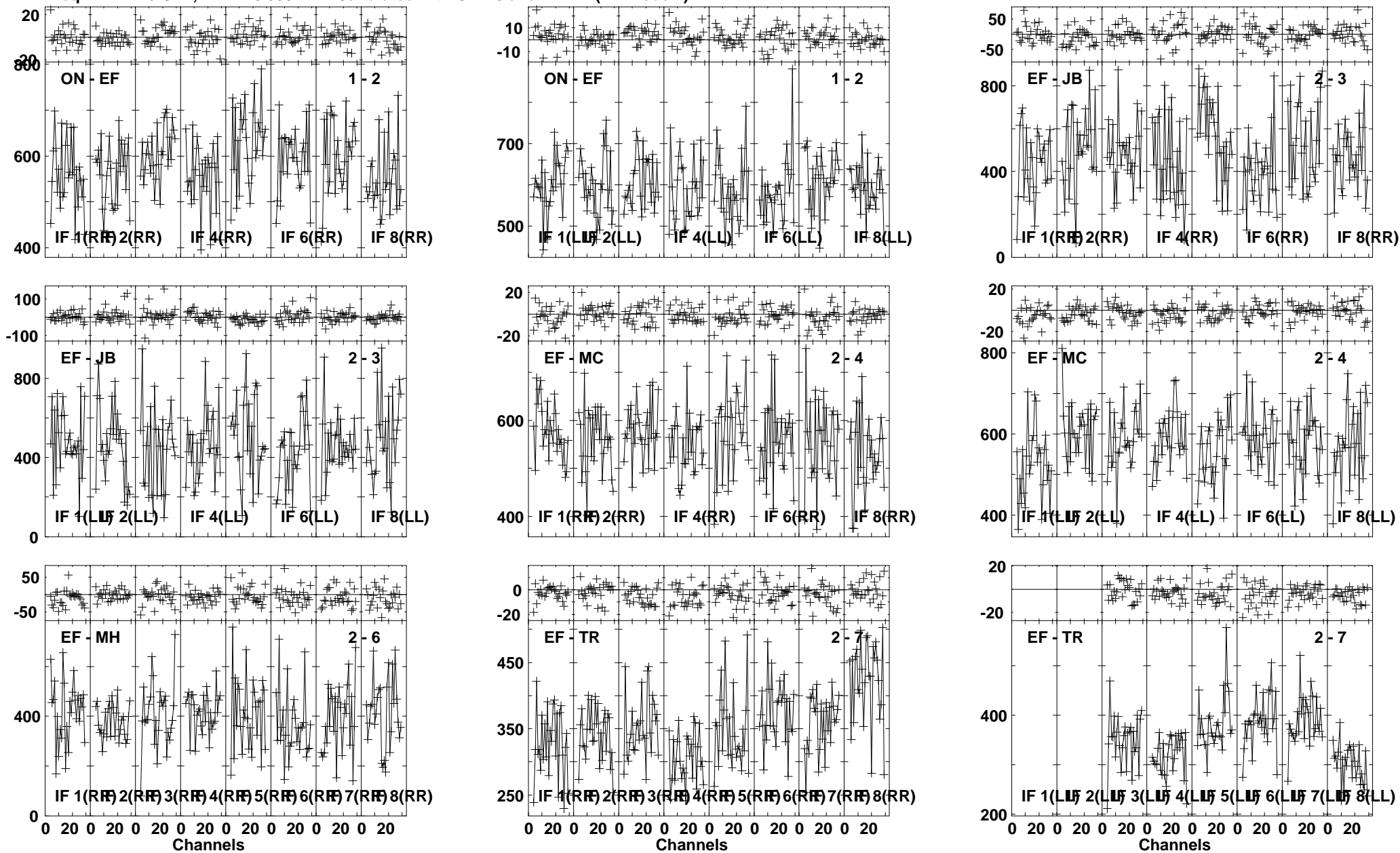

Lower frame: Milli Ampl Jy Top frame: Phas deg
 Vector averaged cross-power spectrum Several baselines displayed
 Timerange: 01/02:56:46 to 01/02:57:44

Plot file version 426 created 26-JUL-2013 10:26:03

J1157 EZ024 1.UVDATA.1

Freq = 22.1720 GHz, Bw = 16.000 MH Calibrated with CL # 3 and BP # 1 (BP mode 1)

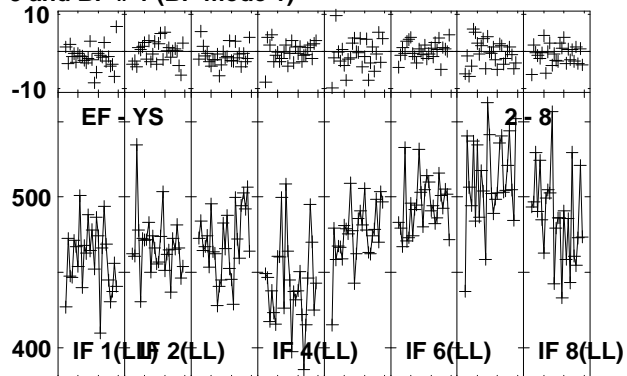
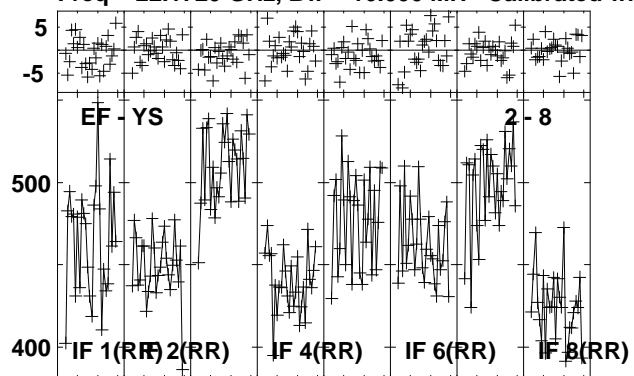

Lower frame: Milli Ampl Jy Top frame: Phas deg
Vector averaged cross-power spectrum Several baselines displayed
Timerange: 01/02:56:46 to 01/02:57:44

Plot file version 427 created 26-JUL-2013 10:26:04
 B1152+199A EZ024 1.UVDATA.1
 Freq = 22.1720 GHz, Bw = 16.000 MH Calibrated with CL # 3 and BP # 1 (BP mode 1)

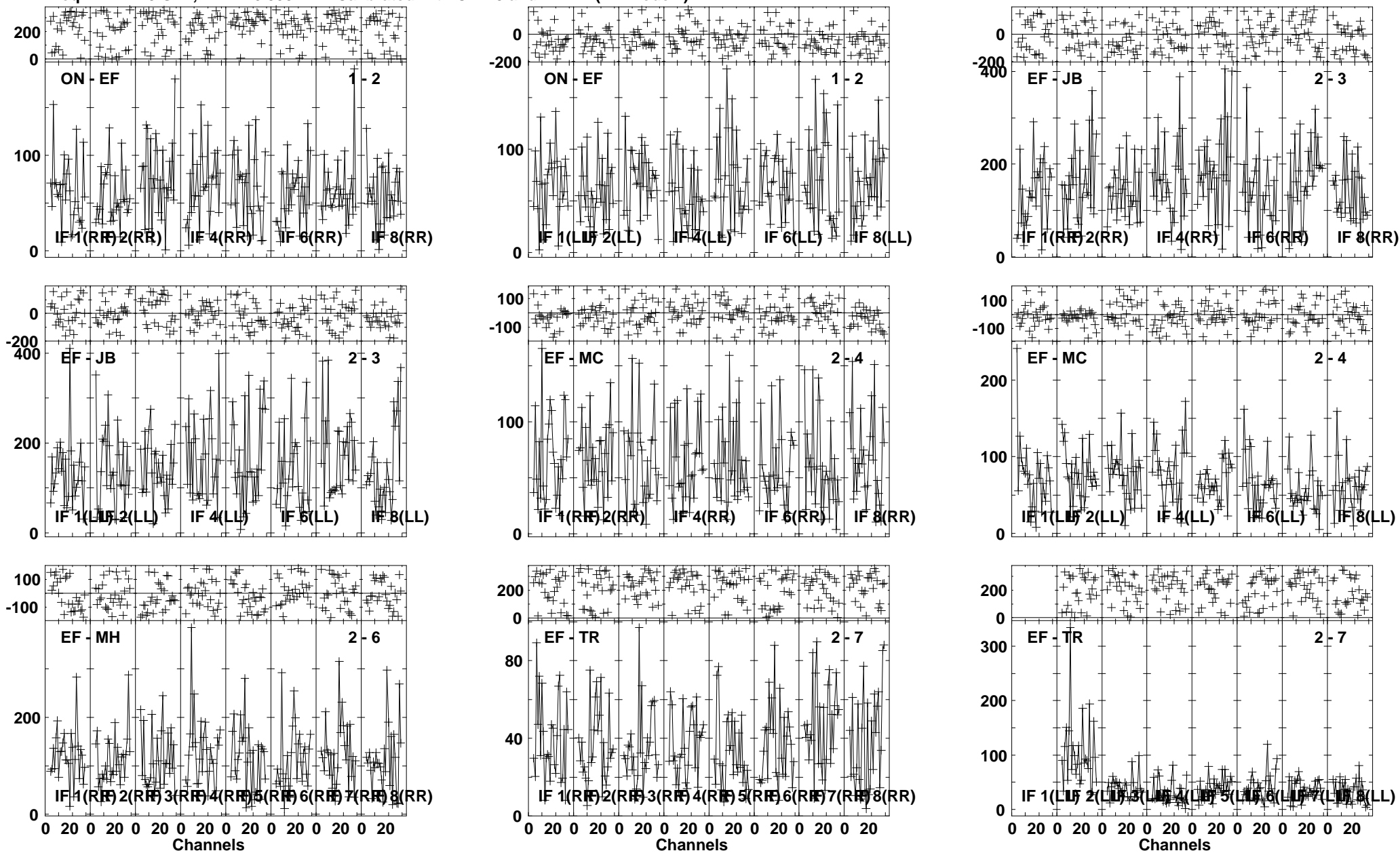

Lower frame: Milli Ampl Jy Top frame: Phas deg
 Vector averaged cross-power spectrum Several baselines displayed
 Timerange: 01/02:58:21 to 01/03:00:19

Plot file version 428 created 26-JUL-2013 10:26:05

B1152+199A EZ024 1.UVDATA.1

Freq = 22.1720 GHz, Bw = 16.000 MH Calibrated with CL # 3 and BP # 1 (BP mode 1)

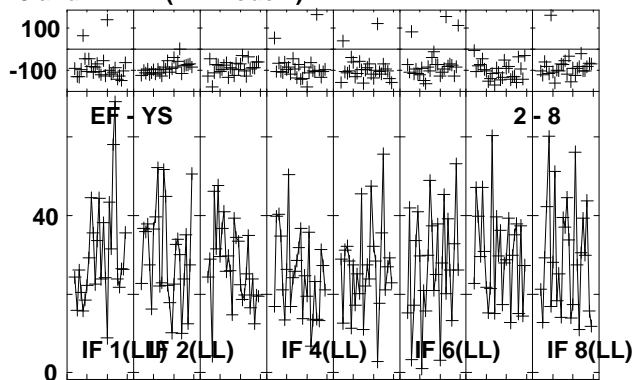
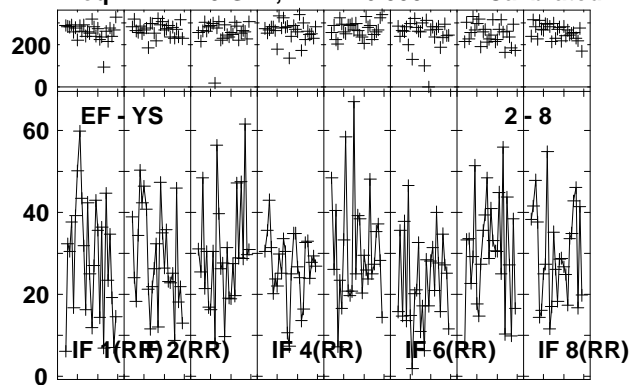

Lower frame: Milli Ampl Jy Top frame: Phas deg
Vector averaged cross-power spectrum Several baselines displayed
Timerange: 01/02:58:21 to 01/03:00:19

Plot file version 429 created 26-JUL-2013 10:26:07
 J1157 EZ2024 1.UVDATA.1
 Freq = 22.1720 GHz, Bw = 16.000 MH Calibrated with CL # 3 and BP # 1 (BP mode 1)

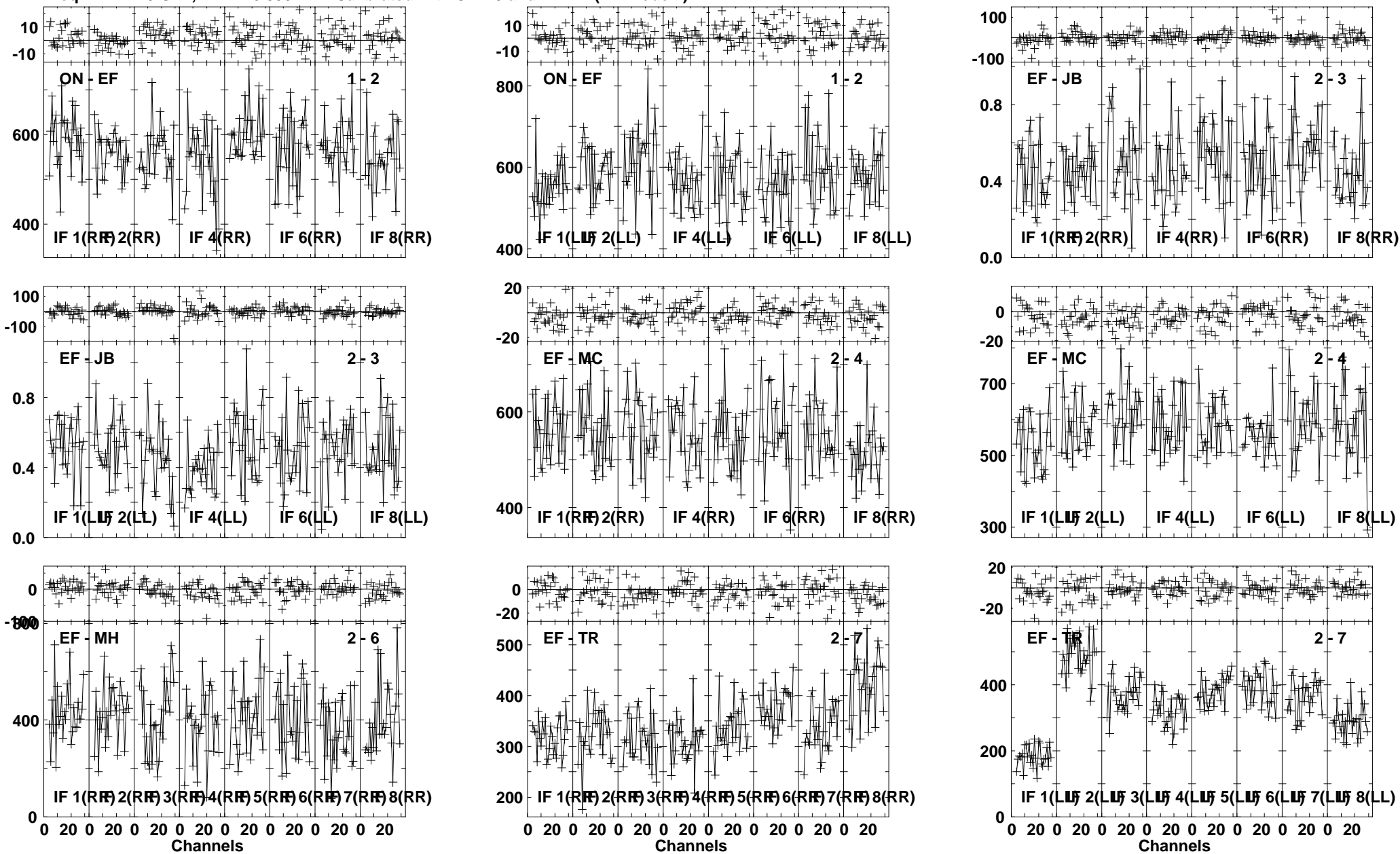

Lower frame: Milli Ampl Jy Top frame: Phas deg
 Vector averaged cross-power spectrum Several baselines displayed
 Timerange: 01/03:00:54 to 01/03:01:52

Plot file version 430 created 26-JUL-2013 10:26:07

J1157 EZ024 1.UVDATA.1

Freq = 22.1720 GHz, Bw = 16.000 MH Calibrated with CL # 3 and BP # 1 (BP mode 1)

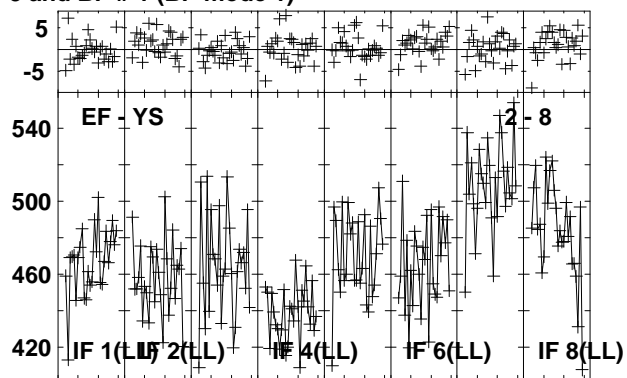
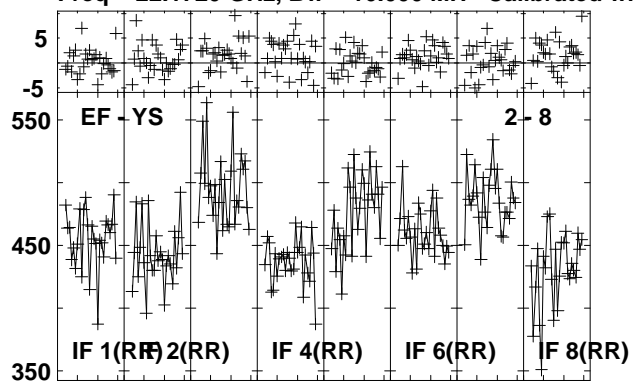

Lower frame: Milli Ampl Jy Top frame: Phas deg
Vector averaged cross-power spectrum Several baselines displayed
Timerange: 01/03:00:54 to 01/03:01:52

Plot file version 431 created 26-JUL-2013 10:26:08
 J1125+2610 EZ024 1.UVDATA.1
 Freq = 22.1720 GHz, Bw = 16.000 MH Calibrated with CL # 3 and BP # 1 (BP mode 1)

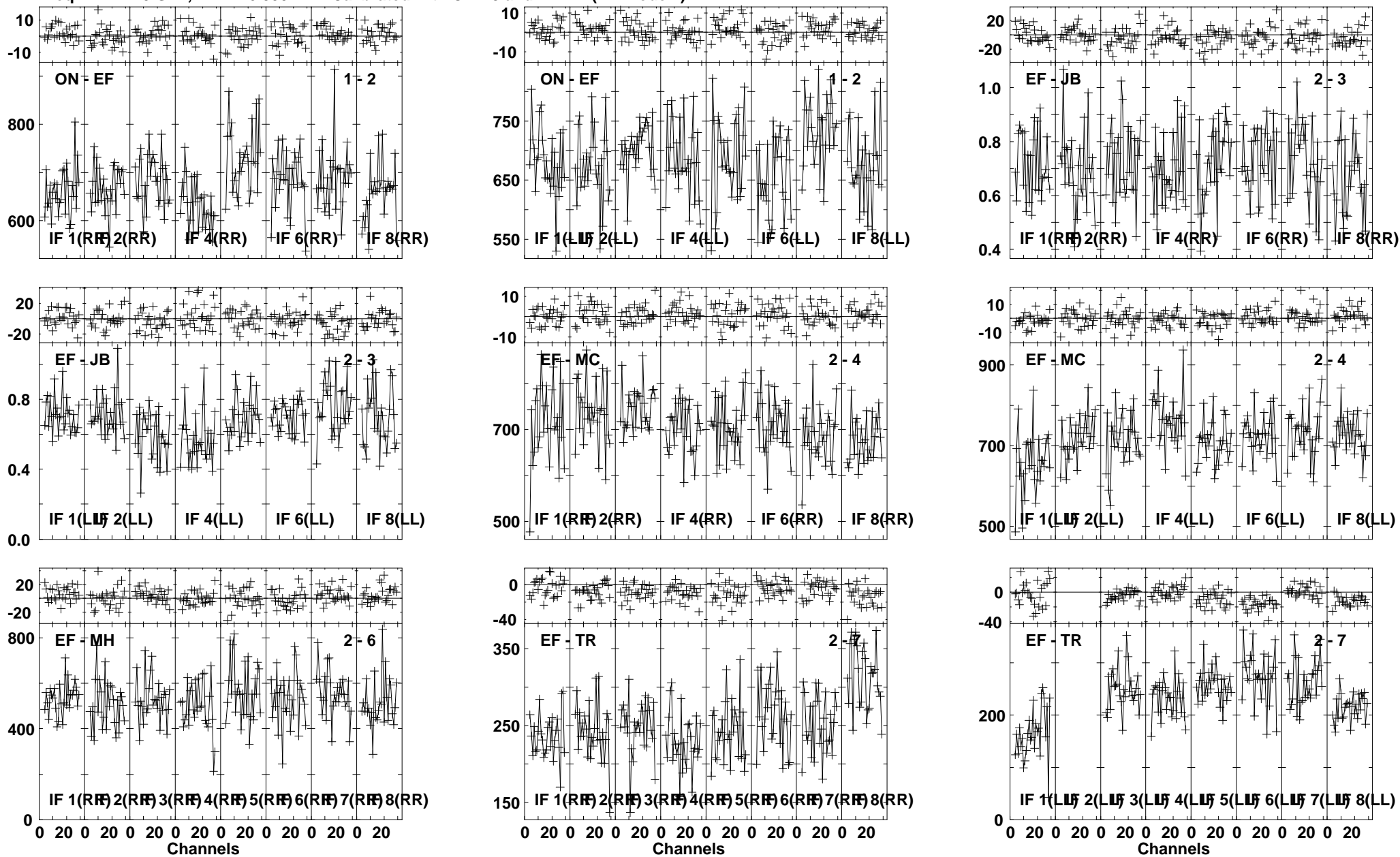

Lower frame: Milli Ampl Jy Top frame: Phas deg
 Vector averaged cross-power spectrum Several baselines displayed
 Timerange: 01/03:03:26 to 01/03:05:08

Plot file version 432 created 26-JUL-2013 10:26:09

J1125+2610 EZ024 1.UVDATA.1

Freq = 22.1720 GHz, Bw = 16.000 MH Calibrated with CL # 3 and BP # 1 (BP mode 1)

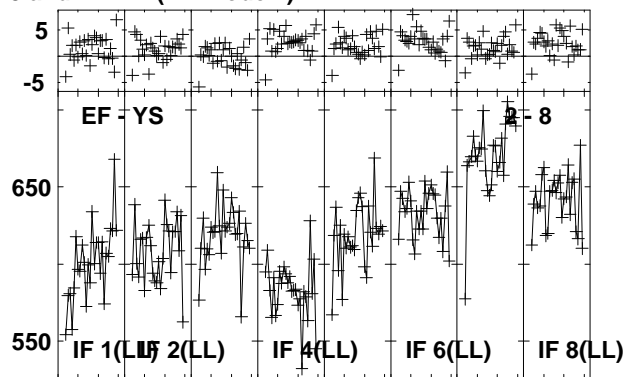
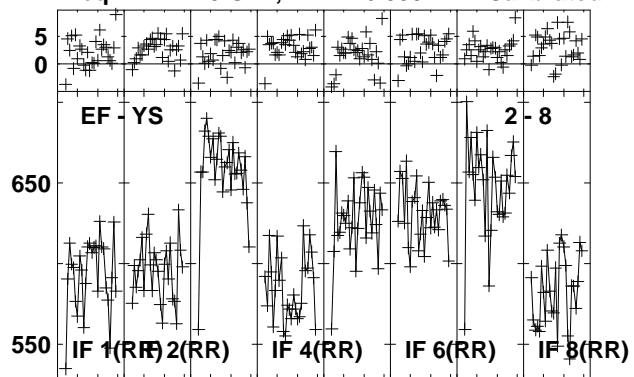

Lower frame: Milli Ampl Jy Top frame: Phas deg
Vector averaged cross-power spectrum Several baselines displayed
Timerange: 01/03:03:26 to 01/03:05:08

Plot file version 433 created 26-JUL-2013 10:26:10
 J1157 EZ024 1.UVDATA.1
 Freq = 22.1720 GHz, Bw = 16.000 MH Calibrated with CL # 3 and BP # 1 (BP mode 1)

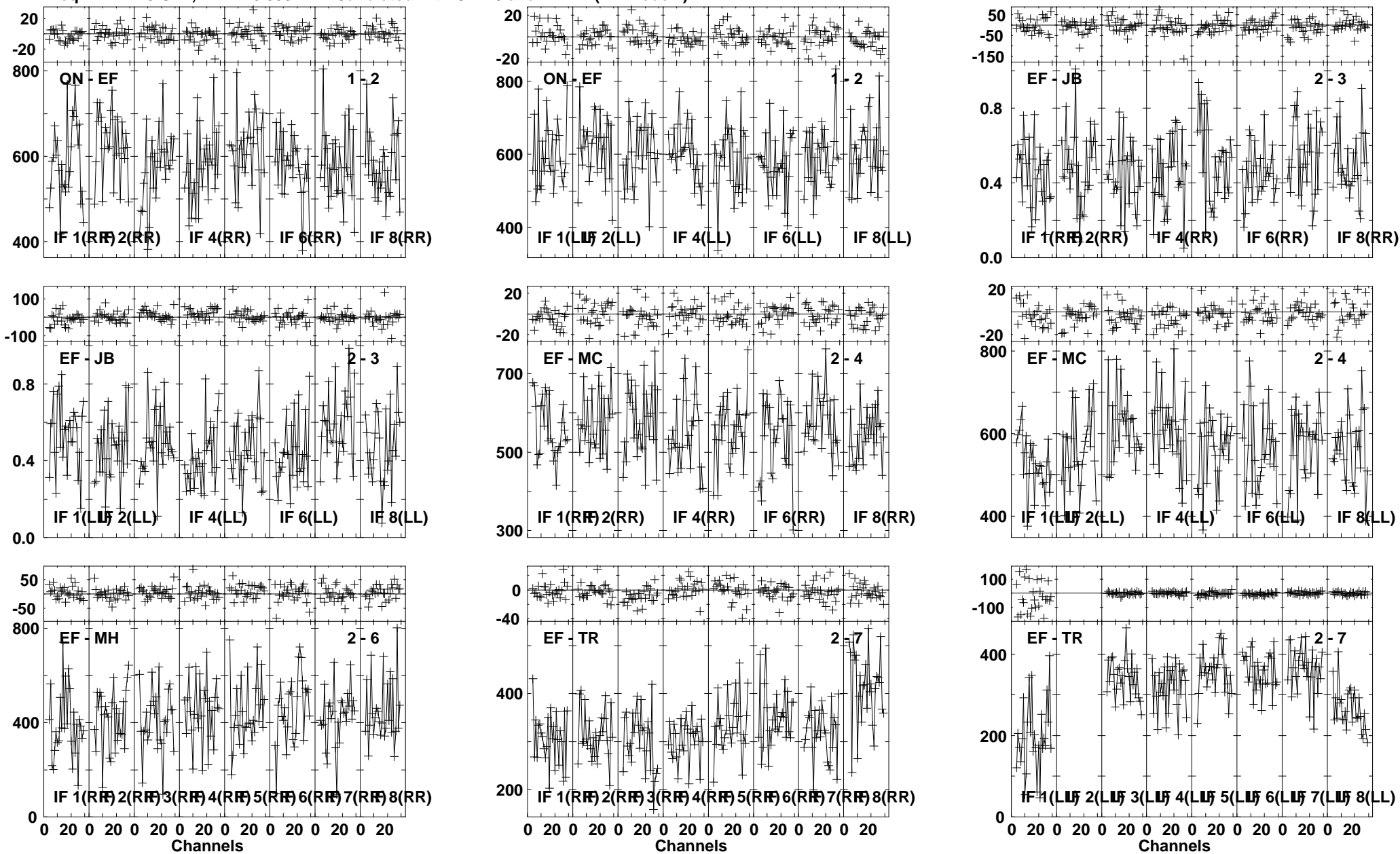

Lower frame: Milli Ampl Jy Top frame: Phas deg
 Vector averaged cross-power spectrum Several baselines displayed
 Timerange: 01/03:06:40 to 01/03:07:22

Plot file version 434 created 26-JUL-2013 10:26:11

J1157 EZ024 1.UVDATA.1

Freq = 22.1720 GHz, Bw = 16.000 MH Calibrated with CL # 3 and BP # 1 (BP mode 1)

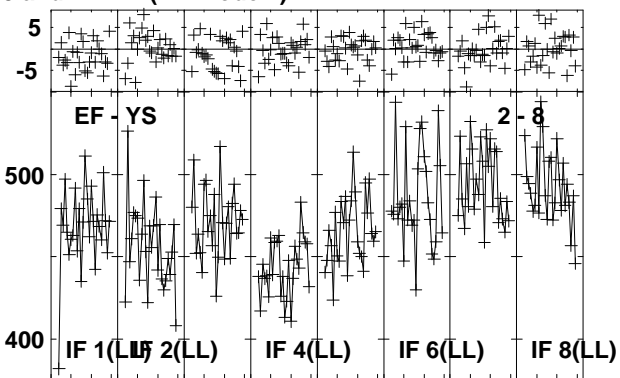
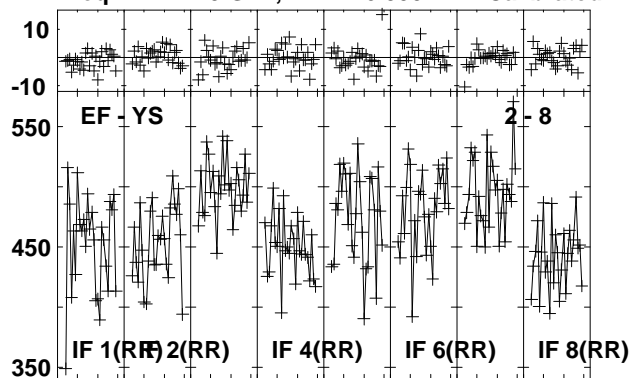

Lower frame: Milli Ampl Jy Top frame: Phas deg
Vector averaged cross-power spectrum Several baselines displayed
Timerange: 01/03:06:40 to 01/03:07:22

Plot file version 435 created 26-JUL-2013 10:26:12
 B1152+199A EZ024 1.UVDATA.1
 Freq = 22.1720 GHz, Bw = 16.000 MH Calibrated with CL # 3 and BP # 1 (BP mode 1)

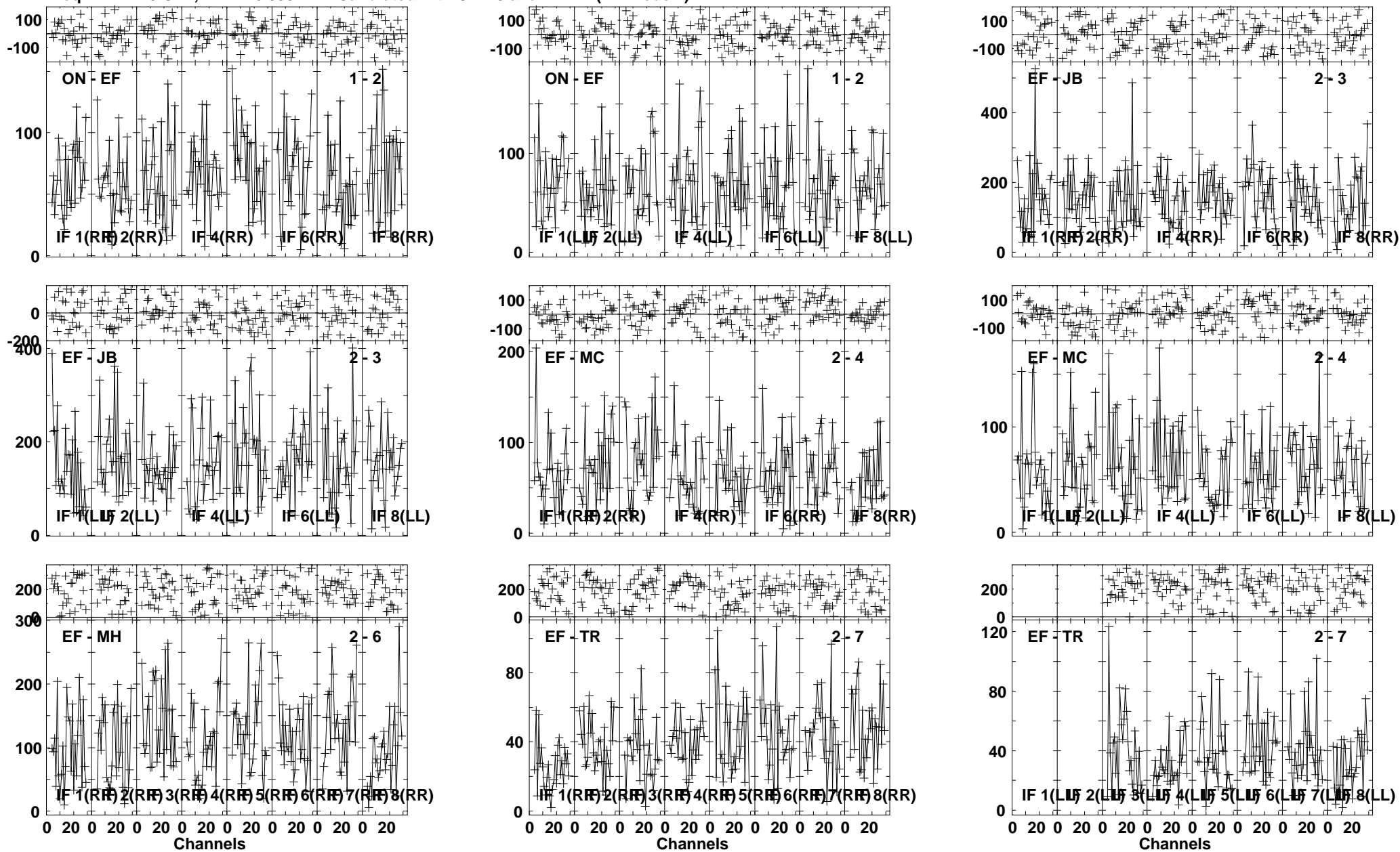

Lower frame: Milli Ampl Jy Top frame: Phas deg
 Vector averaged cross-power spectrum Several baselines displayed
 Timerange: 01/03:07:59 to 01/03:09:57

Plot file version 436 created 26-JUL-2013 10:26:13

B1152+199A EZ024 1.UVDATA.1

Freq = 22.1720 GHz, Bw = 16.000 MH Calibrated with CL # 3 and BP # 1 (BP mode 1)

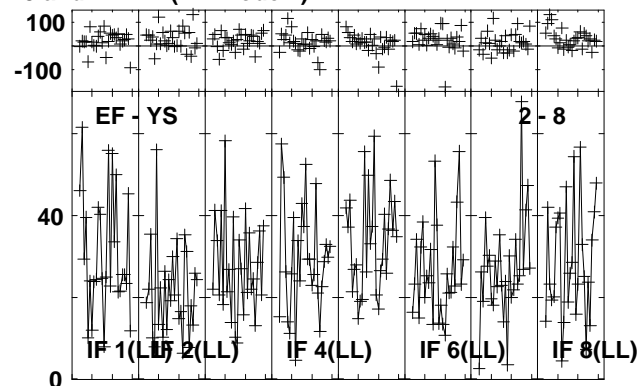
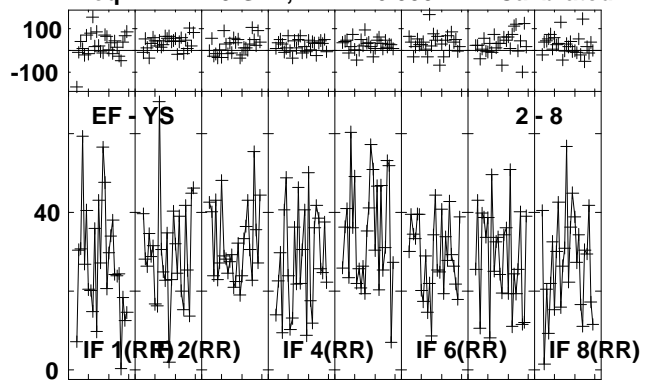

Lower frame: Milli Ampl Jy Top frame: Phas deg
Vector averaged cross-power spectrum Several baselines displayed
Timerange: 01/03:07:59 to 01/03:09:57

Plot file version 437 created 26-JUL-2013 10:26:14
 J1157 EZ024 1.UVDATA.1
 Freq = 22.1720 GHz, Bw = 16.000 MH Calibrated with CL # 3 and BP # 1 (BP mode 1)

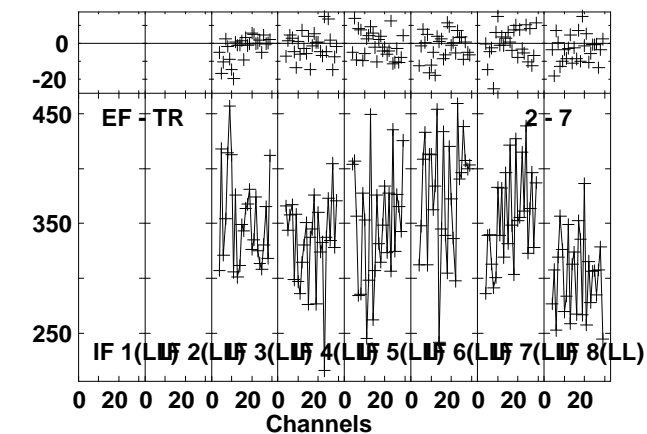
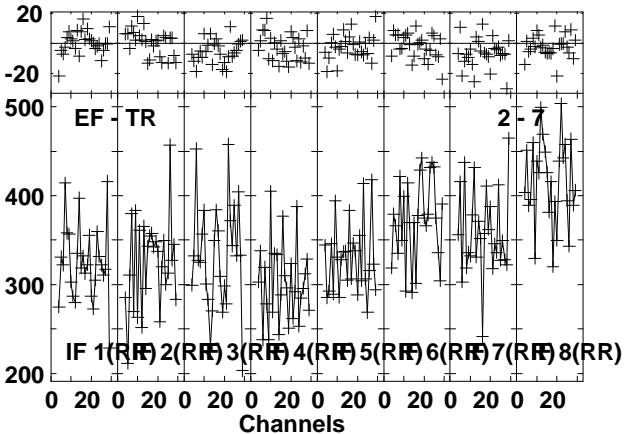
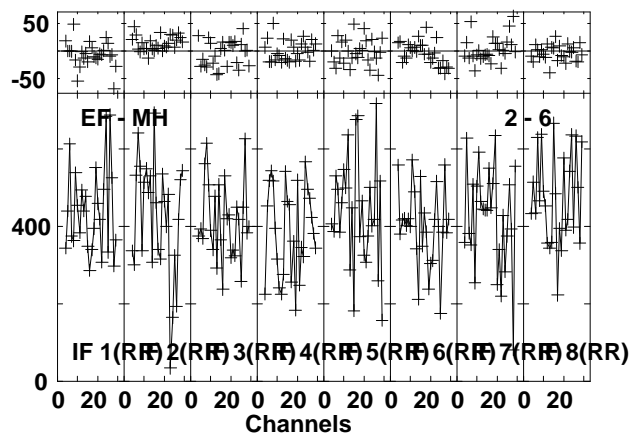
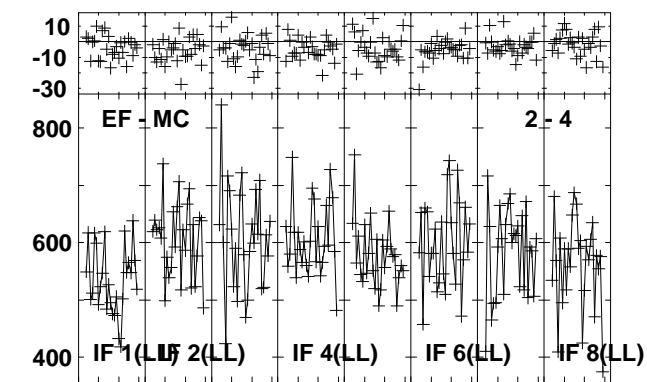
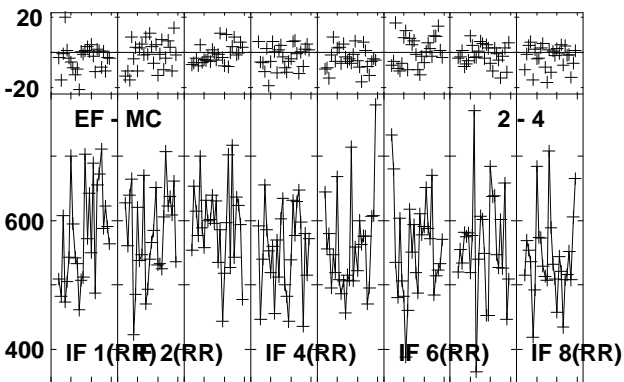
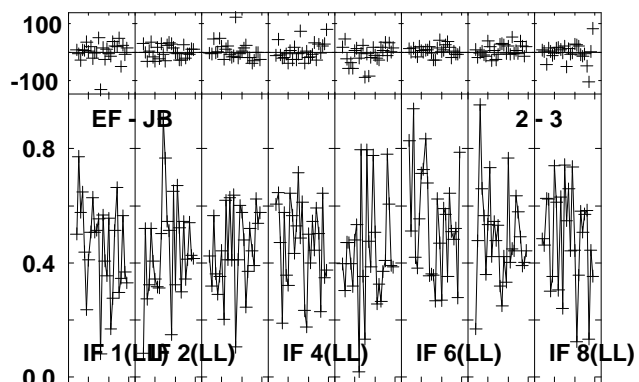
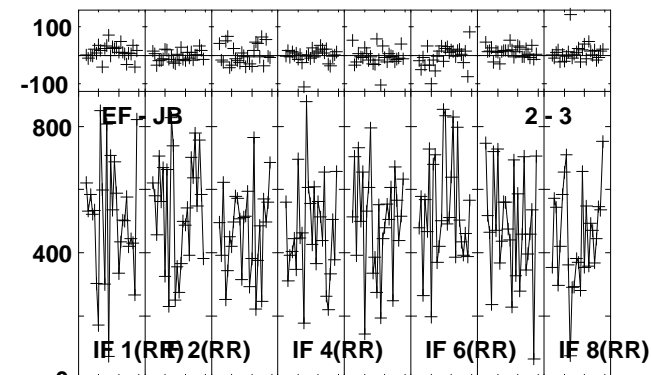
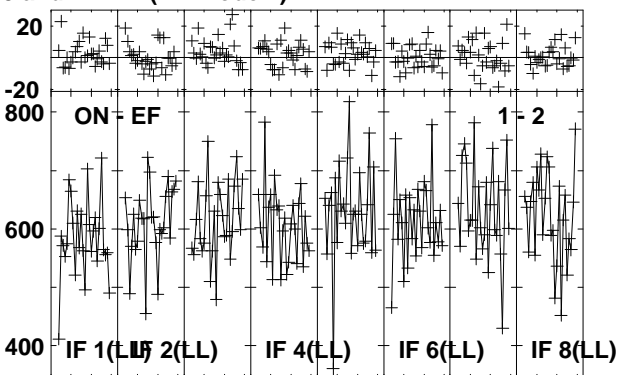
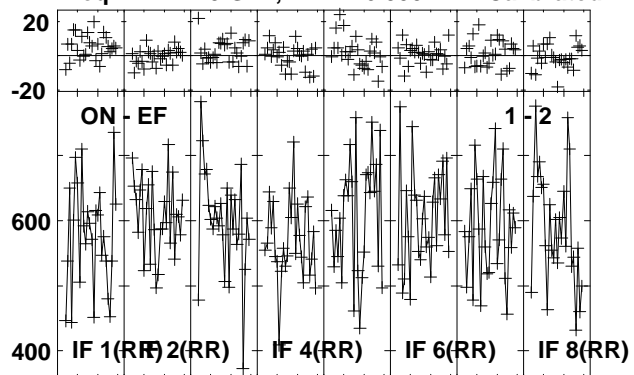

Lower frame: Milli Ampl Jy Top frame: Phas deg
 Vector averaged cross-power spectrum Several baselines displayed
 Timerange: 01/03:10:32 to 01/03:11:30

Plot file version 438 created 26-JUL-2013 10:26:15

J1157 EZ024 1.UVDATA.1

Freq = 22.1720 GHz, Bw = 16.000 MH Calibrated with CL # 3 and BP # 1 (BP mode 1)

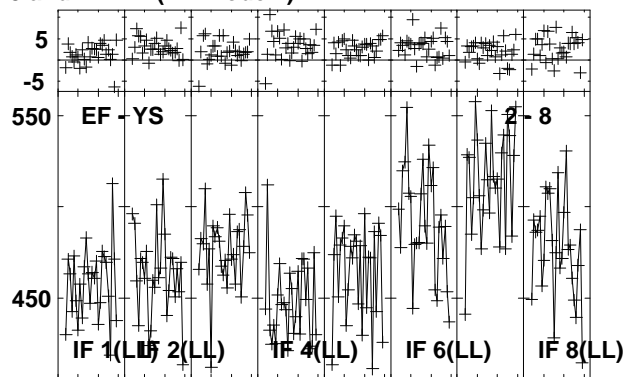
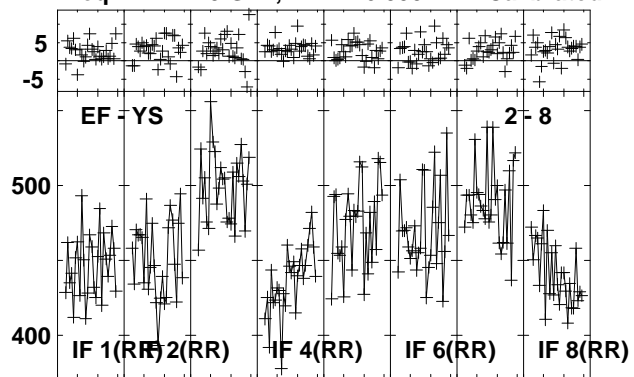

Lower frame: Milli Ampl Jy Top frame: Phas deg
Vector averaged cross-power spectrum Several baselines displayed
Timerange: 01/03:10:32 to 01/03:11:30

Plot file version 439 created 26-JUL-2013 10:26:16
 B1152+199A EZ024 1.UVDATA.1
 Freq = 22.1720 GHz, Bw = 16.000 MH Calibrated with CL # 3 and BP # 1 (BP mode 1)

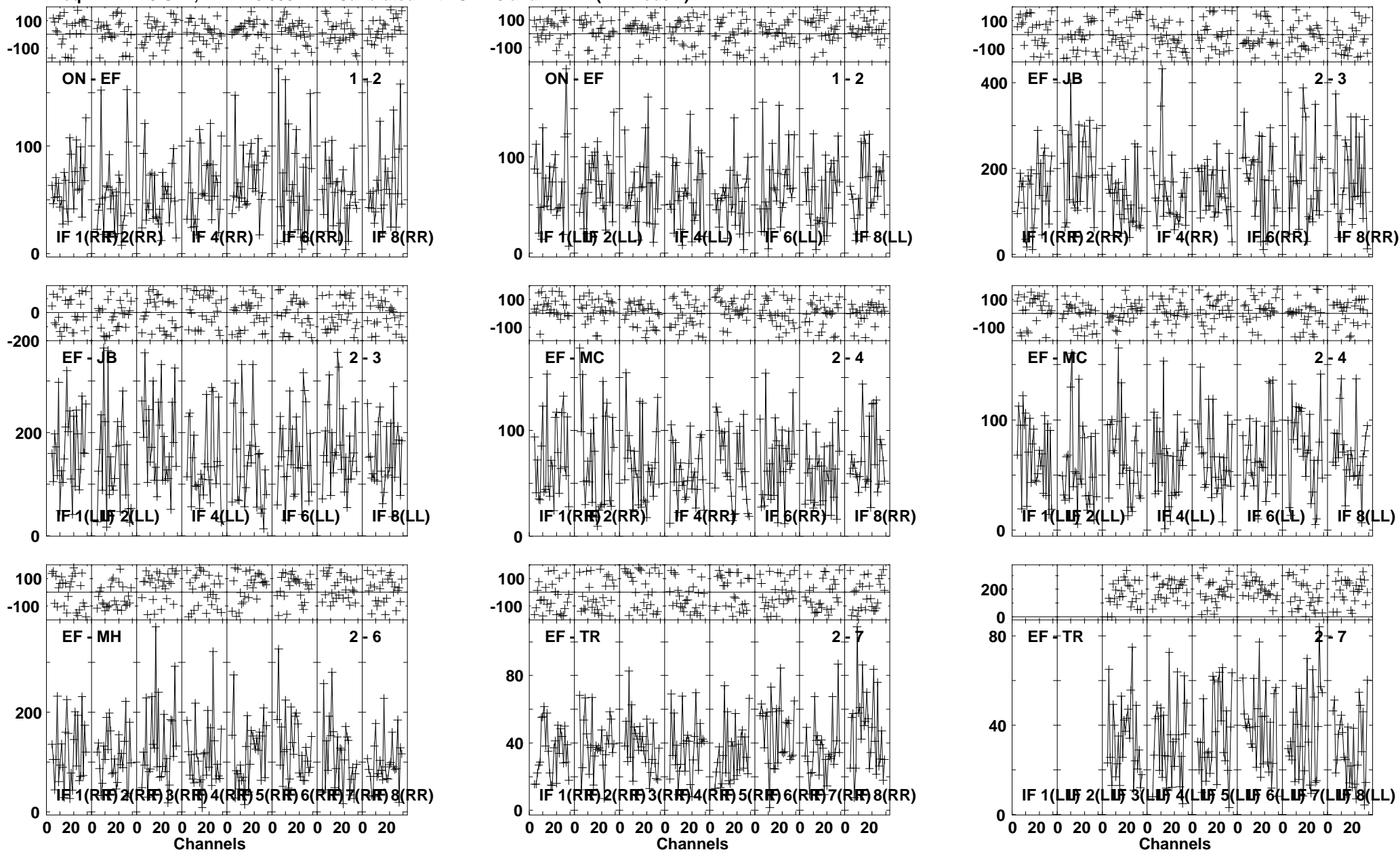

Lower frame: Milli Ampl Jy Top frame: Phas deg
 Vector averaged cross-power spectrum Several baselines displayed
 Timerange: 01/03:12:06 to 01/03:14:04

Plot file version 440 created 26-JUL-2013 10:26:17

B1152+199A EZ024 1.UVDATA.1

Freq = 22.1720 GHz, Bw = 16.000 MH Calibrated with CL # 3 and BP # 1 (BP mode 1)

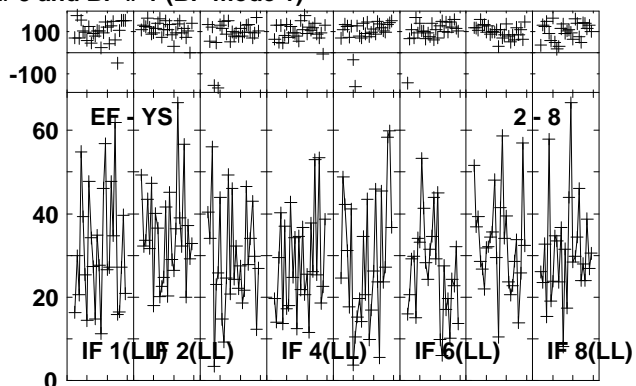
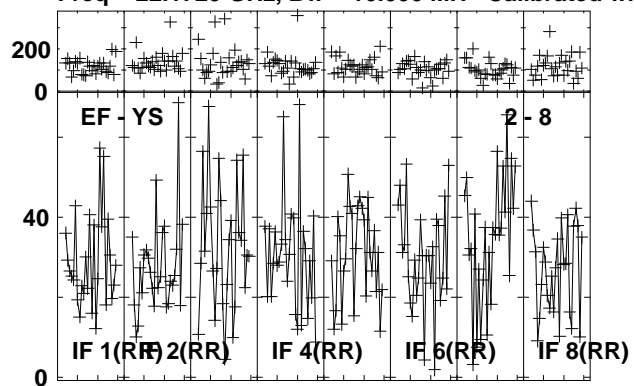

Lower frame: Milli Ampl Jy Top frame: Phas deg
Vector averaged cross-power spectrum Several baselines displayed
Timerange: 01/03:12:06 to 01/03:14:04

Plot file version 441 created 26-JUL-2013 10:26:18

J1157 EZ024 1.UVDATA.1

Freq = 22.1720 GHz, Bw = 16.000 MH Calibrated with CL # 3 and BP # 1 (BP mode 1)

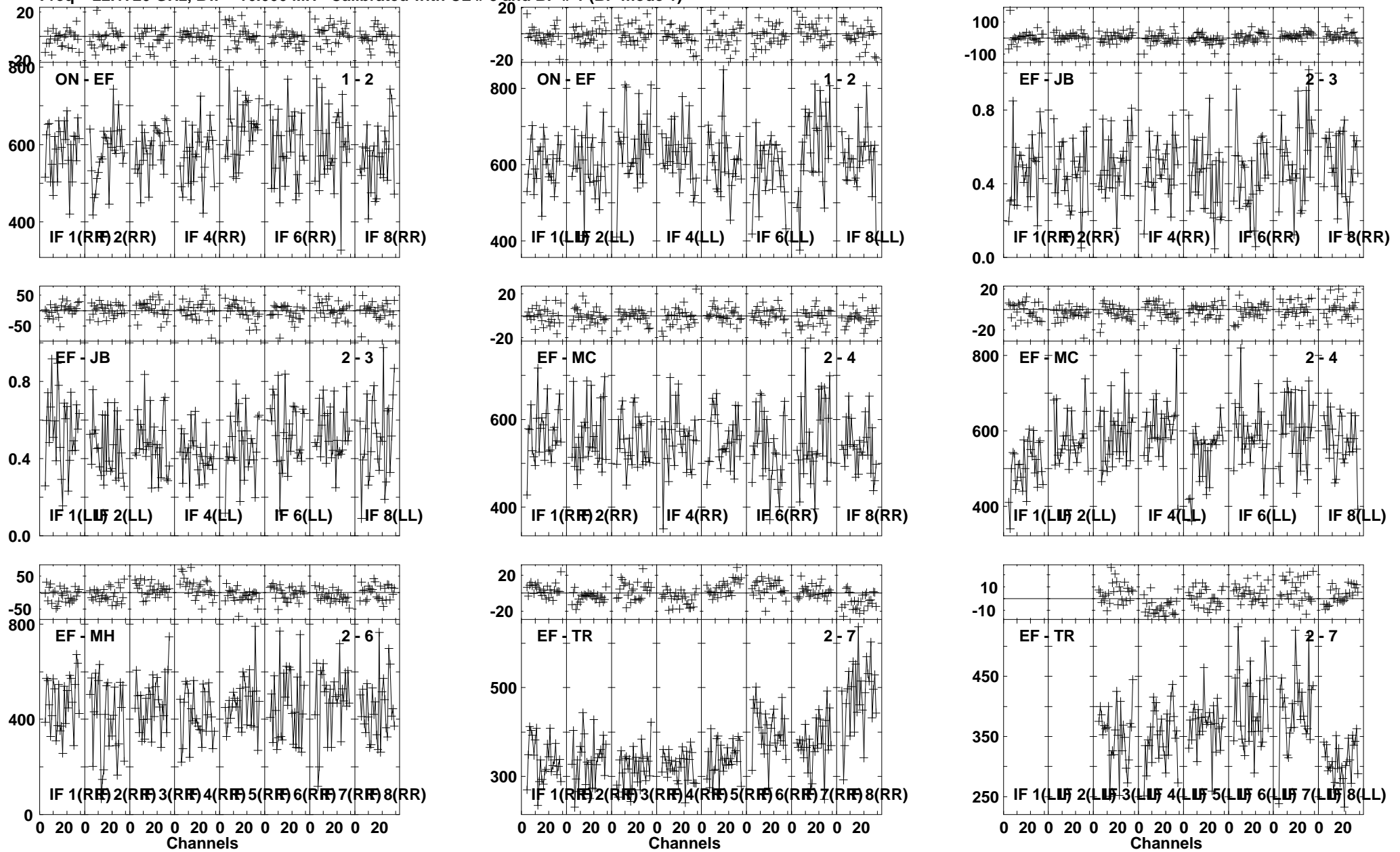

Lower frame: Milli Ampl Jy Top frame: Phas deg
Vector averaged cross-power spectrum Several baselines displayed
Timerange: 01/03:14:39 to 01/03:15:37

Plot file version 442 created 26-JUL-2013 10:26:19

J1157 EZ024 1.UVDATA.1

Freq = 22.1720 GHz, Bw = 16.000 MH Calibrated with CL # 3 and BP # 1 (BP mode 1)

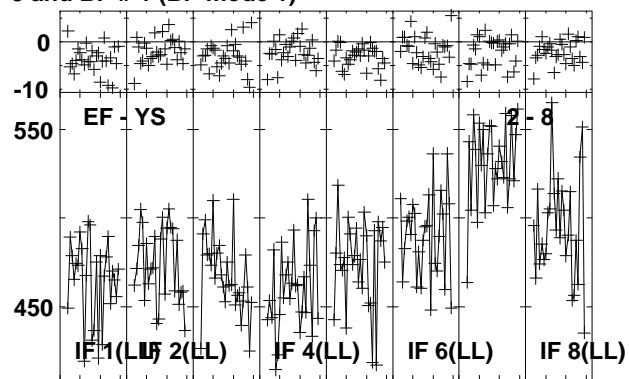
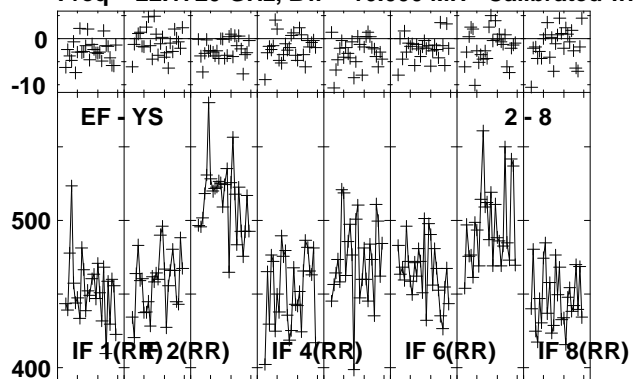

Lower frame: Milli Ampl Jy Top frame: Phas deg
Vector averaged cross-power spectrum Several baselines displayed
Timerange: 01/03:14:39 to 01/03:15:37

Plot file version 443 created 26-JUL-2013 10:26:20
 B1152+199A EZ024 1.UVDATA.1
 Freq = 22.1720 GHz, Bw = 16.000 MH Calibrated with CL # 3 and BP # 1 (BP mode 1)

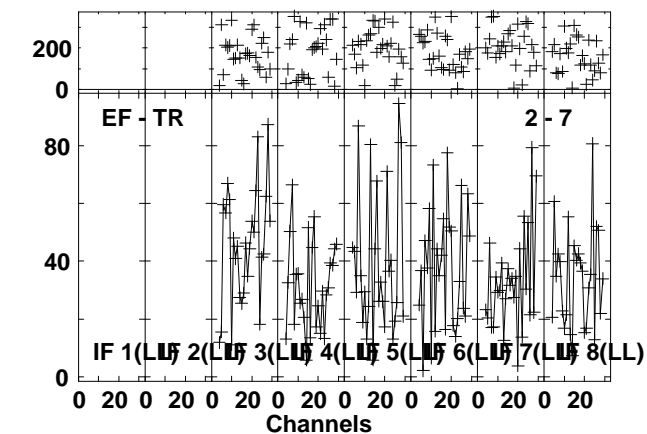
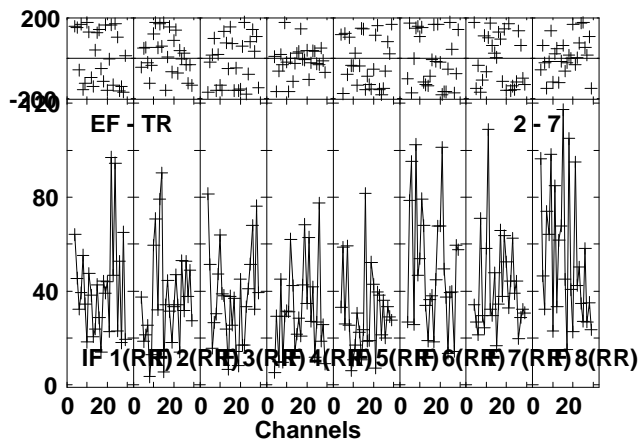
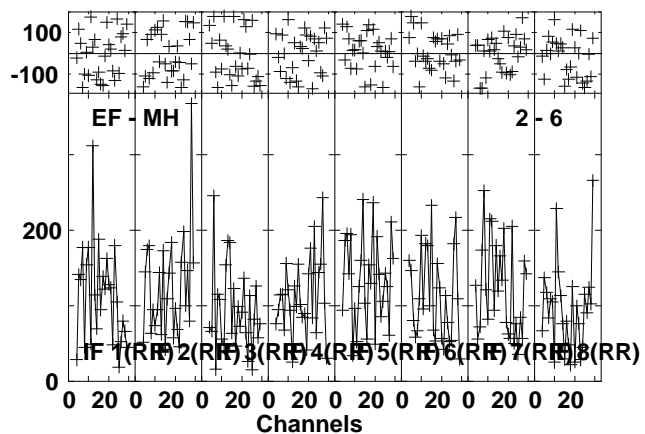
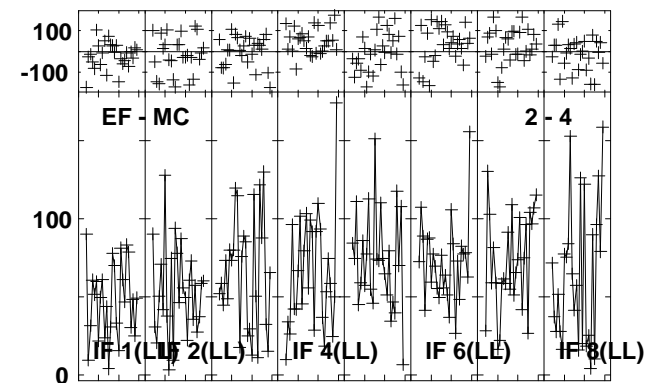
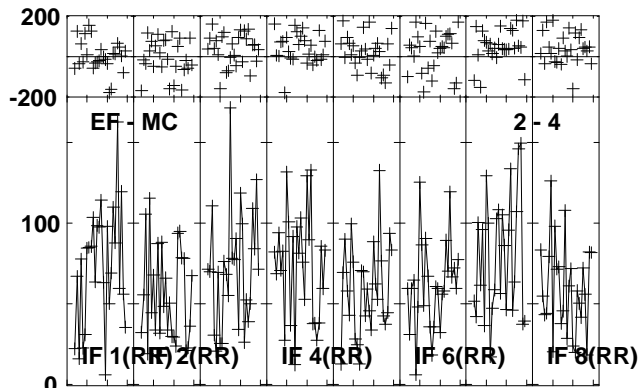
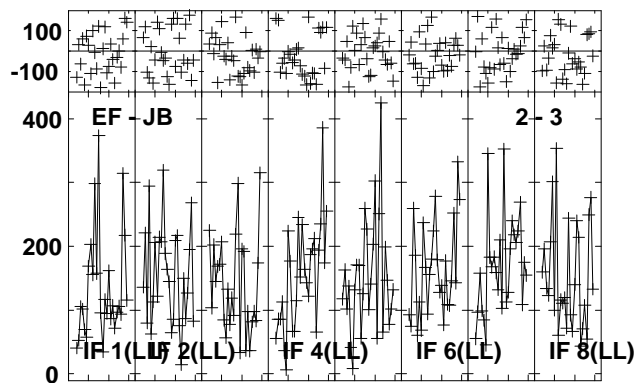
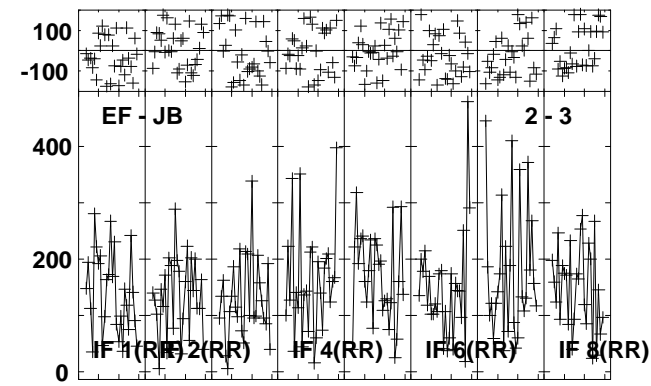
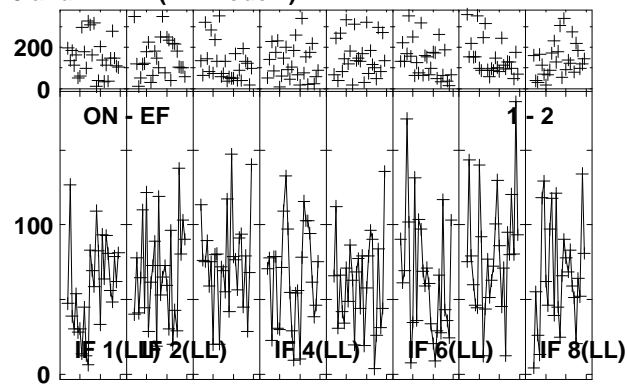
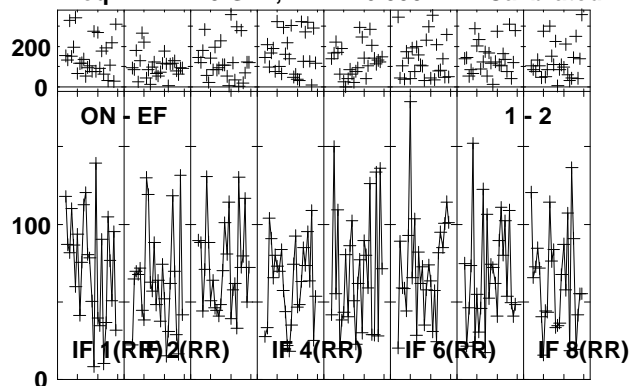

Lower frame: Milli Ampl Jy Top frame: Phas deg
 Vector averaged cross-power spectrum Several baselines displayed
 Timerange: 01/03:16:14 to 01/03:18:12

Plot file version 444 created 26-JUL-2013 10:26:21

B1152+199A EZ024 1.UVDATA.1

Freq = 22.1720 GHz, Bw = 16.000 MH Calibrated with CL # 3 and BP # 1 (BP mode 1)

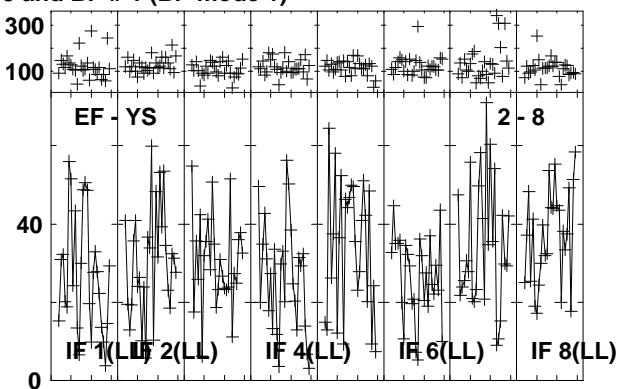
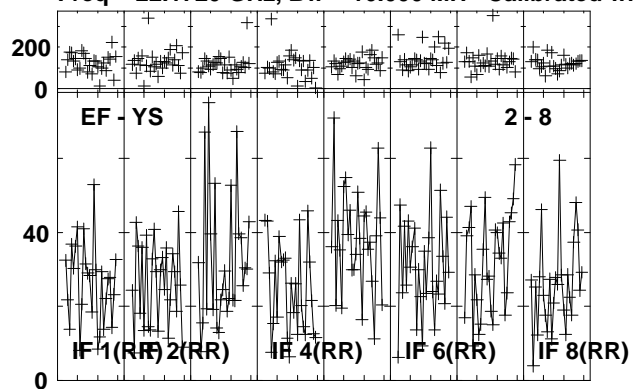

Lower frame: Milli Ampl Jy Top frame: Phas deg
Vector averaged cross-power spectrum Several baselines displayed
Timerange: 01/03:16:14 to 01/03:18:12

Plot file version 445 created 26-JUL-2013 10:26:22
 J1157 EZ024 1.UVDATA.1
 Freq = 22.1720 GHz, Bw = 16.000 MH Calibrated with CL # 3 and BP # 1 (BP mode 1)

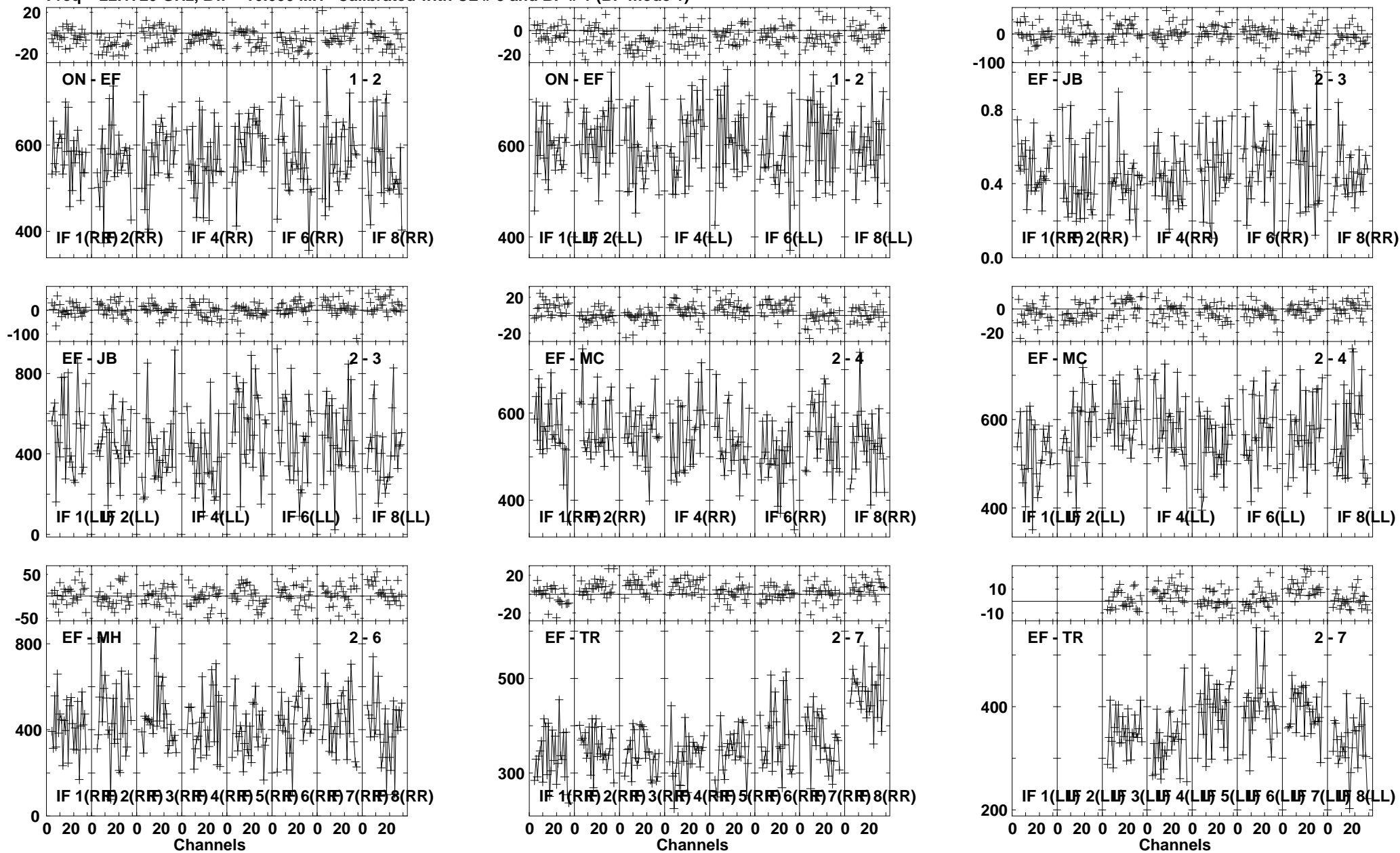

Lower frame: Milli Ampl Jy Top frame: Phas deg
 Vector averaged cross-power spectrum Several baselines displayed
 Timerange: 01/03:18:47 to 01/03:19:45

Plot file version 446 created 26-JUL-2013 10:26:23

J1157 EZ024 1.UVDATA.1

Freq = 22.1720 GHz, Bw = 16.000 MH Calibrated with CL # 3 and BP # 1 (BP mode 1)

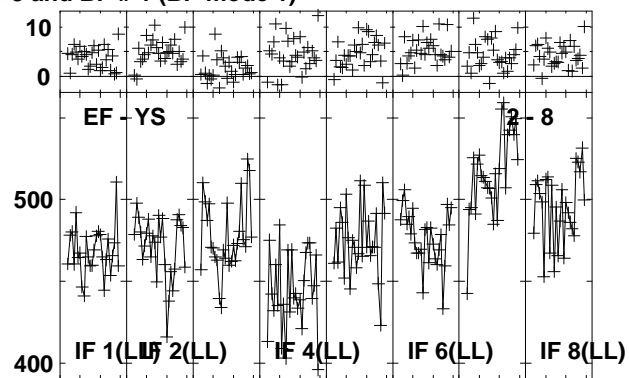
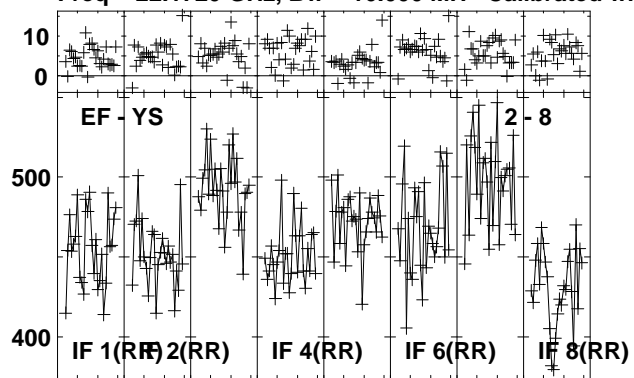

Lower frame: Milli Ampl Jy Top frame: Phas deg
Vector averaged cross-power spectrum Several baselines displayed
Timerange: 01/03:18:47 to 01/03:19:45

Plot file version 447 created 26-JUL-2013 10:26:24
 J1125+2610 EZ024 1.UVDATA.1
 Freq = 22.1720 GHz, Bw = 16.000 MH Calibrated with CL # 3 and BP # 1 (BP mode 1)

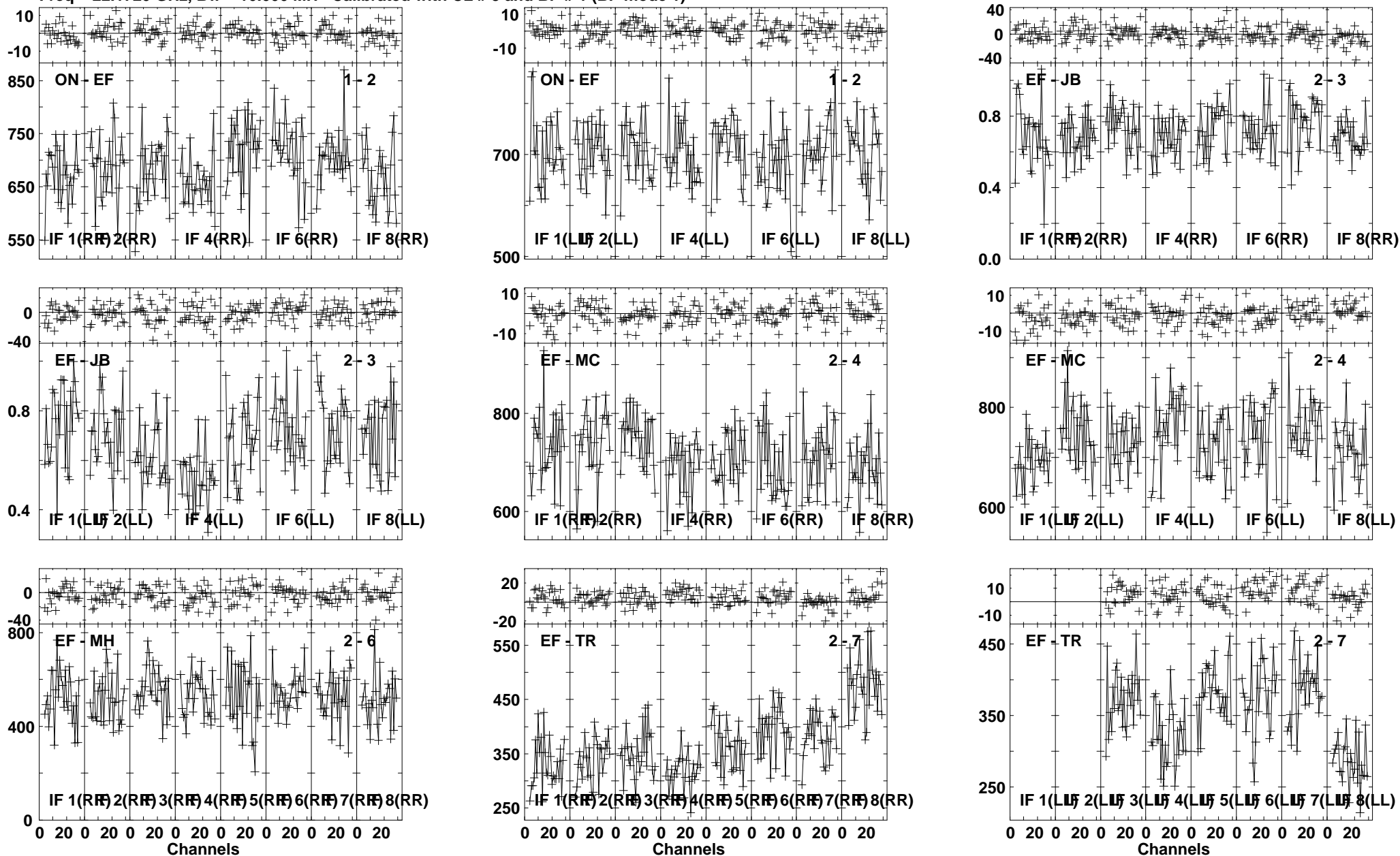

Lower frame: Milli Ampl Jy Top frame: Phas deg
 Vector averaged cross-power spectrum Several baselines displayed
 Timerange: 01/03:21:18 to 01/03:23:00

Plot file version 448 created 26-JUL-2013 10:26:25

J1125+2610 EZ024 1.UVDATA.1

Freq = 22.1720 GHz, Bw = 16.000 MH Calibrated with CL # 3 and BP # 1 (BP mode 1)

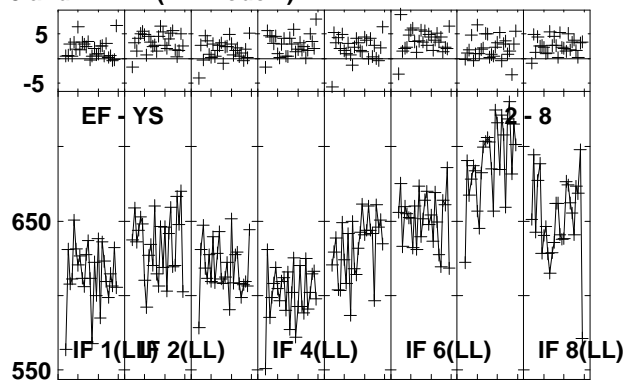
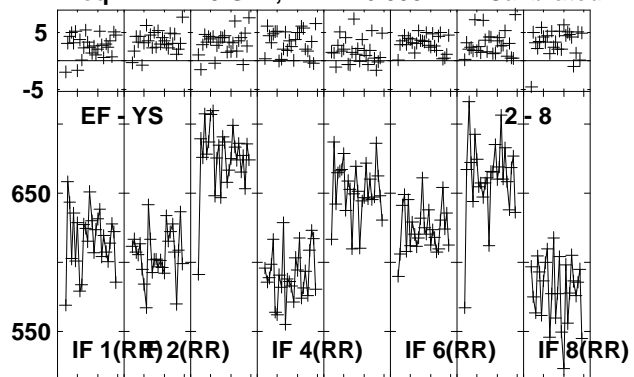

Lower frame: Milli Ampl Jy Top frame: Phas deg
Vector averaged cross-power spectrum Several baselines displayed
Timerange: 01/03:21:18 to 01/03:23:00

Plot file version 449 created 26-JUL-2013 10:26:32

J1157 EZ024 1.UVDATA.1

Freq = 22.1720 GHz, Bw = 16.000 MH Calibrated with CL # 3 and BP # 1 (BP mode 1)

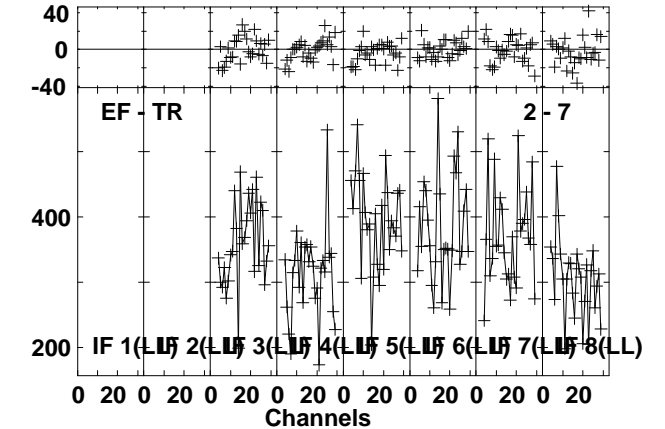
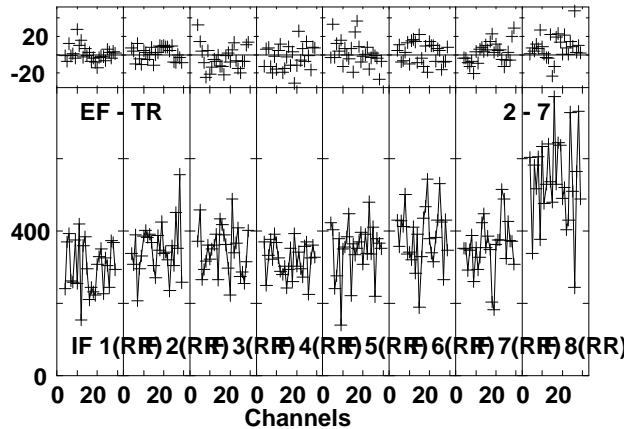
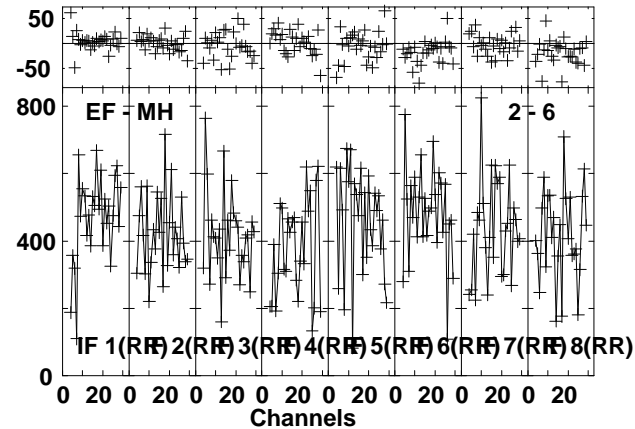
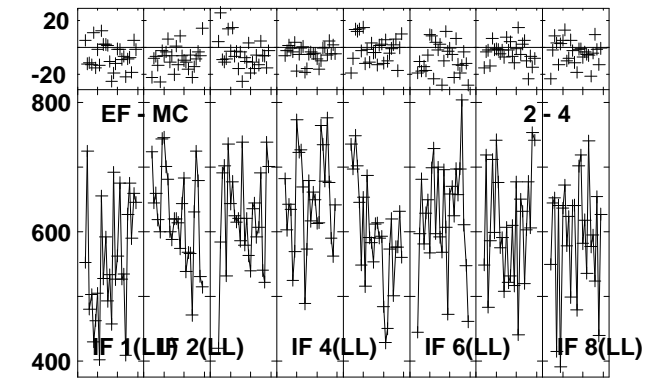
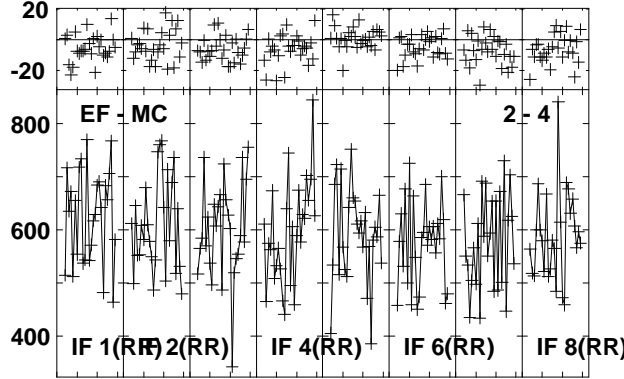
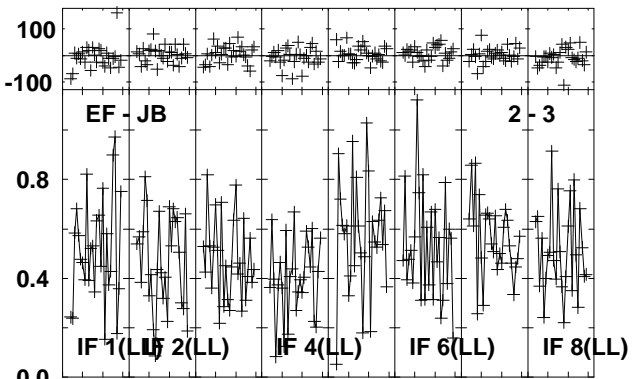
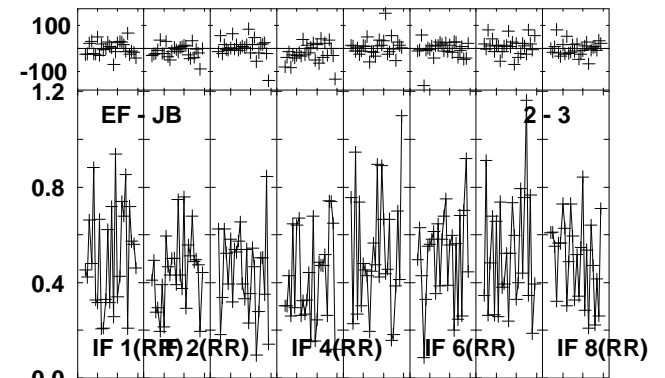
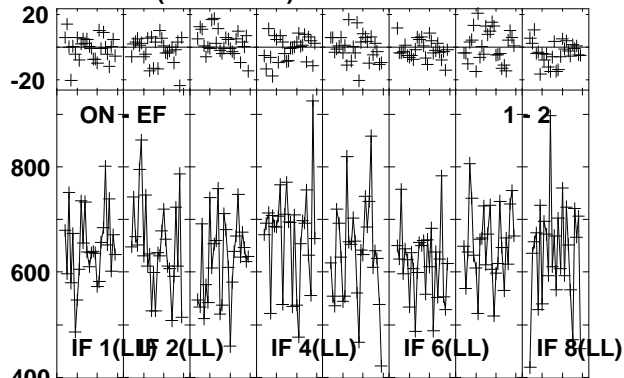
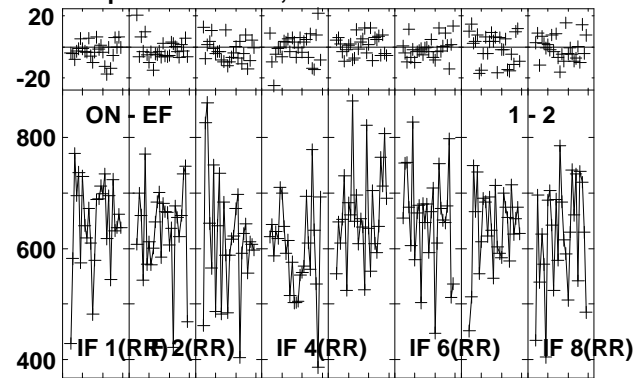

Lower frame: Milli Ampl Jy Top frame: Phas deg
 Vector averaged cross-power spectrum Several baselines displayed
 Timerange: 01/03:32:44 to 01/03:33:26

Plot file version 450 created 26-JUL-2013 10:26:33

J1157 EZ024 1.UVDATA.1

Freq = 22.1720 GHz, Bw = 16.000 MH Calibrated with CL # 3 and BP # 1 (BP mode 1)

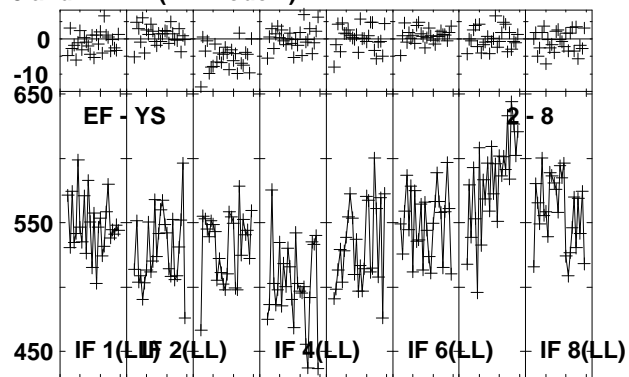
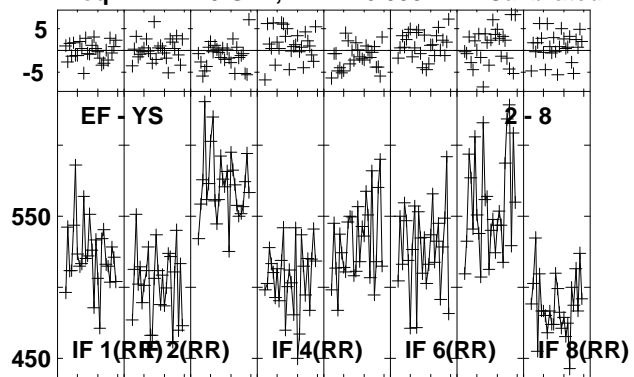

Lower frame: Milli Ampl Jy Top frame: Phas deg
Vector averaged cross-power spectrum Several baselines displayed
Timerange: 01/03:32:44 to 01/03:33:26

Plot file version 451 created 26-JUL-2013 10:26:33
 B1152+199A EZ024 1.UVDATA.1
 Freq = 22.1720 GHz, Bw = 16.000 MH Calibrated with CL # 3 and BP # 1 (BP mode 1)

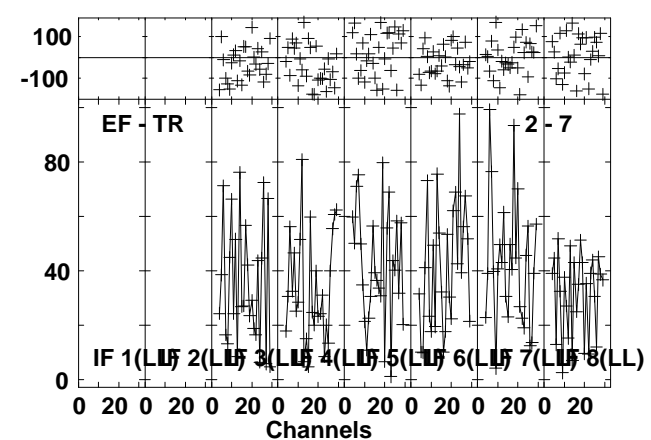
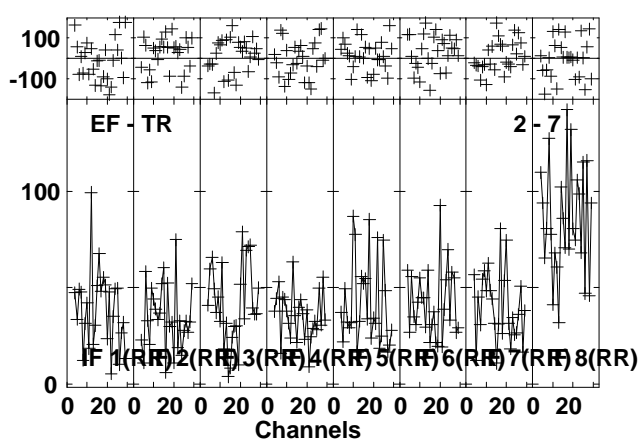
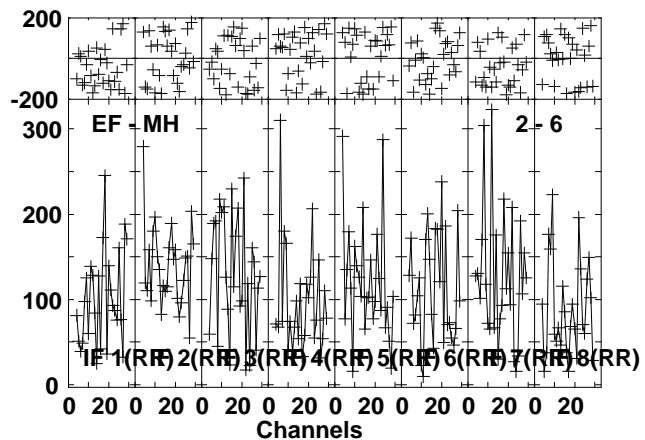
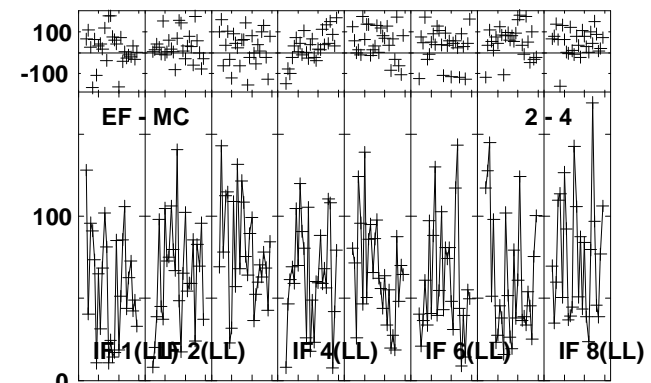
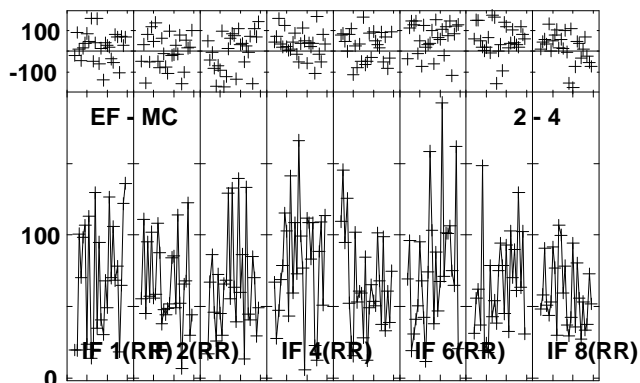
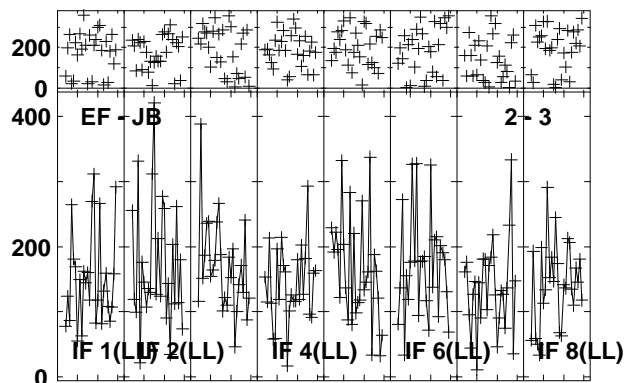
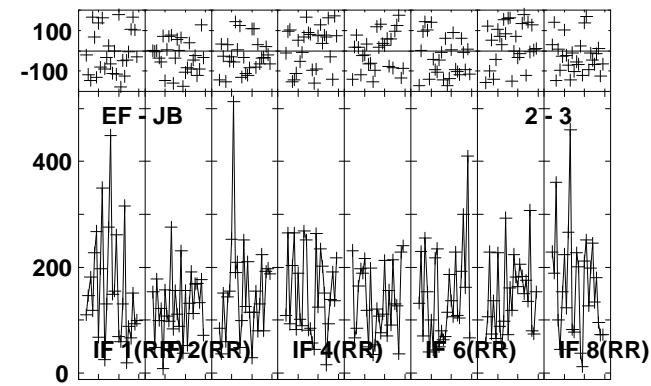
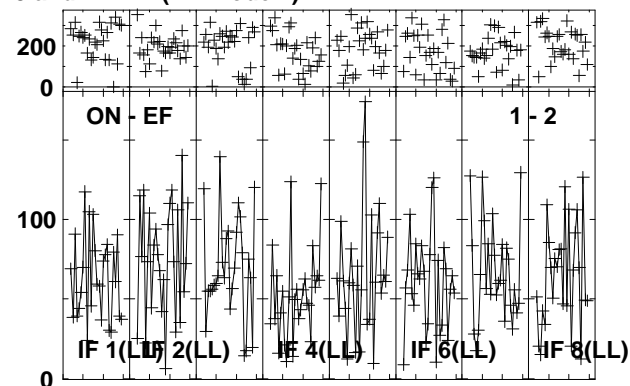
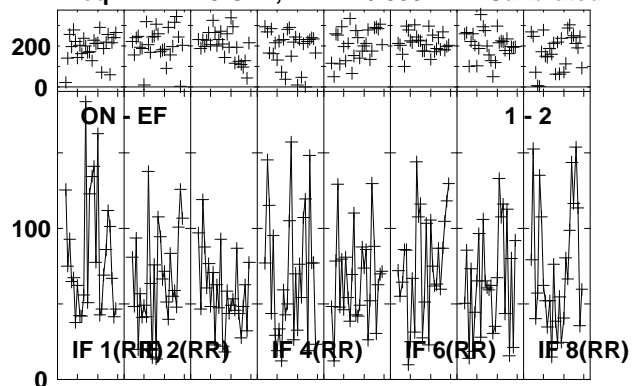

Lower frame: Milli Ampl Jy Top frame: Phas deg
 Vector averaged cross-power spectrum Several baselines displayed
 Timerange: 01/03:34:02 to 01/03:36:00

Plot file version 452 created 26-JUL-2013 10:26:34

B1152+199A EZ024 1.UVDATA.1

Freq = 22.1720 GHz, Bw = 16.000 MH Calibrated with CL # 3 and BP # 1 (BP mode 1)

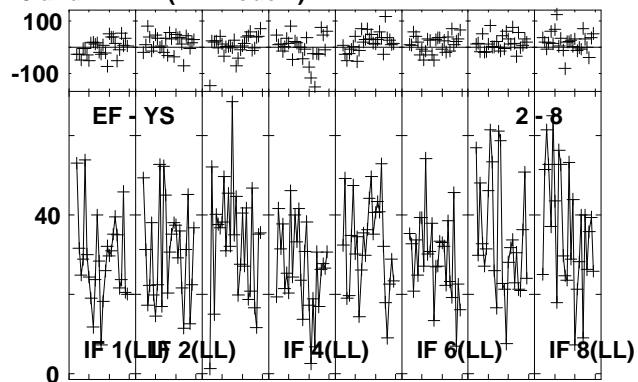
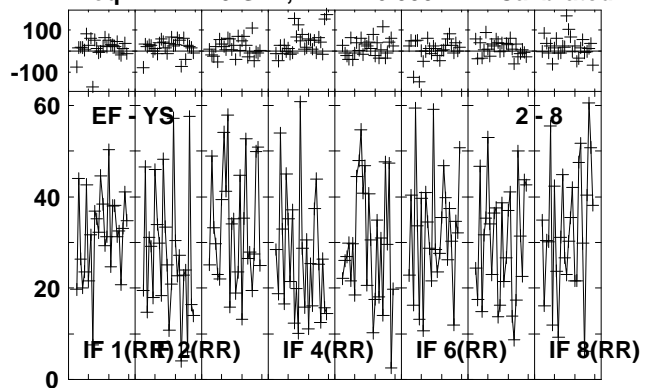

Lower frame: Milli Ampl Jy Top frame: Phas deg
Vector averaged cross-power spectrum Several baselines displayed
Timerange: 01/03:34:02 to 01/03:36:00

Plot file version 453 created 26-JUL-2013 10:26:36
 J1157 EZ024 1.UVDATA.1
 Freq = 22.1720 GHz, Bw = 16.000 MH Calibrated with CL # 3 and BP # 1 (BP mode 1)

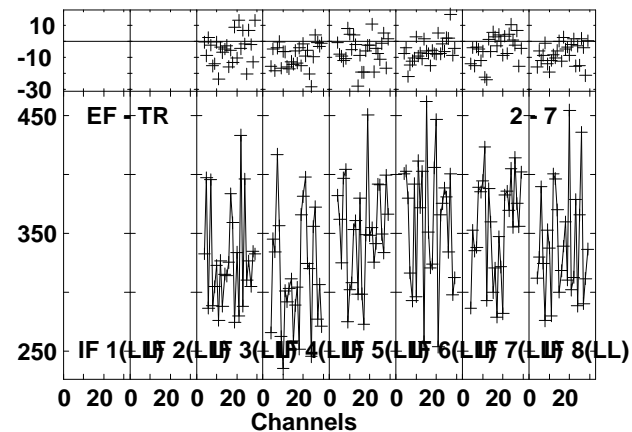
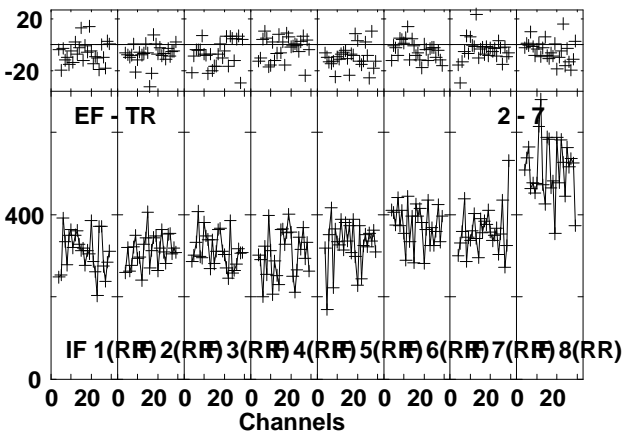
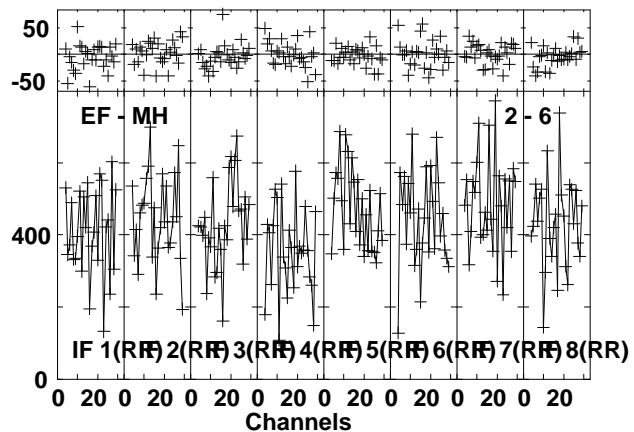
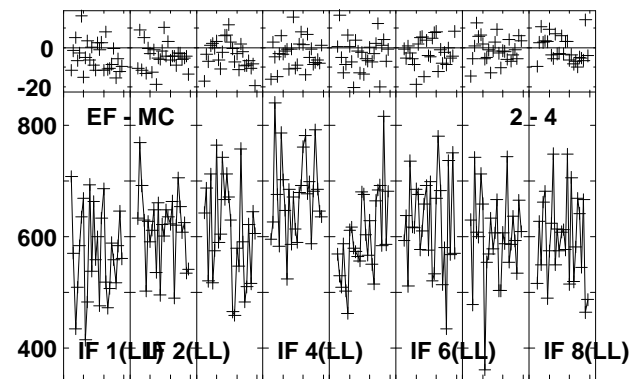
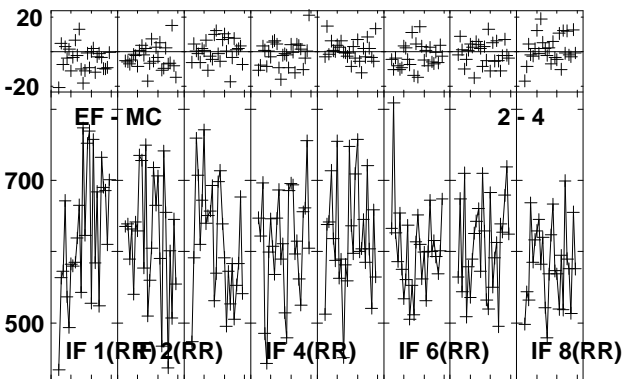
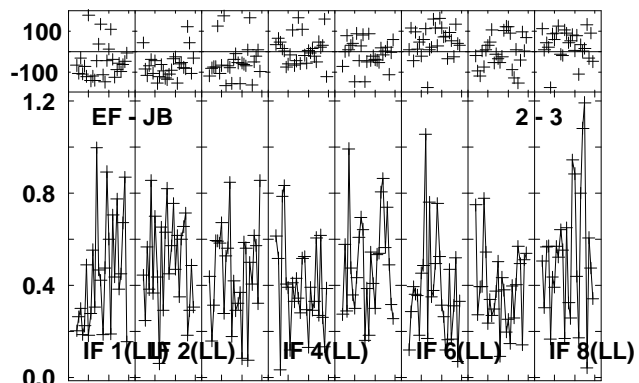
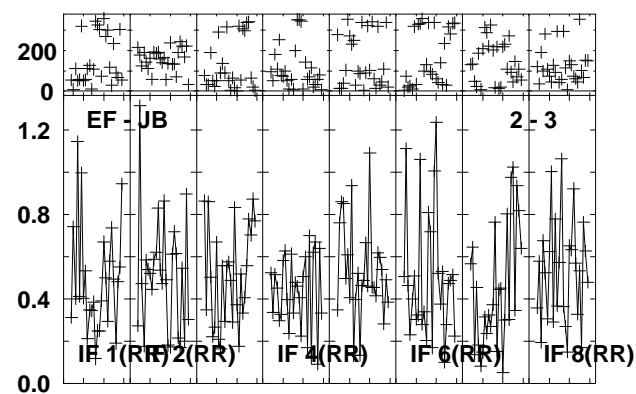
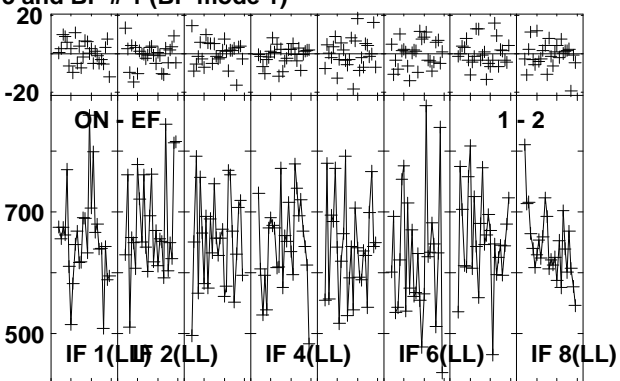
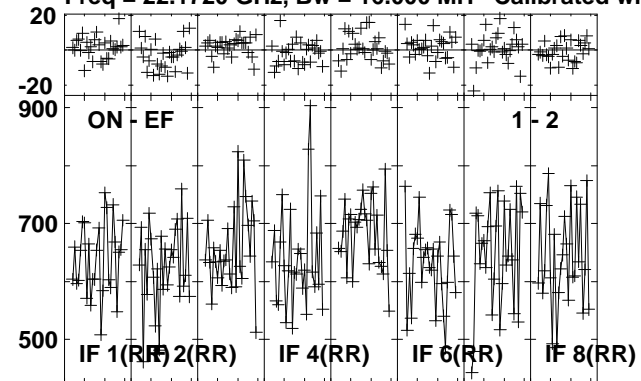

Lower frame: Milli Ampl Jy Top frame: Phas deg
 Vector averaged cross-power spectrum Several baselines displayed
 Timerange: 01/03:36:36 to 01/03:37:34

Plot file version 454 created 26-JUL-2013 10:26:36

J1157 EZ024 1.UVDATA.1

Freq = 22.1720 GHz, Bw = 16.000 MH Calibrated with CL # 3 and BP # 1 (BP mode 1)

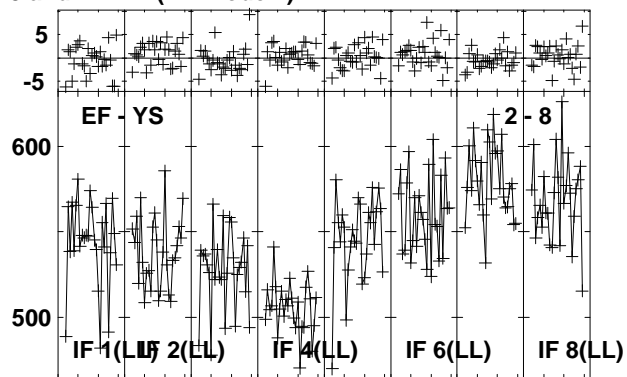
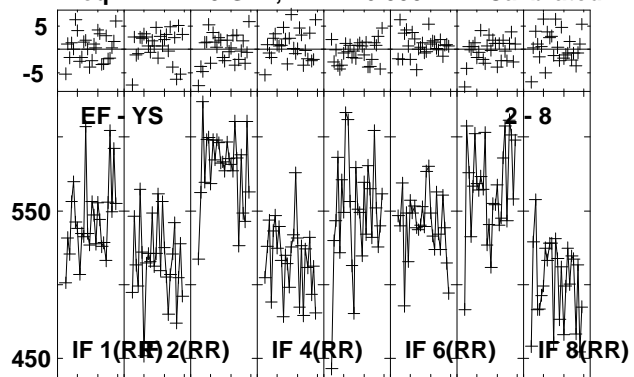

Lower frame: Milli Ampl Jy Top frame: Phas deg
Vector averaged cross-power spectrum Several baselines displayed
Timerange: 01/03:36:36 to 01/03:37:34

Plot file version 455 created 26-JUL-2013 10:26:37

B1152+199A EZ024 1.UVDATA.1

Freq = 22.1720 GHz, Bw = 16.000 MH Calibrated with CL # 3 and BP # 1 (BP mode 1)

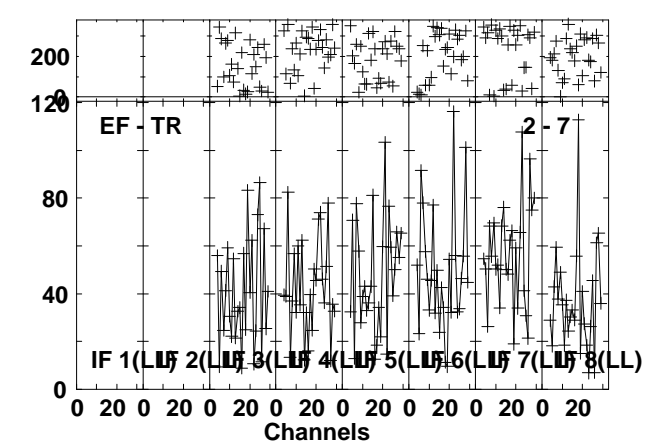
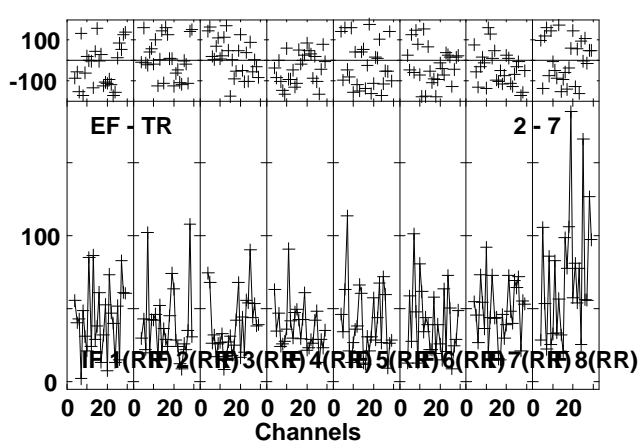
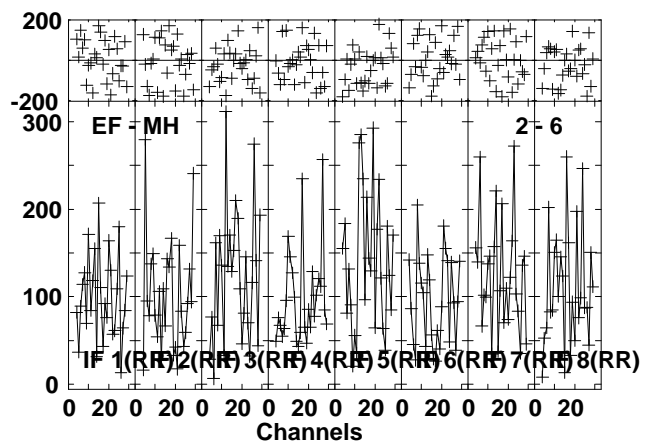
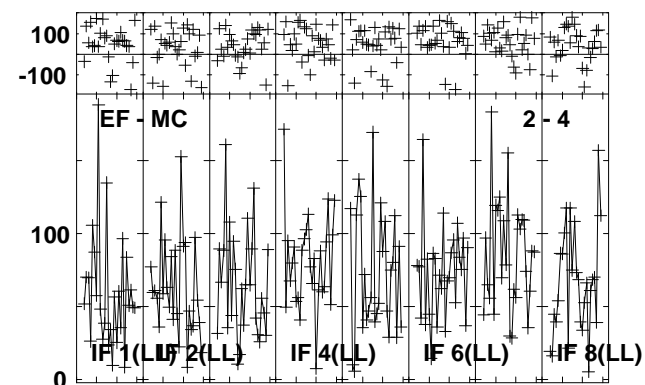
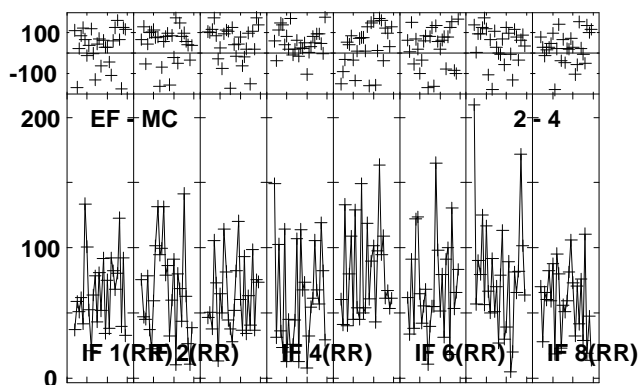
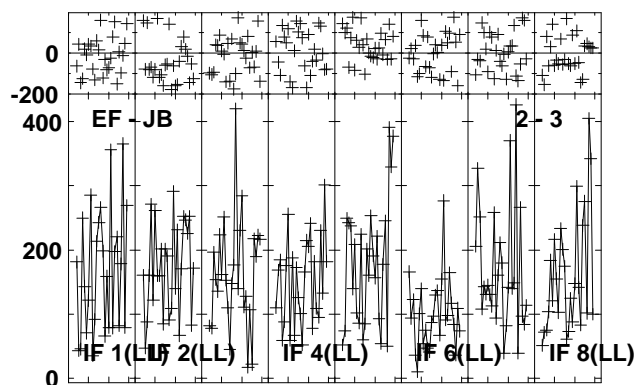
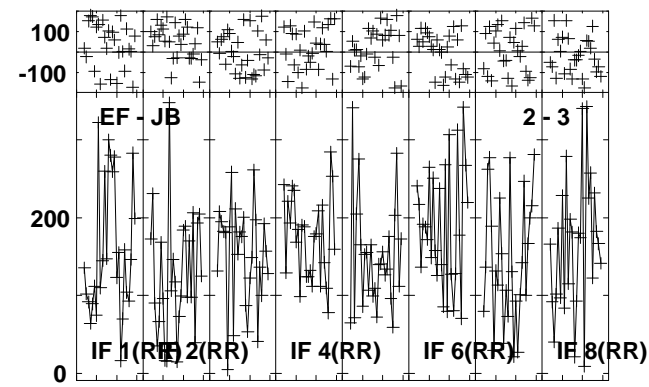
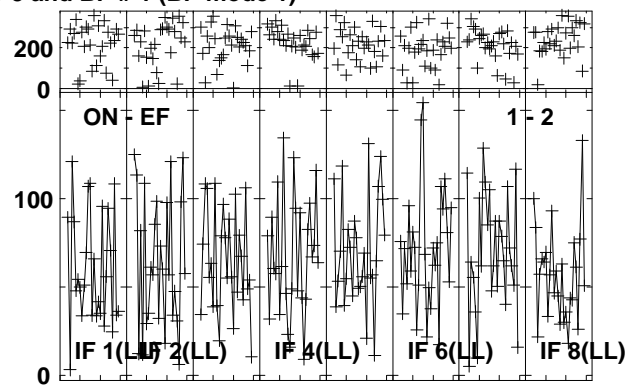
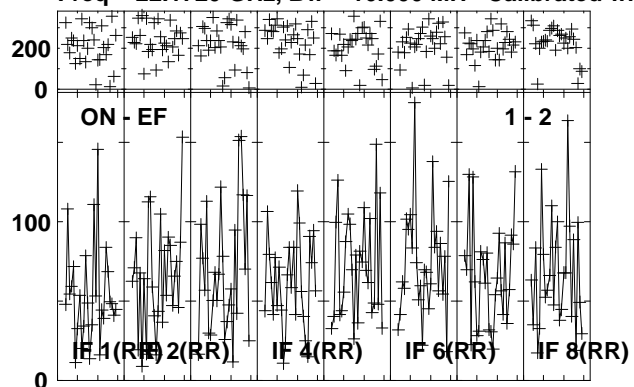

Lower frame: Milli Ampl Jy Top frame: Phas deg
Vector averaged cross-power spectrum Several baselines displayed
Timerange: 01/03:38:10 to 01/03:40:08

Plot file version 456 created 26-JUL-2013 10:26:38

B1152+199A EZ024 1.UVDATA.1

Freq = 22.1720 GHz, Bw = 16.000 MH Calibrated with CL # 3 and BP # 1 (BP mode 1)

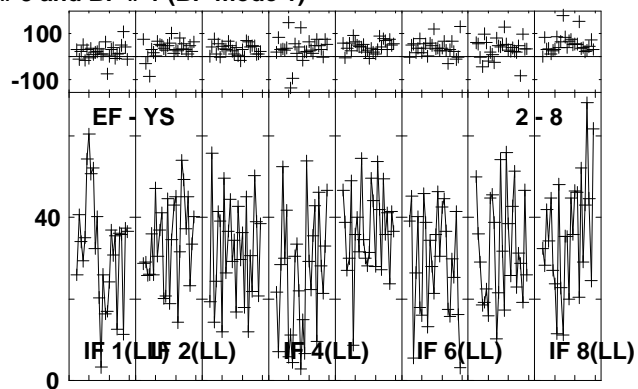
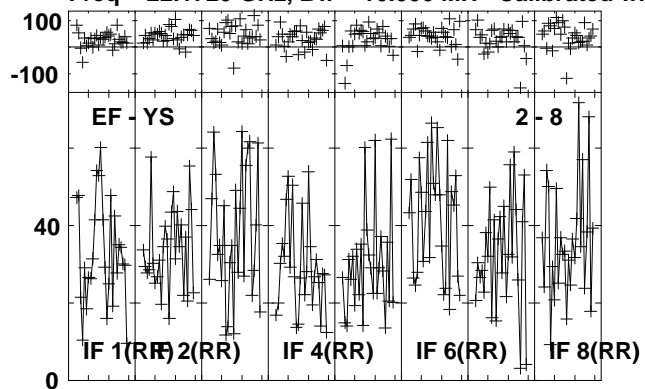

Lower frame: Milli Ampl Jy Top frame: Phas deg
Vector averaged cross-power spectrum Several baselines displayed
Timerange: 01/03:38:10 to 01/03:40:08

Plot file version 457 created 26-JUL-2013 10:26:39

J1157 EZ024 1.UVDATA.1

Freq = 22.1720 GHz, Bw = 16.000 MH Calibrated with CL # 3 and BP # 1 (BP mode 1)

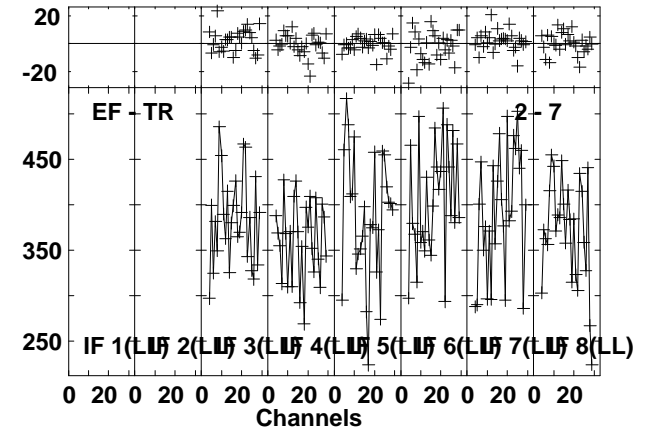
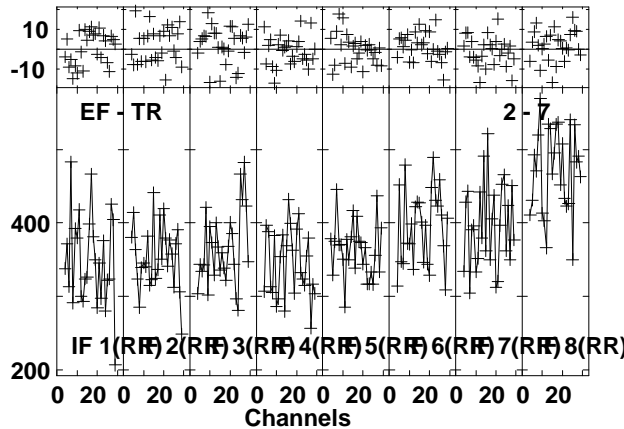
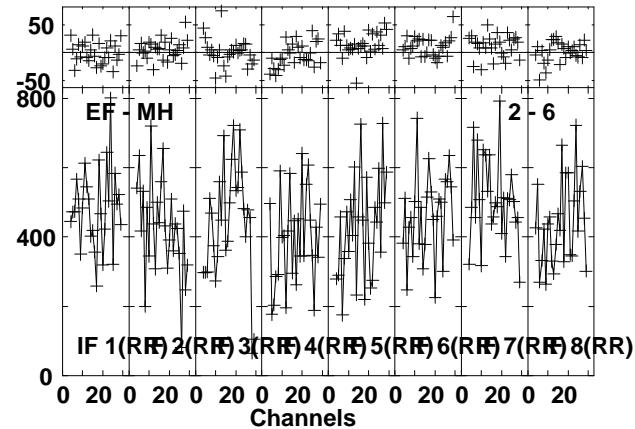
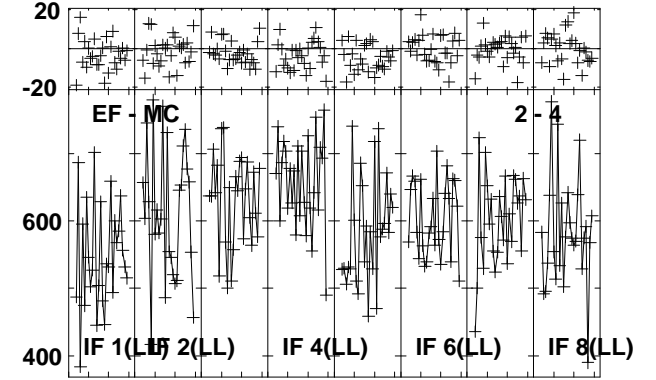
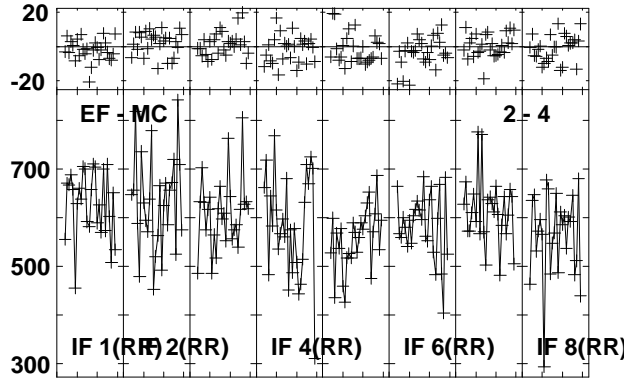
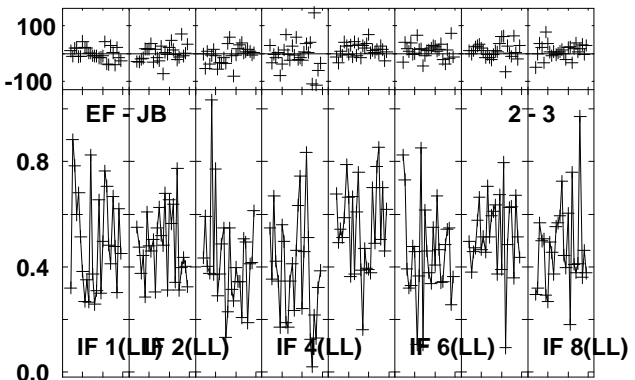
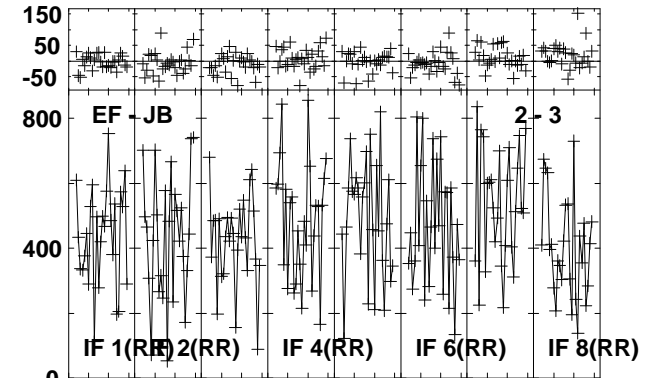
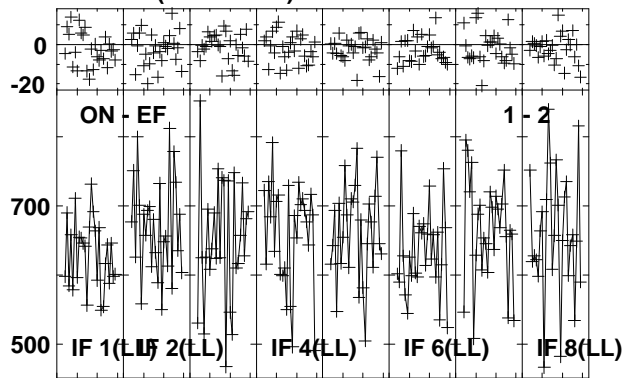
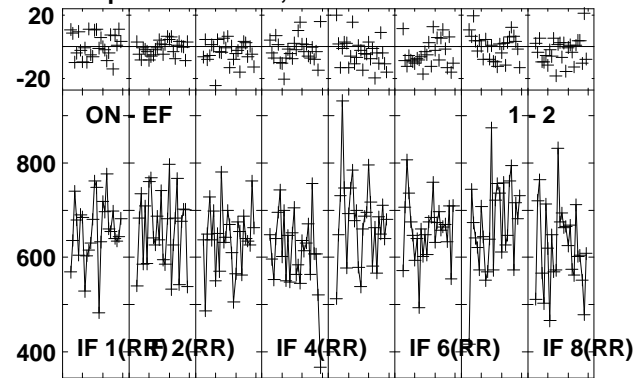

Lower frame: Milli Ampl Jy Top frame: Phas deg
Vector averaged cross-power spectrum Several baselines displayed
Timerange: 01/03:40:43 to 01/03:41:41

Plot file version 458 created 26-JUL-2013 10:26:40

J1157 EZ024 1.UVDATA.1

Freq = 22.1720 GHz, Bw = 16.000 MH Calibrated with CL # 3 and BP # 1 (BP mode 1)

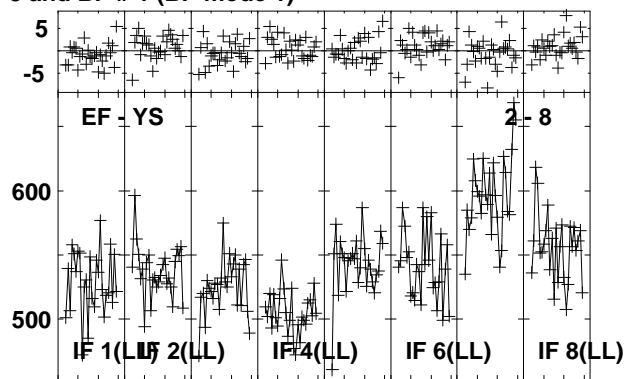
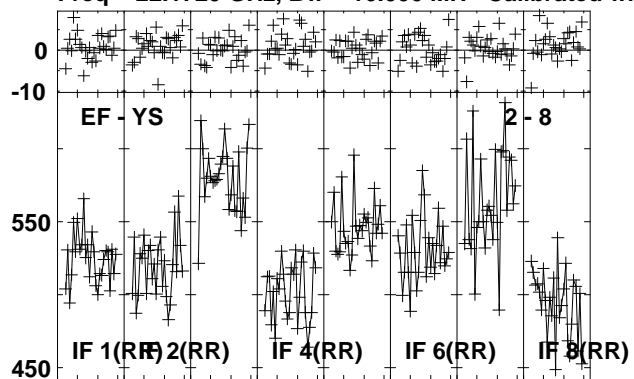

Lower frame: Milli Ampl Jy Top frame: Phas deg
Vector averaged cross-power spectrum Several baselines displayed
Timerange: 01/03:40:43 to 01/03:41:41

Plot file version 459 created 26-JUL-2013 10:26:41
 B1152+199A EZ024 1.UVDATA.1
 Freq = 22.1720 GHz, Bw = 16.000 MH Calibrated with CL # 3 and BP # 1 (BP mode 1)

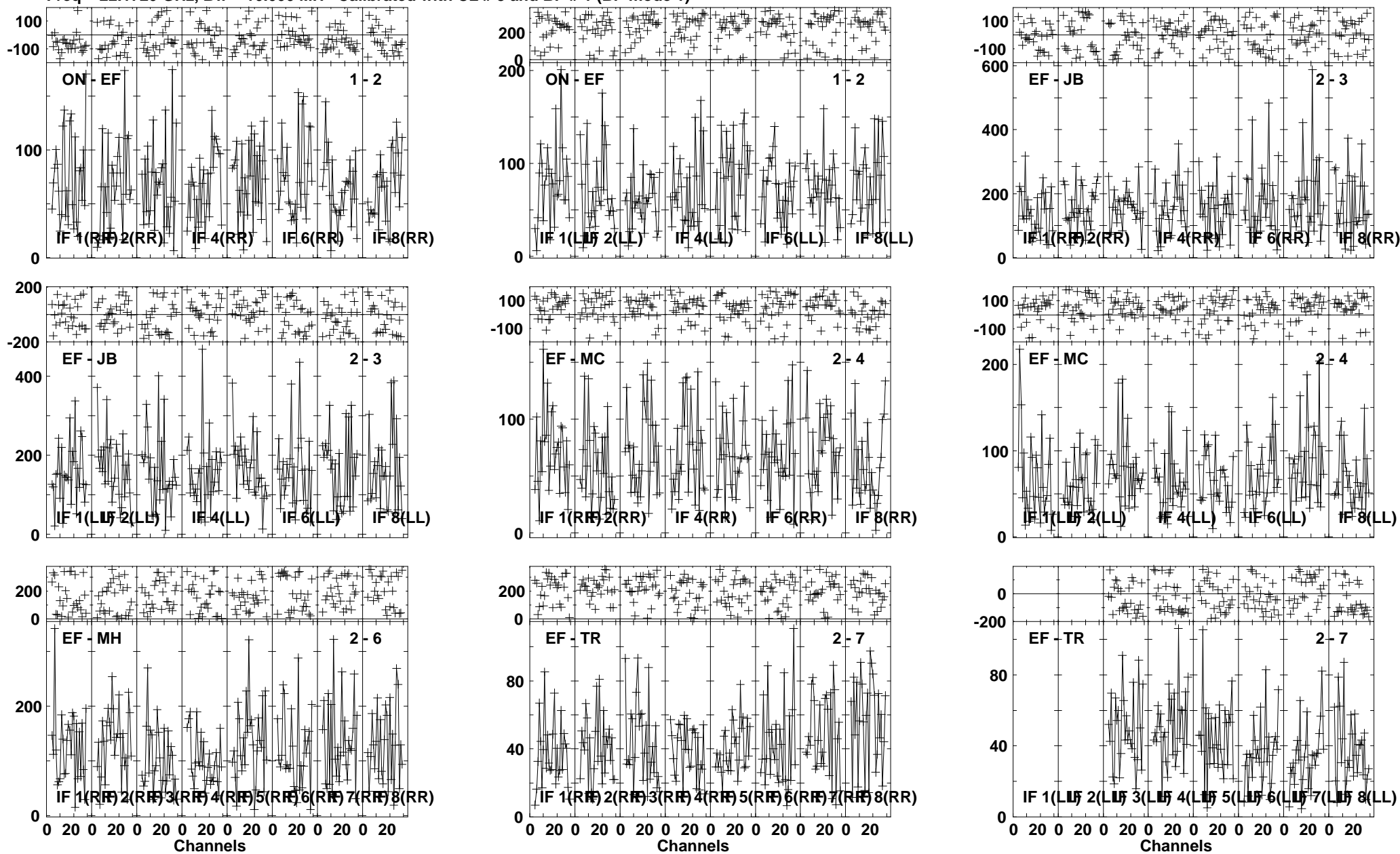

Lower frame: Milli Ampl Jy Top frame: Phas deg
 Vector averaged cross-power spectrum Several baselines displayed
 Timerange: 01/03:42:17 to 01/03:44:15

Plot file version 460 created 26-JUL-2013 10:26:42

B1152+199A EZ024 1.UVDATA.1

Freq = 22.1720 GHz, Bw = 16.000 MH Calibrated with CL # 3 and BP # 1 (BP mode 1)

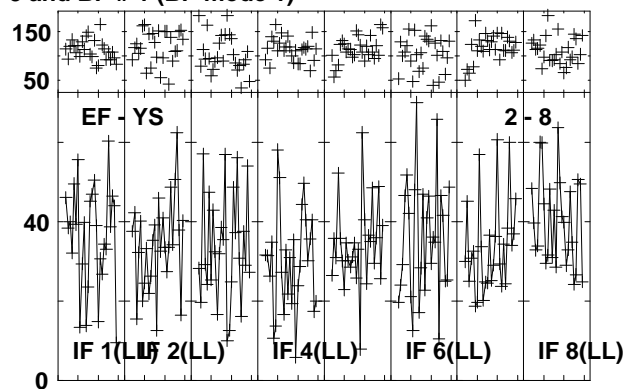
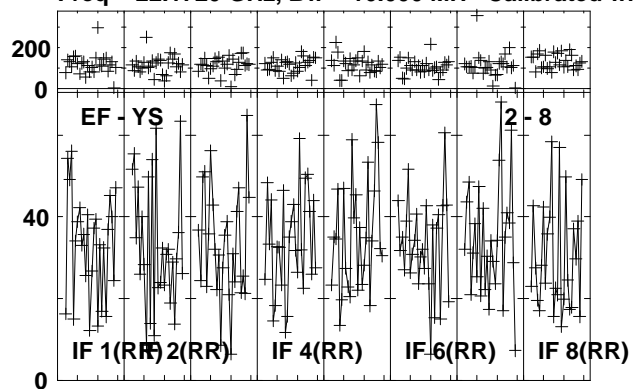

Lower frame: Milli Ampl Jy Top frame: Phas deg
Vector averaged cross-power spectrum Several baselines displayed
Timerange: 01/03:42:17 to 01/03:44:15

Plot file version 461 created 26-JUL-2013 10:26:43

J1157 EZ024 1.UVDATA.1

Freq = 22.1720 GHz, Bw = 16.000 MH Calibrated with CL # 3 and BP # 1 (BP mode 1)

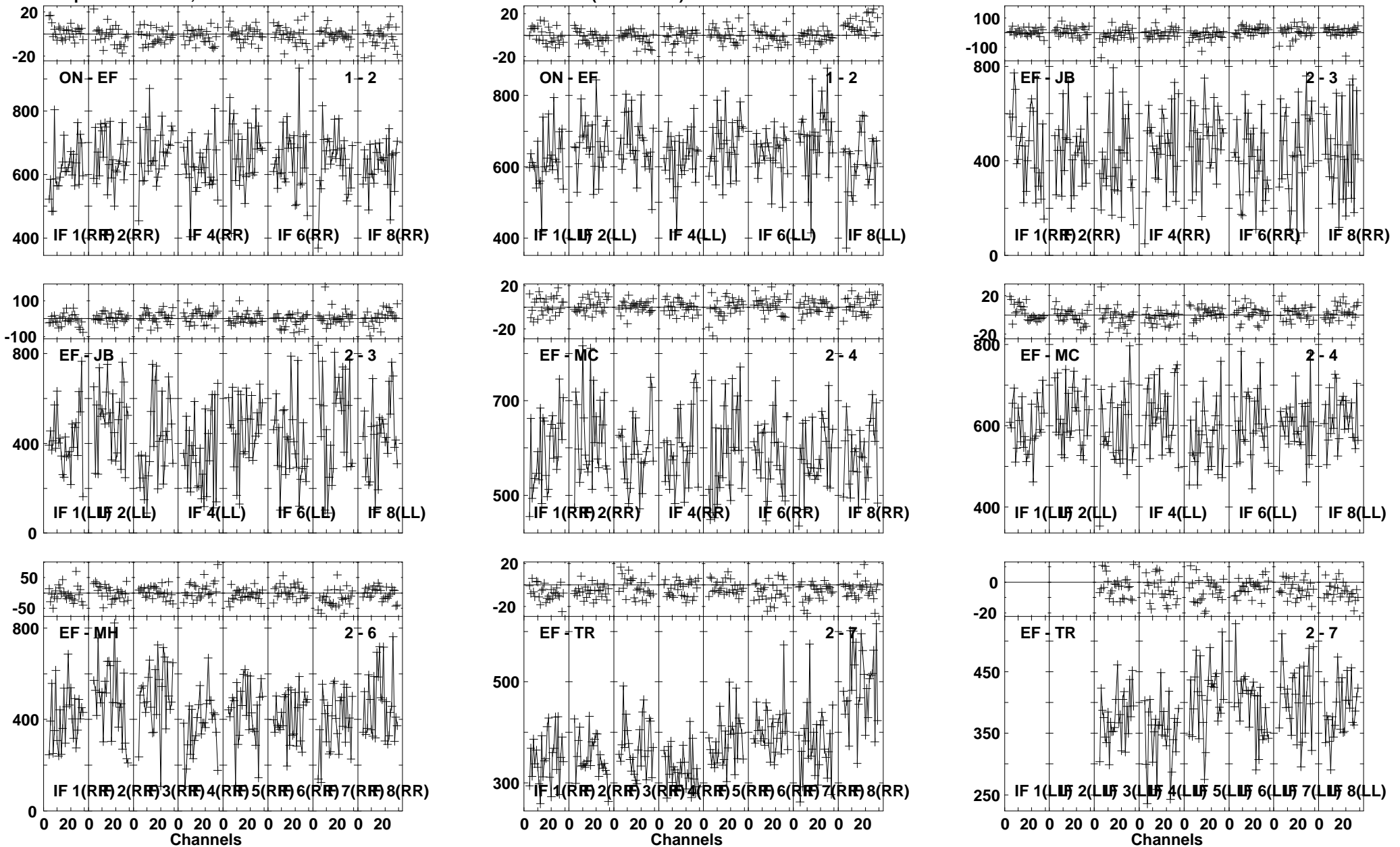

Lower frame: Milli Ampl Jy Top frame: Phas deg
Vector averaged cross-power spectrum Several baselines displayed
Timerange: 01/03:44:50 to 01/03:45:48

Plot file version 462 created 26-JUL-2013 10:26:44

J1157 EZ024 1.UVDATA.1

Freq = 22.1720 GHz, Bw = 16.000 MH Calibrated with CL # 3 and BP # 1 (BP mode 1)

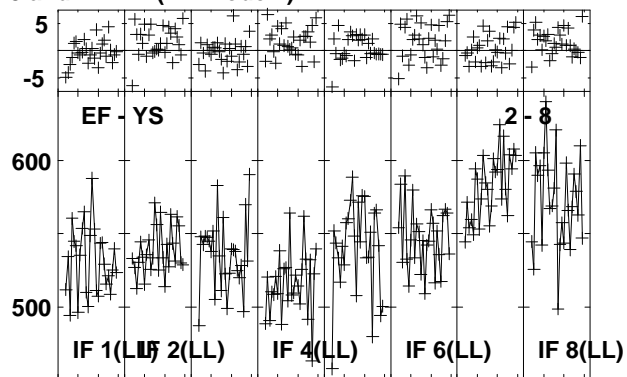
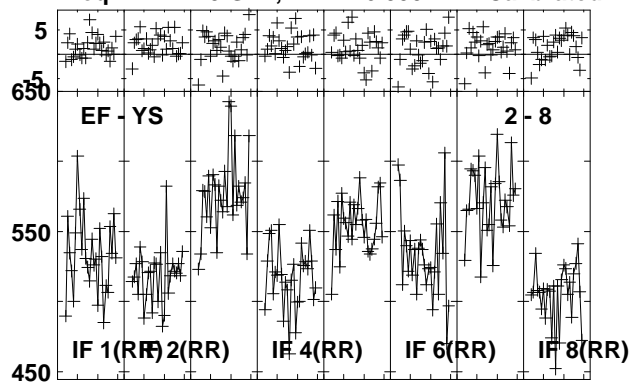

Lower frame: Milli Ampl Jy Top frame: Phas deg
Vector averaged cross-power spectrum Several baselines displayed
Timerange: 01/03:44:50 to 01/03:45:48

Plot file version 463 created 26-JUL-2013 10:26:45
 J1125+2610 EZ024 1.UVDATA.1
 Freq = 22.1720 GHz, Bw = 16.000 MH Calibrated with CL # 3 and BP # 1 (BP mode 1)

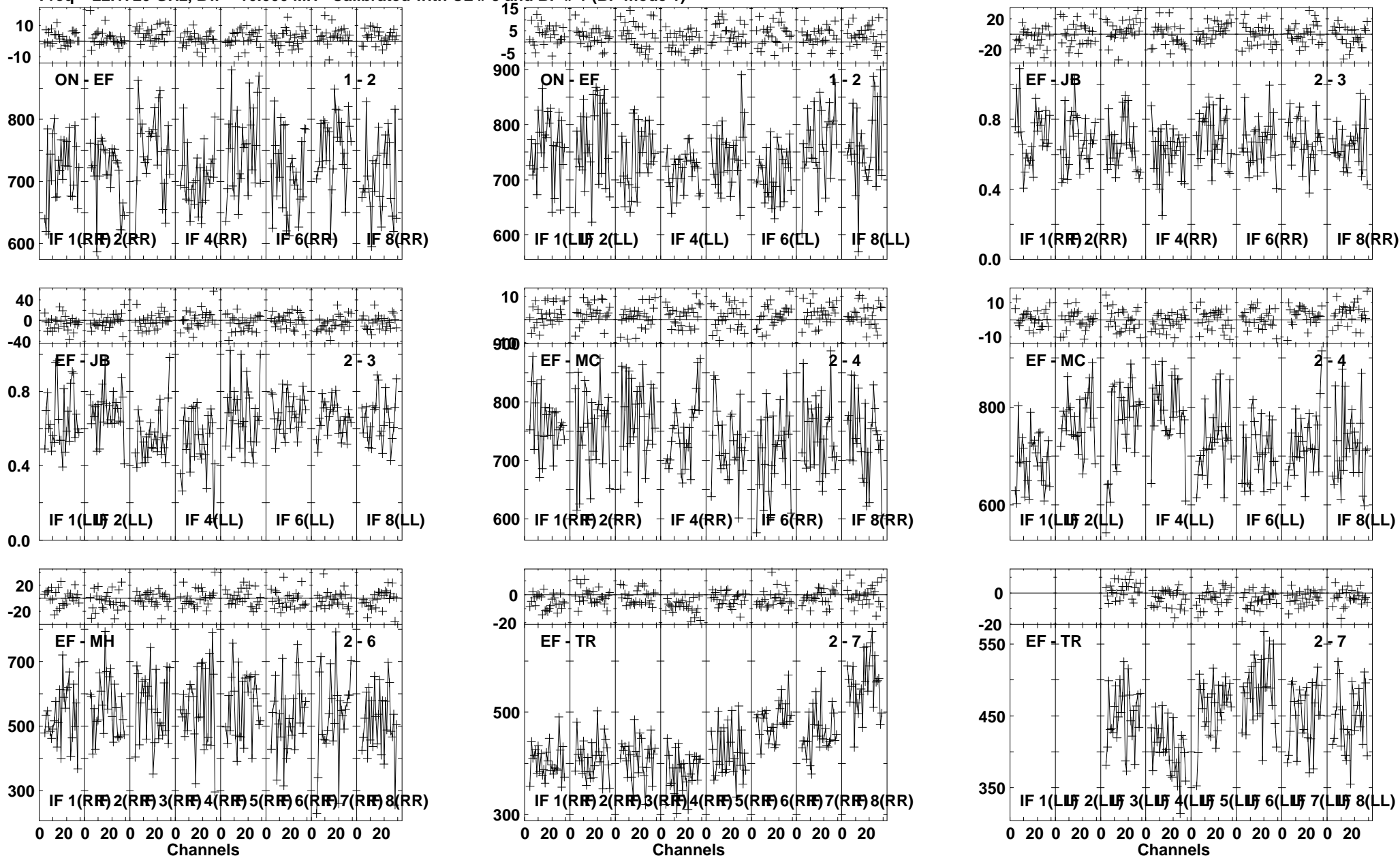

Lower frame: Milli Ampl Jy Top frame: Phas deg
 Vector averaged cross-power spectrum Several baselines displayed
 Timerange: 01/03:47:19 to 01/03:49:01

Plot file version 464 created 26-JUL-2013 10:26:45

J1125+2610 EZ024 1.UVDATA.1

Freq = 22.1720 GHz, Bw = 16.000 MH Calibrated with CL # 3 and BP # 1 (BP mode 1)

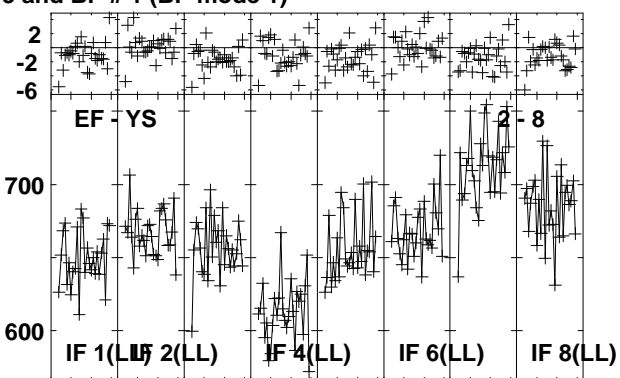
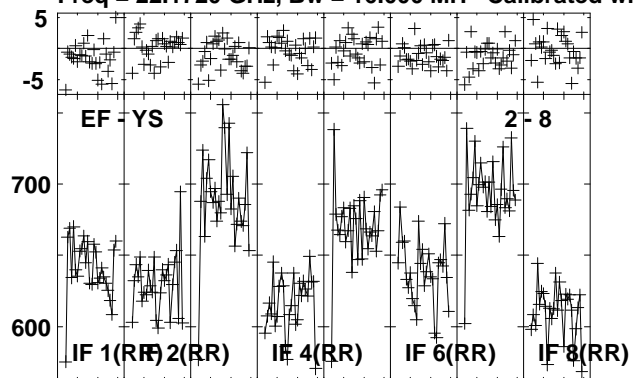

Lower frame: Milli Ampl Jy Top frame: Phas deg
Vector averaged cross-power spectrum Several baselines displayed
Timerange: 01/03:47:19 to 01/03:49:01

Plot file version 465 created 26-JUL-2013 10:26:46
 J1157 EZ024 1.UVDATA.1
 Freq = 22.1720 GHz, Bw = 16.000 MH Calibrated with CL # 3 and BP # 1 (BP mode 1)

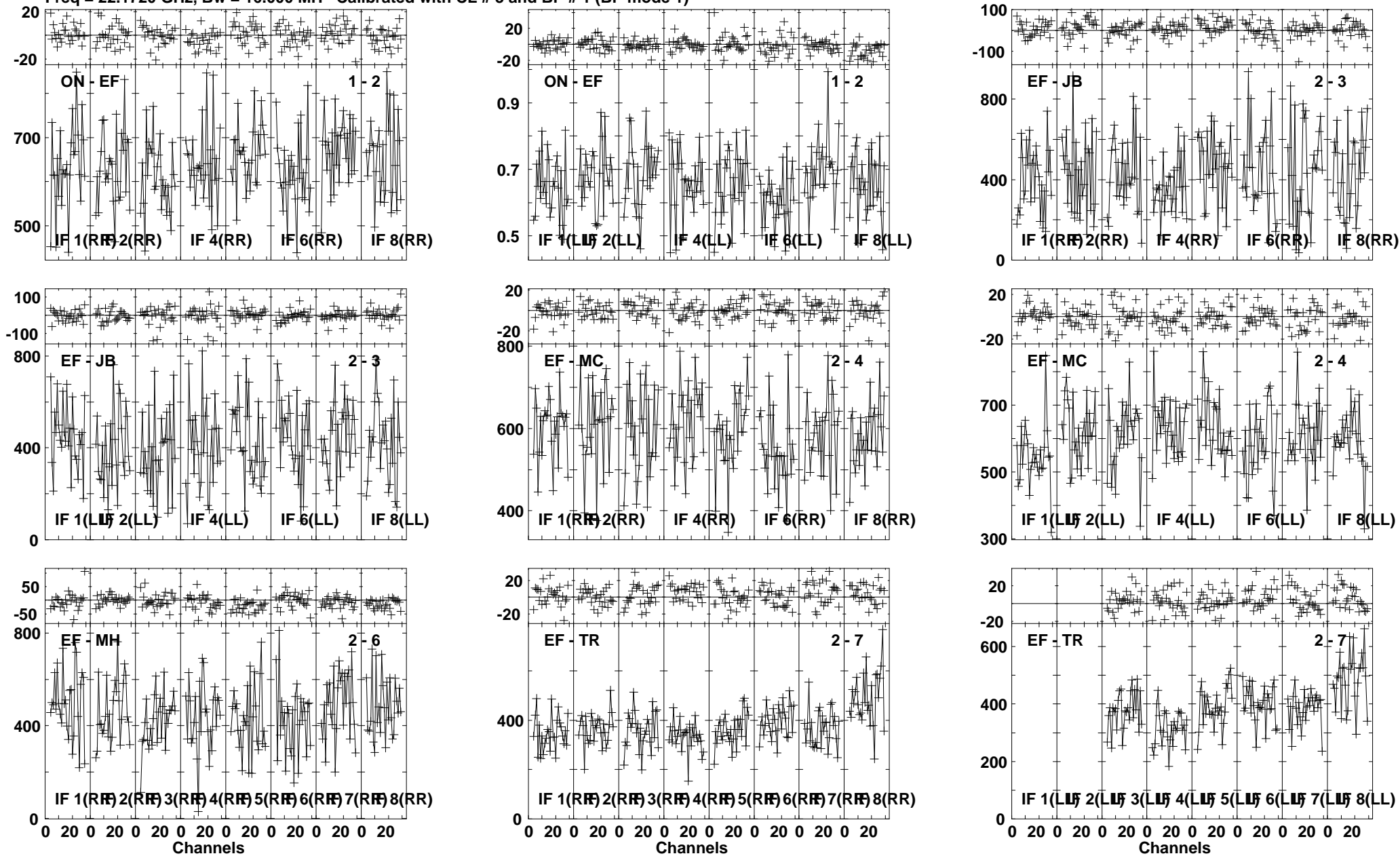

Lower frame: Milli Ampl Jy Top frame: Phas deg
 Vector averaged cross-power spectrum Several baselines displayed
 Timerange: 01/03:50:31 to 01/03:51:13

Plot file version 466 created 26-JUL-2013 10:26:47

J1157 EZ024 1.UVDATA.1

Freq = 22.1720 GHz, Bw = 16.000 MH Calibrated with CL # 3 and BP # 1 (BP mode 1)

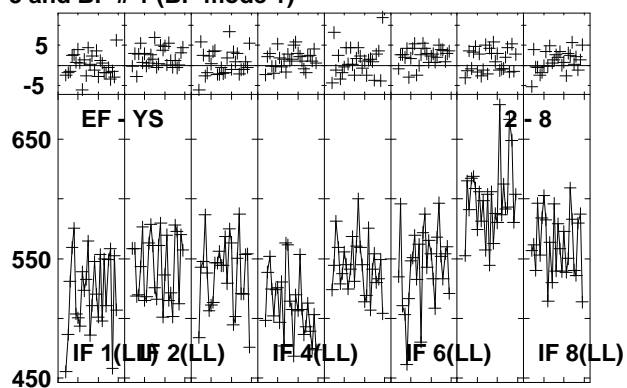
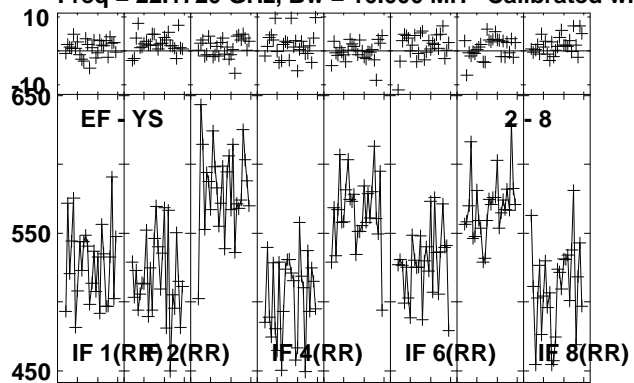

Lower frame: Milli Ampl Jy Top frame: Phas deg
Vector averaged cross-power spectrum Several baselines displayed
Timerange: 01/03:50:31 to 01/03:51:13

Plot file version 467 created 26-JUL-2013 10:26:47
 B1152+199A EZ024 1.UVDATA.1
 Freq = 22.1720 GHz, Bw = 16.000 MH Calibrated with CL # 3 and BP # 1 (BP mode 1)

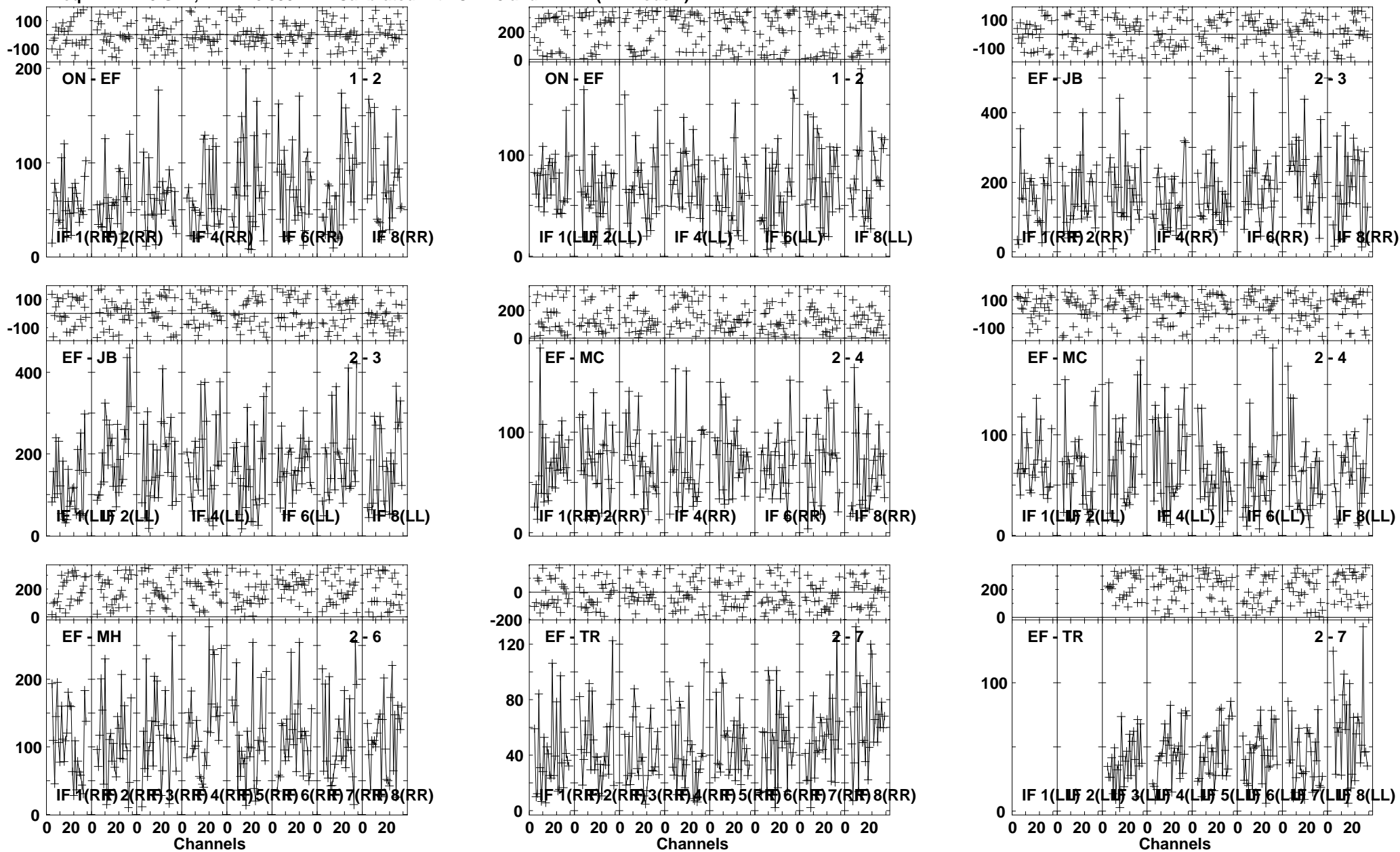

Lower frame: Milli Ampl Jy Top frame: Phas deg
 Vector averaged cross-power spectrum Several baselines displayed
 Timerange: 01/03:51:50 to 01/03:53:48

Plot file version 468 created 26-JUL-2013 10:26:49

B1152+199A EZ024 1.UVDATA.1

Freq = 22.1720 GHz, Bw = 16.000 MH Calibrated with CL # 3 and BP # 1 (BP mode 1)

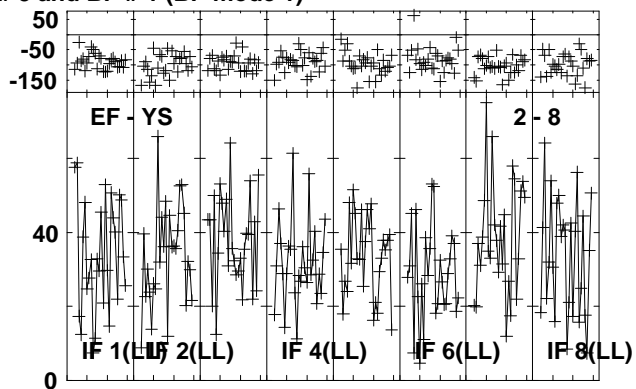
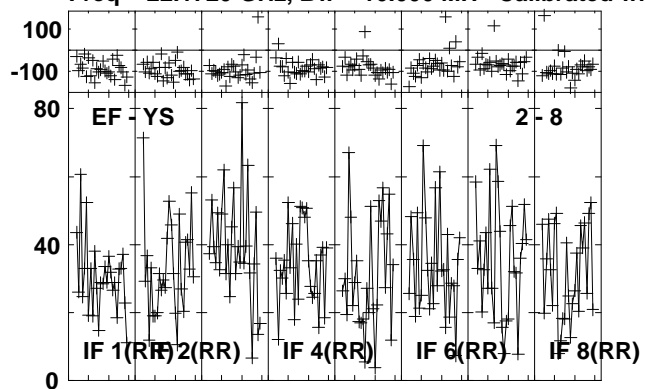

Lower frame: Milli Ampl Jy Top frame: Phas deg
Vector averaged cross-power spectrum Several baselines displayed
Timerange: 01/03:51:50 to 01/03:53:48

Plot file version 469 created 26-JUL-2013 10:26:50

J1157 EZ024 1.UVDATA.1

Freq = 22.1720 GHz, Bw = 16.000 MH Calibrated with CL # 3 and BP # 1 (BP mode 1)

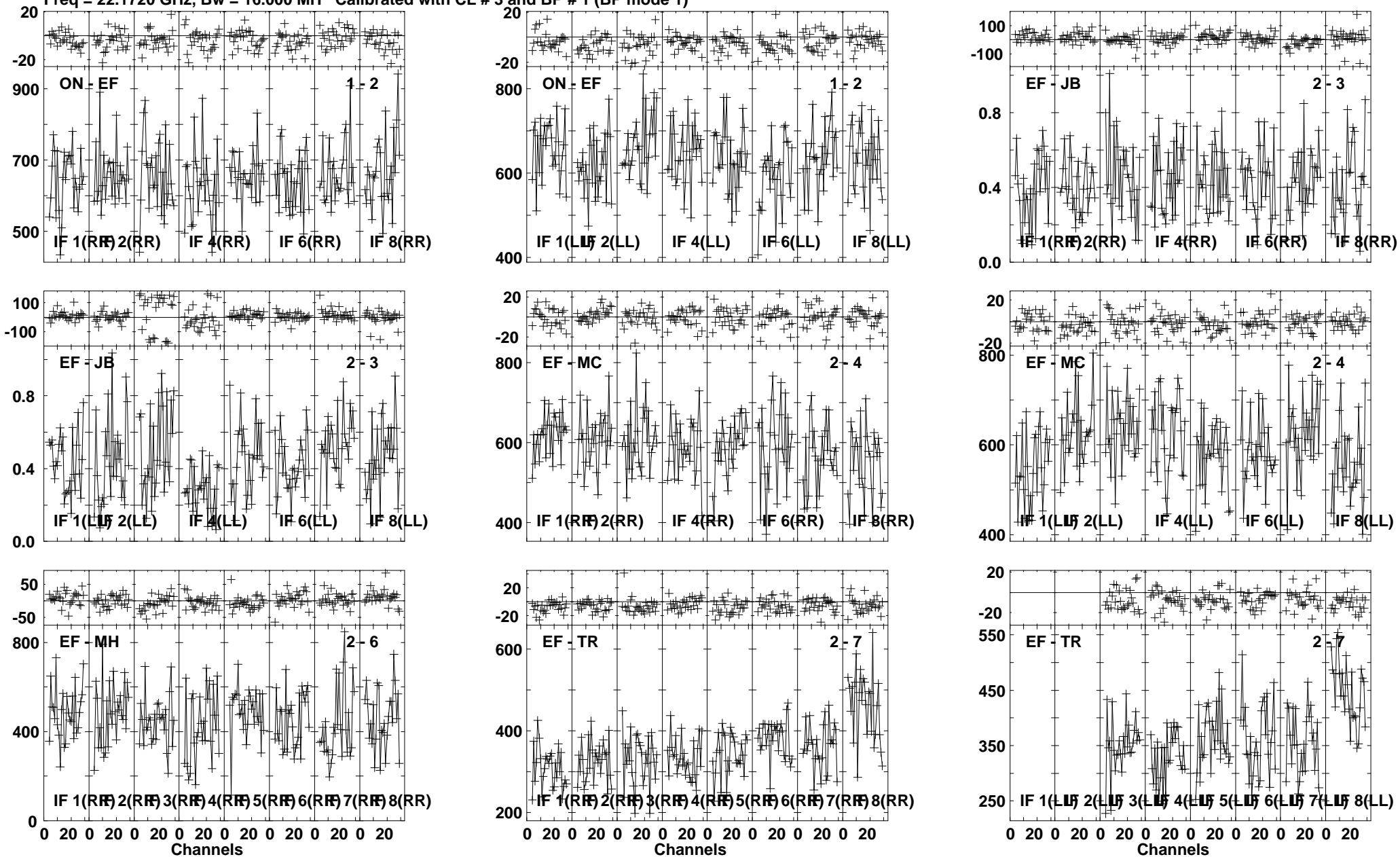

Lower frame: Milli Ampl Jy Top frame: Phas deg
Vector averaged cross-power spectrum Several baselines displayed
Timerange: 01/03:54:23 to 01/03:55:21

Plot file version 470 created 26-JUL-2013 10:26:50

J1157 EZ024 1.UVDATA.1

Freq = 22.1720 GHz, Bw = 16.000 MH Calibrated with CL # 3 and BP # 1 (BP mode 1)

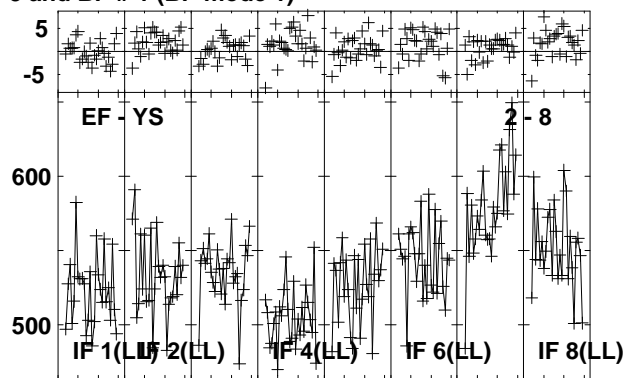
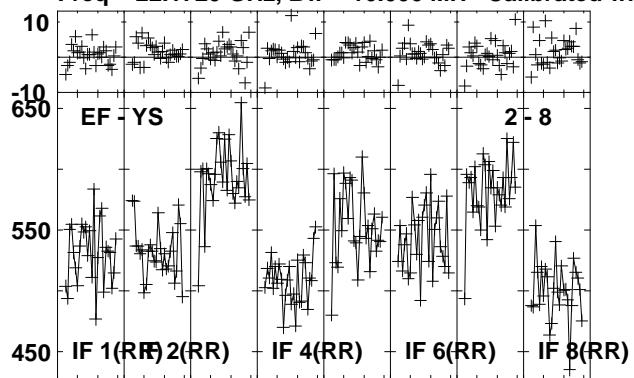

Lower frame: Milli Ampl Jy Top frame: Phas deg
Vector averaged cross-power spectrum Several baselines displayed
Timerange: 01/03:54:23 to 01/03:55:21

Plot file version 471 created 26-JUL-2013 10:26:51
 B1152+199A EZ024 1.UVDATA.1
 Freq = 22.1720 GHz, Bw = 16.000 MH Calibrated with CL # 3 and BP # 1 (BP mode 1)

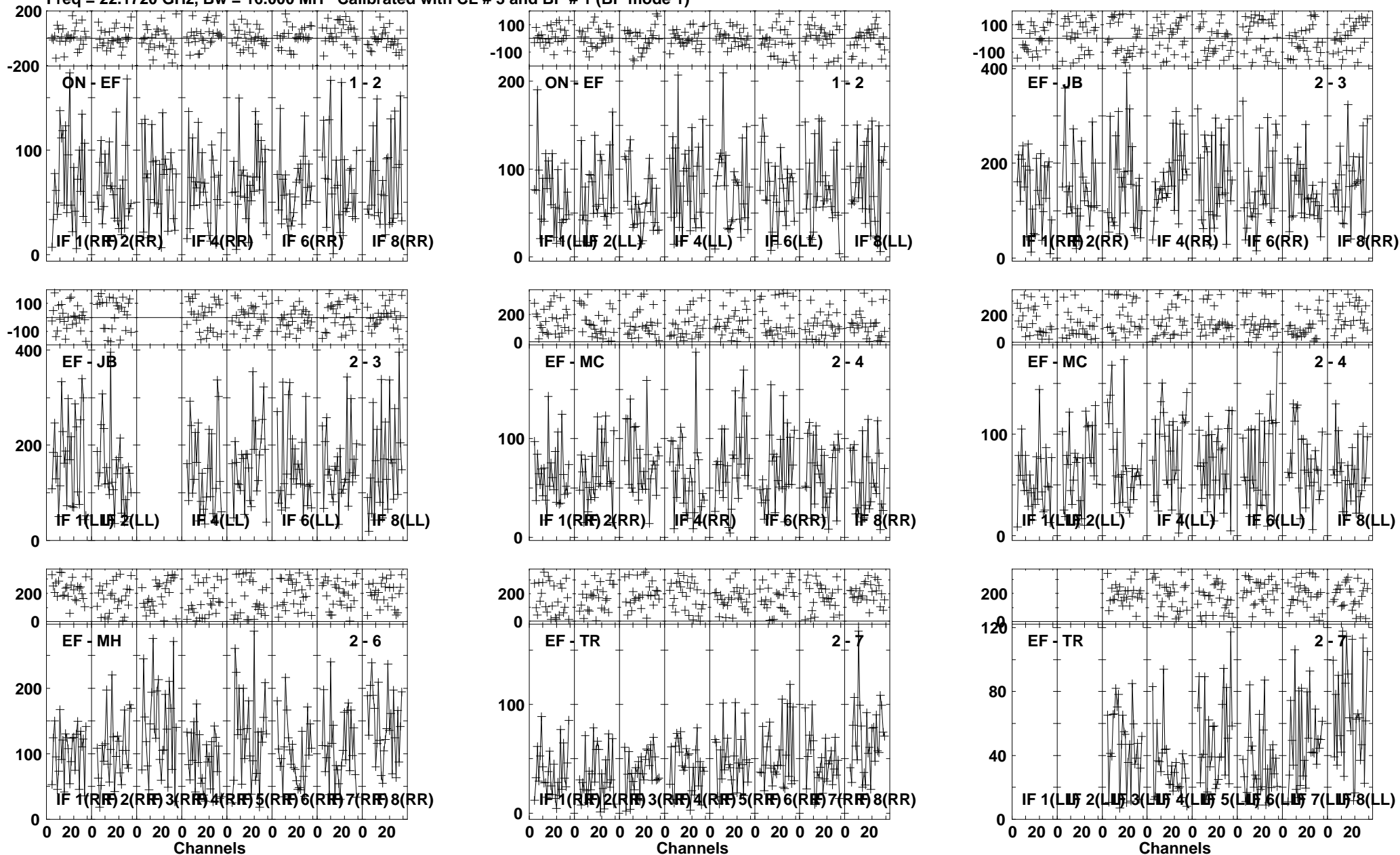

Lower frame: Milli Ampl Jy Top frame: Phas deg
 Vector averaged cross-power spectrum Several baselines displayed
 Timerange: 01/03:55:57 to 01/03:57:55

Plot file version 472 created 26-JUL-2013 10:26:52

B1152+199A EZ024 1.UVDATA.1

Freq = 22.1720 GHz, Bw = 16.000 MH Calibrated with CL # 3 and BP # 1 (BP mode 1)

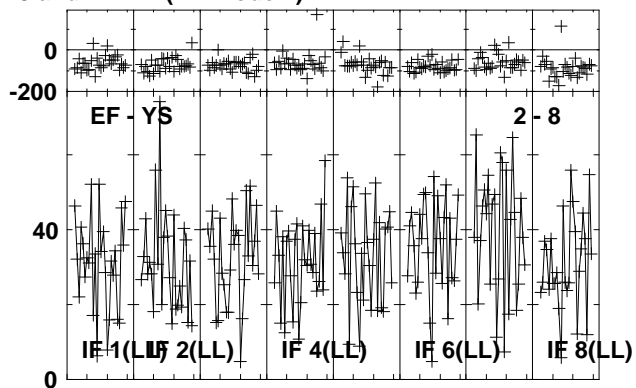
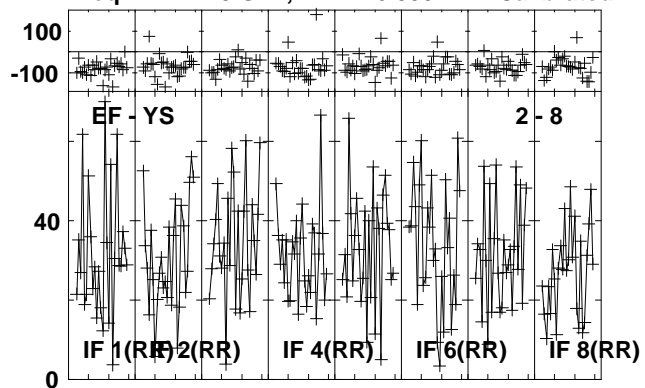

Lower frame: Milli Ampl Jy Top frame: Phas deg
Vector averaged cross-power spectrum Several baselines displayed
Timerange: 01/03:55:57 to 01/03:57:55

Plot file version 473 created 26-JUL-2013 10:26:53

J1157 EZ024 1.UVDATA.1

Freq = 22.1720 GHz, Bw = 16.000 MH Calibrated with CL # 3 and BP # 1 (BP mode 1)

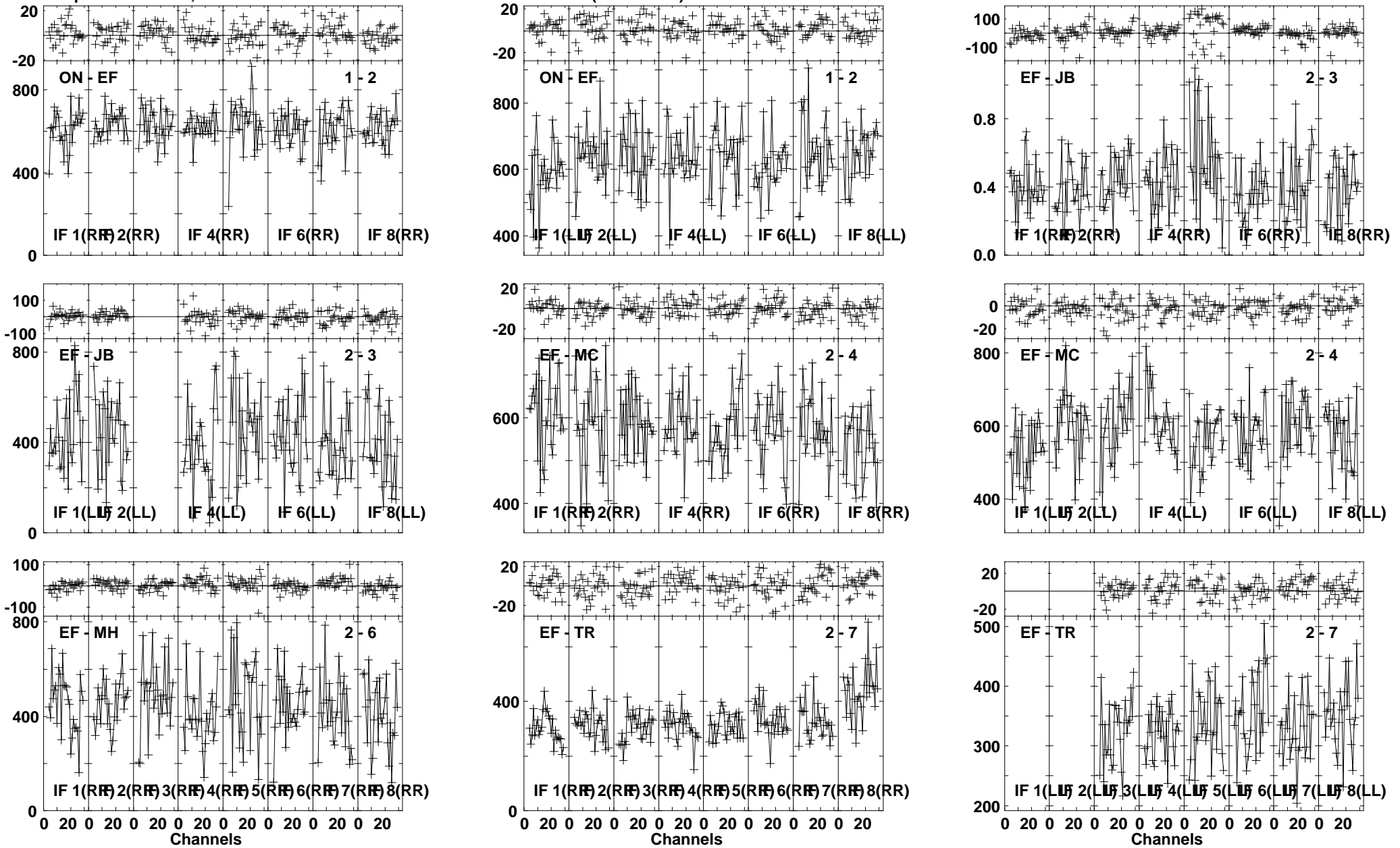

Lower frame: Milli Ampl Jy Top frame: Phas deg
Vector averaged cross-power spectrum Several baselines displayed
Timerange: 01/03:58:30 to 01/03:59:28

Plot file version 474 created 26-JUL-2013 10:26:54

J1157 EZ024 1.UVDATA.1

Freq = 22.1720 GHz, Bw = 16.000 MH Calibrated with CL # 3 and BP # 1 (BP mode 1)

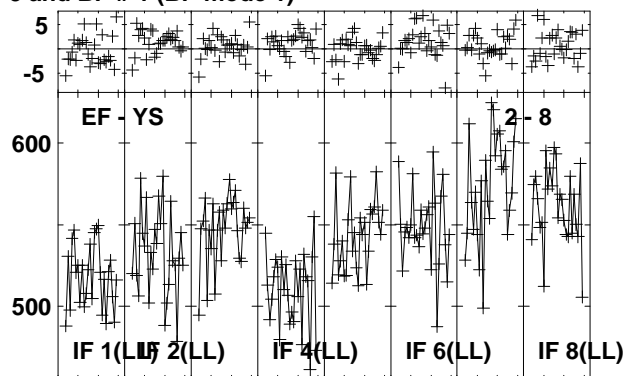
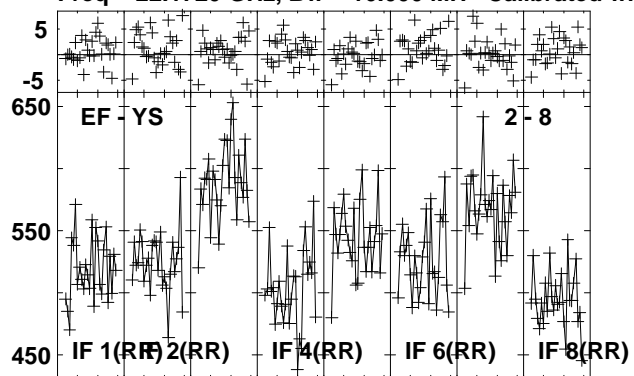

Lower frame: Milli Ampl Jy Top frame: Phas deg
Vector averaged cross-power spectrum Several baselines displayed
Timerange: 01/03:58:30 to 01/03:59:28

Plot file version 475 created 26-JUL-2013 10:26:55
 B1152+199A EZ024 1.UVDATA.1
 Freq = 22.1720 GHz, Bw = 16.000 MH Calibrated with CL # 3 and BP # 1 (BP mode 1)

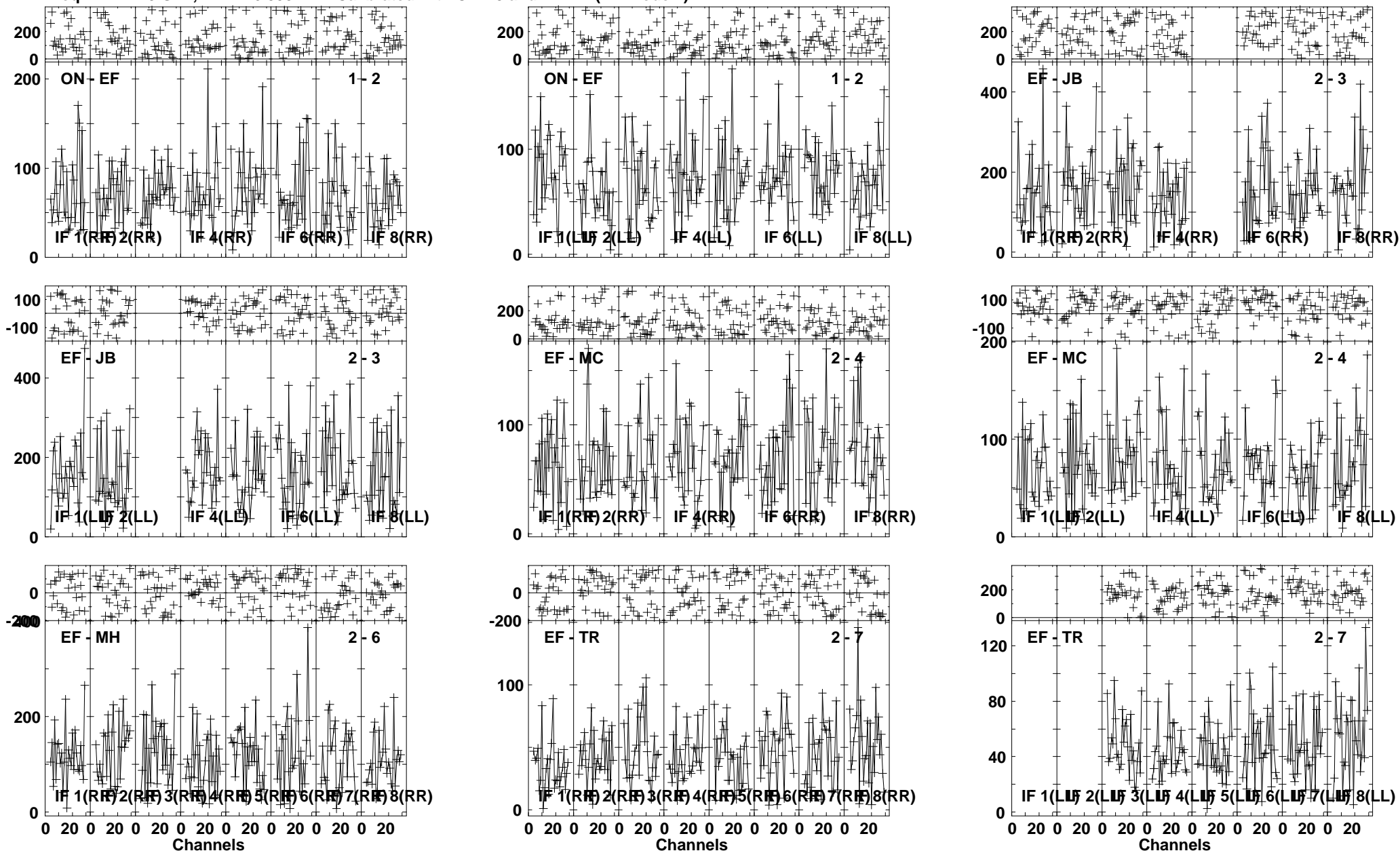

Lower frame: Milli Ampl Jy Top frame: Phas deg
 Vector averaged cross-power spectrum Several baselines displayed
 Timerange: 01/04:00:04 to 01/04:02:02

Plot file version 476 created 26-JUL-2013 10:26:56

B1152+199A EZ024 1.UVDATA.1

Freq = 22.1720 GHz, Bw = 16.000 MH Calibrated with CL # 3 and BP # 1 (BP mode 1)

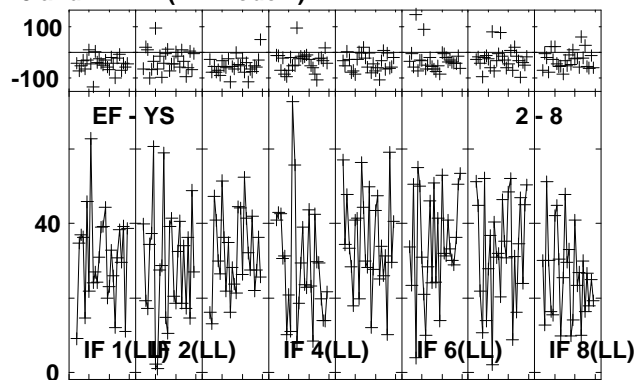
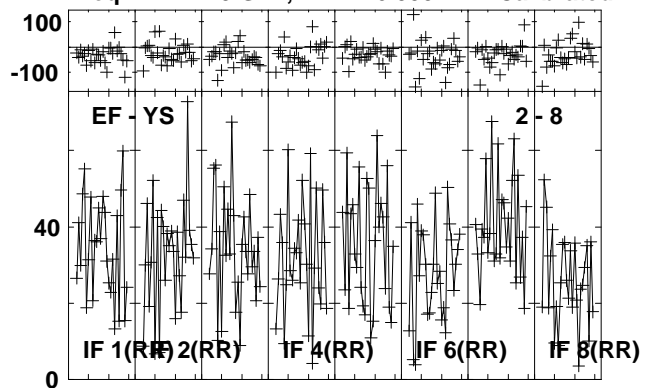

Lower frame: Milli Ampl Jy Top frame: Phas deg
Vector averaged cross-power spectrum Several baselines displayed
Timerange: 01/04:00:04 to 01/04:02:02

Plot file version 477 created 26-JUL-2013 10:26:57
 J1157 EZ2024 1.UVDATA.1
 Freq = 22.1720 GHz, Bw = 16.000 MH Calibrated with CL # 3 and BP # 1 (BP mode 1)

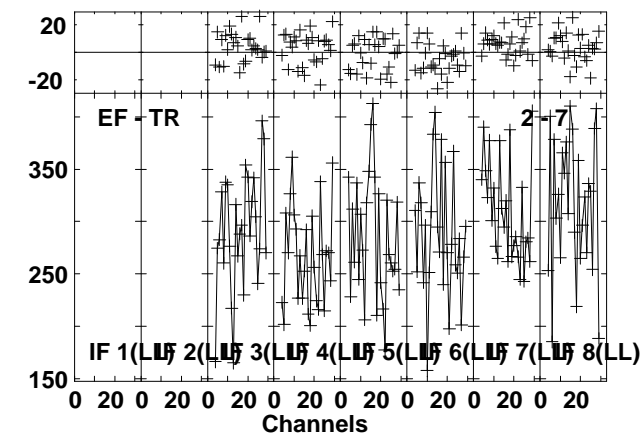
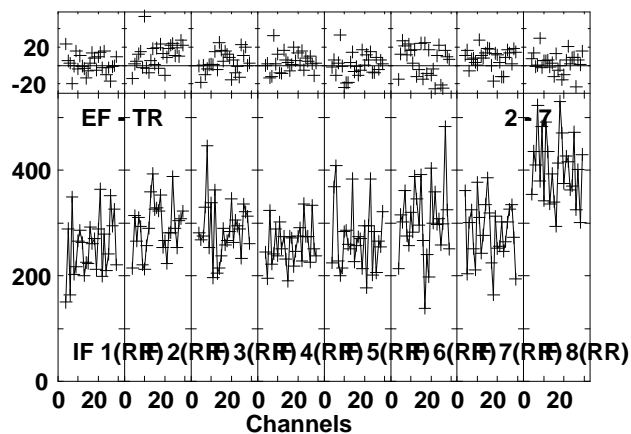
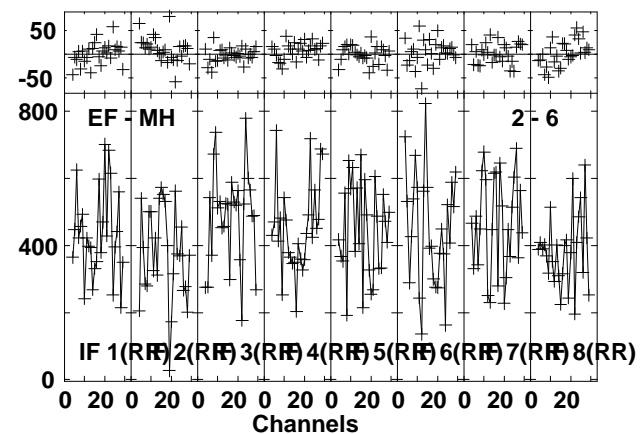
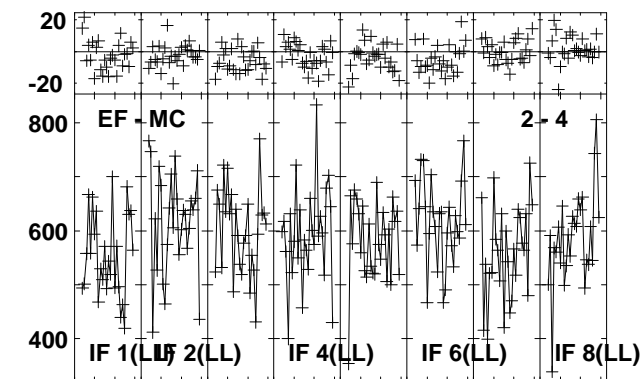
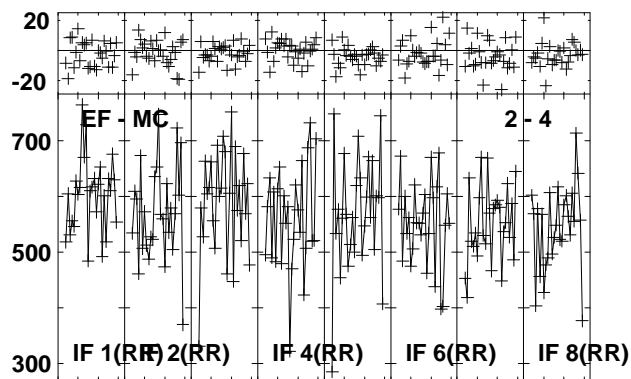
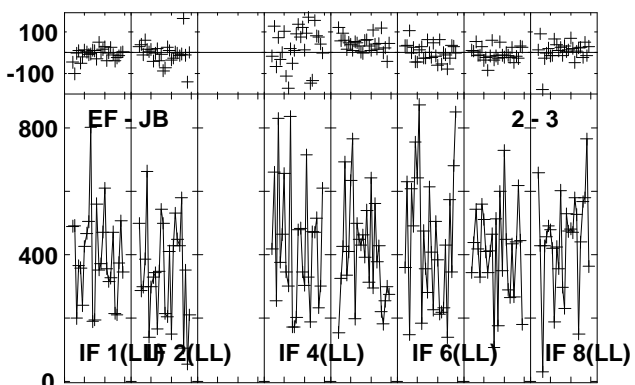
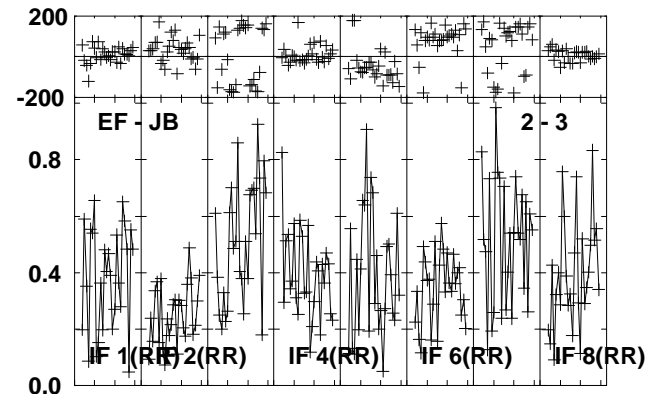
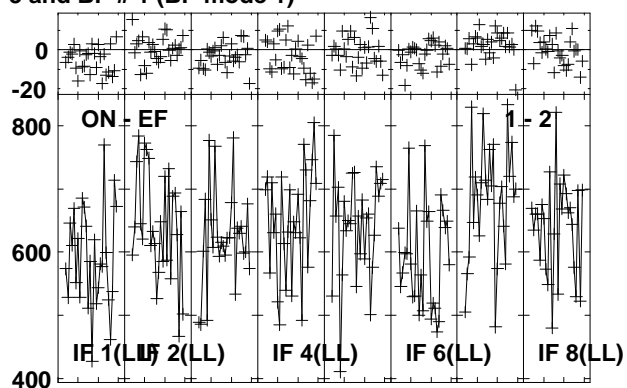
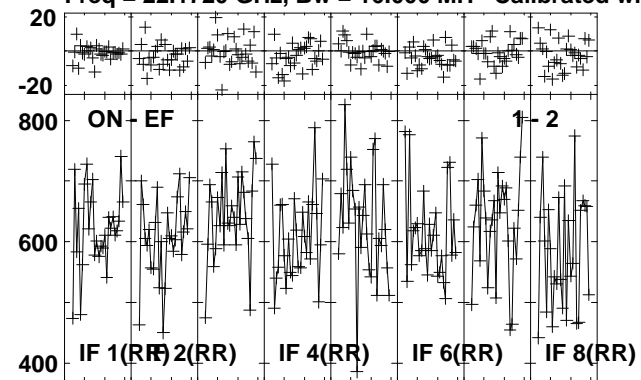

Lower frame: Milli Ampl Jy Top frame: Phas deg
 Vector averaged cross-power spectrum Several baselines displayed
 Timerange: 01/04:02:37 to 01/04:03:35

Plot file version 478 created 26-JUL-2013 10:26:58

J1157 EZ024 1.UVDATA.1

Freq = 22.1720 GHz, Bw = 16.000 MH Calibrated with CL # 3 and BP # 1 (BP mode 1)

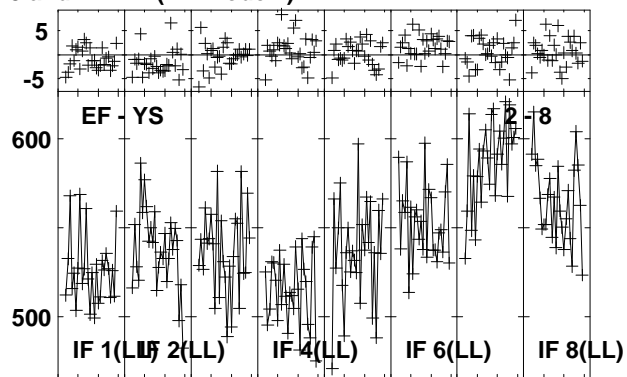
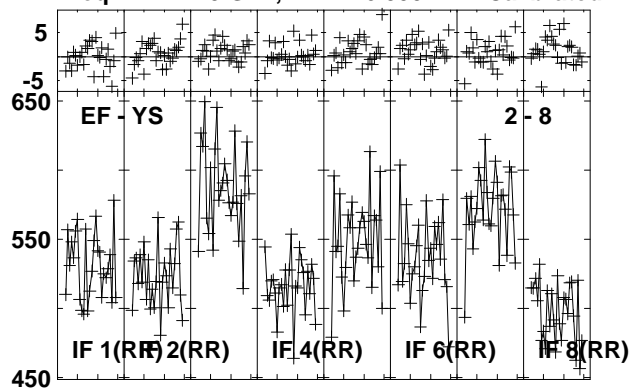

Lower frame: Milli Ampl Jy Top frame: Phas deg
Vector averaged cross-power spectrum Several baselines displayed
Timerange: 01/04:02:37 to 01/04:03:35

Plot file version 479 created 26-JUL-2013 10:26:58
 J1125+2610 EZ024 1.UVDATA.1
 Freq = 22.1720 GHz, Bw = 16.000 MH Calibrated with CL # 3 and BP # 1 (BP mode 1)

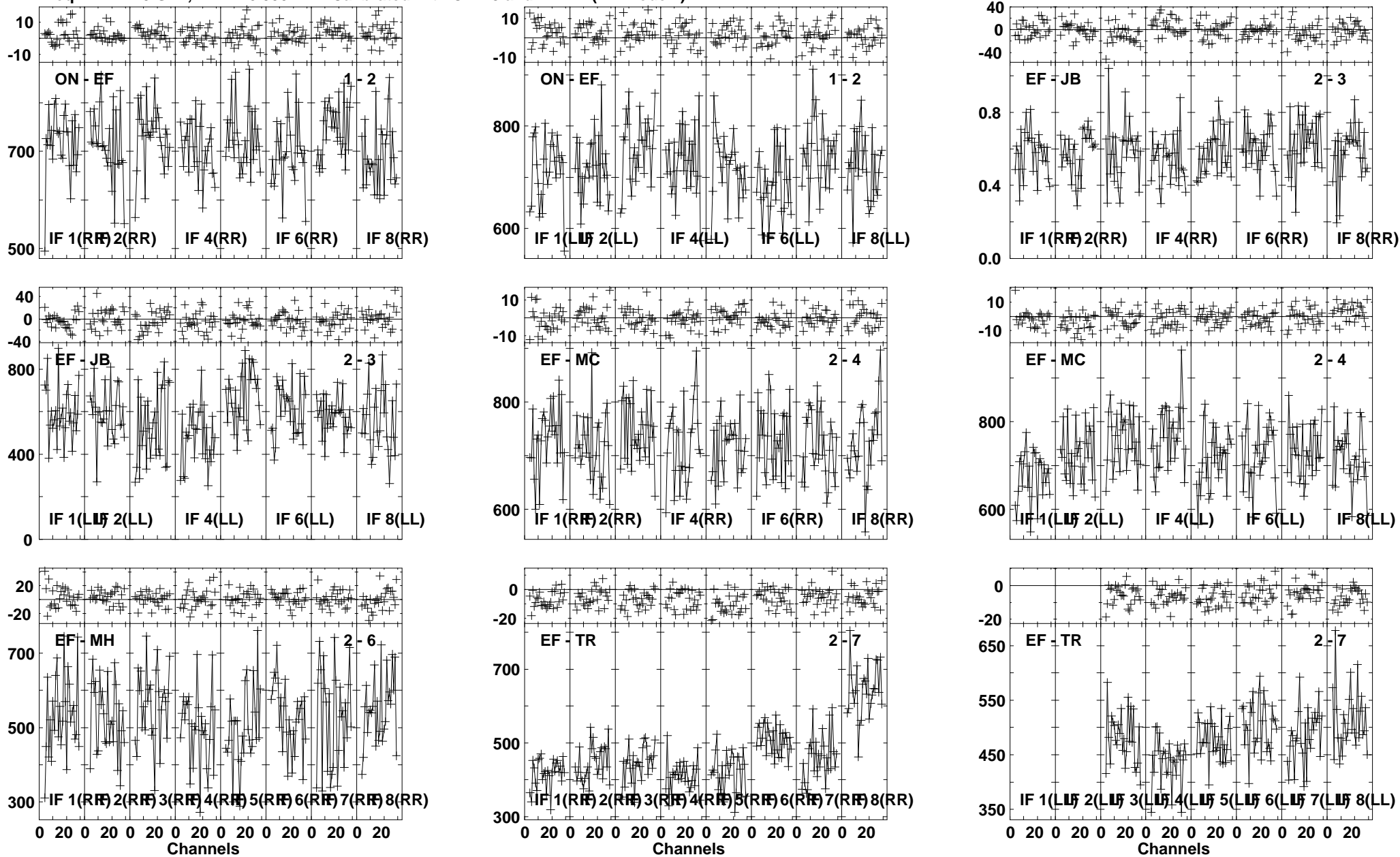

Lower frame: Milli Ampl Jy Top frame: Phas deg
 Vector averaged cross-power spectrum Several baselines displayed
 Timerange: 01/04:05:05 to 01/04:06:47

Plot file version 480 created 26-JUL-2013 10:26:59
J1125+2610 EZ024 1.UVDATA.1
Freq = 22.1720 GHz, Bw = 16.000 MH Calibrated with CL # 3 and BP # 1 (BP mode 1)

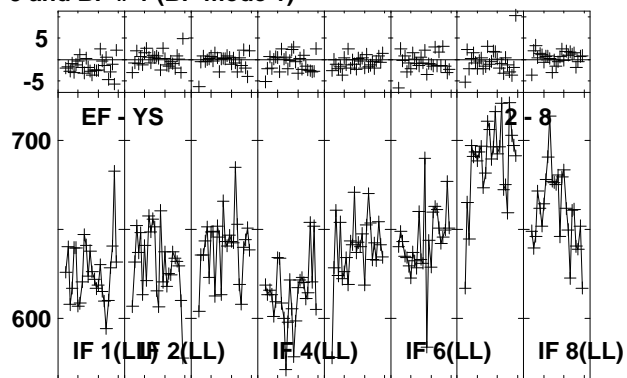
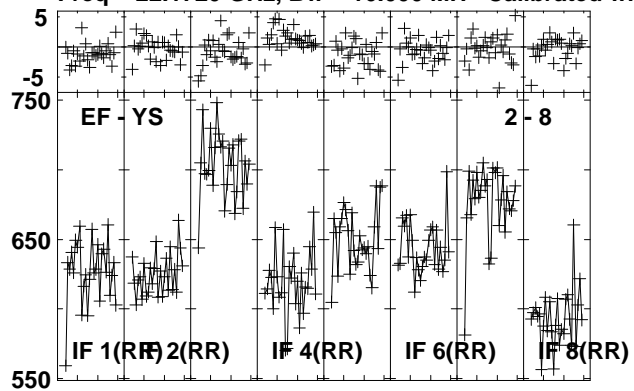

Lower frame: Milli Ampl Jy Top frame: Phas deg
Vector averaged cross-power spectrum Several baselines displayed
Timerange: 01/04:05:05 to 01/04:06:47

Plot file version 481 created 26-JUL-2013 10:27:00

J1157 EZ024 1.UVDATA.1

Freq = 22.1720 GHz, Bw = 16.000 MH Calibrated with CL # 3 and BP # 1 (BP mode 1)

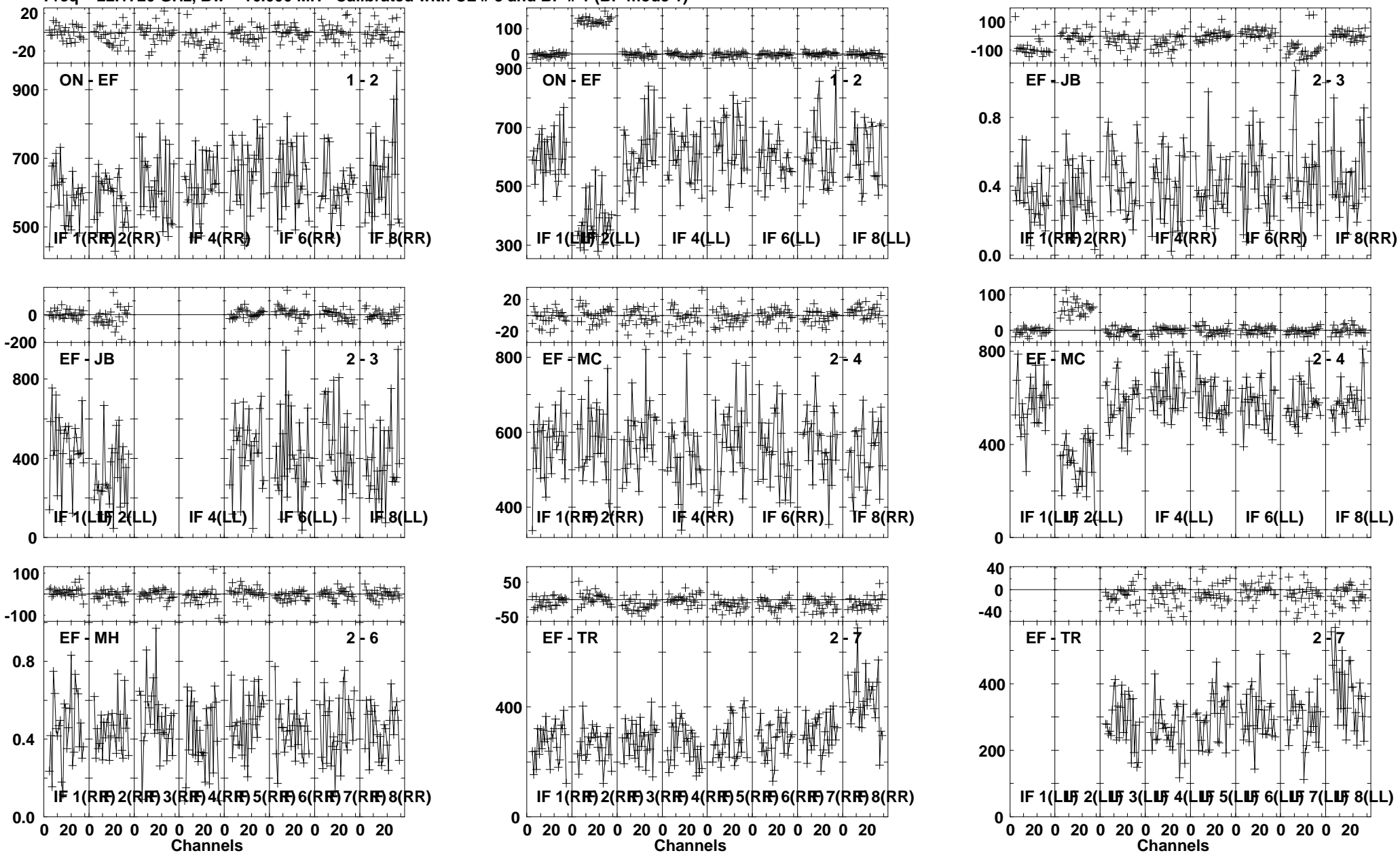

Lower frame: Milli Ampl Jy Top frame: Phas deg
Vector averaged cross-power spectrum Several baselines displayed
Timerange: 01/04:08:15 to 01/04:08:57

Plot file version 482 created 26-JUL-2013 10:27:00
J1157 EZ024 1.UVDATA.1
Freq = 22.1720 GHz, Bw = 16.000 MH Calibrated with CL # 3 and BP # 1 (BP mode 1)

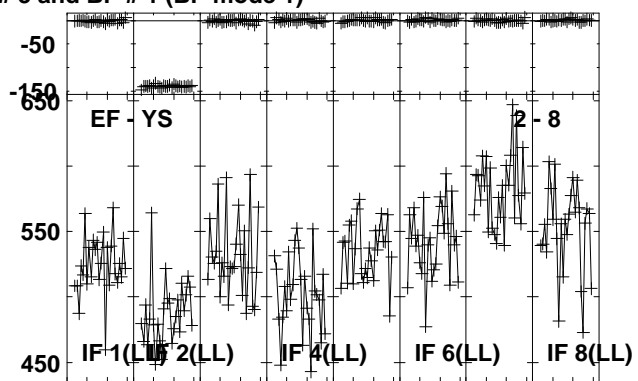
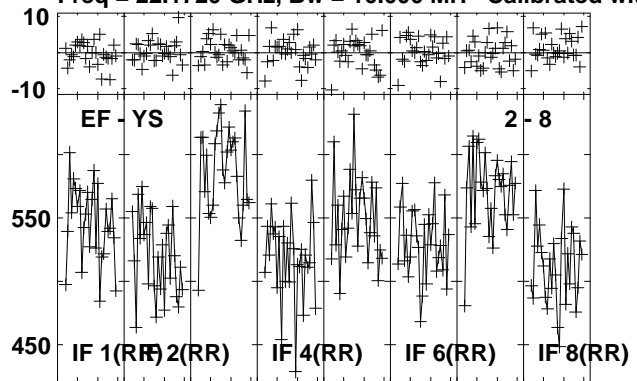

Lower frame: Milli Ampl Jy Top frame: Phas deg
Vector averaged cross-power spectrum Several baselines displayed
Timerange: 01/04:08:15 to 01/04:08:57

Plot file version 483 created 26-JUL-2013 10:27:01
 B1152+199A EZ024 1.UVDATA.1
 Freq = 22.1720 GHz, Bw = 16.000 MH Calibrated with CL # 3 and BP # 1 (BP mode 1)

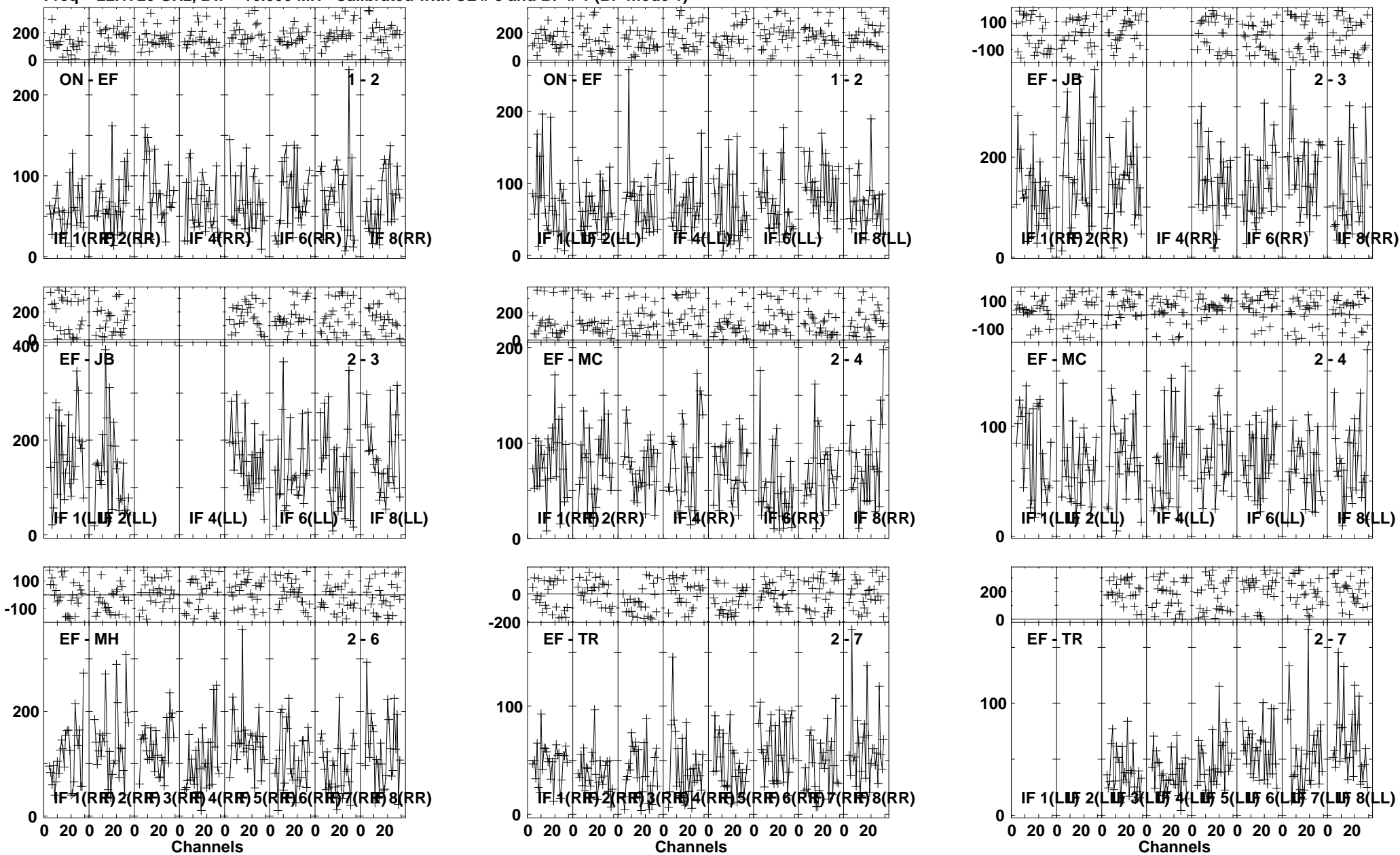

Lower frame: Milli Ampl Jy Top frame: Phas deg
 Vector averaged cross-power spectrum Several baselines displayed
 Timerange: 01/04:09:34 to 01/04:11:32

Plot file version 484 created 26-JUL-2013 10:27:02

B1152+199A EZ024 1.UVDATA.1

Freq = 22.1720 GHz, Bw = 16.000 MH Calibrated with CL # 3 and BP # 1 (BP mode 1)

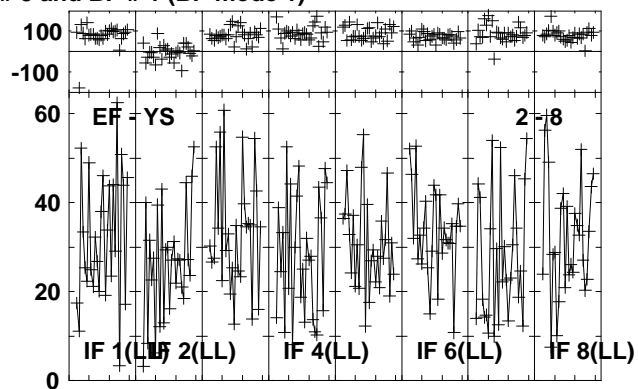
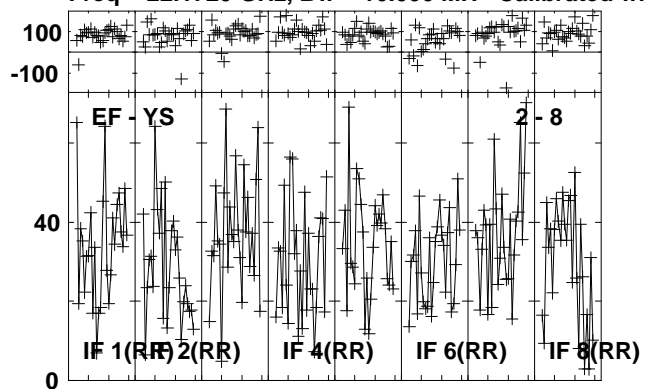

Lower frame: Milli Ampl Jy Top frame: Phas deg
Vector averaged cross-power spectrum Several baselines displayed
Timerange: 01/04:09:34 to 01/04:11:32

Plot file version 485 created 26-JUL-2013 10:27:03

J1157 EZ024 1.UVDATA.1

Freq = 22.1720 GHz, Bw = 16.000 MH Calibrated with CL # 3 and BP # 1 (BP mode 1)

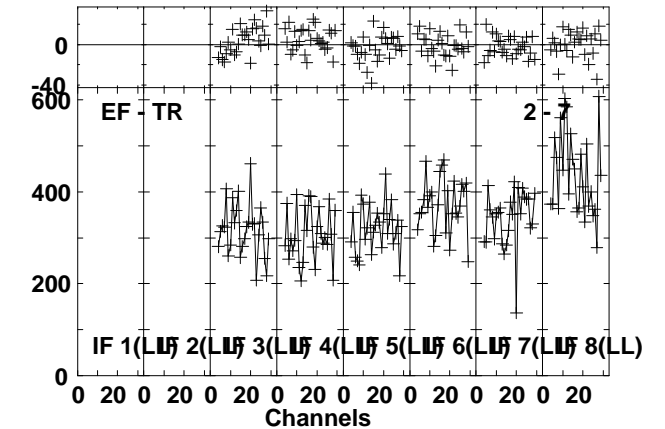
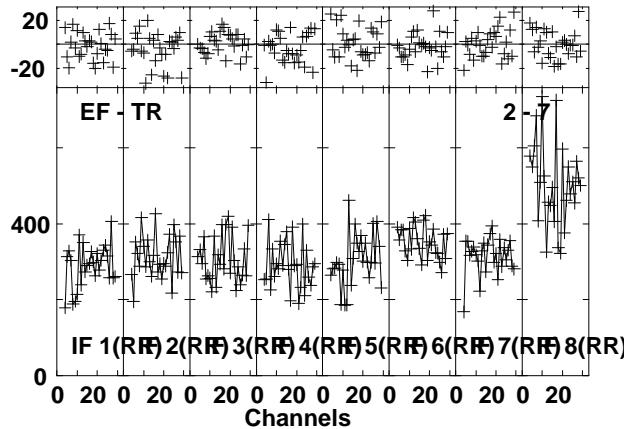
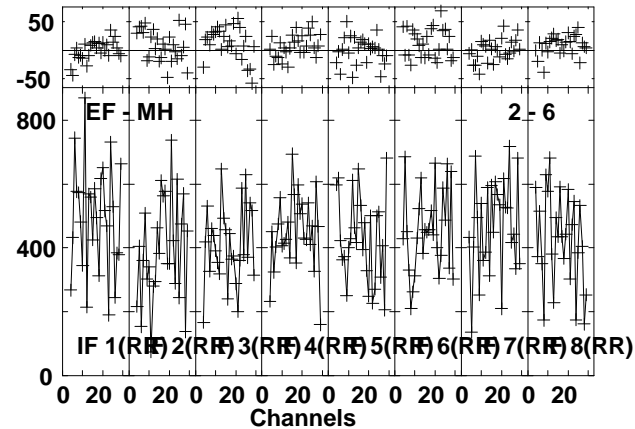
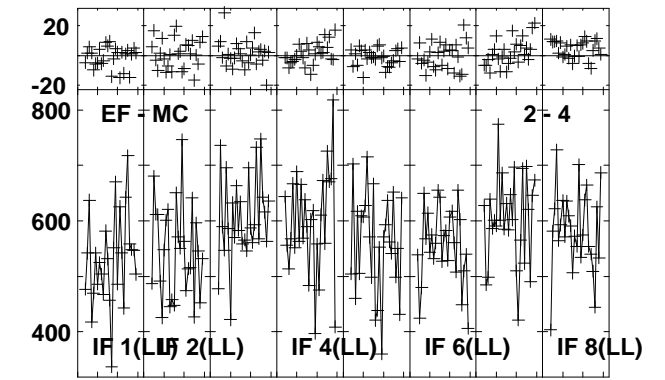
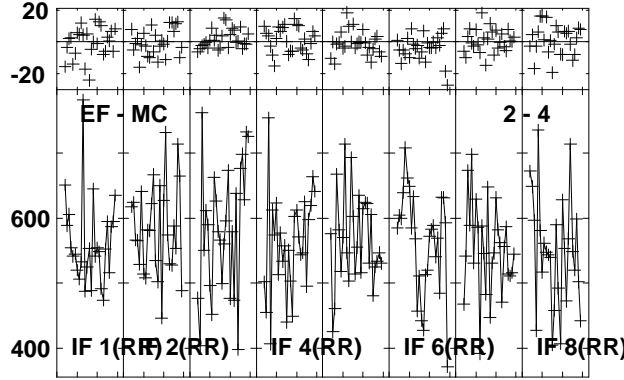
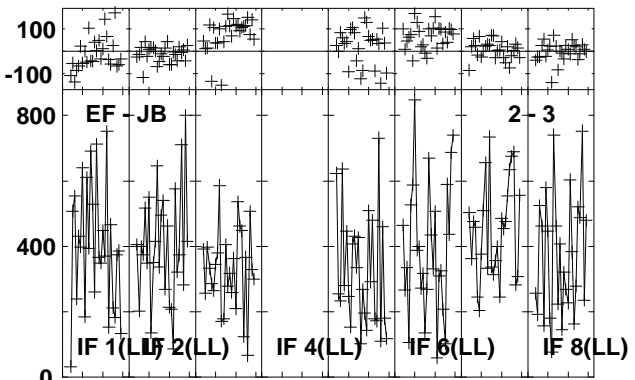
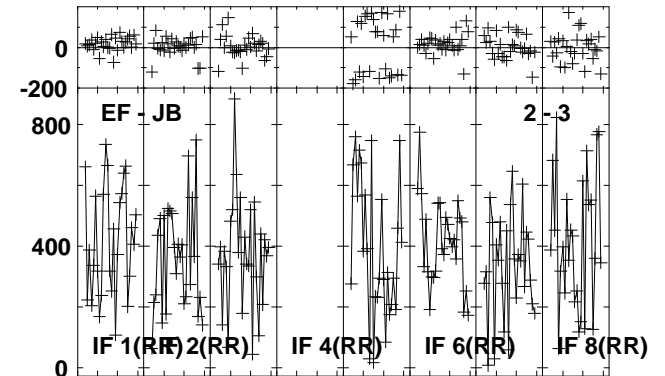
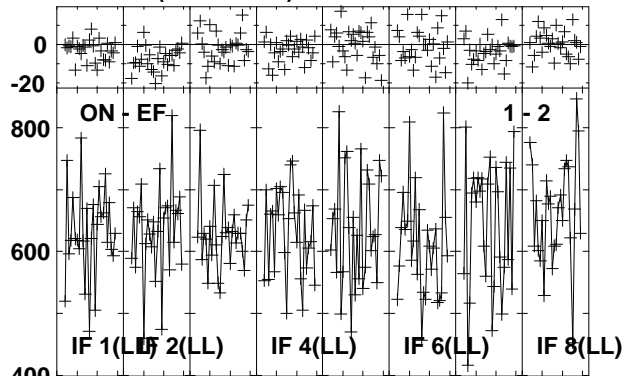
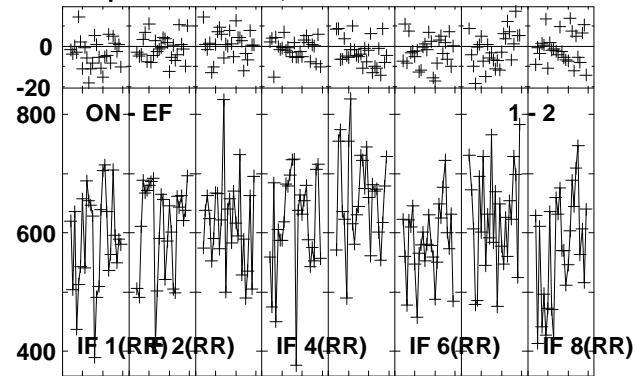

Lower frame: Milli Ampl Jy Top frame: Phas deg
Vector averaged cross-power spectrum Several baselines displayed
Timerange: 01/04:12:07 to 01/04:13:05

Plot file version 486 created 26-JUL-2013 10:27:04

J1157 EZ024 1.UVDATA.1

Freq = 22.1720 GHz, Bw = 16.000 MH Calibrated with CL # 3 and BP # 1 (BP mode 1)

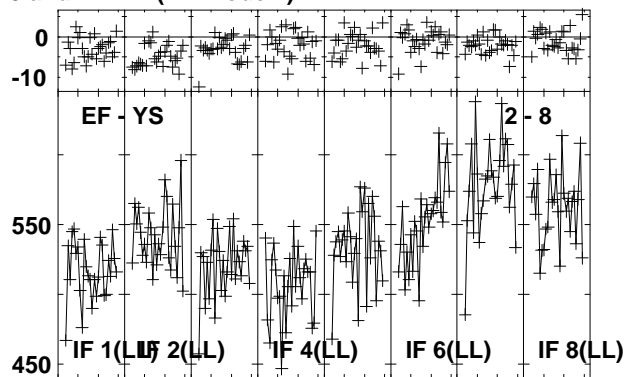
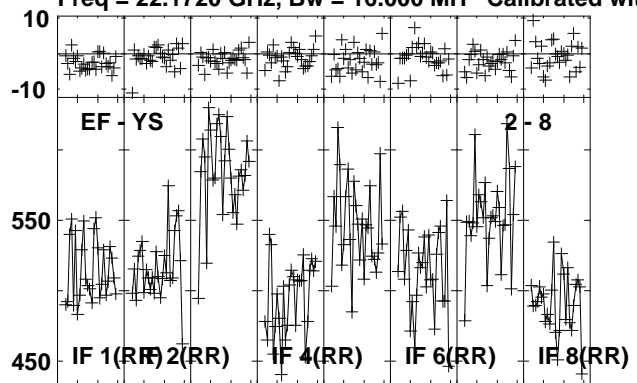

Lower frame: Milli Ampl Jy Top frame: Phas deg
Vector averaged cross-power spectrum Several baselines displayed
Timerange: 01/04:12:07 to 01/04:13:05

Plot file version 487 created 26-JUL-2013 10:27:05
 B1152+199A EZ024 1.UVDATA.1
 Freq = 22.1720 GHz, Bw = 16.000 MH Calibrated with CL # 3 and BP # 1 (BP mode 1)

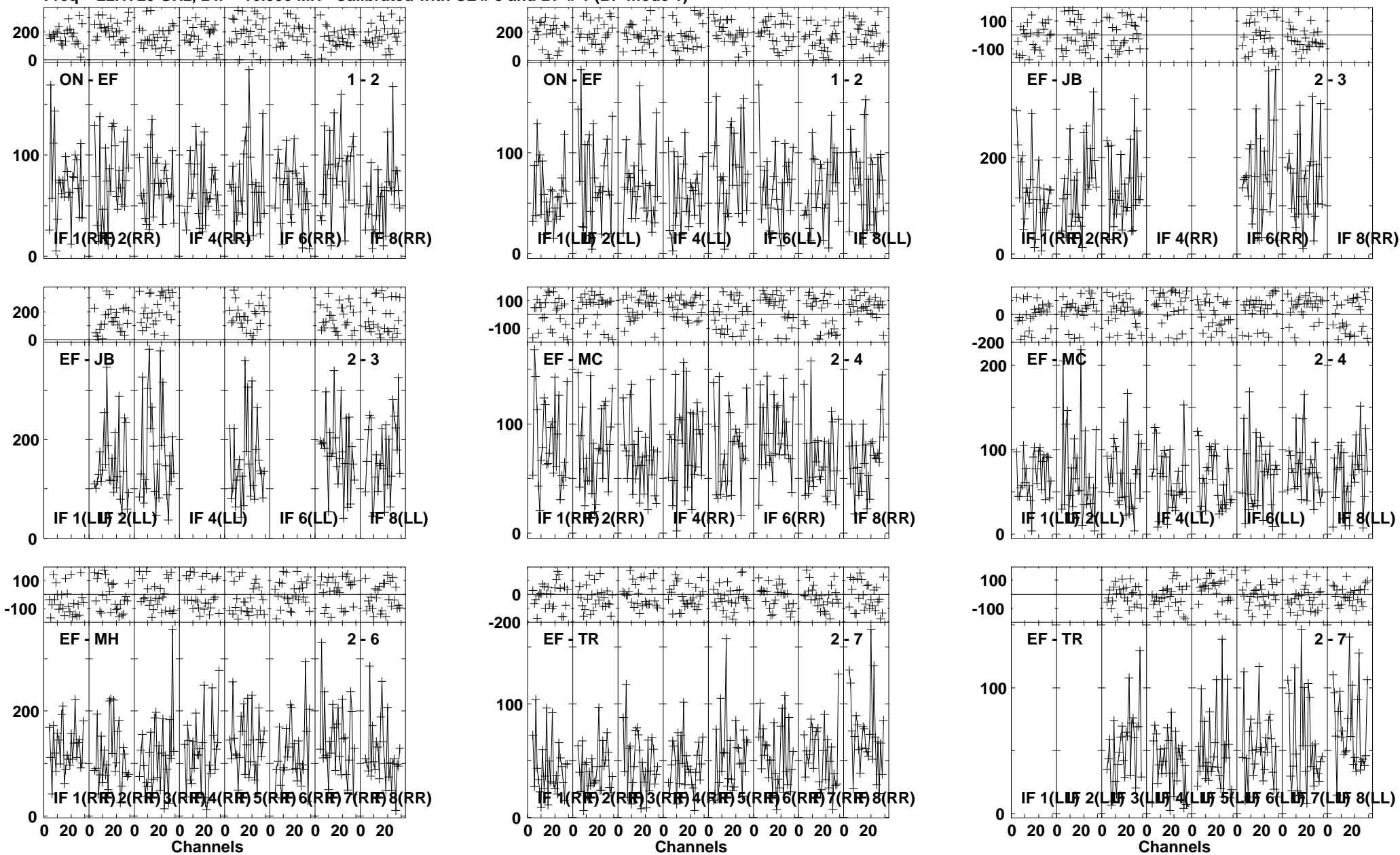

Lower frame: Milli Ampl Jy Top frame: Phas deg
 Vector averaged cross-power spectrum Several baselines displayed
 Timerange: 01/04:13:41 to 01/04:15:39

Plot file version 488 created 26-JUL-2013 10:27:06
B1152+199A EZ024 1.UVDATA.1
Freq = 22.1720 GHz, Bw = 16.000 MH Calibrated with CL # 3 and BP # 1 (BP mode 1)

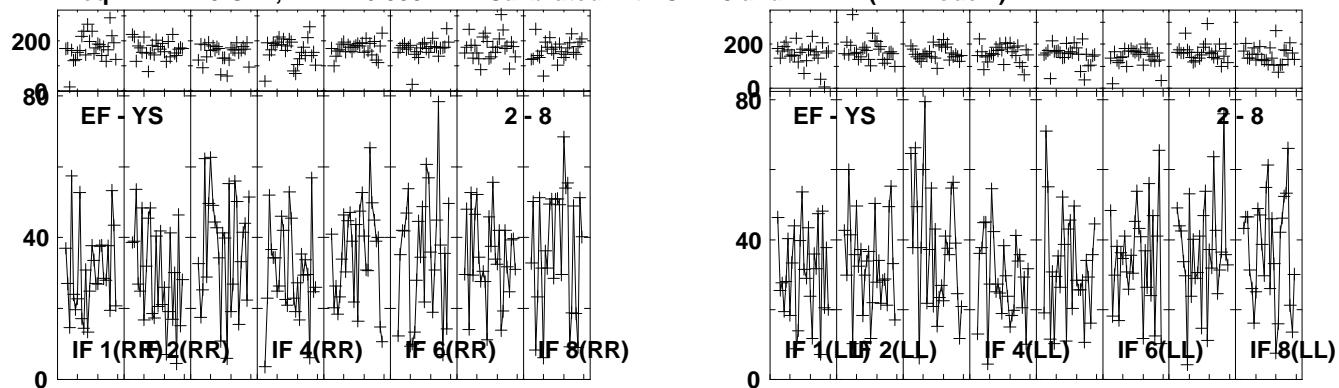

Lower frame: Milli Ampl Jy Top frame: Phas deg
Vector averaged cross-power spectrum Several baselines displayed
Timerange: 01/04:13:41 to 01/04:15:39

Plot file version 489 created 26-JUL-2013 10:27:07

J1157 EZ024 1.UVDATA.1

Freq = 22.1720 GHz, Bw = 16.000 MH Calibrated with CL # 3 and BP # 1 (BP mode 1)

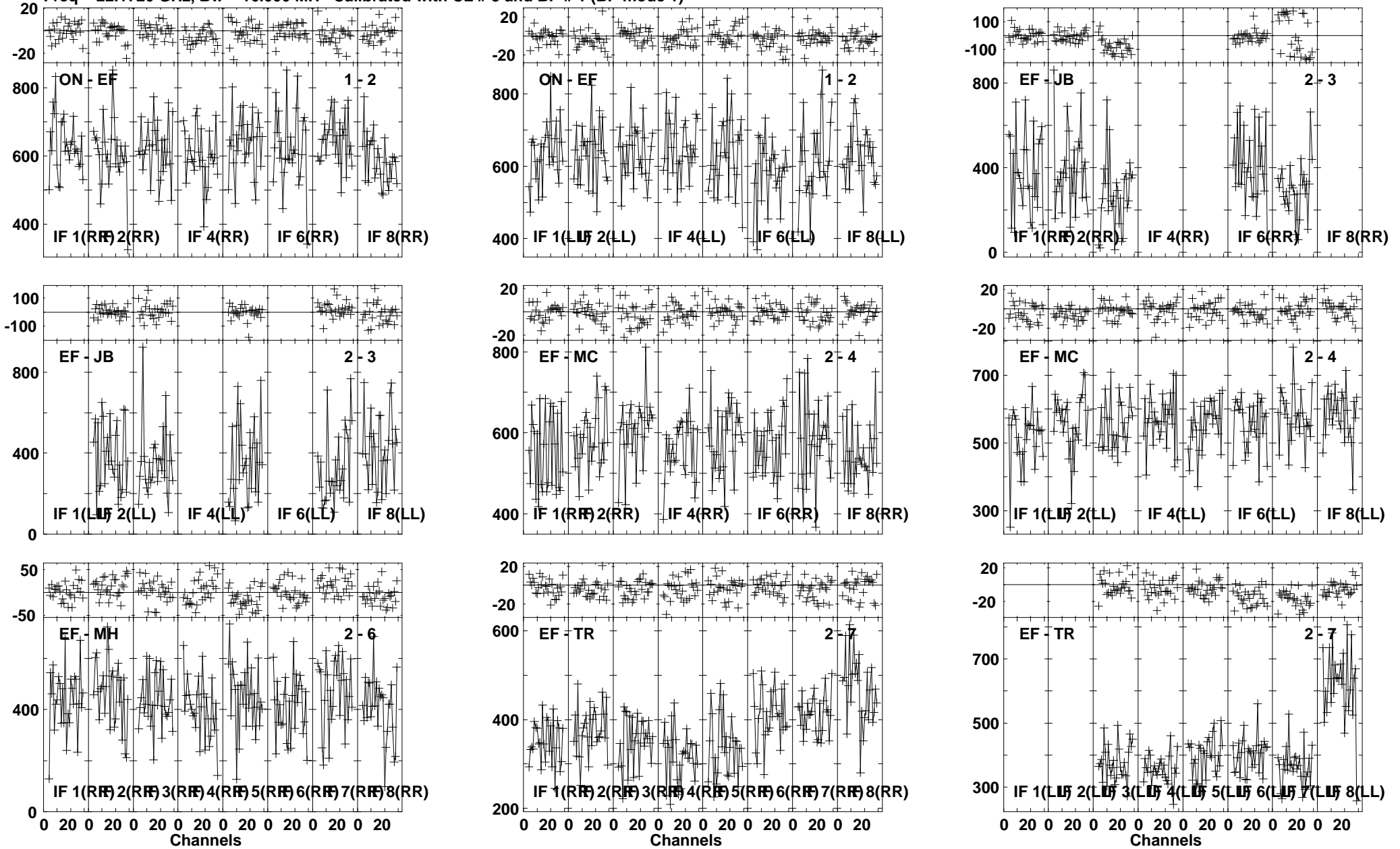

Lower frame: Milli Ampl Jy Top frame: Phas deg
Vector averaged cross-power spectrum Several baselines displayed
Timerange: 01/04:16:14 to 01/04:17:12

Plot file version 490 created 26-JUL-2013 10:27:07

J1157 EZ024 1.UVDATA.1

Freq = 22.1720 GHz, Bw = 16.000 MH Calibrated with CL # 3 and BP # 1 (BP mode 1)

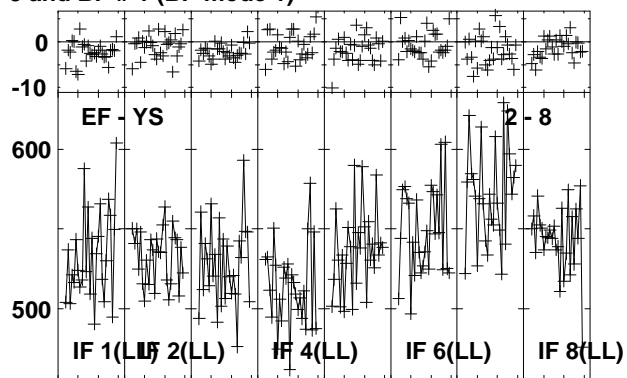
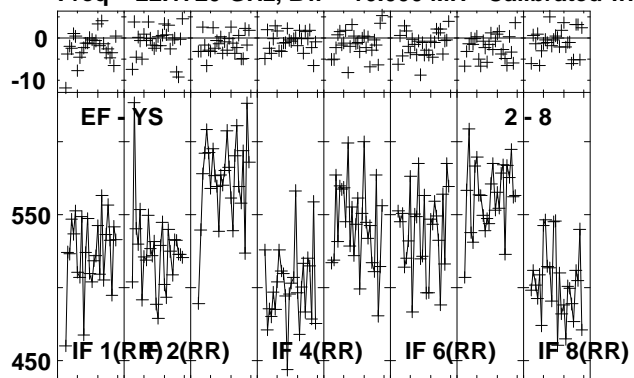

Lower frame: Milli Ampl Jy Top frame: Phas deg
Vector averaged cross-power spectrum Several baselines displayed
Timerange: 01/04:16:14 to 01/04:17:12

Plot file version 491 created 26-JUL-2013 10:27:08
 B1152+199A EZ024 1.UVDATA.1
 Freq = 22.1720 GHz, Bw = 16.000 MH Calibrated with CL # 3 and BP # 1 (BP mode 1)

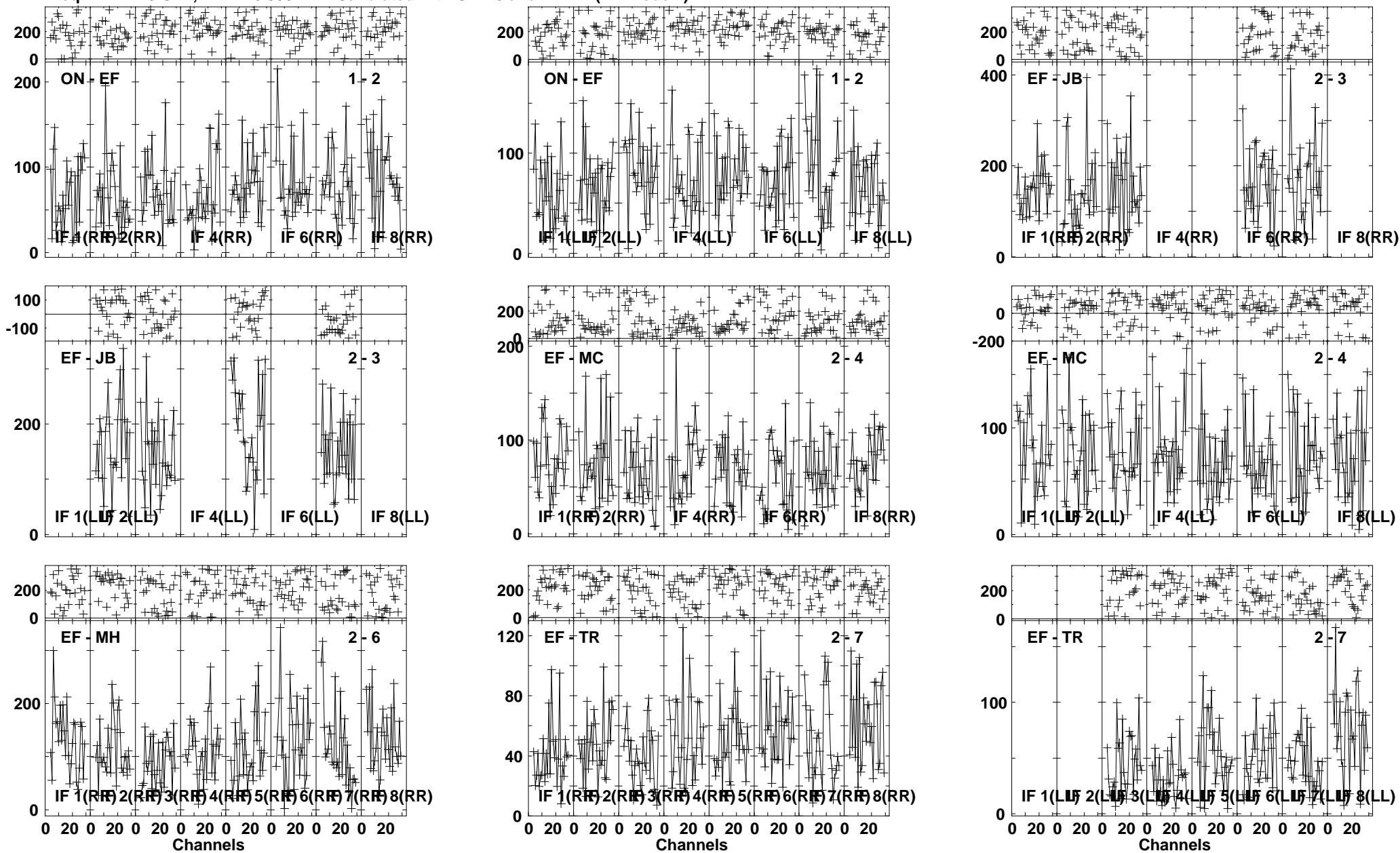

Lower frame: Milli Ampl Jy Top frame: Phas deg
 Vector averaged cross-power spectrum Several baselines displayed
 Timerange: 01/04:17:47 to 01/04:19:45

Plot file version 492 created 26-JUL-2013 10:27:09

B1152+199A EZ024 1.UVDATA.1

Freq = 22.1720 GHz, Bw = 16.000 MH Calibrated with CL # 3 and BP # 1 (BP mode 1)

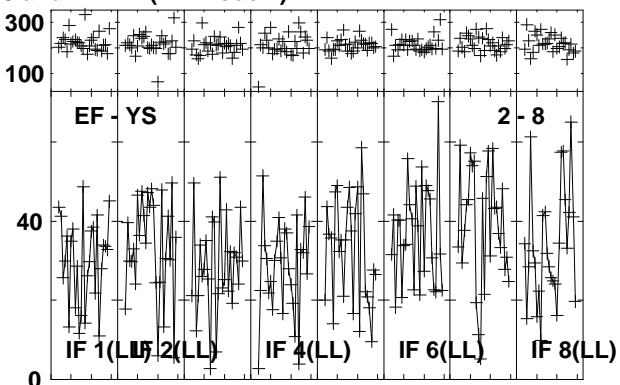
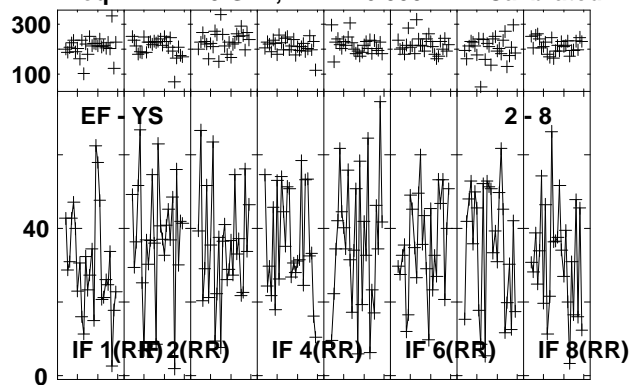

Lower frame: Milli Ampl Jy Top frame: Phas deg
Vector averaged cross-power spectrum Several baselines displayed
Timerange: 01/04:17:47 to 01/04:19:45

Plot file version 493 created 26-JUL-2013 10:27:10

J1157 EZ024 1.UVDATA.1

Freq = 22.1720 GHz, Bw = 16.000 MH Calibrated with CL # 3 and BP # 1 (BP mode 1)

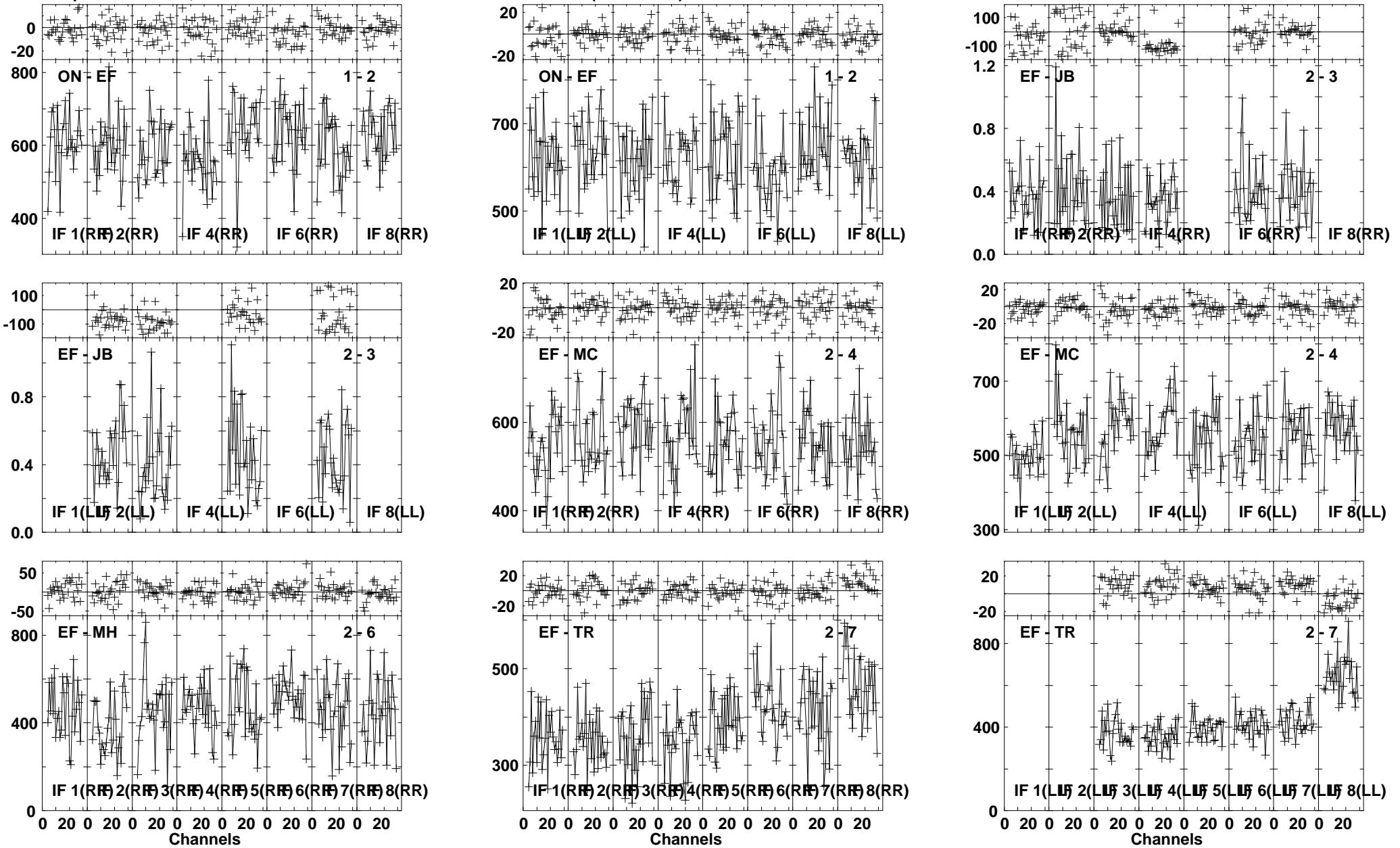

Lower frame: Milli Ampl Jy Top frame: Phas deg
Vector averaged cross-power spectrum Several baselines displayed
Timerange: 01/04:20:20 to 01/04:21:18

Plot file version 494 created 26-JUL-2013 10:27:11

J1157 EZ024 1.UVDATA.1

Freq = 22.1720 GHz, Bw = 16.000 MH Calibrated with CL # 3 and BP # 1 (BP mode 1)

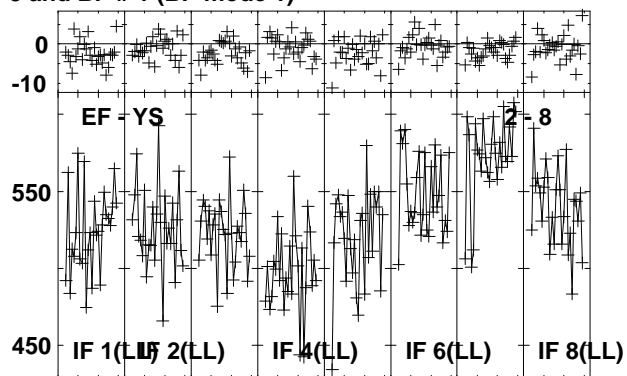
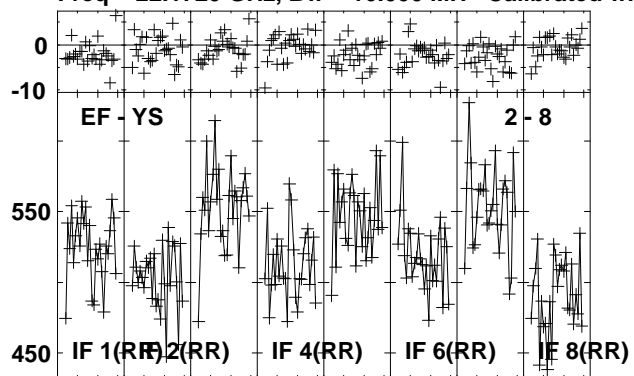

Lower frame: Milli Ampl Jy Top frame: Phas deg
Vector averaged cross-power spectrum Several baselines displayed
Timerange: 01/04:20:20 to 01/04:21:18

Plot file version 495 created 26-JUL-2013 10:27:11
 J1125+2610 EZ024 1.UVDATA.1
 Freq = 22.1720 GHz, Bw = 16.000 MH Calibrated with CL # 3 and BP # 1 (BP mode 1)

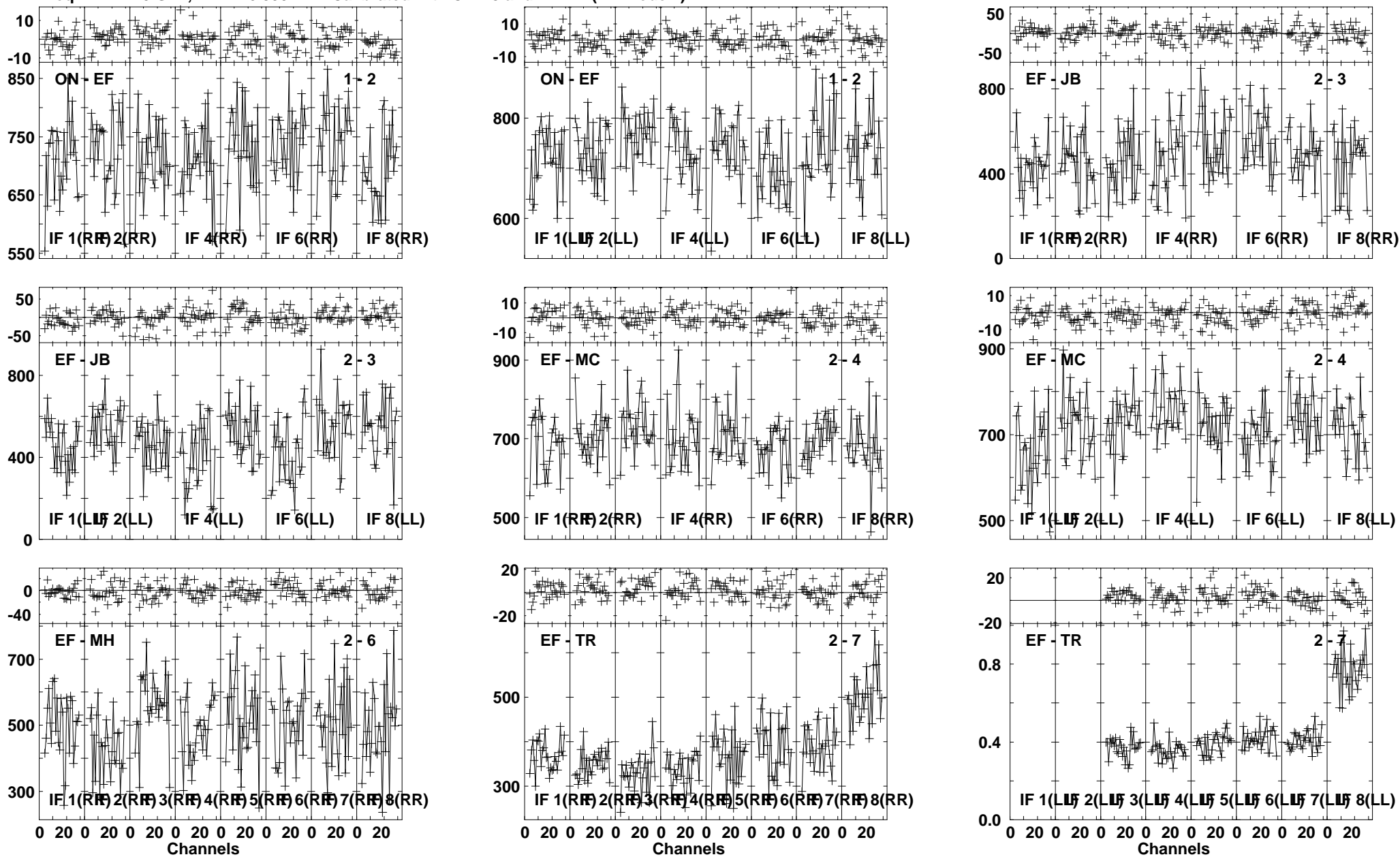

Lower frame: Milli Ampl Jy Top frame: Phas deg
 Vector averaged cross-power spectrum Several baselines displayed
 Timerange: 01/04:22:46 to 01/04:24:28

Plot file version 496 created 26-JUL-2013 10:27:12

J1125+2610 EZ024 1.UVDATA.1

Freq = 22.1720 GHz, Bw = 16.000 MH Calibrated with CL # 3 and BP # 1 (BP mode 1)

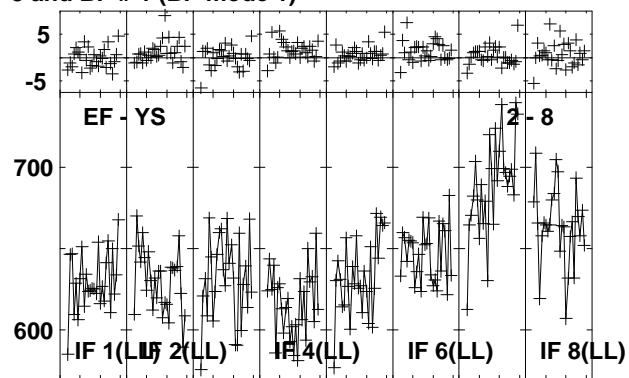
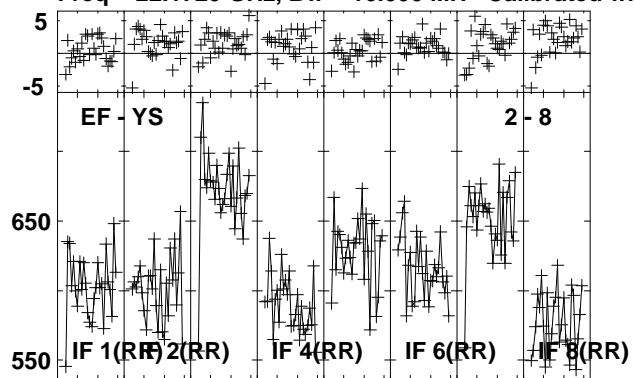

Lower frame: Milli Ampl Jy Top frame: Phas deg
Vector averaged cross-power spectrum Several baselines displayed
Timerange: 01/04:22:46 to 01/04:24:28

Plot file version 497 created 26-JUL-2013 10:27:13

J1157 EZ024 1.UVDATA.1

Freq = 22.1720 GHz, Bw = 16.000 MH Calibrated with CL # 3 and BP # 1 (BP mode 1)

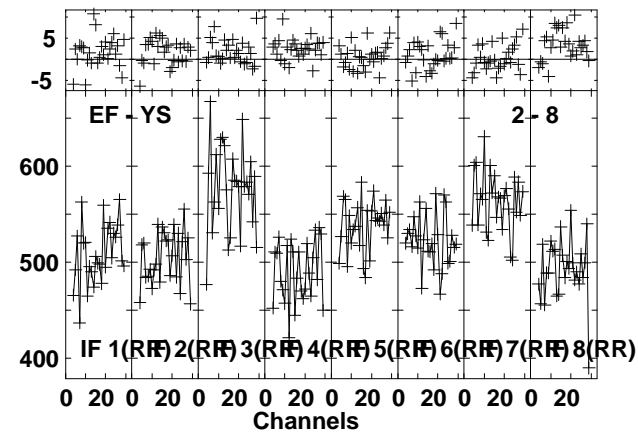
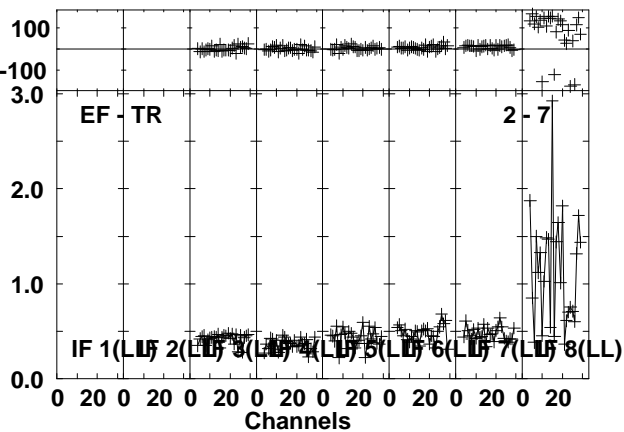
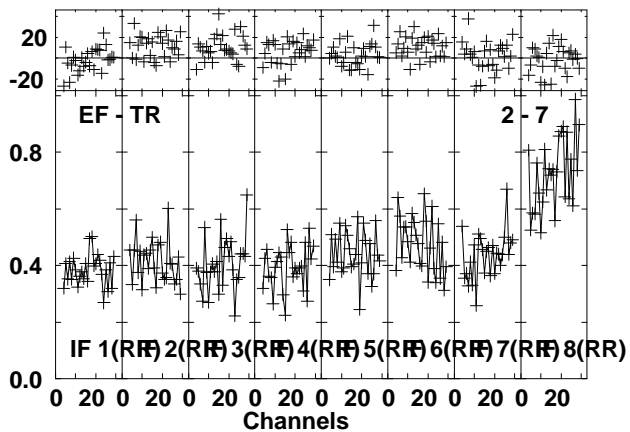
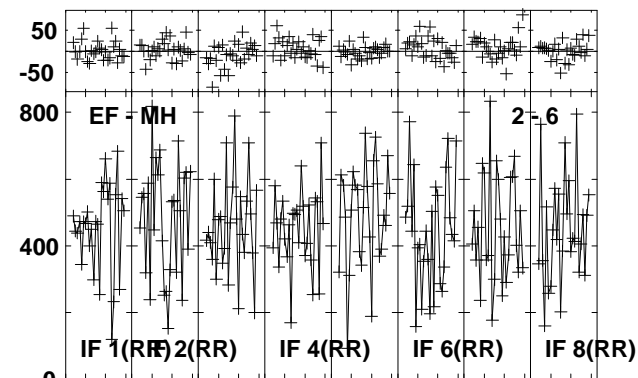
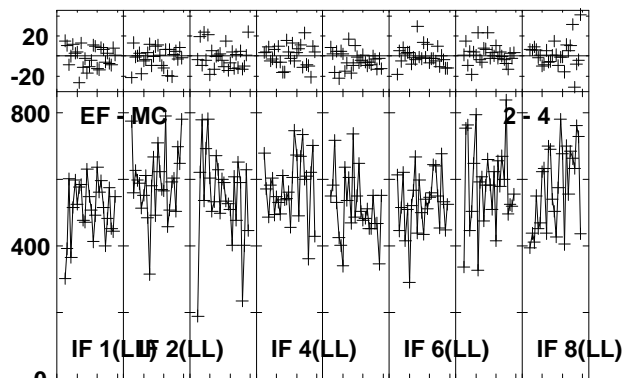
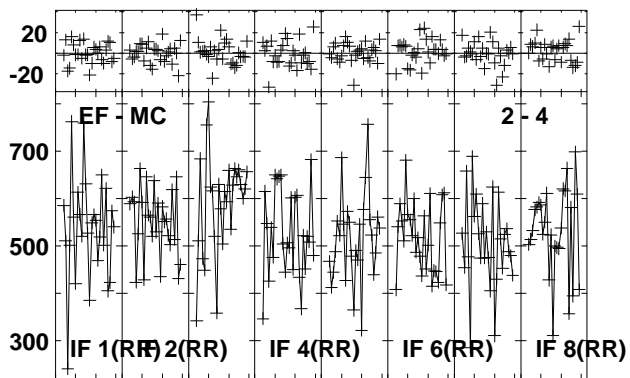
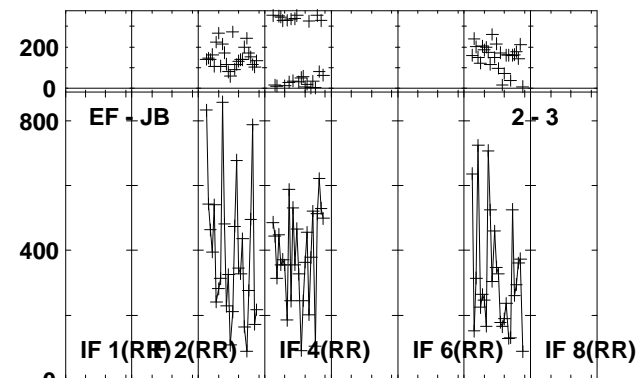
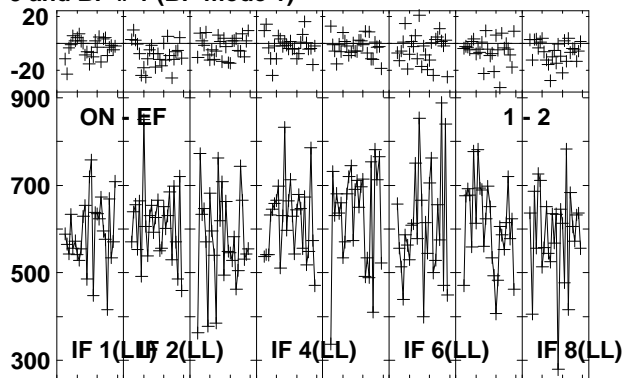
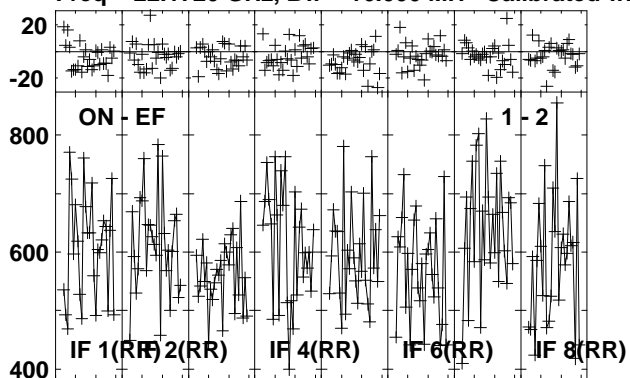

Lower frame: Milli Ampl Jy Top frame: Phas deg
Vector averaged cross-power spectrum Several baselines displayed
Timerange: 01/04:25:55 to 01/04:26:37

Plot file version 498 created 26-JUL-2013 10:27:13
J1157 EZ024 1.UVDATA.1
Freq = 22.1720 GHz, Bw = 16.000 MH Calibrated with CL # 3 and BP # 1 (BP mode 1)

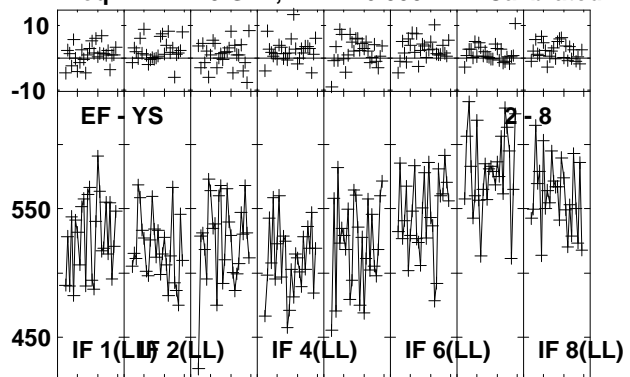

Lower frame: Milli Ampl Jy Top frame: Phas deg
Vector averaged cross-power spectrum Several baselines displayed
Timerange: 01/04:25:55 to 01/04:26:37

Plot file version 499 created 26-JUL-2013 10:27:14
 B1152+199A EZ024 1.UVDATA.1
 Freq = 22.1720 GHz, Bw = 16.000 MH Calibrated with CL # 3 and BP # 1 (BP mode 1)

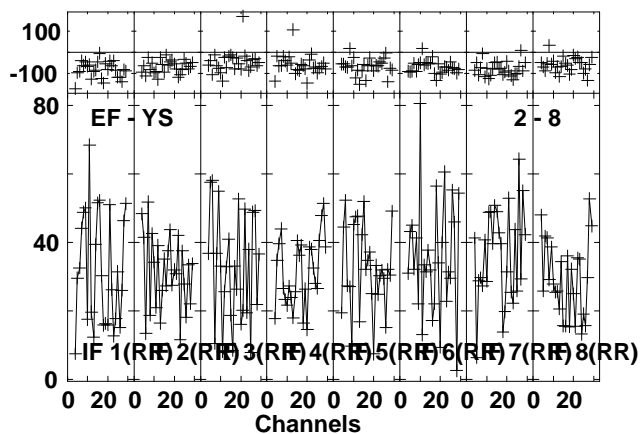
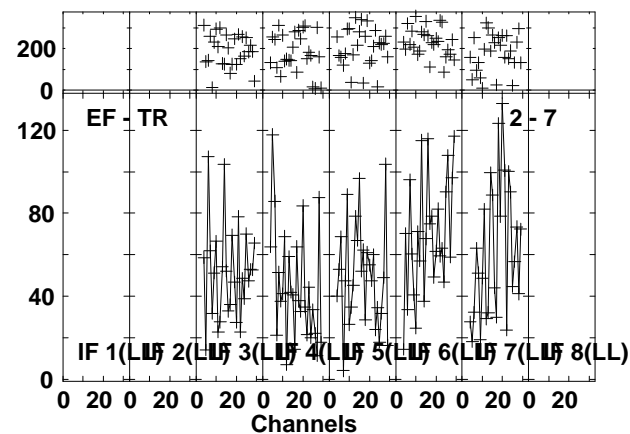
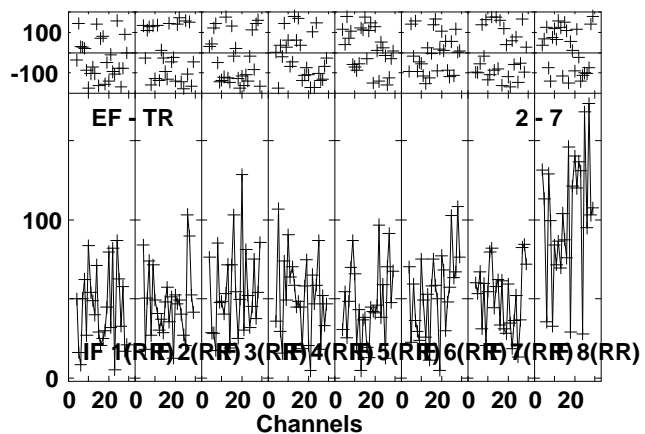
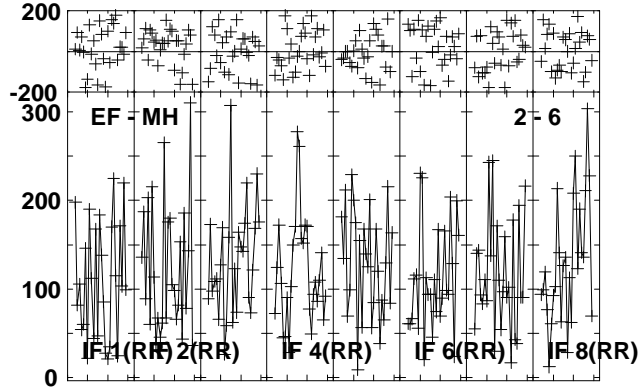
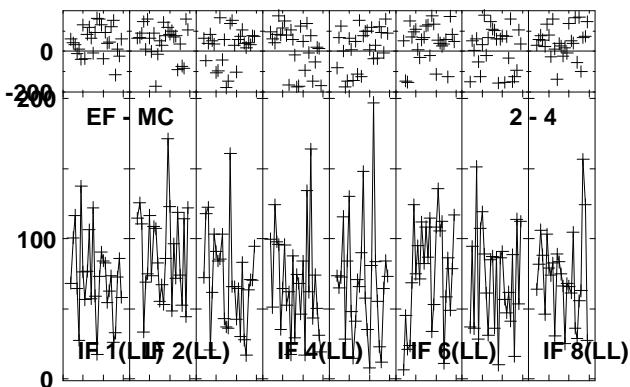
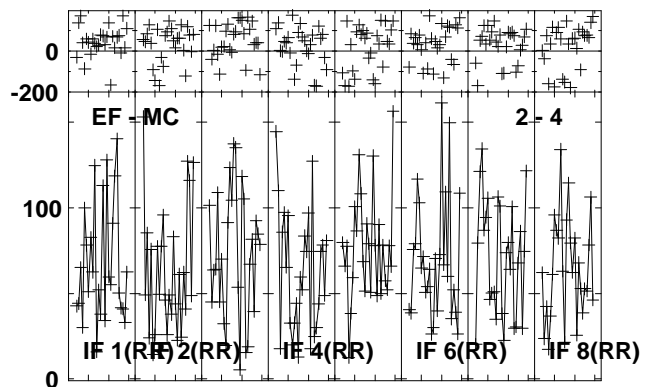
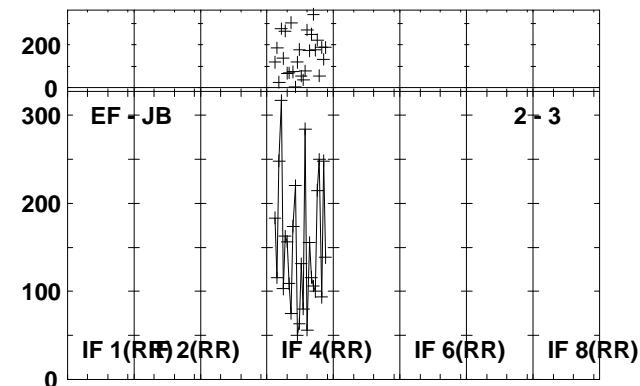
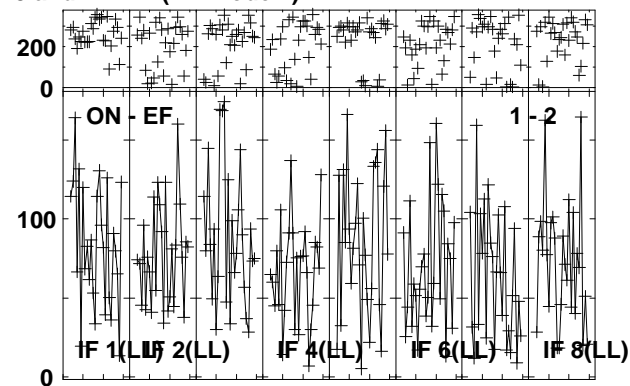
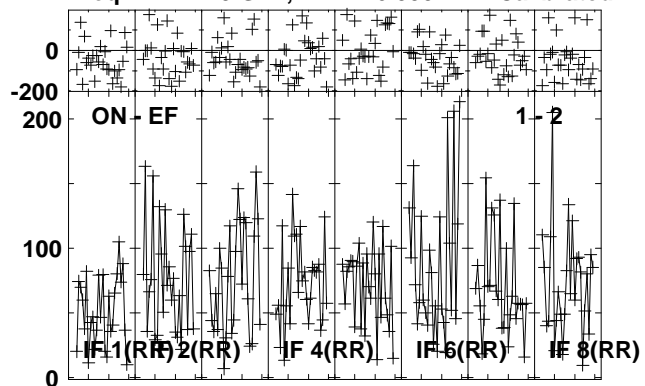

Lower frame: Milli Ampl Jy Top frame: Phas deg
 Vector averaged cross-power spectrum Several baselines displayed
 Timerange: 01/04:27:14 to 01/04:29:12

Plot file version 500 created 26-JUL-2013 10:27:15
B1152+199A EZ024 1.UVDATA.1
Freq = 22.1720 GHz, Bw = 16.000 MH Calibrated with CL # 3 and BP # 1 (BP mode 1)

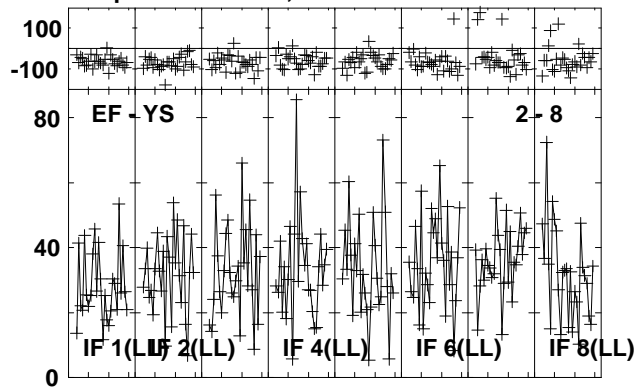

Lower frame: Milli Ampl Jy Top frame: Phas deg
Vector averaged cross-power spectrum Several baselines displayed
Timerange: 01/04:27:14 to 01/04:29:12

Plot file version 501 created 26-JUL-2013 10:27:16

J1157 EZ024 1.UVDATA.1

Freq = 22.1720 GHz, Bw = 16.000 MH Calibrated with CL # 3 and BP # 1 (BP mode 1)

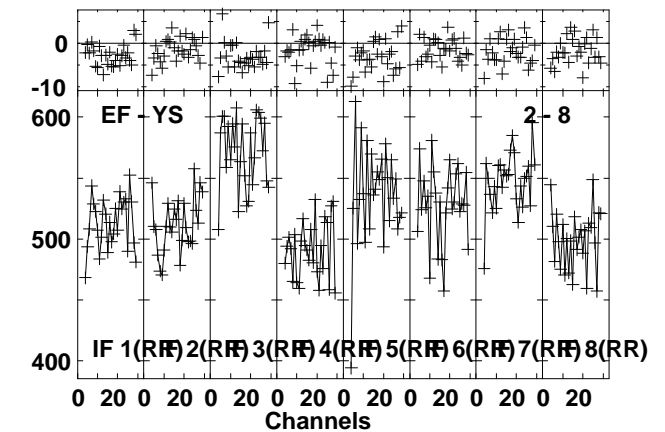
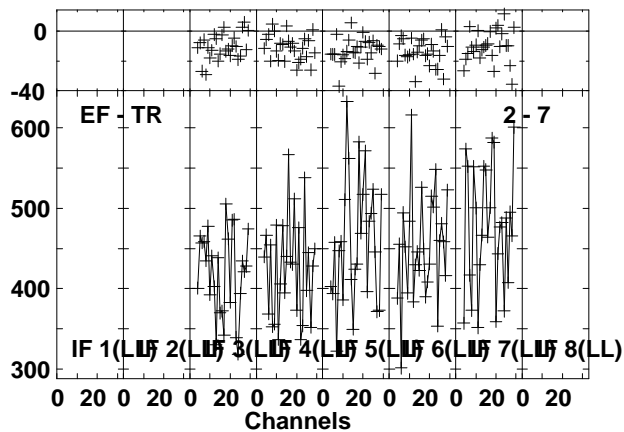
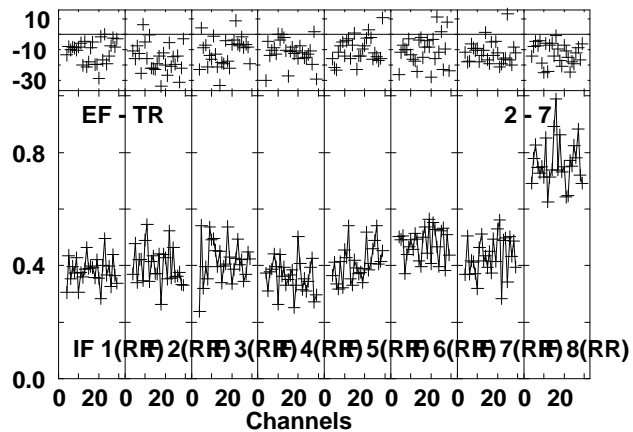
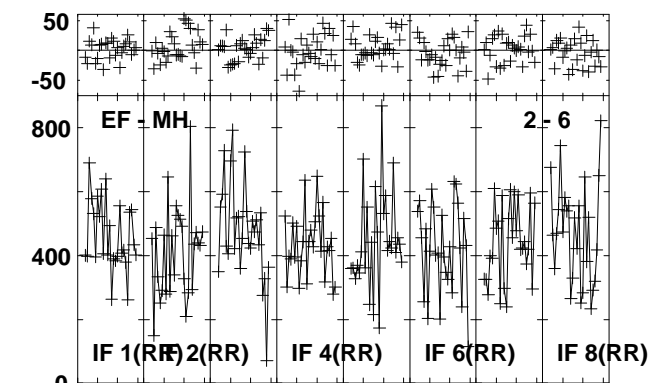
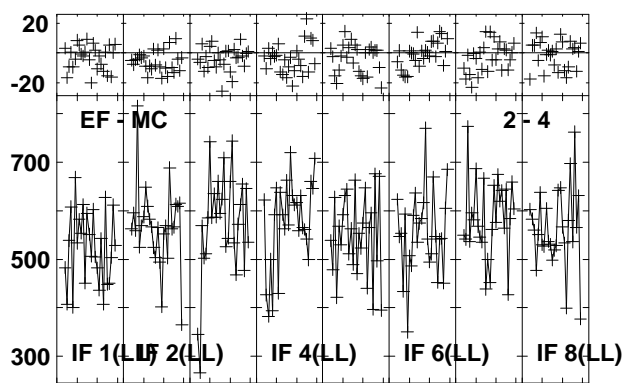
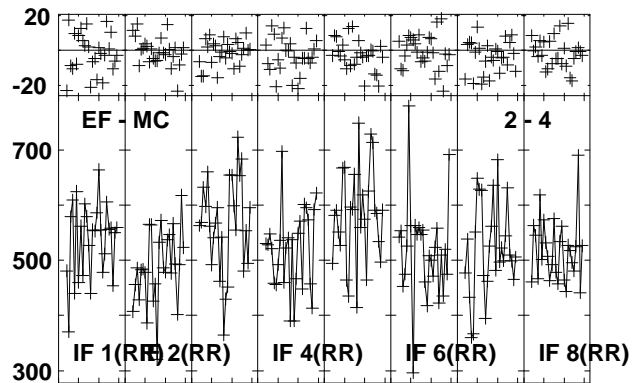
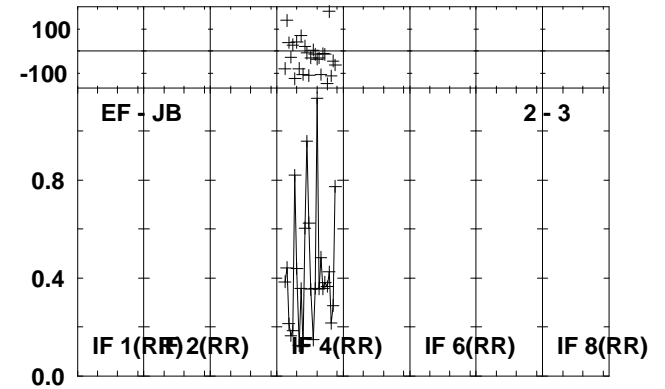
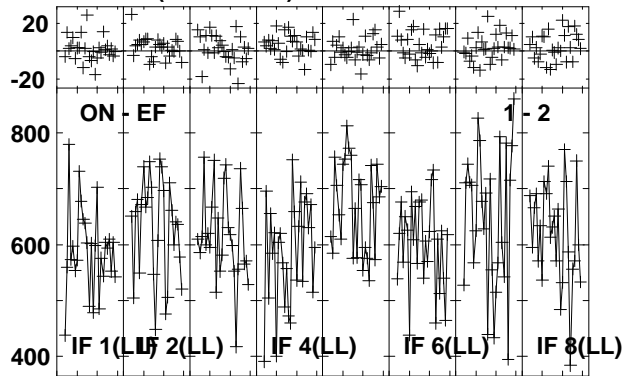
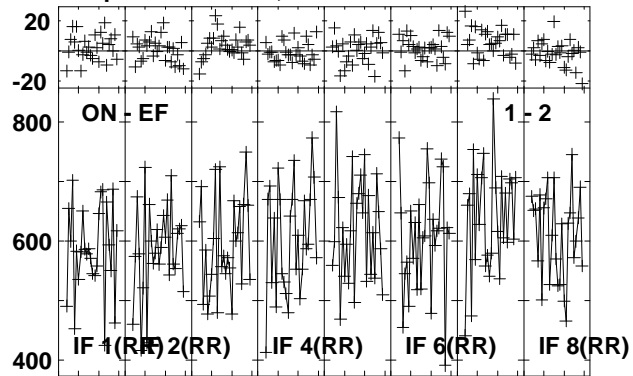

Lower frame: Milli Ampl Jy Top frame: Phas deg
Vector averaged cross-power spectrum Several baselines displayed
Timerange: 01/04:29:46 to 01/04:30:44

Plot file version 502 created 26-JUL-2013 10:27:16
J1157 EZ024 1.UVDATA.1
Freq = 22.1720 GHz, Bw = 16.000 MH Calibrated with CL # 3 and BP # 1 (BP mode 1)

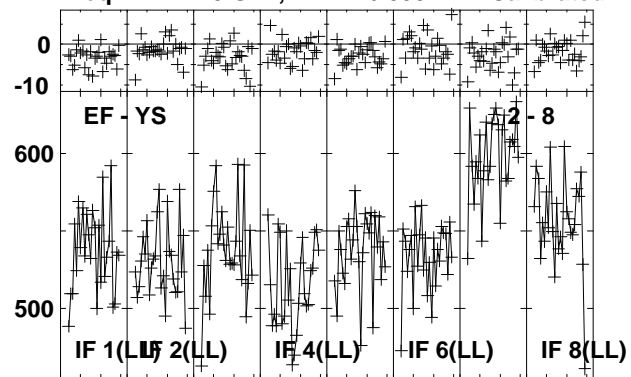

Lower frame: Milli Ampl Jy Top frame: Phas deg
Vector averaged cross-power spectrum Several baselines displayed
Timerange: 01/04:29:46 to 01/04:30:44

Plot file version 503 created 26-JUL-2013 10:27:17
 B1152+199A EZ024 1.UVDATA.1
 Freq = 22.1720 GHz, Bw = 16.000 MH Calibrated with CL # 3 and BP # 1 (BP mode 1)

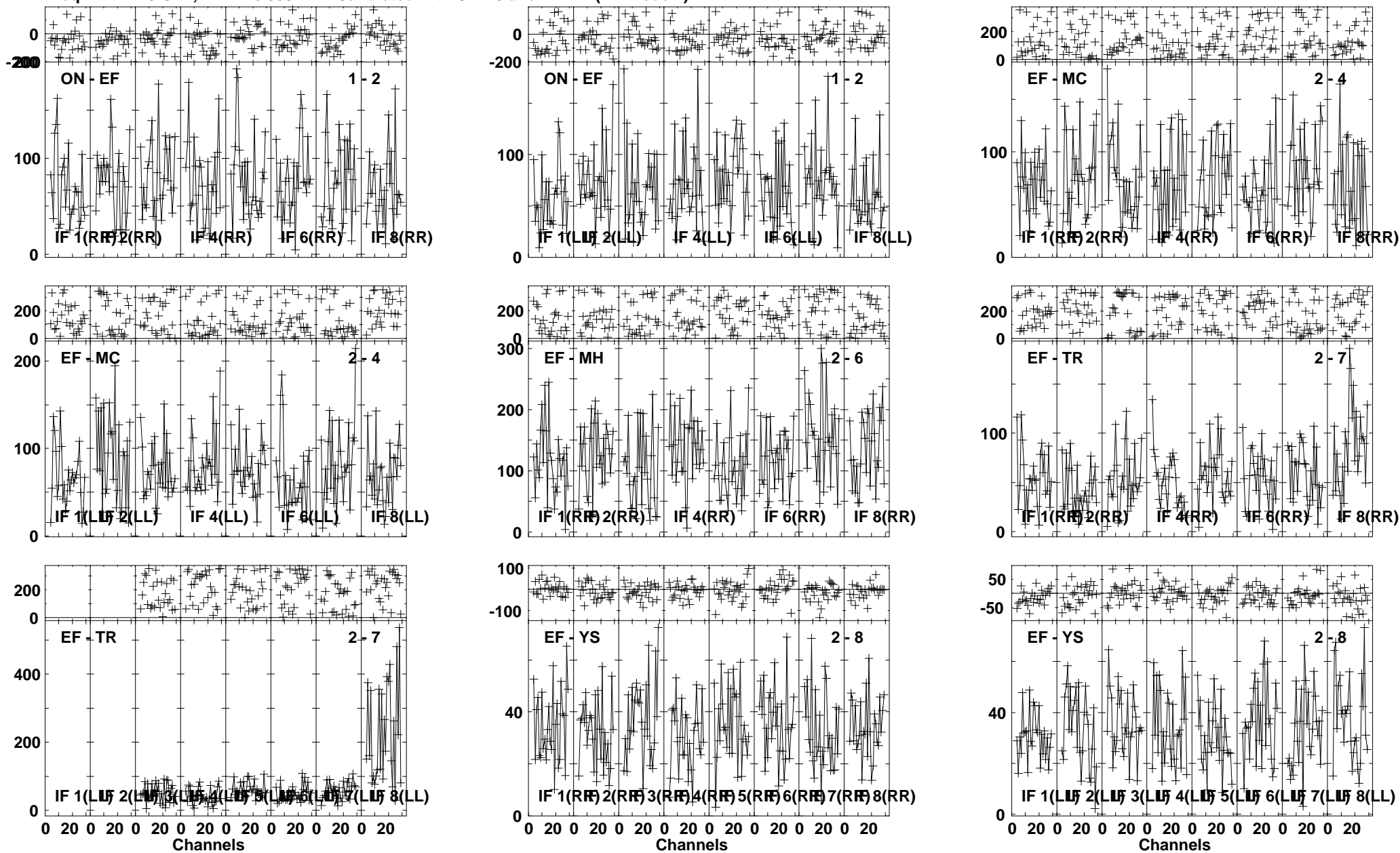

Lower frame: Milli Ampl Jy Top frame: Phas deg
 Vector averaged cross-power spectrum Several baselines displayed
 Timerange: 01/04:31:20 to 01/04:33:18

Plot file version 504 created 26-JUL-2013 10:27:19

J1157 EZ024 1.UVDATA.1

Freq = 22.1720 GHz, Bw = 16.000 MH Calibrated with CL # 3 and BP # 1 (BP mode 1)

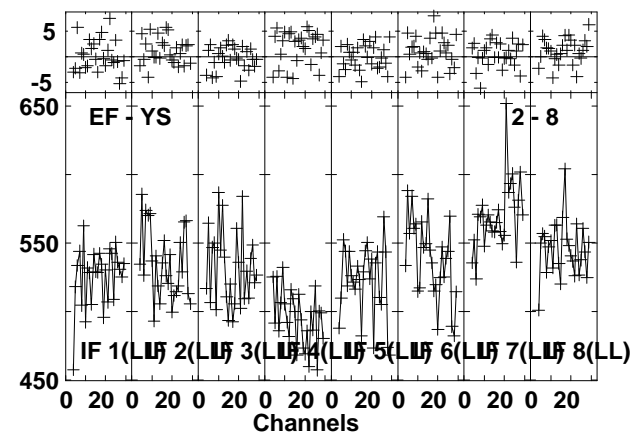
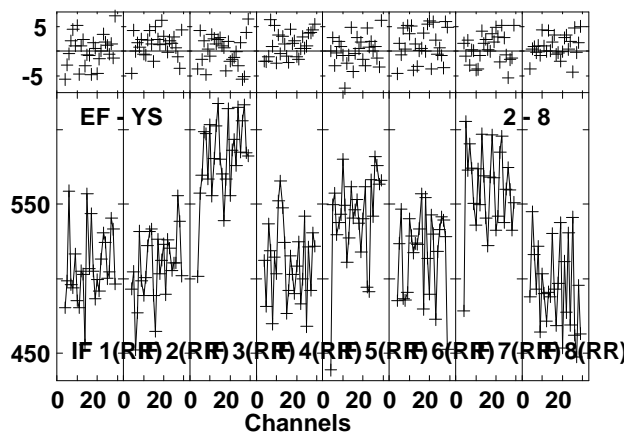
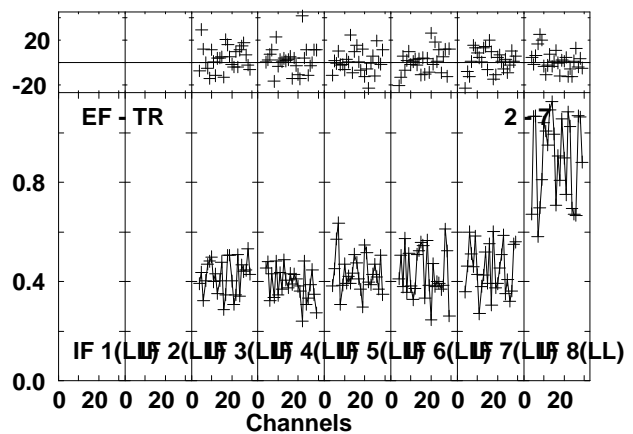
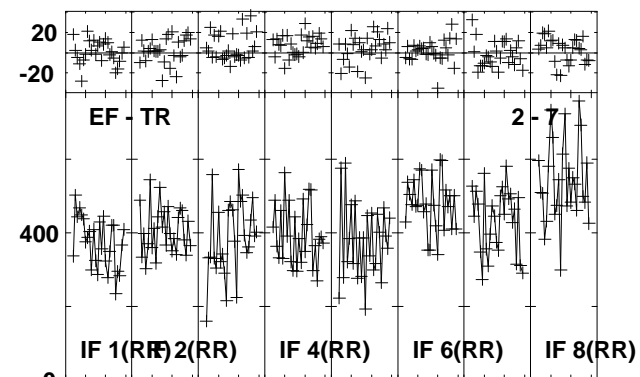
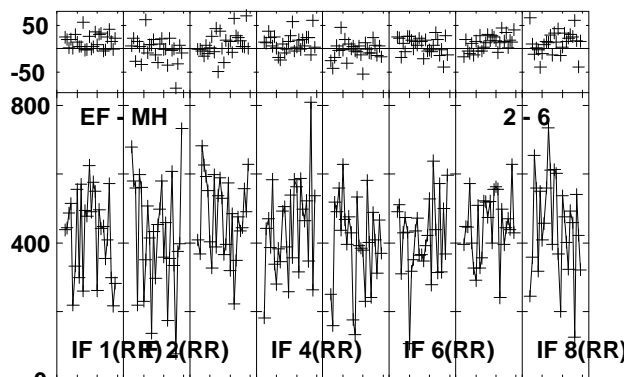
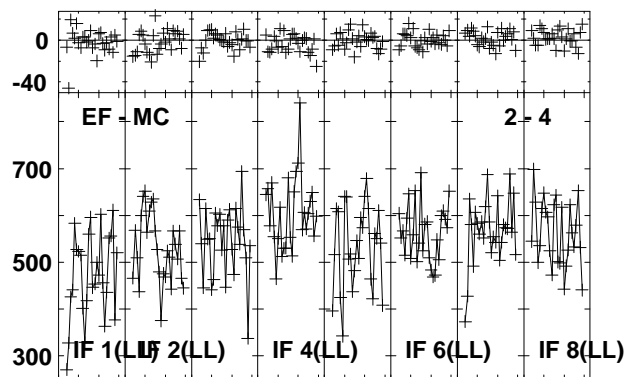
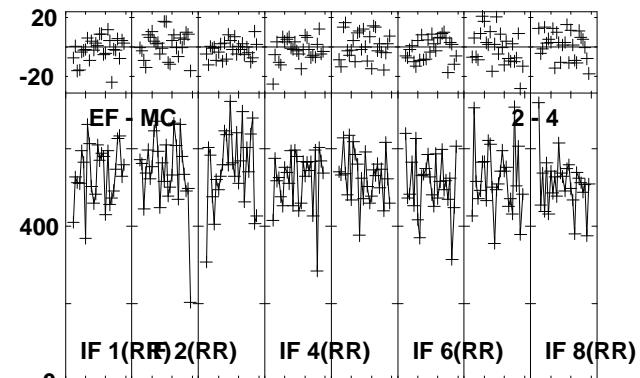
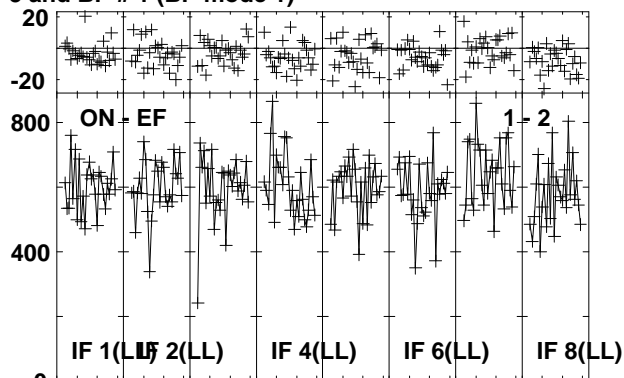
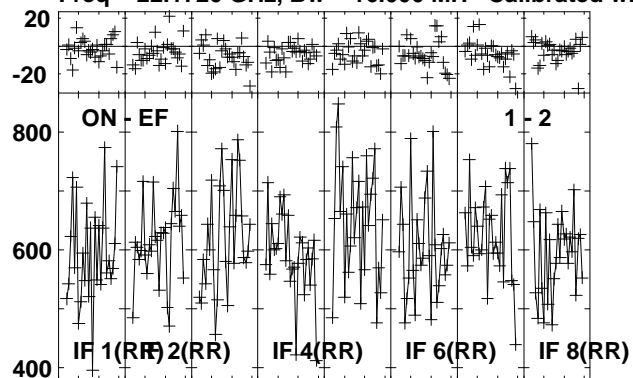

Lower frame: Milli Ampl Jy Top frame: Phas deg
Vector averaged cross-power spectrum Several baselines displayed
Timerange: 01/04:33:53 to 01/04:34:51

Plot file version 505 created 26-JUL-2013 10:27:20
 B1152+199A EZ24 1.UVDATA.1
 Freq = 22.1720 GHz, Bw = 16.000 MH Calibrated with CL # 3 and BP # 1 (BP mode 1)

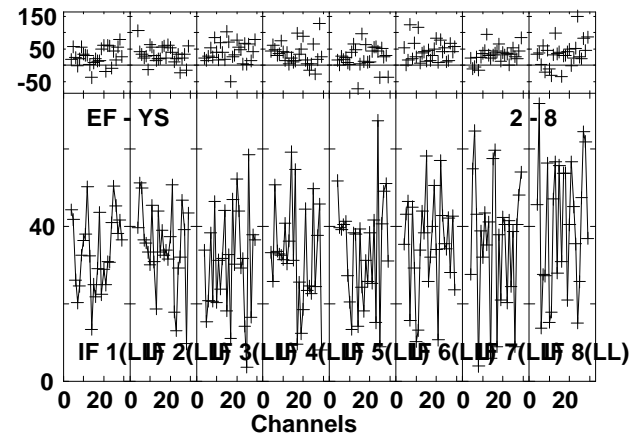
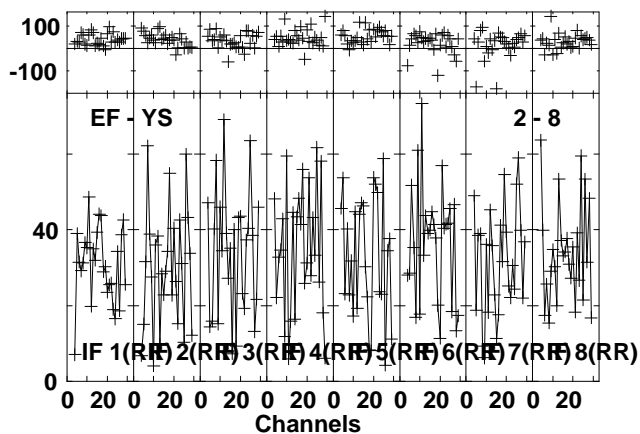
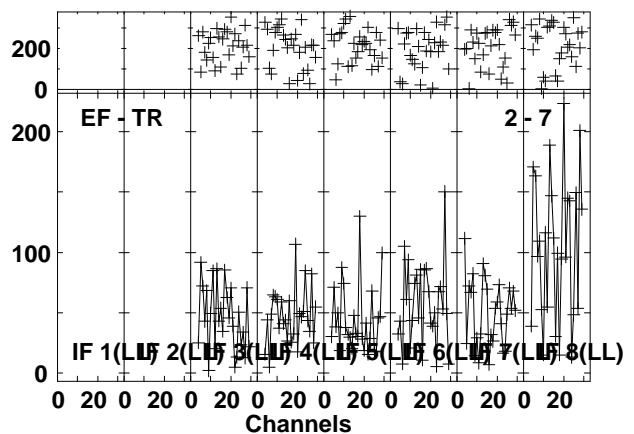
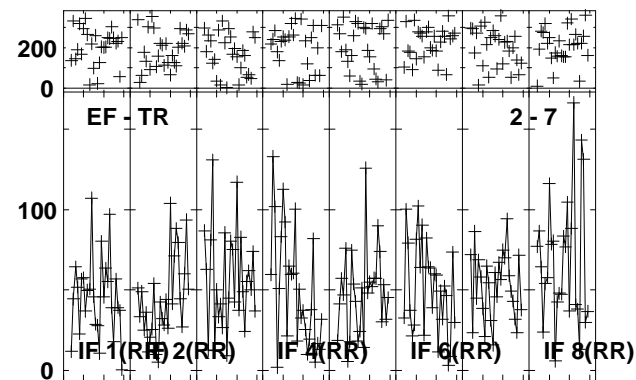
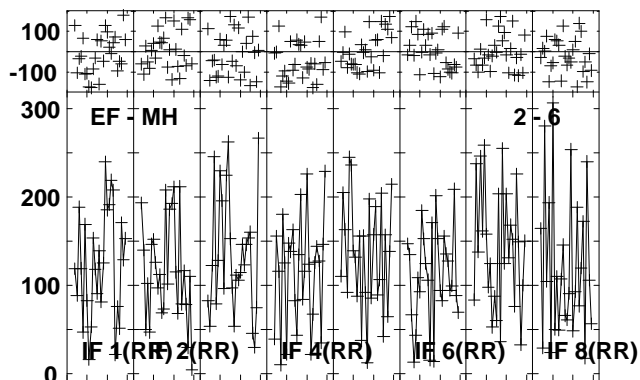
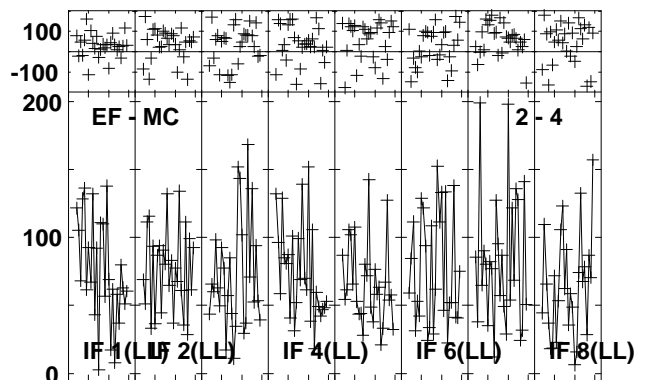
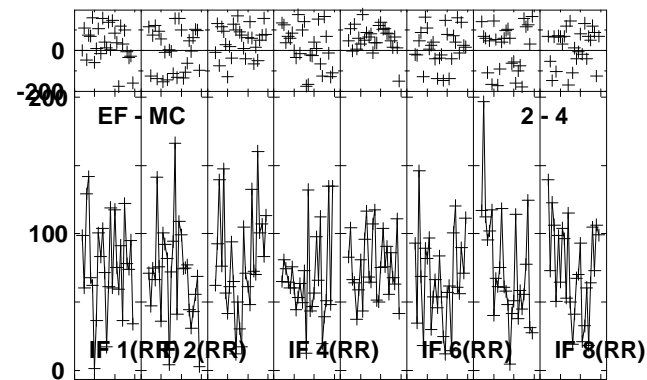
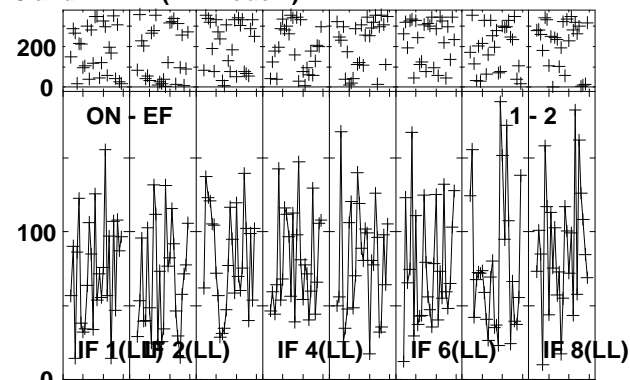
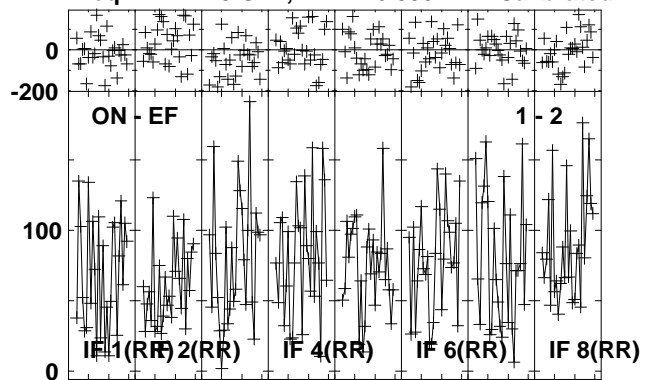

Lower frame: Milli Ampl Jy Top frame: Phas deg
 Vector averaged cross-power spectrum Several baselines displayed
 Timerange: 01/04:35:26 to 01/04:37:24

Plot file version 506 created 26-JUL-2013 10:27:22

J1157 EZ024 1.UVDATA.1

Freq = 22.1720 GHz, Bw = 16.000 MH Calibrated with CL # 3 and BP # 1 (BP mode 1)

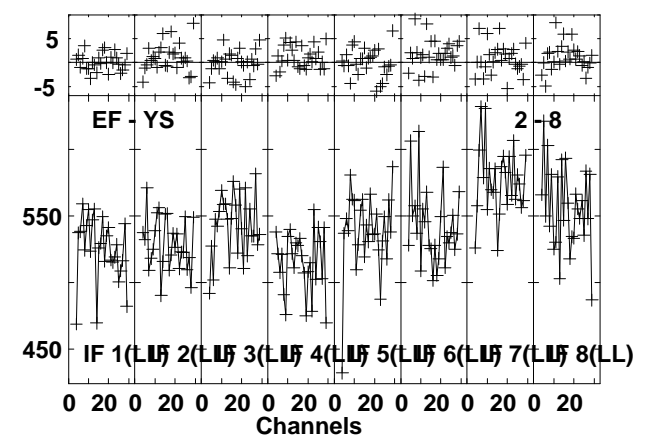
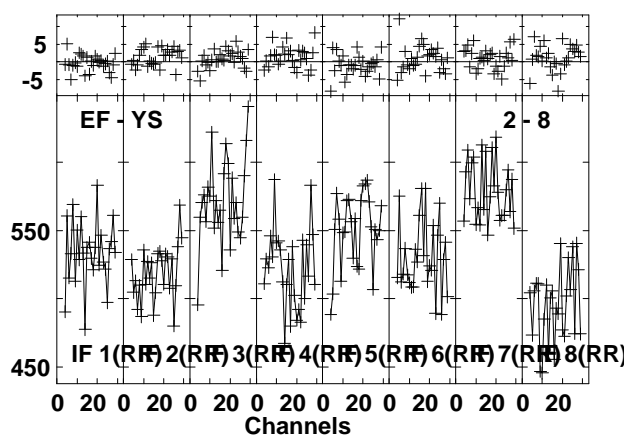
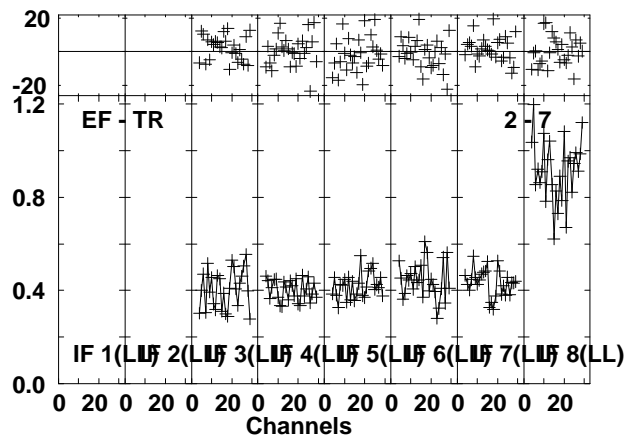
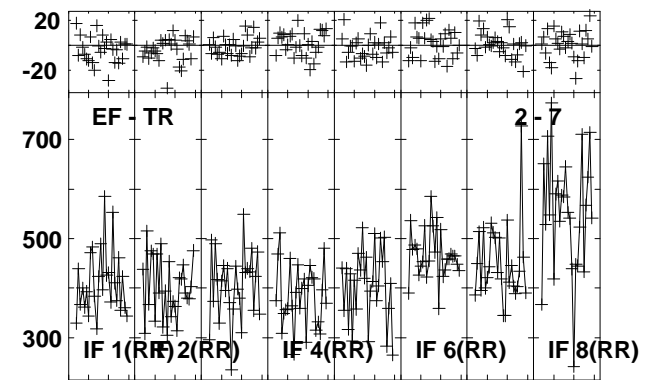
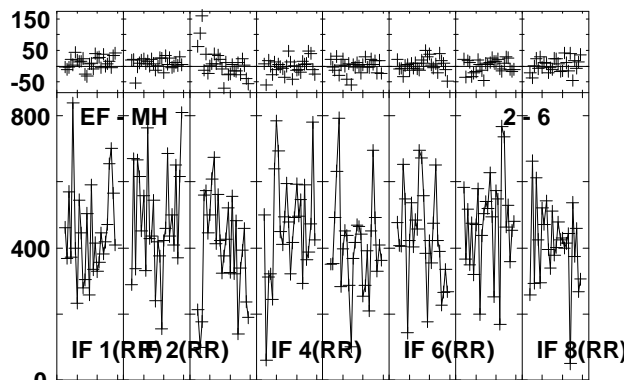
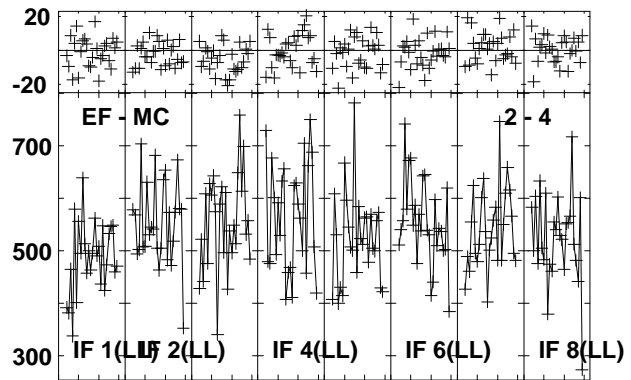
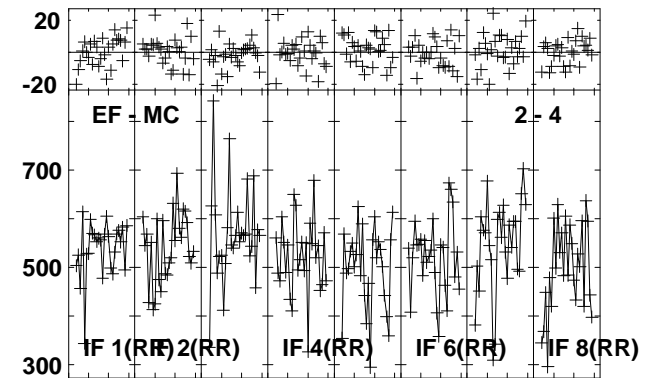
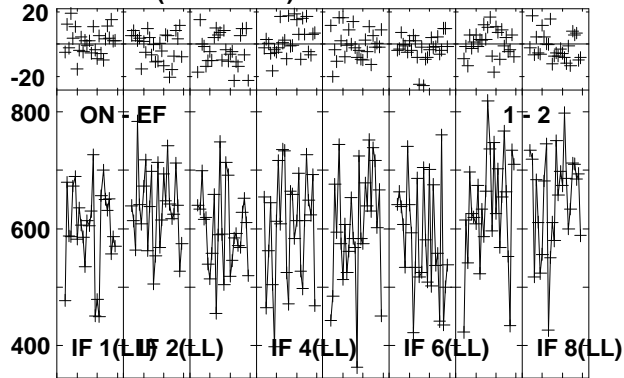
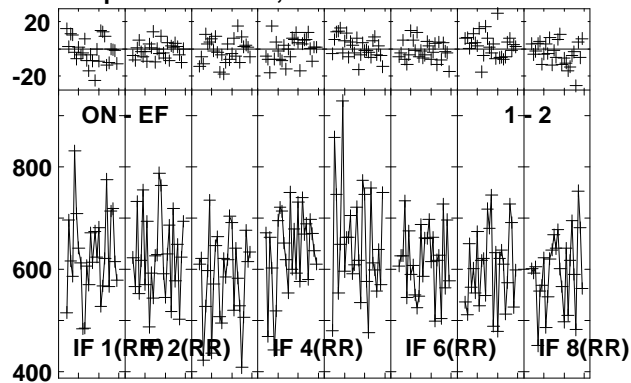

Lower frame: Milli Ampl Jy Top frame: Phas deg
Vector averaged cross-power spectrum Several baselines displayed
Timerange: 01/04:37:59 to 01/04:38:57

Plot file version 507 created 26-JUL-2013 10:27:24
 J1125+2610 EZ024 1.UVDATA.1
 Freq = 22.1720 GHz, Bw = 16.000 MH Calibrated with CL # 3 and BP # 1 (BP mode 1)

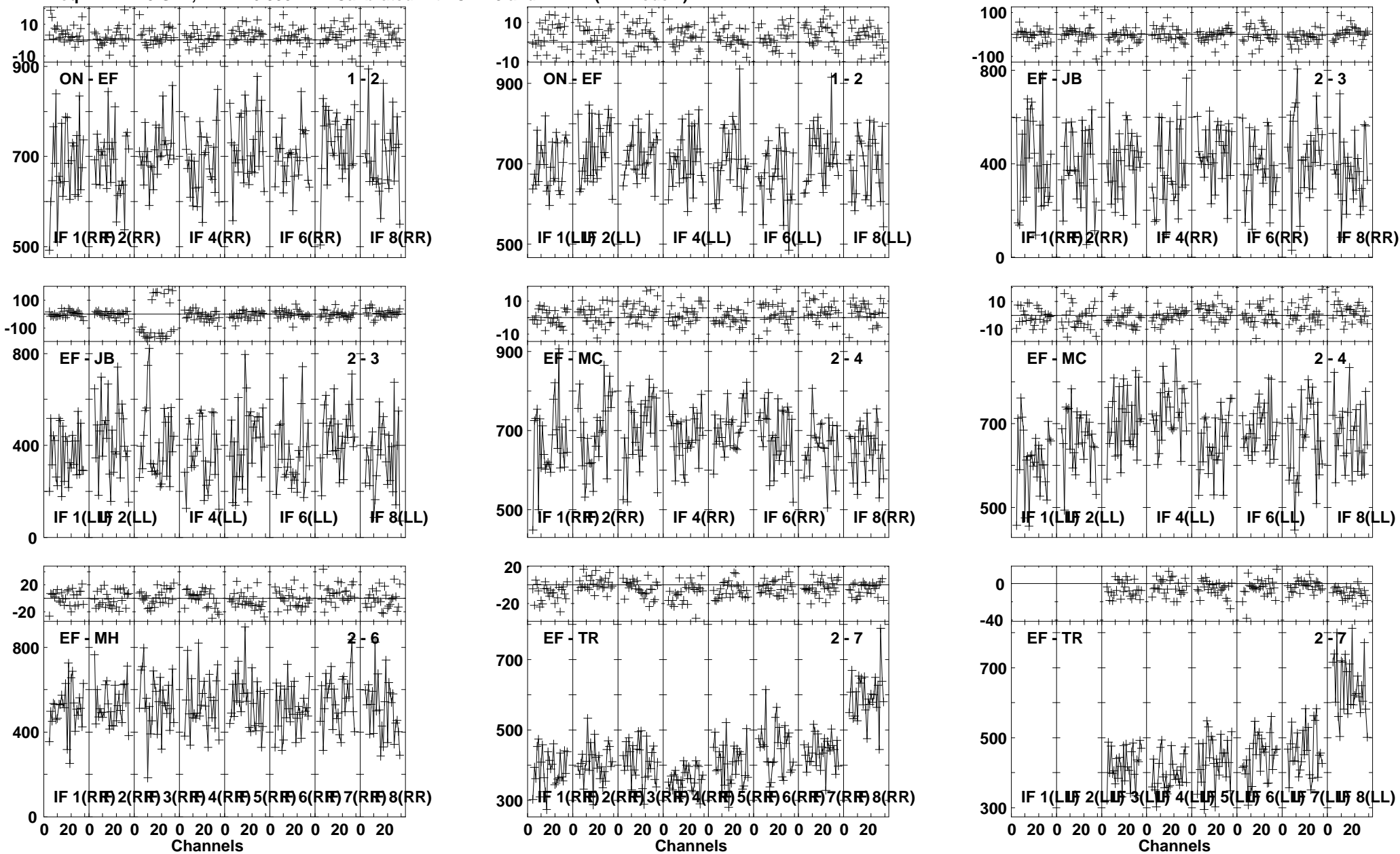

Lower frame: Milli Ampl Jy Top frame: Phas deg
 Vector averaged cross-power spectrum Several baselines displayed
 Timerange: 01/04:40:23 to 01/04:42:05

Plot file version 508 created 26-JUL-2013 10:27:24

J1125+2610 EZ024 1.UVDATA.1

Freq = 22.1720 GHz, Bw = 16.000 MH Calibrated with CL # 3 and BP # 1 (BP mode 1)

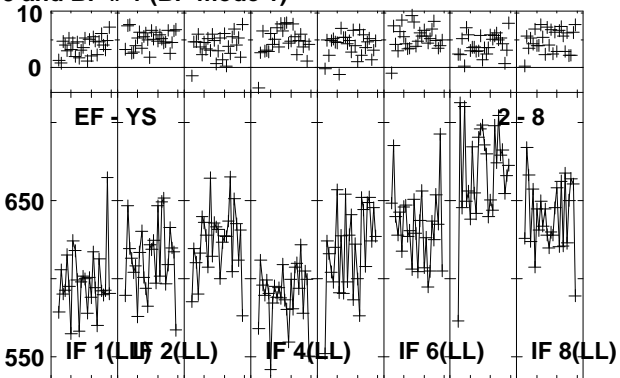
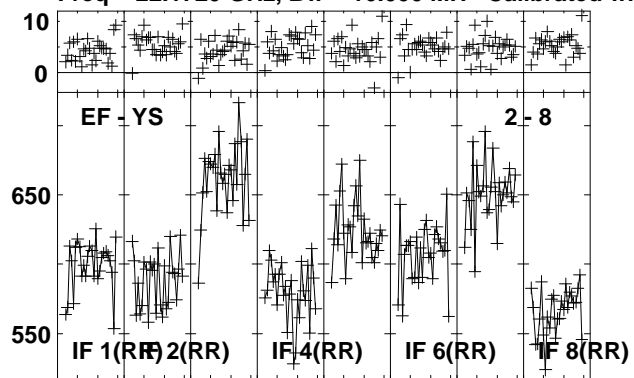

Lower frame: Milli Ampl Jy Top frame: Phas deg
Vector averaged cross-power spectrum Several baselines displayed
Timerange: 01/04:40:23 to 01/04:42:05

Plot file version 509 created 26-JUL-2013 10:27:25

J1157 EZ024 1.UVDATA.1

Freq = 22.1720 GHz, Bw = 16.000 MH Calibrated with CL # 3 and BP # 1 (BP mode 1)

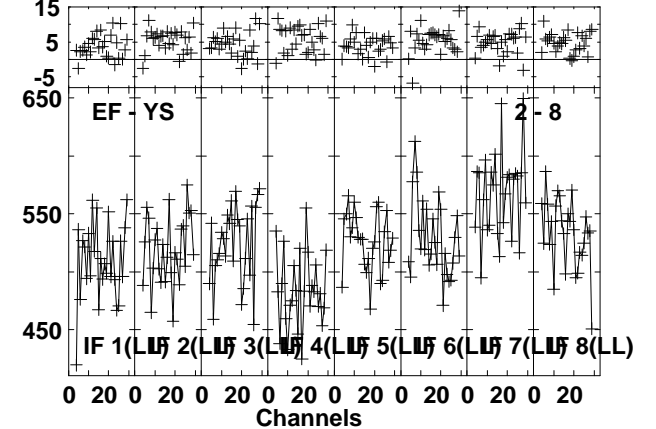
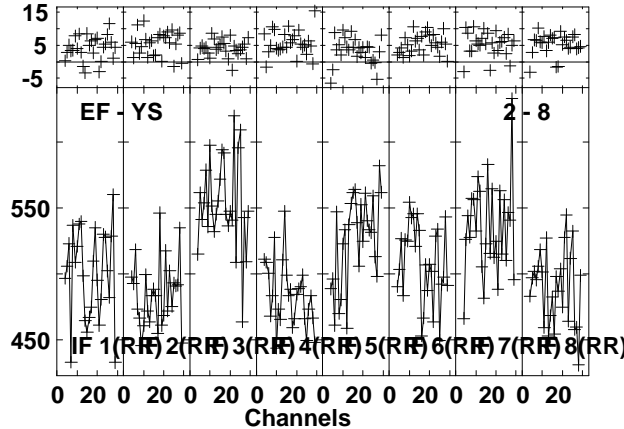
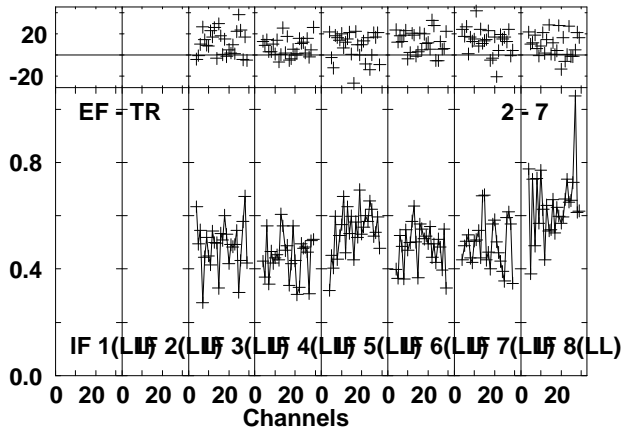
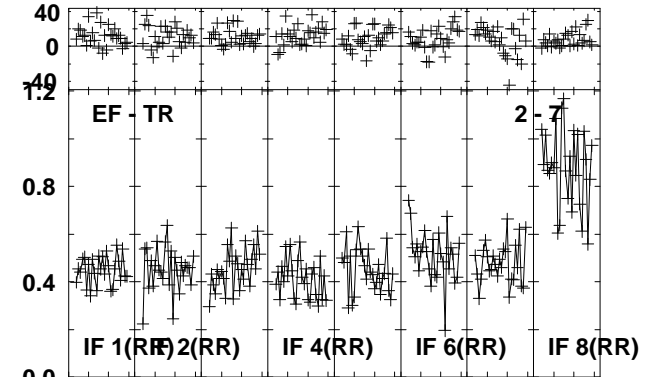
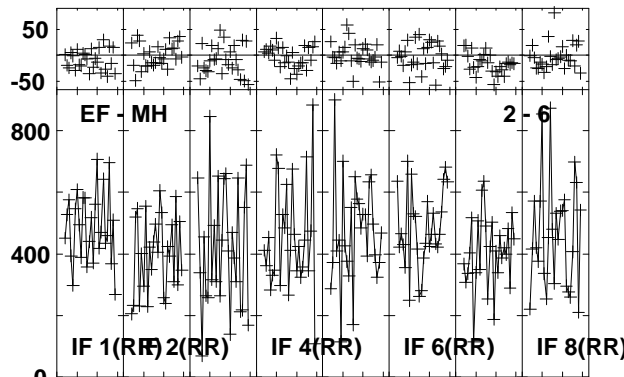
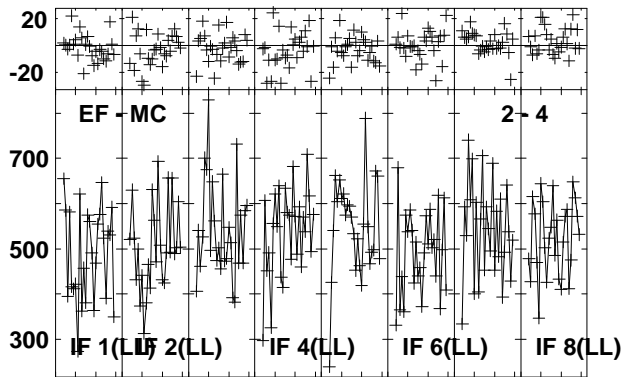
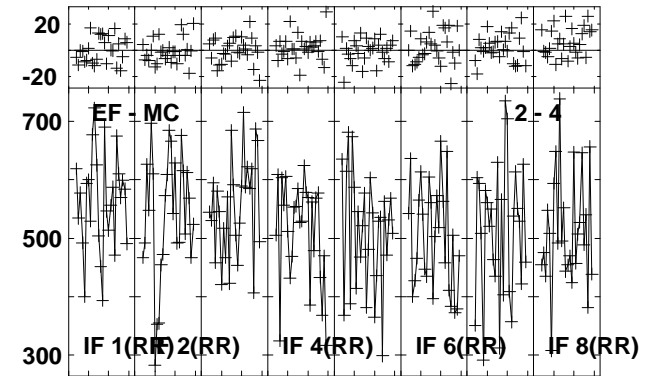
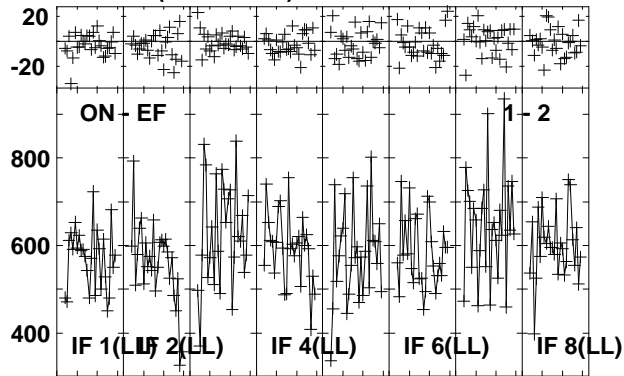
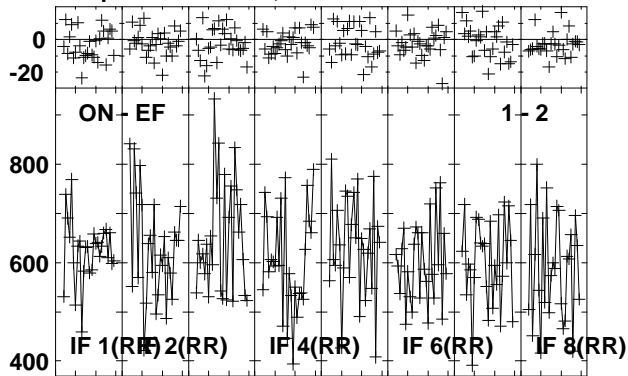

Lower frame: Milli Ampl Jy Top frame: Phas deg
Vector averaged cross-power spectrum Several baselines displayed
Timerange: 01/04:43:31 to 01/04:44:13

Plot file version 510 created 26-JUL-2013 10:27:26
 B1152+199A EZ024 1.UVDATA.1
 Freq = 22.1720 GHz, Bw = 16.000 MH Calibrated with CL # 3 and BP # 1 (BP mode 1)

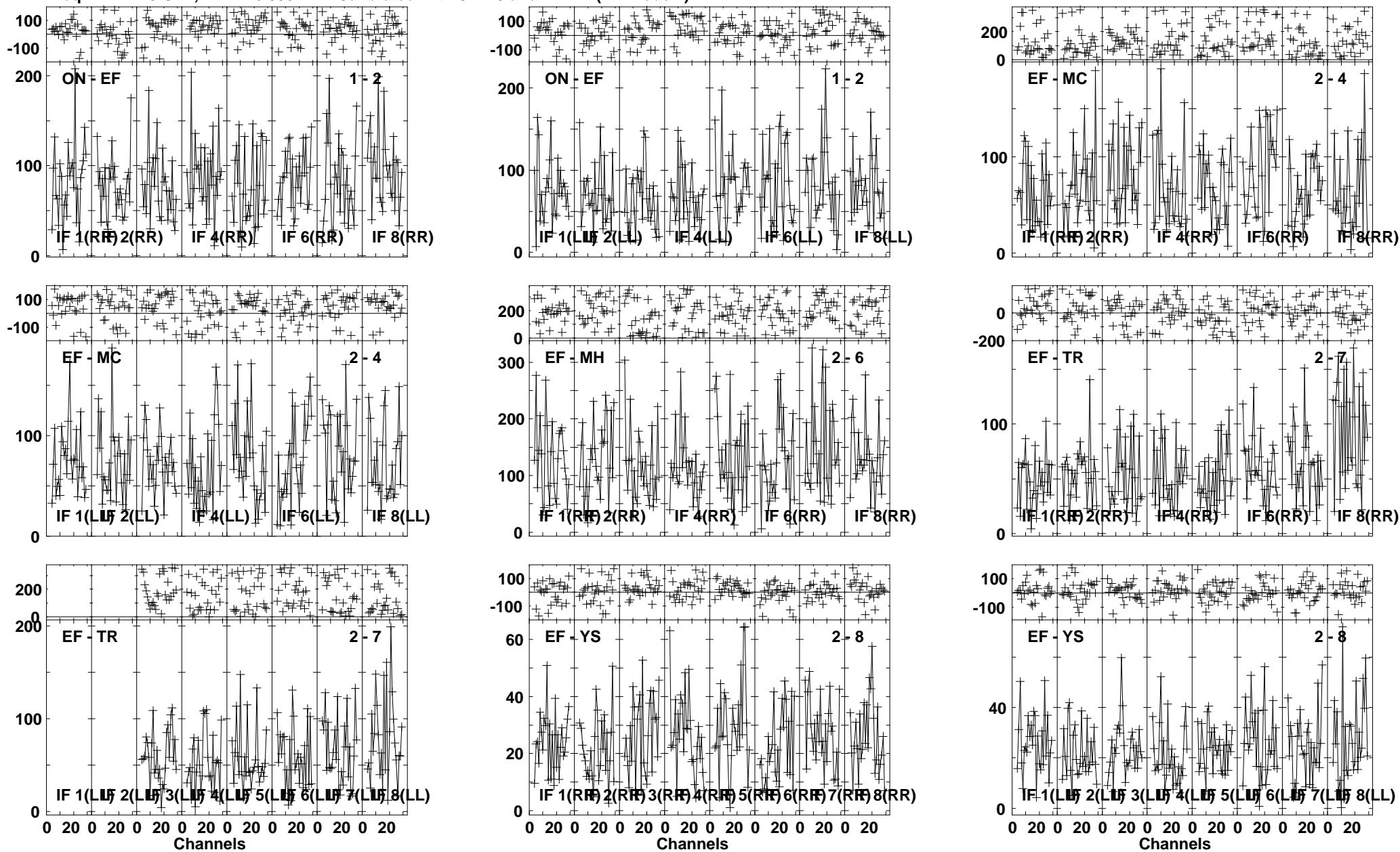

Lower frame: Milli Ampl Jy Top frame: Phas deg
 Vector averaged cross-power spectrum Several baselines displayed
 Timerange: 01/04:44:49 to 01/04:46:47

Plot file version 511 created 26-JUL-2013 10:27:28

J1157 EZ024 1.UVDATA.1

Freq = 22.1720 GHz, Bw = 16.000 MH Calibrated with CL # 3 and BP # 1 (BP mode 1)

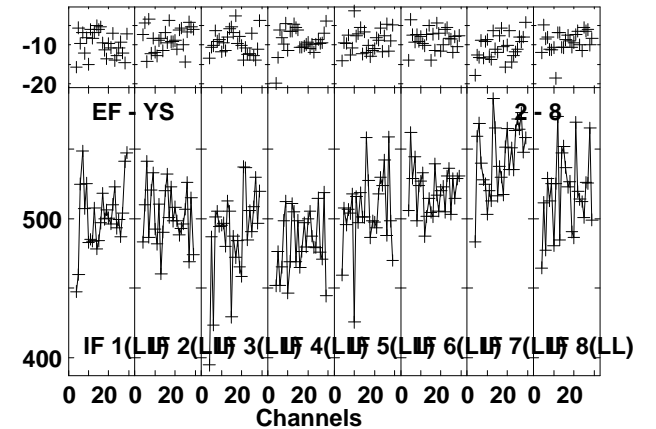
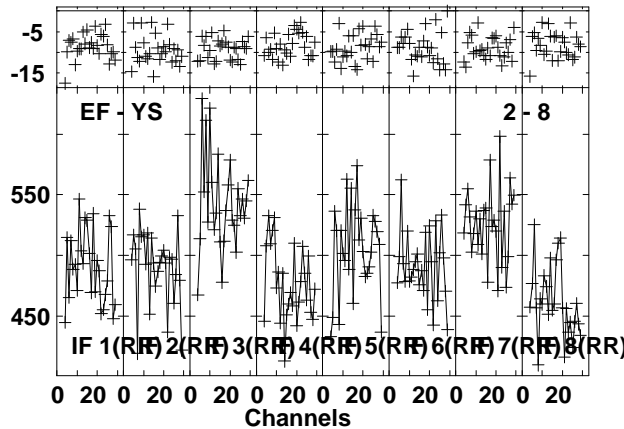
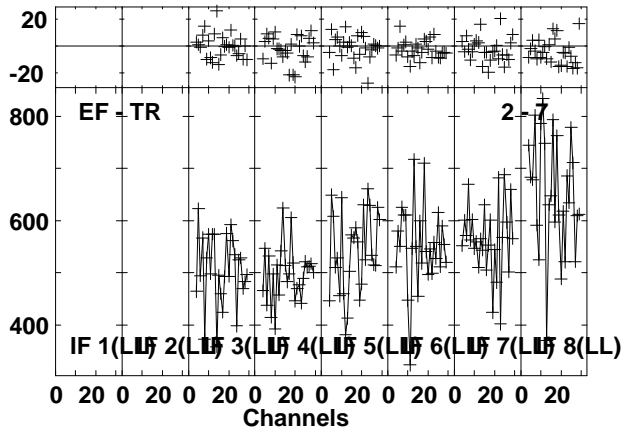
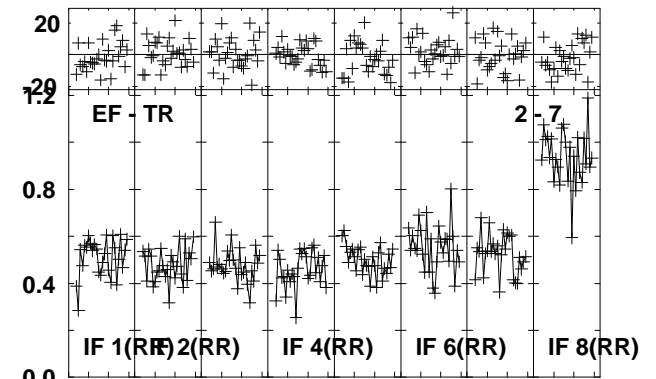
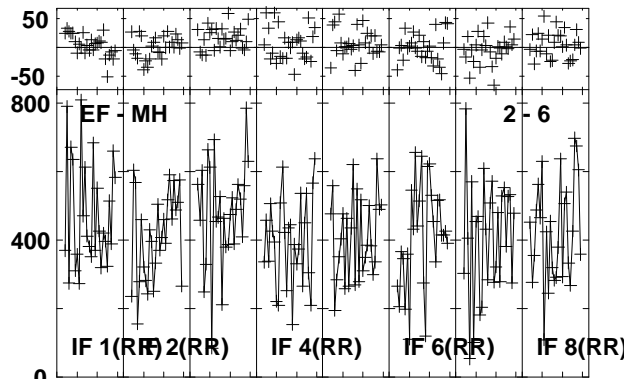
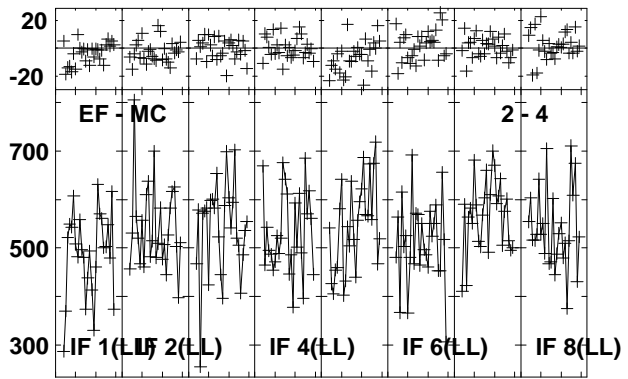
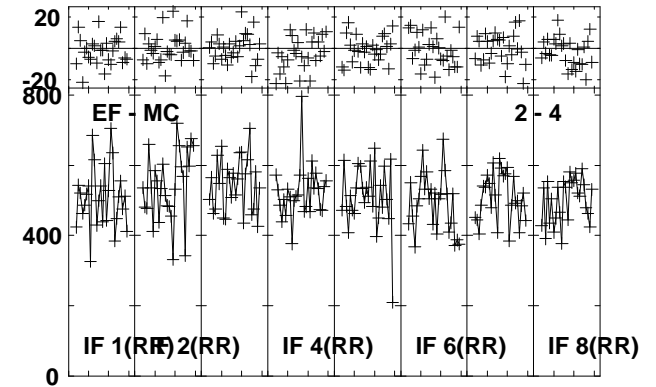
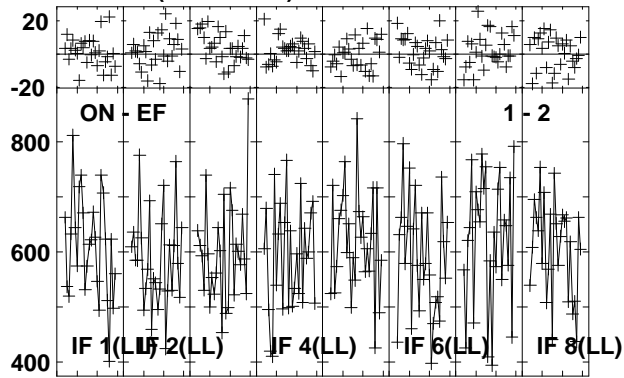
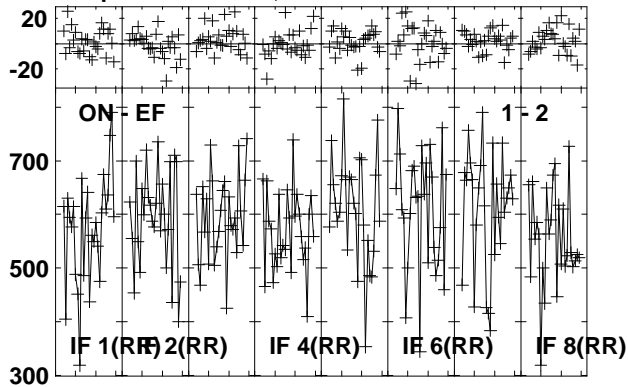

Lower frame: Milli Ampl Jy Top frame: Phas deg
Vector averaged cross-power spectrum Several baselines displayed
Timerange: 01/04:47:21 to 01/04:48:19

Plot file version 512 created 26-JUL-2013 10:27:29
 B1152+199A EZ024 1.UVDATA.1
 Freq = 22.1720 GHz, Bw = 16.000 MH Calibrated with CL # 3 and BP # 1 (BP mode 1)

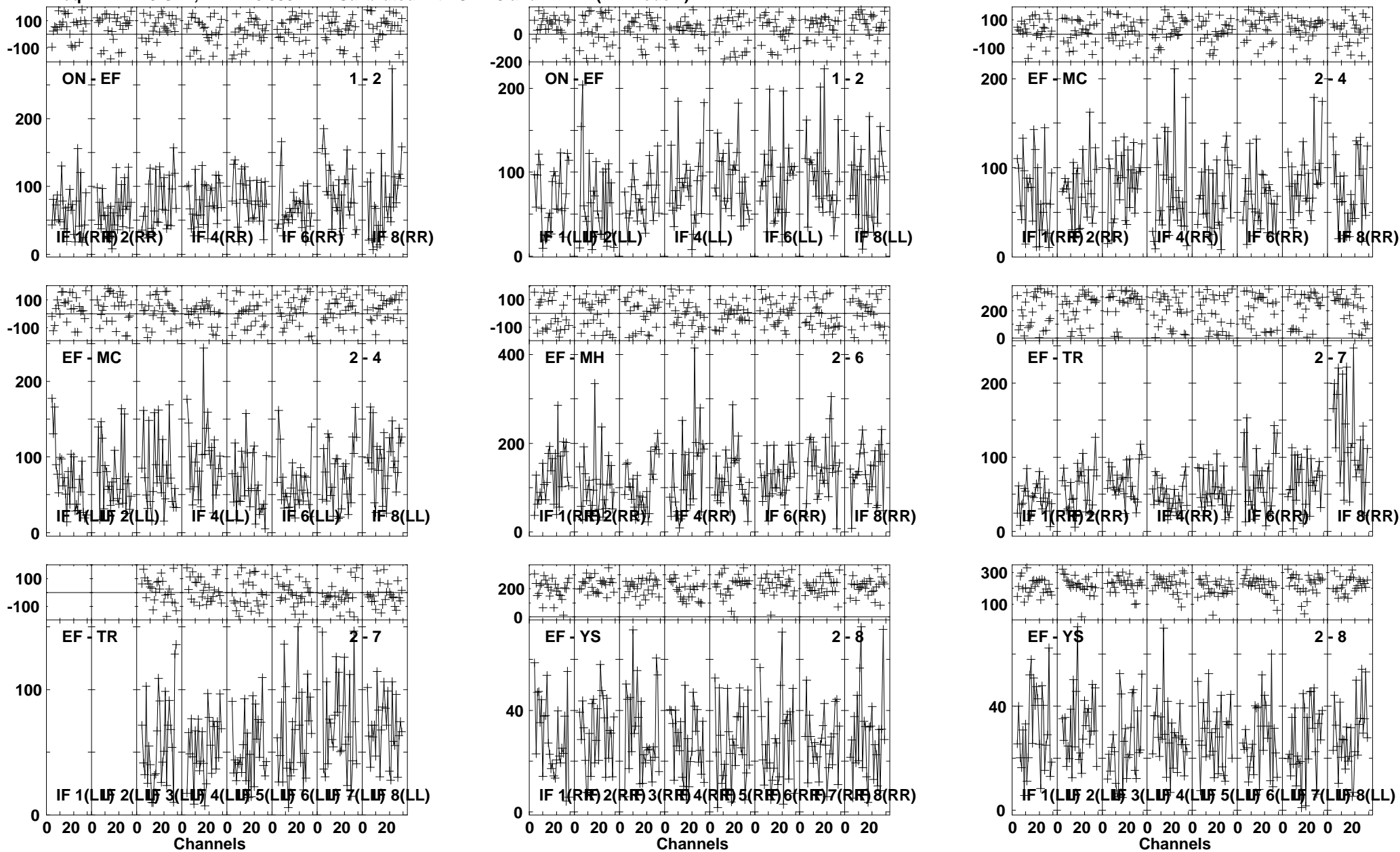

Lower frame: Milli Ampl Jy Top frame: Phas deg
 Vector averaged cross-power spectrum Several baselines displayed
 Timerange: 01/04:48:55 to 01/04:50:53

Plot file version 513 created 26-JUL-2013 10:27:31

J1157 EZ024 1.UVDATA.1

Freq = 22.1720 GHz, Bw = 16.000 MH Calibrated with CL # 3 and BP # 1 (BP mode 1)

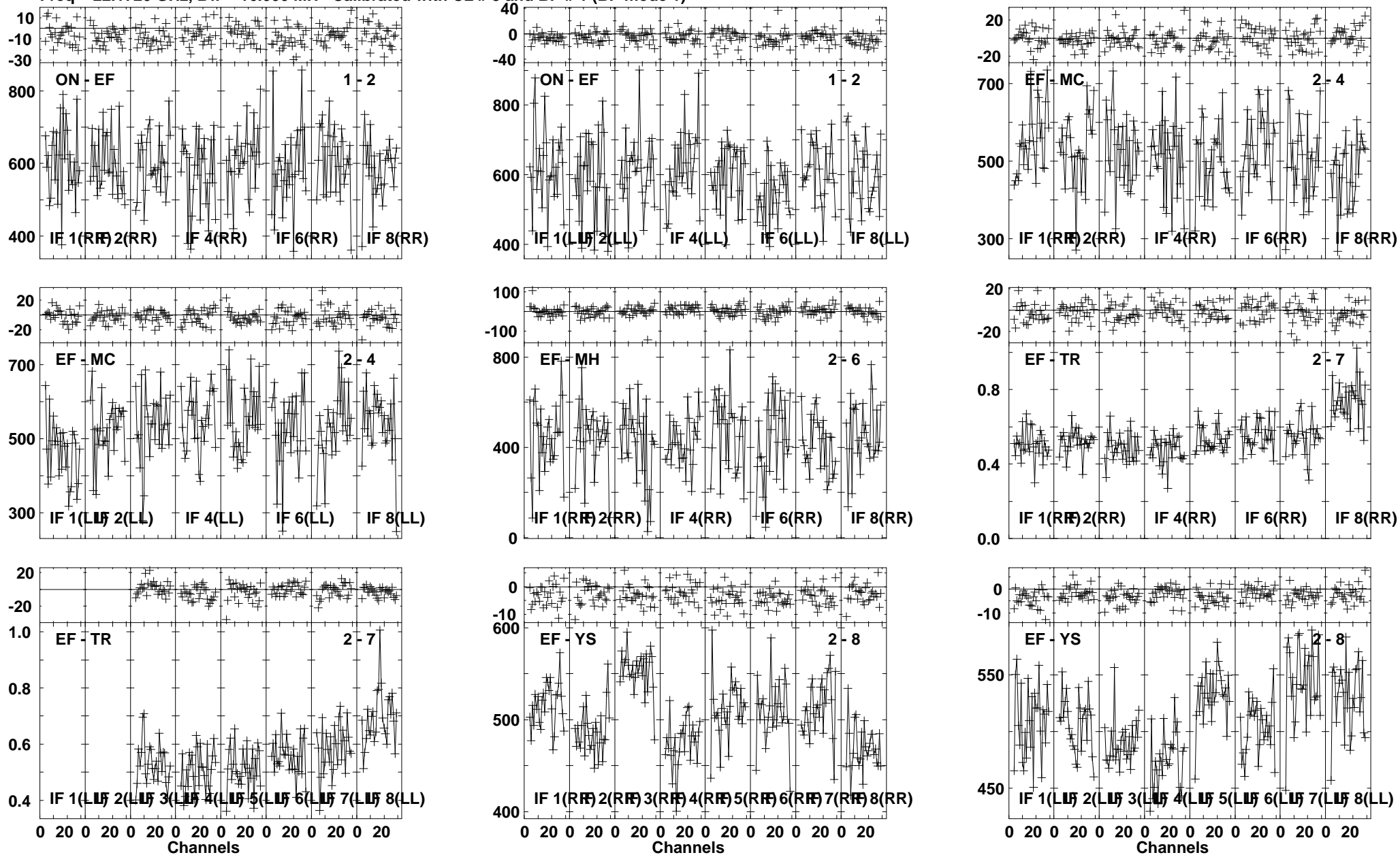

Lower frame: Milli Ampl Jy Top frame: Phas deg
Vector averaged cross-power spectrum Several baselines displayed
Timerange: 01/04:51:27 to 01/04:52:25

Plot file version 514 created 26-JUL-2013 10:27:32
 B1152+199A EZ024 1.UVDATA.1
 Freq = 22.1720 GHz, Bw = 16.000 MH Calibrated with CL # 3 and BP # 1 (BP mode 1)

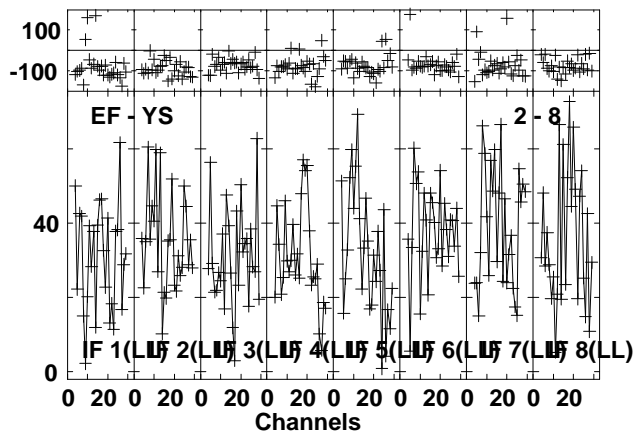
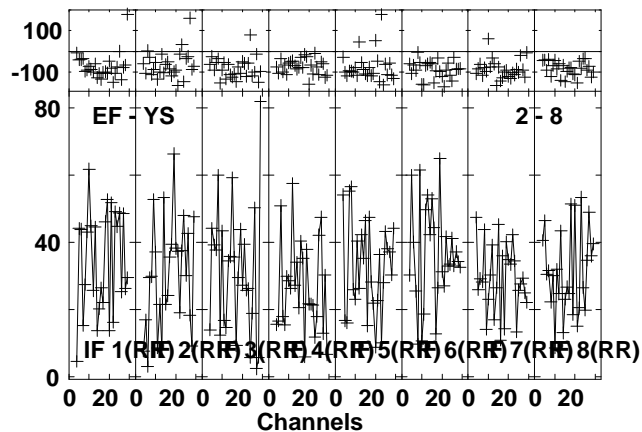
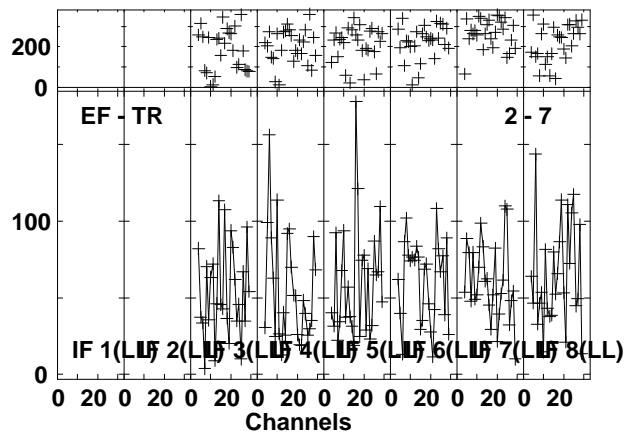
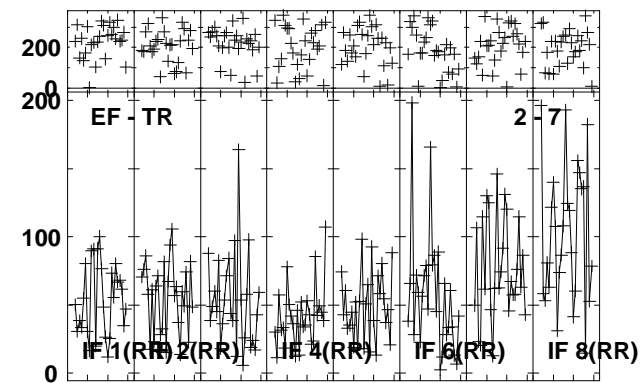
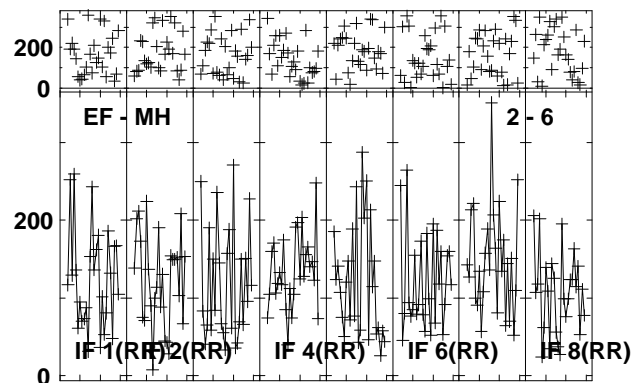
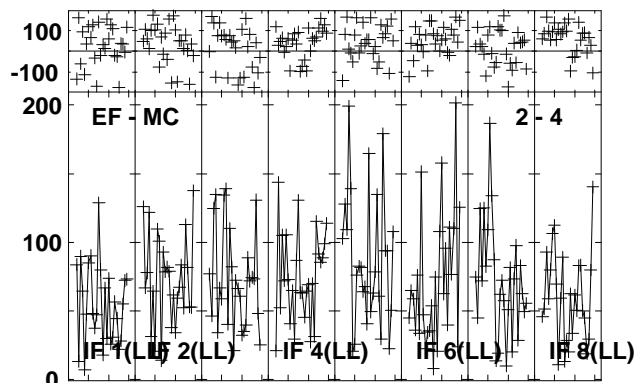
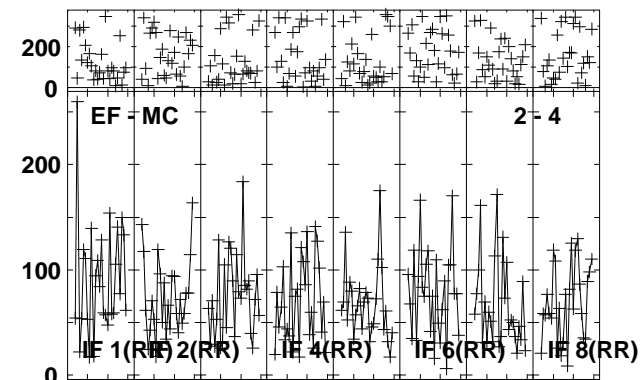
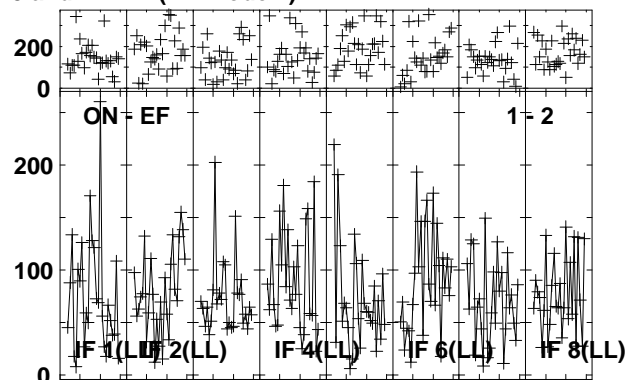
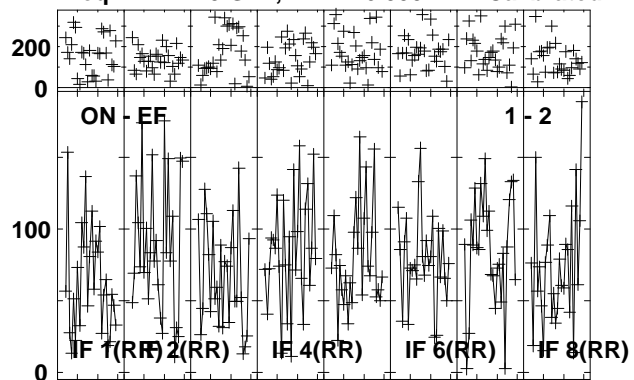

Lower frame: Milli Ampl Jy Top frame: Phas deg
 Vector averaged cross-power spectrum Several baselines displayed
 Timerange: 01/04:53:01 to 01/04:54:59

Plot file version 515 created 26-JUL-2013 10:27:34

J1157 EZ024 1.UVDATA.1

Freq = 22.1720 GHz, Bw = 16.000 MH Calibrated with CL # 3 and BP # 1 (BP mode 1)

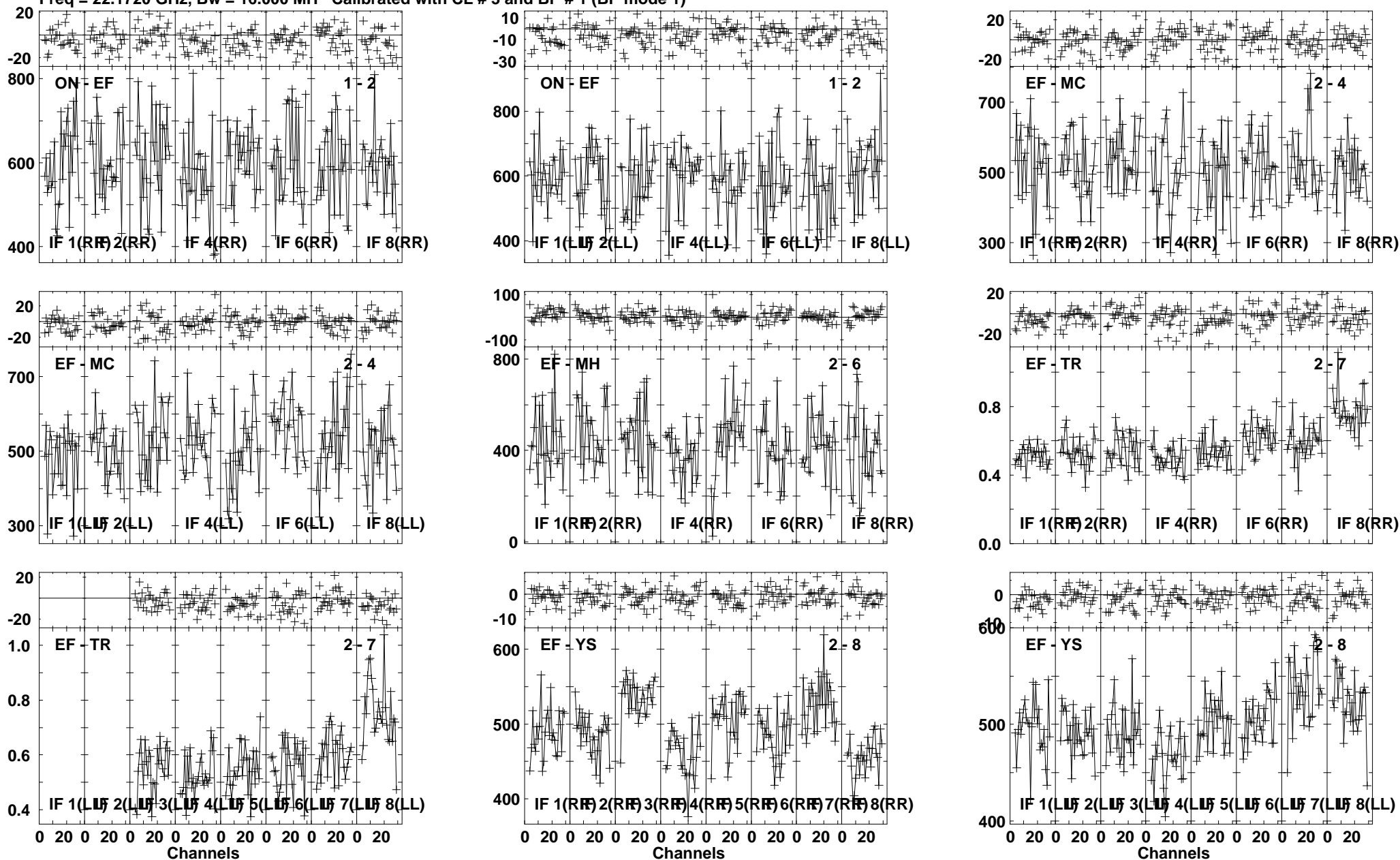

Lower frame: Milli Ampl Jy Top frame: Phas deg
Vector averaged cross-power spectrum Several baselines displayed
Timerange: 01/04:55:33 to 01/04:56:31

Plot file version 516 created 26-JUL-2013 10:27:35
 J1125+2610 EZ024 1.UVDATA.1
 Freq = 22.1720 GHz, Bw = 16.000 MH Calibrated with CL # 3 and BP # 1 (BP mode 1)

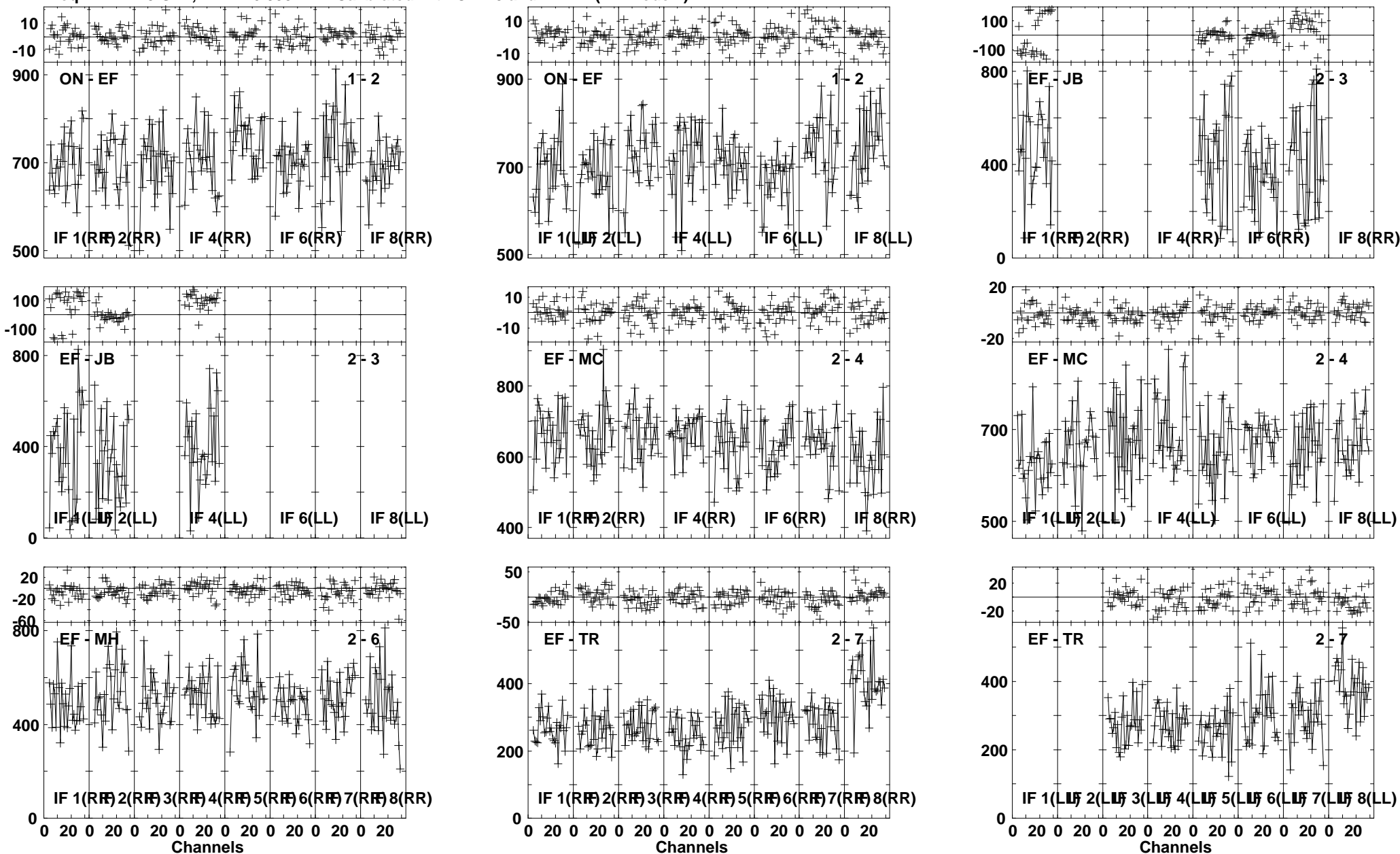

Lower frame: Milli Ampl Jy Top frame: Phas deg
 Vector averaged cross-power spectrum Several baselines displayed
 Timerange: 01/04:57:56 to 01/04:59:38

Plot file version 517 created 26-JUL-2013 10:27:36

J1125+2610 EZ024 1.UVDATA.1

Freq = 22.1720 GHz, Bw = 16.000 MH Calibrated with CL # 3 and BP # 1 (BP mode 1)

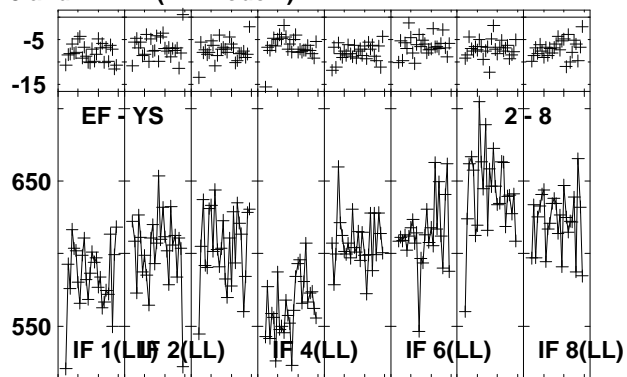
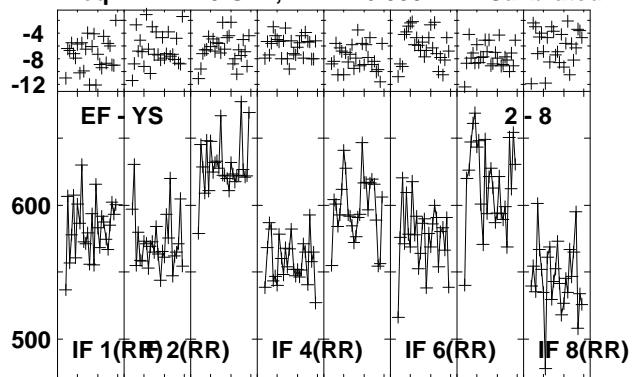

Lower frame: Milli Ampl Jy Top frame: Phas deg
Vector averaged cross-power spectrum Several baselines displayed
Timerange: 01/04:57:56 to 01/04:59:38

Plot file version 518 created 26-JUL-2013 10:27:37

J1157 EZ024 1.UVDATA.1

Freq = 22.1720 GHz, Bw = 16.000 MH Calibrated with CL # 3 and BP # 1 (BP mode 1)

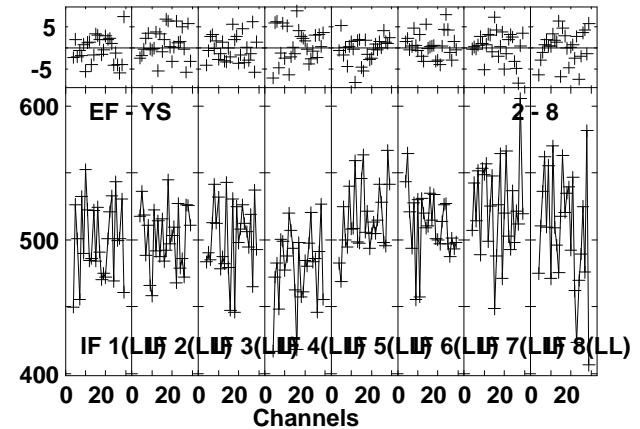
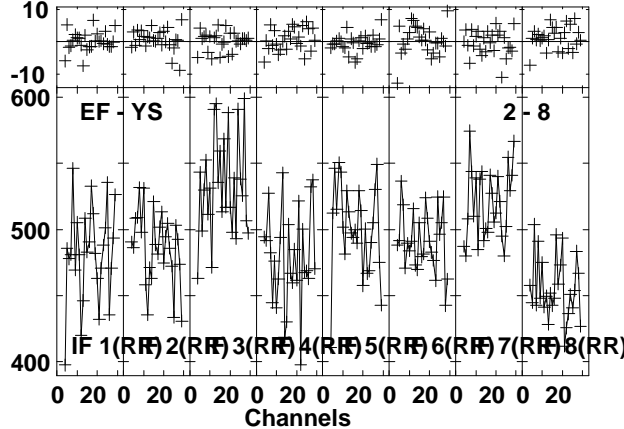
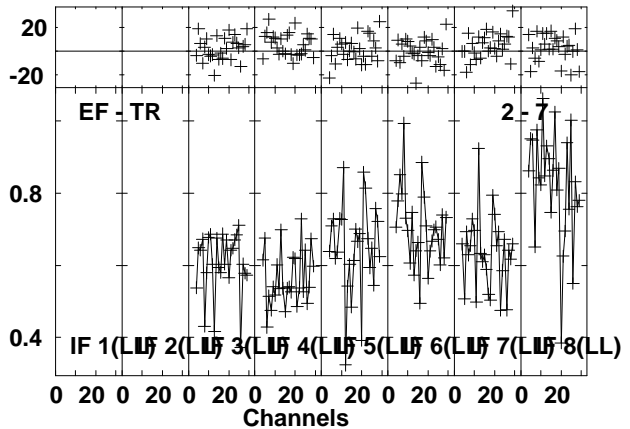
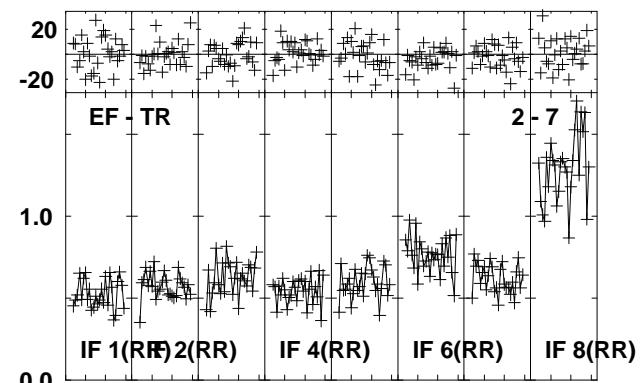
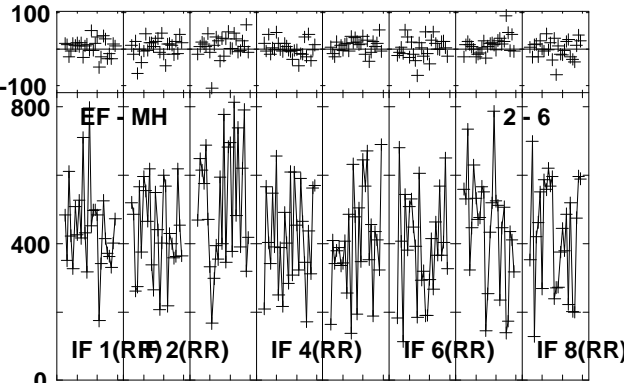
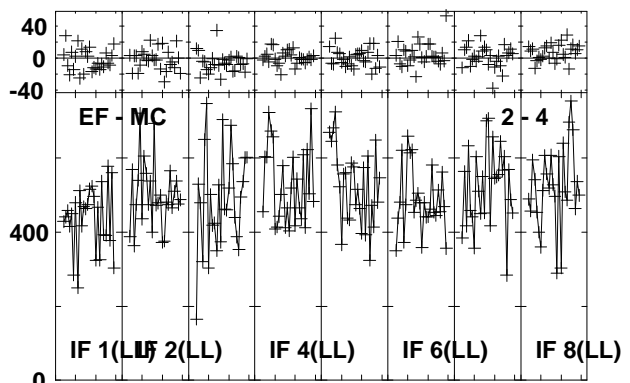
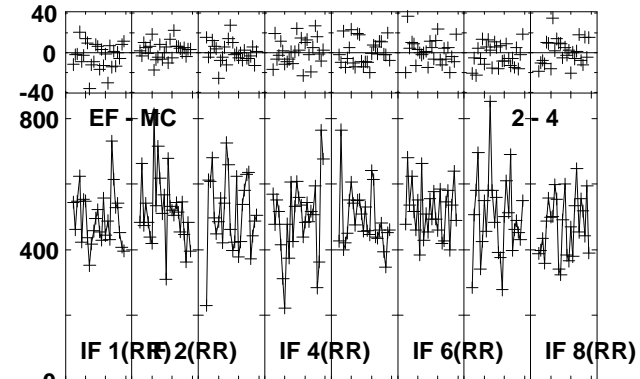
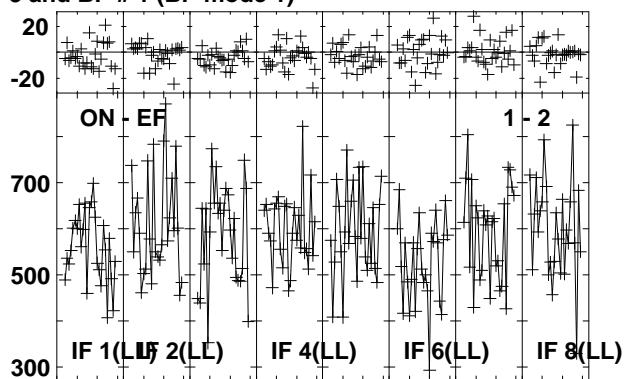
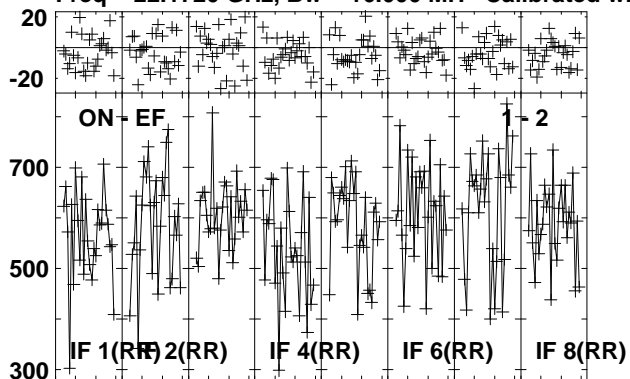

Lower frame: Milli Ampl Jy Top frame: Phas deg
Vector averaged cross-power spectrum Several baselines displayed
Timerange: 01/05:01:02 to 01/05:01:44

Plot file version 519 created 26-JUL-2013 10:27:38
 B1152+199A EZ024 1.UVDATA.1
 Freq = 22.1720 GHz, Bw = 16.000 MH Calibrated with CL # 3 and BP # 1 (BP mode 1)

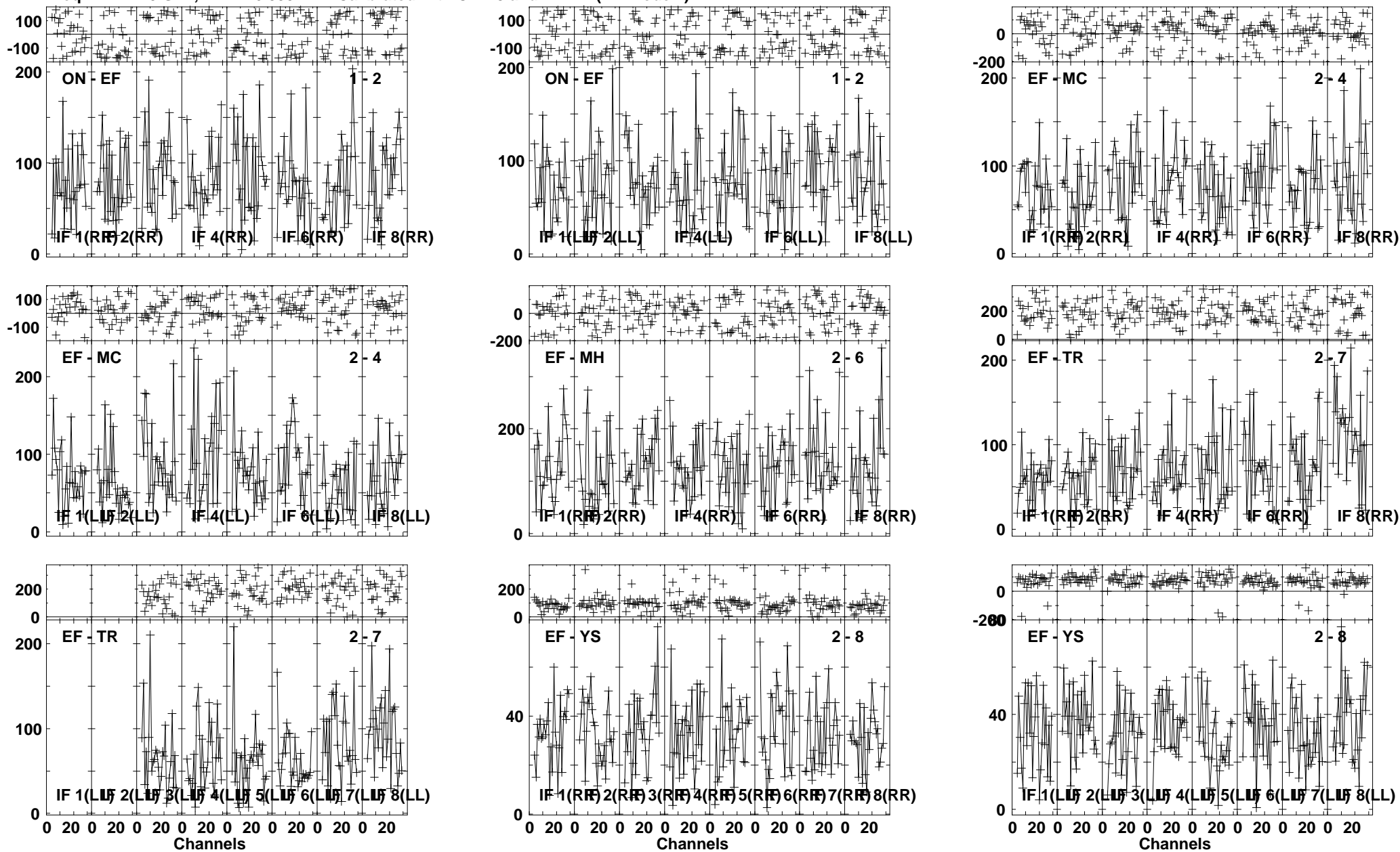

Lower frame: Milli Ampl Jy Top frame: Phas deg
 Vector averaged cross-power spectrum Several baselines displayed
 Timerange: 01/05:02:20 to 01/05:04:18

Plot file version 520 created 26-JUL-2013 10:27:39
 J1157 EZ024 1.UVDATA.1
 Freq = 22.1720 GHz, Bw = 16.000 MH Calibrated with CL # 3 and BP # 1 (BP mode 1)

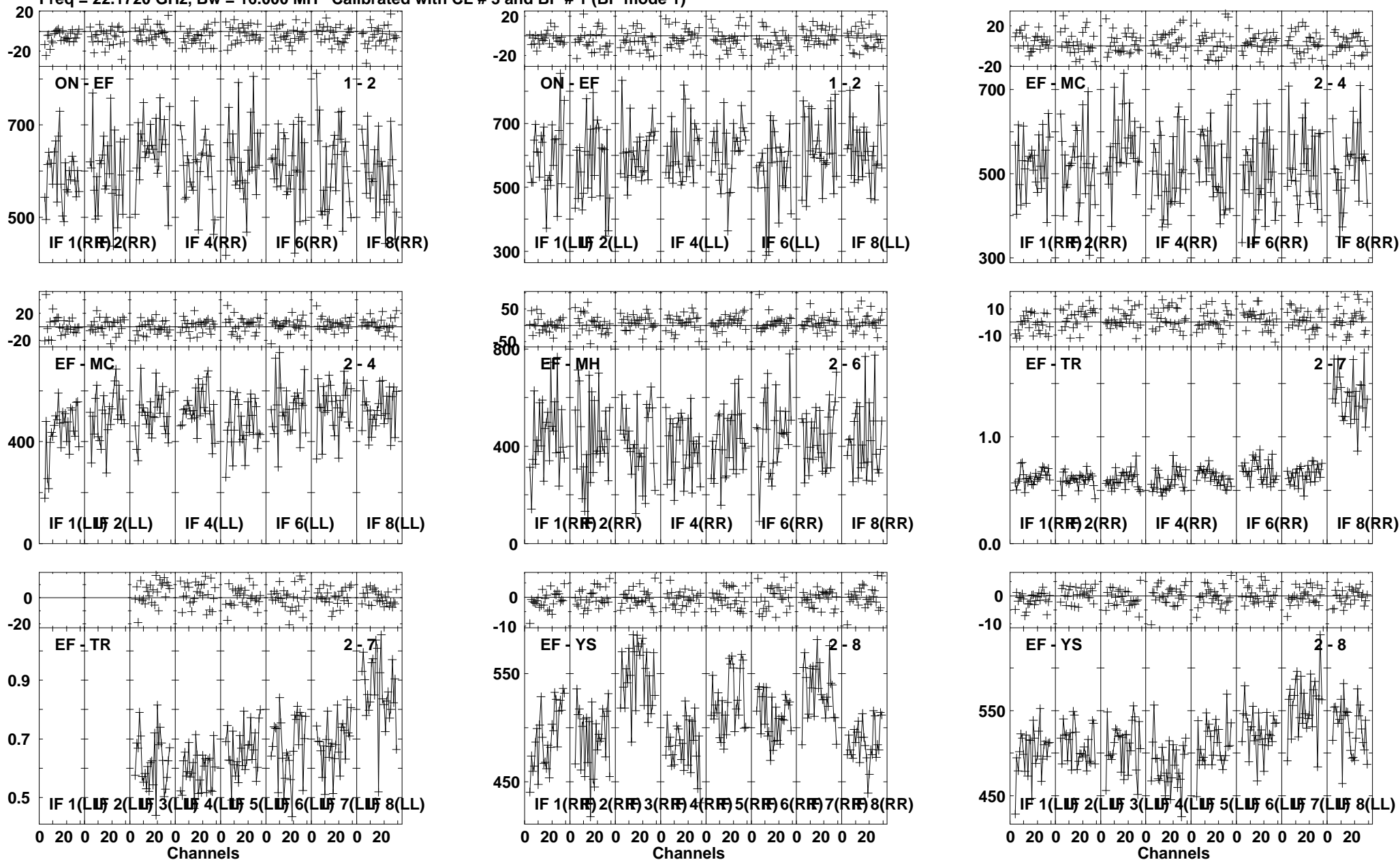

Lower frame: Milli Ampl Jy Top frame: Phas deg
 Vector averaged cross-power spectrum Several baselines displayed
 Timerange: 01/05:04:52 to 01/05:05:50

Plot file version 521 created 26-JUL-2013 10:27:41

B1152+199A EZ24 1.UVDATA.1

Freq = 22.1720 GHz, Bw = 16.000 MH Calibrated with CL # 3 and BP # 1 (BP mode 1)

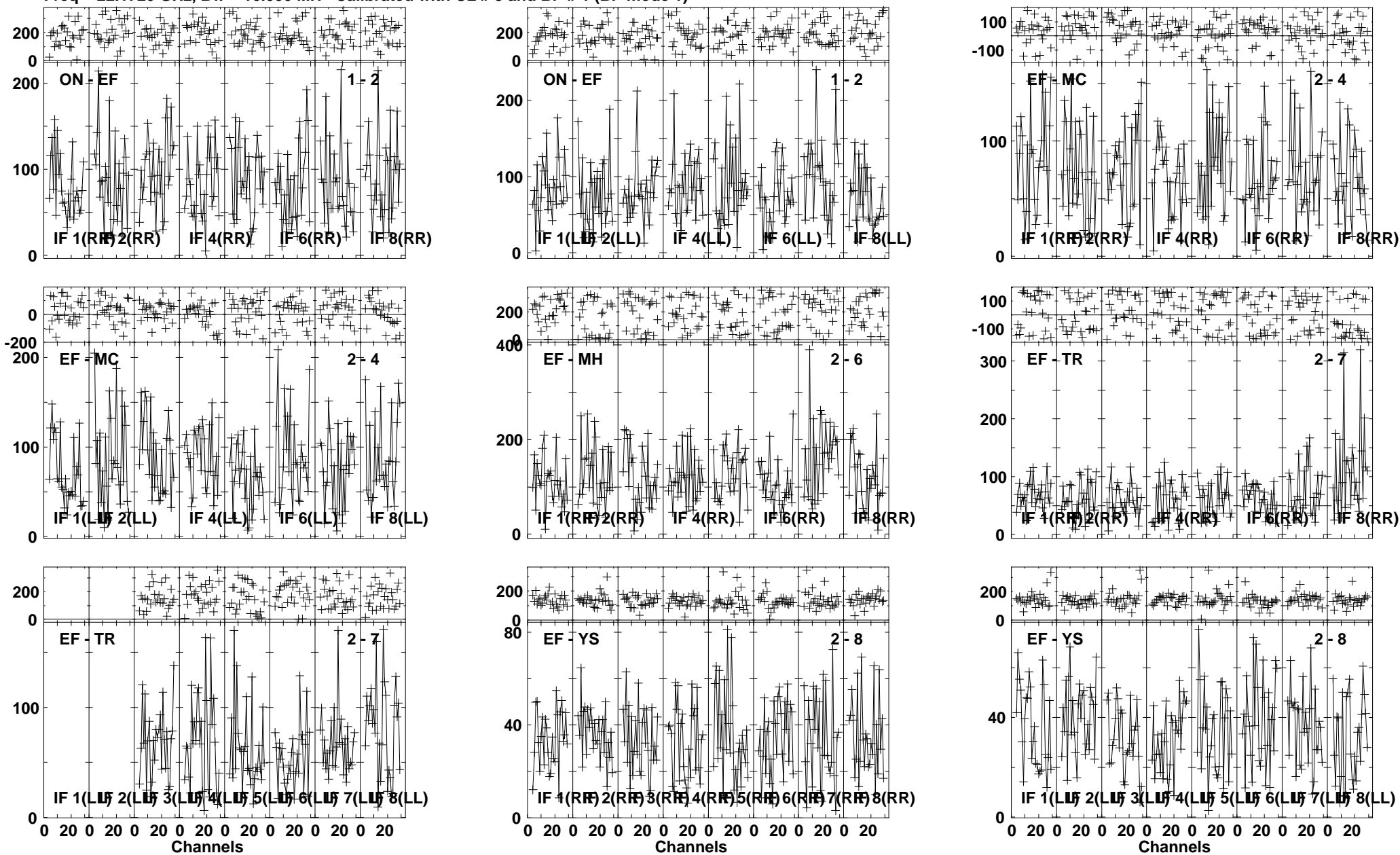

Lower frame: Milli Ampl Jy Top frame: Phas deg
Vector averaged cross-power spectrum Several baselines displayed
Timerange: 01/05:06:25 to 01/05:08:23

Plot file version 522 created 26-JUL-2013 10:27:42

J1157 EZ024 1.UVDATA.1

Freq = 22.1720 GHz, Bw = 16.000 MH Calibrated with CL # 3 and BP # 1 (BP mode 1)

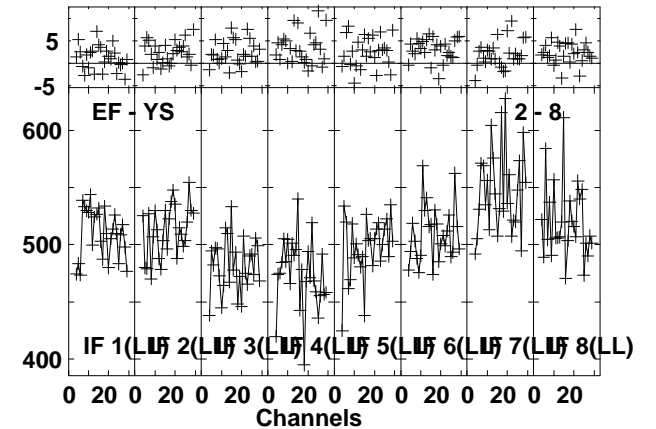
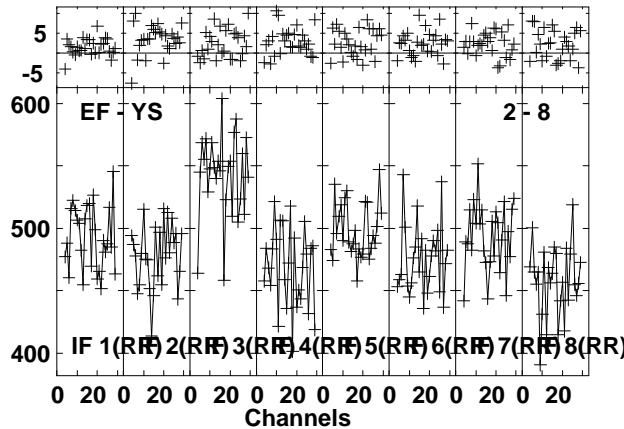
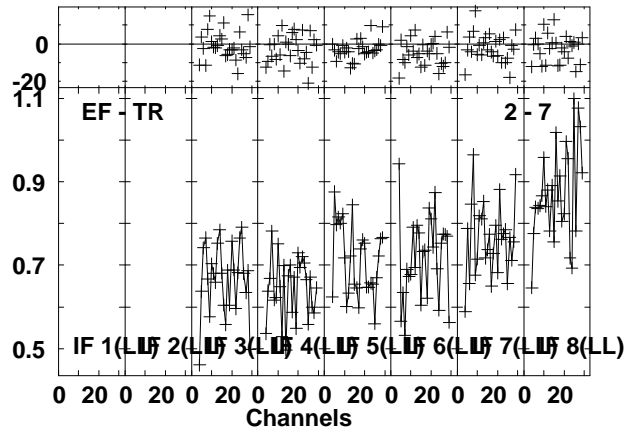
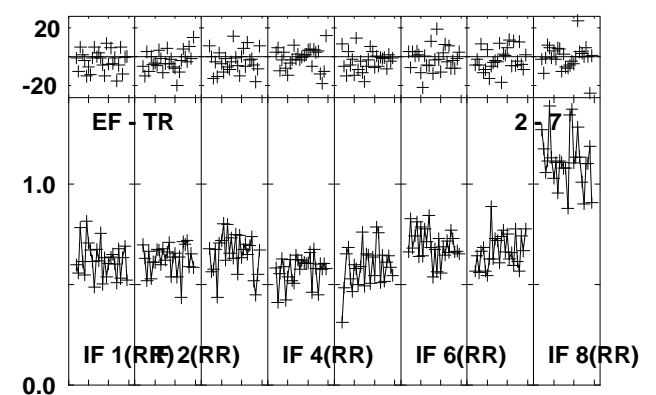
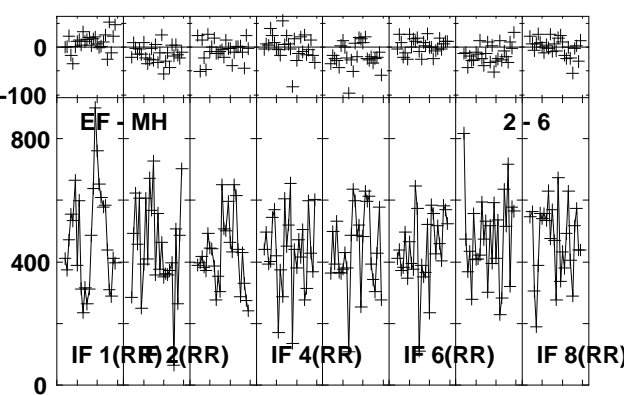
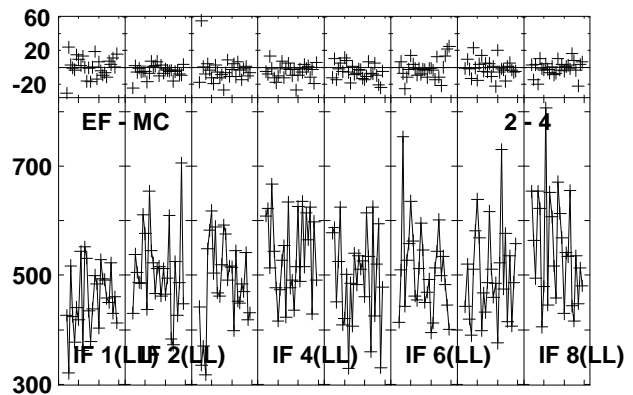
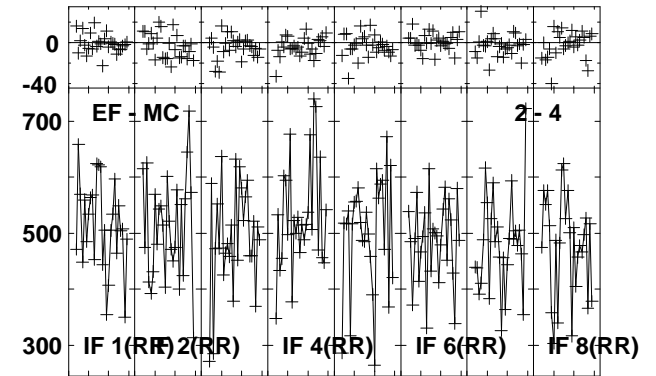
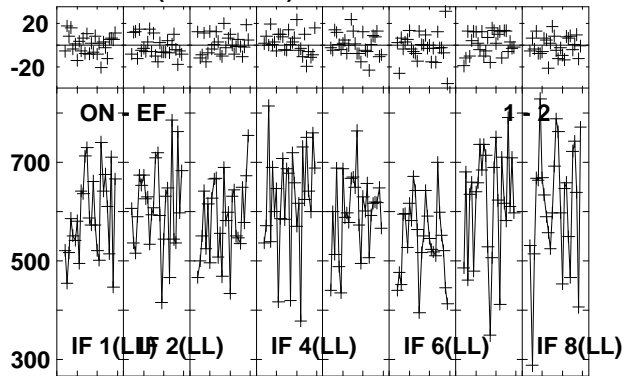
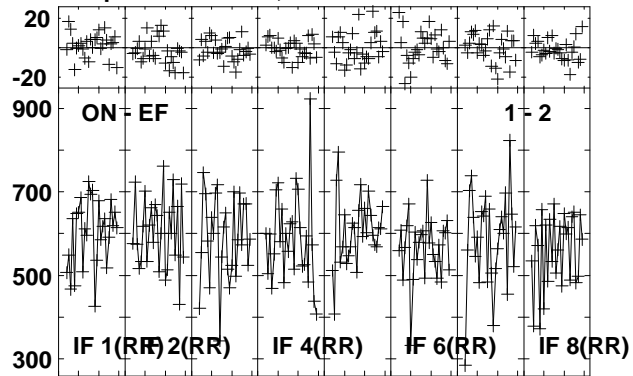

Lower frame: Milli Ampl Jy Top frame: Phas deg
Vector averaged cross-power spectrum Several baselines displayed
Timerange: 01/05:08:58 to 01/05:09:56

Plot file version 523 created 26-JUL-2013 10:27:44
 B1152+199A EZ024 1.UVDATA.1
 Freq = 22.1720 GHz, Bw = 16.000 MH Calibrated with CL # 3 and BP # 1 (BP mode 1)

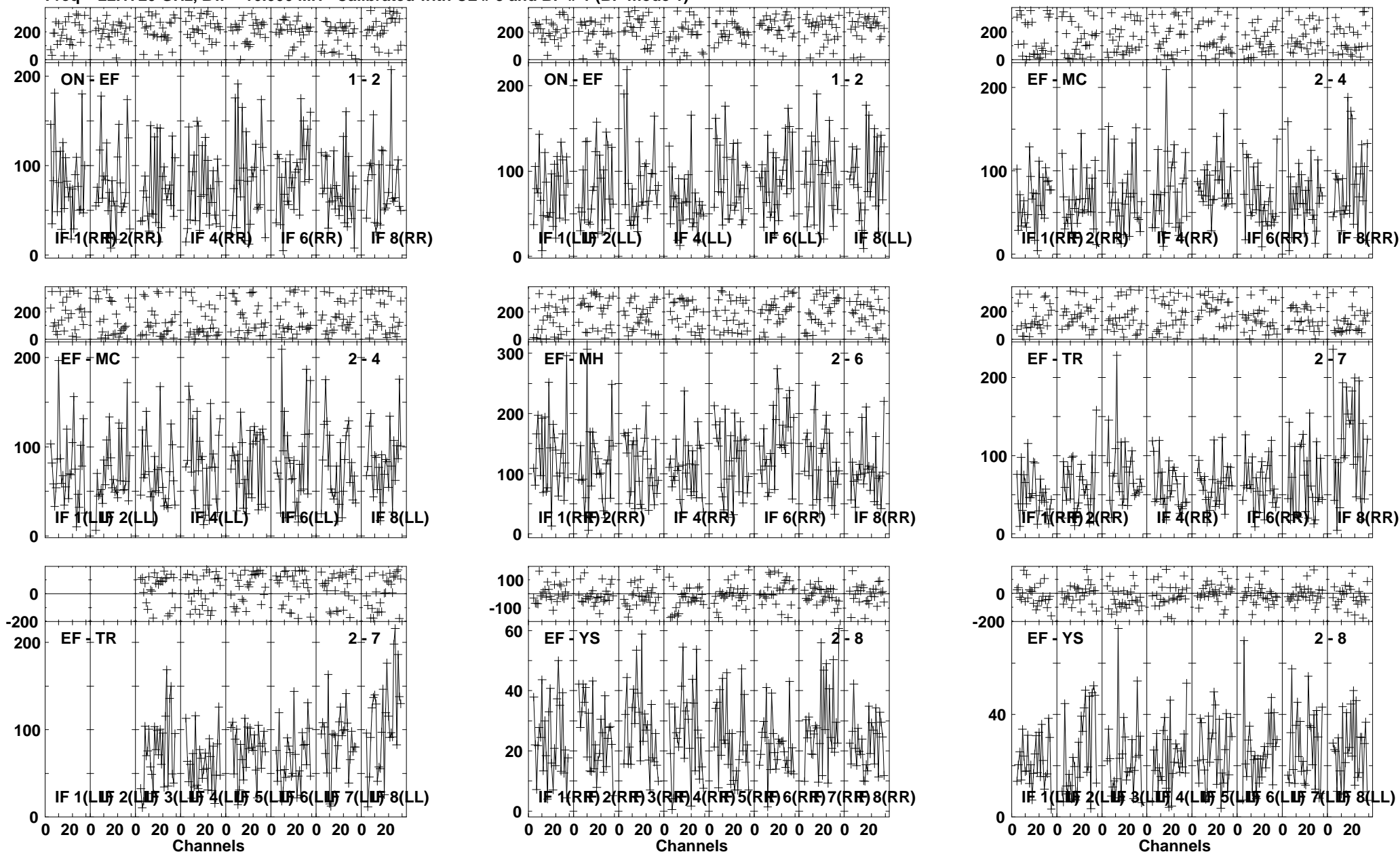

Lower frame: Milli Ampl Jy Top frame: Phas deg
 Vector averaged cross-power spectrum Several baselines displayed
 Timerange: 01/05:10:31 to 01/05:12:29

Plot file version 524 created 26-JUL-2013 10:27:45

J1157 EZ024 1.UVDATA.1

Freq = 22.1720 GHz, Bw = 16.000 MH Calibrated with CL # 3 and BP # 1 (BP mode 1)

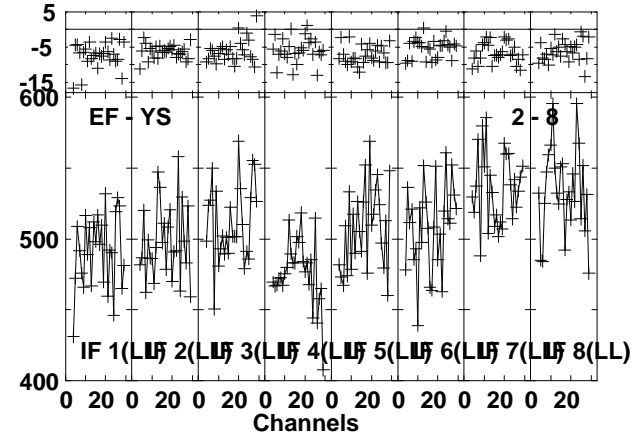
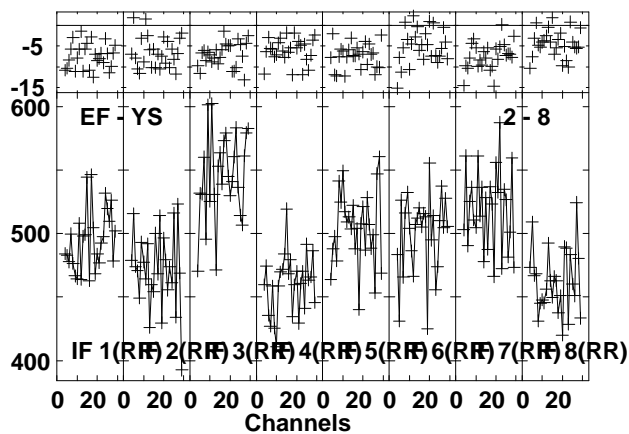
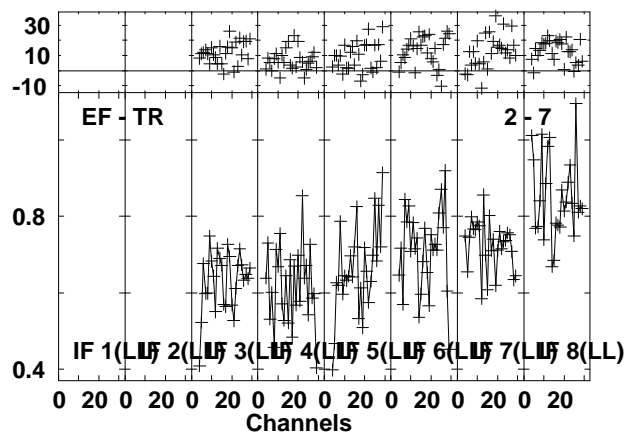
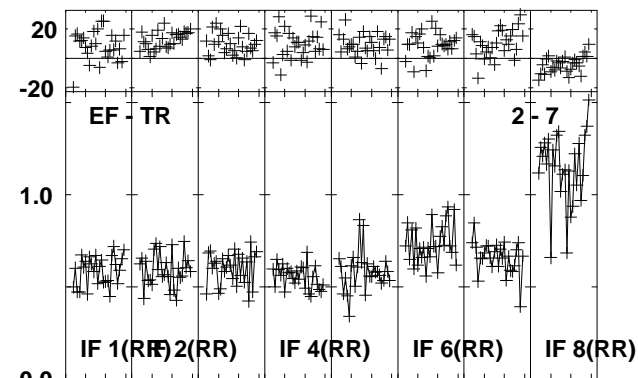
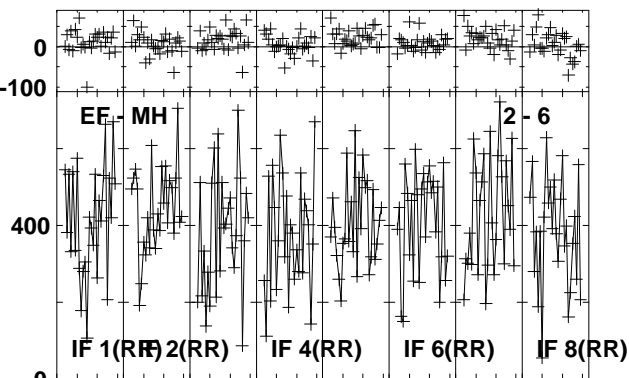
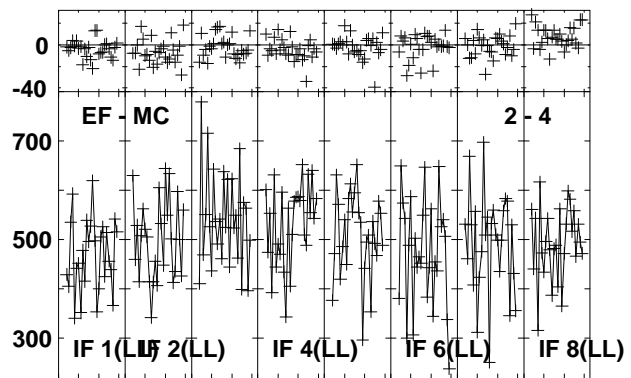
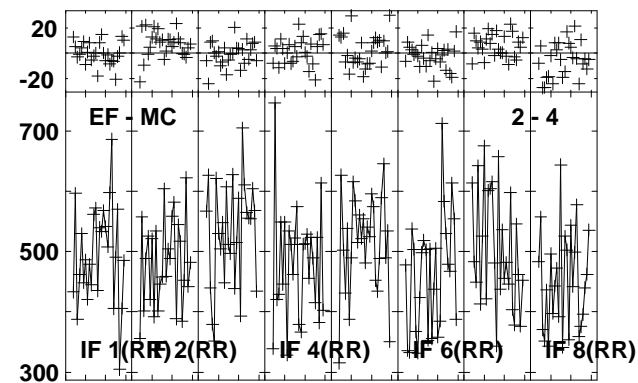
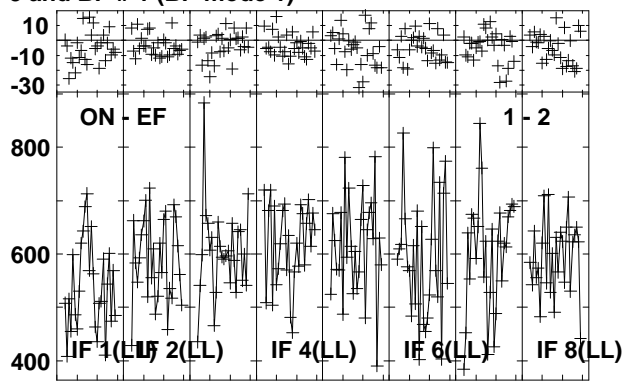
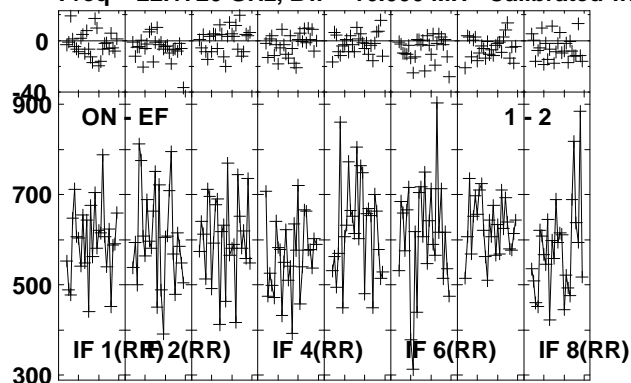

Lower frame: Milli Ampl Jy Top frame: Phas deg
Vector averaged cross-power spectrum Several baselines displayed
Timerange: 01/05:13:03 to 01/05:14:01

Plot file version 525 created 26-JUL-2013 10:27:46
 J1125+2610 EZ024 1.UVDATA.1
 Freq = 22.1720 GHz, Bw = 16.000 MH Calibrated with CL # 3 and BP # 1 (BP mode 1)

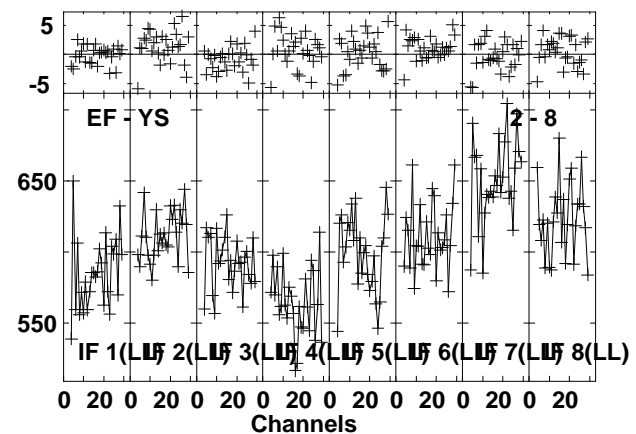
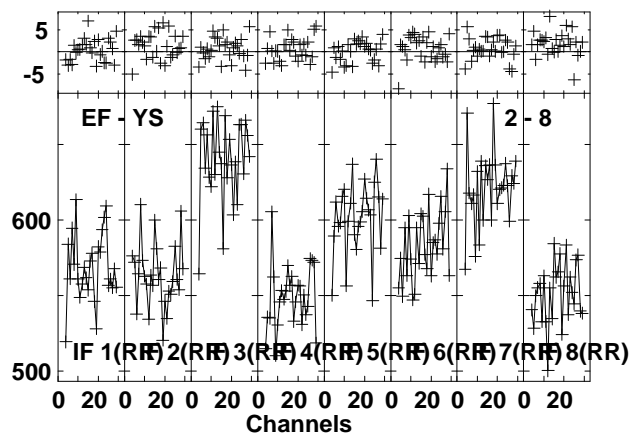
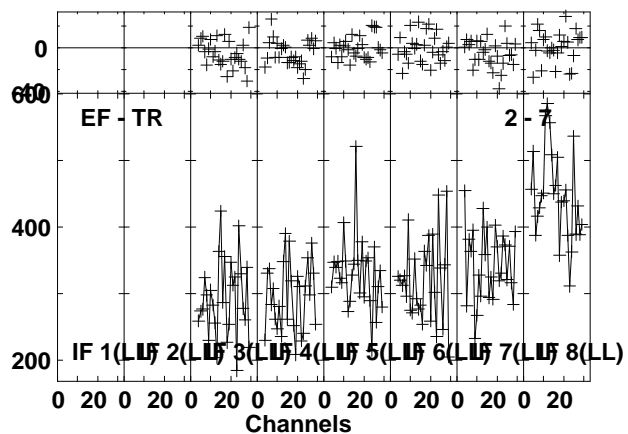
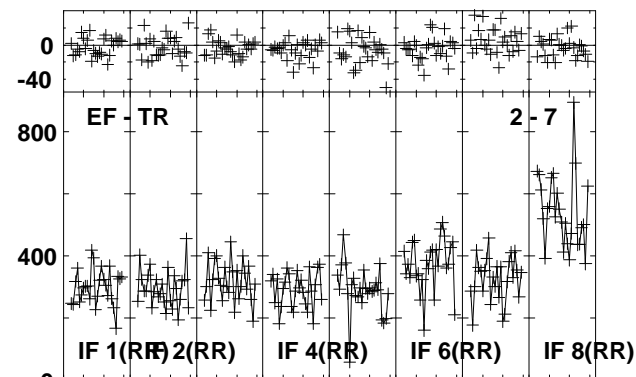
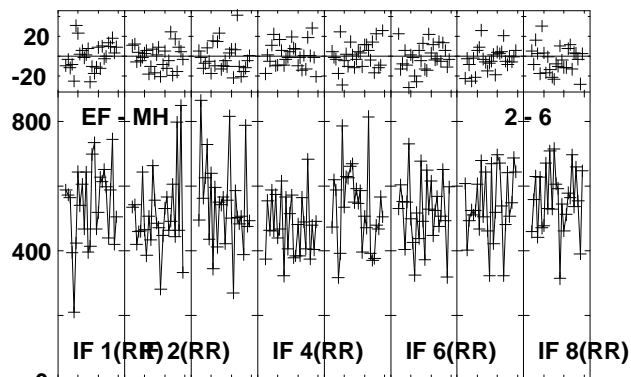
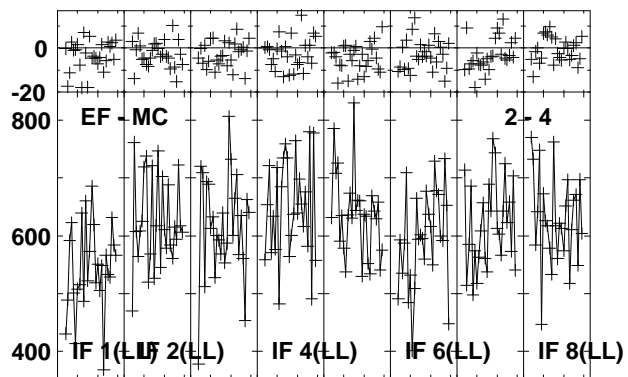
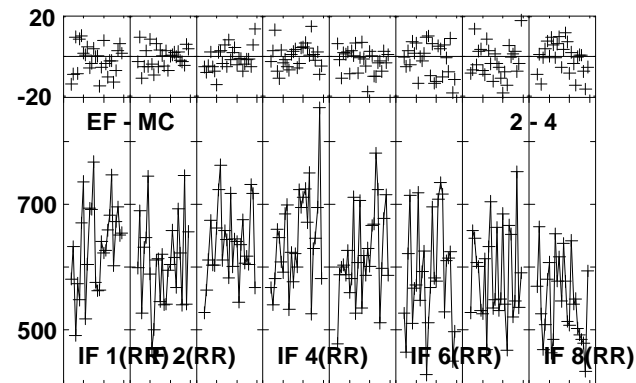
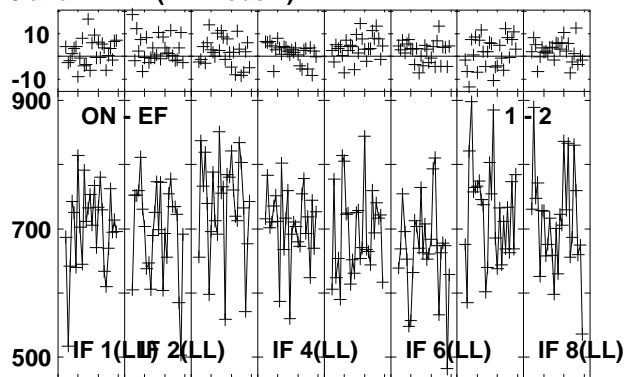
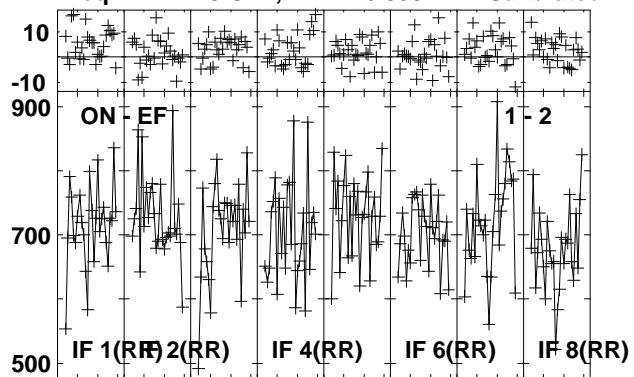

Lower frame: Milli Ampl Jy Top frame: Phas deg
 Vector averaged cross-power spectrum Several baselines displayed
 Timerange: 01/05:15:25 to 01/05:17:07

Plot file version 526 created 26-JUL-2013 10:27:48

J1157 EZ024 1.UVDATA.1

Freq = 22.1720 GHz, Bw = 16.000 MH Calibrated with CL # 3 and BP # 1 (BP mode 1)

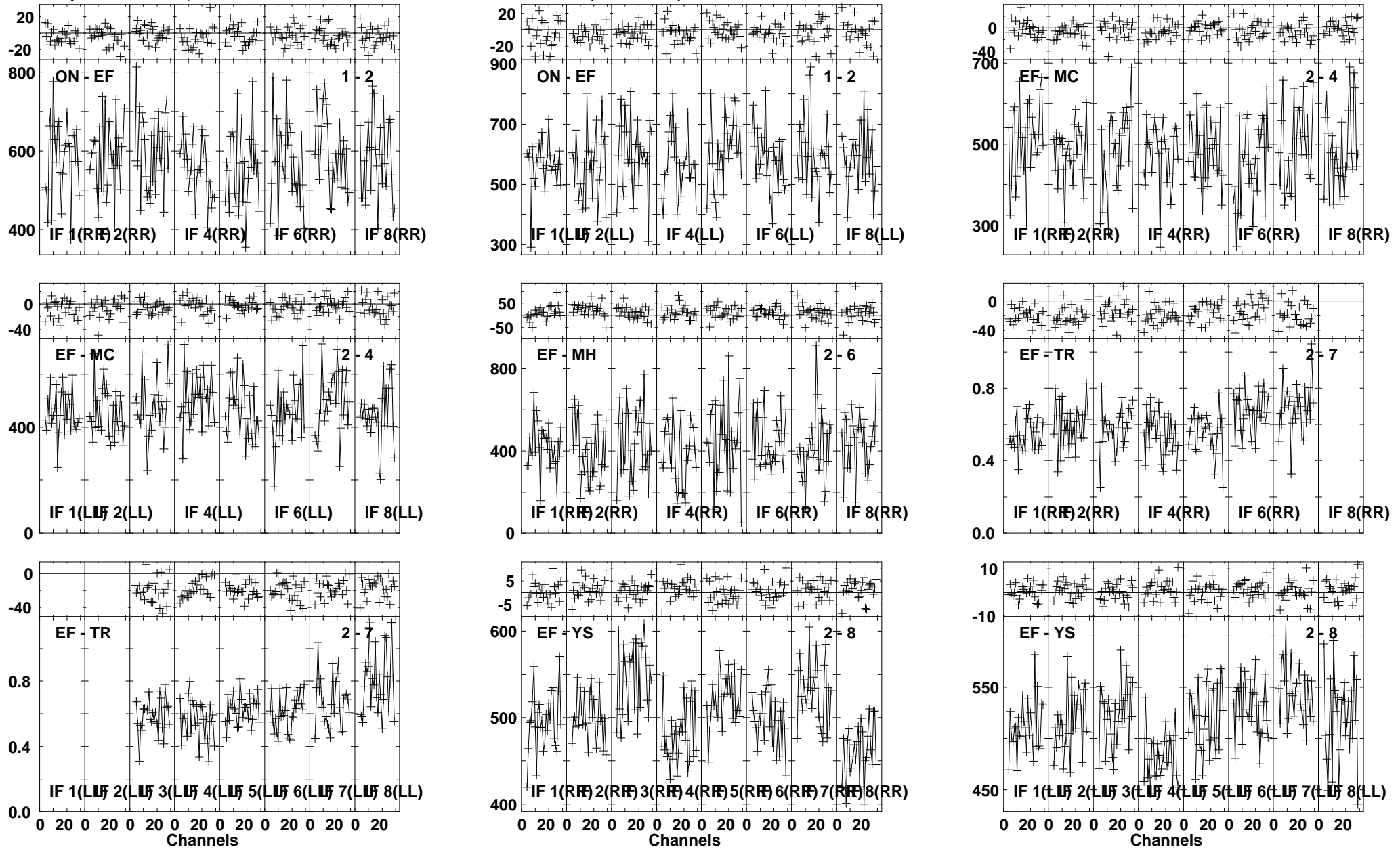

Lower frame: Milli Ampl Jy Top frame: Phas deg
Vector averaged cross-power spectrum Several baselines displayed
Timerange: 01/05:18:30 to 01/05:19:12

Plot file version 527 created 26-JUL-2013 10:27:49
 B1152+199A EZ024 1.UVDATA.1
 Freq = 22.1720 GHz, Bw = 16.000 MH Calibrated with CL # 3 and BP # 1 (BP mode 1)

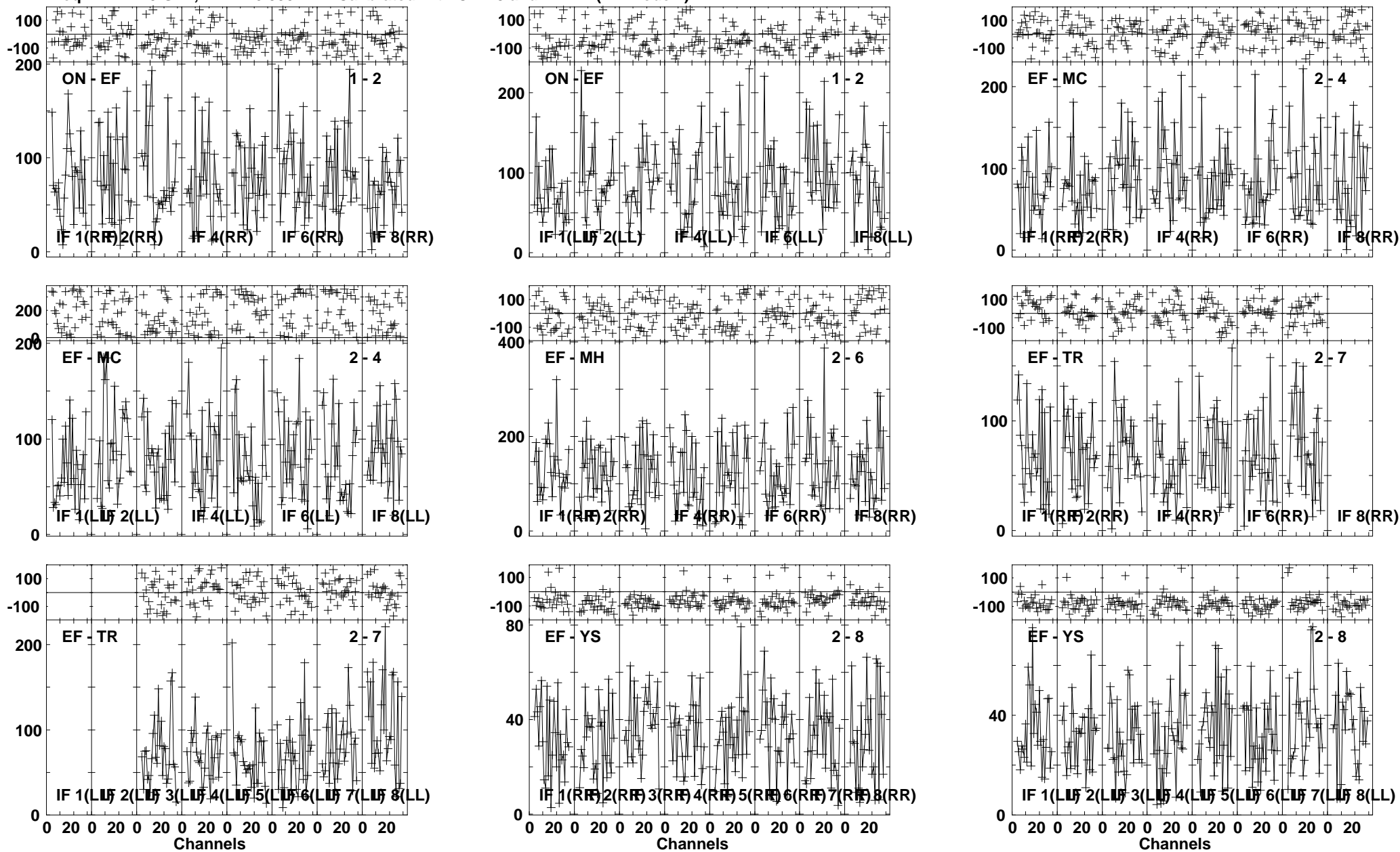

Lower frame: Milli Ampl Jy Top frame: Phas deg
 Vector averaged cross-power spectrum Several baselines displayed
 Timerange: 01/05:19:47 to 01/05:21:45

Plot file version 528 created 26-JUL-2013 10:27:51
 J1157 EZ024 1.UVDATA.1
 Freq = 22.1720 GHz, Bw = 16.000 MH Calibrated with CL # 3 and BP # 1 (BP mode 1)

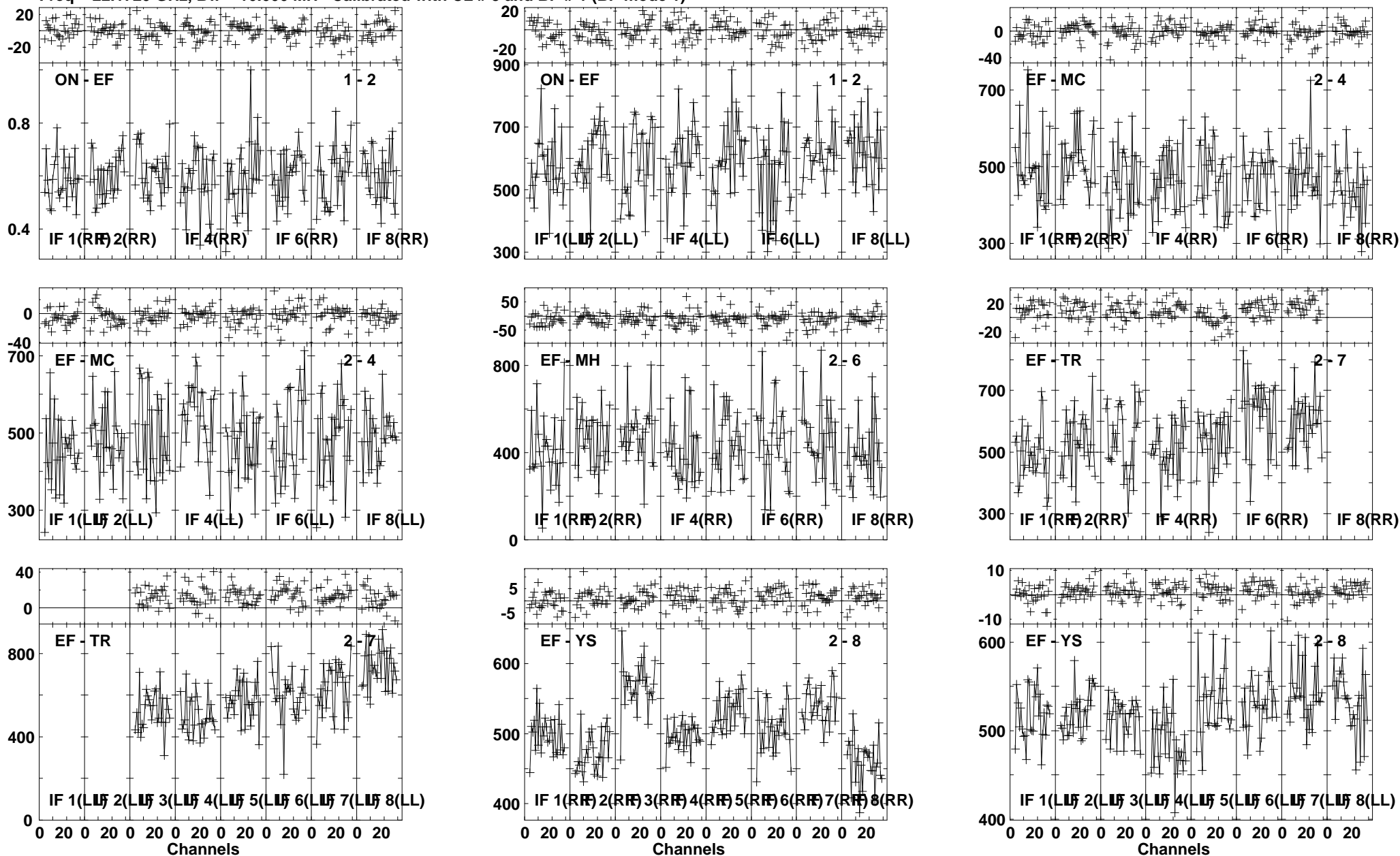

Lower frame: Ampl Jy Top frame: Phas deg
 Vector averaged cross-power spectrum Several baselines displayed
 Timerange: 01/05:22:19 to 01/05:23:17

Plot file version 529 created 26-JUL-2013 10:27:52
 B1152+199A EZ024 1.UVDATA.1
 Freq = 22.1720 GHz, Bw = 16.000 MH Calibrated with CL # 3 and BP # 1 (BP mode 1)

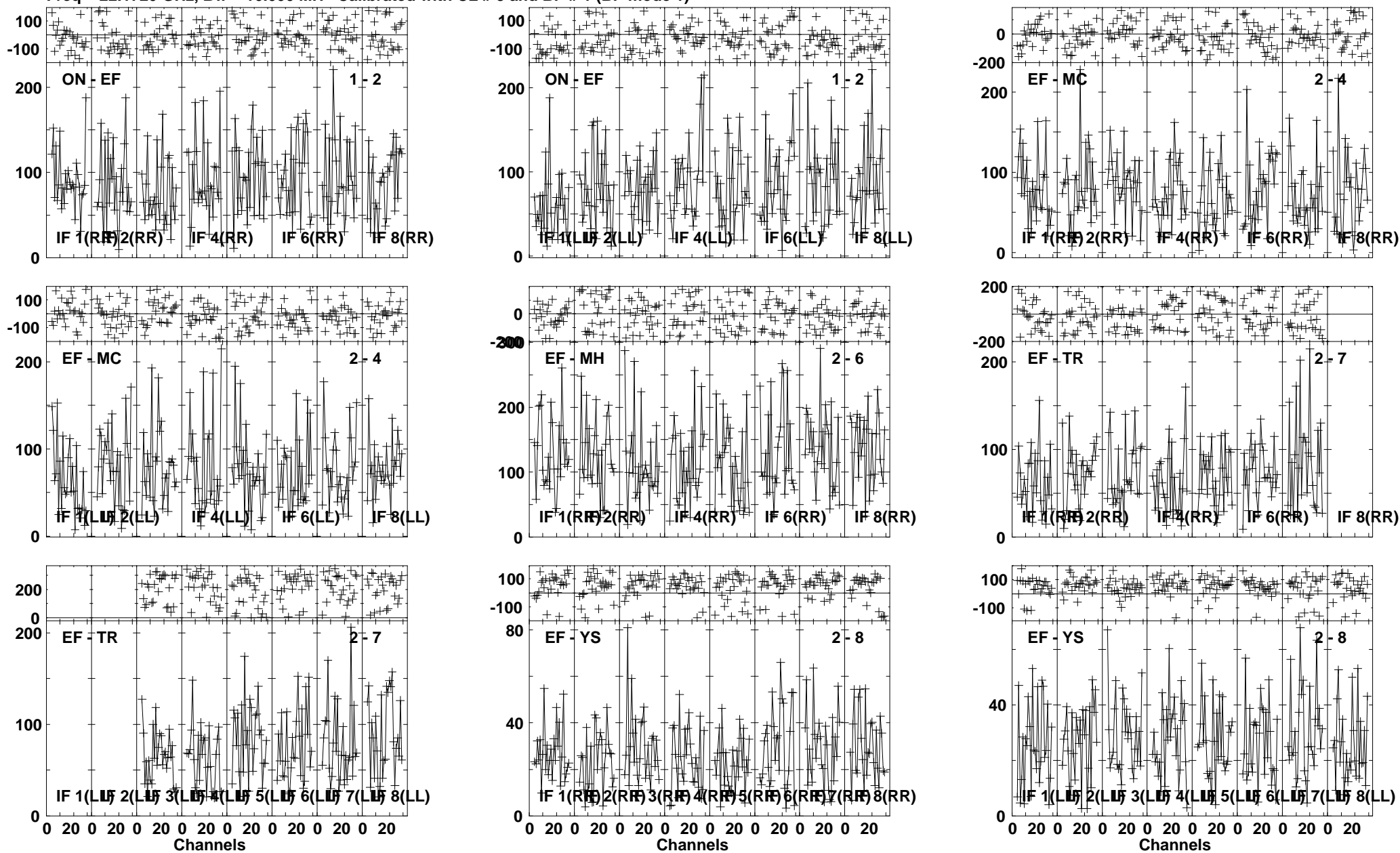

Lower frame: Milli Ampl Jy Top frame: Phas deg
 Vector averaged cross-power spectrum Several baselines displayed
 Timerange: 01/05:23:52 to 01/05:25:50

Plot file version 530 created 26-JUL-2013 10:27:54

J1157 EZ024 1.UVDATA.1

Freq = 22.1720 GHz, Bw = 16.000 MH Calibrated with CL # 3 and BP # 1 (BP mode 1)

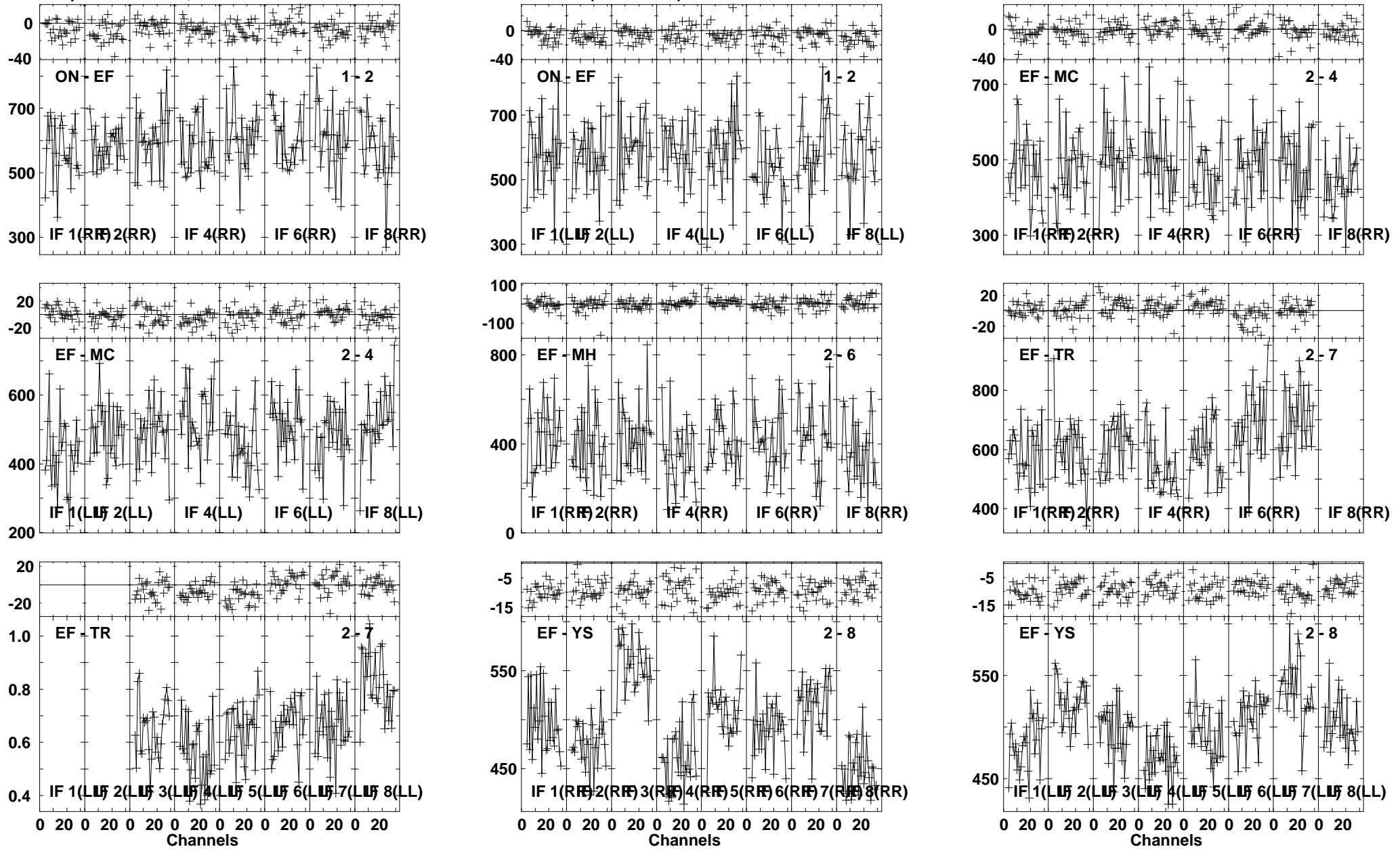

Lower frame: Milli Ampl Jy Top frame: Phas deg
Vector averaged cross-power spectrum Several baselines displayed
Timerange: 01/05:26:24 to 01/05:27:22

Plot file version 531 created 26-JUL-2013 10:27:55
 B1152+199A EZ024 1.UVDATA.1
 Freq = 22.1720 GHz, Bw = 16.000 MH Calibrated with CL # 3 and BP # 1 (BP mode 1)

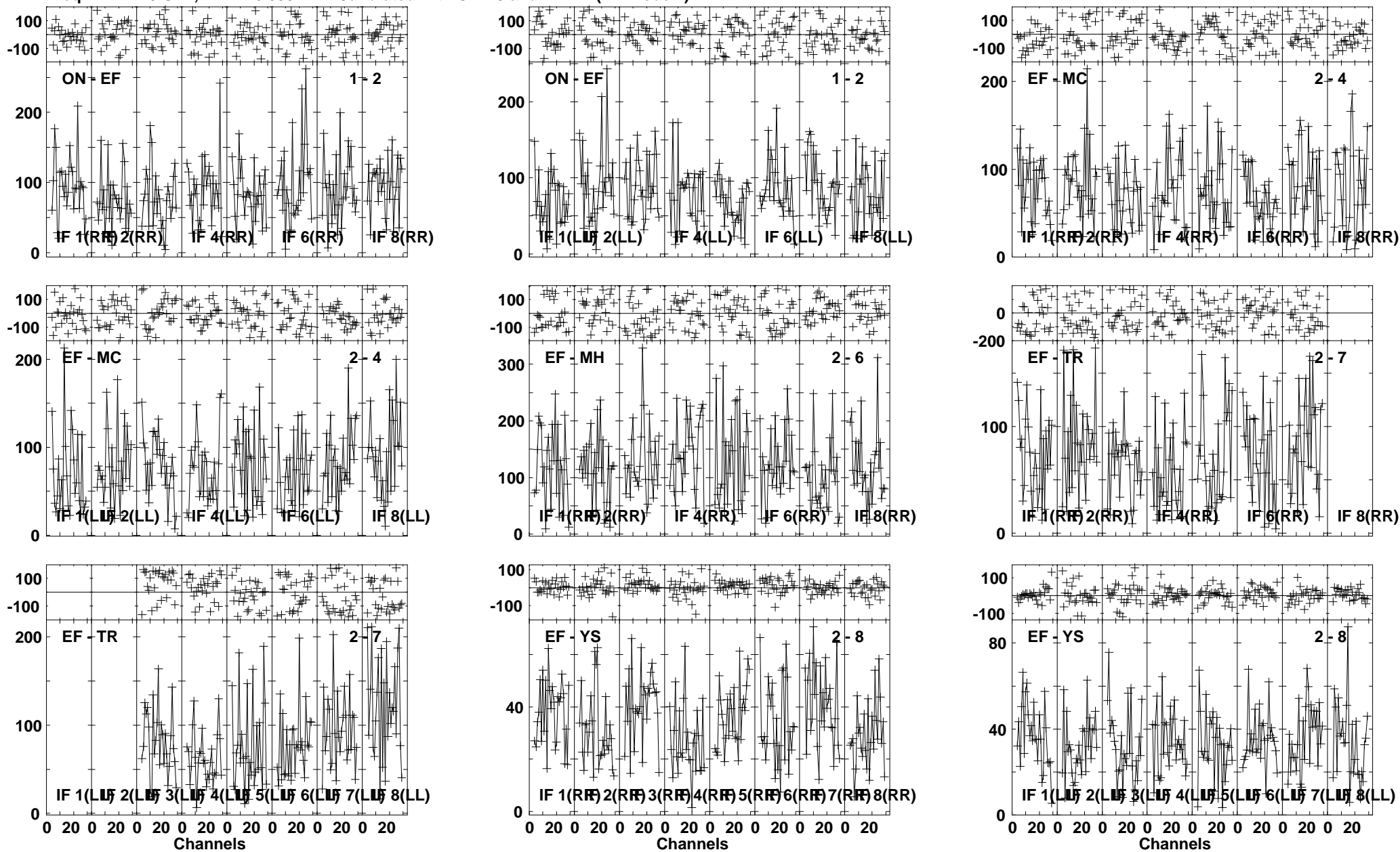

Lower frame: Milli Ampl Jy Top frame: Phas deg
 Vector averaged cross-power spectrum Several baselines displayed
 Timerange: 01/05:27:57 to 01/05:29:55

Plot file version 532 created 26-JUL-2013 10:27:56

J1157 EZ024 1.UVDATA.1

Freq = 22.1720 GHz, Bw = 16.000 MH Calibrated with CL # 3 and BP # 1 (BP mode 1)

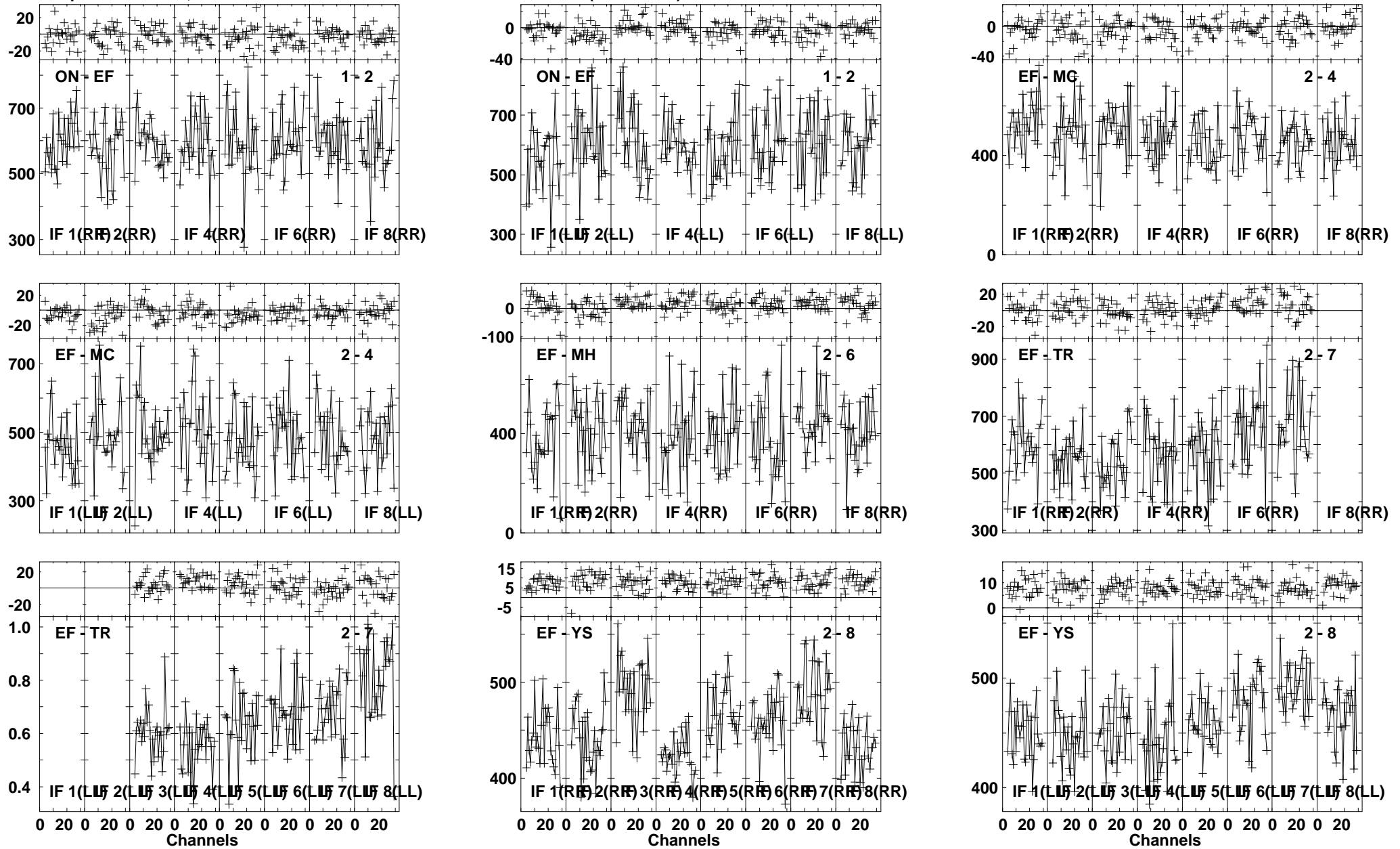

Lower frame: Milli Ampl Jy Top frame: Phas deg
Vector averaged cross-power spectrum Several baselines displayed
Timerange: 01/05:30:29 to 01/05:31:27

Plot file version 533 created 26-JUL-2013 10:27:57
 J1125+2610 EZ024 1.UVDATA.1
 Freq = 22.1720 GHz, Bw = 16.000 MH Calibrated with CL # 3 and BP # 1 (BP mode 1)

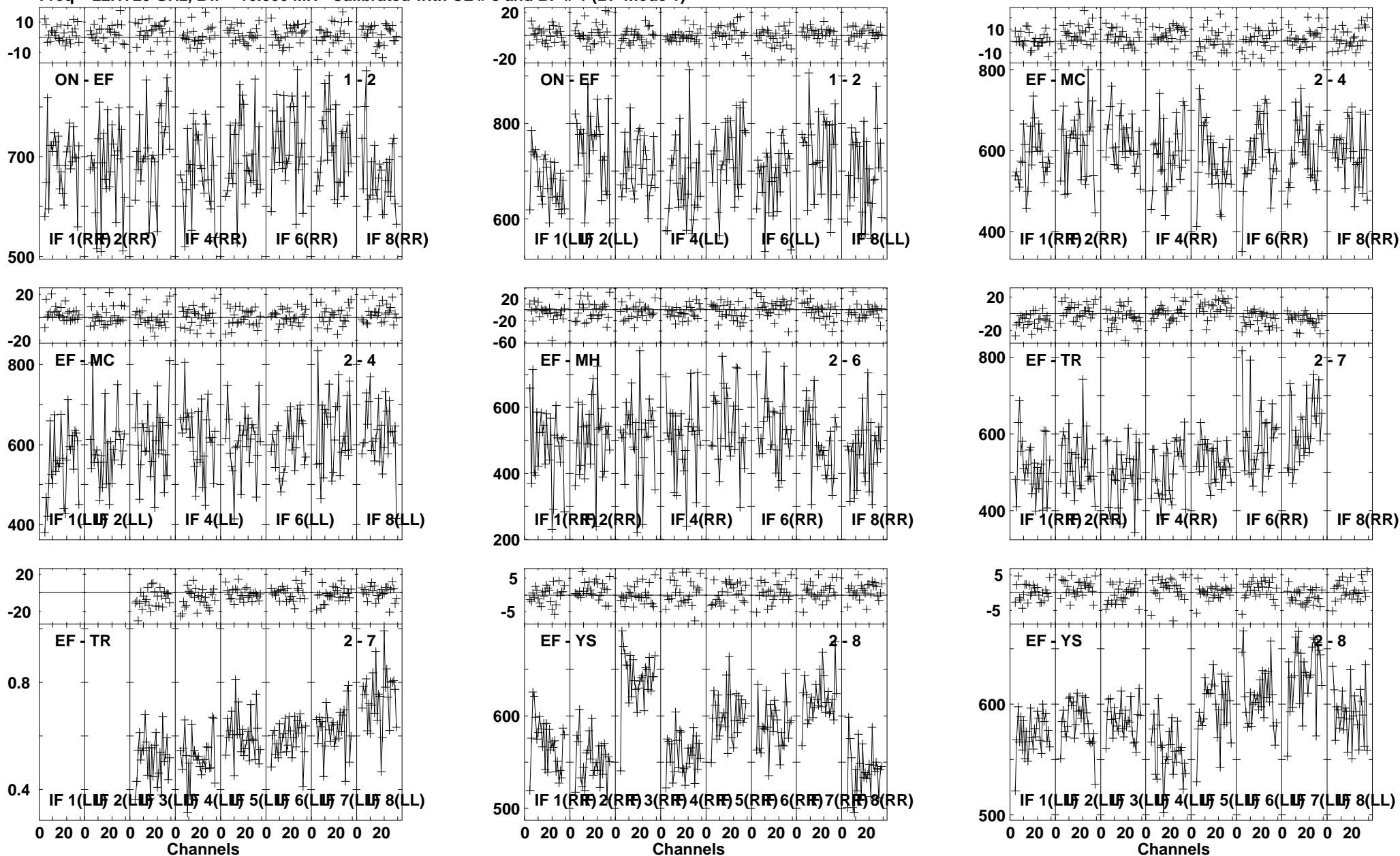

Lower frame: Milli Ampl Jy Top frame: Phas deg
 Vector averaged cross-power spectrum Several baselines displayed
 Timerange: 01/05:32:49 to 01/05:34:31

Plot file version 534 created 26-JUL-2013 10:27:59

J1157 EZ024 1.UVDATA.1

Freq = 22.1720 GHz, Bw = 16.000 MH Calibrated with CL # 3 and BP # 1 (BP mode 1)

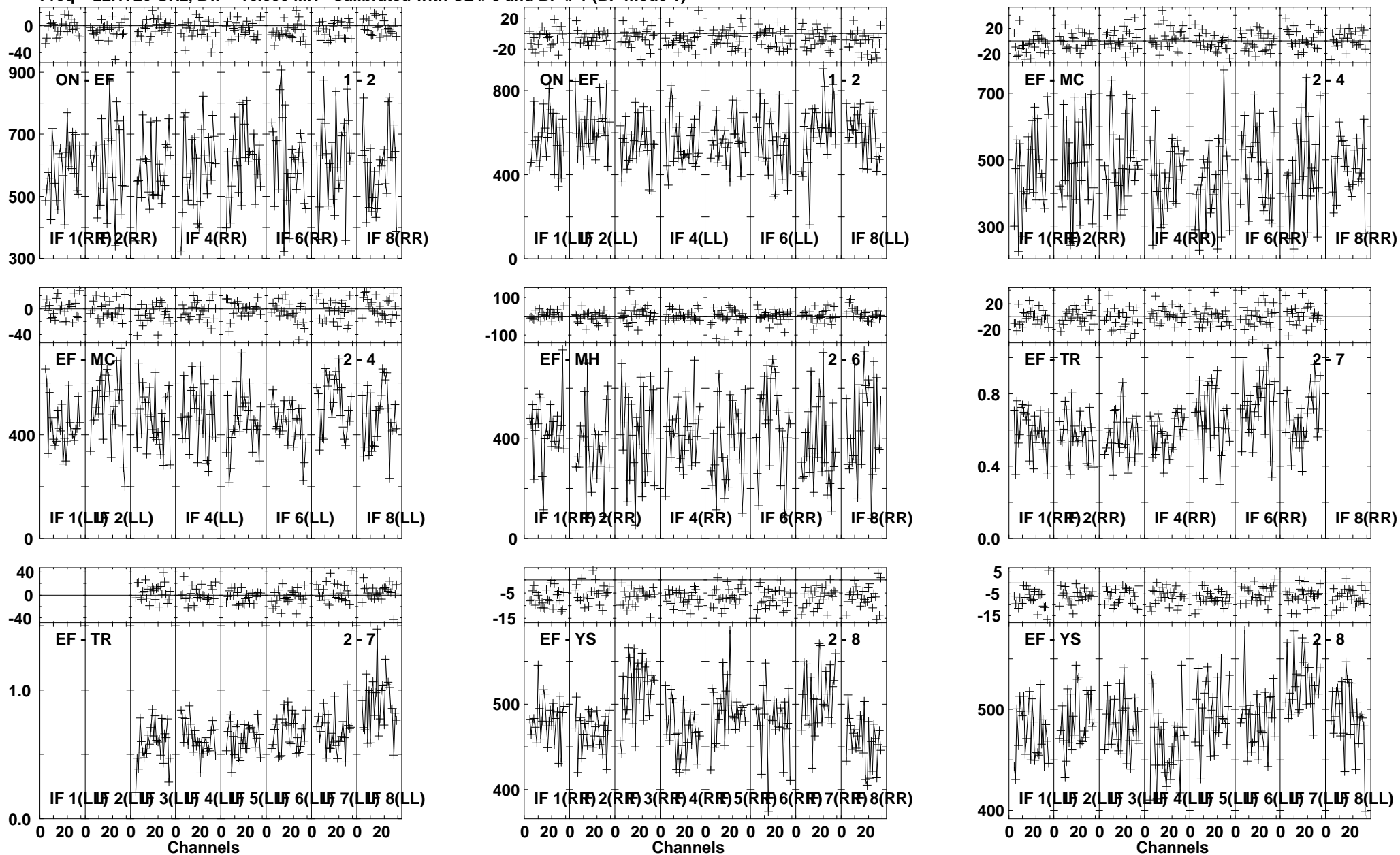

Lower frame: Milli Ampl Jy Top frame: Phas deg
Vector averaged cross-power spectrum Several baselines displayed
Timerange: 01/05:35:53 to 01/05:36:35

Plot file version 535 created 26-JUL-2013 10:28:00
 B1152+199A EZ024 1.UVDATA.1
 Freq = 22.1720 GHz, Bw = 16.000 MH Calibrated with CL # 3 and BP # 1 (BP mode 1)

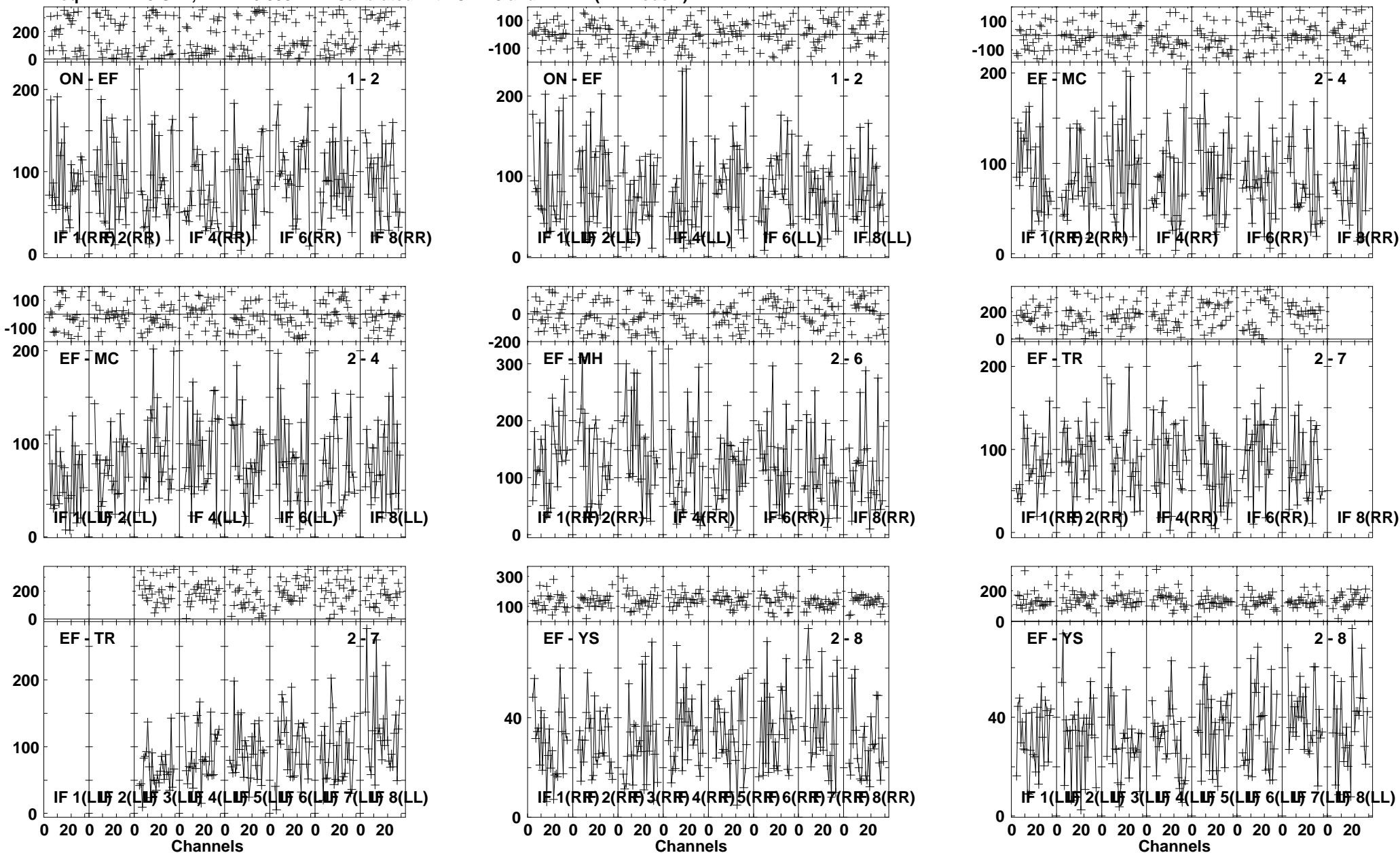

Lower frame: Milli Ampl Jy Top frame: Phas deg
 Vector averaged cross-power spectrum Several baselines displayed
 Timerange: 01/05:37:10 to 01/05:39:08

Plot file version 536 created 26-JUL-2013 10:28:01

J1157 EZ024 1.UVDATA.1

Freq = 22.1720 GHz, Bw = 16.000 MH Calibrated with CL # 3 and BP # 1 (BP mode 1)

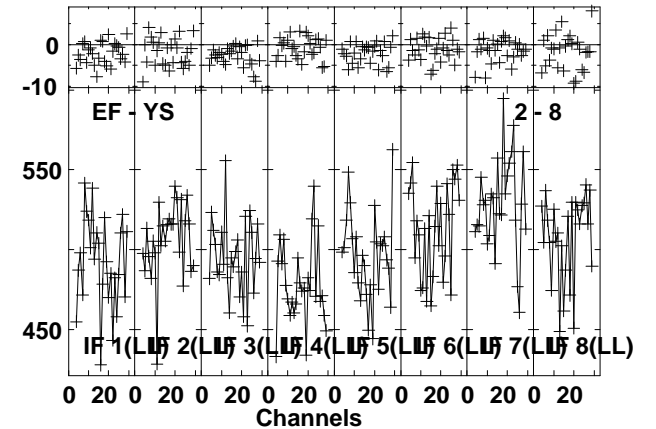
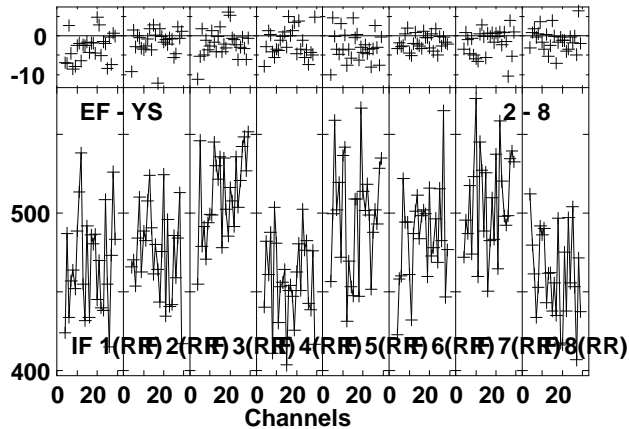
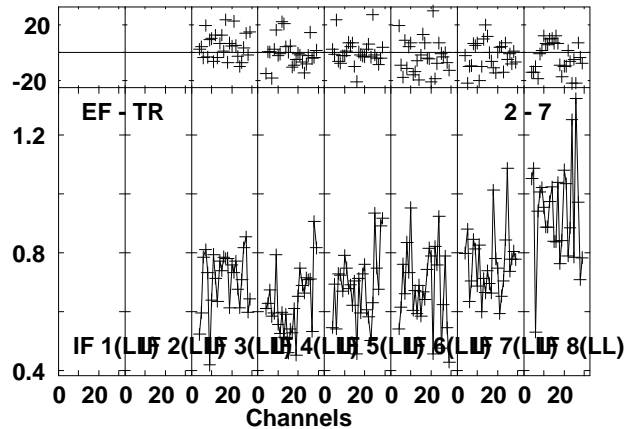
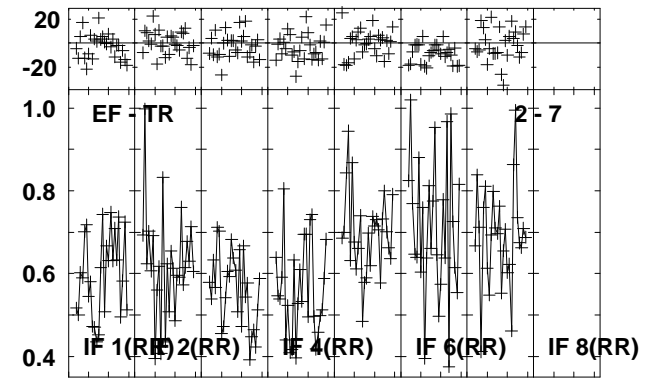
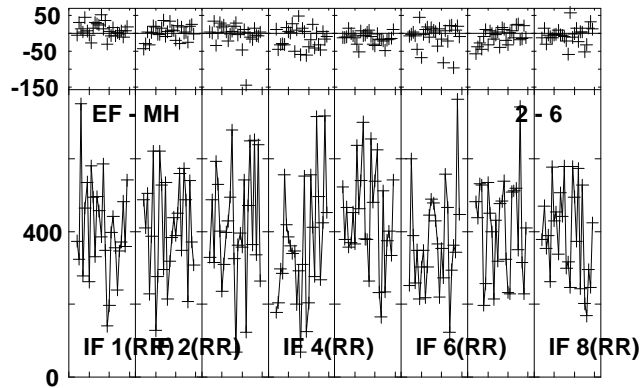
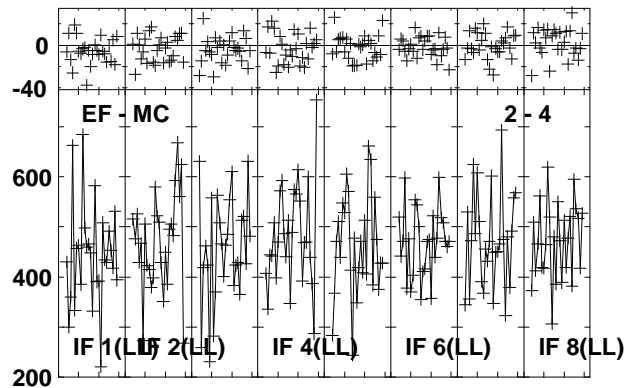
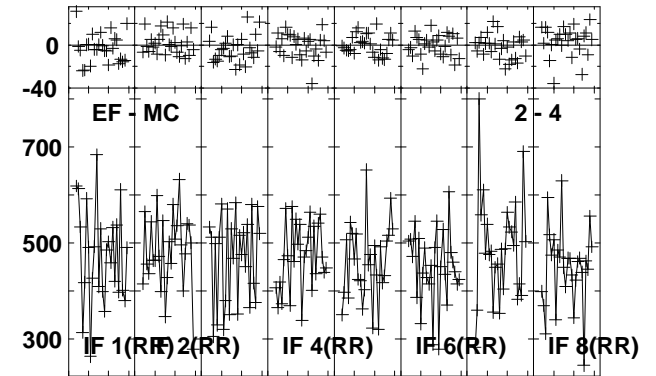
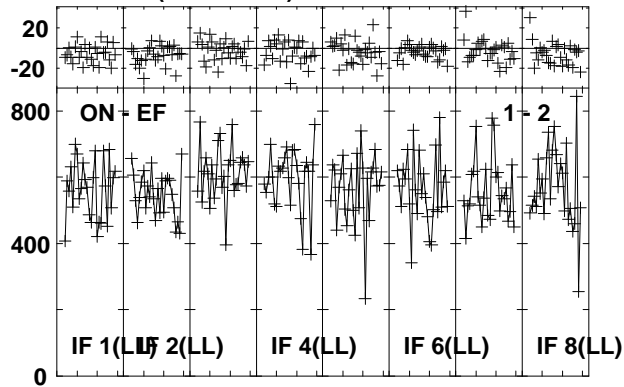
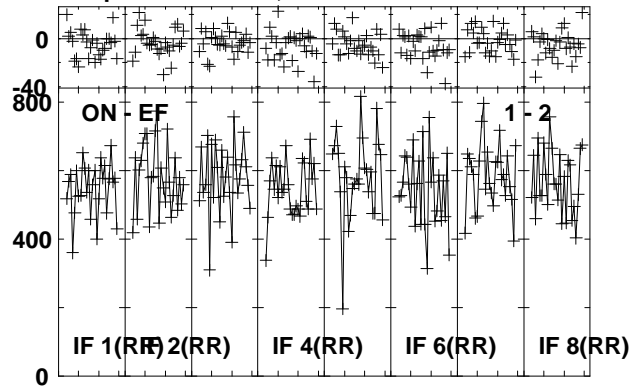

Lower frame: Milli Ampl Jy Top frame: Phas deg
Vector averaged cross-power spectrum Several baselines displayed
Timerange: 01/05:39:42 to 01/05:40:40

Plot file version 537 created 26-JUL-2013 10:28:02
 B1152+199A EZ024 1.UVDATA.1
 Freq = 22.1720 GHz, Bw = 16.000 MH Calibrated with CL # 3 and BP # 1 (BP mode 1)

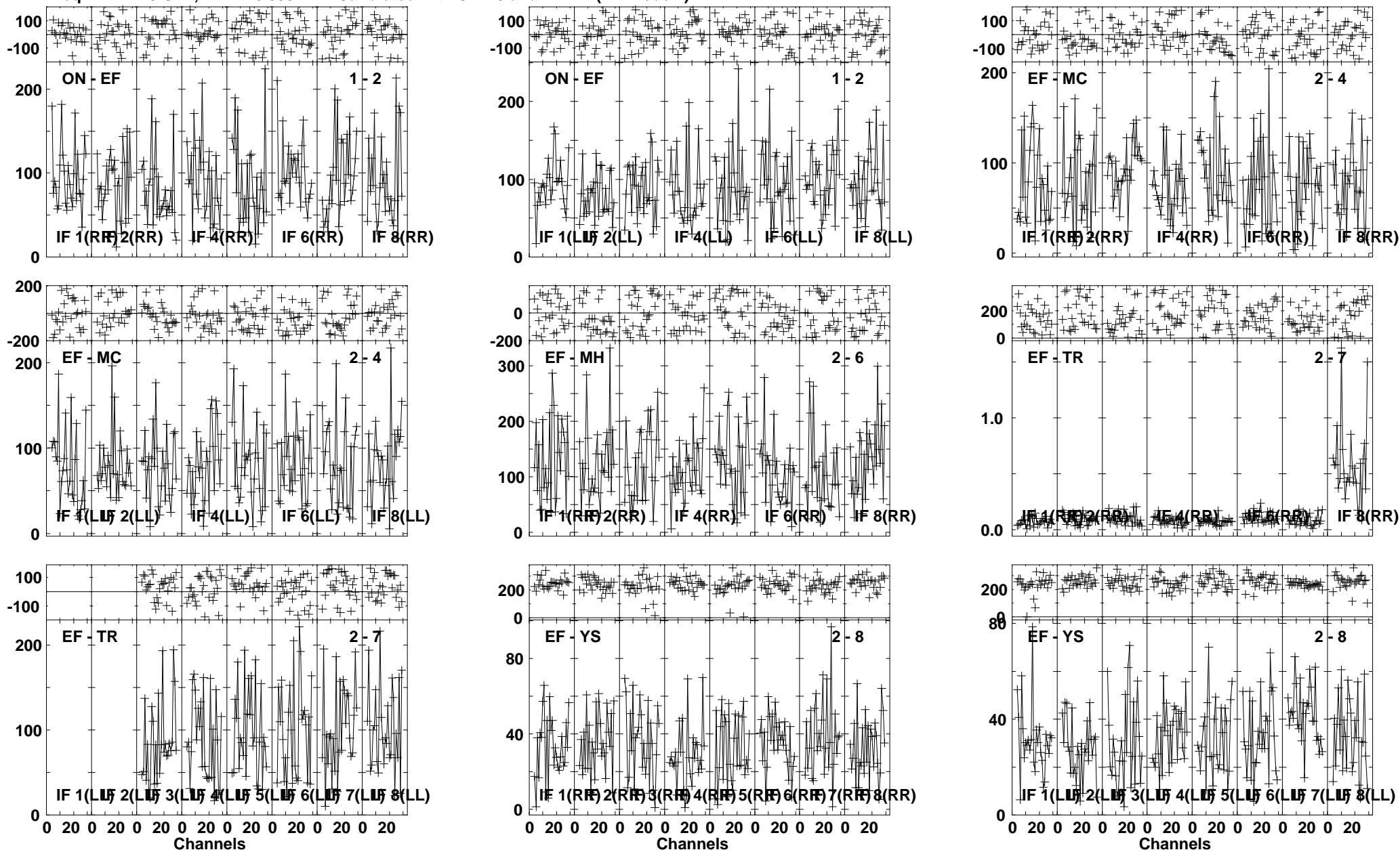

Lower frame: Milli Ampl Jy Top frame: Phas deg
 Vector averaged cross-power spectrum Several baselines displayed
 Timerange: 01/05:41:15 to 01/05:43:13

Plot file version 538 created 26-JUL-2013 10:28:04

J1157 EZ024 1.UVDATA.1

Freq = 22.1720 GHz, Bw = 16.000 MH Calibrated with CL # 3 and BP # 1 (BP mode 1)

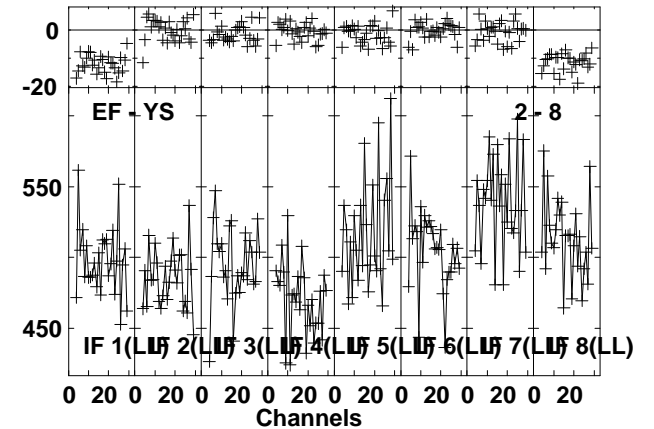
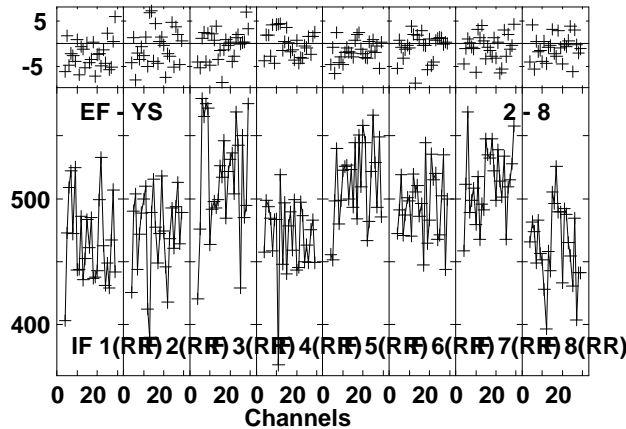
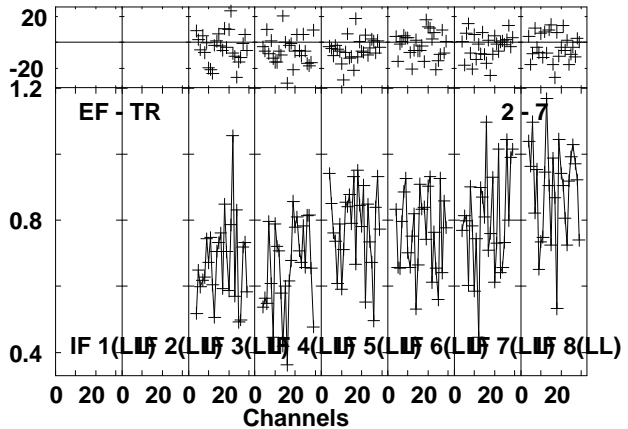
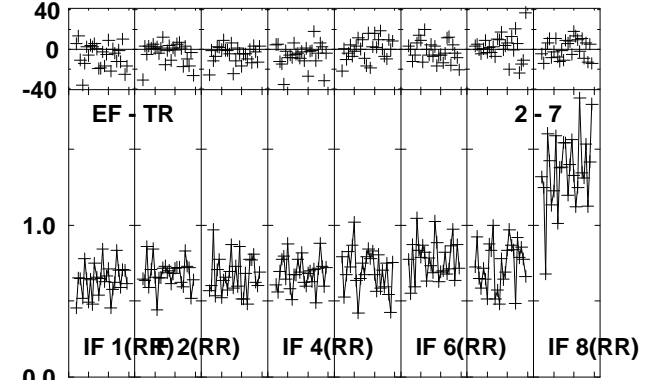
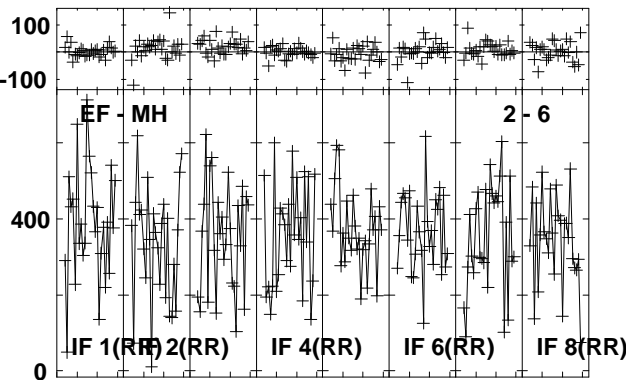
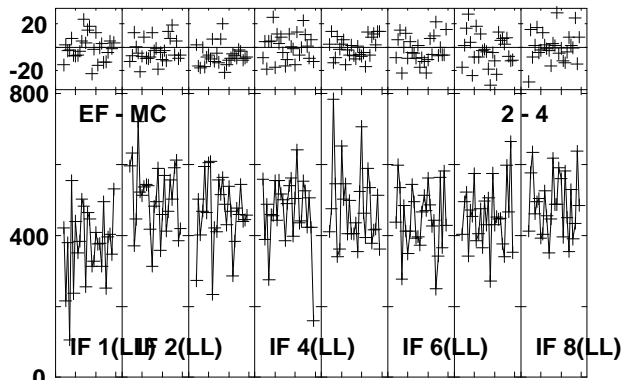
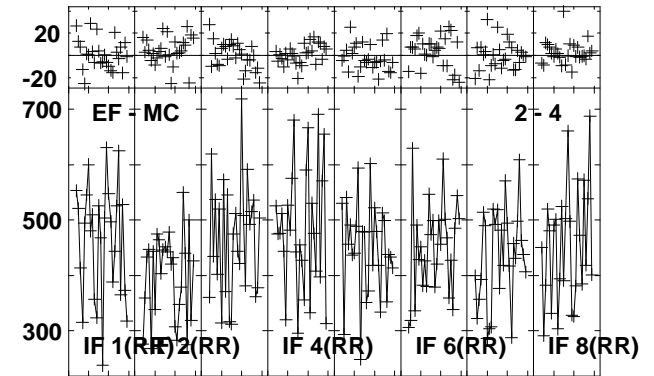
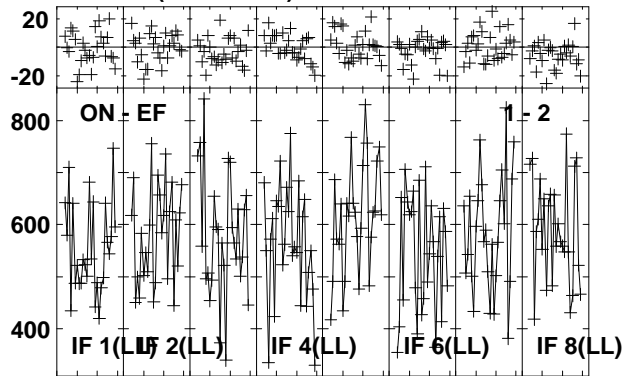
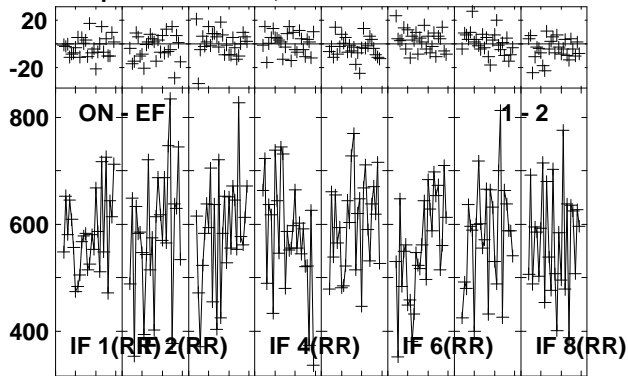

Lower frame: Milli Ampl Jy Top frame: Phas deg
Vector averaged cross-power spectrum Several baselines displayed
Timerange: 01/05:43:46 to 01/05:44:44

Plot file version 539 created 26-JUL-2013 10:28:05
 B1152+199A EZ024 1.UVDATA.1
 Freq = 22.1720 GHz, Bw = 16.000 MH Calibrated with CL # 3 and BP # 1 (BP mode 1)

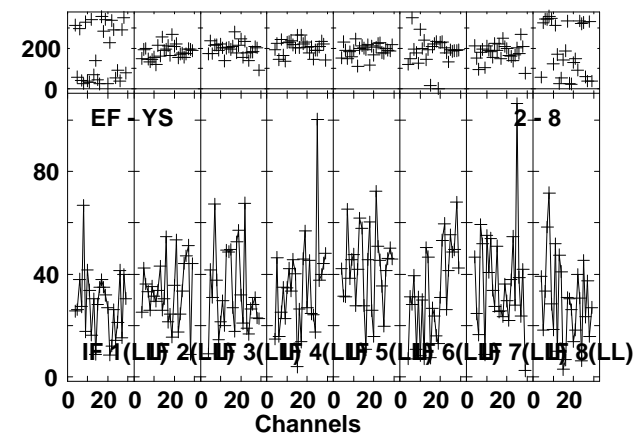
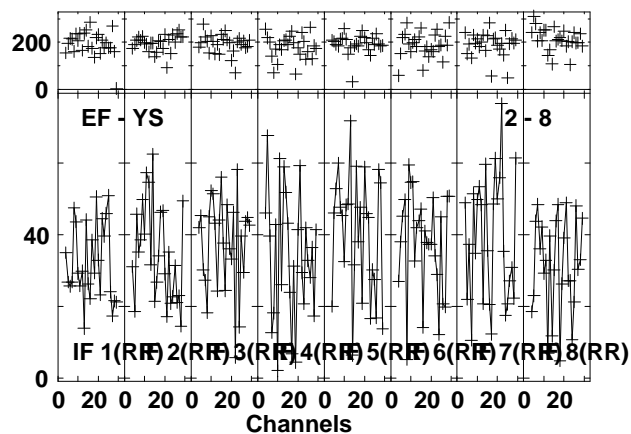
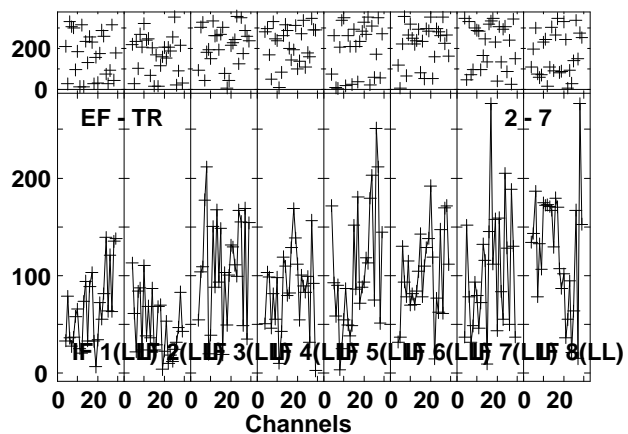
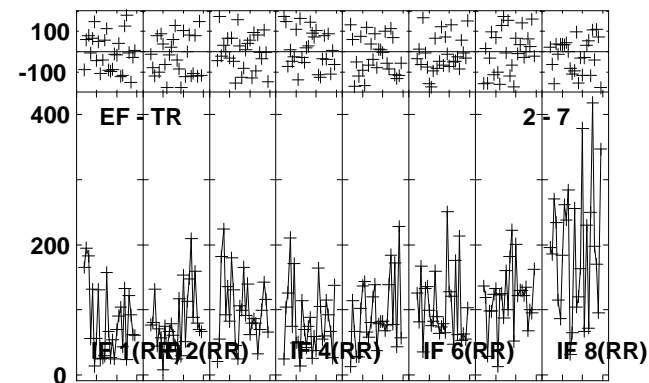
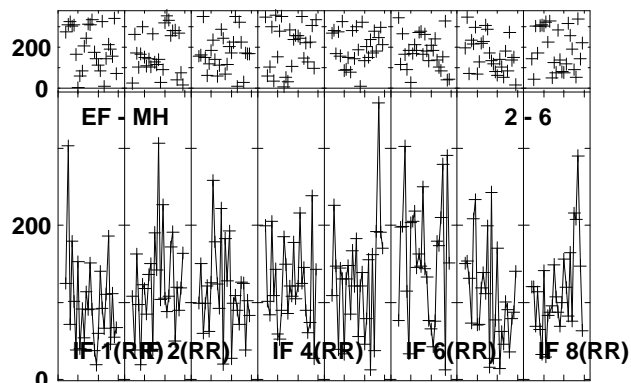
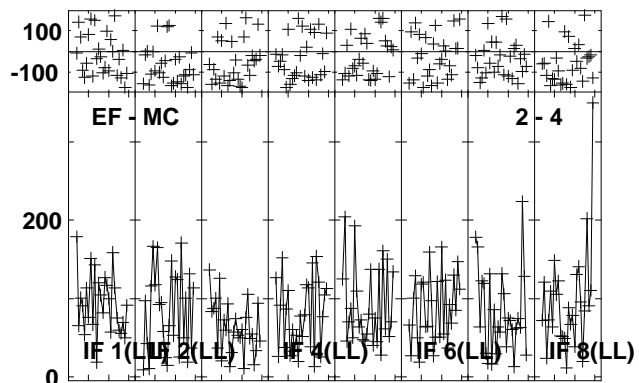
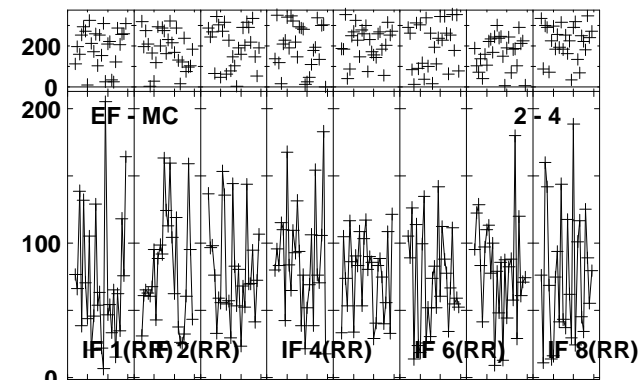
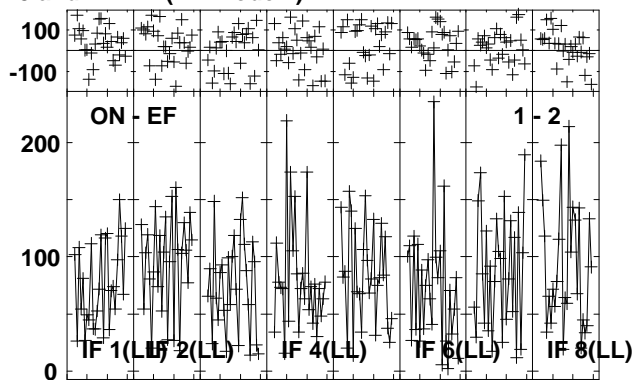
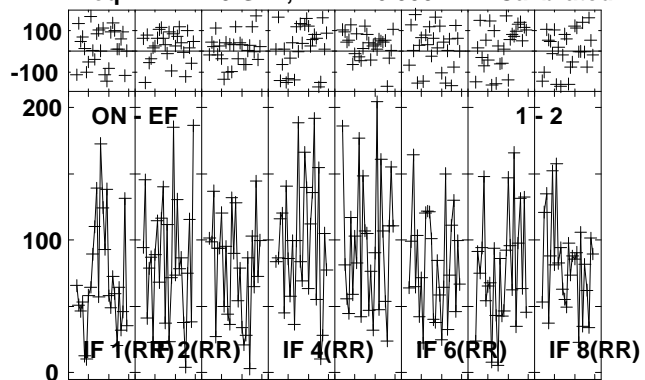

Lower frame: Milli Ampl Jy Top frame: Phas deg
 Vector averaged cross-power spectrum Several baselines displayed
 Timerange: 01/05:45:19 to 01/05:47:17

Plot file version 540 created 26-JUL-2013 10:28:07
 J1157 EZ024 1.UVDATA.1
 Freq = 22.1720 GHz, Bw = 16.000 MH Calibrated with CL # 3 and BP # 1 (BP mode 1)

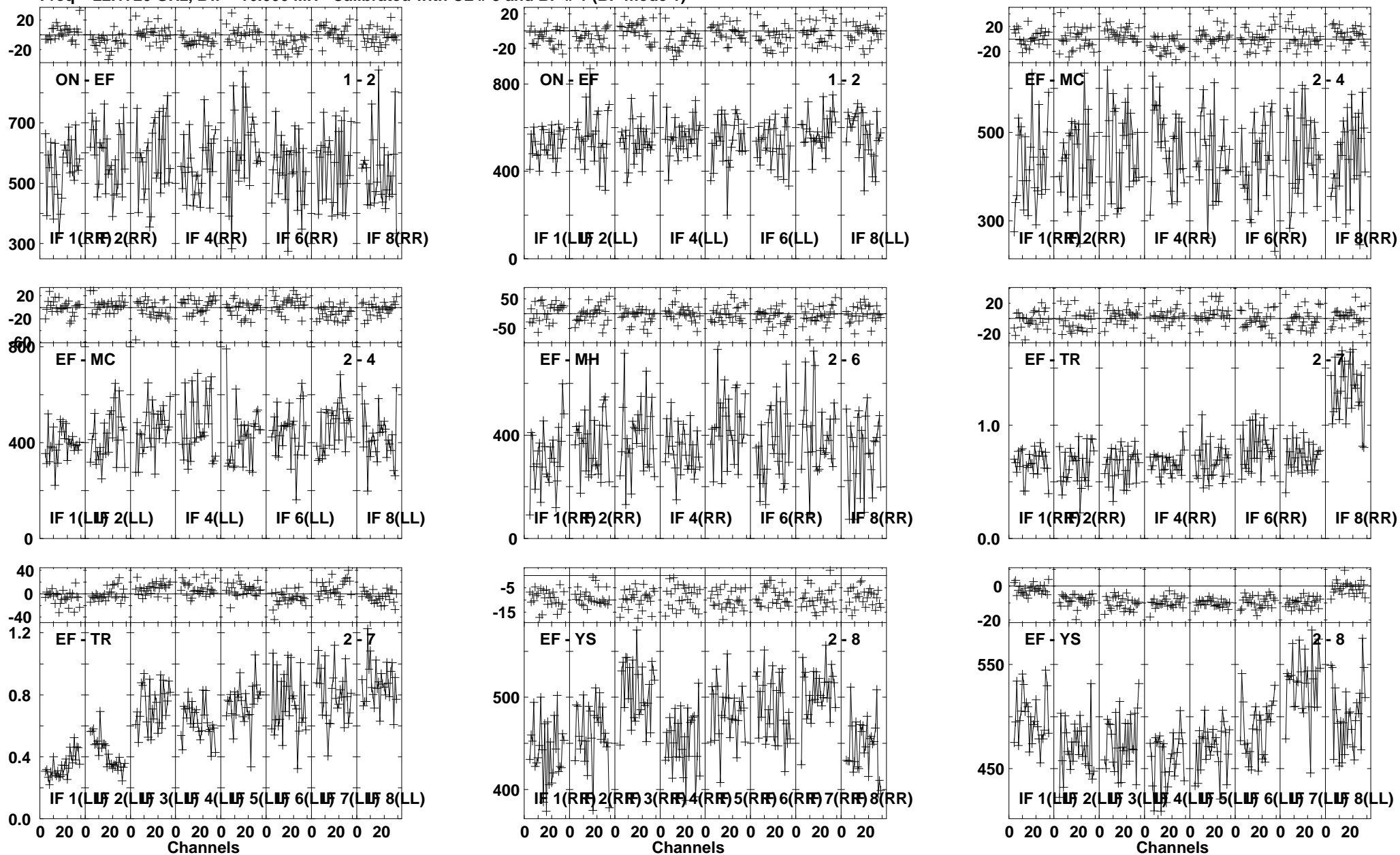

Lower frame: Milli Ampl Jy Top frame: Phas deg
 Vector averaged cross-power spectrum Several baselines displayed
 Timerange: 01/05:47:51 to 01/05:48:49

Plot file version 541 created 26-JUL-2013 10:28:08

J1125+2610 EZ024 1.UVDATA.1

Freq = 22.1720 GHz, Bw = 16.000 MH Calibrated with CL # 3 and BP # 1 (BP mode 1)

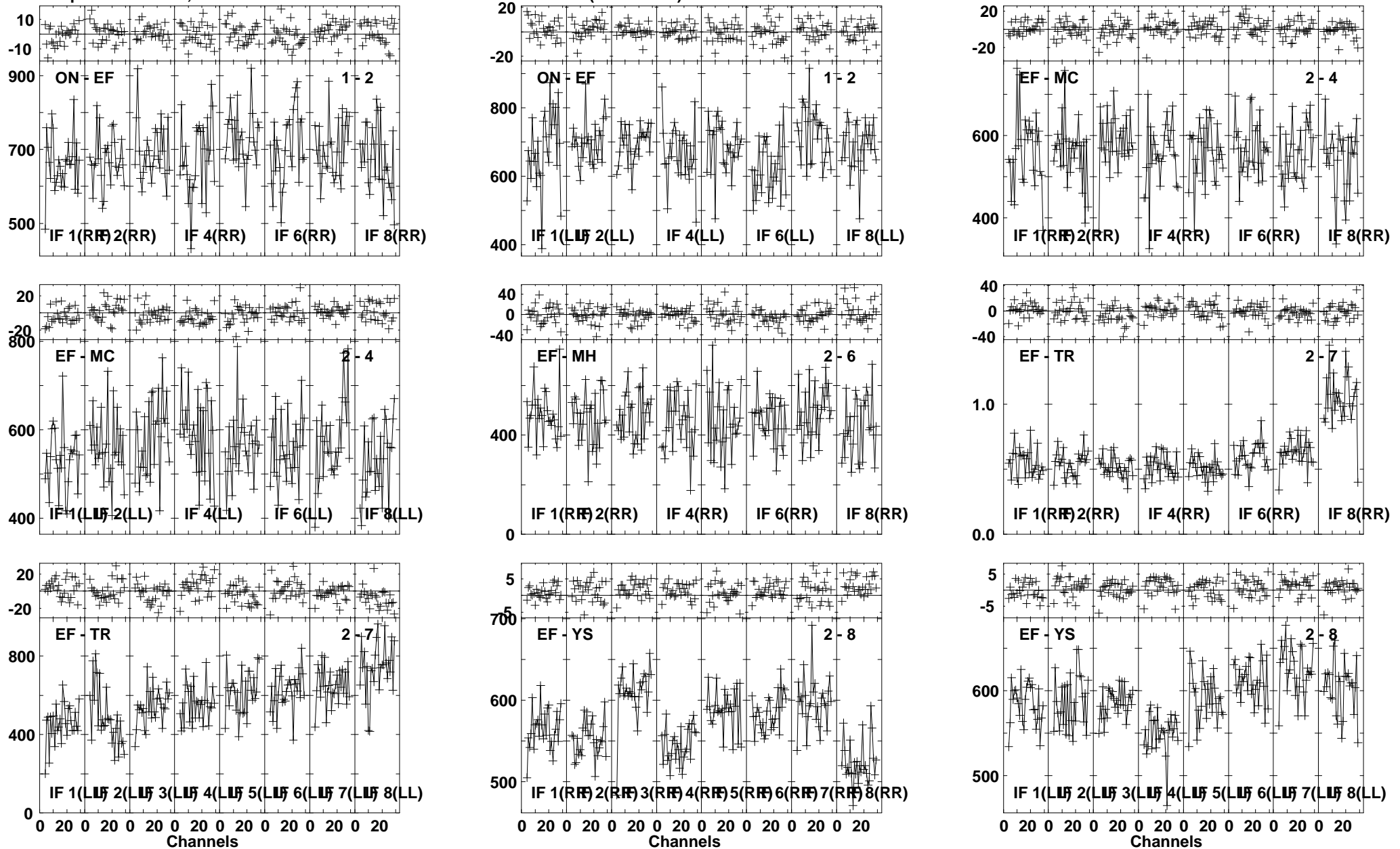

Plot file version 542 created 26-JUL-2013 10:28:09

J1157 EZ024 1.UVDATA.1

Freq = 22.1720 GHz, Bw = 16.000 MH Calibrated with CL # 3 and BP # 1 (BP mode 1)

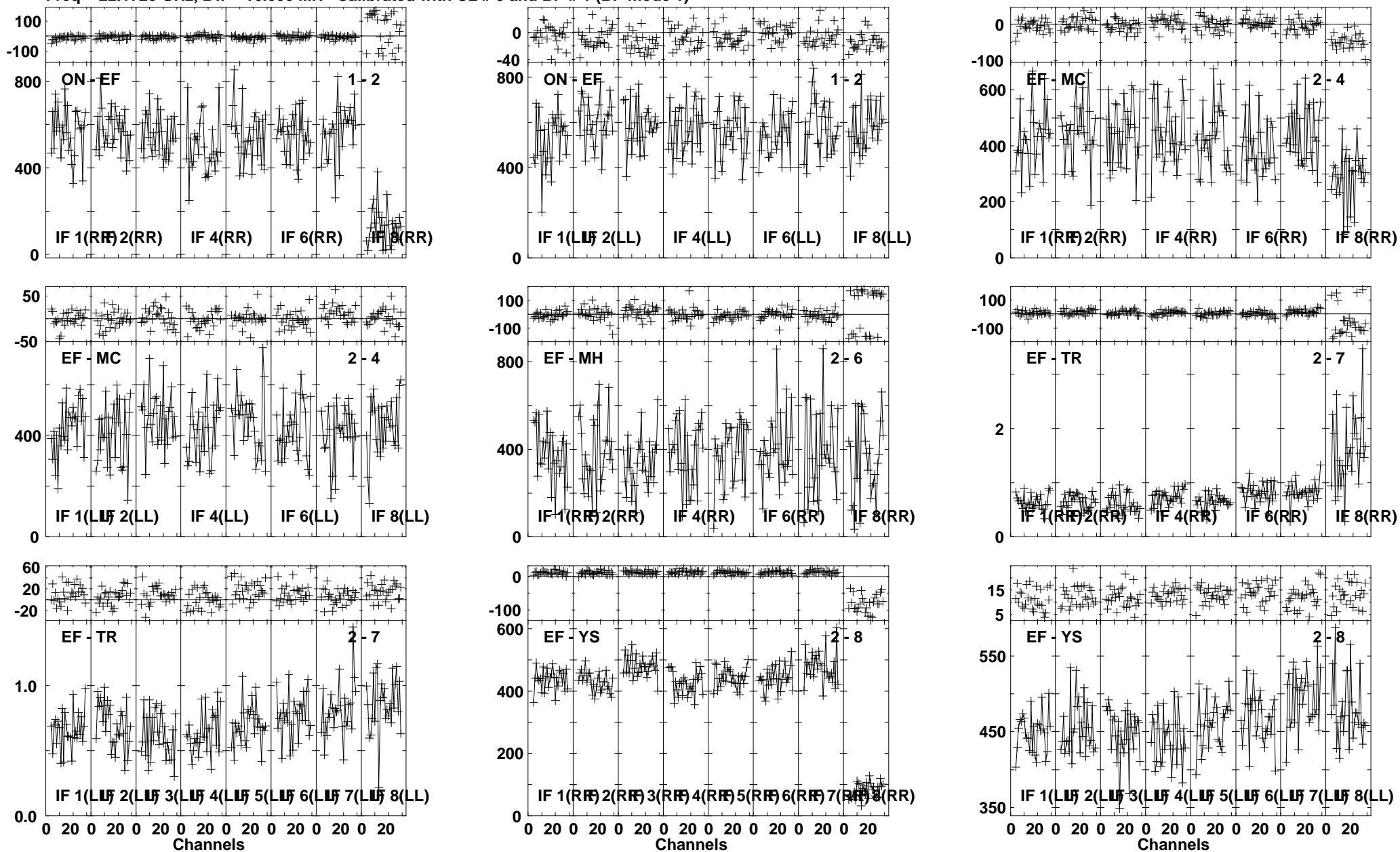

Lower frame: Milli Ampl Jy Top frame: Phas deg
Vector averaged cross-power spectrum Several baselines displayed
Timerange: 01/05:53:13 to 01/05:53:55

Plot file version 543 created 26-JUL-2013 10:28:10
 B1152+199A EZ024 1.UVDATA.1
 Freq = 22.1720 GHz, Bw = 16.000 MH Calibrated with CL # 3 and BP # 1 (BP mode 1)

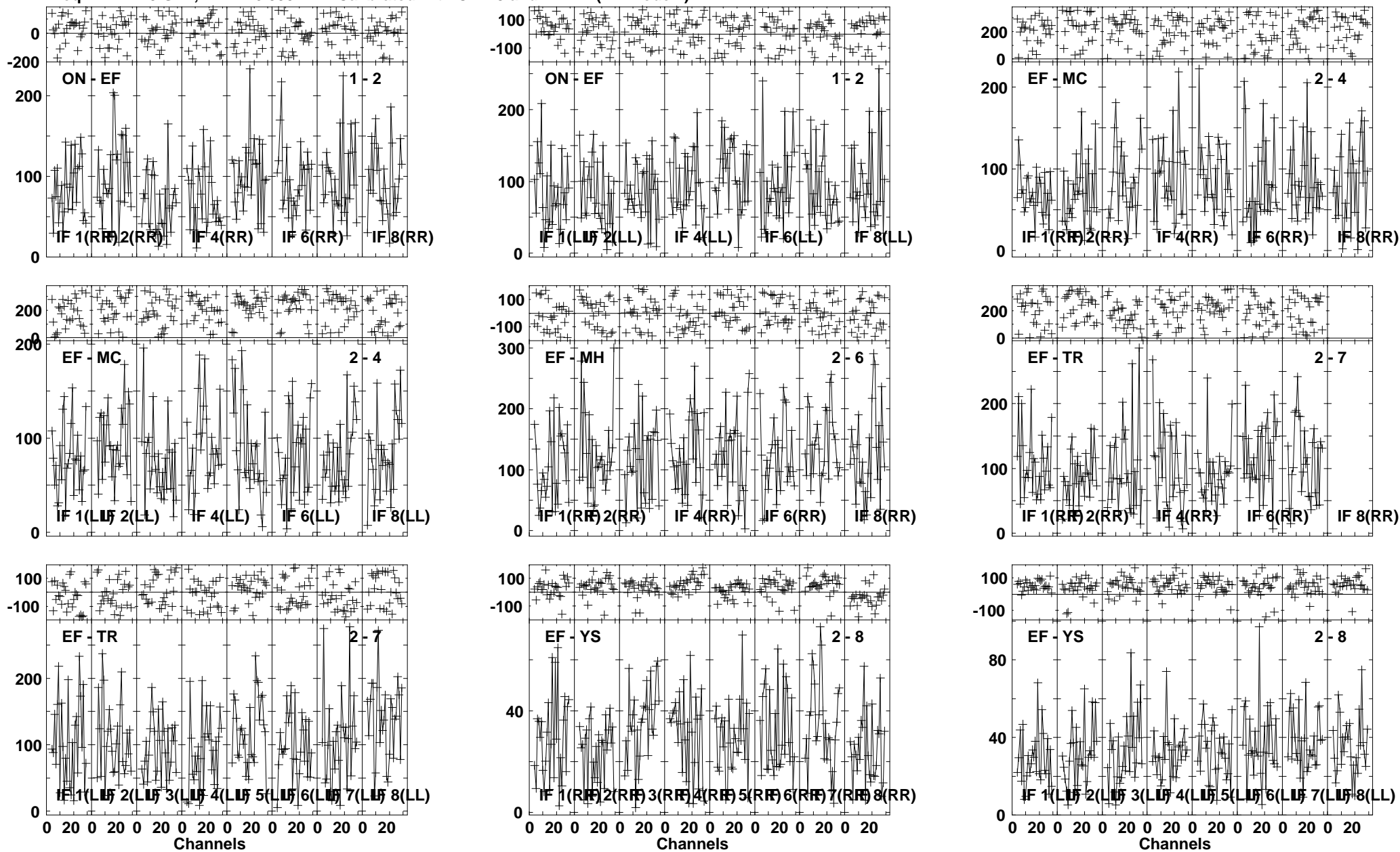

Lower frame: Milli Ampl Jy Top frame: Phas deg
 Vector averaged cross-power spectrum Several baselines displayed
 Timerange: 01/05:54:30 to 01/05:56:28

Plot file version 544 created 26-JUL-2013 10:28:12

J1157 EZ024 1.UVDATA.1

Freq = 22.1720 GHz, Bw = 16.000 MH Calibrated with CL # 3 and BP # 1 (BP mode 1)

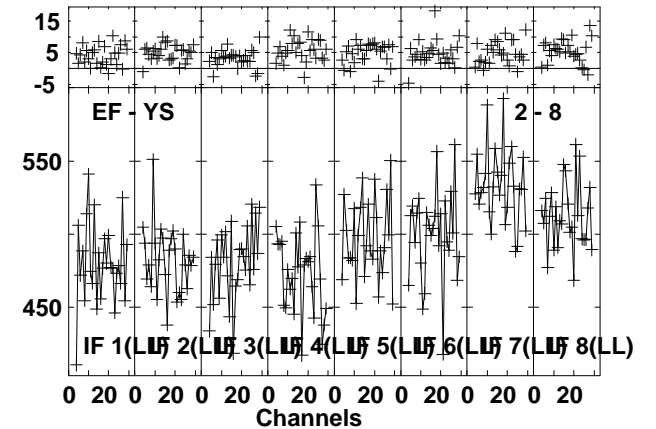
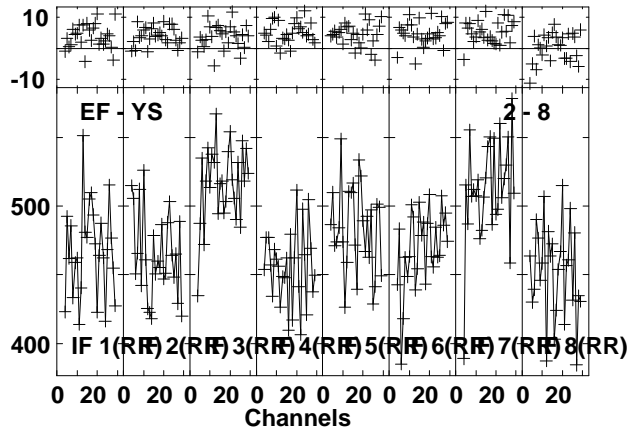
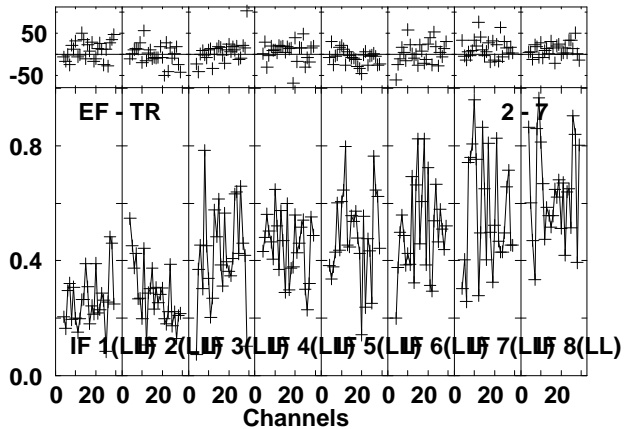
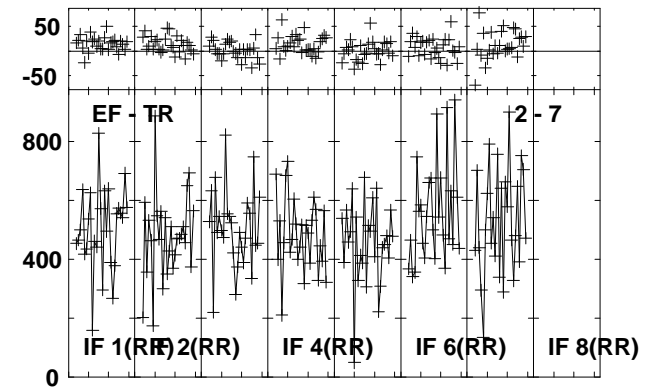
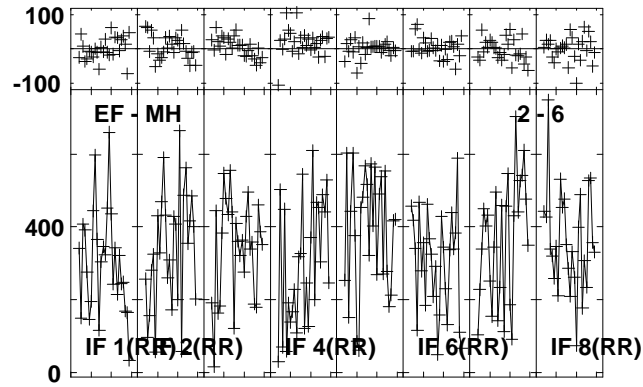
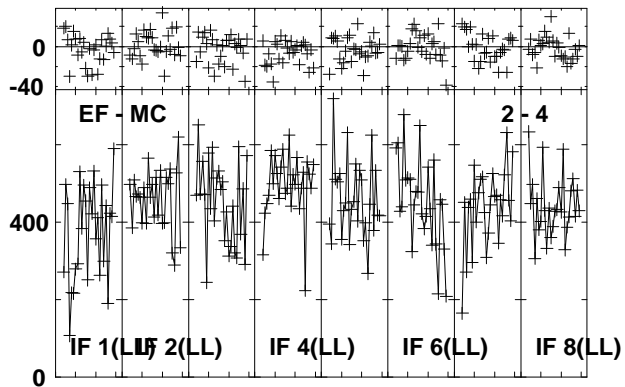
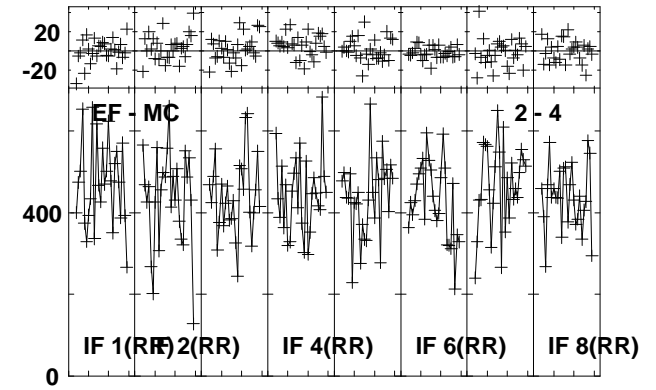
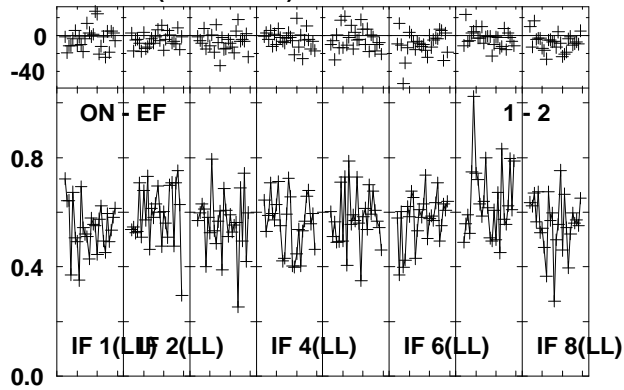
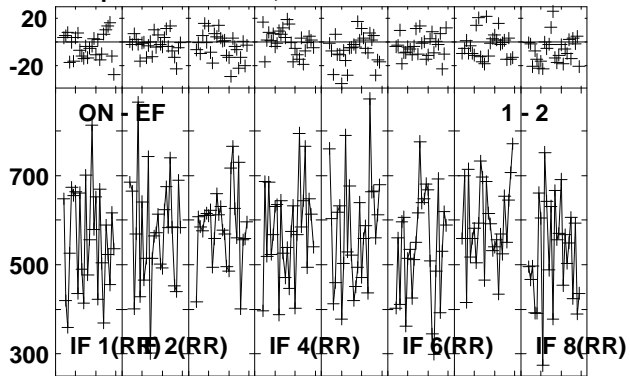

Lower frame: Milli Ampl Jy Top frame: Phas deg
Vector averaged cross-power spectrum Several baselines displayed
Timerange: 01/05:57:01 to 01/05:57:59

Plot file version 545 created 26-JUL-2013 10:28:13
 B1152+199A EZ024 1.UVDATA.1
 Freq = 22.1720 GHz, Bw = 16.000 MH Calibrated with CL # 3 and BP # 1 (BP mode 1)

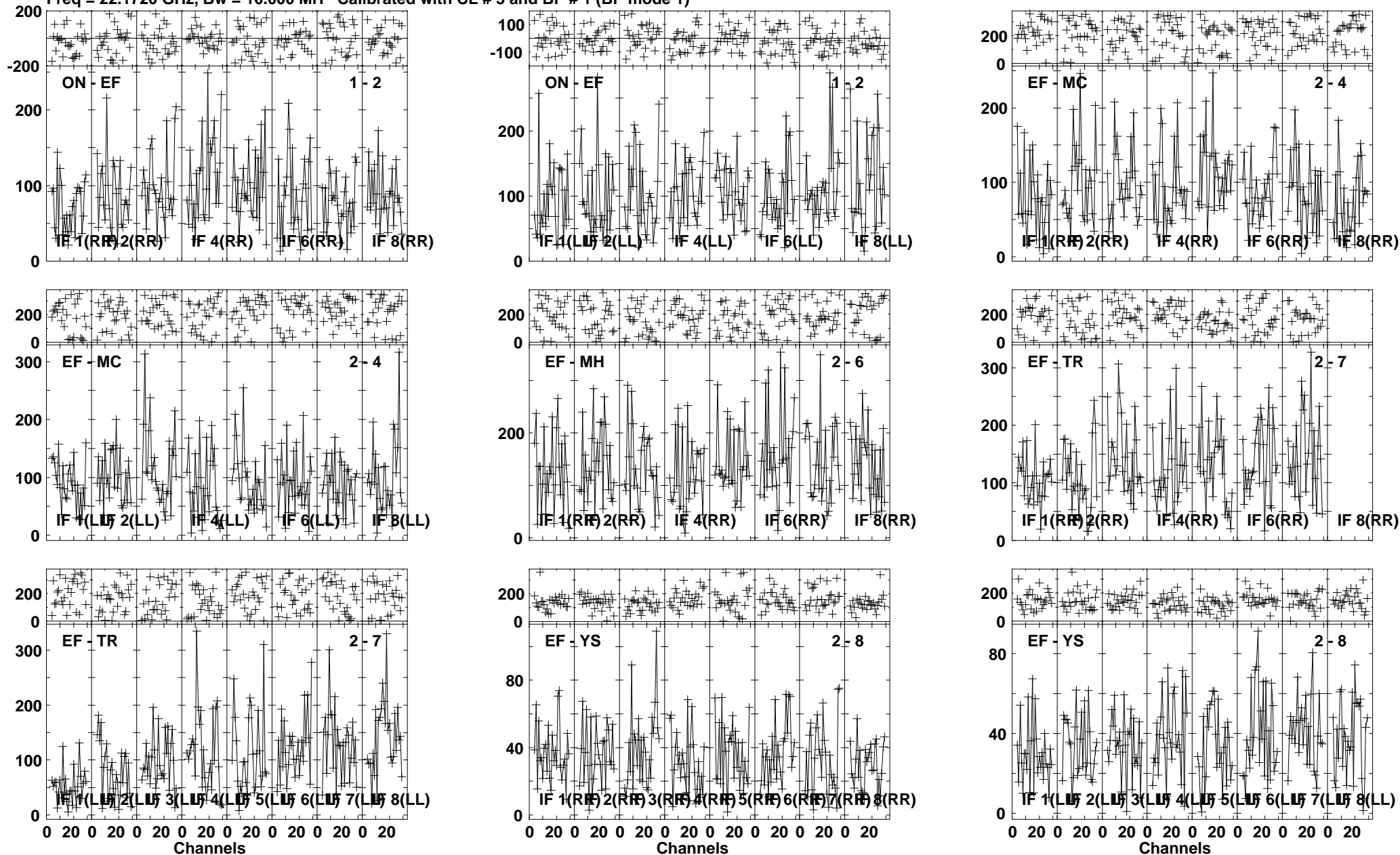

Lower frame: Milli Ampl Jy Top frame: Phas deg
 Vector averaged cross-power spectrum Several baselines displayed
 Timerange: 01/05:58:34 to 01/06:00:02