

Plot file version 1 created 23-AUG-2016 15:00:40

W3IRS5 GA035B 1.UVDATA.1

Freq = 22.2125 GHz, Bw = 16.000 MH No calibration applied and no bandpass applied

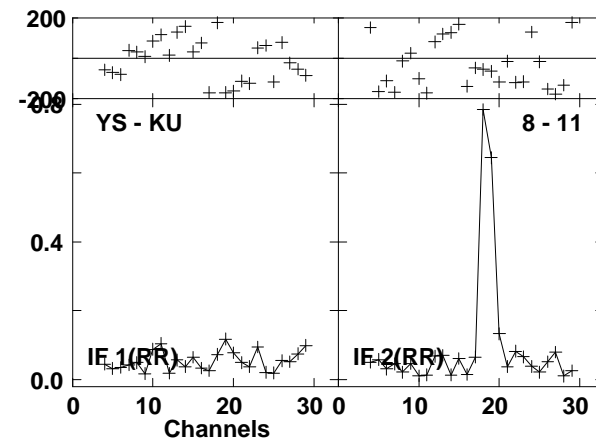
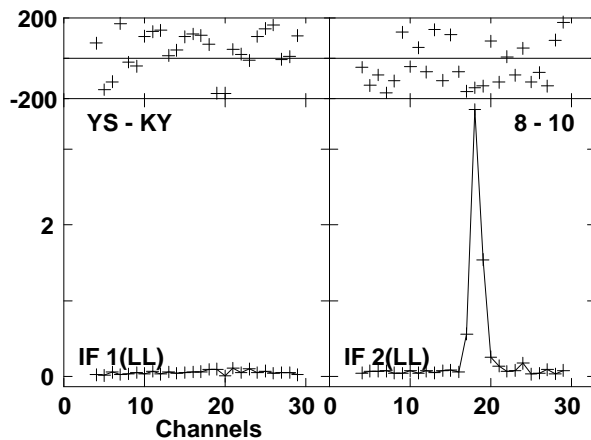
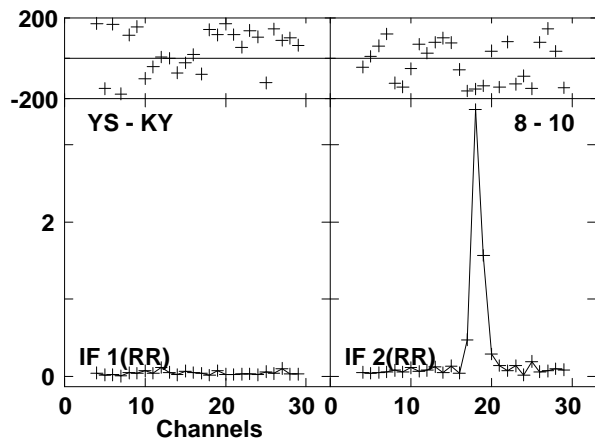
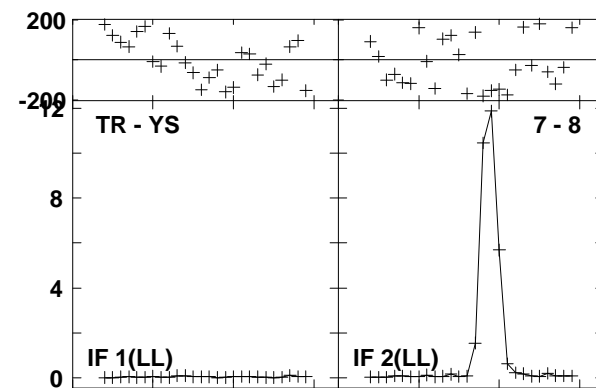
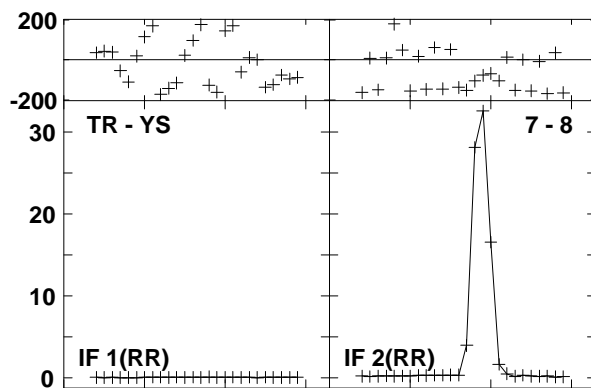
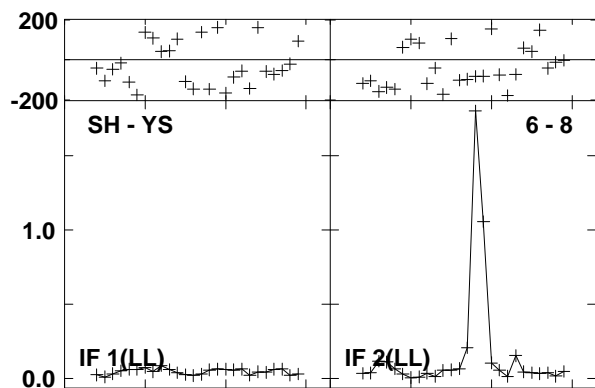
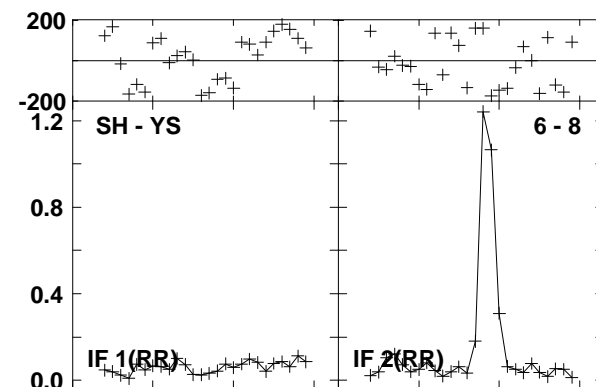
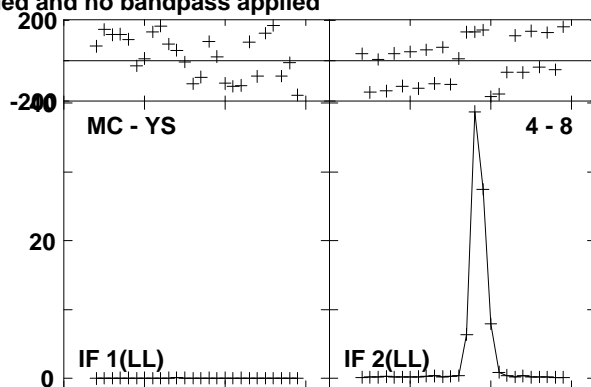
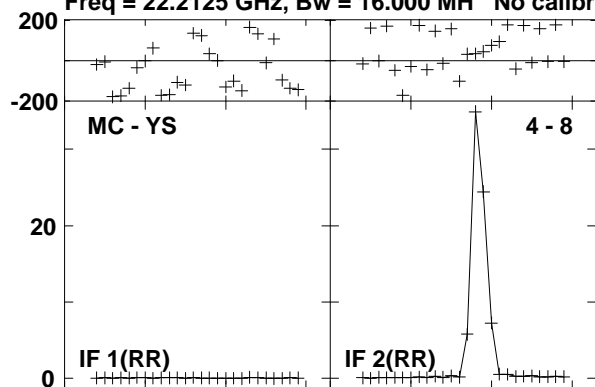

Lower frame: Milli Ampl Jy Top frame: Phas deg  
Vector averaged cross-power spectrum Baseline: MC (04) - YS (08)  
Timerange: 00/07:21:01 to 00/07:30:00

Plot file version 2 created 23-AUG-2016 15:00:40  
W3IRS5 GA035B 1.UVDATA.1

Freq = 22.2125 GHz, Bw = 16.000 MH No calibration applied and no bandpass applied

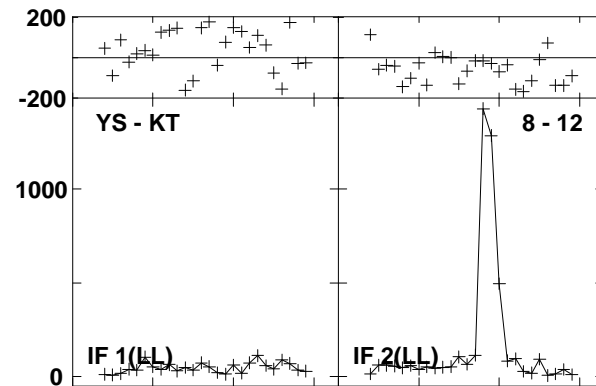
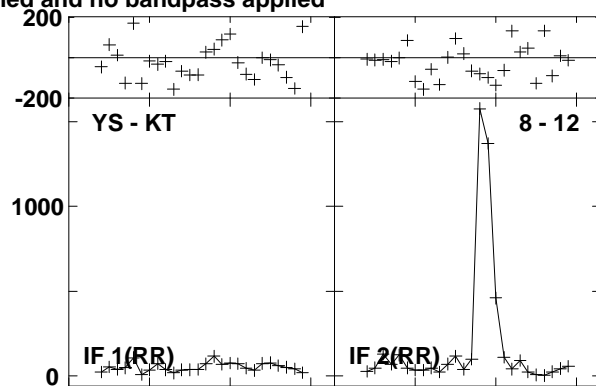
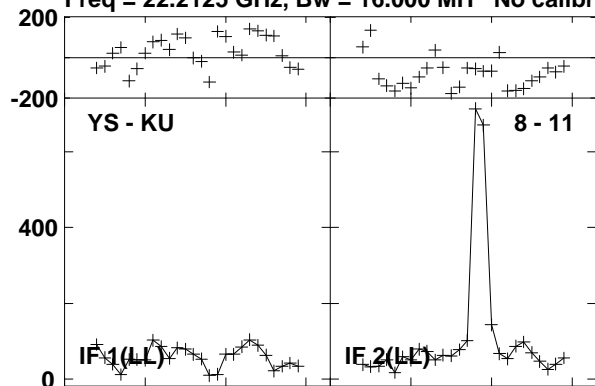

Lower frame: Micro Ampl Jy Top frame: Phas deg  
Vector averaged cross-power spectrum Baseline: YS (08) - KU (11)  
Timerange: 00/07:21:01 to 00/07:30:00

Plot file version 3 created 23-AUG-2016 15:00:40

W3IRS5 GA035B 1.UVDATA.1

Freq = 22.2125 GHz, Bw = 16.000 MH No calibration applied and no bandpass applied

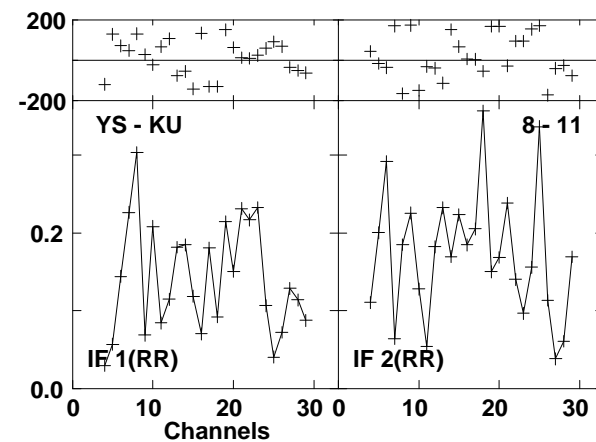
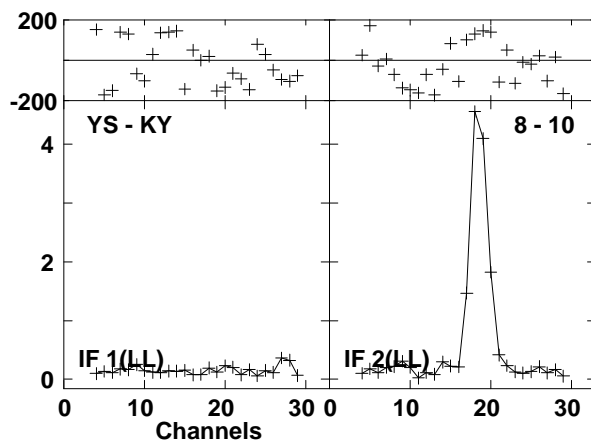
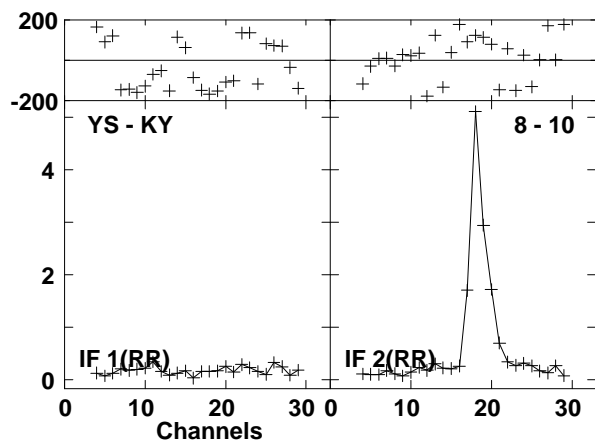
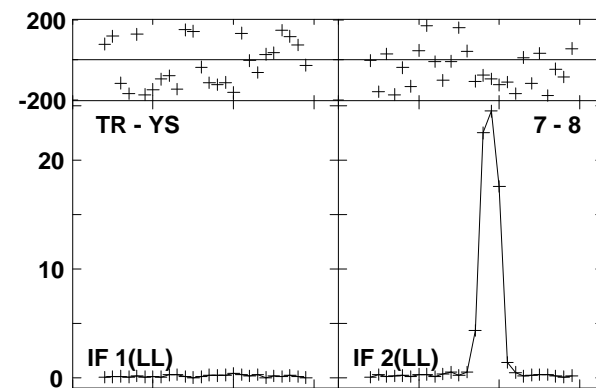
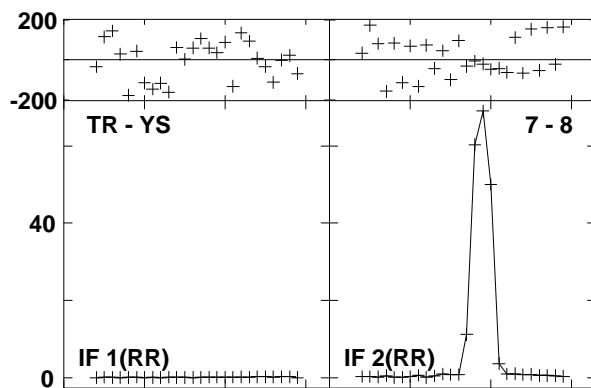
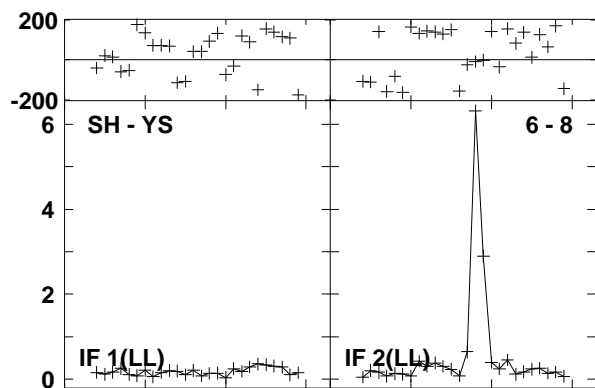
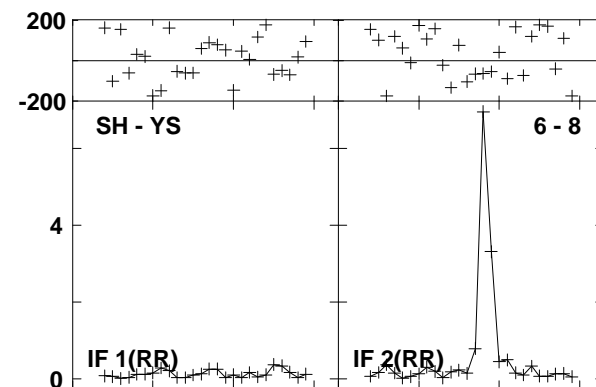
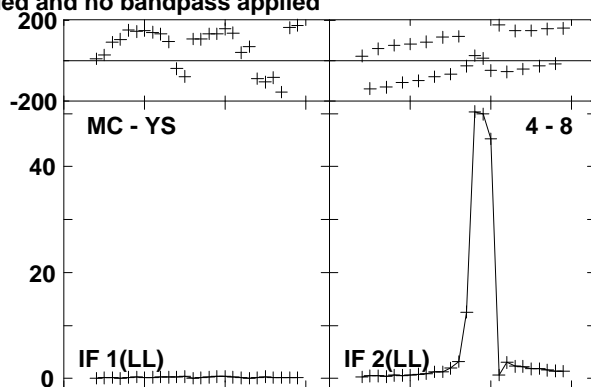
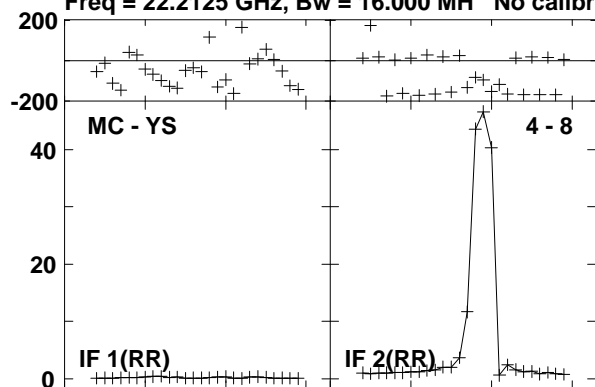

Lower frame: Milli Ampl Jy Top frame: Phas deg  
Vector averaged cross-power spectrum Baseline: MC (04) - YS (08)  
Timerange: 00/07:32:26 to 00/07:33:25

Plot file version 4 created 23-AUG-2016 15:00:40  
W3IRS5 GA035B 1.UVDATA.1

Freq = 22.2125 GHz, Bw = 16.000 MH No calibration applied and no bandpass applied

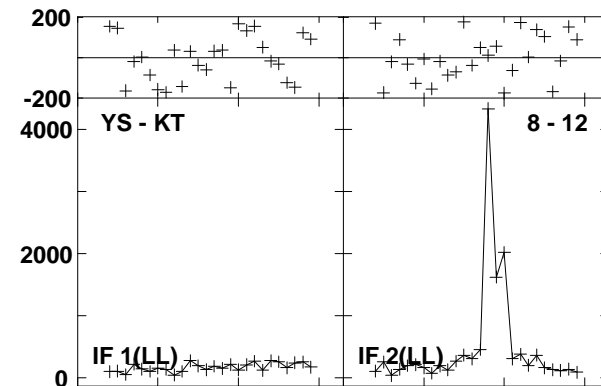
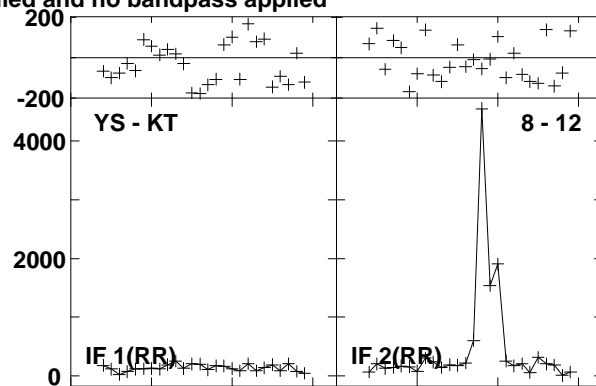
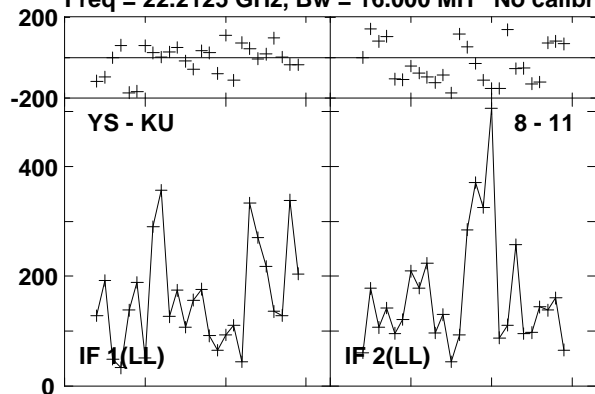

Lower frame: Micro Ampl Jy Top frame: Phas deg  
Vector averaged cross-power spectrum Baseline: YS (08) - KU (11)  
Timerange: 00/07:32:26 to 00/07:33:25

Plot file version 5 created 23-AUG-2016 15:00:40

0219+628 GA035B 1.UVDATA.1

Freq = 22.2125 GHz, Bw = 16.000 MH No calibration applied and no bandpass applied

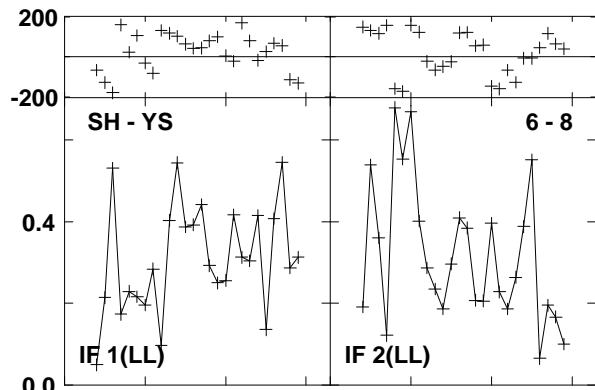
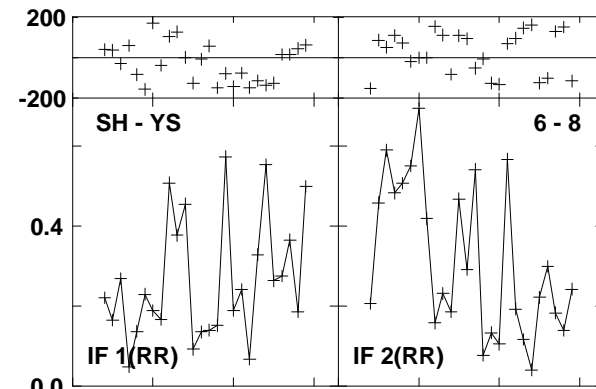
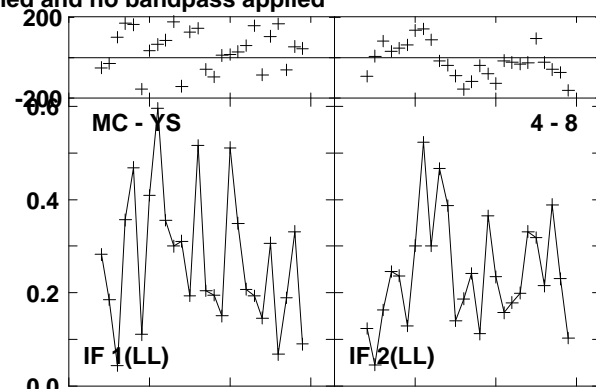
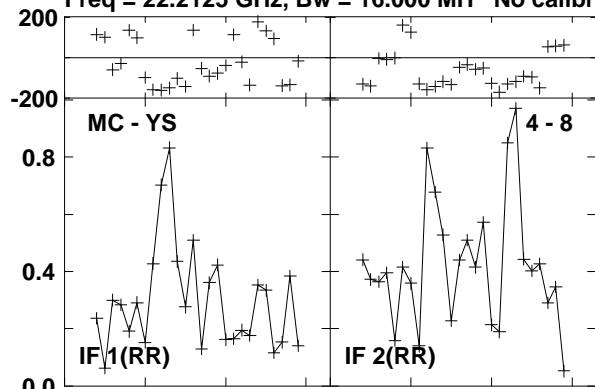

Lower frame: Milli Ampl Jy Top frame: Phas deg  
Vector averaged cross-power spectrum Baseline: MC (04) - YS (08)  
Timerange: 00/07:33:52 to 00/07:34:09

Plot file version 6 created 23-AUG-2016 15:00:40  
W3IRS5 GA035B 1.UVDATA.1

Freq = 22.2125 GHz, Bw = 16.000 MH No calibration applied and no bandpass applied

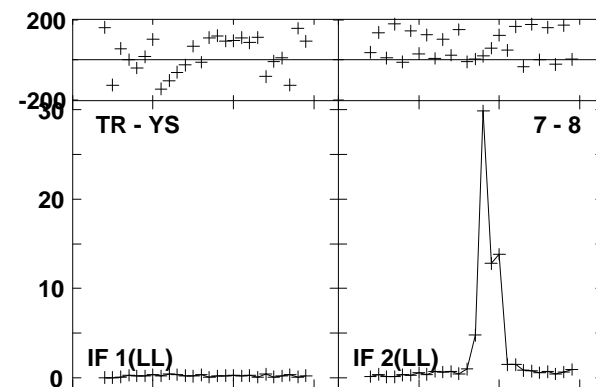
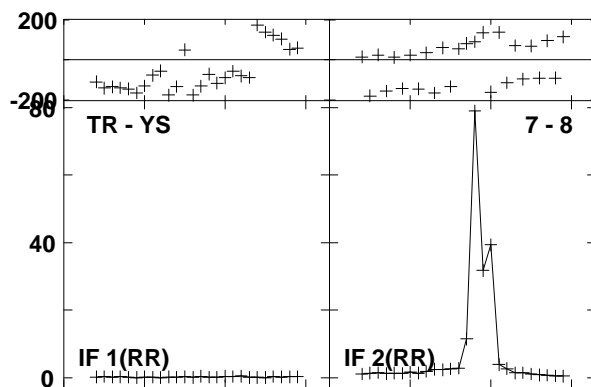
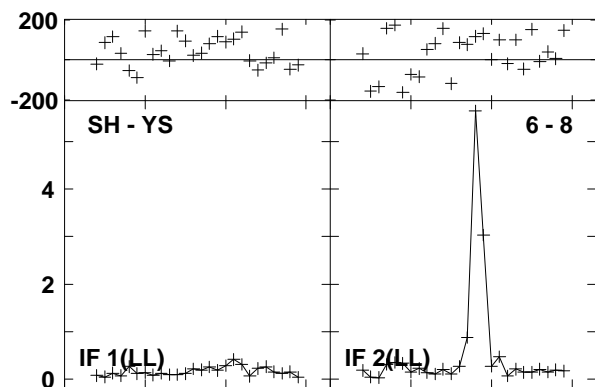
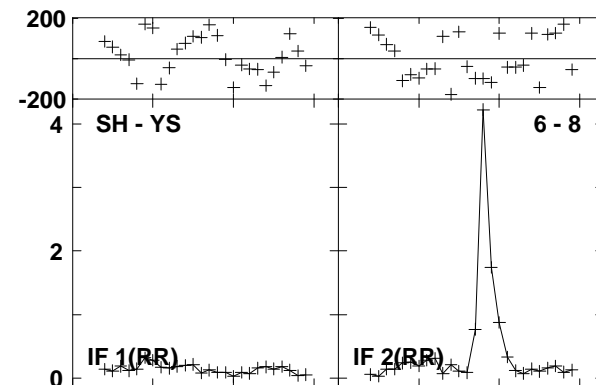
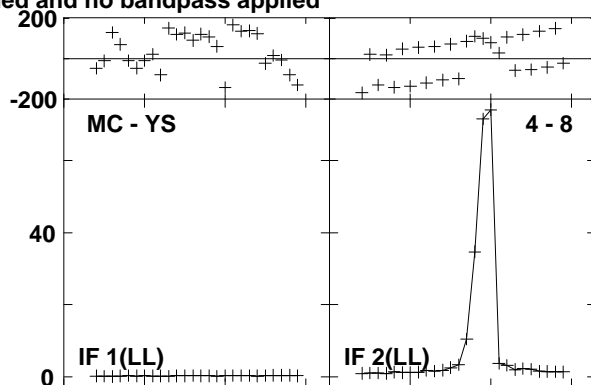
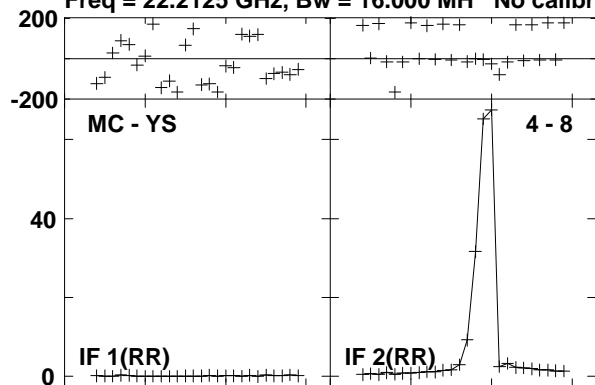

Lower frame: Milli Ampl Jy Top frame: Phas deg  
Vector averaged cross-power spectrum Baseline: MC (04) - YS (08)  
Timerange: 00/07:34:37 to 00/07:35:34

Plot file version 7 created 23-AUG-2016 15:00:40

0219+628 GA035B 1.UVDATA.1

Freq = 22.2125 GHz, Bw = 16.000 MH No calibration applied and no bandpass applied

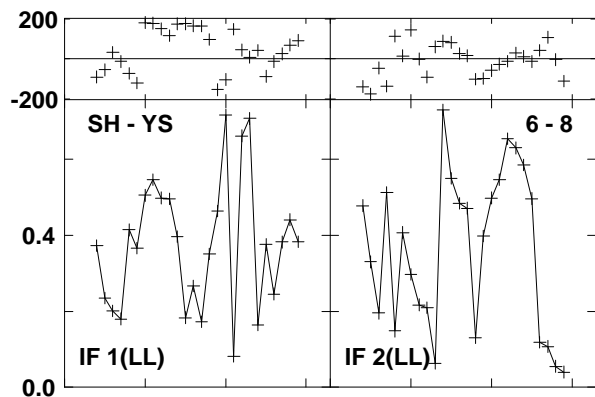
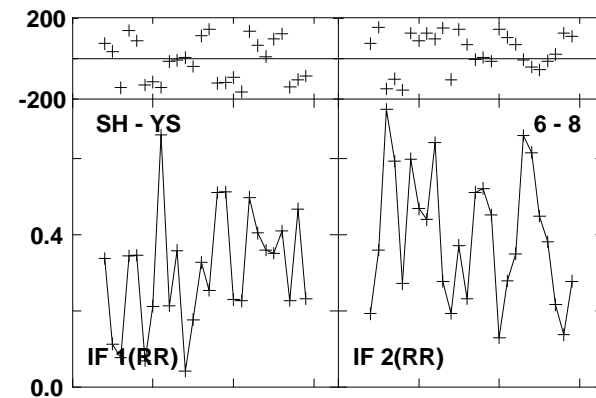
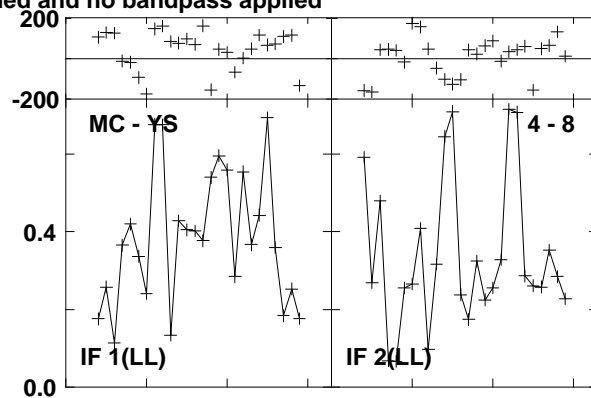
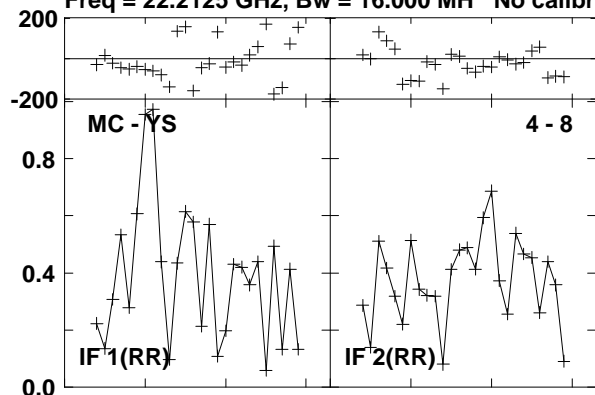

Lower frame: Milli Ampl Jy Top frame: Phas deg  
Vector averaged cross-power spectrum Baseline: MC (04) - YS (08)  
Timerange: 00/07:36:02 to 00/07:36:19

Plot file version 8 created 23-AUG-2016 15:00:40  
W3IRS5 GA035B 1.UVDATA.1

Freq = 22.2125 GHz, Bw = 16.000 MH No calibration applied and no bandpass applied

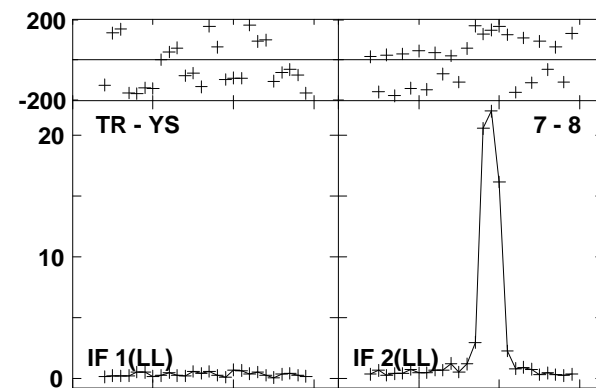
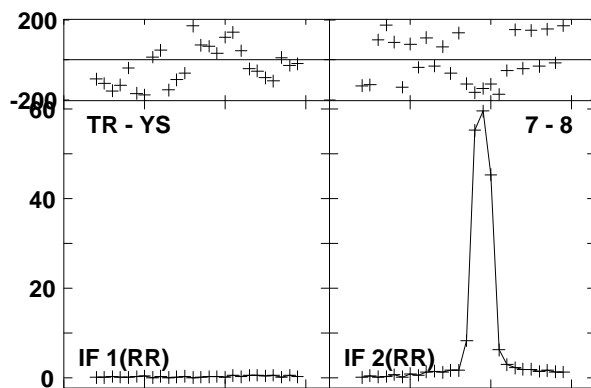
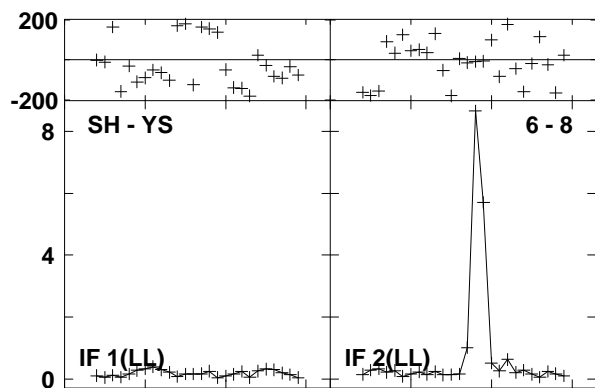
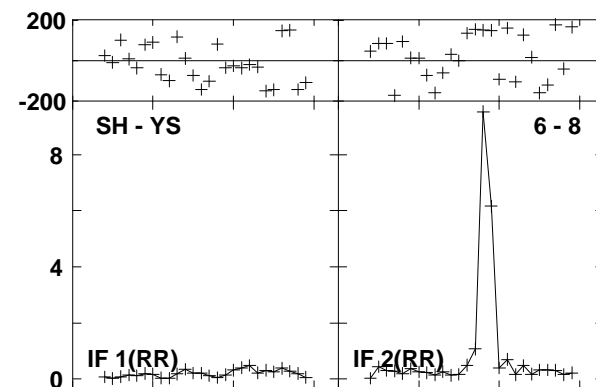
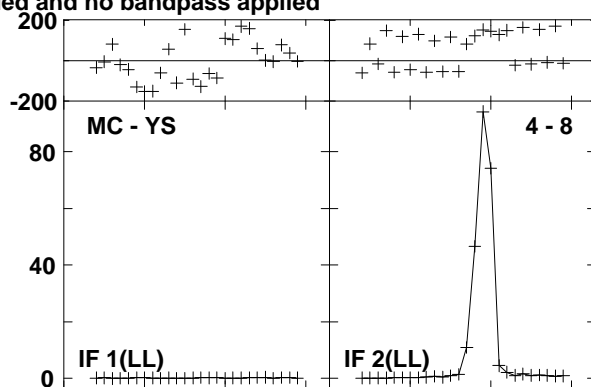
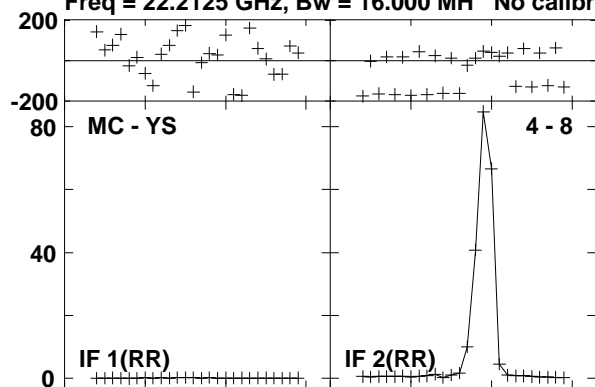

Lower frame: Milli Ampl Jy Top frame: Phas deg  
Vector averaged cross-power spectrum Baseline: MC (04) - YS (08)  
Timerange: 00/07:36:47 to 00/07:37:45



Plot file version 9 created 23-AUG-2016 15:00:40

0219+628 GA035B 1.UVDATA.1

Freq = 22.2125 GHz, Bw = 16.000 MH No calibration applied and no bandpass applied

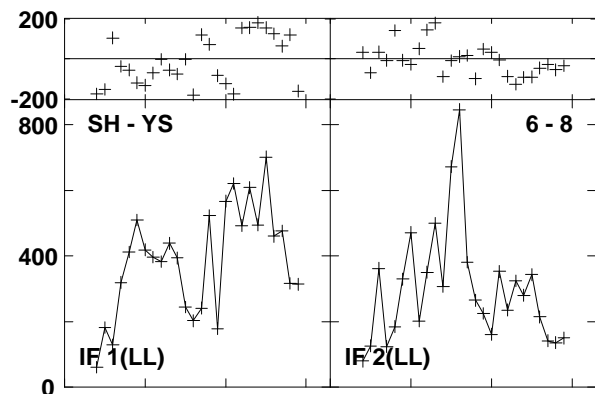
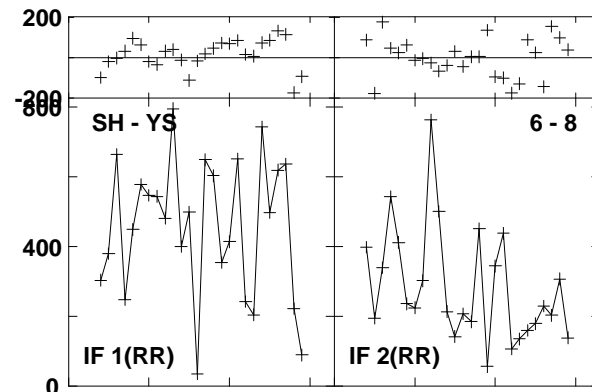
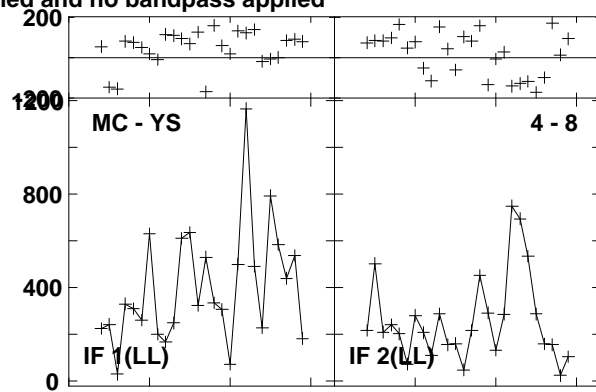
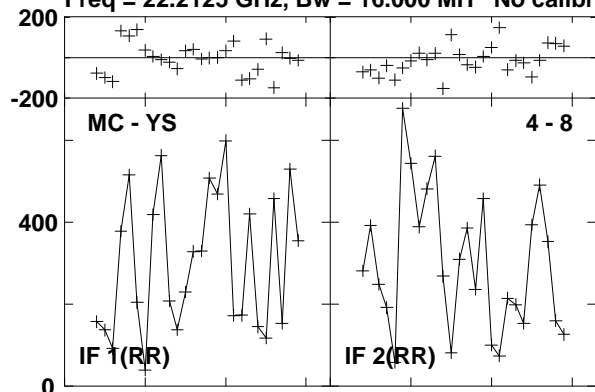

Lower frame: Micro Ampl Jy Top frame: Phas deg  
Vector averaged cross-power spectrum Baseline: MC (04) - YS (08)  
Timerange: 00/07:38:10 to 00/07:38:29

Plot file version 10 created 23-AUG-2016 15:00:40

W3IRS5 GA035B 1.UVDATA.1

Freq = 22.2125 GHz, Bw = 16.000 MH No calibration applied and no bandpass applied

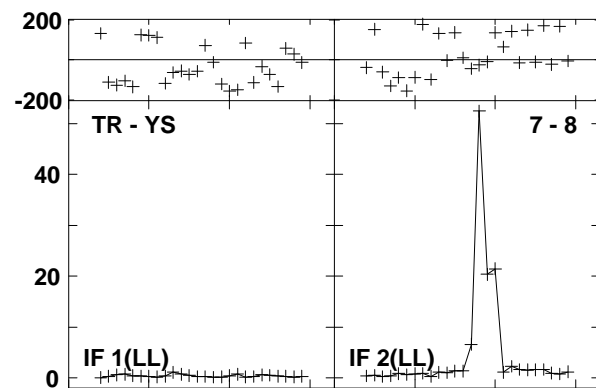
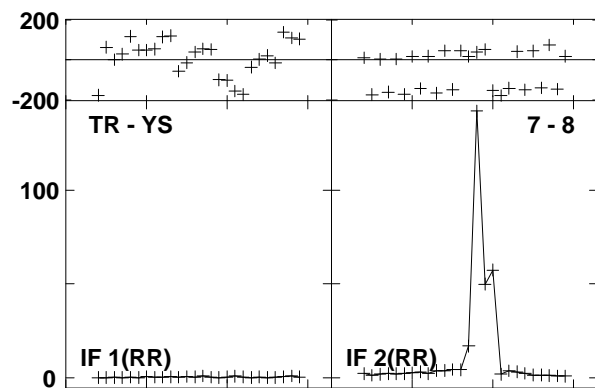
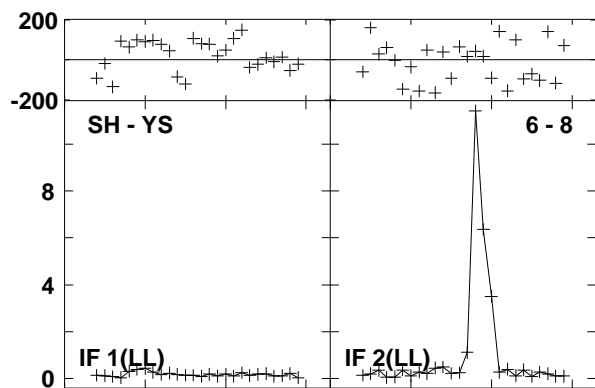
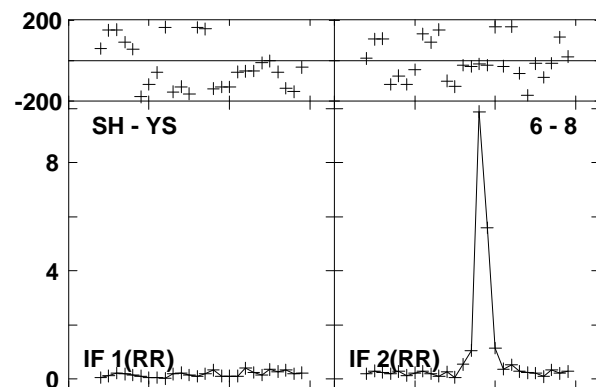
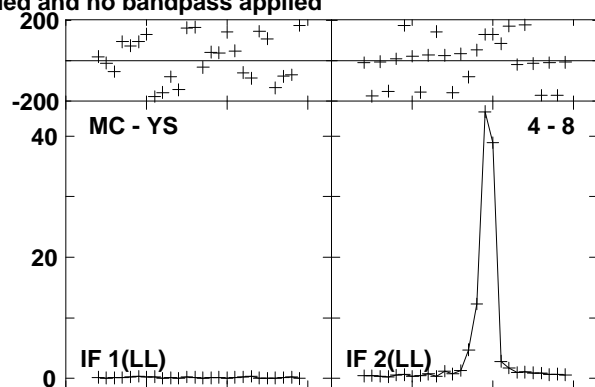
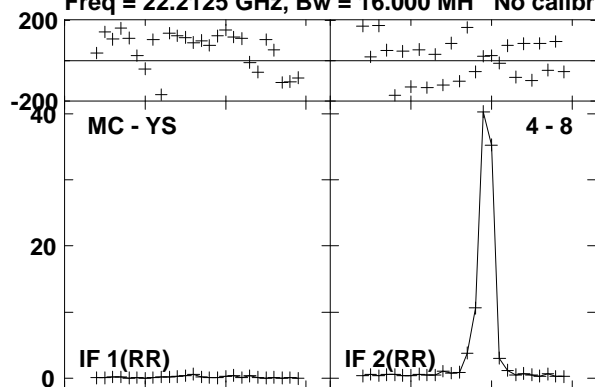

Lower frame: Milli Ampl Jy Top frame: Phas deg  
Vector averaged cross-power spectrum Baseline: MC (04) - YS (08)  
Timerange: 00/07:38:57 to 00/07:39:54

Plot file version 11 created 23-AUG-2016 15:00:40

0219+628 GA035B 1.UVDATA.1

Freq = 22.2125 GHz, Bw = 16.000 MH No calibration applied and no bandpass applied

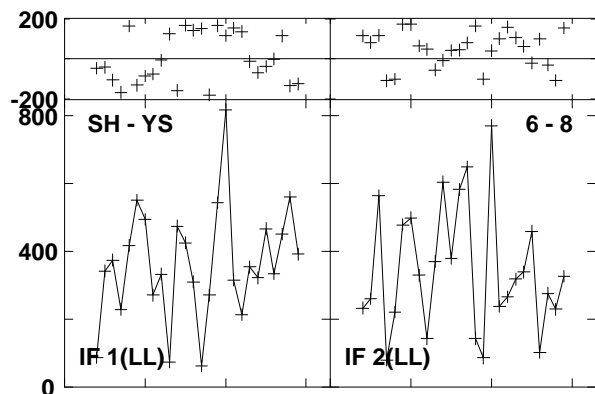
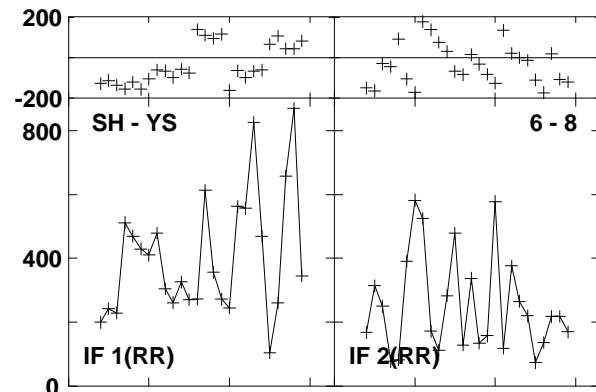
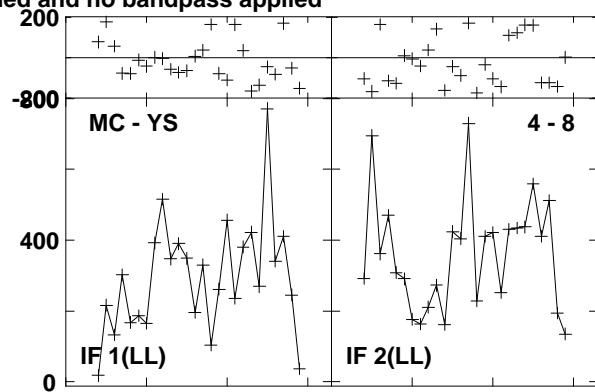
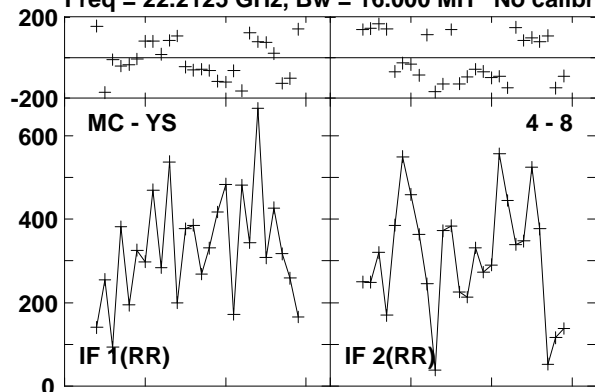

Lower frame: Micro Ampl Jy Top frame: Phas deg  
Vector averaged cross-power spectrum Baseline: MC (04) - YS (08)  
Timerange: 00/07:40:22 to 00/07:40:40

Plot file version 12 created 23-AUG-2016 15:00:40

W3IRS5 GA035B 1.UVDATA.1

Freq = 22.2125 GHz, Bw = 16.000 MH No calibration applied and no bandpass applied

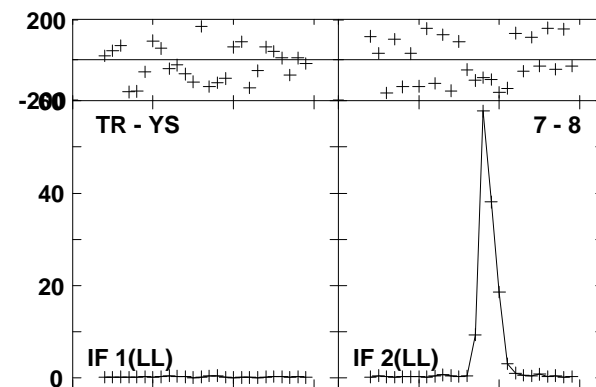
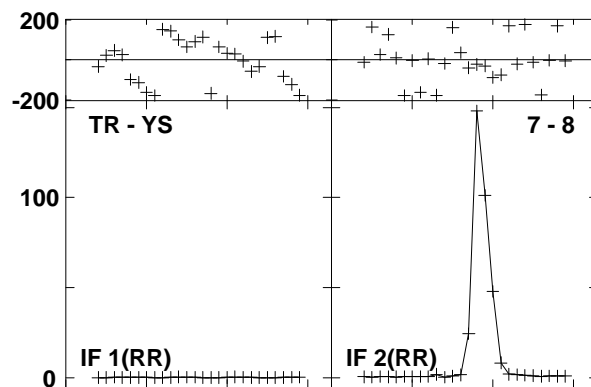
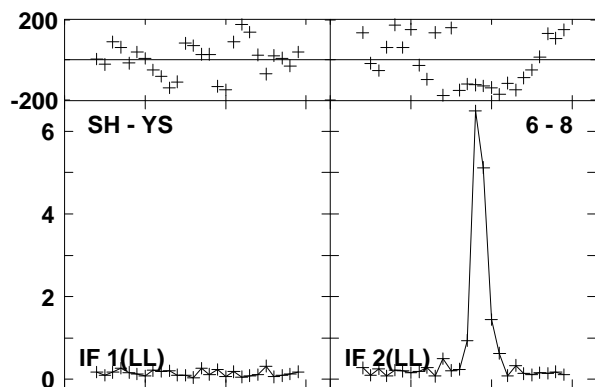
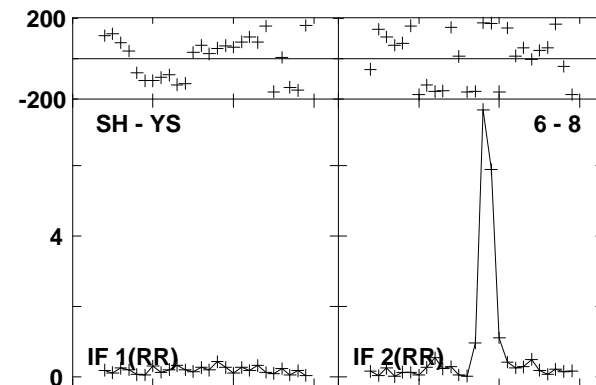
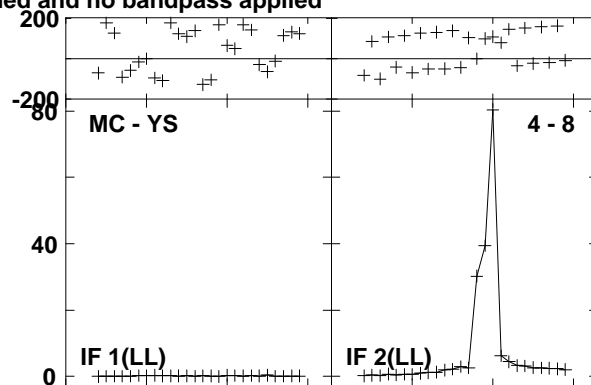
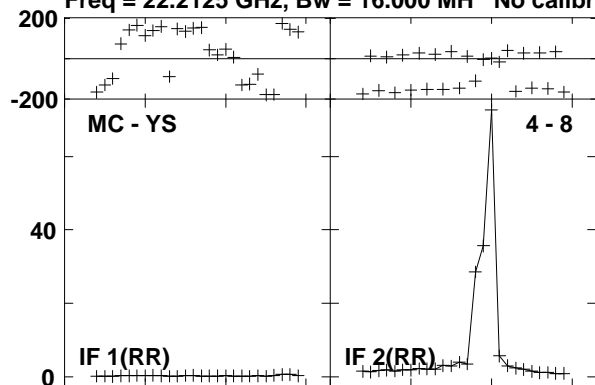

Lower frame: Milli Ampl Jy Top frame: Phas deg  
Vector averaged cross-power spectrum Baseline: MC (04) - YS (08)  
Timerange: 00/07:41:07 to 00/07:42:05

Plot file version 13 created 23-AUG-2016 15:00:40

0219+628 GA035B 1.UVDATA.1

Freq = 22.2125 GHz, Bw = 16.000 MH No calibration applied and no bandpass applied

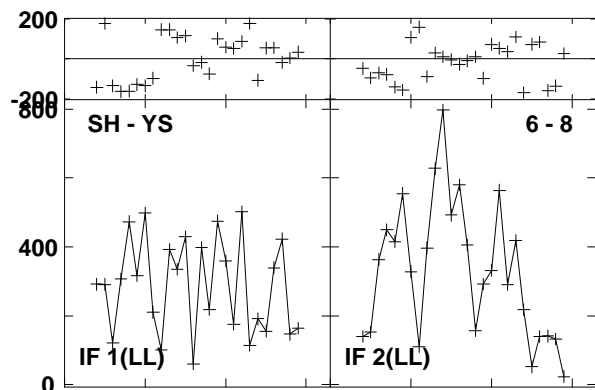
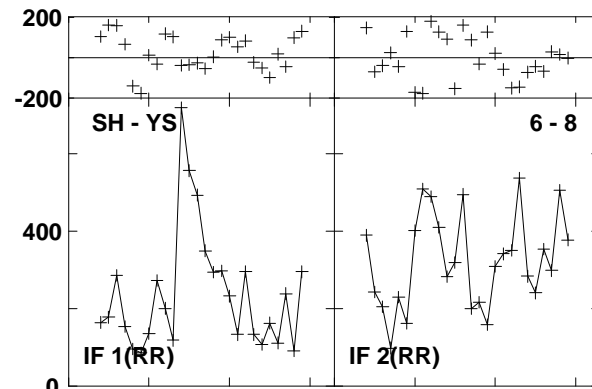
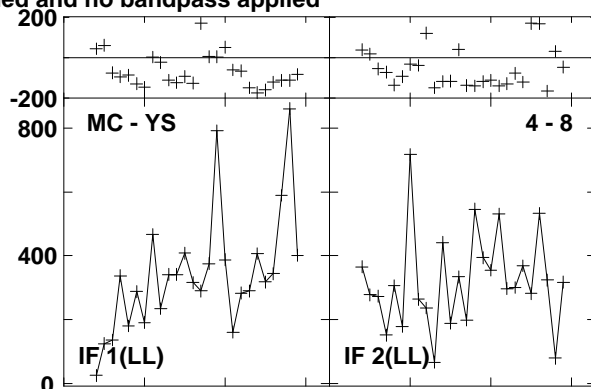
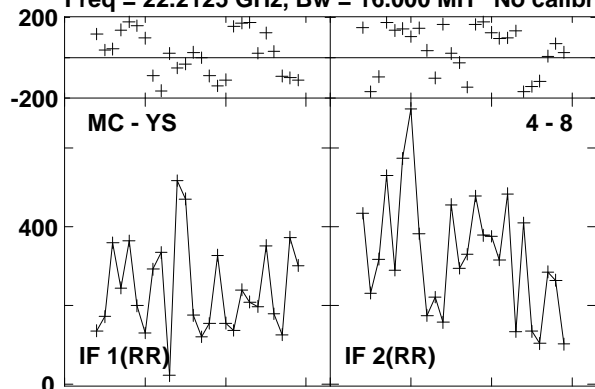

Lower frame: Micro Ampl Jy Top frame: Phas deg  
Vector averaged cross-power spectrum Baseline: MC (04) - YS (08)  
Timerange: 00/07:42:32 to 00/07:42:49

Plot file version 14 created 23-AUG-2016 15:00:41

2021+614 GA035B 1.UVDATA.1

Freq = 22.2125 GHz, Bw = 16.000 MH No calibration applied and no bandpass applied

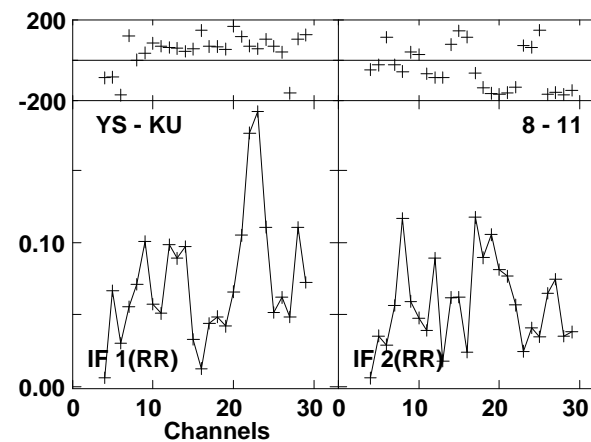
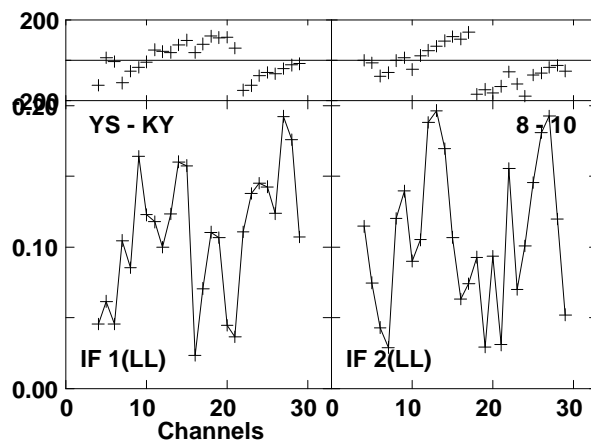
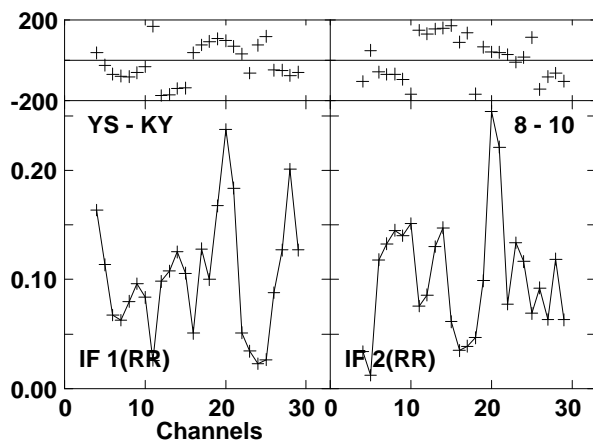
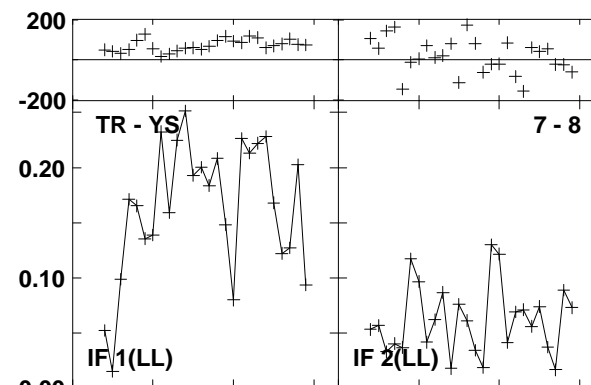
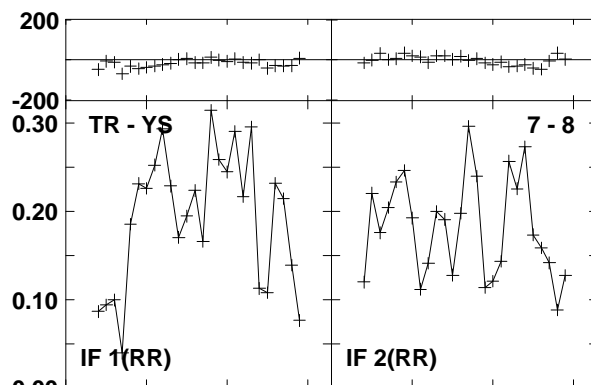
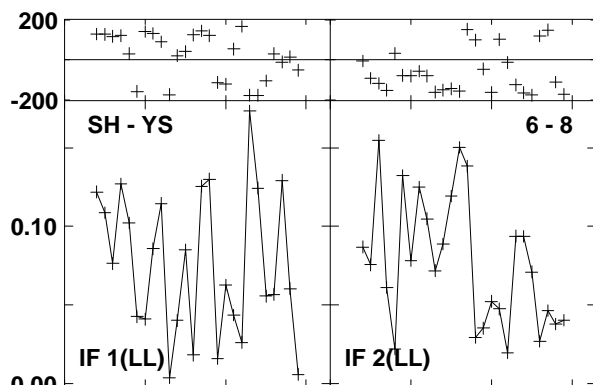
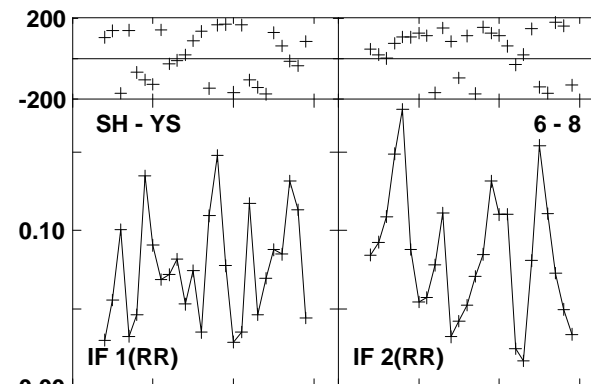
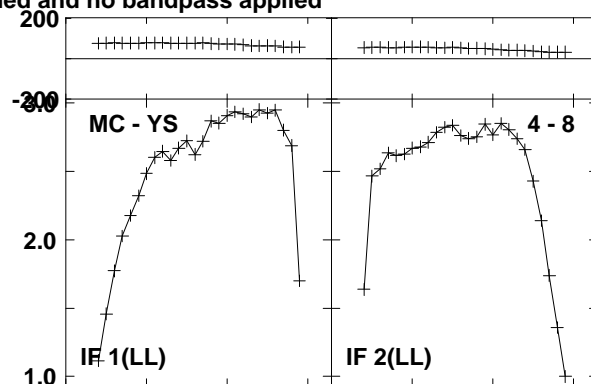
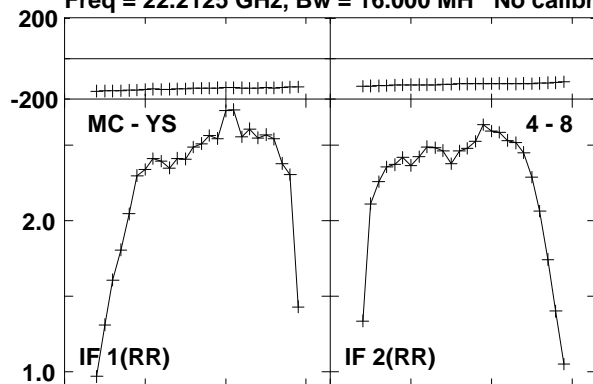

Lower frame: Milli Ampl Jy Top frame: Phas deg  
Vector averaged cross-power spectrum Baseline: MC (04) - YS (08)  
Timerange: 00/07:45:21 to 00/07:50:39

Plot file version 15 created 23-AUG-2016 15:00:41

2021+614 GA035B 1.UVDATA.1

Freq = 22.2125 GHz, Bw = 16.000 MH No calibration applied and no bandpass applied

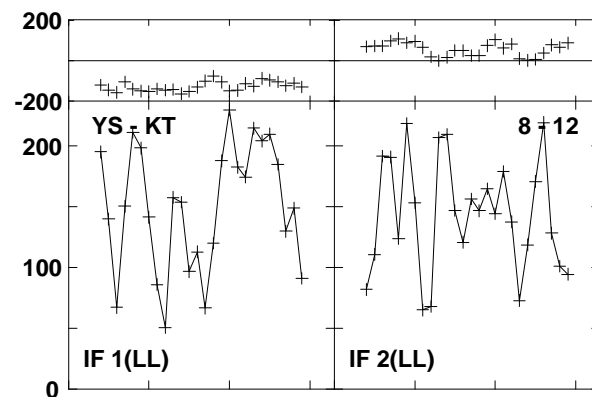
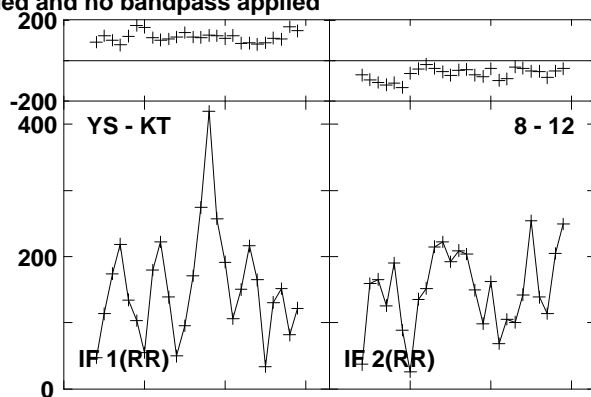
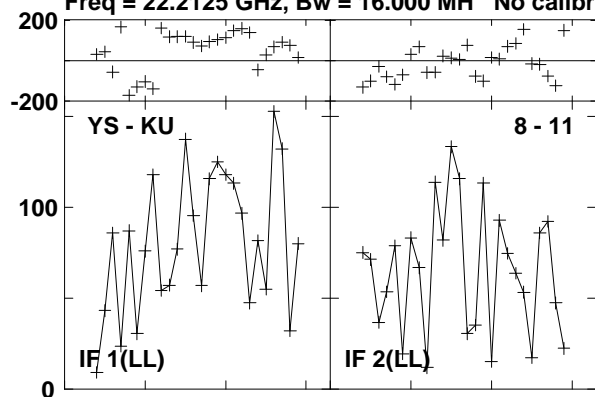

Lower frame: Micro Ampl Jy Top frame: Phas deg  
Vector averaged cross-power spectrum Baseline: YS (08) - KU (11)  
Timerange: 00/07:45:21 to 00/07:50:39

Plot file version 16 created 23-AUG-2016 15:00:41

0241+622 GA035B 1.UVDATA.1

Freq = 22.2125 GHz, Bw = 16.000 MH No calibration applied and no bandpass applied

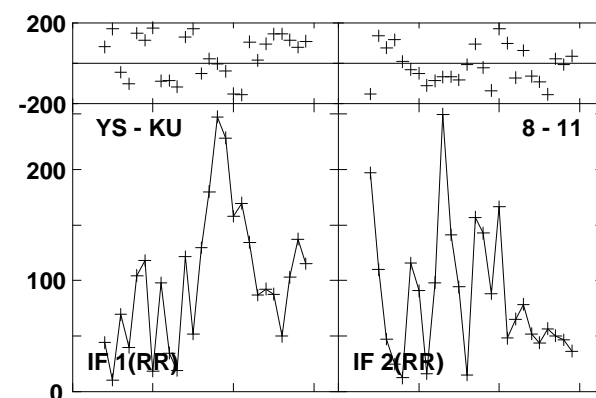
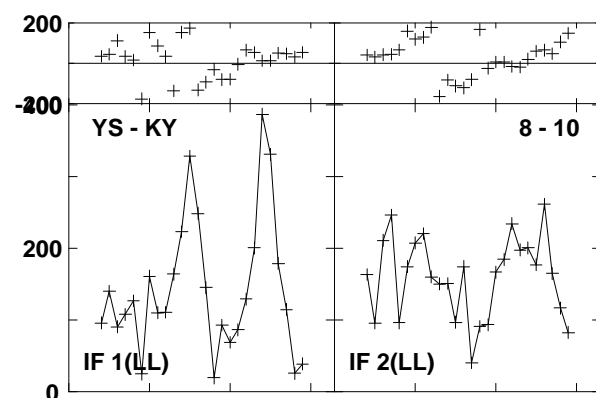
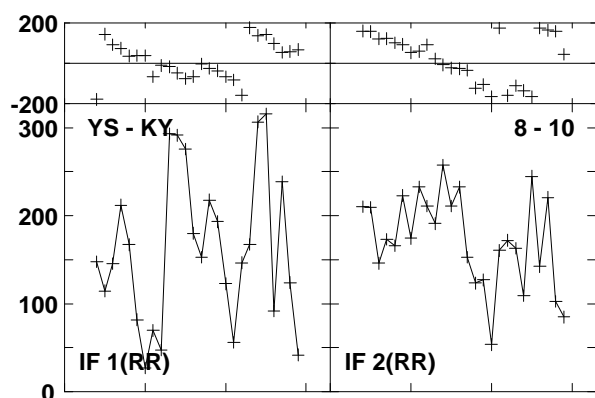
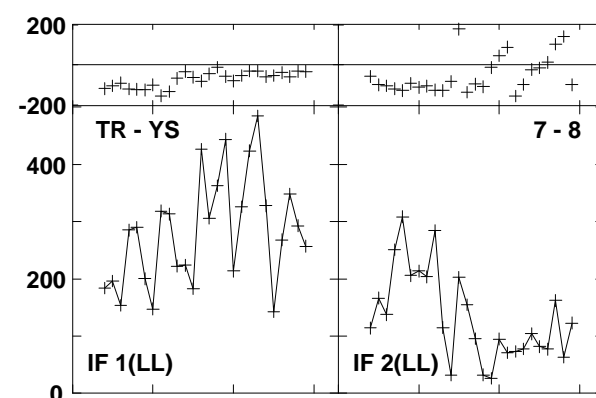
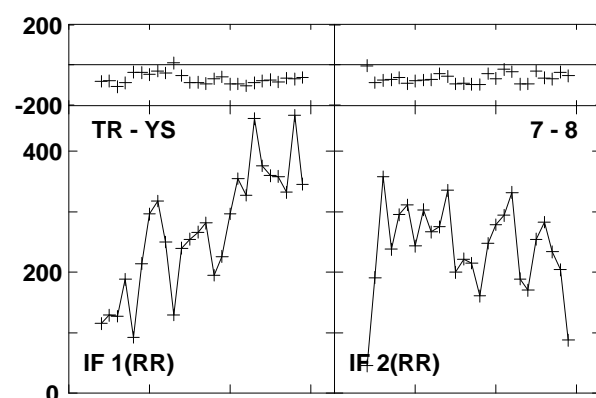
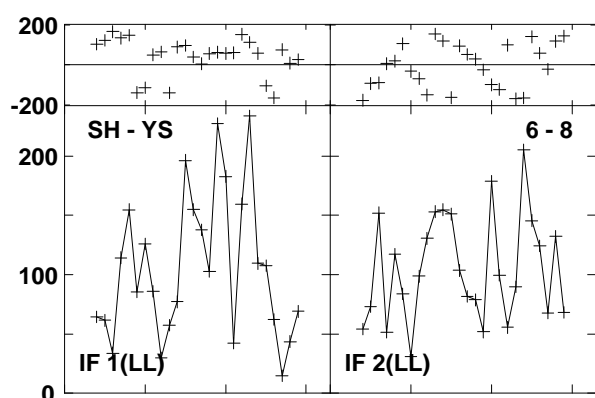
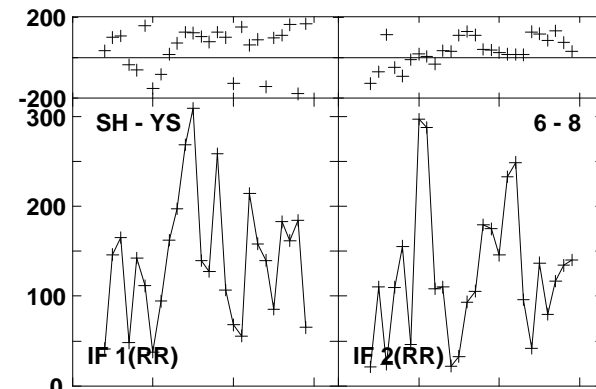
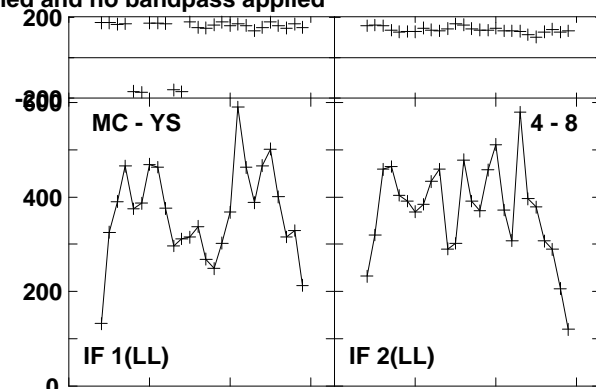
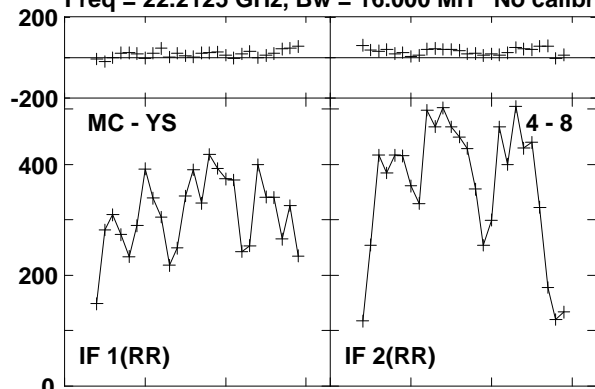

Lower frame: Micro Ampl Jy Top frame: Phas deg  
Vector averaged cross-power spectrum Baseline: MC (04) - YS (08)  
Timerange: 00/07:53:16 to 00/07:55:16



Plot file version 17 created 23-AUG-2016 15:00:41

0241+622 GA035B 1.UVDATA.1

Freq = 22.2125 GHz, Bw = 16.000 MH No calibration applied and no bandpass applied

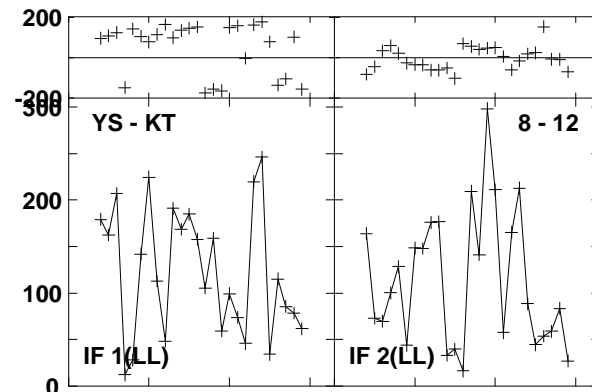
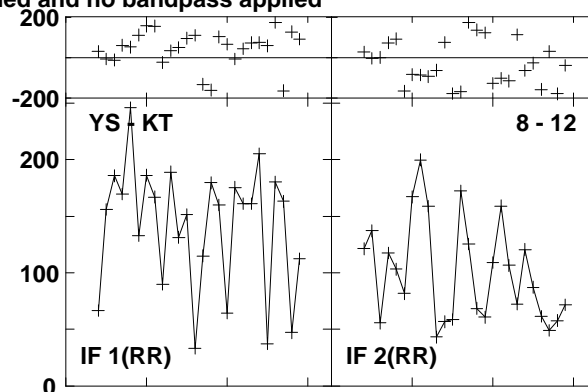
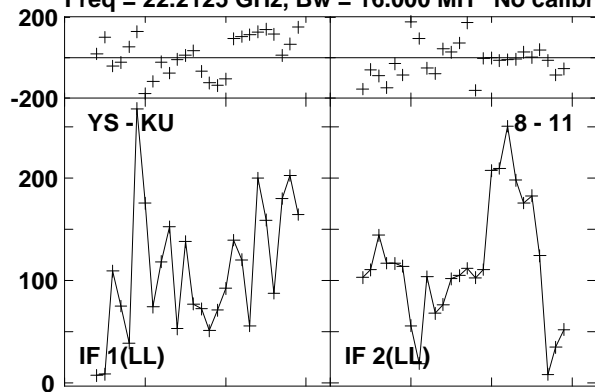

Lower frame: Micro Ampl Jy Top frame: Phas deg  
Vector averaged cross-power spectrum Baseline: YS (08) - KU (11)  
Timerange: 00/07:53:16 to 00/07:55:16

Plot file version 18 created 23-AUG-2016 15:00:41

W3IRS5 GA035B 1.UVDATA.1

Freq = 22.2125 GHz, Bw = 16.000 MH No calibration applied and no bandpass applied

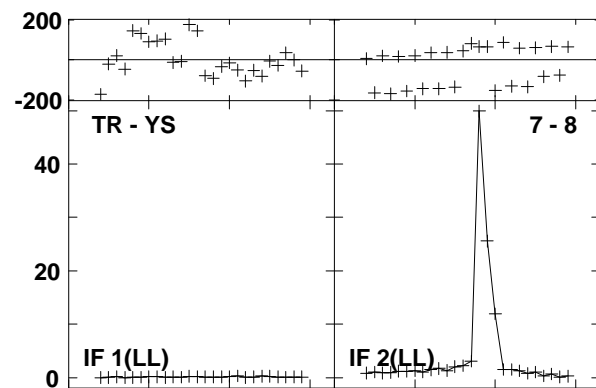
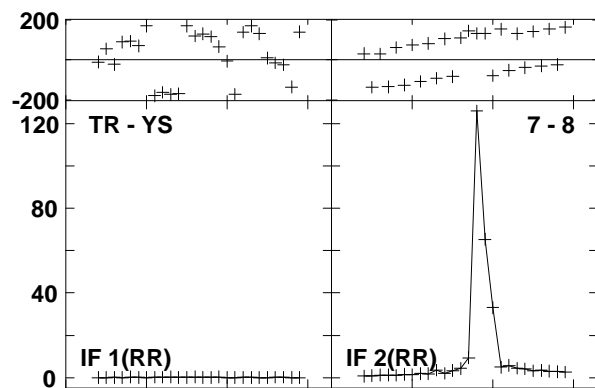
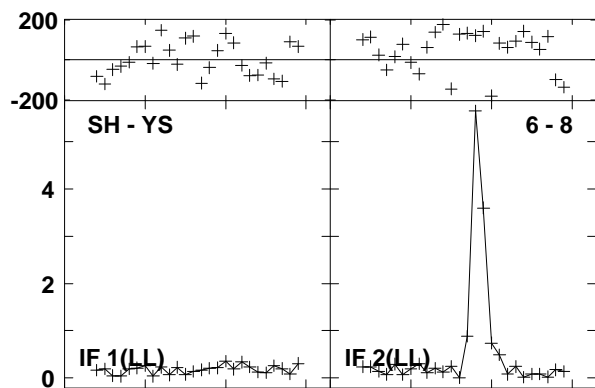
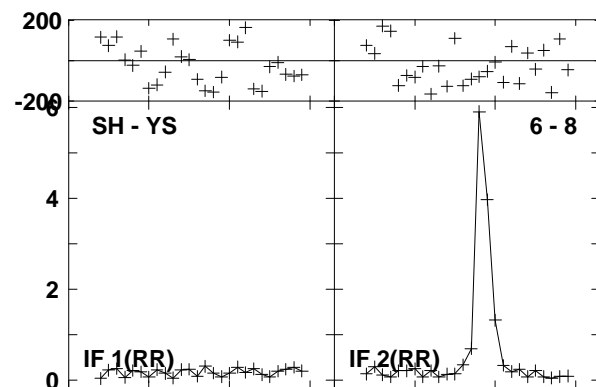
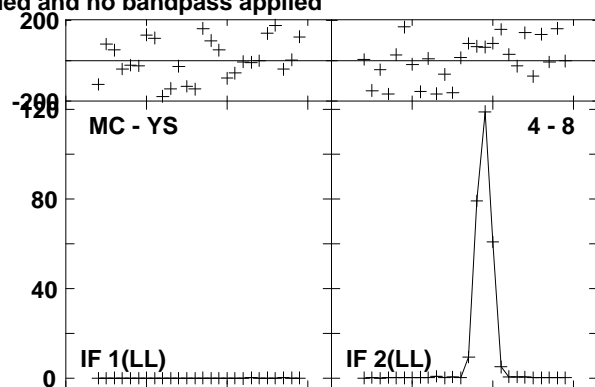
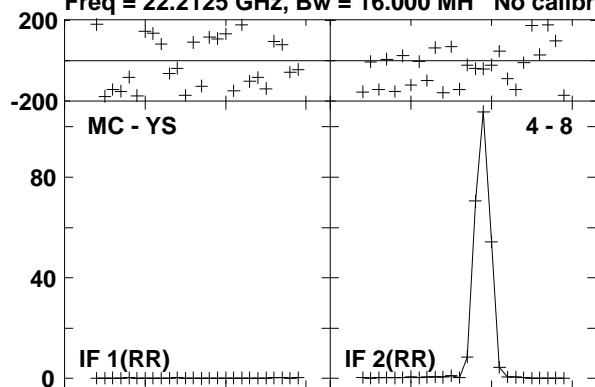

Lower frame: Milli Ampl Jy Top frame: Phas deg  
Vector averaged cross-power spectrum Baseline: MC (04) - YS (08)  
Timerange: 00/07:55:58 to 00/07:56:56

Plot file version 19 created 23-AUG-2016 15:00:41

0219+628 GA035B 1.UVDATA.1

Freq = 22.2125 GHz, Bw = 16.000 MH No calibration applied and no bandpass applied

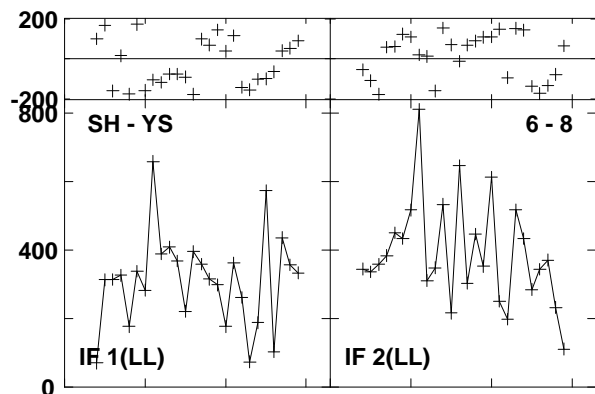
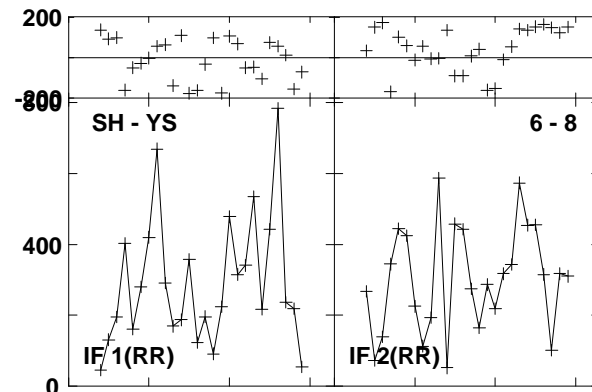
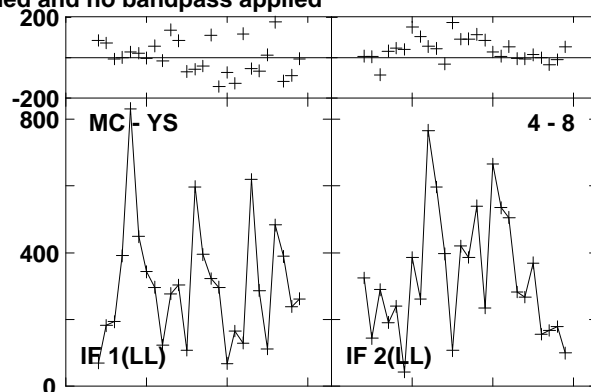
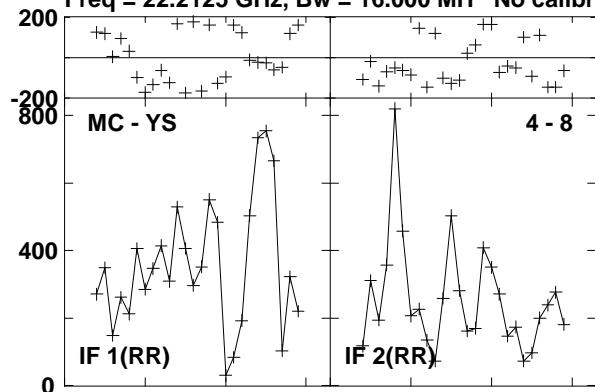

Lower frame: Micro Ampl Jy Top frame: Phas deg  
Vector averaged cross-power spectrum Baseline: MC (04) - YS (08)  
Timerange: 00/07:57:23 to 00/07:57:40

Plot file version 20 created 23-AUG-2016 15:00:41  
W3IRS5 GA035B 1.UVDATA.1

Freq = 22.2125 GHz, Bw = 16.000 MH No calibration applied and no bandpass applied

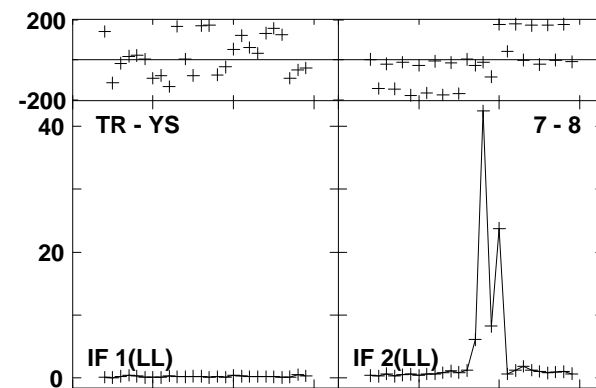
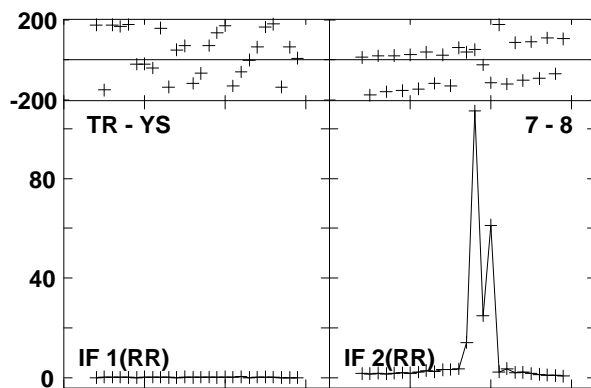
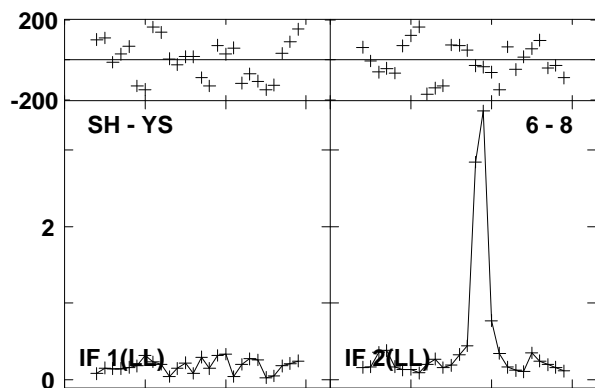
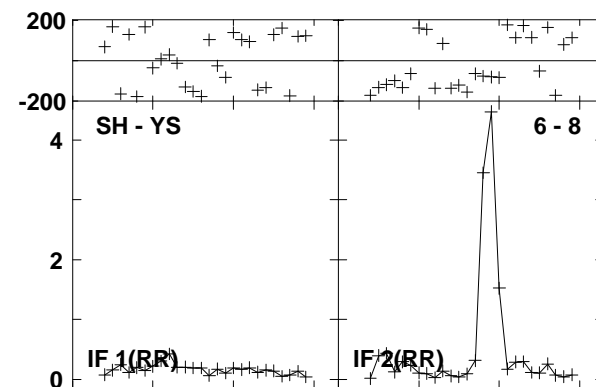
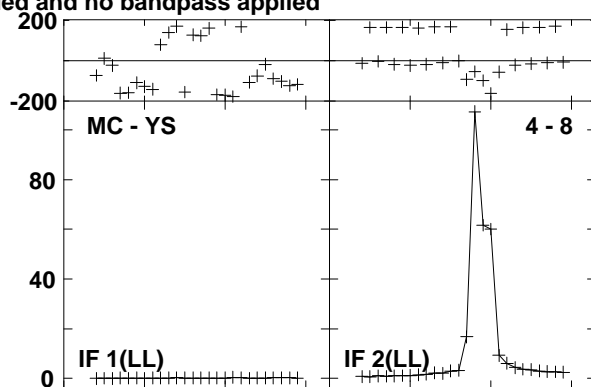
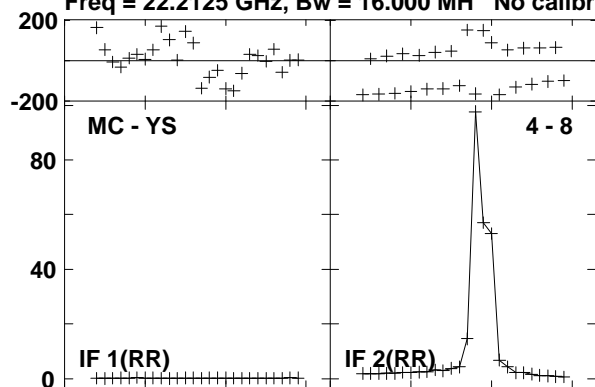

Lower frame: Milli Ampl Jy Top frame: Phas deg  
Vector averaged cross-power spectrum Baseline: MC (04) - YS (08)  
Timerange: 00/07:58:08 to 00/07:59:05

Plot file version 21 created 23-AUG-2016 15:00:41

0219+628 GA035B 1.UVDATA.1

Freq = 22.2125 GHz, Bw = 16.000 MH No calibration applied and no bandpass applied

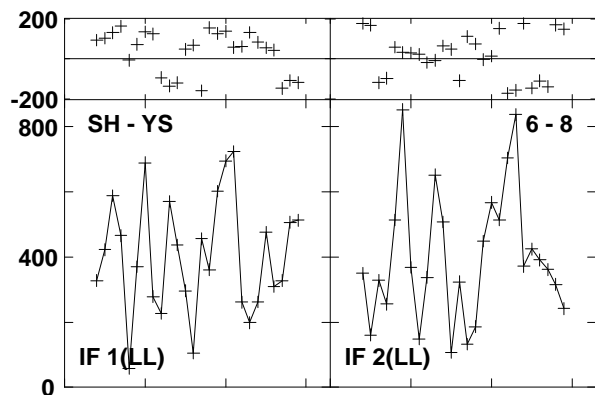
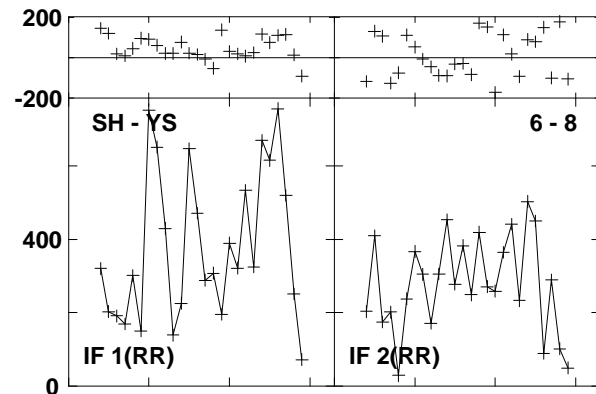
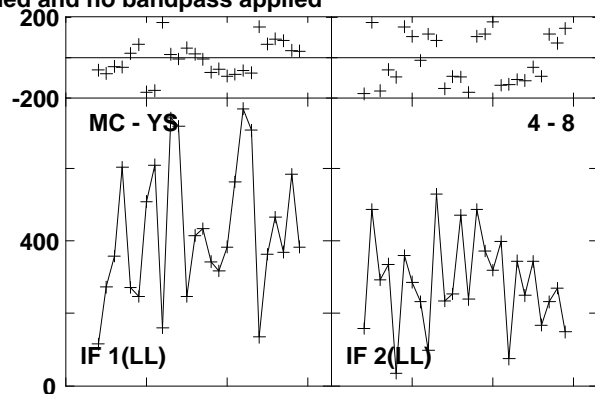
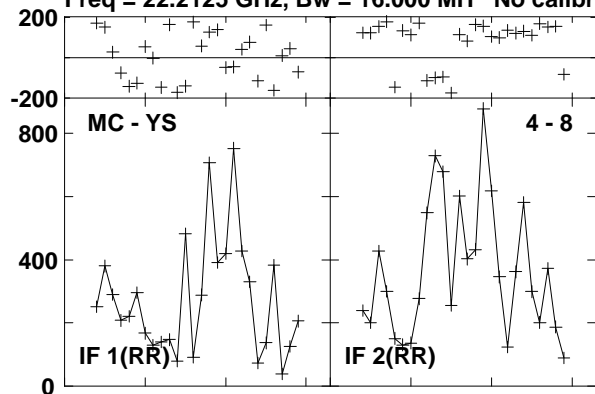

Lower frame: Micro Ampl Jy Top frame: Phas deg  
Vector averaged cross-power spectrum Baseline: MC (04) - YS (08)  
Timerange: 00/07:59:32 to 00/07:59:51

Plot file version 22 created 23-AUG-2016 15:00:41

W3IRS5 GA035B 1.UVDATA.1

Freq = 22.2125 GHz, Bw = 16.000 MH No calibration applied and no bandpass applied

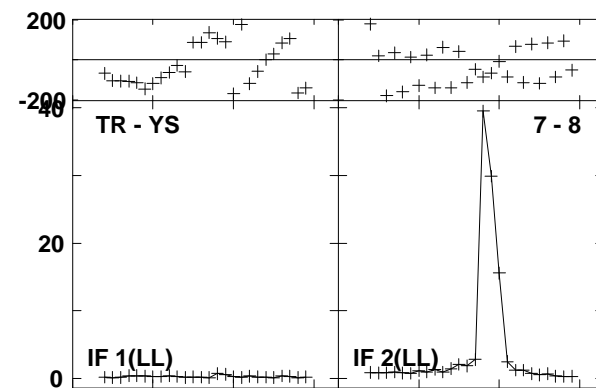
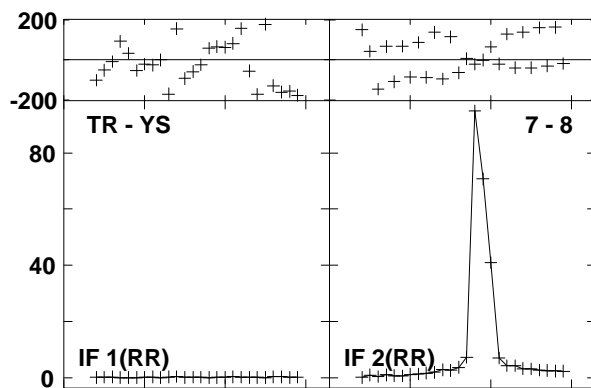
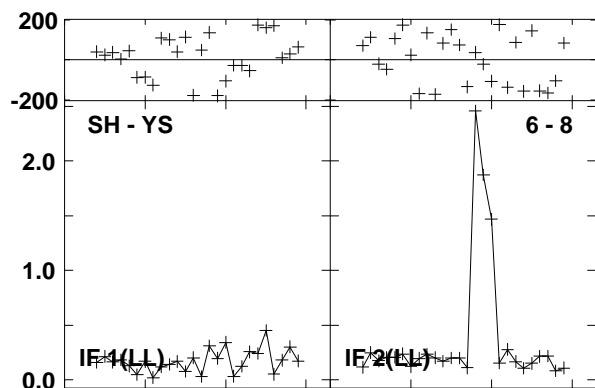
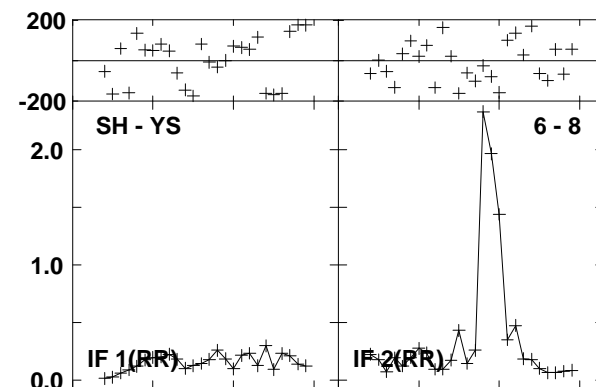
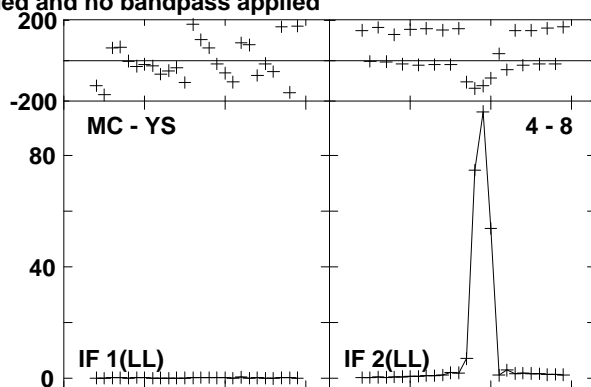
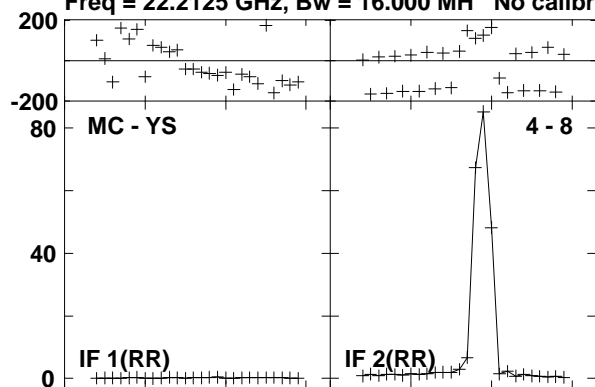

Lower frame: Milli Ampl Jy Top frame: Phas deg  
Vector averaged cross-power spectrum Baseline: MC (04) - YS (08)  
Timerange: 00/08:00:18 to 00/08:01:16

Plot file version 23 created 23-AUG-2016 15:00:41

0219+628 GA035B 1.UVDATA.1

Freq = 22.2125 GHz, Bw = 16.000 MH No calibration applied and no bandpass applied

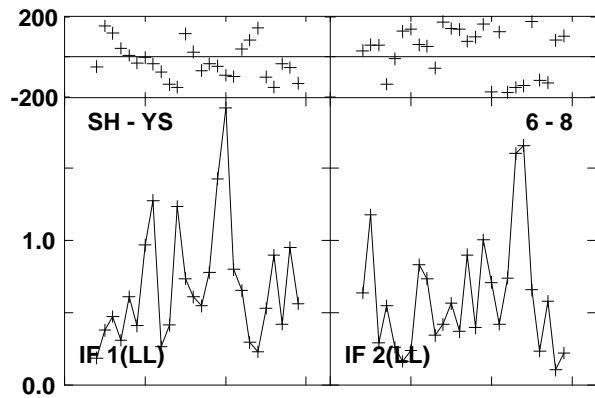
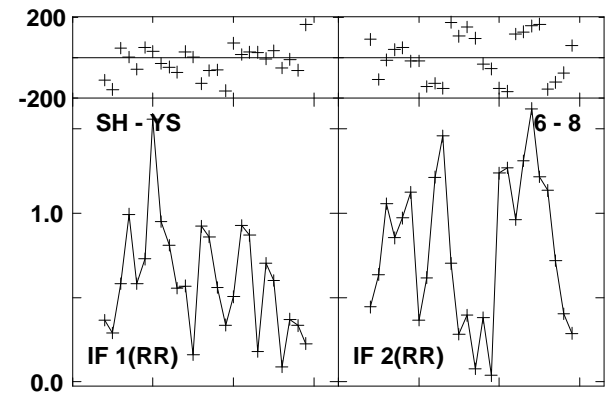
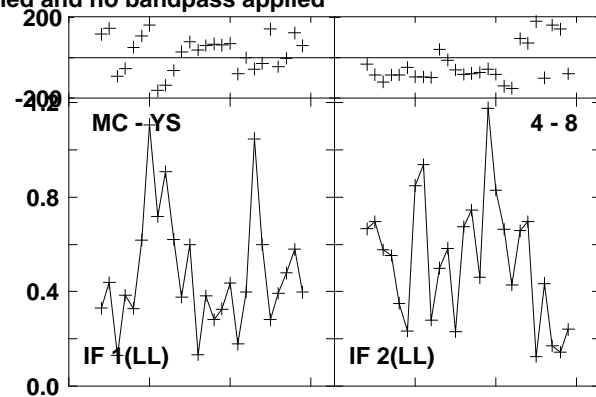
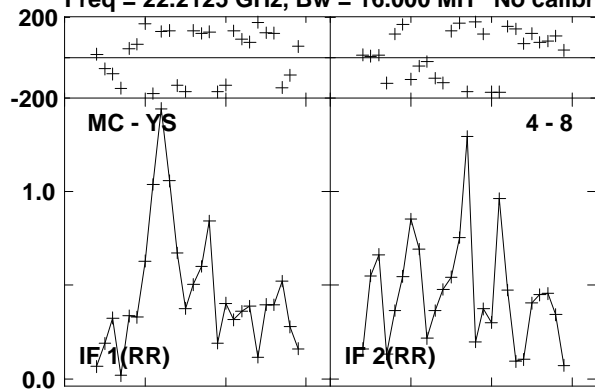

Lower frame: Milli Ampl Jy Top frame: Phas deg  
Vector averaged cross-power spectrum Baseline: MC (04) - YS (08)  
Timerange: 00/08:01:43 to 00/08:02:00

Plot file version 24 created 23-AUG-2016 15:00:41

W3IRS5 GA035B 1.UVDATA.1

Freq = 22.2125 GHz, Bw = 16.000 MH No calibration applied and no bandpass applied

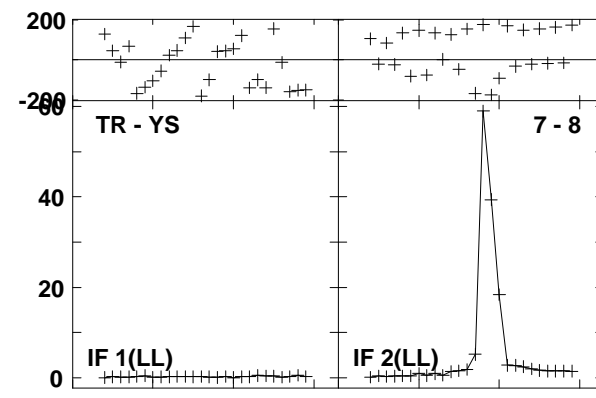
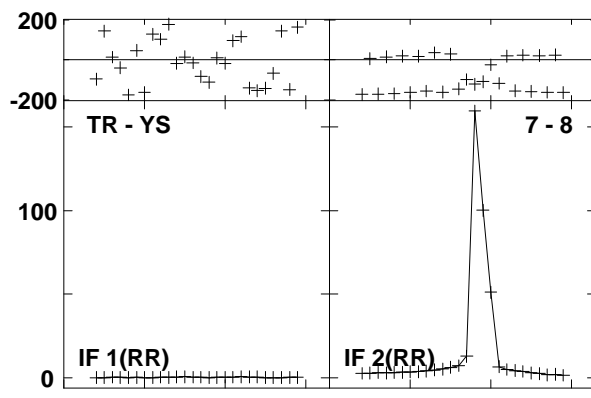
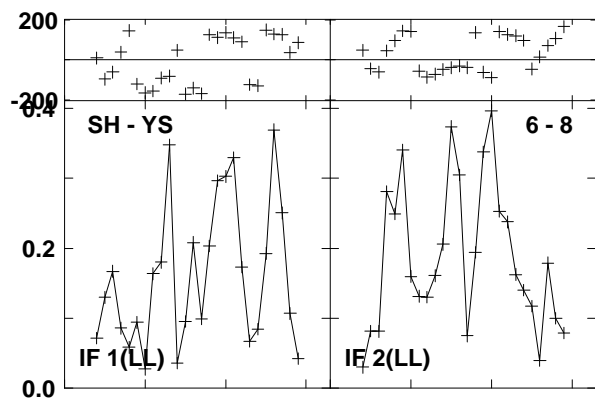
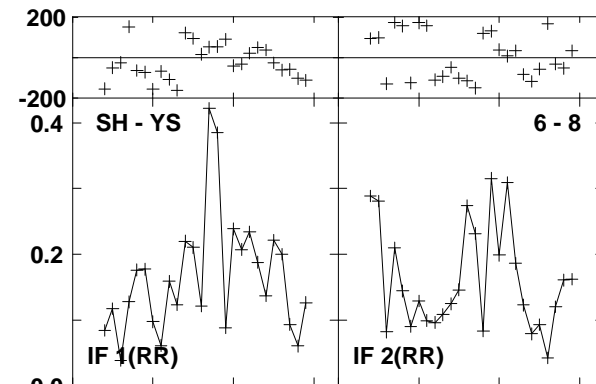
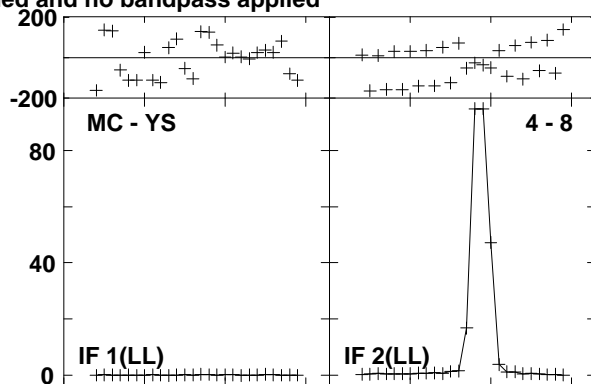
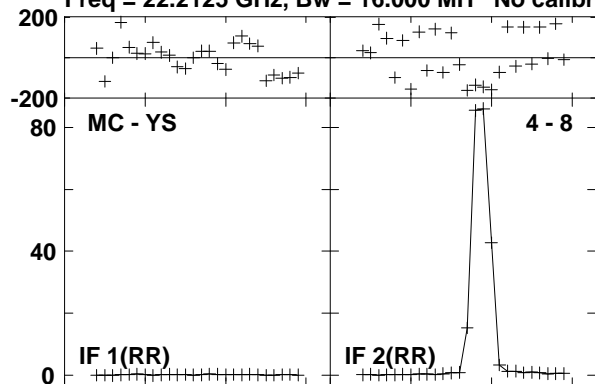

Lower frame: Milli Ampl Jy Top frame: Phas deg  
Vector averaged cross-power spectrum Baseline: MC (04) - YS (08)  
Timerange: 00/08:02:27 to 00/08:03:25



Plot file version 25 created 23-AUG-2016 15:00:41  
0219+628 GA035B 1.UVDATA.1

Freq = 22.2125 GHz, Bw = 16.000 MH No calibration applied and no bandpass applied

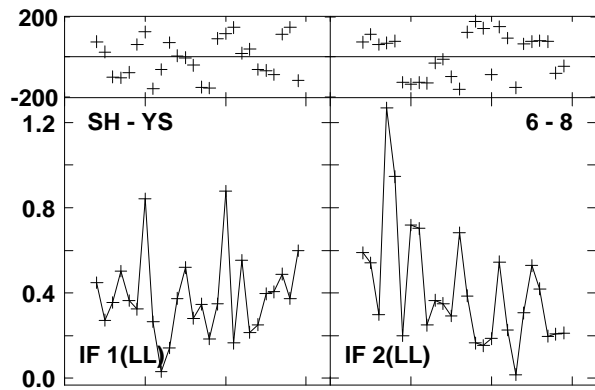
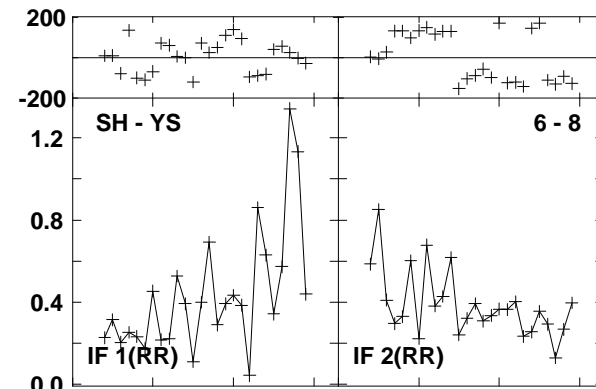
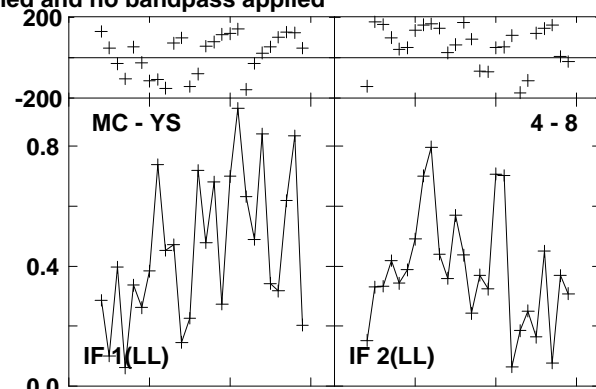
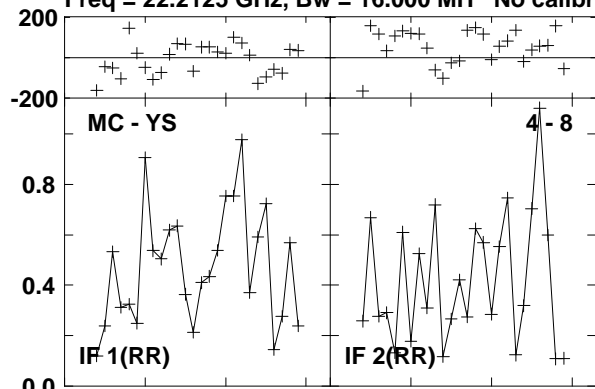

Lower frame: Milli Ampl Jy Top frame: Phas deg  
Vector averaged cross-power spectrum Baseline: MC (04) - YS (08)  
Timerange: 00/08:03:53 to 00/08:04:10

Plot file version 26 created 23-AUG-2016 15:00:41

W3IRS5 GA035B 1.UVDATA.1

Freq = 22.2125 GHz, Bw = 16.000 MH No calibration applied and no bandpass applied

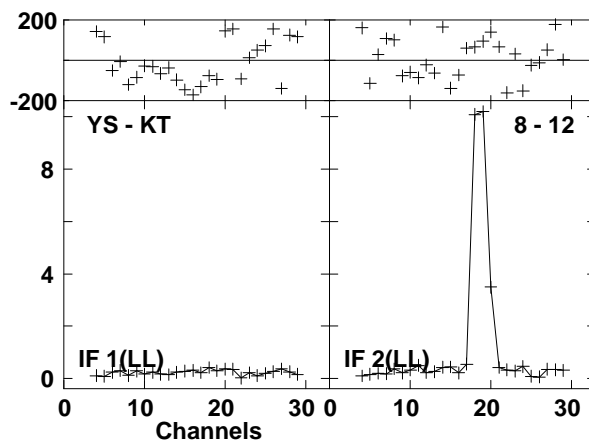
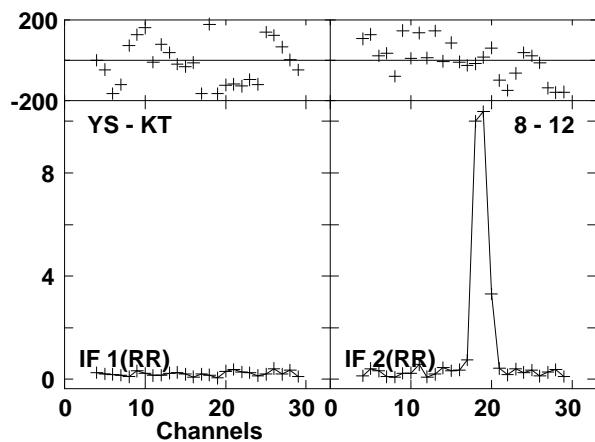
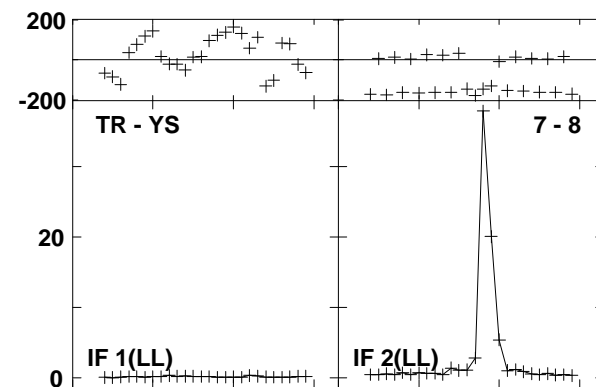
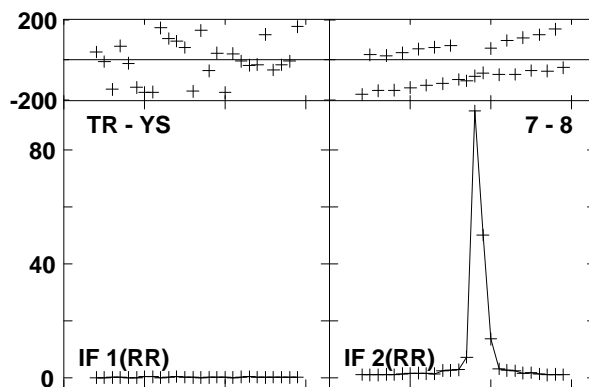
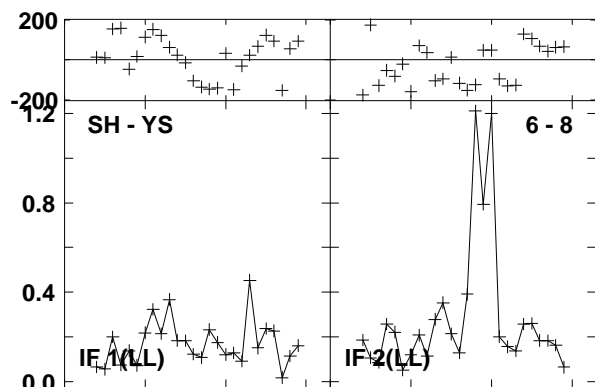
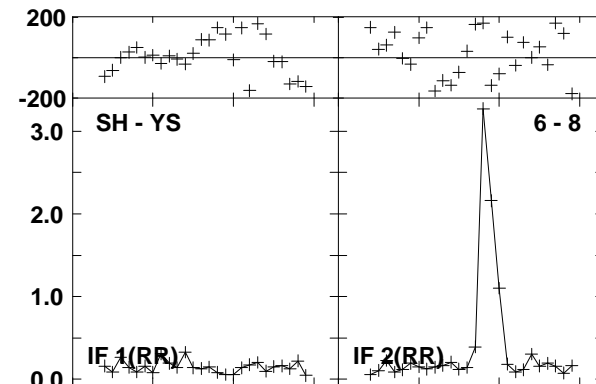
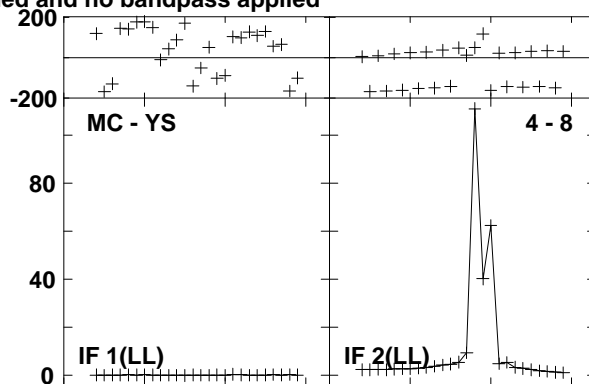
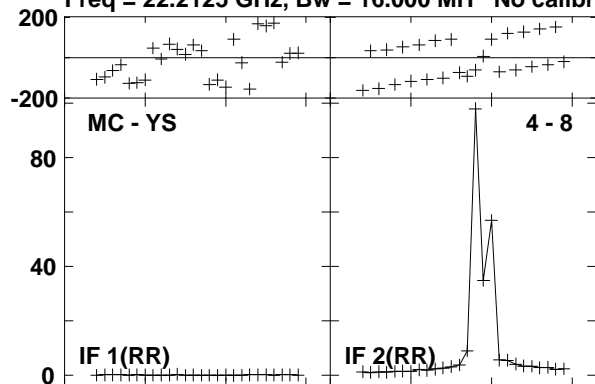

Lower frame: Milli Ampl Jy Top frame: Phas deg

Vector averaged cross-power spectrum Baseline: MC (04) - YS (08)

Timerange: 00/08:05:52 to 00/08:06:50

Plot file version 27 created 23-AUG-2016 15:00:41

0219+628 GA035B 1.UVDATA.1

Freq = 22.2125 GHz, Bw = 16.000 MH No calibration applied and no bandpass applied

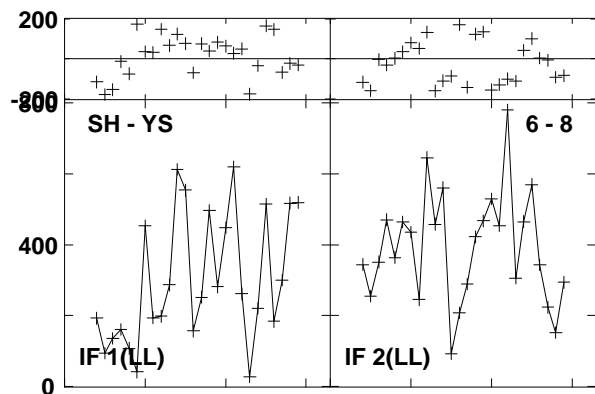
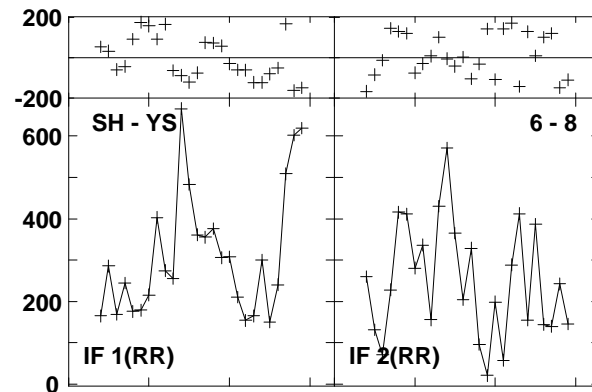
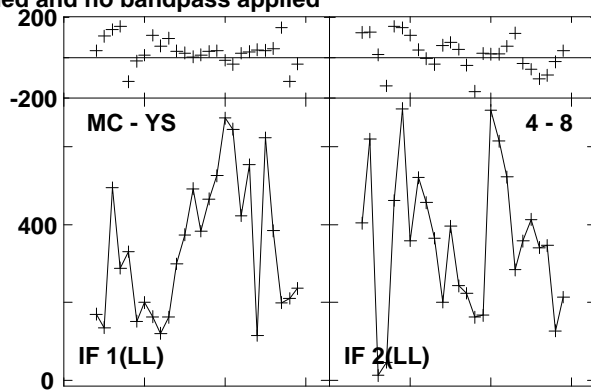
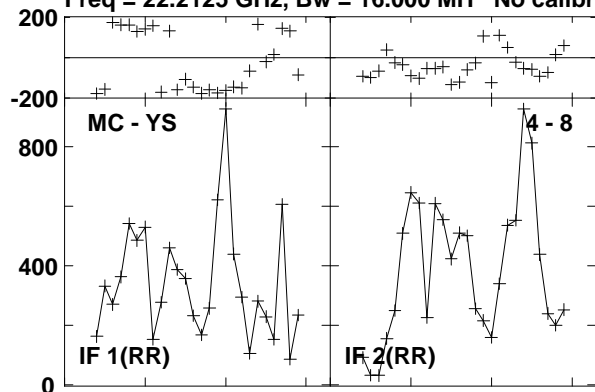

Lower frame: Micro Ampl Jy Top frame: Phas deg  
Vector averaged cross-power spectrum Baseline: MC (04) - YS (08)  
Timerange: 00/08:07:17 to 00/08:07:36

Plot file version 28 created 23-AUG-2016 15:00:41

W3IRS5 GA035B 1.UVDATA.1

Freq = 22.2125 GHz, Bw = 16.000 MH No calibration applied and no bandpass applied

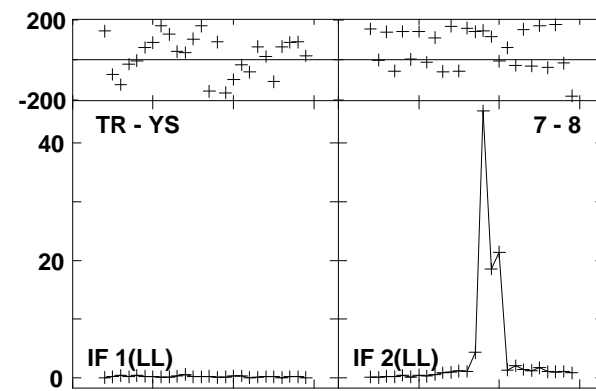
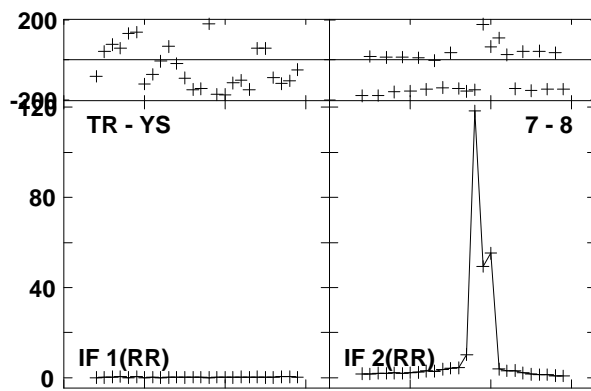
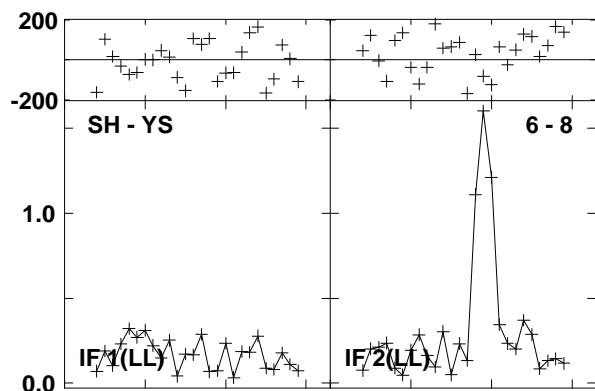
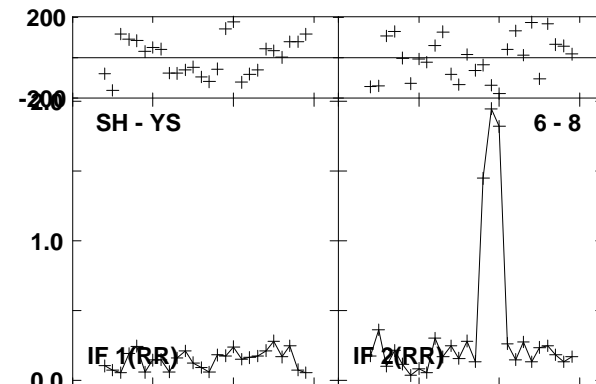
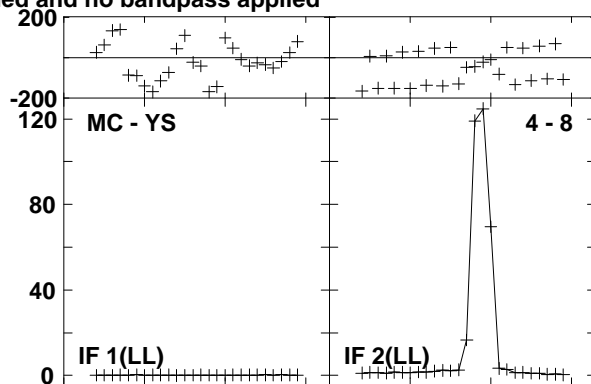
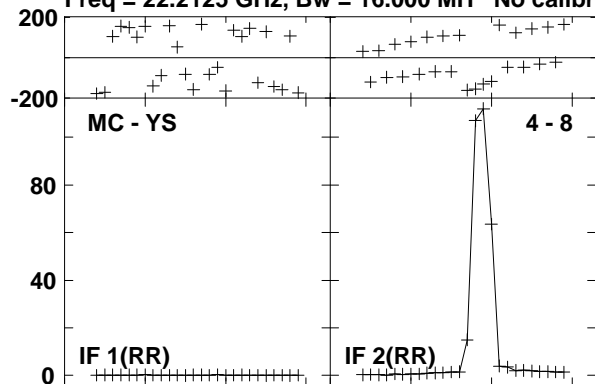

Lower frame: Milli Ampl Jy Top frame: Phas deg  
Vector averaged cross-power spectrum Baseline: MC (04) - YS (08)  
Timerange: 00/08:08:03 to 00/08:09:00

Plot file version 29 created 23-AUG-2016 15:00:41

0219+628 GA035B 1.UVDATA.1

Freq = 22.2125 GHz, Bw = 16.000 MH No calibration applied and no bandpass applied

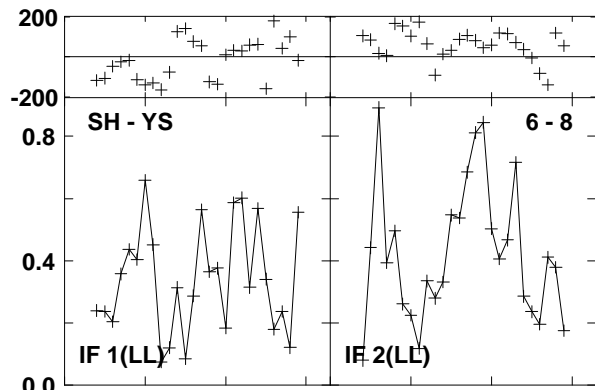
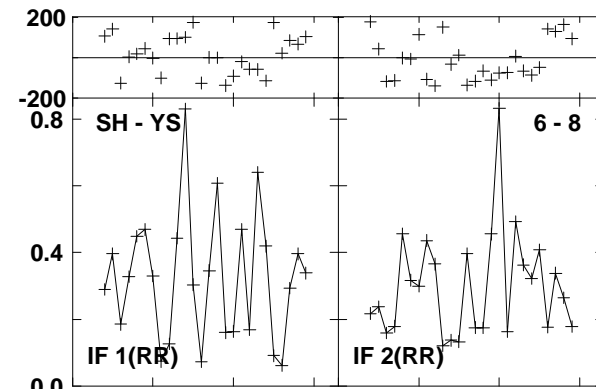
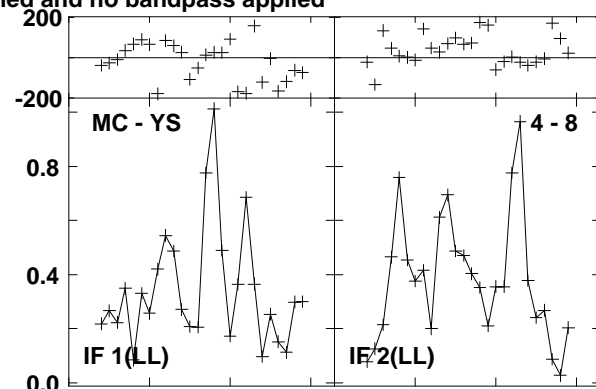
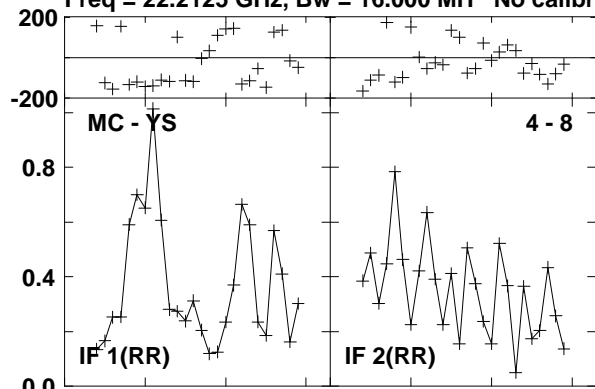

Lower frame: Milli Ampl Jy Top frame: Phas deg  
Vector averaged cross-power spectrum Baseline: MC (04) - YS (08)  
Timerange: 00/08:09:26 to 00/08:09:45

Plot file version 30 created 23-AUG-2016 15:00:41

W3IRS5 GA035B 1.UVDATA.1

Freq = 22.2125 GHz, Bw = 16.000 MH No calibration applied and no bandpass applied

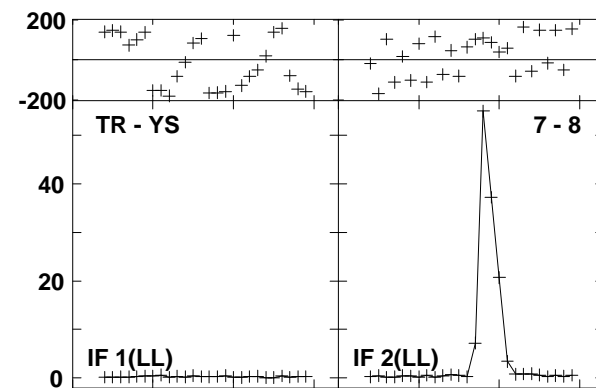
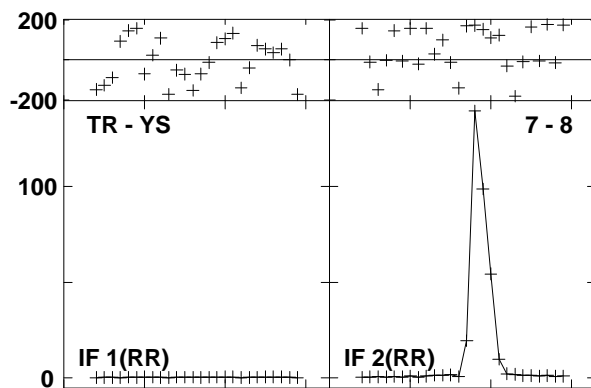
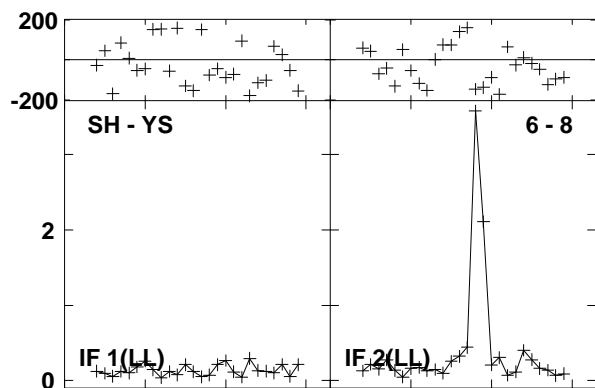
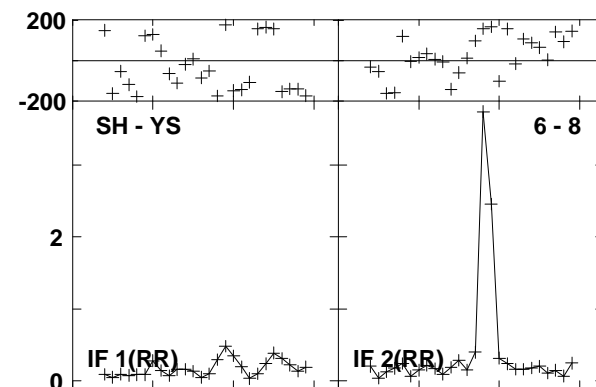
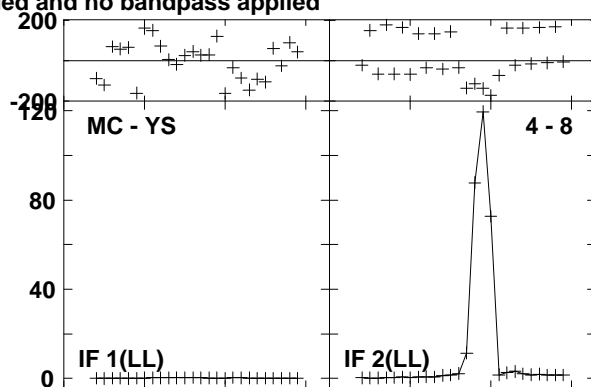
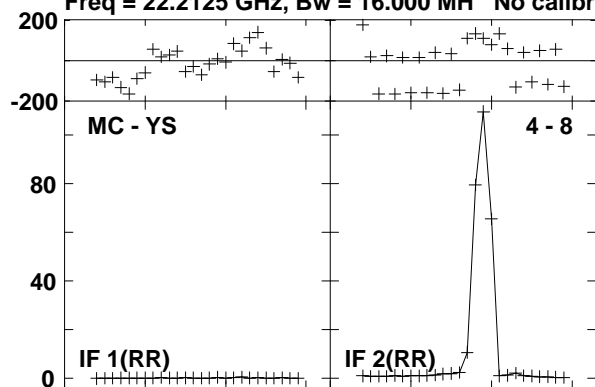

Lower frame: Milli Ampl Jy Top frame: Phas deg  
Vector averaged cross-power spectrum Baseline: MC (04) - YS (08)  
Timerange: 00/08:10:11 to 00/08:11:10

Plot file version 31 created 23-AUG-2016 15:00:41

0219+628 GA035B 1.UVDATA.1

Freq = 22.2125 GHz, Bw = 16.000 MH No calibration applied and no bandpass applied

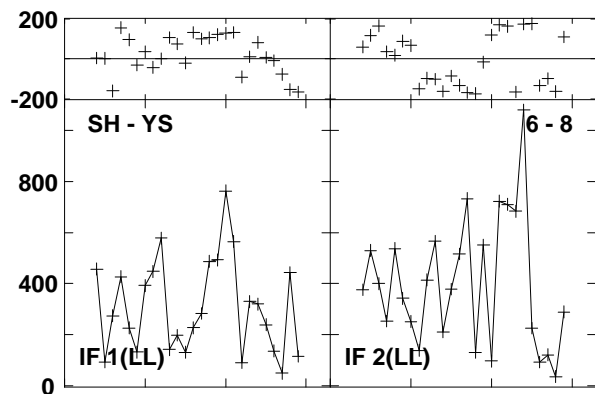
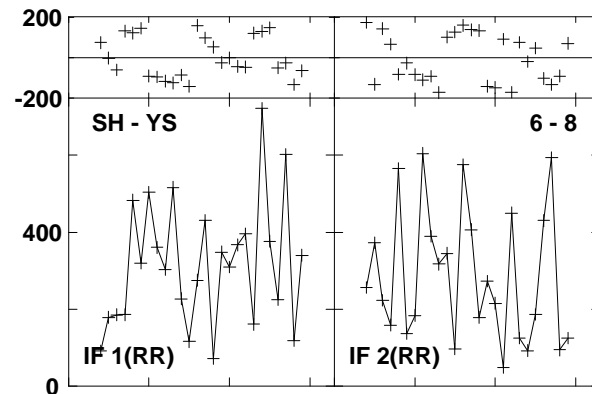
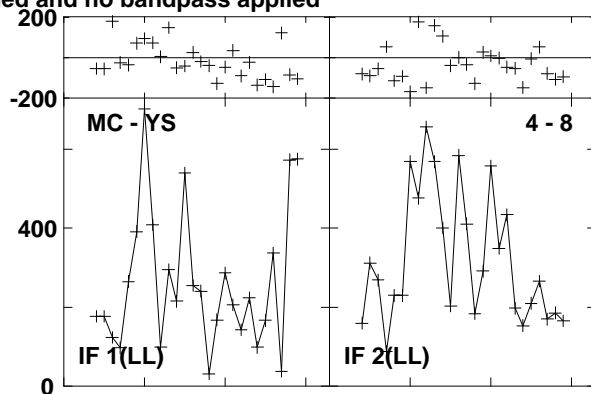
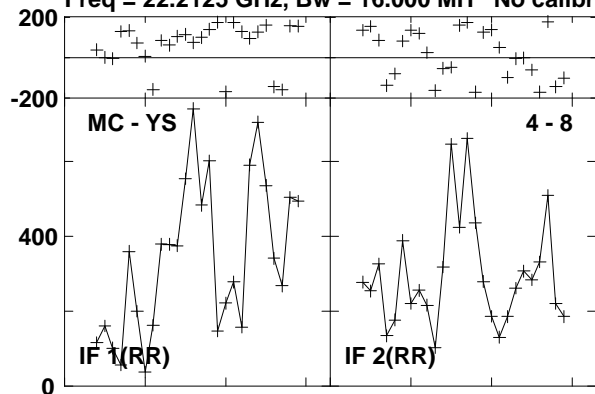

Lower frame: Micro Ampl Jy Top frame: Phas deg  
Vector averaged cross-power spectrum Baseline: MC (04) - YS (08)  
Timerange: 00/08:11:36 to 00/08:11:56

Plot file version 32 created 23-AUG-2016 15:00:41

W3IRS5 GA035B 1.UVDATA.1

Freq = 22.2125 GHz, Bw = 16.000 MH No calibration applied and no bandpass applied

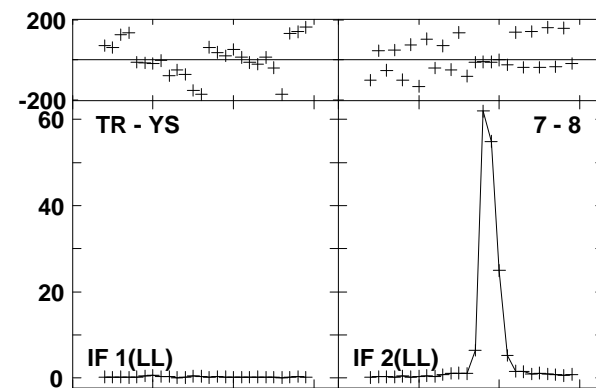
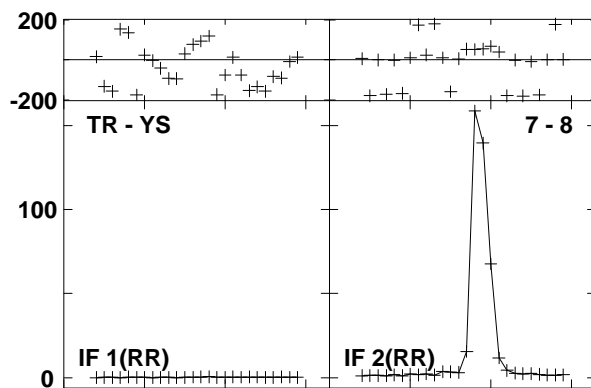
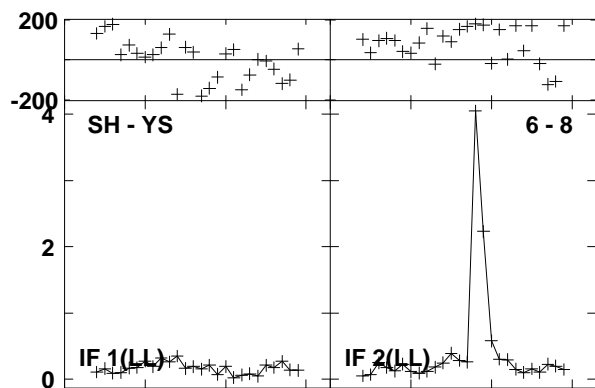
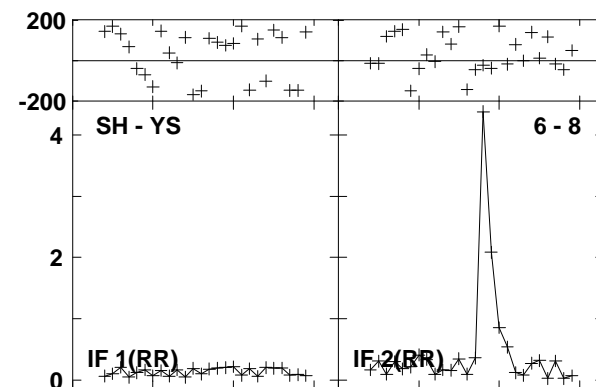
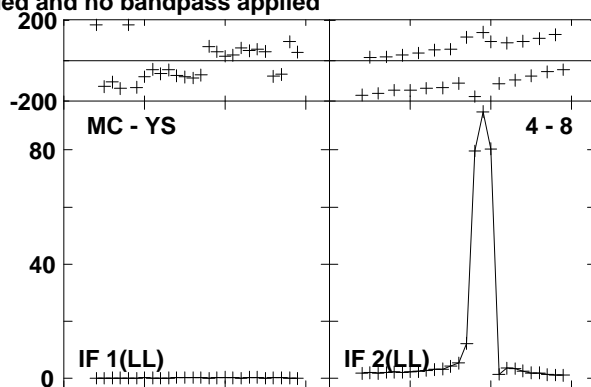
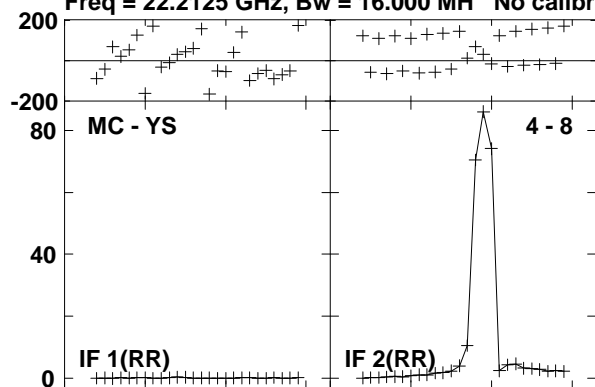

Lower frame: Milli Ampl Jy Top frame: Phas deg

Vector averaged cross-power spectrum Baseline: MC (04) - YS (08)

Timerange: 00/08:12:22 to 00/08:13:20



Plot file version 33 created 23-AUG-2016 15:00:41

0219+628 GA035B 1.UVDATA.1

Freq = 22.2125 GHz, Bw = 16.000 MH No calibration applied and no bandpass applied

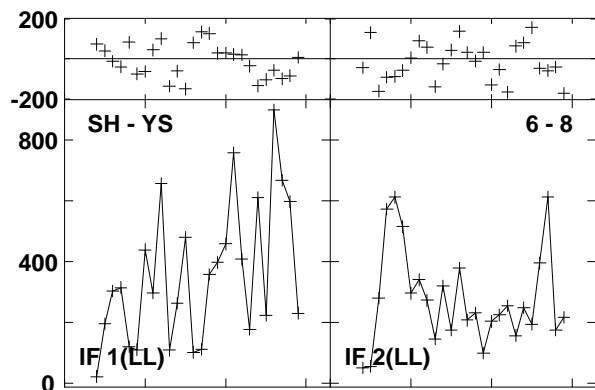
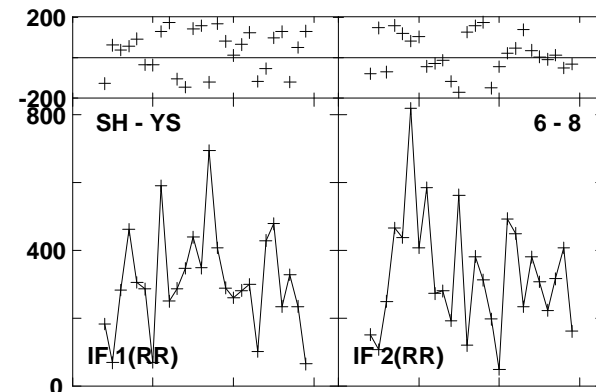
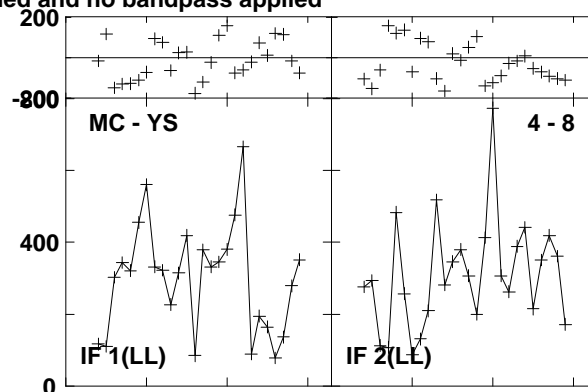
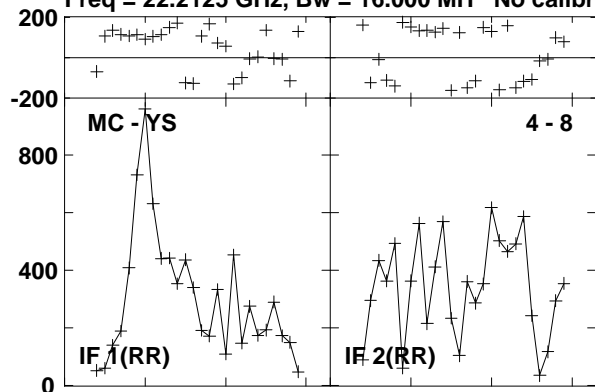

Lower frame: Micro Ampl Jy Top frame: Phas deg  
Vector averaged cross-power spectrum Baseline: MC (04) - YS (08)  
Timerange: 00/08:13:46 to 00/08:14:06

Plot file version 34 created 23-AUG-2016 15:00:41

W3IRS5 GA035B 1.UVDATA.1

Freq = 22.2125 GHz, Bw = 16.000 MH No calibration applied and no bandpass applied

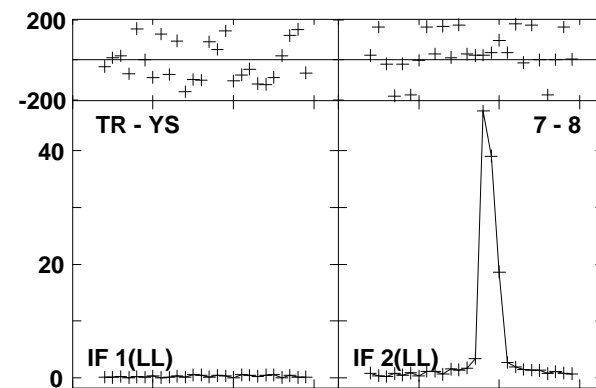
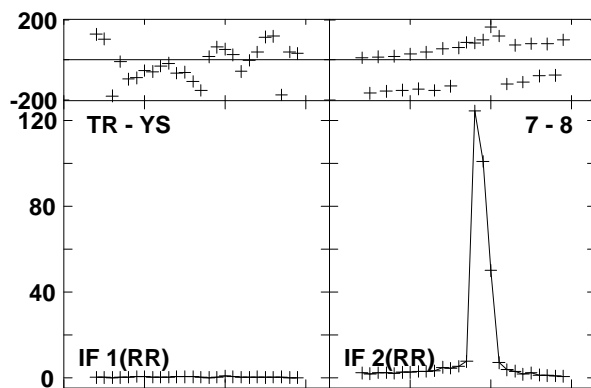
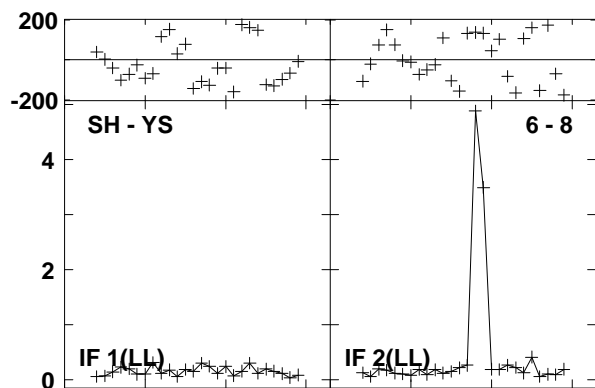
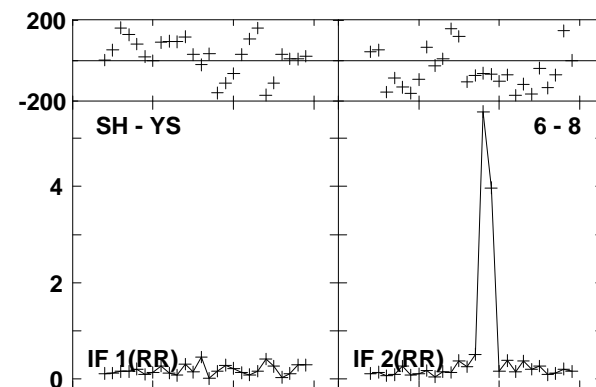
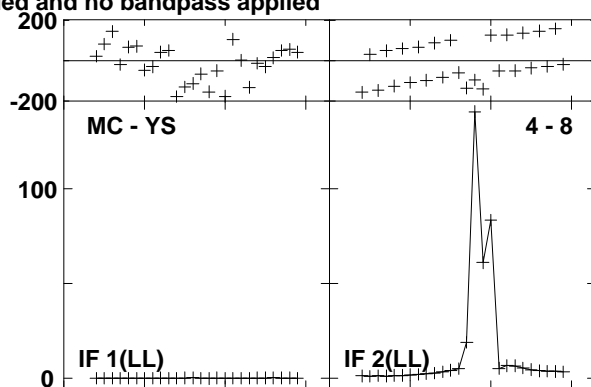
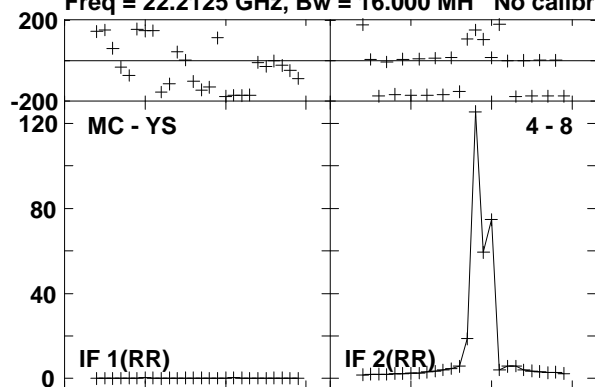

Lower frame: Milli Ampl Jy Top frame: Phas deg  
Vector averaged cross-power spectrum Baseline: MC (04) - YS (08)  
Timerange: 00/08:14:32 to 00/08:15:30

Plot file version 35 created 23-AUG-2016 15:00:41

0219+628 GA035B 1.UVDATA.1

Freq = 22.2125 GHz, Bw = 16.000 MH No calibration applied and no bandpass applied

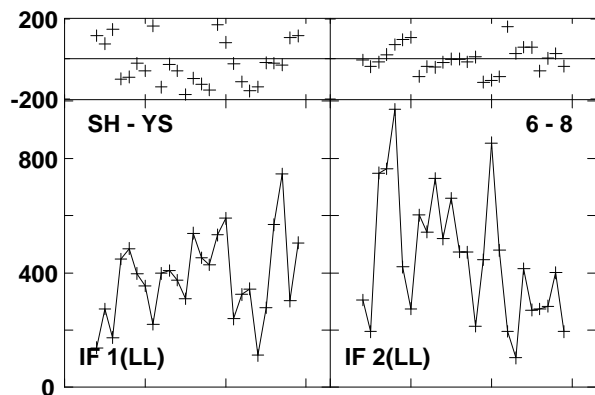
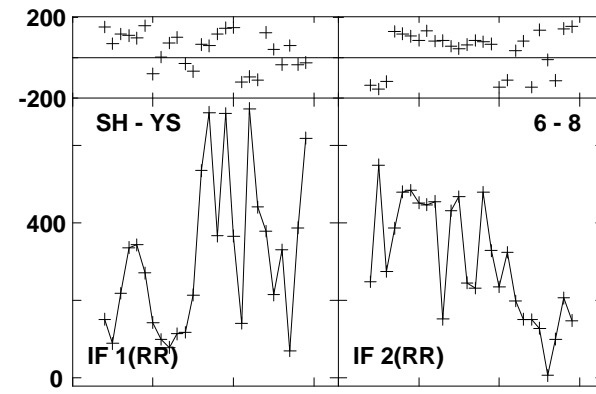
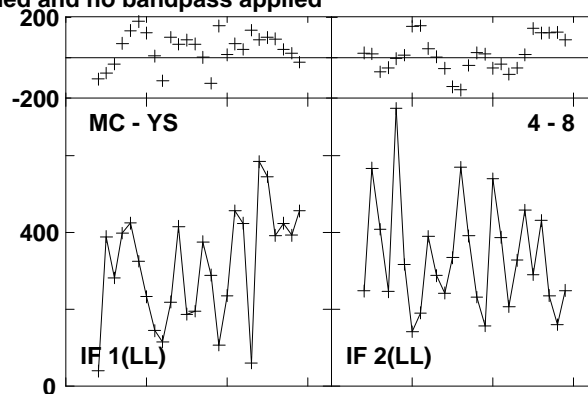
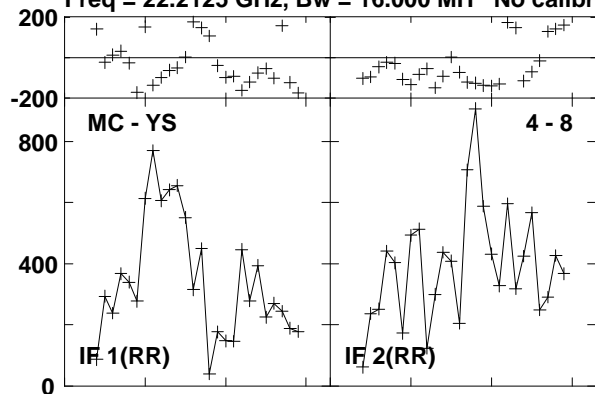

Lower frame: Micro Ampl Jy Top frame: Phas deg  
Vector averaged cross-power spectrum Baseline: MC (04) - YS (08)  
Timerange: 00/08:15:56 to 00/08:16:16

Plot file version 36 created 23-AUG-2016 15:00:41

W3IRS5 GA035B 1.UVDATA.1

Freq = 22.2125 GHz, Bw = 16.000 MH No calibration applied and no bandpass applied

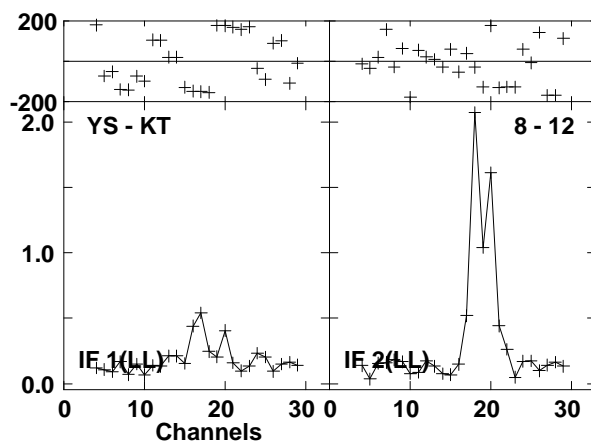
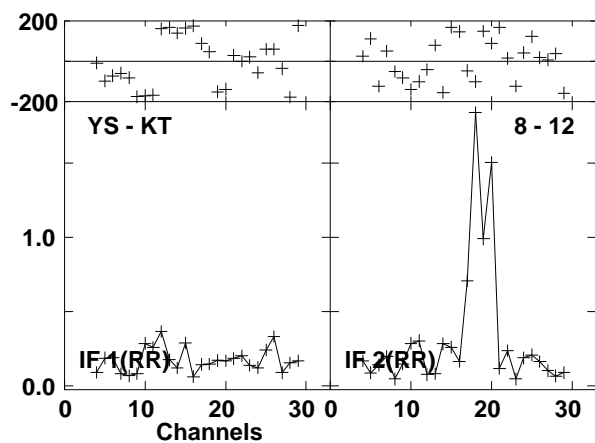
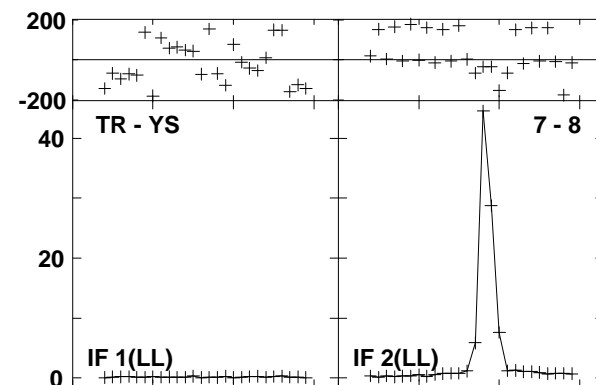
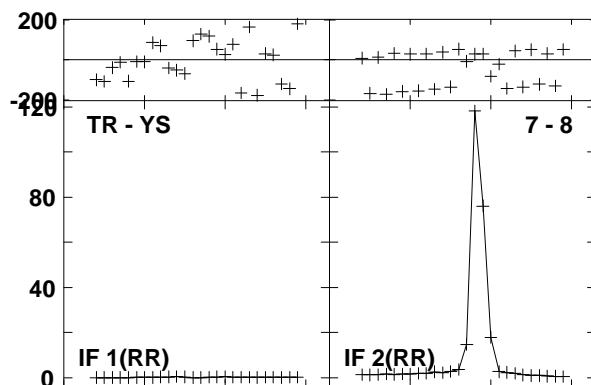
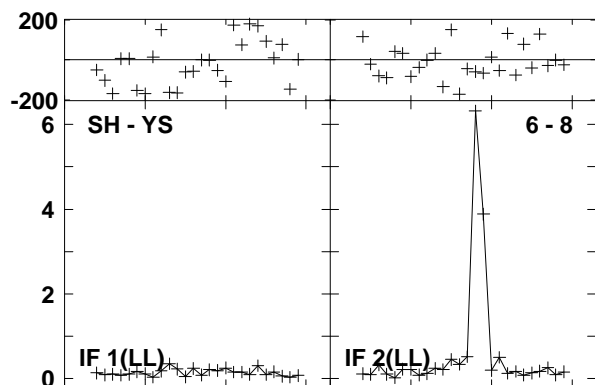
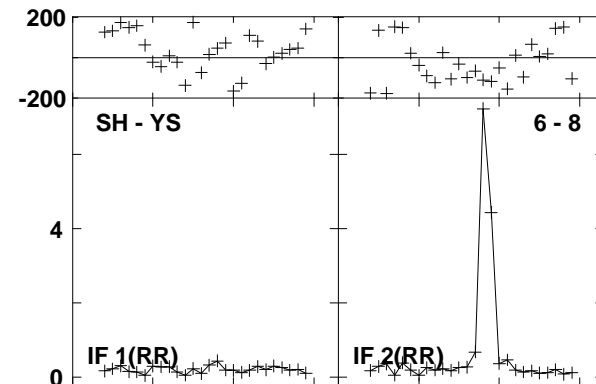
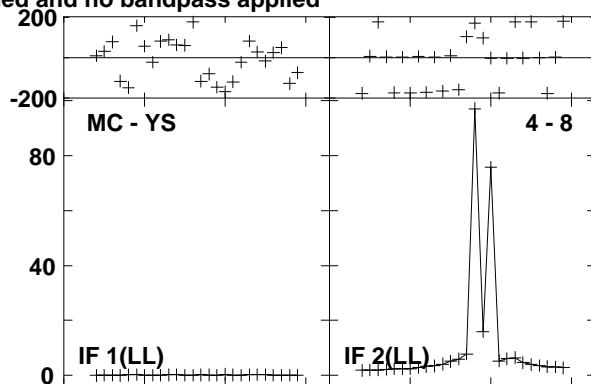
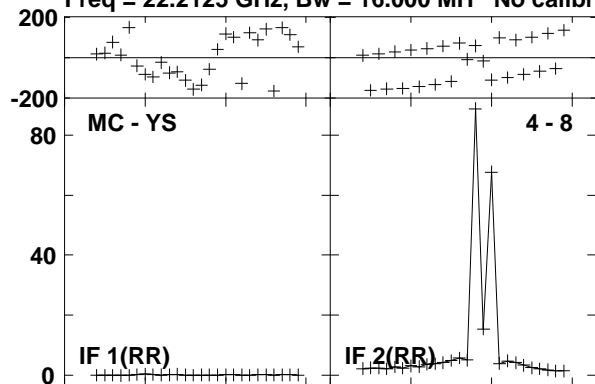

Lower frame: Milli Ampl Jy Top frame: Phas deg  
Vector averaged cross-power spectrum Baseline: MC (04) - YS (08)  
Timerange: 00/08:17:57 to 00/08:18:55

Plot file version 37 created 23-AUG-2016 15:00:41

0219+628 GA035B 1.UVDATA.1

Freq = 22.2125 GHz, Bw = 16.000 MH No calibration applied and no bandpass applied

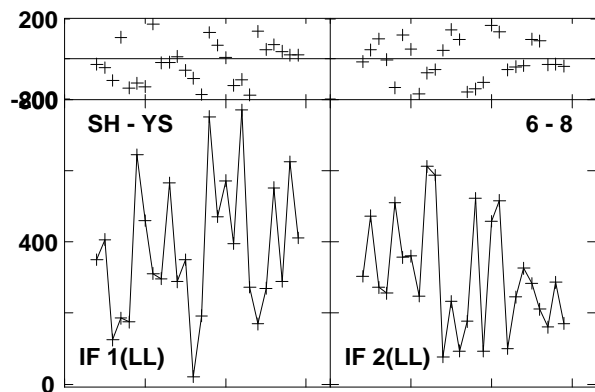
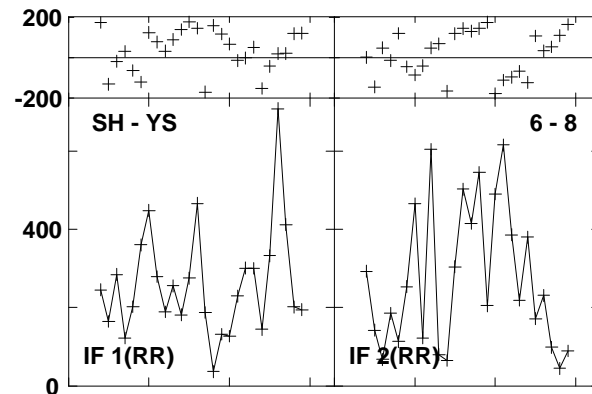
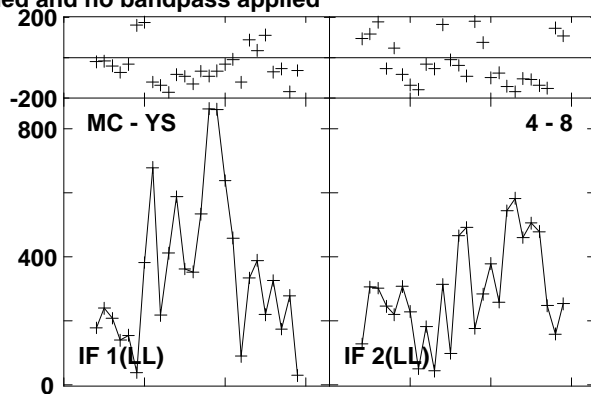
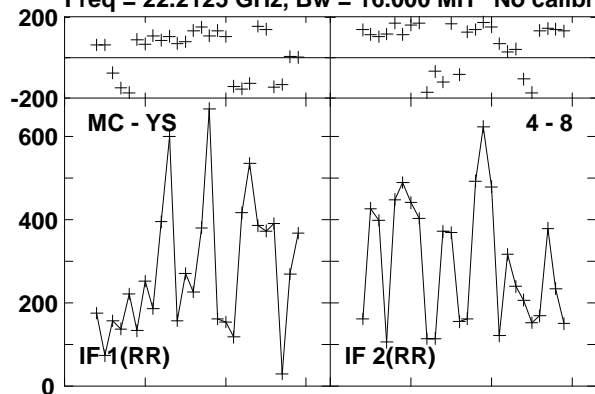

Lower frame: Micro Ampl Jy Top frame: Phas deg  
Vector averaged cross-power spectrum Baseline: MC (04) - YS (08)  
Timerange: 00/08:19:22 to 00/08:19:40

Plot file version 38 created 23-AUG-2016 15:00:41

W3IRS5 GA035B 1.UVDATA.1

Freq = 22.2125 GHz, Bw = 16.000 MH No calibration applied and no bandpass applied

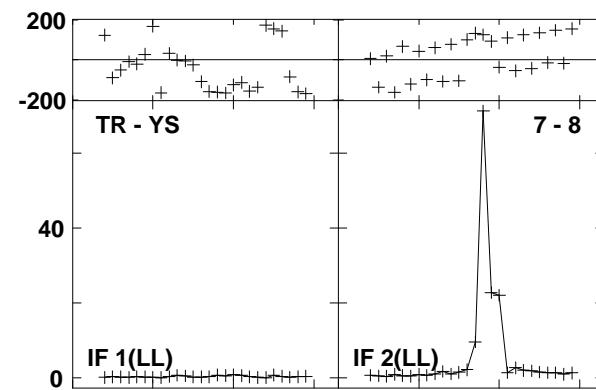
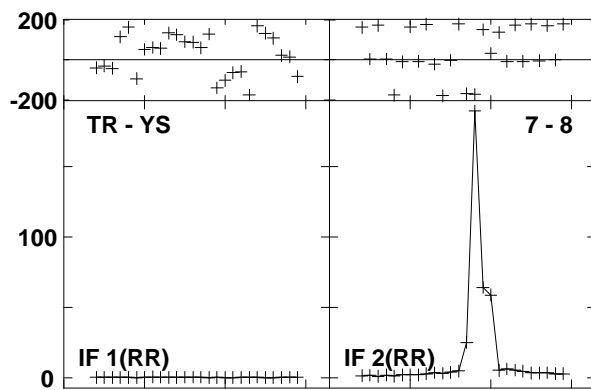
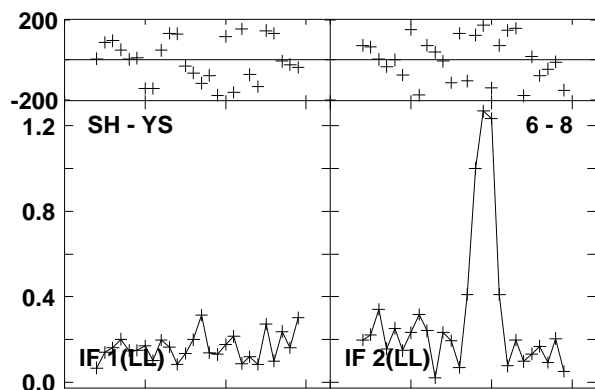
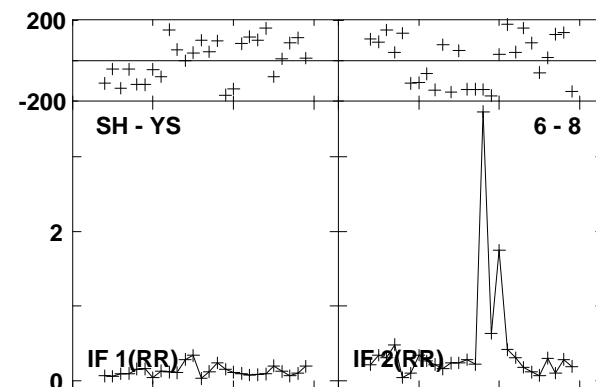
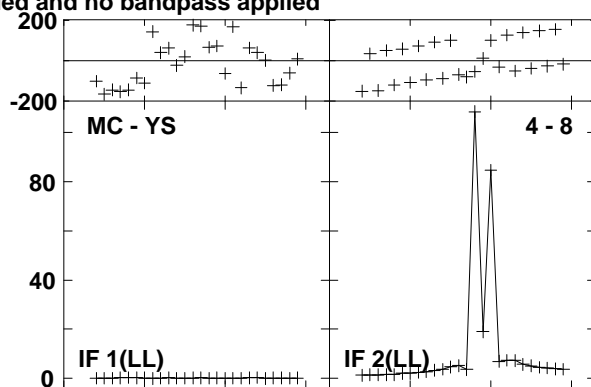
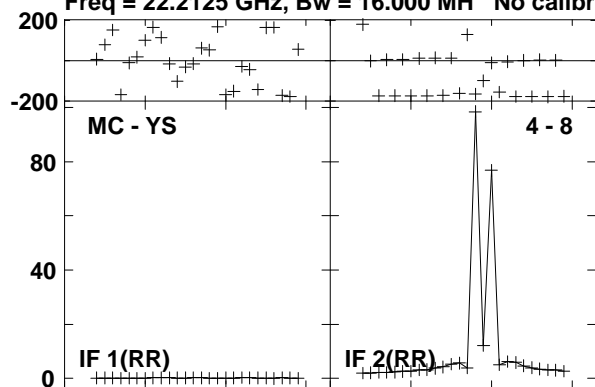

Lower frame: Milli Ampl Jy Top frame: Phas deg  
Vector averaged cross-power spectrum Baseline: MC (04) - YS (08)  
Timerange: 00/08:20:07 to 00/08:21:06

Plot file version 39 created 23-AUG-2016 15:00:41  
0219+628 GA035B 1.UVDATA.1

Freq = 22.2125 GHz, Bw = 16.000 MH No calibration applied and no bandpass applied

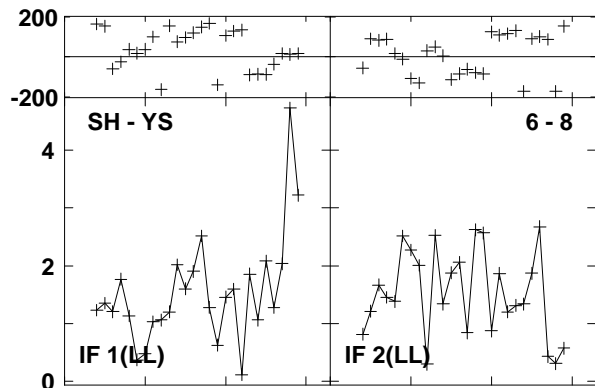
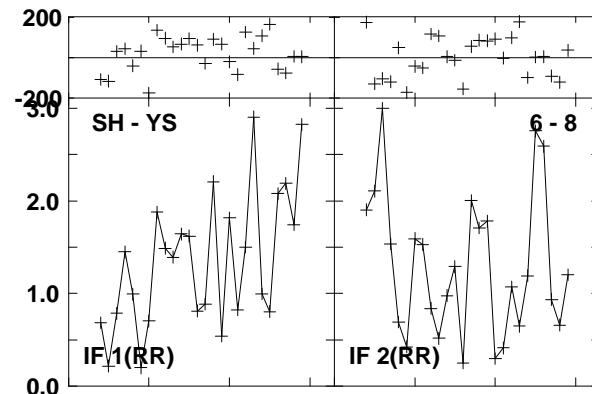
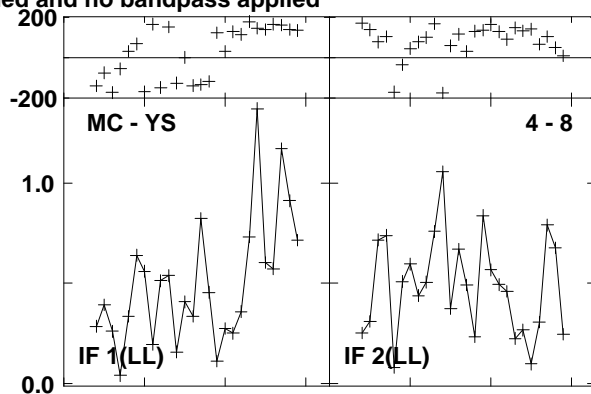
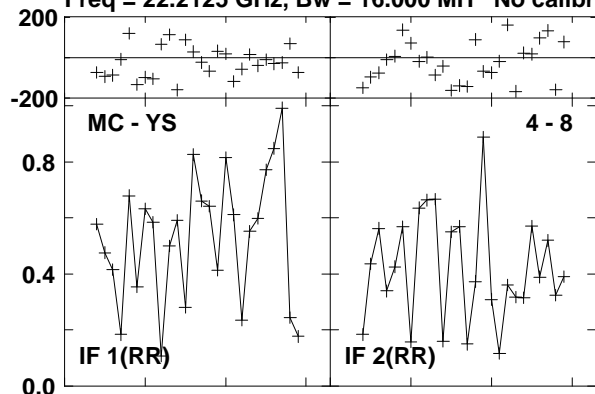

Lower frame: Milli Ampl Jy Top frame: Phas deg  
Vector averaged cross-power spectrum Baseline: MC (04) - YS (08)  
Timerange: 00/08:21:32 to 00/08:21:50

Plot file version 40 created 23-AUG-2016 15:00:42

W3IRS5 GA035B 1.UVDATA.1

Freq = 22.2125 GHz, Bw = 16.000 MH No calibration applied and no bandpass applied

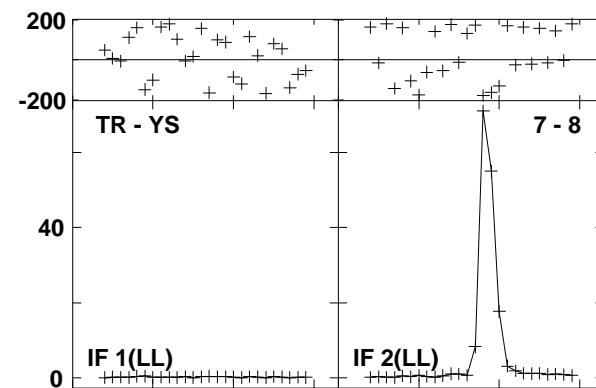
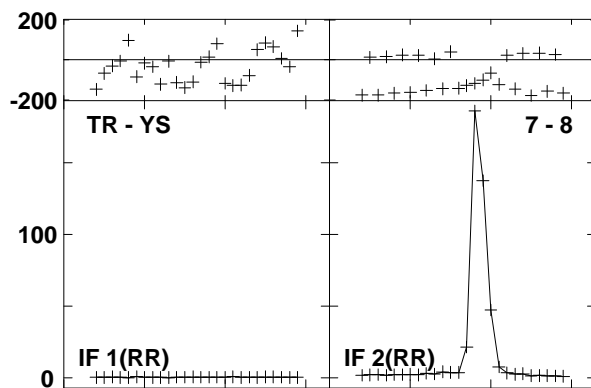
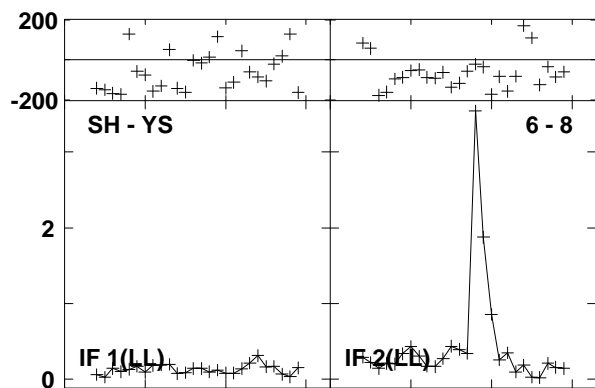
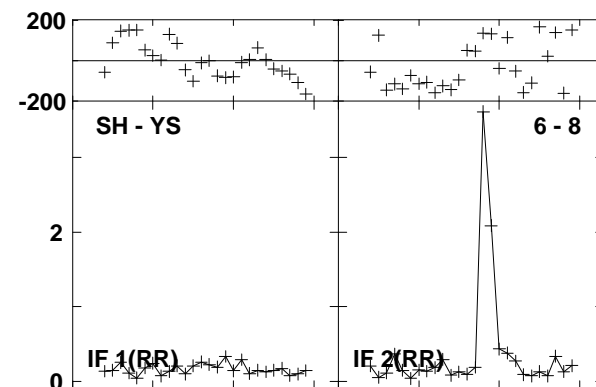
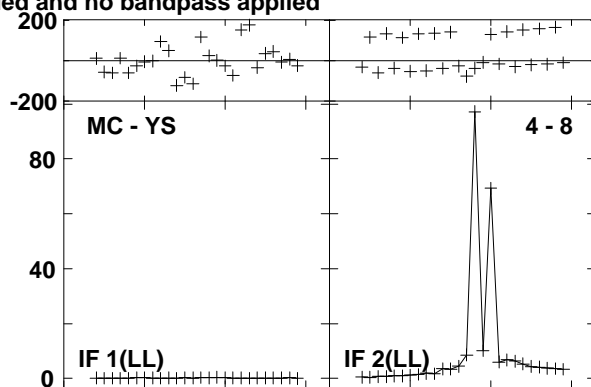
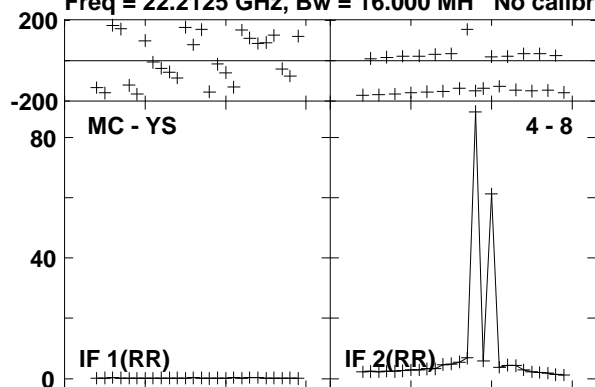

Lower frame: Milli Ampl Jy Top frame: Phas deg  
Vector averaged cross-power spectrum Baseline: MC (04) - YS (08)  
Timerange: 00/08:22:17 to 00/08:23:15



Plot file version 41 created 23-AUG-2016 15:00:42

0219+628 GA035B 1.UVDATA.1

Freq = 22.2125 GHz, Bw = 16.000 MH No calibration applied and no bandpass applied

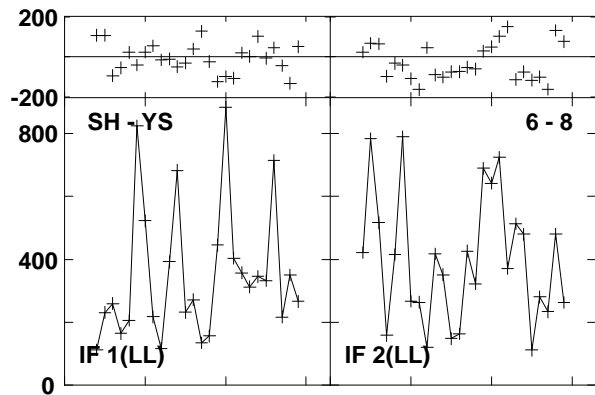
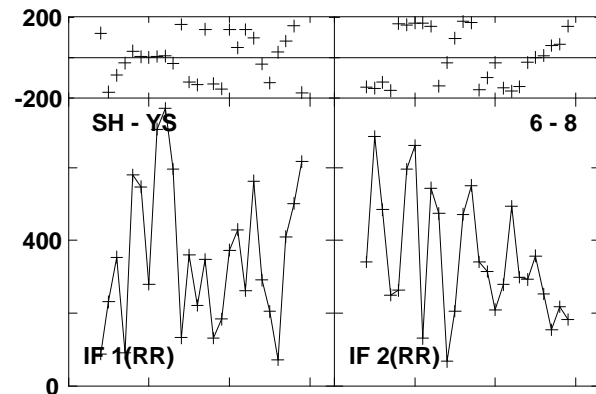
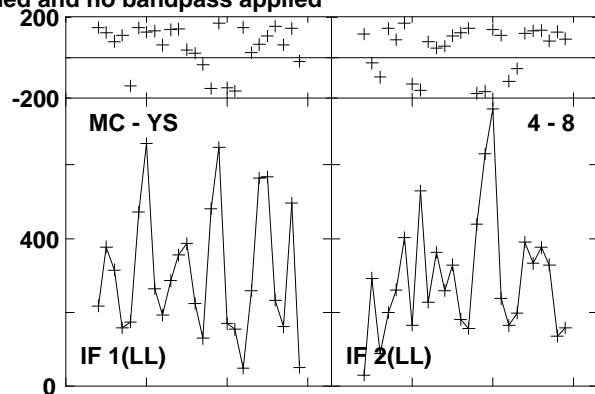
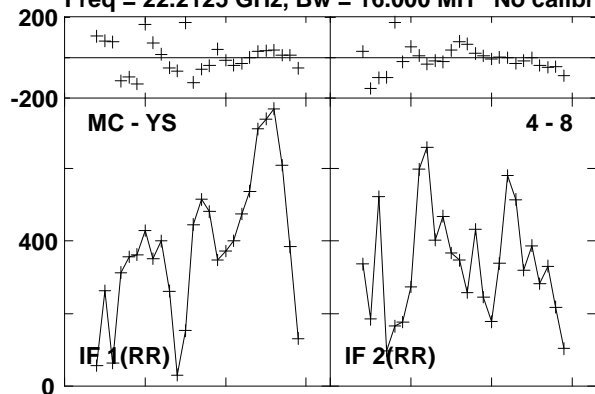

Lower frame: Micro Ampl Jy Top frame: Phas deg  
Vector averaged cross-power spectrum Baseline: MC (04) - YS (08)  
Timerange: 00/08:23:42 to 00/08:24:00

Plot file version 42 created 23-AUG-2016 15:00:42

W3IRS5 GA035B 1.UVDATA.1

Freq = 22.2125 GHz, Bw = 16.000 MH No calibration applied and no bandpass applied

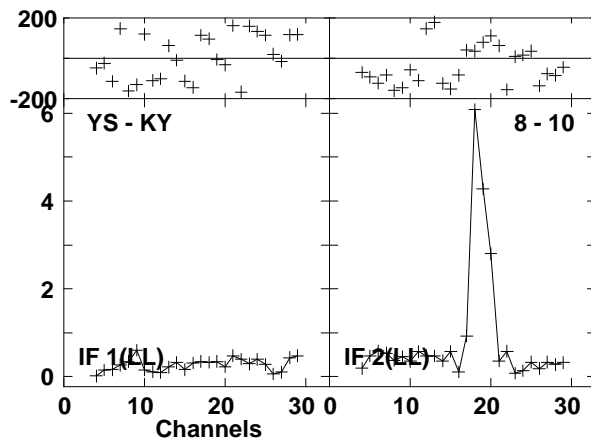
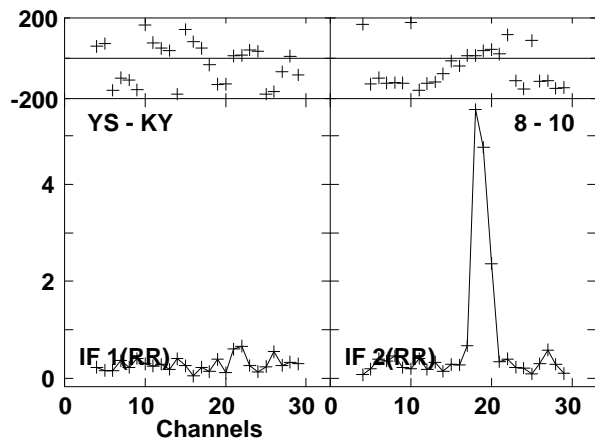
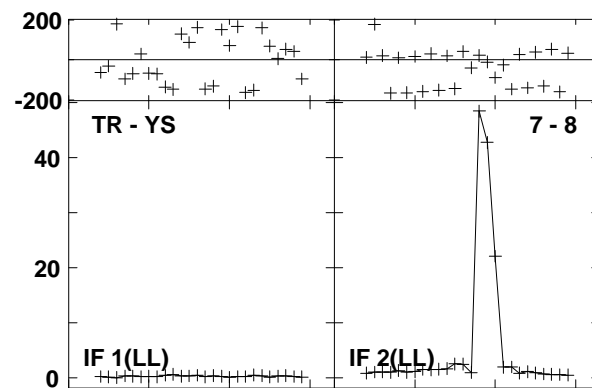
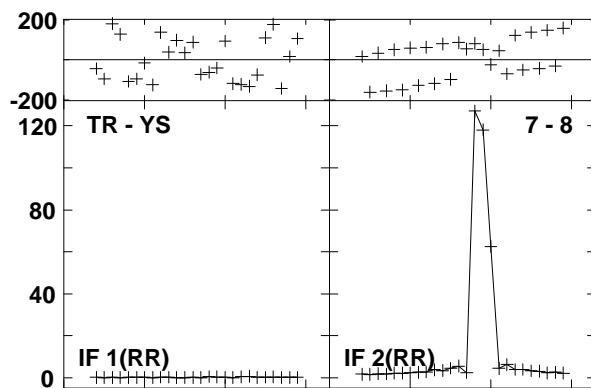
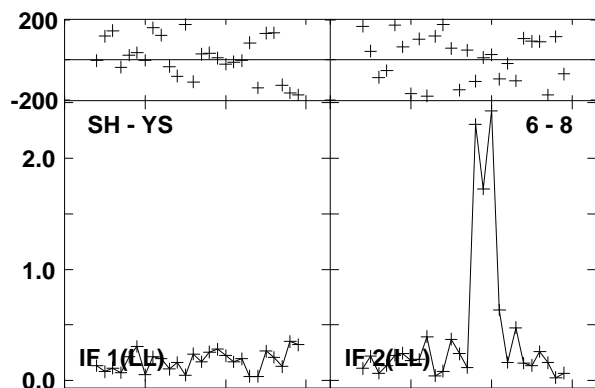
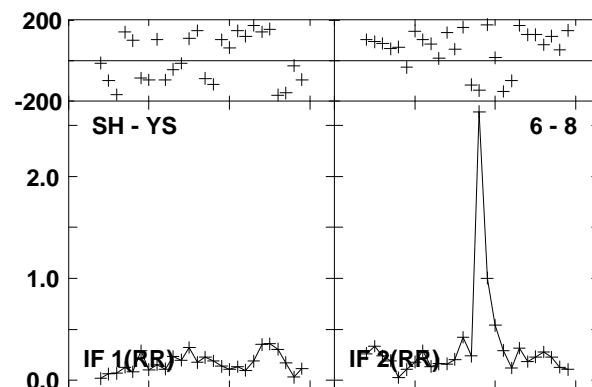
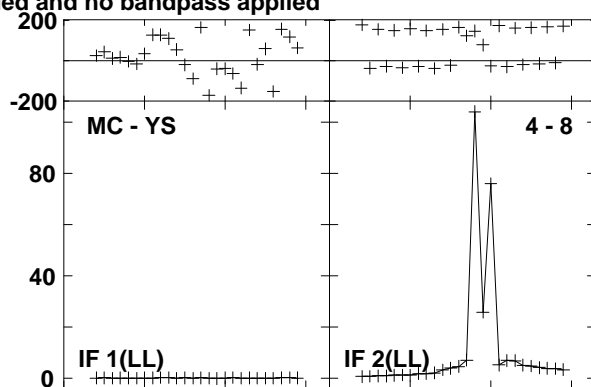
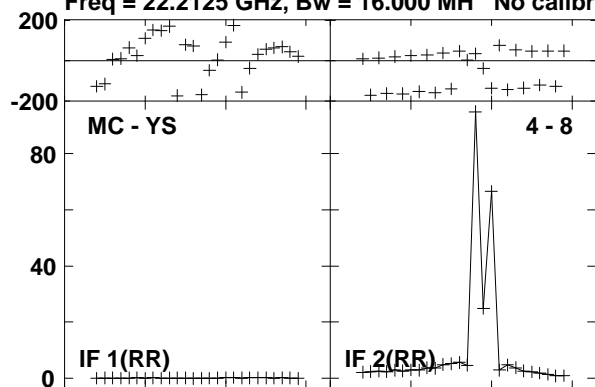

Lower frame: Milli Ampl Jy Top frame: Phas deg  
Vector averaged cross-power spectrum Baseline: MC (04) - YS (08)  
Timerange: 00/08:24:27 to 00/08:25:25

Plot file version 43 created 23-AUG-2016 15:00:42

0219+628 GA035B 1.UVDATA.1

Freq = 22.2125 GHz, Bw = 16.000 MH No calibration applied and no bandpass applied

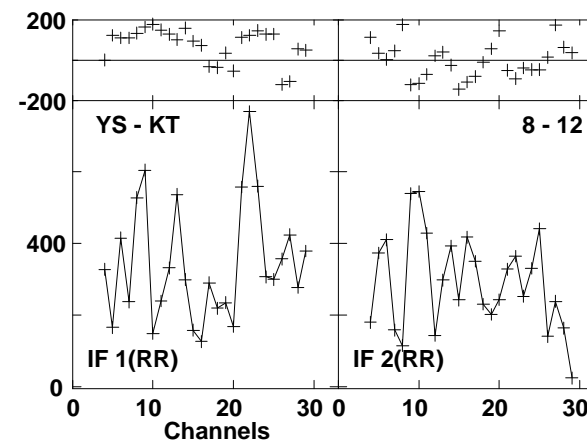
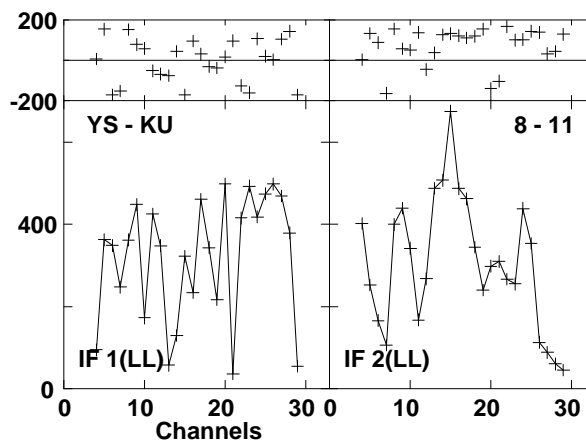
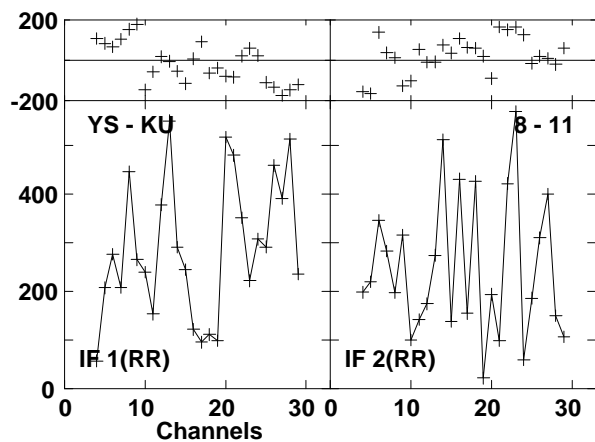
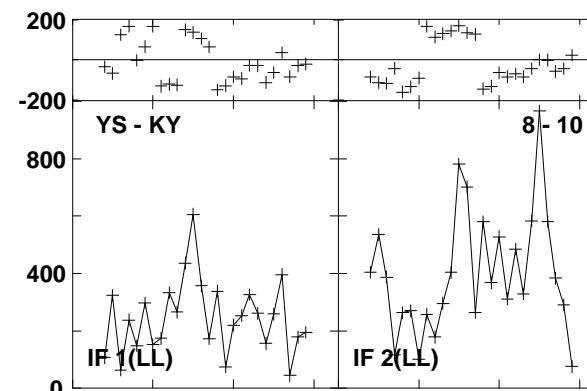
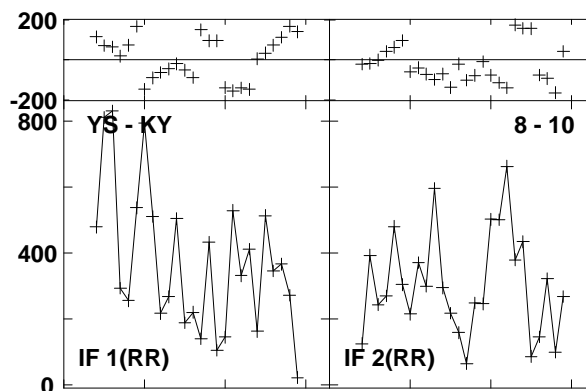
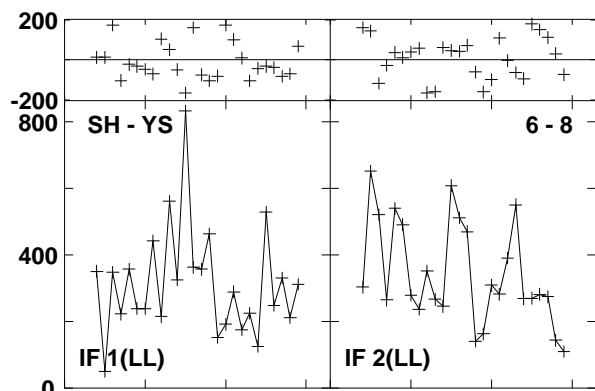
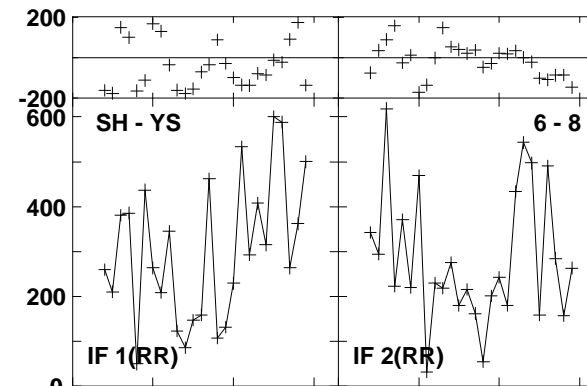
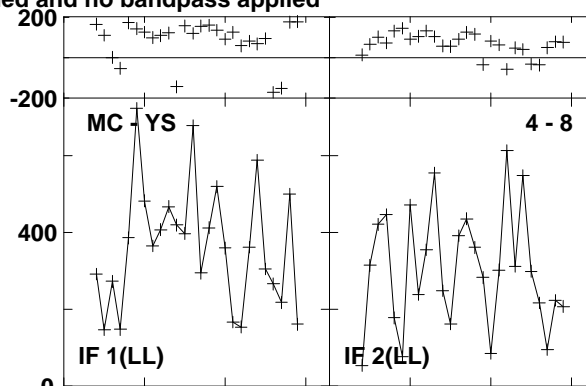
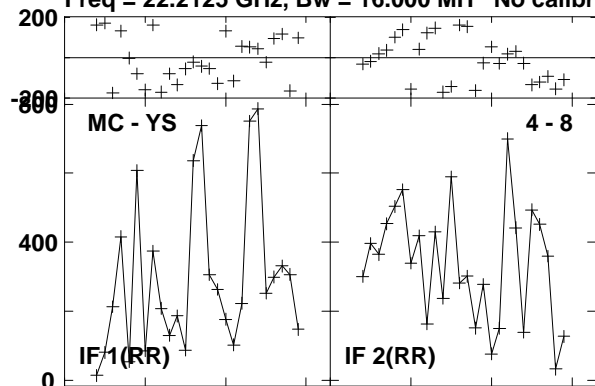

Lower frame: Micro Ampl Jy Top frame: Phas deg  
Vector averaged cross-power spectrum Baseline: MC (04) - YS (08)  
Timerange: 00/08:25:52 to 00/08:26:10

Plot file version 44 created 23-AUG-2016 15:00:42

0219+628 GA035B 1.UVDATA.1

Freq = 22.2125 GHz, Bw = 16.000 MH No calibration applied and no bandpass applied

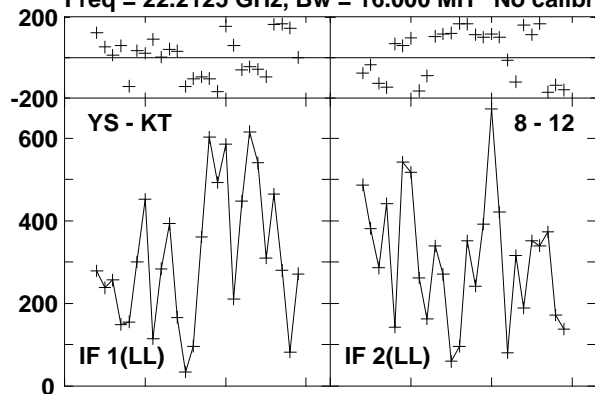

Lower frame: Micro Ampl Jy Top frame: Phas deg  
Vector averaged cross-power spectrum Baseline: YS (08) - KT (12)  
Timerange: 00/08:25:52 to 00/08:26:10

Plot file version 45 created 23-AUG-2016 15:00:42

W3IRS5 GA035B 1.UVDATA.1

Freq = 22.2125 GHz, Bw = 16.000 MH No calibration applied and no bandpass applied

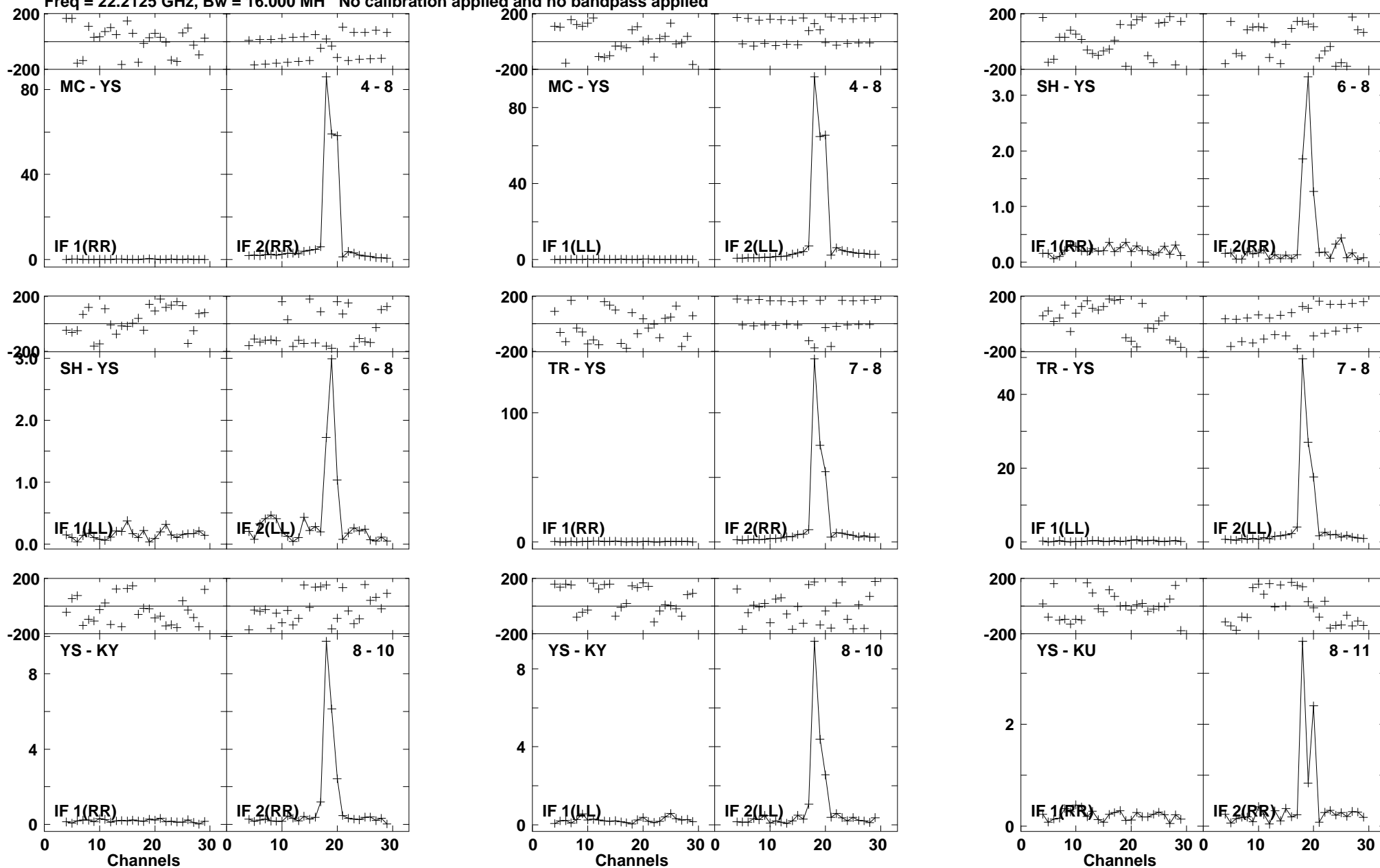

Lower frame: Milli Ampl Jy Top frame: Phas deg  
Vector averaged cross-power spectrum Baseline: MC (04) - YS (08)  
Timerange: 00/08:26:36 to 00/08:27:35

Plot file version 46 created 23-AUG-2016 15:00:42

W3IRS5 GA035B 1.UVDATA.1

Freq = 22.2125 GHz, Bw = 16.000 MH No calibration applied and no bandpass applied

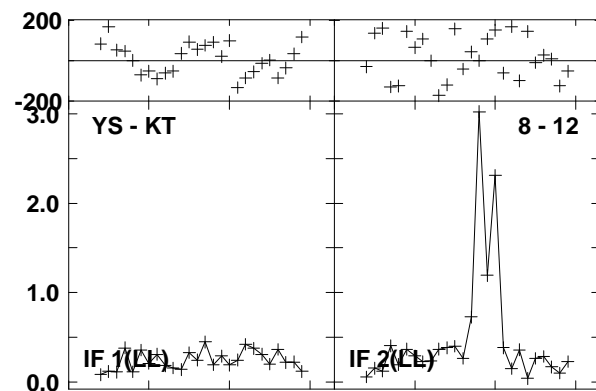
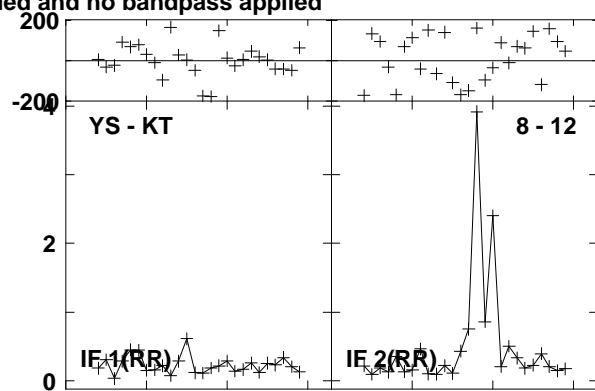
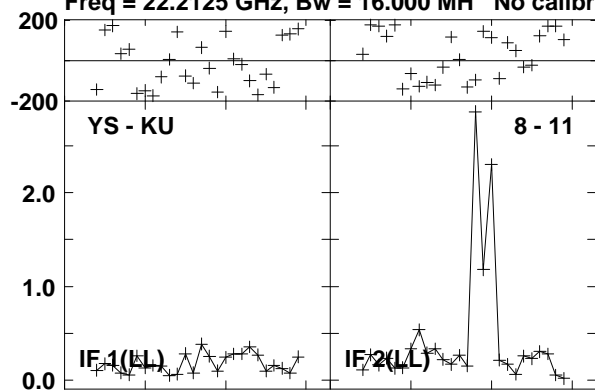

Lower frame: Milli Ampl Jy Top frame: Phas deg  
Vector averaged cross-power spectrum Baseline: YS (08) - KU (11)  
Timerange: 00/08:26:36 to 00/08:27:35

Plot file version 47 created 23-AUG-2016 15:00:42

0219+628 GA035B 1.UVDATA.1

Freq = 22.2125 GHz, Bw = 16.000 MH No calibration applied and no bandpass applied

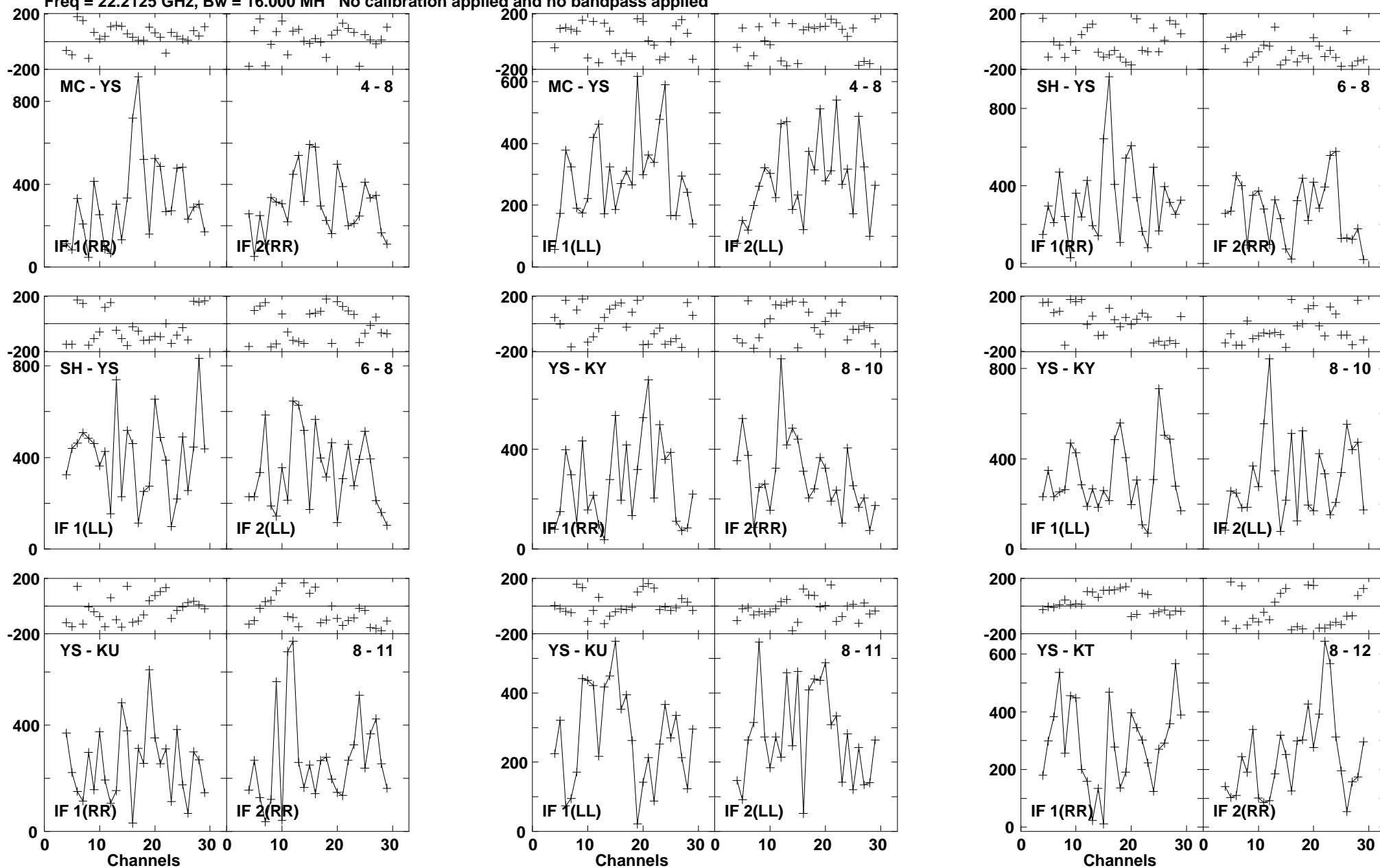

Lower frame: Micro Ampl Jy Top frame: Phas deg  
Vector averaged cross-power spectrum Baseline: MC (04) - YS (08)  
Timerange: 00/08:28:01 to 00/08:28:21

Plot file version 48 created 23-AUG-2016 15:00:42  
0219+628 GA035B 1.UVDATA.1  
Freq = 22.2125 GHz, Bw = 16.000 MH No calibration applied and no bandpass applied

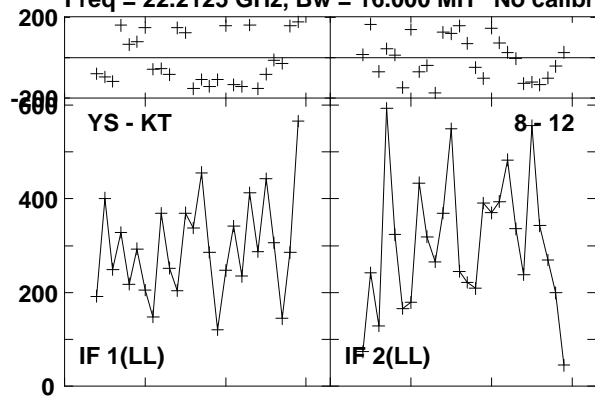

Lower frame: Micro Ampl Jy Top frame: Phas deg  
Vector averaged cross-power spectrum Baseline: YS (08) - KT (12)  
Timerange: 00/08:28:01 to 00/08:28:21



Plot file version 49 created 23-AUG-2016 15:00:42

0716+714 GA035B 1.UVDATA.1

Freq = 22.2125 GHz, Bw = 16.000 MH No calibration applied and no bandpass applied

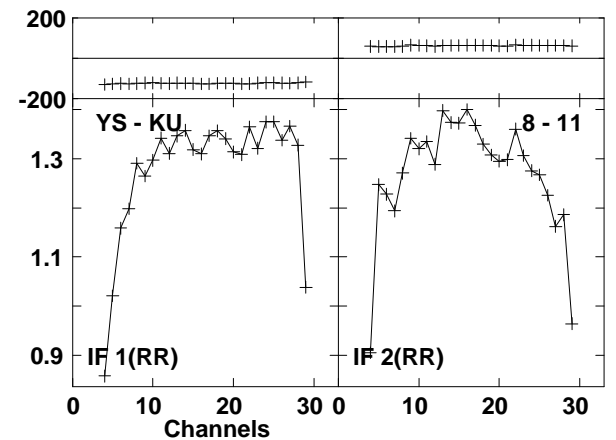
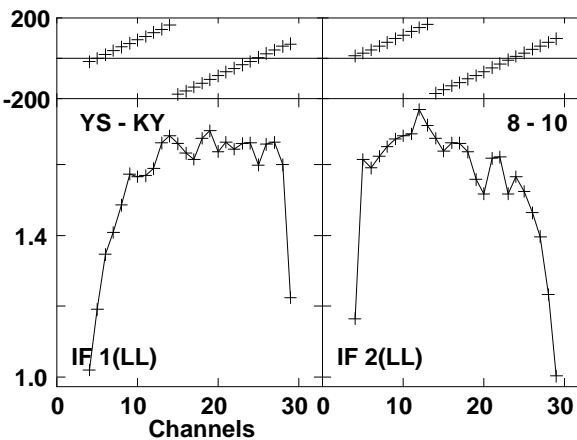
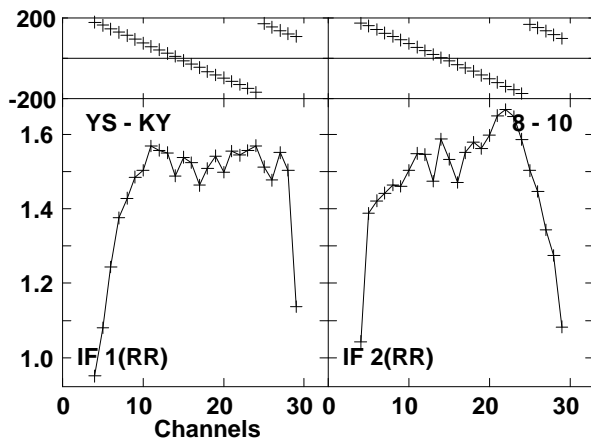
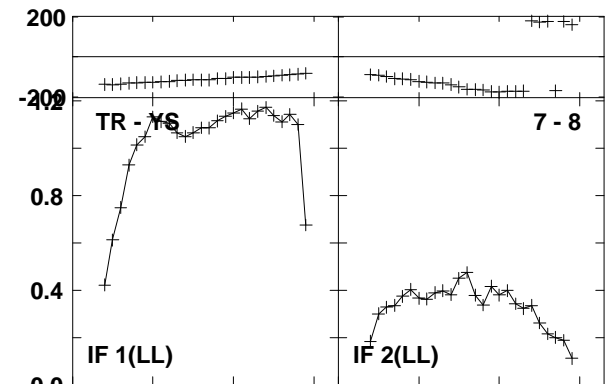
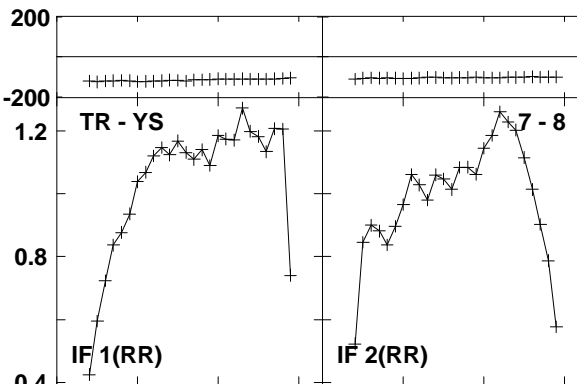
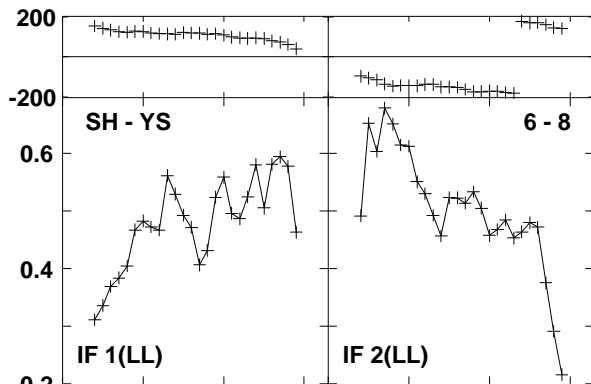
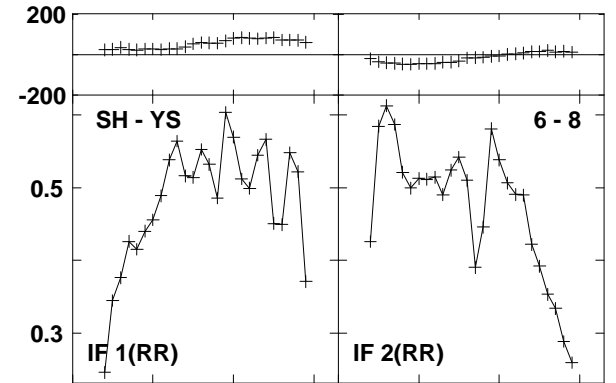
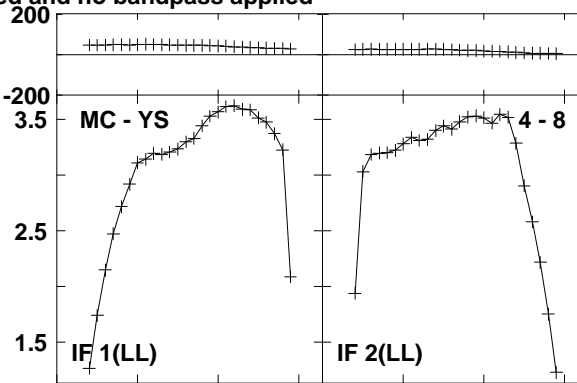
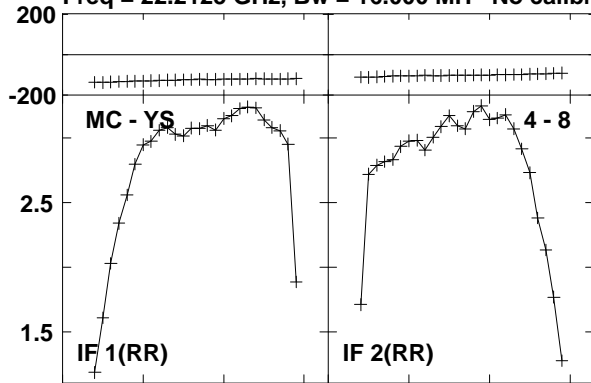

Lower frame: Milli Ampl Jy Top frame: Phas deg  
Vector averaged cross-power spectrum Baseline: MC (04) - YS (08)  
Timerange: 00/08:35:01 to 00/08:44:00

Plot file version 50 created 23-AUG-2016 15:00:42  
 0716+714 GA035B 1.UVDATA.1  
 Freq = 22.2125 GHz, Bw = 16.000 MH No calibration applied and no bandpass applied

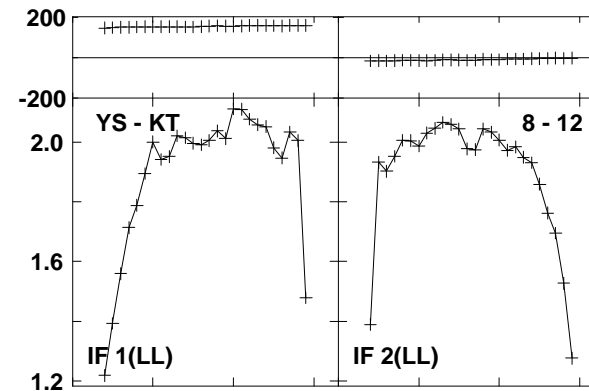
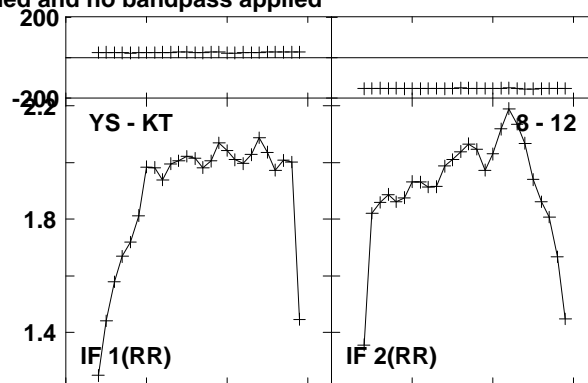
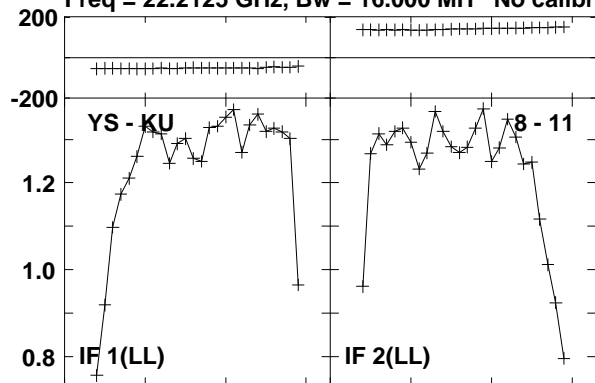

Lower frame: Milli Ampl Jy Top frame: Phas deg  
 Vector averaged cross-power spectrum Baseline: YS (08) - KU (11)  
 Timerange: 00/08:35:01 to 00/08:44:00

Plot file version 51 created 23-AUG-2016 15:00:43  
 0716+714 GA035B 1.UVDATA.1  
 Freq = 22.2125 GHz, Bw = 16.000 MH No calibration applied and no bandpass applied

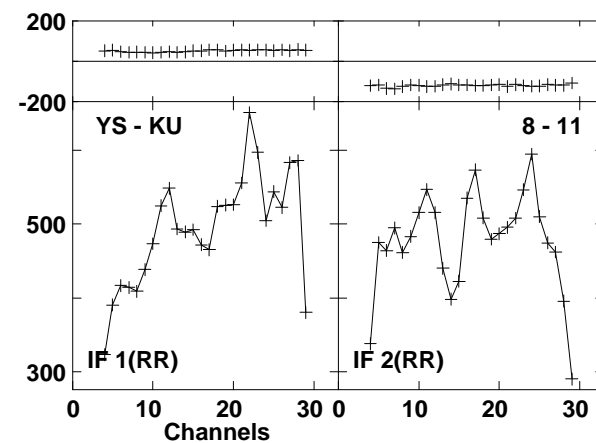
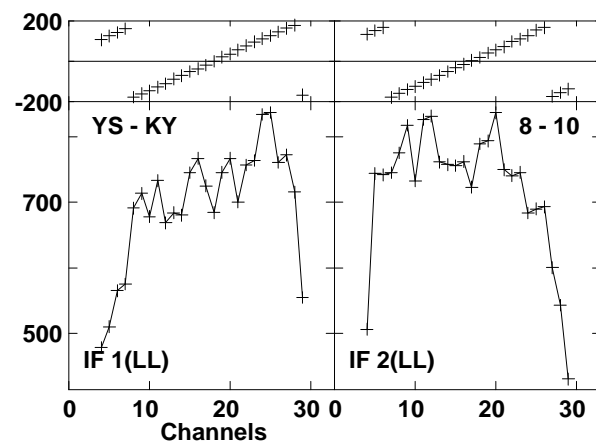
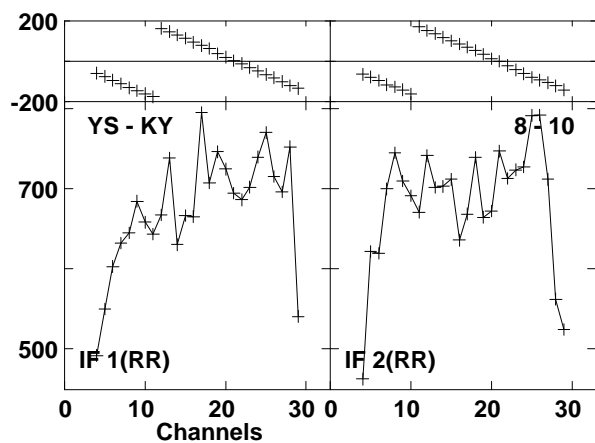
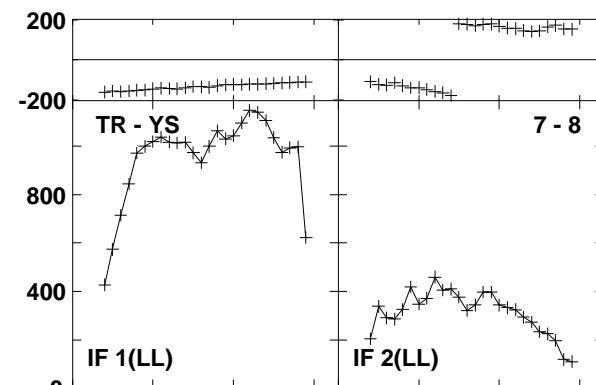
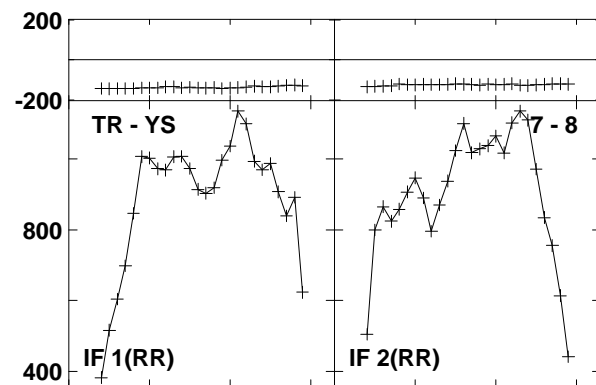
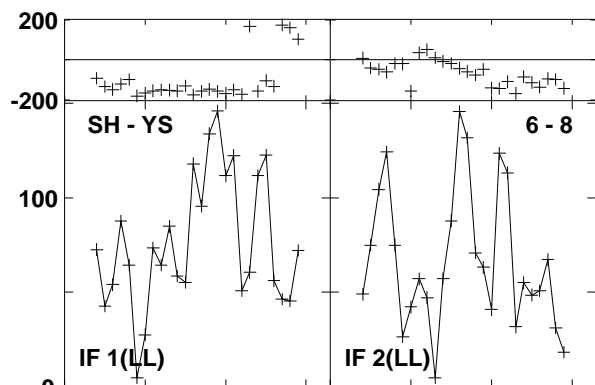
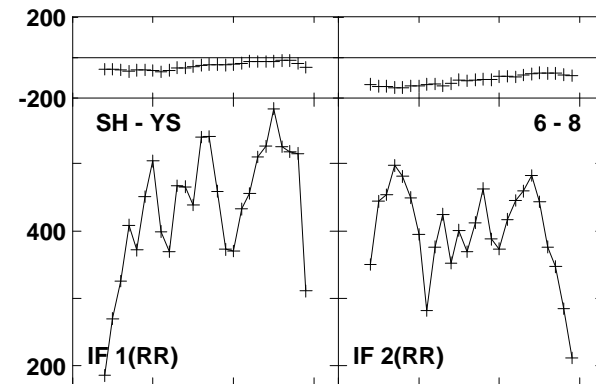
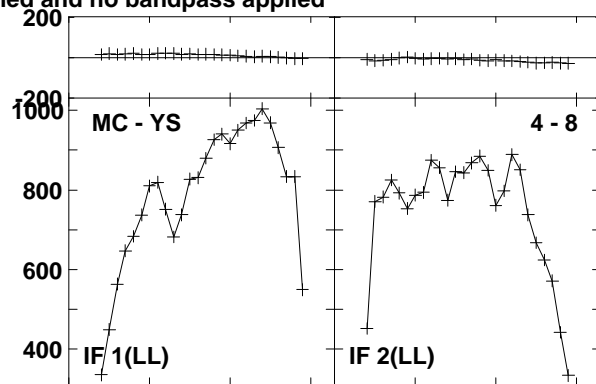
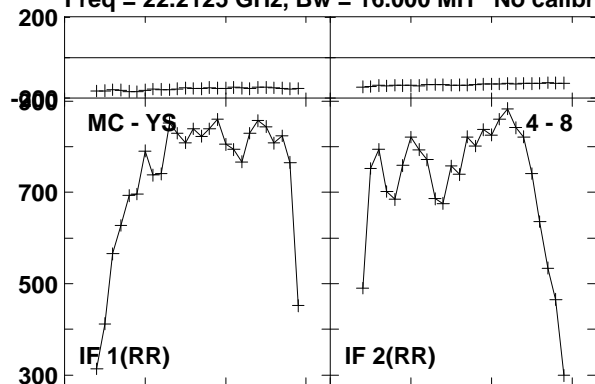

Lower frame: Micro Ampl Jy Top frame: Phas deg  
 Vector averaged cross-power spectrum Baseline: MC (04) - YS (08)  
 Timerange: 00/08:45:31 to 00/08:53:59

Plot file version 52 created 23-AUG-2016 15:00:43

0716+714 GA035B 1.UVDATA.1

Freq = 22.2125 GHz, Bw = 16.000 MH No calibration applied and no bandpass applied

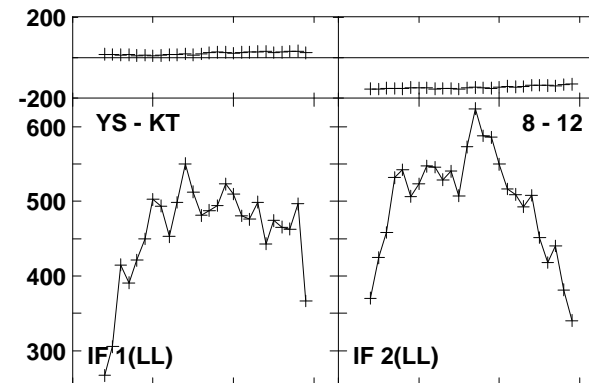
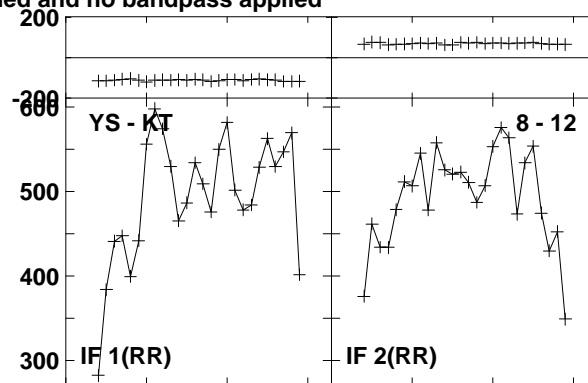
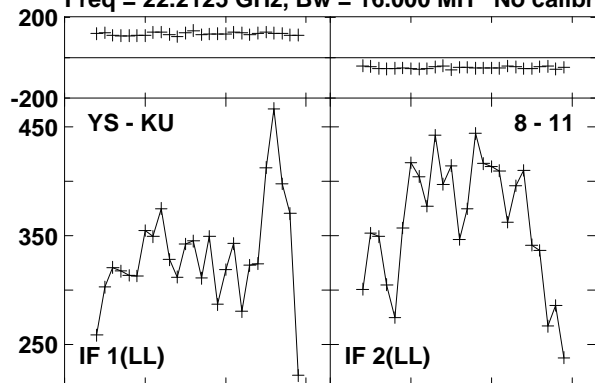

Lower frame: Micro Ampl Jy Top frame: Phas deg  
Vector averaged cross-power spectrum Baseline: YS (08) - KU (11)  
Timerange: 00/08:45:31 to 00/08:53:59

Plot file version 53 created 23-AUG-2016 15:00:43  
 0716+714 GA035B 1.UVDATA.1  
 Freq = 22.2125 GHz, Bw = 16.000 MH No calibration applied and no bandpass applied

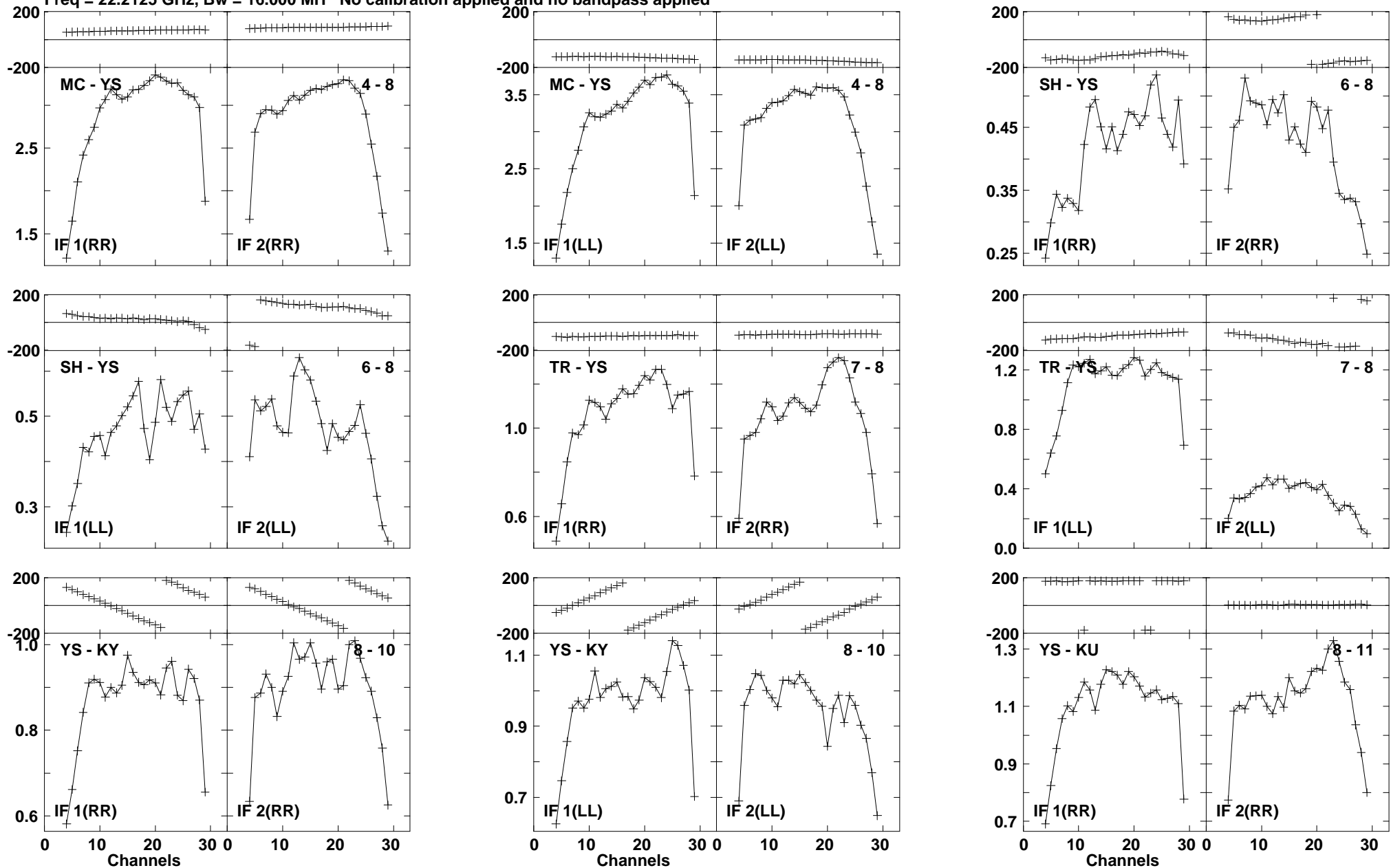

Lower frame: Milli Ampl Jy Top frame: Phas deg  
 Vector averaged cross-power spectrum Baseline: MC (04) - YS (08)  
 Timerange: 00/08:56:00 to 00/09:05:00

Plot file version 54 created 23-AUG-2016 15:00:43

0716+714 GA035B 1.UVDATA.1

Freq = 22.2125 GHz, Bw = 16.000 MH No calibration applied and no bandpass applied

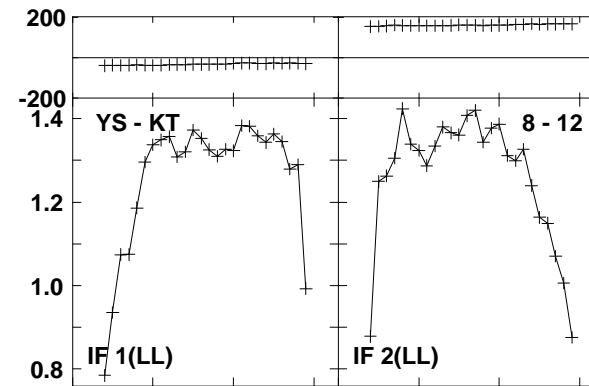
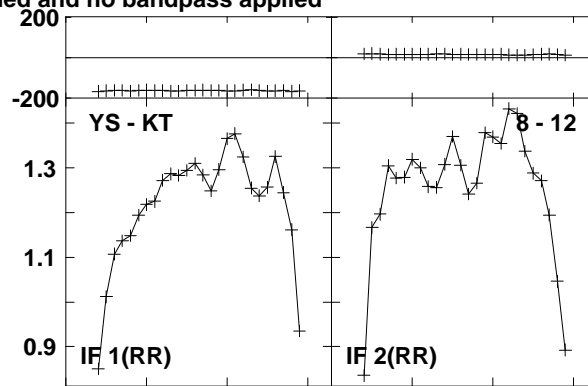
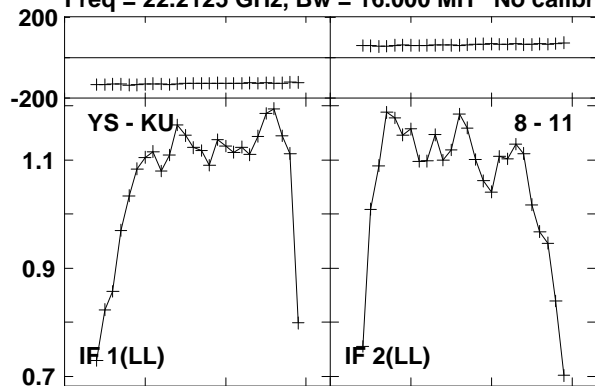

Lower frame: Milli Ampl Jy Top frame: Phas deg  
Vector averaged cross-power spectrum Baseline: YS (08) - KU (11)  
Timerange: 00/08:56:00 to 00/09:05:00

Plot file version 55 created 23-AUG-2016 15:00:43

W3IRS5 GA035B 1.UVDATA.1

Freq = 22.2125 GHz, Bw = 16.000 MH No calibration applied and no bandpass applied

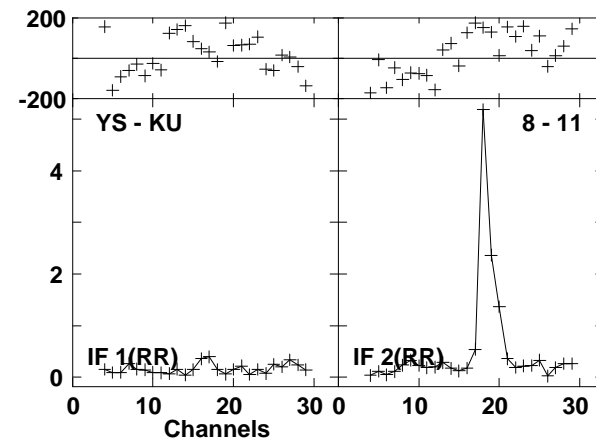
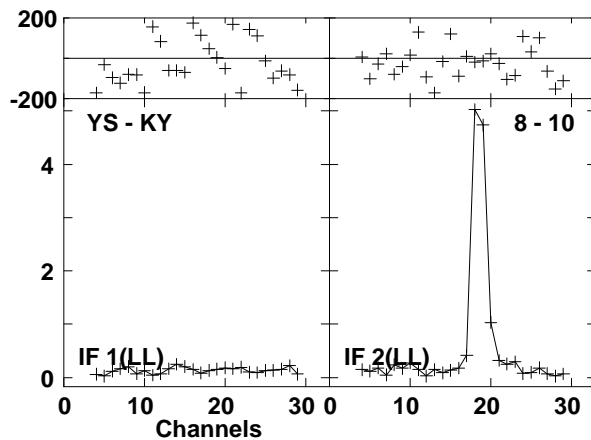
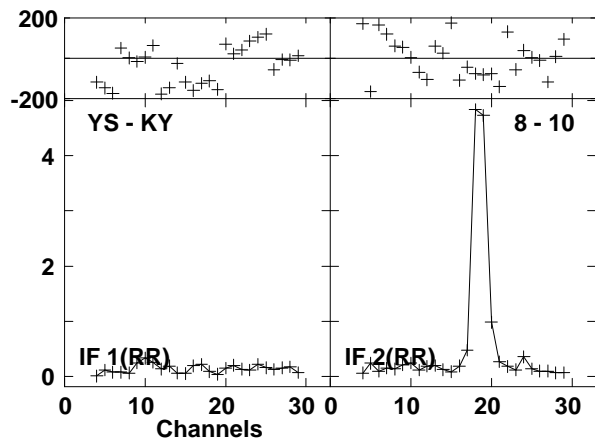
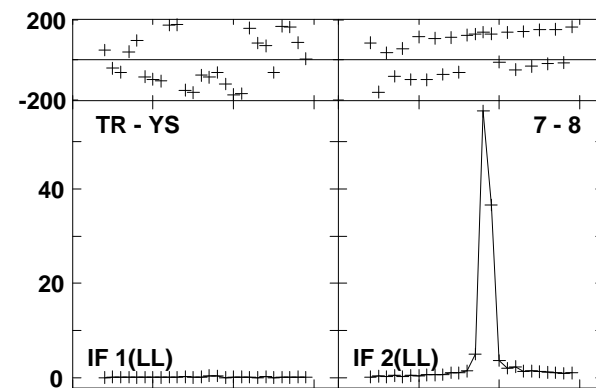
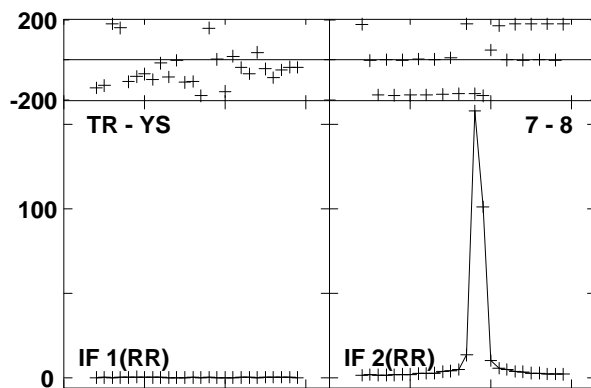
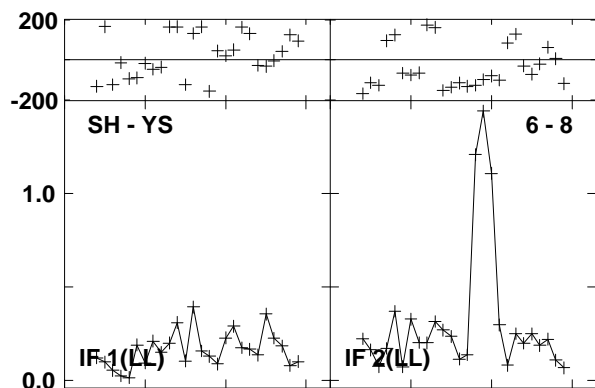
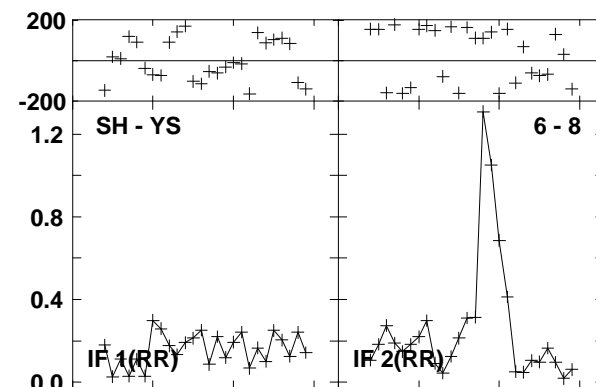
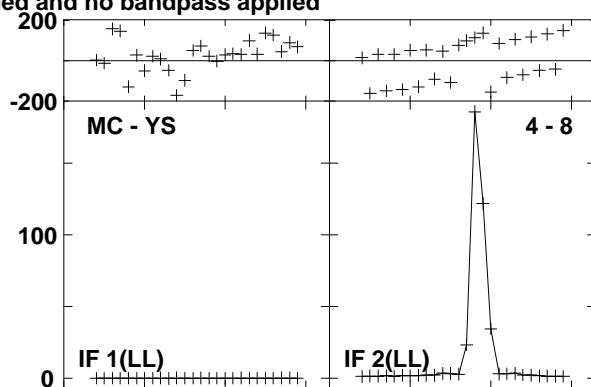
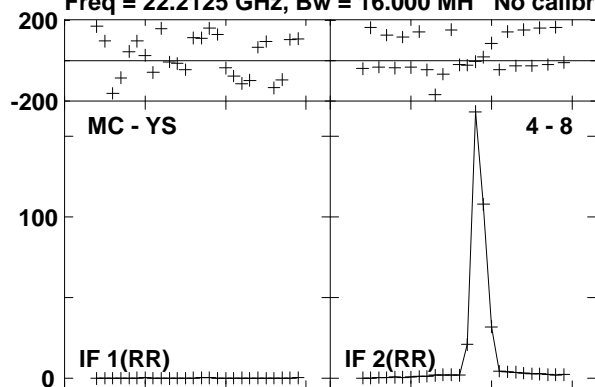

Lower frame: Milli Ampl Jy Top frame: Phas deg  
Vector averaged cross-power spectrum Baseline: MC (04) - YS (08)  
Timerange: 00/09:11:06 to 00/09:12:05

Plot file version 56 created 23-AUG-2016 15:00:43

W3IRS5 GA035B 1.UVDATA.1

Freq = 22.2125 GHz, Bw = 16.000 MH No calibration applied and no bandpass applied

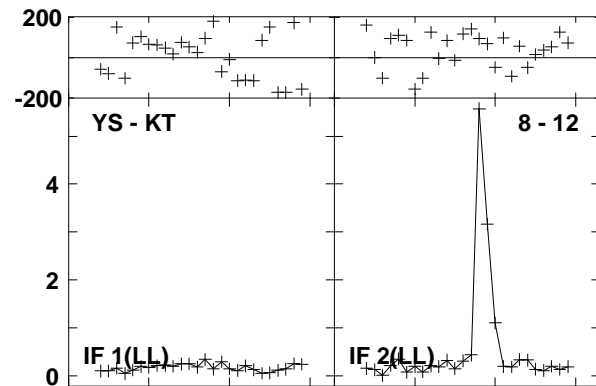
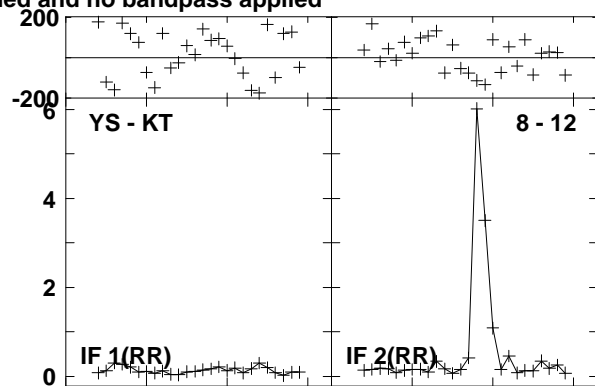
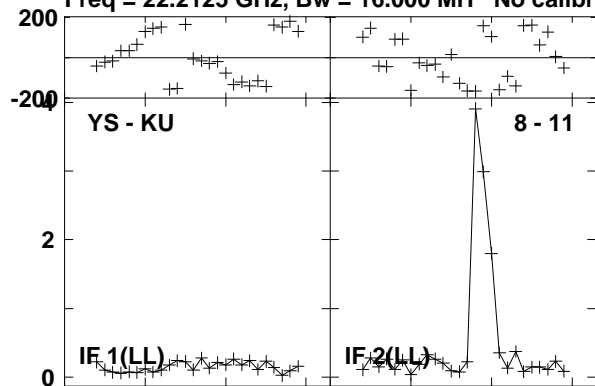

Lower frame: Milli Ampl Jy Top frame: Phas deg  
Vector averaged cross-power spectrum Baseline: YS (08) - KU (11)  
Timerange: 00/09:11:06 to 00/09:12:05



Plot file version 57 created 23-AUG-2016 15:00:43

0219+628 GA035B 1.UVDATA.1

Freq = 22.2125 GHz, Bw = 16.000 MH No calibration applied and no bandpass applied

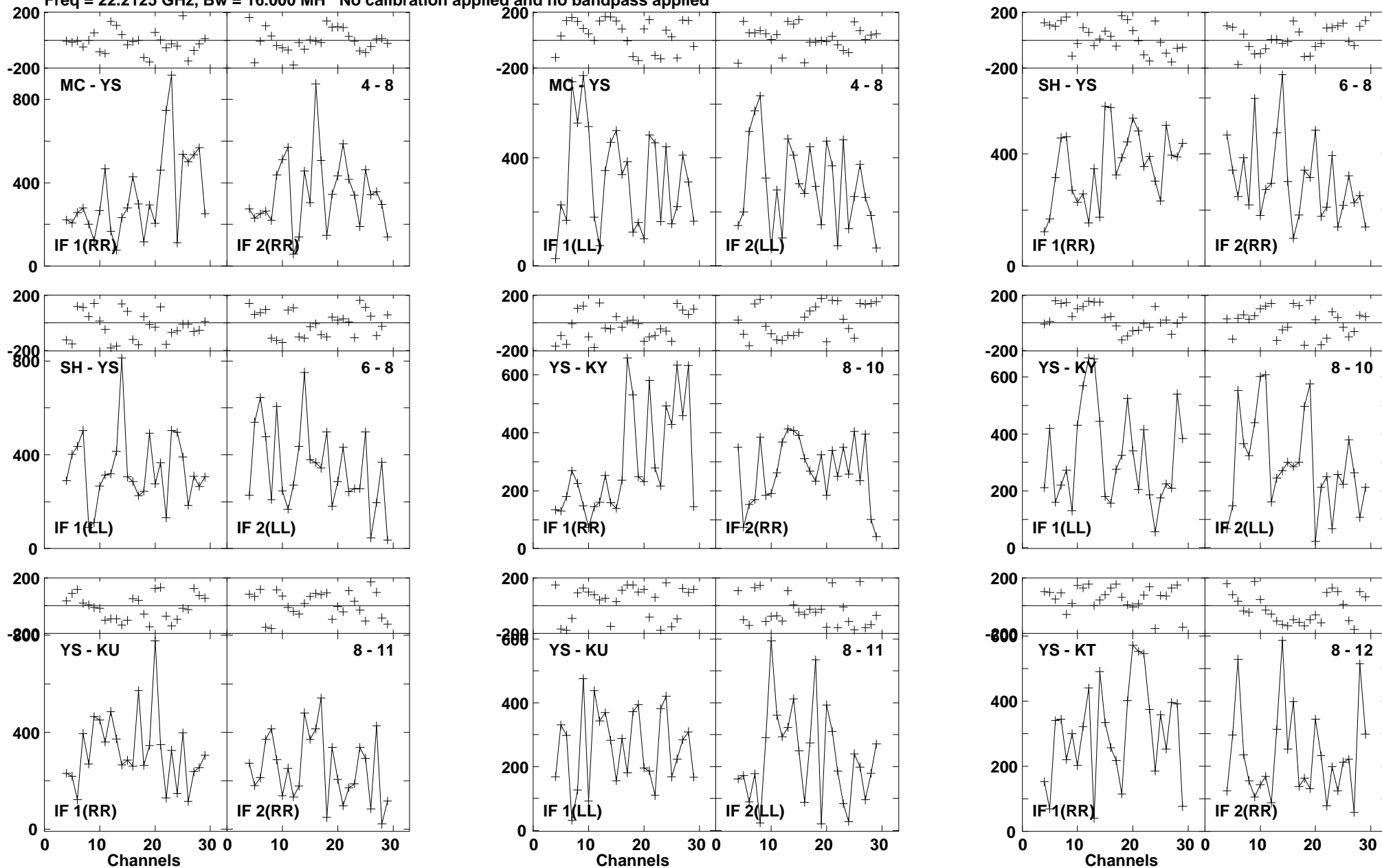

Lower frame: Micro Ampl Jy Top frame: Phas deg  
Vector averaged cross-power spectrum Baseline: MC (04) - YS (08)  
Timerange: 00/09:12:30 to 00/09:12:49

Plot file version 58 created 23-AUG-2016 15:00:43  
0219+628 GA035B 1.UVDATA.1  
Freq = 22.2125 GHz, Bw = 16.000 MH No calibration applied and no bandpass applied

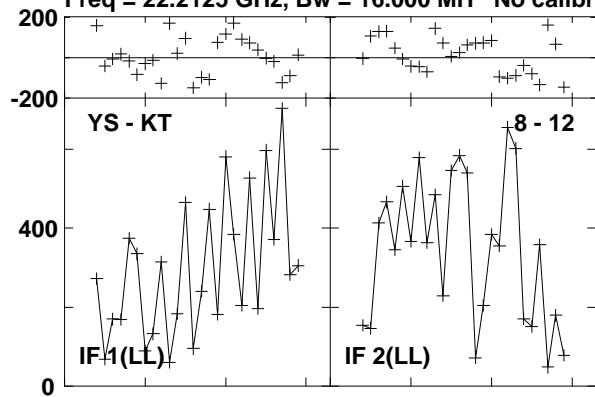

Lower frame: Micro Ampl Jy Top frame: Phas deg  
Vector averaged cross-power spectrum Baseline: YS (08) - KT (12)  
Timerange: 00/09:12:30 to 00/09:12:49

Plot file version 59 created 23-AUG-2016 15:00:43  
 W3IRS5 GA035B 1.UVDATA.1  
 Freq = 22.2125 GHz, Bw = 16.000 MH No calibration applied and no bandpass applied

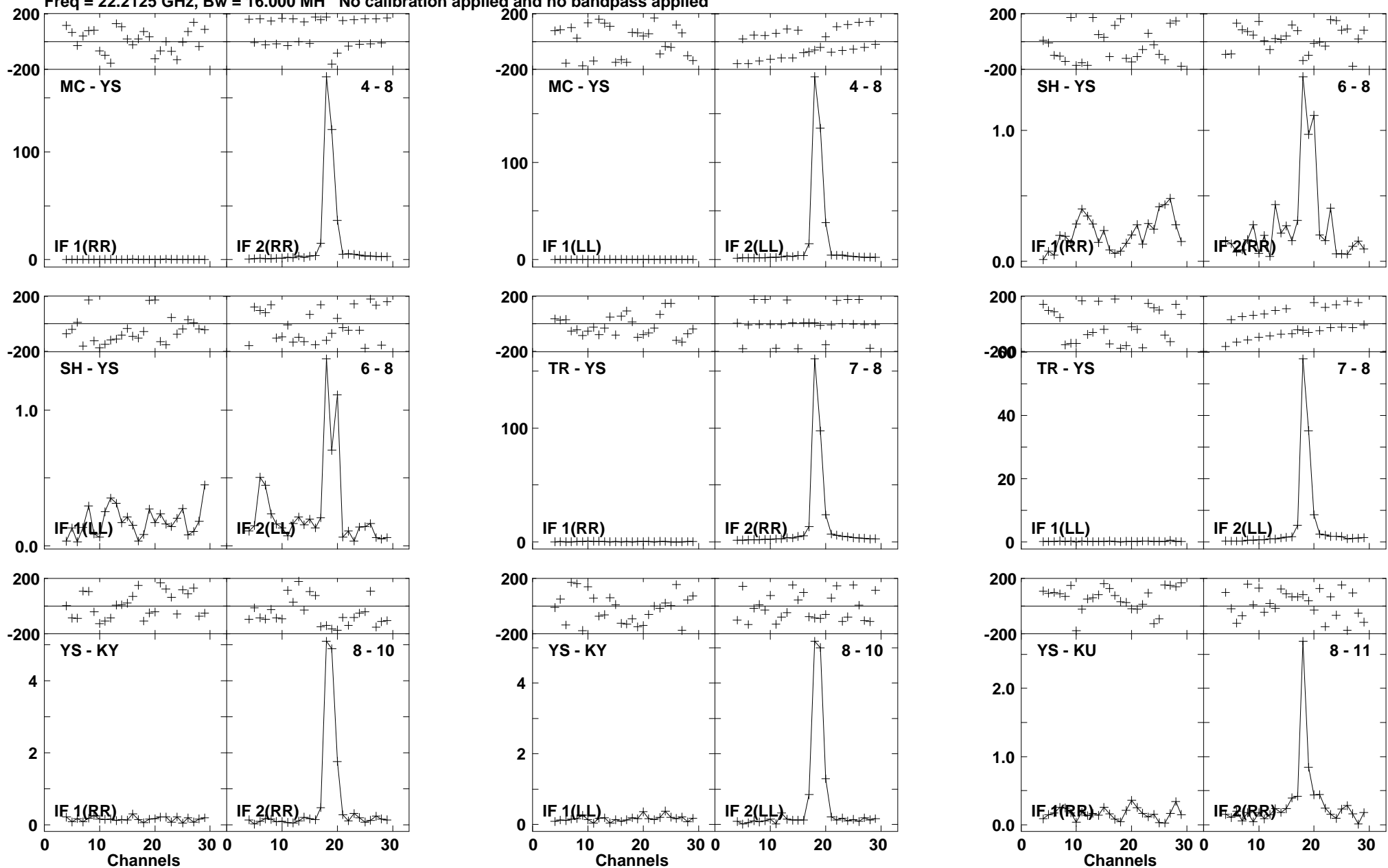

Lower frame: Milli Ampl Jy Top frame: Phas deg  
 Vector averaged cross-power spectrum Baseline: MC (04) - YS (08)  
 Timerange: 00/09:13:15 to 00/09:14:14

Plot file version 60 created 23-AUG-2016 15:00:43

W3IRS5 GA035B 1.UVDATA.1

Freq = 22.2125 GHz, Bw = 16.000 MH No calibration applied and no bandpass applied

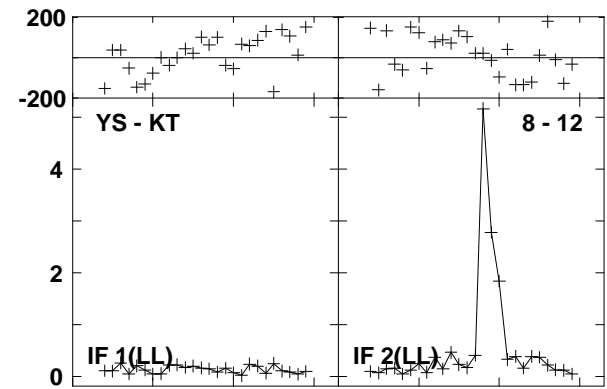
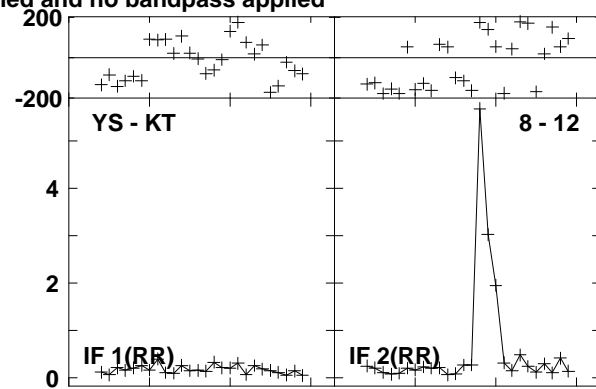
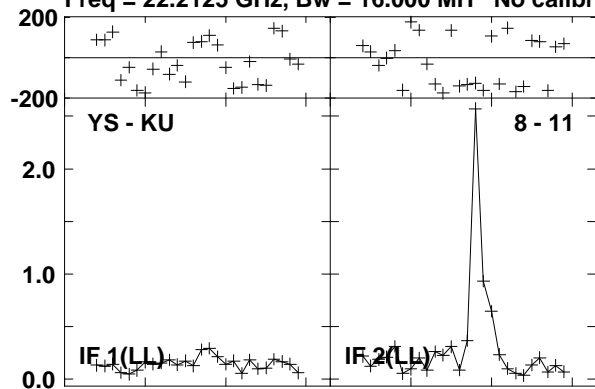

Lower frame: Milli Ampl Jy Top frame: Phas deg  
Vector averaged cross-power spectrum Baseline: YS (08) - KU (11)  
Timerange: 00/09:13:15 to 00/09:14:14

Plot file version 61 created 23-AUG-2016 15:00:44  
 0219+628 GA035B 1.UVDATA.1

Freq = 22.2125 GHz, Bw = 16.000 MH No calibration applied and no bandpass applied

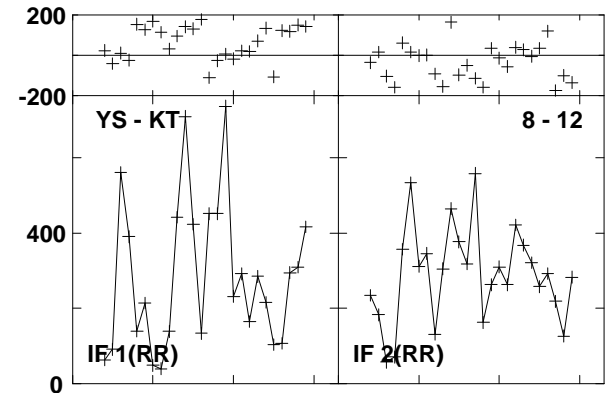
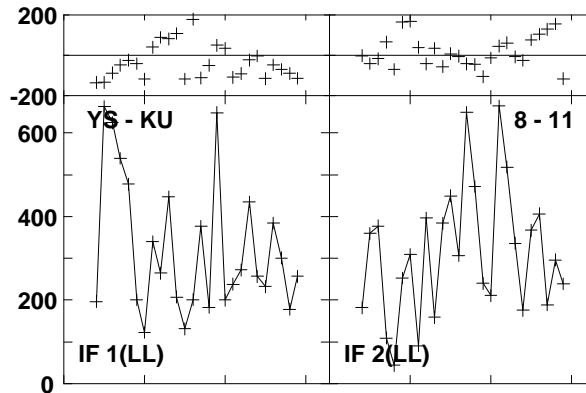
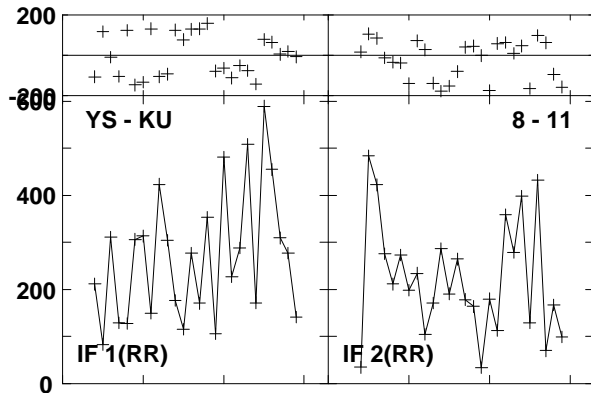
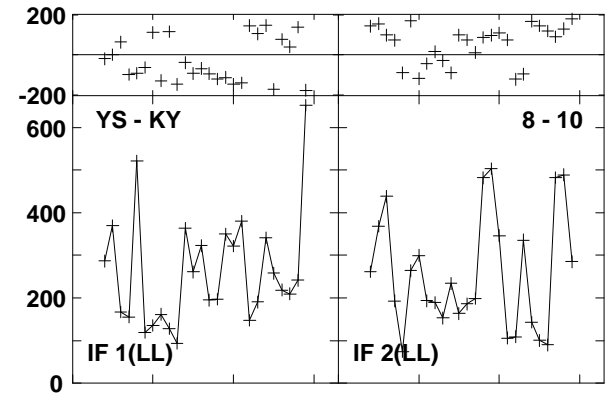
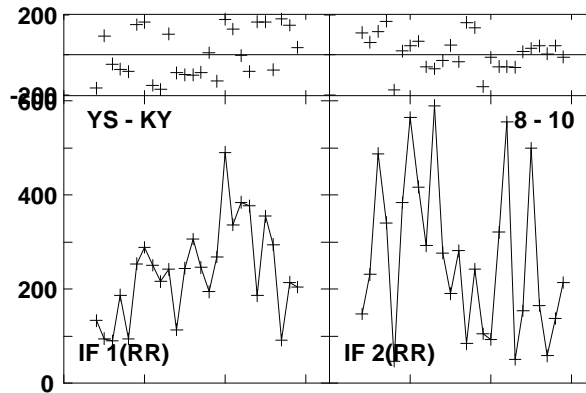
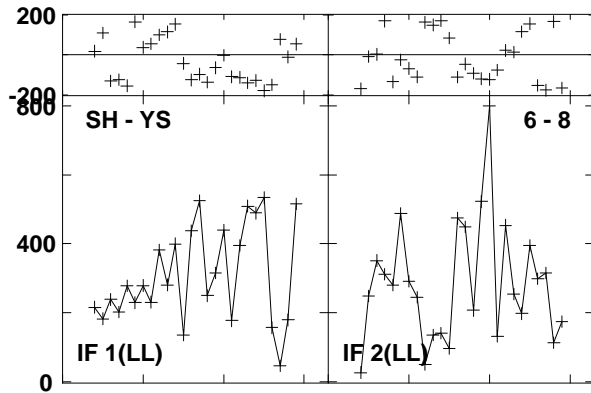
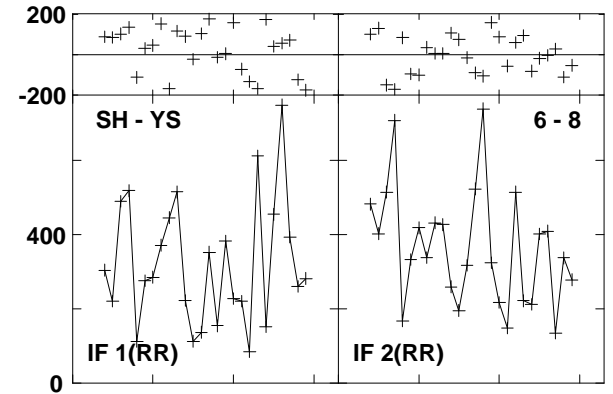
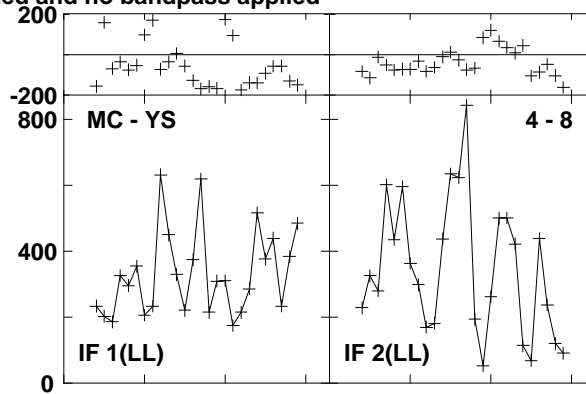
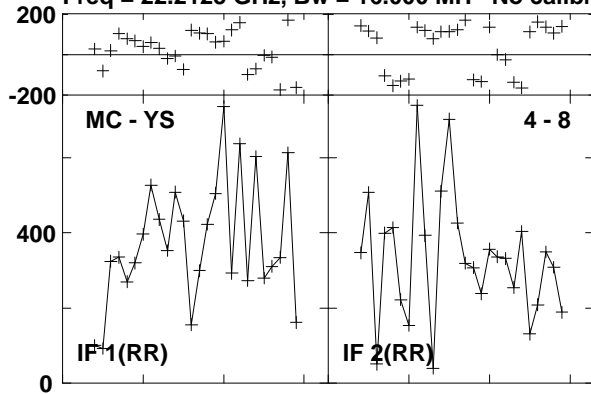

Lower frame: Micro Ampl Jy Top frame: Phas deg  
 Vector averaged cross-power spectrum Baseline: MC (04) - YS (08)  
 Timerange: 00/09:14:40 to 00/09:15:00

Plot file version 62 created 23-AUG-2016 15:00:44  
0219+628 GA035B 1.UVDATA.1  
Freq = 22.2125 GHz, Bw = 16.000 MH No calibration applied and no bandpass applied

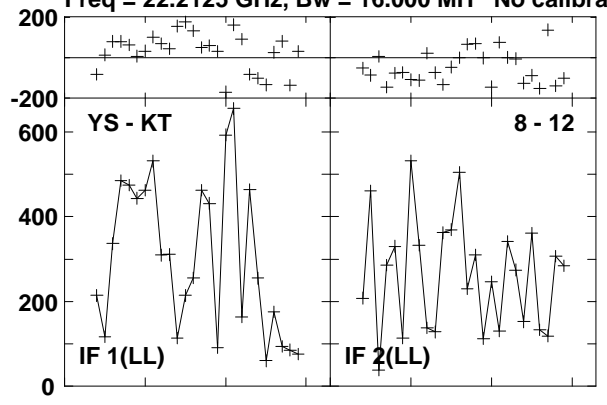

Lower frame: Micro Ampl Jy Top frame: Phas deg  
Vector averaged cross-power spectrum Baseline: YS (08) - KT (12)  
Timerange: 00/09:14:40 to 00/09:15:00

Plot file version 63 created 23-AUG-2016 15:00:44

W3IRS5 GA035B 1.UVDATA.1

Freq = 22.2125 GHz, Bw = 16.000 MH No calibration applied and no bandpass applied

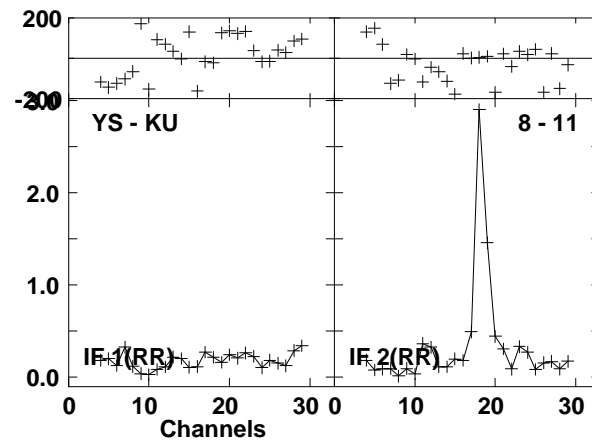
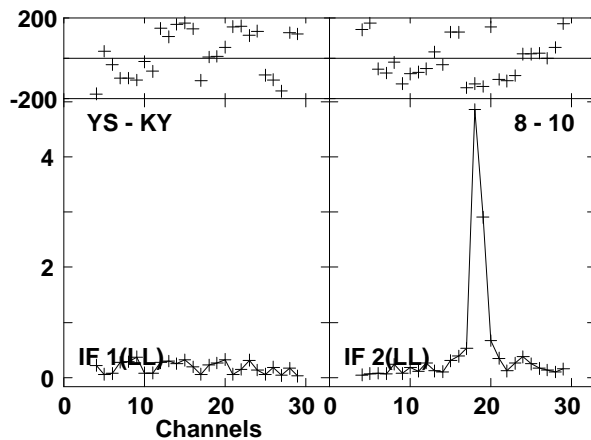
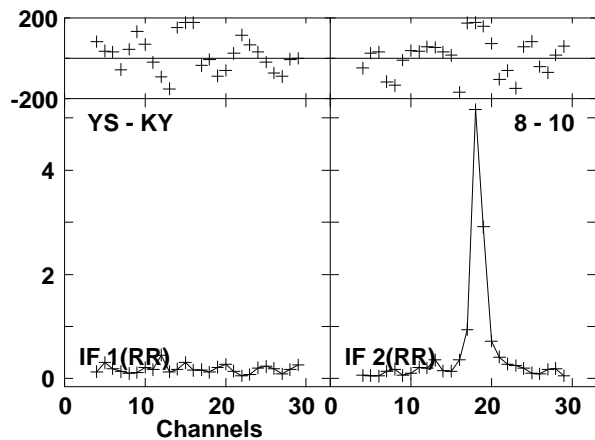
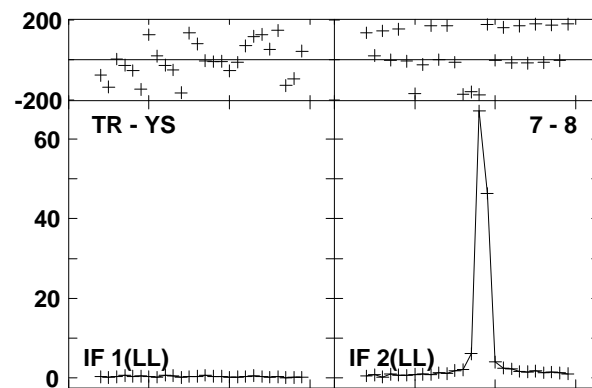
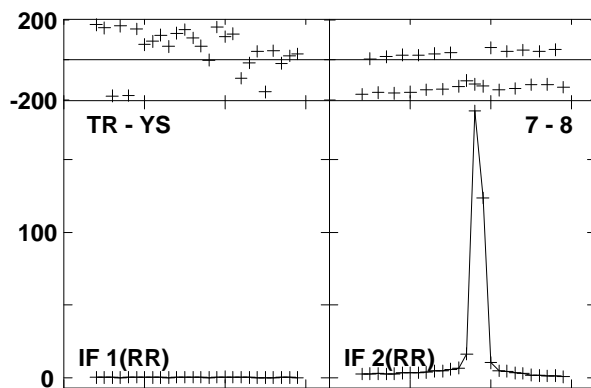
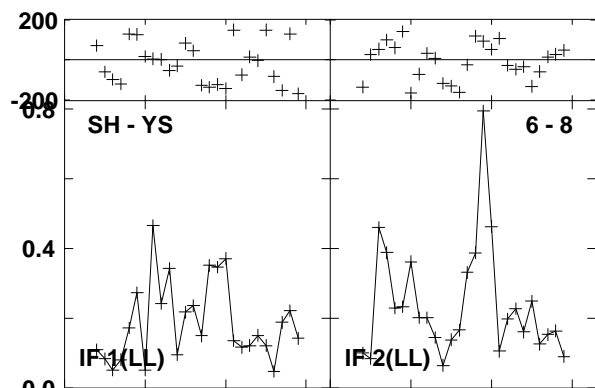
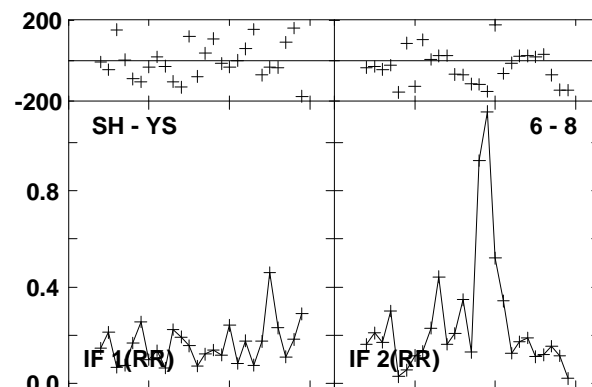
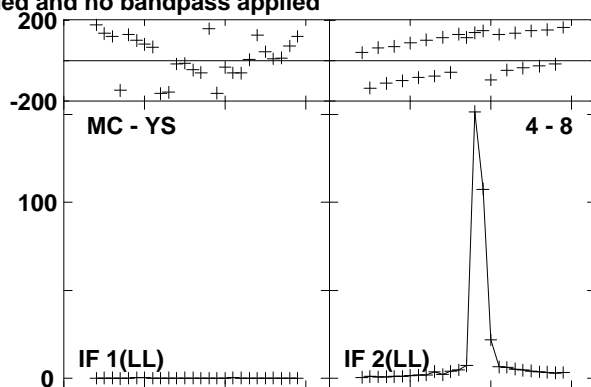
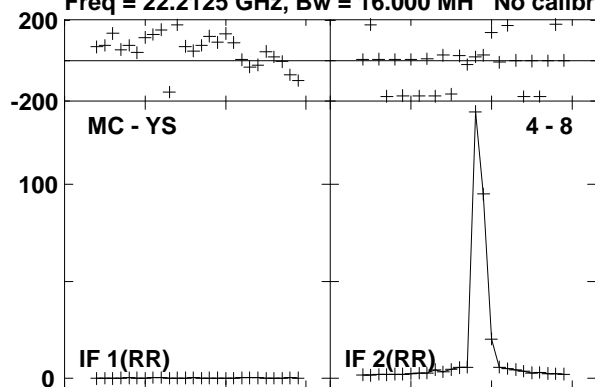

Lower frame: Milli Ampl Jy Top frame: Phas deg  
Vector averaged cross-power spectrum Baseline: MC (04) - YS (08)  
Timerange: 00/09:15:26 to 00/09:16:24

Plot file version 64 created 23-AUG-2016 15:00:44

W3IRS5 GA035B 1.UVDATA.1

Freq = 22.2125 GHz, Bw = 16.000 MH No calibration applied and no bandpass applied

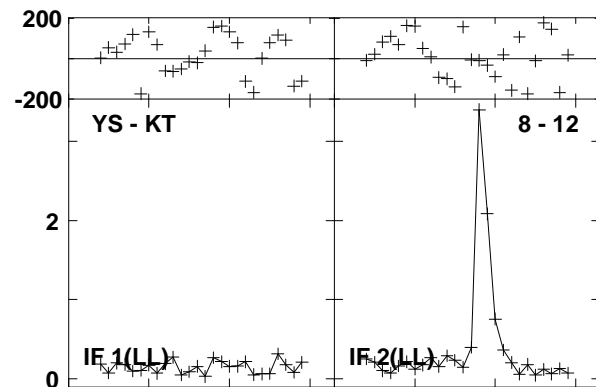
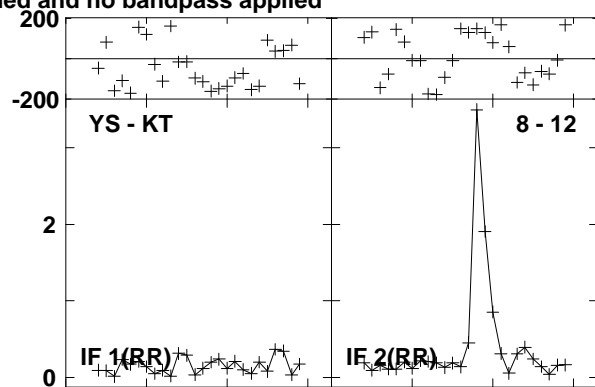
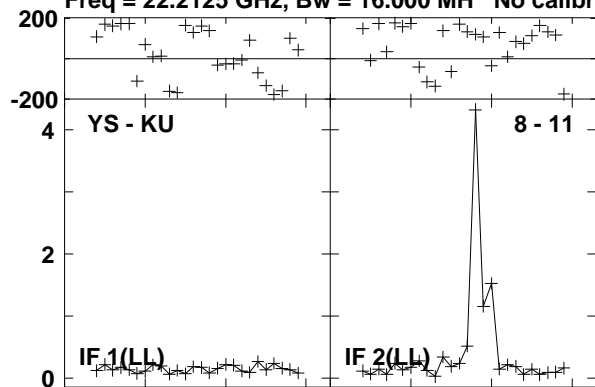

Lower frame: Milli Ampl Jy Top frame: Phas deg  
Vector averaged cross-power spectrum Baseline: YS (08) - KU (11)  
Timerange: 00/09:15:26 to 00/09:16:24



Plot file version 65 created 23-AUG-2016 15:00:44

0219+628 GA035B 1.UVDATA.1

Freq = 22.2125 GHz, Bw = 16.000 MH No calibration applied and no bandpass applied

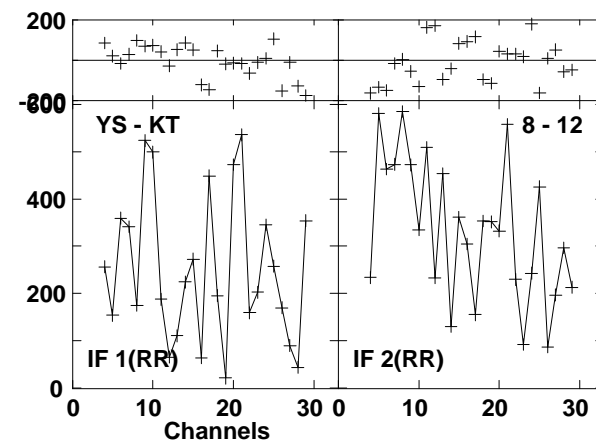
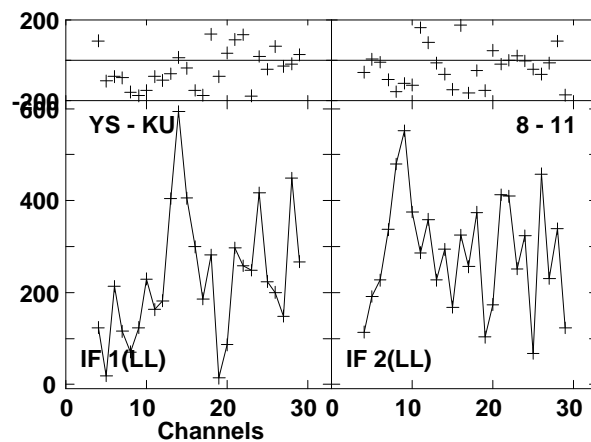
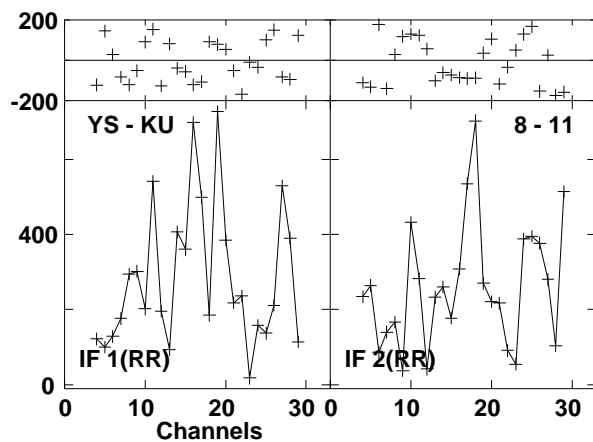
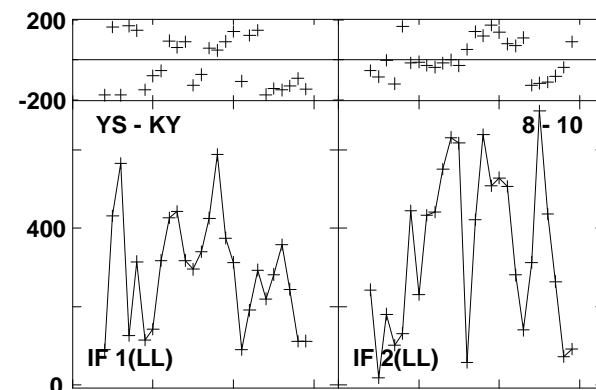
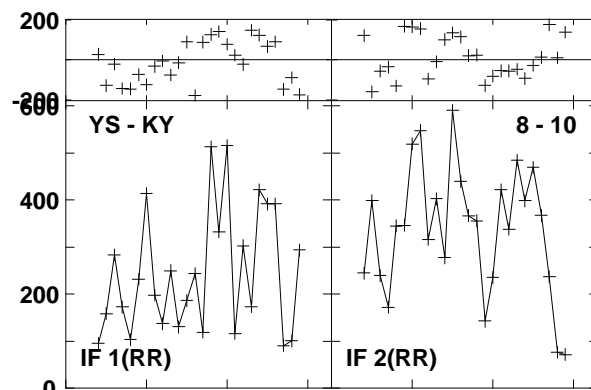
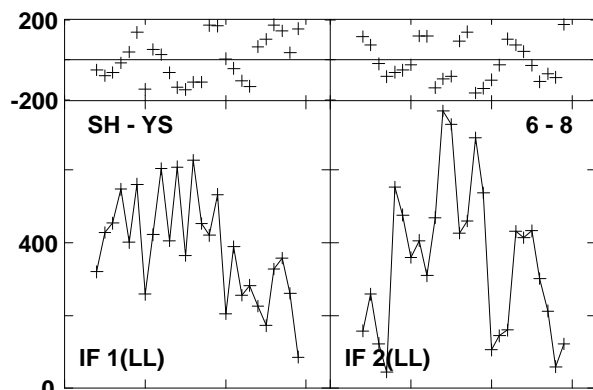
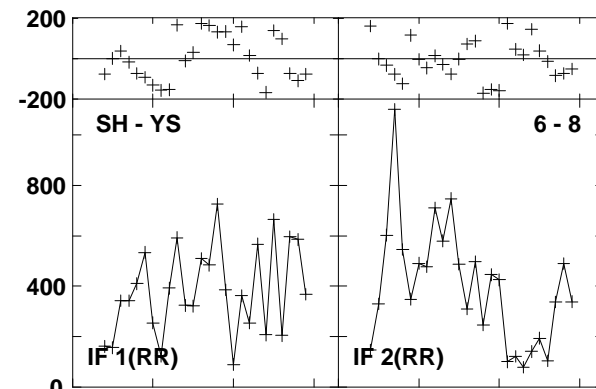
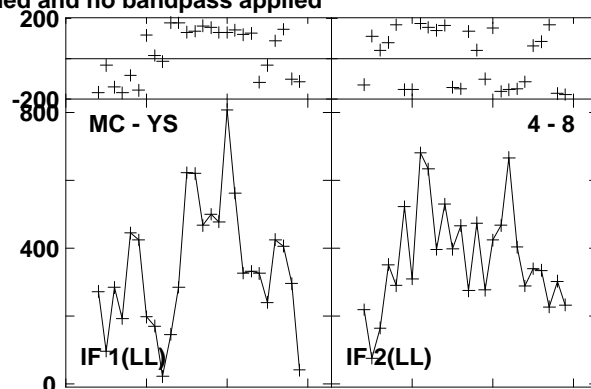
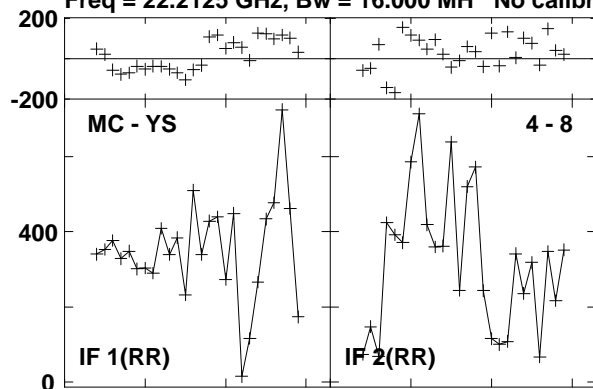

Lower frame: Micro Ampl Jy Top frame: Phas deg

Vector averaged cross-power spectrum Baseline: MC (04) - YS (08)

Timerange: 00/09:16:50 to 00/09:17:10

Plot file version 66 created 23-AUG-2016 15:00:44  
0219+628 GA035B 1.UVDATA.1  
Freq = 22.2125 GHz, Bw = 16.000 MH No calibration applied and no bandpass applied

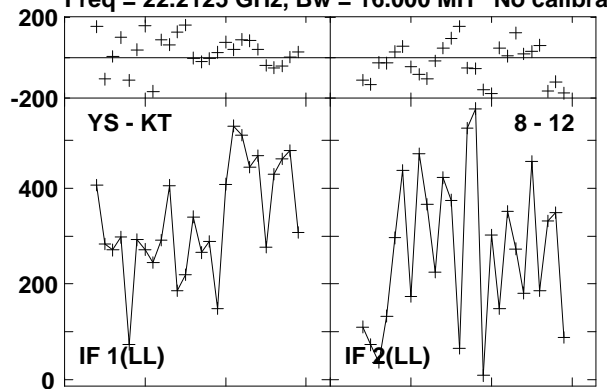

Lower frame: Micro Ampl Jy Top frame: Phas deg  
Vector averaged cross-power spectrum Baseline: YS (08) - KT (12)  
Timerange: 00/09:16:50 to 00/09:17:10

Plot file version 67 created 23-AUG-2016 15:00:44

0219+628 GA035B 1.UVDATA.1

Freq = 22.2125 GHz, Bw = 16.000 MH No calibration applied and no bandpass applied

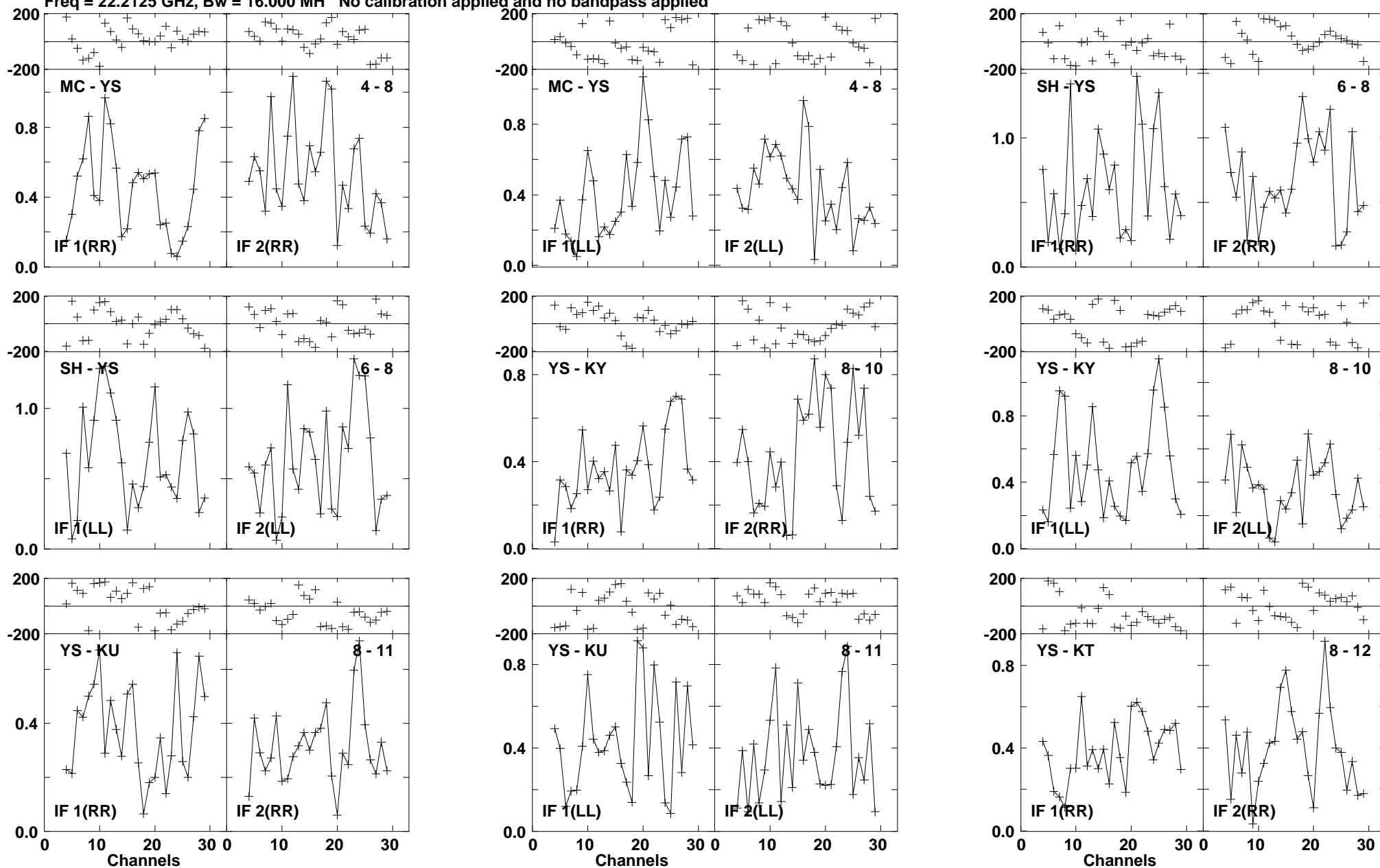

Lower frame: Milli Ampl Jy Top frame: Phas deg  
Vector averaged cross-power spectrum Baseline: MC (04) - YS (08)  
Timerange: 00/09:19:00 to 00/09:19:20

Plot file version 68 created 23-AUG-2016 15:00:44  
0219+628 GA035B 1.UVDATA.1  
Freq = 22.2125 GHz, Bw = 16.000 MH No calibration applied and no bandpass applied

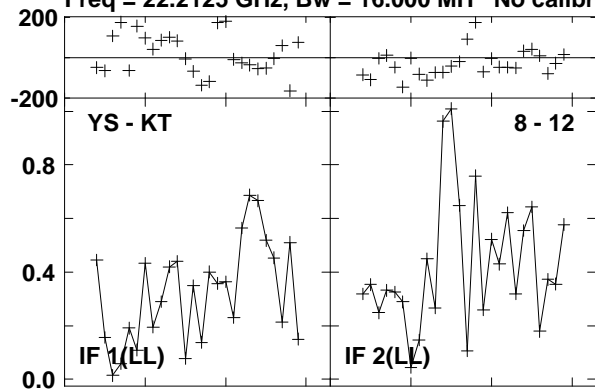

Lower frame: Milli Ampl Jy Top frame: Phas deg  
Vector averaged cross-power spectrum Baseline: YS (08) - KT (12)  
Timerange: 00/09:19:00 to 00/09:19:20

Plot file version 69 created 23-AUG-2016 15:00:44

W3IRS5 GA035B 1.UVDATA.1

Freq = 22.2125 GHz, Bw = 16.000 MH No calibration applied and no bandpass applied

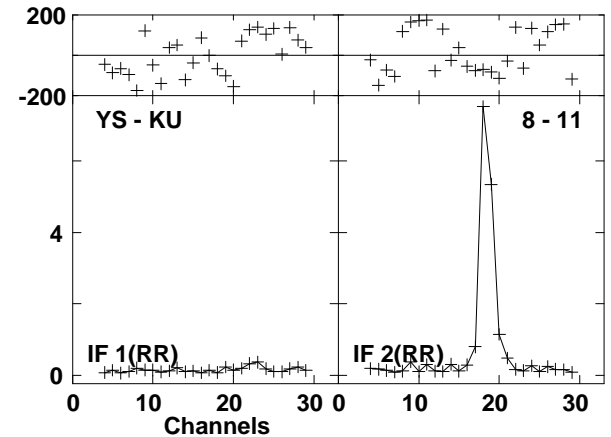
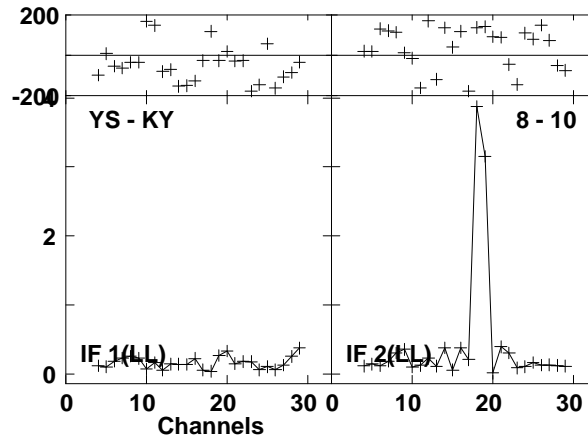
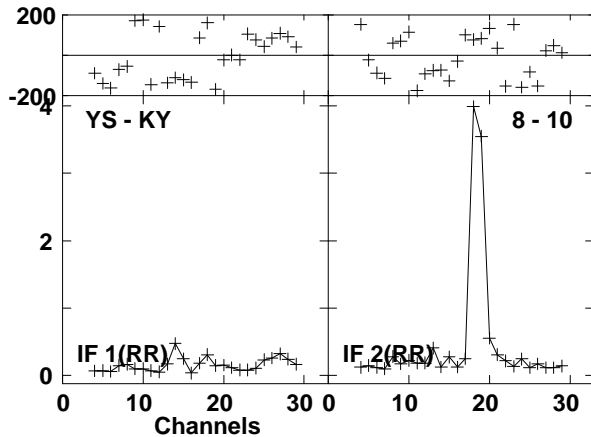
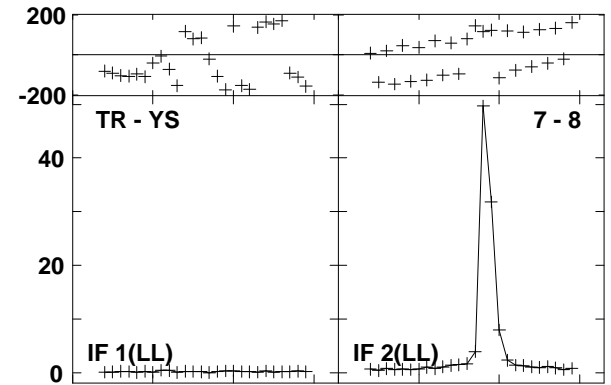
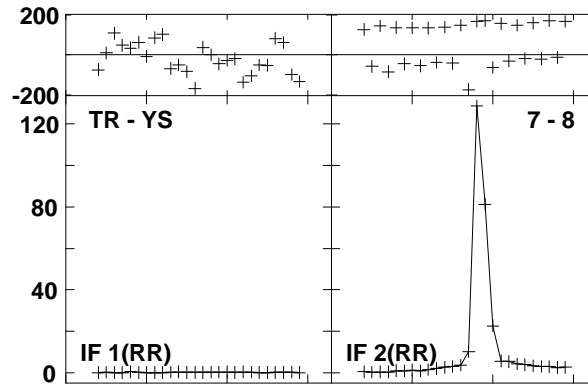
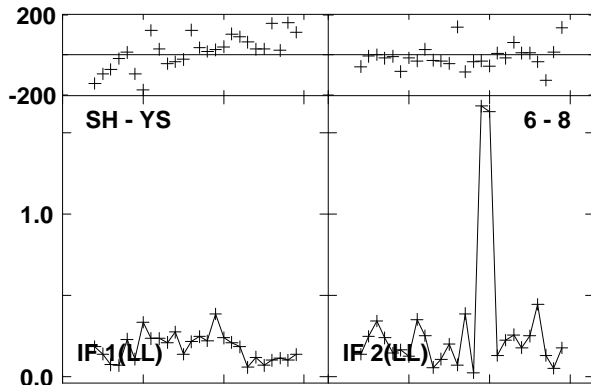
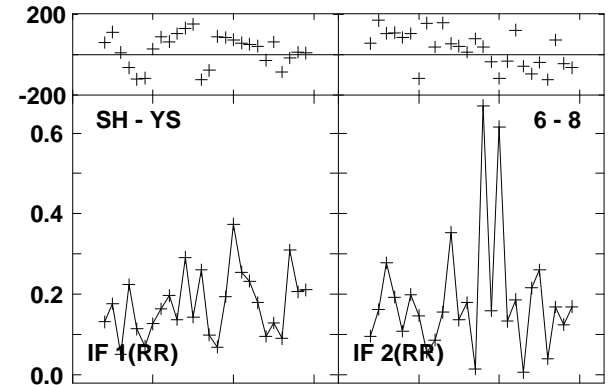
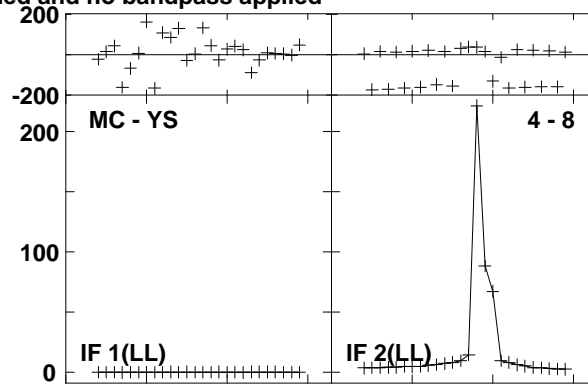
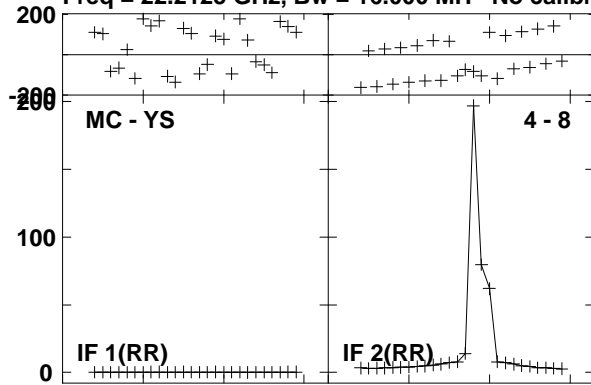

Lower frame: Milli Ampl Jy Top frame: Phas deg

Vector averaged cross-power spectrum Baseline: MC (04) - YS (08)

Timerange: 00/09:19:46 to 00/09:20:45

Plot file version 70 created 23-AUG-2016 15:00:44  
W3IRS5 GA035B 1.UVDATA.1

Freq = 22.2125 GHz, Bw = 16.000 MH No calibration applied and no bandpass applied

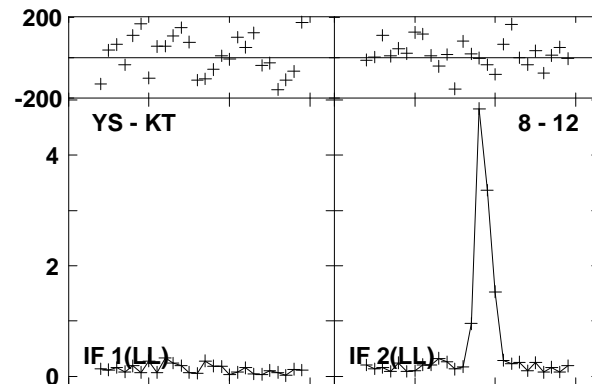
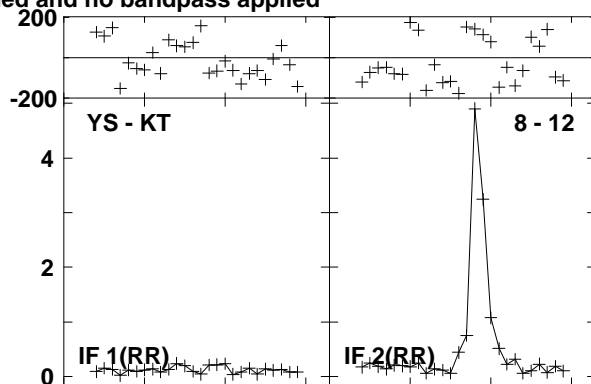
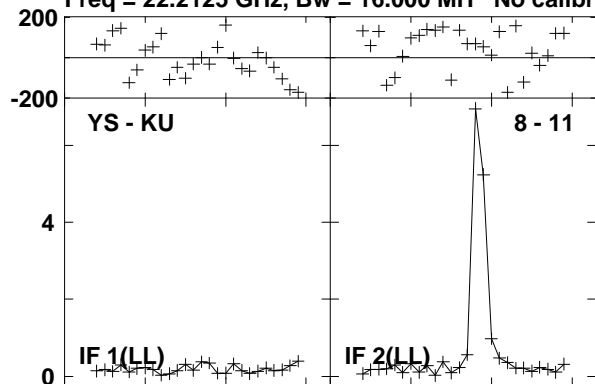

Lower frame: Milli Ampl Jy Top frame: Phas deg  
Vector averaged cross-power spectrum Baseline: YS (08) - KU (11)  
Timerange: 00/09:19:46 to 00/09:20:45

Plot file version 71 created 23-AUG-2016 15:00:44

0219+628 GA035B 1.UVDATA.1

Freq = 22.2125 GHz, Bw = 16.000 MH No calibration applied and no bandpass applied

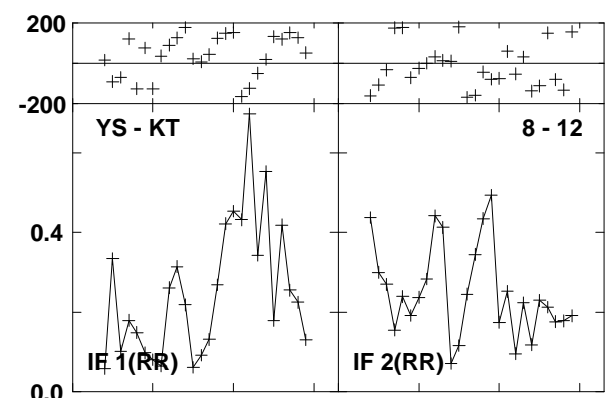
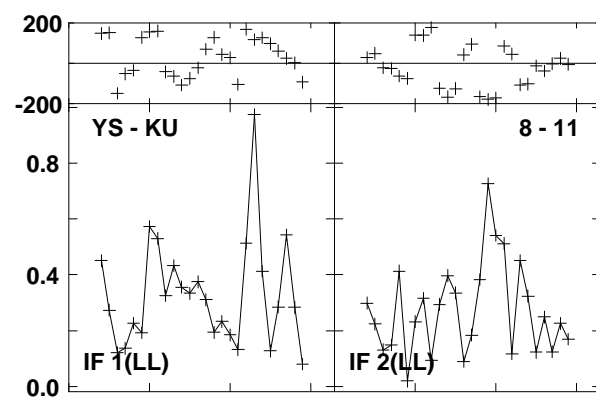
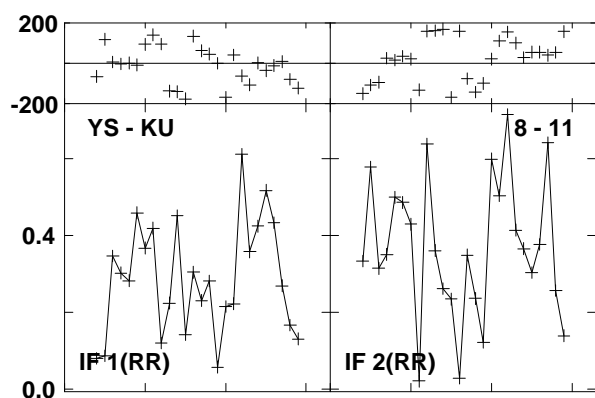
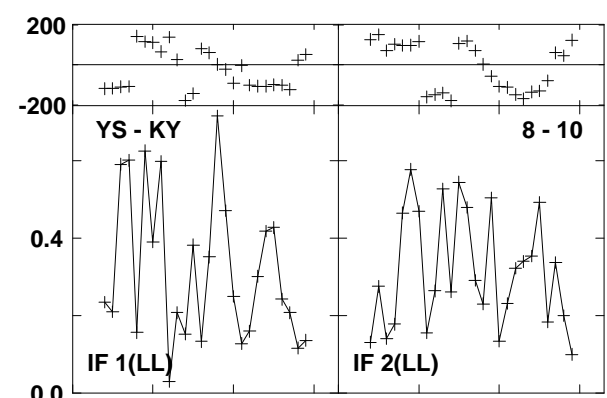
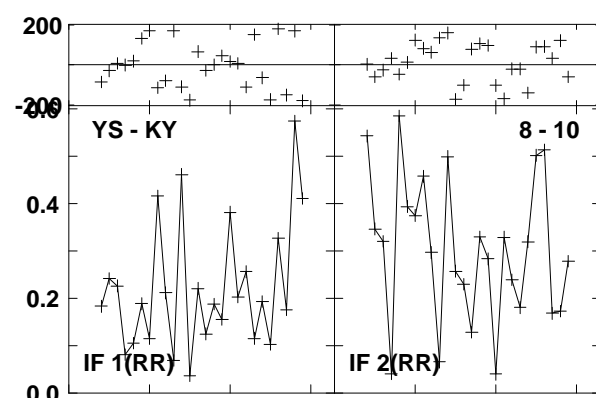
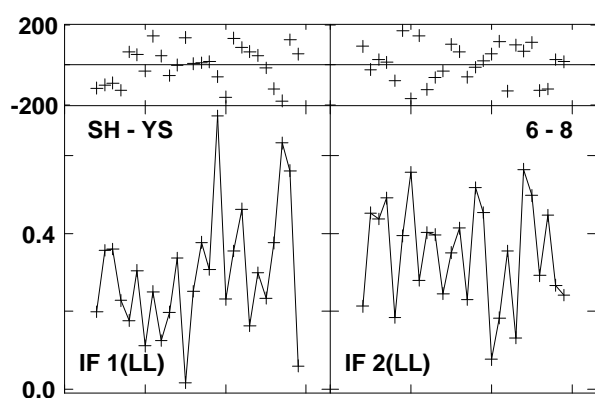
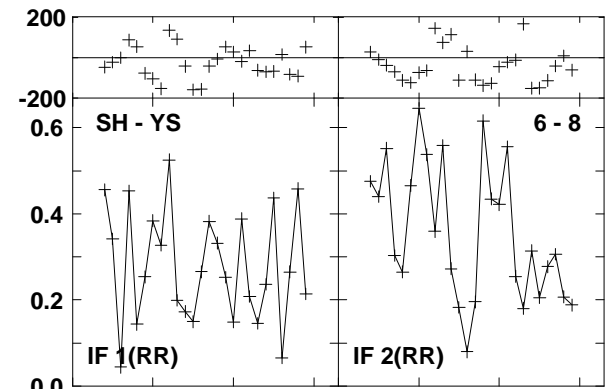
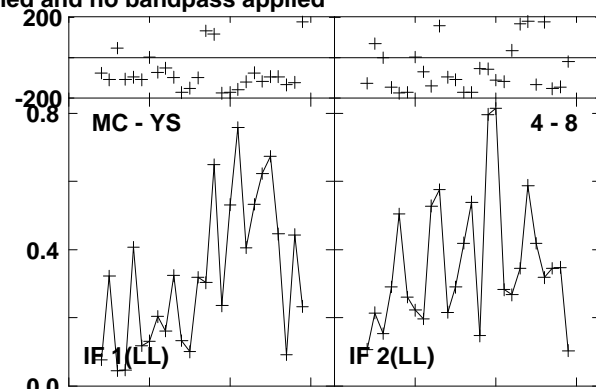
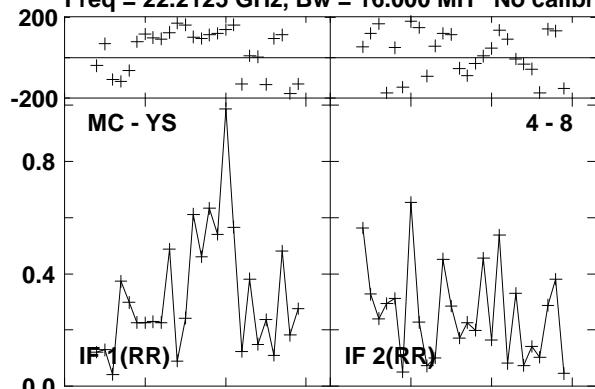

Lower frame: Milli Ampl Jy Top frame: Phas deg  
Vector averaged cross-power spectrum Baseline: MC (04) - YS (08)  
Timerange: 00/09:21:10 to 00/09:21:29

Plot file version 72 created 23-AUG-2016 15:00:44  
0219+628 GA035B 1.UVDATA.1  
Freq = 22.2125 GHz, Bw = 16.000 MH No calibration applied and no bandpass applied

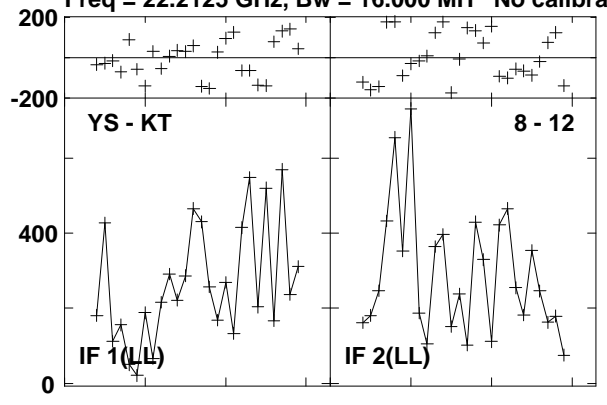

Lower frame: Micro Ampl Jy Top frame: Phas deg  
Vector averaged cross-power spectrum Baseline: YS (08) - KT (12)  
Timerange: 00/09:21:10 to 00/09:21:29



Plot file version 73 created 23-AUG-2016 15:00:44  
 2021+614 GA035B 1.UVDATA.1  
 Freq = 22.2125 GHz, Bw = 16.000 MH No calibration applied and no bandpass applied

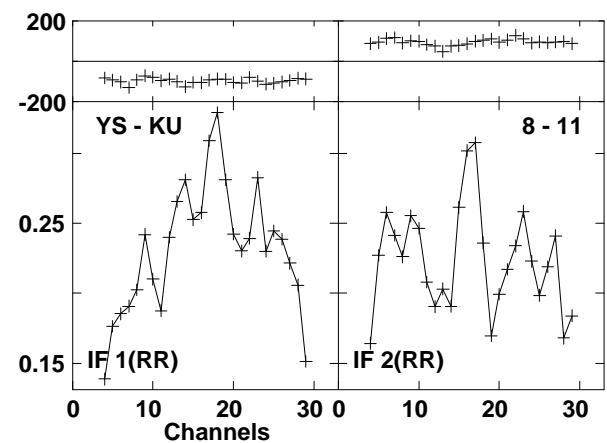
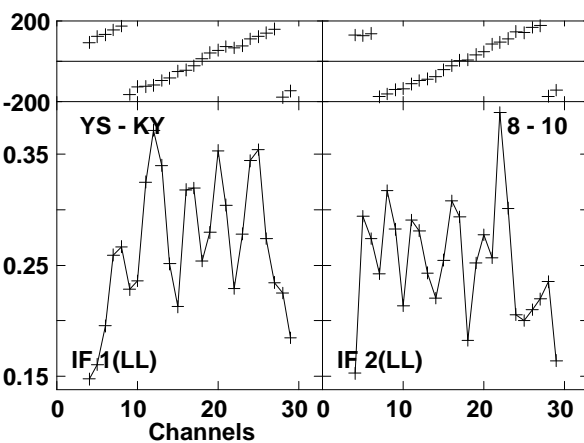
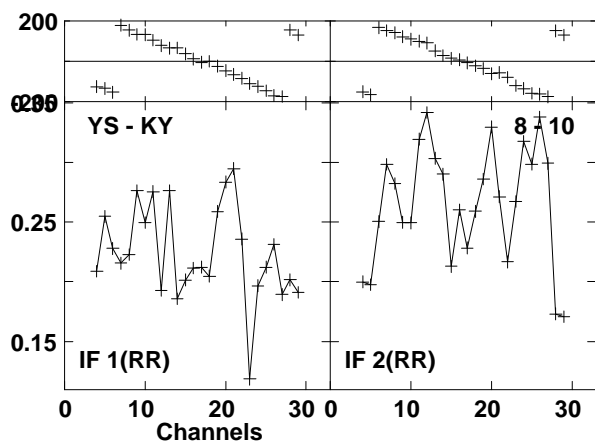
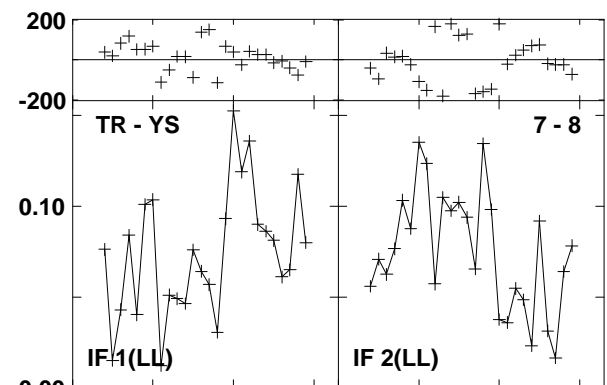
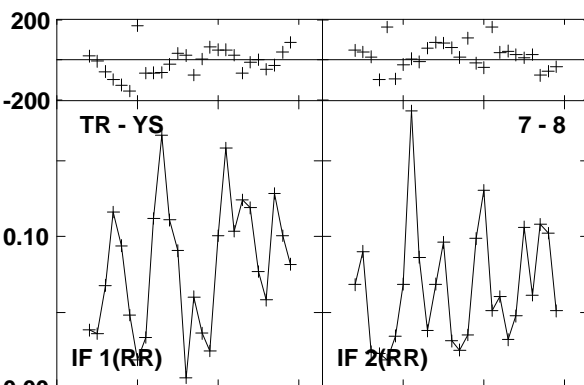
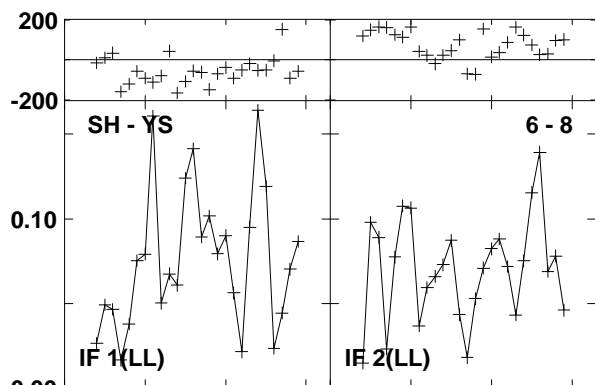
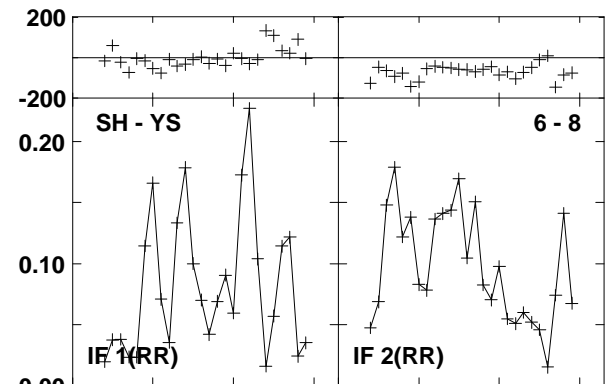
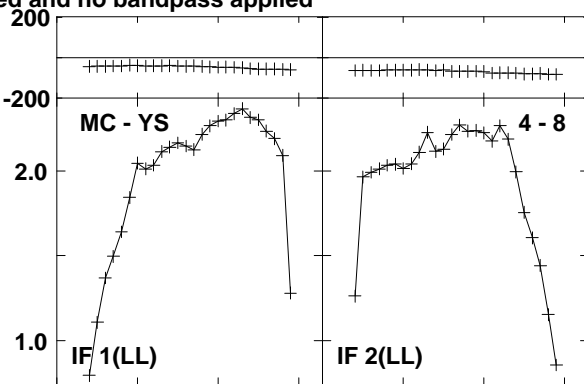
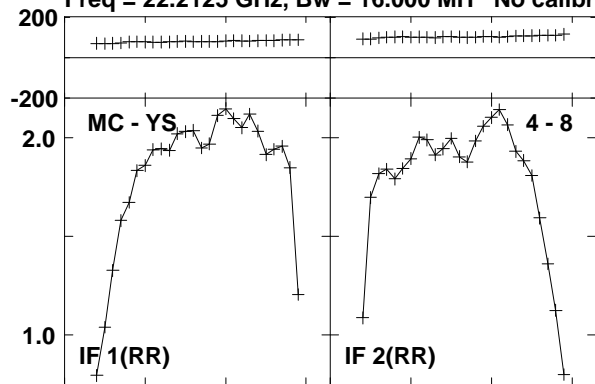

Lower frame: Milli Ampl Jy Top frame: Phas deg  
 Vector averaged cross-power spectrum Baseline: MC (04) - YS (08)  
 Timerange: 00/09:24:30 to 00/09:29:50

Plot file version 74 created 23-AUG-2016 15:00:44

2021+614 GA035B 1.UVDATA.1

Freq = 22.2125 GHz, Bw = 16.000 MH No calibration applied and no bandpass applied

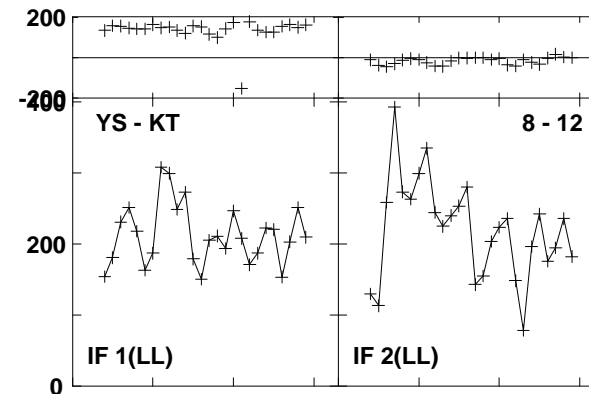
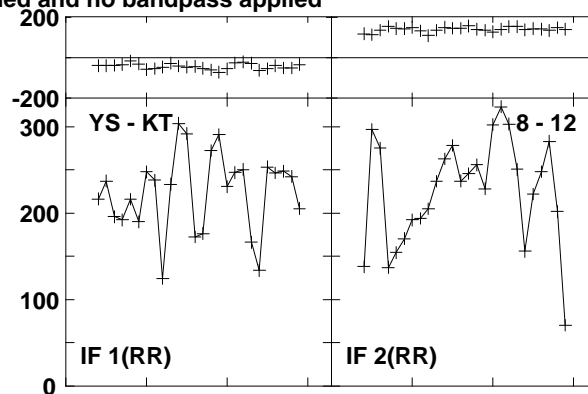
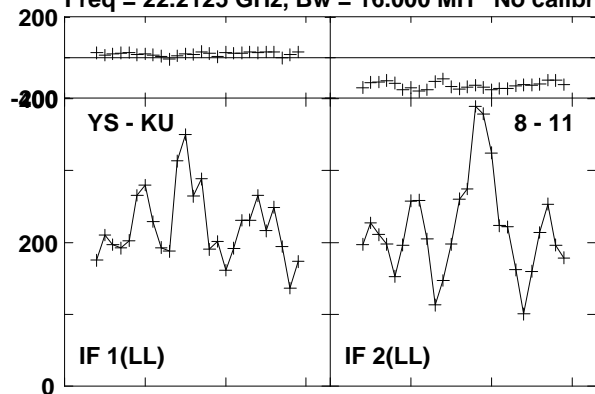

Lower frame: Micro Ampl Jy Top frame: Phas deg  
Vector averaged cross-power spectrum Baseline: YS (08) - KU (11)  
Timerange: 00/09:24:30 to 00/09:29:50

Plot file version 75 created 23-AUG-2016 15:00:44

0241+622 GA035B 1.UVDATA.1

Freq = 22.2125 GHz, Bw = 16.000 MH No calibration applied and no bandpass applied

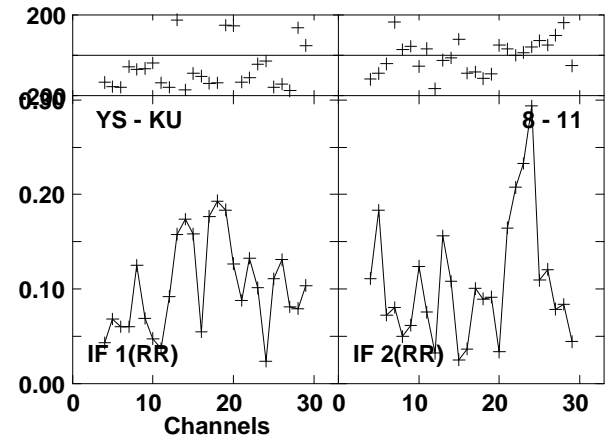
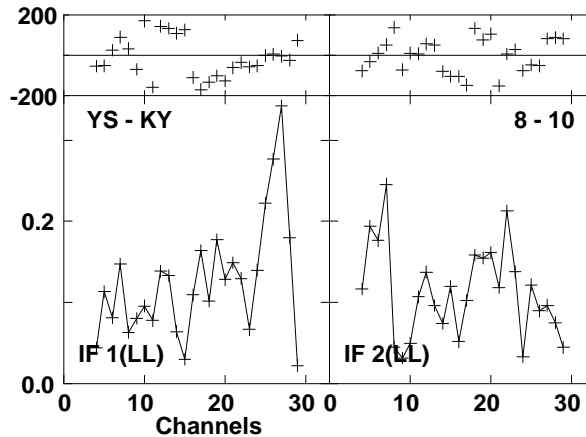
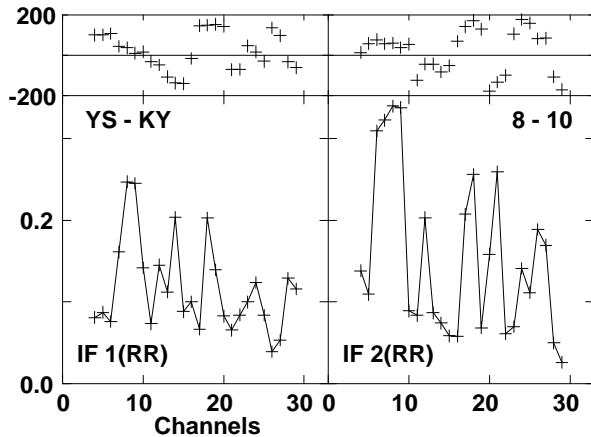
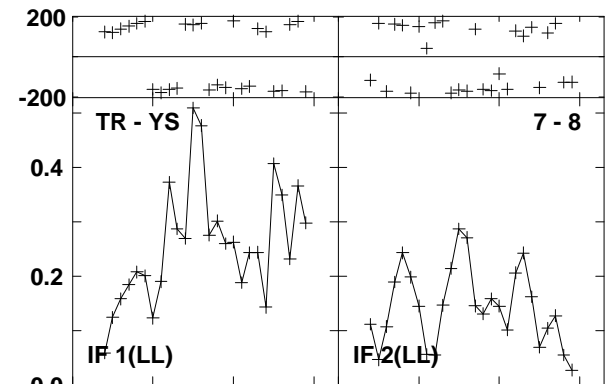
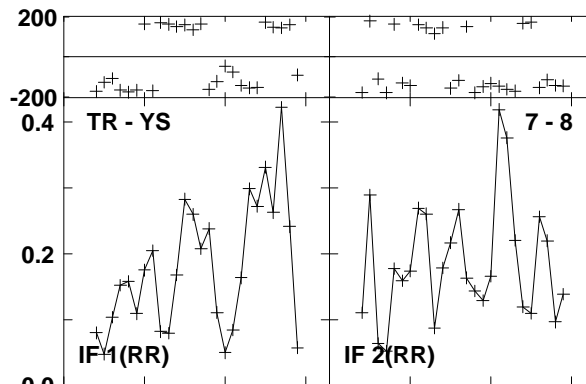
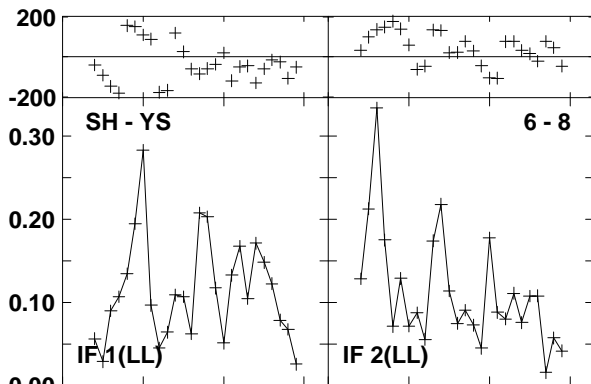
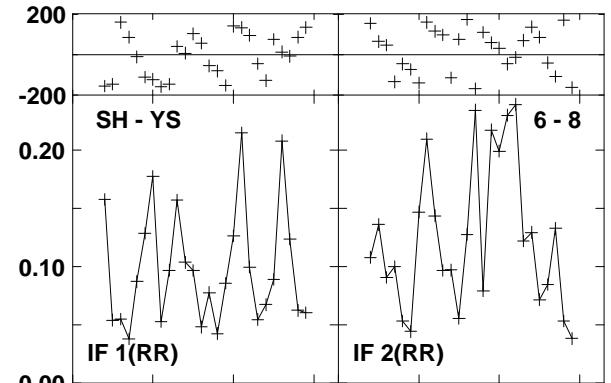
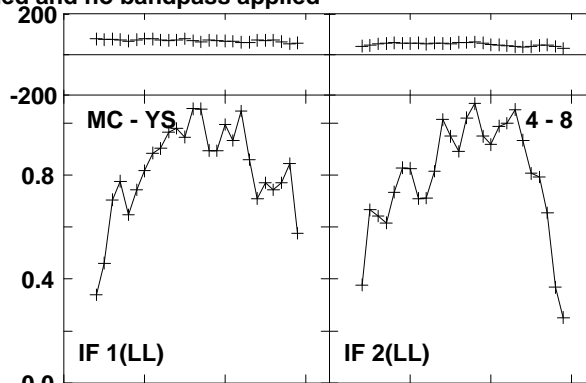
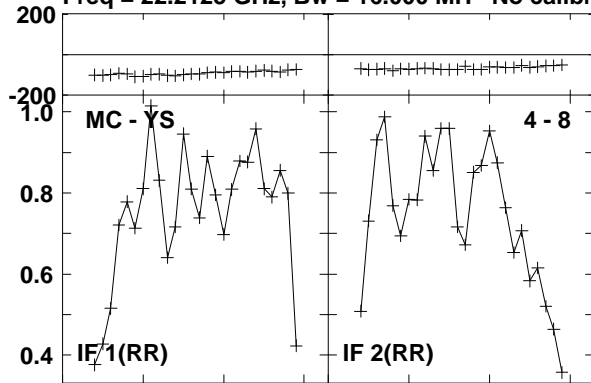

Lower frame: Milli Ampl Jy Top frame: Phas deg

Vector averaged cross-power spectrum Baseline: MC (04) - YS (08)

Timerange: 00/09:32:51 to 00/09:34:50

Plot file version 76 created 23-AUG-2016 15:00:44

0241+622 GA035B 1.UVDATA.1

Freq = 22.2125 GHz, Bw = 16.000 MH No calibration applied and no bandpass applied

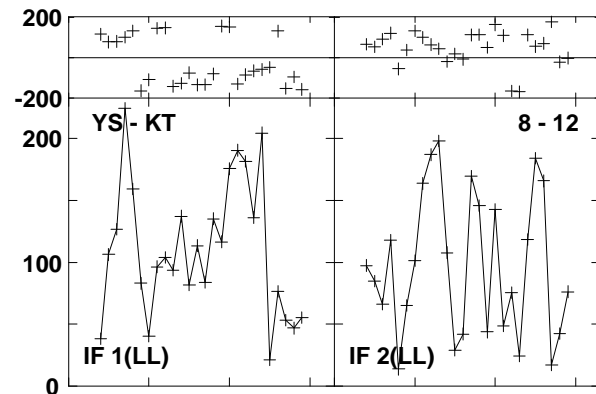
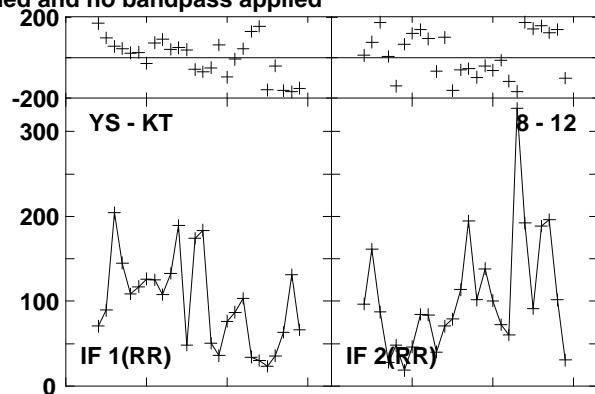
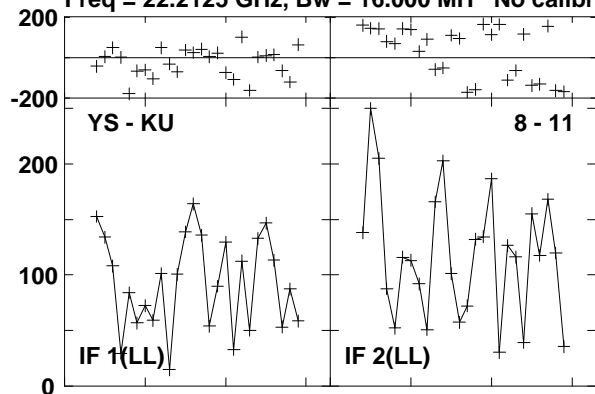

Lower frame: Micro Ampl Jy Top frame: Phas deg  
Vector averaged cross-power spectrum Baseline: YS (08) - KU (11)  
Timerange: 00/09:32:51 to 00/09:34:50

Plot file version 77 created 23-AUG-2016 15:00:44

W3IRS5 GA035B 1.UVDATA.1

Freq = 22.2125 GHz, Bw = 16.000 MH No calibration applied and no bandpass applied

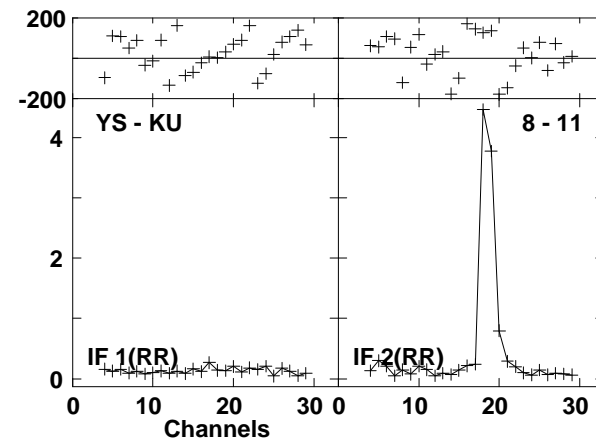
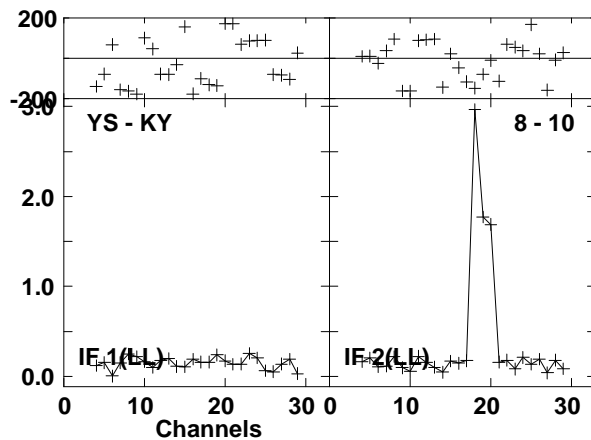
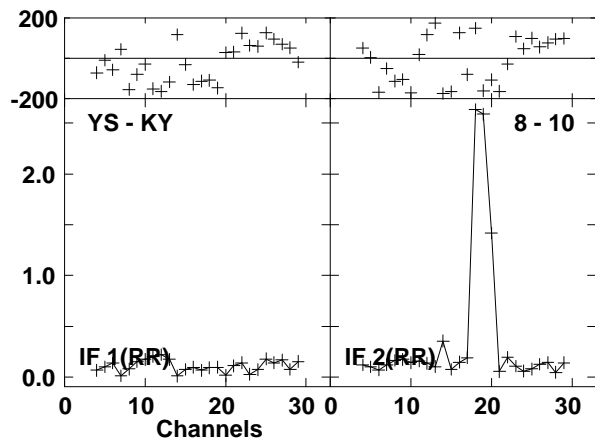
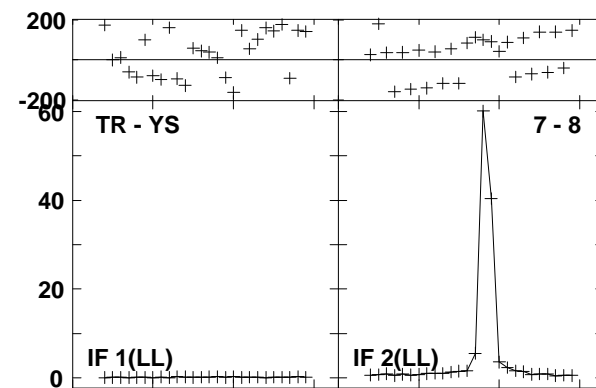
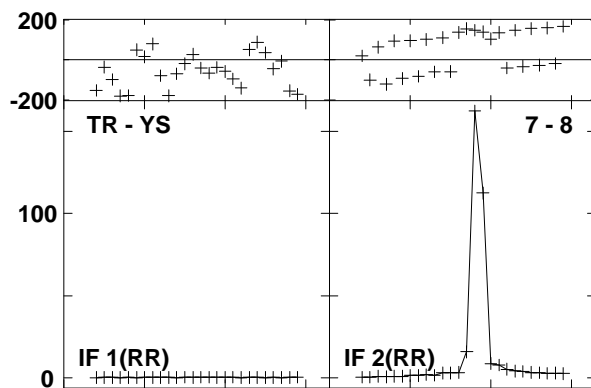
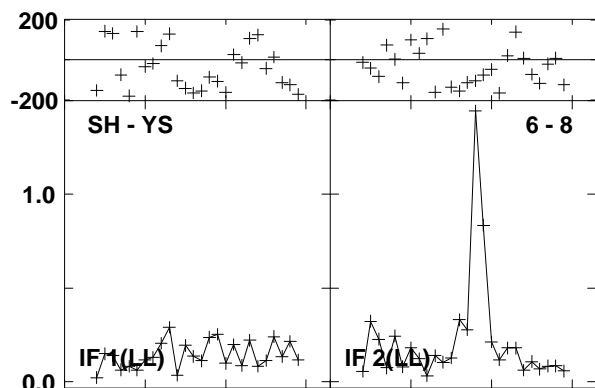
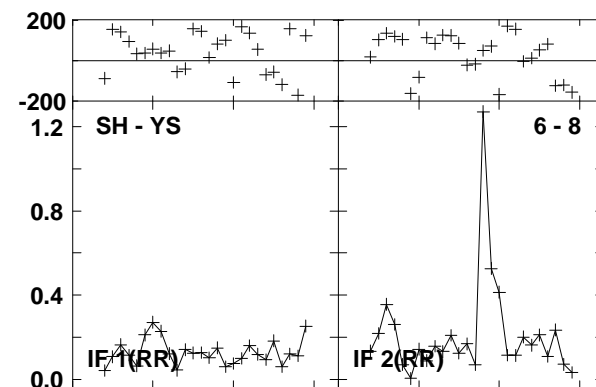
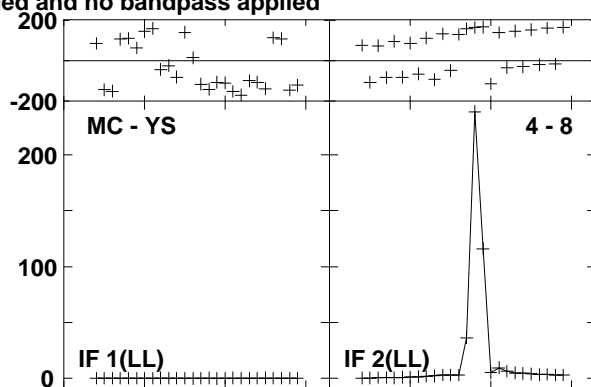
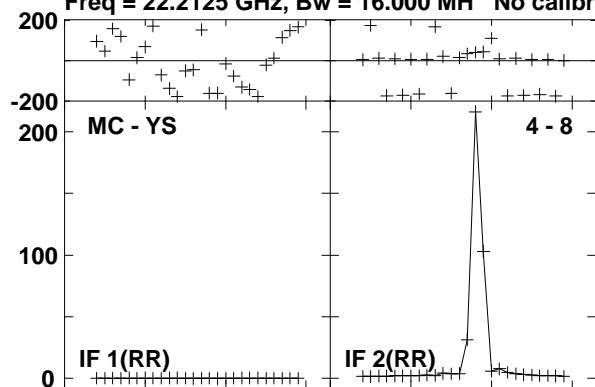

Lower frame: Milli Ampl Jy Top frame: Phas deg  
Vector averaged cross-power spectrum Baseline: MC (04) - YS (08)  
Timerange: 00/09:35:30 to 00/09:36:29

Plot file version 78 created 23-AUG-2016 15:00:44

W3IRS5 GA035B 1.UVDATA.1

Freq = 22.2125 GHz, Bw = 16.000 MH No calibration applied and no bandpass applied

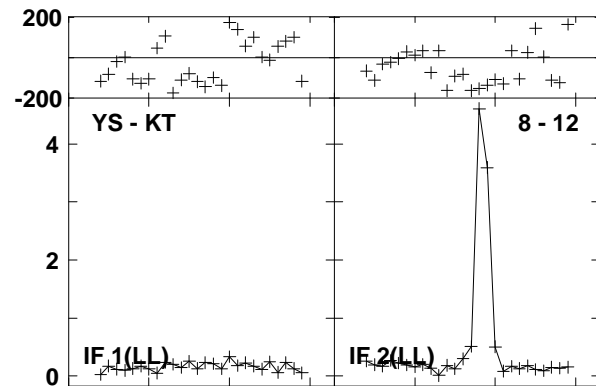
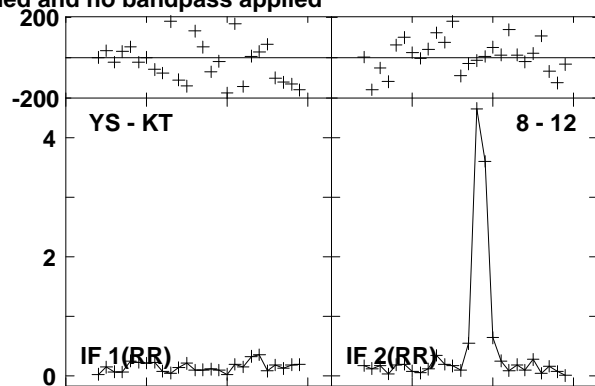
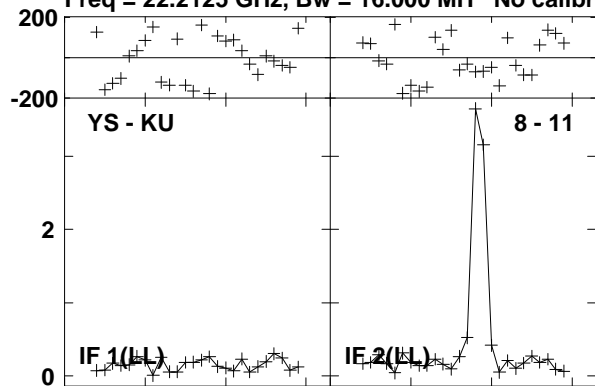

Lower frame: Milli Ampl Jy Top frame: Phas deg  
Vector averaged cross-power spectrum Baseline: YS (08) - KU (11)  
Timerange: 00/09:35:30 to 00/09:36:29

Plot file version 79 created 23-AUG-2016 15:00:44

0219+628 GA035B 1.UVDATA.1

Freq = 22.2125 GHz, Bw = 16.000 MH No calibration applied and no bandpass applied

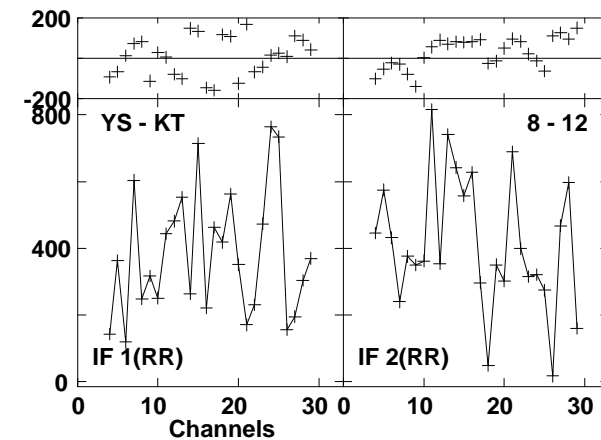
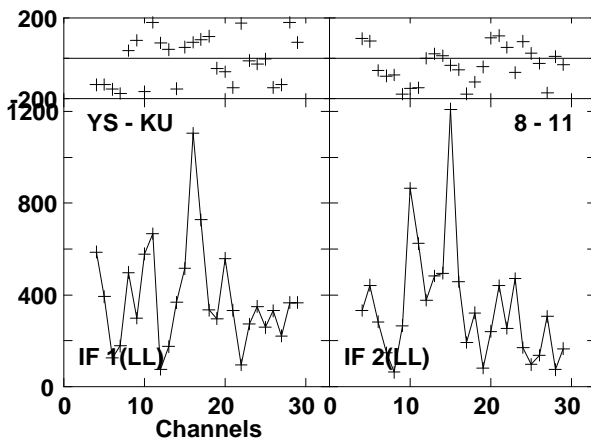
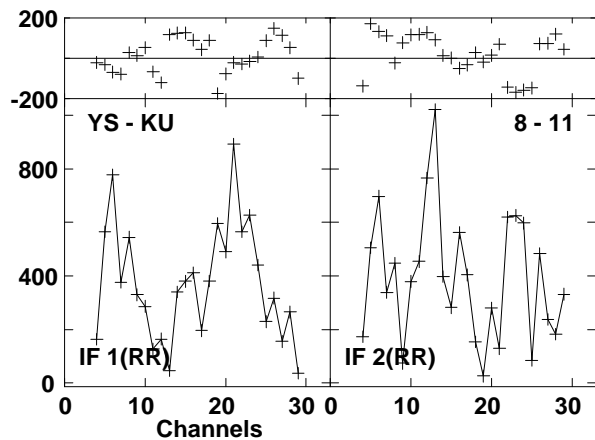
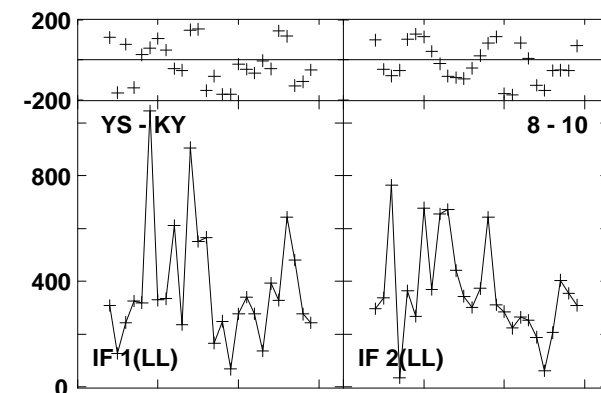
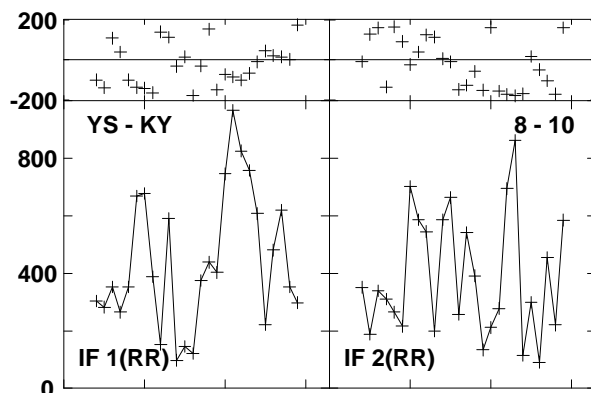
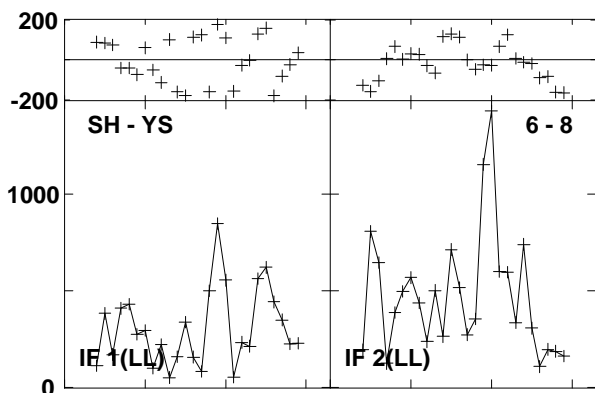
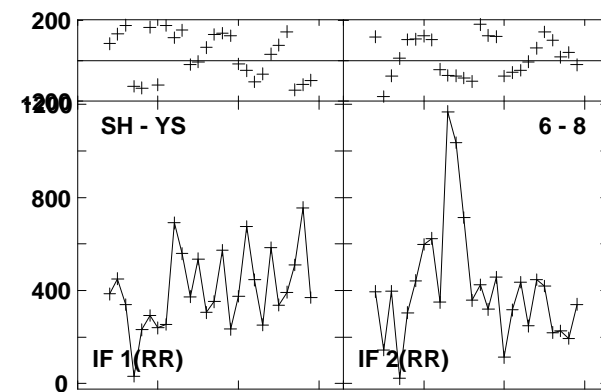
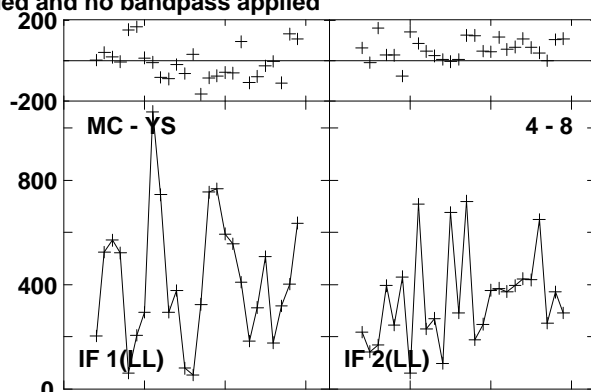
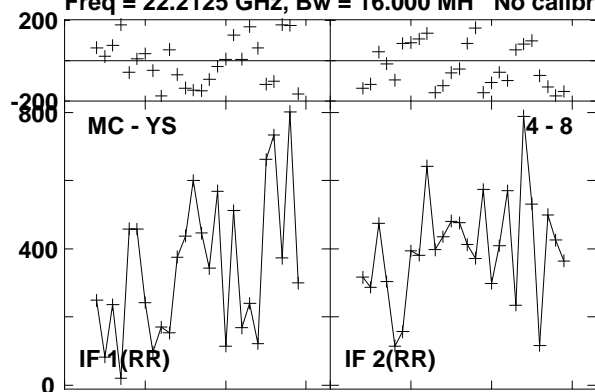

Lower frame: Micro Ampl Jy Top frame: Phas deg  
Vector averaged cross-power spectrum Baseline: MC (04) - YS (08)  
Timerange: 00/09:36:55 to 00/09:37:15

Plot file version 80 created 23-AUG-2016 15:00:44  
0219+628 GA035B 1.UVDATA.1  
Freq = 22.2125 GHz, Bw = 16.000 MH No calibration applied and no bandpass applied

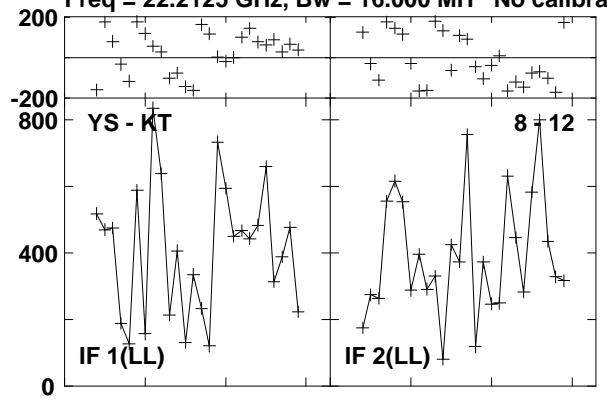

Lower frame: Micro Ampl Jy Top frame: Phas deg  
Vector averaged cross-power spectrum Baseline: YS (08) - KT (12)  
Timerange: 00/09:36:55 to 00/09:37:15



Plot file version 81 created 23-AUG-2016 15:00:44

W3IRS5 GA035B 1.UVDATA.1

Freq = 22.2125 GHz, Bw = 16.000 MH No calibration applied and no bandpass applied

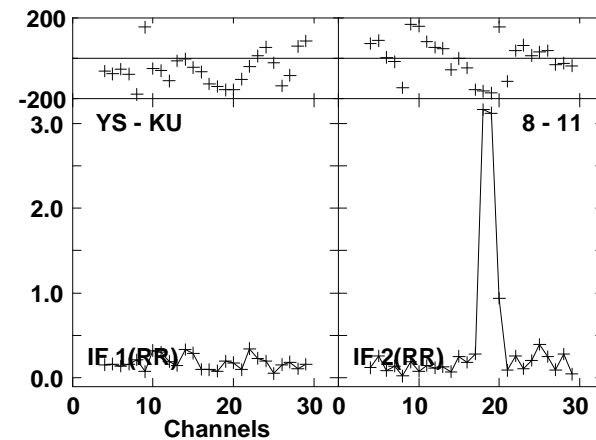
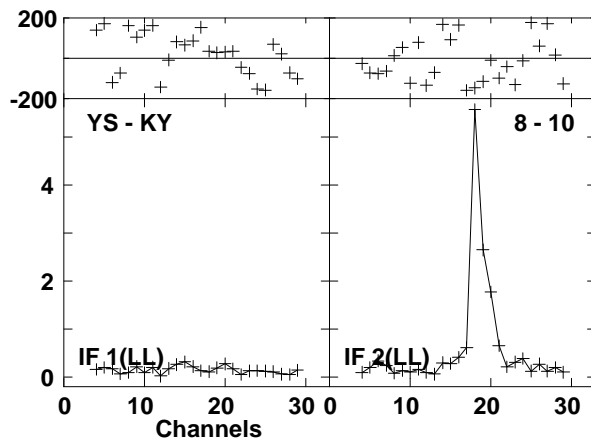
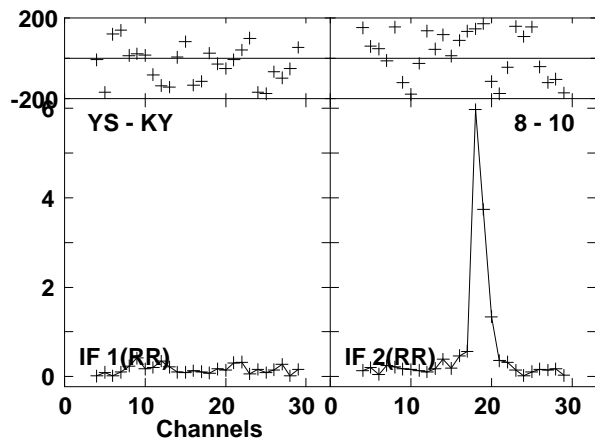
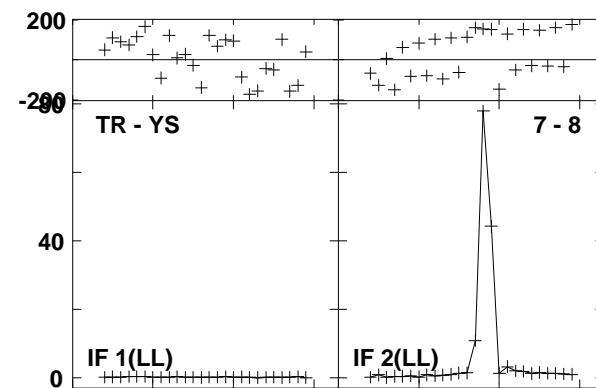
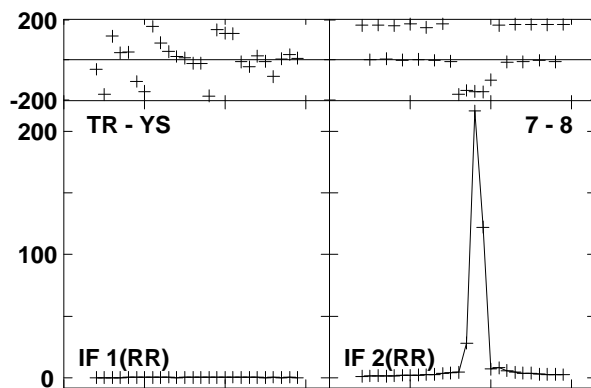
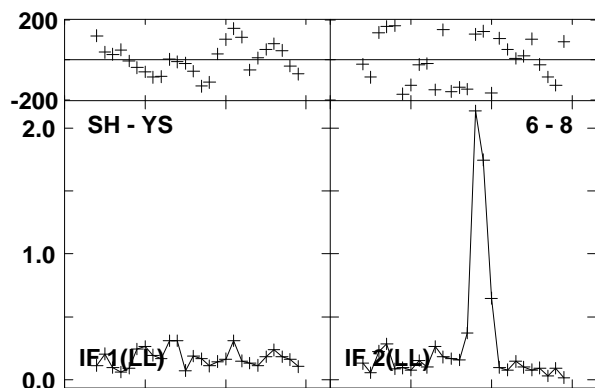
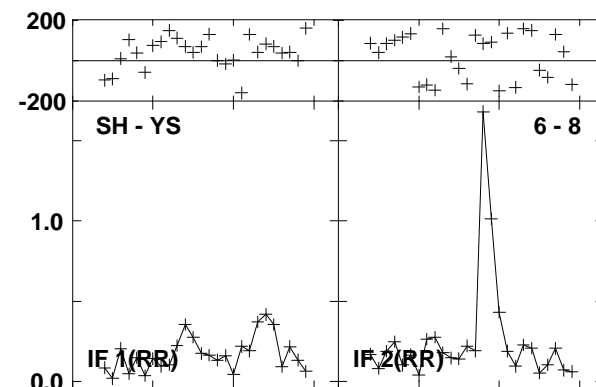
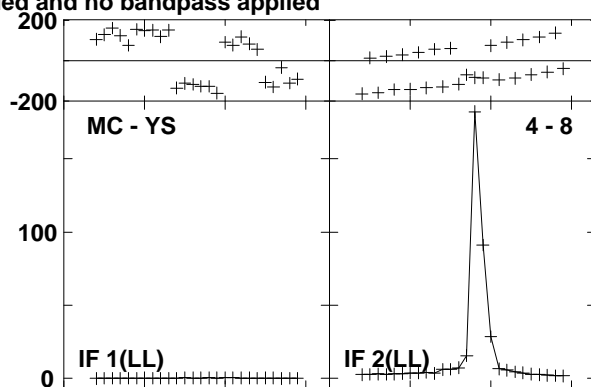
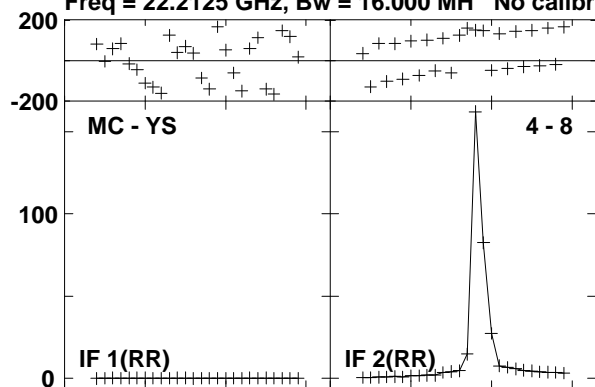

Lower frame: Milli Ampl Jy Top frame: Phas deg  
Vector averaged cross-power spectrum Baseline: MC (04) - YS (08)  
Timerange: 00/09:37:41 to 00/09:38:39

Plot file version 82 created 23-AUG-2016 15:00:44  
W3IRS5 GA035B 1.UVDATA.1

Freq = 22.2125 GHz, Bw = 16.000 MH No calibration applied and no bandpass applied

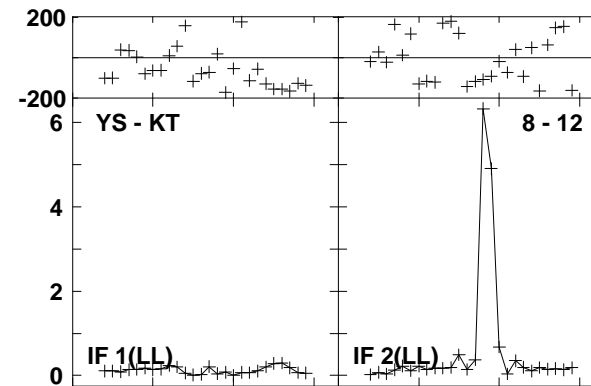
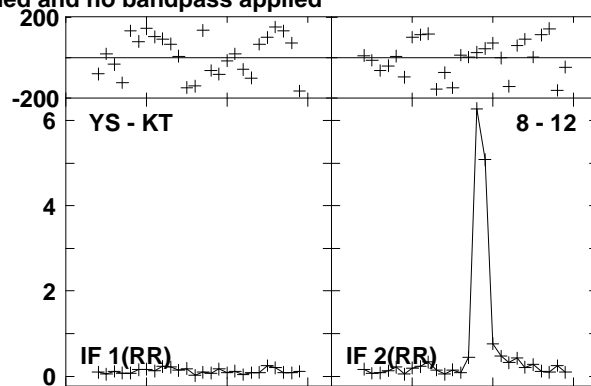
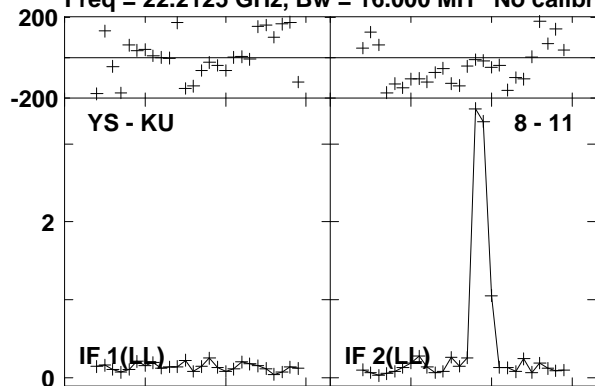

Lower frame: Milli Ampl Jy Top frame: Phas deg  
Vector averaged cross-power spectrum Baseline: YS (08) - KU (11)  
Timerange: 00/09:37:41 to 00/09:38:39

Plot file version 83 created 23-AUG-2016 15:00:44

0219+628 GA035B 1.UVDATA.1

Freq = 22.2125 GHz, Bw = 16.000 MH No calibration applied and no bandpass applied

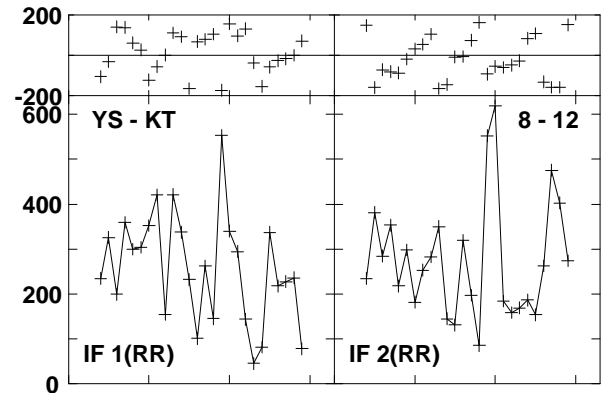
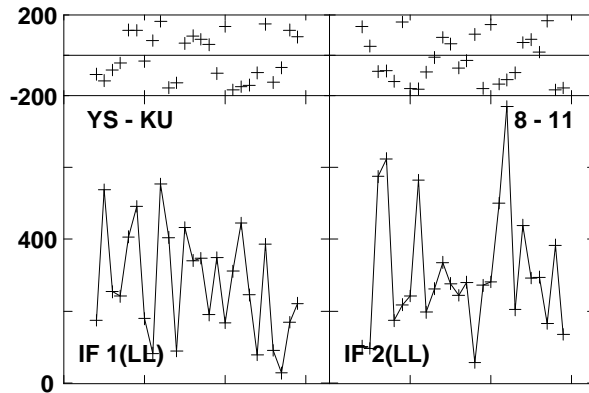
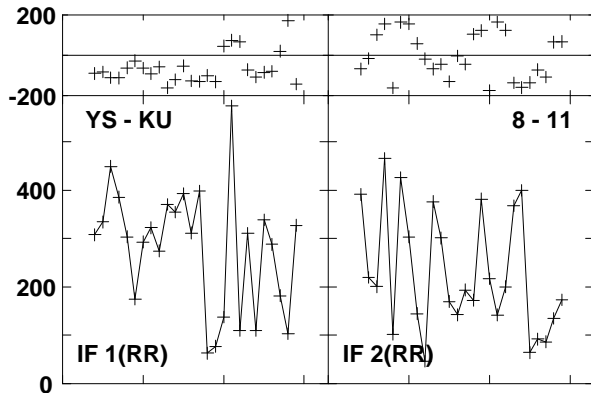
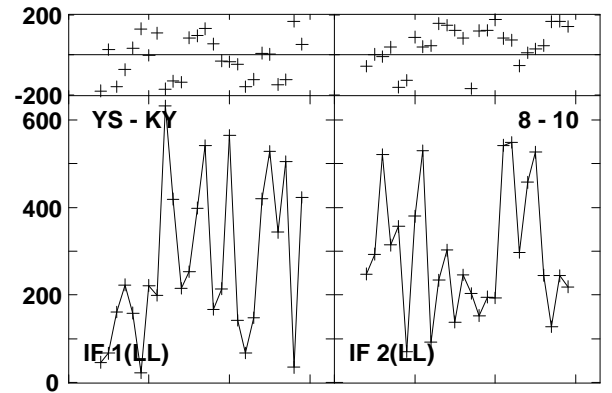
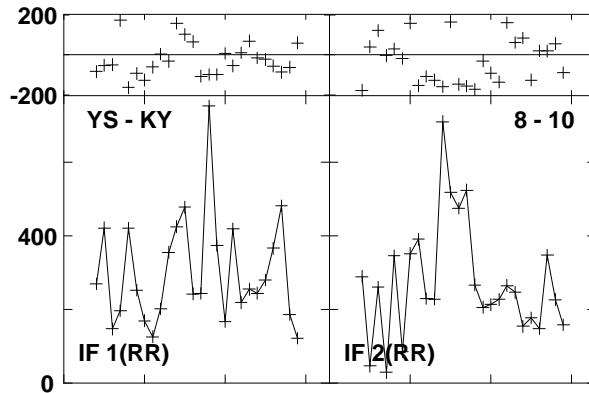
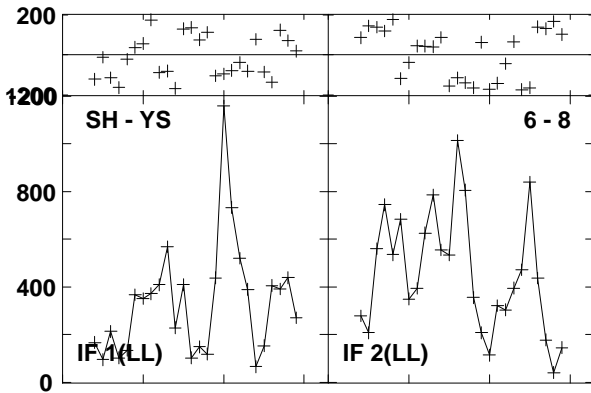
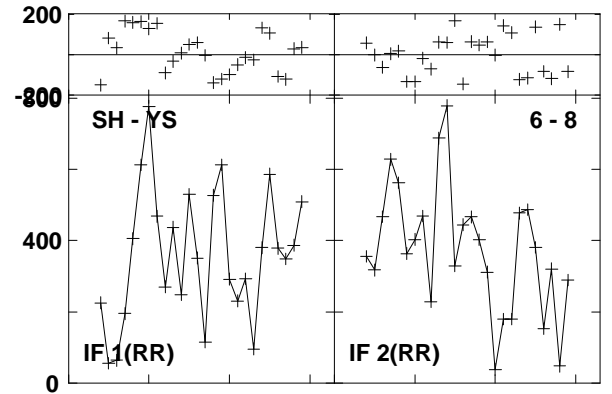
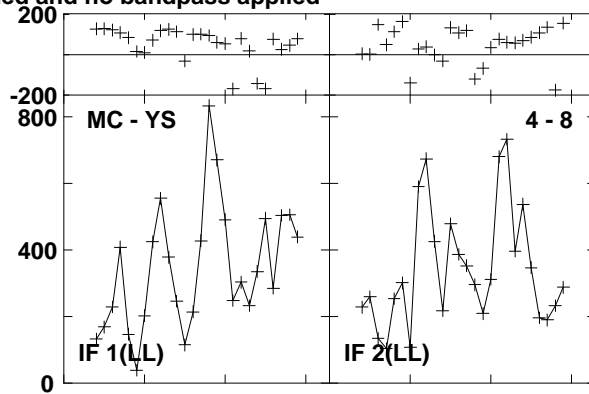
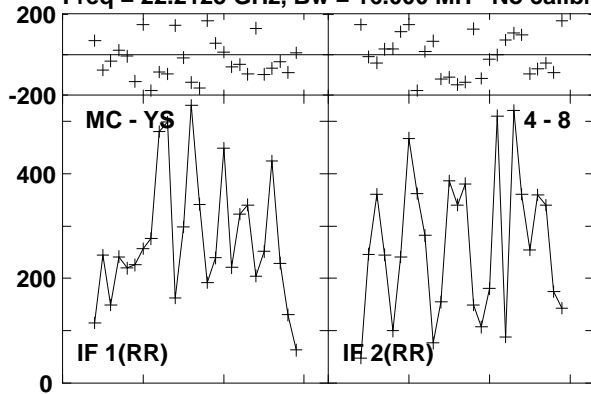

Lower frame: Micro Ampl Jy Top frame: Phas deg  
Vector averaged cross-power spectrum Baseline: MC (04) - YS (08)  
Timerange: 00/09:39:05 to 00/09:39:25

Plot file version 84 created 23-AUG-2016 15:00:44  
0219+628 GA035B 1.UVDATA.1  
Freq = 22.2125 GHz, Bw = 16.000 MH No calibration applied and no bandpass applied

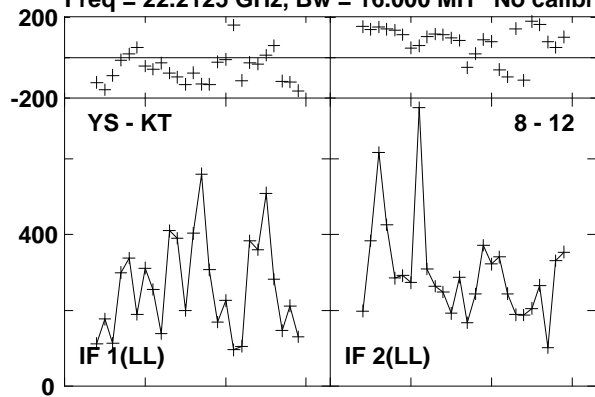

Lower frame: Micro Ampl Jy Top frame: Phas deg  
Vector averaged cross-power spectrum Baseline: YS (08) - KT (12)  
Timerange: 00/09:39:05 to 00/09:39:25

Plot file version 85 created 23-AUG-2016 15:00:44

W3IRS5 GA035B 1.UVDATA.1

Freq = 22.2125 GHz, Bw = 16.000 MH No calibration applied and no bandpass applied

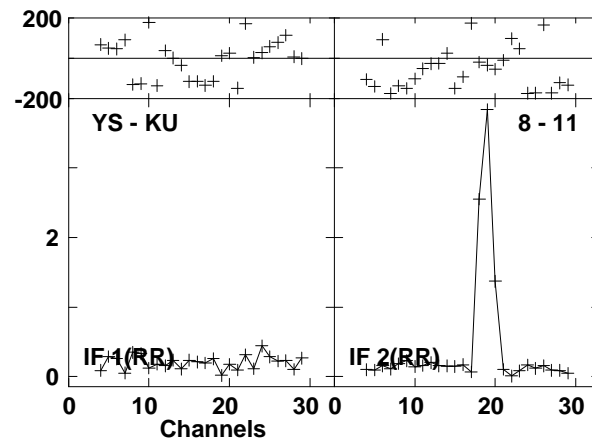
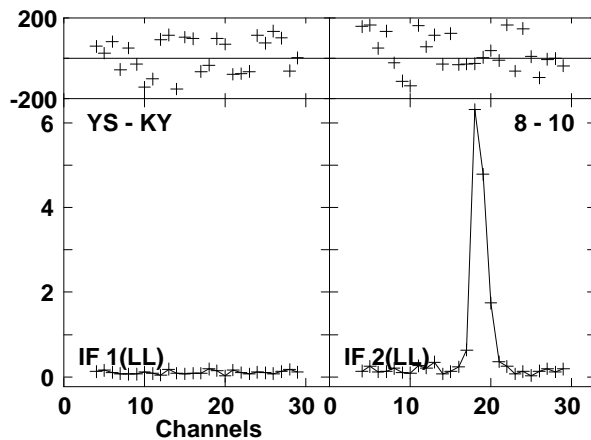
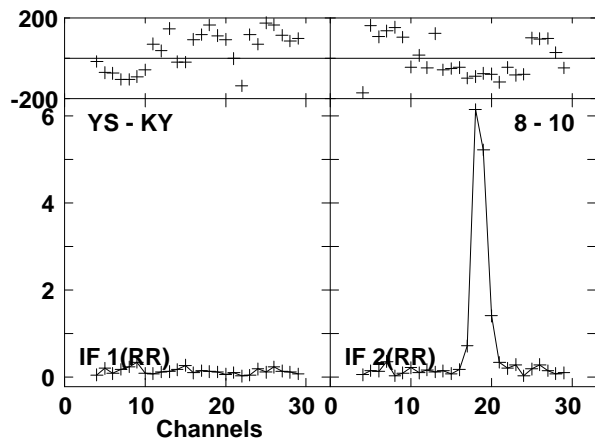
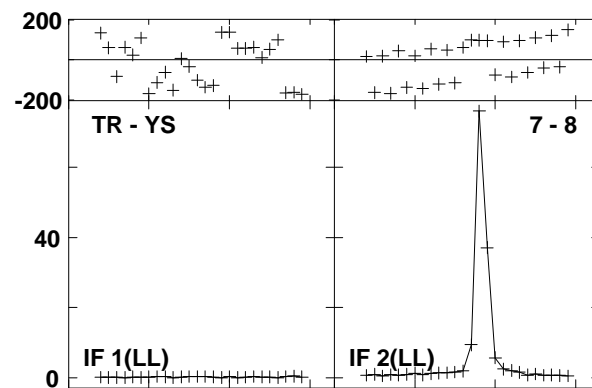
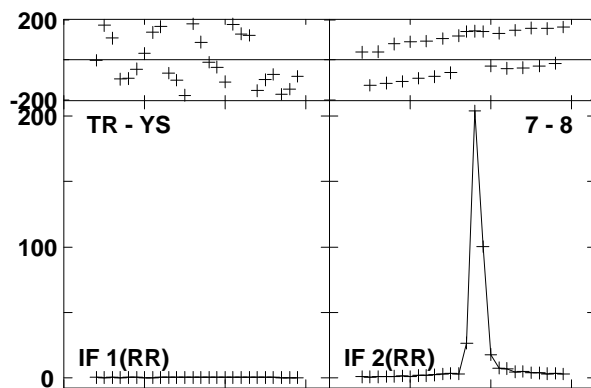
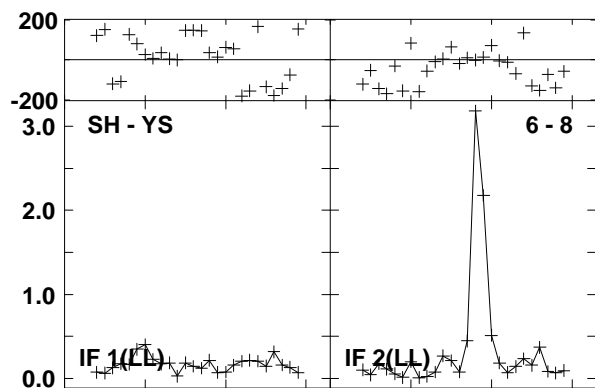
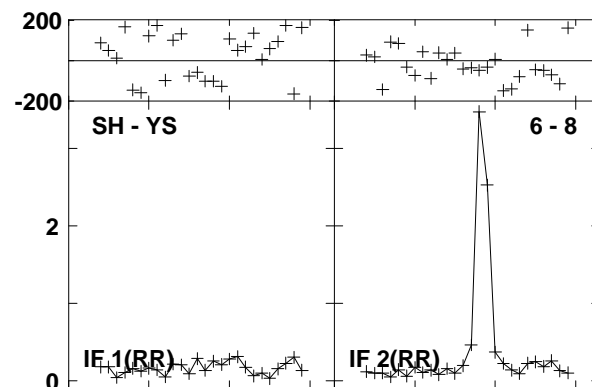
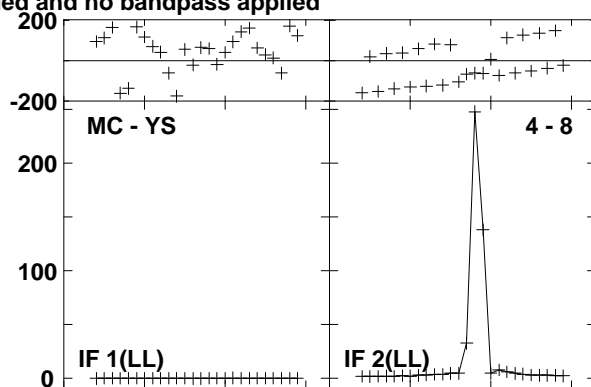
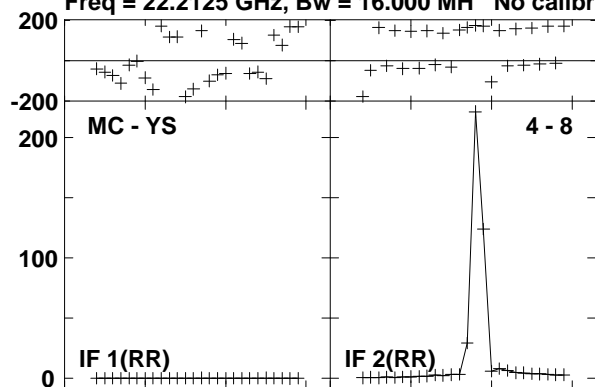

Lower frame: Milli Ampl Jy Top frame: Phas deg  
Vector averaged cross-power spectrum Baseline: MC (04) - YS (08)  
Timerange: 00/09:39:51 to 00/09:40:49

Plot file version 86 created 23-AUG-2016 15:00:44

W3IRS5 GA035B 1.UVDATA.1

Freq = 22.2125 GHz, Bw = 16.000 MH No calibration applied and no bandpass applied

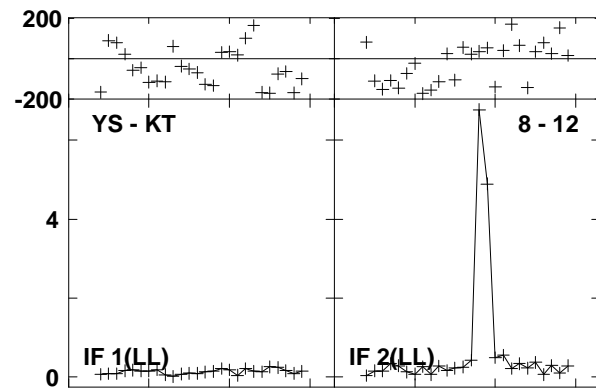
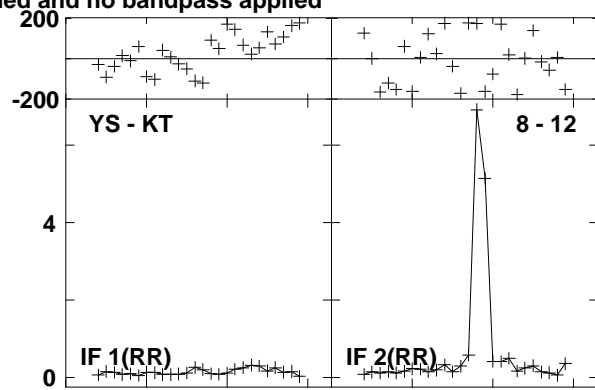
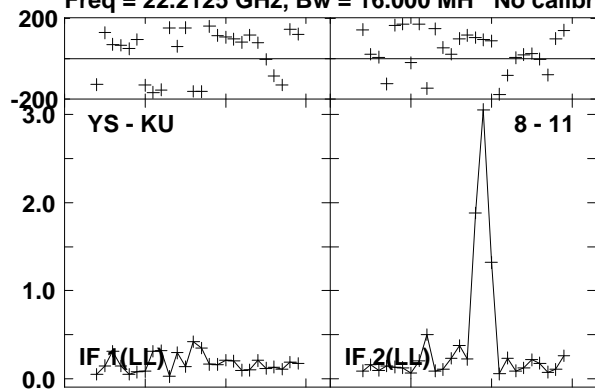

Lower frame: Milli Ampl Jy Top frame: Phas deg  
Vector averaged cross-power spectrum Baseline: YS (08) - KU (11)  
Timerange: 00/09:39:51 to 00/09:40:49

Plot file version 87 created 23-AUG-2016 15:00:44

0219+628 GA035B 1.UVDATA.1

Freq = 22.2125 GHz, Bw = 16.000 MH No calibration applied and no bandpass applied

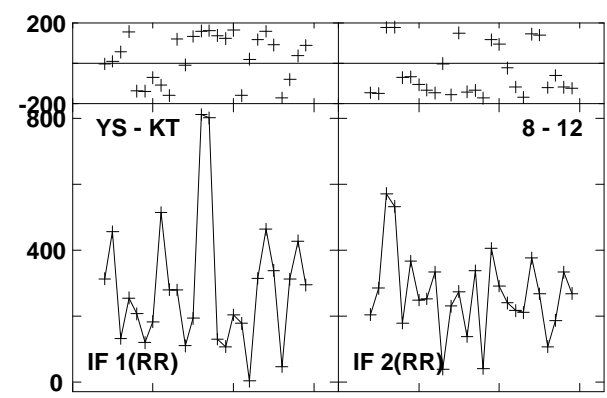
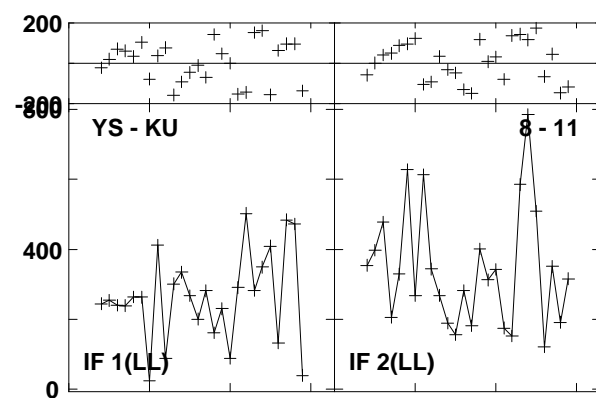
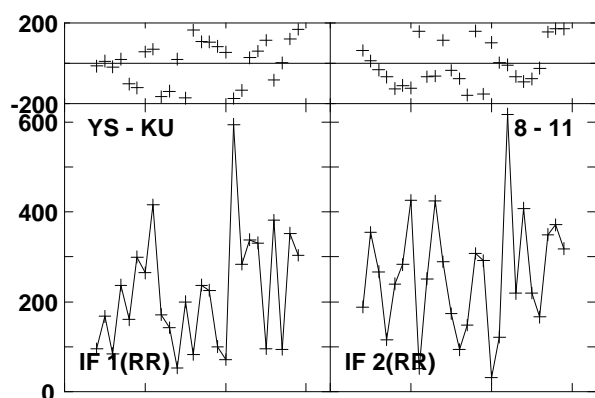
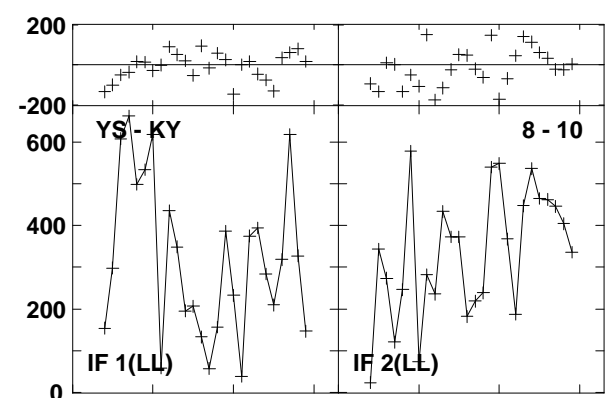
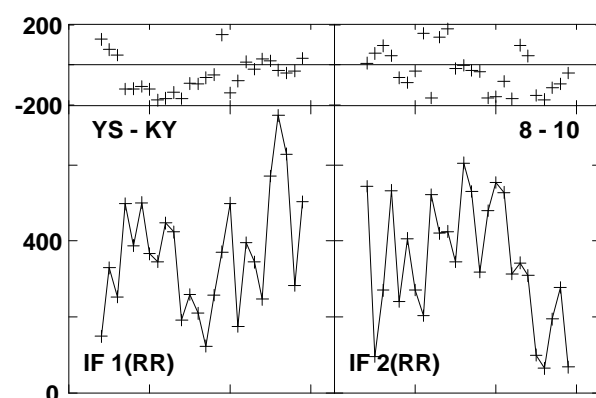
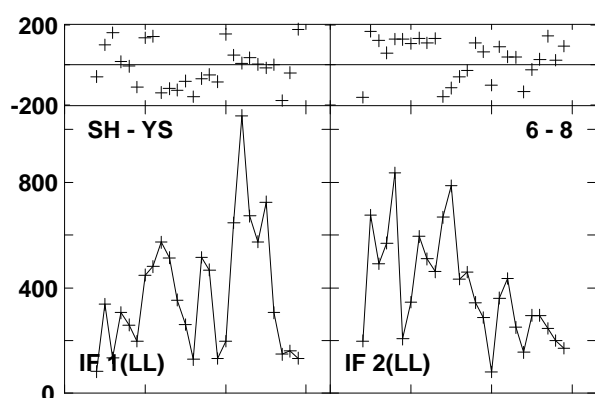
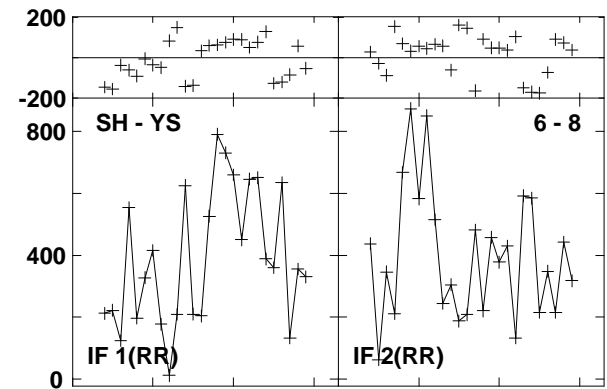
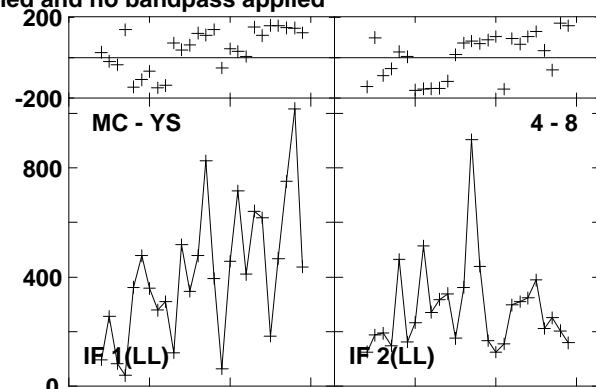
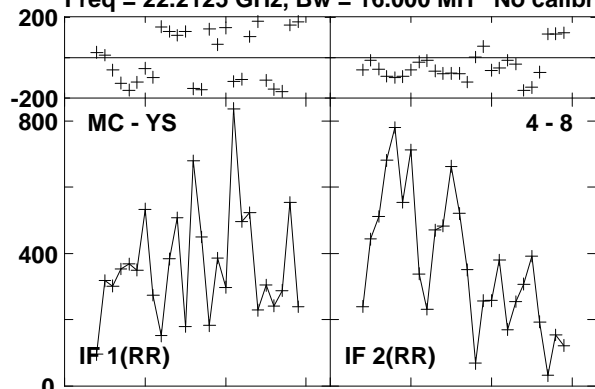

Lower frame: Micro Ampl Jy Top frame: Phas deg  
Vector averaged cross-power spectrum Baseline: MC (04) - YS (08)  
Timerange: 00/09:41:15 to 00/09:41:35

Plot file version 88 created 23-AUG-2016 15:00:44  
0219+628 GA035B 1.UVDATA.1  
Freq = 22.2125 GHz, Bw = 16.000 MH No calibration applied and no bandpass applied

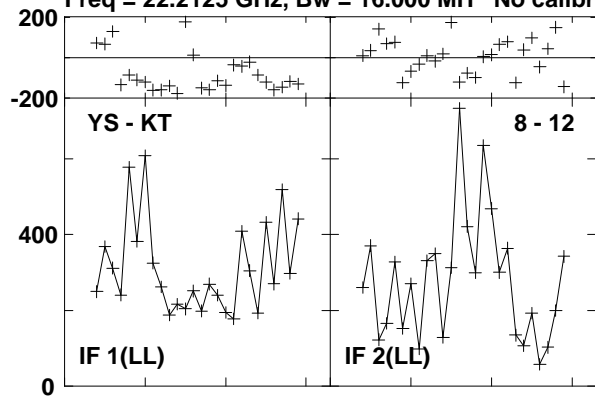

Lower frame: Micro Ampl Jy Top frame: Phas deg  
Vector averaged cross-power spectrum Baseline: YS (08) - KT (12)  
Timerange: 00/09:41:15 to 00/09:41:35



Plot file version 89 created 23-AUG-2016 15:00:44

W3IRS5 GA035B 1.UVDATA.1

Freq = 22.2125 GHz, Bw = 16.000 MH No calibration applied and no bandpass applied

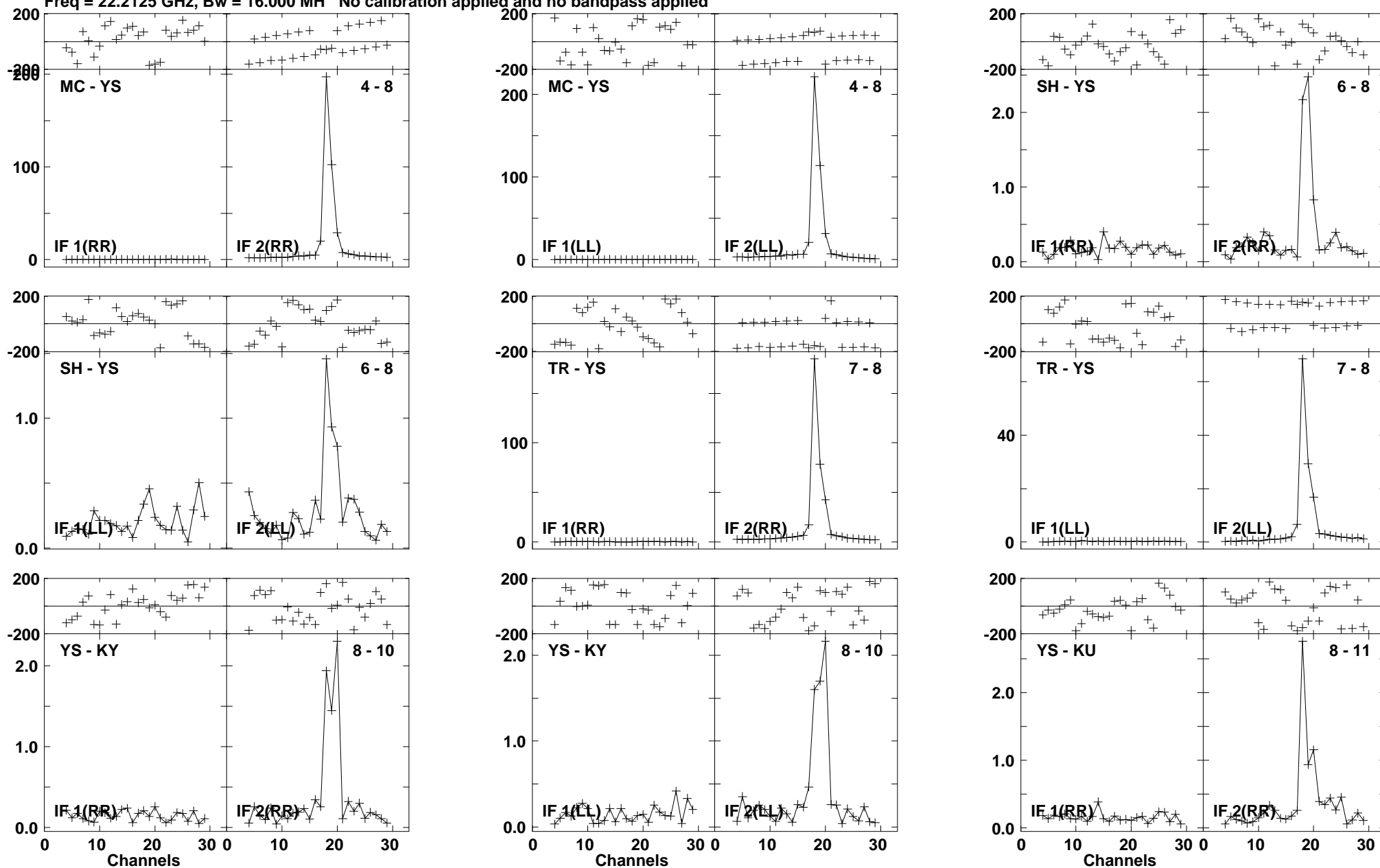

Lower frame: Milli Ampl Jy Top frame: Phas deg  
Vector averaged cross-power spectrum Baseline: MC (04) - YS (08)  
Timerange: 00/09:43:06 to 00/09:44:04

Plot file version 90 created 23-AUG-2016 15:00:44

W3IRS5 GA035B 1.UVDATA.1

Freq = 22.2125 GHz, Bw = 16.000 MH No calibration applied and no bandpass applied

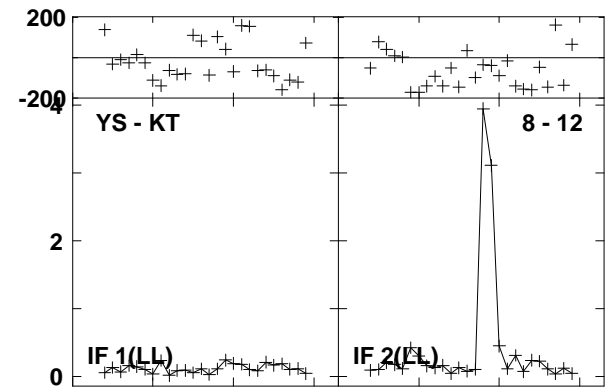
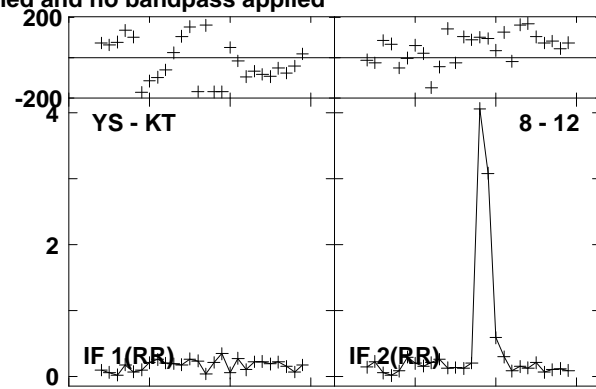
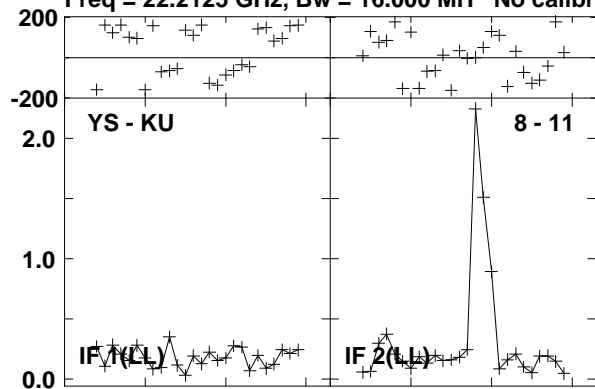

Lower frame: Milli Ampl Jy Top frame: Phas deg  
Vector averaged cross-power spectrum Baseline: YS (08) - KU (11)  
Timerange: 00/09:43:06 to 00/09:44:04

Plot file version 91 created 23-AUG-2016 15:00:45

0219+628 GA035B 1.UVDATA.1

Freq = 22.2125 GHz, Bw = 16.000 MH No calibration applied and no bandpass applied

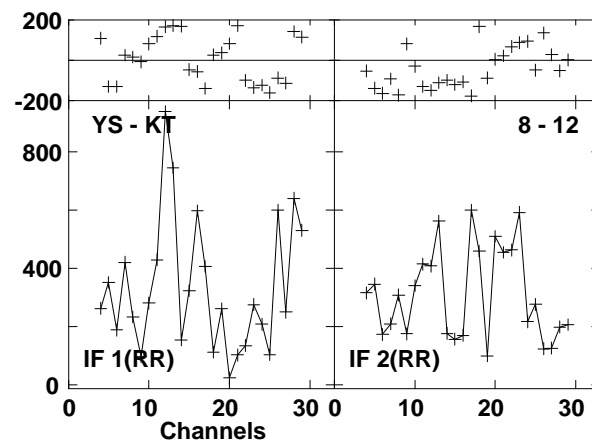
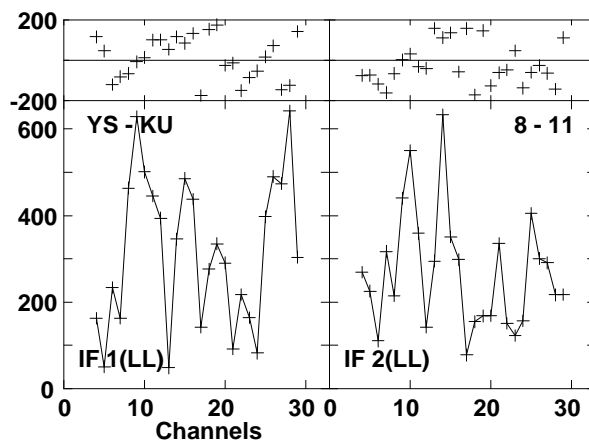
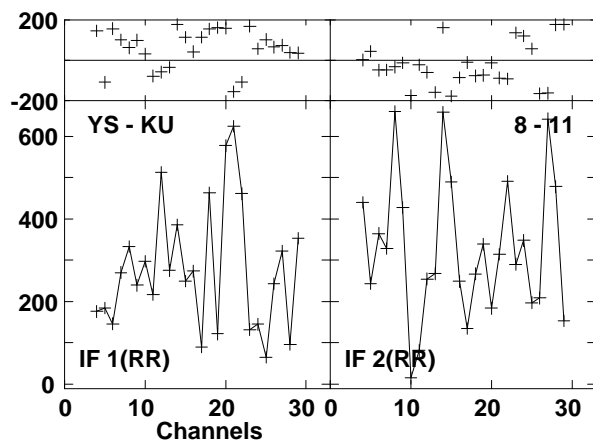
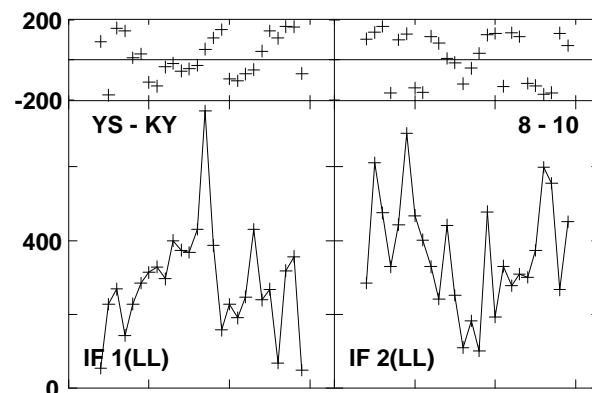
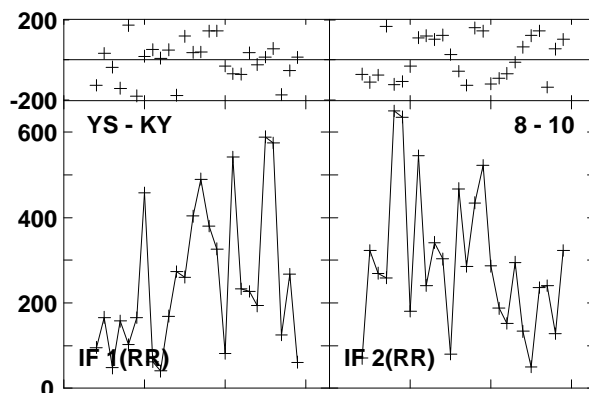
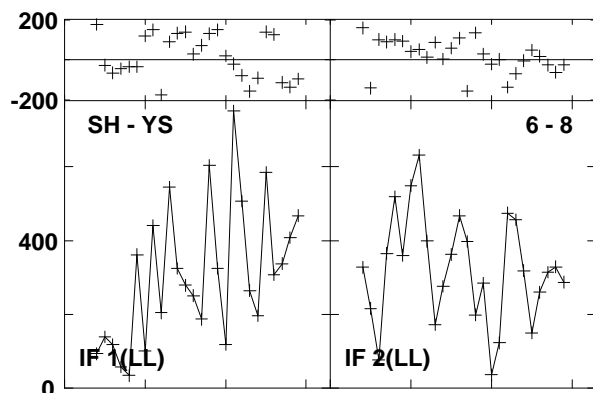
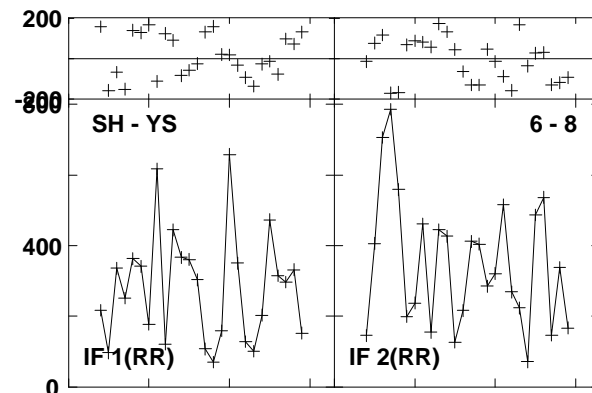
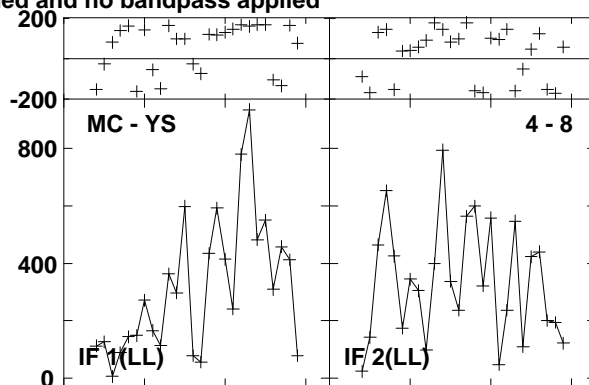
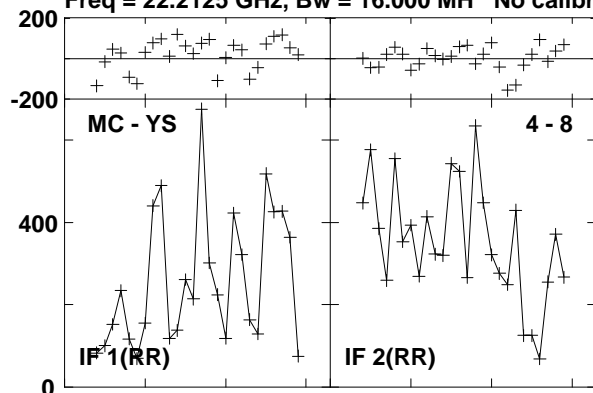

Lower frame: Micro Ampl Jy Top frame: Phas deg  
Vector averaged cross-power spectrum Baseline: MC (04) - YS (08)  
Timerange: 00/09:44:30 to 00/09:44:50

Plot file version 92 created 23-AUG-2016 15:00:45  
0219+628 GA035B 1.UVDATA.1  
Freq = 22.2125 GHz, Bw = 16.000 MH No calibration applied and no bandpass applied

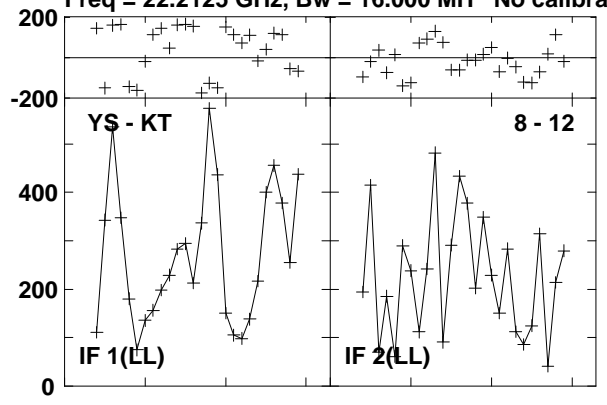

Lower frame: Micro Ampl Jy Top frame: Phas deg  
Vector averaged cross-power spectrum Baseline: YS (08) - KT (12)  
Timerange: 00/09:44:30 to 00/09:44:50

Plot file version 93 created 23-AUG-2016 15:00:45

W3IRS5 GA035B 1.UVDATA.1

Freq = 22.2125 GHz, Bw = 16.000 MH No calibration applied and no bandpass applied

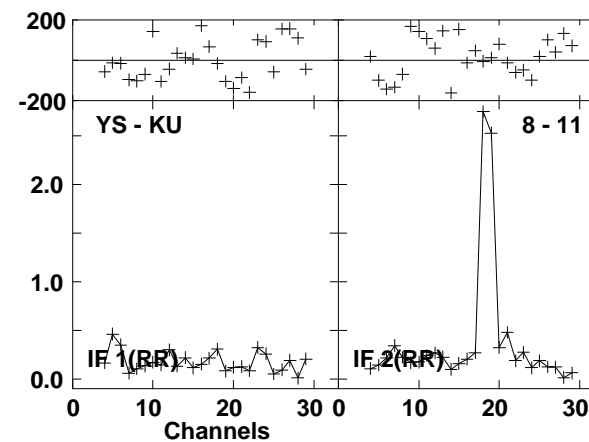
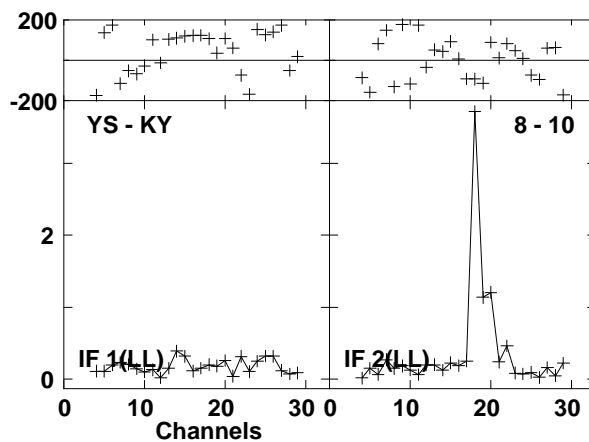
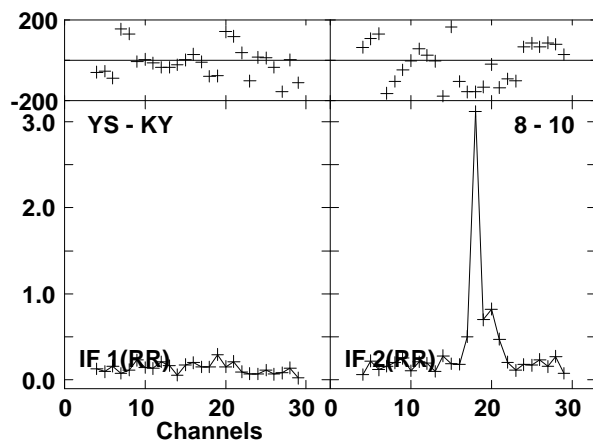
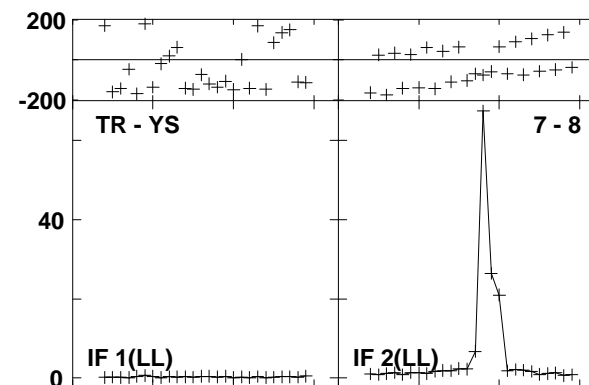
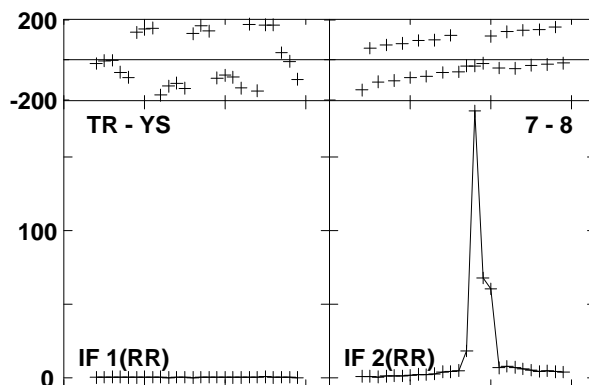
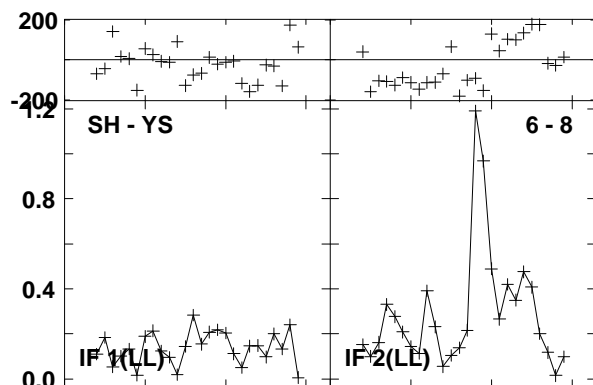
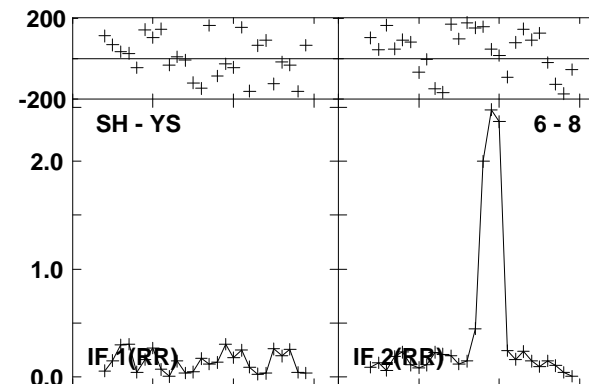
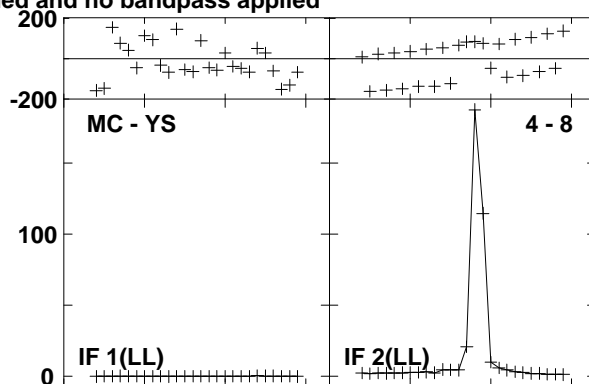
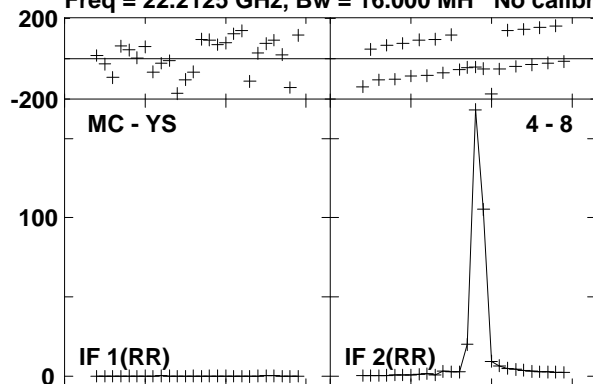

Lower frame: Milli Ampl Jy Top frame: Phas deg  
Vector averaged cross-power spectrum Baseline: MC (04) - YS (08)  
Timerange: 00/09:45:16 to 00/09:46:14

Plot file version 94 created 23-AUG-2016 15:00:45

W3IRS5 GA035B 1.UVDATA.1

Freq = 22.2125 GHz, Bw = 16.000 MH No calibration applied and no bandpass applied

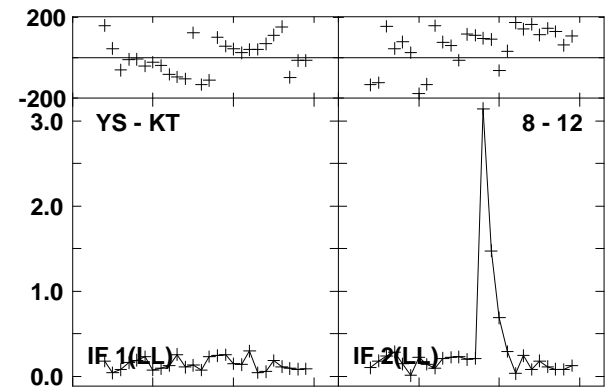
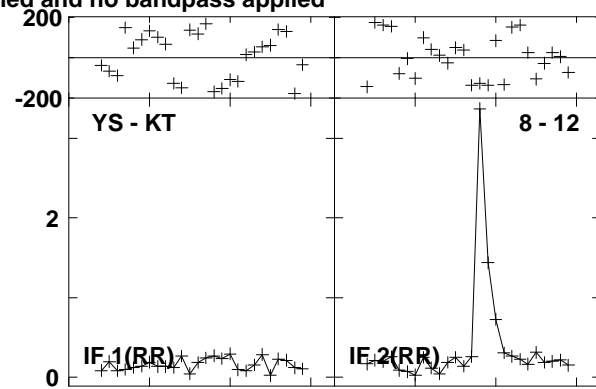
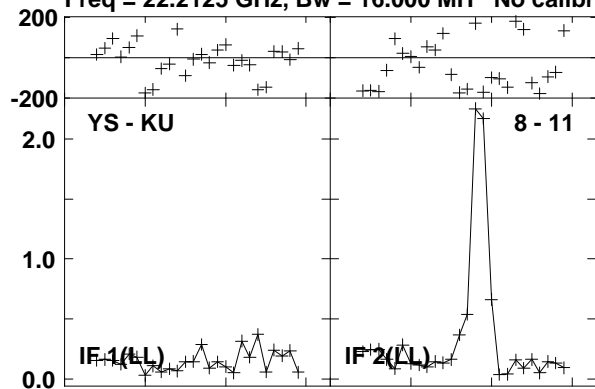

Lower frame: Milli Ampl Jy Top frame: Phas deg  
Vector averaged cross-power spectrum Baseline: YS (08) - KU (11)  
Timerange: 00/09:45:16 to 00/09:46:14

Plot file version 95 created 23-AUG-2016 15:00:45

0219+628 GA035B 1.UVDATA.1

Freq = 22.2125 GHz, Bw = 16.000 MH No calibration applied and no bandpass applied

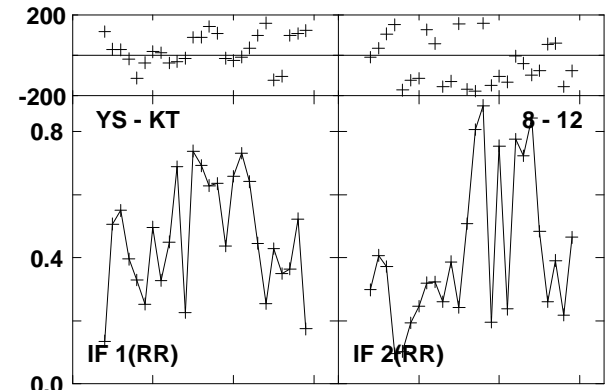
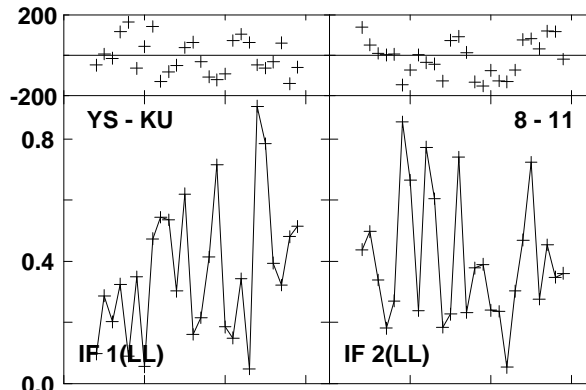
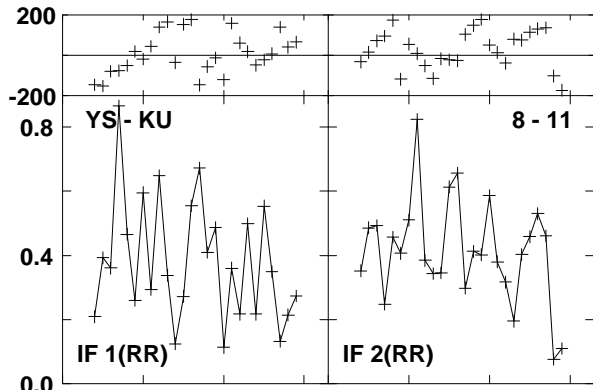
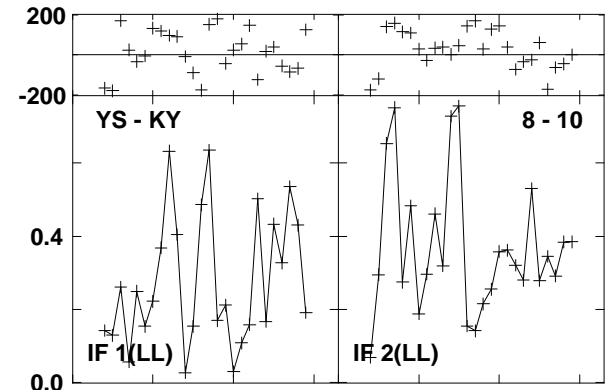
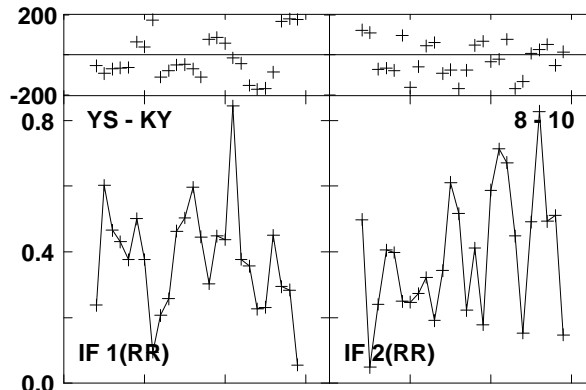
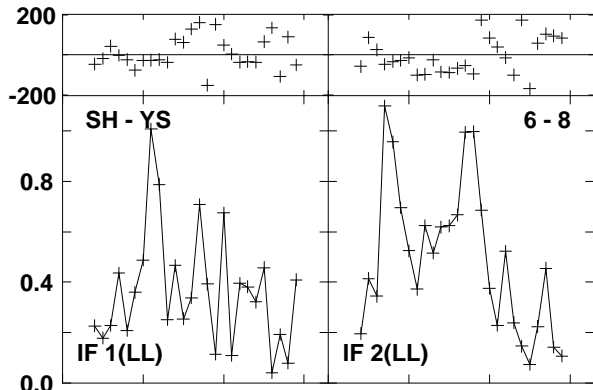
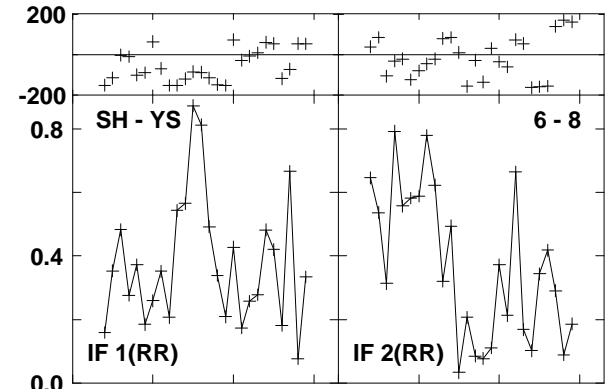
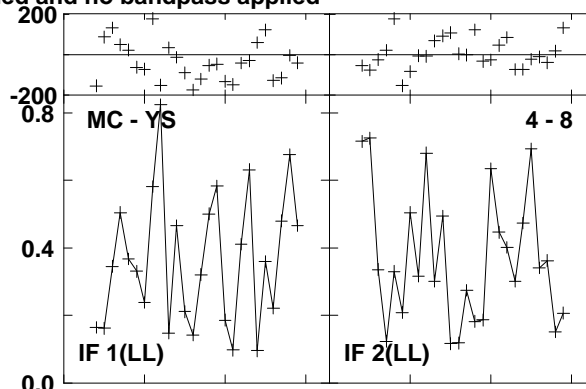
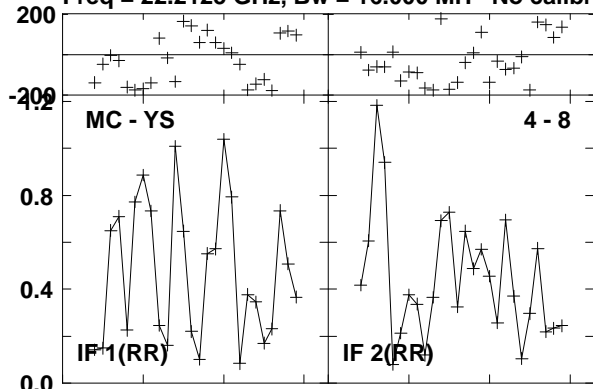

Lower frame: Milli Ampl Jy Top frame: Phas deg  
Vector averaged cross-power spectrum Baseline: MC (04) - YS (08)  
Timerange: 00/09:46:40 to 00/09:47:00

Plot file version 96 created 23-AUG-2016 15:00:45  
0219+628 GA035B 1.UVDATA.1  
Freq = 22.2125 GHz, Bw = 16.000 MH No calibration applied and no bandpass applied

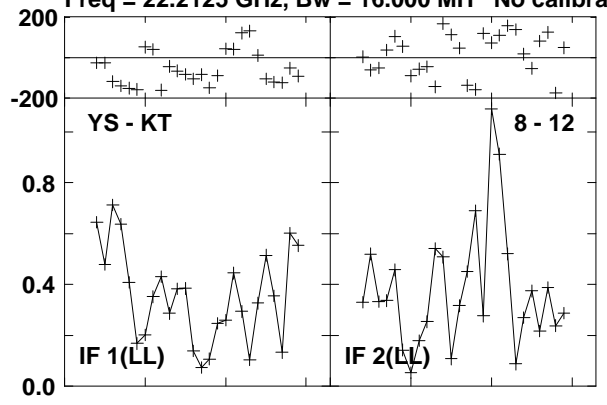

Lower frame: Milli Ampl Jy Top frame: Phas deg  
Vector averaged cross-power spectrum Baseline: YS (08) - KT (12)  
Timerange: 00/09:46:40 to 00/09:47:00



Plot file version 97 created 23-AUG-2016 15:00:45

W3IRS5 GA035B 1.UVDATA.1

Freq = 22.2125 GHz, Bw = 16.000 MH No calibration applied and no bandpass applied

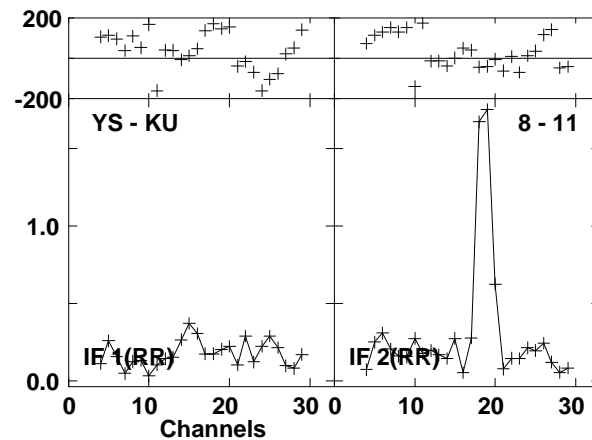
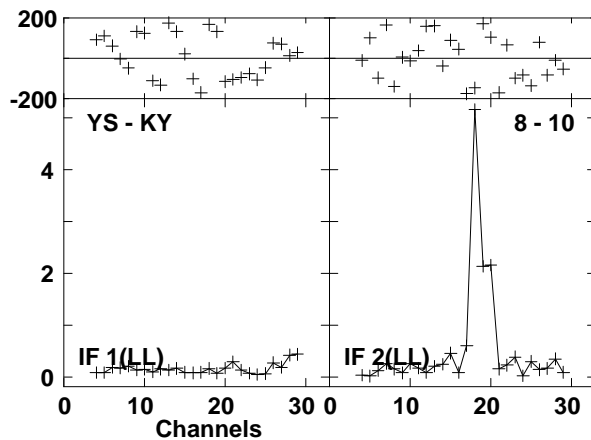
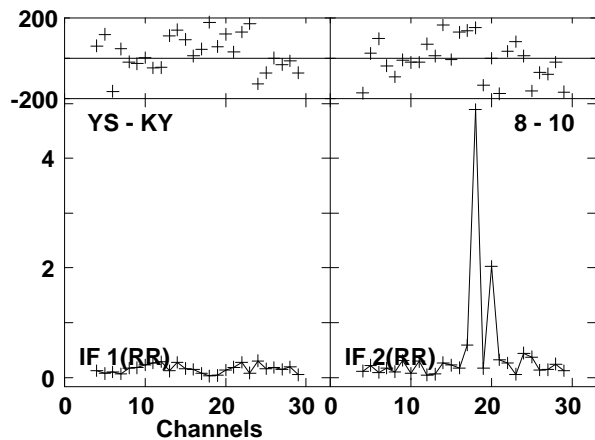
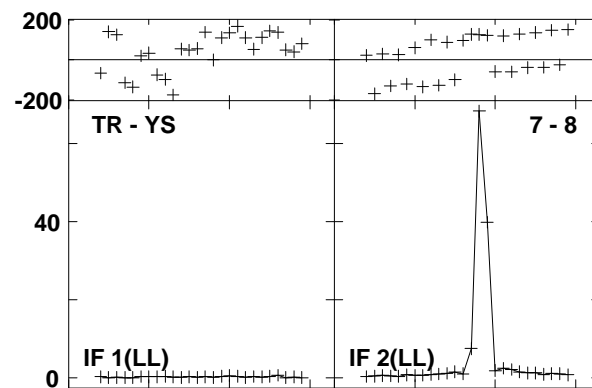
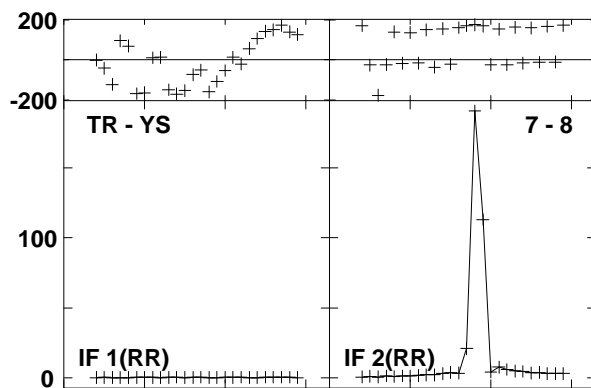
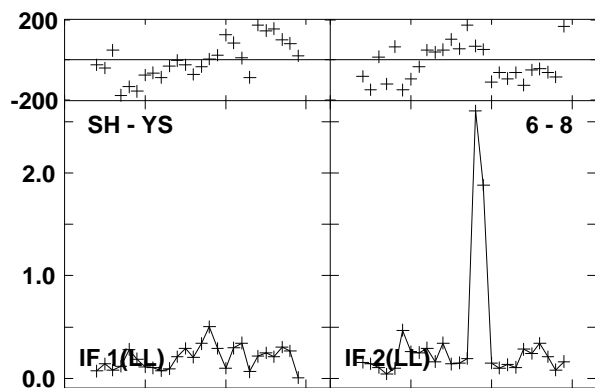
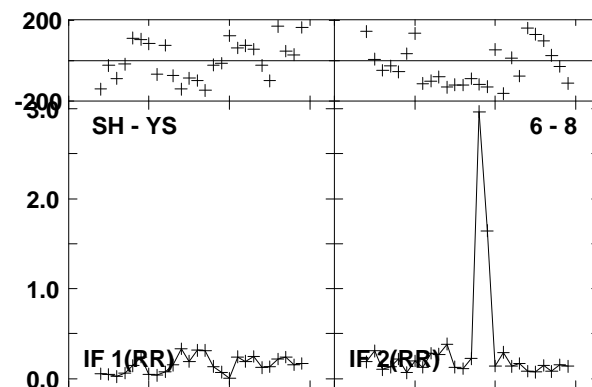
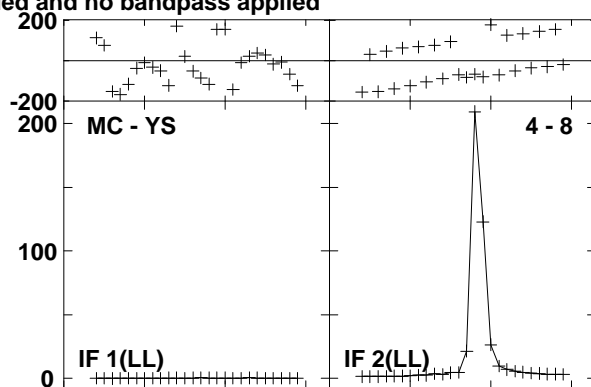
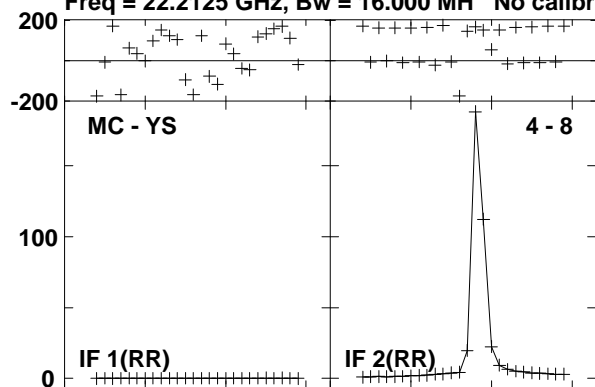

Lower frame: Milli Ampl Jy Top frame: Phas deg  
Vector averaged cross-power spectrum Baseline: MC (04) - YS (08)  
Timerange: 00/09:47:26 to 00/09:48:25

Plot file version 98 created 23-AUG-2016 15:00:45

W3IRS5 GA035B 1.UVDATA.1

Freq = 22.2125 GHz, Bw = 16.000 MH No calibration applied and no bandpass applied

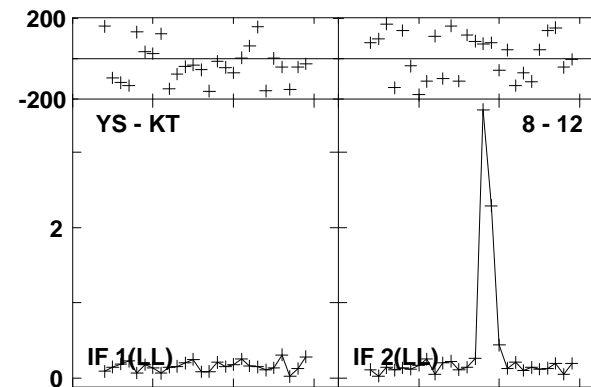
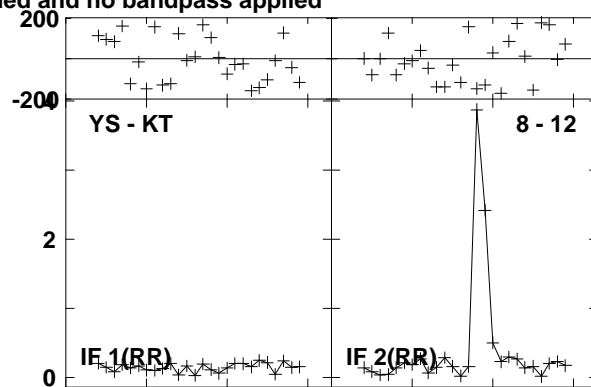
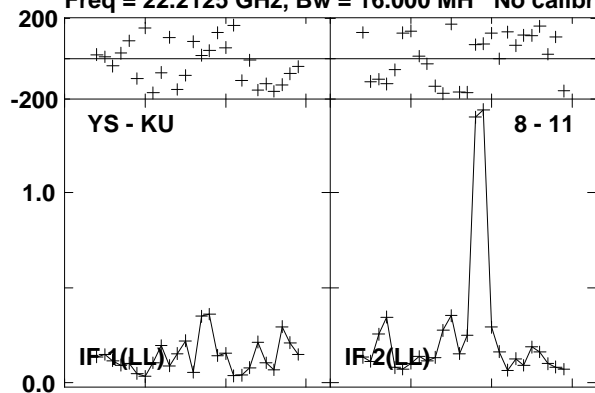

Lower frame: Milli Ampl Jy Top frame: Phas deg  
Vector averaged cross-power spectrum Baseline: YS (08) - KU (11)  
Timerange: 00/09:47:26 to 00/09:48:25

Plot file version 99 created 23-AUG-2016 15:00:45

0219+628 GA035B 1.UVDATA.1

Freq = 22.2125 GHz, Bw = 16.000 MH No calibration applied and no bandpass applied

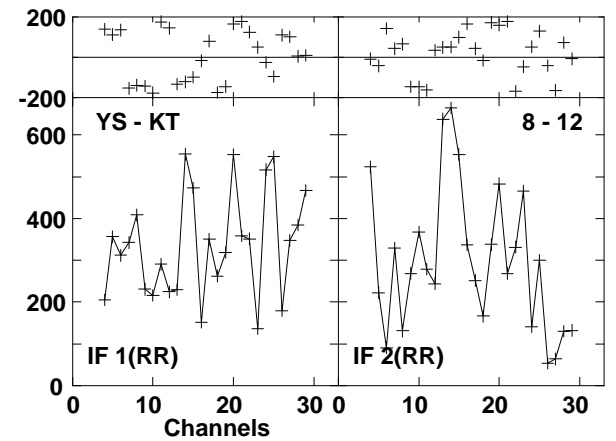
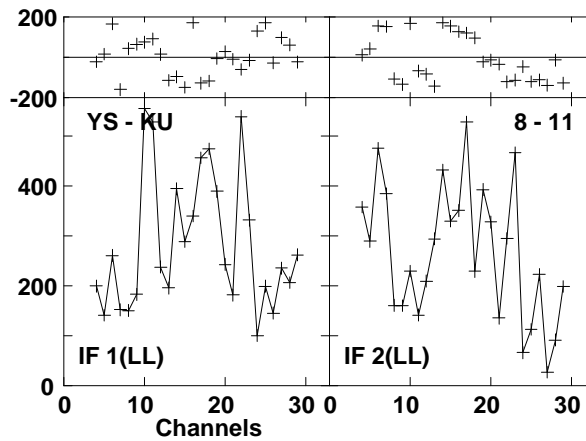
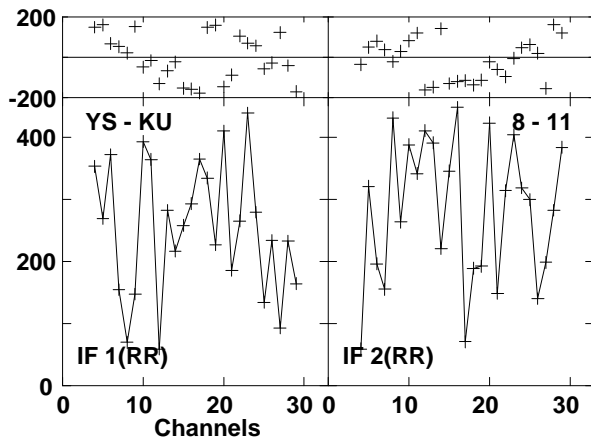
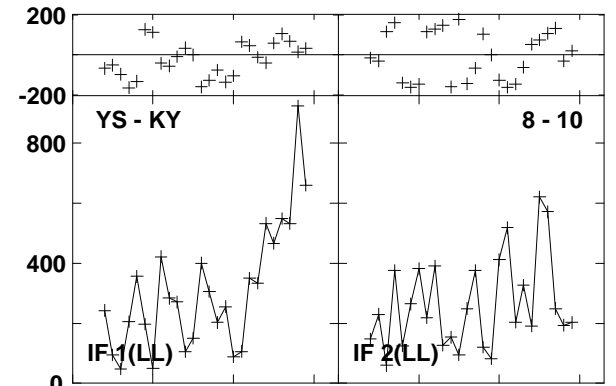
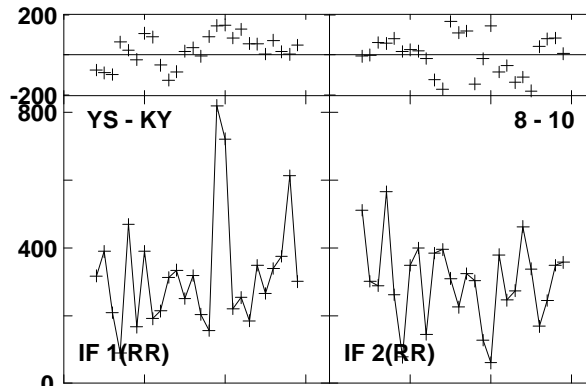
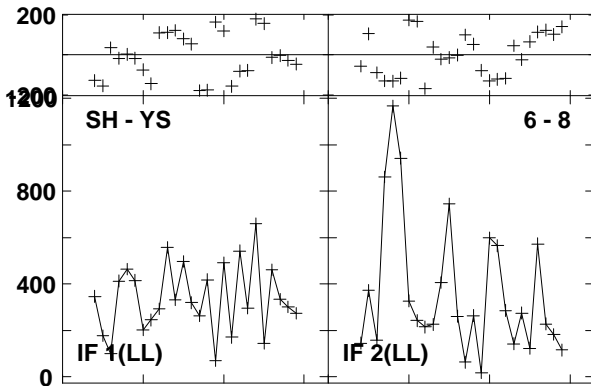
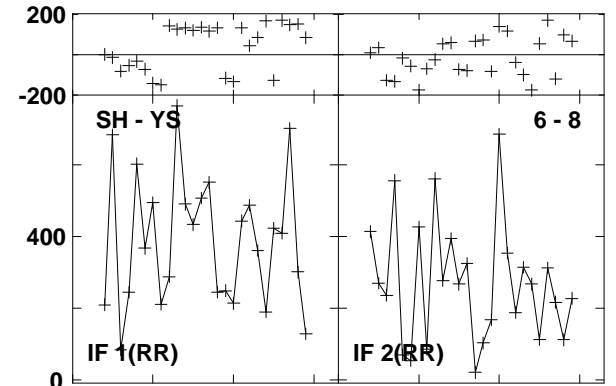
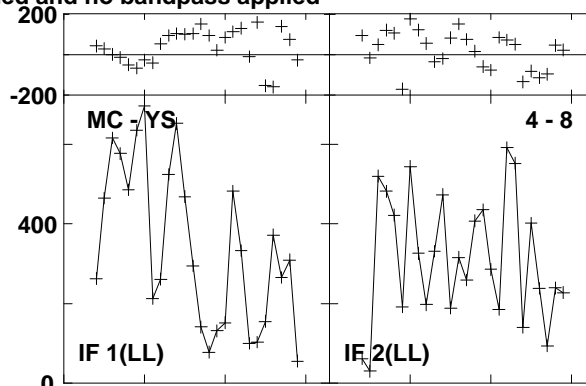
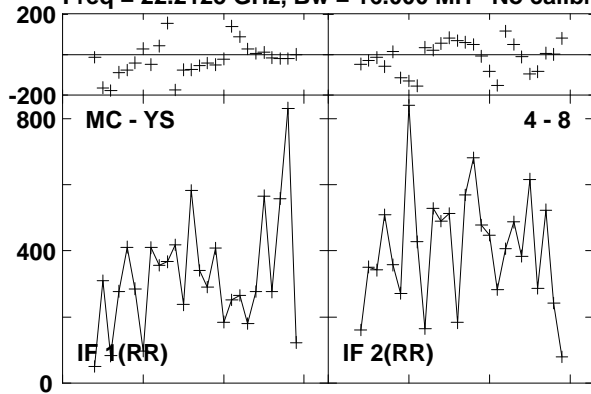

Lower frame: Micro Ampl Jy Top frame: Phas deg  
Vector averaged cross-power spectrum Baseline: MC (04) - YS (08)  
Timerange: 00/09:48:50 to 00/09:49:09

Plot file version 100 created 23-AUG-2016 15:00:45  
0219+628 GA035B 1.UVDATA.1  
Freq = 22.2125 GHz, Bw = 16.000 MH No calibration applied and no bandpass applied

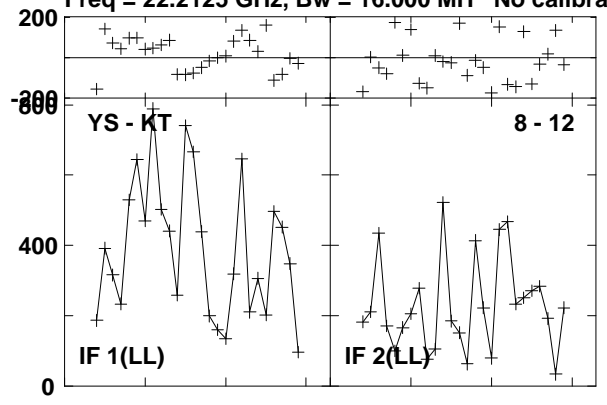

Lower frame: Micro Ampl Jy Top frame: Phas deg  
Vector averaged cross-power spectrum Baseline: YS (08) - KT (12)  
Timerange: 00/09:48:50 to 00/09:49:09

Plot file version 101 created 23-AUG-2016 15:00:45

W3IRS5 GA035B 1.UVDATA.1

Freq = 22.2125 GHz, Bw = 16.000 MH No calibration applied and no bandpass applied

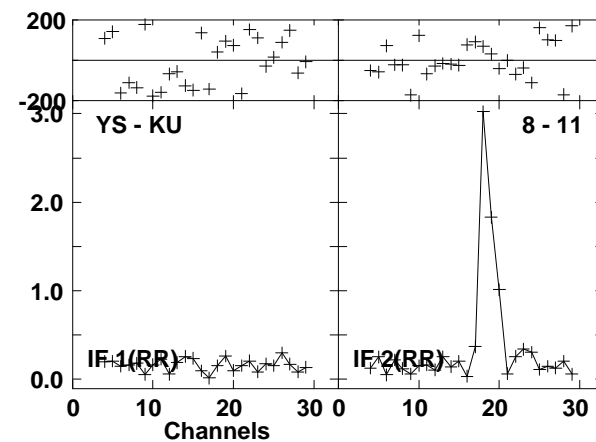
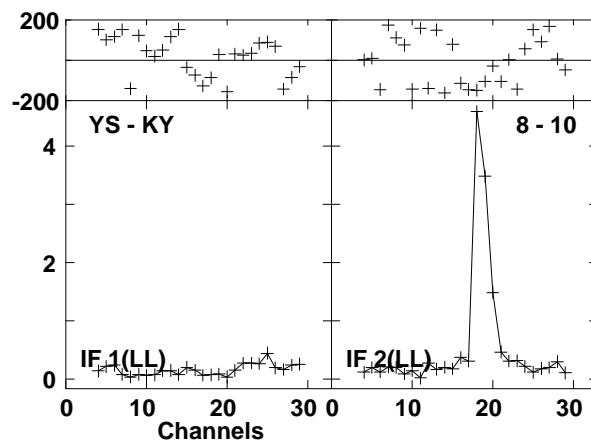
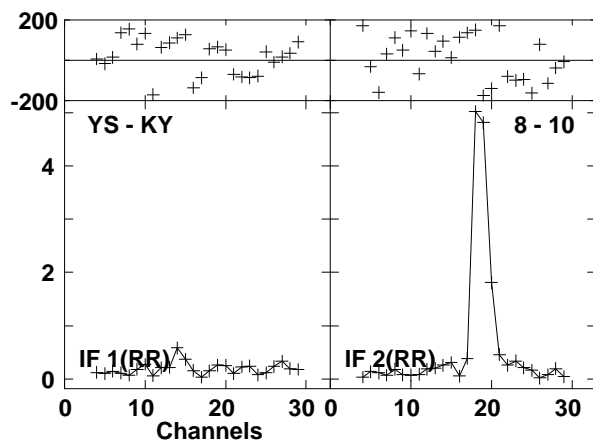
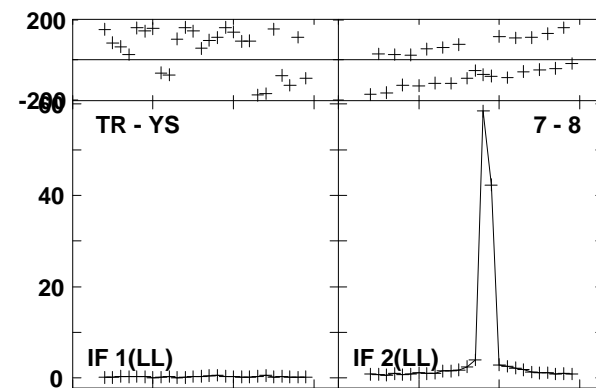
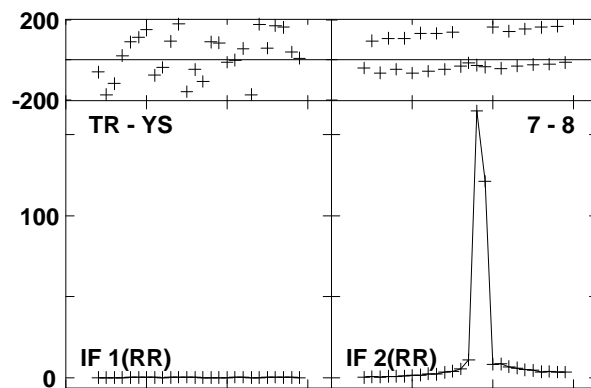
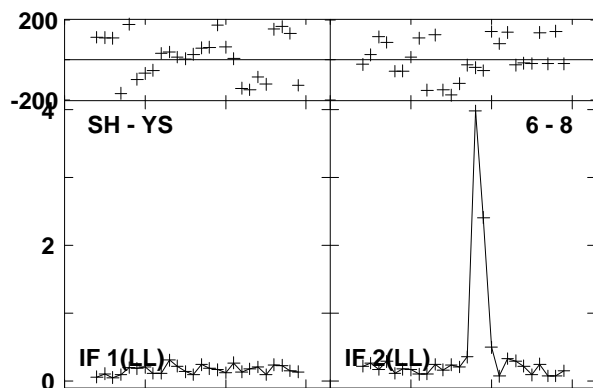
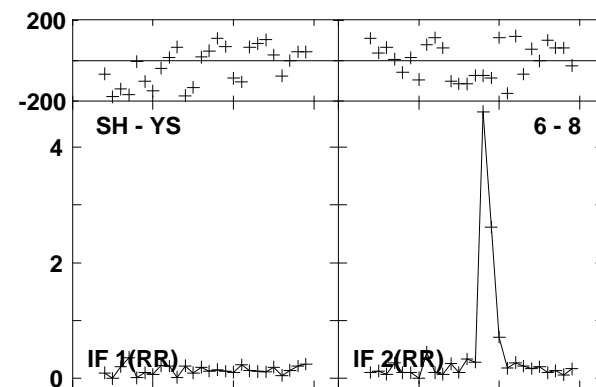
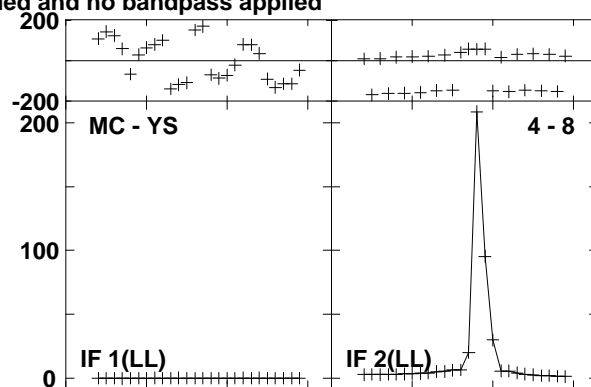
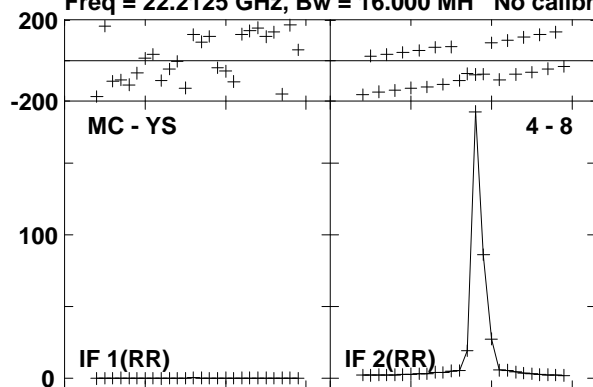

Lower frame: Milli Ampl Jy Top frame: Phas deg  
Vector averaged cross-power spectrum Baseline: MC (04) - YS (08)  
Timerange: 00/09:49:36 to 00/09:50:34

Plot file version 102 created 23-AUG-2016 15:00:45

W3IRS5 GA035B 1.UVDATA.1

Freq = 22.2125 GHz, Bw = 16.000 MH No calibration applied and no bandpass applied

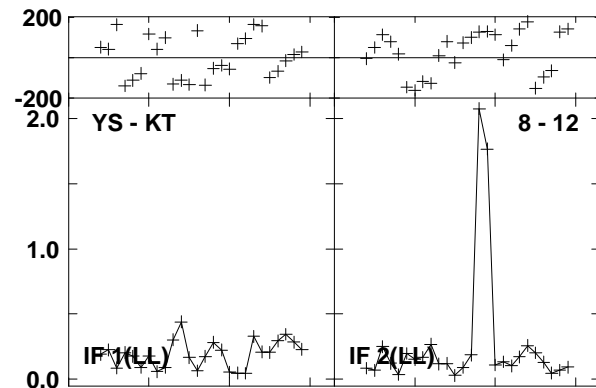
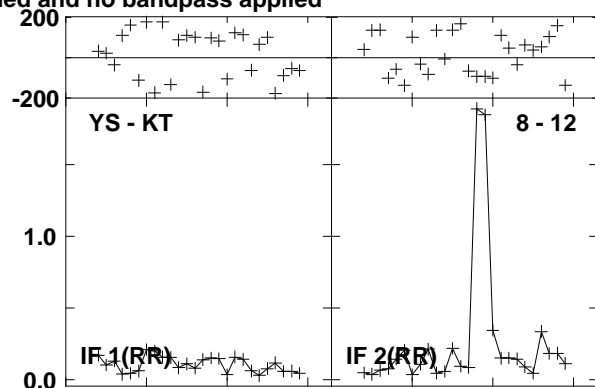
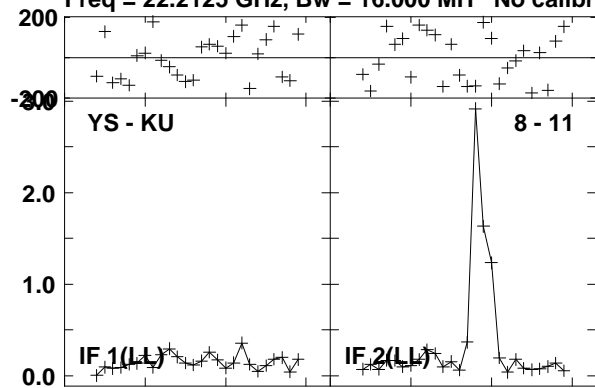

Lower frame: Milli Ampl Jy Top frame: Phas deg  
Vector averaged cross-power spectrum Baseline: YS (08) - KU (11)  
Timerange: 00/09:49:36 to 00/09:50:34

Plot file version 103 created 23-AUG-2016 15:00:45

0219+628 GA035B 1.UVDATA.1

Freq = 22.2125 GHz, Bw = 16.000 MH No calibration applied and no bandpass applied

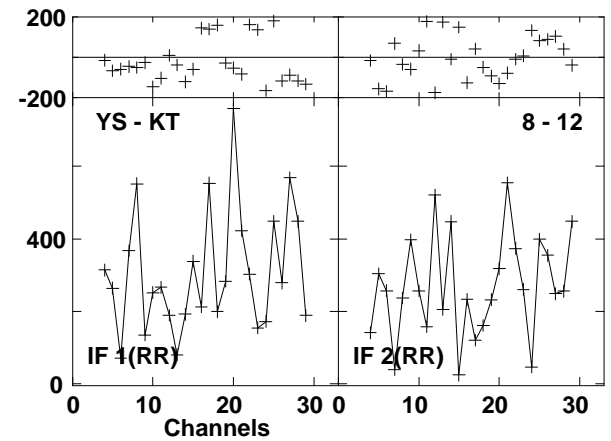
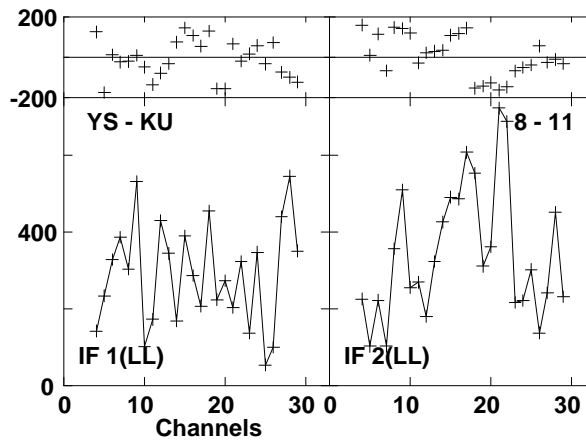
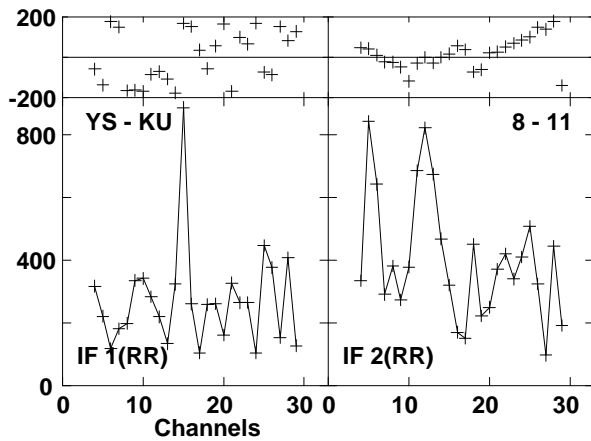
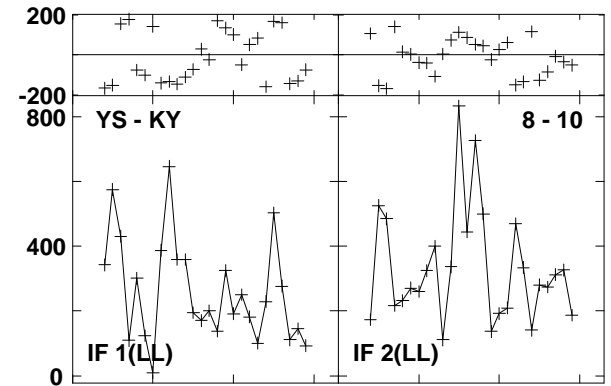
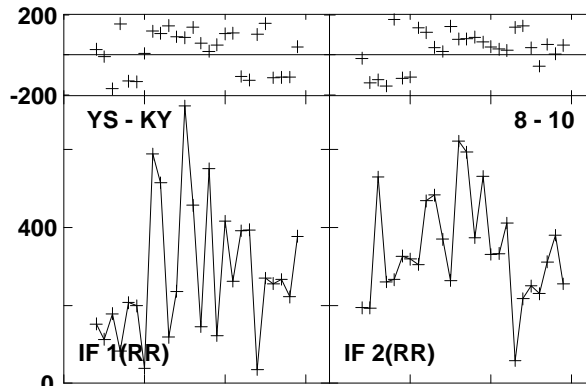
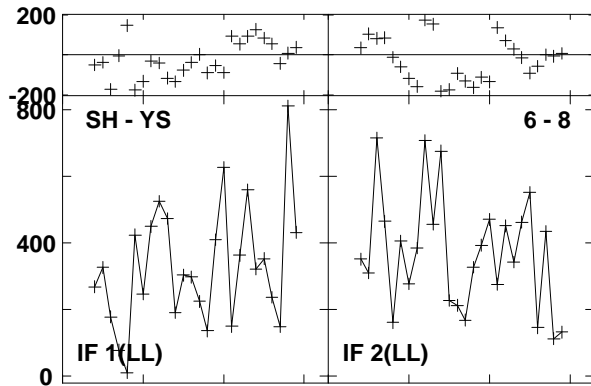
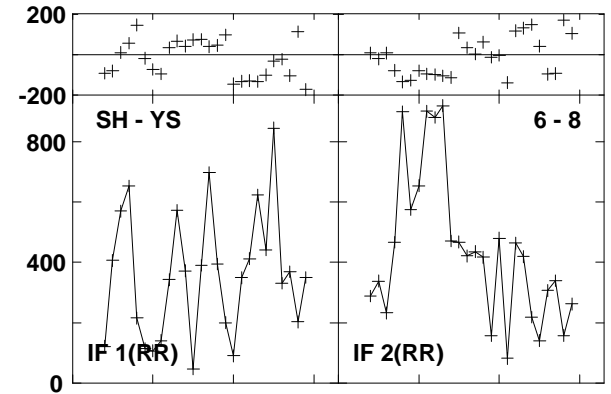
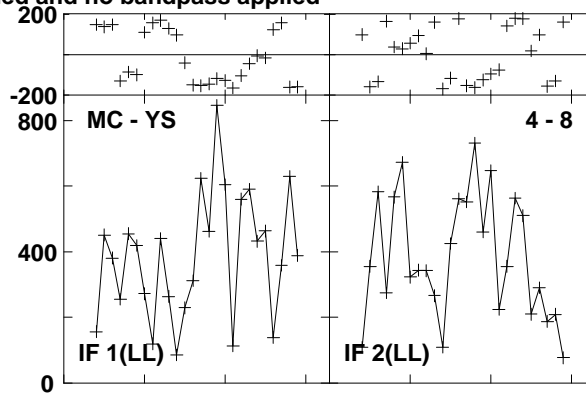
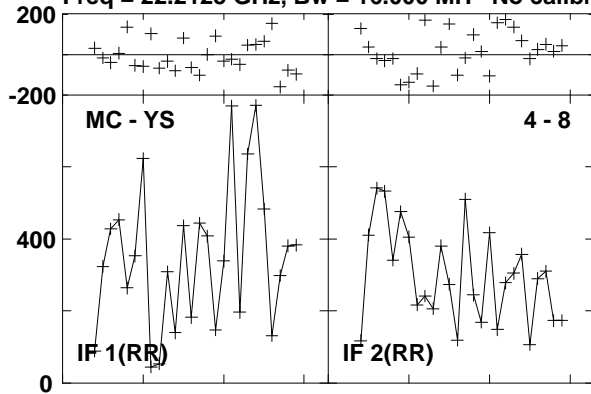

Lower frame: Micro Ampl Jy Top frame: Phas deg  
Vector averaged cross-power spectrum Baseline: MC (04) - YS (08)  
Timerange: 00/09:51:00 to 00/09:51:20

Plot file version 104 created 23-AUG-2016 15:00:45  
0219+628 GA035B 1.UVDATA.1  
Freq = 22.2125 GHz, Bw = 16.000 MH No calibration applied and no bandpass applied

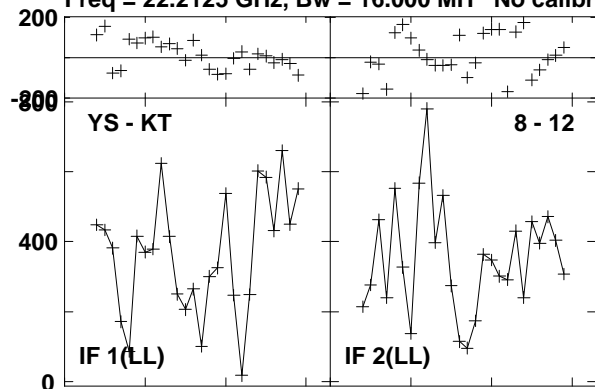

Lower frame: Micro Ampl Jy Top frame: Phas deg  
Vector averaged cross-power spectrum Baseline: YS (08) - KT (12)  
Timerange: 00/09:51:00 to 00/09:51:20



Plot file version 105 created 23-AUG-2016 15:00:45

W3IRS5 GA035B 1.UVDATA.1

Freq = 22.2125 GHz, Bw = 16.000 MH No calibration applied and no bandpass applied

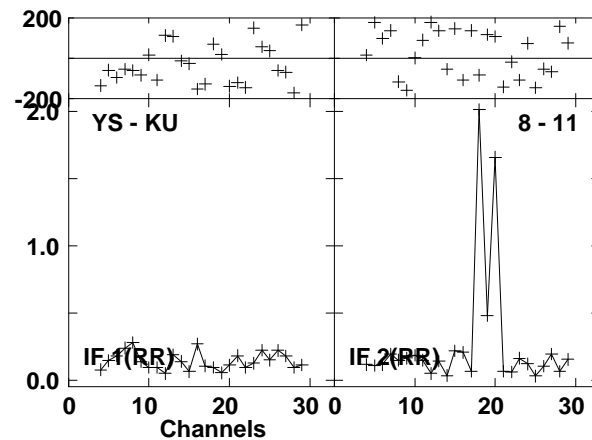
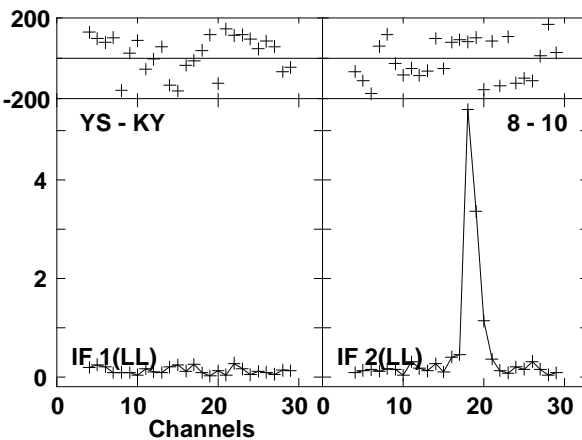
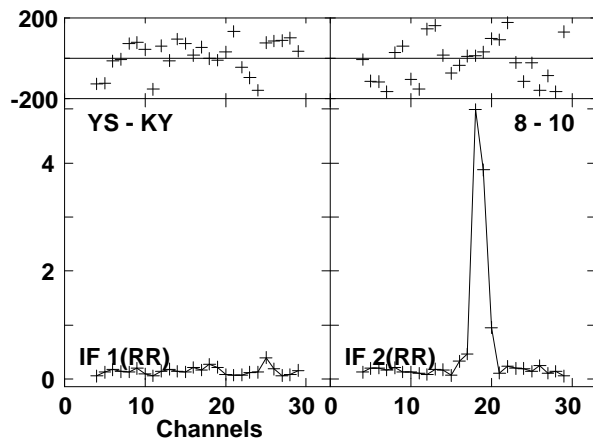
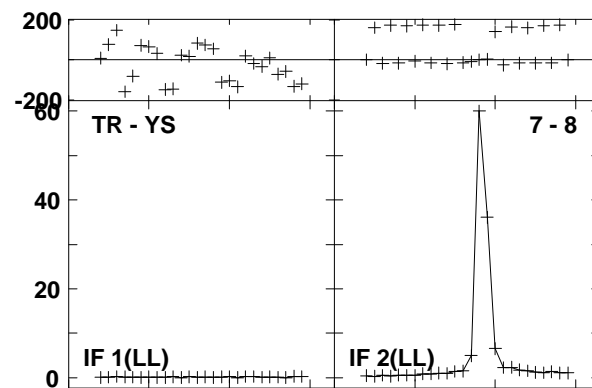
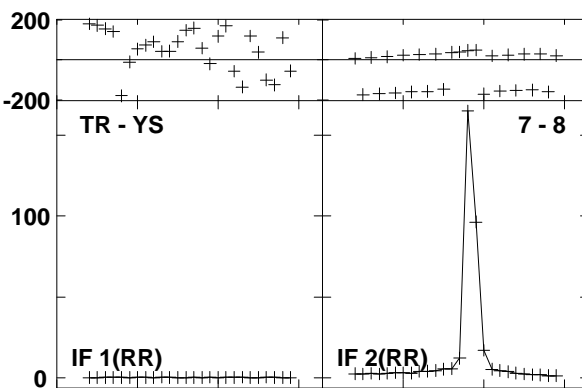
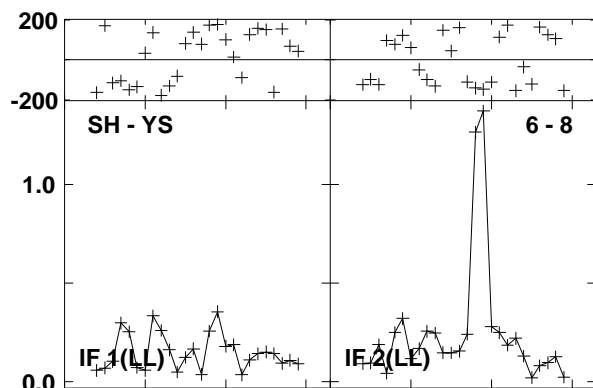
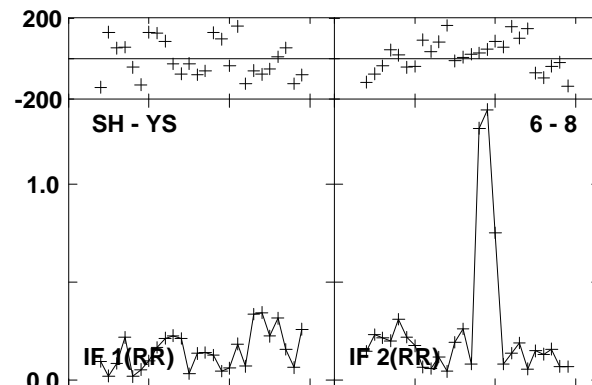
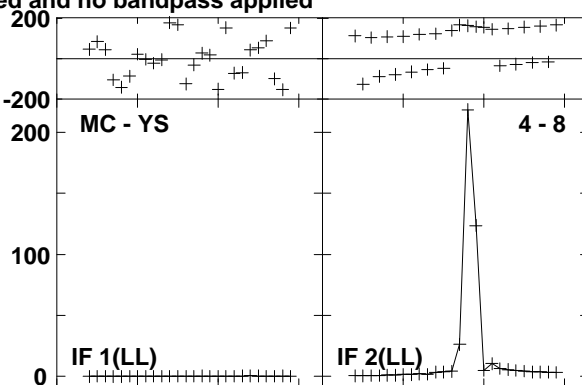
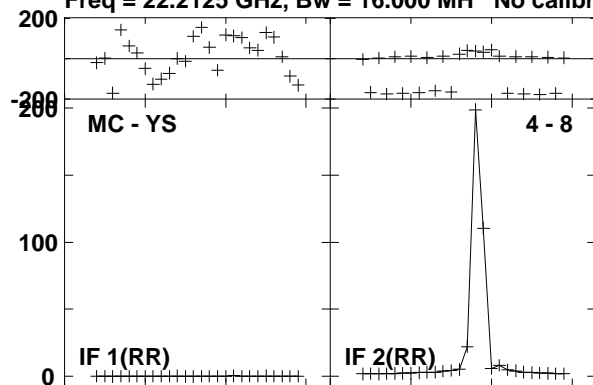

Lower frame: Milli Ampl Jy Top frame: Phas deg  
Vector averaged cross-power spectrum Baseline: MC (04) - YS (08)  
Timerange: 00/09:52:50 to 00/09:53:49

Plot file version 106 created 23-AUG-2016 15:00:45  
W3IRS5 GA035B 1.UVDATA.1

Freq = 22.2125 GHz, Bw = 16.000 MH No calibration applied and no bandpass applied

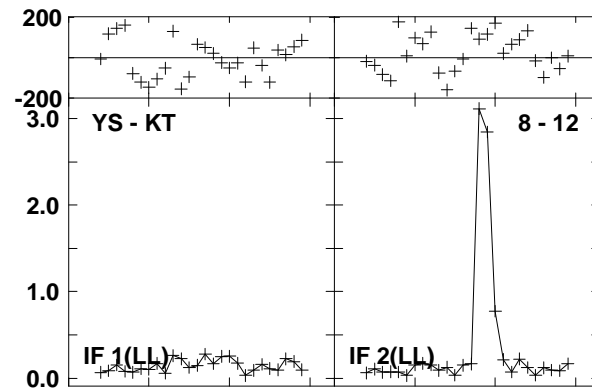
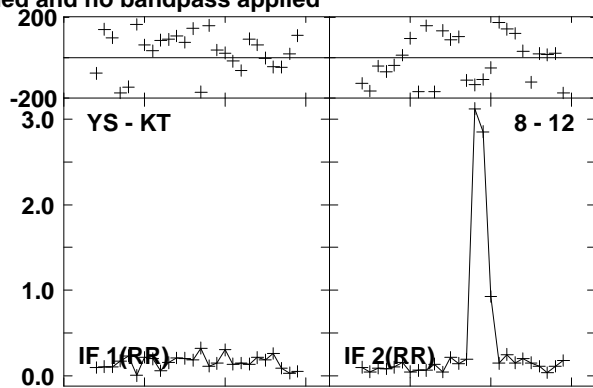
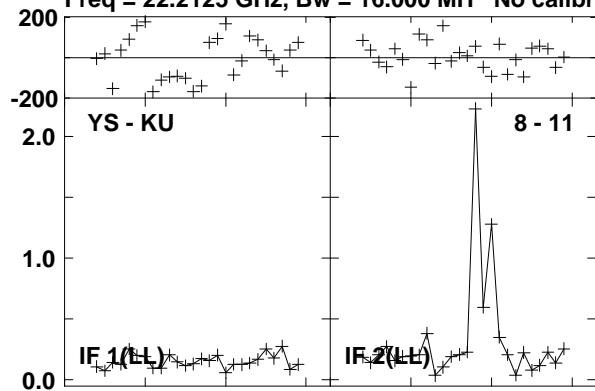

Lower frame: Milli Ampl Jy Top frame: Phas deg  
Vector averaged cross-power spectrum Baseline: YS (08) - KU (11)  
Timerange: 00/09:52:50 to 00/09:53:49

Plot file version 107 created 23-AUG-2016 15:00:45  
 0219+628 GA035B 1.UVDATA.1  
 Freq = 22.2125 GHz, Bw = 16.000 MH No calibration applied and no bandpass applied

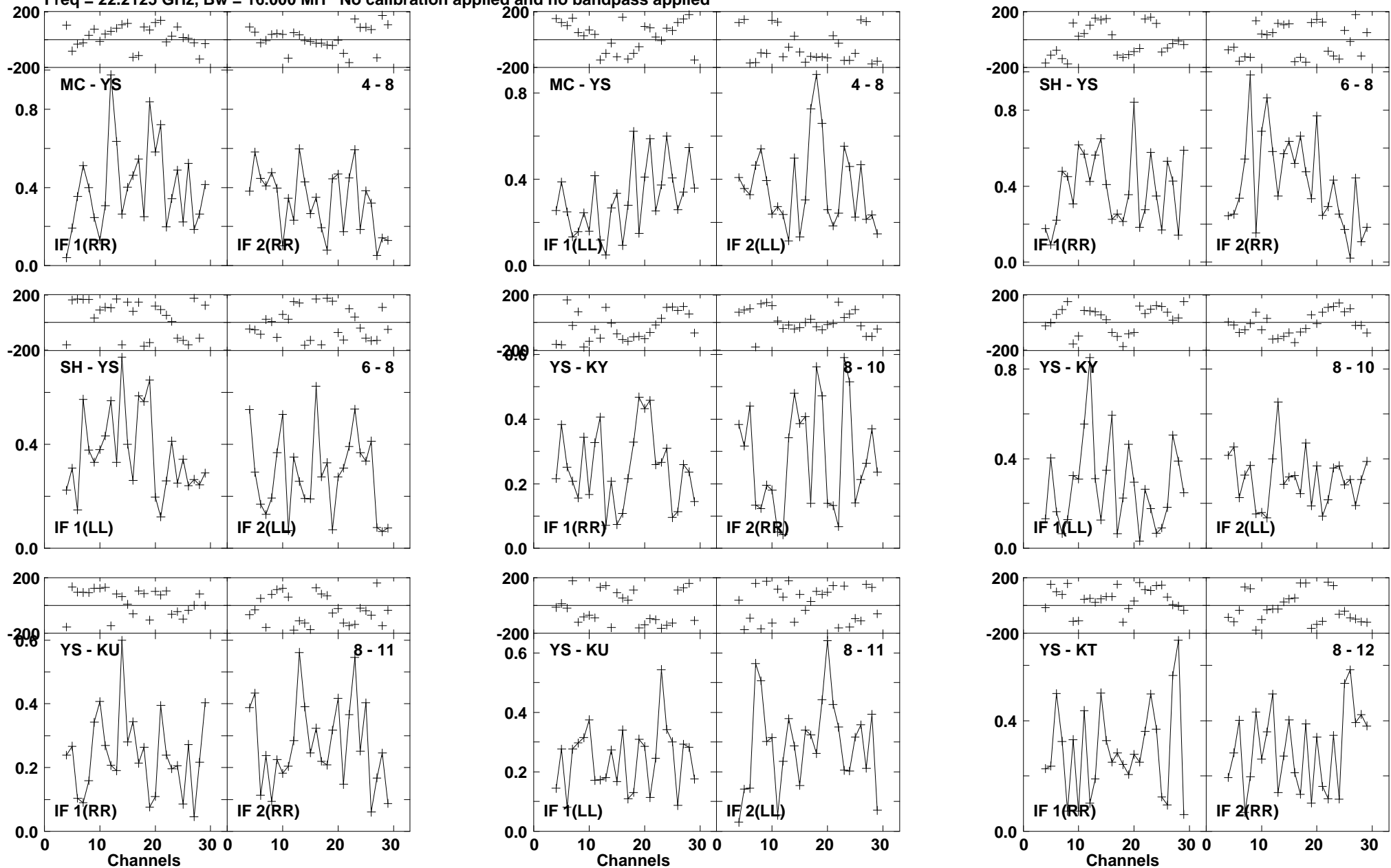

Lower frame: Milli Ampl Jy Top frame: Phas deg  
 Vector averaged cross-power spectrum Baseline: MC (04) - YS (08)  
 Timerange: 00/09:54:15 to 00/09:54:35

Plot file version 108 created 23-AUG-2016 15:00:45  
0219+628 GA035B 1.UVDATA.1  
Freq = 22.2125 GHz, Bw = 16.000 MH No calibration applied and no bandpass applied

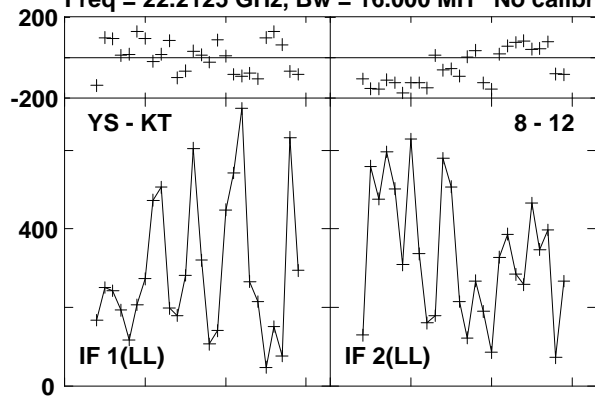

Lower frame: Micro Ampl Jy Top frame: Phas deg  
Vector averaged cross-power spectrum Baseline: YS (08) - KT (12)  
Timerange: 00/09:54:15 to 00/09:54:35

Plot file version 109 created 23-AUG-2016 15:00:45

W3IRS5 GA035B 1.UVDATA.1

Freq = 22.2125 GHz, Bw = 16.000 MH No calibration applied and no bandpass applied

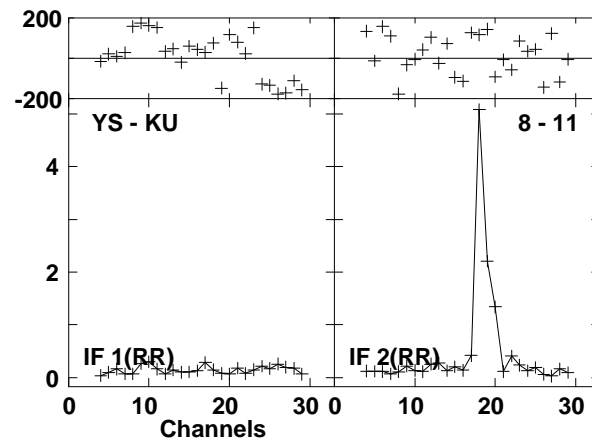
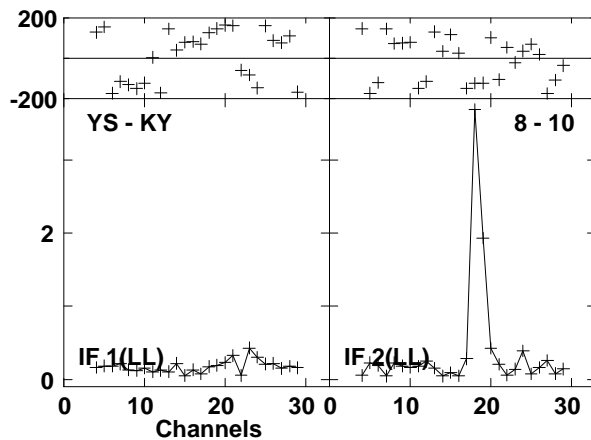
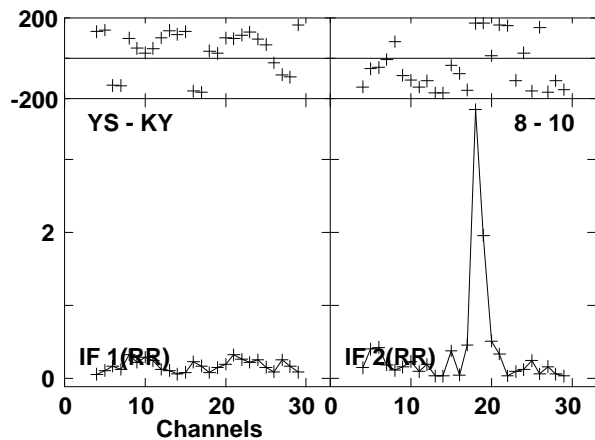
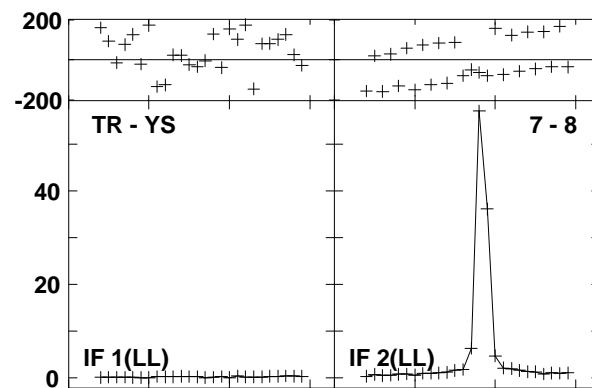
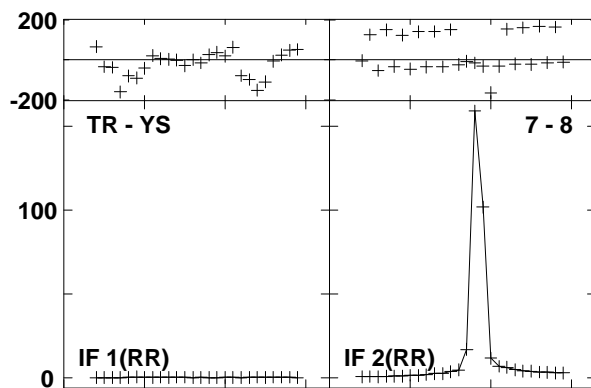
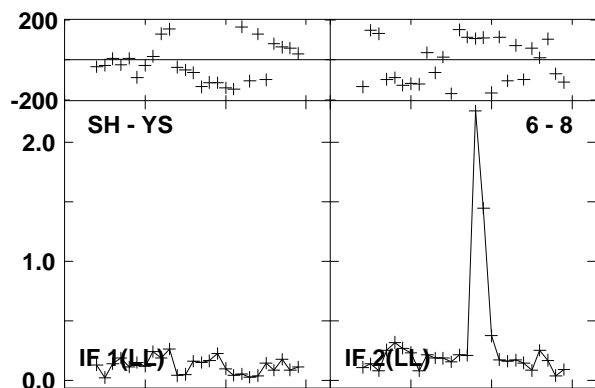
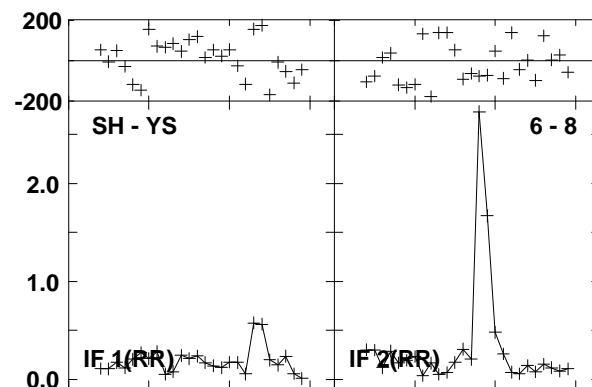
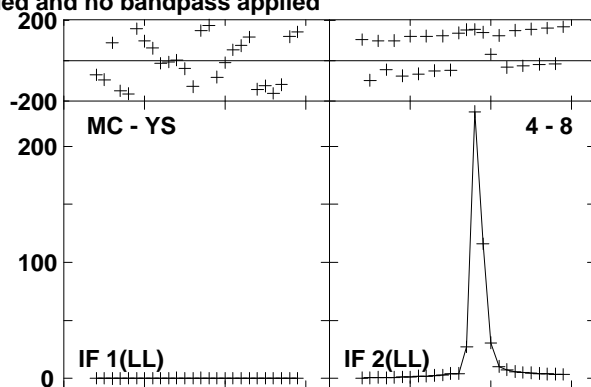
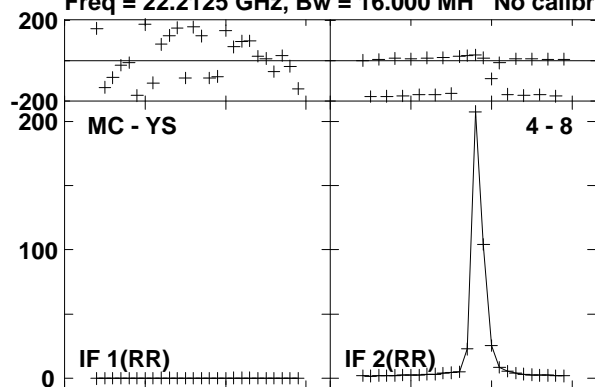

Lower frame: Milli Ampl Jy Top frame: Phas deg  
Vector averaged cross-power spectrum Baseline: MC (04) - YS (08)  
Timerange: 00/09:55:01 to 00/09:55:59

Plot file version 110 created 23-AUG-2016 15:00:45

W3IRS5 GA035B 1.UVDATA.1

Freq = 22.2125 GHz, Bw = 16.000 MH No calibration applied and no bandpass applied

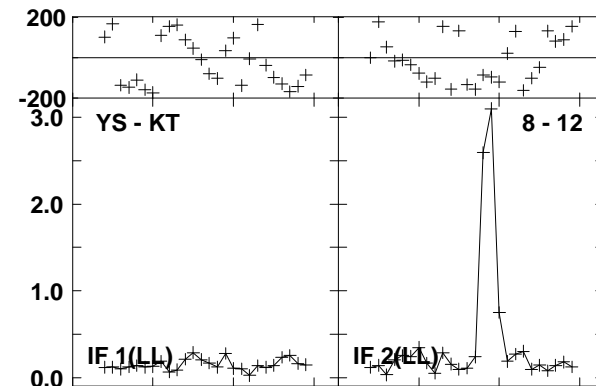
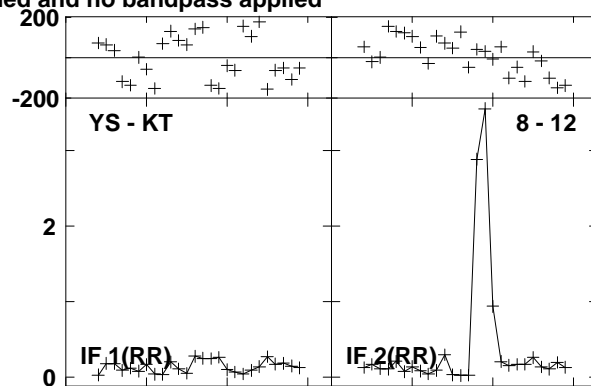
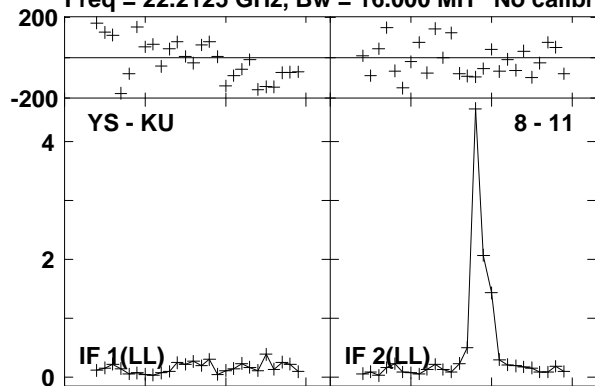

Lower frame: Milli Ampl Jy Top frame: Phas deg  
Vector averaged cross-power spectrum Baseline: YS (08) - KU (11)  
Timerange: 00/09:55:01 to 00/09:55:59

Plot file version 111 created 23-AUG-2016 15:00:45

0219+628 GA035B 1.UVDATA.1

Freq = 22.2125 GHz, Bw = 16.000 MH No calibration applied and no bandpass applied

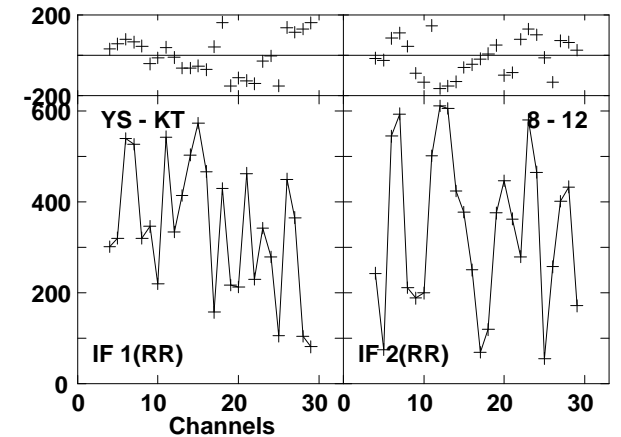
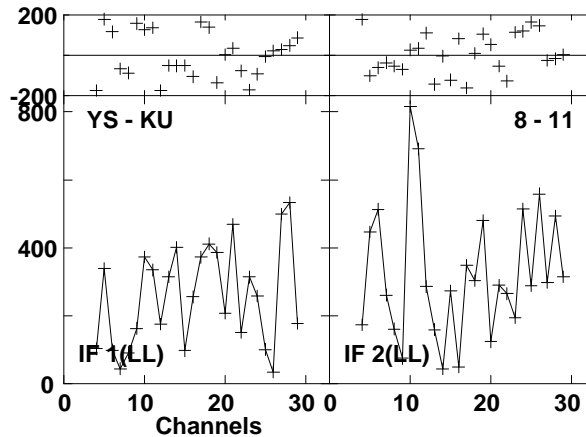
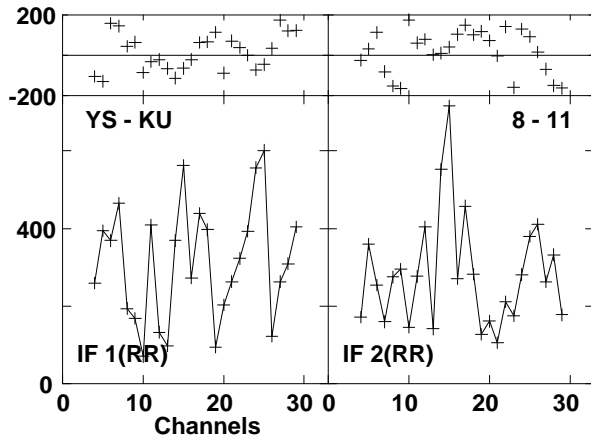
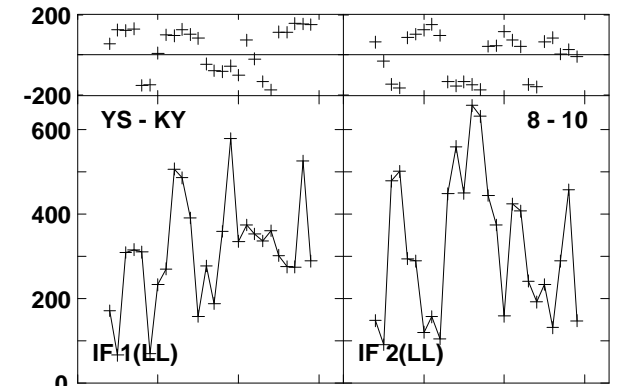
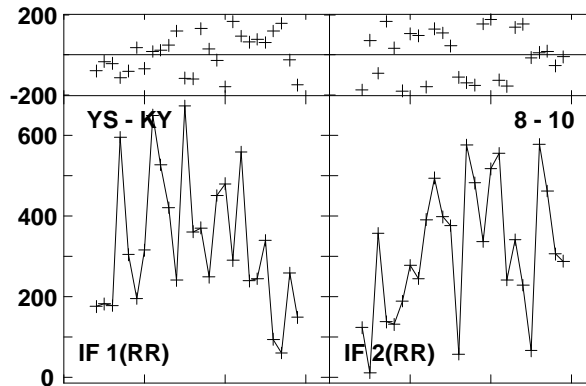
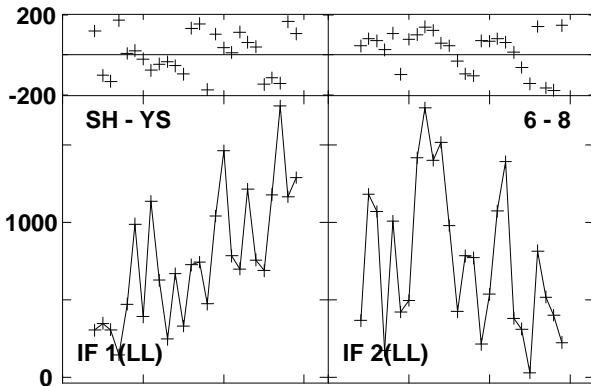
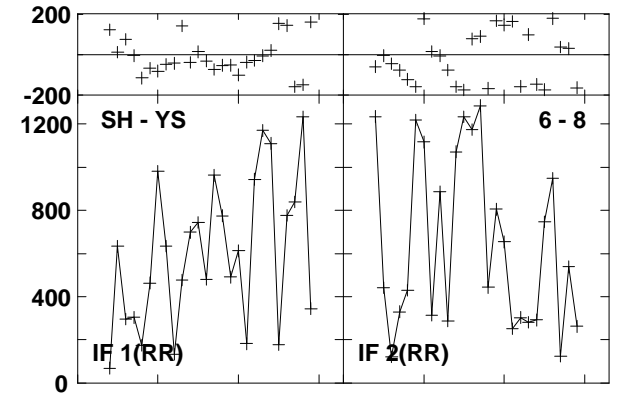
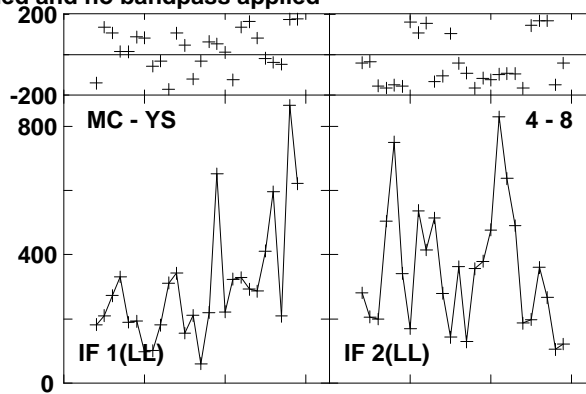
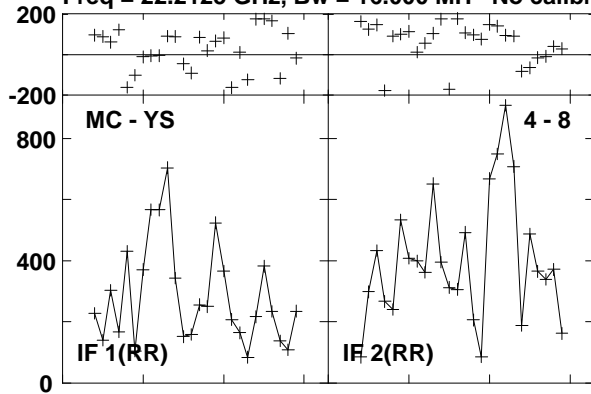

Lower frame: Micro Ampl Jy Top frame: Phas deg  
Vector averaged cross-power spectrum Baseline: MC (04) - YS (08)  
Timerange: 00/09:56:25 to 00/09:56:45

Plot file version 112 created 23-AUG-2016 15:00:45  
0219+628 GA035B 1.UVDATA.1  
Freq = 22.2125 GHz, Bw = 16.000 MH No calibration applied and no bandpass applied

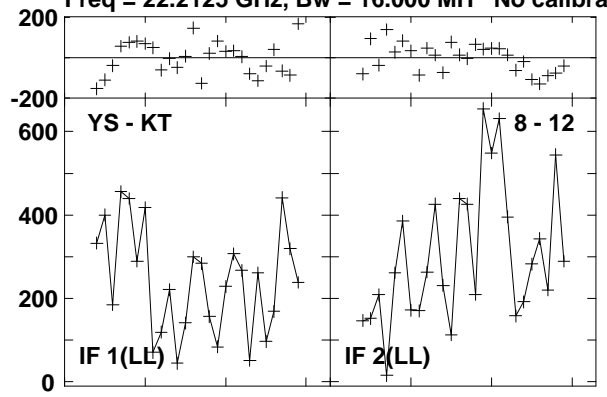

Lower frame: Micro Ampl Jy Top frame: Phas deg  
Vector averaged cross-power spectrum Baseline: YS (08) - KT (12)  
Timerange: 00/09:56:25 to 00/09:56:45



Plot file version 113 created 23-AUG-2016 15:00:45

W3IRS5 GA035B 1.UVDATA.1

Freq = 22.2125 GHz, Bw = 16.000 MH No calibration applied and no bandpass applied

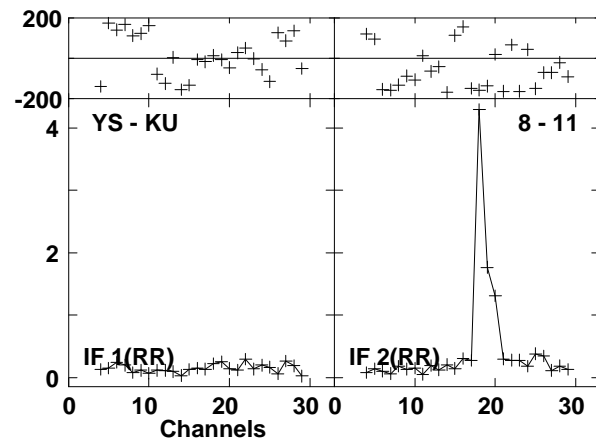
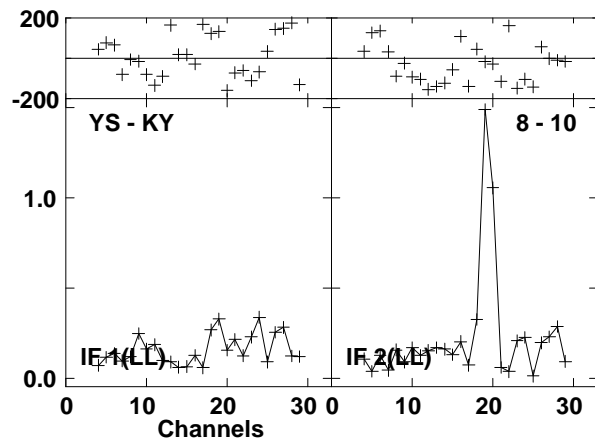
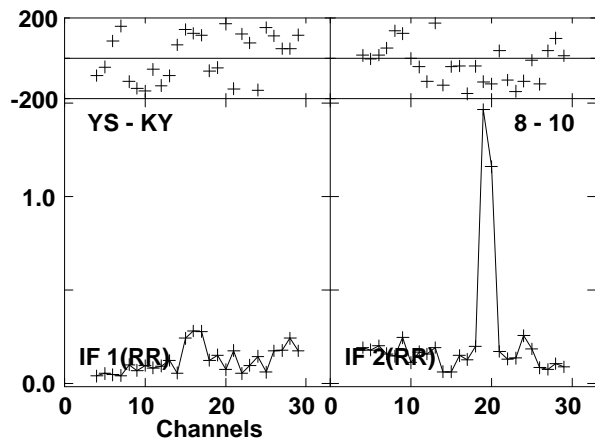
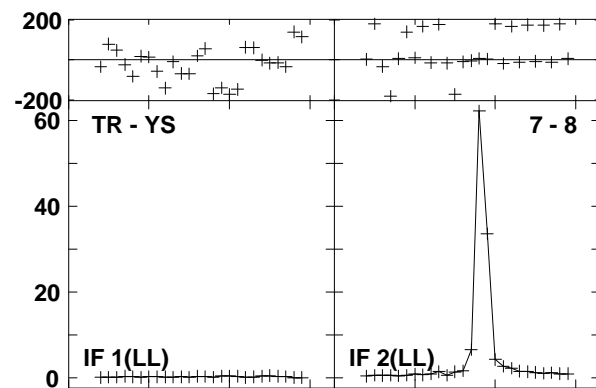
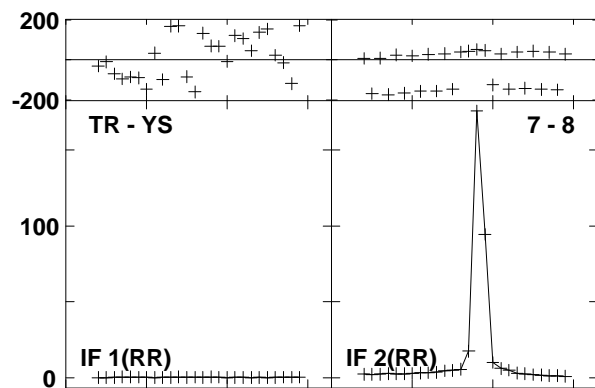
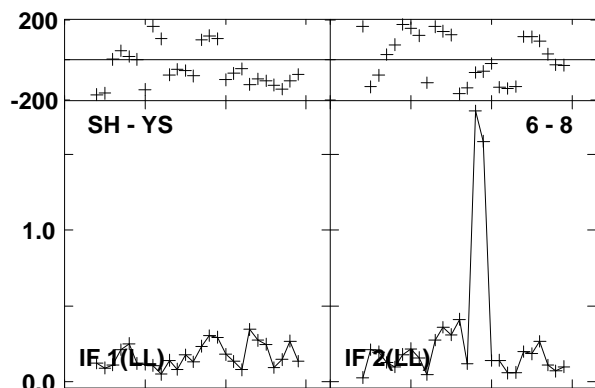
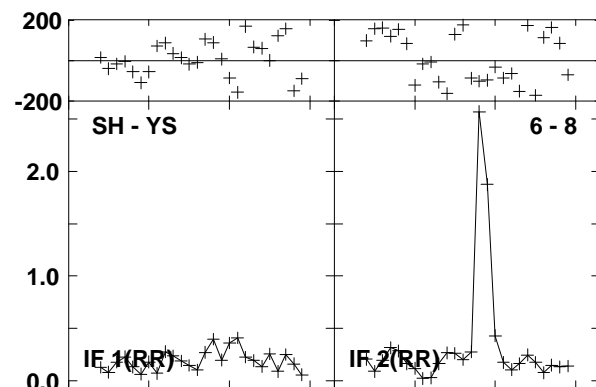
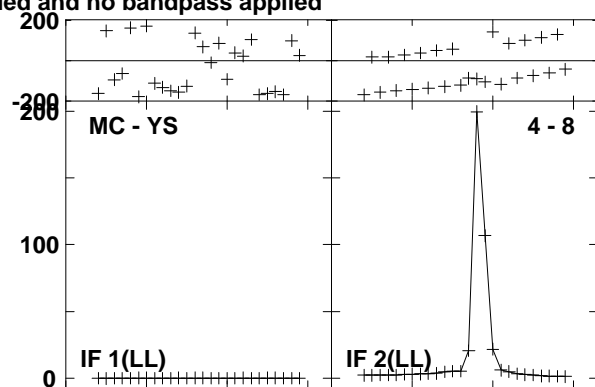
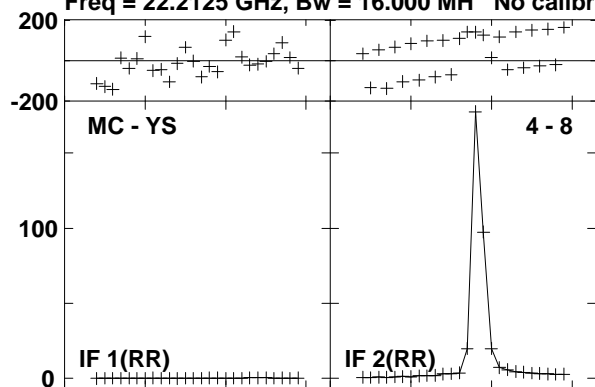

Lower frame: Milli Ampl Jy Top frame: Phas deg  
Vector averaged cross-power spectrum Baseline: MC (04) - YS (08)  
Timerange: 00/09:57:11 to 00/09:58:09

Plot file version 114 created 23-AUG-2016 15:00:45

W3IRS5 GA035B 1.UVDATA.1

Freq = 22.2125 GHz, Bw = 16.000 MH No calibration applied and no bandpass applied

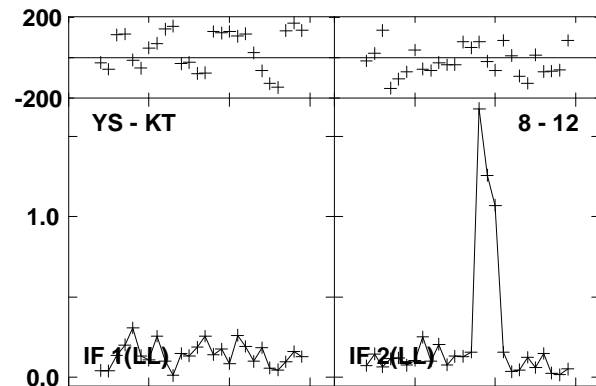
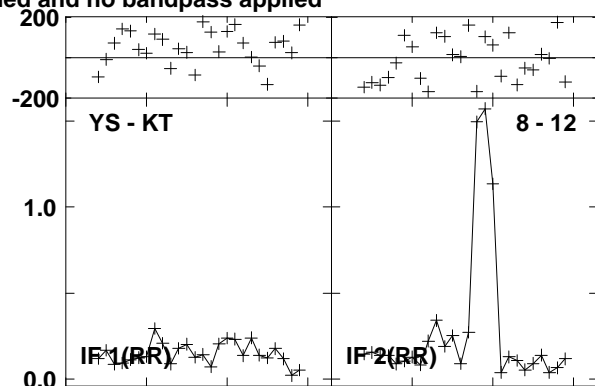
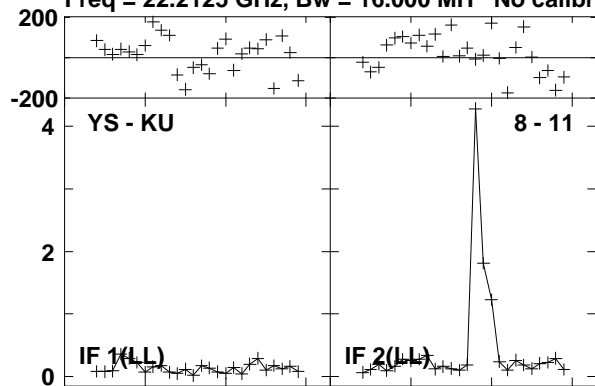

Lower frame: Milli Ampl Jy Top frame: Phas deg  
Vector averaged cross-power spectrum Baseline: YS (08) - KU (11)  
Timerange: 00/09:57:11 to 00/09:58:09

Plot file version 115 created 23-AUG-2016 15:00:45

0219+628 GA035B 1.UVDATA.1

Freq = 22.2125 GHz, Bw = 16.000 MH No calibration applied and no bandpass applied

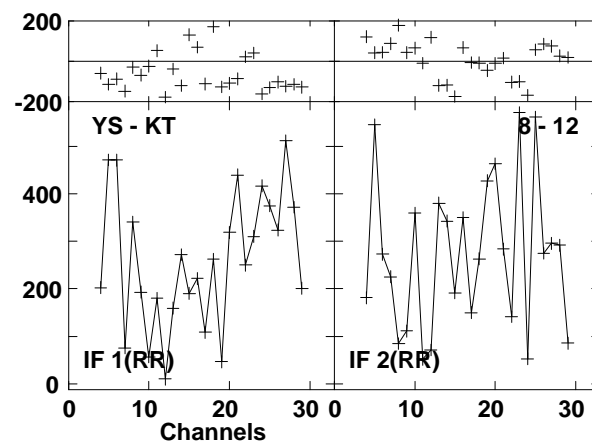
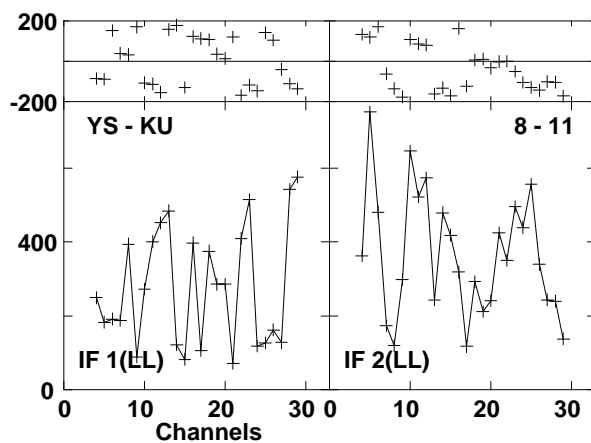
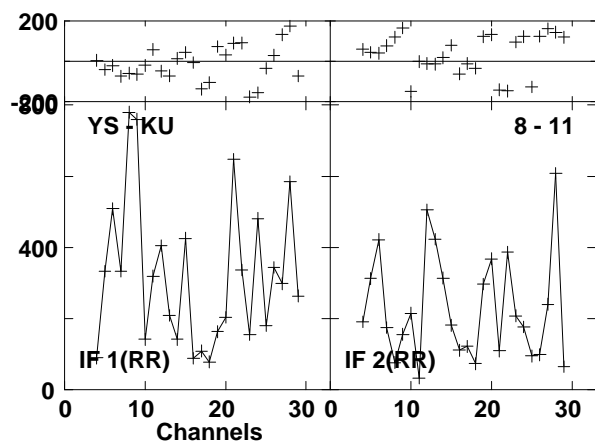
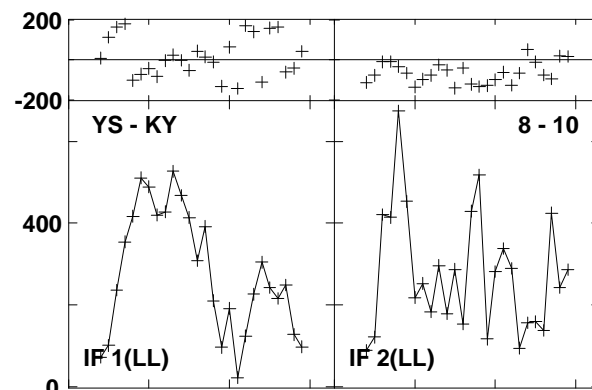
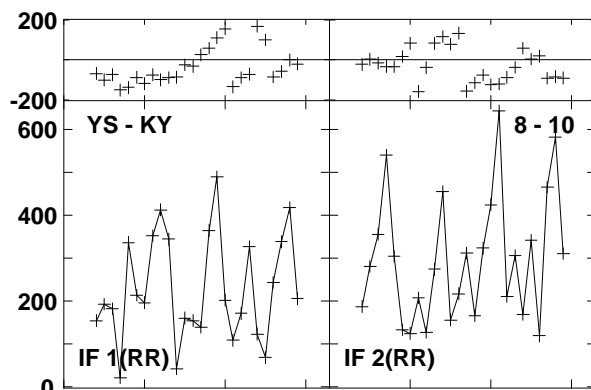
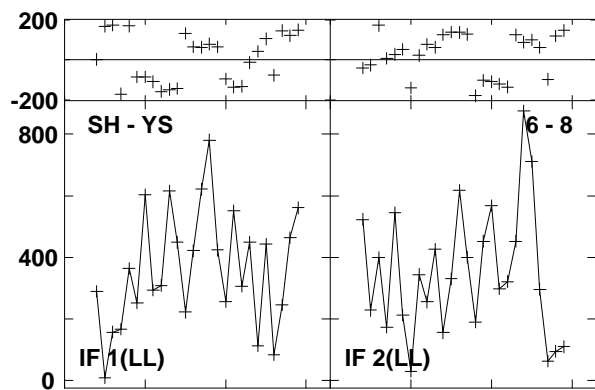
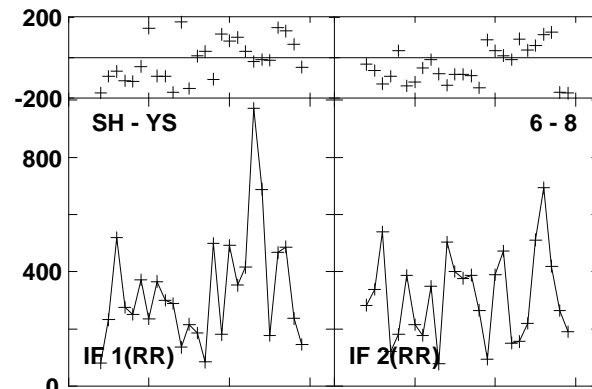
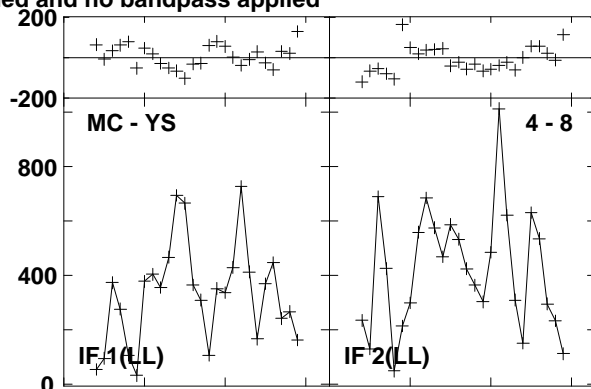
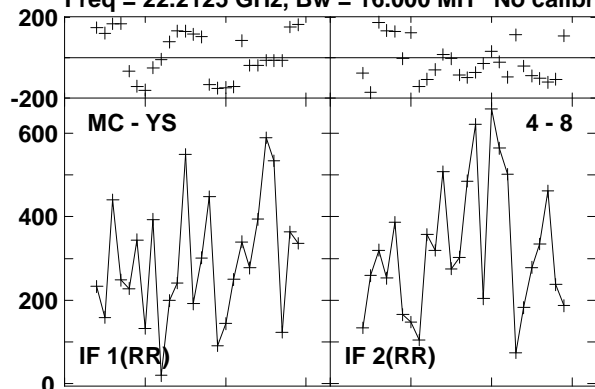

Lower frame: Micro Ampl Jy Top frame: Phas deg  
Vector averaged cross-power spectrum Baseline: MC (04) - YS (08)  
Timerange: 00/09:58:35 to 00/09:58:55

Plot file version 116 created 23-AUG-2016 15:00:45

0219+628 GA035B 1.UVDATA.1

Freq = 22.2125 GHz, Bw = 16.000 MH No calibration applied and no bandpass applied

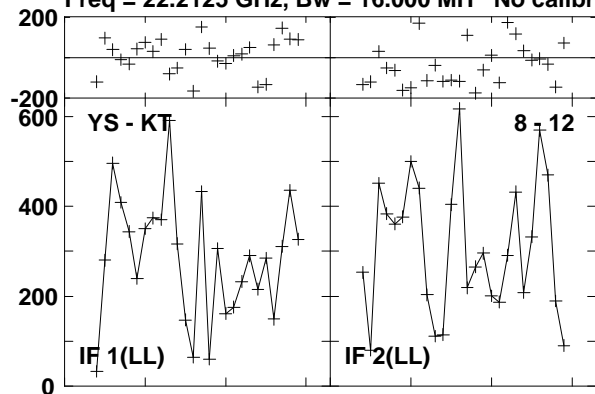

Lower frame: Micro Ampl Jy Top frame: Phas deg  
Vector averaged cross-power spectrum Baseline: YS (08) - KT (12)  
Timerange: 00/09:58:35 to 00/09:58:55

Plot file version 117 created 23-AUG-2016 15:00:45

W3IRS5 GA035B 1.UVDATA.1

Freq = 22.2125 GHz, Bw = 16.000 MH No calibration applied and no bandpass applied

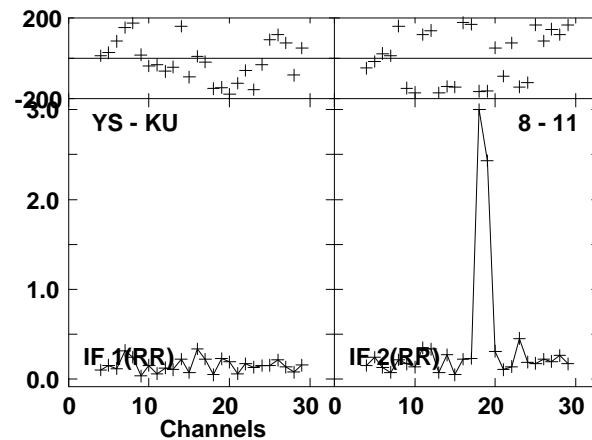
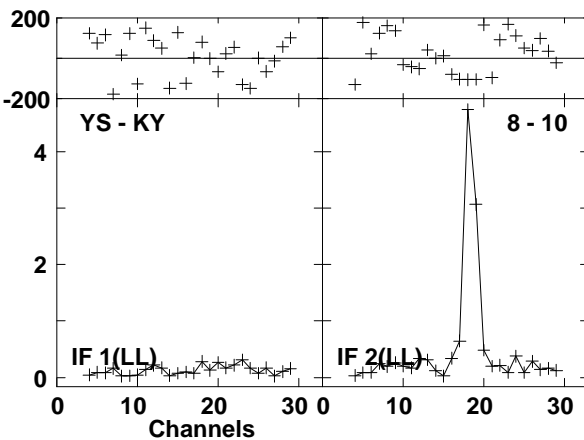
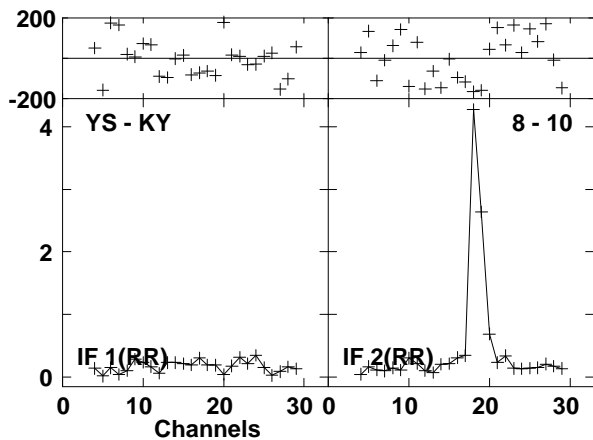
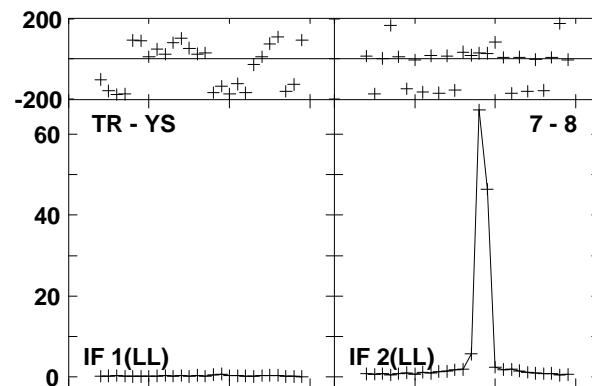
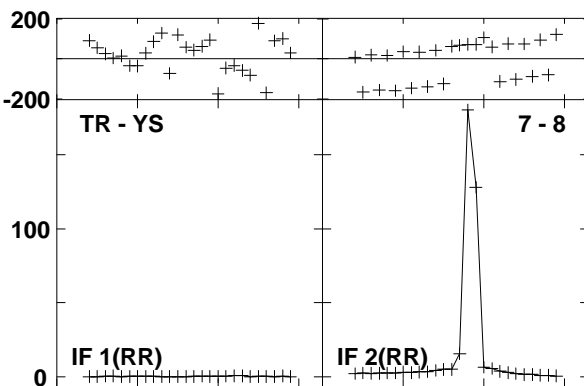
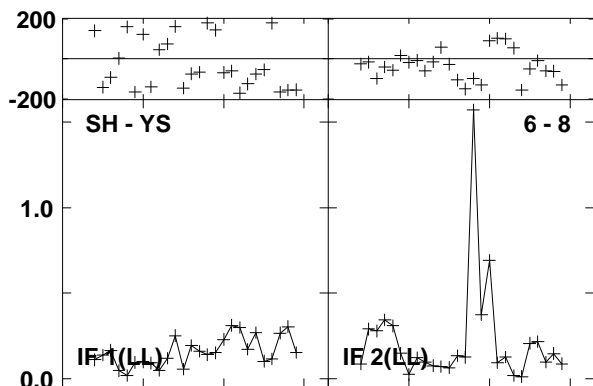
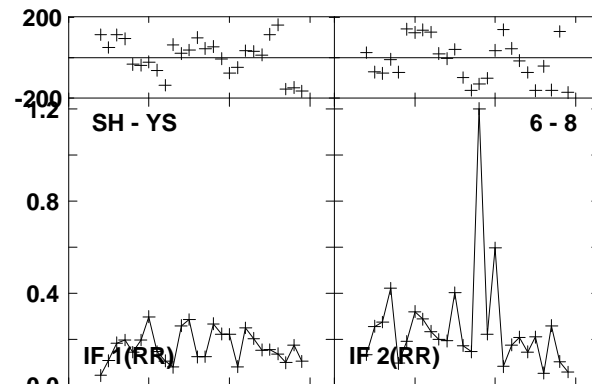
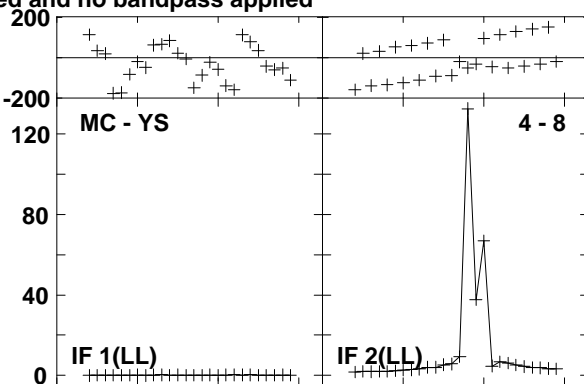
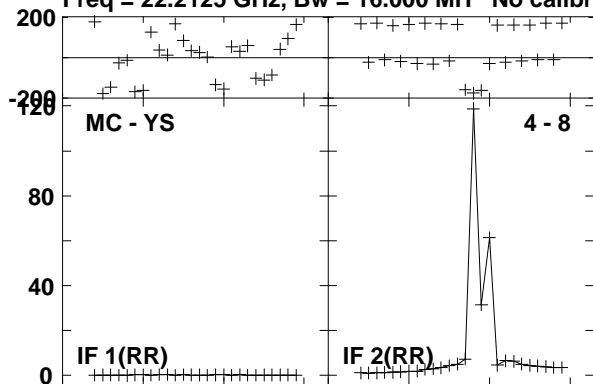

Lower frame: Milli Ampl Jy Top frame: Phas deg  
Vector averaged cross-power spectrum Baseline: MC (04) - YS (08)  
Timerange: 00/09:59:21 to 00/10:00:20

Plot file version 118 created 23-AUG-2016 15:00:45

W3IRS5 GA035B 1.UVDATA.1

Freq = 22.2125 GHz, Bw = 16.000 MH No calibration applied and no bandpass applied

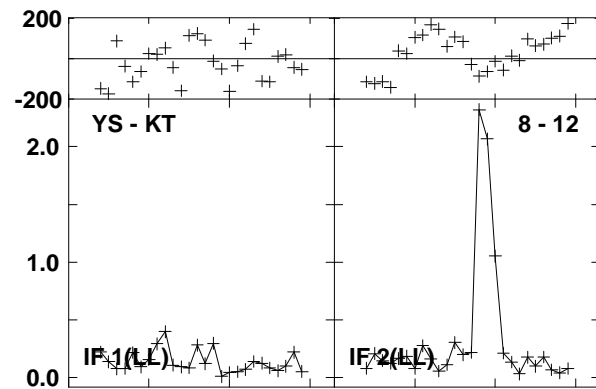
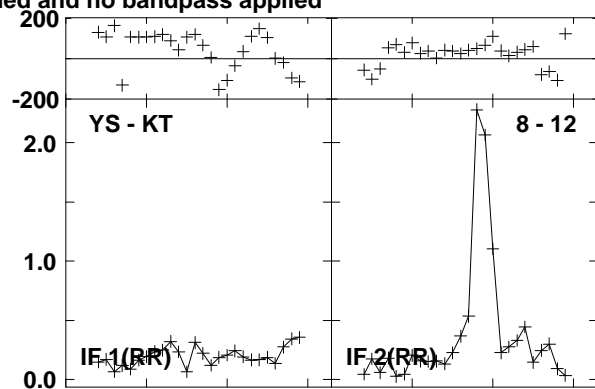
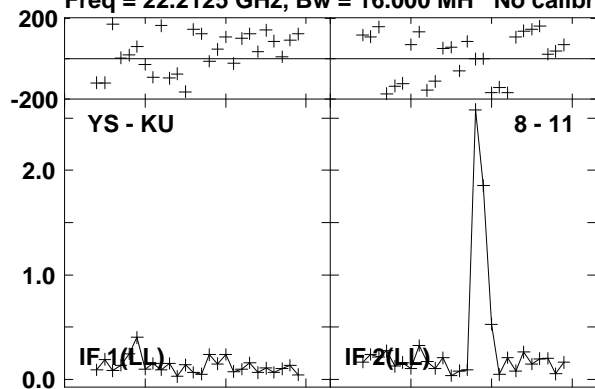

Lower frame: Milli Ampl Jy Top frame: Phas deg  
Vector averaged cross-power spectrum Baseline: YS (08) - KU (11)  
Timerange: 00/09:59:21 to 00/10:00:20

Plot file version 119 created 23-AUG-2016 15:00:45

0219+628 GA035B 1.UVDATA.1

Freq = 22.2125 GHz, Bw = 16.000 MH No calibration applied and no bandpass applied

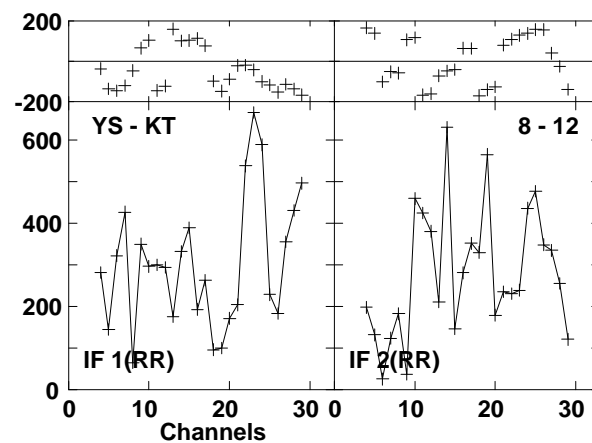
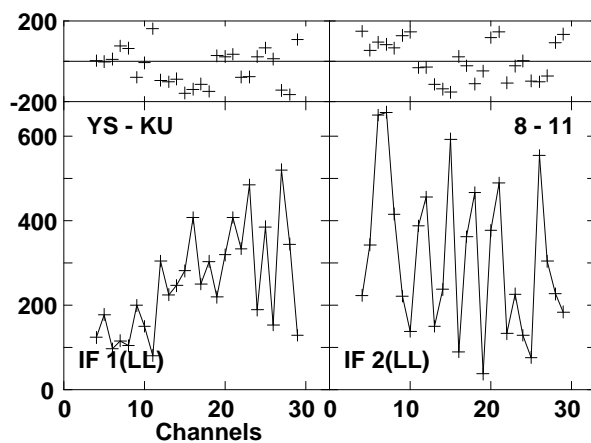
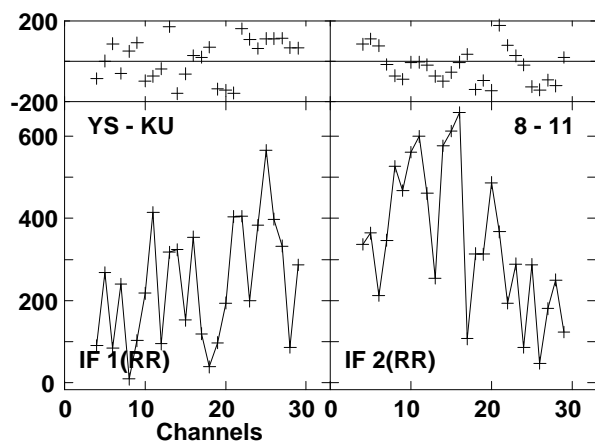
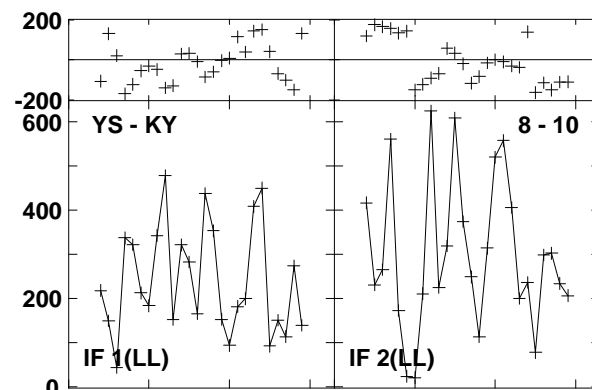
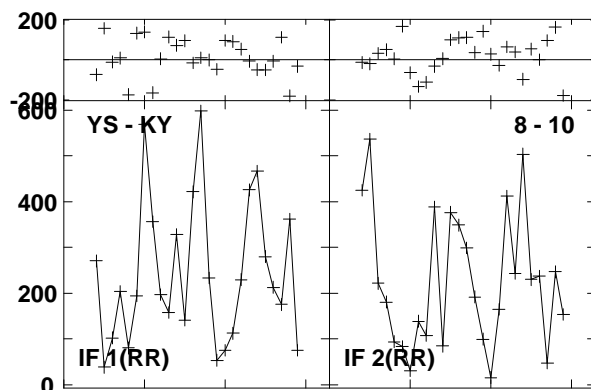
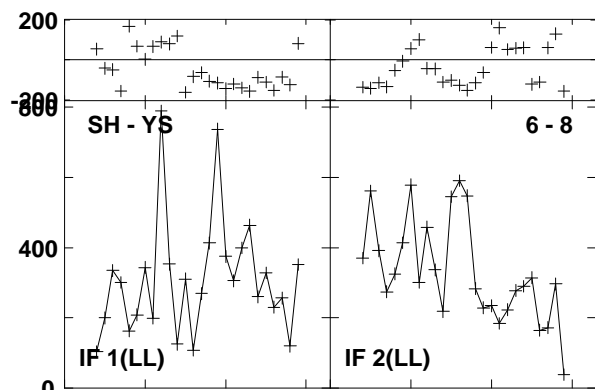
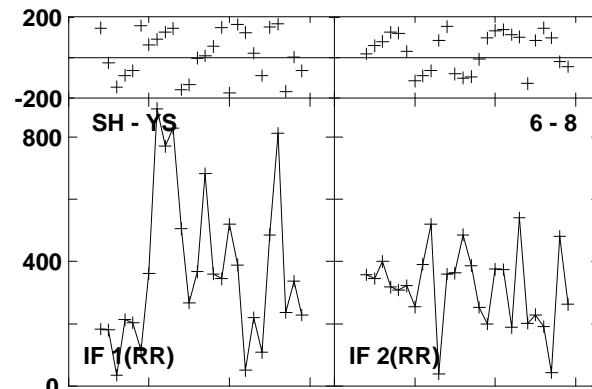
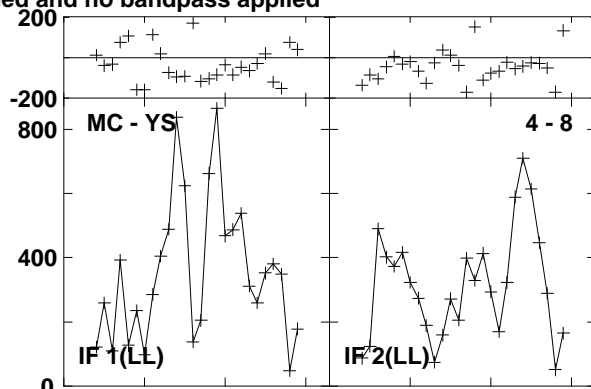
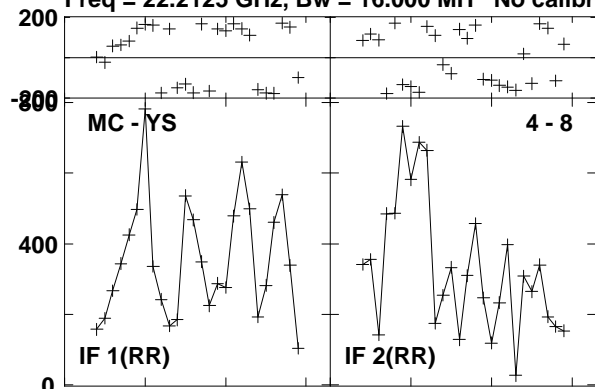

Lower frame: Micro Ampl Jy Top frame: Phas deg  
Vector averaged cross-power spectrum Baseline: MC (04) - YS (08)  
Timerange: 00/10:00:46 to 00/10:01:05

Plot file version 120 created 23-AUG-2016 15:00:45  
0219+628 GA035B 1.UVDATA.1  
Freq = 22.2125 GHz, Bw = 16.000 MH No calibration applied and no bandpass applied

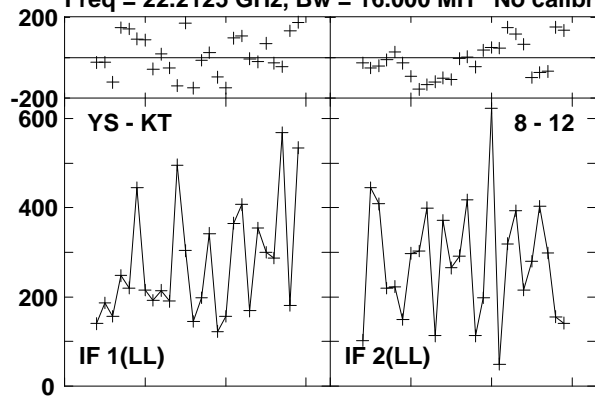

Lower frame: Micro Ampl Jy Top frame: Phas deg  
Vector averaged cross-power spectrum Baseline: YS (08) - KT (12)  
Timerange: 00/10:00:46 to 00/10:01:05



Plot file version 121 created 23-AUG-2016 15:00:45  
W3IRS5 GA035B 1.UVDATA.1

Freq = 22.2125 GHz, Bw = 16.000 MH No calibration applied and no bandpass applied

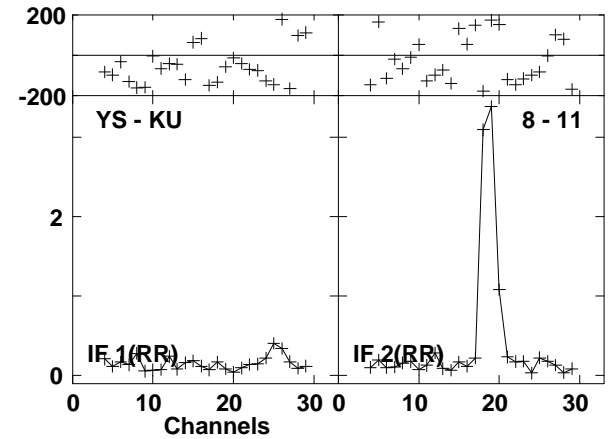
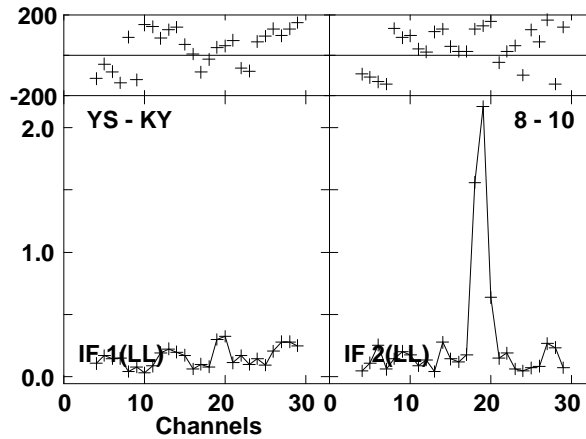
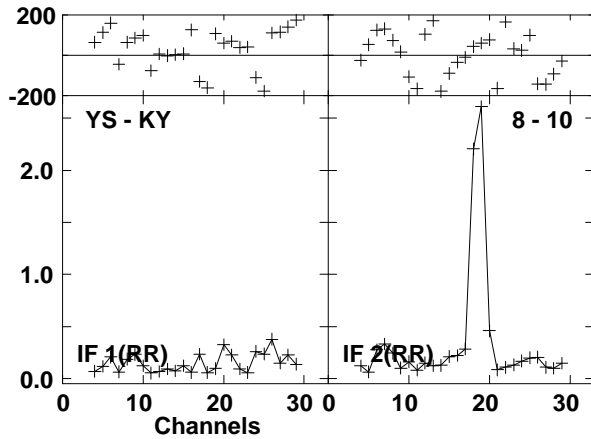
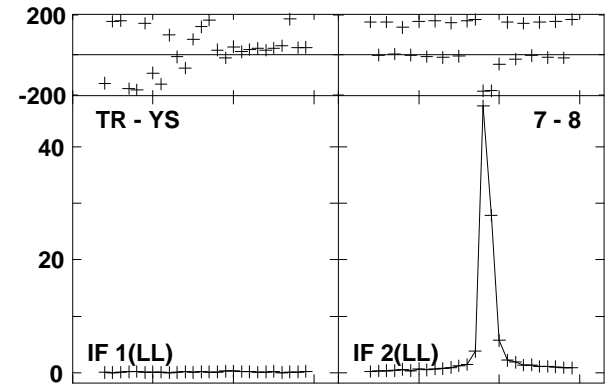
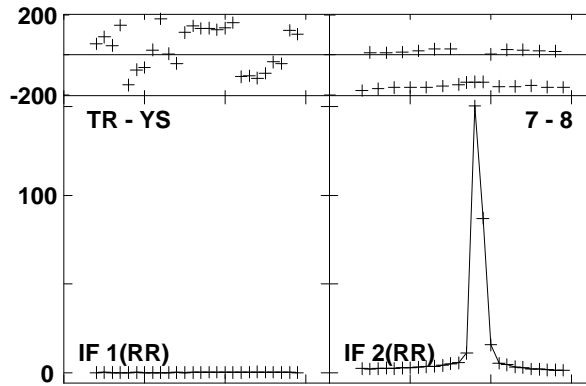
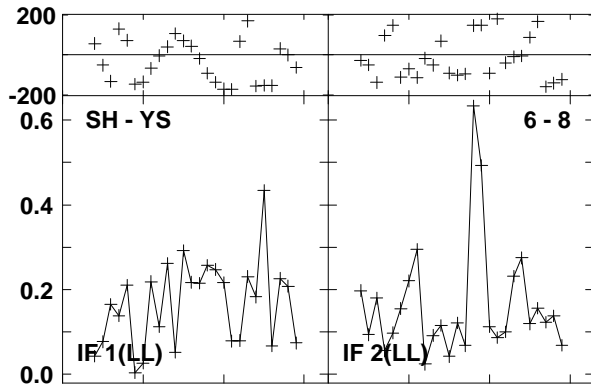
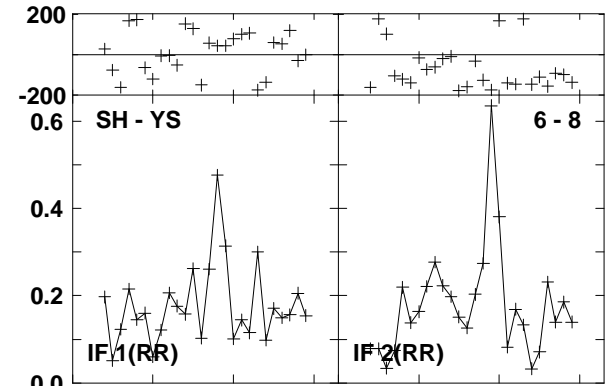
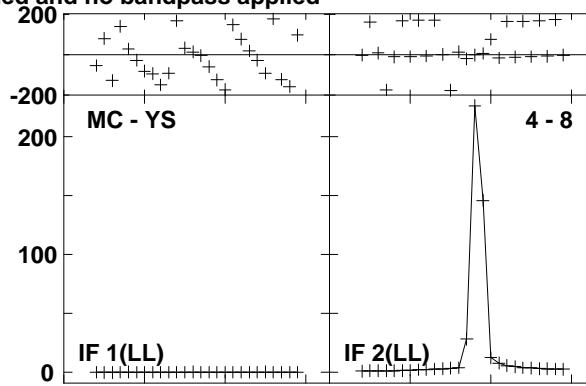
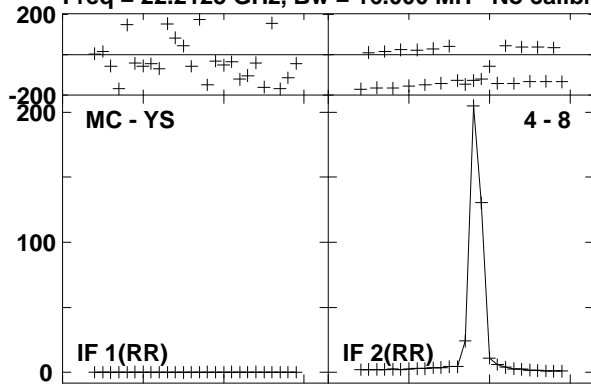

Lower frame: Milli Ampl Jy Top frame: Phas deg  
Vector averaged cross-power spectrum Baseline: MC (04) - YS (08)  
Timerange: 00/10/02:36 to 00/10/03:34

Plot file version 122 created 23-AUG-2016 15:00:45

W3IRS5 GA035B 1.UVDATA.1

Freq = 22.2125 GHz, Bw = 16.000 MH No calibration applied and no bandpass applied

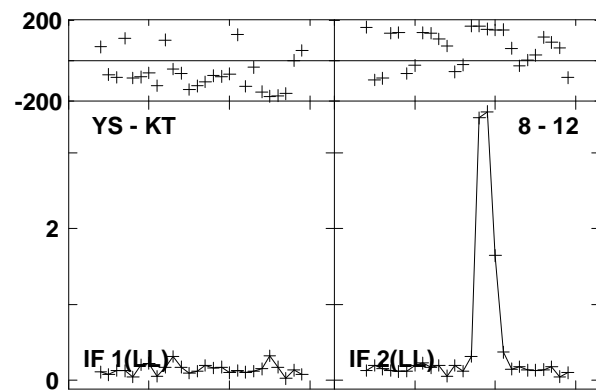
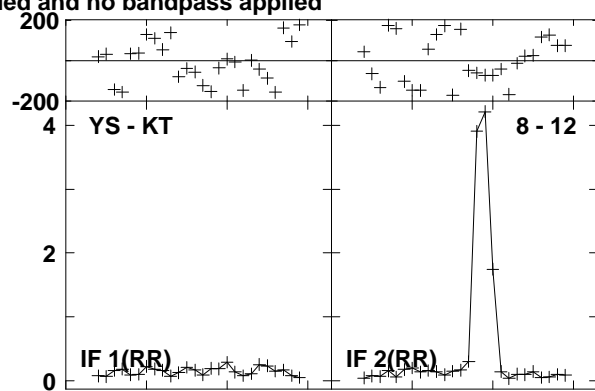
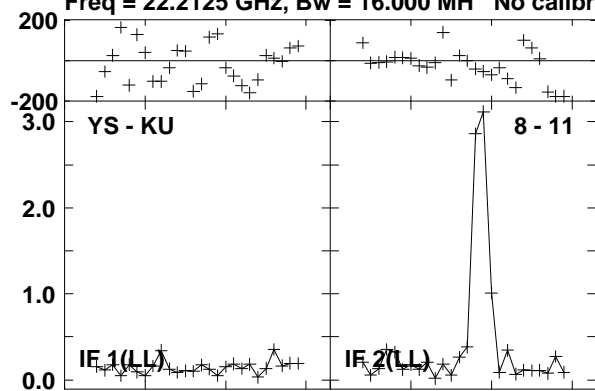

Lower frame: Milli Ampl Jy Top frame: Phas deg  
Vector averaged cross-power spectrum Baseline: YS (08) - KU (11)  
Timerange: 00/10:02:36 to 00/10:03:34

Plot file version 123 created 23-AUG-2016 15:00:45

0219+628 GA035B 1.UVDATA.1

Freq = 22.2125 GHz, Bw = 16.000 MH No calibration applied and no bandpass applied

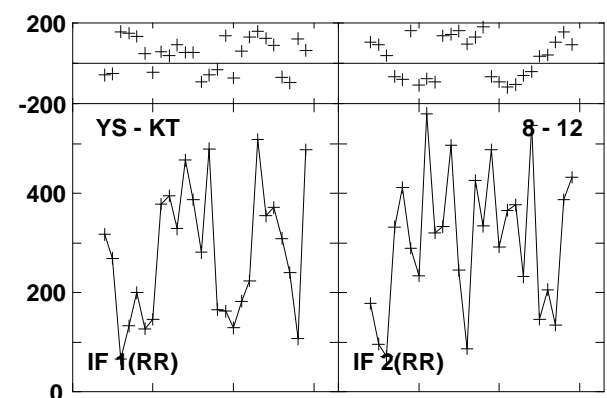
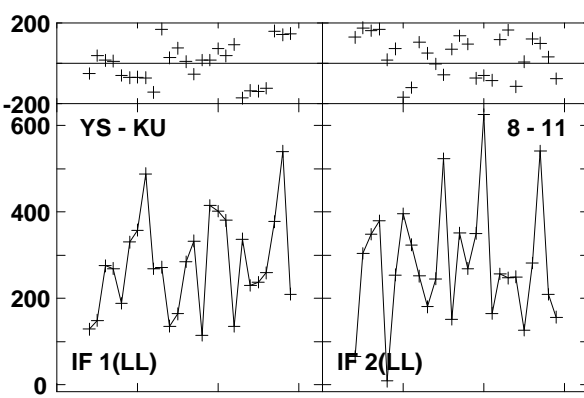
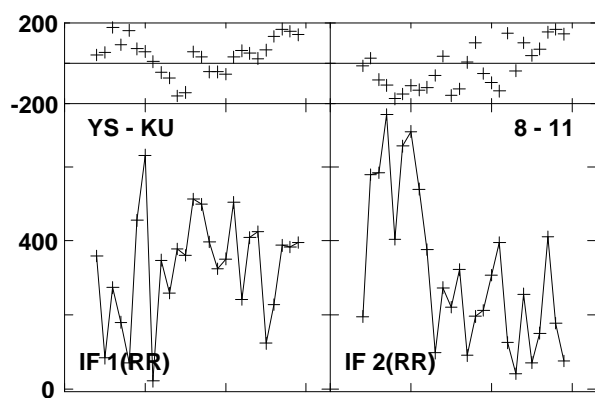
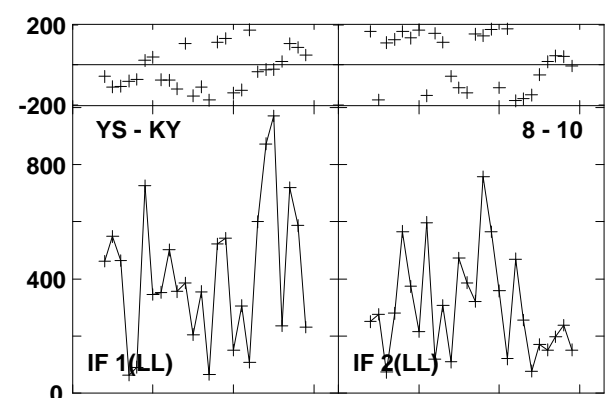
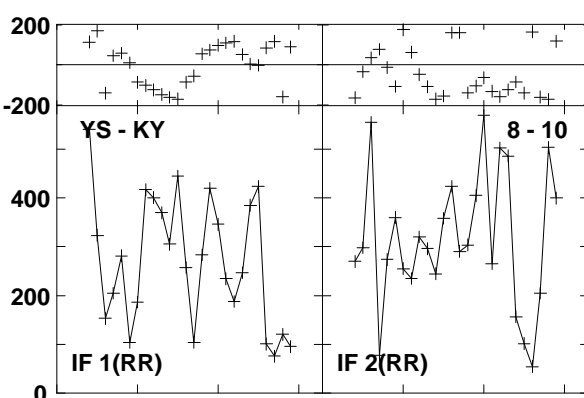
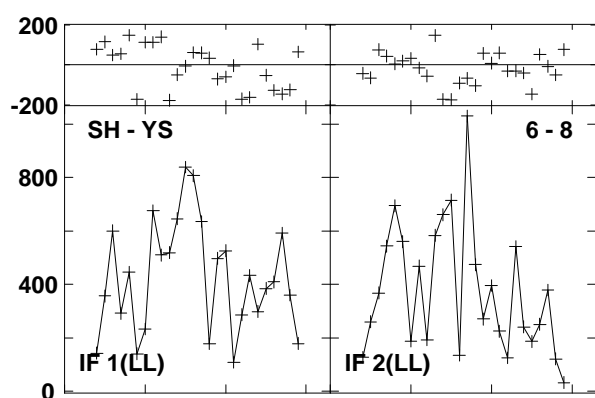
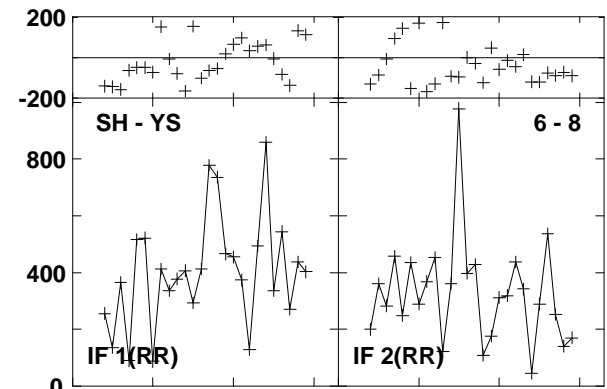
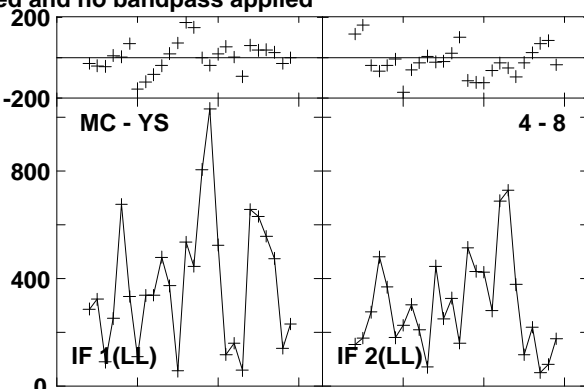
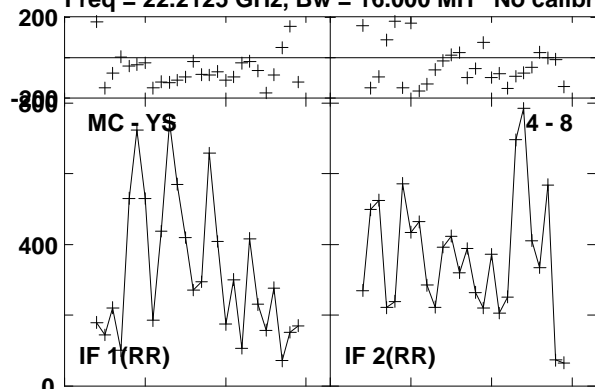

Lower frame: Micro Ampl Jy Top frame: Phas deg  
Vector averaged cross-power spectrum Baseline: MC (04) - YS (08)  
Timerange: 00/10:04:00 to 00/10:04:20

Plot file version 124 created 23-AUG-2016 15:00:45  
0219+628 GA035B 1.UVDATA.1  
Freq = 22.2125 GHz, Bw = 16.000 MH No calibration applied and no bandpass applied

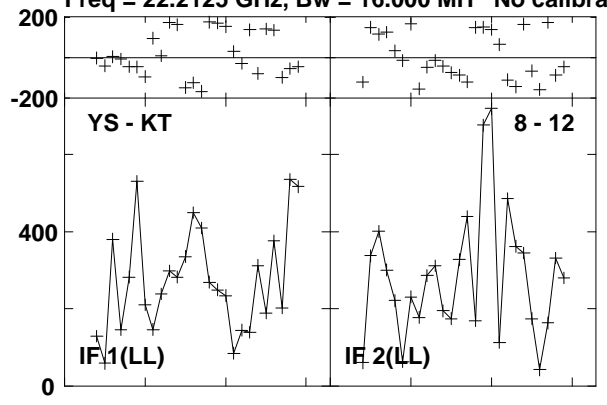

Lower frame: Micro Ampl Jy Top frame: Phas deg  
Vector averaged cross-power spectrum Baseline: YS (08) - KT (12)  
Timerange: 00/10:04:00 to 00/10:04:20

Plot file version 125 created 23-AUG-2016 15:00:45  
 W3IRS5 GA035B 1.UVDATA.1

Freq = 22.2125 GHz, Bw = 16.000 MH No calibration applied and no bandpass applied

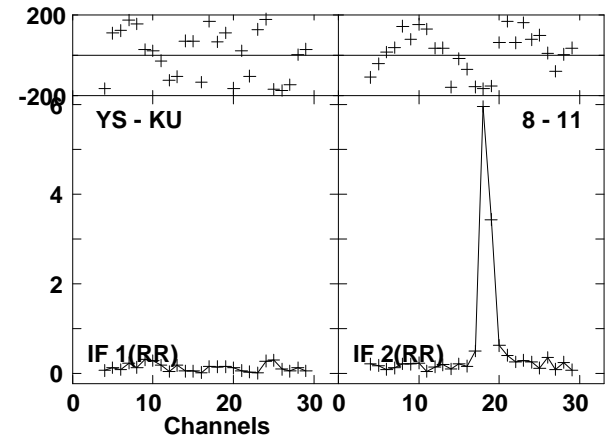
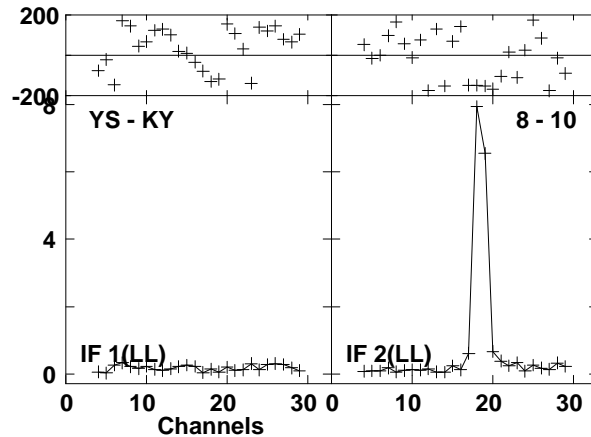
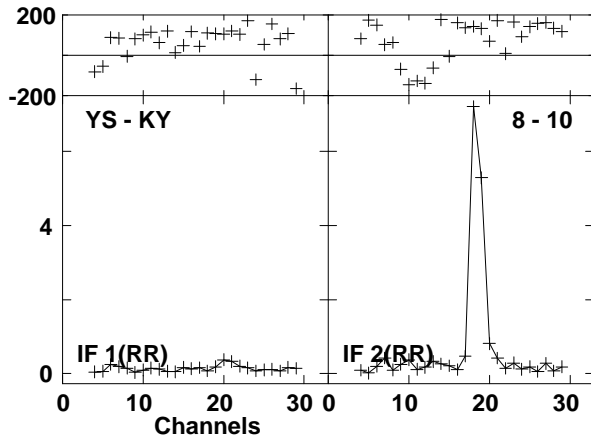
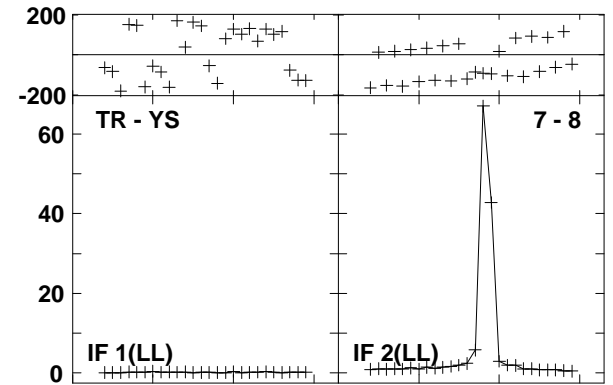
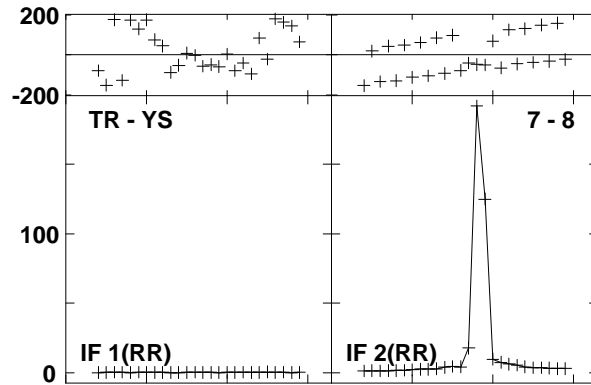
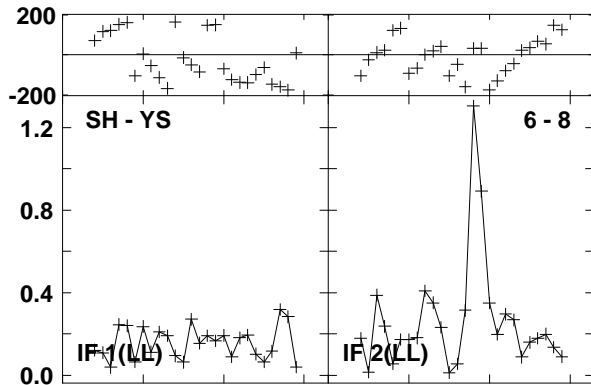
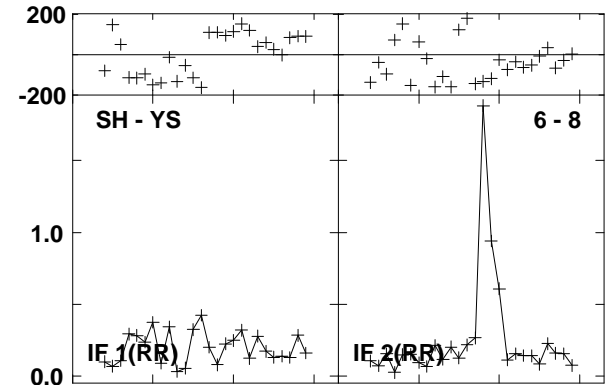
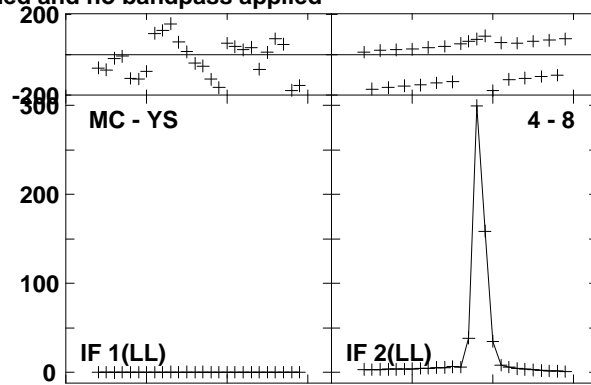
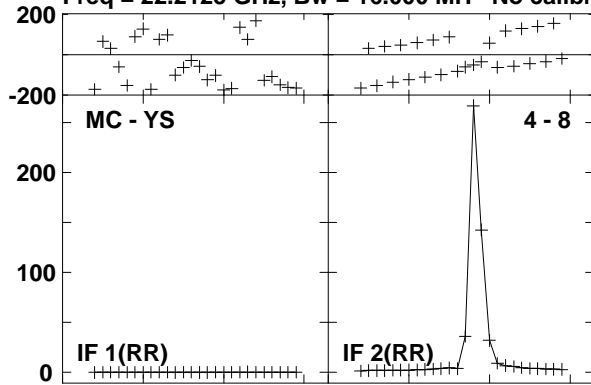

Lower frame: Milli Ampl Jy Top frame: Phas deg  
 Vector averaged cross-power spectrum Baseline: MC (04) - YS (08)  
 Timerange: 00/10:04:46 to 00/10:05:45

Plot file version 126 created 23-AUG-2016 15:00:45  
W3IRS5 GA035B 1.UVDATA.1

Freq = 22.2125 GHz, Bw = 16.000 MH No calibration applied and no bandpass applied

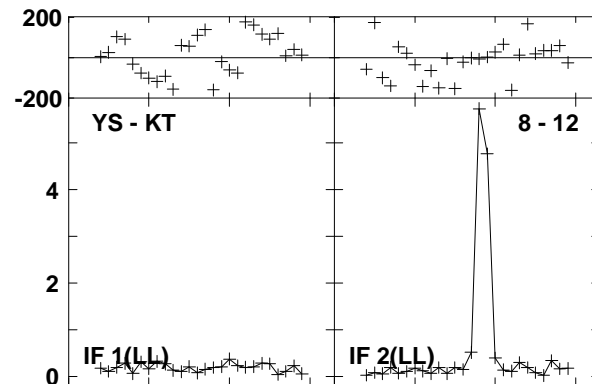
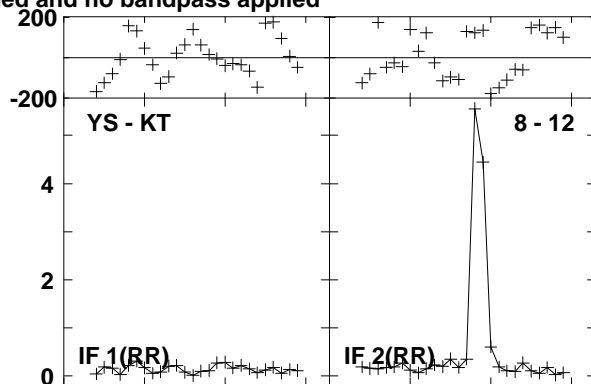
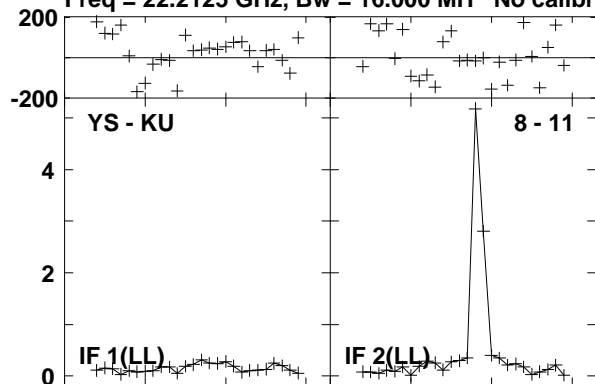

Lower frame: Milli Ampl Jy Top frame: Phas deg  
Vector averaged cross-power spectrum Baseline: YS (08) - KU (11)  
Timerange: 00/10:04:46 to 00/10:05:45

Plot file version 127 created 23-AUG-2016 15:00:45

0219+628 GA035B 1.UVDATA.1

Freq = 22.2125 GHz, Bw = 16.000 MH No calibration applied and no bandpass applied

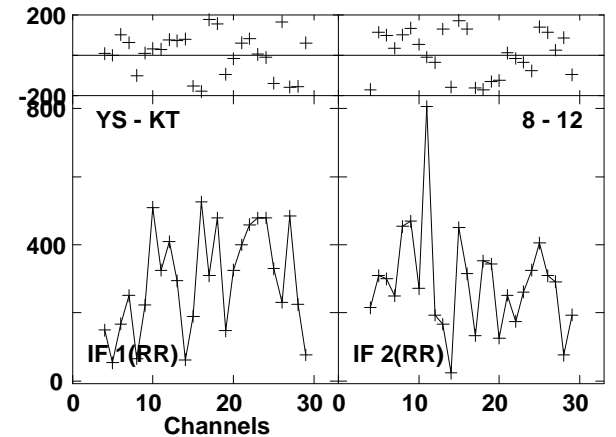
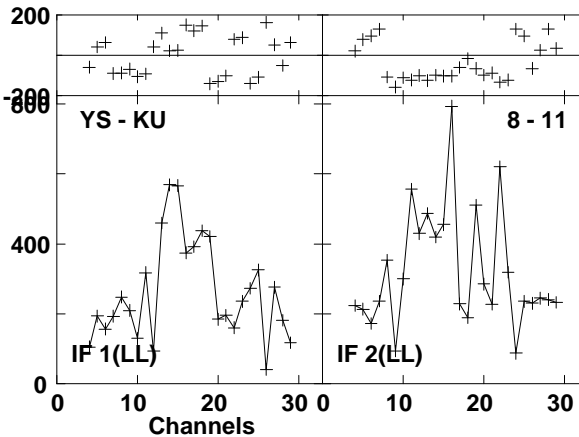
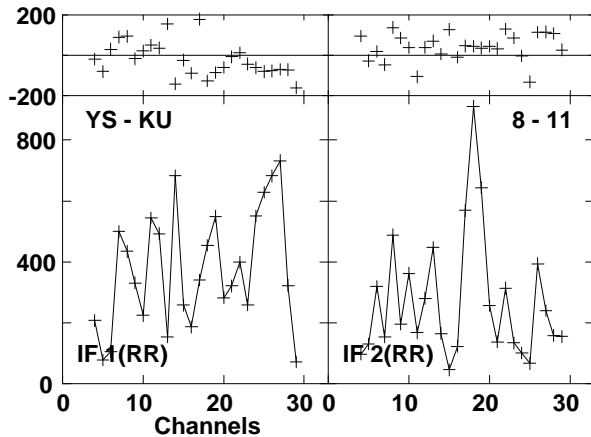
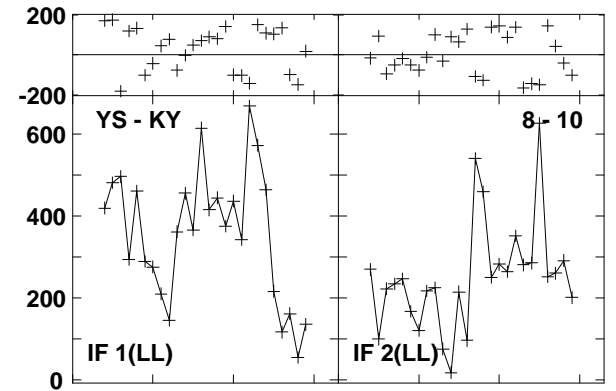
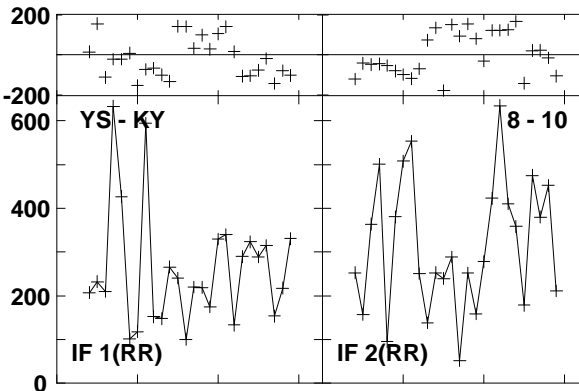
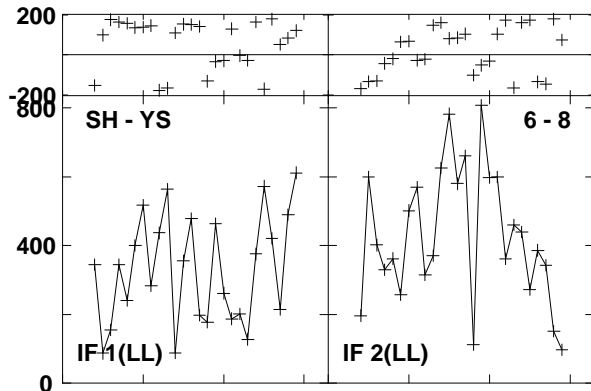
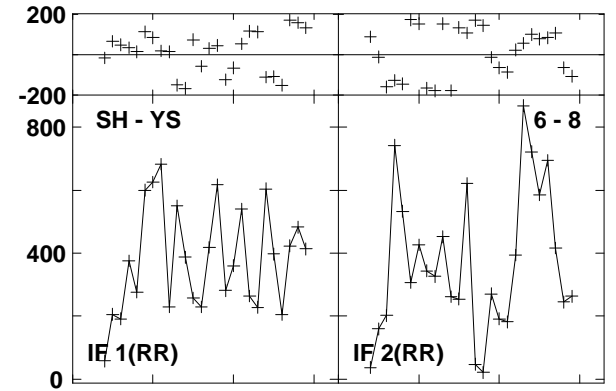
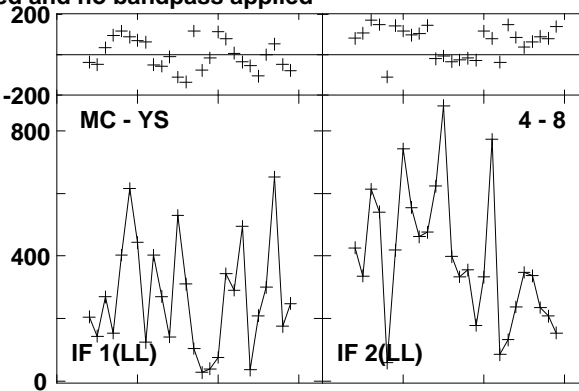
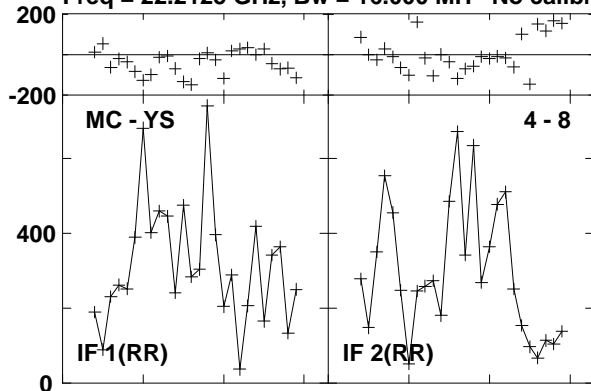

Lower frame: Micro Ampl Jy Top frame: Phas deg

Vector averaged cross-power spectrum Baseline: MC (04) - YS (08)

Timerange: 00/10:06:10 to 00/10:06:29

Plot file version 128 created 23-AUG-2016 15:00:45  
0219+628 GA035B 1.UVDATA.1  
Freq = 22.2125 GHz, Bw = 16.000 MH No calibration applied and no bandpass applied

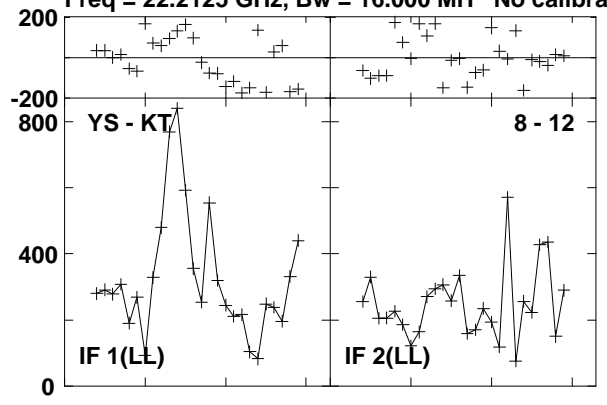

Lower frame: Micro Ampl Jy Top frame: Phas deg  
Vector averaged cross-power spectrum Baseline: YS (08) - KT (12)  
Timerange: 00/10:06:10 to 00/10:06:29



Plot file version 129 created 23-AUG-2016 15:00:45  
 W3IRS5 GA035B 1.UVDATA.1

Freq = 22.2125 GHz, Bw = 16.000 MH No calibration applied and no bandpass applied

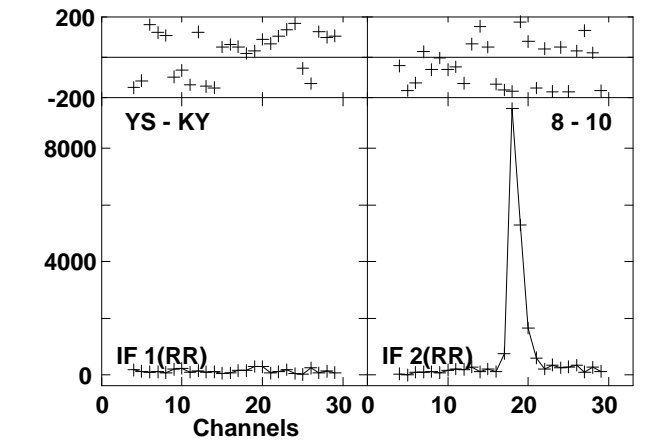
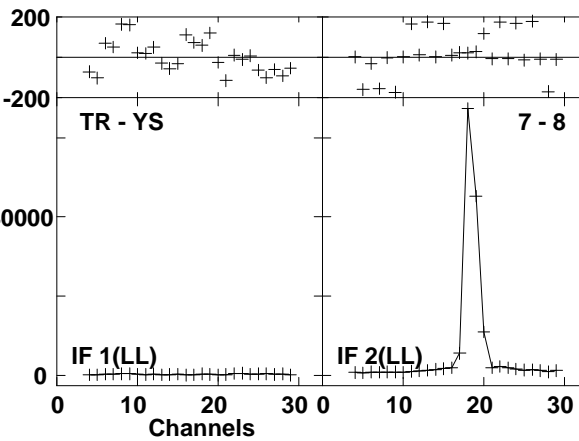
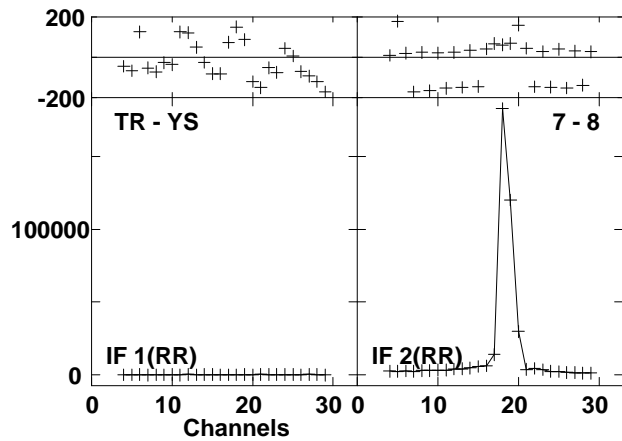
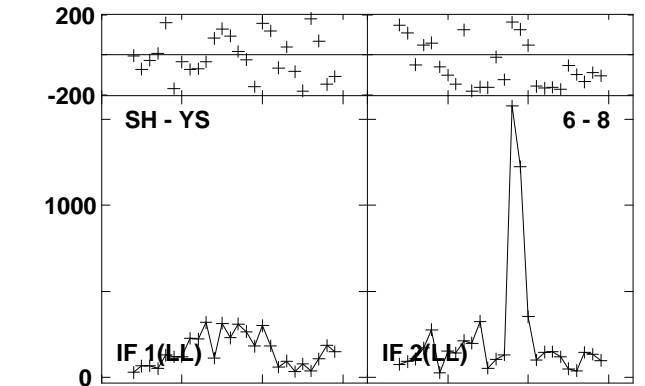
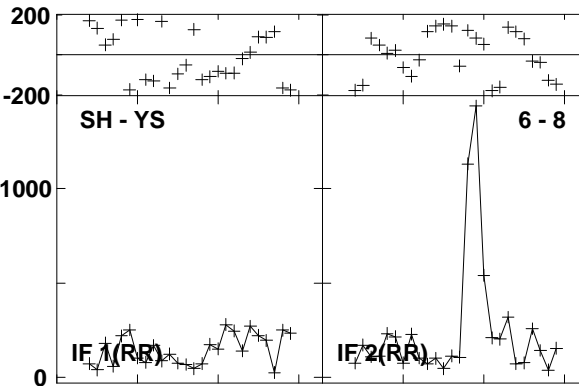
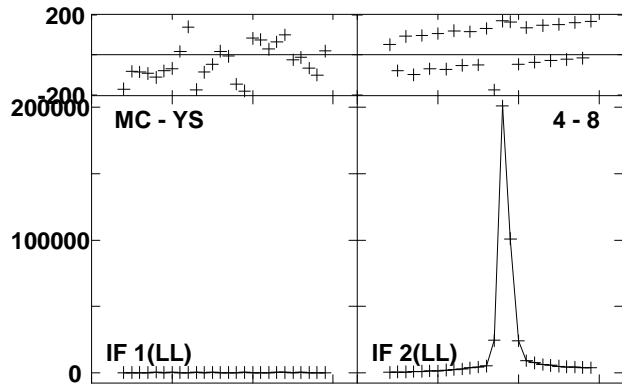
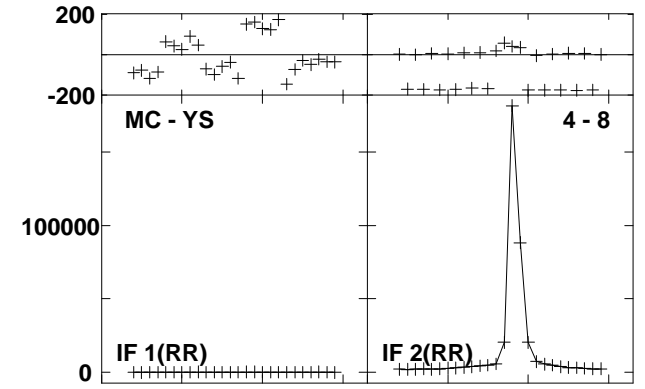
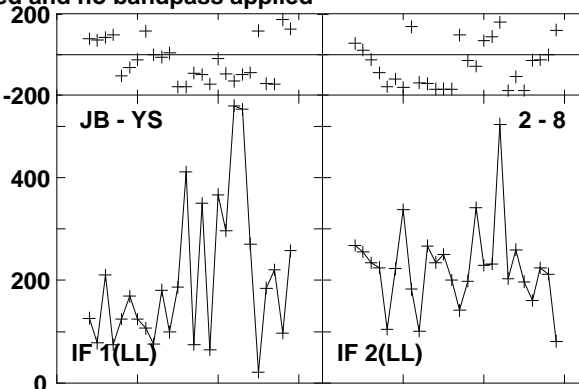
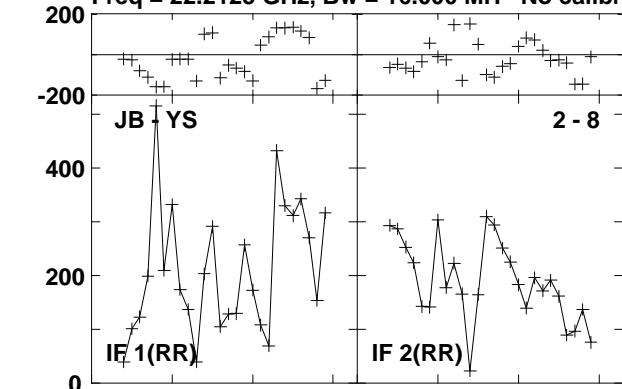

Lower frame: Micro Ampl Jy Top frame: Phas deg  
 Vector averaged cross-power spectrum Baseline: JB (02) - YS (08)  
 Timerange: 00/10:06:56 to 00/10:07:54

Plot file version 130 created 23-AUG-2016 15:00:46  
W3IRS5 GA035B 1.UVDATA.1

Freq = 22.2125 GHz, Bw = 16.000 MH No calibration applied and no bandpass applied

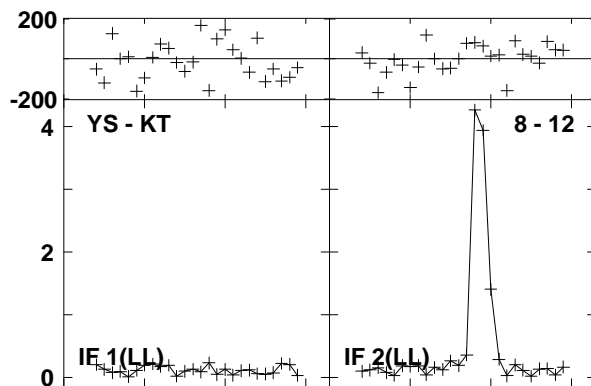
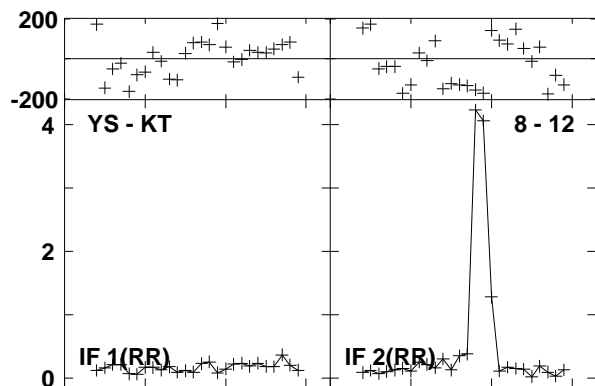
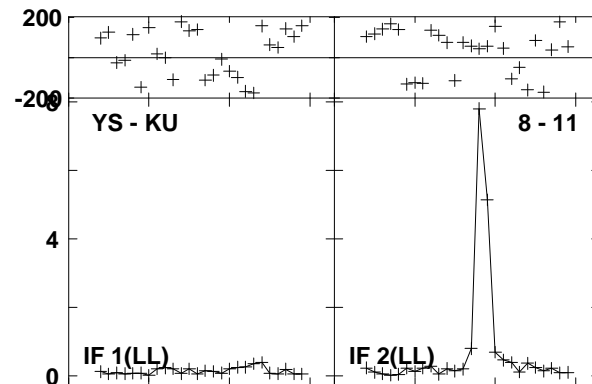
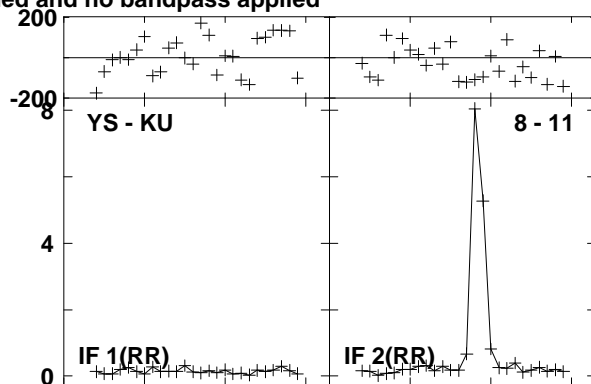
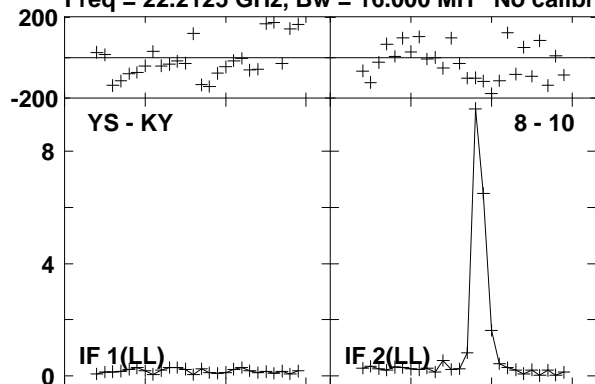

Lower frame: Milli Ampl Jy Top frame: Phas deg  
Vector averaged cross-power spectrum Baseline: YS (08) - KY (10)  
Timerange: 00/10:06:56 to 00/10:07:54

Plot file version 131 created 23-AUG-2016 15:00:46

0219+628 GA035B 1.UVDATA.1

Freq = 22.2125 GHz, Bw = 16.000 MH No calibration applied and no bandpass applied

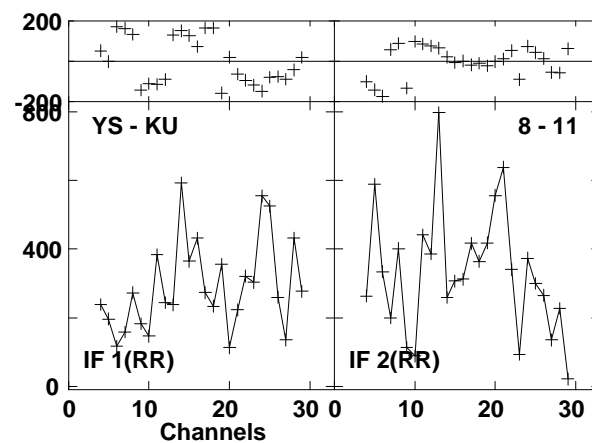
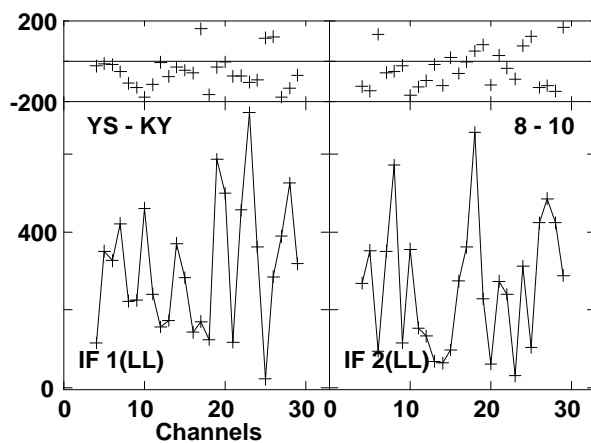
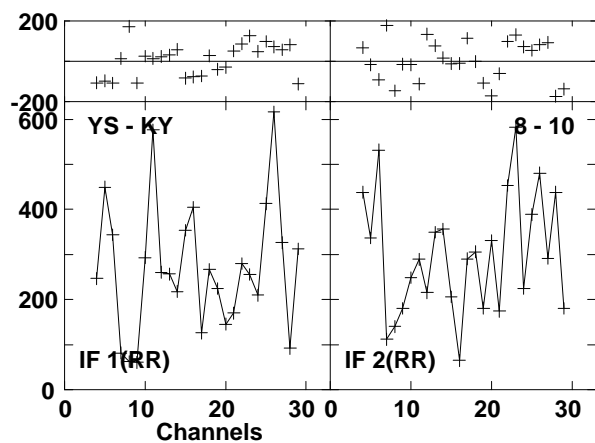
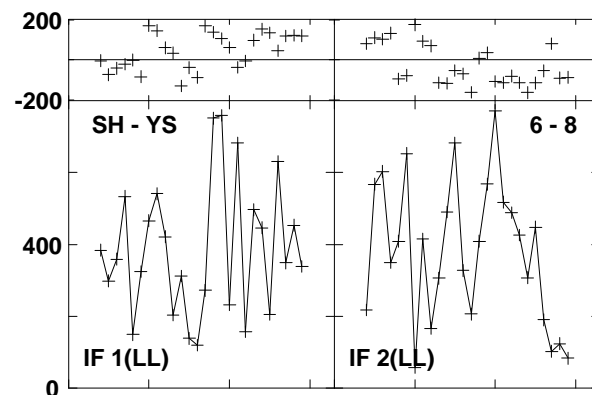
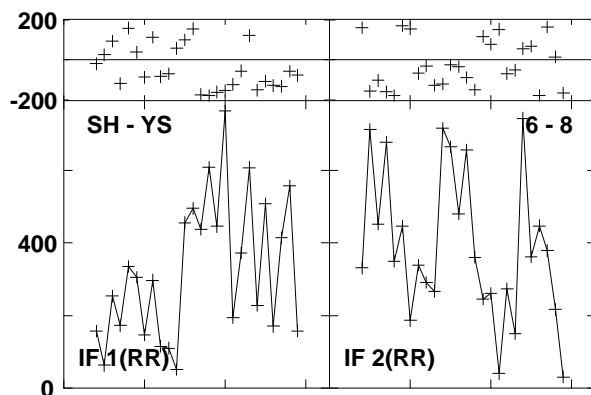
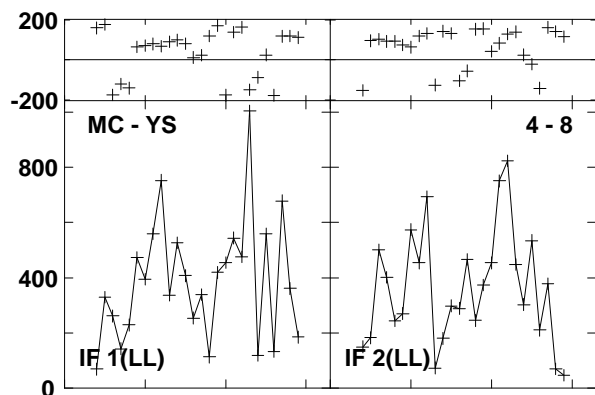
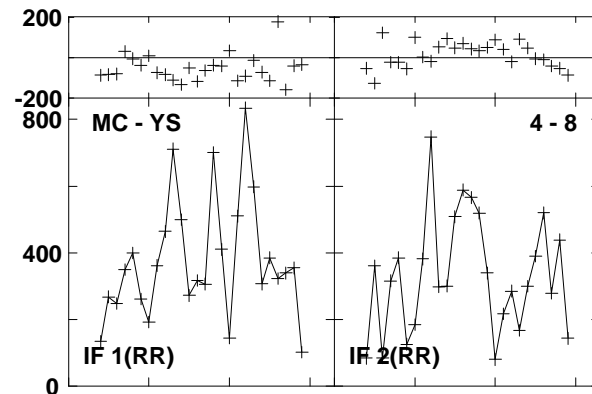
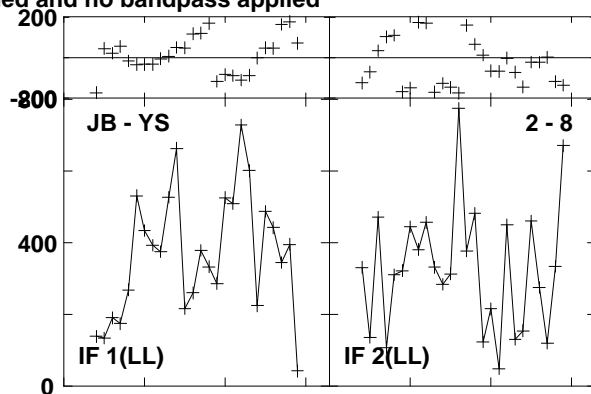
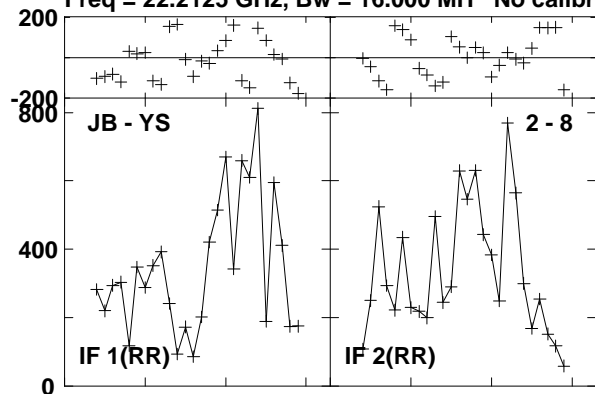

Lower frame: Micro Ampl Jy Top frame: Phas deg  
Vector averaged cross-power spectrum Baseline: JB (02) - YS (08)  
Timerange: 00/10/08:20 to 00/10/08:40

Plot file version 132 created 23-AUG-2016 15:00:46

0219+628 GA035B 1.UVDATA.1

Freq = 22.2125 GHz, Bw = 16.000 MH No calibration applied and no bandpass applied

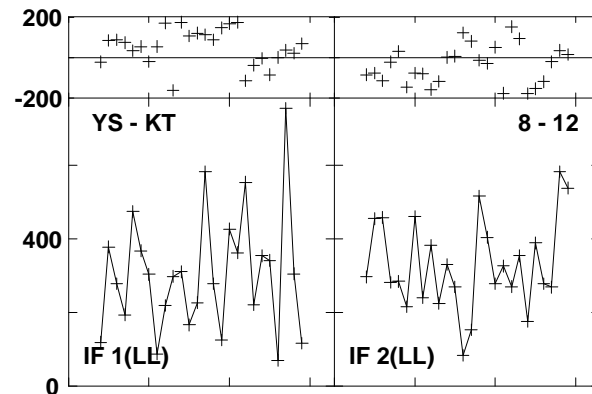
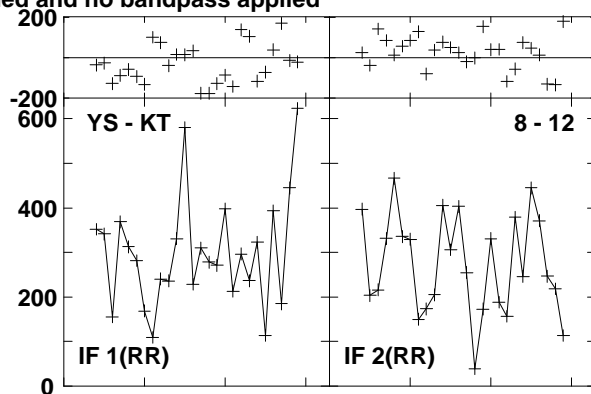
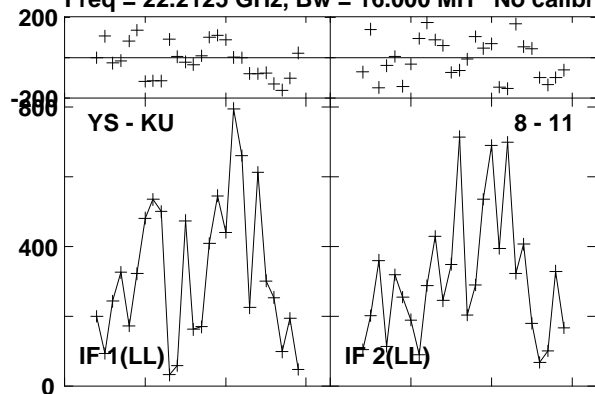

Lower frame: Micro Ampl Jy Top frame: Phas deg  
Vector averaged cross-power spectrum Baseline: YS (08) - KU (11)  
Timerange: 00/10/08:20 to 00/10/08:40

Plot file version 133 created 23-AUG-2016 15:00:46

W3IRS5 GA035B 1.UVDATA.1

Freq = 22.2125 GHz, Bw = 16.000 MH No calibration applied and no bandpass applied

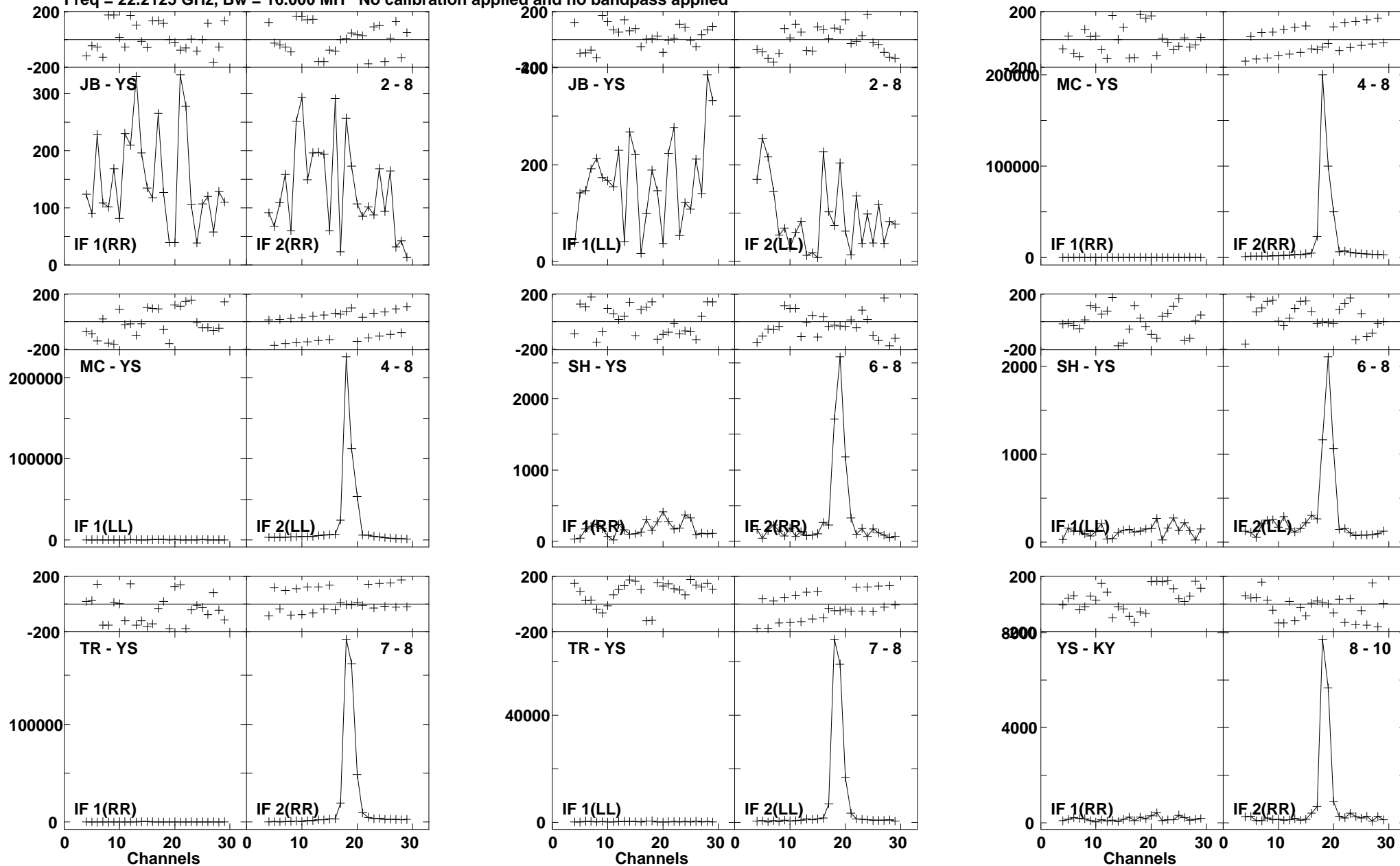

Lower frame: Micro Ampl Jy Top frame: Phas deg  
Vector averaged cross-power spectrum Baseline: JB (02) - YS (08)  
Timerange: 00/10:09:06 to 00/10:10:05

Plot file version 134 created 23-AUG-2016 15:00:46

W3IRS5 GA035B 1.UVDATA.1

Freq = 22.2125 GHz, Bw = 16.000 MH No calibration applied and no bandpass applied

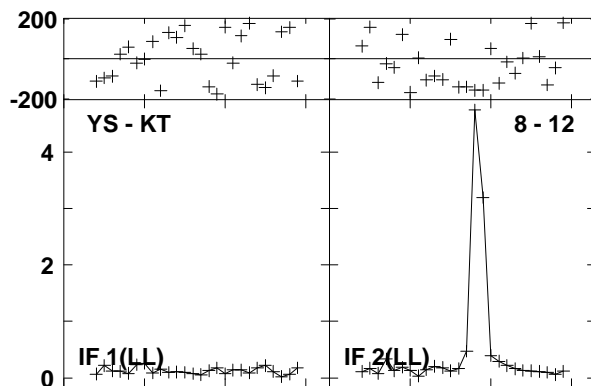
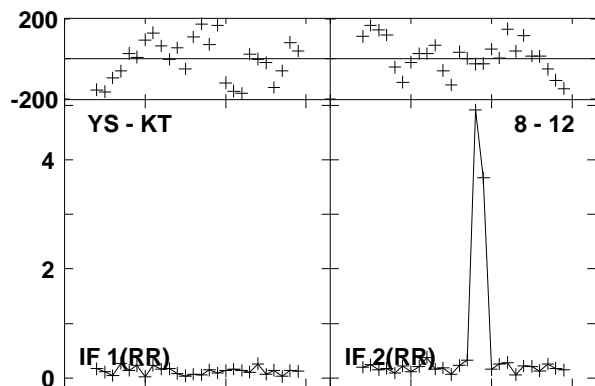
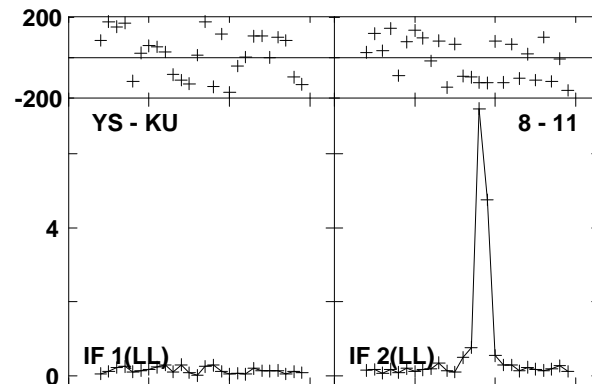
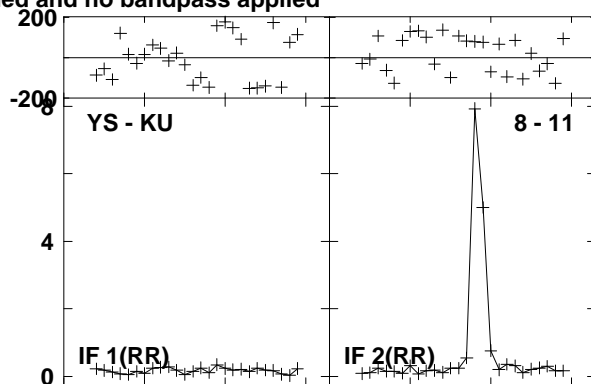
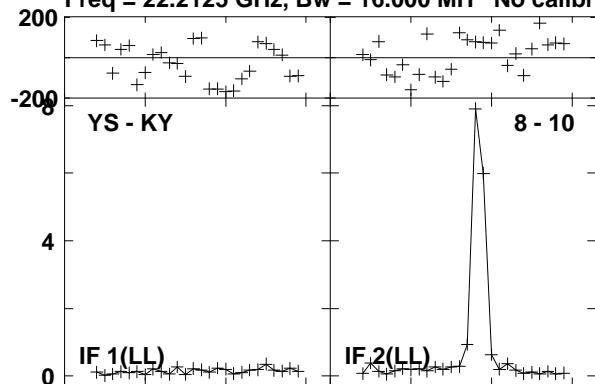

Lower frame: Milli Ampl Jy Top frame: Phas deg  
Vector averaged cross-power spectrum Baseline: YS (08) - KY (10)  
Timerange: 00/10:09:06 to 00/10:10:05

Plot file version 135 created 23-AUG-2016 15:00:46

0219+628 GA035B 1.UVDATA.1

Freq = 22.2125 GHz, Bw = 16.000 MH No calibration applied and no bandpass applied

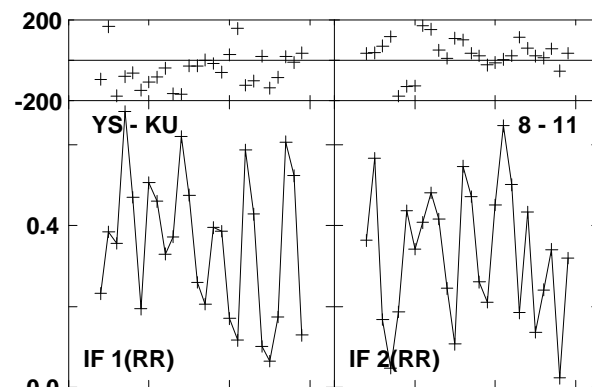
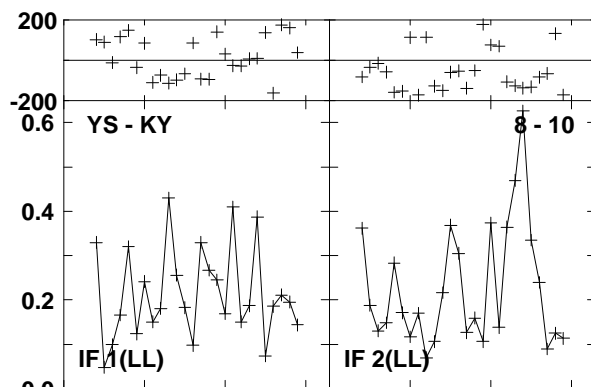
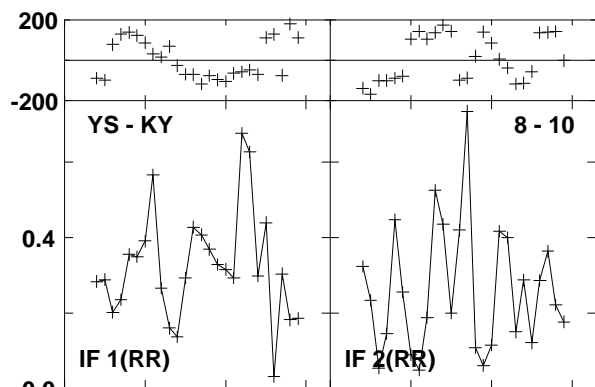
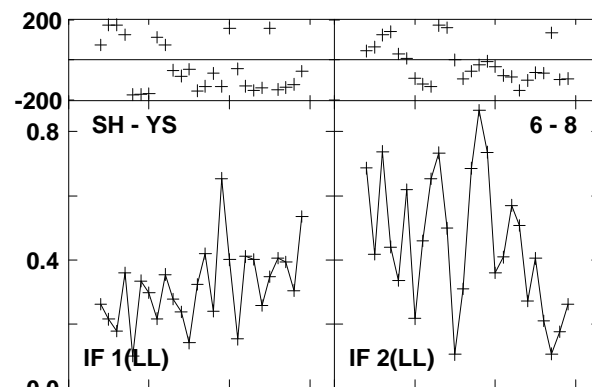
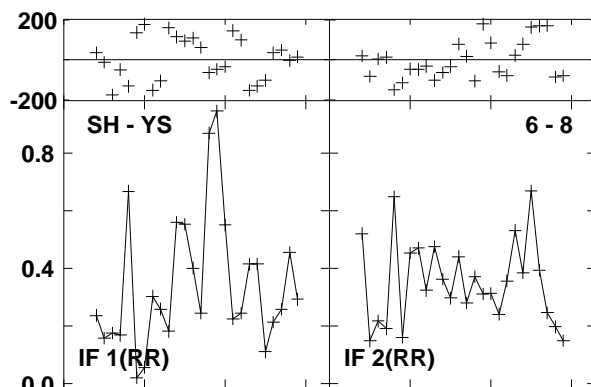
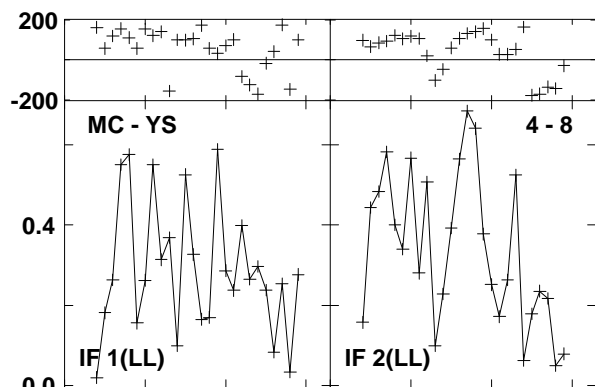
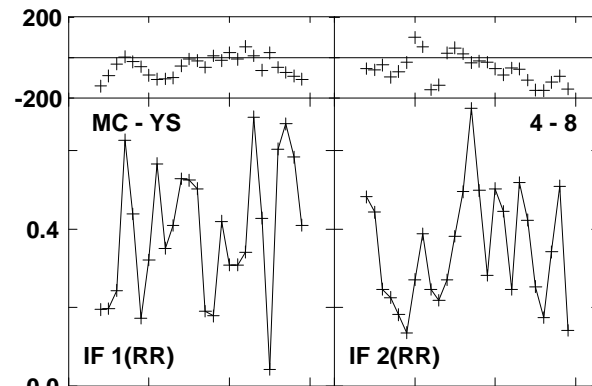
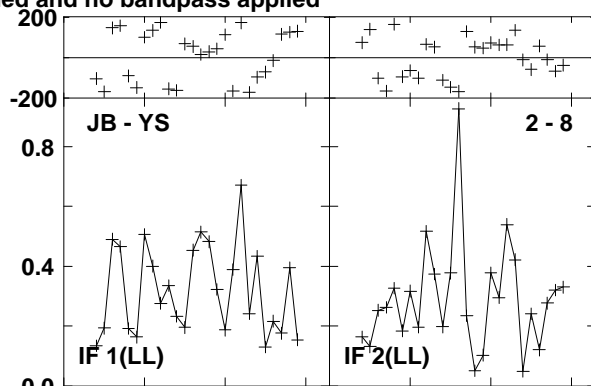
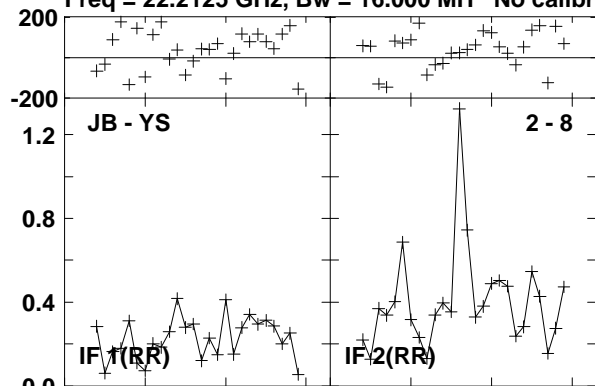

Channels

Lower frame: Milli Ampl Jy Top frame: Phas deg

Vector averaged cross-power spectrum Baseline: JB (02) - YS (08)

Timerange: 00/10:10:30 to 00/10:10:49

Plot file version 136 created 23-AUG-2016 15:00:46

0219+628 GA035B 1.UVDATA.1

Freq = 22.2125 GHz, Bw = 16.000 MH No calibration applied and no bandpass applied

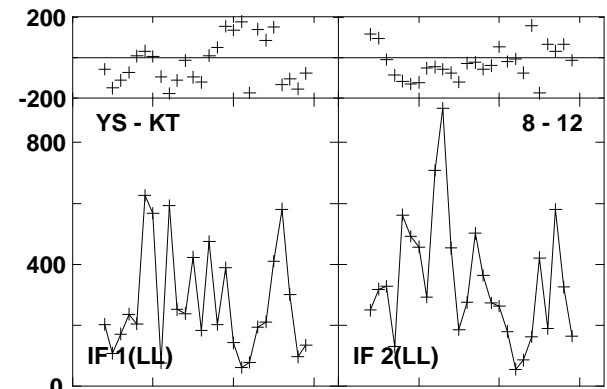
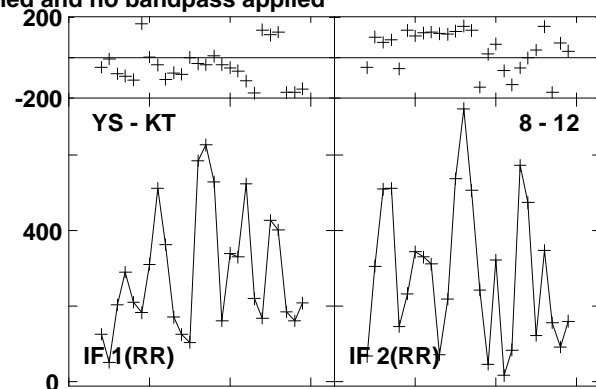
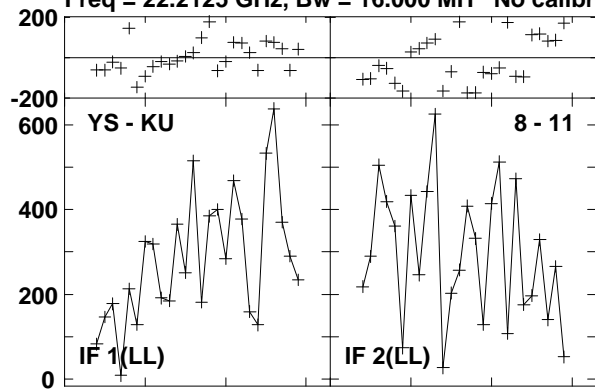

Lower frame: Micro Ampl Jy Top frame: Phas deg  
Vector averaged cross-power spectrum Baseline: YS (08) - KU (11)  
Timerange: 00/10:10:30 to 00/10:10:49



Plot file version 137 created 23-AUG-2016 15:00:46  
 W3IRS5 GA035B 1.UVDATA.1

Freq = 22.2125 GHz, Bw = 16.000 MH No calibration applied and no bandpass applied

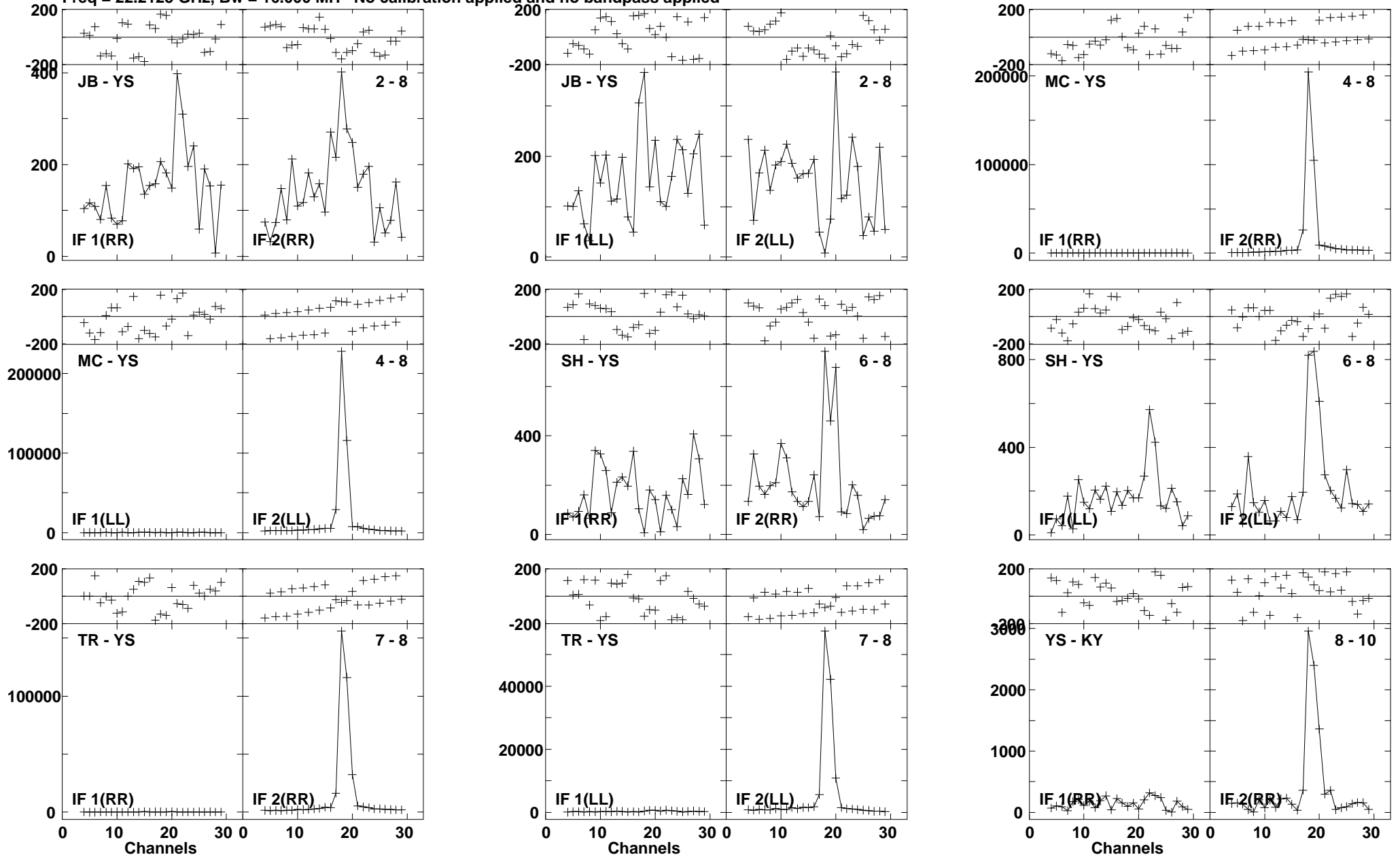

Lower frame: Micro Ampl Jy Top frame: Phas deg  
 Vector averaged cross-power spectrum Baseline: JB (02) - YS (08)  
 Timerange: 00/10/11:16 to 00/10/12:14

Plot file version 138 created 23-AUG-2016 15:00:46  
W3IRS5 GA035B 1.UVDATA.1

Freq = 22.2125 GHz, Bw = 16.000 MH No calibration applied and no bandpass applied

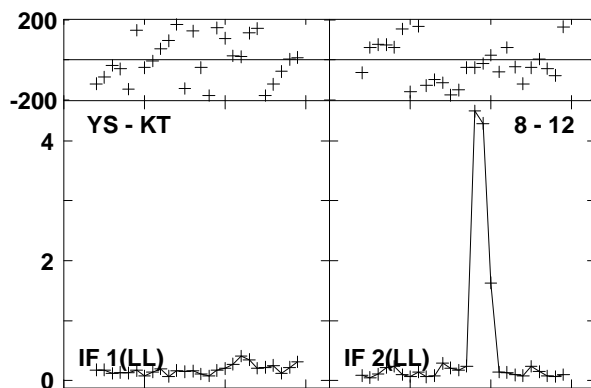
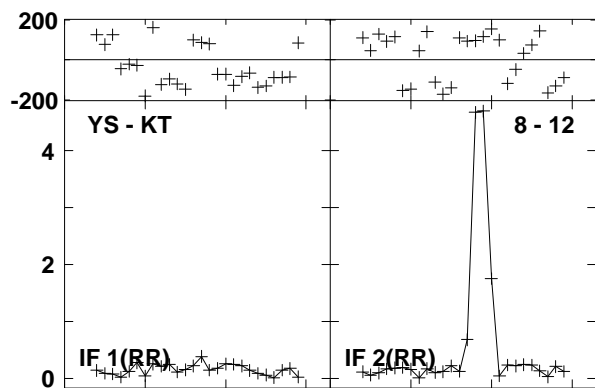
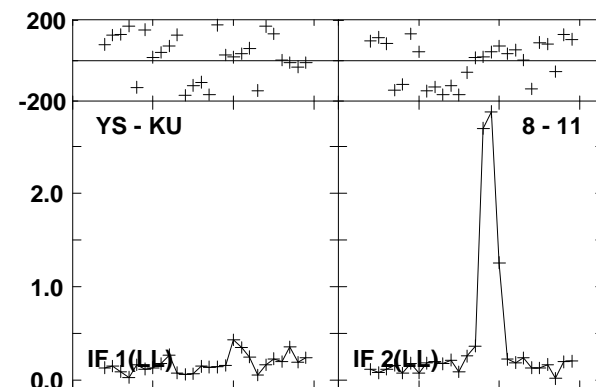
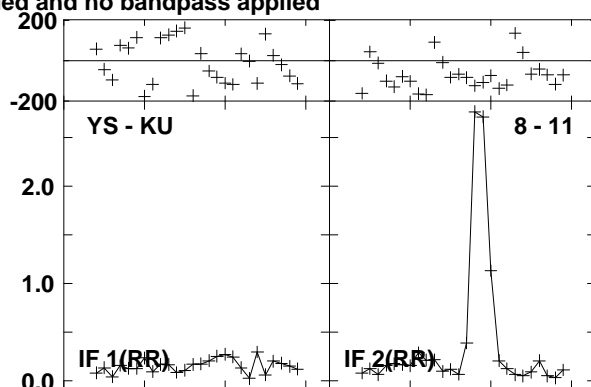
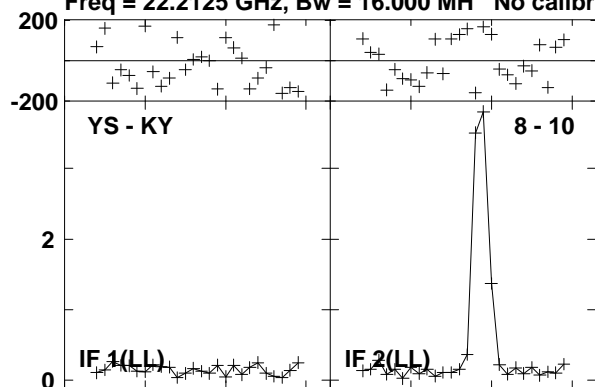

Lower frame: Milli Ampl Jy Top frame: Phas deg  
Vector averaged cross-power spectrum Baseline: YS (08) - KY (10)  
Timerange: 00/10:11:16 to 00/10:12:14

Plot file version 139 created 23-AUG-2016 15:00:46

0219+628 GA035B 1.UVDATA.1

Freq = 22.2125 GHz, Bw = 16.000 MH No calibration applied and no bandpass applied

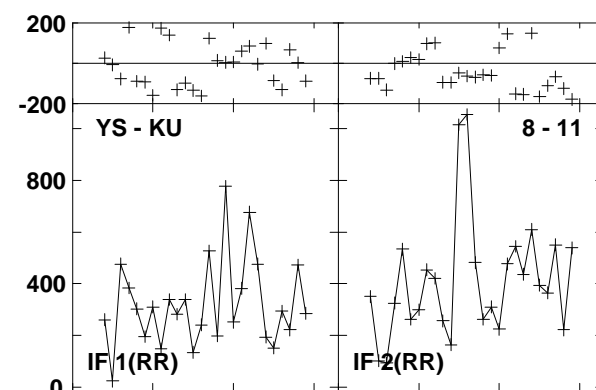
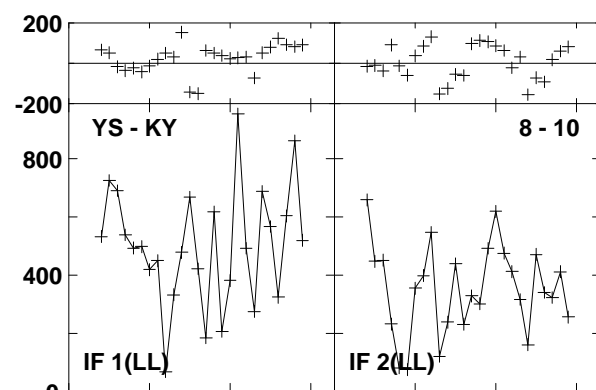
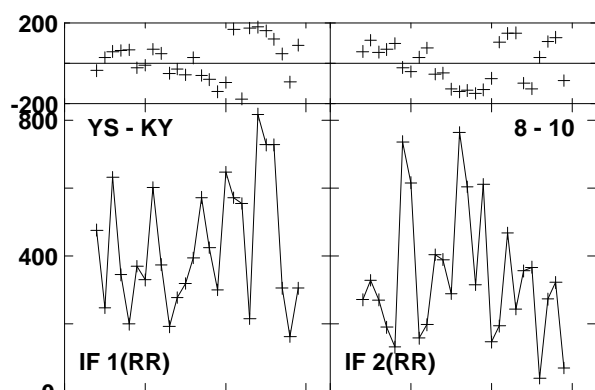
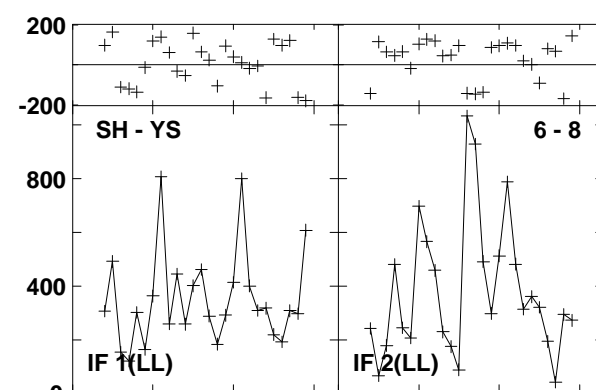
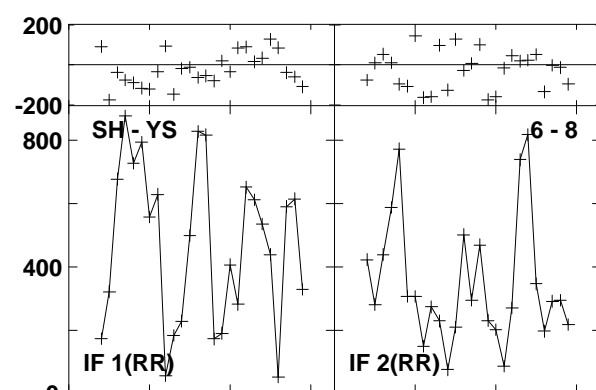
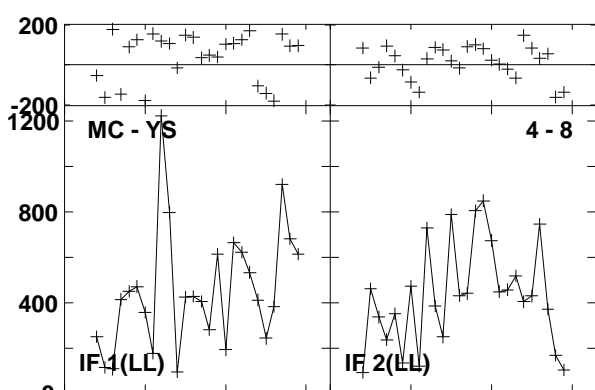
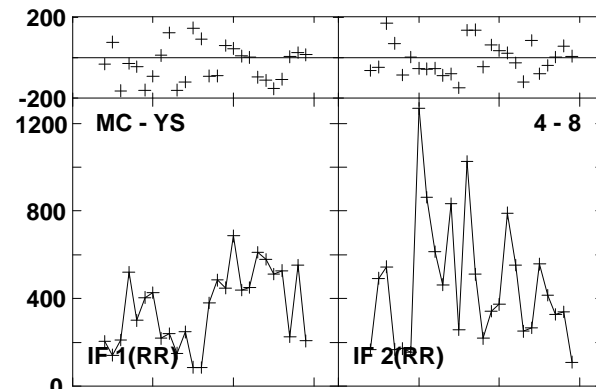
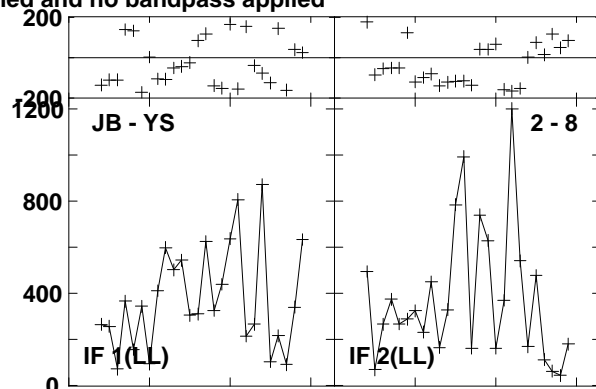
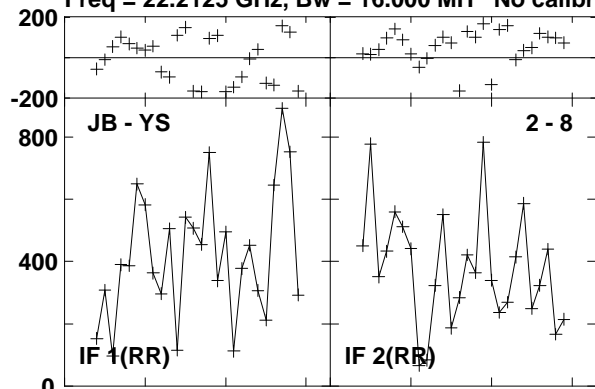

Lower frame: Micro Ampl Jy Top frame: Phas deg  
Vector averaged cross-power spectrum Baseline: JB (02) - YS (08)  
Timerange: 00/10:12:41 to 00/10:13:00

Plot file version 140 created 23-AUG-2016 15:00:46  
0219+628 GA035B 1.UVDATA.1

Freq = 22.2125 GHz, Bw = 16.000 MH No calibration applied and no bandpass applied

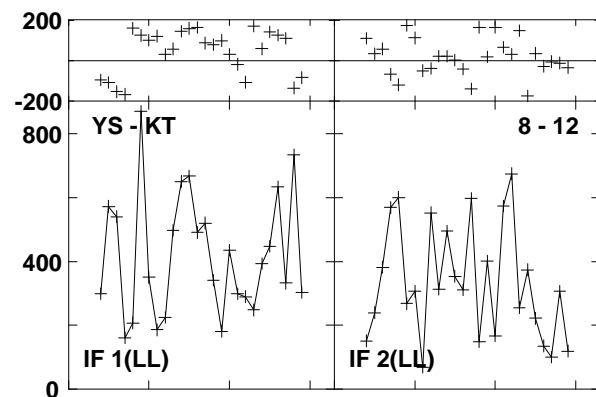
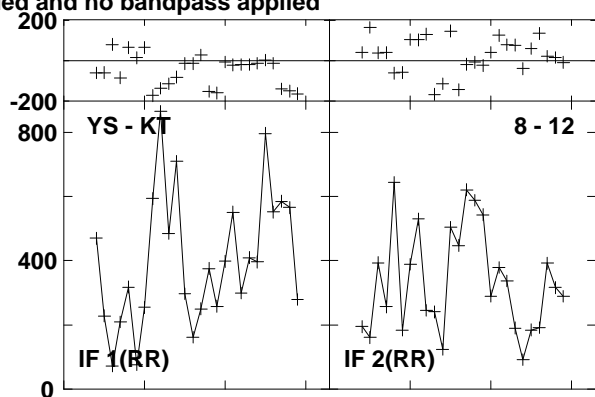
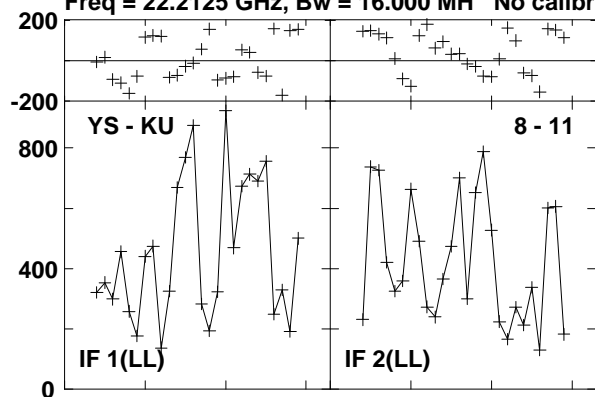

Lower frame: Micro Ampl Jy Top frame: Phas deg  
Vector averaged cross-power spectrum Baseline: YS (08) - KU (11)  
Timerange: 00/10:12:41 to 00/10:13:00

Plot file version 141 created 23-AUG-2016 15:00:46

W3IRS5 GA035B 1.UVDATA.1

Freq = 22.2125 GHz, Bw = 16.000 MH No calibration applied and no bandpass applied

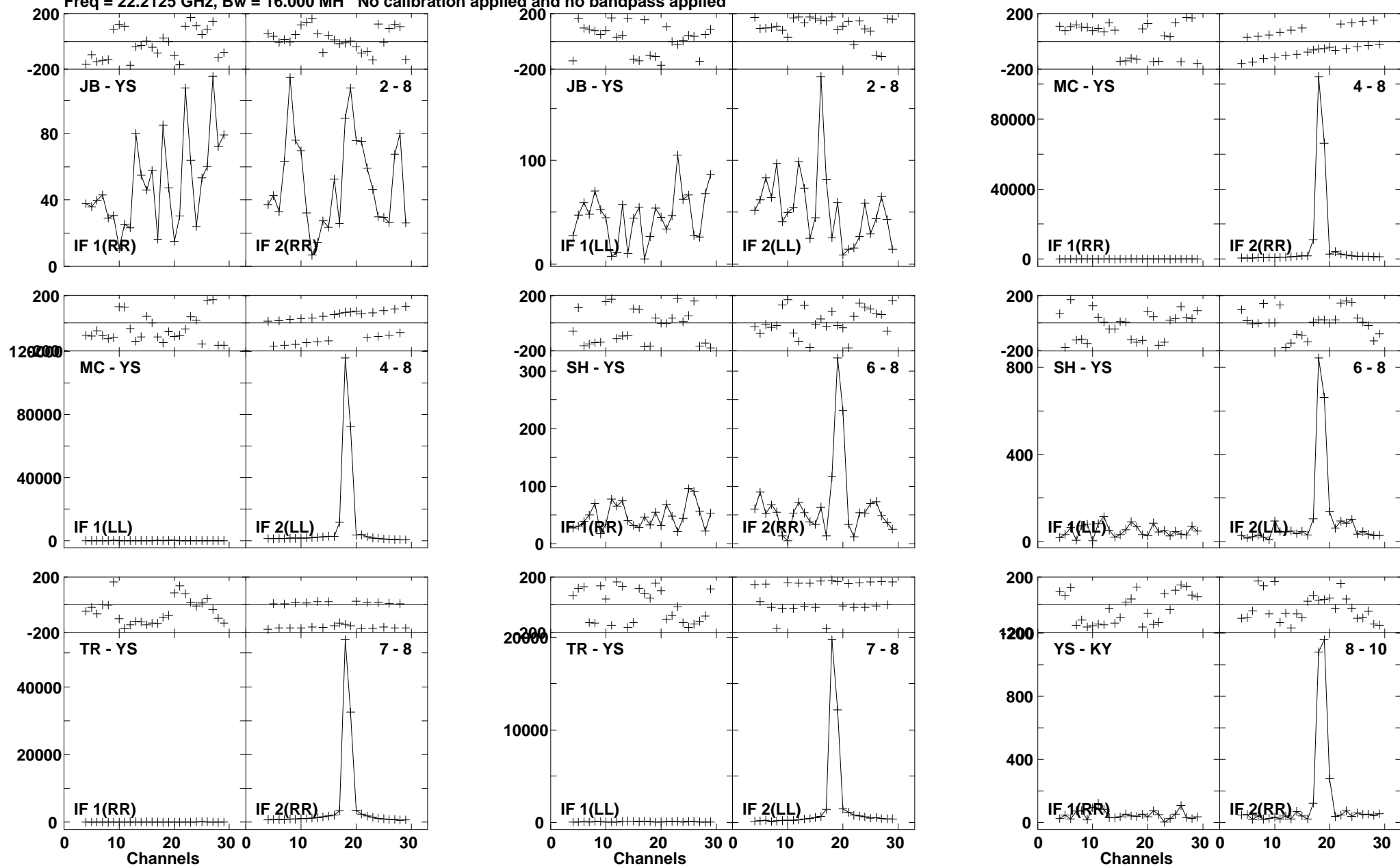

Lower frame: Micro Ampl Jy Top frame: Phas deg  
Vector averaged cross-power spectrum Baseline: JB (02) - YS (08)  
Timerange: 00/10:15:00 to 00/10:24:00

Plot file version 142 created 23-AUG-2016 15:00:46

W3IRS5 GA035B 1.UVDATA.1

Freq = 22.2125 GHz, Bw = 16.000 MH No calibration applied and no bandpass applied

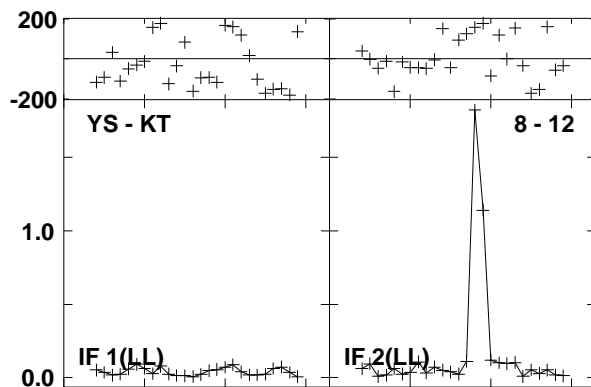
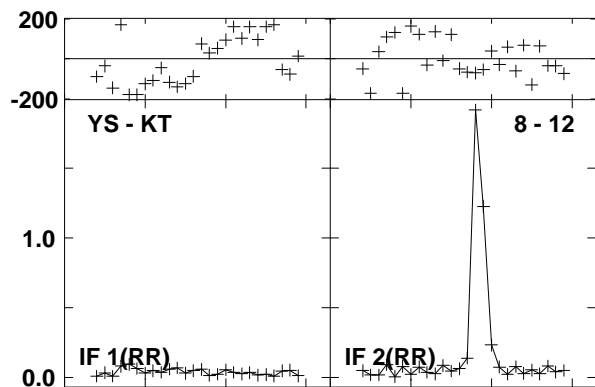
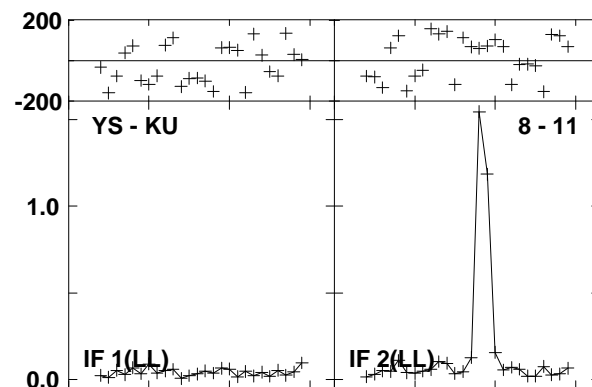
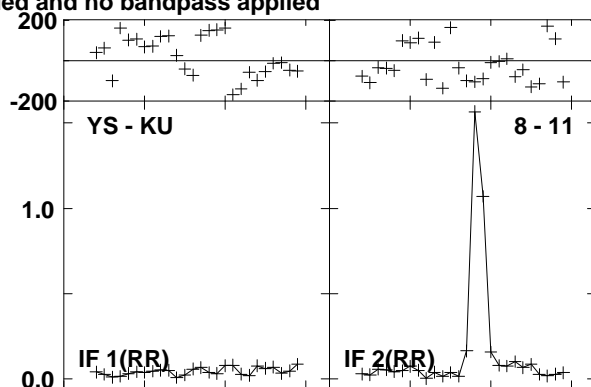
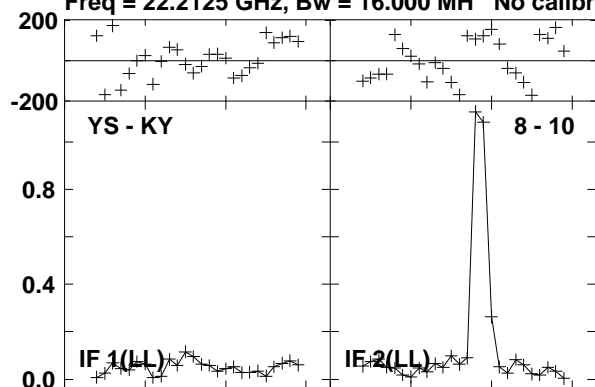

Lower frame: Milli Ampl Jy Top frame: Phas deg  
Vector averaged cross-power spectrum Baseline: YS (08) - KY (10)  
Timerange: 00/10:15:00 to 00/10:24:00

Plot file version 143 created 23-AUG-2016 15:00:47

W3IRS5 GA035B 1.UVDATA.1

Freq = 22.2125 GHz, Bw = 16.000 MH No calibration applied and no bandpass applied

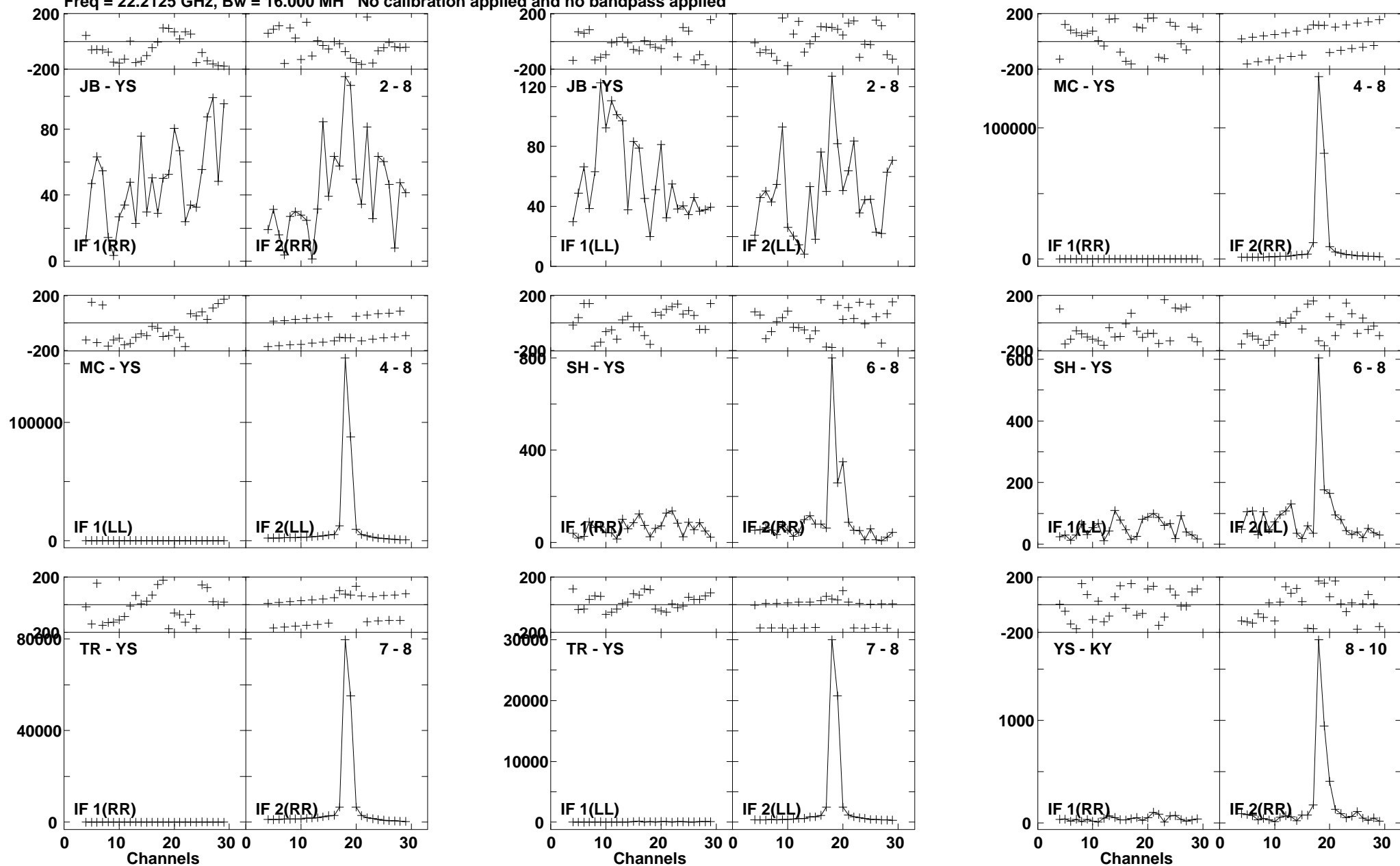

Lower frame: Micro Ampl Jy Top frame: Phas deg  
Vector averaged cross-power spectrum Baseline: JB (02) - YS (08)  
Timerange: 00/10:25:31 to 00/10:34:29

Plot file version 144 created 23-AUG-2016 15:00:47

W3IRS5 GA035B 1.UVDATA.1

Freq = 22.2125 GHz, Bw = 16.000 MH No calibration applied and no bandpass applied

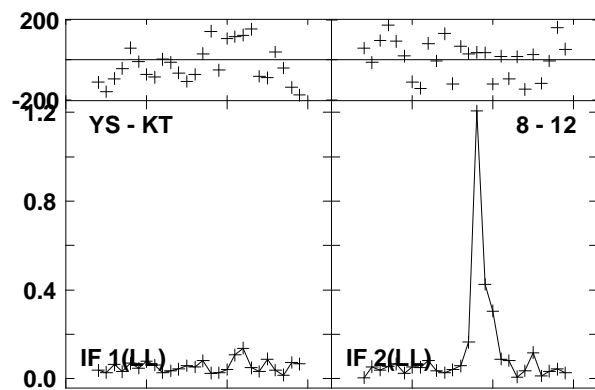
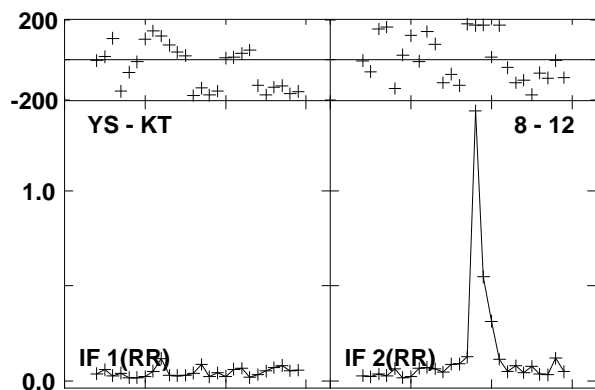
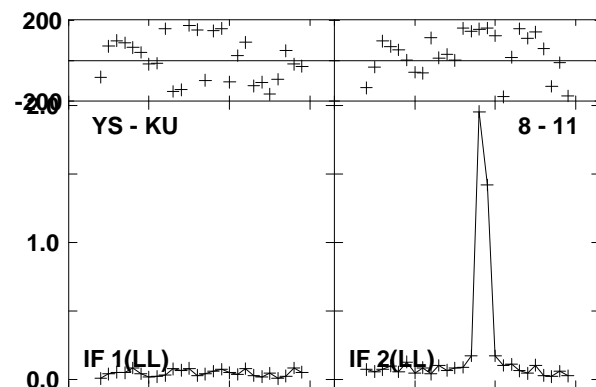
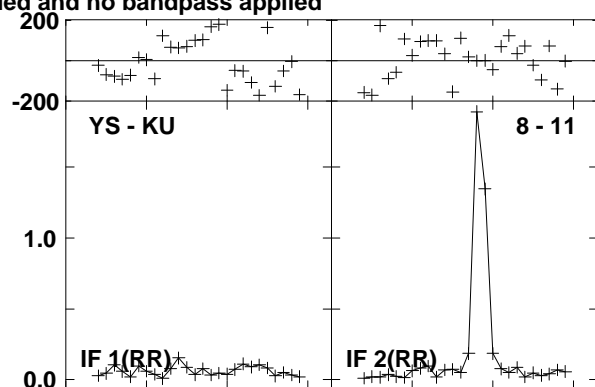
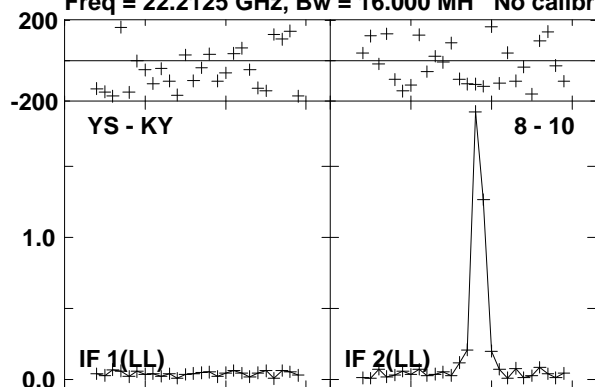

Lower frame: Milli Ampl Jy Top frame: Phas deg

Vector averaged cross-power spectrum Baseline: YS (08) - KY (10)

Timerange: 00/10:25:31 to 00/10:34:29



Plot file version 145 created 23-AUG-2016 15:00:47

W3IRS5 GA035B 1.UVDATA.1

Freq = 22.2125 GHz, Bw = 16.000 MH No calibration applied and no bandpass applied

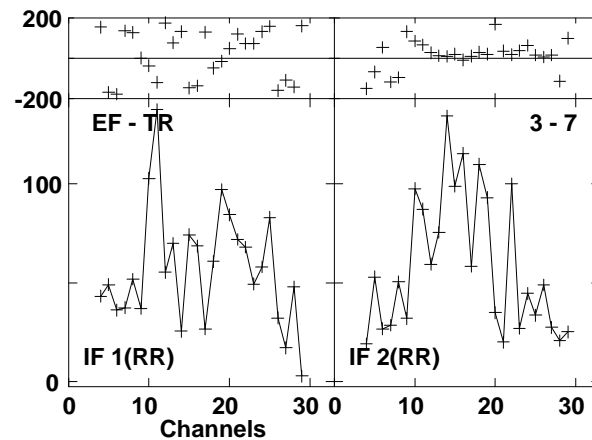
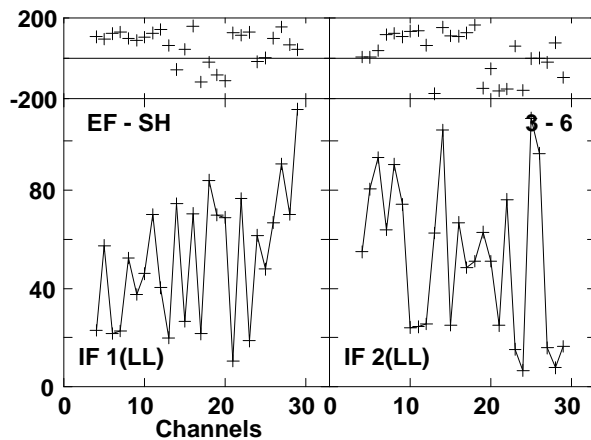
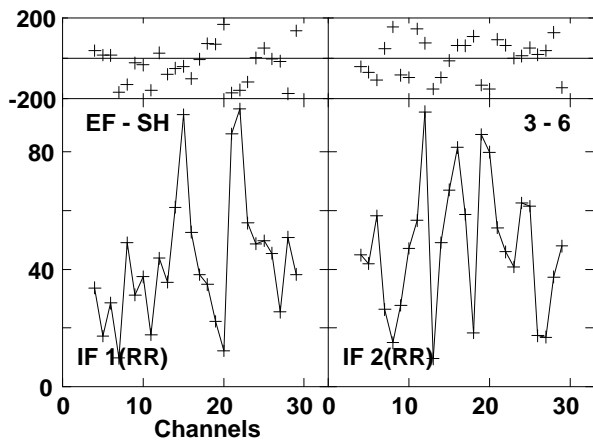
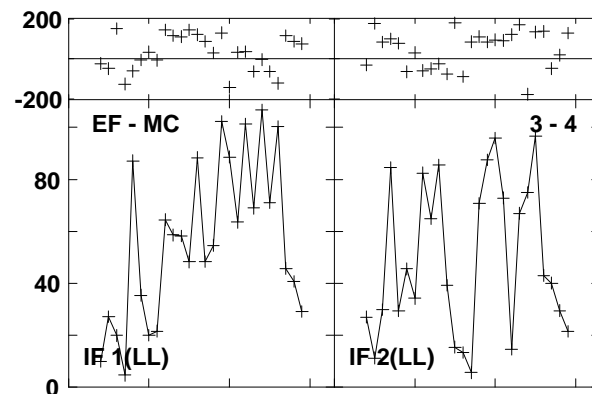
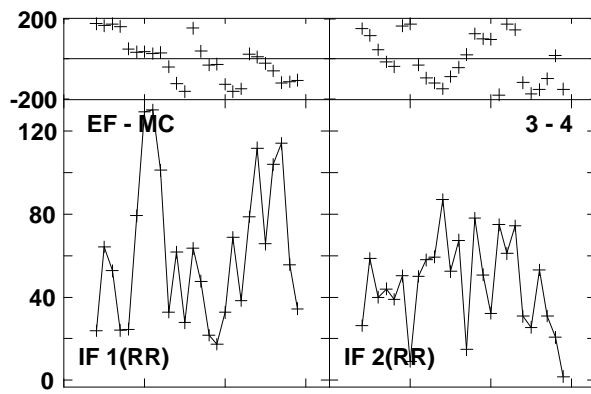
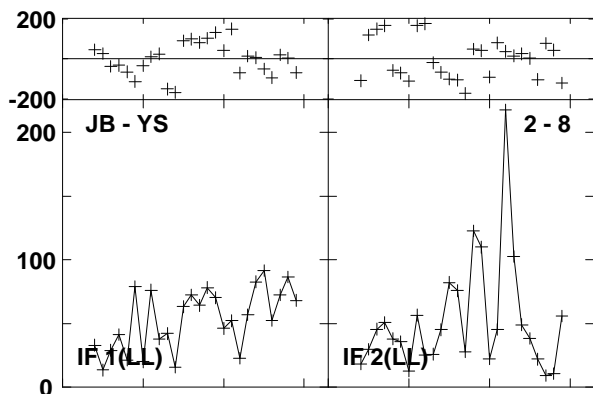
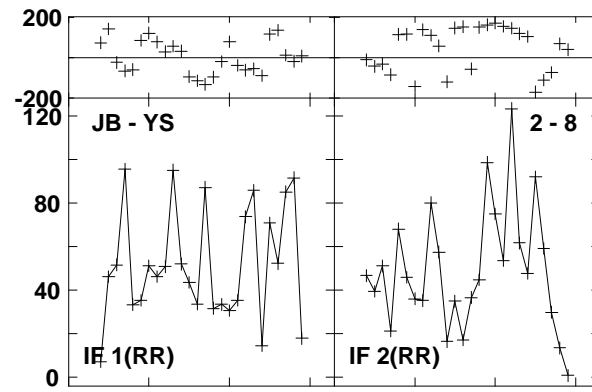
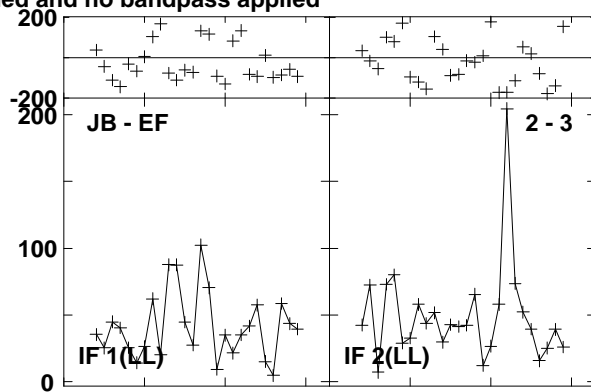
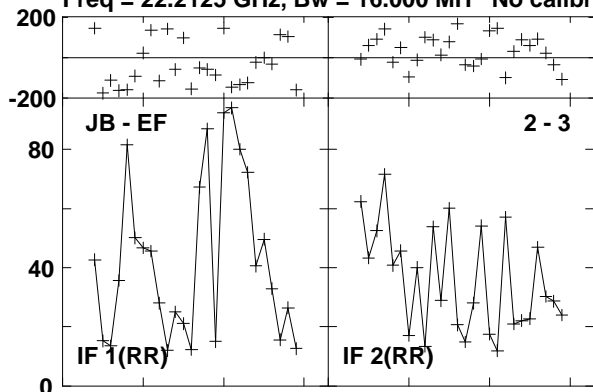

Lower frame: Micro Ampl Jy Top frame: Phas deg  
Vector averaged cross-power spectrum Baseline: JB (02) - EF (03)  
Timerange: 00/10:36:00 to 00/10:45:00

Plot file version 146 created 23-AUG-2016 15:00:47

W3IRS5 GA035B 1.UVDATA.1

Freq = 22.2125 GHz, Bw = 16.000 MH No calibration applied and no bandpass applied

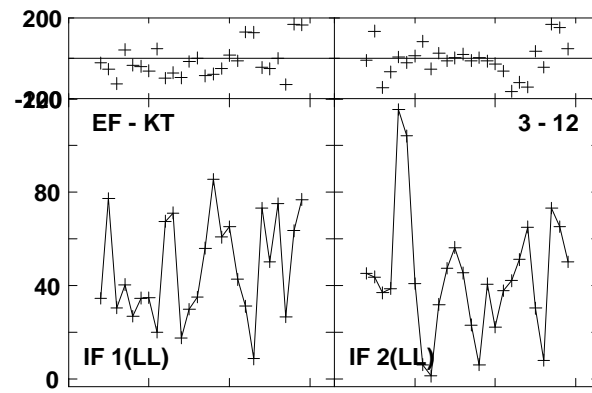
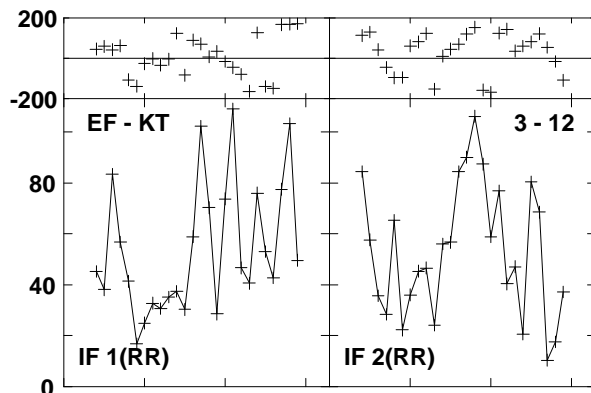
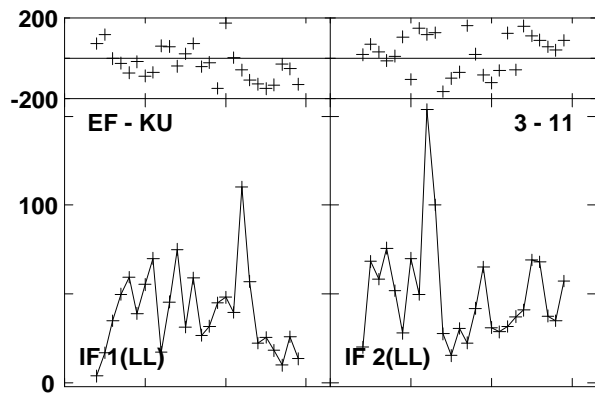
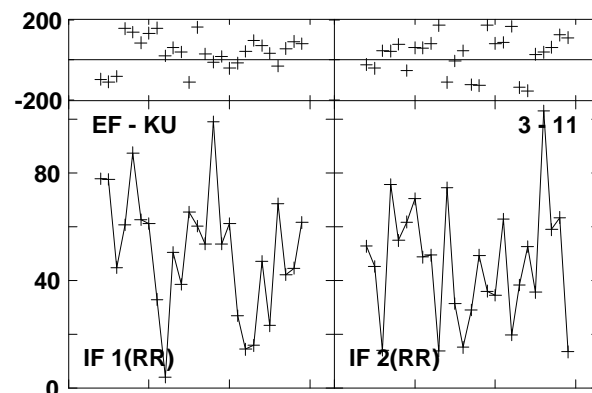
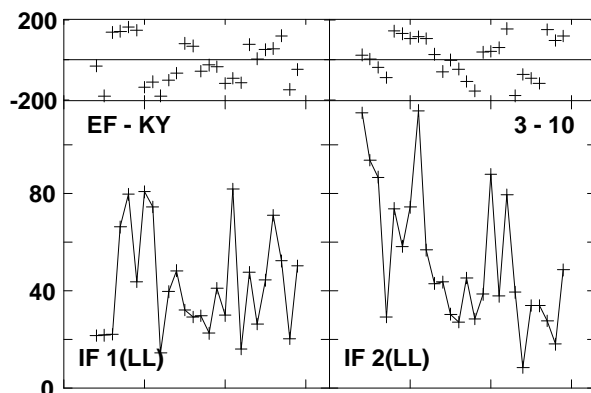
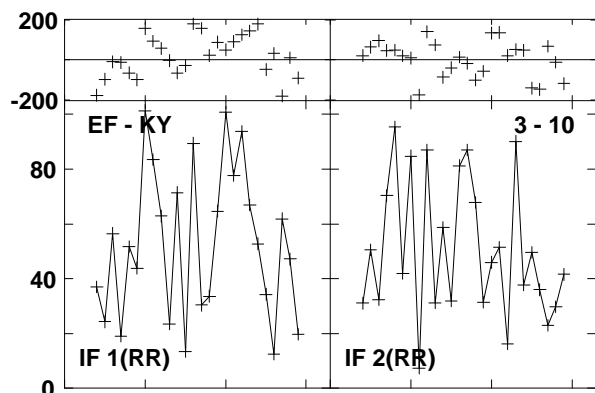
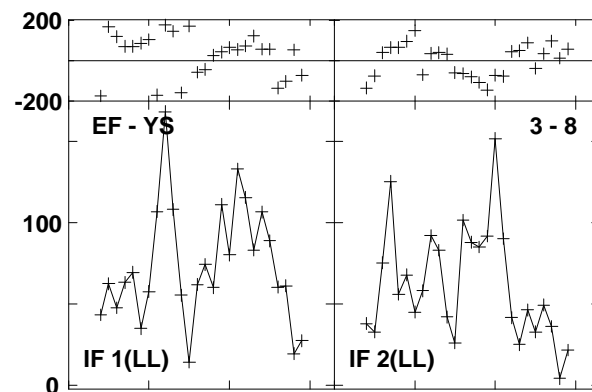
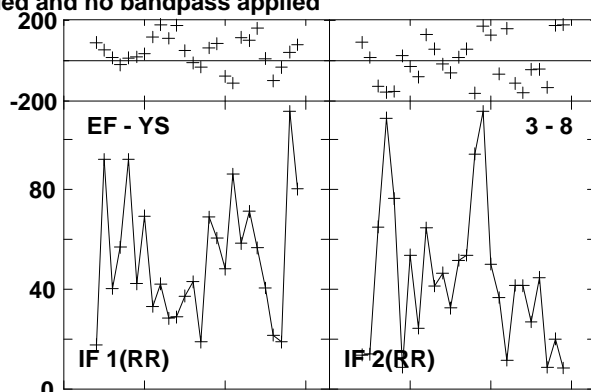
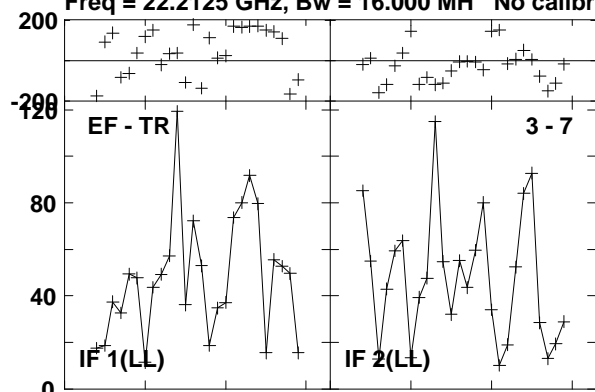

Lower frame: Micro Ampl Jy Top frame: Phas deg  
Vector averaged cross-power spectrum Baseline: EF (03) - TR (07)  
Timerange: 00/10:36:00 to 00/10:45:00

Plot file version 147 created 23-AUG-2016 15:00:48

W3IRS5 GA035B 1.UVDATA.1

Freq = 22.2125 GHz, Bw = 16.000 MH No calibration applied and no bandpass applied

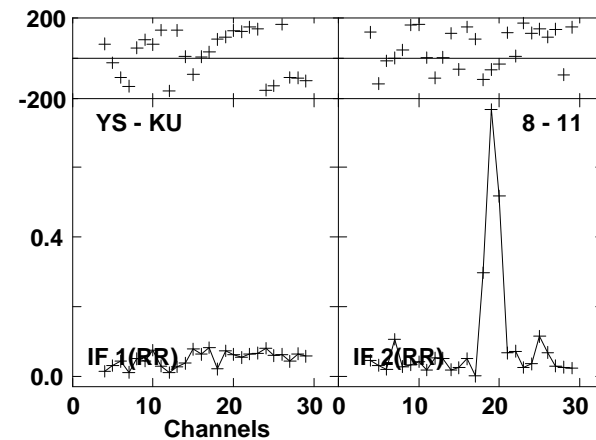
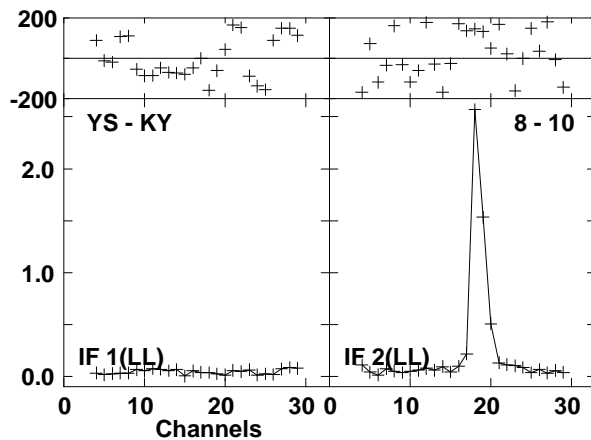
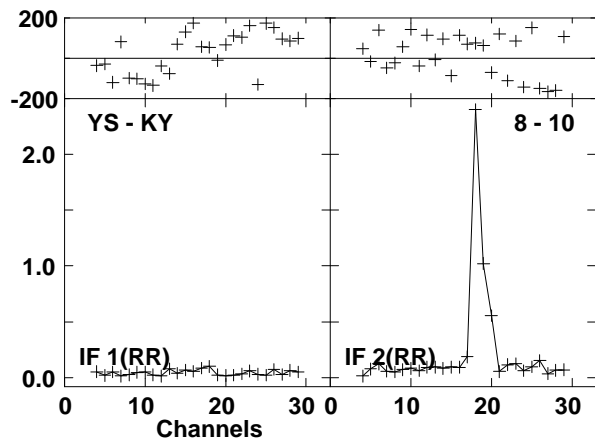
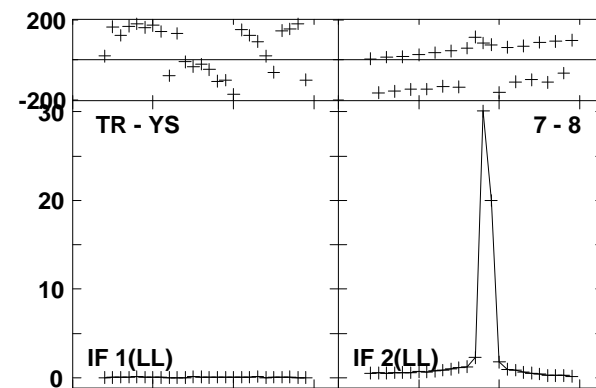
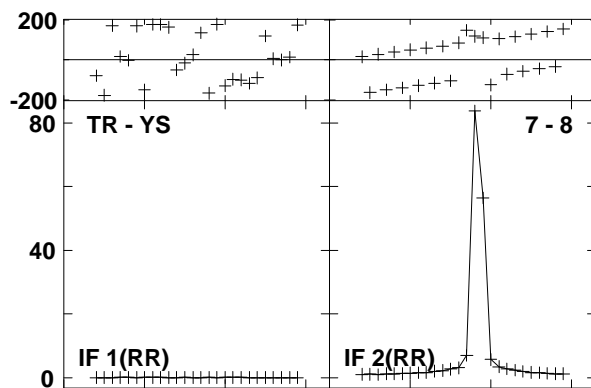
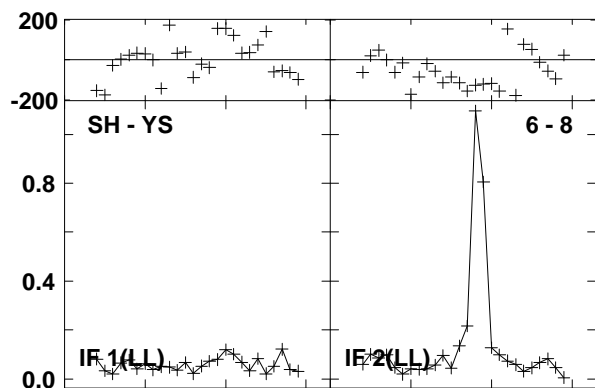
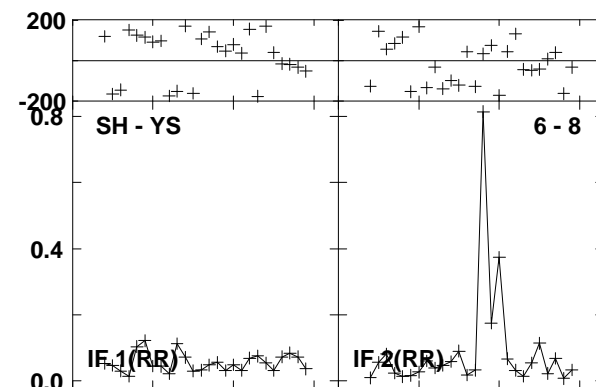
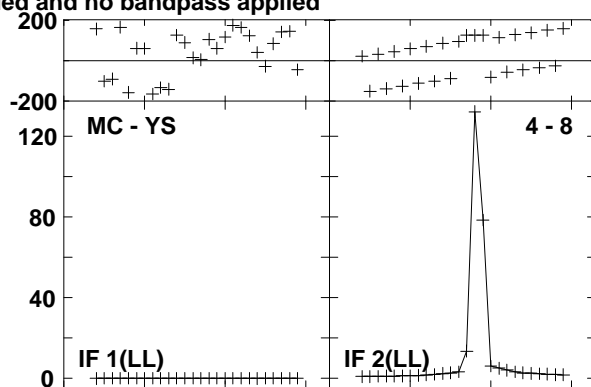
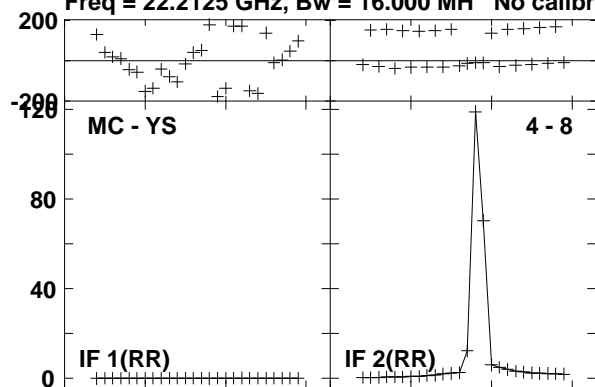

Lower frame: Milli Ampl Jy Top frame: Phas deg  
Vector averaged cross-power spectrum Baseline: MC (04) - YS (08)  
Timerange: 00/10:36:00 to 00/10:45:00

Plot file version 148 created 23-AUG-2016 15:00:48

W3IRS5 GA035B 1.UVDATA.1

Freq = 22.2125 GHz, Bw = 16.000 MH No calibration applied and no bandpass applied

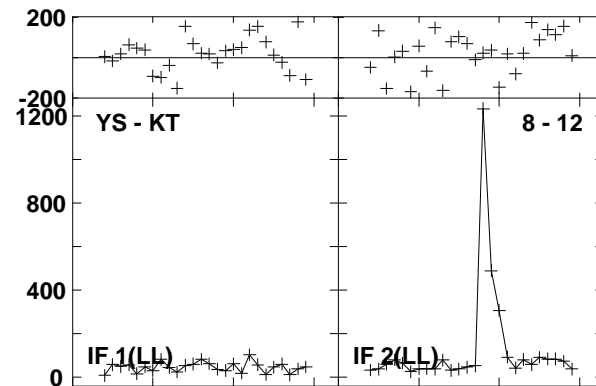
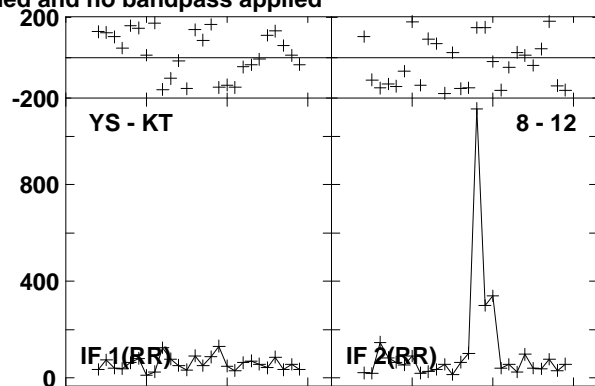
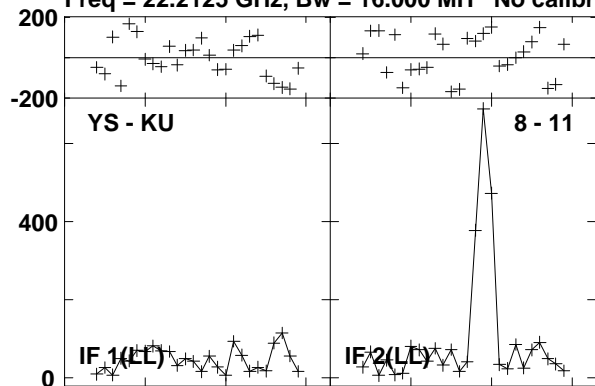

Lower frame: Micro Ampl Jy Top frame: Phas deg  
Vector averaged cross-power spectrum Baseline: YS (08) - KU (11)  
Timerange: 00/10:36:00 to 00/10:45:00

Plot file version 149 created 23-AUG-2016 15:00:48

W3IRS5 GA035B 1.UVDATA.1

Freq = 22.2125 GHz, Bw = 16.000 MH No calibration applied and no bandpass applied

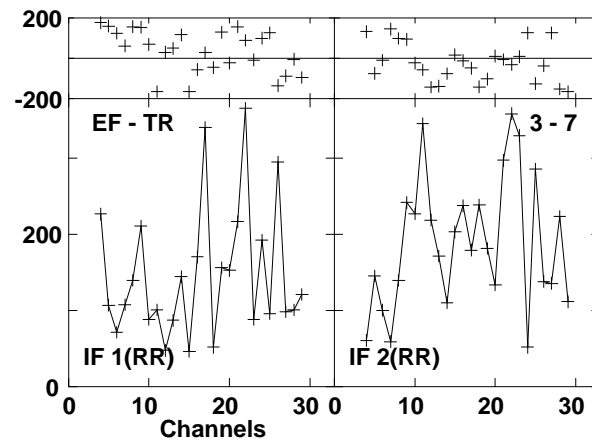
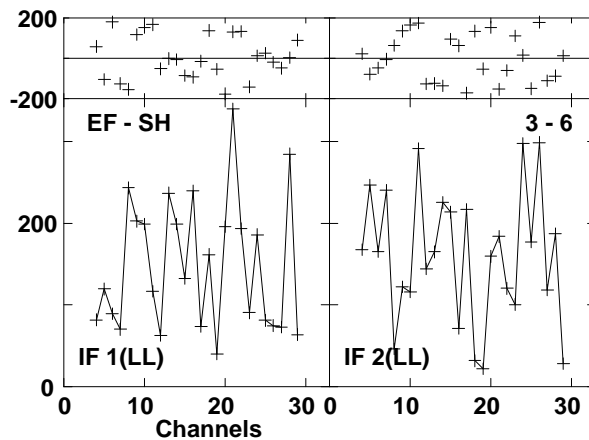
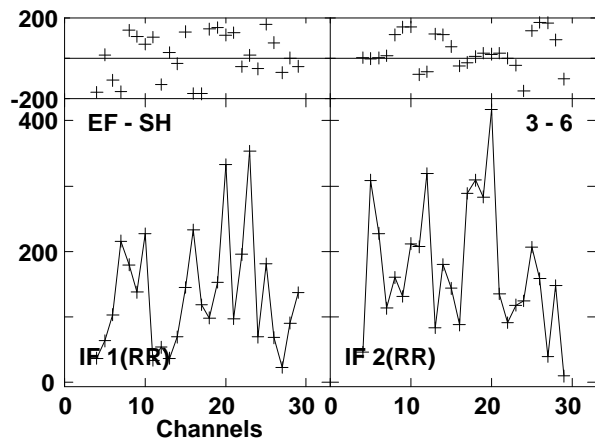
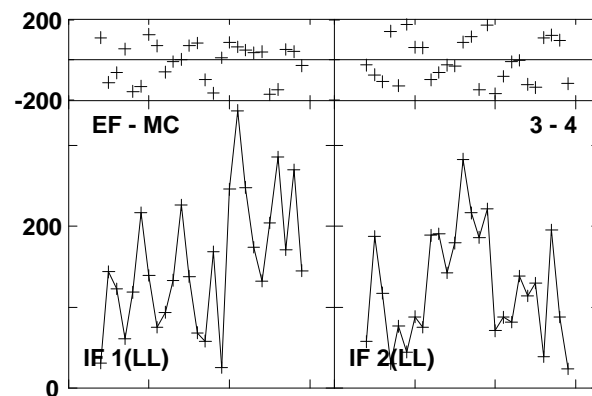
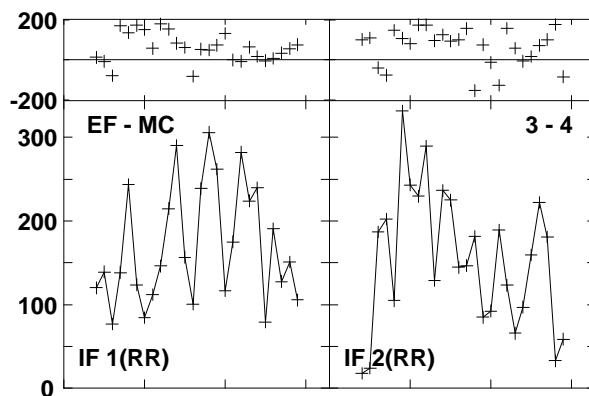
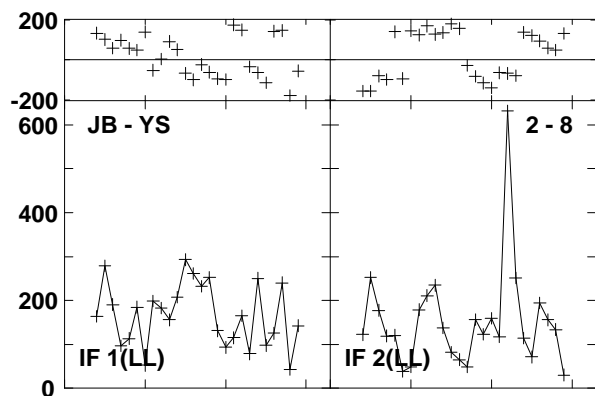
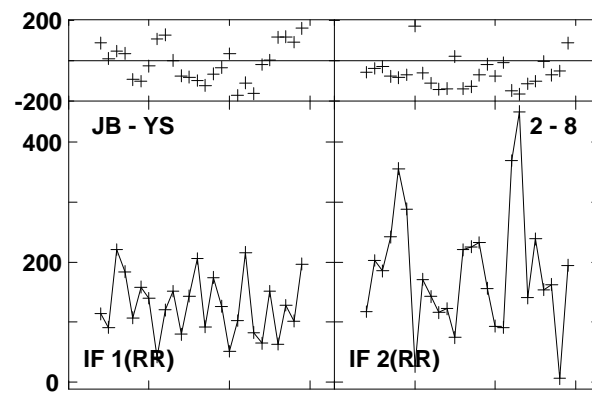
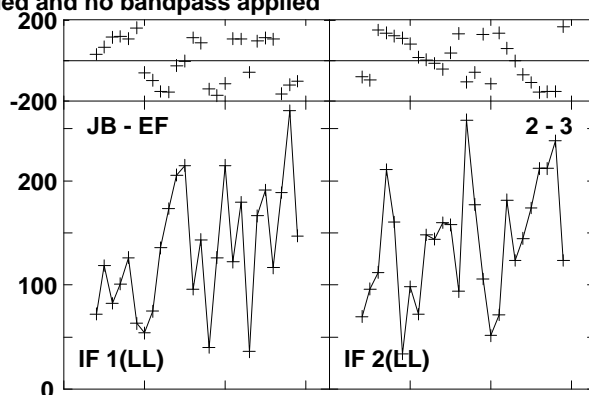
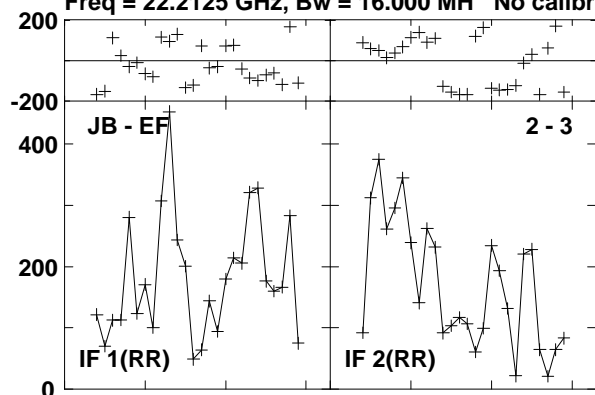

Lower frame: Micro Ampl Jy Top frame: Phas deg  
Vector averaged cross-power spectrum Baseline: JB (02) - EF (03)  
Timerange: 00/10:47:26 to 00/10:48:24

Plot file version 150 created 23-AUG-2016 15:00:48

W3IRS5 GA035B 1.UVDATA.1

Freq = 22.2125 GHz, Bw = 16.000 MH No calibration applied and no bandpass applied

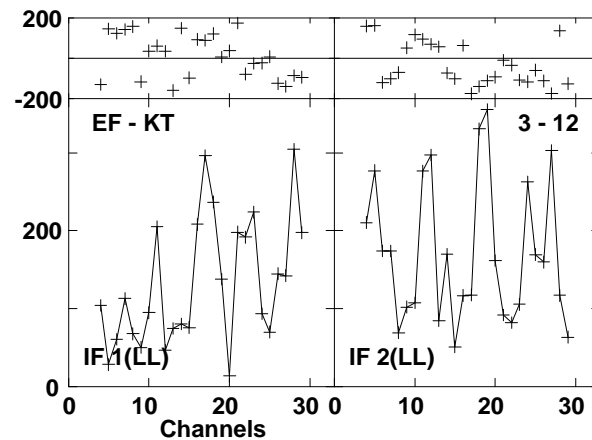
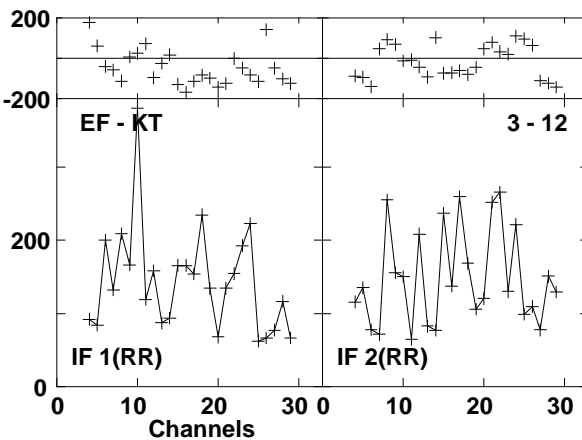
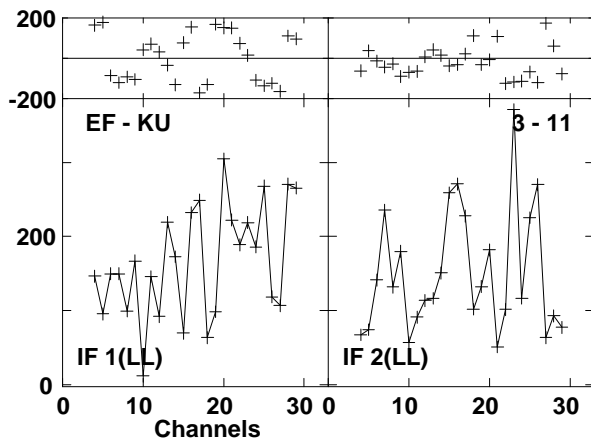
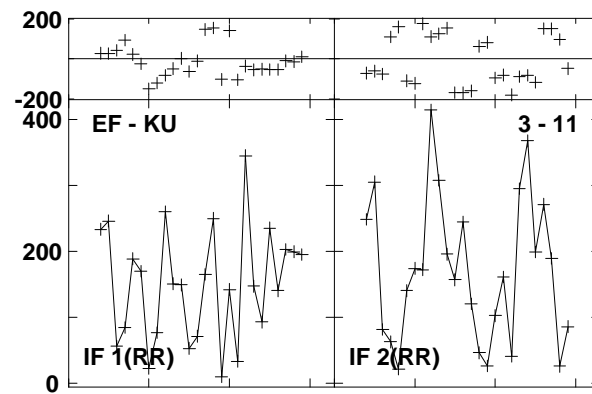
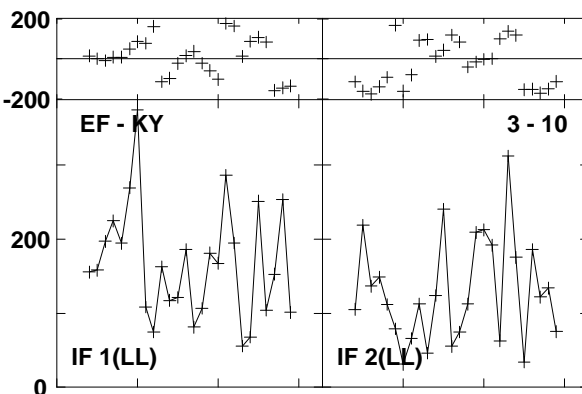
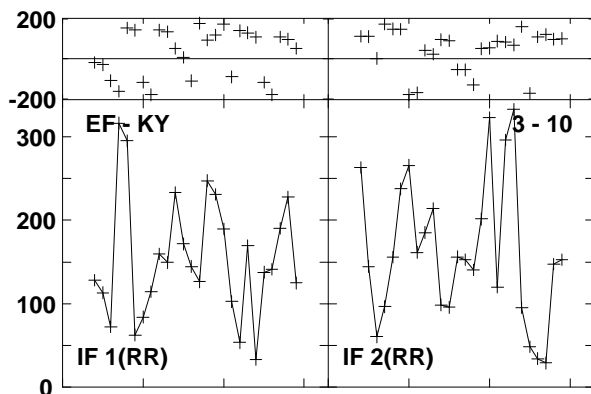
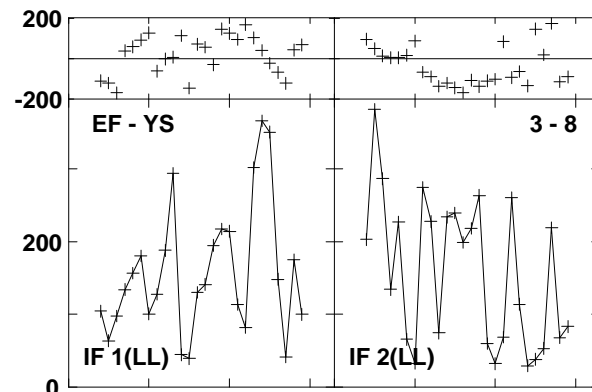
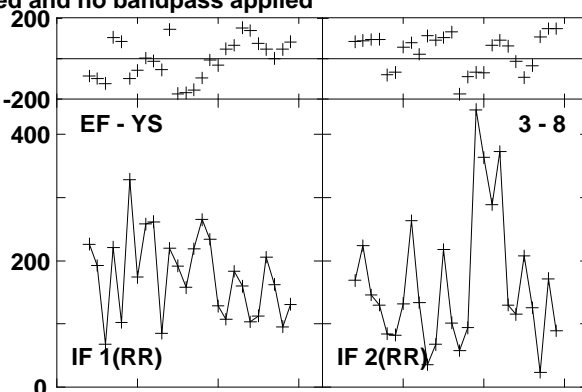
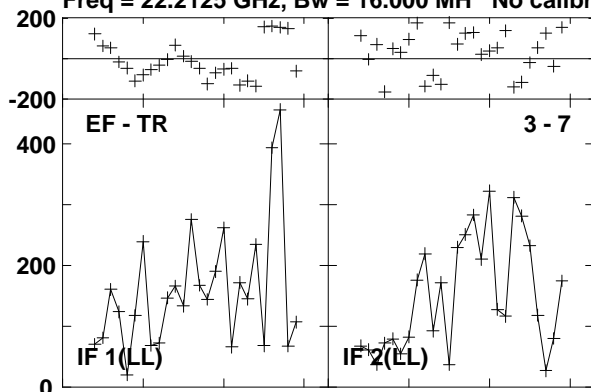

Lower frame: Micro Ampl Jy Top frame: Phas deg  
Vector averaged cross-power spectrum Baseline: EF (03) - TR (07)  
Timerange: 00/10:47:26 to 00/10:48:24

Plot file version 151 created 23-AUG-2016 15:00:48  
W3IRS5 GA035B 1.UVDATA.1

Freq = 22.2125 GHz, Bw = 16.000 MH No calibration applied and no bandpass applied

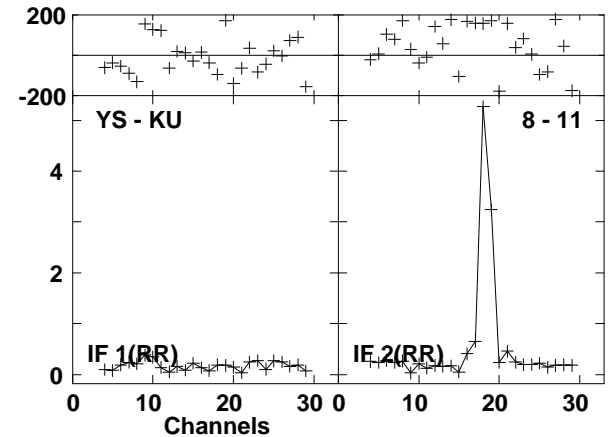
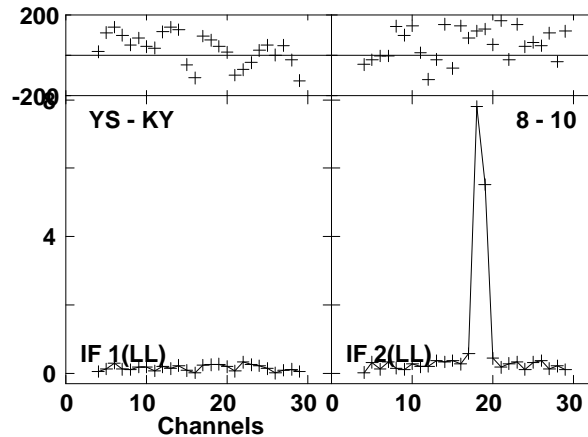
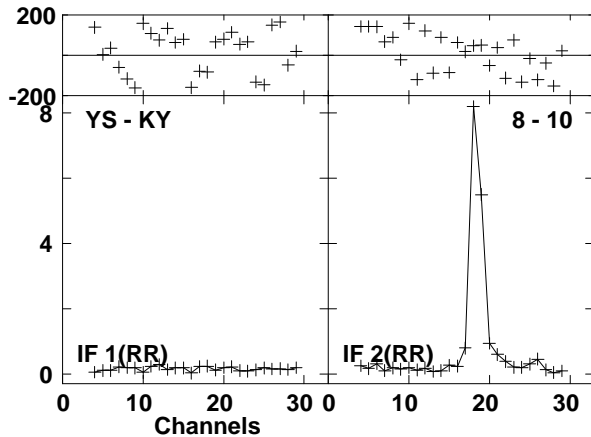
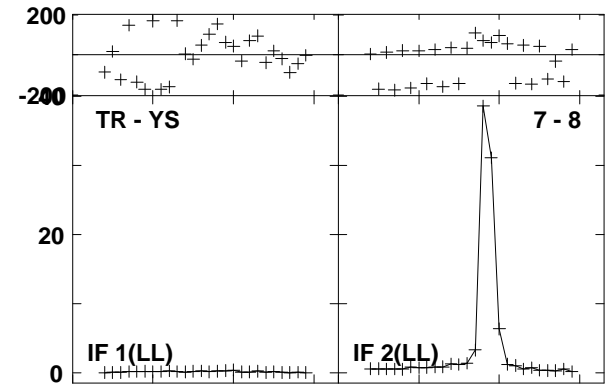
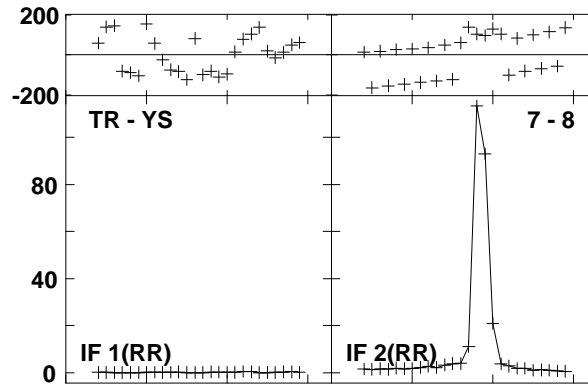
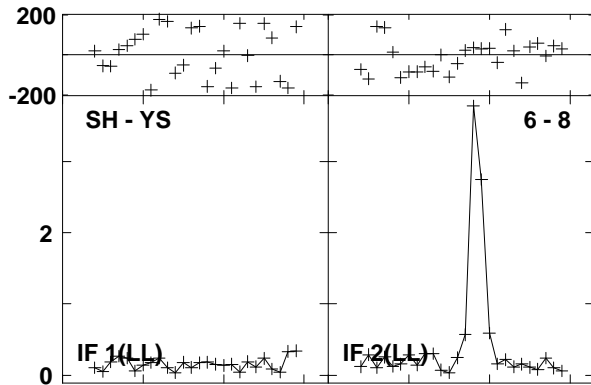
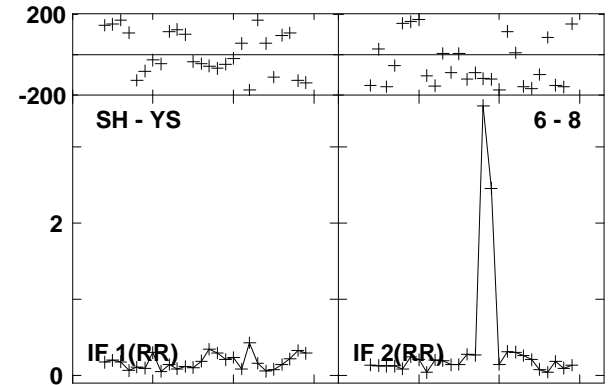
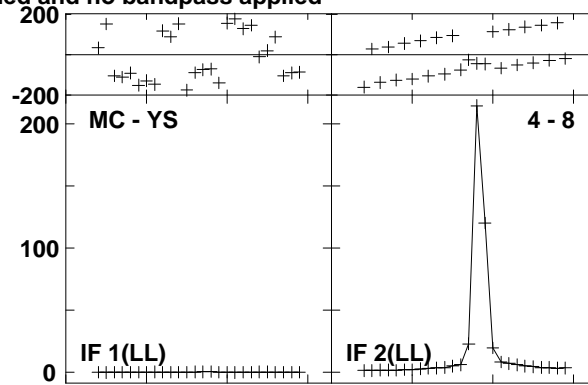
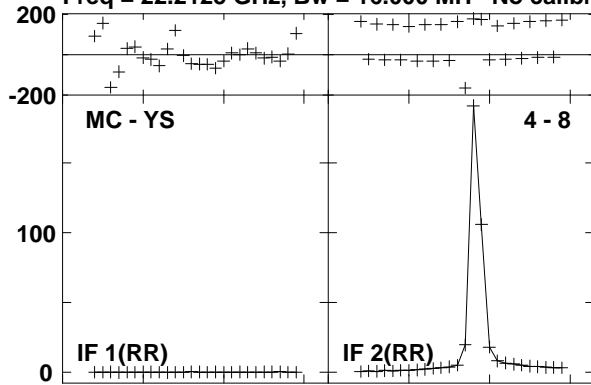

Lower frame: Milli Ampl Jy Top frame: Phas deg  
Vector averaged cross-power spectrum Baseline: MC (04) - YS (08)  
Timerange: 00/10:47:26 to 00/10:48:24

Plot file version 152 created 23-AUG-2016 15:00:48  
W3IRS5 GA035B 1.UVDATA.1

Freq = 22.2125 GHz, Bw = 16.000 MH No calibration applied and no bandpass applied

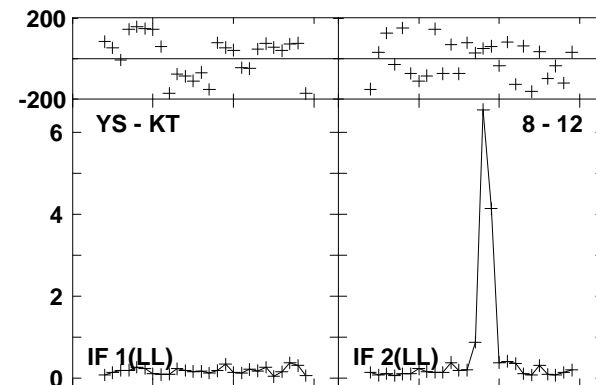
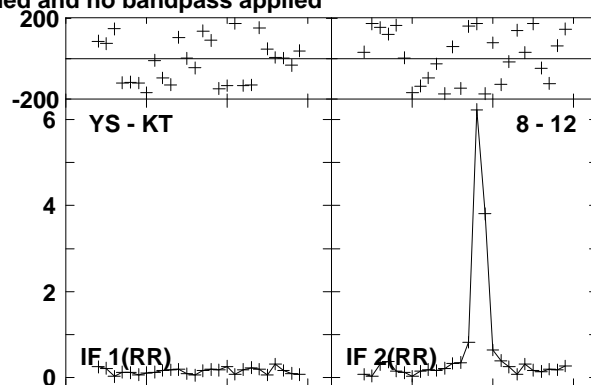
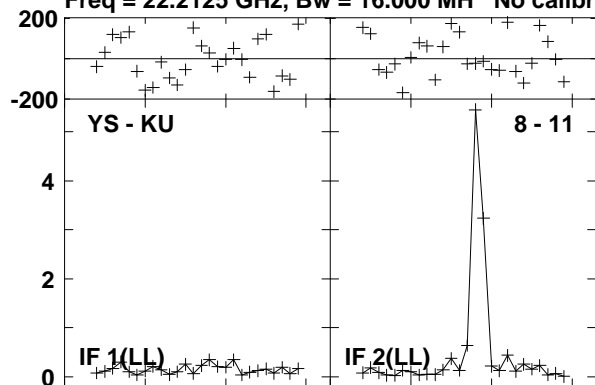

Lower frame: Milli Ampl Jy Top frame: Phas deg  
Vector averaged cross-power spectrum Baseline: YS (08) - KU (11)  
Timerange: 00/10:47:26 to 00/10:48:24



Plot file version 153 created 23-AUG-2016 15:00:48

0219+628 GA035B 1.UVDATA.1

Freq = 22.2125 GHz, Bw = 16.000 MH No calibration applied and no bandpass applied

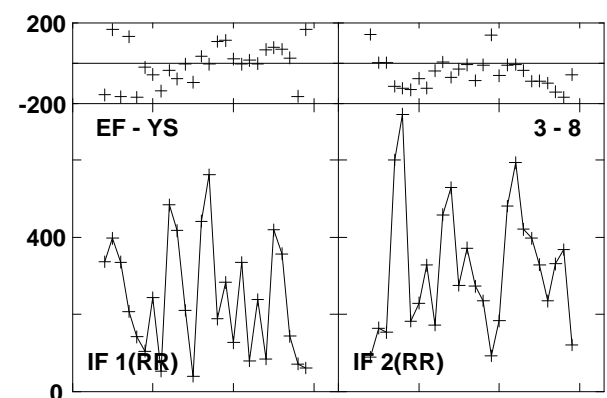
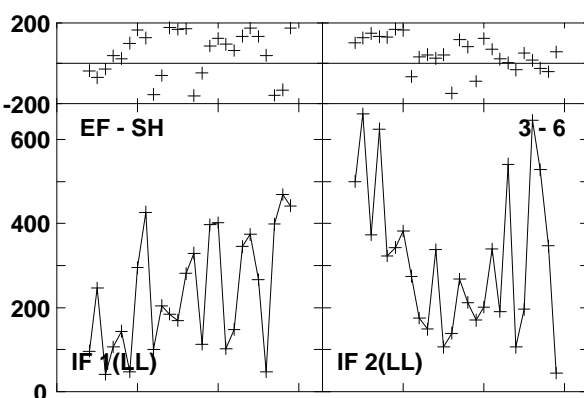
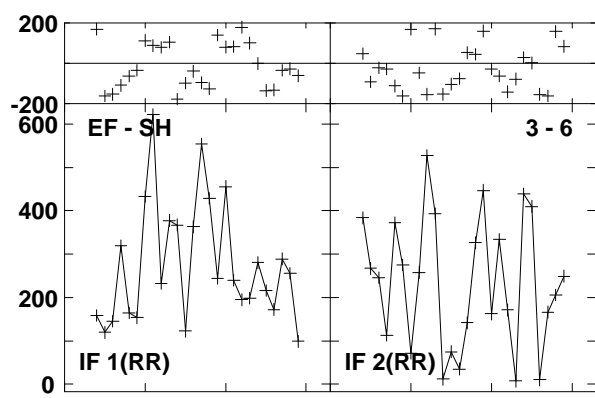
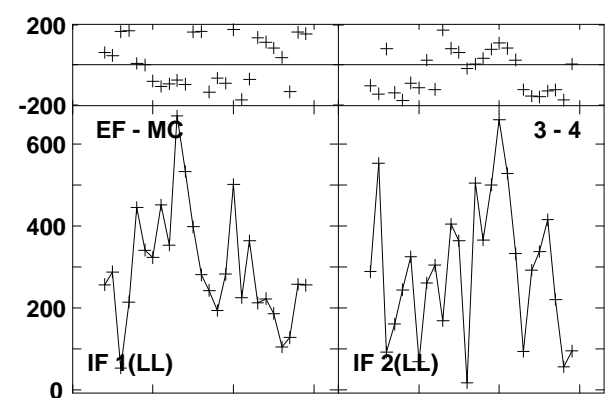
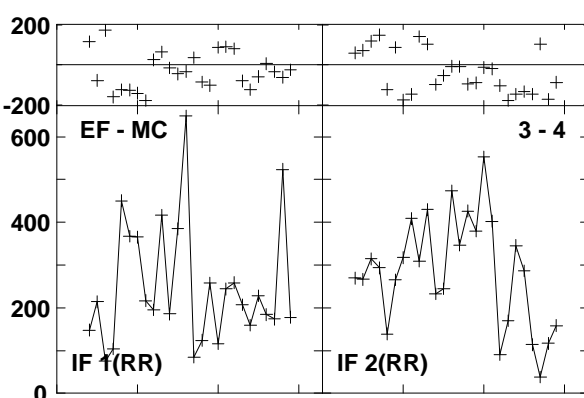
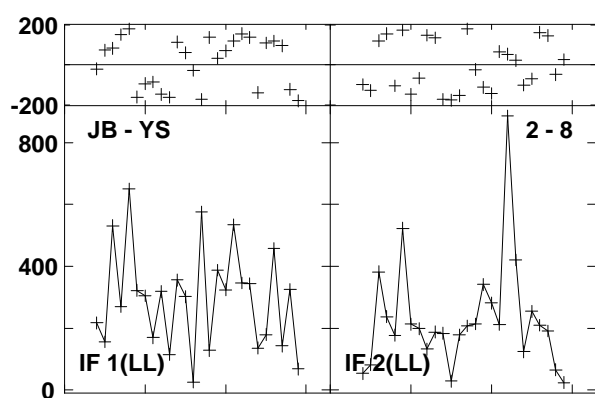
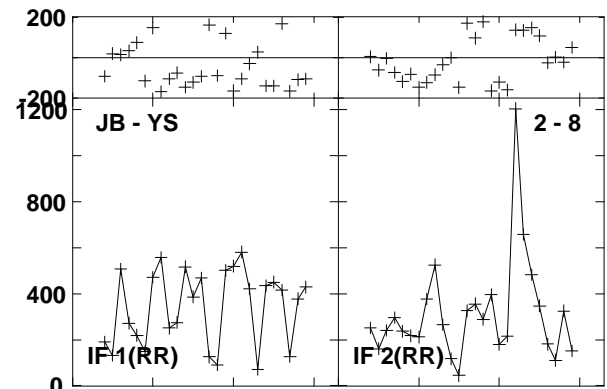
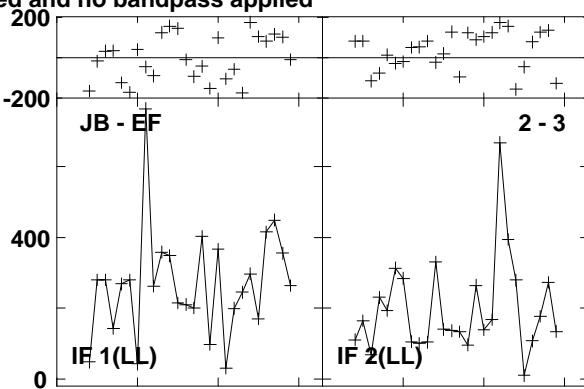
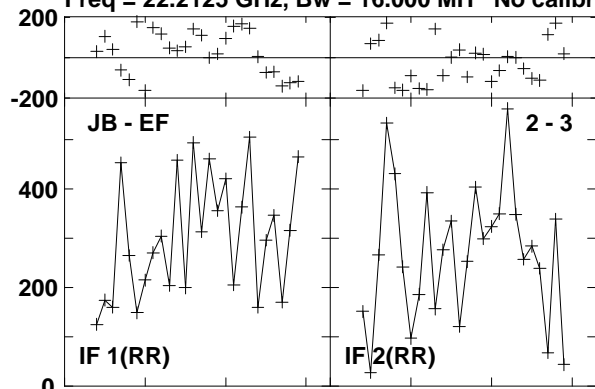

Lower frame: Micro Ampl Jy Top frame: Phas deg  
Vector averaged cross-power spectrum Baseline: JB (02) - EF (03)  
Timerange: 00/10:48:51 to 00/10:49:09

Plot file version 154 created 23-AUG-2016 15:00:48

0219+628 GA035B 1.UVDATA.1

Freq = 22.2125 GHz, Bw = 16.000 MH No calibration applied and no bandpass applied

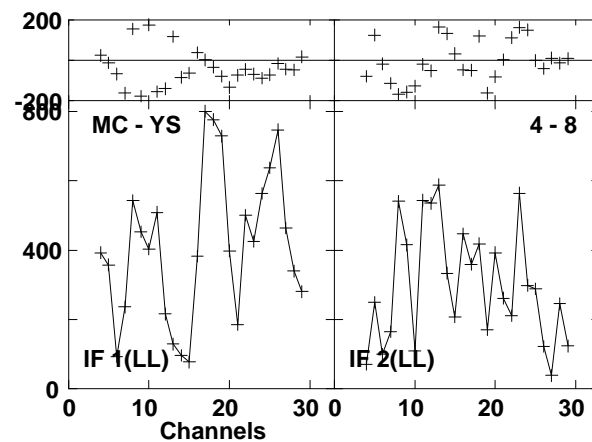
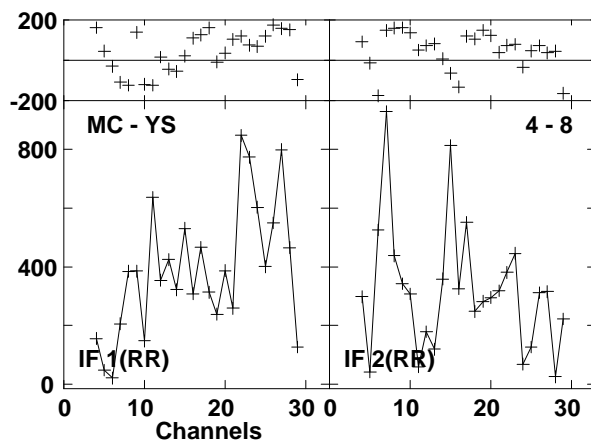
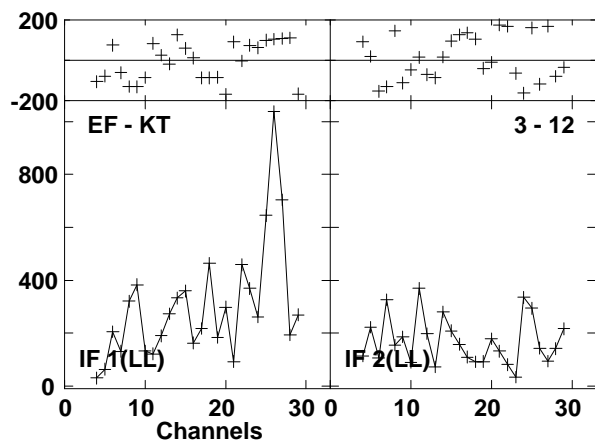
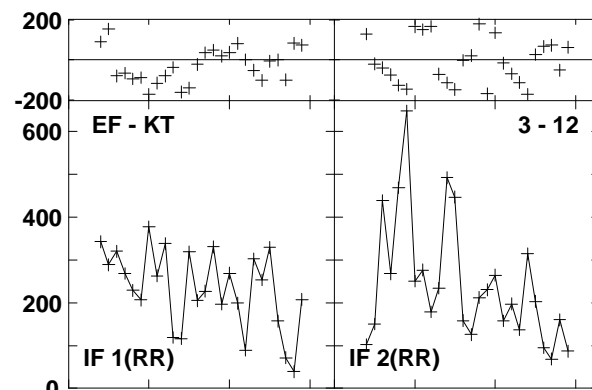
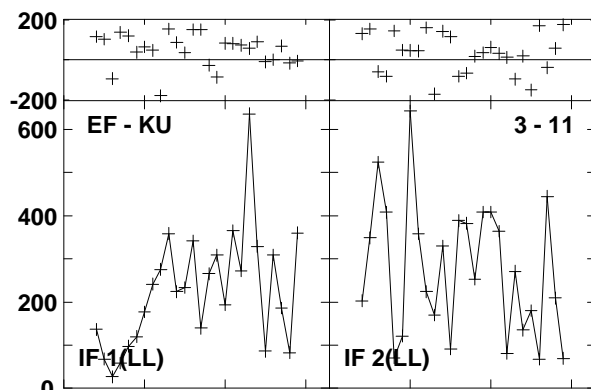
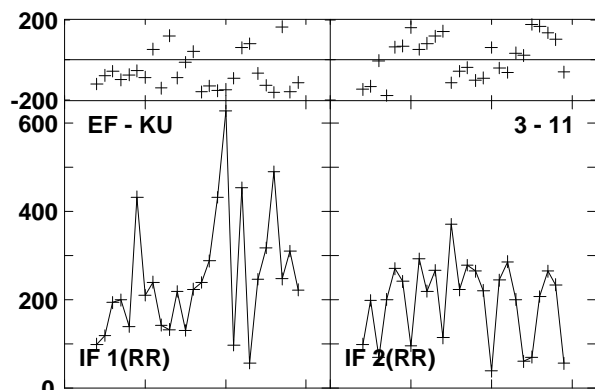
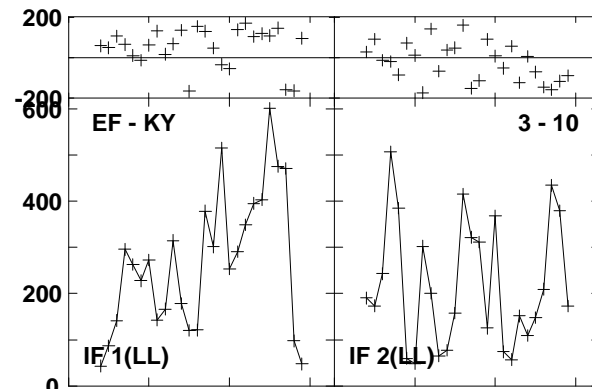
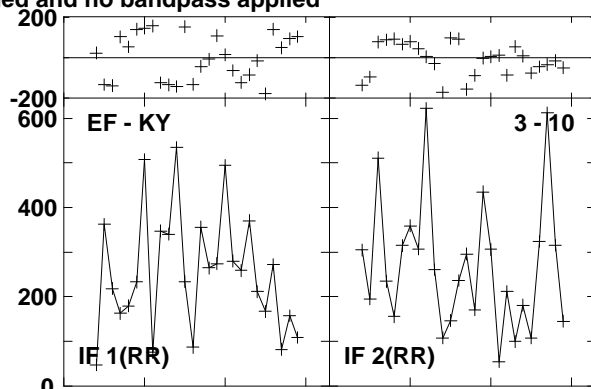
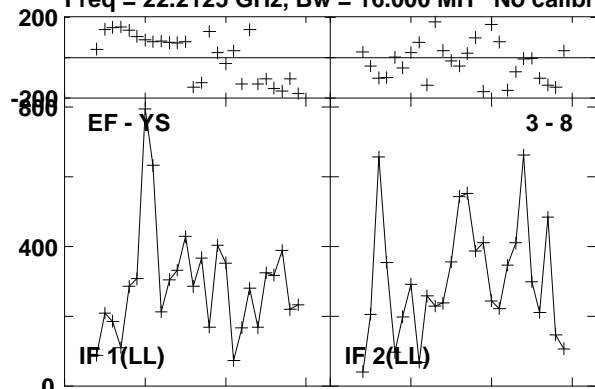

Lower frame: Micro Ampl Jy Top frame: Phas deg  
Vector averaged cross-power spectrum Baseline: EF (03) - YS (08)  
Timerange: 00/10:48:51 to 00/10:49:09

Plot file version 155 created 23-AUG-2016 15:00:48

0219+628 GA035B 1.UVDATA.1

Freq = 22.2125 GHz, Bw = 16.000 MH No calibration applied and no bandpass applied

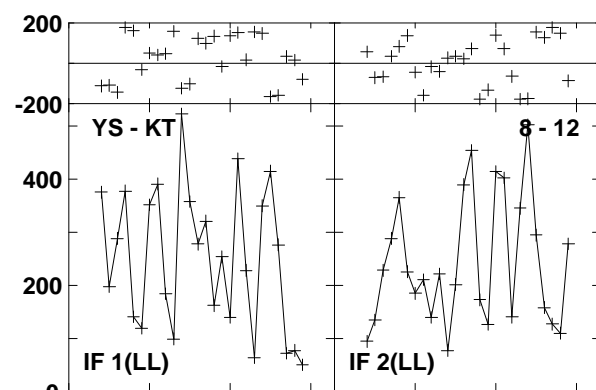
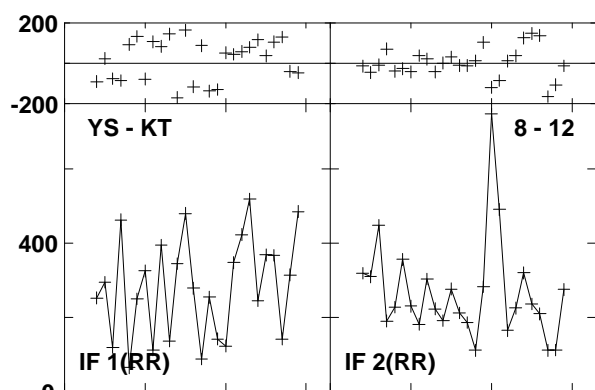
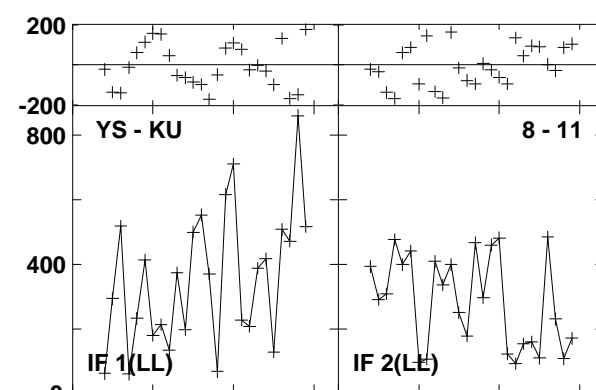
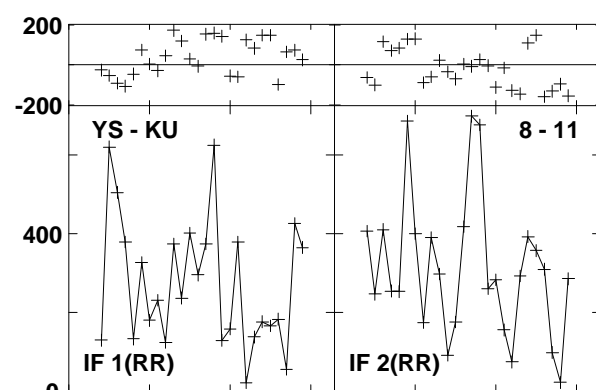
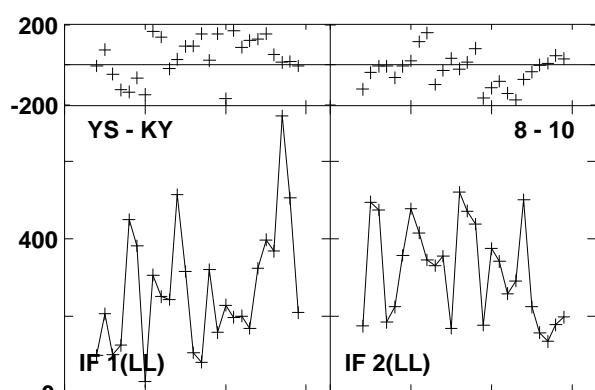
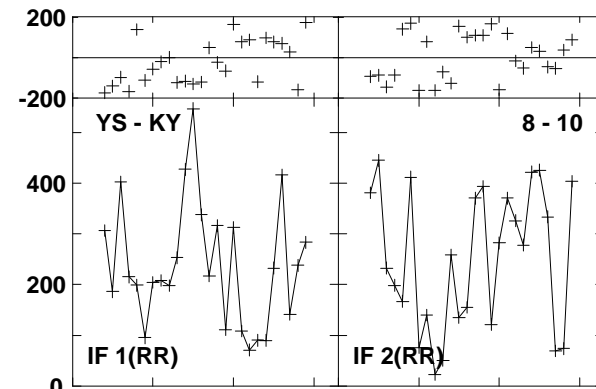
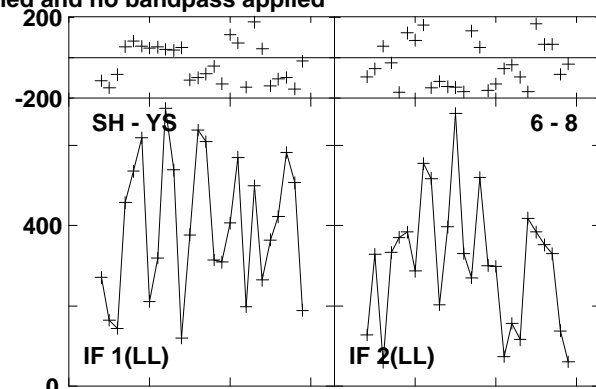
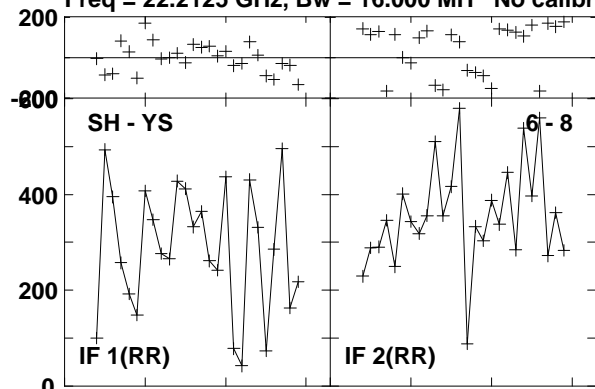

Lower frame: Micro Ampl Jy Top frame: Phas deg  
Vector averaged cross-power spectrum Baseline: SH (06) - YS (08)  
Timerange: 00/10:48:51 to 00/10:49:09

Plot file version 156 created 23-AUG-2016 15:00:48

W3IRS5 GA035B 1.UVDATA.1

Freq = 22.2125 GHz, Bw = 16.000 MH No calibration applied and no bandpass applied

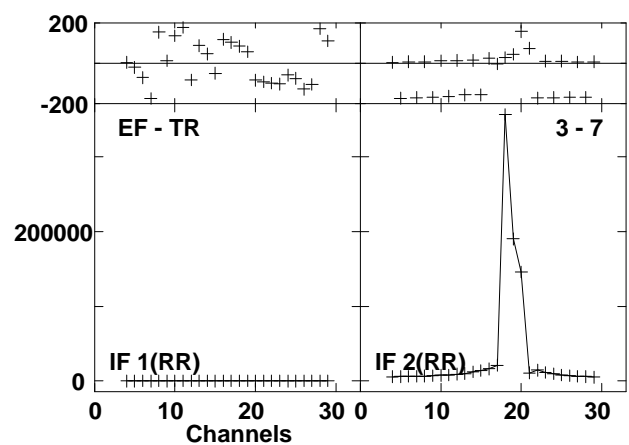
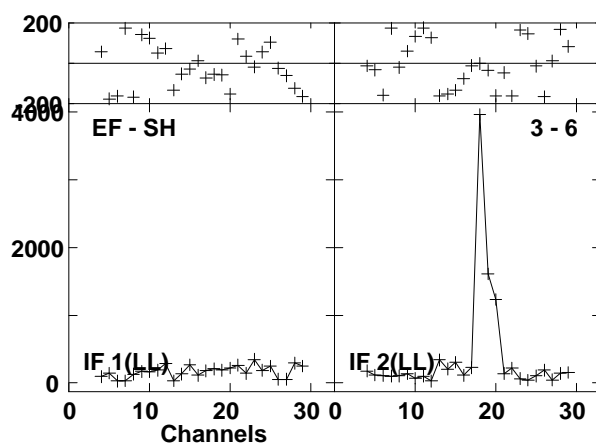
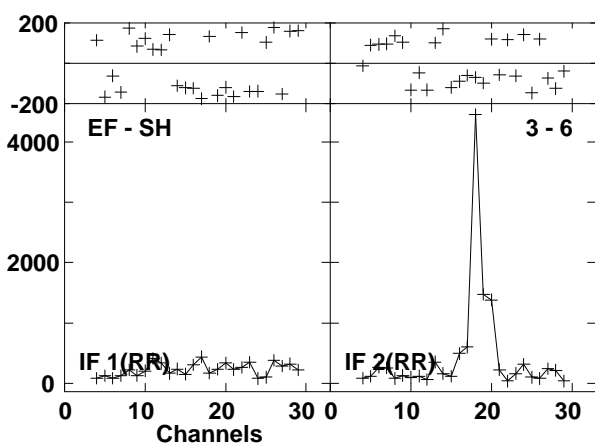
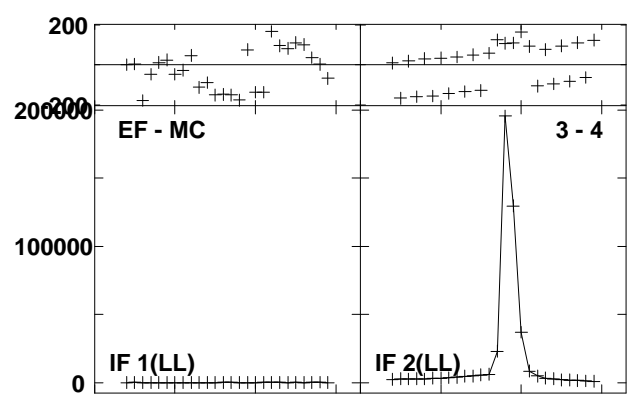
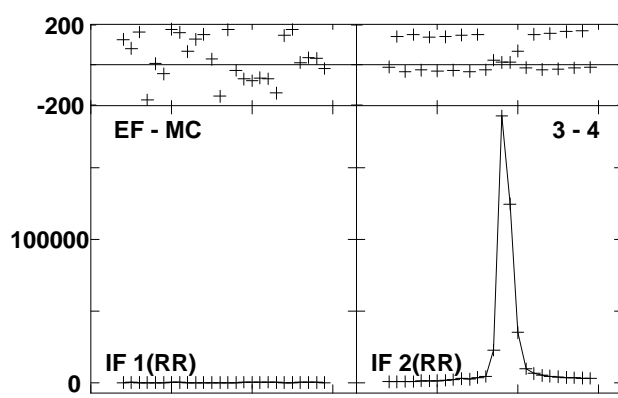
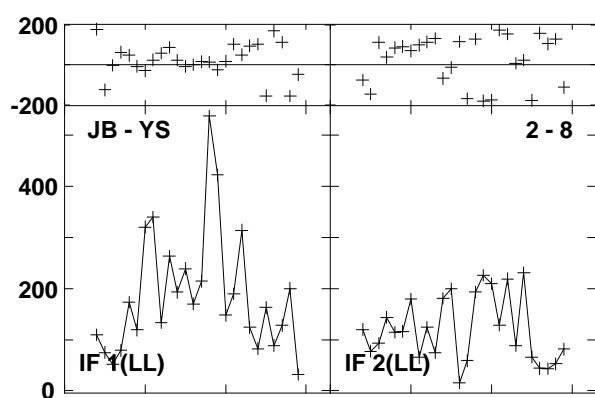
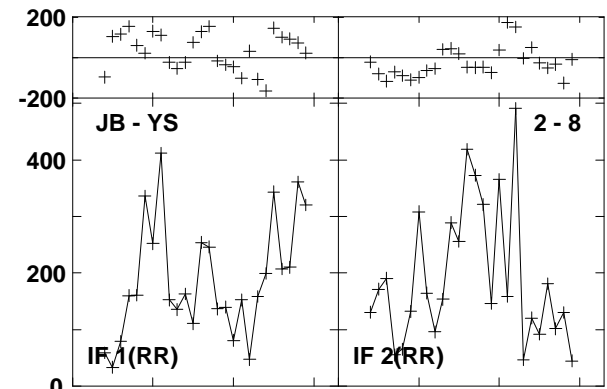
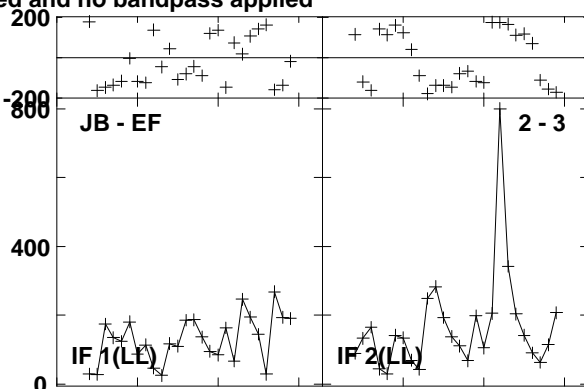
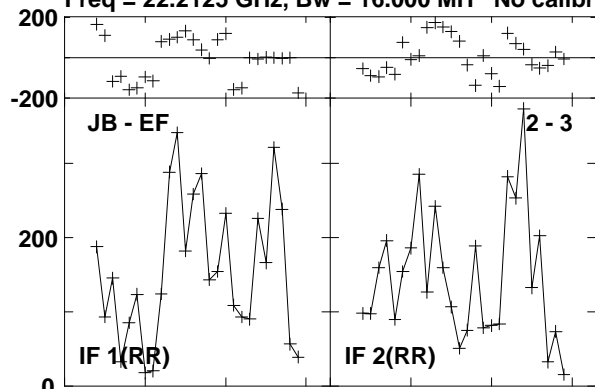

Lower frame: Micro Ampl Jy Top frame: Phas deg  
Vector averaged cross-power spectrum Baseline: JB (02) - EF (03)  
Timerange: 00/10:49:36 to 00/10:50:34

Plot file version 157 created 23-AUG-2016 15:00:48

W3IRS5 GA035B 1.UVDATA.1

Freq = 22.2125 GHz, Bw = 16.000 MH No calibration applied and no bandpass applied

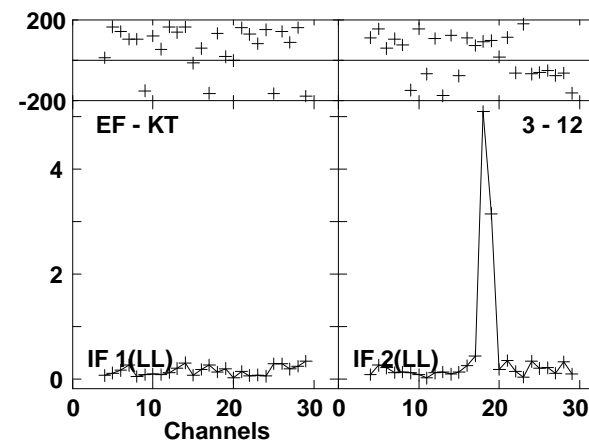
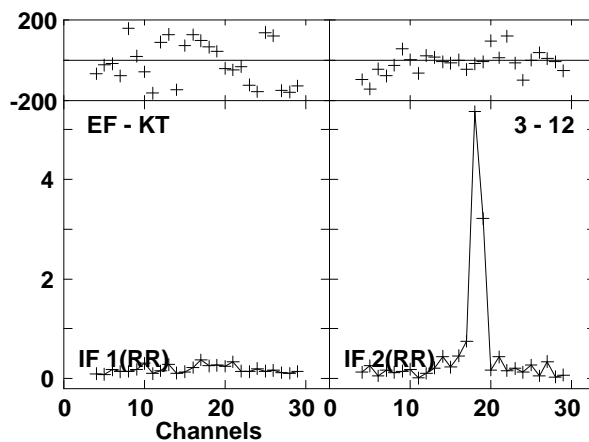
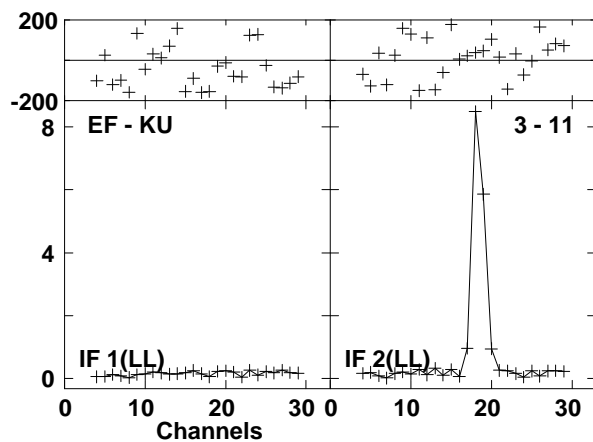
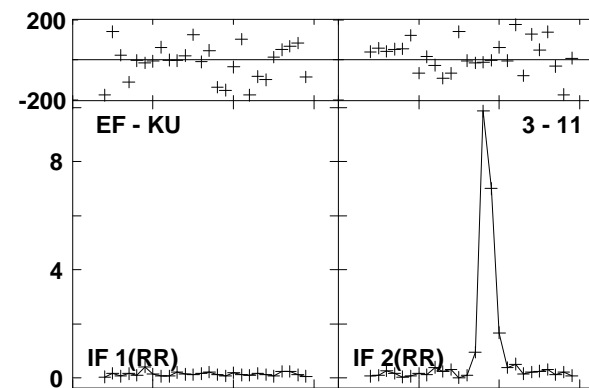
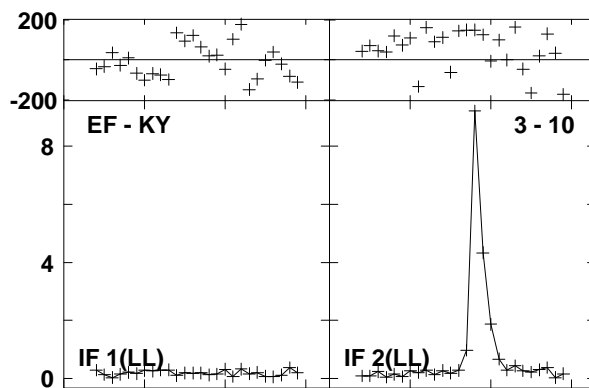
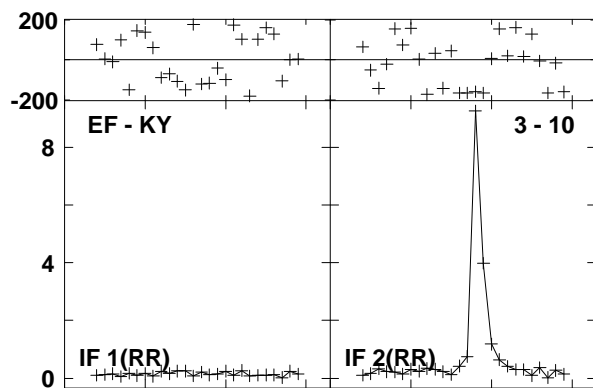
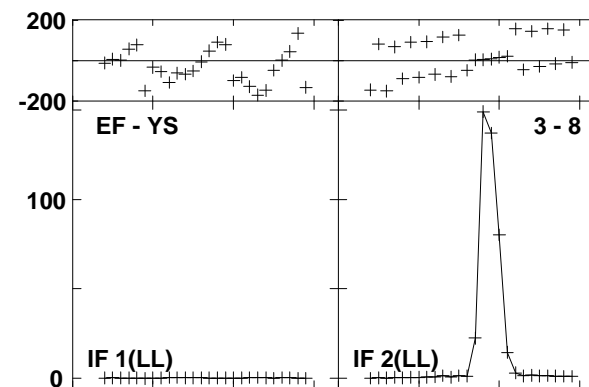
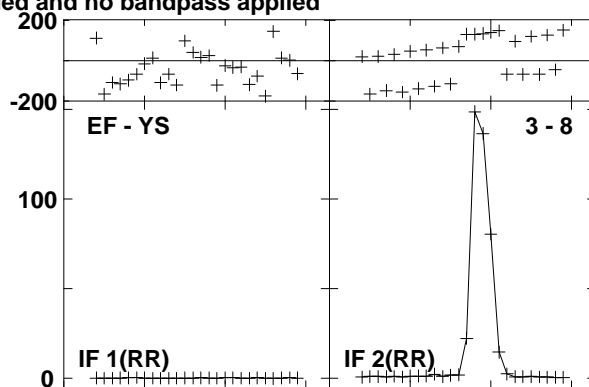
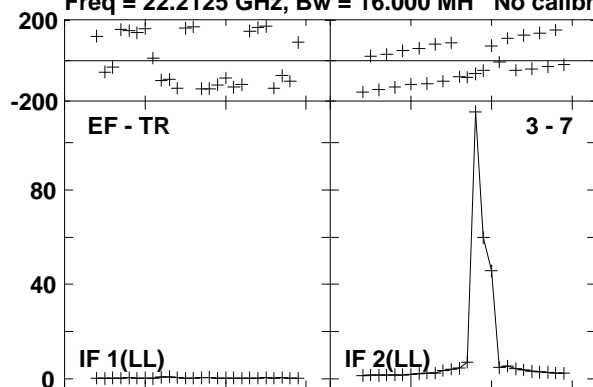

Lower frame: Milli Ampl Jy Top frame: Phas deg  
Vector averaged cross-power spectrum Baseline: EF (03) - TR (07)  
Timerange: 00/10:49:36 to 00/10:50:34

Plot file version 158 created 23-AUG-2016 15:00:48  
W3IRS5 GA035B 1.UVDATA.1

Freq = 22.2125 GHz, Bw = 16.000 MH No calibration applied and no bandpass applied

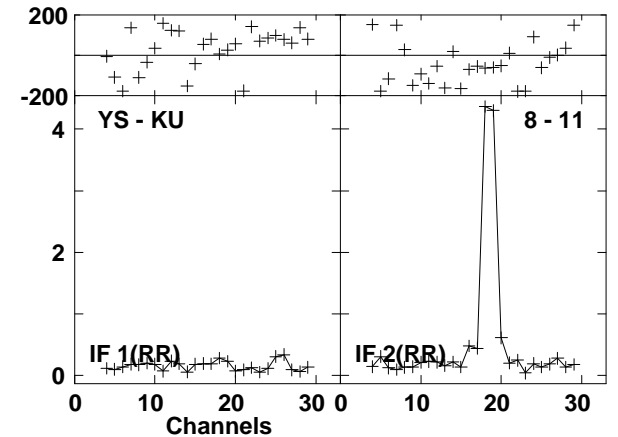
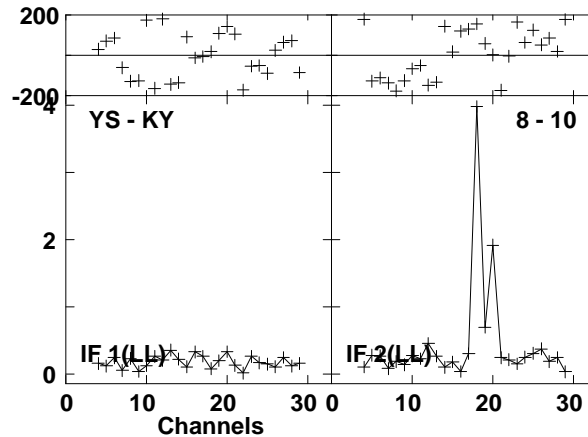
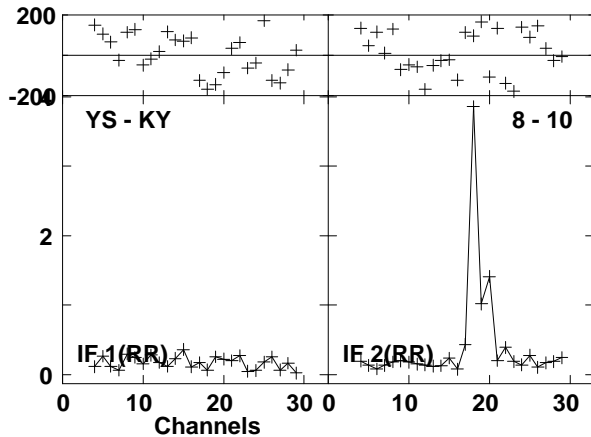
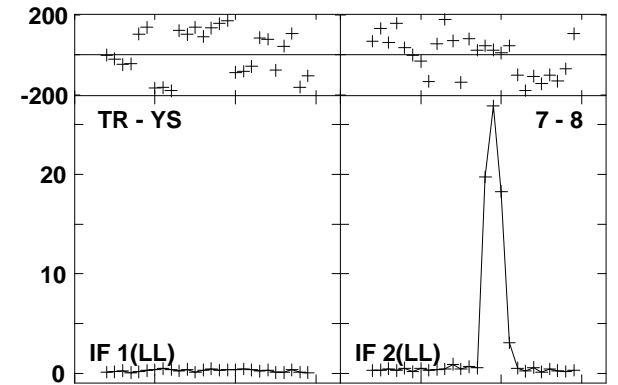
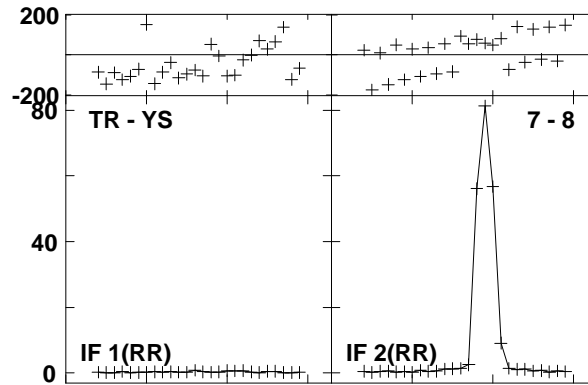
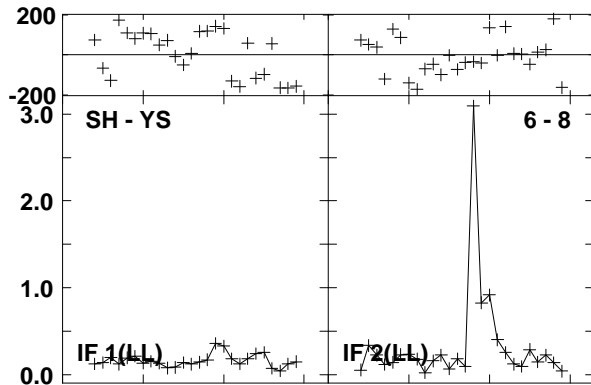
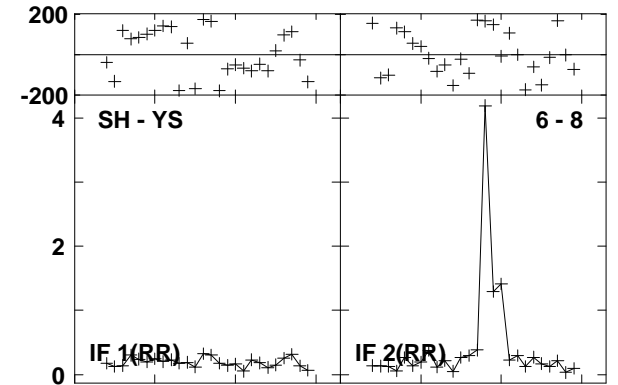
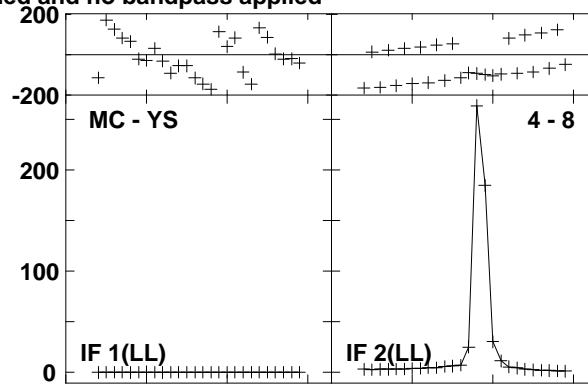
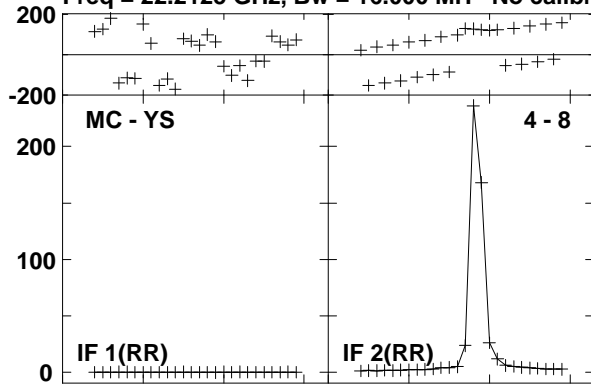

Lower frame: Milli Ampl Jy Top frame: Phas deg  
Vector averaged cross-power spectrum Baseline: MC (04) - YS (08)  
Timerange: 00/10:49:36 to 00/10:50:34

Plot file version 159 created 23-AUG-2016 15:00:48

W3IRS5 GA035B 1.UVDATA.1

Freq = 22.2125 GHz, Bw = 16.000 MH No calibration applied and no bandpass applied

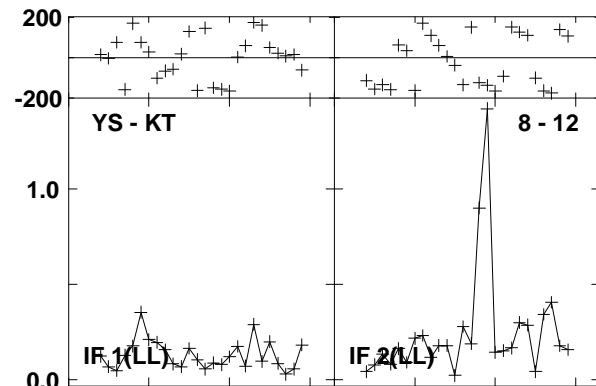
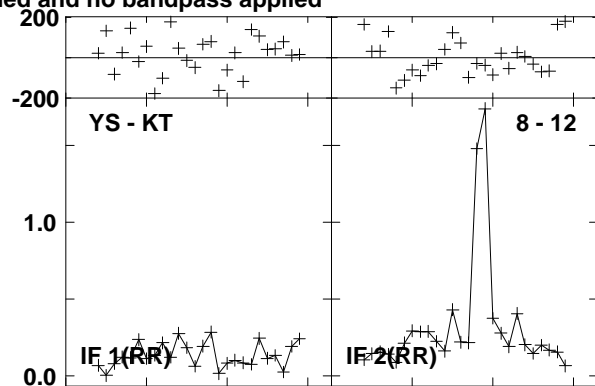
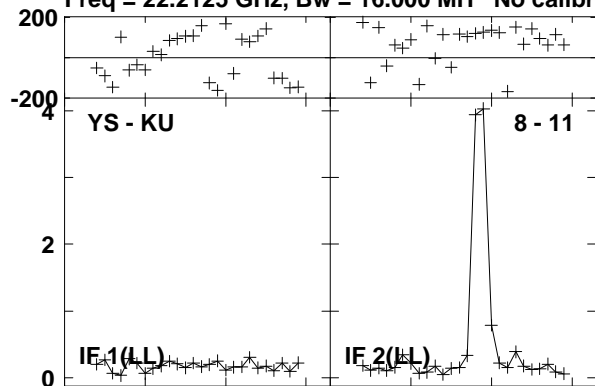

Lower frame: Milli Ampl Jy Top frame: Phas deg  
Vector averaged cross-power spectrum Baseline: YS (08) - KU (11)  
Timerange: 00/10:49:36 to 00/10:50:34

Plot file version 160 created 23-AUG-2016 15:00:48

0219+628 GA035B 1.UVDATA.1

Freq = 22.2125 GHz, Bw = 16.000 MH No calibration applied and no bandpass applied

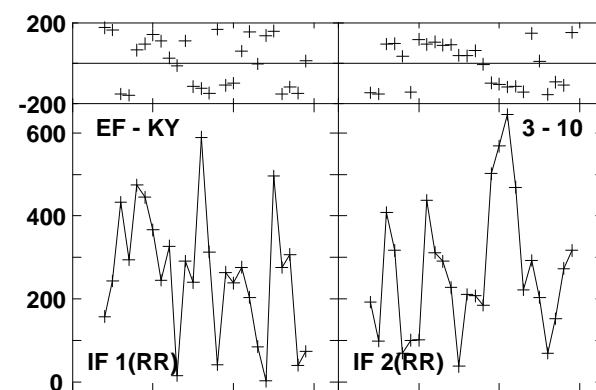
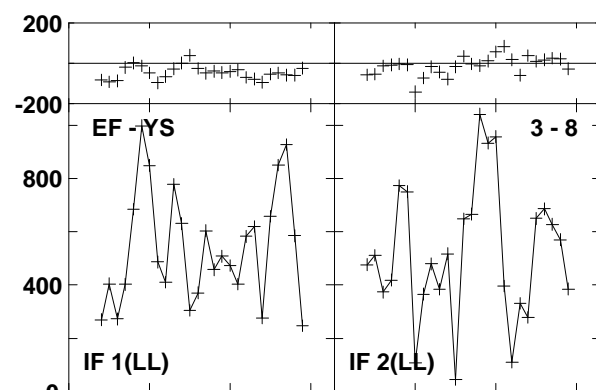
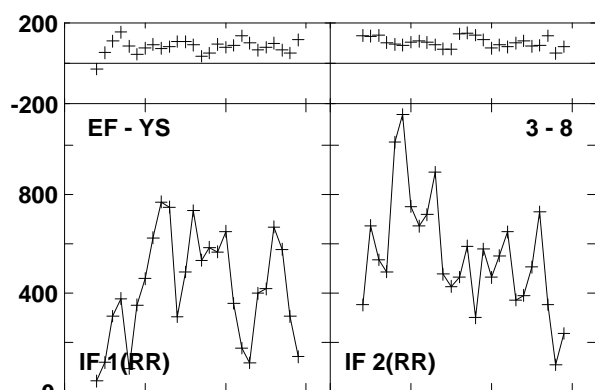
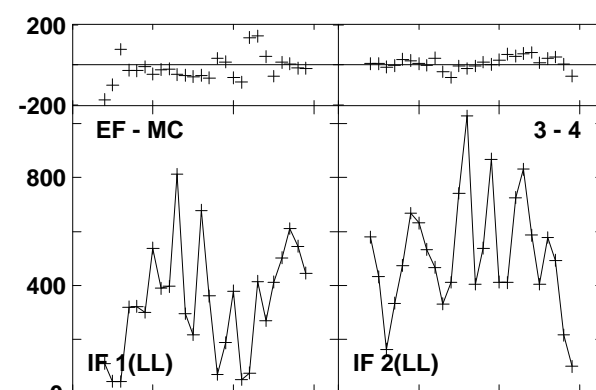
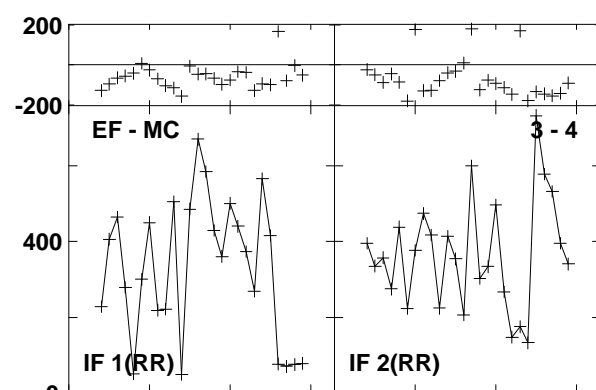
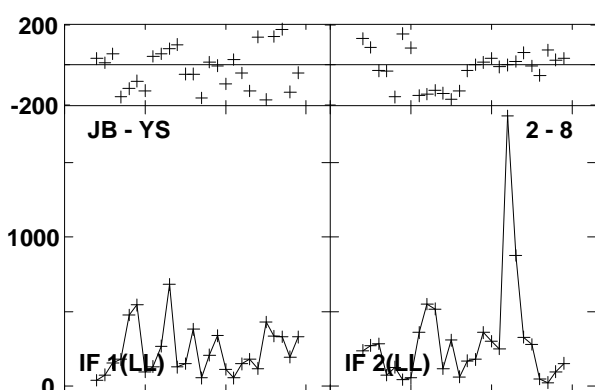
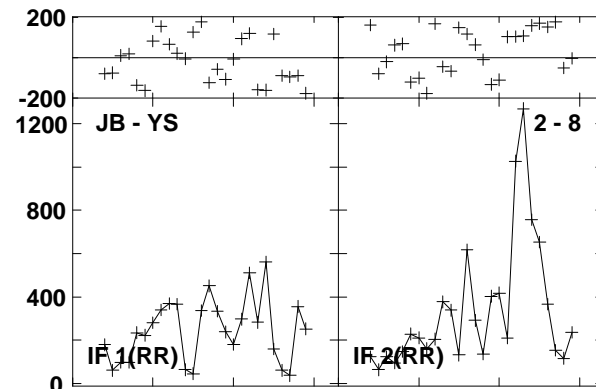
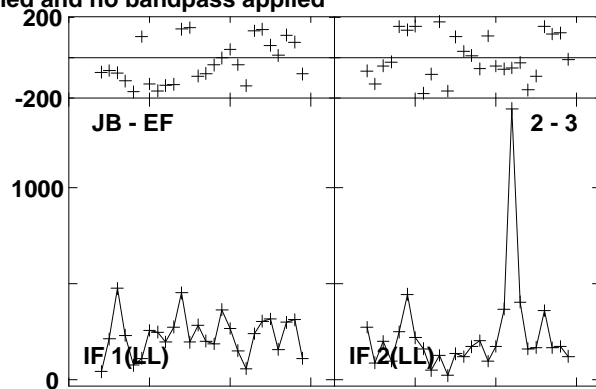
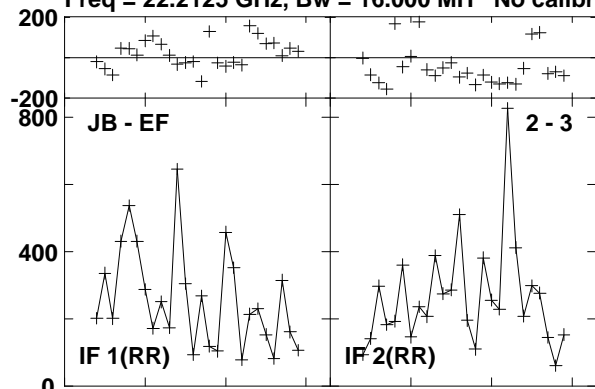

Lower frame: Micro Ampl Jy Top frame: Phas deg  
Vector averaged cross-power spectrum Baseline: JB (02) - EF (03)  
Timerange: 00/10:51:01 to 00/10:51:20



Plot file version 161 created 23-AUG-2016 15:00:48

0219+628 GA035B 1.UVDATA.1

Freq = 22.2125 GHz, Bw = 16.000 MH No calibration applied and no bandpass applied

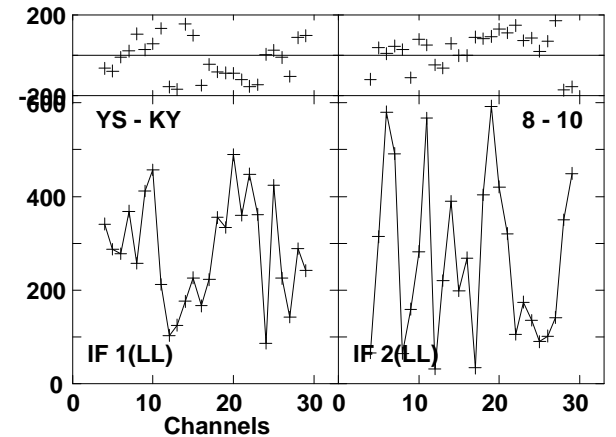
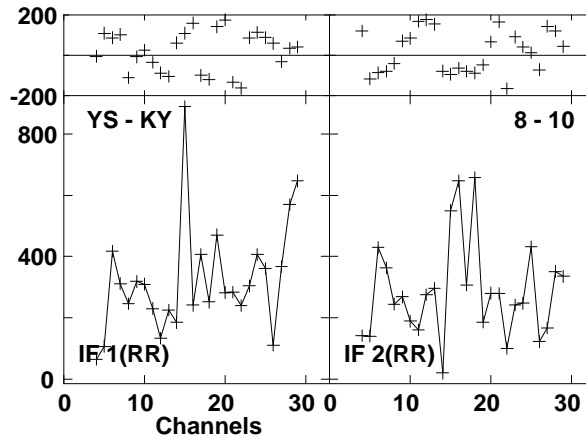
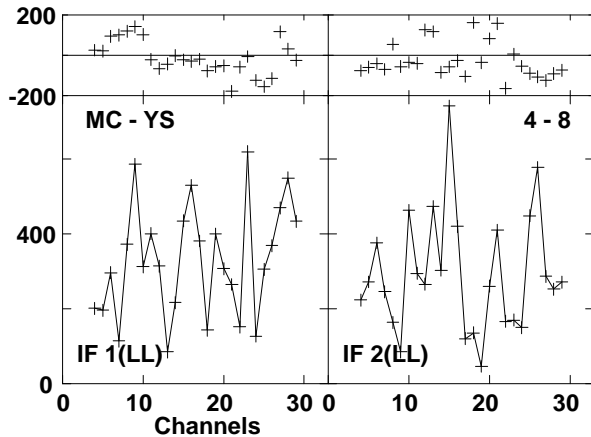
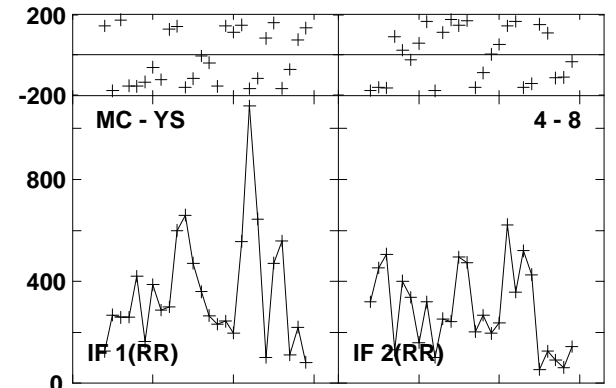
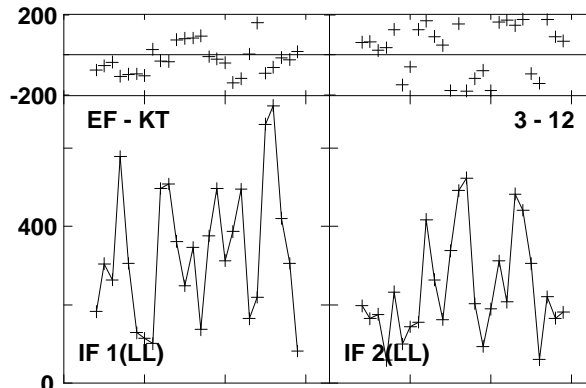
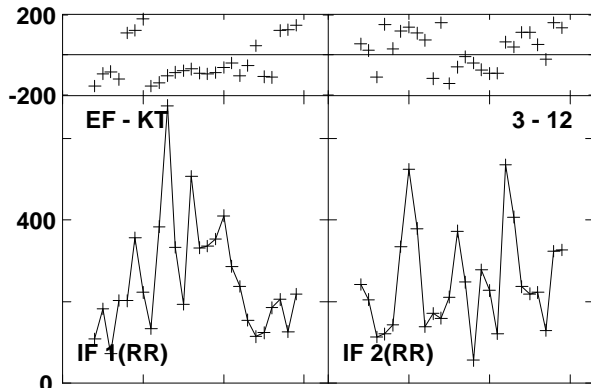
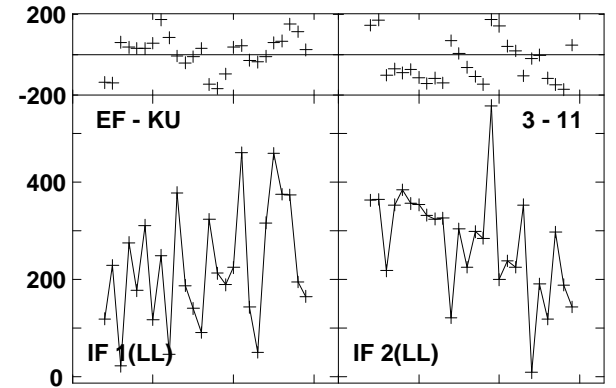
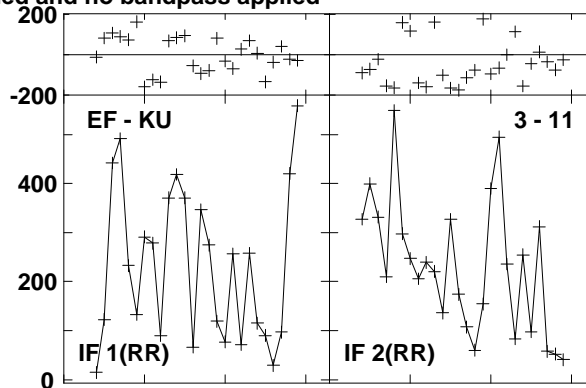
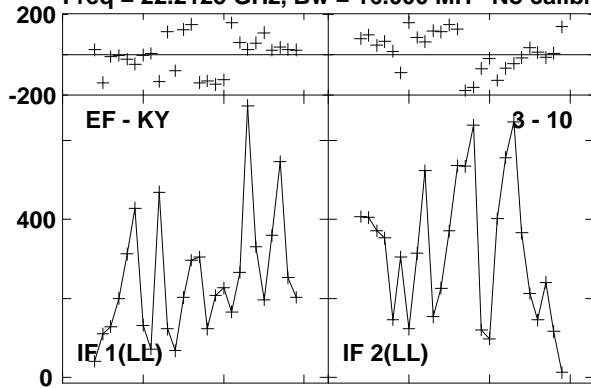

Lower frame: Micro Ampl Jy Top frame: Phas deg  
Vector averaged cross-power spectrum Baseline: EF (03) - KY (10)  
Timerange: 00/10:51:01 to 00/10:51:20

Plot file version 162 created 23-AUG-2016 15:00:48

0219+628 GA035B 1.UVDATA.1

Freq = 22.2125 GHz, Bw = 16.000 MH No calibration applied and no bandpass applied

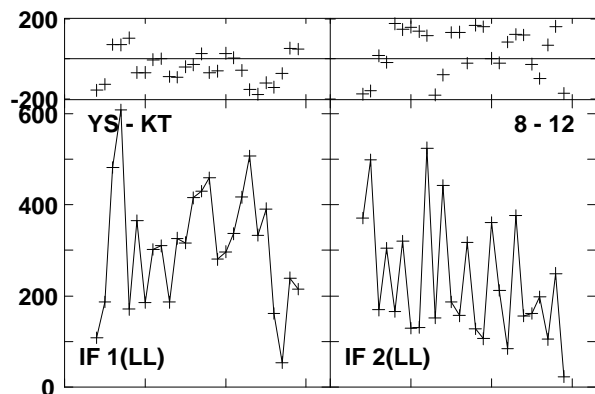
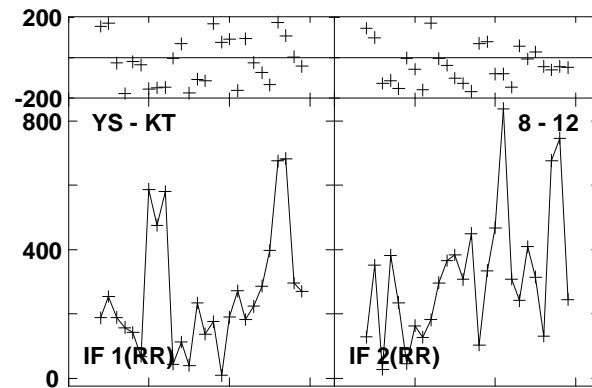
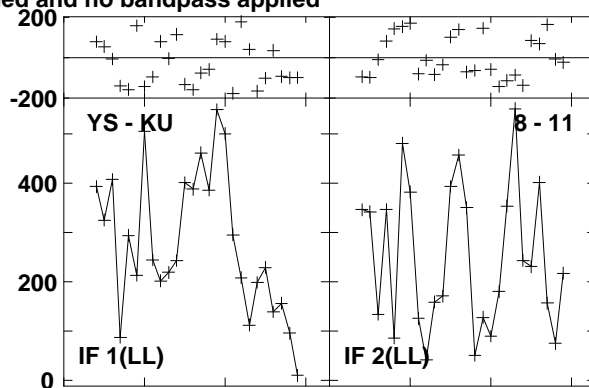
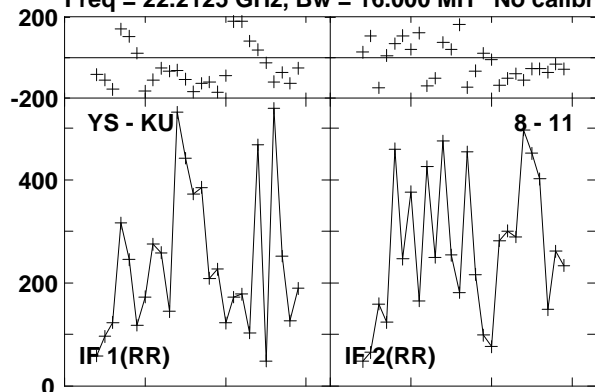

Lower frame: Micro Ampl Jy Top frame: Phas deg  
Vector averaged cross-power spectrum Baseline: YS (08) - KU (11)  
Timerange: 00/10:51:01 to 00/10:51:20

Plot file version 163 created 23-AUG-2016 15:00:48  
 W3IRS5 GA035B 1.UVDATA.1

Freq = 22.2125 GHz, Bw = 16.000 MH No calibration applied and no bandpass applied

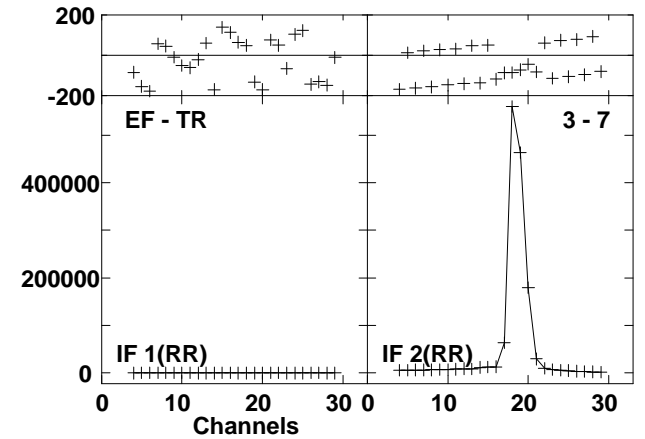
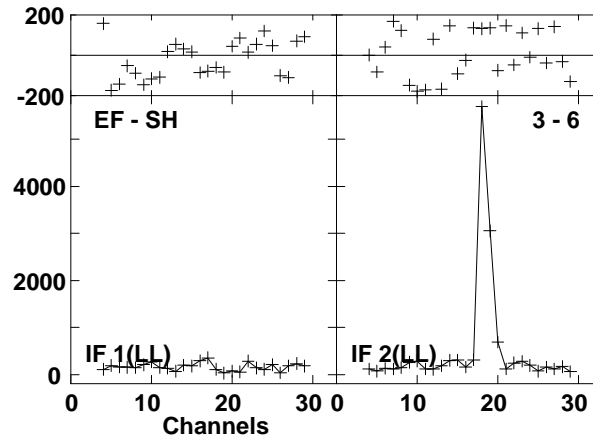
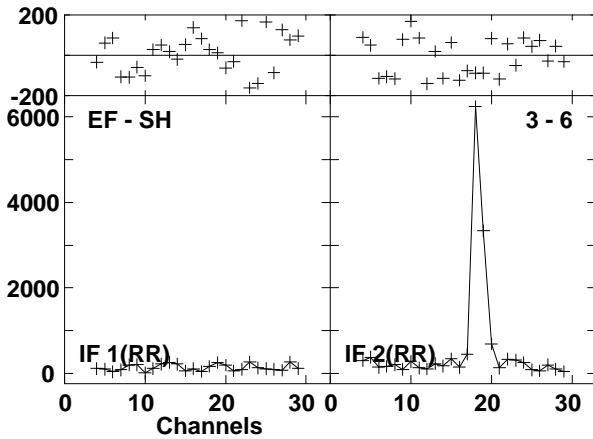
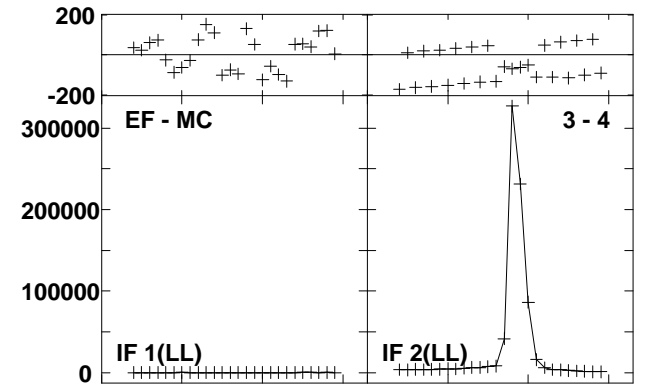
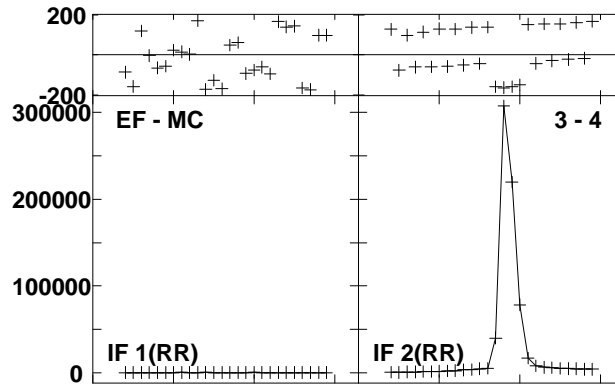
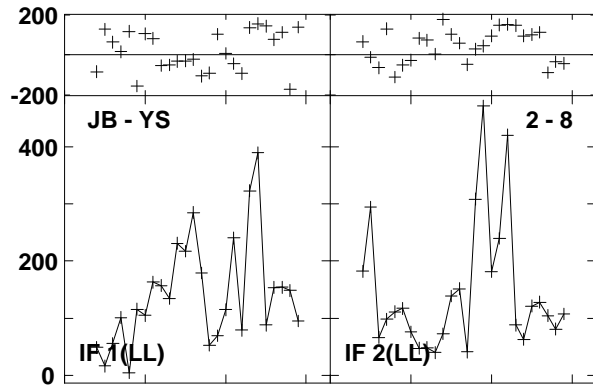
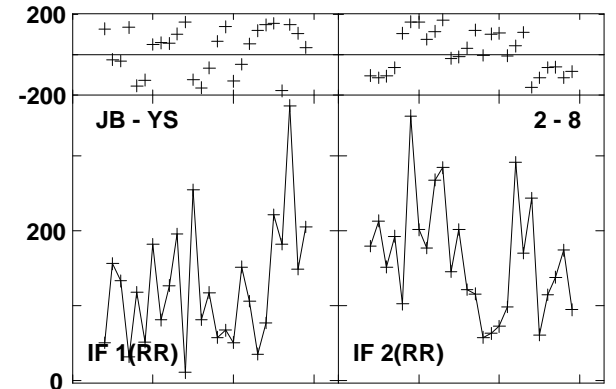
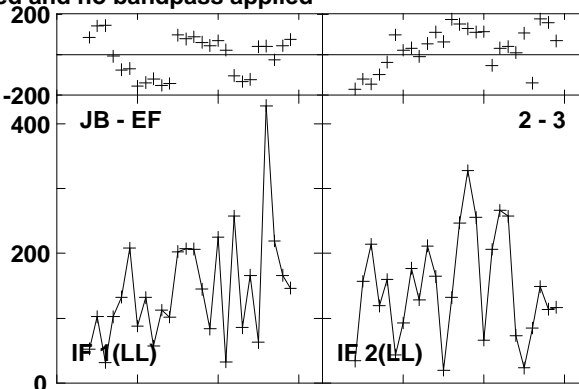
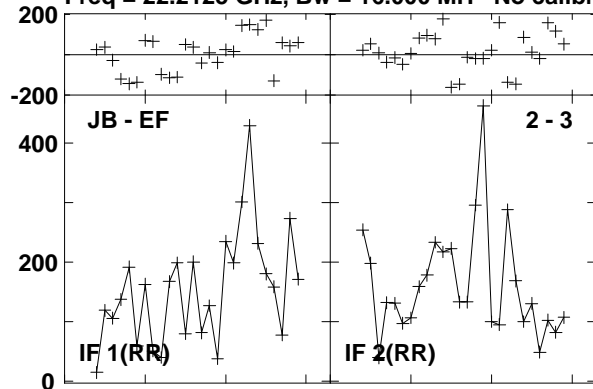

Lower frame: Micro Ampl Jy Top frame: Phas deg  
 Vector averaged cross-power spectrum Baseline: JB (02) - EF (03)  
 Timerange: 00/10:51:45 to 00/10:52:44

Plot file version 164 created 23-AUG-2016 15:00:48  
W3IRS5 GA035B 1.UVDATA.1

Freq = 22.2125 GHz, Bw = 16.000 MH No calibration applied and no bandpass applied

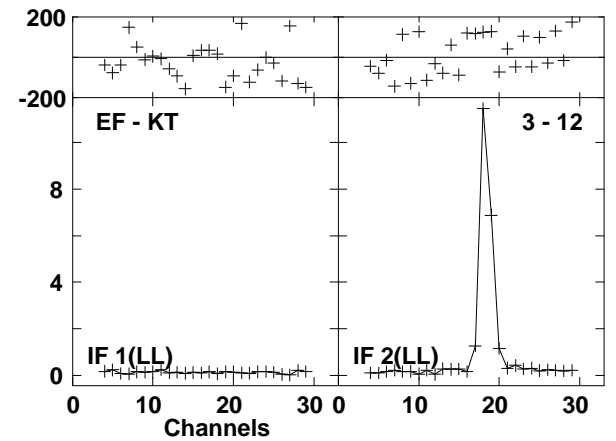
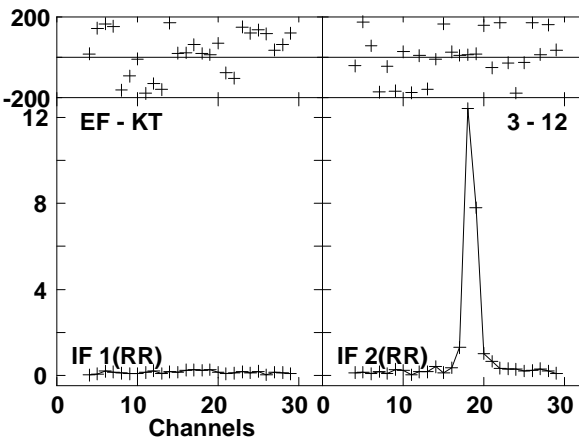
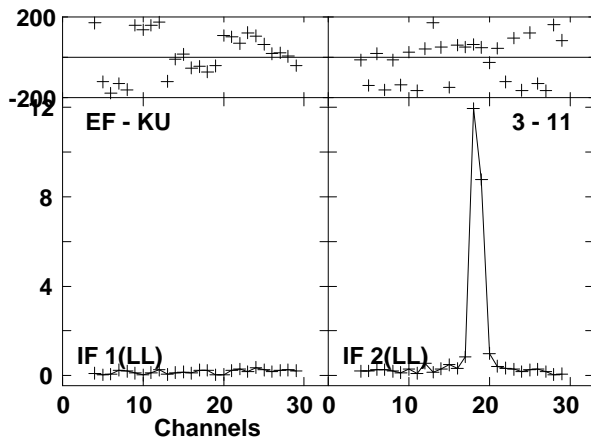
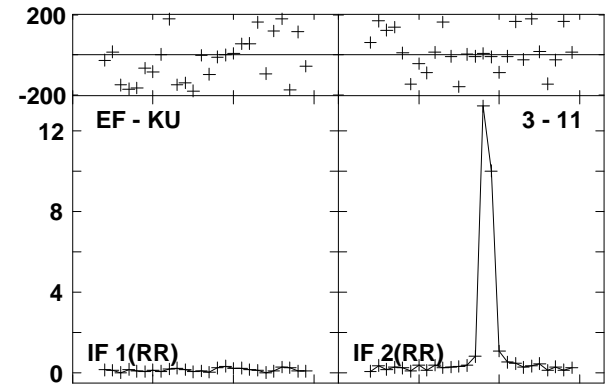
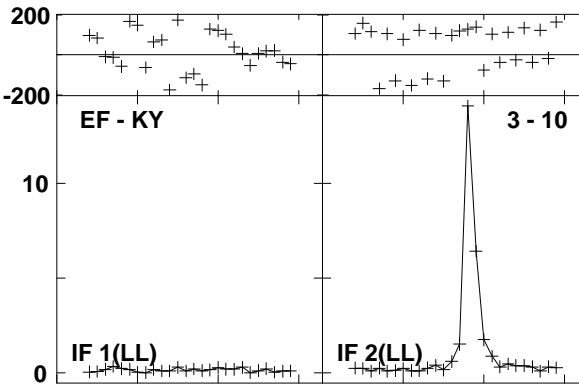
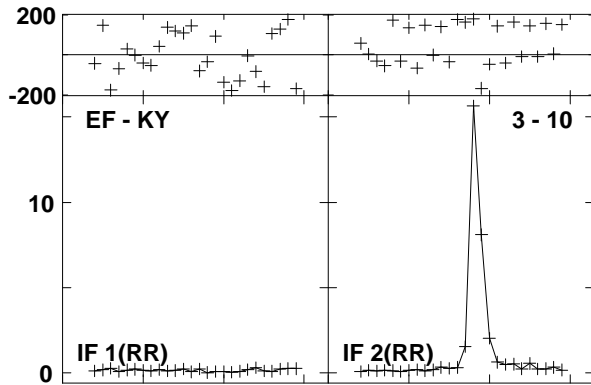
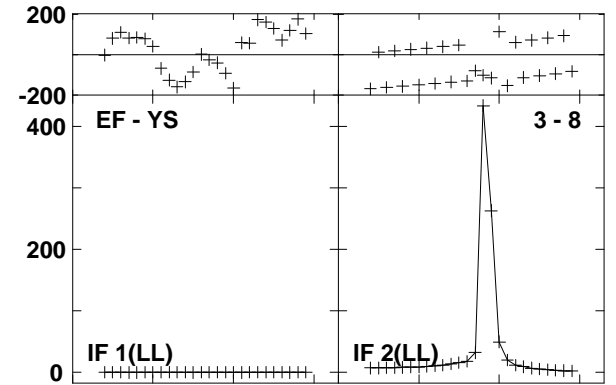
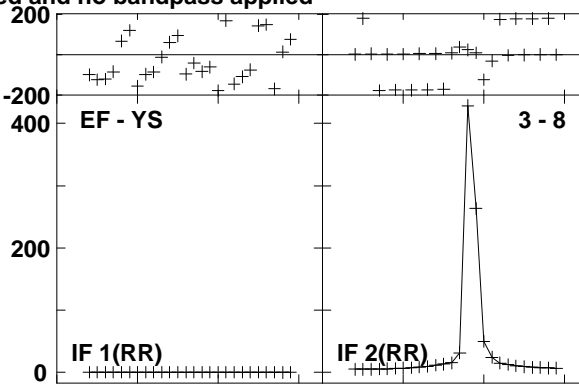
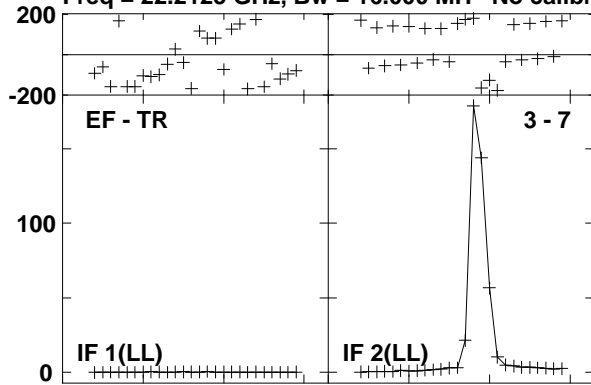

Lower frame: Milli Ampl Jy Top frame: Phas deg  
Vector averaged cross-power spectrum Baseline: EF (03) - TR (07)  
Timerange: 00/10:51:45 to 00/10:52:44

Plot file version 165 created 23-AUG-2016 15:00:48

W3IRS5 GA035B 1.UVDATA.1

Freq = 22.2125 GHz, Bw = 16.000 MH No calibration applied and no bandpass applied

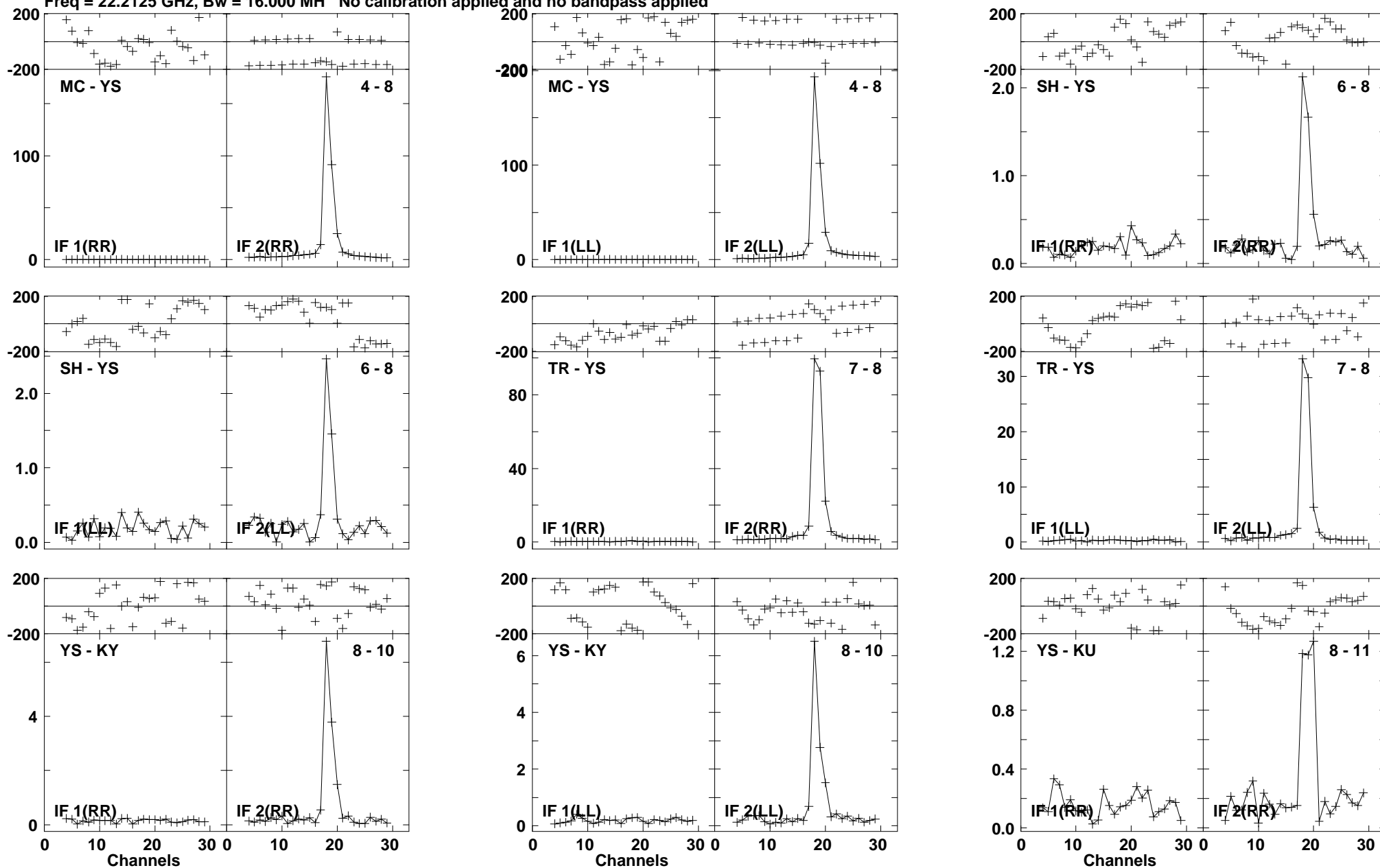

Lower frame: Milli Ampl Jy Top frame: Phas deg  
Vector averaged cross-power spectrum Baseline: MC (04) - YS (08)  
Timerange: 00/10:51:45 to 00/10:52:44

Plot file version 166 created 23-AUG-2016 15:00:48  
W3IRS5 GA035B 1.UVDATA.1

Freq = 22.2125 GHz, Bw = 16.000 MH No calibration applied and no bandpass applied

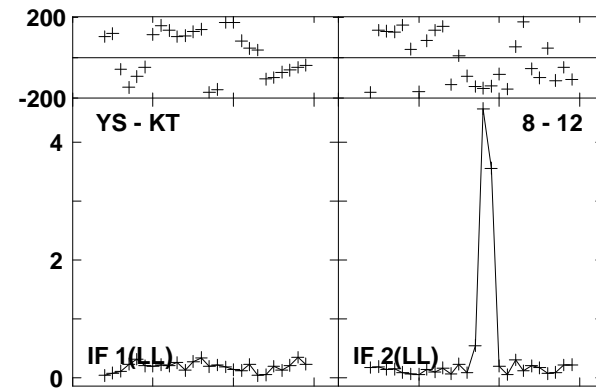
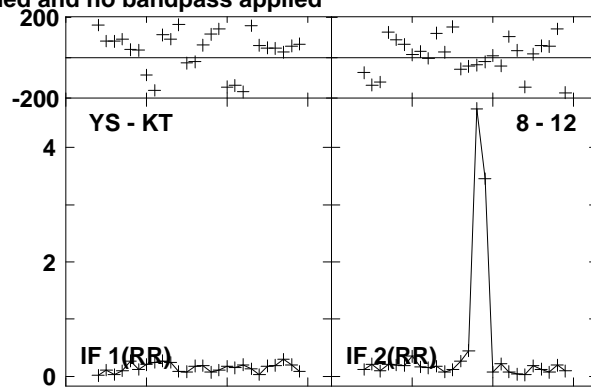
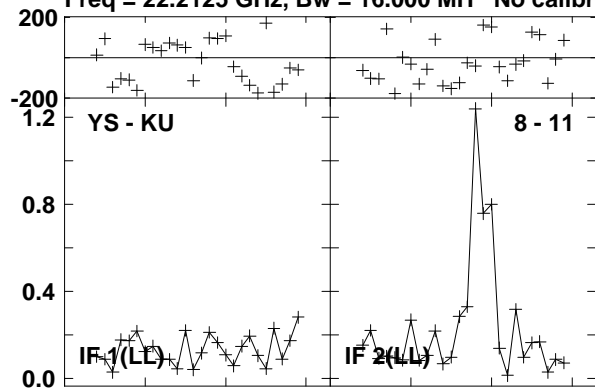

Lower frame: Milli Ampl Jy Top frame: Phas deg  
Vector averaged cross-power spectrum Baseline: YS (08) - KU (11)  
Timerange: 00/10:51:45 to 00/10:52:44

Plot file version 167 created 23-AUG-2016 15:00:48

0219+628 GA035B 1.UVDATA.1

Freq = 22.2125 GHz, Bw = 16.000 MH No calibration applied and no bandpass applied

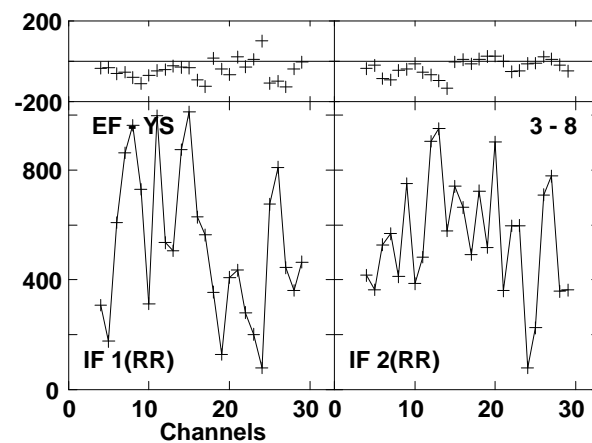
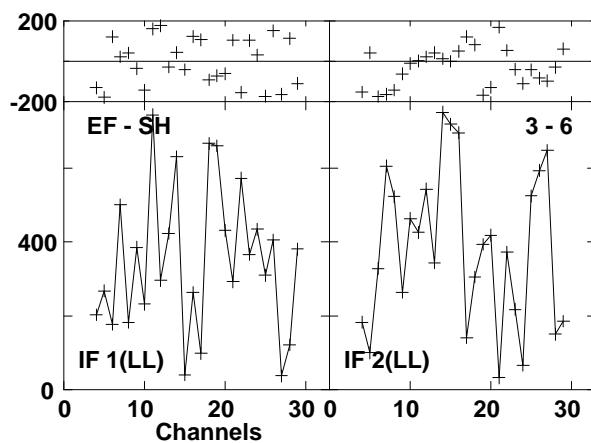
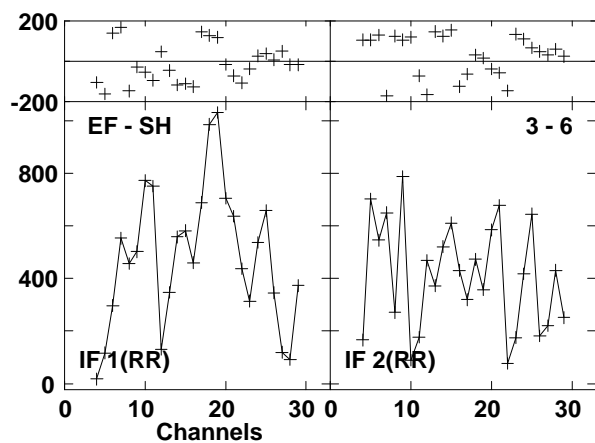
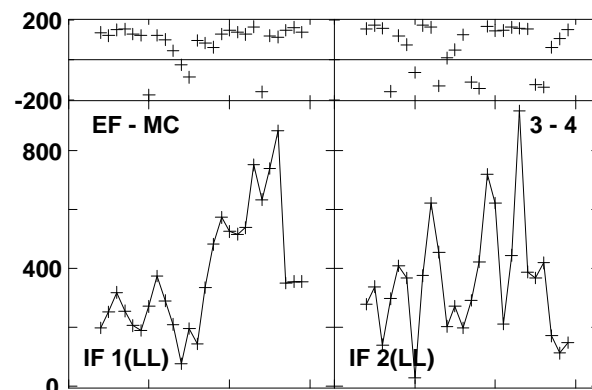
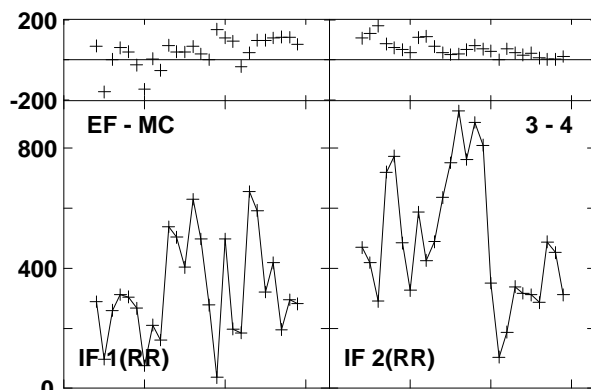
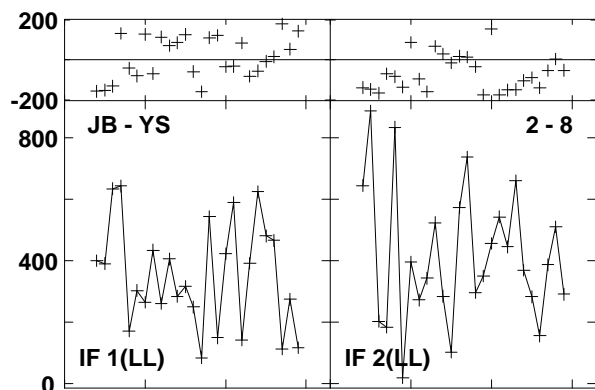
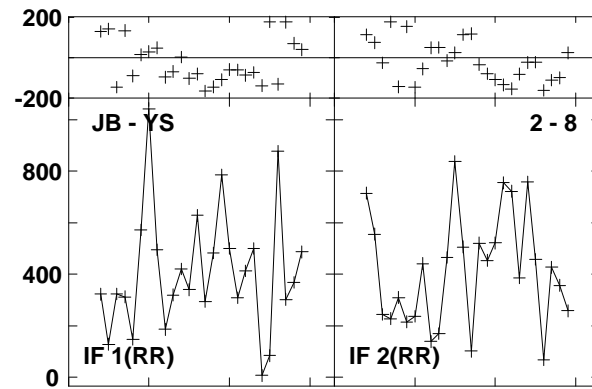
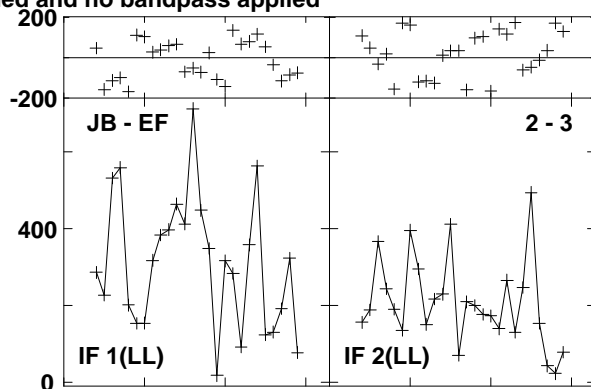
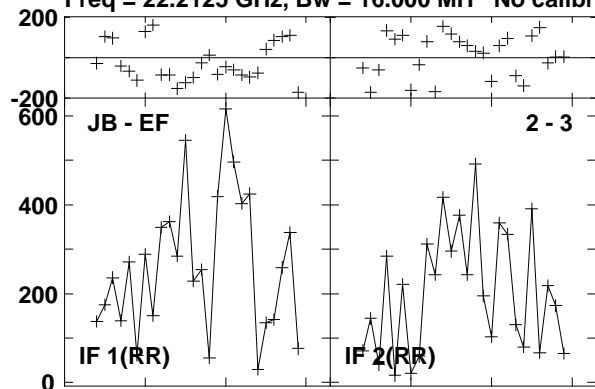

Lower frame: Micro Ampl Jy Top frame: Phas deg  
Vector averaged cross-power spectrum Baseline: JB (02) - EF (03)  
Timerange: 00/10:53:10 to 00/10:53:30

Plot file version 168 created 23-AUG-2016 15:00:48

0219+628 GA035B 1.UVDATA.1

Freq = 22.2125 GHz, Bw = 16.000 MH No calibration applied and no bandpass applied

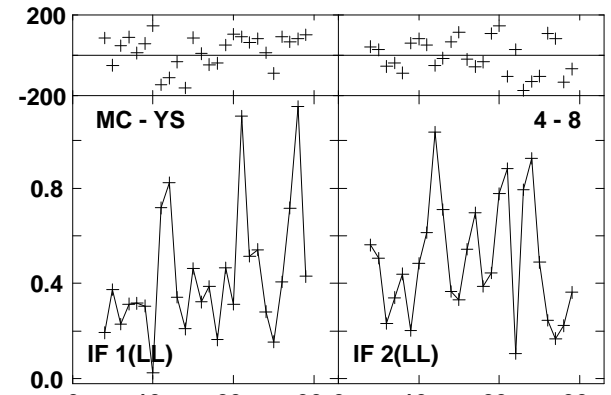
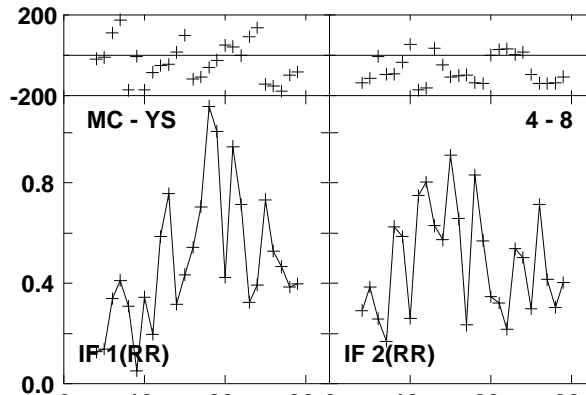
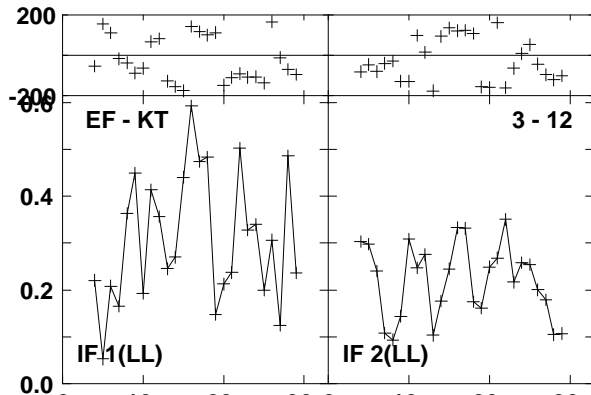
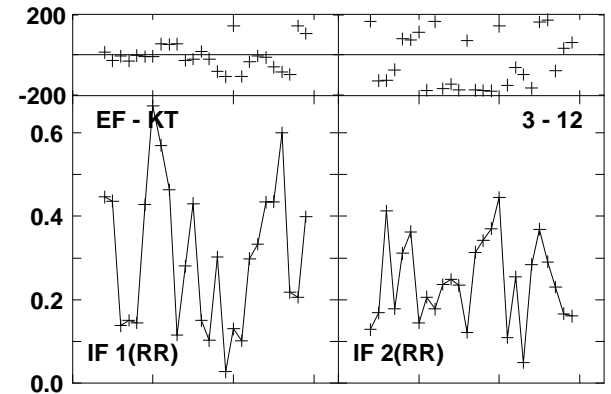
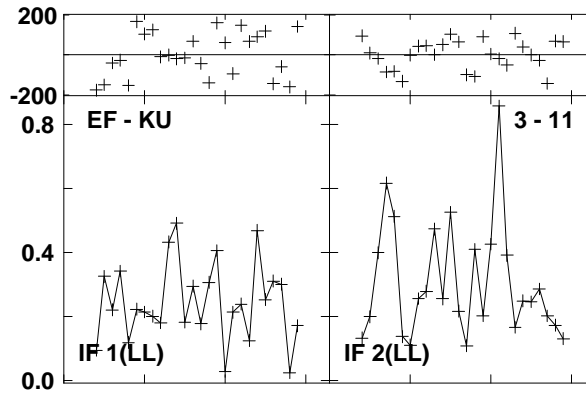
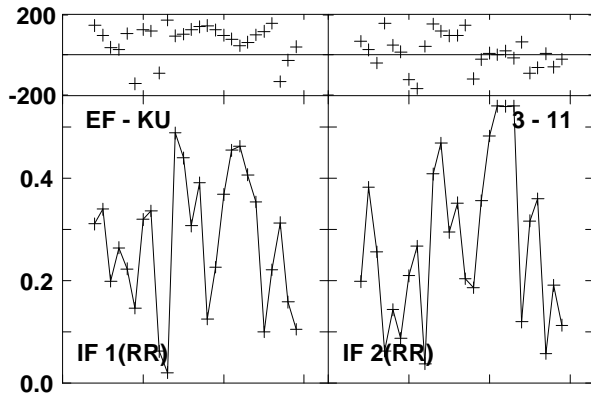
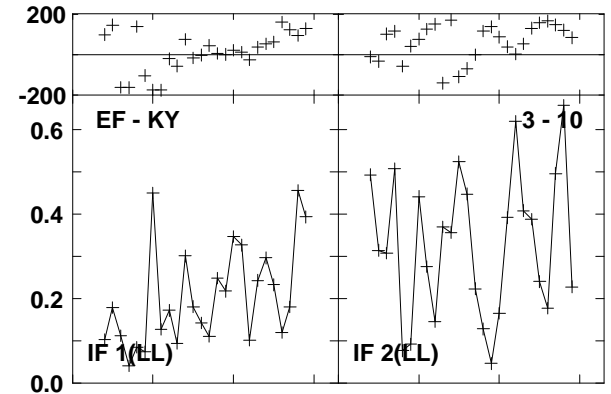
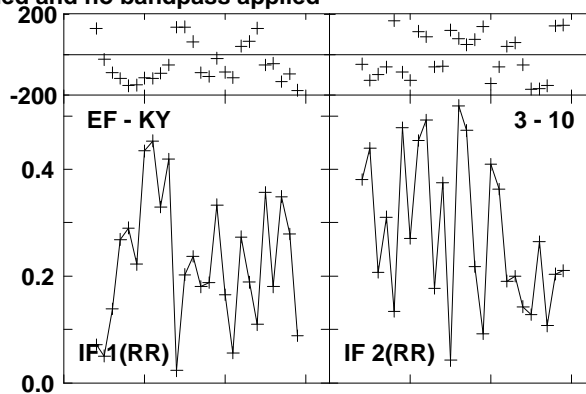
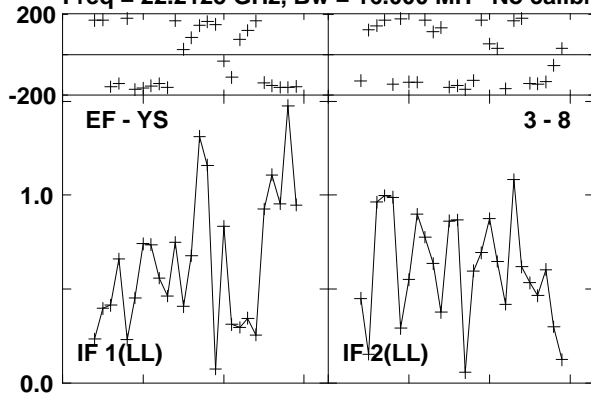

Lower frame: Milli Ampl Jy Top frame: Phas deg  
Vector averaged cross-power spectrum Baseline: EF (03) - YS (08)  
Timerange: 00/10:53:10 to 00/10:53:30



Plot file version 169 created 23-AUG-2016 15:00:48

0219+628 GA035B 1.UVDATA.1

Freq = 22.2125 GHz, Bw = 16.000 MH No calibration applied and no bandpass applied

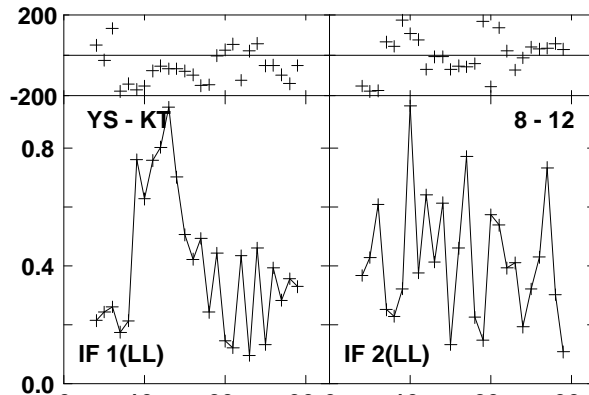
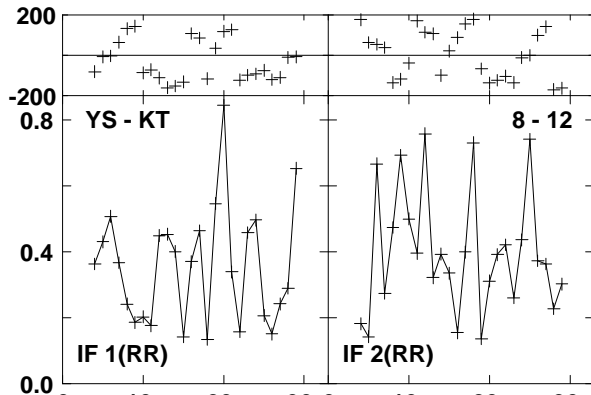
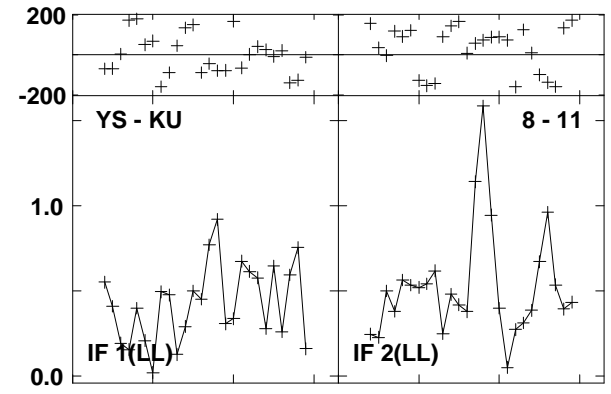
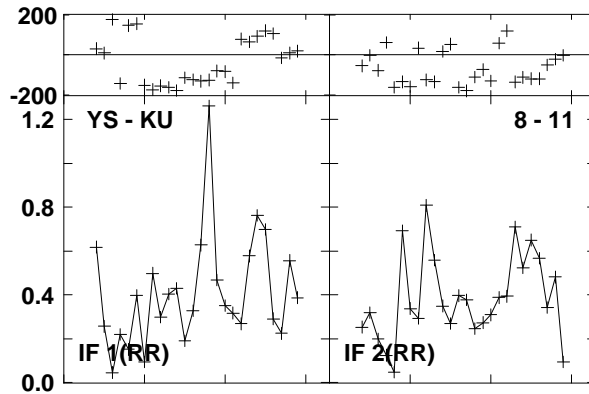
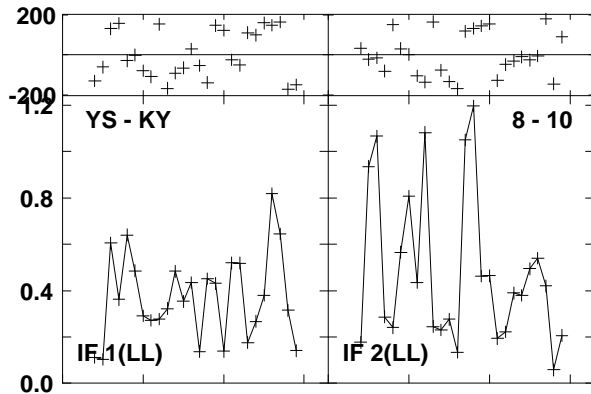
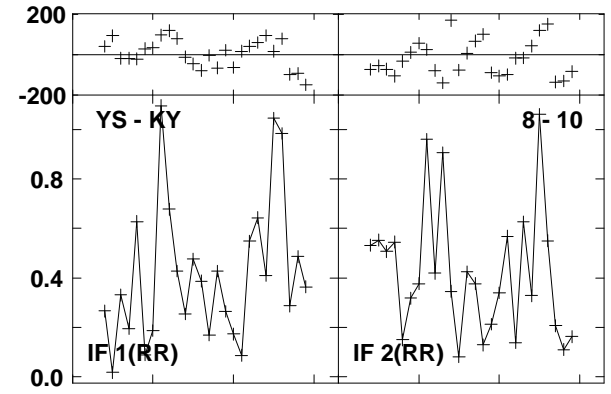
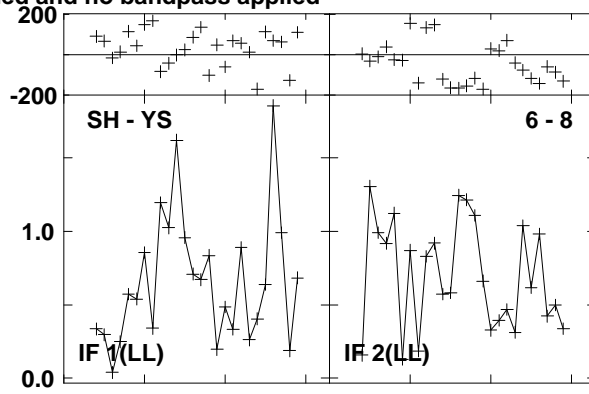
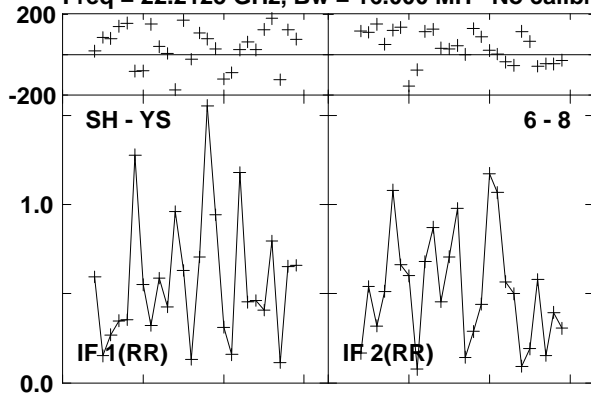

Lower frame: Milli Ampl Jy Top frame: Phas deg

Vector averaged cross-power spectrum Baseline: SH (06) - YS (08)

Timerange: 00/10:53:10 to 00/10:53:30

Plot file version 170 created 23-AUG-2016 15:00:48

W3IRS5 GA035B 1.UVDATA.1

Freq = 22.2125 GHz, Bw = 16.000 MH No calibration applied and no bandpass applied

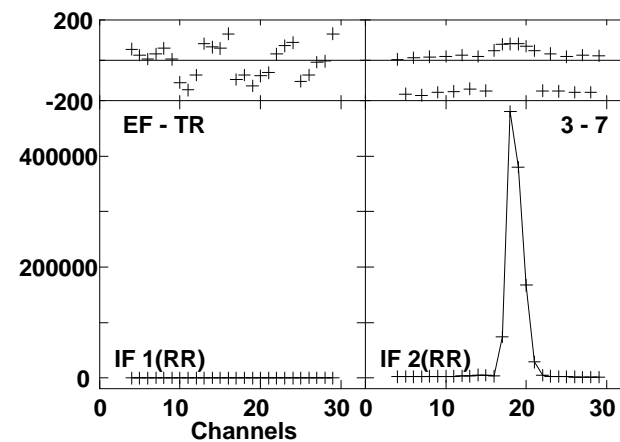
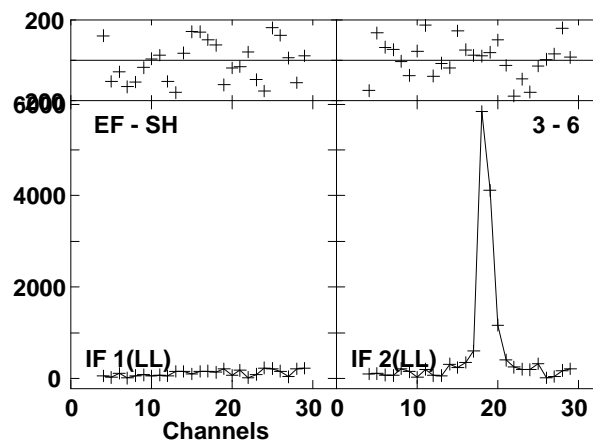
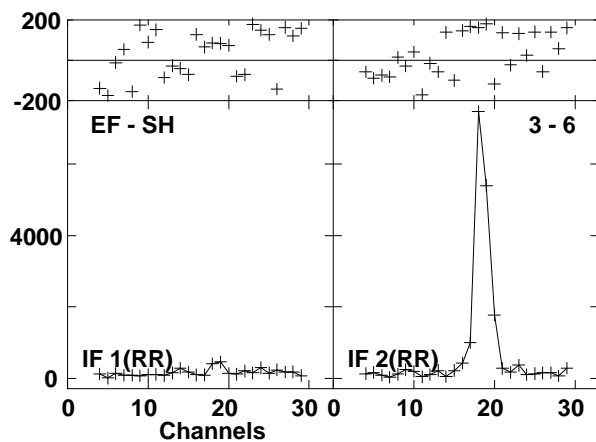
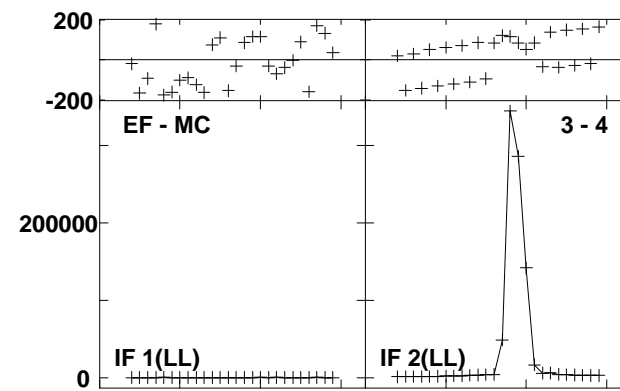
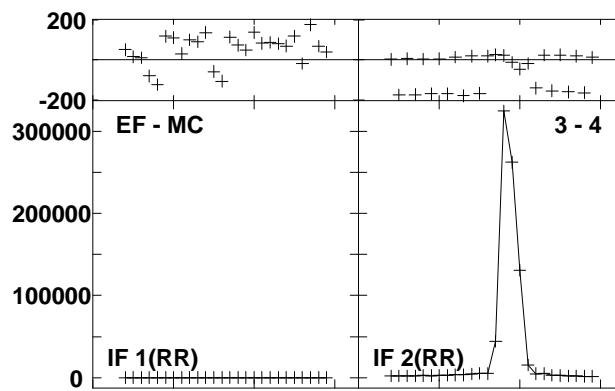
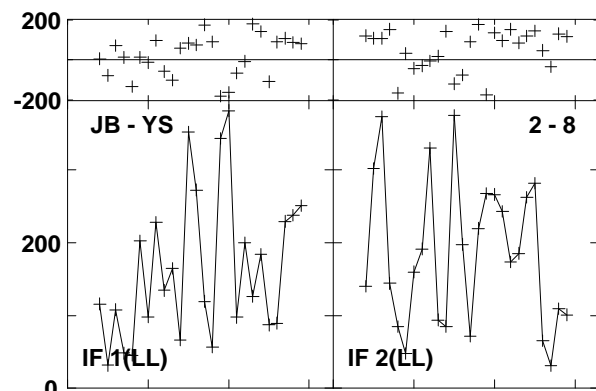
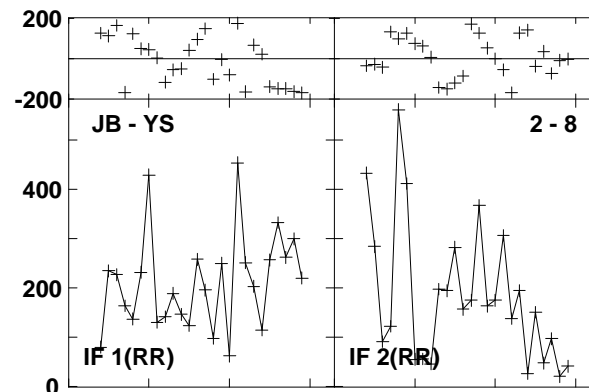
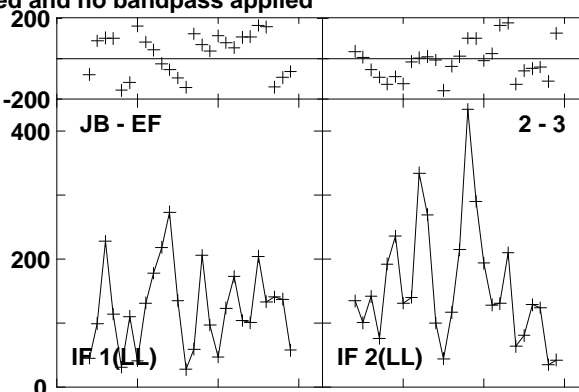
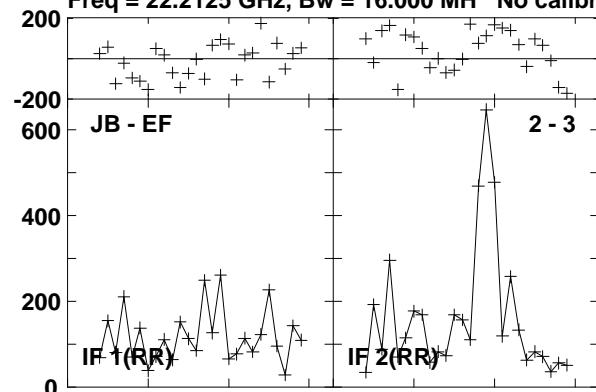

Lower frame: Micro Ampl Jy Top frame: Phas deg  
Vector averaged cross-power spectrum Baseline: JB (02) - EF (03)  
Timerange: 00/10:53:56 to 00/10:54:54

Plot file version 171 created 23-AUG-2016 15:00:48

W3IRS5 GA035B 1.UVDATA.1

Freq = 22.2125 GHz, Bw = 16.000 MH No calibration applied and no bandpass applied

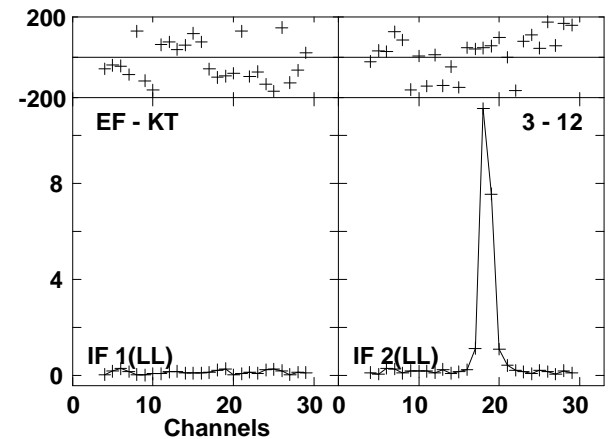
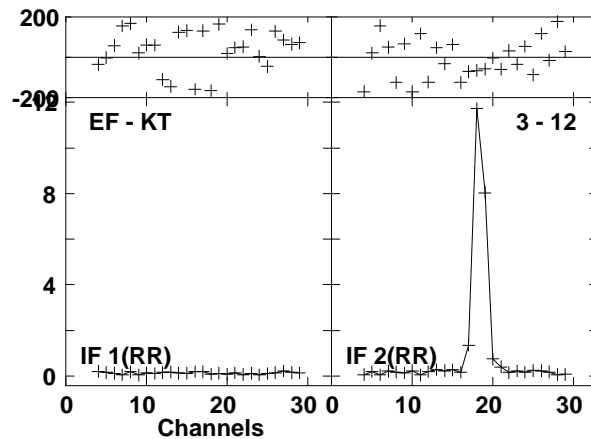
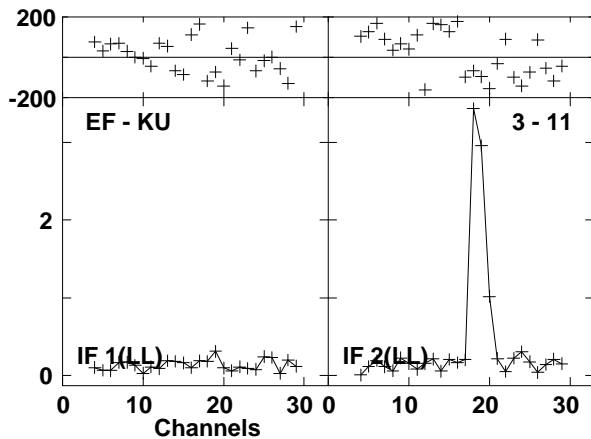
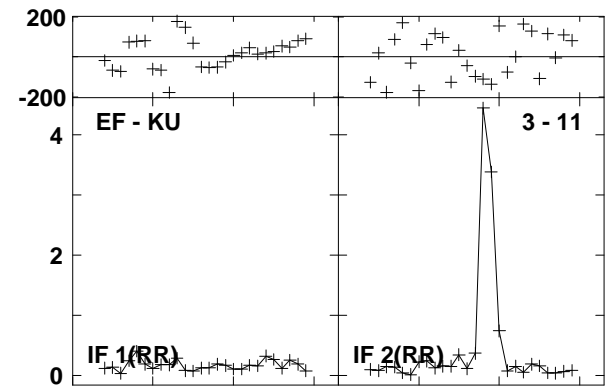
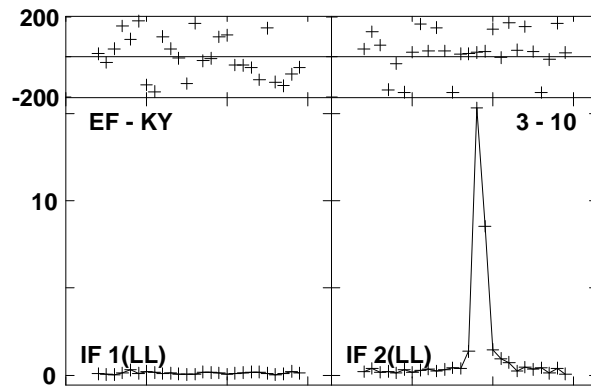
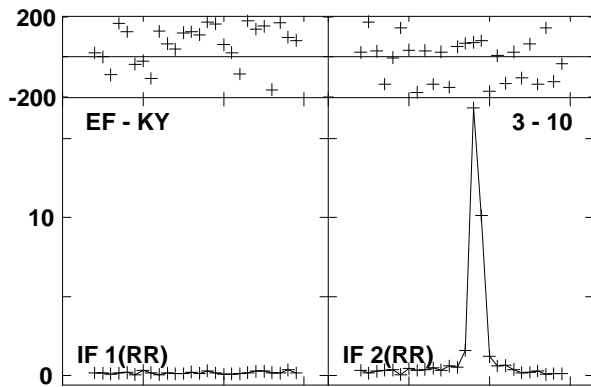
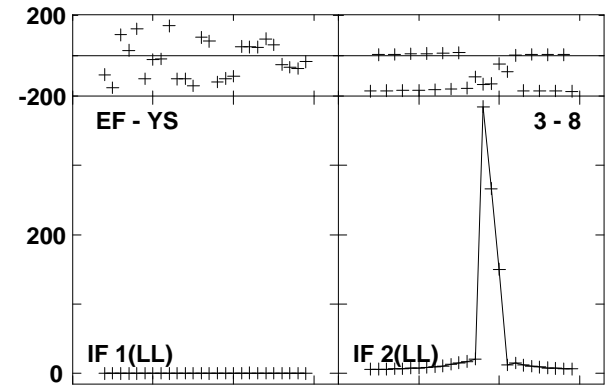
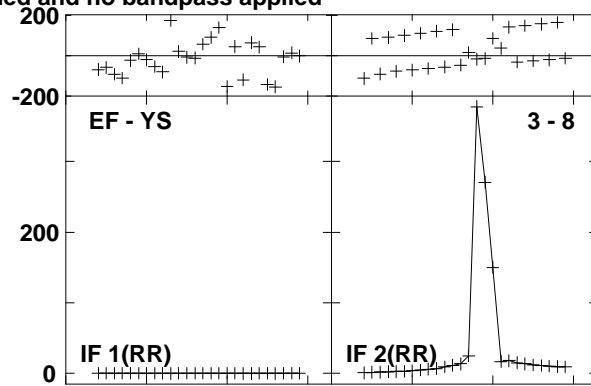
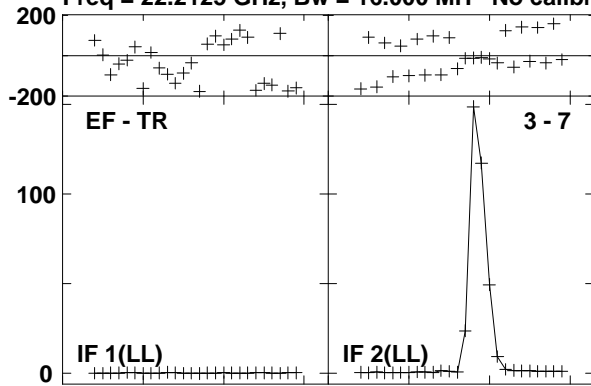

Lower frame: Milli Ampl Jy Top frame: Phas deg  
Vector averaged cross-power spectrum Baseline: EF (03) - TR (07)  
Timerange: 00/10:53:56 to 00/10:54:54

Plot file version 172 created 23-AUG-2016 15:00:48

W3IRS5 GA035B 1.UVDATA.1

Freq = 22.2125 GHz, Bw = 16.000 MH No calibration applied and no bandpass applied

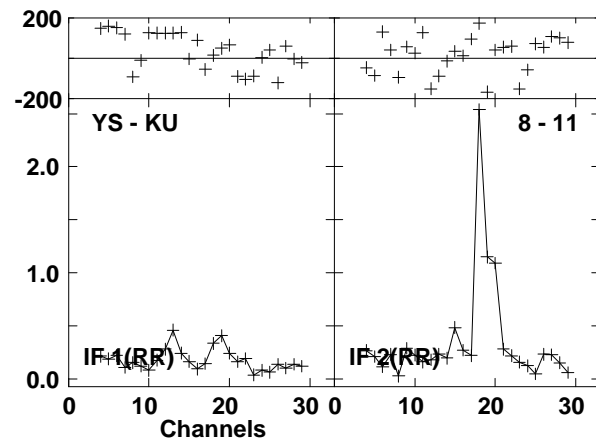
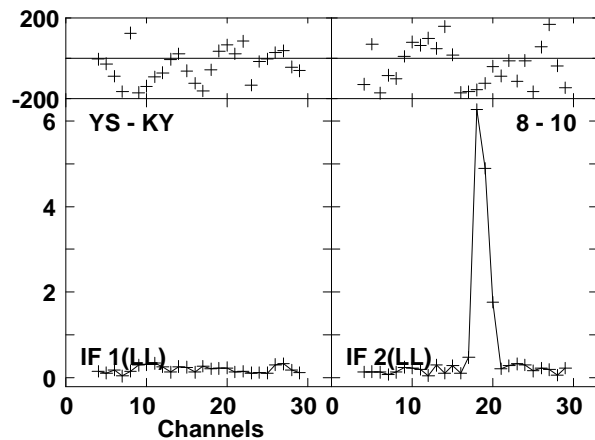
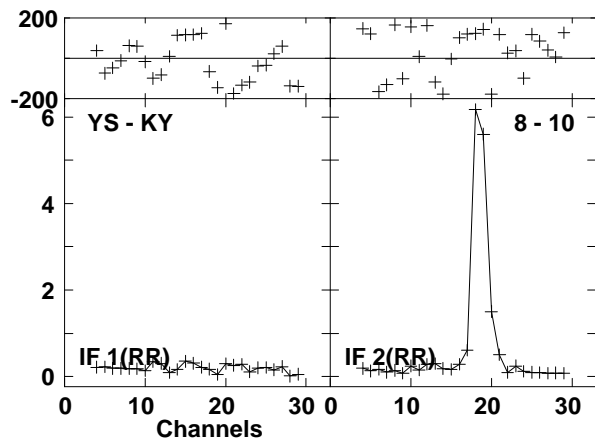
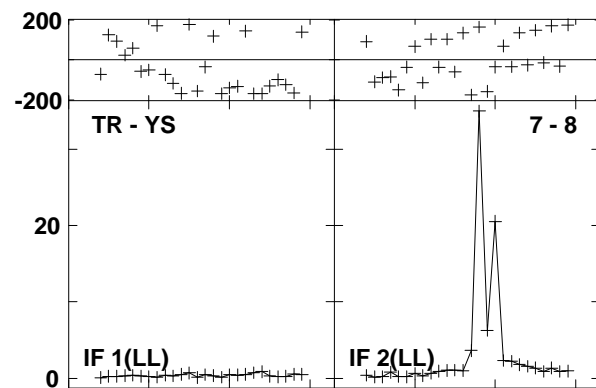
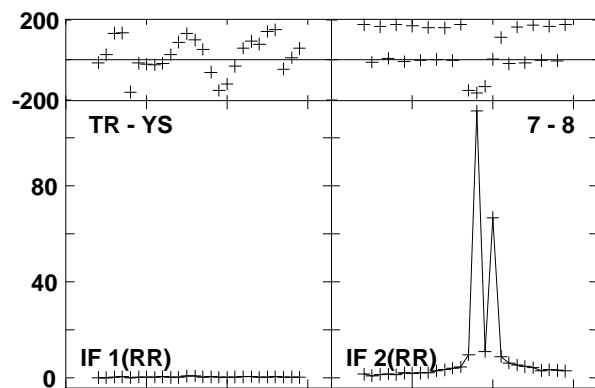
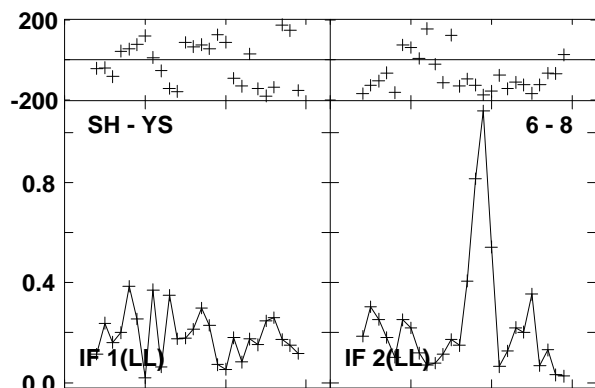
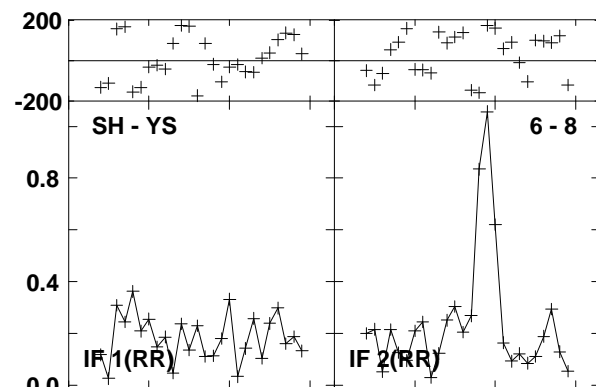
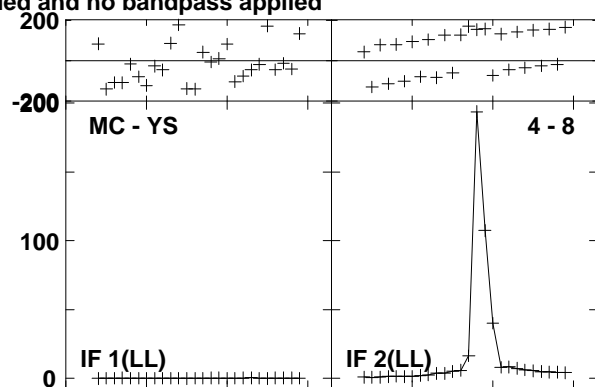
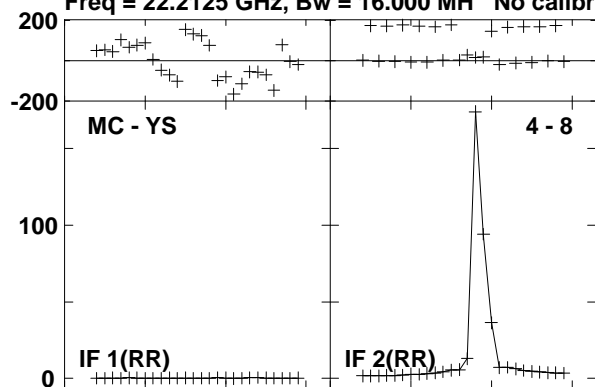

Lower frame: Milli Ampl Jy Top frame: Phas deg  
Vector averaged cross-power spectrum Baseline: MC (04) - YS (08)  
Timerange: 00/10:53:56 to 00/10:54:54

Plot file version 173 created 23-AUG-2016 15:00:48

W3IRS5 GA035B 1.UVDATA.1

Freq = 22.2125 GHz, Bw = 16.000 MH No calibration applied and no bandpass applied

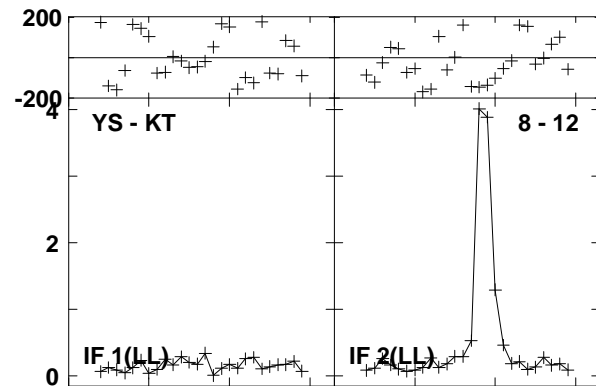
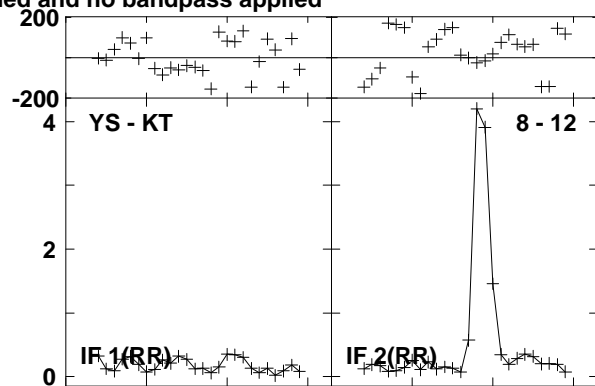
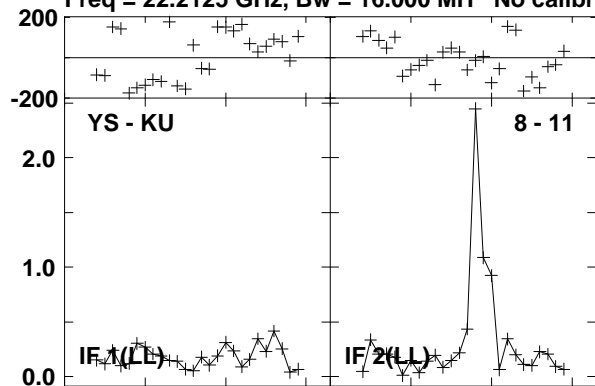

Lower frame: Milli Ampl Jy Top frame: Phas deg  
Vector averaged cross-power spectrum Baseline: YS (08) - KU (11)  
Timerange: 00/10:53:56 to 00/10:54:54

Plot file version 174 created 23-AUG-2016 15:00:48

0219+628 GA035B 1.UVDATA.1

Freq = 22.2125 GHz, Bw = 16.000 MH No calibration applied and no bandpass applied

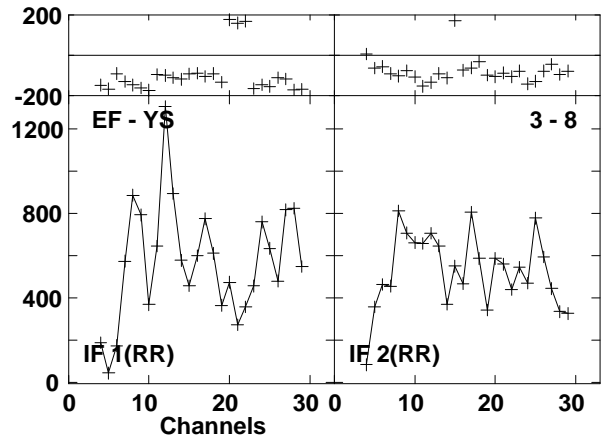
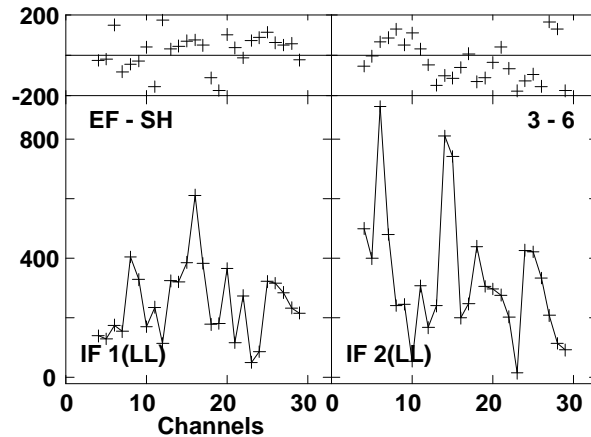
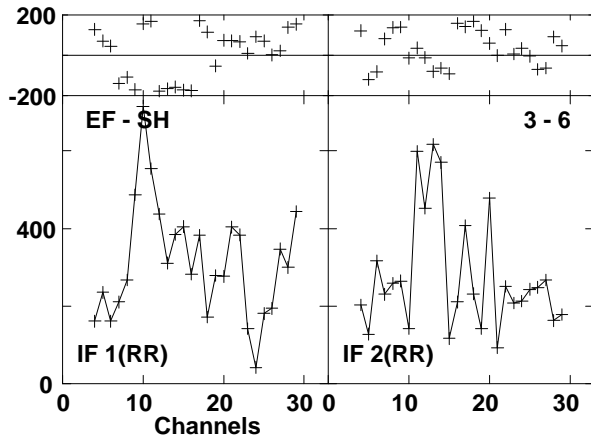
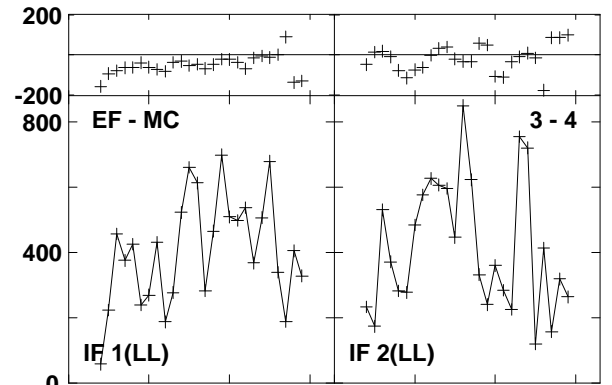
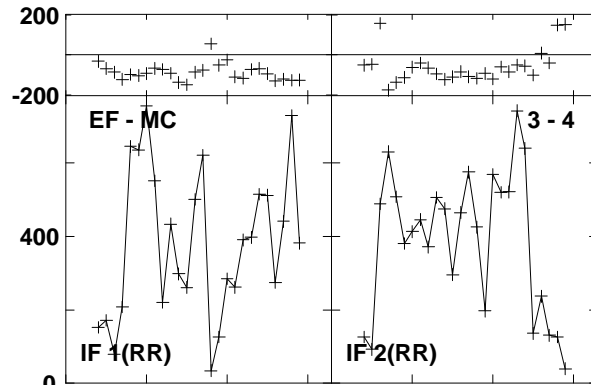
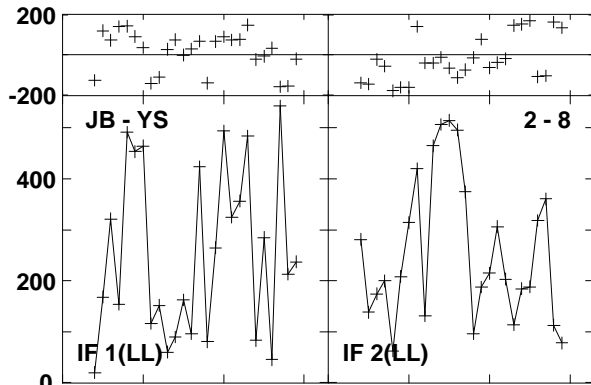
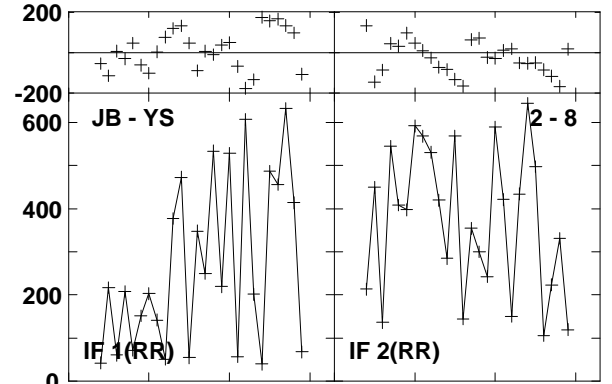
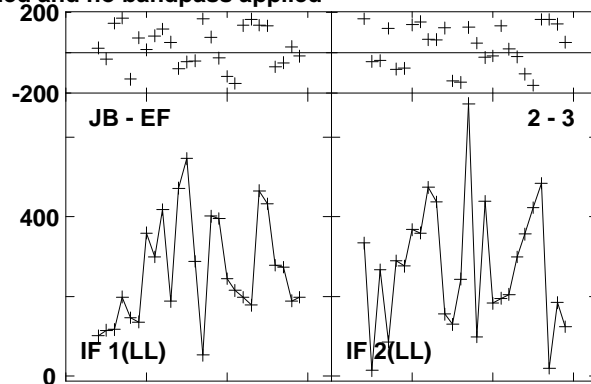
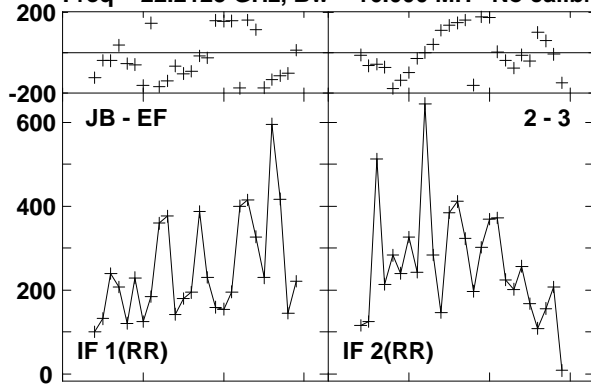

Lower frame: Micro Ampl Jy Top frame: Phas deg  
Vector averaged cross-power spectrum Baseline: JB (02) - EF (03)  
Timerange: 00/10:55:21 to 00/10:55:40

Plot file version 175 created 23-AUG-2016 15:00:48

0219+628 GA035B 1.UVDATA.1

Freq = 22.2125 GHz, Bw = 16.000 MH No calibration applied and no bandpass applied

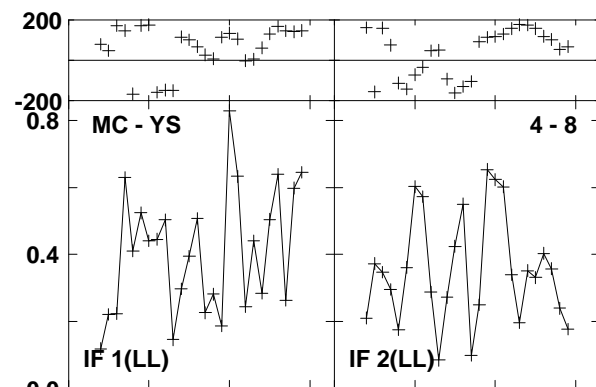
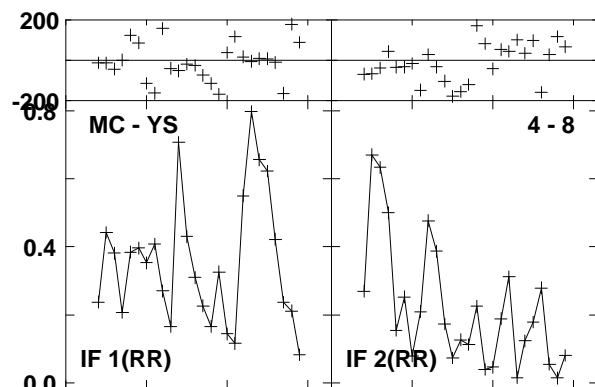
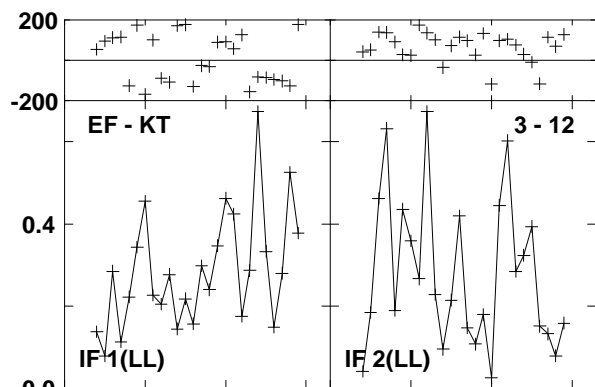
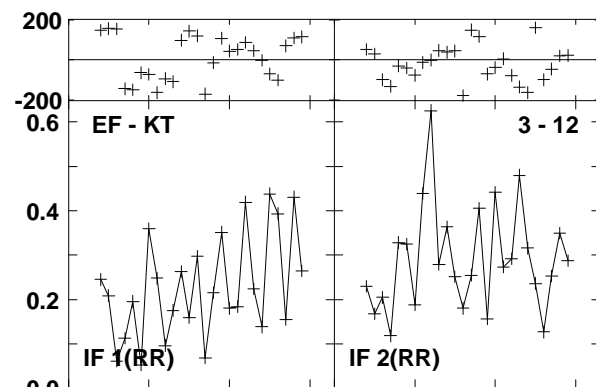
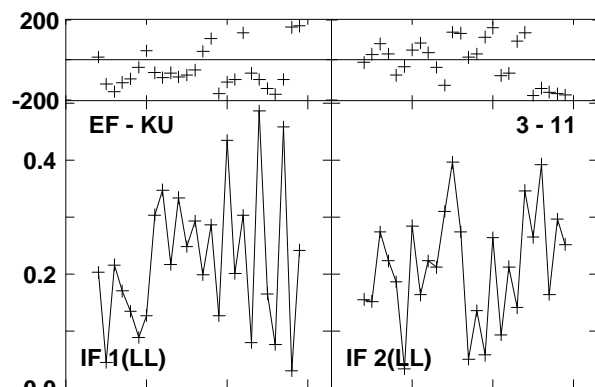
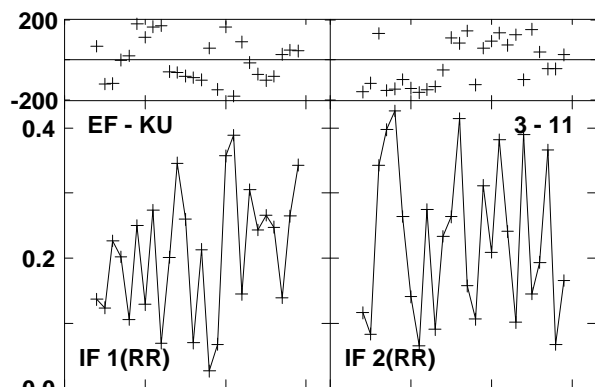
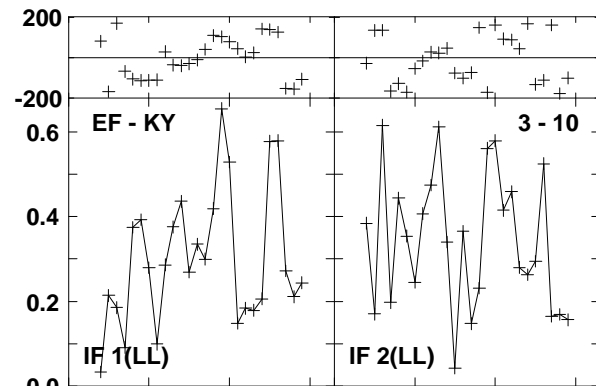
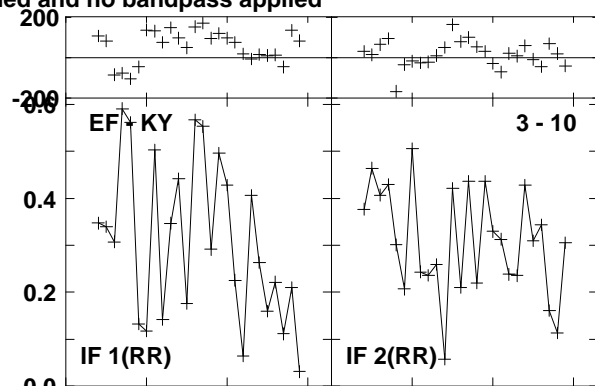
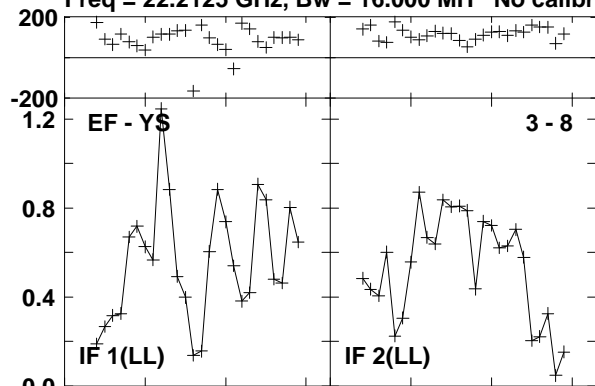

Lower frame: Milli Ampl Jy Top frame: Phas deg

Vector averaged cross-power spectrum Baseline: EF (03) - YS (08)

Timerange: 00/10:55:21 to 00/10:55:40

Plot file version 176 created 23-AUG-2016 15:00:48

0219+628 GA035B 1.UVDATA.1

Freq = 22.2125 GHz, Bw = 16.000 MH No calibration applied and no bandpass applied

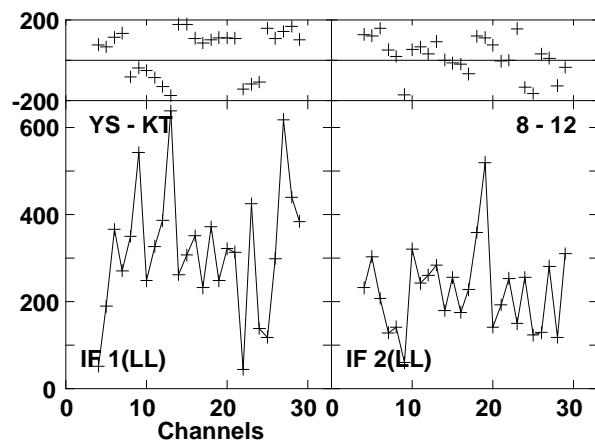
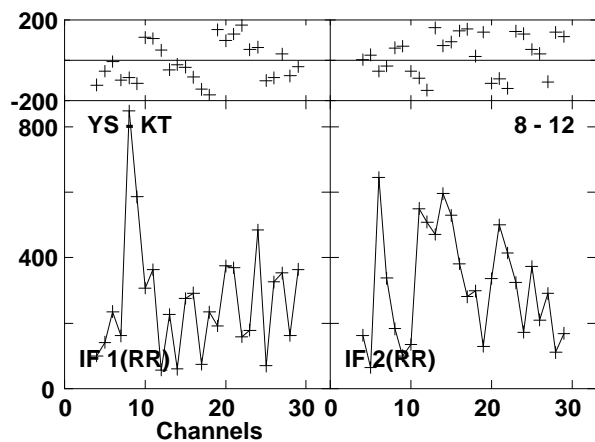
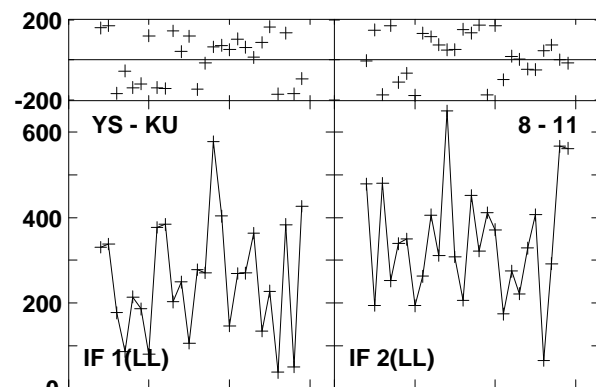
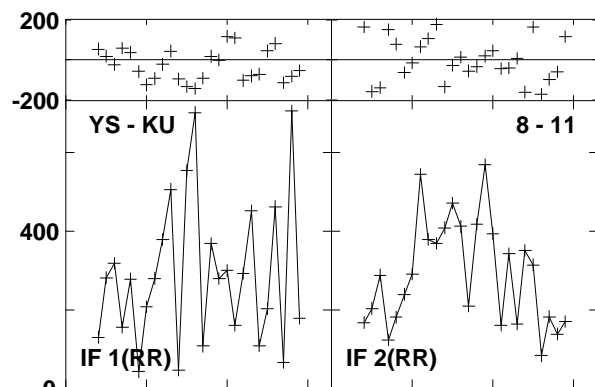
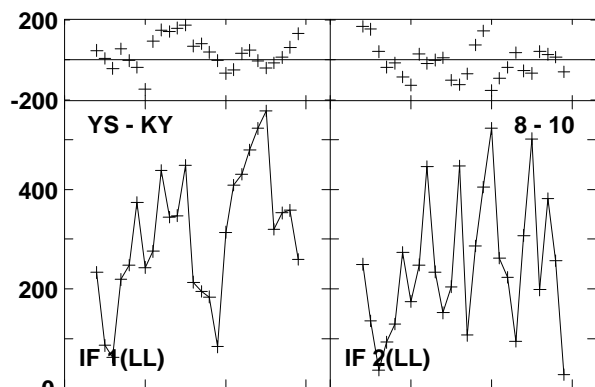
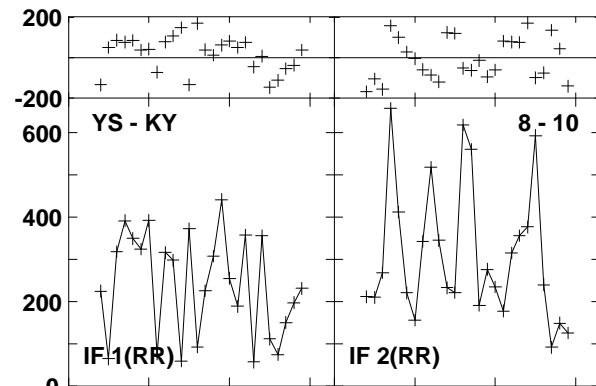
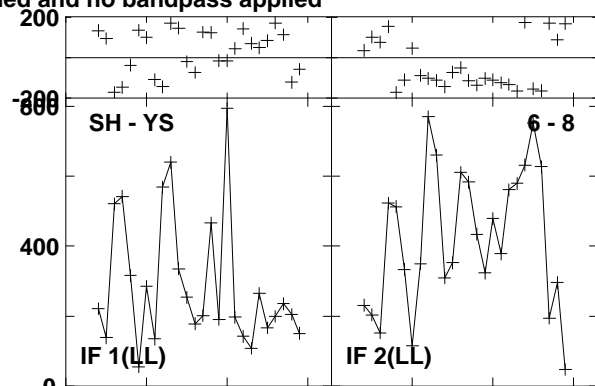
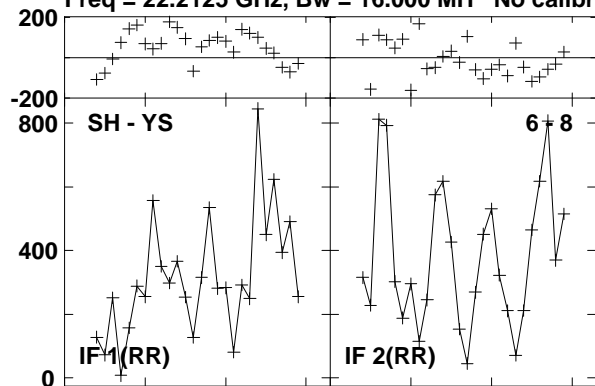

Lower frame: Micro Ampl Jy Top frame: Phas deg  
Vector averaged cross-power spectrum Baseline: SH (06) - YS (08)  
Timerange: 00/10:55:21 to 00/10:55:40



Plot file version 177 created 23-AUG-2016 15:00:48

W3IRS5 GA035B 1.UVDATA.1

Freq = 22.2125 GHz, Bw = 16.000 MH No calibration applied and no bandpass applied

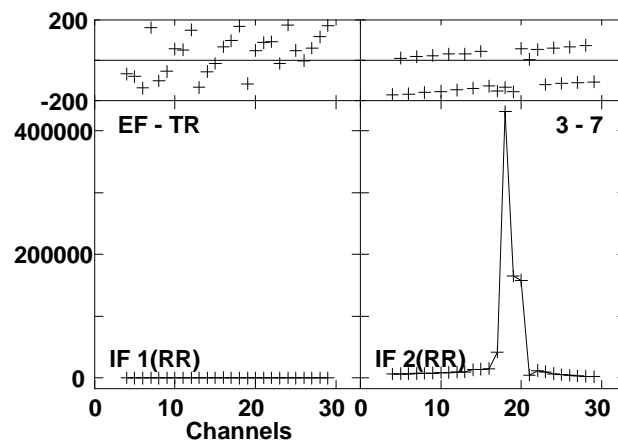
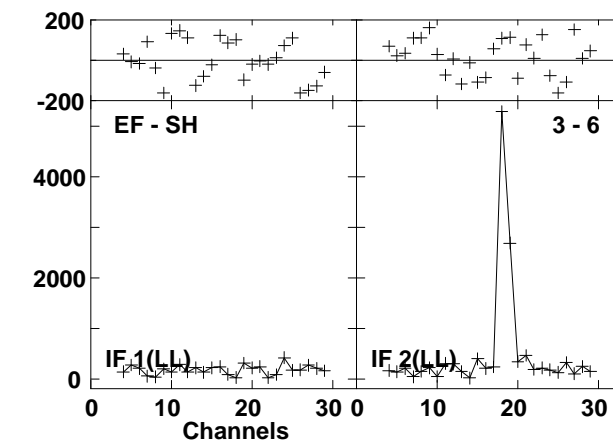
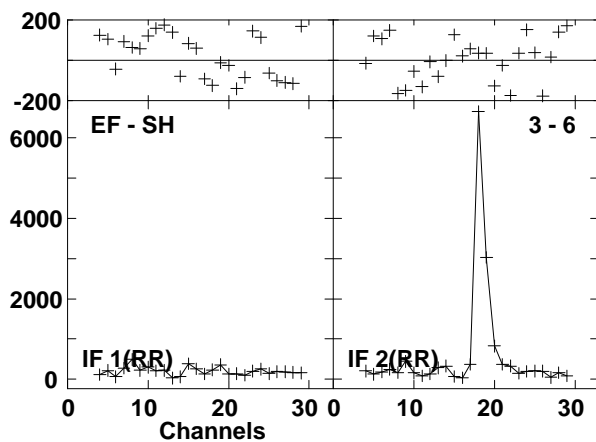
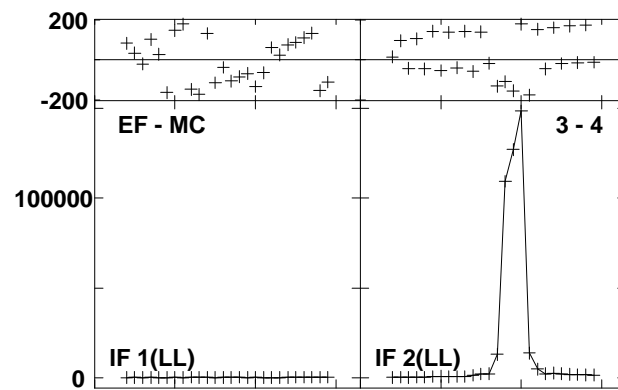
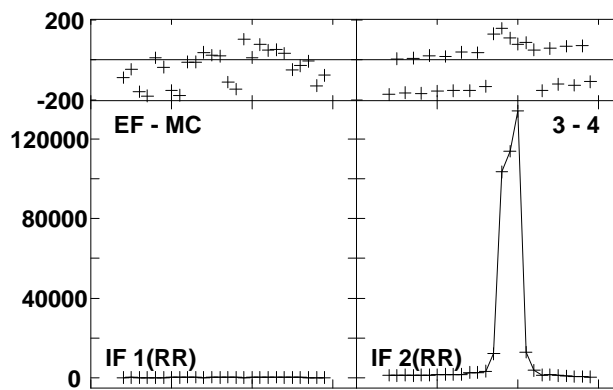
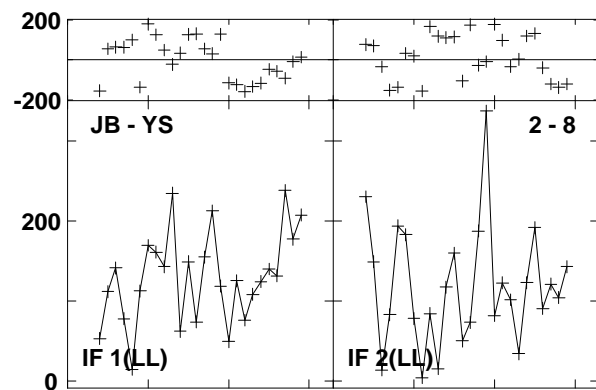
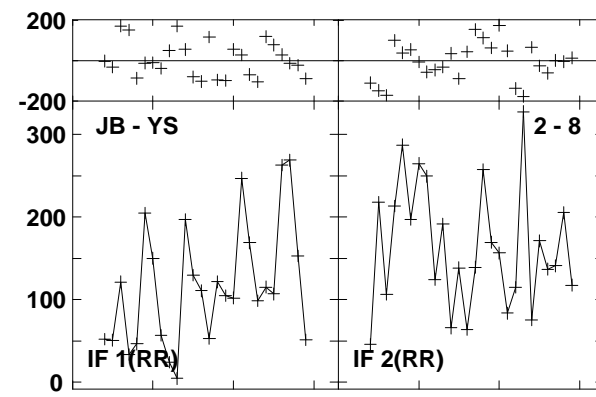
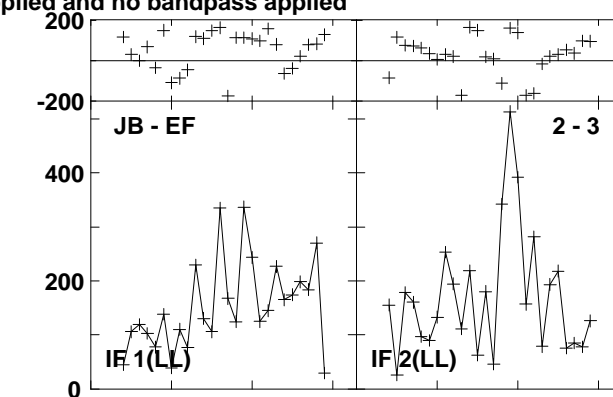
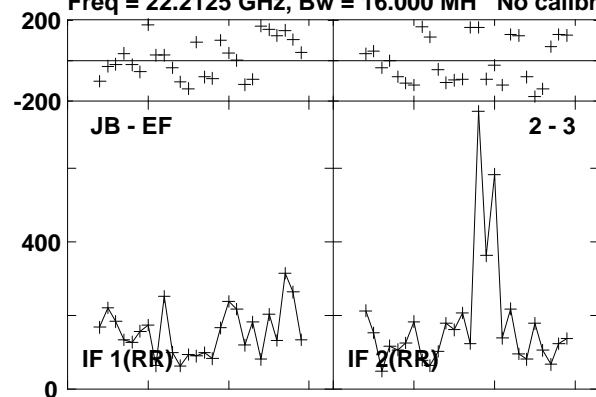

Lower frame: Micro Ampl Jy Top frame: Phas deg  
Vector averaged cross-power spectrum Baseline: JB (02) - EF (03)  
Timerange: 00/10:56:06 to 00/10:57:04

Plot file version 178 created 23-AUG-2016 15:00:48

W3IRS5 GA035B 1.UVDATA.1

Freq = 22.2125 GHz, Bw = 16.000 MH No calibration applied and no bandpass applied

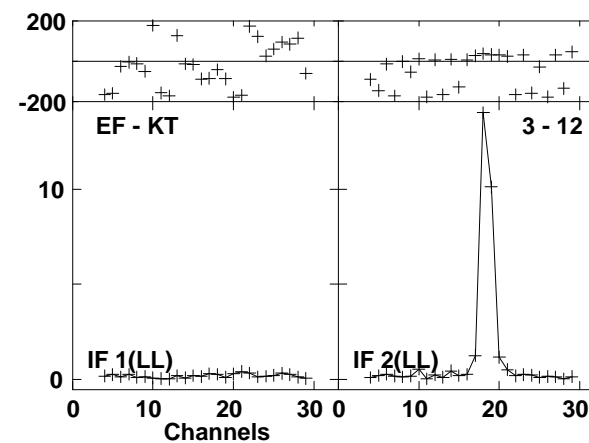
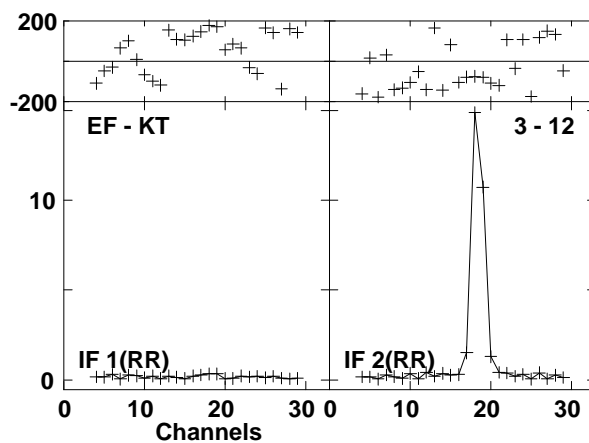
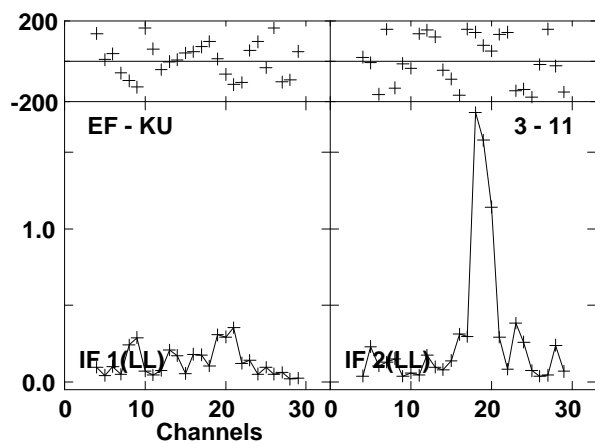
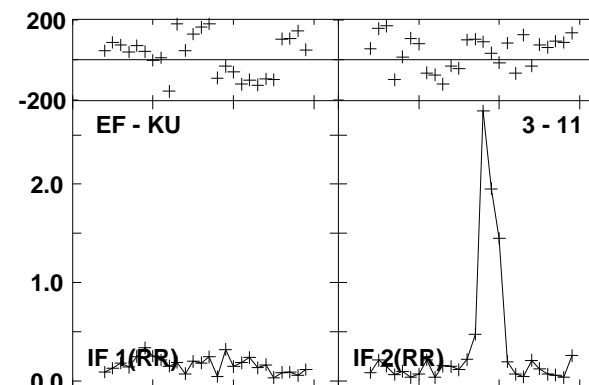
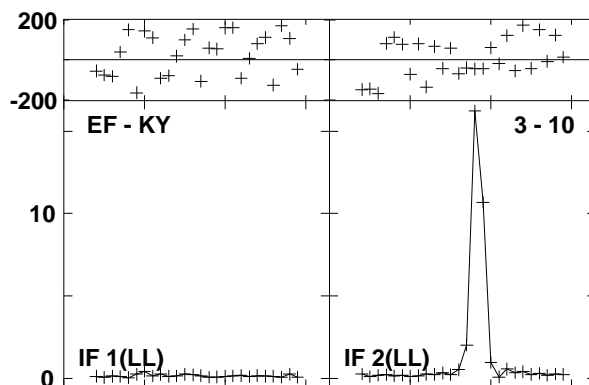
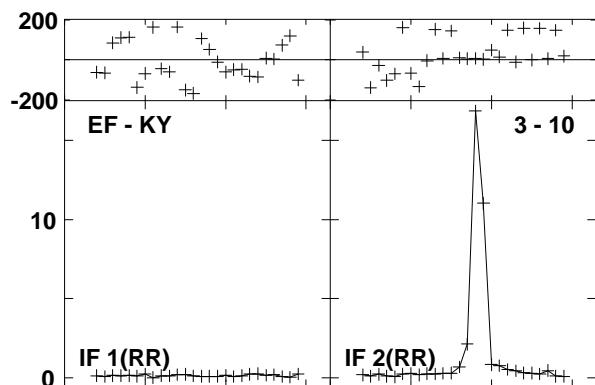
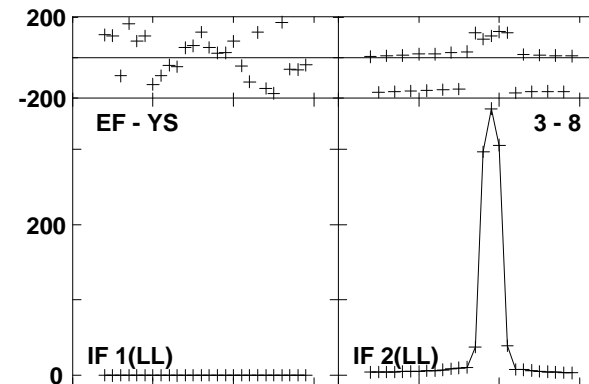
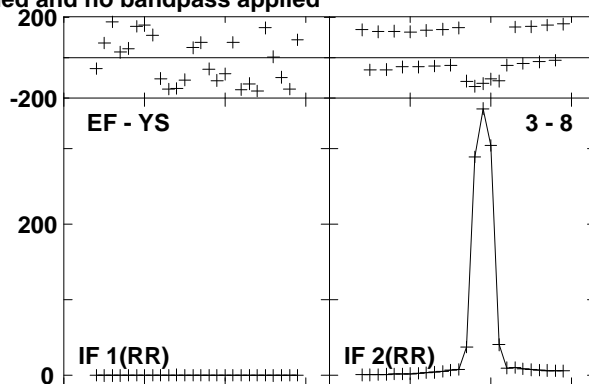
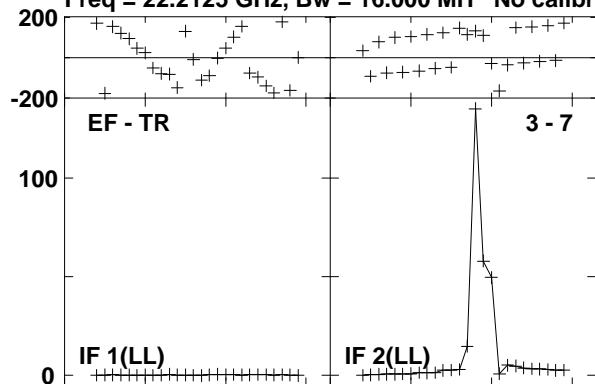

Lower frame: Milli Ampl Jy Top frame: Phas deg  
Vector averaged cross-power spectrum Baseline: EF (03) - TR (07)  
Timerange: 00/10:56:06 to 00/10:57:04

Plot file version 179 created 23-AUG-2016 15:00:48

W3IRS5 GA035B 1.UVDATA.1

Freq = 22.2125 GHz, Bw = 16.000 MH No calibration applied and no bandpass applied

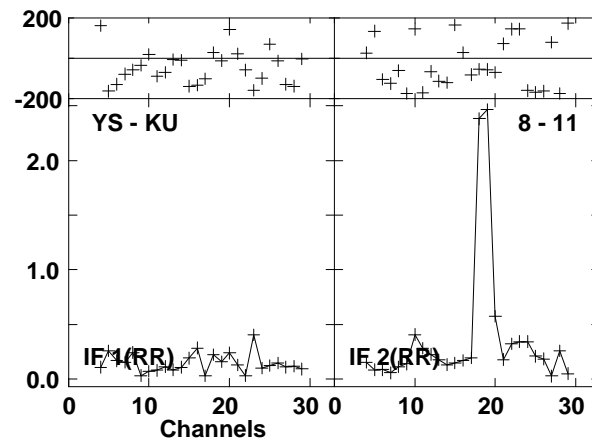
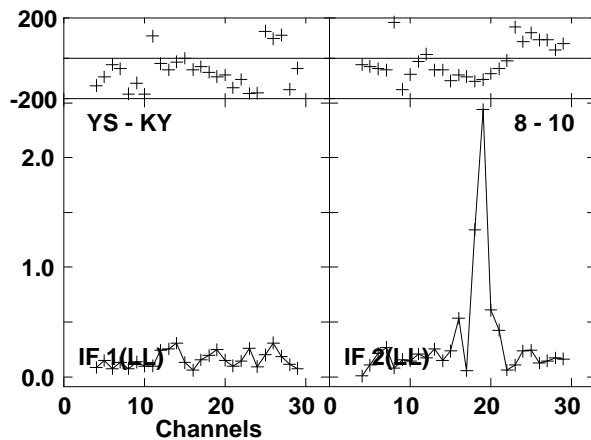
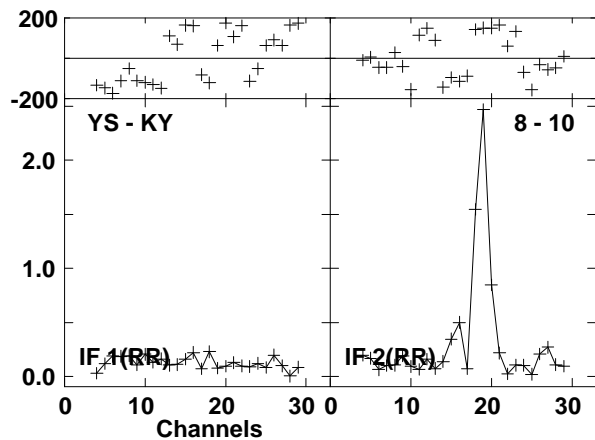
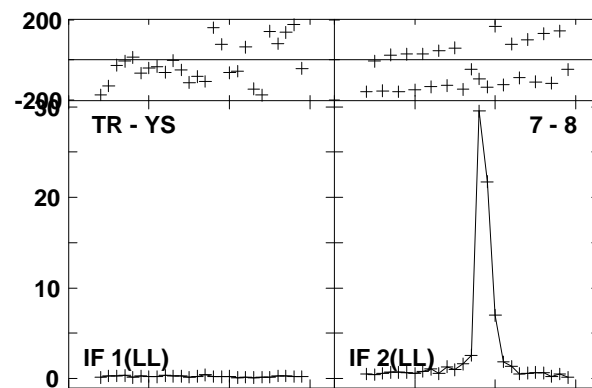
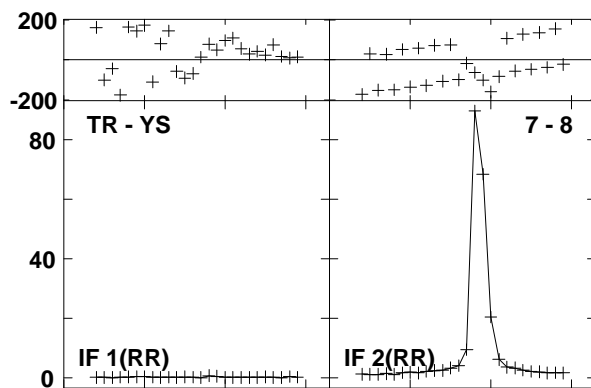
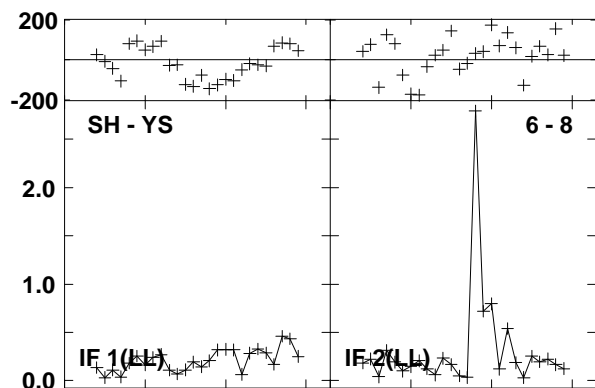
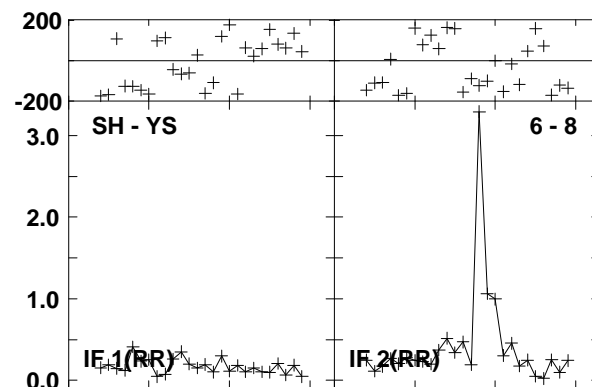
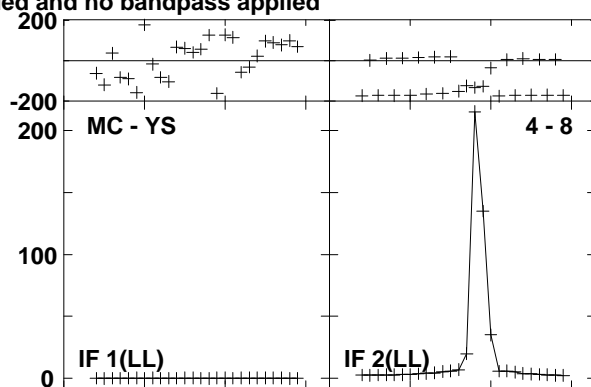
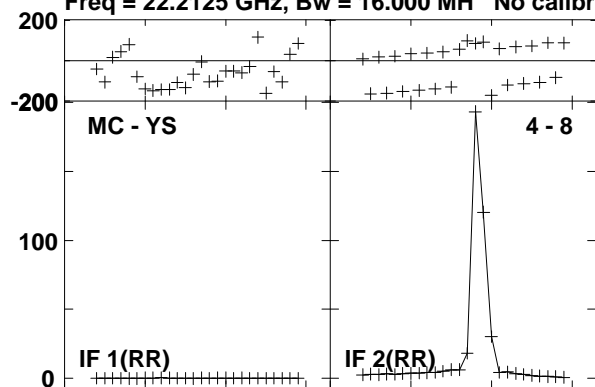

Lower frame: Milli Ampl Jy Top frame: Phas deg  
Vector averaged cross-power spectrum Baseline: MC (04) - YS (08)  
Timerange: 00/10:56:06 to 00/10:57:04

Plot file version 180 created 23-AUG-2016 15:00:48

W3IRS5 GA035B 1.UVDATA.1

Freq = 22.2125 GHz, Bw = 16.000 MH No calibration applied and no bandpass applied

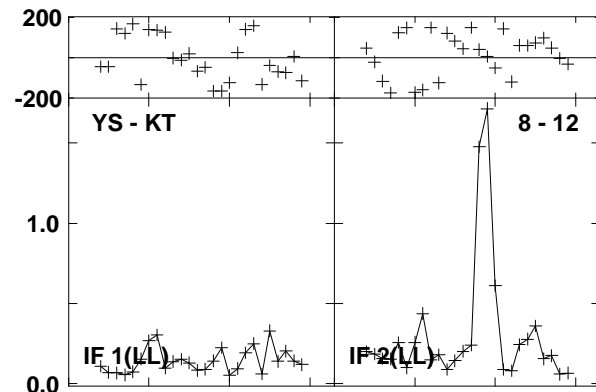
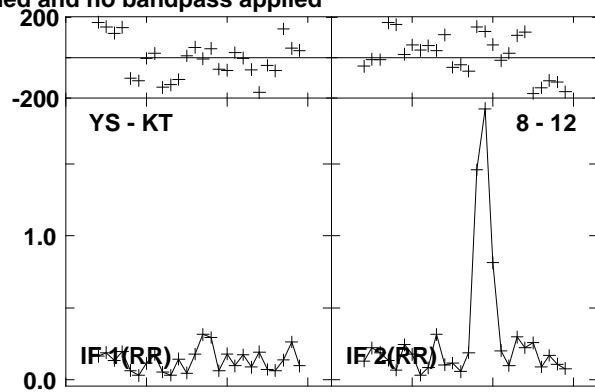
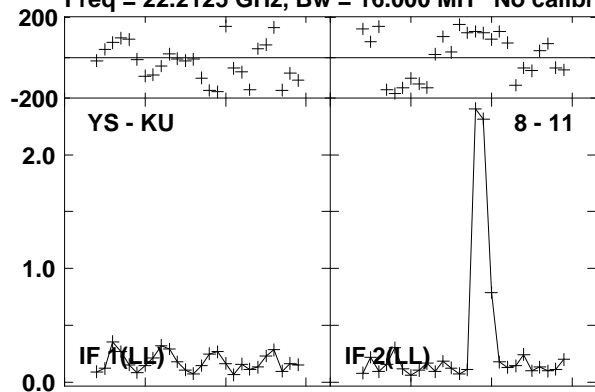

Lower frame: Milli Ampl Jy Top frame: Phas deg  
Vector averaged cross-power spectrum Baseline: YS (08) - KU (11)  
Timerange: 00/10:56:06 to 00/10:57:04

Plot file version 181 created 23-AUG-2016 15:00:48

0219+628 GA035B 1.UVDATA.1

Freq = 22.2125 GHz, Bw = 16.000 MH No calibration applied and no bandpass applied

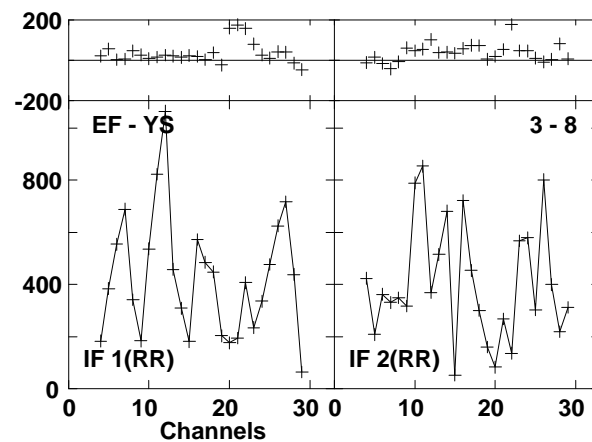
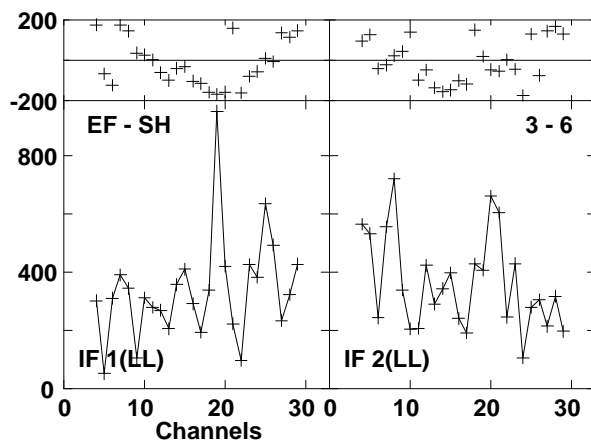
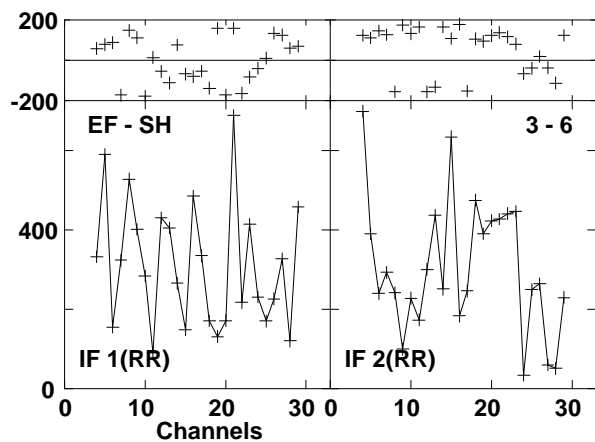
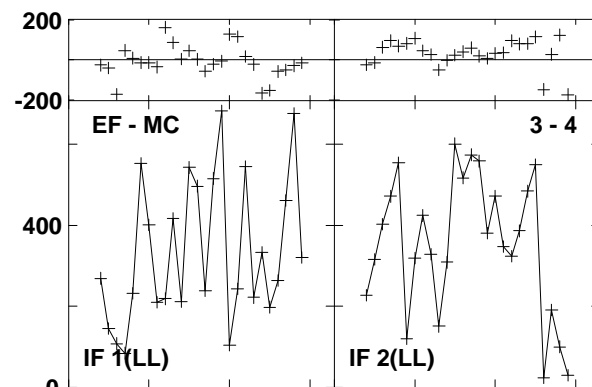
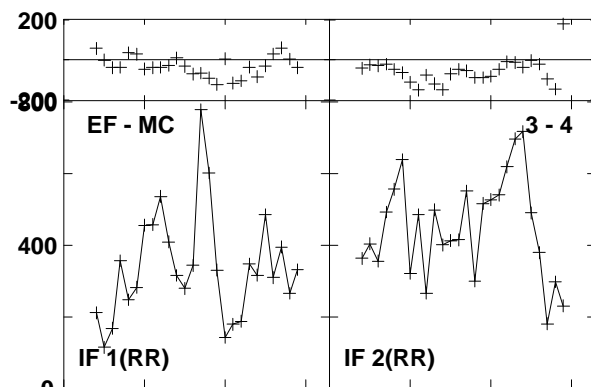
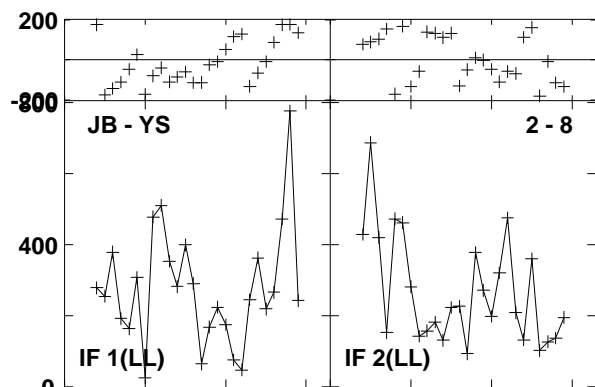
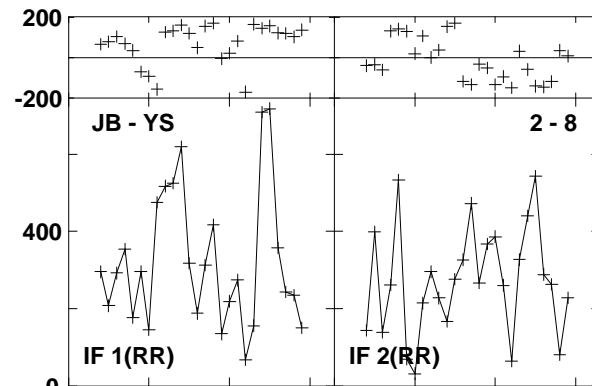
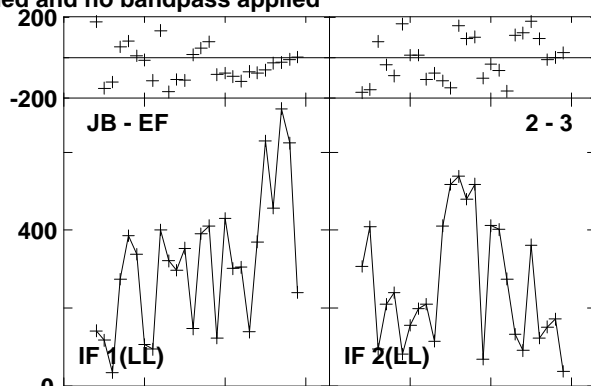
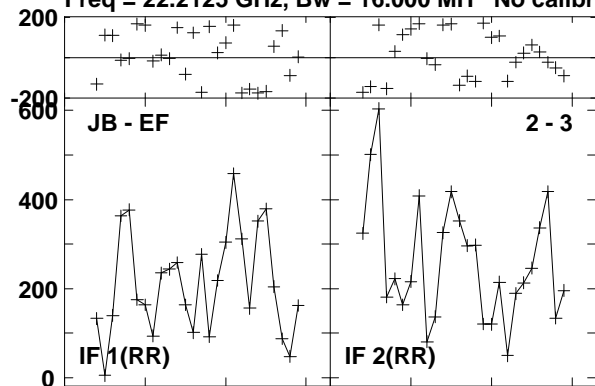

Lower frame: Micro Ampl Jy Top frame: Phas deg

Vector averaged cross-power spectrum Baseline: JB (02) - EF (03)

Timerange: 00/10:57:31 to 00/10:57:49

Plot file version 182 created 23-AUG-2016 15:00:48

0219+628 GA035B 1.UVDATA.1

Freq = 22.2125 GHz, Bw = 16.000 MH No calibration applied and no bandpass applied

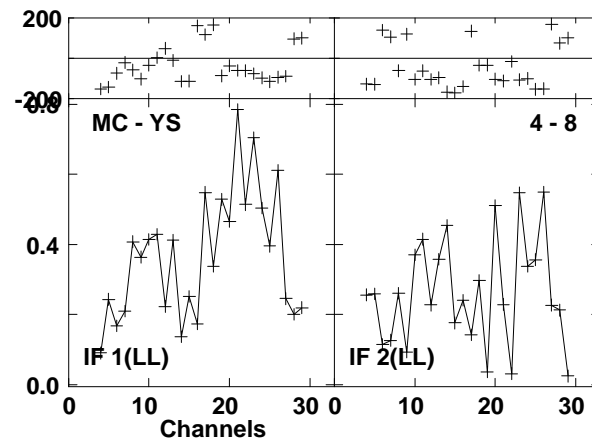
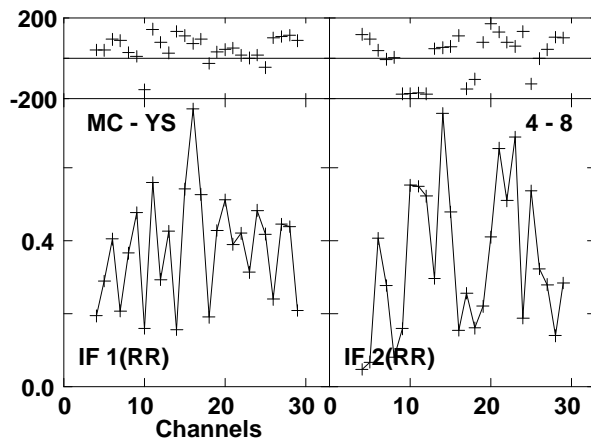
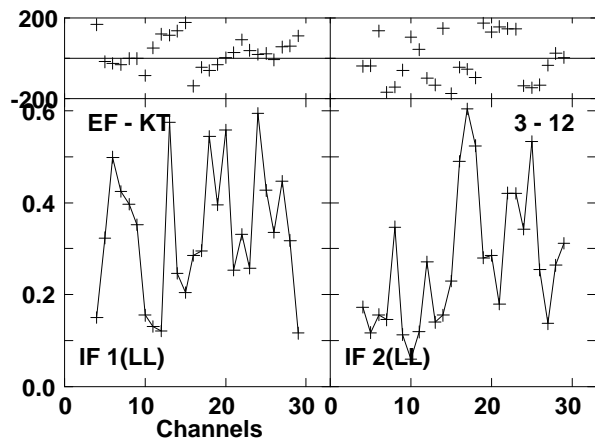
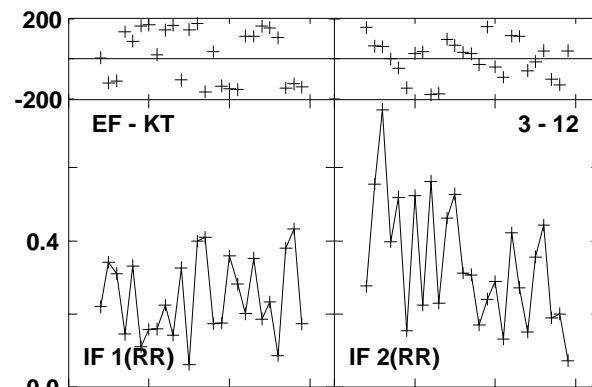
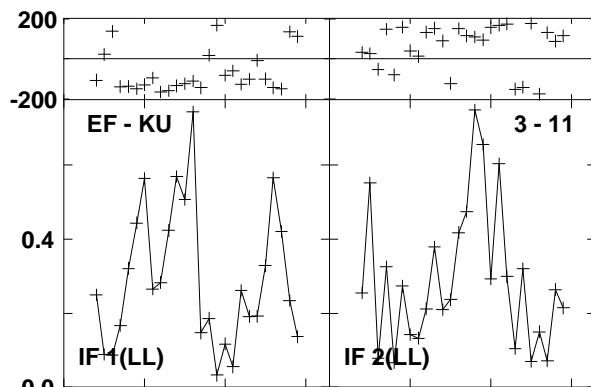
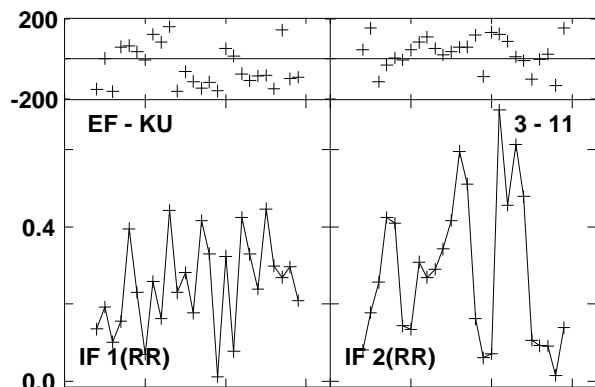
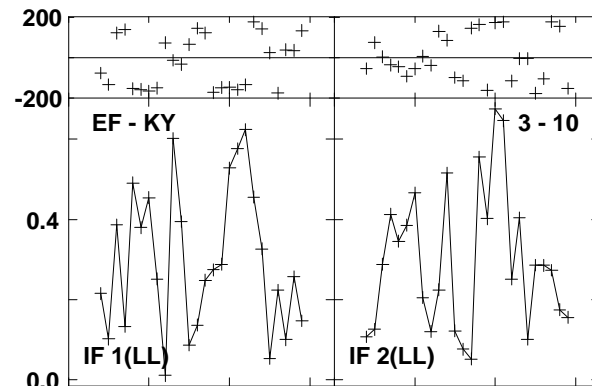
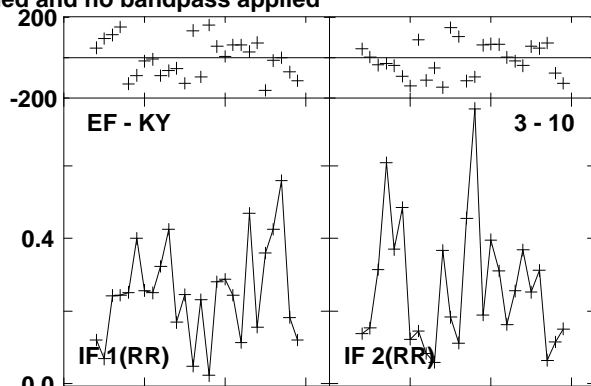
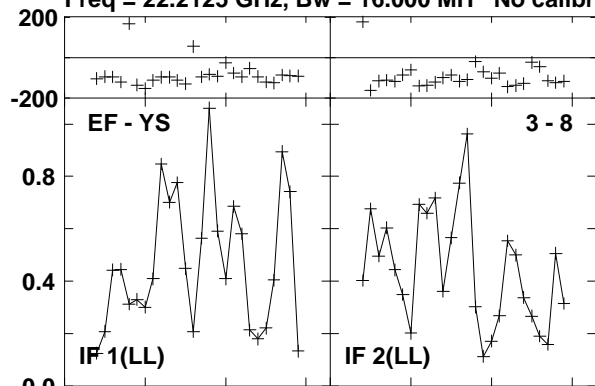

Lower frame: Milli Ampl Jy Top frame: Phas deg  
Vector averaged cross-power spectrum Baseline: EF (03) - YS (08)  
Timerange: 00/10:57:31 to 00/10:57:49

Plot file version 183 created 23-AUG-2016 15:00:48

0219+628 GA035B 1.UVDATA.1

Freq = 22.2125 GHz, Bw = 16.000 MH No calibration applied and no bandpass applied

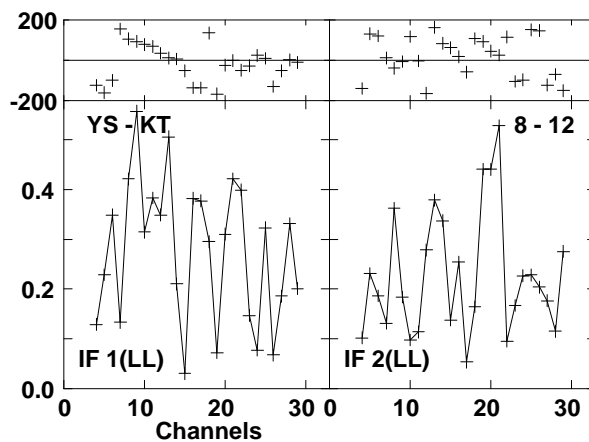
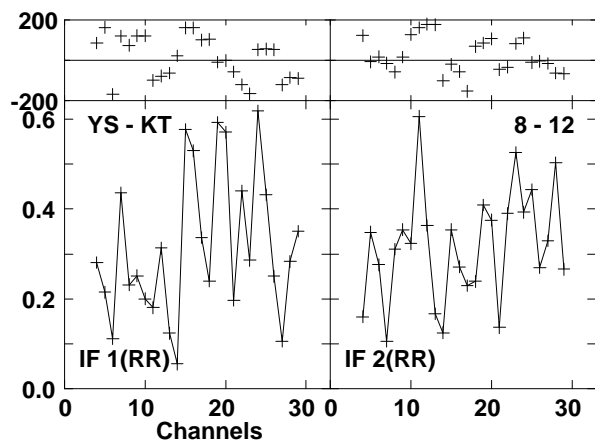
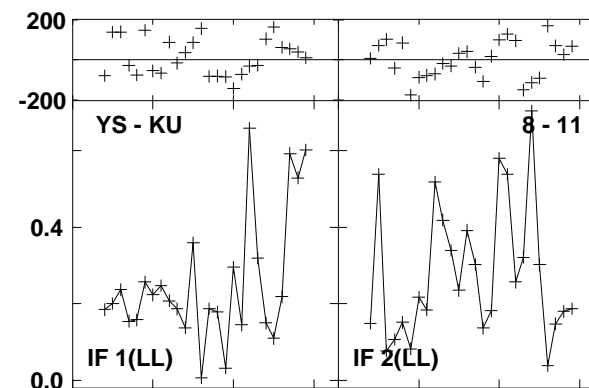
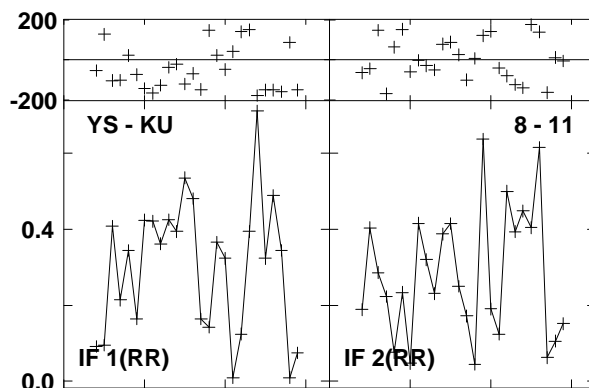
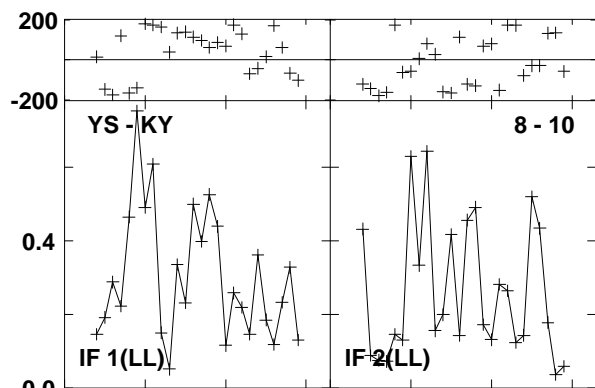
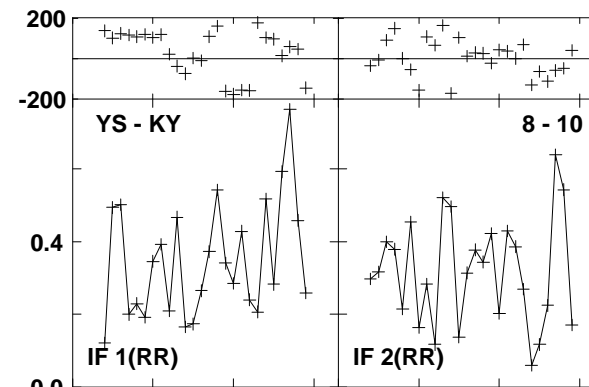
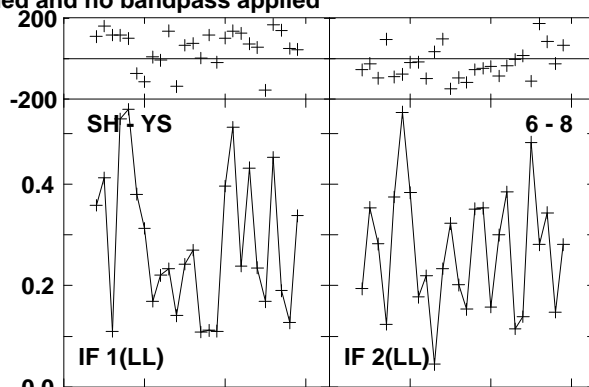
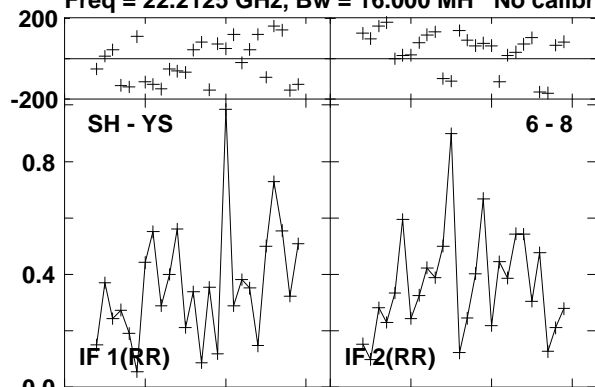

Lower frame: Milli Ampl Jy Top frame: Phas deg  
Vector averaged cross-power spectrum Baseline: SH (06) - YS (08)  
Timerange: 00/10:57:31 to 00/10:57:49

Plot file version 184 created 23-AUG-2016 15:00:49

2021+614 GA035B 1.UVDATA.1

Freq = 22.2125 GHz, Bw = 16.000 MH No calibration applied and no bandpass applied

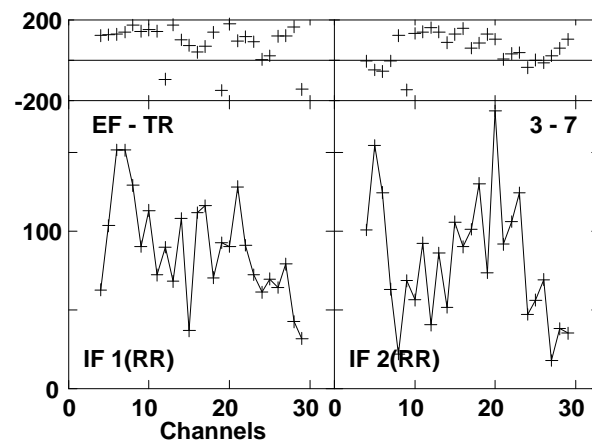
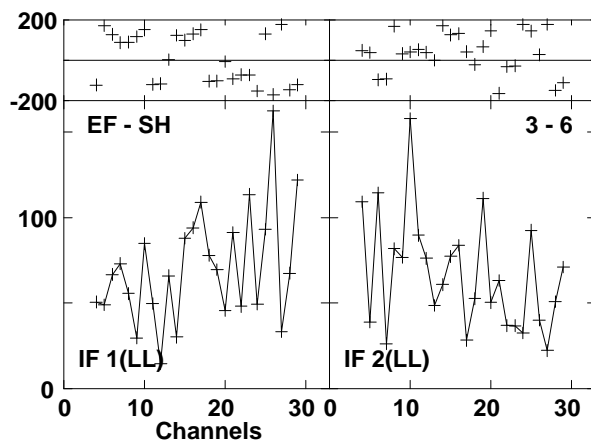
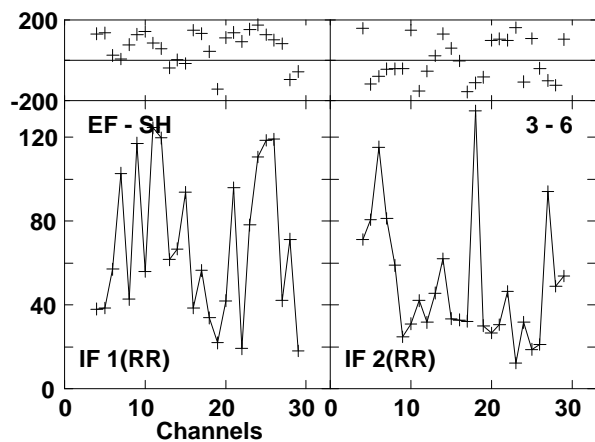
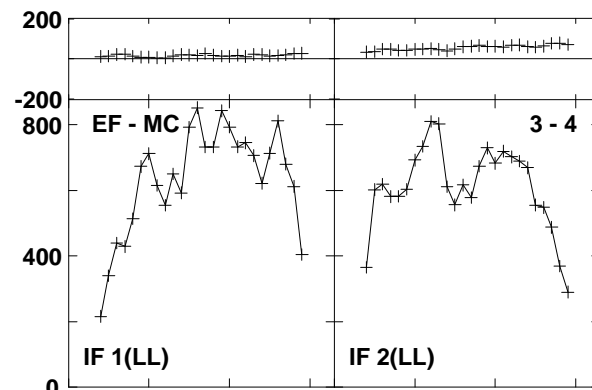
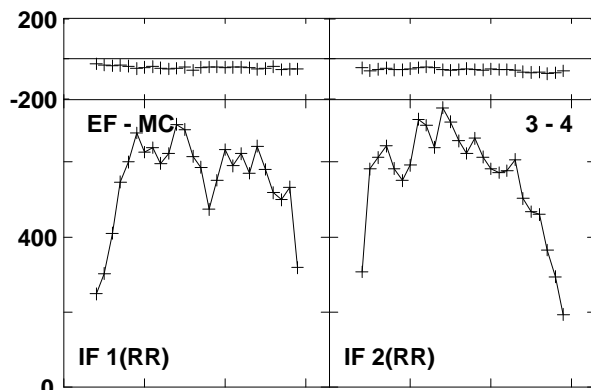
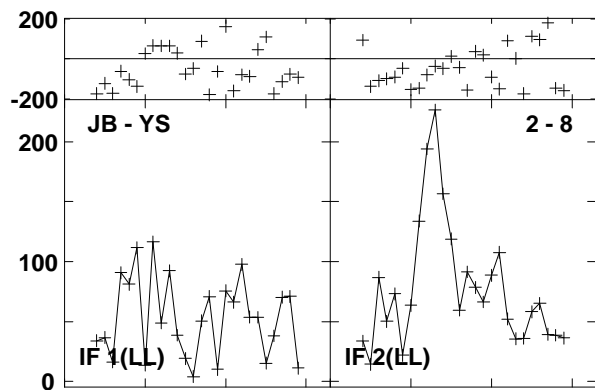
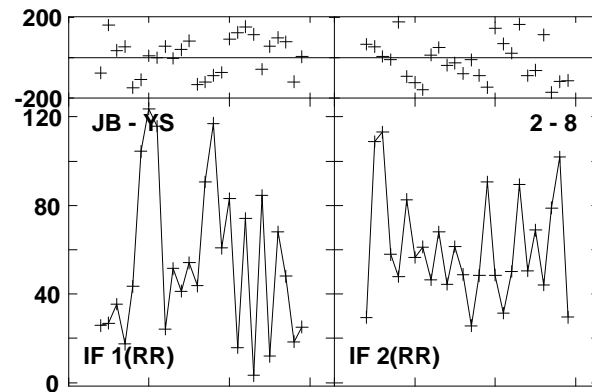
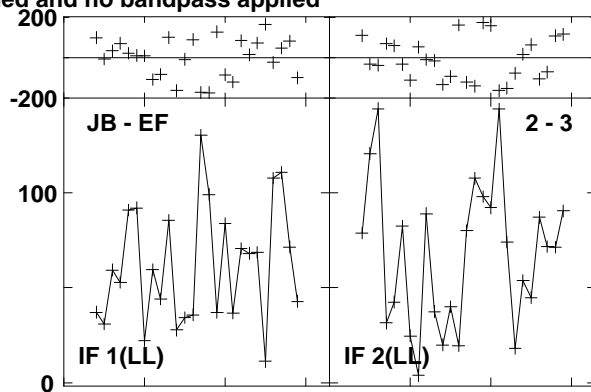
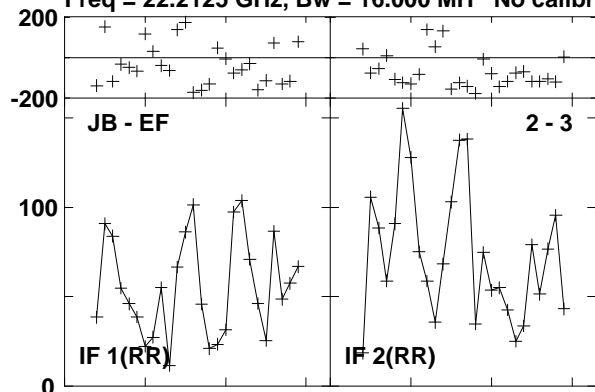

Lower frame: Micro Ampl Jy Top frame: Phas deg  
Vector averaged cross-power spectrum Baseline: JB (02) - EF (03)  
Timerange: 00/11:00:50 to 00/11:05:49



Plot file version 185 created 23-AUG-2016 15:00:49

2021+614 GA035B 1.UVDATA.1

Freq = 22.2125 GHz, Bw = 16.000 MH No calibration applied and no bandpass applied

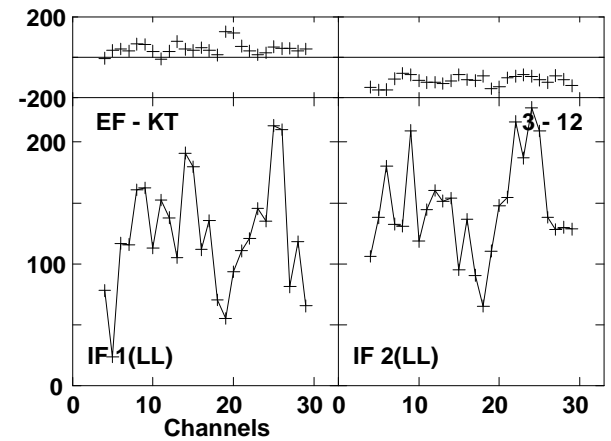
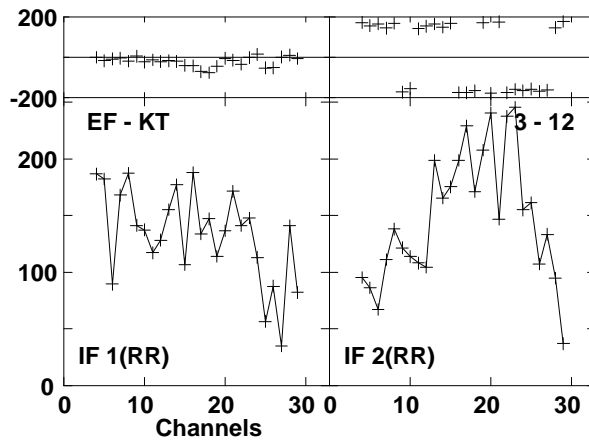
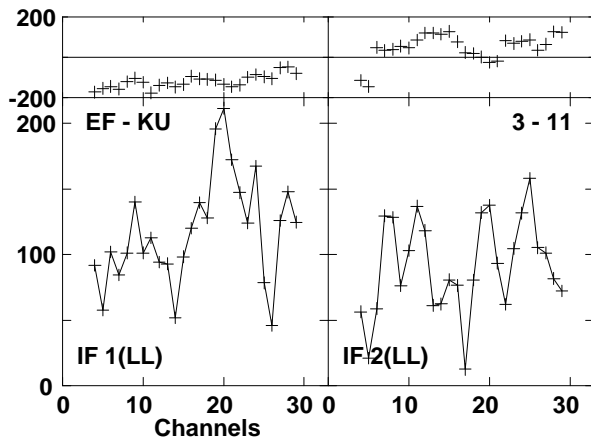
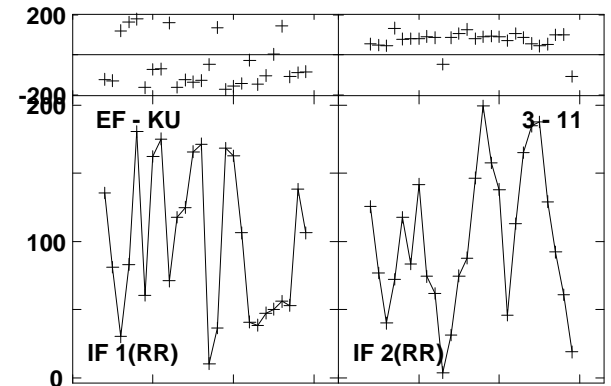
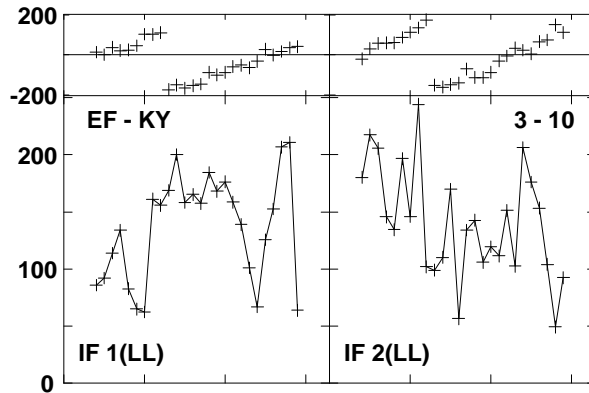
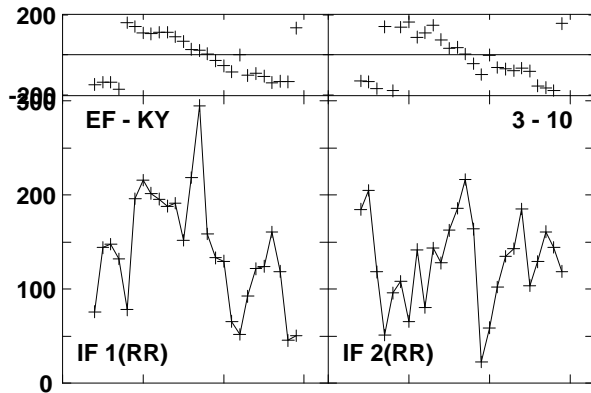
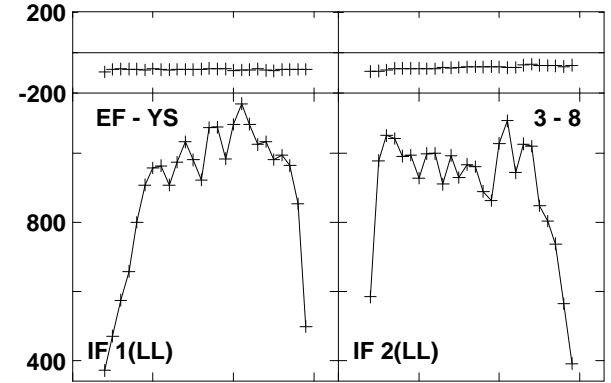
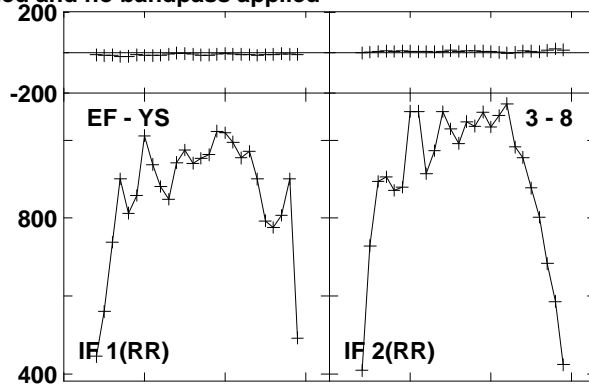
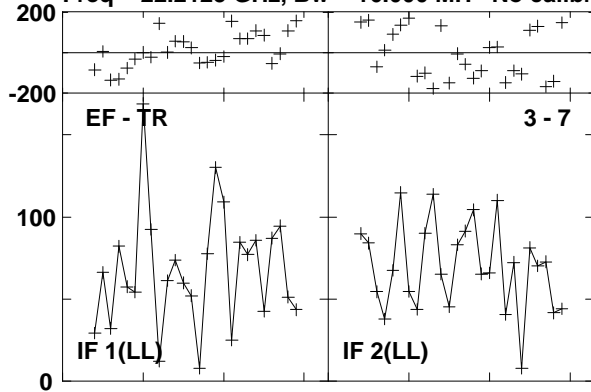

Lower frame: Micro Ampl Jy Top frame: Phas deg

Vector averaged cross-power spectrum Baseline: EF (03) - TR (07)

Timerange: 00/11:00:50 to 00/11:05:49

Plot file version 186 created 23-AUG-2016 15:00:49

2021+614 GA035B 1.UVDATA.1

Freq = 22.2125 GHz, Bw = 16.000 MH No calibration applied and no bandpass applied

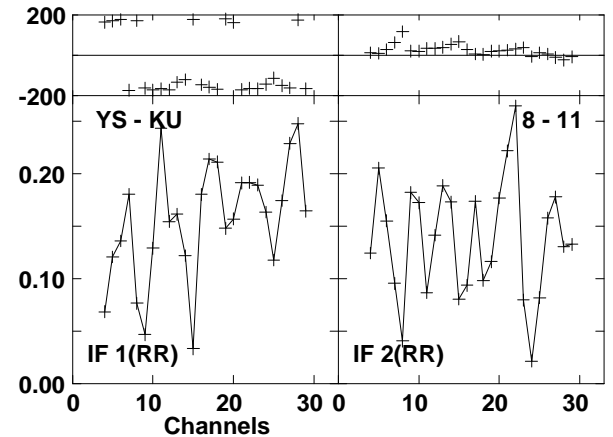
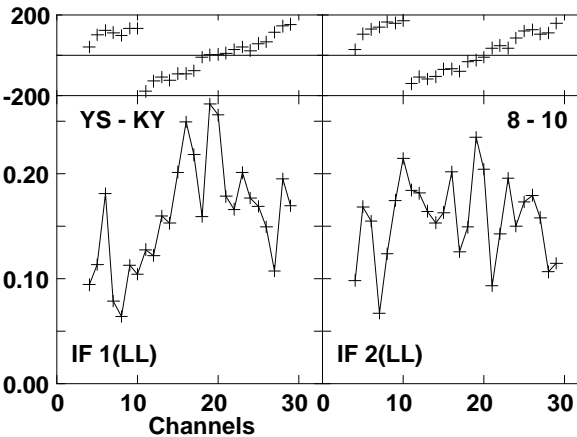
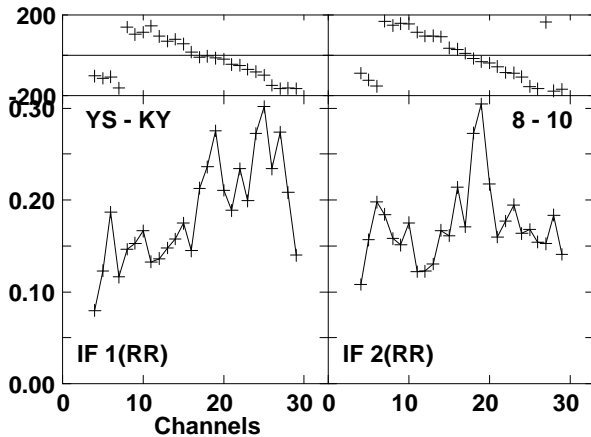
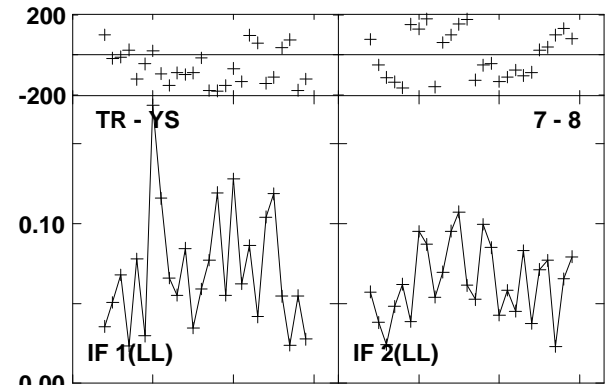
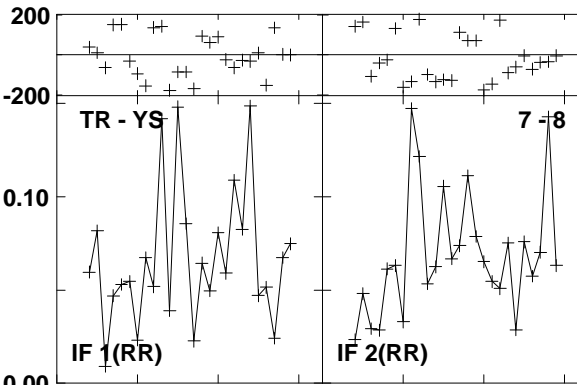
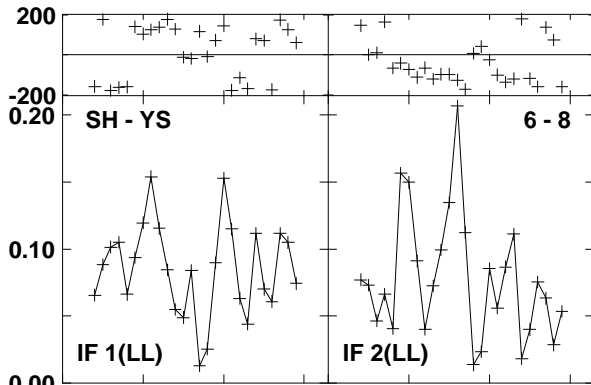
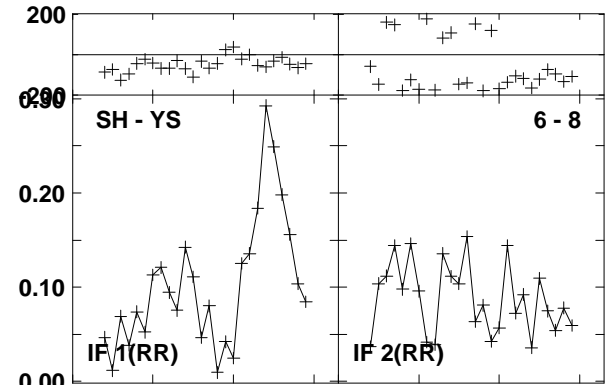
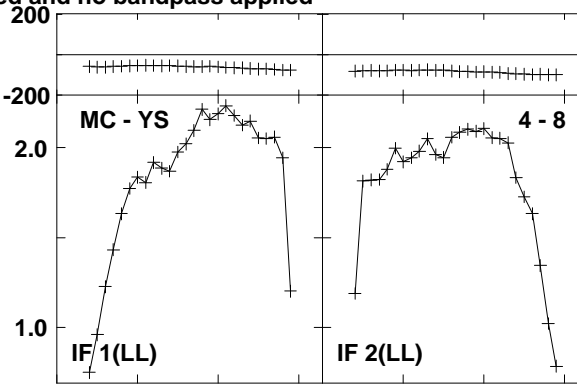
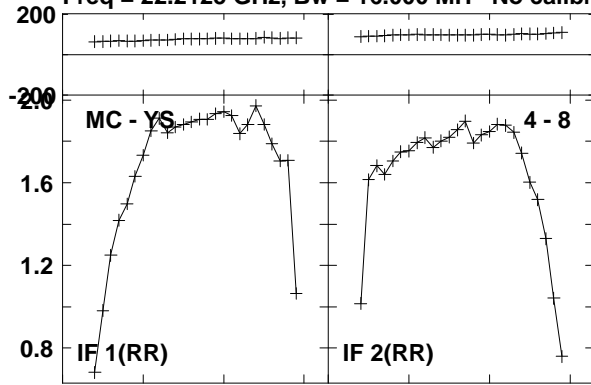

Lower frame: Milli Ampl Jy Top frame: Phas deg  
Vector averaged cross-power spectrum Baseline: MC (04) - YS (08)  
Timerange: 00/11:00:50 to 00/11:05:49

Plot file version 187 created 23-AUG-2016 15:00:49

2021+614 GA035B 1.UVDATA.1

Freq = 22.2125 GHz, Bw = 16.000 MH No calibration applied and no bandpass applied

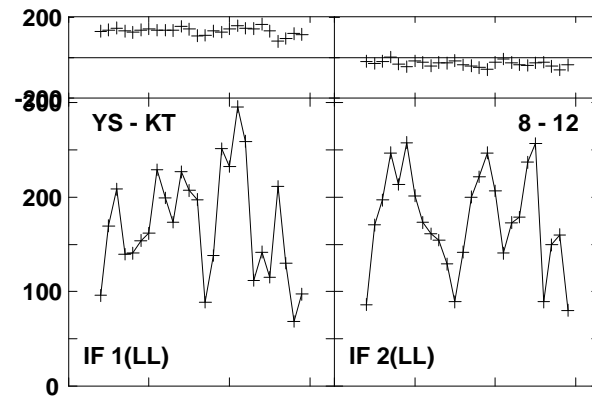
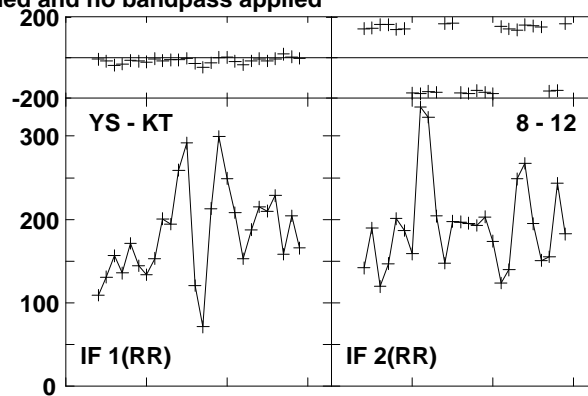
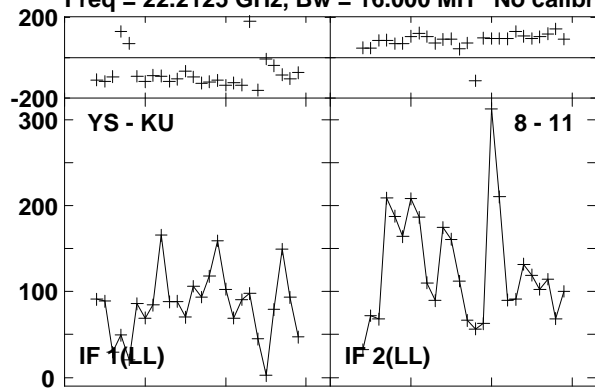

Lower frame: Micro Ampl Jy Top frame: Phas deg  
Vector averaged cross-power spectrum Baseline: YS (08) - KU (11)  
Timerange: 00/11:00:50 to 00/11:05:49

Plot file version 188 created 23-AUG-2016 15:00:49

0241+622 GA035B 1.UVDATA.1

Freq = 22.2125 GHz, Bw = 16.000 MH No calibration applied and no bandpass applied

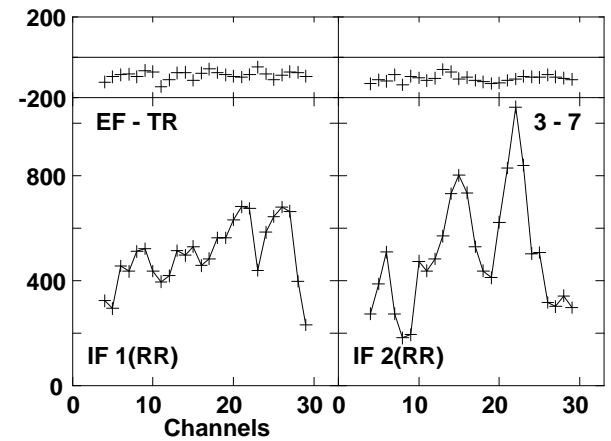
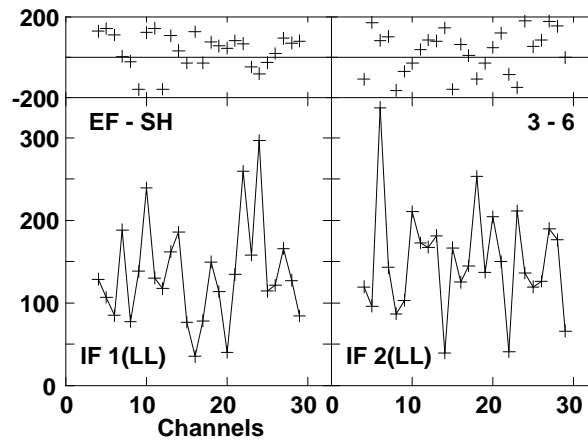
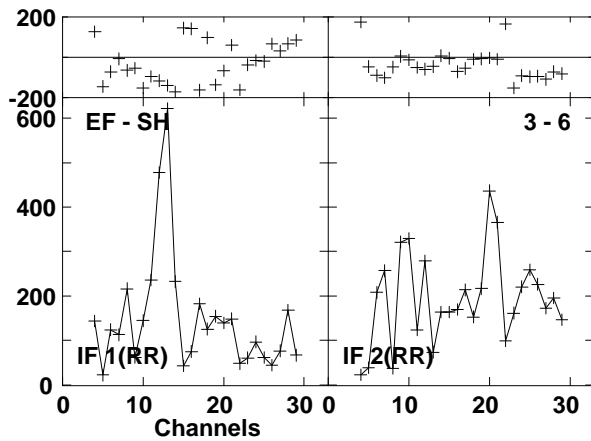
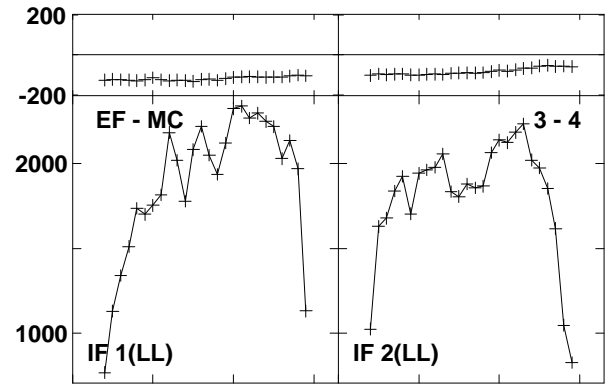
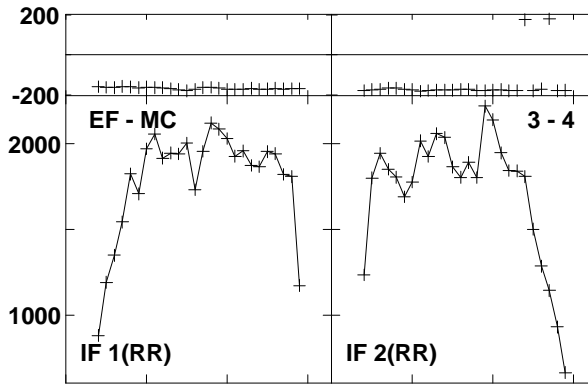
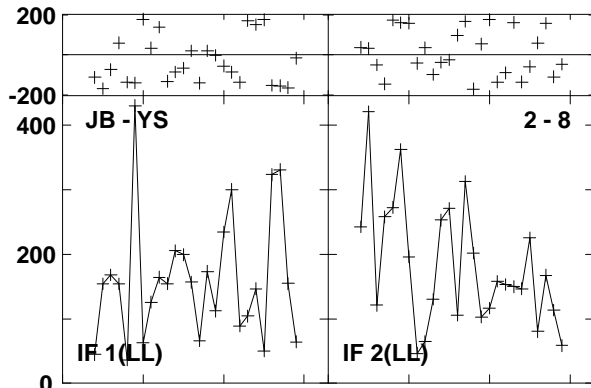
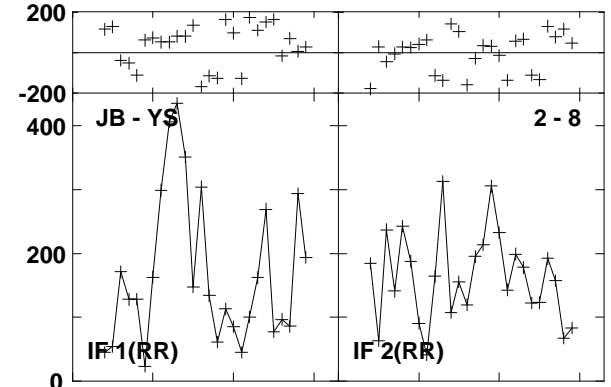
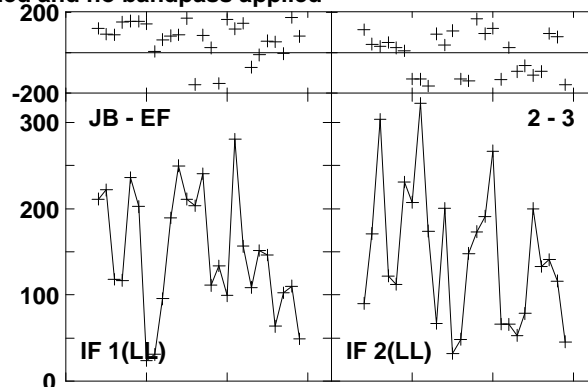
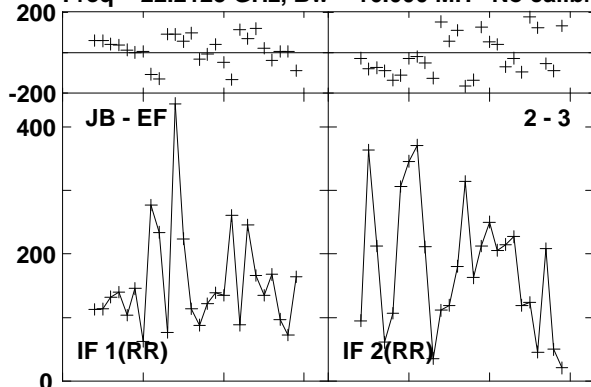

Lower frame: Micro Ampl Jy Top frame: Phas deg  
Vector averaged cross-power spectrum Baseline: JB (02) - EF (03)  
Timerange: 00/11:09:11 to 00/11:10:09

Plot file version 189 created 23-AUG-2016 15:00:49

0241+622 GA035B 1.UVDATA.1

Freq = 22.2125 GHz, Bw = 16.000 MH No calibration applied and no bandpass applied

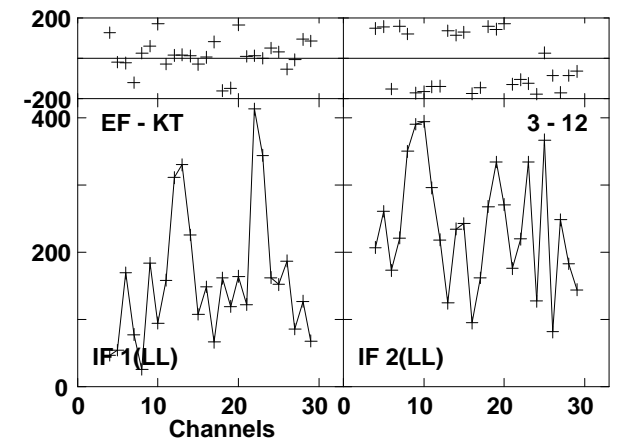
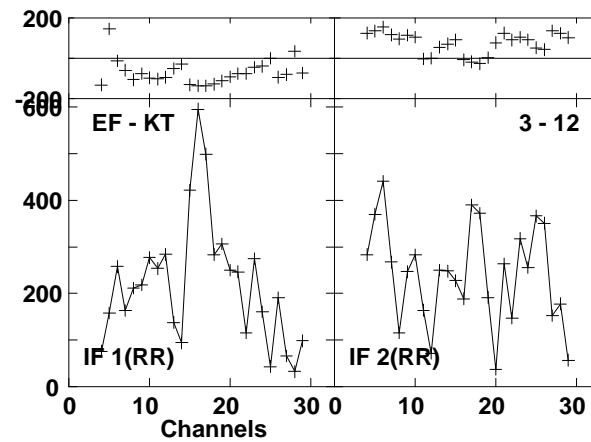
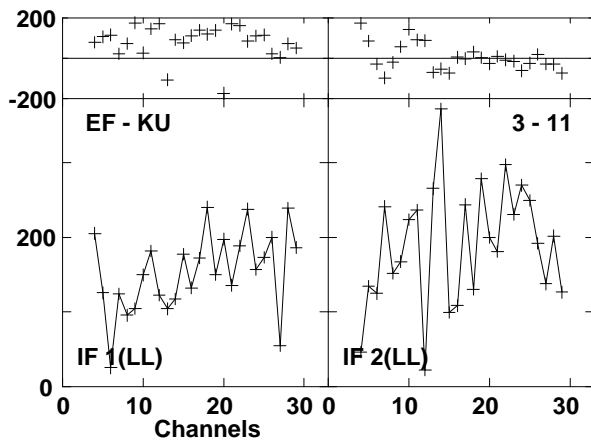
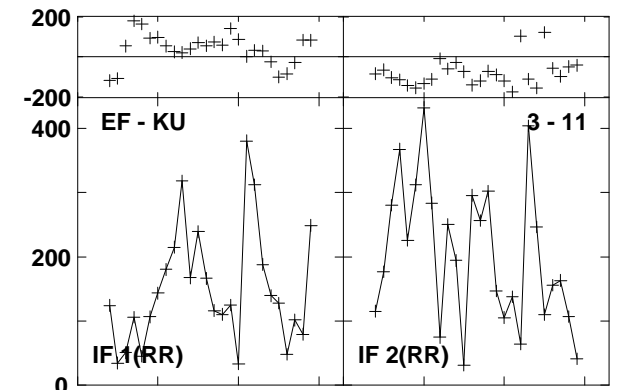
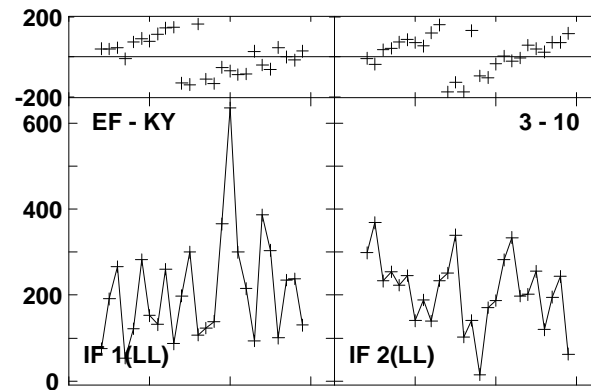
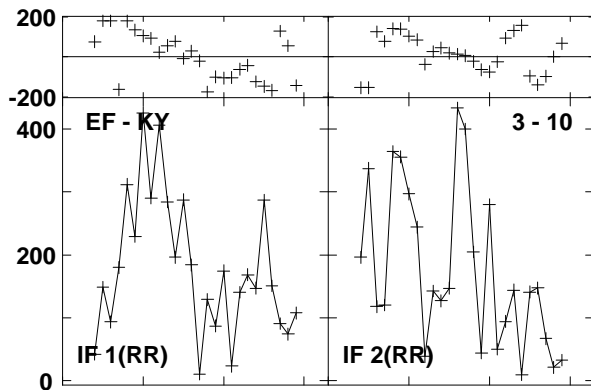
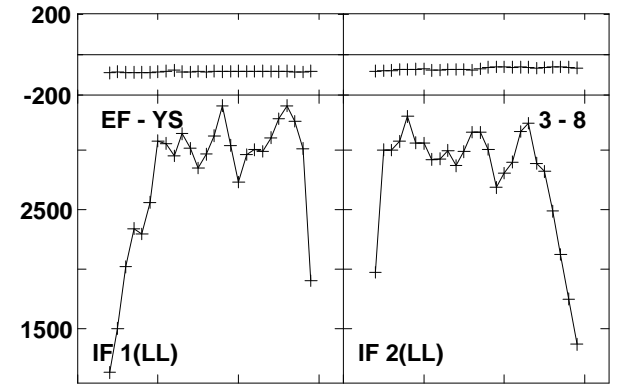
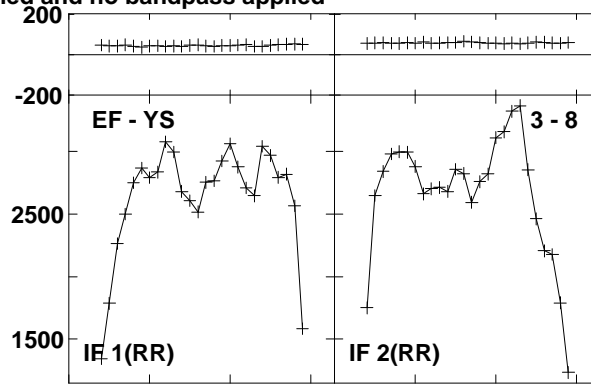
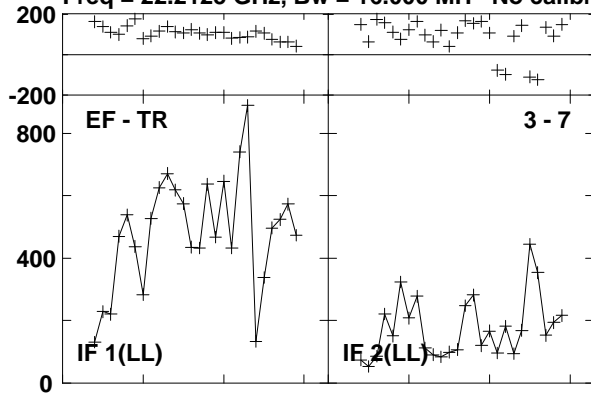

Lower frame: Micro Ampl Jy Top frame: Phas deg  
Vector averaged cross-power spectrum Baseline: EF (03) - TR (07)  
Timerange: 00/11:09:11 to 00/11:10:09

Plot file version 190 created 23-AUG-2016 15:00:49

0241+622 GA035B 1.UVDATA.1

Freq = 22.2125 GHz, Bw = 16.000 MH No calibration applied and no bandpass applied

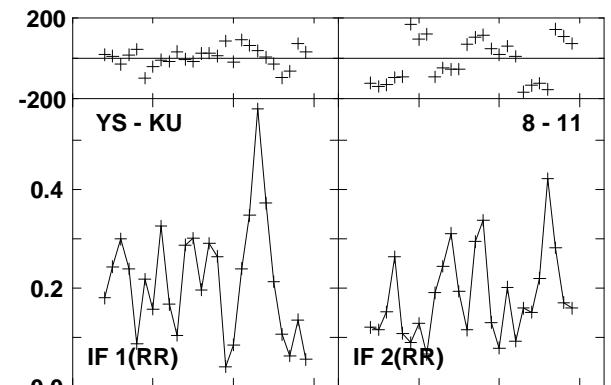
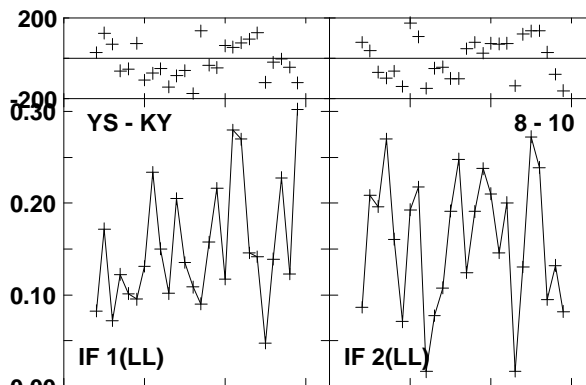
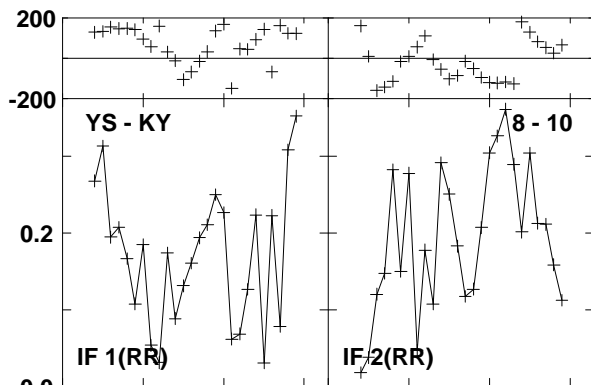
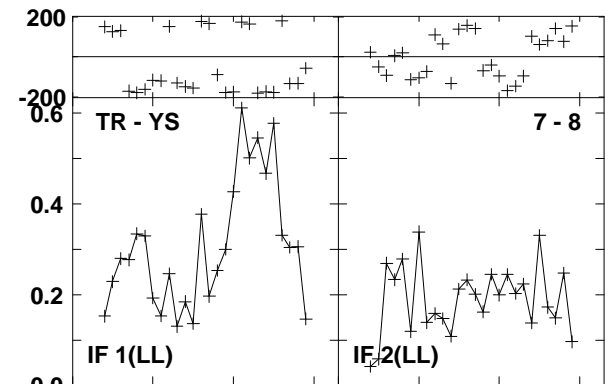
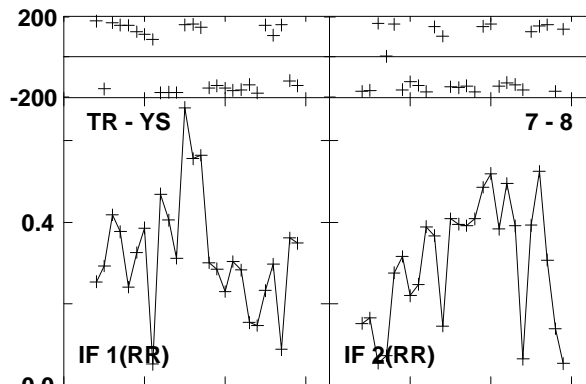
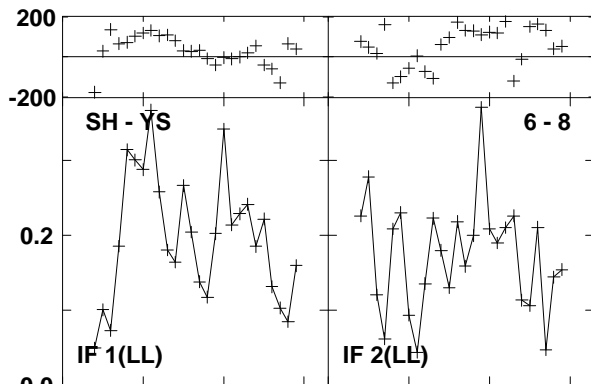
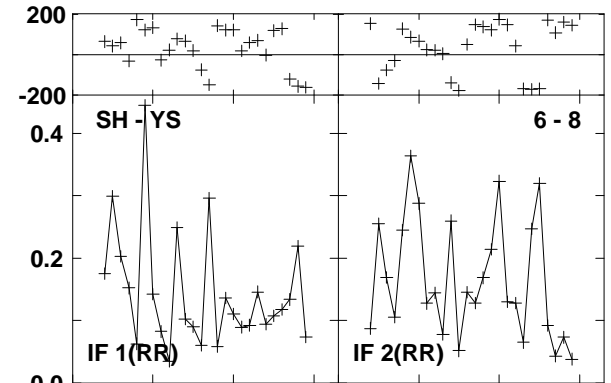
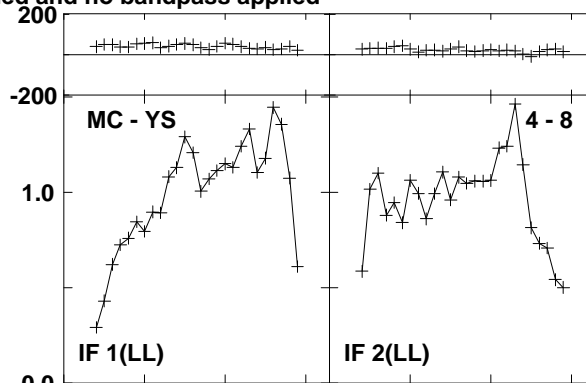
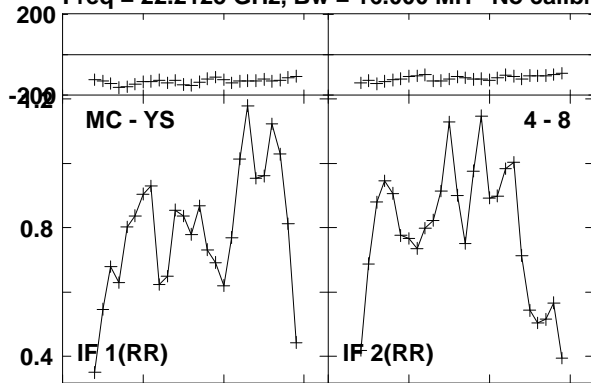

Channels

Lower frame: Milli Ampl Jy Top frame: Phas deg

Vector averaged cross-power spectrum Baseline: MC (04) - YS (08)

Timerange: 00/11:09:11 to 00/11:10:09

Plot file version 191 created 23-AUG-2016 15:00:49

0241+622 GA035B 1.UVDATA.1

Freq = 22.2125 GHz, Bw = 16.000 MH No calibration applied and no bandpass applied

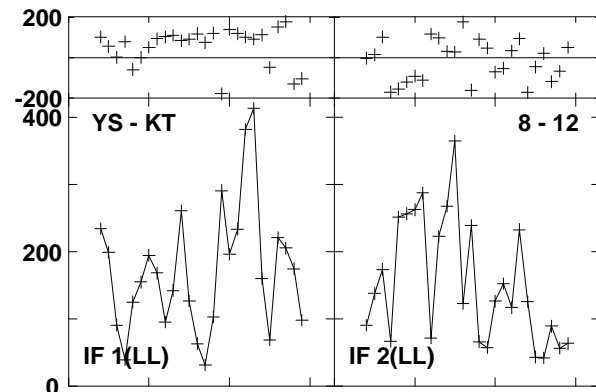
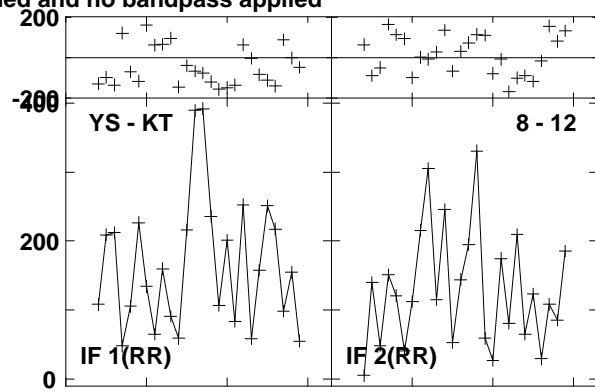
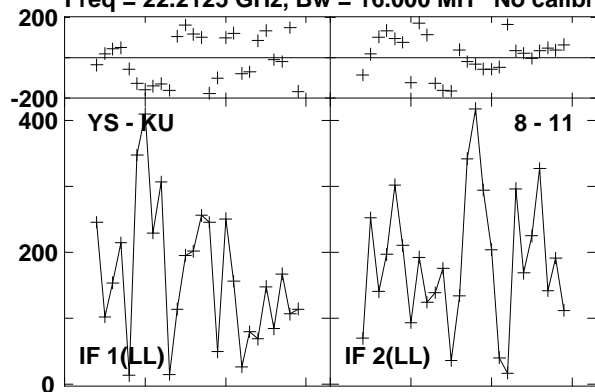

Lower frame: Micro Ampl Jy Top frame: Phas deg  
Vector averaged cross-power spectrum Baseline: YS (08) - KU (11)  
Timerange: 00/11:09:11 to 00/11:10:09

Plot file version 192 created 23-AUG-2016 15:00:49

W3IRS5 GA035B 1.UVDATA.1

Freq = 22.2125 GHz, Bw = 16.000 MH No calibration applied and no bandpass applied

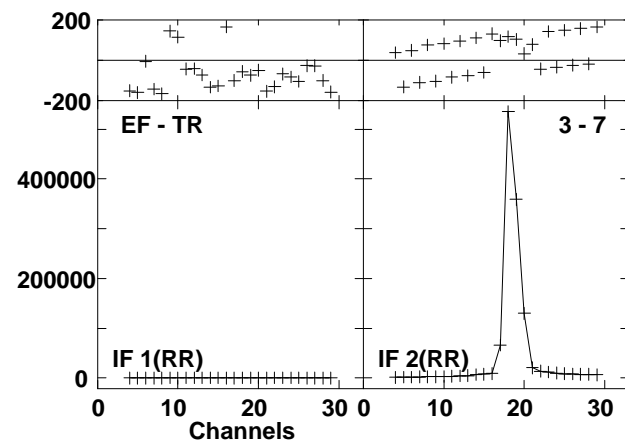
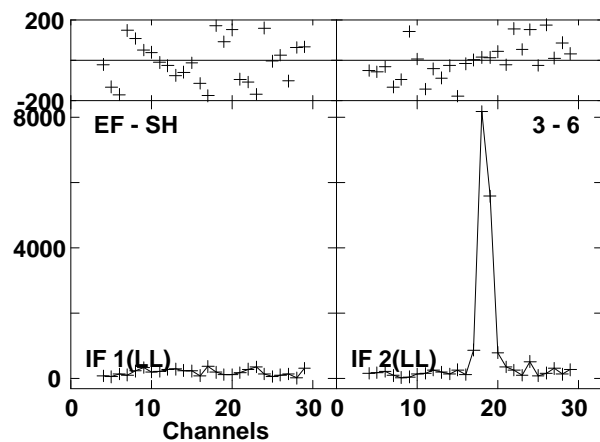
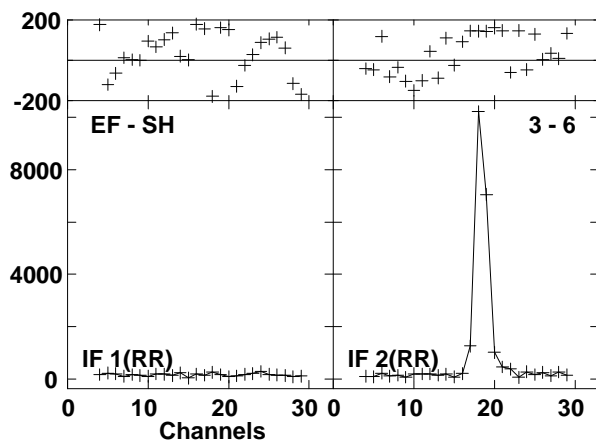
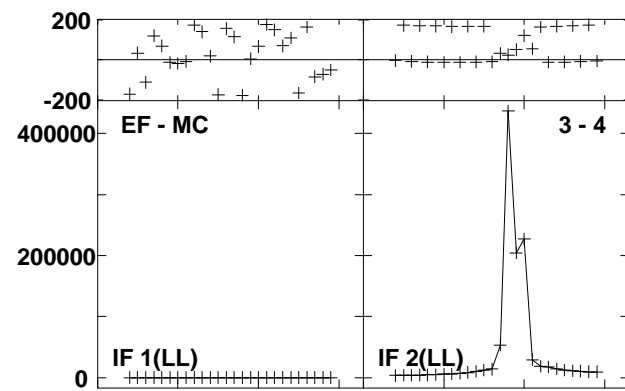
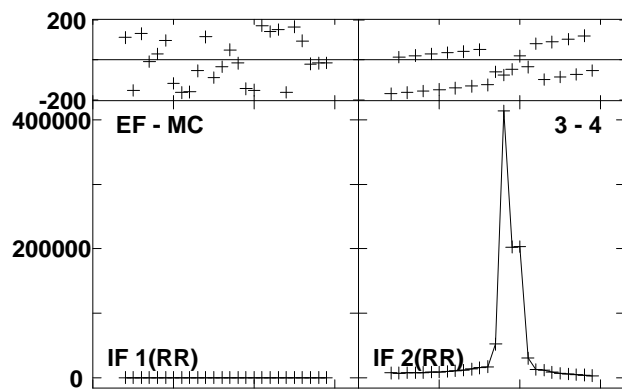
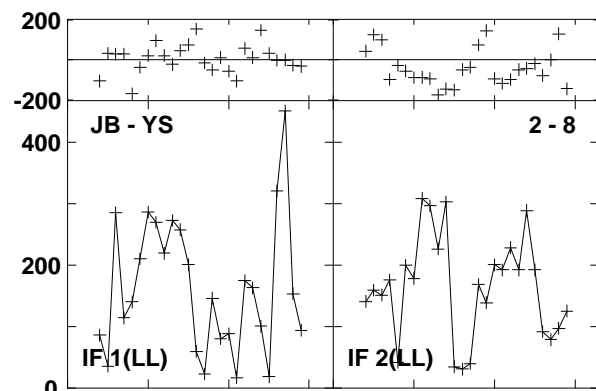
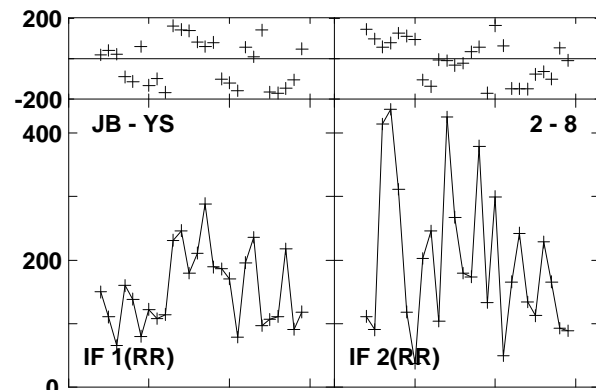
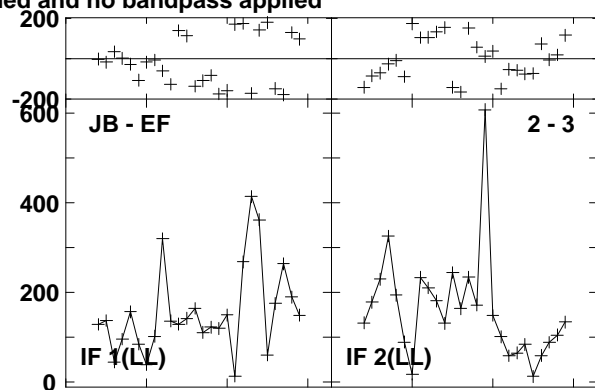
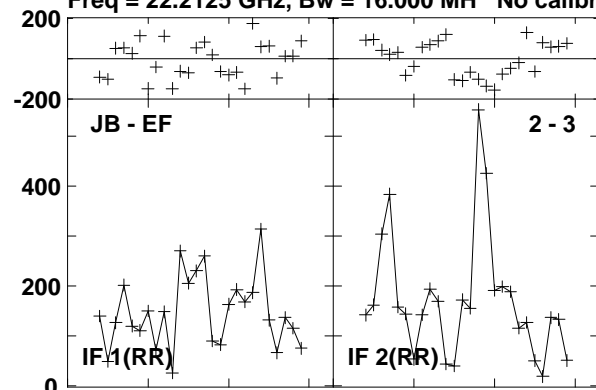

Lower frame: Micro Ampl Jy Top frame: Phas deg  
Vector averaged cross-power spectrum Baseline: JB (02) - EF (03)  
Timerange: 00/11:10:40 to 00/11:11:39



Plot file version 193 created 23-AUG-2016 15:00:49

W3IRS5 GA035B 1.UVDATA.1

Freq = 22.2125 GHz, Bw = 16.000 MH No calibration applied and no bandpass applied

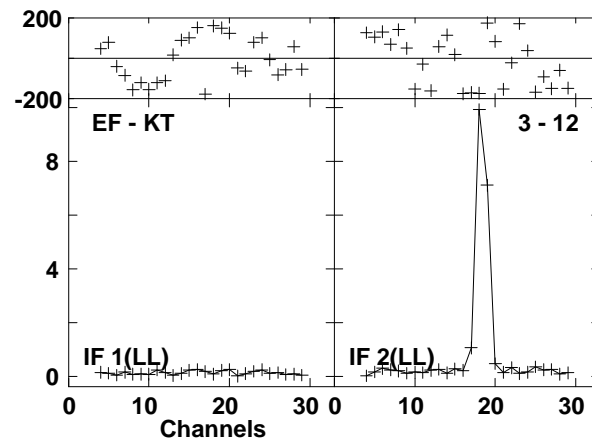
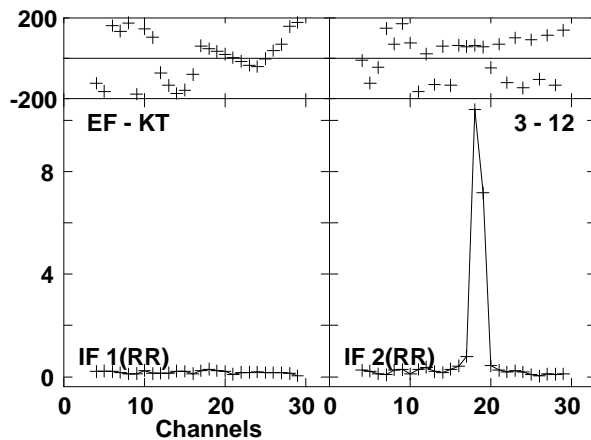
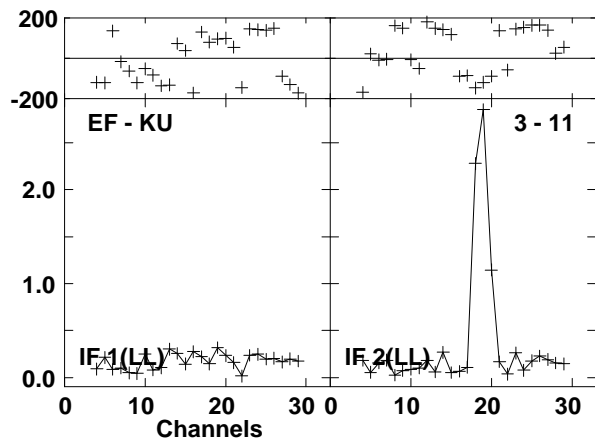
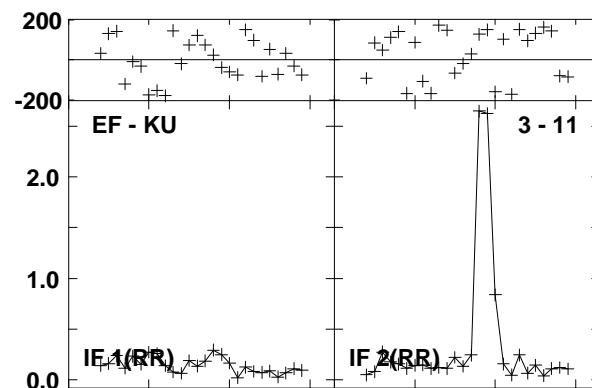
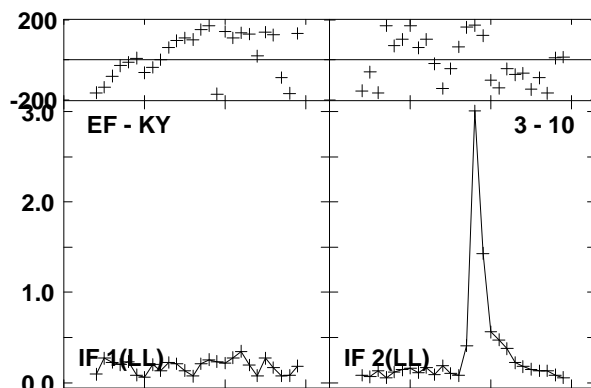
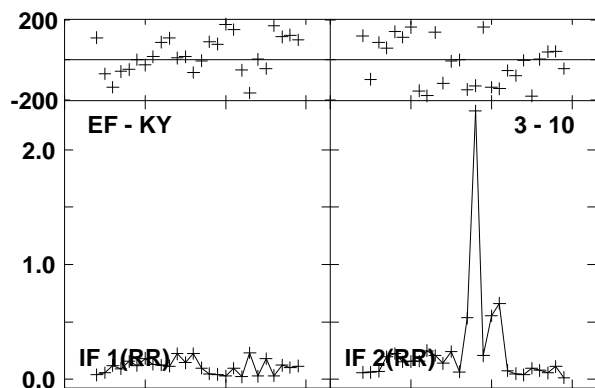
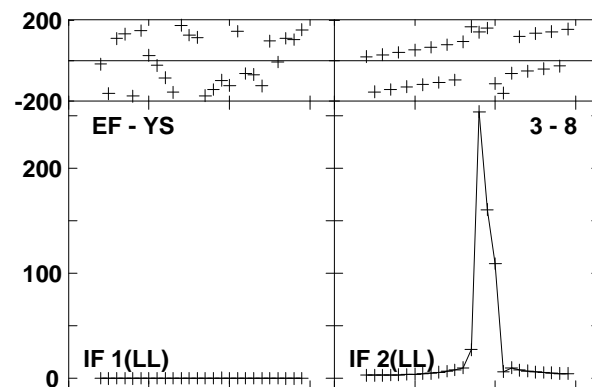
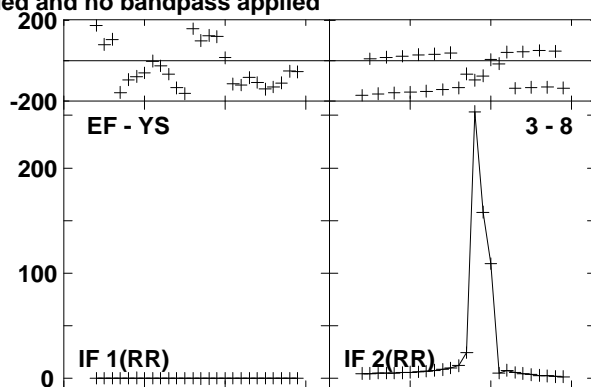
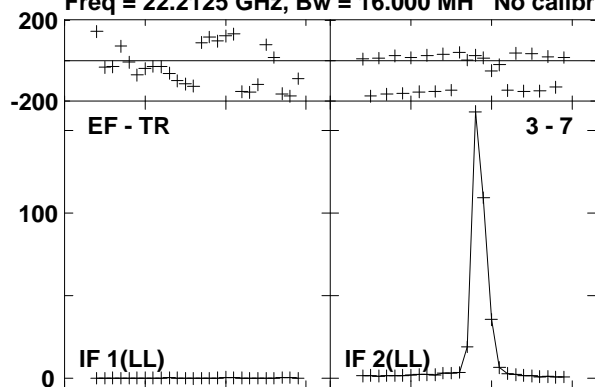

Lower frame: Milli Ampl Jy Top frame: Phas deg  
Vector averaged cross-power spectrum Baseline: EF (03) - TR (07)  
Timerange: 00/11:10:40 to 00/11:11:39

Plot file version 194 created 23-AUG-2016 15:00:49  
 W3IRS5 GA035B 1.UVDATA.1

Freq = 22.2125 GHz, Bw = 16.000 MH No calibration applied and no bandpass applied

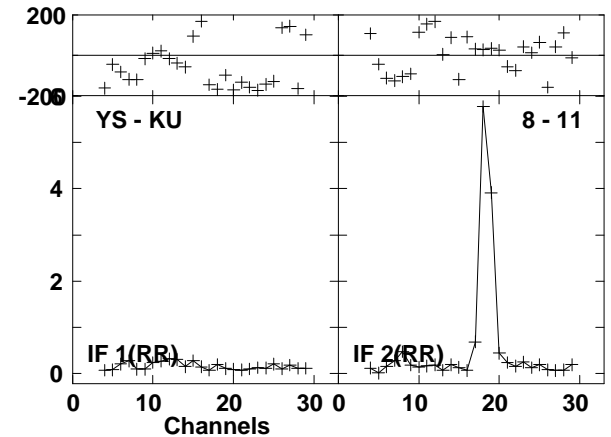
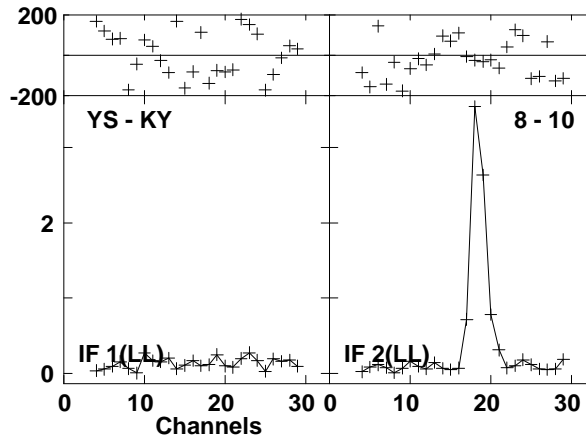
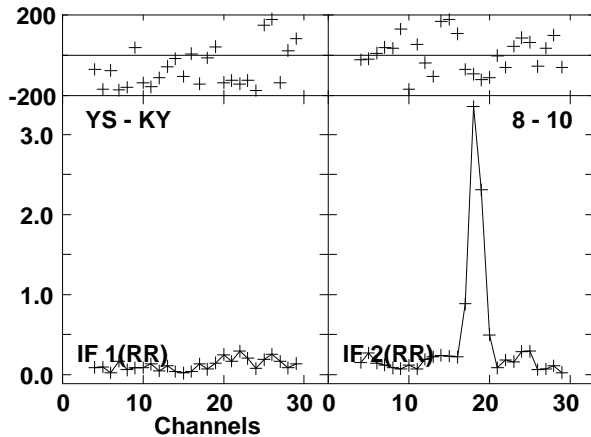
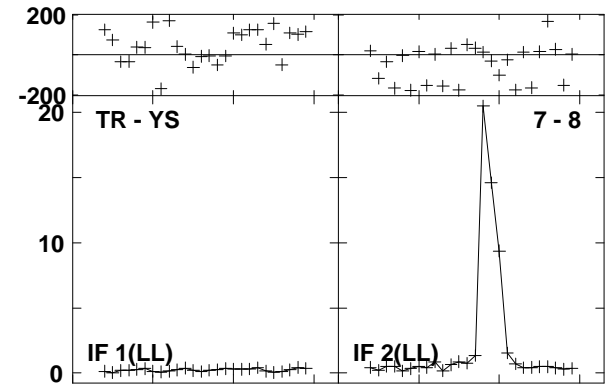
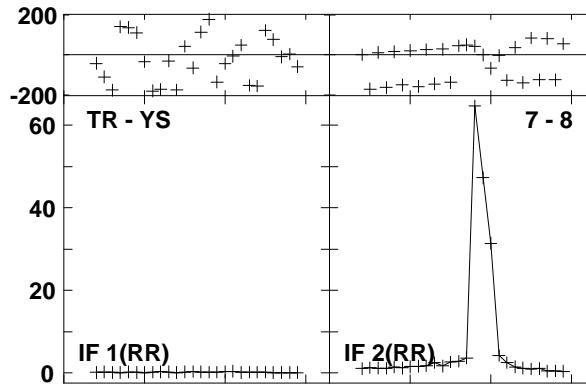
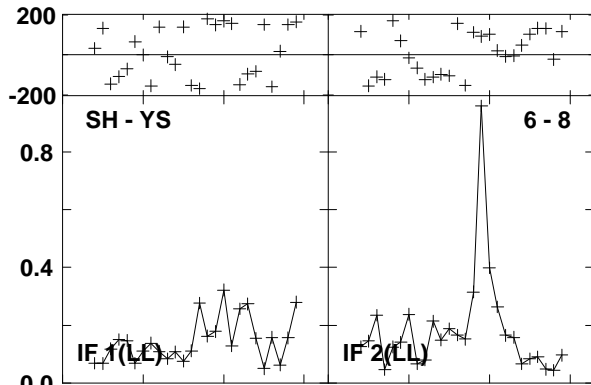
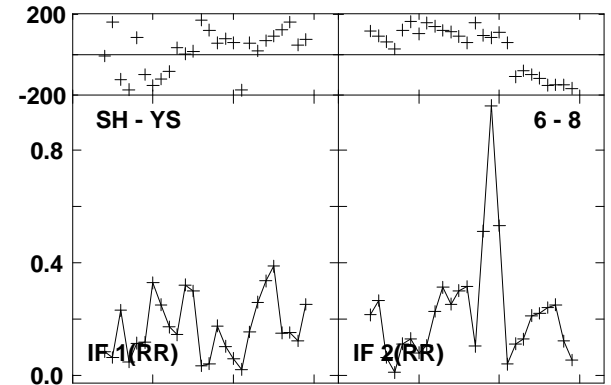
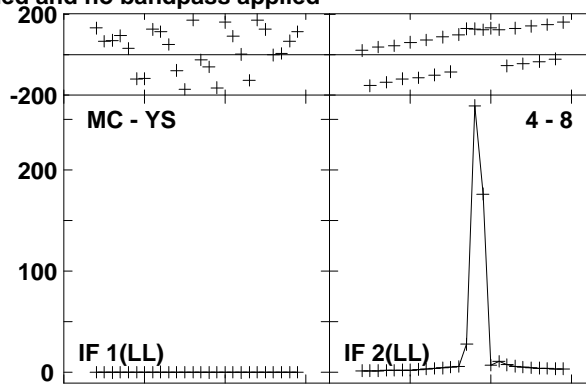
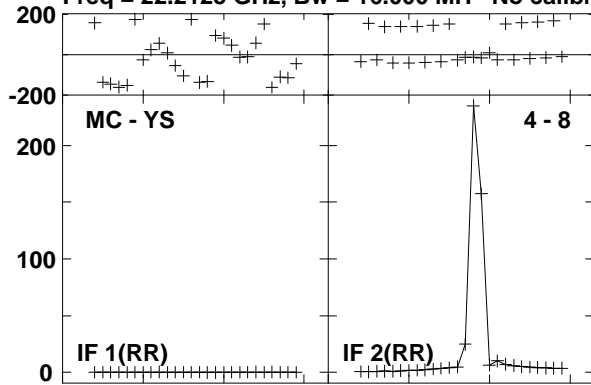

Lower frame: Milli Ampl Jy Top frame: Phas deg  
 Vector averaged cross-power spectrum Baseline: MC (04) - YS (08)  
 Timerange: 00/11:10:40 to 00/11:11:39

Plot file version 195 created 23-AUG-2016 15:00:49

W3IRS5 GA035B 1.UVDATA.1

Freq = 22.2125 GHz, Bw = 16.000 MH No calibration applied and no bandpass applied

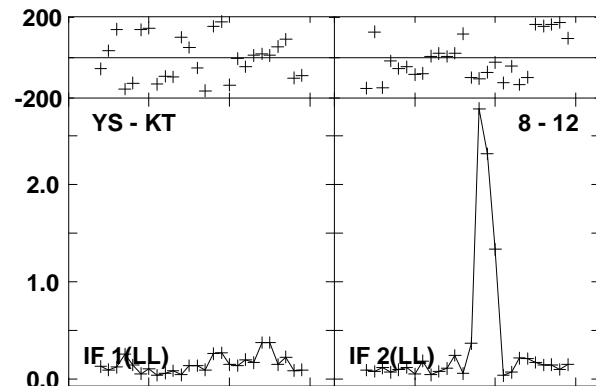
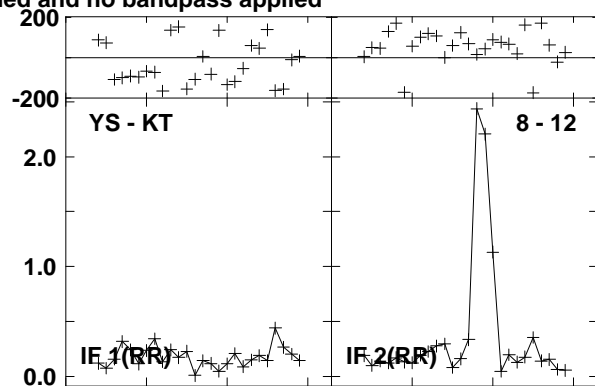
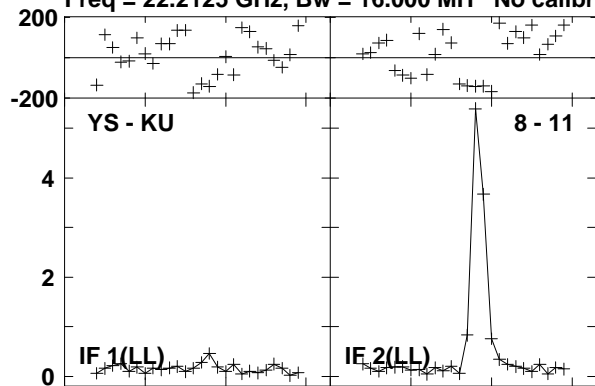

Lower frame: Milli Ampl Jy Top frame: Phas deg  
Vector averaged cross-power spectrum Baseline: YS (08) - KU (11)  
Timerange: 00/11:10:40 to 00/11:11:39

Plot file version 196 created 23-AUG-2016 15:00:49

0219+628 GA035B 1.UVDATA.1

Freq = 22.2125 GHz, Bw = 16.000 MH No calibration applied and no bandpass applied

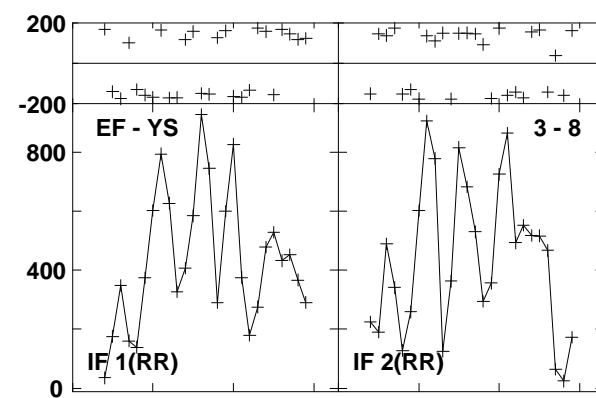
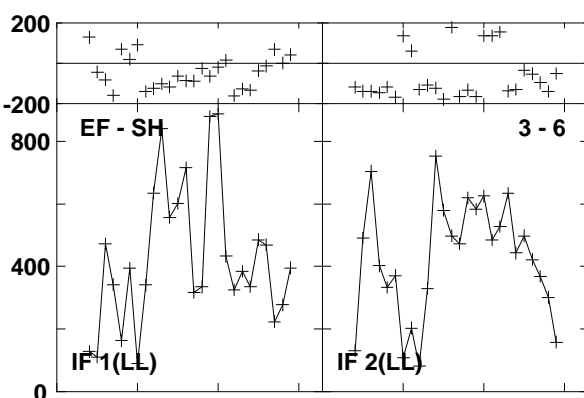
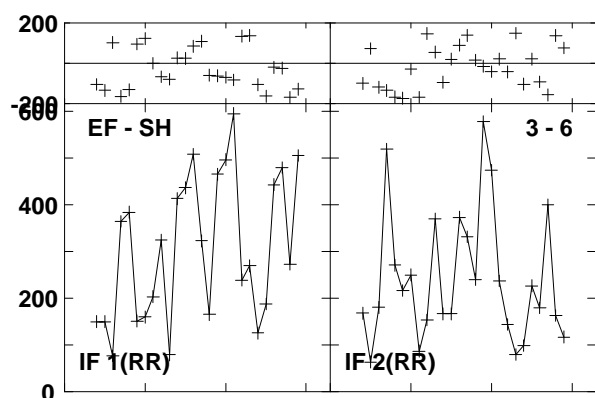
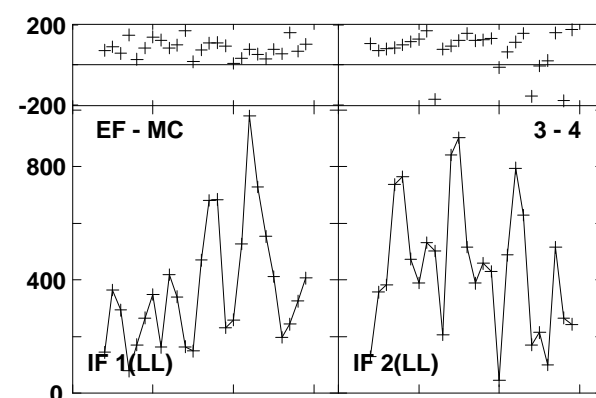
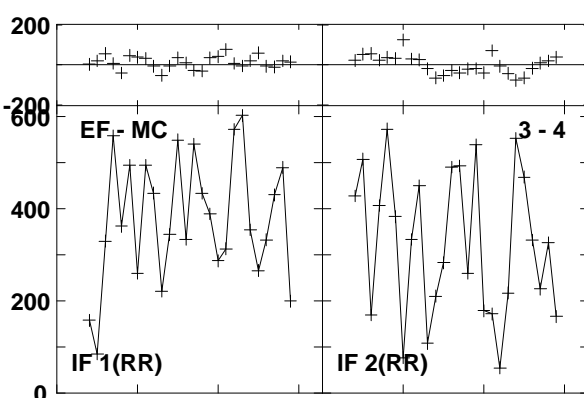
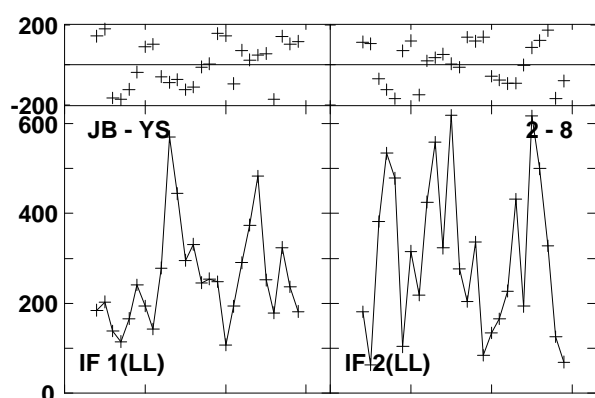
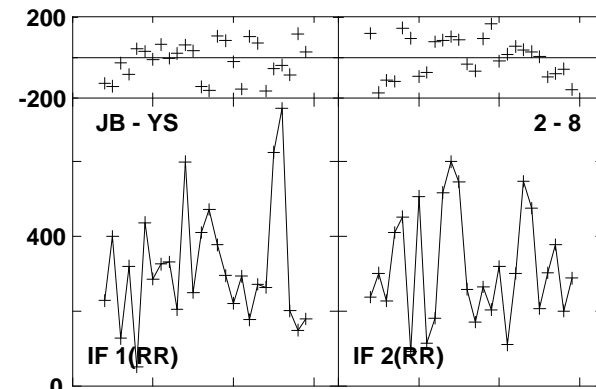
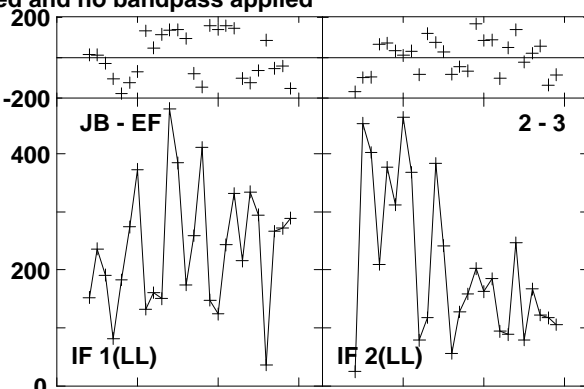
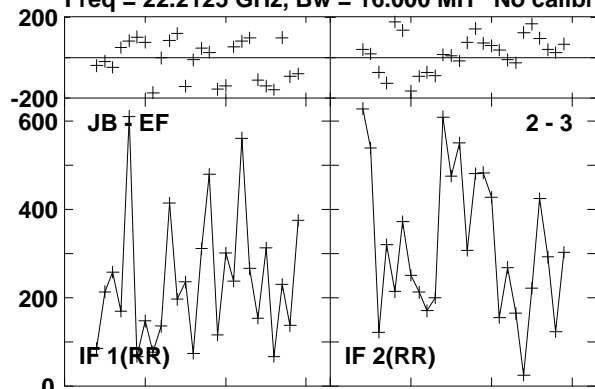

Lower frame: Micro Ampl Jy Top frame: Phas deg  
Vector averaged cross-power spectrum Baseline: JB (02) - EF (03)  
Timerange: 00/11:12:05 to 00/11:12:25

Plot file version 197 created 23-AUG-2016 15:00:49

0219+628 GA035B 1.UVDATA.1

Freq = 22.2125 GHz, Bw = 16.000 MH No calibration applied and no bandpass applied

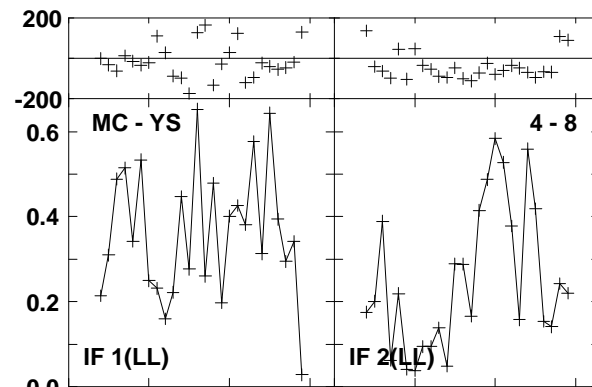
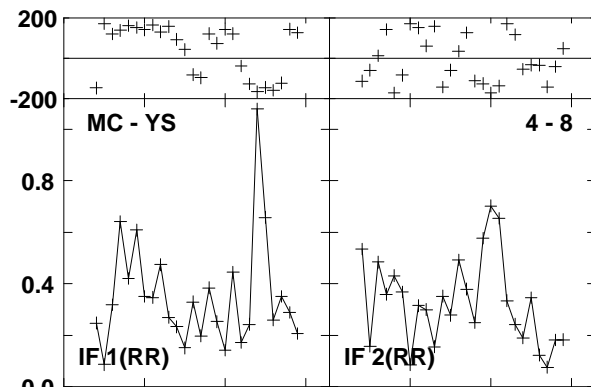
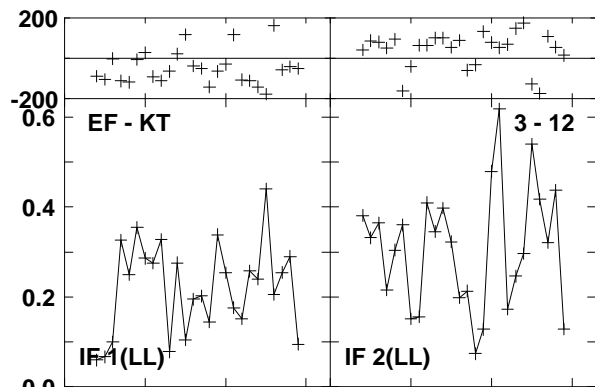
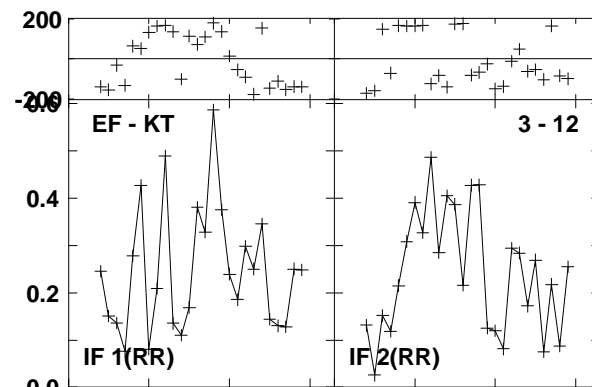
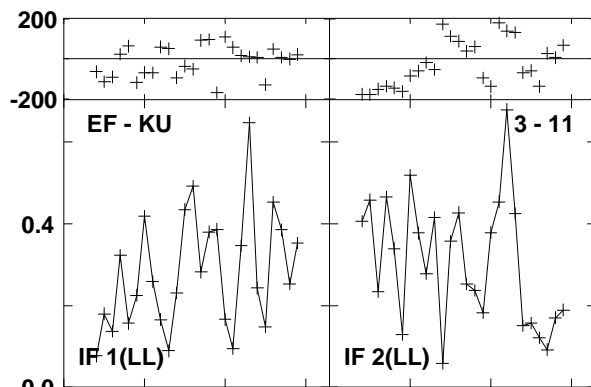
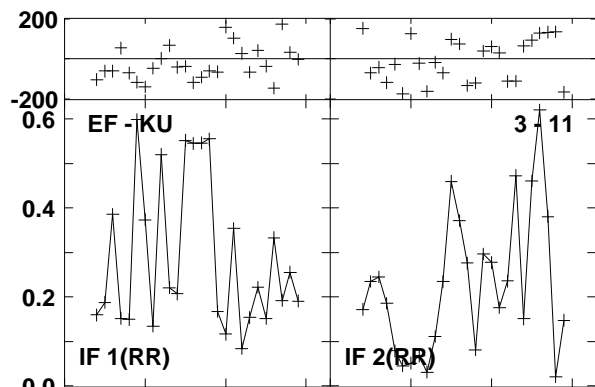
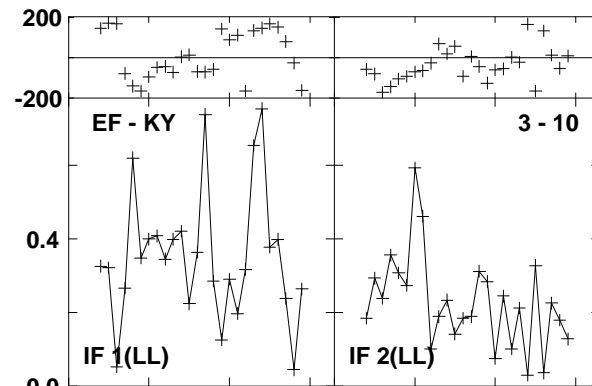
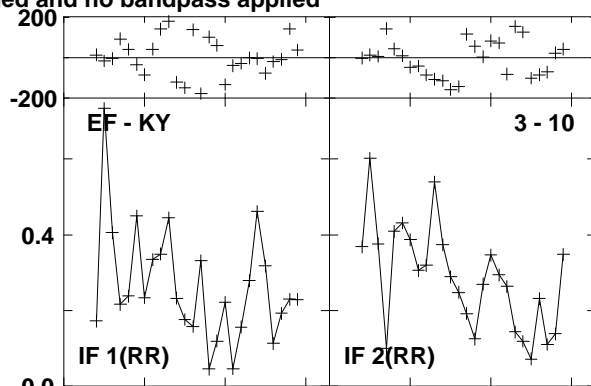
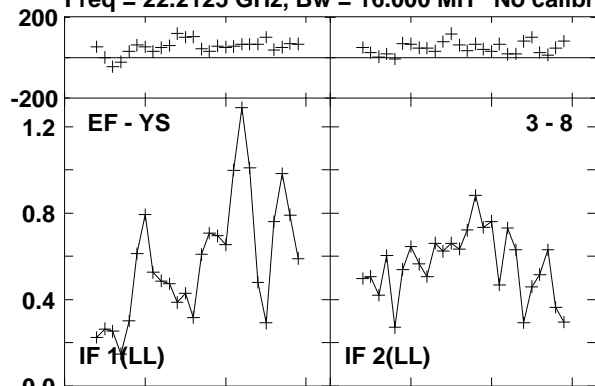

Lower frame: Milli Ampl Jy Top frame: Phas deg  
Vector averaged cross-power spectrum Baseline: EF (03) - YS (08)  
Timerange: 00/11:12:05 to 00/11:12:25

Plot file version 198 created 23-AUG-2016 15:00:49

0219+628 GA035B 1.UVDATA.1

Freq = 22.2125 GHz, Bw = 16.000 MH No calibration applied and no bandpass applied

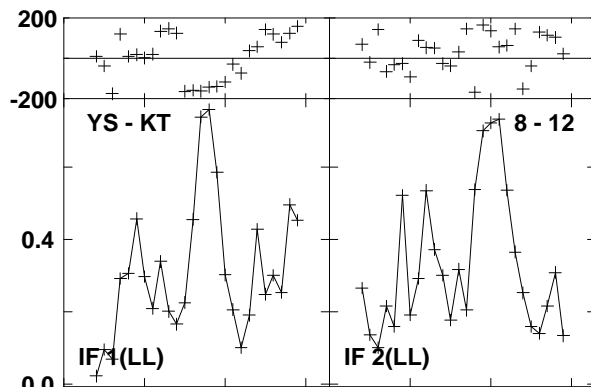
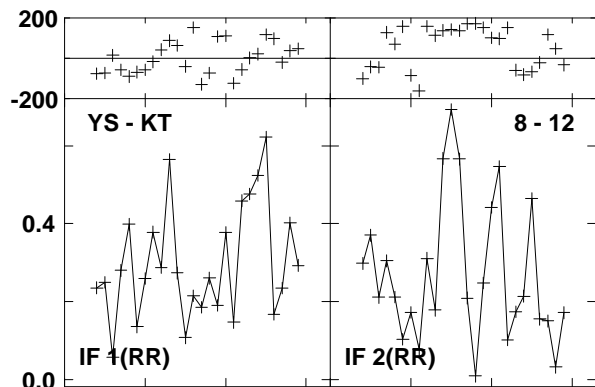
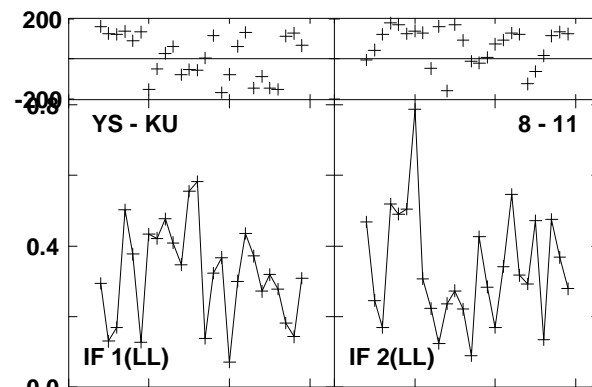
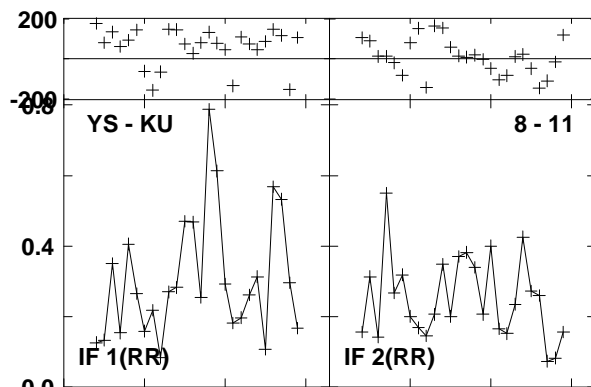
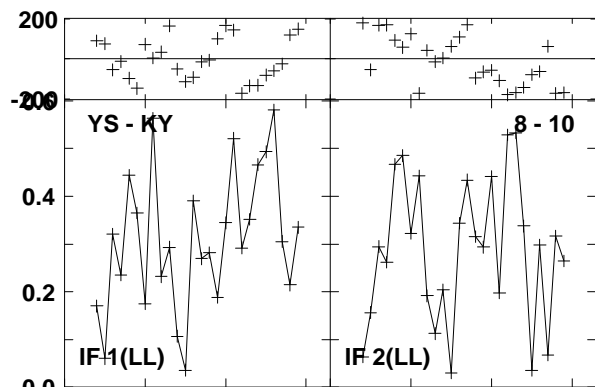
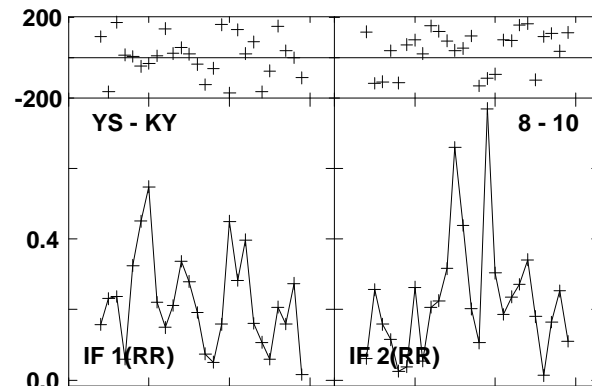
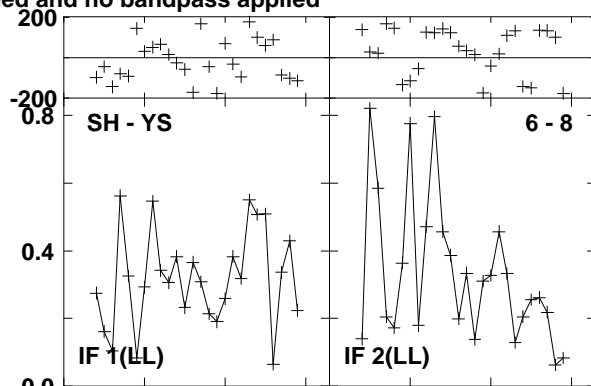
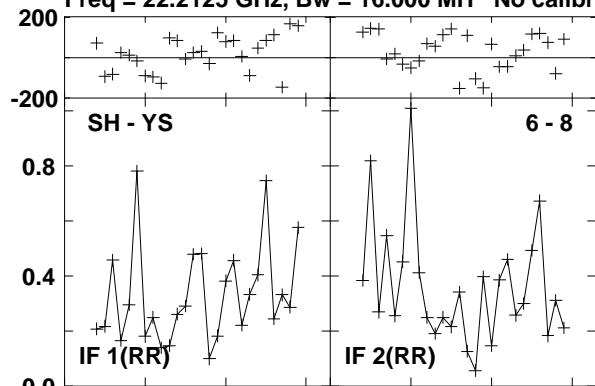

Lower frame: Milli Ampl Jy Top frame: Phas deg

Vector averaged cross-power spectrum Baseline: SH (06) - YS (08)

Timerange: 00/11:12:05 to 00/11:12:25

Plot file version 199 created 23-AUG-2016 15:00:49  
 W3IRS5 GA035B 1.UVDATA.1

Freq = 22.2125 GHz, Bw = 16.000 MH No calibration applied and no bandpass applied

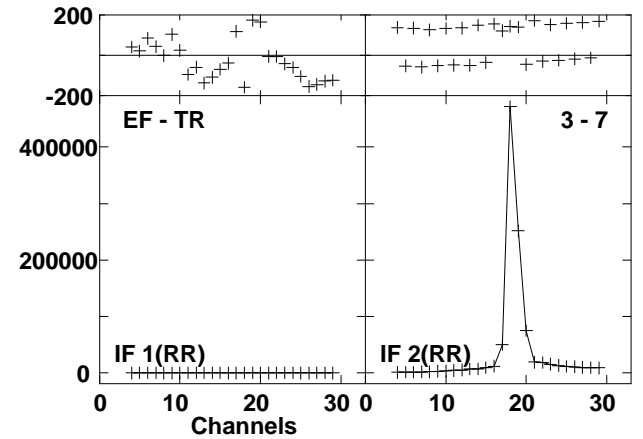
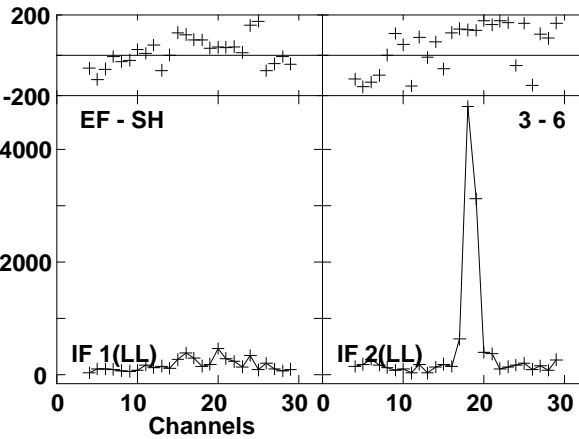
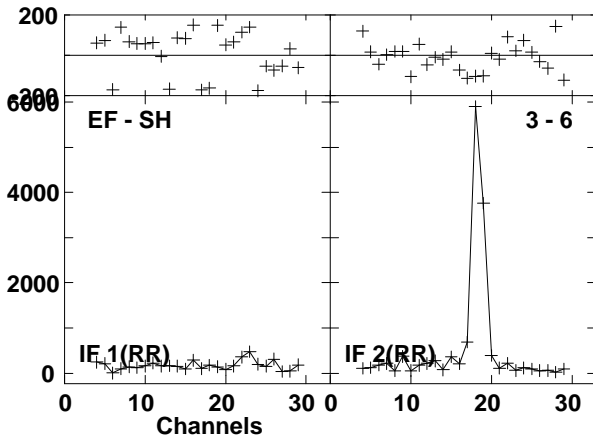
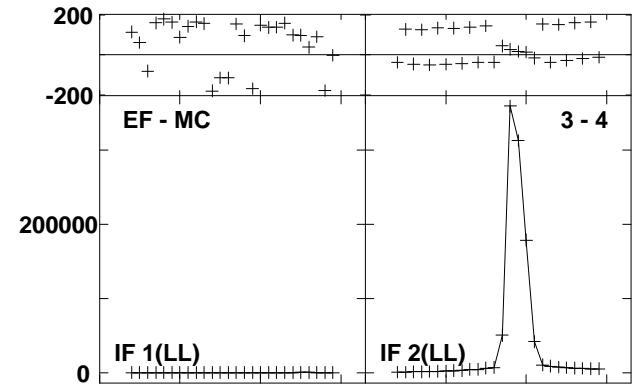
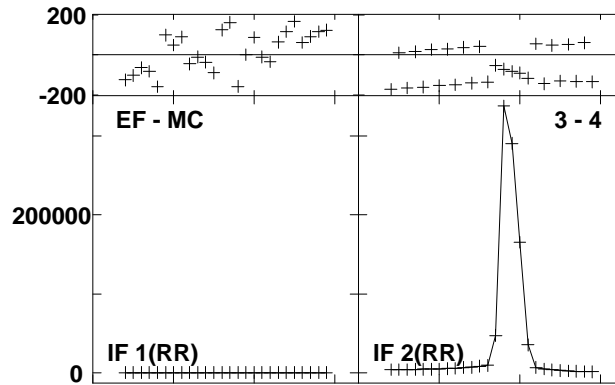
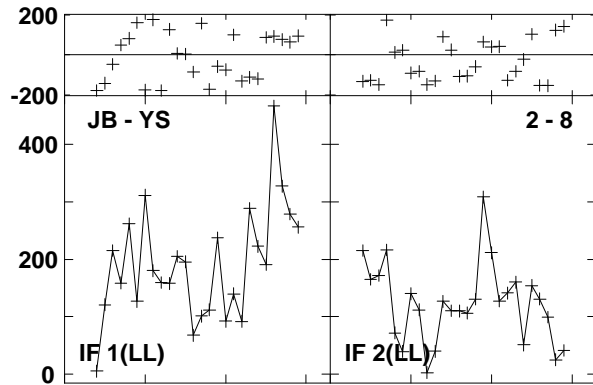
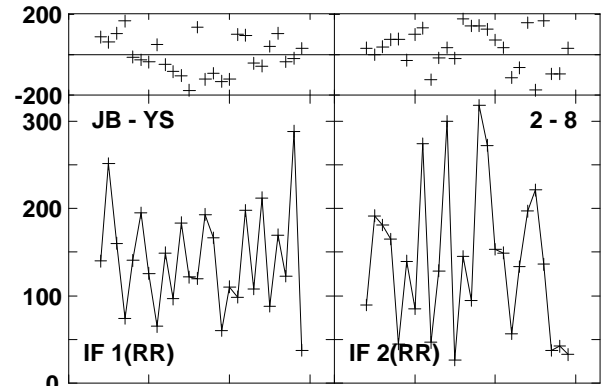
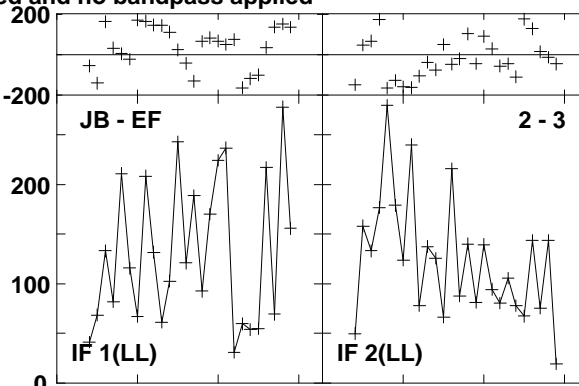
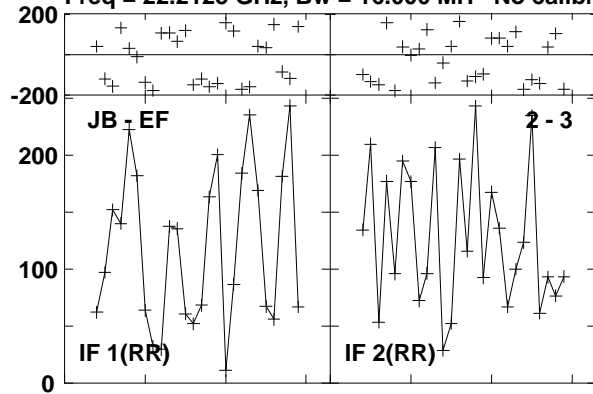

Lower frame: Micro Ampl Jy Top frame: Phas deg  
 Vector averaged cross-power spectrum Baseline: JB (02) - EF (03)  
 Timerange: 00/11:12:50 to 00/11:13:50

Plot file version 200 created 23-AUG-2016 15:00:49

W3IRS5 GA035B 1.UVDATA.1

Freq = 22.2125 GHz, Bw = 16.000 MH No calibration applied and no bandpass applied

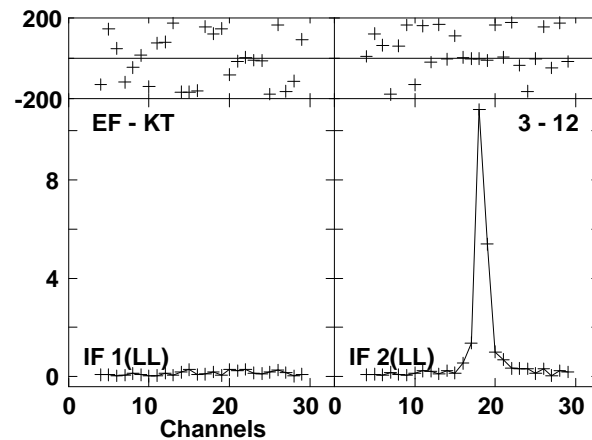
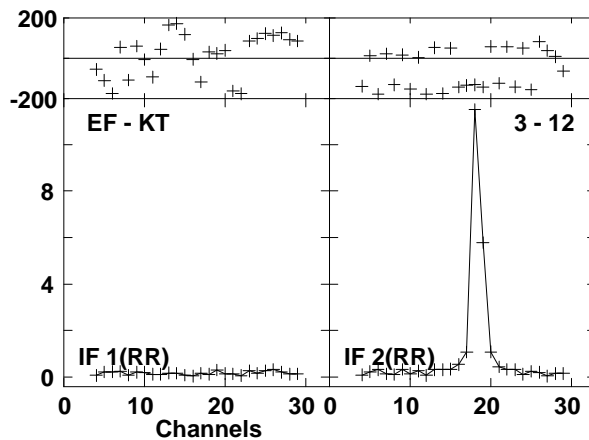
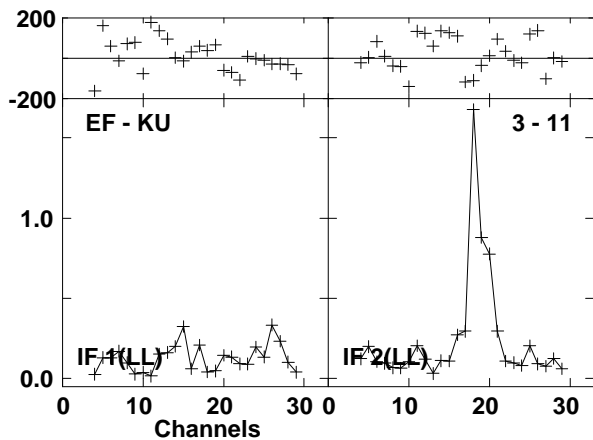
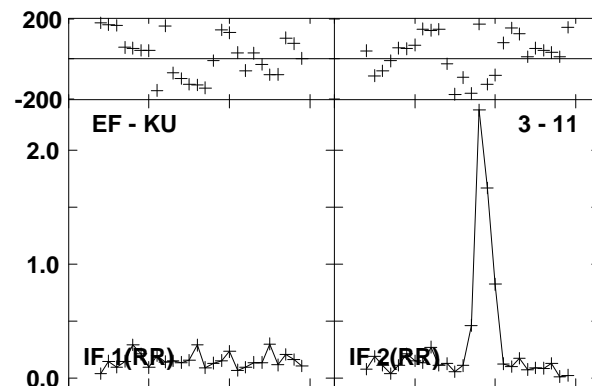
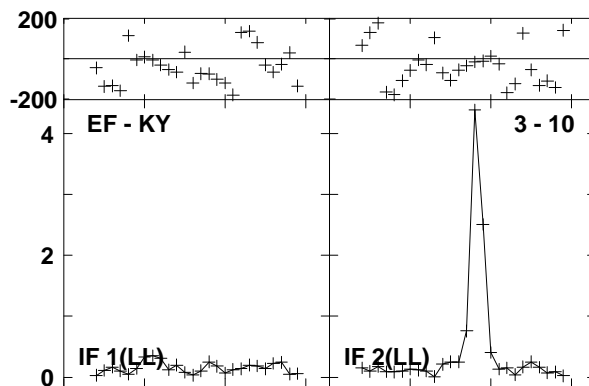
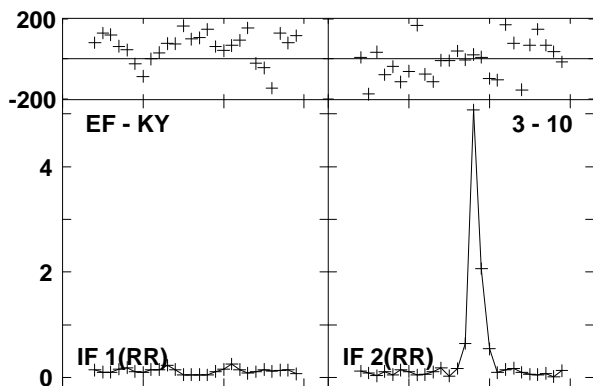
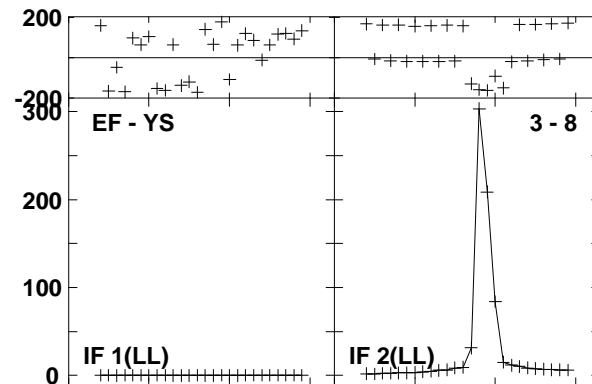
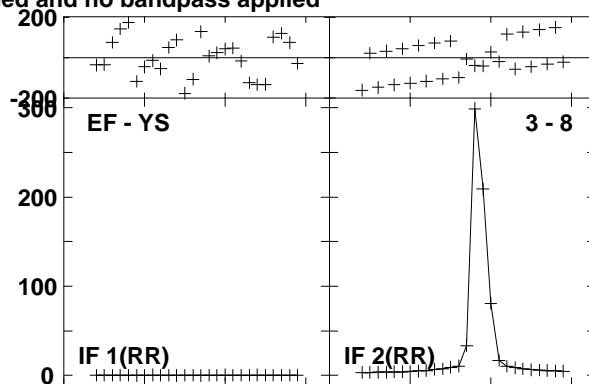
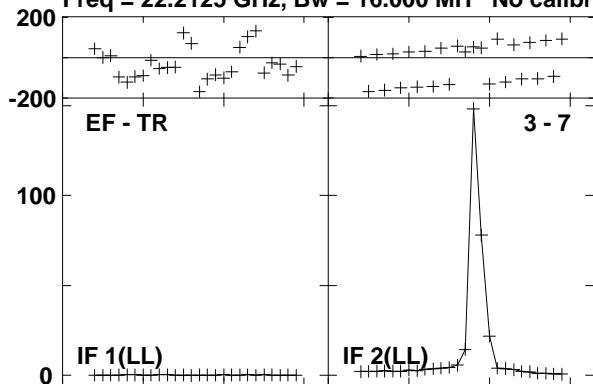

Lower frame: Milli Ampl Jy Top frame: Phas deg  
Vector averaged cross-power spectrum Baseline: EF (03) - TR (07)  
Timerange: 00/11:12:50 to 00/11:13:50



Plot file version 201 created 23-AUG-2016 15:00:49  
W3IRS5 GA035B 1.UVDATA.1

Freq = 22.2125 GHz, Bw = 16.000 MH No calibration applied and no bandpass applied

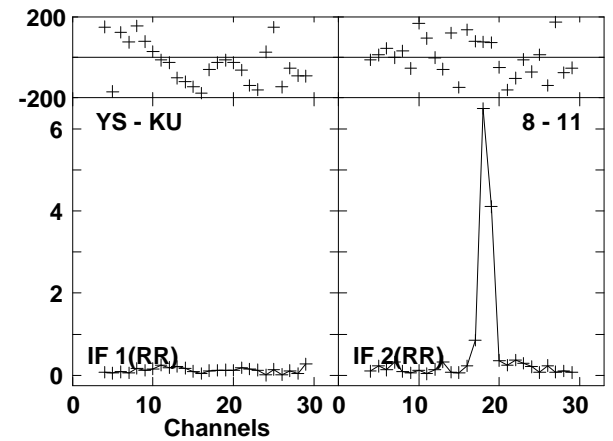
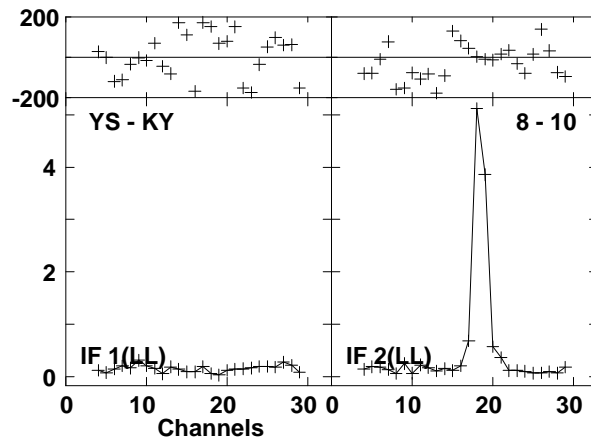
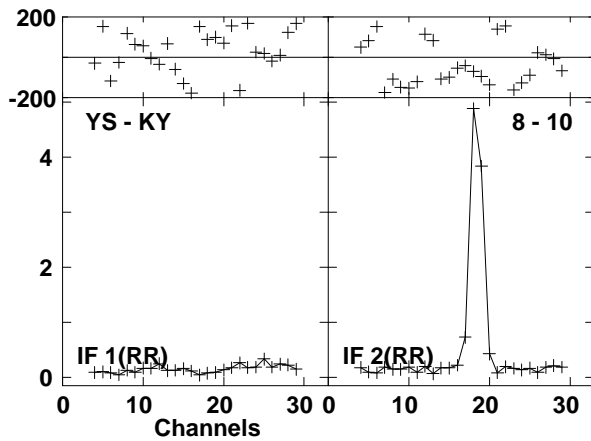
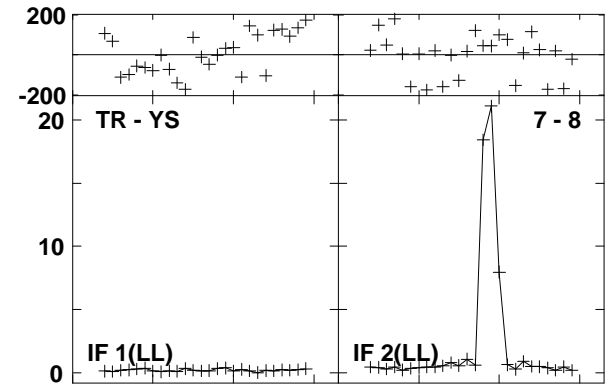
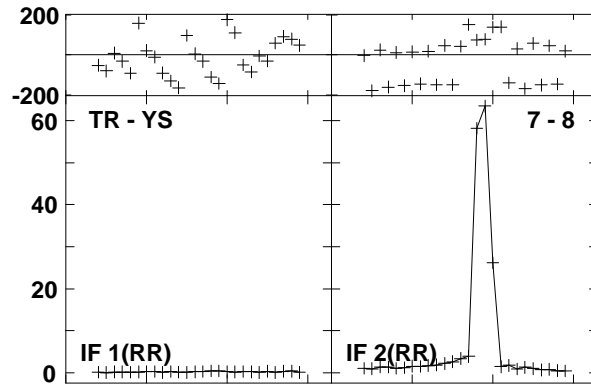
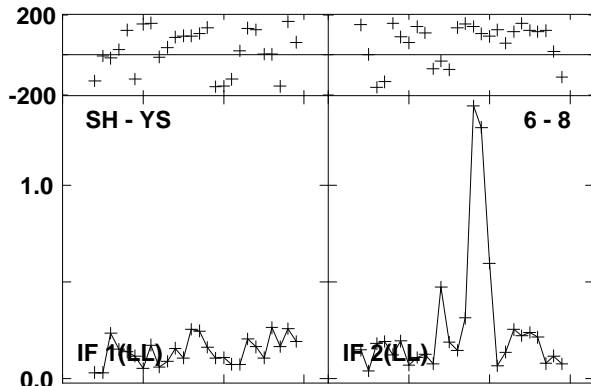
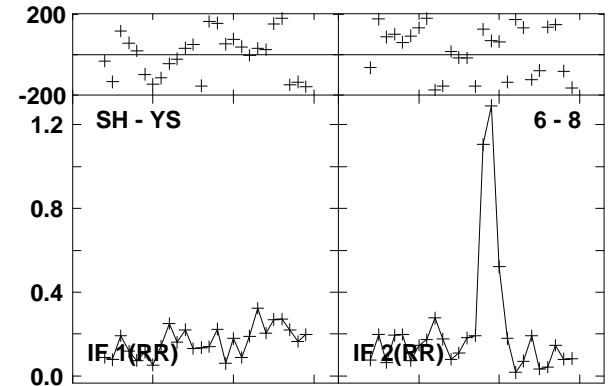
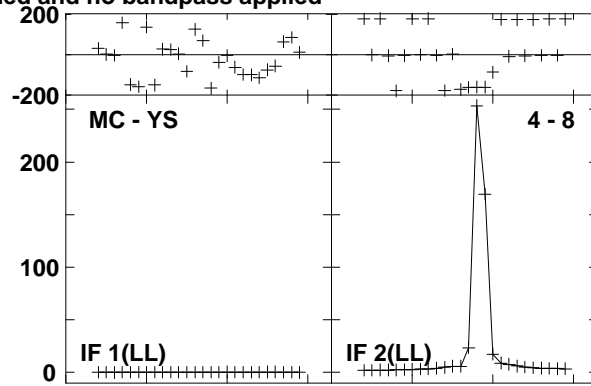
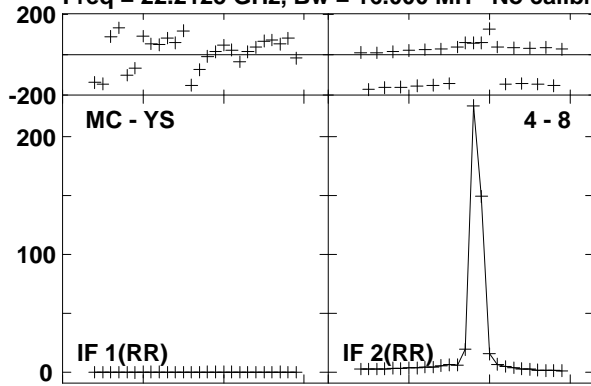

Lower frame: Milli Ampl Jy Top frame: Phas deg  
Vector averaged cross-power spectrum Baseline: MC (04) - YS (08)  
Timerange: 00/11:12:50 to 00/11:13:50

Plot file version 202 created 23-AUG-2016 15:00:49  
W3IRS5 GA035B 1.UVDATA.1

Freq = 22.2125 GHz, Bw = 16.000 MH No calibration applied and no bandpass applied

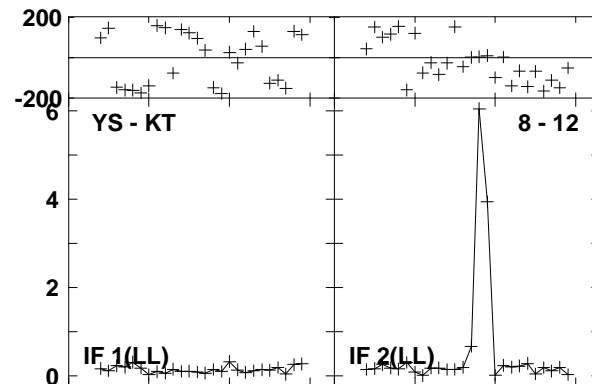
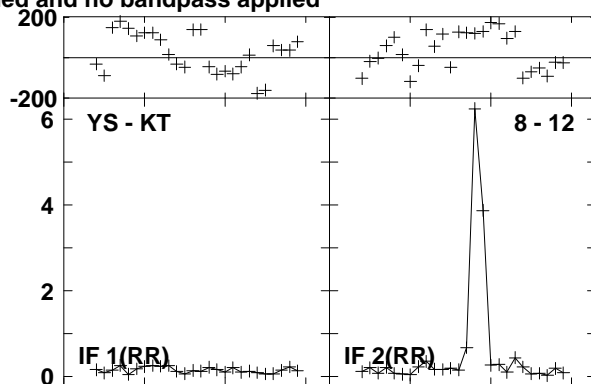
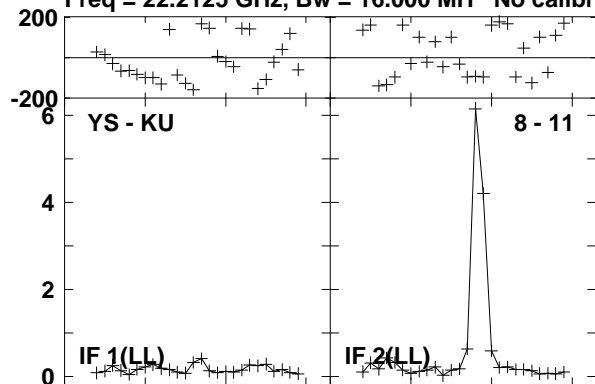

Lower frame: Milli Ampl Jy Top frame: Phas deg  
Vector averaged cross-power spectrum Baseline: YS (08) - KU (11)  
Timerange: 00/11:12:50 to 00/11:13:50

Plot file version 203 created 23-AUG-2016 15:00:49

0219+628 GA035B 1.UVDATA.1

Freq = 22.2125 GHz, Bw = 16.000 MH No calibration applied and no bandpass applied

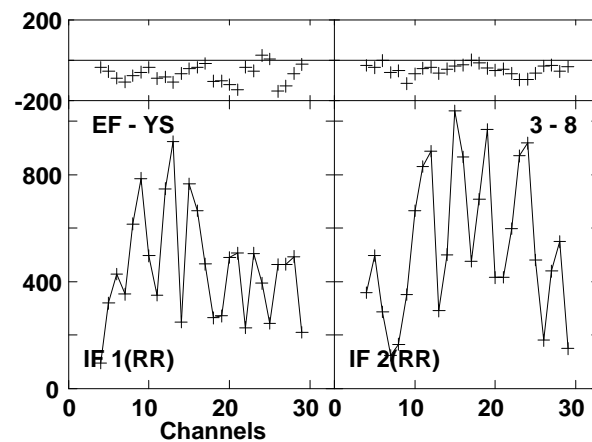
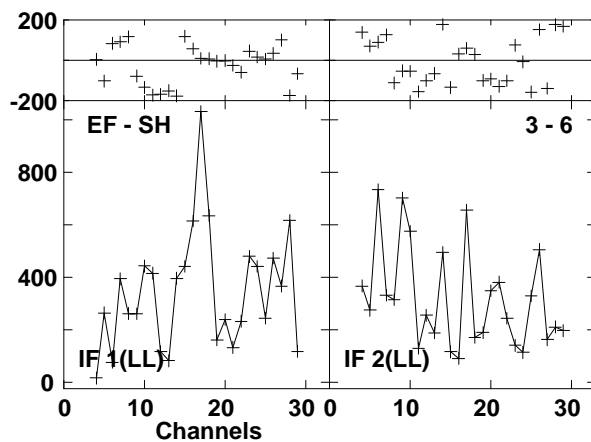
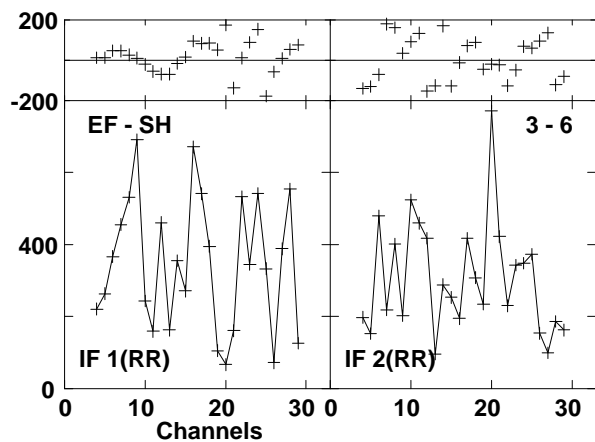
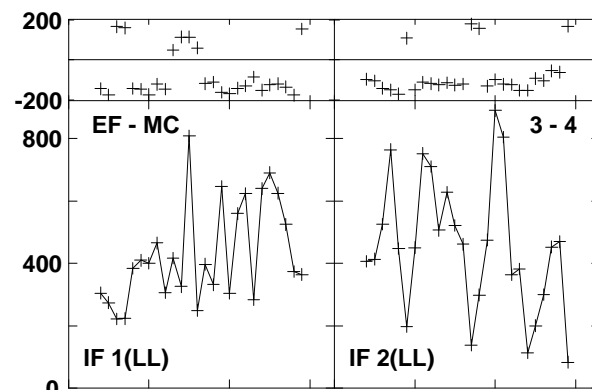
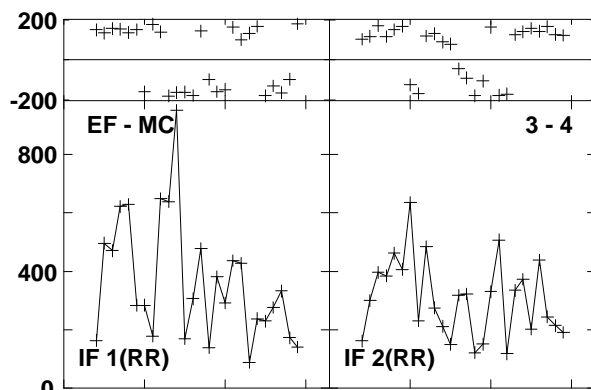
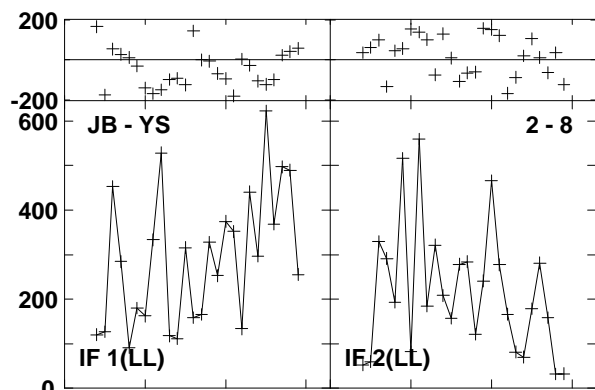
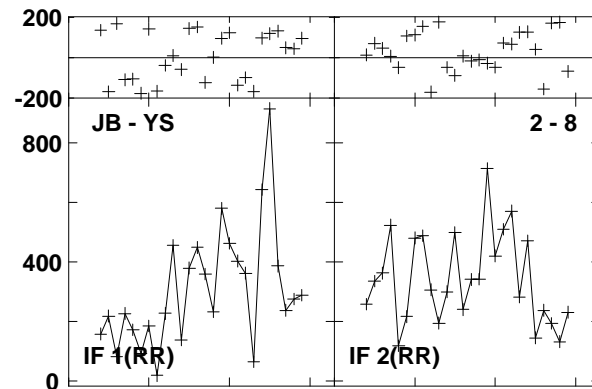
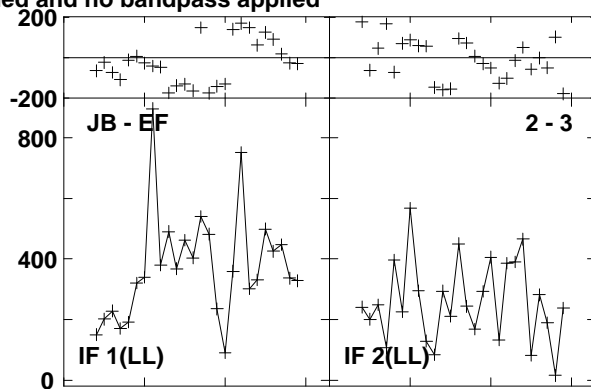
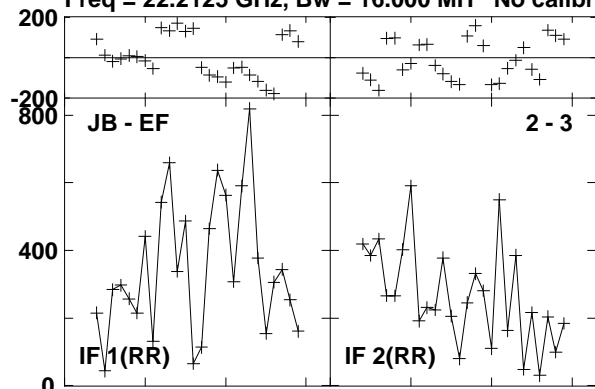

Lower frame: Micro Ampl Jy Top frame: Phas deg  
Vector averaged cross-power spectrum Baseline: JB (02) - EF (03)  
Timerange: 00/11:14:15 to 00/11:14:35

Plot file version 204 created 23-AUG-2016 15:00:49

0219+628 GA035B 1.UVDATA.1

Freq = 22.2125 GHz, Bw = 16.000 MH No calibration applied and no bandpass applied

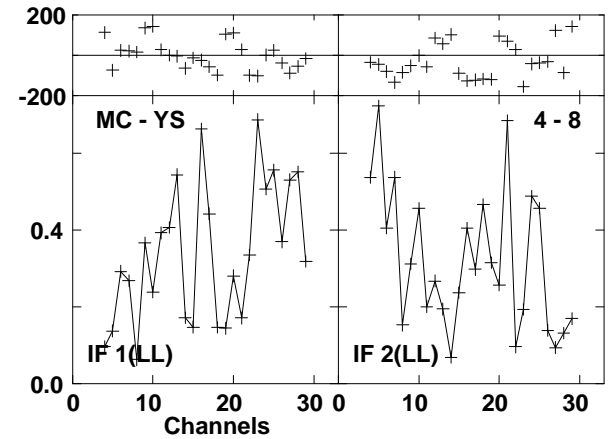
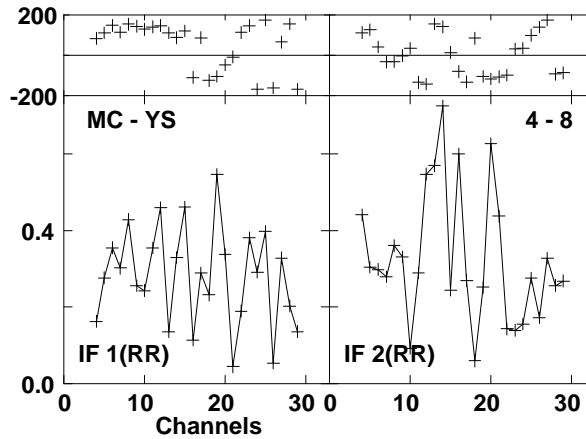
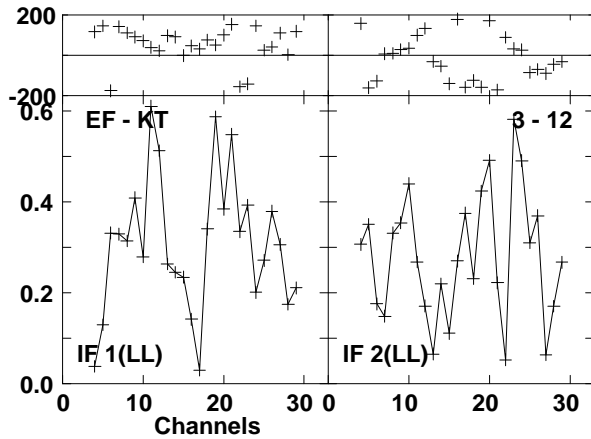
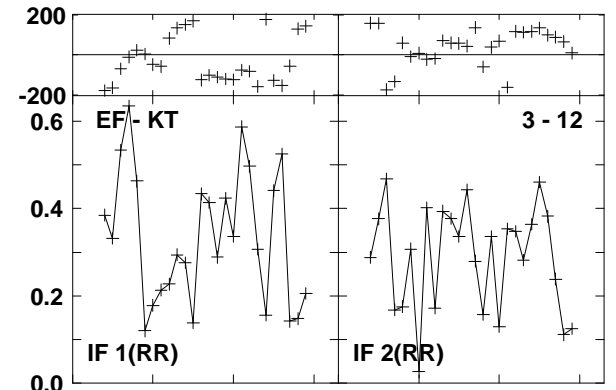
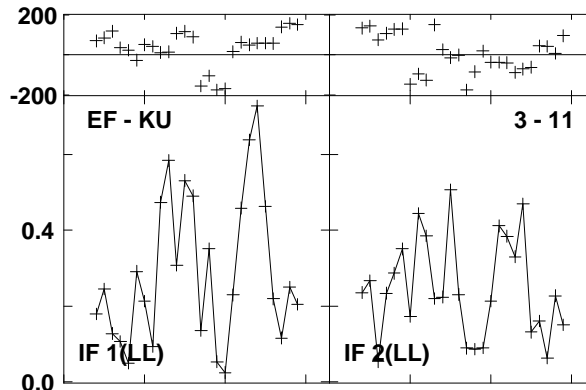
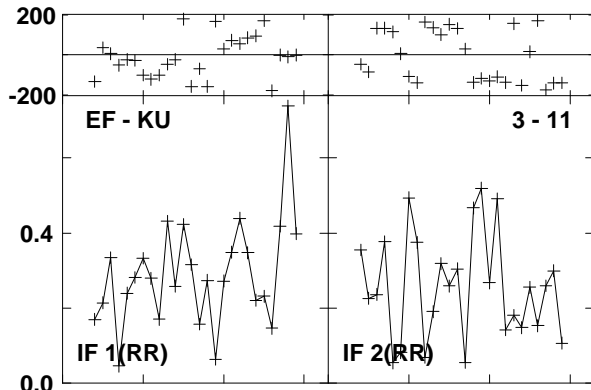
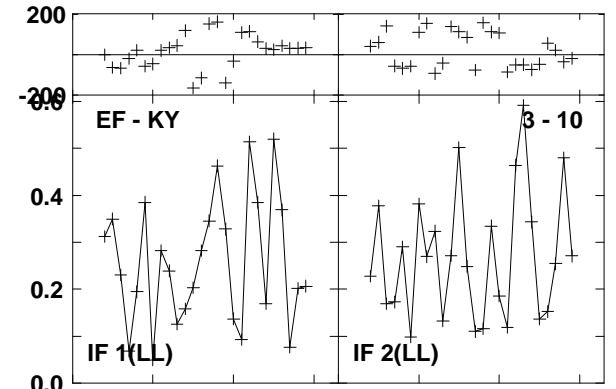
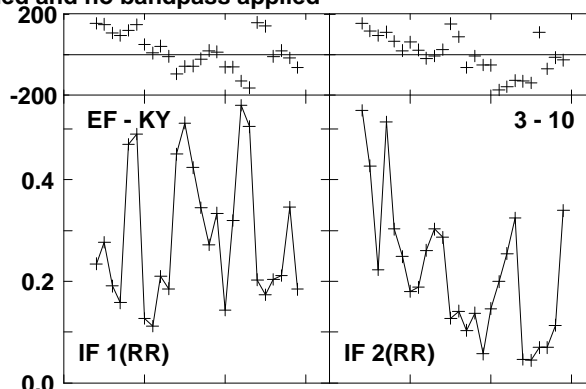
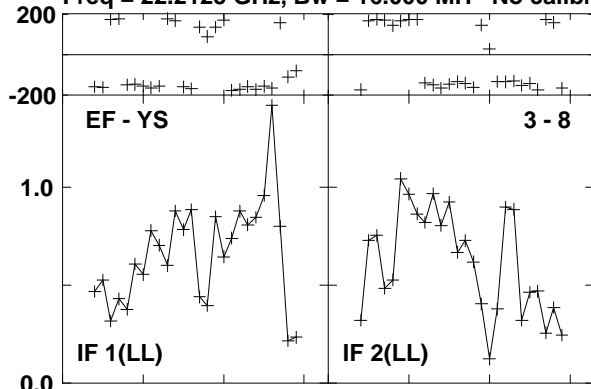

Lower frame: Milli Ampl Jy Top frame: Phas deg  
Vector averaged cross-power spectrum Baseline: EF (03) - YS (08)  
Timerange: 00/11:14:15 to 00/11:14:35

Plot file version 205 created 23-AUG-2016 15:00:49

0219+628 GA035B 1.UVDATA.1

Freq = 22.2125 GHz, Bw = 16.000 MH No calibration applied and no bandpass applied

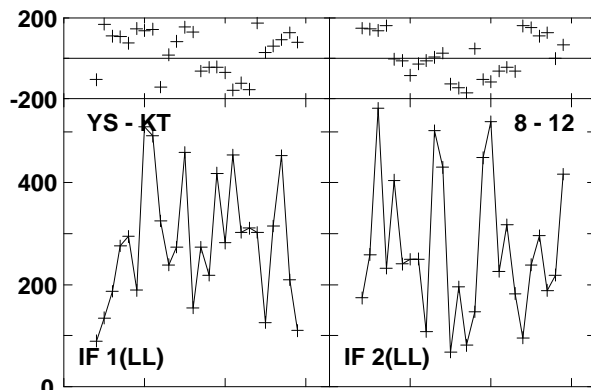
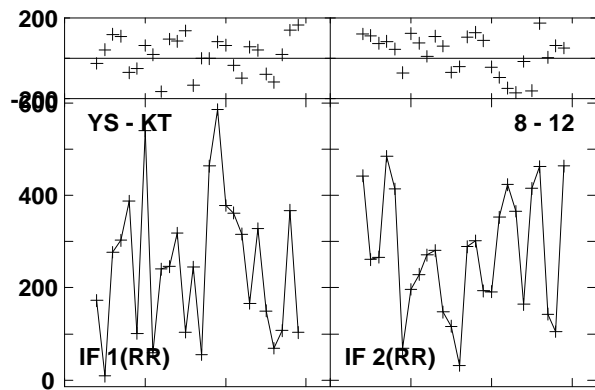
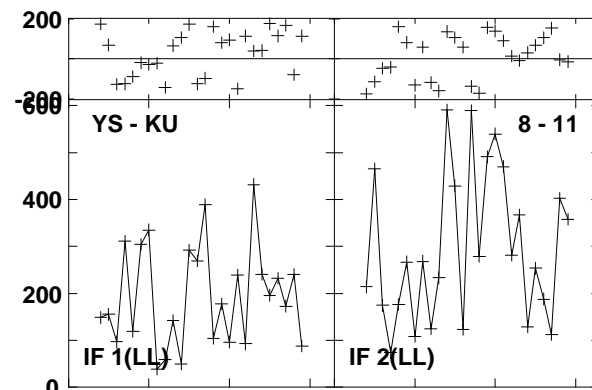
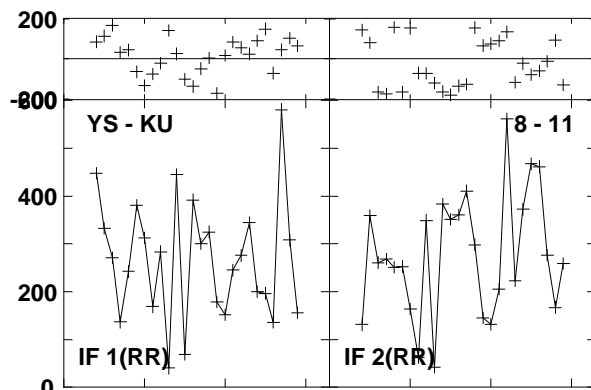
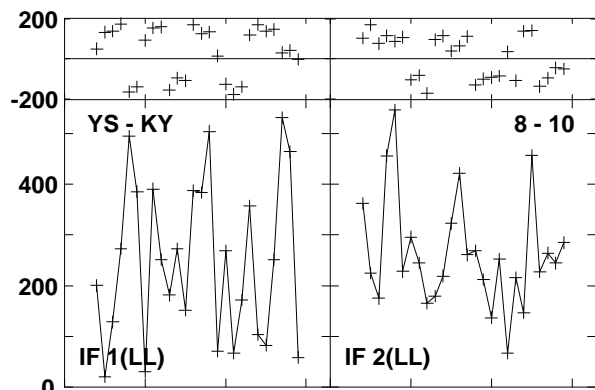
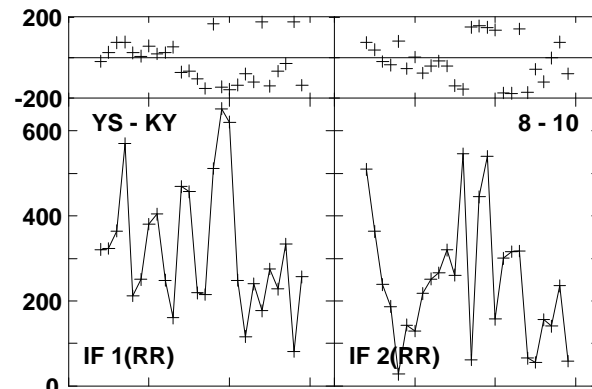
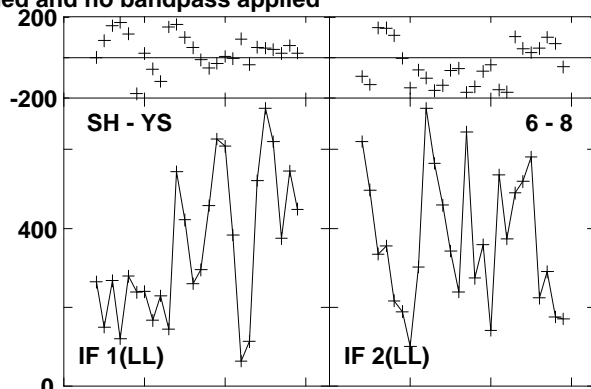
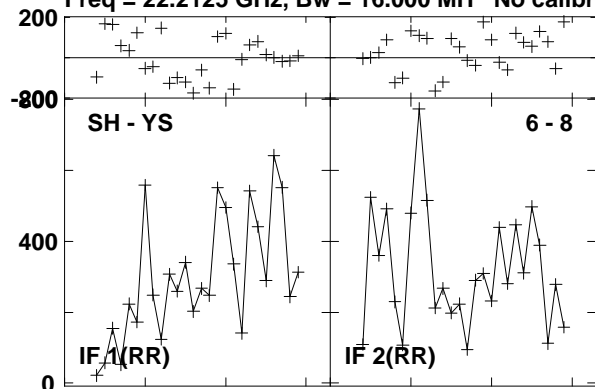

Lower frame: Micro Ampl Jy Top frame: Phas deg  
Vector averaged cross-power spectrum Baseline: SH (06) - YS (08)  
Timerange: 00/11:14:15 to 00/11:14:35

Plot file version 206 created 23-AUG-2016 15:00:49  
 W3IRS5 GA035B 1.UVDATA.1

Freq = 22.2125 GHz, Bw = 16.000 MH No calibration applied and no bandpass applied

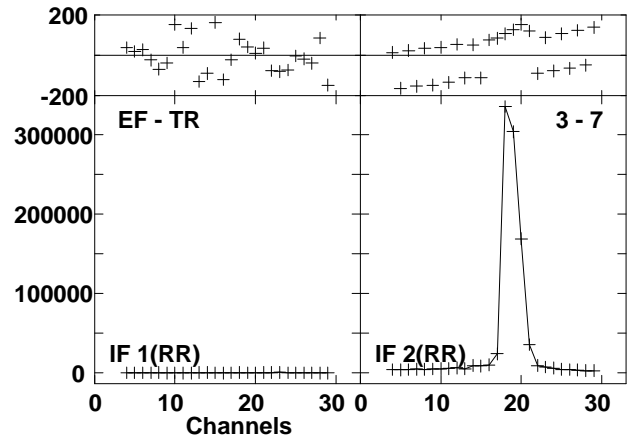
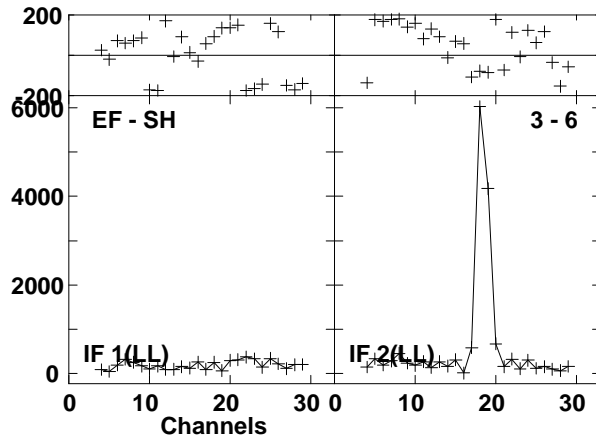
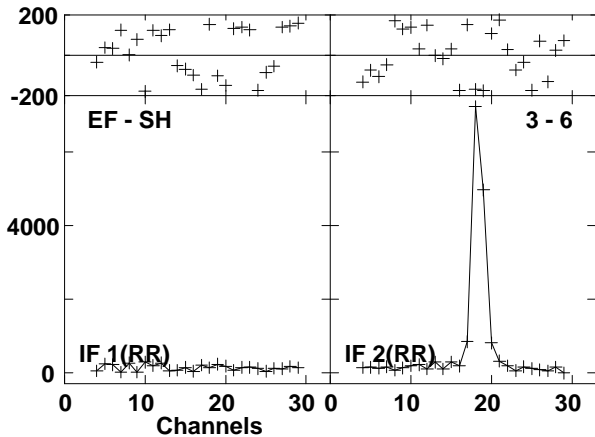
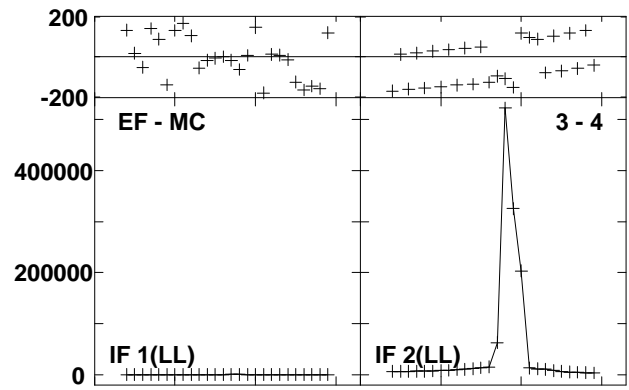
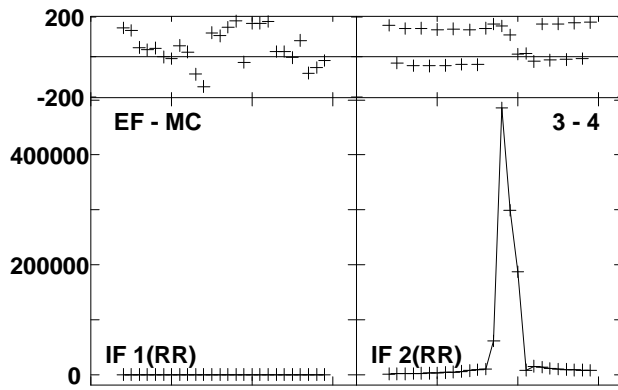
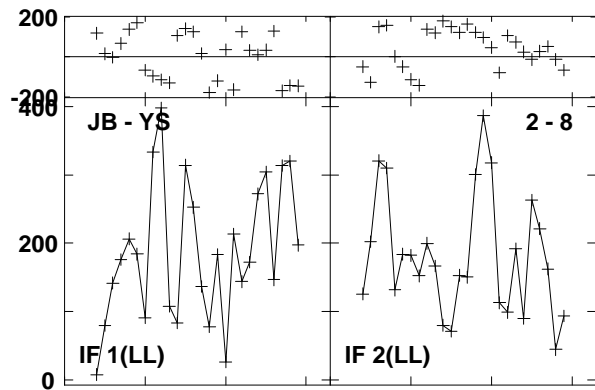
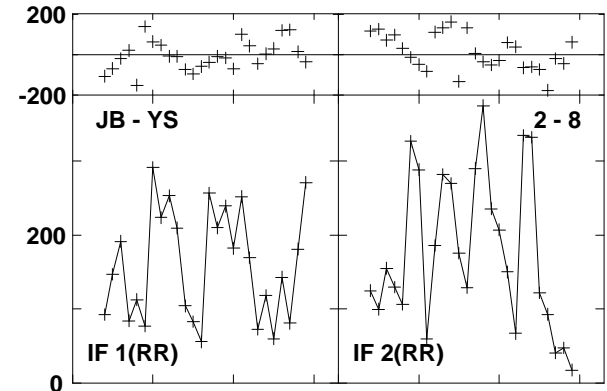
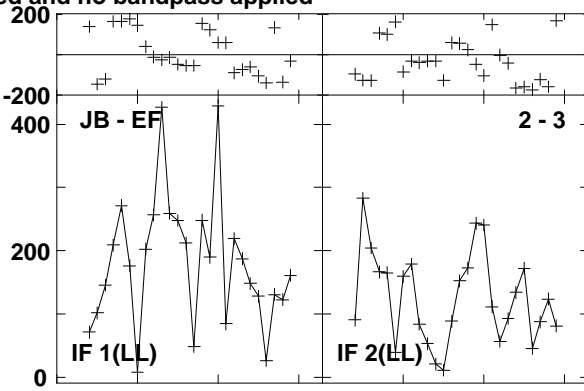
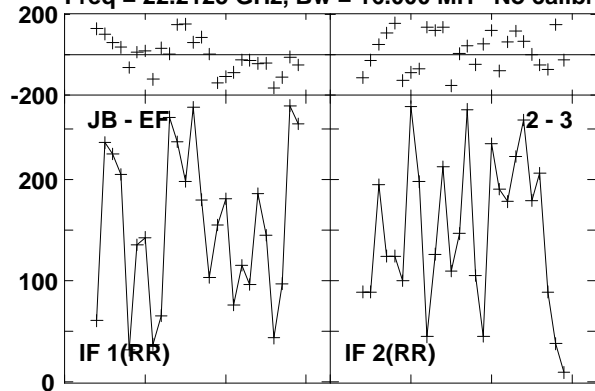

Lower frame: Micro Ampl Jy Top frame: Phas deg  
 Vector averaged cross-power spectrum Baseline: JB (02) - EF (03)  
 Timerange: 00/11:15:01 to 00/11:16:00

Plot file version 207 created 23-AUG-2016 15:00:49

W3IRS5 GA035B 1.UVDATA.1

Freq = 22.2125 GHz, Bw = 16.000 MH No calibration applied and no bandpass applied

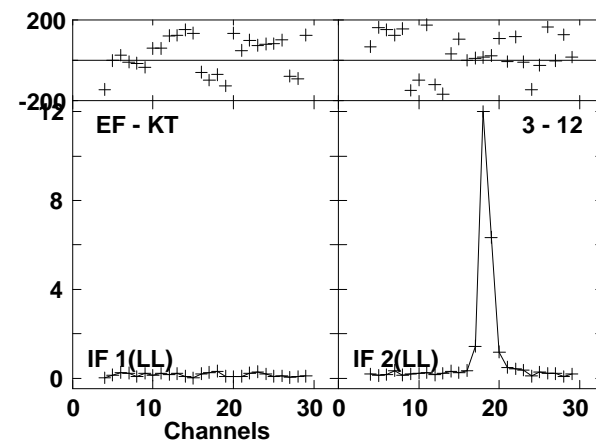
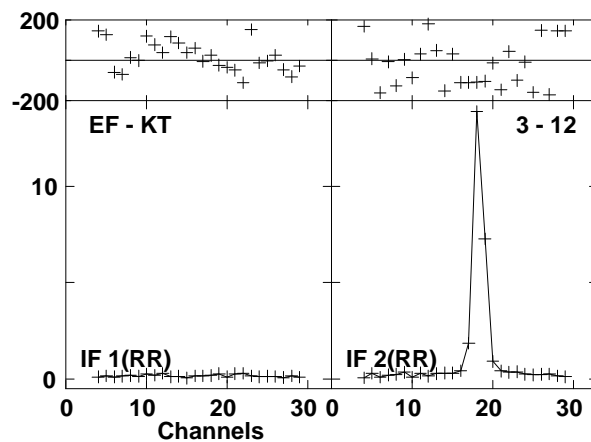
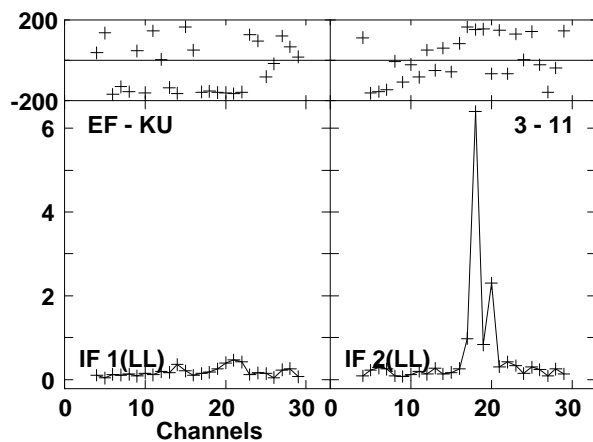
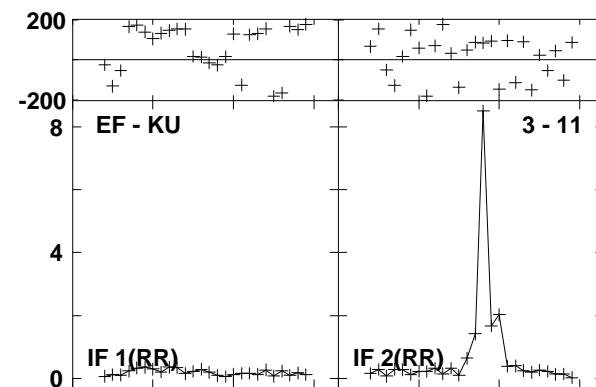
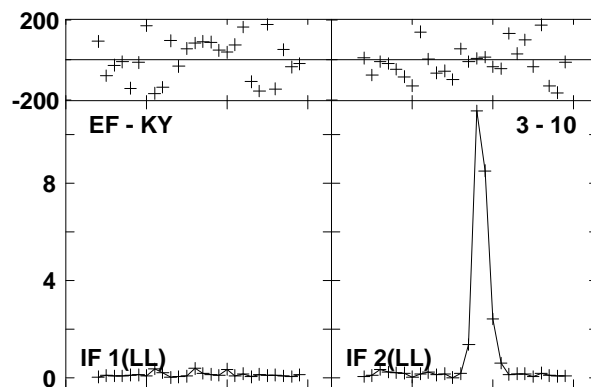
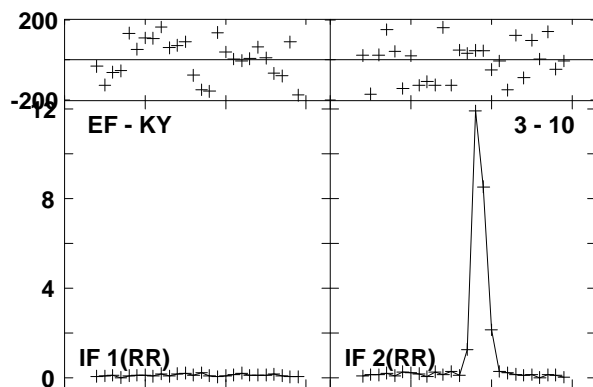
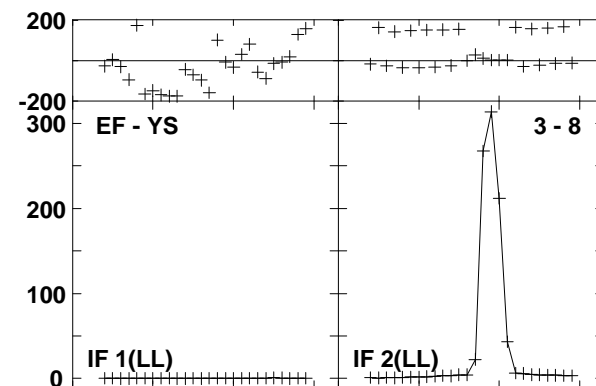
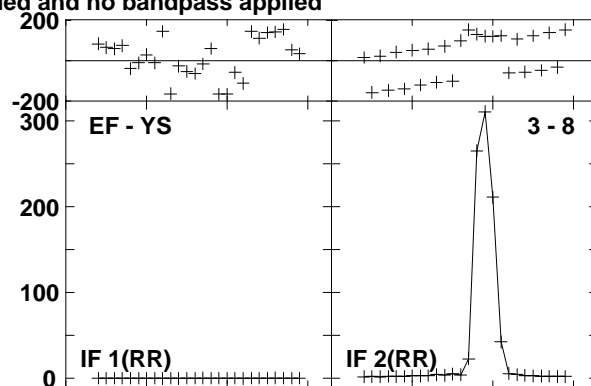
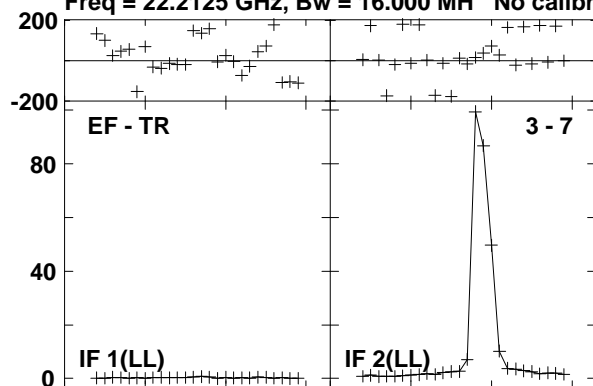

Lower frame: Milli Ampl Jy Top frame: Phas deg  
Vector averaged cross-power spectrum Baseline: EF (03) - TR (07)  
Timerange: 00/11:15:01 to 00/11:16:00

Plot file version 208 created 23-AUG-2016 15:00:49  
W3IRS5 GA035B 1.UVDATA.1

Freq = 22.2125 GHz, Bw = 16.000 MH No calibration applied and no bandpass applied

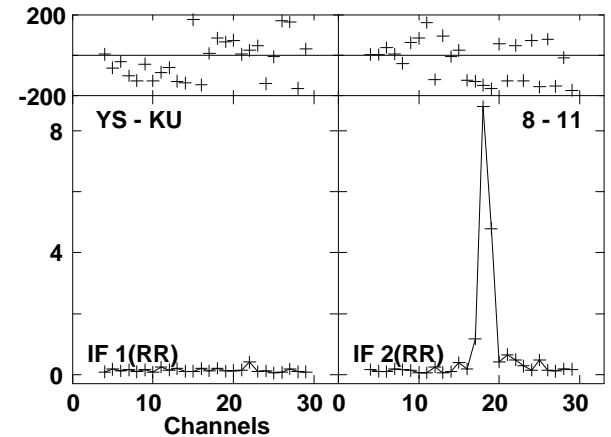
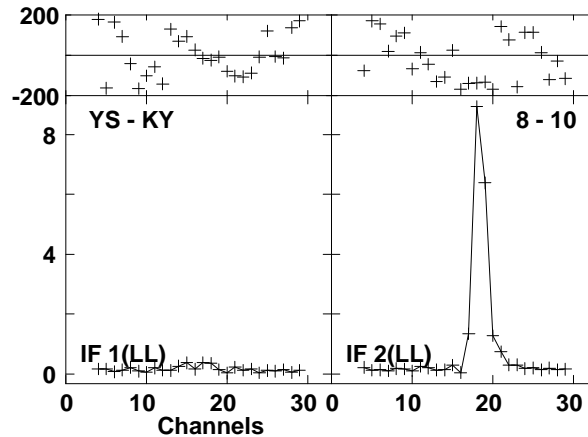
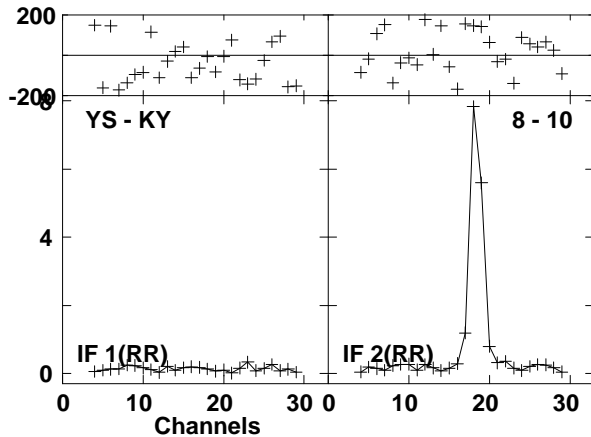
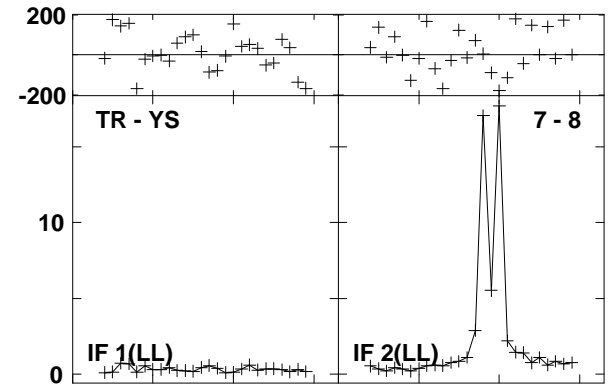
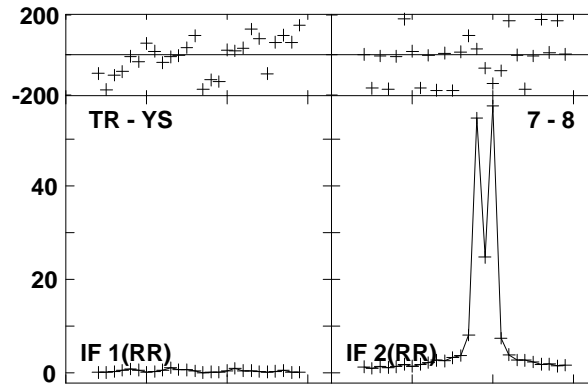
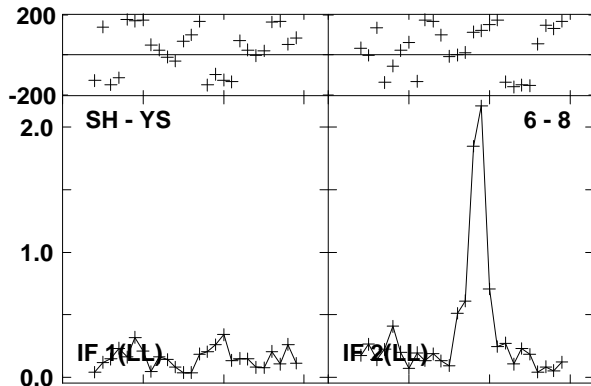
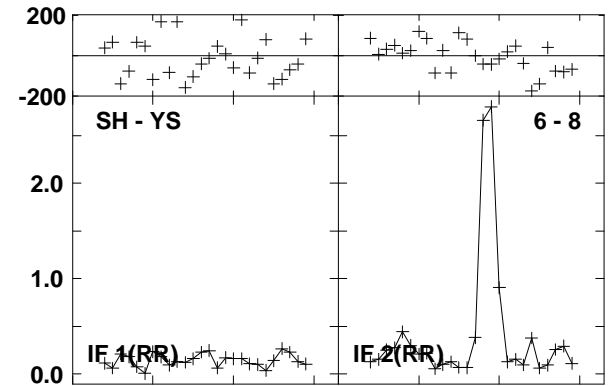
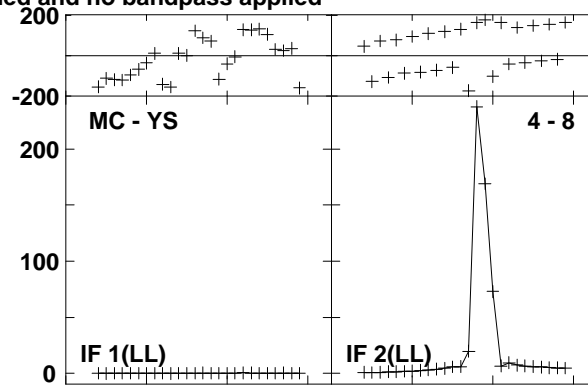
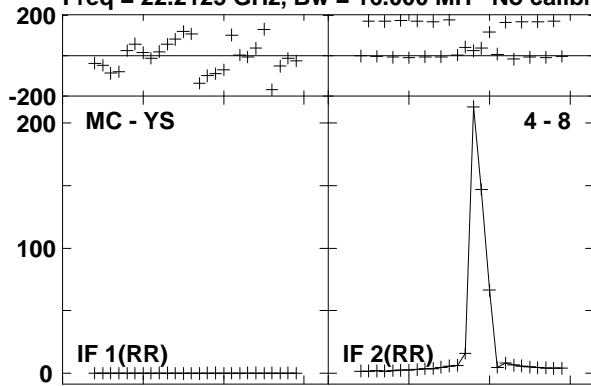

Lower frame: Milli Ampl Jy Top frame: Phas deg  
Vector averaged cross-power spectrum Baseline: MC (04) - YS (08)  
Timerange: 00/11:15:01 to 00/11:16:00



Plot file version 209 created 23-AUG-2016 15:00:49

W3IRS5 GA035B 1.UVDATA.1

Freq = 22.2125 GHz, Bw = 16.000 MH No calibration applied and no bandpass applied

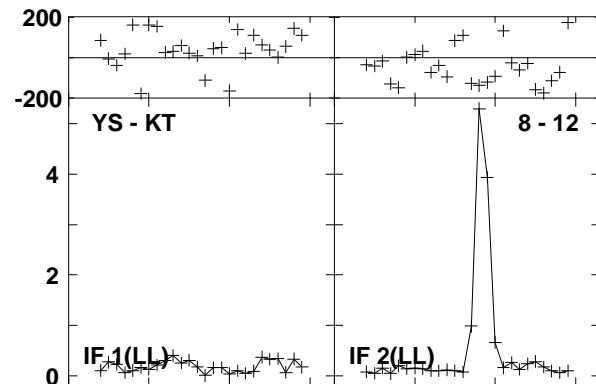
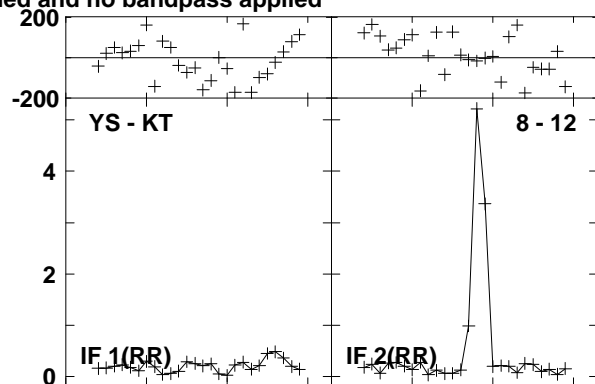
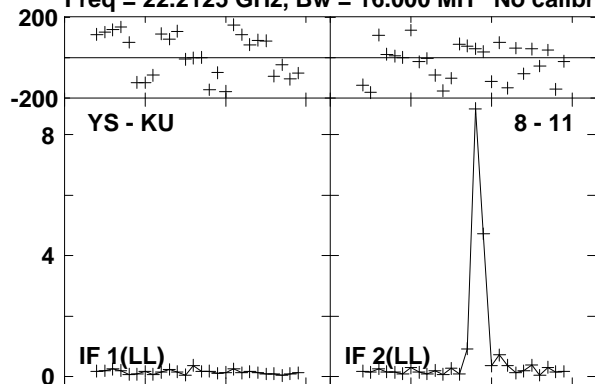

Lower frame: Milli Ampl Jy Top frame: Phas deg  
Vector averaged cross-power spectrum Baseline: YS (08) - KU (11)  
Timerange: 00/11:15:01 to 00/11:16:00

Plot file version 210 created 23-AUG-2016 15:00:49

0219+628 GA035B 1.UVDATA.1

Freq = 22.2125 GHz, Bw = 16.000 MH No calibration applied and no bandpass applied

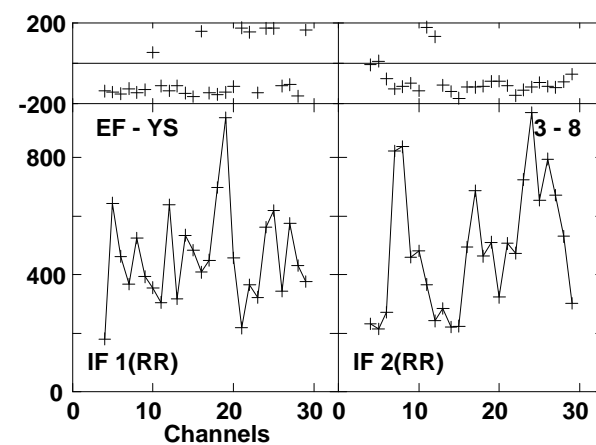
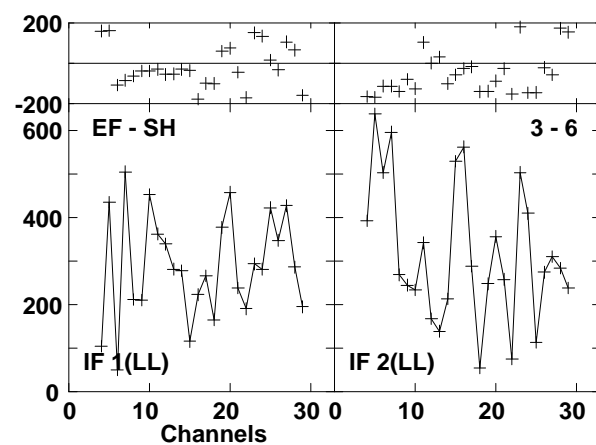
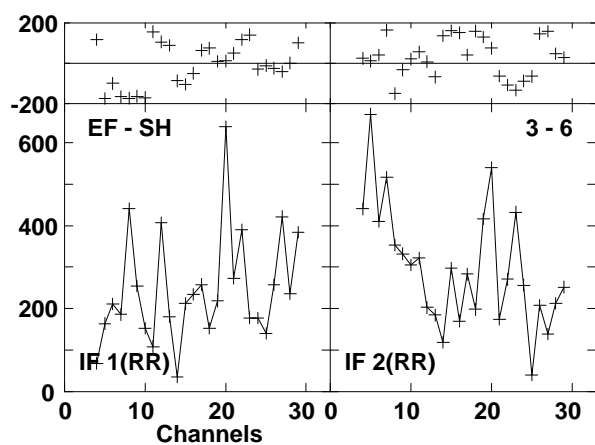
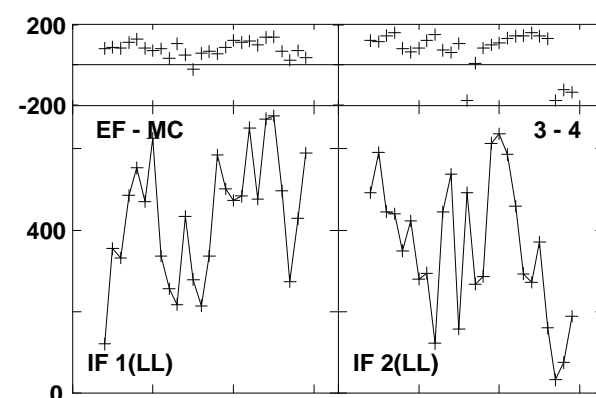
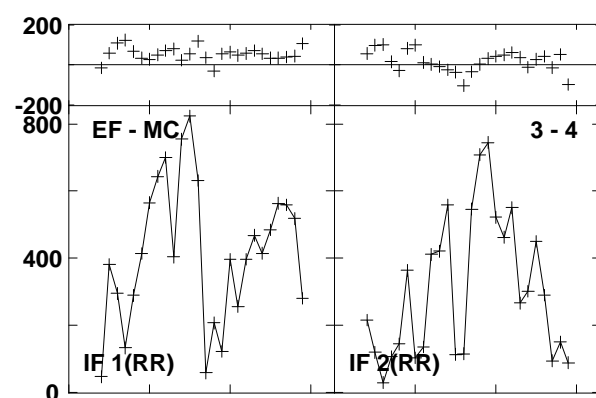
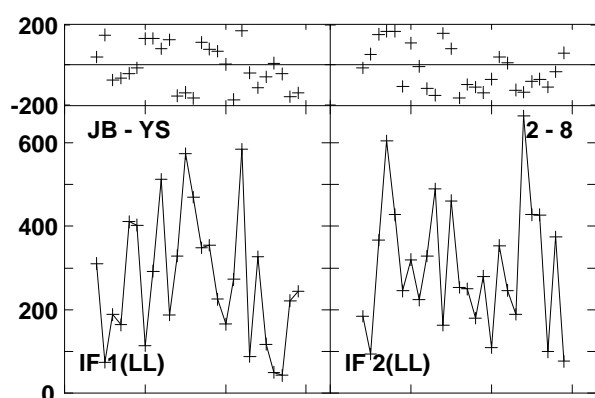
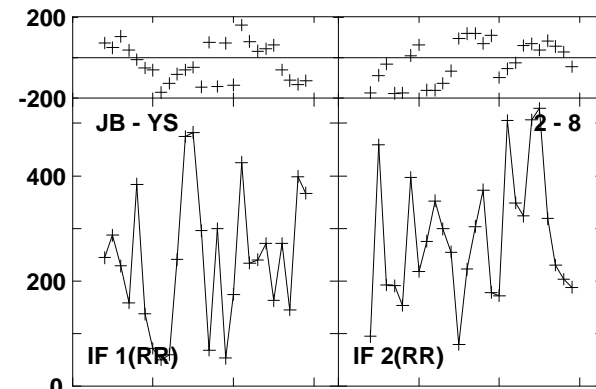
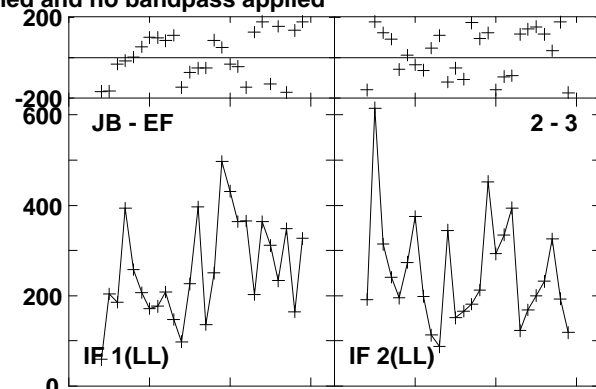
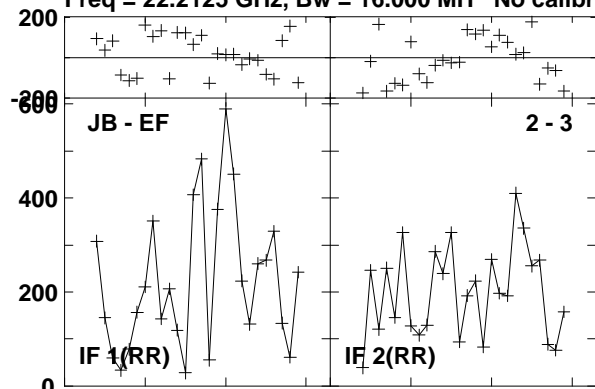

Lower frame: Micro Ampl Jy Top frame: Phas deg  
Vector averaged cross-power spectrum Baseline: JB (02) - EF (03)  
Timerange: 00/11:16:25 to 00/11:16:45

Plot file version 211 created 23-AUG-2016 15:00:49

0219+628 GA035B 1.UVDATA.1

Freq = 22.2125 GHz, Bw = 16.000 MH No calibration applied and no bandpass applied

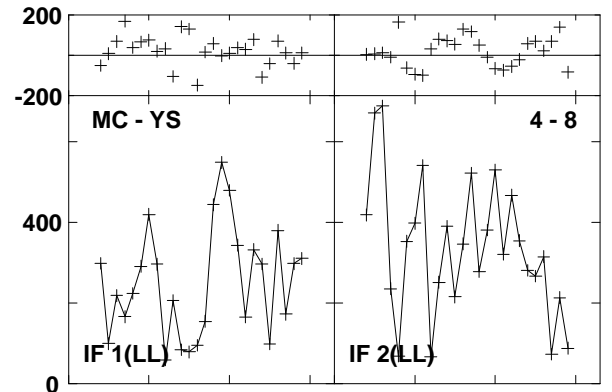
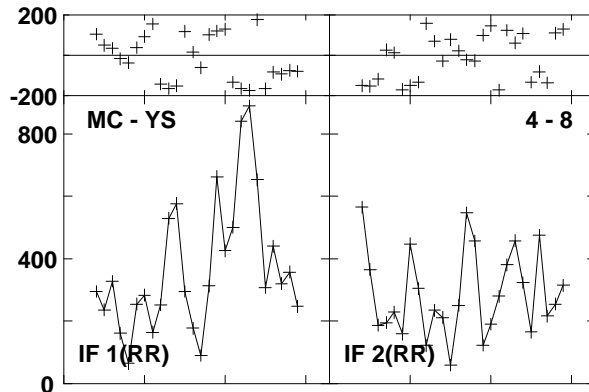
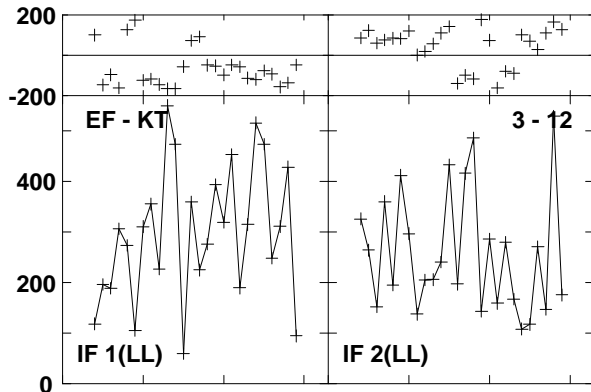
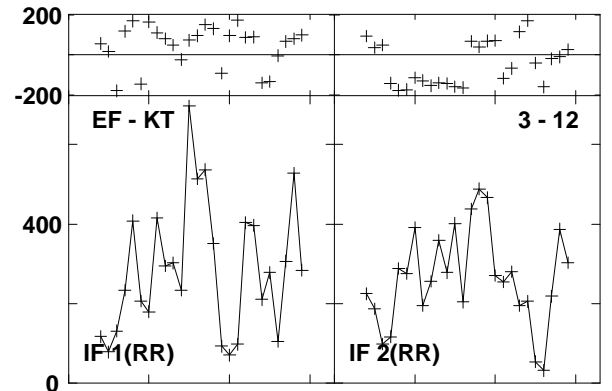
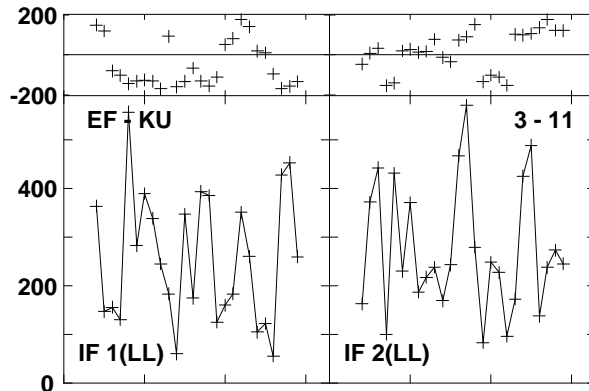
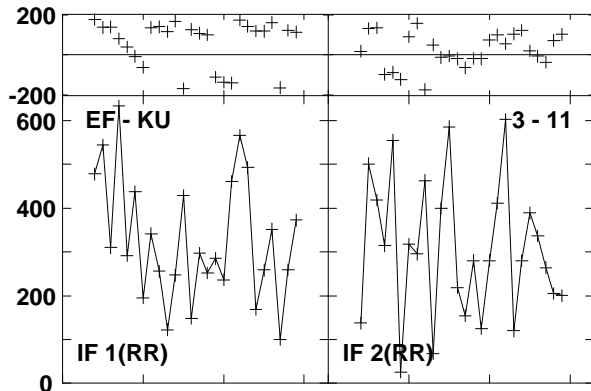
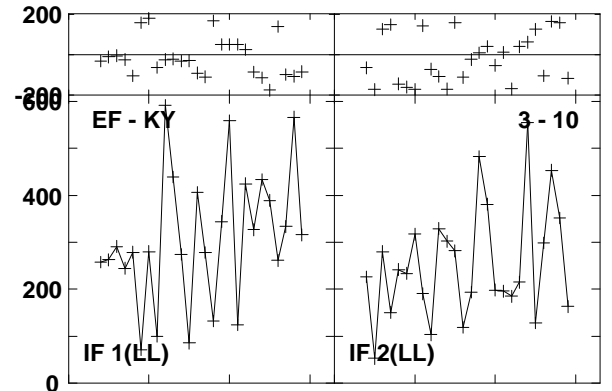
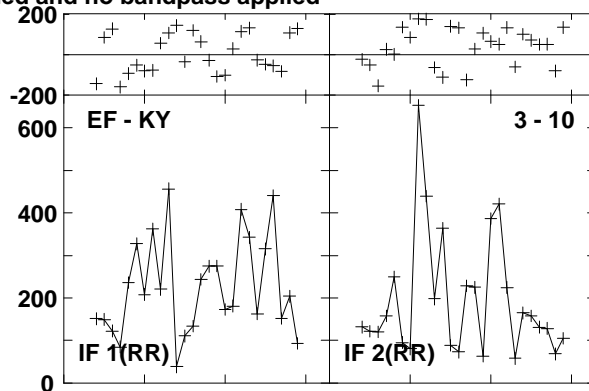
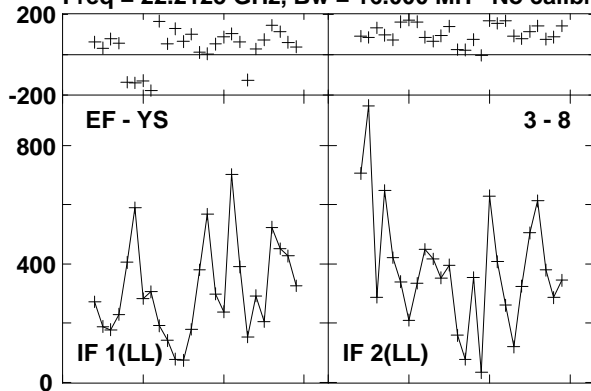

Lower frame: Micro Ampl Jy Top frame: Phas deg  
Vector averaged cross-power spectrum Baseline: EF (03) - YS (08)  
Timerange: 00/11:16:25 to 00/11:16:45

Plot file version 212 created 23-AUG-2016 15:00:49

0219+628 GA035B 1.UVDATA.1

Freq = 22.2125 GHz, Bw = 16.000 MH No calibration applied and no bandpass applied

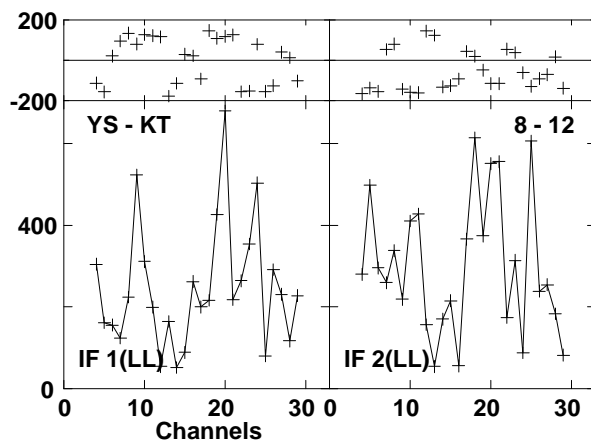
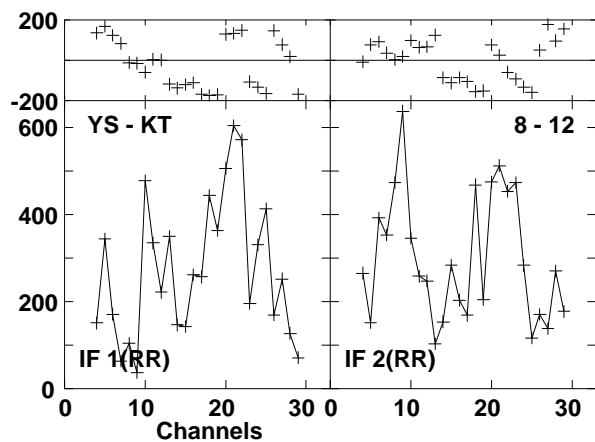
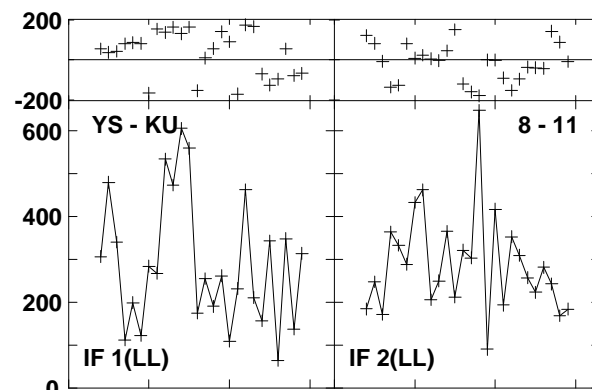
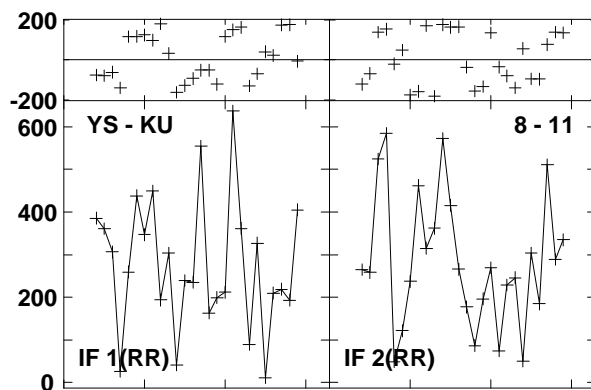
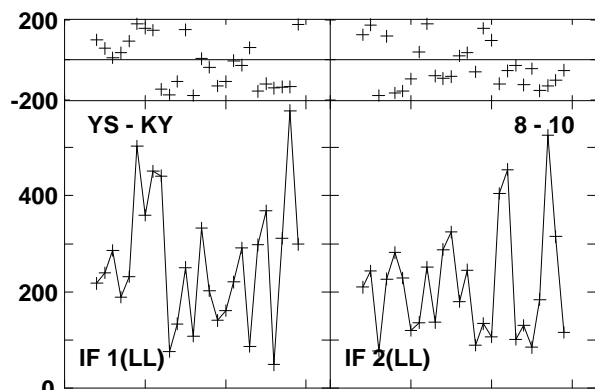
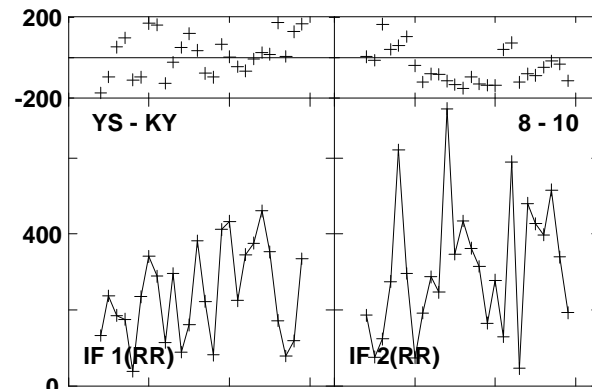
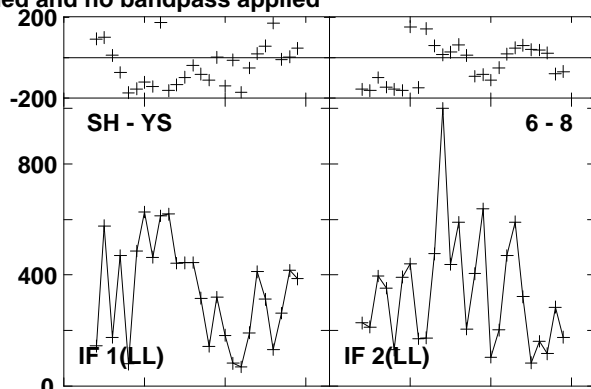
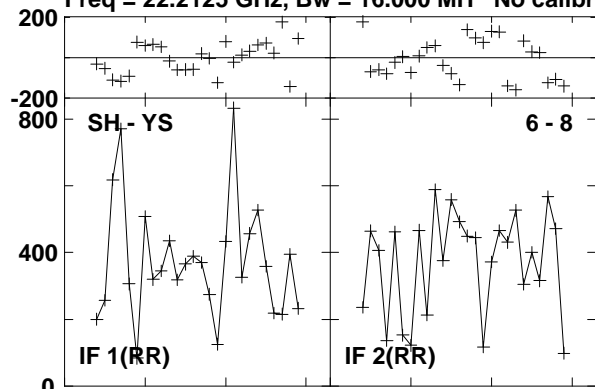

Lower frame: Micro Ampl Jy Top frame: Phas deg  
Vector averaged cross-power spectrum Baseline: SH (06) - YS (08)  
Timerange: 00/11:16:25 to 00/11:16:45

Plot file version 213 created 23-AUG-2016 15:00:49  
 W3IRS5 GA035B 1.UVDATA.1

Freq = 22.2125 GHz, Bw = 16.000 MH No calibration applied and no bandpass applied

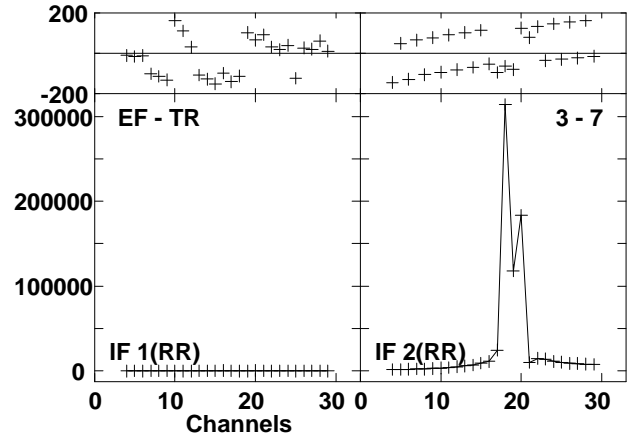
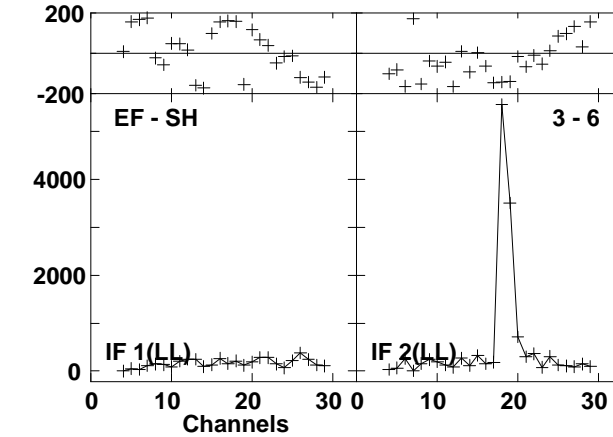
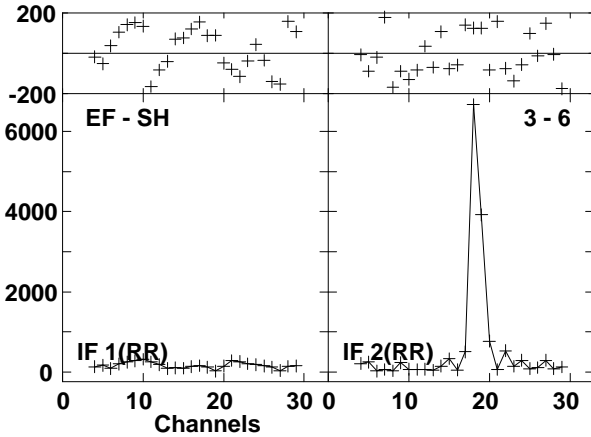
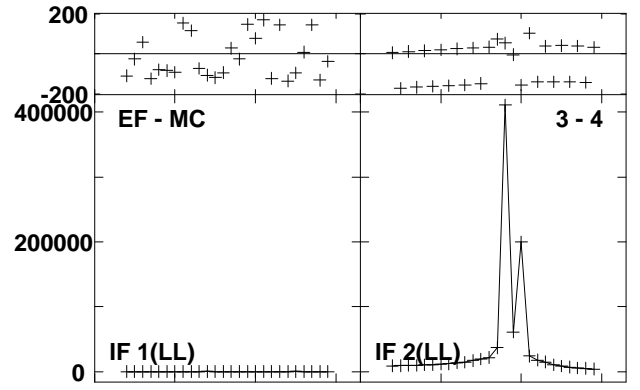
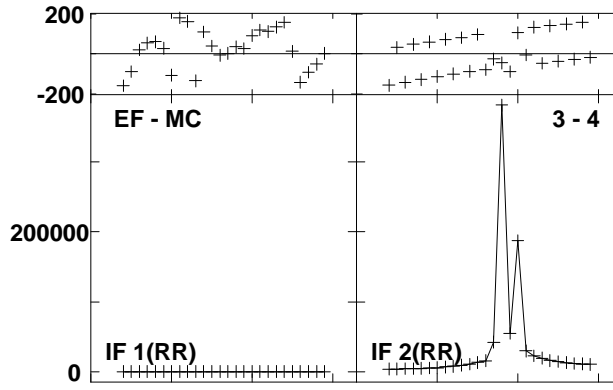
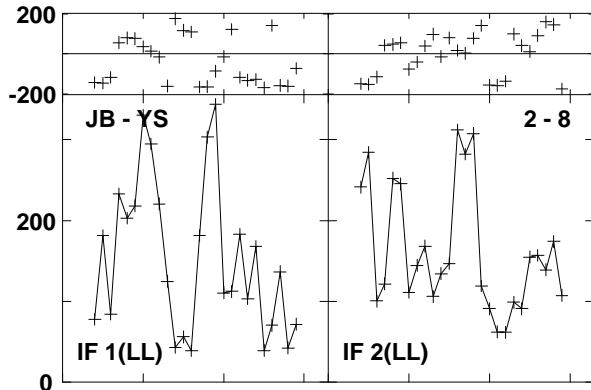
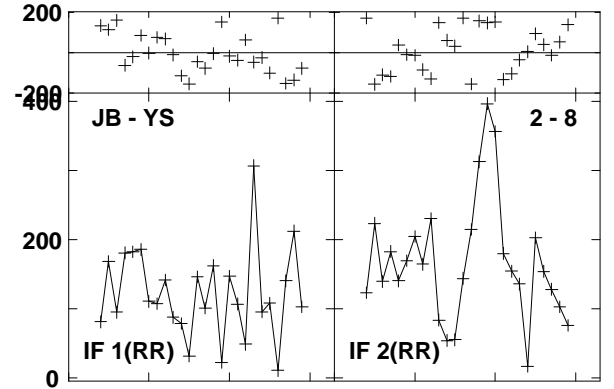
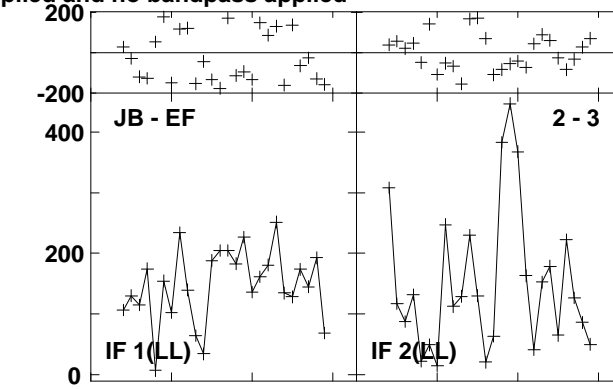
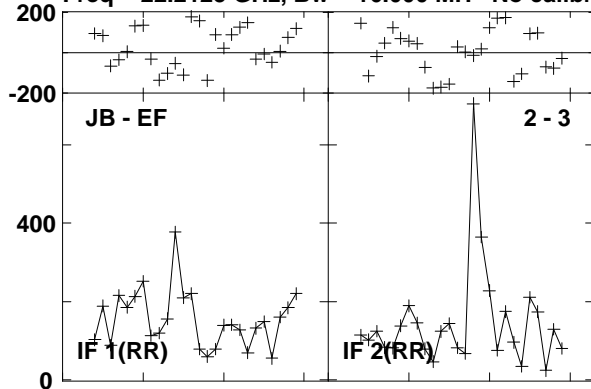

Lower frame: Micro Ampl Jy Top frame: Phas deg  
 Vector averaged cross-power spectrum Baseline: JB (02) - EF (03)  
 Timerange: 00/11:17:11 to 00/11:18:10

Plot file version 214 created 23-AUG-2016 15:00:49

W3IRS5 GA035B 1.UVDATA.1

Freq = 22.2125 GHz, Bw = 16.000 MH No calibration applied and no bandpass applied

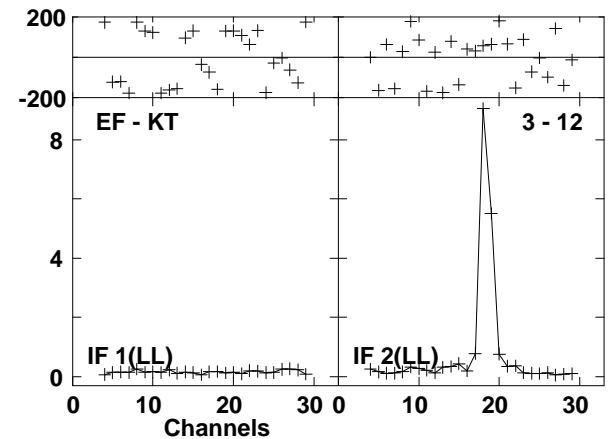
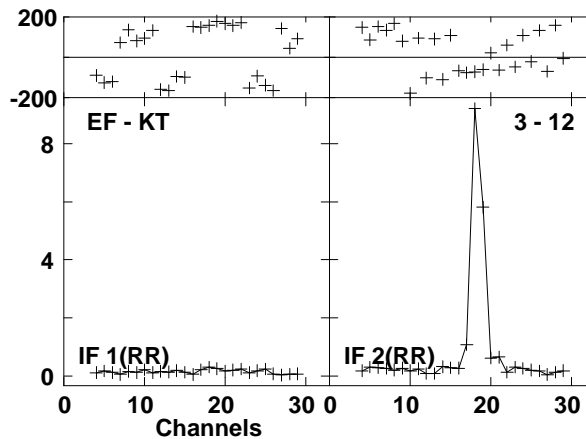
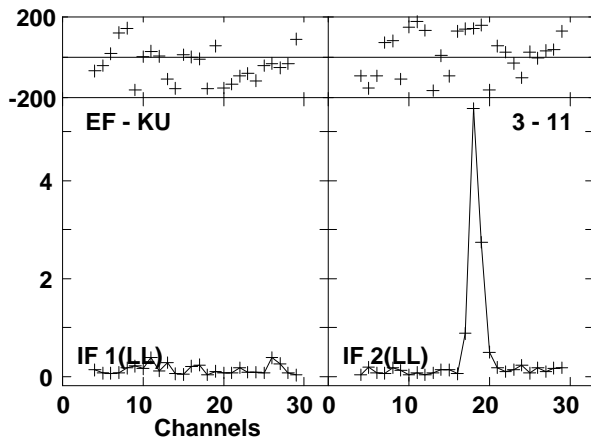
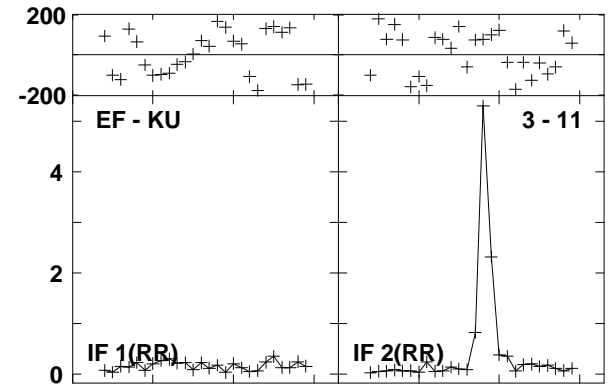
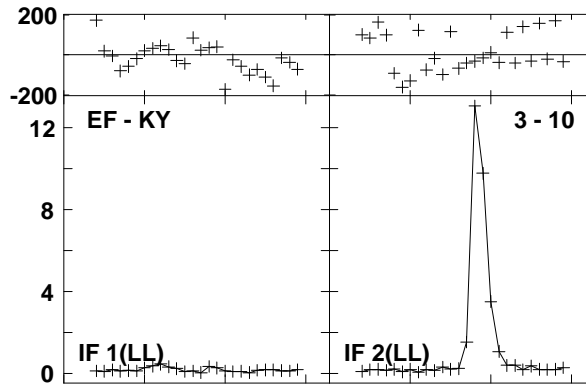
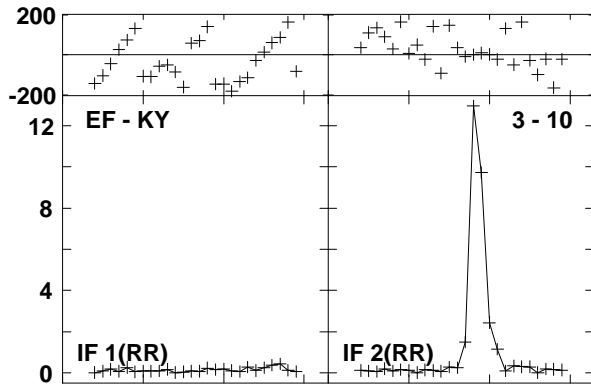
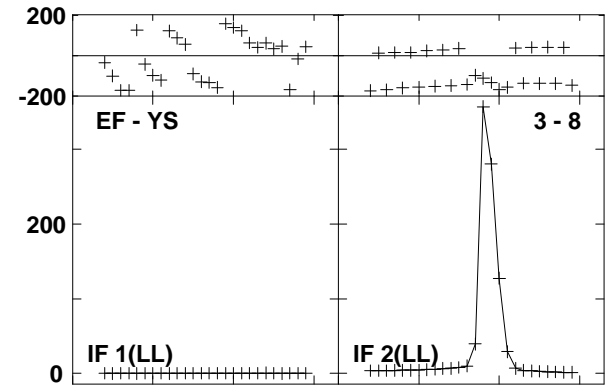
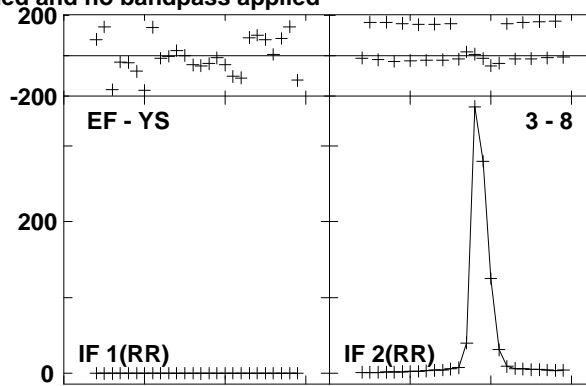
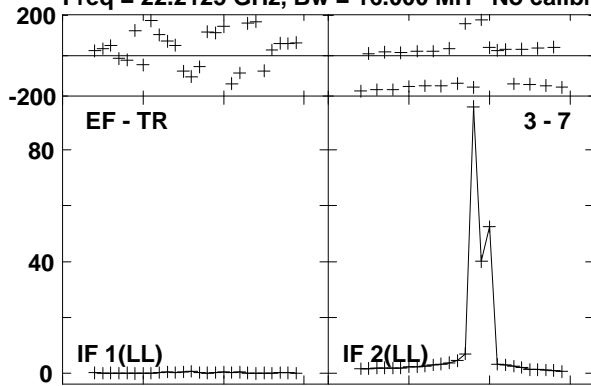

Lower frame: Milli Ampl Jy Top frame: Phas deg  
Vector averaged cross-power spectrum Baseline: EF (03) - TR (07)  
Timerange: 00/11:17:11 to 00/11:18:10

Plot file version 215 created 23-AUG-2016 15:00:49

W3IRS5 GA035B 1.UVDATA.1

Freq = 22.2125 GHz, Bw = 16.000 MH No calibration applied and no bandpass applied

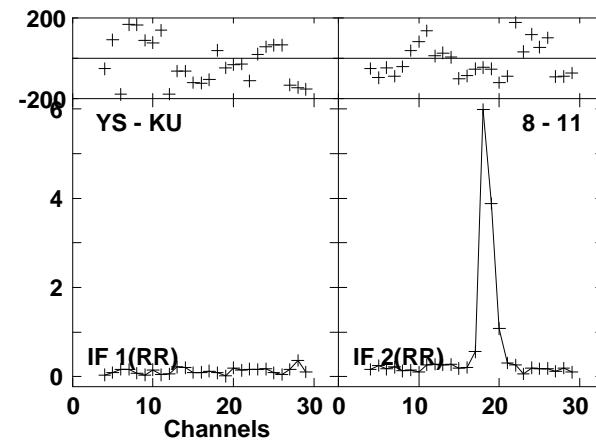
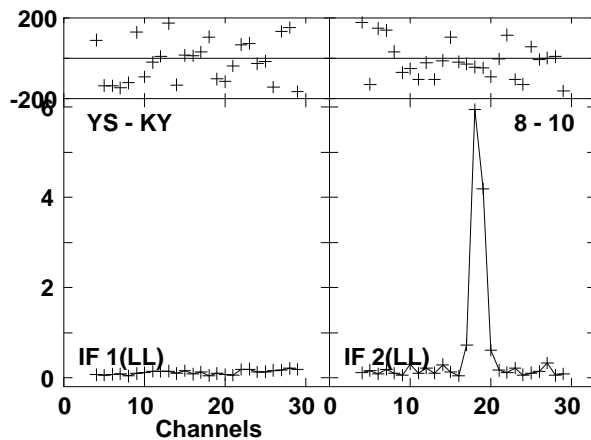
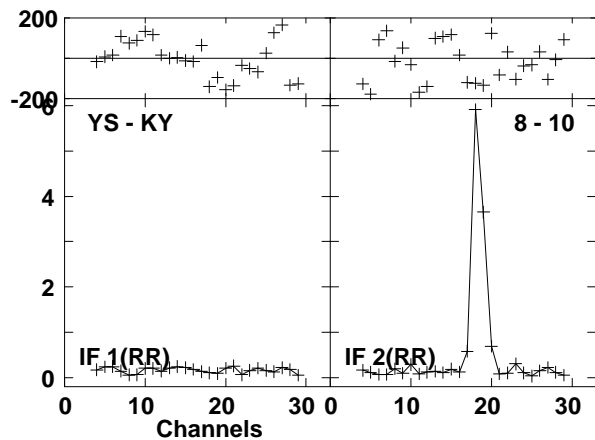
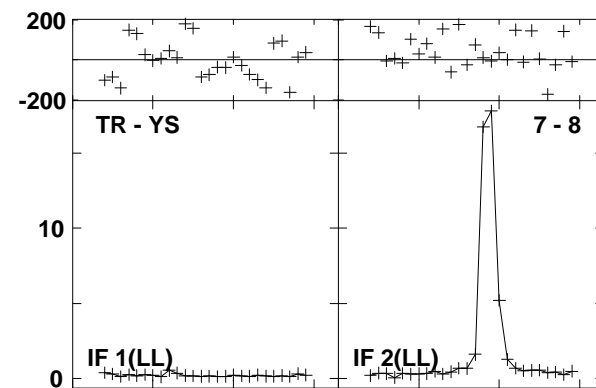
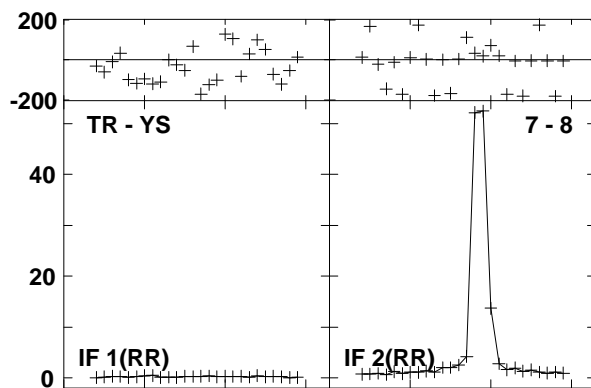
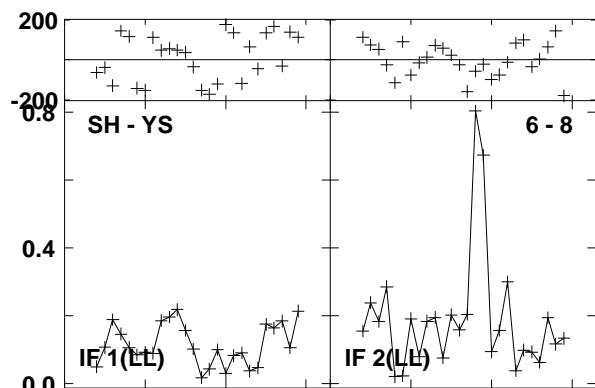
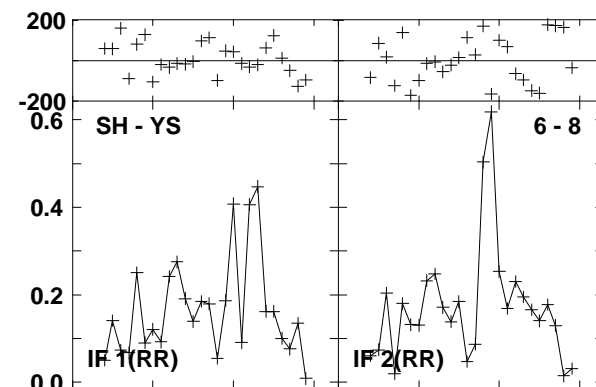
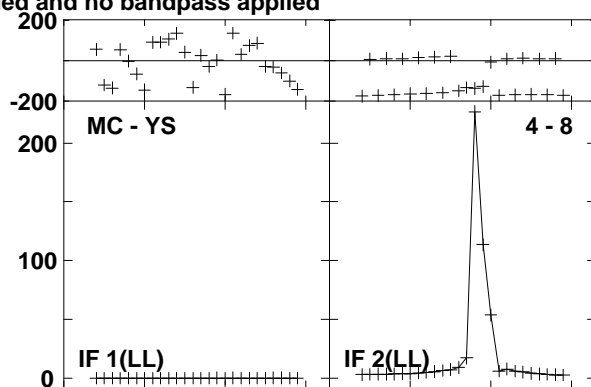
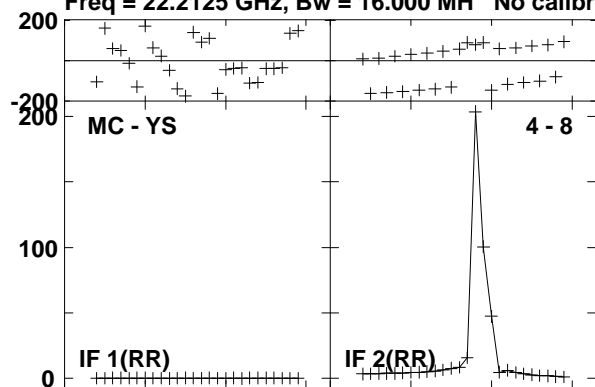

Lower frame: Milli Ampl Jy Top frame: Phas deg  
Vector averaged cross-power spectrum Baseline: MC (04) - YS (08)  
Timerange: 00/11:17:11 to 00/11:18:10

Plot file version 216 created 23-AUG-2016 15:00:49

W3IRS5 GA035B 1.UVDATA.1

Freq = 22.2125 GHz, Bw = 16.000 MH No calibration applied and no bandpass applied

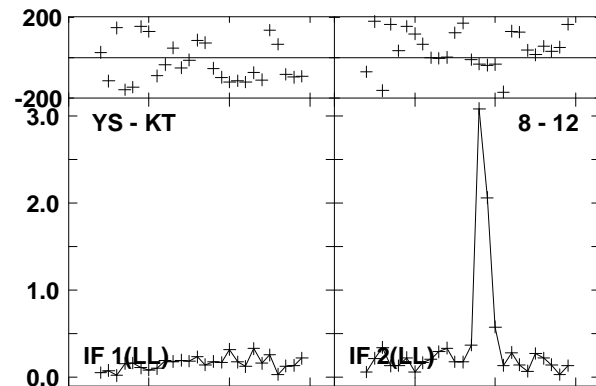
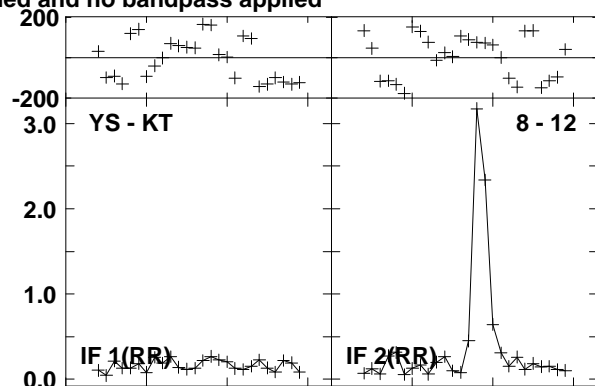
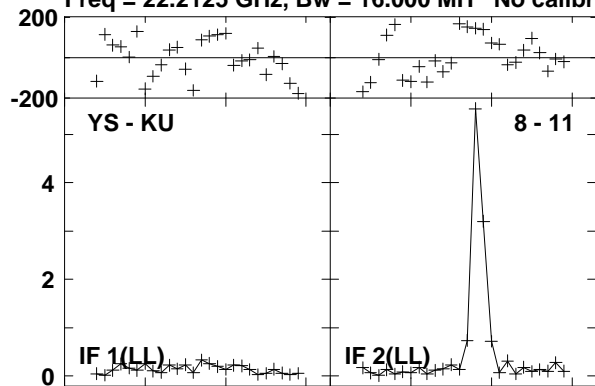

Lower frame: Milli Ampl Jy Top frame: Phas deg  
Vector averaged cross-power spectrum Baseline: YS (08) - KU (11)  
Timerange: 00/11:17:11 to 00/11:18:10



Plot file version 217 created 23-AUG-2016 15:00:49

0219+628 GA035B 1.UVDATA.1

Freq = 22.2125 GHz, Bw = 16.000 MH No calibration applied and no bandpass applied

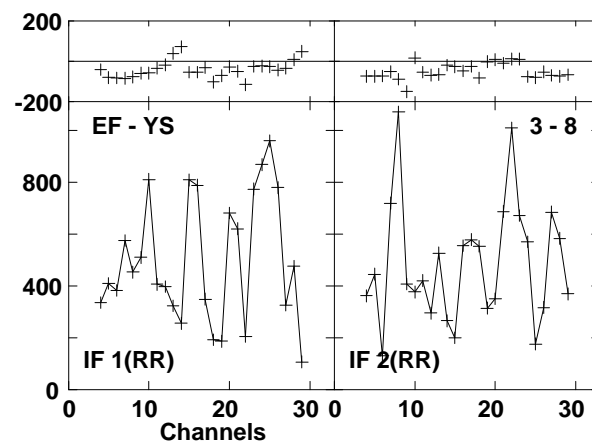
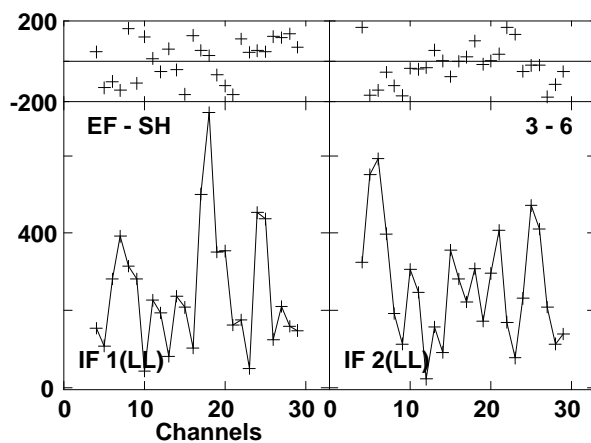
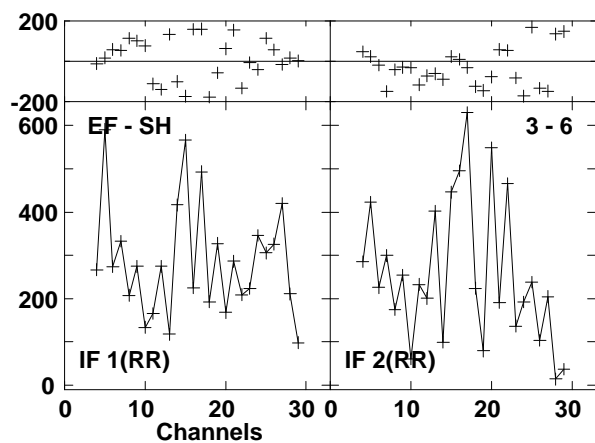
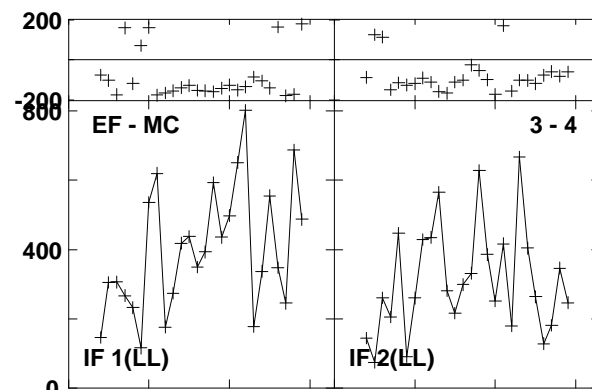
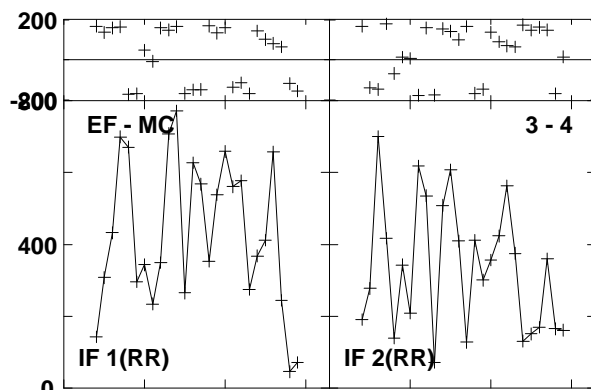
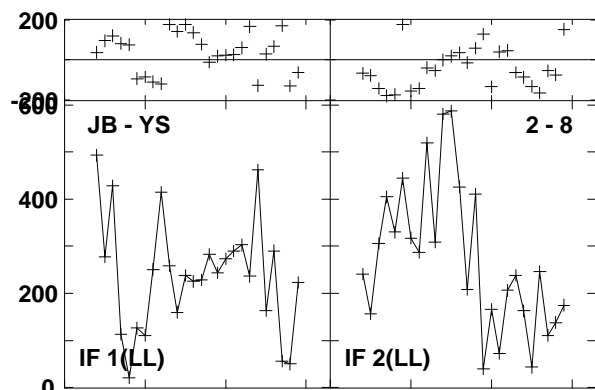
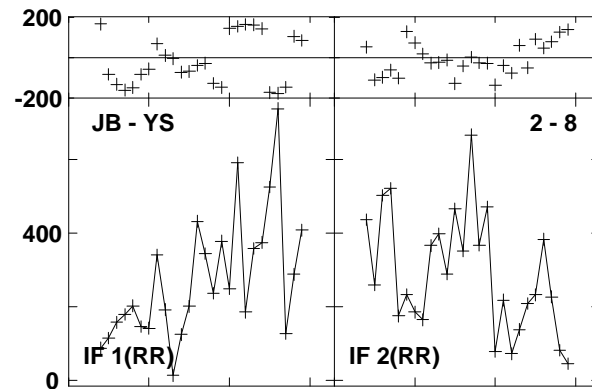
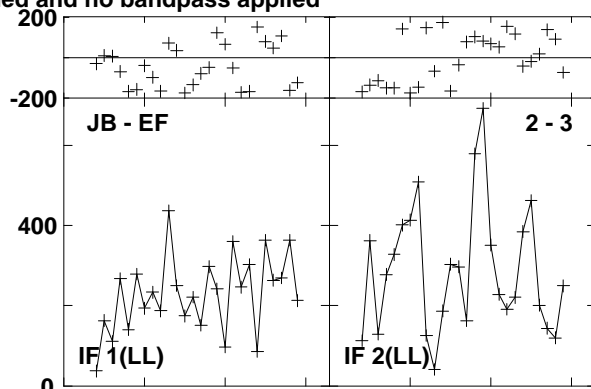
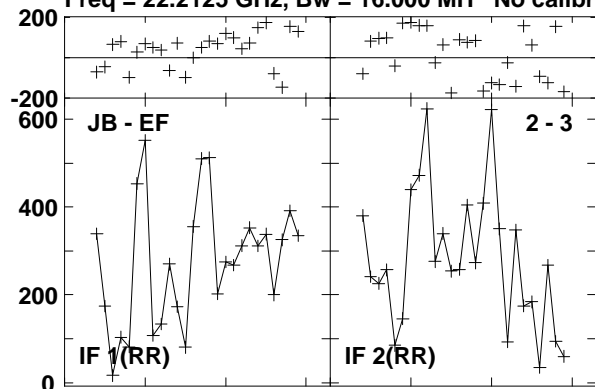

Lower frame: Micro Ampl Jy Top frame: Phas deg  
Vector averaged cross-power spectrum Baseline: JB (02) - EF (03)  
Timerange: 00/11:18:36 to 00/11:18:55

Plot file version 218 created 23-AUG-2016 15:00:49  
 0219+628 GA035B 1.UVDATA.1  
 Freq = 22.2125 GHz, Bw = 16.000 MH No calibration applied and no bandpass applied

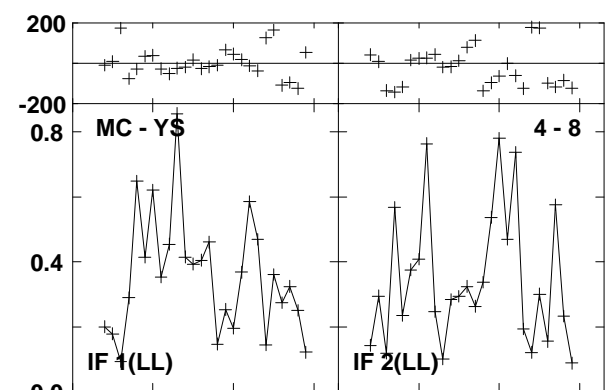
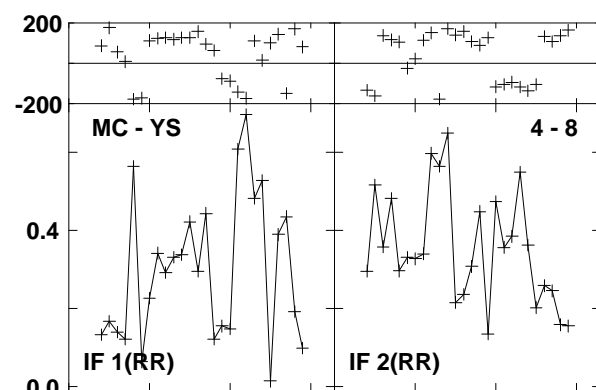
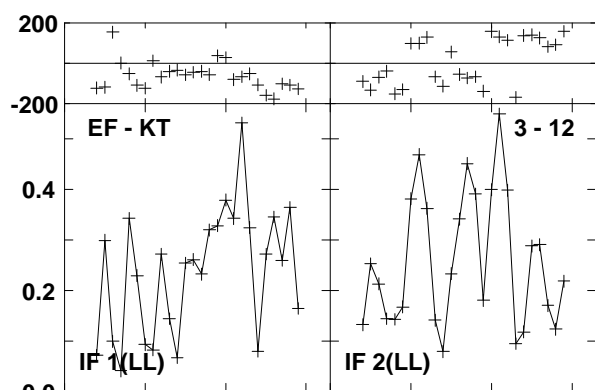
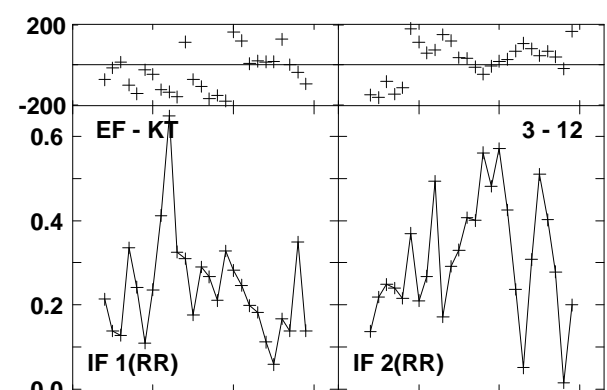
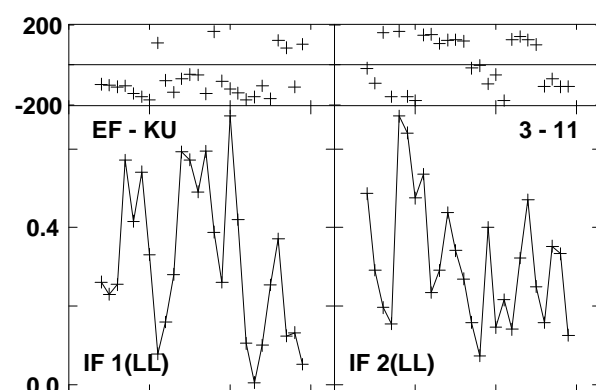
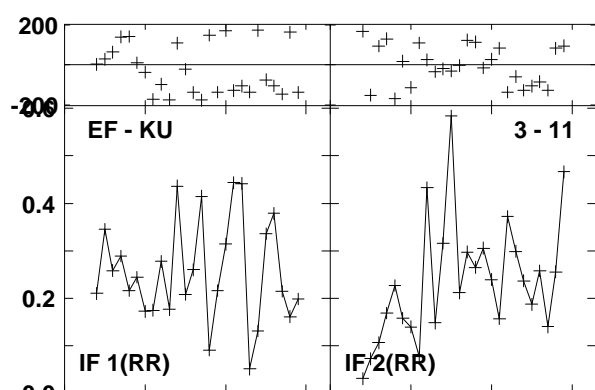
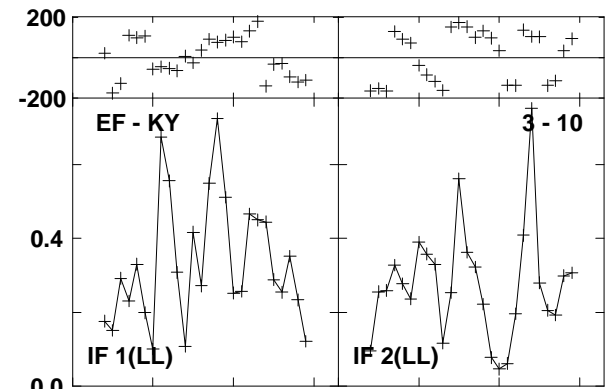
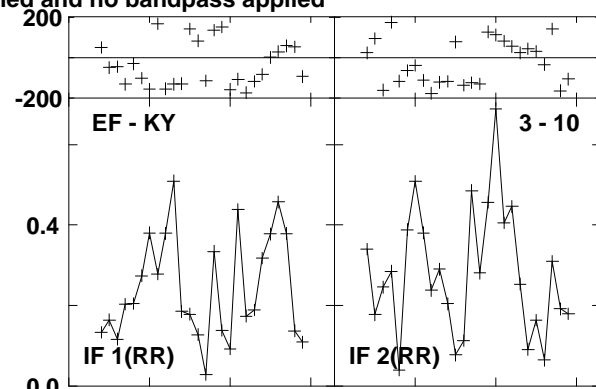
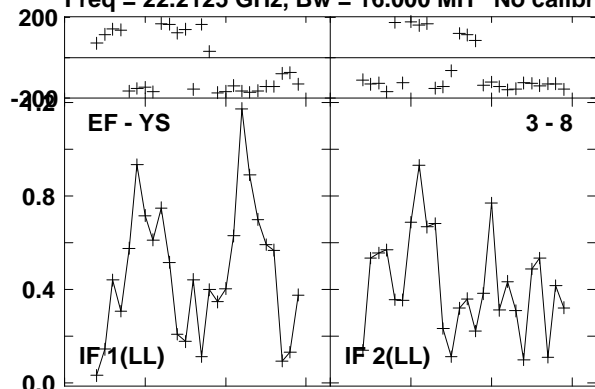

Lower frame: Milli Ampl Jy Top frame: Phas deg  
 Vector averaged cross-power spectrum Baseline: EF (03) - YS (08)  
 Timerange: 00/11:18:36 to 00/11:18:55

Plot file version 219 created 23-AUG-2016 15:00:49  
 0219+628 GA035B 1.UVDATA.1  
 Freq = 22.2125 GHz, Bw = 16.000 MH No calibration applied and no bandpass applied

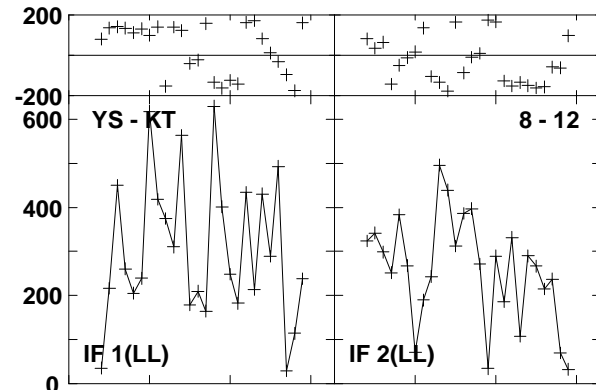
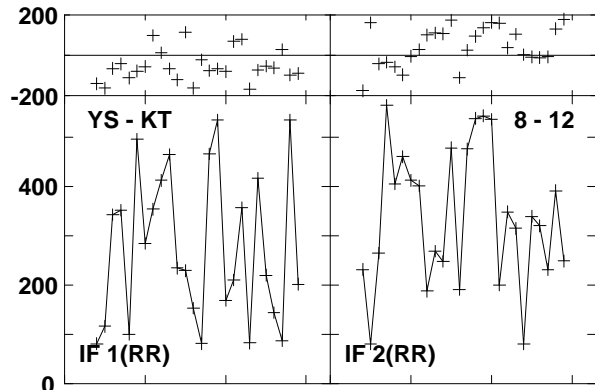
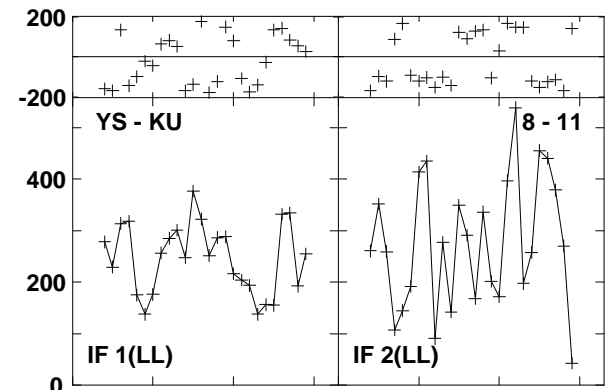
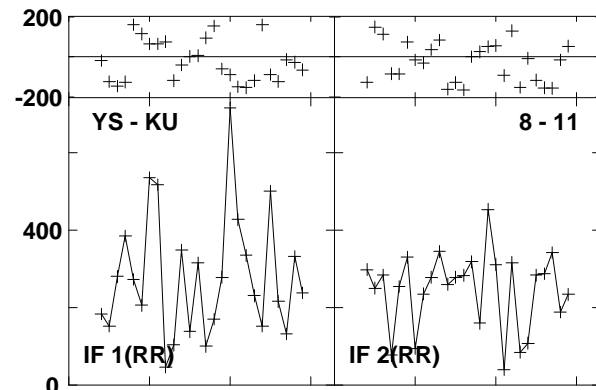
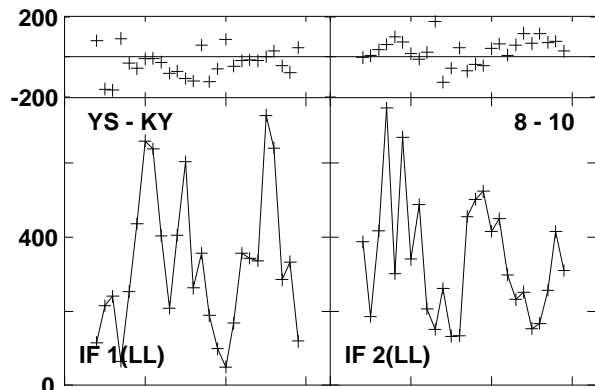
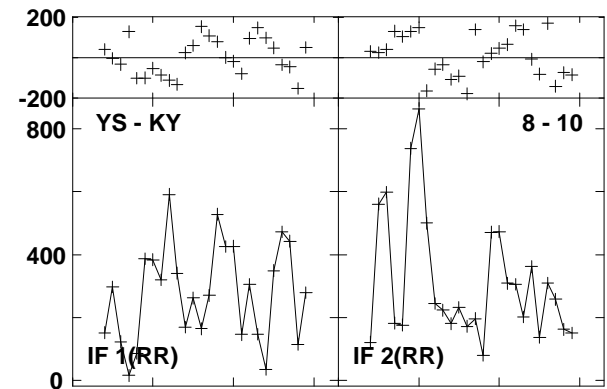
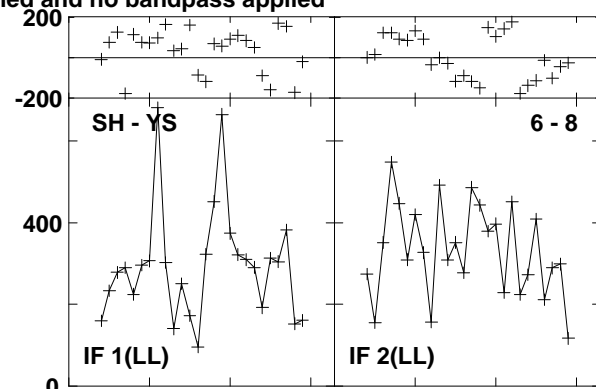
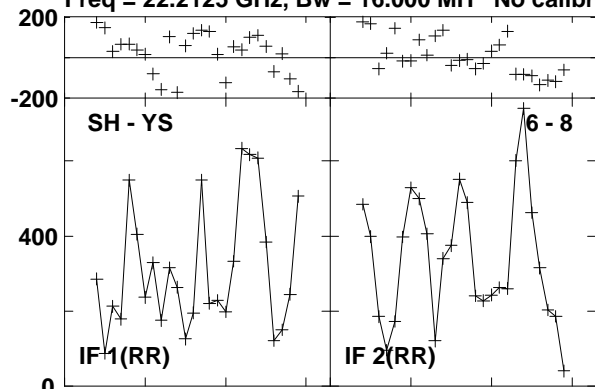

Lower frame: Micro Ampl Jy Top frame: Phas deg  
 Vector averaged cross-power spectrum Baseline: SH (06) - YS (08)  
 Timerange: 00/11:18:36 to 00/11:18:55

Plot file version 220 created 23-AUG-2016 15:00:49

W3IRS5 GA035B 1.UVDATA.1

Freq = 22.2125 GHz, Bw = 16.000 MH No calibration applied and no bandpass applied

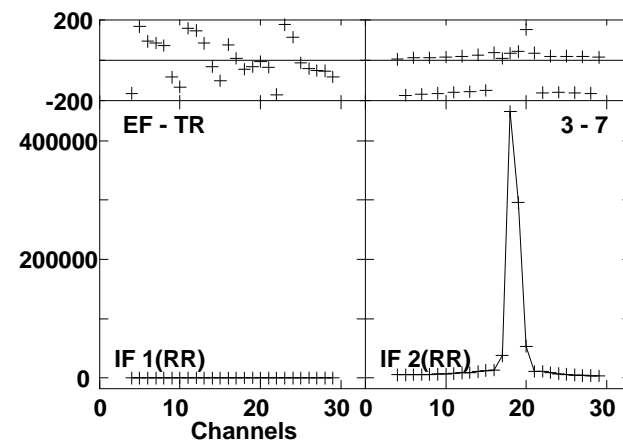
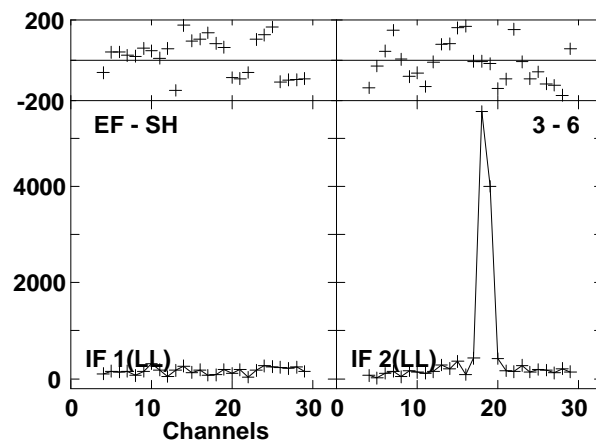
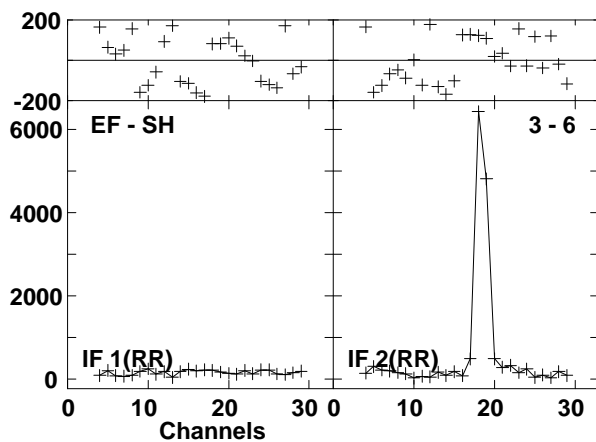
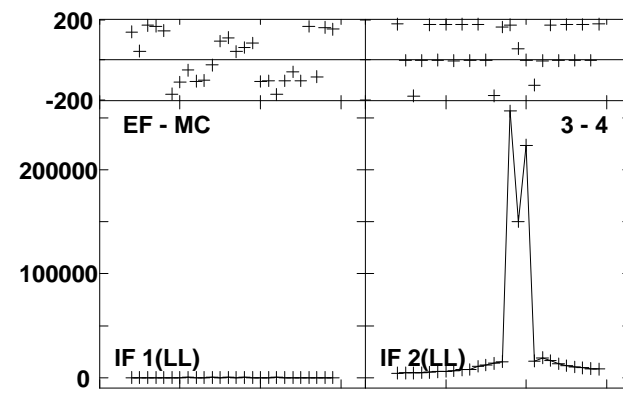
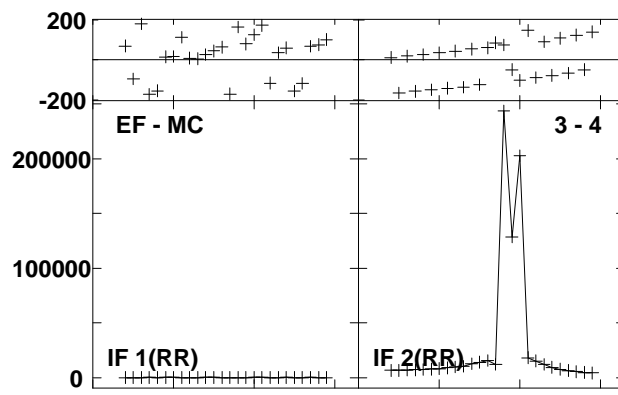
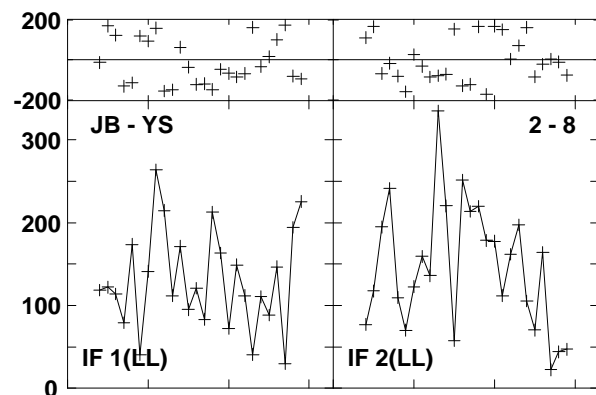
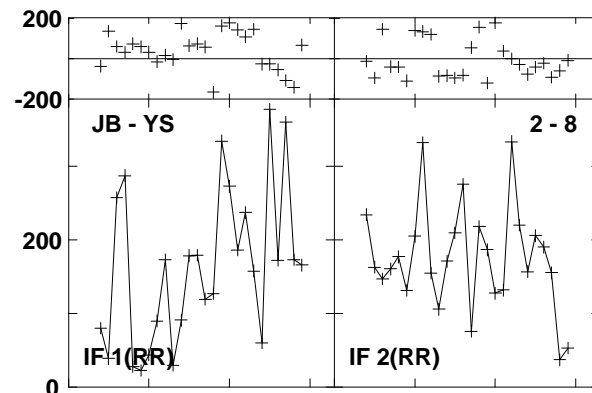
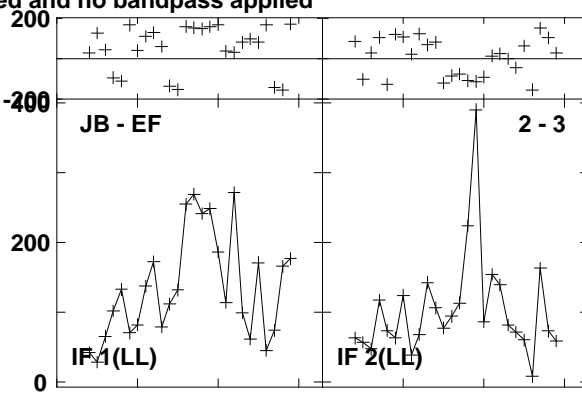
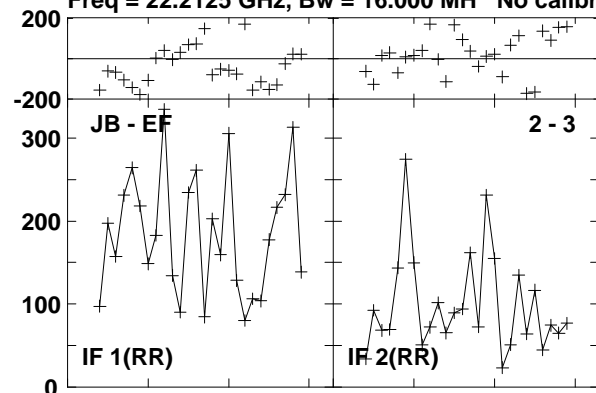

Lower frame: Micro Ampl Jy Top frame: Phas deg  
Vector averaged cross-power spectrum Baseline: JB (02) - EF (03)  
Timerange: 00/11:20:35 to 00/11:21:35

Plot file version 221 created 23-AUG-2016 15:00:49

W3IRS5 GA035B 1.UVDATA.1

Freq = 22.2125 GHz, Bw = 16.000 MH No calibration applied and no bandpass applied

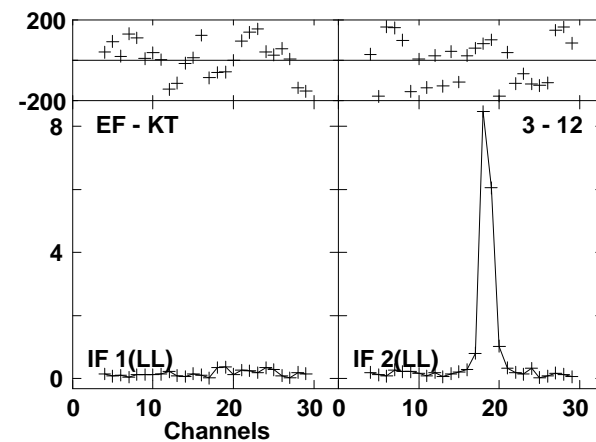
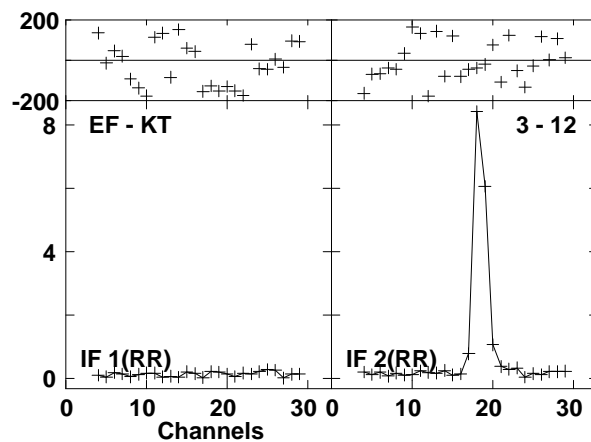
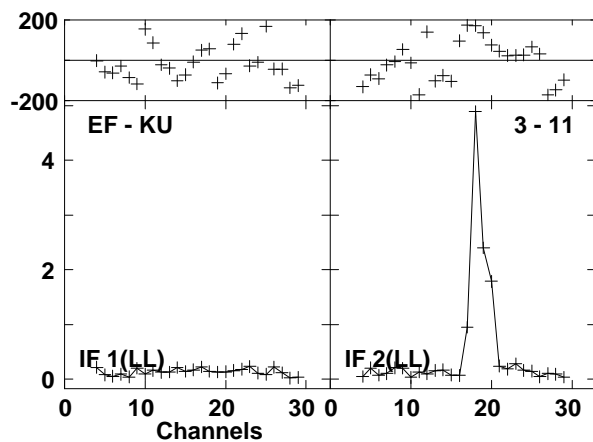
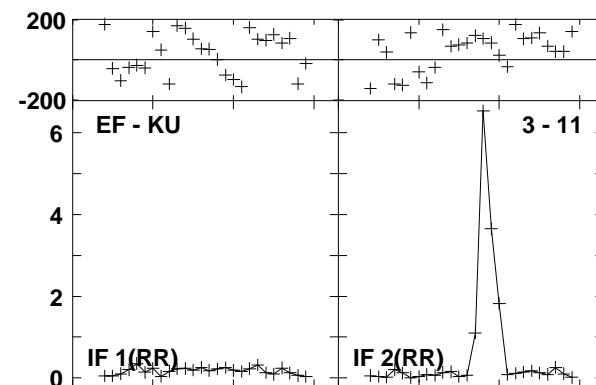
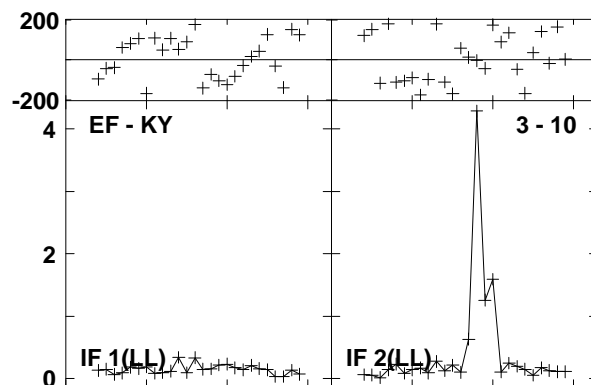
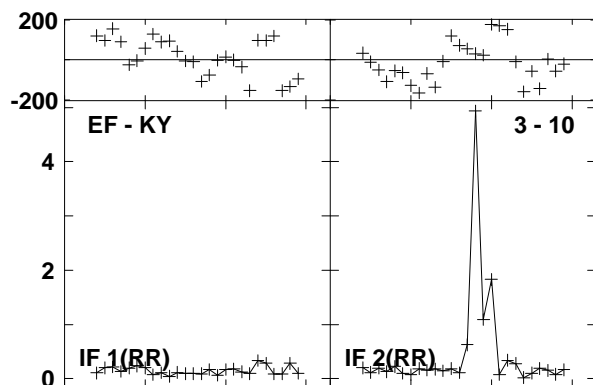
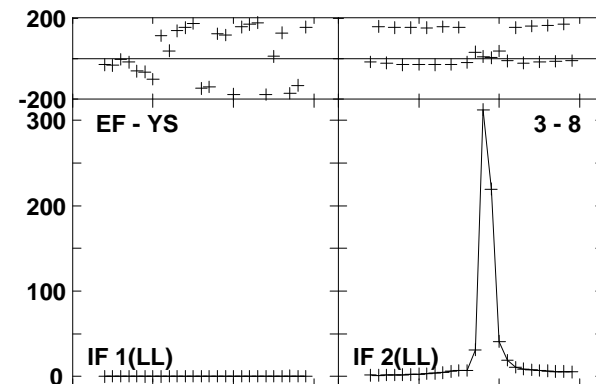
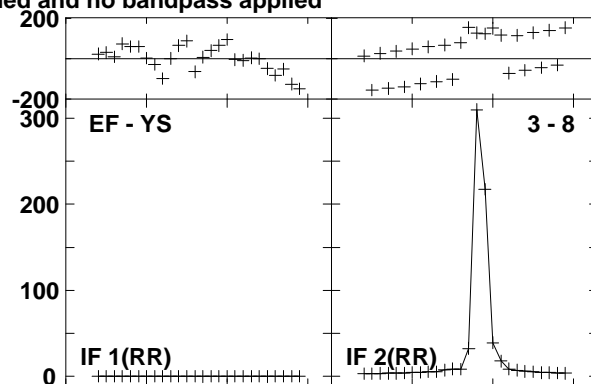
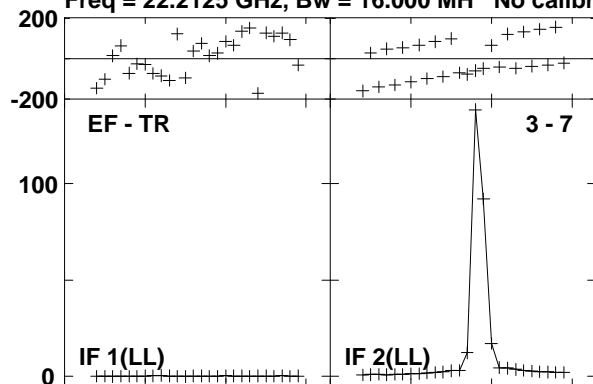

Lower frame: Milli Ampl Jy Top frame: Phas deg  
Vector averaged cross-power spectrum Baseline: EF (03) - TR (07)  
Timerange: 00/11:20:35 to 00/11:21:35

Plot file version 222 created 23-AUG-2016 15:00:49

W3IRS5 GA035B 1.UVDATA.1

Freq = 22.2125 GHz, Bw = 16.000 MH No calibration applied and no bandpass applied

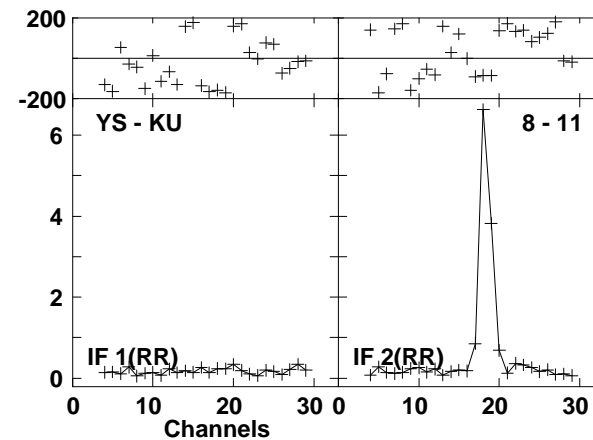
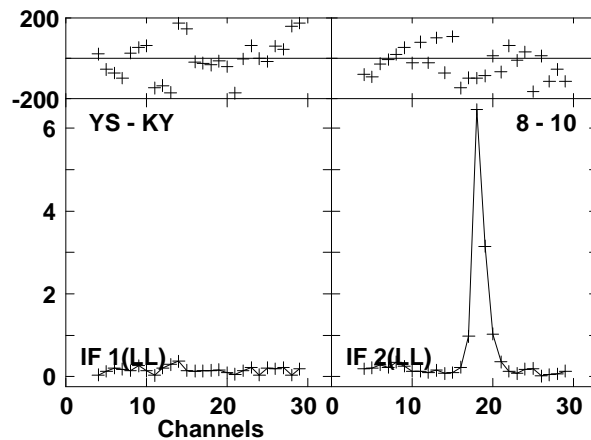
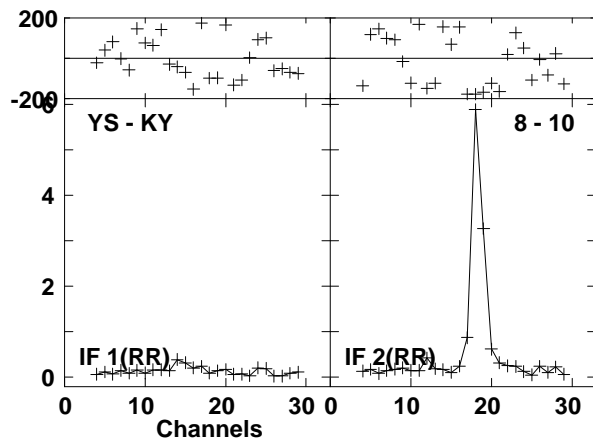
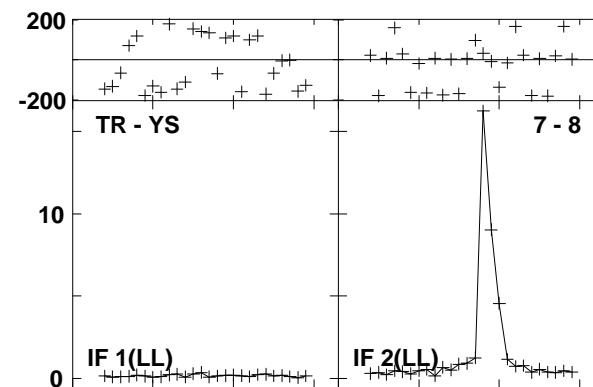
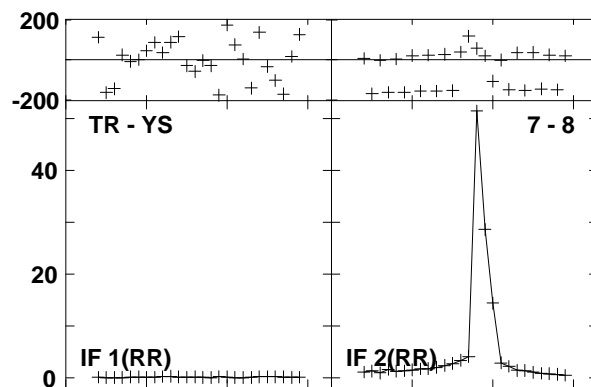
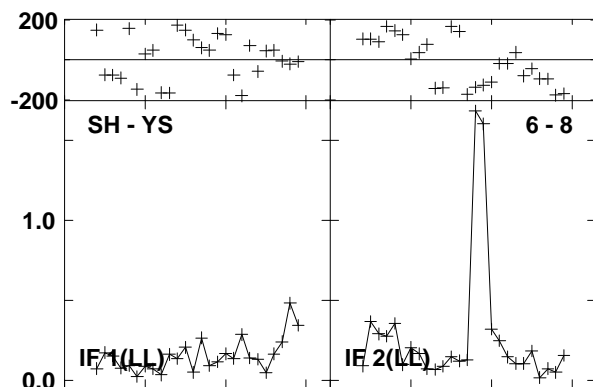
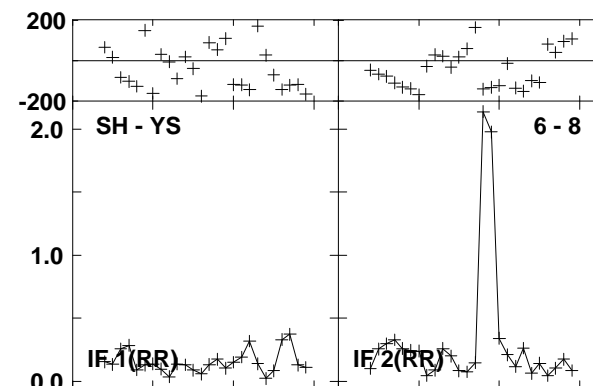
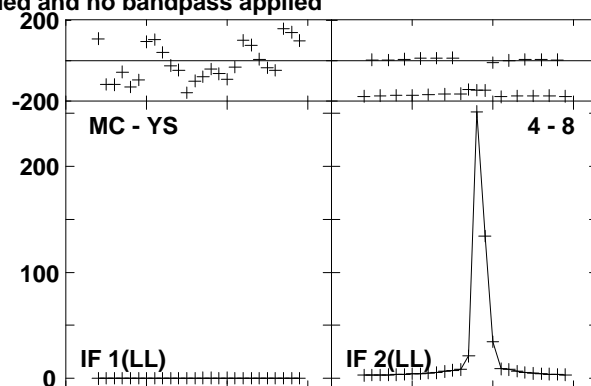
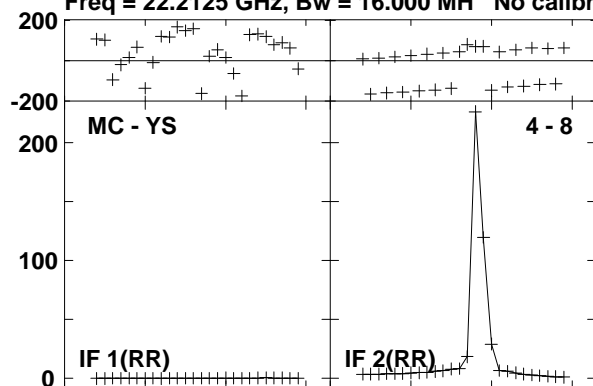

Lower frame: Milli Ampl Jy Top frame: Phas deg  
Vector averaged cross-power spectrum Baseline: MC (04) - YS (08)  
Timerange: 00/11:20:35 to 00/11:21:35

Plot file version 223 created 23-AUG-2016 15:00:49

W3IRS5 GA035B 1.UVDATA.1

Freq = 22.2125 GHz, Bw = 16.000 MH No calibration applied and no bandpass applied

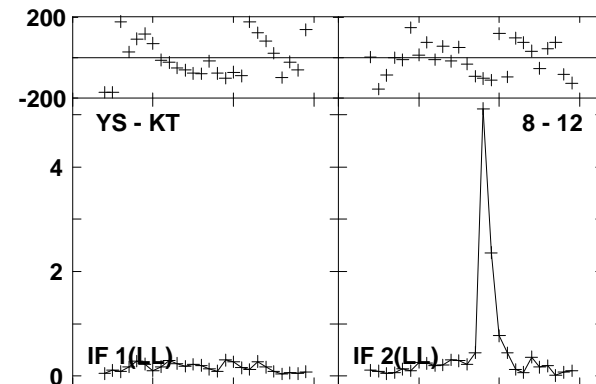
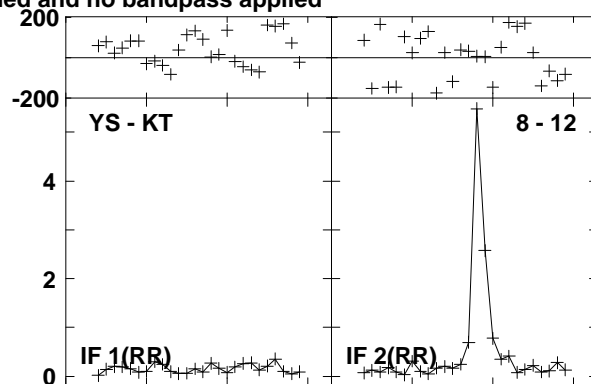
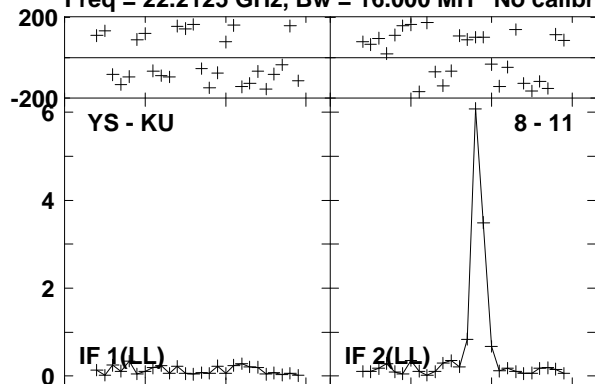

Lower frame: Milli Ampl Jy Top frame: Phas deg  
Vector averaged cross-power spectrum Baseline: YS (08) - KU (11)  
Timerange: 00/11:20:35 to 00/11:21:35

Plot file version 224 created 23-AUG-2016 15:00:49

0219+628 GA035B 1.UVDATA.1

Freq = 22.2125 GHz, Bw = 16.000 MH No calibration applied and no bandpass applied

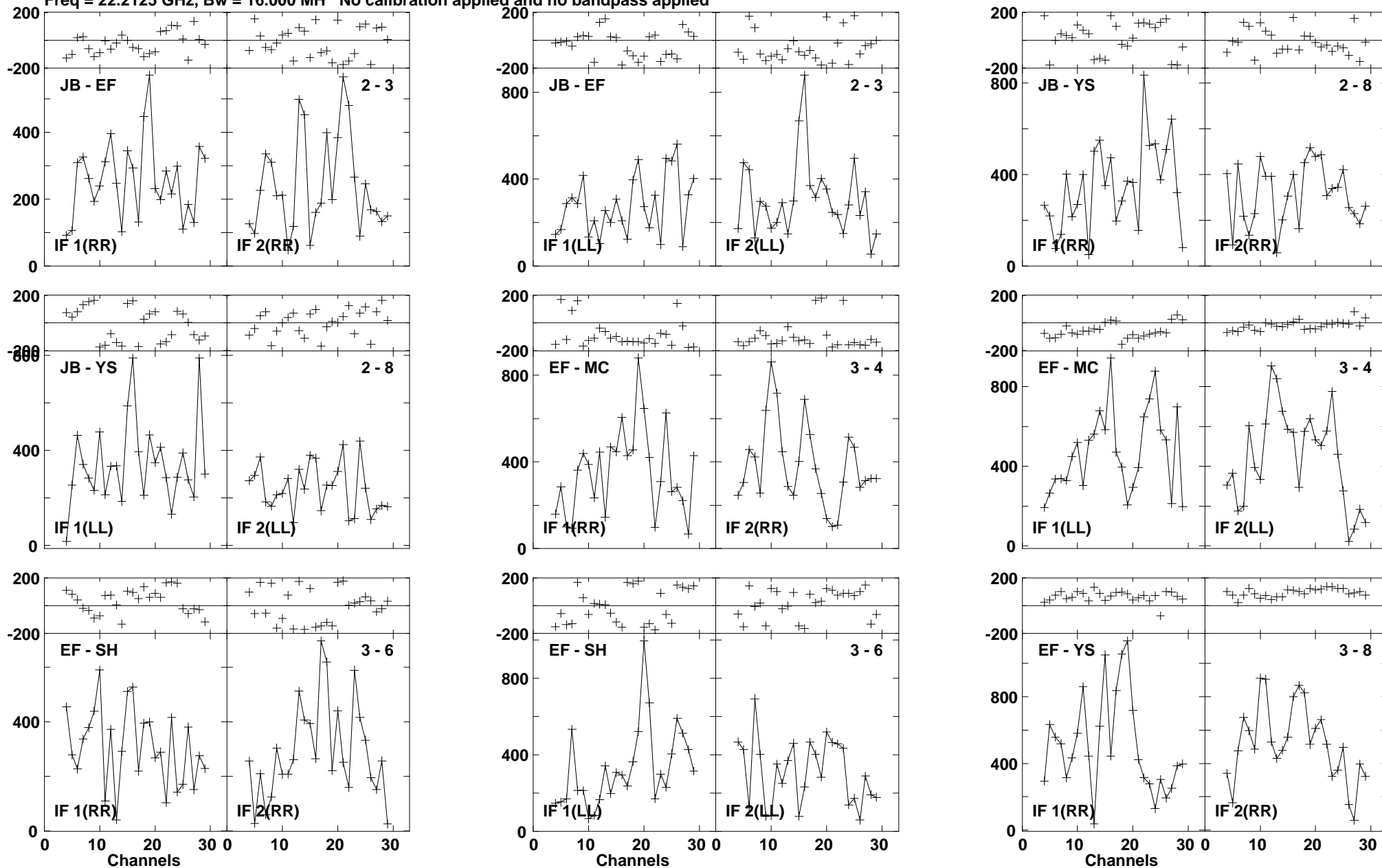

Lower frame: Micro Ampl Jy Top frame: Phas deg  
Vector averaged cross-power spectrum Baseline: JB (02) - EF (03)  
Timerange: 00/11:22:01 to 00/11:22:20



Plot file version 225 created 23-AUG-2016 15:00:50

0219+628 GA035B 1.UVDATA.1

Freq = 22.2125 GHz, Bw = 16.000 MH No calibration applied and no bandpass applied

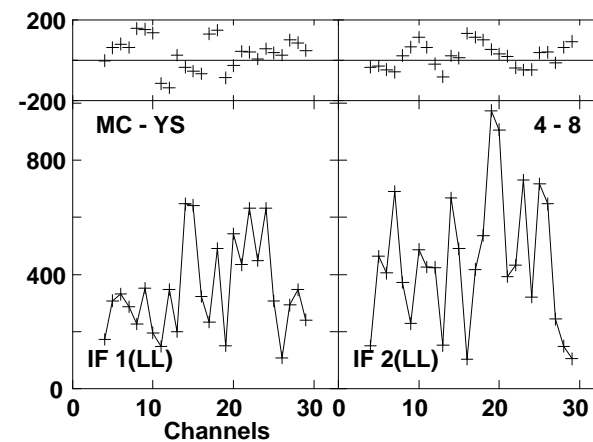
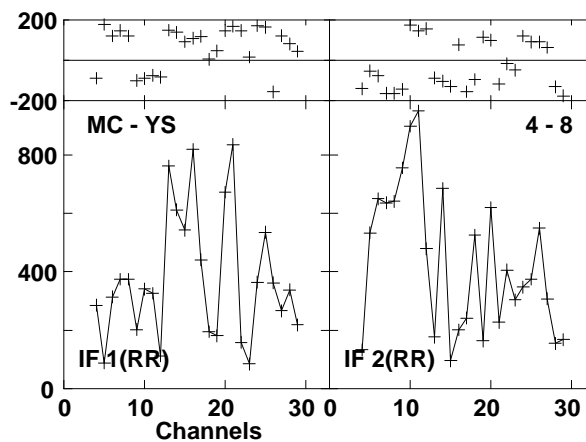
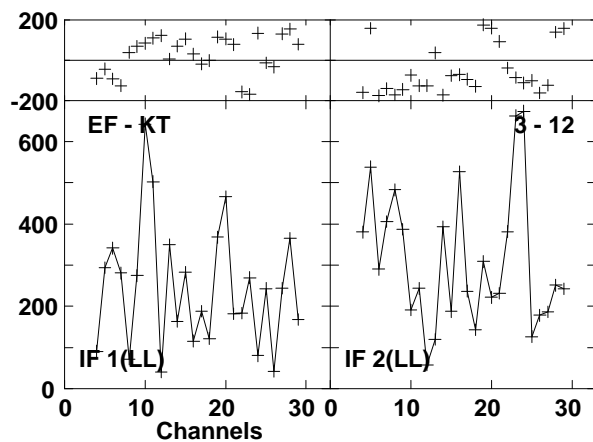
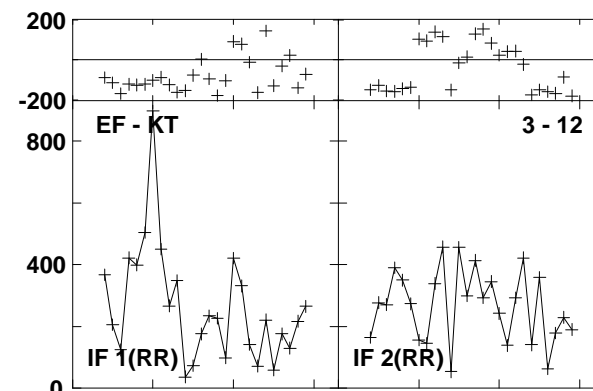
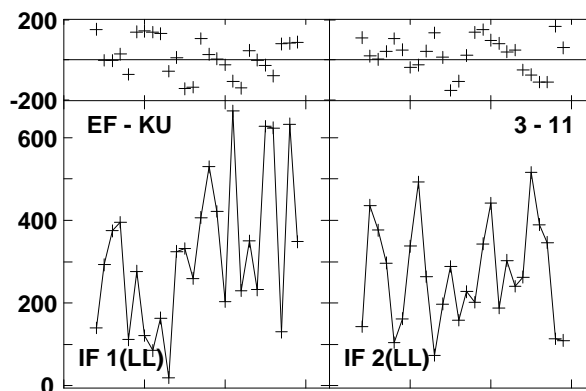
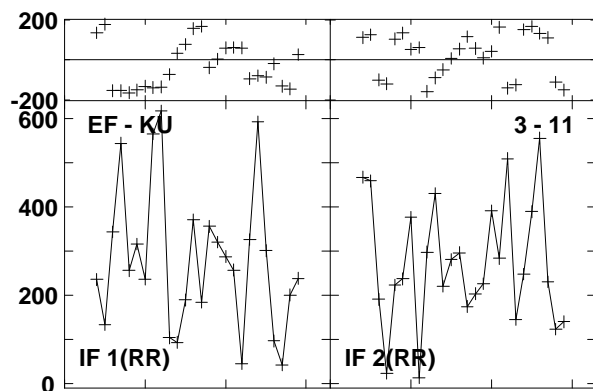
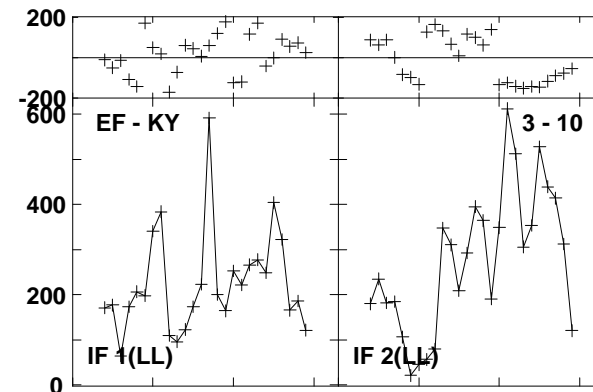
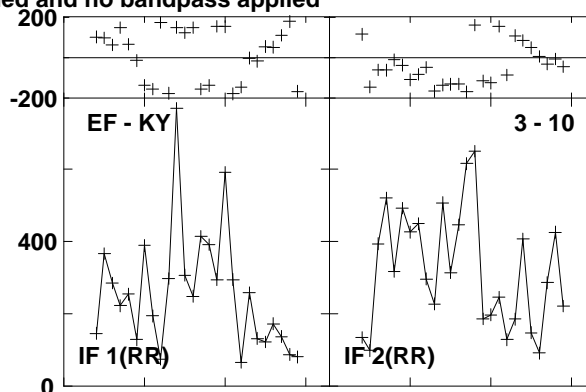
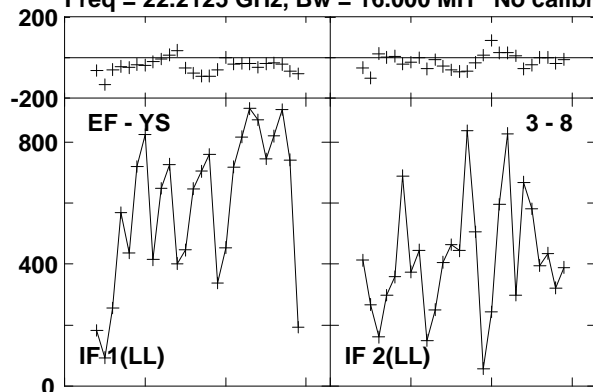

Lower frame: Micro Ampl Jy Top frame: Phas deg  
Vector averaged cross-power spectrum Baseline: EF (03) - YS (08)  
Timerange: 00/11:22:01 to 00/11:22:20

Plot file version 226 created 23-AUG-2016 15:00:50

0219+628 GA035B 1.UVDATA.1

Freq = 22.2125 GHz, Bw = 16.000 MH No calibration applied and no bandpass applied

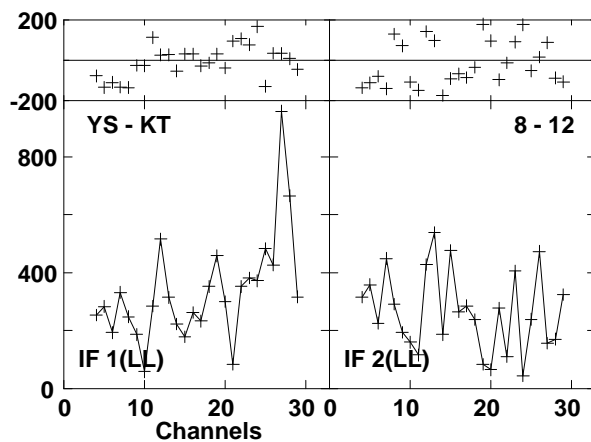
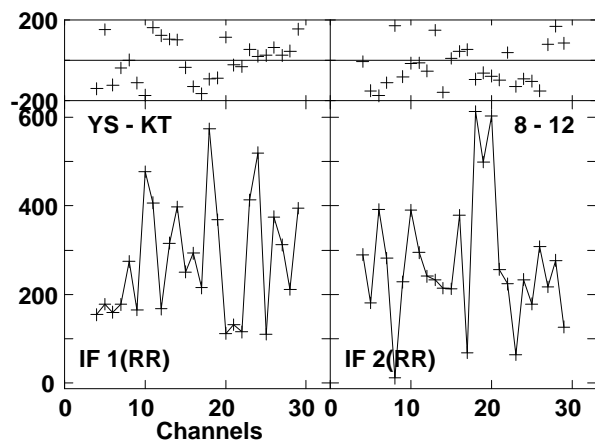
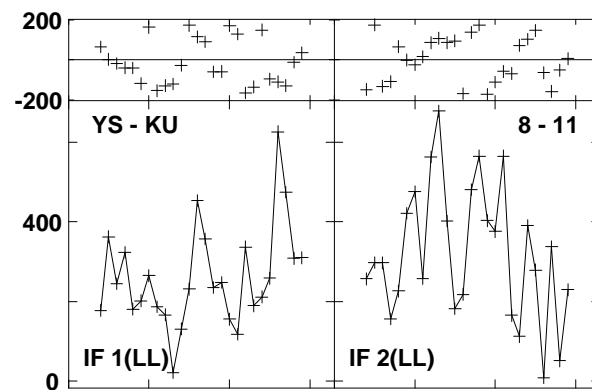
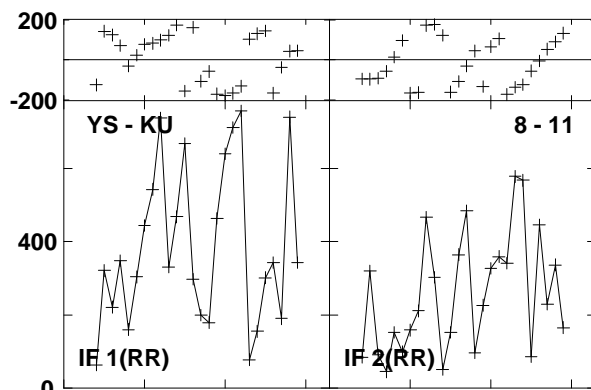
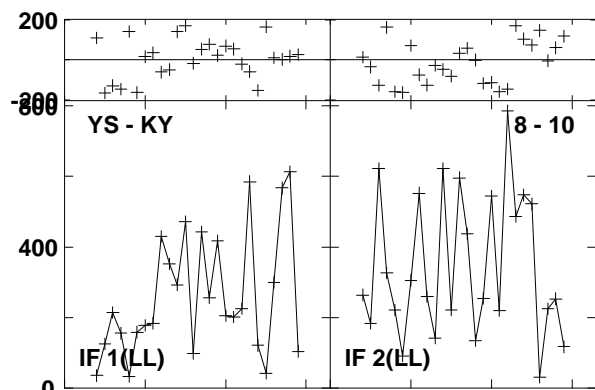
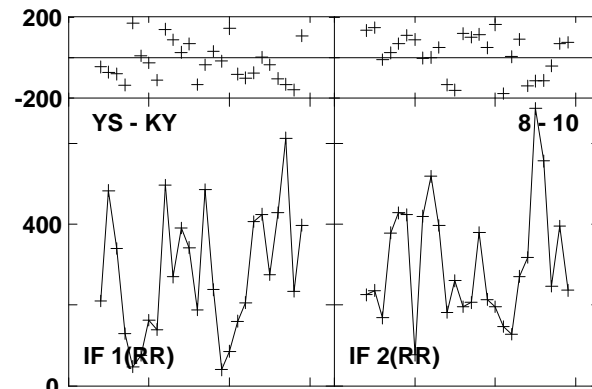
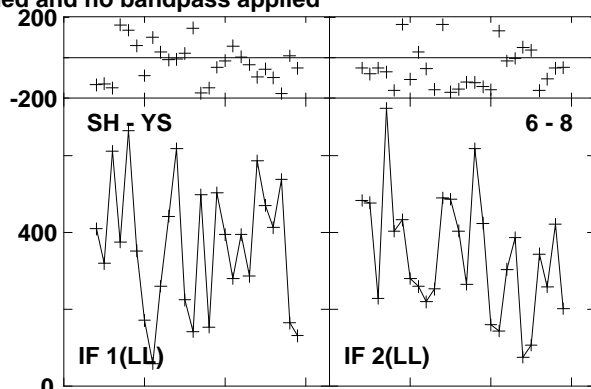
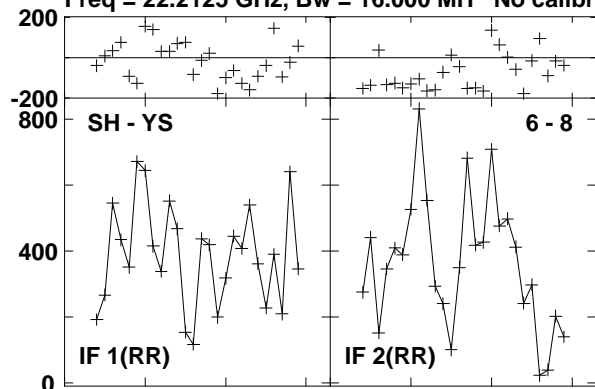

Lower frame: Micro Ampl Jy Top frame: Phas deg  
Vector averaged cross-power spectrum Baseline: SH (06) - YS (08)  
Timerange: 00/11:22:01 to 00/11:22:20

Plot file version 227 created 23-AUG-2016 15:00:50  
 W3IRS5 GA035B 1.UVDATA.1

Freq = 22.2125 GHz, Bw = 16.000 MH No calibration applied and no bandpass applied

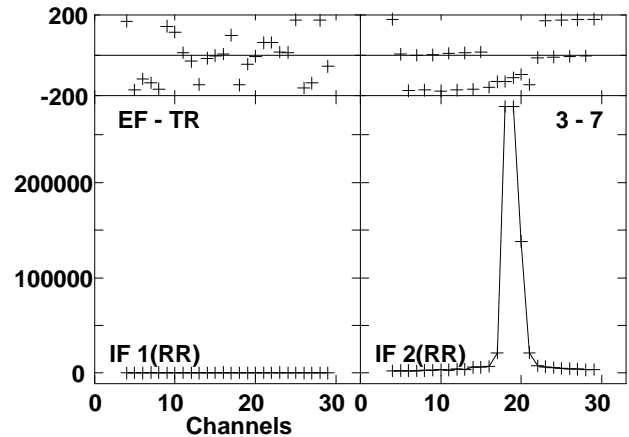
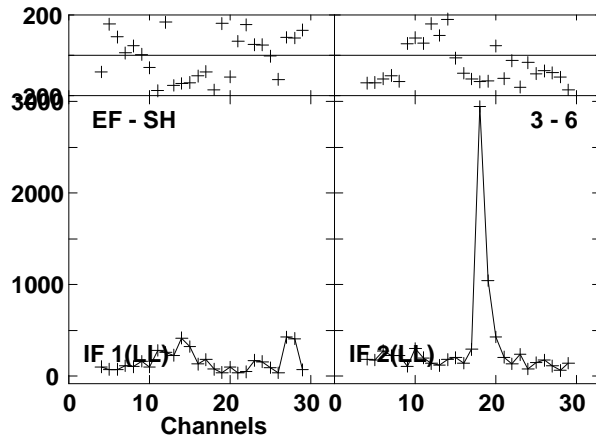
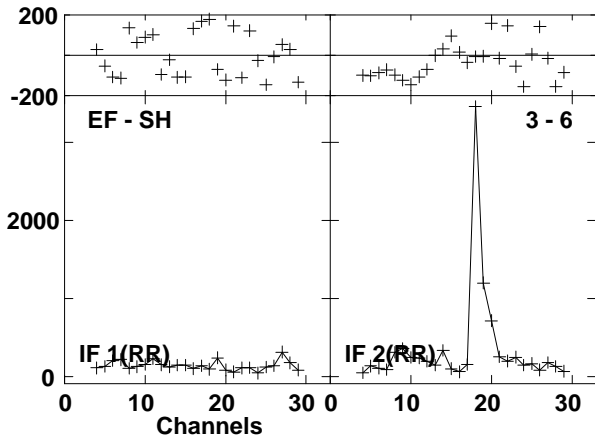
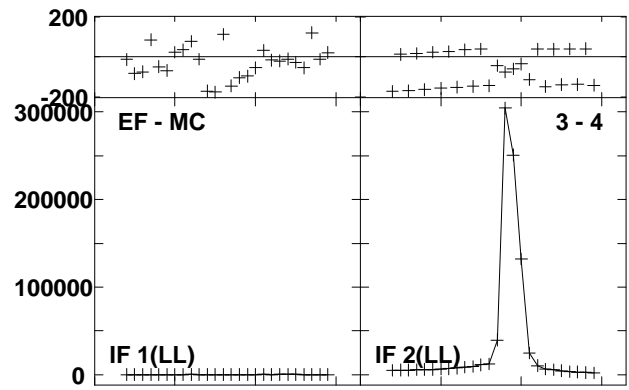
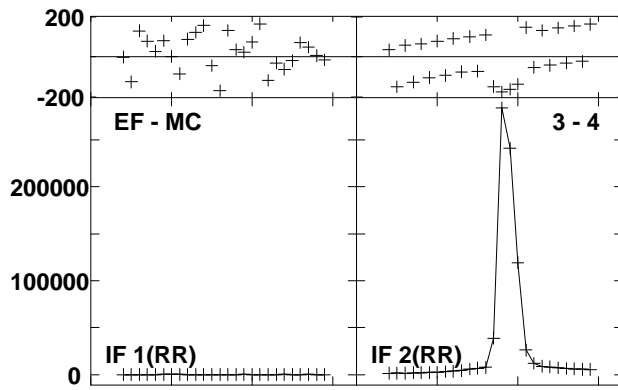
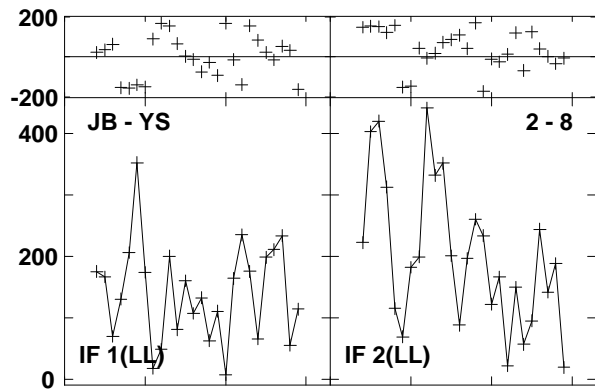
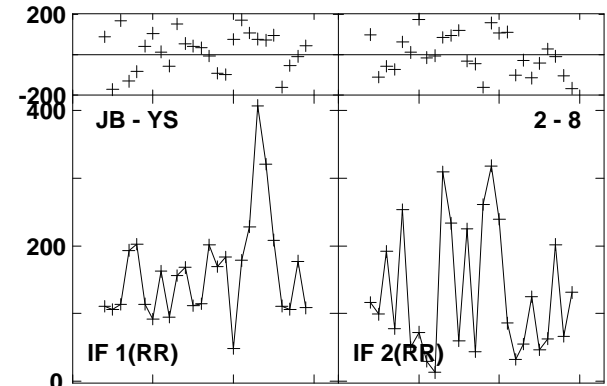
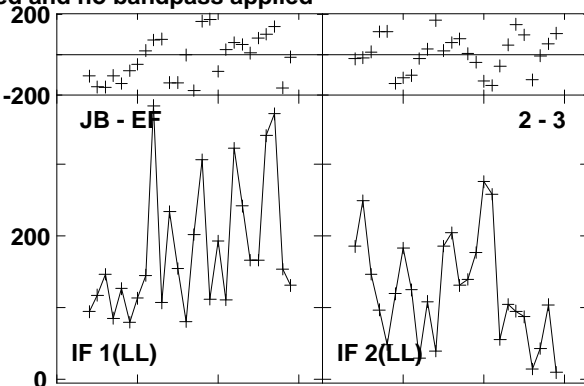
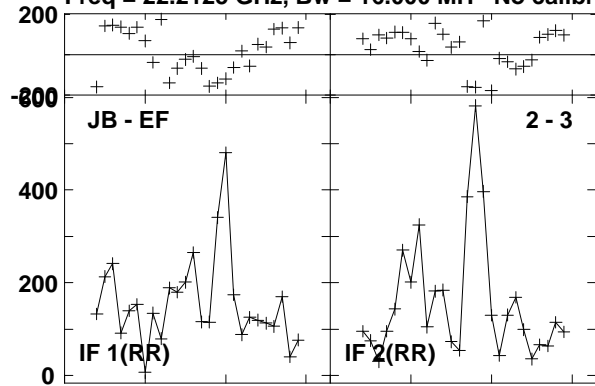

Lower frame: Micro Ampl Jy Top frame: Phas deg  
 Vector averaged cross-power spectrum Baseline: JB (02) - EF (03)  
 Timerange: 00/11:22:45 to 00/11:23:45

Plot file version 228 created 23-AUG-2016 15:00:50

W3IRS5 GA035B 1.UVDATA.1

Freq = 22.2125 GHz, Bw = 16.000 MH No calibration applied and no bandpass applied

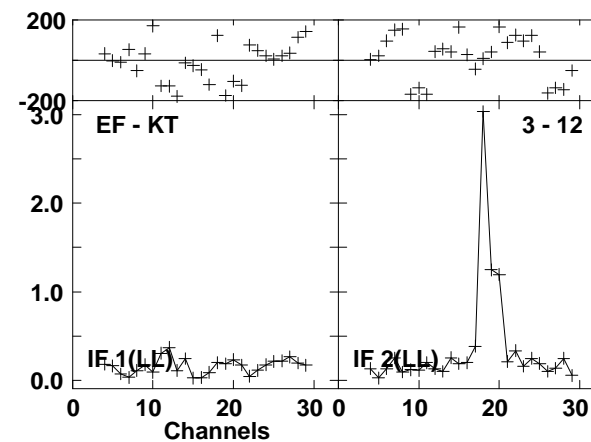
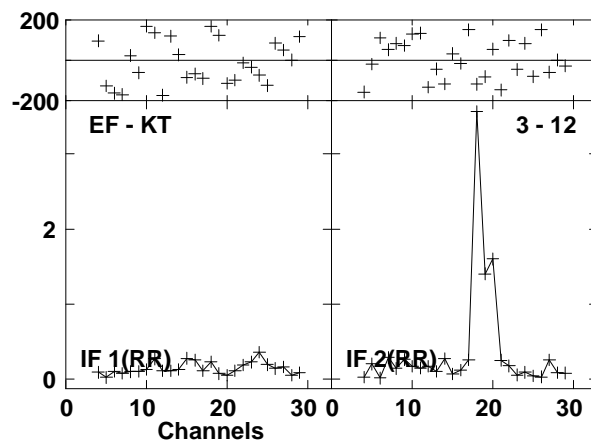
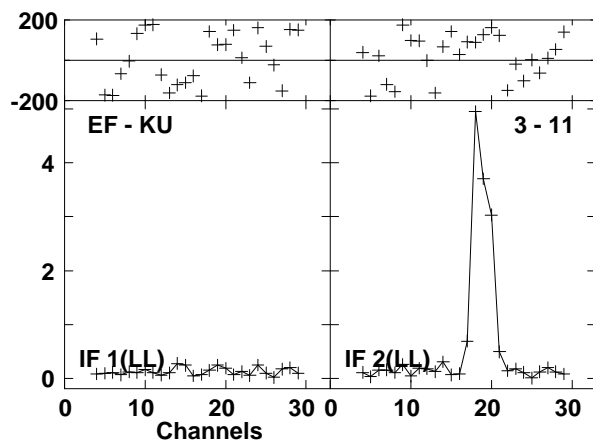
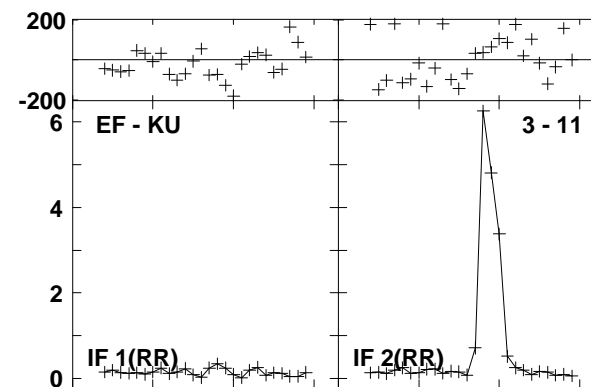
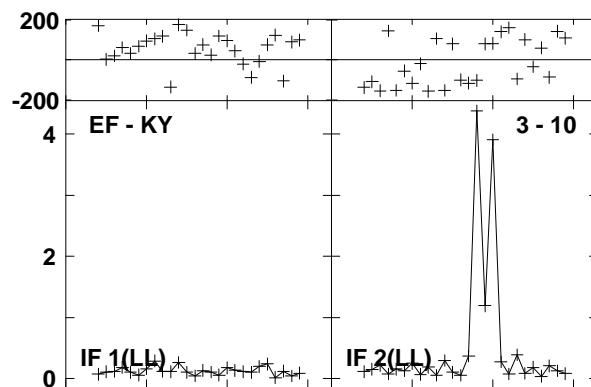
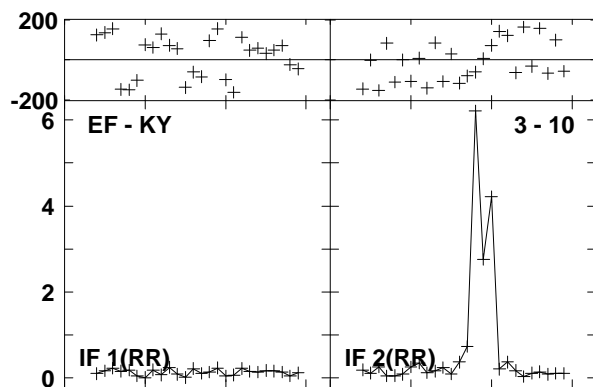
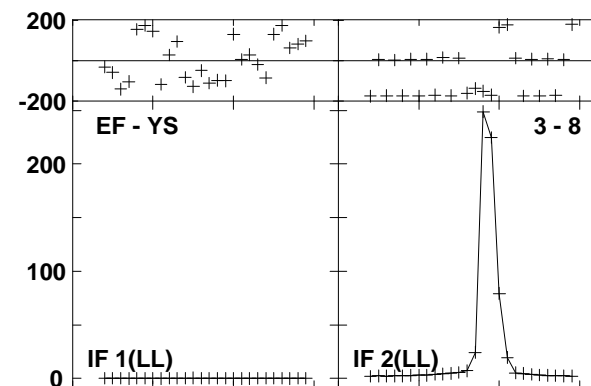
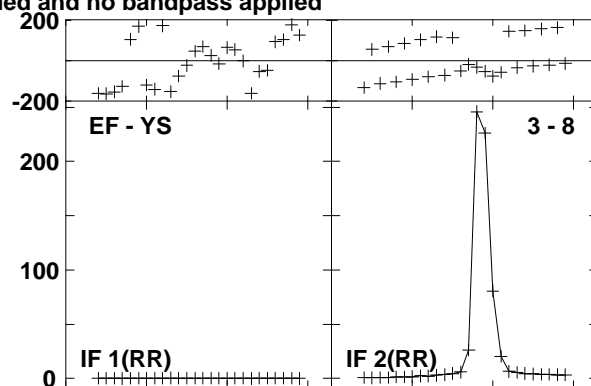
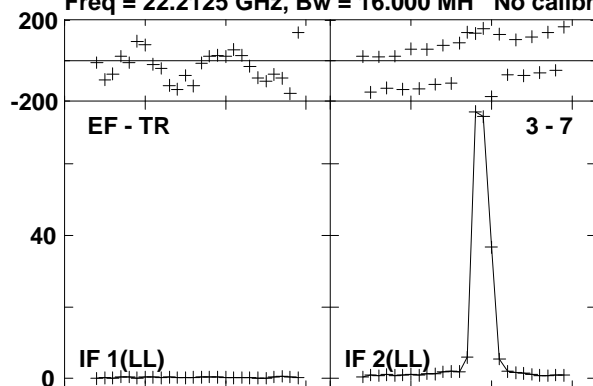

Lower frame: Milli Ampl Jy Top frame: Phas deg  
Vector averaged cross-power spectrum Baseline: EF (03) - TR (07)  
Timerange: 00/11:22:45 to 00/11:23:45

Plot file version 229 created 23-AUG-2016 15:00:50  
 W3IRS5 GA035B 1.UVDATA.1

Freq = 22.2125 GHz, Bw = 16.000 MH No calibration applied and no bandpass applied

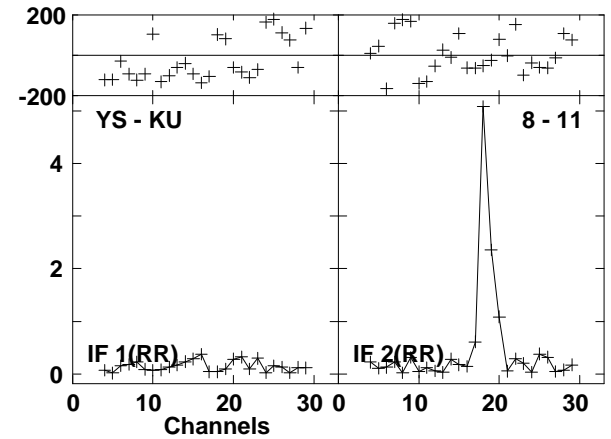
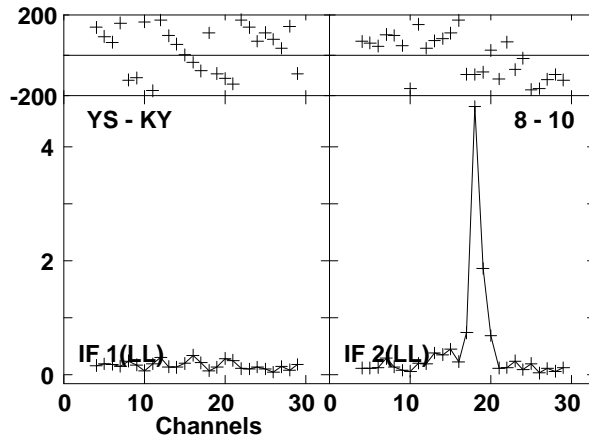
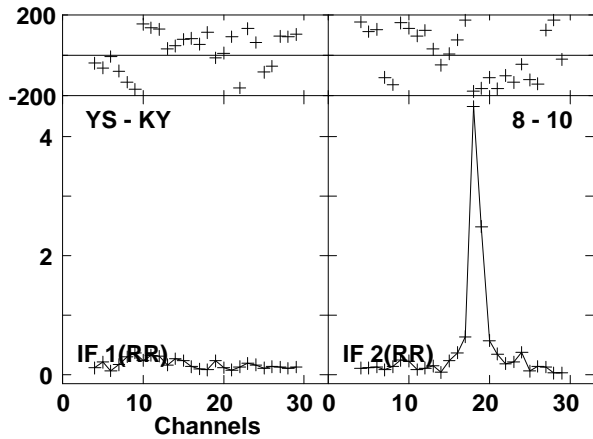
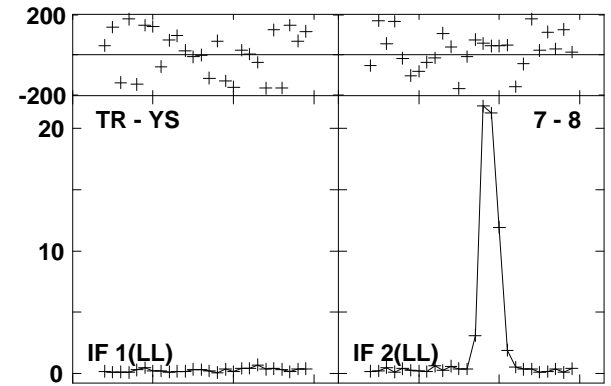
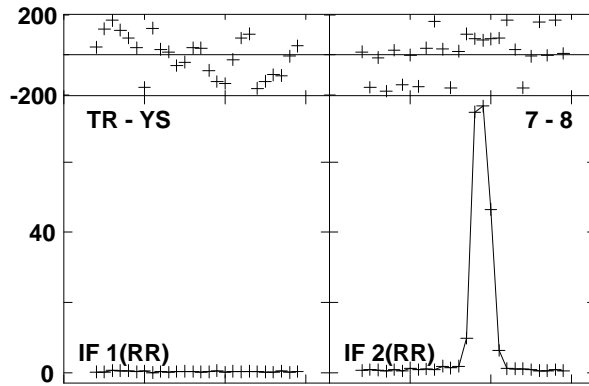
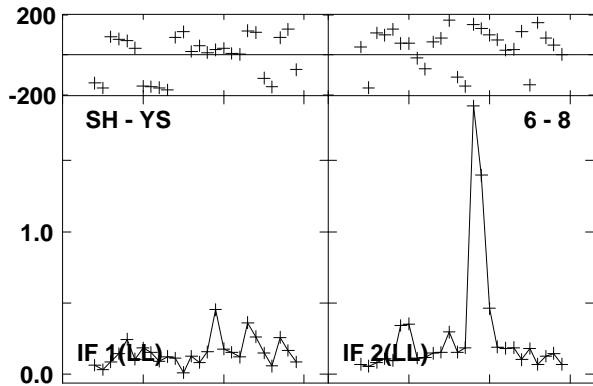
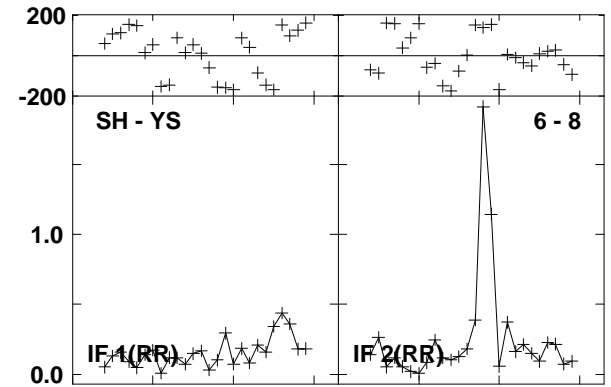
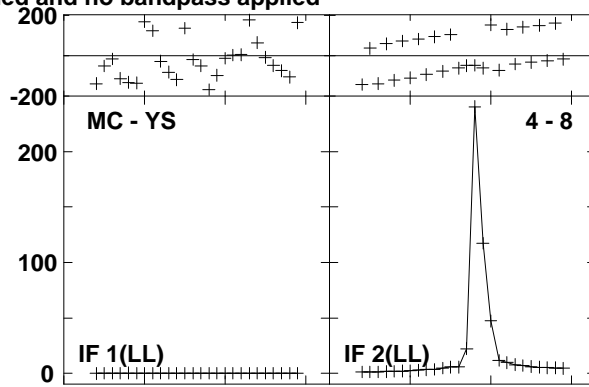
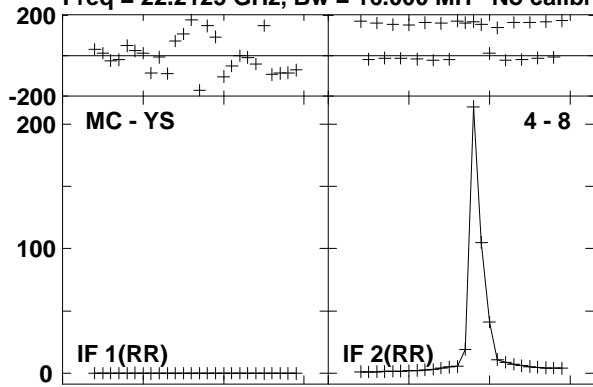

Lower frame: Milli Ampl Jy Top frame: Phas deg  
 Vector averaged cross-power spectrum Baseline: MC (04) - YS (08)  
 Timerange: 00/11:22:45 to 00/11:23:45

Plot file version 230 created 23-AUG-2016 15:00:50  
W3IRS5 GA035B 1.UVDATA.1

Freq = 22.2125 GHz, Bw = 16.000 MH No calibration applied and no bandpass applied

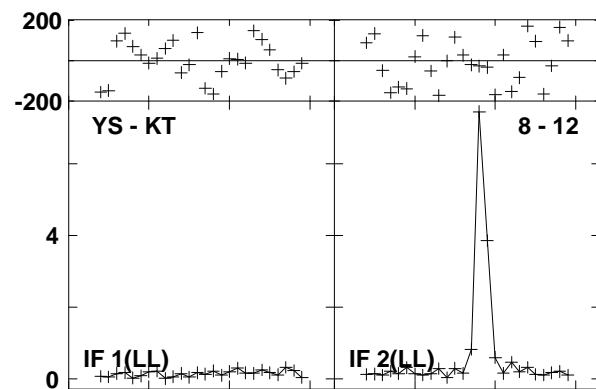
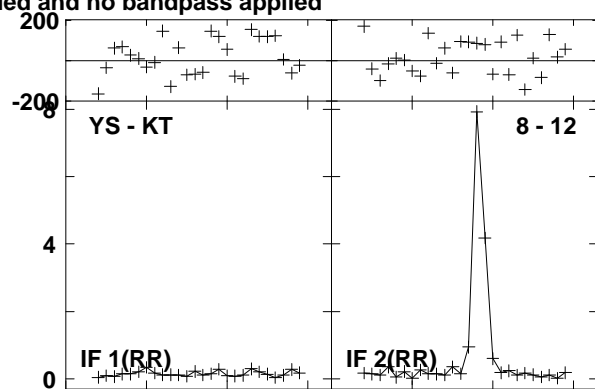
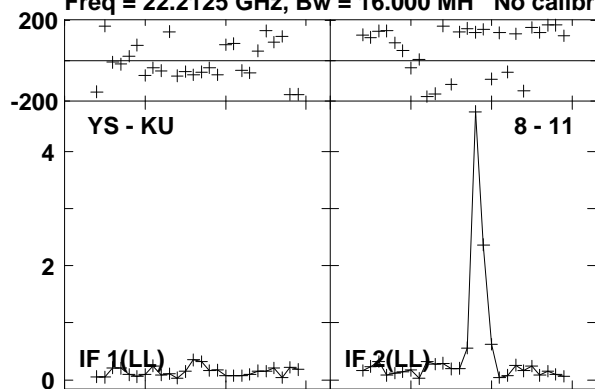

Lower frame: Milli Ampl Jy Top frame: Phas deg  
Vector averaged cross-power spectrum Baseline: YS (08) - KU (11)  
Timerange: 00/11:22:45 to 00/11:23:45

Plot file version 231 created 23-AUG-2016 15:00:50

0219+628 GA035B 1.UVDATA.1

Freq = 22.2125 GHz, Bw = 16.000 MH No calibration applied and no bandpass applied

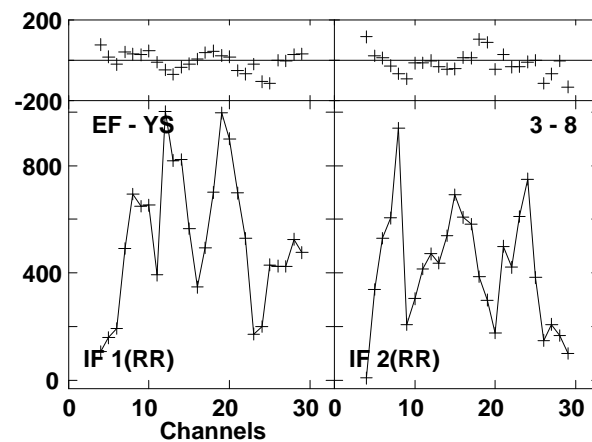
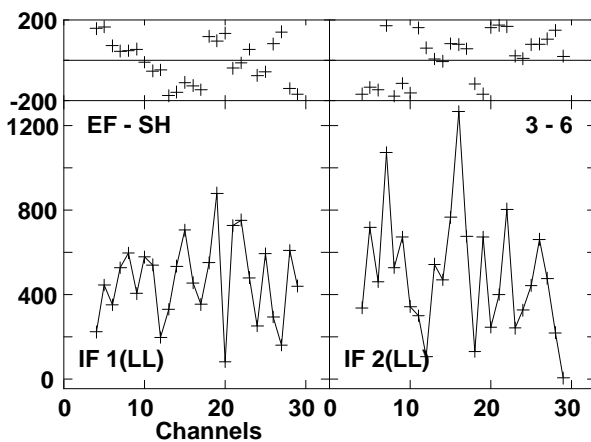
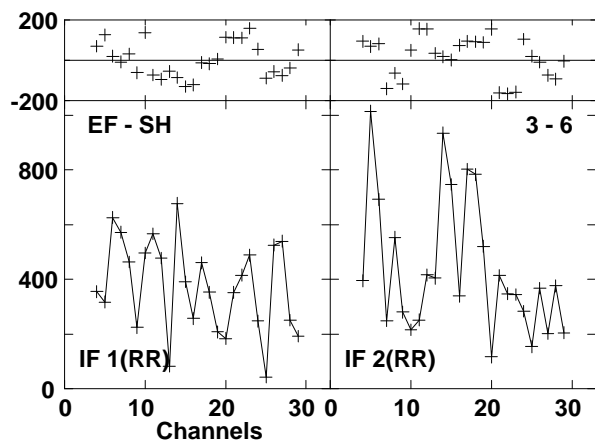
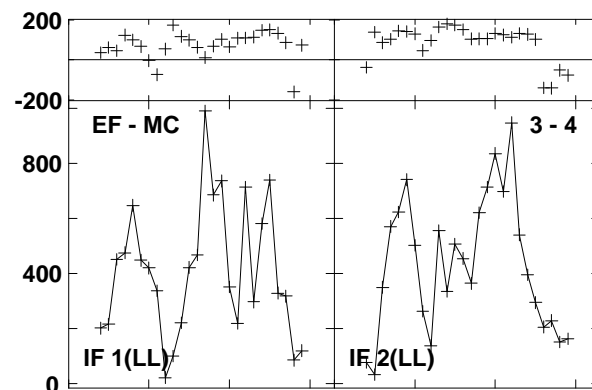
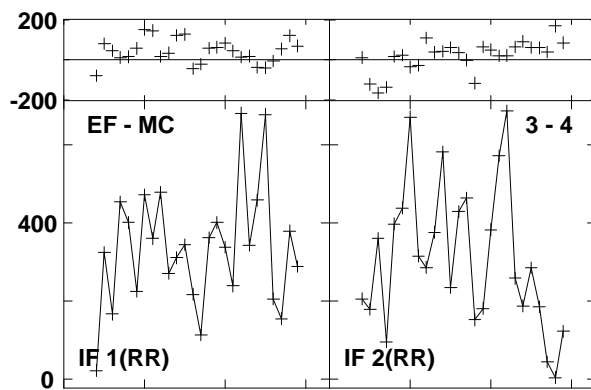
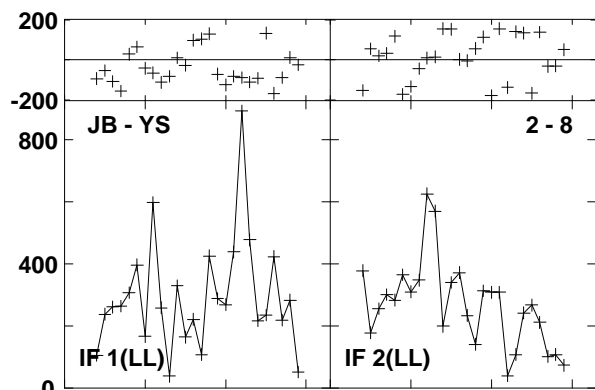
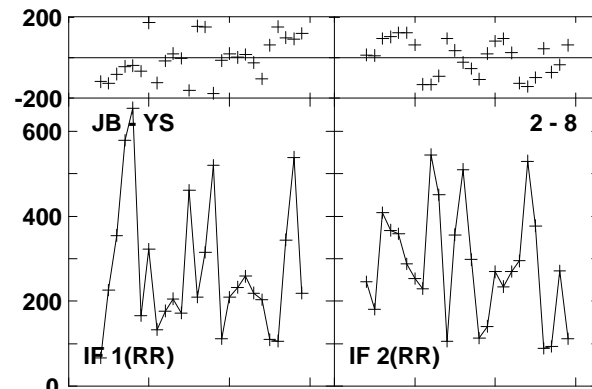
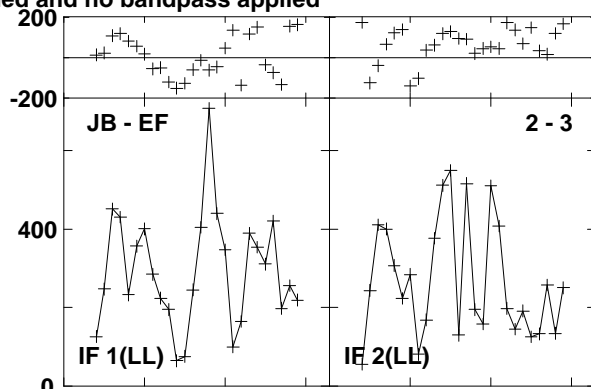
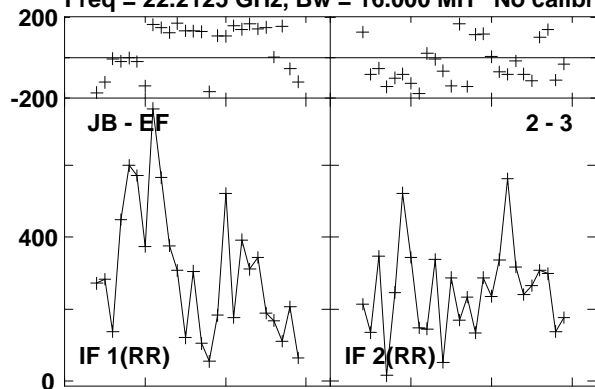

Lower frame: Micro Ampl Jy Top frame: Phas deg  
Vector averaged cross-power spectrum Baseline: JB (02) - EF (03)  
Timerange: 00/11:24:10 to 00/11:24:30

Plot file version 232 created 23-AUG-2016 15:00:50

0219+628 GA035B 1.UVDATA.1

Freq = 22.2125 GHz, Bw = 16.000 MH No calibration applied and no bandpass applied

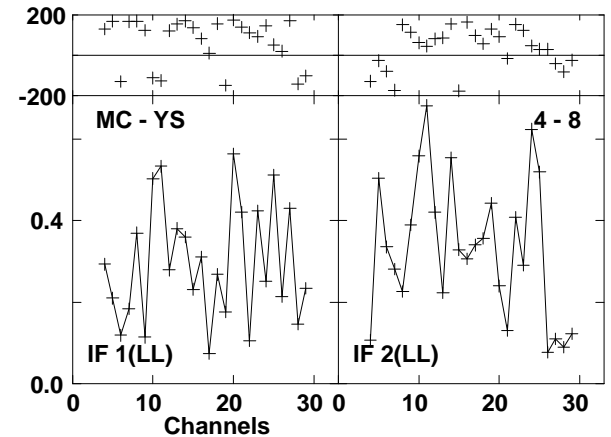
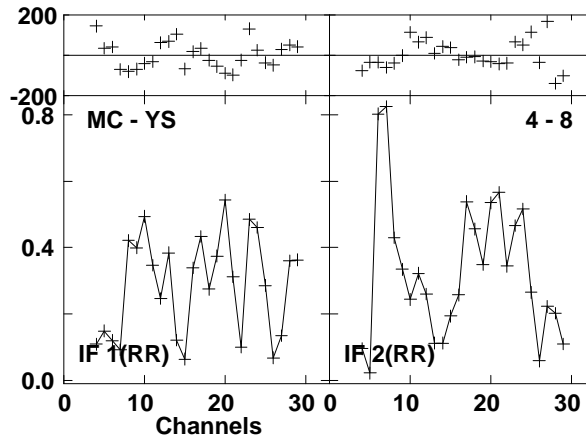
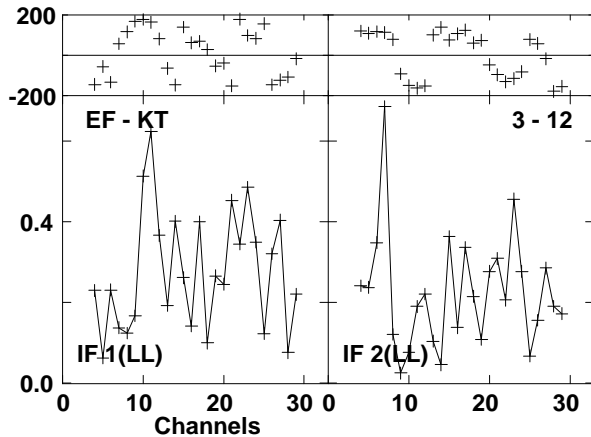
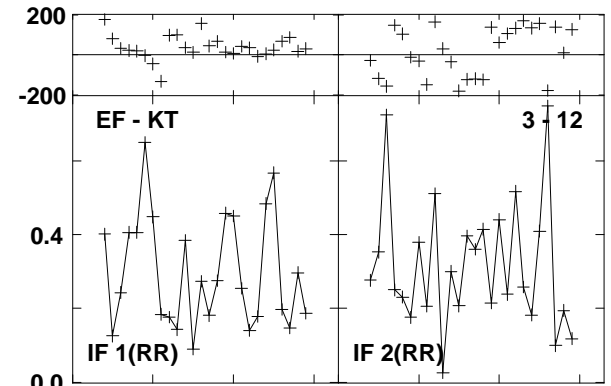
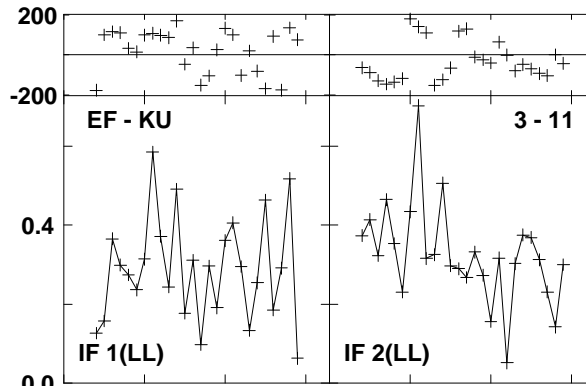
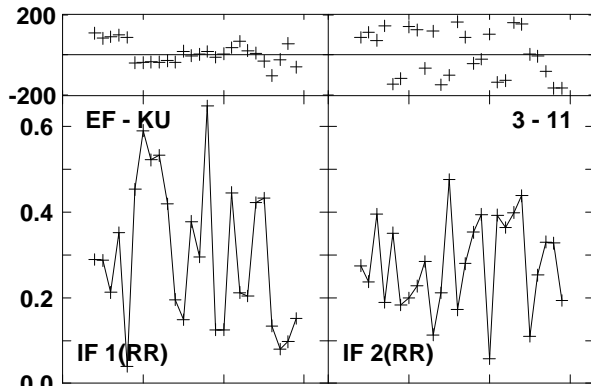
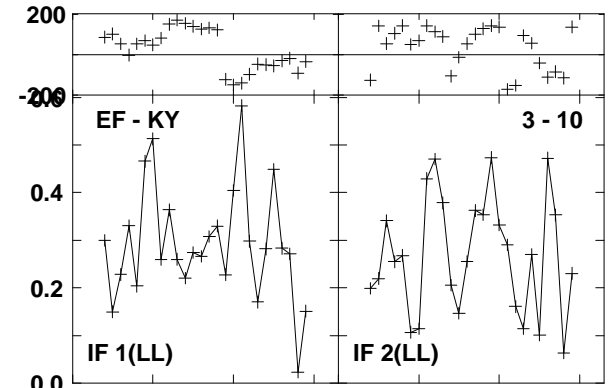
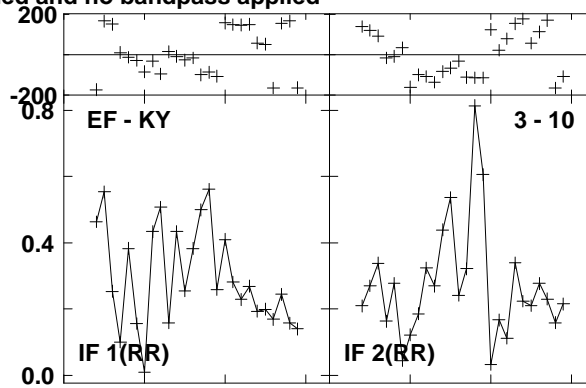
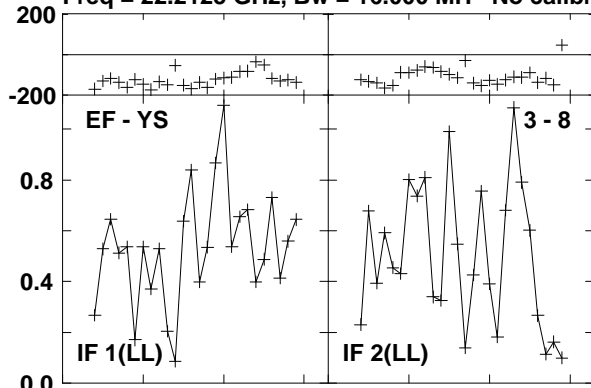

Lower frame: Milli Ampl Jy Top frame: Phas deg  
Vector averaged cross-power spectrum Baseline: EF (03) - YS (08)  
Timerange: 00/11:24:10 to 00/11:24:30



Plot file version 233 created 23-AUG-2016 15:00:50

0219+628 GA035B 1.UVDATA.1

Freq = 22.2125 GHz, Bw = 16.000 MH No calibration applied and no bandpass applied

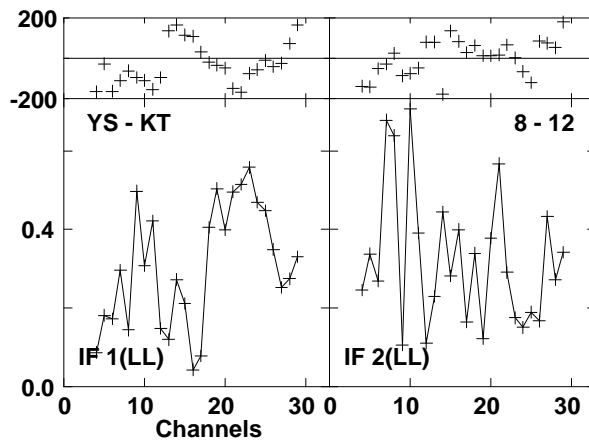
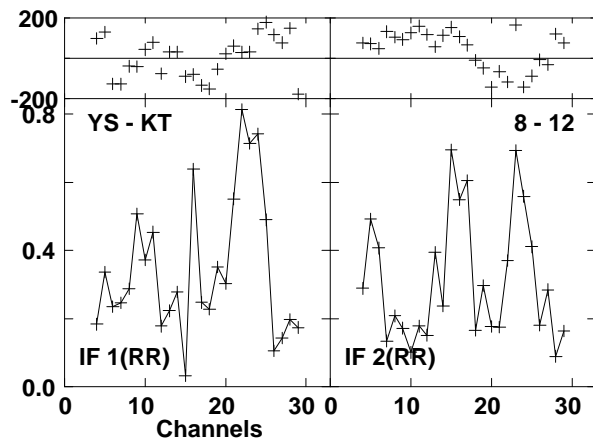
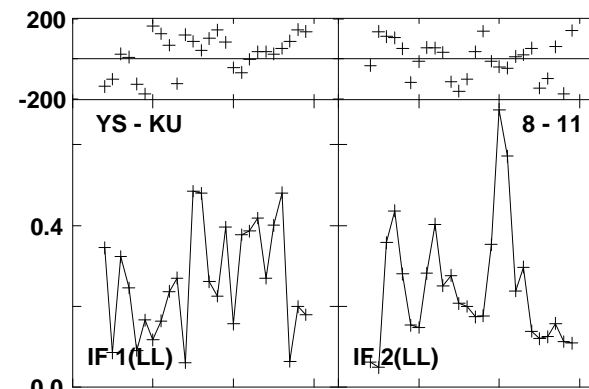
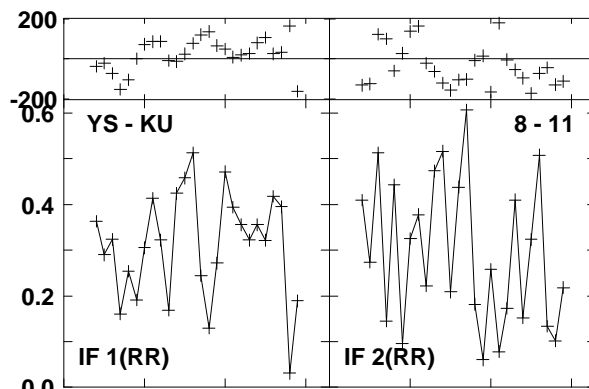
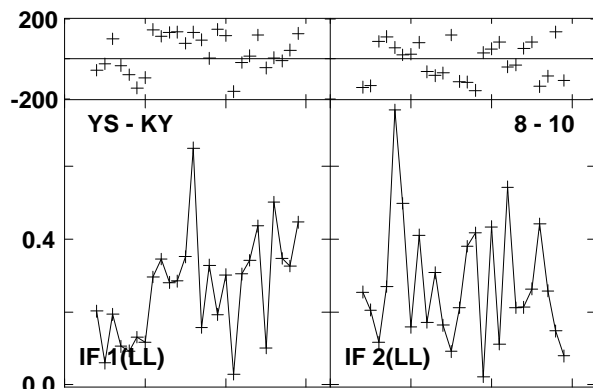
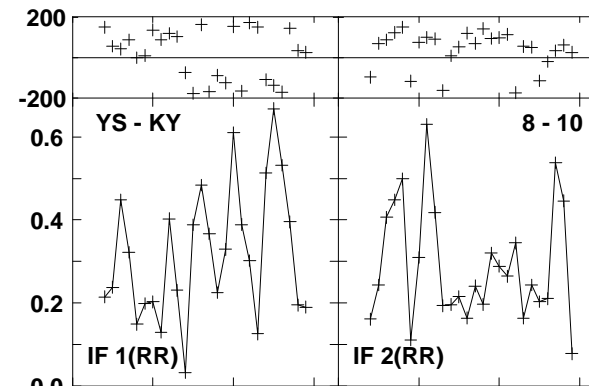
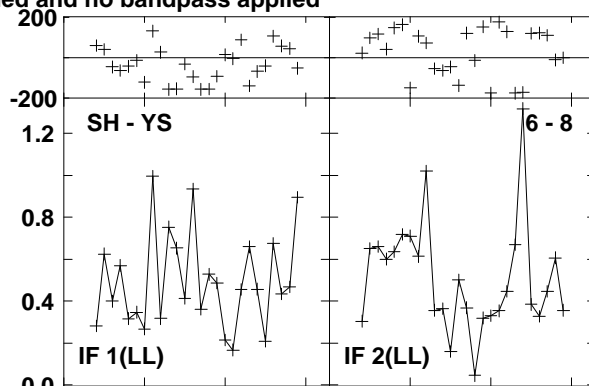
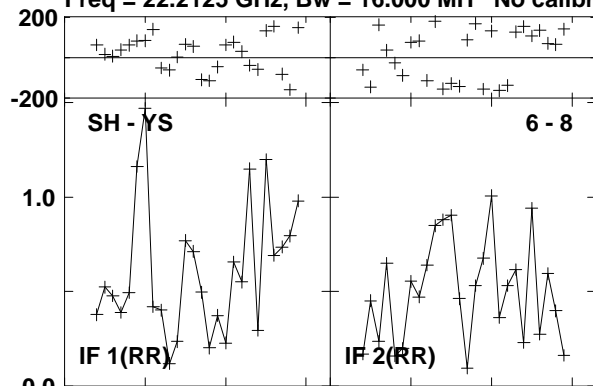

Lower frame: Milli Ampl Jy Top frame: Phas deg  
Vector averaged cross-power spectrum Baseline: SH (06) - YS (08)  
Timerange: 00/11:24:10 to 00/11:24:30

Plot file version 234 created 23-AUG-2016 15:00:50  
 W3IRS5 GA035B 1.UVDATA.1

Freq = 22.2125 GHz, Bw = 16.000 MH No calibration applied and no bandpass applied

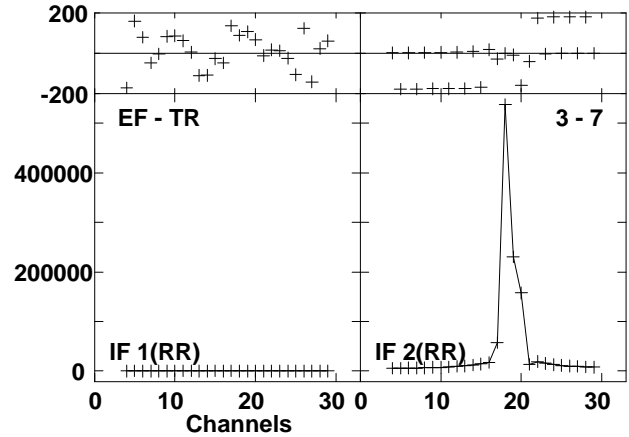
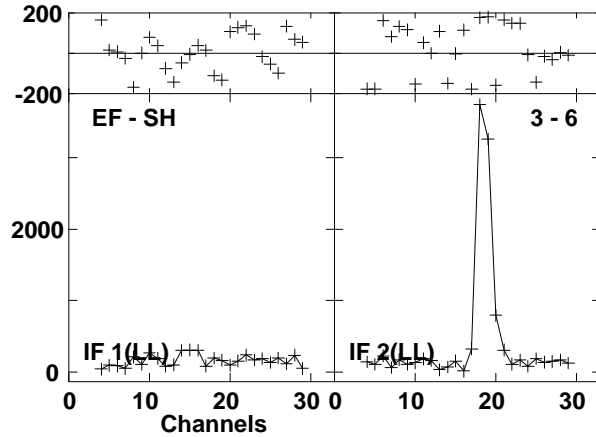
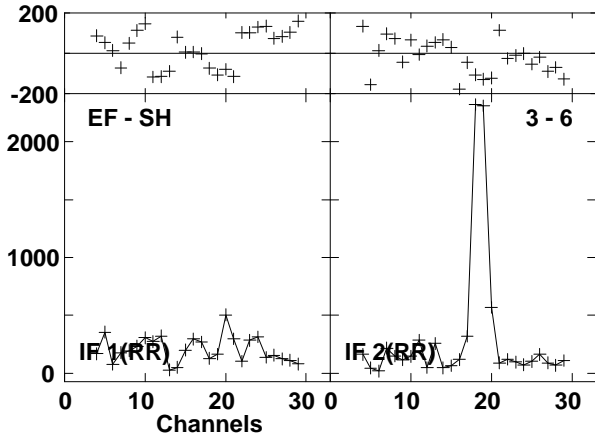
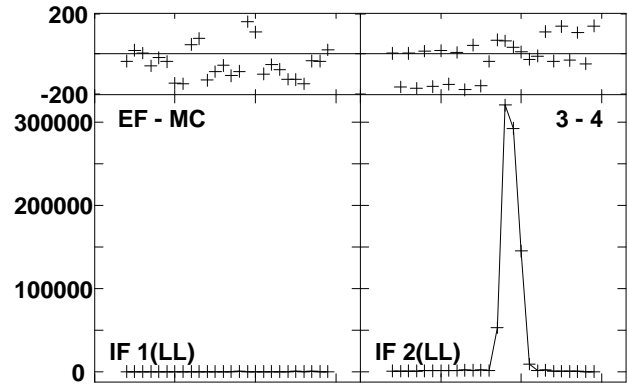
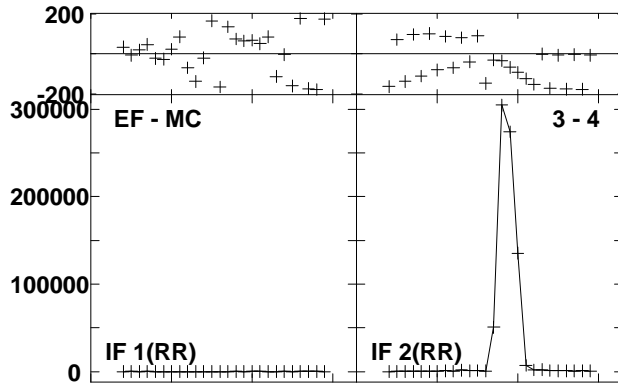
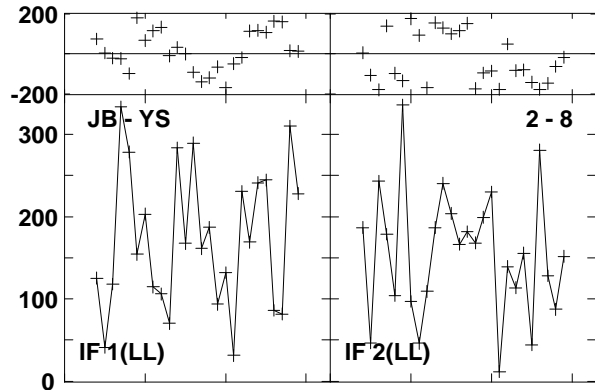
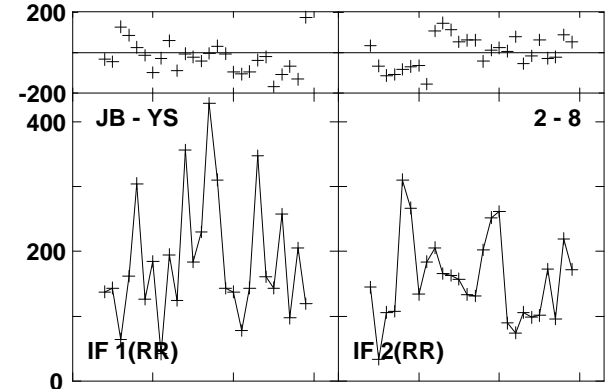
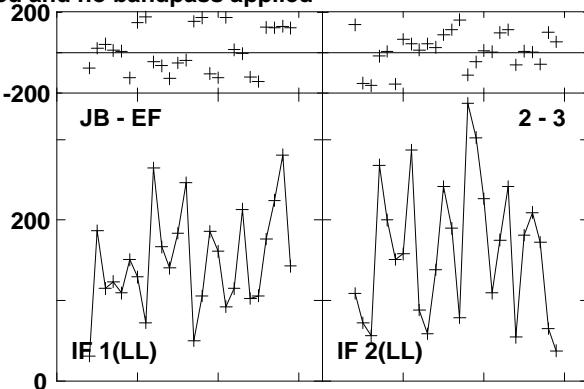
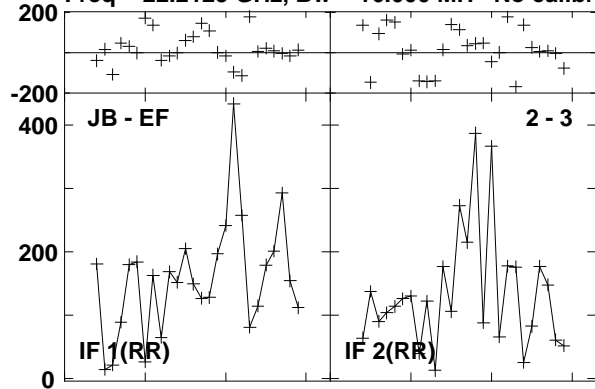

Lower frame: Micro Ampl Jy Top frame: Phas deg  
 Vector averaged cross-power spectrum Baseline: JB (02) - EF (03)  
 Timerange: 00/11:24:56 to 00/11:25:55

Plot file version 235 created 23-AUG-2016 15:00:50

W3IRS5 GA035B 1.UVDATA.1

Freq = 22.2125 GHz, Bw = 16.000 MH No calibration applied and no bandpass applied

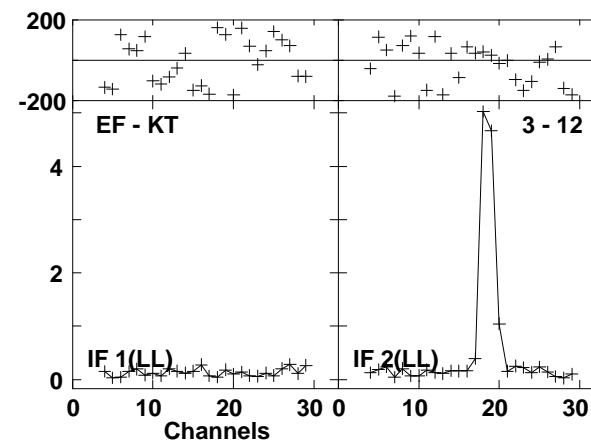
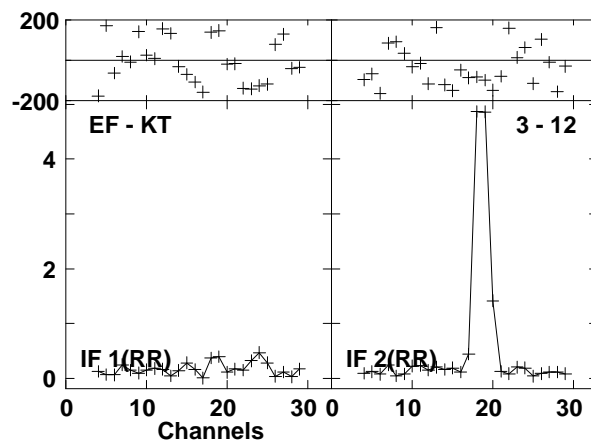
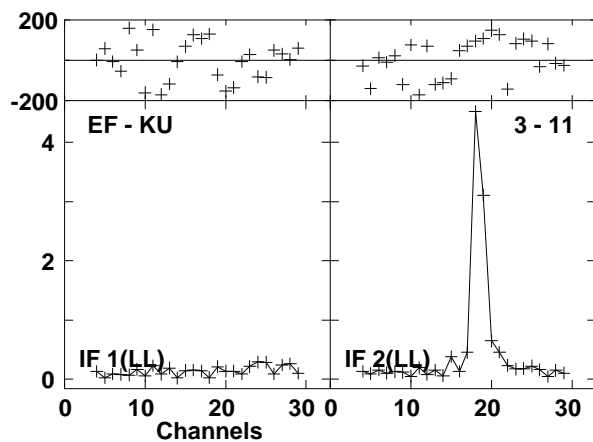
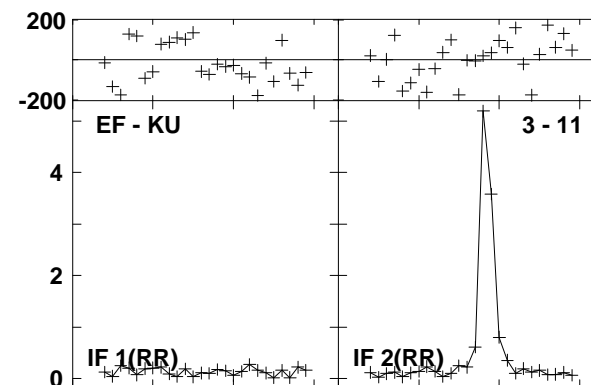
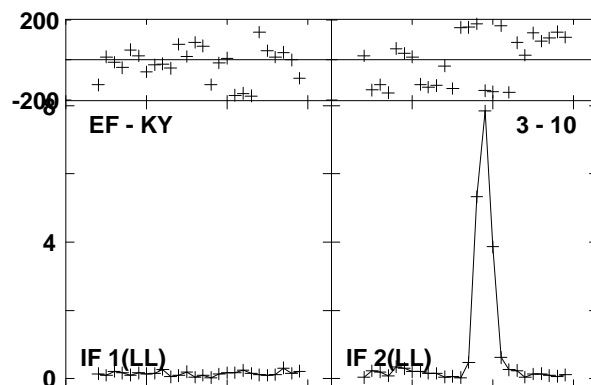
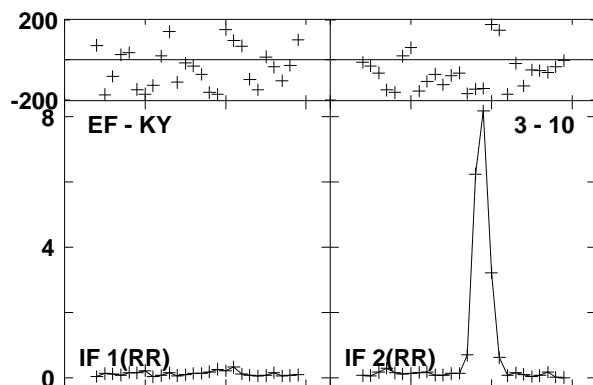
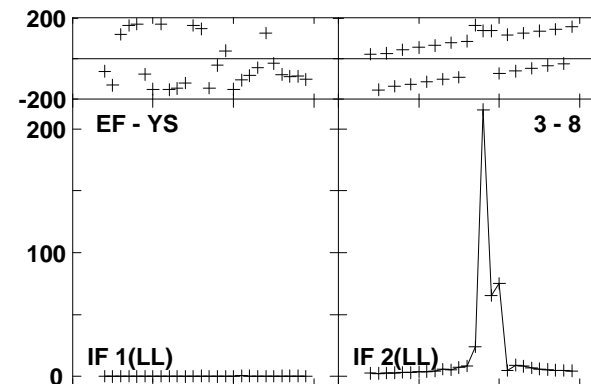
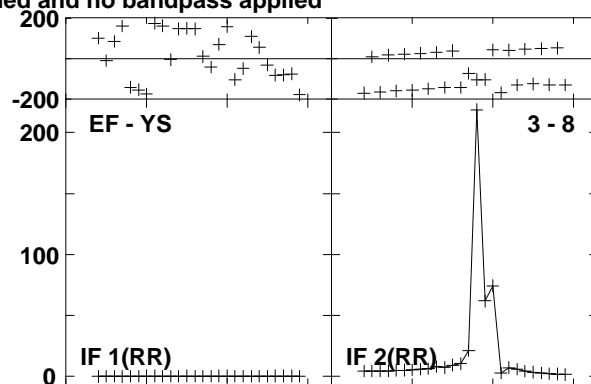
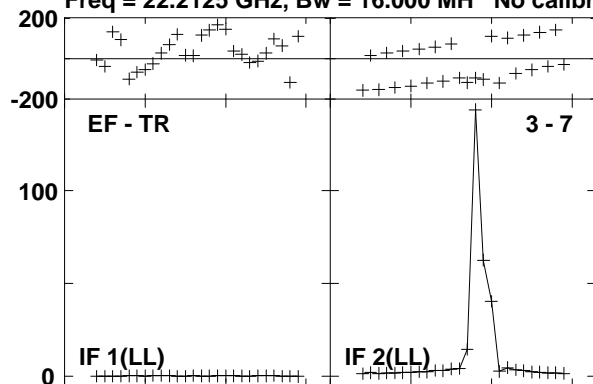

Lower frame: Milli Ampl Jy Top frame: Phas deg  
Vector averaged cross-power spectrum Baseline: EF (03) - TR (07)  
Timerange: 00/11:24:56 to 00/11:25:55

Plot file version 236 created 23-AUG-2016 15:00:50  
 W3IRS5 GA035B 1.UVDATA.1

Freq = 22.2125 GHz, Bw = 16.000 MH No calibration applied and no bandpass applied

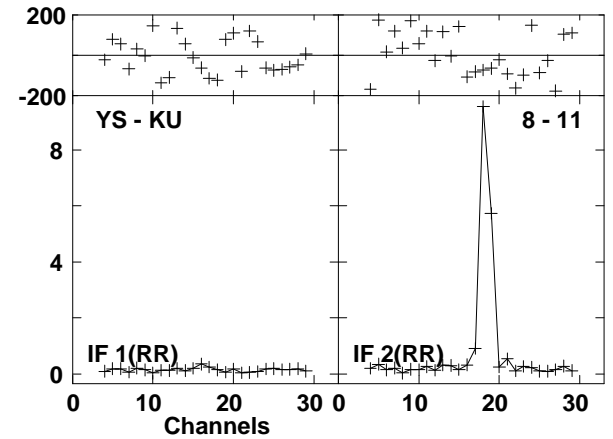
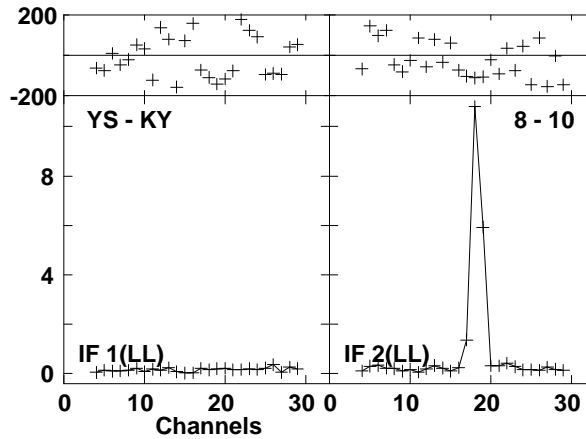
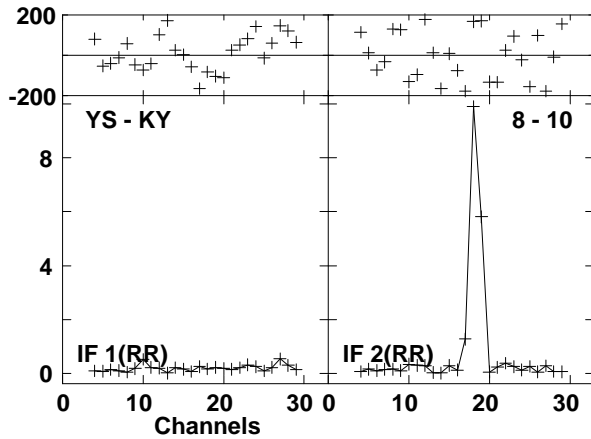
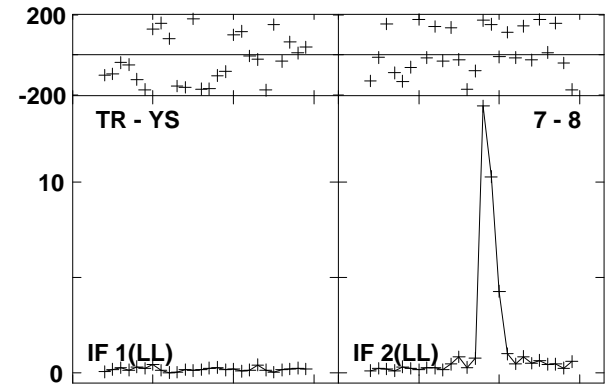
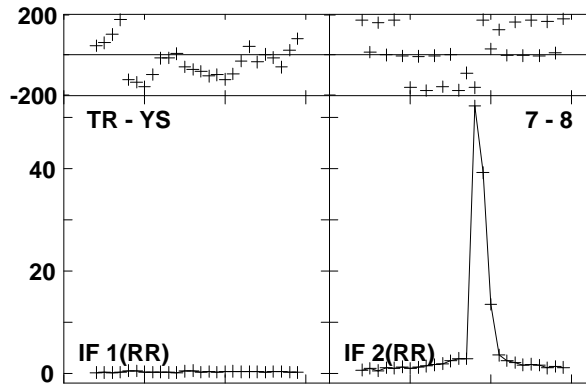
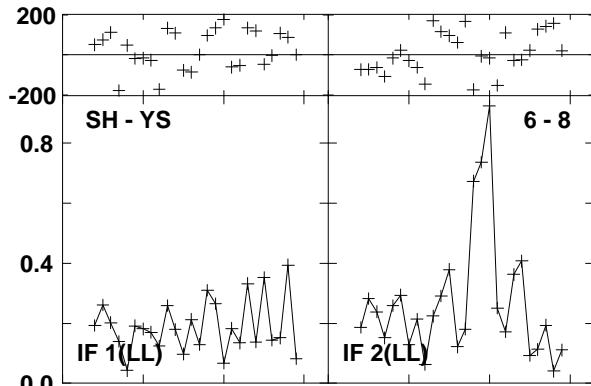
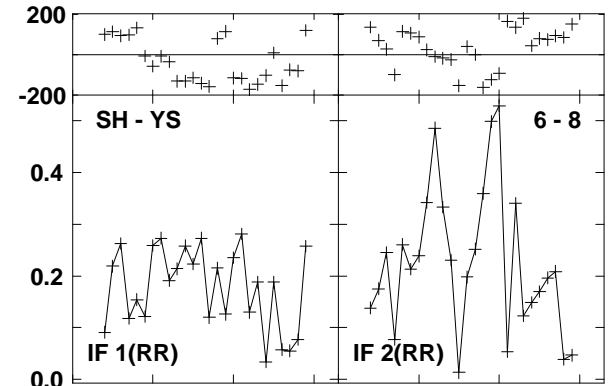
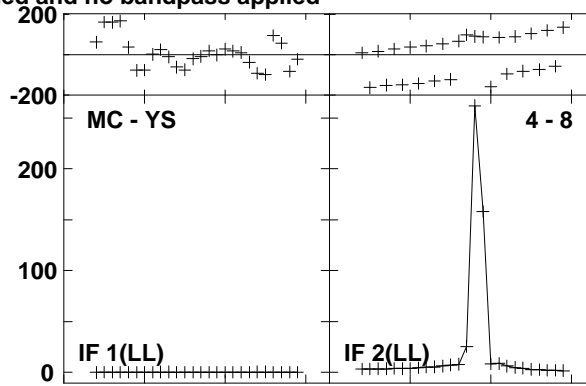
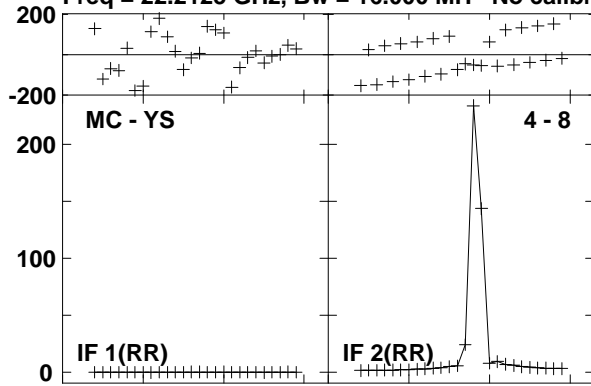

Lower frame: Milli Ampl Jy Top frame: Phas deg  
 Vector averaged cross-power spectrum Baseline: MC (04) - YS (08)  
 Timerange: 00/11:24:56 to 00/11:25:55

Plot file version 237 created 23-AUG-2016 15:00:50  
W3IRS5 GA035B 1.UVDATA.1

Freq = 22.2125 GHz, Bw = 16.000 MH No calibration applied and no bandpass applied

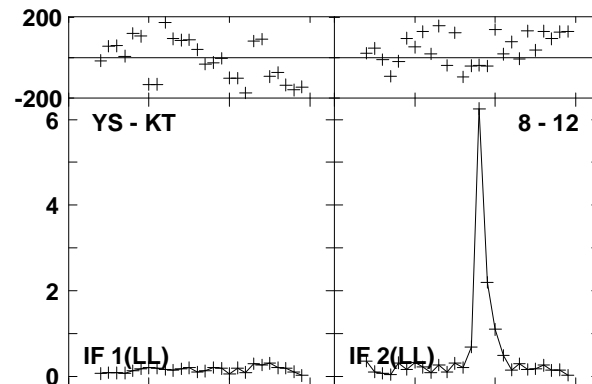
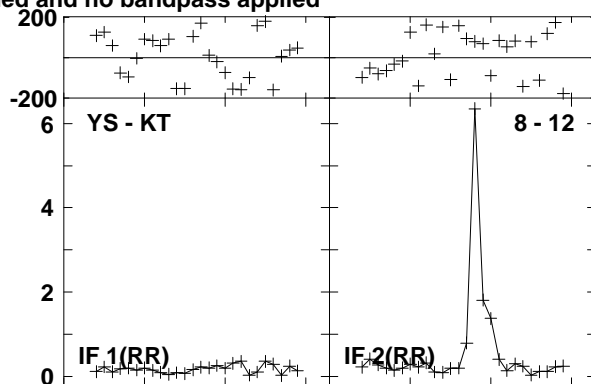
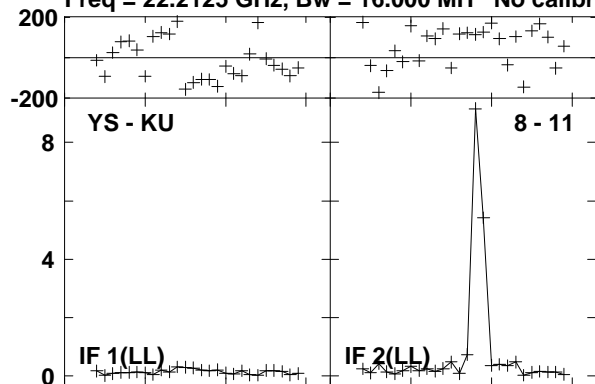

Lower frame: Milli Ampl Jy Top frame: Phas deg  
Vector averaged cross-power spectrum Baseline: YS (08) - KU (11)  
Timerange: 00/11:24:56 to 00/11:25:55

Plot file version 238 created 23-AUG-2016 15:00:50

0219+628 GA035B 1.UVDATA.1

Freq = 22.2125 GHz, Bw = 16.000 MH No calibration applied and no bandpass applied

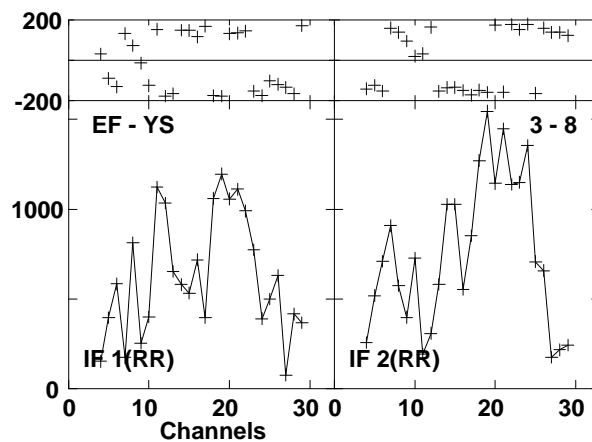
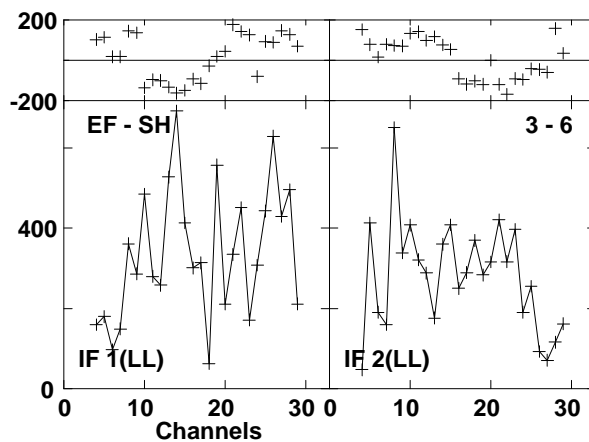
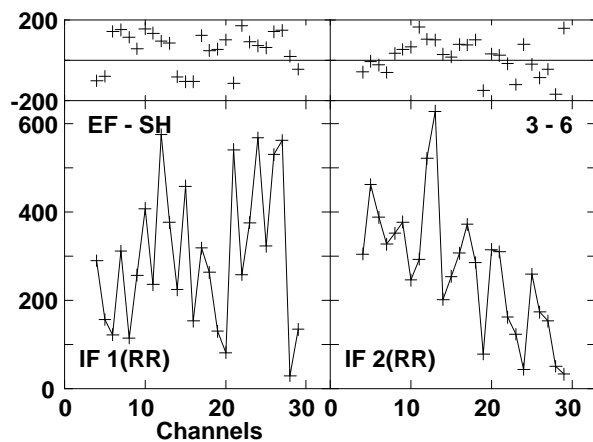
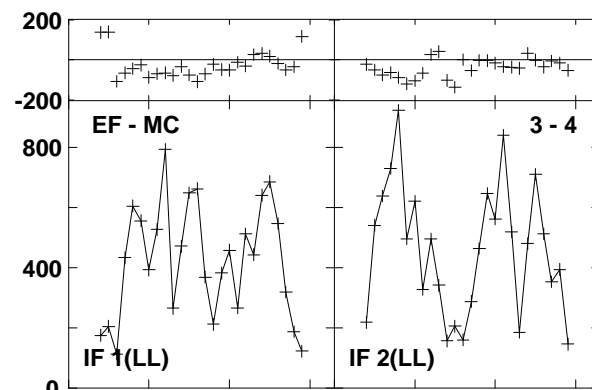
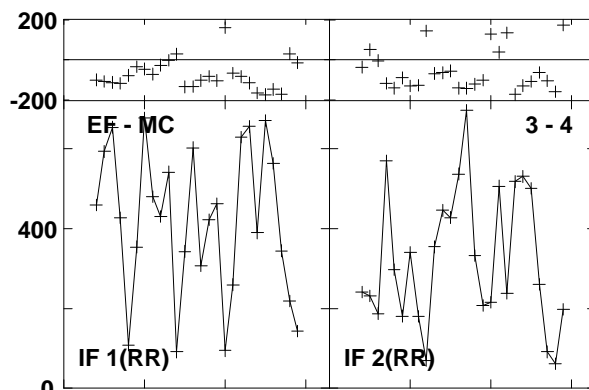
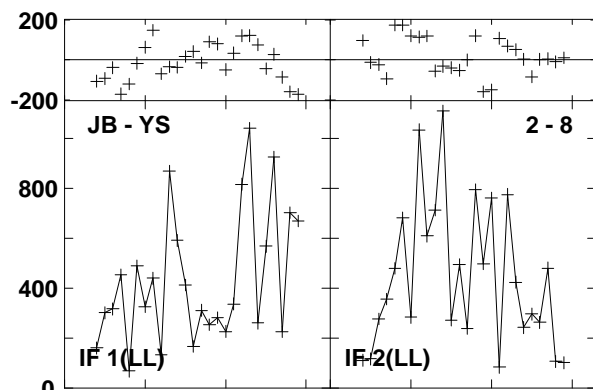
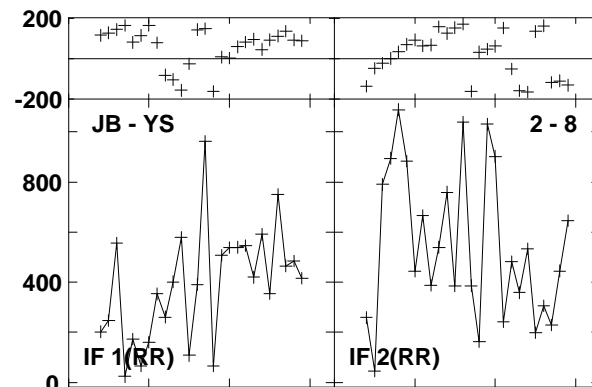
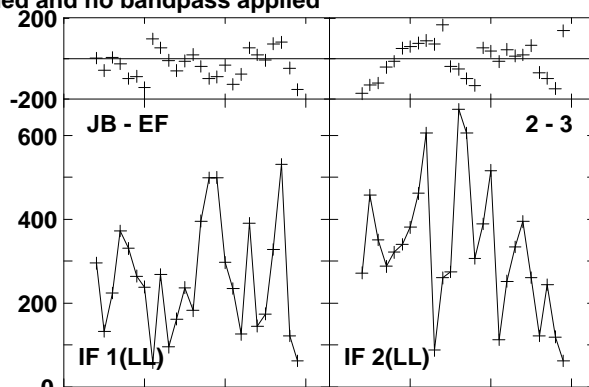
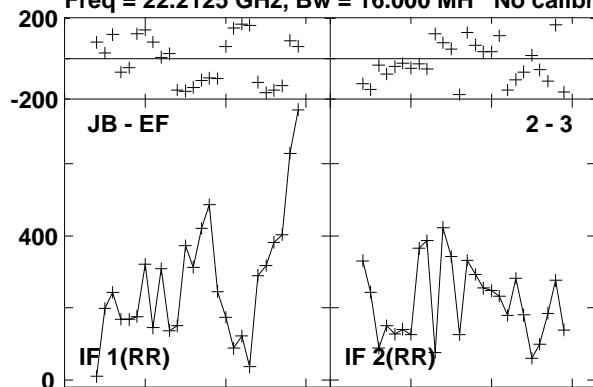

Lower frame: Micro Ampl Jy Top frame: Phas deg  
Vector averaged cross-power spectrum Baseline: JB (02) - EF (03)  
Timerange: 00/11:26:21 to 00/11:26:40

Plot file version 239 created 23-AUG-2016 15:00:50

0219+628 GA035B 1.UVDATA.1

Freq = 22.2125 GHz, Bw = 16.000 MH No calibration applied and no bandpass applied

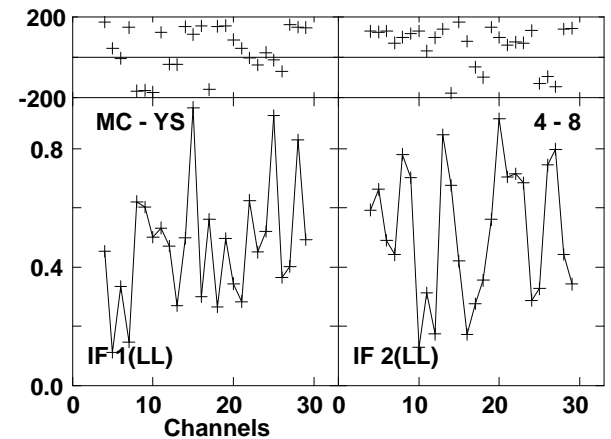
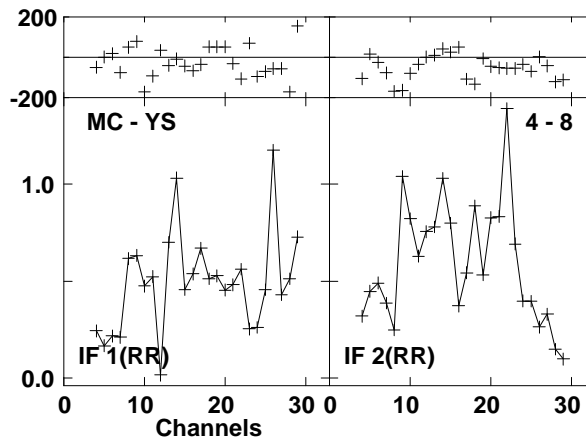
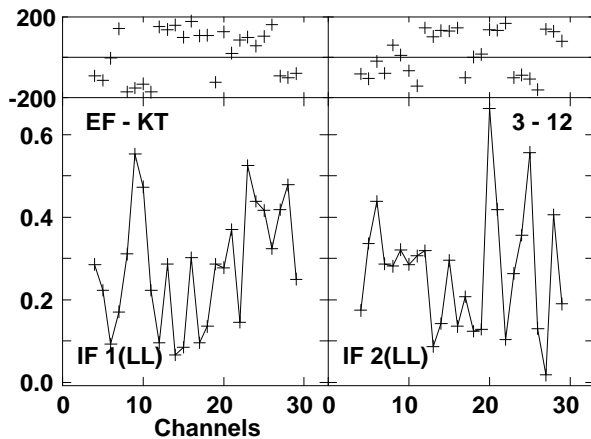
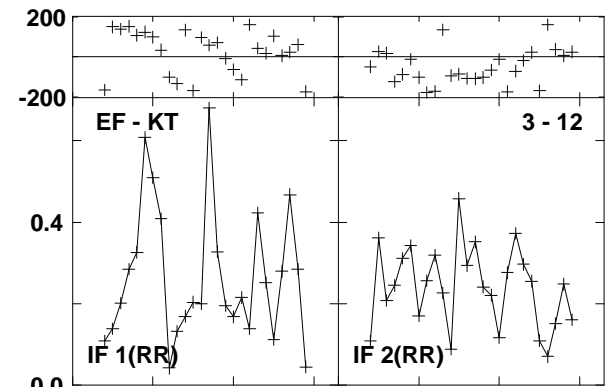
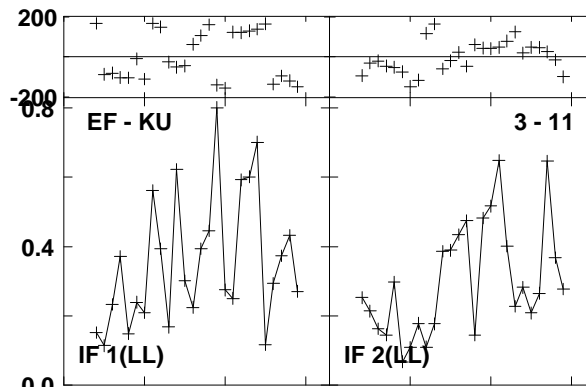
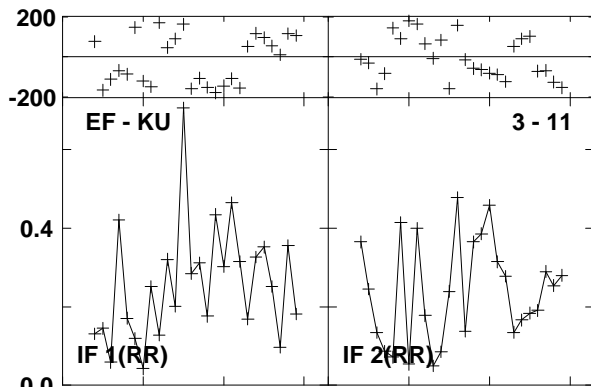
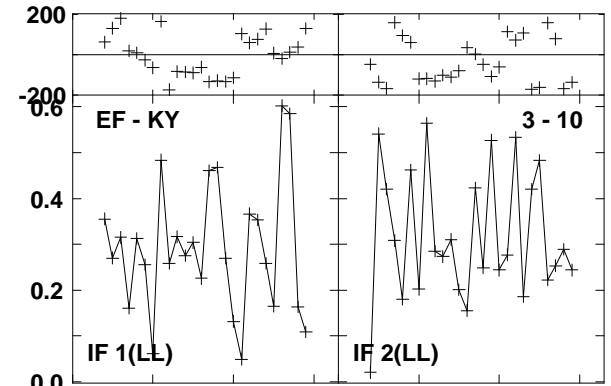
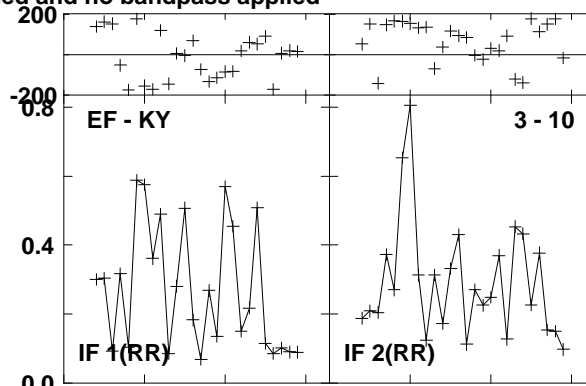
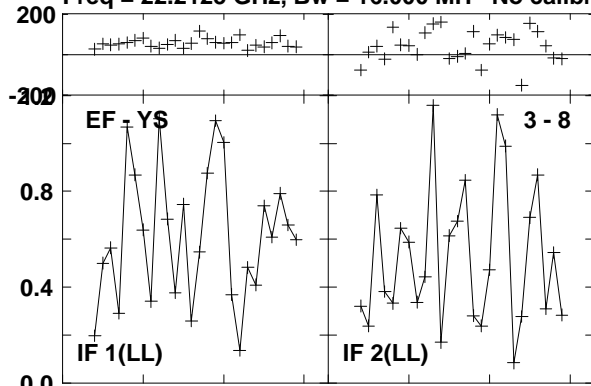

Lower frame: Milli Ampl Jy Top frame: Phas deg

Vector averaged cross-power spectrum Baseline: EF (03) - YS (08)

Timerange: 00/11:26:21 to 00/11:26:40

Plot file version 240 created 23-AUG-2016 15:00:50

0219+628 GA035B 1.UVDATA.1

Freq = 22.2125 GHz, Bw = 16.000 MH No calibration applied and no bandpass applied

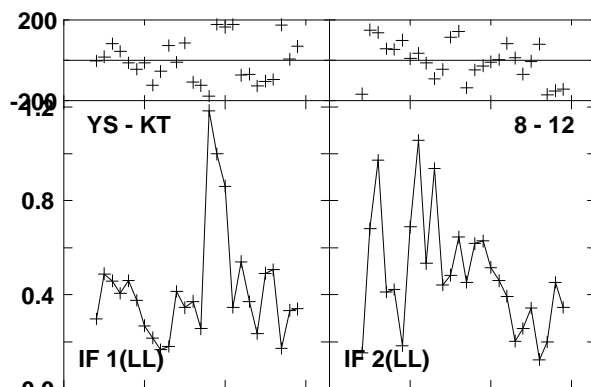
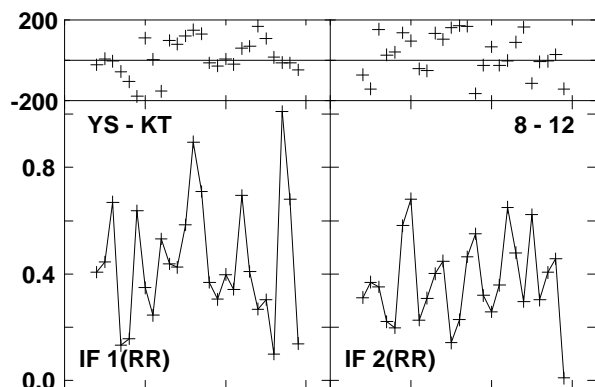
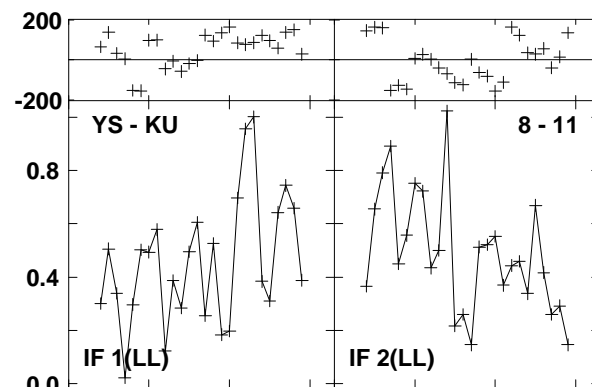
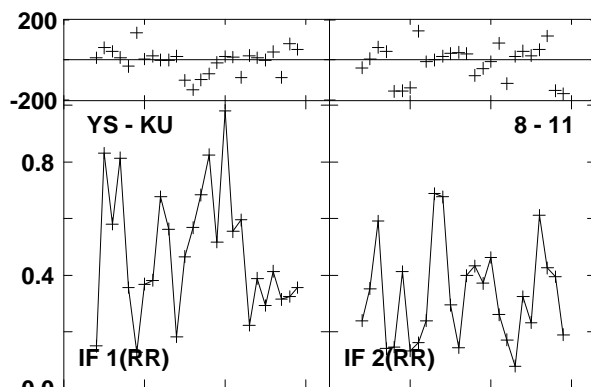
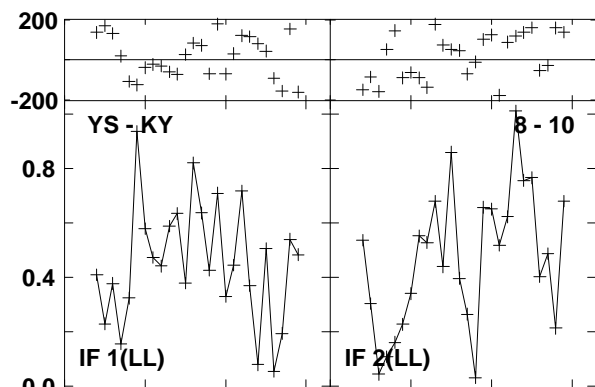
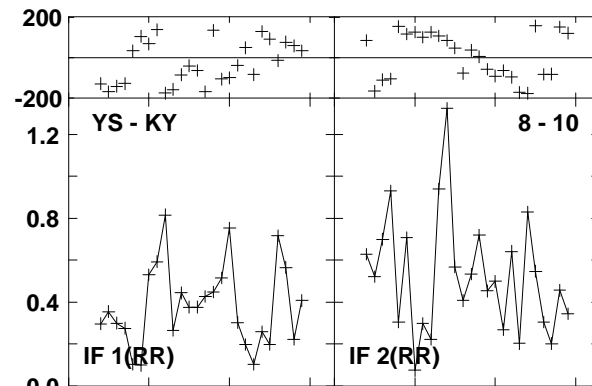
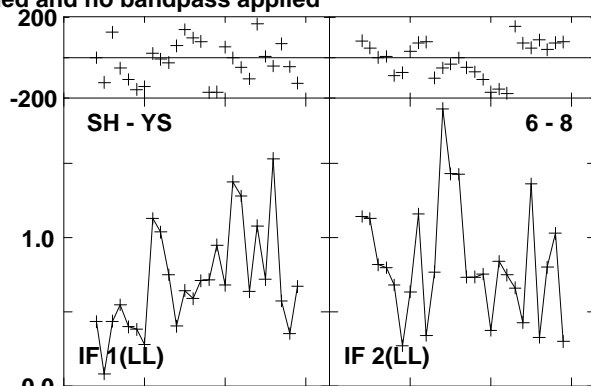
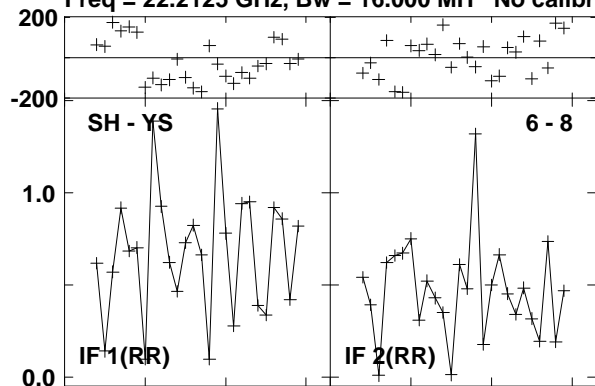

Lower frame: Milli Ampl Jy Top frame: Phas deg

Vector averaged cross-power spectrum Baseline: SH (06) - YS (08)

Timerange: 00/11:26:21 to 00/11:26:40



Plot file version 241 created 23-AUG-2016 15:00:50  
 W3IRS5 GA035B 1.UVDATA.1

Freq = 22.2125 GHz, Bw = 16.000 MH No calibration applied and no bandpass applied

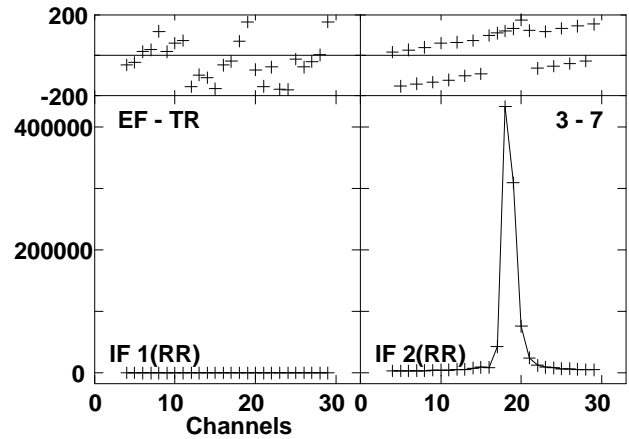
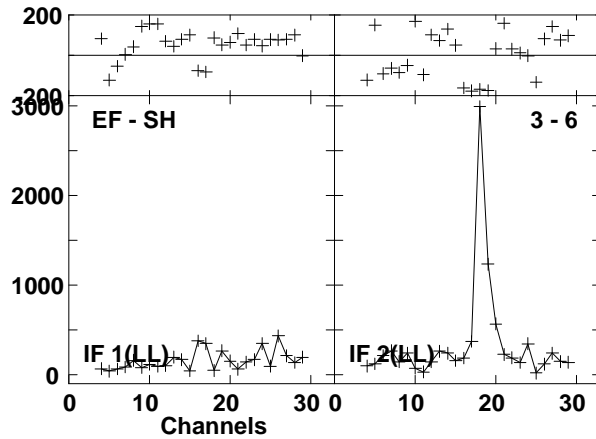
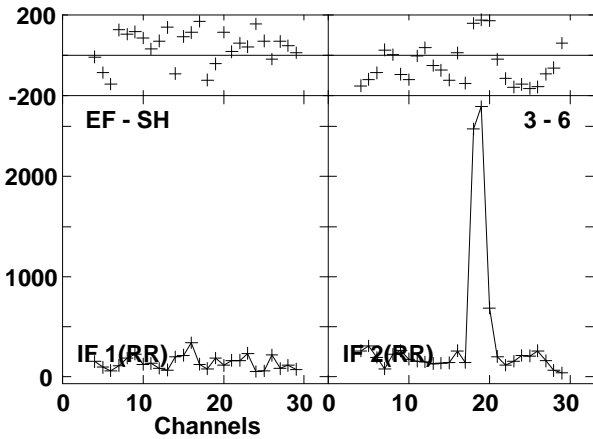
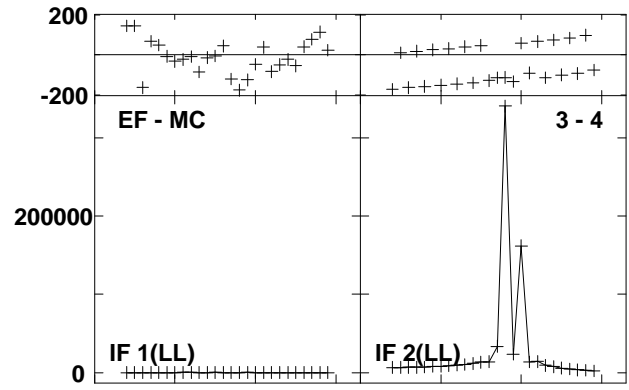
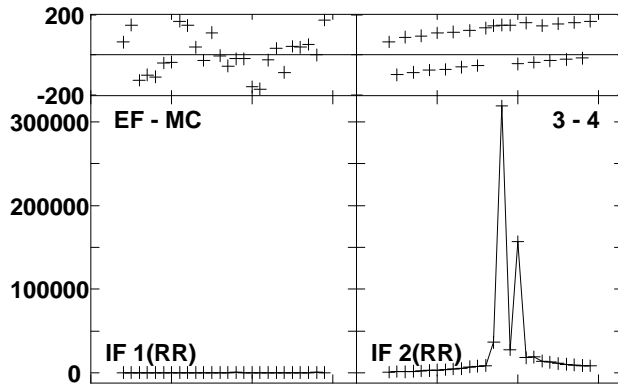
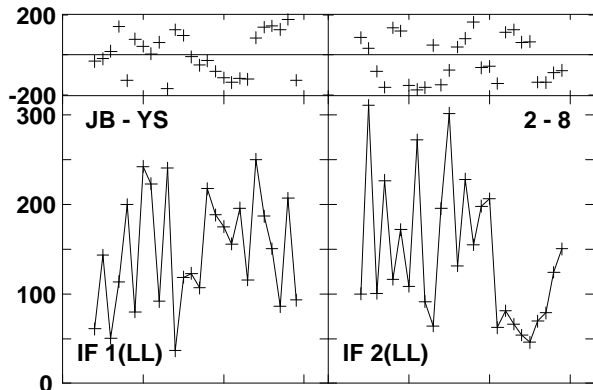
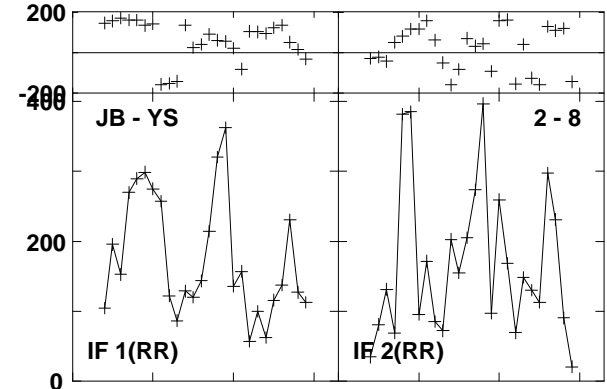
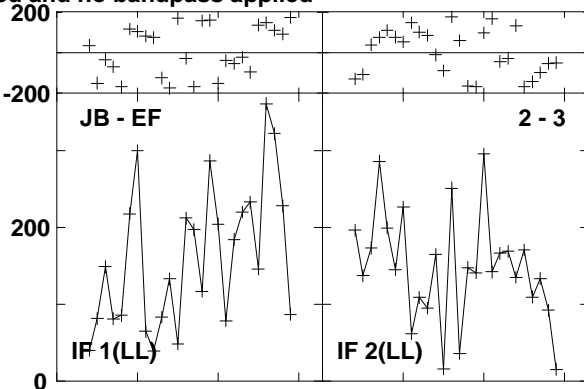
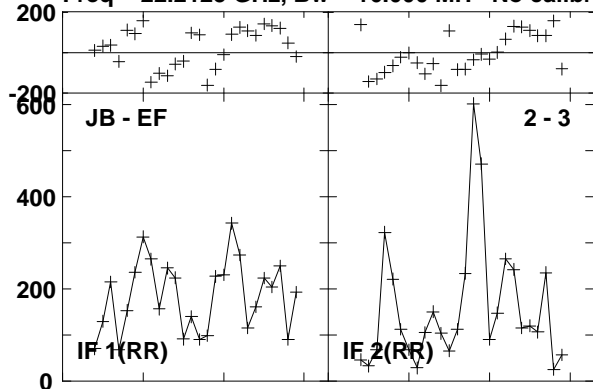

Lower frame: Micro Ampl Jy Top frame: Phas deg  
 Vector averaged cross-power spectrum Baseline: JB (02) - EF (03)  
 Timerange: 00/11:27:05 to 00/11:28:04

Plot file version 242 created 23-AUG-2016 15:00:50

W3IRS5 GA035B 1.UVDATA.1

Freq = 22.2125 GHz, Bw = 16.000 MH No calibration applied and no bandpass applied

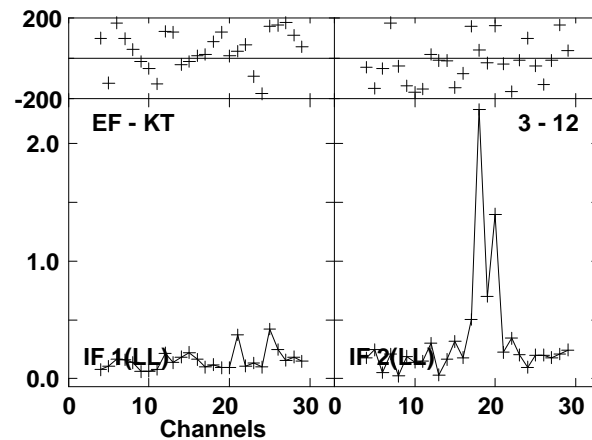
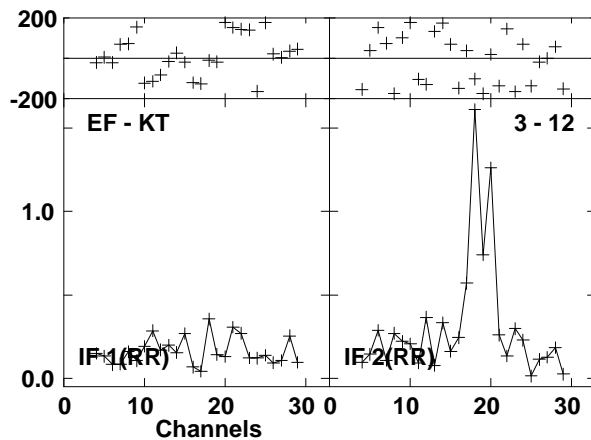
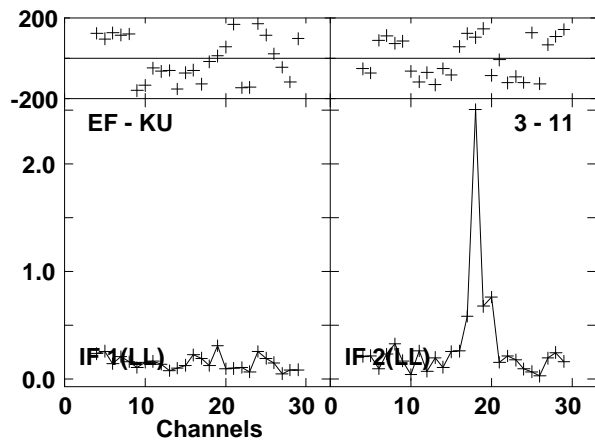
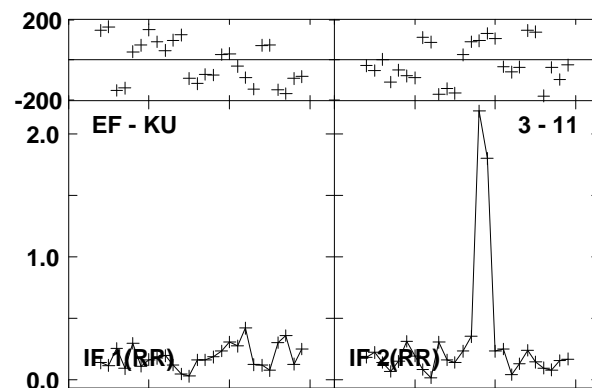
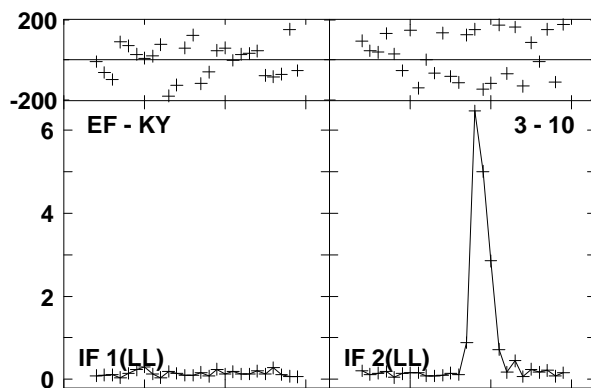
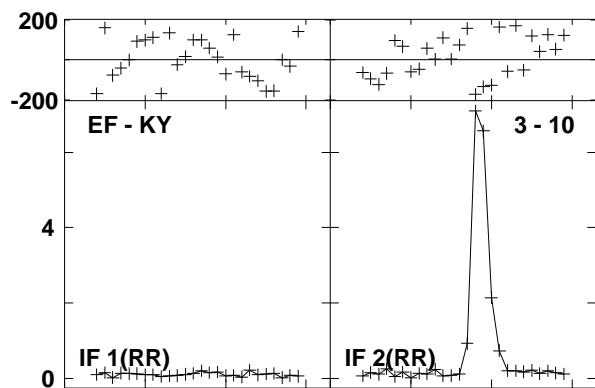
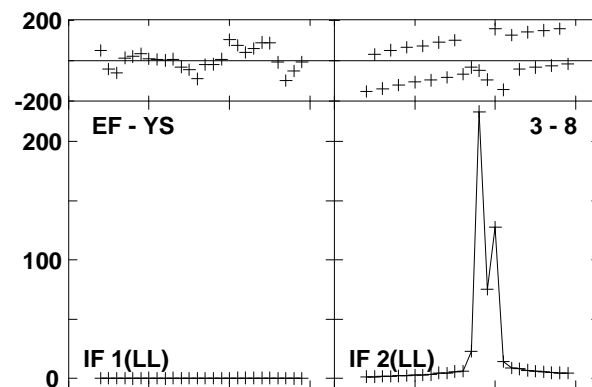
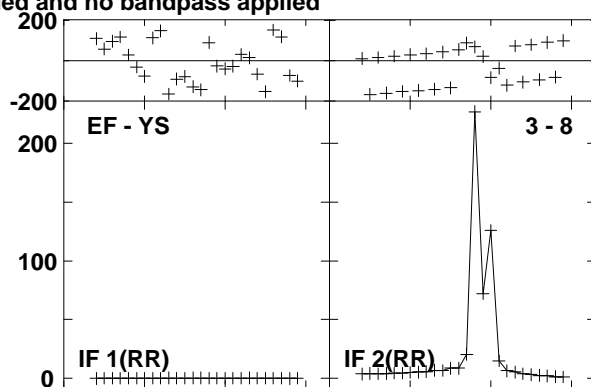
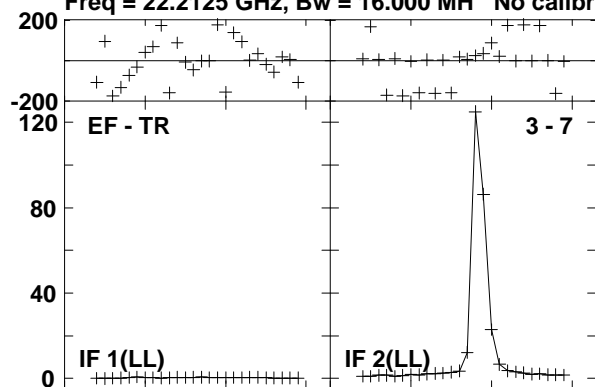

Lower frame: Milli Ampl Jy Top frame: Phas deg  
Vector averaged cross-power spectrum Baseline: EF (03) - TR (07)  
Timerange: 00/11:27:05 to 00/11:28:04

Plot file version 243 created 23-AUG-2016 15:00:50

W3IRS5 GA035B 1.UVDATA.1

Freq = 22.2125 GHz, Bw = 16.000 MH No calibration applied and no bandpass applied

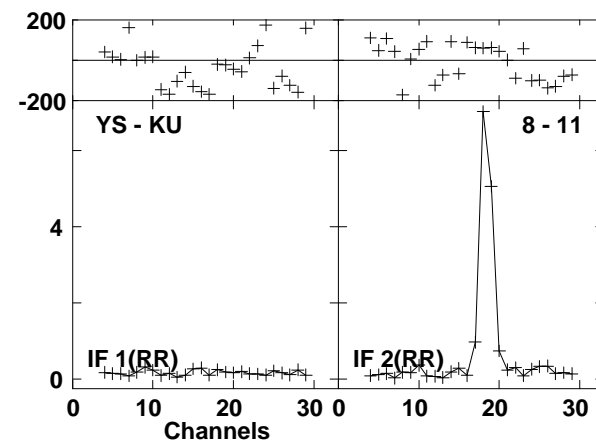
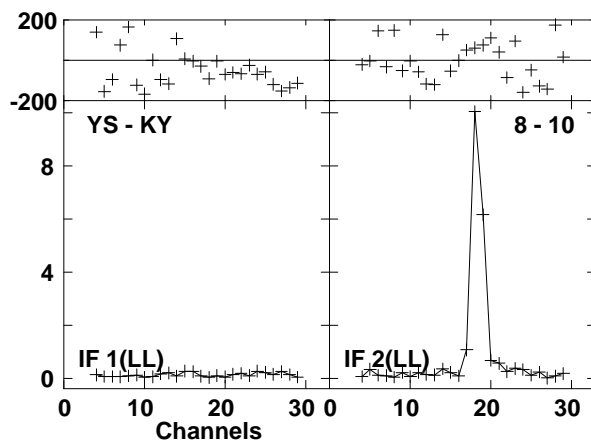
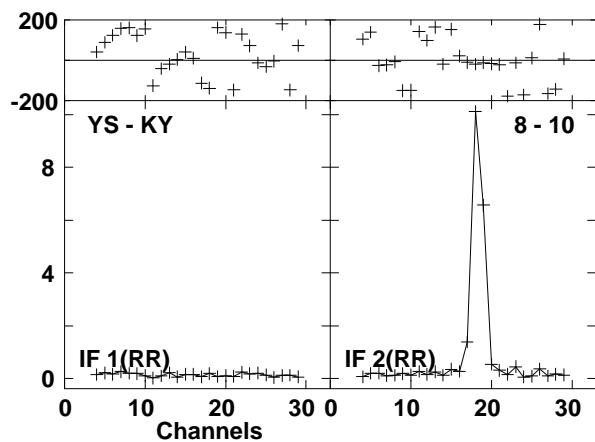
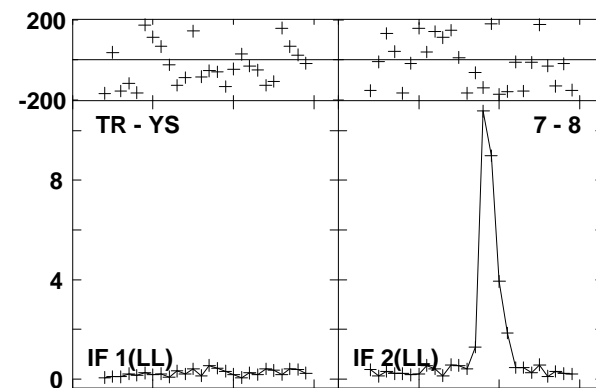
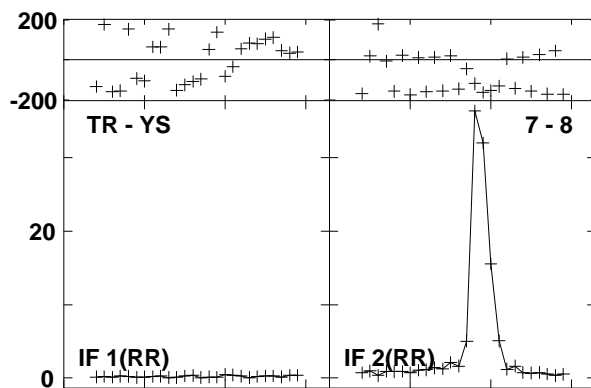
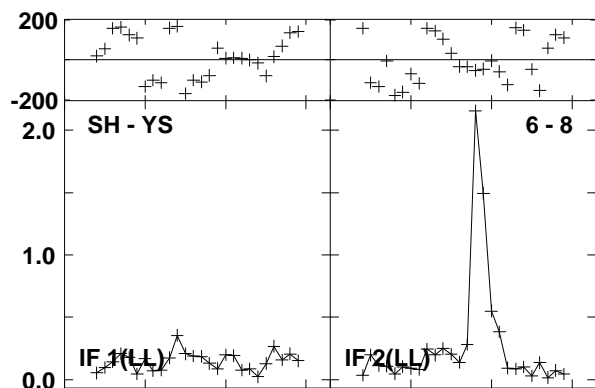
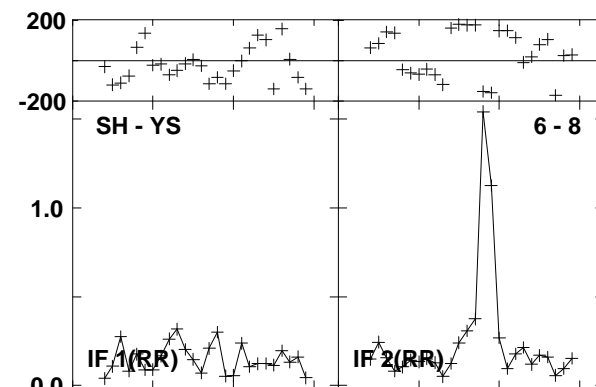
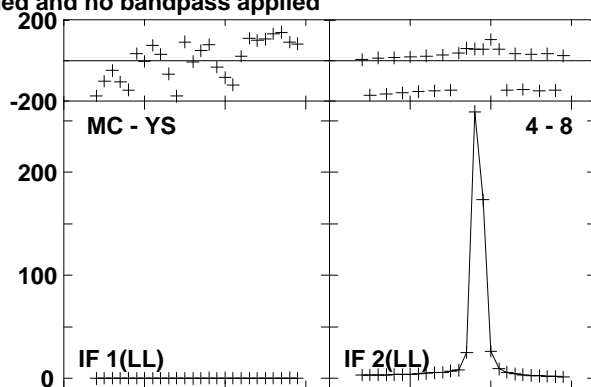
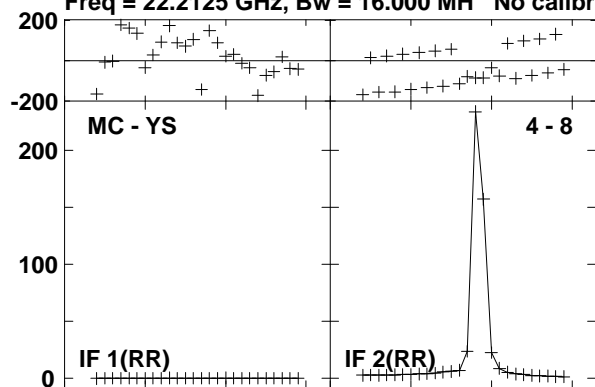

Lower frame: Milli Ampl Jy Top frame: Phas deg  
Vector averaged cross-power spectrum Baseline: MC (04) - YS (08)  
Timerange: 00/11:27:05 to 00/11:28:04

Plot file version 244 created 23-AUG-2016 15:00:50

W3IRS5 GA035B 1.UVDATA.1

Freq = 22.2125 GHz, Bw = 16.000 MH No calibration applied and no bandpass applied

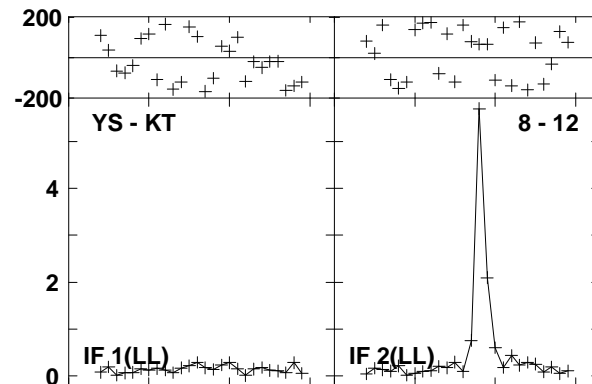
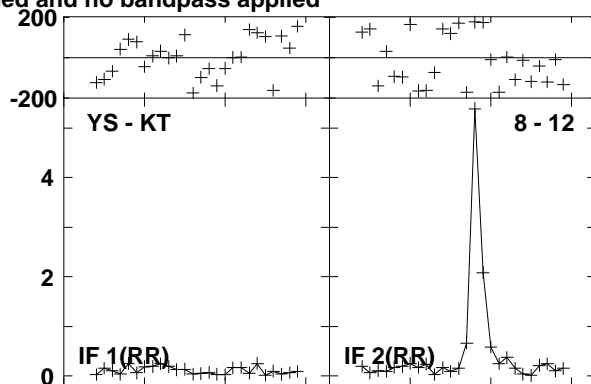
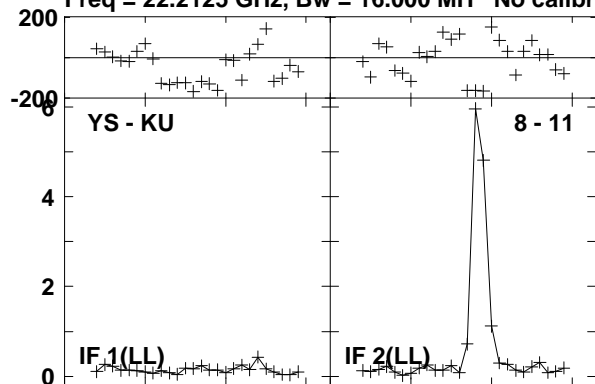

Lower frame: Milli Ampl Jy Top frame: Phas deg  
Vector averaged cross-power spectrum Baseline: YS (08) - KU (11)  
Timerange: 00/11:27:05 to 00/11:28:04

Plot file version 245 created 23-AUG-2016 15:00:50

0219+628 GA035B 1.UVDATA.1

Freq = 22.2125 GHz, Bw = 16.000 MH No calibration applied and no bandpass applied

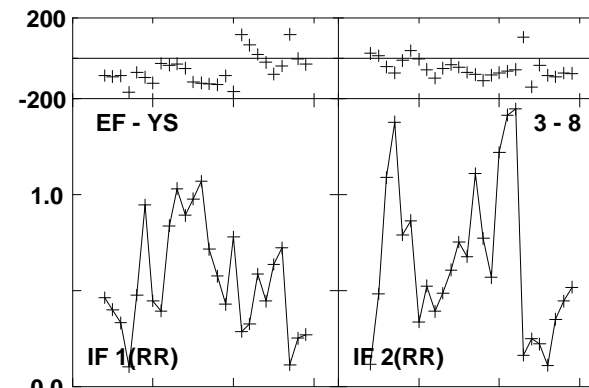
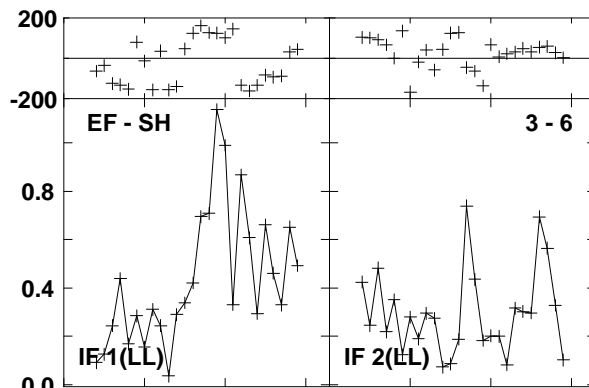
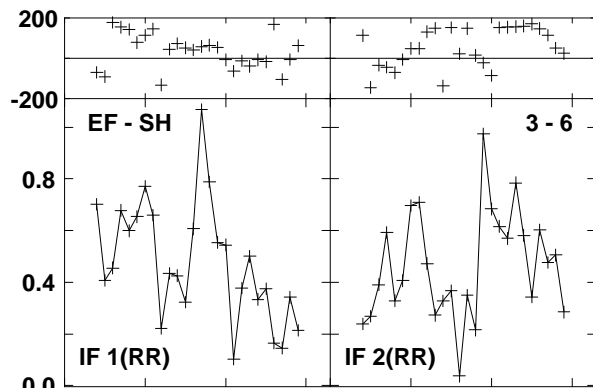
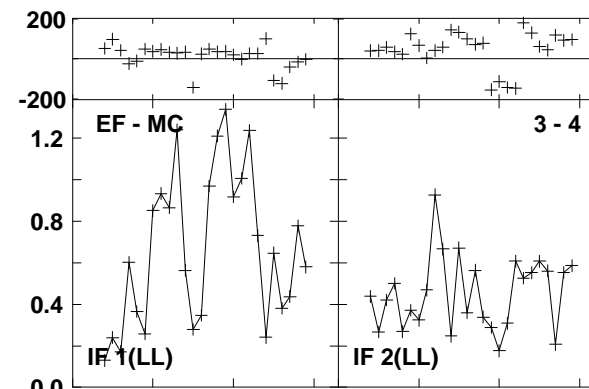
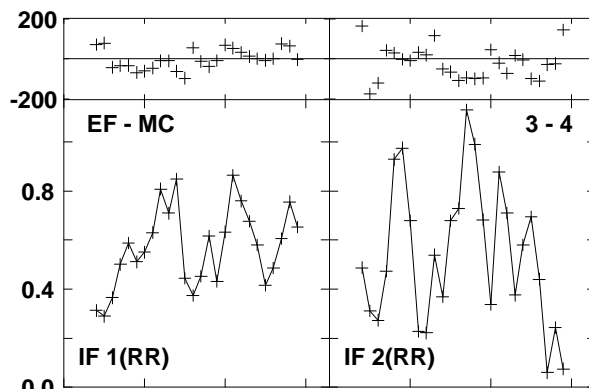
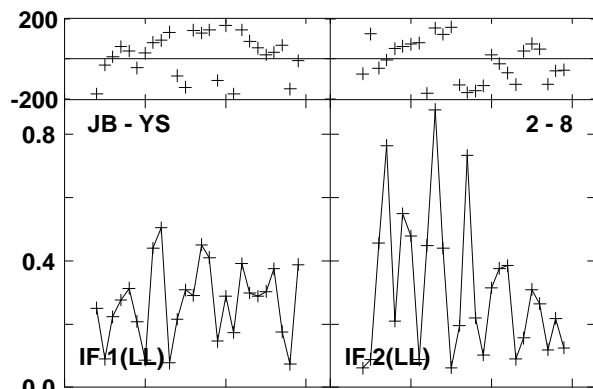
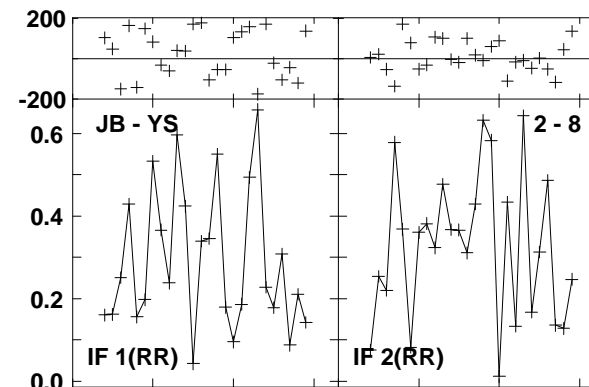
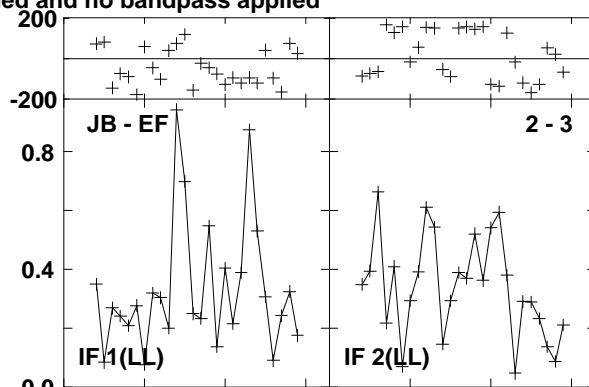
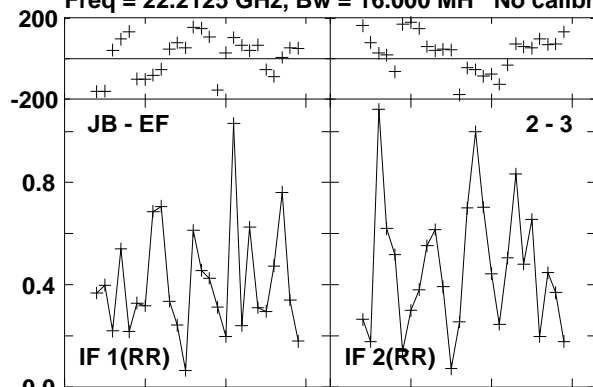

Lower frame: Milli Ampl Jy Top frame: Phas deg  
Vector averaged cross-power spectrum Baseline: JB (02) - EF (03)  
Timerange: 00/11:28:30 to 00/11:28:50

Plot file version 246 created 23-AUG-2016 15:00:50

0219+628 GA035B 1.UVDATA.1

Freq = 22.2125 GHz, Bw = 16.000 MH No calibration applied and no bandpass applied

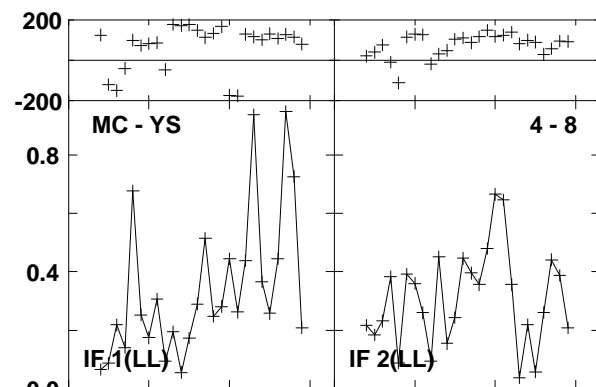
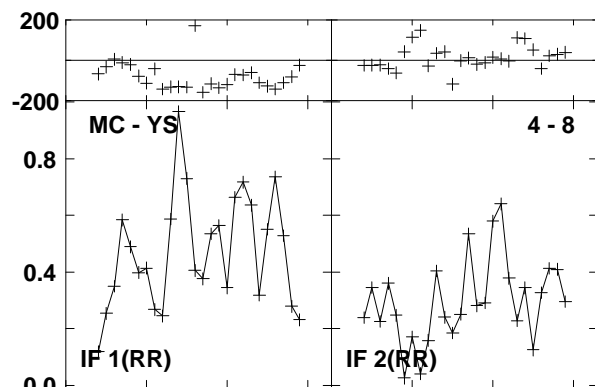
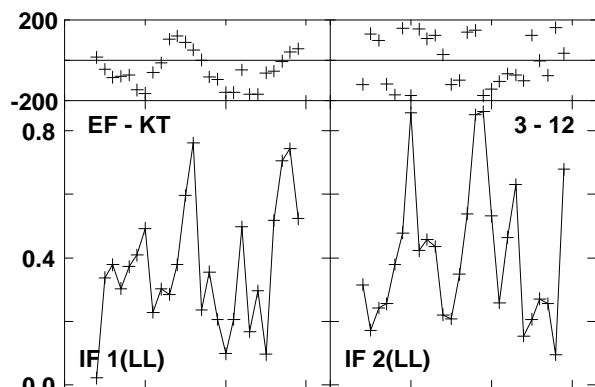
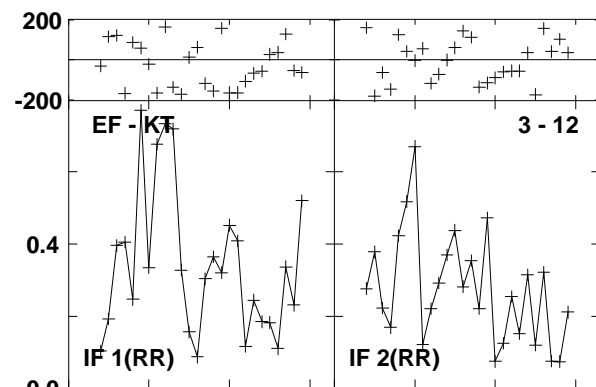
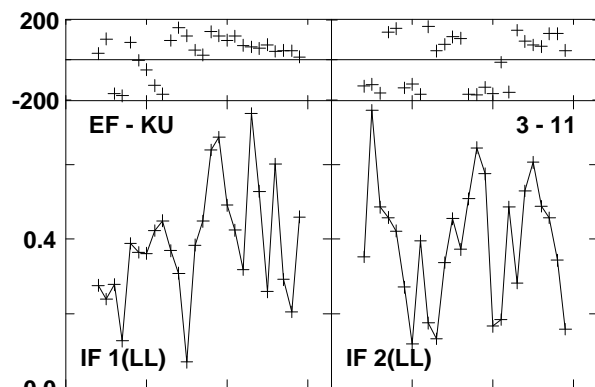
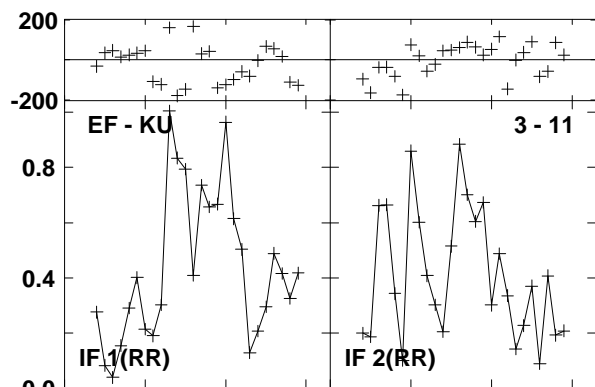
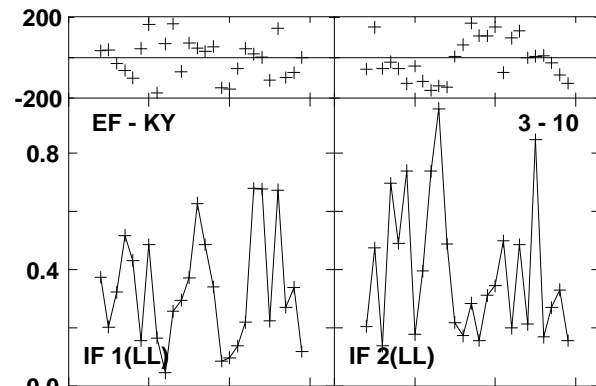
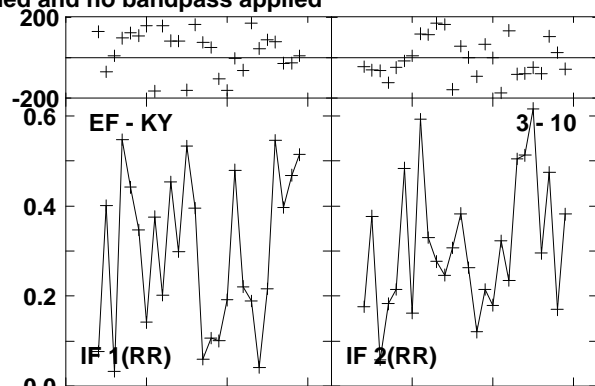
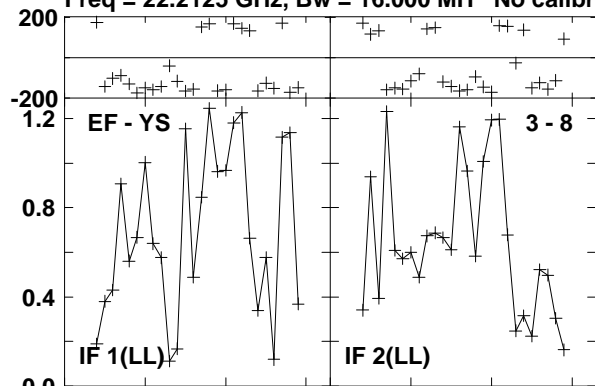

Lower frame: Milli Ampl Jy Top frame: Phas deg  
Vector averaged cross-power spectrum Baseline: EF (03) - YS (08)  
Timerange: 00/11:28:30 to 00/11:28:50

Plot file version 247 created 23-AUG-2016 15:00:50

0219+628 GA035B 1.UVDATA.1

Freq = 22.2125 GHz, Bw = 16.000 MH No calibration applied and no bandpass applied

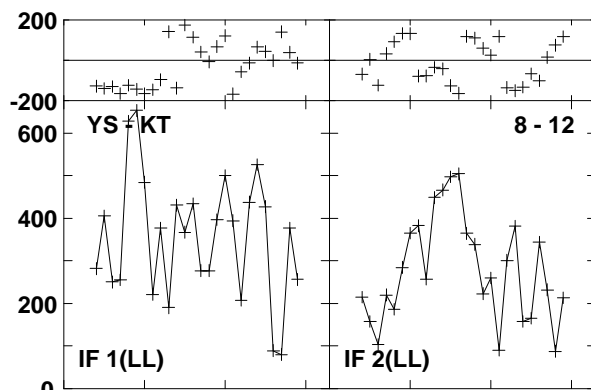
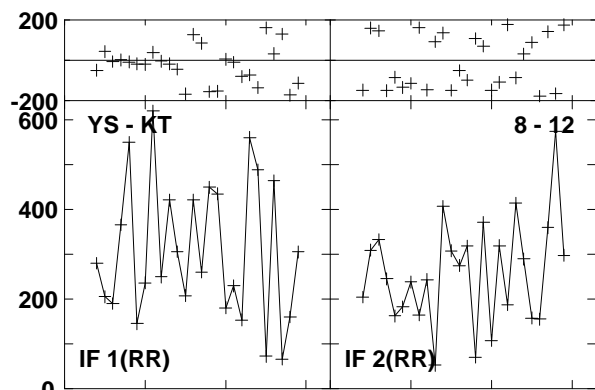
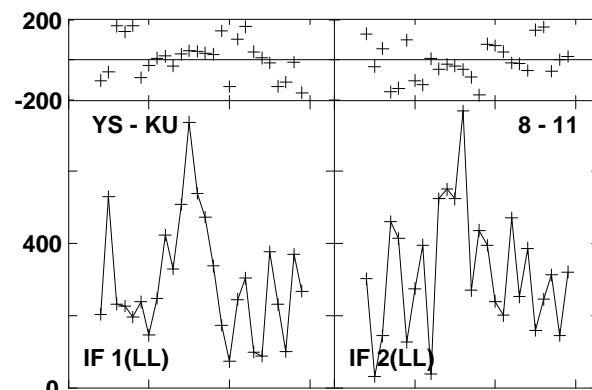
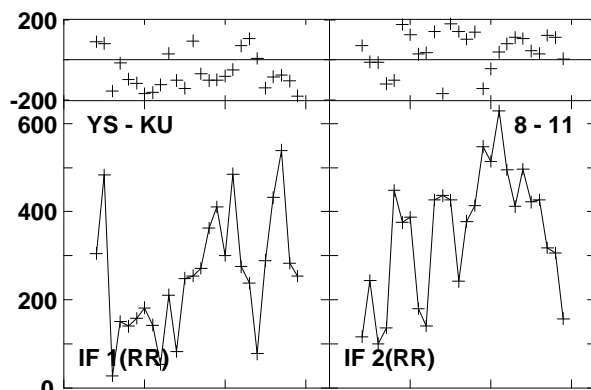
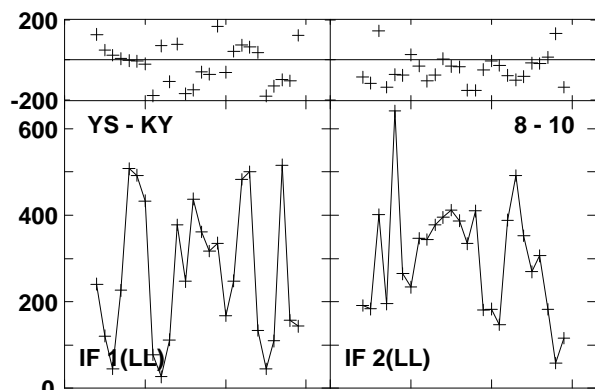
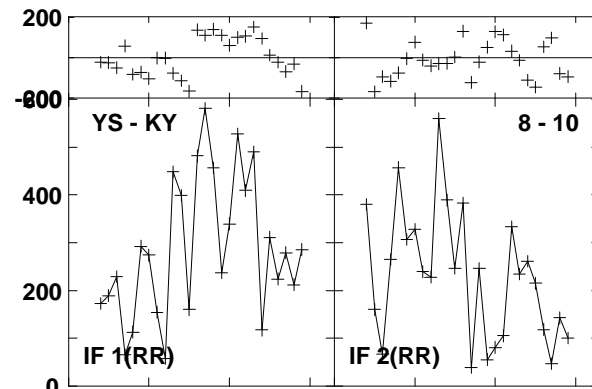
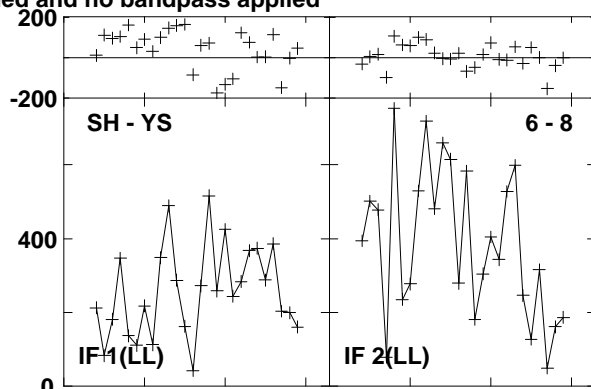
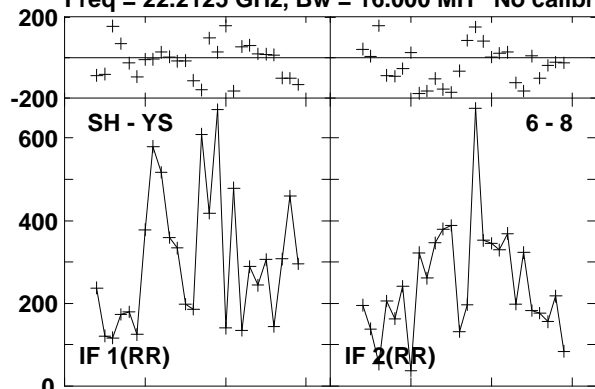

Lower frame: Micro Ampl Jy Top frame: Phas deg  
Vector averaged cross-power spectrum Baseline: SH (06) - YS (08)  
Timerange: 00/11:28:30 to 00/11:28:50

Plot file version 248 created 23-AUG-2016 15:00:50

W3IRS5 GA035B 1.UVDATA.1

Freq = 22.2125 GHz, Bw = 16.000 MH No calibration applied and no bandpass applied

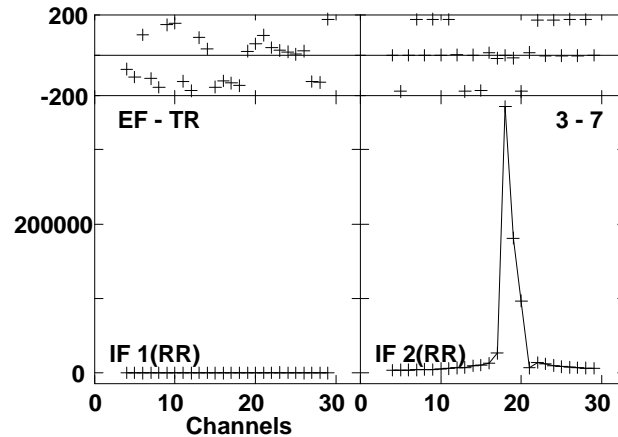
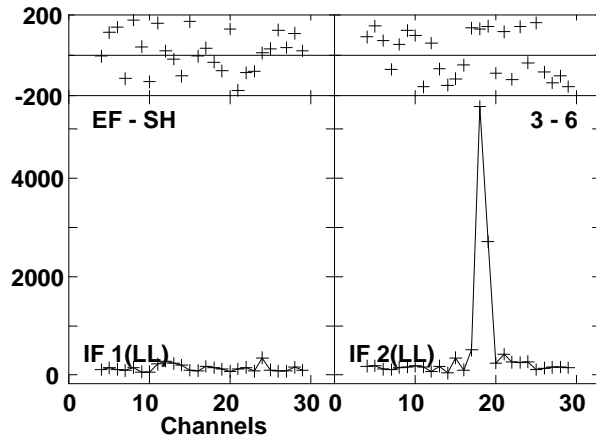
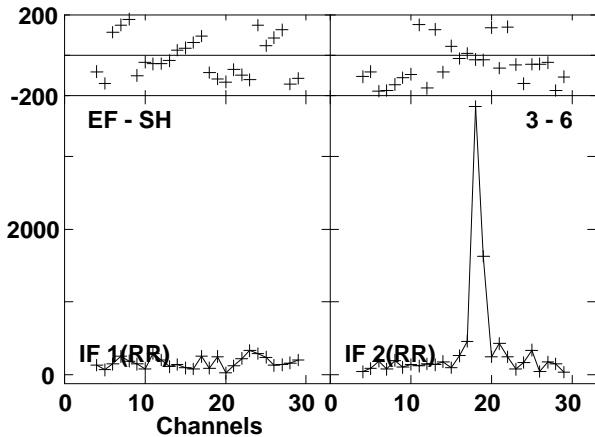
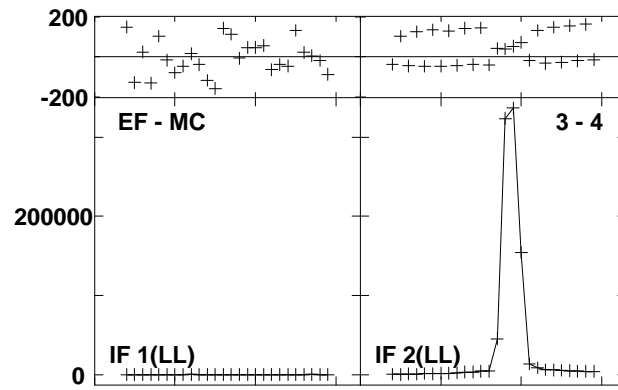
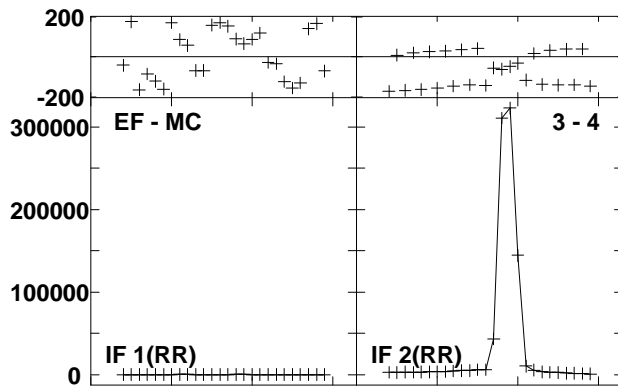
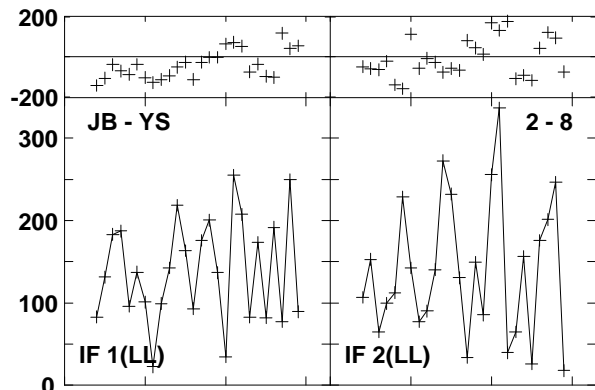
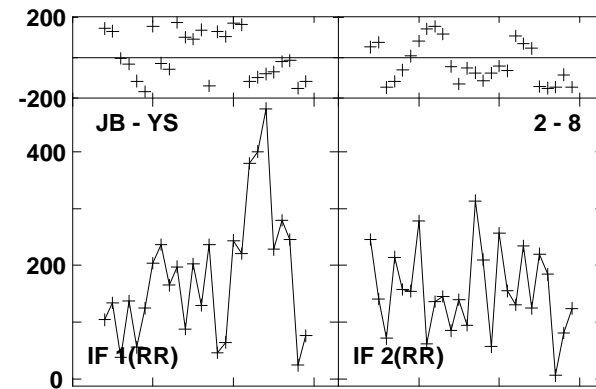
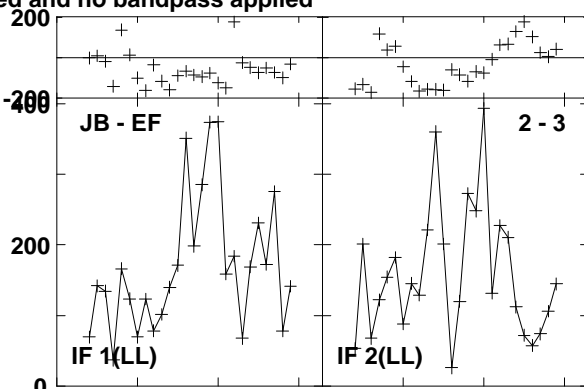
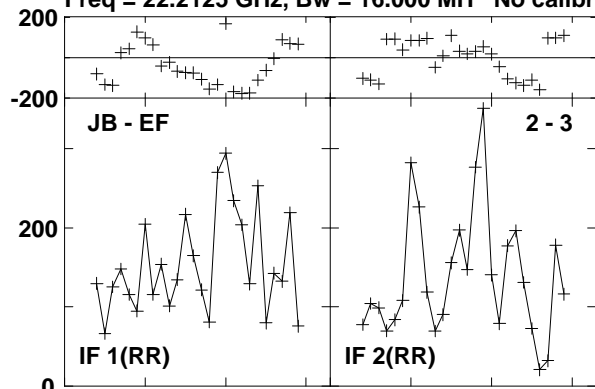

Lower frame: Micro Ampl Jy Top frame: Phas deg  
Vector averaged cross-power spectrum Baseline: JB (02) - EF (03)  
Timerange: 00/11:29:15 to 00/11:30:15



Plot file version 249 created 23-AUG-2016 15:00:50

W3IRS5 GA035B 1.UVDATA.1

Freq = 22.2125 GHz, Bw = 16.000 MH No calibration applied and no bandpass applied

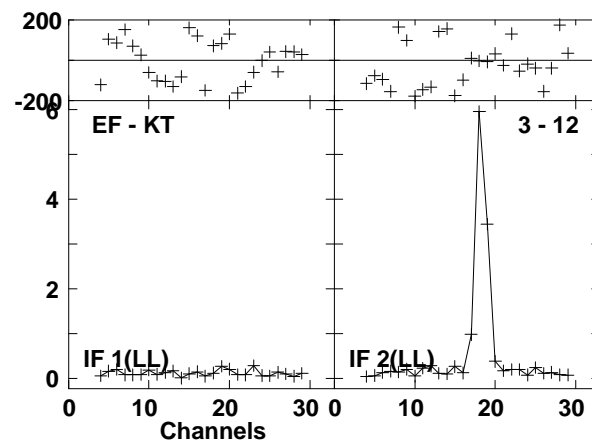
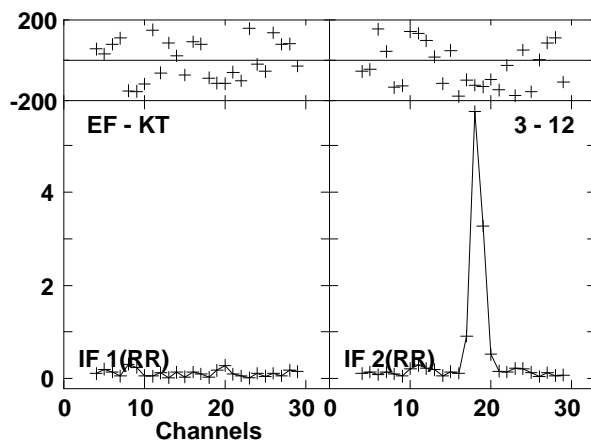
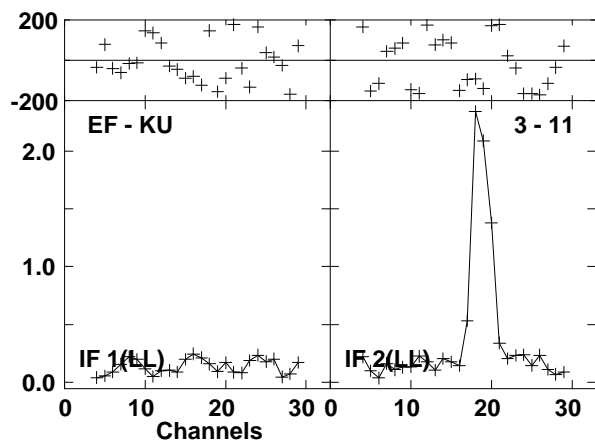
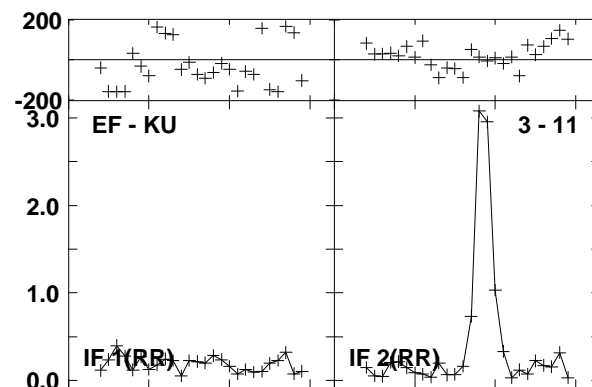
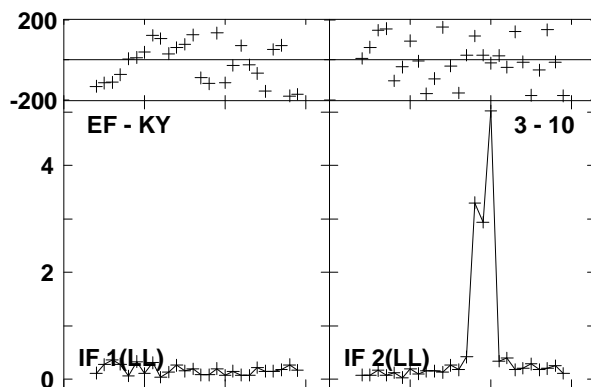
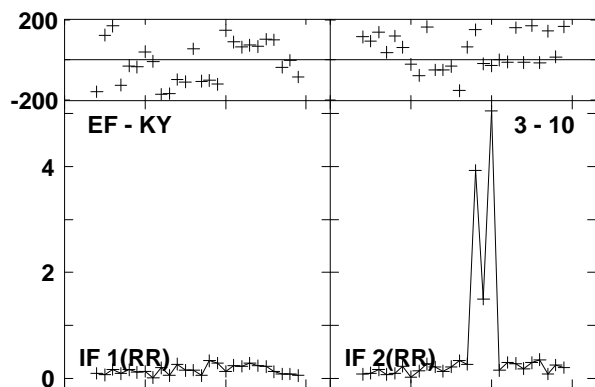
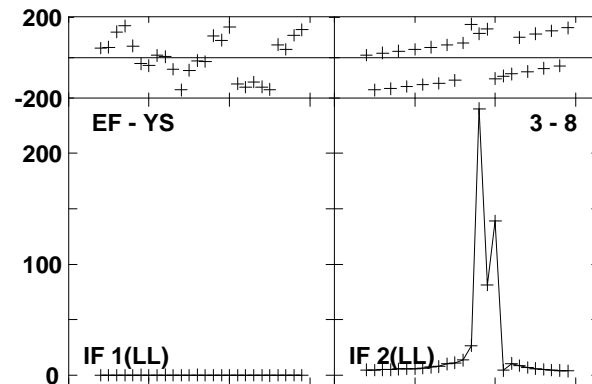
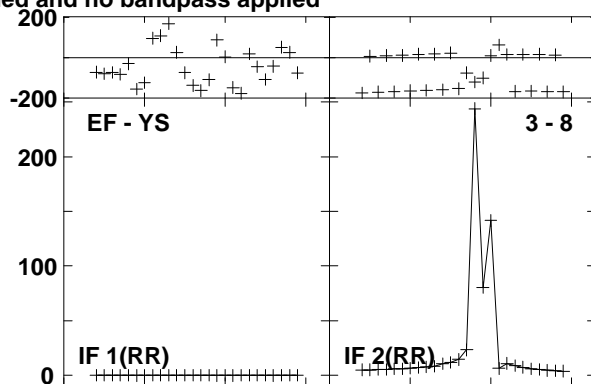
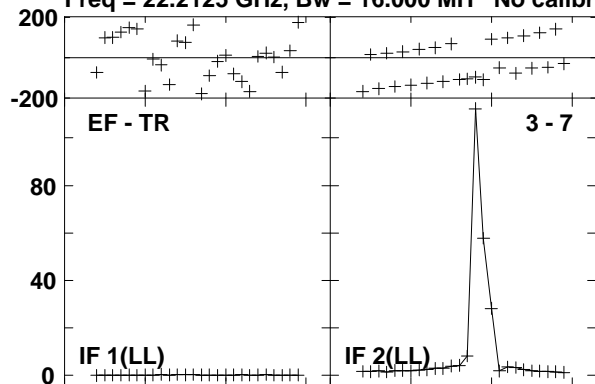

Lower frame: Milli Ampl Jy Top frame: Phas deg  
Vector averaged cross-power spectrum Baseline: EF (03) - TR (07)  
Timerange: 00/11:29:15 to 00/11:30:15

Plot file version 250 created 23-AUG-2016 15:00:50  
 W3IRS5 GA035B 1.UVDATA.1

Freq = 22.2125 GHz, Bw = 16.000 MH No calibration applied and no bandpass applied

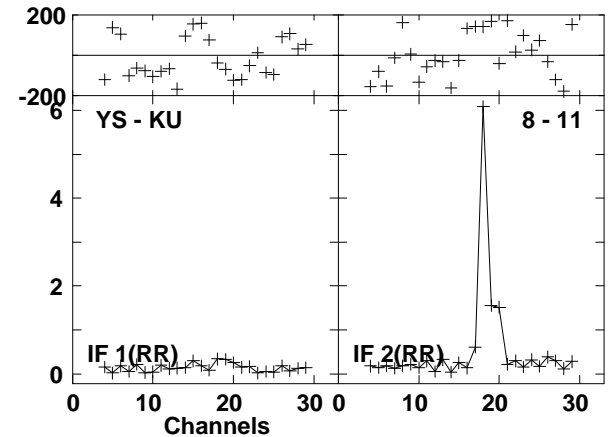
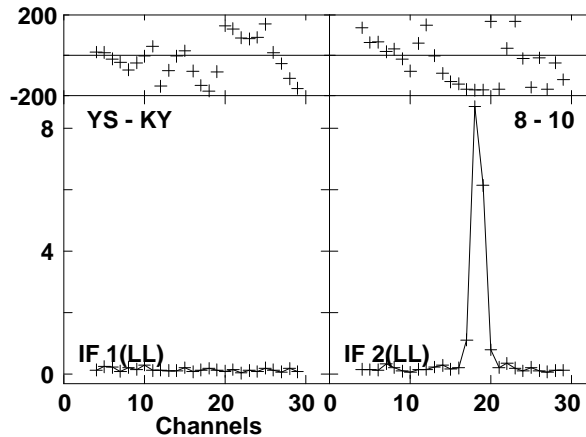
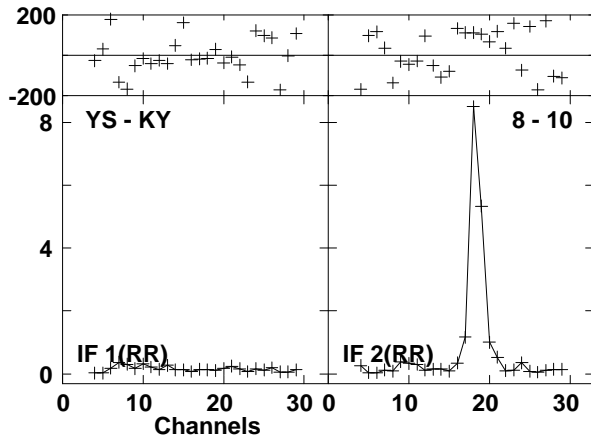
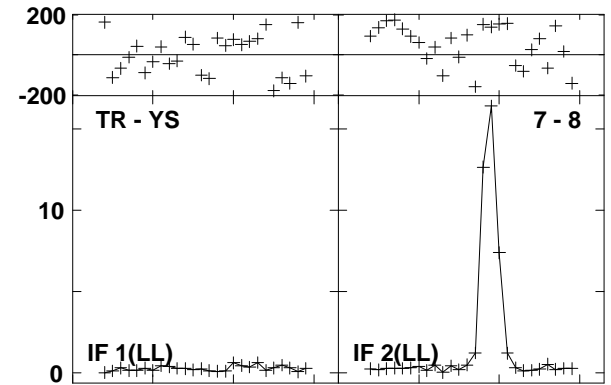
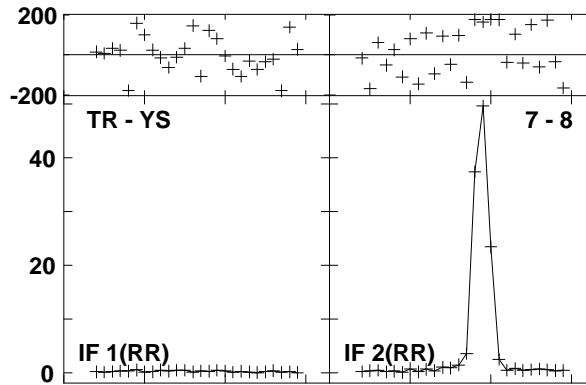
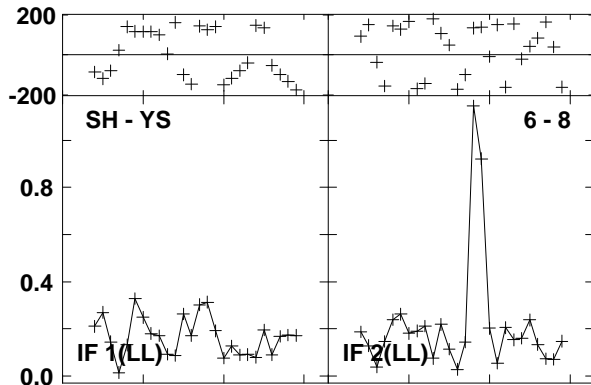
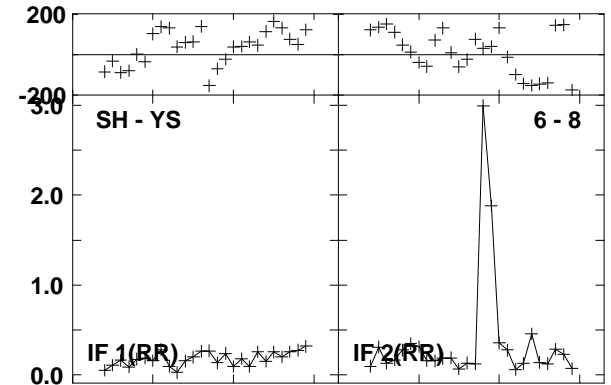
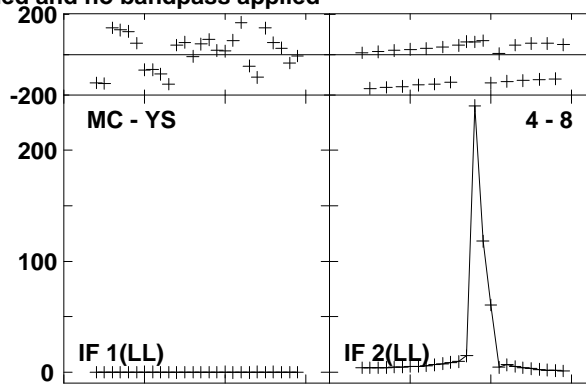
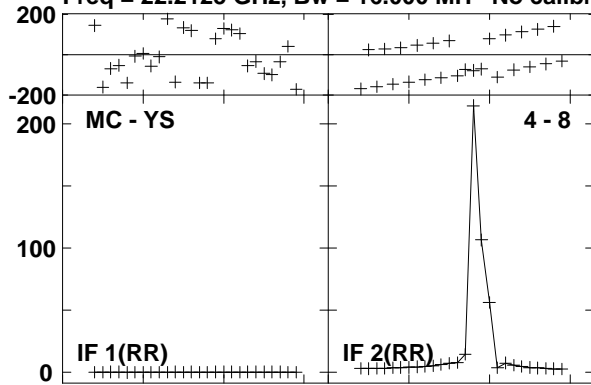

Lower frame: Milli Ampl Jy Top frame: Phas deg  
 Vector averaged cross-power spectrum Baseline: MC (04) - YS (08)  
 Timerange: 00/11:29:15 to 00/11:30:15

Plot file version 251 created 23-AUG-2016 15:00:50  
W3IRS5 GA035B 1.UVDATA.1

Freq = 22.2125 GHz, Bw = 16.000 MH No calibration applied and no bandpass applied

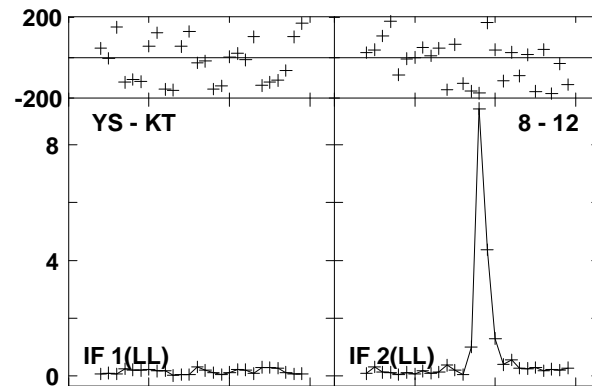
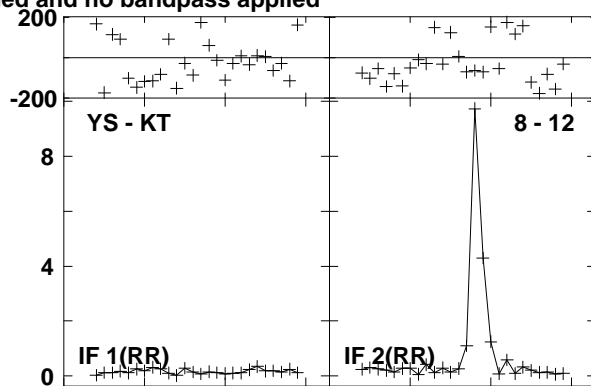
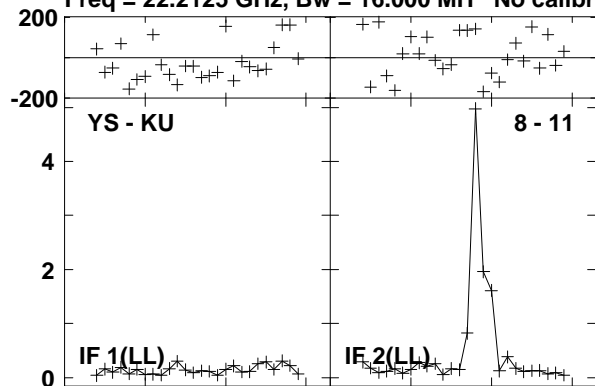

Lower frame: Milli Ampl Jy Top frame: Phas deg  
Vector averaged cross-power spectrum Baseline: YS (08) - KU (11)  
Timerange: 00/11:29:15 to 00/11:30:15

Plot file version 252 created 23-AUG-2016 15:00:50

0219+628 GA035B 1.UVDATA.1

Freq = 22.2125 GHz, Bw = 16.000 MH No calibration applied and no bandpass applied

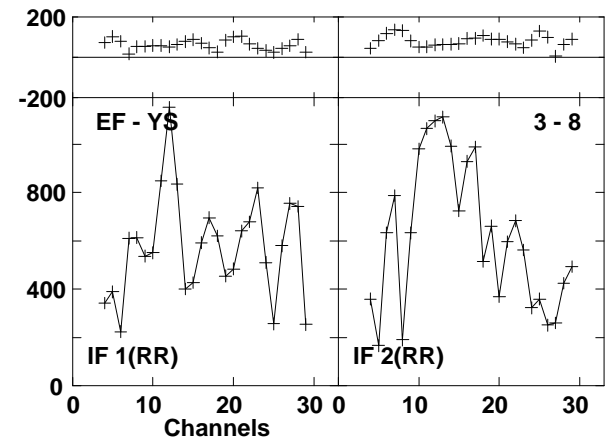
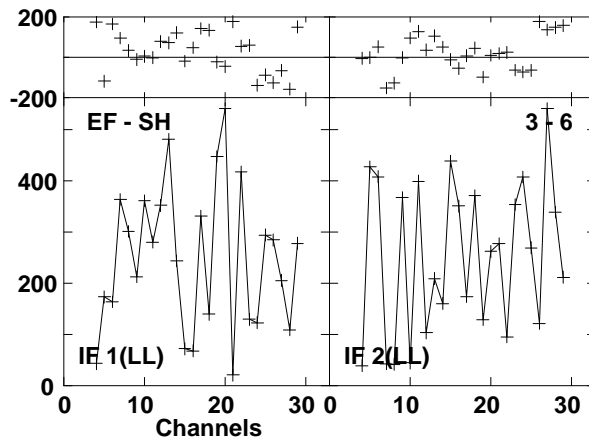
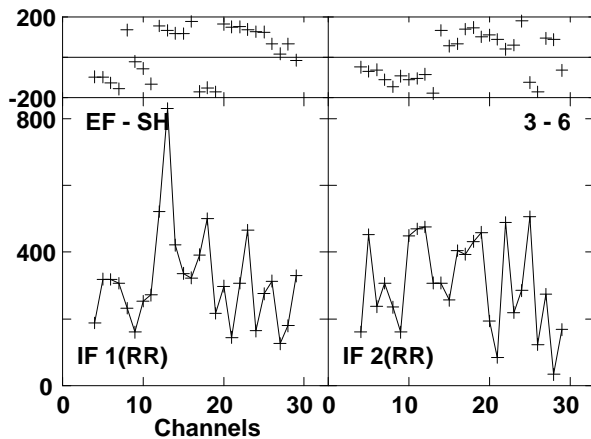
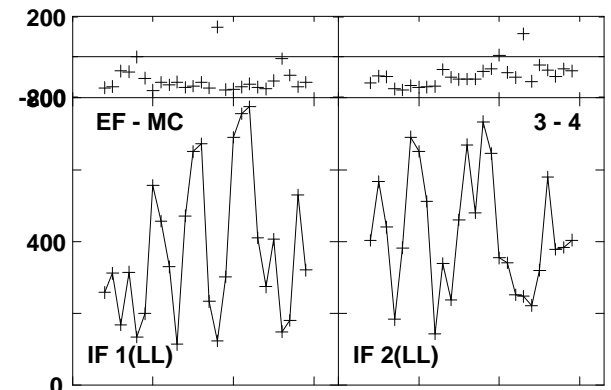
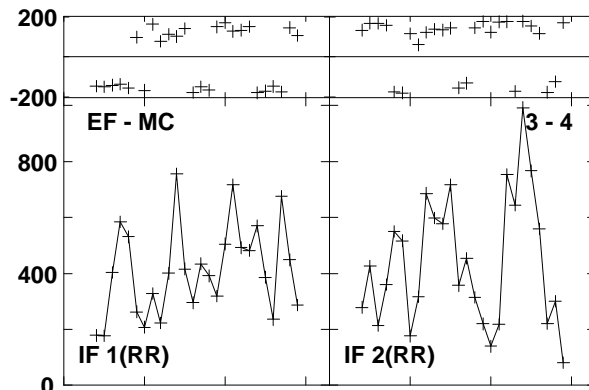
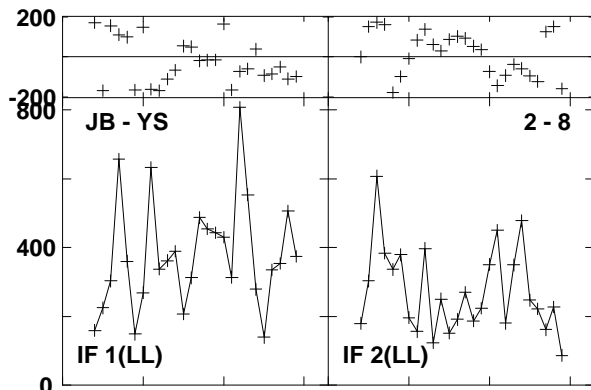
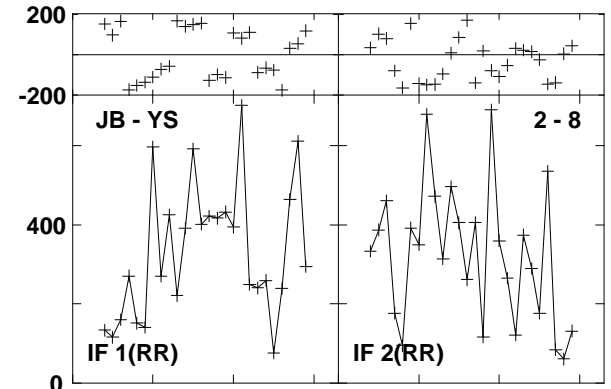
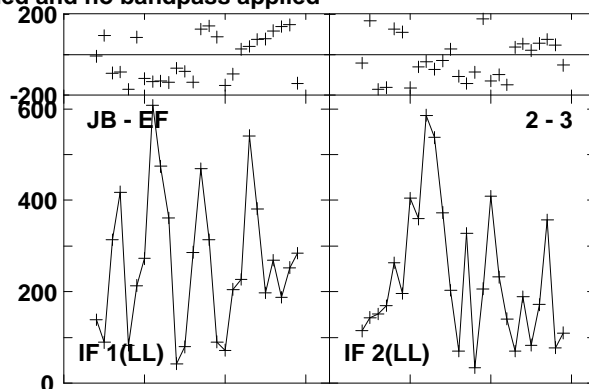
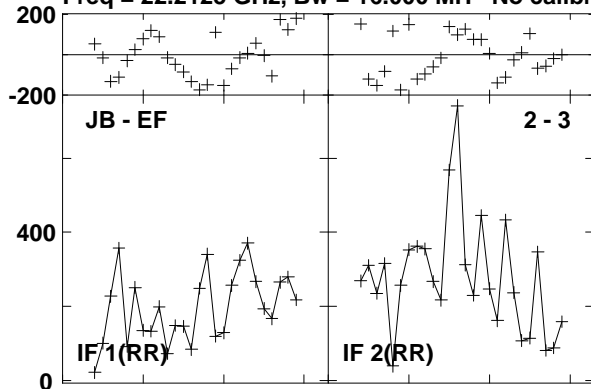

Lower frame: Micro Ampl Jy Top frame: Phas deg

Vector averaged cross-power spectrum Baseline: JB (02) - EF (03)

Timerange: 00/11:30:40 to 00/11:31:00

Plot file version 253 created 23-AUG-2016 15:00:50  
 0219+628 GA035B 1.UVDATA.1  
 Freq = 22.2125 GHz, Bw = 16.000 MH No calibration applied and no bandpass applied

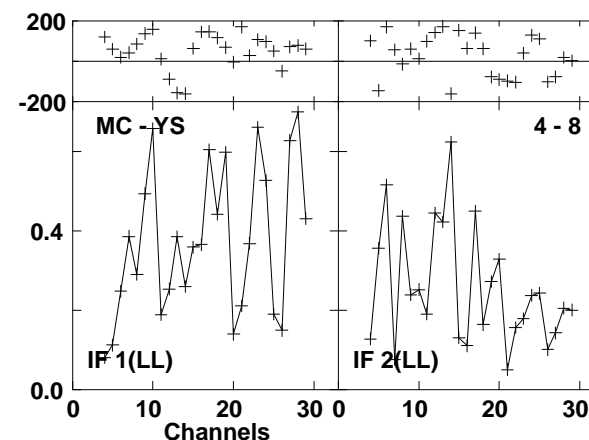
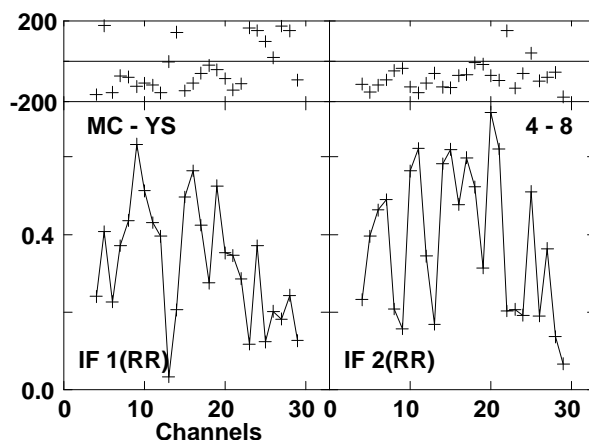
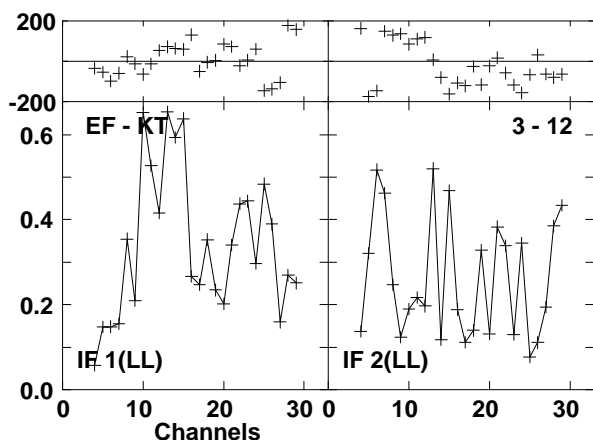
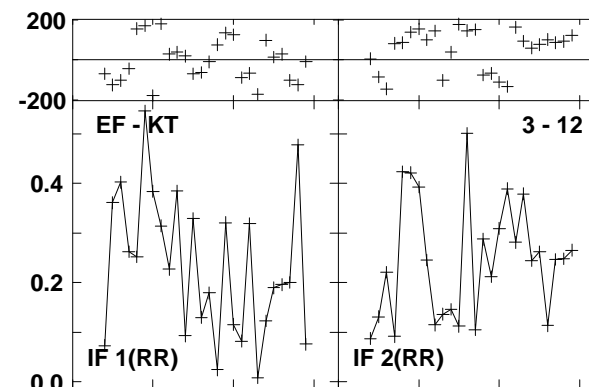
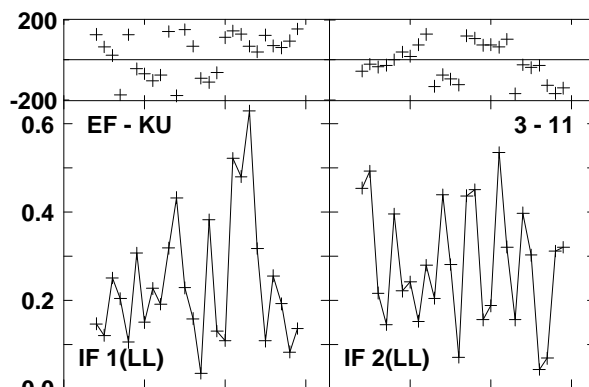
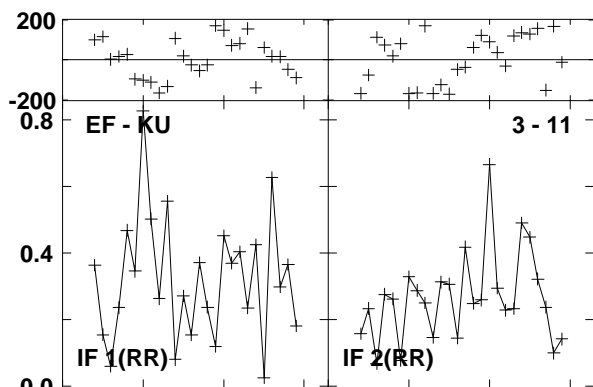
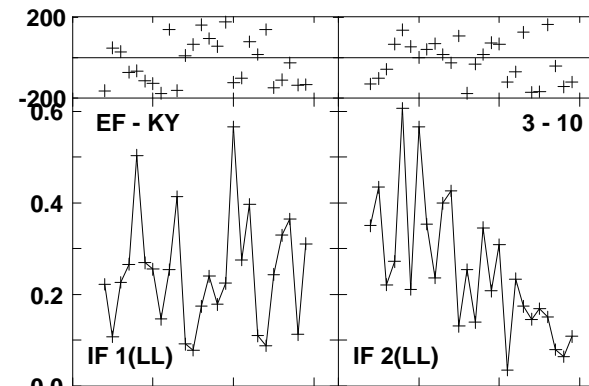
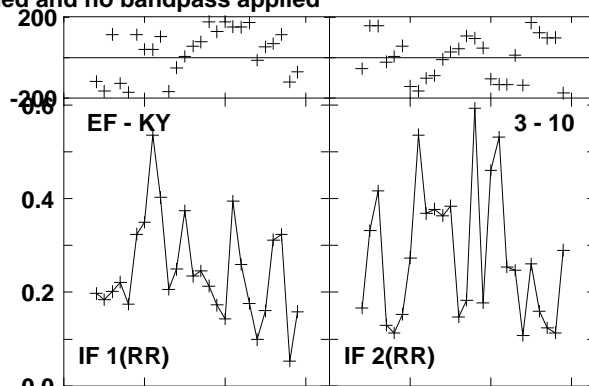
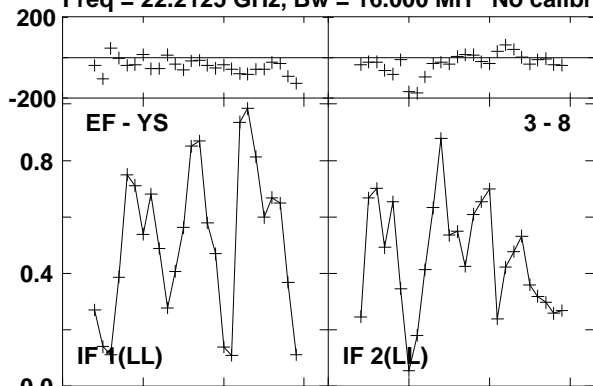

Lower frame: Milli Ampl Jy Top frame: Phas deg  
 Vector averaged cross-power spectrum Baseline: EF (03) - YS (08)  
 Timerange: 00/11:30:40 to 00/11:31:00

Plot file version 254 created 23-AUG-2016 15:00:50

0219+628 GA035B 1.UVDATA.1

Freq = 22.2125 GHz, Bw = 16.000 MH No calibration applied and no bandpass applied

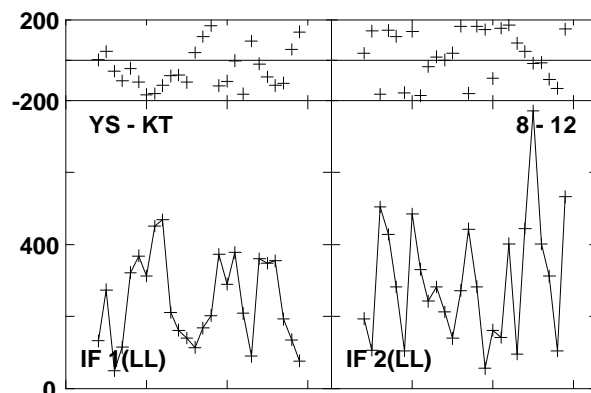
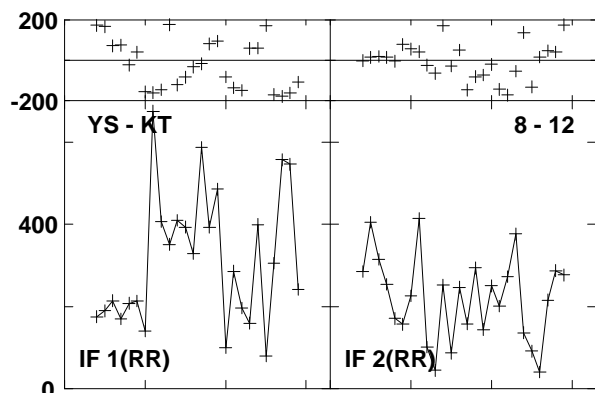
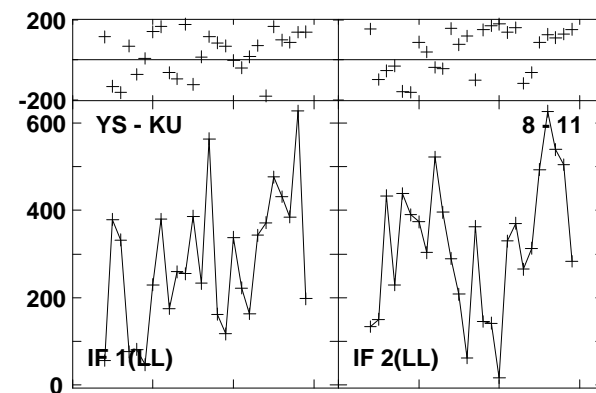
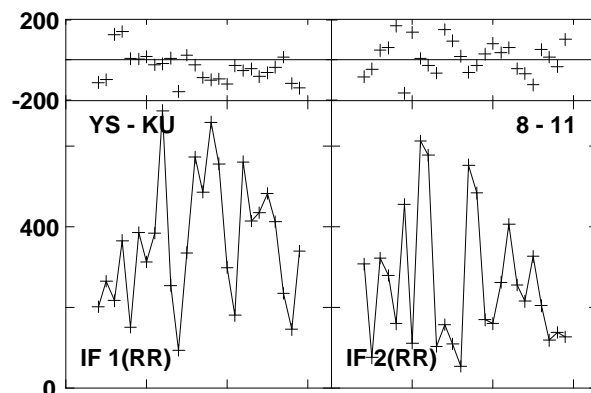
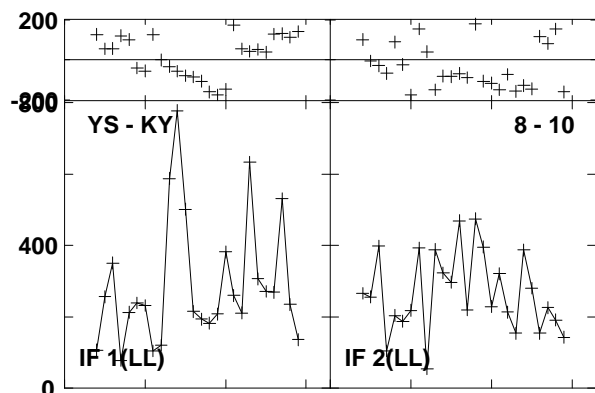
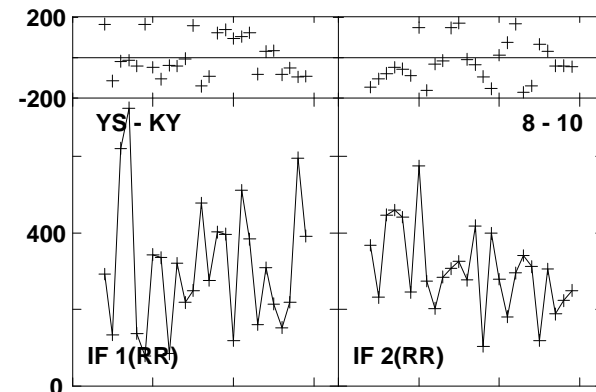
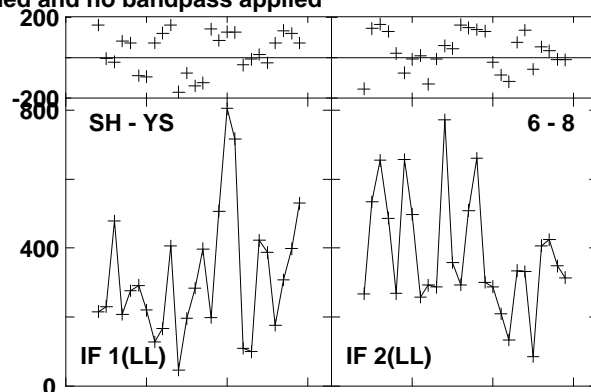
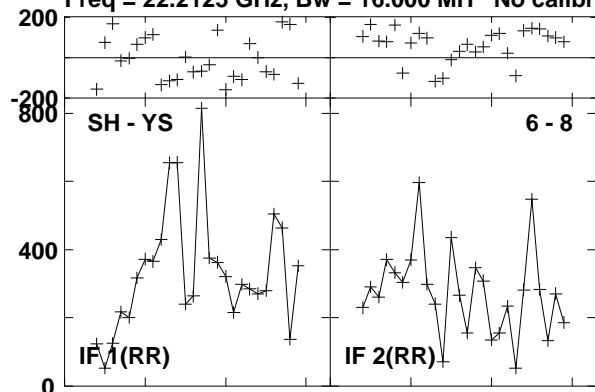

Lower frame: Micro Ampl Jy Top frame: Phas deg  
Vector averaged cross-power spectrum Baseline: SH (06) - YS (08)  
Timerange: 00/11:30:40 to 00/11:31:00

Plot file version 255 created 23-AUG-2016 15:00:50

W3IRS5 GA035B 1.UVDATA.1

Freq = 22.2125 GHz, Bw = 16.000 MH No calibration applied and no bandpass applied

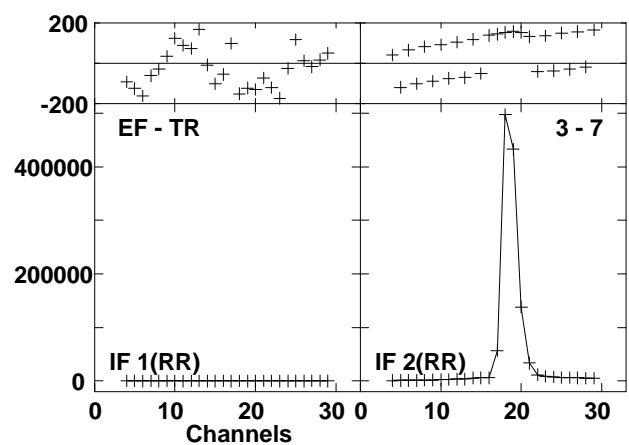
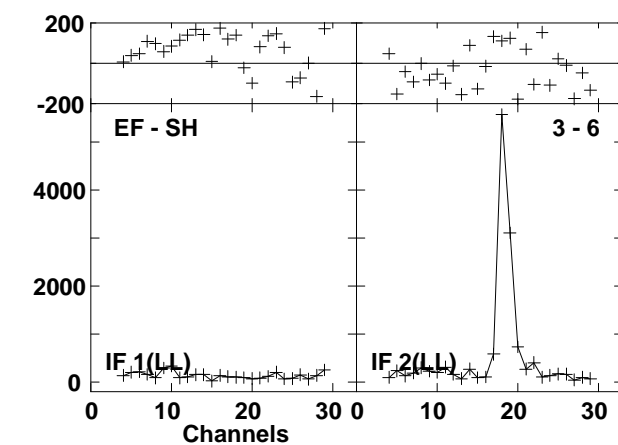
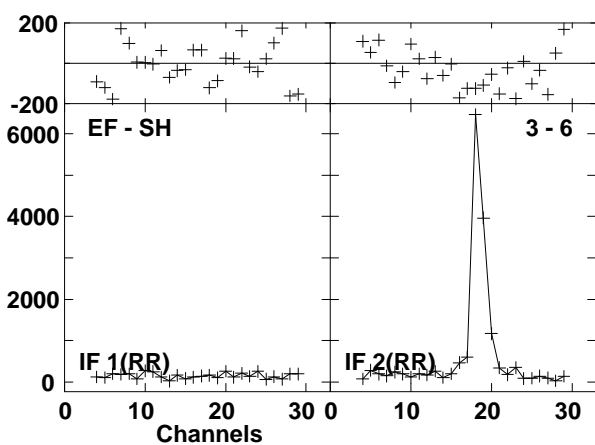
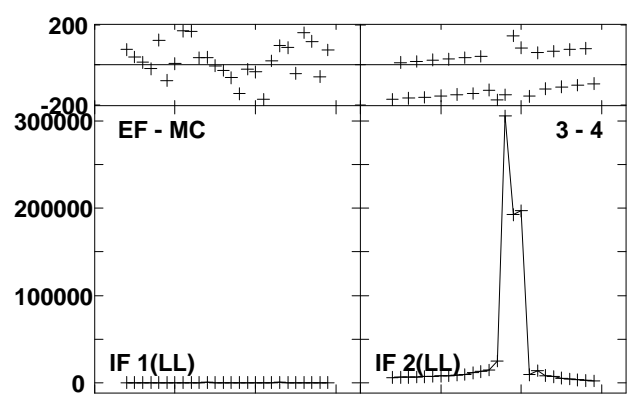
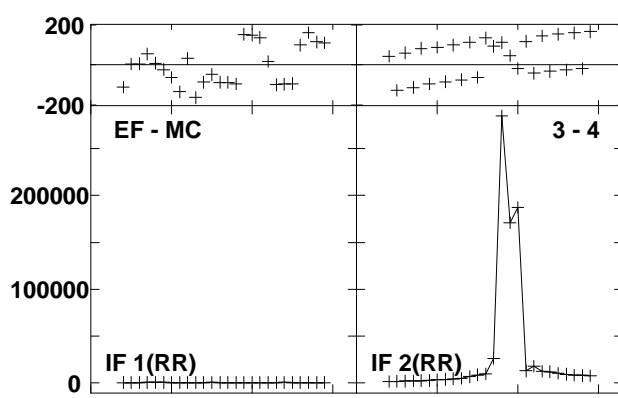
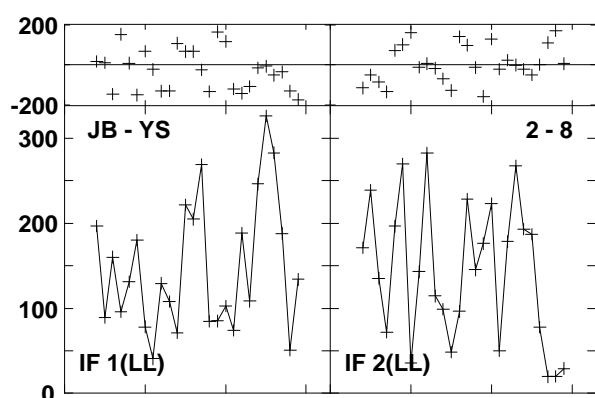
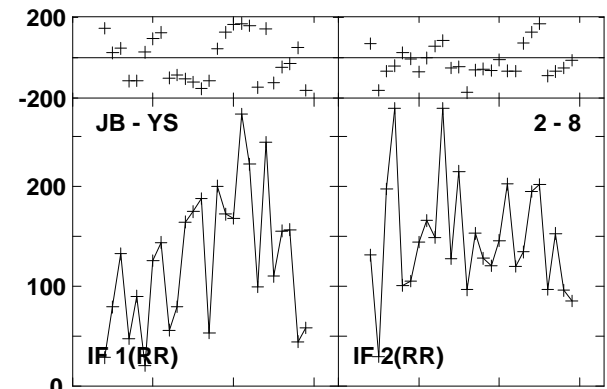
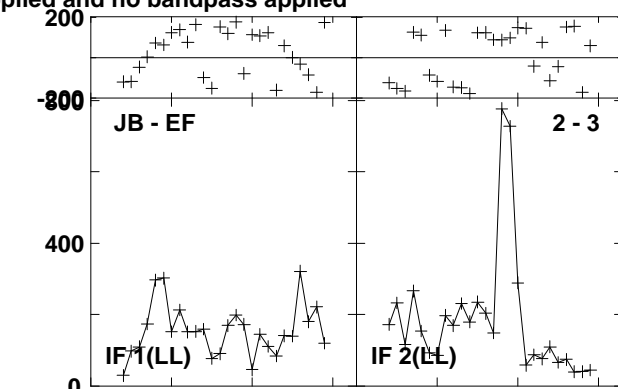
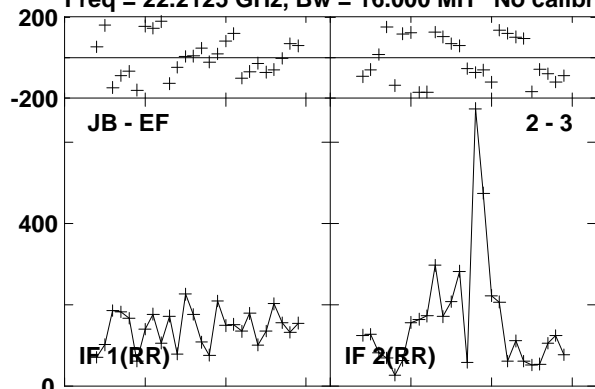

Lower frame: Micro Ampl Jy Top frame: Phas deg  
Vector averaged cross-power spectrum Baseline: JB (02) - EF (03)  
Timerange: 00/11:31:26 to 00/11:32:25

Plot file version 256 created 23-AUG-2016 15:00:50

W3IRS5 GA035B 1.UVDATA.1

Freq = 22.2125 GHz, Bw = 16.000 MH No calibration applied and no bandpass applied

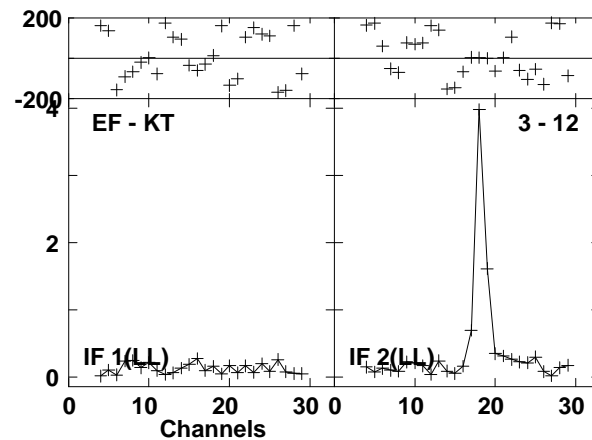
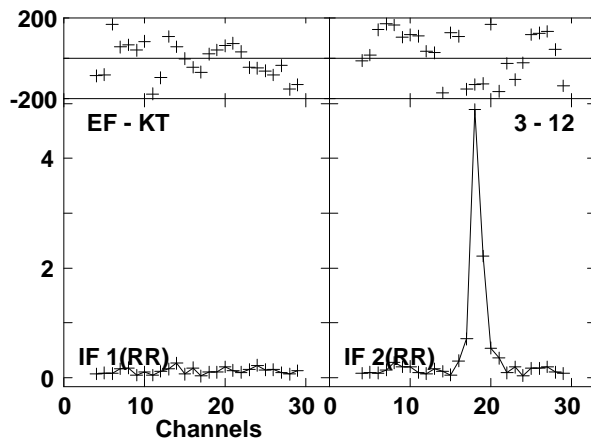
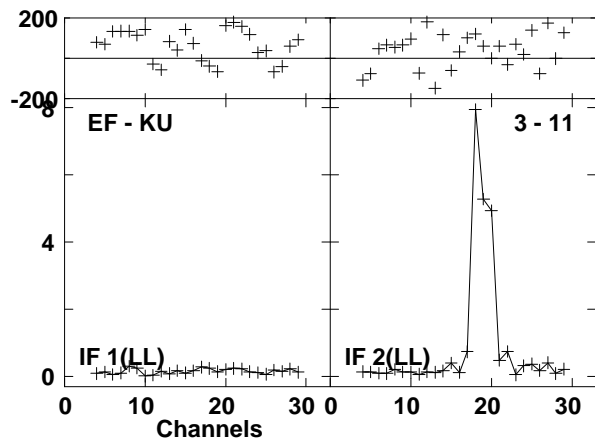
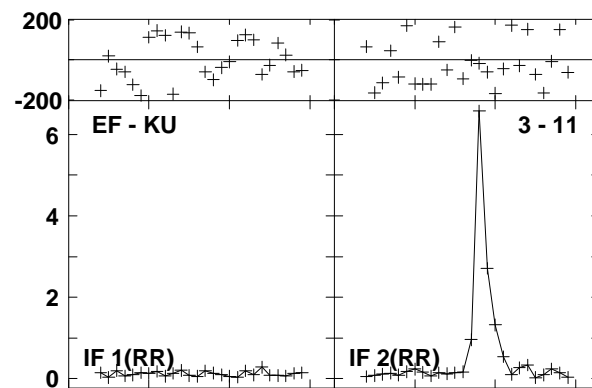
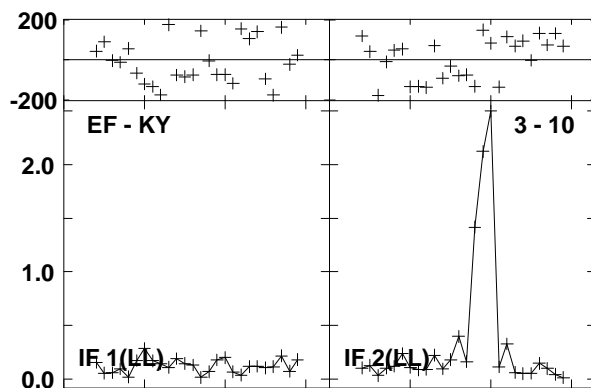
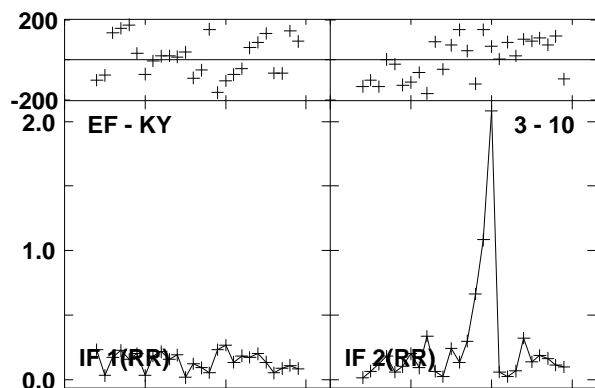
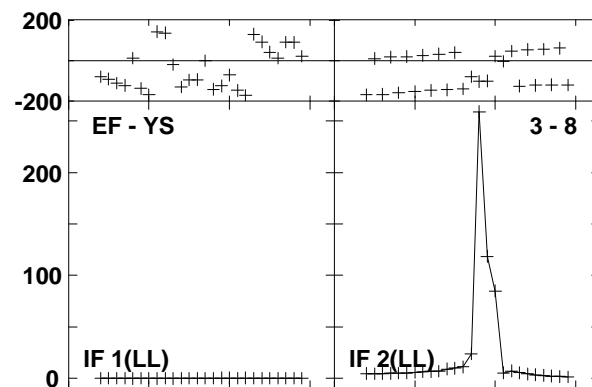
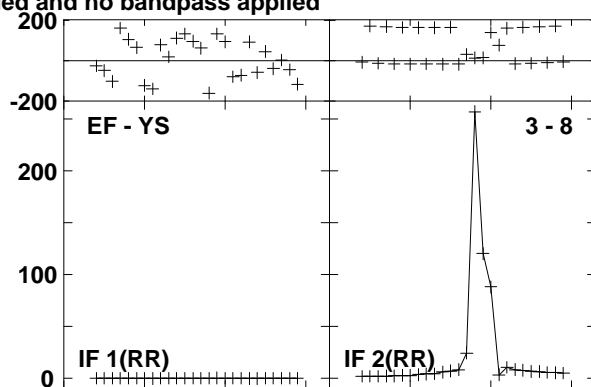
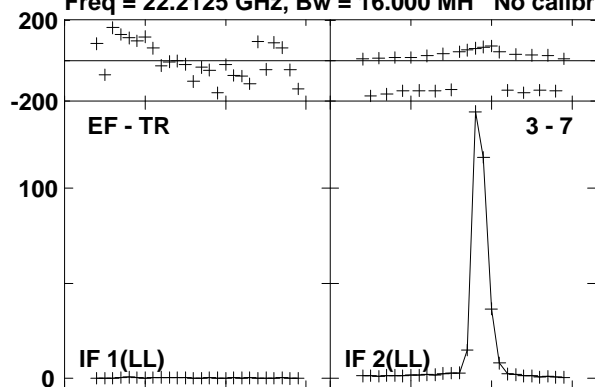

Lower frame: Milli Ampl Jy Top frame: Phas deg  
Vector averaged cross-power spectrum Baseline: EF (03) - TR (07)  
Timerange: 00/11:31:26 to 00/11:32:25



Plot file version 257 created 23-AUG-2016 15:00:50

W3IRS5 GA035B 1.UVDATA.1

Freq = 22.2125 GHz, Bw = 16.000 MH No calibration applied and no bandpass applied

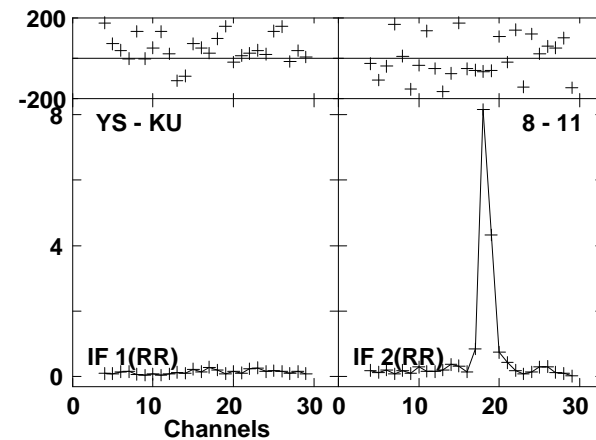
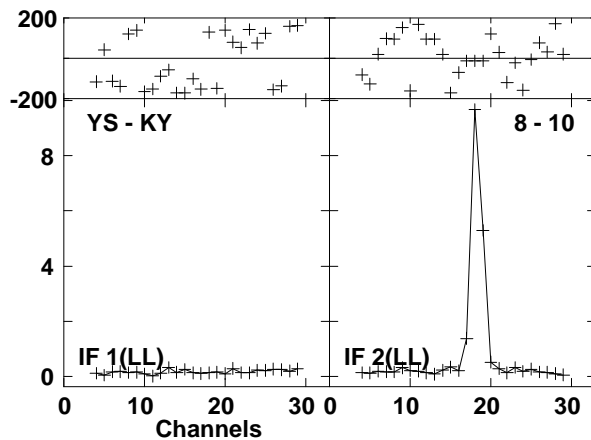
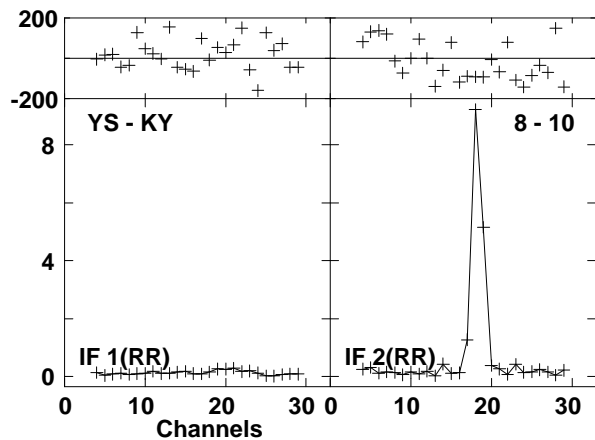
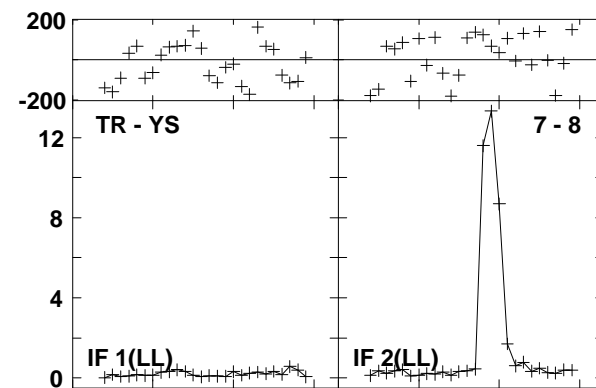
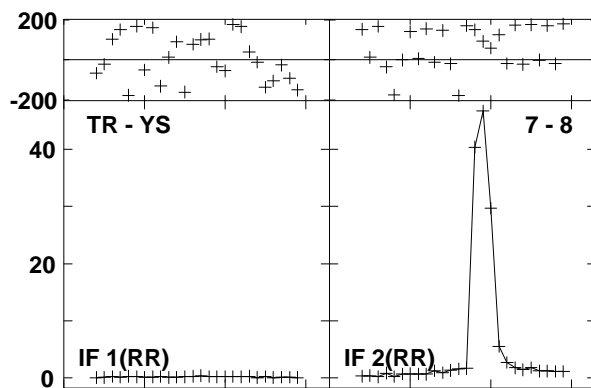
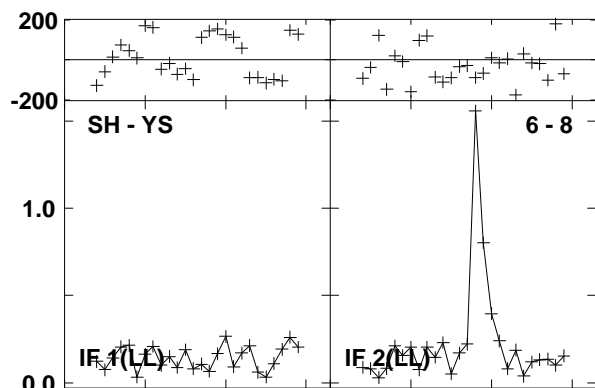
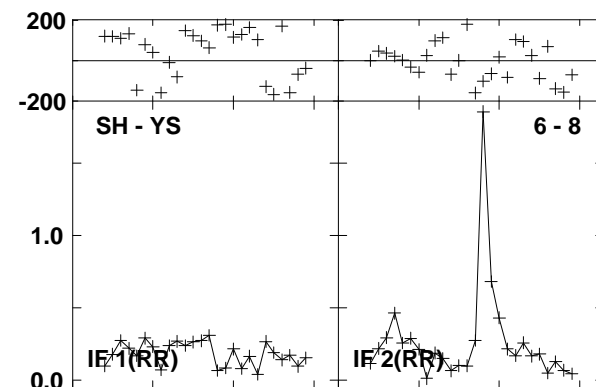
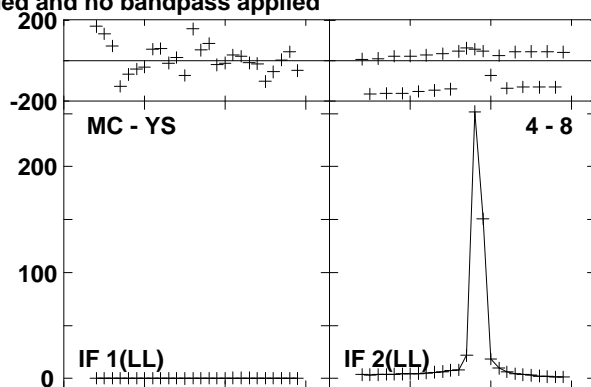
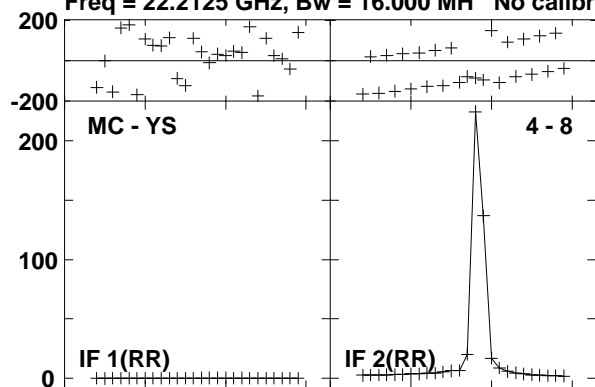

Lower frame: Milli Ampl Jy Top frame: Phas deg  
Vector averaged cross-power spectrum Baseline: MC (04) - YS (08)  
Timerange: 00/11:31:26 to 00/11:32:25

Plot file version 258 created 23-AUG-2016 15:00:50

W3IRS5 GA035B 1.UVDATA.1

Freq = 22.2125 GHz, Bw = 16.000 MH No calibration applied and no bandpass applied

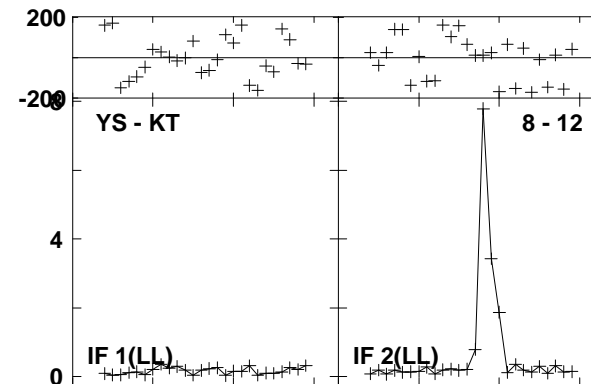
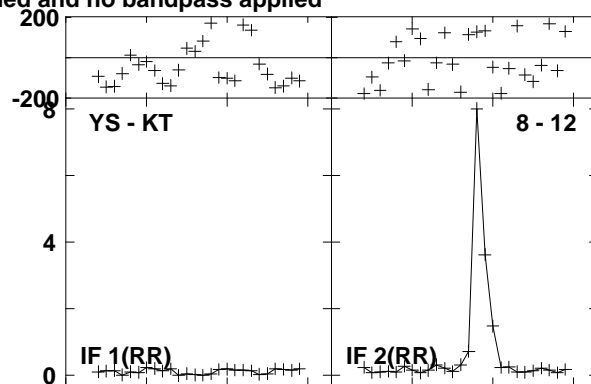
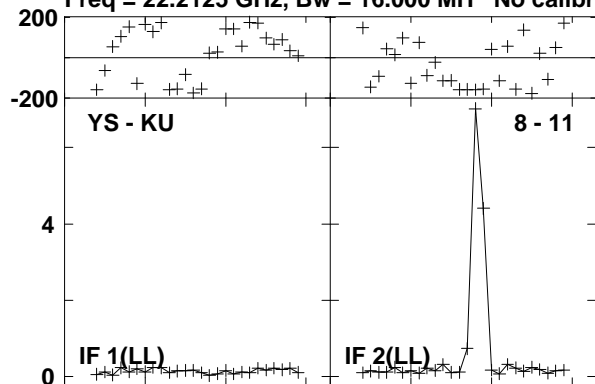

Lower frame: Milli Ampl Jy Top frame: Phas deg  
Vector averaged cross-power spectrum Baseline: YS (08) - KU (11)  
Timerange: 00/11:31:26 to 00/11:32:25

Plot file version 259 created 23-AUG-2016 15:00:50

0219+628 GA035B 1.UVDATA.1

Freq = 22.2125 GHz, Bw = 16.000 MH No calibration applied and no bandpass applied

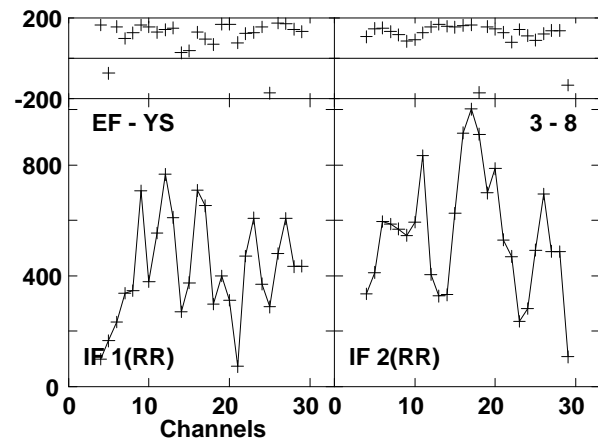
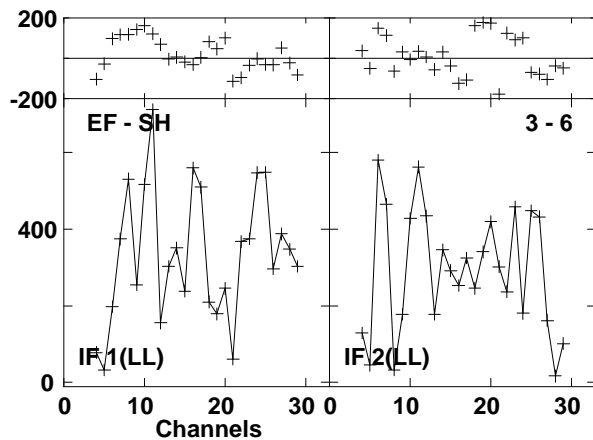
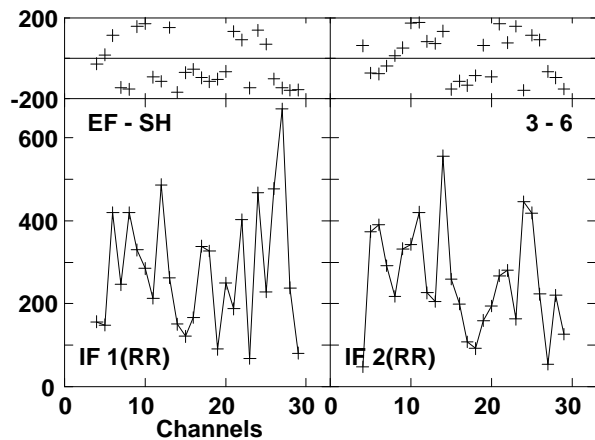
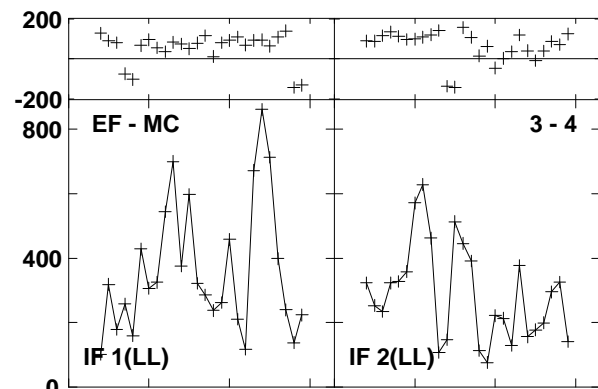
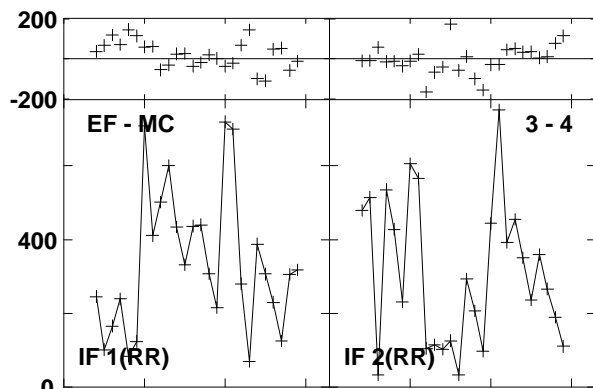
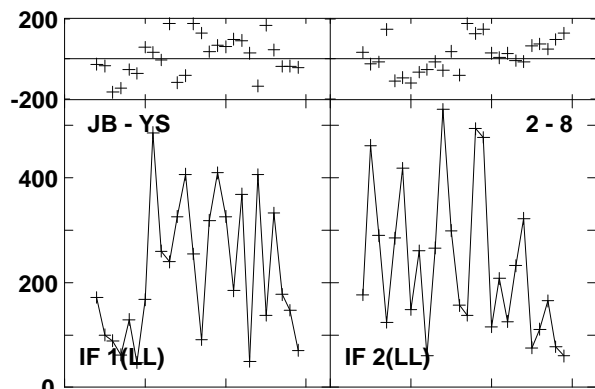
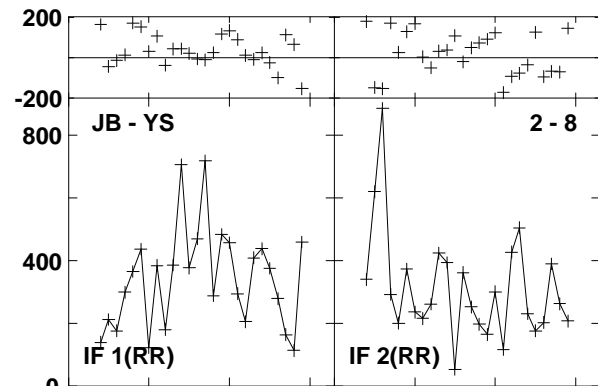
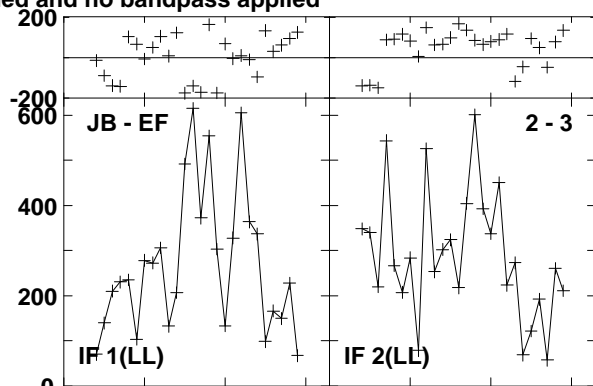
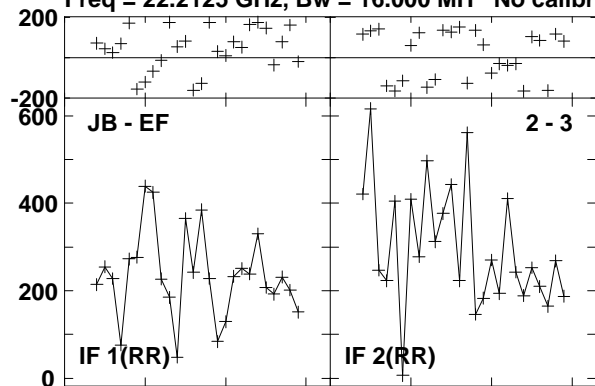

Lower frame: Micro Ampl Jy Top frame: Phas deg  
Vector averaged cross-power spectrum Baseline: JB (02) - EF (03)  
Timerange: 00/11:32:50 to 00/11:33:10

Plot file version 260 created 23-AUG-2016 15:00:50

0219+628 GA035B 1.UVDATA.1

Freq = 22.2125 GHz, Bw = 16.000 MH No calibration applied and no bandpass applied

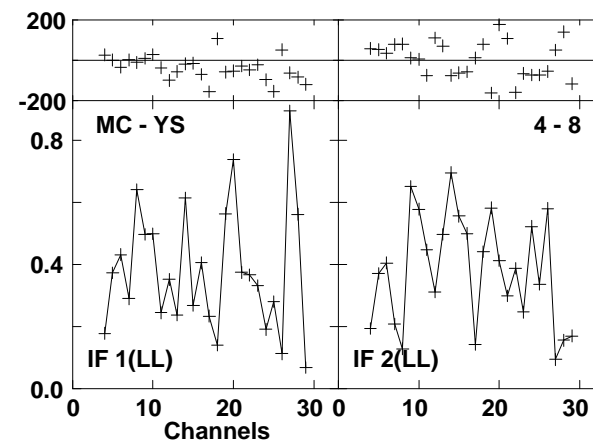
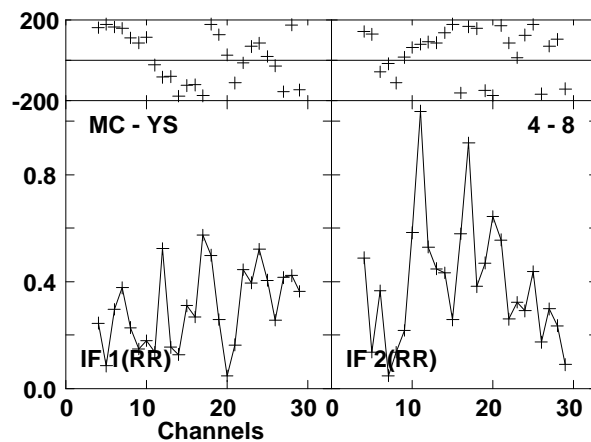
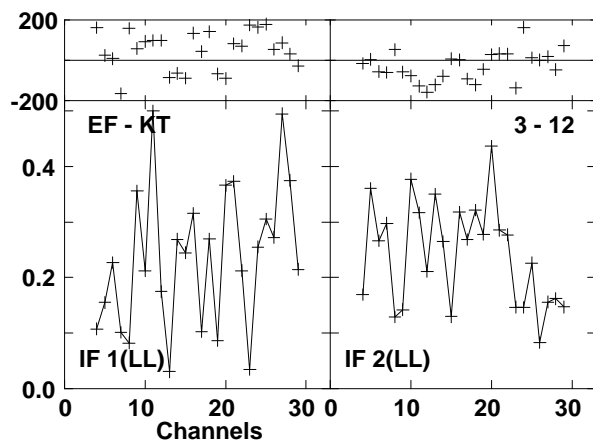
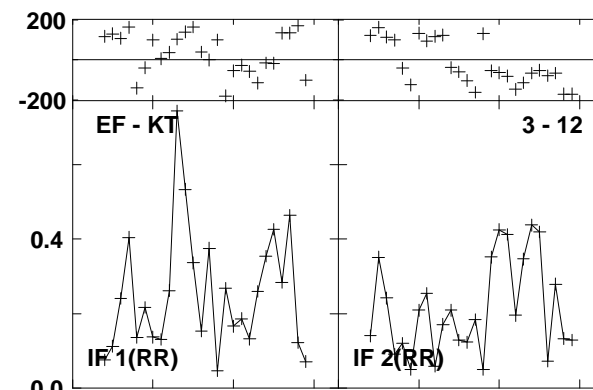
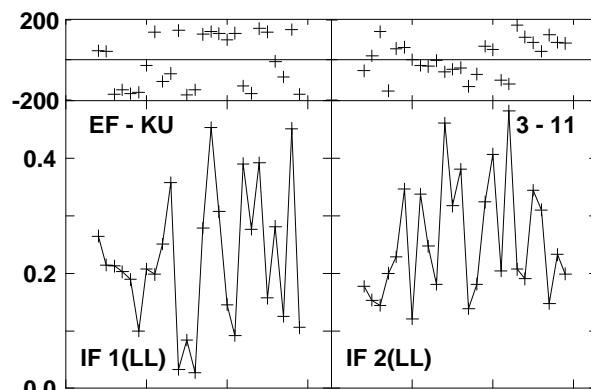
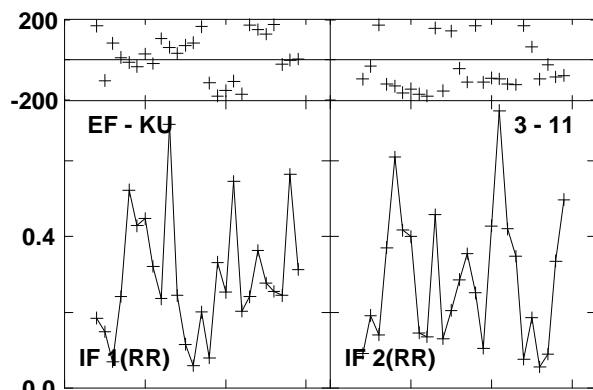
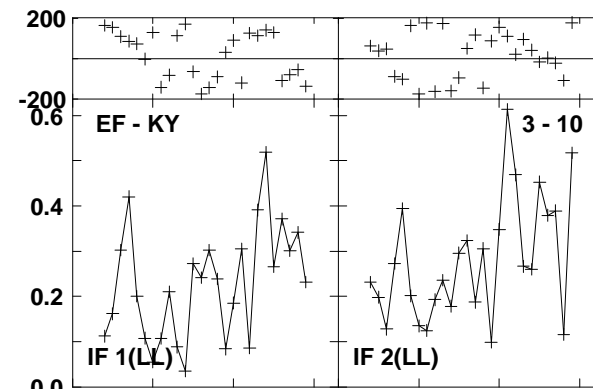
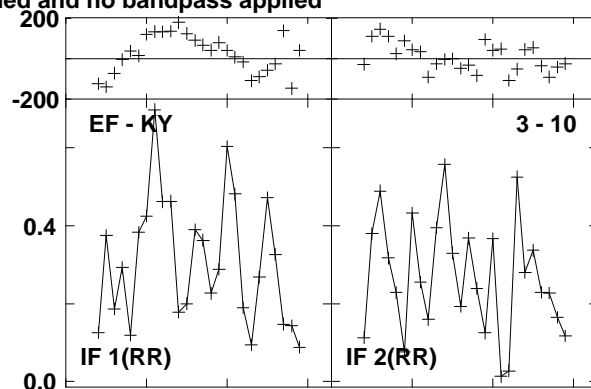
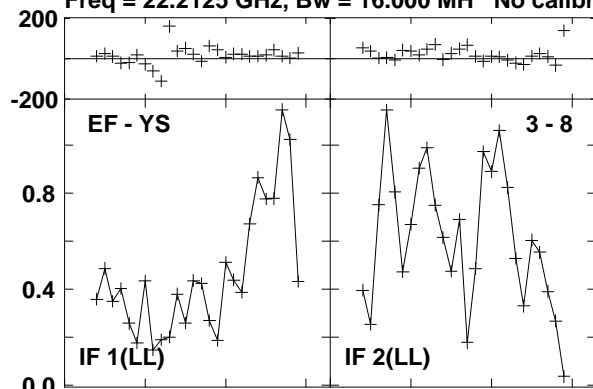

Lower frame: Milli Ampl Jy Top frame: Phas deg

Vector averaged cross-power spectrum Baseline: EF (03) - YS (08)

Timerange: 00/11:32:50 to 00/11:33:10

Plot file version 261 created 23-AUG-2016 15:00:50  
 0219+628 GA035B 1.UVDATA.1

Freq = 22.2125 GHz, Bw = 16.000 MH No calibration applied and no bandpass applied

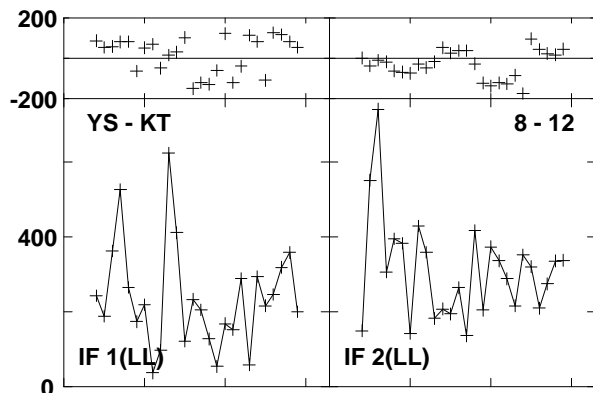
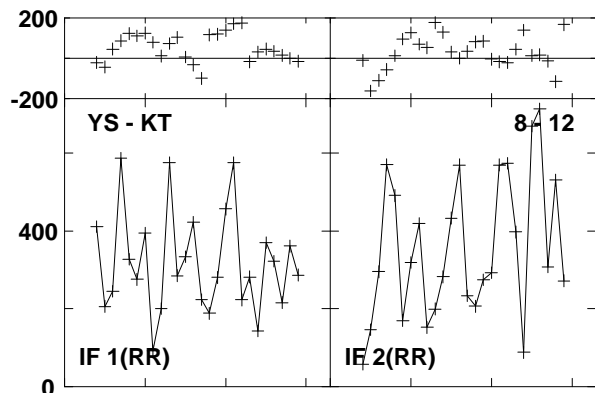
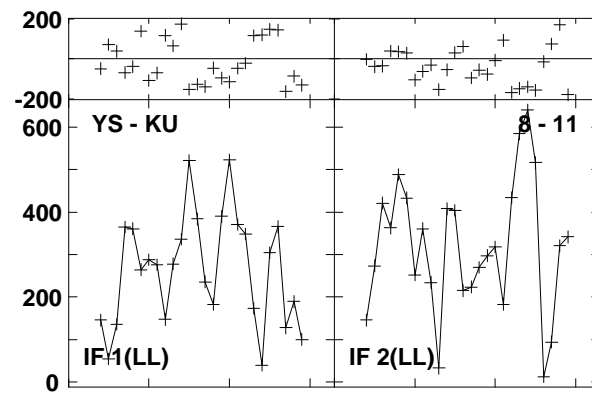
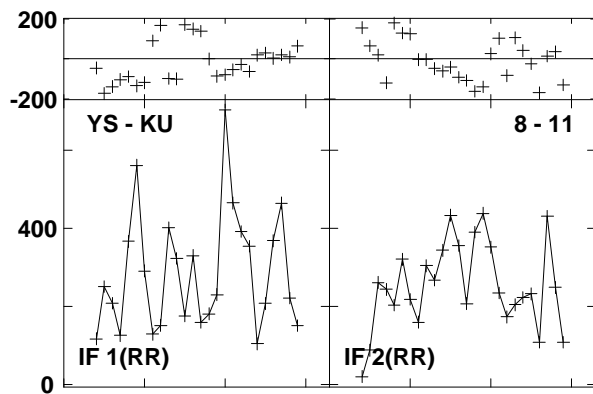
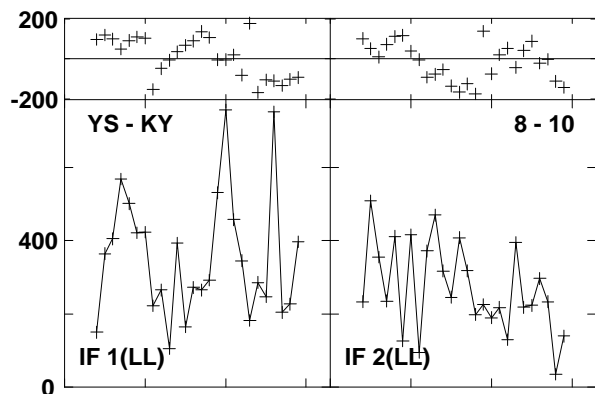
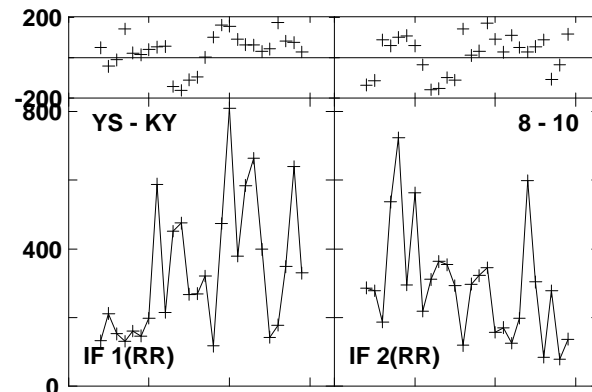
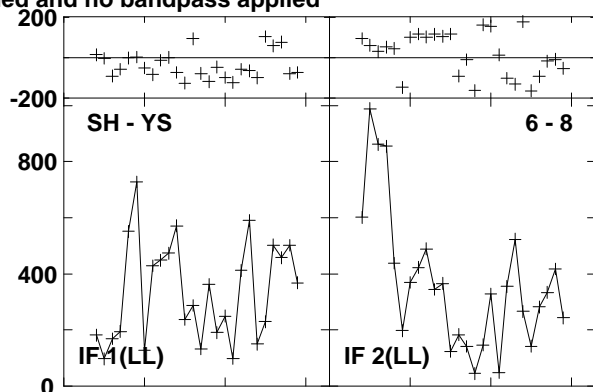
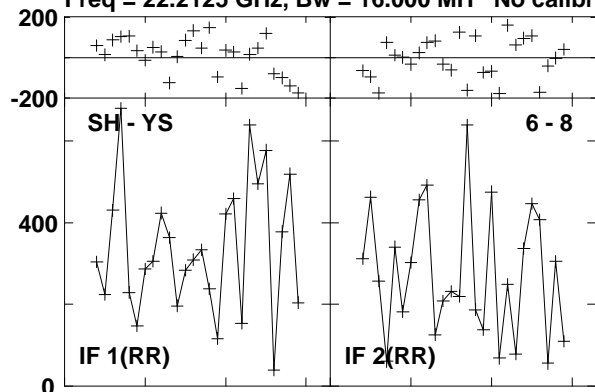

Lower frame: Micro Ampl Jy Top frame: Phas deg  
 Vector averaged cross-power spectrum Baseline: SH (06) - YS (08)  
 Timerange: 00/11:32:50 to 00/11:33:10

Plot file version 262 created 23-AUG-2016 15:00:50

W3IRS5 GA035B 1.UVDATA.1

Freq = 22.2125 GHz, Bw = 16.000 MH No calibration applied and no bandpass applied

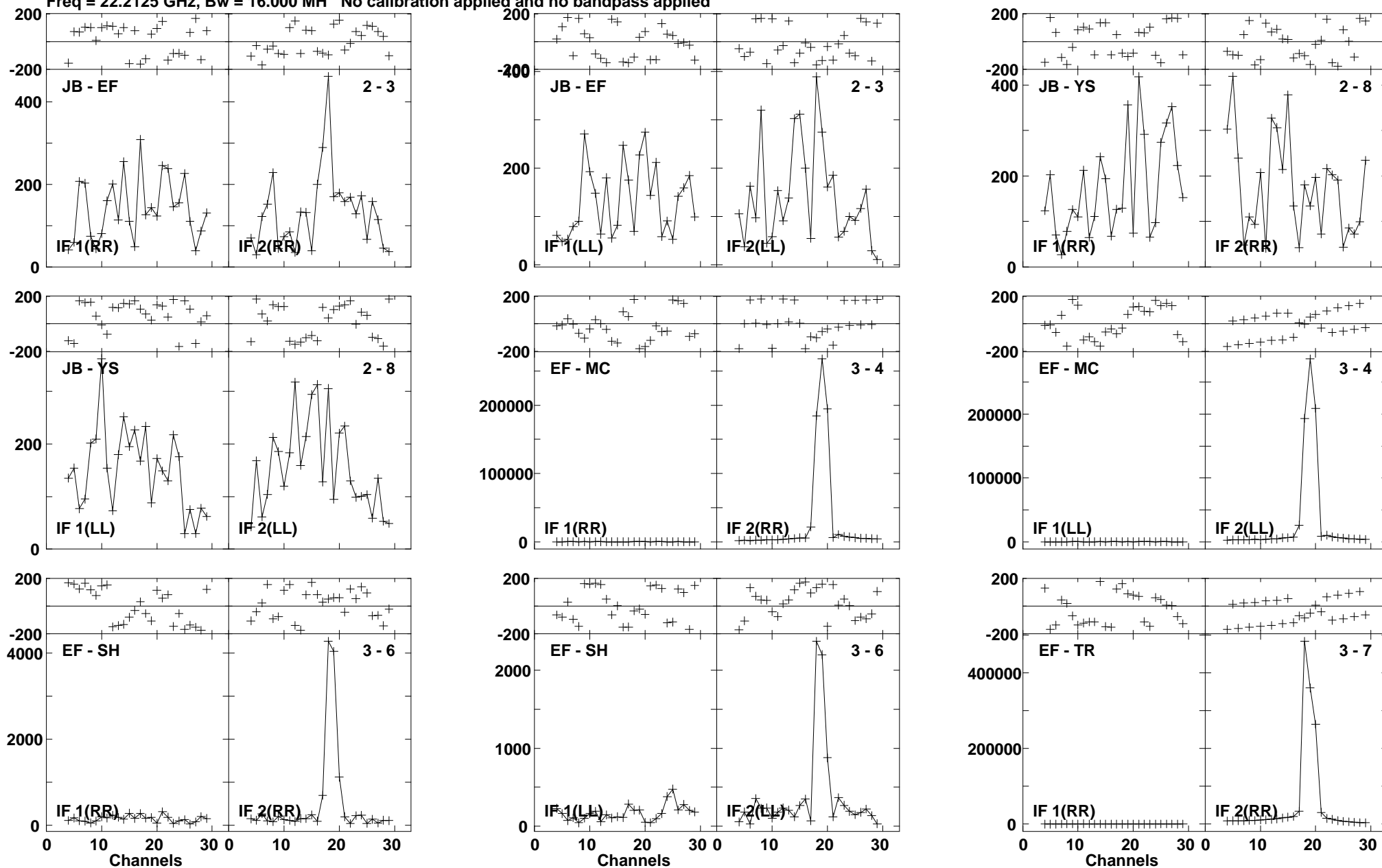

Lower frame: Micro Ampl Jy Top frame: Phas deg  
Vector averaged cross-power spectrum Baseline: JB (02) - EF (03)  
Timerange: 00/11:33:36 to 00/11:34:35

Plot file version 263 created 23-AUG-2016 15:00:50

W3IRS5 GA035B 1.UVDATA.1

Freq = 22.2125 GHz, Bw = 16.000 MH No calibration applied and no bandpass applied

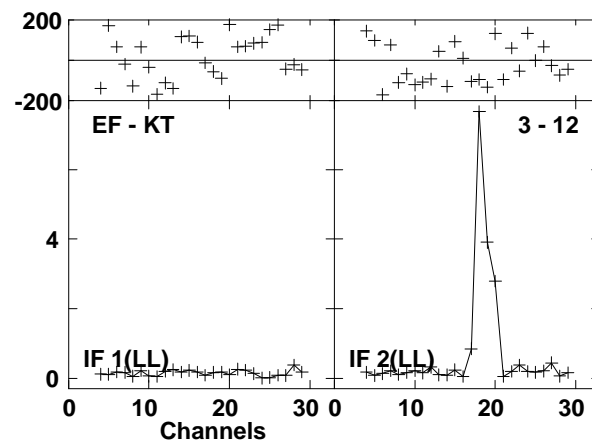
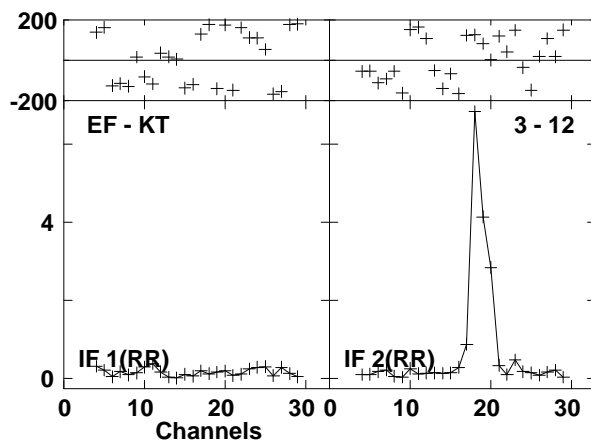
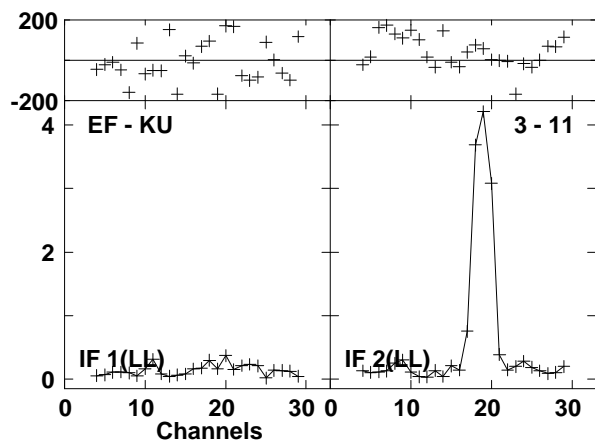
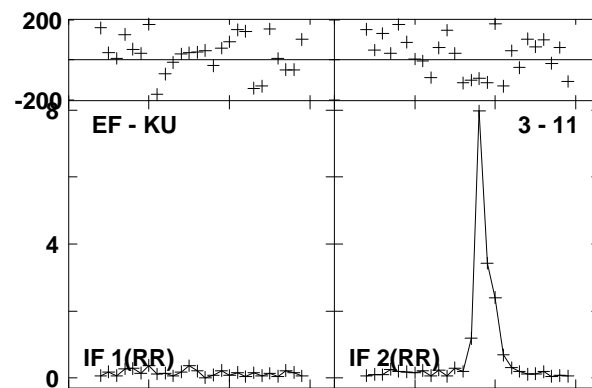
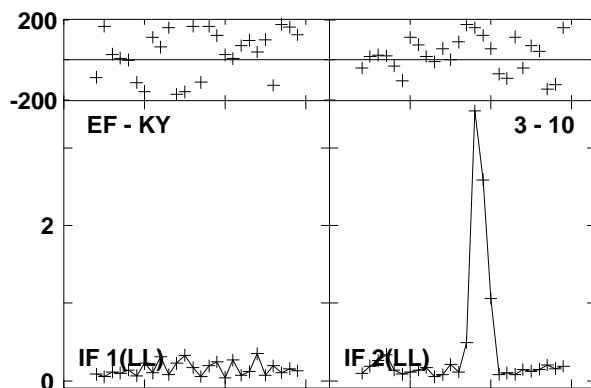
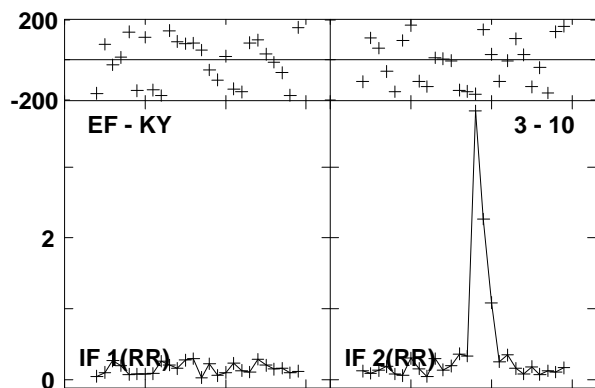
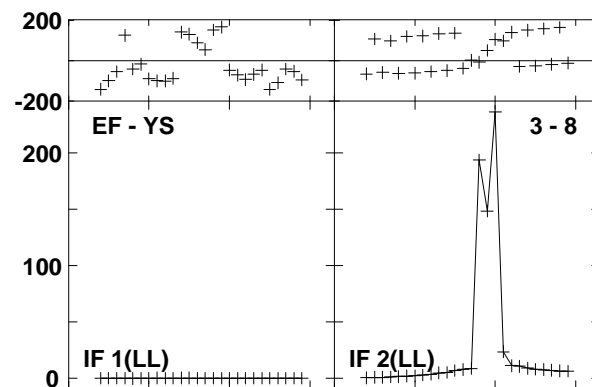
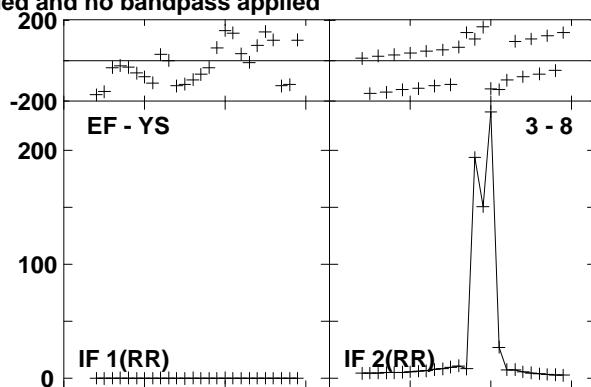
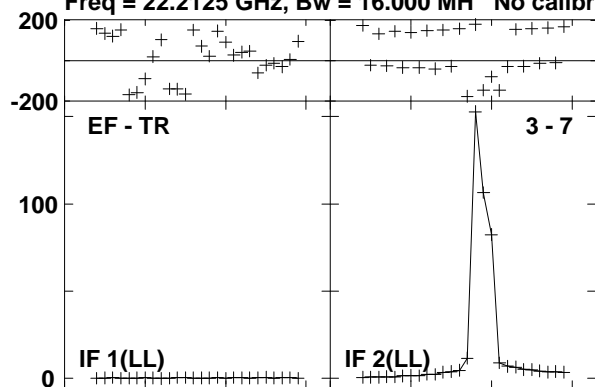

Lower frame: Milli Ampl Jy Top frame: Phas deg  
Vector averaged cross-power spectrum Baseline: EF (03) - TR (07)  
Timerange: 00/11:33:36 to 00/11:34:35

Plot file version 264 created 23-AUG-2016 15:00:50  
W3IRS5 GA035B 1.UVDATA.1

Freq = 22.2125 GHz, Bw = 16.000 MH No calibration applied and no bandpass applied

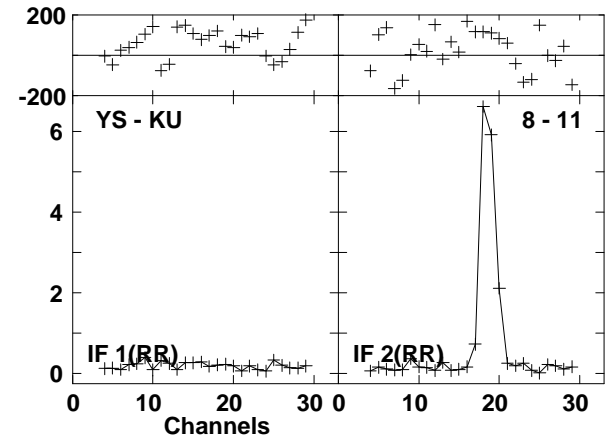
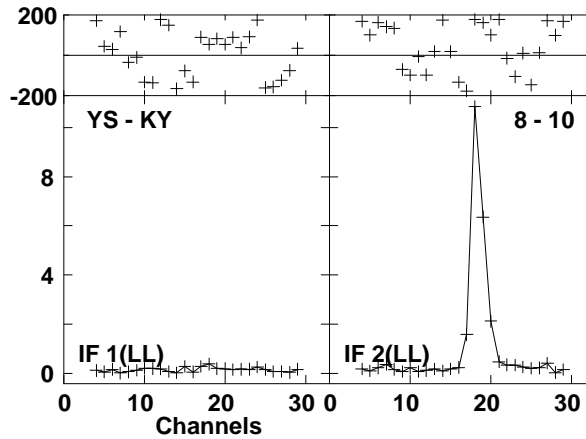
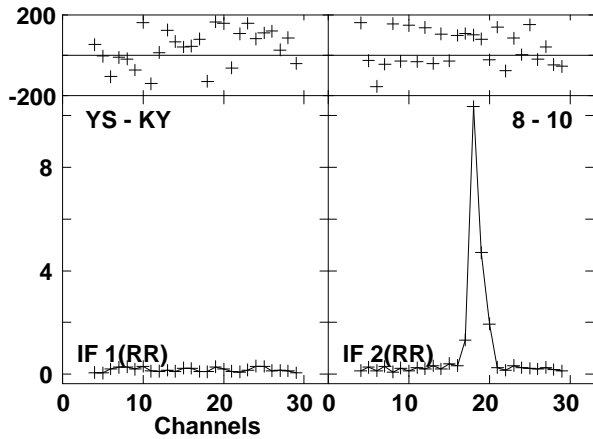
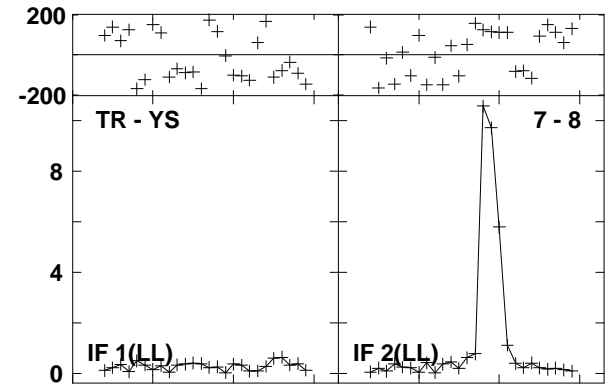
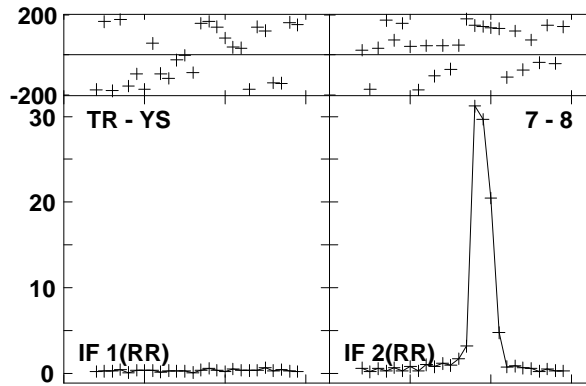
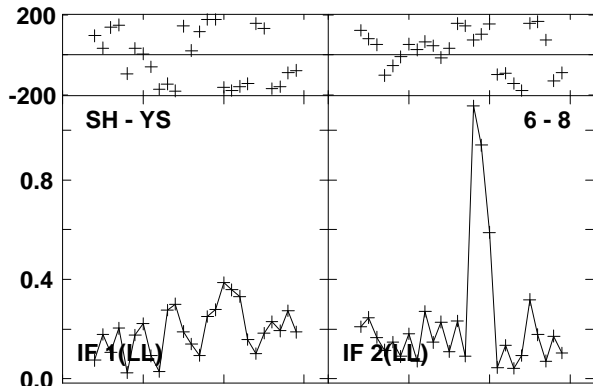
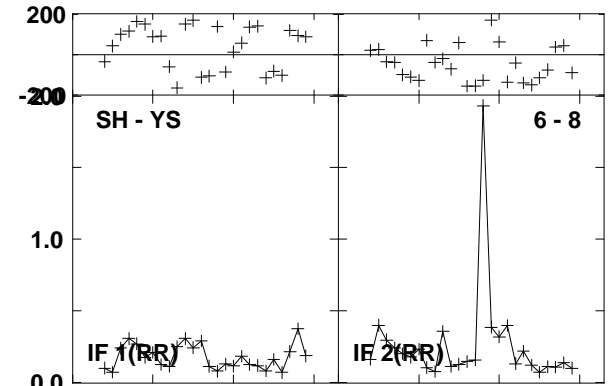
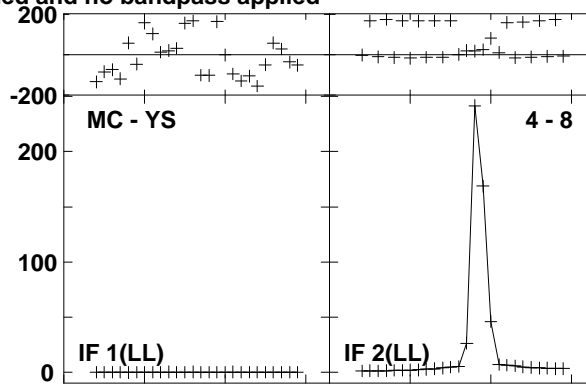
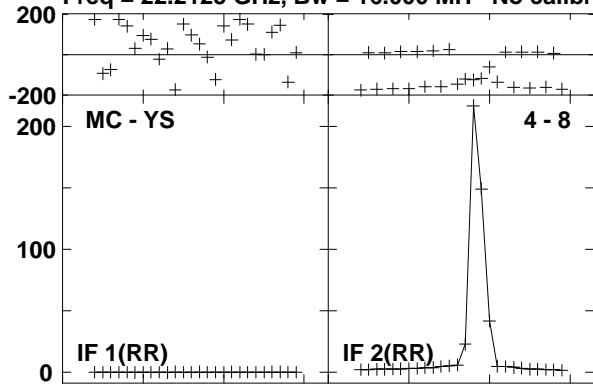

Lower frame: Milli Ampl Jy Top frame: Phas deg  
Vector averaged cross-power spectrum Baseline: MC (04) - YS (08)  
Timerange: 00/11:33:36 to 00/11:34:35



Plot file version 265 created 23-AUG-2016 15:00:50  
W3IRS5 GA035B 1.UVDATA.1

Freq = 22.2125 GHz, Bw = 16.000 MH No calibration applied and no bandpass applied

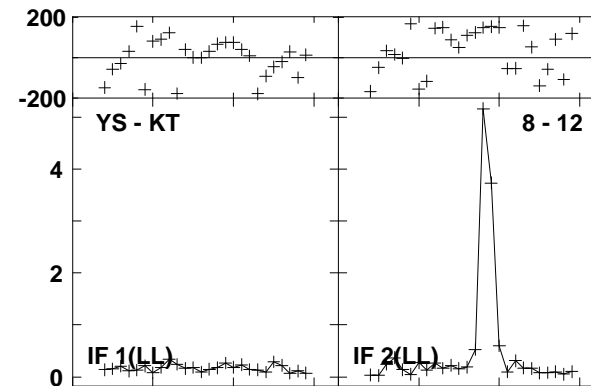
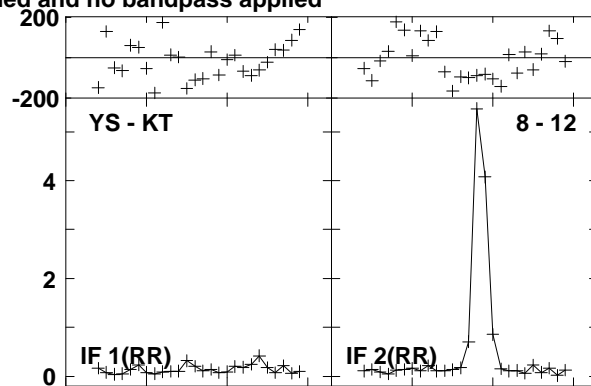
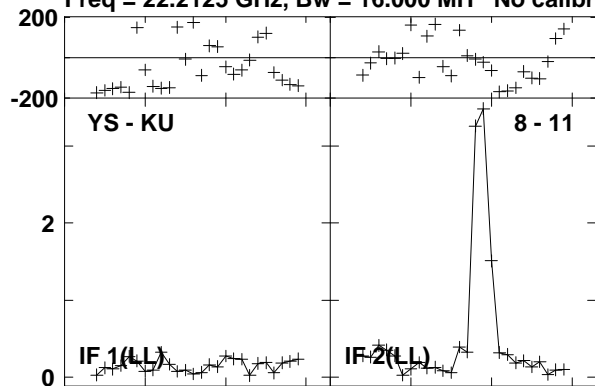

Lower frame: Milli Ampl Jy Top frame: Phas deg  
Vector averaged cross-power spectrum Baseline: YS (08) - KU (11)  
Timerange: 00/11:33:36 to 00/11:34:35

Plot file version 266 created 23-AUG-2016 15:00:50

0219+628 GA035B 1.UVDATA.1

Freq = 22.2125 GHz, Bw = 16.000 MH No calibration applied and no bandpass applied

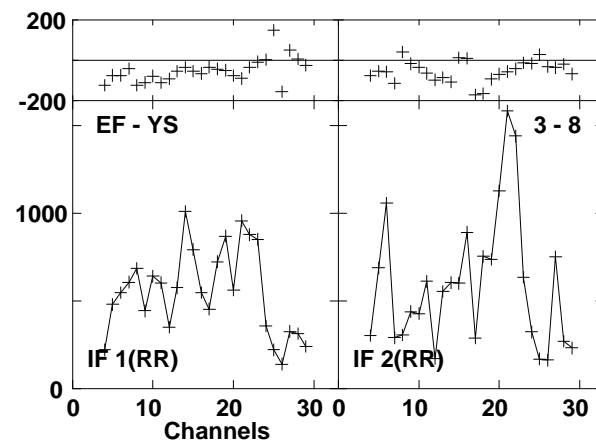
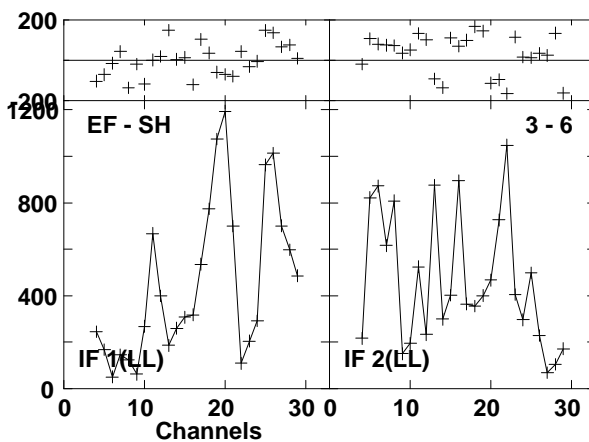
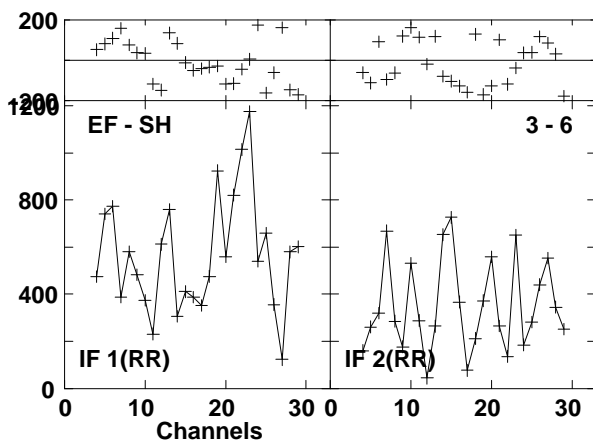
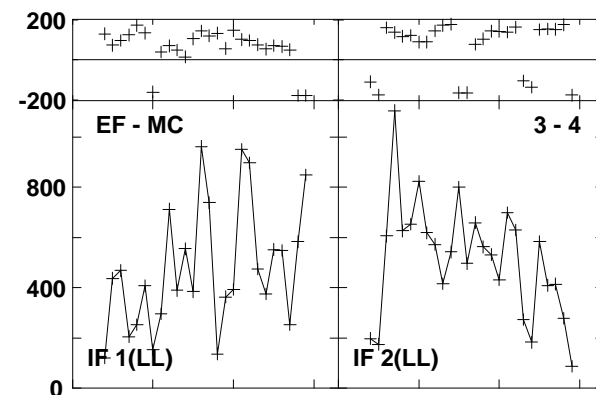
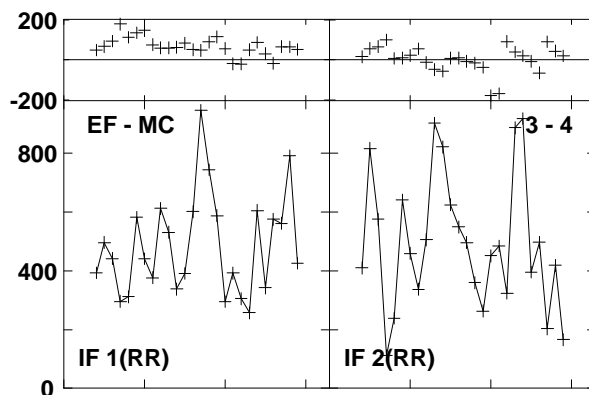
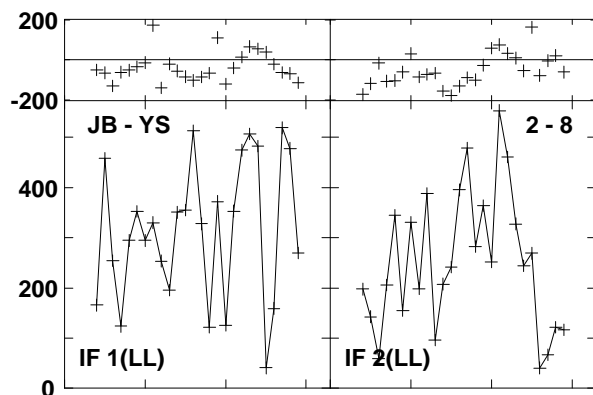
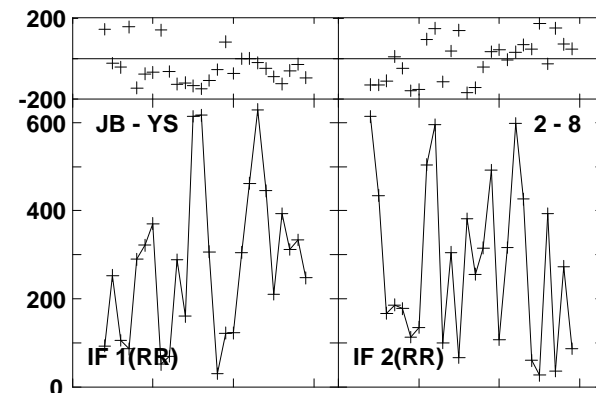
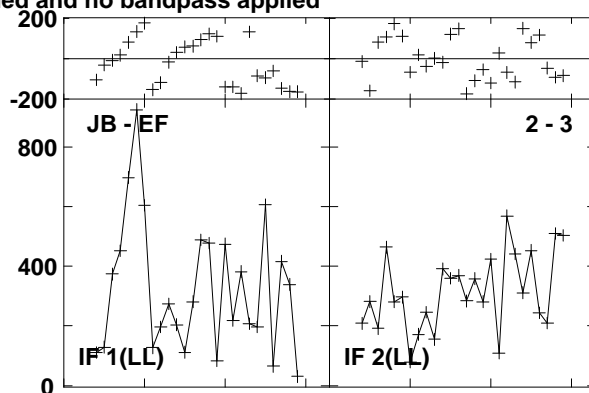
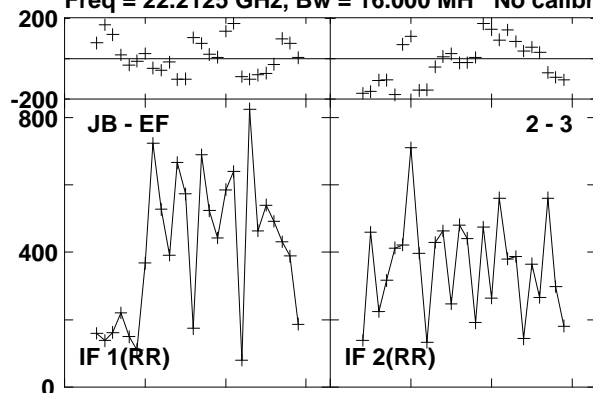

Lower frame: Micro Ampl Jy Top frame: Phas deg  
Vector averaged cross-power spectrum Baseline: JB (02) - EF (03)  
Timerange: 00/11:35:01 to 00/11:35:20

Plot file version 267 created 23-AUG-2016 15:00:50  
 0219+628 GA035B 1.UVDATA.1  
 Freq = 22.2125 GHz, Bw = 16.000 MH No calibration applied and no bandpass applied

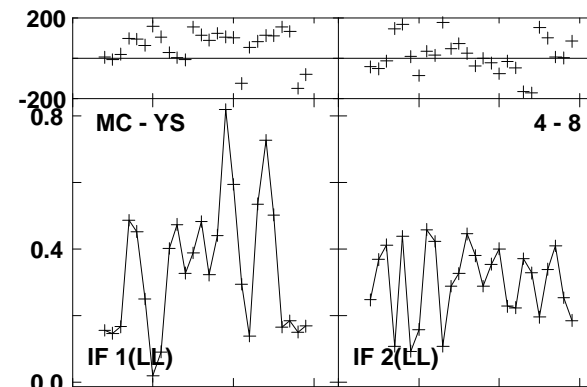
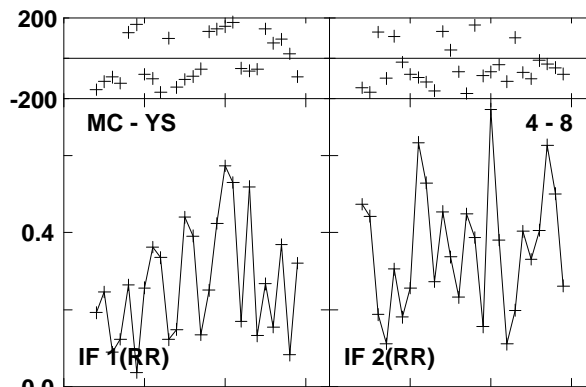
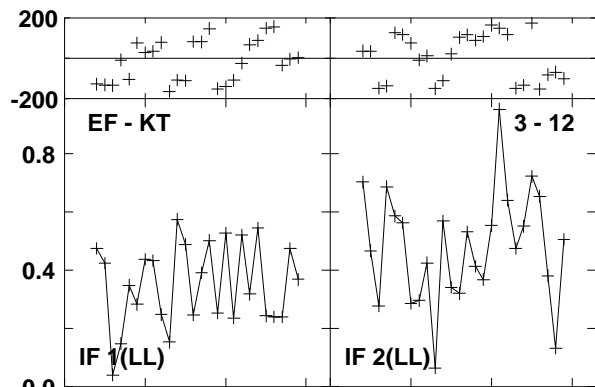
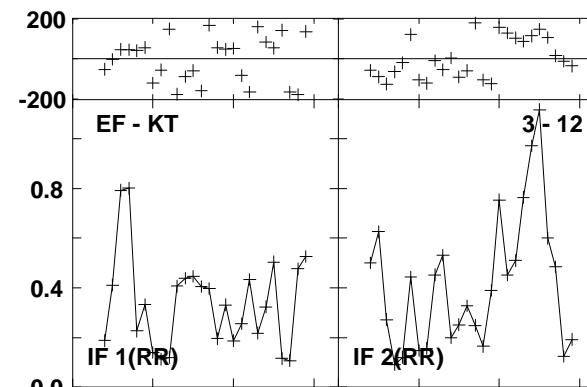
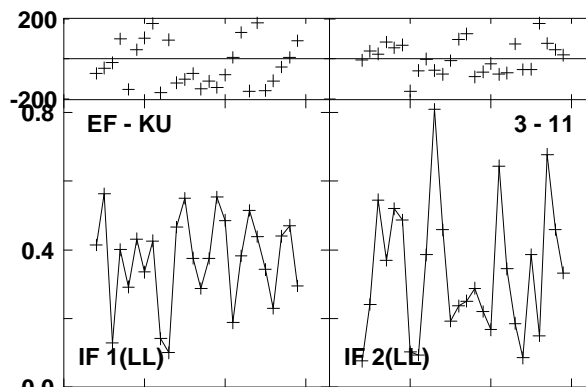
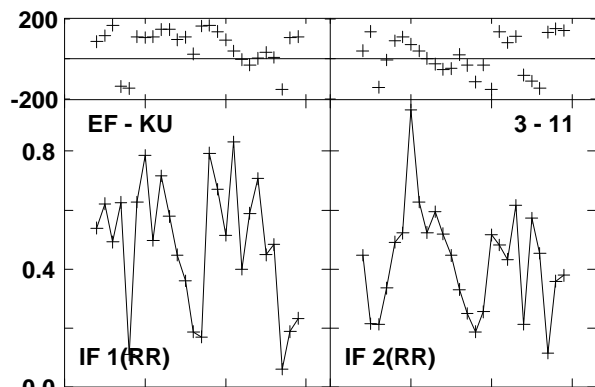
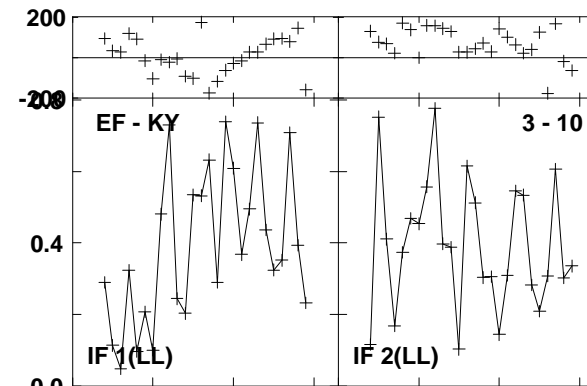
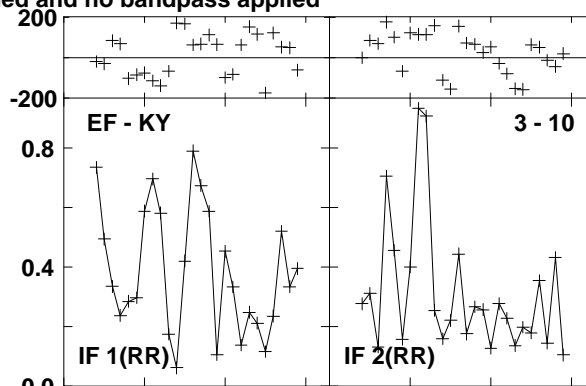
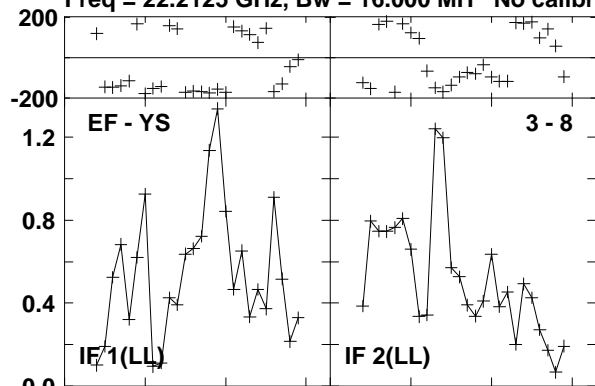

Lower frame: Milli Ampl Jy Top frame: Phas deg  
 Vector averaged cross-power spectrum Baseline: EF (03) - YS (08)  
 Timerange: 00/11:35:01 to 00/11:35:20

Plot file version 268 created 23-AUG-2016 15:00:51

0219+628 GA035B 1.UVDATA.1

Freq = 22.2125 GHz, Bw = 16.000 MH No calibration applied and no bandpass applied

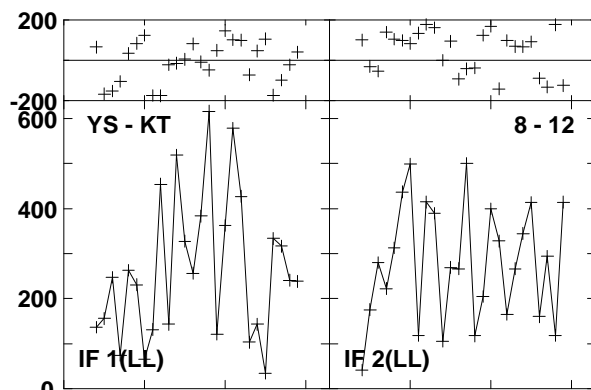
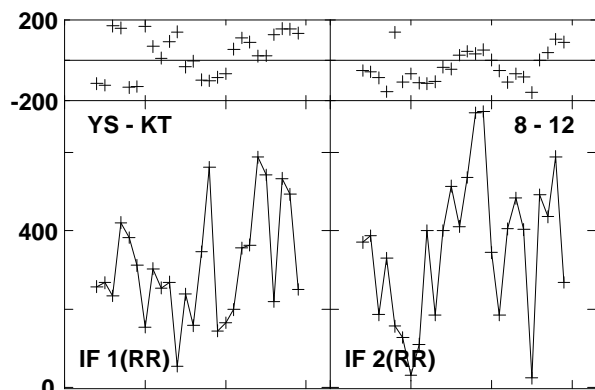
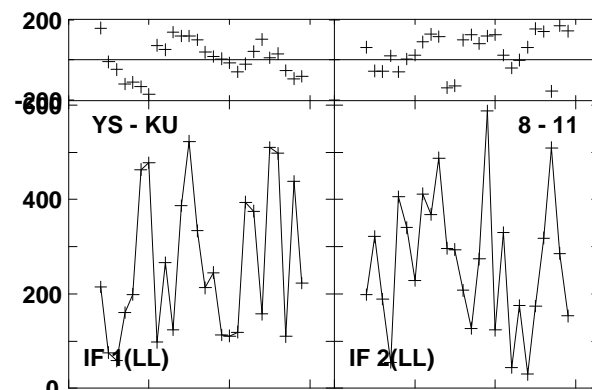
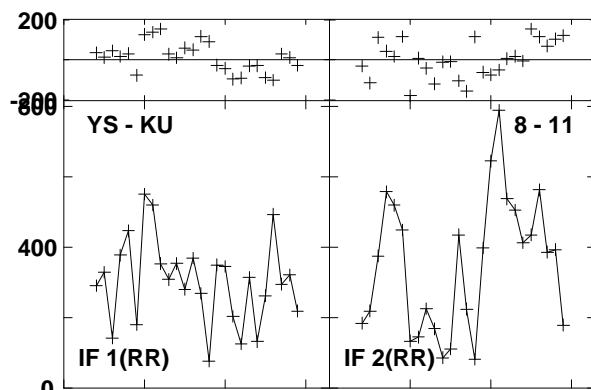
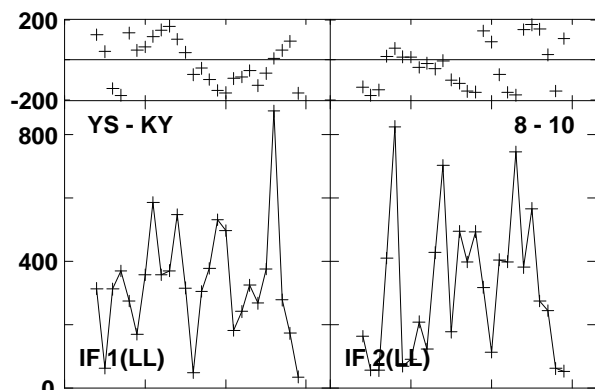
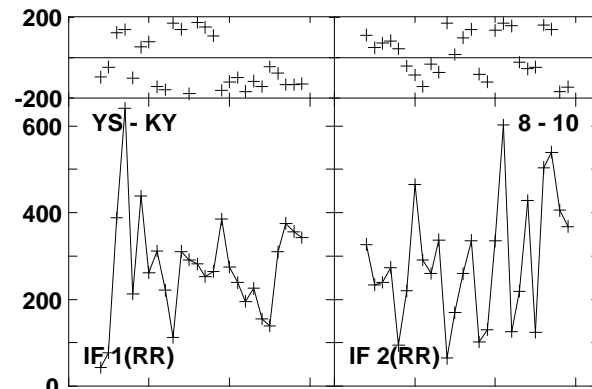
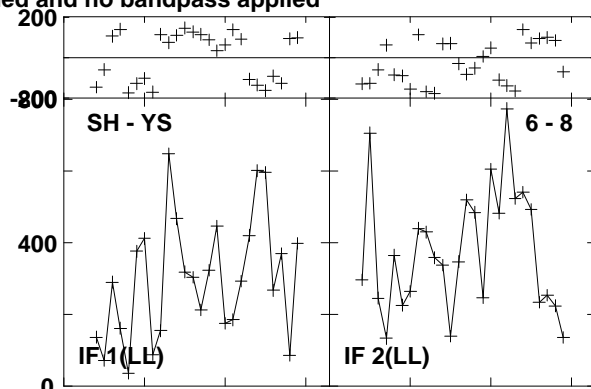
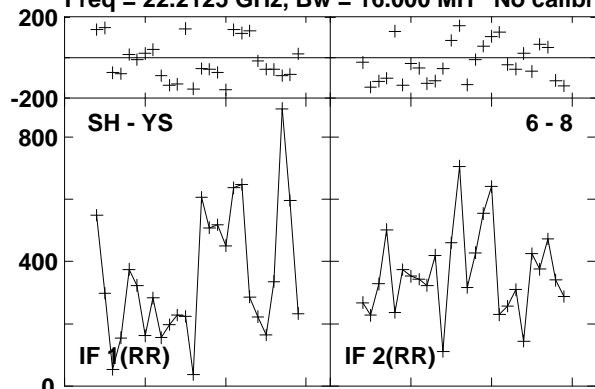

Lower frame: Micro Ampl Jy Top frame: Phas deg  
Vector averaged cross-power spectrum Baseline: SH (06) - YS (08)  
Timerange: 00/11:35:01 to 00/11:35:20

Plot file version 269 created 23-AUG-2016 15:00:51  
 W3IRS5 GA035B 1.UVDATA.1

Freq = 22.2125 GHz, Bw = 16.000 MH No calibration applied and no bandpass applied

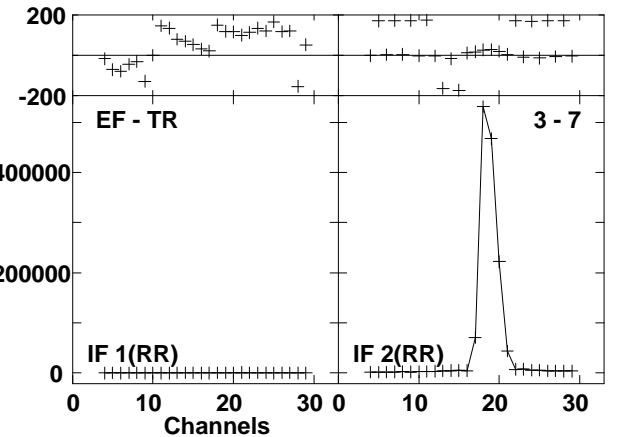
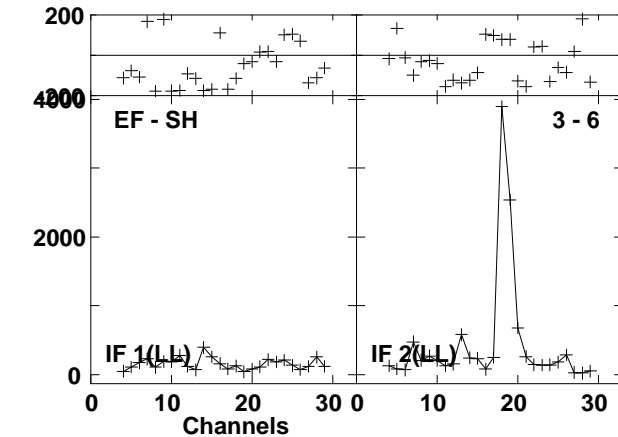
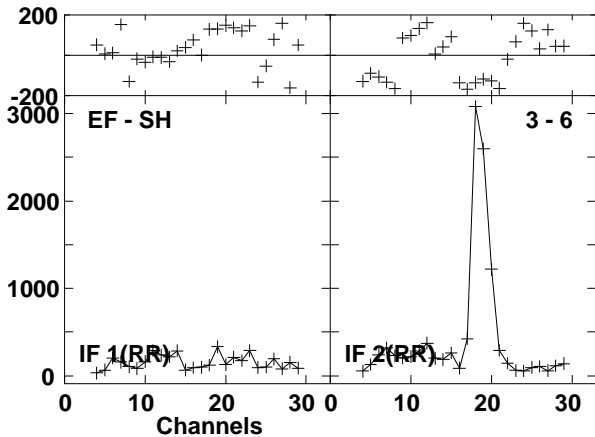
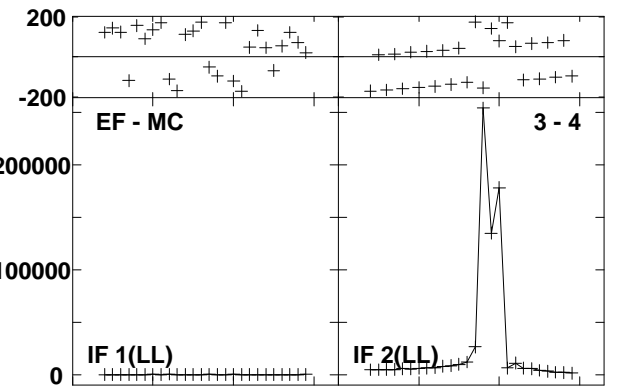
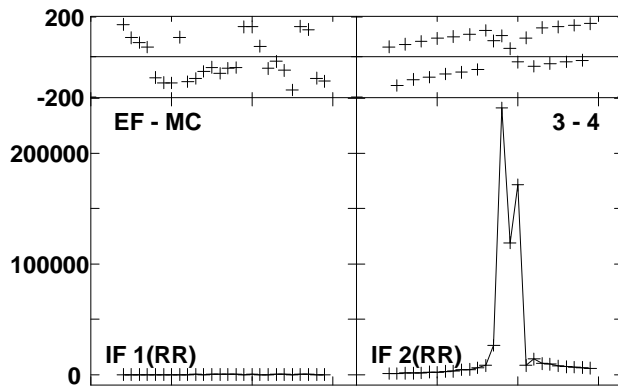
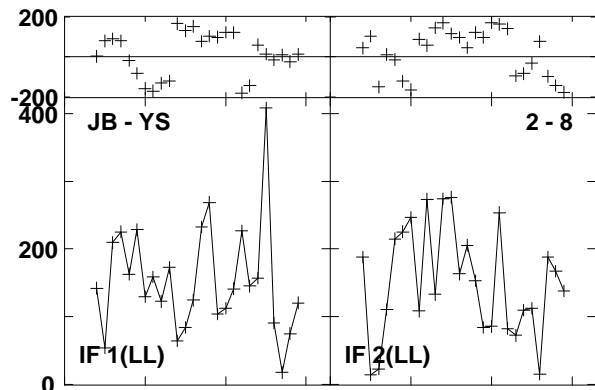
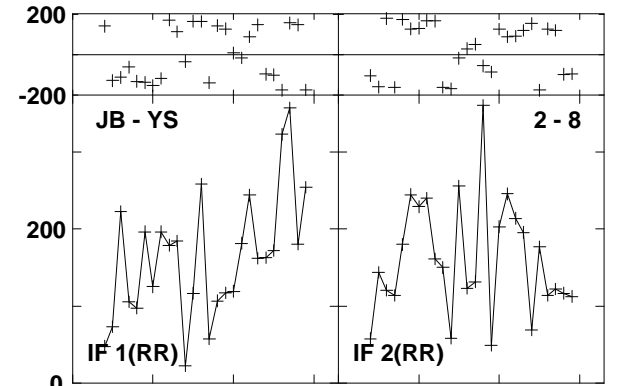
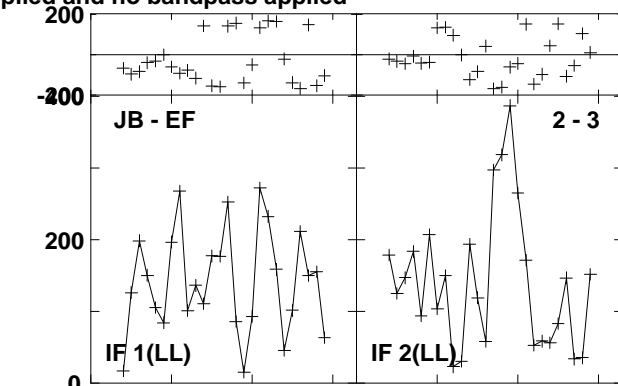
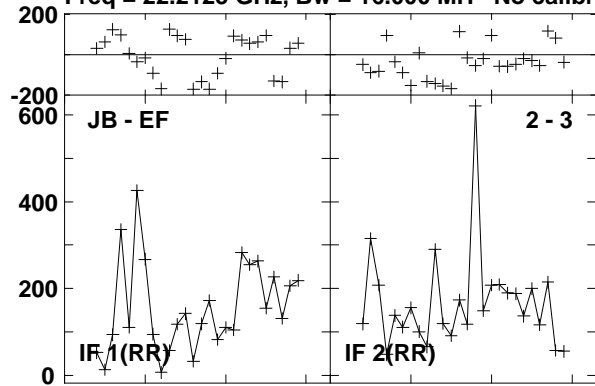

Lower frame: Micro Ampl Jy Top frame: Phas deg  
 Vector averaged cross-power spectrum Baseline: JB (02) - EF (03)  
 Timerange: 00/11:35:45 to 00/11:36:45

Plot file version 270 created 23-AUG-2016 15:00:51

W3IRS5 GA035B 1.UVDATA.1

Freq = 22.2125 GHz, Bw = 16.000 MH No calibration applied and no bandpass applied

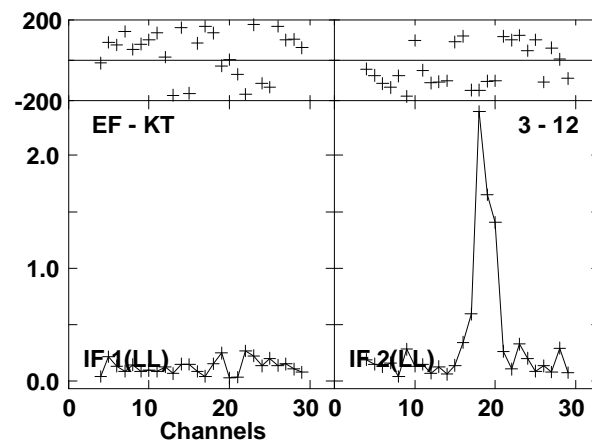
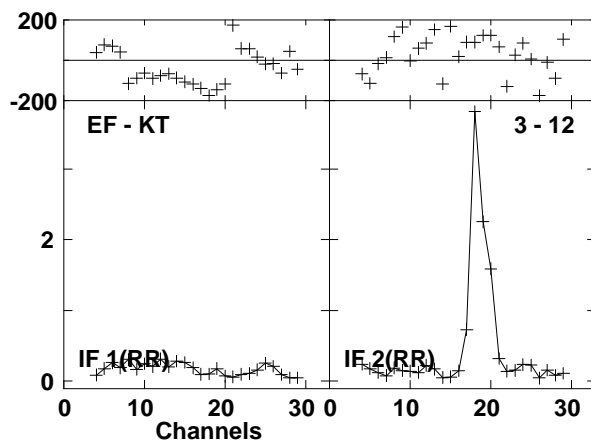
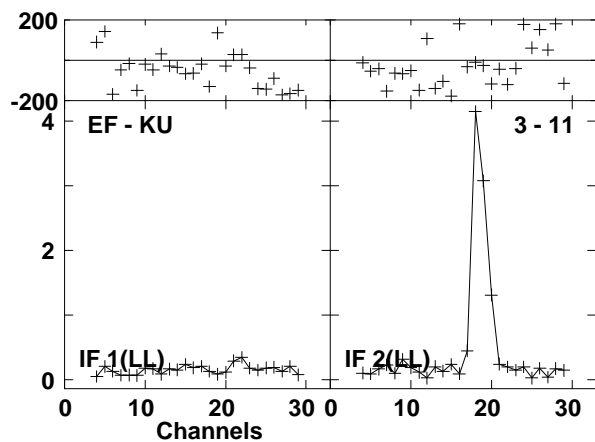
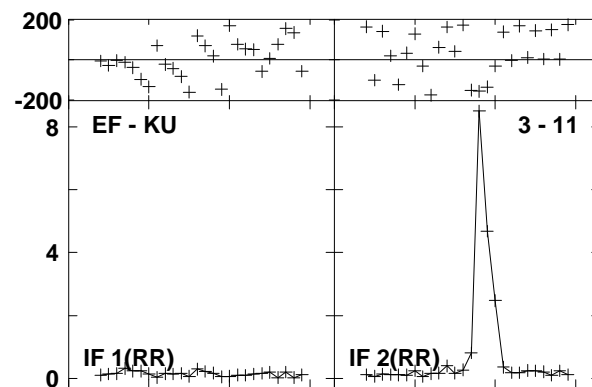
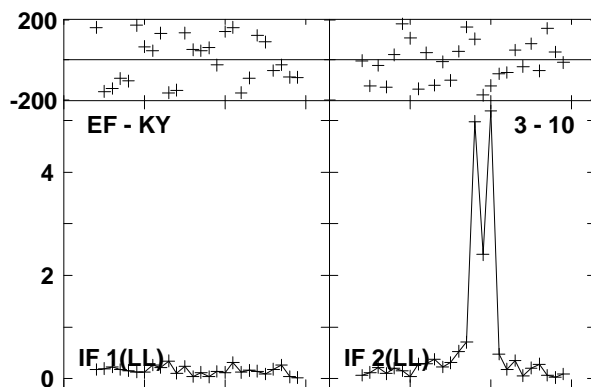
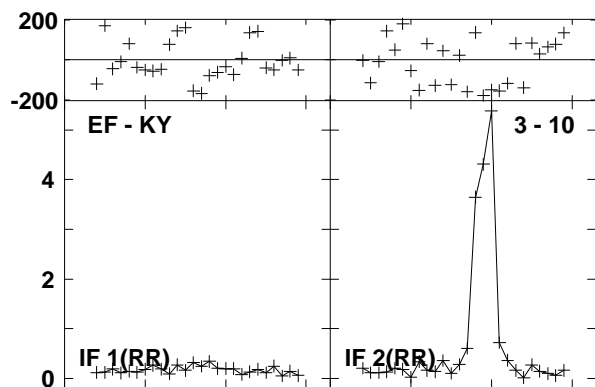
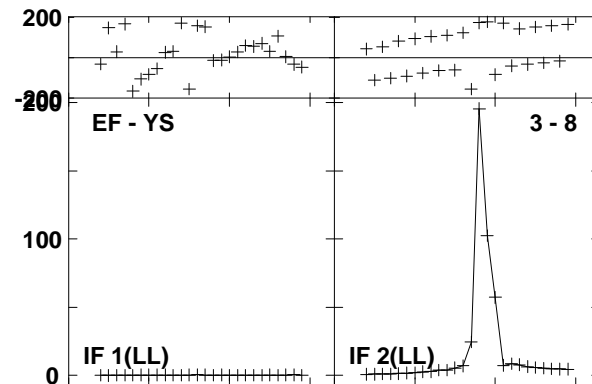
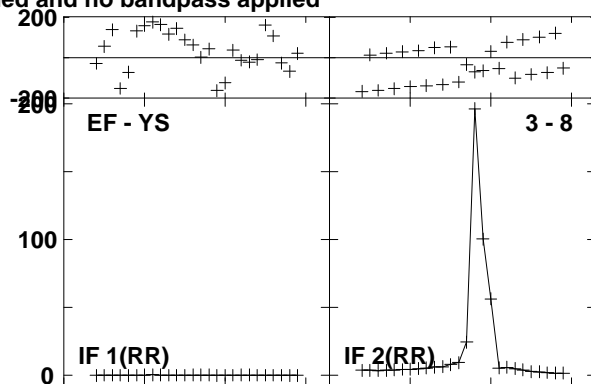
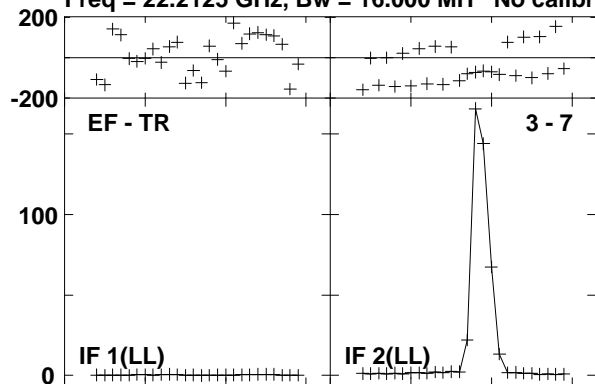

Lower frame: Milli Ampl Jy Top frame: Phas deg

Vector averaged cross-power spectrum Baseline: EF (03) - TR (07)

Timerange: 00/11:35:45 to 00/11:36:45

Plot file version 271 created 23-AUG-2016 15:00:51

W3IRS5 GA035B 1.UVDATA.1

Freq = 22.2125 GHz, Bw = 16.000 MH No calibration applied and no bandpass applied

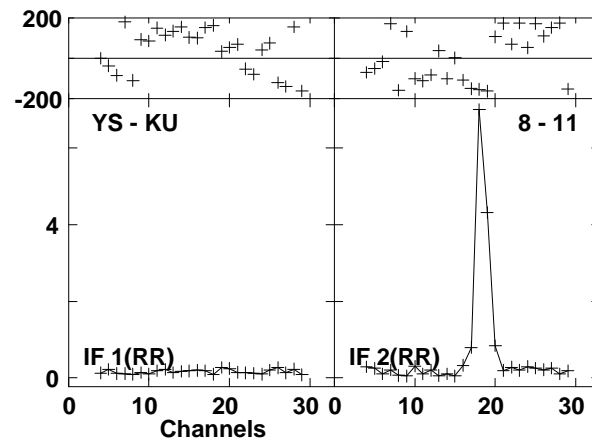
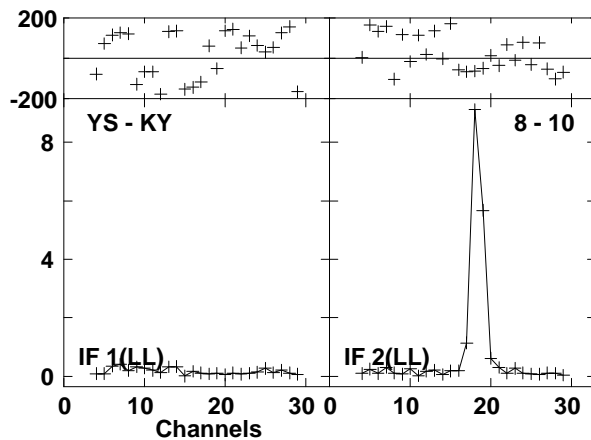
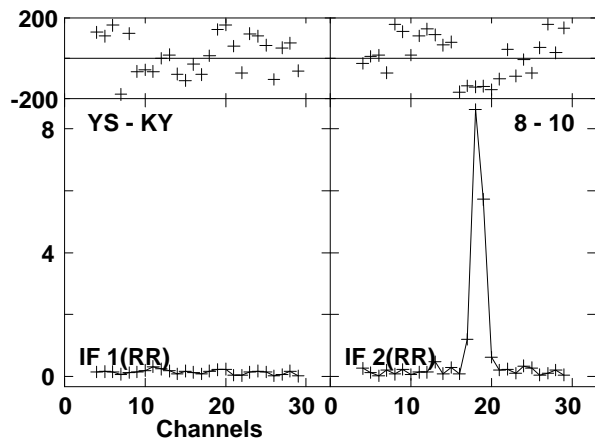
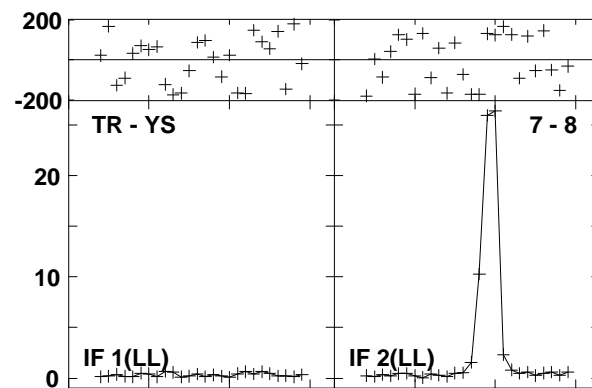
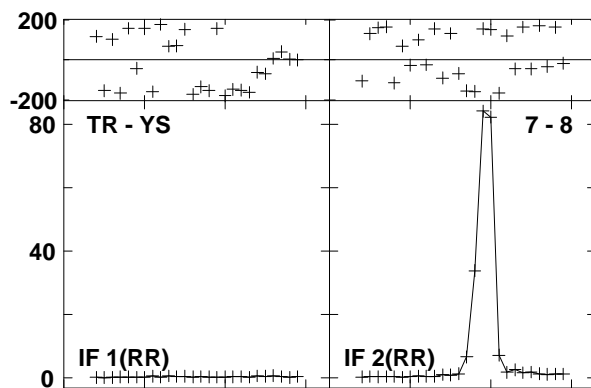
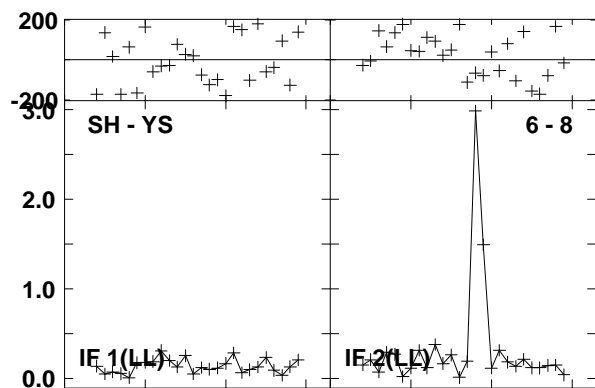
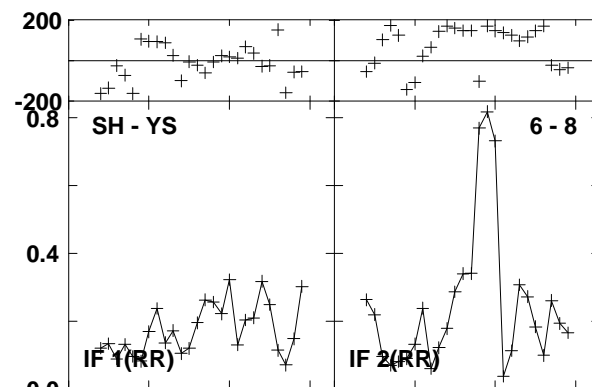
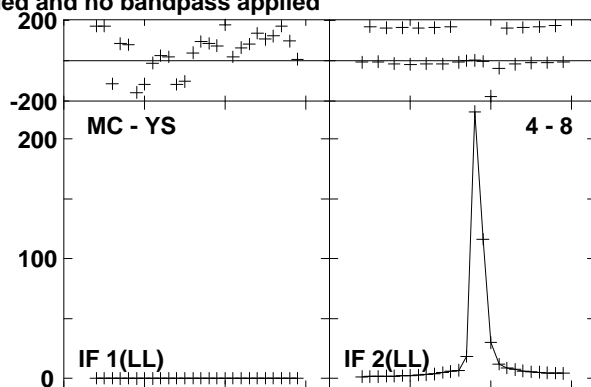
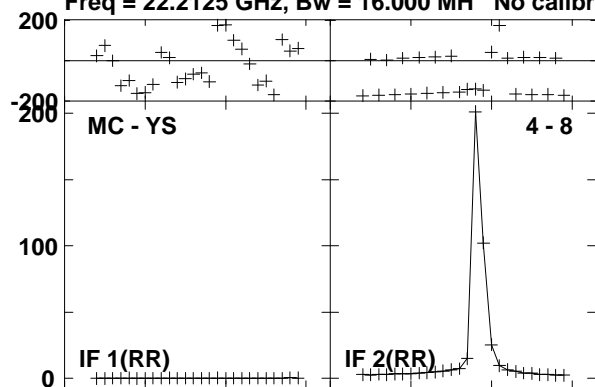

Lower frame: Milli Ampl Jy Top frame: Phas deg  
Vector averaged cross-power spectrum Baseline: MC (04) - YS (08)  
Timerange: 00/11:35:45 to 00/11:36:45

Plot file version 272 created 23-AUG-2016 15:00:51  
W3IRS5 GA035B 1.UVDATA.1

Freq = 22.2125 GHz, Bw = 16.000 MH No calibration applied and no bandpass applied

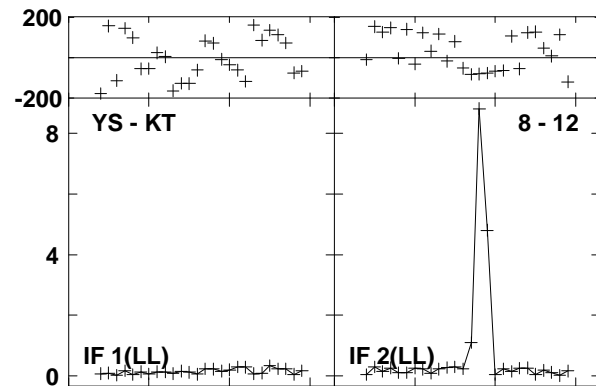
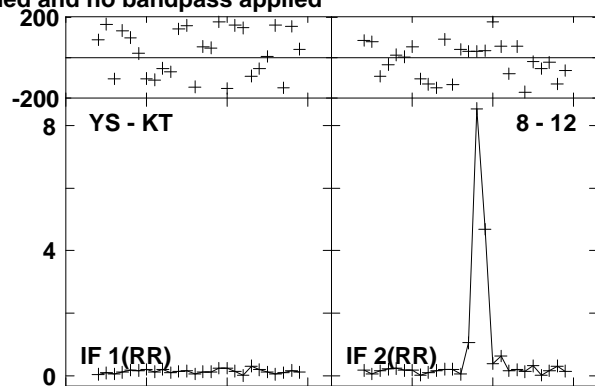
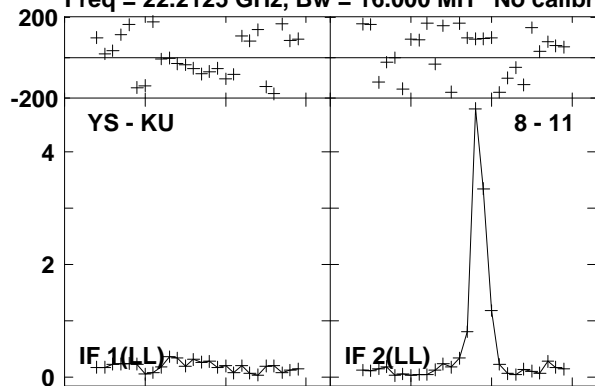

Lower frame: Milli Ampl Jy Top frame: Phas deg  
Vector averaged cross-power spectrum Baseline: YS (08) - KU (11)  
Timerange: 00/11:35:45 to 00/11:36:45



Plot file version 273 created 23-AUG-2016 15:00:51

0219+628 GA035B 1.UVDATA.1

Freq = 22.2125 GHz, Bw = 16.000 MH No calibration applied and no bandpass applied

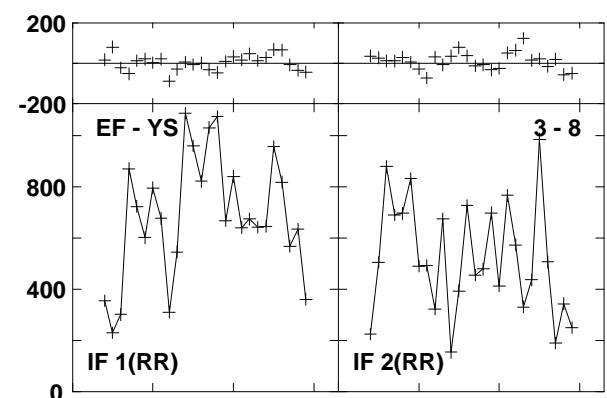
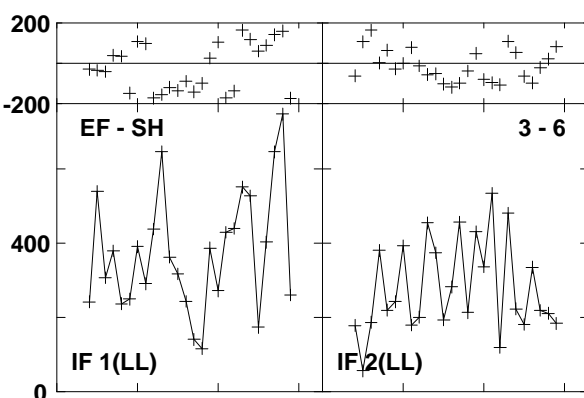
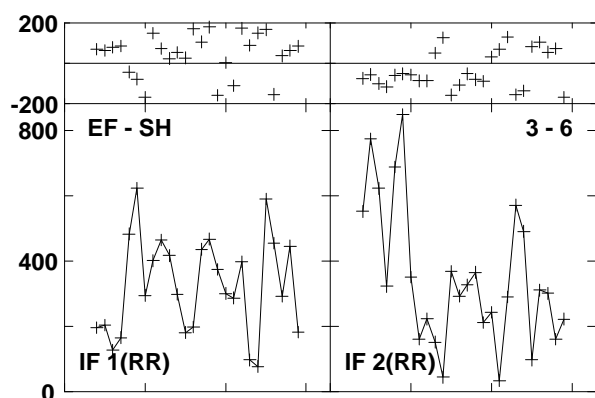
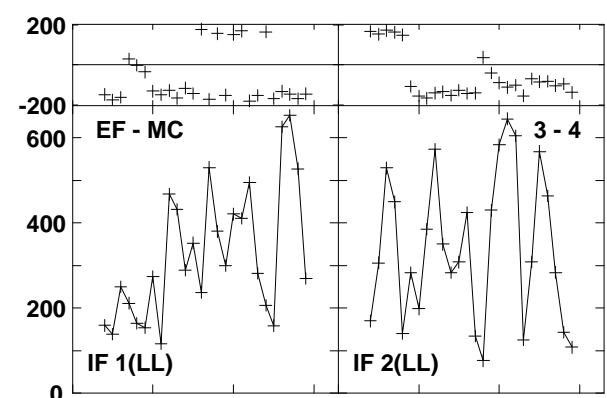
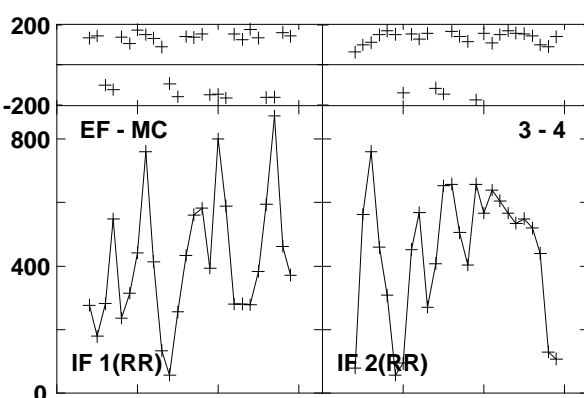
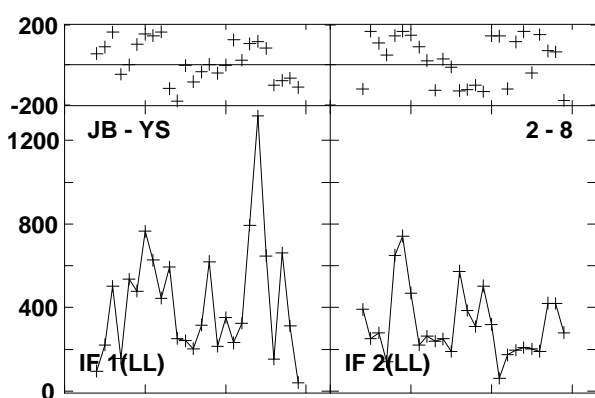
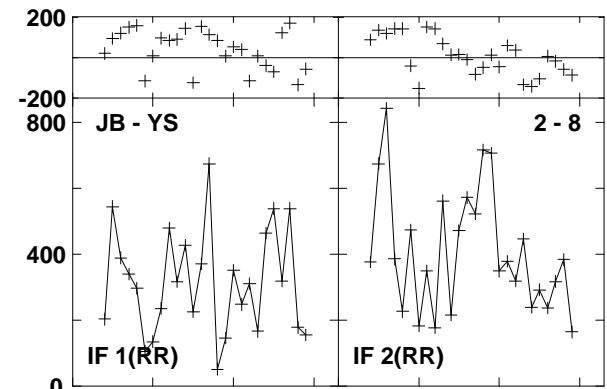
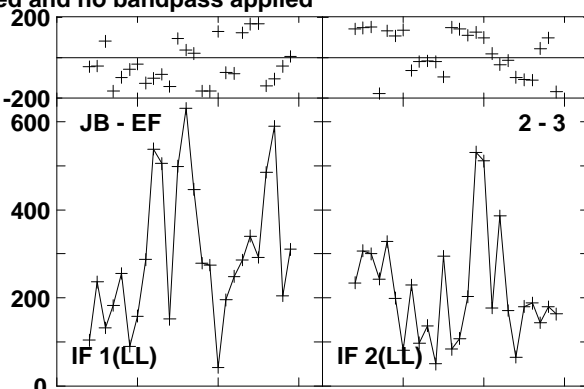
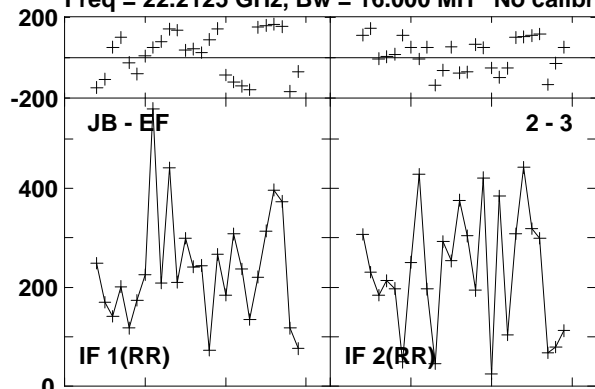

Lower frame: Micro Ampl Jy Top frame: Phas deg  
Vector averaged cross-power spectrum Baseline: JB (02) - EF (03)  
Timerange: 00/11:37:10 to 00/11:37:29

Plot file version 274 created 23-AUG-2016 15:00:51

0219+628 GA035B 1.UVDATA.1

Freq = 22.2125 GHz, Bw = 16.000 MH No calibration applied and no bandpass applied

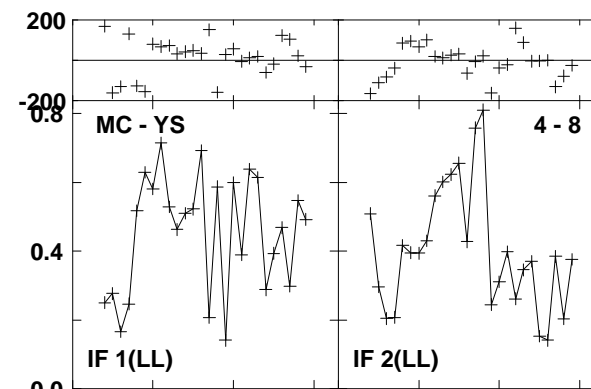
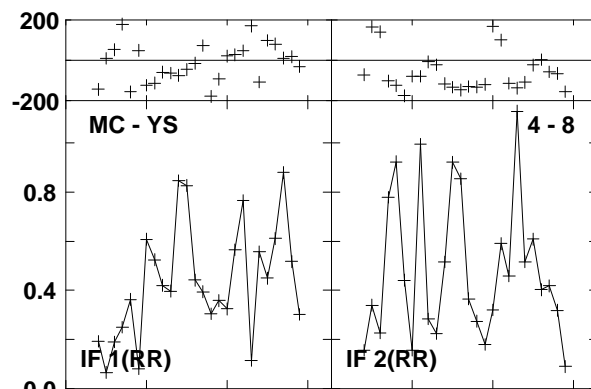
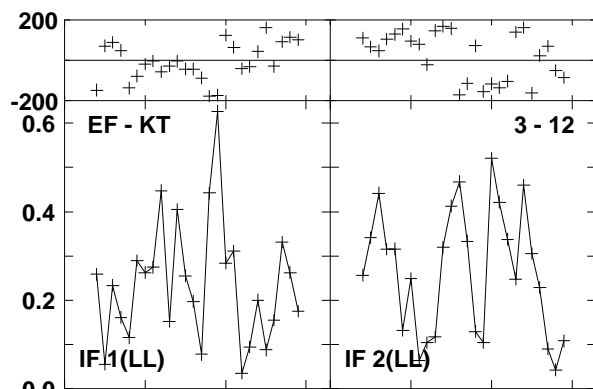
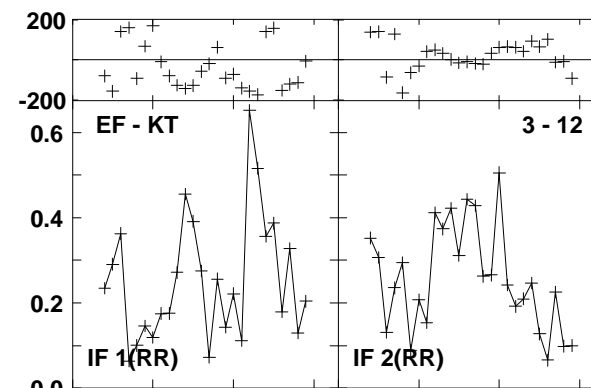
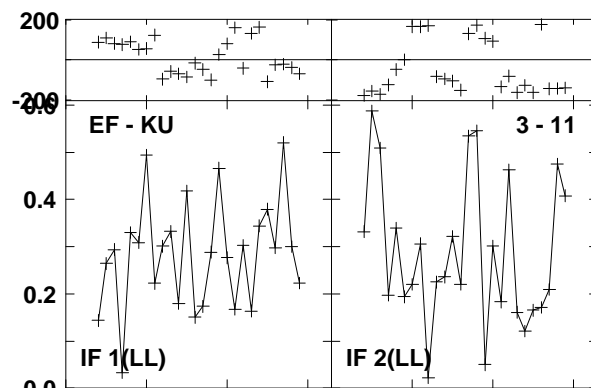
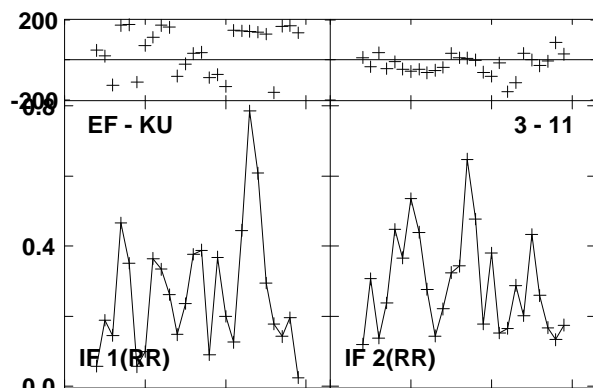
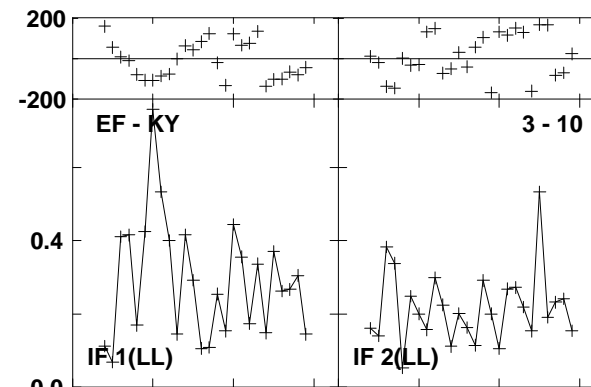
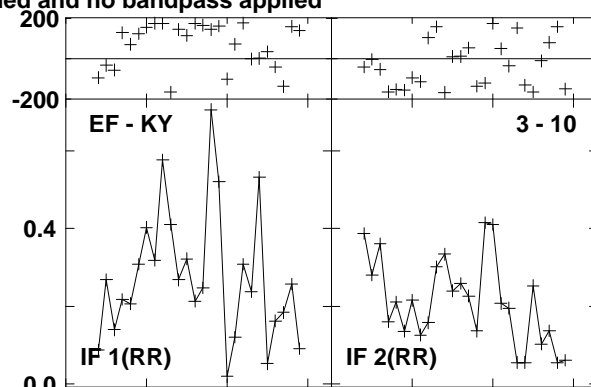
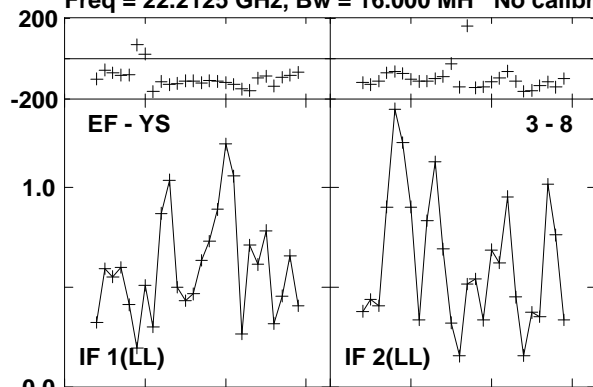

Lower frame: Milli Ampl Jy Top frame: Phas deg  
Vector averaged cross-power spectrum Baseline: EF (03) - YS (08)  
Timerange: 00/11:37:10 to 00/11:37:29

Plot file version 275 created 23-AUG-2016 15:00:51

0219+628 GA035B 1.UVDATA.1

Freq = 22.2125 GHz, Bw = 16.000 MH No calibration applied and no bandpass applied

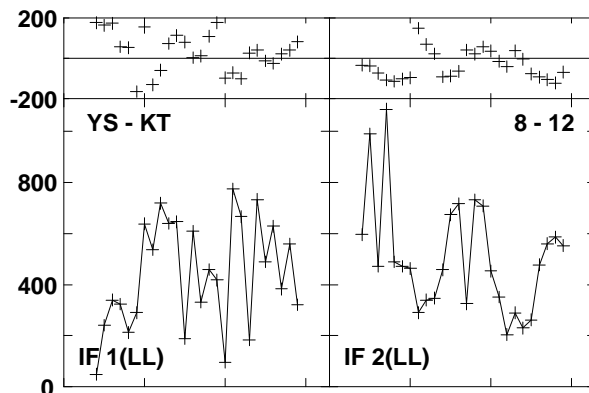
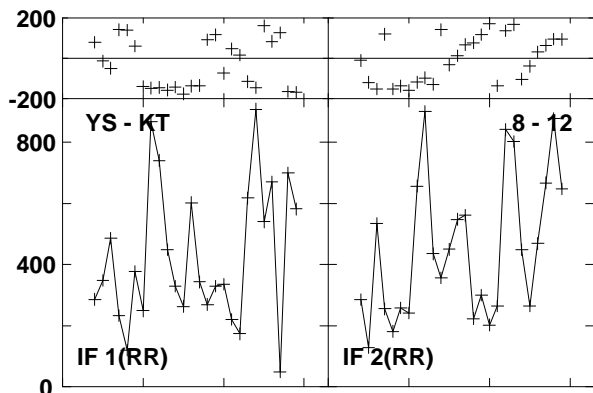
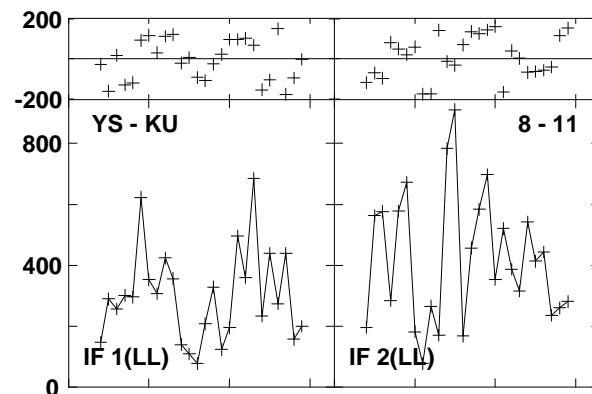
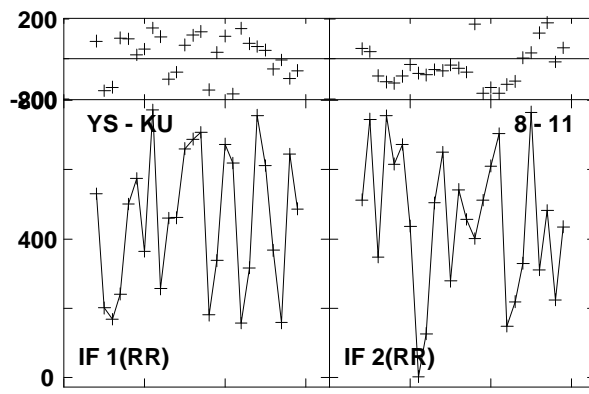
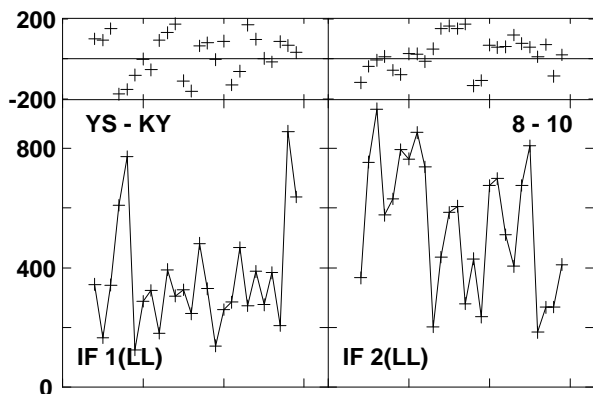
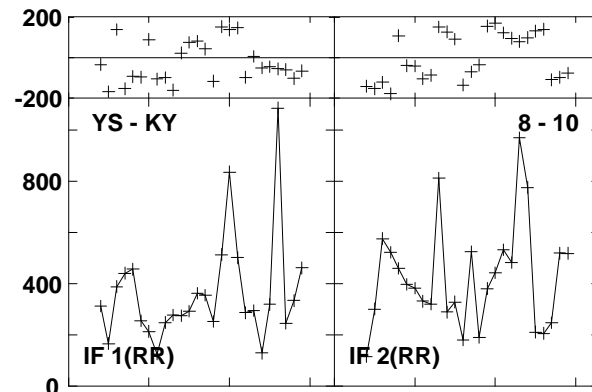
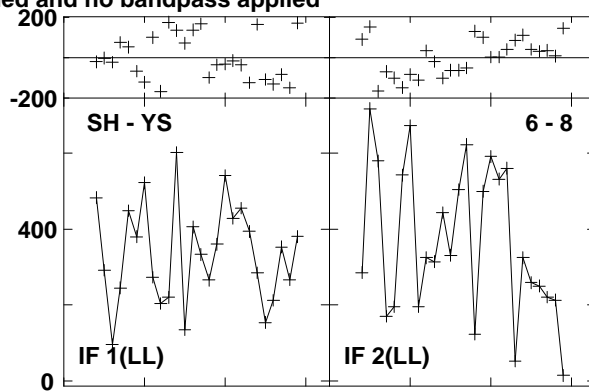
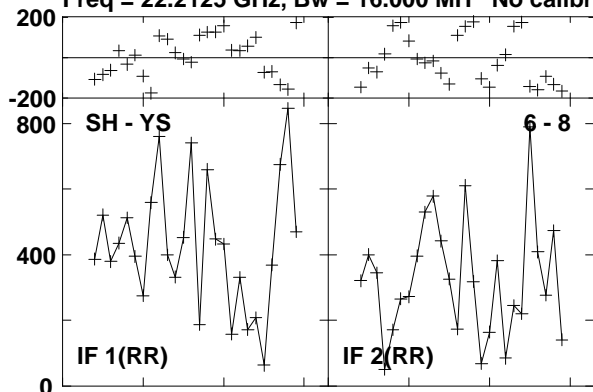

Lower frame: Micro Ampl Jy Top frame: Phas deg  
Vector averaged cross-power spectrum Baseline: SH (06) - YS (08)  
Timerange: 00/11:37:10 to 00/11:37:29

Plot file version 276 created 23-AUG-2016 15:00:51

W3IRS5 GA035B 1.UVDATA.1

Freq = 22.2125 GHz, Bw = 16.000 MH No calibration applied and no bandpass applied

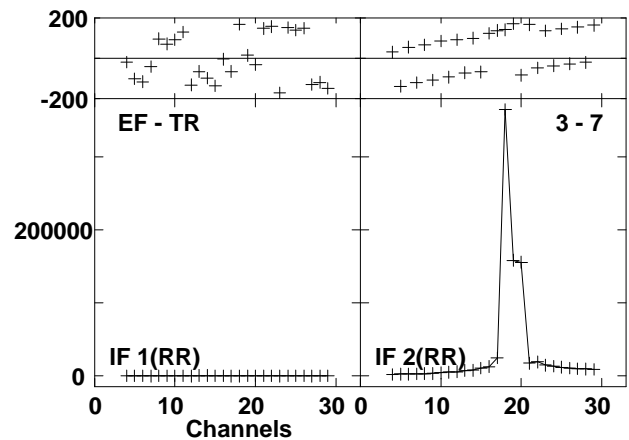
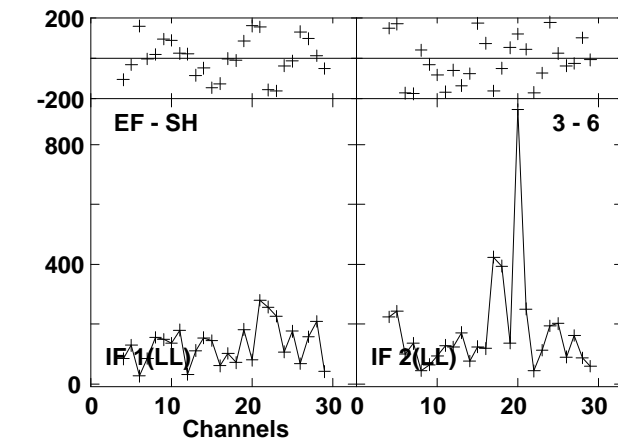
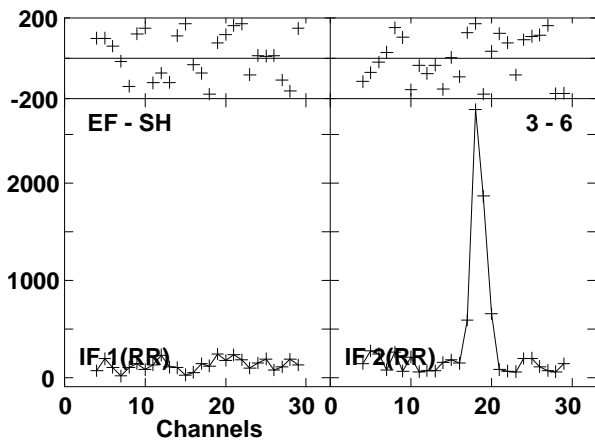
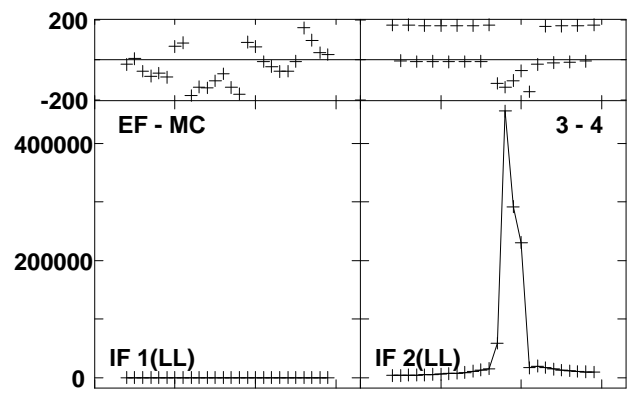
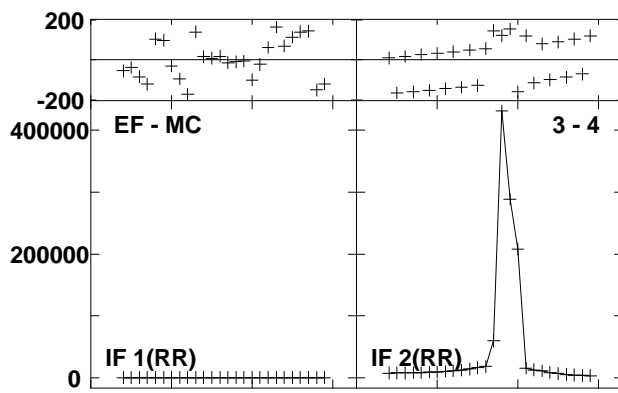
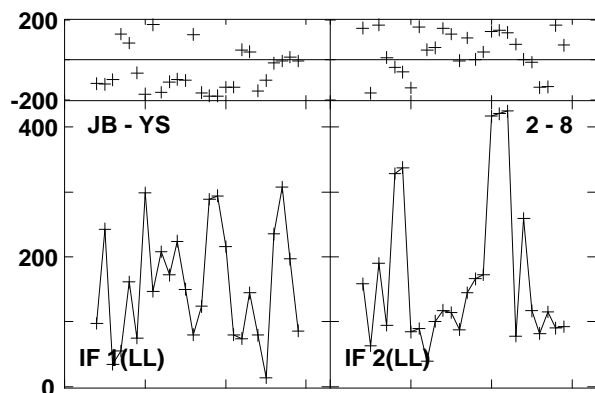
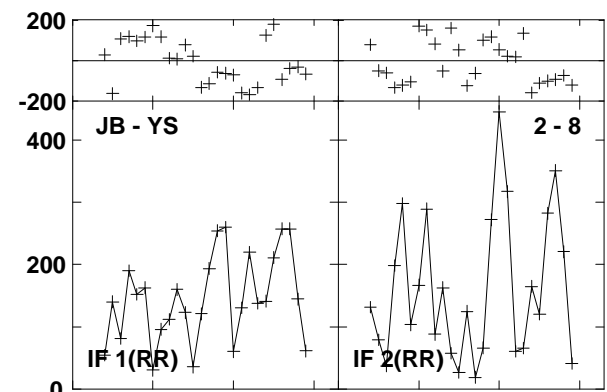
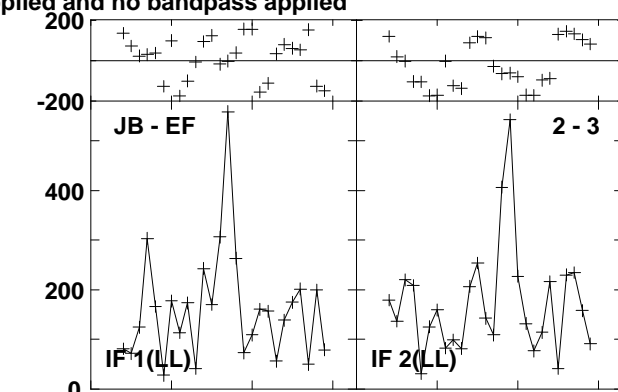
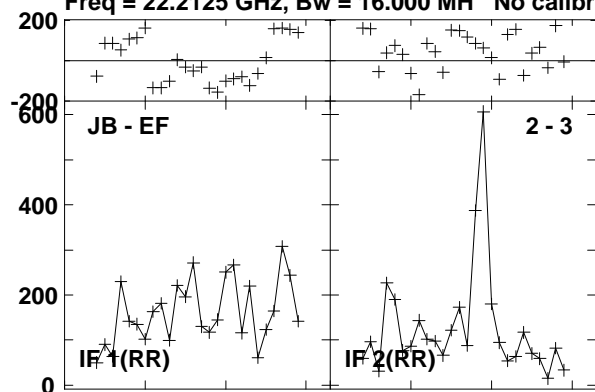

Lower frame: Micro Ampl Jy Top frame: Phas deg  
Vector averaged cross-power spectrum Baseline: JB (02) - EF (03)  
Timerange: 00/11:37:55 to 00/11:38:55

Plot file version 277 created 23-AUG-2016 15:00:51

W3IRS5 GA035B 1.UVDATA.1

Freq = 22.2125 GHz, Bw = 16.000 MH No calibration applied and no bandpass applied

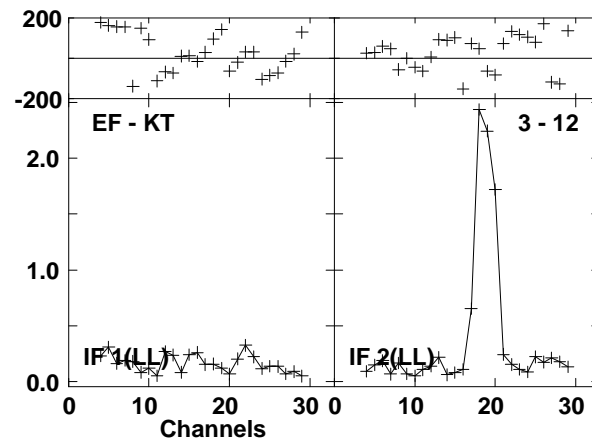
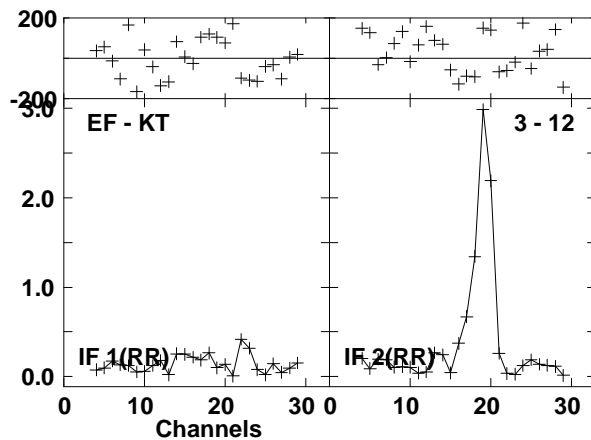
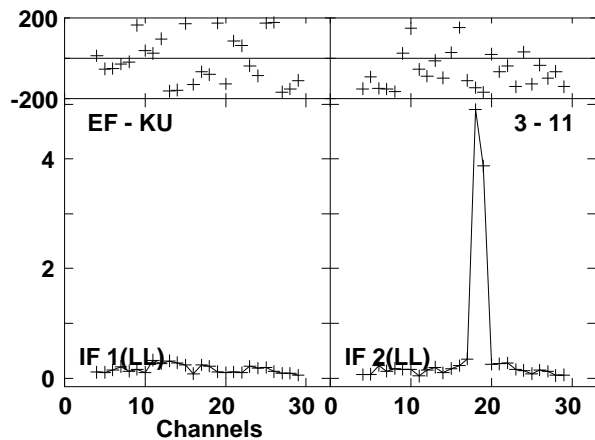
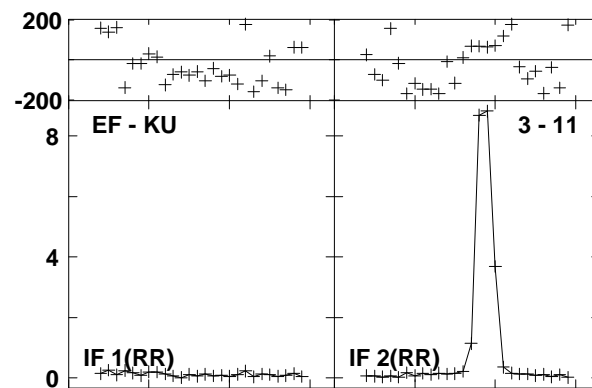
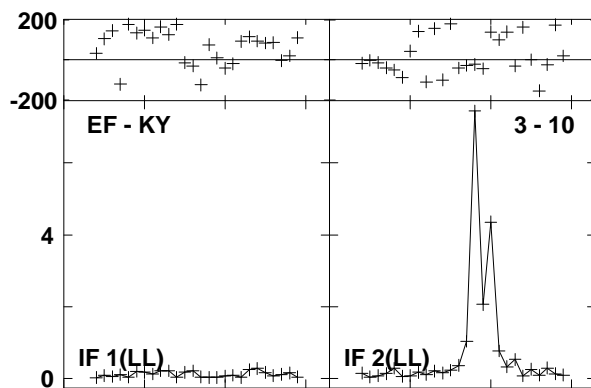
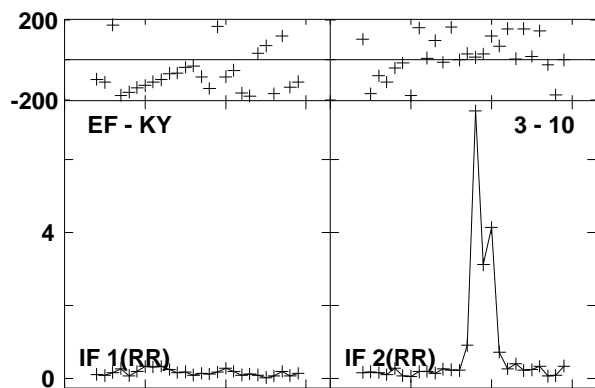
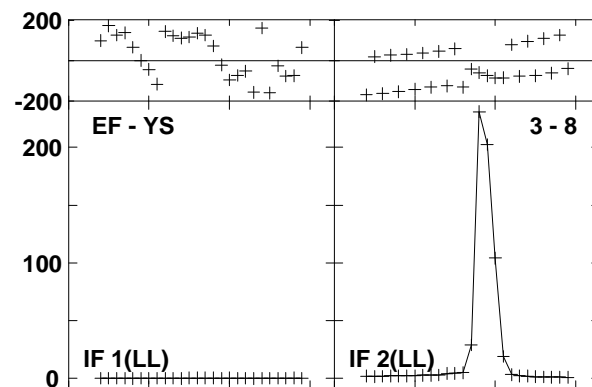
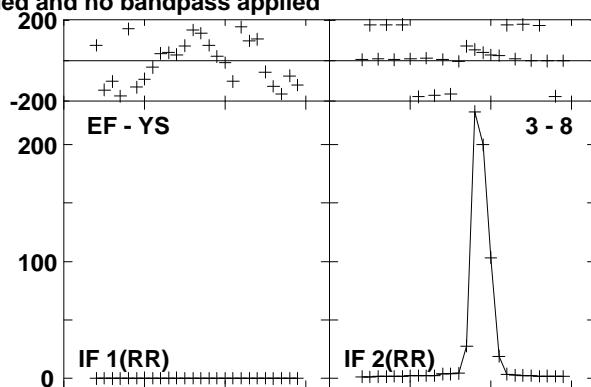
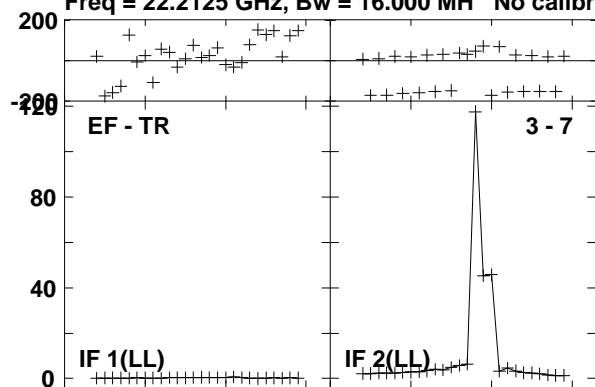

Lower frame: Milli Ampl Jy Top frame: Phas deg  
Vector averaged cross-power spectrum Baseline: EF (03) - TR (07)  
Timerange: 00/11:37:55 to 00/11:38:55

Plot file version 278 created 23-AUG-2016 15:00:51

W3IRS5 GA035B 1.UVDATA.1

Freq = 22.2125 GHz, Bw = 16.000 MH No calibration applied and no bandpass applied

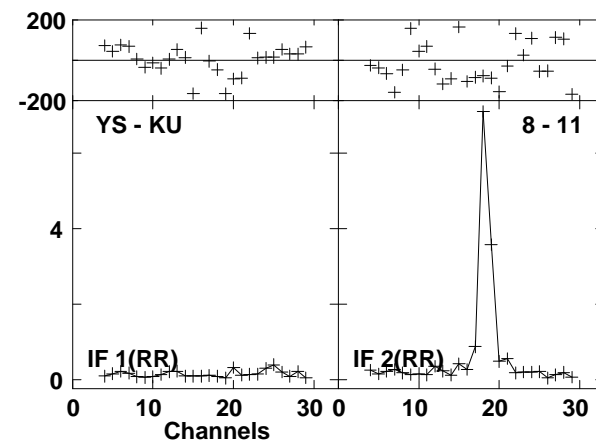
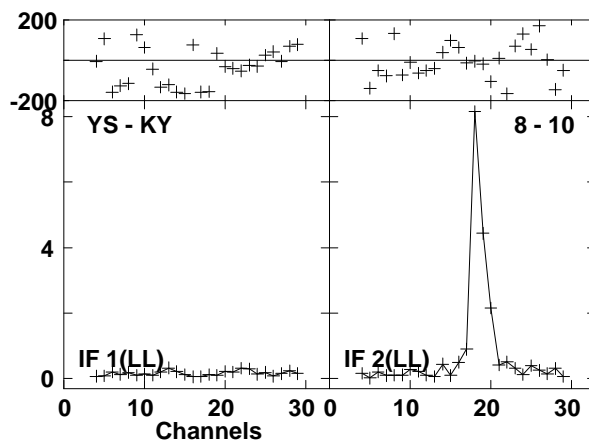
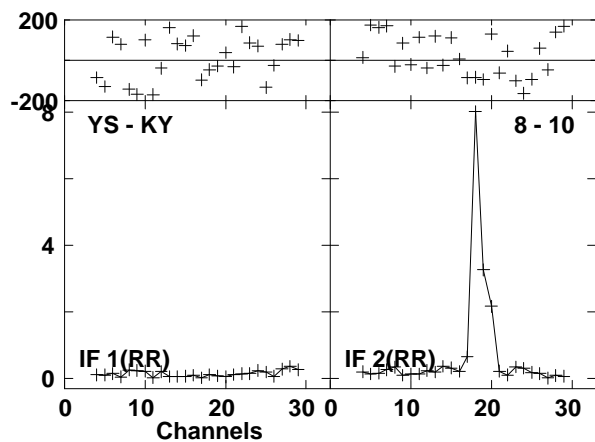
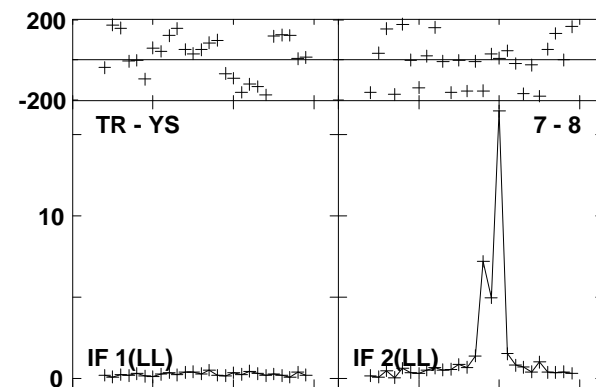
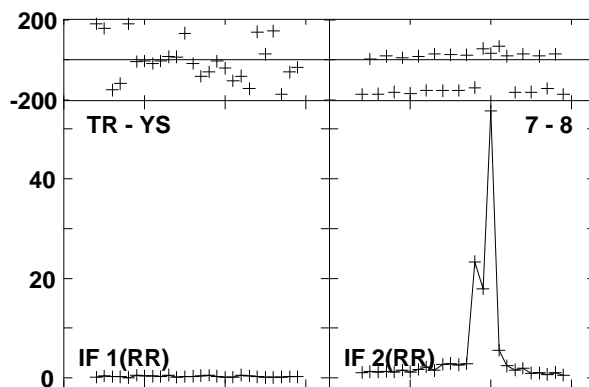
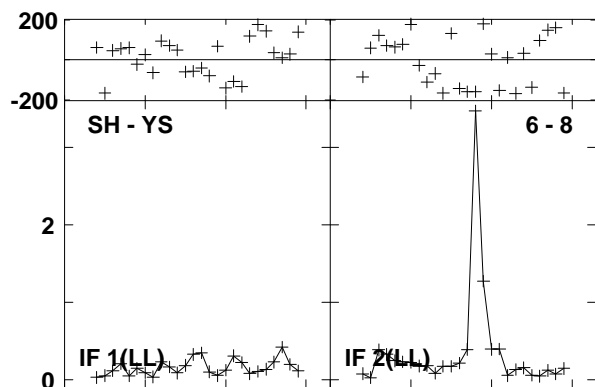
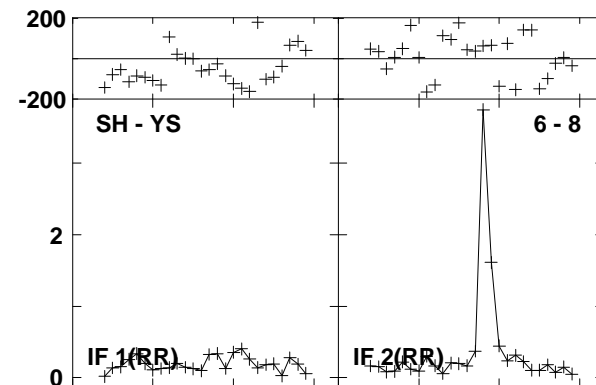
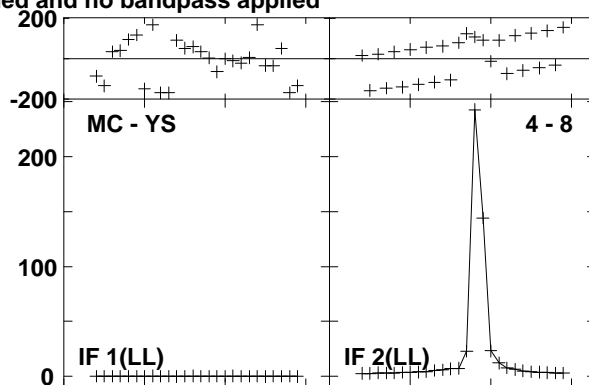
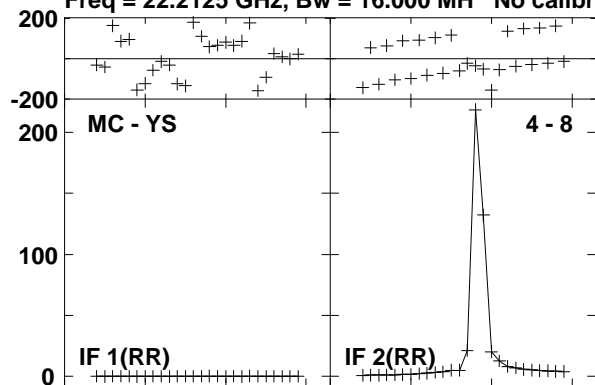

Lower frame: Milli Ampl Jy Top frame: Phas deg  
Vector averaged cross-power spectrum Baseline: MC (04) - YS (08)  
Timerange: 00/11:37:55 to 00/11:38:55

Plot file version 279 created 23-AUG-2016 15:00:51  
W3IRS5 GA035B 1.UVDATA.1

Freq = 22.2125 GHz, Bw = 16.000 MH No calibration applied and no bandpass applied

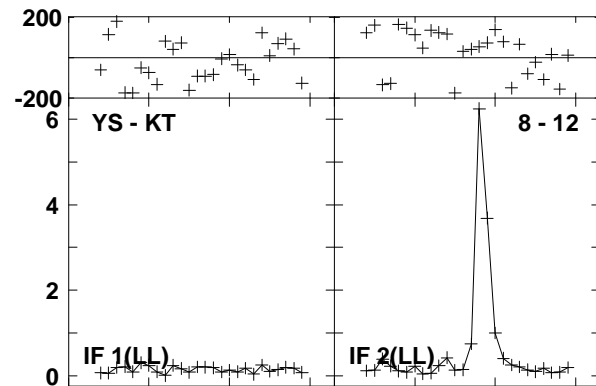
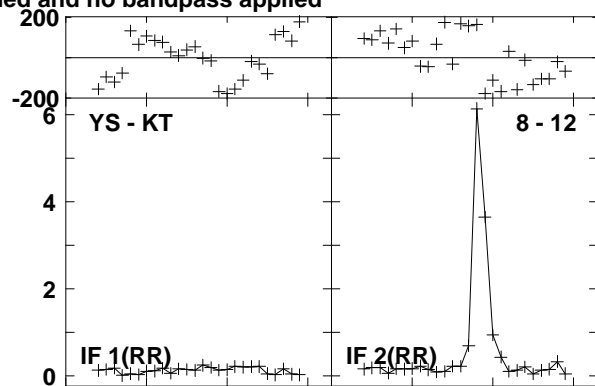
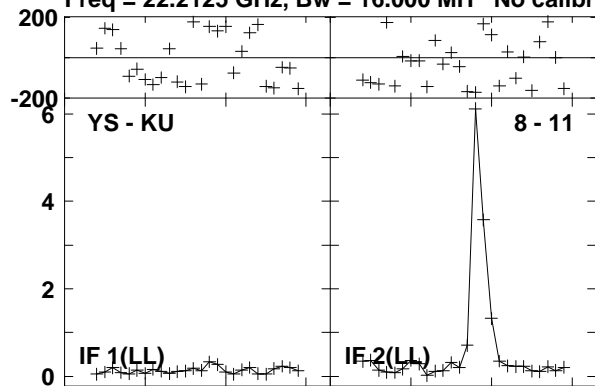

Lower frame: Milli Ampl Jy Top frame: Phas deg  
Vector averaged cross-power spectrum Baseline: YS (08) - KU (11)  
Timerange: 00/11:37:55 to 00/11:38:55

Plot file version 280 created 23-AUG-2016 15:00:51

0219+628 GA035B 1.UVDATA.1

Freq = 22.2125 GHz, Bw = 16.000 MH No calibration applied and no bandpass applied

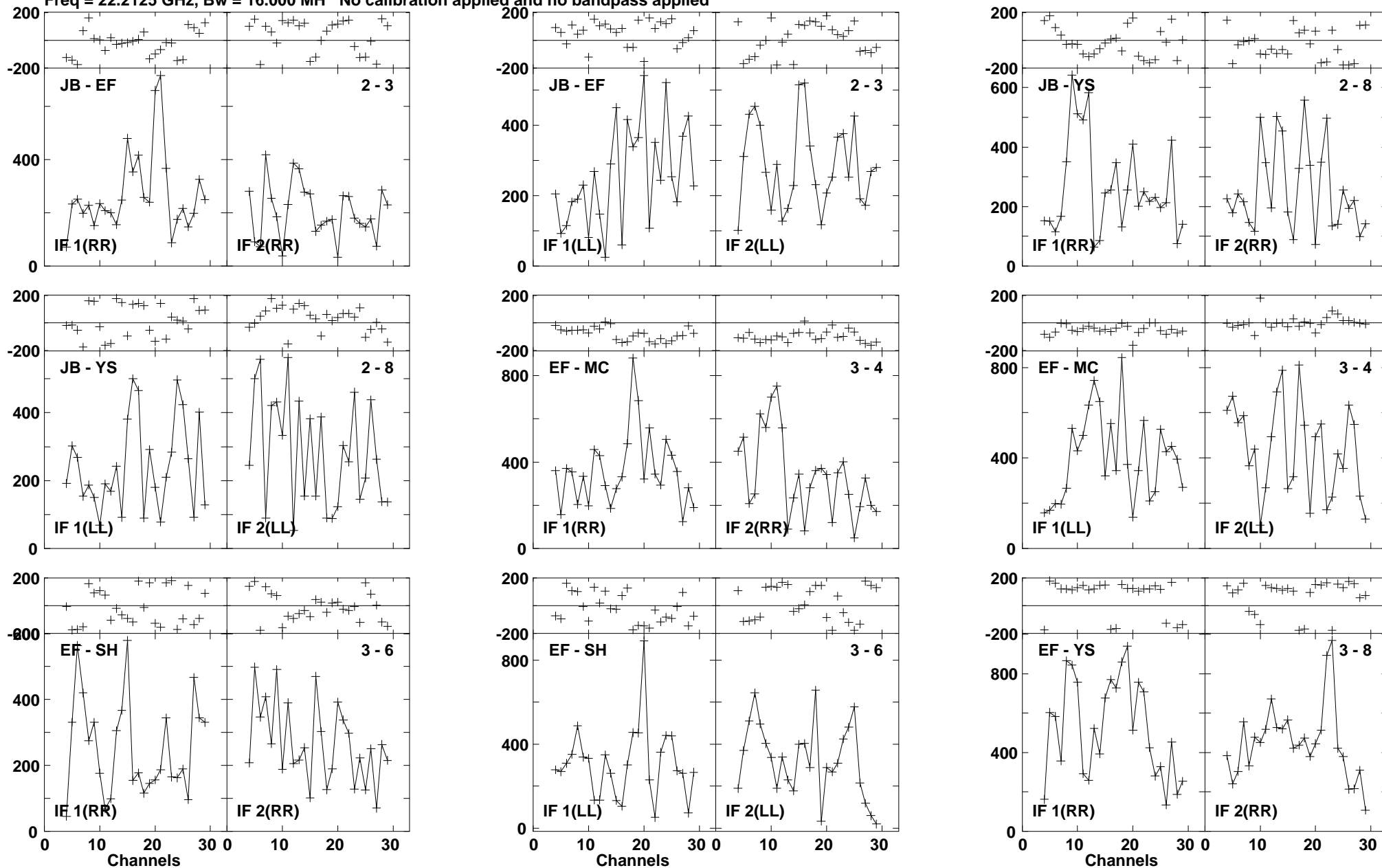

Lower frame: Micro Ampl Jy Top frame: Phas deg  
Vector averaged cross-power spectrum Baseline: JB (02) - EF (03)  
Timerange: 00/11:39:21 to 00/11:39:40



Plot file version 281 created 23-AUG-2016 15:00:51  
 0219+628 GA035B 1.UVDATA.1

Freq = 22.2125 GHz, Bw = 16.000 MH No calibration applied and no bandpass applied

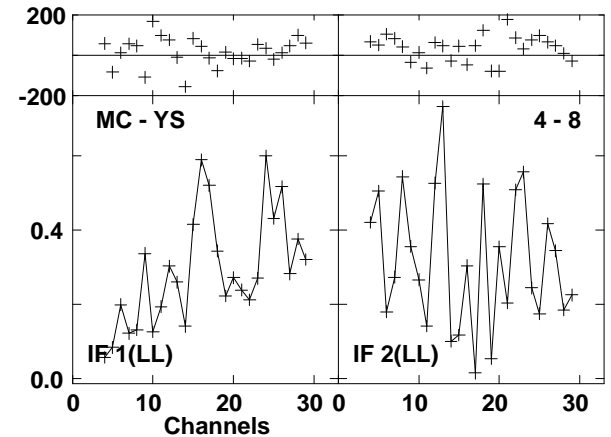
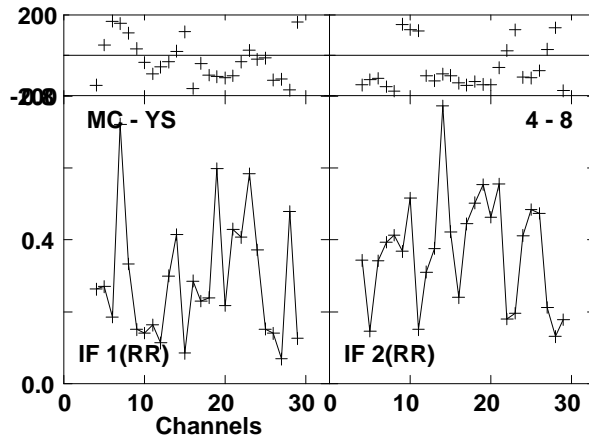
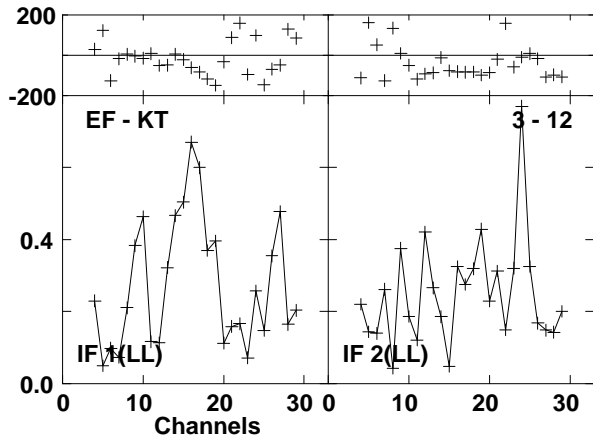
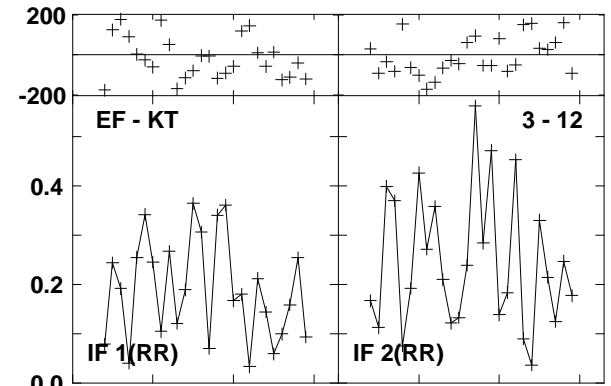
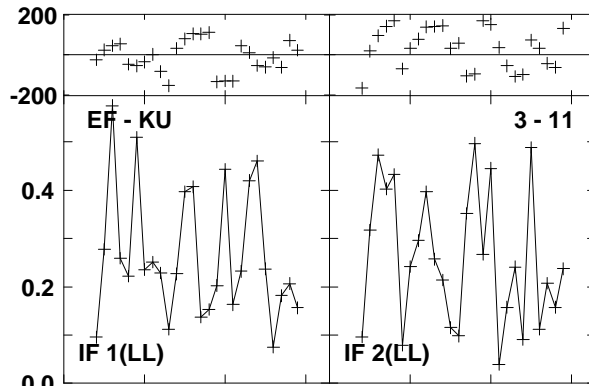
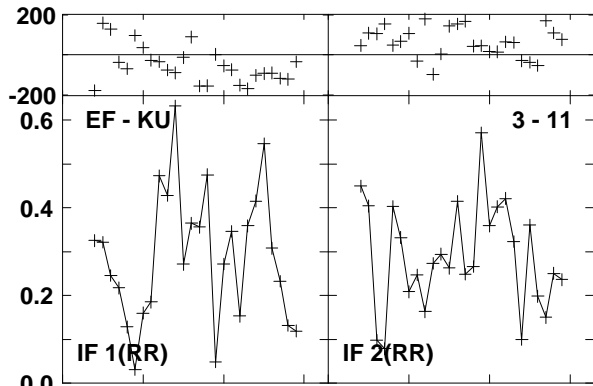
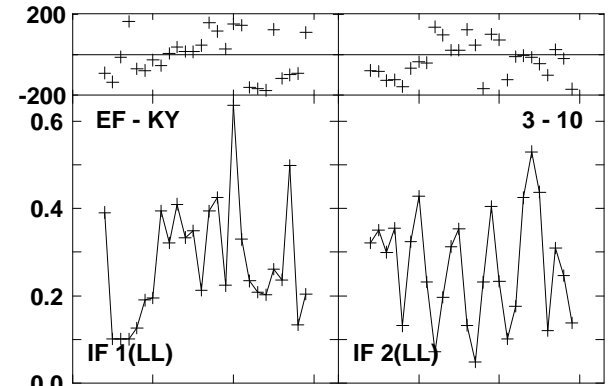
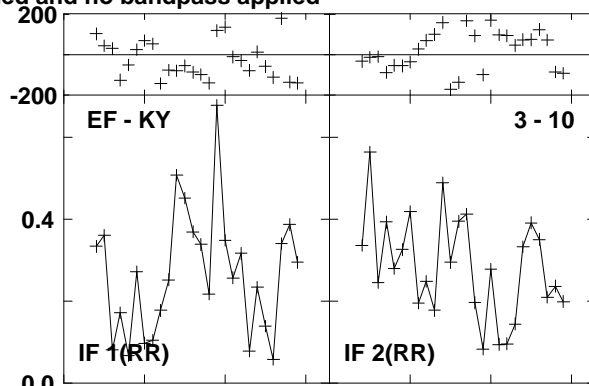
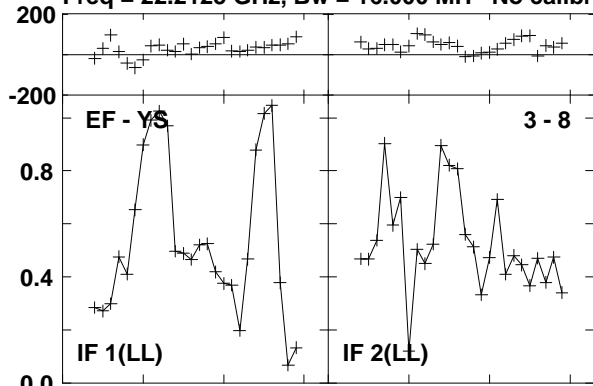

Lower frame: Milli Ampl Jy Top frame: Phas deg  
 Vector averaged cross-power spectrum Baseline: EF (03) - YS (08)  
 Timerange: 00/11:39:21 to 00/11:39:40

Plot file version 282 created 23-AUG-2016 15:00:51

0219+628 GA035B 1.UVDATA.1

Freq = 22.2125 GHz, Bw = 16.000 MH No calibration applied and no bandpass applied

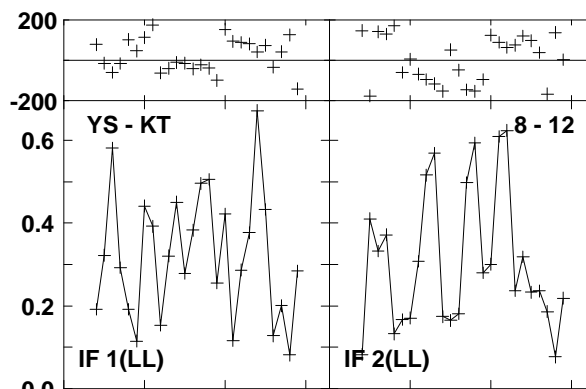
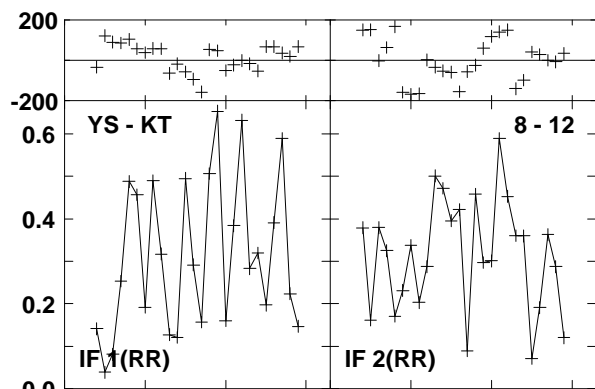
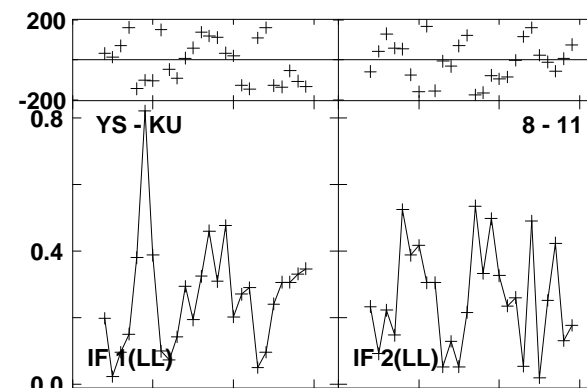
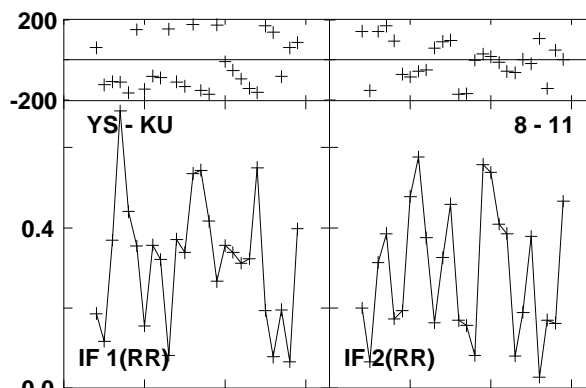
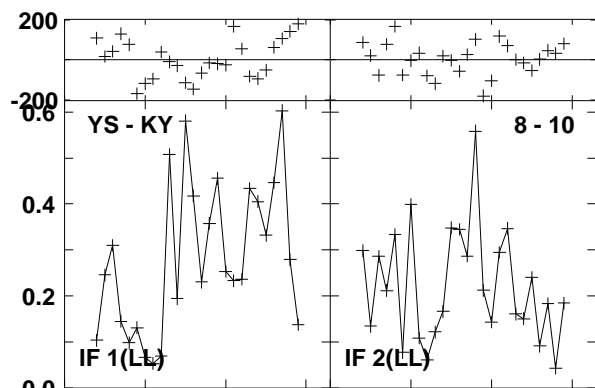
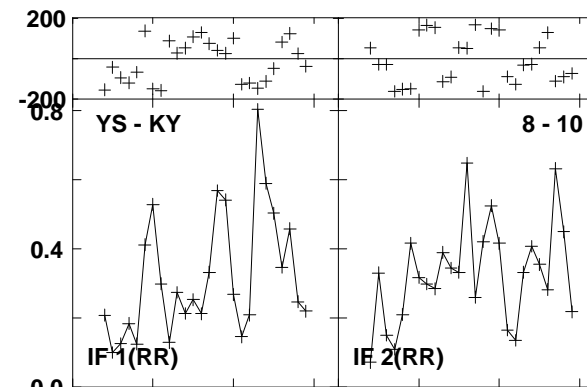
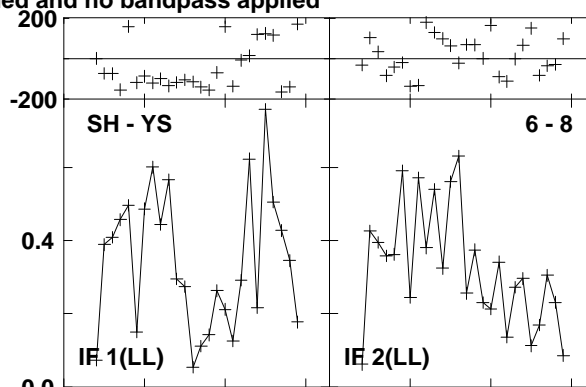
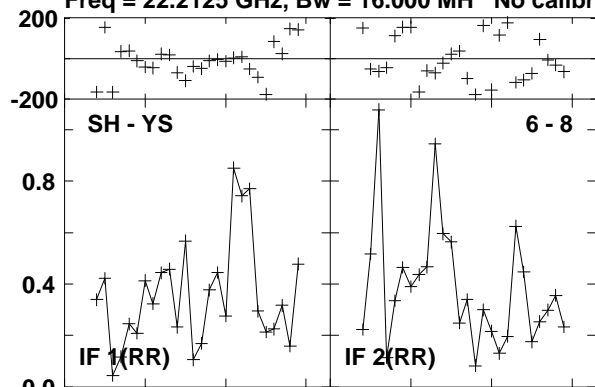

Lower frame: Milli Ampl Jy Top frame: Phas deg

Vector averaged cross-power spectrum Baseline: SH (06) - YS (08)

Timerange: 00/11:39:21 to 00/11:39:40

Plot file version 283 created 23-AUG-2016 15:00:51

W3IRS5 GA035B 1.UVDATA.1

Freq = 22.2125 GHz, Bw = 16.000 MH No calibration applied and no bandpass applied

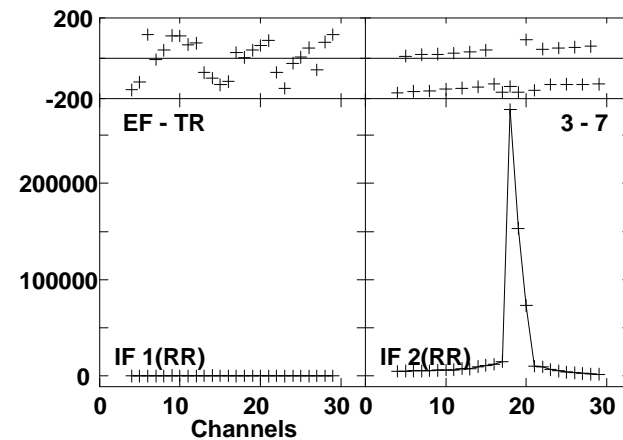
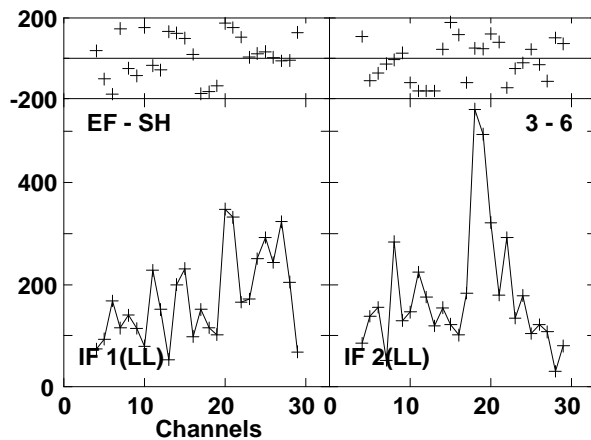
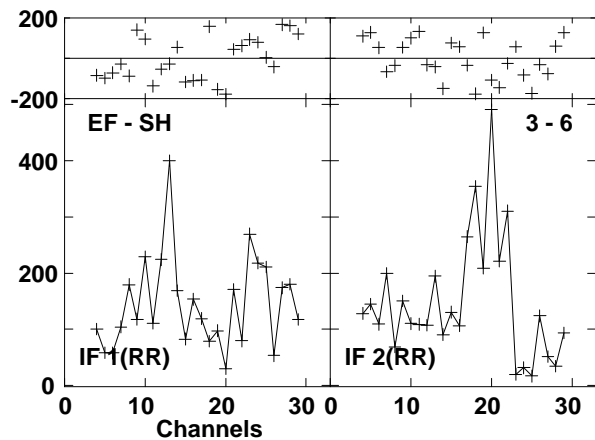
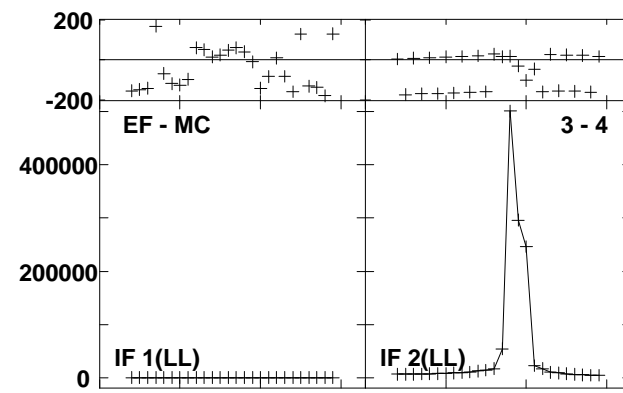
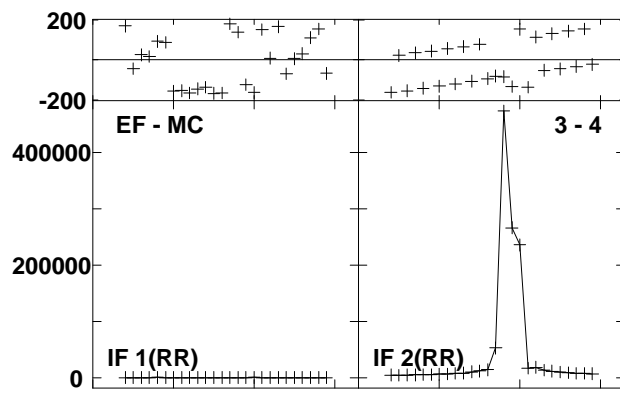
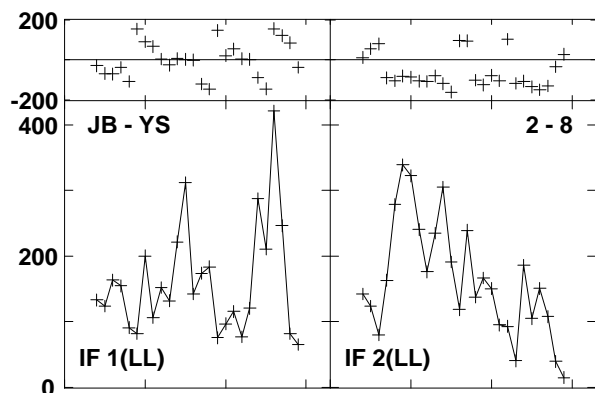
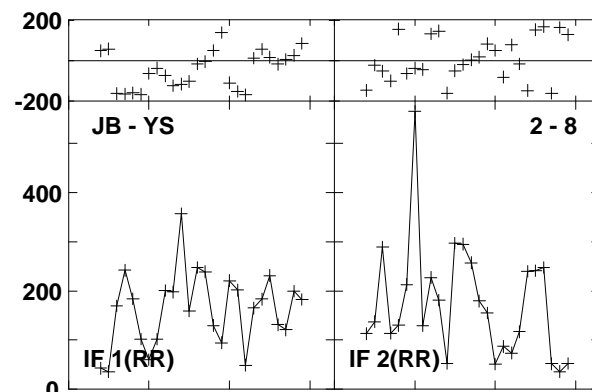
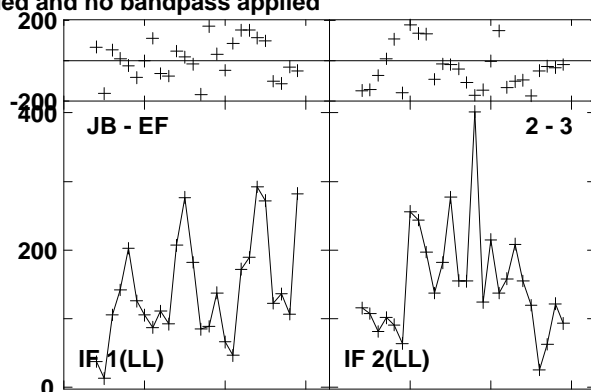
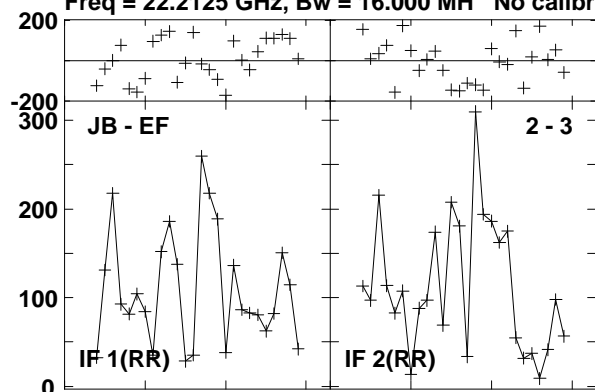

Lower frame: Micro Ampl Jy Top frame: Phas deg  
Vector averaged cross-power spectrum Baseline: JB (02) - EF (03)  
Timerange: 00/11:40:05 to 00/11:41:05

Plot file version 284 created 23-AUG-2016 15:00:51

W3IRS5 GA035B 1.UVDATA.1

Freq = 22.2125 GHz, Bw = 16.000 MH No calibration applied and no bandpass applied

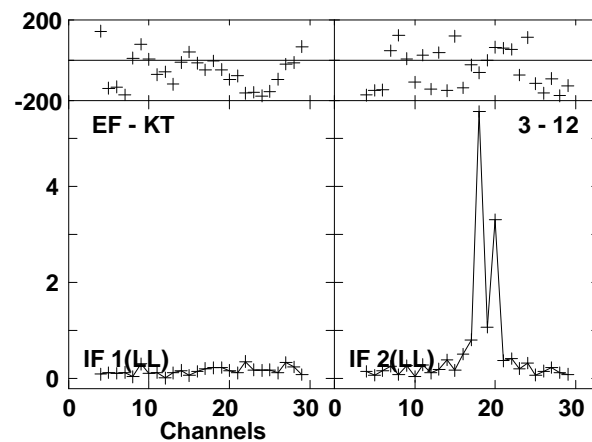
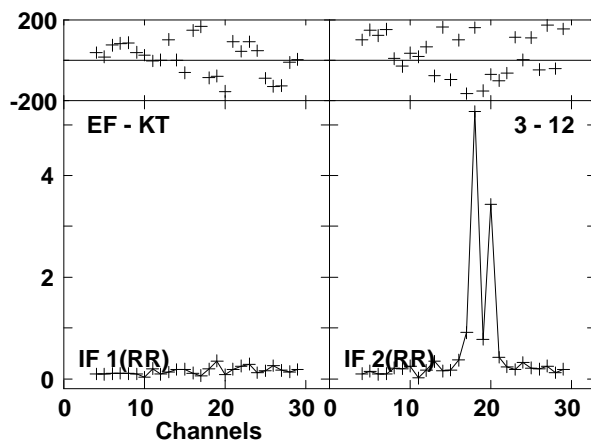
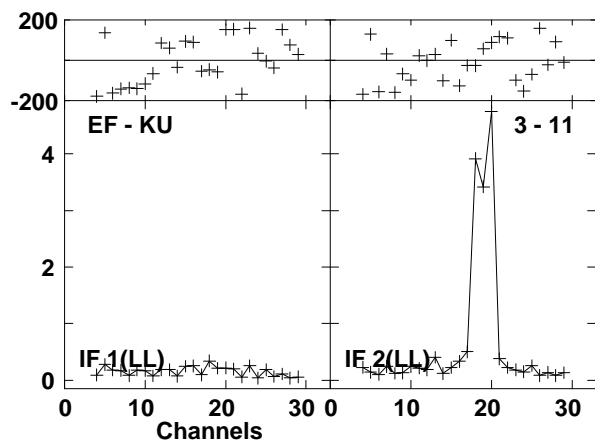
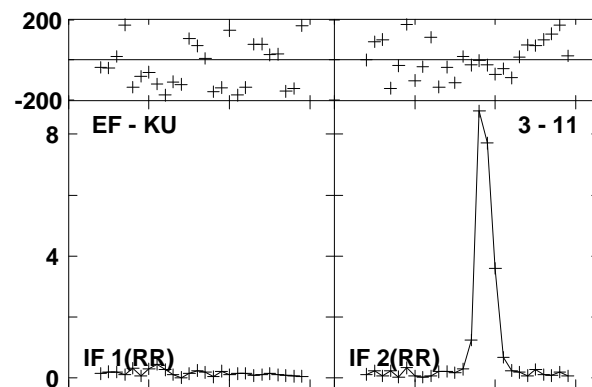
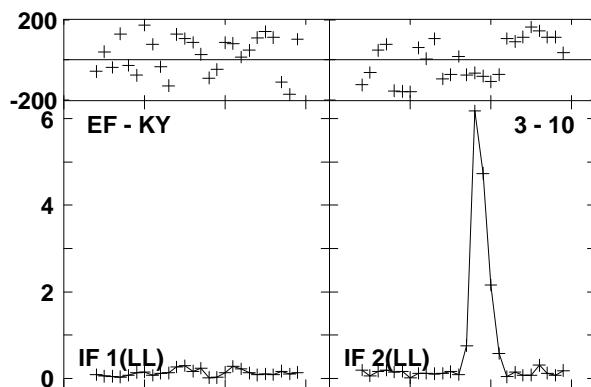
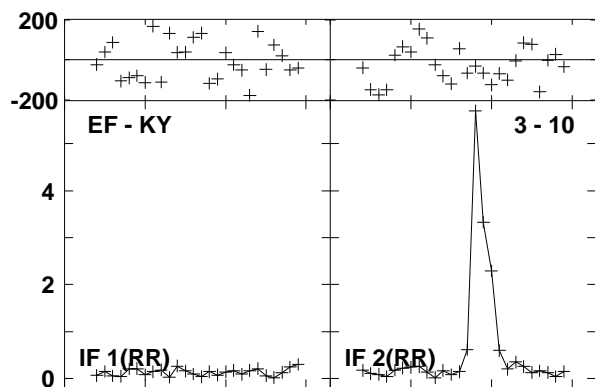
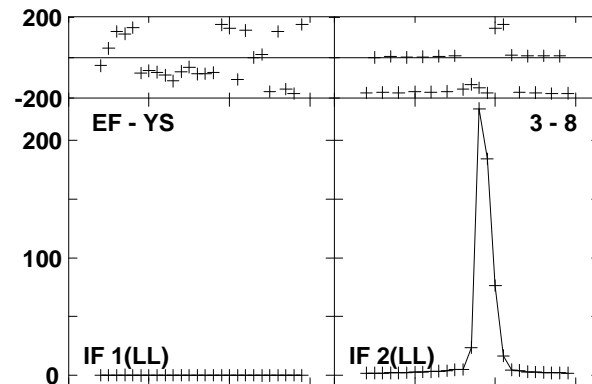
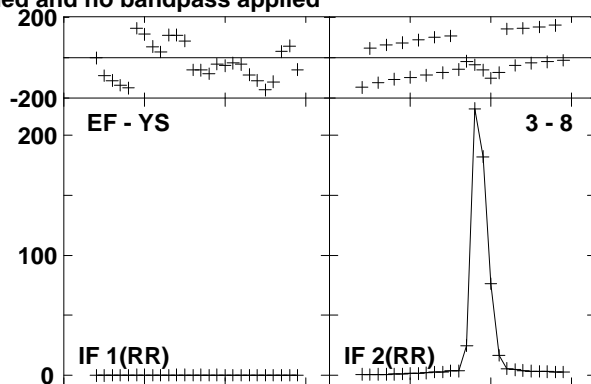
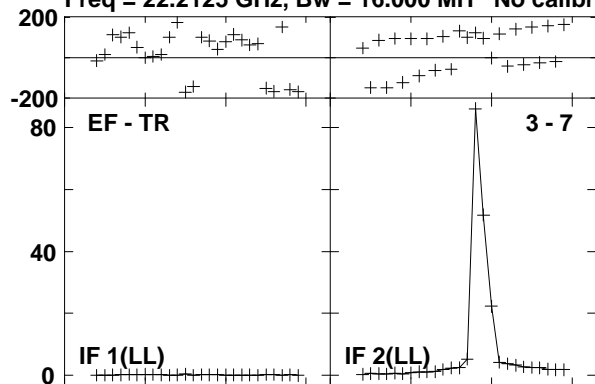

Lower frame: Milli Ampl Jy Top frame: Phas deg  
Vector averaged cross-power spectrum Baseline: EF (03) - TR (07)  
Timerange: 00/11:40:05 to 00/11:41:05

Plot file version 285 created 23-AUG-2016 15:00:51

W3IRS5 GA035B 1.UVDATA.1

Freq = 22.2125 GHz, Bw = 16.000 MH No calibration applied and no bandpass applied

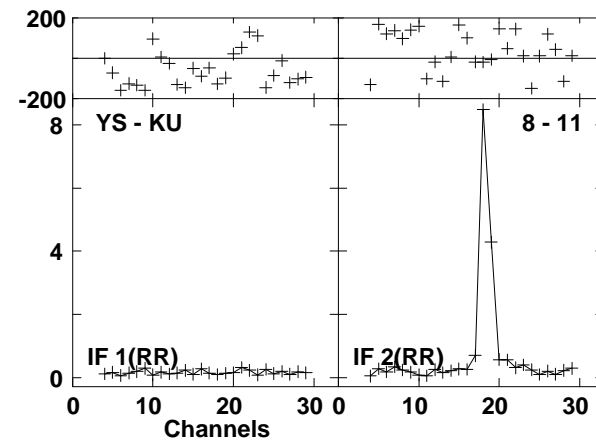
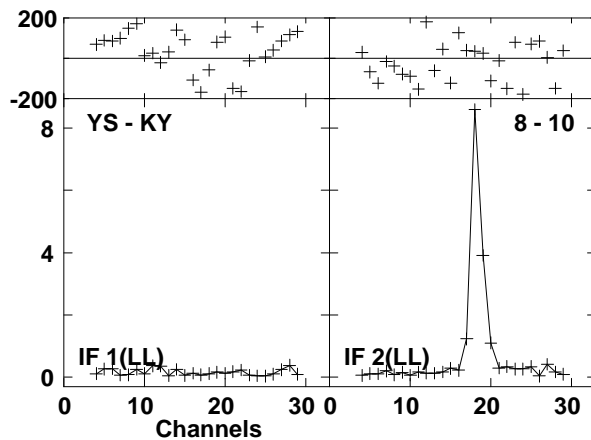
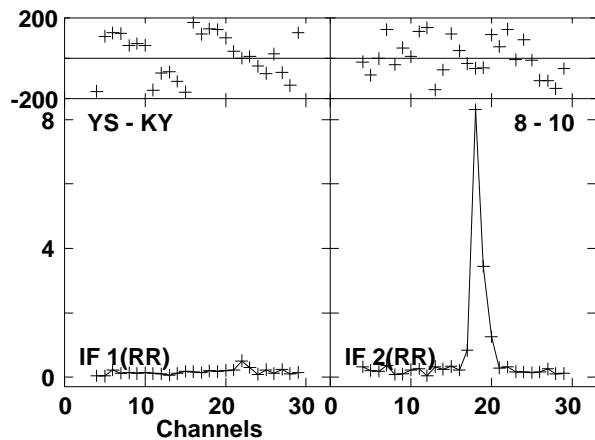
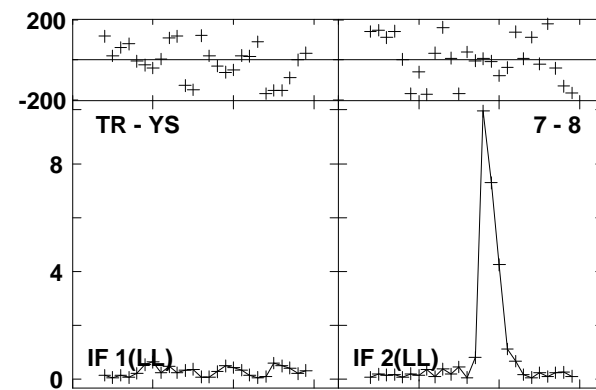
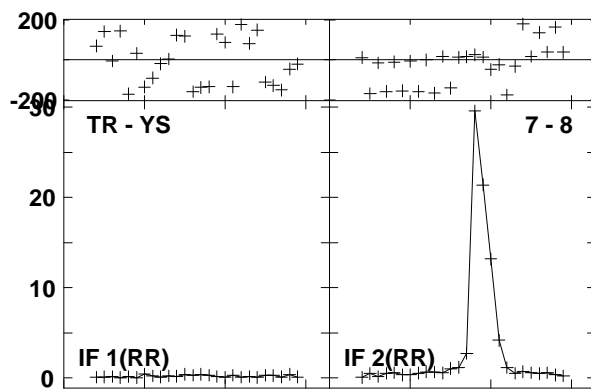
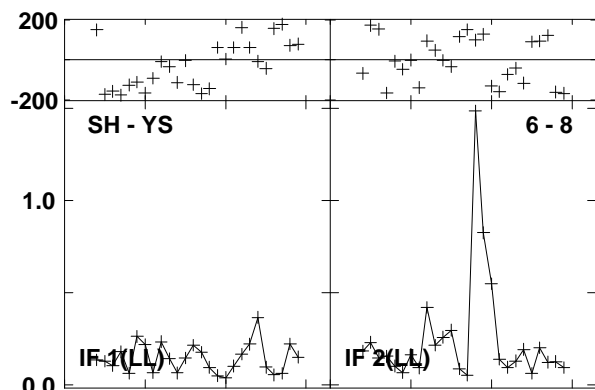
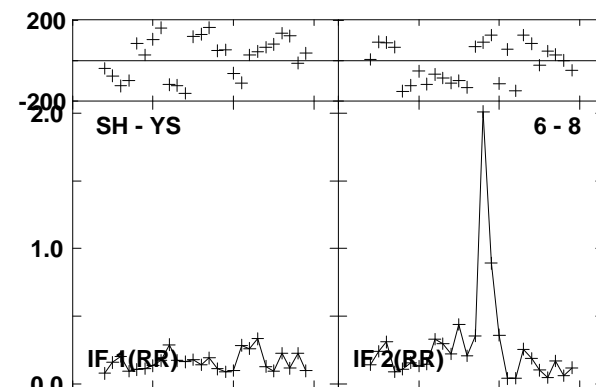
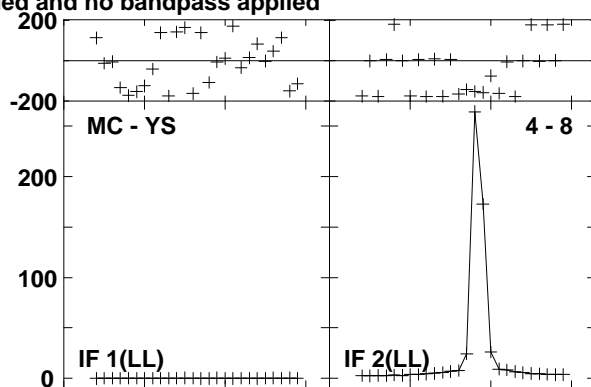
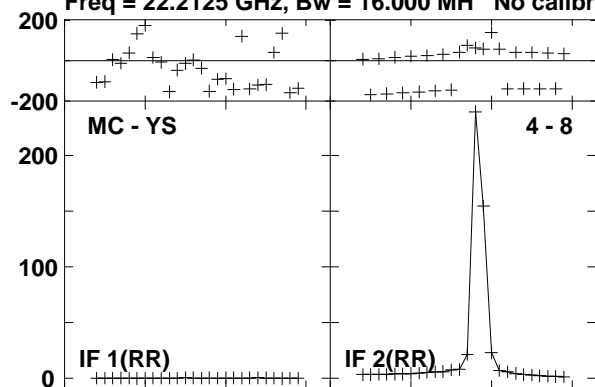

Lower frame: Milli Ampl Jy Top frame: Phas deg  
Vector averaged cross-power spectrum Baseline: MC (04) - YS (08)  
Timerange: 00/11:40:05 to 00/11:41:05

Plot file version 286 created 23-AUG-2016 15:00:51  
W3IRS5 GA035B 1.UVDATA.1

Freq = 22.2125 GHz, Bw = 16.000 MH No calibration applied and no bandpass applied

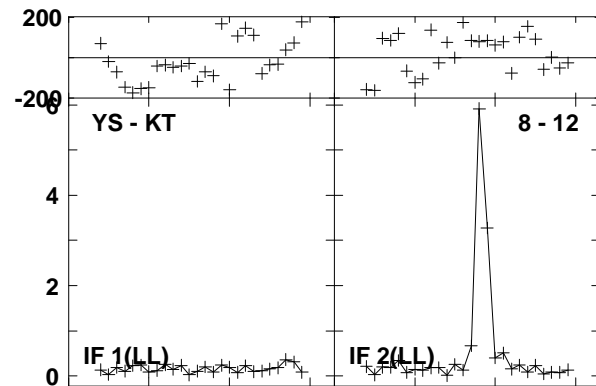
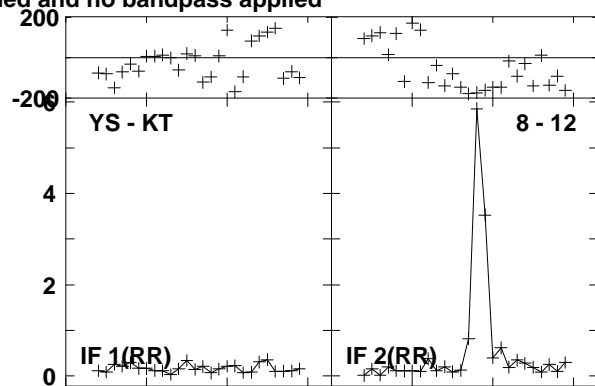
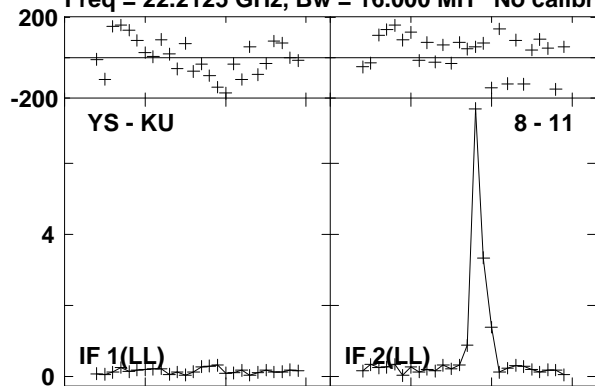

Lower frame: Milli Ampl Jy Top frame: Phas deg  
Vector averaged cross-power spectrum Baseline: YS (08) - KU (11)  
Timerange: 00/11:40:05 to 00/11:41:05

Plot file version 287 created 23-AUG-2016 15:00:51

0219+628 GA035B 1.UVDATA.1

Freq = 22.2125 GHz, Bw = 16.000 MH No calibration applied and no bandpass applied

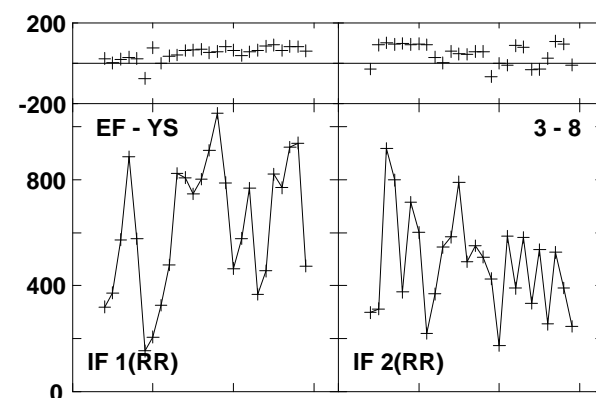
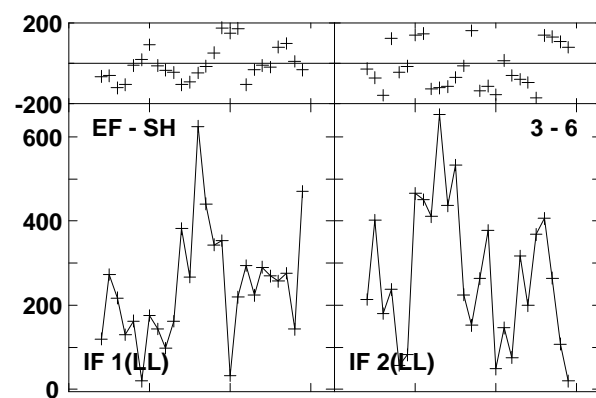
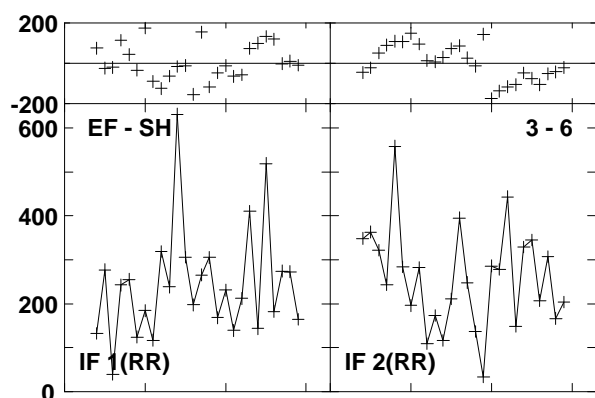
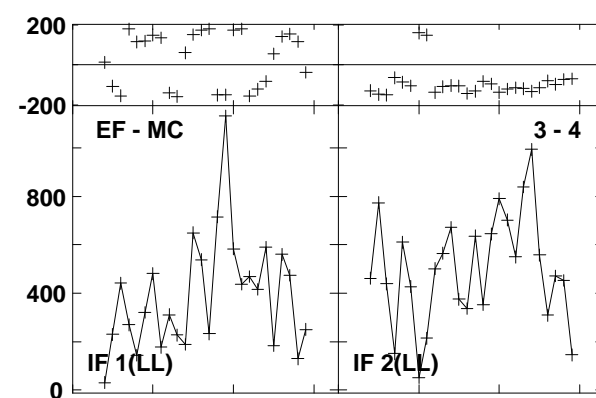
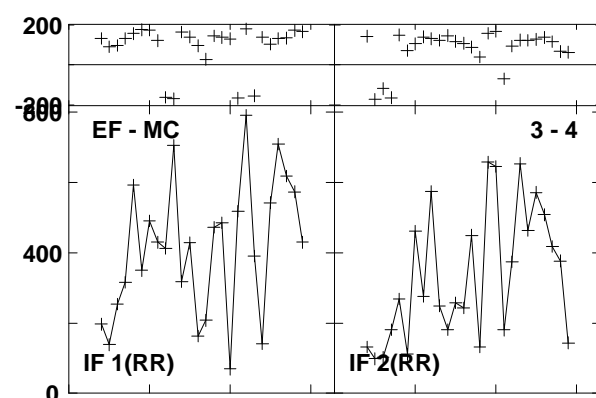
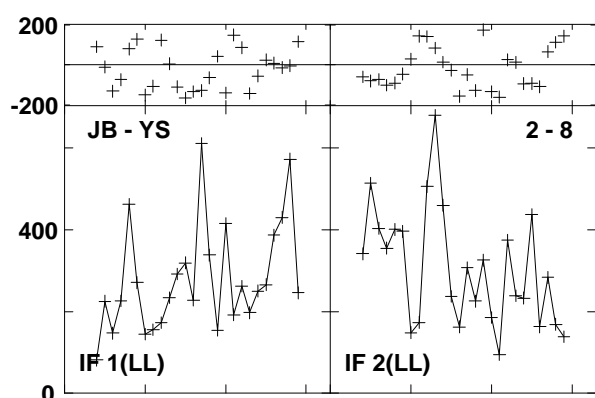
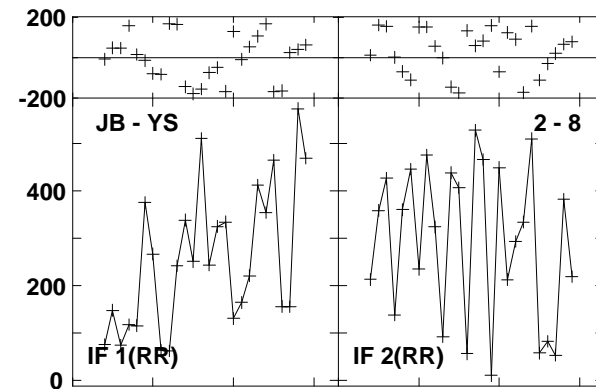
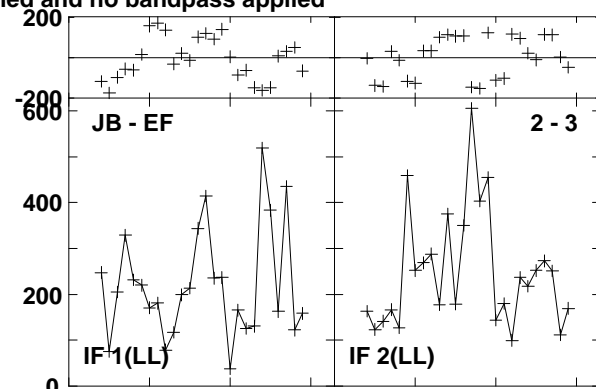
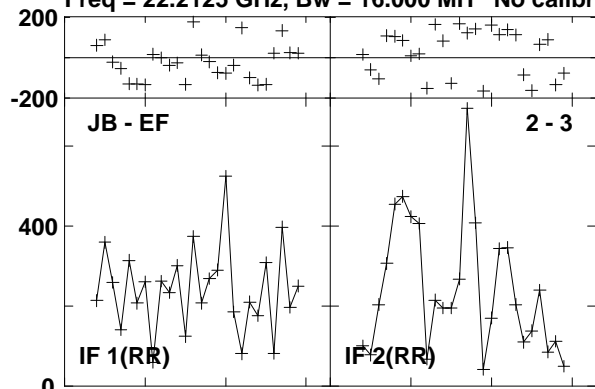

Channels

Lower frame: Micro Ampl Jy Top frame: Phas deg

Vector averaged cross-power spectrum Baseline: JB (02) - EF (03)

Timerange: 00/11:41:30 to 00/11:41:50

Plot file version 288 created 23-AUG-2016 15:00:51

0219+628 GA035B 1.UVDATA.1

Freq = 22.2125 GHz, Bw = 16.000 MH No calibration applied and no bandpass applied

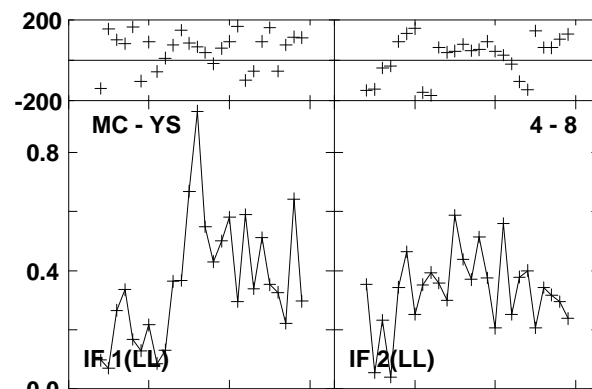
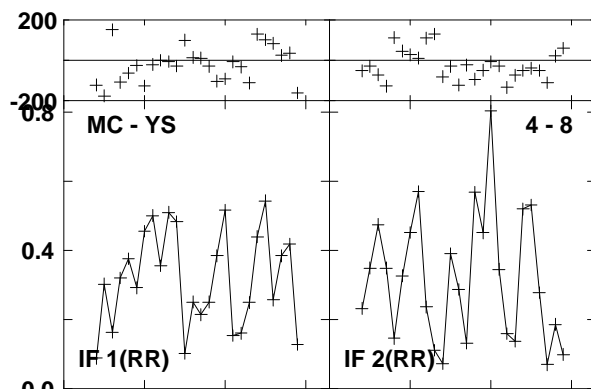
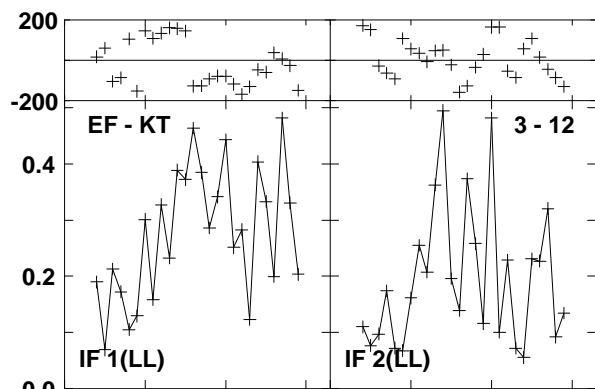
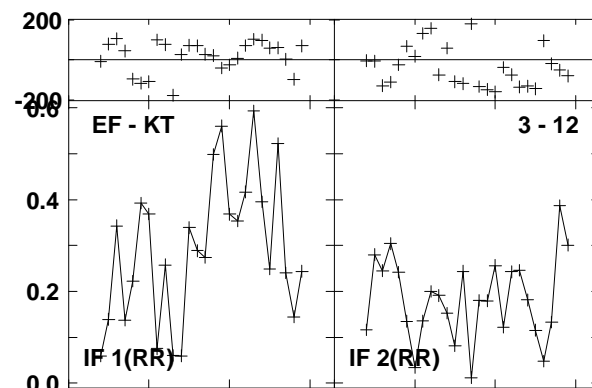
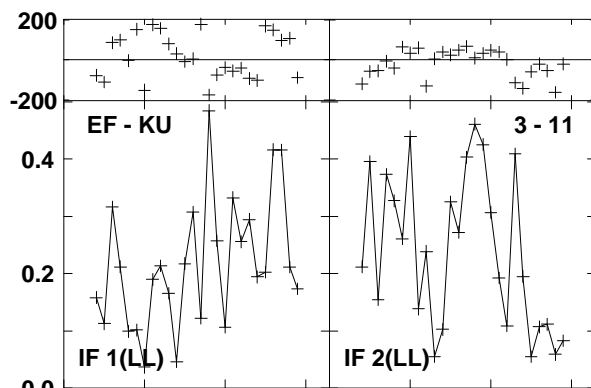
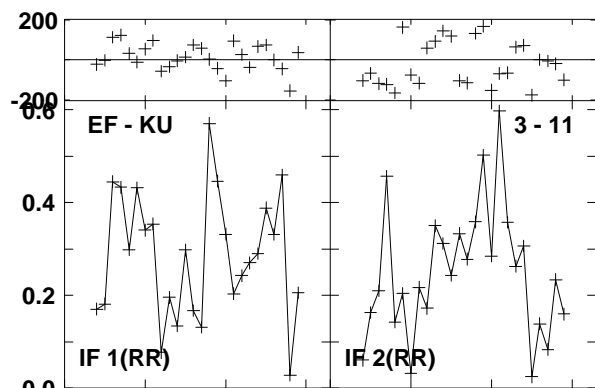
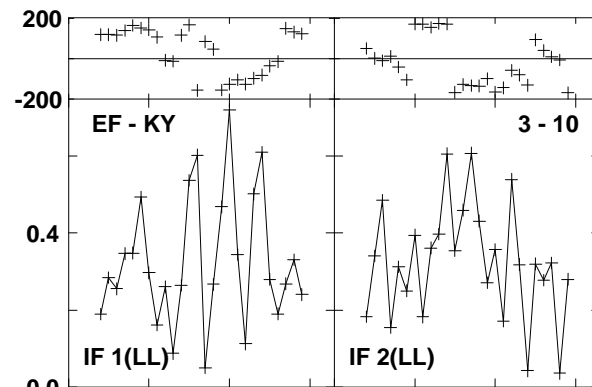
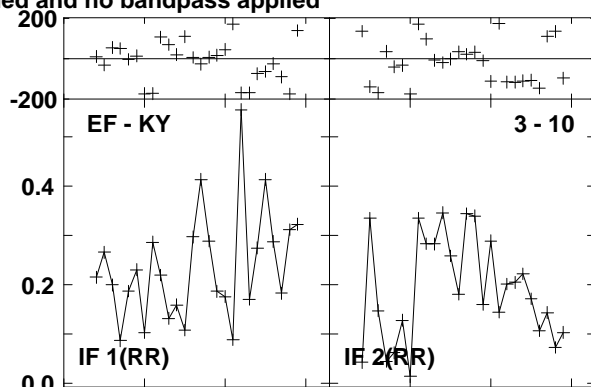
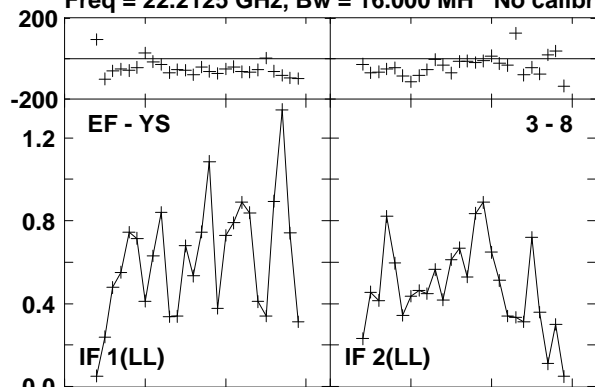

Channels

Lower frame: Milli Ampl Jy Top frame: Phas deg

Vector averaged cross-power spectrum Baseline: EF (03) - YS (08)

Timerange: 00/11:41:30 to 00/11:41:50



Plot file version 289 created 23-AUG-2016 15:00:51

0219+628 GA035B 1.UVDATA.1

Freq = 22.2125 GHz, Bw = 16.000 MH No calibration applied and no bandpass applied

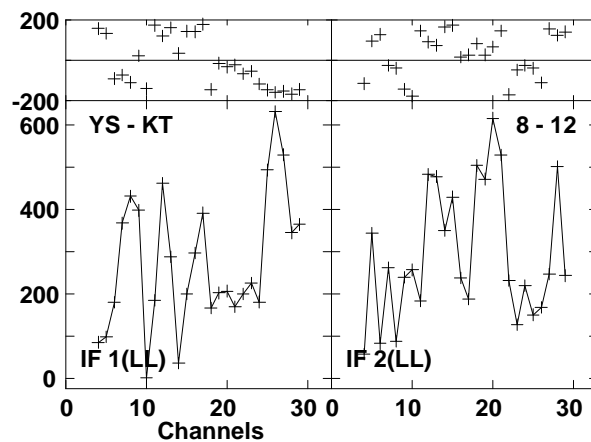
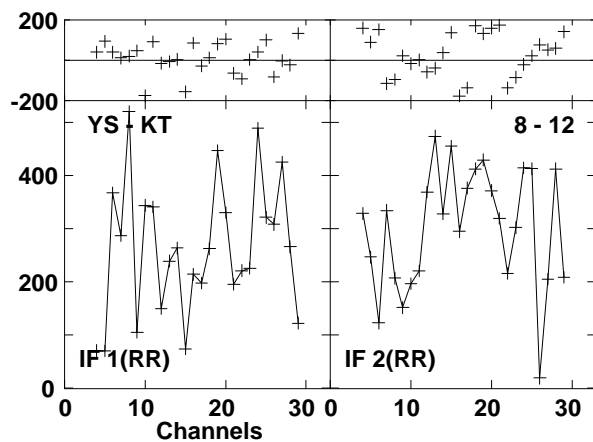
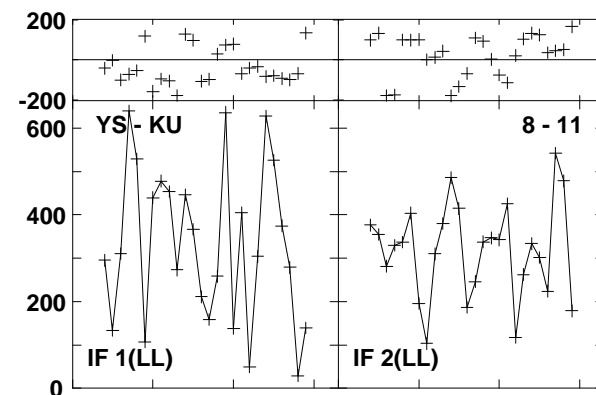
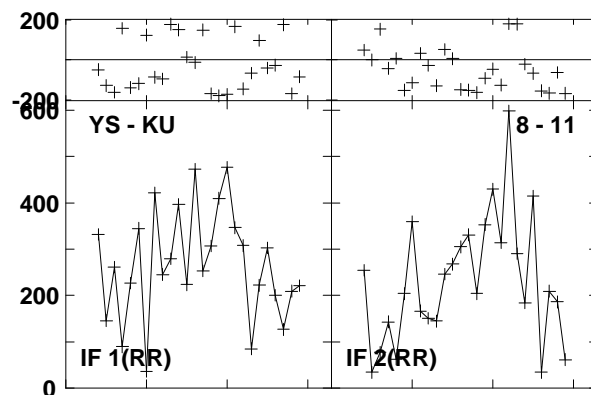
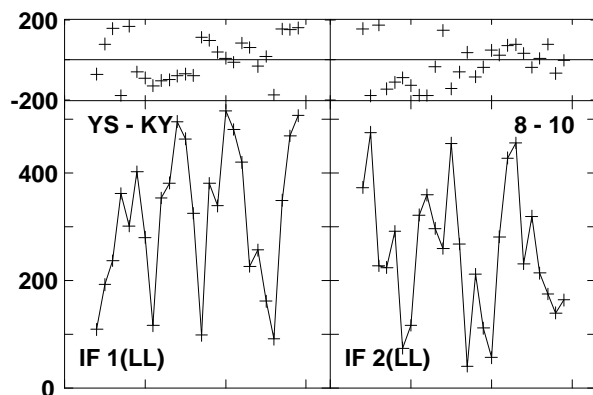
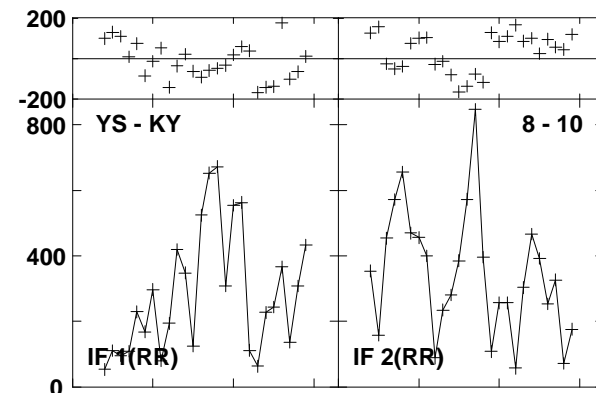
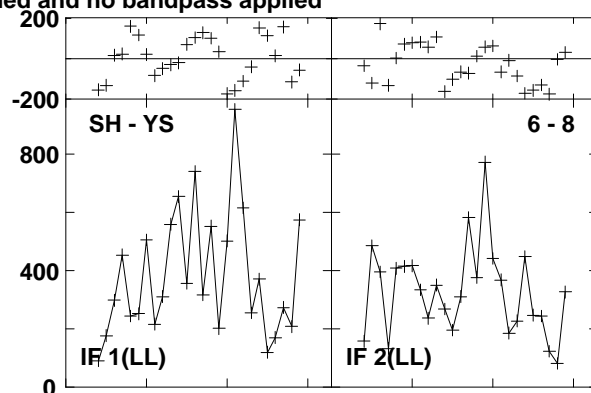
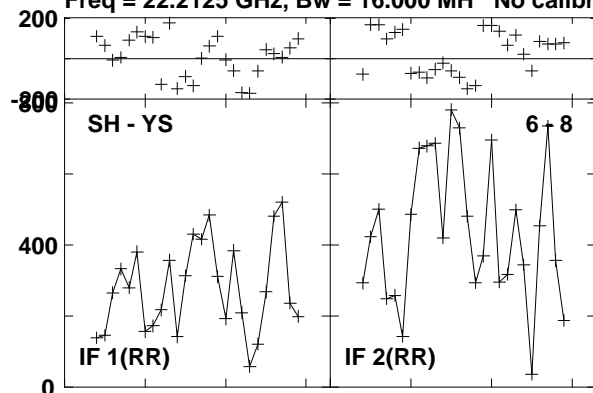

Lower frame: Micro Ampl Jy Top frame: Phas deg

Vector averaged cross-power spectrum Baseline: SH (06) - YS (08)

Timerange: 00/11:41:30 to 00/11:41:50

Plot file version 290 created 23-AUG-2016 15:00:51  
 W3IRS5 GA035B 1.UVDATA.1

Freq = 22.2125 GHz, Bw = 16.000 MH No calibration applied and no bandpass applied

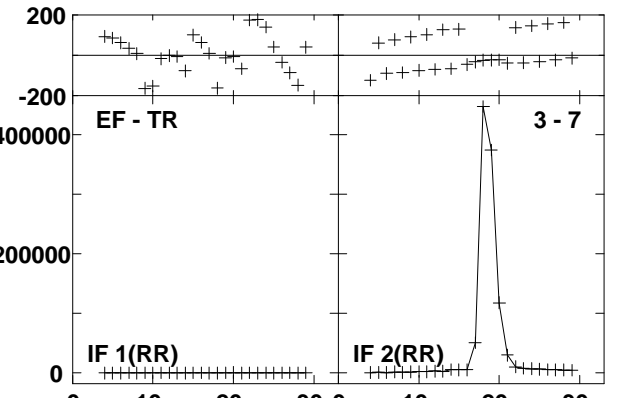
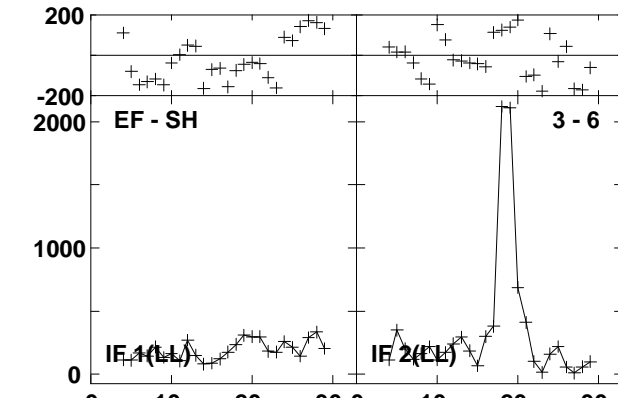
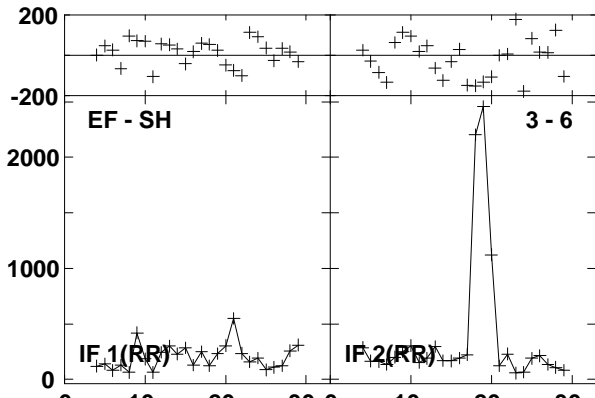
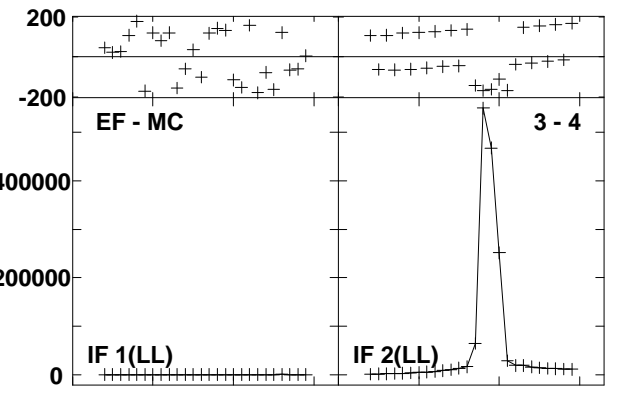
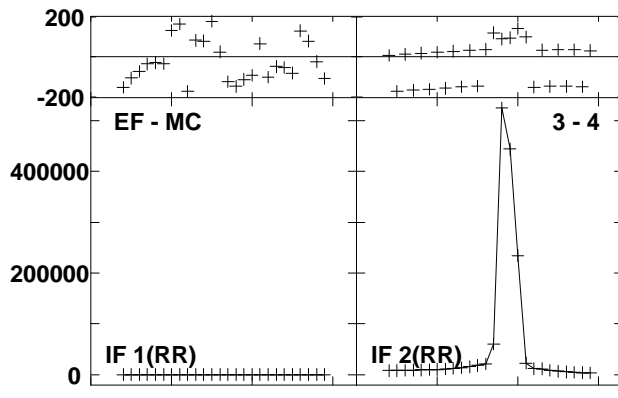
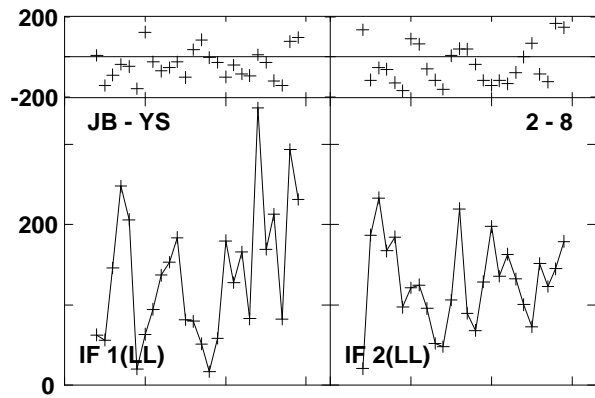
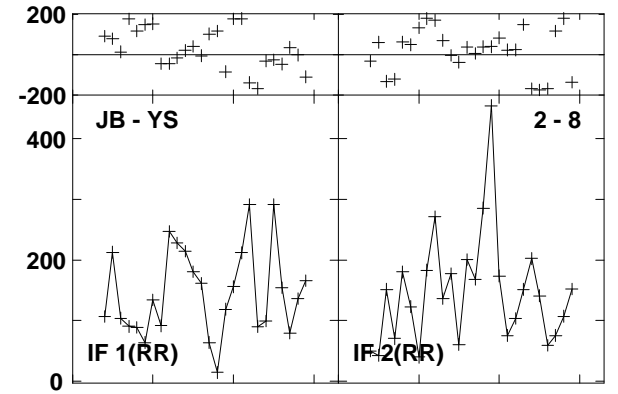
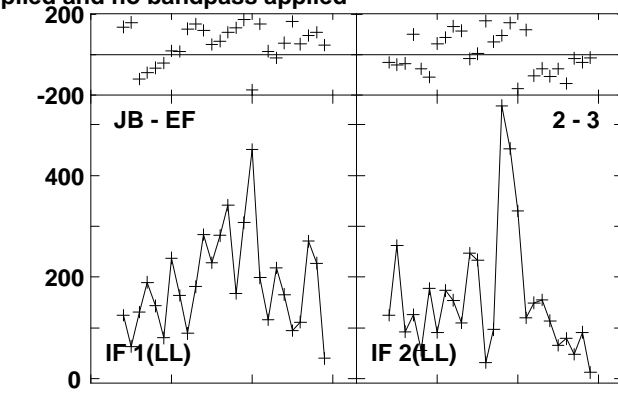
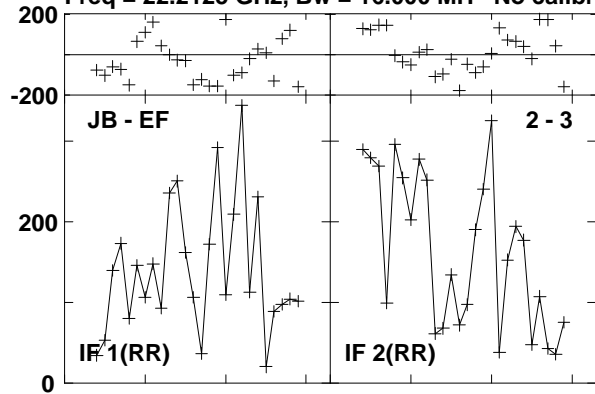

Lower frame: Micro Ampl Jy Top frame: Phas deg  
 Vector averaged cross-power spectrum Baseline: JB (02) - EF (03)  
 Timerange: 00/11:42:16 to 00/11:43:15

Plot file version 291 created 23-AUG-2016 15:00:51

W3IRS5 GA035B 1.UVDATA.1

Freq = 22.2125 GHz, Bw = 16.000 MH No calibration applied and no bandpass applied

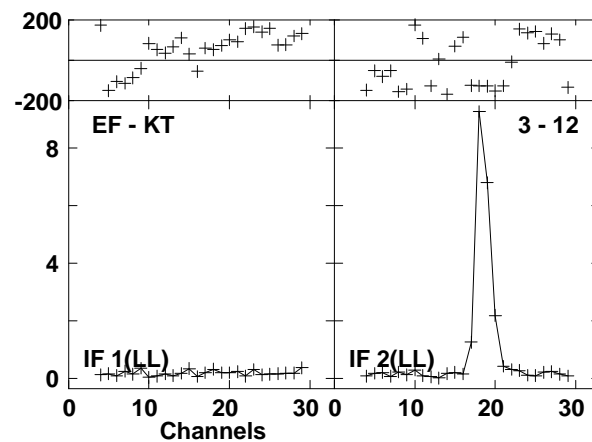
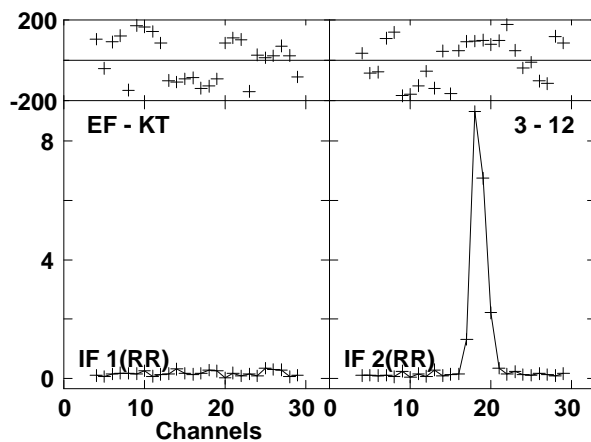
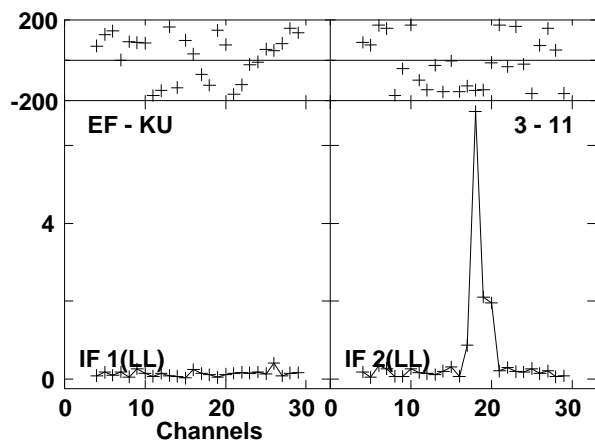
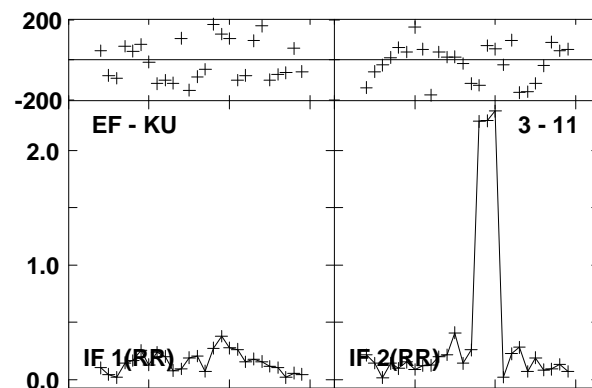
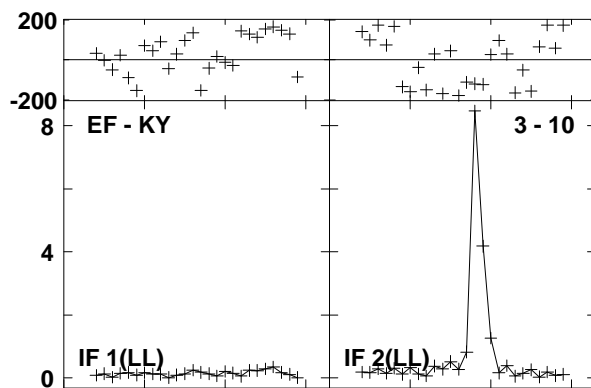
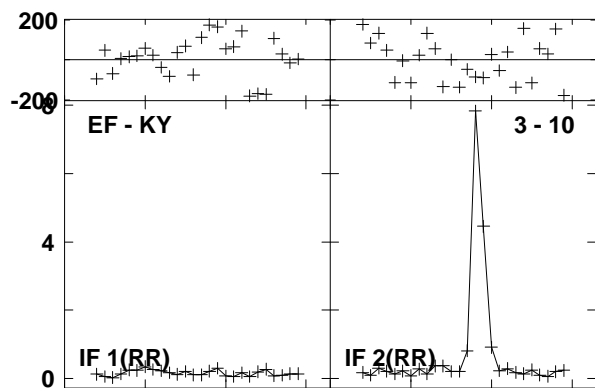
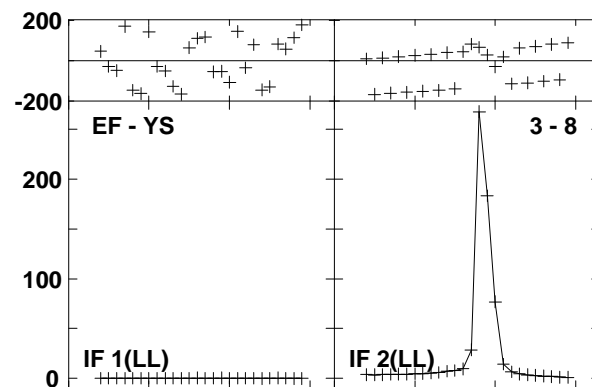
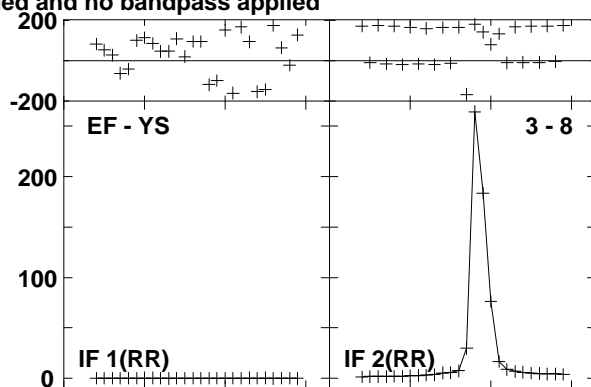
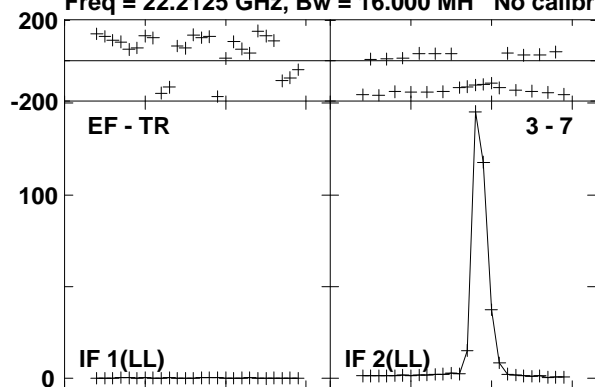

Lower frame: Milli Ampl Jy Top frame: Phas deg

Vector averaged cross-power spectrum Baseline: EF (03) - TR (07)

Timerange: 00/11:42:16 to 00/11:43:15

Plot file version 292 created 23-AUG-2016 15:00:51

W3IRS5 GA035B 1.UVDATA.1

Freq = 22.2125 GHz, Bw = 16.000 MH No calibration applied and no bandpass applied

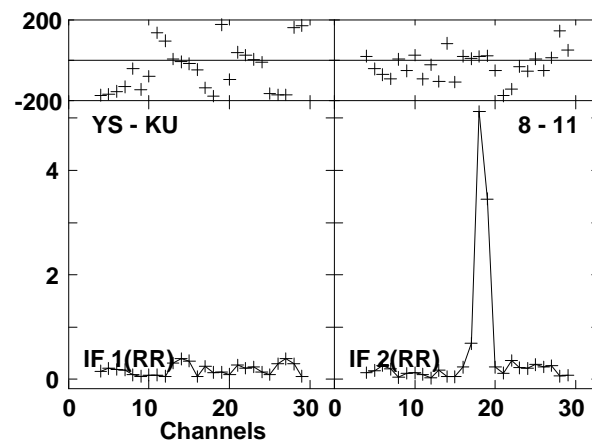
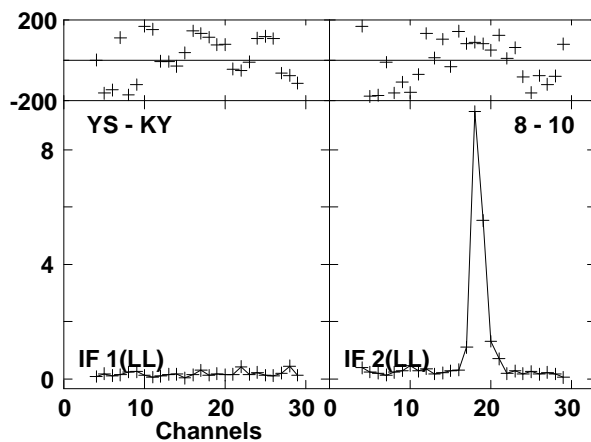
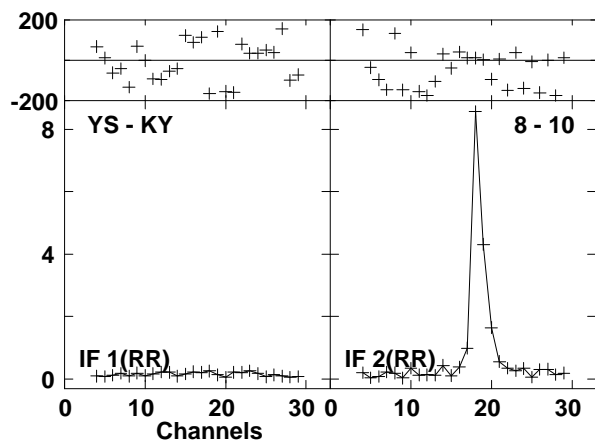
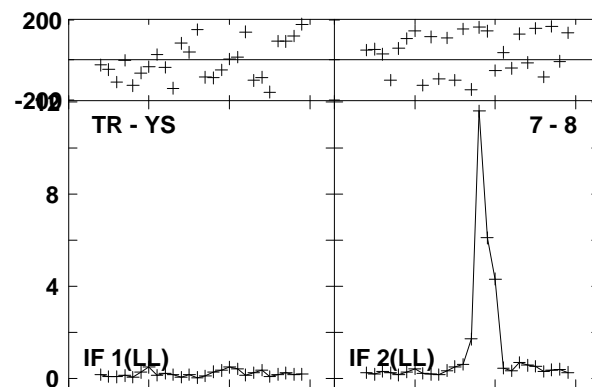
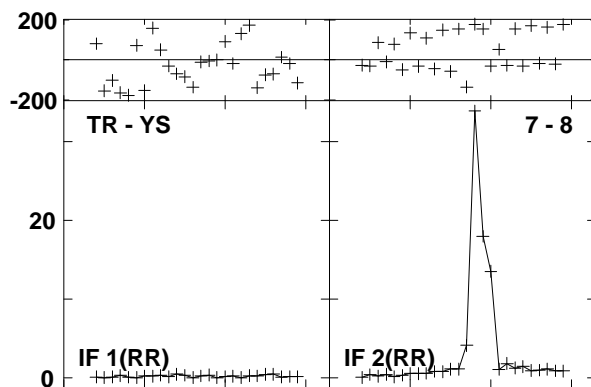
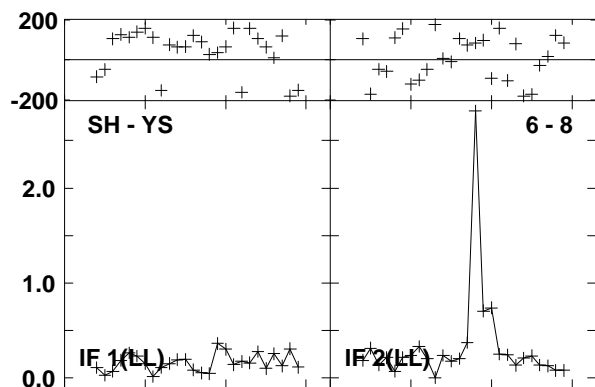
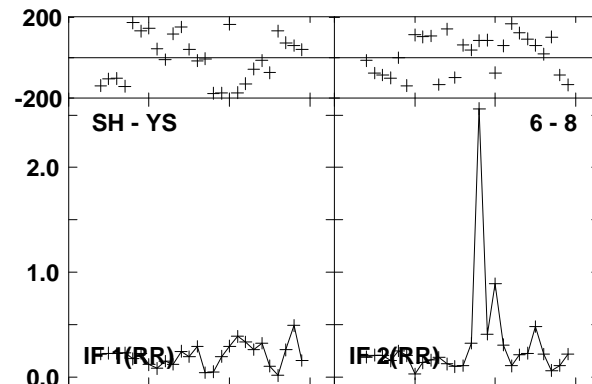
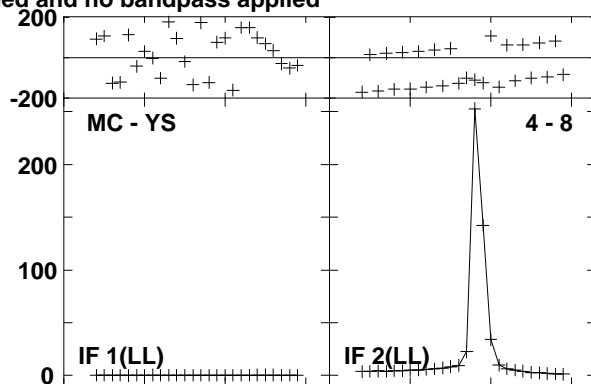
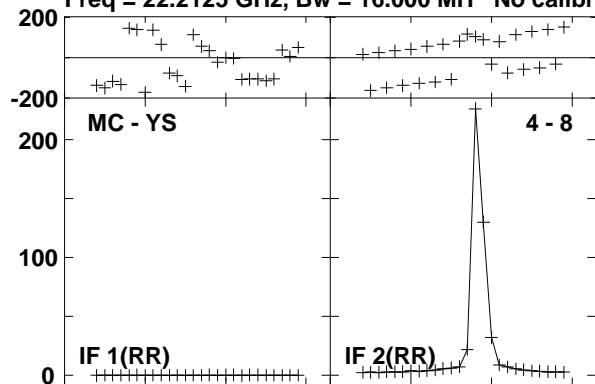

Lower frame: Milli Ampl Jy Top frame: Phas deg  
Vector averaged cross-power spectrum Baseline: MC (04) - YS (08)  
Timerange: 00/11:42:16 to 00/11:43:15

Plot file version 293 created 23-AUG-2016 15:00:51  
W3IRS5 GA035B 1.UVDATA.1

Freq = 22.2125 GHz, Bw = 16.000 MH No calibration applied and no bandpass applied

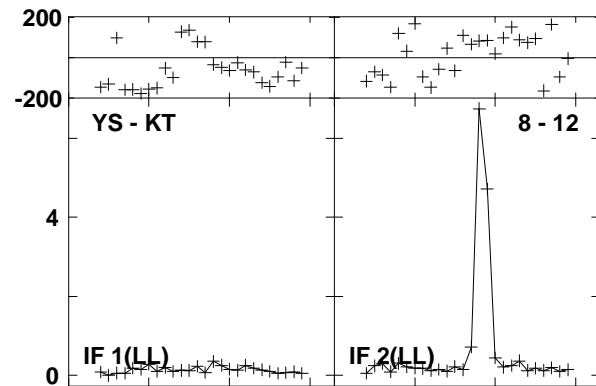
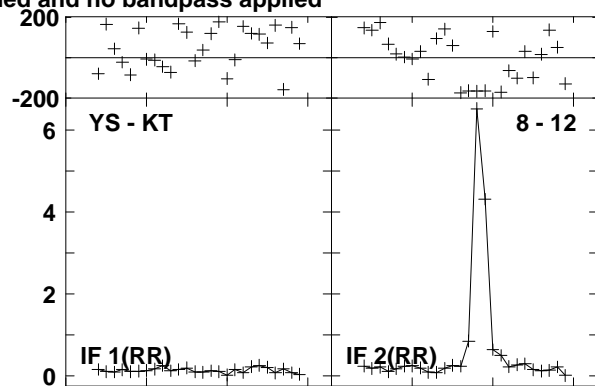
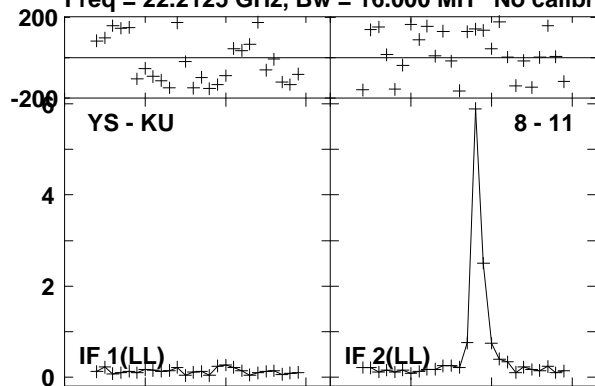

Lower frame: Milli Ampl Jy Top frame: Phas deg  
Vector averaged cross-power spectrum Baseline: YS (08) - KU (11)  
Timerange: 00/11:42:16 to 00/11:43:15

Plot file version 294 created 23-AUG-2016 15:00:51

0219+628 GA035B 1.UVDATA.1

Freq = 22.2125 GHz, Bw = 16.000 MH No calibration applied and no bandpass applied

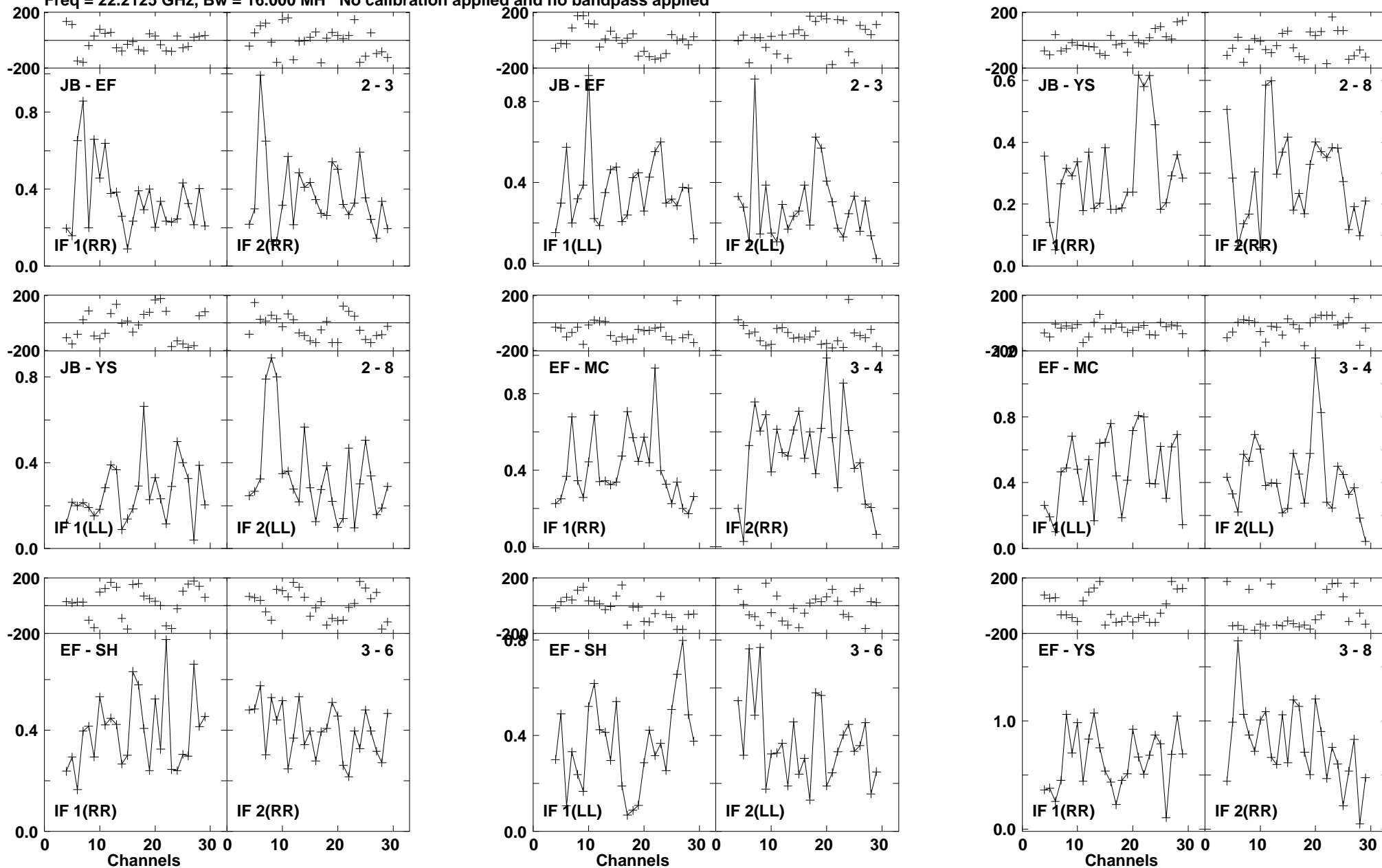

Lower frame: Milli Ampl Jy Top frame: Phas deg  
Vector averaged cross-power spectrum Baseline: JB (02) - EF (03)  
Timerange: 00/11:43:41 to 00/11:44:00

Plot file version 295 created 23-AUG-2016 15:00:51

0219+628 GA035B 1.UVDATA.1

Freq = 22.2125 GHz, Bw = 16.000 MH No calibration applied and no bandpass applied

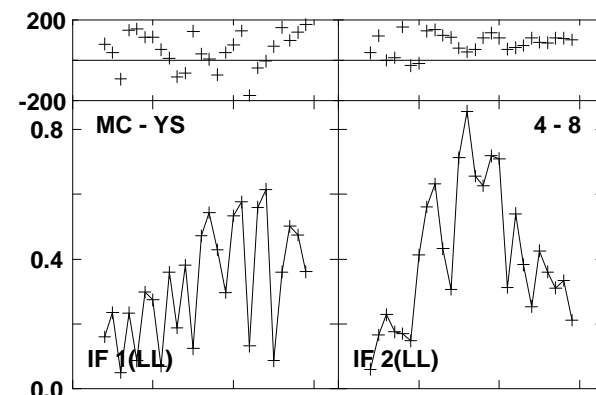
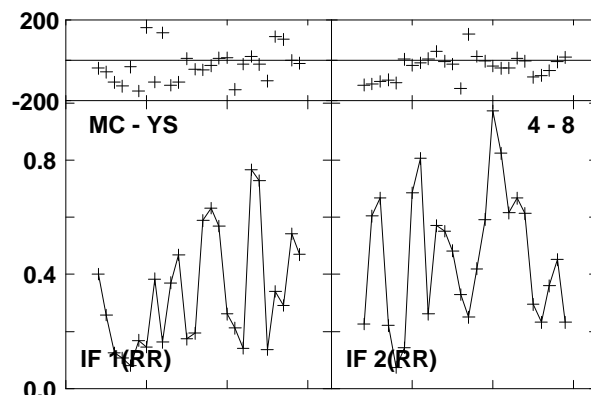
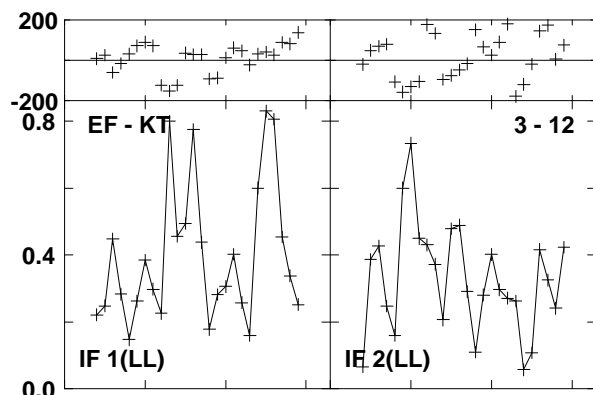
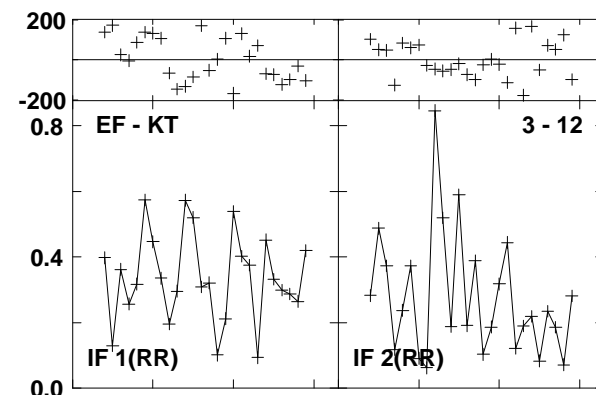
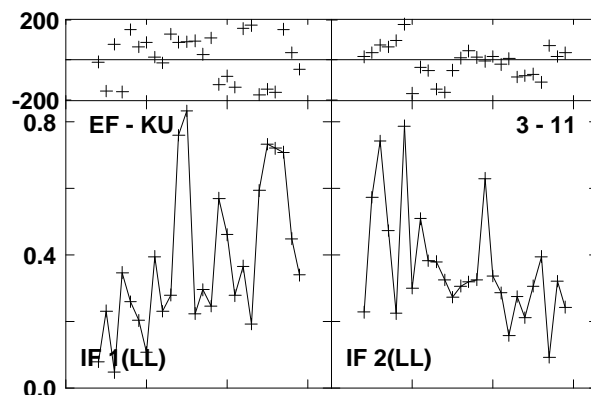
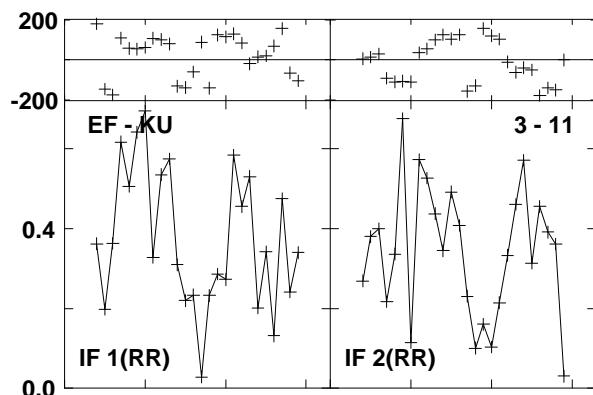
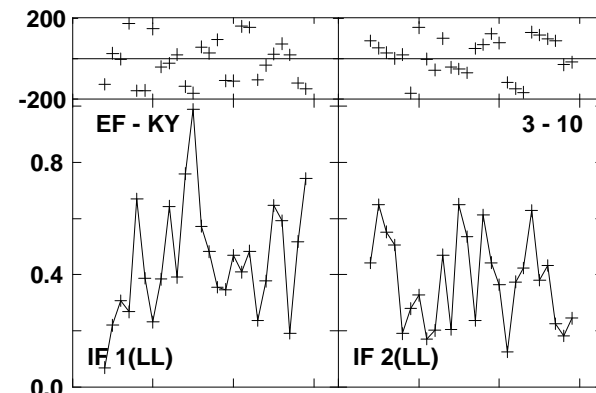
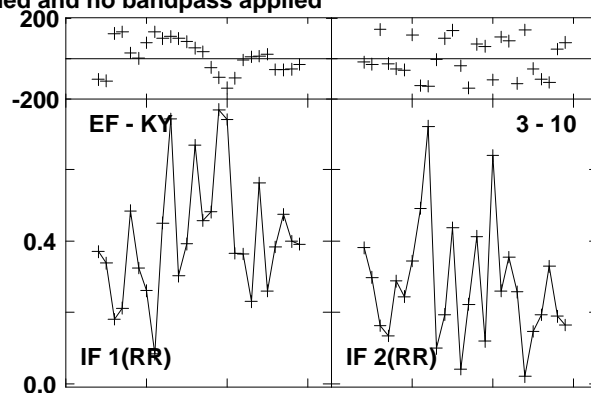
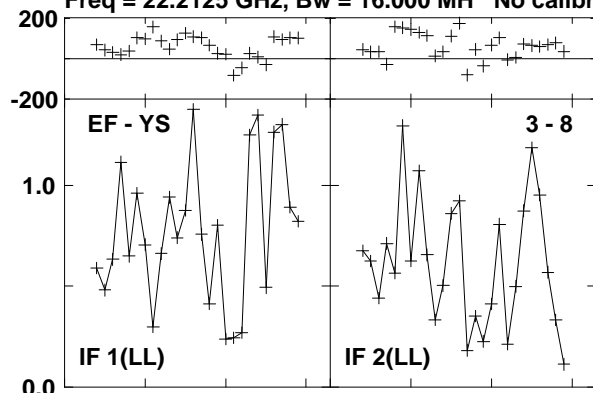

Lower frame: Milli Ampl Jy Top frame: Phas deg

Vector averaged cross-power spectrum Baseline: EF (03) - YS (08)

Timerange: 00/11:43:41 to 00/11:44:00

Plot file version 296 created 23-AUG-2016 15:00:51

0219+628 GA035B 1.UVDATA.1

Freq = 22.2125 GHz, Bw = 16.000 MH No calibration applied and no bandpass applied

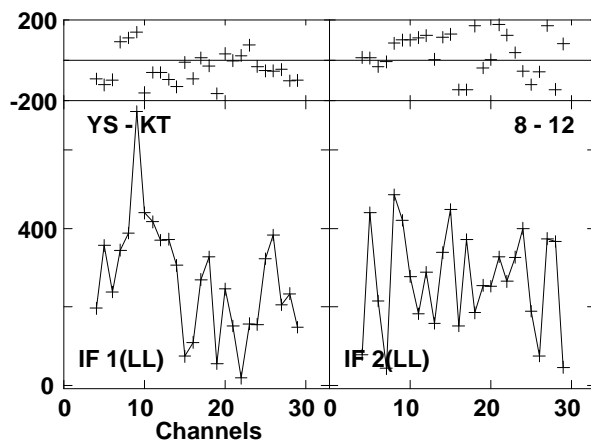
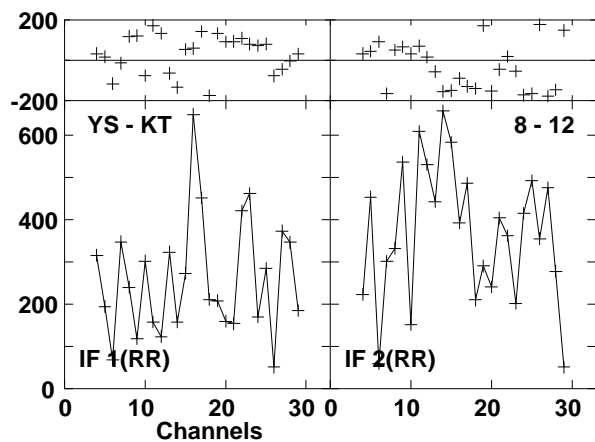
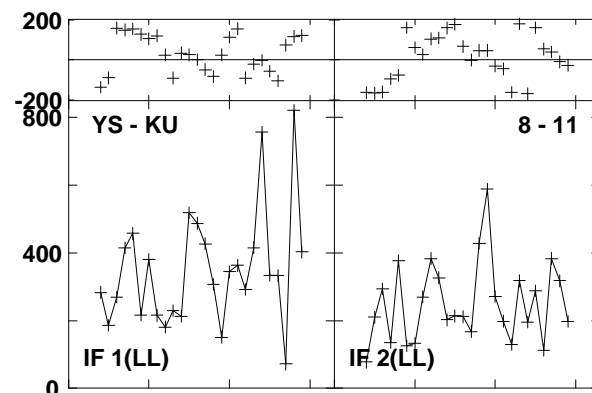
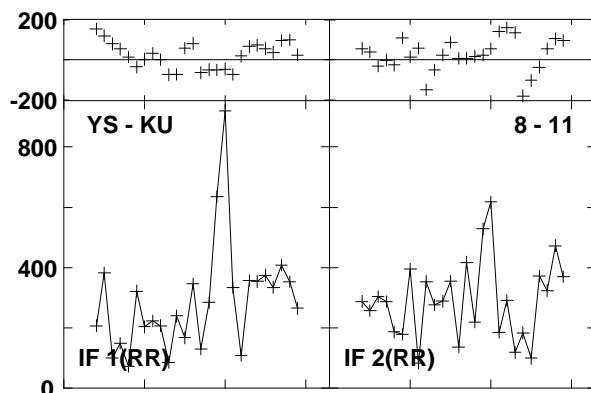
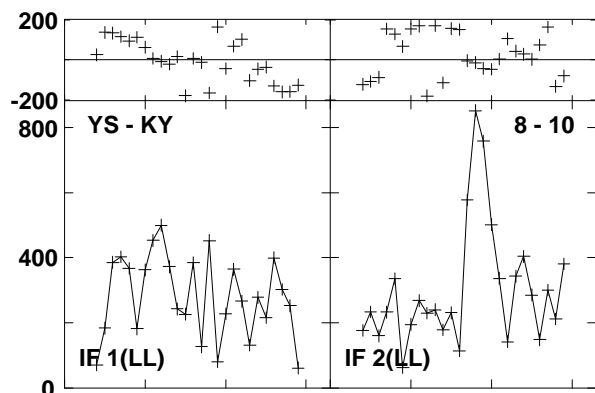
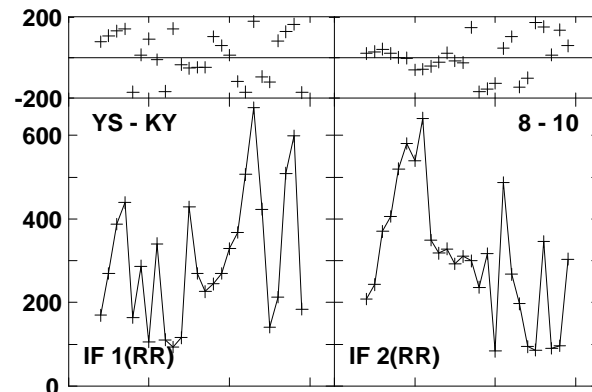
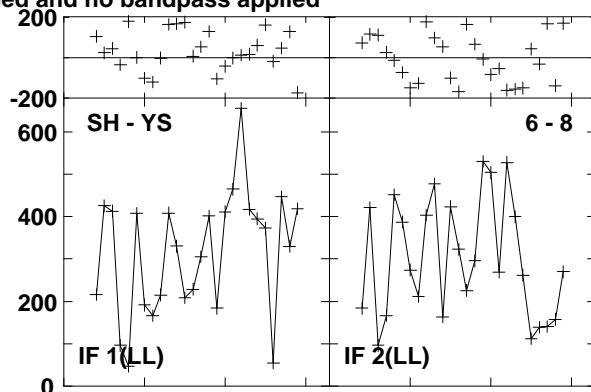
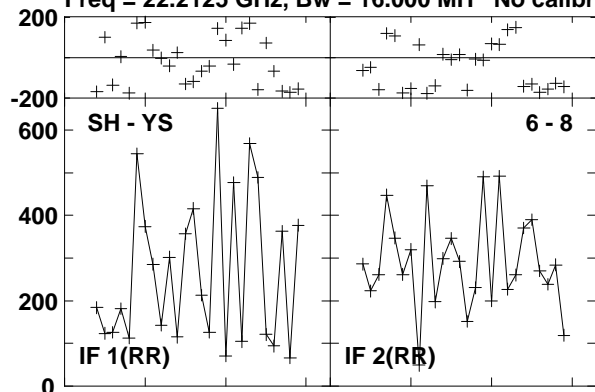

Lower frame: Micro Ampl Jy Top frame: Phas deg

Vector averaged cross-power spectrum Baseline: SH (06) - YS (08)

Timerange: 00/11:43:41 to 00/11:44:00



Plot file version 297 created 23-AUG-2016 15:00:51  
 W3IRS5 GA035B 1.UVDATA.1

Freq = 22.2125 GHz, Bw = 16.000 MH No calibration applied and no bandpass applied

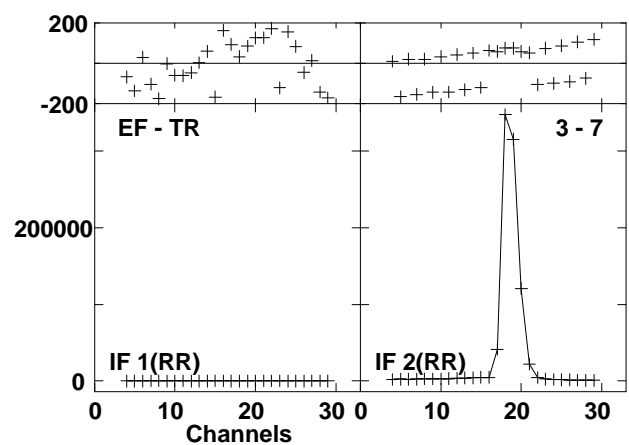
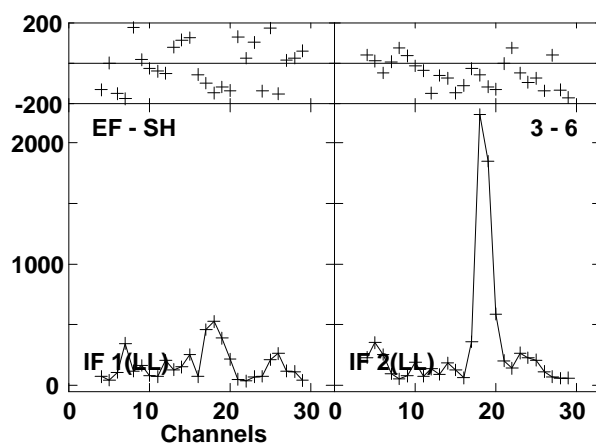
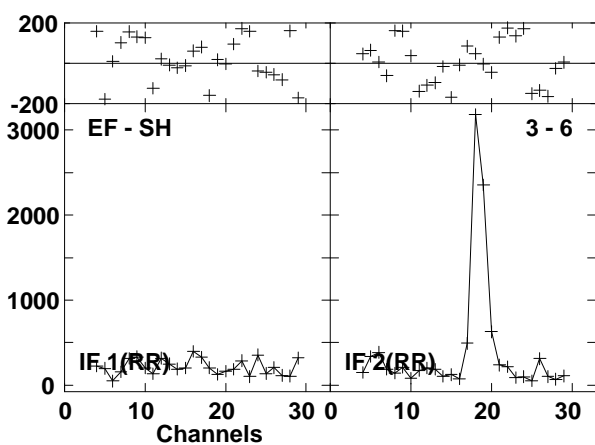
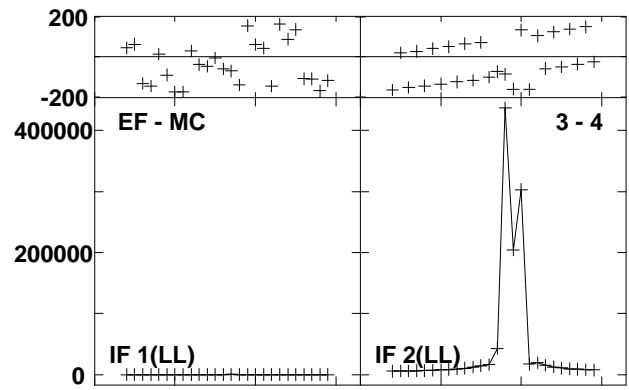
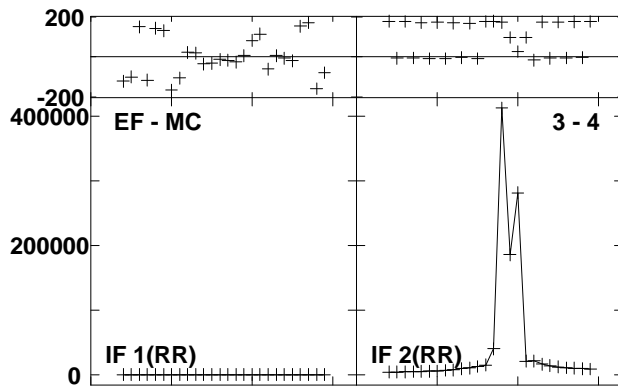
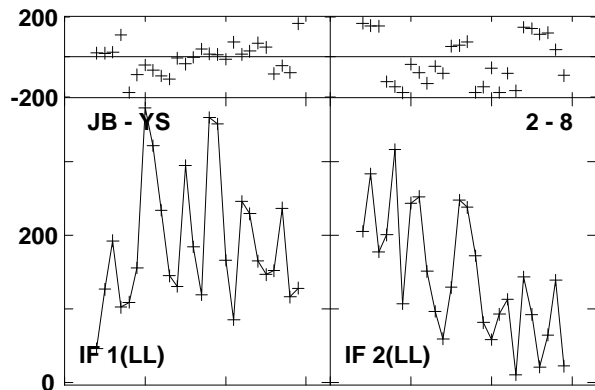
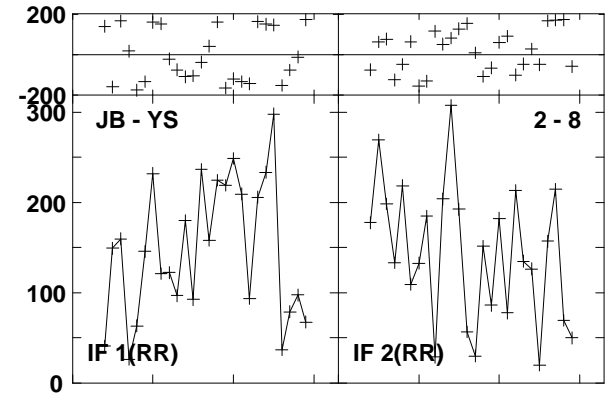
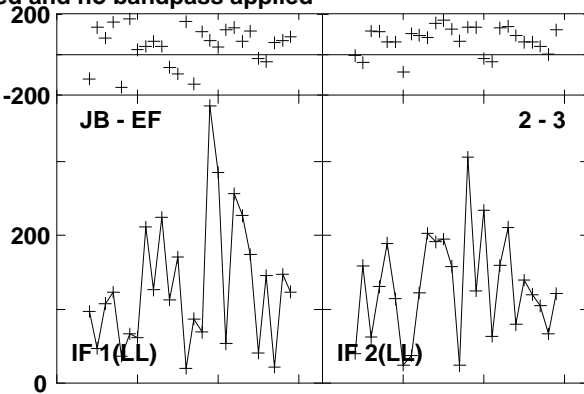
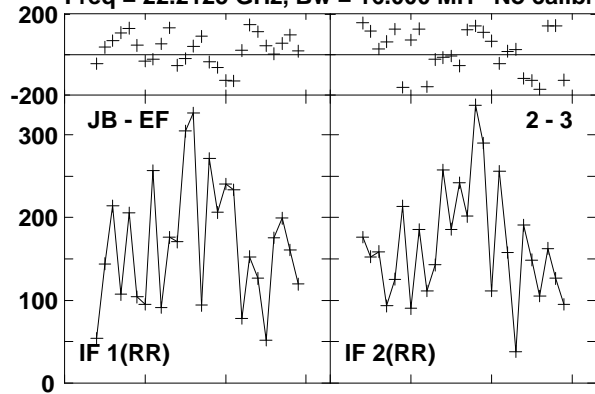

Lower frame: Micro Ampl Jy Top frame: Phas deg  
 Vector averaged cross-power spectrum Baseline: JB (02) - EF (03)  
 Timerange: 00/11:44:25 to 00/11:45:24

Plot file version 298 created 23-AUG-2016 15:00:51

W3IRS5 GA035B 1.UVDATA.1

Freq = 22.2125 GHz, Bw = 16.000 MH No calibration applied and no bandpass applied

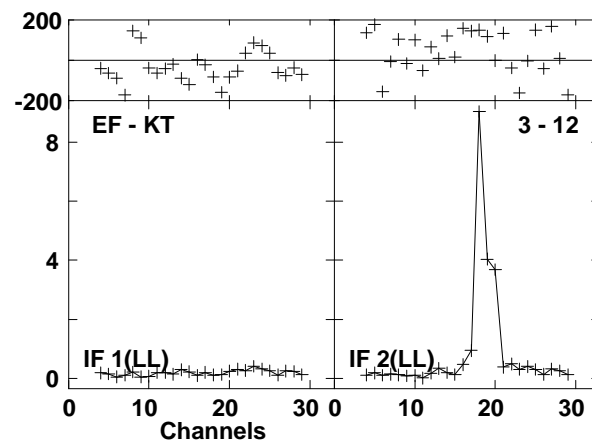
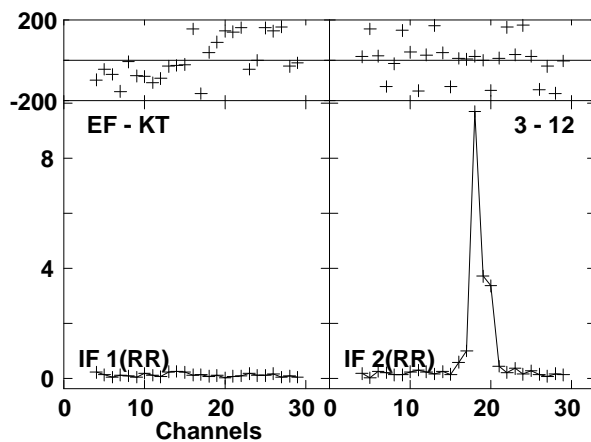
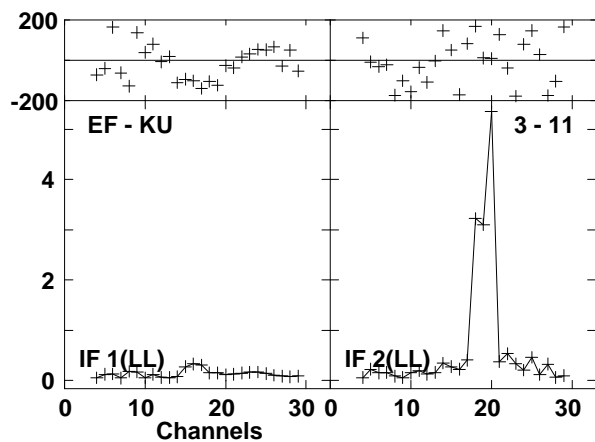
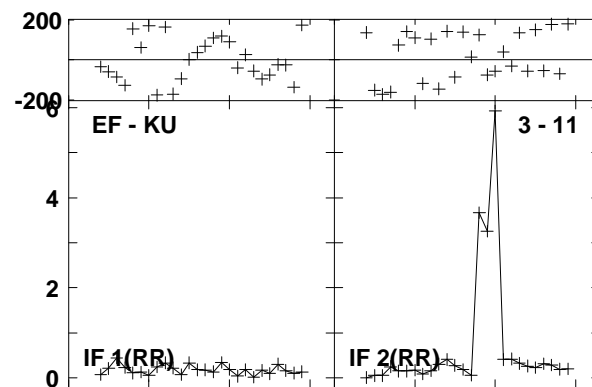
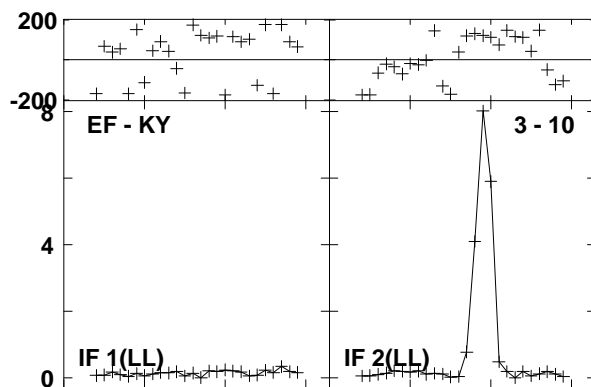
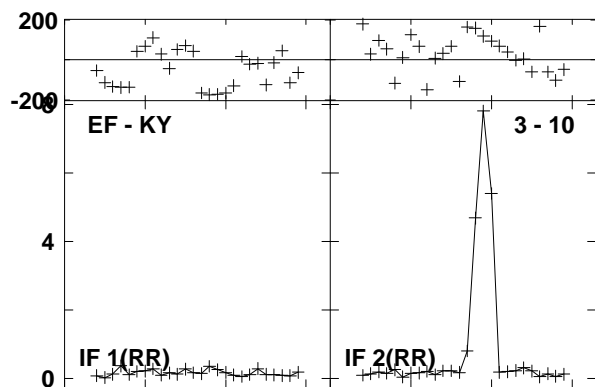
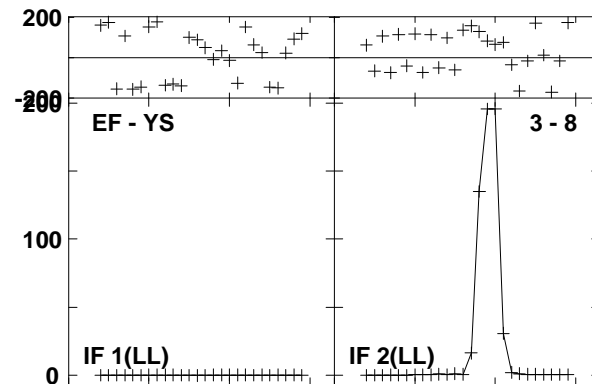
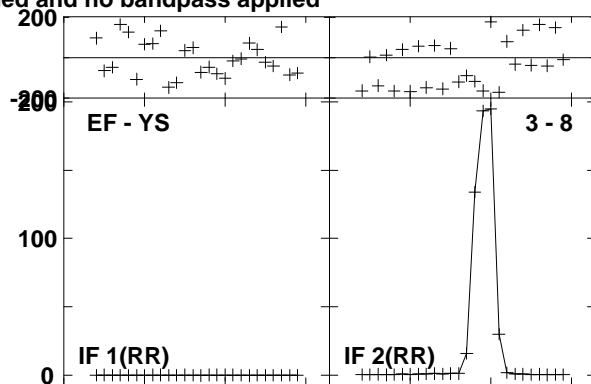
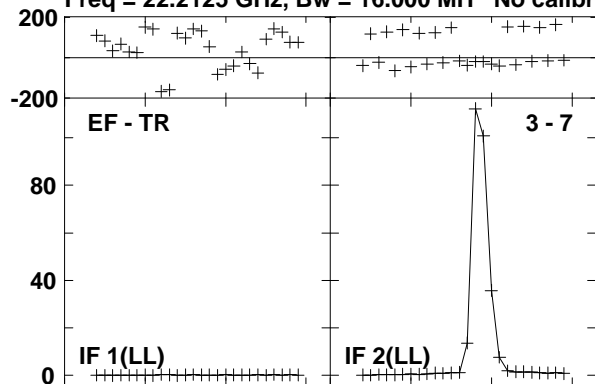

Lower frame: Milli Ampl Jy Top frame: Phas deg  
Vector averaged cross-power spectrum Baseline: EF (03) - TR (07)  
Timerange: 00/11:44:25 to 00/11:45:24

Plot file version 299 created 23-AUG-2016 15:00:51

W3IRS5 GA035B 1.UVDATA.1

Freq = 22.2125 GHz, Bw = 16.000 MH No calibration applied and no bandpass applied

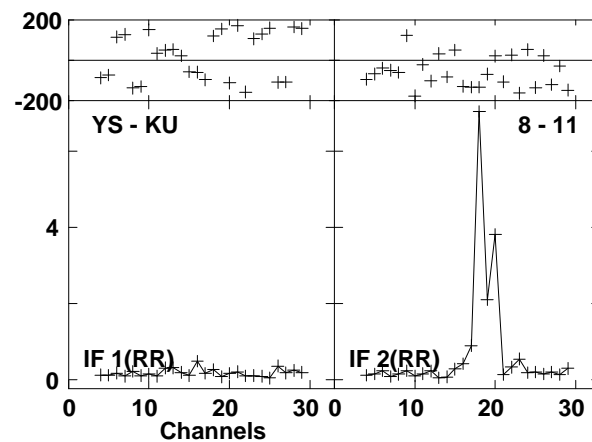
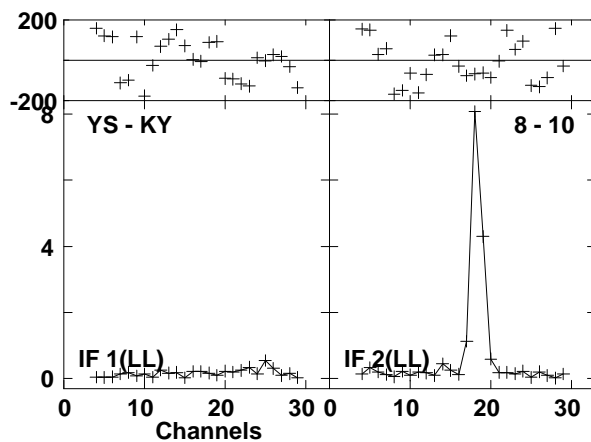
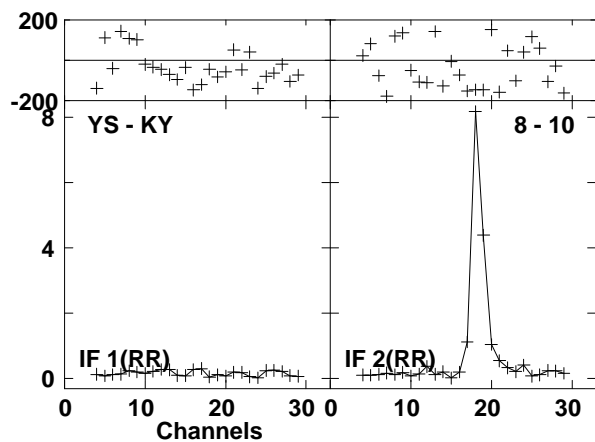
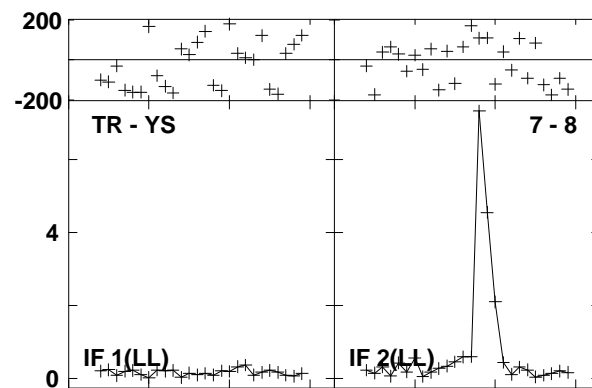
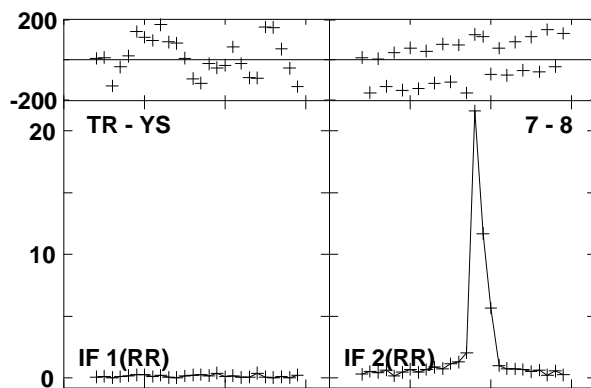
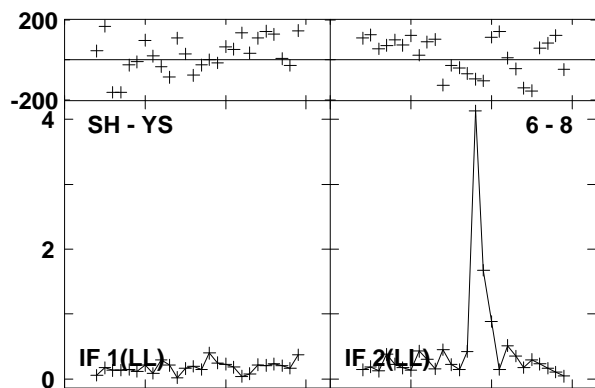
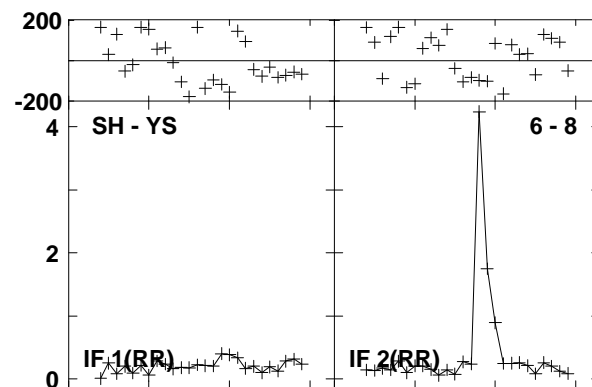
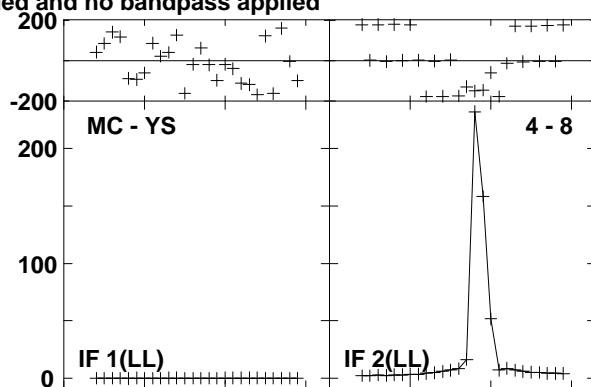
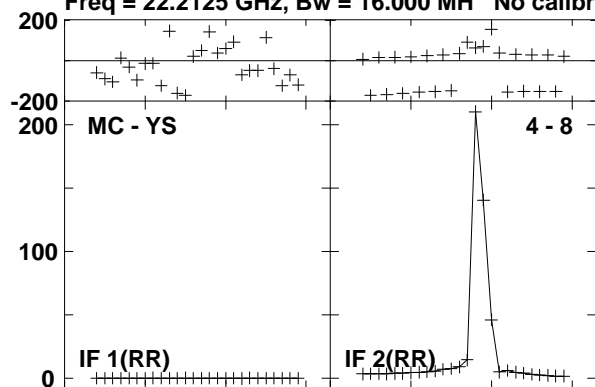

Lower frame: Milli Ampl Jy Top frame: Phas deg  
Vector averaged cross-power spectrum Baseline: MC (04) - YS (08)  
Timerange: 00/11:44:25 to 00/11:45:24

Plot file version 300 created 23-AUG-2016 15:00:51  
W3IRS5 GA035B 1.UVDATA.1

Freq = 22.2125 GHz, Bw = 16.000 MH No calibration applied and no bandpass applied

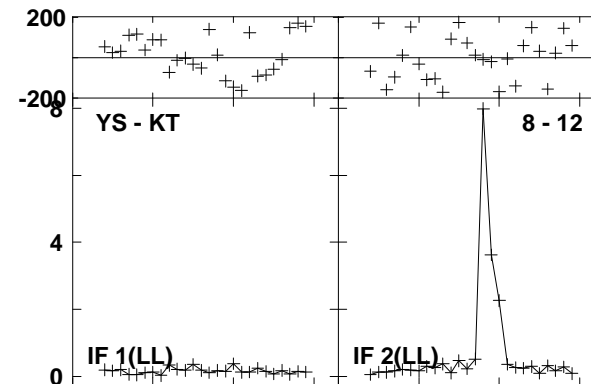
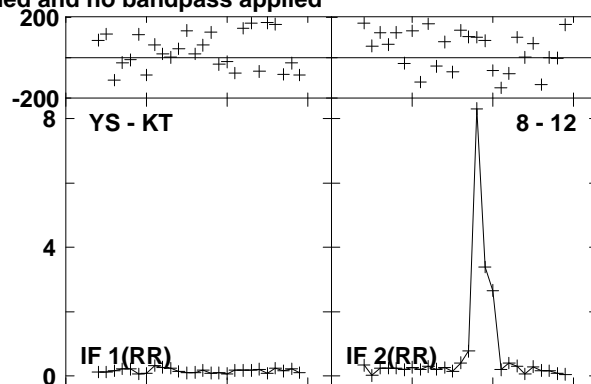
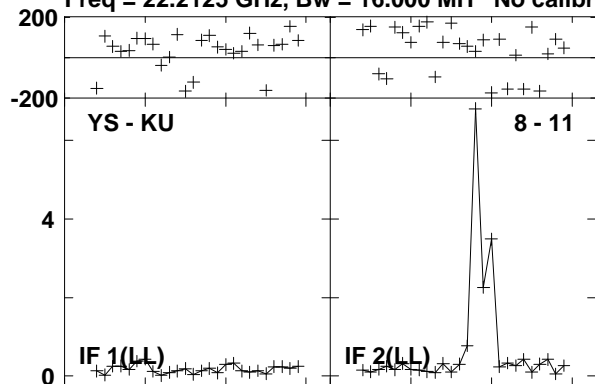

Lower frame: Milli Ampl Jy Top frame: Phas deg  
Vector averaged cross-power spectrum Baseline: YS (08) - KU (11)  
Timerange: 00/11:44:25 to 00/11:45:24

Plot file version 301 created 23-AUG-2016 15:00:51

0219+628 GA035B 1.UVDATA.1

Freq = 22.2125 GHz, Bw = 16.000 MH No calibration applied and no bandpass applied

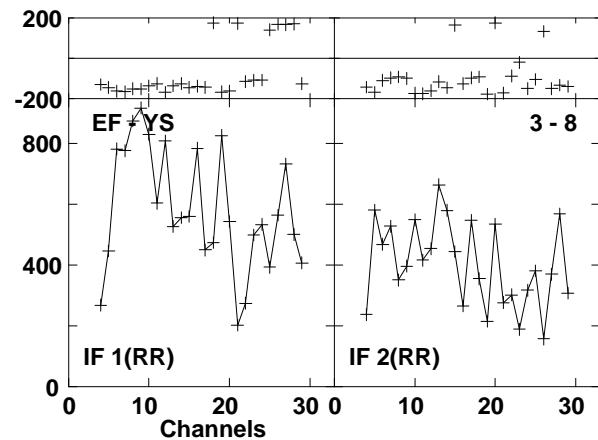
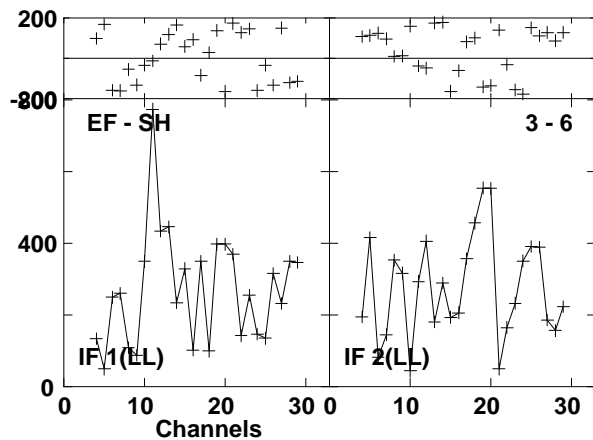
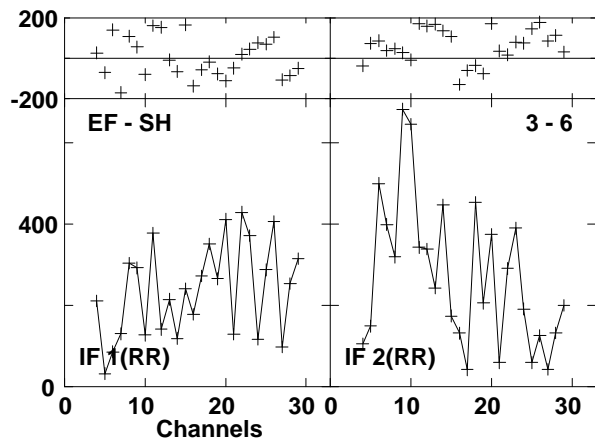
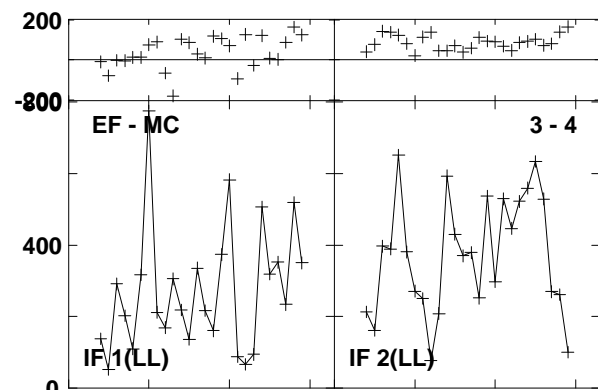
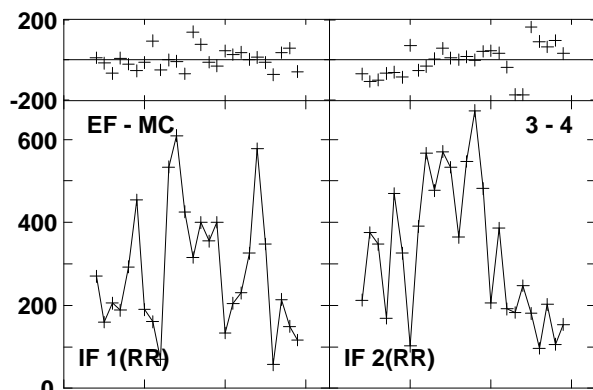
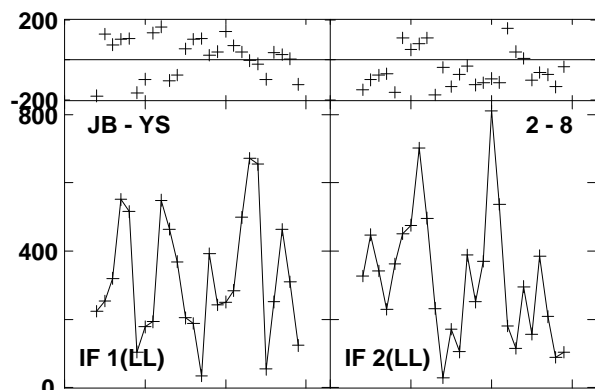
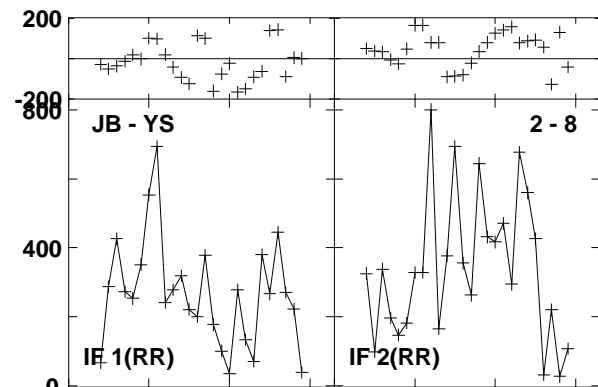
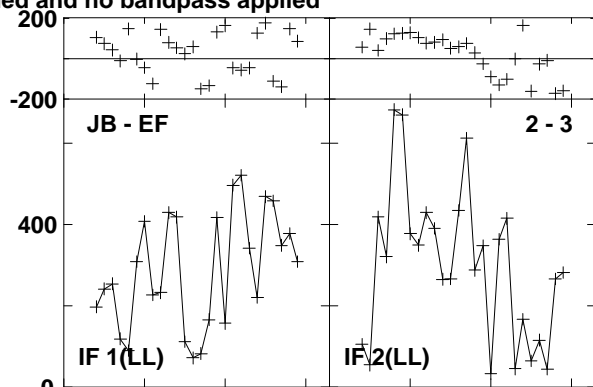
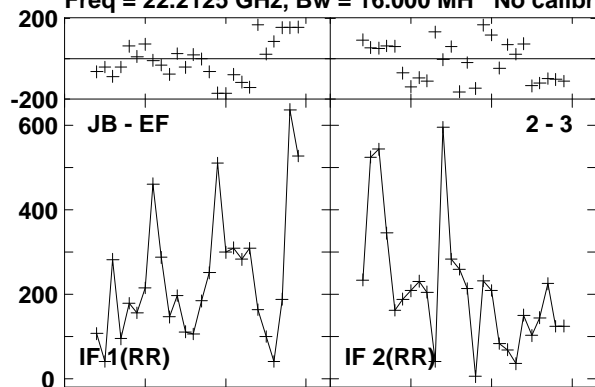

Lower frame: Micro Ampl Jy Top frame: Phas deg  
Vector averaged cross-power spectrum Baseline: JB (02) - EF (03)  
Timerange: 00/11:45:50 to 00/11:46:10

Plot file version 302 created 23-AUG-2016 15:00:51

0219+628 GA035B 1.UVDATA.1

Freq = 22.2125 GHz, Bw = 16.000 MH No calibration applied and no bandpass applied

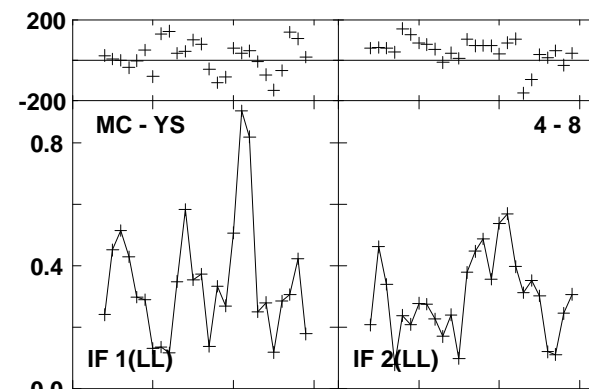
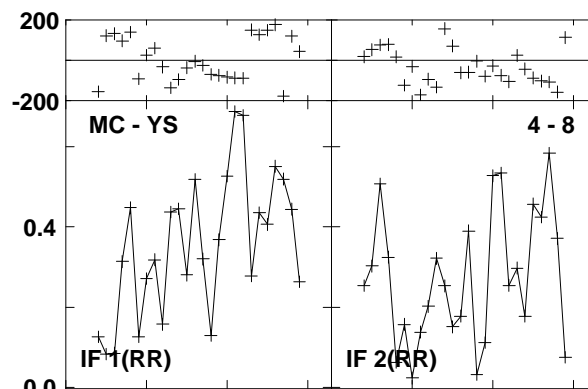
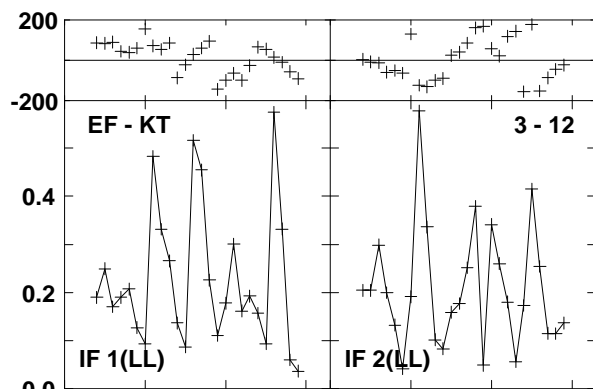
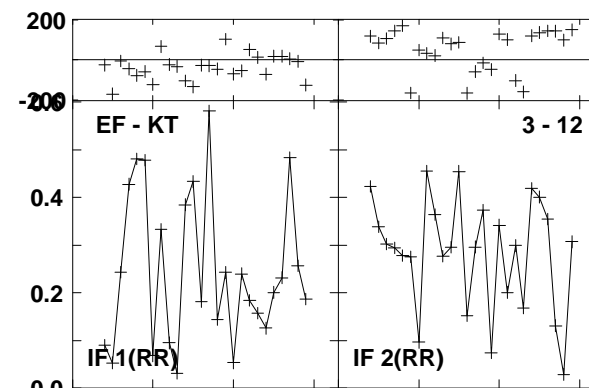
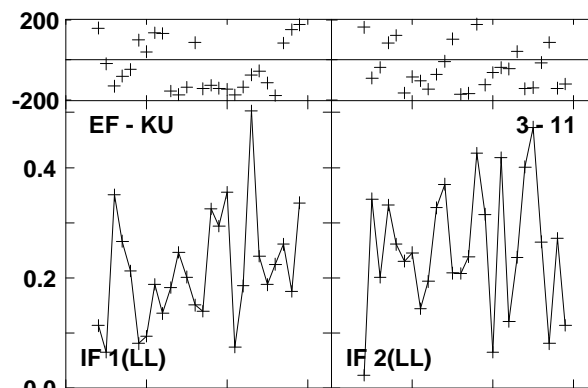
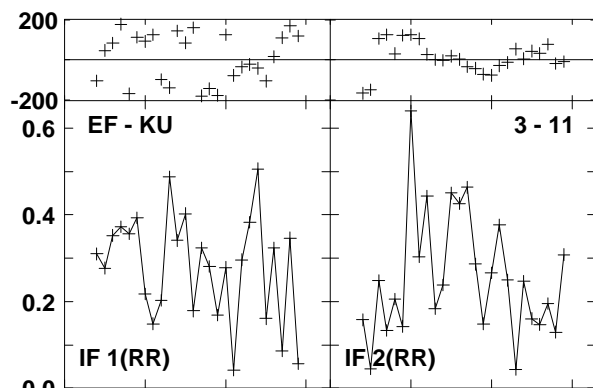
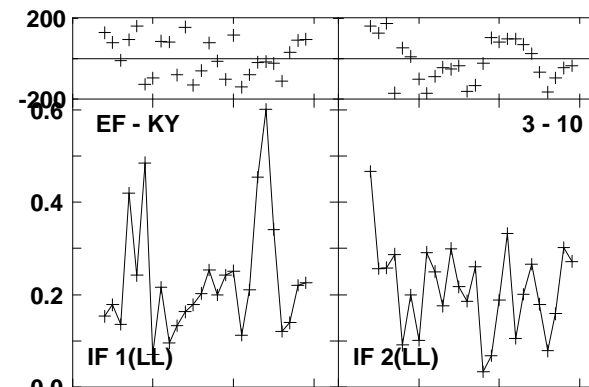
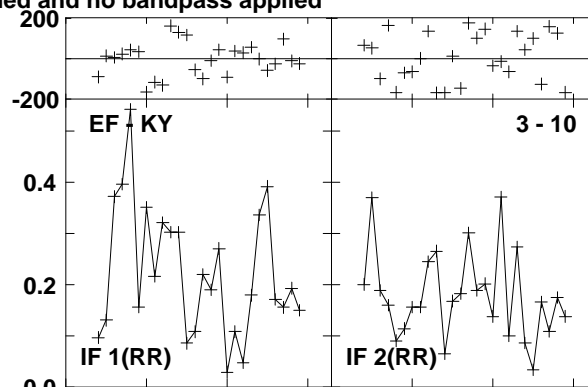
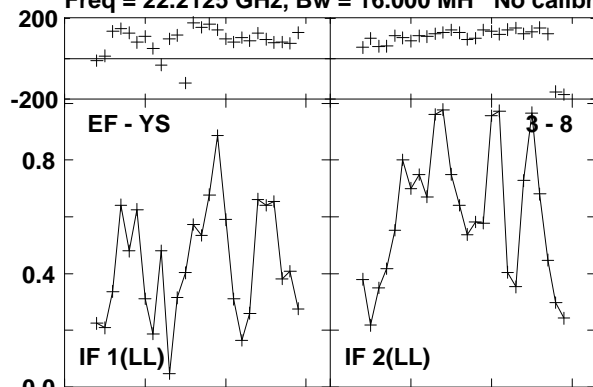

Lower frame: Milli Ampl Jy Top frame: Phas deg

Vector averaged cross-power spectrum Baseline: EF (03) - YS (08)

Timerange: 00/11:45:50 to 00/11:46:10

Plot file version 303 created 23-AUG-2016 15:00:51

0219+628 GA035B 1.UVDATA.1

Freq = 22.2125 GHz, Bw = 16.000 MH No calibration applied and no bandpass applied

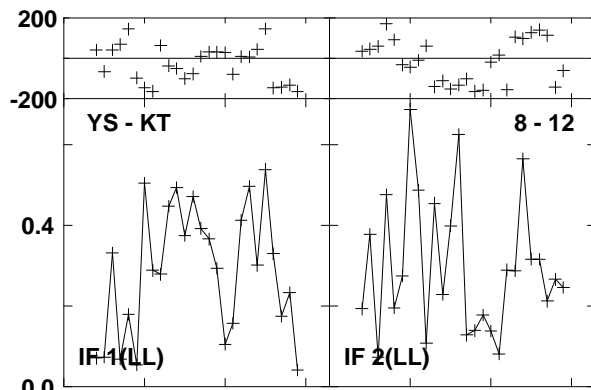
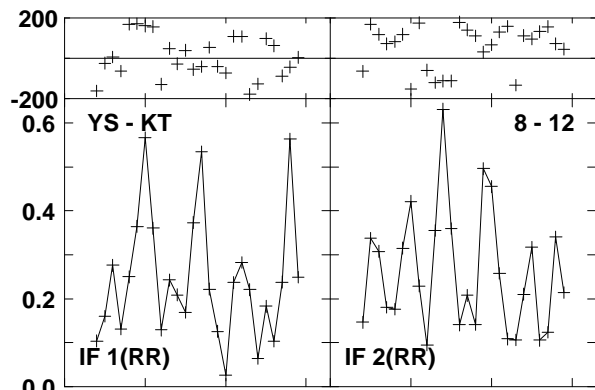
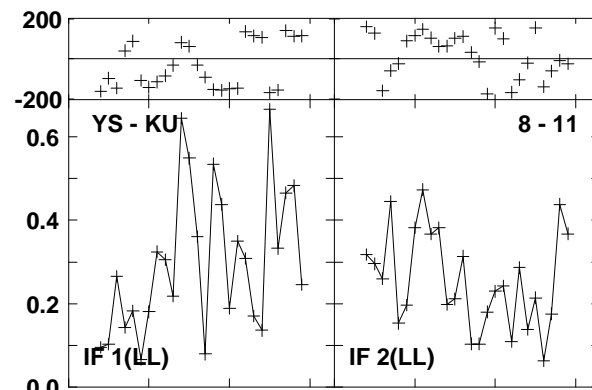
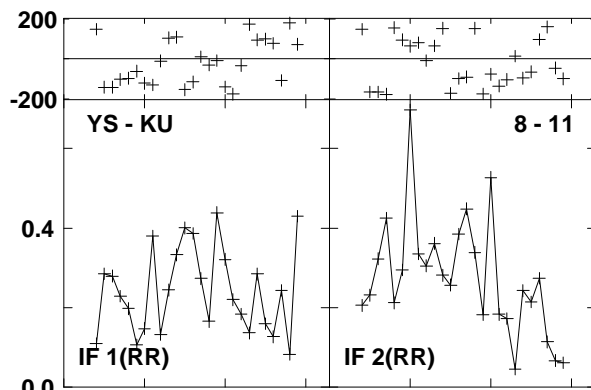
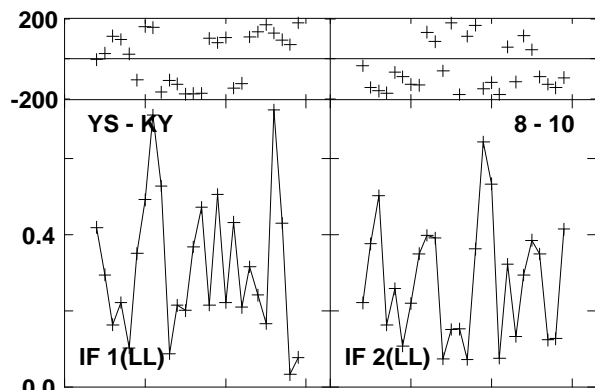
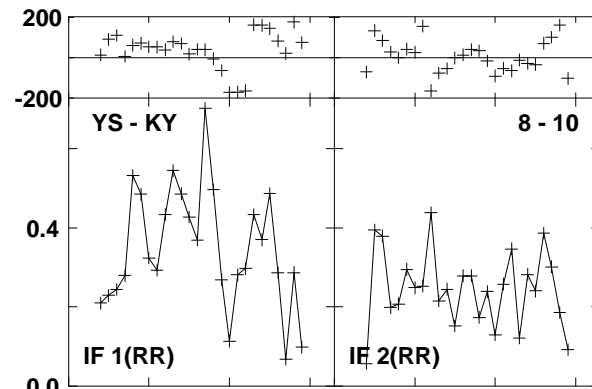
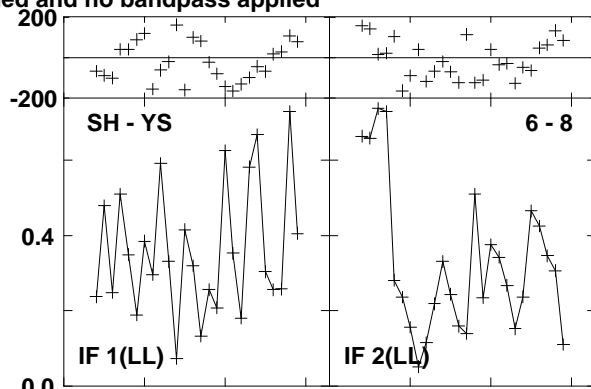
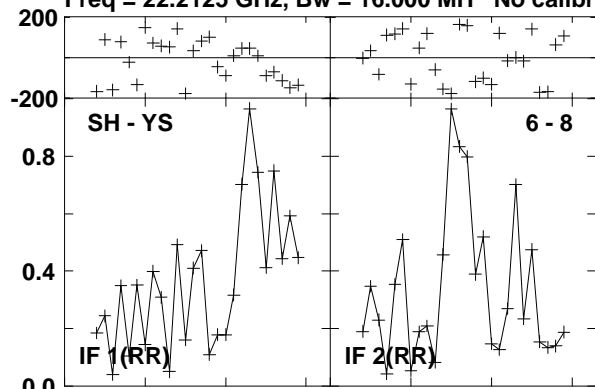

Lower frame: Milli Ampl Jy Top frame: Phas deg

Vector averaged cross-power spectrum Baseline: SH (06) - YS (08)

Timerange: 00/11:45:50 to 00/11:46:10

Plot file version 304 created 23-AUG-2016 15:00:51  
 W3IRS5 GA035B 1.UVDATA.1

Freq = 22.2125 GHz, Bw = 16.000 MH No calibration applied and no bandpass applied

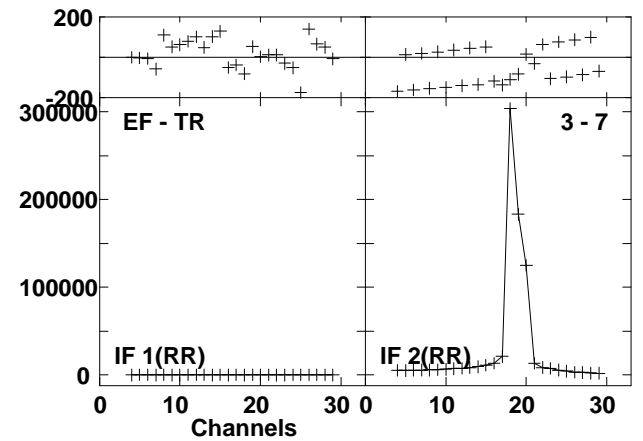
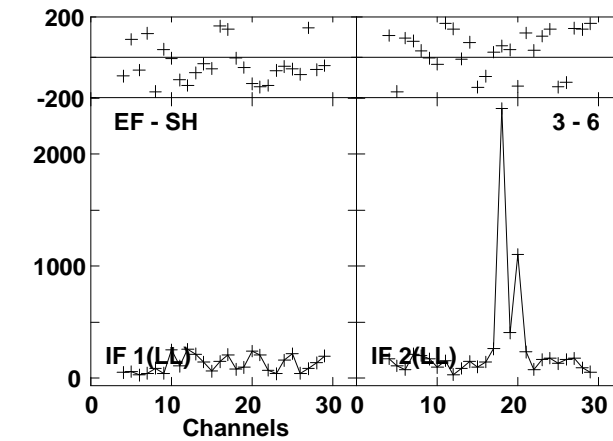
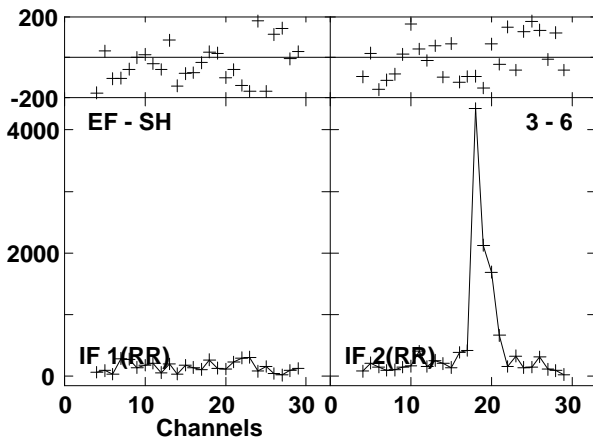
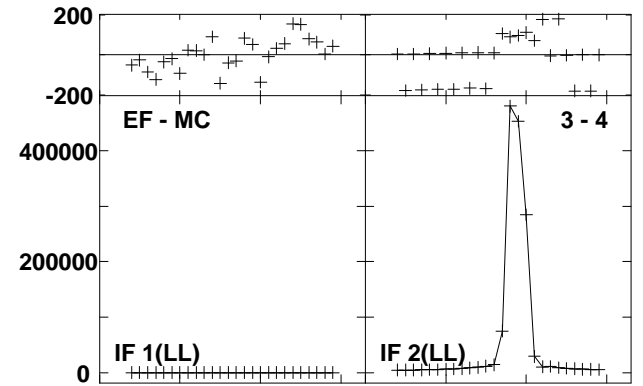
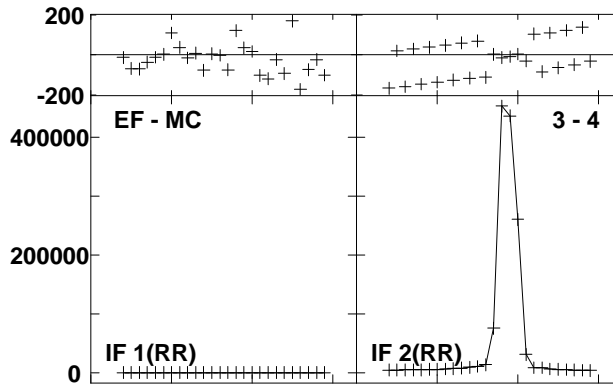
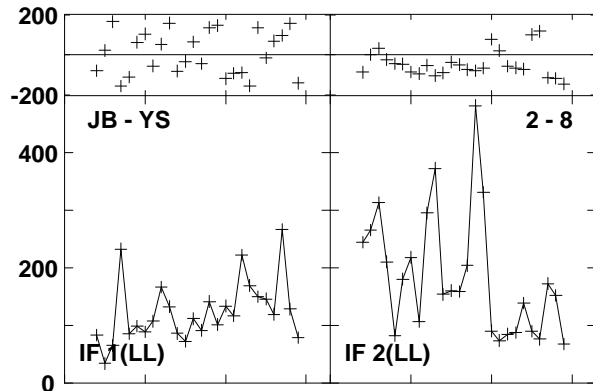
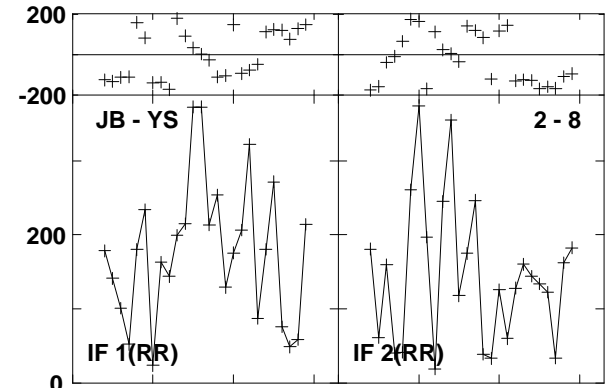
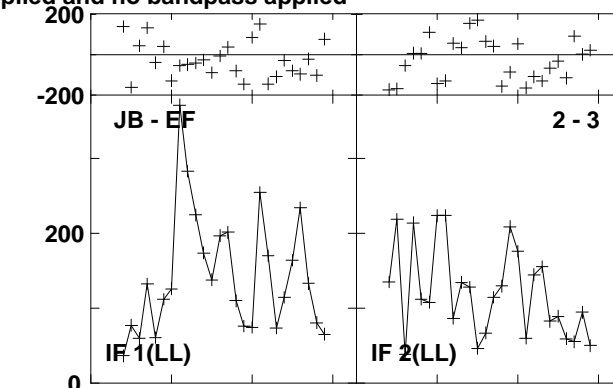
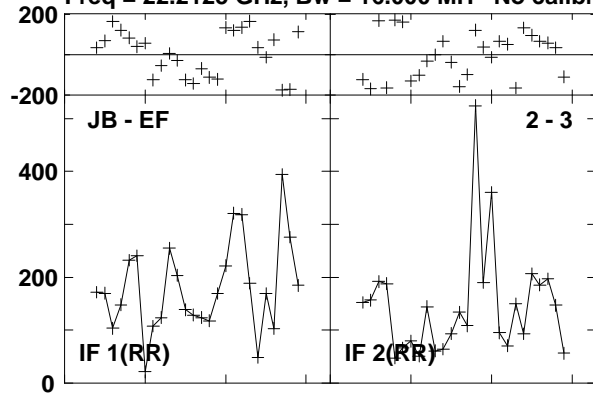

Lower frame: Micro Ampl Jy Top frame: Phas deg  
 Vector averaged cross-power spectrum Baseline: JB (02) - EF (03)  
 Timerange: 00/11:46:35 to 00/11:47:35



Plot file version 305 created 23-AUG-2016 15:00:51

W3IRS5 GA035B 1.UVDATA.1

Freq = 22.2125 GHz, Bw = 16.000 MH No calibration applied and no bandpass applied

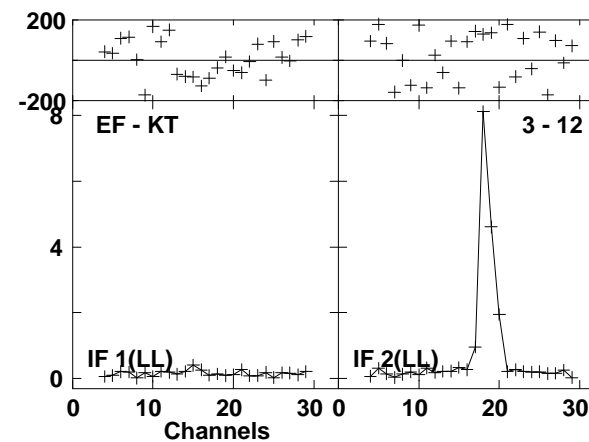
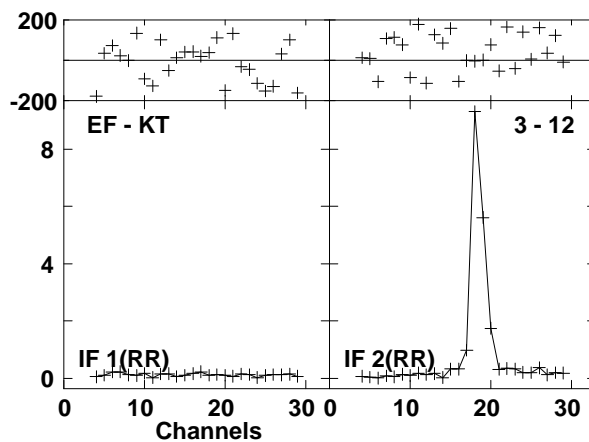
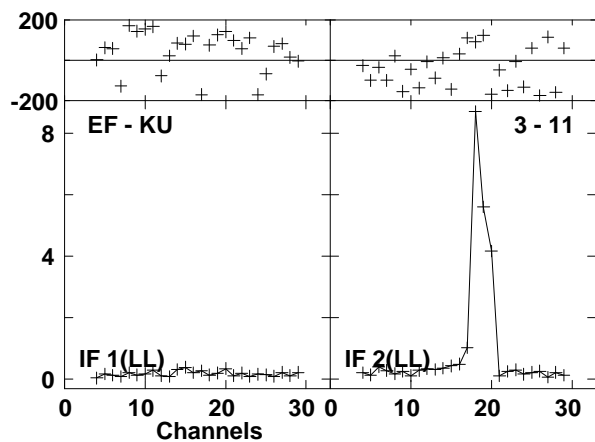
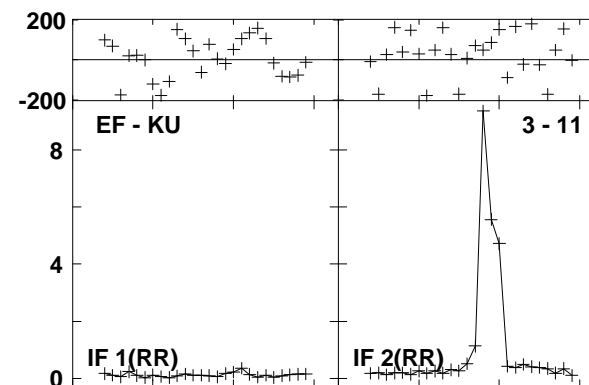
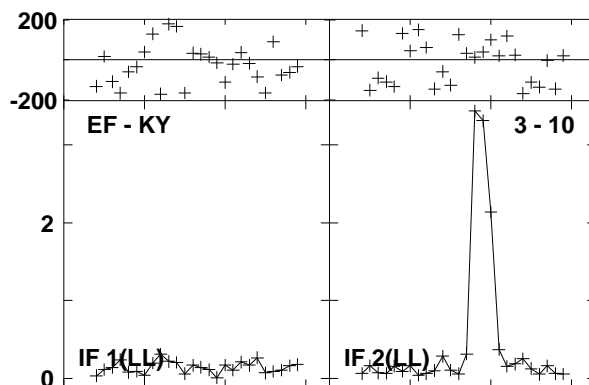
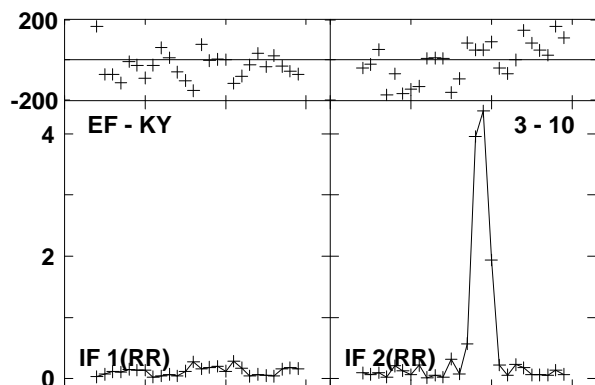
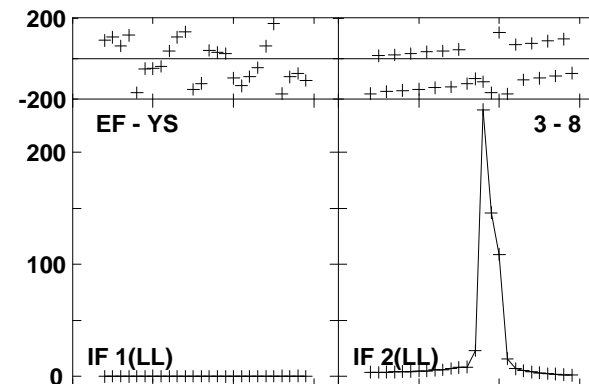
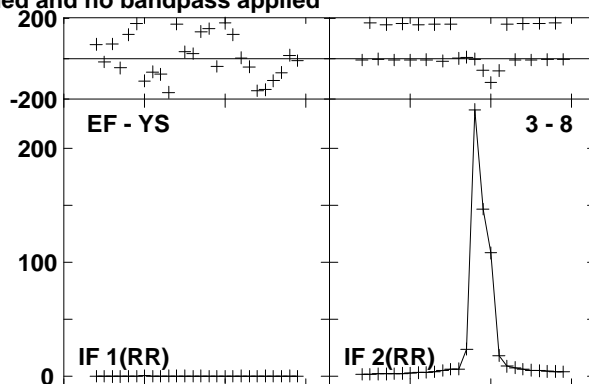
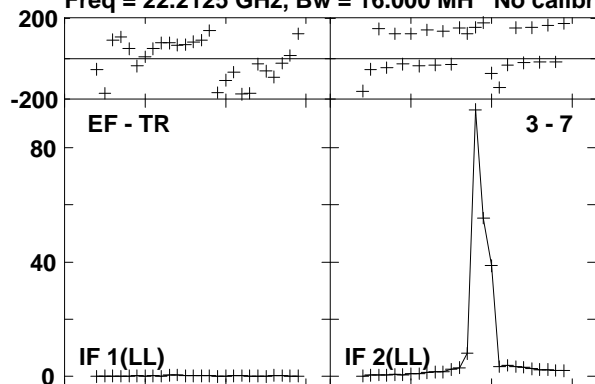

Lower frame: Milli Ampl Jy Top frame: Phas deg  
Vector averaged cross-power spectrum Baseline: EF (03) - TR (07)  
Timerange: 00/11:46:35 to 00/11:47:35

Plot file version 306 created 23-AUG-2016 15:00:51

W3IRS5 GA035B 1.UVDATA.1

Freq = 22.2125 GHz, Bw = 16.000 MH No calibration applied and no bandpass applied

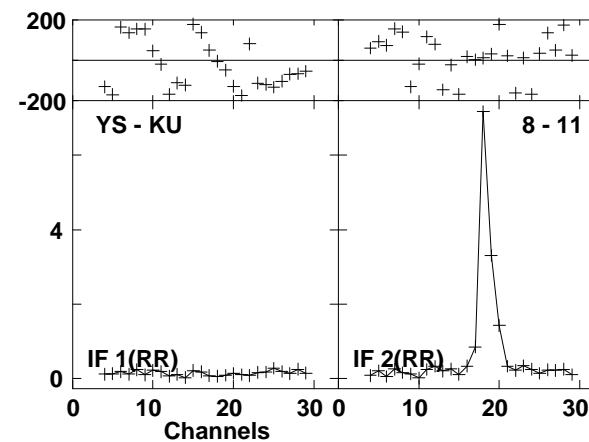
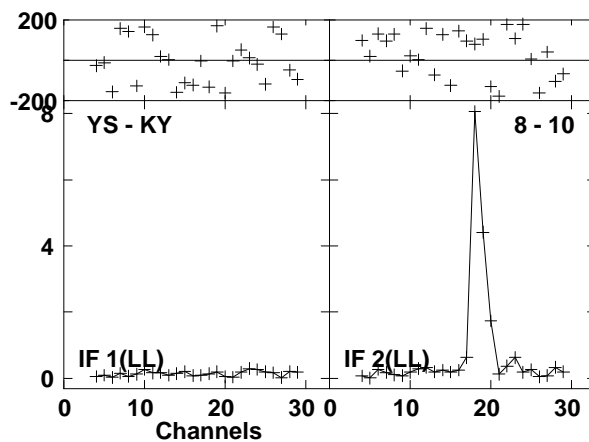
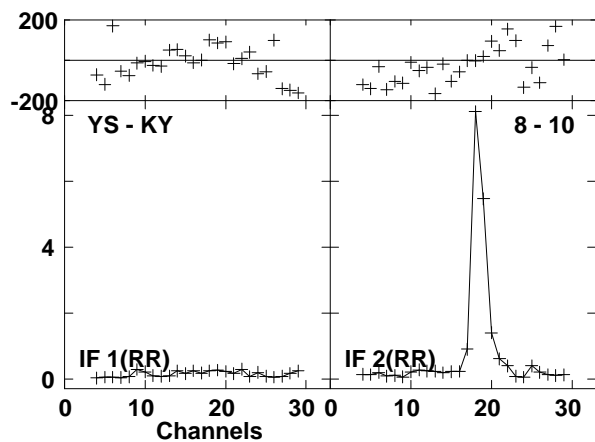
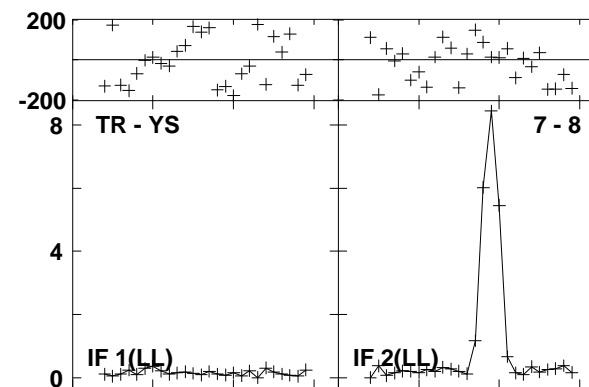
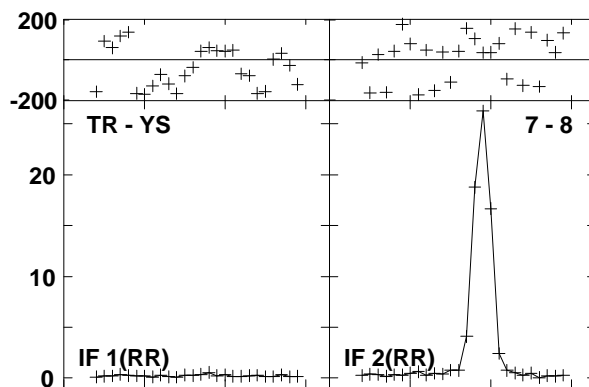
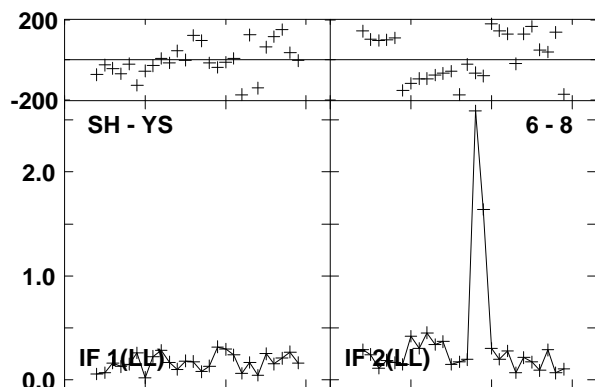
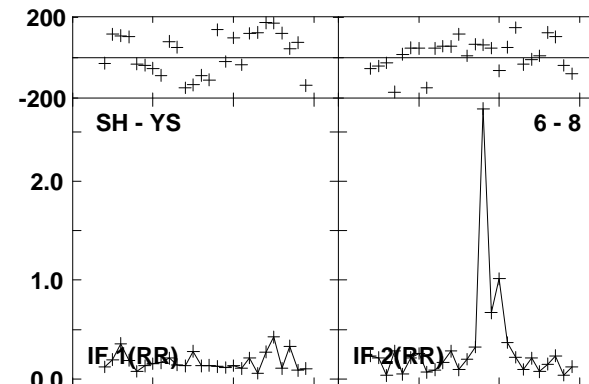
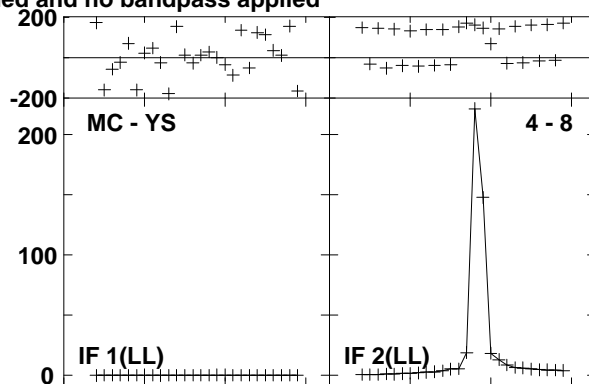
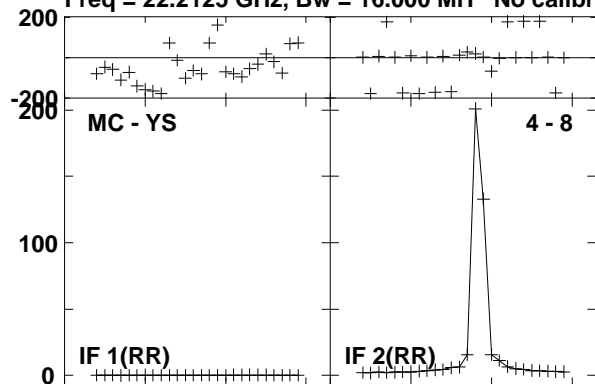

Lower frame: Milli Ampl Jy Top frame: Phas deg

Vector averaged cross-power spectrum Baseline: MC (04) - YS (08)

Timerange: 00/11:46:35 to 00/11:47:35

Plot file version 307 created 23-AUG-2016 15:00:51  
W3IRS5 GA035B 1.UVDATA.1

Freq = 22.2125 GHz, Bw = 16.000 MH No calibration applied and no bandpass applied

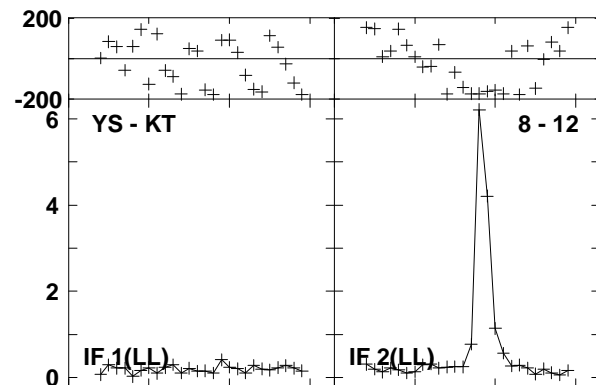
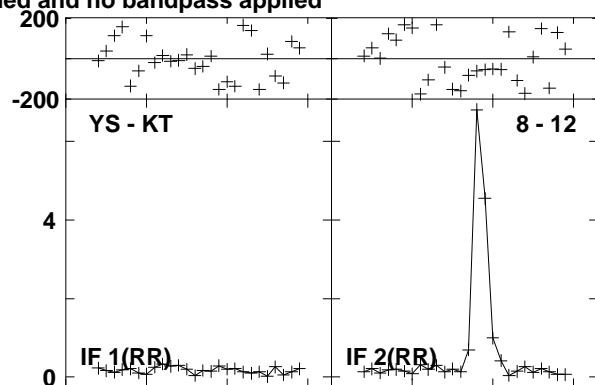
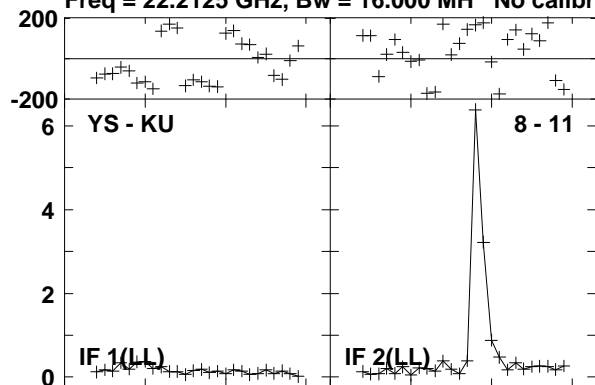

Lower frame: Milli Ampl Jy Top frame: Phas deg  
Vector averaged cross-power spectrum Baseline: YS (08) - KU (11)  
Timerange: 00/11:46:35 to 00/11:47:35

Plot file version 308 created 23-AUG-2016 15:00:51

0219+628 GA035B 1.UVDATA.1

Freq = 22.2125 GHz, Bw = 16.000 MH No calibration applied and no bandpass applied

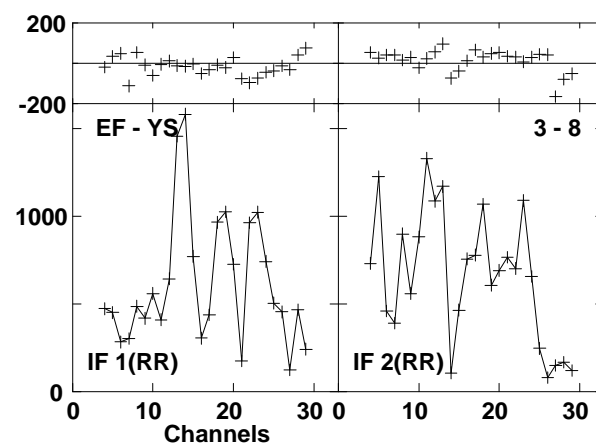
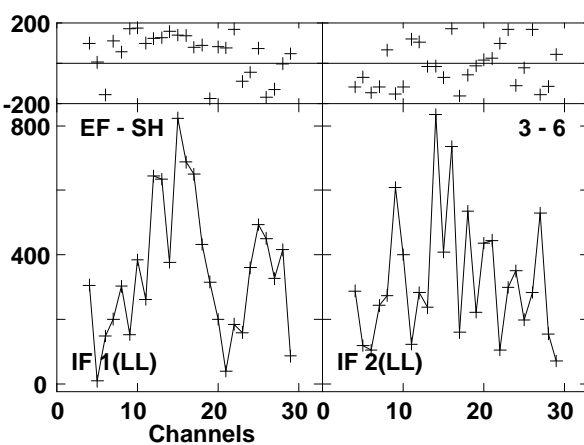
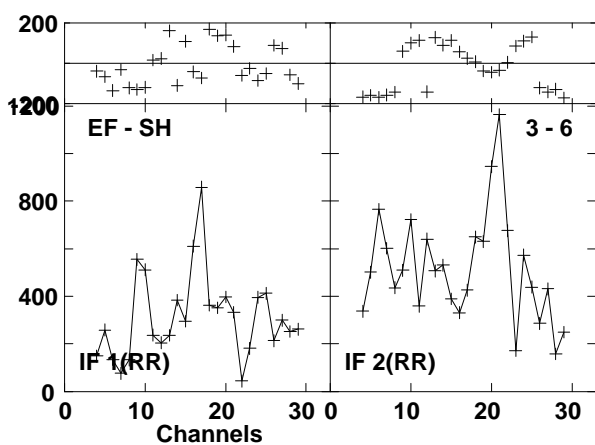
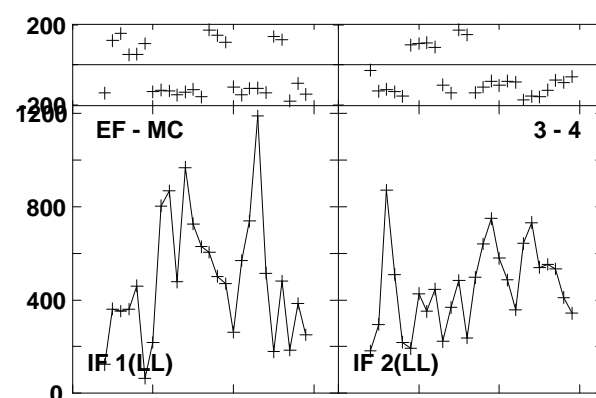
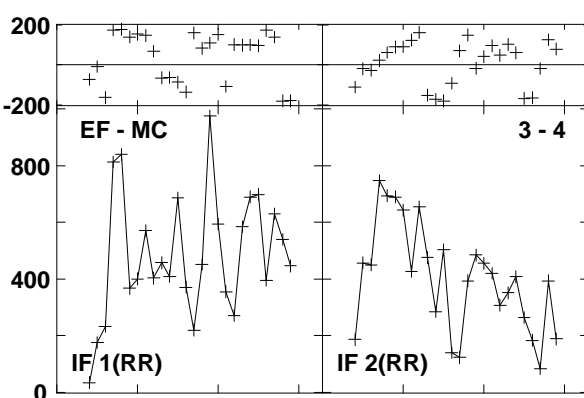
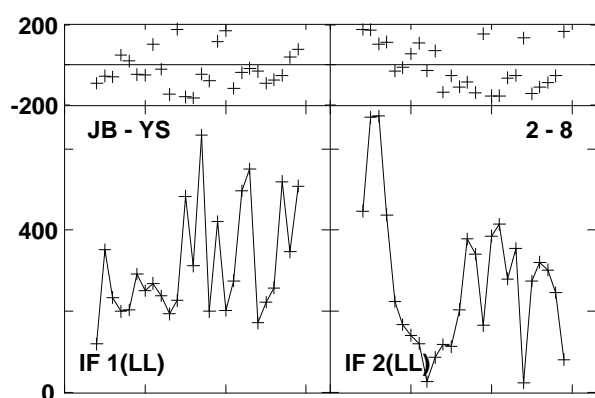
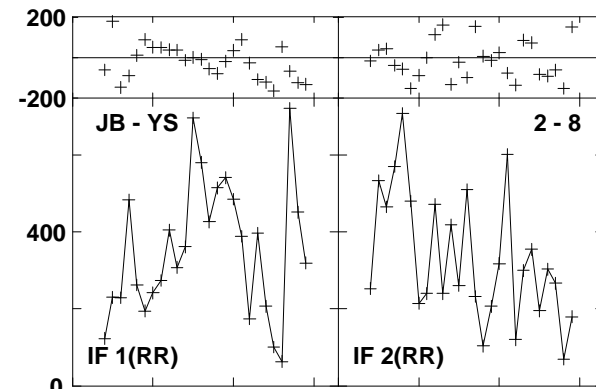
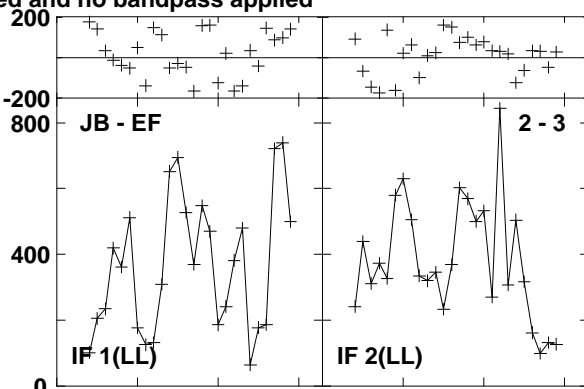
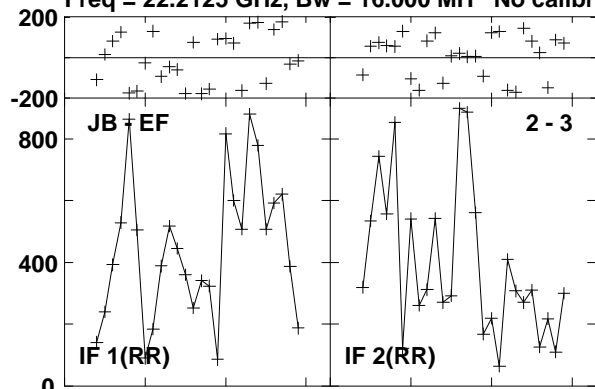

Lower frame: Micro Ampl Jy Top frame: Phas deg  
Vector averaged cross-power spectrum Baseline: JB (02) - EF (03)  
Timerange: 00/11:48:00 to 00/11:48:20

Plot file version 309 created 23-AUG-2016 15:00:51

0219+628 GA035B 1.UVDATA.1

Freq = 22.2125 GHz, Bw = 16.000 MH No calibration applied and no bandpass applied

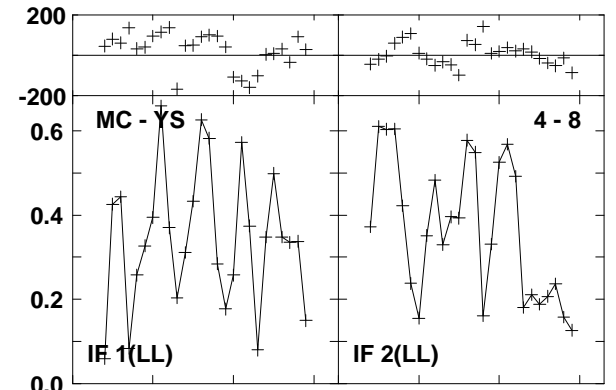
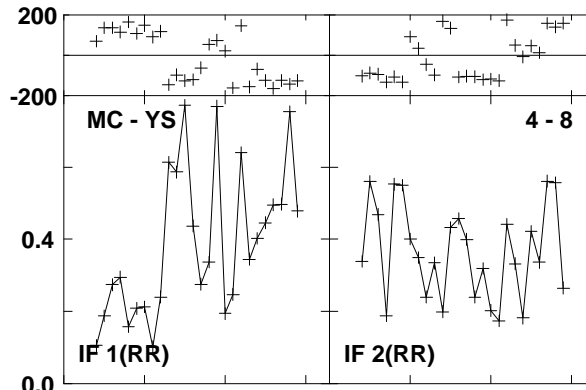
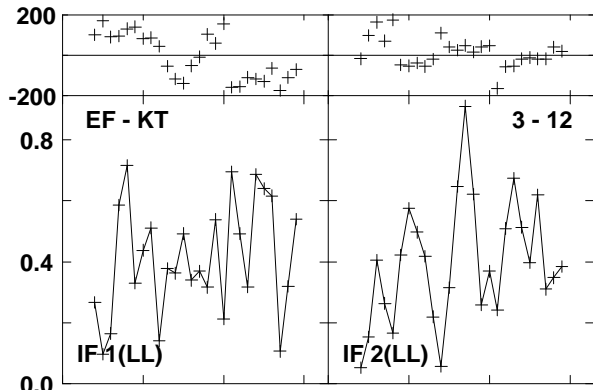
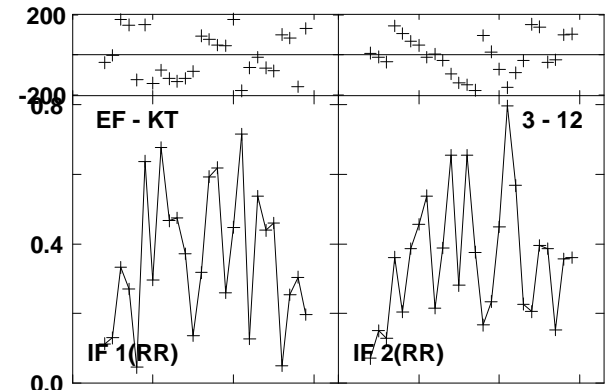
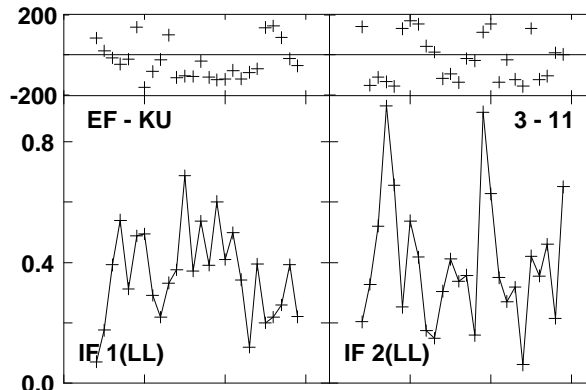
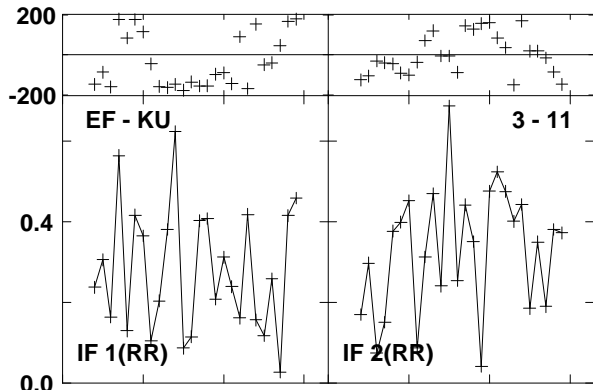
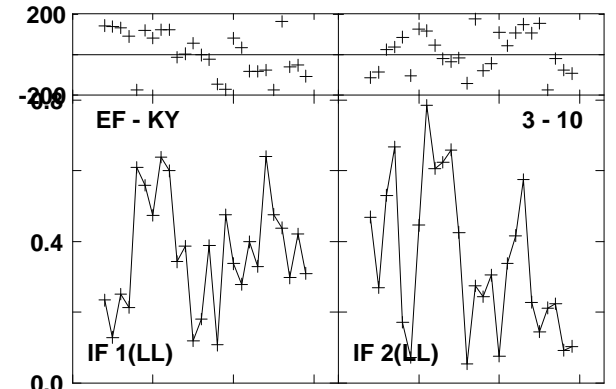
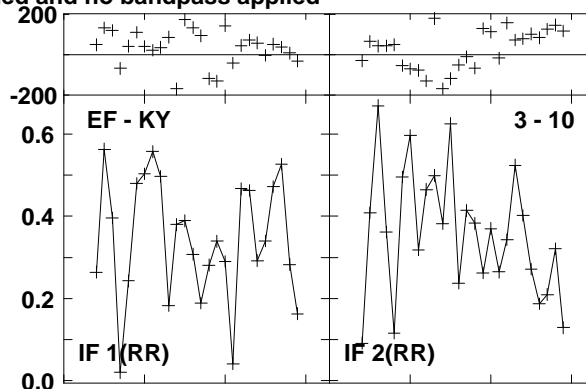
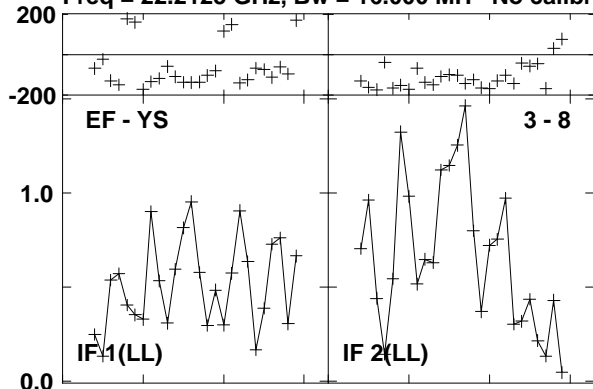

Lower frame: Milli Ampl Jy Top frame: Phas deg  
Vector averaged cross-power spectrum Baseline: EF (03) - YS (08)  
Timerange: 00/11:48:00 to 00/11:48:20

Plot file version 310 created 23-AUG-2016 15:00:51

0219+628 GA035B 1.UVDATA.1

Freq = 22.2125 GHz, Bw = 16.000 MH No calibration applied and no bandpass applied

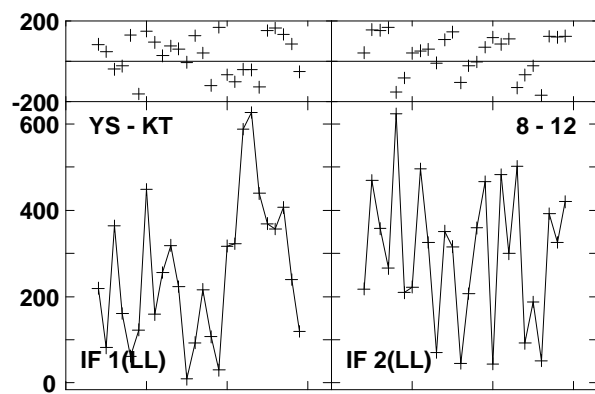
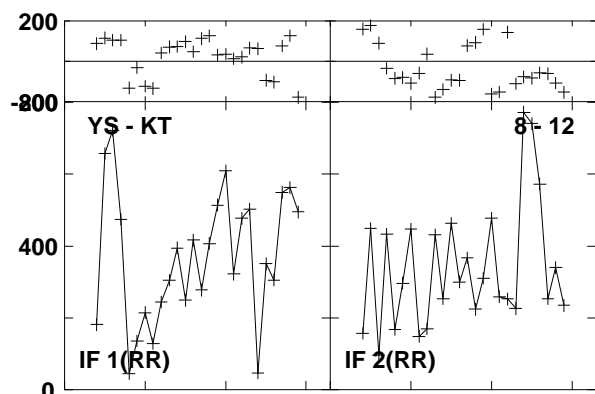
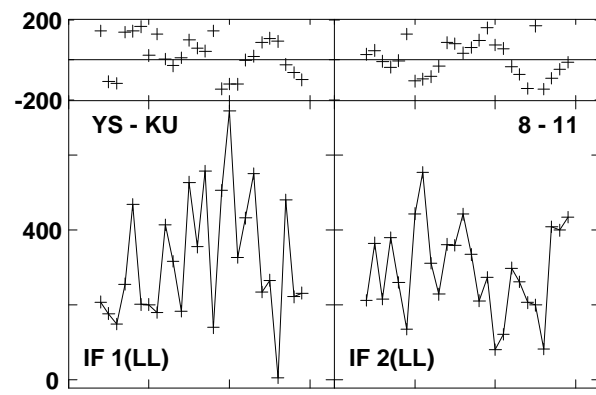
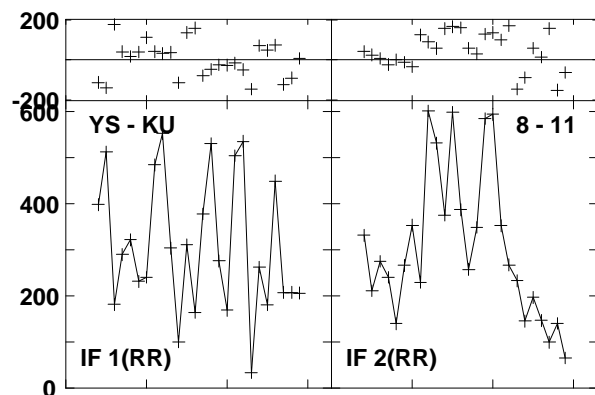
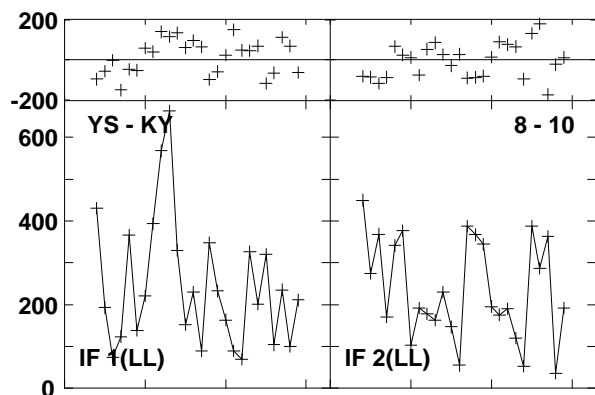
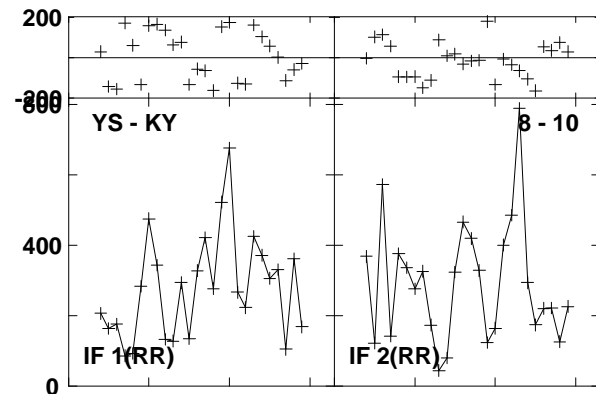
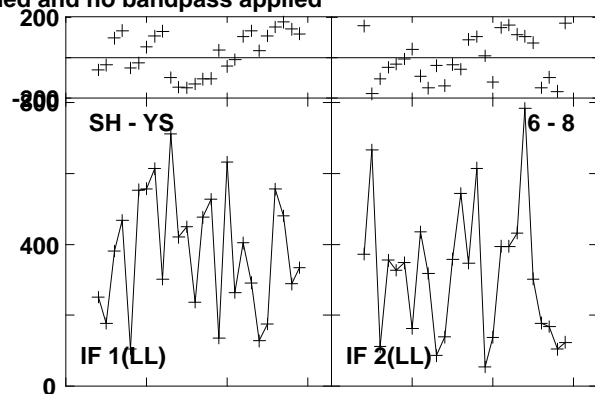
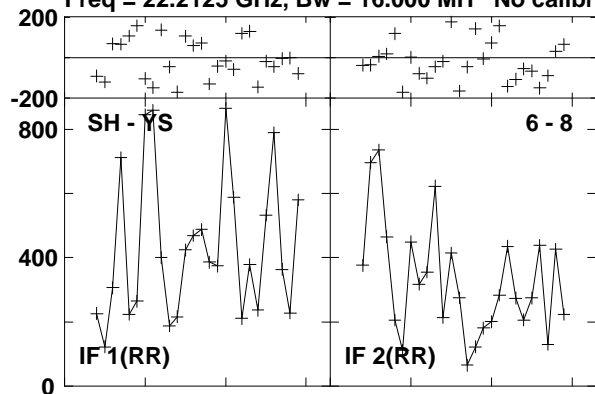

Lower frame: Micro Ampl Jy Top frame: Phas deg  
Vector averaged cross-power spectrum Baseline: SH (06) - YS (08)  
Timerange: 00/11:48:00 to 00/11:48:20

Plot file version 311 created 23-AUG-2016 15:00:51  
 W3IRS5 GA035B 1.UVDATA.1

Freq = 22.2125 GHz, Bw = 16.000 MH No calibration applied and no bandpass applied

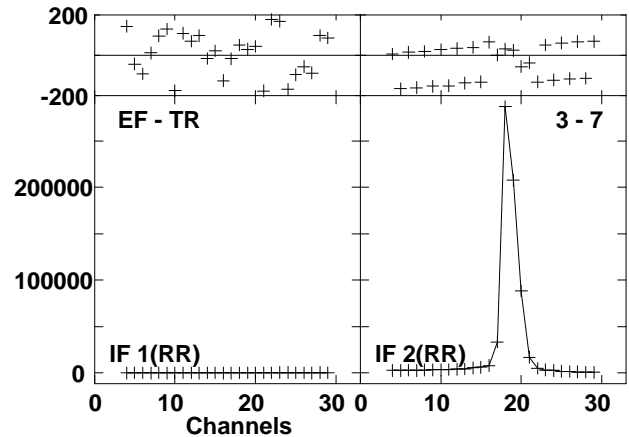
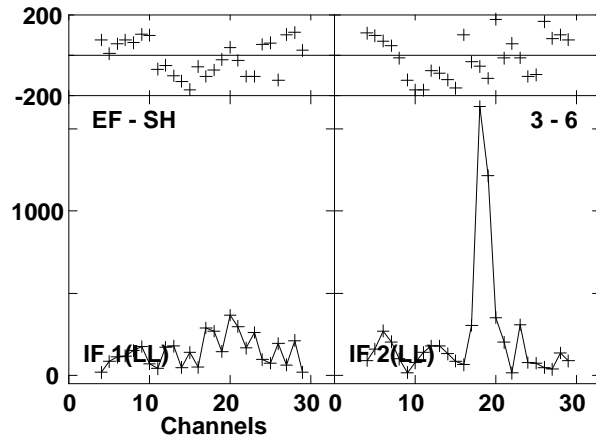
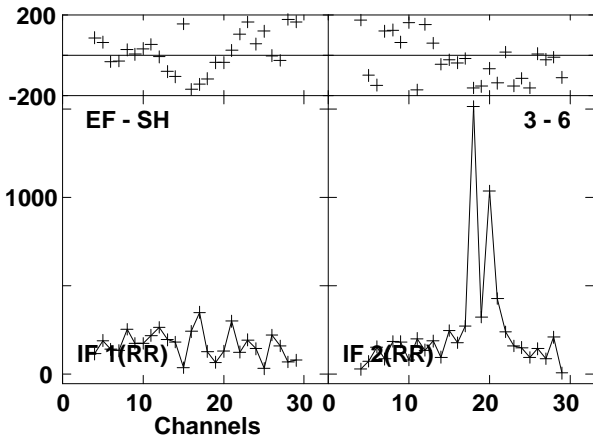
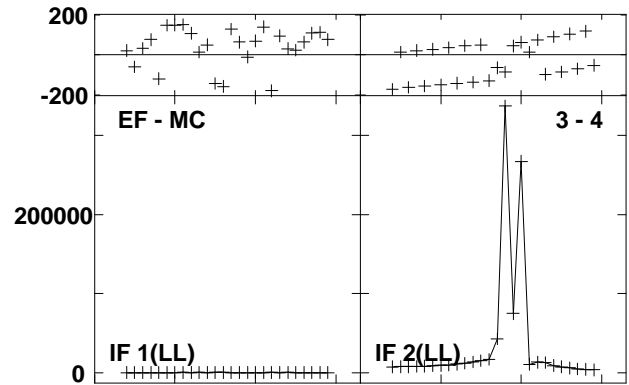
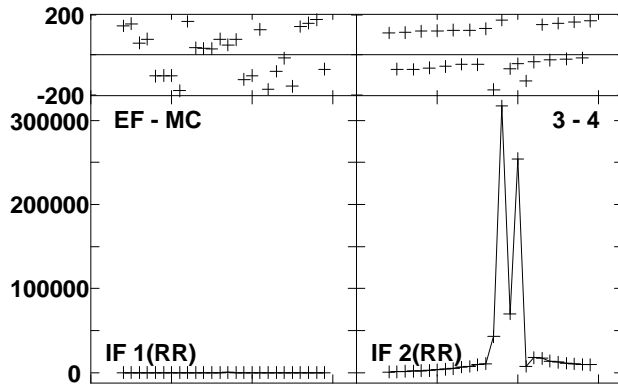
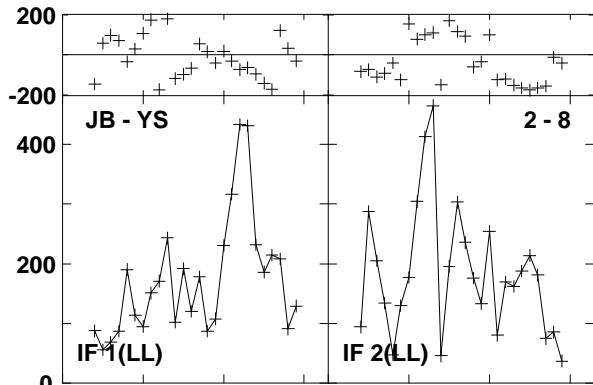
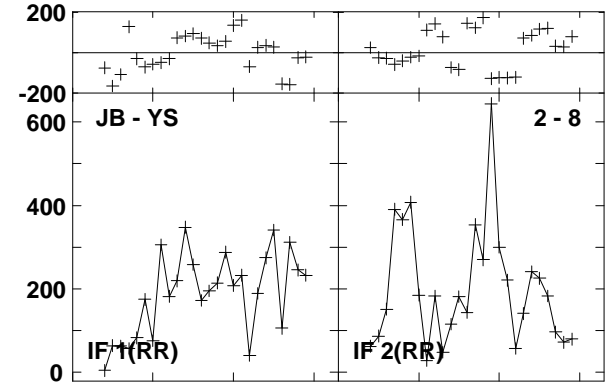
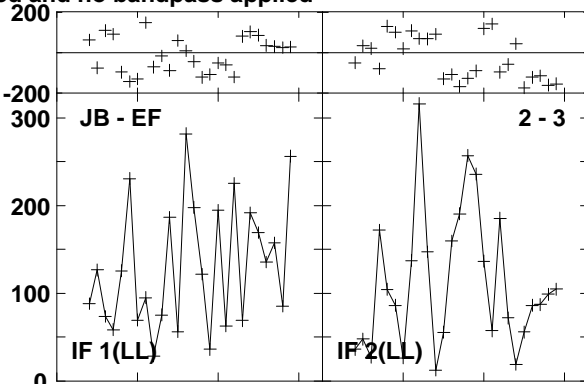
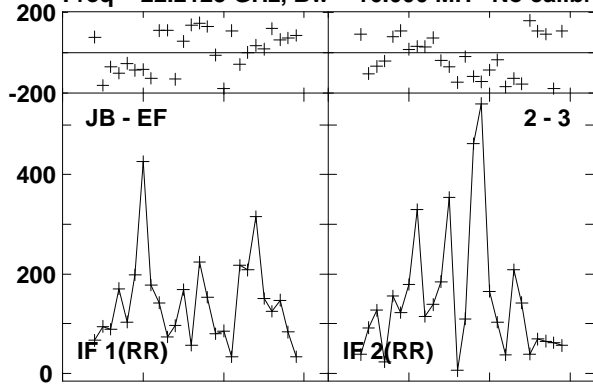

Lower frame: Micro Ampl Jy Top frame: Phas deg  
 Vector averaged cross-power spectrum Baseline: JB (02) - EF (03)  
 Timerange: 00/11:48:46 to 00/11:49:45

Plot file version 312 created 23-AUG-2016 15:00:51

W3IRS5 GA035B 1.UVDATA.1

Freq = 22.2125 GHz, Bw = 16.000 MH No calibration applied and no bandpass applied

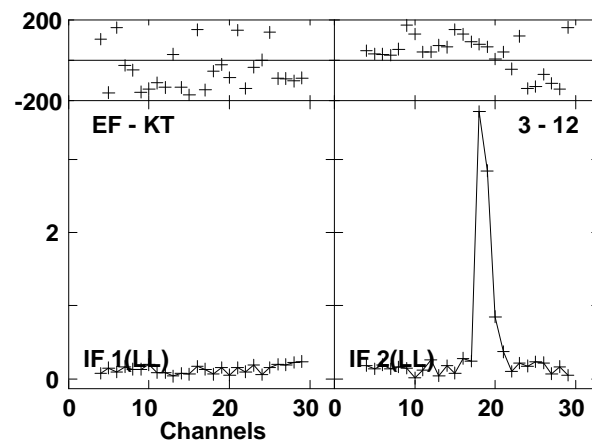
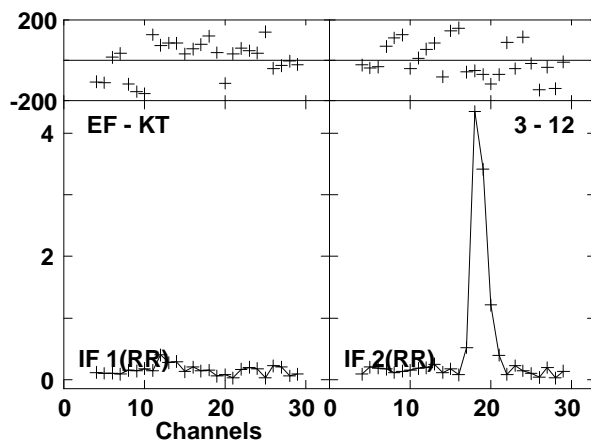
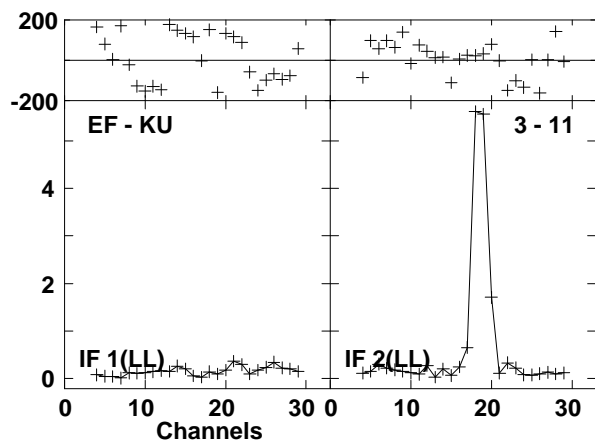
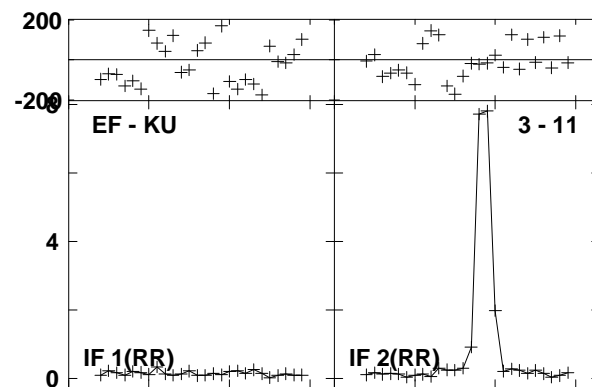
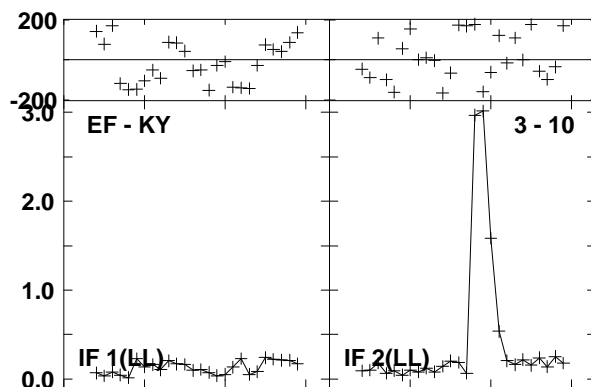
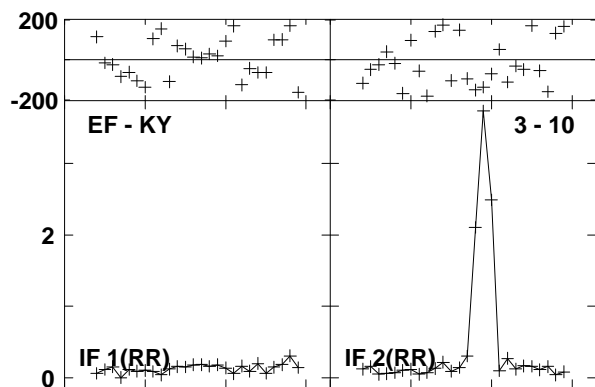
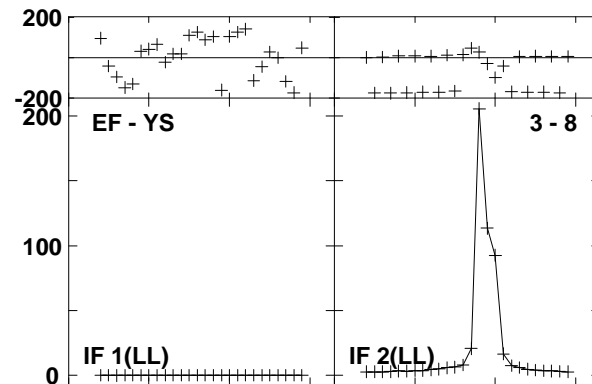
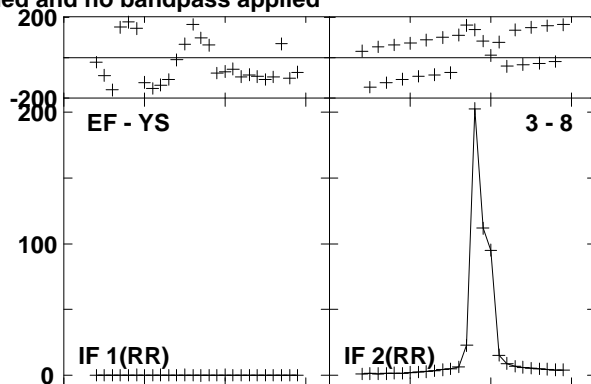
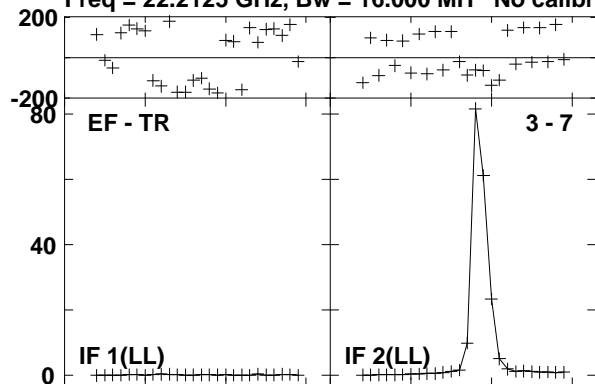

Lower frame: Milli Ampl Jy Top frame: Phas deg  
Vector averaged cross-power spectrum Baseline: EF (03) - TR (07)  
Timerange: 00/11:48:46 to 00/11:49:45



Plot file version 313 created 23-AUG-2016 15:00:52

W3IRS5 GA035B 1.UVDATA.1

Freq = 22.2125 GHz, Bw = 16.0000 MH No calibration applied and no bandpass applied

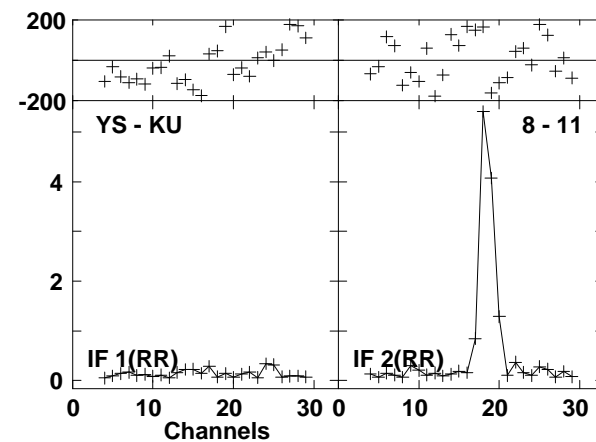
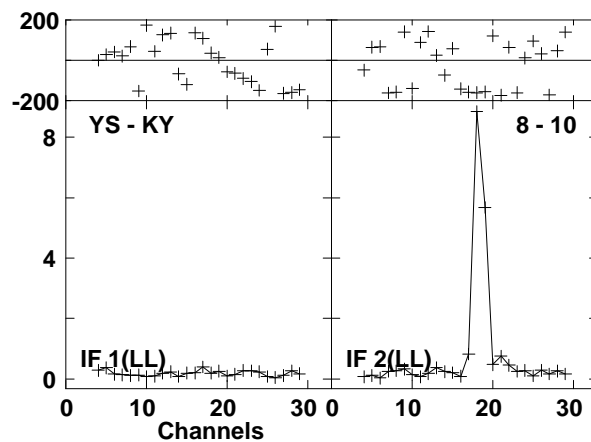
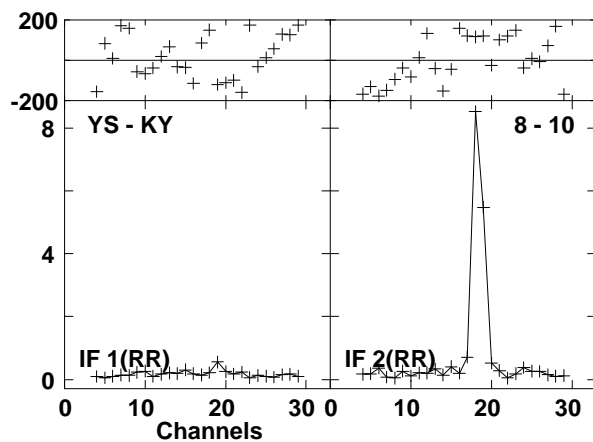
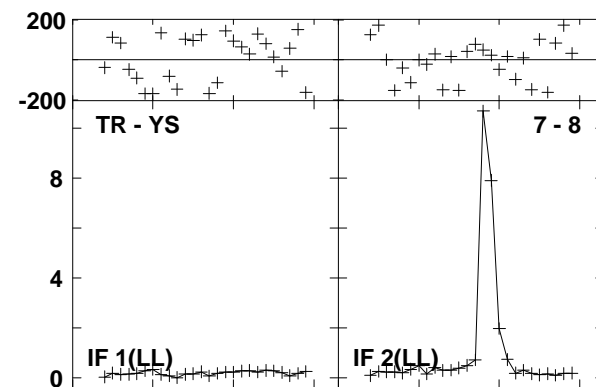
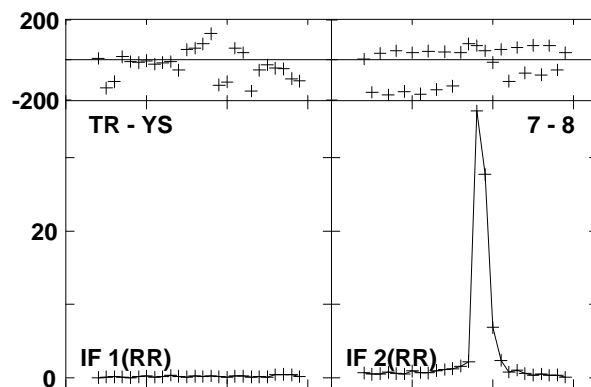
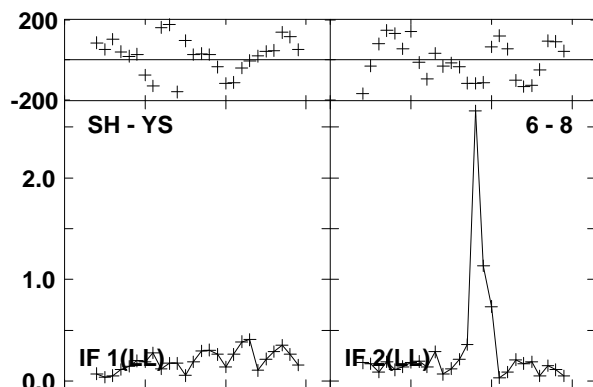
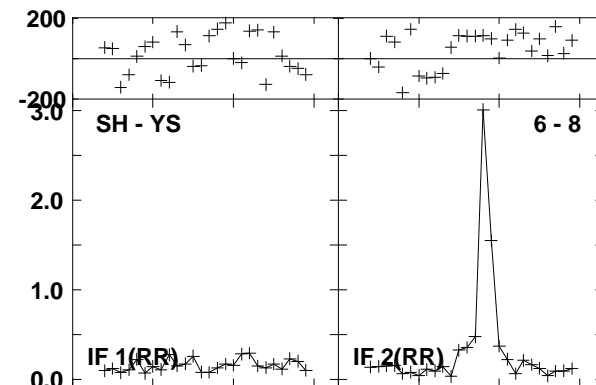
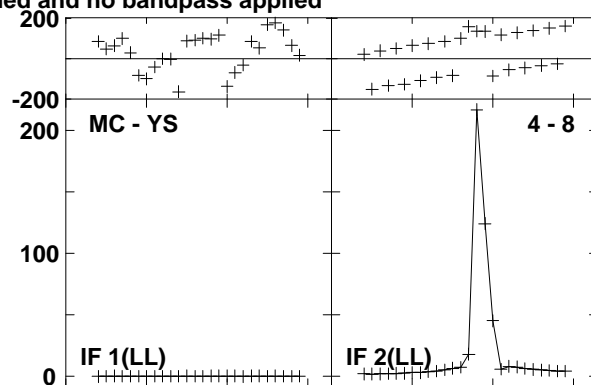
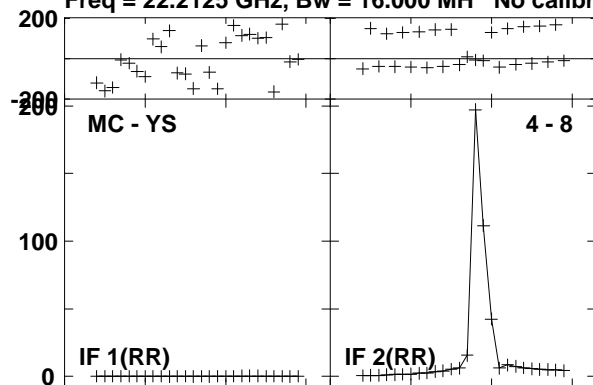

Lower frame: Milli Ampl Jy Top frame: Phas deg  
Vector averaged cross-power spectrum Baseline: MC (04) - YS (08)  
Timerange: 00/11:48:46 to 00/11:49:45

Plot file version 314 created 23-AUG-2016 15:00:52  
W3IRS5 GA035B 1.UVDATA.1

Freq = 22.2125 GHz, Bw = 16.000 MH No calibration applied and no bandpass applied

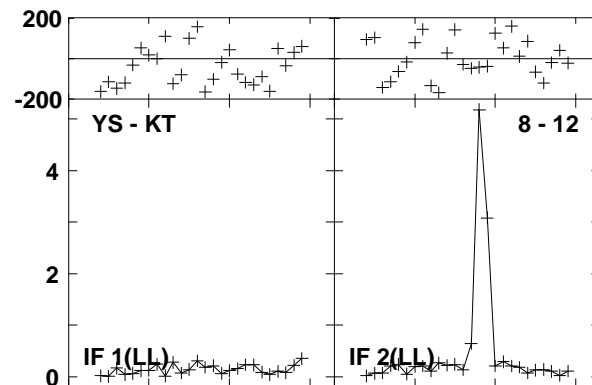
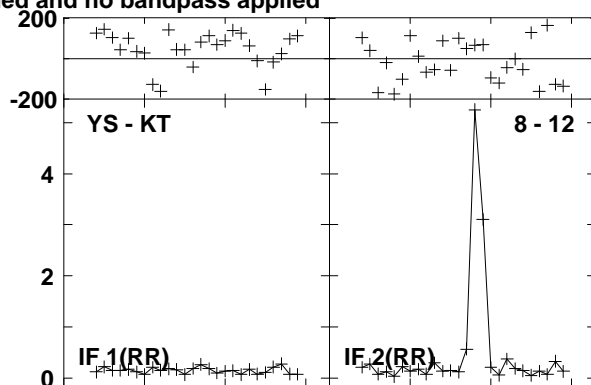
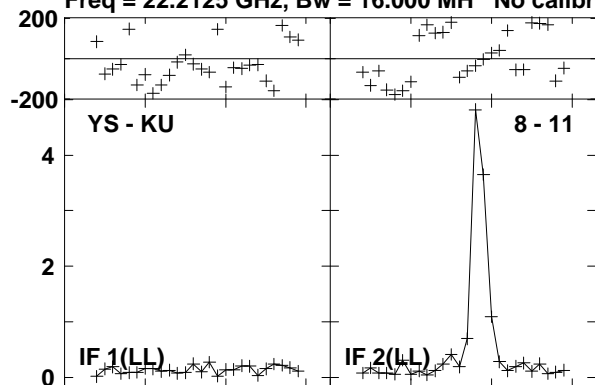

Lower frame: Milli Ampl Jy Top frame: Phas deg  
Vector averaged cross-power spectrum Baseline: YS (08) - KU (11)  
Timerange: 00/11:48:46 to 00/11:49:45

Plot file version 315 created 23-AUG-2016 15:00:52

0219+628 GA035B 1.UVDATA.1

Freq = 22.2125 GHz, Bw = 16.000 MH No calibration applied and no bandpass applied

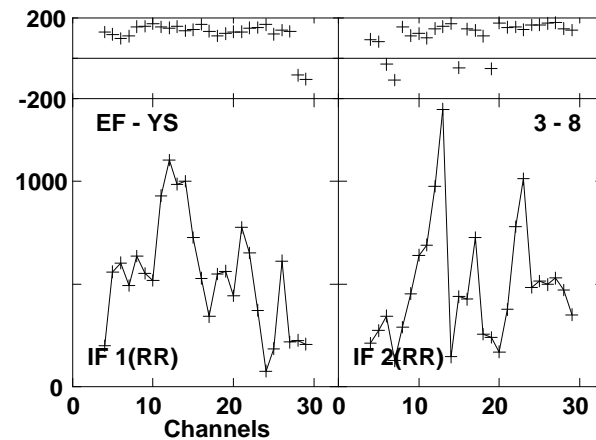
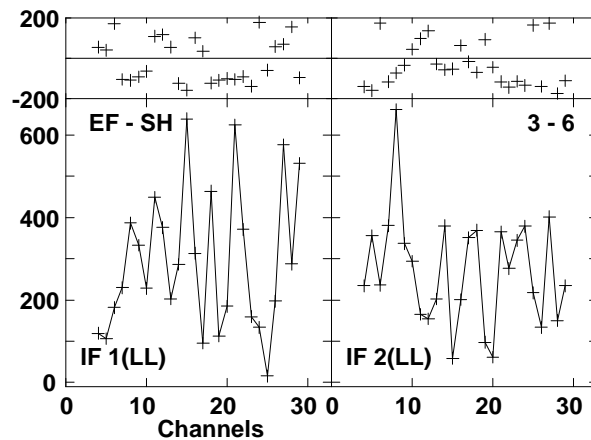
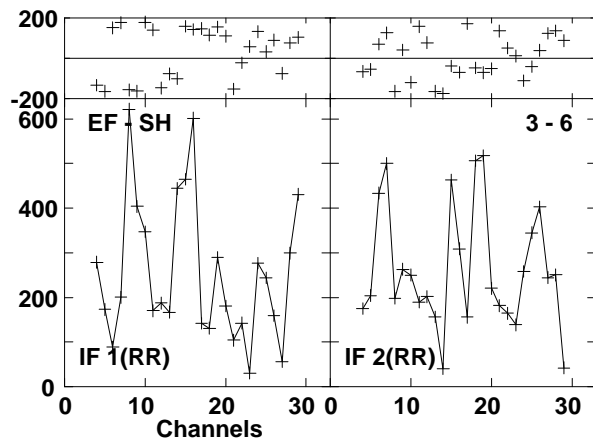
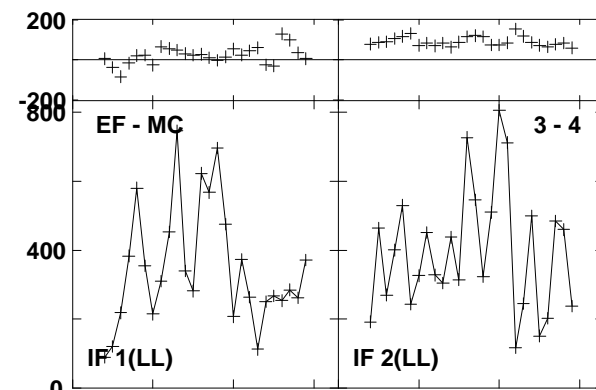
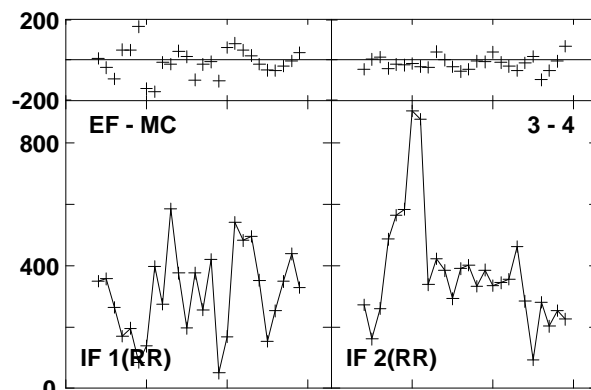
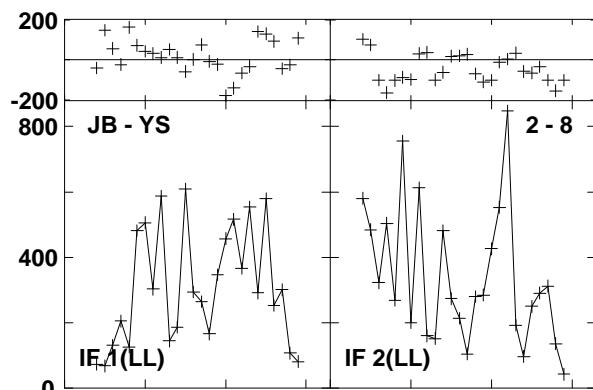
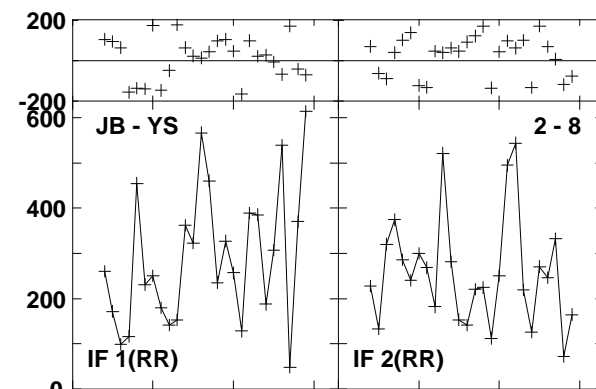
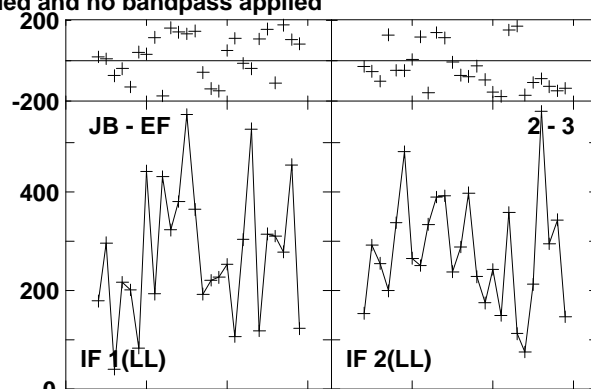
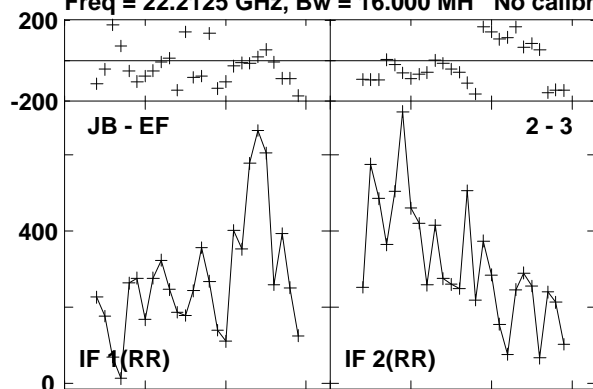

Lower frame: Micro Ampl Jy Top frame: Phas deg  
Vector averaged cross-power spectrum Baseline: JB (02) - EF (03)  
Timerange: 00/11:50:10 to 00/11:50:30

Plot file version 316 created 23-AUG-2016 15:00:52

0219+628 GA035B 1.UVDATA.1

Freq = 22.2125 GHz, Bw = 16.000 MH No calibration applied and no bandpass applied

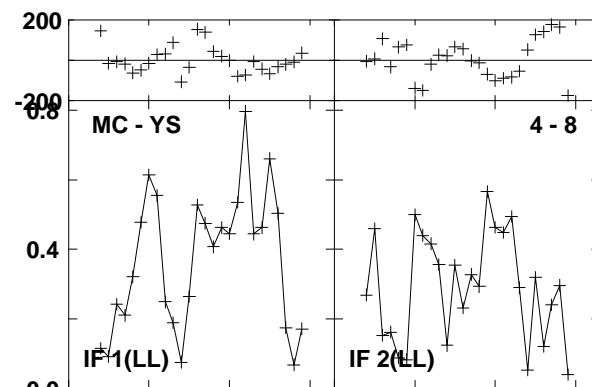
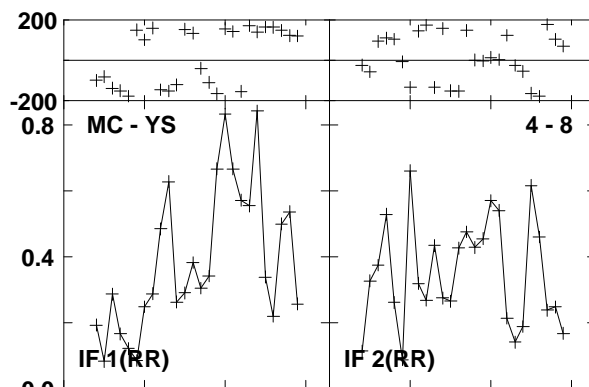
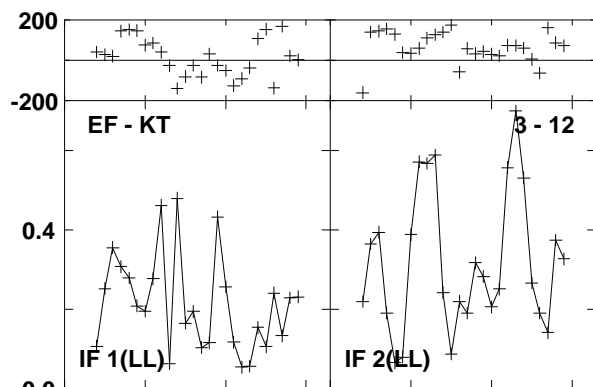
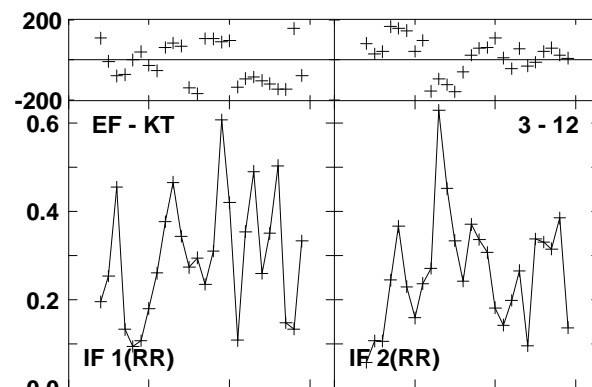
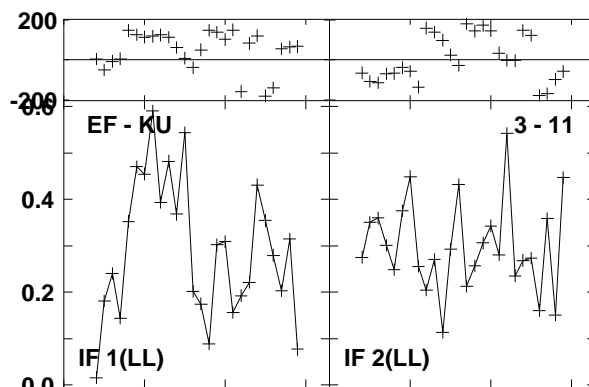
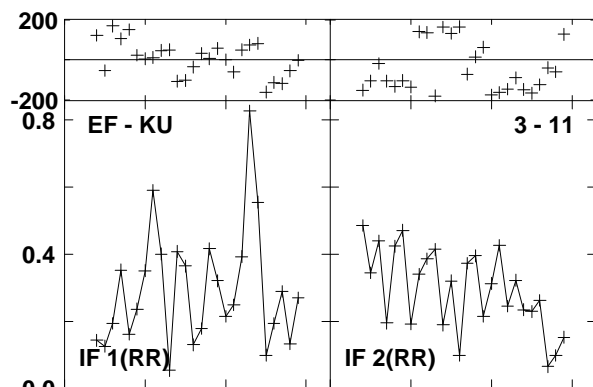
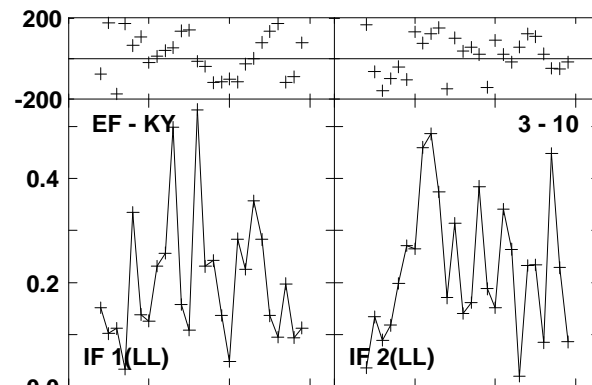
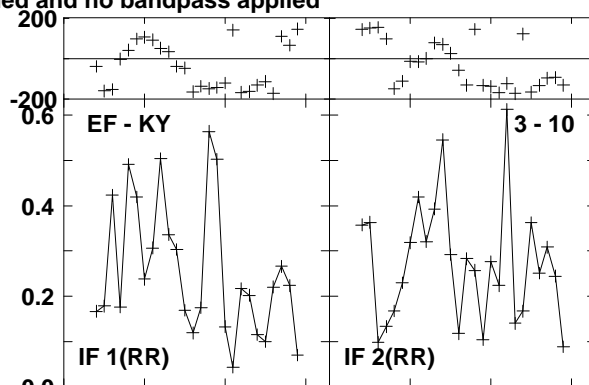
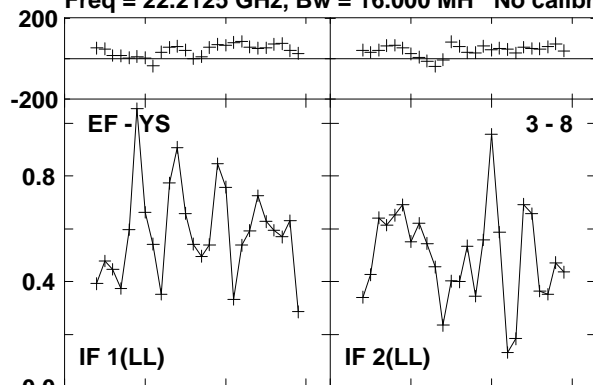

Lower frame: Milli Ampl Jy Top frame: Phas deg  
Vector averaged cross-power spectrum Baseline: EF (03) - YS (08)  
Timerange: 00/11:50:10 to 00/11:50:30

Plot file version 317 created 23-AUG-2016 15:00:52

0219+628 GA035B 1.UVDATA.1

Freq = 22.2125 GHz, Bw = 16.000 MH No calibration applied and no bandpass applied

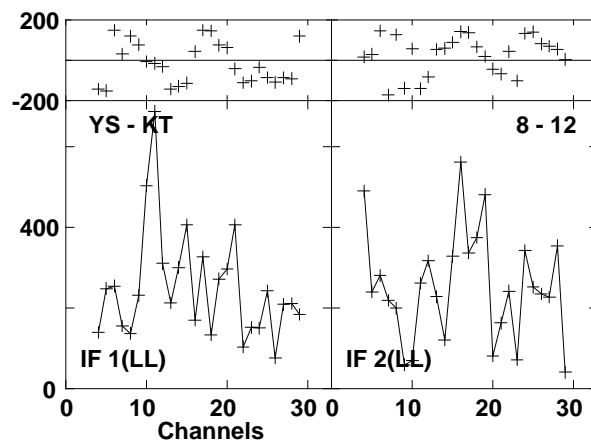
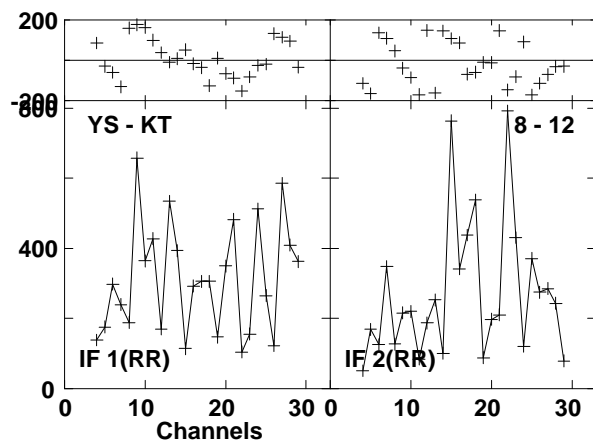
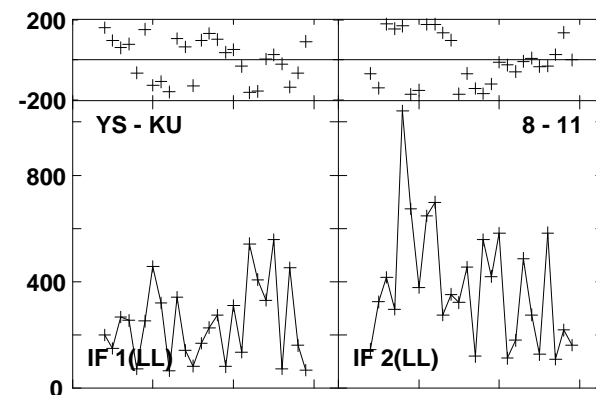
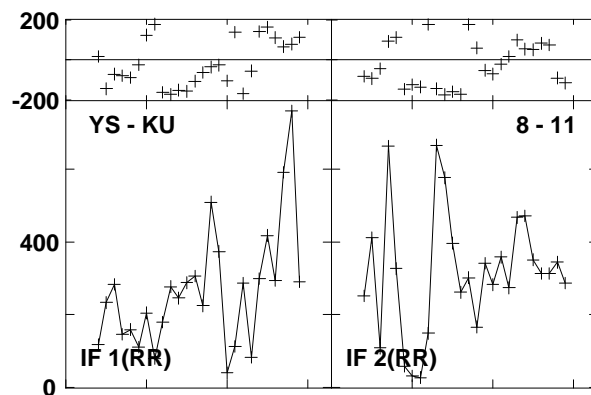
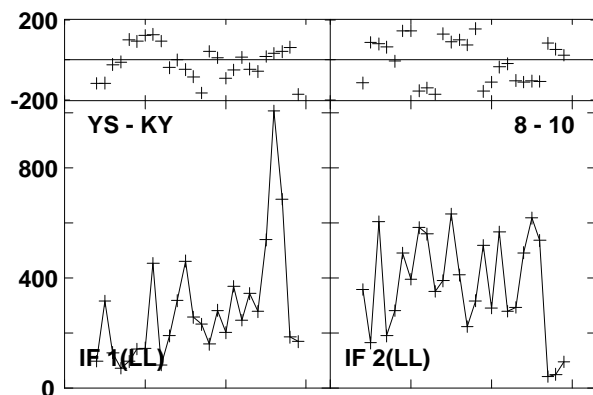
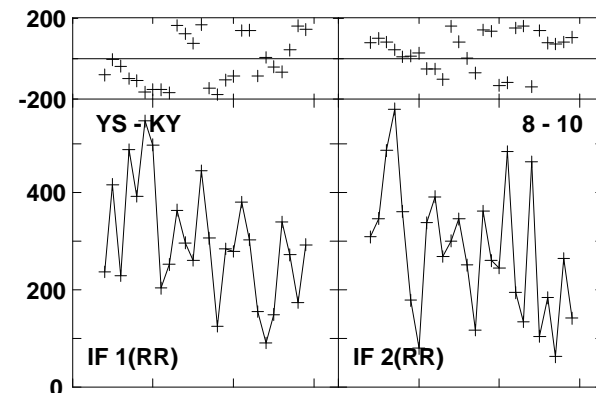
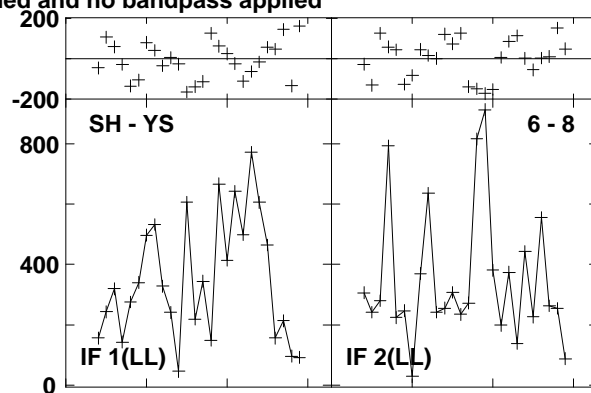
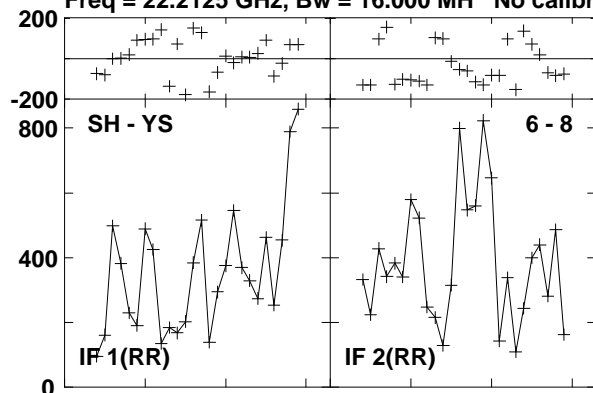

Lower frame: Micro Ampl Jy Top frame: Phas deg

Vector averaged cross-power spectrum Baseline: SH (06) - YS (08)

Timerange: 00/11:50:10 to 00/11:50:30

Plot file version 318 created 23-AUG-2016 15:00:52  
W3IRS5 GA035B 1.UVDATA.1

Freq = 22.2125 GHz, Bw = 16.000 MH No calibration applied and no bandpass applied

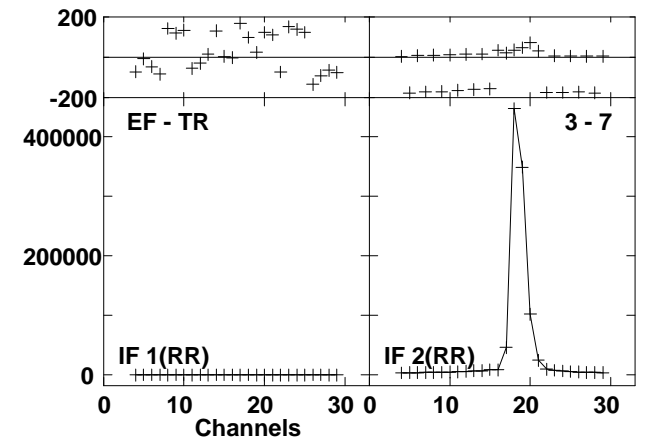
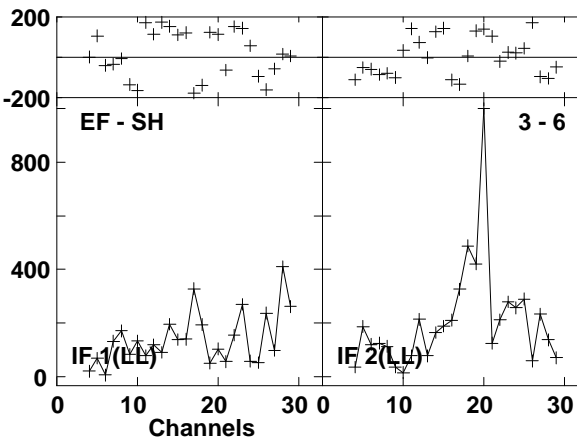
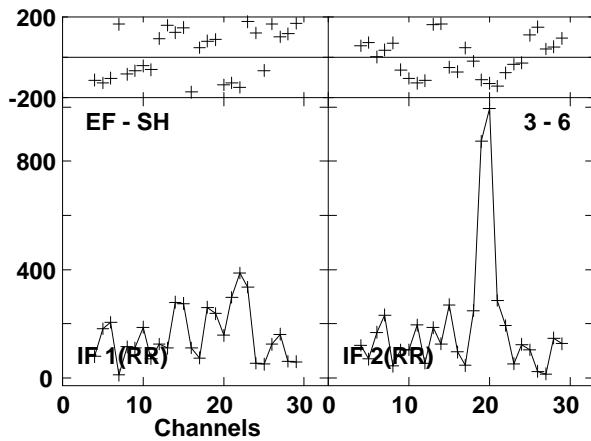
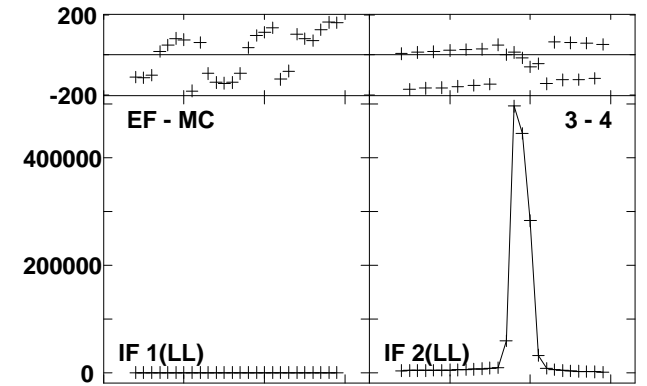
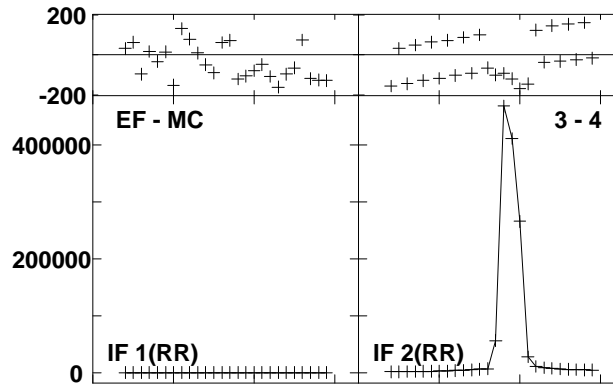
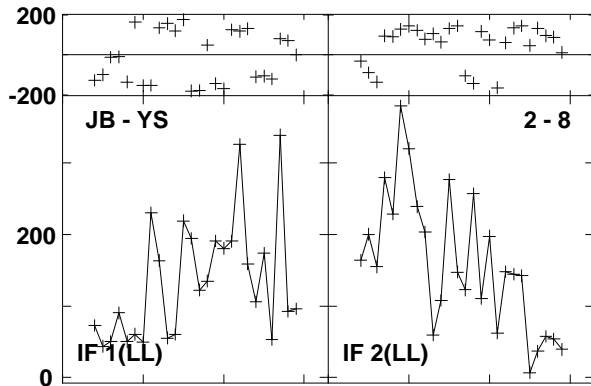
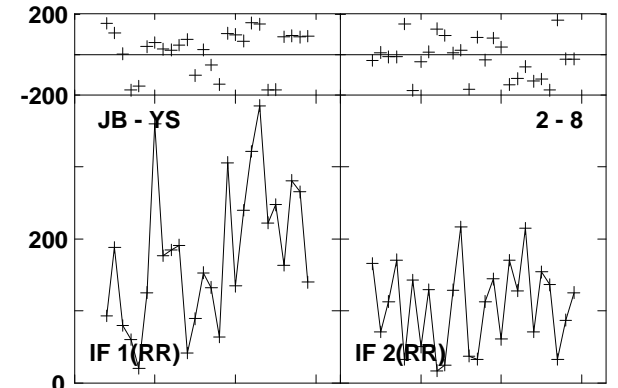
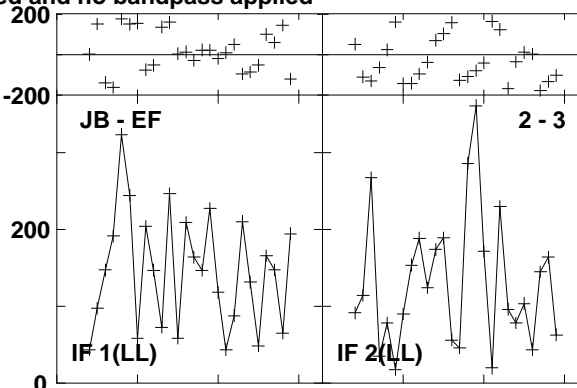
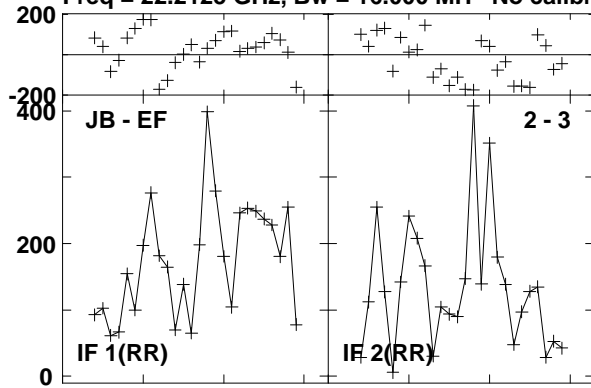

Lower frame: Micro Ampl Jy Top frame: Phas deg  
Vector averaged cross-power spectrum Baseline: JB (02) - EF (03)  
Timerange: 00/11:50:56 to 00/11:51:55

Plot file version 319 created 23-AUG-2016 15:00:52  
W3IRS5 GA035B 1.UVDATA.1

Freq = 22.2125 GHz, Bw = 16.000 MH No calibration applied and no bandpass applied

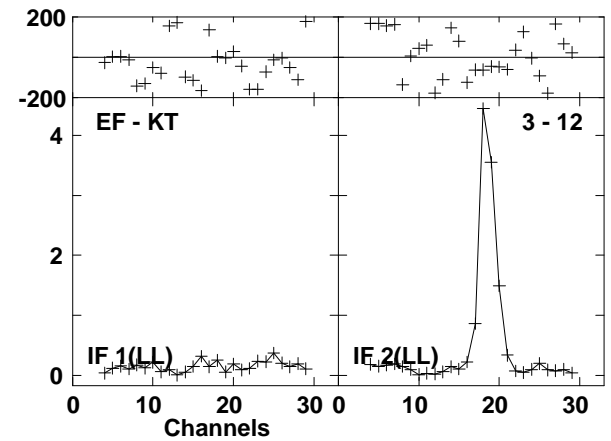
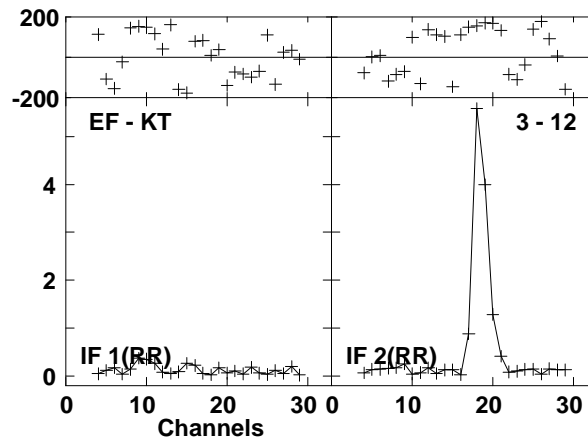
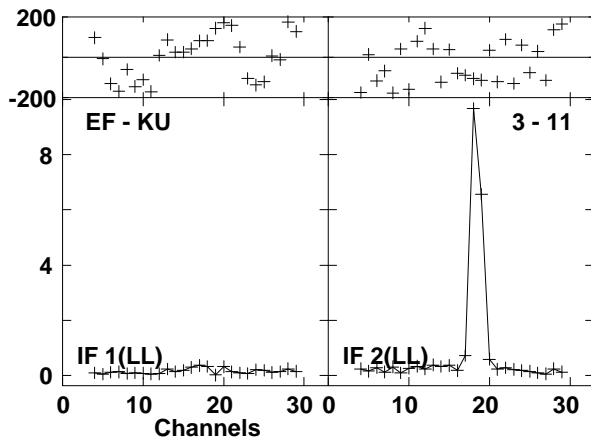
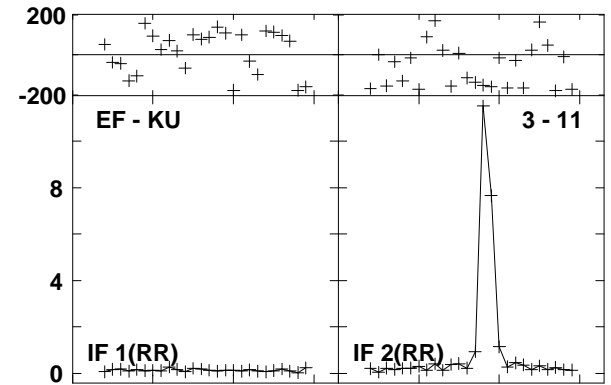
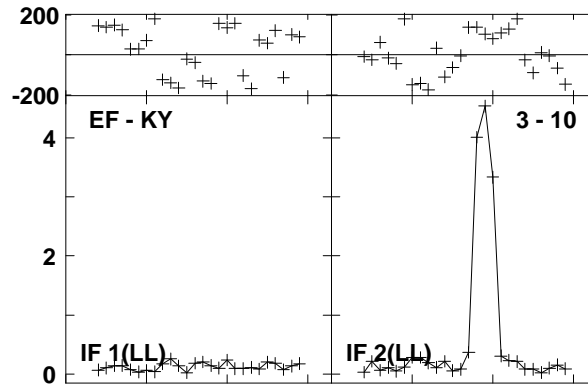
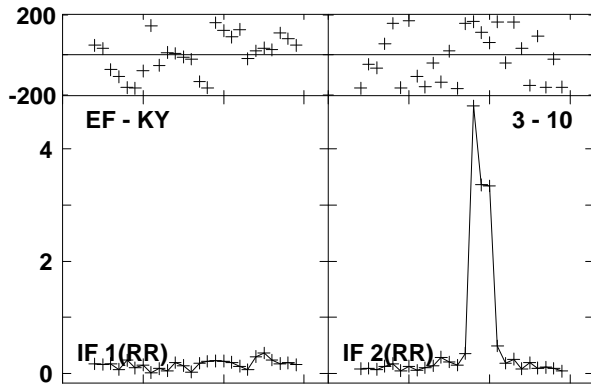
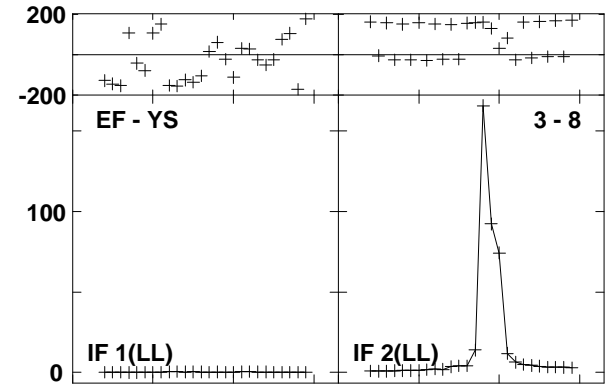
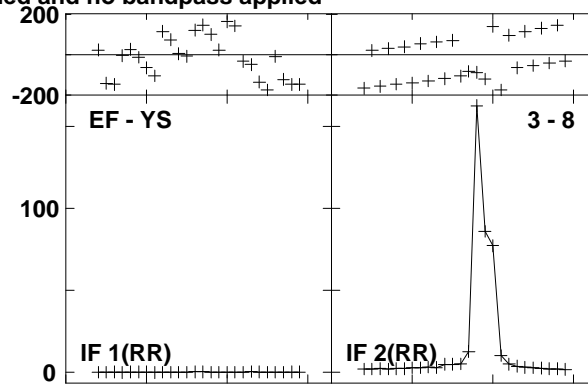
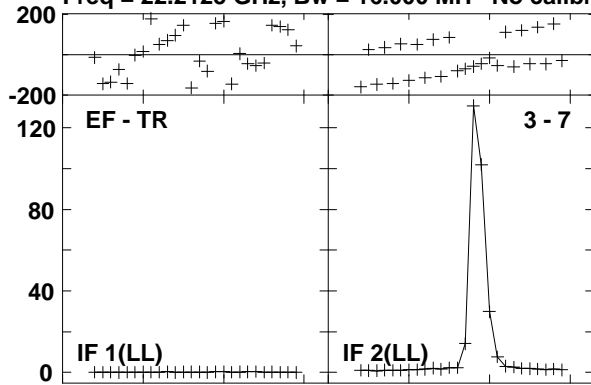

Lower frame: Milli Ampl Jy Top frame: Phas deg  
Vector averaged cross-power spectrum Baseline: EF (03) - TR (07)  
Timerange: 00/11:50:56 to 00/11:51:55

Plot file version 320 created 23-AUG-2016 15:00:52

W3IRS5 GA035B 1.UVDATA.1

Freq = 22.2125 GHz, Bw = 16.000 MH No calibration applied and no bandpass applied

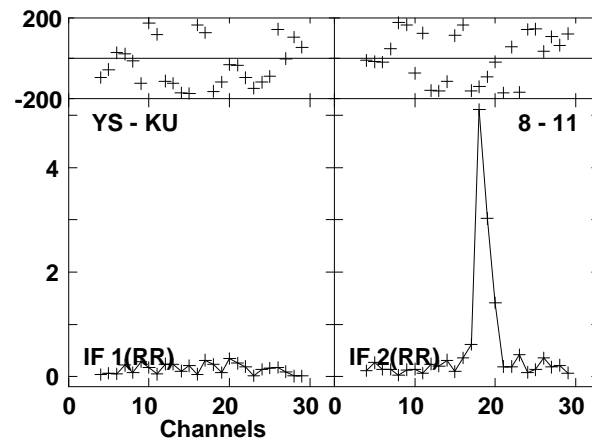
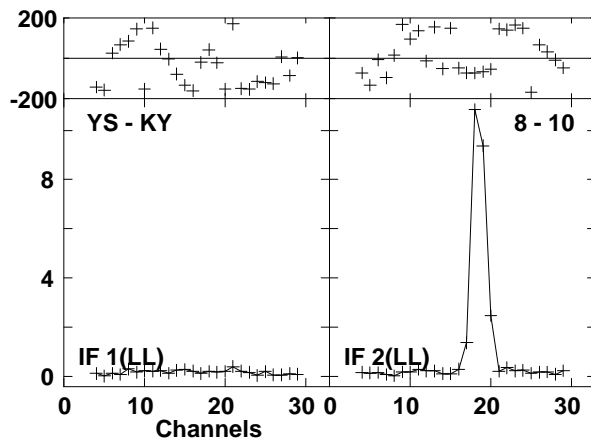
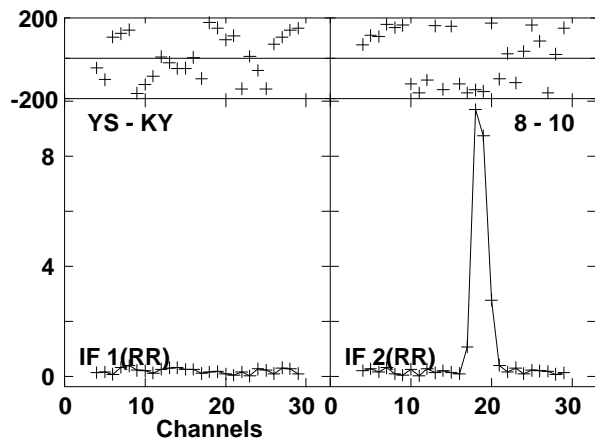
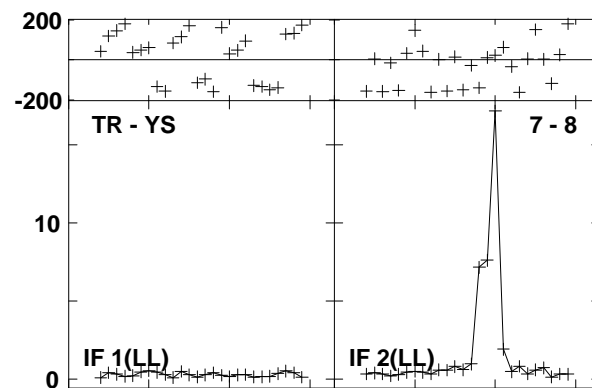
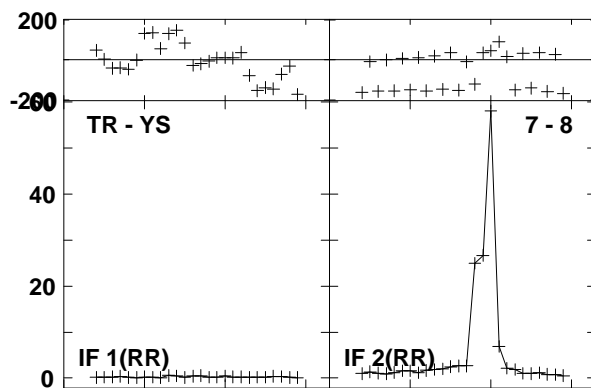
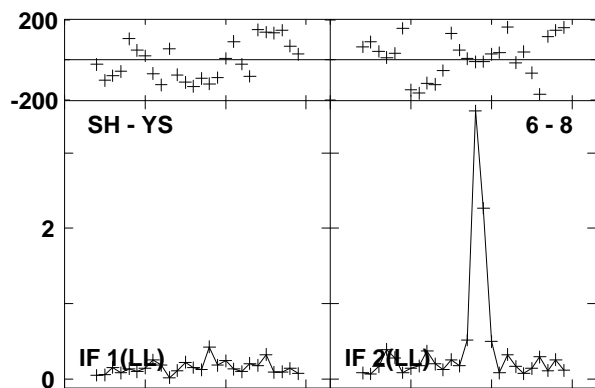
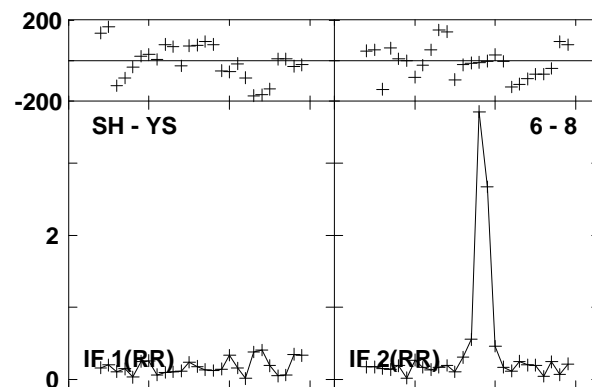
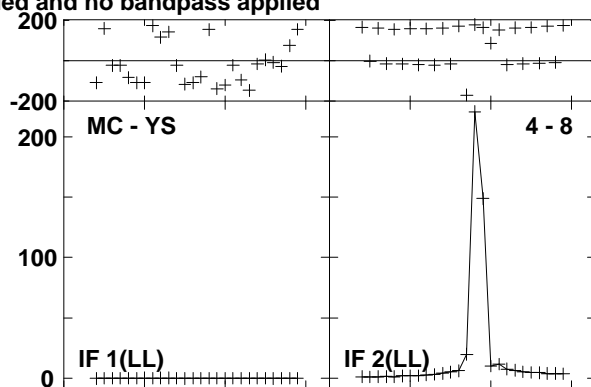
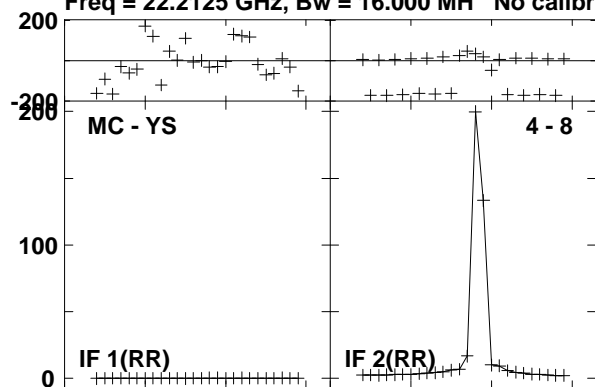

Lower frame: Milli Ampl Jy Top frame: Phas deg  
Vector averaged cross-power spectrum Baseline: MC (04) - YS (08)  
Timerange: 00/11:50:56 to 00/11:51:55



Plot file version 321 created 23-AUG-2016 15:00:52

W3IRS5 GA035B 1.UVDATA.1

Freq = 22.2125 GHz, Bw = 16.000 MH No calibration applied and no bandpass applied

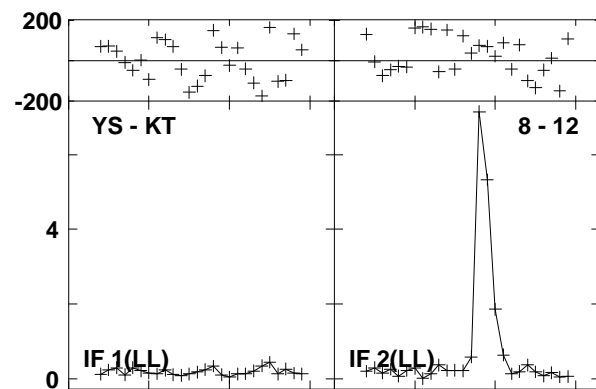
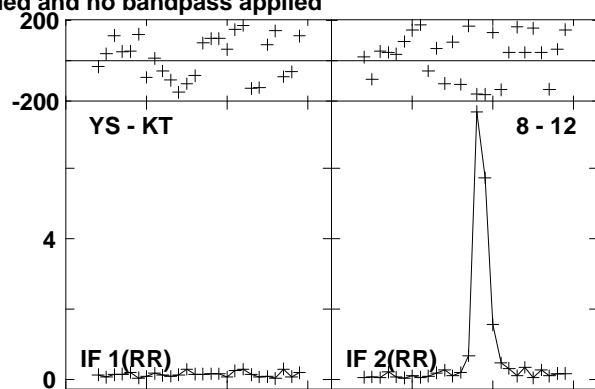
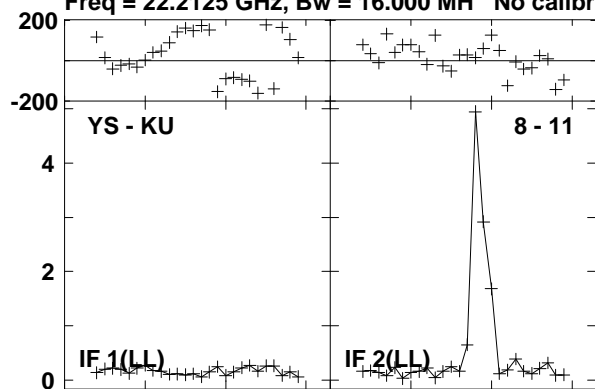

Lower frame: Milli Ampl Jy Top frame: Phas deg  
Vector averaged cross-power spectrum Baseline: YS (08) - KU (11)  
Timerange: 00/11:50:56 to 00/11:51:55

Plot file version 322 created 23-AUG-2016 15:00:52

0219+628 GA035B 1.UVDATA.1

Freq = 22.2125 GHz, Bw = 16.000 MH No calibration applied and no bandpass applied

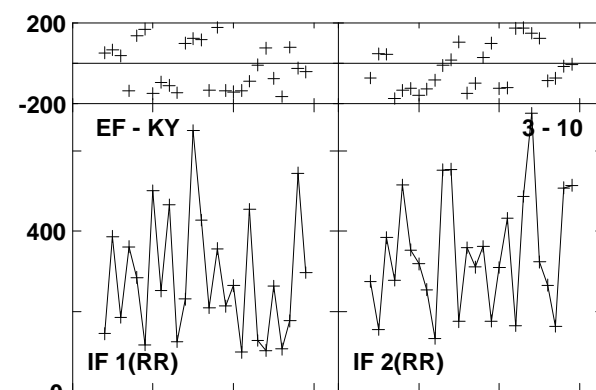
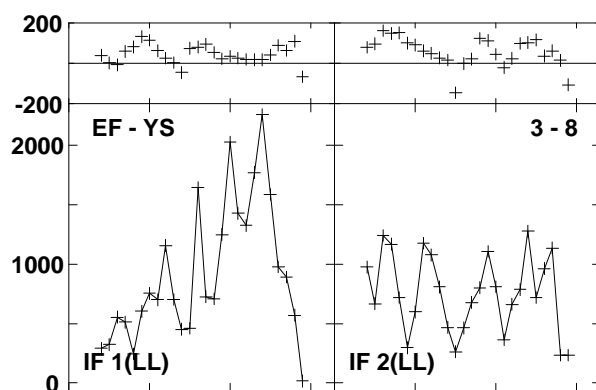
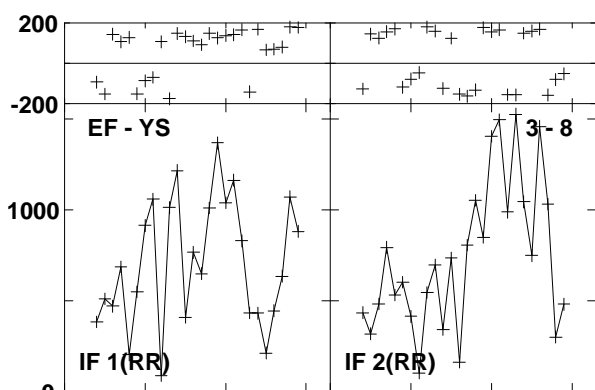
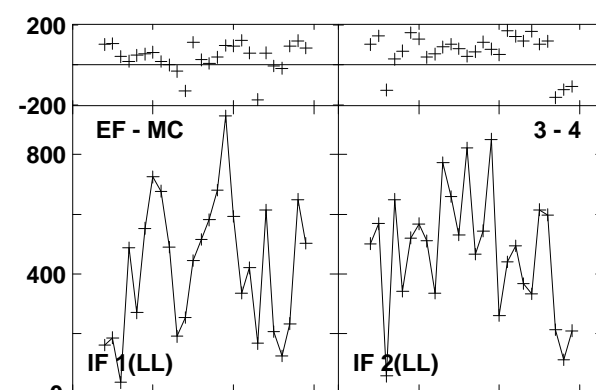
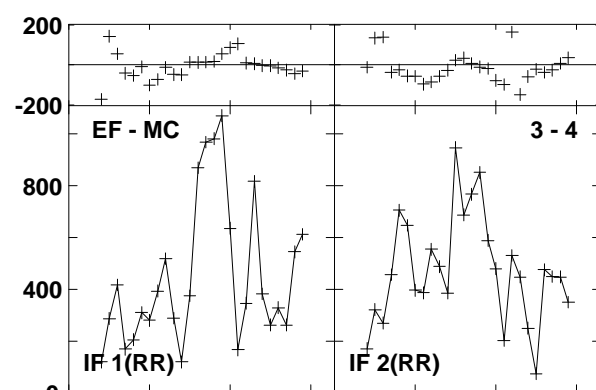
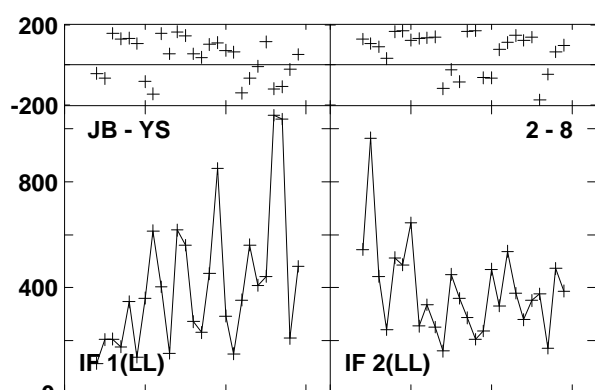
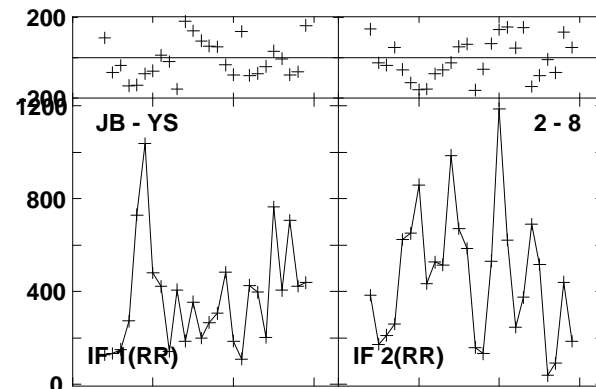
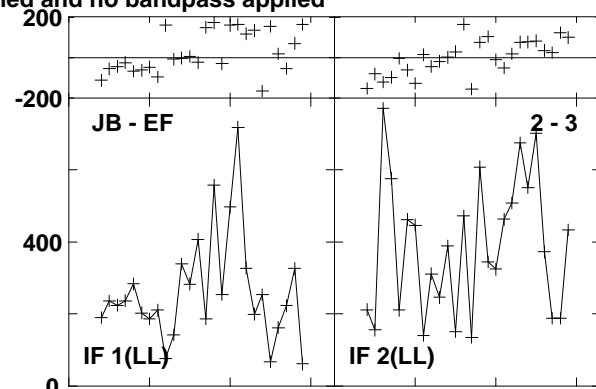
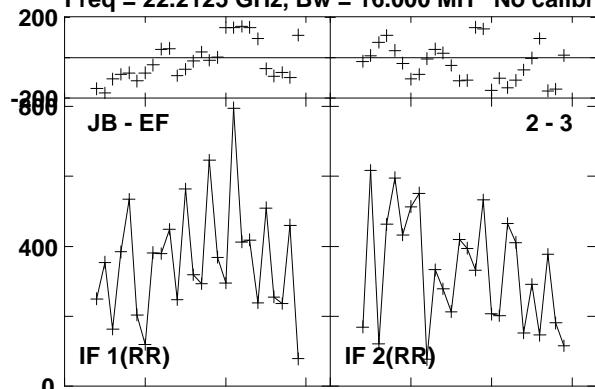

Lower frame: Micro Ampl Jy Top frame: Phas deg  
Vector averaged cross-power spectrum Baseline: JB (02) - EF (03)  
Timerange: 00/11:52:21 to 00/11:52:40

Plot file version 323 created 23-AUG-2016 15:00:52

0219+628 GA035B 1.UVDATA.1

Freq = 22.2125 GHz, Bw = 16.000 MH No calibration applied and no bandpass applied

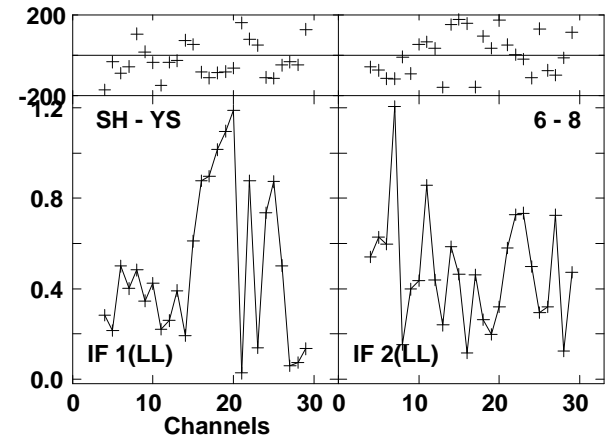
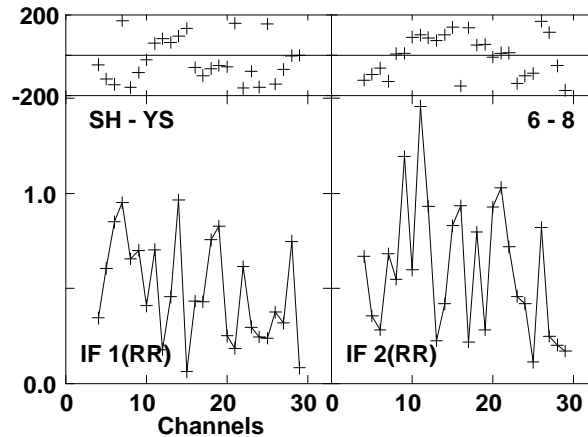
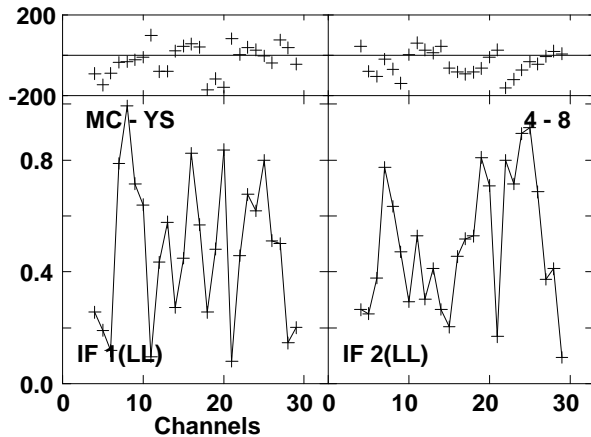
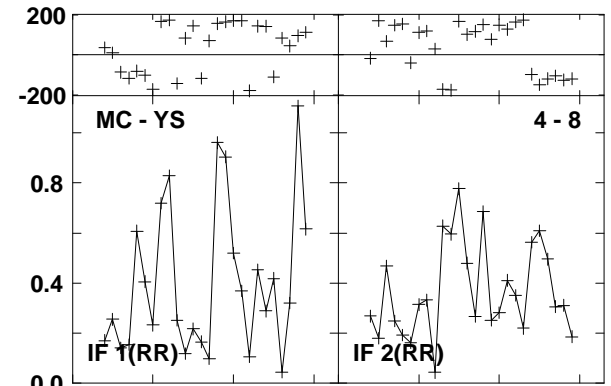
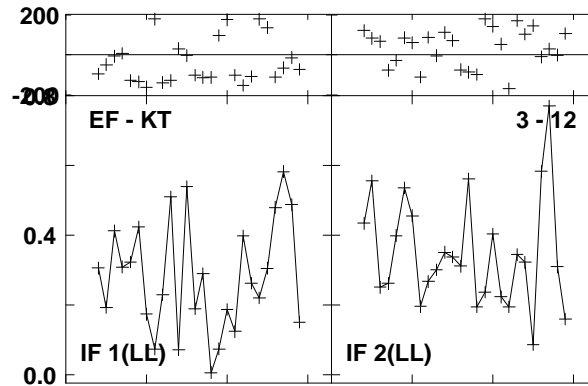
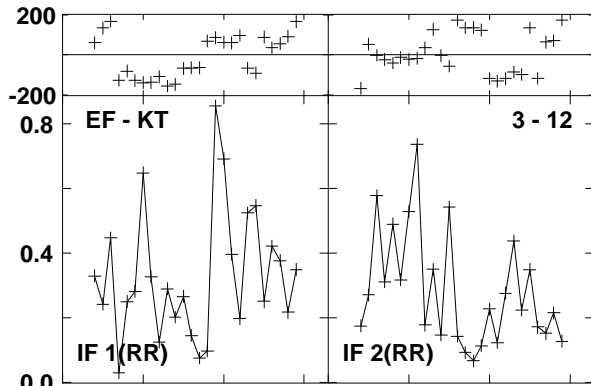
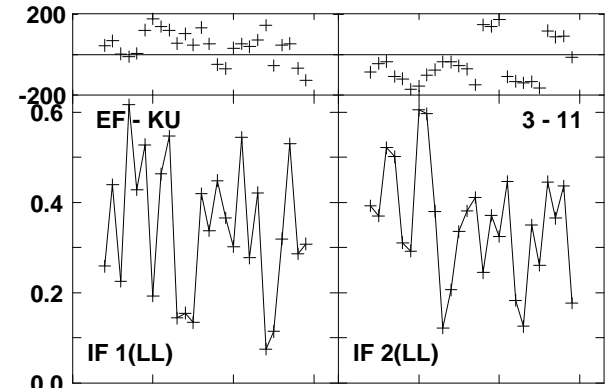
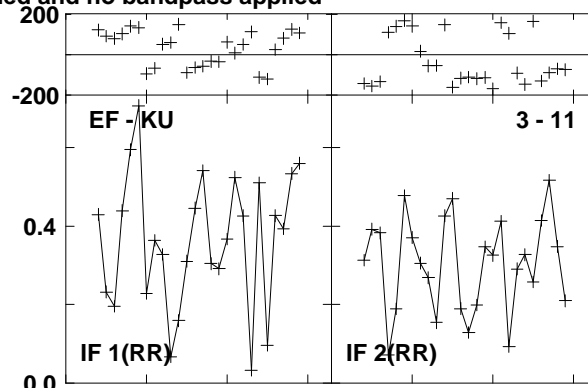
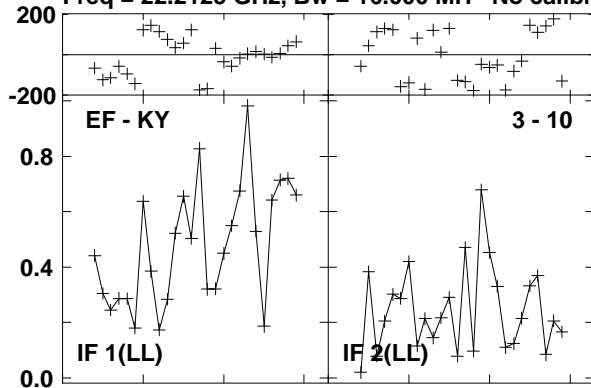

Lower frame: Milli Ampl Jy Top frame: Phas deg  
Vector averaged cross-power spectrum Baseline: EF (03) - KY (10)  
Timerange: 00/11:52:21 to 00/11:52:40

Plot file version 324 created 23-AUG-2016 15:00:52

0219+628 GA035B 1.UVDATA.1

Freq = 22.2125 GHz, Bw = 16.000 MH No calibration applied and no bandpass applied

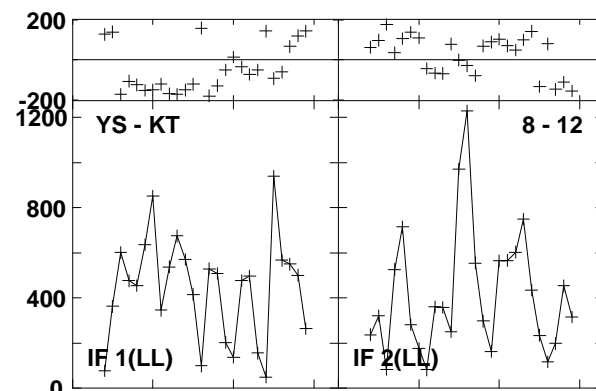
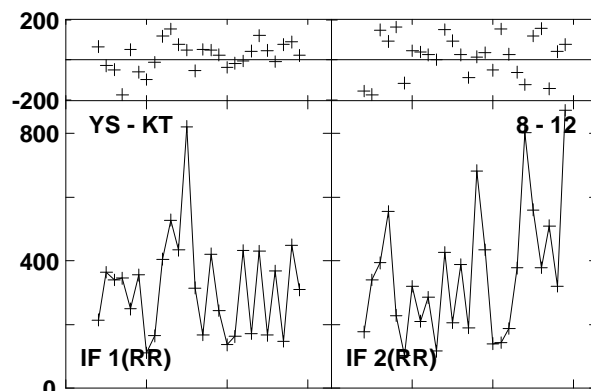
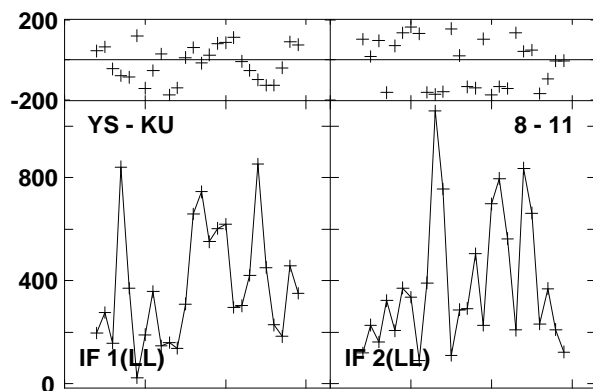
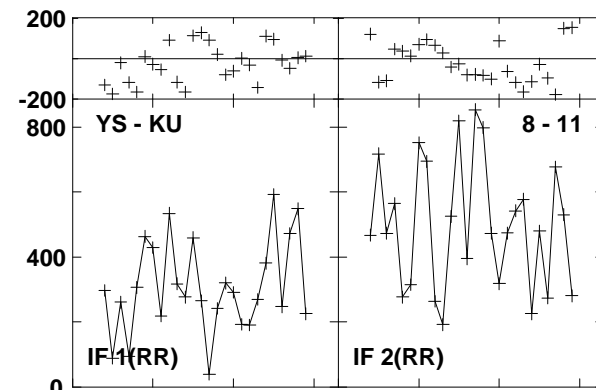
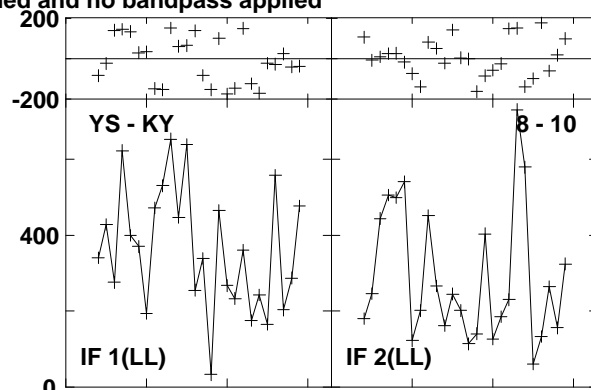
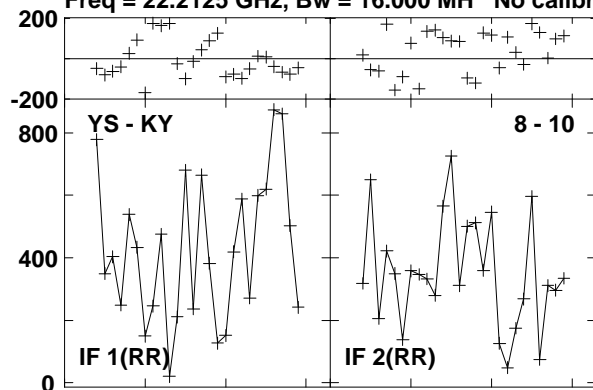

Lower frame: Micro Ampl Jy Top frame: Phas deg  
Vector averaged cross-power spectrum Baseline: YS (08) - KY (10)  
Timerange: 00/11:52:21 to 00/11:52:40

Plot file version 325 created 23-AUG-2016 15:00:52

W3IRS5 GA035B 1.UVDATA.1

Freq = 22.2125 GHz, Bw = 16.000 MH No calibration applied and no bandpass applied

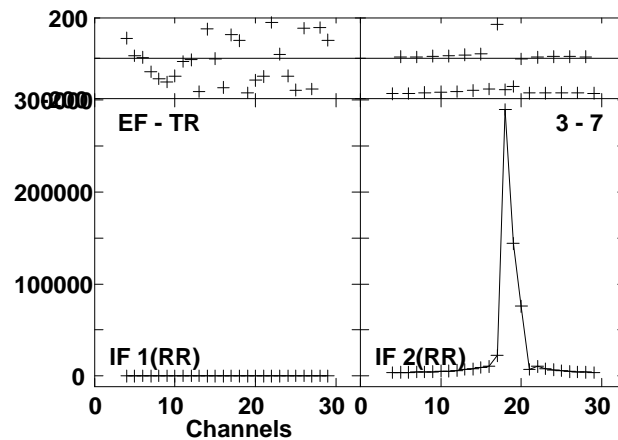
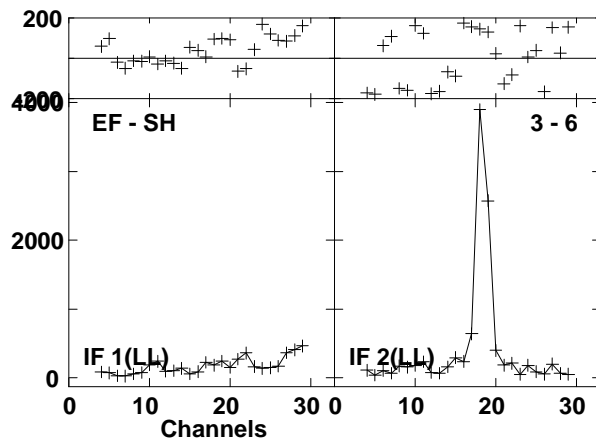
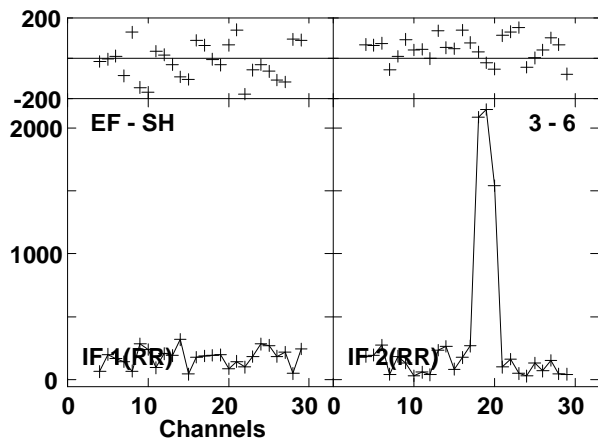
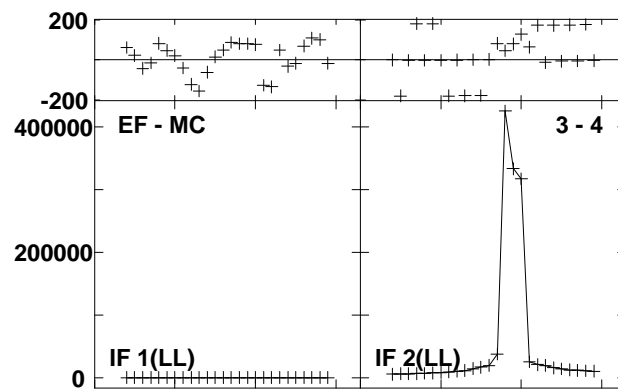
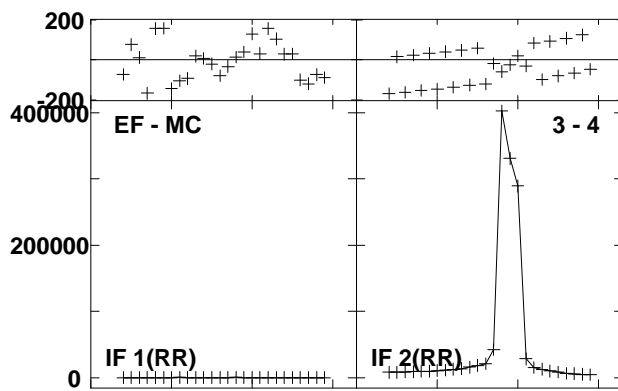
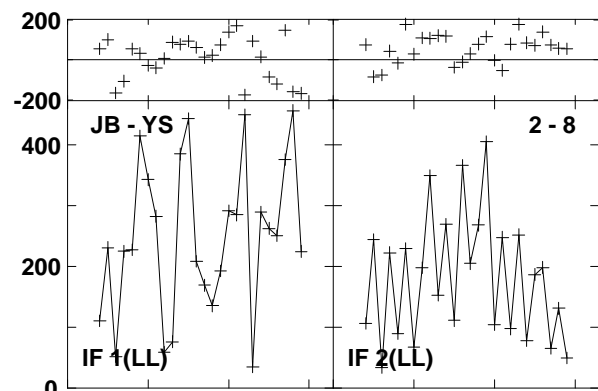
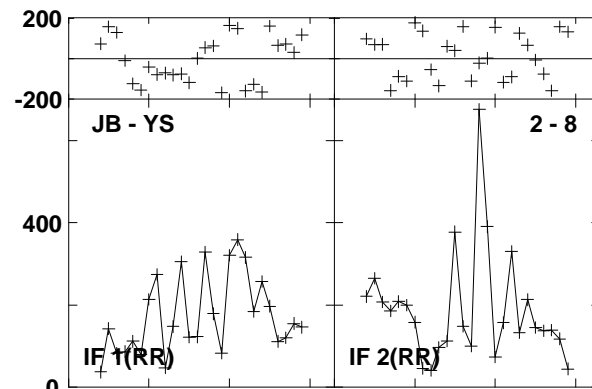
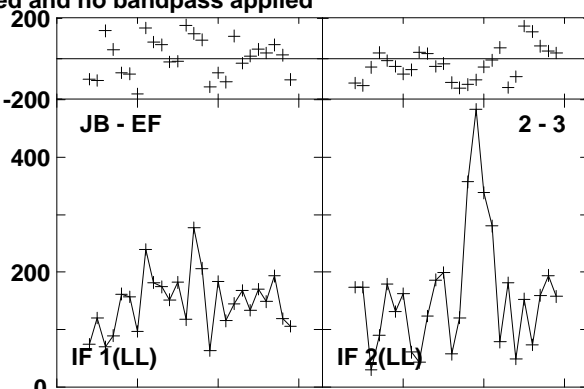
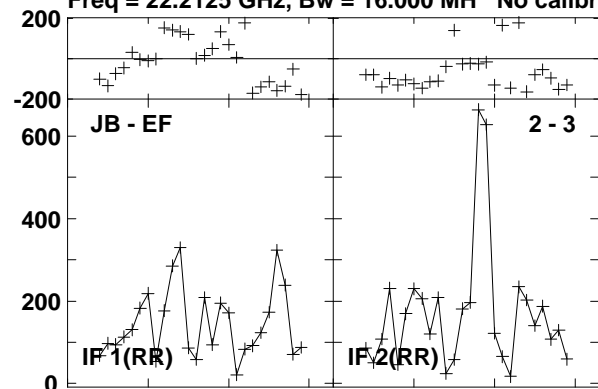

Lower frame: Micro Ampl Jy Top frame: Phas deg  
Vector averaged cross-power spectrum Baseline: JB (02) - EF (03)  
Timerange: 00/11:53:05 to 00/11:54:04

Plot file version 326 created 23-AUG-2016 15:00:52

W3IRS5 GA035B 1.UVDATA.1

Freq = 22.2125 GHz, Bw = 16.000 MH No calibration applied and no bandpass applied

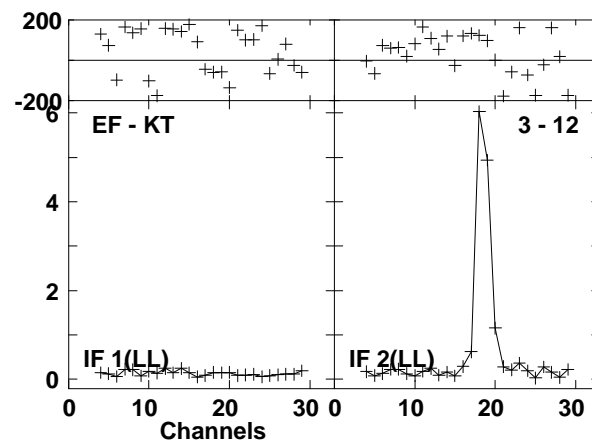
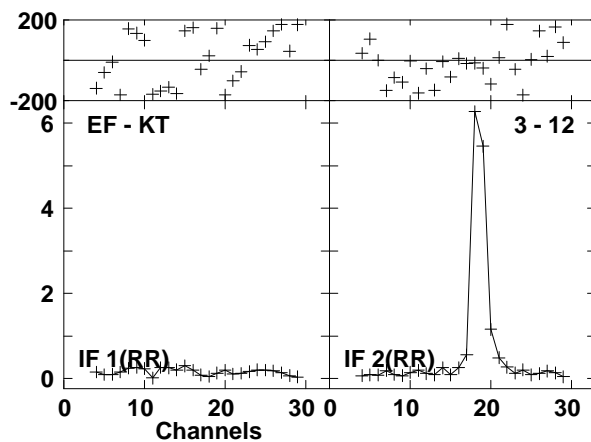
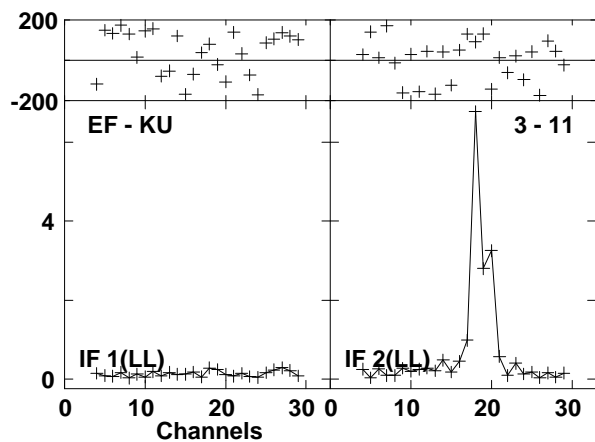
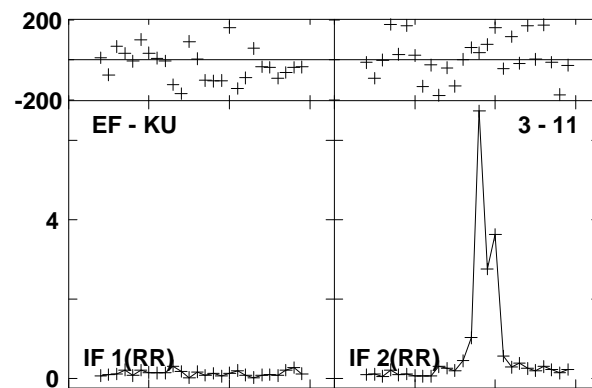
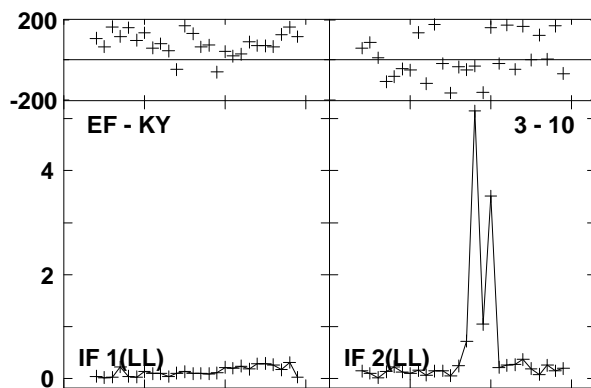
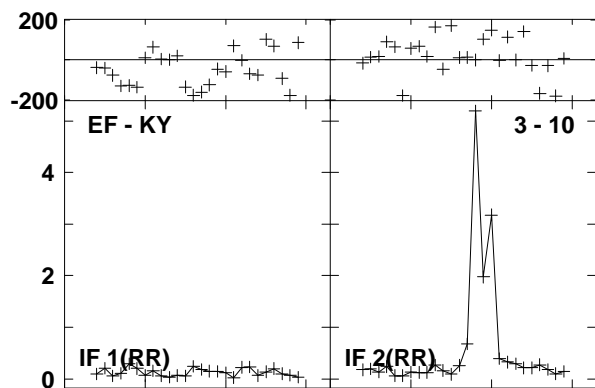
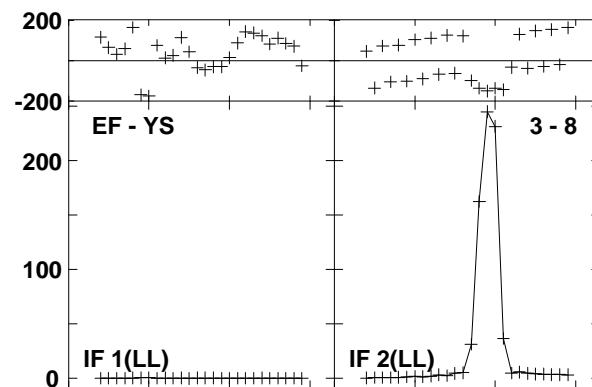
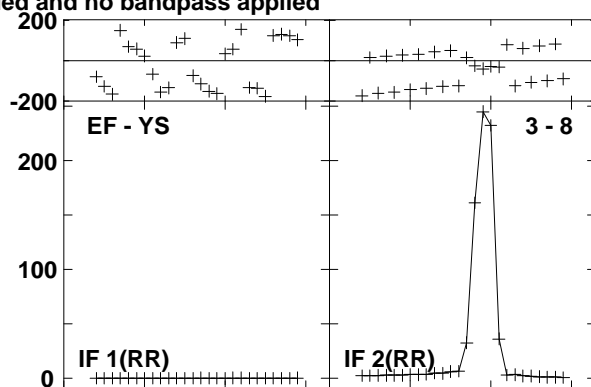
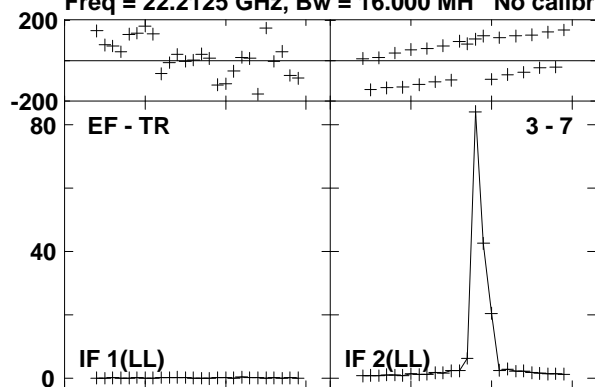

Lower frame: Milli Ampl Jy Top frame: Phas deg  
Vector averaged cross-power spectrum Baseline: EF (03) - TR (07)  
Timerange: 00/11:53:05 to 00/11:54:04

Plot file version 327 created 23-AUG-2016 15:00:52

W3IRS5 GA035B 1.UVDATA.1

Freq = 22.2125 GHz, Bw = 16.000 MH No calibration applied and no bandpass applied

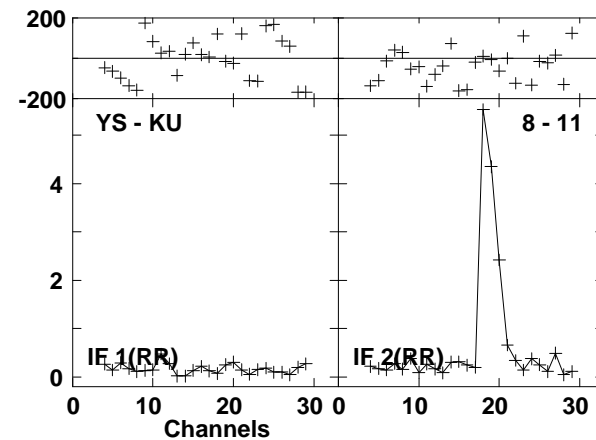
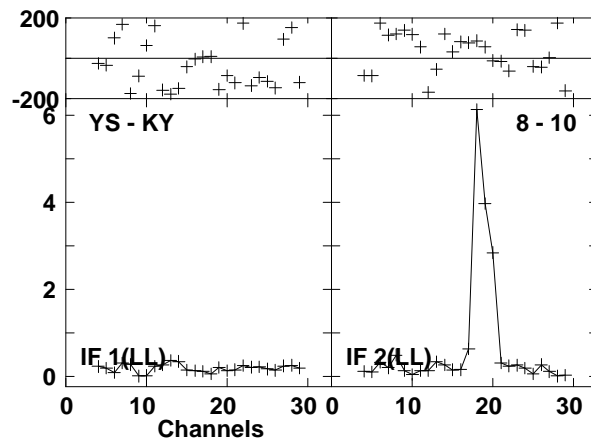
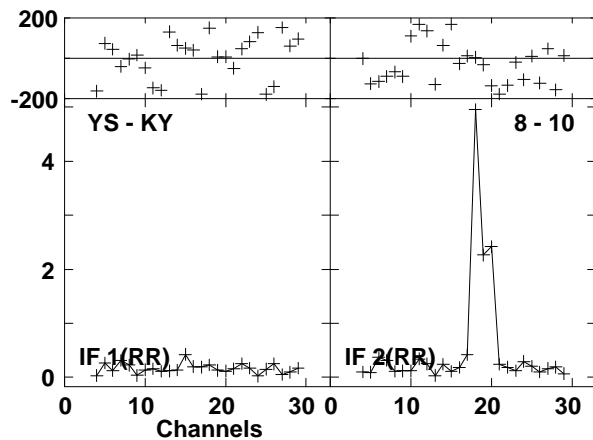
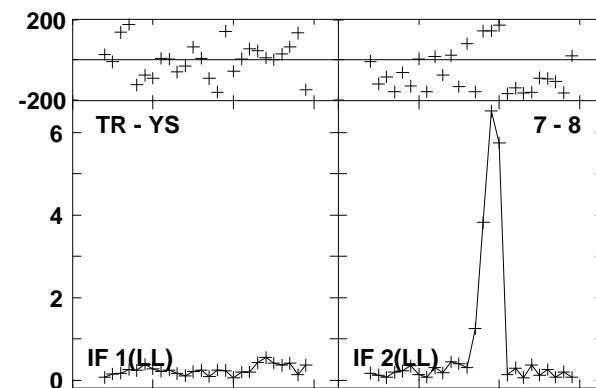
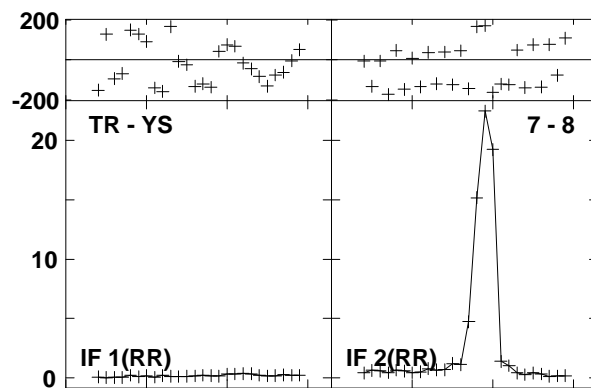
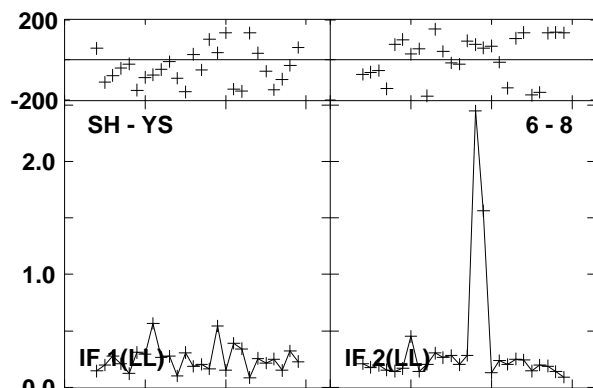
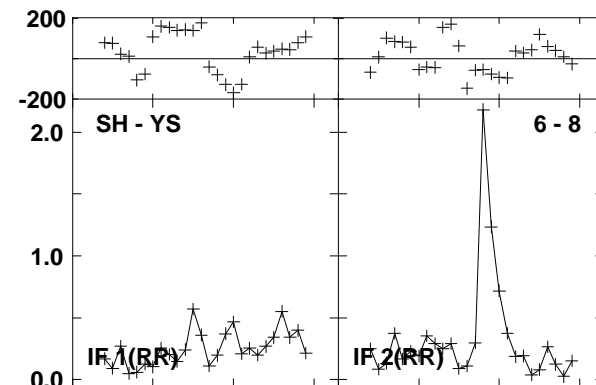
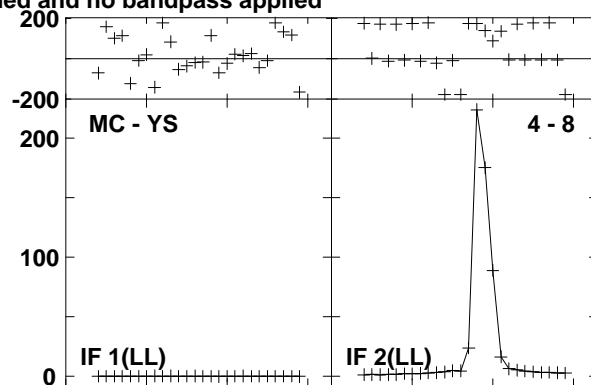
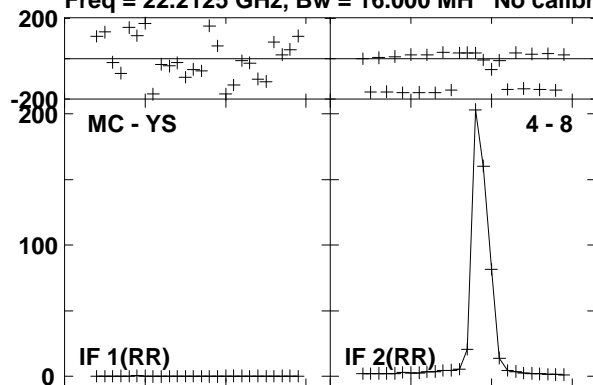

Lower frame: Milli Ampl Jy Top frame: Phas deg  
Vector averaged cross-power spectrum Baseline: MC (04) - YS (08)  
Timerange: 00/11:53:05 to 00/11:54:04

Plot file version 328 created 23-AUG-2016 15:00:52

W3IRS5 GA035B 1.UVDATA.1

Freq = 22.2125 GHz, Bw = 16.000 MH No calibration applied and no bandpass applied

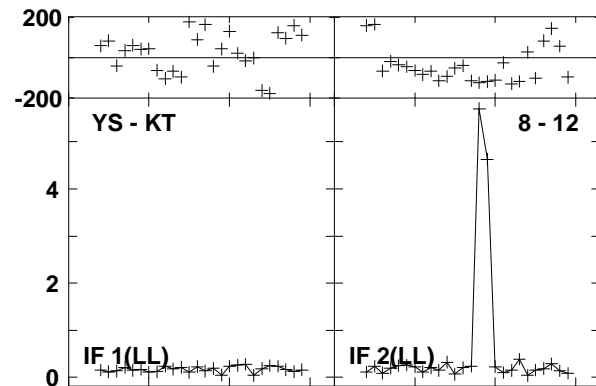
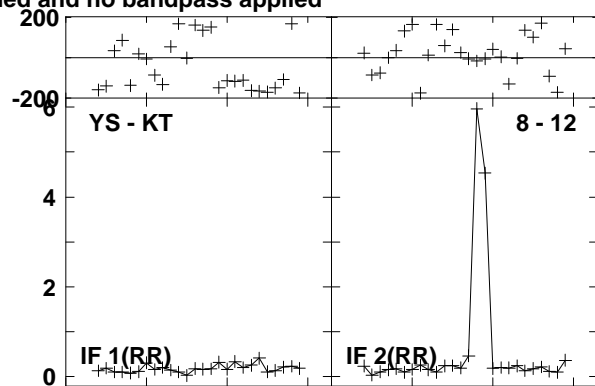
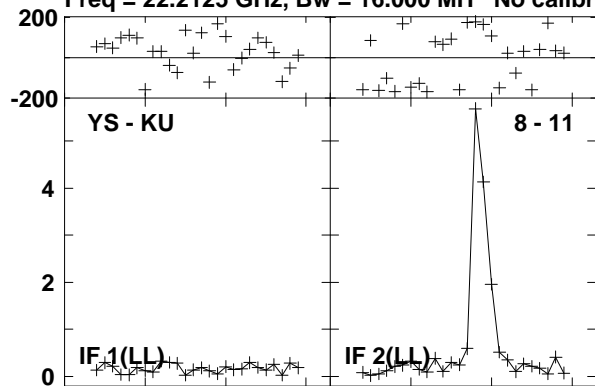

Lower frame: Milli Ampl Jy Top frame: Phas deg  
Vector averaged cross-power spectrum Baseline: YS (08) - KU (11)  
Timerange: 00/11:53:05 to 00/11:54:04



Plot file version 329 created 23-AUG-2016 15:00:52  
W3IRS5 GA035B 1.UVDATA.1

Freq = 22.2125 GHz, Bw = 16.000 MH No calibration applied and no bandpass applied

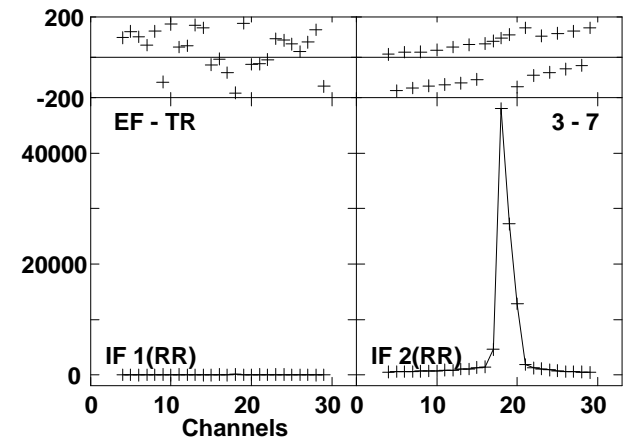
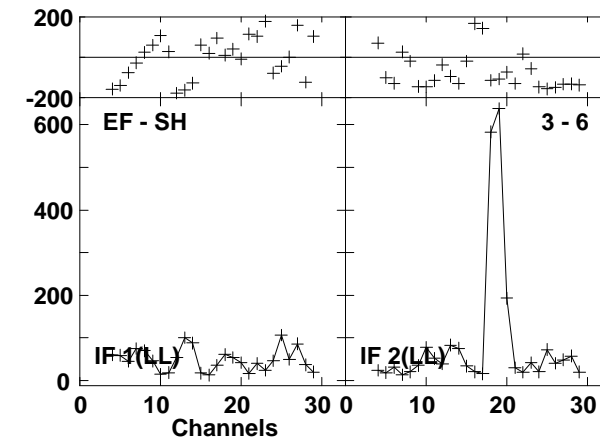
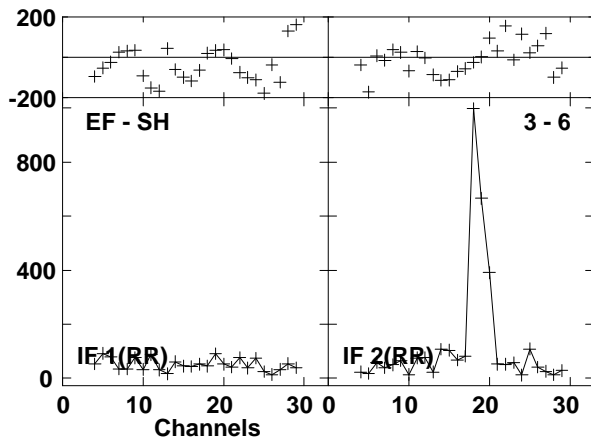
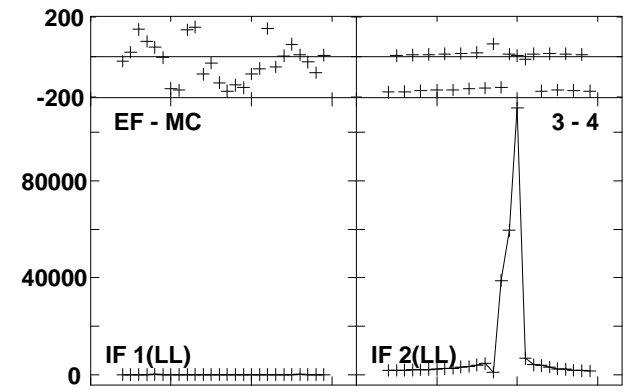
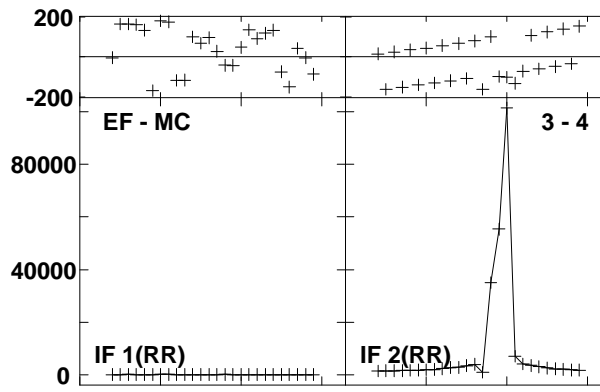
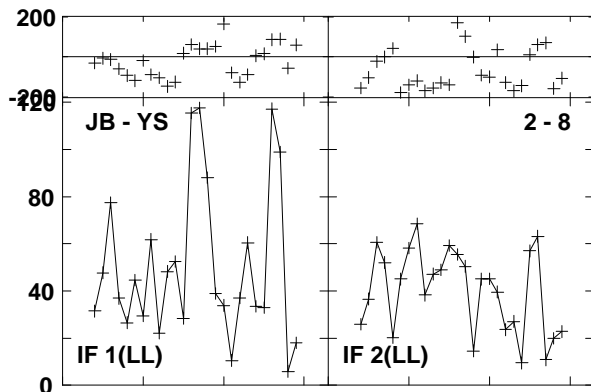
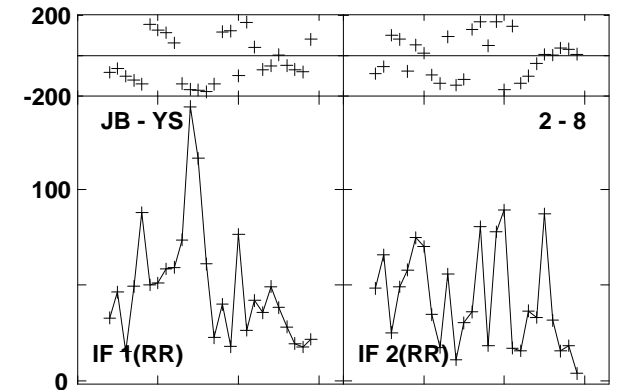
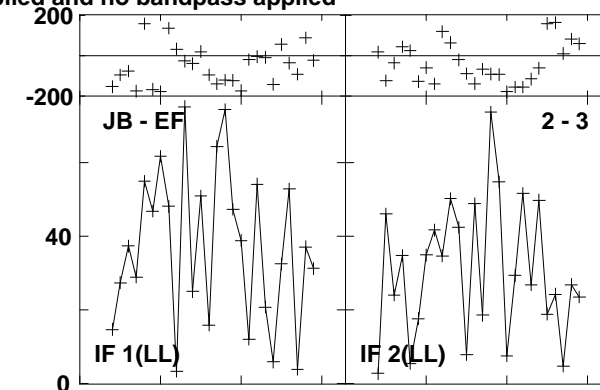
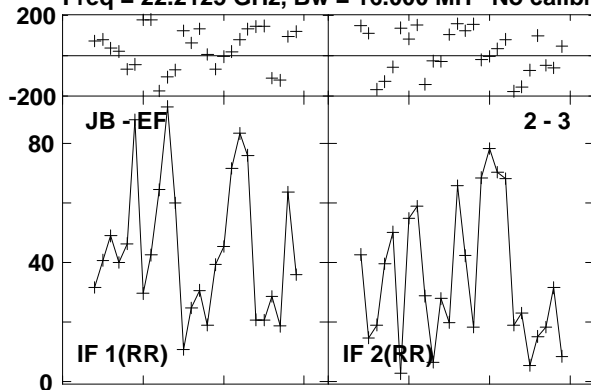

Lower frame: Micro Ampl Jy Top frame: Phas deg  
Vector averaged cross-power spectrum Baseline: JB (02) - EF (03)  
Timerange: 00/11:55:00 to 00/12:04:30

Plot file version 330 created 23-AUG-2016 15:00:52

W3IRS5 GA035B 1.UVDATA.1

Freq = 22.2125 GHz, Bw = 16.000 MH No calibration applied and no bandpass applied

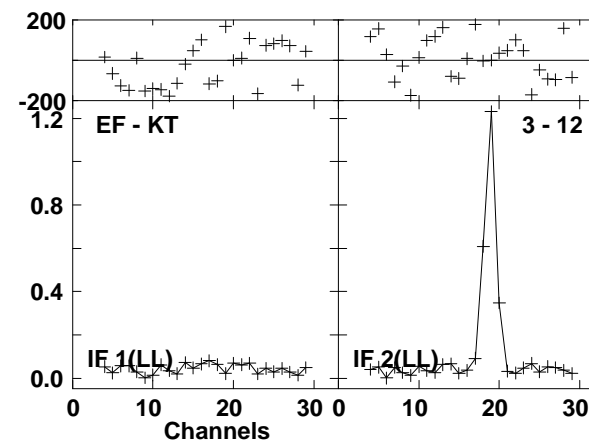
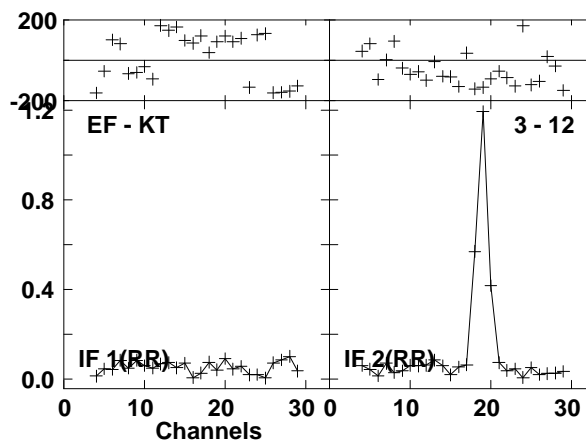
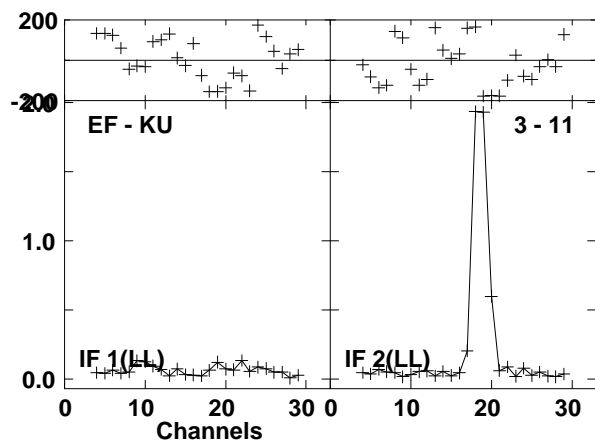
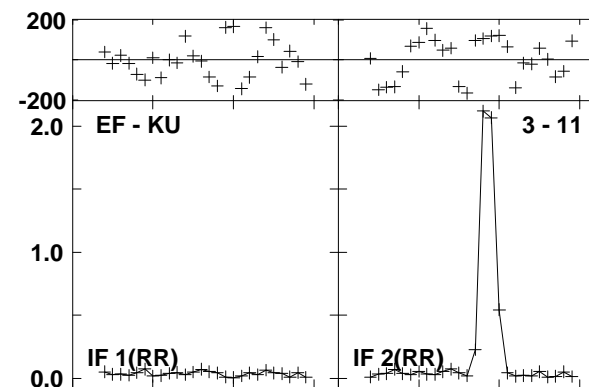
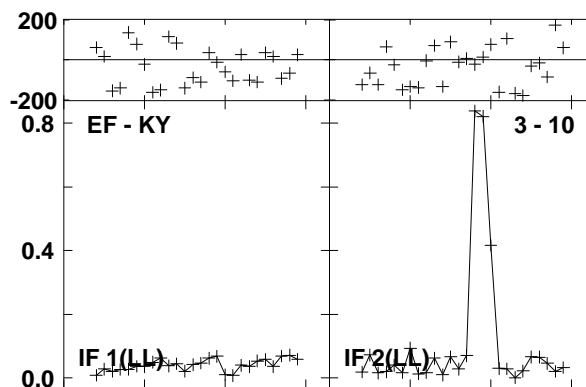
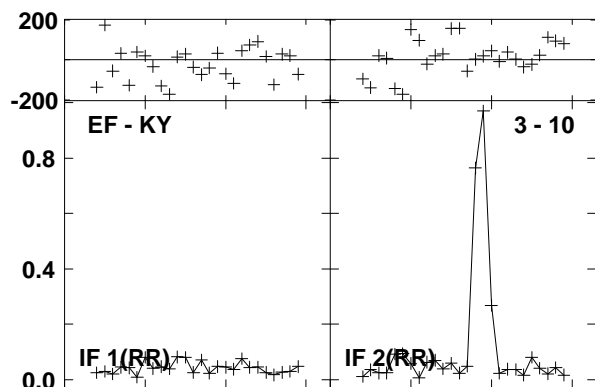
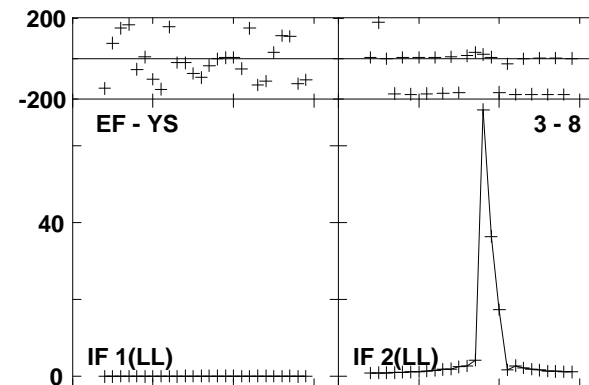
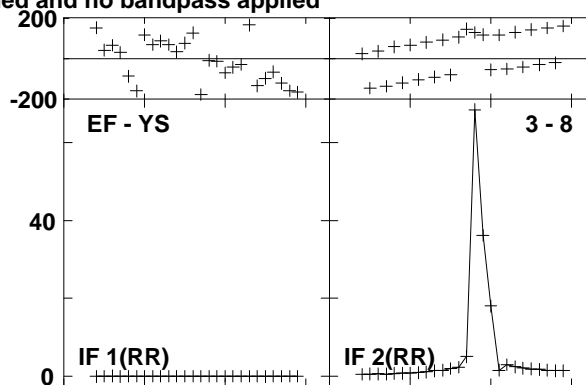
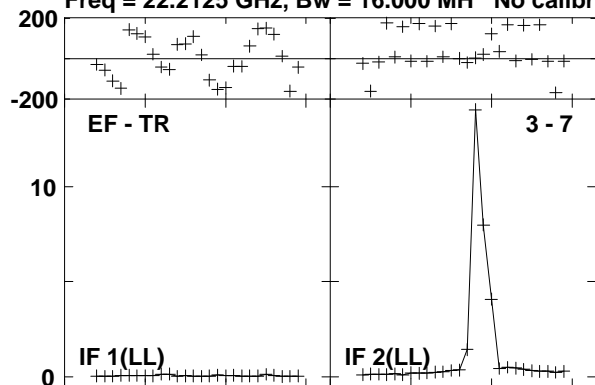

Lower frame: Milli Ampl Jy Top frame: Phas deg  
Vector averaged cross-power spectrum Baseline: EF (03) - TR (07)  
Timerange: 00/11:55:00 to 00/12:04:30

Plot file version 331 created 23-AUG-2016 15:00:52

W3IRS5 GA035B 1.UVDATA.1

Freq = 22.2125 GHz, Bw = 16.000 MH No calibration applied and no bandpass applied

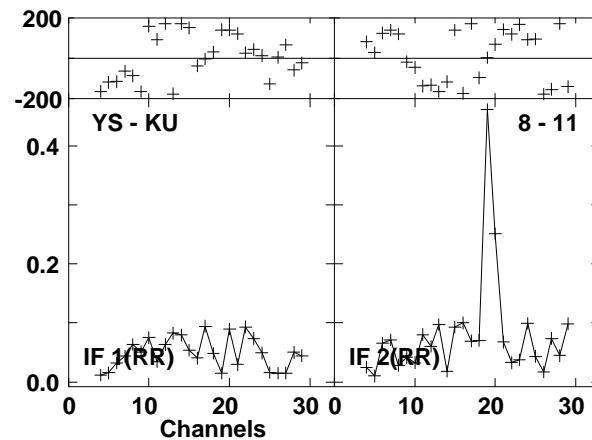
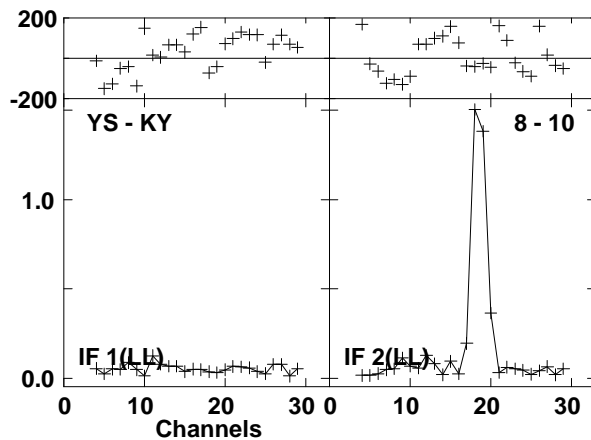
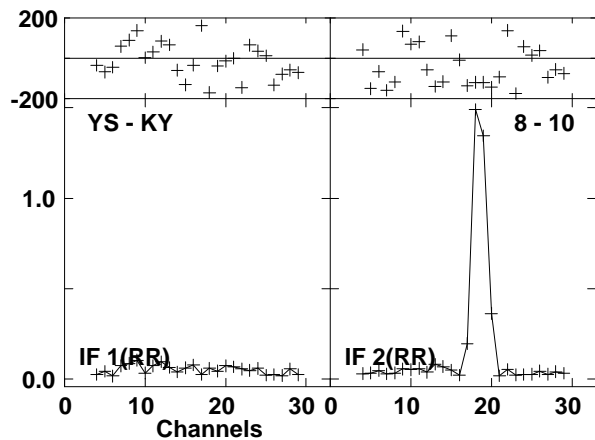
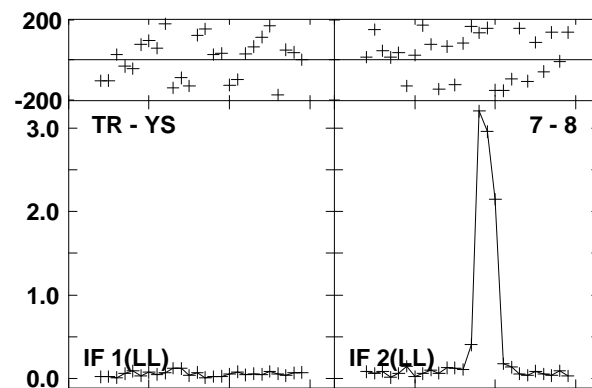
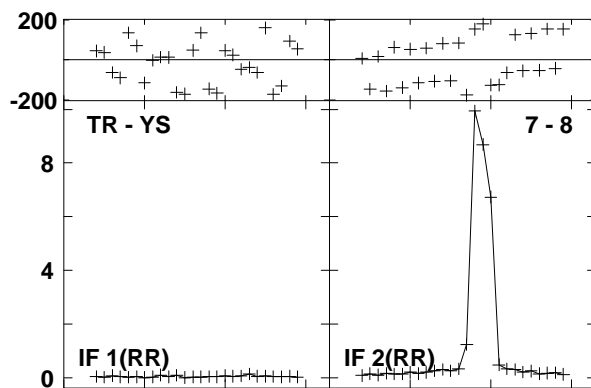
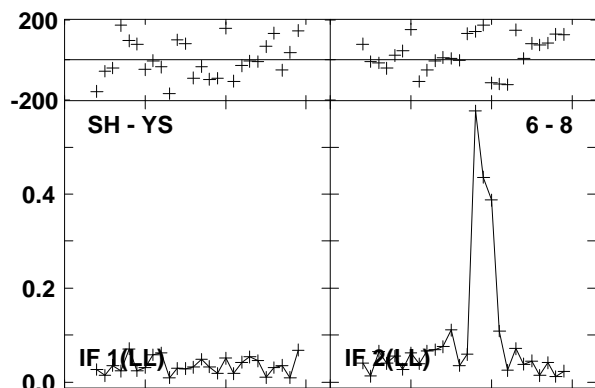
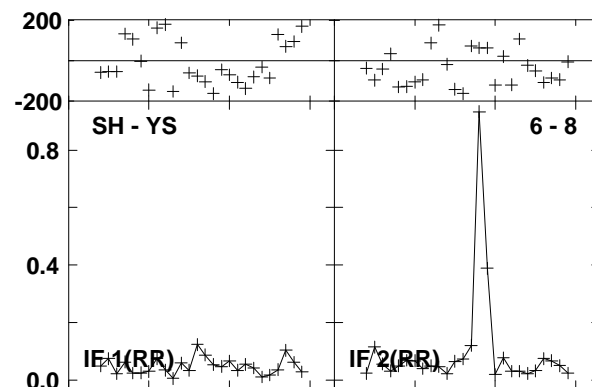
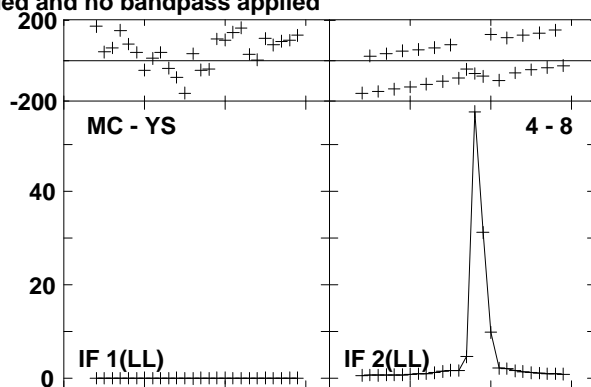
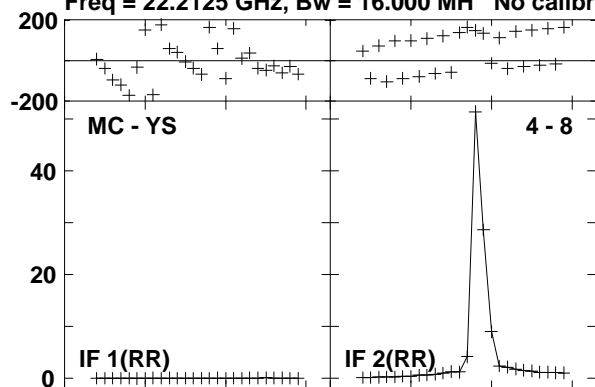

Lower frame: Milli Ampl Jy Top frame: Phas deg  
Vector averaged cross-power spectrum Baseline: MC (04) - YS (08)  
Timerange: 00/11:55:00 to 00/12:04:30

Plot file version 332 created 23-AUG-2016 15:00:53

W3IRS5 GA035B 1.UVDATA.1

Freq = 22.2125 GHz, Bw = 16.000 MH No calibration applied and no bandpass applied

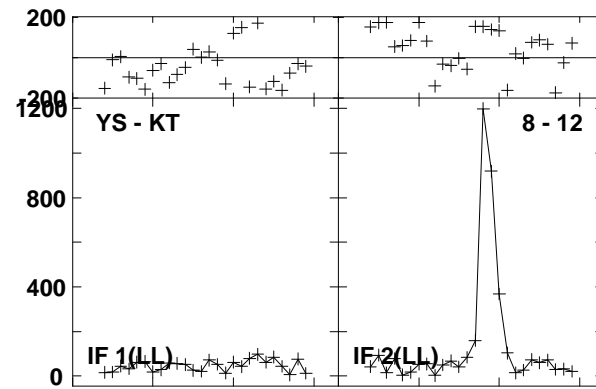
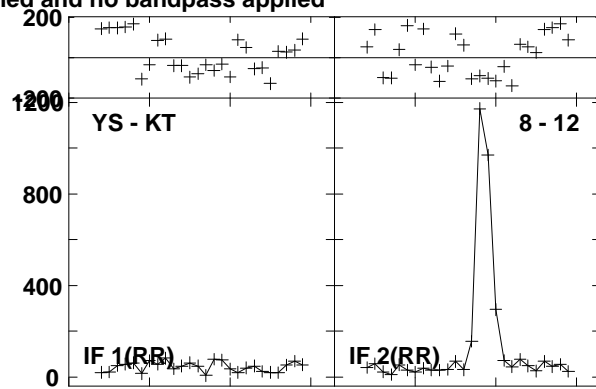
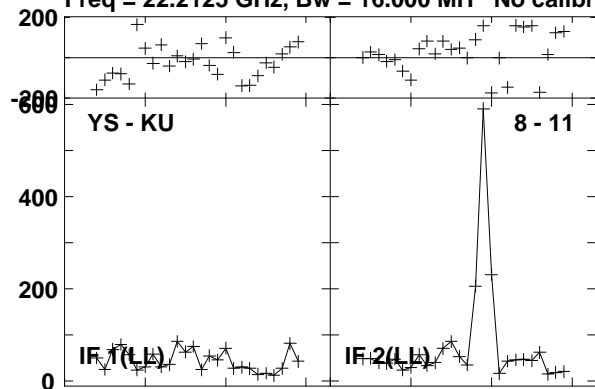

Lower frame: Micro Ampl Jy Top frame: Phas deg  
Vector averaged cross-power spectrum Baseline: YS (08) - KU (11)  
Timerange: 00/11:55:00 to 00/12:04:30

Plot file version 333 created 23-AUG-2016 15:00:53

W3IRS5 GA035B 1.UVDATA.1

Freq = 22.2125 GHz, Bw = 16.000 MH No calibration applied and no bandpass applied

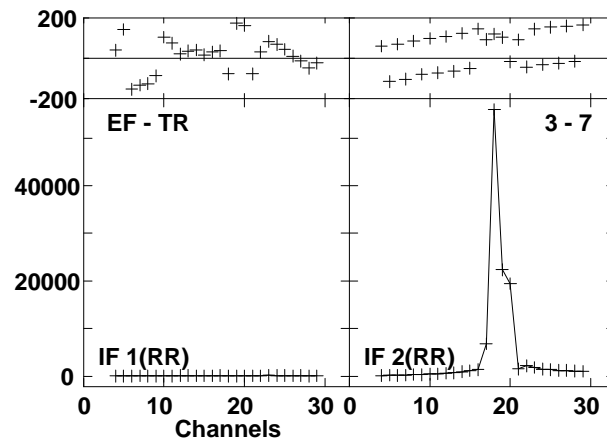
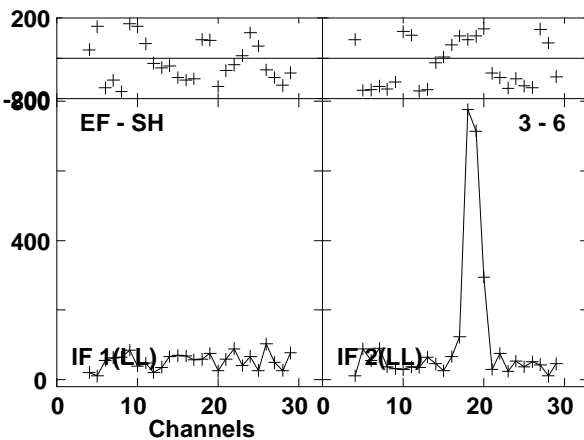
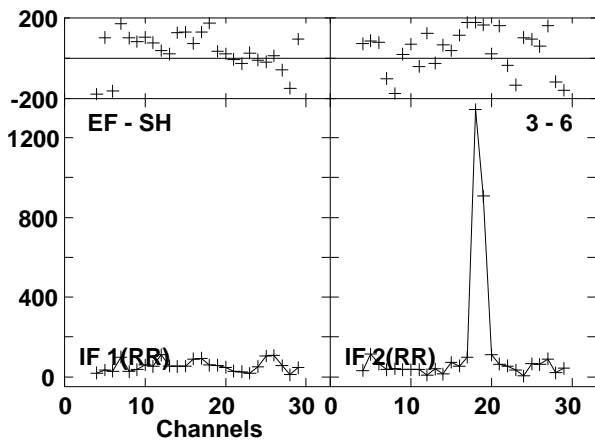
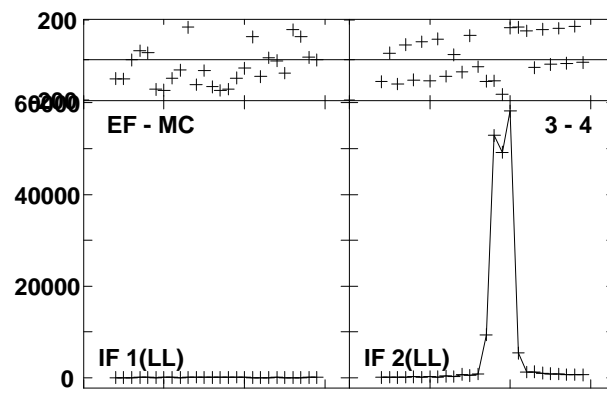
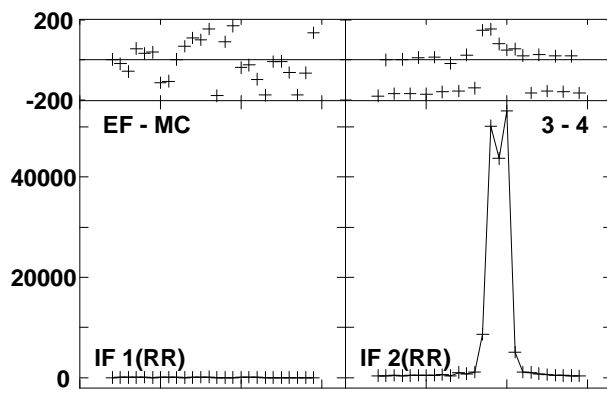
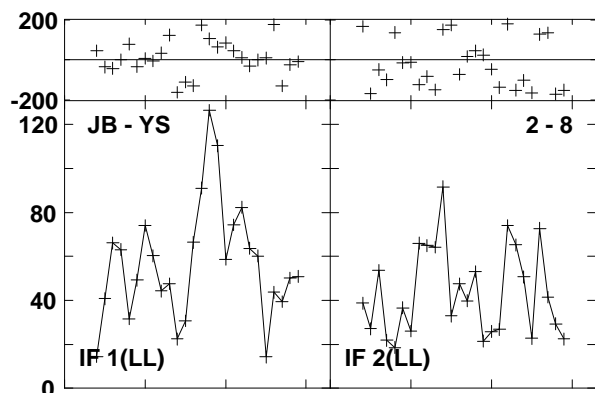
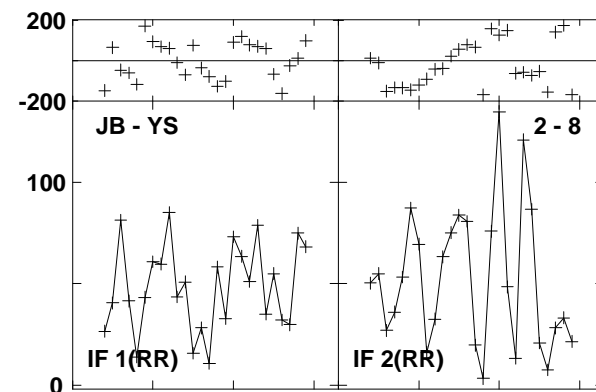
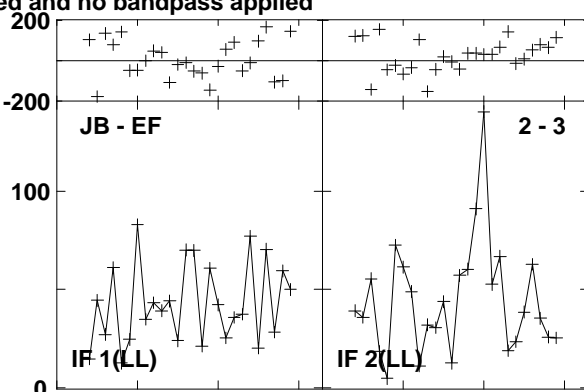
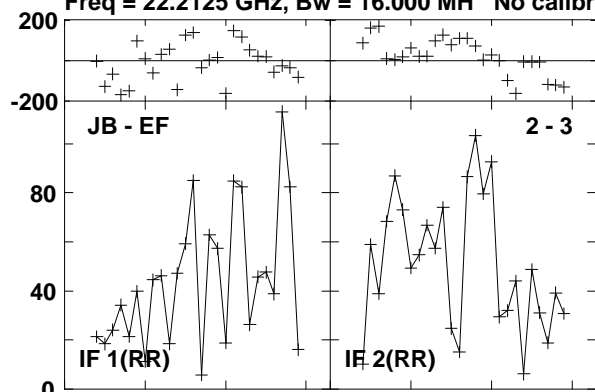

Lower frame: Micro Ampl Jy Top frame: Phas deg  
Vector averaged cross-power spectrum Baseline: JB (02) - EF (03)  
Timerange: 00:12:05:01 to 00:12:14:29

Plot file version 334 created 23-AUG-2016 15:00:53

W3IRS5 GA035B 1.UVDATA.1

Freq = 22.2125 GHz, Bw = 16.000 MH No calibration applied and no bandpass applied

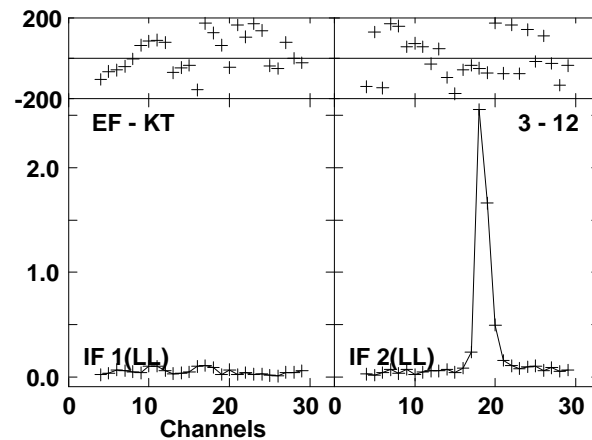
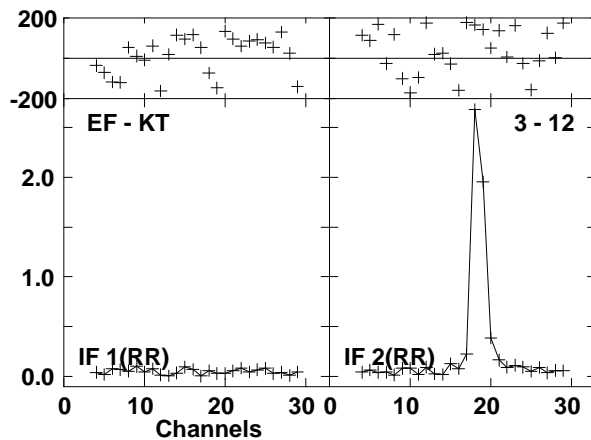
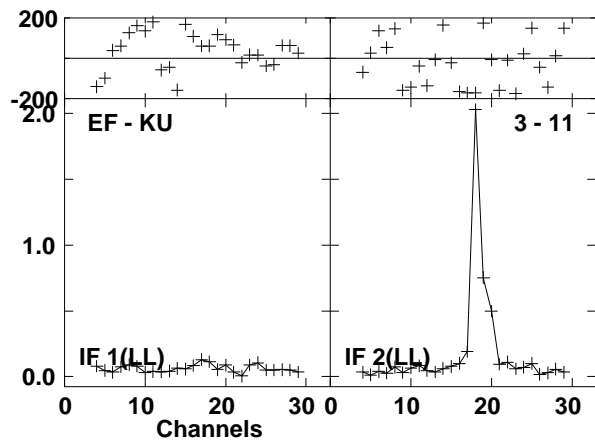
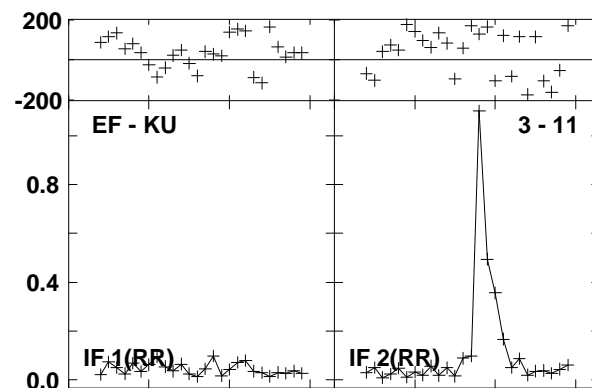
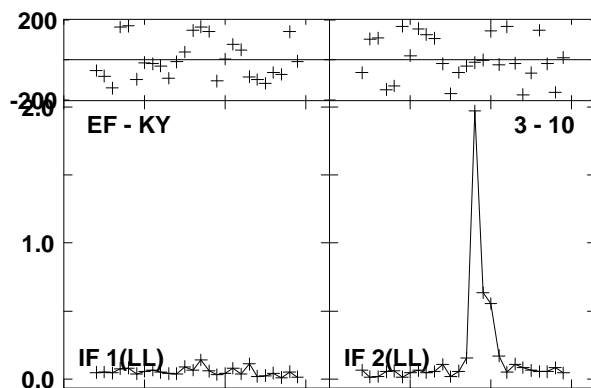
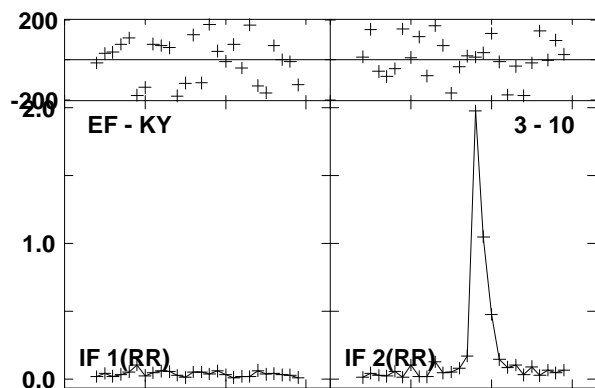
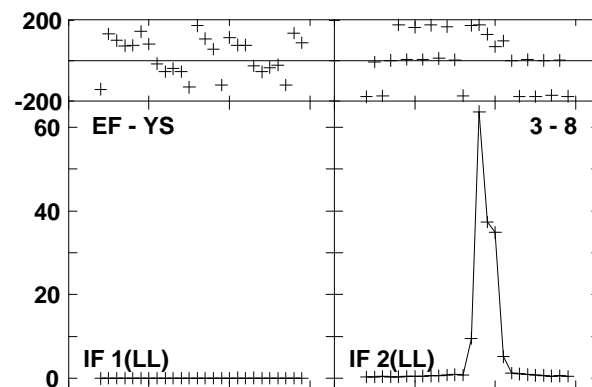
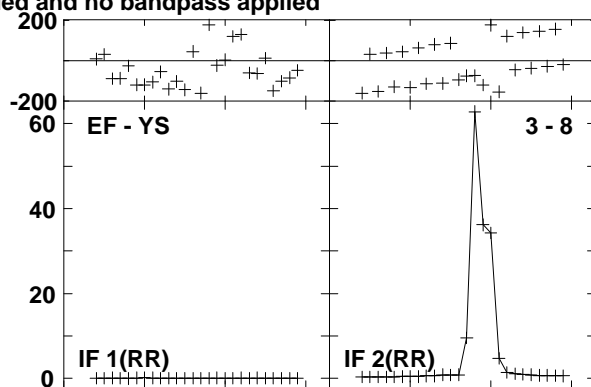
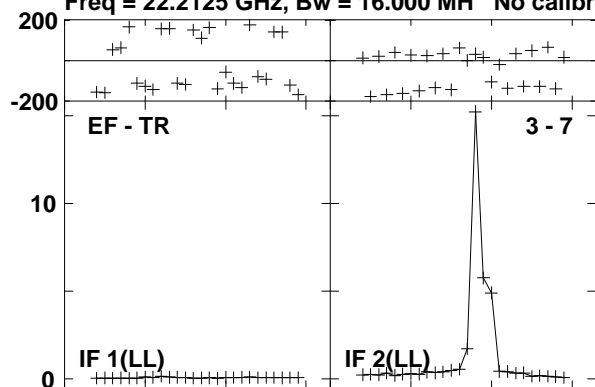

Lower frame: Milli Ampl Jy Top frame: Phas deg  
Vector averaged cross-power spectrum Baseline: EF (03) - TR (07)  
Timerange: 00/12:05:01 to 00/12:14:29

Plot file version 335 created 23-AUG-2016 15:00:53

W3IRS5 GA035B 1.UVDATA.1

Freq = 22.2125 GHz, Bw = 16.000 MH No calibration applied and no bandpass applied

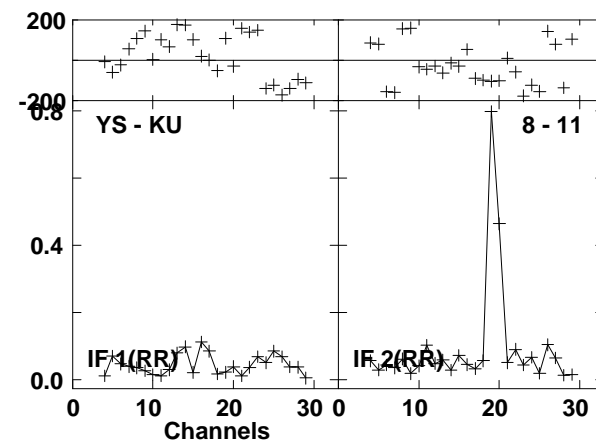
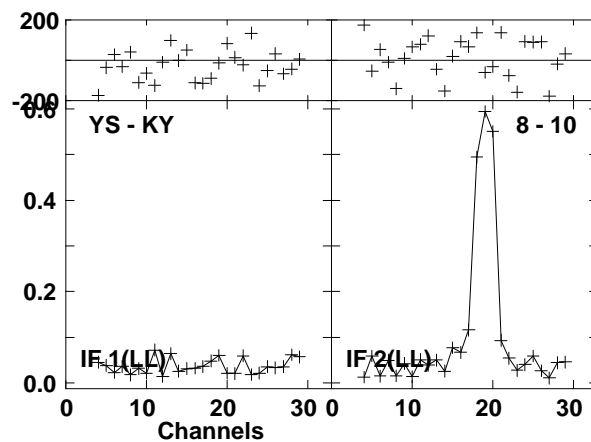
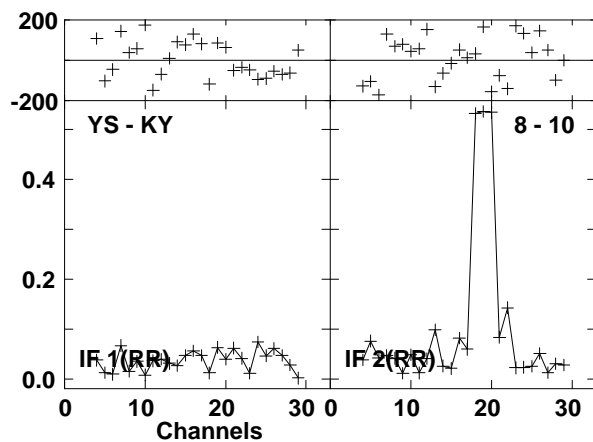
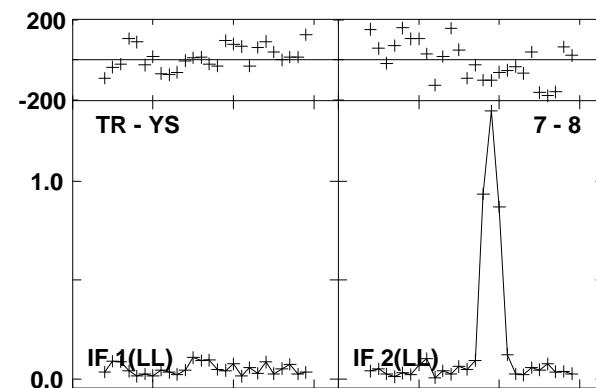
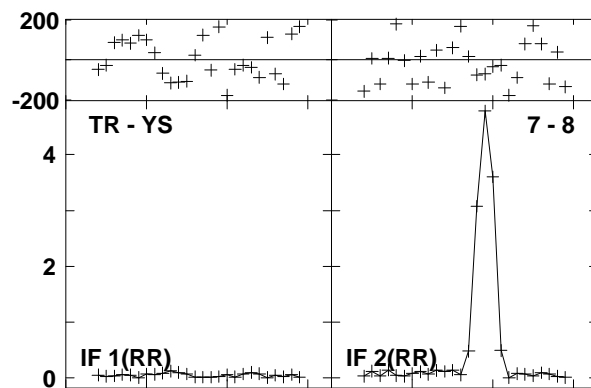
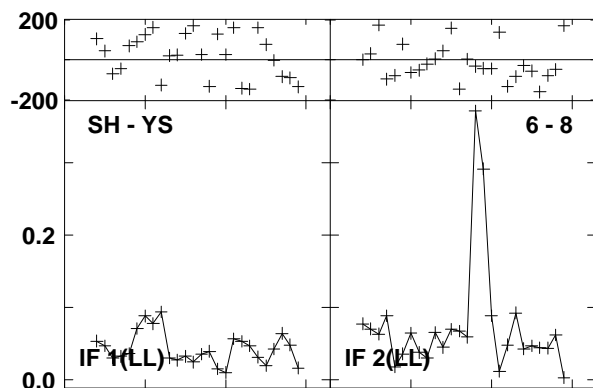
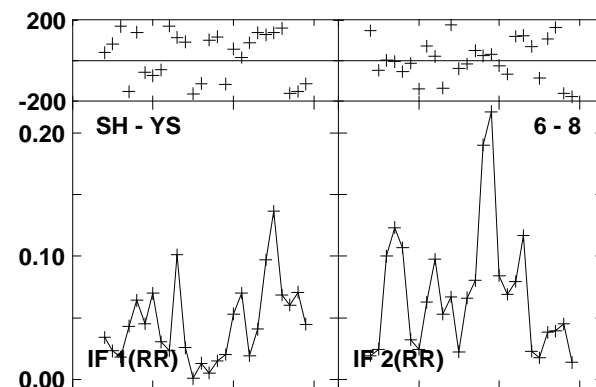
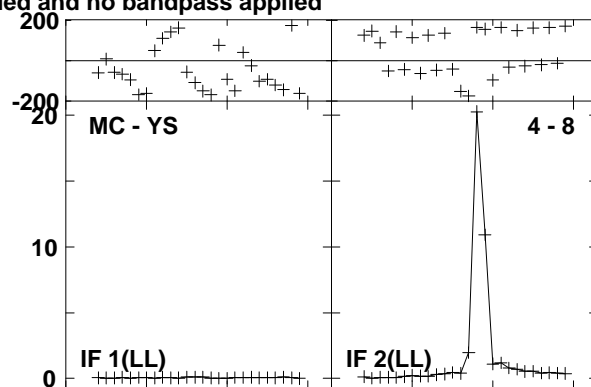
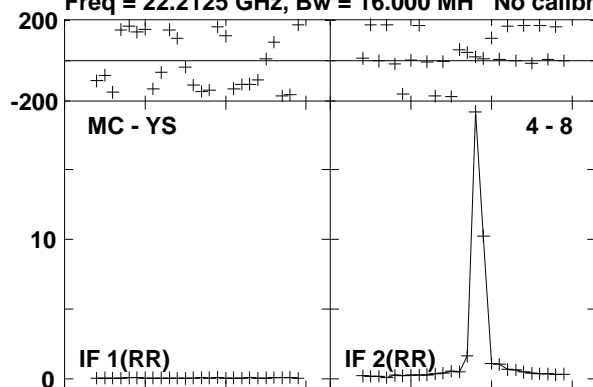

Lower frame: Milli Ampl Jy Top frame: Phas deg  
Vector averaged cross-power spectrum Baseline: MC (04) - YS (08)  
Timerange: 00/12:05:01 to 00/12:14:29

Plot file version 336 created 23-AUG-2016 15:00:53

W3IRS5 GA035B 1.UVDATA.1

Freq = 22.2125 GHz, Bw = 16.000 MH No calibration applied and no bandpass applied

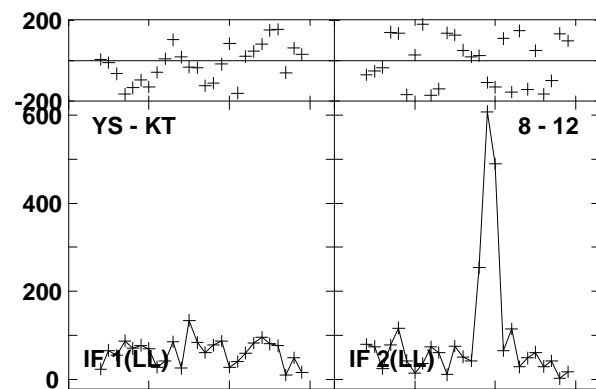
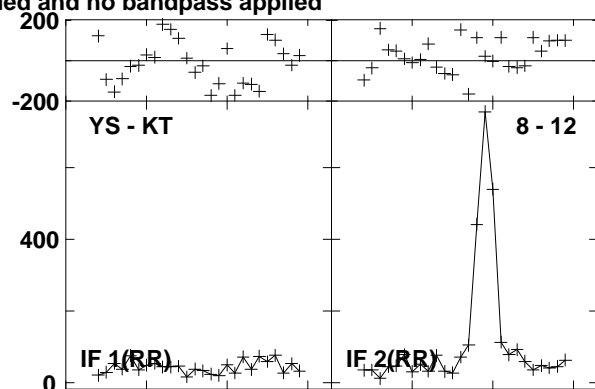
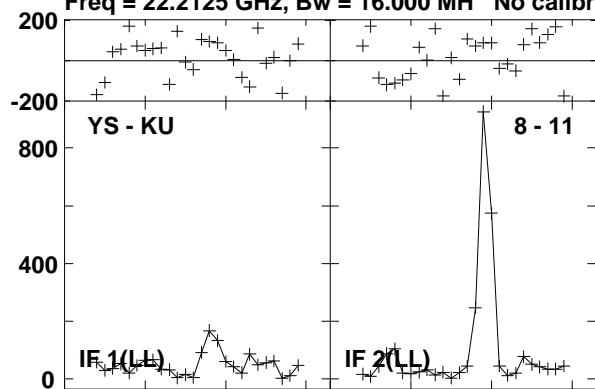

Lower frame: Micro Ampl Jy Top frame: Phas deg  
Vector averaged cross-power spectrum Baseline: YS (08) - KU (11)  
Timerange: 00/12:05:01 to 00/12:14:29



Plot file version 337 created 23-AUG-2016 15:00:54

W3IRS5 GA035B 1.UVDATA.1

Freq = 22.2125 GHz, Bw = 16.000 MH No calibration applied and no bandpass applied

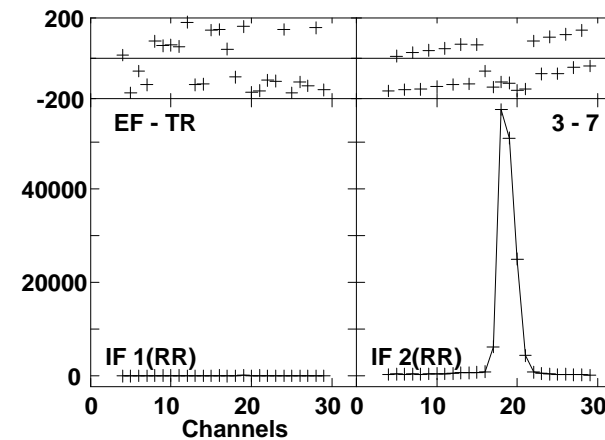
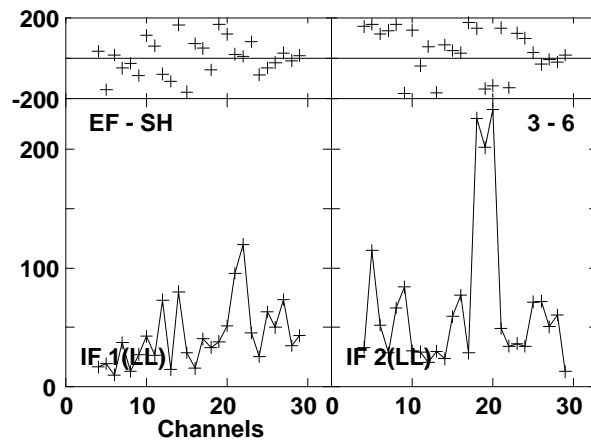
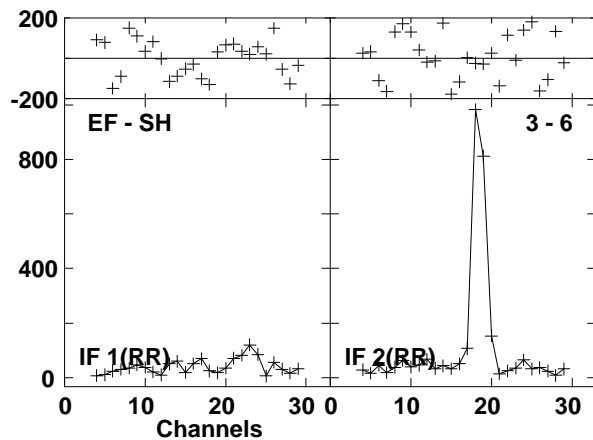
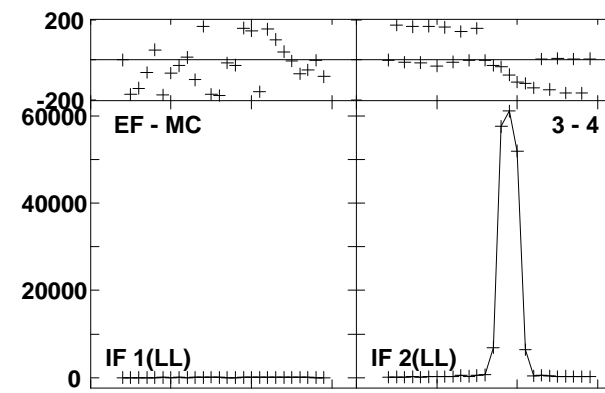
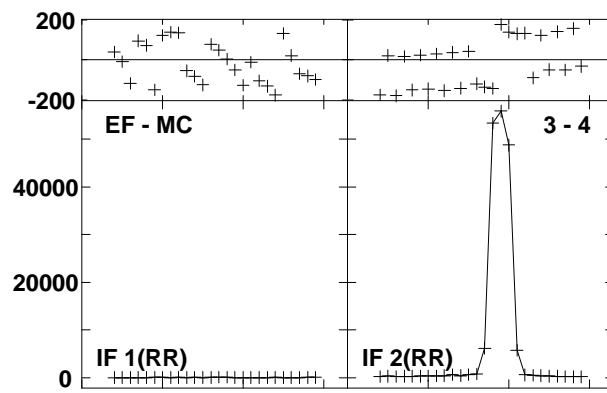
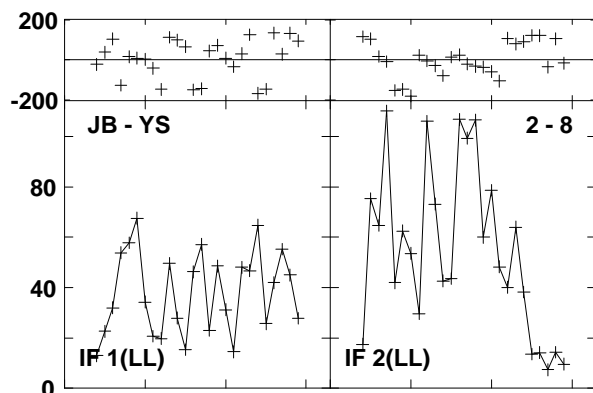
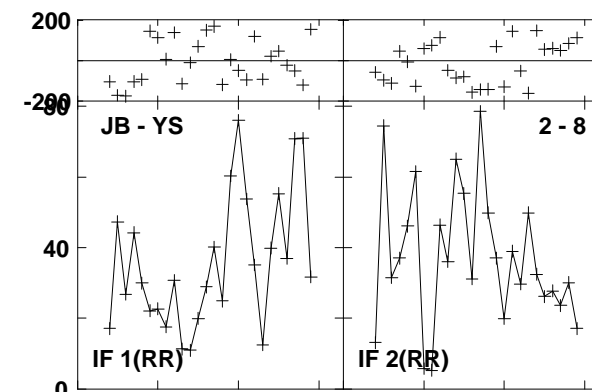
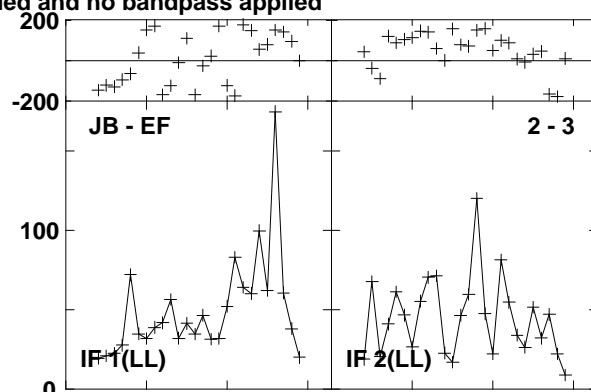
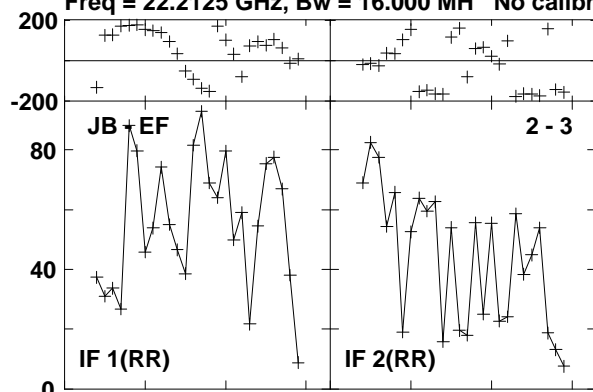

Lower frame: Micro Ampl Jy Top frame: Phas deg  
Vector averaged cross-power spectrum Baseline: JB (02) - EF (03)  
Timerange: 00/12:15:01 to 00/12:24:59

Plot file version 338 created 23-AUG-2016 15:00:54  
W3IRS5 GA035B 1.UVDATA.1

Freq = 22.2125 GHz, Bw = 16.000 MH No calibration applied and no bandpass applied

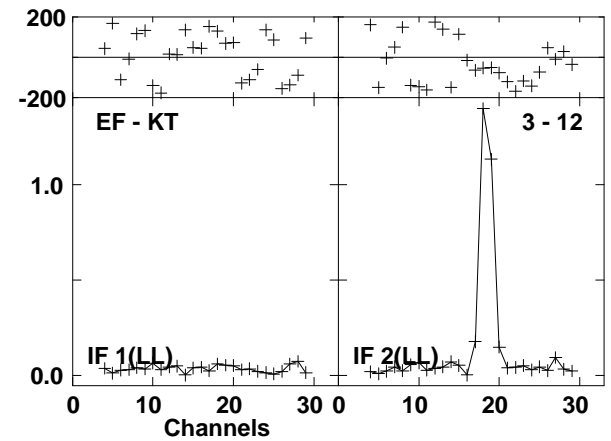
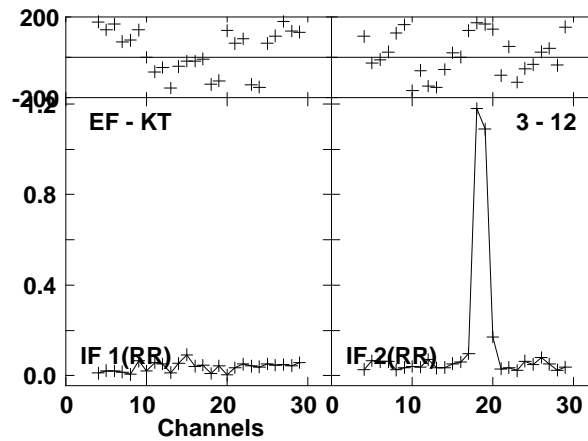
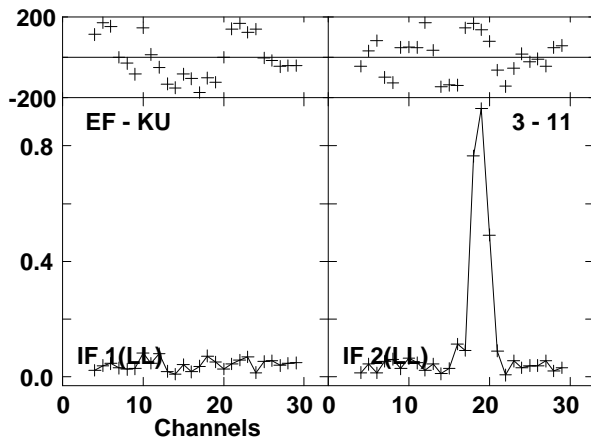
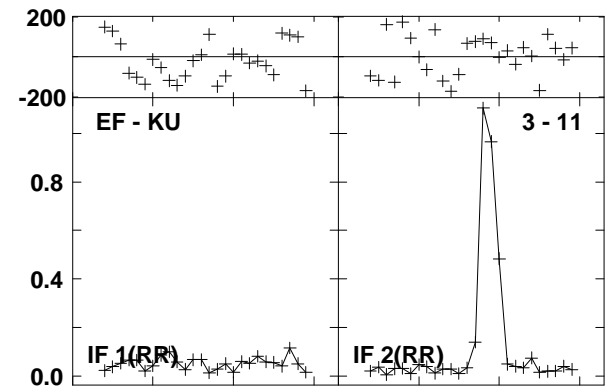
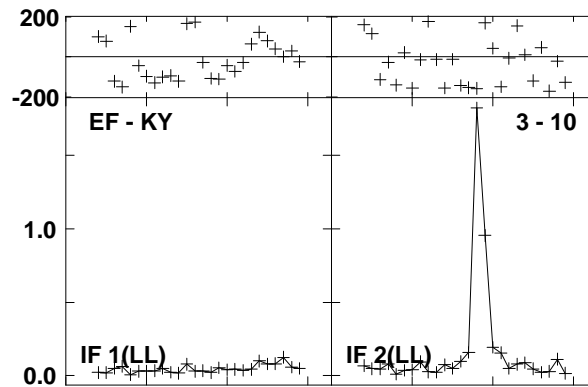
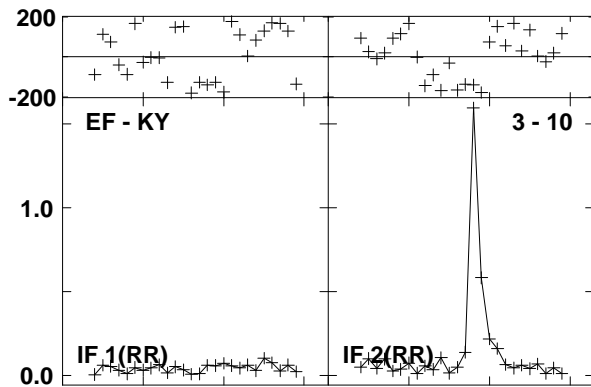
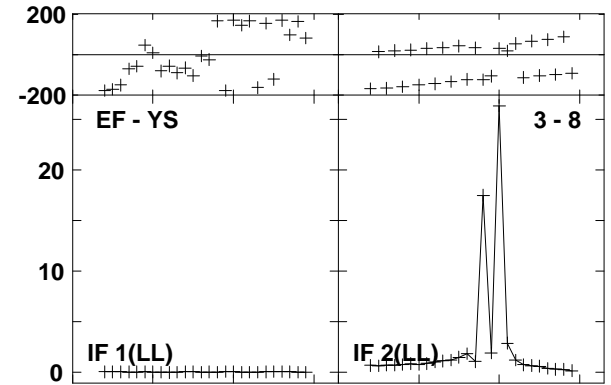
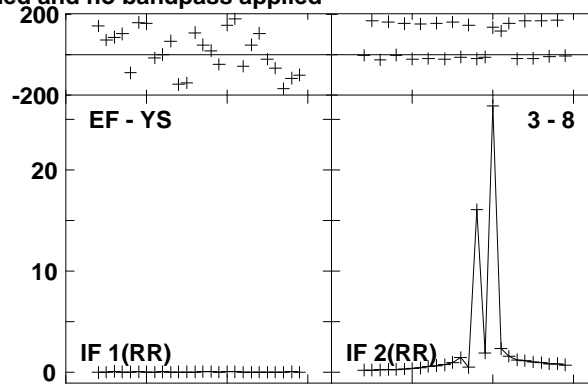
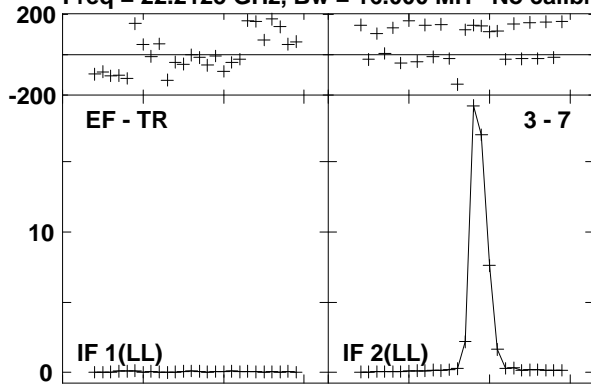

Lower frame: Milli Ampl Jy Top frame: Phas deg  
Vector averaged cross-power spectrum Baseline: EF (03) - TR (07)  
Timerange: 00/12:15:01 to 00/12:24:59

Plot file version 339 created 23-AUG-2016 15:00:54  
 W3IRS5 GA035B 1.UVDATA.1

Freq = 22.2125 GHz, Bw = 16.000 MH No calibration applied and no bandpass applied

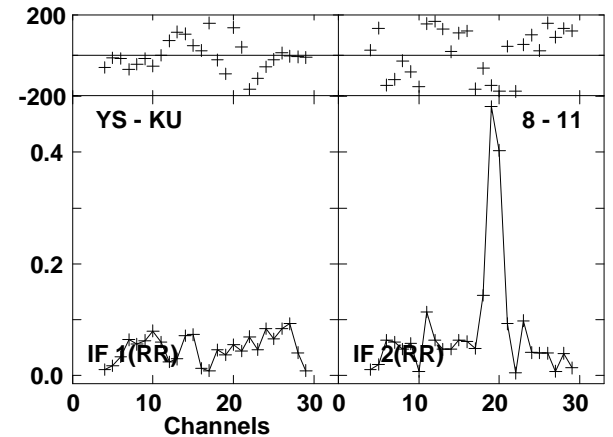
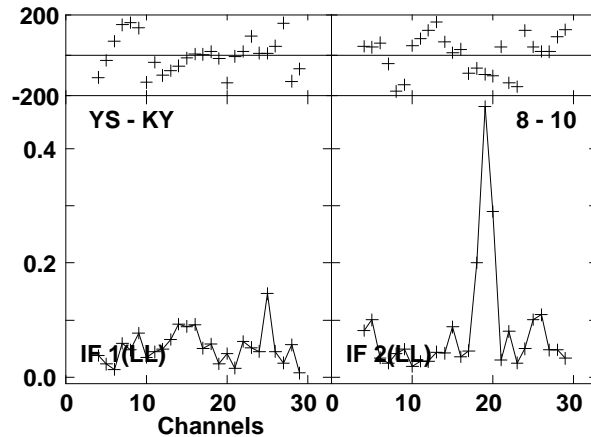
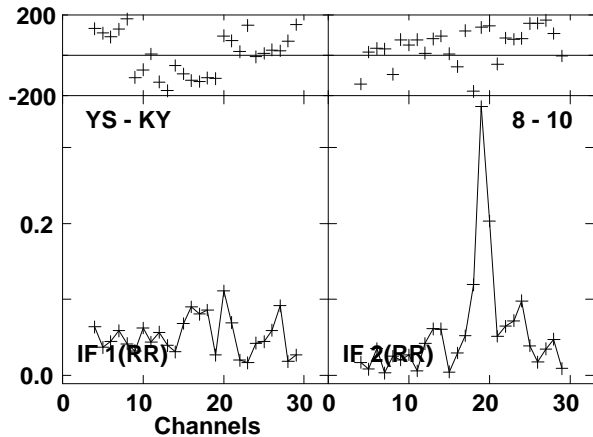
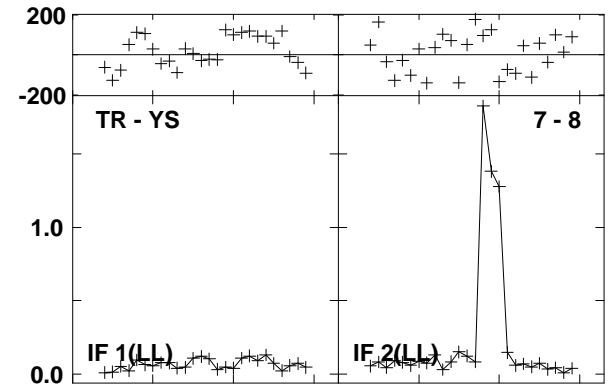
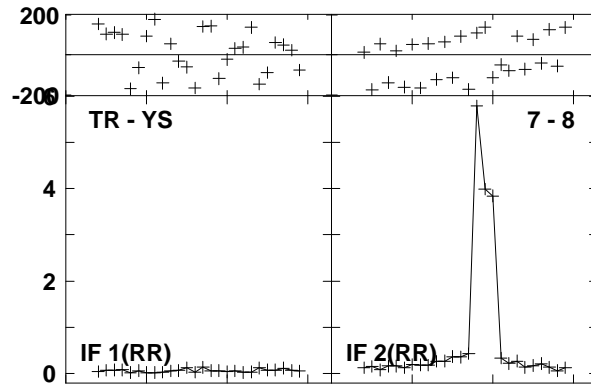
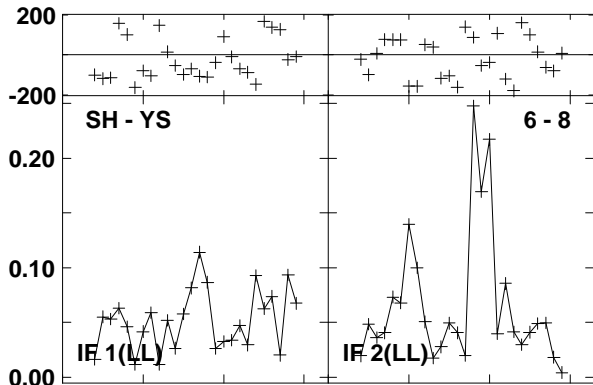
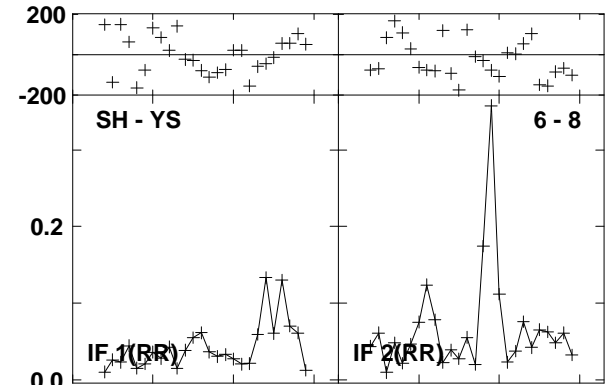
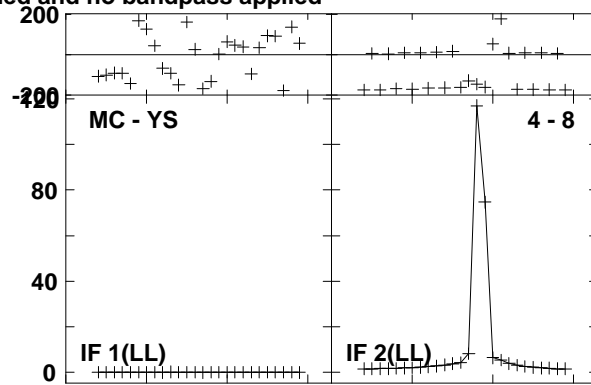
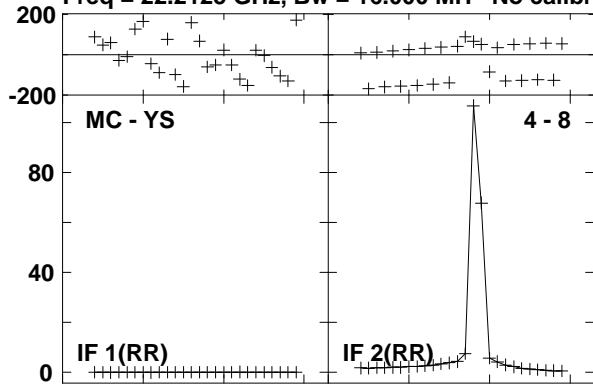

Lower frame: Milli Ampl Jy Top frame: Phas deg  
 Vector averaged cross-power spectrum Baseline: MC (04) - YS (08)  
 Timerange: 00/12:15:01 to 00/12:24:59

Plot file version 340 created 23-AUG-2016 15:00:54  
W3IRS5 GA035B 1.UVDATA.1

Freq = 22.2125 GHz, Bw = 16.000 MH No calibration applied and no bandpass applied

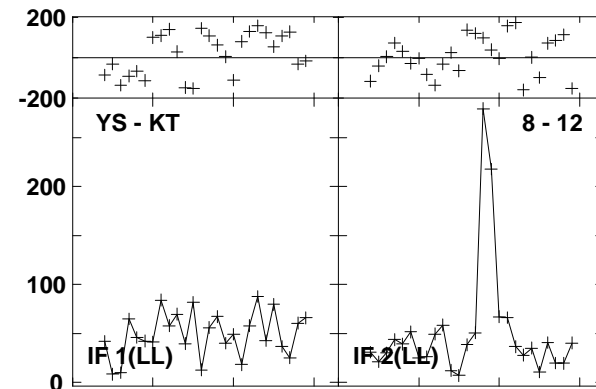
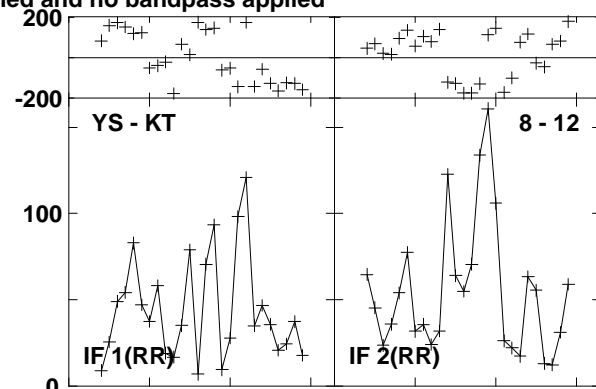
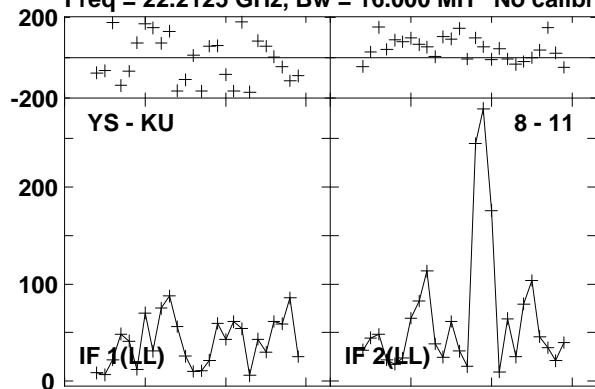

Lower frame: Micro Ampl Jy Top frame: Phas deg  
Vector averaged cross-power spectrum Baseline: YS (08) - KU (11)  
Timerange: 00/12:15:01 to 00/12:24:59

Plot file version 341 created 23-AUG-2016 15:00:54

W3IRS5 GA035B 1.UVDATA.1

Freq = 22.2125 GHz, Bw = 16.000 MH No calibration applied and no bandpass applied

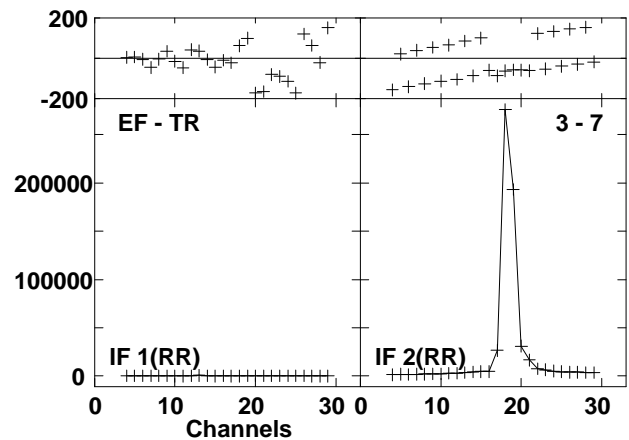
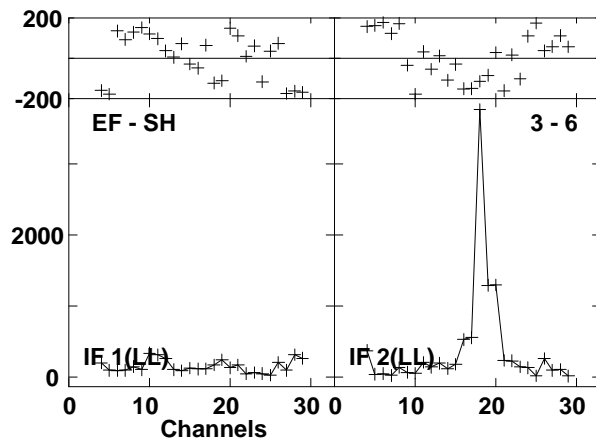
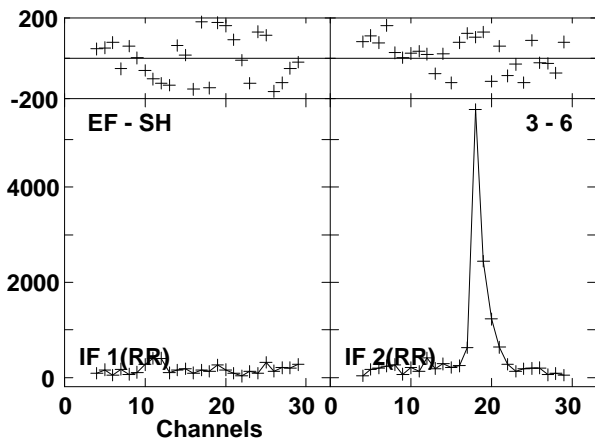
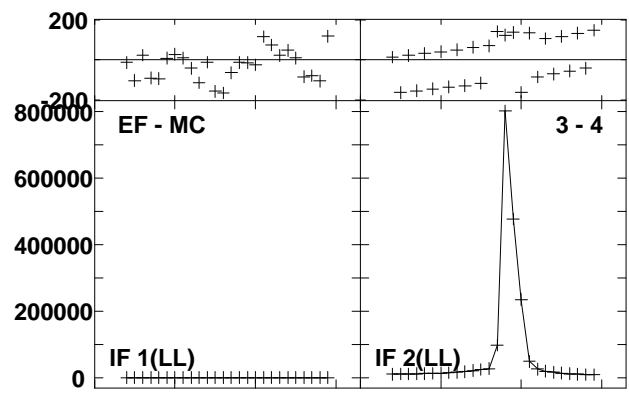
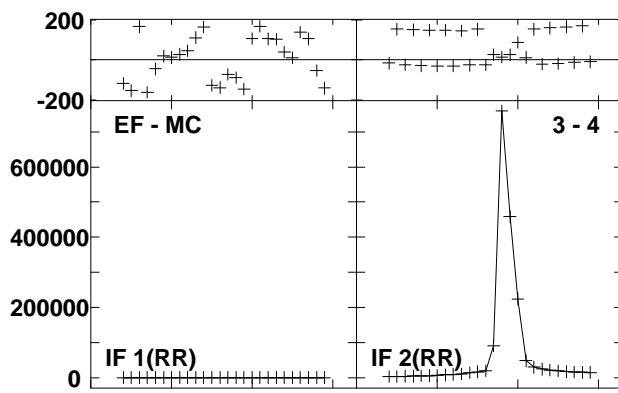
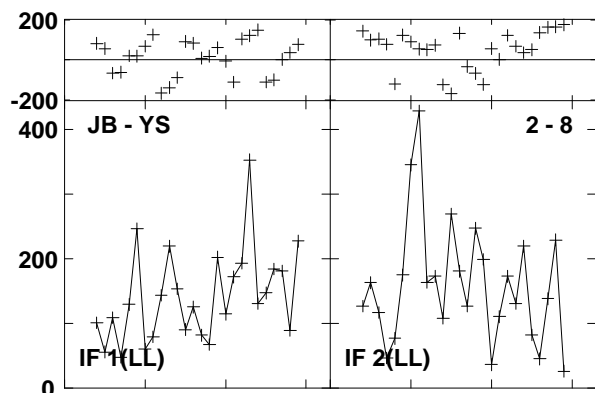
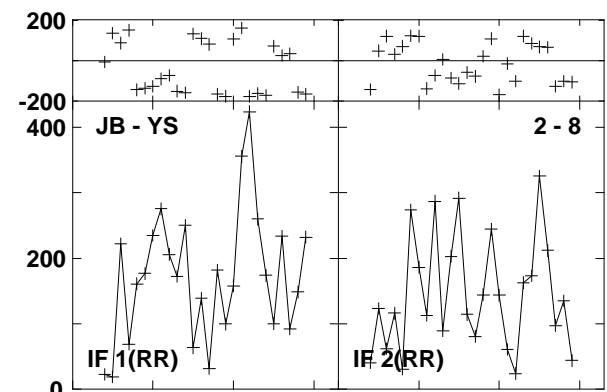
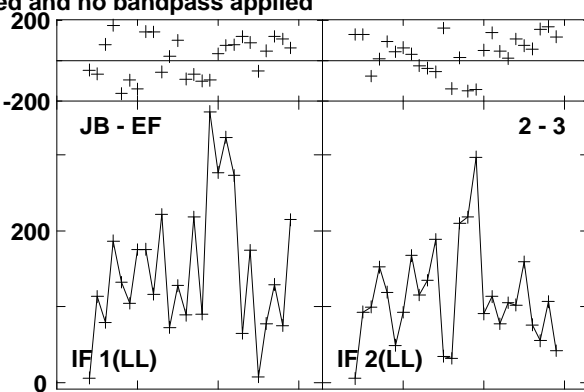
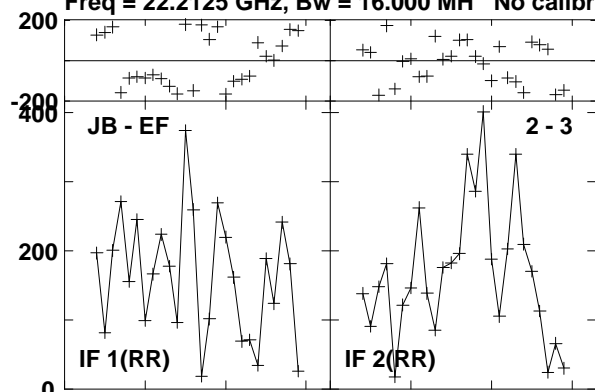

Lower frame: Micro Ampl Jy Top frame: Phas deg  
Vector averaged cross-power spectrum Baseline: JB (02) - EF (03)  
Timerange: 00/12:26:01 to 00/12:27:00

Plot file version 342 created 23-AUG-2016 15:00:54

W3IRS5 GA035B 1.UVDATA.1

Freq = 22.2125 GHz, Bw = 16.000 MH No calibration applied and no bandpass applied

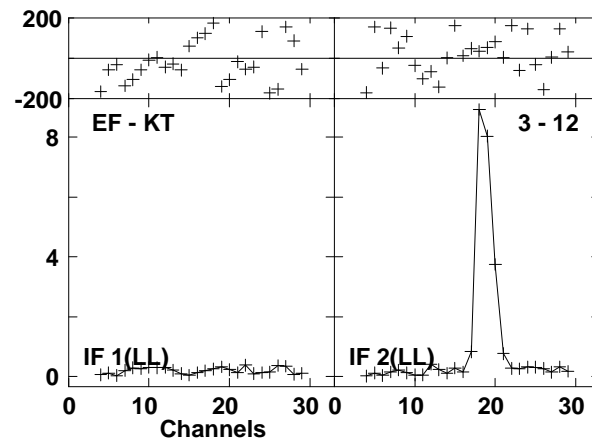
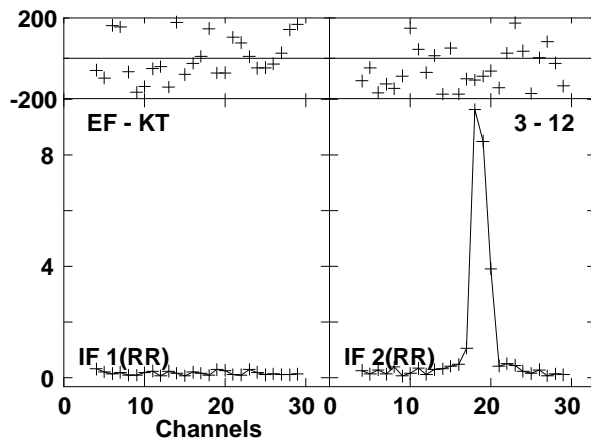
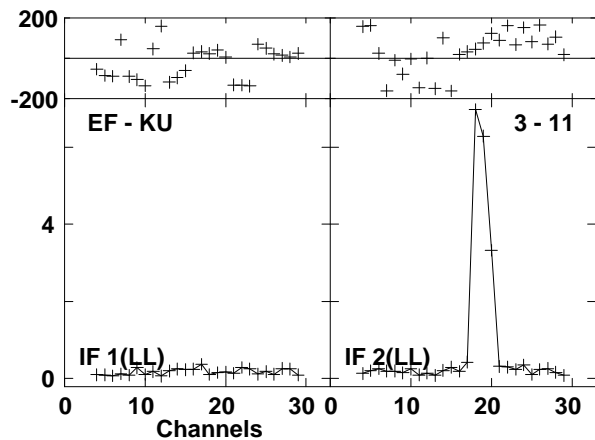
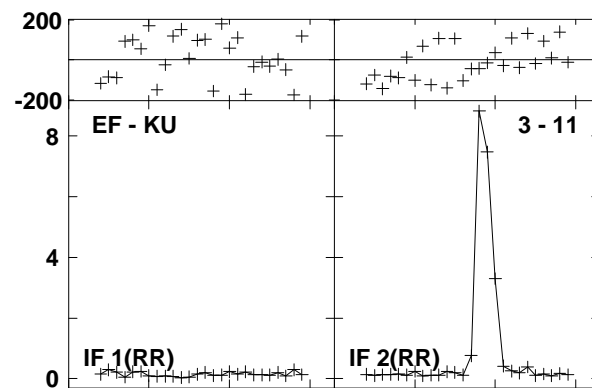
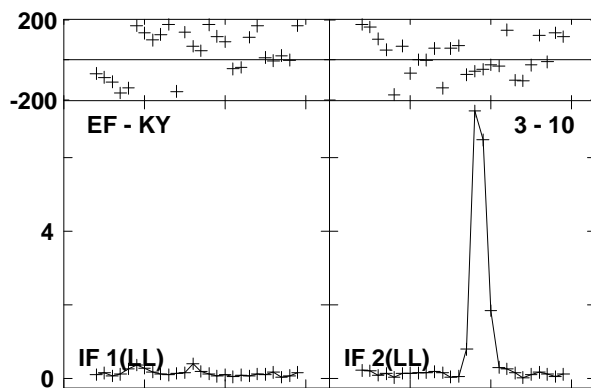
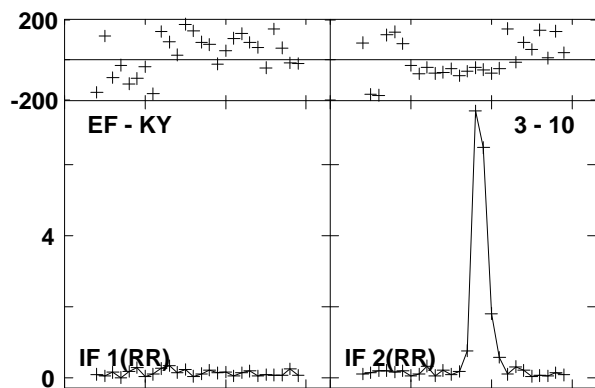
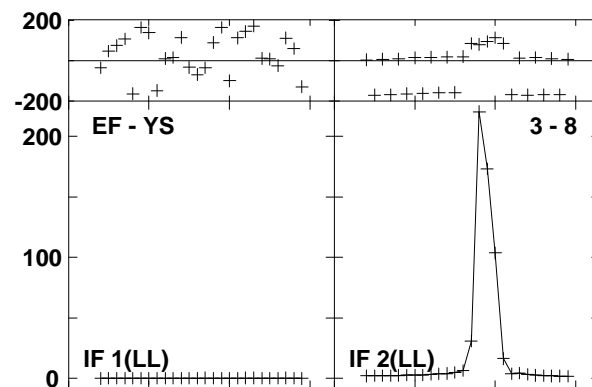
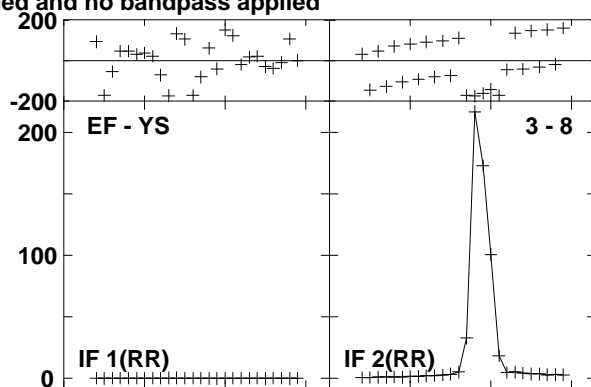
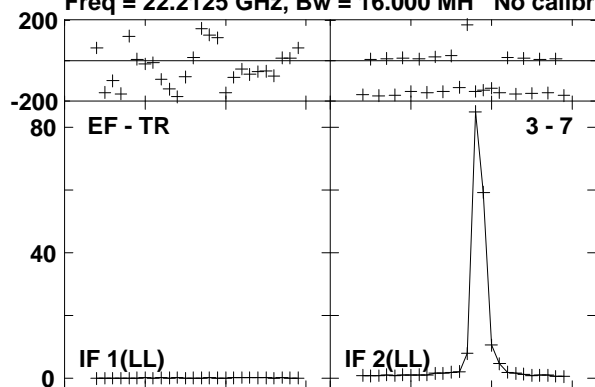

Lower frame: Milli Ampl Jy Top frame: Phas deg  
Vector averaged cross-power spectrum Baseline: EF (03) - TR (07)  
Timerange: 00/12:26:01 to 00/12:27:00

Plot file version 343 created 23-AUG-2016 15:00:54

W3IRS5 GA035B 1.UVDATA.1

Freq = 22.2125 GHz, Bw = 16.000 MH No calibration applied and no bandpass applied

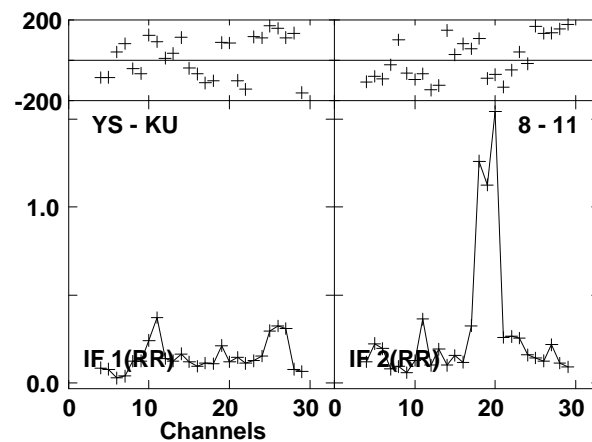
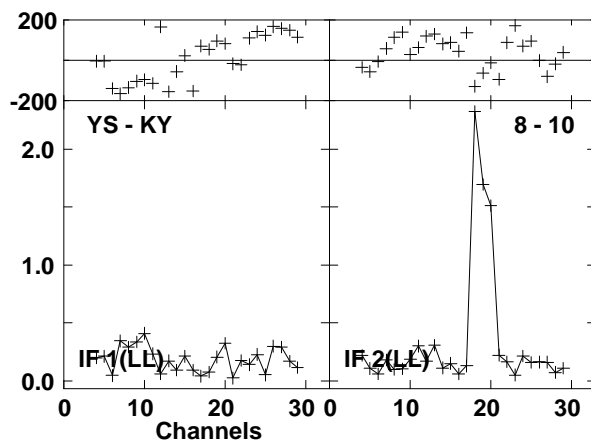
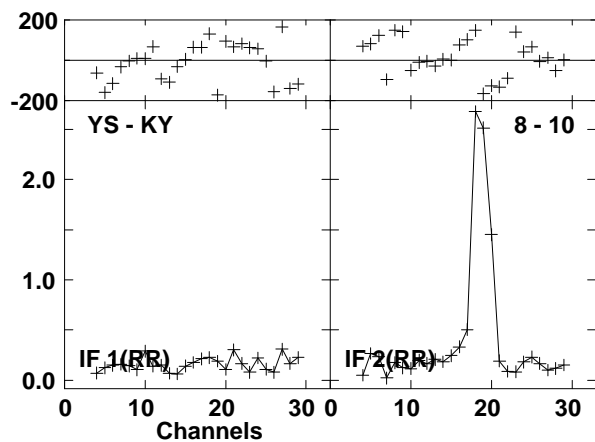
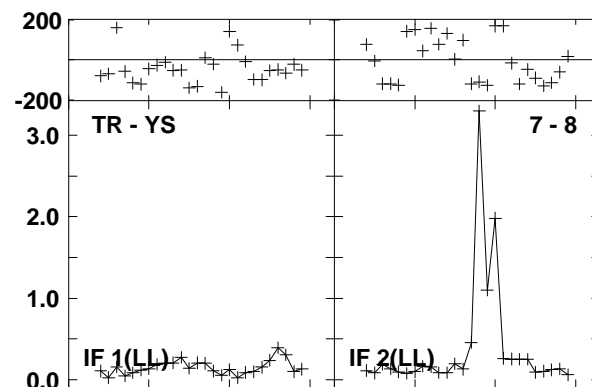
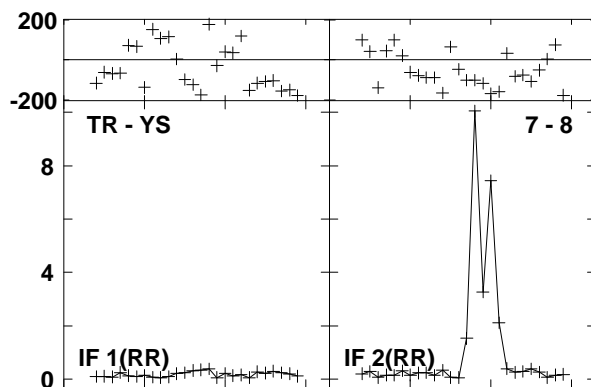
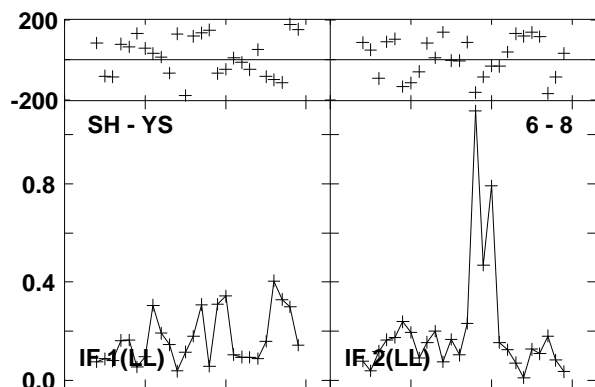
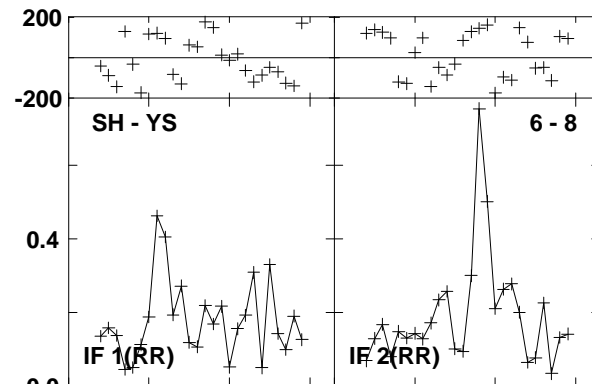
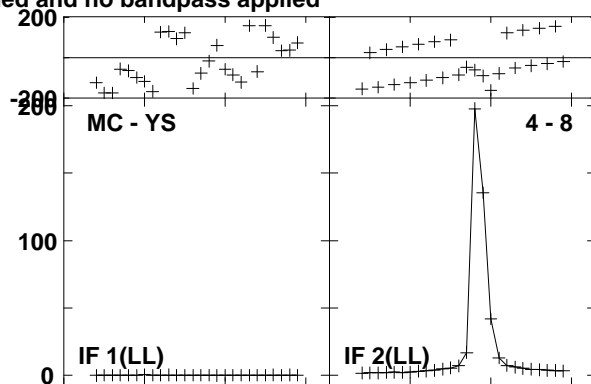
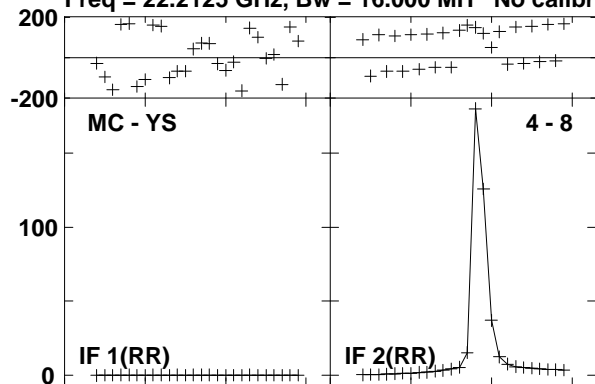

Lower frame: Milli Ampl Jy Top frame: Phas deg

Vector averaged cross-power spectrum Baseline: MC (04) - YS (08)

Timerange: 00/12:26:01 to 00/12:27:00

Plot file version 344 created 23-AUG-2016 15:00:54  
W3IRS5 GA035B 1.UVDATA.1

Freq = 22.2125 GHz, Bw = 16.000 MH No calibration applied and no bandpass applied

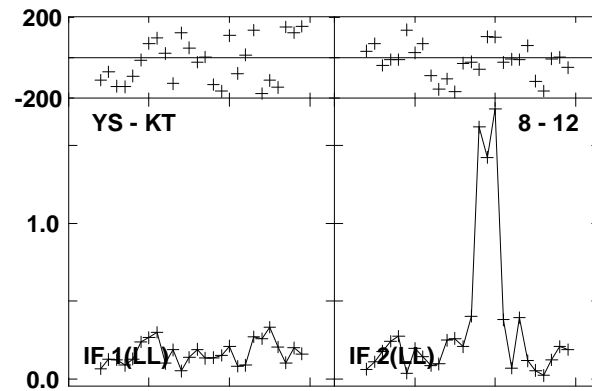
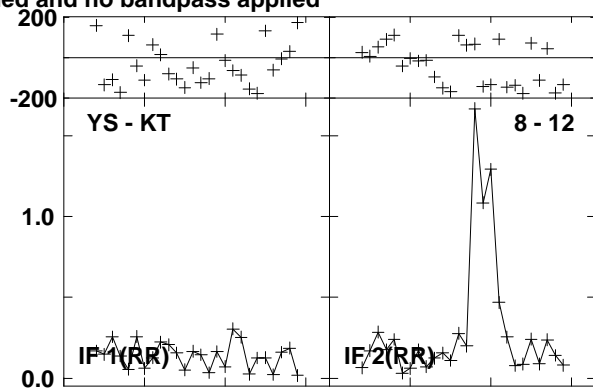
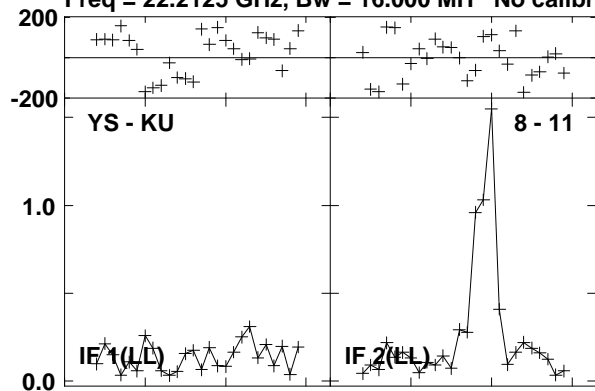

Lower frame: Milli Ampl Jy Top frame: Phas deg  
Vector averaged cross-power spectrum Baseline: YS (08) - KU (11)  
Timerange: 00/12:26:01 to 00/12:27:00



Plot file version 345 created 23-AUG-2016 15:00:54

0219+628 GA035B 1.UVDATA.1

Freq = 22.2125 GHz, Bw = 16.000 MH No calibration applied and no bandpass applied

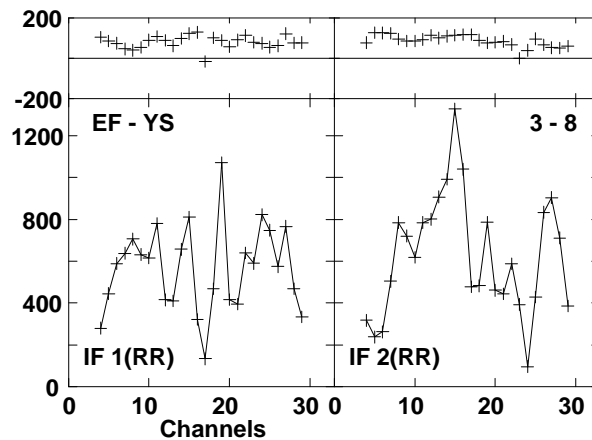
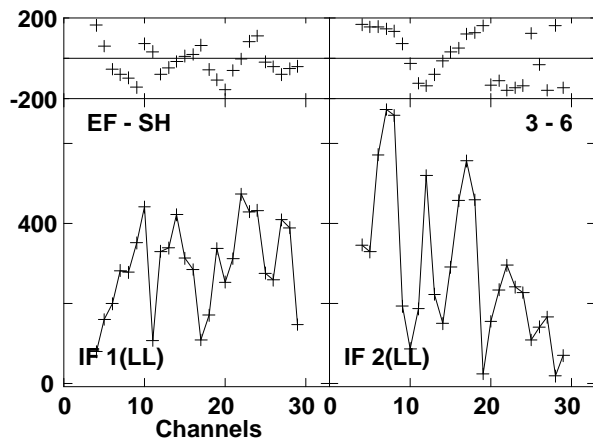
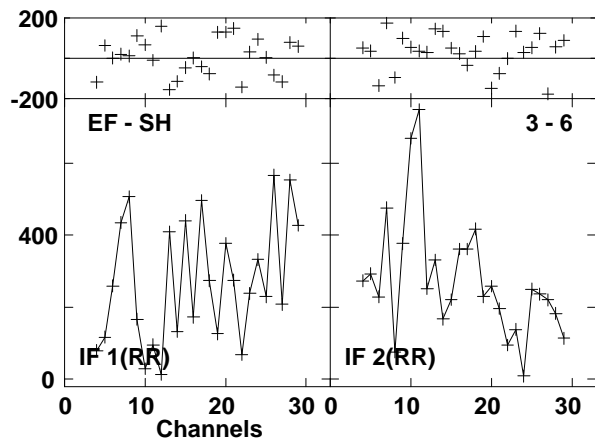
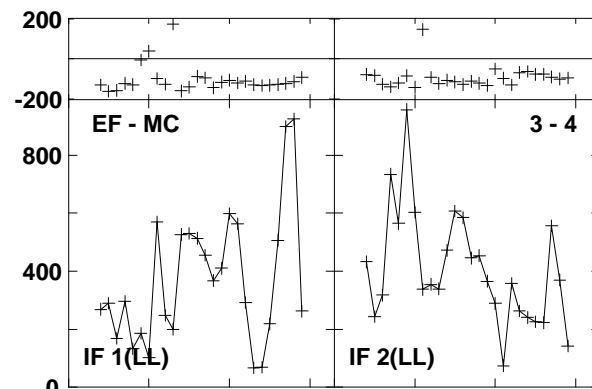
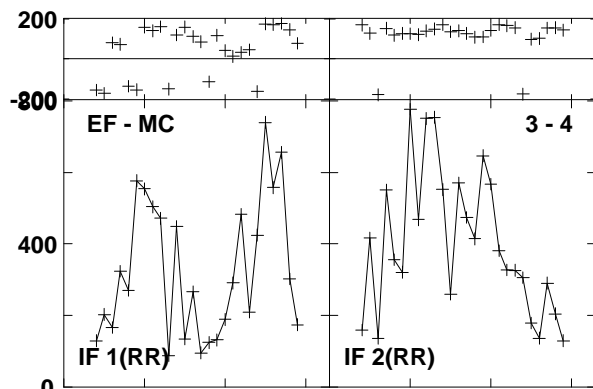
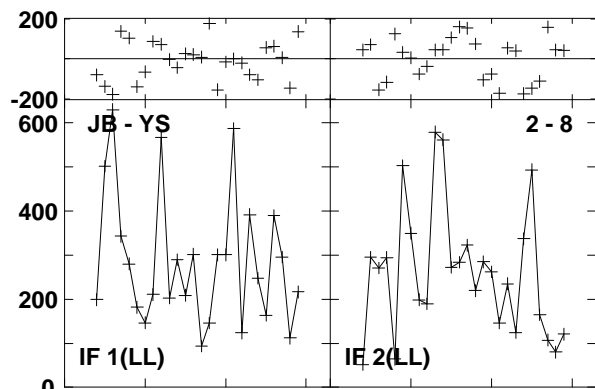
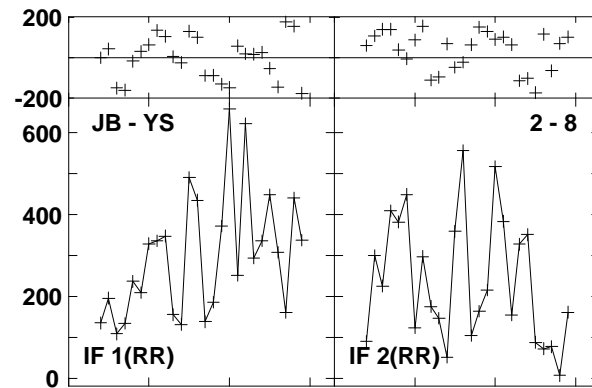
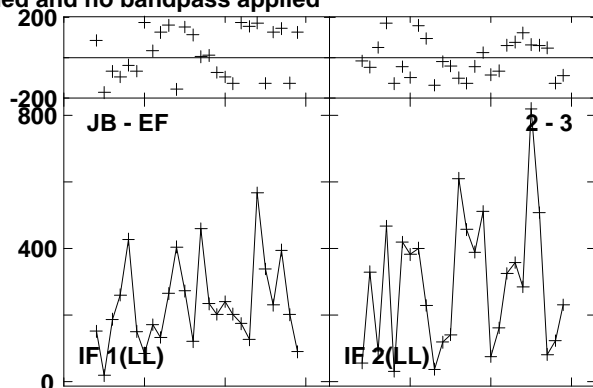
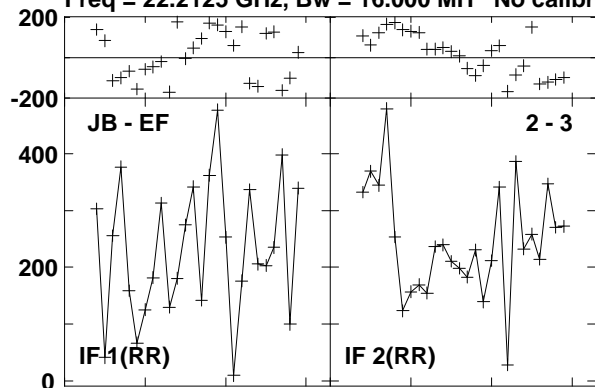

Lower frame: Micro Ampl Jy Top frame: Phas deg  
Vector averaged cross-power spectrum Baseline: JB (02) - EF (03)  
Timerange: 00/12:27:30 to 00/12:27:50

Plot file version 346 created 23-AUG-2016 15:00:54  
 0219+628 GA035B 1.UVDATA.1

Freq = 22.2125 GHz, Bw = 16.000 MH No calibration applied and no bandpass applied

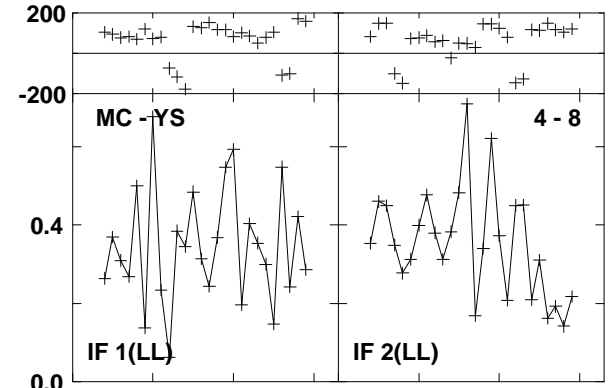
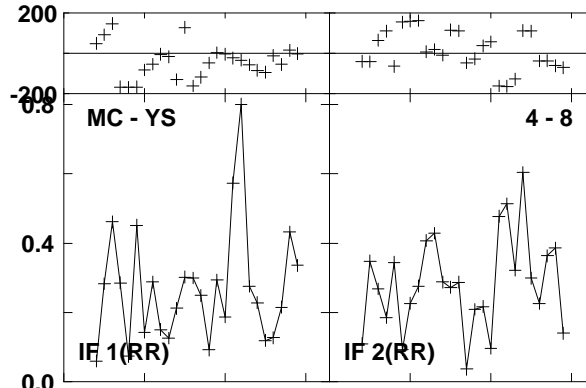
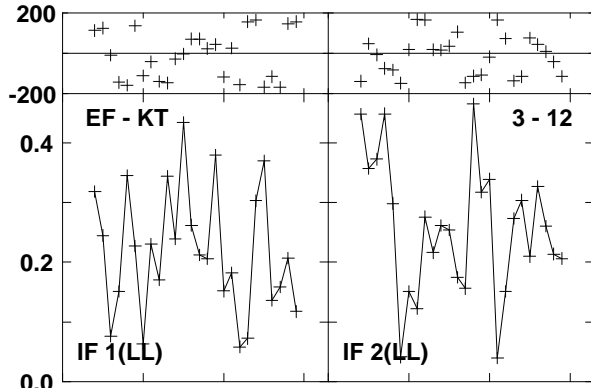
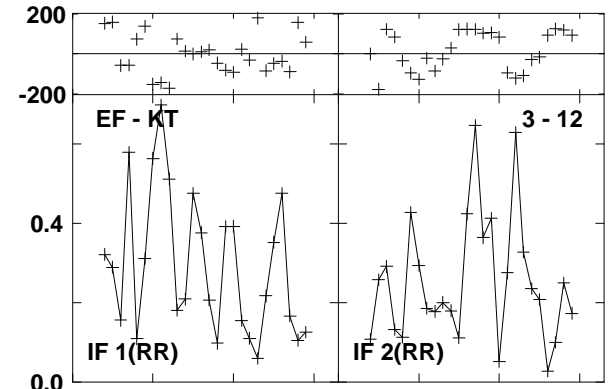
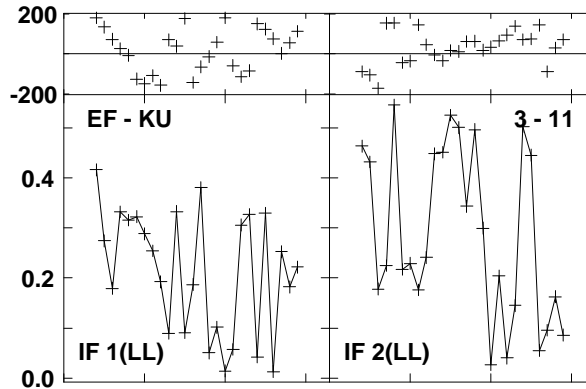
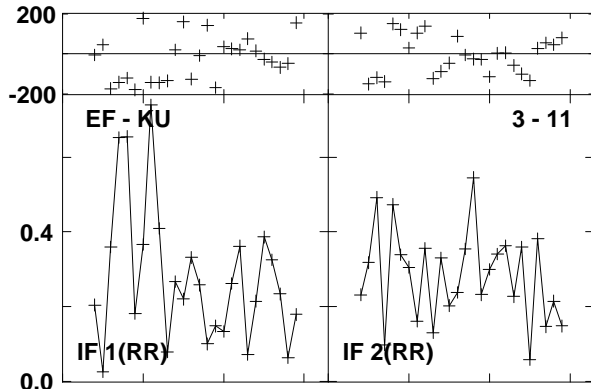
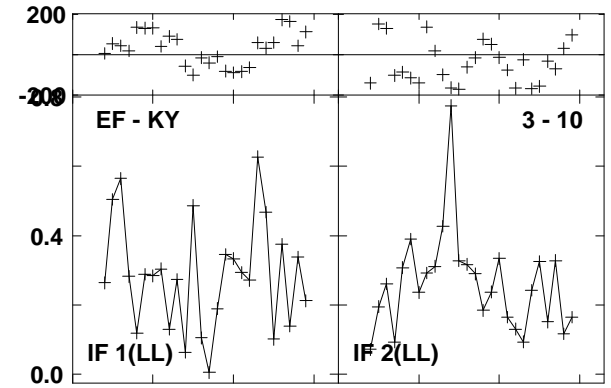
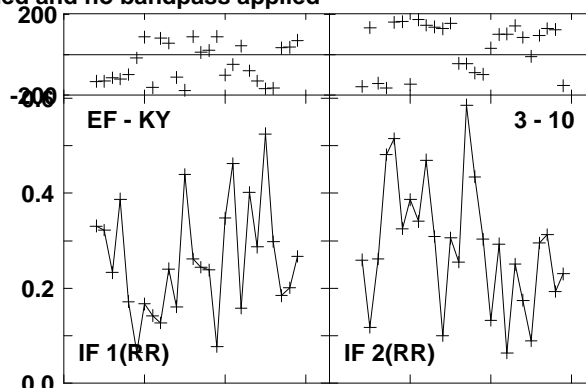
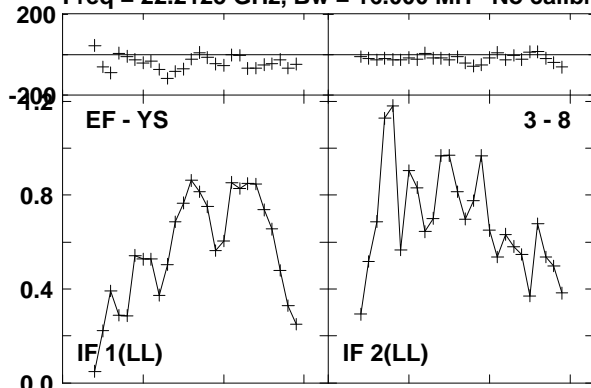

Lower frame: Milli Ampl Jy Top frame: Phas deg  
 Vector averaged cross-power spectrum Baseline: EF (03) - YS (08)  
 Timerange: 00/12:27:30 to 00/12:27:50

Plot file version 347 created 23-AUG-2016 15:00:54

0219+628 GA035B 1.UVDATA.1

Freq = 22.2125 GHz, Bw = 16.000 MH No calibration applied and no bandpass applied

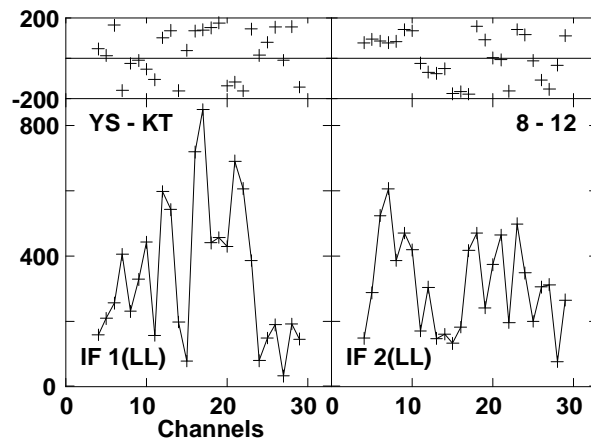
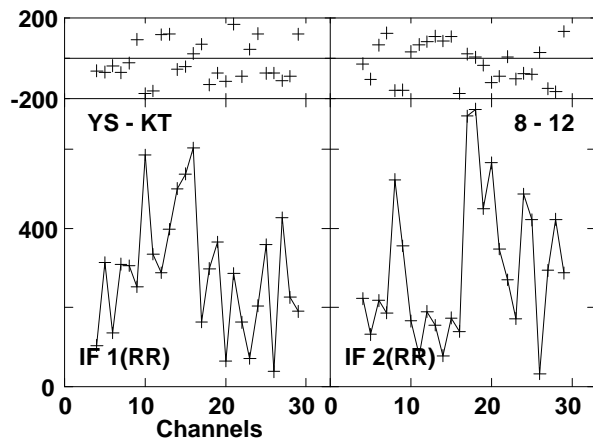
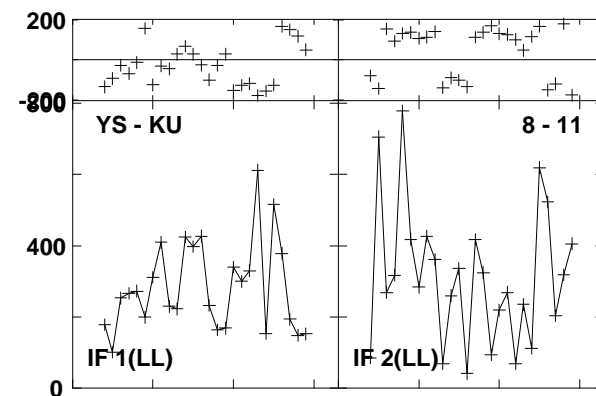
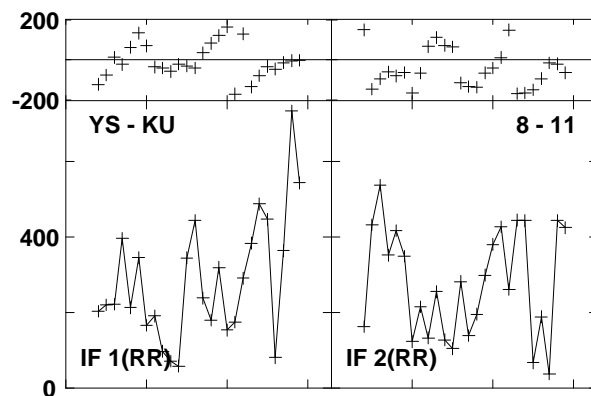
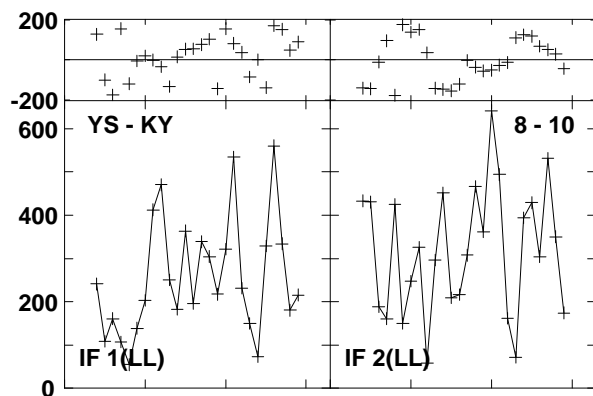
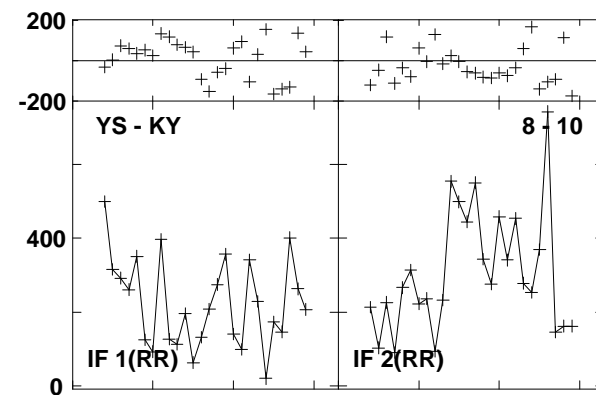
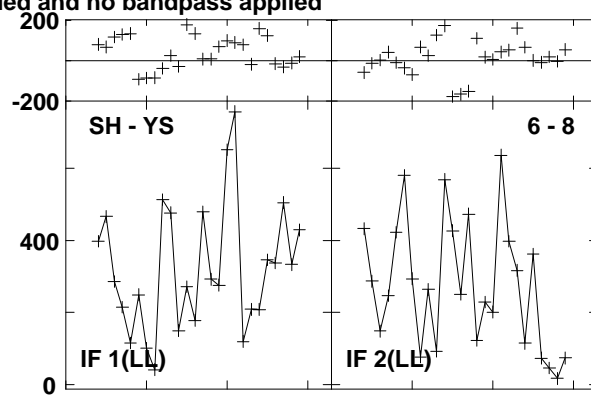
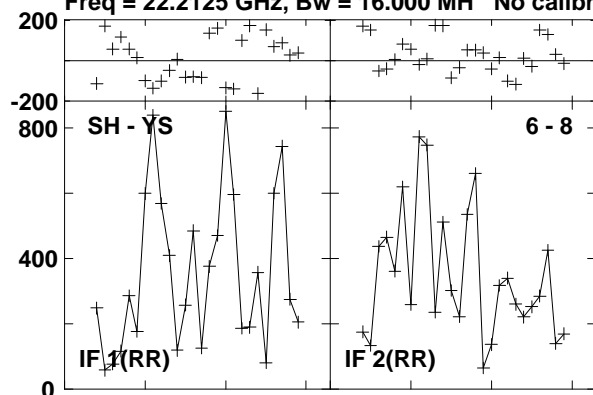

Lower frame: Micro Ampl Jy Top frame: Phas deg

Vector averaged cross-power spectrum Baseline: SH (06) - YS (08)

Timerange: 00/12:27:30 to 00/12:27:50

Plot file version 348 created 23-AUG-2016 15:00:54

W3IRS5 GA035B 1.UVDATA.1

Freq = 22.2125 GHz, Bw = 16.000 MH No calibration applied and no bandpass applied

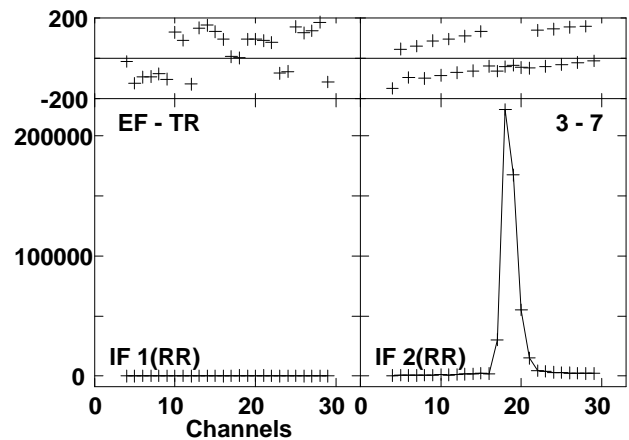
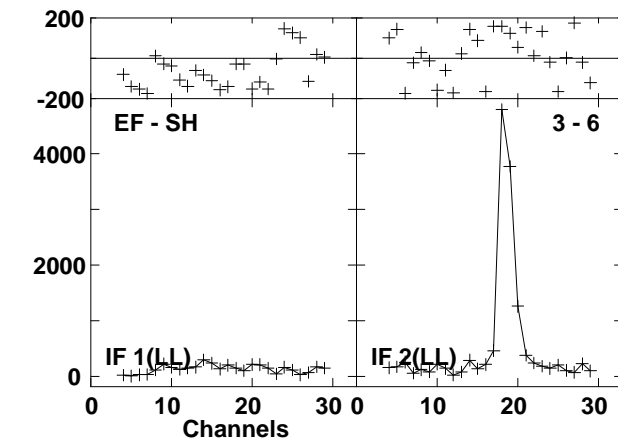
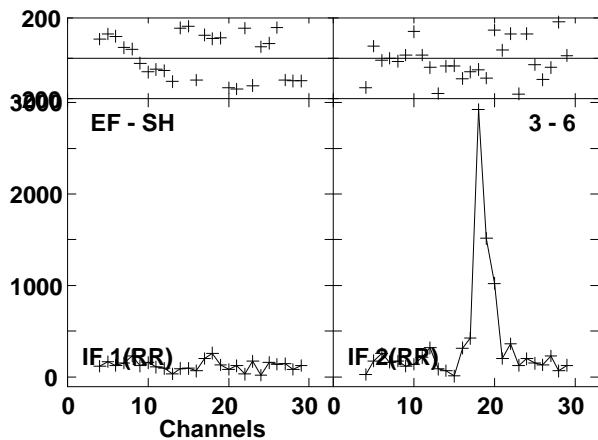
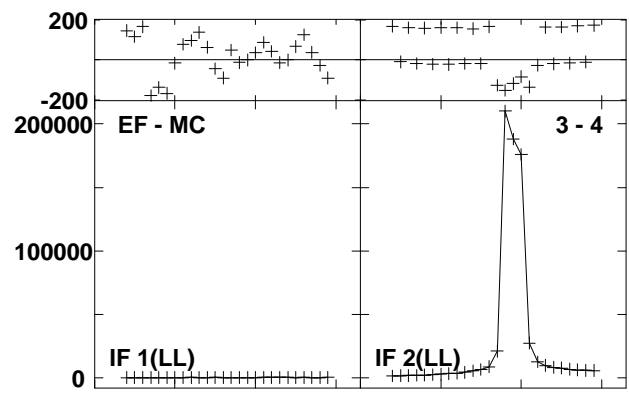
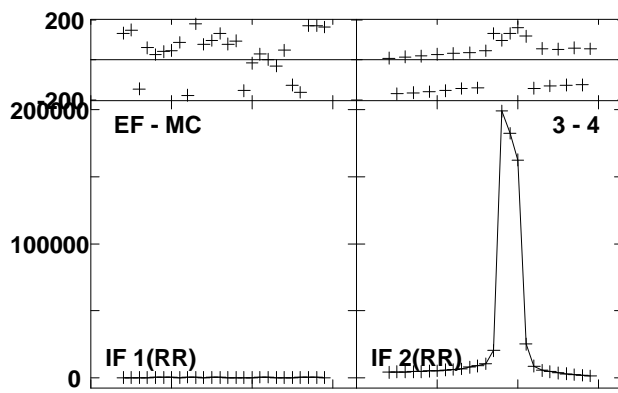
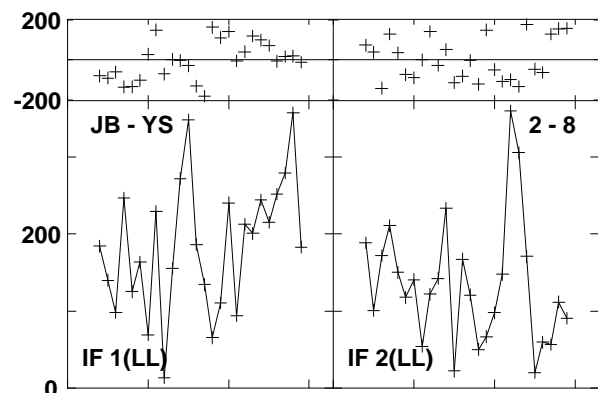
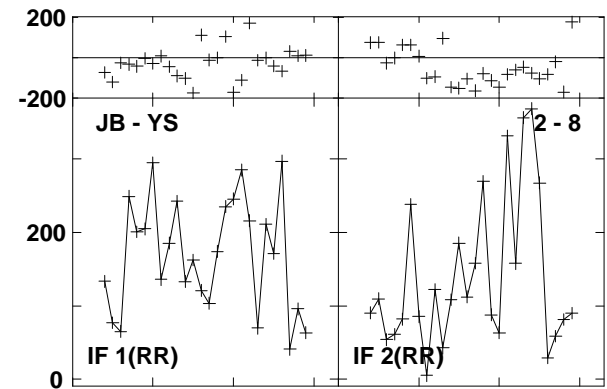
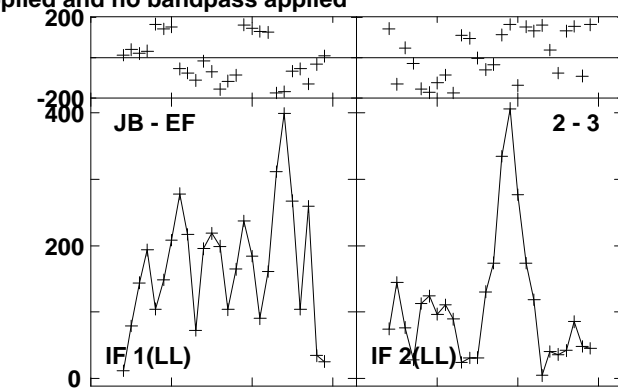
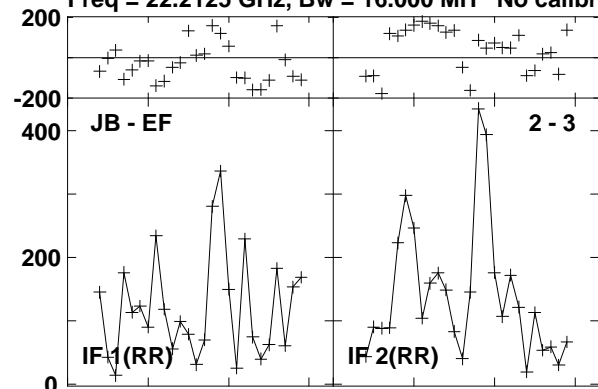

Lower frame: Micro Ampl Jy Top frame: Phas deg  
Vector averaged cross-power spectrum Baseline: JB (02) - EF (03)  
Timerange: 00:12:28:20 to 00:12:29:19

Plot file version 349 created 23-AUG-2016 15:00:54

W3IRS5 GA035B 1.UVDATA.1

Freq = 22.2125 GHz, Bw = 16.000 MH No calibration applied and no bandpass applied

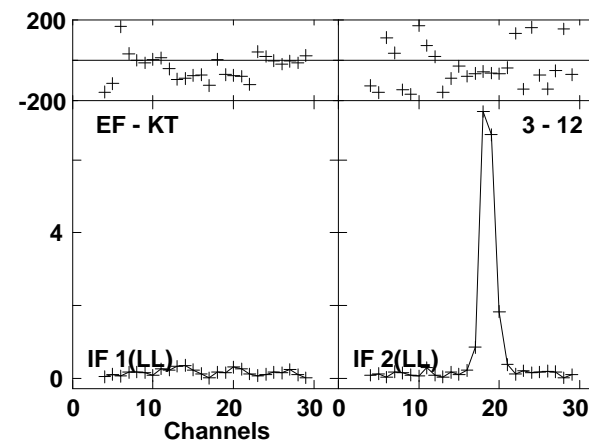
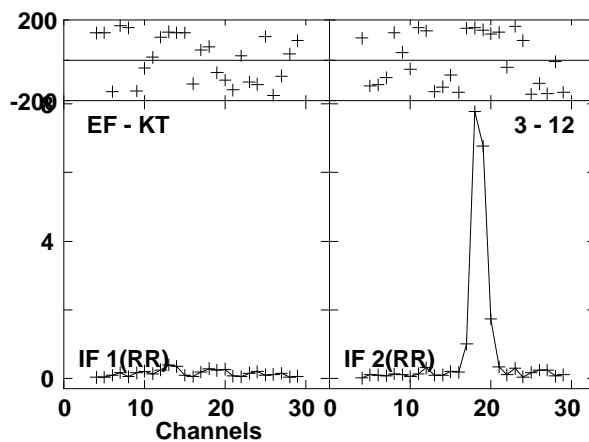
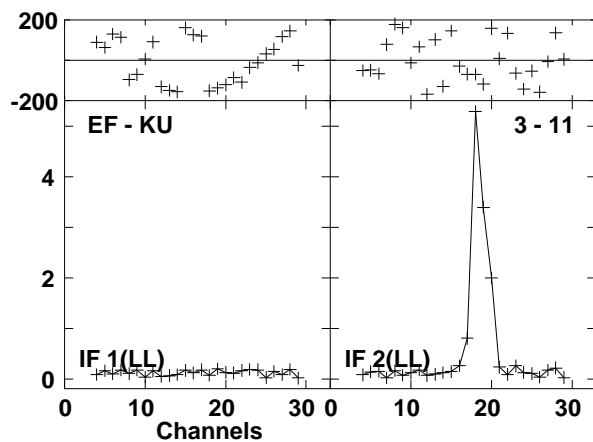
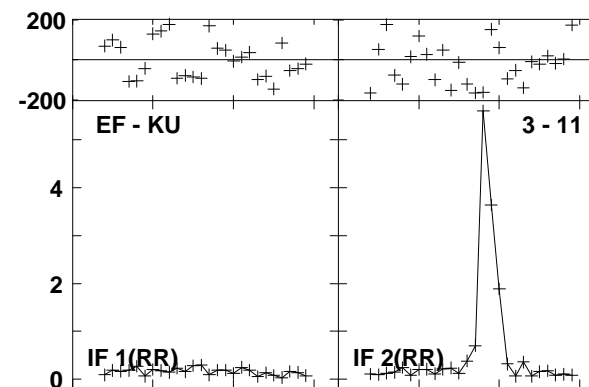
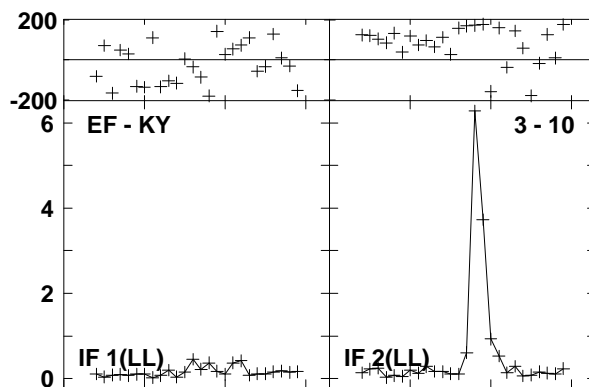
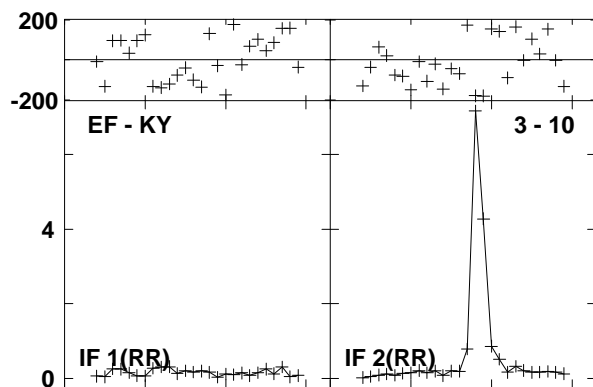
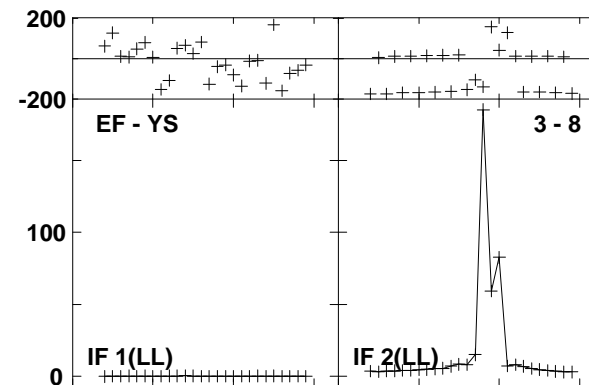
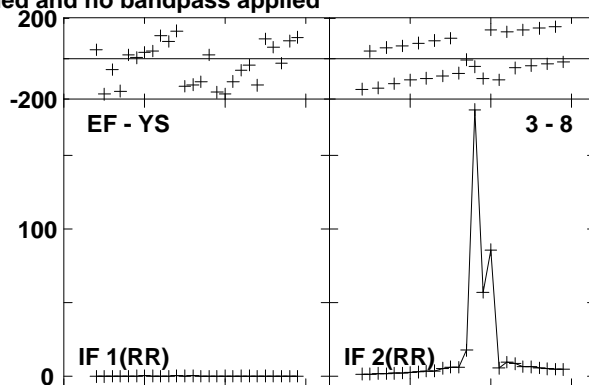
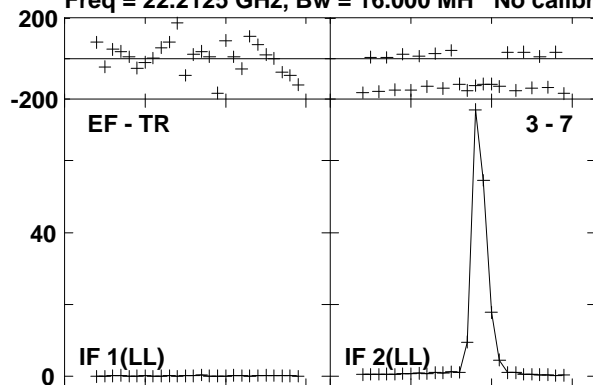

Lower frame: Milli Ampl Jy Top frame: Phas deg  
Vector averaged cross-power spectrum Baseline: EF (03) - TR (07)  
Timerange: 00/12:28:20 to 00/12:29:19

Plot file version 350 created 23-AUG-2016 15:00:54

W3IRS5 GA035B 1.UVDATA.1

Freq = 22.2125 GHz, Bw = 16.000 MH No calibration applied and no bandpass applied

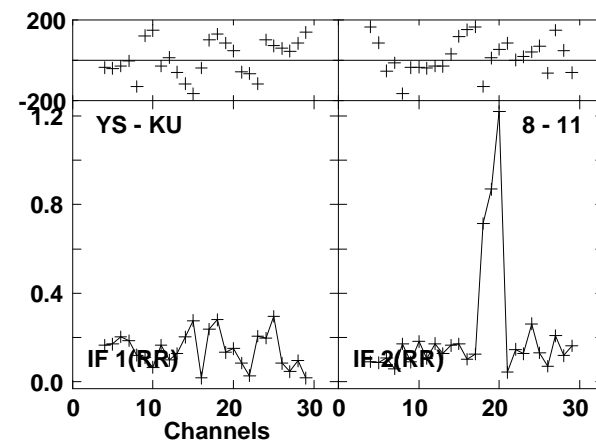
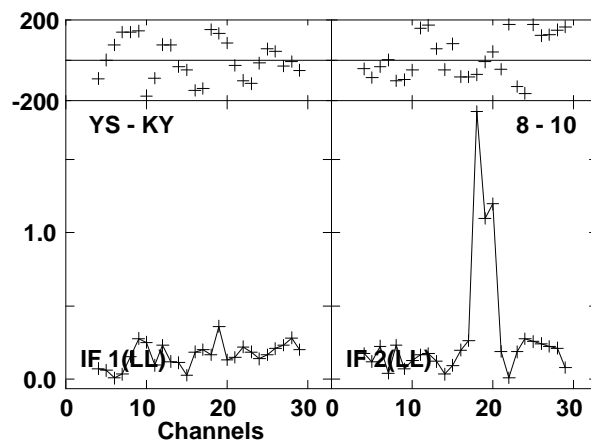
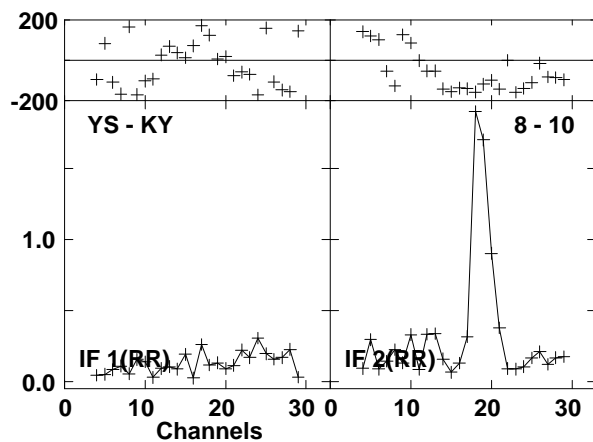
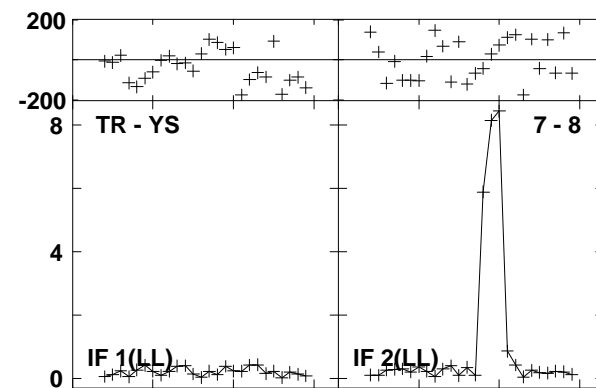
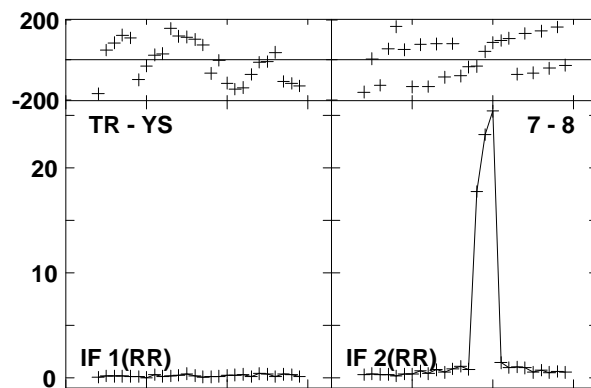
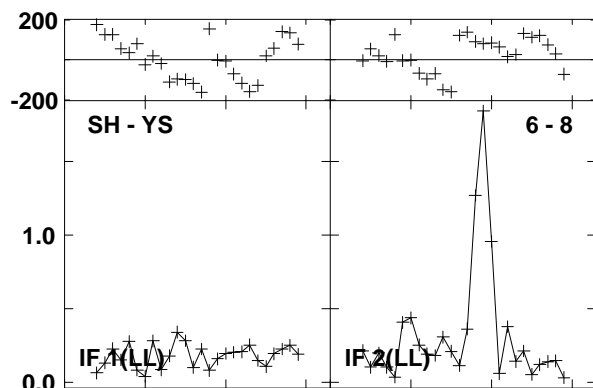
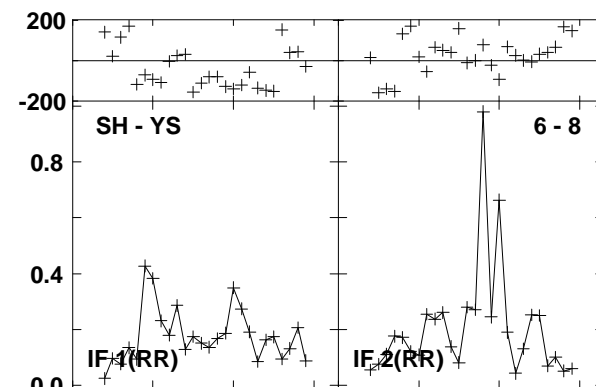
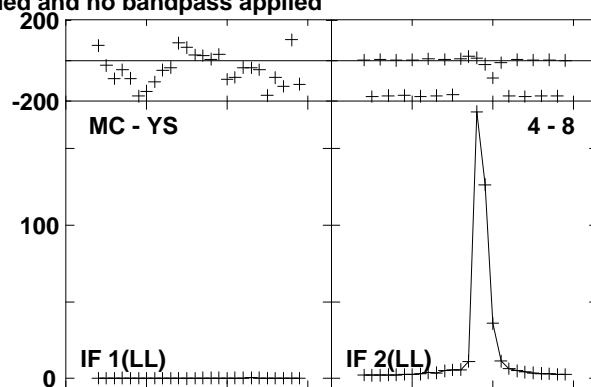
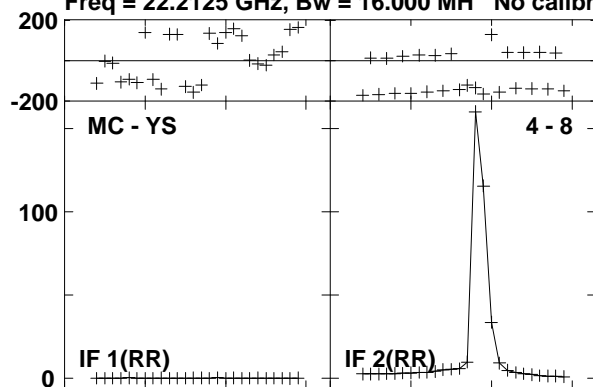

Lower frame: Milli Ampl Jy Top frame: Phas deg  
Vector averaged cross-power spectrum Baseline: MC (04) - YS (08)  
Timerange: 00/12:28:20 to 00/12:29:19

Plot file version 351 created 23-AUG-2016 15:00:54

W3IRS5 GA035B 1.UVDATA.1

Freq = 22.2125 GHz, Bw = 16.000 MH No calibration applied and no bandpass applied

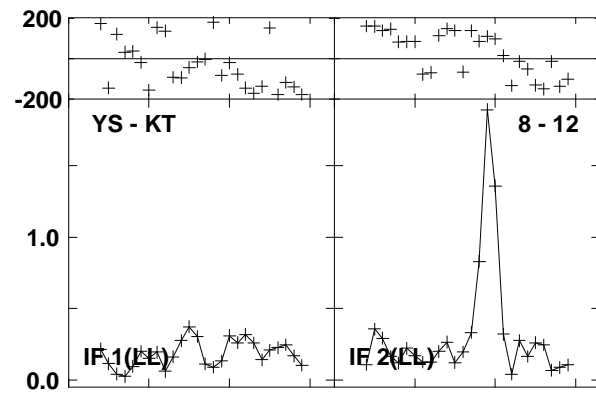
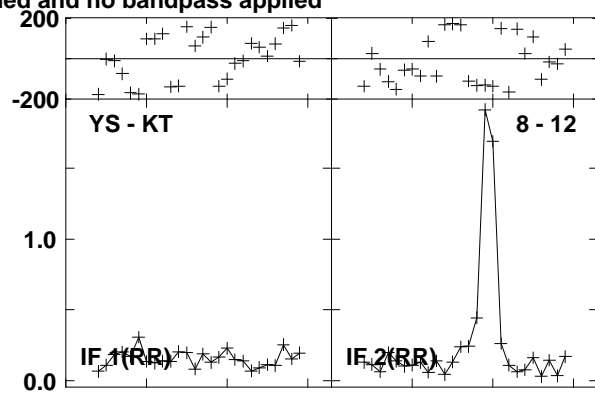
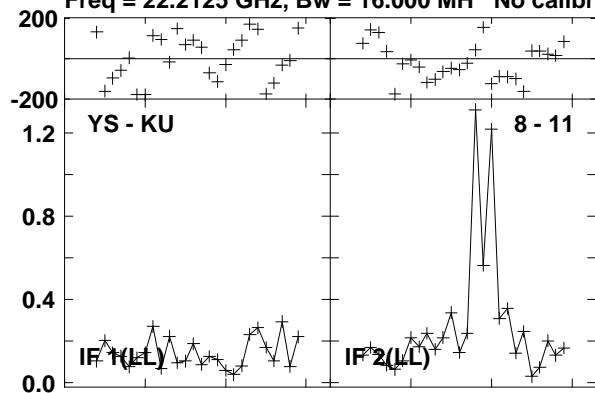

Lower frame: Milli Ampl Jy Top frame: Phas deg  
Vector averaged cross-power spectrum Baseline: YS (08) - KU (11)  
Timerange: 00/12:28:20 to 00/12:29:19

Plot file version 352 created 23-AUG-2016 15:00:54

0219+628 GA035B 1.UVDATA.1

Freq = 22.2125 GHz, Bw = 16.000 MH No calibration applied and no bandpass applied

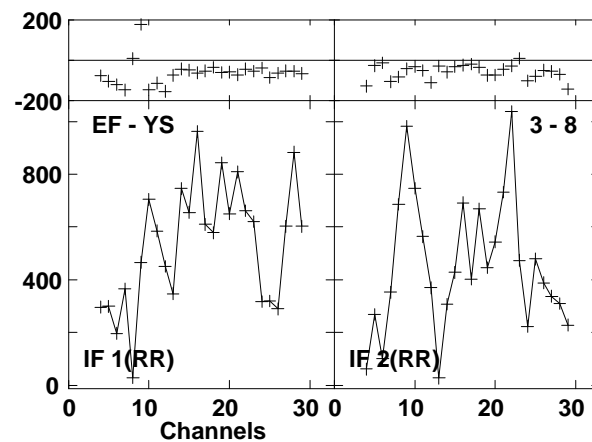
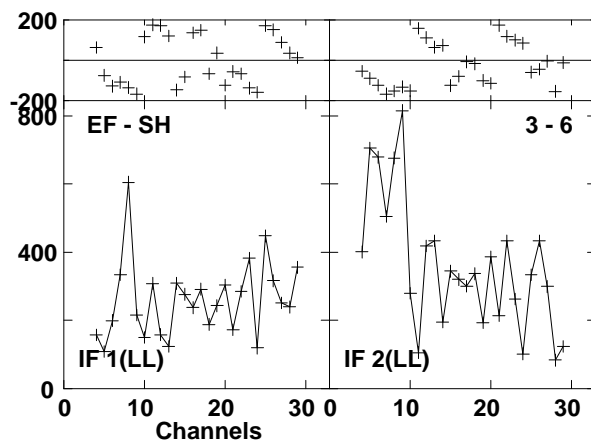
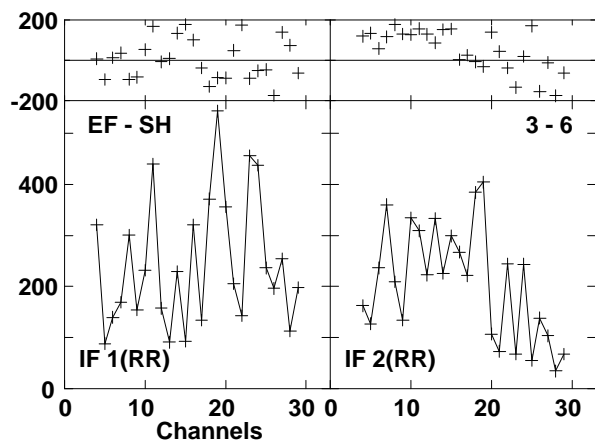
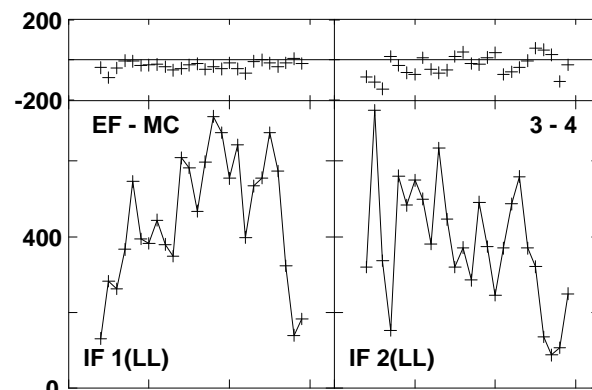
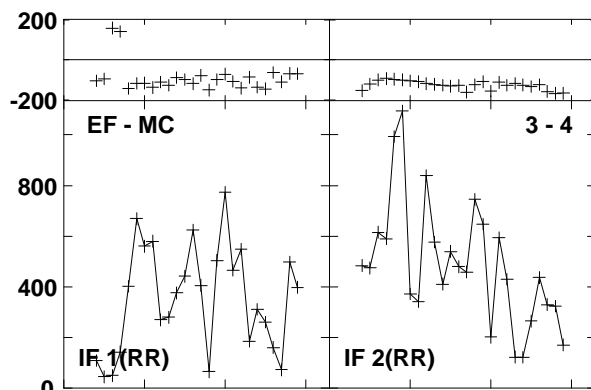
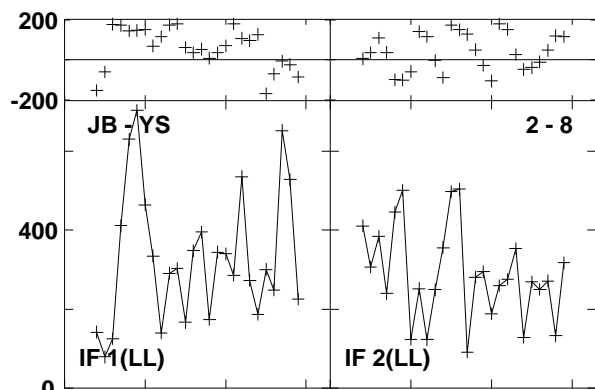
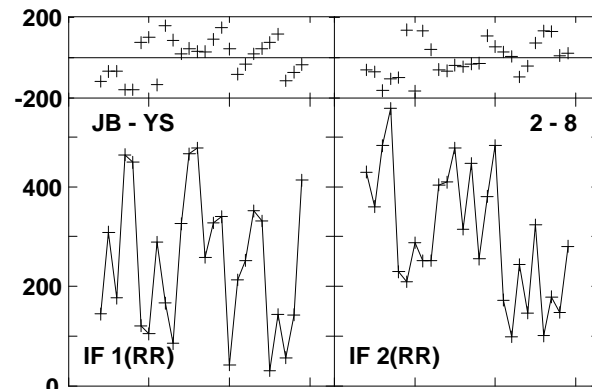
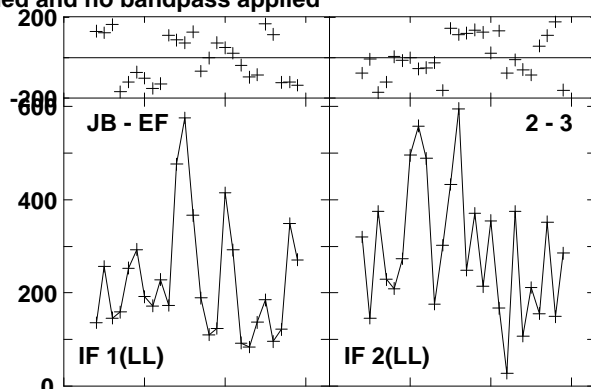
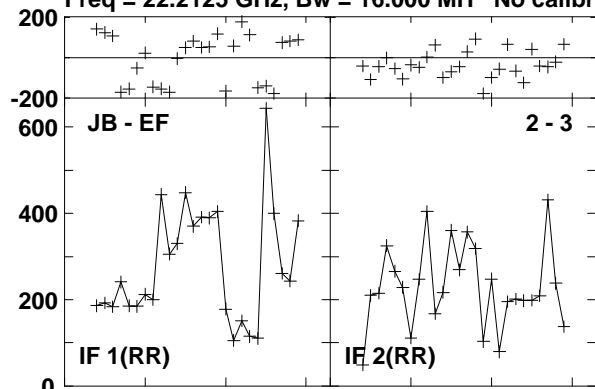

Lower frame: Micro Ampl Jy Top frame: Phas deg

Vector averaged cross-power spectrum Baseline: JB (02) - EF (03)

Timerange: 00/12:29:51 to 00/12:30:09



Plot file version 353 created 23-AUG-2016 15:00:54

0219+628 GA035B 1.UVDATA.1

Freq = 22.2125 GHz, Bw = 16.000 MH No calibration applied and no bandpass applied

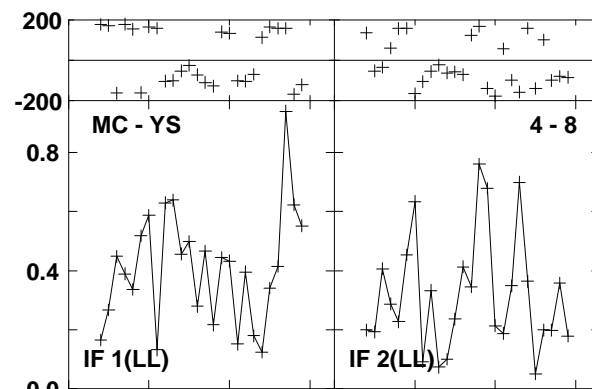
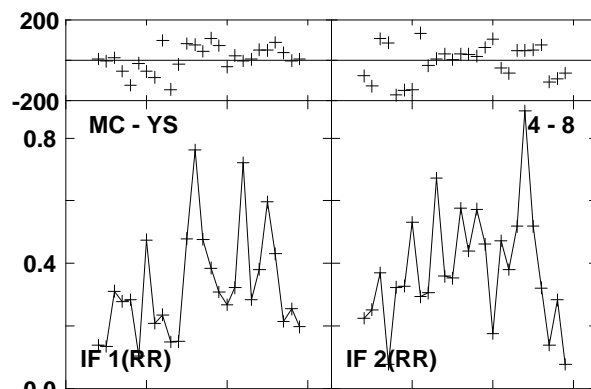
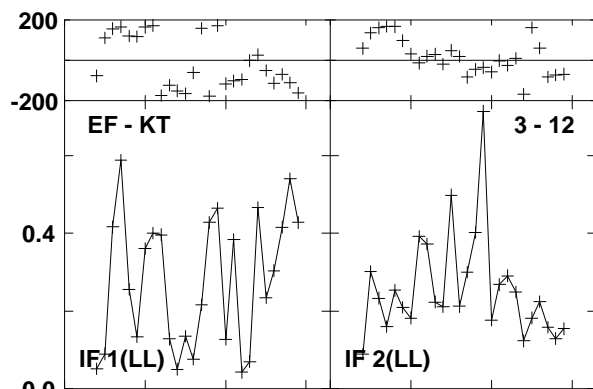
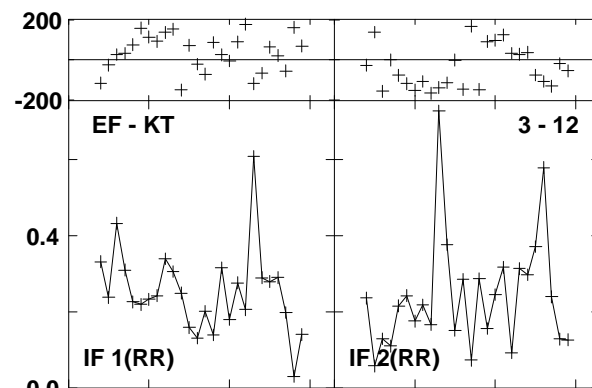
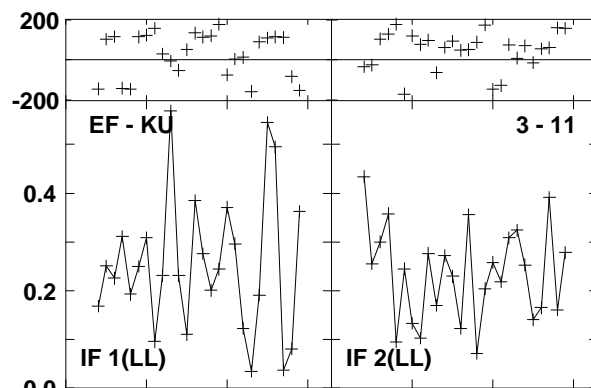
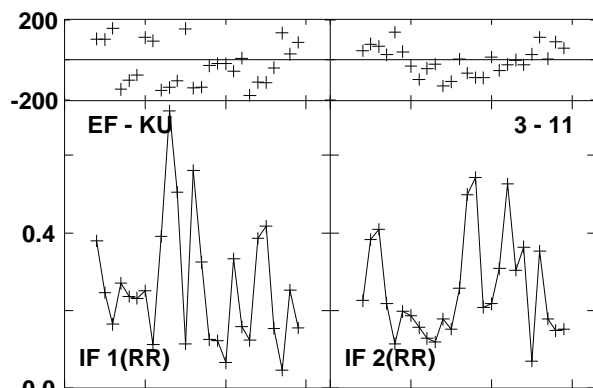
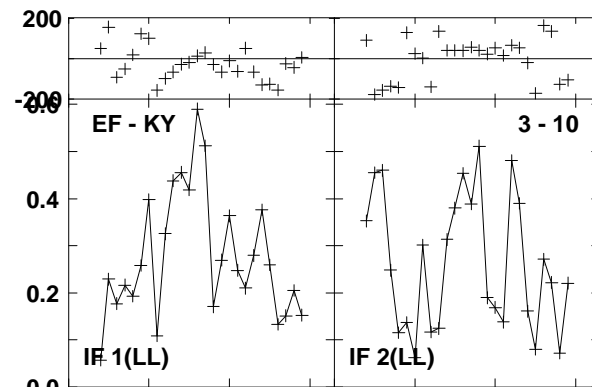
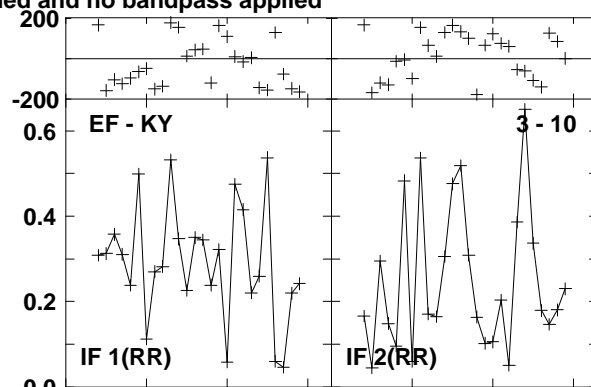
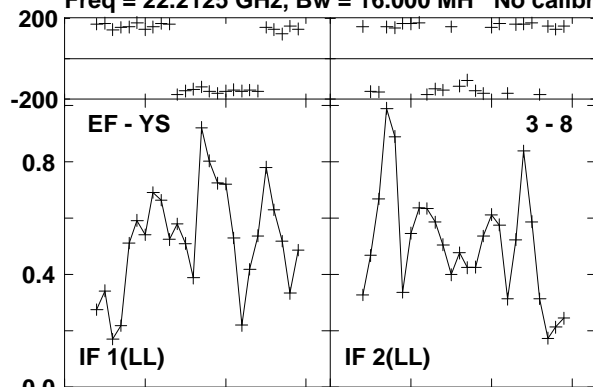

Lower frame: Milli Ampl Jy Top frame: Phas deg  
Vector averaged cross-power spectrum Baseline: EF (03) - YS (08)  
Timerange: 00/12:29:51 to 00/12:30:09

Plot file version 354 created 23-AUG-2016 15:00:54

0219+628 GA035B 1.UVDATA.1

Freq = 22.2125 GHz, Bw = 16.000 MH No calibration applied and no bandpass applied

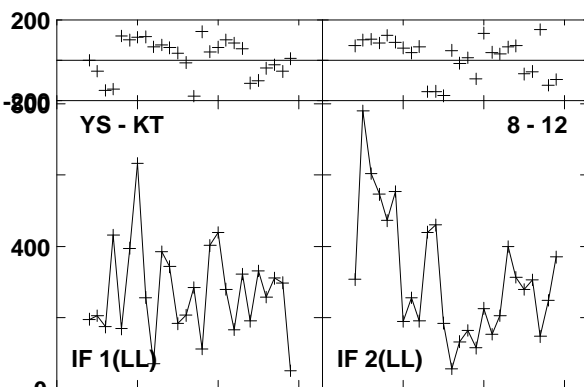
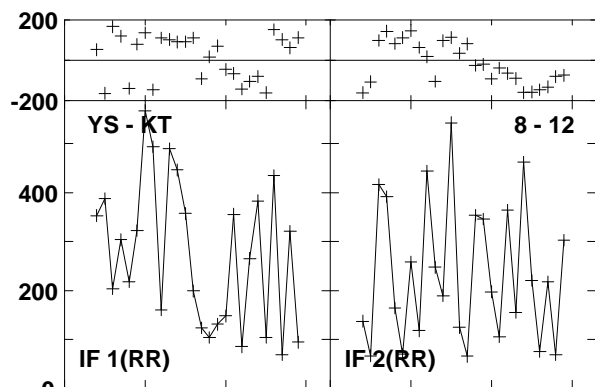
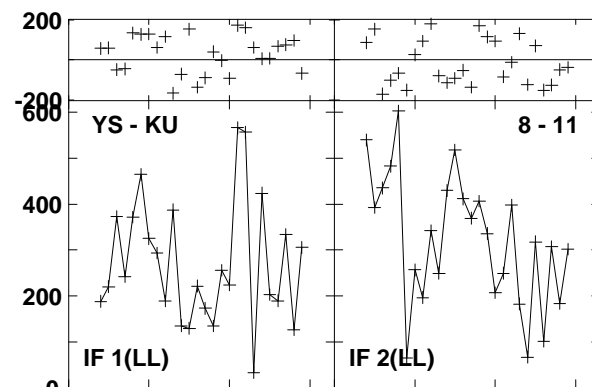
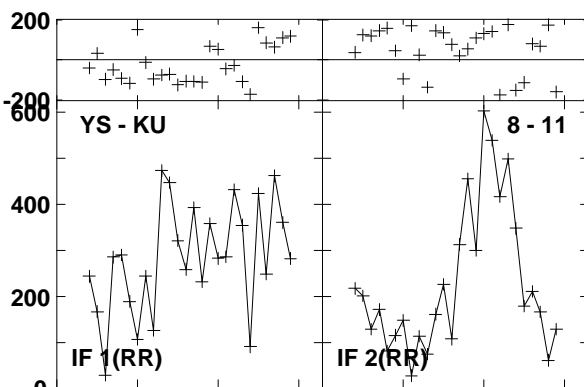
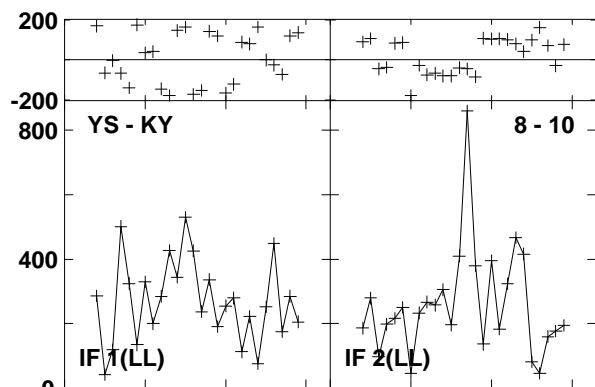
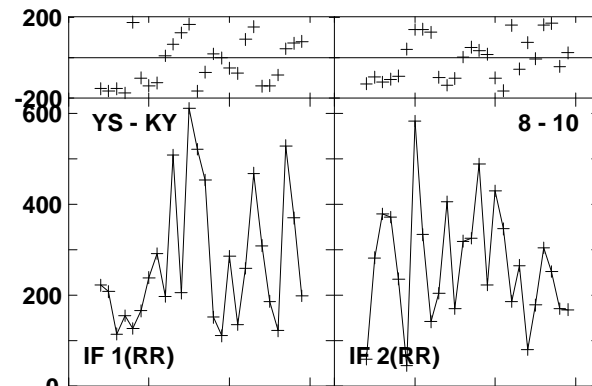
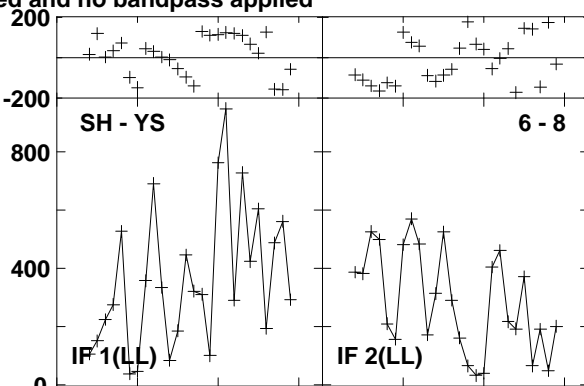
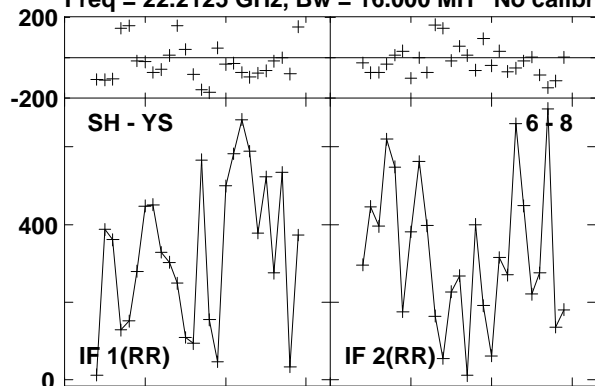

Lower frame: Micro Ampl Jy Top frame: Phas deg  
Vector averaged cross-power spectrum Baseline: SH (06) - YS (08)  
Timerange: 00/12:29:51 to 00/12:30:09

Plot file version 355 created 23-AUG-2016 15:00:54

W3IRS5 GA035B 1.UVDATA.1

Freq = 22.2125 GHz, Bw = 16.000 MH No calibration applied and no bandpass applied

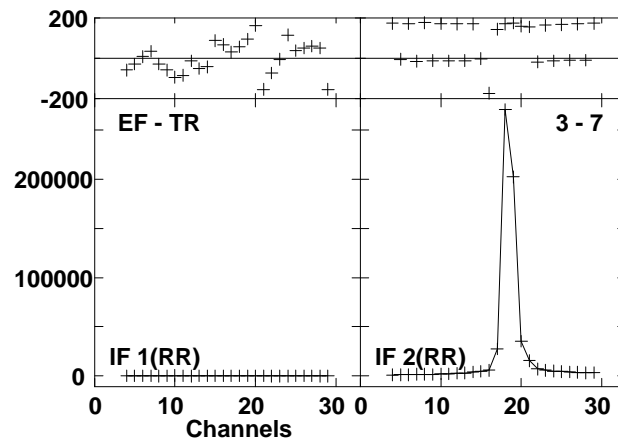
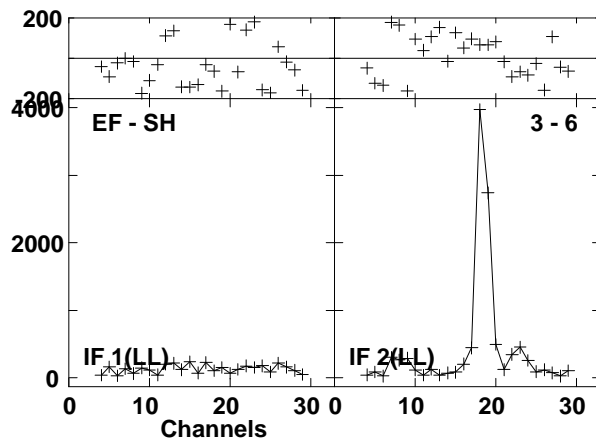
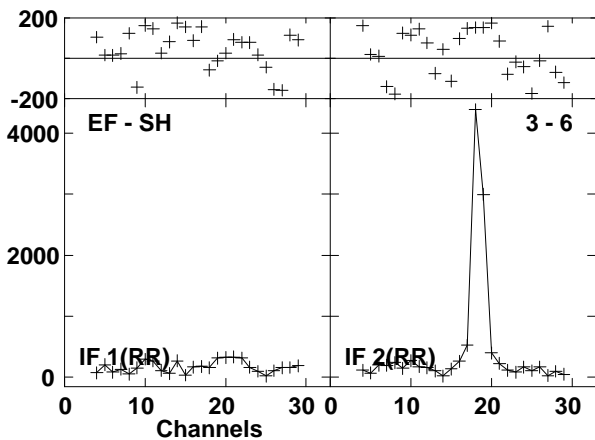
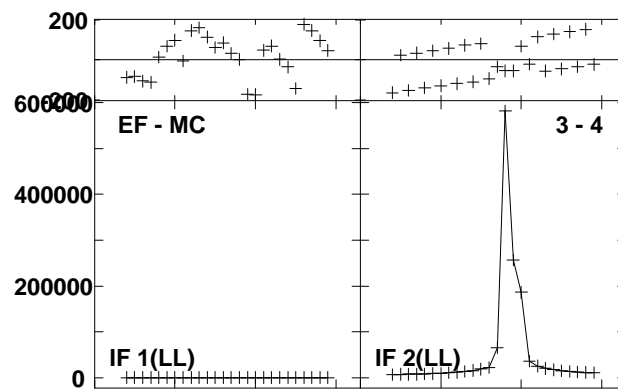
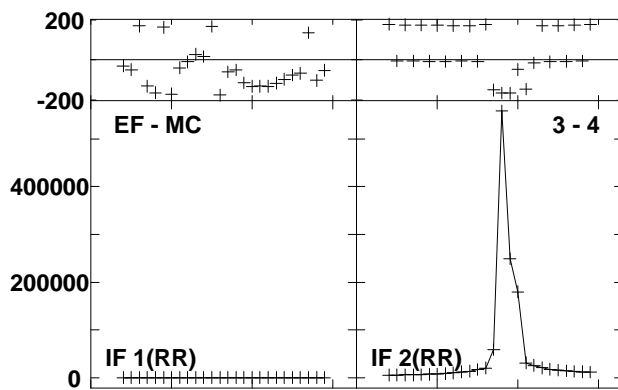
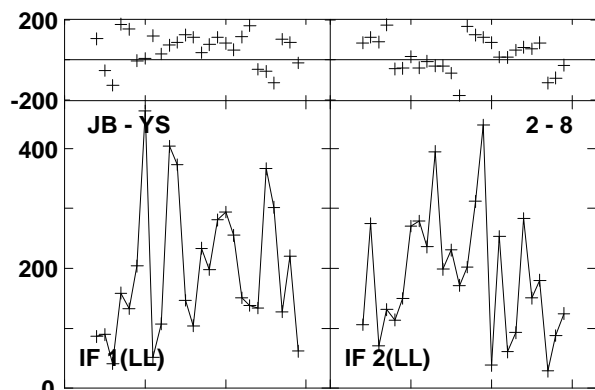
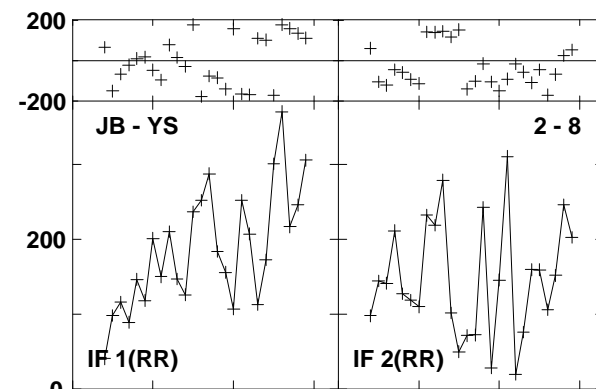
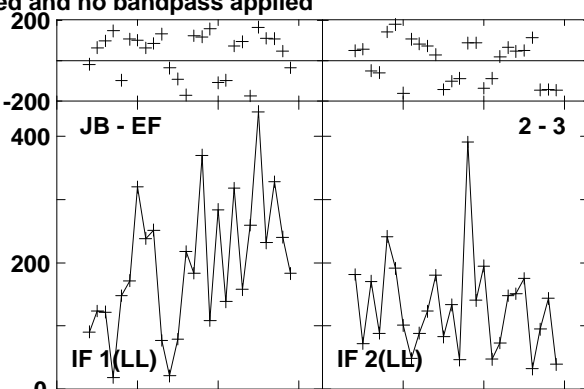
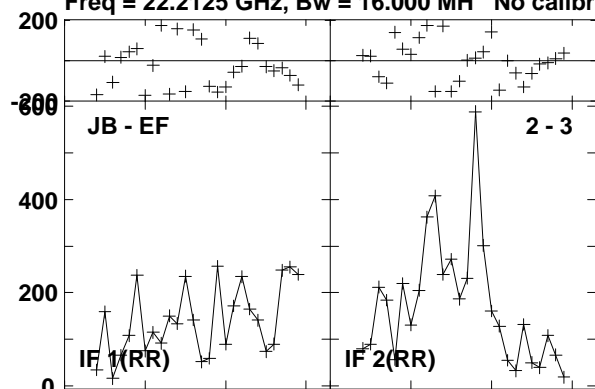

Lower frame: Micro Ampl Jy Top frame: Phas deg  
Vector averaged cross-power spectrum Baseline: JB (02) - EF (03)  
Timerange: 00:12:30:41 to 00:12:31:39

Plot file version 356 created 23-AUG-2016 15:00:54

W3IRS5 GA035B 1.UVDATA.1

Freq = 22.2125 GHz, Bw = 16.000 MH No calibration applied and no bandpass applied

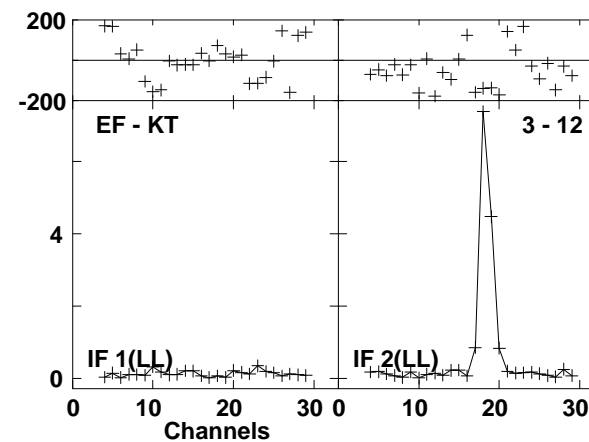
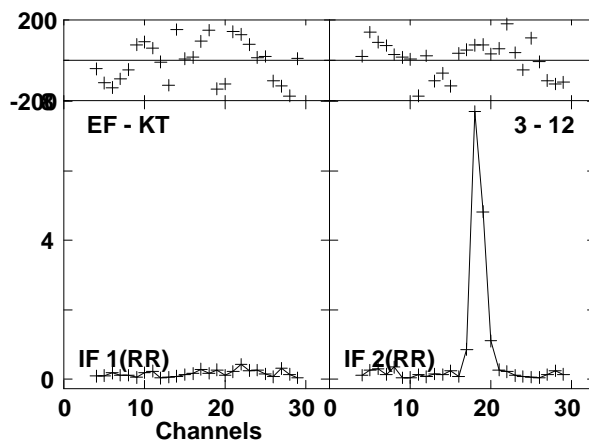
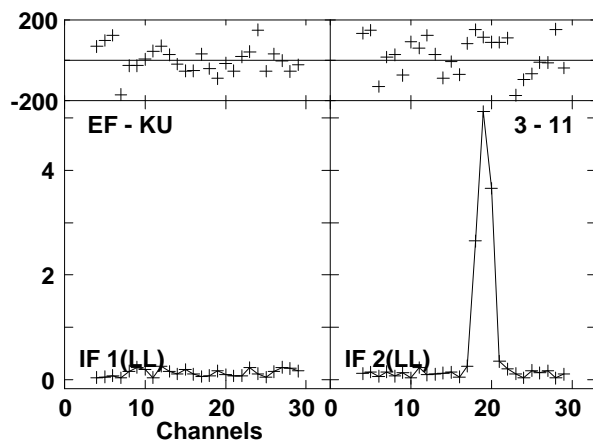
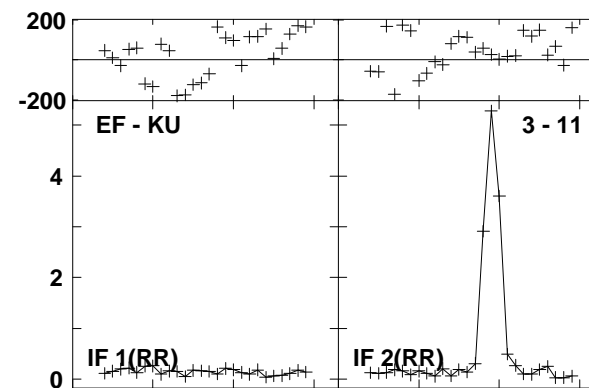
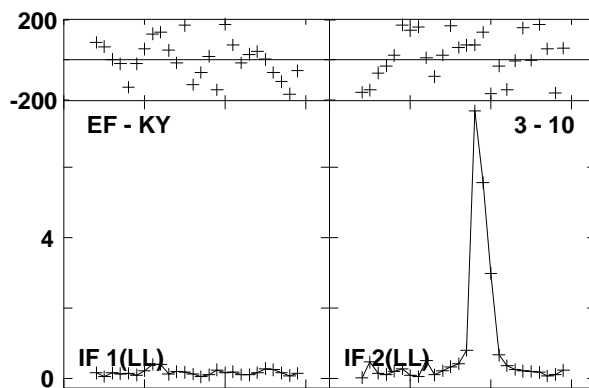
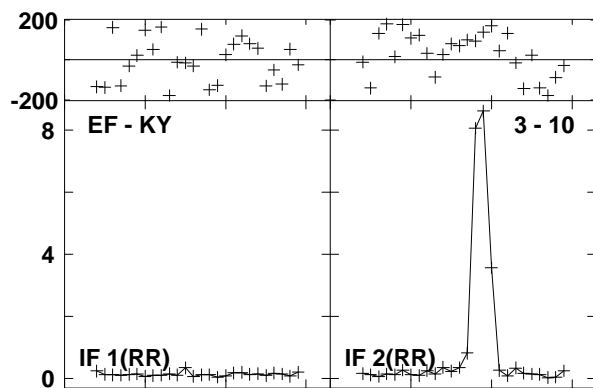
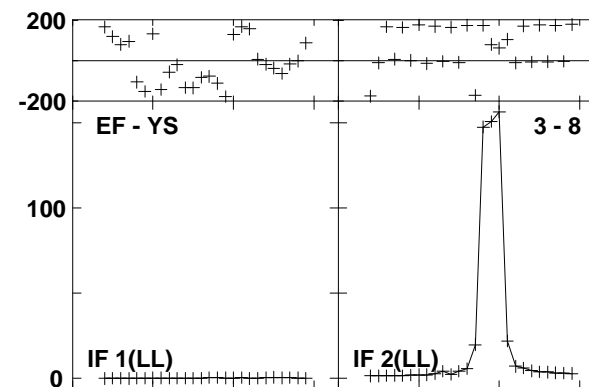
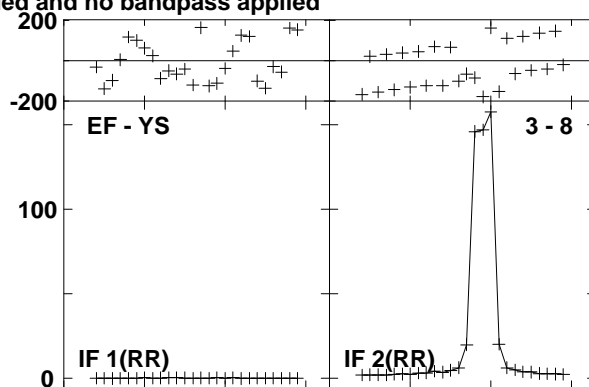
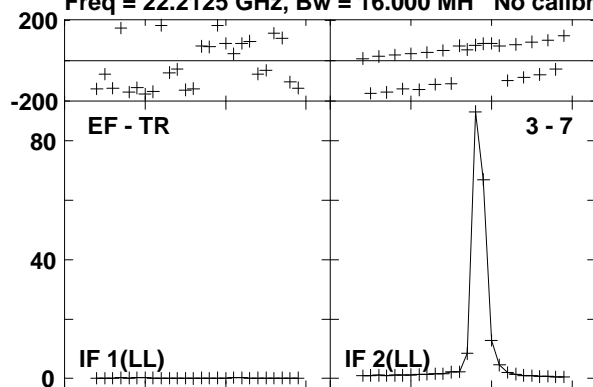

Lower frame: Milli Ampl Jy Top frame: Phas deg  
Vector averaged cross-power spectrum Baseline: EF (03) - TR (07)  
Timerange: 00/12:30:41 to 00/12:31:39

Plot file version 357 created 23-AUG-2016 15:00:54

W3IRS5 GA035B 1.UVDATA.1

Freq = 22.2125 GHz, Bw = 16.000 MH No calibration applied and no bandpass applied

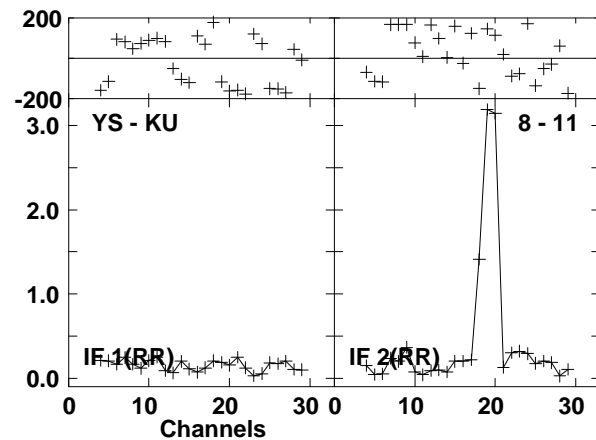
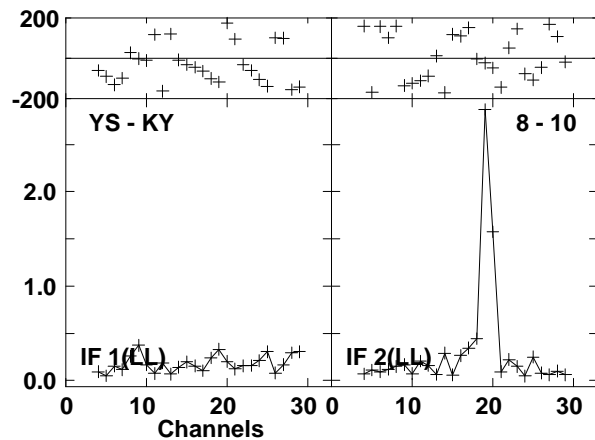
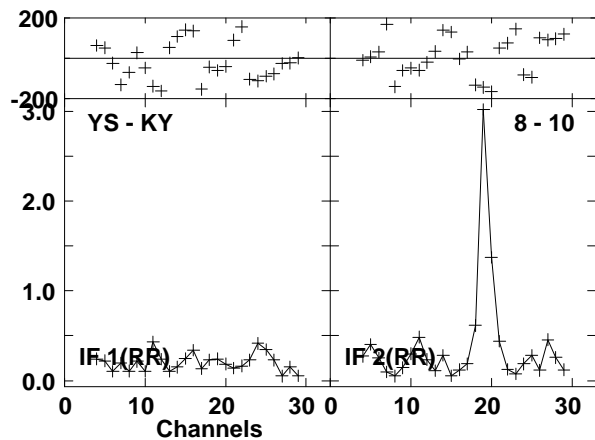
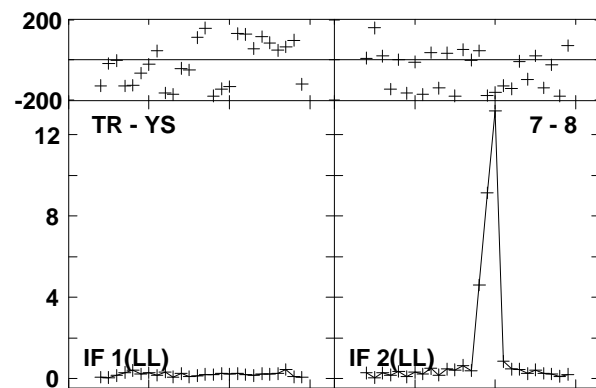
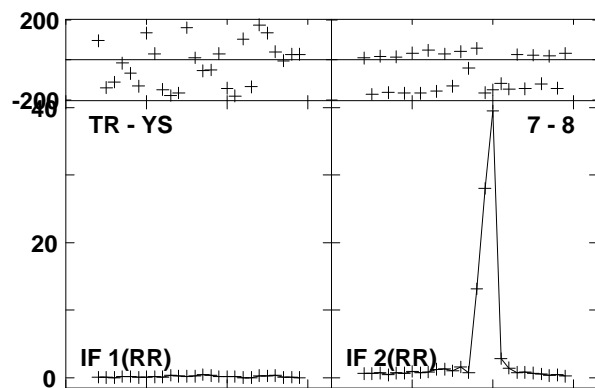
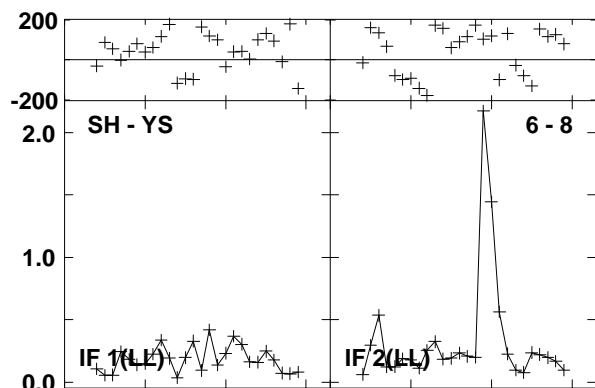
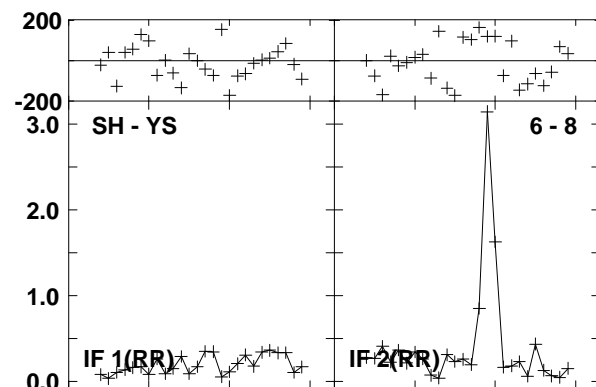
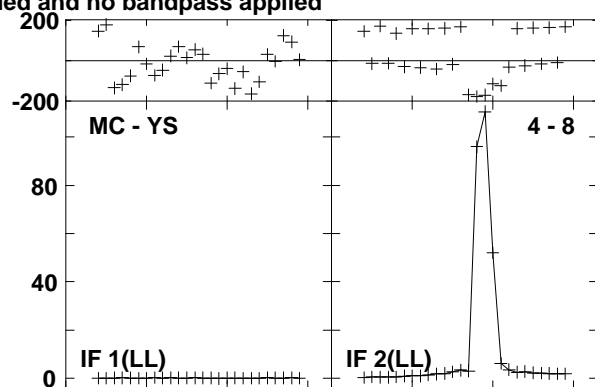
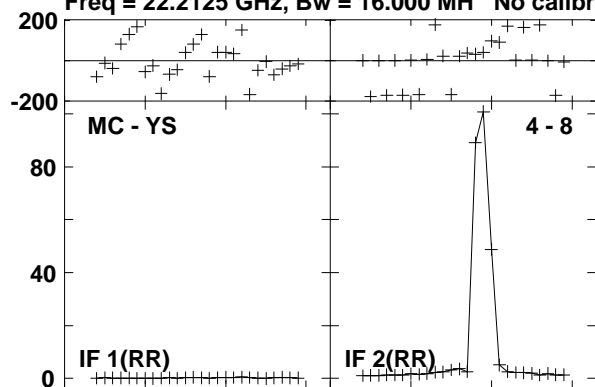

Lower frame: Milli Ampl Jy Top frame: Phas deg  
Vector averaged cross-power spectrum Baseline: MC (04) - YS (08)  
Timerange: 00/12:30:41 to 00/12:31:39

Plot file version 358 created 23-AUG-2016 15:00:54  
W3IRS5 GA035B 1.UVDATA.1

Freq = 22.2125 GHz, Bw = 16.000 MH No calibration applied and no bandpass applied

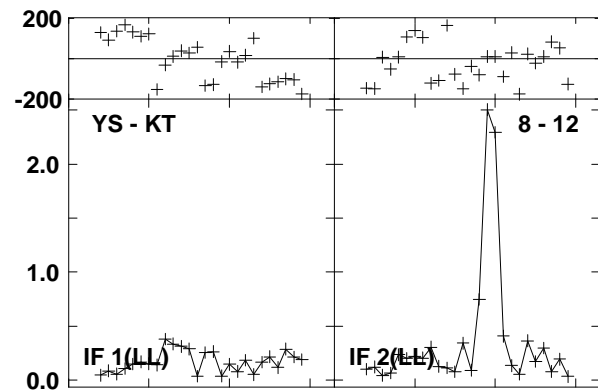
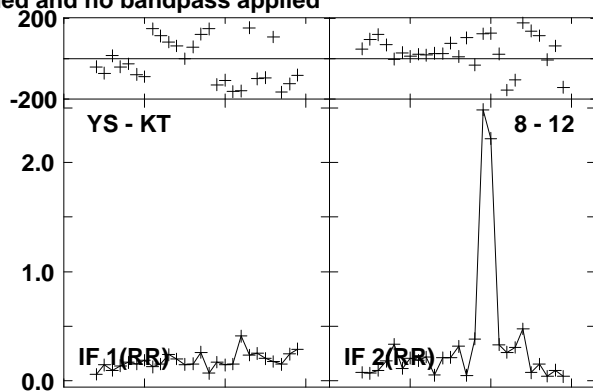
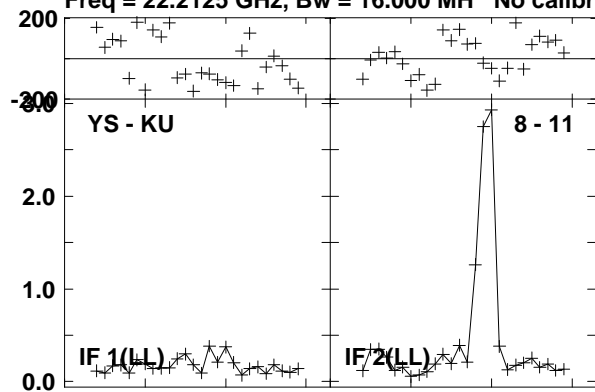

Lower frame: Milli Ampl Jy Top frame: Phas deg  
Vector averaged cross-power spectrum Baseline: YS (08) - KU (11)  
Timerange: 00/12:30:41 to 00/12:31:39

Plot file version 359 created 23-AUG-2016 15:00:54

0219+628 GA035B 1.UVDATA.1

Freq = 22.2125 GHz, Bw = 16.000 MH No calibration applied and no bandpass applied

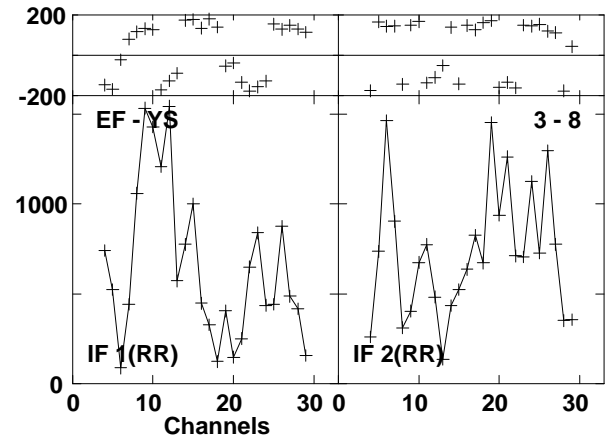
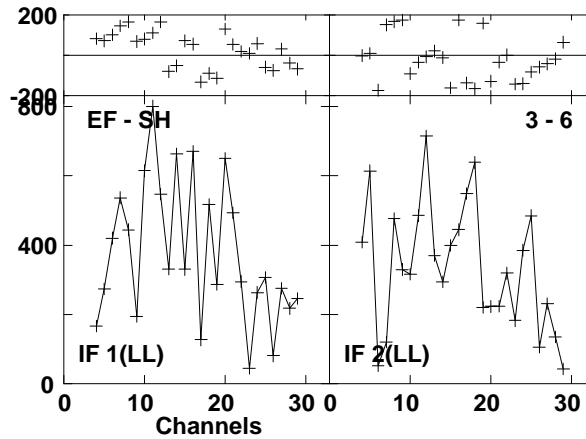
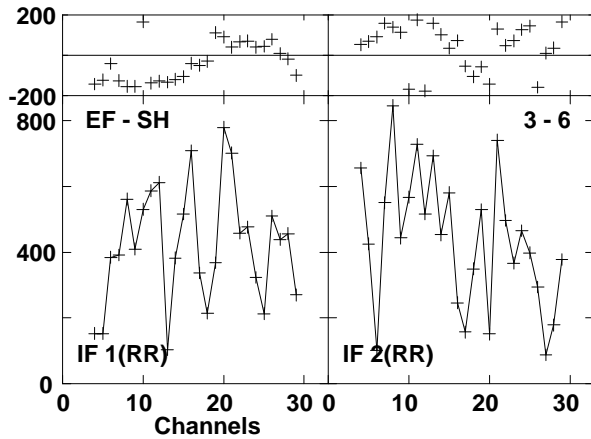
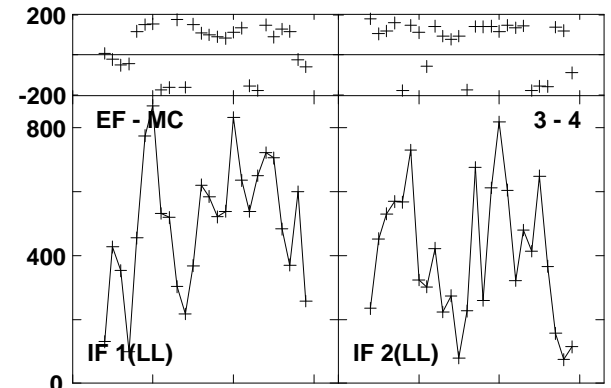
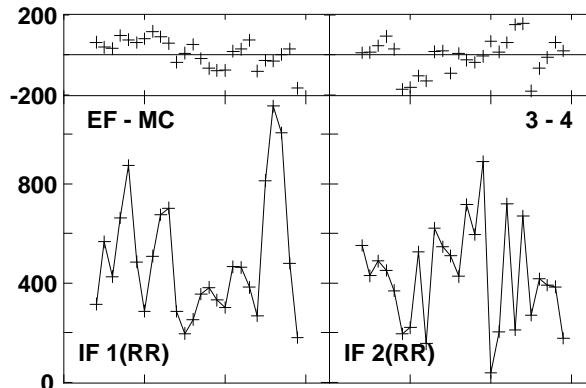
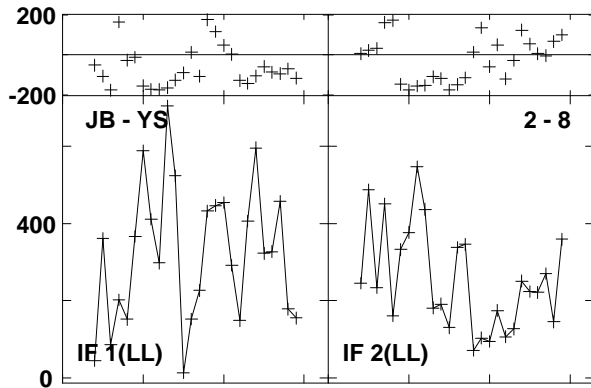
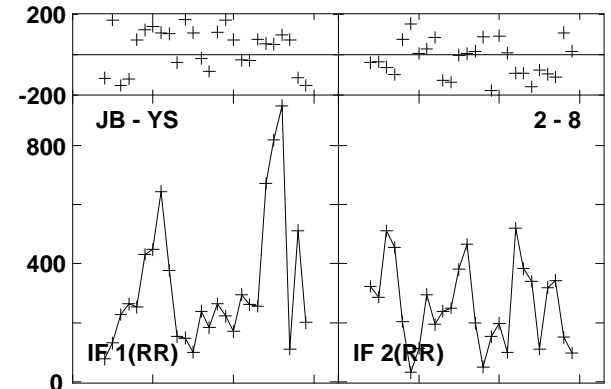
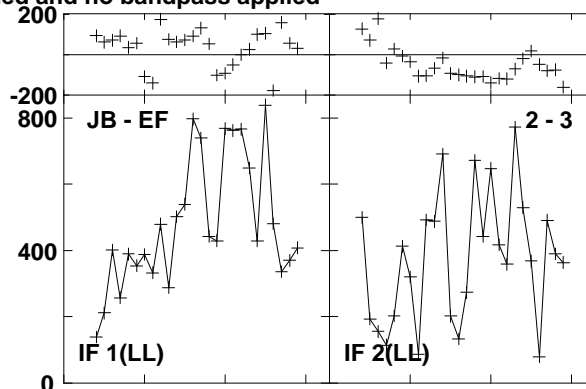
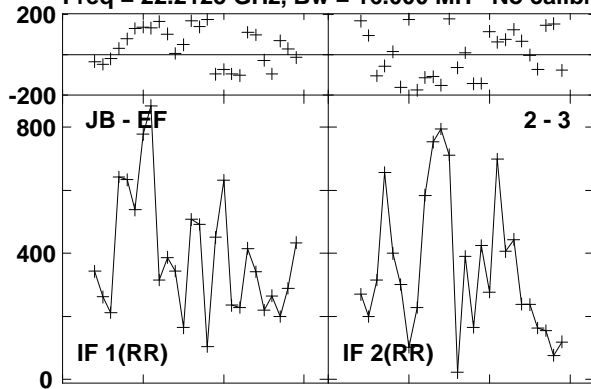

Lower frame: Micro Ampl Jy Top frame: Phas deg  
Vector averaged cross-power spectrum Baseline: JB (02) - EF (03)  
Timerange: 00/12:32:11 to 00/12:32:29

Plot file version 360 created 23-AUG-2016 15:00:54

0219+628 GA035B 1.UVDATA.1

Freq = 22.2125 GHz, Bw = 16.000 MH No calibration applied and no bandpass applied

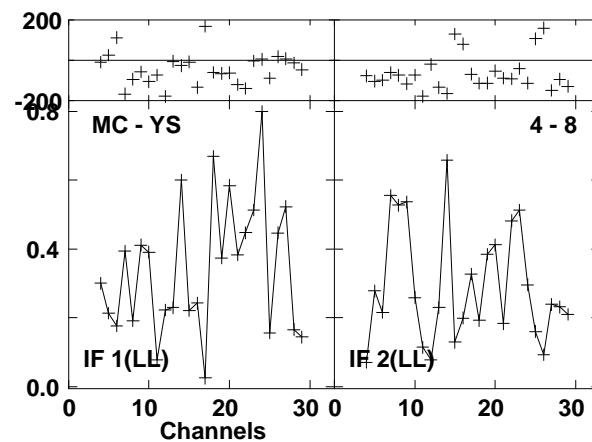
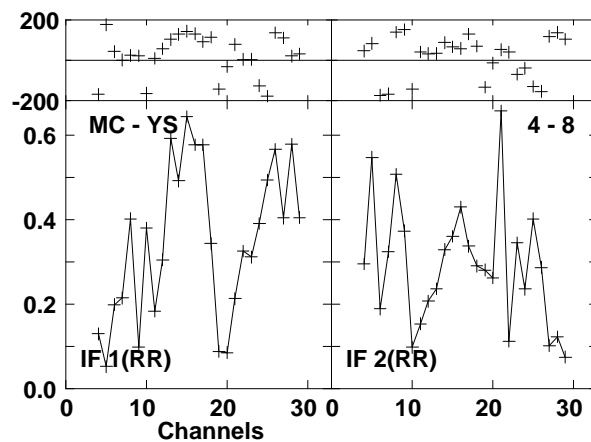
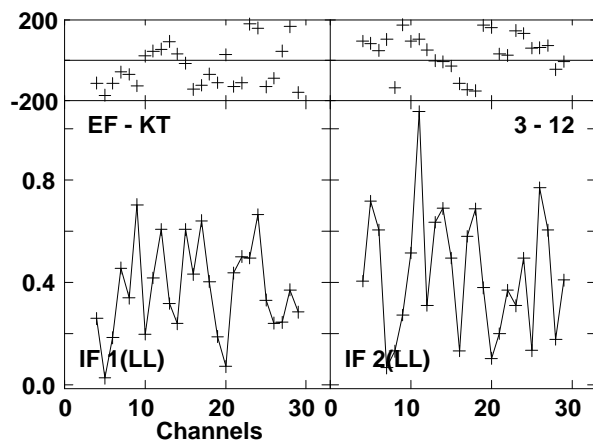
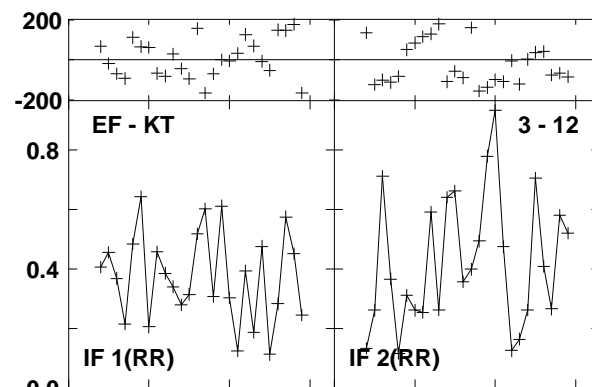
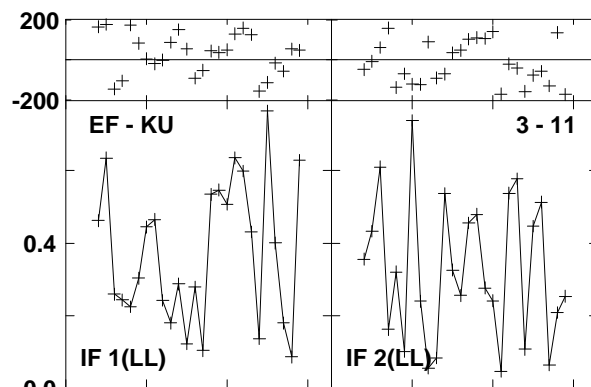
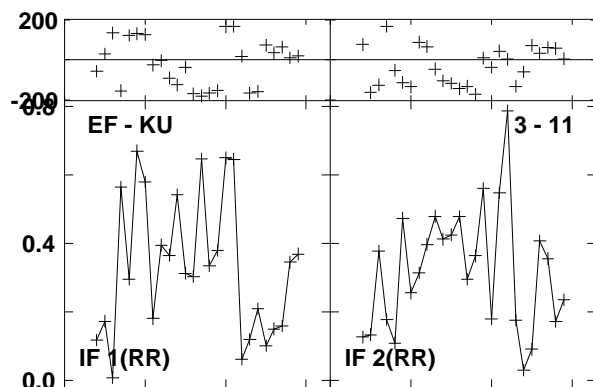
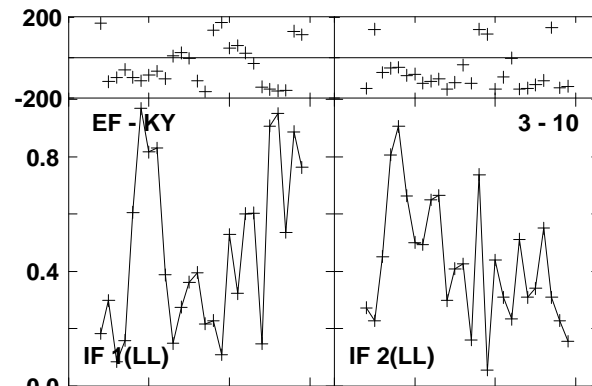
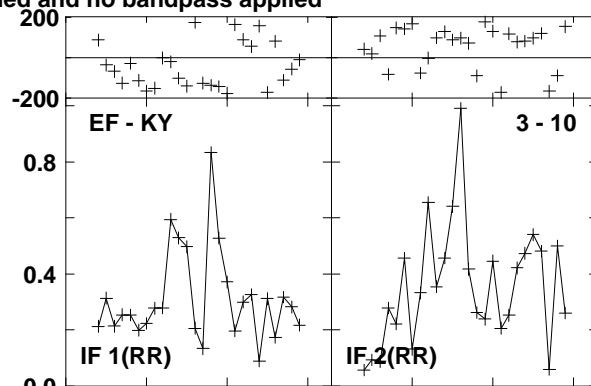
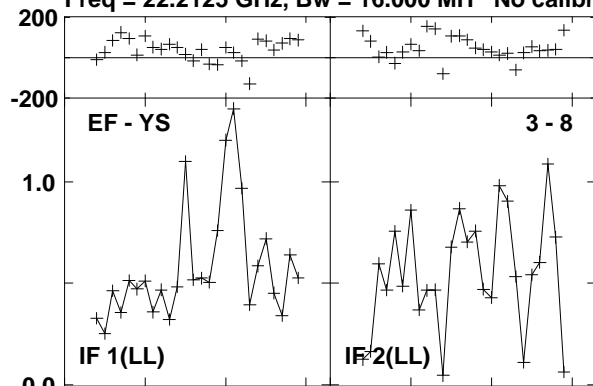

Lower frame: Milli Ampl Jy Top frame: Phas deg  
Vector averaged cross-power spectrum Baseline: EF (03) - YS (08)  
Timerange: 00/12:32:11 to 00/12:32:29



Plot file version 361 created 23-AUG-2016 15:00:55

0219+628 GA035B 1.UVDATA.1

Freq = 22.2125 GHz, Bw = 16.000 MH No calibration applied and no bandpass applied

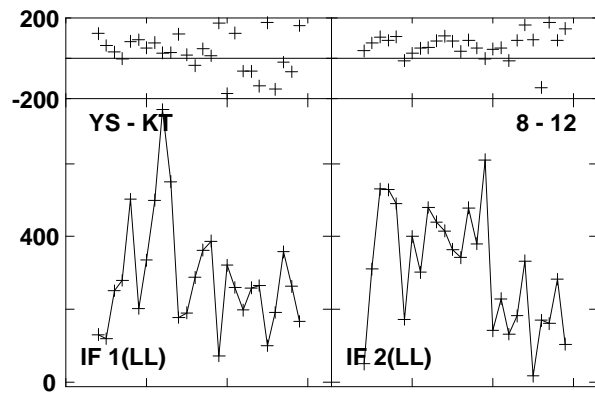
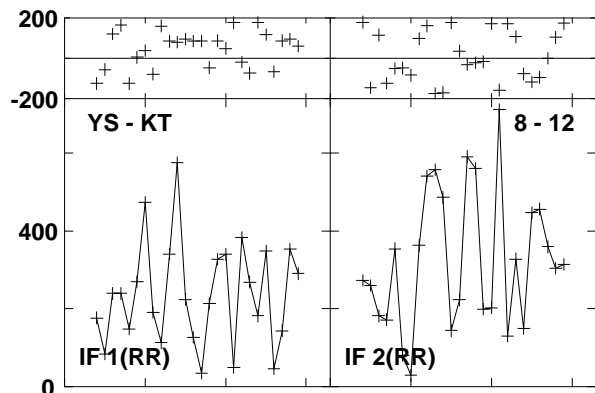
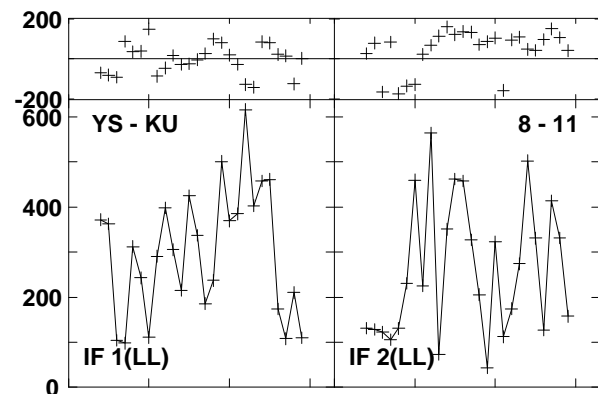
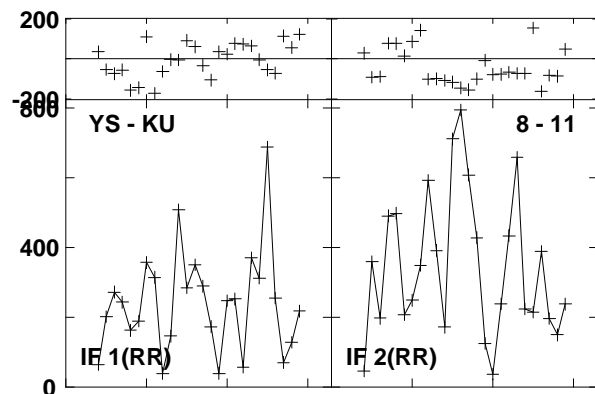
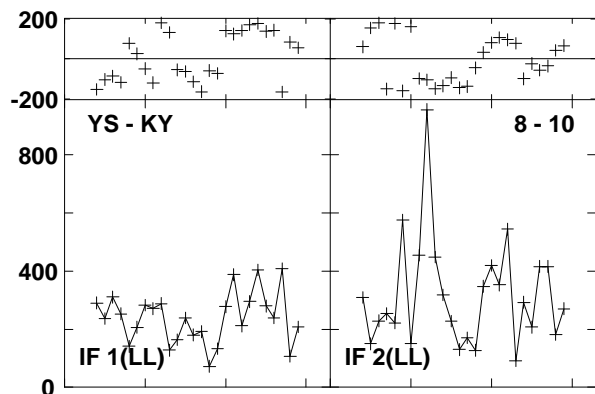
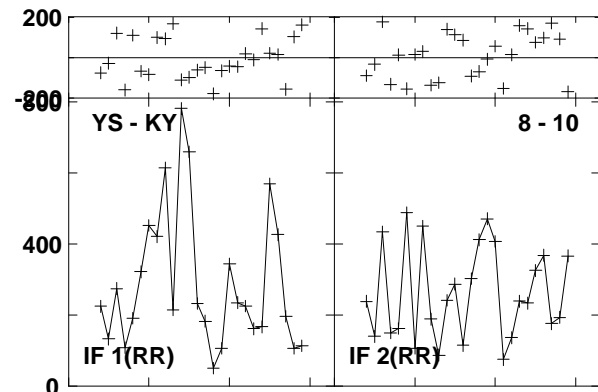
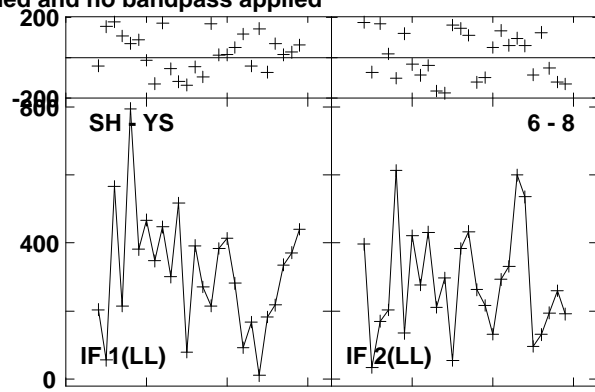
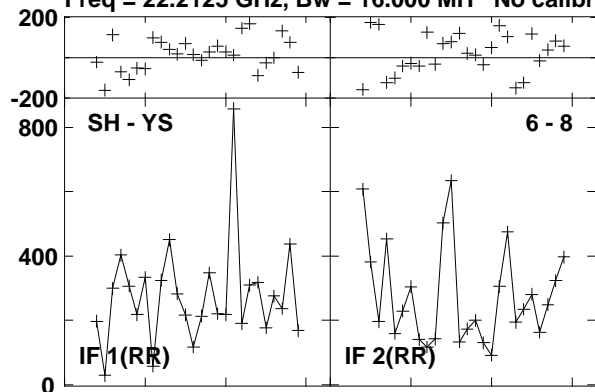

Lower frame: Micro Ampl Jy Top frame: Phas deg  
Vector averaged cross-power spectrum Baseline: SH (06) - YS (08)  
Timerange: 00/12:32:11 to 00/12:32:29

Plot file version 362 created 23-AUG-2016 15:00:55

W3IRS5 GA035B 1.UVDATA.1

Freq = 22.2125 GHz, Bw = 16.000 MH No calibration applied and no bandpass applied

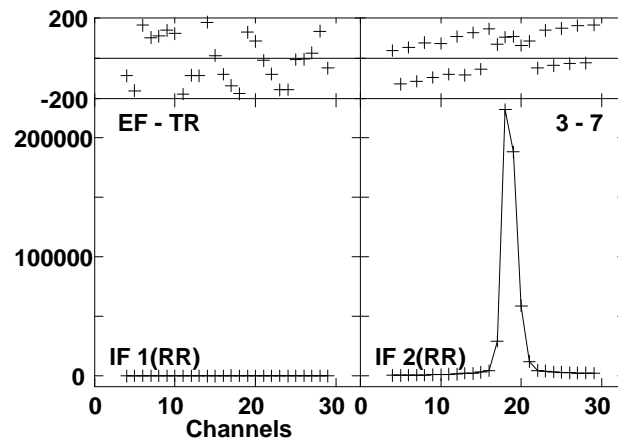
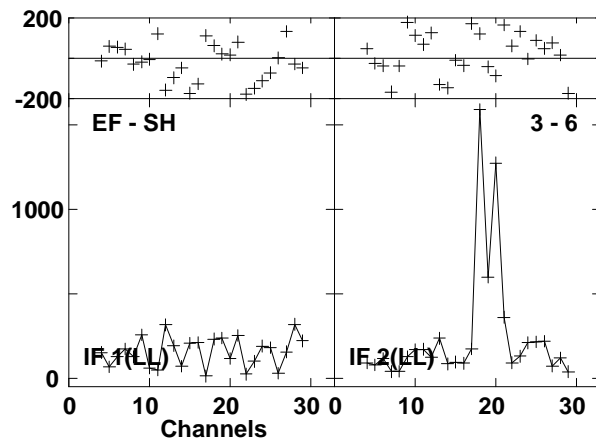
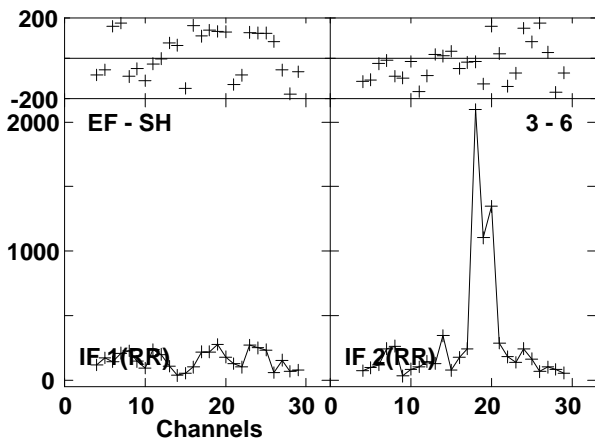
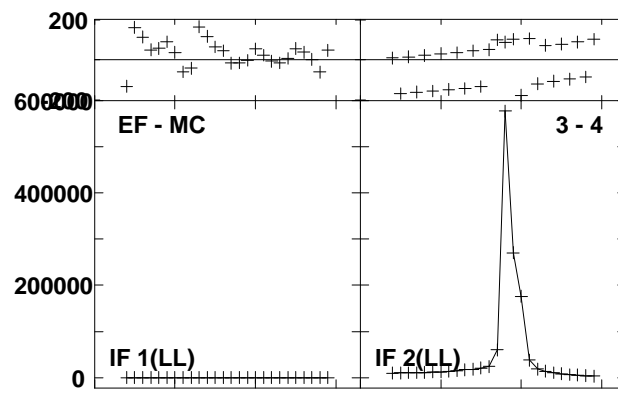
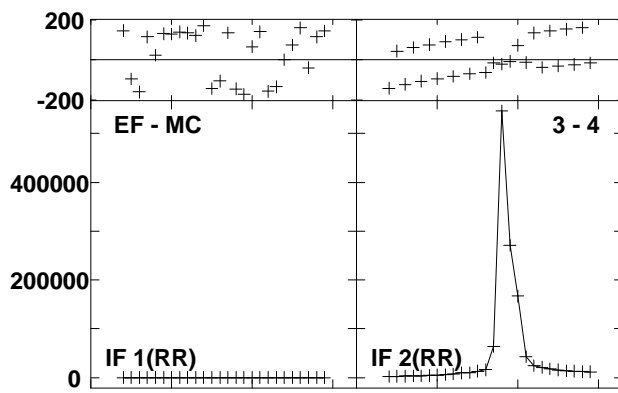
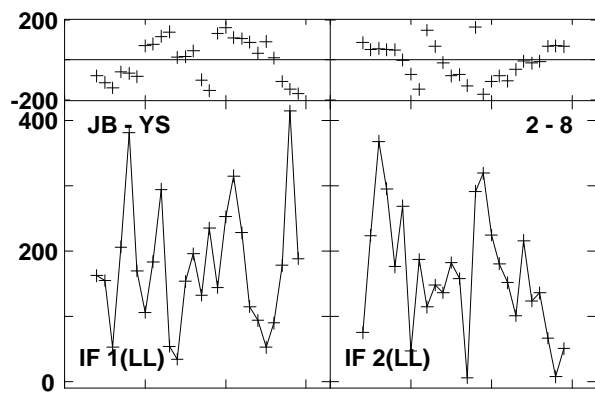
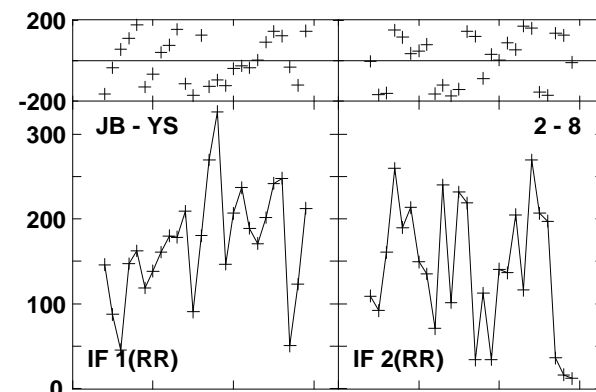
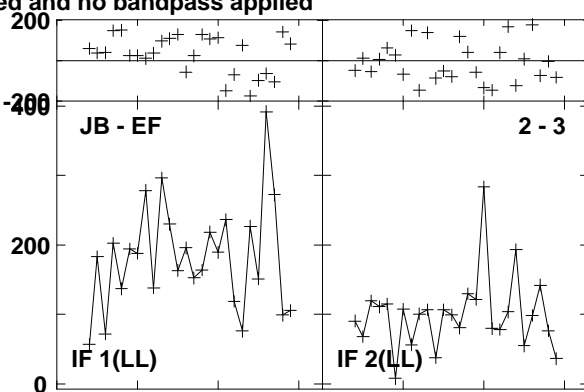
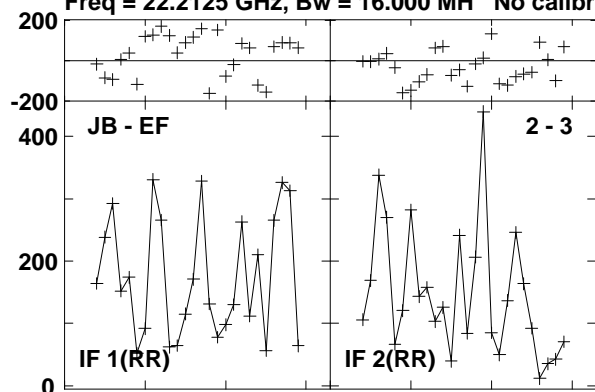

Lower frame: Micro Ampl Jy Top frame: Phas deg  
Vector averaged cross-power spectrum Baseline: JB (02) - EF (03)  
Timerange: 00/12:33:01 to 00/12:34:00

Plot file version 363 created 23-AUG-2016 15:00:55

W3IRS5 GA035B 1.UVDATA.1

Freq = 22.2125 GHz, Bw = 16.000 MH No calibration applied and no bandpass applied

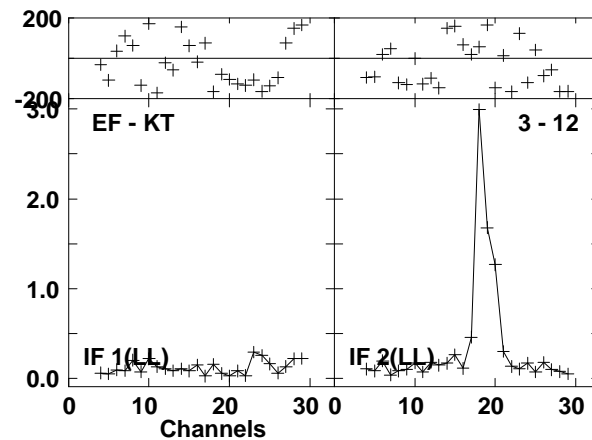
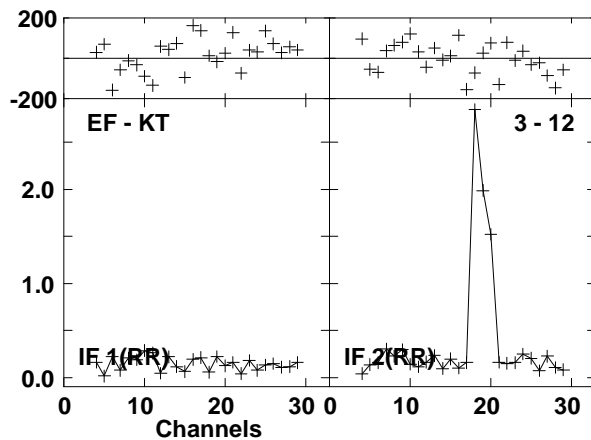
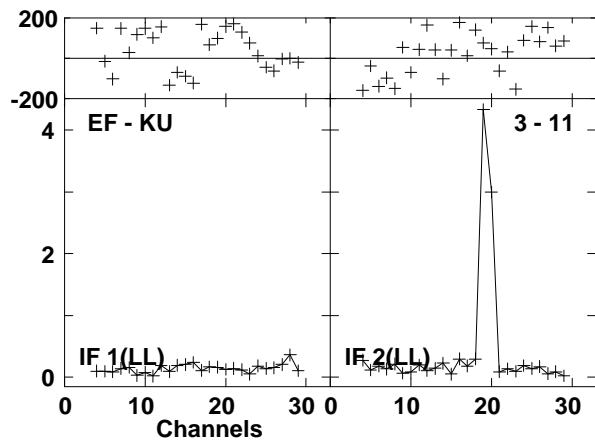
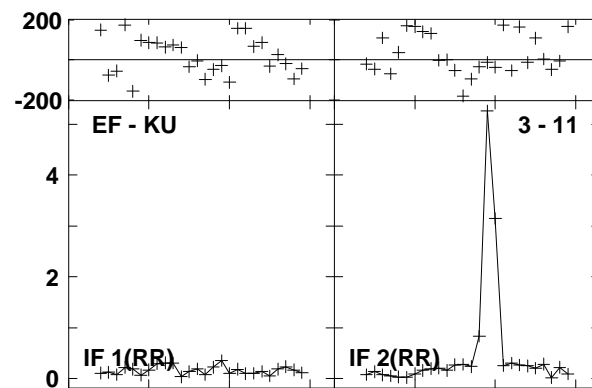
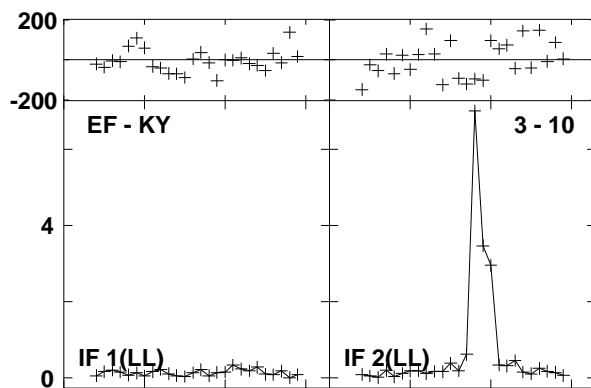
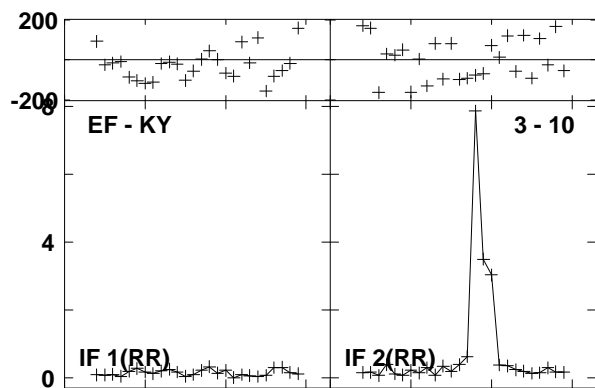
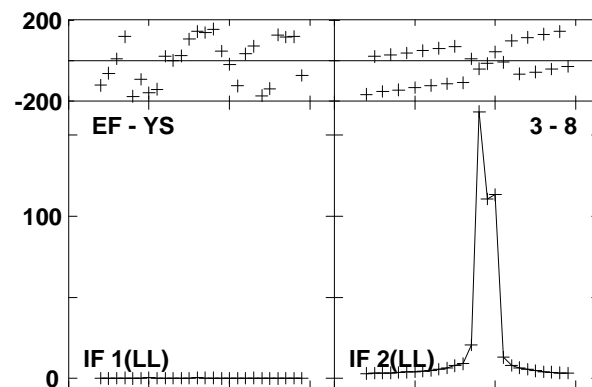
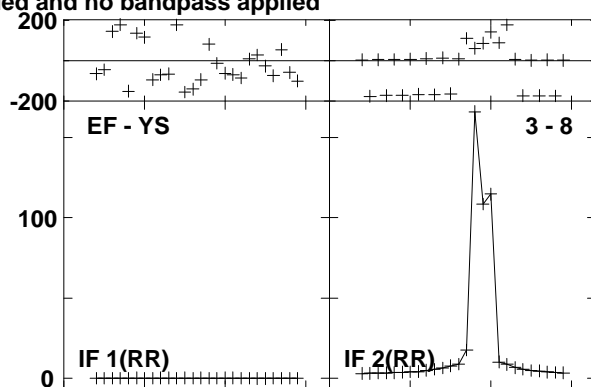
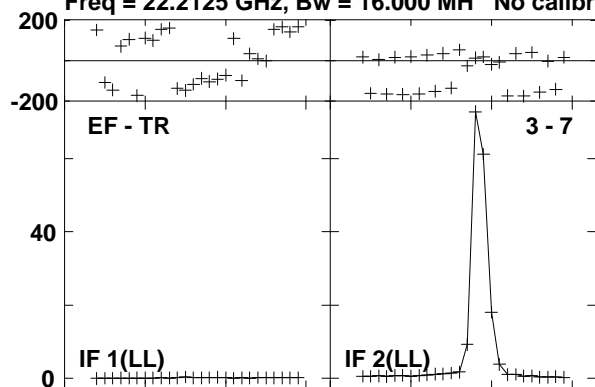

Lower frame: Milli Ampl Jy Top frame: Phas deg  
Vector averaged cross-power spectrum Baseline: EF (03) - TR (07)  
Timerange: 00/12:33:01 to 00/12:34:00

Plot file version 364 created 23-AUG-2016 15:00:55  
 W3IRS5 GA035B 1.UVDATA.1  
 Freq = 22.2125 GHz, Bw = 16.000 MH No calibration applied and no bandpass applied

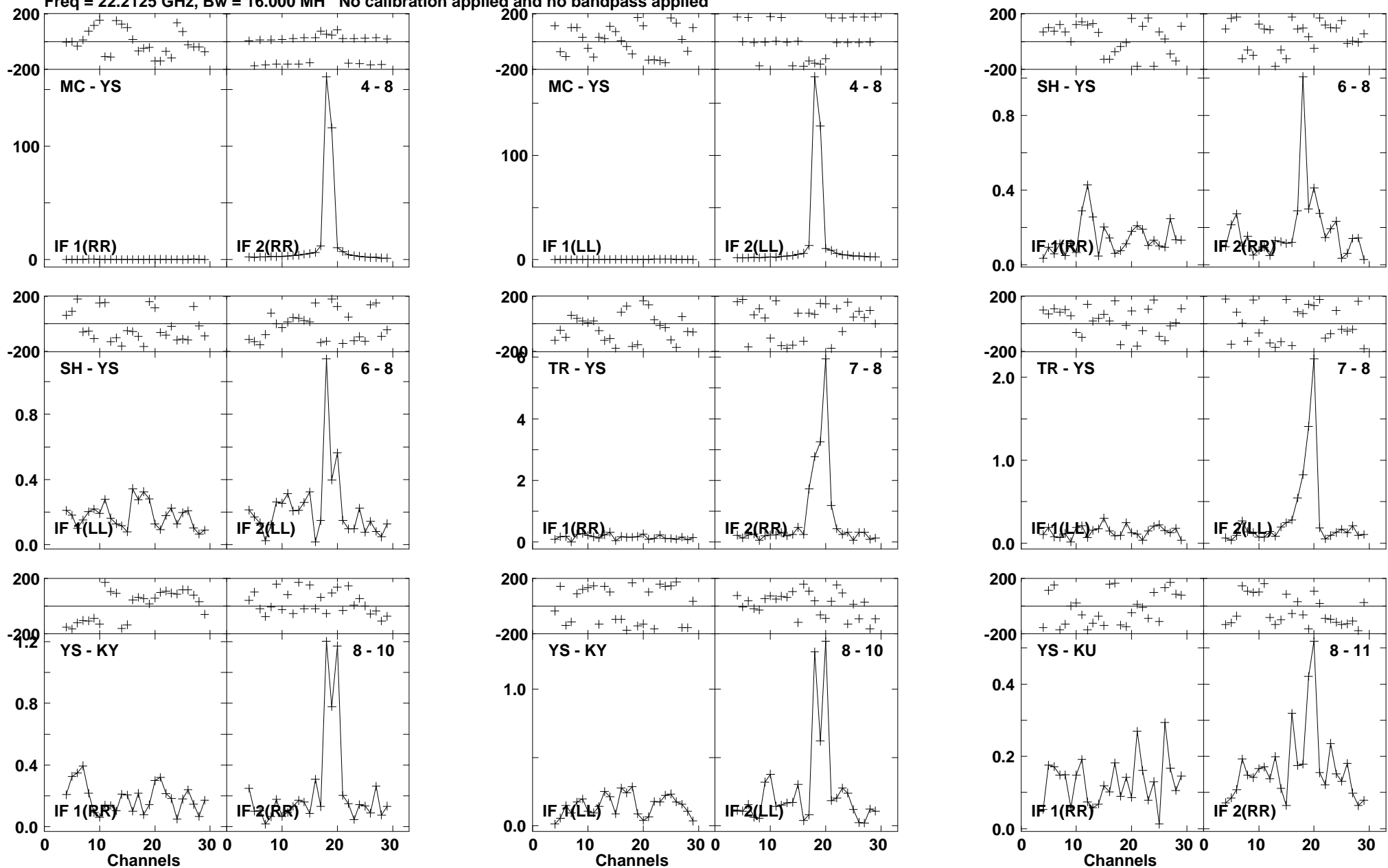

Lower frame: Milli Ampl Jy Top frame: Phas deg  
 Vector averaged cross-power spectrum Baseline: MC (04) - YS (08)  
 Timerange: 00/12:33:01 to 00/12:34:00

Plot file version 365 created 23-AUG-2016 15:00:55

W3IRS5 GA035B 1.UVDATA.1

Freq = 22.2125 GHz, Bw = 16.000 MH No calibration applied and no bandpass applied

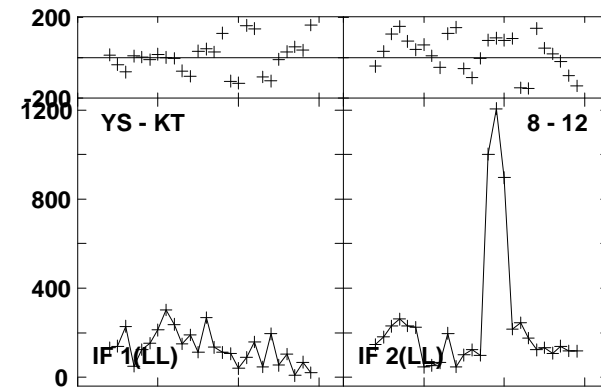
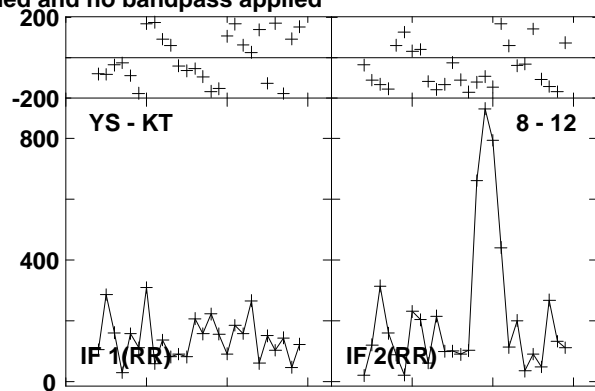
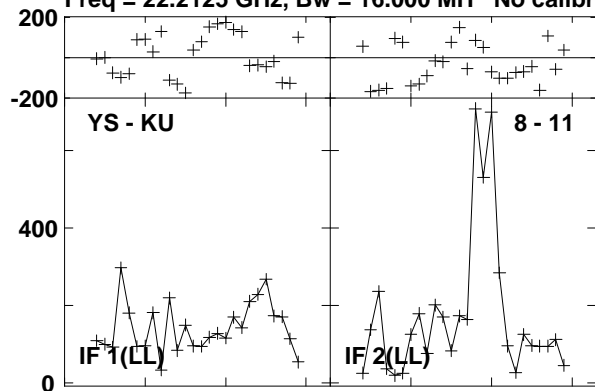

Lower frame: Micro Ampl Jy Top frame: Phas deg  
Vector averaged cross-power spectrum Baseline: YS (08) - KU (11)  
Timerange: 00/12:33:01 to 00/12:34:00

Plot file version 366 created 23-AUG-2016 15:00:55

0219+628 GA035B 1.UVDATA.1

Freq = 22.2125 GHz, Bw = 16.000 MH No calibration applied and no bandpass applied

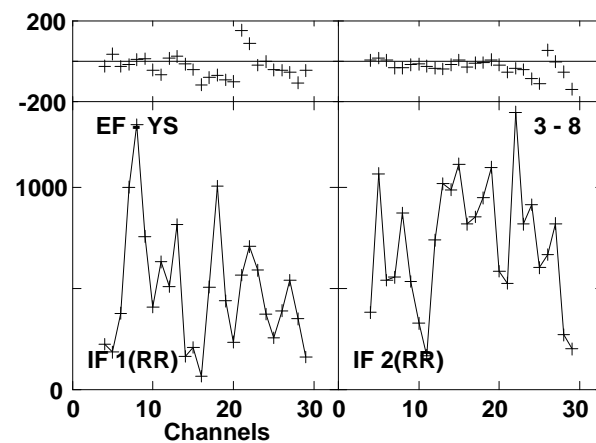
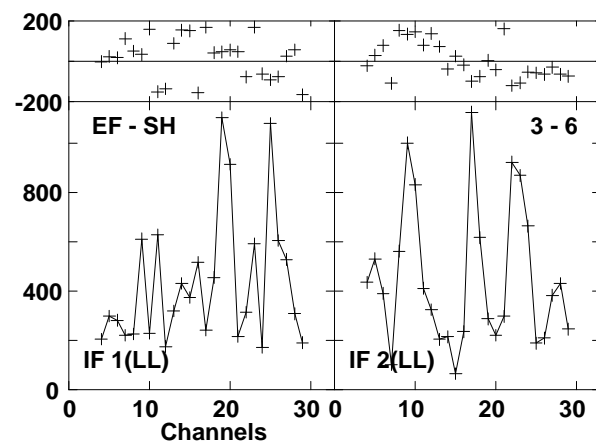
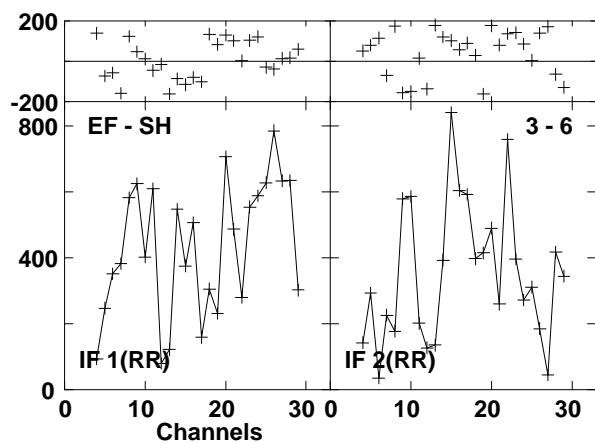
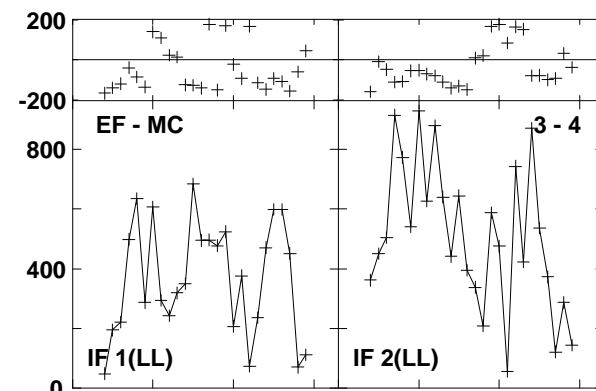
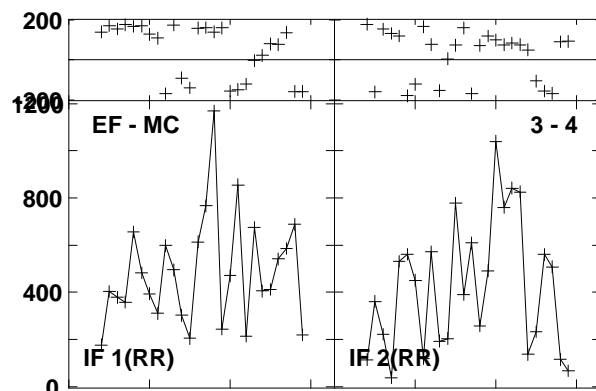
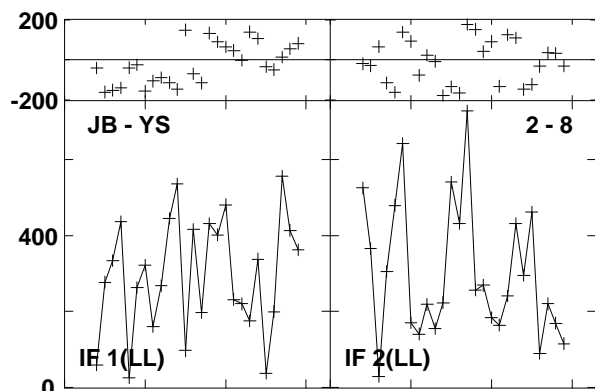
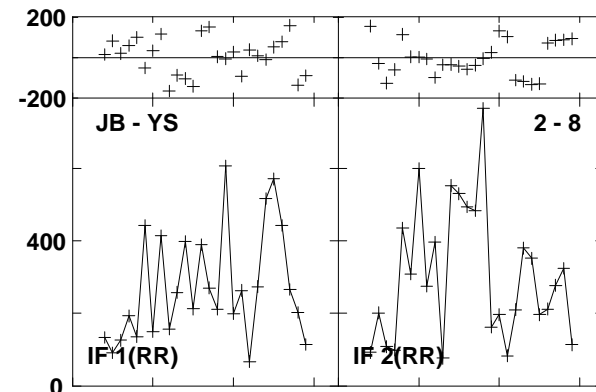
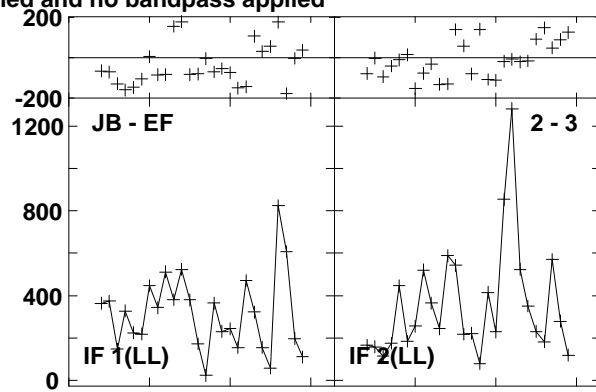
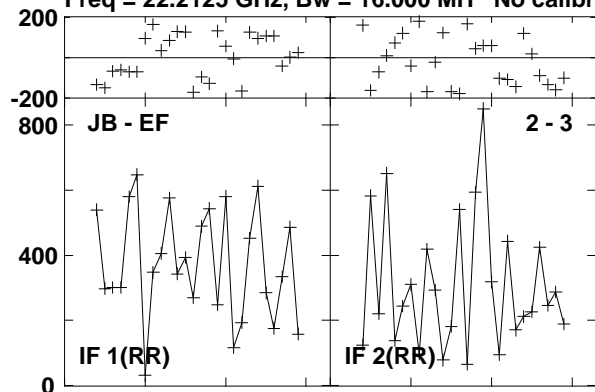

Lower frame: Micro Ampl Jy Top frame: Phas deg  
Vector averaged cross-power spectrum Baseline: JB (02) - EF (03)  
Timerange: 00/12:34:30 to 00/12:34:50

Plot file version 367 created 23-AUG-2016 15:00:55

0219+628 GA035B 1.UVDATA.1

Freq = 22.2125 GHz, Bw = 16.000 MH No calibration applied and no bandpass applied

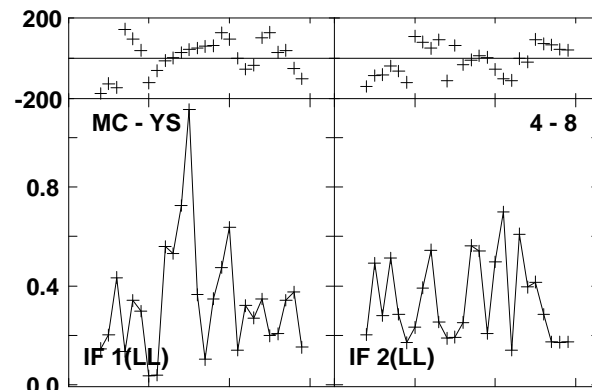
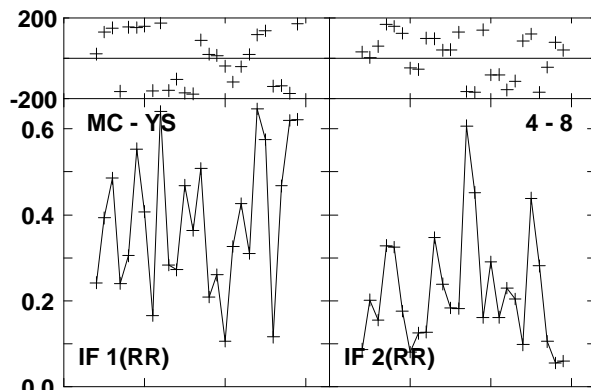
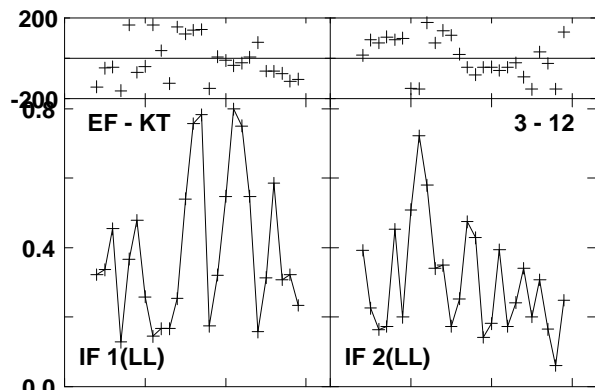
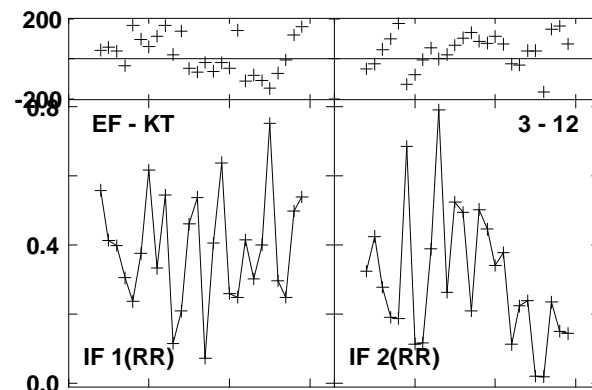
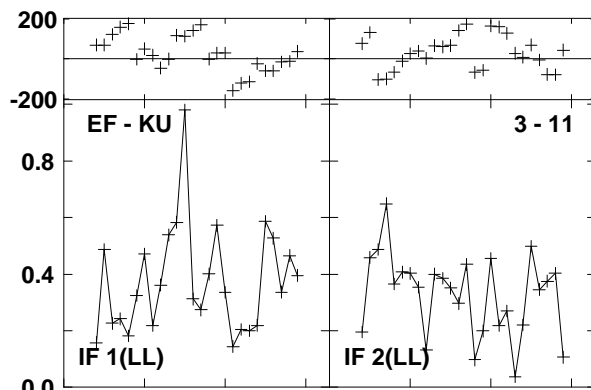
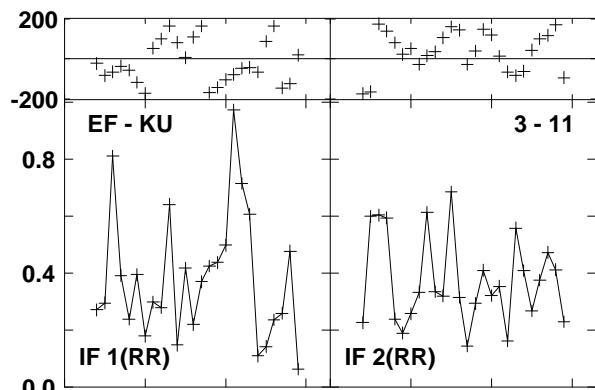
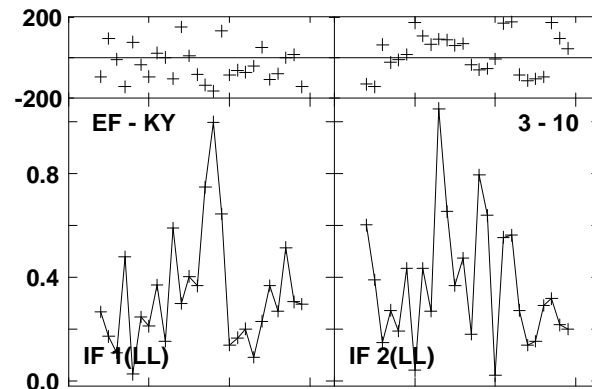
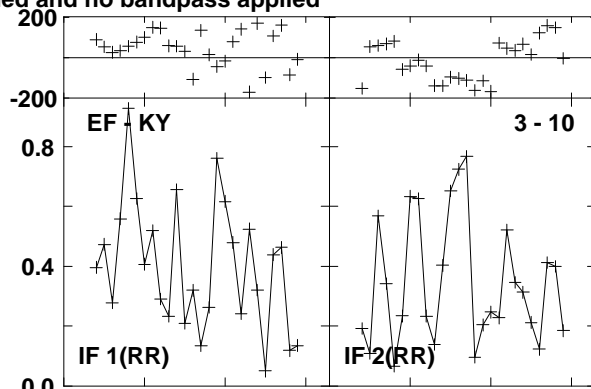
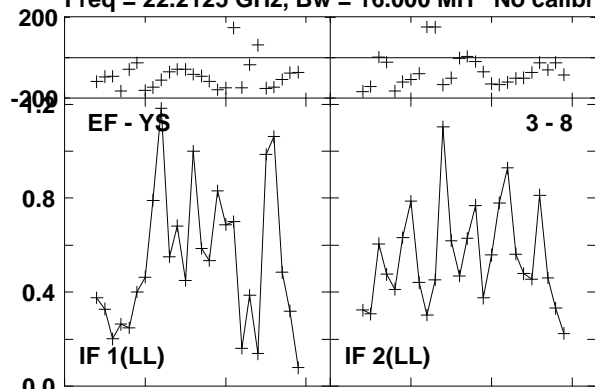

Lower frame: Milli Ampl Jy Top frame: Phas deg  
Vector averaged cross-power spectrum Baseline: EF (03) - YS (08)  
Timerange: 00/12:34:30 to 00/12:34:50

Plot file version 368 created 23-AUG-2016 15:00:55

0219+628 GA035B 1.UVDATA.1

Freq = 22.2125 GHz, Bw = 16.000 MH No calibration applied and no bandpass applied

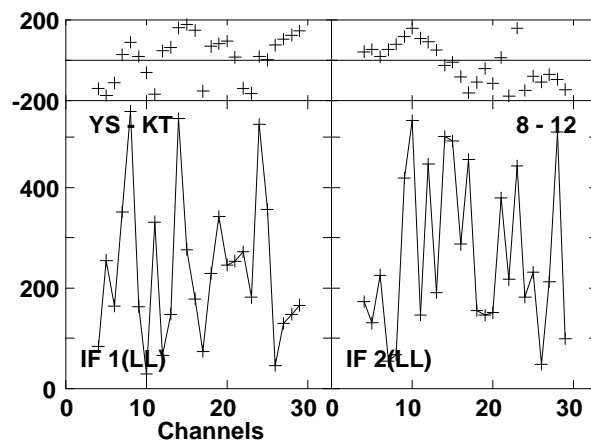
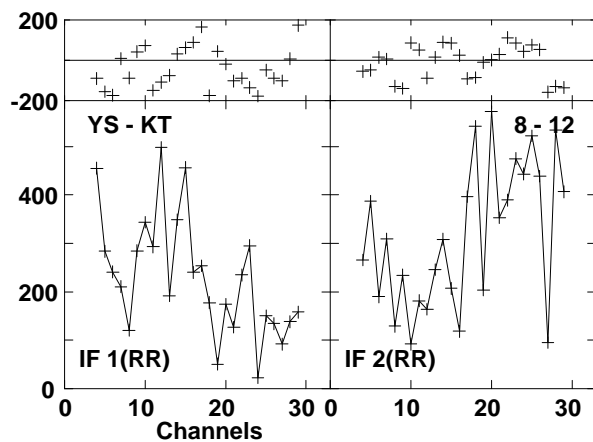
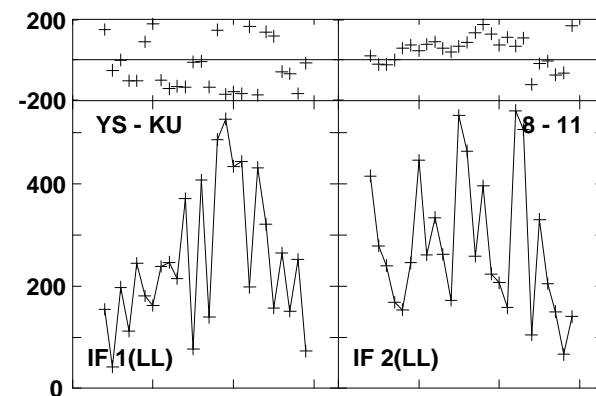
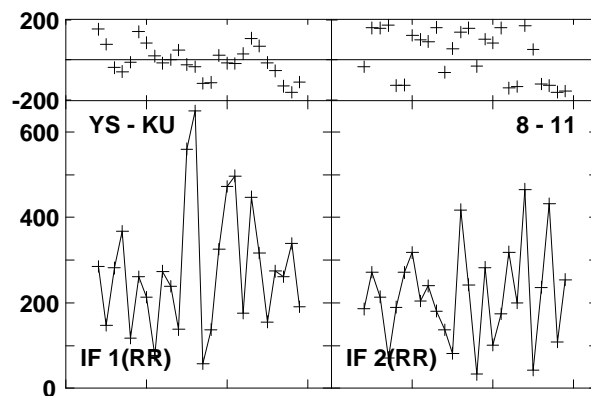
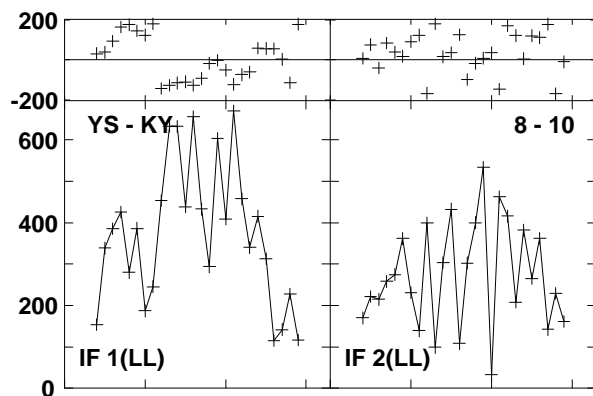
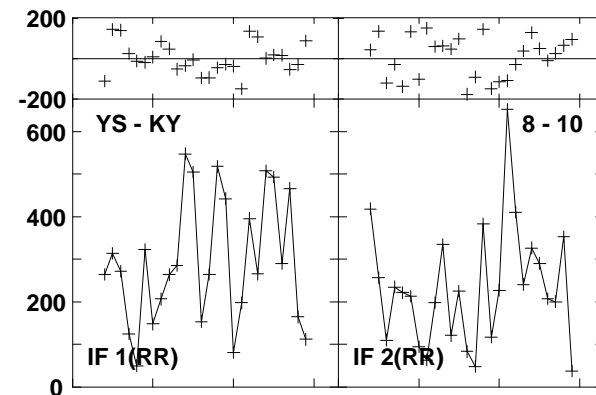
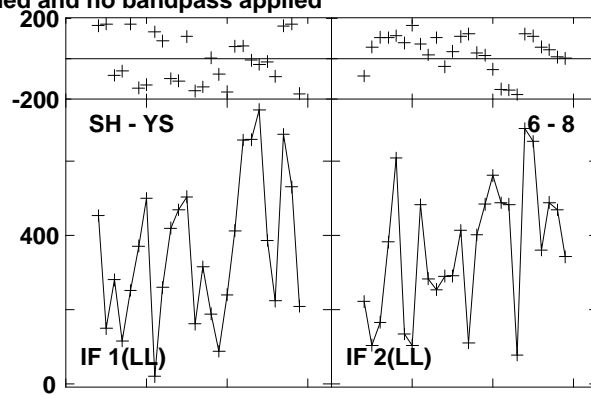
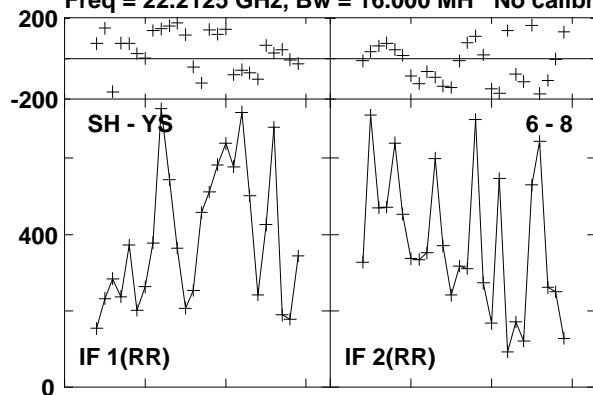

Lower frame: Micro Ampl Jy Top frame: Phas deg  
Vector averaged cross-power spectrum Baseline: SH (06) - YS (08)  
Timerange: 00/12:34:30 to 00/12:34:50



Plot file version 369 created 23-AUG-2016 15:00:55  
 W3IRS5 GA035B 1.UVDATA.1

Freq = 22.2125 GHz, Bw = 16.000 MH No calibration applied and no bandpass applied

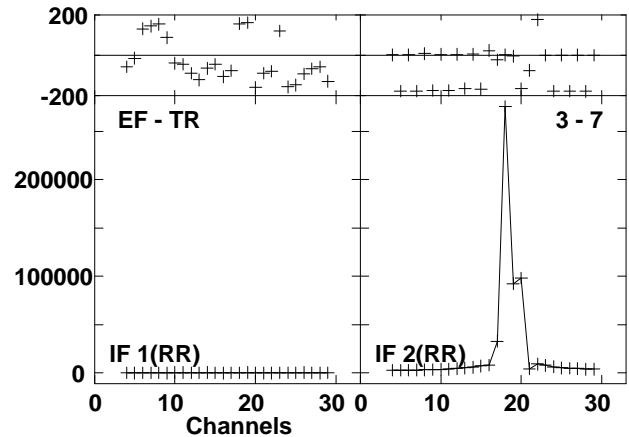
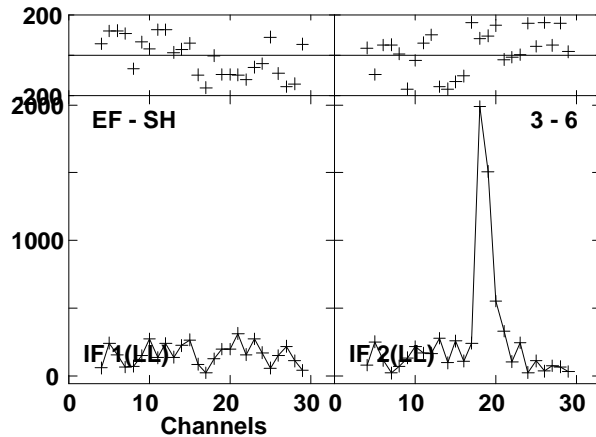
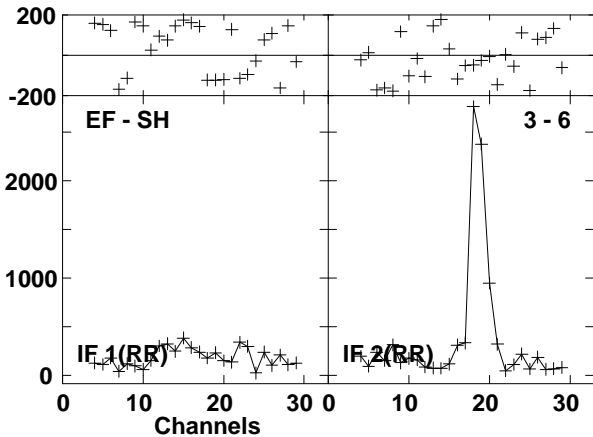
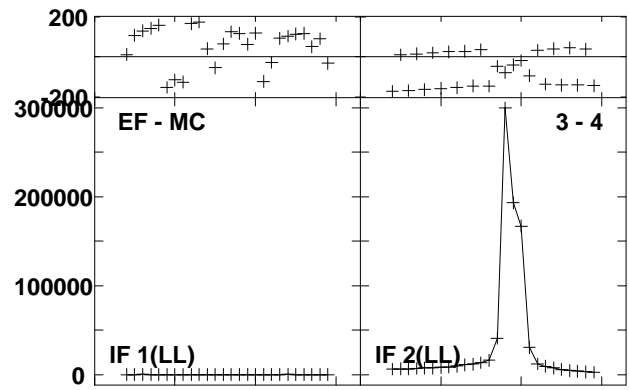
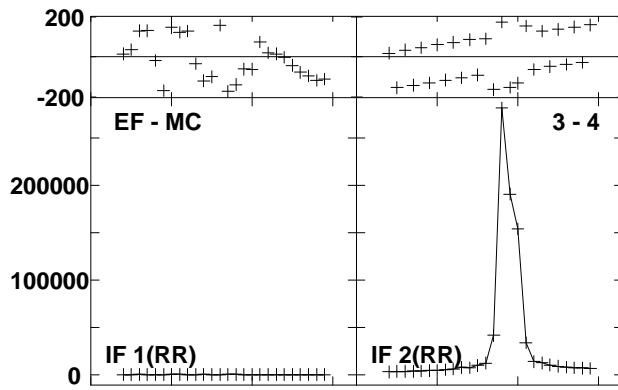
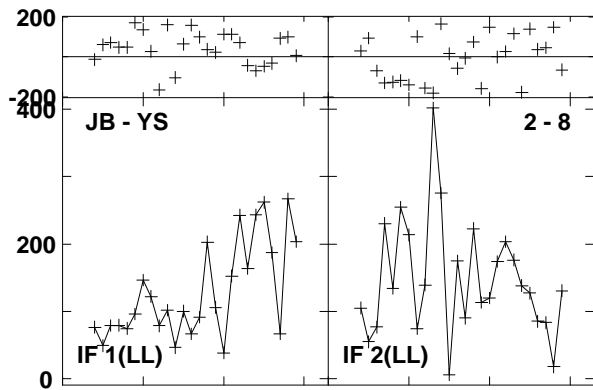
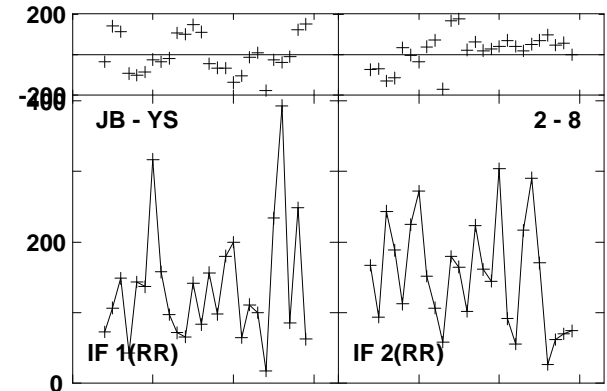
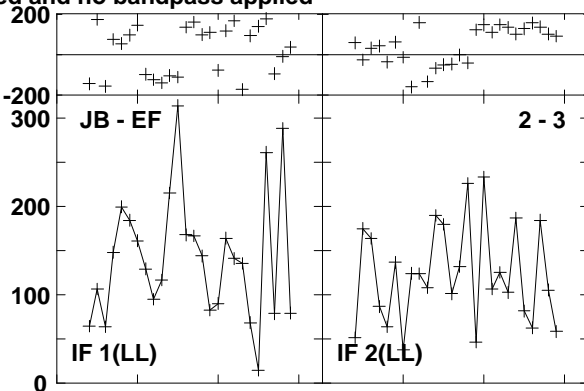
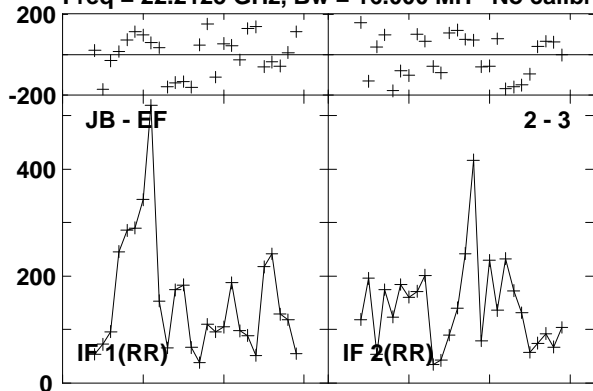

Lower frame: Micro Ampl Jy Top frame: Phas deg  
 Vector averaged cross-power spectrum Baseline: JB (02) - EF (03)  
 Timerange: 00/12:35:20 to 00/12:36:19

Plot file version 370 created 23-AUG-2016 15:00:55

W3IRS5 GA035B 1.UVDATA.1

Freq = 22.2125 GHz, Bw = 16.000 MH No calibration applied and no bandpass applied

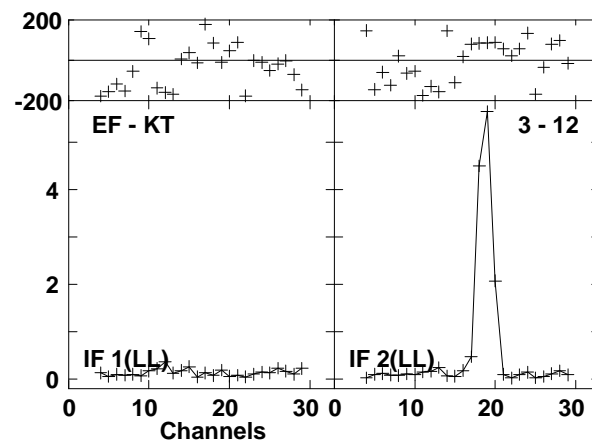
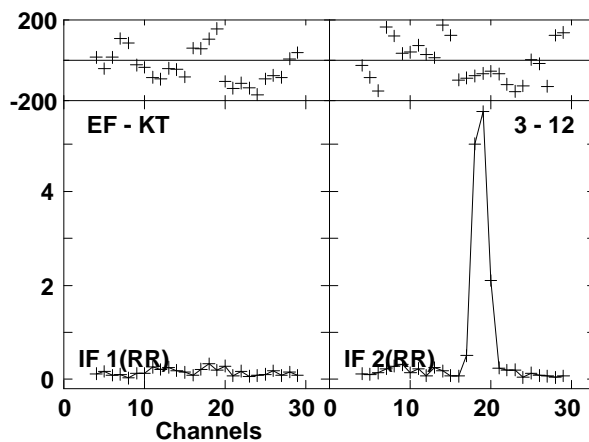
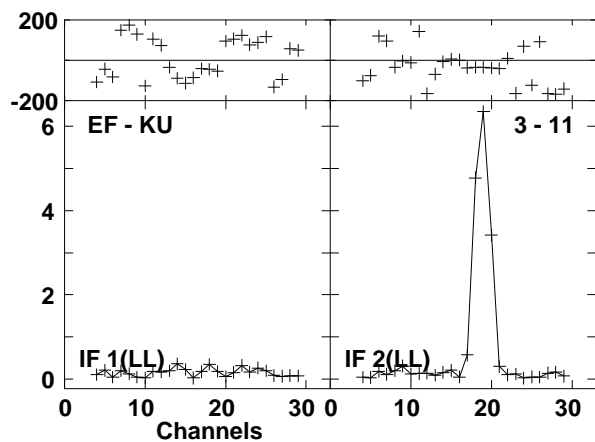
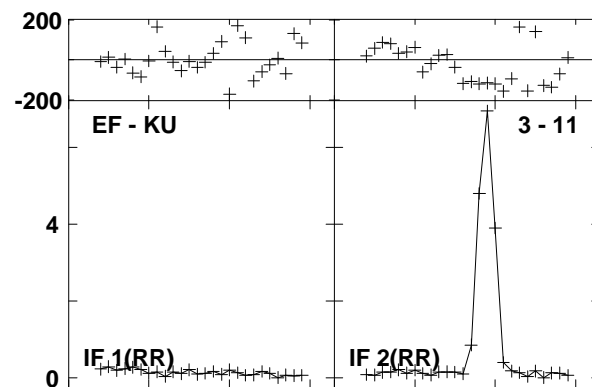
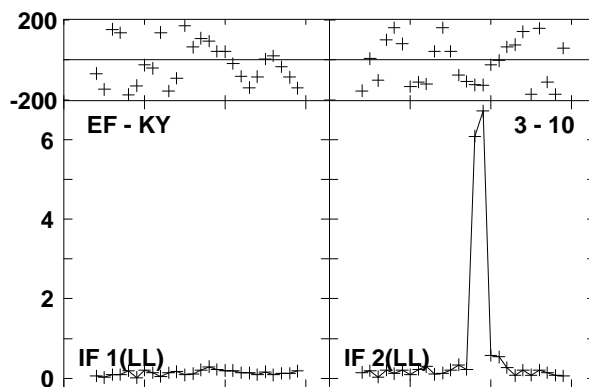
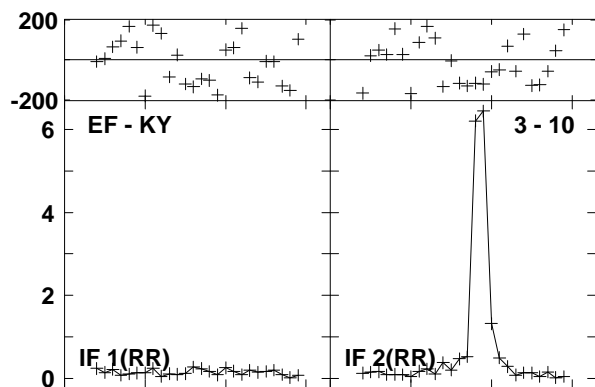
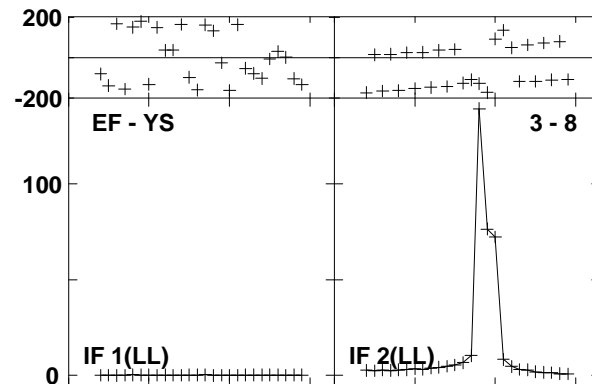
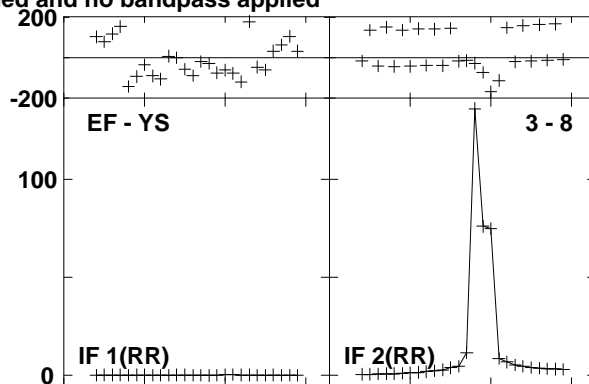
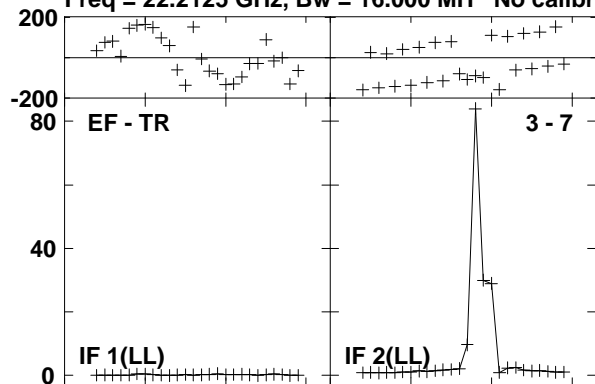

Lower frame: Milli Ampl Jy Top frame: Phas deg  
Vector averaged cross-power spectrum Baseline: EF (03) - TR (07)  
Timerange: 00/12:35:20 to 00/12:36:19

Plot file version 371 created 23-AUG-2016 15:00:55

W3IRS5 GA035B 1.UVDATA.1

Freq = 22.2125 GHz, Bw = 16.000 MH No calibration applied and no bandpass applied

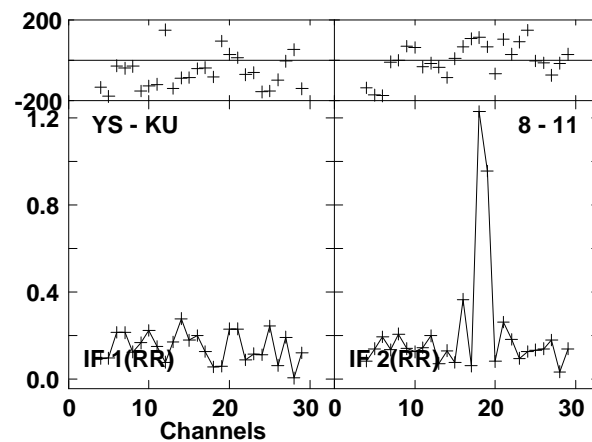
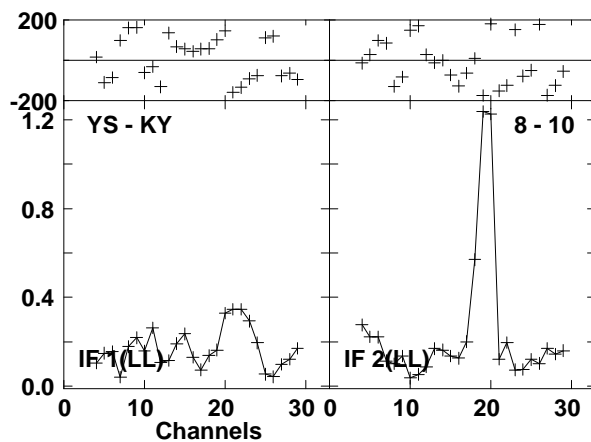
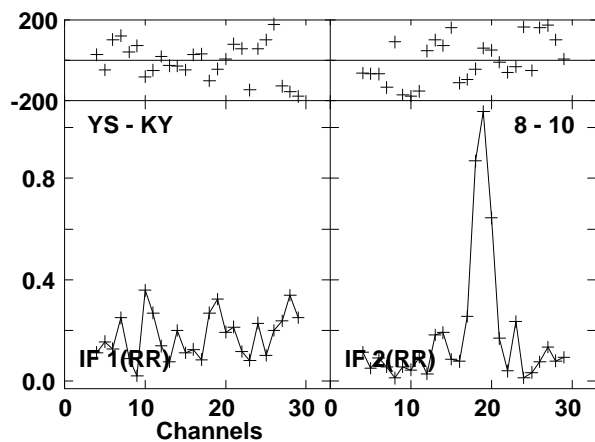
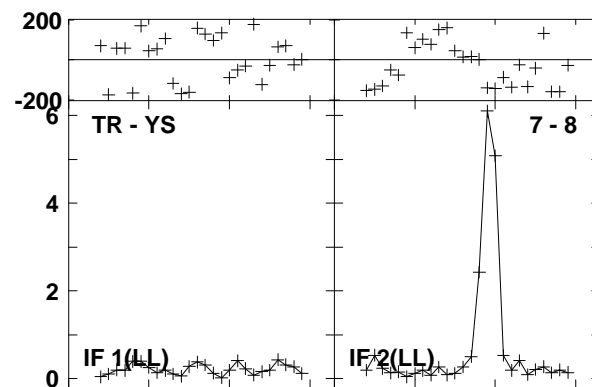
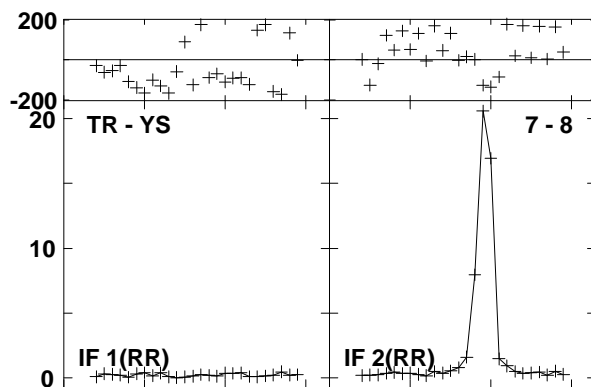
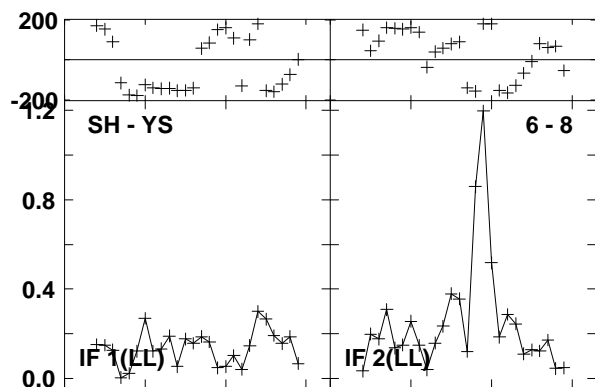
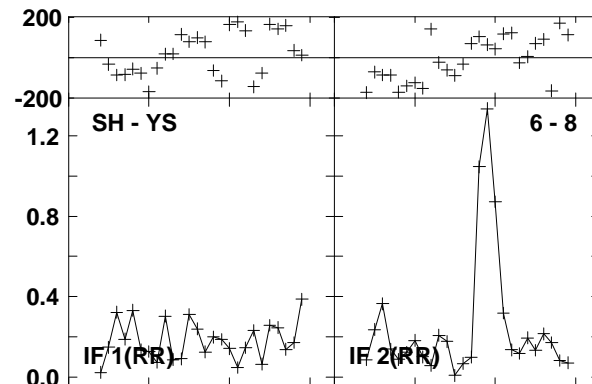
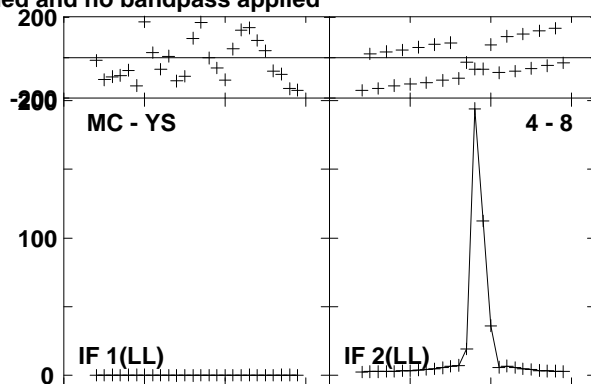
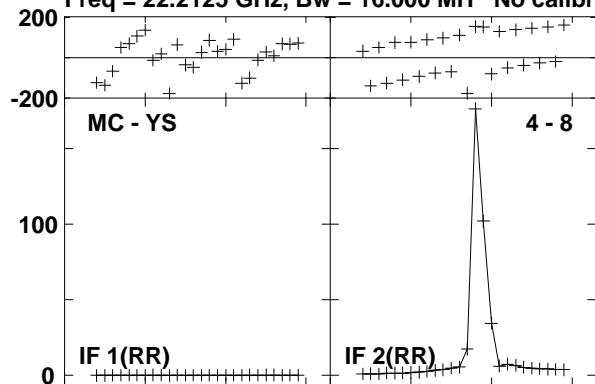

Lower frame: Milli Ampl Jy Top frame: Phas deg  
Vector averaged cross-power spectrum Baseline: MC (04) - YS (08)  
Timerange: 00/12:35:20 to 00/12:36:19

Plot file version 372 created 23-AUG-2016 15:00:55

W3IRS5 GA035B 1.UVDATA.1

Freq = 22.2125 GHz, Bw = 16.000 MH No calibration applied and no bandpass applied

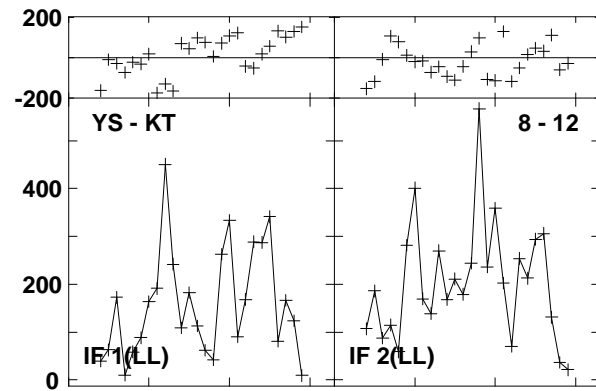
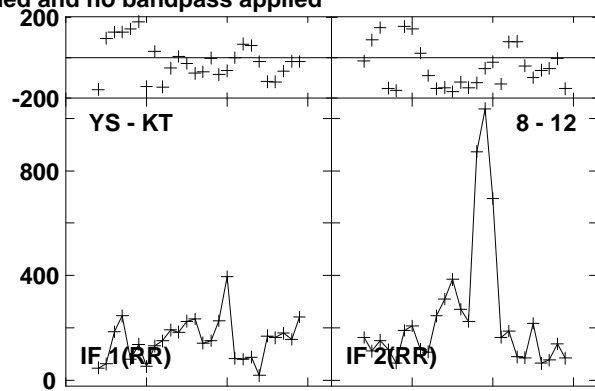
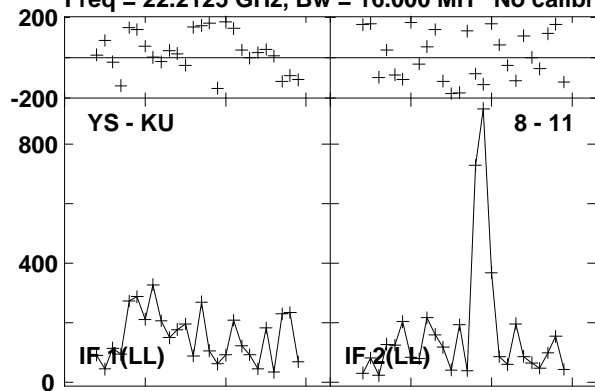

Lower frame: Micro Ampl Jy Top frame: Phas deg  
Vector averaged cross-power spectrum Baseline: YS (08) - KU (11)  
Timerange: 00/12:35:20 to 00/12:36:19

Plot file version 373 created 23-AUG-2016 15:00:55

0219+628 GA035B 1.UVDATA.1

Freq = 22.2125 GHz, Bw = 16.000 MH No calibration applied and no bandpass applied

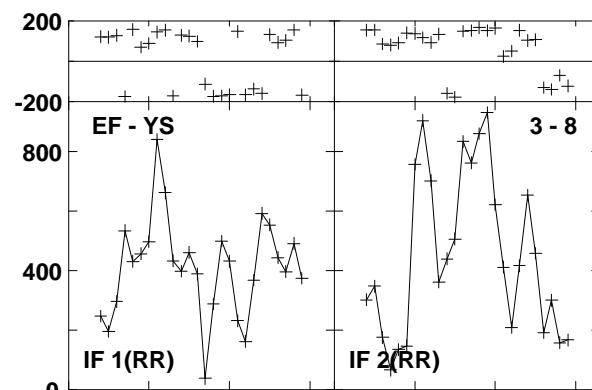
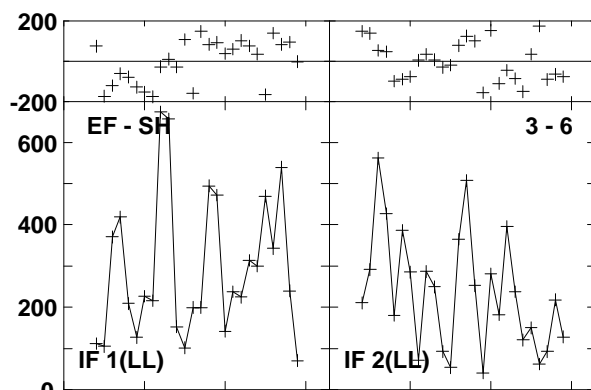
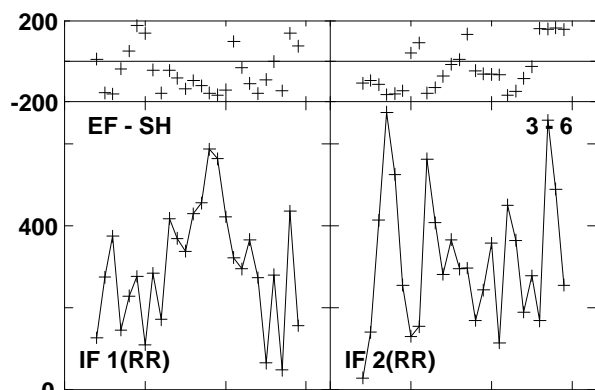
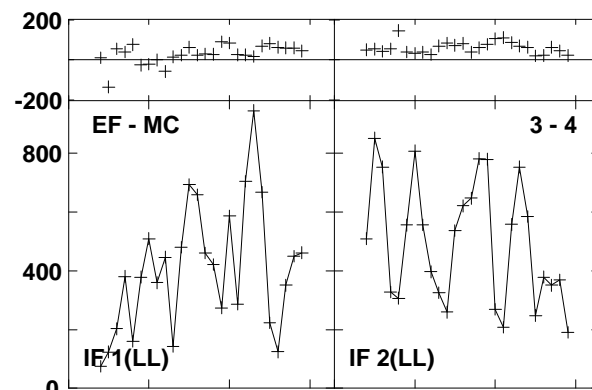
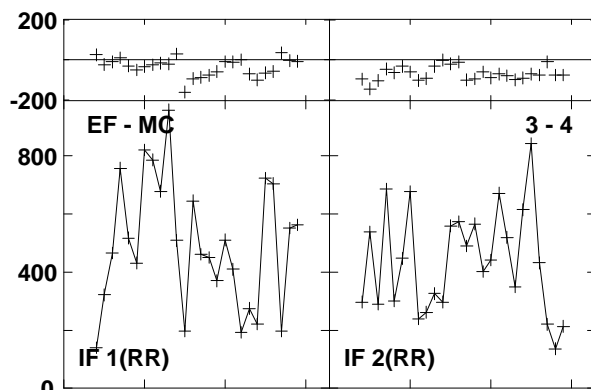
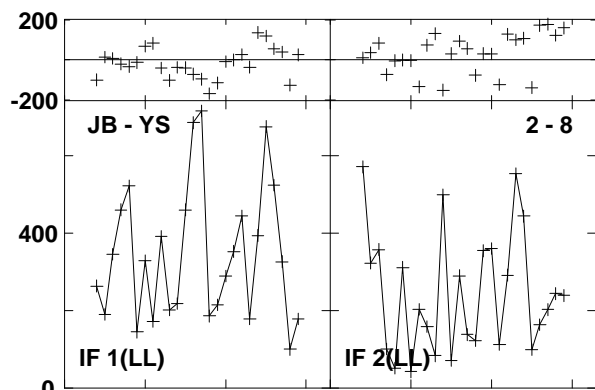
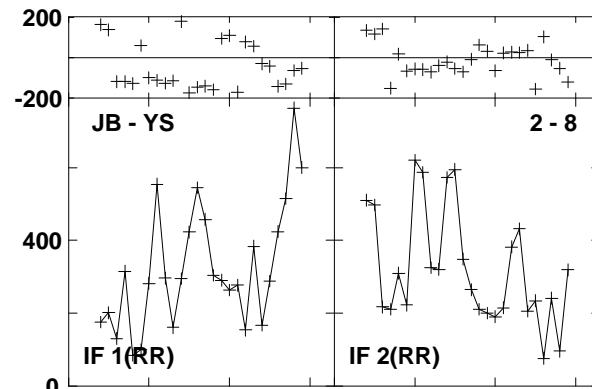
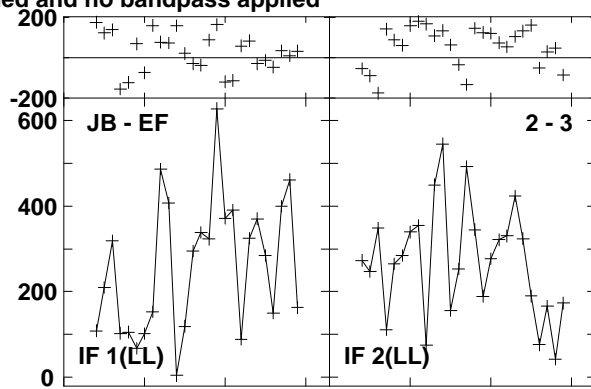
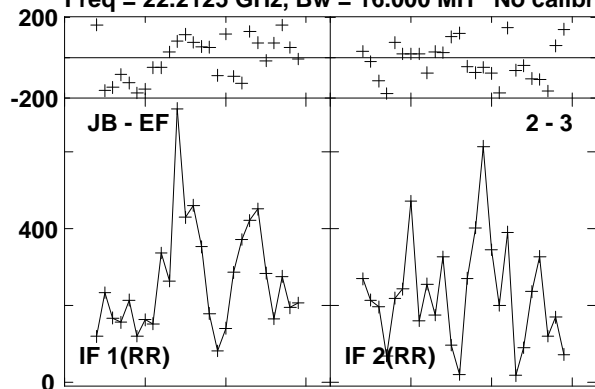

Lower frame: Micro Ampl Jy Top frame: Phas deg  
Vector averaged cross-power spectrum Baseline: JB (02) - EF (03)  
Timerange: 00/12:36:51 to 00/12:37:10

Plot file version 374 created 23-AUG-2016 15:00:55

0219+628 GA035B 1.UVDATA.1

Freq = 22.2125 GHz, Bw = 16.000 MH No calibration applied and no bandpass applied

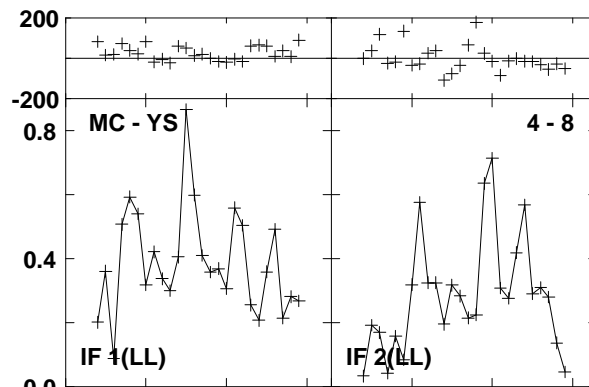
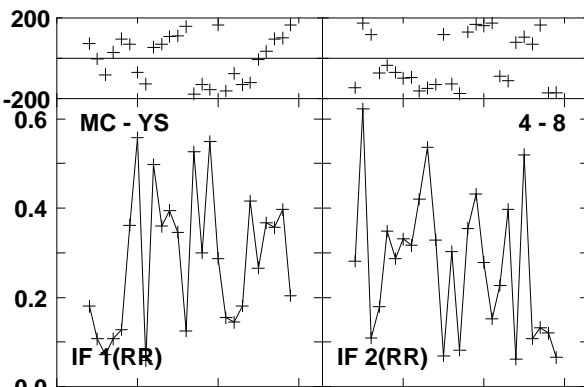
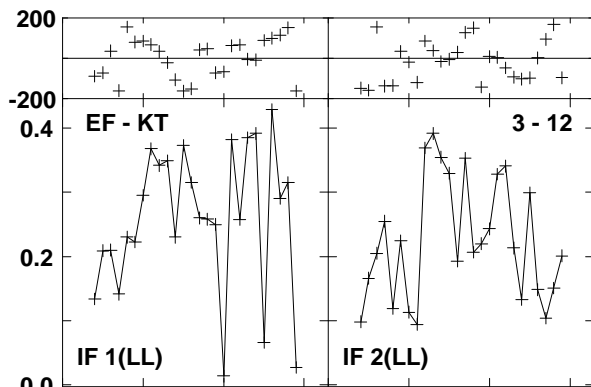
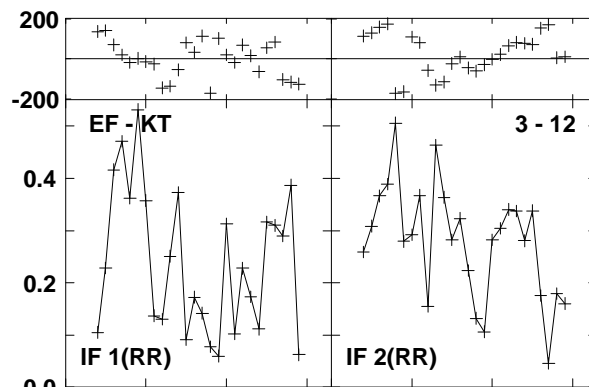
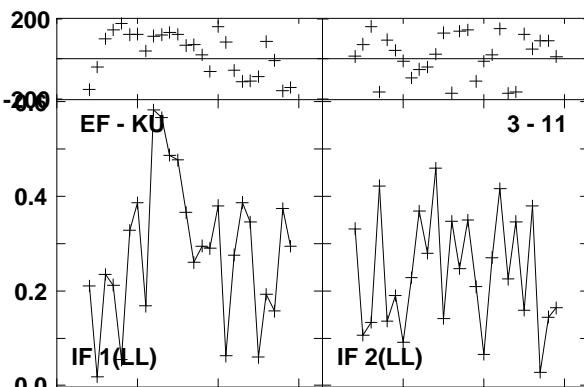
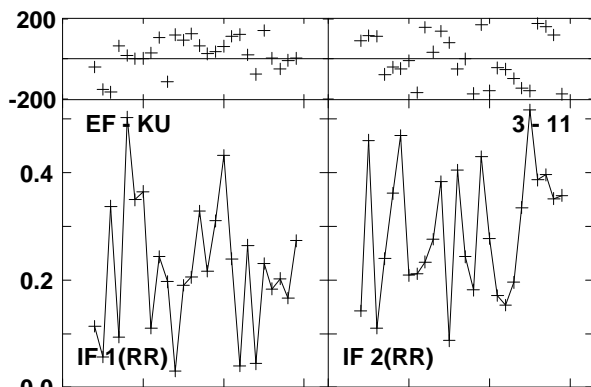
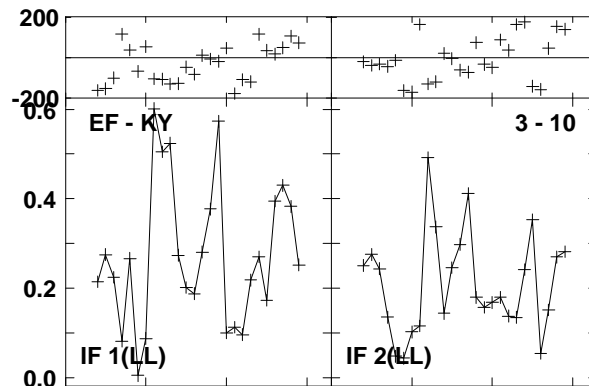
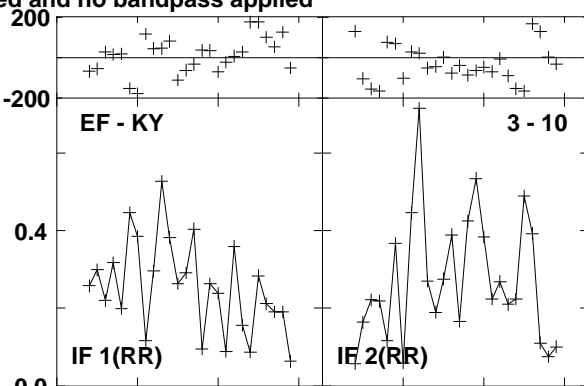
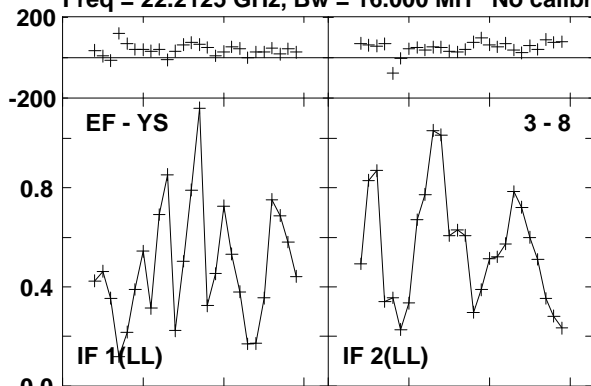

Lower frame: Milli Ampl Jy Top frame: Phas deg  
Vector averaged cross-power spectrum Baseline: EF (03) - YS (08)  
Timerange: 00/12:36:51 to 00/12:37:10

Plot file version 375 created 23-AUG-2016 15:00:55

0219+628 GA035B 1.UVDATA.1

Freq = 22.2125 GHz, Bw = 16.000 MH No calibration applied and no bandpass applied

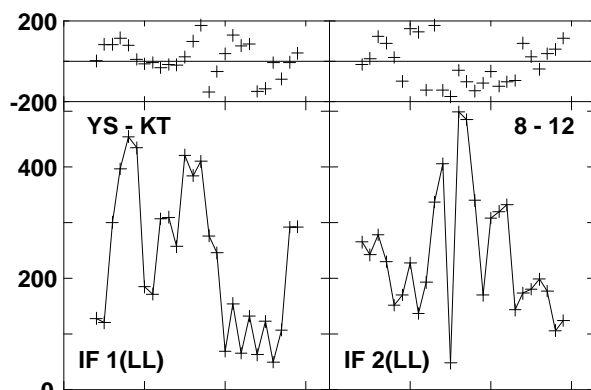
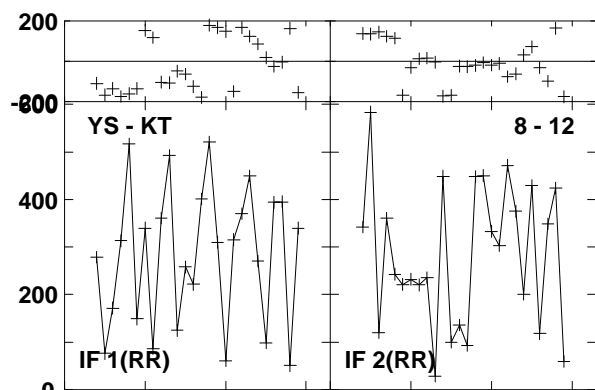
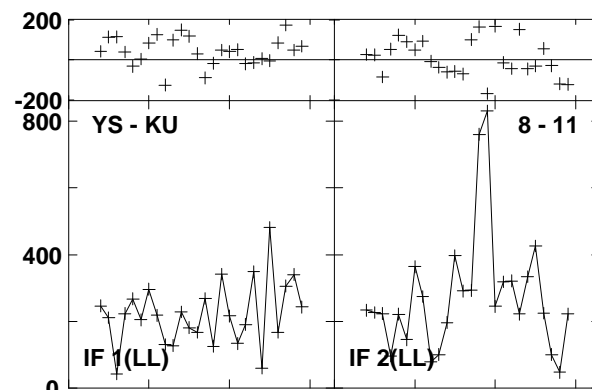
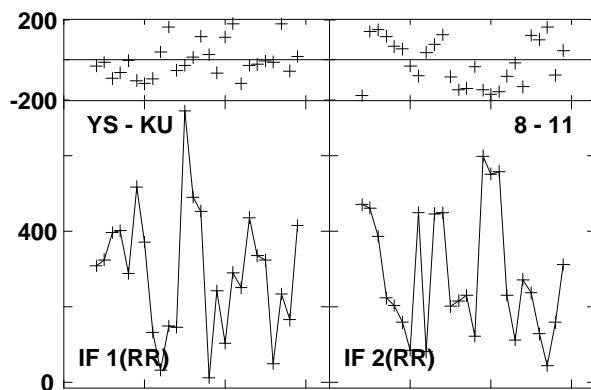
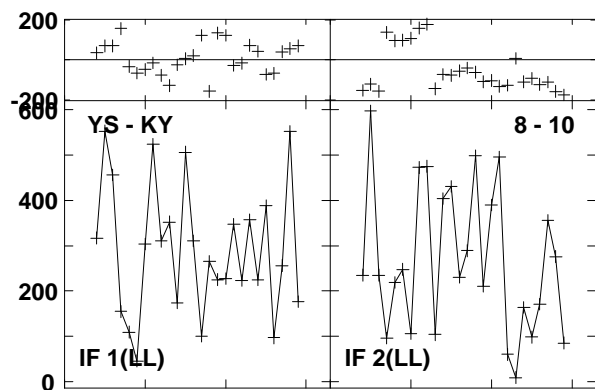
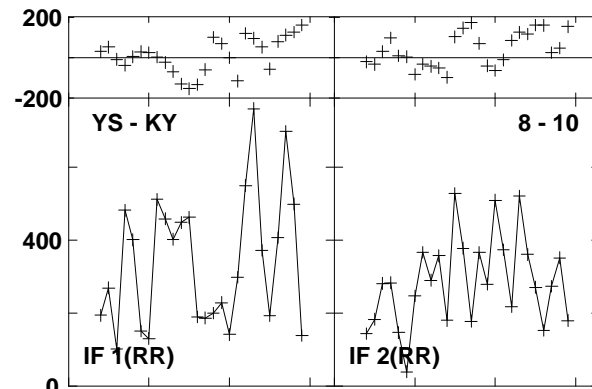
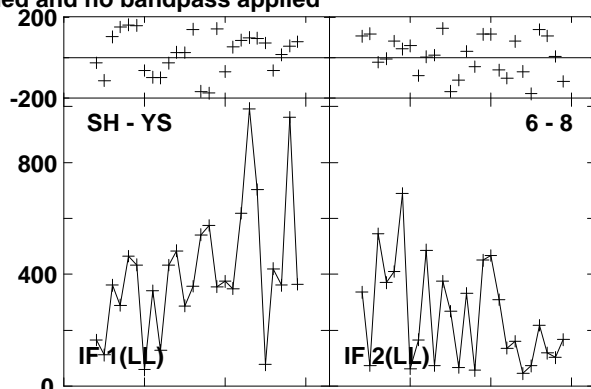
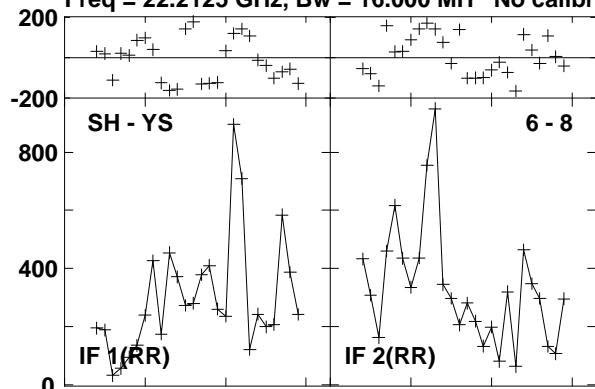

Lower frame: Micro Ampl Jy Top frame: Phas deg  
Vector averaged cross-power spectrum Baseline: SH (06) - YS (08)  
Timerange: 00/12:36:51 to 00/12:37:10

Plot file version 376 created 23-AUG-2016 15:00:55

0716+714 GA035B 1.UVDATA.1

Freq = 22.2125 GHz, Bw = 16.000 MH No calibration applied and no bandpass applied

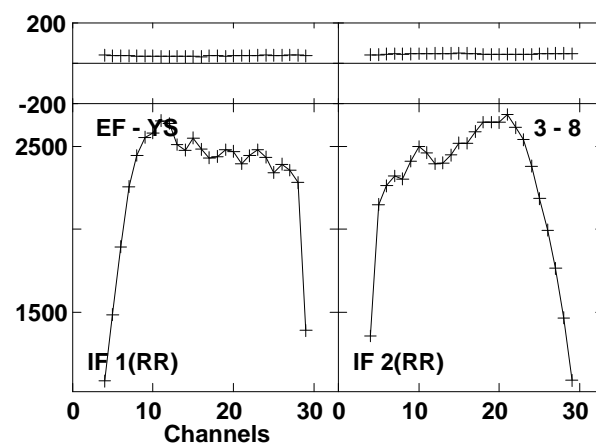
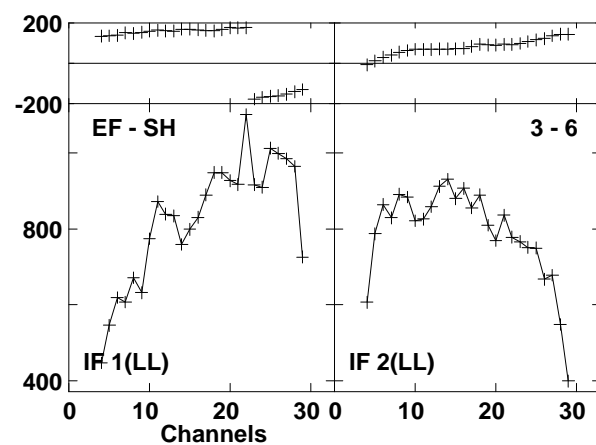
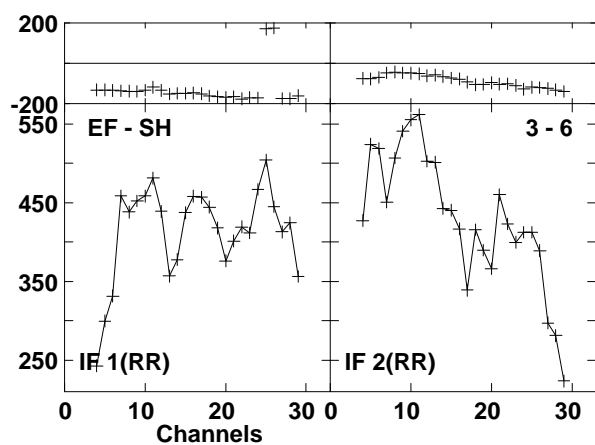
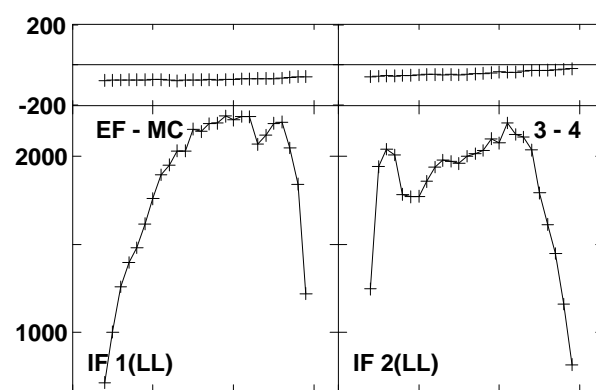
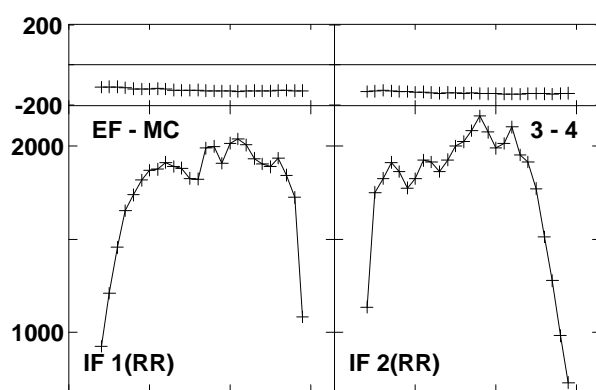
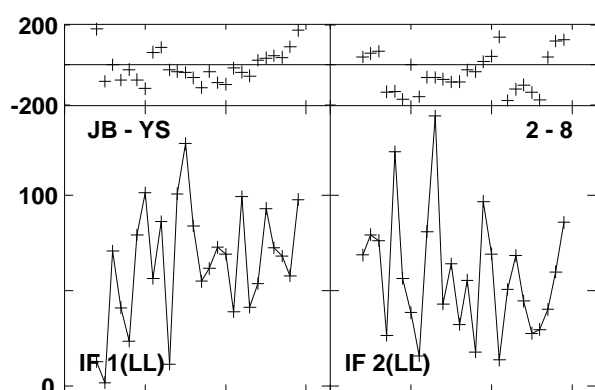
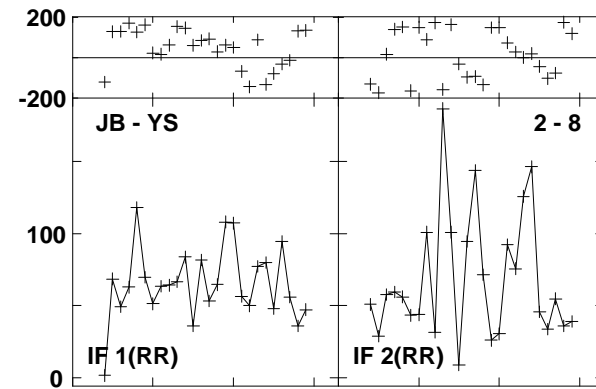
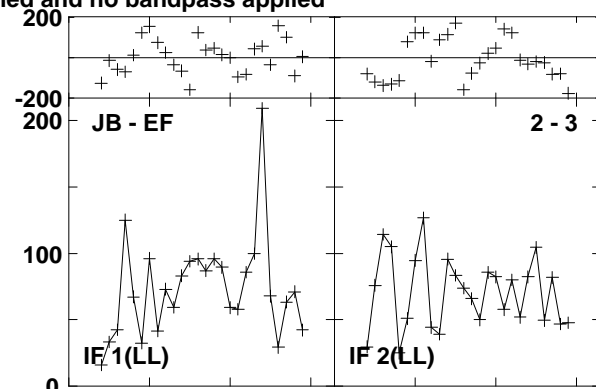
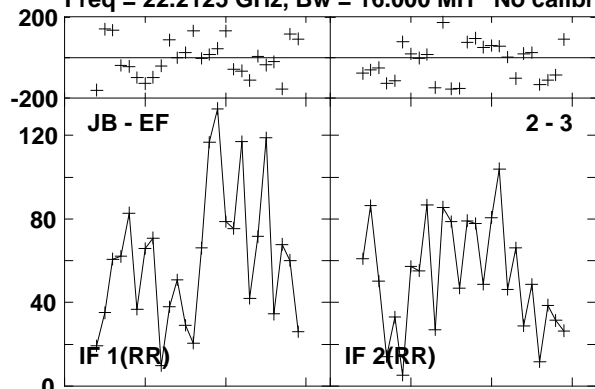

Lower frame: Micro Ampl Jy Top frame: Phas deg  
Vector averaged cross-power spectrum Baseline: JB (02) - EF (03)  
Timerange: 00/12:39:21 to 00/12:44:20



Plot file version 377 created 23-AUG-2016 15:00:55

0716+714 GA035B 1.UVDATA.1

Freq = 22.2125 GHz, Bw = 16.000 MH No calibration applied and no bandpass applied

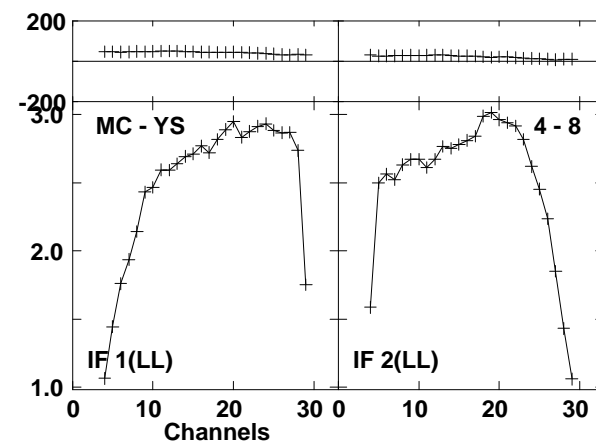
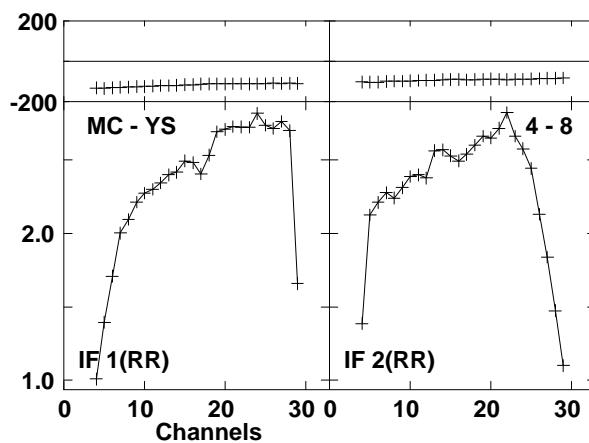
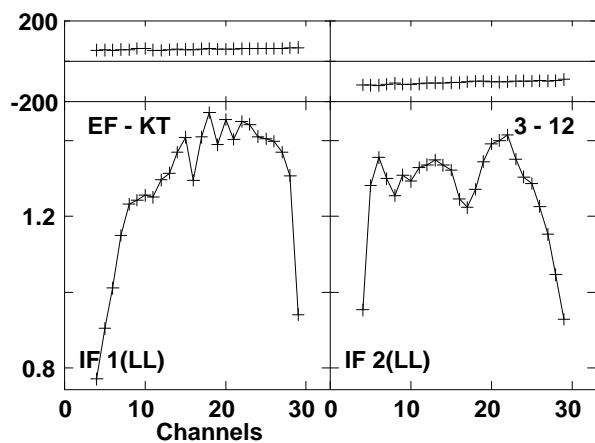
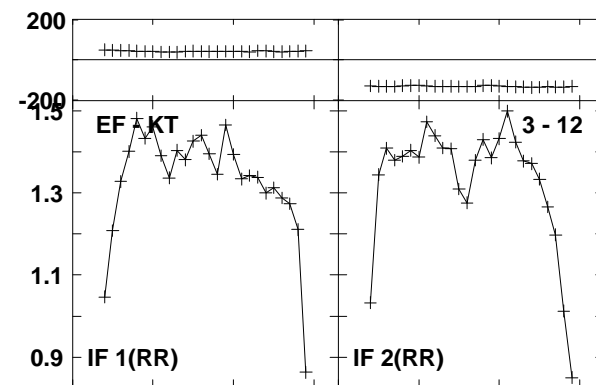
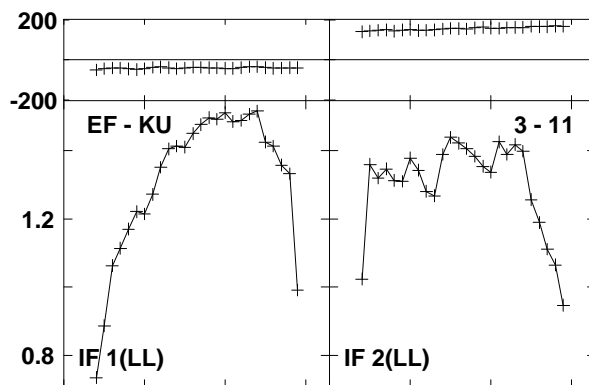
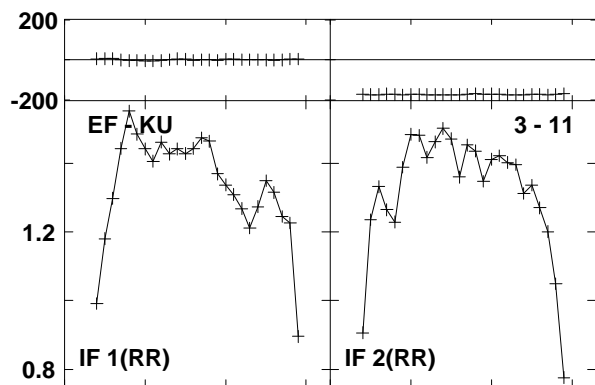
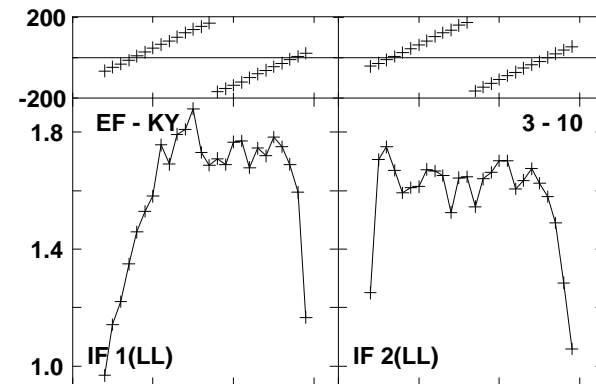
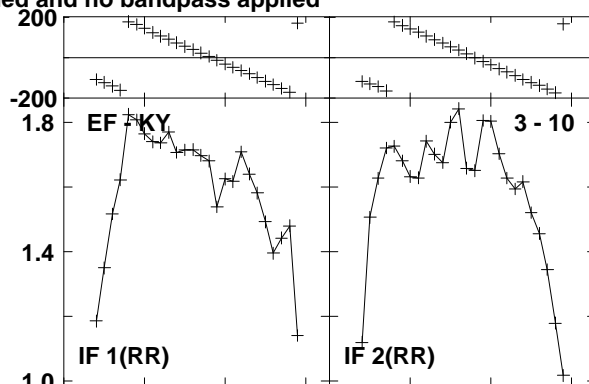
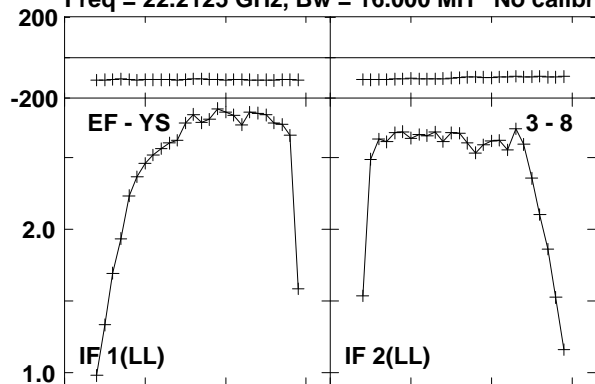

Lower frame: Milli Ampl Jy Top frame: Phas deg  
Vector averaged cross-power spectrum Baseline: EF (03) - YS (08)  
Timerange: 00/12:39:21 to 00/12:44:20

Plot file version 378 created 23-AUG-2016 15:00:55

0716+714 GA035B 1.UVDATA.1

Freq = 22.2125 GHz, Bw = 16.000 MH No calibration applied and no bandpass applied

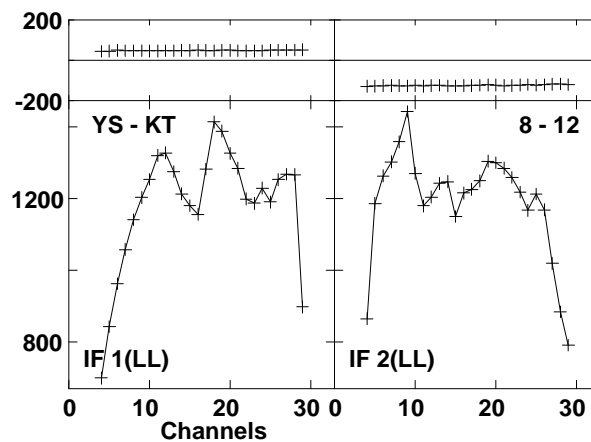
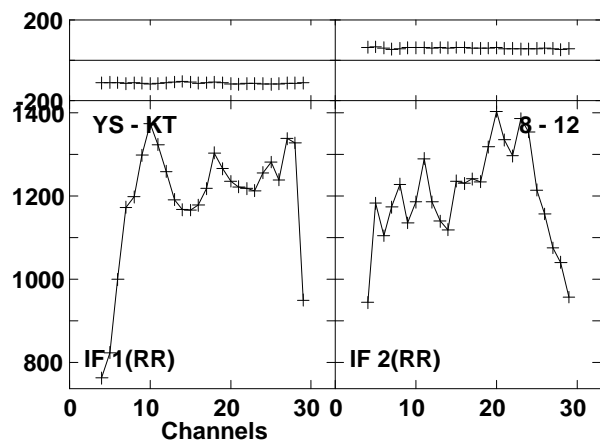
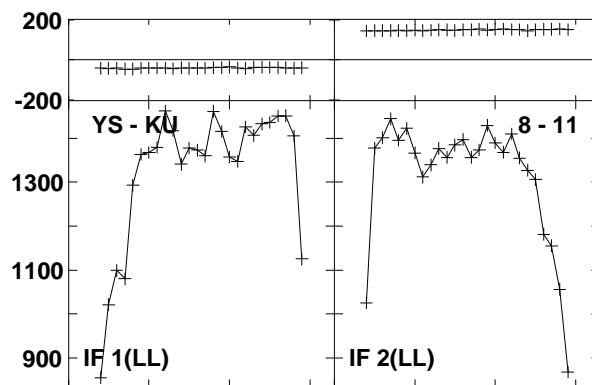
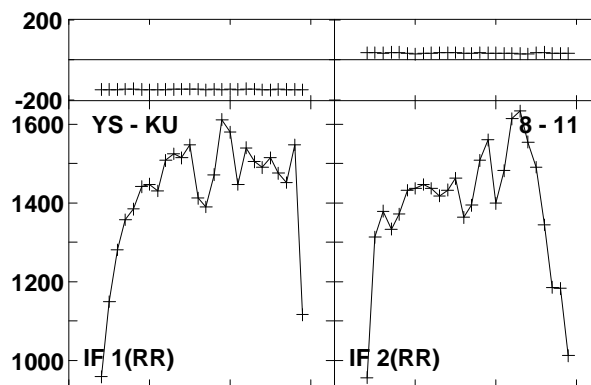
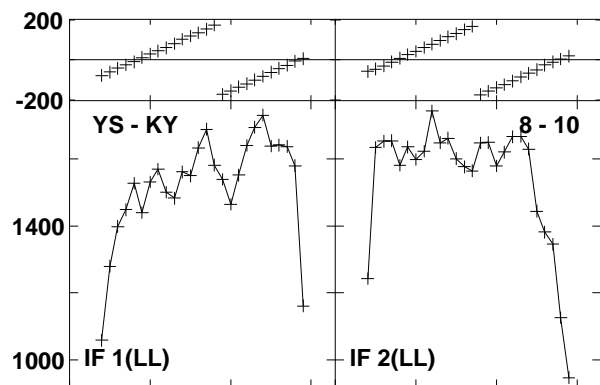
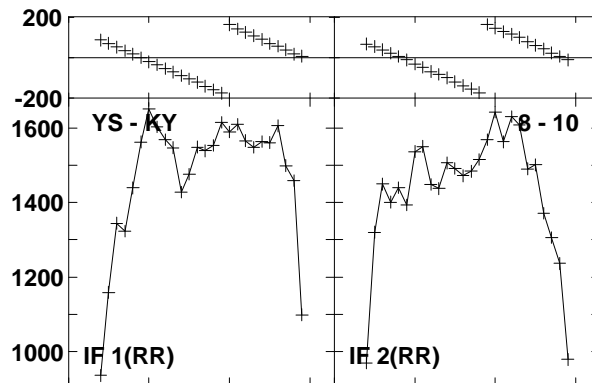
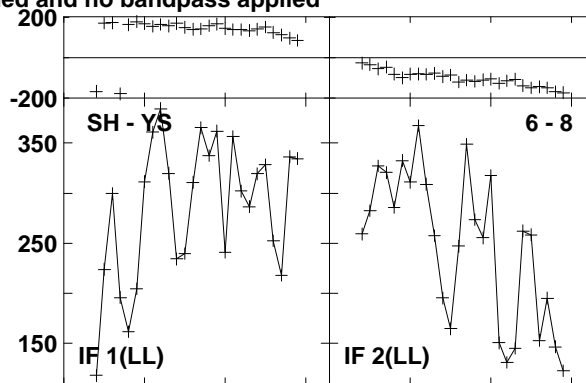
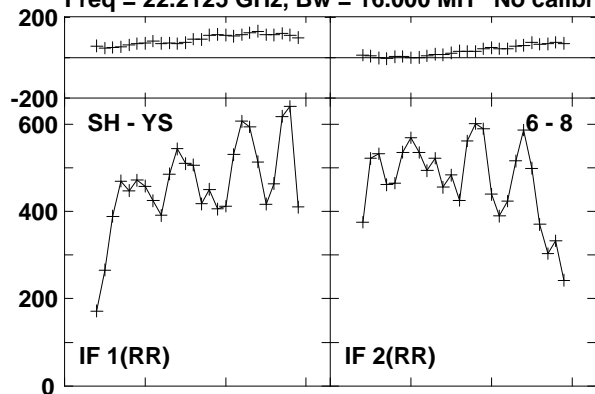

Lower frame: Micro Ampl Jy Top frame: Phas deg  
Vector averaged cross-power spectrum Baseline: SH (06) - YS (08)  
Timerange: 00/12:39:21 to 00/12:44:20

Plot file version 379 created 23-AUG-2016 15:00:55

0219+628 GA035B 1.UVDATA.1

Freq = 22.2125 GHz, Bw = 16.000 MH No calibration applied and no bandpass applied

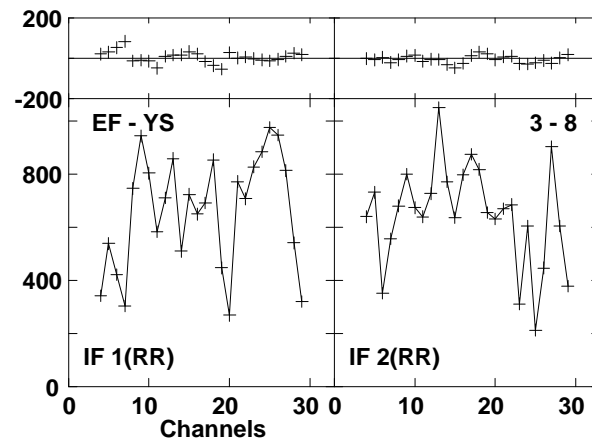
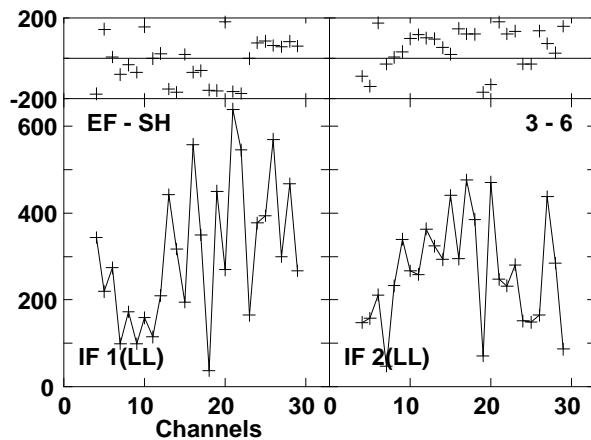
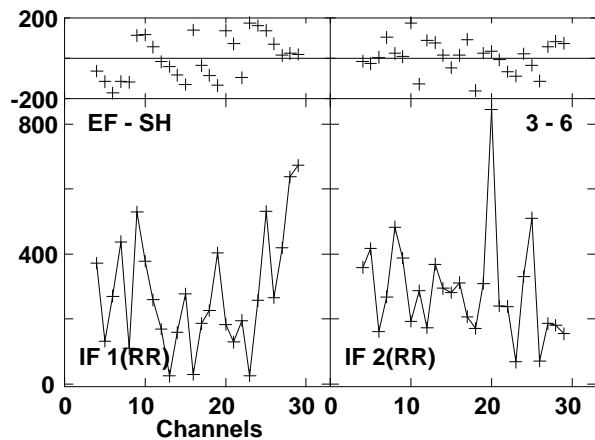
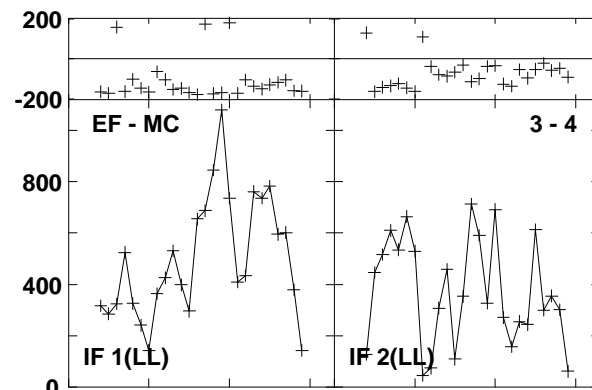
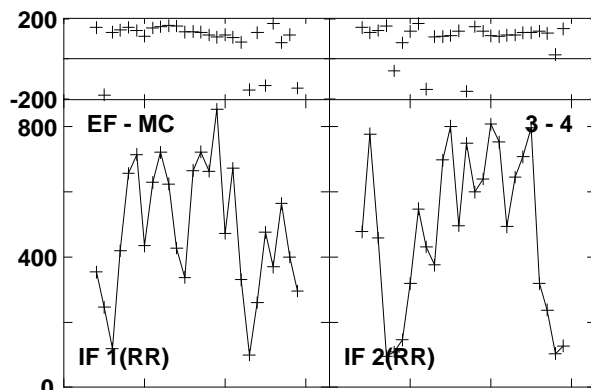
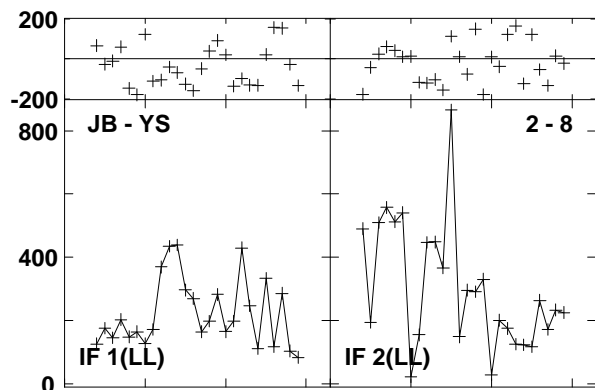
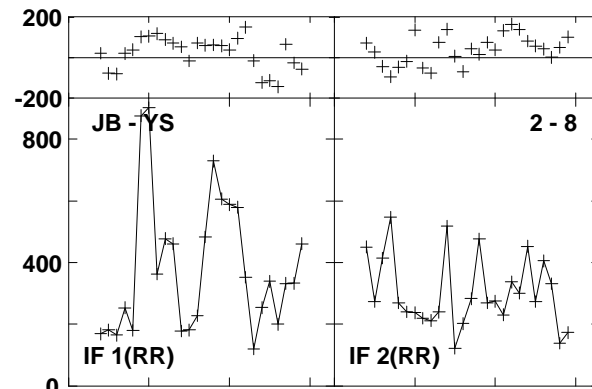
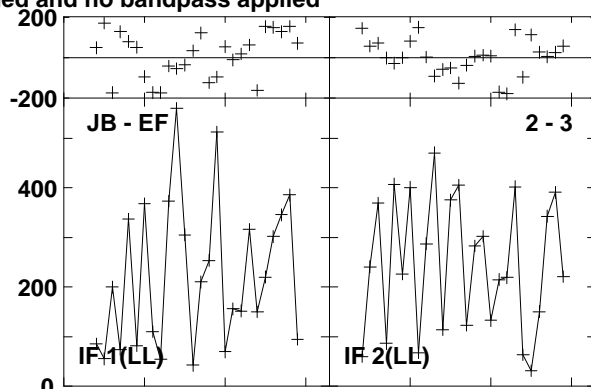
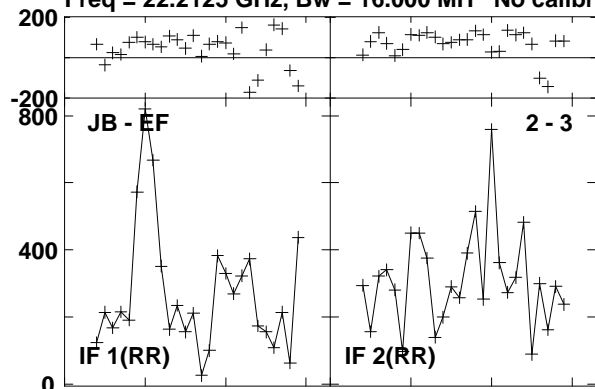

Lower frame: Micro Ampl Jy Top frame: Phas deg  
Vector averaged cross-power spectrum Baseline: JB (02) - EF (03)  
Timerange: 00/12:46:30 to 00/12:46:49

Plot file version 380 created 23-AUG-2016 15:00:55

0219+628 GA035B 1.UVDATA.1

Freq = 22.2125 GHz, Bw = 16.000 MH No calibration applied and no bandpass applied

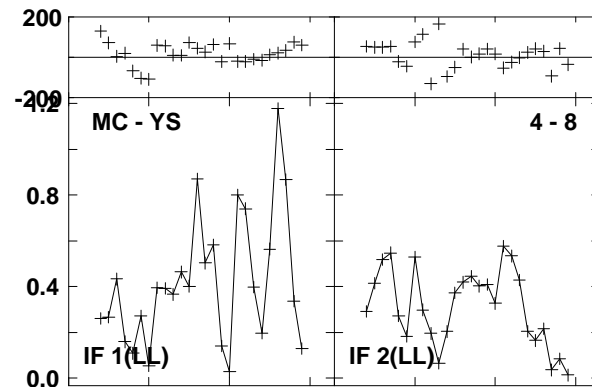
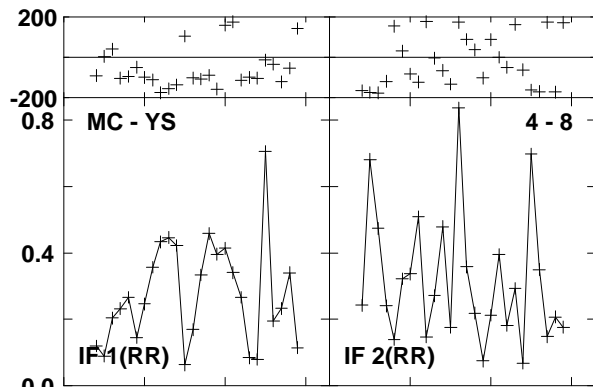
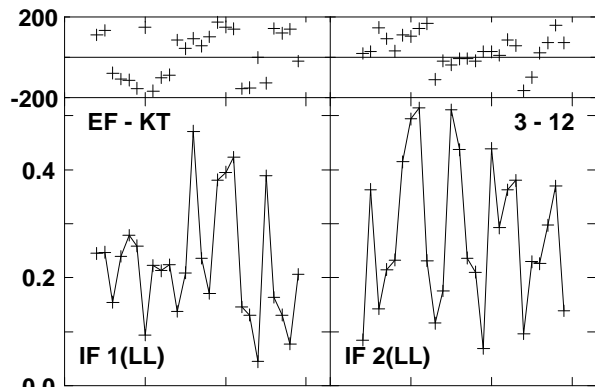
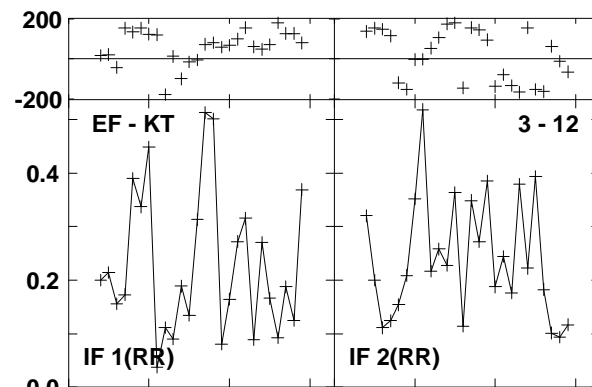
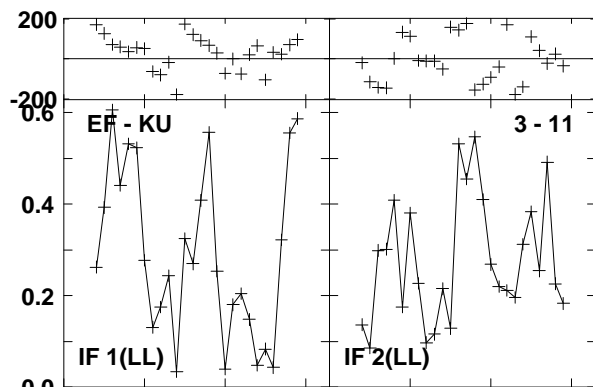
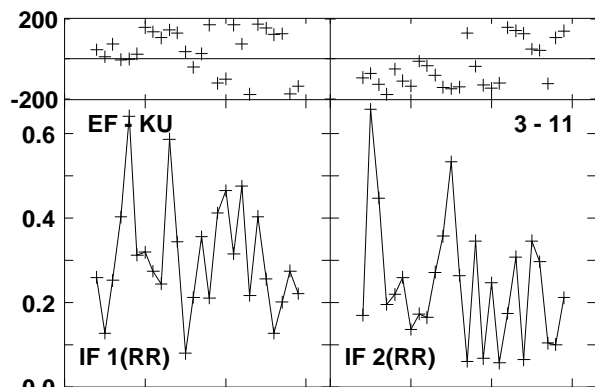
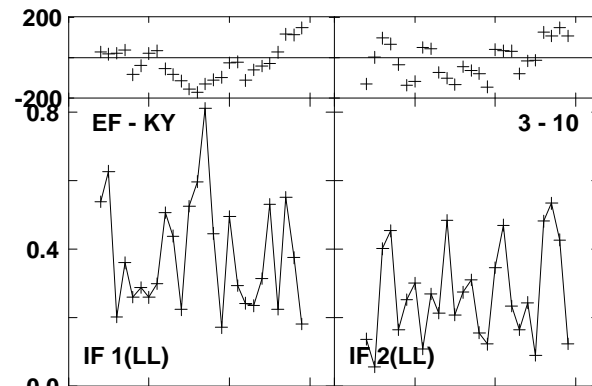
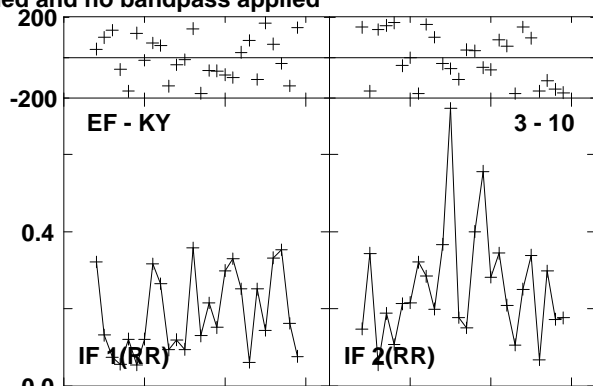
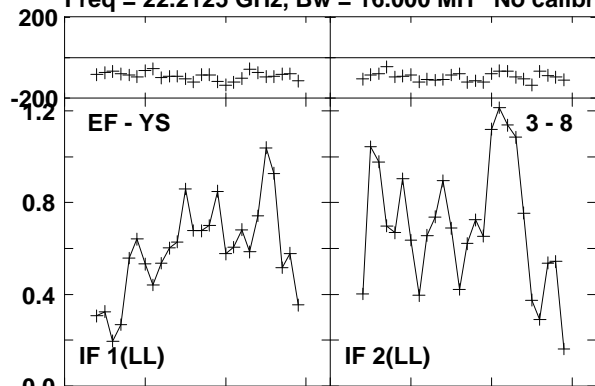

Lower frame: Milli Ampl Jy Top frame: Phas deg  
Vector averaged cross-power spectrum Baseline: EF (03) - YS (08)  
Timerange: 00/12:46:30 to 00/12:46:49

Plot file version 381 created 23-AUG-2016 15:00:55  
0219+628 GA035B 1.UVDATA.1

Freq = 22.2125 GHz, Bw = 16.000 MH No calibration applied and no bandpass applied

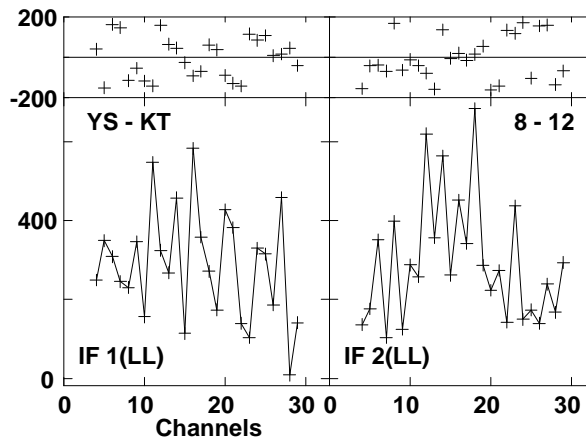
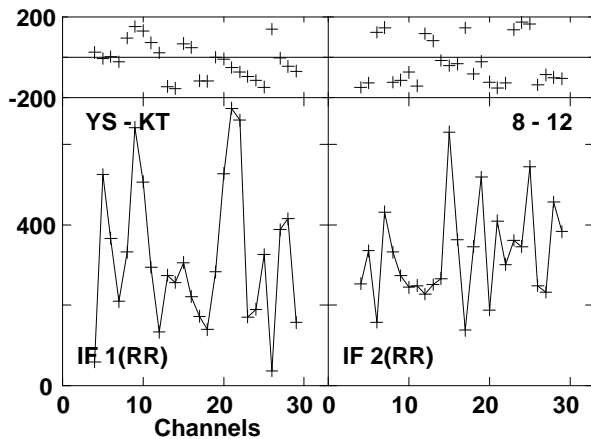
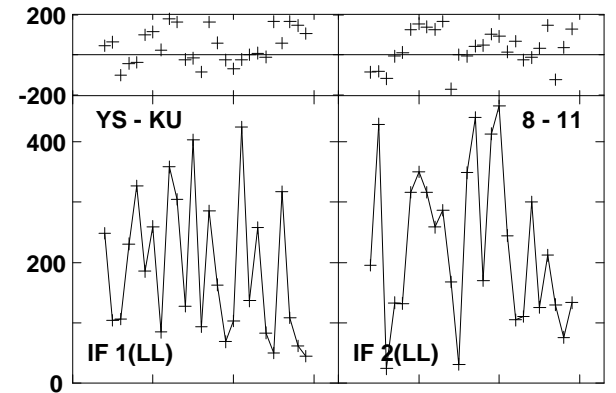
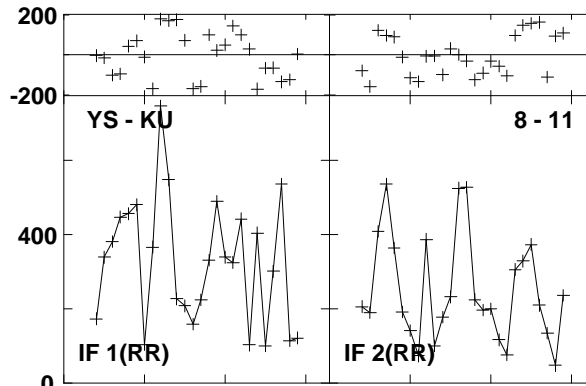
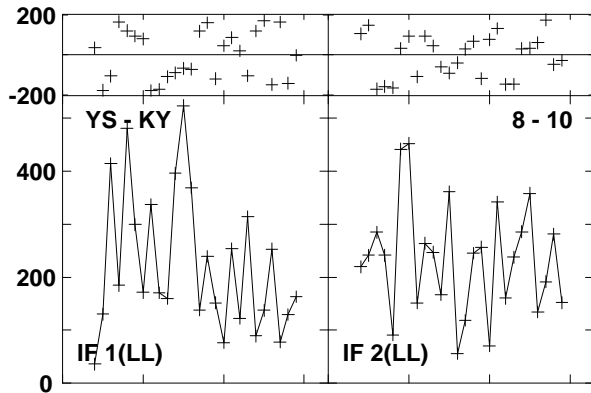
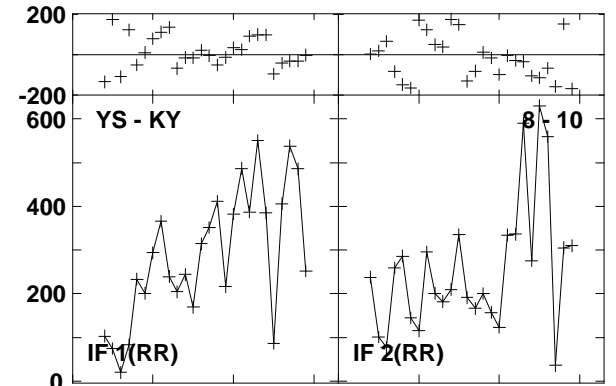
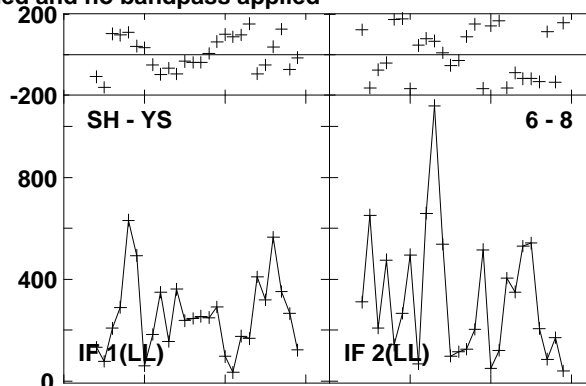
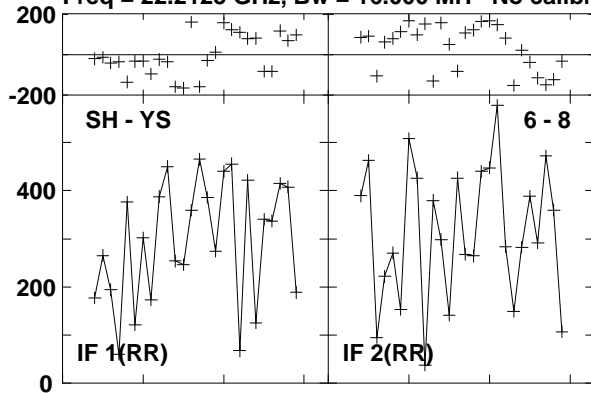

Lower frame: Micro Ampl Jy Top frame: Phas deg  
Vector averaged cross-power spectrum Baseline: SH (06) - YS (08)  
Timerange: 00/12:46:30 to 00/12:46:49

Plot file version 382 created 23-AUG-2016 15:00:55  
 W3IRS5 GA035B 1.UVDATA.1

Freq = 22.2125 GHz, Bw = 16.000 MH No calibration applied and no bandpass applied

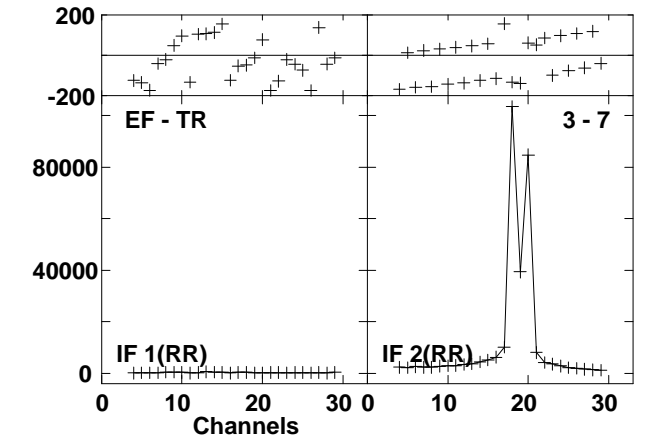
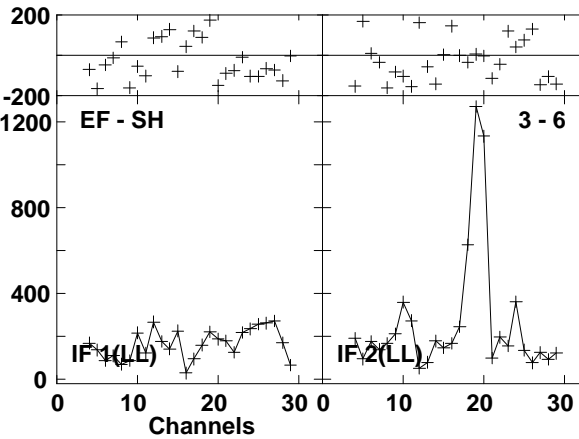
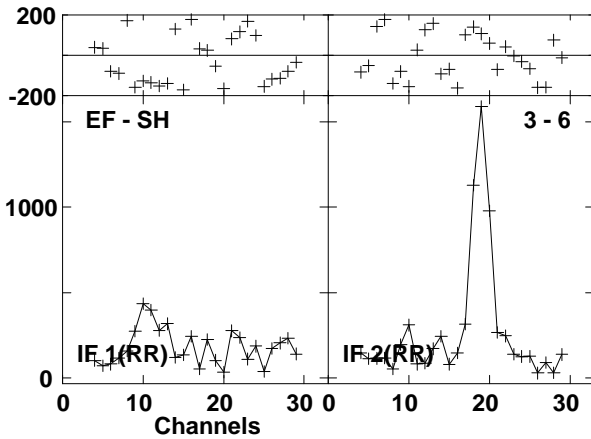
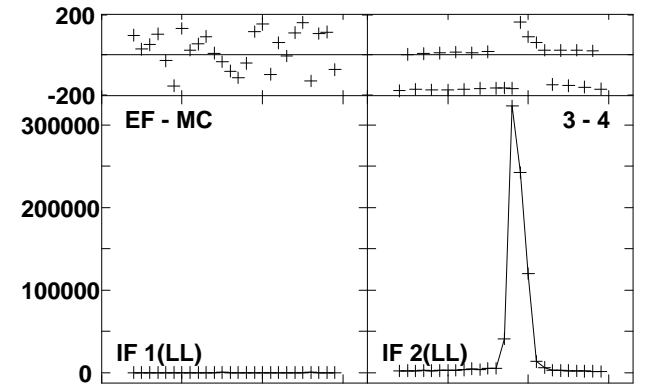
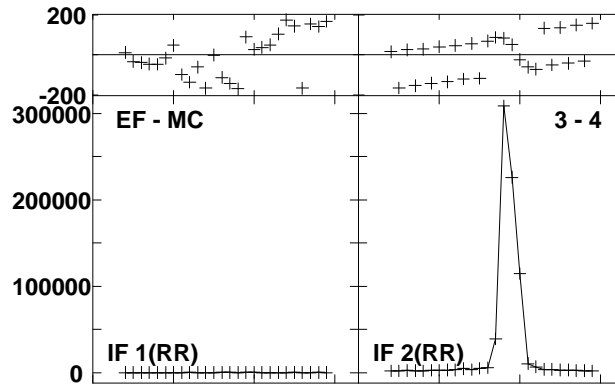
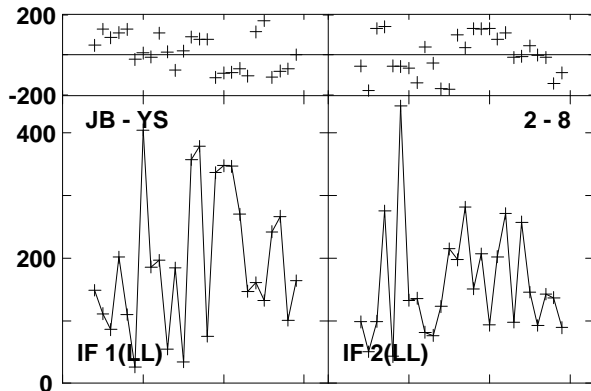
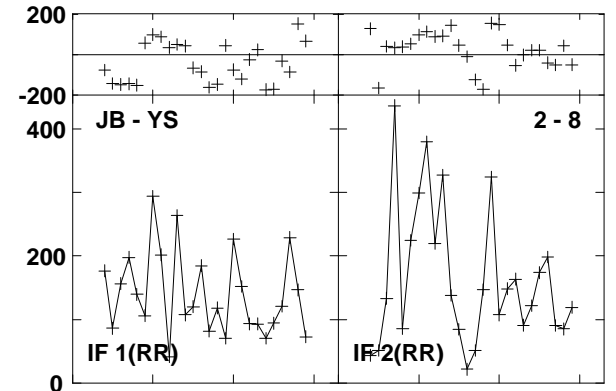
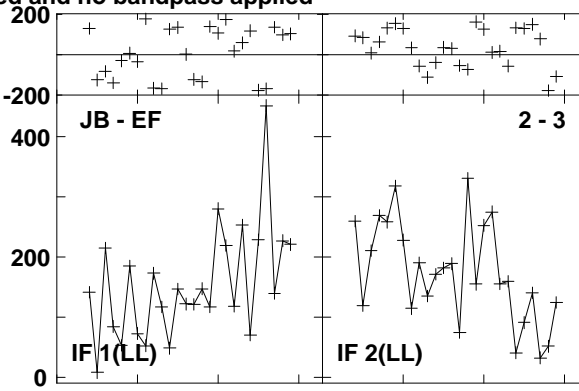
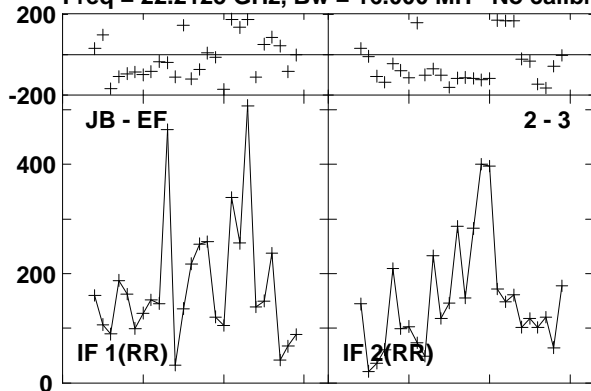

Lower frame: Micro Ampl Jy Top frame: Phas deg  
 Vector averaged cross-power spectrum Baseline: JB (02) - EF (03)  
 Timerange: 00/12:47:20 to 00/12:48:19

Plot file version 383 created 23-AUG-2016 15:00:55

W3IRS5 GA035B 1.UVDATA.1

Freq = 22.2125 GHz, Bw = 16.000 MH No calibration applied and no bandpass applied

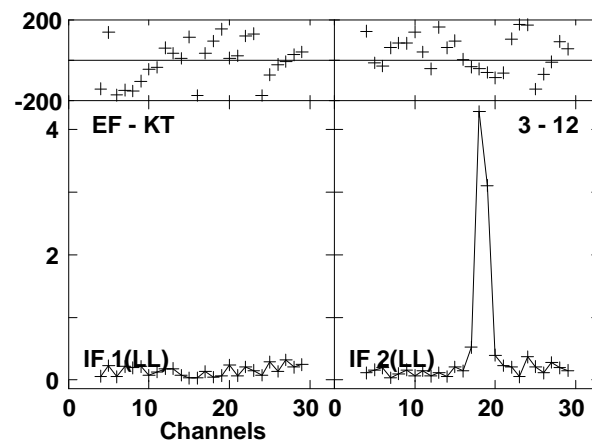
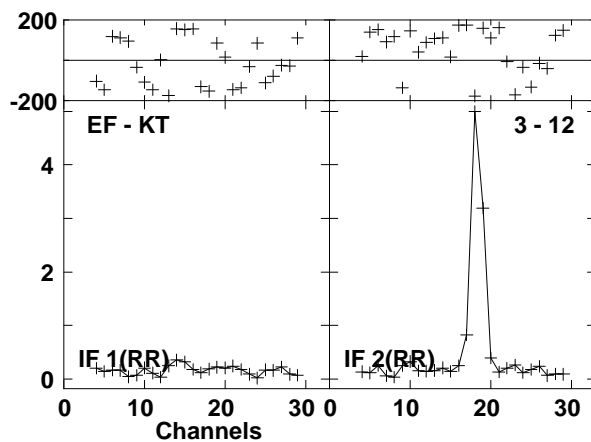
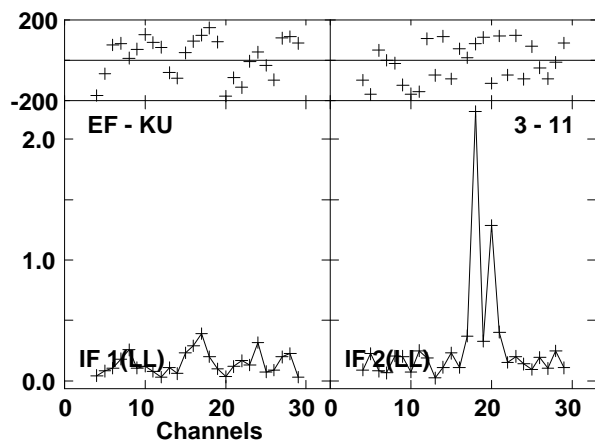
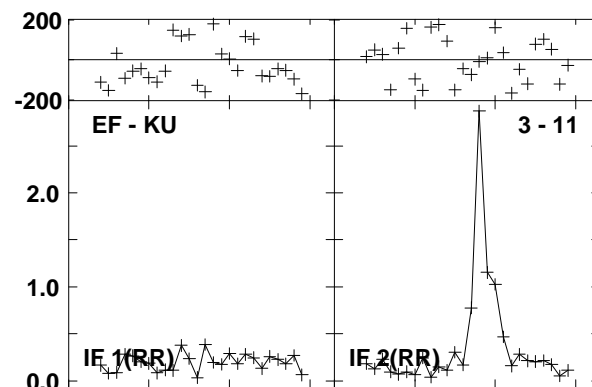
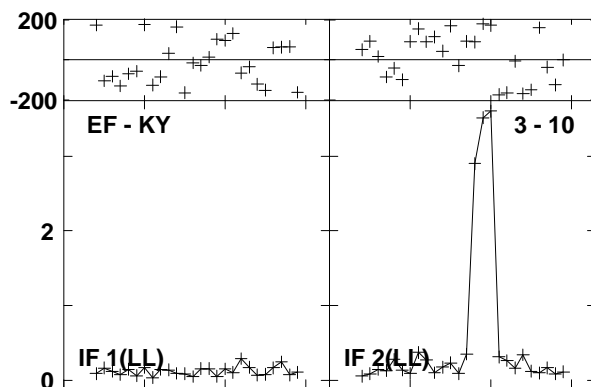
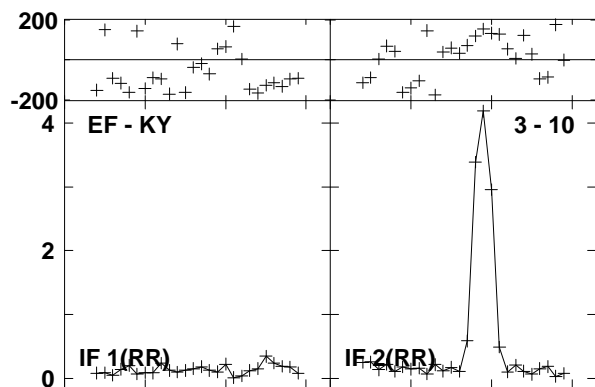
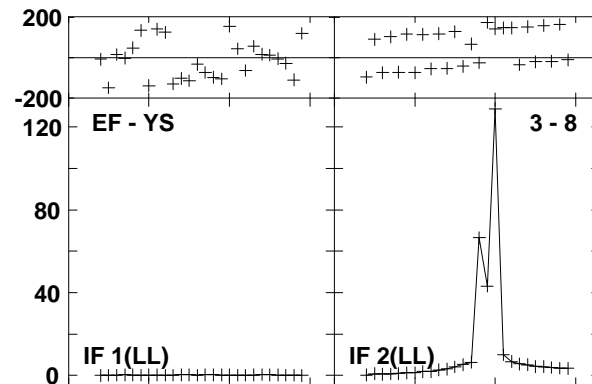
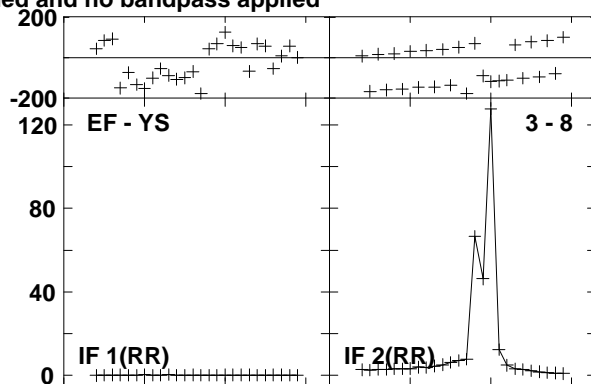
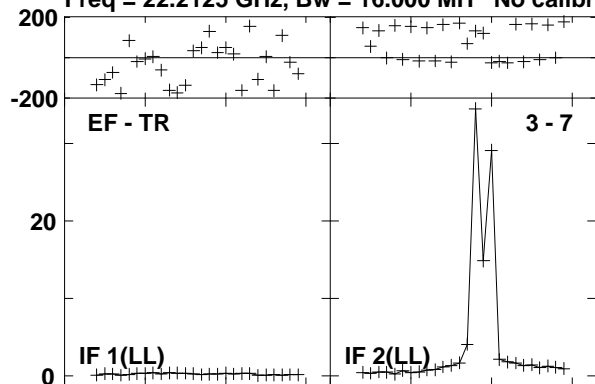

Lower frame: Milli Ampl Jy Top frame: Phas deg  
Vector averaged cross-power spectrum Baseline: EF (03) - TR (07)  
Timerange: 00/12:47:20 to 00/12:48:19

Plot file version 384 created 23-AUG-2016 15:00:55  
W3IRS5 GA035B 1.UVDATA.1

Freq = 22.2125 GHz, Bw = 16.000 MH No calibration applied and no bandpass applied

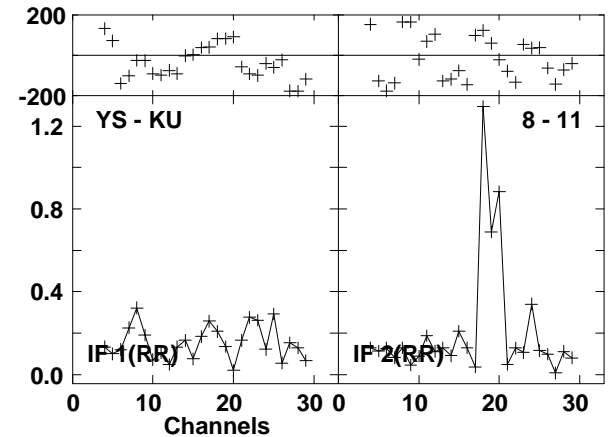
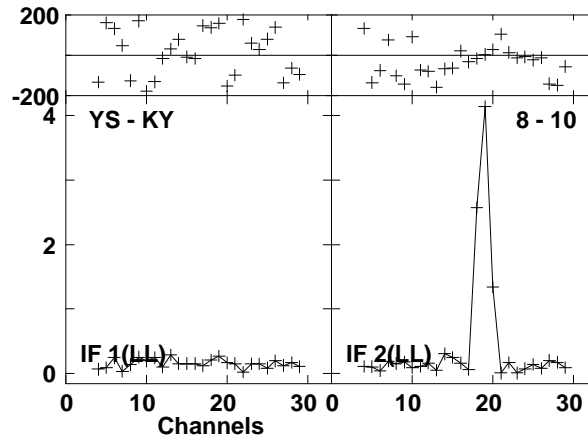
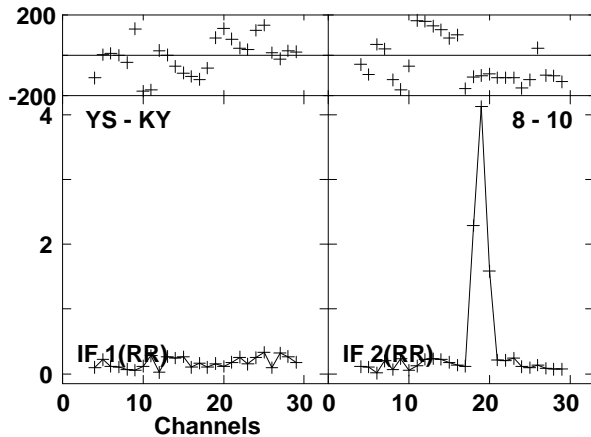
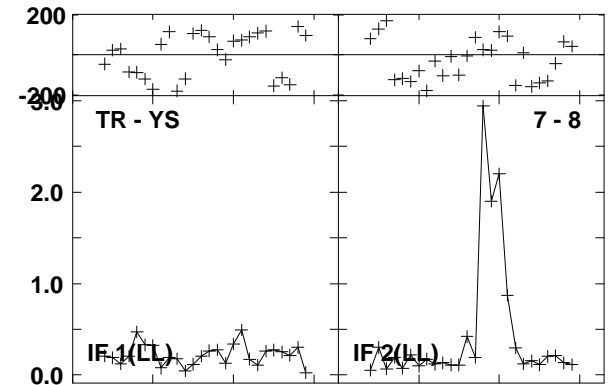
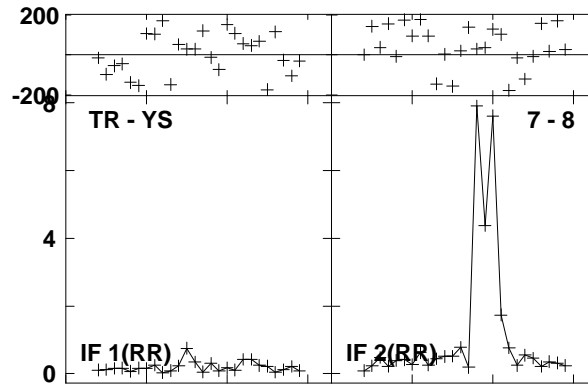
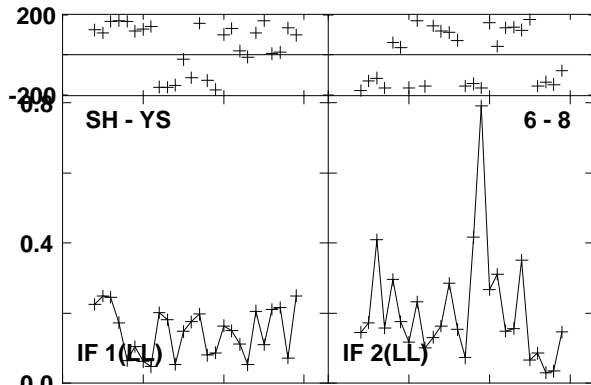
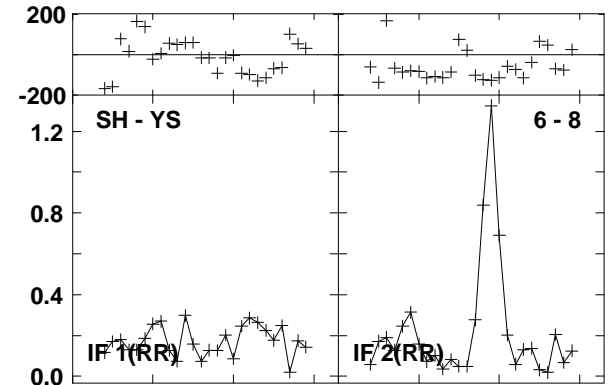
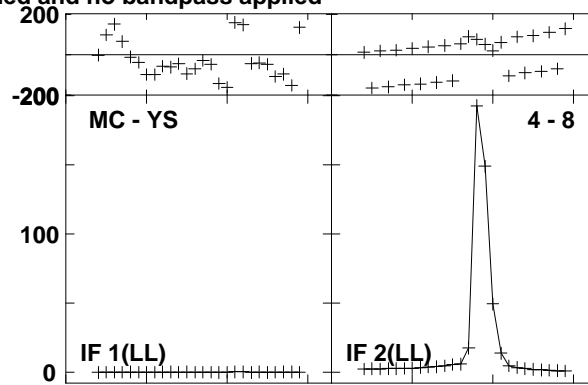
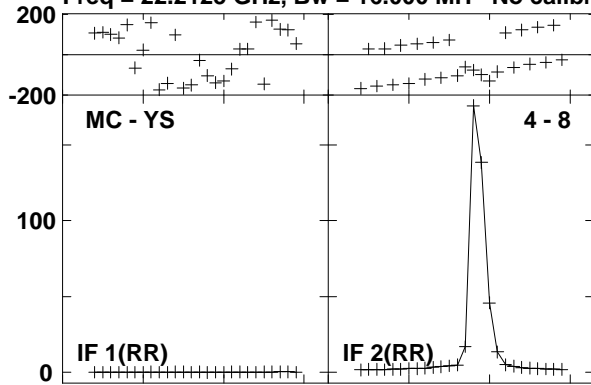

Lower frame: Milli Ampl Jy Top frame: Phas deg  
Vector averaged cross-power spectrum Baseline: MC (04) - YS (08)  
Timerange: 00:12:47:20 to 00:12:48:19



Plot file version 385 created 23-AUG-2016 15:00:55

W3IRS5 GA035B 1.UVDATA.1

Freq = 22.2125 GHz, Bw = 16.000 MH No calibration applied and no bandpass applied

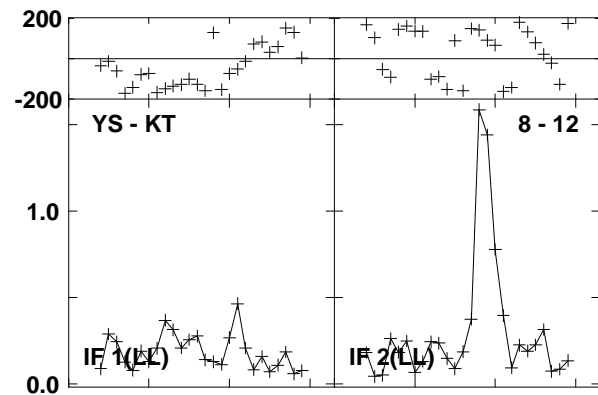
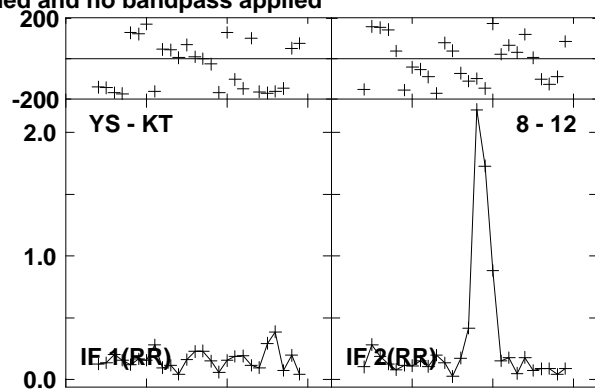
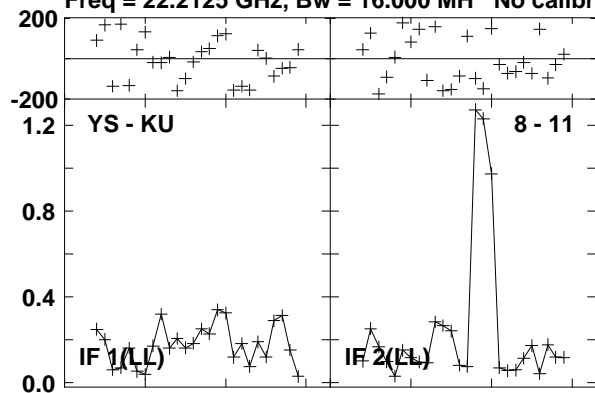

Lower frame: Milli Ampl Jy Top frame: Phas deg  
Vector averaged cross-power spectrum Baseline: YS (08) - KU (11)  
Timerange: 00/12:47:20 to 00/12:48:19

Plot file version 386 created 23-AUG-2016 15:00:55

0219+628 GA035B 1.UVDATA.1

Freq = 22.2125 GHz, Bw = 16.000 MH No calibration applied and no bandpass applied

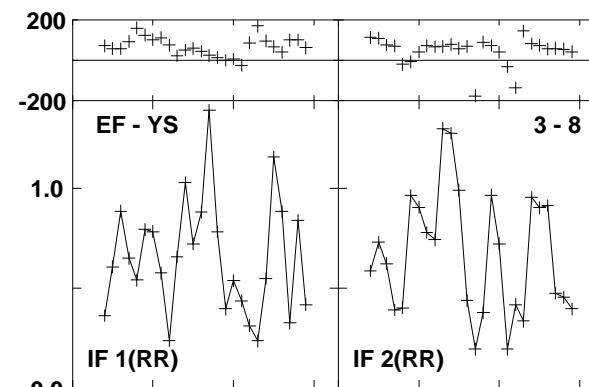
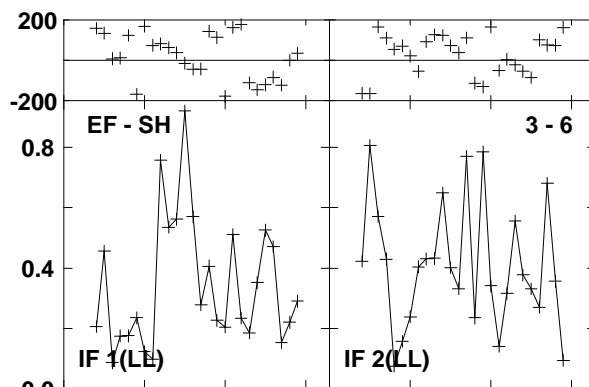
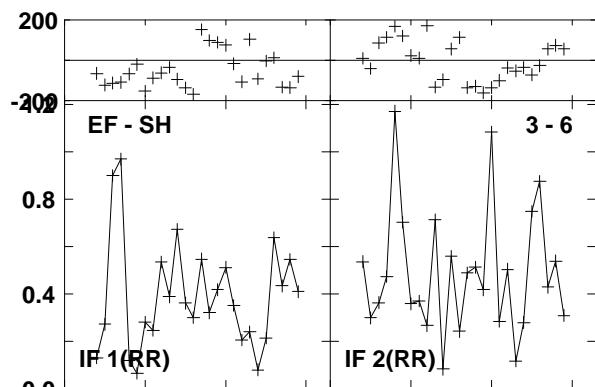
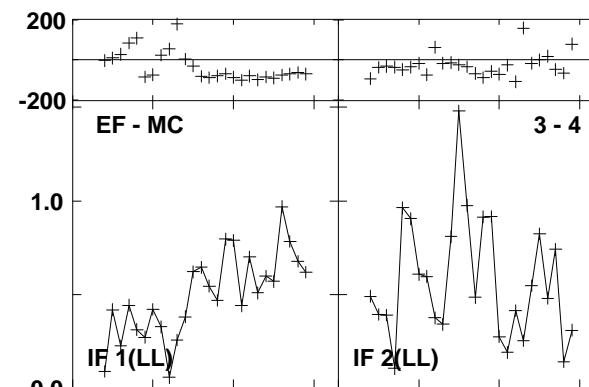
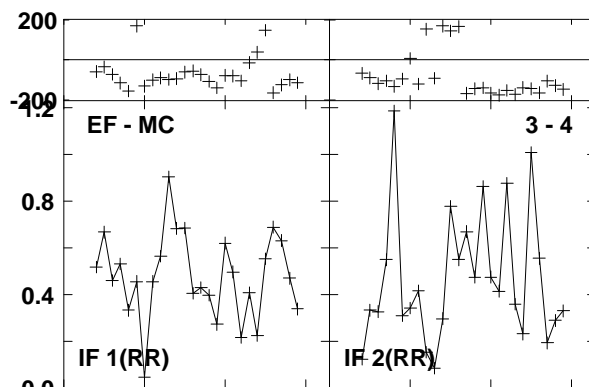
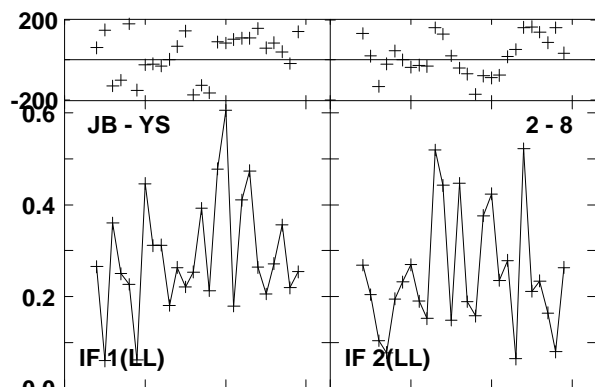
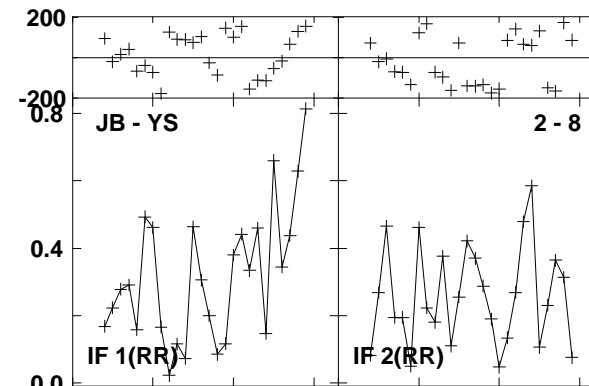
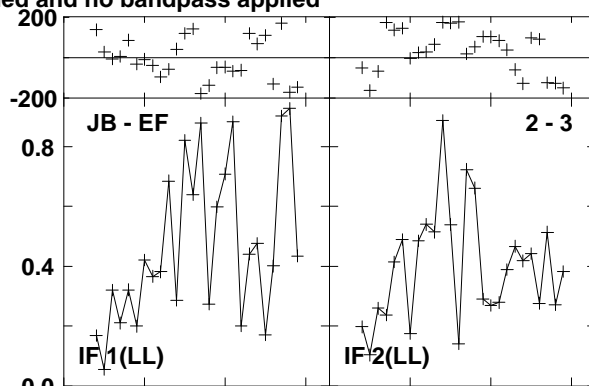
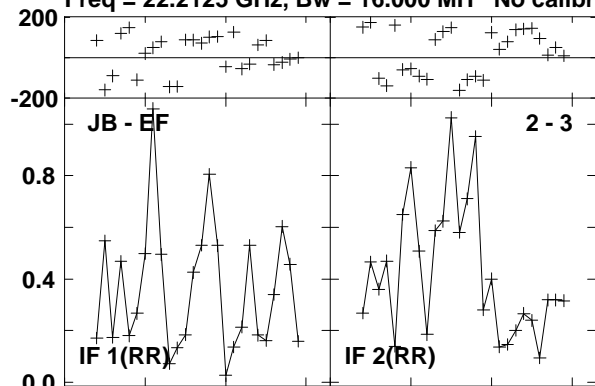

Lower frame: Milli Ampl Jy Top frame: Phas deg  
Vector averaged cross-power spectrum Baseline: JB (02) - EF (03)  
Timerange: 00/12:48:51 to 00/12:49:09

Plot file version 387 created 23-AUG-2016 15:00:55  
0219+628 GA035B 1.UVDATA.1

Freq = 22.2125 GHz, Bw = 16.0000 MH No calibration applied and no bandpass applied

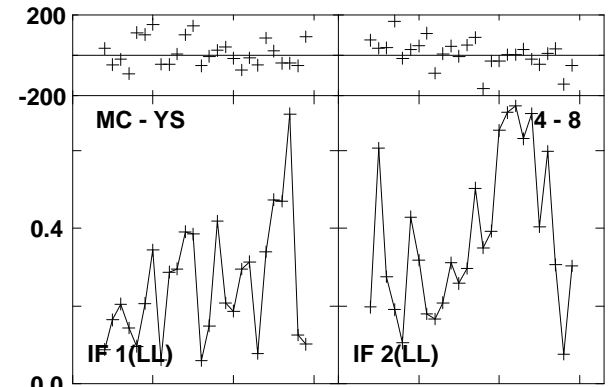
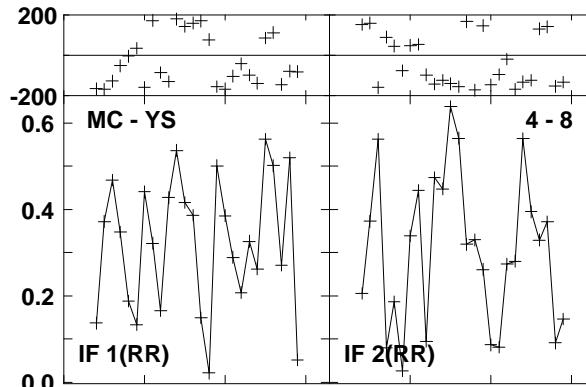
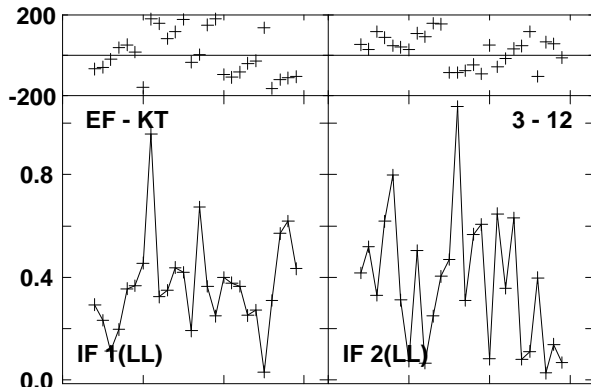
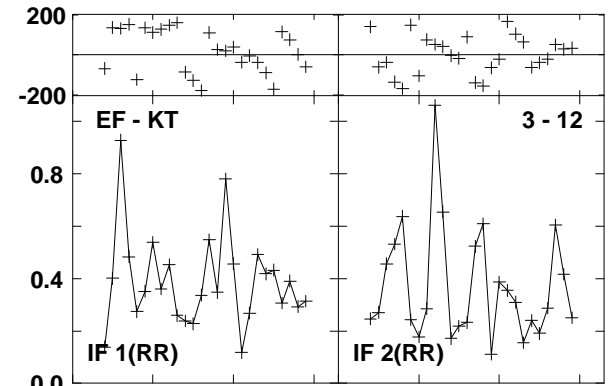
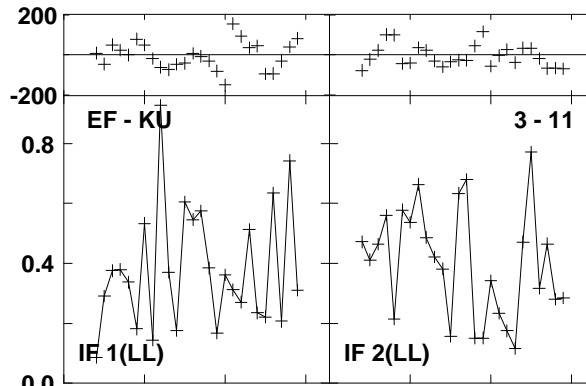
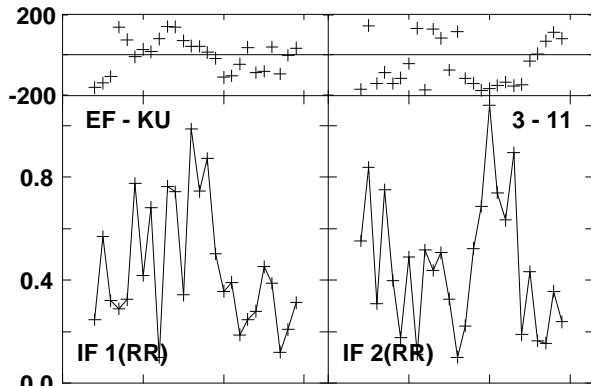
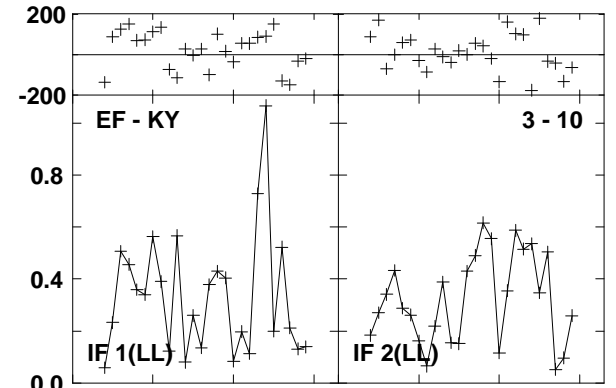
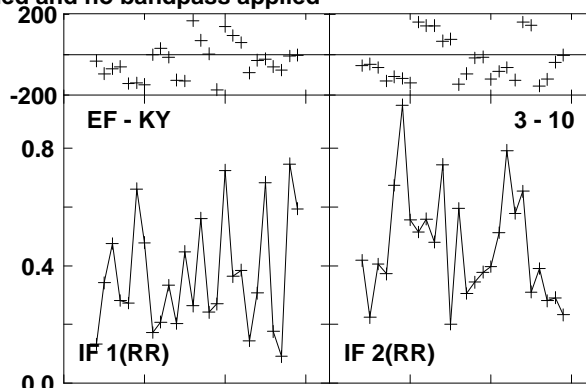
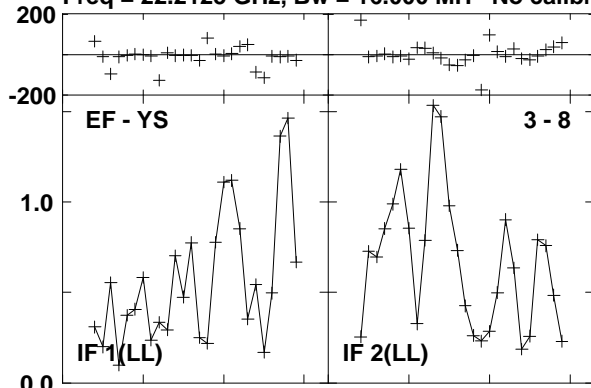

Lower frame: Milli Ampl Jy Top frame: Phas deg  
Vector averaged cross-power spectrum Baseline: EF (03) - YS (08)  
Timerange: 00/12:48:51 to 00/12:49:09

Plot file version 388 created 23-AUG-2016 15:00:55

0219+628 GA035B 1.UVDATA.1

Freq = 22.2125 GHz, Bw = 16.000 MH No calibration applied and no bandpass applied

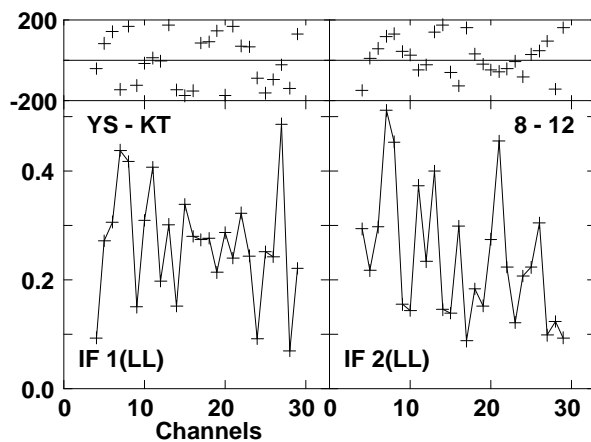
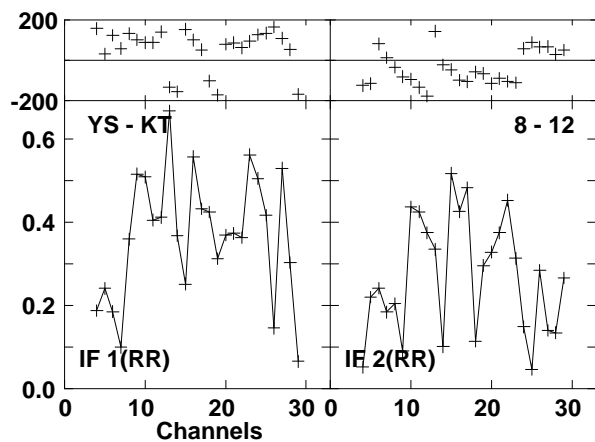
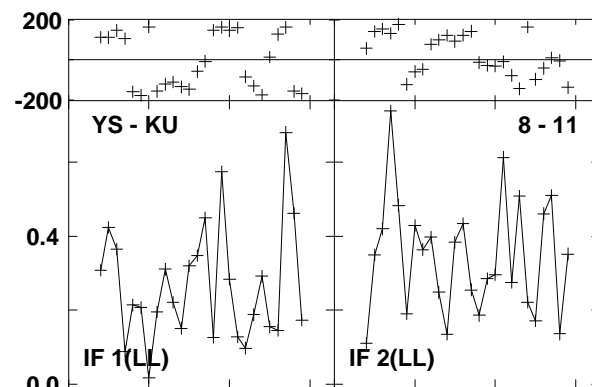
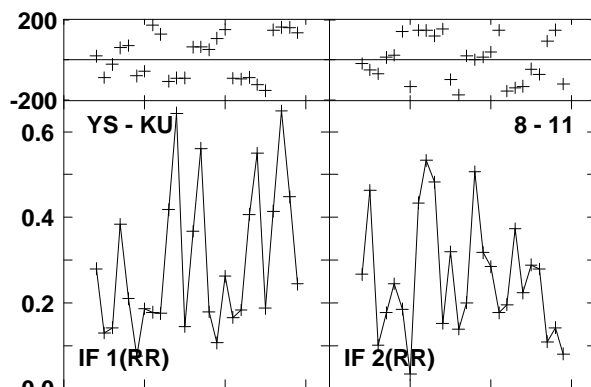
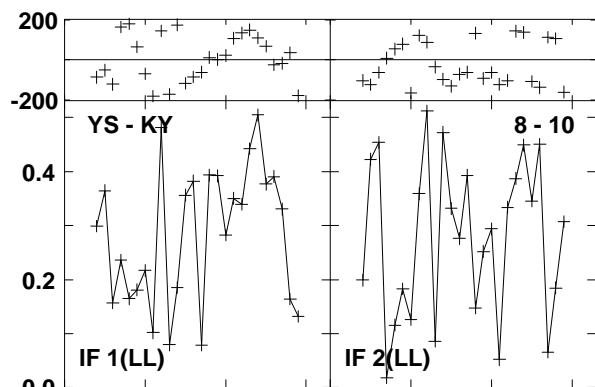
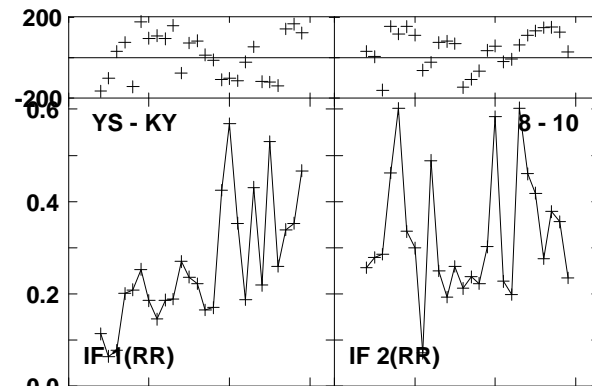
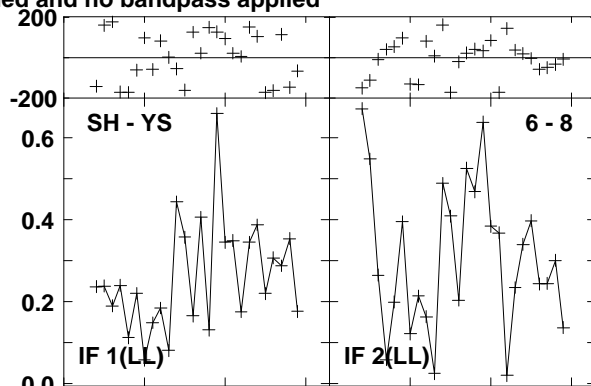
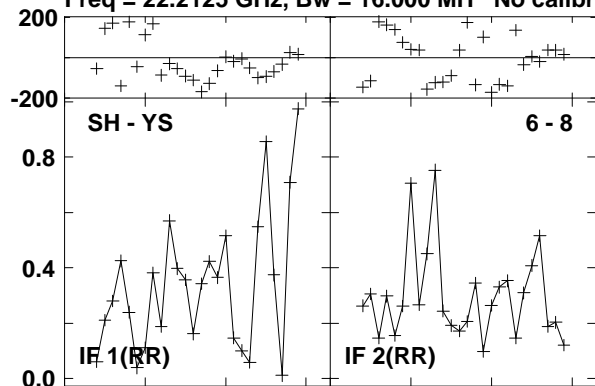

Lower frame: Milli Ampl Jy Top frame: Phas deg

Vector averaged cross-power spectrum Baseline: SH (06) - YS (08)

Timerange: 00/12:48:51 to 00/12:49:09

Plot file version 389 created 23-AUG-2016 15:00:55

W3IRS5 GA035B 1.UVDATA.1

Freq = 22.2125 GHz, Bw = 16.000 MH No calibration applied and no bandpass applied

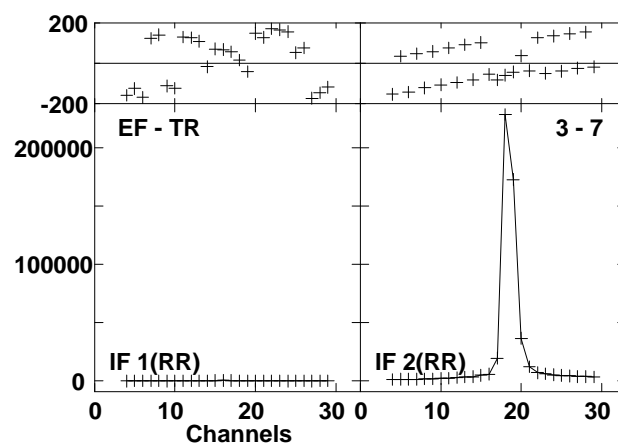
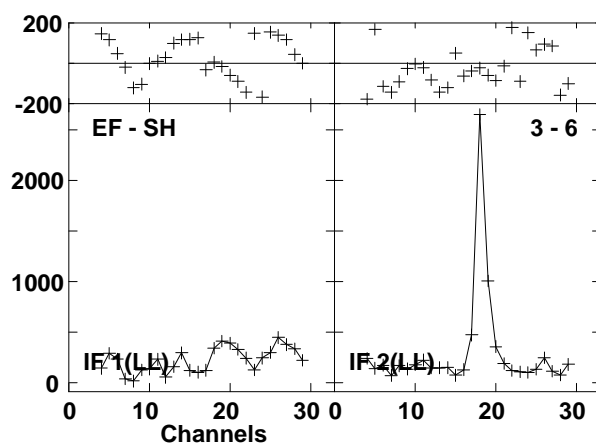
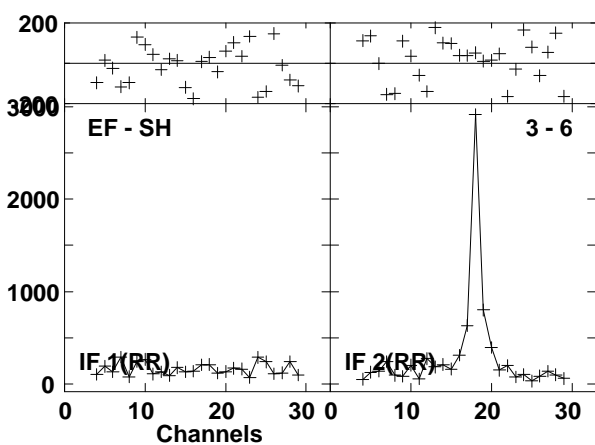
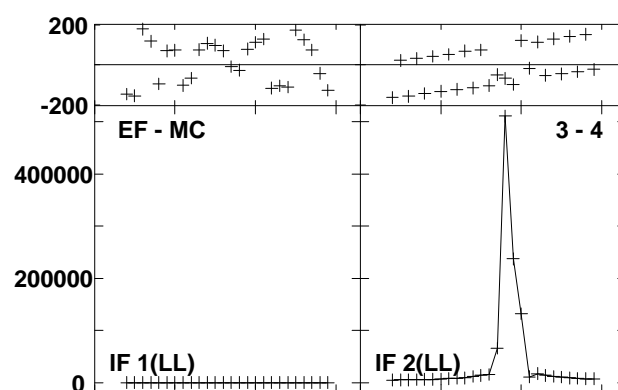
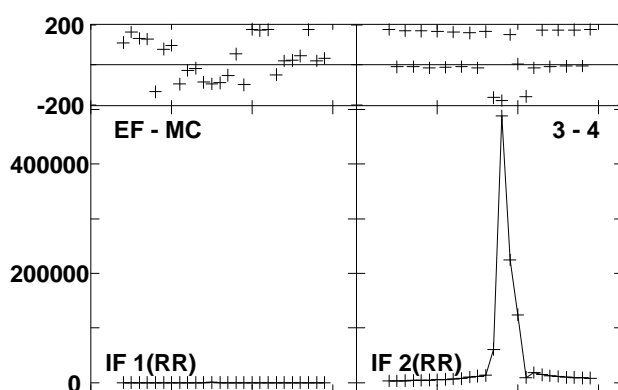
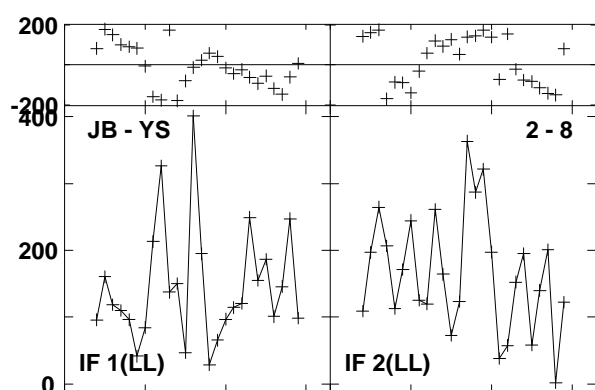
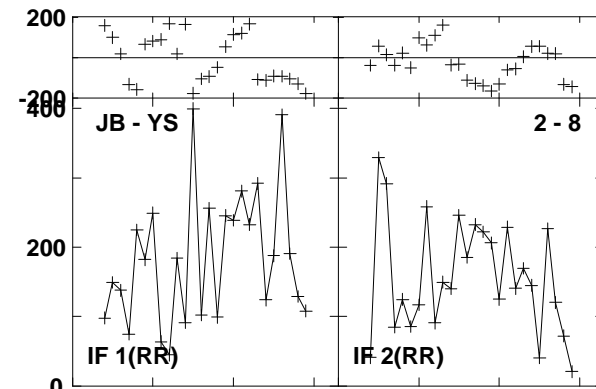
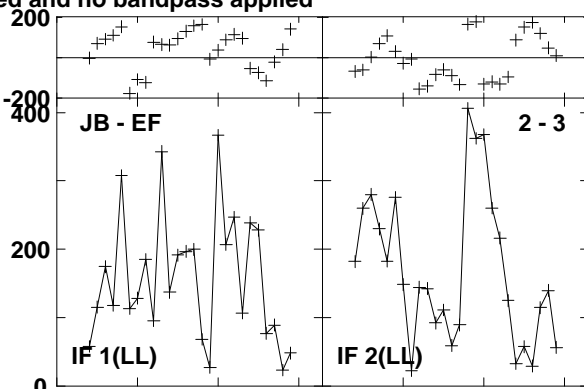
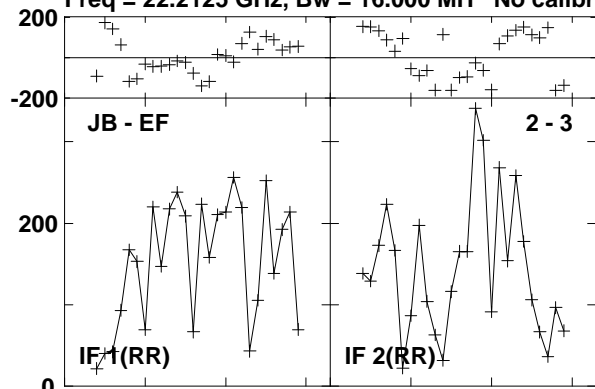

Lower frame: Micro Ampl Jy Top frame: Phas deg  
Vector averaged cross-power spectrum Baseline: JB (02) - EF (03)  
Timerange: 00/12:49:41 to 00/12:50:39

Plot file version 390 created 23-AUG-2016 15:00:56

W3IRS5 GA035B 1.UVDATA.1

Freq = 22.2125 GHz, Bw = 16.000 MH No calibration applied and no bandpass applied

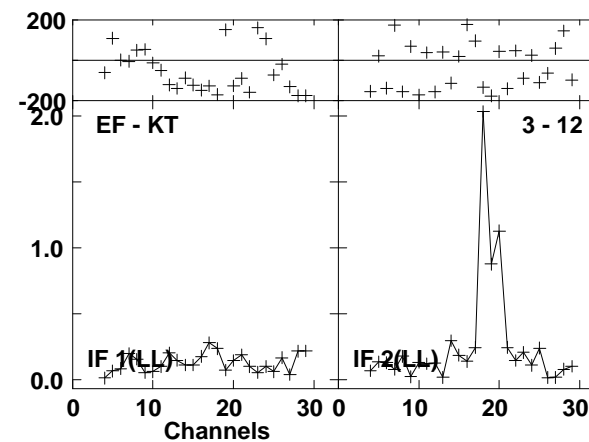
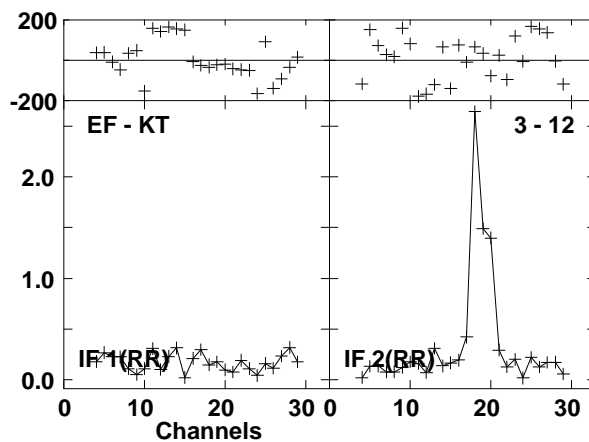
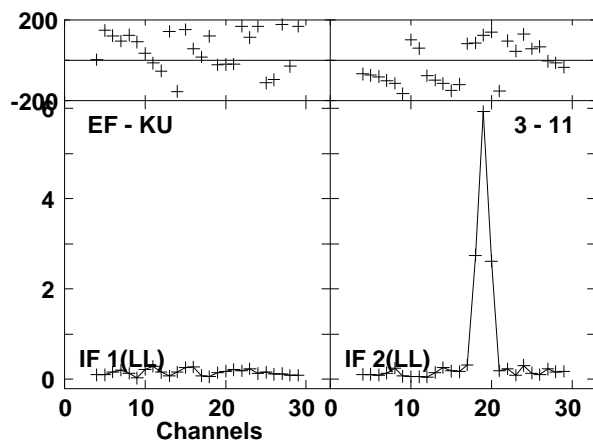
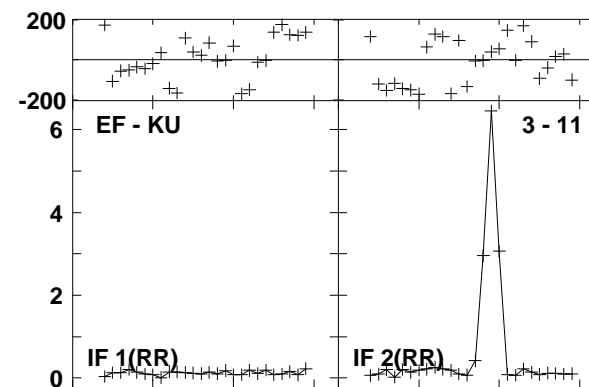
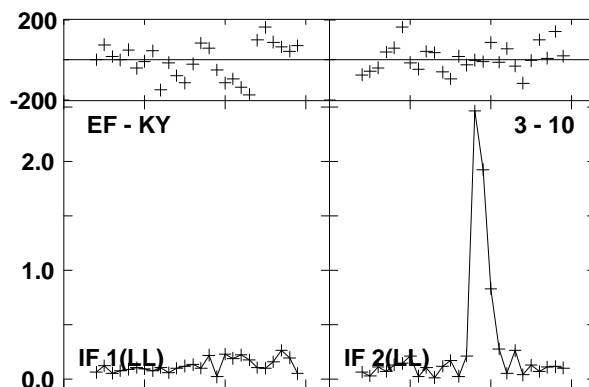
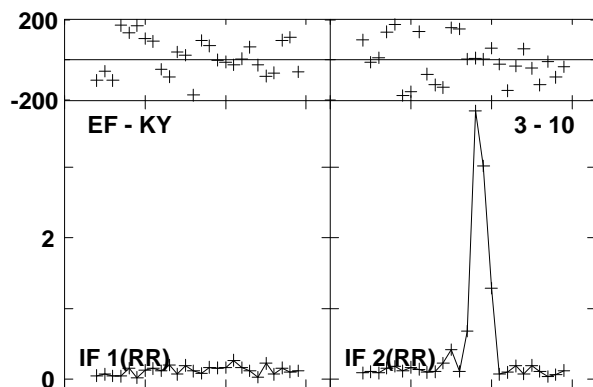
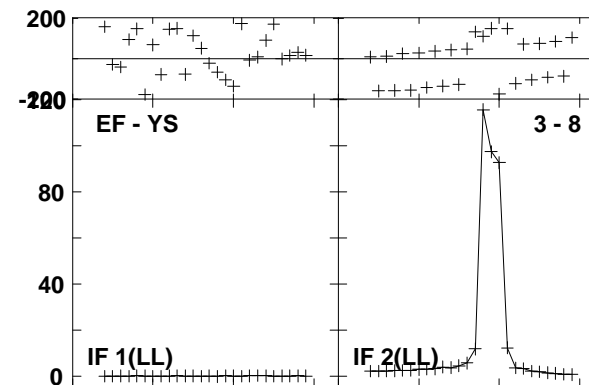
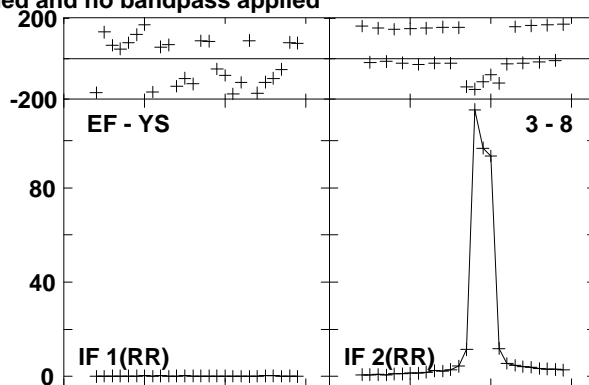
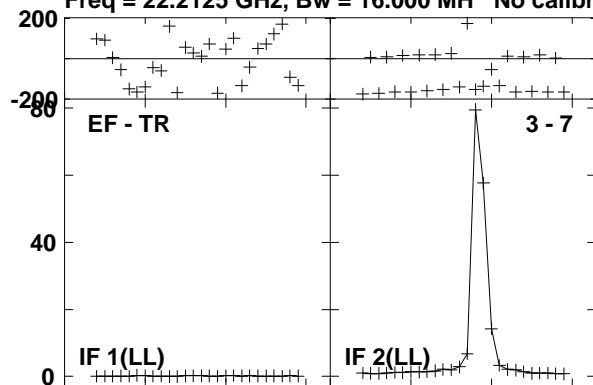

Lower frame: Milli Ampl Jy Top frame: Phas deg

Vector averaged cross-power spectrum Baseline: EF (03) - TR (07)

Timerange: 00/12:49:41 to 00/12:50:39

Plot file version 391 created 23-AUG-2016 15:00:56

W3IRS5 GA035B 1.UVDATA.1

Freq = 22.2125 GHz, Bw = 16.000 MH No calibration applied and no bandpass applied

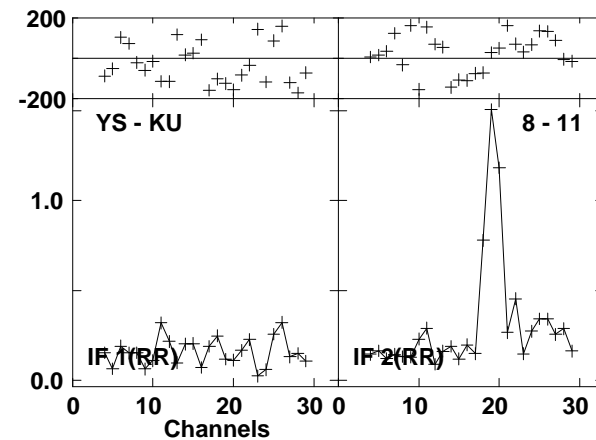
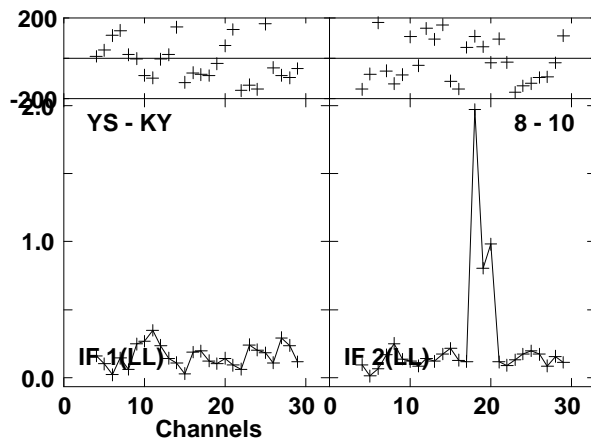
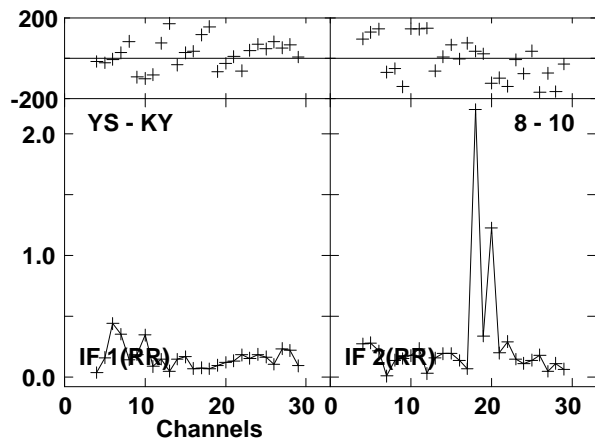
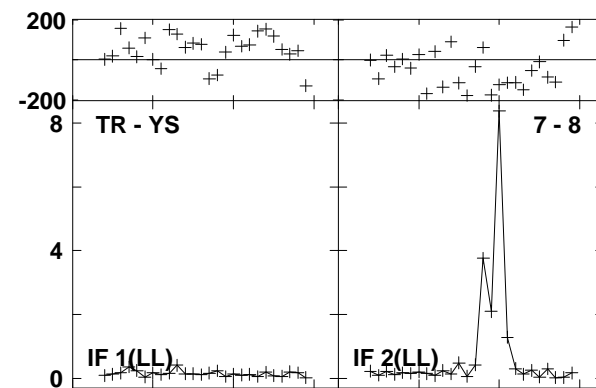
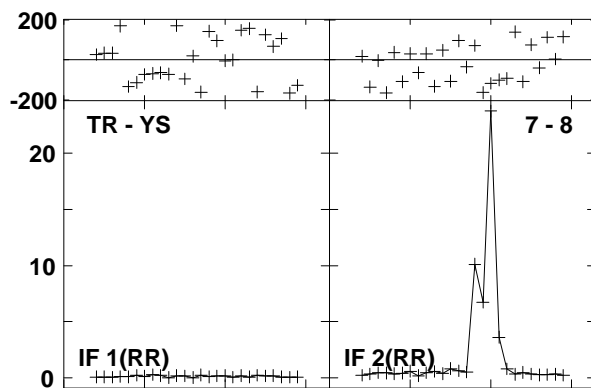
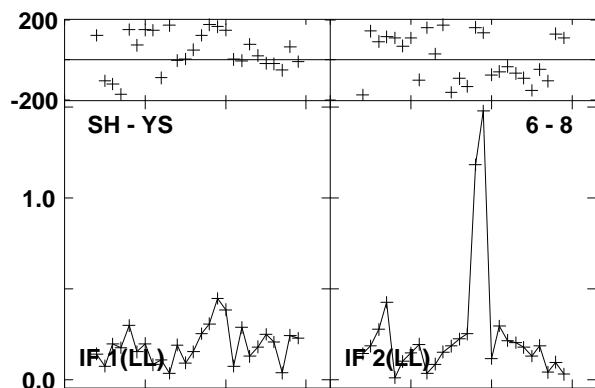
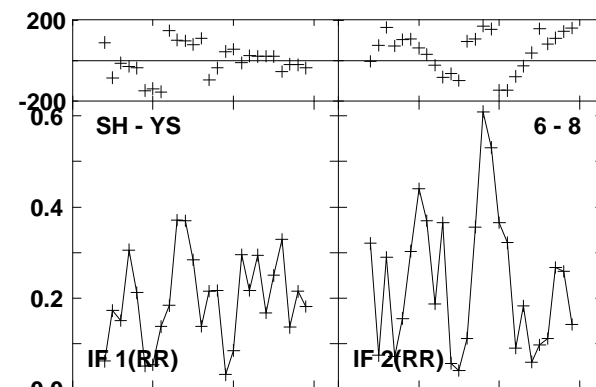
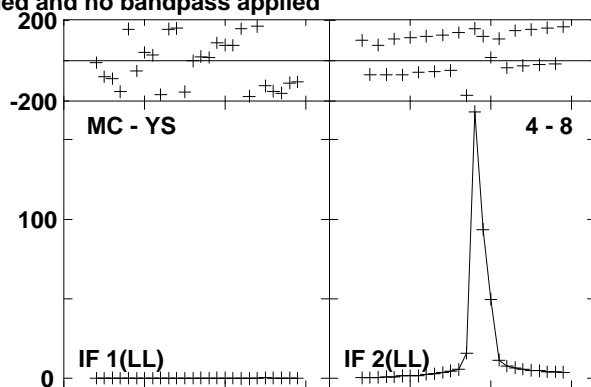
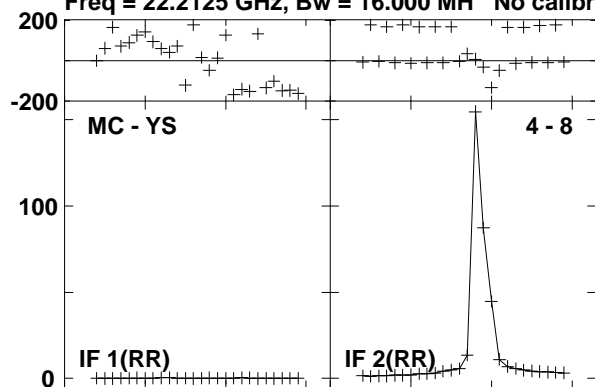

Lower frame: Milli Ampl Jy Top frame: Phas deg

Vector averaged cross-power spectrum Baseline: MC (04) - YS (08)

Timerange: 00/12:49:41 to 00/12:50:39

Plot file version 392 created 23-AUG-2016 15:00:56  
W3IRS5 GA035B 1.UVDATA.1

Freq = 22.2125 GHz, Bw = 16.000 MH No calibration applied and no bandpass applied

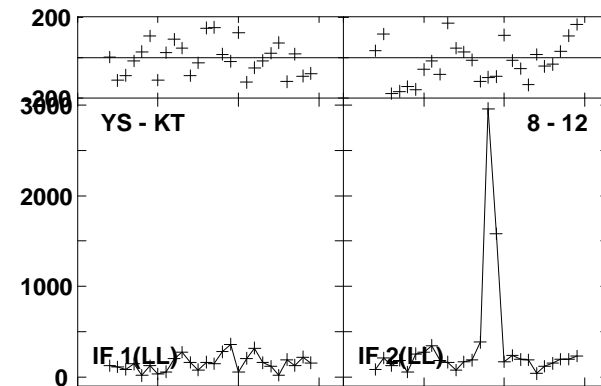
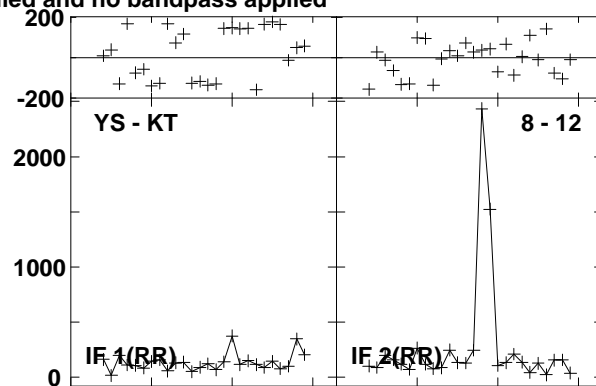
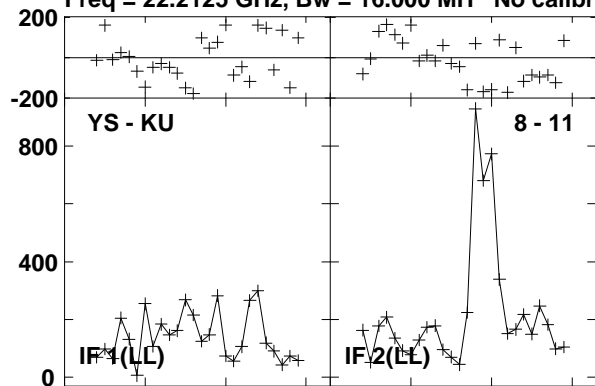

Lower frame: Micro Ampl Jy Top frame: Phas deg  
Vector averaged cross-power spectrum Baseline: YS (08) - KU (11)  
Timerange: 00/12:49:41 to 00/12:50:39



Plot file version 393 created 23-AUG-2016 15:00:56

0219+628 GA035B 1.UVDATA.1

Freq = 22.2125 GHz, Bw = 16.000 MH No calibration applied and no bandpass applied

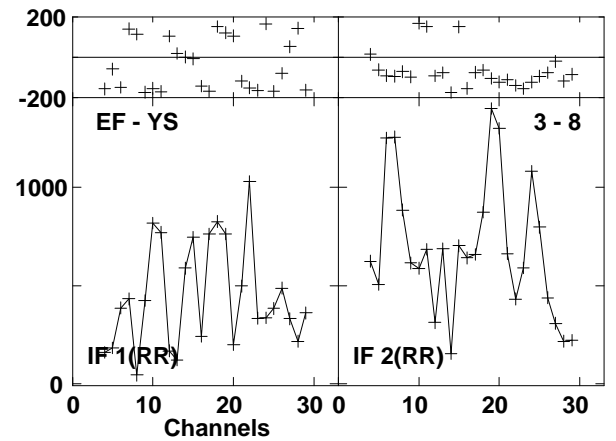
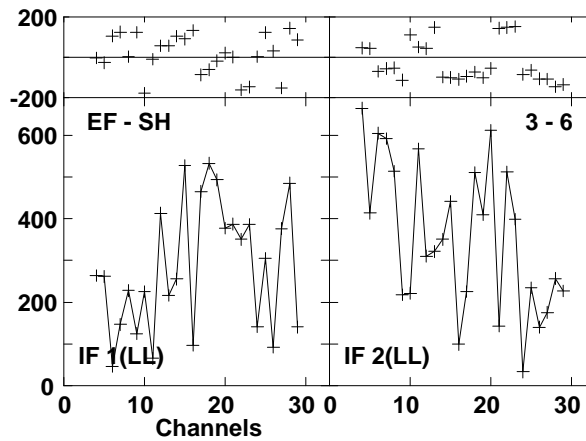
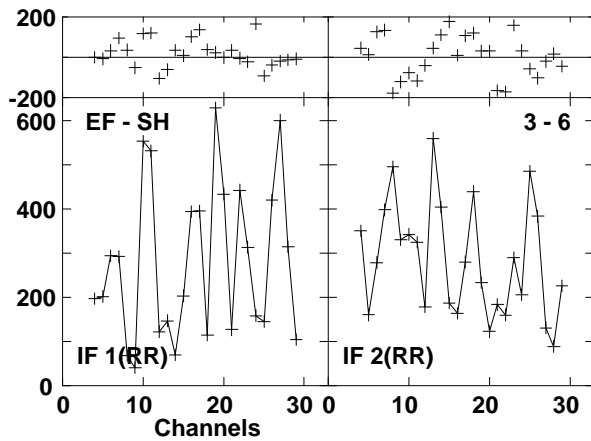
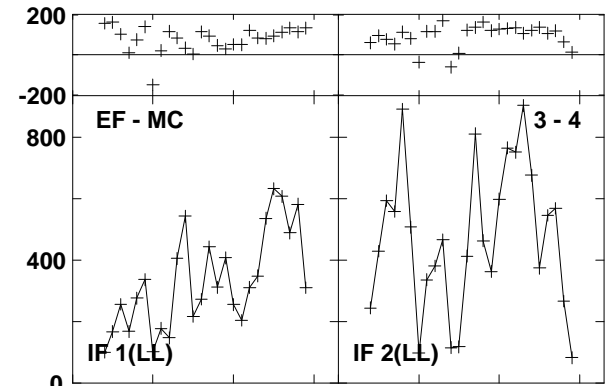
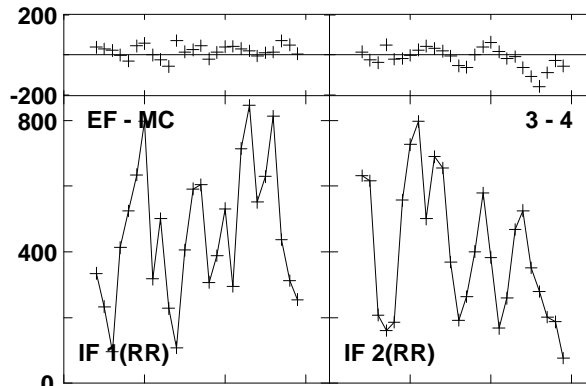
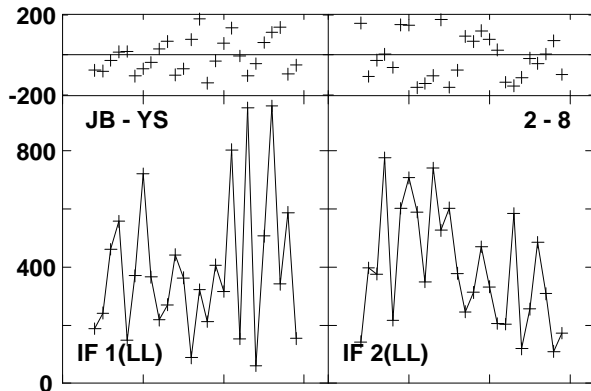
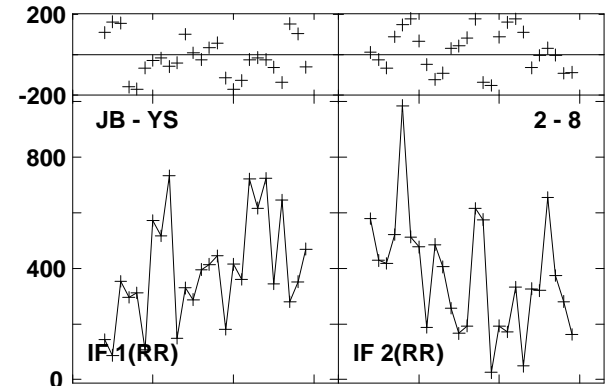
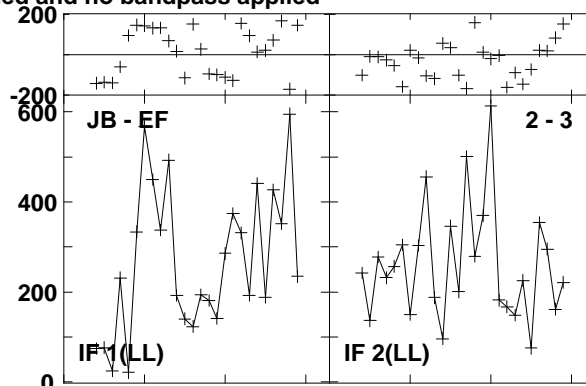
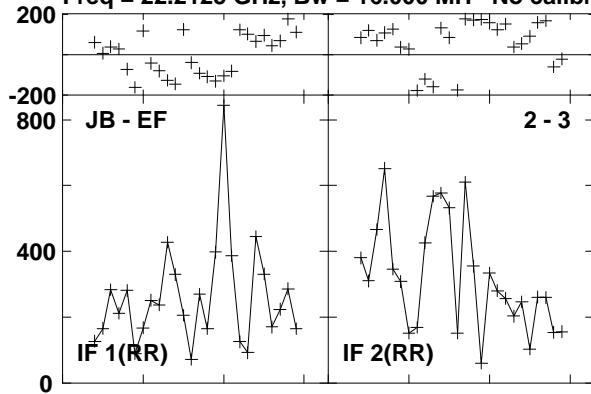

Lower frame: Micro Ampl Jy Top frame: Phas deg  
Vector averaged cross-power spectrum Baseline: JB (02) - EF (03)  
Timerange: 00/12:51:11 to 00/12:51:29

Plot file version 394 created 23-AUG-2016 15:00:56

0219+628 GA035B 1.UVDATA.1

Freq = 22.2125 GHz, Bw = 16.000 MH No calibration applied and no bandpass applied

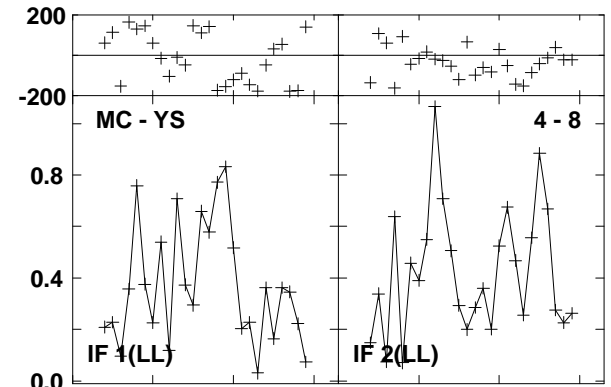
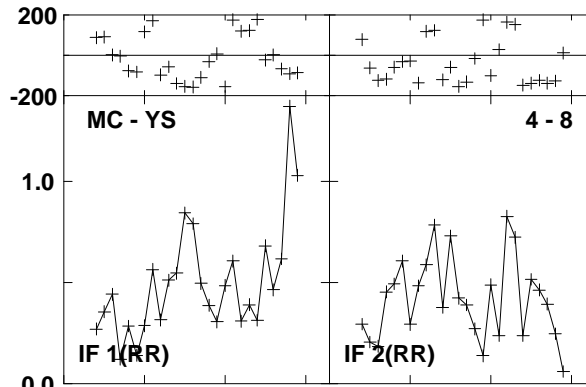
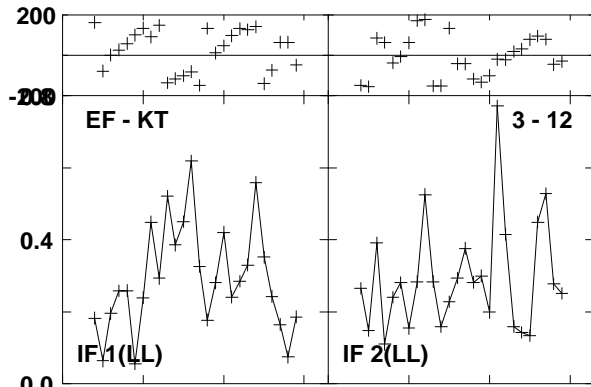
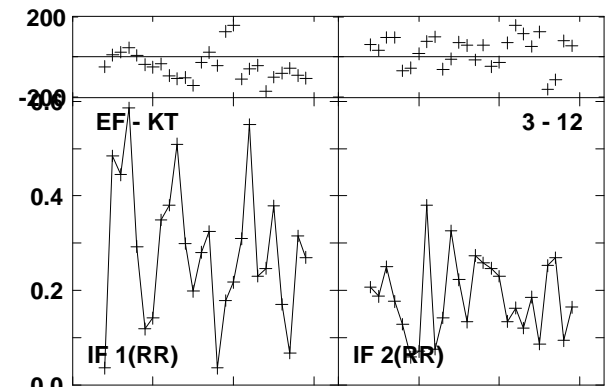
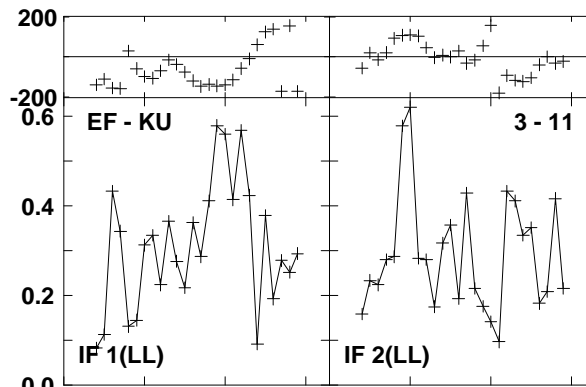
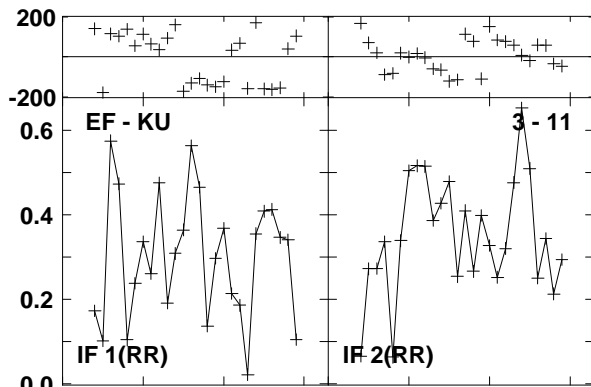
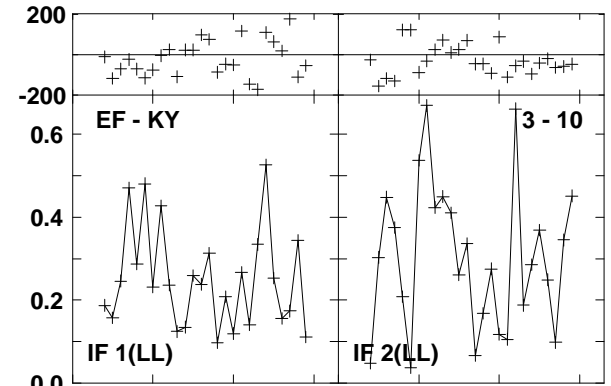
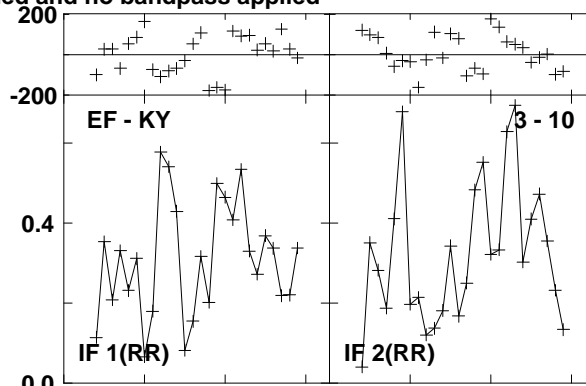
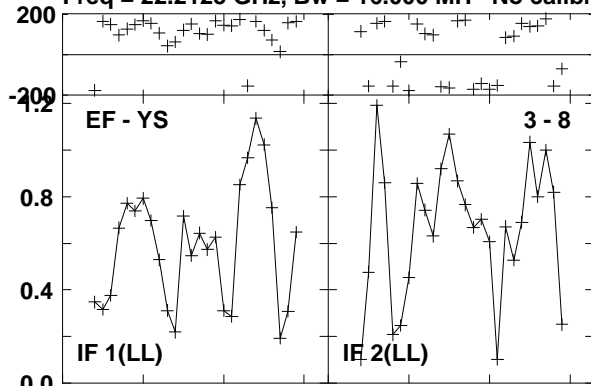

Lower frame: Milli Ampl Jy Top frame: Phas deg  
Vector averaged cross-power spectrum Baseline: EF (03) - YS (08)  
Timerange: 00/12:51:11 to 00/12:51:29

Plot file version 395 created 23-AUG-2016 15:00:56

0219+628 GA035B 1.UVDATA.1

Freq = 22.2125 GHz, Bw = 16.000 MH No calibration applied and no bandpass applied

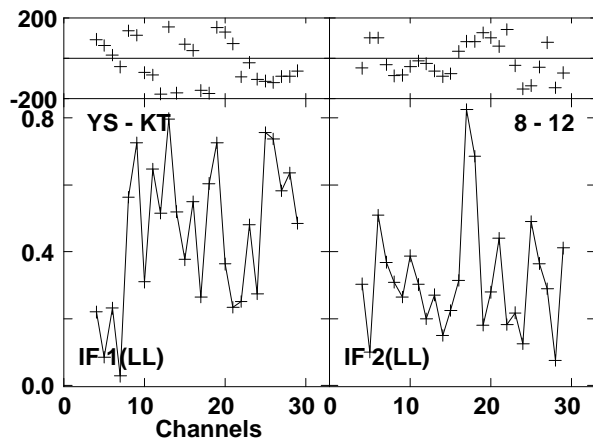
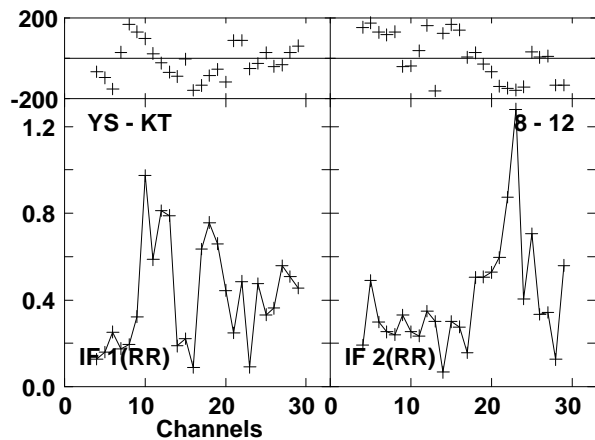
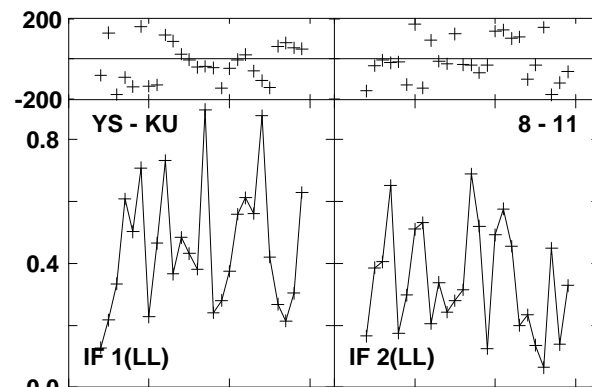
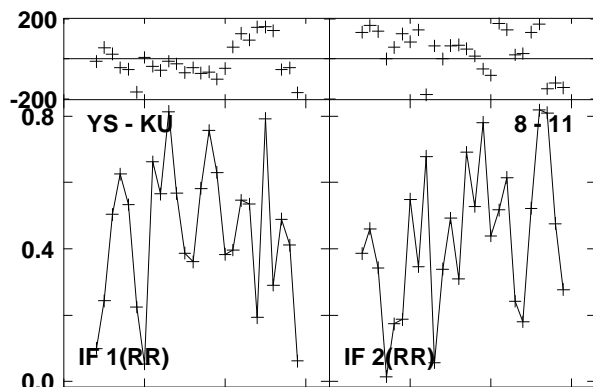
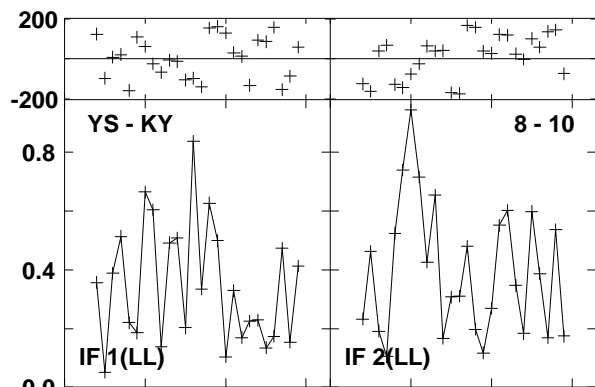
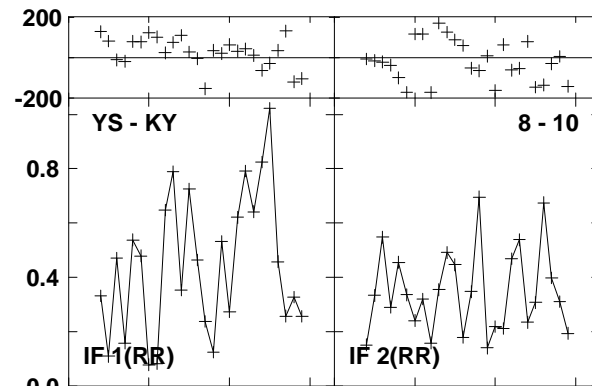
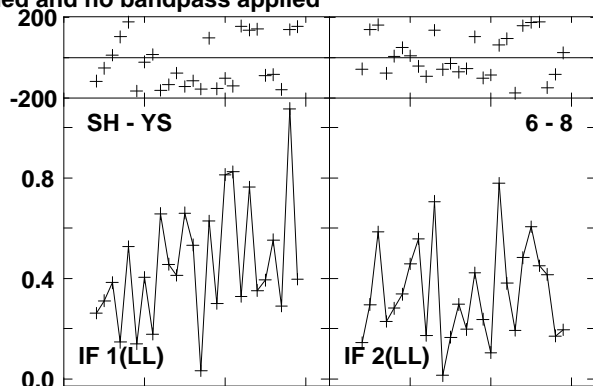
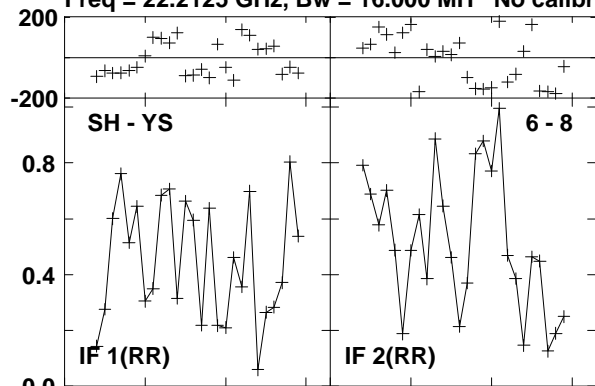

Lower frame: Milli Ampl Jy Top frame: Phas deg

Vector averaged cross-power spectrum Baseline: SH (06) - YS (08)

Timerange: 00:12:51:11 to 00:12:51:29

Plot file version 396 created 23-AUG-2016 15:00:56

W3IRS5 GA035B 1.UVDATA.1

Freq = 22.2125 GHz, Bw = 16.000 MH No calibration applied and no bandpass applied

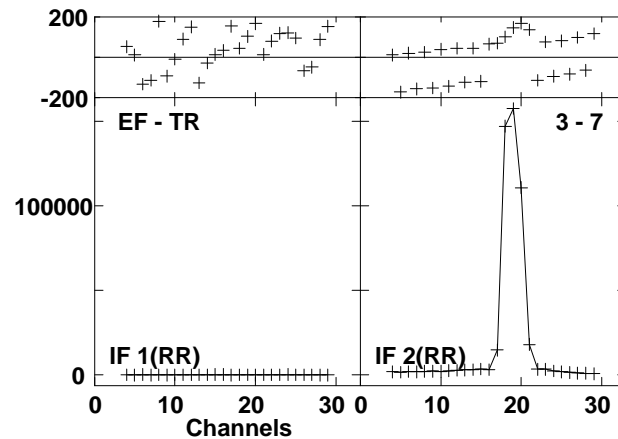
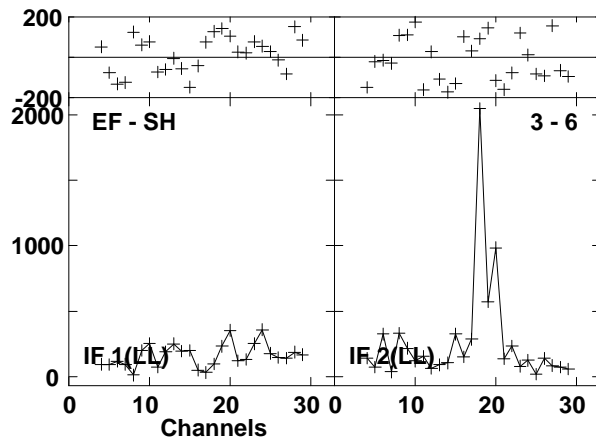
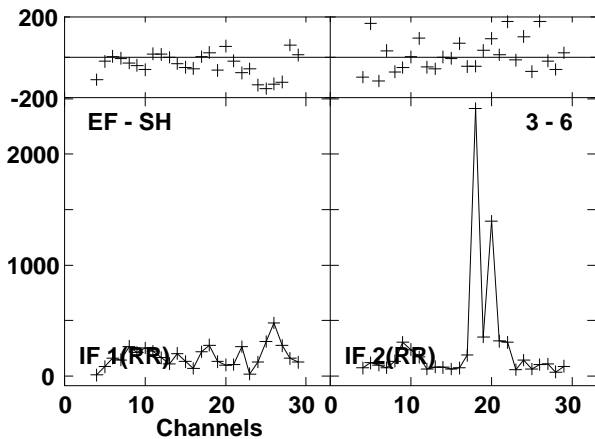
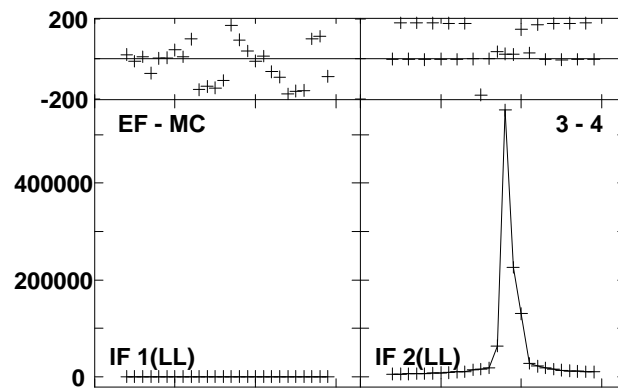
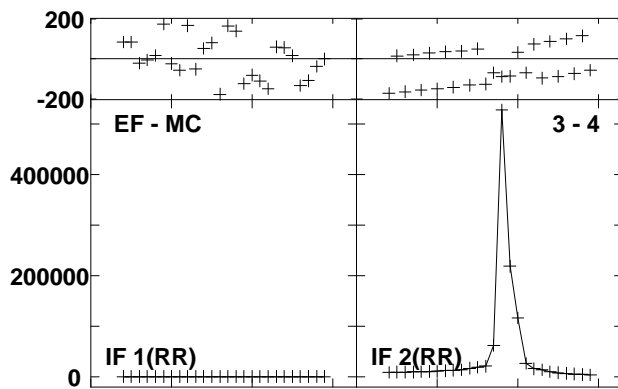
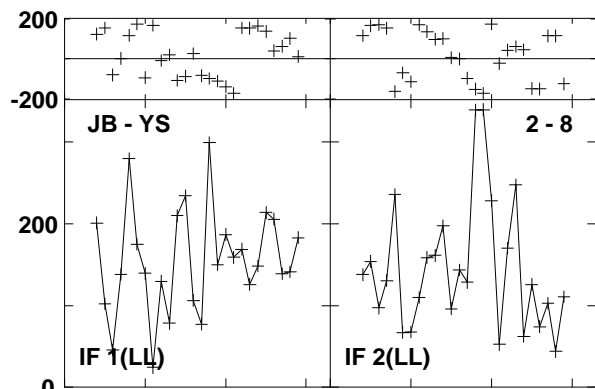
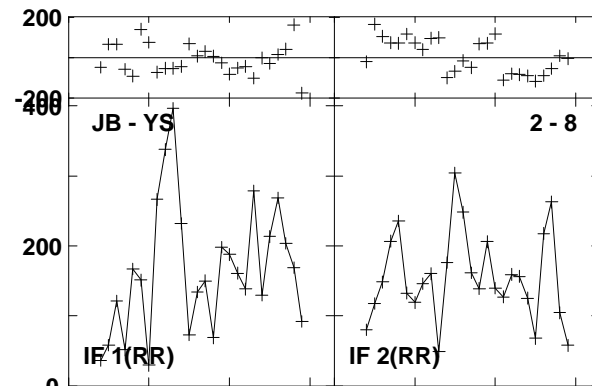
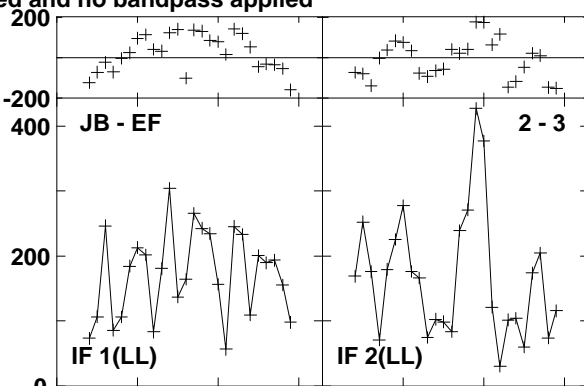
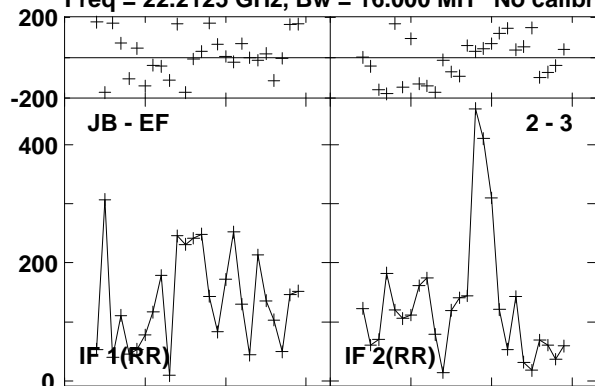

Lower frame: Micro Ampl Jy Top frame: Phas deg  
Vector averaged cross-power spectrum Baseline: JB (02) - EF (03)  
Timerange: 00/12:52:01 to 00/12:53:00

Plot file version 397 created 23-AUG-2016 15:00:56

W3IRS5 GA035B 1.UVDATA.1

Freq = 22.2125 GHz, Bw = 16.0000 MH No calibration applied and no bandpass applied

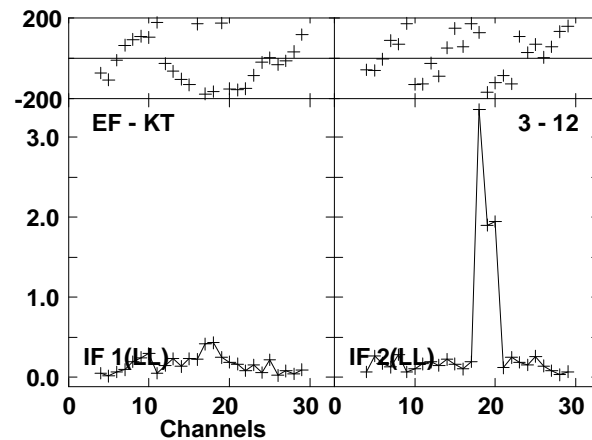
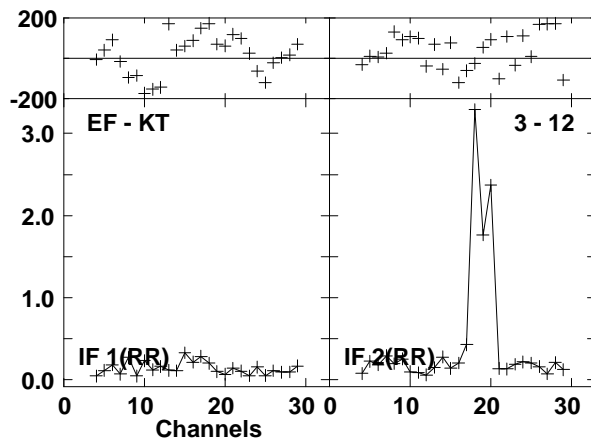
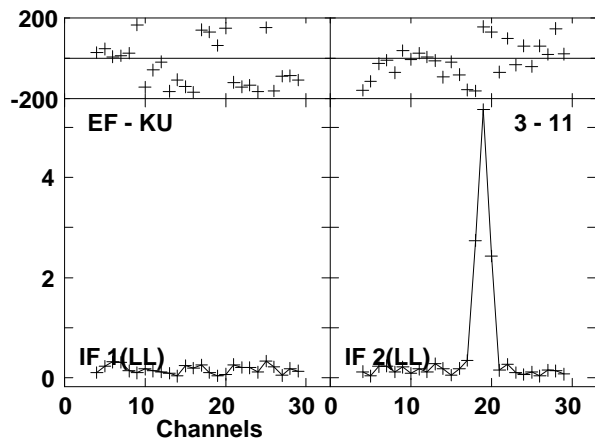
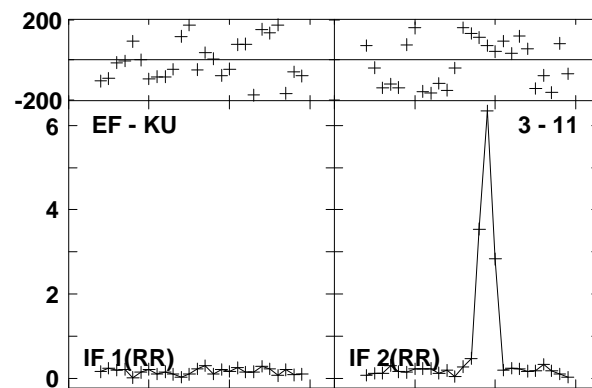
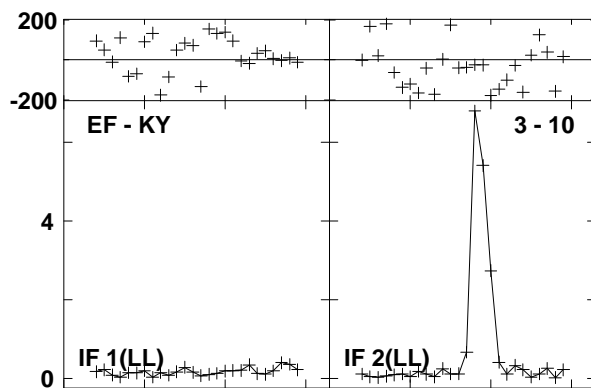
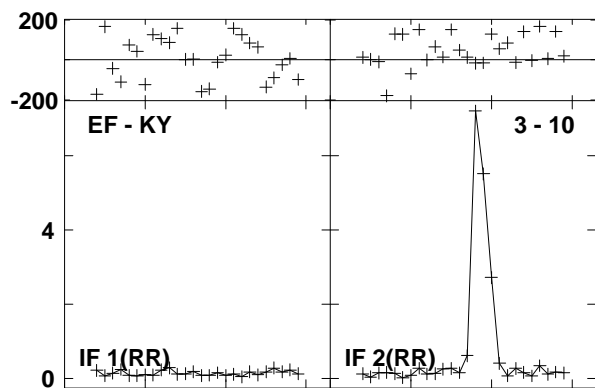
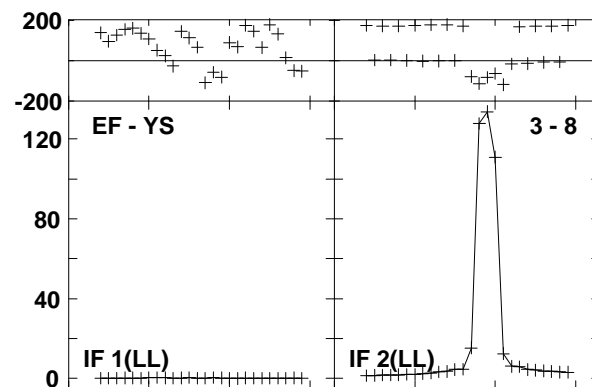
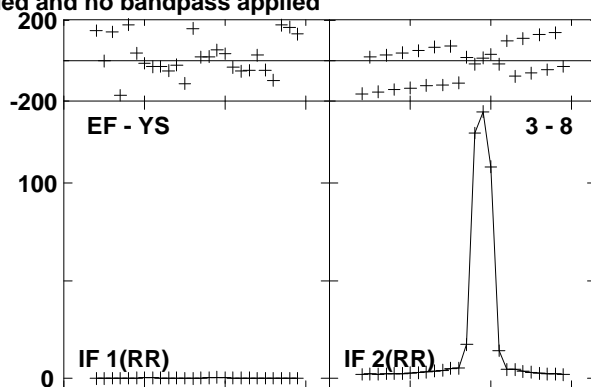
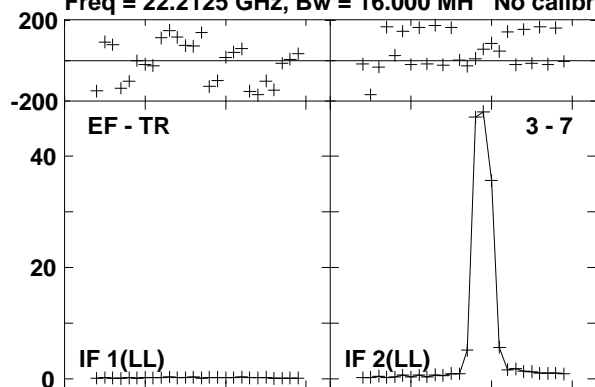

Lower frame: Milli Ampl Jy Top frame: Phas deg  
Vector averaged cross-power spectrum Baseline: EF (03) - TR (07)  
Timerange: 00/12:52:01 to 00/12:53:00

Plot file version 398 created 23-AUG-2016 15:00:56

W3IRS5 GA035B 1.UVDATA.1

Freq = 22.2125 GHz, Bw = 16.000 MH No calibration applied and no bandpass applied

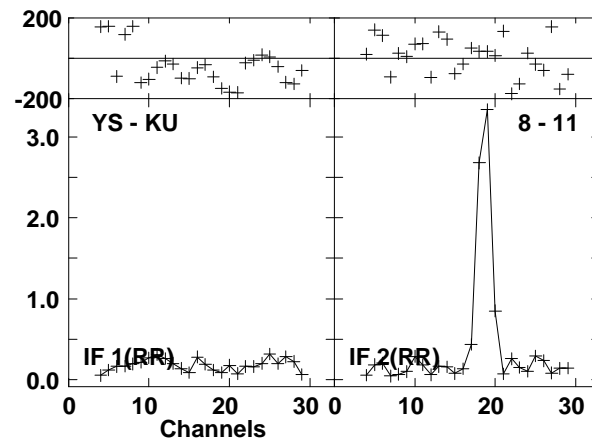
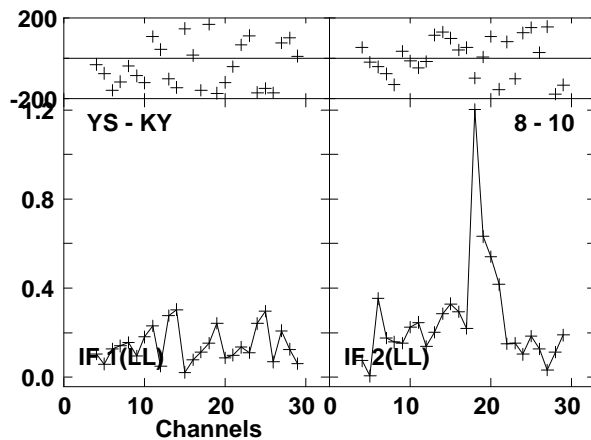
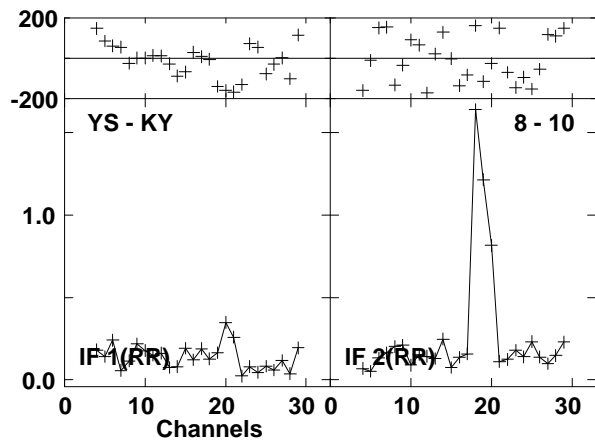
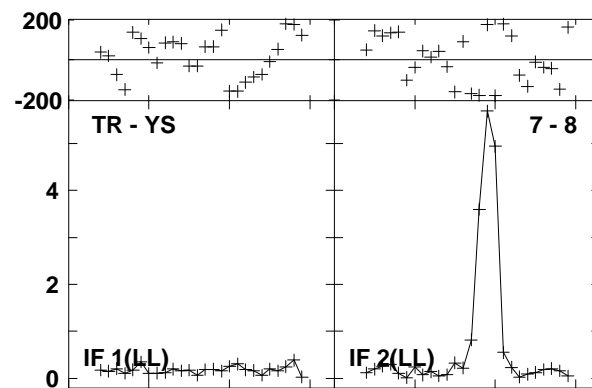
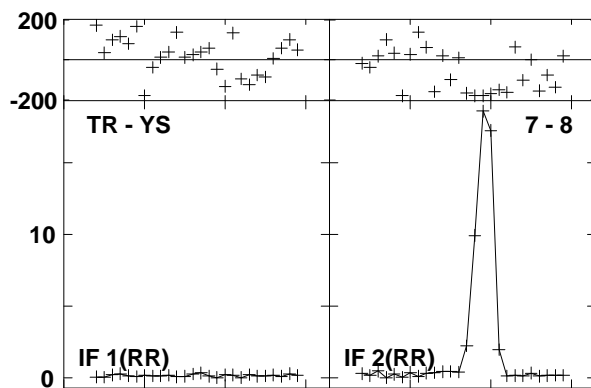
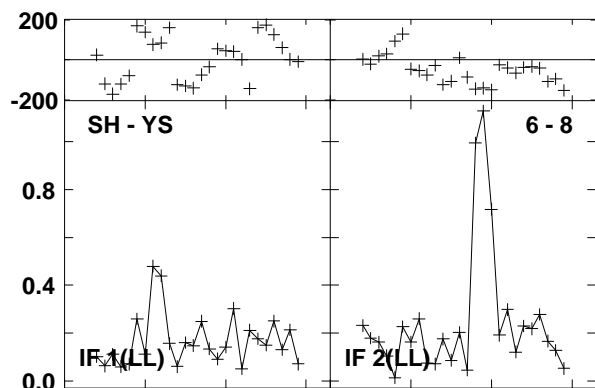
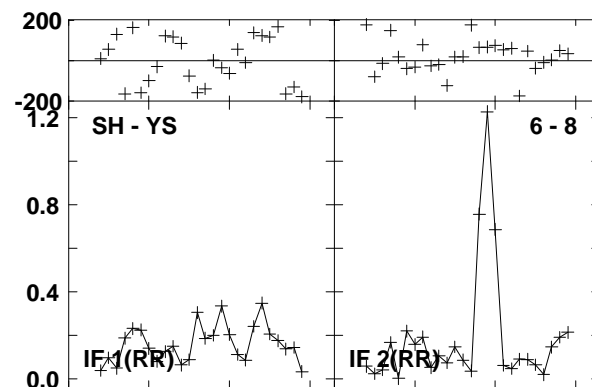
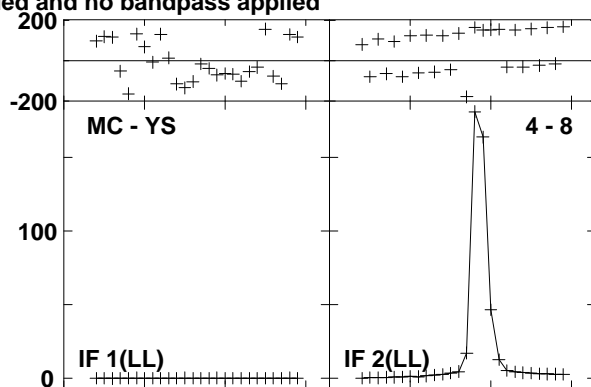
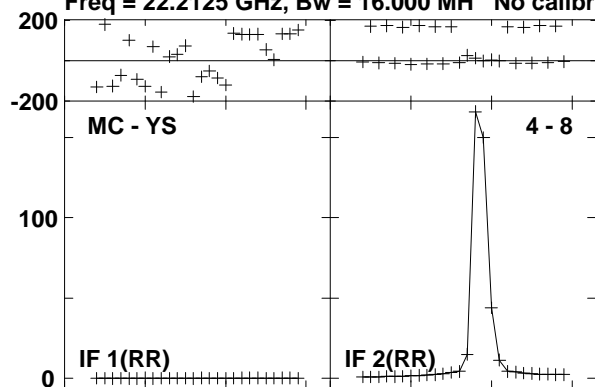

Lower frame: Milli Ampl Jy Top frame: Phas deg  
Vector averaged cross-power spectrum Baseline: MC (04) - YS (08)  
Timerange: 00/12:52:01 to 00/12:53:00

Plot file version 399 created 23-AUG-2016 15:00:56  
W3IRS5 GA035B 1.UVDATA.1

Freq = 22.2125 GHz, Bw = 16.000 MH No calibration applied and no bandpass applied

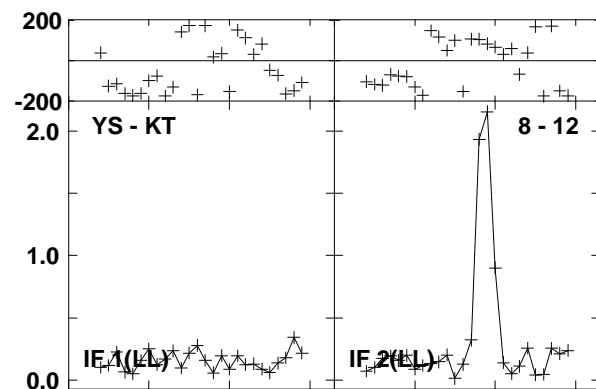
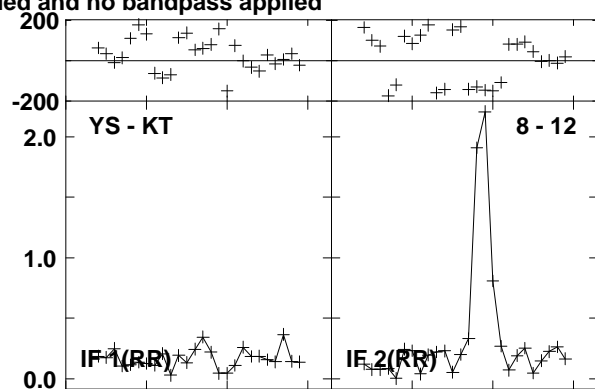
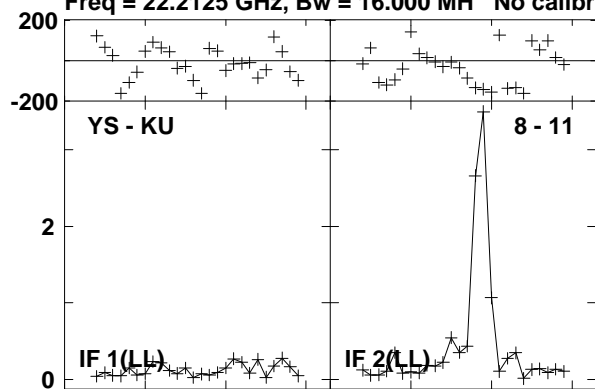

Lower frame: Milli Ampl Jy Top frame: Phas deg  
Vector averaged cross-power spectrum Baseline: YS (08) - KU (11)  
Timerange: 00/12:52:01 to 00/12:53:00

Plot file version 400 created 23-AUG-2016 15:00:56  
 0219+628 GA035B 1.UVDATA.1  
 Freq = 22.2125 GHz, Bw = 16.000 MH No calibration applied and no bandpass applied

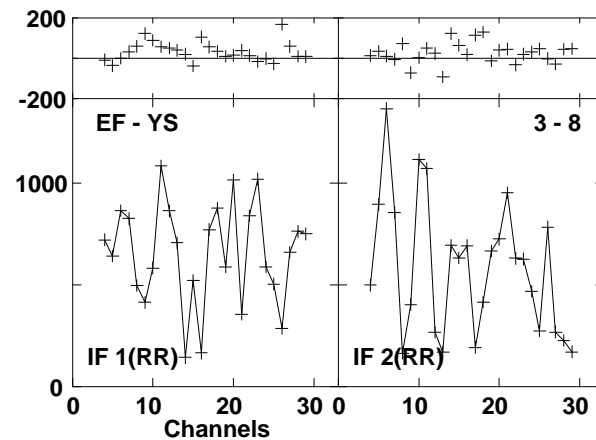
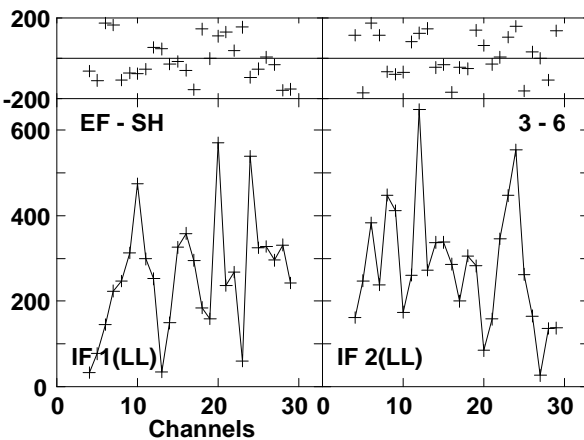
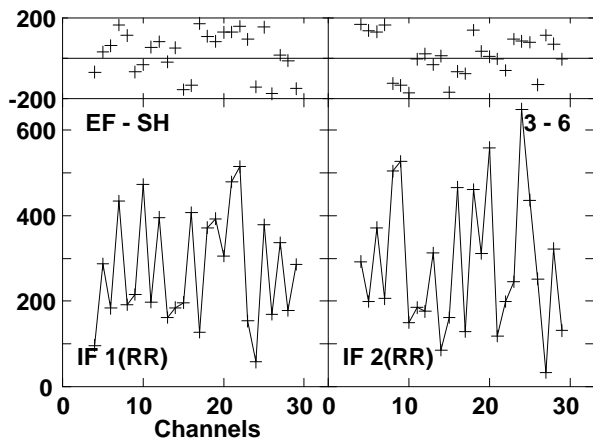
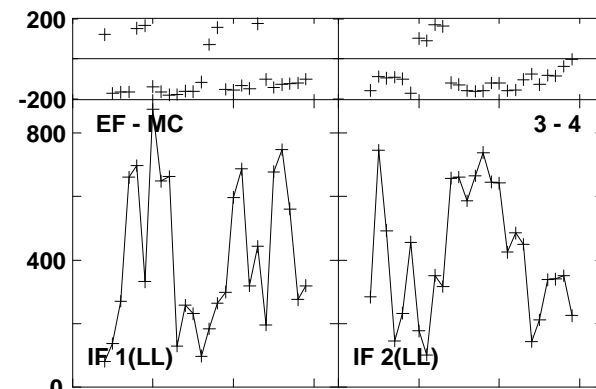
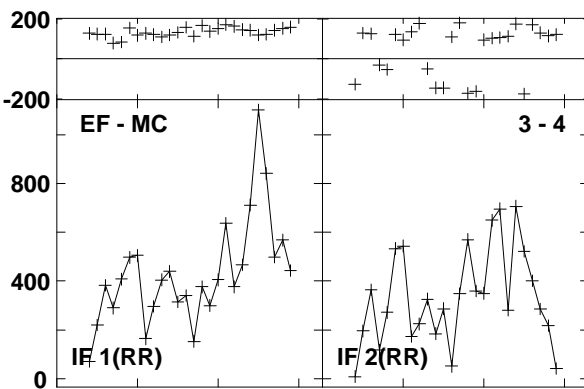
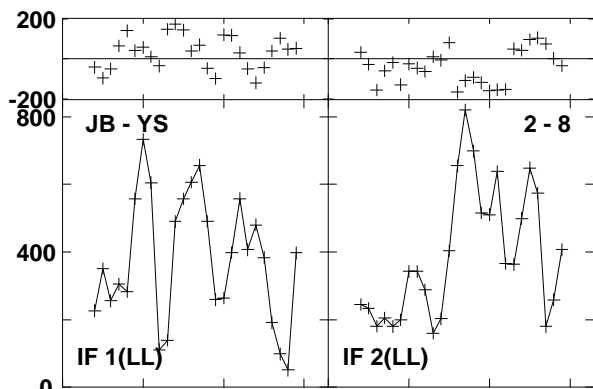
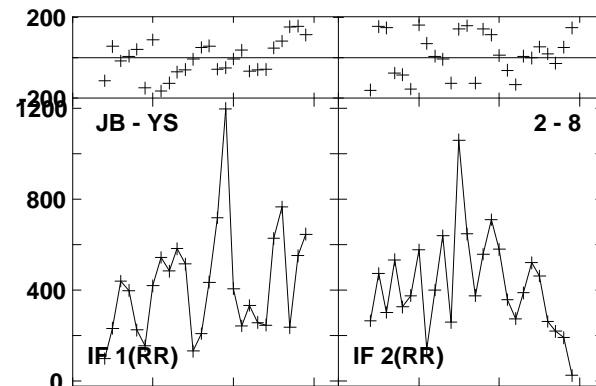
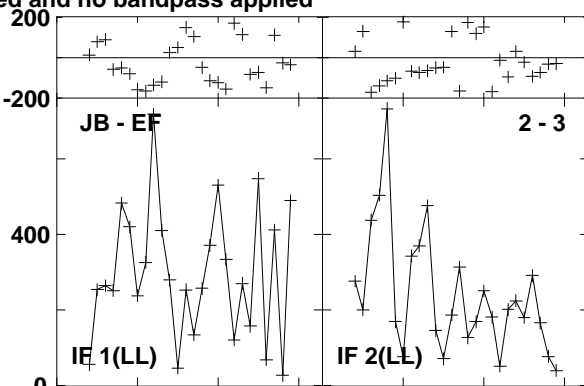
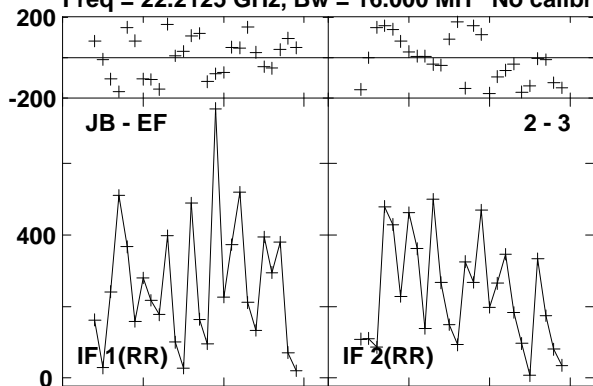

Lower frame: Micro Ampl Jy Top frame: Phas deg  
 Vector averaged cross-power spectrum Baseline: JB (02) - EF (03)  
 Timerange: 00/12:53:31 to 00/12:53:49



Plot file version 401 created 23-AUG-2016 15:00:56  
0219+628 GA035B 1.UVDATA.1

Freq = 22.2125 GHz, Bw = 16.000 MH No calibration applied and no bandpass applied

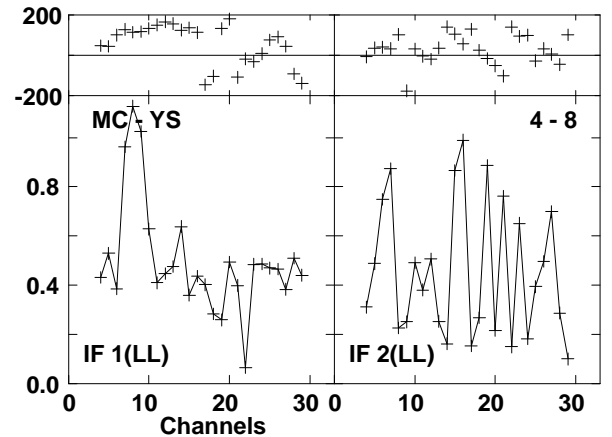
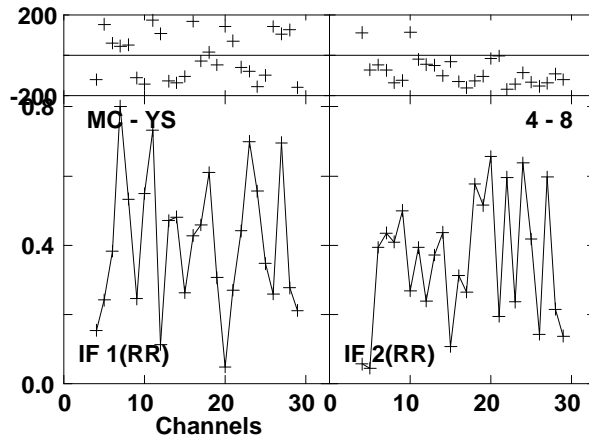
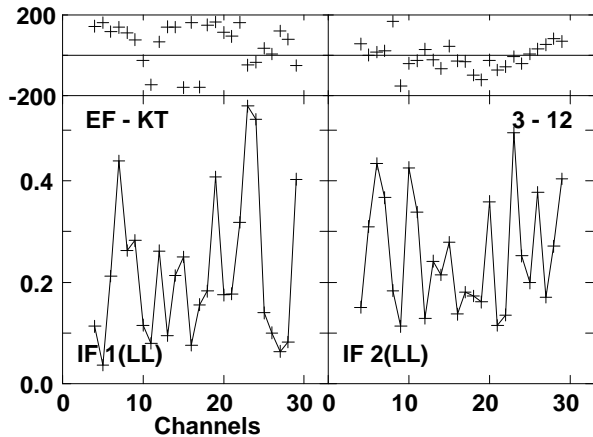
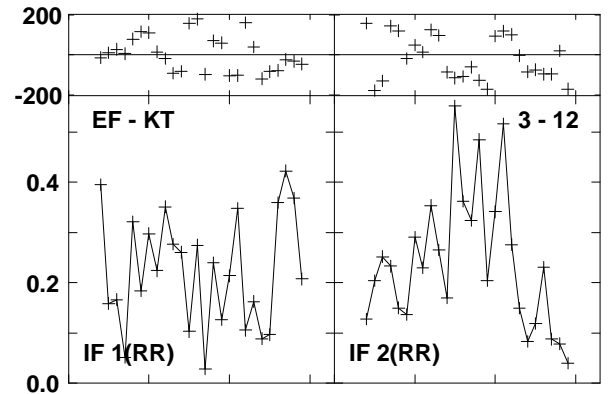
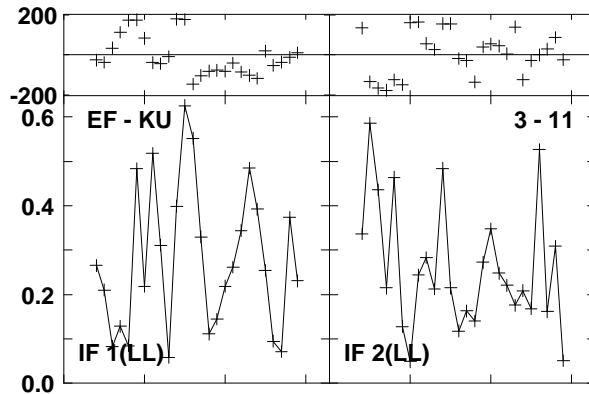
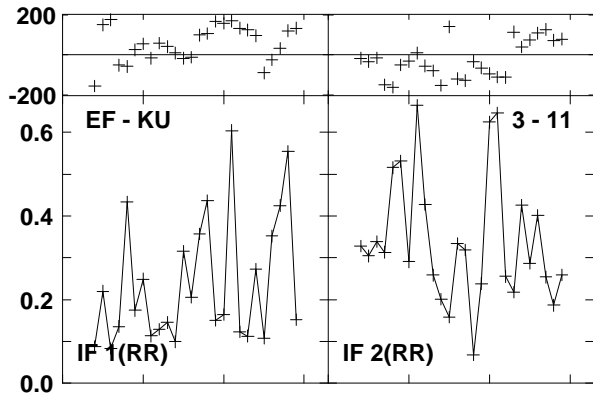
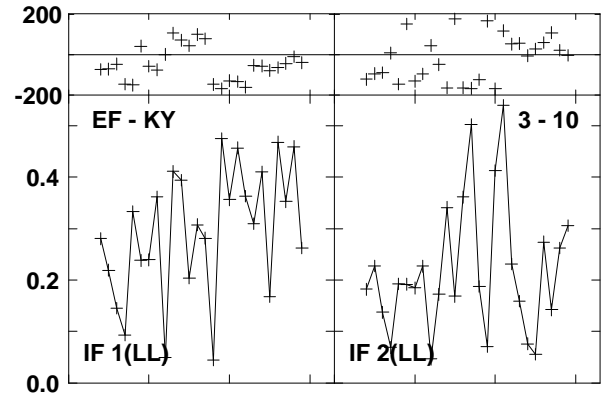
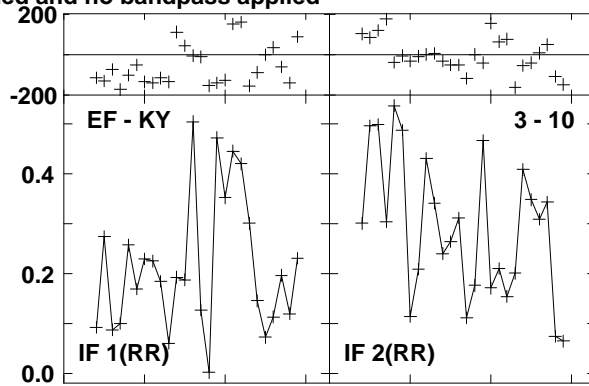
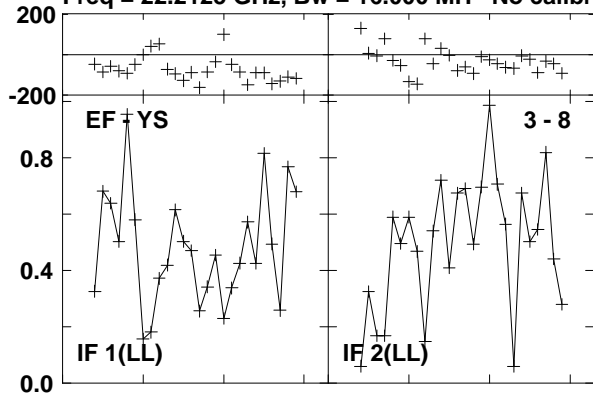

Lower frame: Milli Ampl Jy Top frame: Phas deg  
Vector averaged cross-power spectrum Baseline: EF (03) - YS (08)  
Timerange: 00/12:53:31 to 00/12:53:49

Plot file version 402 created 23-AUG-2016 15:00:56

0219+628 GA035B 1.UVDATA.1

Freq = 22.2125 GHz, Bw = 16.000 MH No calibration applied and no bandpass applied

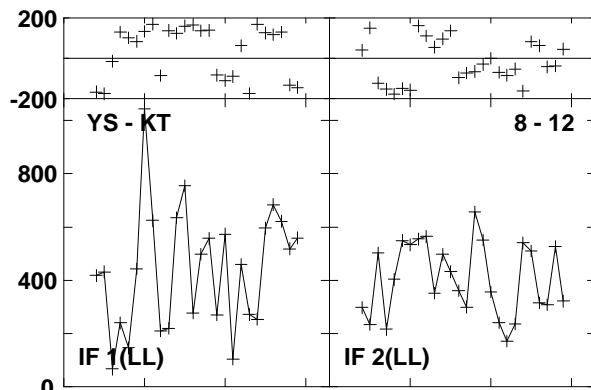
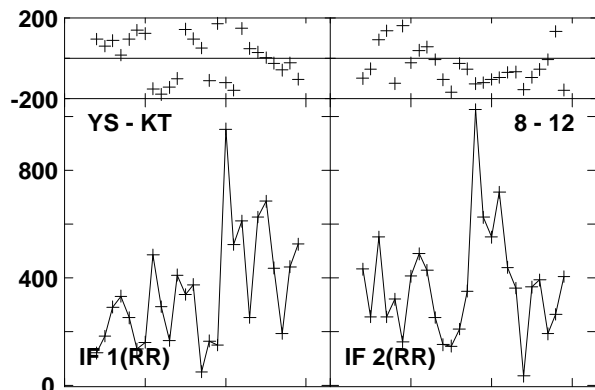
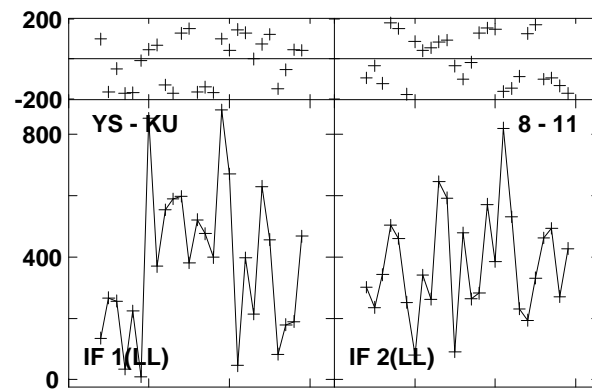
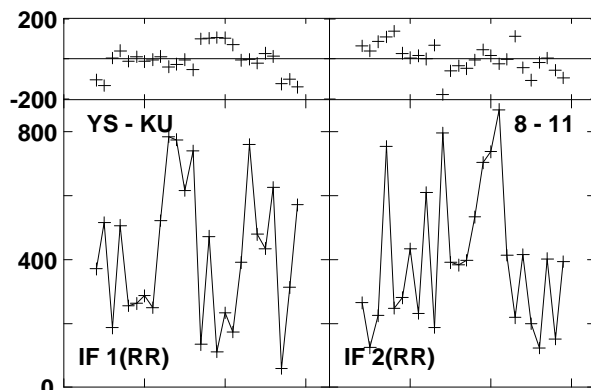
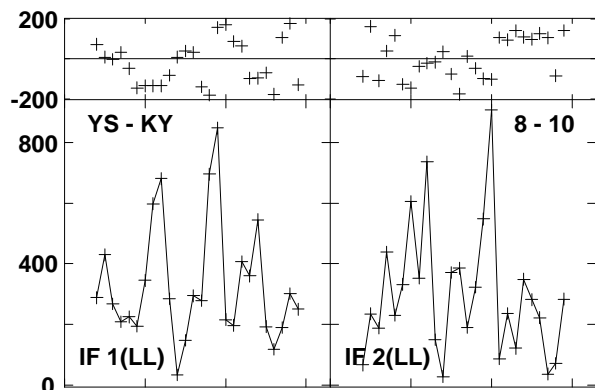
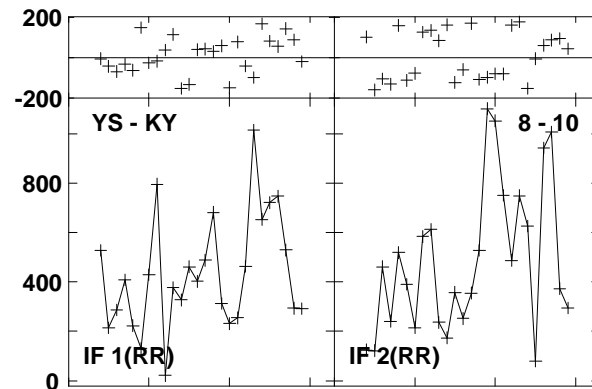
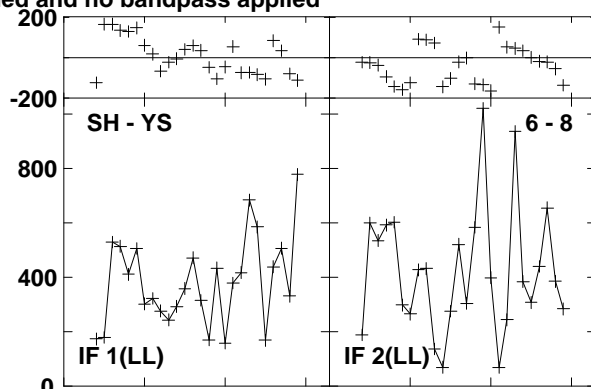
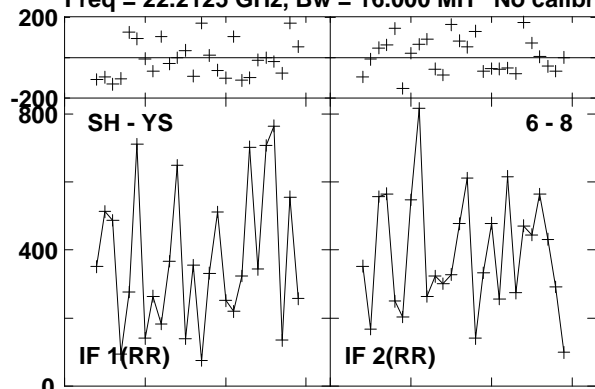

Lower frame: Micro Ampl Jy Top frame: Phas deg  
Vector averaged cross-power spectrum Baseline: SH (06) - YS (08)  
Timerange: 00/12:53:31 to 00/12:53:49

Plot file version 403 created 23-AUG-2016 15:00:56

W3IRS5 GA035B 1.UVDATA.1

Freq = 22.2125 GHz, Bw = 16.000 MH No calibration applied and no bandpass applied

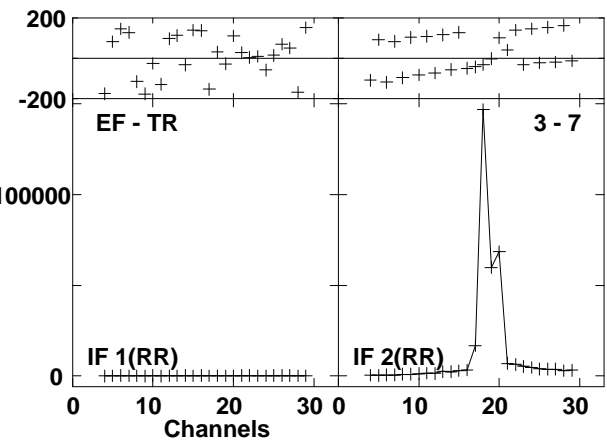
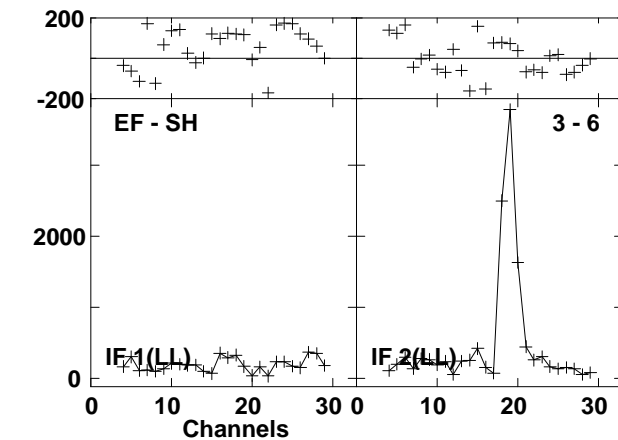
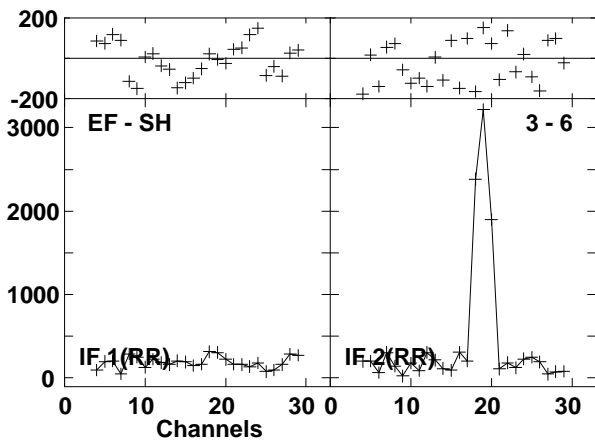
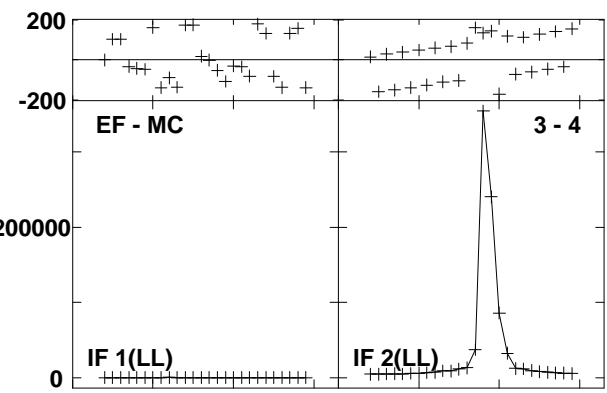
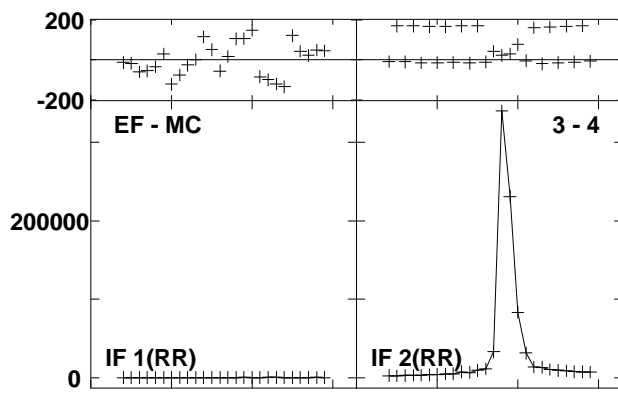
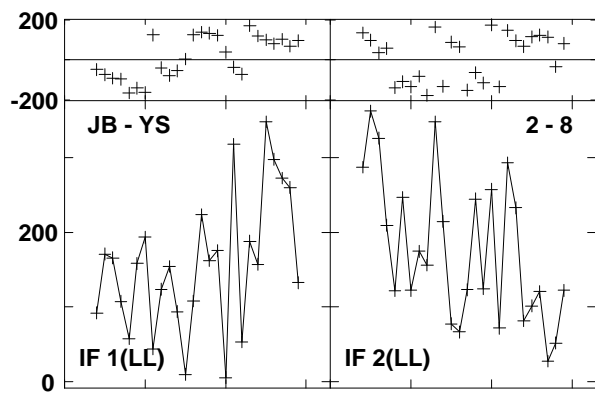
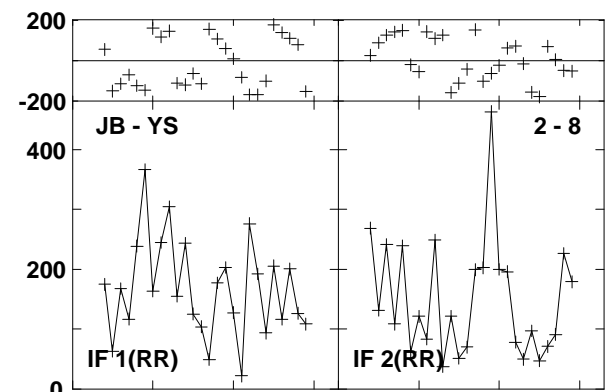
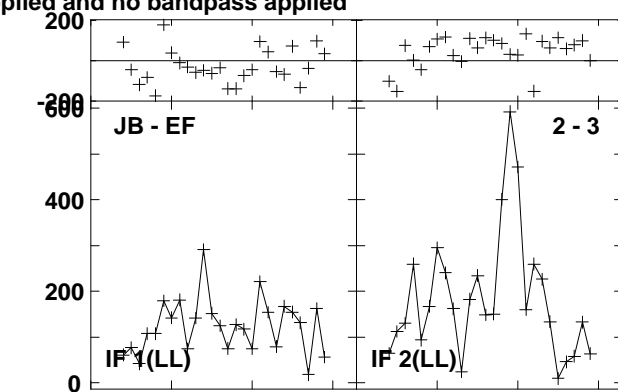
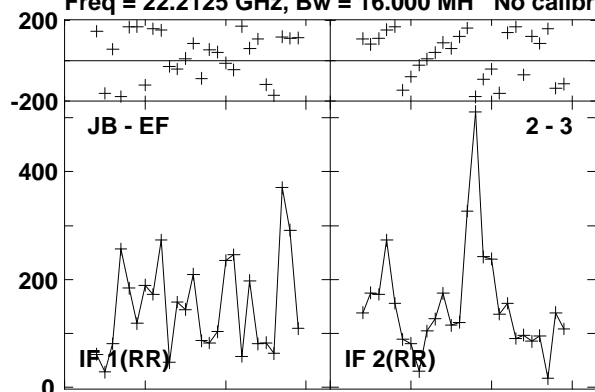

Lower frame: Micro Ampl Jy Top frame: Phas deg  
Vector averaged cross-power spectrum Baseline: JB (02) - EF (03)  
Timerange: 00:12:54:20 to 00:12:55:19

Plot file version 404 created 23-AUG-2016 15:00:56  
W3IRS5 GA035B 1.UVDATA.1

Freq = 22.2125 GHz, Bw = 16.000 MH No calibration applied and no bandpass applied

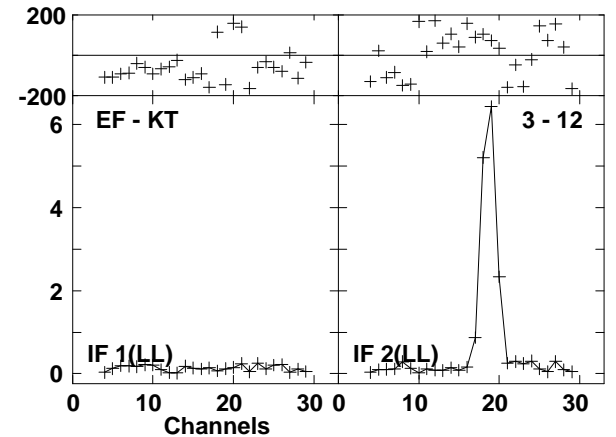
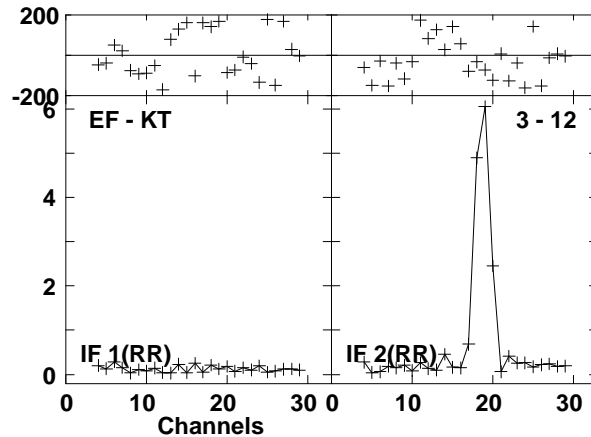
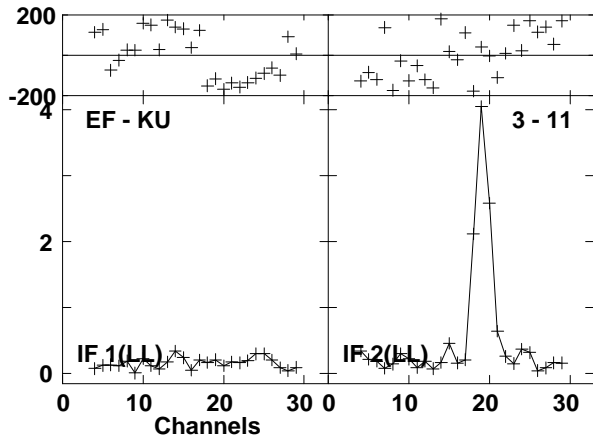
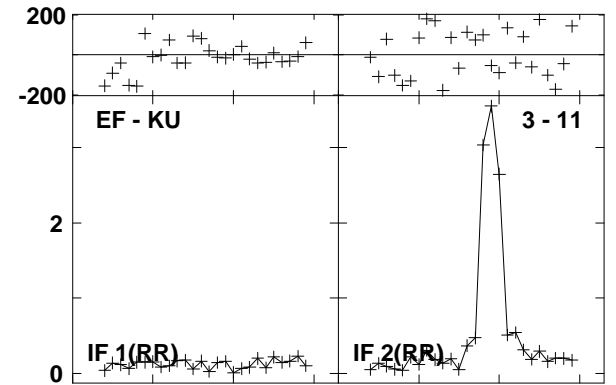
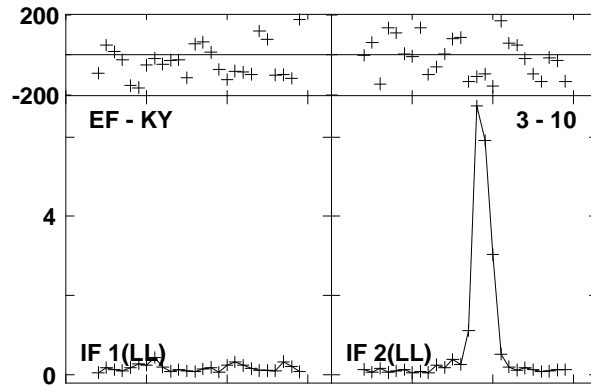
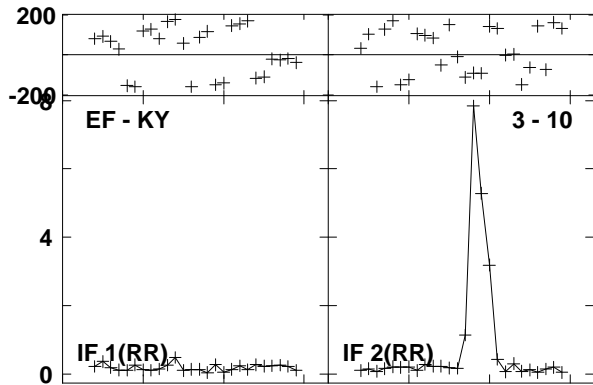
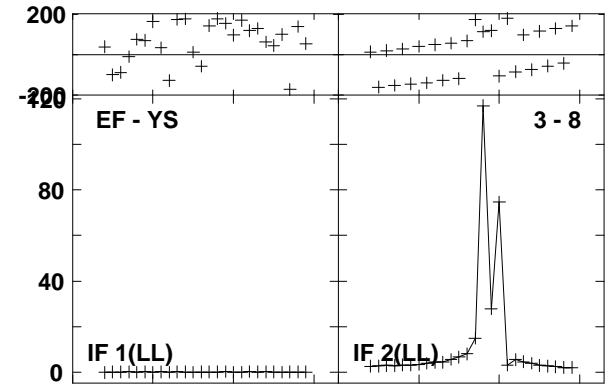
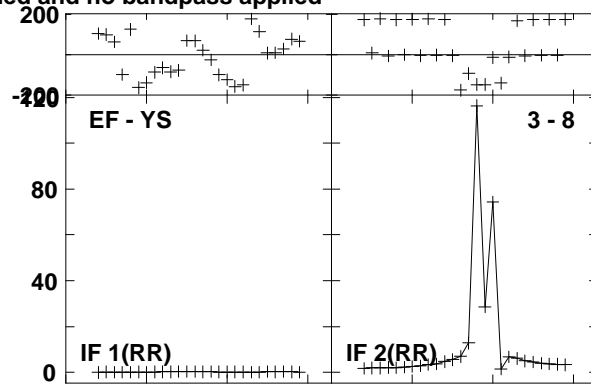
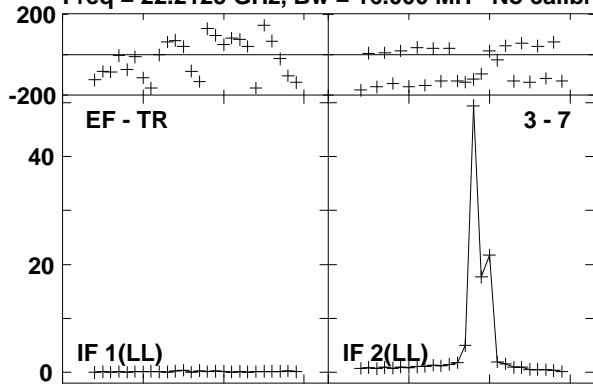

Lower frame: Milli Ampl Jy Top frame: Phas deg  
Vector averaged cross-power spectrum Baseline: EF (03) - TR (07)  
Timerange: 00/12:54:20 to 00/12:55:19

Plot file version 405 created 23-AUG-2016 15:00:56

W3IRS5 GA035B 1.UVDATA.1

Freq = 22.2125 GHz, Bw = 16.000 MH No calibration applied and no bandpass applied

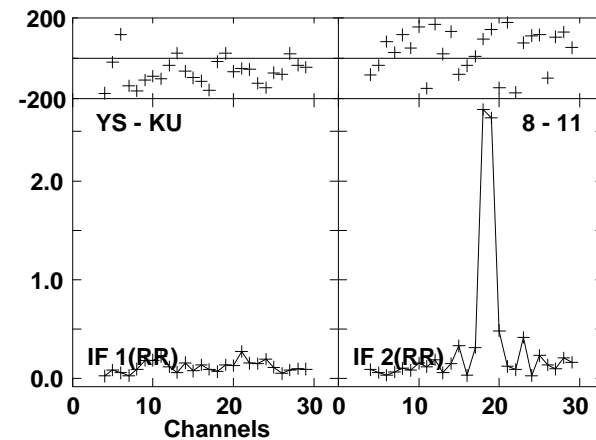
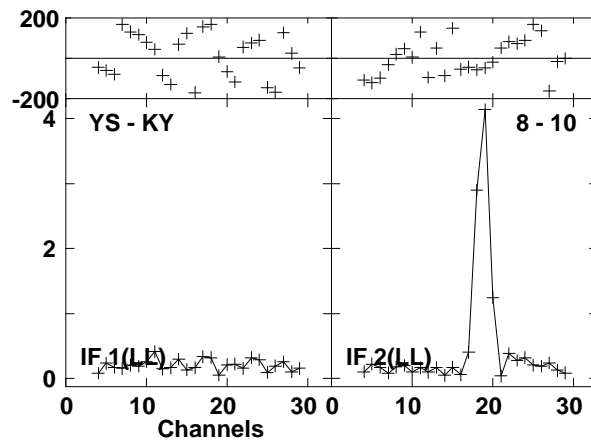
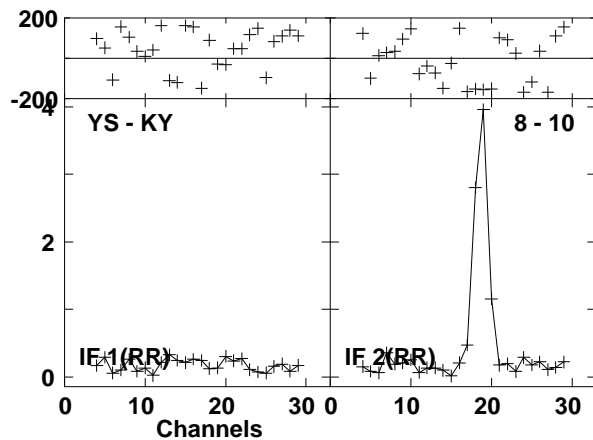
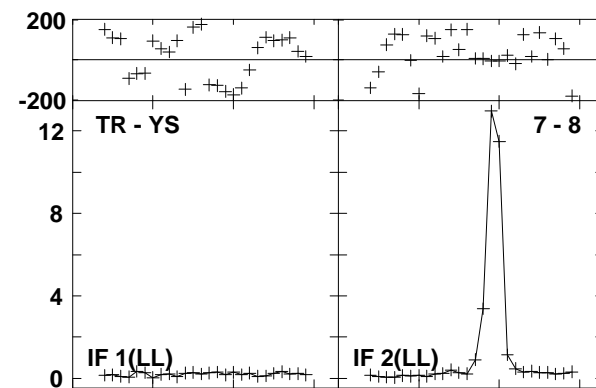
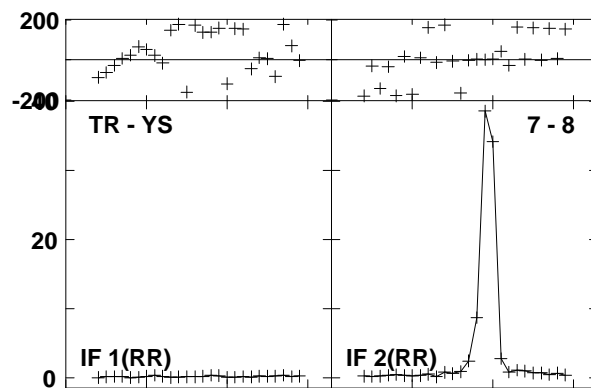
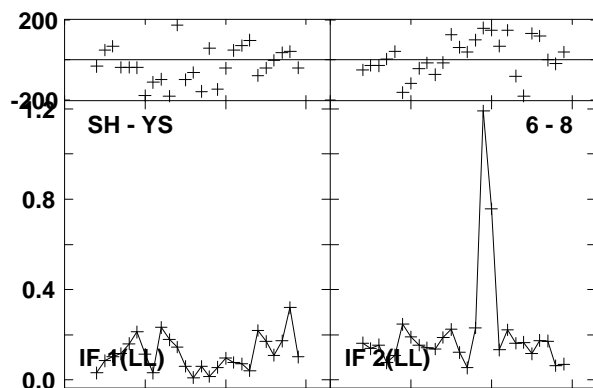
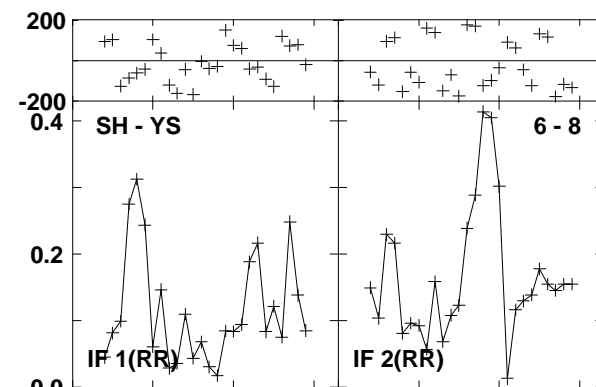
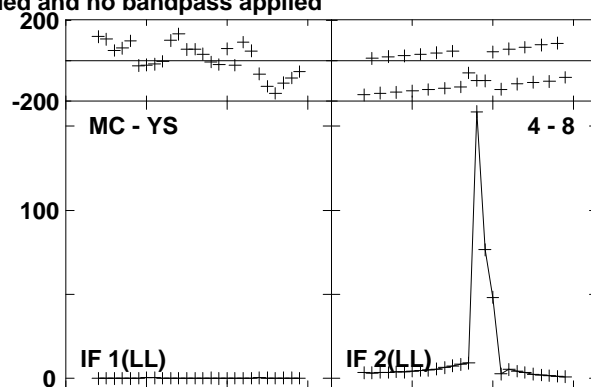
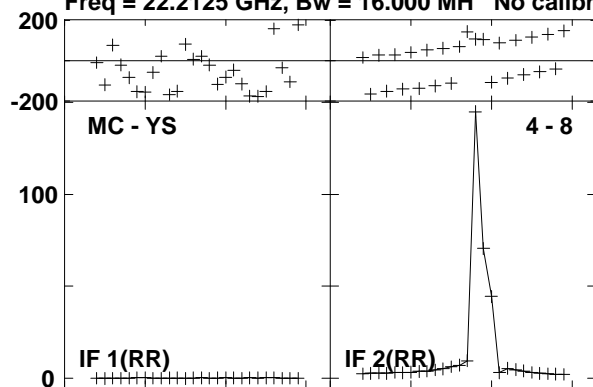

Lower frame: Milli Ampl Jy Top frame: Phas deg  
Vector averaged cross-power spectrum Baseline: MC (04) - YS (08)  
Timerange: 00/12:54:20 to 00/12:55:19

Plot file version 406 created 23-AUG-2016 15:00:56

W3IRS5 GA035B 1.UVDATA.1

Freq = 22.2125 GHz, Bw = 16.000 MH No calibration applied and no bandpass applied

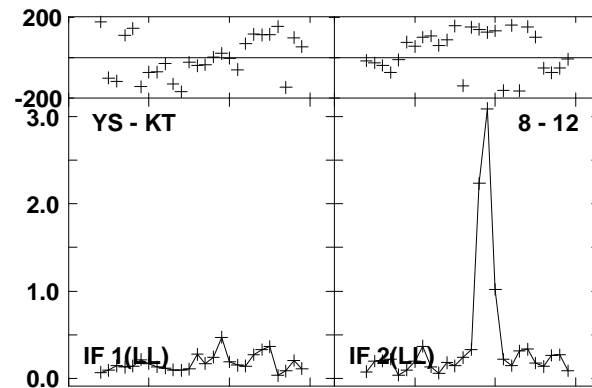
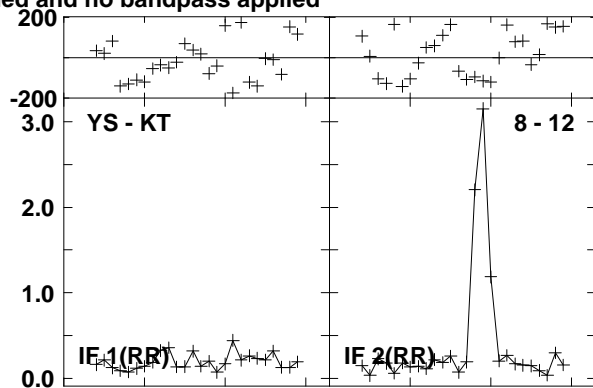
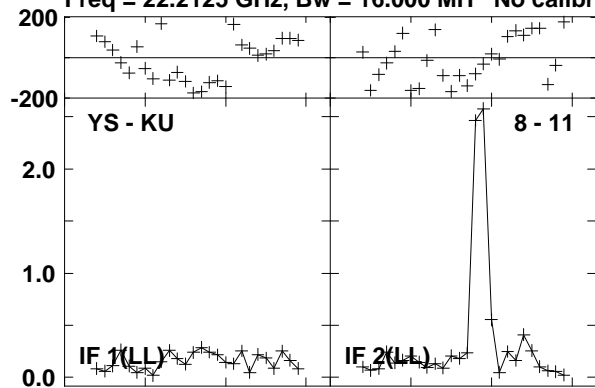

Lower frame: Milli Ampl Jy Top frame: Phas deg  
Vector averaged cross-power spectrum Baseline: YS (08) - KU (11)  
Timerange: 00/12:54:20 to 00/12:55:19

Plot file version 407 created 23-AUG-2016 15:00:56

0219+628 GA035B 1.UVDATA.1

Freq = 22.2125 GHz, Bw = 16.000 MH No calibration applied and no bandpass applied

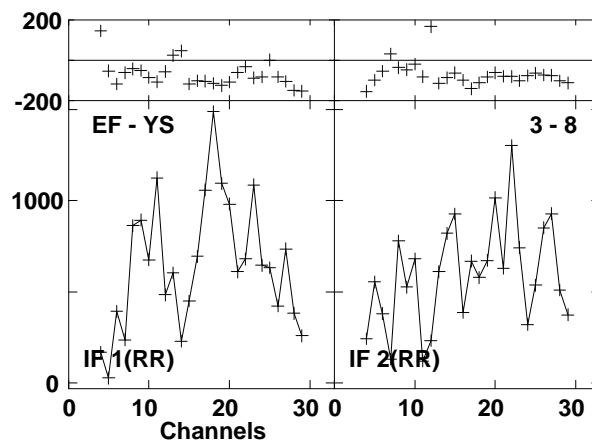
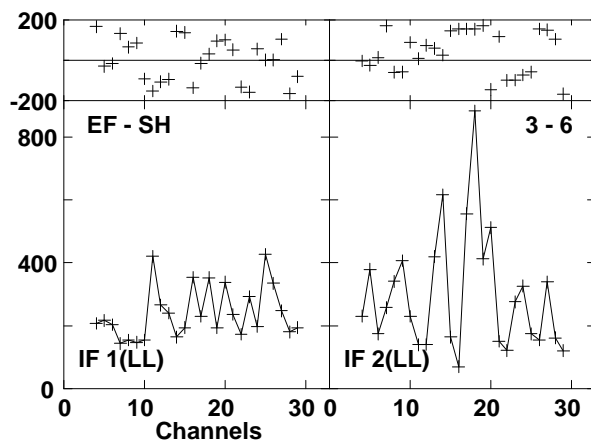
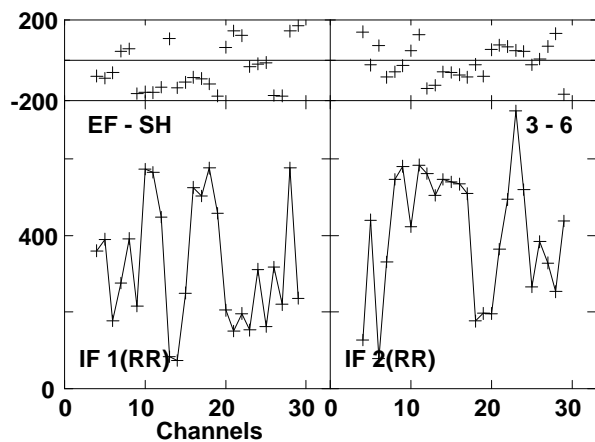
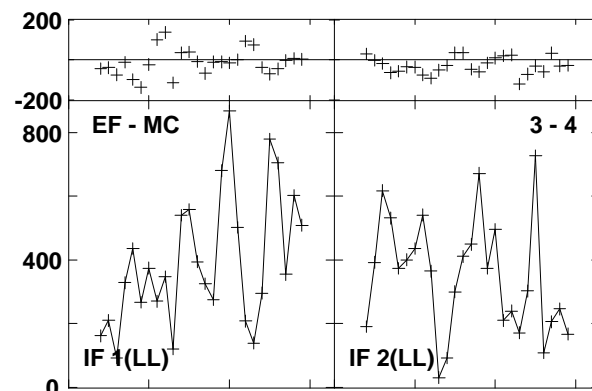
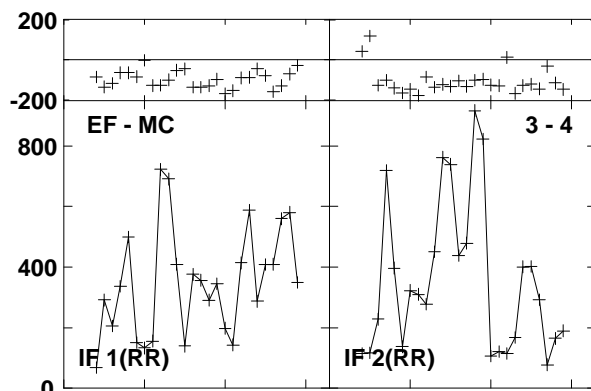
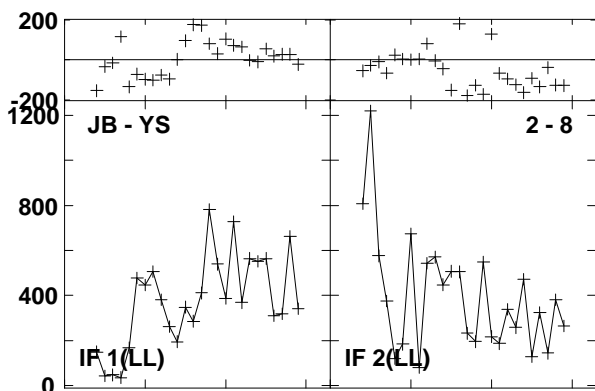
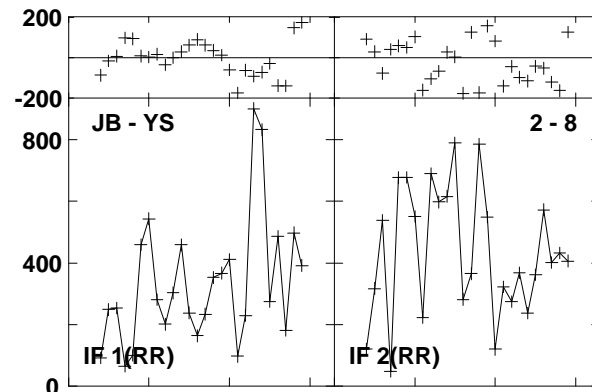
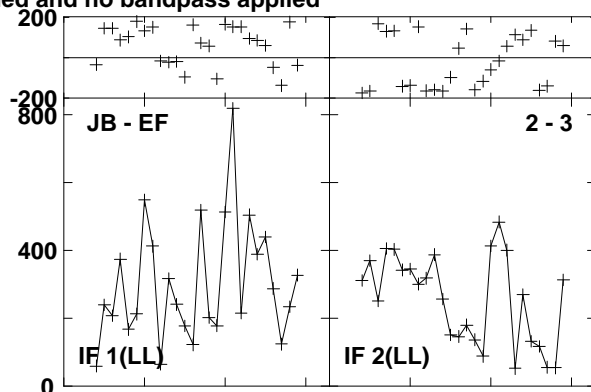
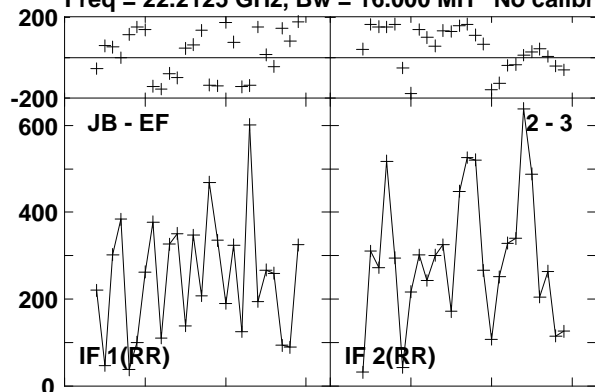

Lower frame: Micro Ampl Jy Top frame: Phas deg

Vector averaged cross-power spectrum Baseline: JB (02) - EF (03)

Timerange: 00/12:55:51 to 00/12:56:09

Plot file version 408 created 23-AUG-2016 15:00:56

0219+628 GA035B 1.UVDATA.1

Freq = 22.2125 GHz, Bw = 16.000 MH No calibration applied and no bandpass applied

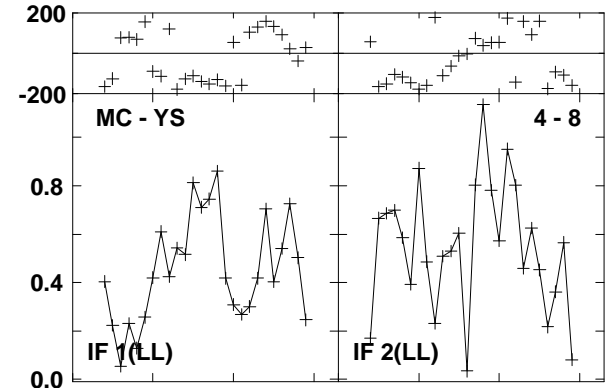
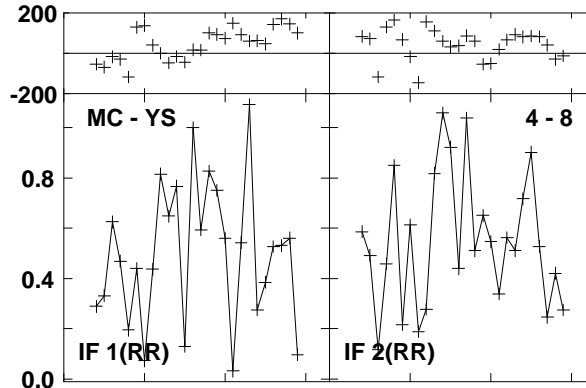
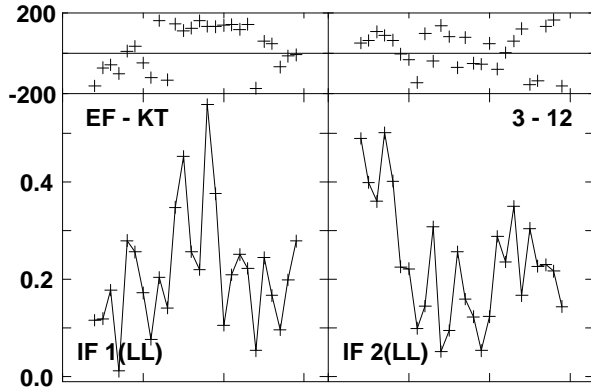
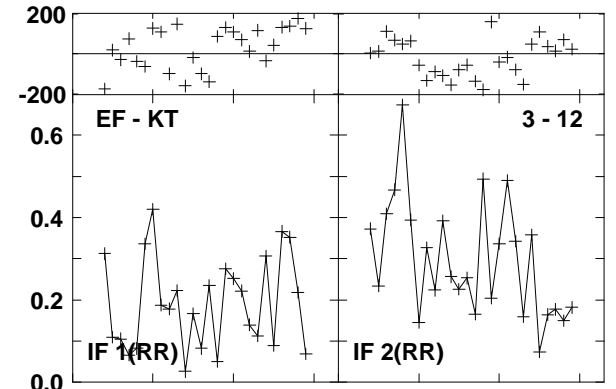
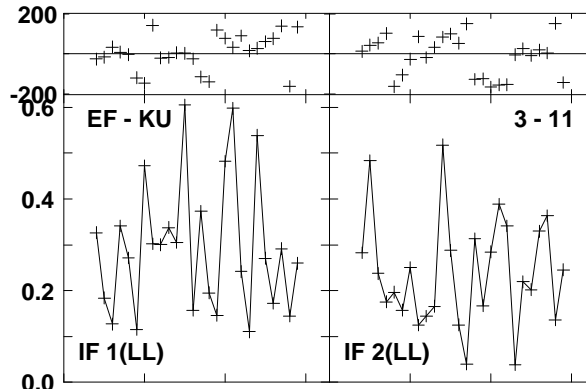
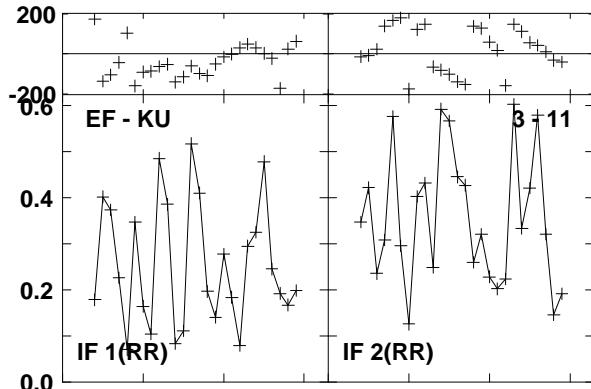
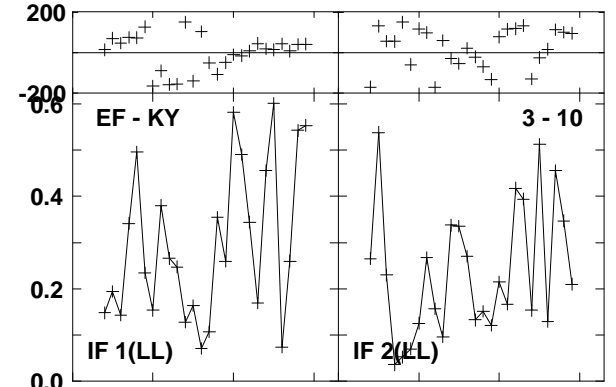
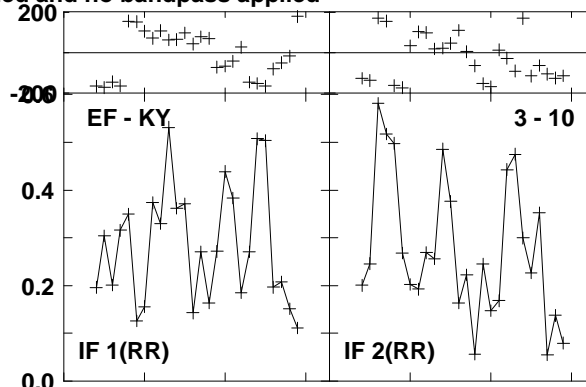
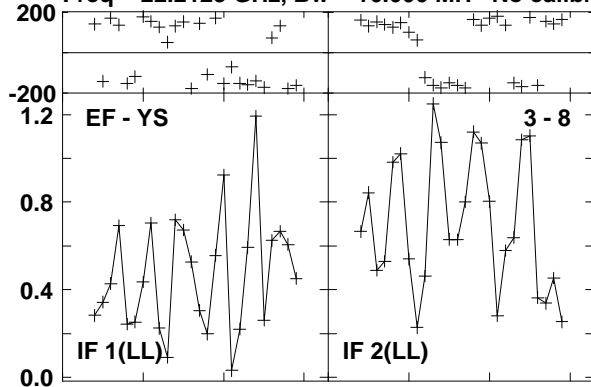

Lower frame: Milli Ampl Jy Top frame: Phas deg  
Vector averaged cross-power spectrum Baseline: EF (03) - YS (08)  
Timerange: 00/12:55:51 to 00/12:56:09



Plot file version 409 created 23-AUG-2016 15:00:56

0219+628 GA035B 1.UVDATA.1

Freq = 22.2125 GHz, Bw = 16.000 MH No calibration applied and no bandpass applied

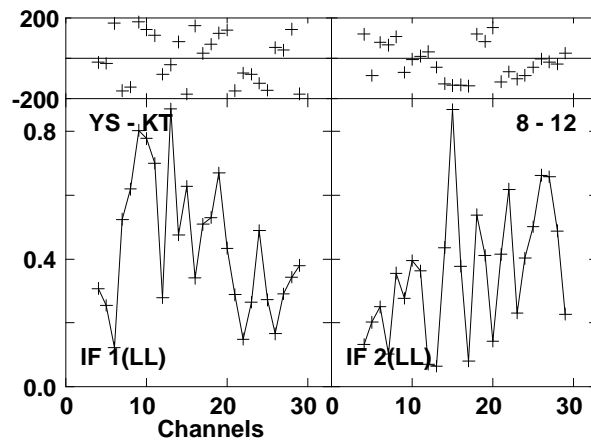
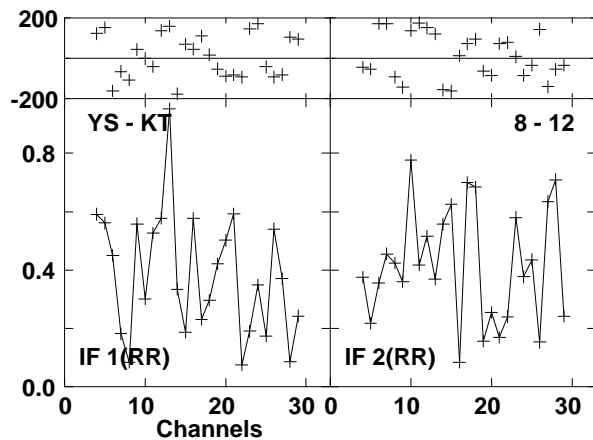
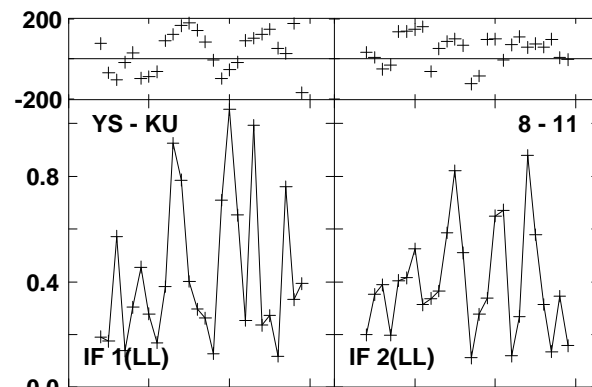
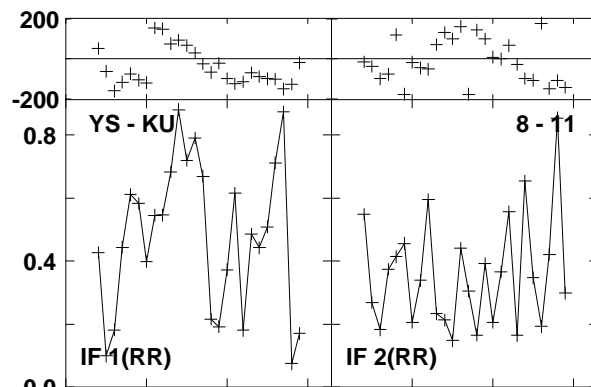
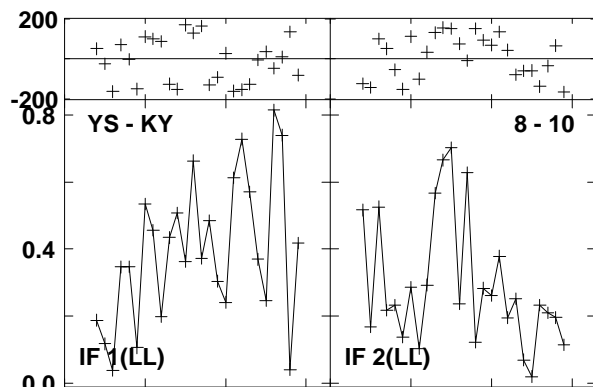
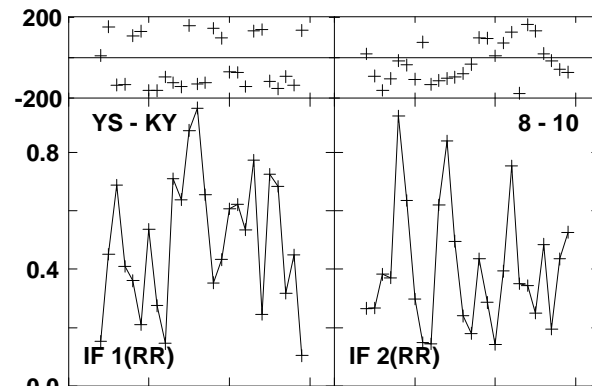
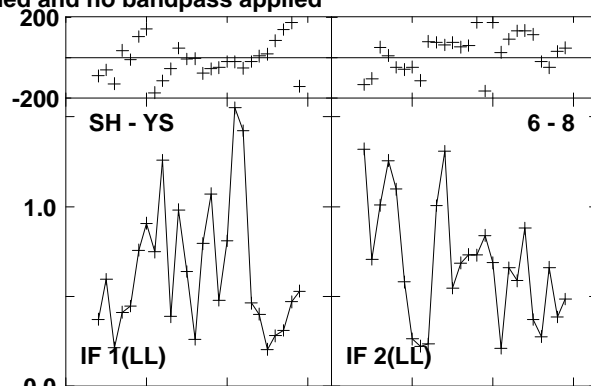
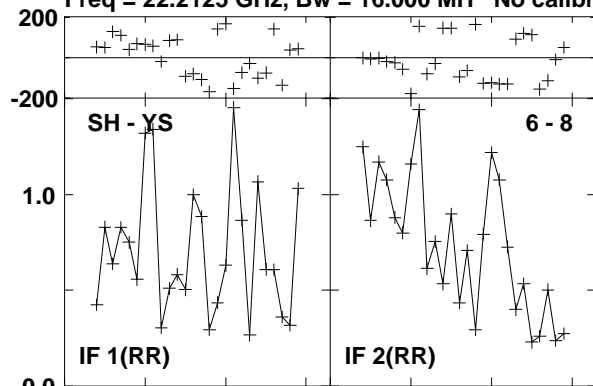

Lower frame: Milli Ampl Jy Top frame: Phas deg

Vector averaged cross-power spectrum Baseline: SH (06) - YS (08)

Timerange: 00/12:55:51 to 00/12:56:09

Plot file version 410 created 23-AUG-2016 15:00:56

W3IRS5 GA035B 1.UVDATA.1

Freq = 22.2125 GHz, Bw = 16.000 MH No calibration applied and no bandpass applied

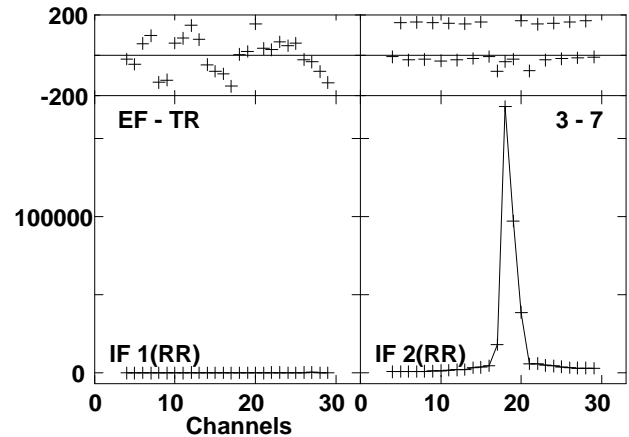
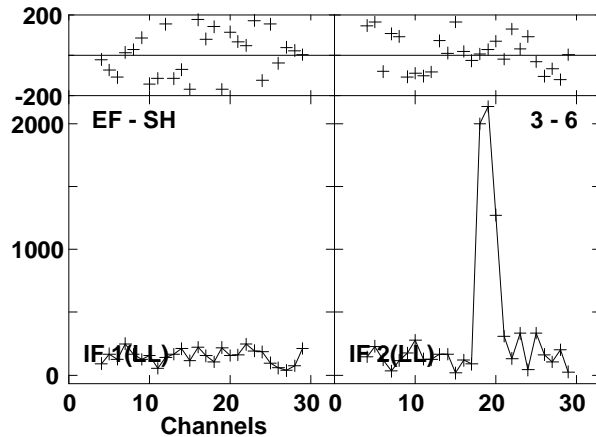
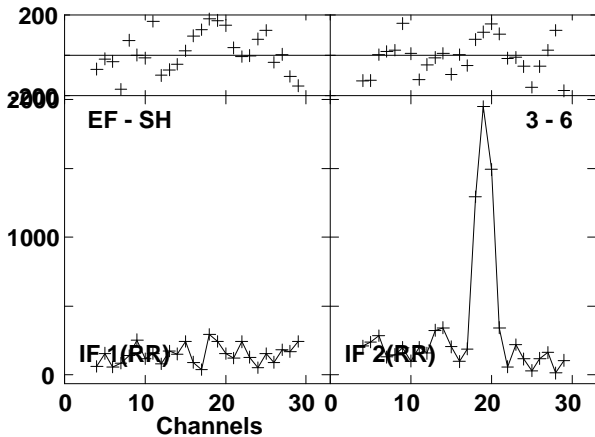
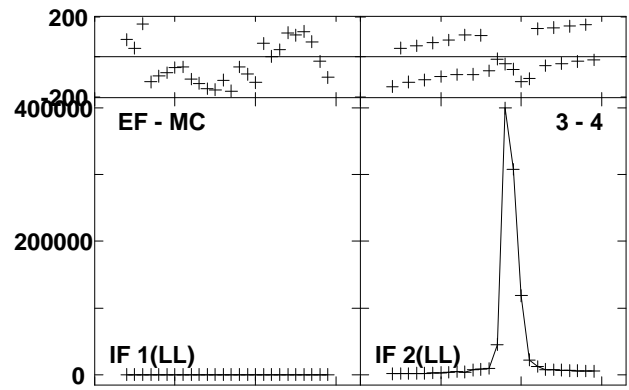
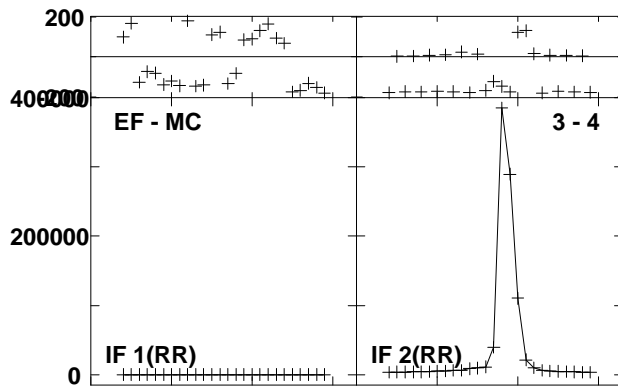
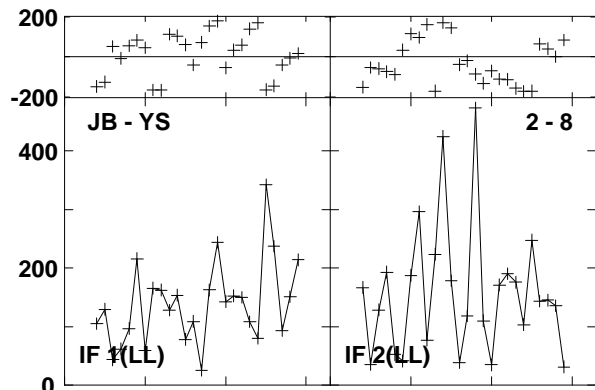
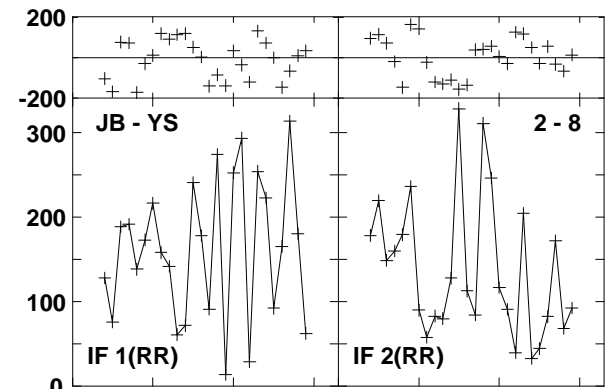
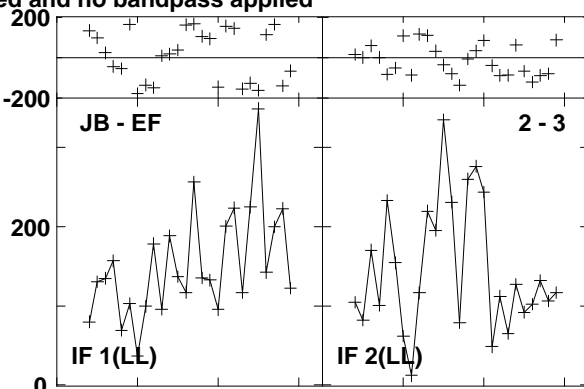
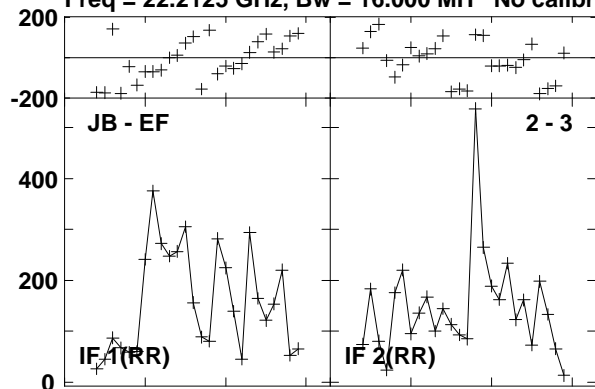

Lower frame: Micro Ampl Jy Top frame: Phas deg  
Vector averaged cross-power spectrum Baseline: JB (02) - EF (03)  
Timerange: 00:12:56:41 to 00:12:57:39

Plot file version 411 created 23-AUG-2016 15:00:56

W3IRS5 GA035B 1.UVDATA.1

Freq = 22.2125 GHz, Bw = 16.000 MH No calibration applied and no bandpass applied

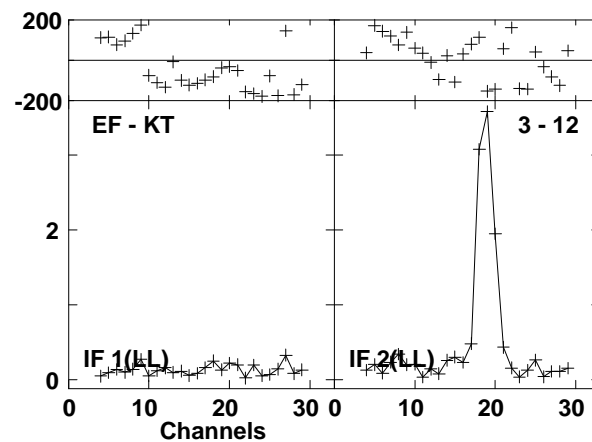
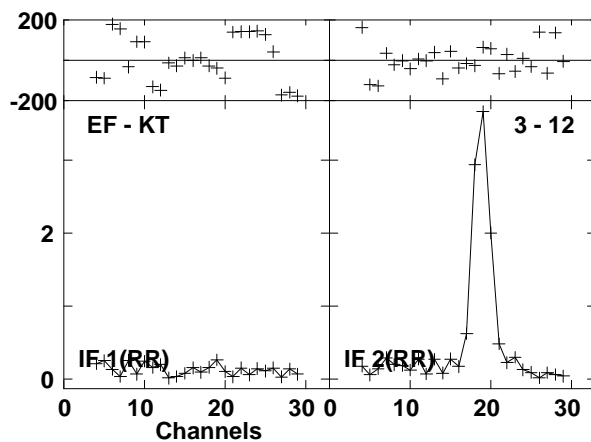
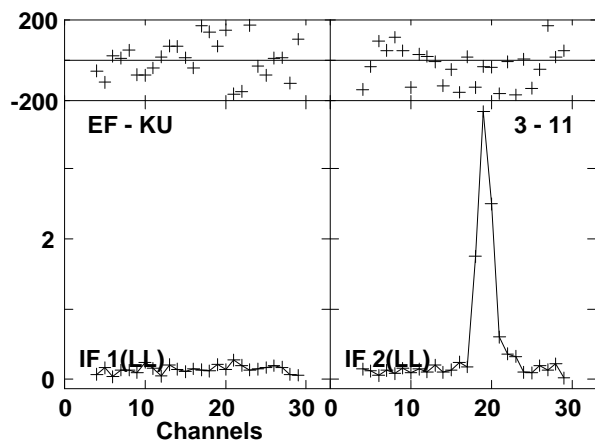
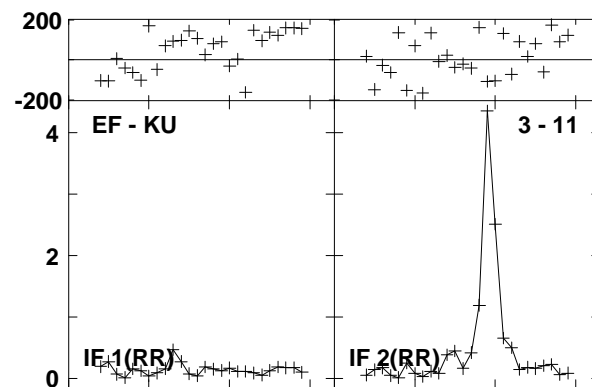
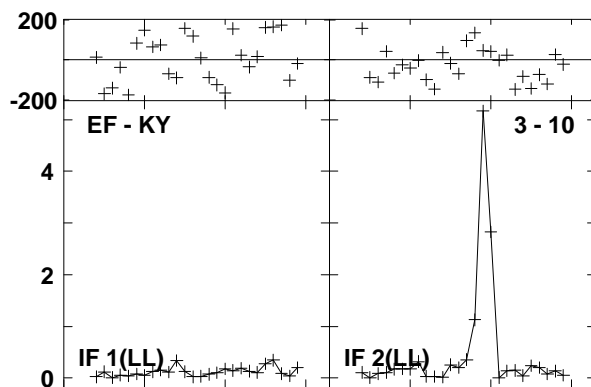
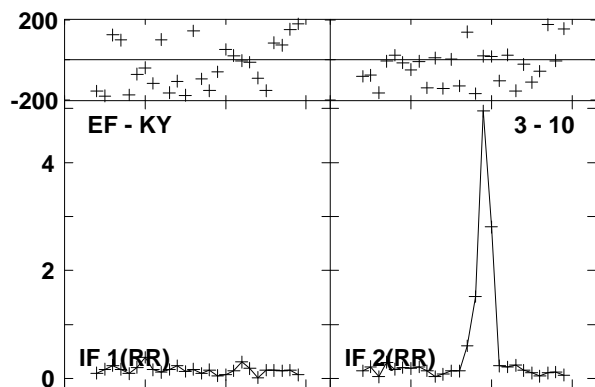
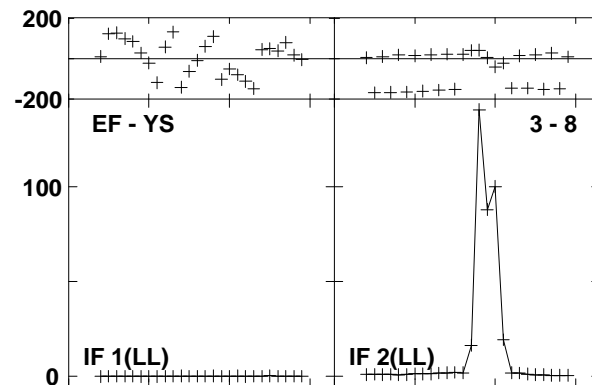
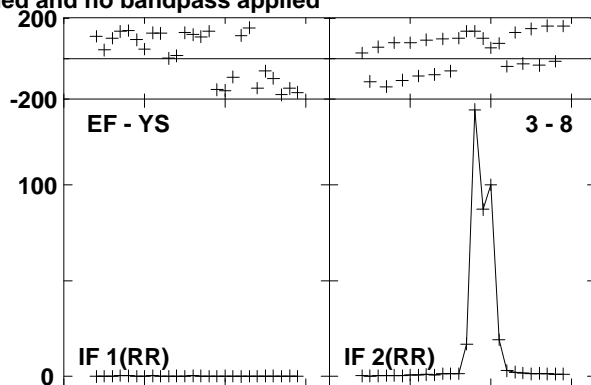
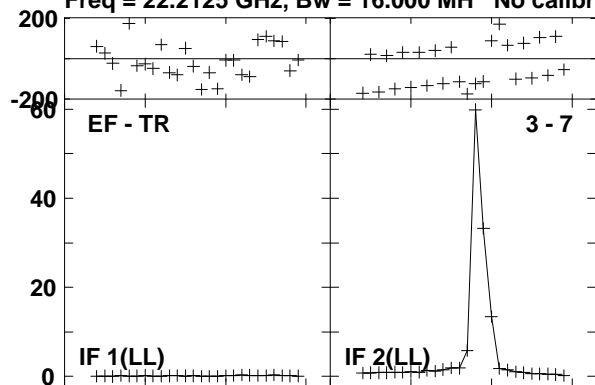

Lower frame: Milli Ampl Jy Top frame: Phas deg  
Vector averaged cross-power spectrum Baseline: EF (03) - TR (07)  
Timerange: 00/12:56:41 to 00/12:57:39

Plot file version 412 created 23-AUG-2016 15:00:56

W3IRS5 GA035B 1.UVDATA.1

Freq = 22.2125 GHz, Bw = 16.000 MH No calibration applied and no bandpass applied

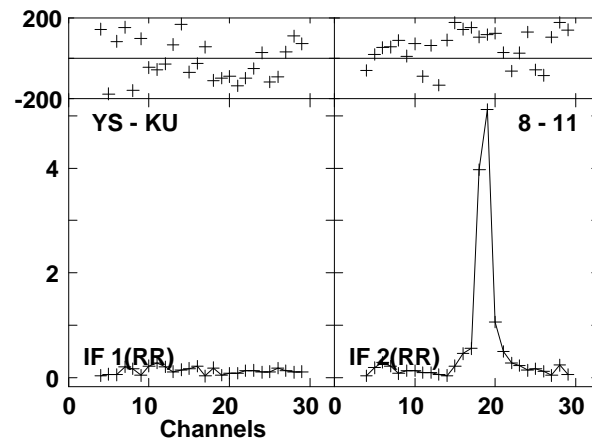
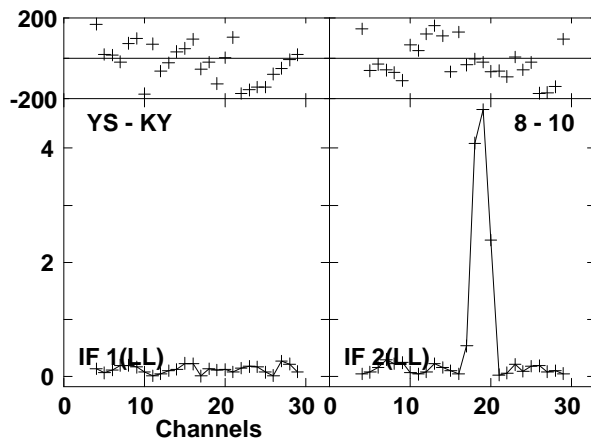
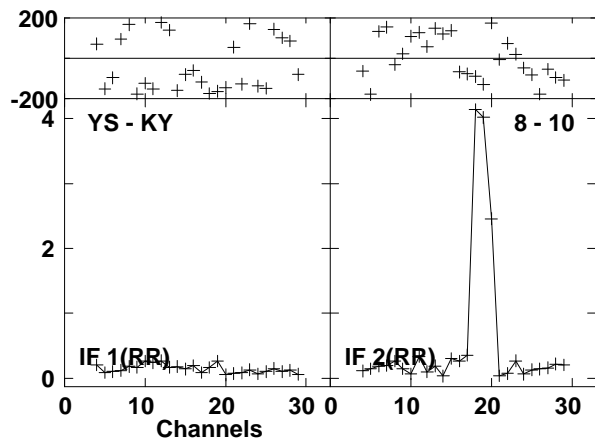
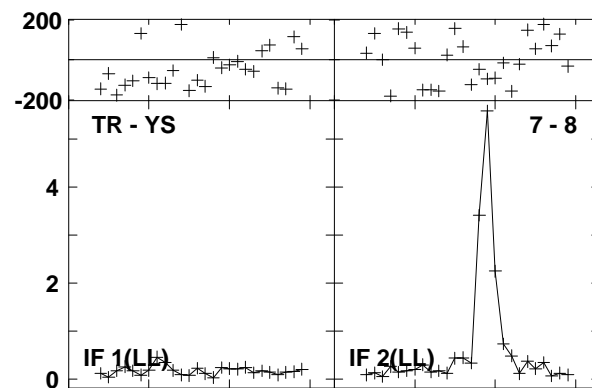
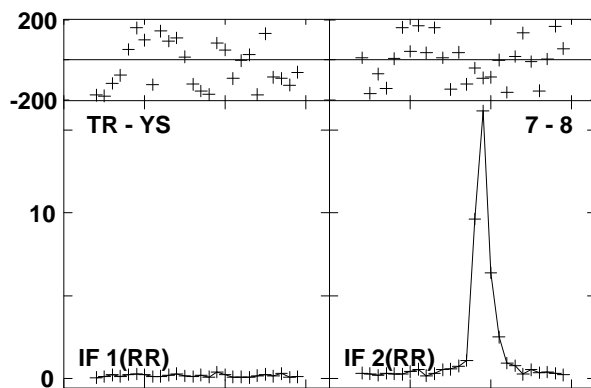
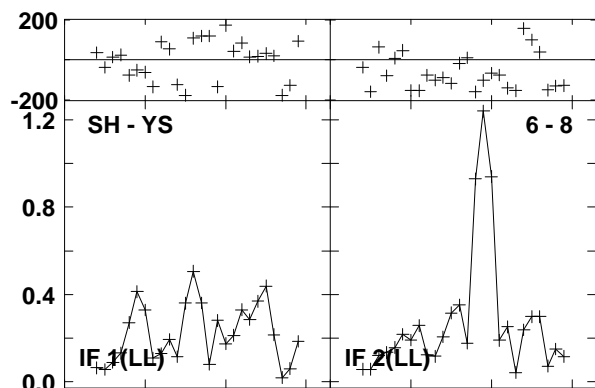
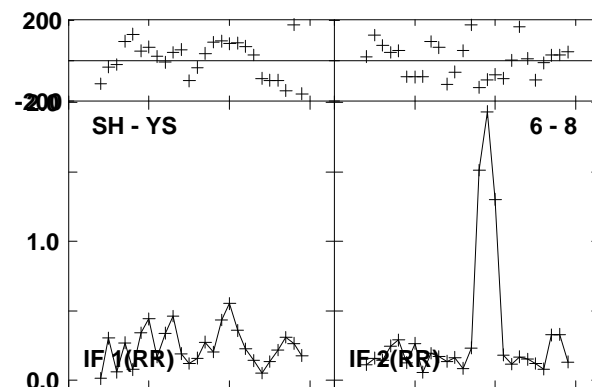
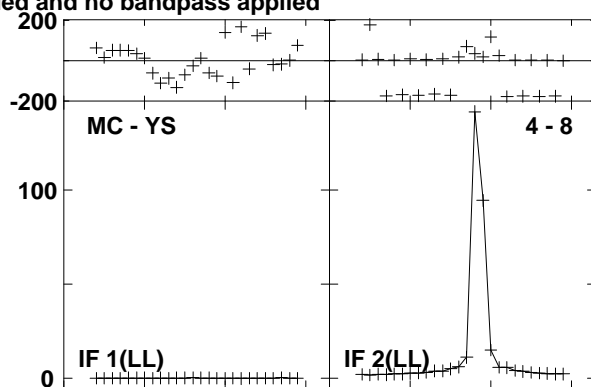
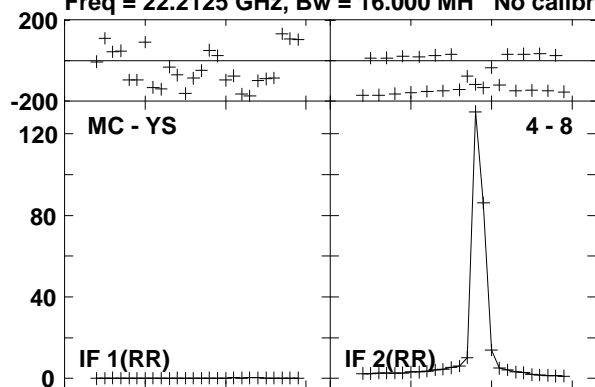

Lower frame: Milli Ampl Jy Top frame: Phas deg  
Vector averaged cross-power spectrum Baseline: MC (04) - YS (08)  
Timerange: 00/12:56:41 to 00/12:57:39

Plot file version 413 created 23-AUG-2016 15:00:56  
W3IRS5 GA035B 1.UVDATA.1

Freq = 22.2125 GHz, Bw = 16.000 MH No calibration applied and no bandpass applied

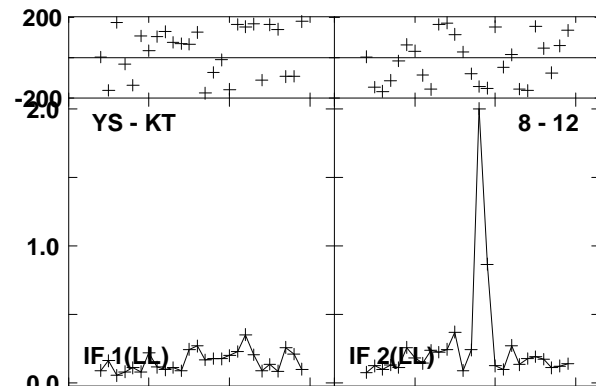
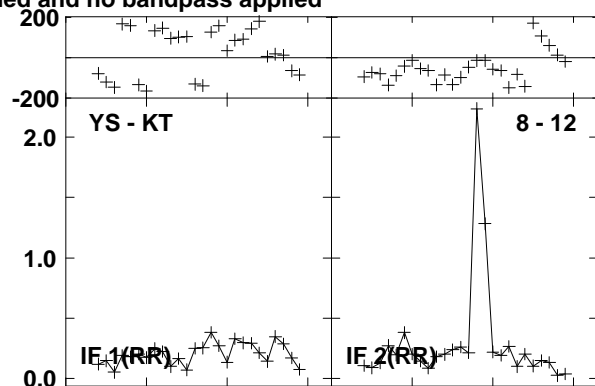
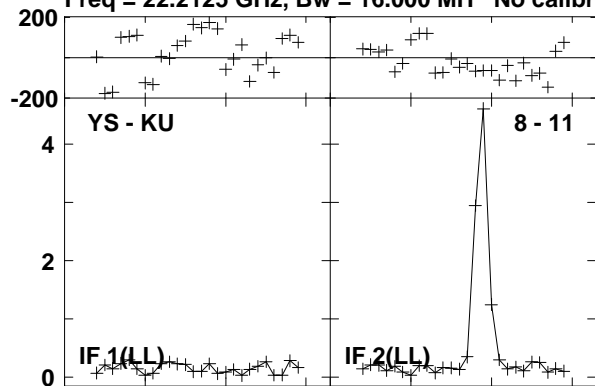

Lower frame: Milli Ampl Jy Top frame: Phas deg  
Vector averaged cross-power spectrum Baseline: YS (08) - KU (11)  
Timerange: 00/12:56:41 to 00/12:57:39

Plot file version 414 created 23-AUG-2016 15:00:56

0219+628 GA035B 1.UVDATA.1

Freq = 22.2125 GHz, Bw = 16.000 MH No calibration applied and no bandpass applied

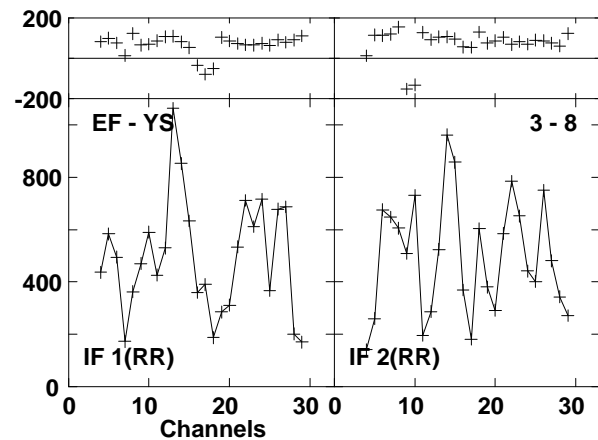
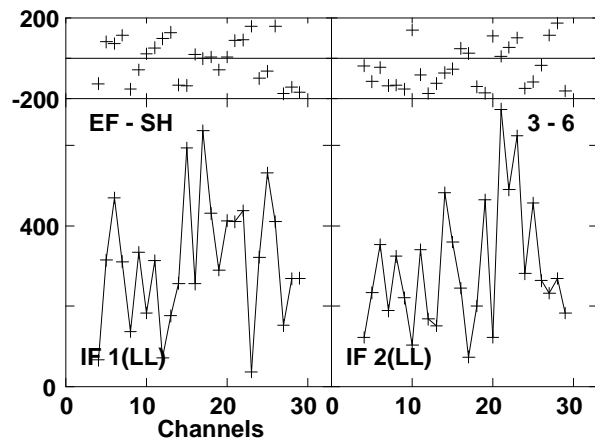
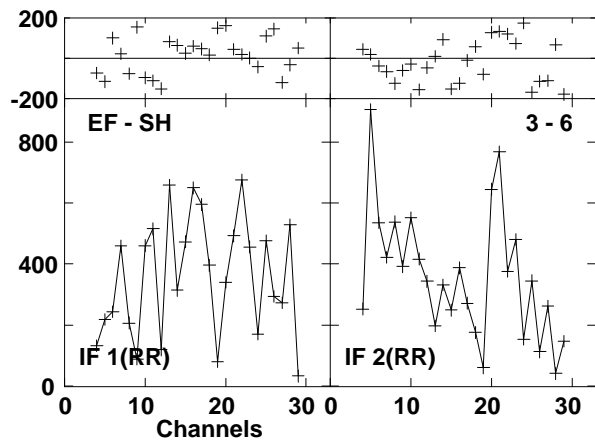
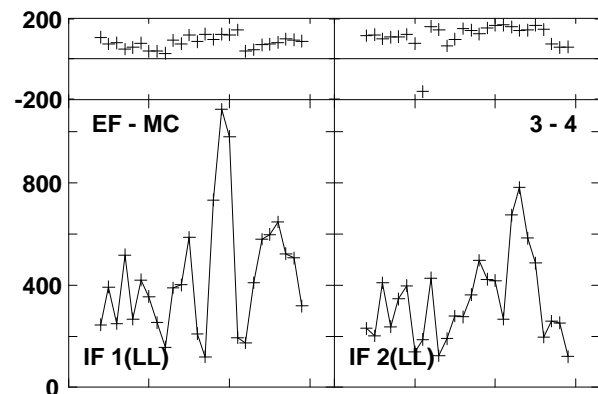
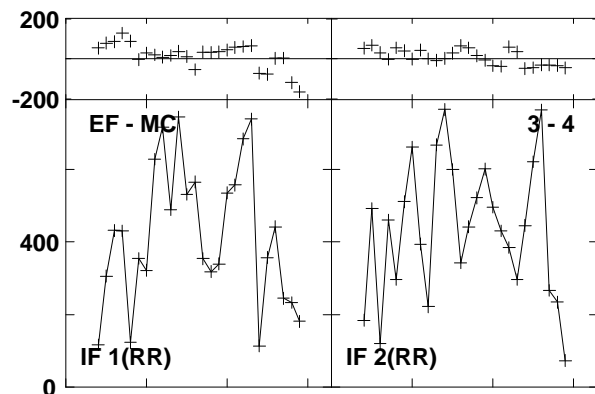
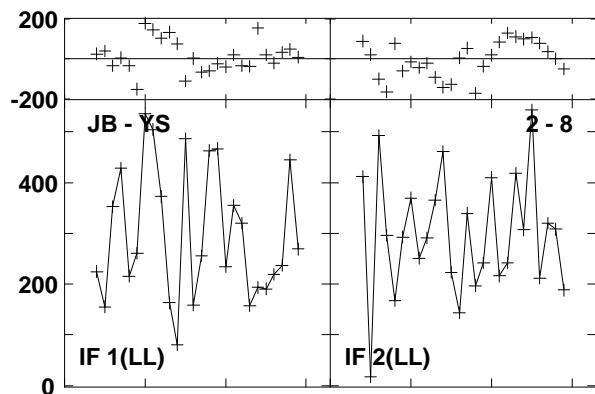
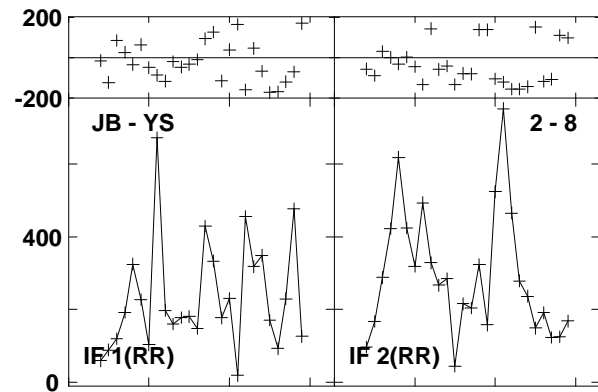
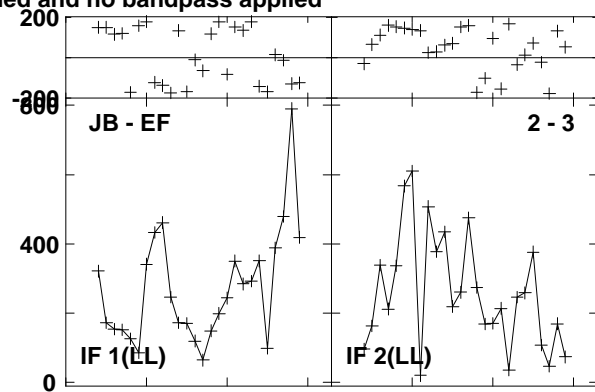
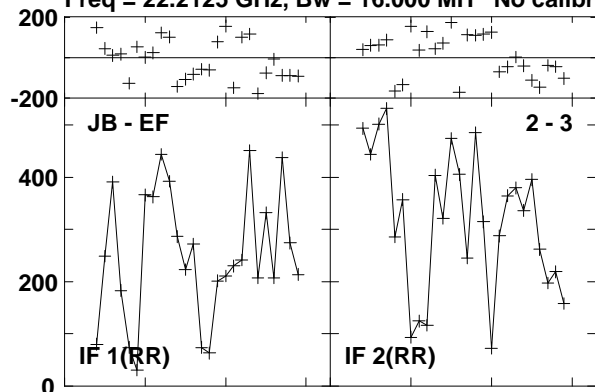

Lower frame: Micro Ampl Jy Top frame: Phas deg  
Vector averaged cross-power spectrum Baseline: JB (02) - EF (03)  
Timerange: 00/12:58:11 to 00/12:58:29

Plot file version 415 created 23-AUG-2016 15:00:56

0219+628 GA035B 1.UVDATA.1

Freq = 22.2125 GHz, Bw = 16.000 MH No calibration applied and no bandpass applied

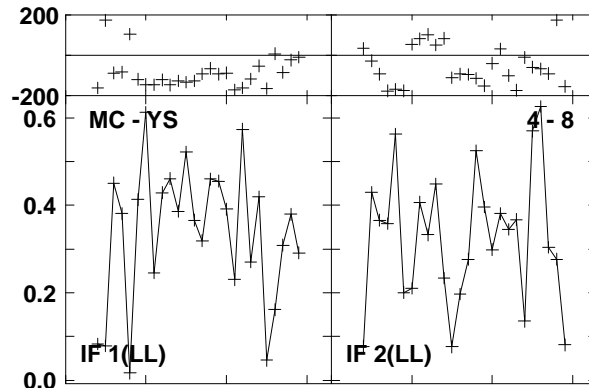
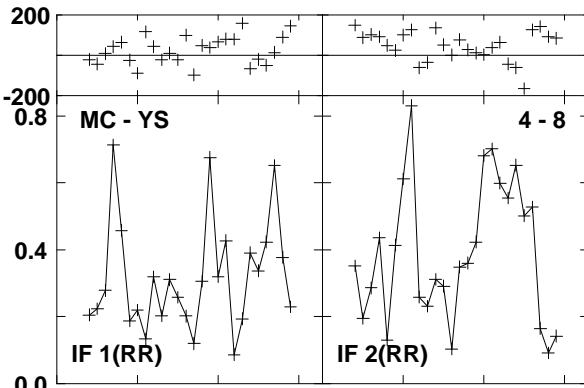
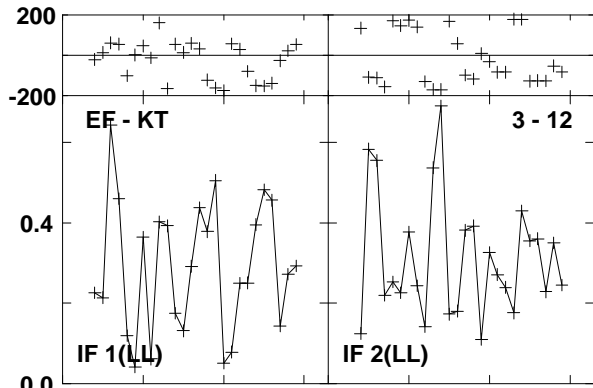
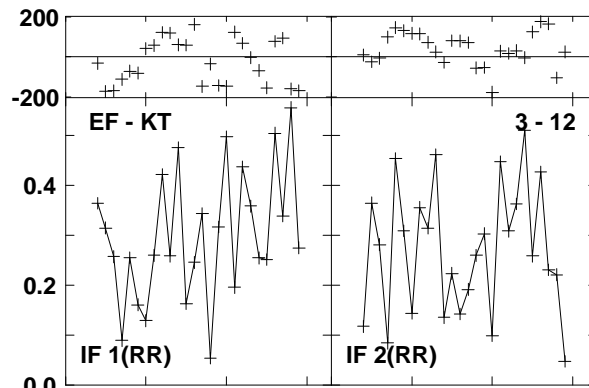
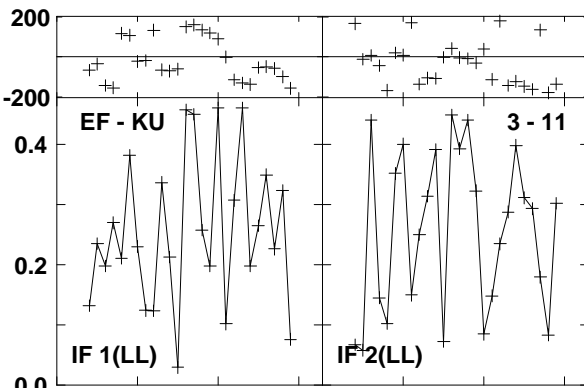
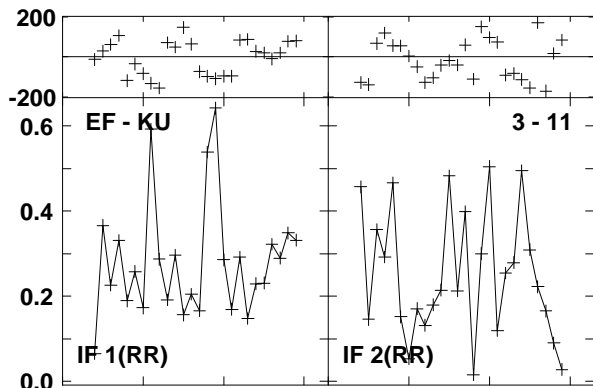
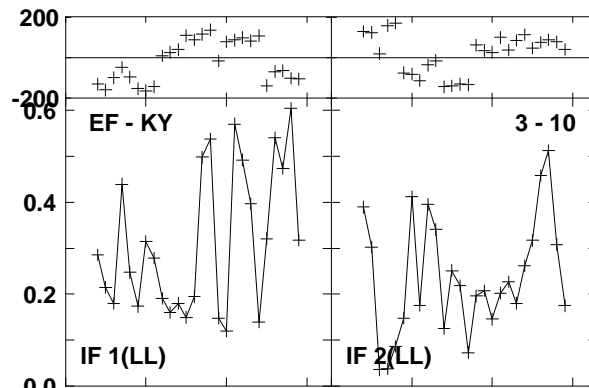
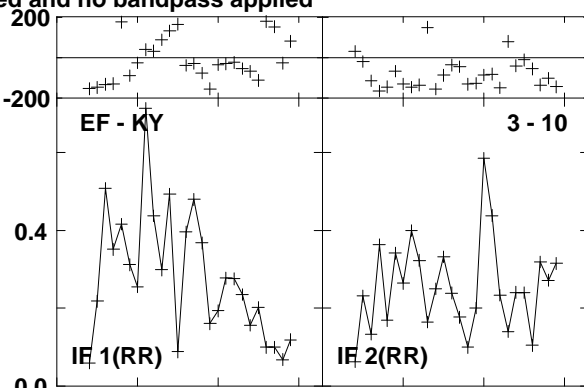
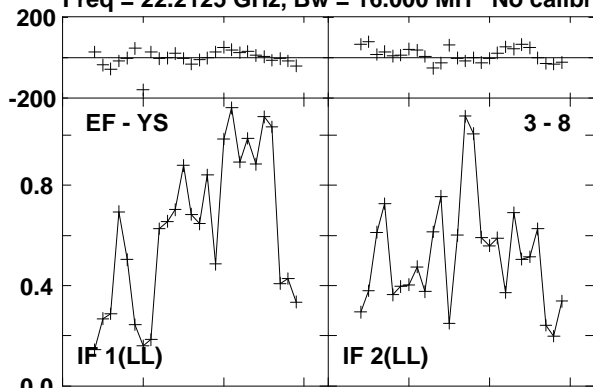

Lower frame: Milli Ampl Jy Top frame: Phas deg  
Vector averaged cross-power spectrum Baseline: EF (03) - YS (08)  
Timerange: 00/12:58:11 to 00/12:58:29

Plot file version 416 created 23-AUG-2016 15:00:56

0219+628 GA035B 1.UVDATA.1

Freq = 22.2125 GHz, Bw = 16.000 MH No calibration applied and no bandpass applied

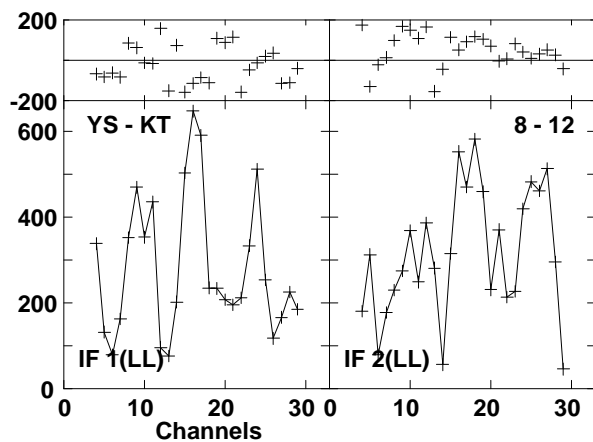
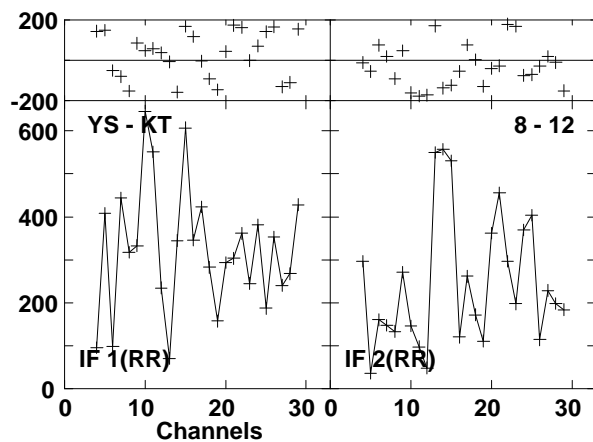
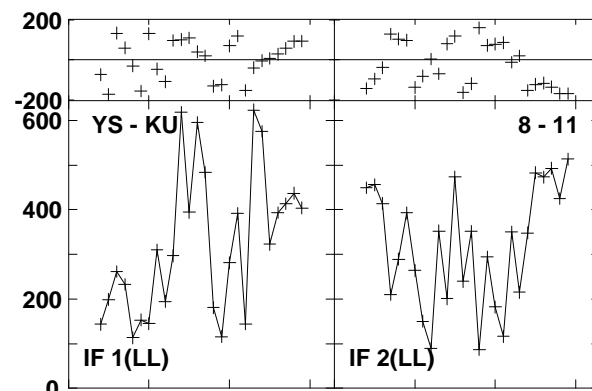
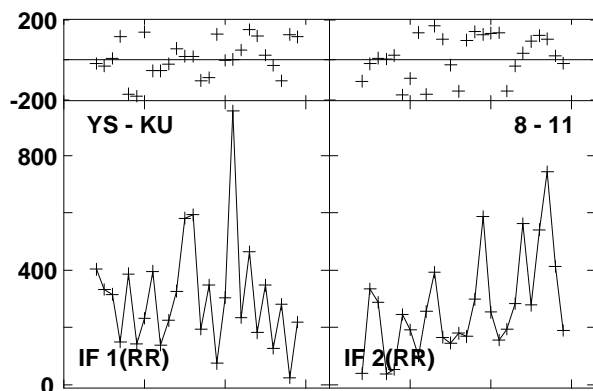
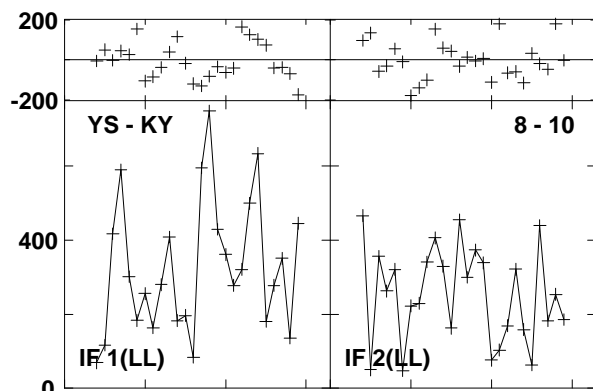
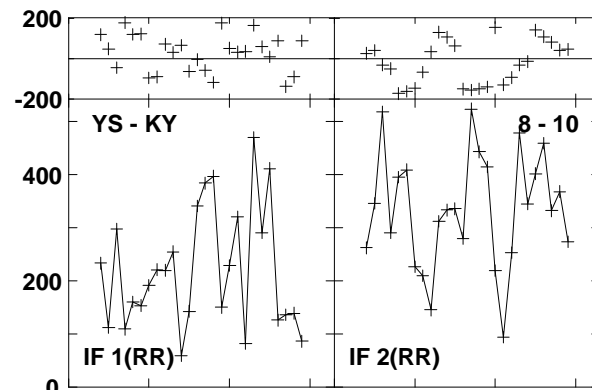
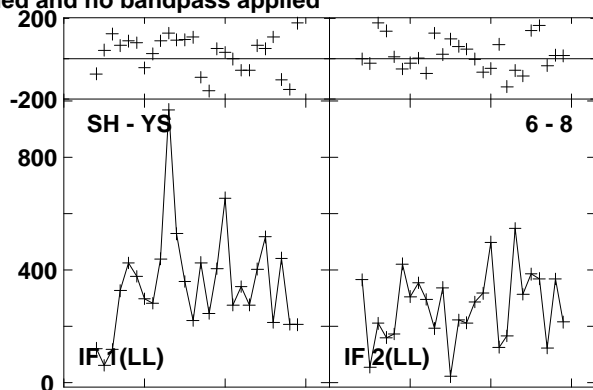
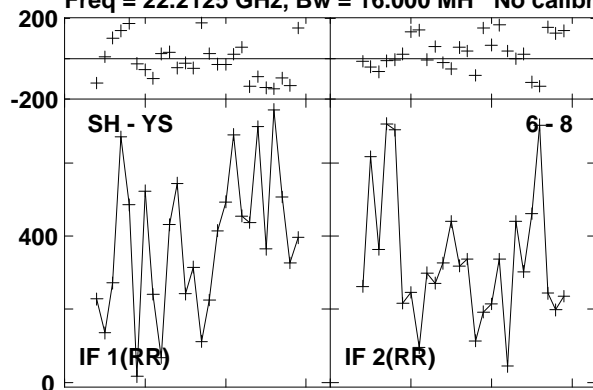

Lower frame: Micro Ampl Jy Top frame: Phas deg  
Vector averaged cross-power spectrum Baseline: SH (06) - YS (08)  
Timerange: 00/12:58:11 to 00/12:58:29



Plot file version 417 created 23-AUG-2016 15:00:56

W3IRS5 GA035B 1.UVDATA.1

Freq = 22.2125 GHz, Bw = 16.000 MH No calibration applied and no bandpass applied

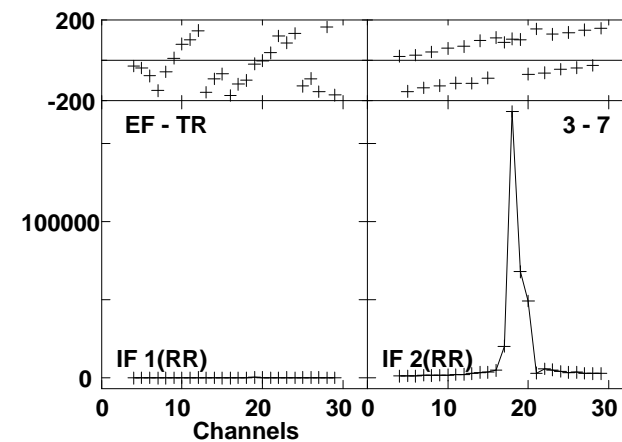
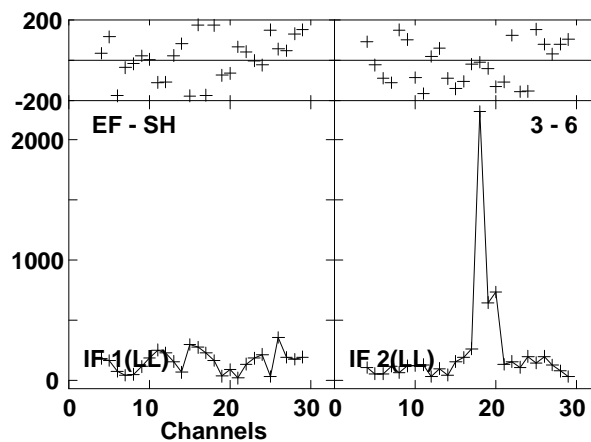
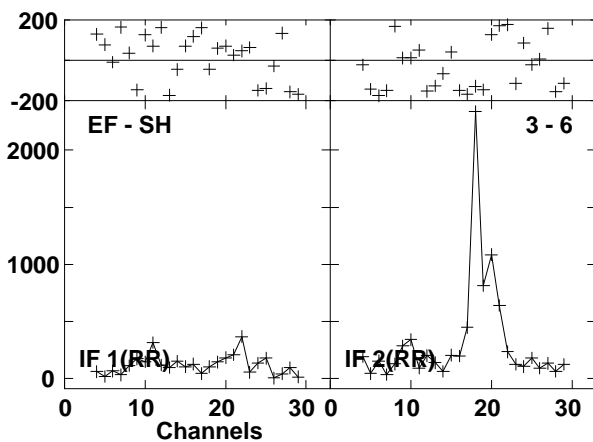
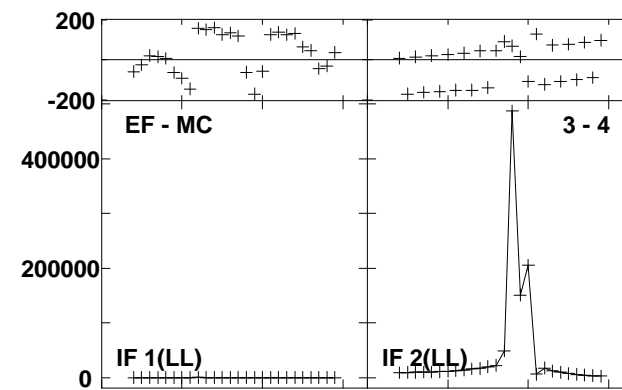
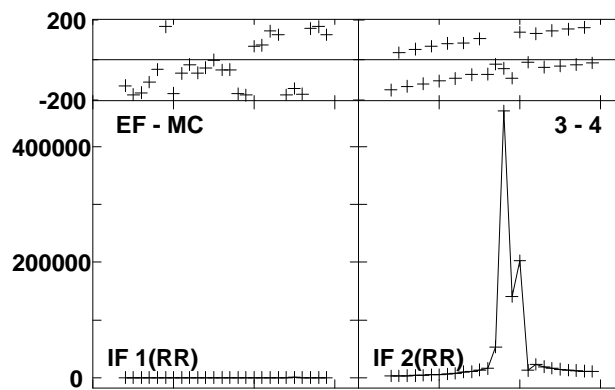
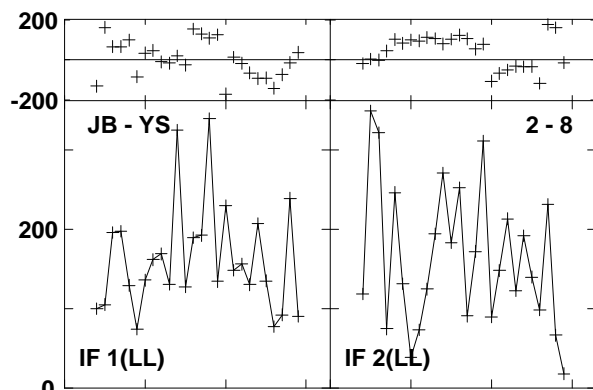
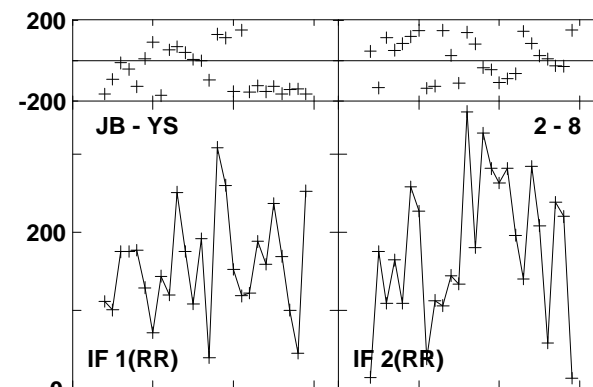
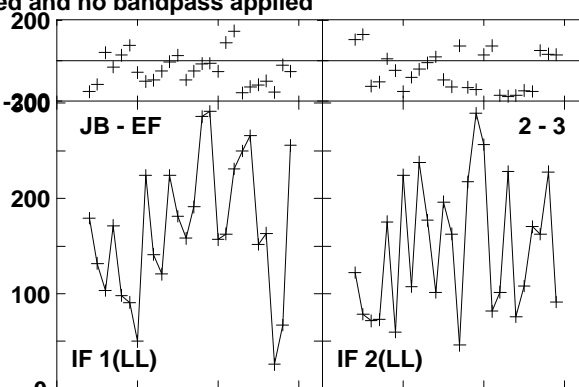
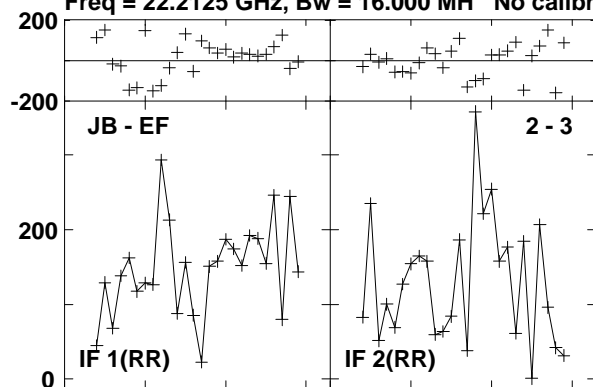

Lower frame: Micro Ampl Jy Top frame: Phas deg  
Vector averaged cross-power spectrum Baseline: JB (02) - EF (03)  
Timerange: 00/12:59:01 to 00/13:00:00

Plot file version 418 created 23-AUG-2016 15:00:56

W3IRS5 GA035B 1.UVDATA.1

Freq = 22.2125 GHz, Bw = 16.000 MH No calibration applied and no bandpass applied

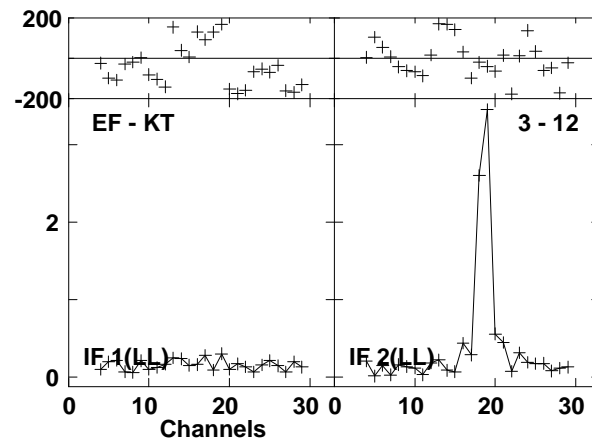
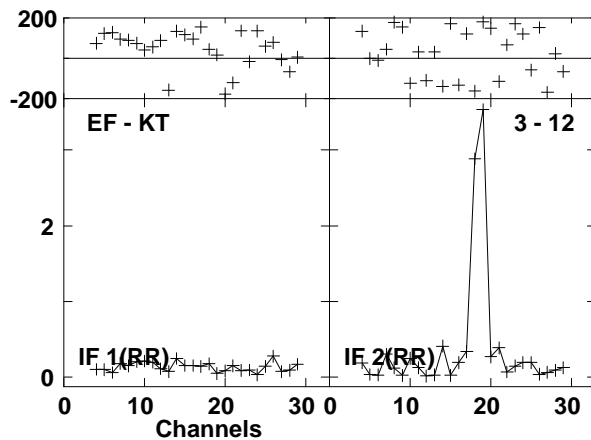
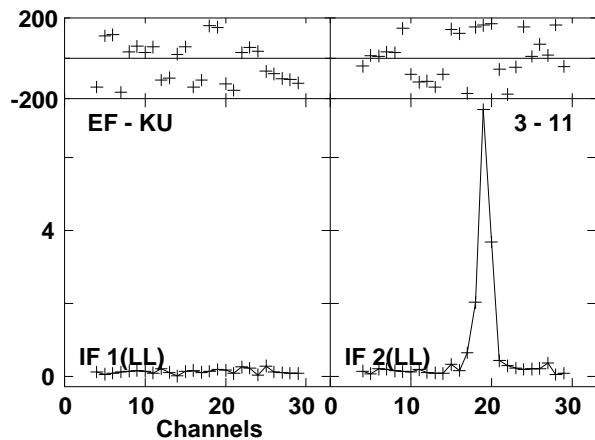
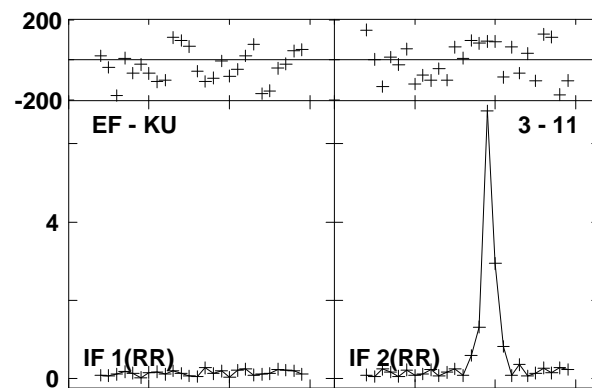
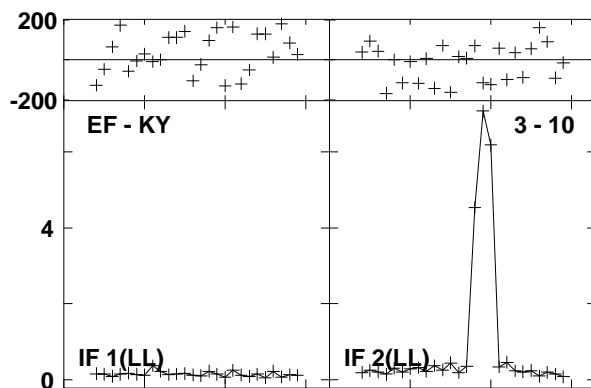
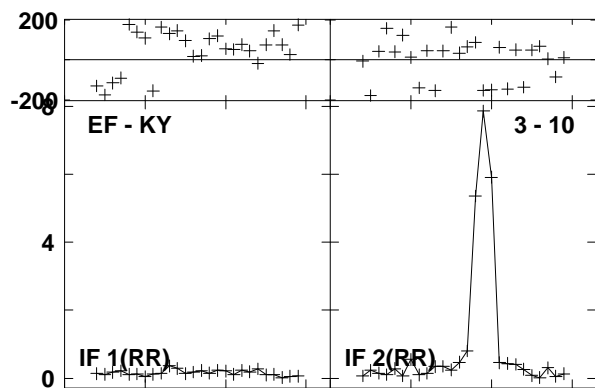
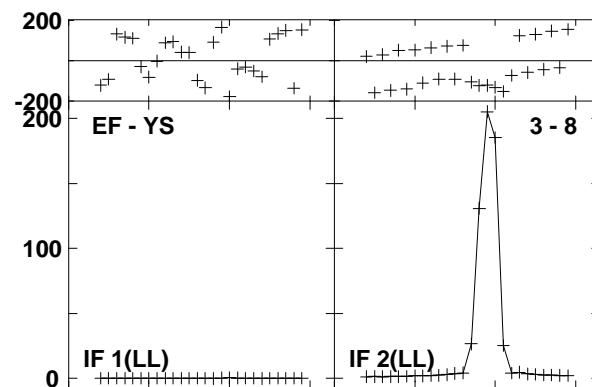
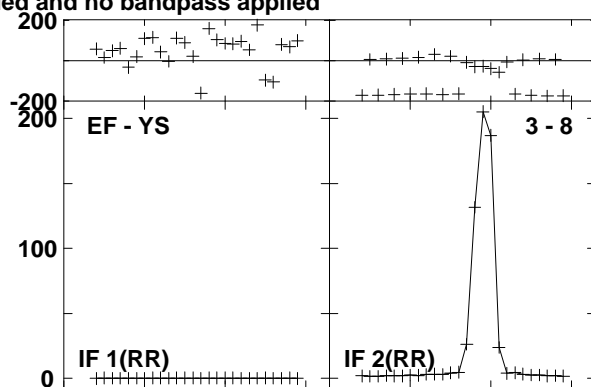
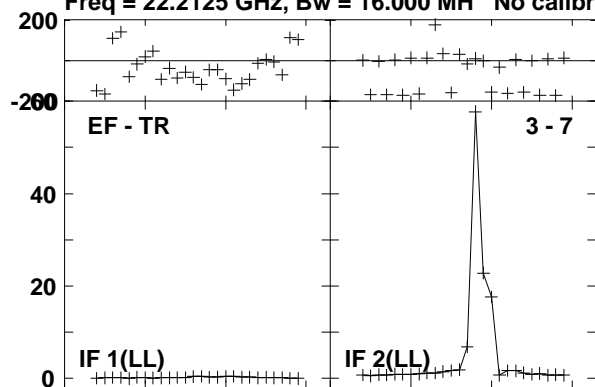

Lower frame: Milli Ampl Jy Top frame: Phas deg  
Vector averaged cross-power spectrum Baseline: EF (03) - TR (07)  
Timerange: 00/12:59:01 to 00/13:00:00

Plot file version 419 created 23-AUG-2016 15:00:56

W3IRS5 GA035B 1.UVDATA.1

Freq = 22.2125 GHz, Bw = 16.000 MH No calibration applied and no bandpass applied

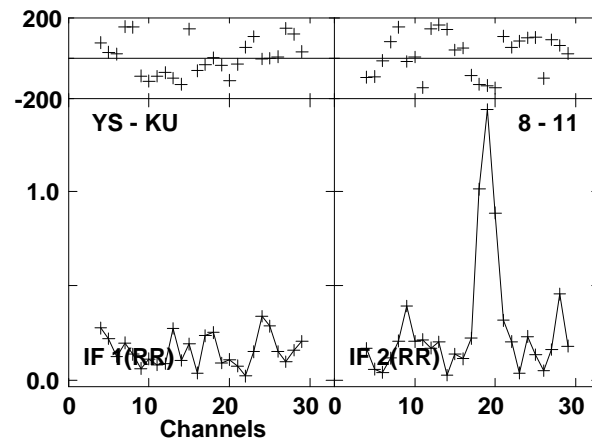
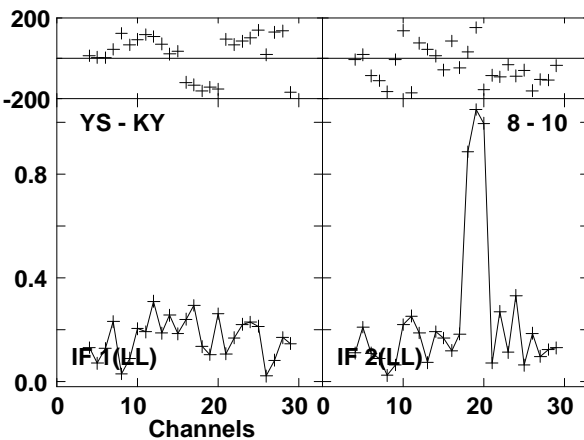
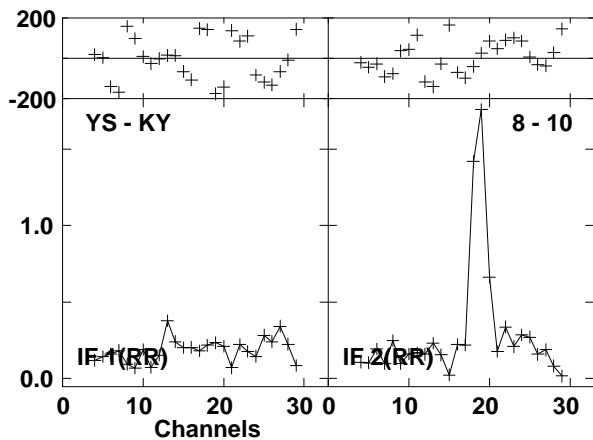
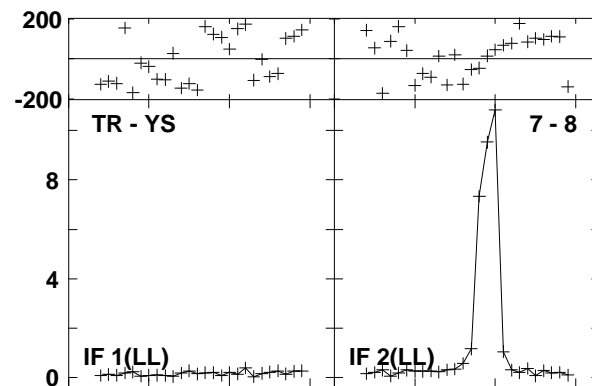
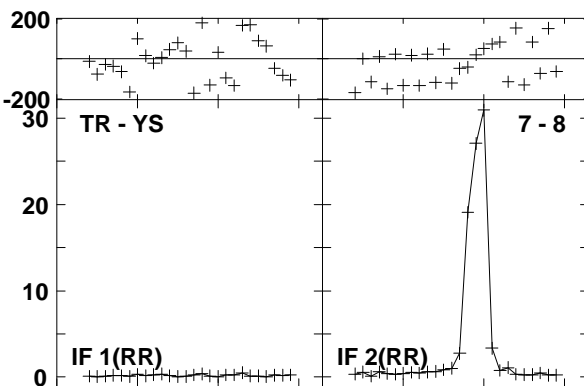
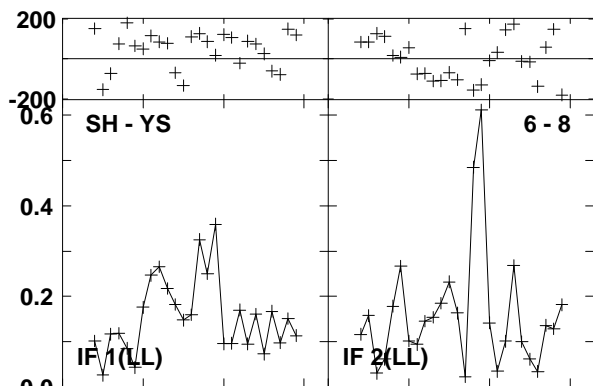
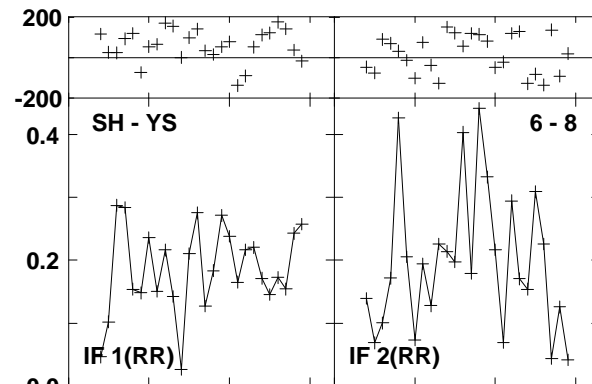
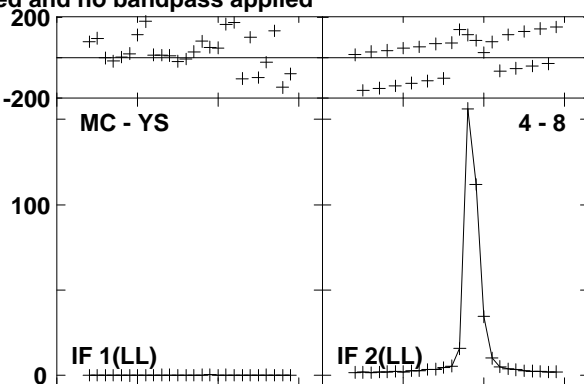
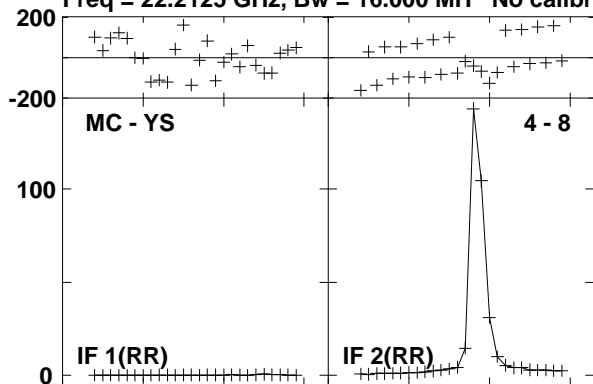

Lower frame: Milli Ampl Jy Top frame: Phas deg

Vector averaged cross-power spectrum Baseline: MC (04) - YS (08)

Timerange: 00/12:59:01 to 00/13:00:00

Plot file version 420 created 23-AUG-2016 15:00:56  
W3IRS5 GA035B 1.UVDATA.1

Freq = 22.2125 GHz, Bw = 16.000 MH No calibration applied and no bandpass applied

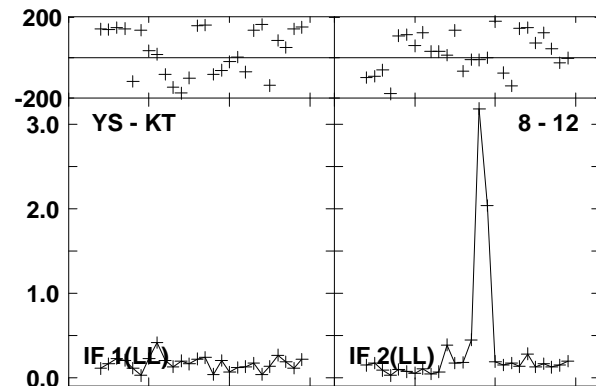
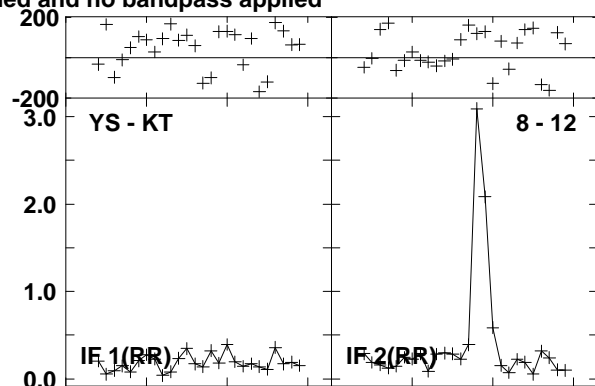
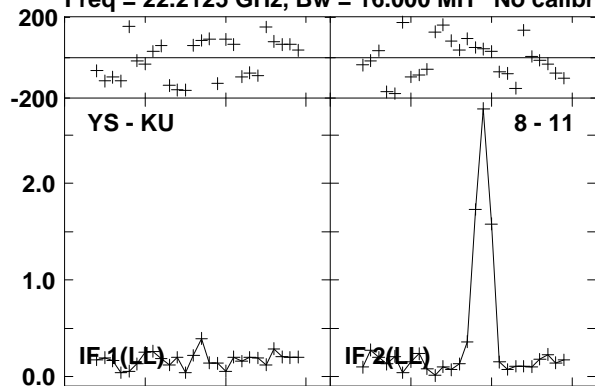

Lower frame: Milli Ampl Jy Top frame: Phas deg  
Vector averaged cross-power spectrum Baseline: YS (08) - KU (11)  
Timerange: 00/12:59:01 to 00/13:00:00

Plot file version 421 created 23-AUG-2016 15:00:56

0219+628 GA035B 1.UVDATA.1

Freq = 22.2125 GHz, Bw = 16.000 MH No calibration applied and no bandpass applied

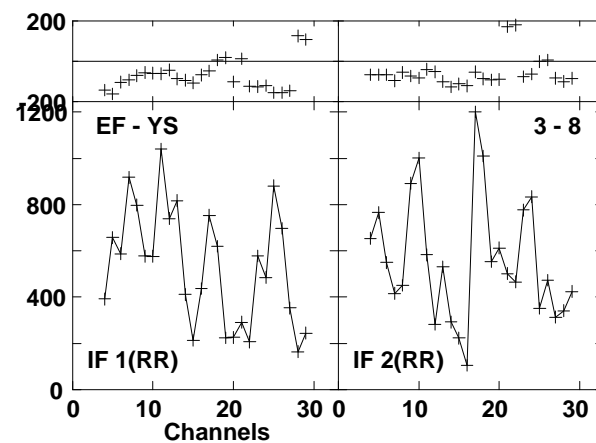
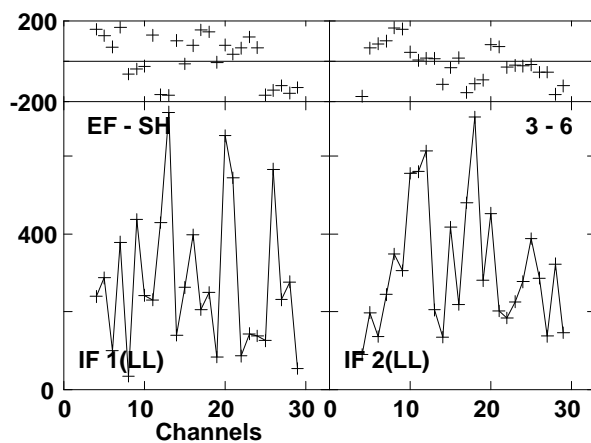
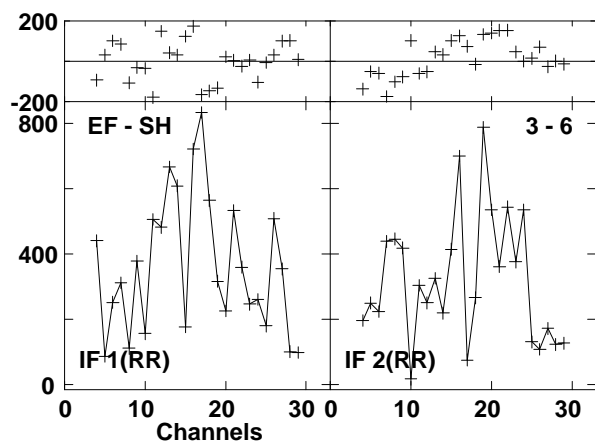
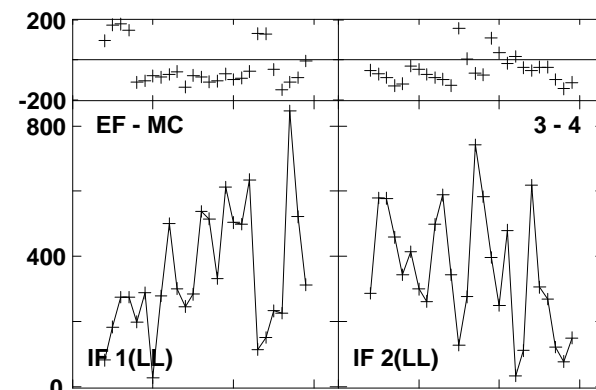
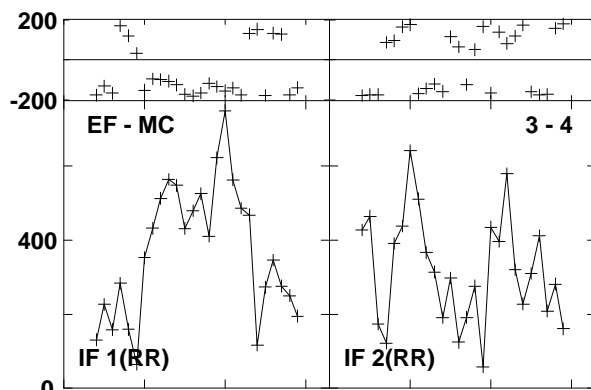
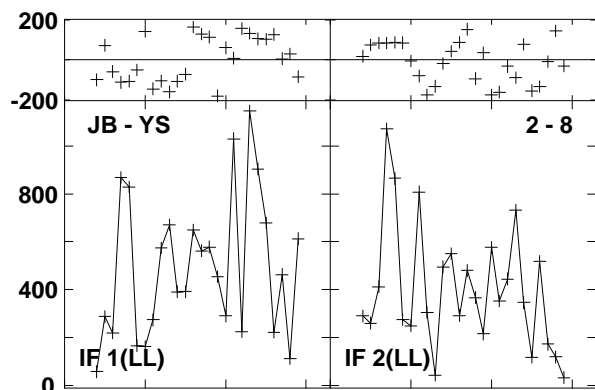
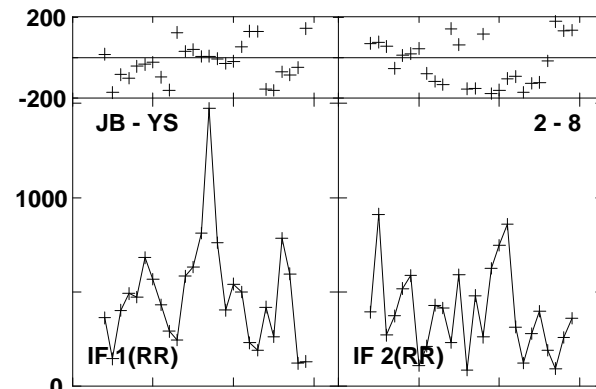
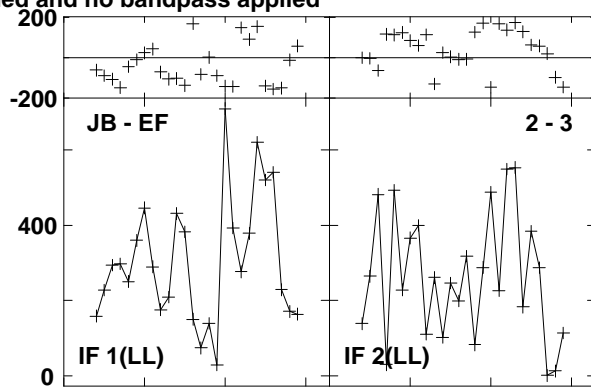
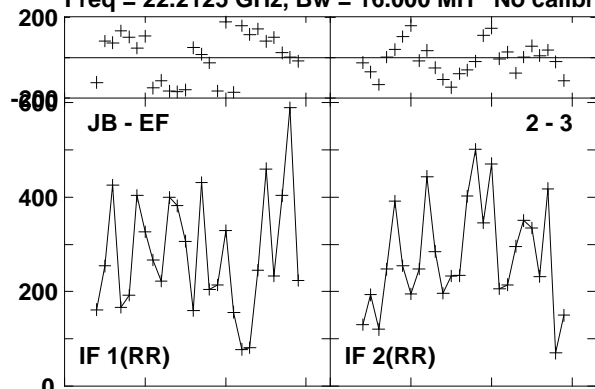

Lower frame: Micro Ampl Jy Top frame: Phas deg  
Vector averaged cross-power spectrum Baseline: JB (02) - EF (03)  
Timerange: 00/13:00:31 to 00/13:00:50

Plot file version 422 created 23-AUG-2016 15:00:56  
 0219+628 GA035B 1.UVDATA.1  
 Freq = 22.2125 GHz, Bw = 16.000 MH No calibration applied and no bandpass applied

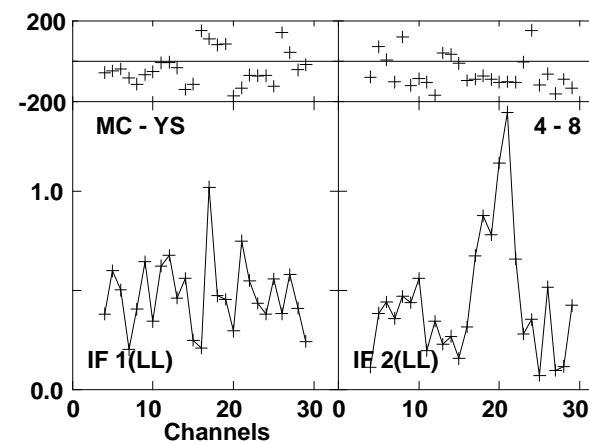
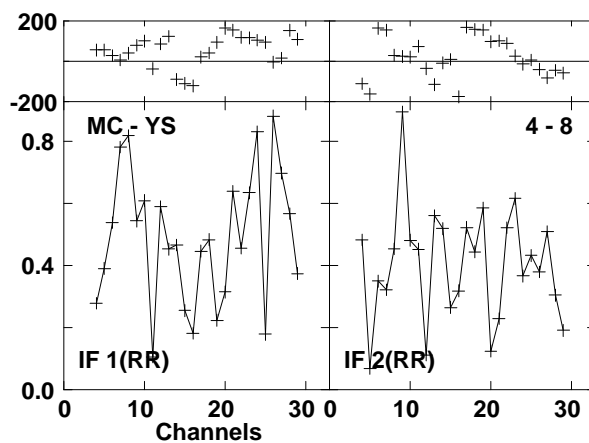
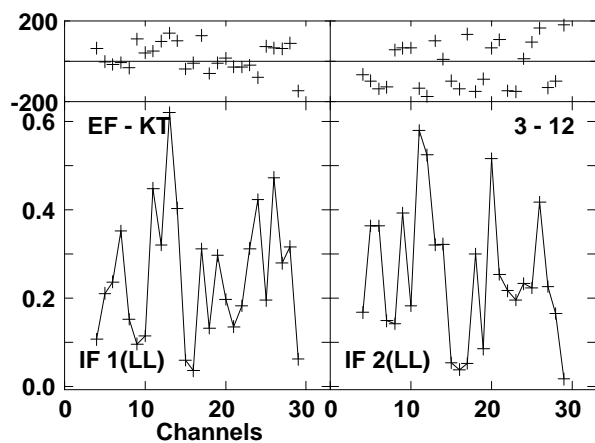
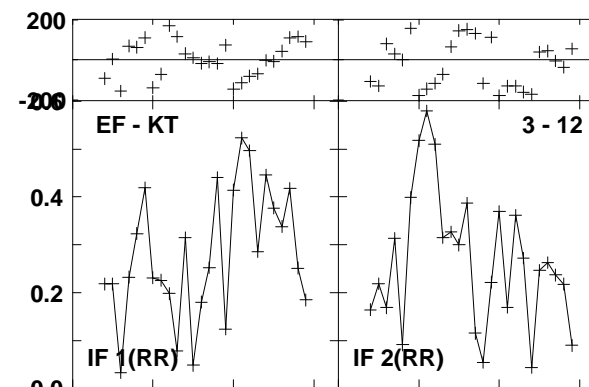
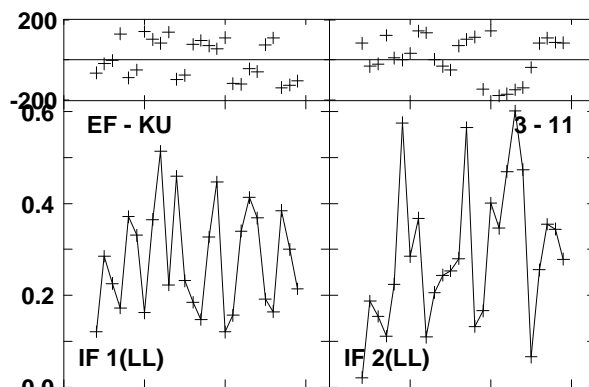
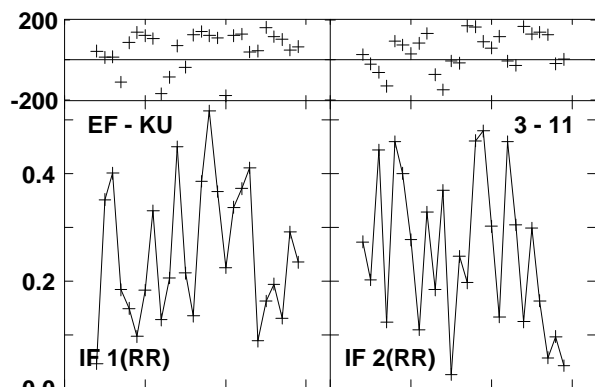
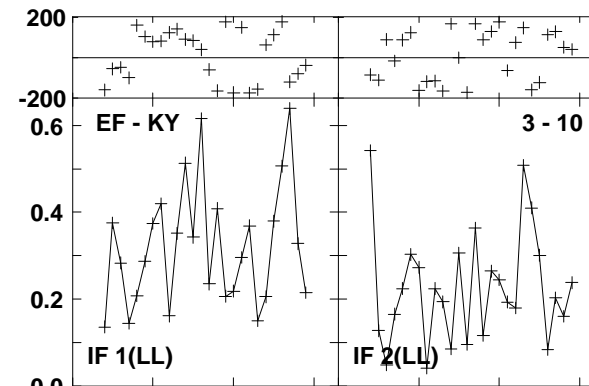
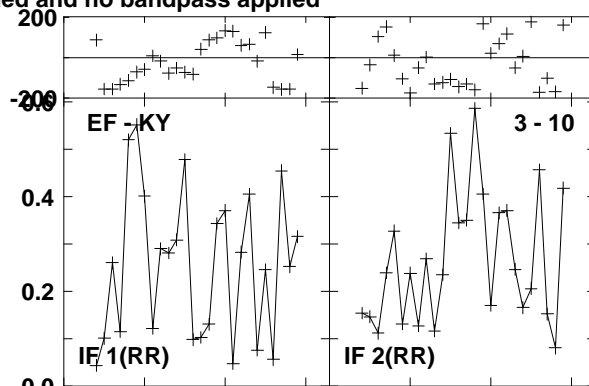
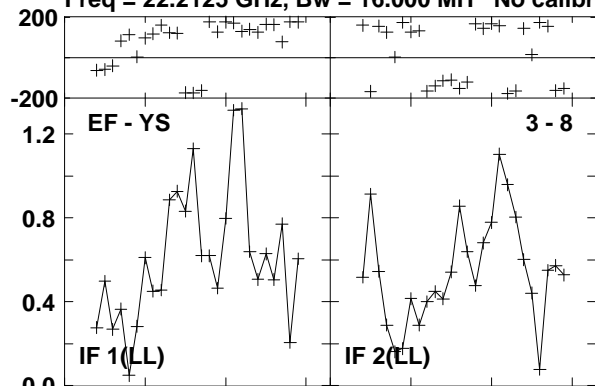

Lower frame: Milli Ampl Jy Top frame: Phas deg  
 Vector averaged cross-power spectrum Baseline: EF (03) - YS (08)  
 Timerange: 00/13:00:31 to 00/13:00:50

Plot file version 423 created 23-AUG-2016 15:00:56

0219+628 GA035B 1.UVDATA.1

Freq = 22.2125 GHz, Bw = 16.000 MH No calibration applied and no bandpass applied

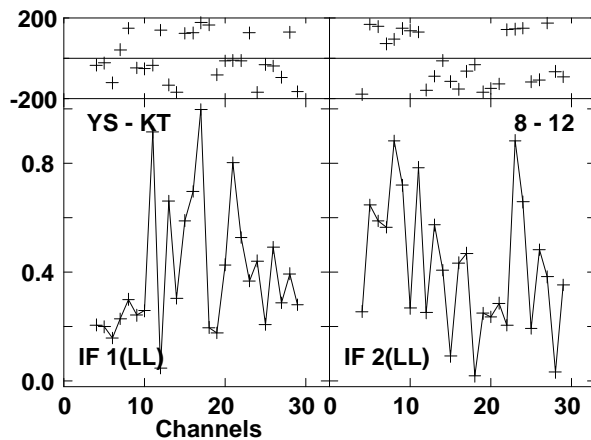
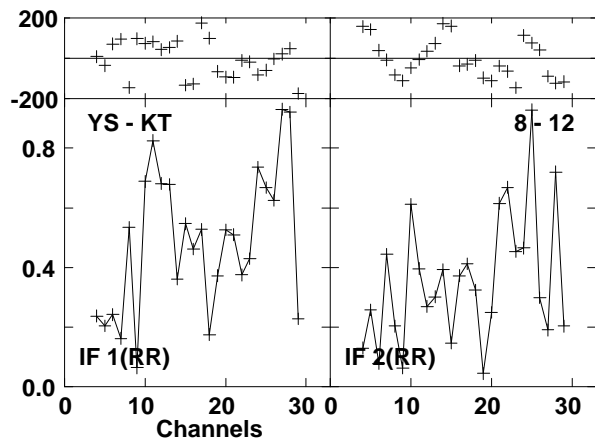
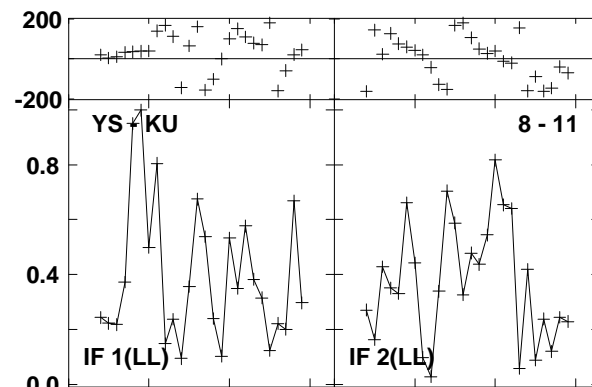
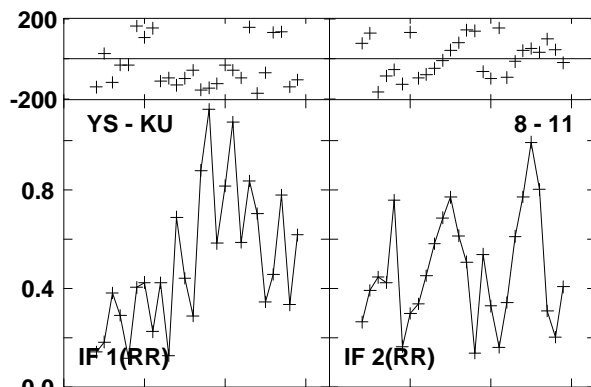
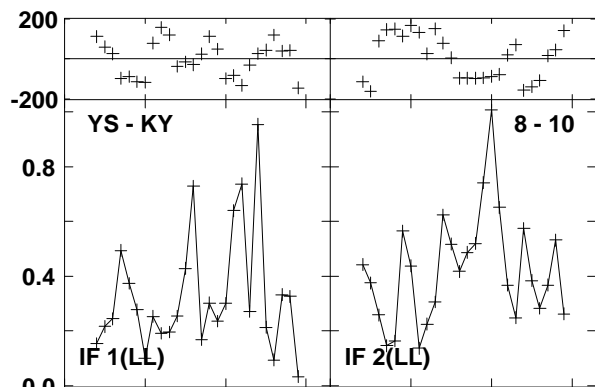
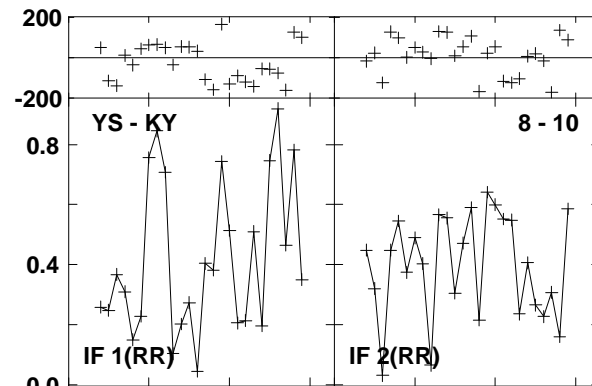
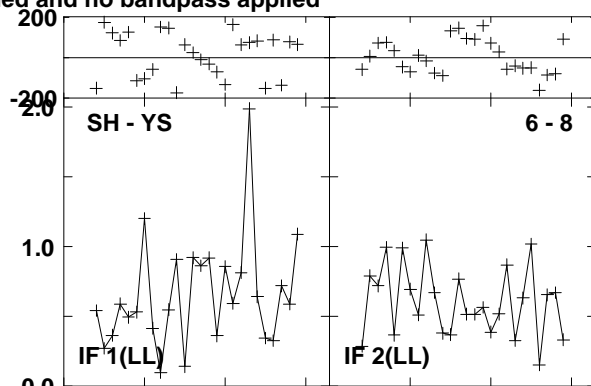
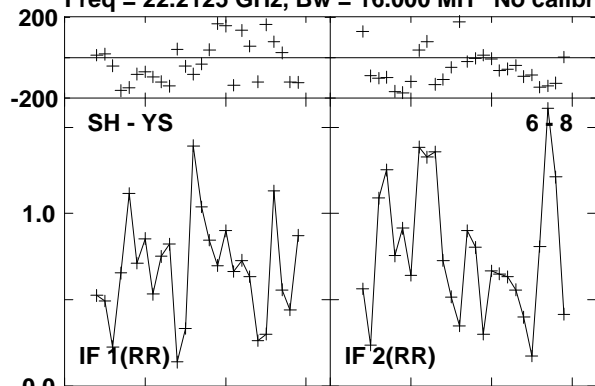

Lower frame: Milli Ampl Jy Top frame: Phas deg  
Vector averaged cross-power spectrum Baseline: SH (06) - YS (08)  
Timerange: 00/13:00:31 to 00/13:00:50

Plot file version 424 created 23-AUG-2016 15:00:56  
 W3IRS5 GA035B 1.UVDATA.1

Freq = 22.2125 GHz, Bw = 16.000 MH No calibration applied and no bandpass applied

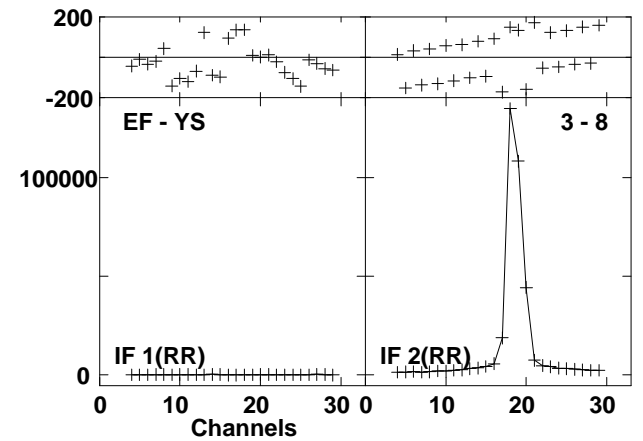
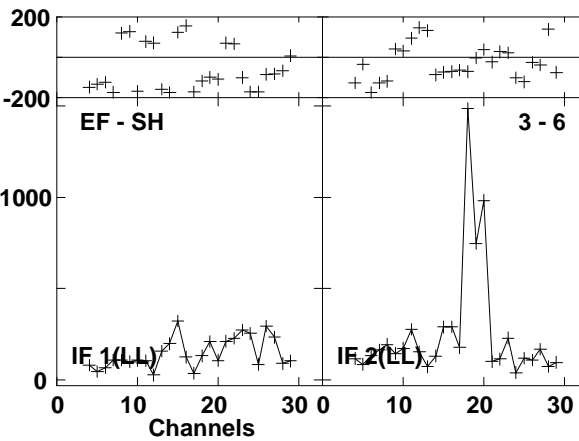
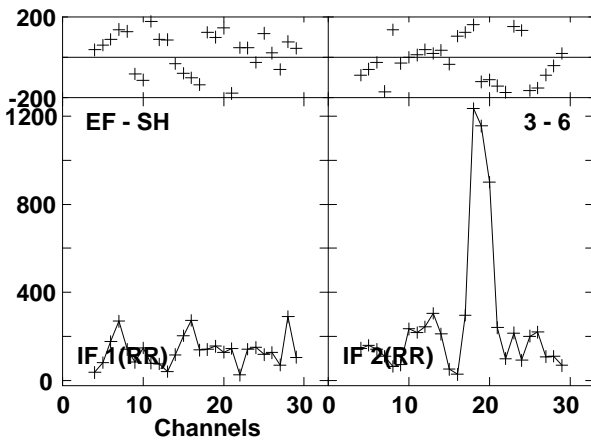
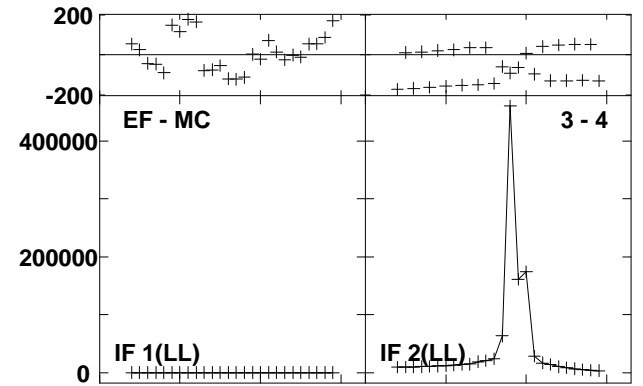
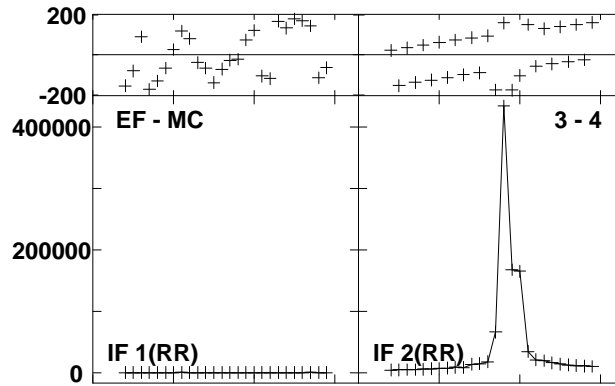
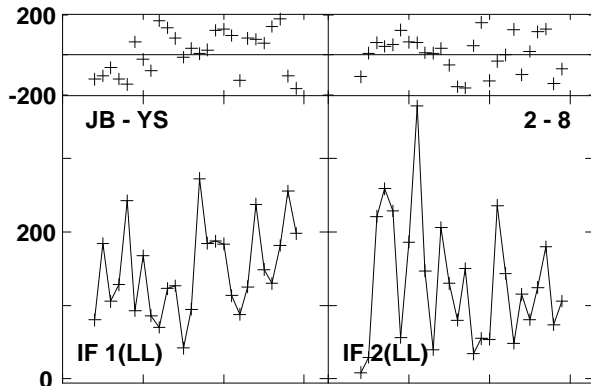
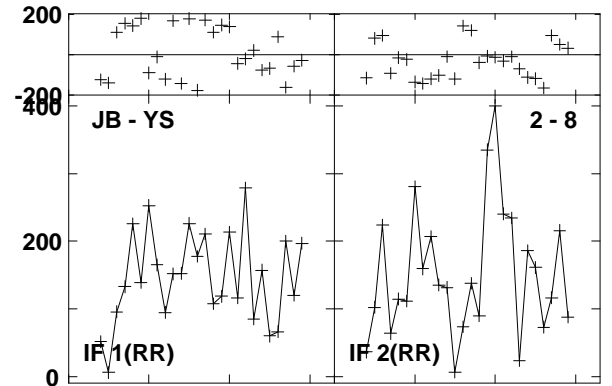
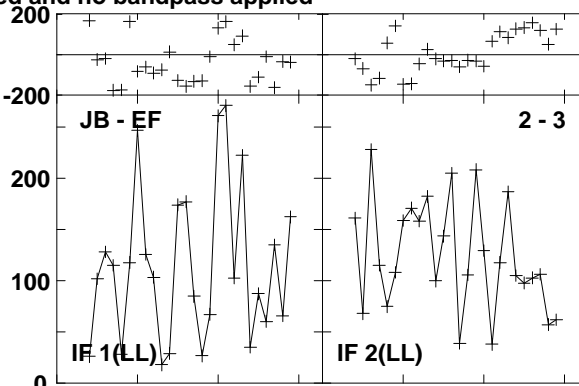
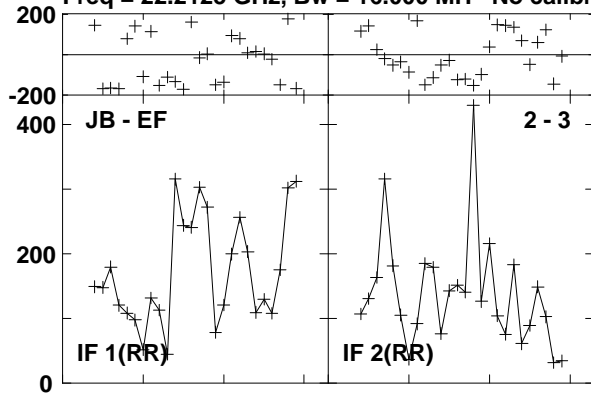

Lower frame: Micro Ampl Jy Top frame: Phas deg  
 Vector averaged cross-power spectrum Baseline: JB (02) - EF (03)  
 Timerange: 00/13:01:20 to 00/13:02:19



Plot file version 425 created 23-AUG-2016 15:00:56

W3IRS5 GA035B 1.UVDATA.1

Freq = 22.2125 GHz, Bw = 16.000 MH No calibration applied and no bandpass applied

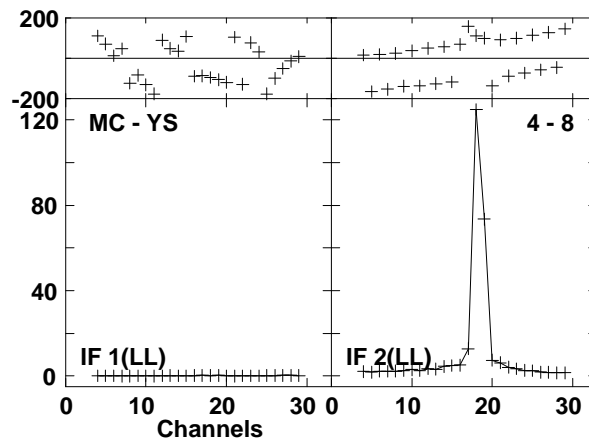
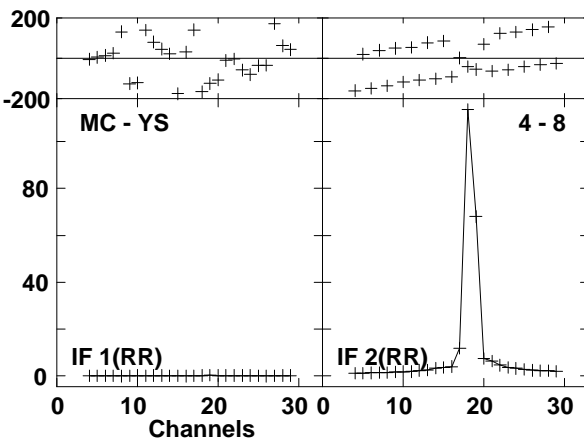
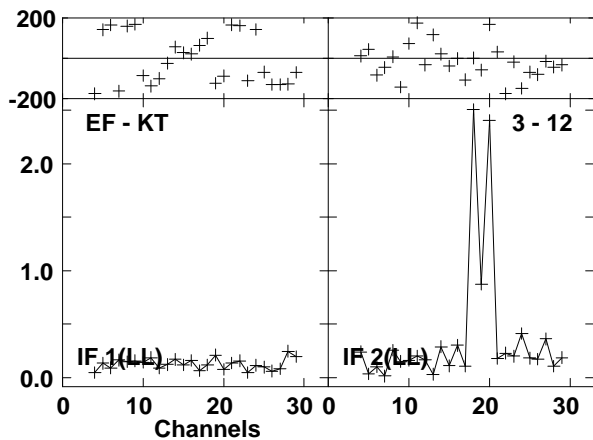
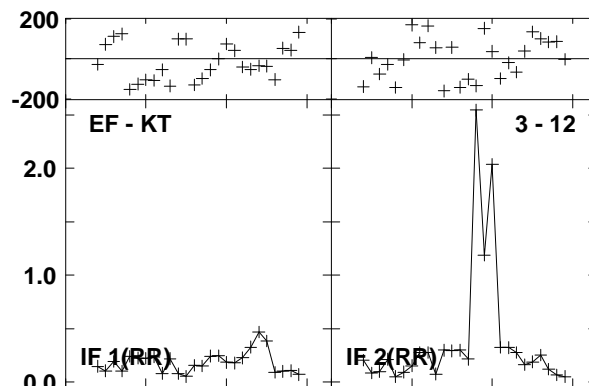
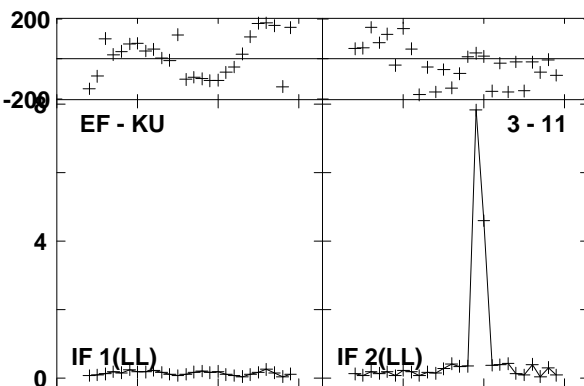
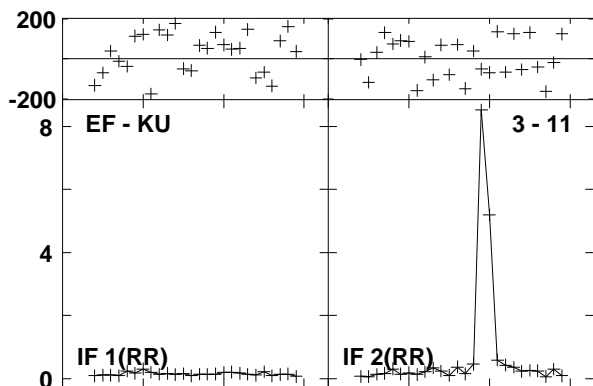
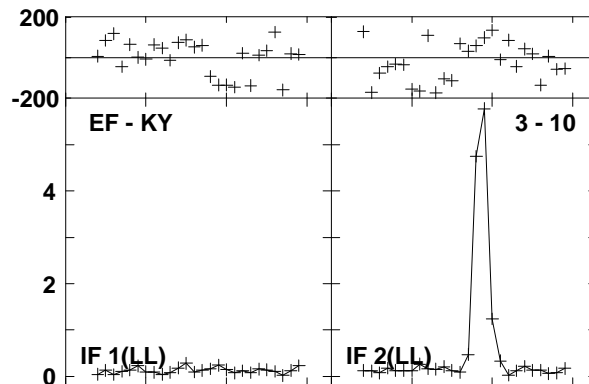
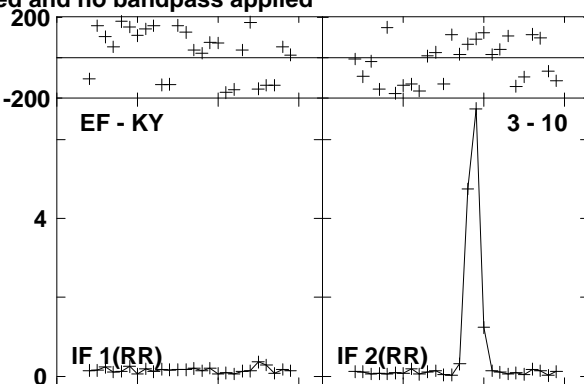
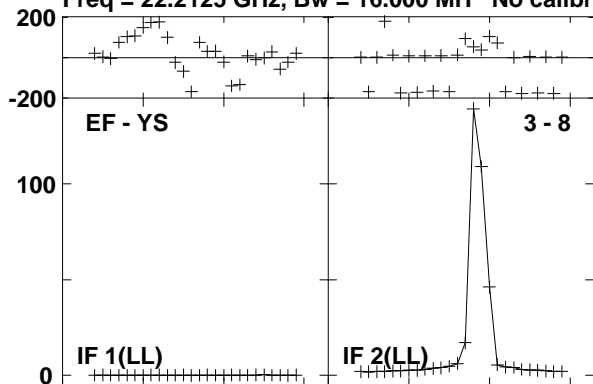

Lower frame: Milli Ampl Jy Top frame: Phas deg  
Vector averaged cross-power spectrum Baseline: EF (03) - YS (08)  
Timerange: 00/13:01:20 to 00/13:02:19

Plot file version 426 created 23-AUG-2016 15:00:56

W3IRS5 GAO35B 1.UVDATA.1

Freq = 22.2125 GHz, Bw = 16.000 MH No calibration applied and no bandpass applied

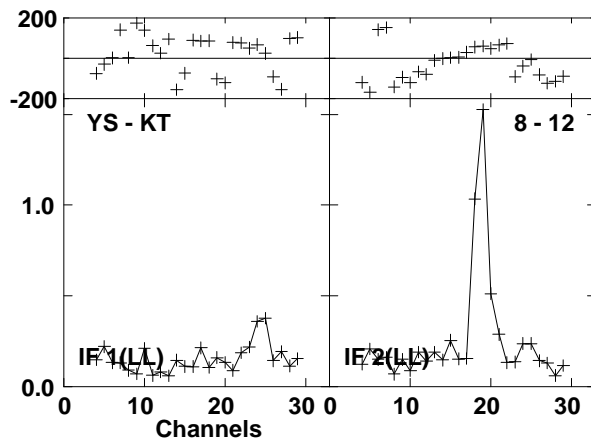
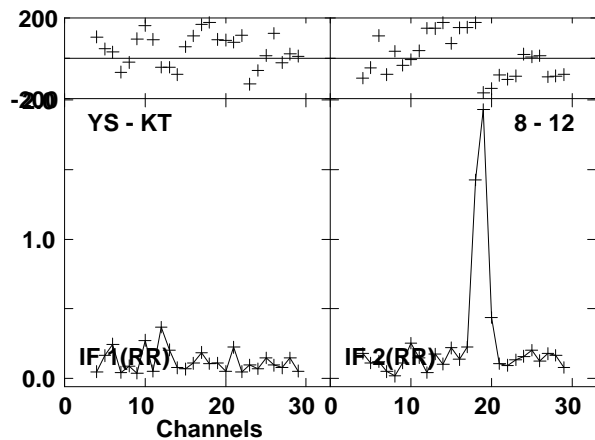
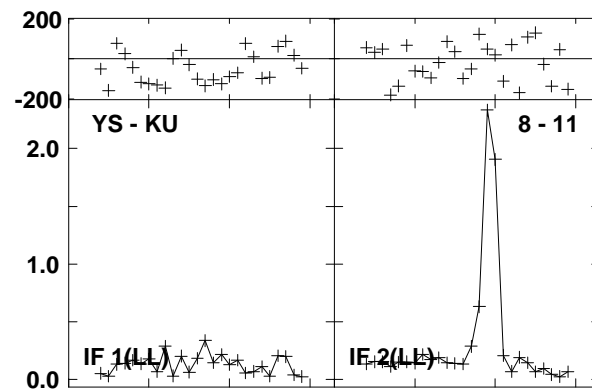
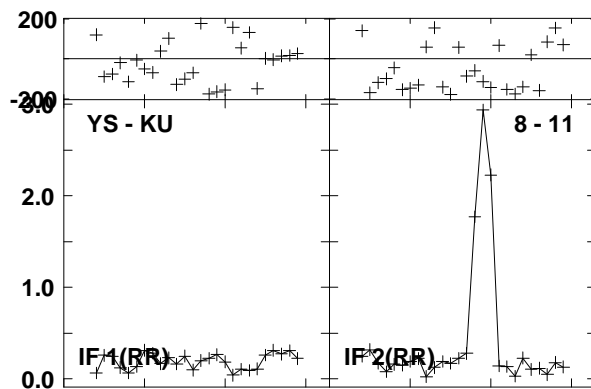
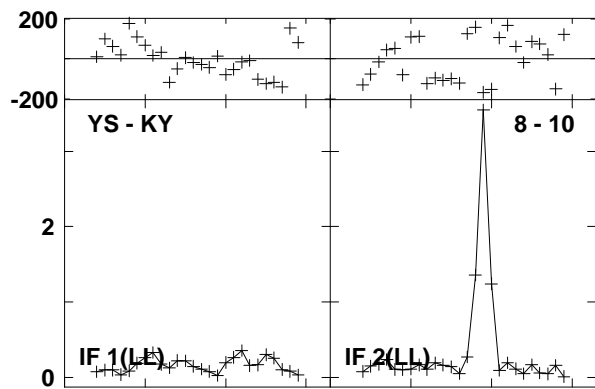
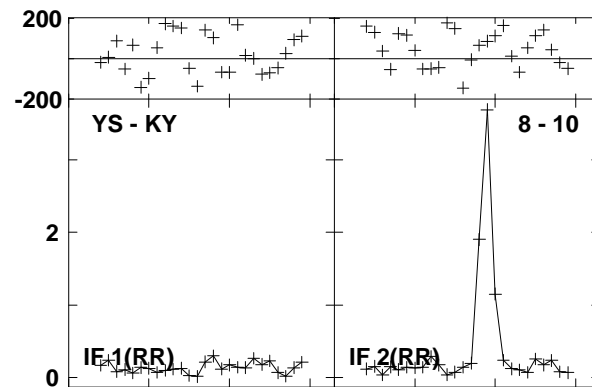
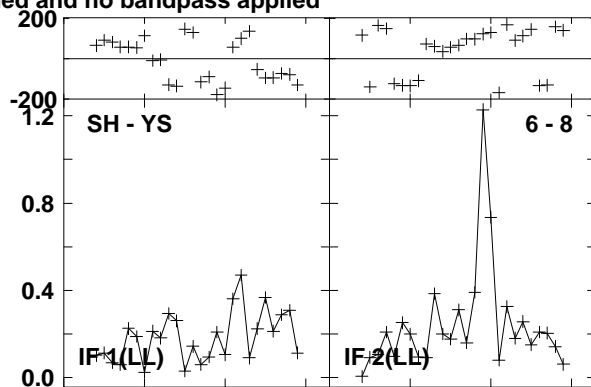
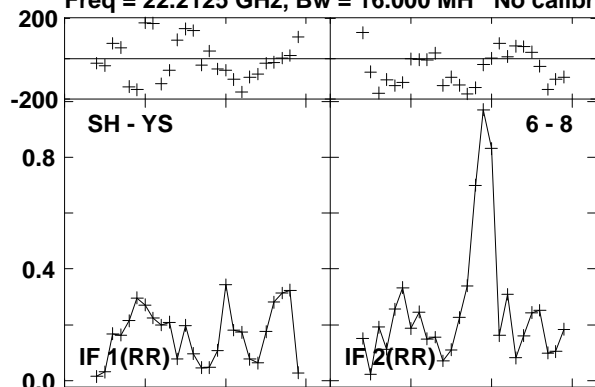

Lower frame: Milli Ampl Jy Top frame: Phas deg

Vector averaged cross-power spectrum Baseline: SH (06) - YS (08)

Timerange: 00/13:01:20 to 00/13:02:19

Plot file version 427 created 23-AUG-2016 15:00:56

0219+628 GA035B 1.UVDATA.1

Freq = 22.2125 GHz, Bw = 16.000 MH No calibration applied and no bandpass applied

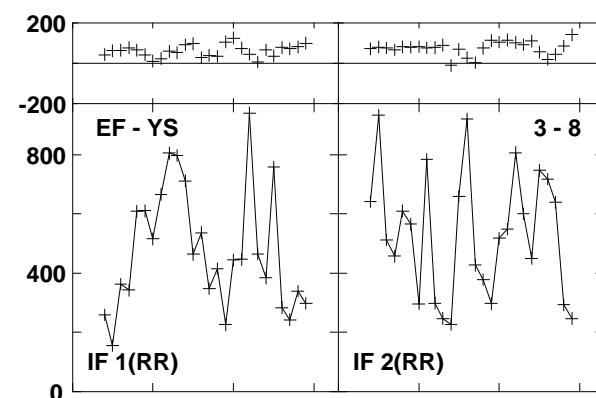
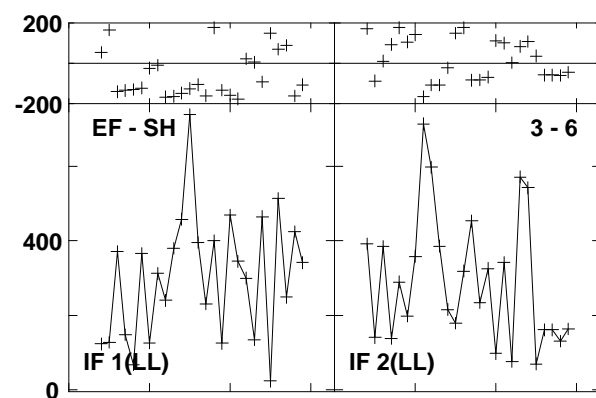
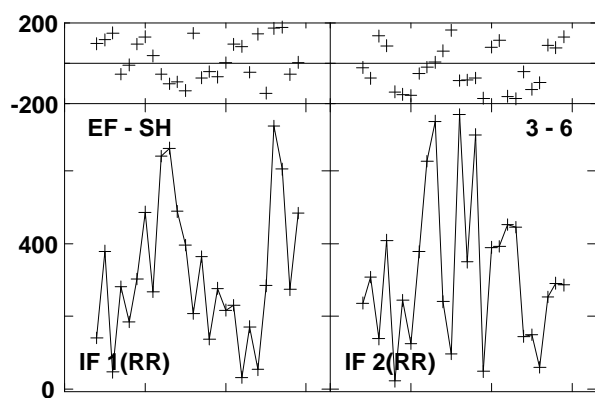
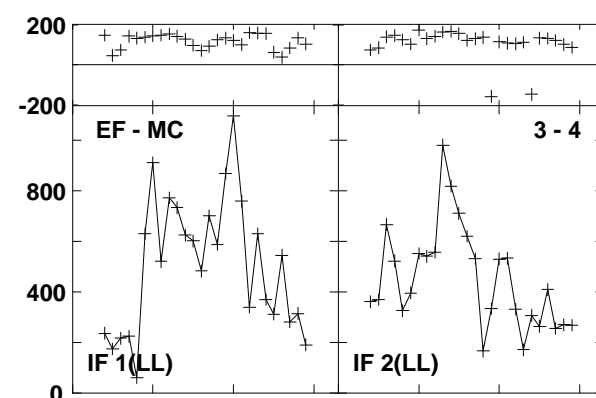
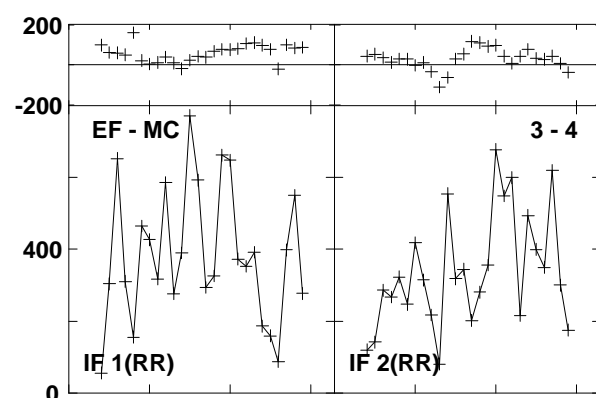
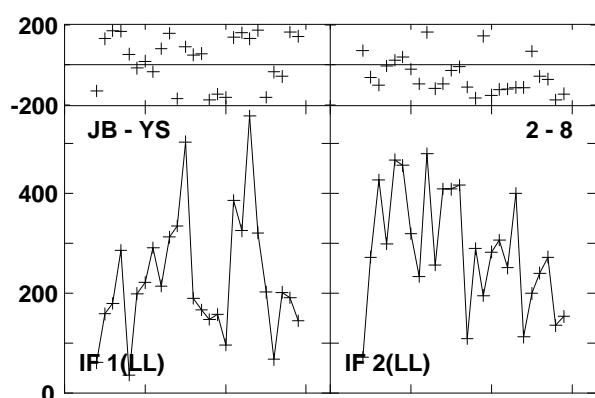
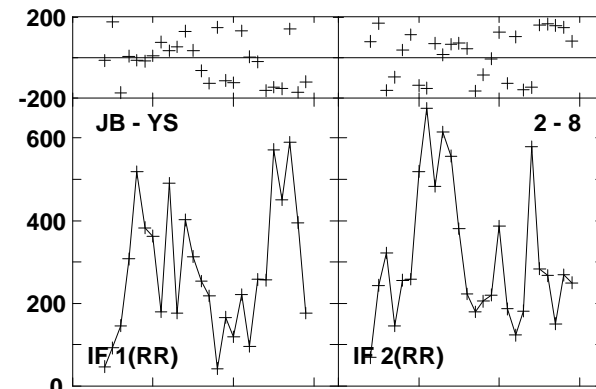
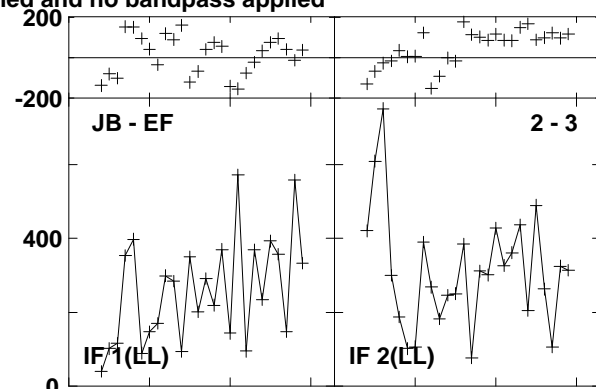
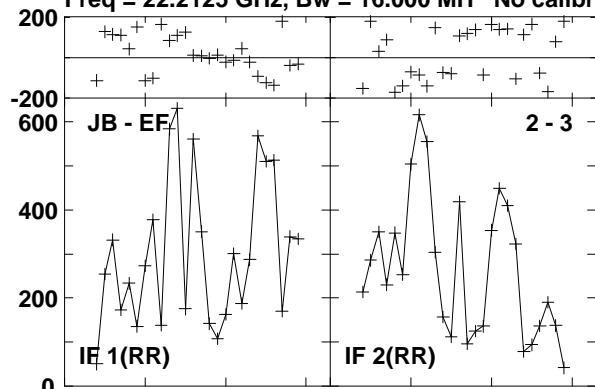

Lower frame: Micro Ampl Jy Top frame: Phas deg

Vector averaged cross-power spectrum Baseline: JB (02) - EF (03)

Timerange: 00/13:02:50 to 00/13:03:10

Plot file version 428 created 23-AUG-2016 15:00:56

0219+628 GA035B 1.UVDATA.1

Freq = 22.2125 GHz, Bw = 16.000 MH No calibration applied and no bandpass applied

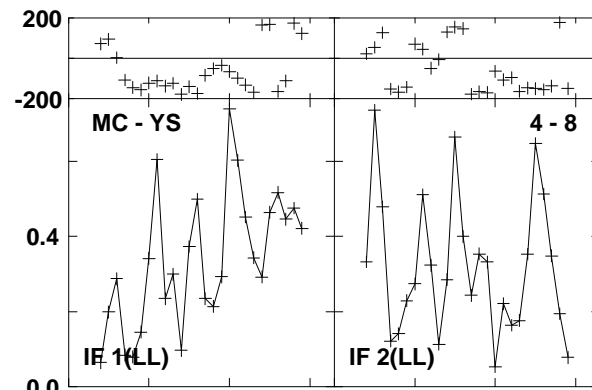
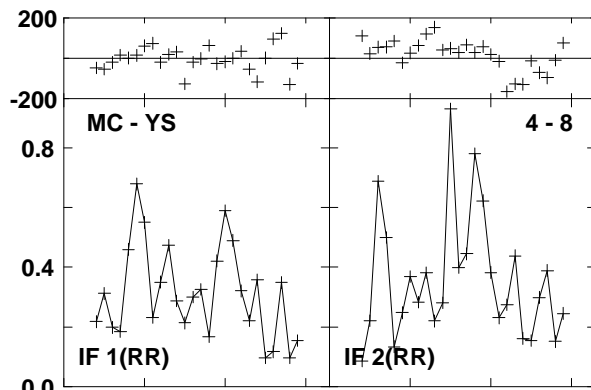
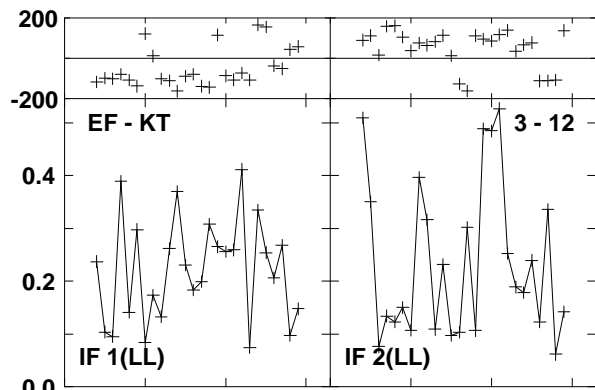
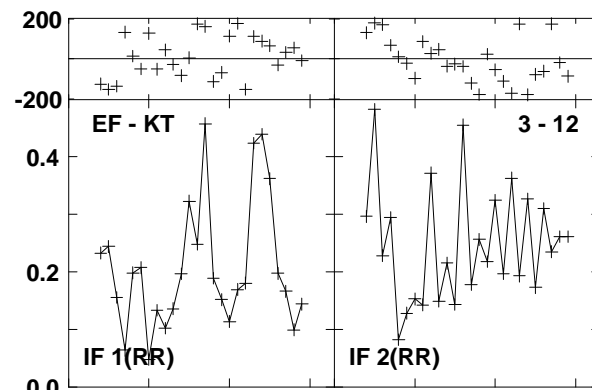
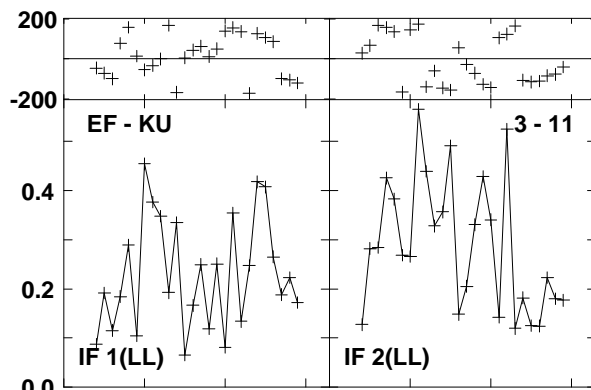
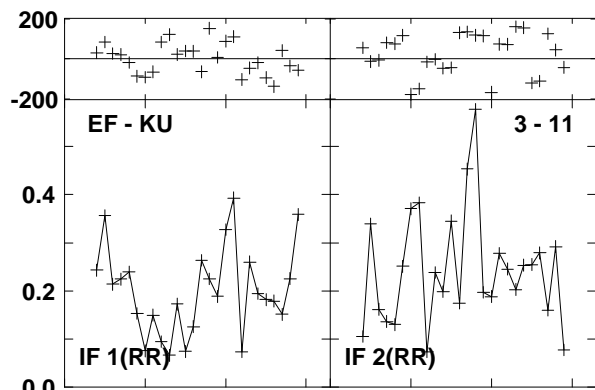
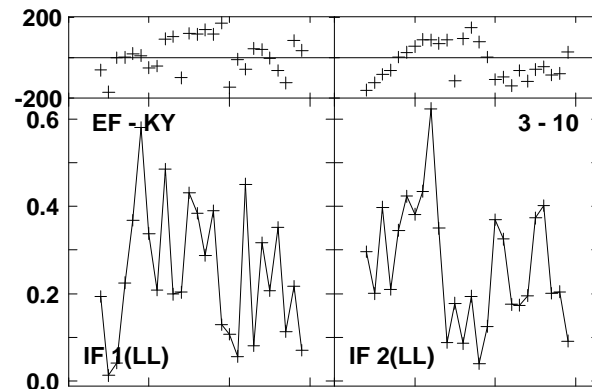
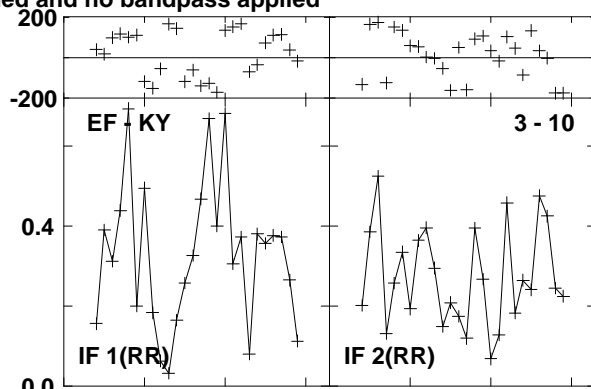
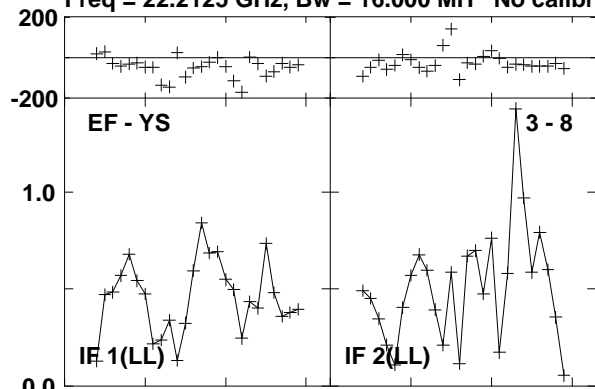

Lower frame: Milli Ampl Jy Top frame: Phas deg  
Vector averaged cross-power spectrum Baseline: EF (03) - YS (08)  
Timerange: 00/13:02:50 to 00/13:03:10

Plot file version 429 created 23-AUG-2016 15:00:56

0219+628 GA035B 1.UVDATA.1

Freq = 22.2125 GHz, Bw = 16.000 MH No calibration applied and no bandpass applied

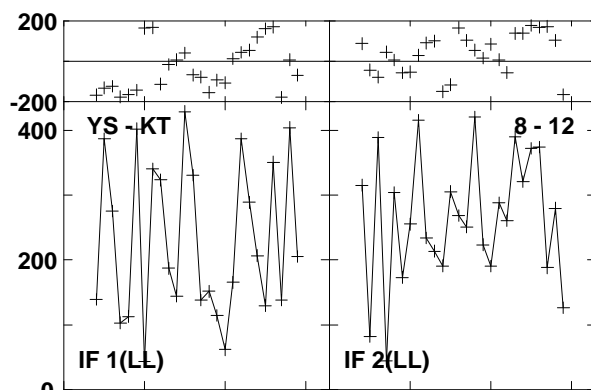
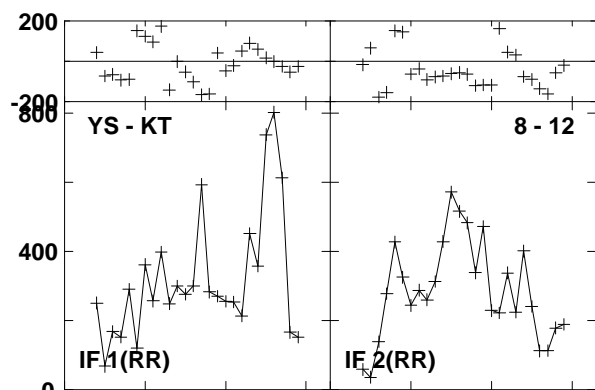
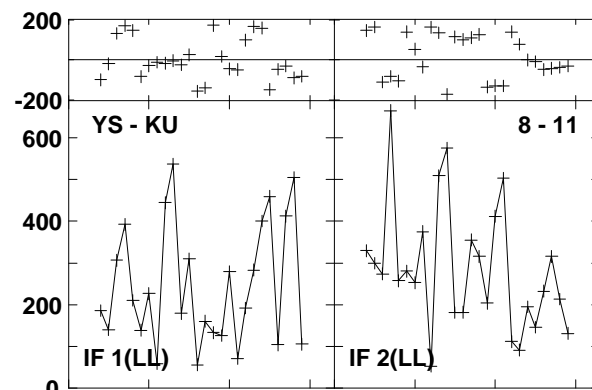
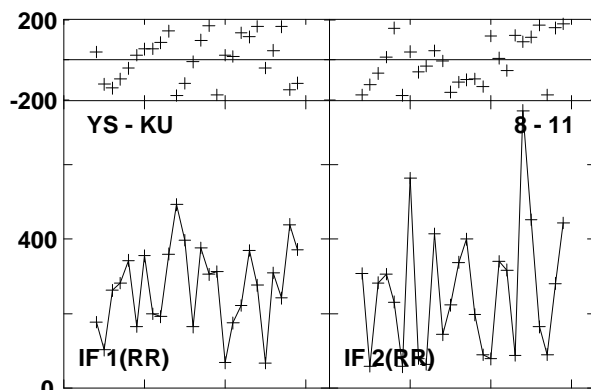
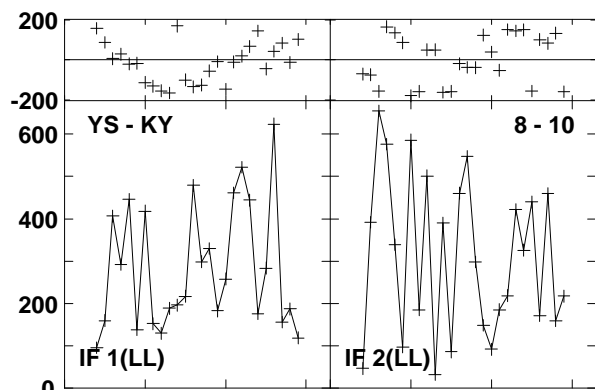
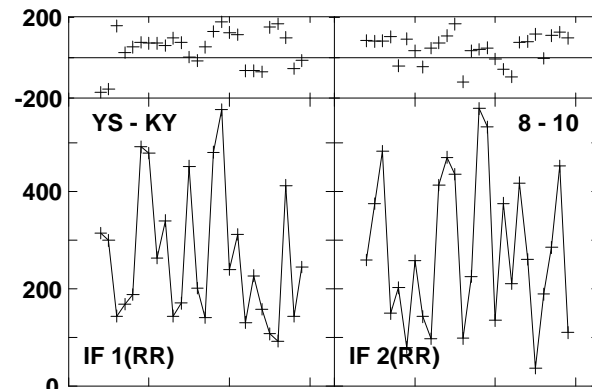
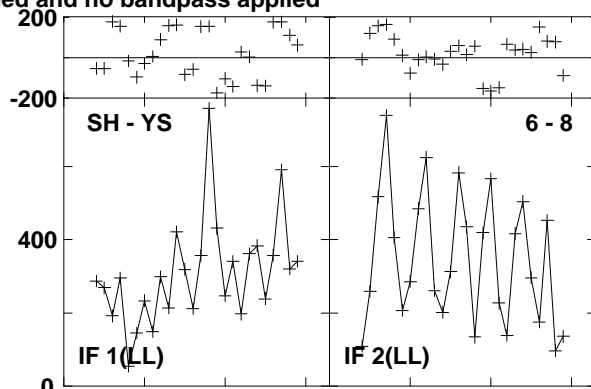
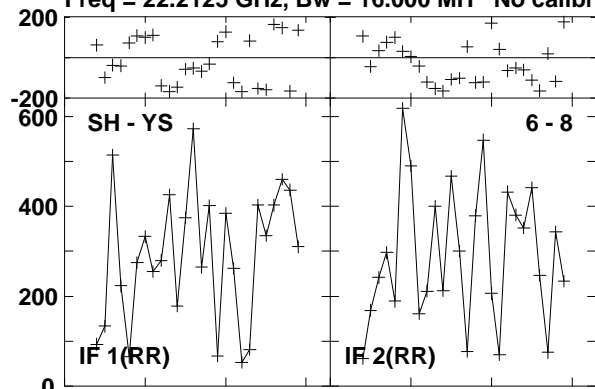

Lower frame: Micro Ampl Jy Top frame: Phas deg  
Vector averaged cross-power spectrum Baseline: SH (06) - YS (08)  
Timerange: 00/13:02:50 to 00/13:03:10

Plot file version 430 created 23-AUG-2016 15:00:56  
 W3IRS5 GA035B 1.UVDATA.1

Freq = 22.2125 GHz, Bw = 16.000 MH No calibration applied and no bandpass applied

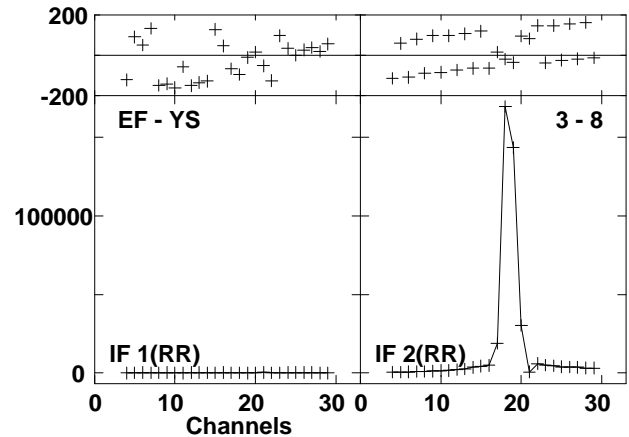
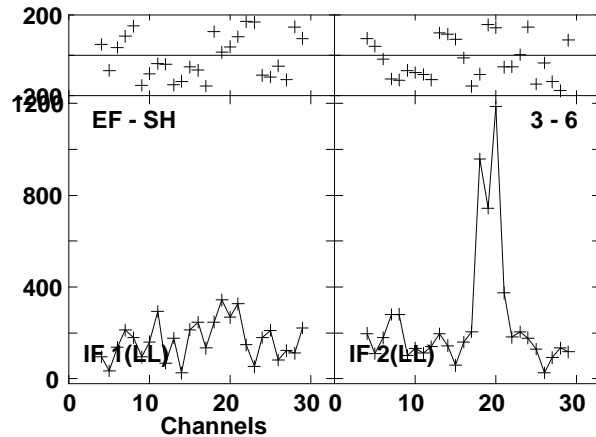
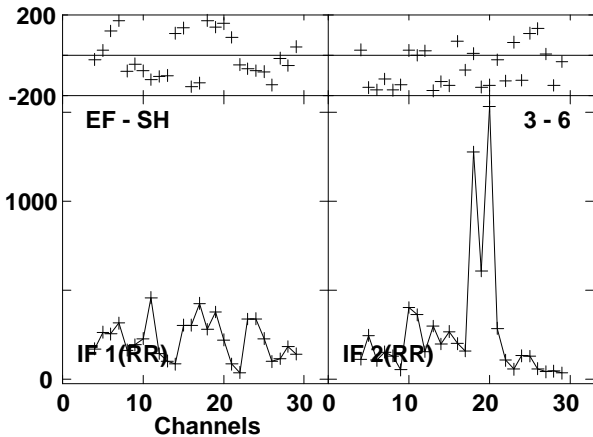
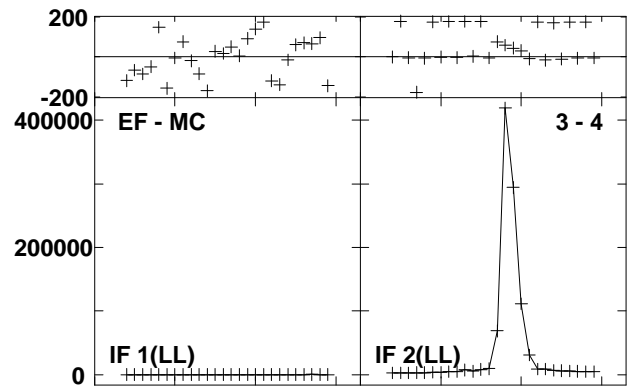
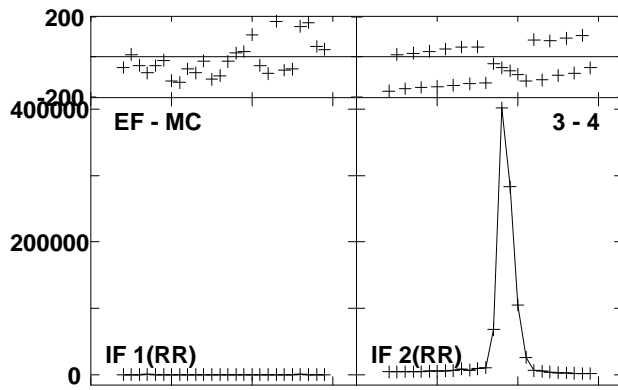
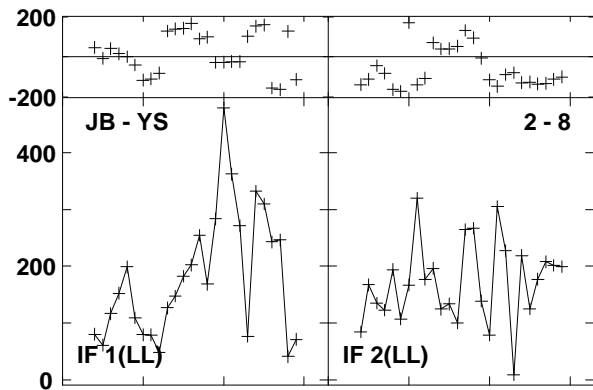
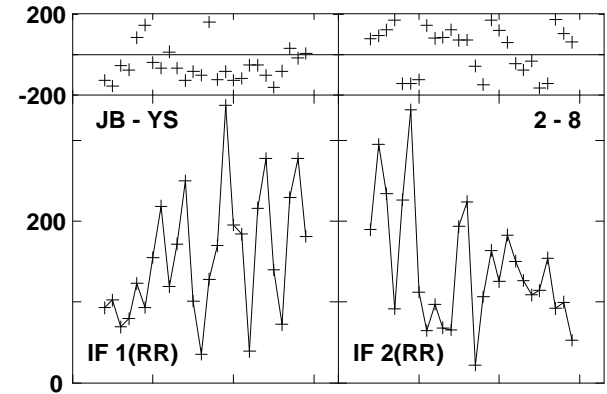
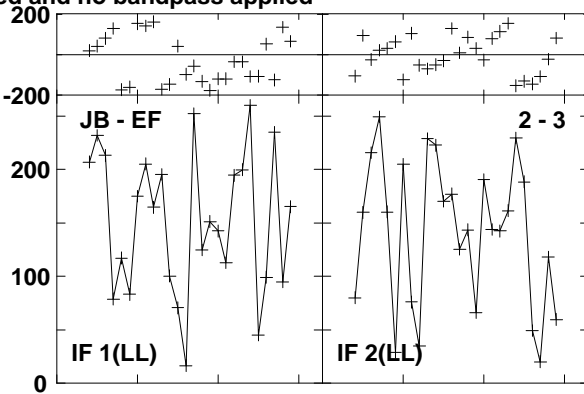
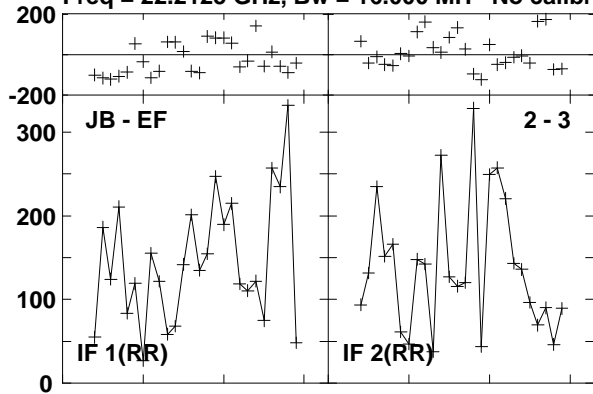

Lower frame: Micro Ampl Jy Top frame: Phas deg  
 Vector averaged cross-power spectrum Baseline: JB (02) - EF (03)  
 Timerange: 00/13:03:41 to 00/13:04:39

Plot file version 431 created 23-AUG-2016 15:00:56  
W3IRS5 GA035B 1.UVDATA.1

Freq = 22.2125 GHz, Bw = 16.000 MH No calibration applied and no bandpass applied

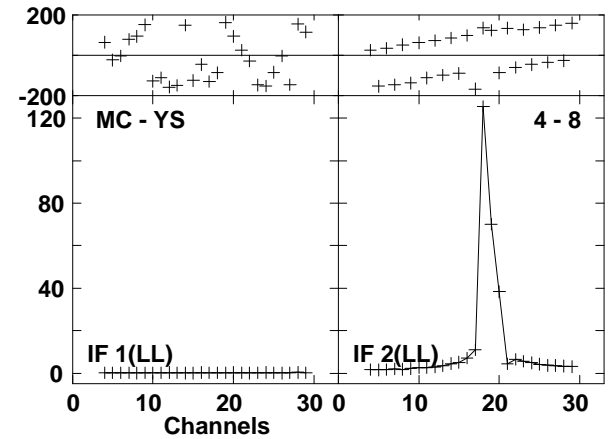
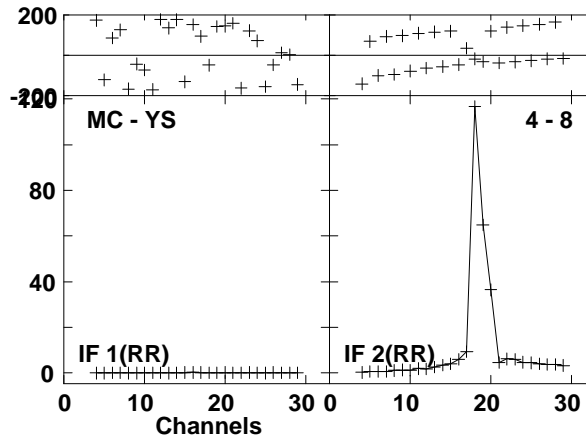
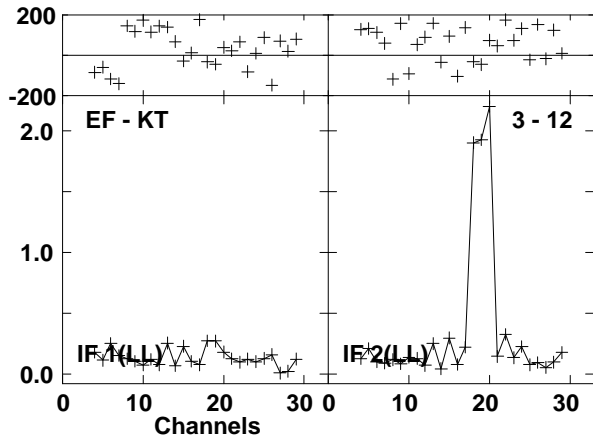
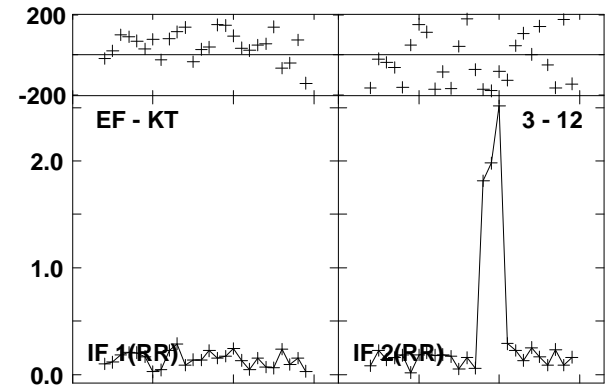
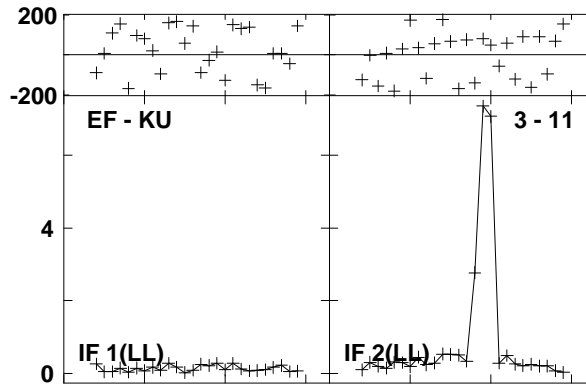
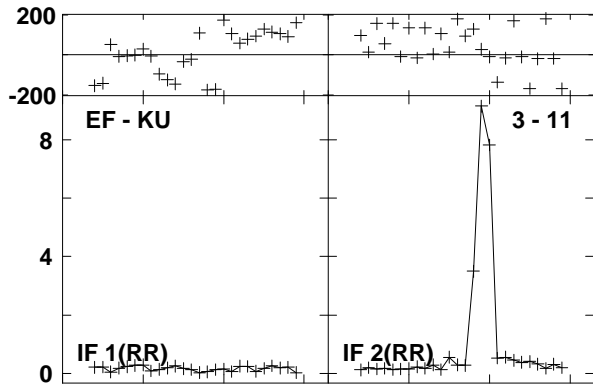
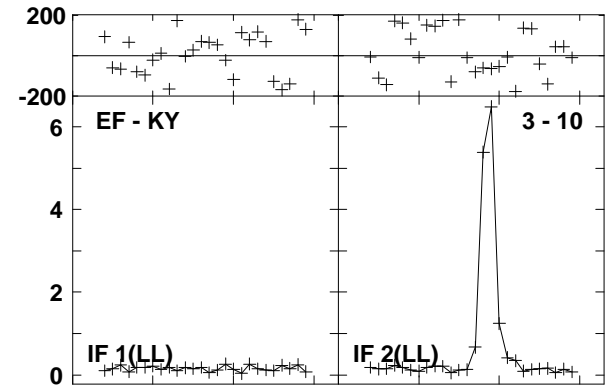
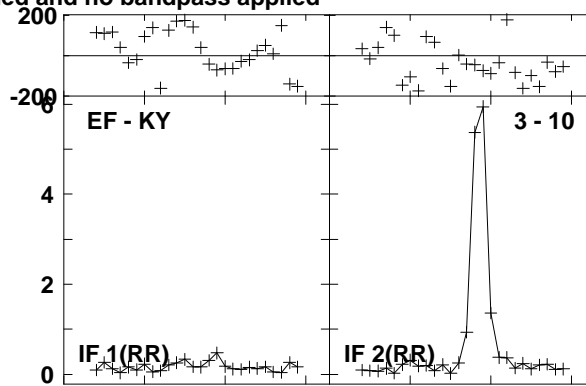
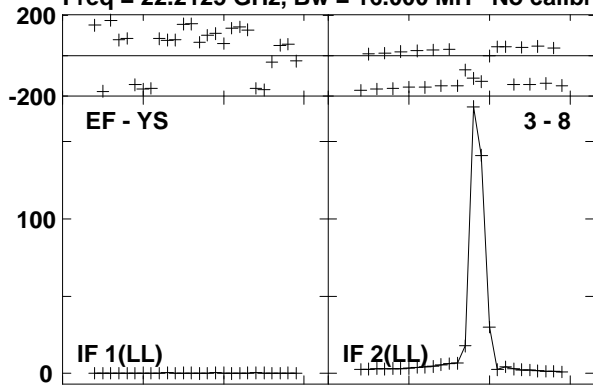

Lower frame: Milli Ampl Jy Top frame: Phas deg  
Vector averaged cross-power spectrum Baseline: EF (03) - YS (08)  
Timerange: 00/13:03:41 to 00/13:04:39

Plot file version 432 created 23-AUG-2016 15:00:57

W3IRS5 GA035B 1.UVDATA.1

Freq = 22.2125 GHz, Bw = 16.000 MH No calibration applied and no bandpass applied

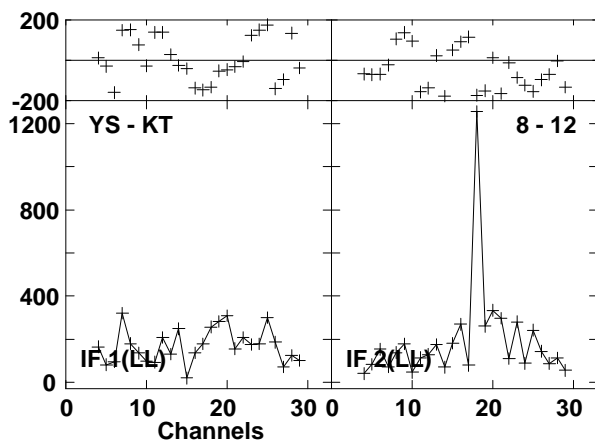
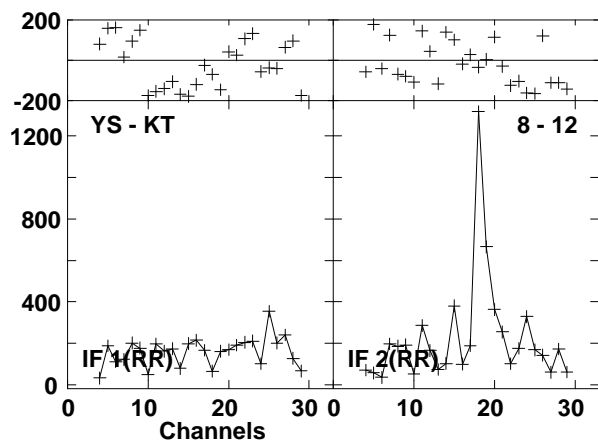
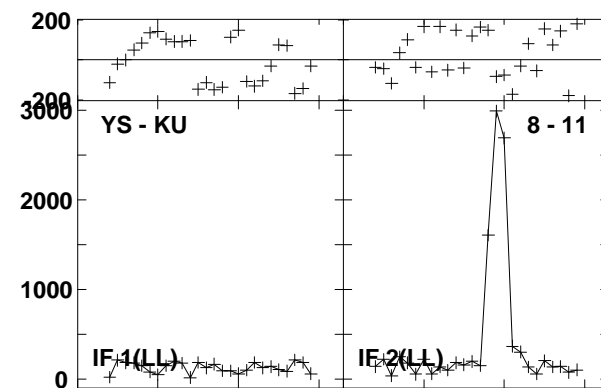
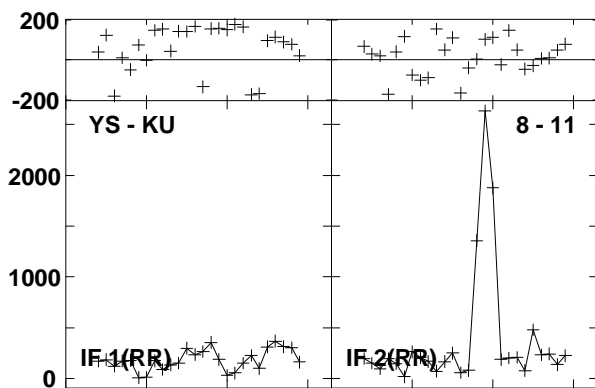
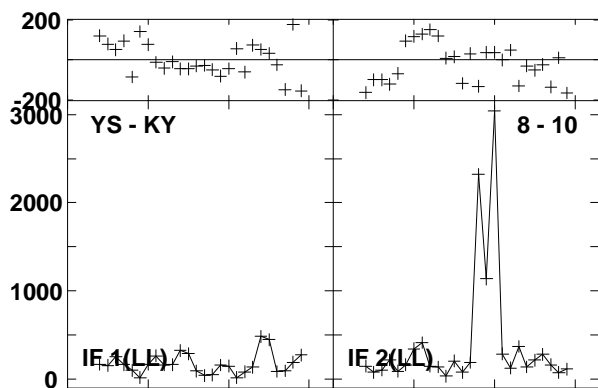
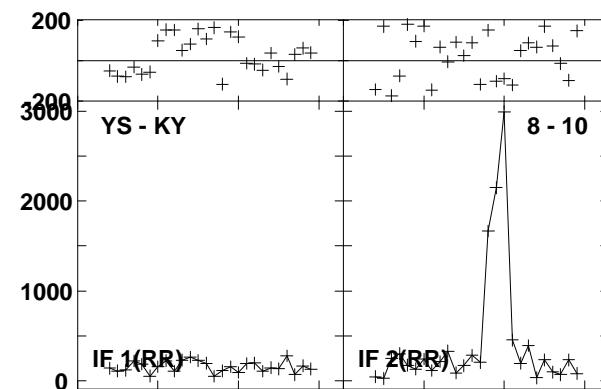
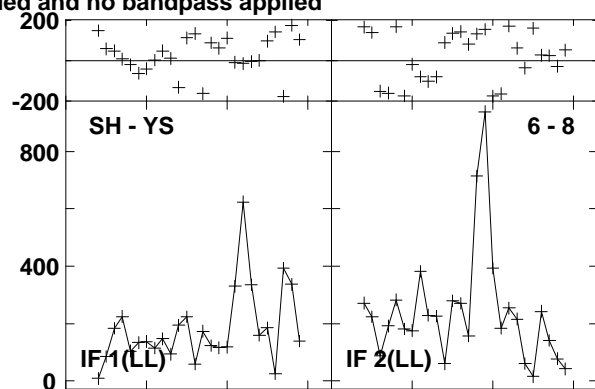
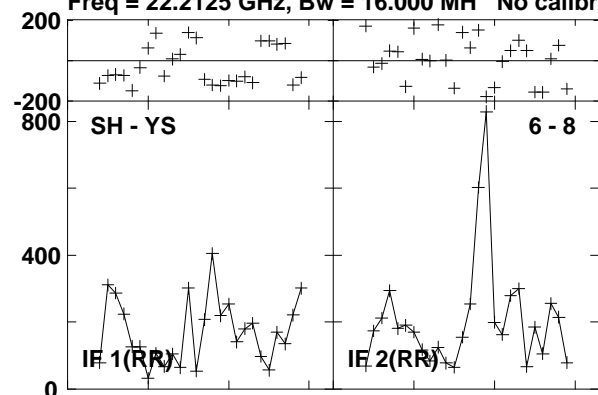

Lower frame: Micro Ampl Jy Top frame: Phas deg

Vector averaged cross-power spectrum Baseline: SH (06) - YS (08)

Timerange: 00/13:03:41 to 00/13:04:39



Plot file version 433 created 23-AUG-2016 15:00:57  
 0219+628 GA035B 1.UVDATA.1

Freq = 22.2125 GHz, Bw = 16.000 MH No calibration applied and no bandpass applied

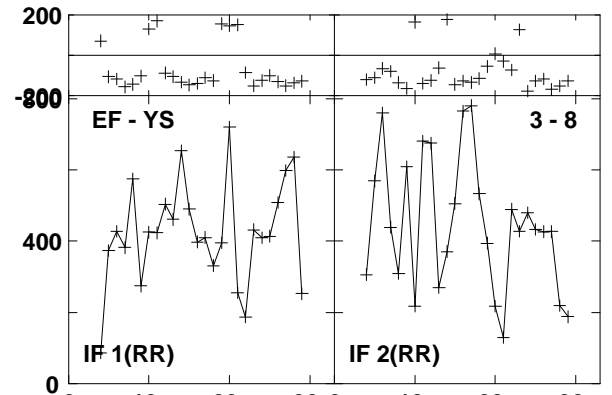
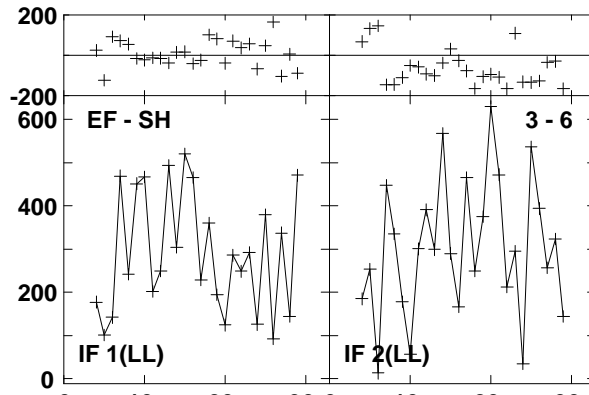
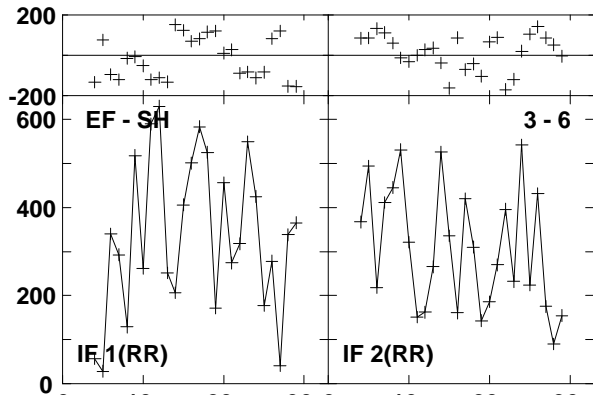
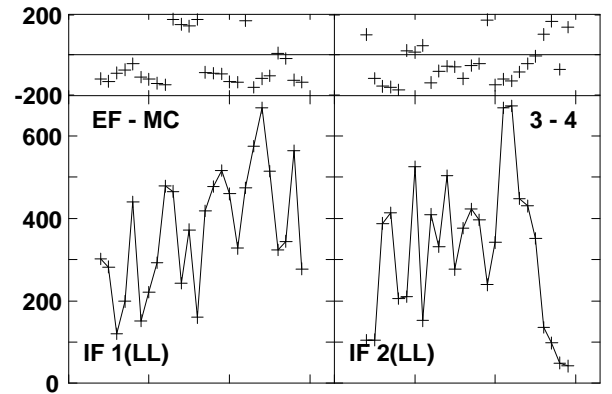
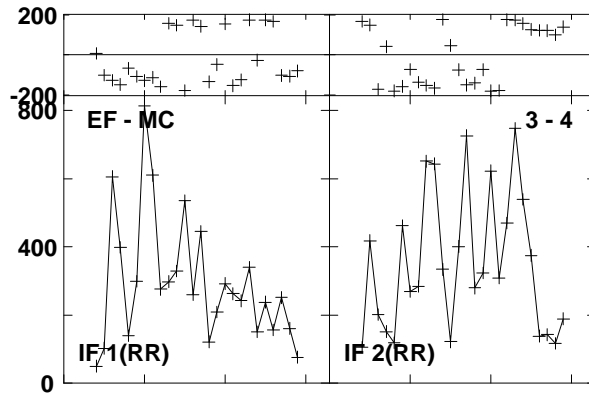
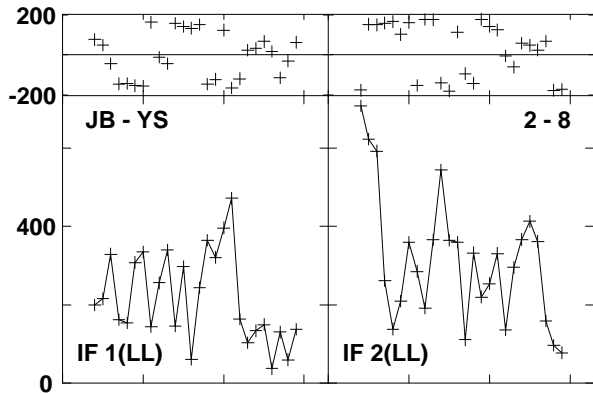
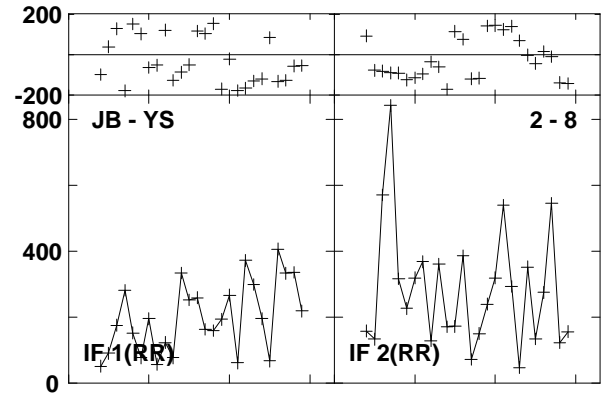
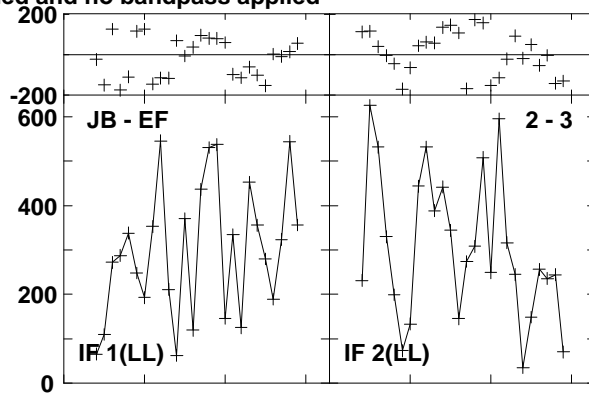
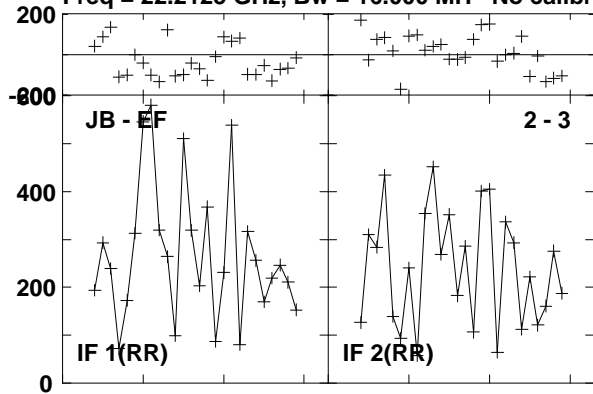

Lower frame: Micro Ampl Jy Top frame: Phas deg  
 Vector averaged cross-power spectrum Baseline: JB (02) - EF (03)  
 Timerange: 00/13:05:11 to 00/13:05:29

Plot file version 434 created 23-AUG-2016 15:00:57

0219+628 GA035B 1.UVDATA.1

Freq = 22.2125 GHz, Bw = 16.000 MH No calibration applied and no bandpass applied

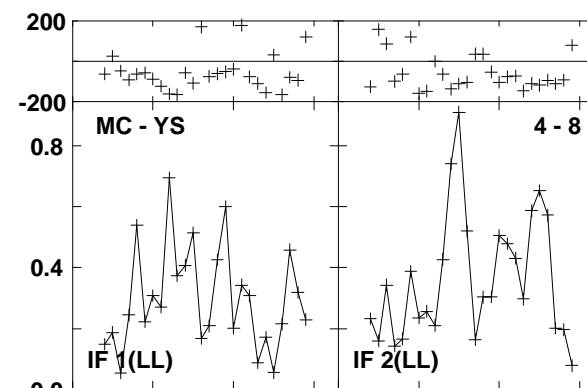
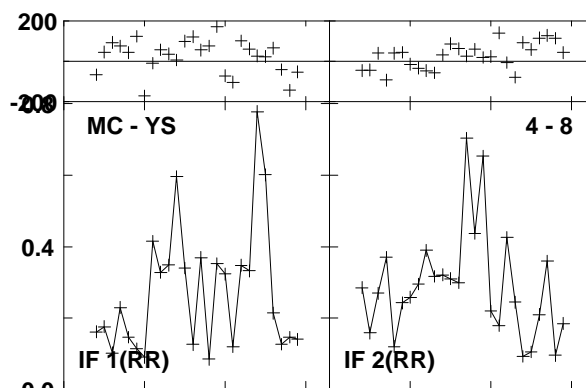
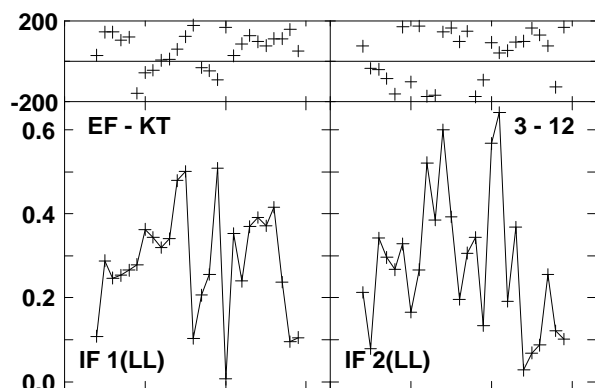
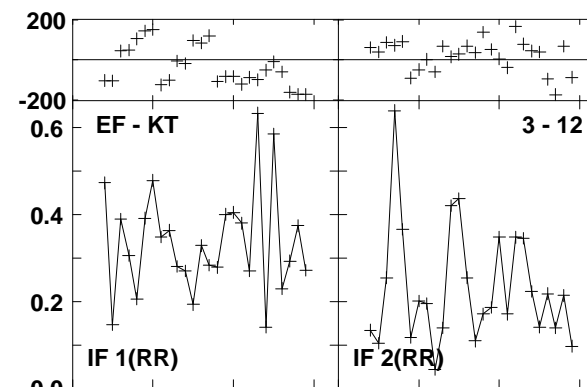
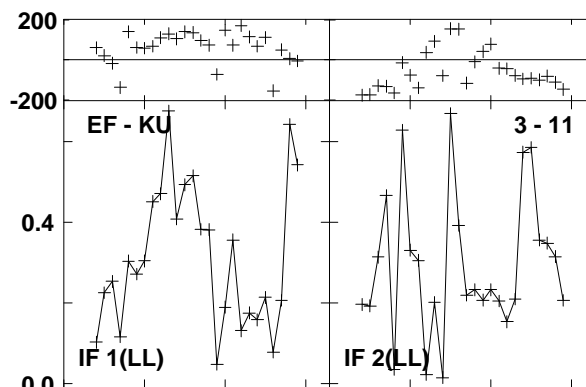
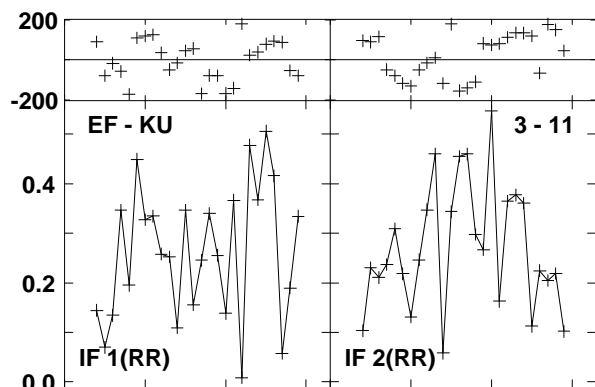
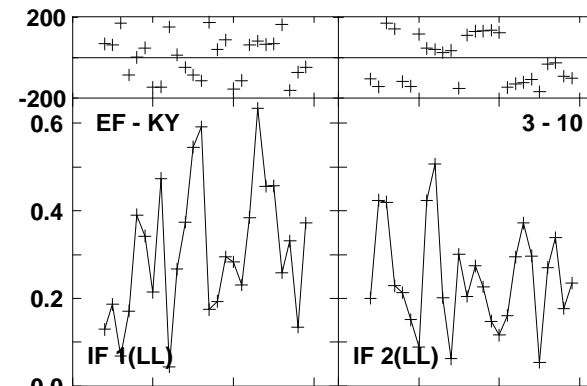
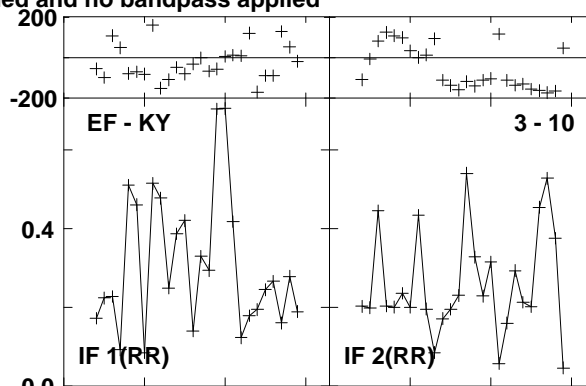
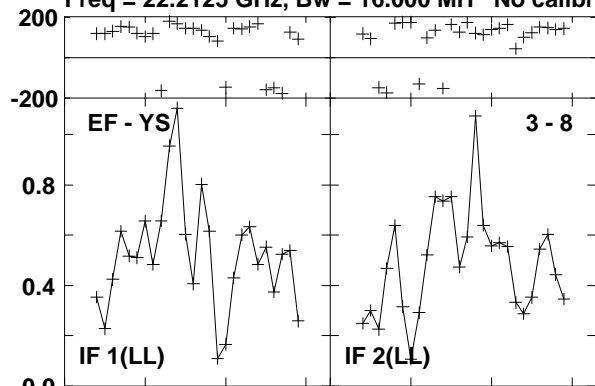

Channels

Lower frame: Milli Ampl Jy Top frame: Phas deg

Vector averaged cross-power spectrum Baseline: EF (03) - YS (08)

Timerange: 00/13:05:11 to 00/13:05:29

Plot file version 435 created 23-AUG-2016 15:00:57

0219+628 GA035B 1.UVDATA.1

Freq = 22.2125 GHz, Bw = 16.000 MH No calibration applied and no bandpass applied

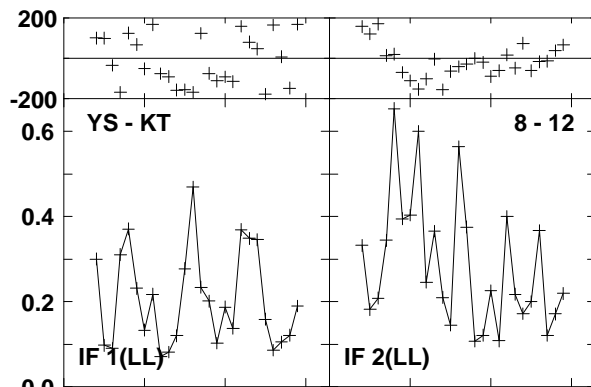
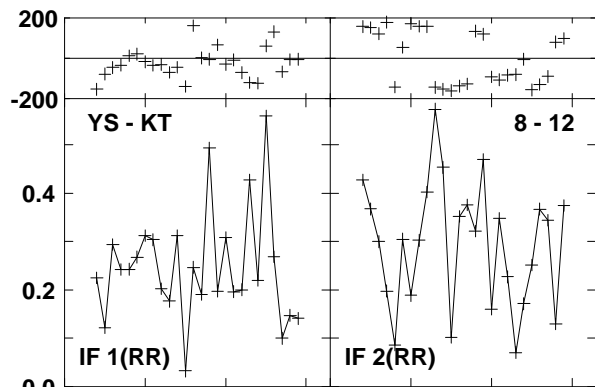
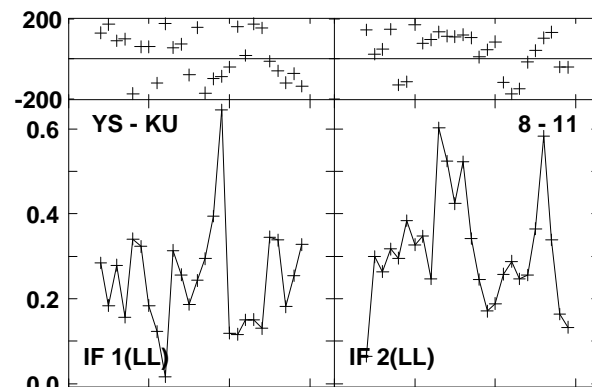
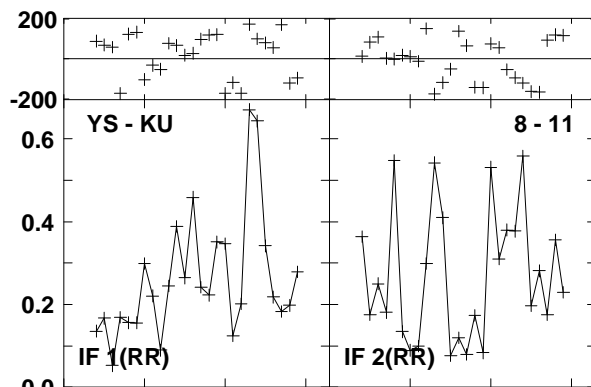
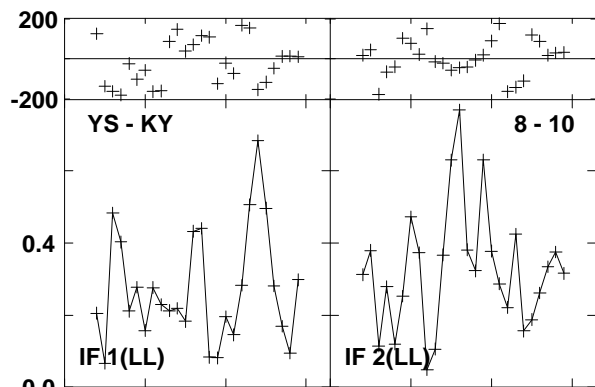
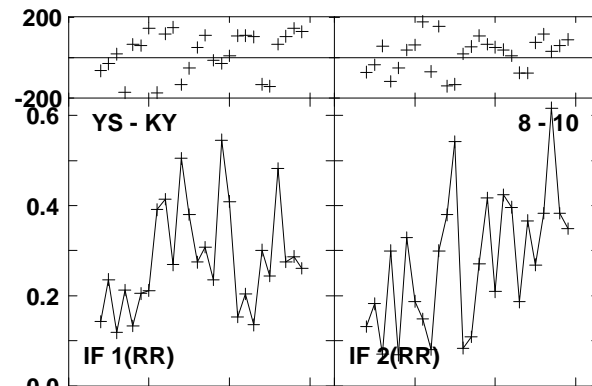
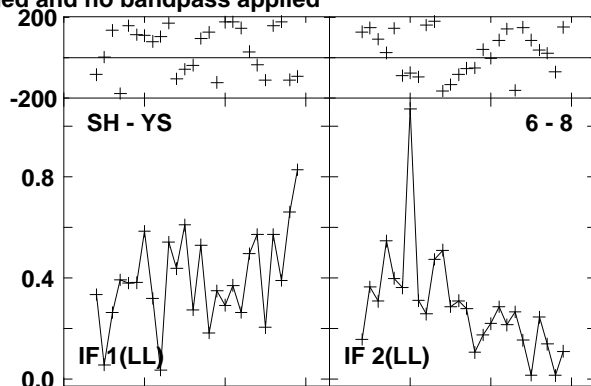
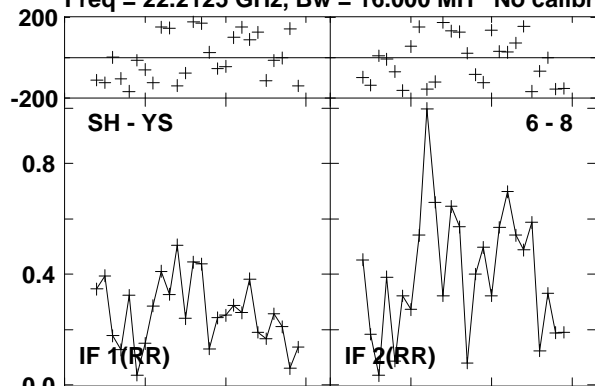

Lower frame: Milli Ampl Jy Top frame: Phas deg

Vector averaged cross-power spectrum Baseline: SH (06) - YS (08)

Timerange: 00/13:05:11 to 00/13:05:29

Plot file version 436 created 23-AUG-2016 15:00:57

0241+622 GA035B 1.UVDATA.1

Freq = 22.2125 GHz, Bw = 16.000 MH No calibration applied and no bandpass applied

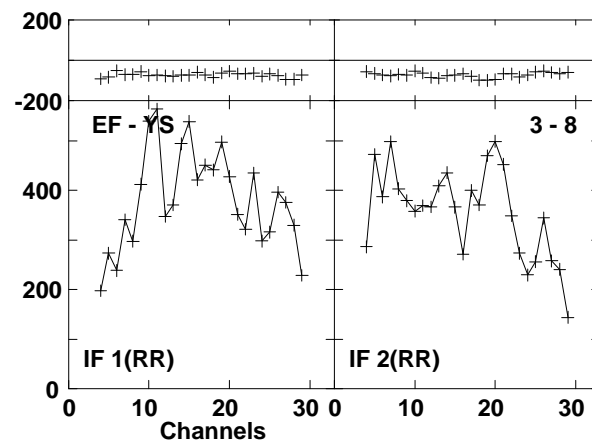
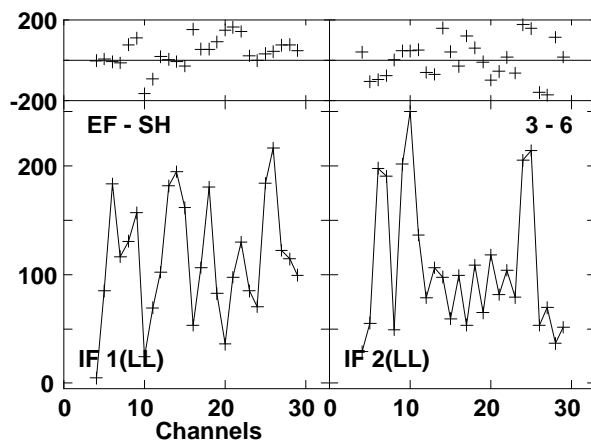
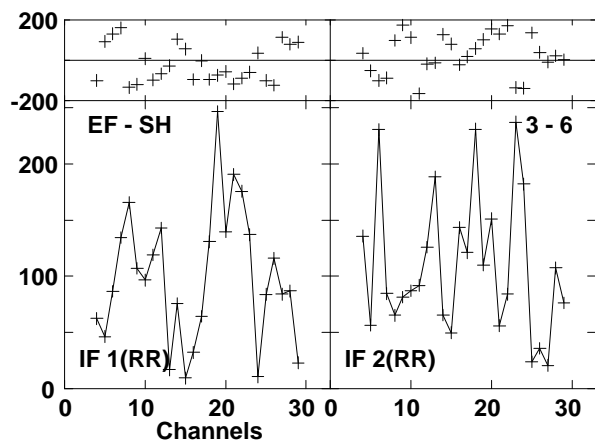
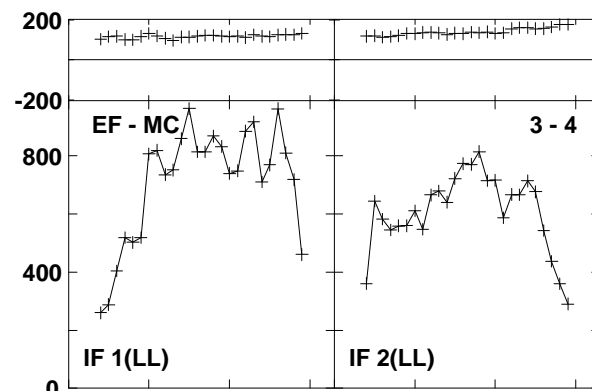
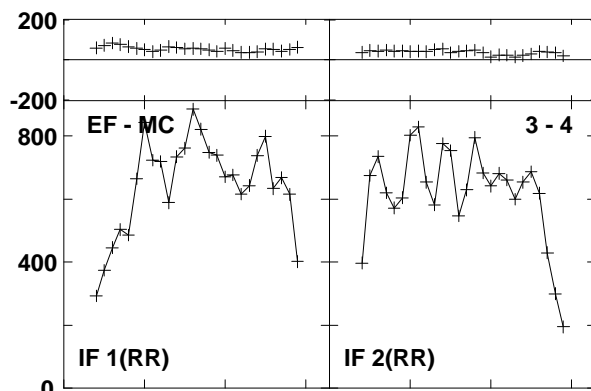
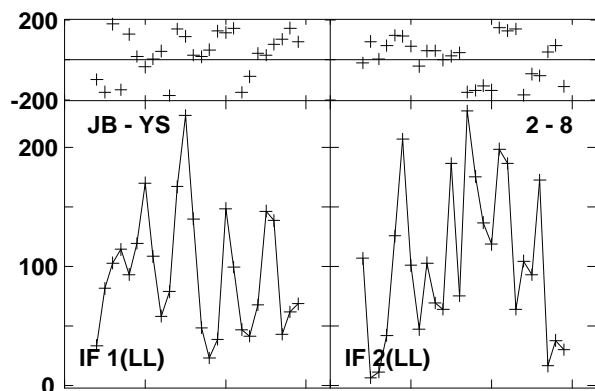
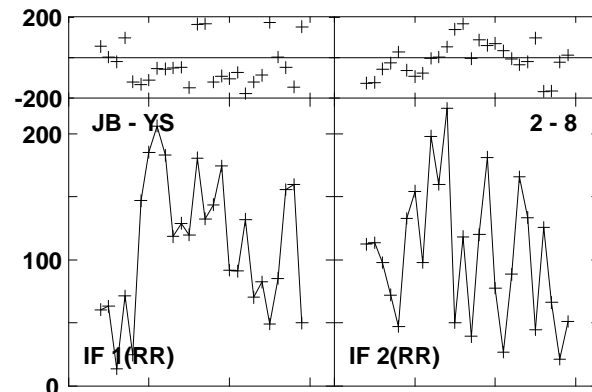
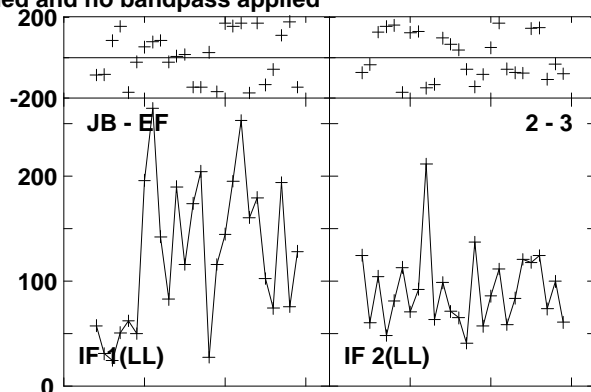
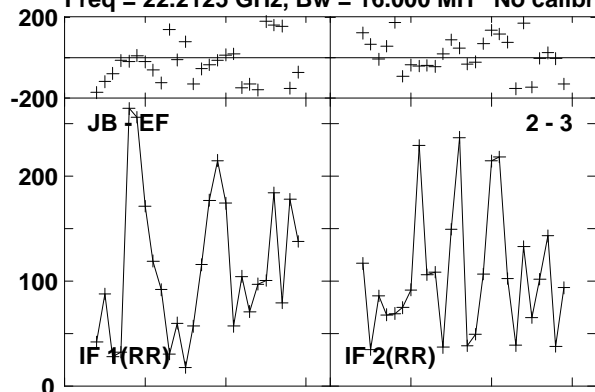

Lower frame: Micro Ampl Jy Top frame: Phas deg  
Vector averaged cross-power spectrum Baseline: JB (02) - EF (03)  
Timerange: 00/13:06:10 to 00/13:08:09

Plot file version 437 created 23-AUG-2016 15:00:57

0241+622 GA035B 1.UVDATA.1

Freq = 22.2125 GHz, Bw = 16.000 MH No calibration applied and no bandpass applied

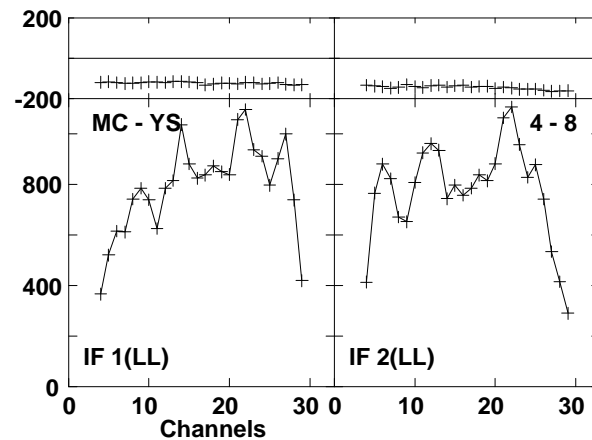
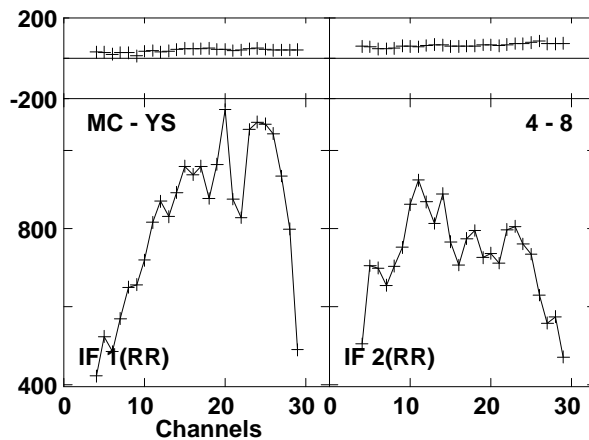
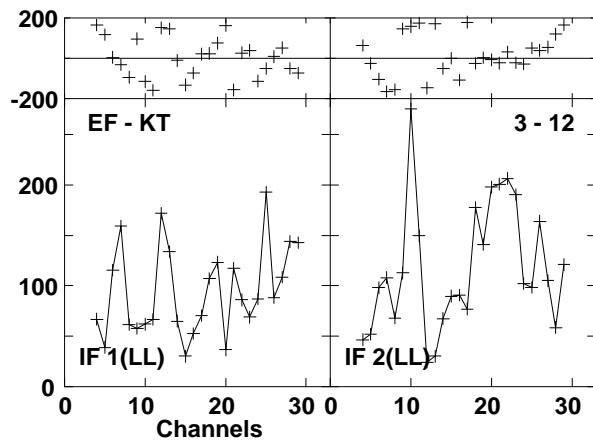
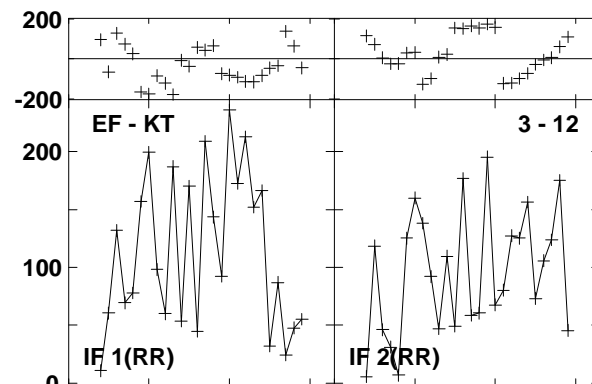
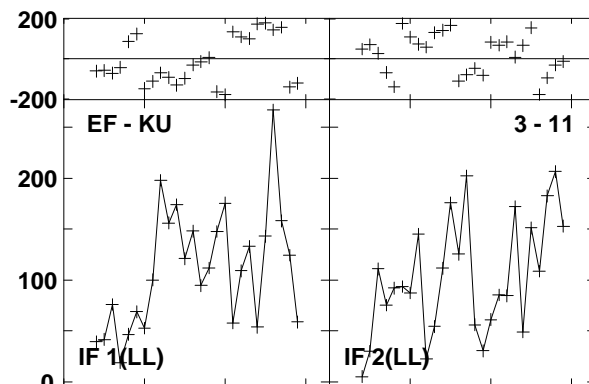
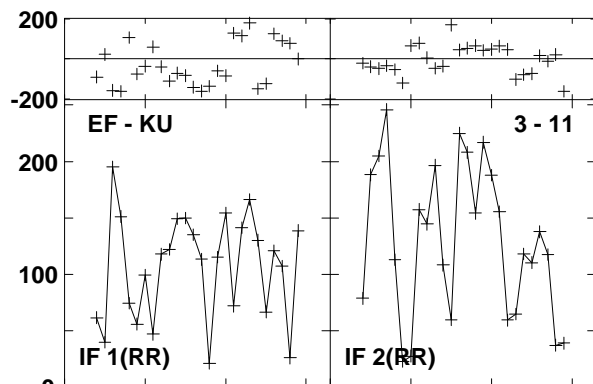
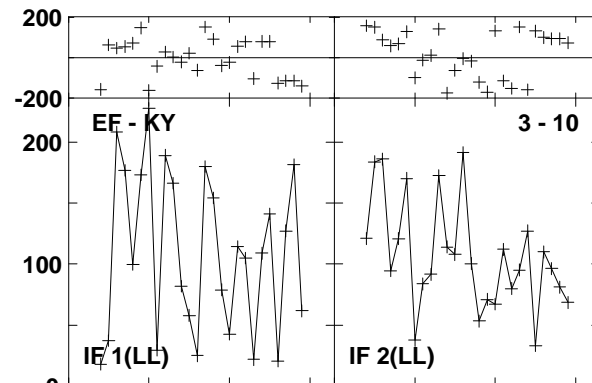
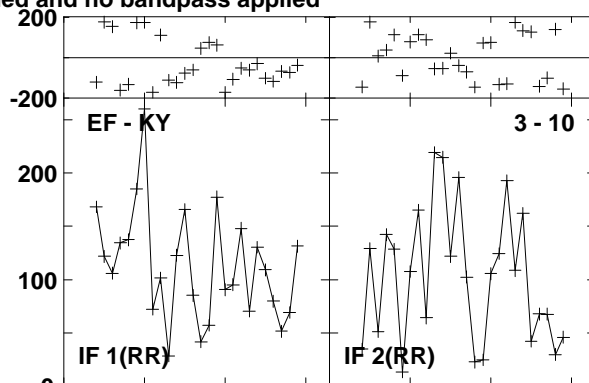
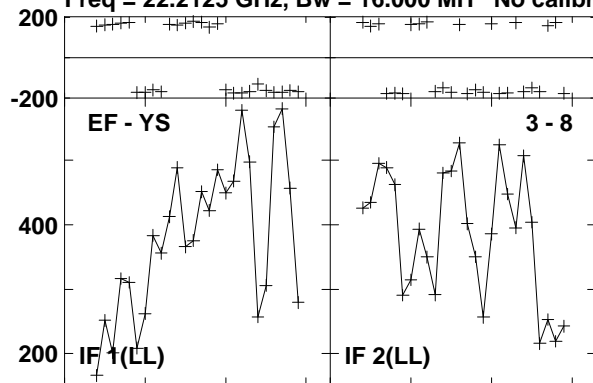

Lower frame: Micro Ampl Jy Top frame: Phas deg  
Vector averaged cross-power spectrum Baseline: EF (03) - YS (08)  
Timerange: 00/13:06:10 to 00/13:08:09

Plot file version 438 created 23-AUG-2016 15:00:57

0241+622 GA035B 1.UVDATA.1

Freq = 22.2125 GHz, Bw = 16.000 MH No calibration applied and no bandpass applied

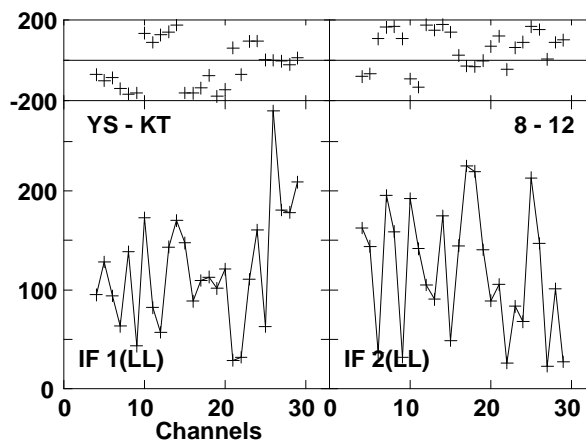
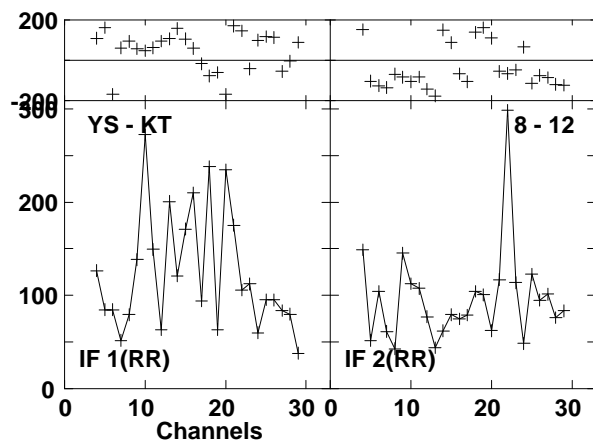
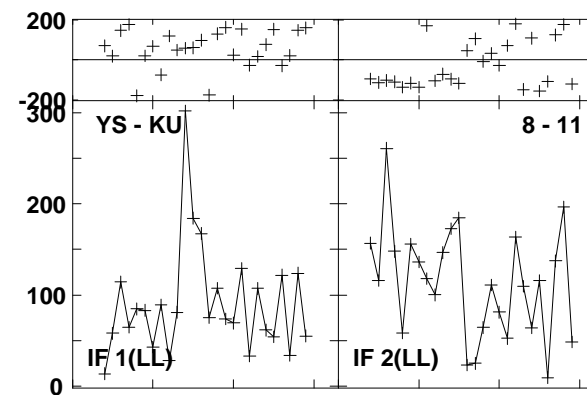
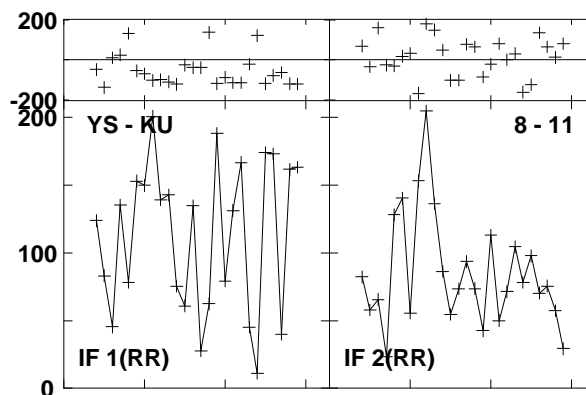
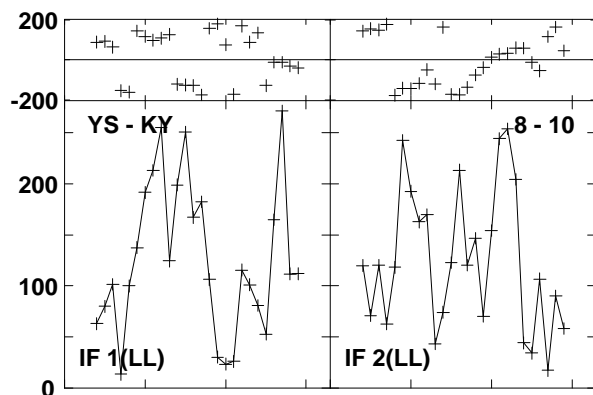
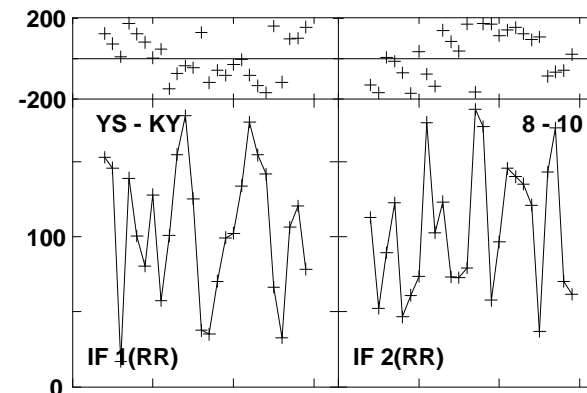
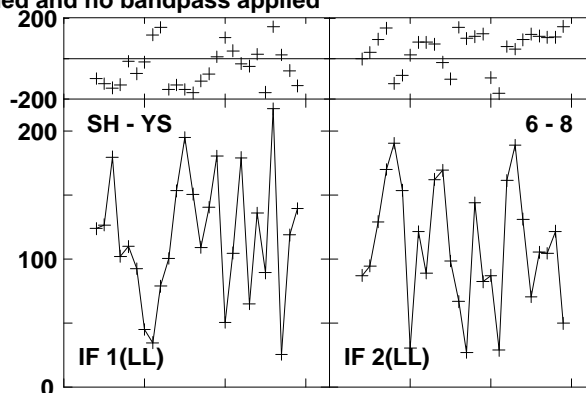
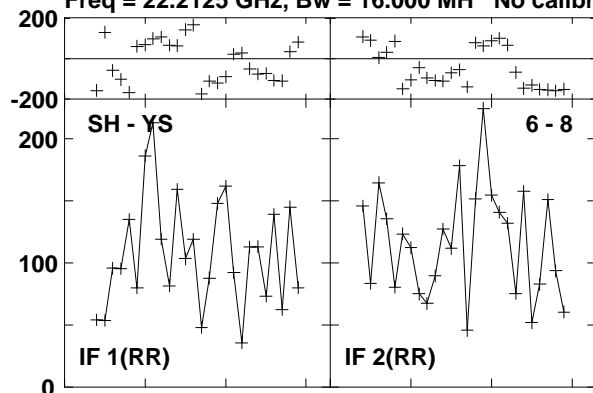

Lower frame: Micro Ampl Jy Top frame: Phas deg  
Vector averaged cross-power spectrum Baseline: SH (06) - YS (08)  
Timerange: 00/13:06:10 to 00/13:08:09

Plot file version 439 created 23-AUG-2016 15:00:57  
 W3IRS5 GA035B 1.UVDATA.1

Freq = 22.2125 GHz, Bw = 16.000 MH No calibration applied and no bandpass applied

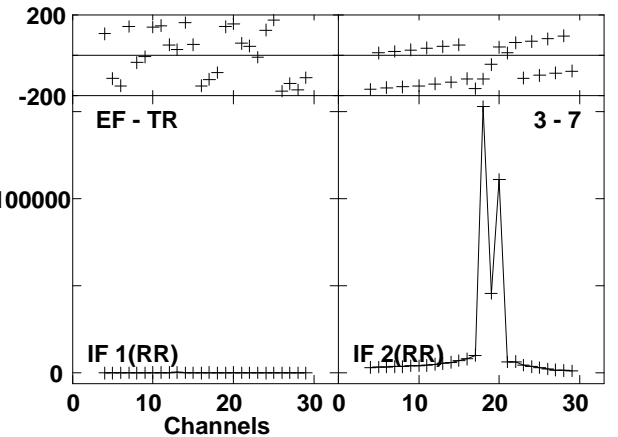
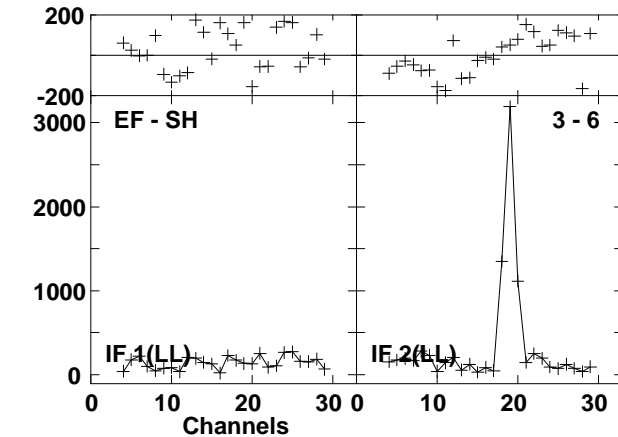
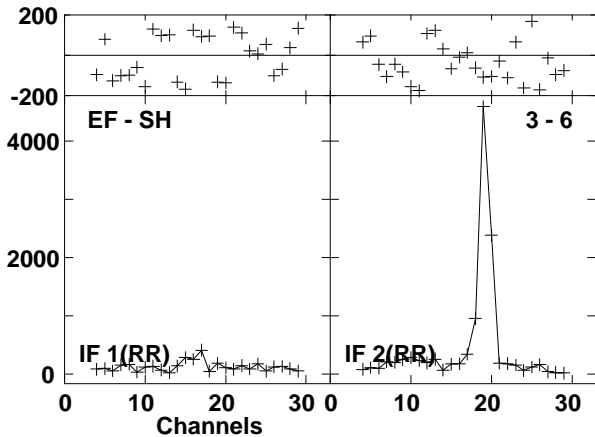
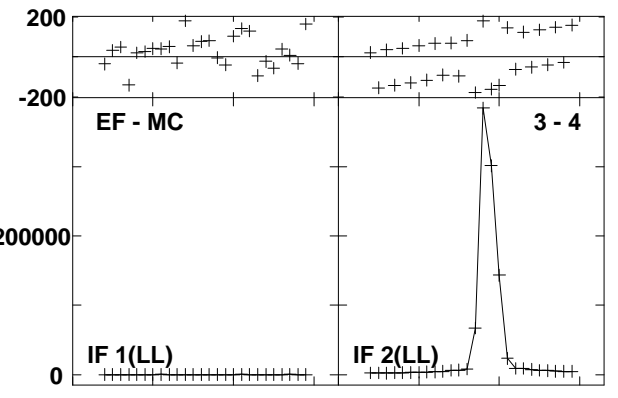
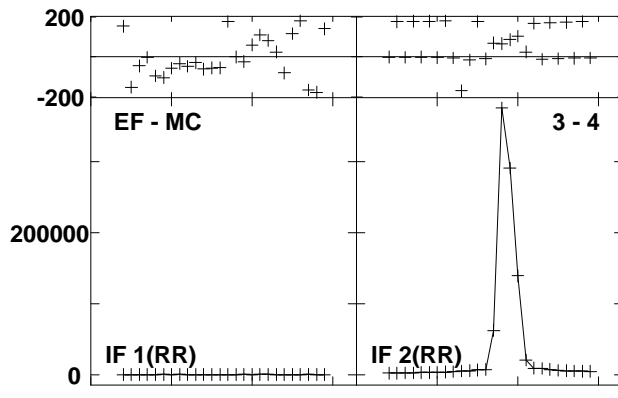
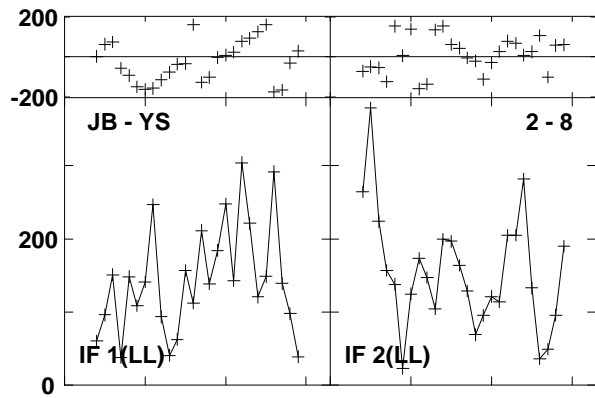
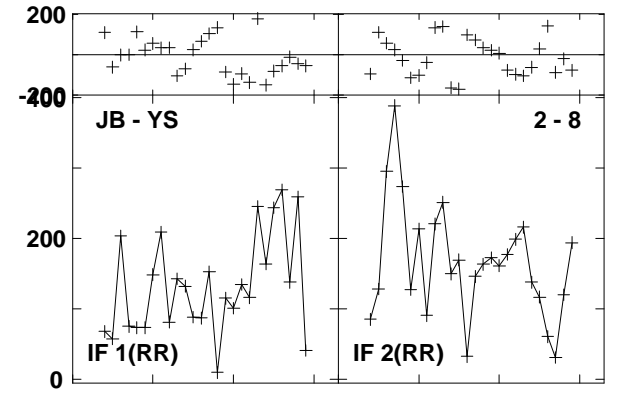
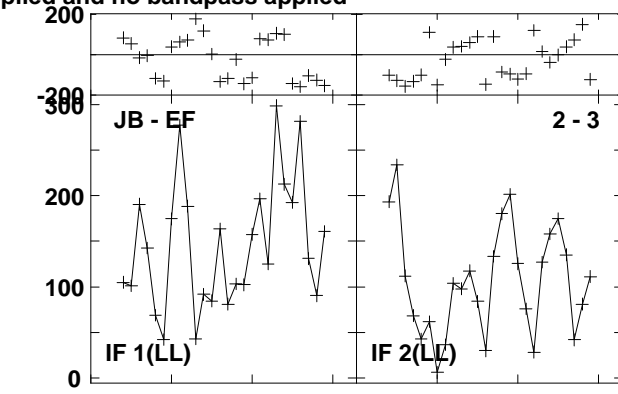
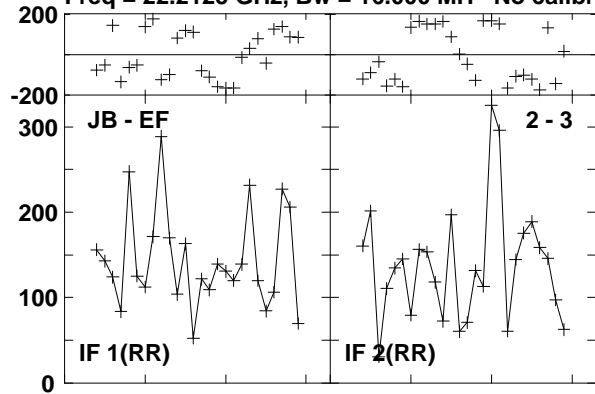

Lower frame: Micro Ampl Jy Top frame: Phas deg  
 Vector averaged cross-power spectrum Baseline: JB (02) - EF (03)  
 Timerange: 00/13:08:41 to 00/13:09:39

Plot file version 440 created 23-AUG-2016 15:00:57

W3IRS5 GA035B 1.UVDATA.1

Freq = 22.2125 GHz, Bw = 16.000 MH No calibration applied and no bandpass applied

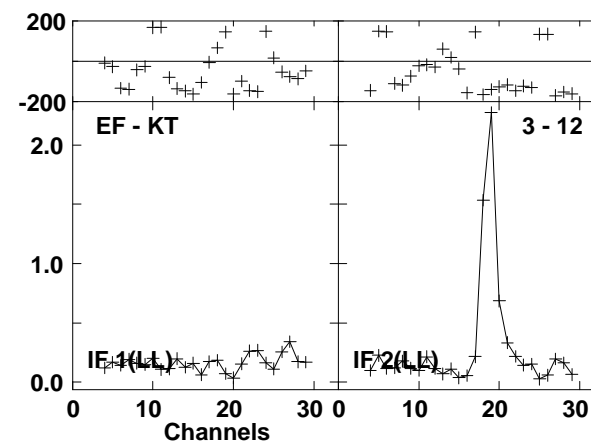
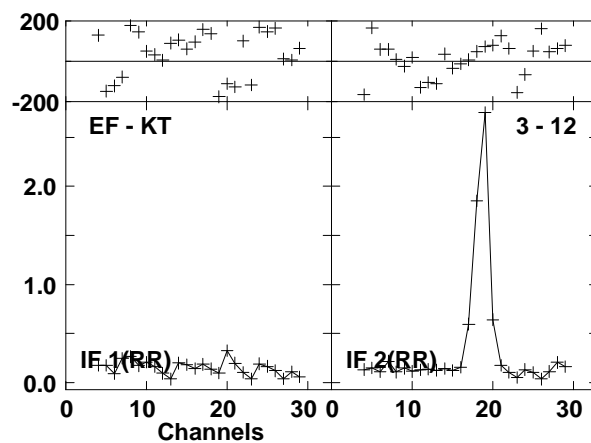
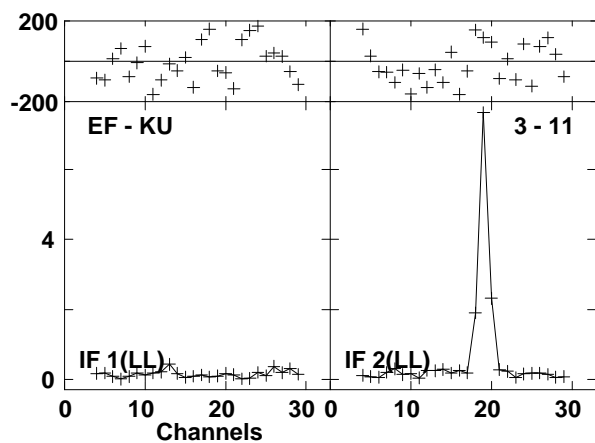
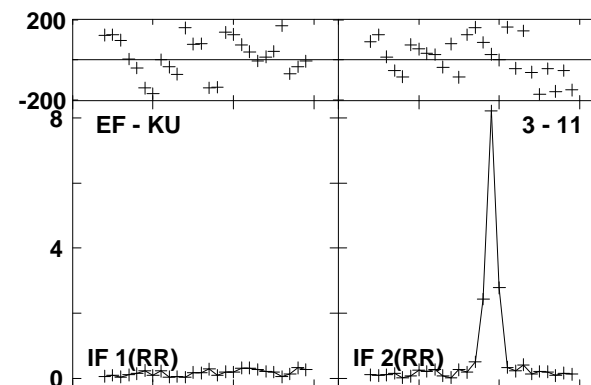
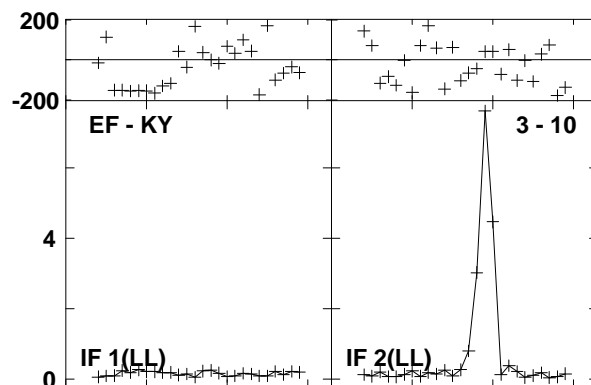
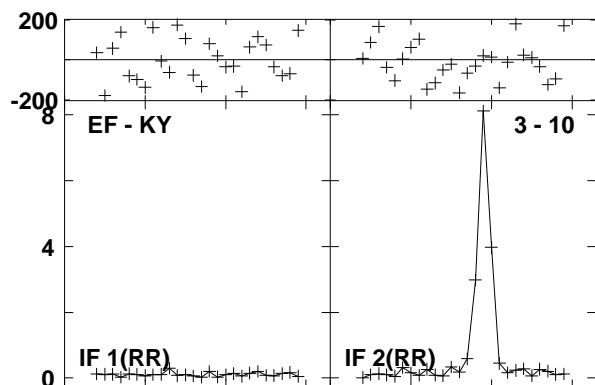
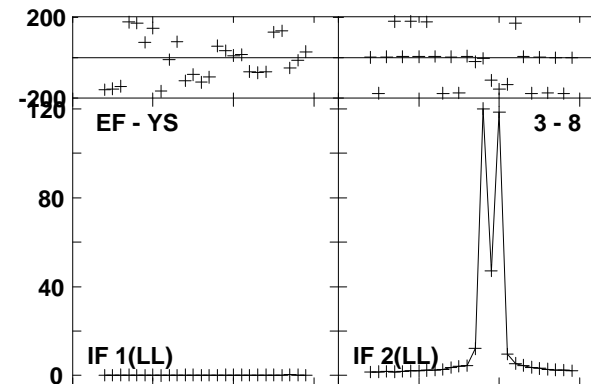
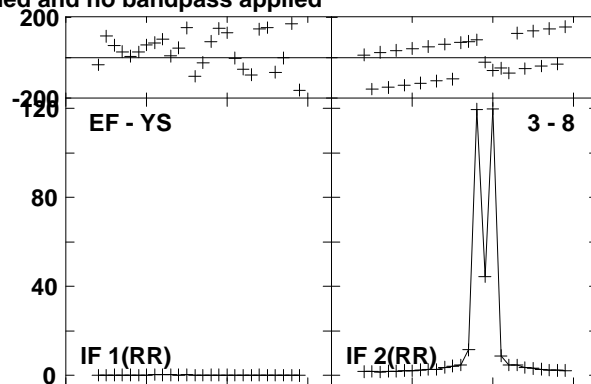
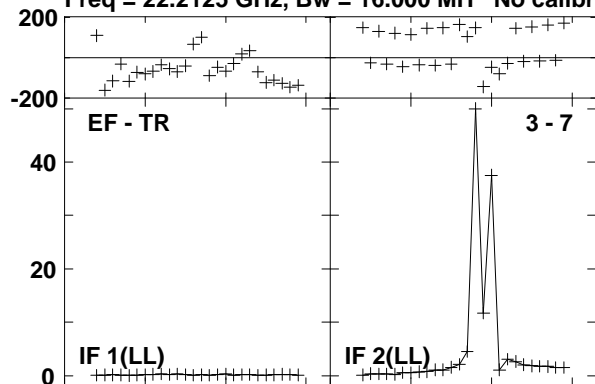

Lower frame: Milli Ampl Jy Top frame: Phas deg  
Vector averaged cross-power spectrum Baseline: EF (03) - TR (07)  
Timerange: 00/13:08:41 to 00/13:09:39



Plot file version 441 created 23-AUG-2016 15:00:57

W3IRS5 GA035B 1.UVDATA.1

Freq = 22.2125 GHz, Bw = 16.000 MH No calibration applied and no bandpass applied

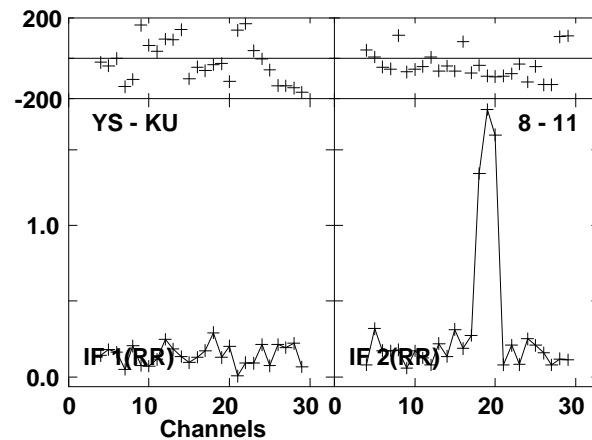
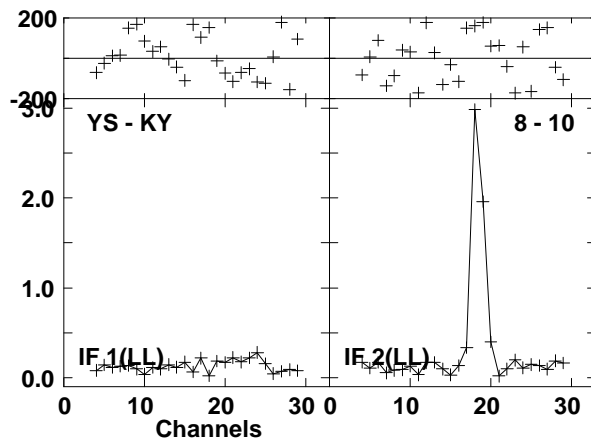
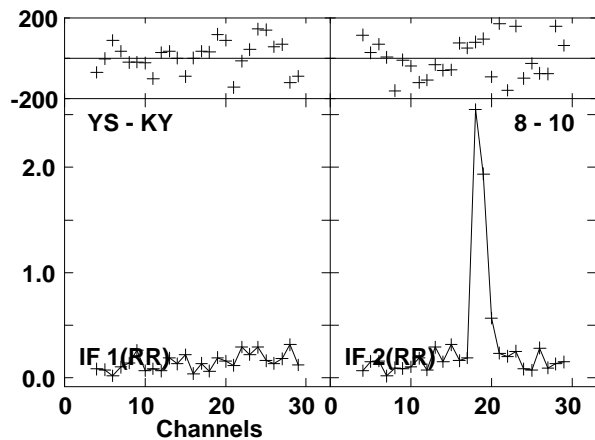
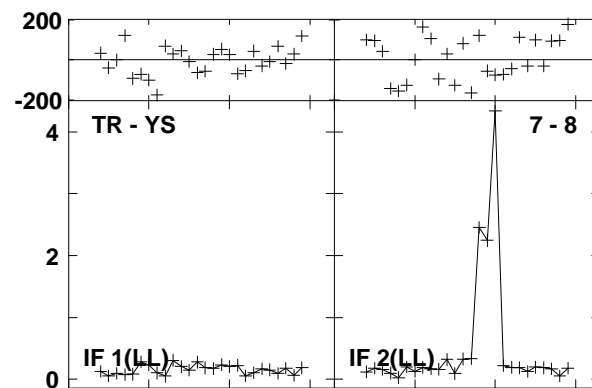
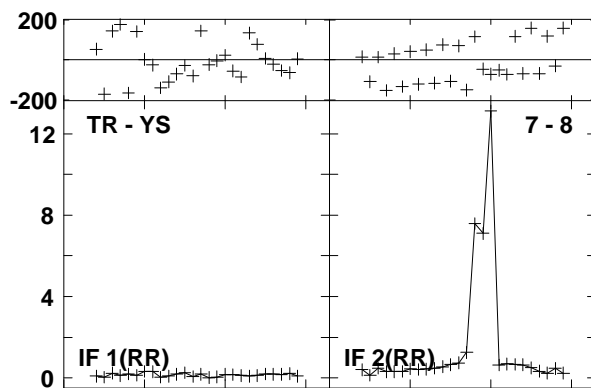
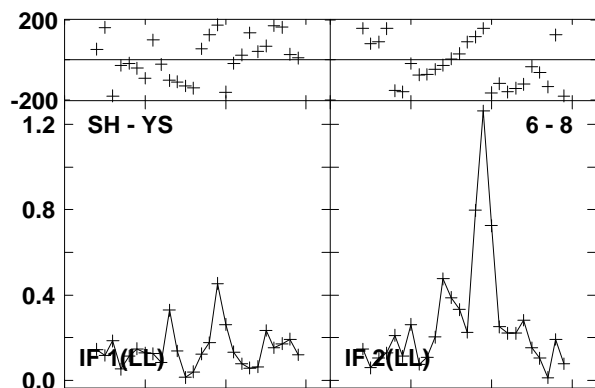
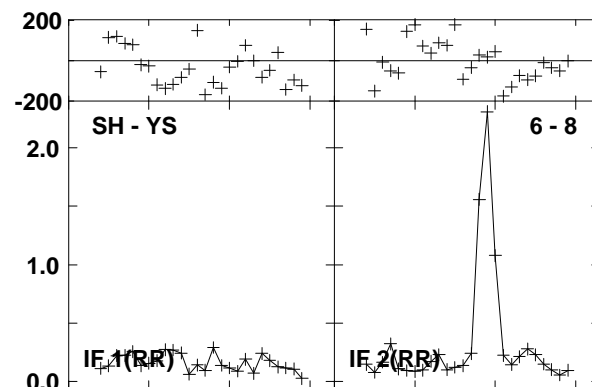
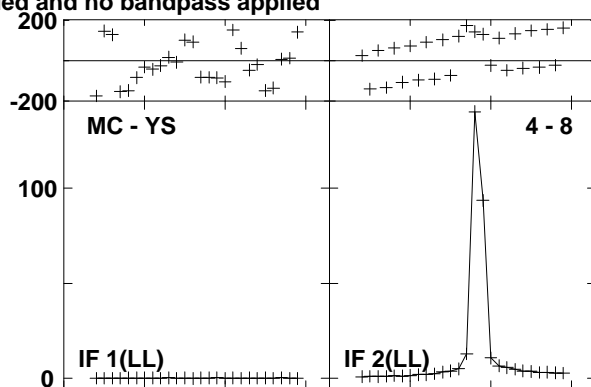
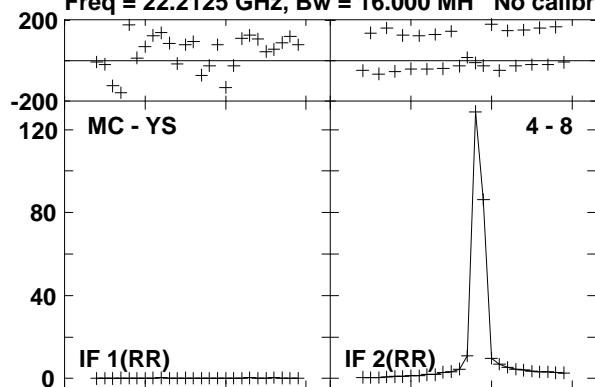

Lower frame: Milli Ampl Jy Top frame: Phas deg  
Vector averaged cross-power spectrum Baseline: MC (04) - YS (08)  
Timerange: 00/13:08:41 to 00/13:09:39

Plot file version 442 created 23-AUG-2016 15:00:57

W3IRS5 GA035B 1.UVDATA.1

Freq = 22.2125 GHz, Bw = 16.000 MH No calibration applied and no bandpass applied

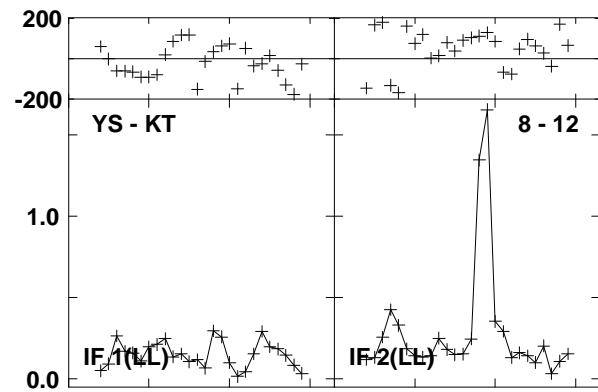
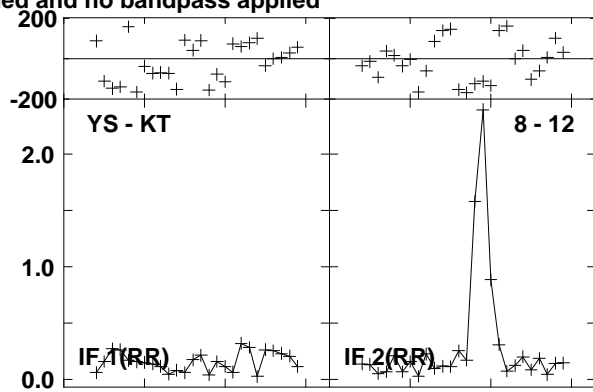
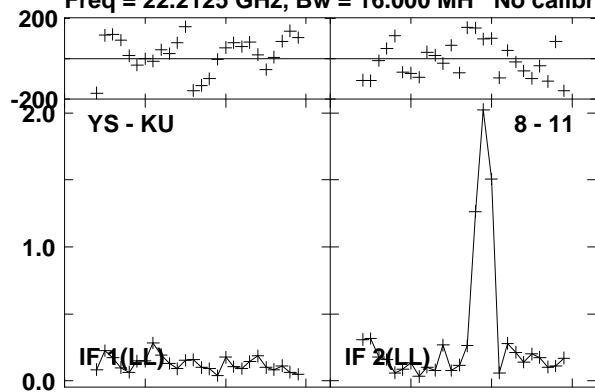

Lower frame: Milli Ampl Jy Top frame: Phas deg  
Vector averaged cross-power spectrum Baseline: YS (08) - KU (11)  
Timerange: 00/13:08:41 to 00/13:09:39

Plot file version 443 created 23-AUG-2016 15:00:57

0219+628 GA035B 1.UVDATA.1

Freq = 22.2125 GHz, Bw = 16.000 MH No calibration applied and no bandpass applied

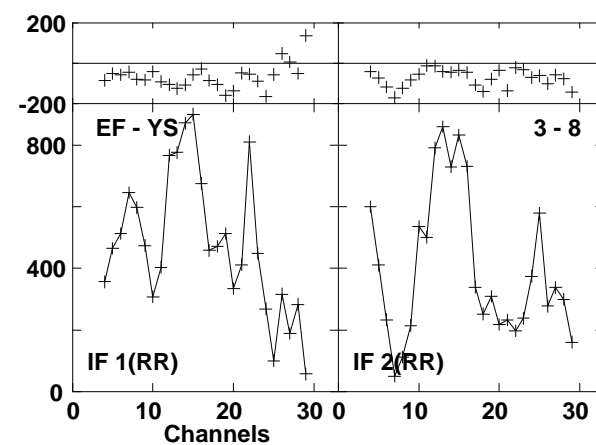
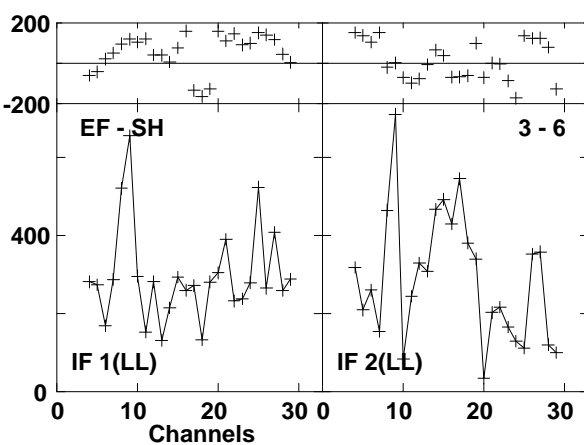
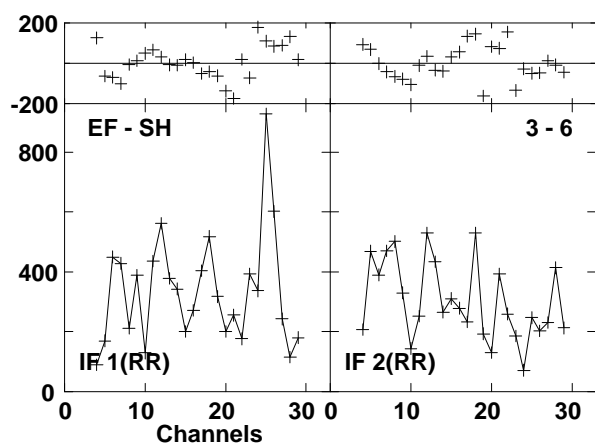
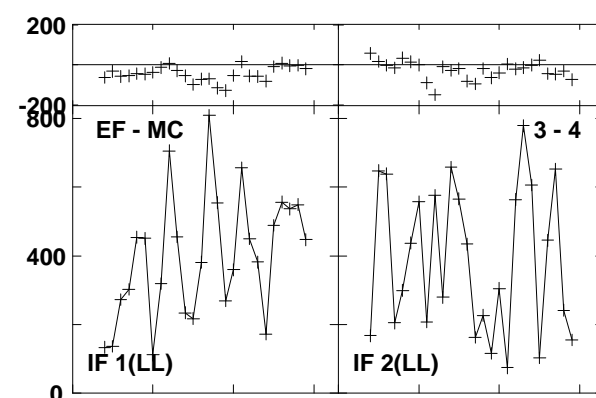
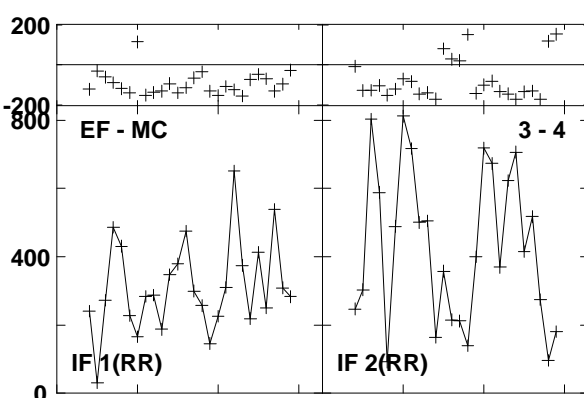
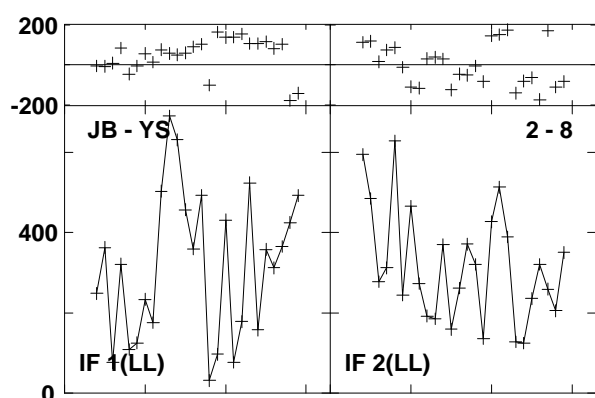
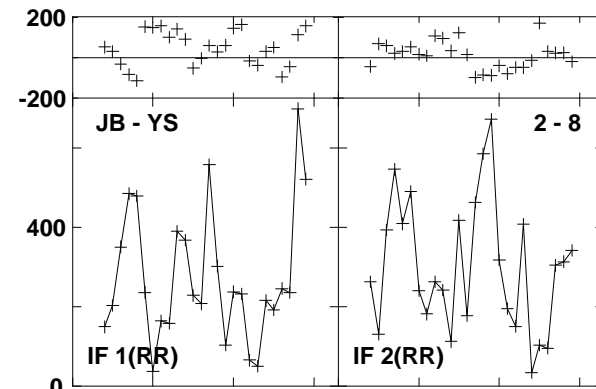
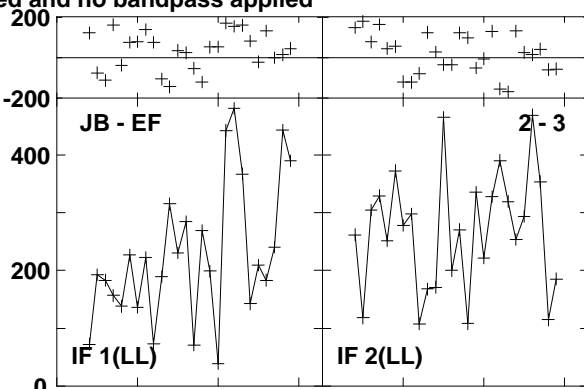
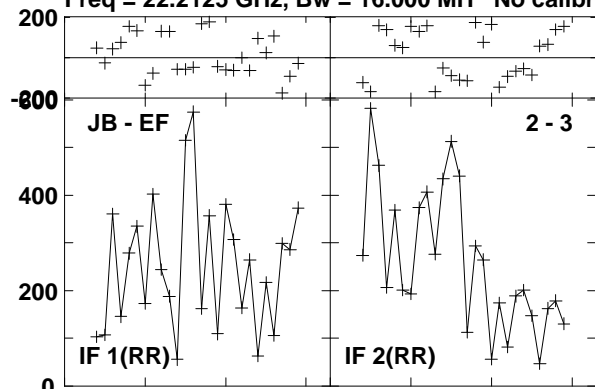

Lower frame: Micro Ampl Jy Top frame: Phas deg  
Vector averaged cross-power spectrum Baseline: JB (02) - EF (03)  
Timerange: 00/13:10:10 to 00/13:10:29

Plot file version 444 created 23-AUG-2016 15:00:57

0219+628 GA035B 1.UVDATA.1

Freq = 22.2125 GHz, Bw = 16.000 MH No calibration applied and no bandpass applied

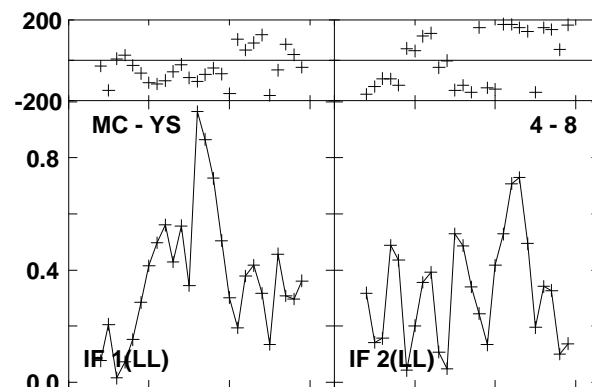
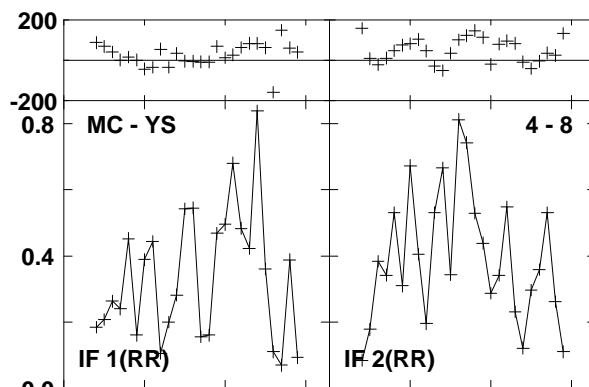
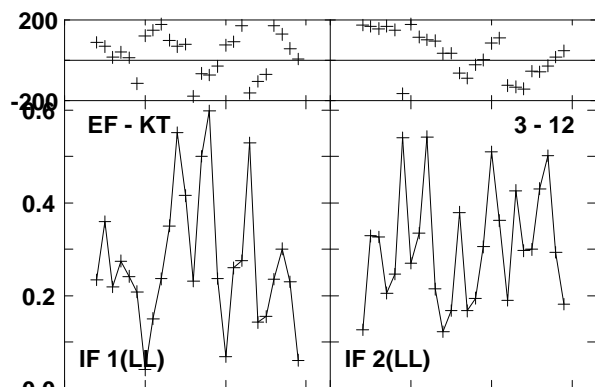
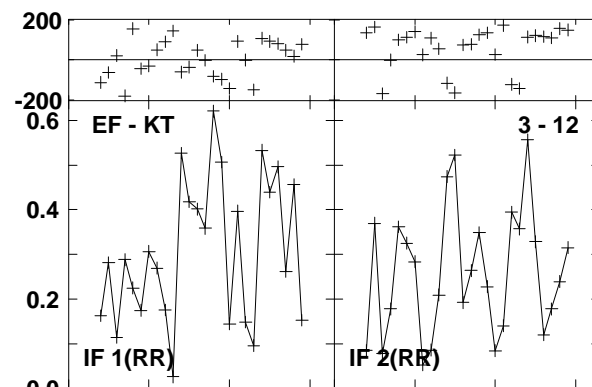
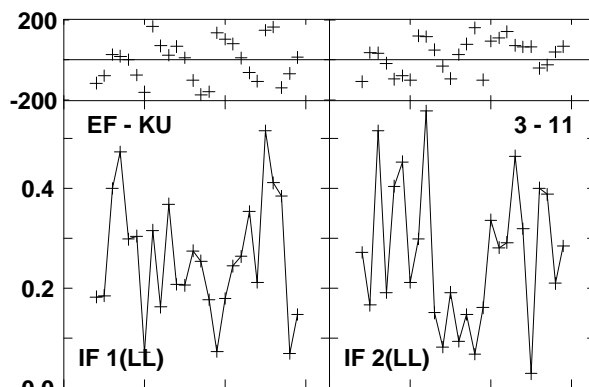
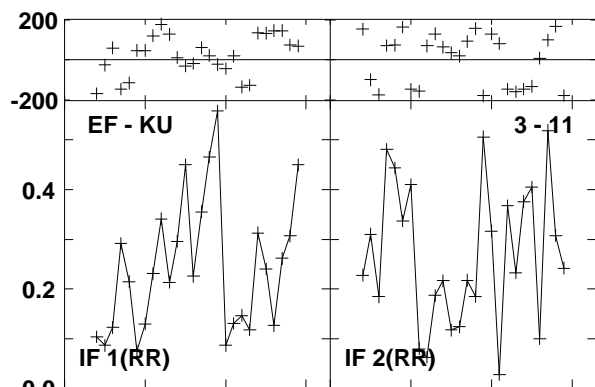
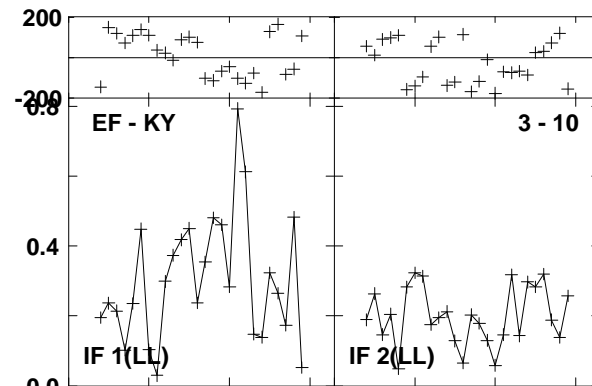
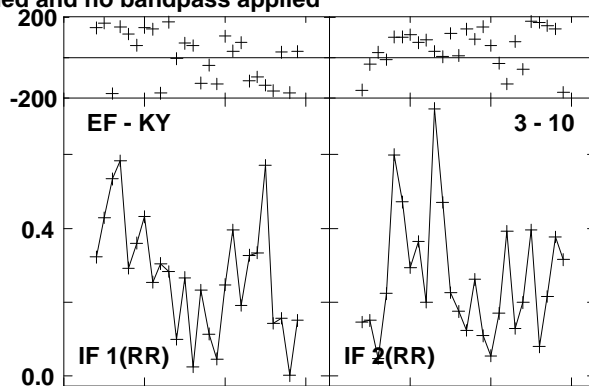
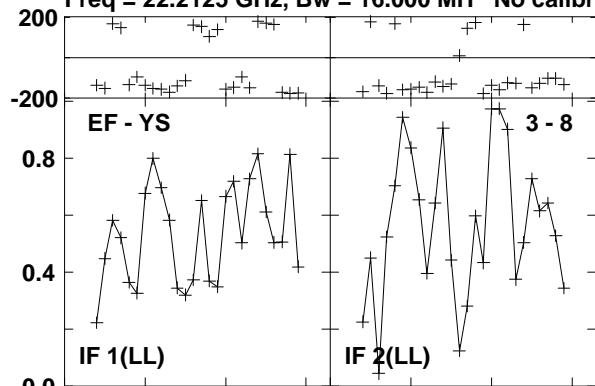

Lower frame: Milli Ampl Jy Top frame: Phas deg  
Vector averaged cross-power spectrum Baseline: EF (03) - YS (08)  
Timerange: 00/13:10:10 to 00/13:10:29

Plot file version 445 created 23-AUG-2016 15:00:57

0219+628 GA035B 1.UVDATA.1

Freq = 22.2125 GHz, Bw = 16.000 MH No calibration applied and no bandpass applied

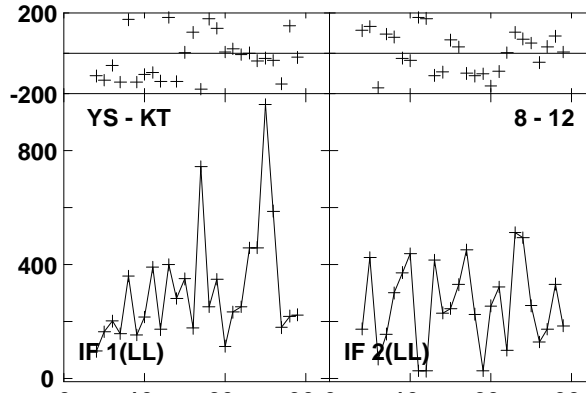
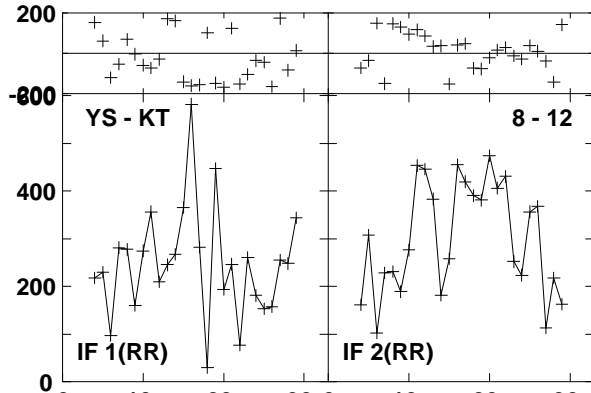
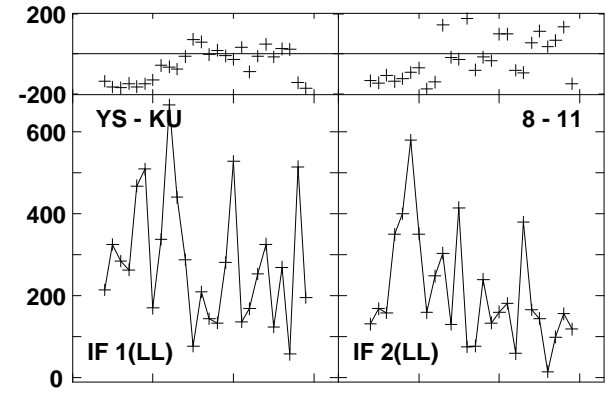
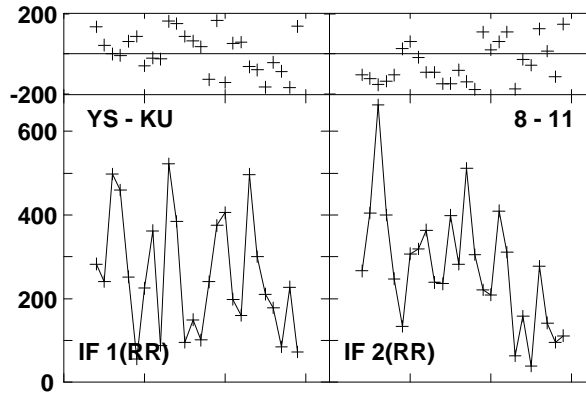
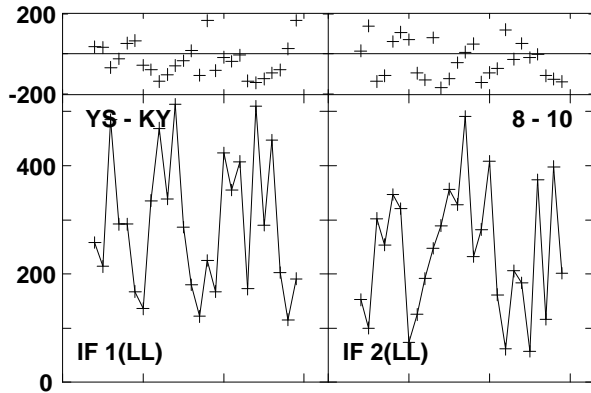
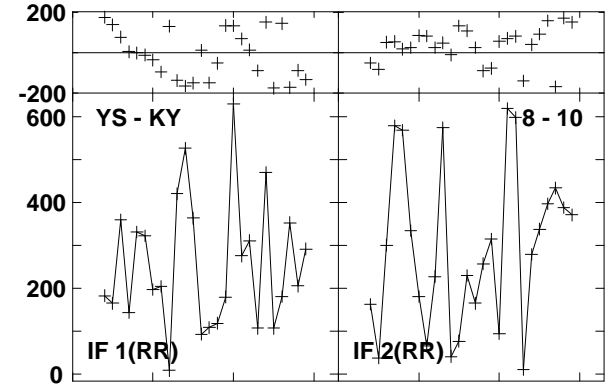
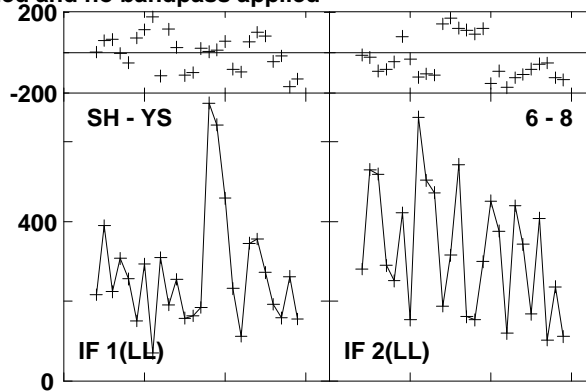
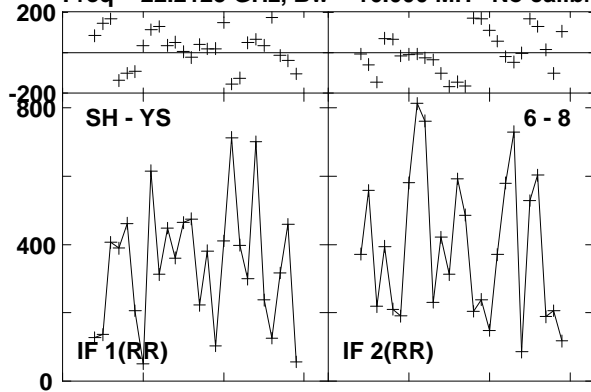

Lower frame: Micro Ampl Jy Top frame: Phas deg  
Vector averaged cross-power spectrum Baseline: SH (06) - YS (08)  
Timerange: 00/13:10:10 to 00/13:10:29

Plot file version 446 created 23-AUG-2016 15:00:57  
 W3IRS5 GA035B 1.UVDATA.1

Freq = 22.2125 GHz, Bw = 16.0000 MH No calibration applied and no bandpass applied

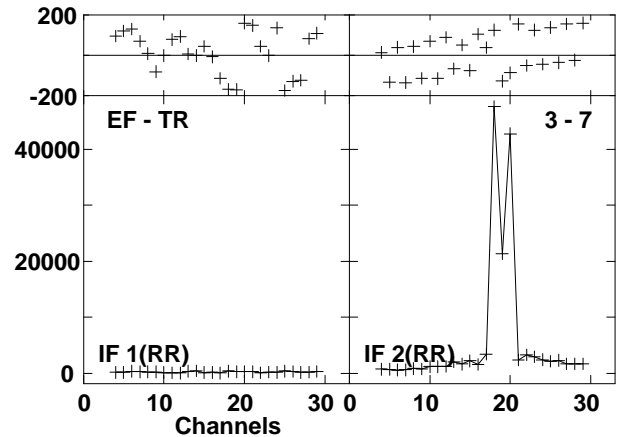
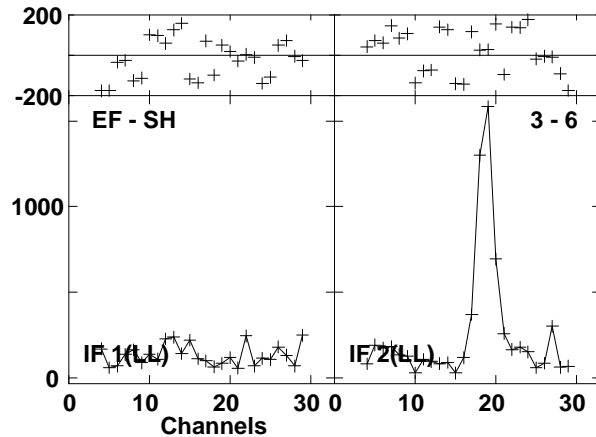
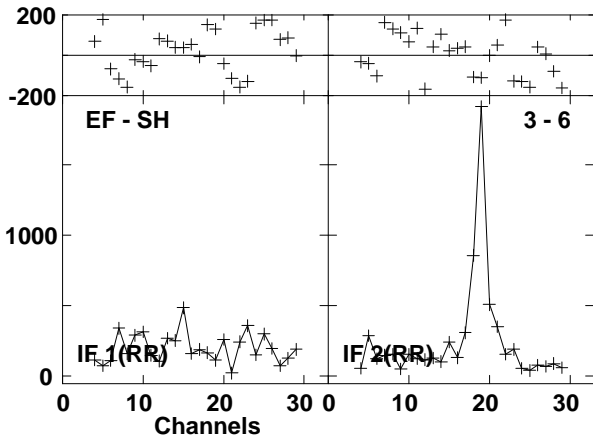
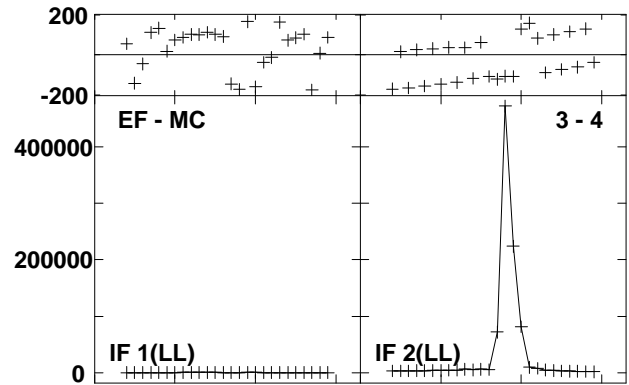
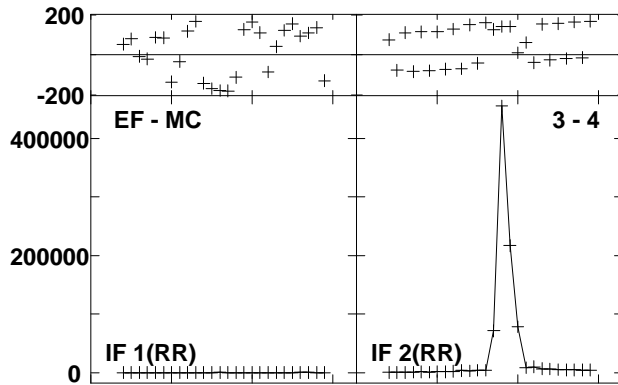
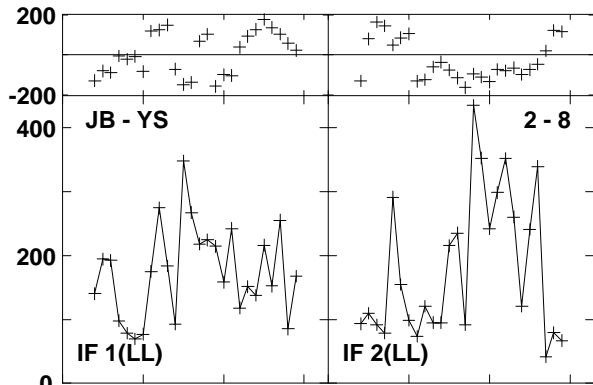
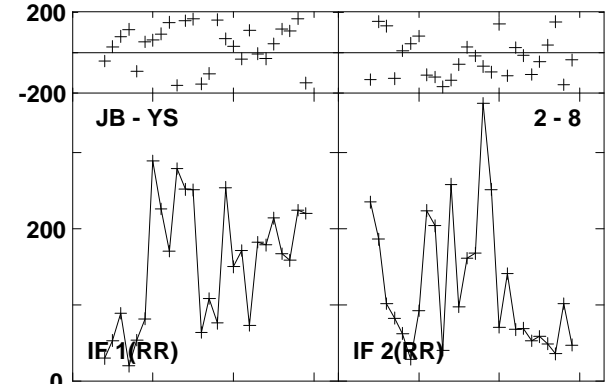
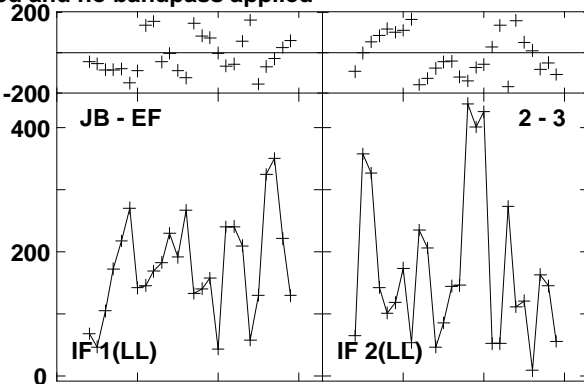
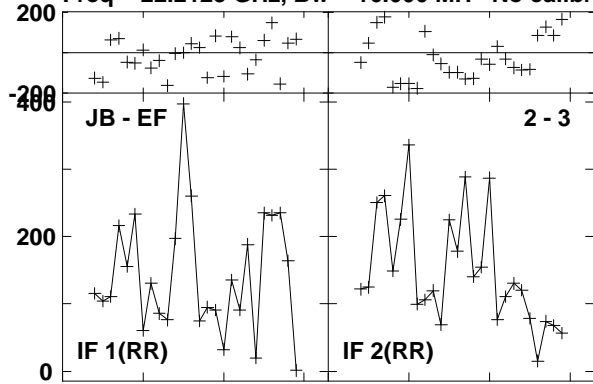

Lower frame: Micro Ampl Jy Top frame: Phas deg  
 Vector averaged cross-power spectrum Baseline: JB (02) - EF (03)  
 Timerange: 00/13:11:01 to 00/13:12:00

Plot file version 447 created 23-AUG-2016 15:00:57

W3IRS5 GA035B 1.UVDATA.1

Freq = 22.2125 GHz, Bw = 16.000 MH No calibration applied and no bandpass applied

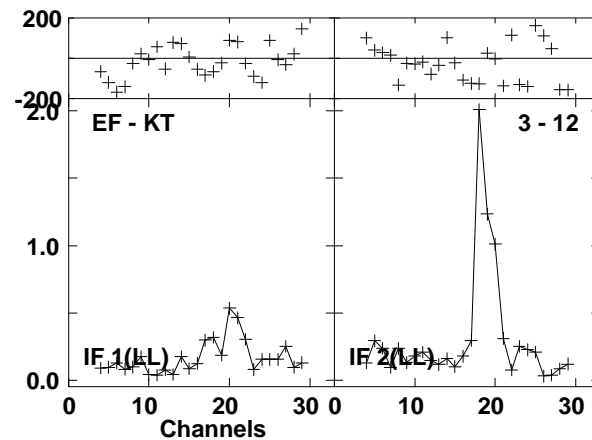
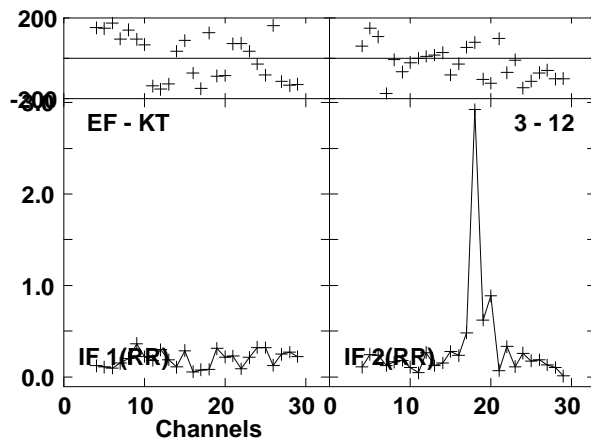
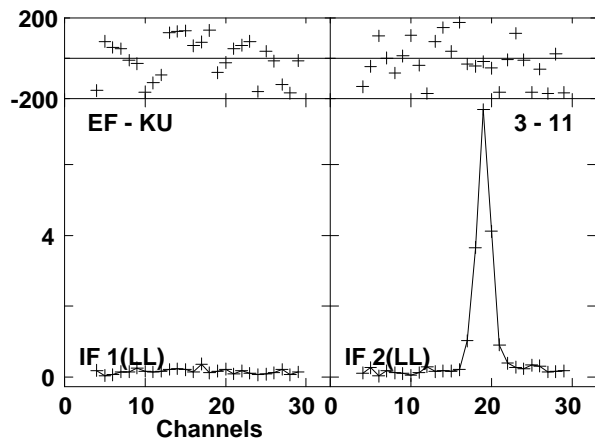
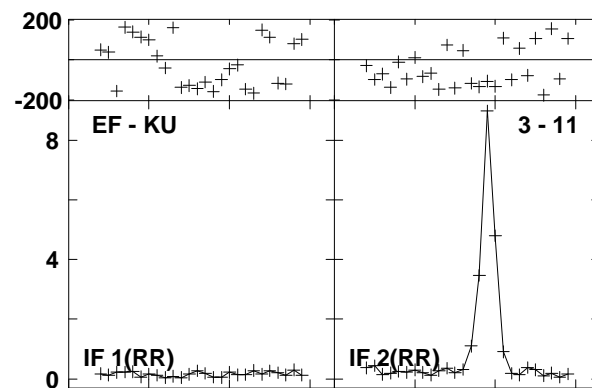
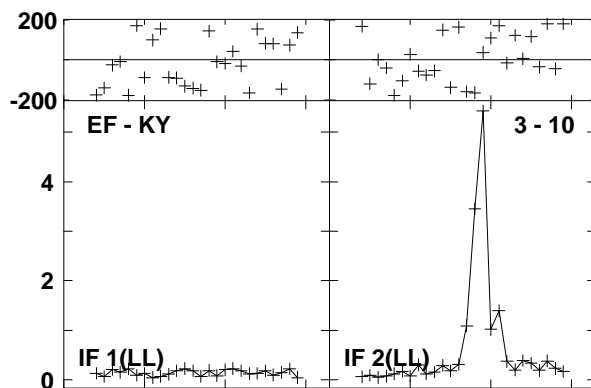
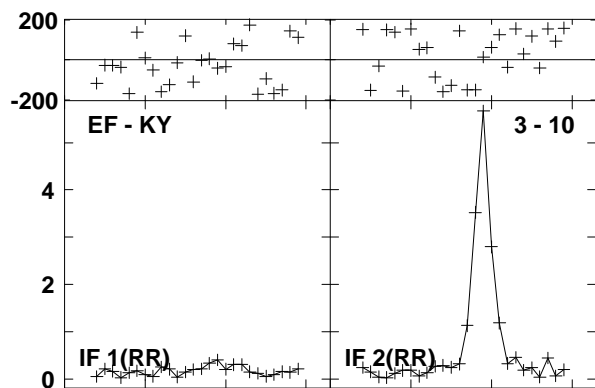
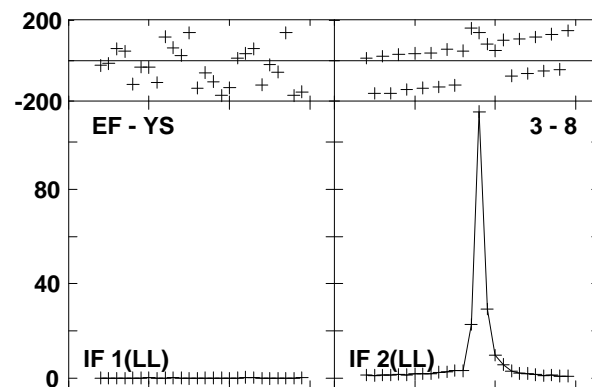
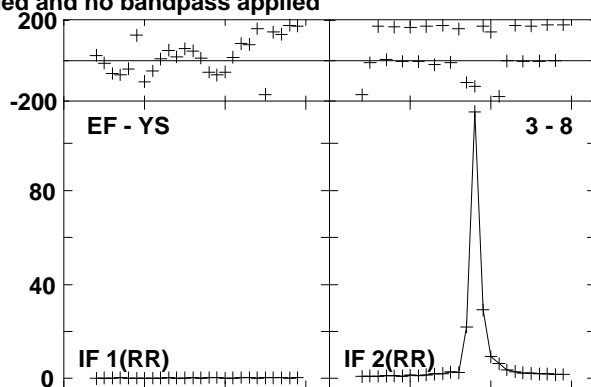
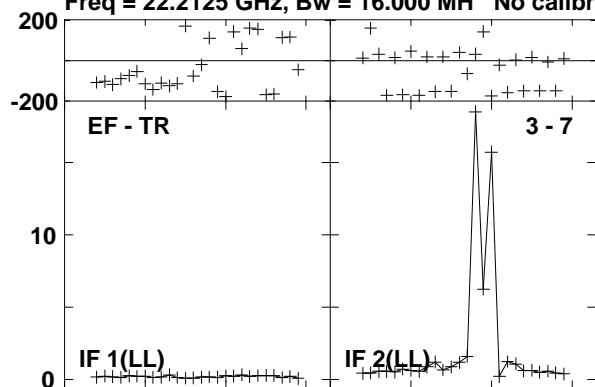

Lower frame: Milli Ampl Jy Top frame: Phas deg  
Vector averaged cross-power spectrum Baseline: EF (03) - TR (07)  
Timerange: 00/13:11:01 to 00/13:12:00

Plot file version 448 created 23-AUG-2016 15:00:57

W3IRS5 GA035B 1.UVDATA.1

Freq = 22.2125 GHz, Bw = 16.000 MH No calibration applied and no bandpass applied

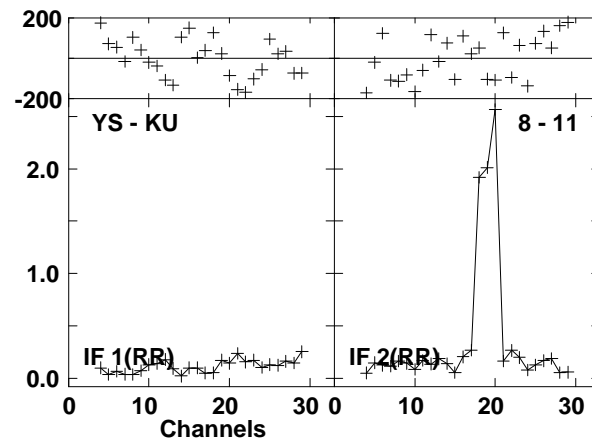
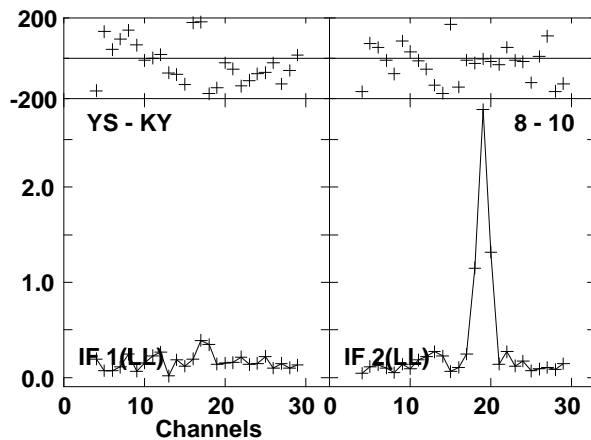
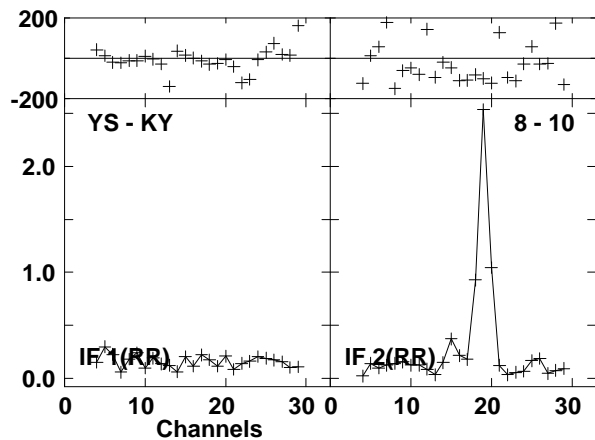
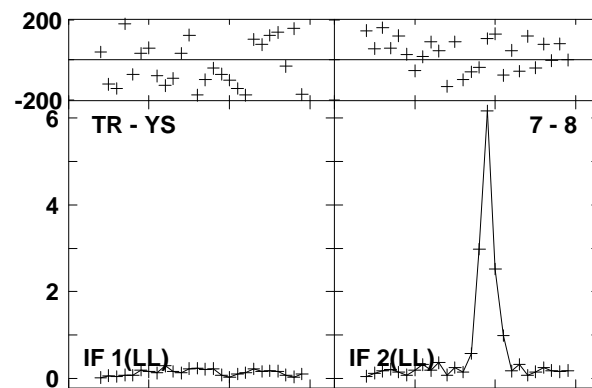
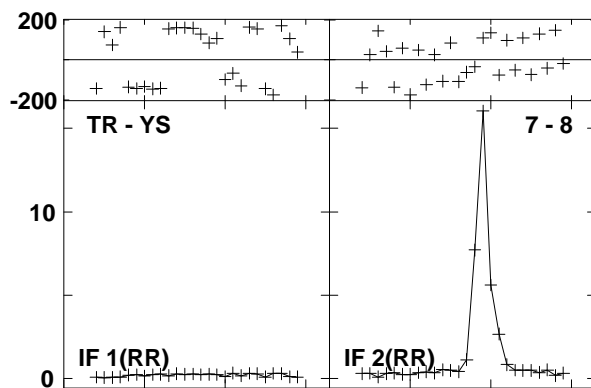
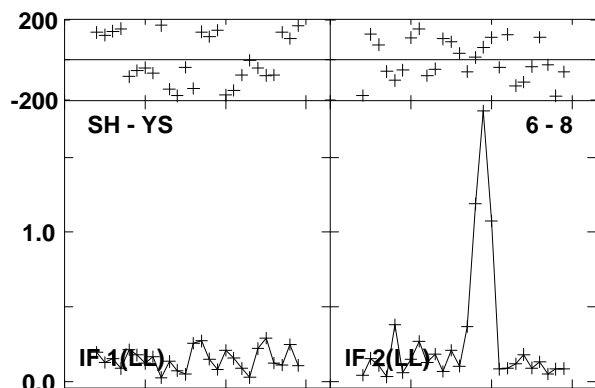
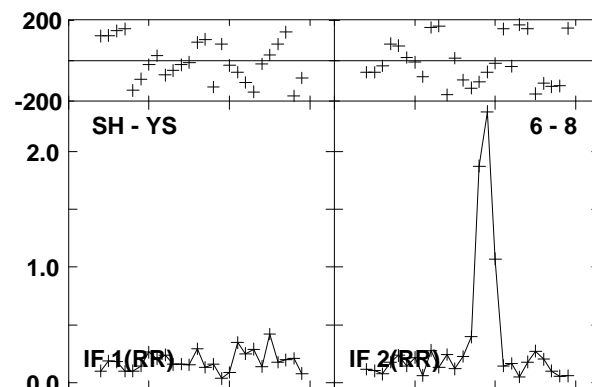
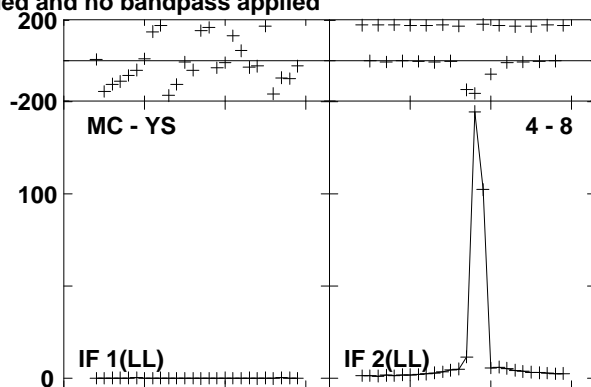
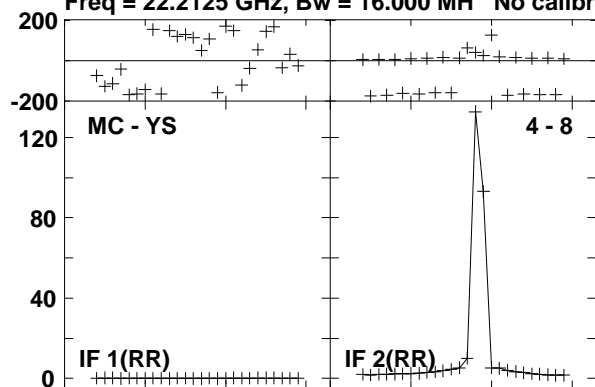

Lower frame: Milli Ampl Jy Top frame: Phas deg  
Vector averaged cross-power spectrum Baseline: MC (04) - YS (08)  
Timerange: 00/13:11:01 to 00/13:12:00



Plot file version 449 created 23-AUG-2016 15:00:57  
W3IRS5 GA035B 1.UVDATA.1

Freq = 22.2125 GHz, Bw = 16.000 MH No calibration applied and no bandpass applied

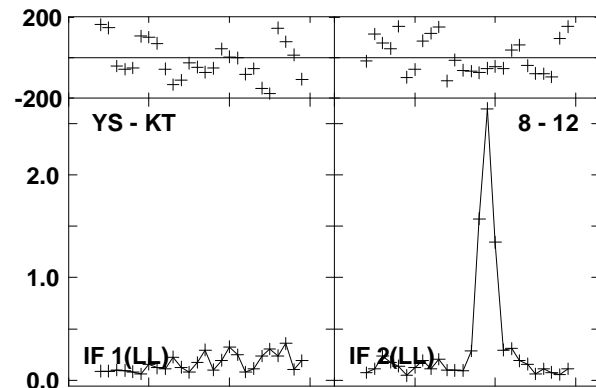
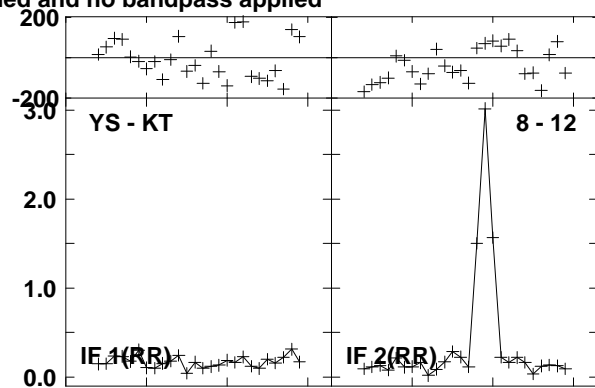
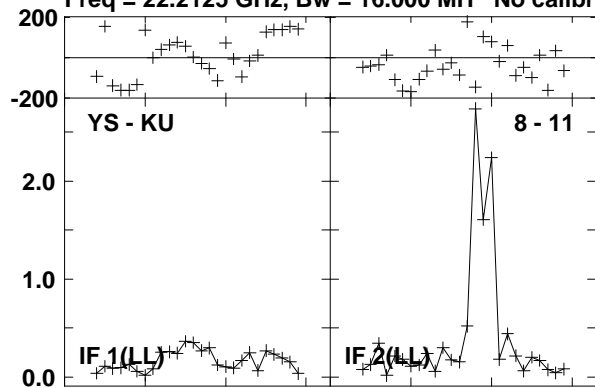

Lower frame: Milli Ampl Jy Top frame: Phas deg  
Vector averaged cross-power spectrum Baseline: YS (08) - KU (11)  
Timerange: 00/13:11:01 to 00/13:12:00

Plot file version 450 created 23-AUG-2016 15:00:57

0219+628 GA035B 1.UVDATA.1

Freq = 22.2125 GHz, Bw = 16.000 MH No calibration applied and no bandpass applied

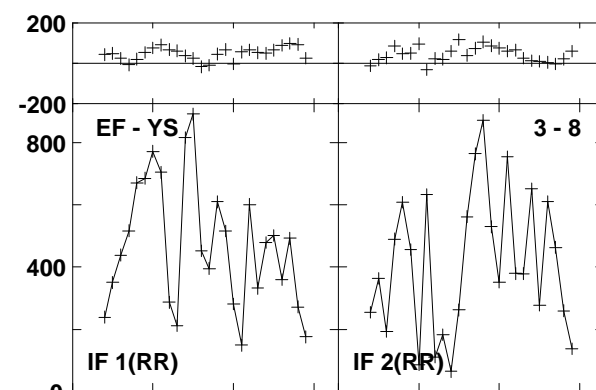
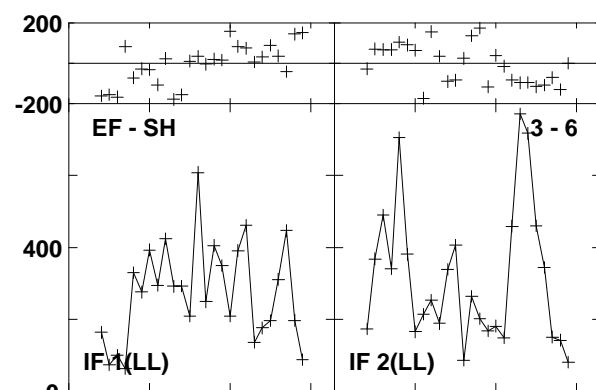
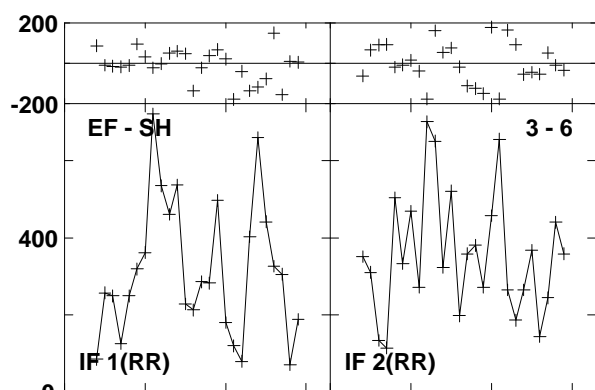
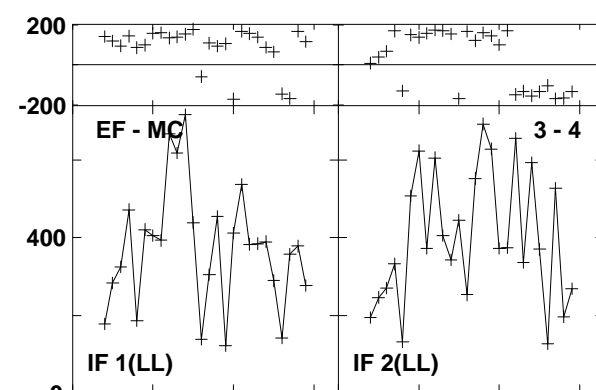
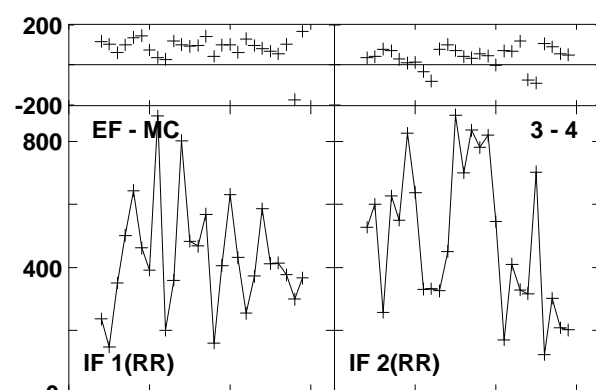
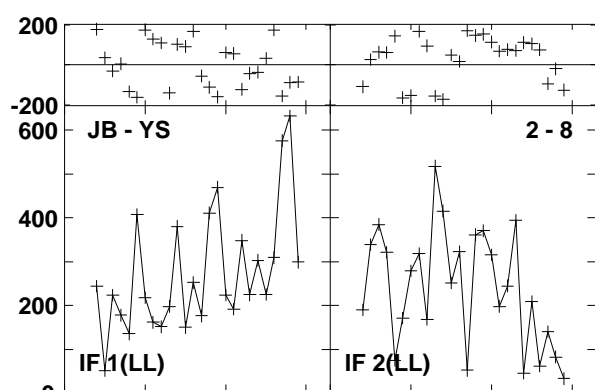
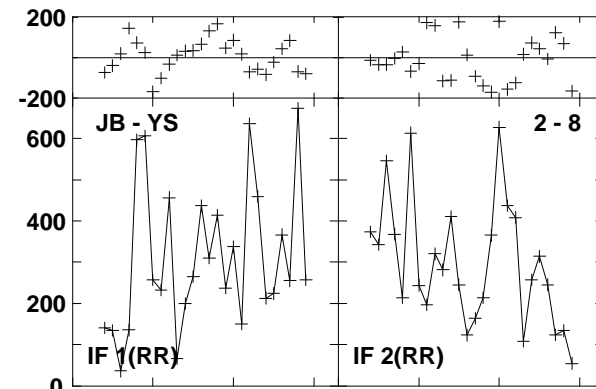
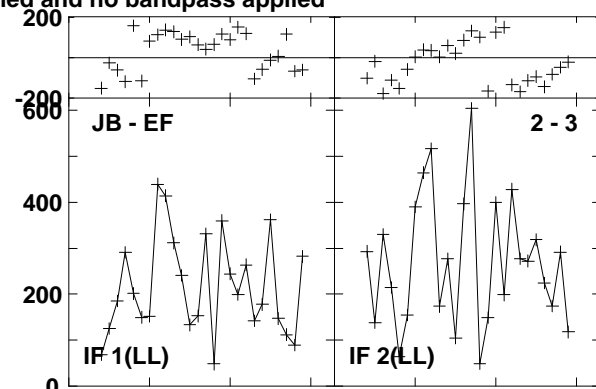
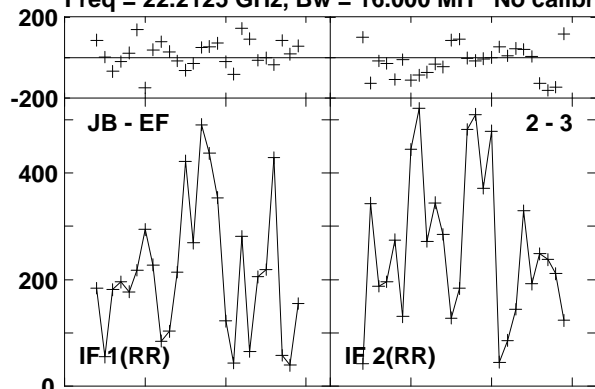

Lower frame: Micro Ampl Jy Top frame: Phas deg  
Vector averaged cross-power spectrum Baseline: JB (02) - EF (03)  
Timerange: 00/13:12:30 to 00/13:12:50

Plot file version 451 created 23-AUG-2016 15:00:57

0219+628 GA035B 1.UVDATA.1

Freq = 22.2125 GHz, Bw = 16.000 MH No calibration applied and no bandpass applied

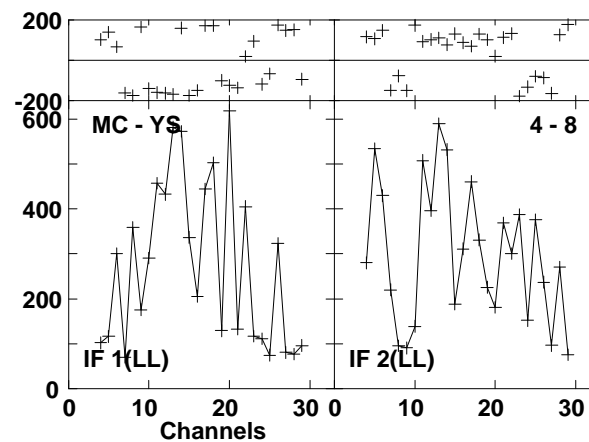
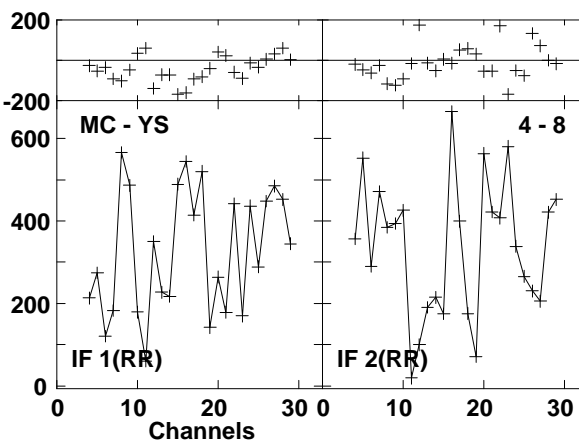
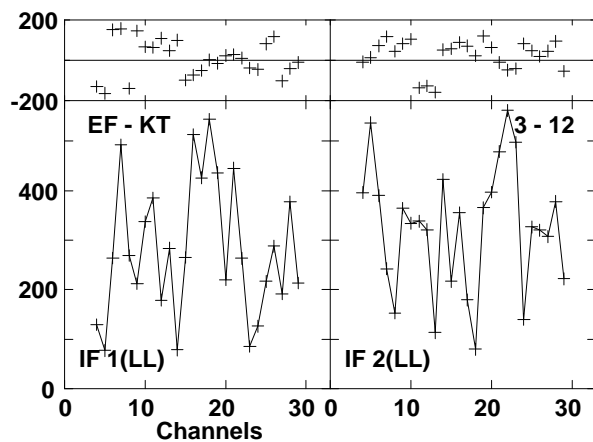
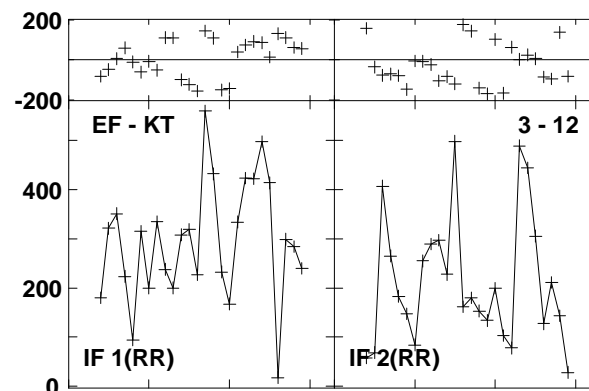
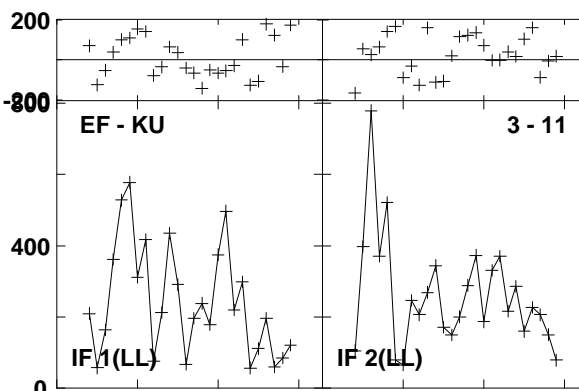
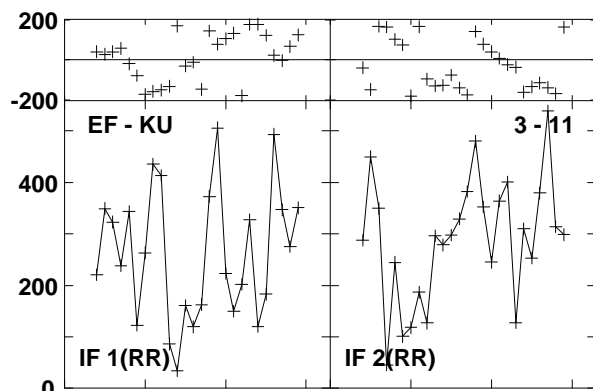
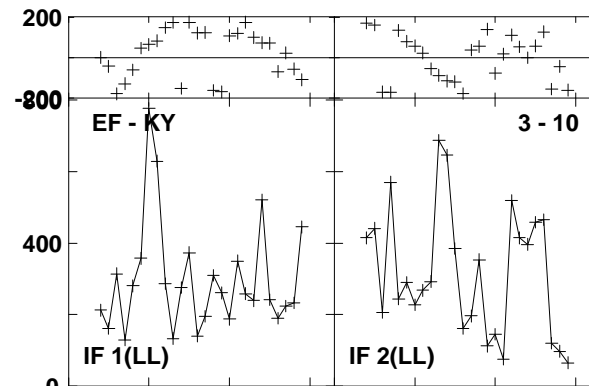
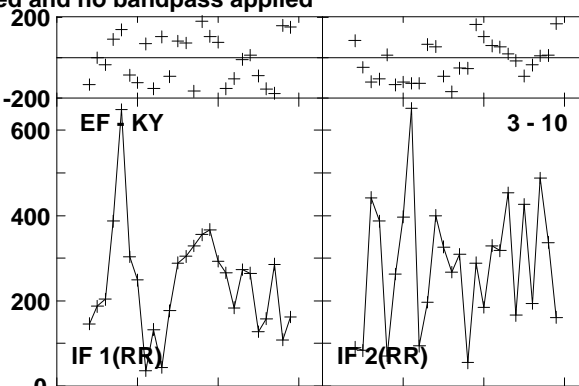
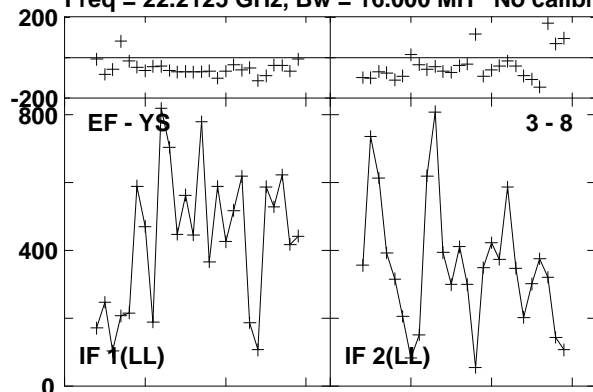

Lower frame: Micro Ampl Jy Top frame: Phas deg  
Vector averaged cross-power spectrum Baseline: EF (03) - YS (08)  
Timerange: 00/13:12:30 to 00/13:12:50

Plot file version 452 created 23-AUG-2016 15:00:57

0219+628 GA035B 1.UVDATA.1

Freq = 22.2125 GHz, Bw = 16.000 MH No calibration applied and no bandpass applied

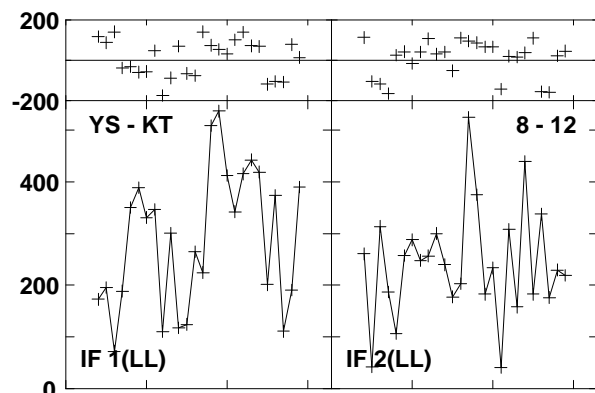
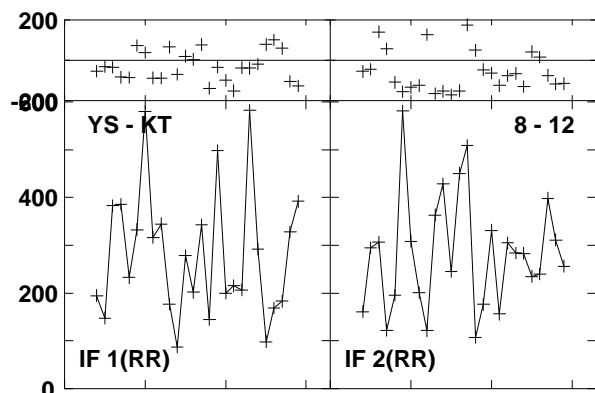
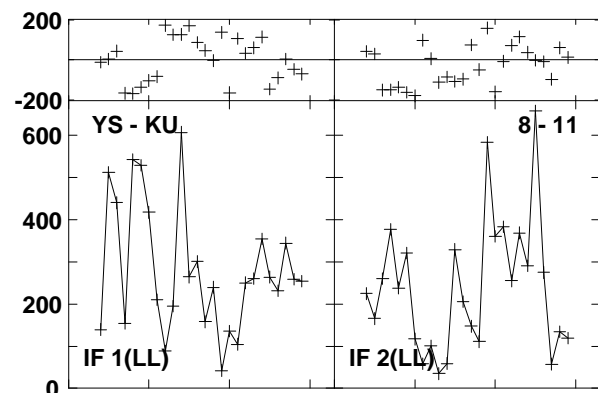
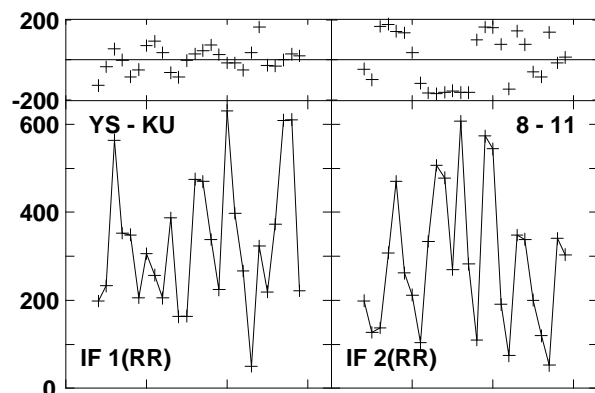
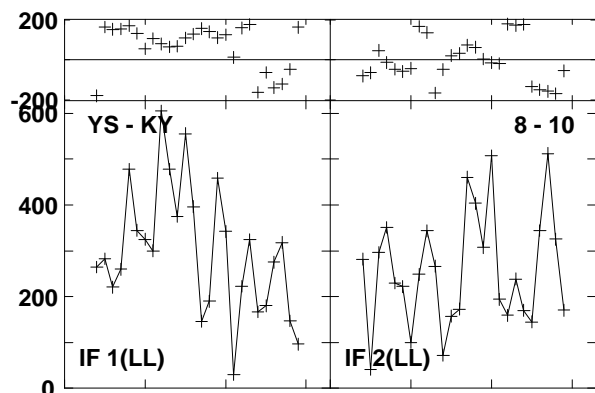
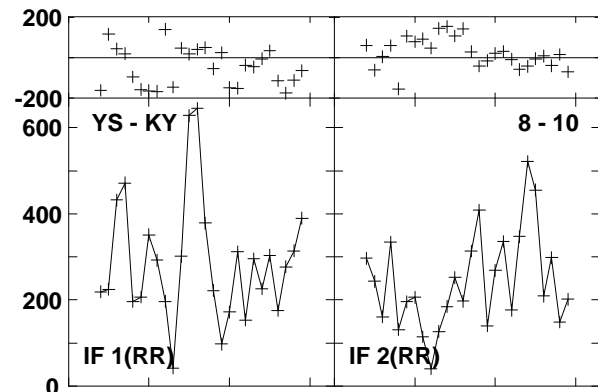
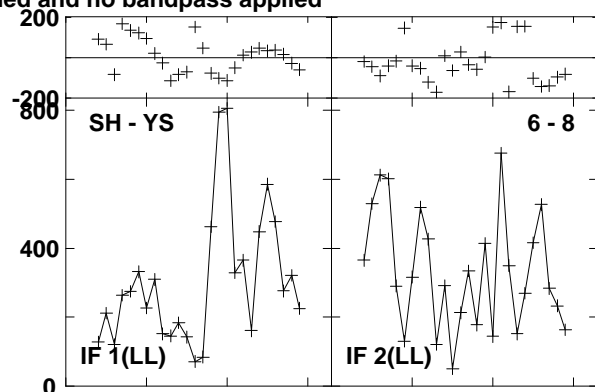
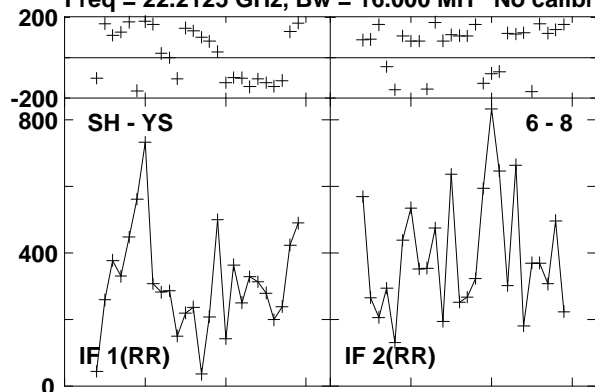

Lower frame: Micro Ampl Jy Top frame: Phas deg  
Vector averaged cross-power spectrum Baseline: SH (06) - YS (08)  
Timerange: 00/13:12:30 to 00/13:12:50

Plot file version 453 created 23-AUG-2016 15:00:57

W3IRS5 GA035B 1.UVDATA.1

Freq = 22.2125 GHz, Bw = 16.000 MH No calibration applied and no bandpass applied

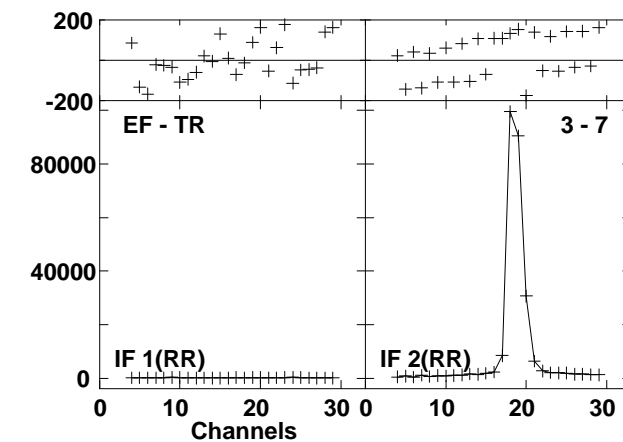
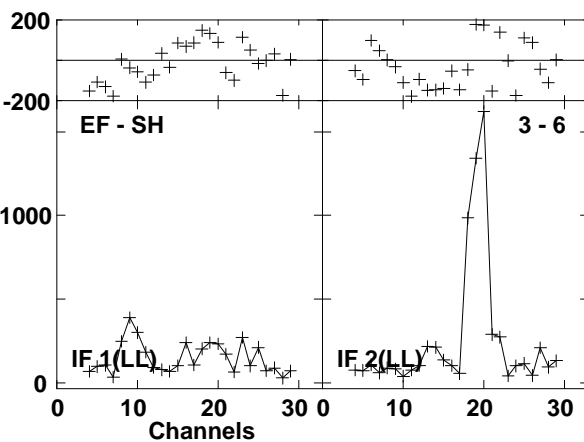
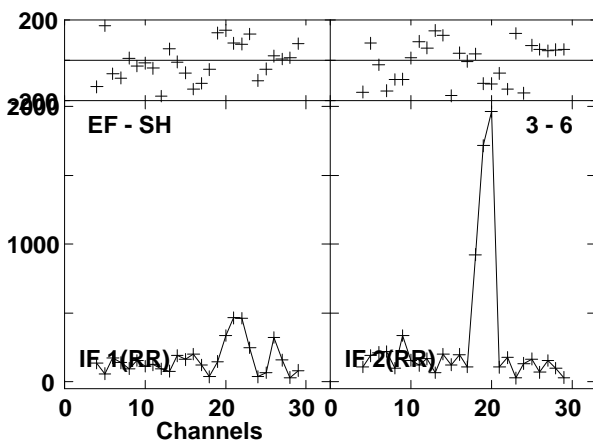
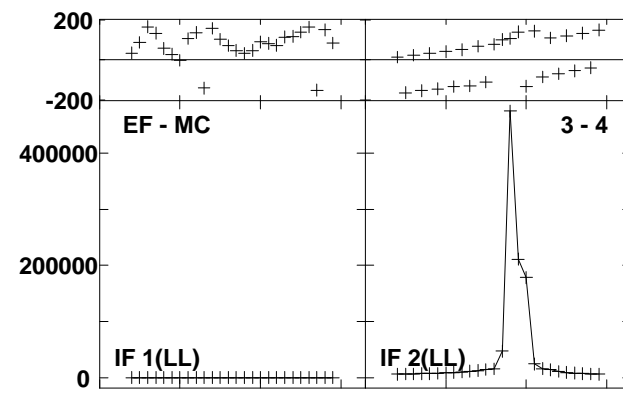
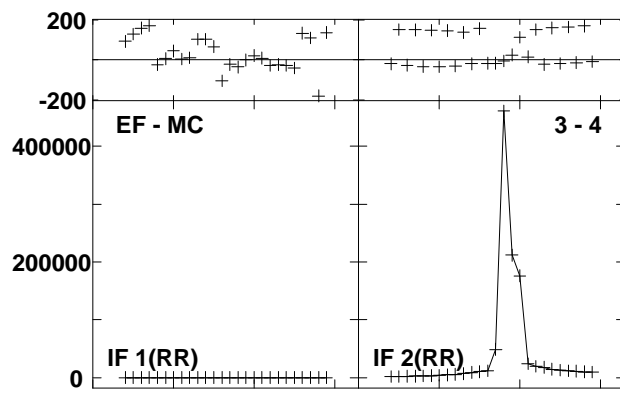
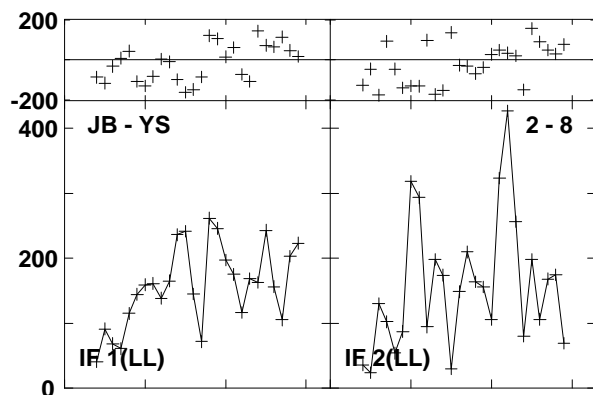
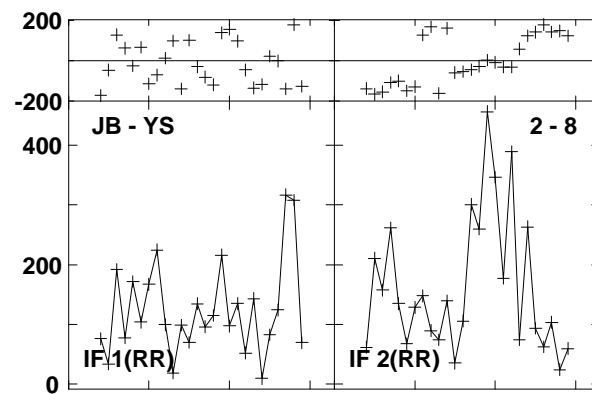
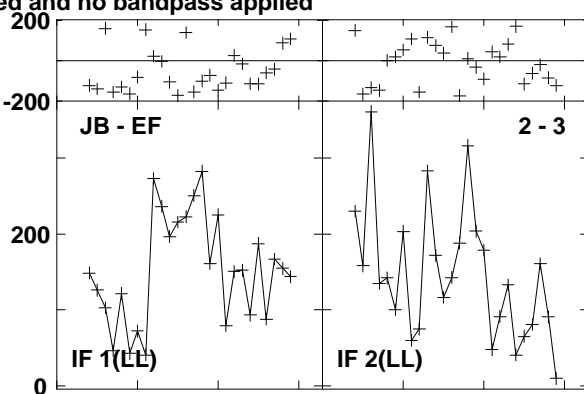
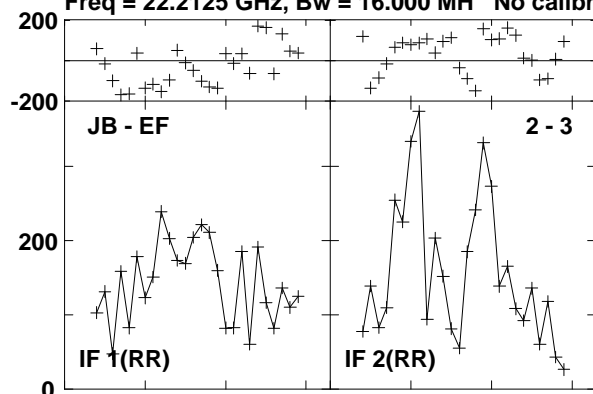

Lower frame: Micro Ampl Jy Top frame: Phas deg  
Vector averaged cross-power spectrum Baseline: JB (02) - EF (03)  
Timerange: 00/13:13:20 to 00/13:14:19

Plot file version 454 created 23-AUG-2016 15:00:57

W3IRS5 GA035B 1.UVDATA.1

Freq = 22.2125 GHz, Bw = 16.000 MH No calibration applied and no bandpass applied

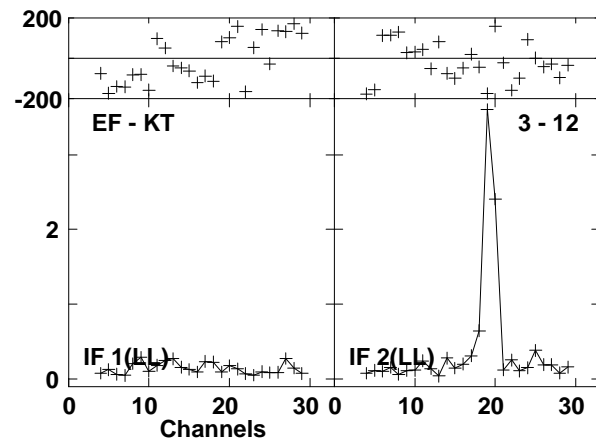
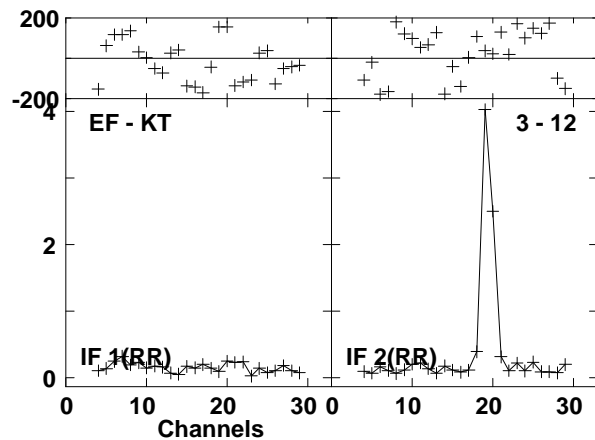
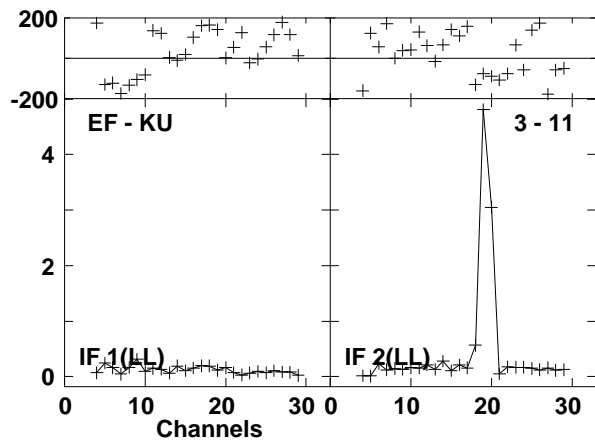
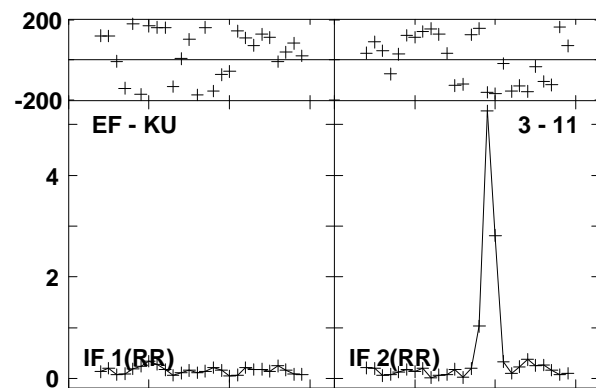
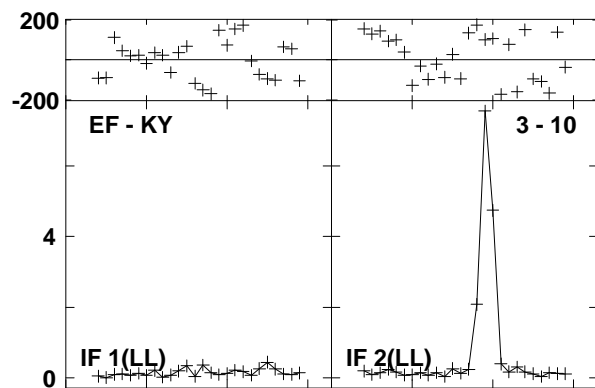
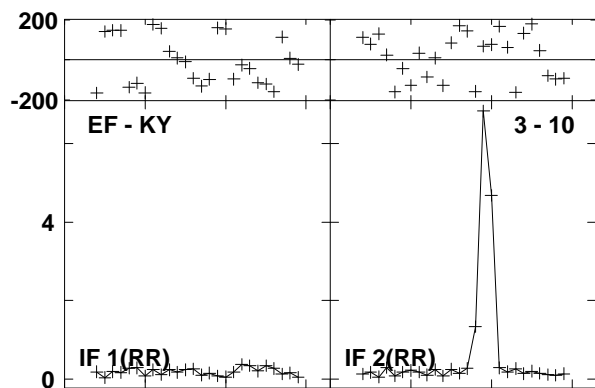
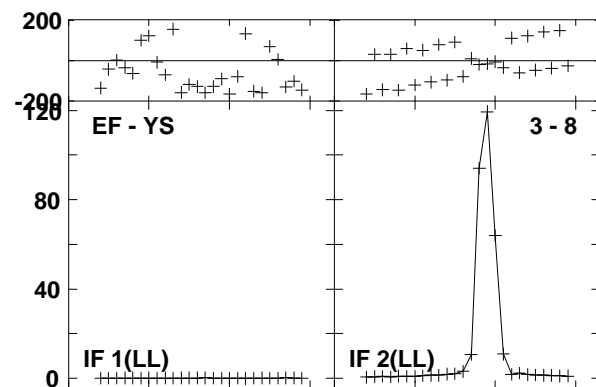
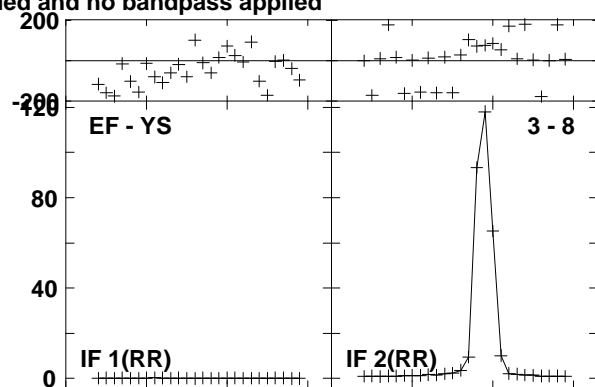
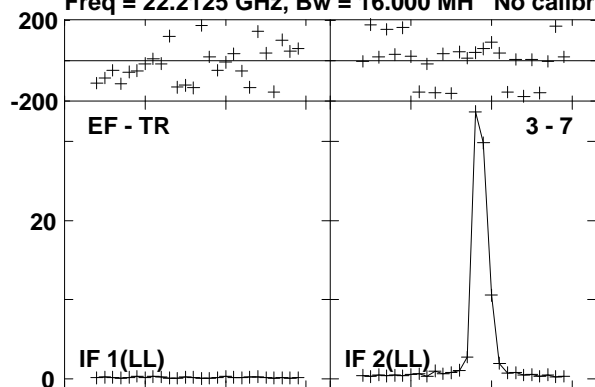

Lower frame: Milli Ampl Jy Top frame: Phas deg  
Vector averaged cross-power spectrum Baseline: EF (03) - TR (07)  
Timerange: 00/13:13:20 to 00/13:14:19

Plot file version 455 created 23-AUG-2016 15:00:57  
W3IRS5 GA035B 1.UVDATA.1

Freq = 22.2125 GHz, Bw = 16.000 MH No calibration applied and no bandpass applied

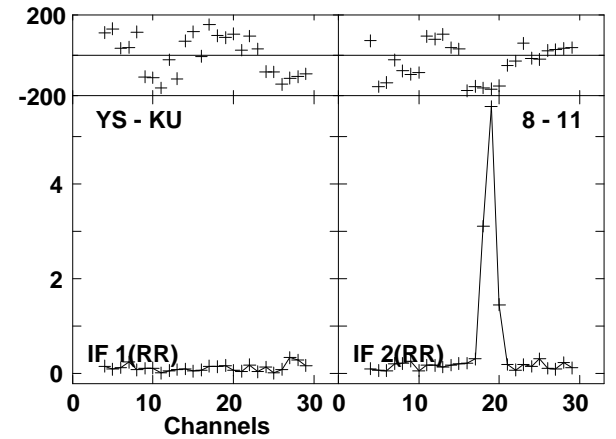
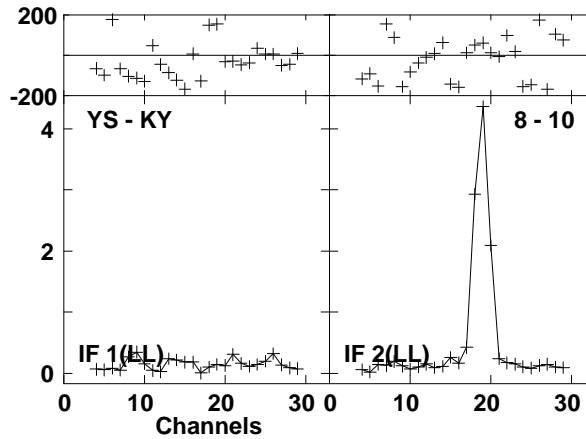
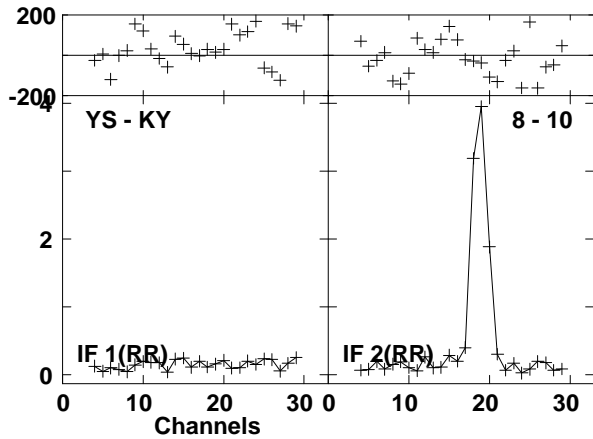
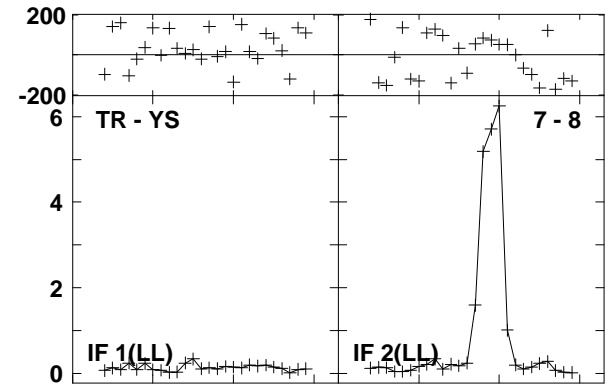
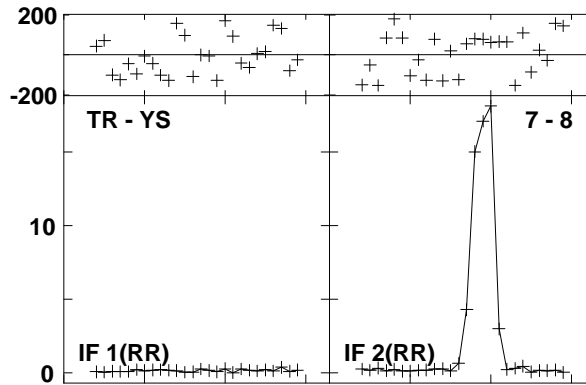
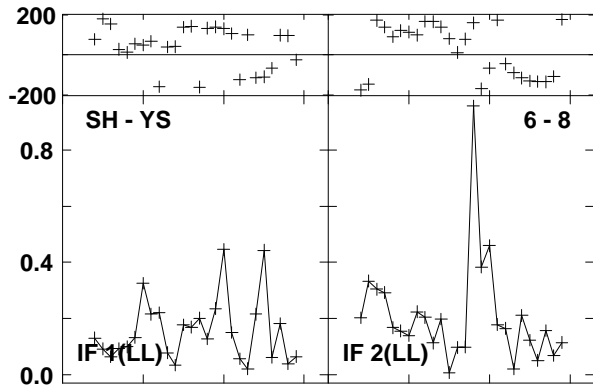
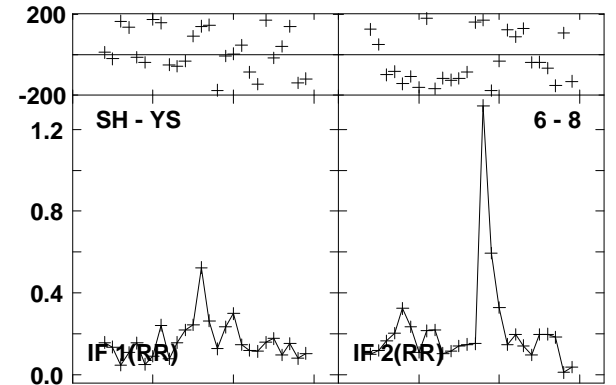
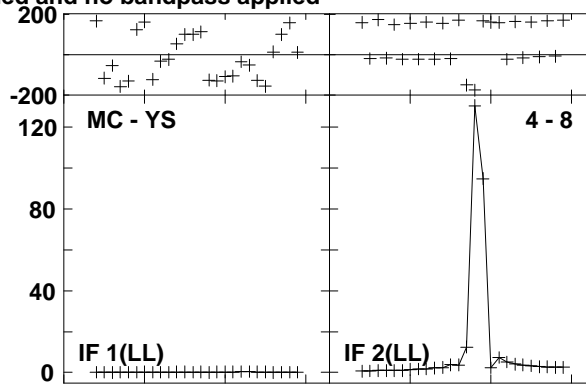
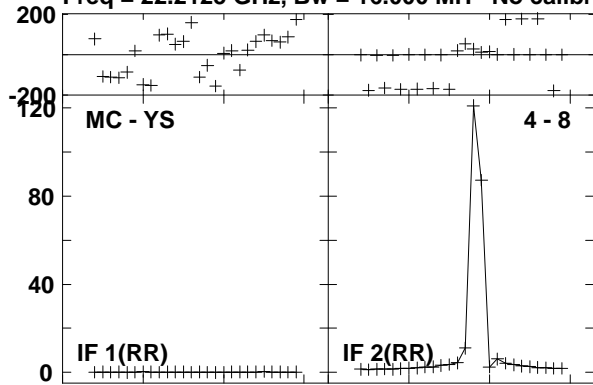

Lower frame: Milli Ampl Jy Top frame: Phas deg  
Vector averaged cross-power spectrum Baseline: MC (04) - YS (08)  
Timerange: 00/13:13:20 to 00/13:14:19

Plot file version 456 created 23-AUG-2016 15:00:57

W3IRS5 GA035B 1.UVDATA.1

Freq = 22.2125 GHz, Bw = 16.000 MH No calibration applied and no bandpass applied

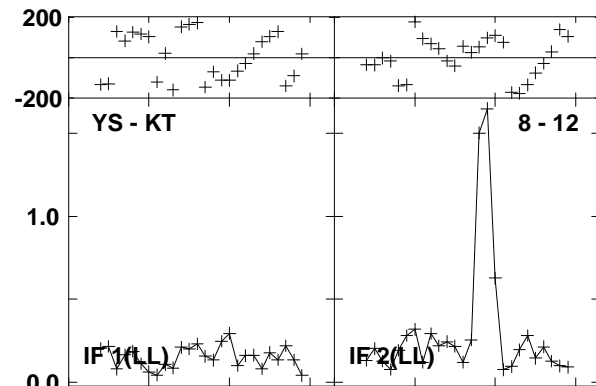
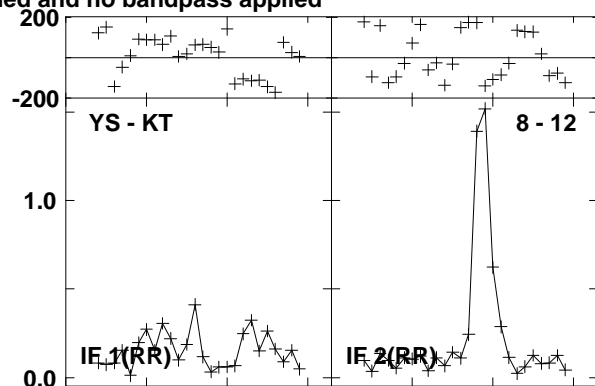
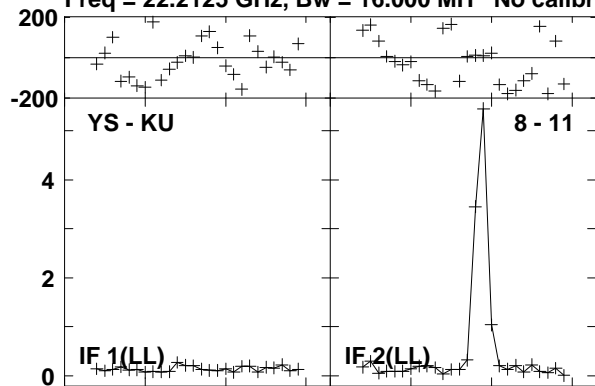

Lower frame: Milli Ampl Jy Top frame: Phas deg  
Vector averaged cross-power spectrum Baseline: YS (08) - KU (11)  
Timerange: 00/13:13:20 to 00/13:14:19



Plot file version 457 created 23-AUG-2016 15:00:57

0219+628 GA035B 1.UVDATA.1

Freq = 22.2125 GHz, Bw = 16.000 MH No calibration applied and no bandpass applied

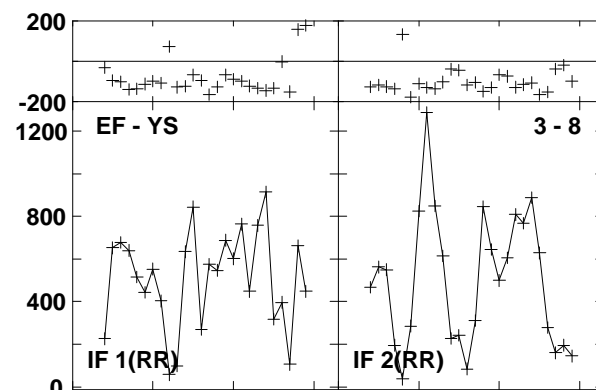
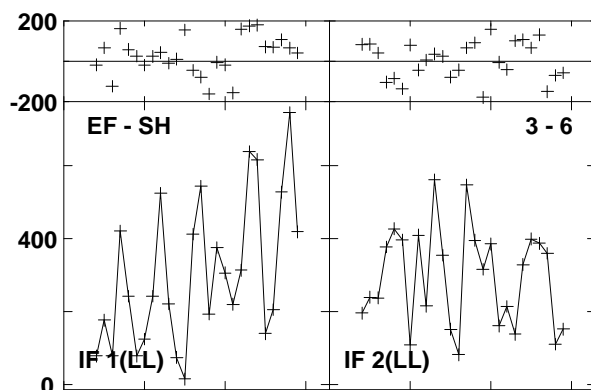
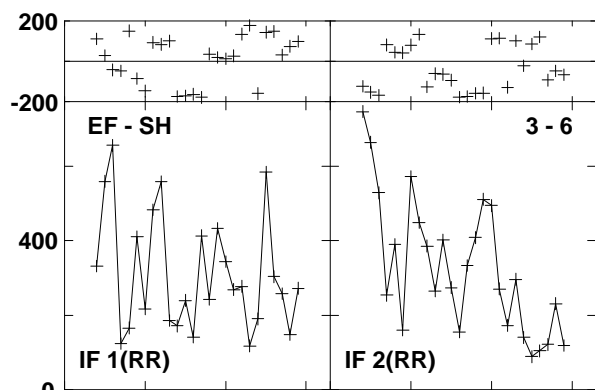
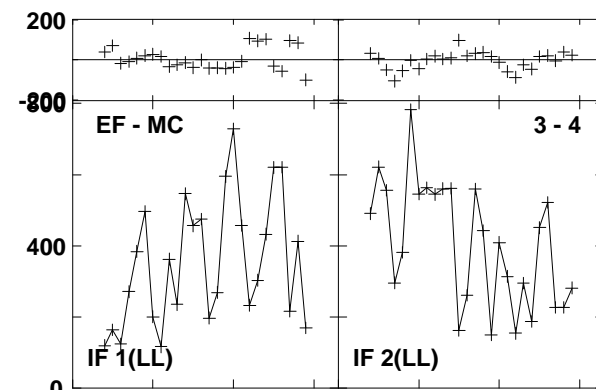
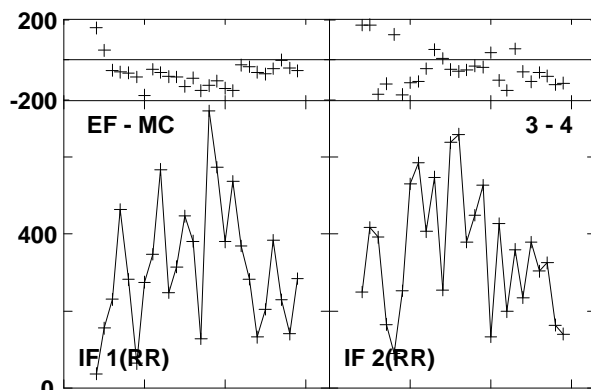
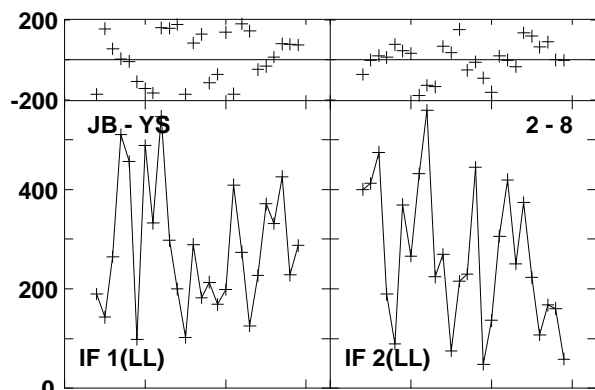
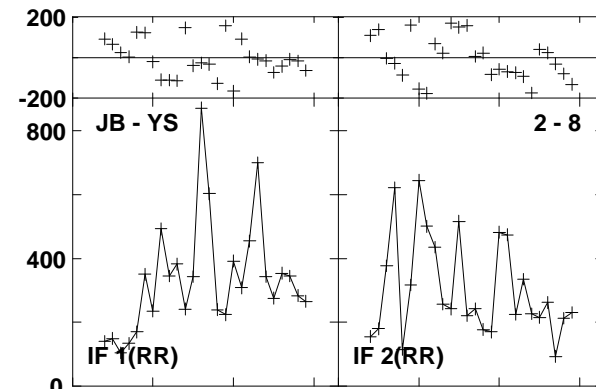
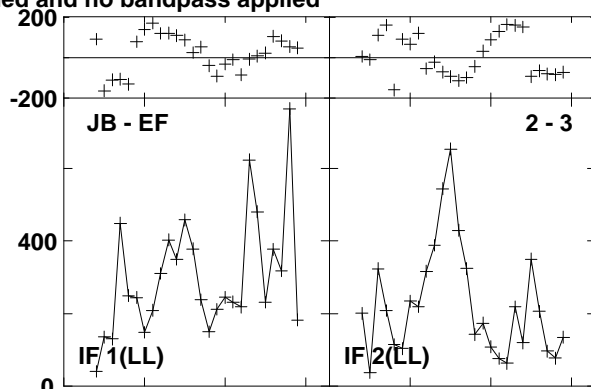
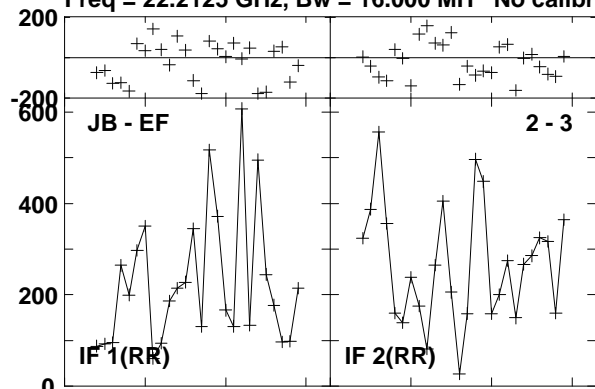

Lower frame: Micro Ampl Jy Top frame: Phas deg  
Vector averaged cross-power spectrum Baseline: JB (02) - EF (03)  
Timerange: 00/13:14:51 to 00/13:15:09

Plot file version 458 created 23-AUG-2016 15:00:57

0219+628 GA035B 1.UVDATA.1

Freq = 22.2125 GHz, Bw = 16.000 MH No calibration applied and no bandpass applied

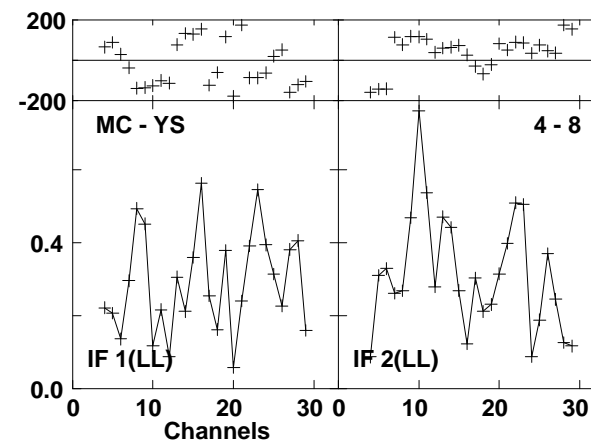
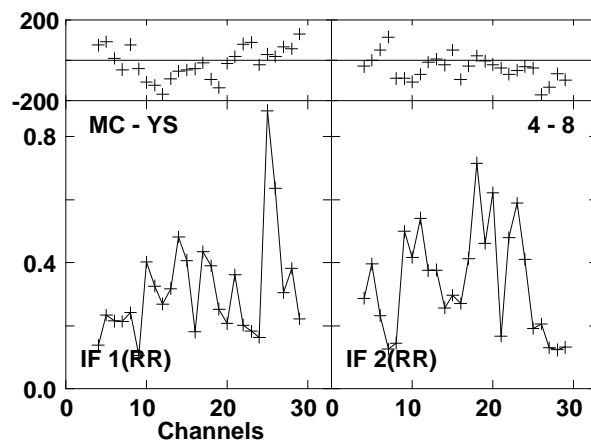
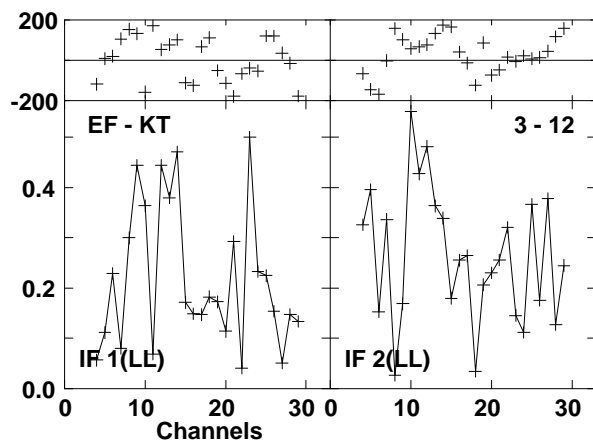
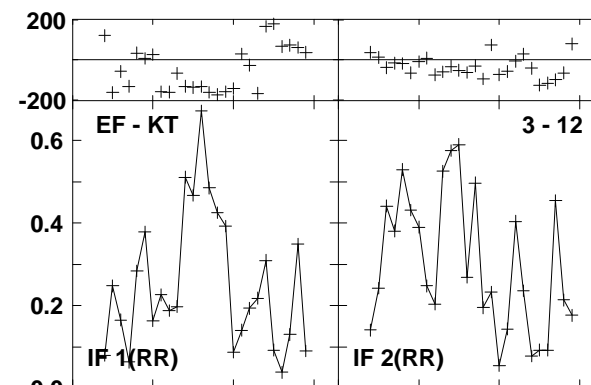
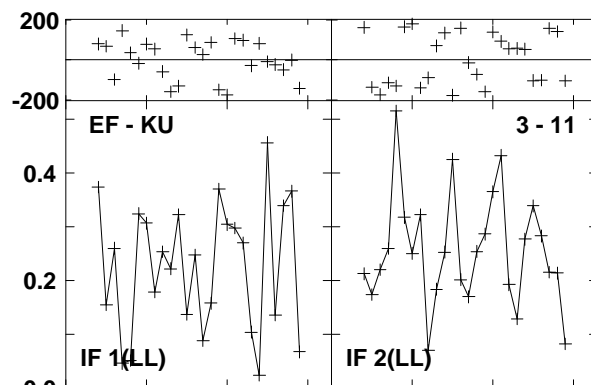
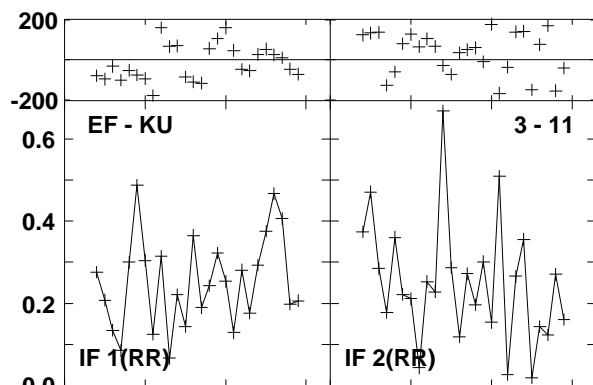
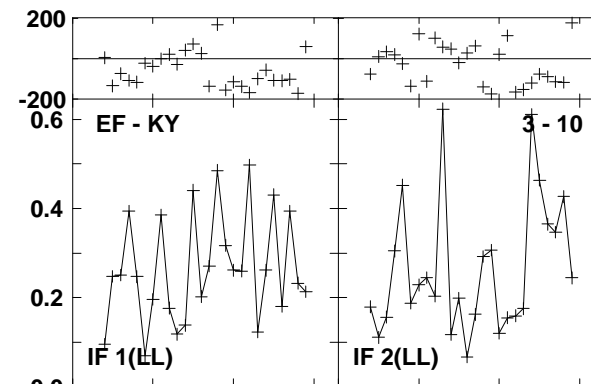
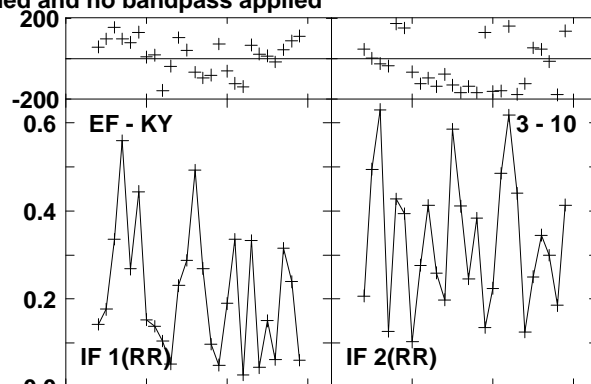
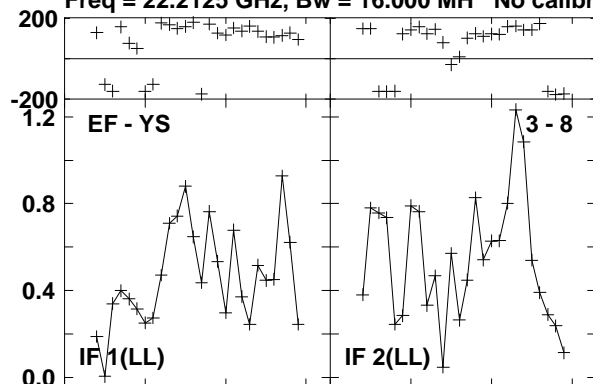

Lower frame: Milli Ampl Jy Top frame: Phas deg  
Vector averaged cross-power spectrum Baseline: EF (03) - YS (08)  
Timerange: 00/13:14:51 to 00/13:15:09

Plot file version 459 created 23-AUG-2016 15:00:57

0219+628 GA035B 1.UVDATA.1

Freq = 22.2125 GHz, Bw = 16.000 MH No calibration applied and no bandpass applied

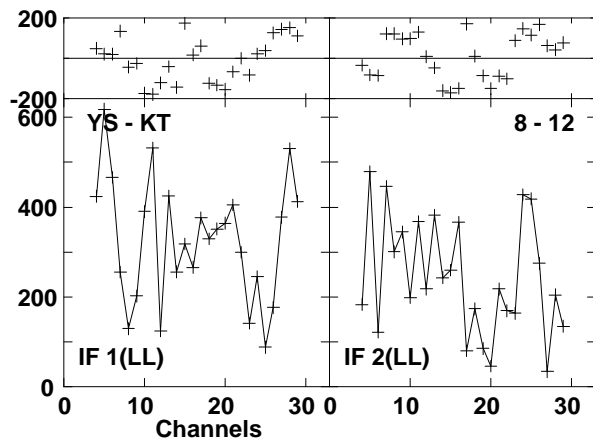
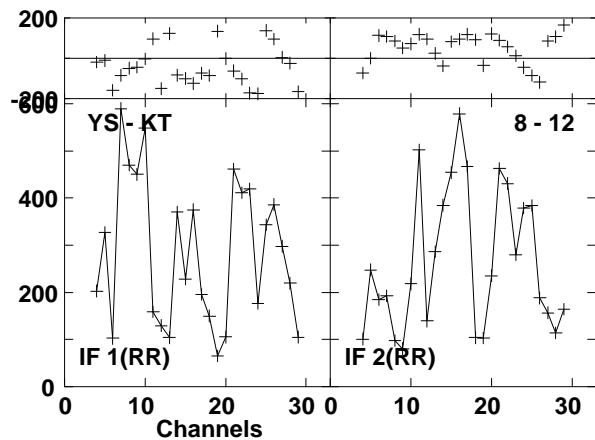
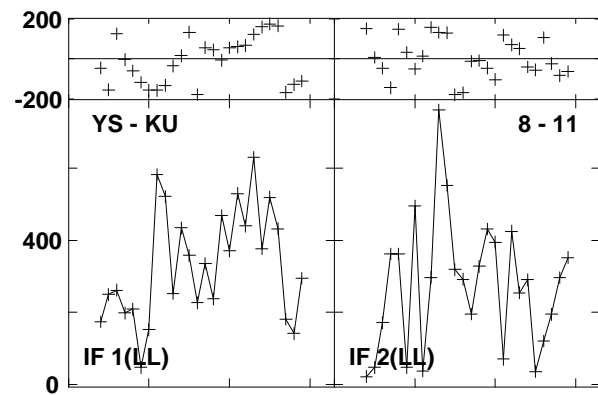
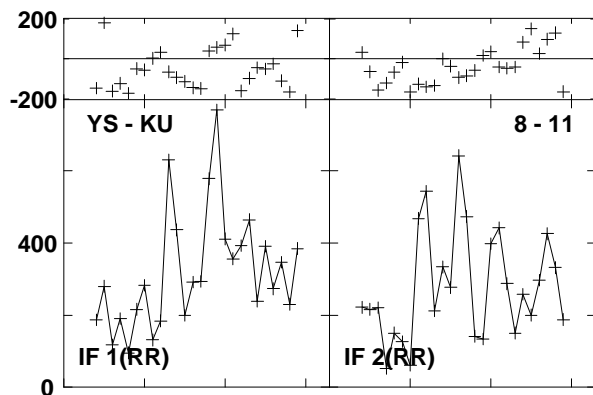
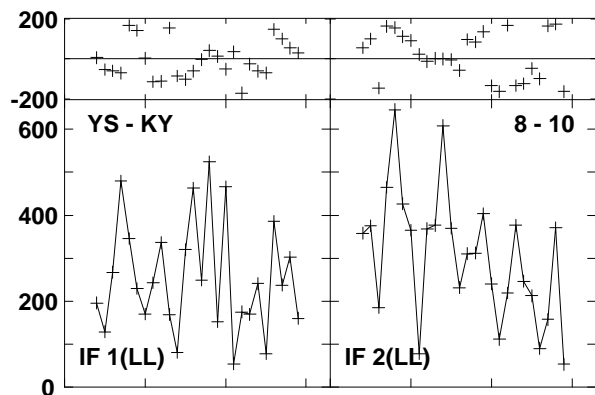
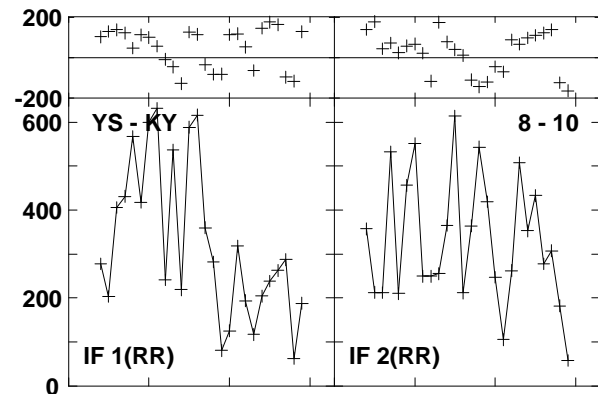
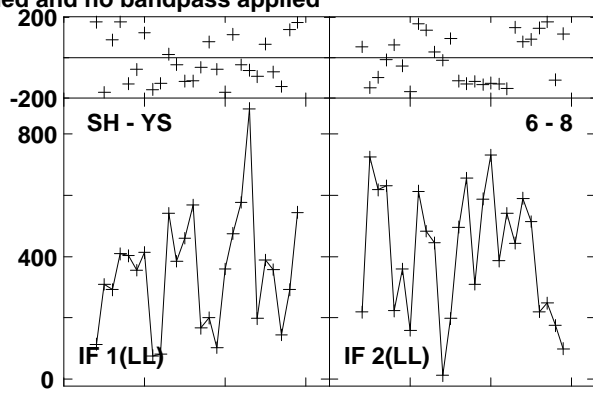
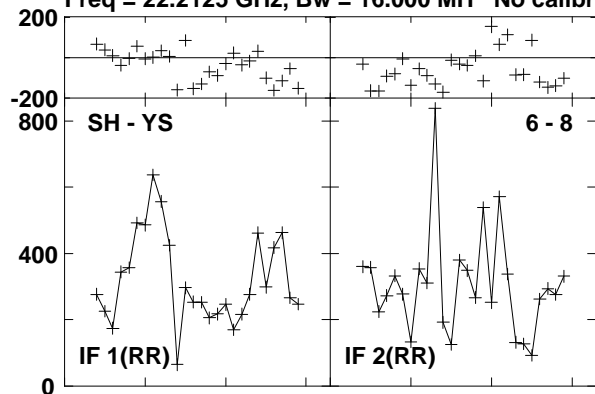

Lower frame: Micro Ampl Jy Top frame: Phas deg  
Vector averaged cross-power spectrum Baseline: SH (06) - YS (08)  
Timerange: 00/13:14:51 to 00/13:15:09

Plot file version 460 created 23-AUG-2016 15:00:57

W3IRS5 GA035B 1.UVDATA.1

Freq = 22.2125 GHz, Bw = 16.000 MH No calibration applied and no bandpass applied

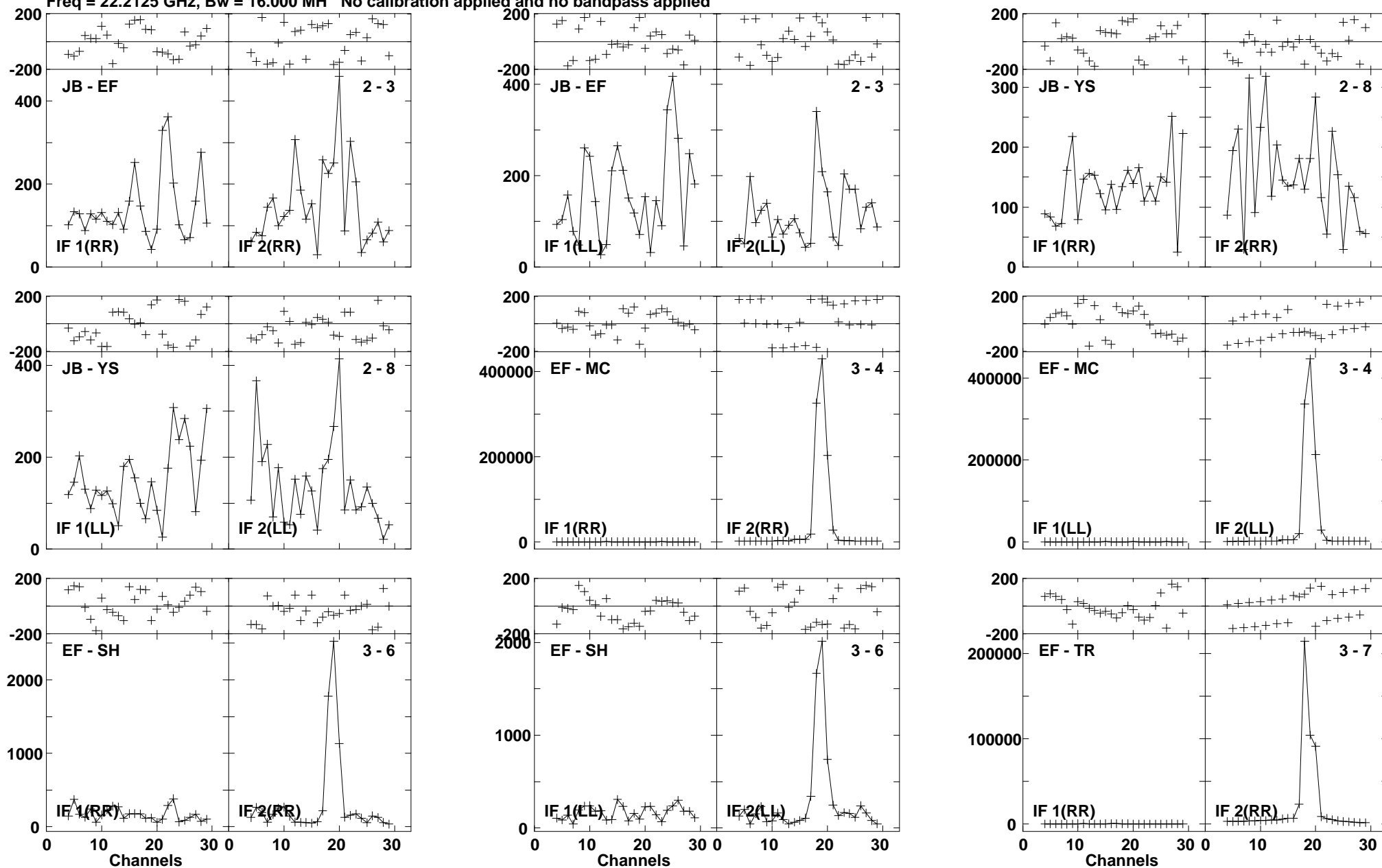

Lower frame: Micro Ampl Jy Top frame: Phas deg  
Vector averaged cross-power spectrum Baseline: JB (02) - EF (03)  
Timerange: 00/13:15:41 to 00/13:16:39

Plot file version 461 created 23-AUG-2016 15:00:57

W3IRS5 GA035B 1.UVDATA.1

Freq = 22.2125 GHz, Bw = 16.000 MH No calibration applied and no bandpass applied

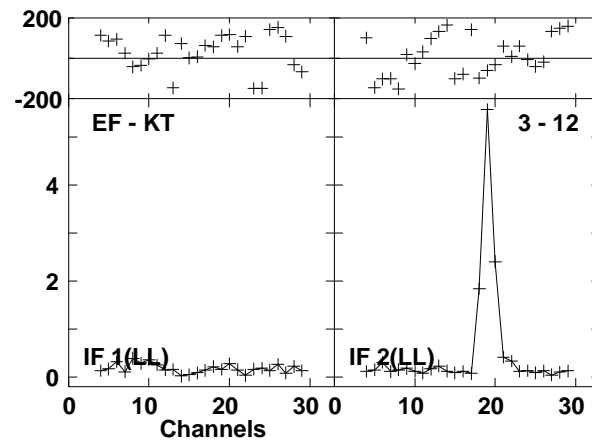
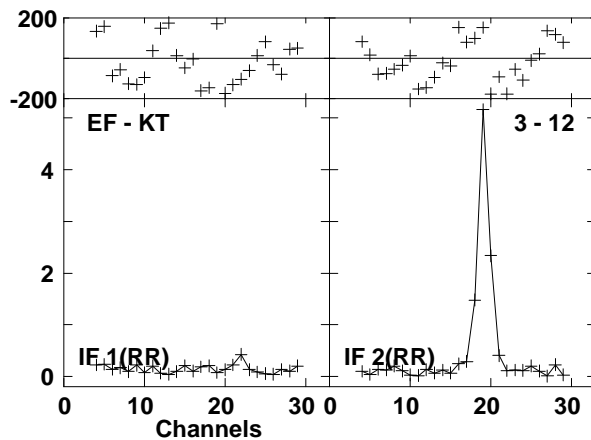
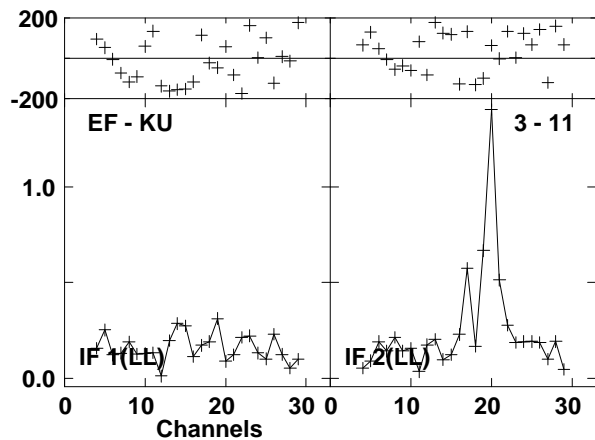
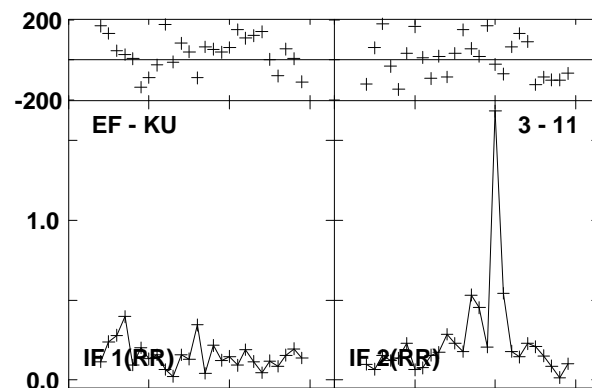
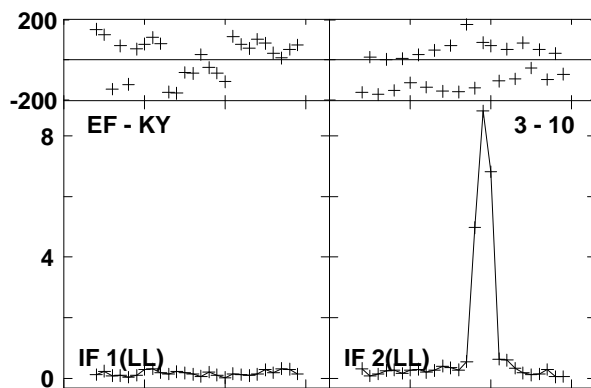
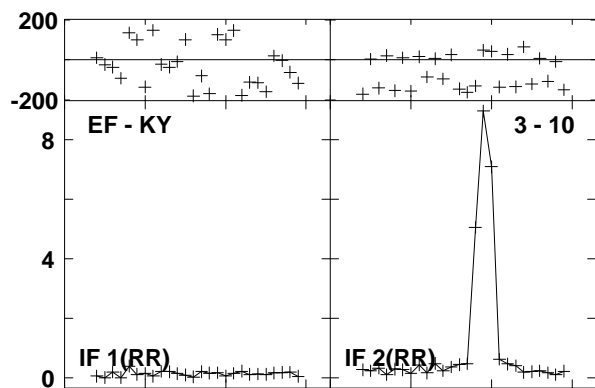
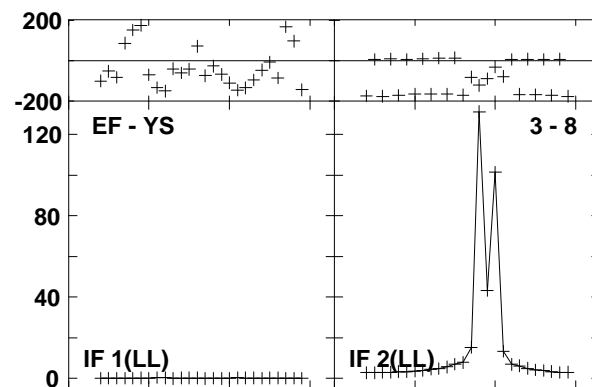
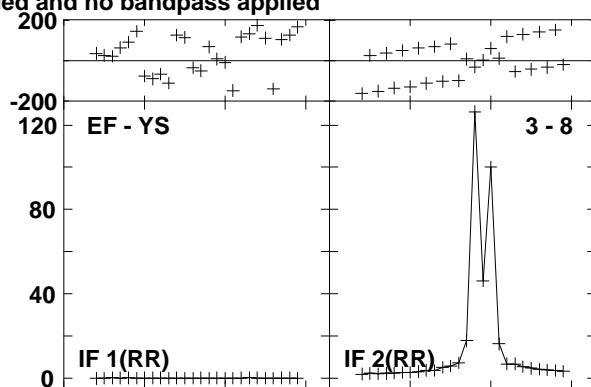
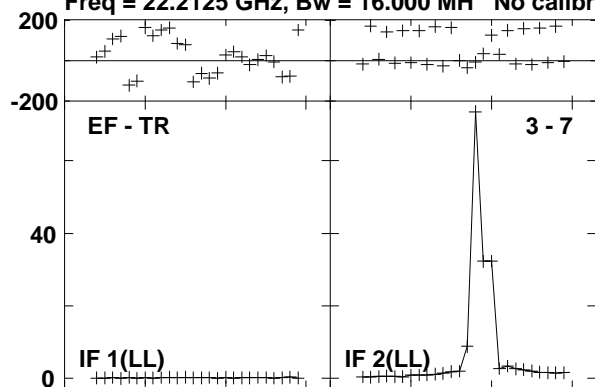

Lower frame: Milli Ampl Jy Top frame: Phas deg

Vector averaged cross-power spectrum Baseline: EF (03) - TR (07)

Timerange: 00/13:15:41 to 00/13:16:39

Plot file version 462 created 23-AUG-2016 15:00:57

W3IRS5 GA035B 1.UVDATA.1

Freq = 22.2125 GHz, Bw = 16.000 MH No calibration applied and no bandpass applied

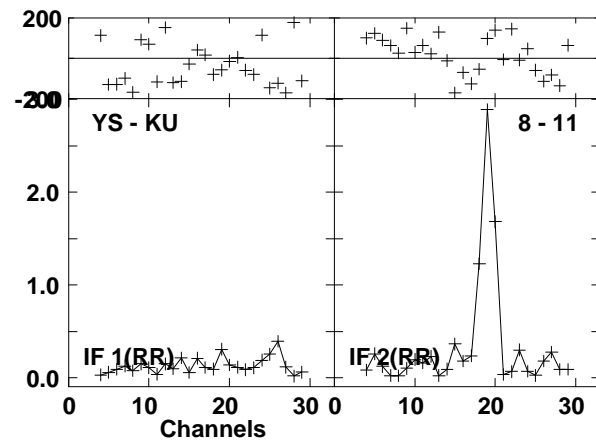
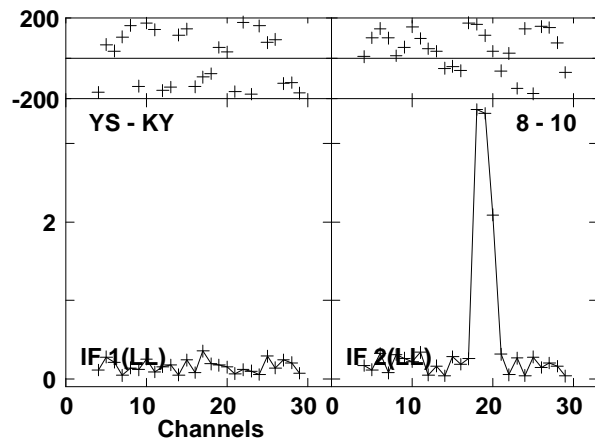
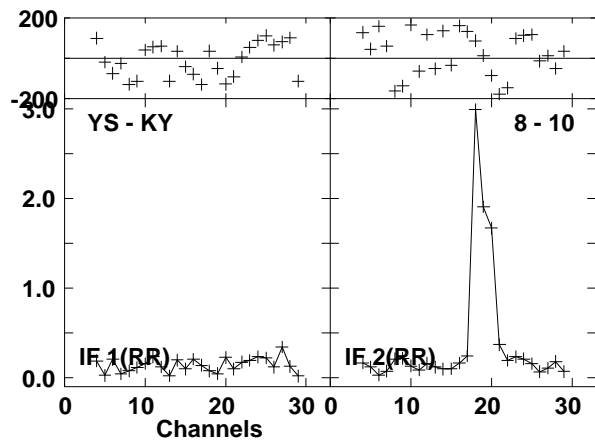
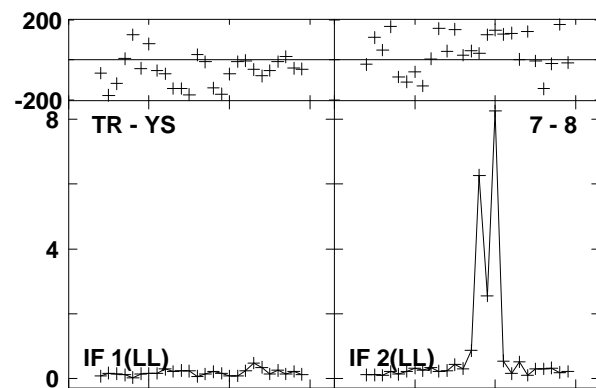
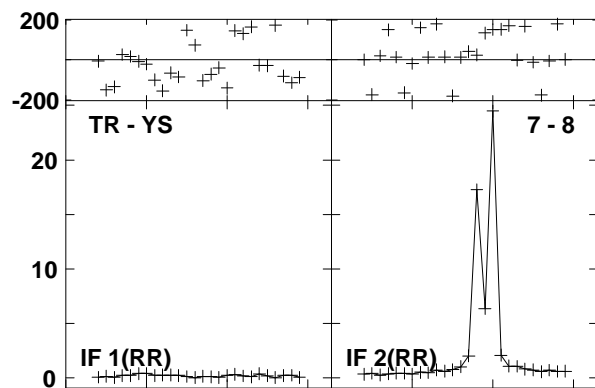
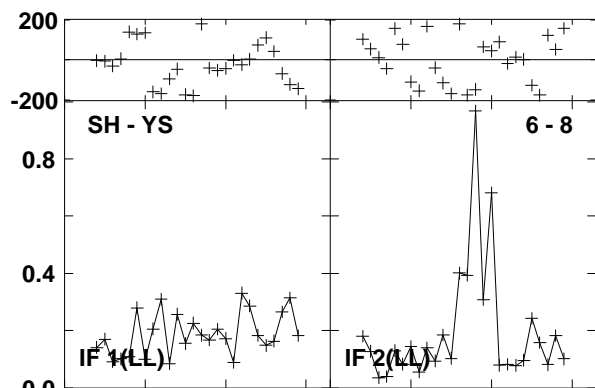
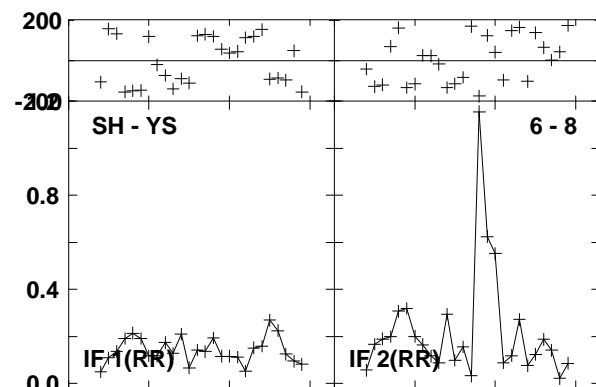
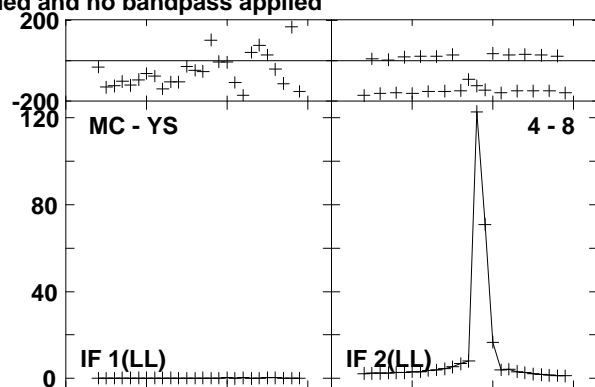
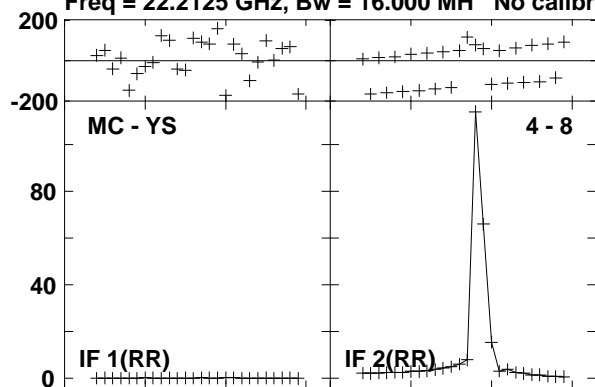

Lower frame: Milli Ampl Jy Top frame: Phas deg  
Vector averaged cross-power spectrum Baseline: MC (04) - YS (08)  
Timerange: 00/13:15:41 to 00/13:16:39

Plot file version 463 created 23-AUG-2016 15:00:57  
W3IRS5 GA035B 1.UVDATA.1

Freq = 22.2125 GHz, Bw = 16.000 MH No calibration applied and no bandpass applied

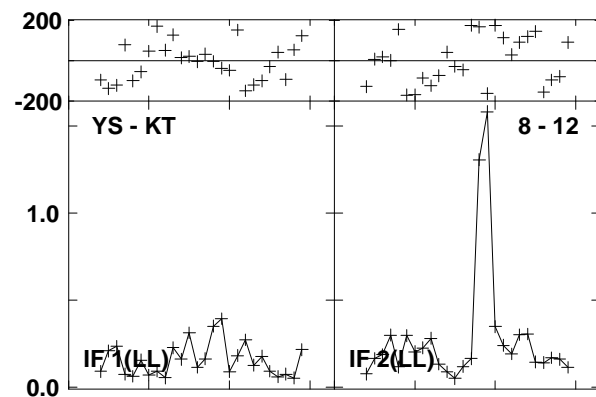
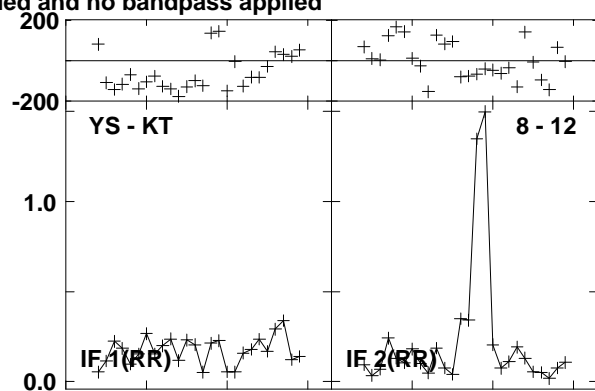
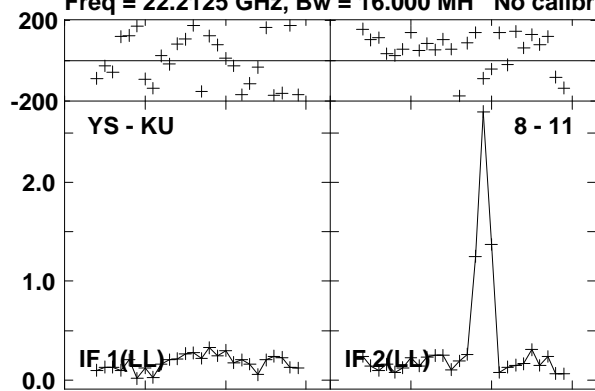

Lower frame: Milli Ampl Jy Top frame: Phas deg  
Vector averaged cross-power spectrum Baseline: YS (08) - KU (11)  
Timerange: 00/13:15:41 to 00/13:16:39

Plot file version 464 created 23-AUG-2016 15:00:57

0219+628 GA035B 1.UVDATA.1

Freq = 22.2125 GHz, Bw = 16.000 MH No calibration applied and no bandpass applied

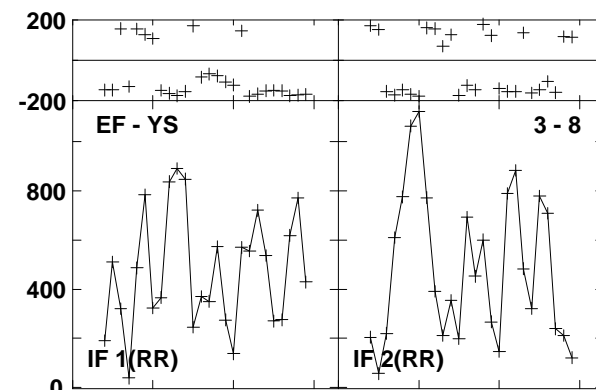
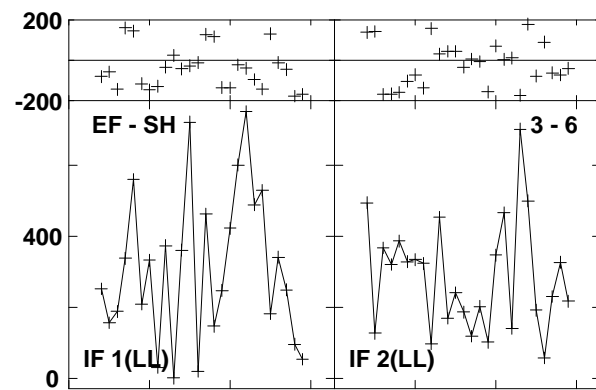
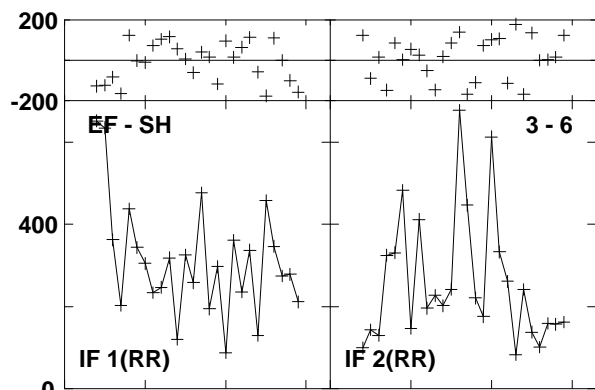
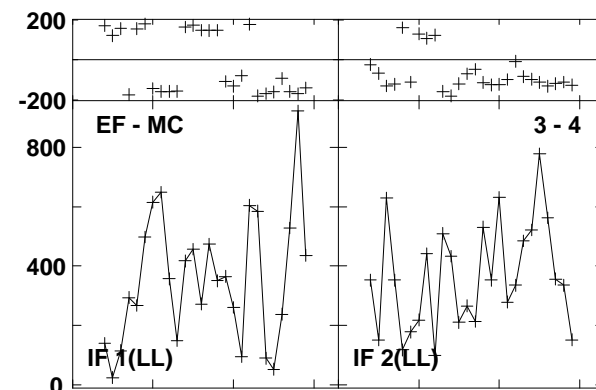
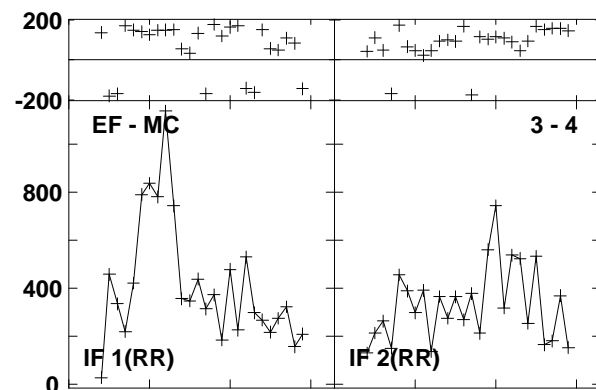
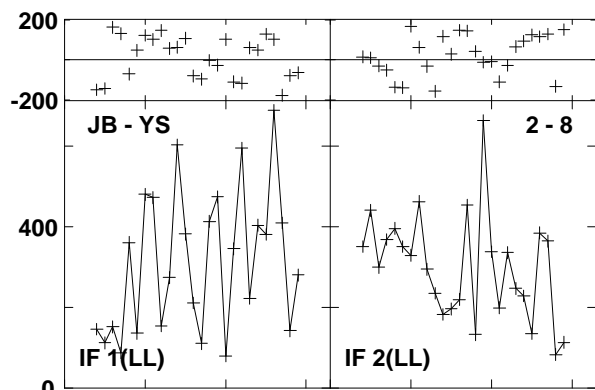
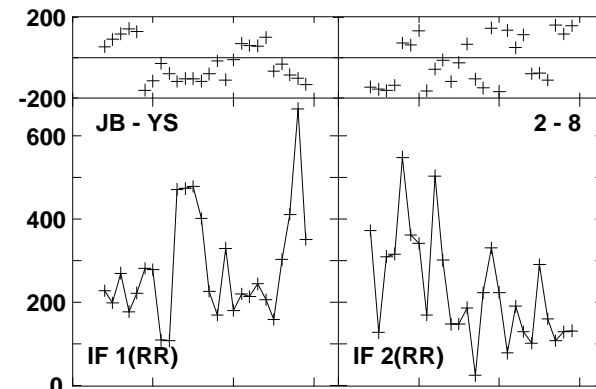
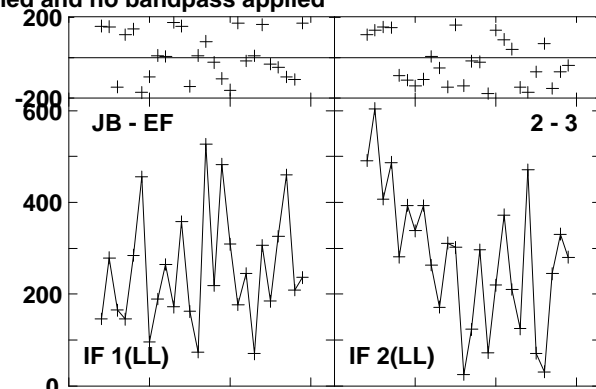
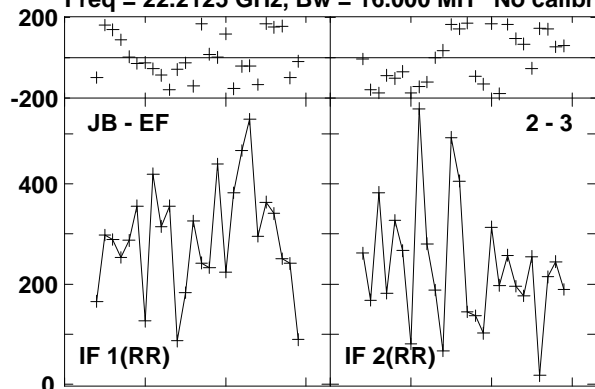

Lower frame: Micro Ampl Jy Top frame: Phas deg  
Vector averaged cross-power spectrum Baseline: JB (02) - EF (03)  
Timerange: 00/13:17:11 to 00/13:17:29



Plot file version 465 created 23-AUG-2016 15:00:57

0219+628 GA035B 1.UVDATA.1

Freq = 22.2125 GHz, Bw = 16.000 MH No calibration applied and no bandpass applied

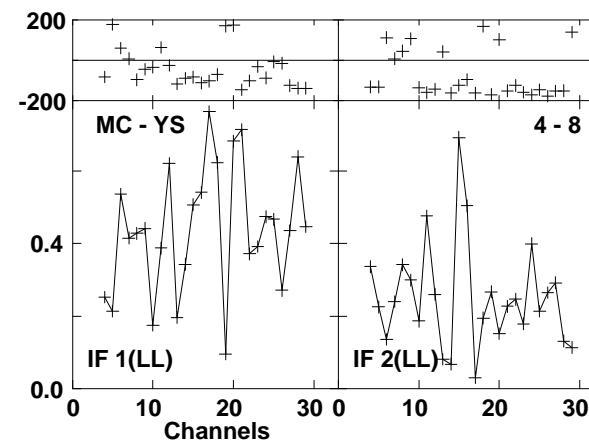
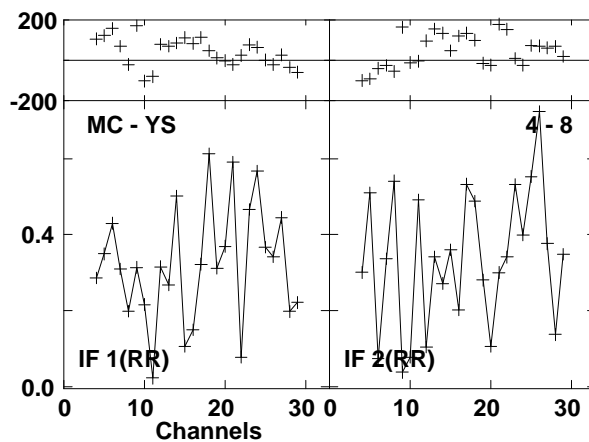
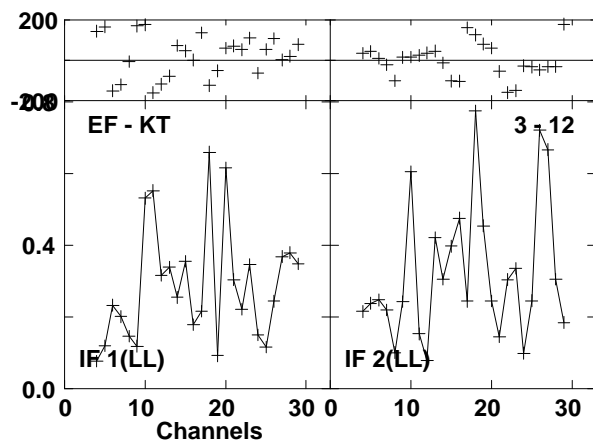
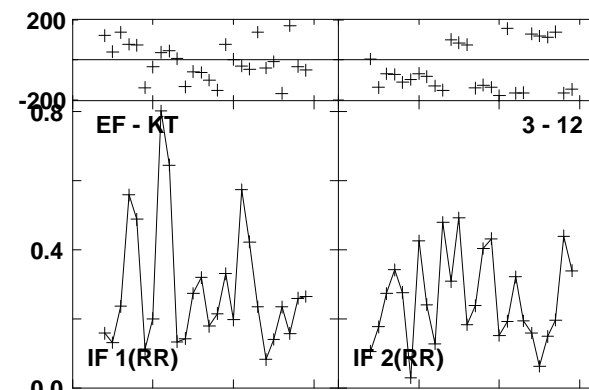
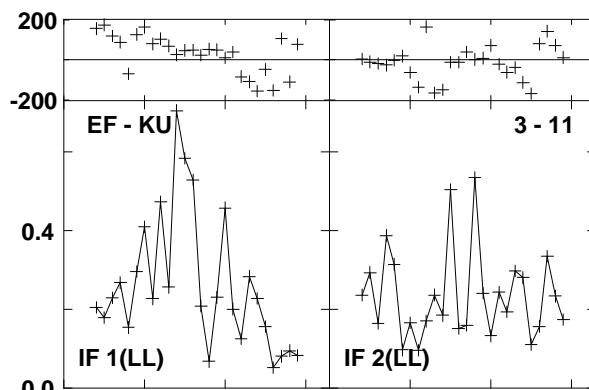
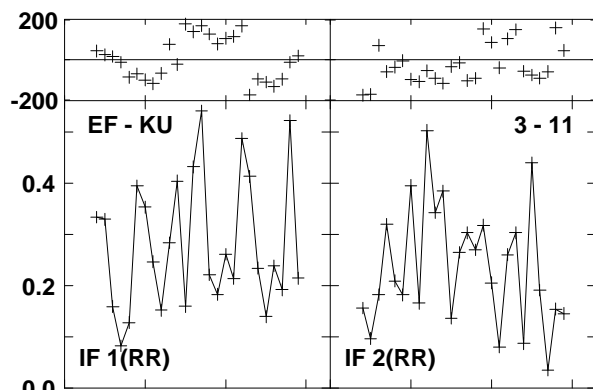
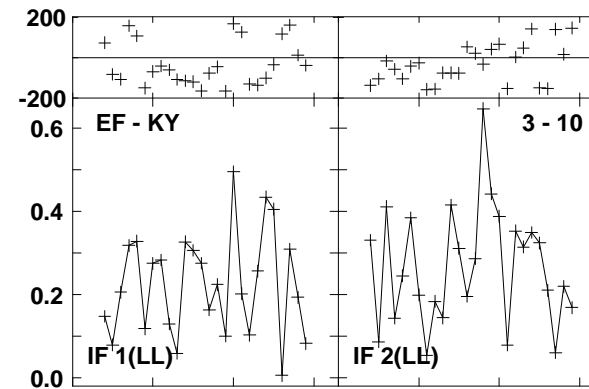
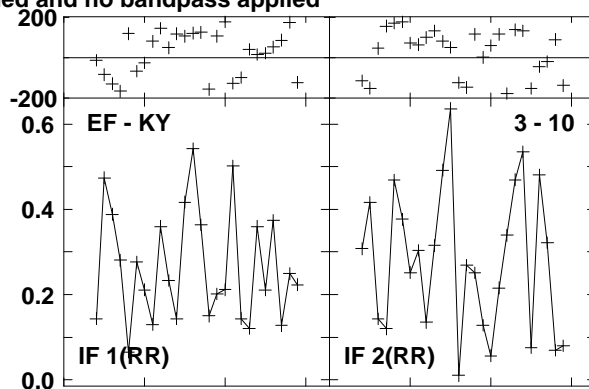
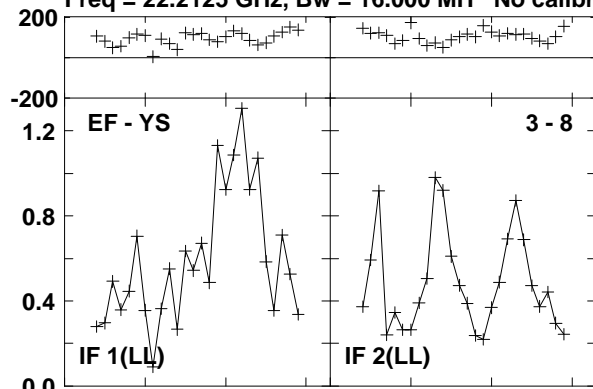

Lower frame: Milli Ampl Jy Top frame: Phas deg  
Vector averaged cross-power spectrum Baseline: EF (03) - YS (08)  
Timerange: 00/13:17:11 to 00/13:17:29

Plot file version 466 created 23-AUG-2016 15:00:57

0219+628 GA035B 1.UVDATA.1

Freq = 22.2125 GHz, Bw = 16.000 MH No calibration applied and no bandpass applied

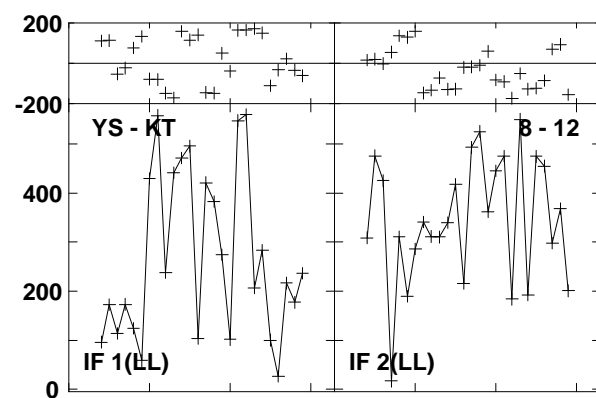
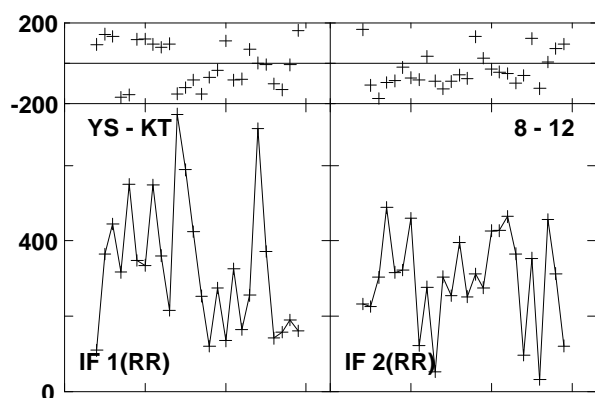
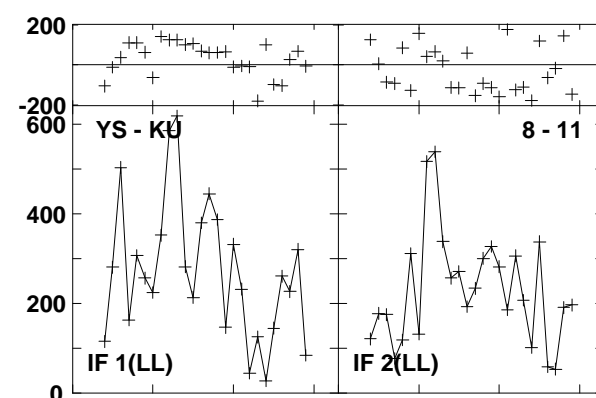
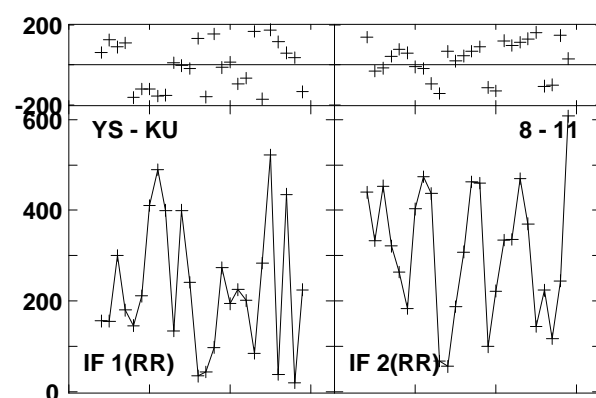
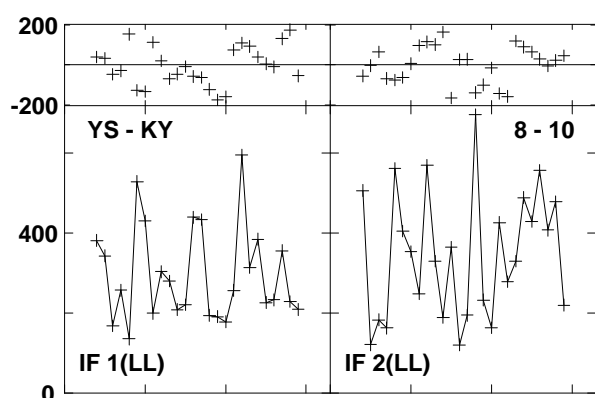
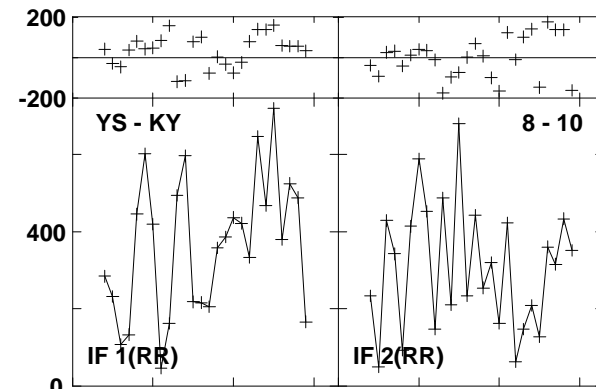
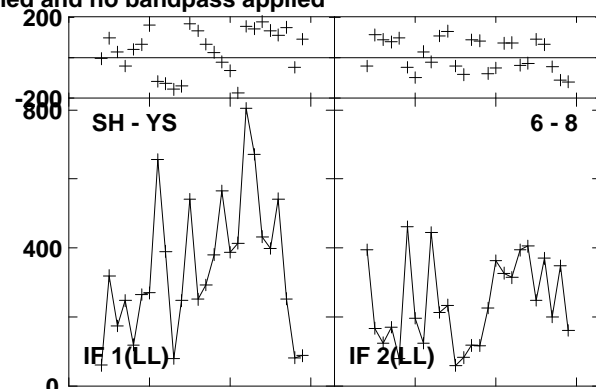
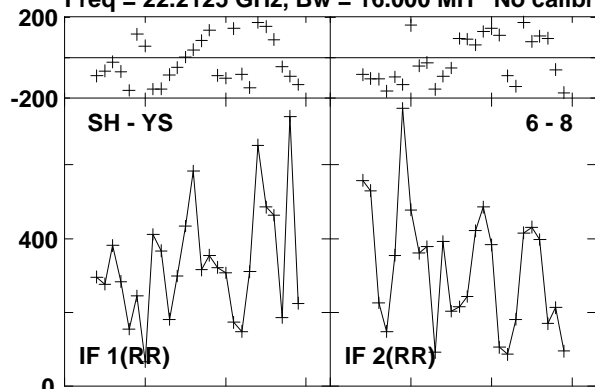

Lower frame: Micro Ampl Jy Top frame: Phas deg  
Vector averaged cross-power spectrum Baseline: SH (06) - YS (08)  
Timerange: 00/13:17:11 to 00/13:17:29

Plot file version 467 created 23-AUG-2016 15:00:57

W3IRS5 GA035B 1.UVDATA.1

Freq = 22.2125 GHz, Bw = 16.000 MH No calibration applied and no bandpass applied

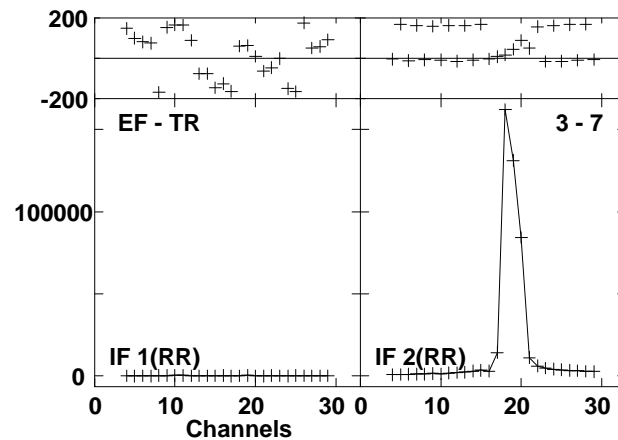
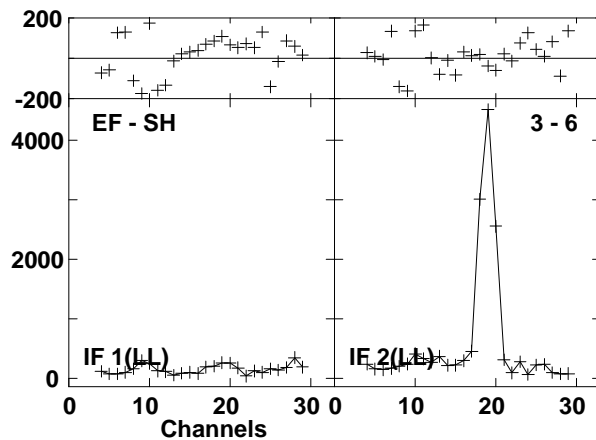
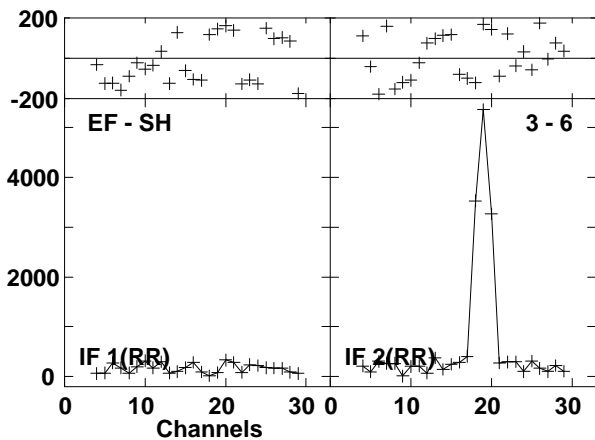
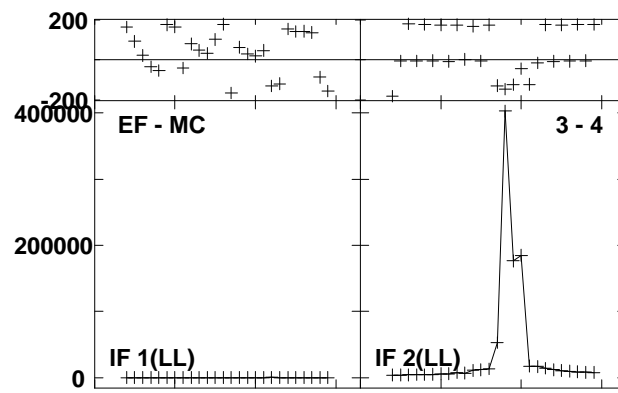
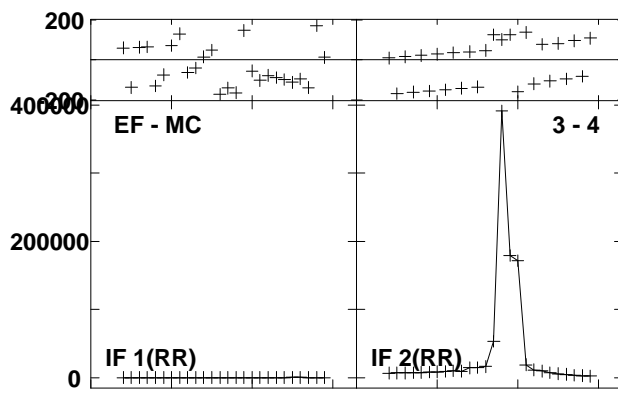
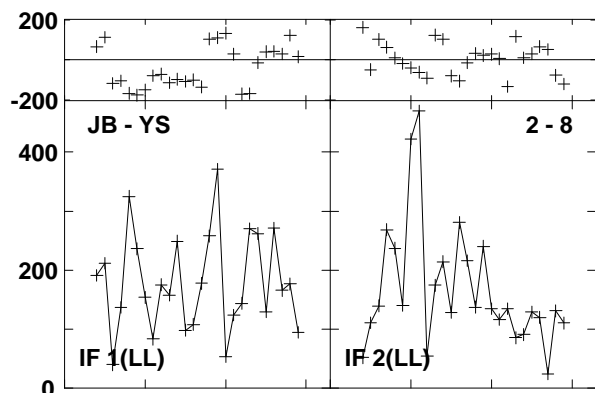
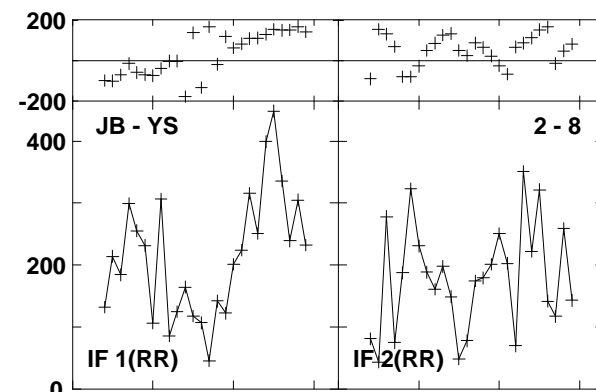
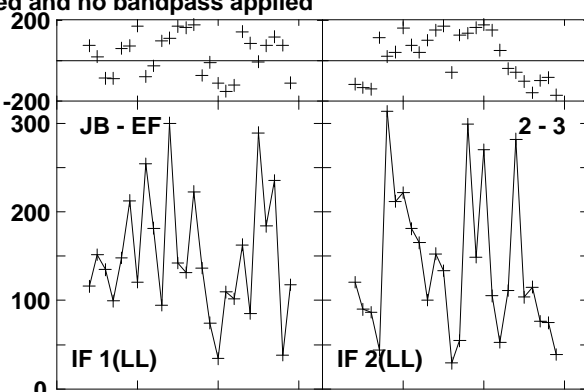
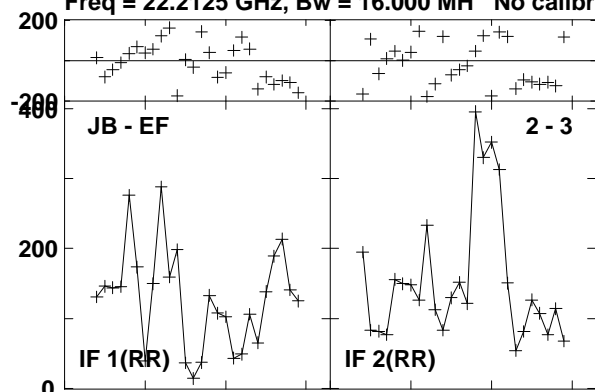

Lower frame: Micro Ampl Jy Top frame: Phas deg  
Vector averaged cross-power spectrum Baseline: JB (02) - EF (03)  
Timerange: 00/13:18:01 to 00/13:19:00

Plot file version 468 created 23-AUG-2016 15:00:58

W3IRS5 GA035B 1.UVDATA.1

Freq = 22.2125 GHz, Bw = 16.000 MH No calibration applied and no bandpass applied

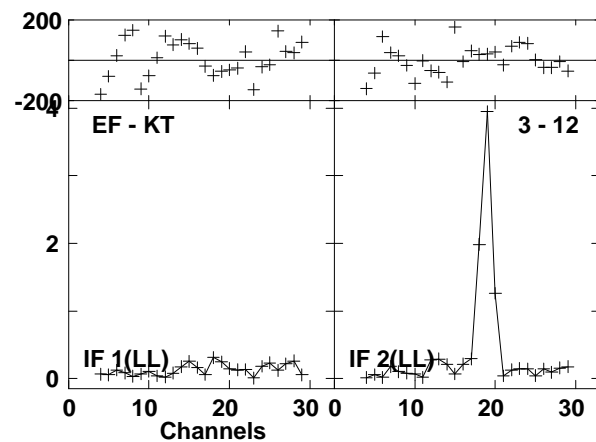
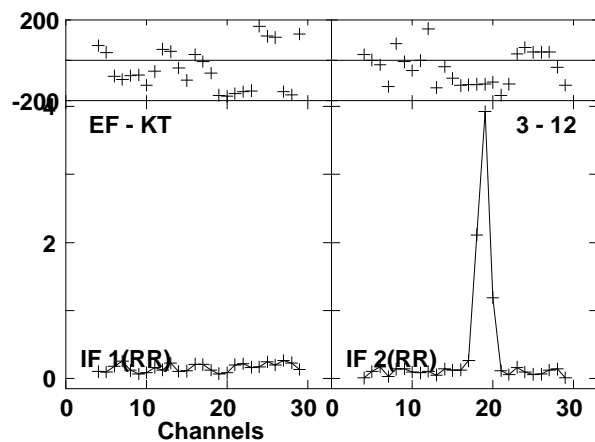
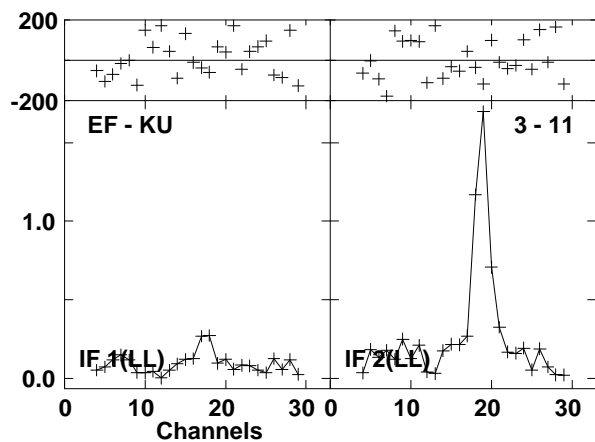
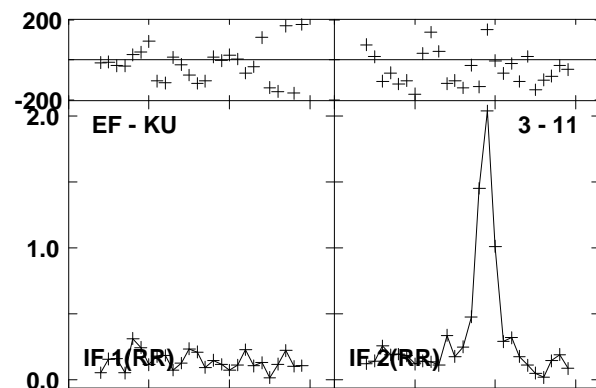
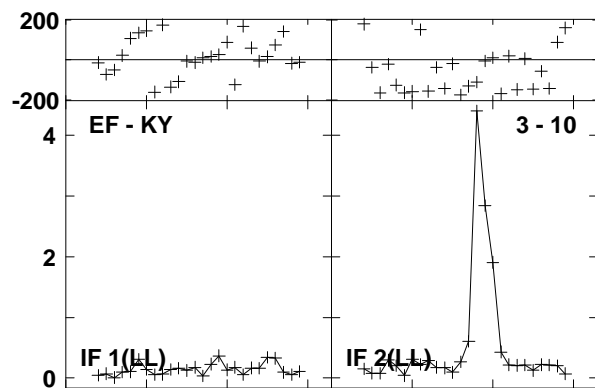
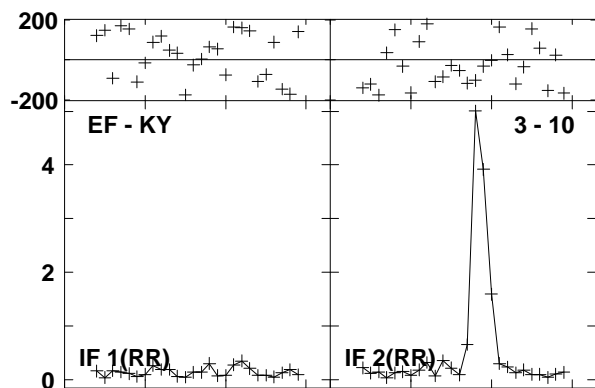
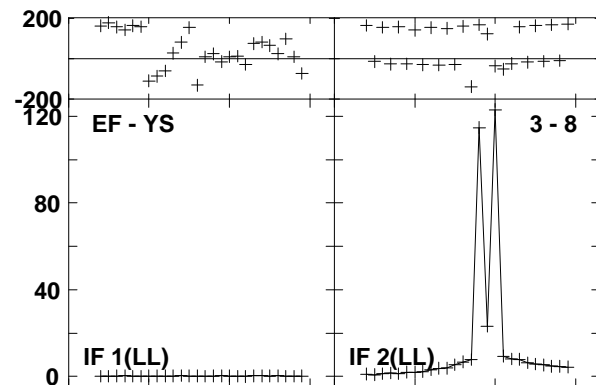
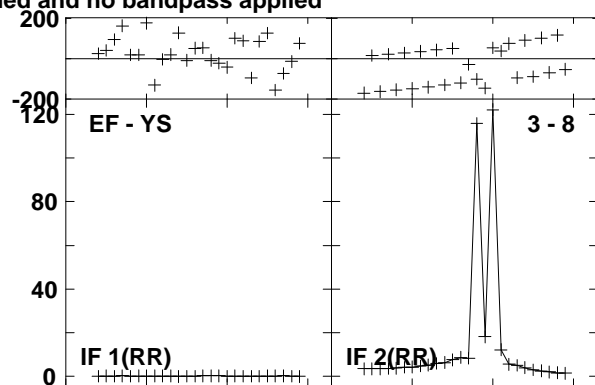
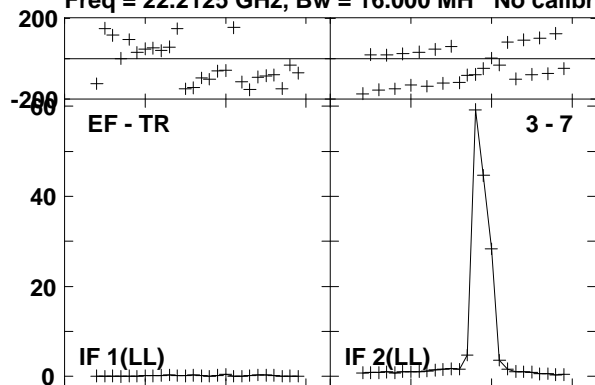

Lower frame: Milli Ampl Jy Top frame: Phas deg  
Vector averaged cross-power spectrum Baseline: EF (03) - TR (07)  
Timerange: 00/13:18:01 to 00/13:19:00

Plot file version 469 created 23-AUG-2016 15:00:58  
 W3IRS5 GA035B 1.UVDATA.1

Freq = 22.2125 GHz, Bw = 16.000 MH No calibration applied and no bandpass applied

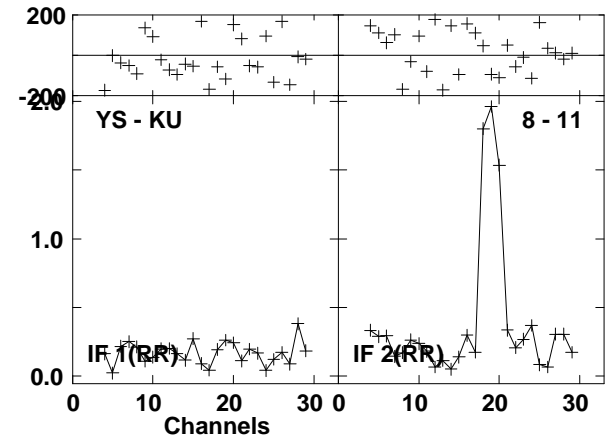
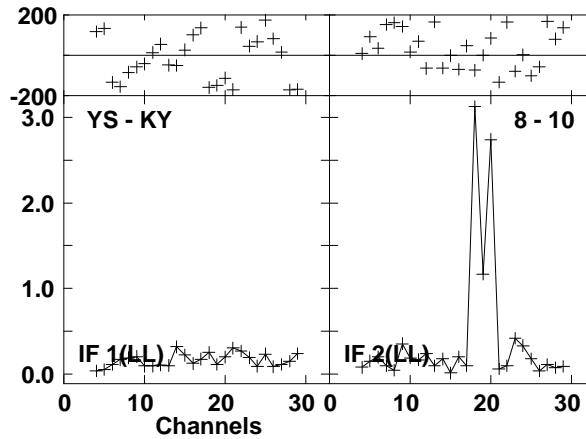
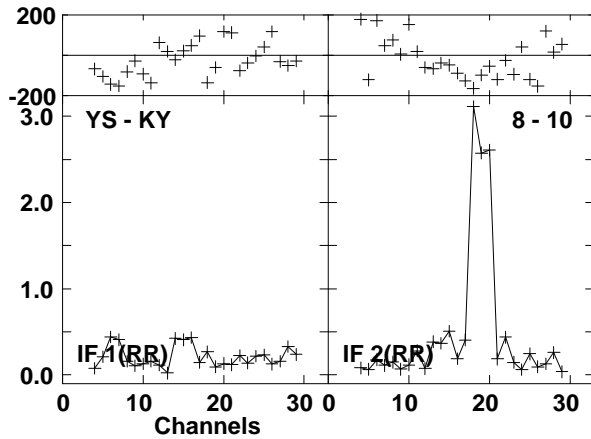
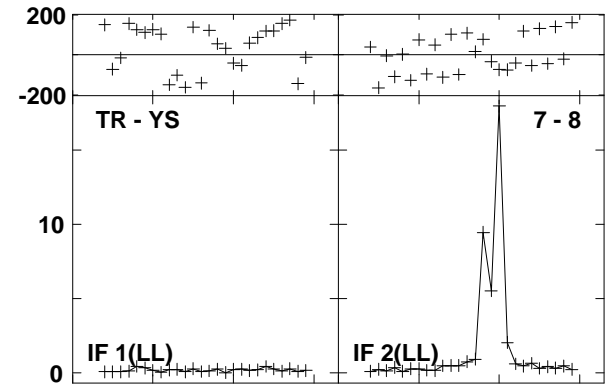
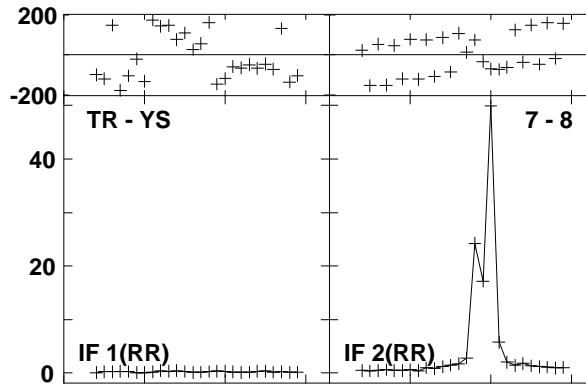
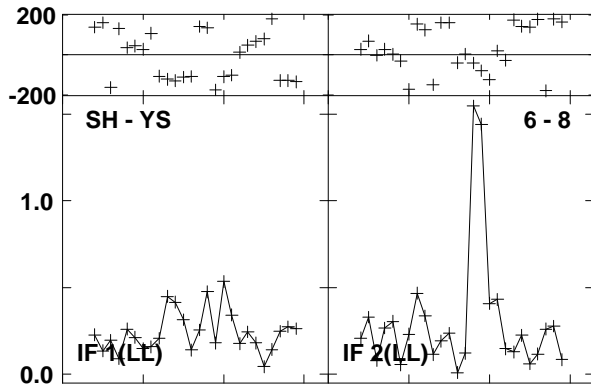
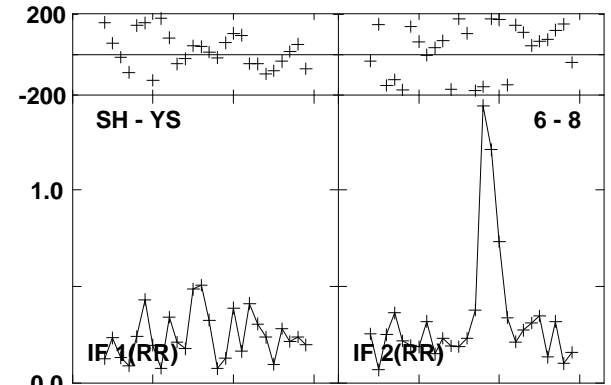
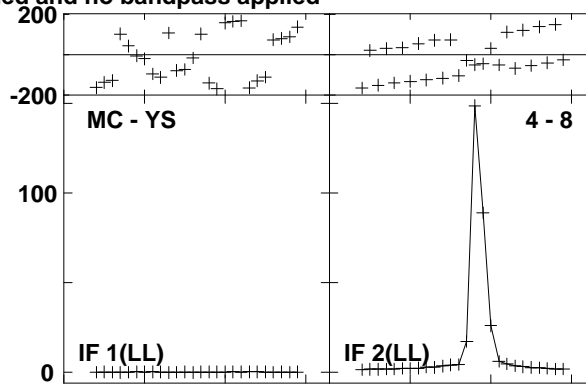
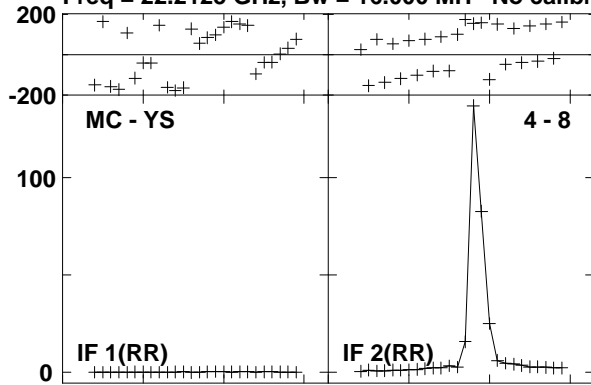

Lower frame: Milli Ampl Jy Top frame: Phas deg  
 Vector averaged cross-power spectrum Baseline: MC (04) - YS (08)  
 Timerange: 00/13:18:01 to 00/13:19:00

Plot file version 470 created 23-AUG-2016 15:00:58  
W3IRS5 GA035B 1.UVDATA.1

Freq = 22.2125 GHz, Bw = 16.000 MH No calibration applied and no bandpass applied

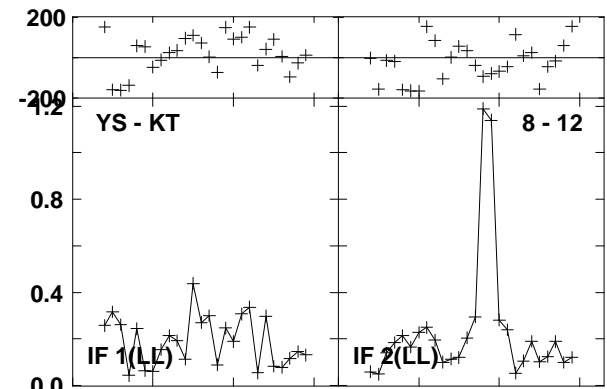
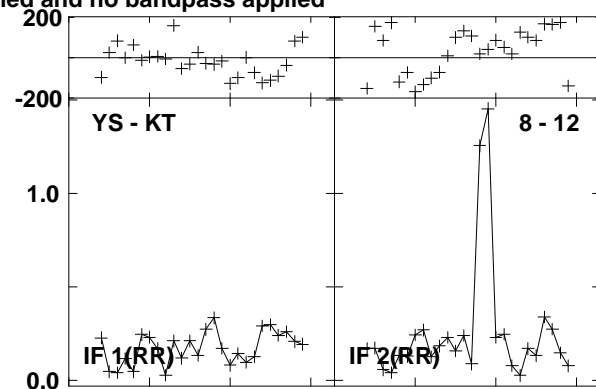
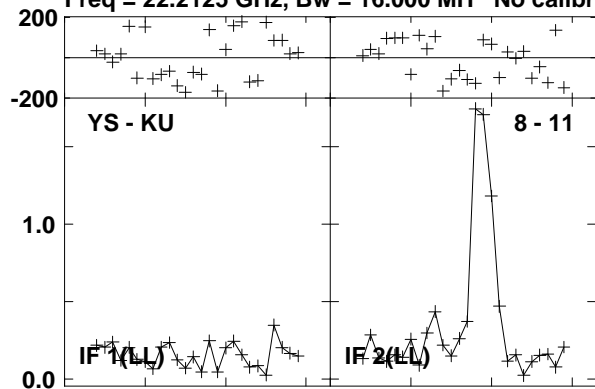

Lower frame: Milli Ampl Jy Top frame: Phas deg  
Vector averaged cross-power spectrum Baseline: YS (08) - KU (11)  
Timerange: 00/13:18:01 to 00/13:19:00

Plot file version 471 created 23-AUG-2016 15:00:58

0219+628 GA035B 1.UVDATA.1

Freq = 22.2125 GHz, Bw = 16.000 MH No calibration applied and no bandpass applied

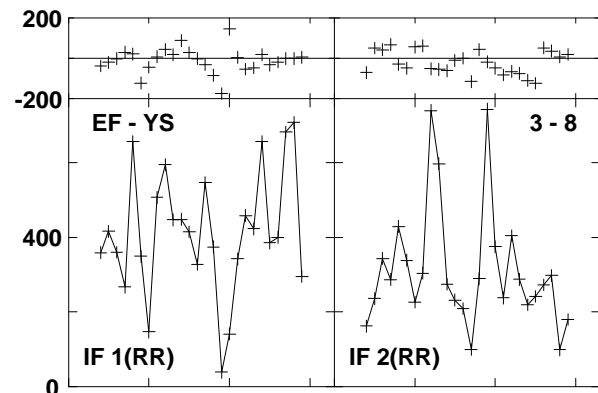
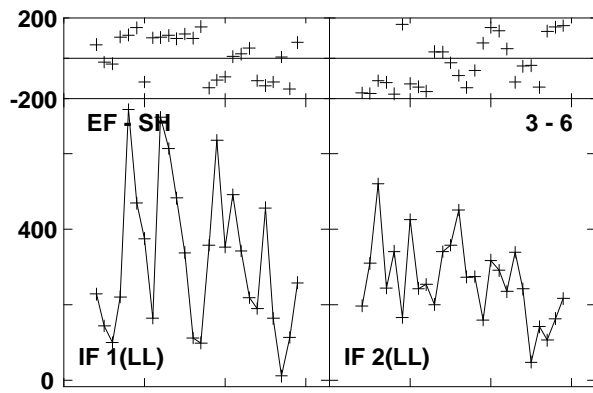
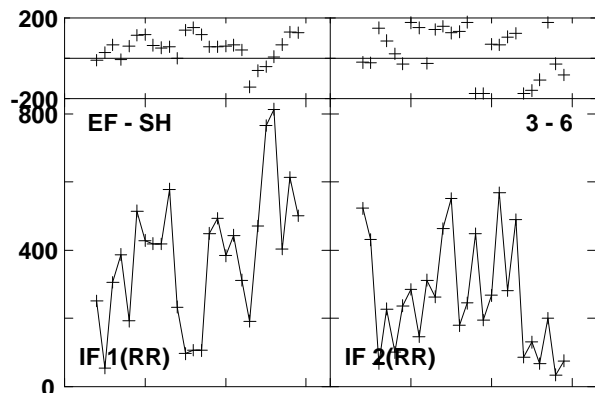
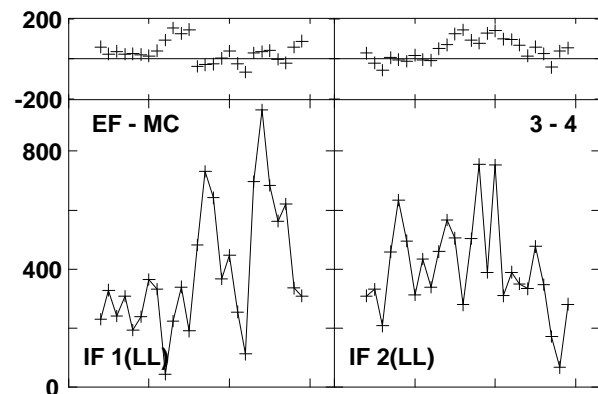
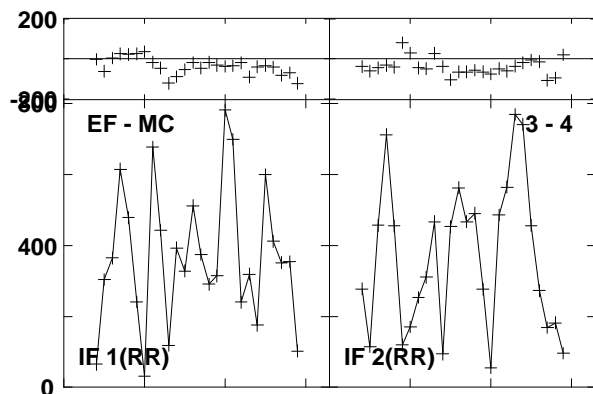
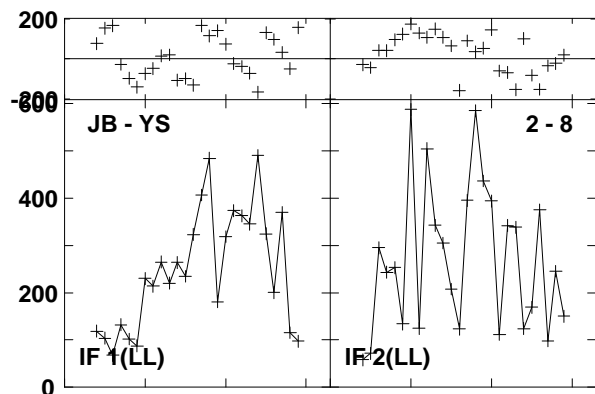
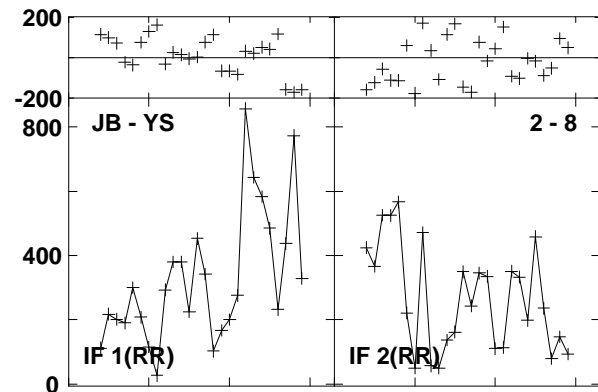
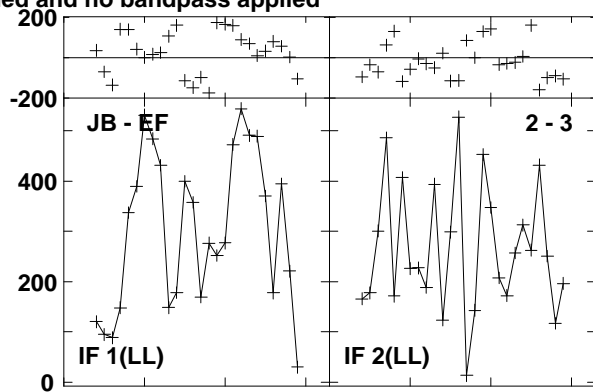
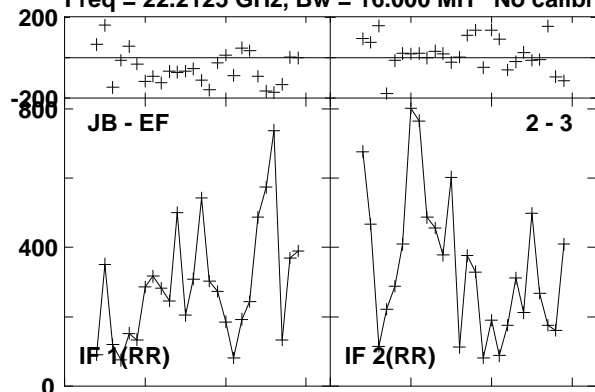

Lower frame: Micro Ampl Jy Top frame: Phas deg  
Vector averaged cross-power spectrum Baseline: JB (02) - EF (03)  
Timerange: 00/13:19:30 to 00/13:19:50

Plot file version 472 created 23-AUG-2016 15:00:58

0219+628 GA035B 1.UVDATA.1

Freq = 22.2125 GHz, Bw = 16.000 MH No calibration applied and no bandpass applied

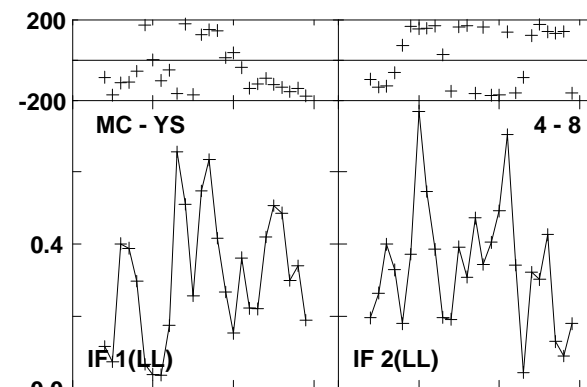
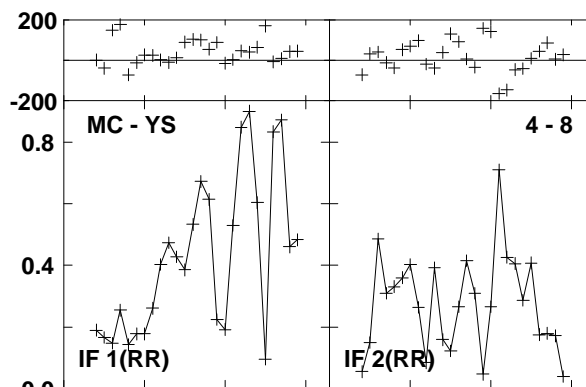
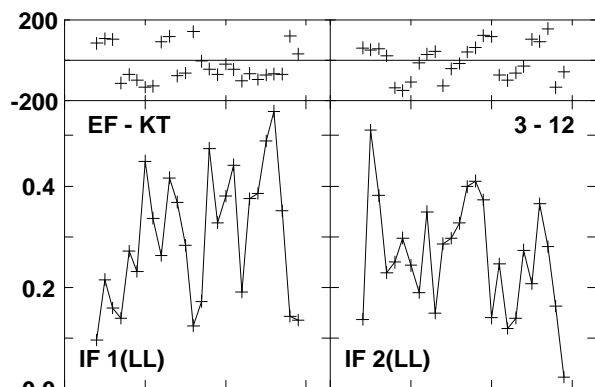
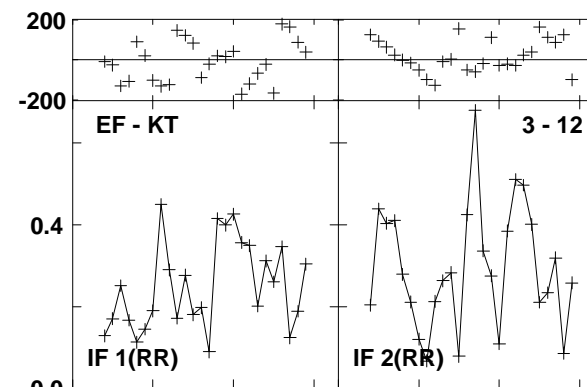
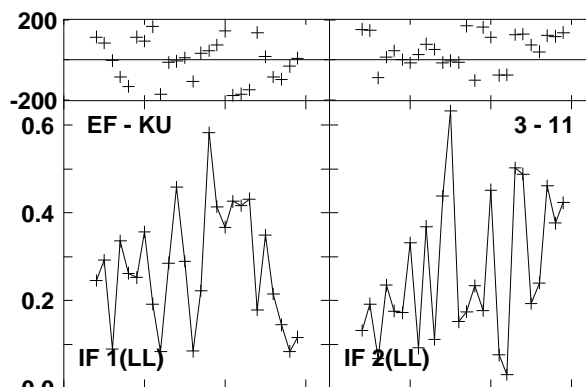
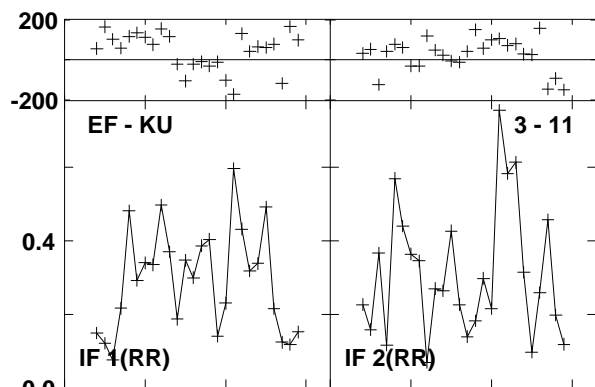
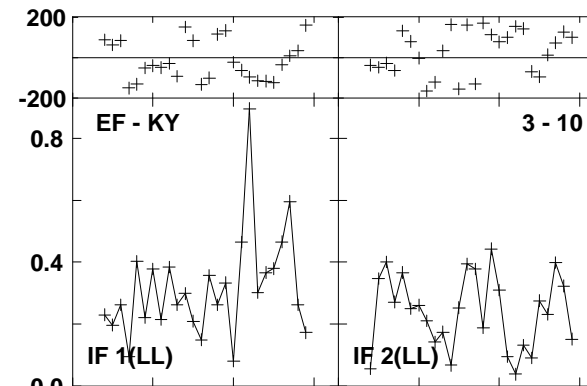
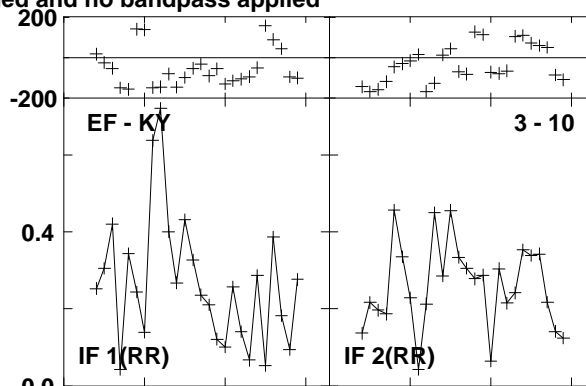
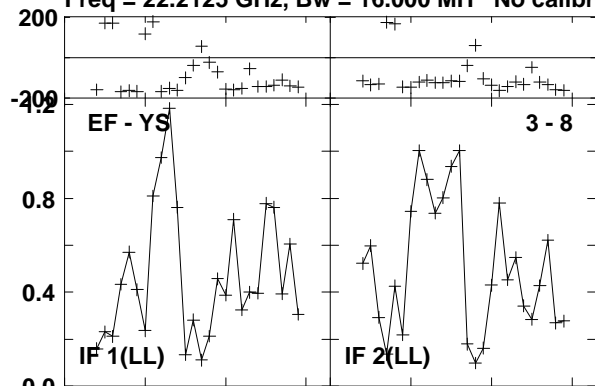

Lower frame: Milli Ampl Jy Top frame: Phas deg  
Vector averaged cross-power spectrum Baseline: EF (03) - YS (08)  
Timerange: 00/13:19:30 to 00/13:19:50



Plot file version 473 created 23-AUG-2016 15:00:58

0219+628 GA035B 1.UVDATA.1

Freq = 22.2125 GHz, Bw = 16.000 MH No calibration applied and no bandpass applied

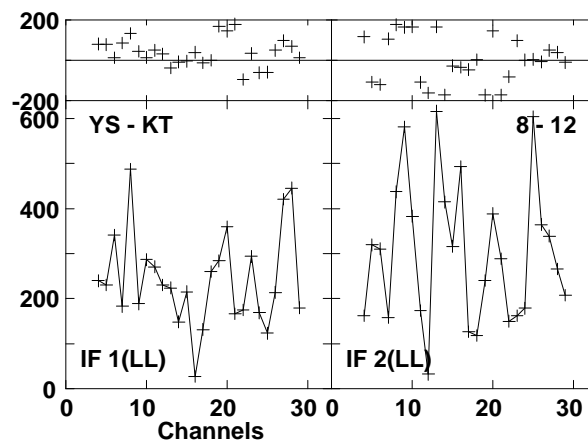
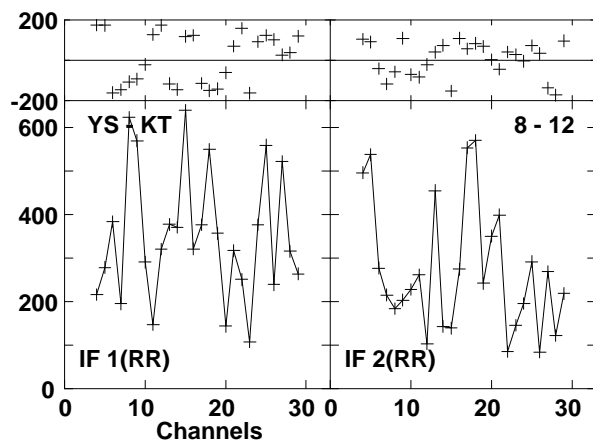
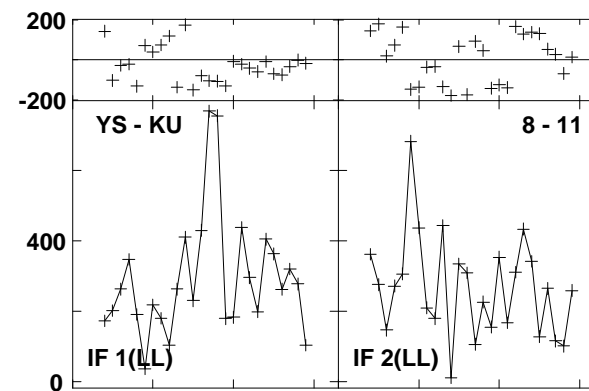
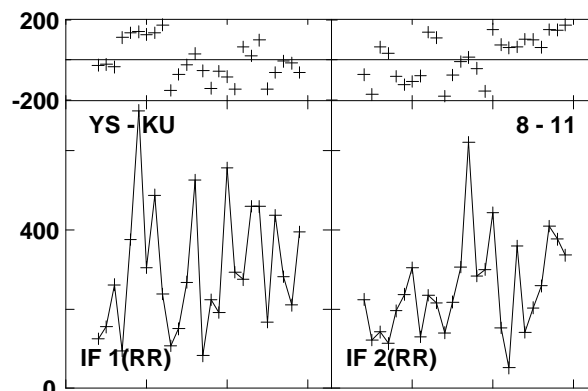
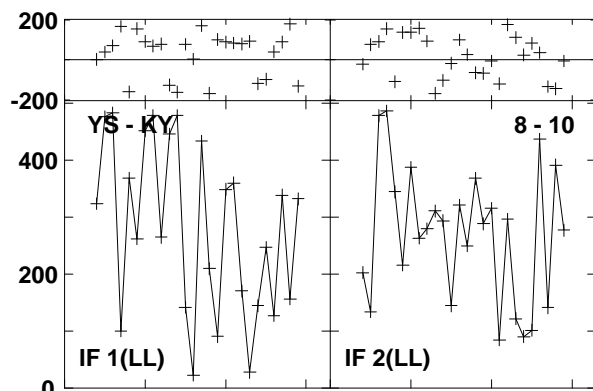
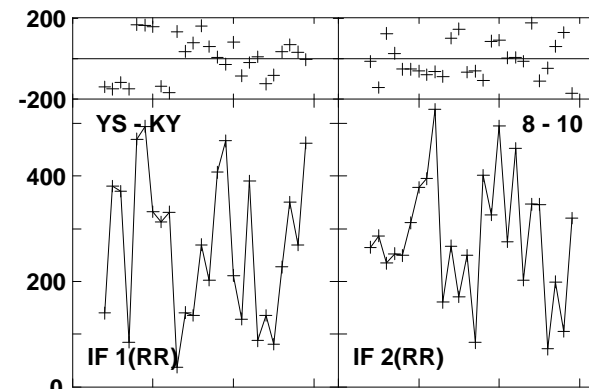
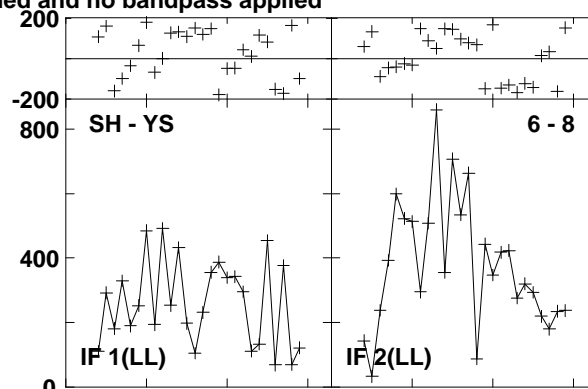
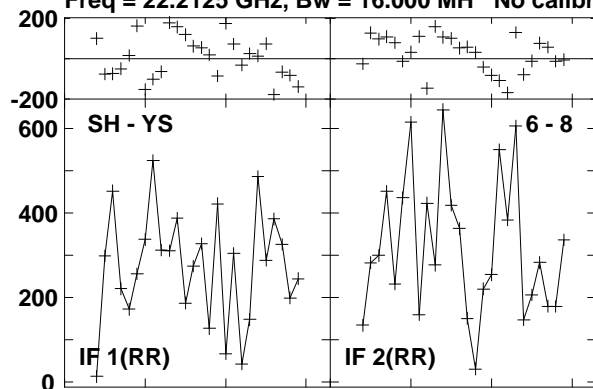

Lower frame: Micro Ampl Jy Top frame: Phas deg

Vector averaged cross-power spectrum Baseline: SH (06) - YS (08)

Timerange: 00/13:19:30 to 00/13:19:50

Plot file version 474 created 23-AUG-2016 15:00:58  
 W3IRS5 GA035B 1.UVDATA.1

Freq = 22.2125 GHz, Bw = 16.000 MH No calibration applied and no bandpass applied

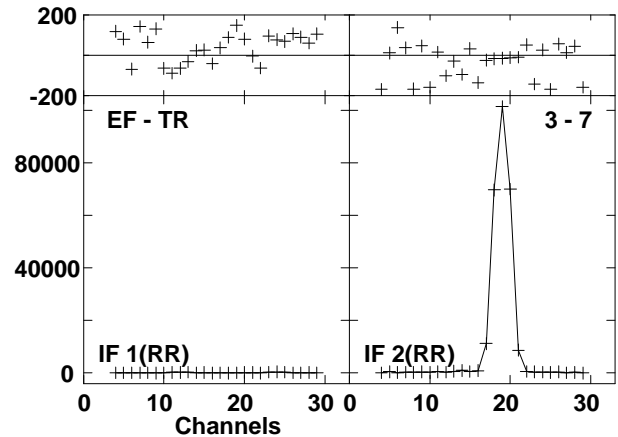
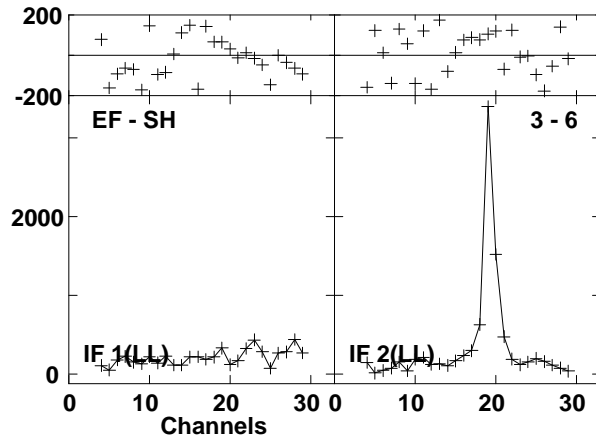
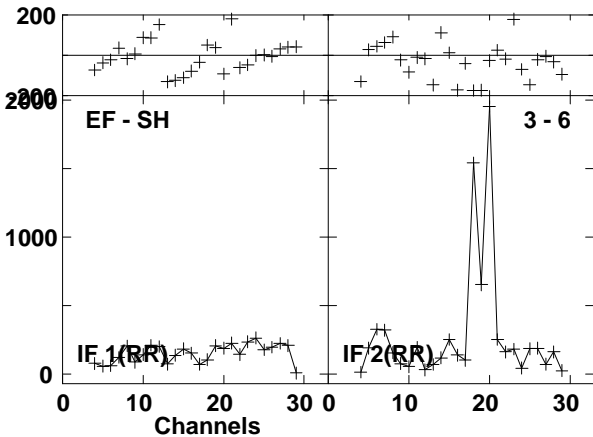
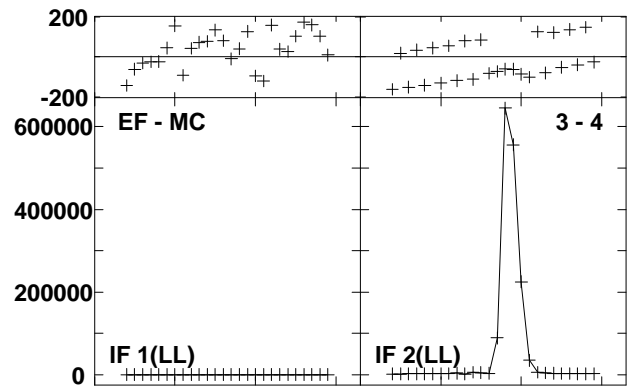
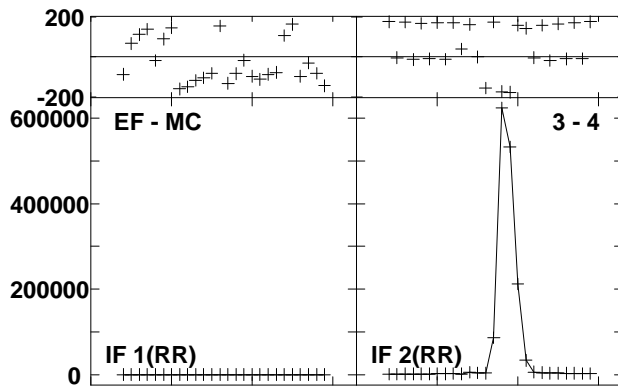
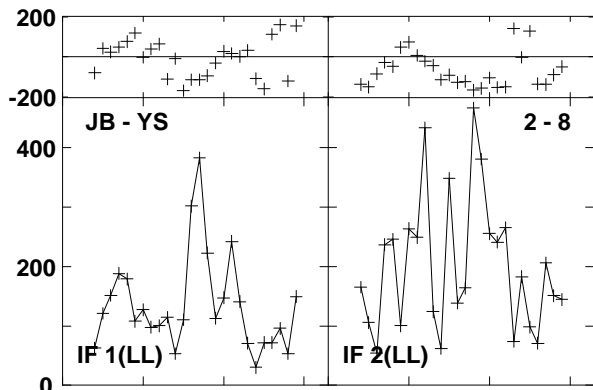
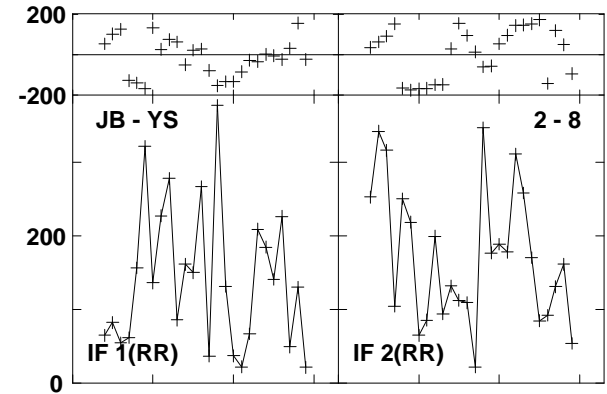
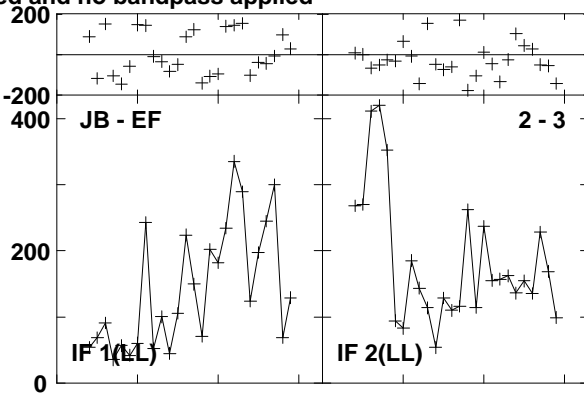
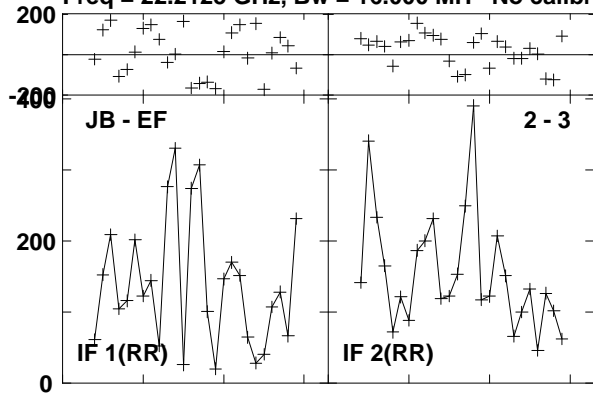

Lower frame: Micro Ampl Jy Top frame: Phas deg  
 Vector averaged cross-power spectrum Baseline: JB (02) - EF (03)  
 Timerange: 00/13:20:20 to 00/13:21:19

Plot file version 475 created 23-AUG-2016 15:00:58  
W3IRS5 GA035B 1.UVDATA.1

Freq = 22.2125 GHz, Bw = 16.000 MH No calibration applied and no bandpass applied

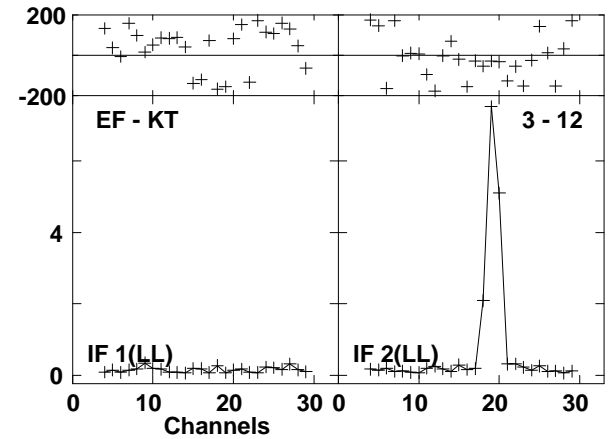
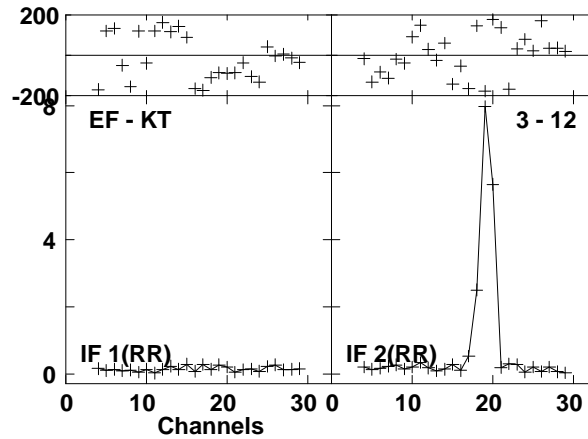
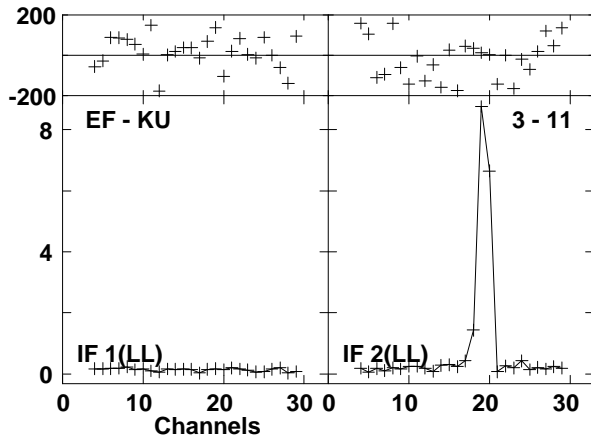
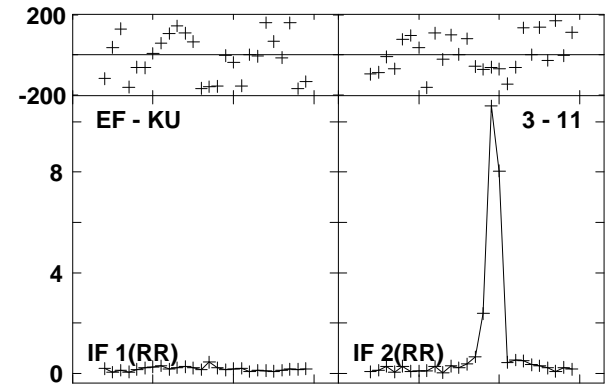
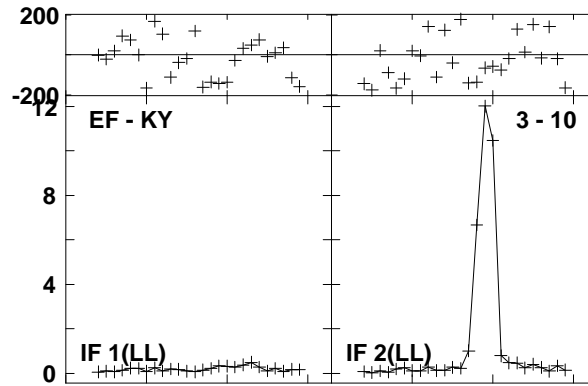
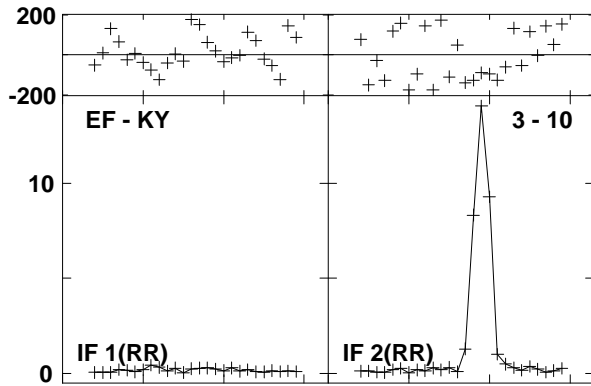
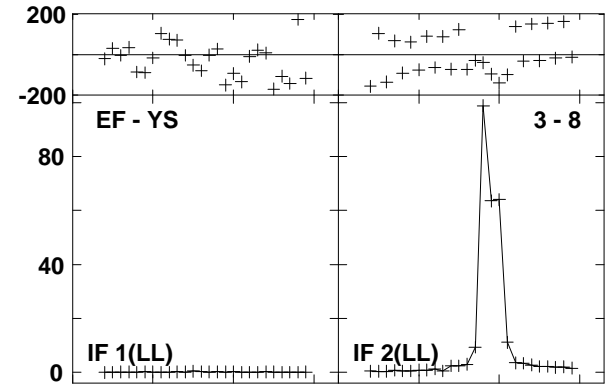
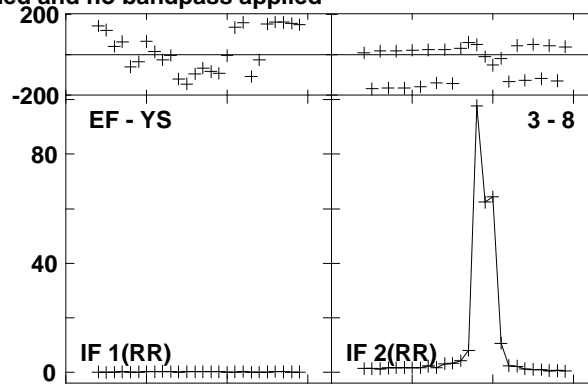
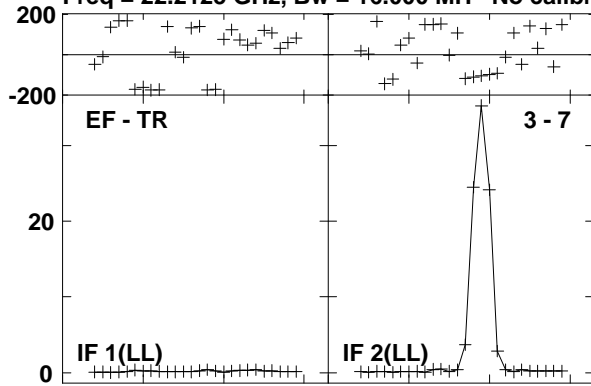

Lower frame: Milli Ampl Jy Top frame: Phas deg  
Vector averaged cross-power spectrum Baseline: EF (03) - TR (07)  
Timerange: 00/13:20:20 to 00/13:21:19

Plot file version 476 created 23-AUG-2016 15:00:58

W3IRS5 GA035B 1.UVDATA.1

Freq = 22.2125 GHz, Bw = 16.000 MH No calibration applied and no bandpass applied

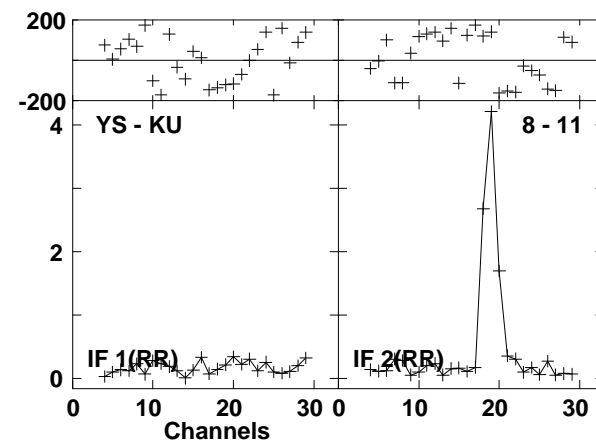
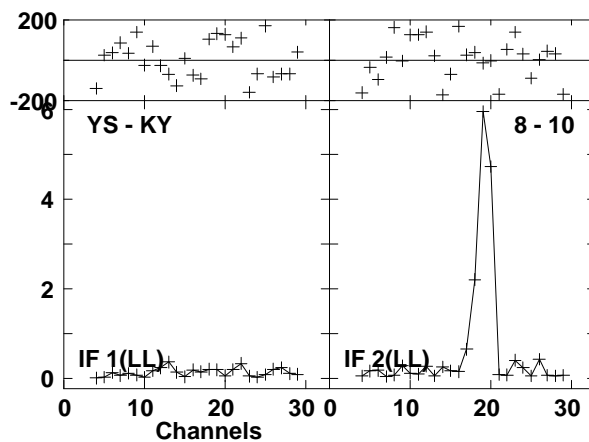
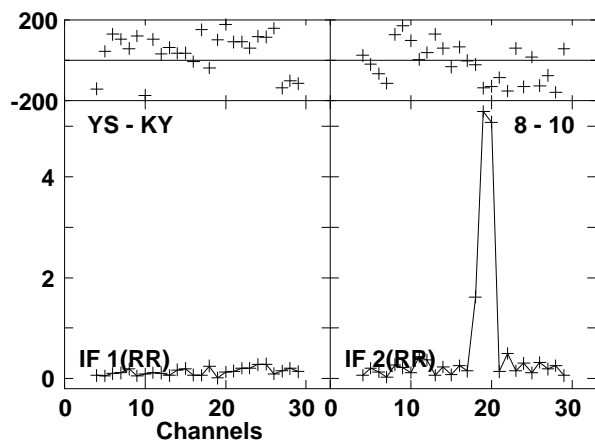
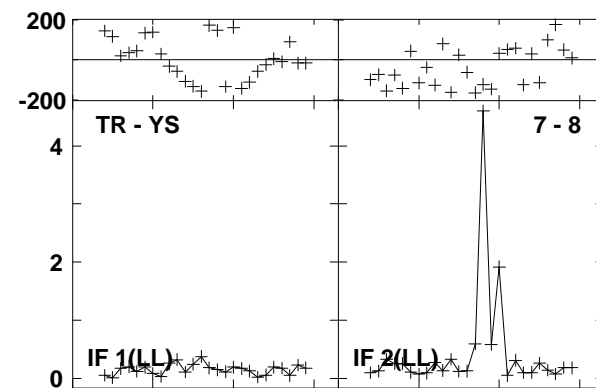
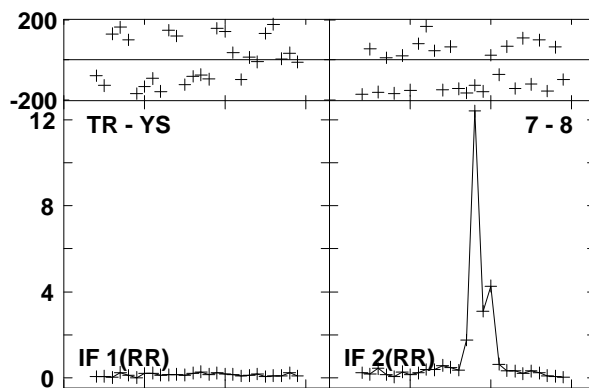
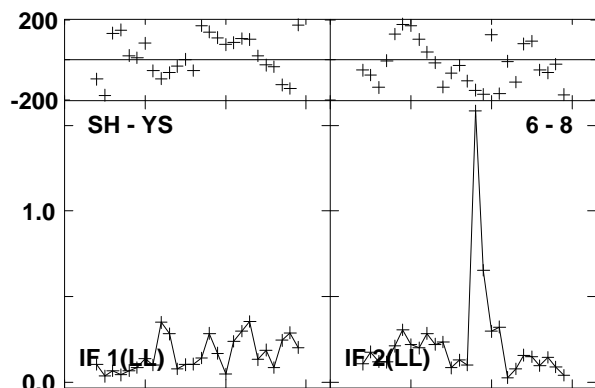
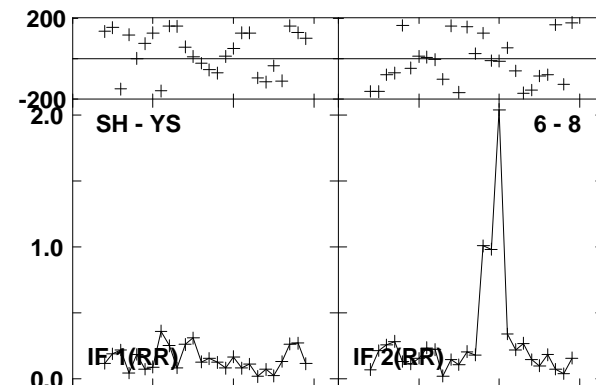
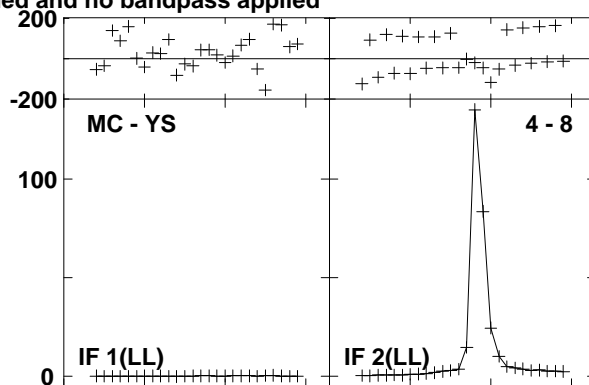
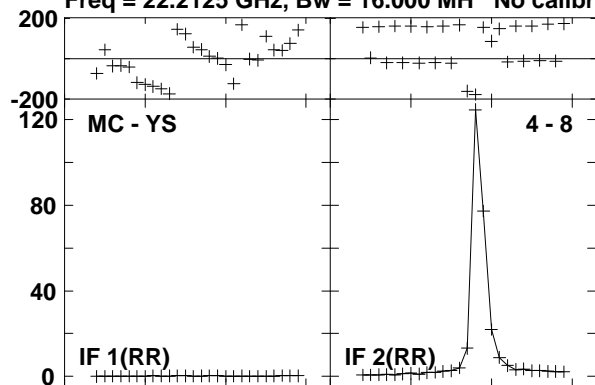

Lower frame: Milli Ampl Jy Top frame: Phas deg  
Vector averaged cross-power spectrum Baseline: MC (04) - YS (08)  
Timerange: 00/13:20:20 to 00/13:21:19

Plot file version 477 created 23-AUG-2016 15:00:58  
W3IRS5 GA035B 1.UVDATA.1

Freq = 22.2125 GHz, Bw = 16.000 MH No calibration applied and no bandpass applied

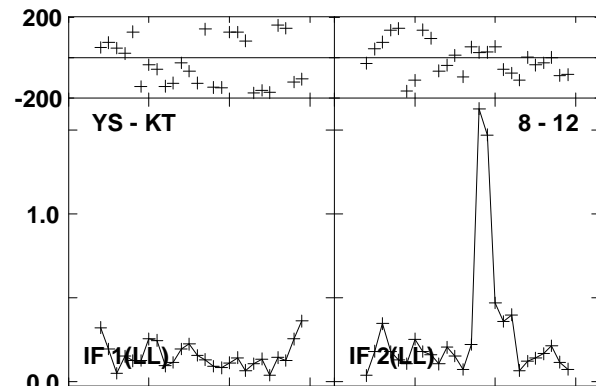
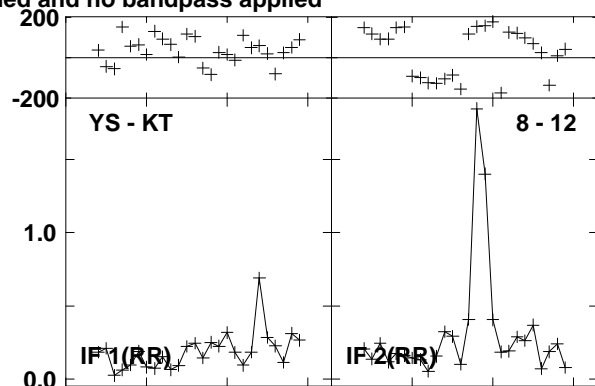
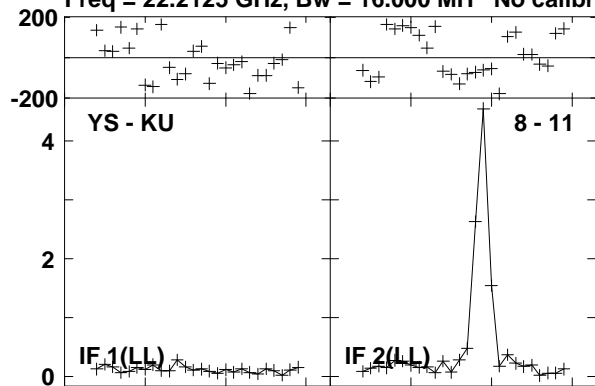

Lower frame: Milli Ampl Jy Top frame: Phas deg  
Vector averaged cross-power spectrum Baseline: YS (08) - KU (11)  
Timerange: 00/13:20:20 to 00/13:21:19

Plot file version 478 created 23-AUG-2016 15:00:58

0219+628 GA035B 1.UVDATA.1

Freq = 22.2125 GHz, Bw = 16.000 MH No calibration applied and no bandpass applied

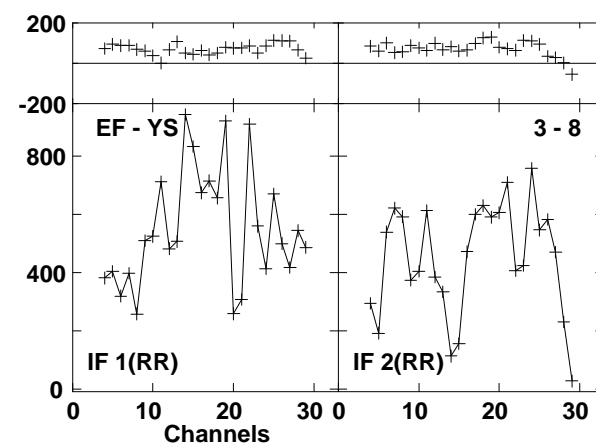
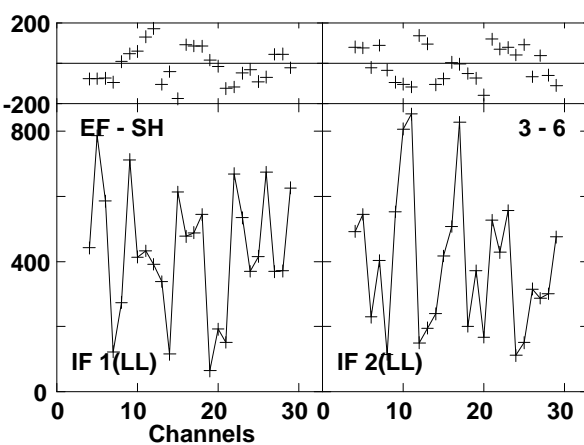
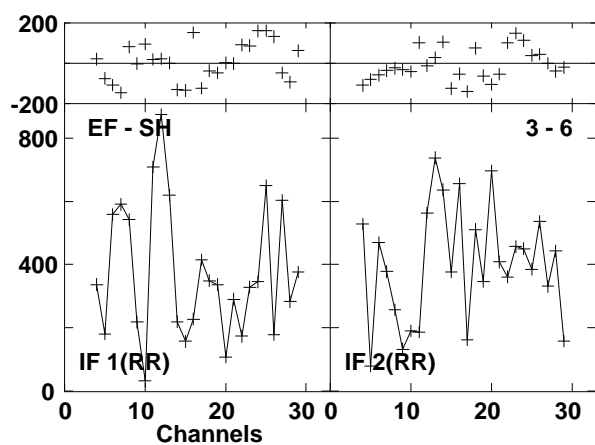
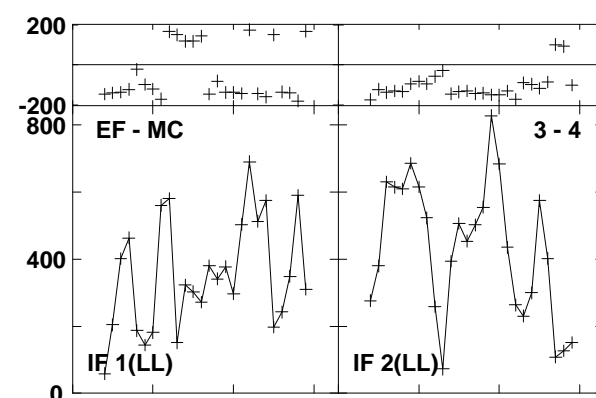
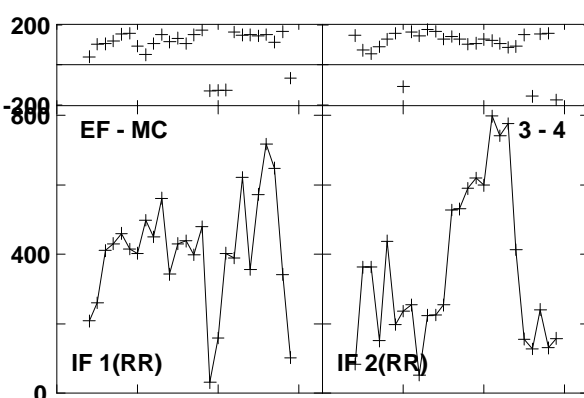
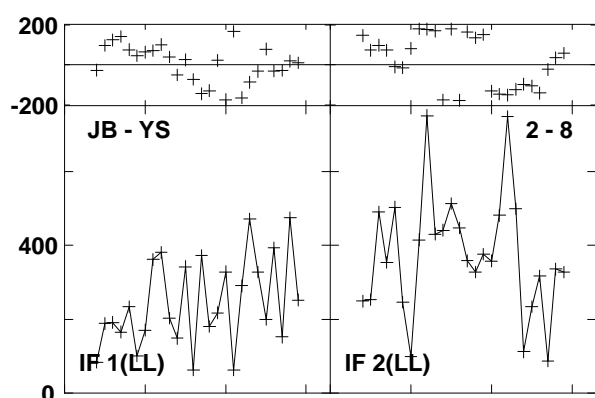
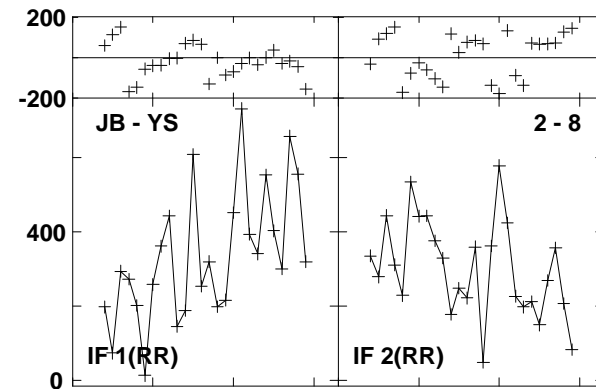
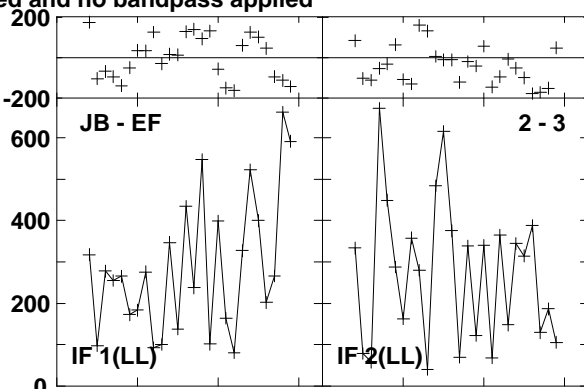
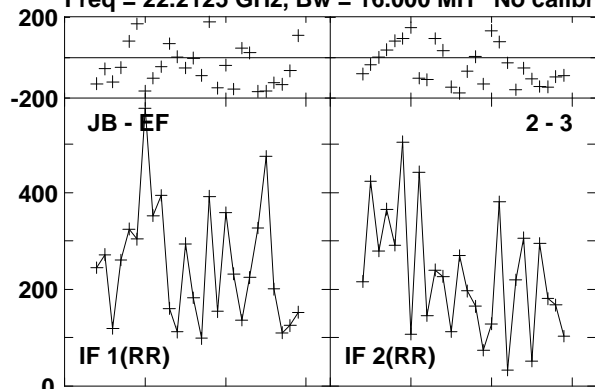

Lower frame: Micro Ampl Jy Top frame: Phas deg  
Vector averaged cross-power spectrum Baseline: JB (02) - EF (03)  
Timerange: 00/13:21:51 to 00/13:22:10

Plot file version 479 created 23-AUG-2016 15:00:58

0219+628 GA035B 1.UVDATA.1

Freq = 22.2125 GHz, Bw = 16.000 MH No calibration applied and no bandpass applied

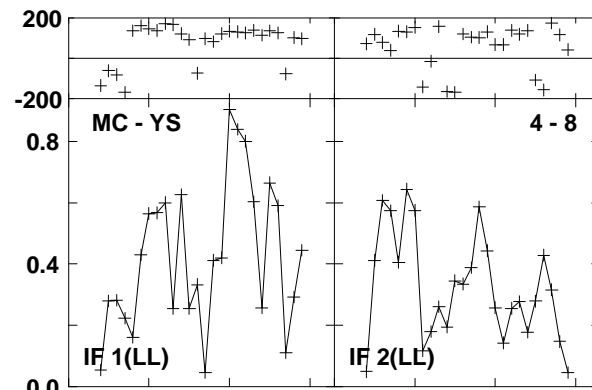
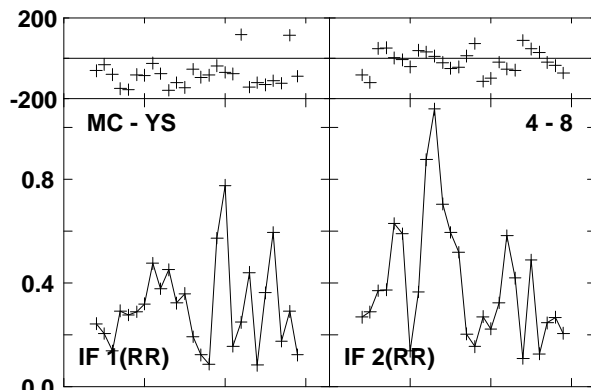
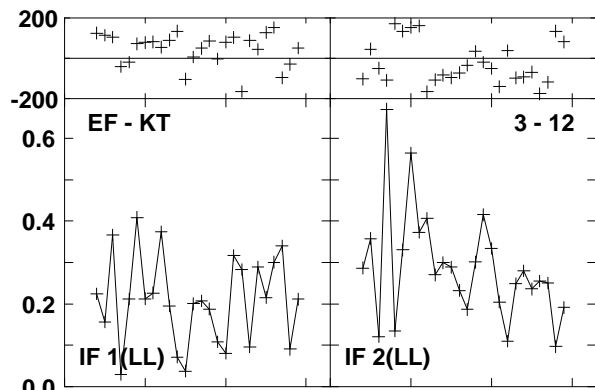
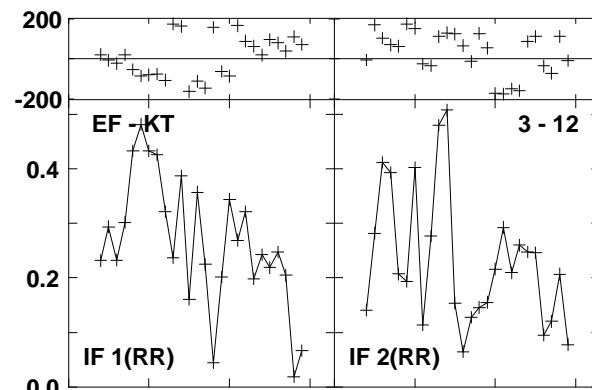
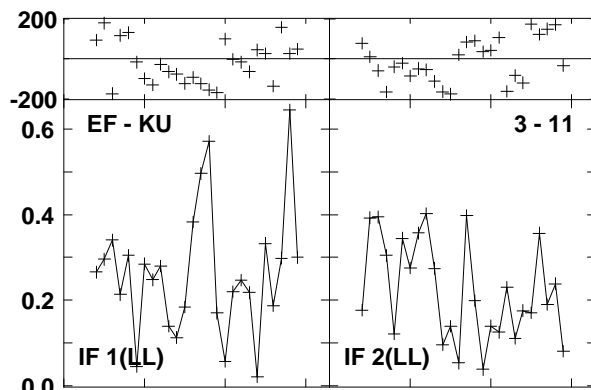
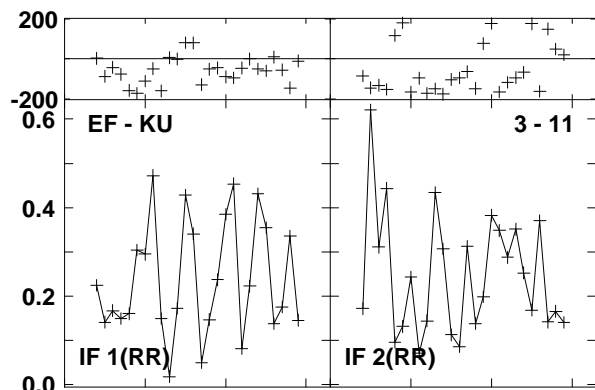
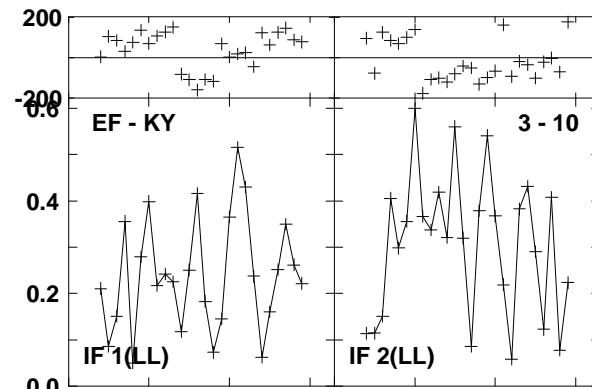
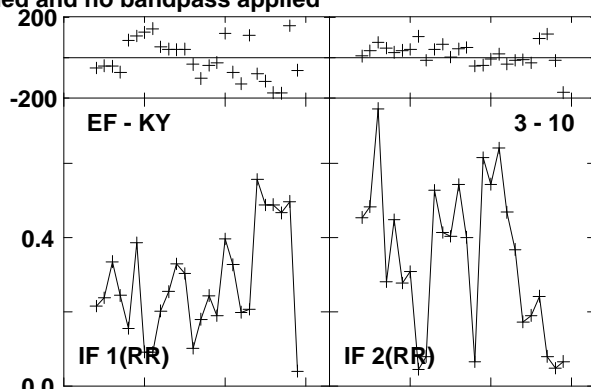
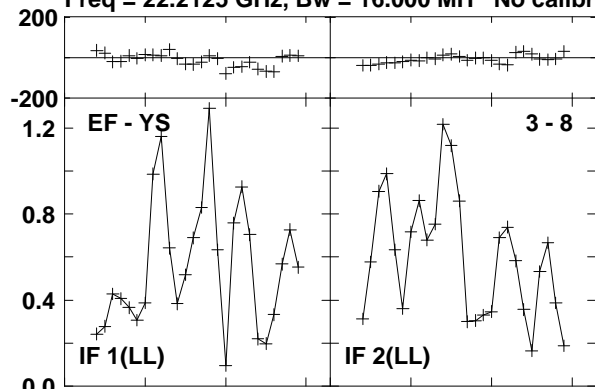

Lower frame: Milli Ampl Jy Top frame: Phas deg

Vector averaged cross-power spectrum Baseline: EF (03) - YS (08)

Timerange: 00/13:21:51 to 00/13:22:10

Plot file version 480 created 23-AUG-2016 15:00:58

0219+628 GA035B 1.UVDATA.1

Freq = 22.2125 GHz, Bw = 16.000 MH No calibration applied and no bandpass applied

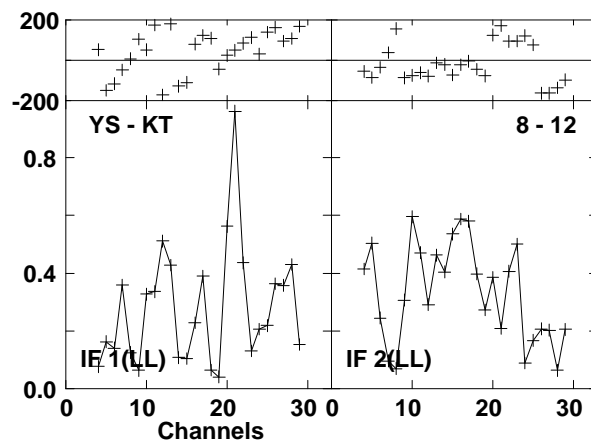
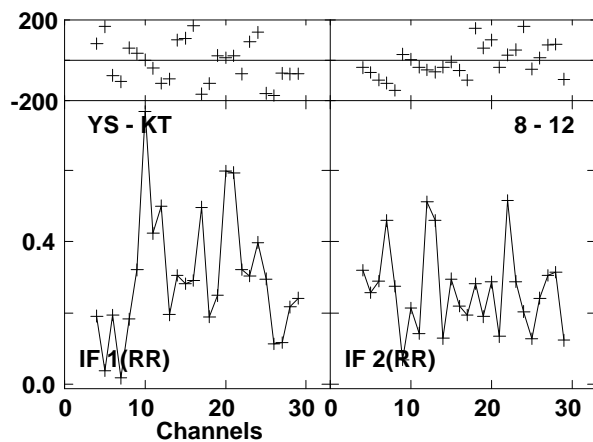
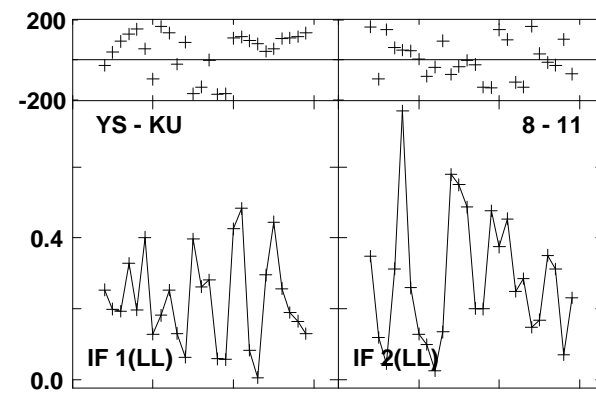
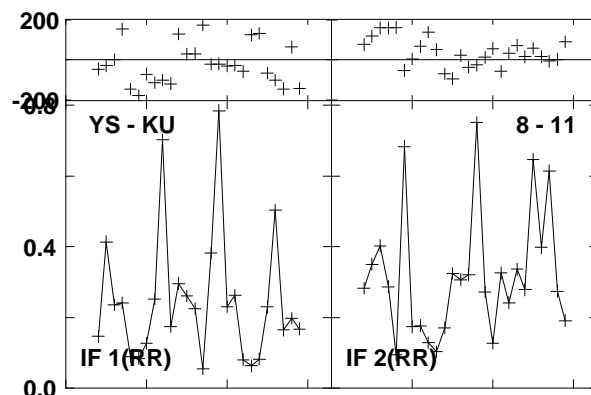
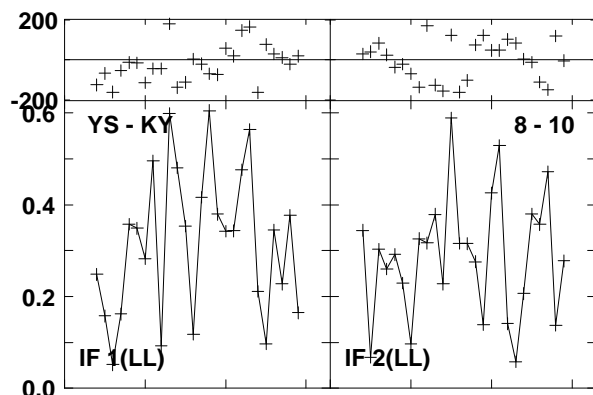
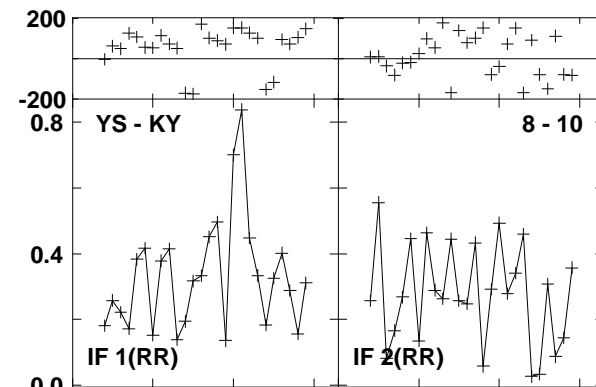
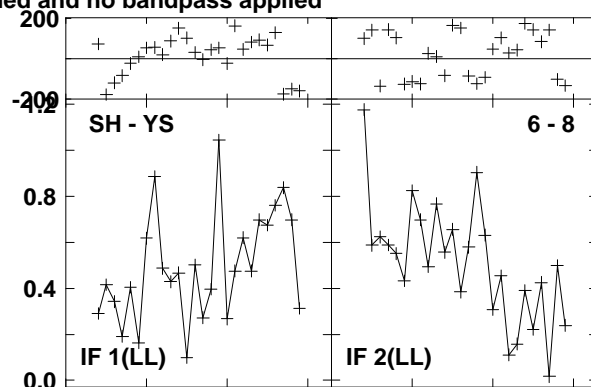
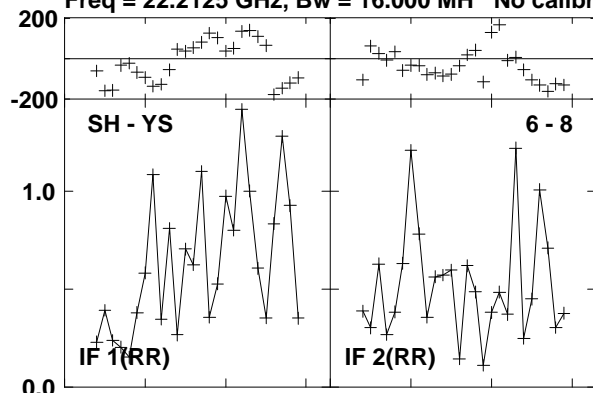

Lower frame: Milli Ampl Jy Top frame: Phas deg

Vector averaged cross-power spectrum Baseline: SH (06) - YS (08)

Timerange: 00/13:21:51 to 00/13:22:10



Plot file version 481 created 23-AUG-2016 15:00:58  
 W3IRS5 GA035B 1.UVDATA.1

Freq = 22.2125 GHz, Bw = 16.000 MH No calibration applied and no bandpass applied

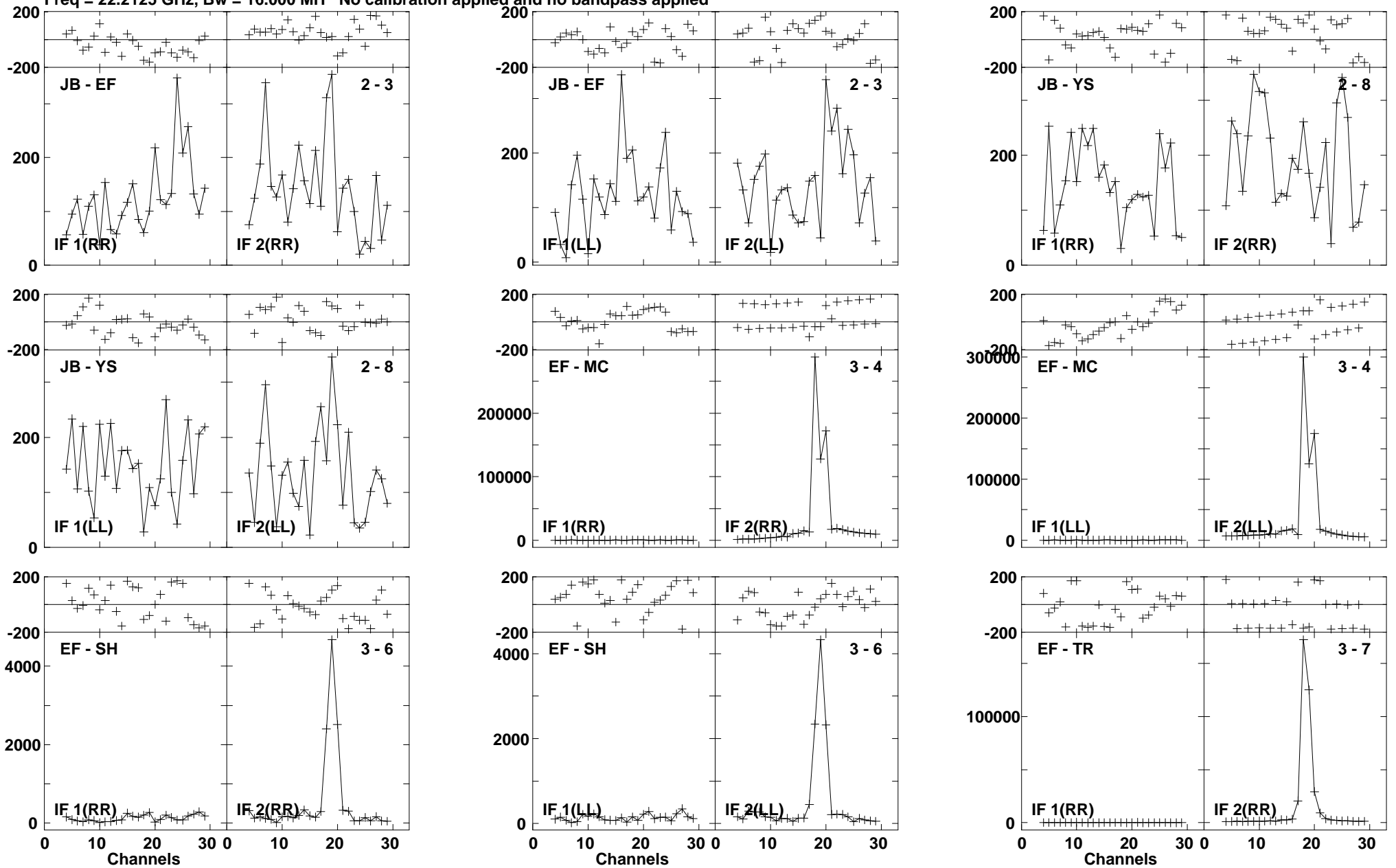

Lower frame: Micro Ampl Jy Top frame: Phas deg  
 Vector averaged cross-power spectrum Baseline: JB (02) - EF (03)  
 Timerange: 00/13:22:41 to 00/13:23:39

Plot file version 482 created 23-AUG-2016 15:00:58

W3IRS5 GA035B 1.UVDATA.1

Freq = 22.2125 GHz, Bw = 16.000 MH No calibration applied and no bandpass applied

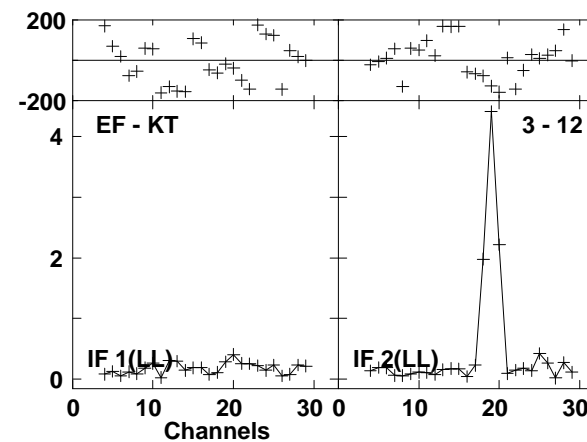
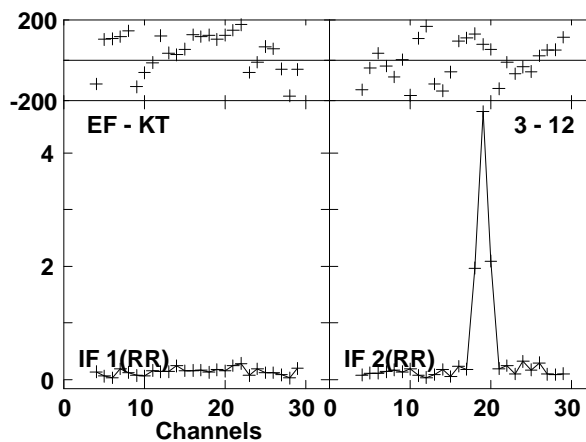
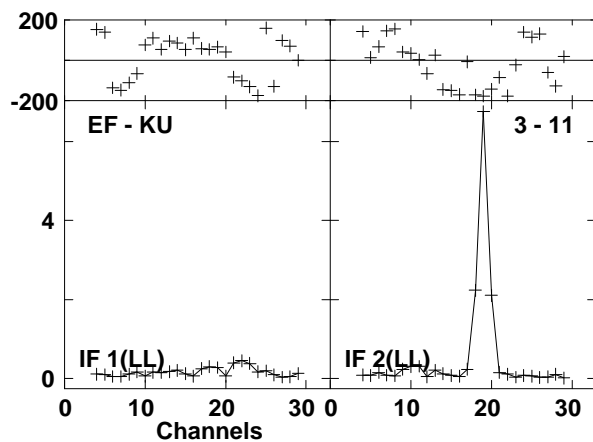
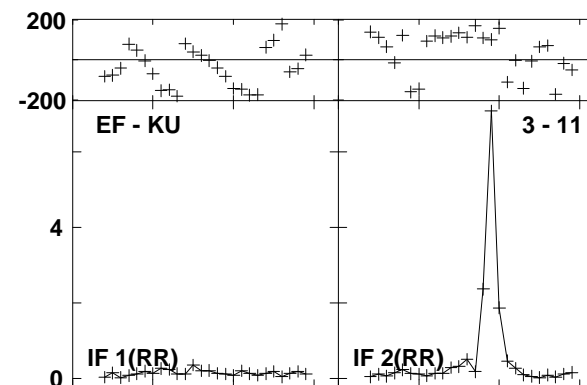
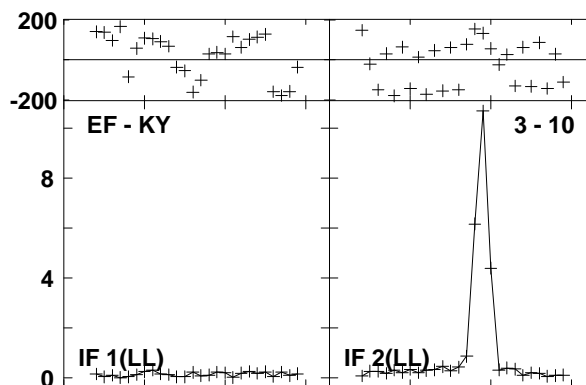
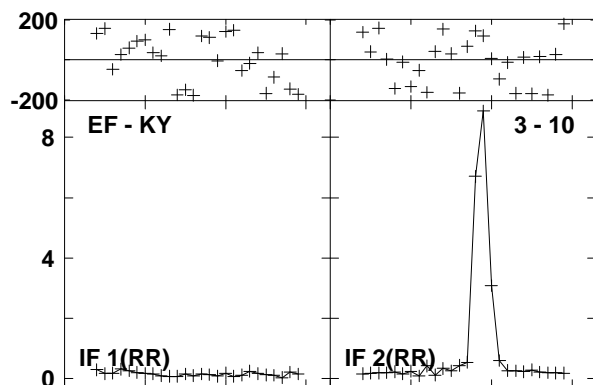
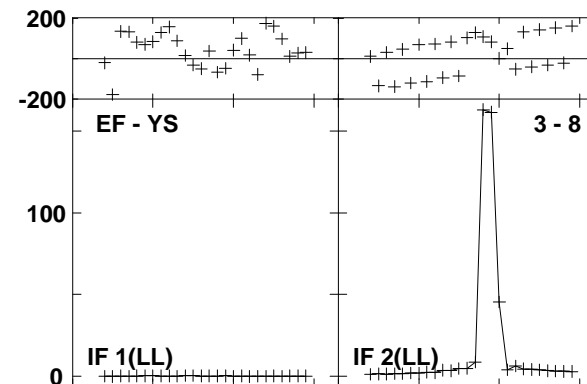
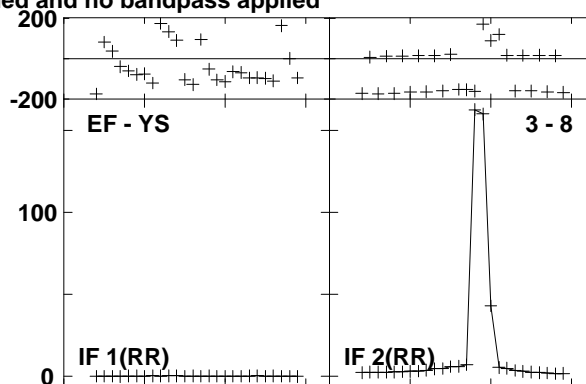
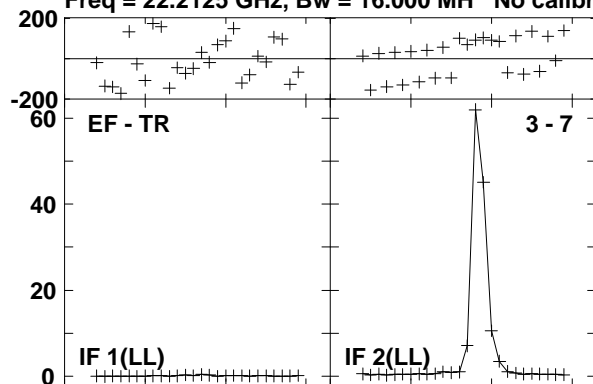

Lower frame: Milli Ampl Jy Top frame: Phas deg  
Vector averaged cross-power spectrum Baseline: EF (03) - TR (07)  
Timerange: 00/13:22:41 to 00/13:23:39

Plot file version 483 created 23-AUG-2016 15:00:58  
W3IRS5 GA035B 1.UVDATA.1

Freq = 22.2125 GHz, Bw = 16.000 MH No calibration applied and no bandpass applied

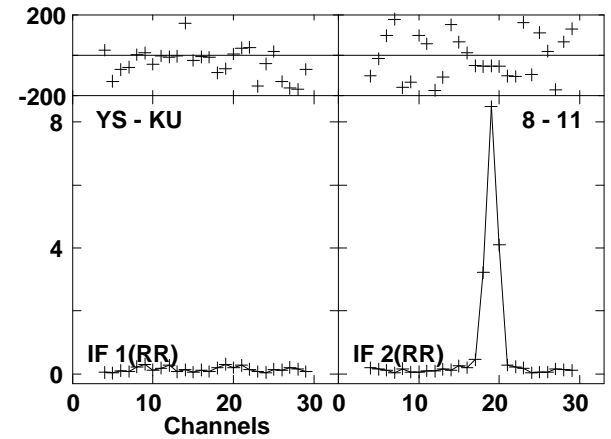
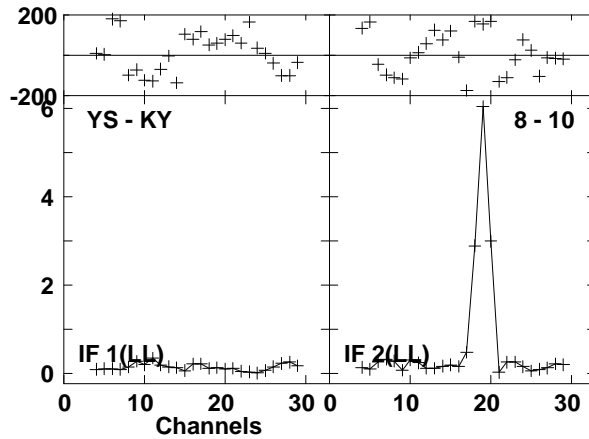
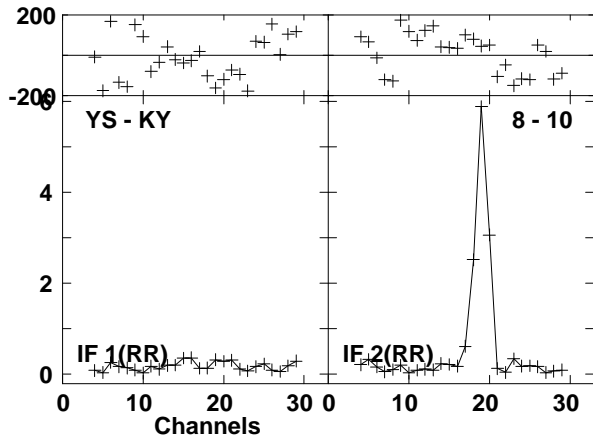
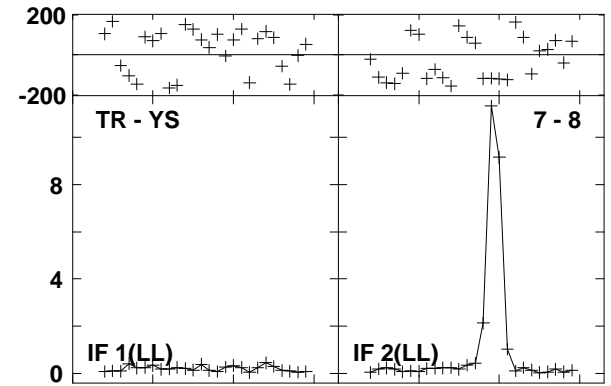
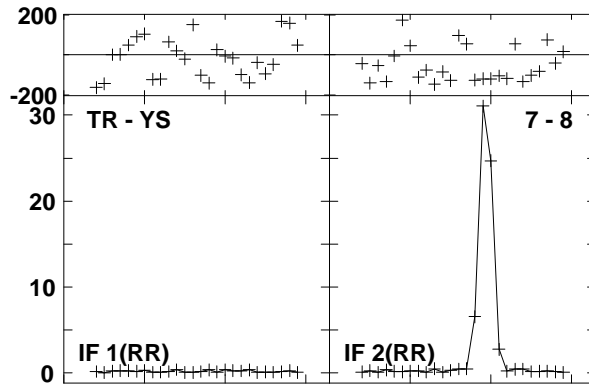
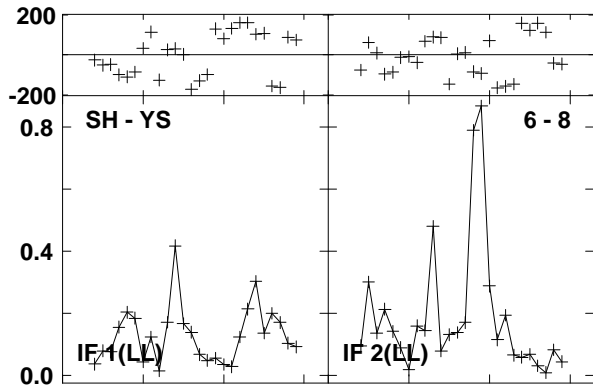
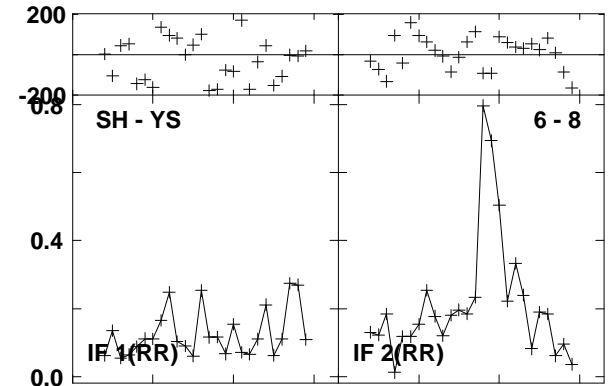
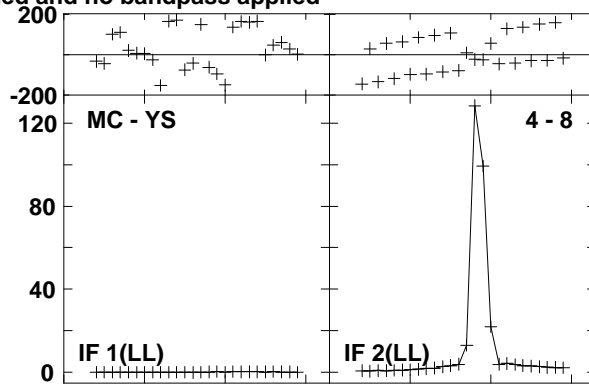
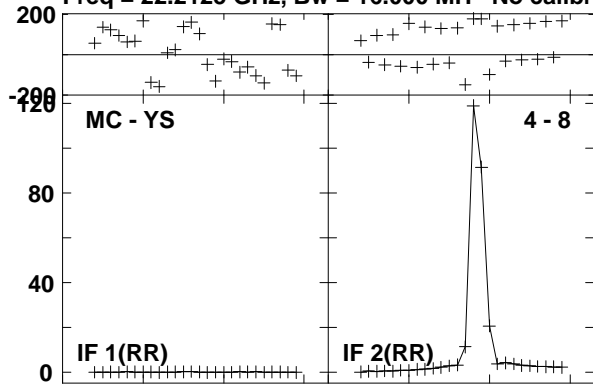

Lower frame: Milli Ampl Jy Top frame: Phas deg  
Vector averaged cross-power spectrum Baseline: MC (04) - YS (08)  
Timerange: 00/13:22:41 to 00/13:23:39

Plot file version 484 created 23-AUG-2016 15:00:58  
W3IRS5 GA035B 1.UVDATA.1

Freq = 22.2125 GHz, Bw = 16.000 MH No calibration applied and no bandpass applied

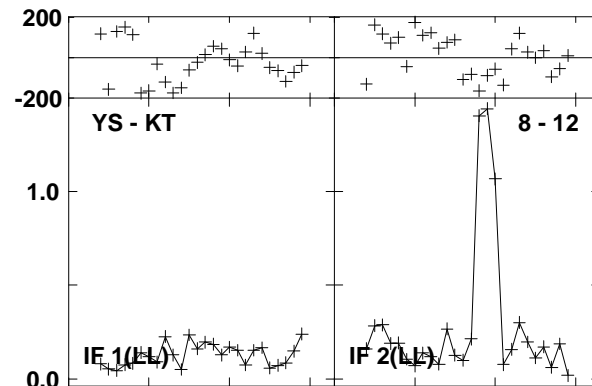
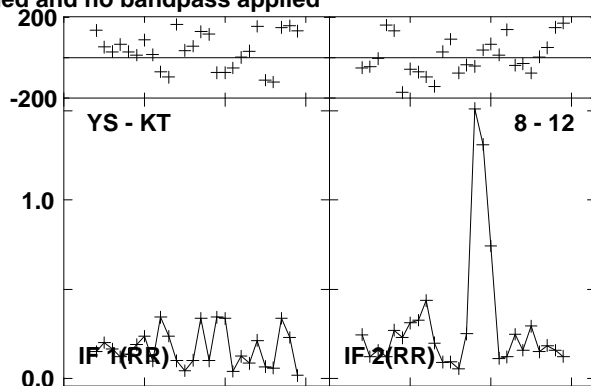
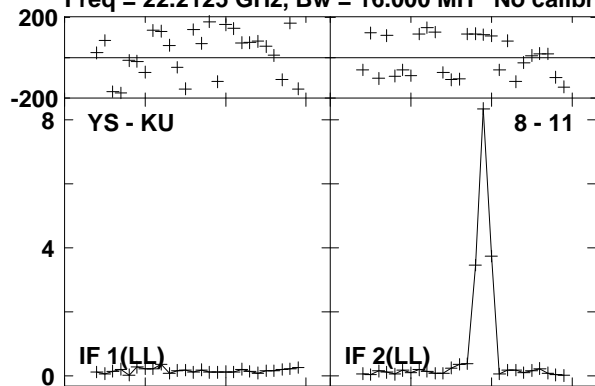

Lower frame: Milli Ampl Jy Top frame: Phas deg  
Vector averaged cross-power spectrum Baseline: YS (08) - KU (11)  
Timerange: 00/13:22:41 to 00/13:23:39

Plot file version 485 created 23-AUG-2016 15:00:58

0219+628 GA035B 1.UVDATA.1

Freq = 22.2125 GHz, Bw = 16.000 MH No calibration applied and no bandpass applied

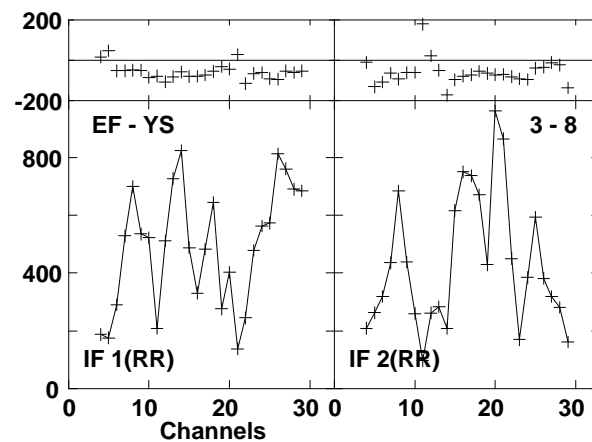
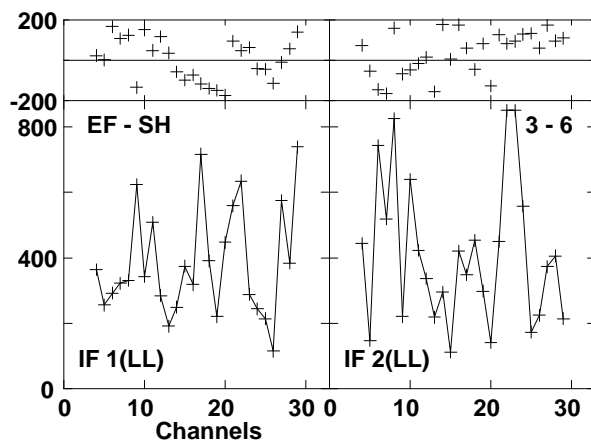
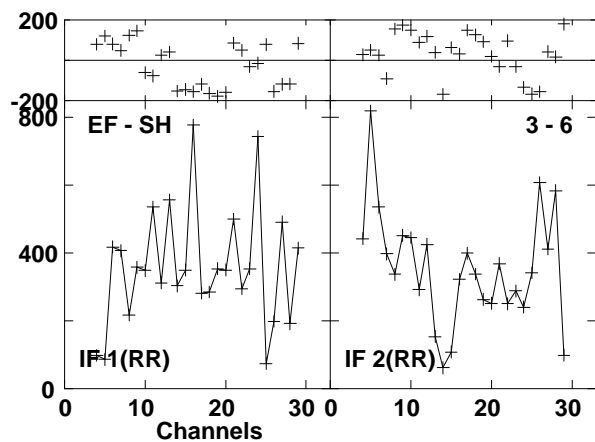
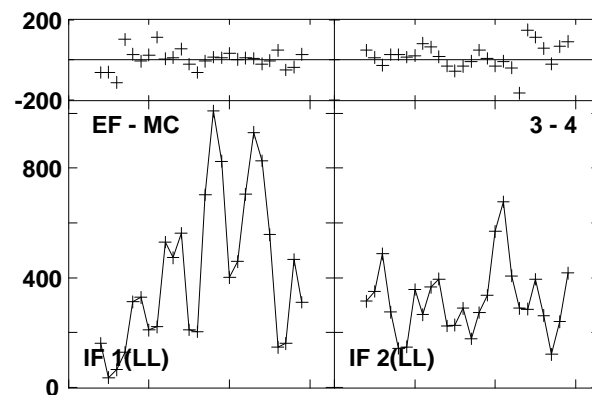
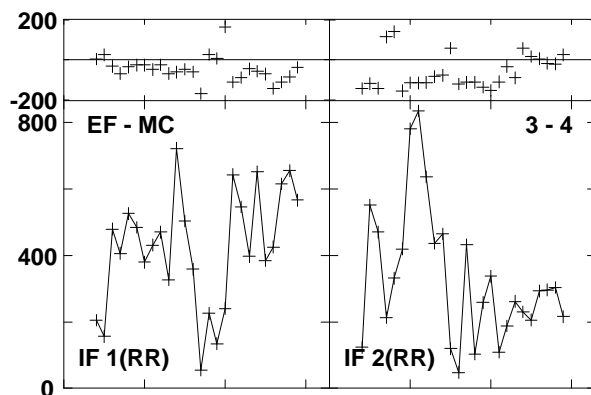
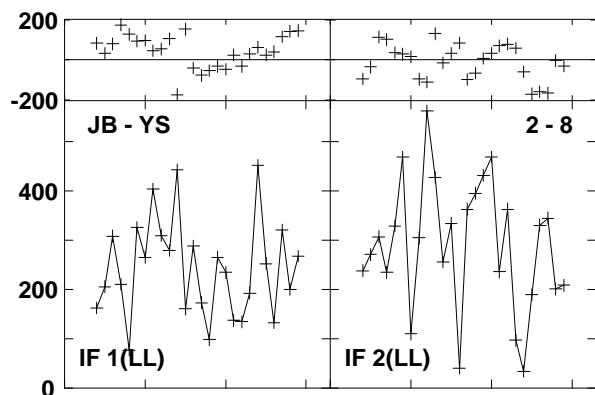
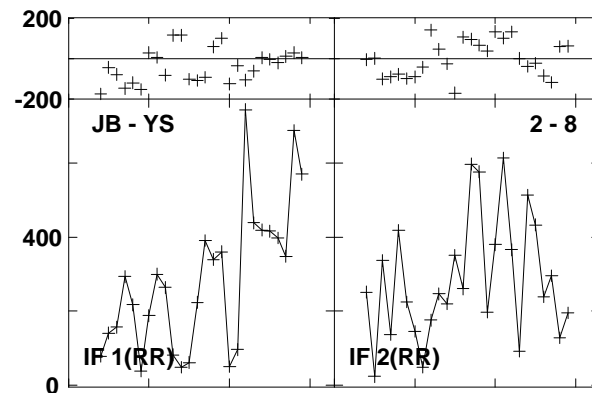
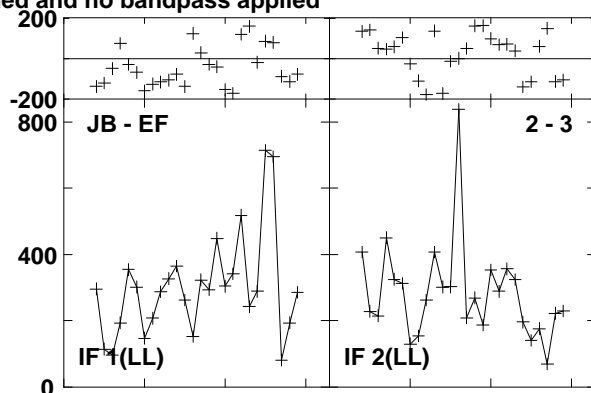
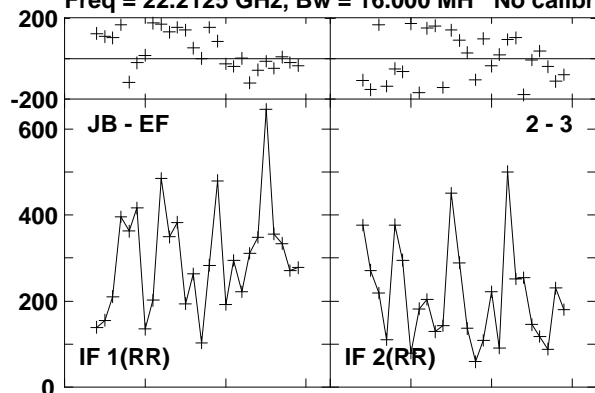

Lower frame: Micro Ampl Jy Top frame: Phas deg  
Vector averaged cross-power spectrum Baseline: JB (02) - EF (03)  
Timerange: 00/13:24:11 to 00/13:24:29

Plot file version 486 created 23-AUG-2016 15:00:58  
 0219+628 GA035B 1.UVDATA.1  
 Freq = 22.2125 GHz, Bw = 16.000 MH No calibration applied and no bandpass applied

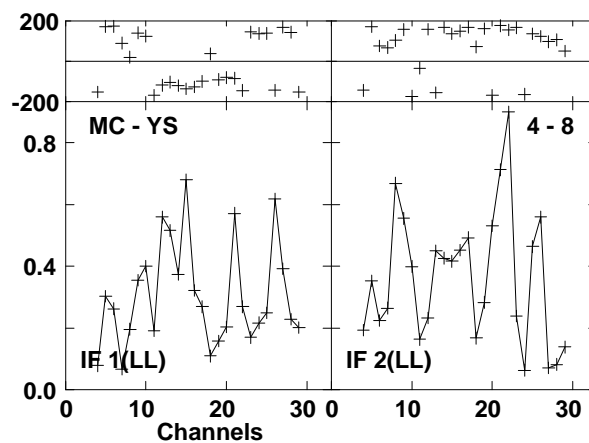
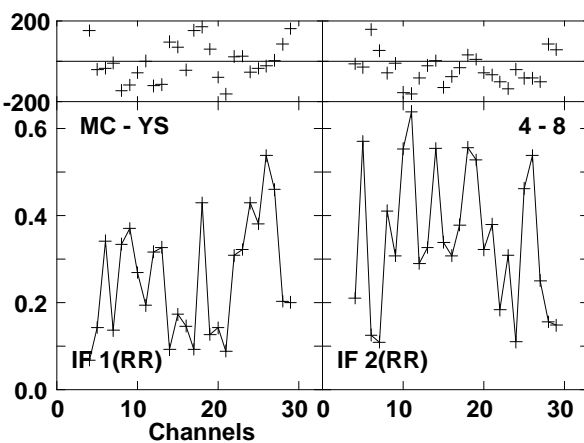
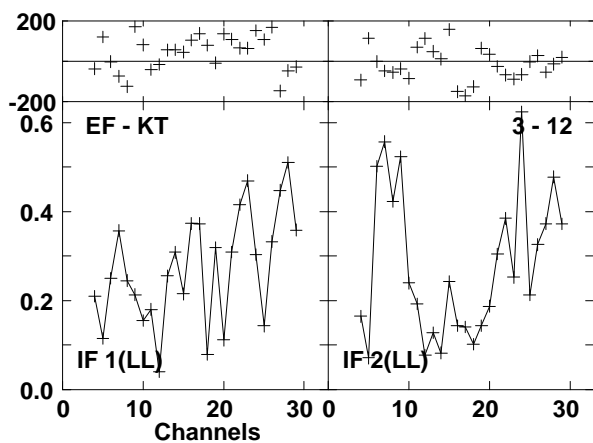
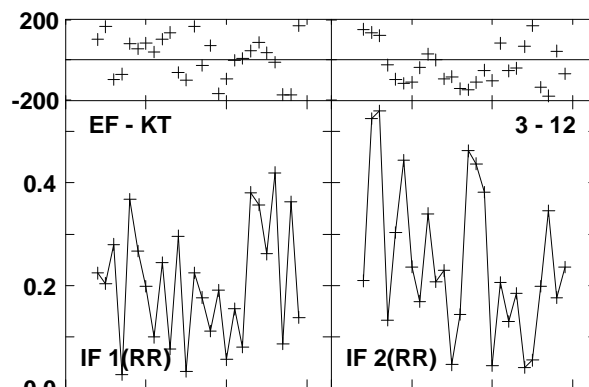
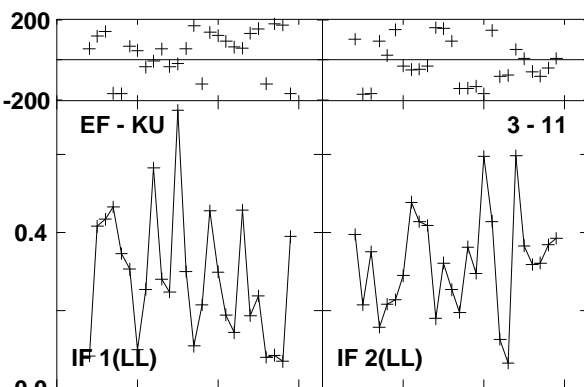
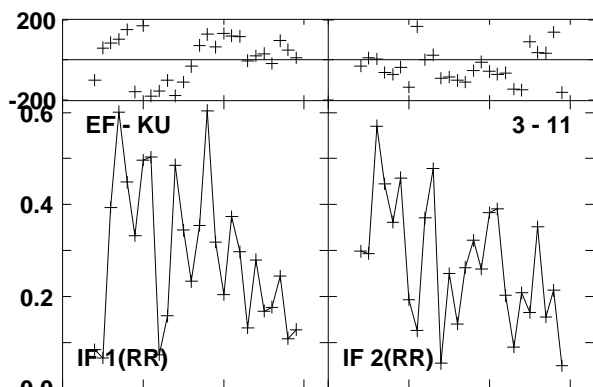
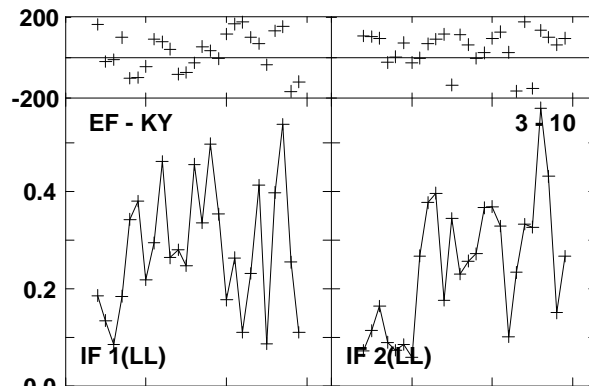
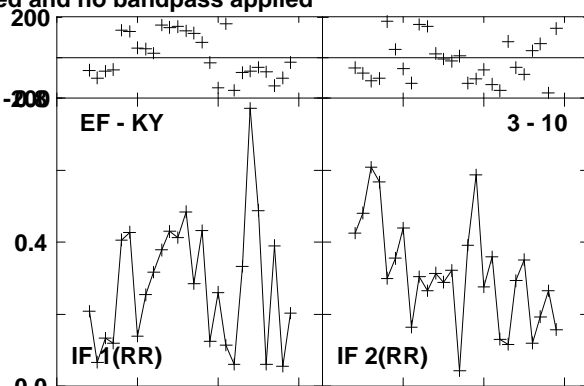
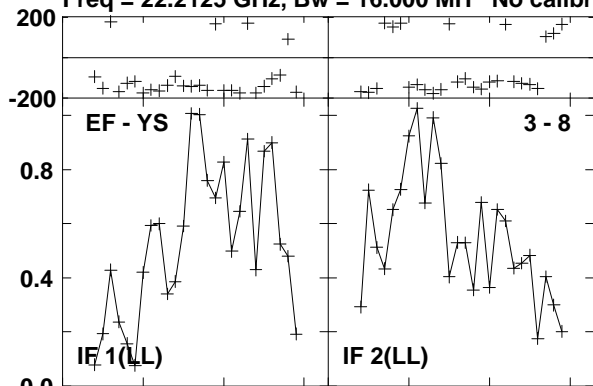

Lower frame: Milli Ampl Jy Top frame: Phas deg  
 Vector averaged cross-power spectrum Baseline: EF (03) - YS (08)  
 Timerange: 00/13:24:11 to 00/13:24:29

Plot file version 487 created 23-AUG-2016 15:00:58

0219+628 GA035B 1.UVDATA.1

Freq = 22.2125 GHz, Bw = 16.000 MH No calibration applied and no bandpass applied

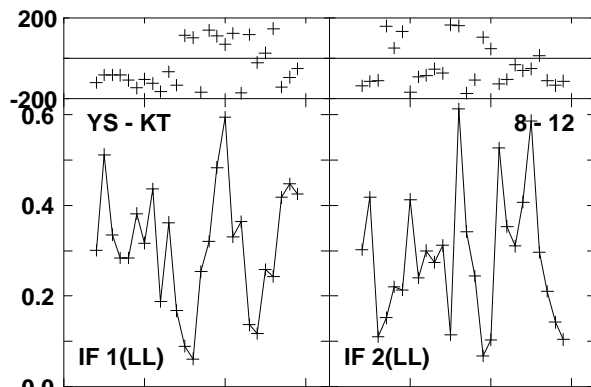
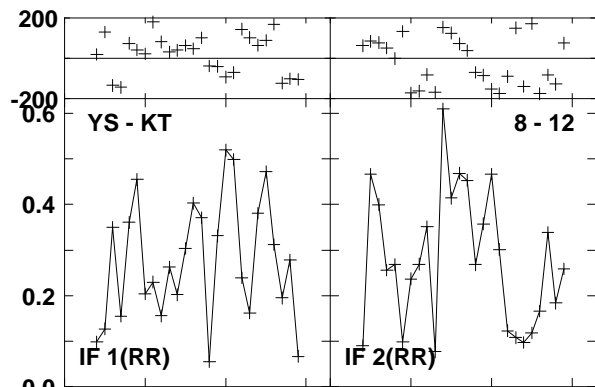
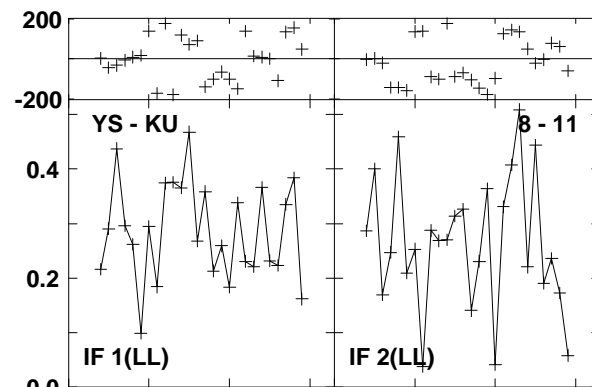
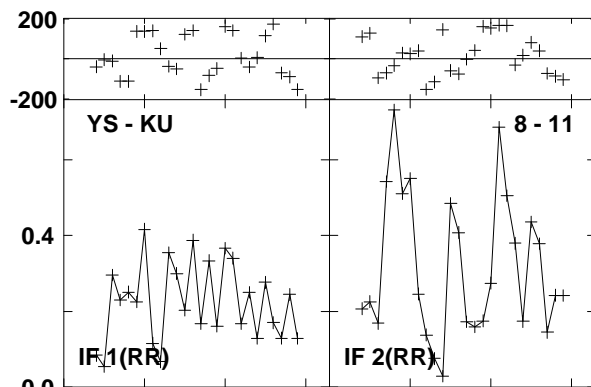
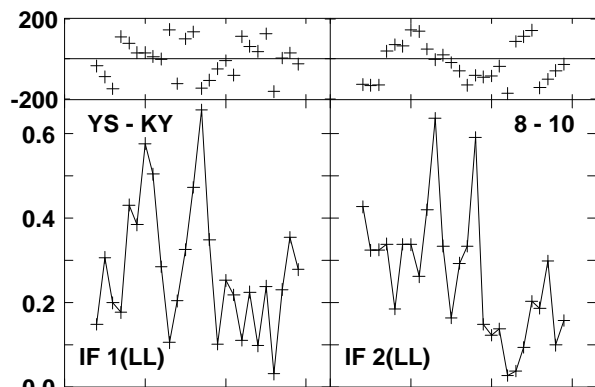
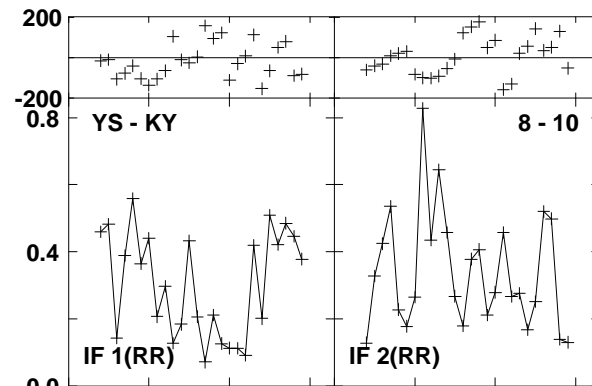
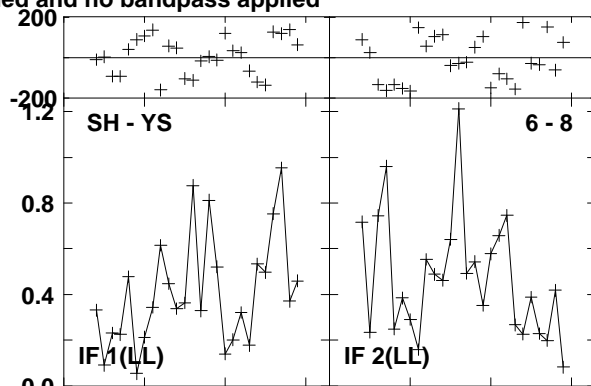
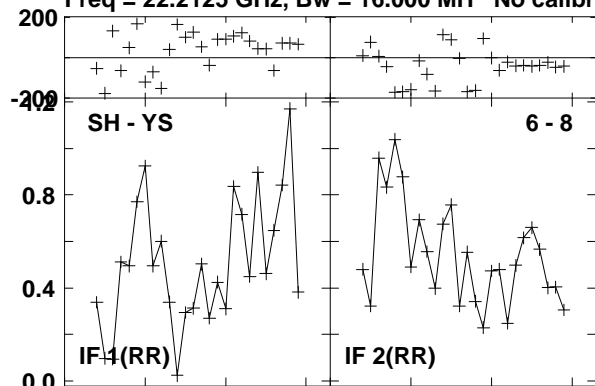

Lower frame: Milli Ampl Jy Top frame: Phas deg

Vector averaged cross-power spectrum Baseline: SH (06) - YS (08)

Timerange: 00/13:24:11 to 00/13:24:29

Plot file version 488 created 23-AUG-2016 15:00:58

W3IRS5 GA035B 1.UVDATA.1

Freq = 22.2125 GHz, Bw = 16.000 MH No calibration applied and no bandpass applied

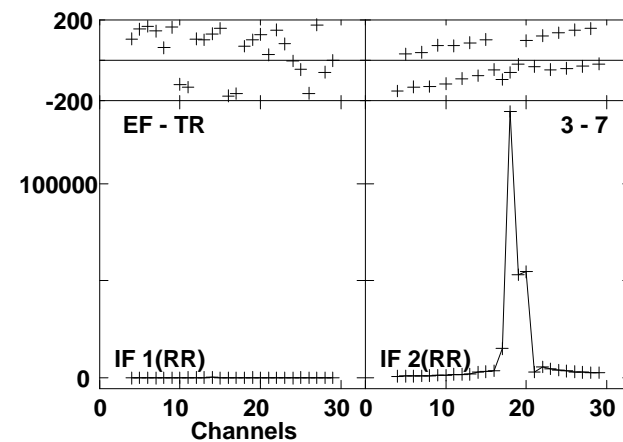
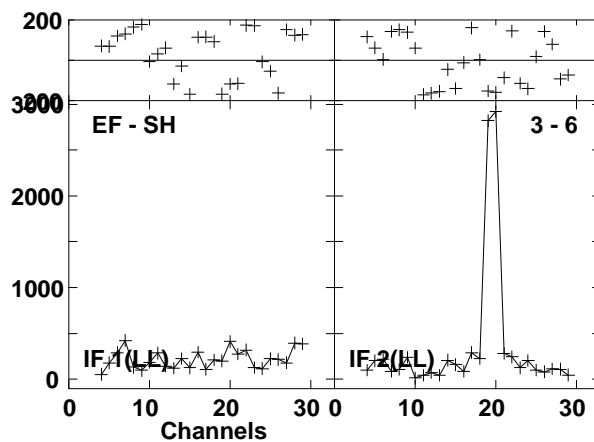
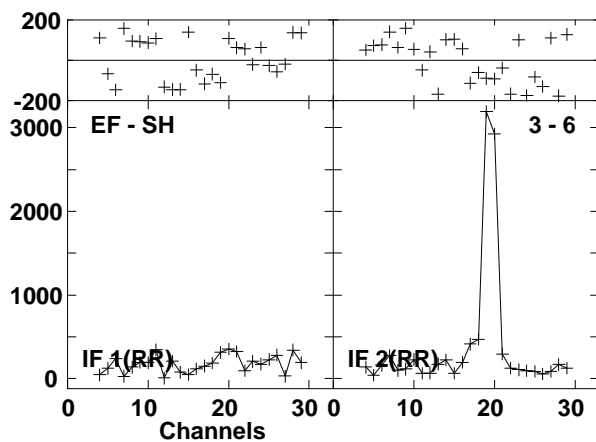
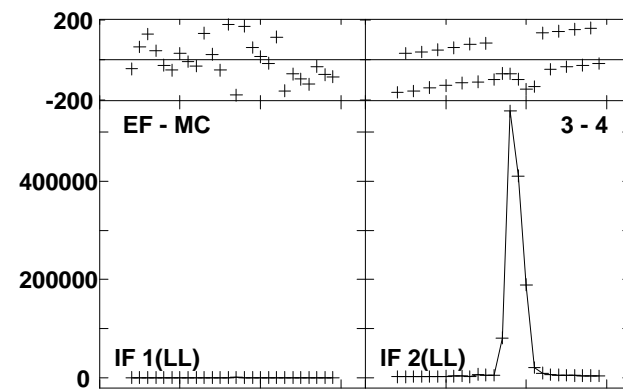
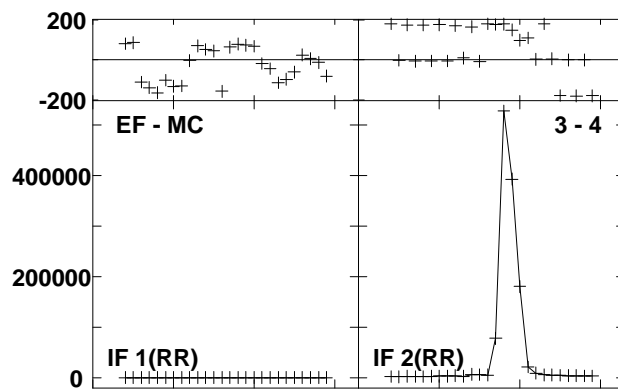
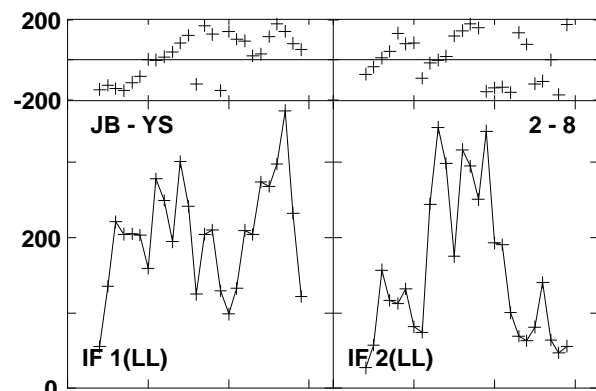
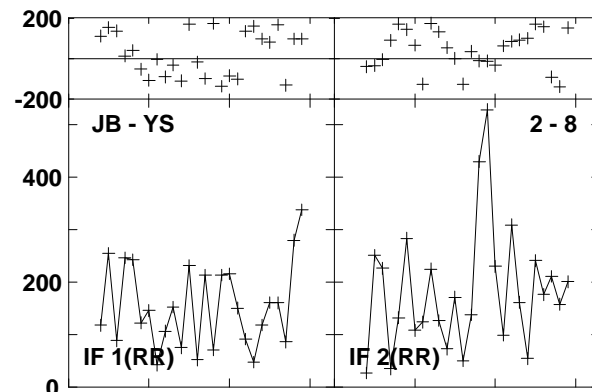
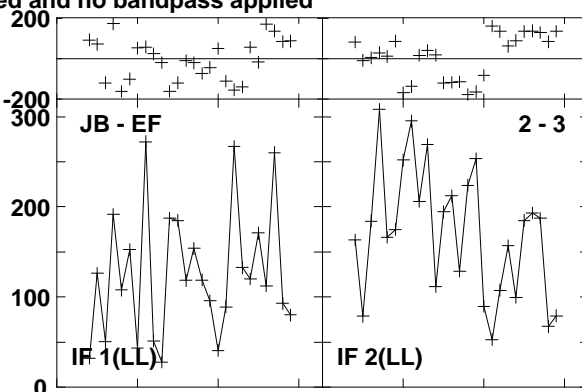
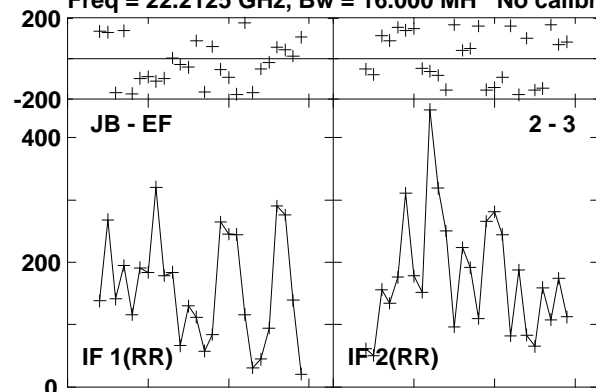

Lower frame: Micro Ampl Jy Top frame: Phas deg  
Vector averaged cross-power spectrum Baseline: JB (02) - EF (03)  
Timerange: 00/13:25:01 to 00/13:26:00



Plot file version 489 created 23-AUG-2016 15:00:58

W3IRS5 GA035B 1.UVDATA.1

Freq = 22.2125 GHz, Bw = 16.000 MH No calibration applied and no bandpass applied

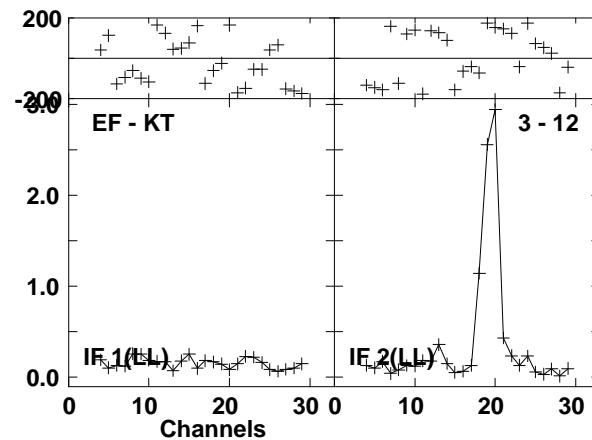
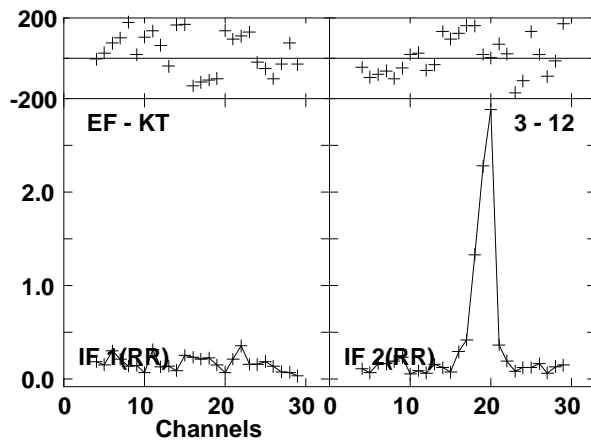
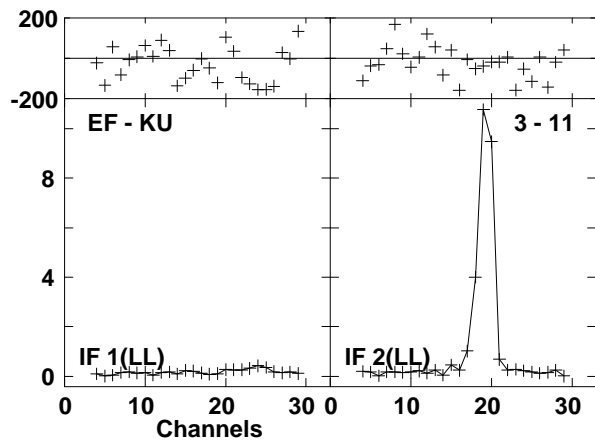
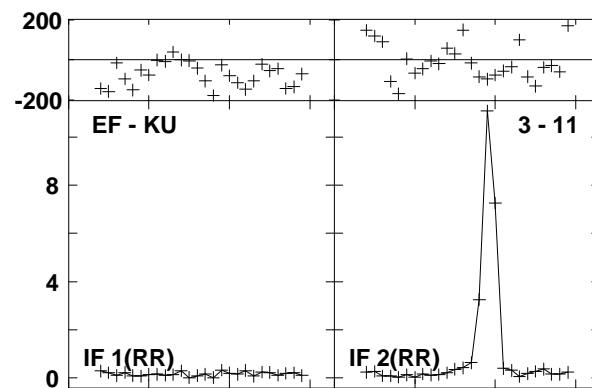
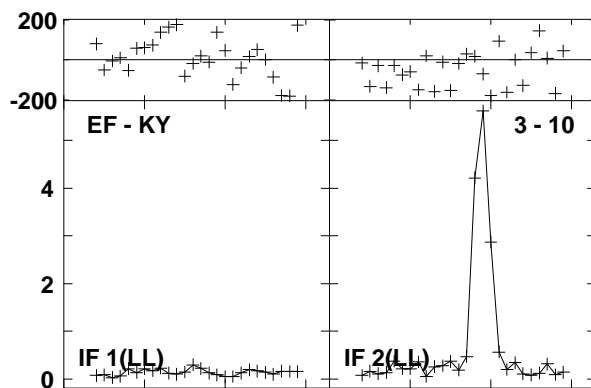
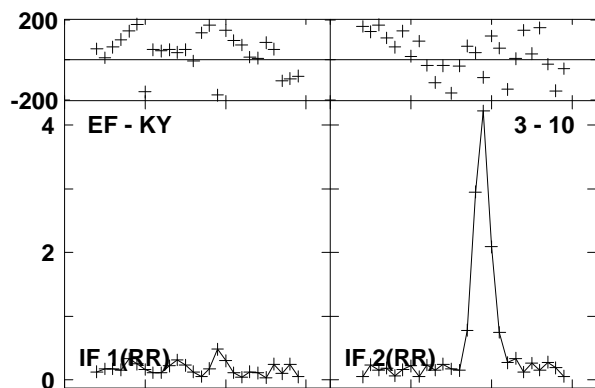
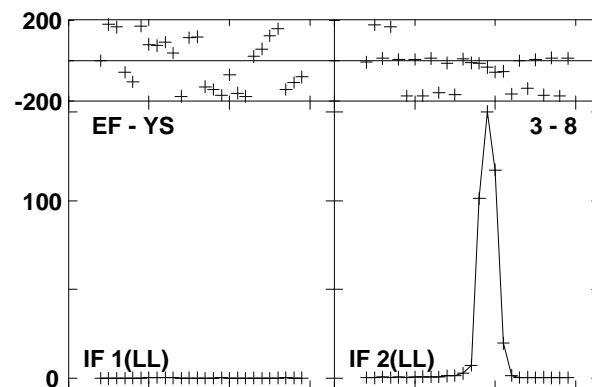
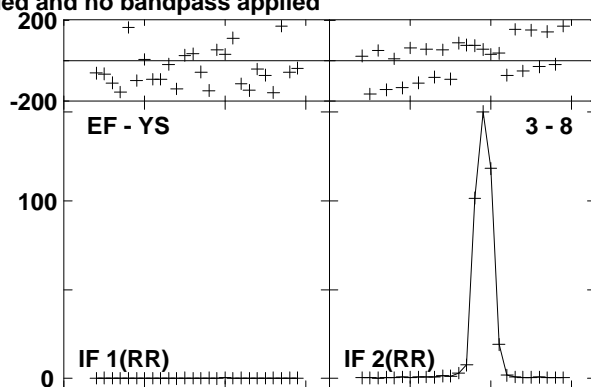
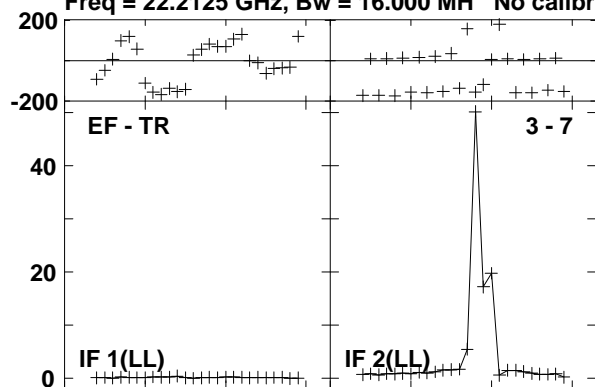

Lower frame: Milli Ampl Jy Top frame: Phas deg  
Vector averaged cross-power spectrum Baseline: EF (03) - TR (07)  
Timerange: 00/13:25:01 to 00/13:26:00

Plot file version 490 created 23-AUG-2016 15:00:58

W3IRS5 GA035B 1.UVDATA.1

Freq = 22.2125 GHz, Bw = 16.000 MH No calibration applied and no bandpass applied

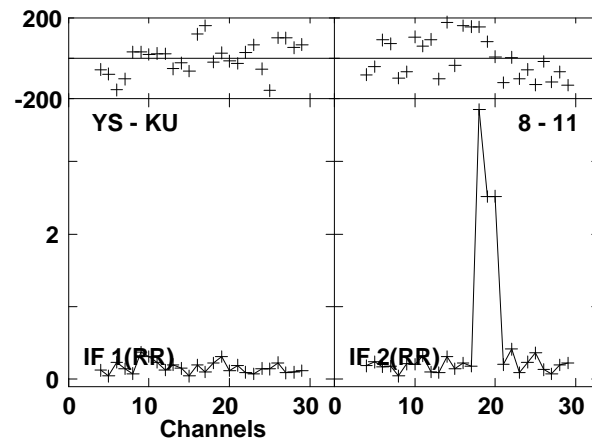
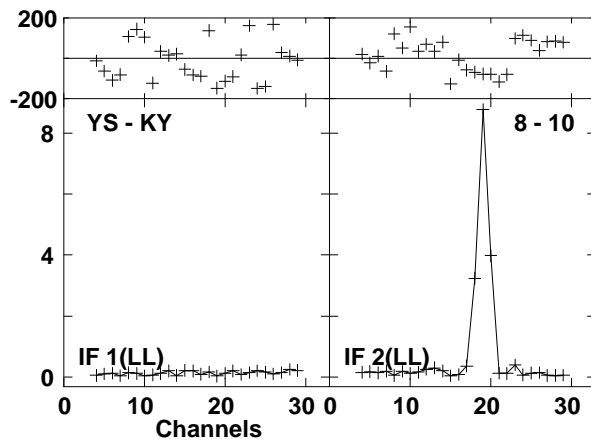
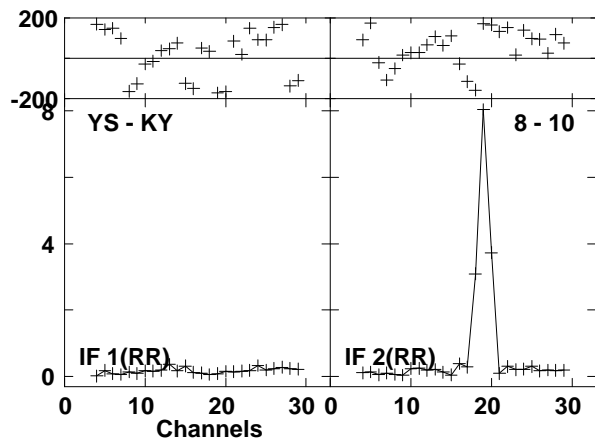
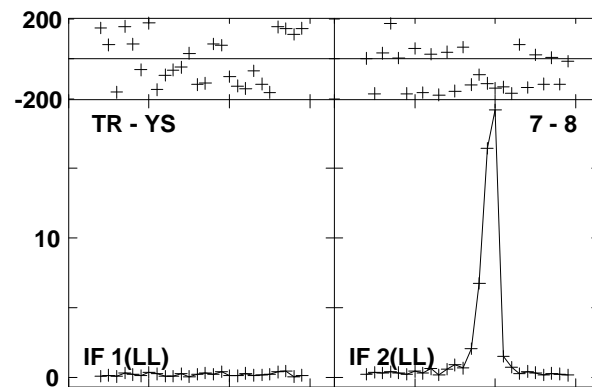
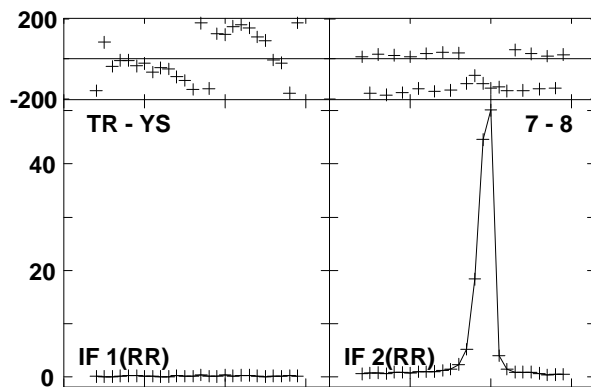
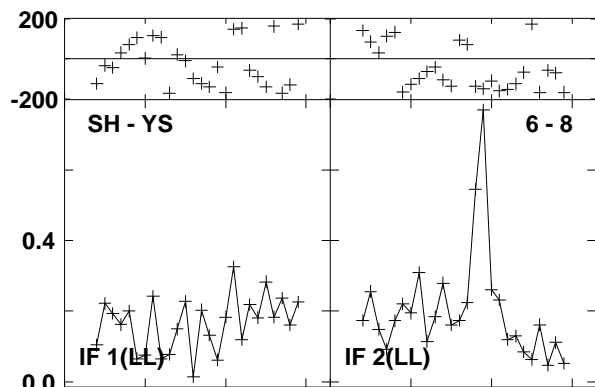
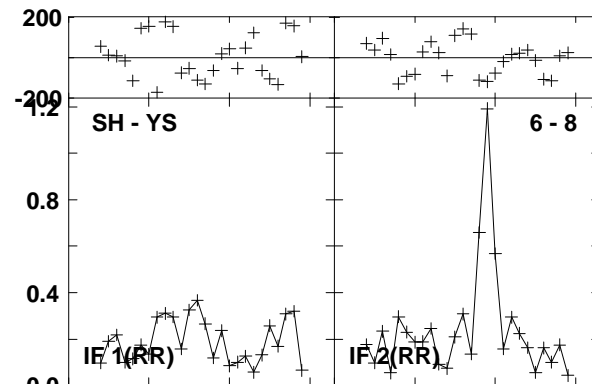
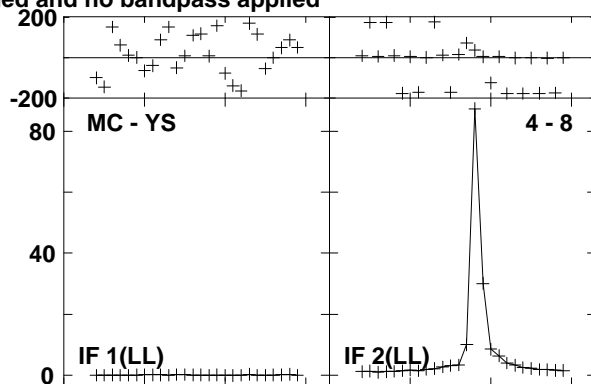
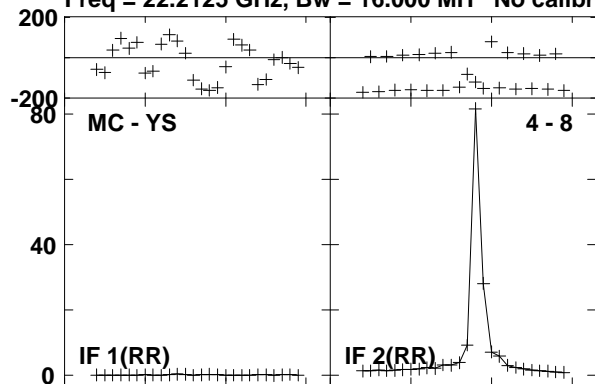

Lower frame: Milli Ampl Jy Top frame: Phas deg

Vector averaged cross-power spectrum Baseline: MC (04) - YS (08)

Timerange: 00/13:25:01 to 00/13:26:00

Plot file version 491 created 23-AUG-2016 15:00:58  
W3IRS5 GA035B 1.UVDATA.1

Freq = 22.2125 GHz, Bw = 16.000 MH No calibration applied and no bandpass applied

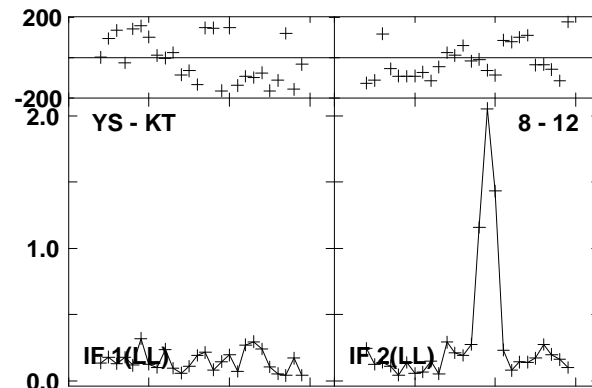
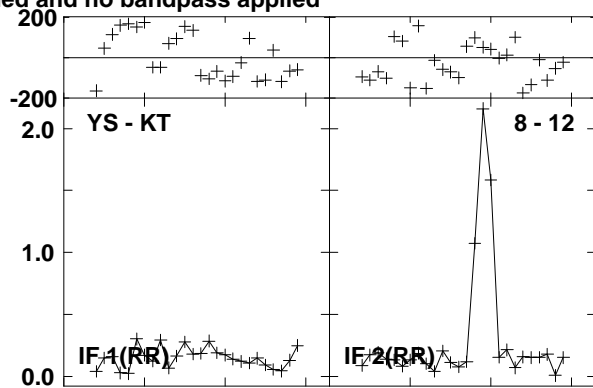
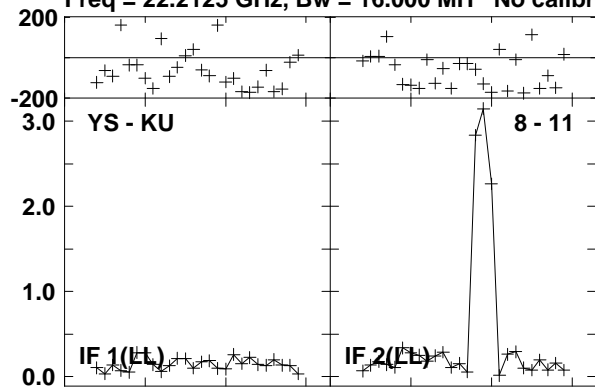

Lower frame: Milli Ampl Jy Top frame: Phas deg  
Vector averaged cross-power spectrum Baseline: YS (08) - KU (11)  
Timerange: 00/13:25:01 to 00/13:26:00

Plot file version 492 created 23-AUG-2016 15:00:58

0219+628 GA035B 1.UVDATA.1

Freq = 22.2125 GHz, Bw = 16.000 MH No calibration applied and no bandpass applied

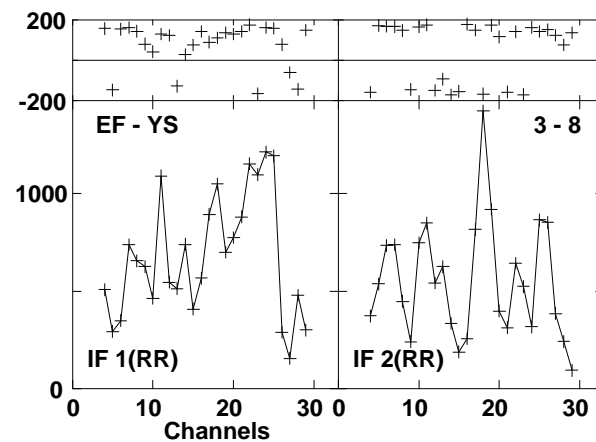
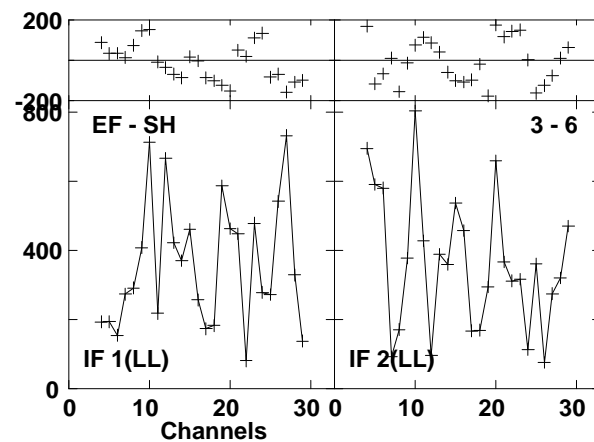
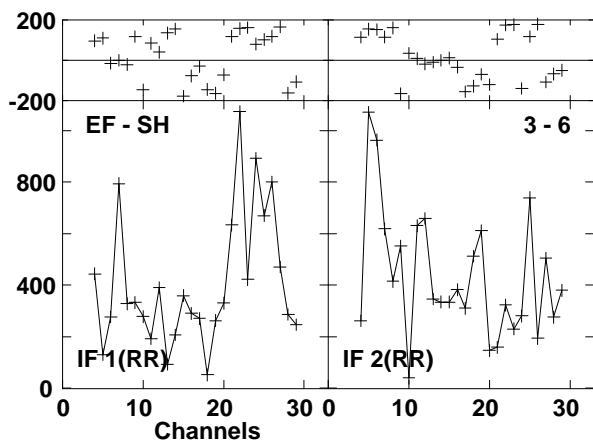
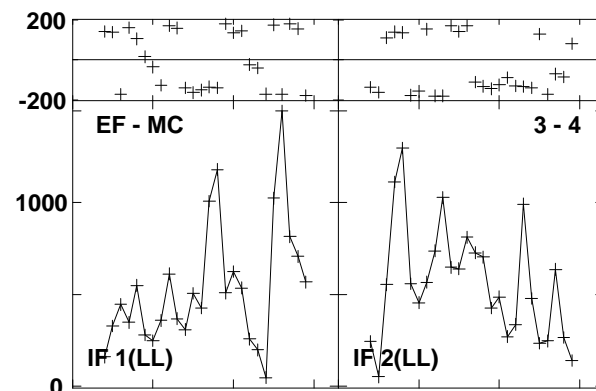
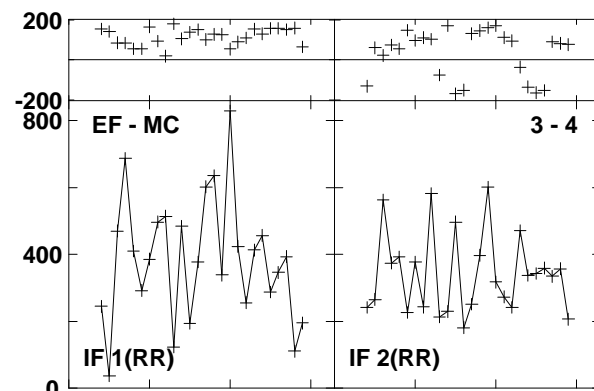
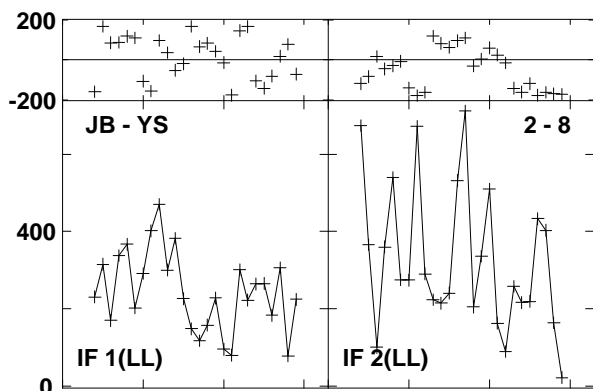
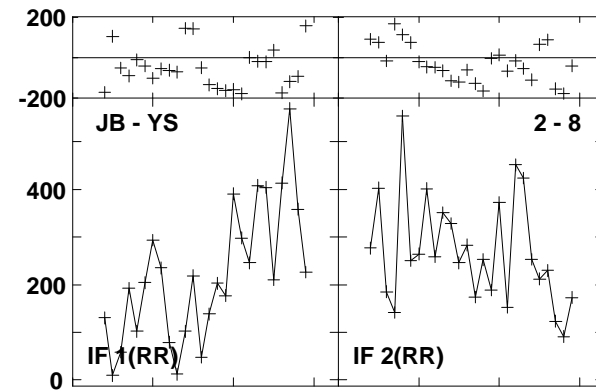
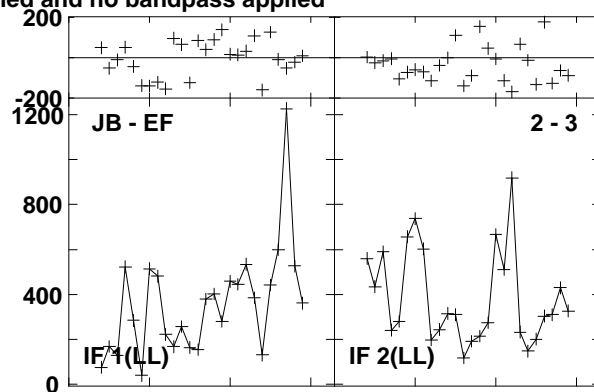
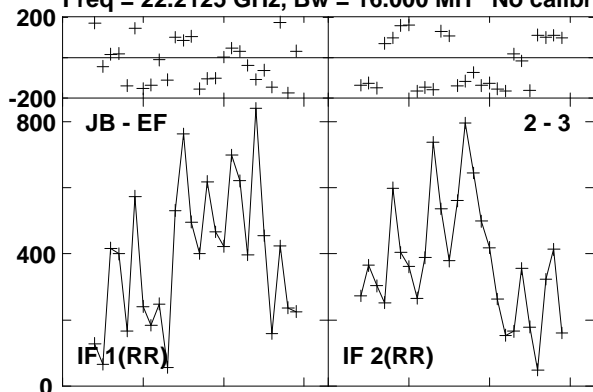

Lower frame: Micro Ampl Jy Top frame: Phas deg  
Vector averaged cross-power spectrum Baseline: JB (02) - EF (03)  
Timerange: 00/13:26:30 to 00/13:26:50

Plot file version 493 created 23-AUG-2016 15:00:58

0219+628 GA035B 1.UVDATA.1

Freq = 22.2125 GHz, Bw = 16.000 MH No calibration applied and no bandpass applied

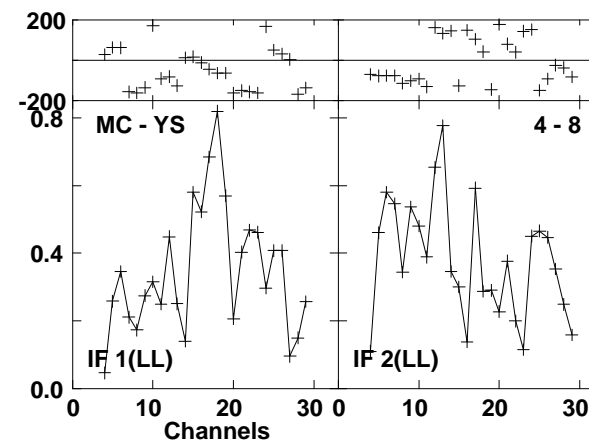
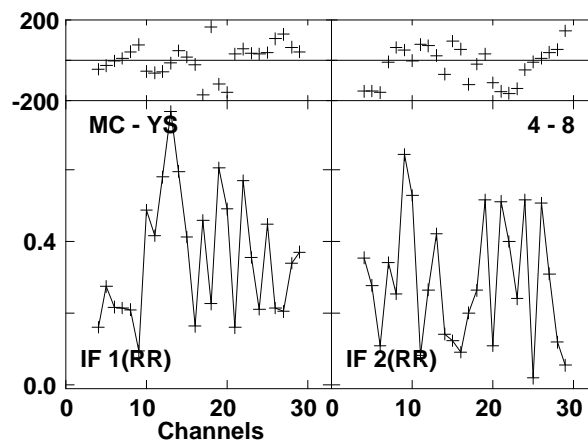
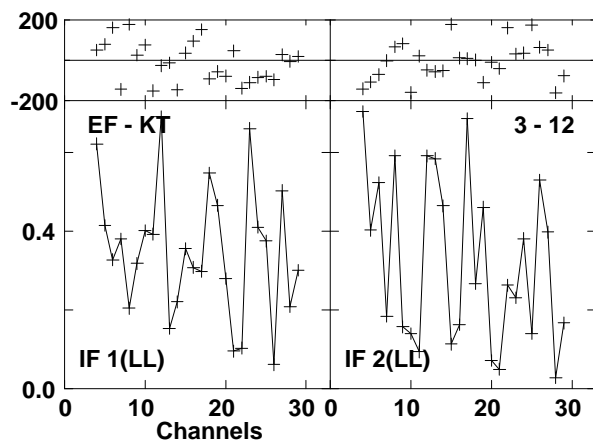
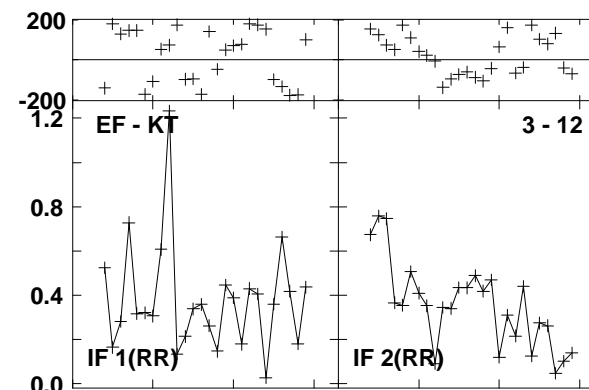
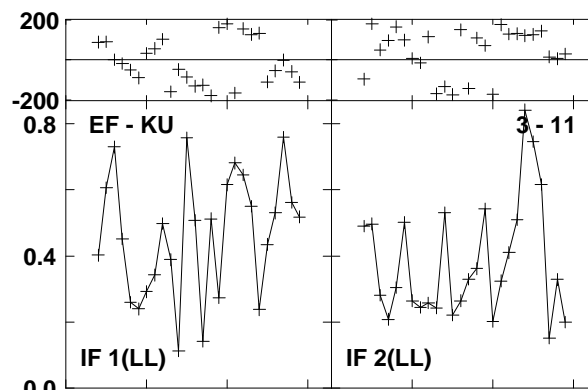
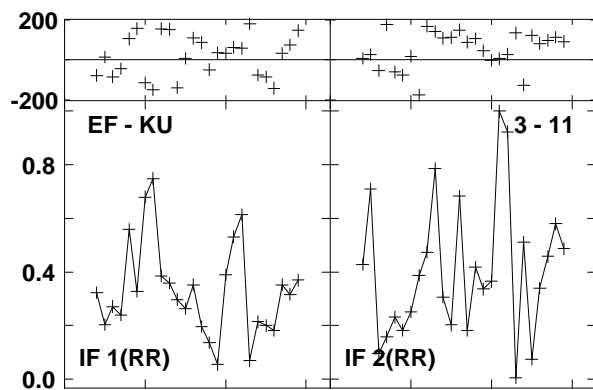
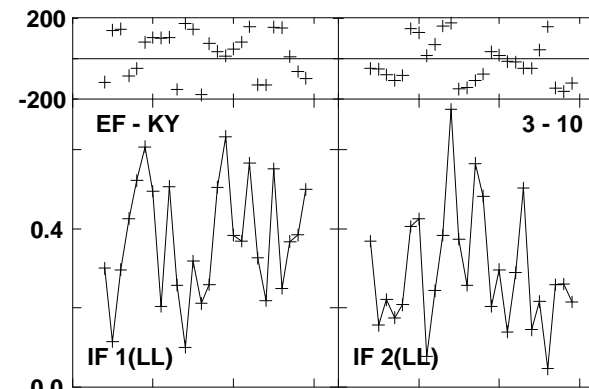
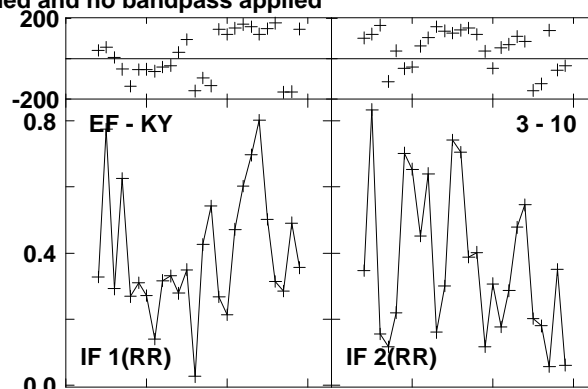
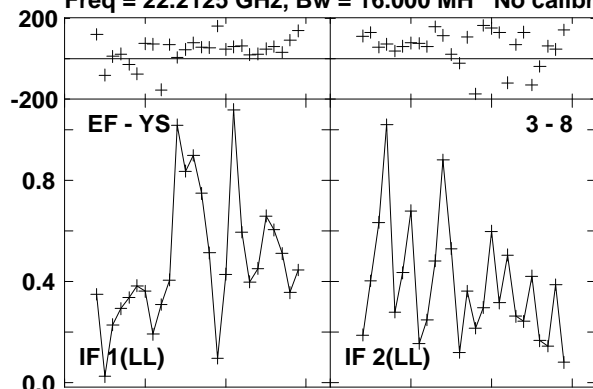

Lower frame: Milli Ampl Jy Top frame: Phas deg  
Vector averaged cross-power spectrum Baseline: EF (03) - YS (08)  
Timerange: 00/13:26:30 to 00/13:26:50

Plot file version 494 created 23-AUG-2016 15:00:58

0219+628 GA035B 1.UVDATA.1

Freq = 22.2125 GHz, Bw = 16.000 MH No calibration applied and no bandpass applied

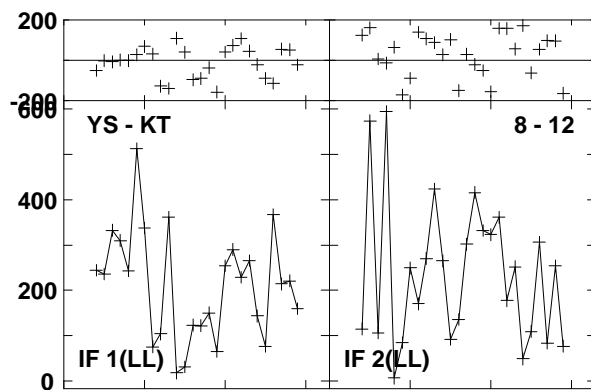
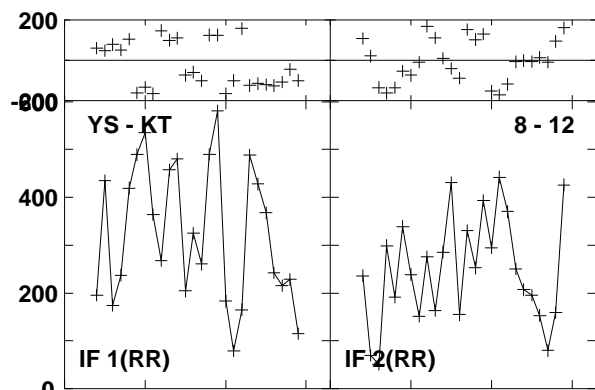
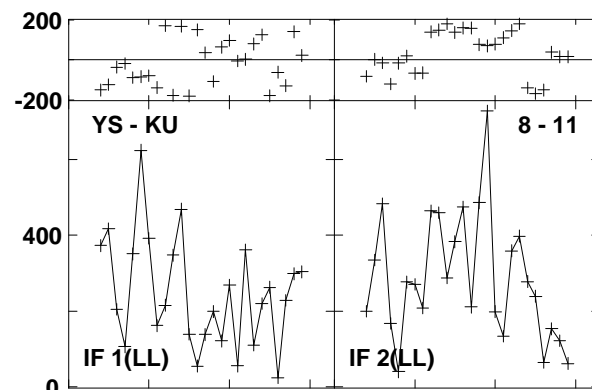
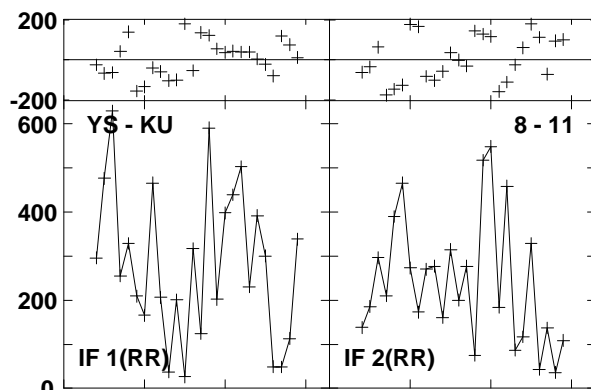
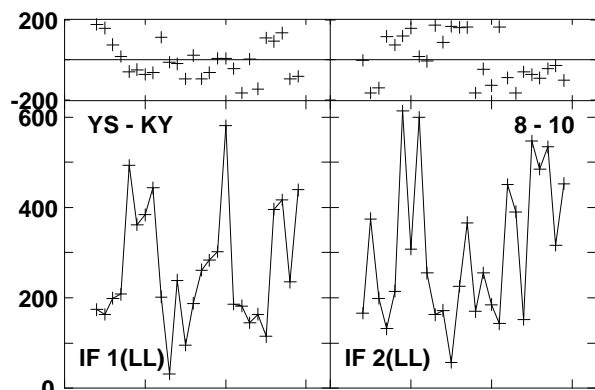
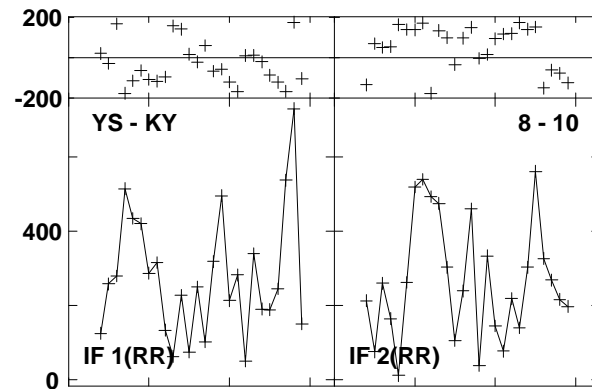
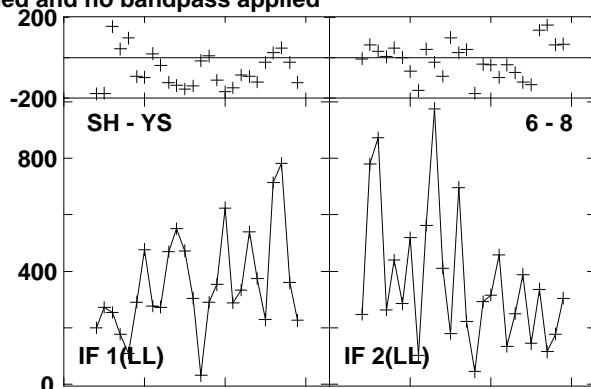
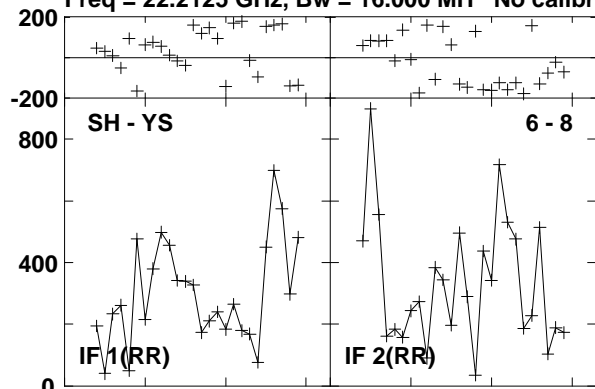

Lower frame: Micro Ampl Jy Top frame: Phas deg  
Vector averaged cross-power spectrum Baseline: SH (06) - YS (08)  
Timerange: 00/13:26:30 to 00/13:26:50

Plot file version 495 created 23-AUG-2016 15:00:58  
 W3IRS5 GA035B 1.UVDATA.1

Freq = 22.2125 GHz, Bw = 16.000 MH No calibration applied and no bandpass applied

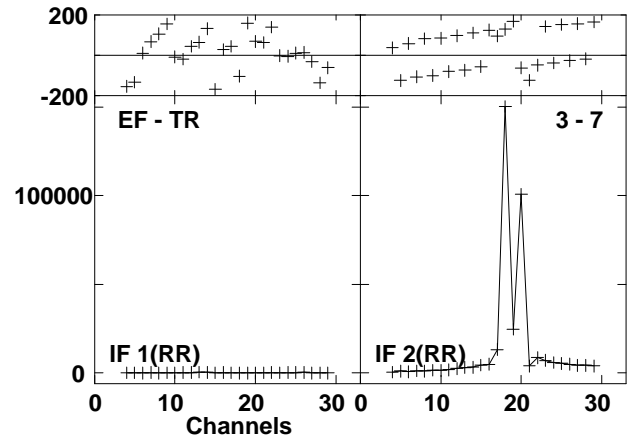
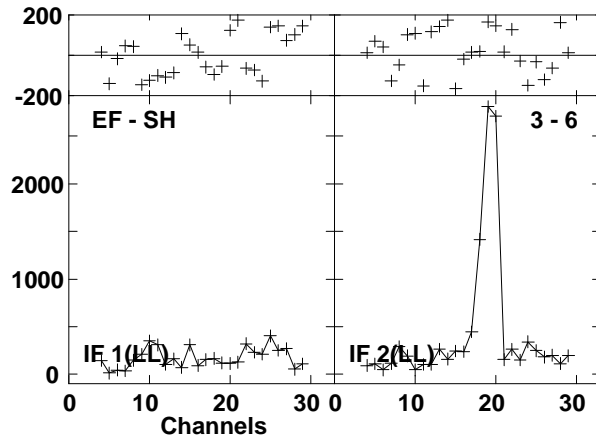
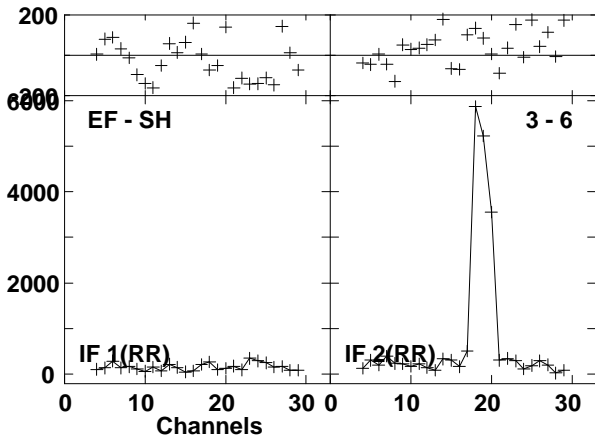
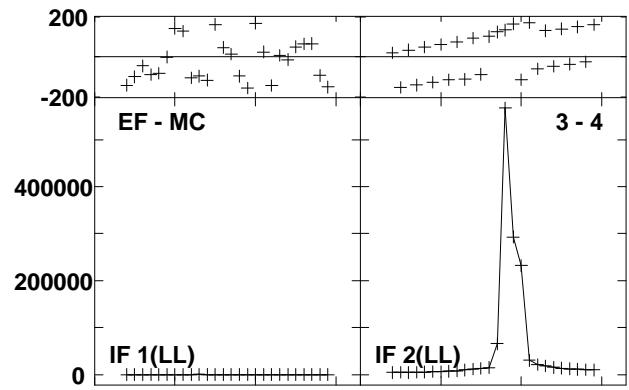
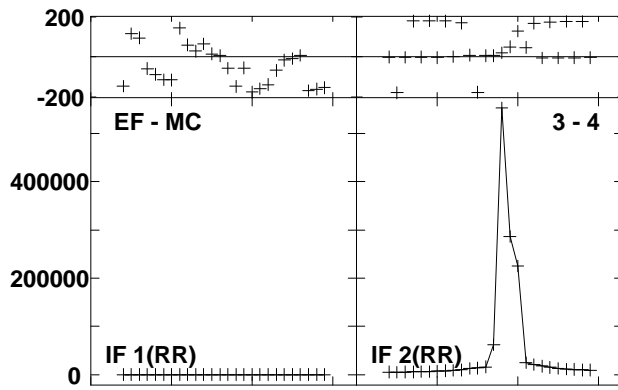
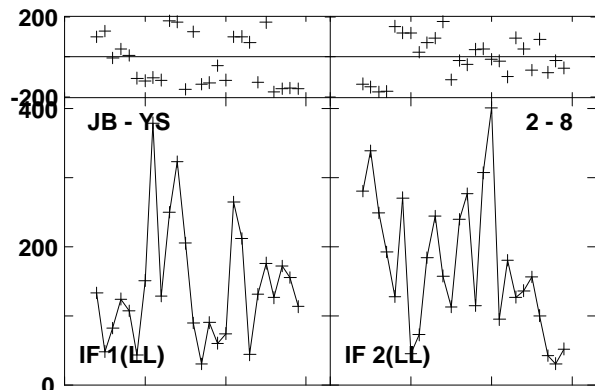
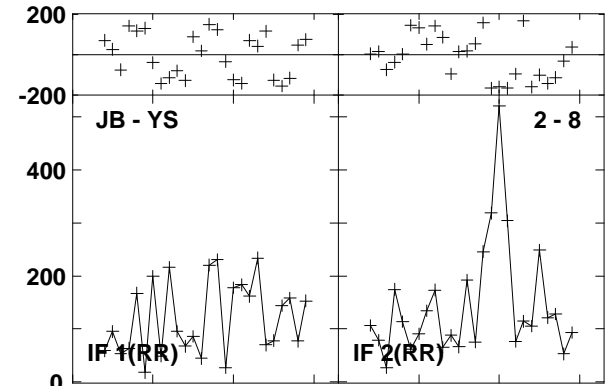
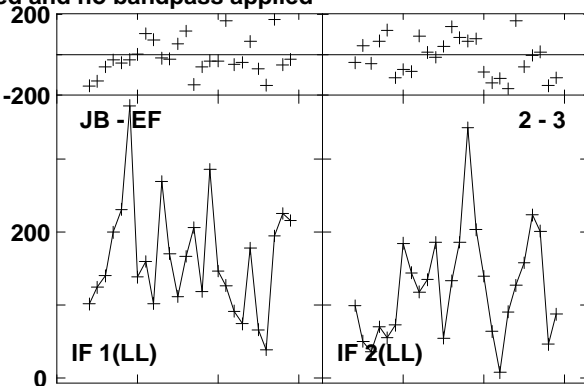
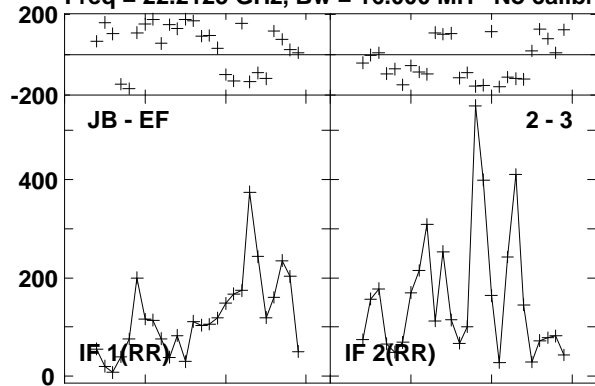

Lower frame: Micro Ampl Jy Top frame: Phas deg  
 Vector averaged cross-power spectrum Baseline: JB (02) - EF (03)  
 Timerange: 00/13:27:20 to 00/13:28:19

Plot file version 496 created 23-AUG-2016 15:00:58

W3IRS5 GA035B 1.UVDATA.1

Freq = 22.2125 GHz, Bw = 16.000 MH No calibration applied and no bandpass applied

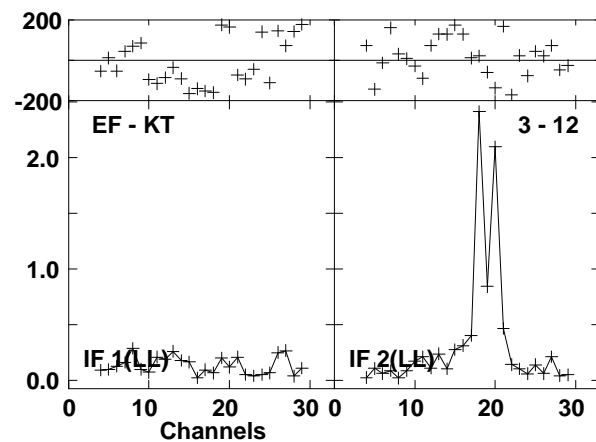
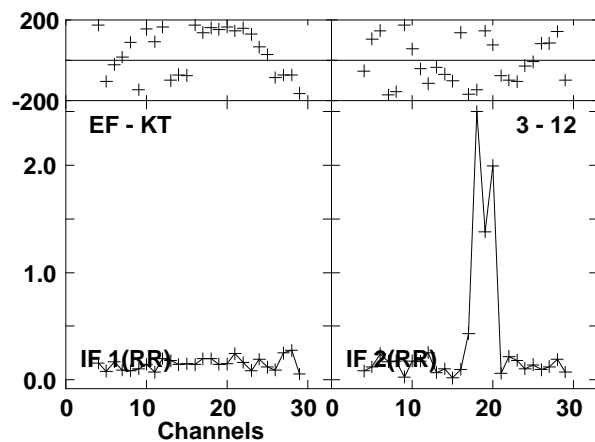
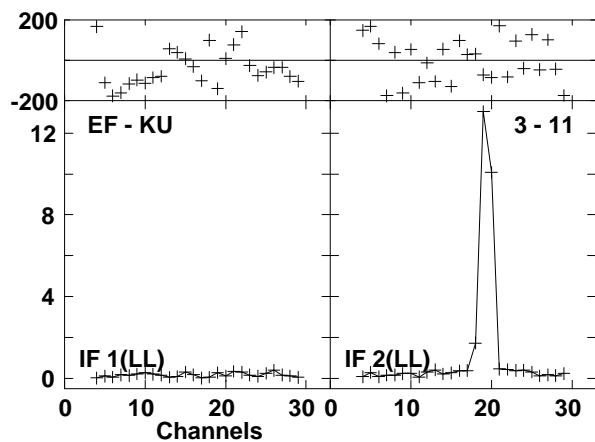
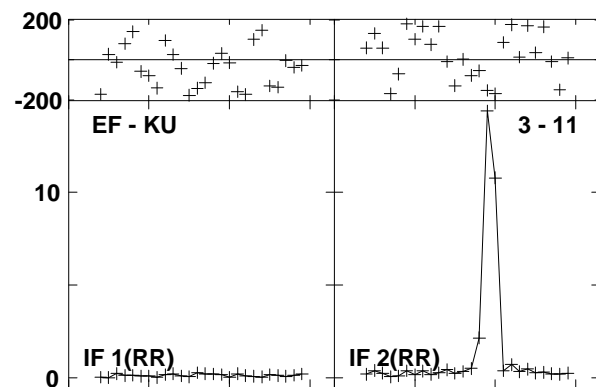
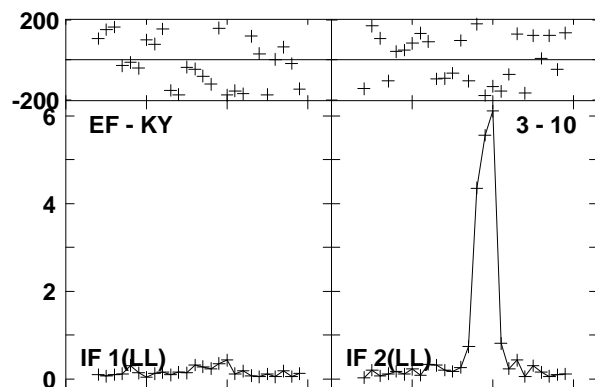
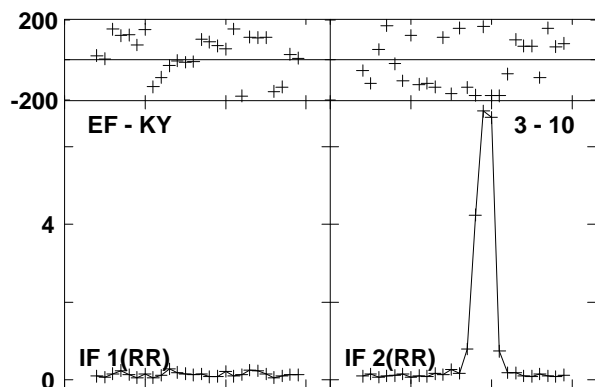
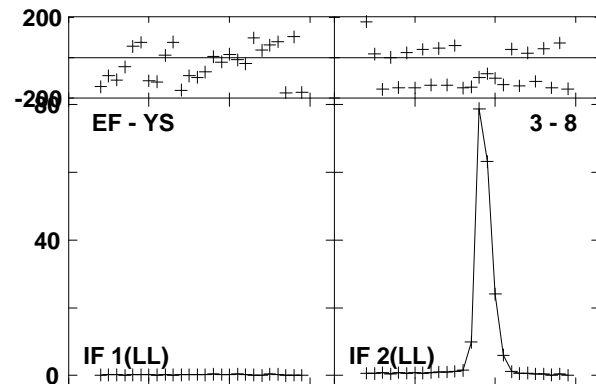
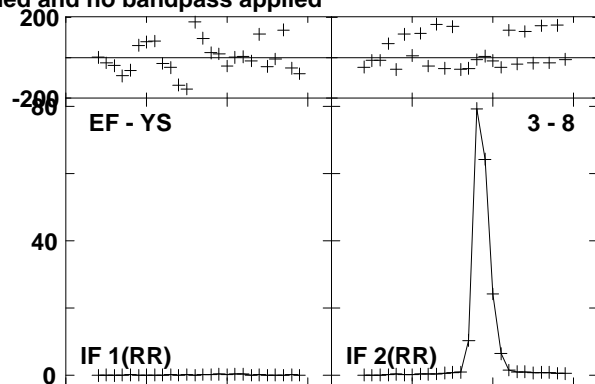
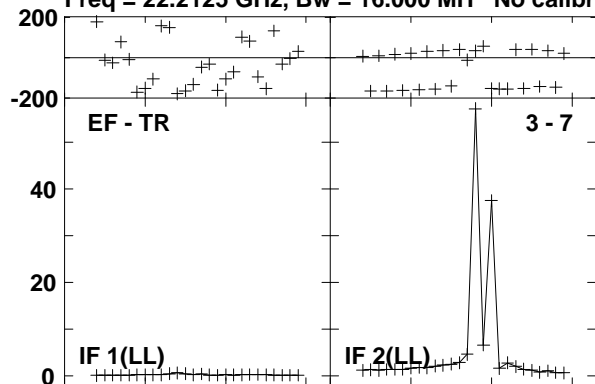

Lower frame: Milli Ampl Jy Top frame: Phas deg

Vector averaged cross-power spectrum Baseline: EF (03) - TR (07)

Timerange: 00/13:27:20 to 00/13:28:19



Plot file version 497 created 23-AUG-2016 15:00:58

W3IRS5 GA035B 1.UVDATA.1

Freq = 22.2125 GHz, Bw = 16.000 MH No calibration applied and no bandpass applied

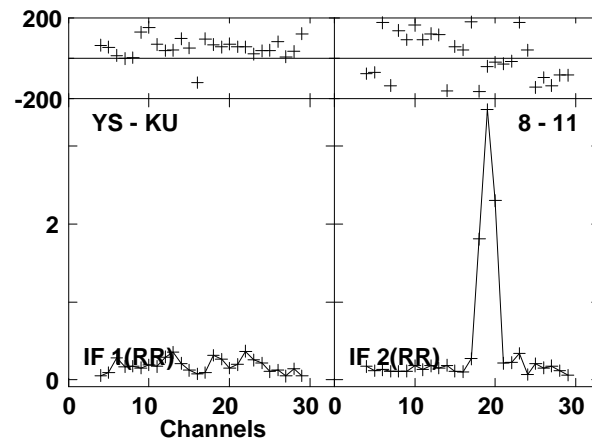
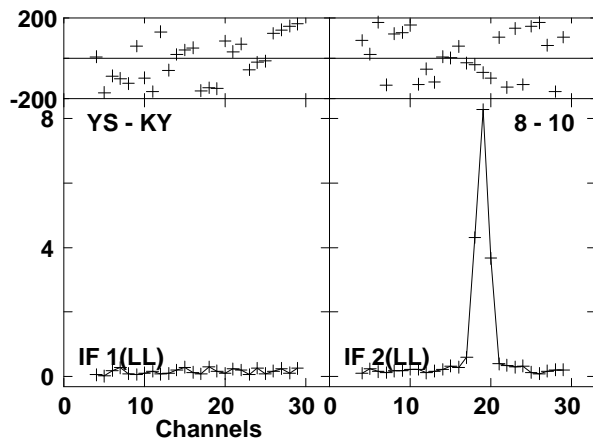
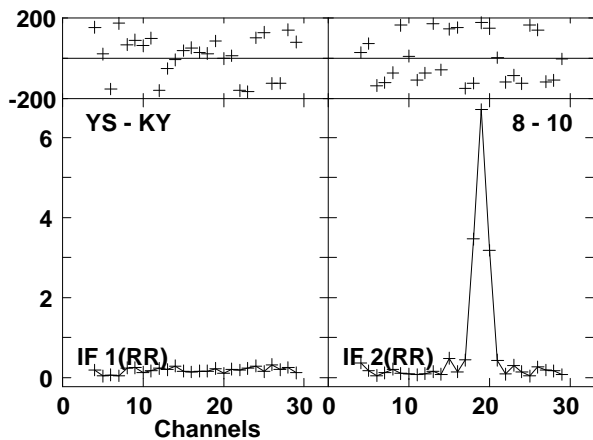
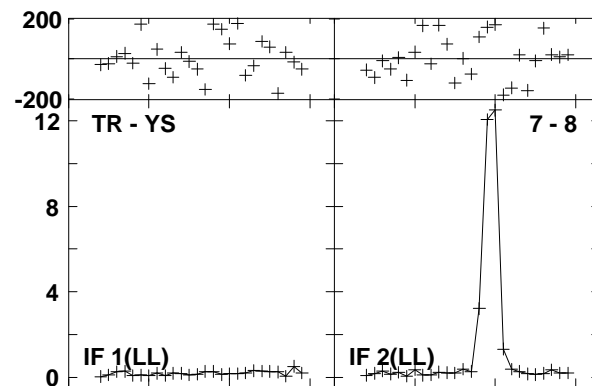
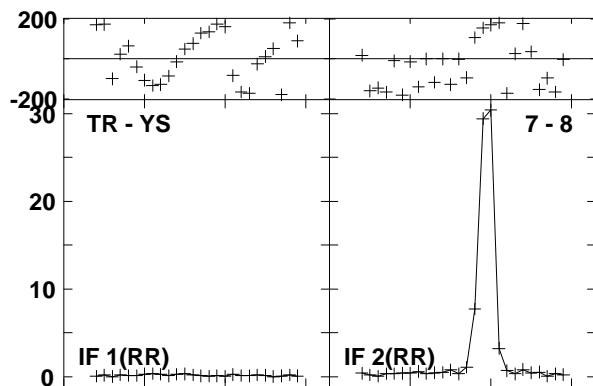
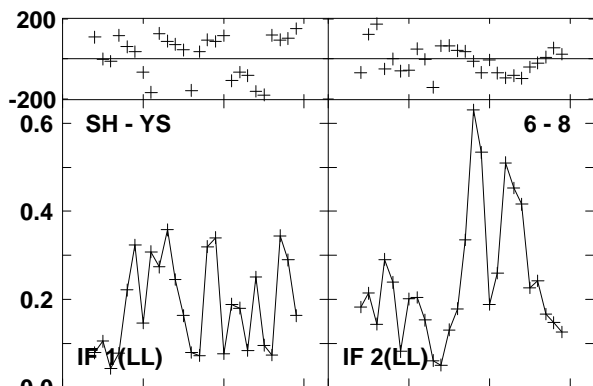
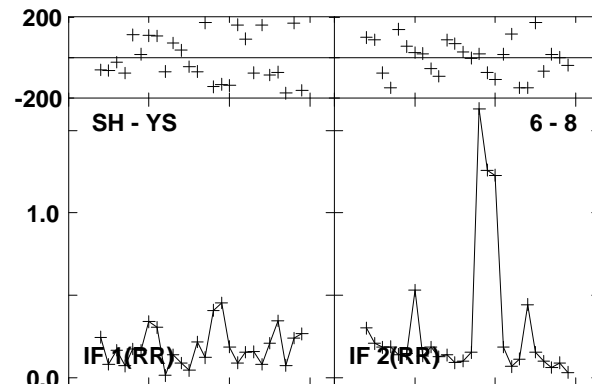
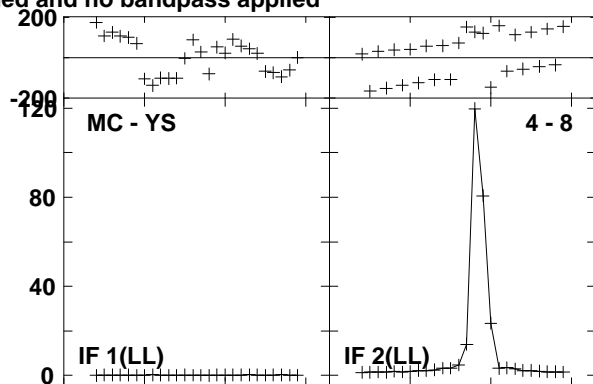
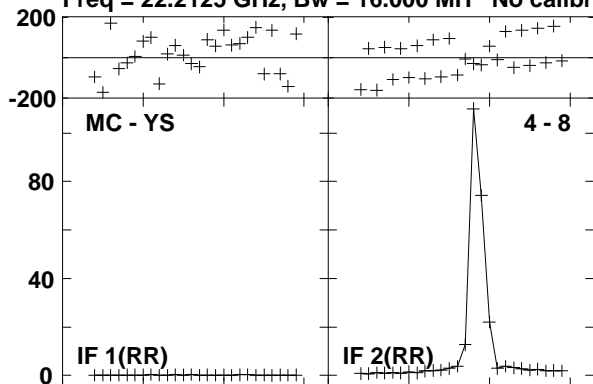

Lower frame: Milli Ampl Jy Top frame: Phas deg  
Vector averaged cross-power spectrum Baseline: MC (04) - YS (08)  
Timerange: 00/13:27:20 to 00/13:28:19

Plot file version 498 created 23-AUG-2016 15:00:58  
W3IRS5 GA035B 1.UVDATA.1

Freq = 22.2125 GHz, Bw = 16.000 MH No calibration applied and no bandpass applied

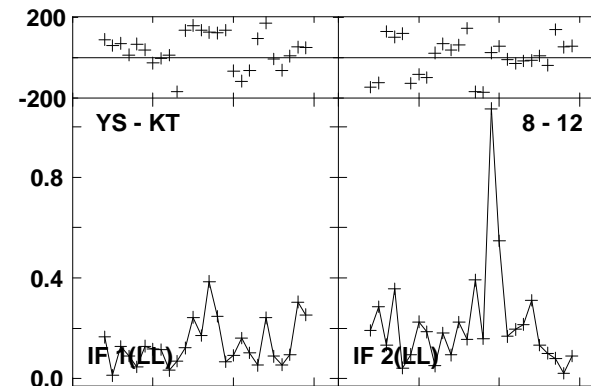
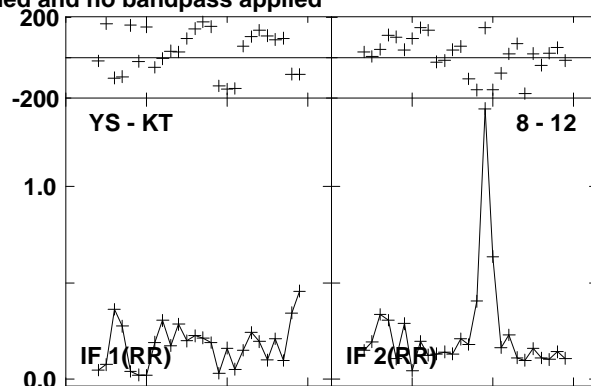
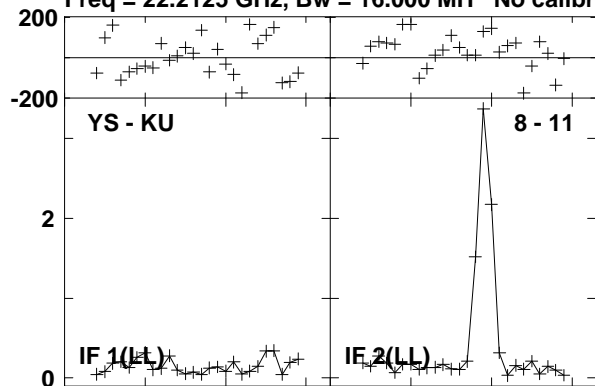

Lower frame: Milli Ampl Jy Top frame: Phas deg  
Vector averaged cross-power spectrum Baseline: YS (08) - KU (11)  
Timerange: 00/13:27:20 to 00/13:28:19

Plot file version 499 created 23-AUG-2016 15:00:58

0219+628 GA035B 1.UVDATA.1

Freq = 22.2125 GHz, Bw = 16.000 MH No calibration applied and no bandpass applied

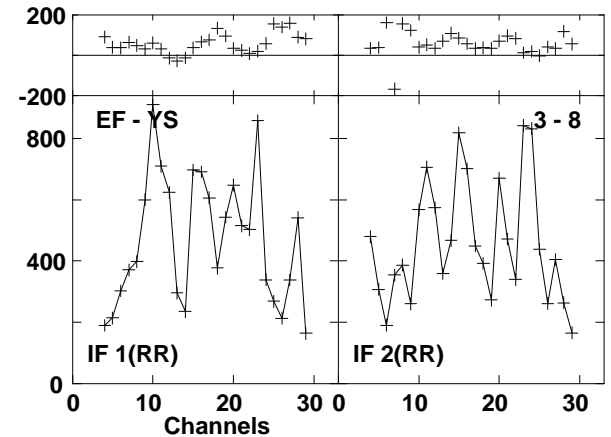
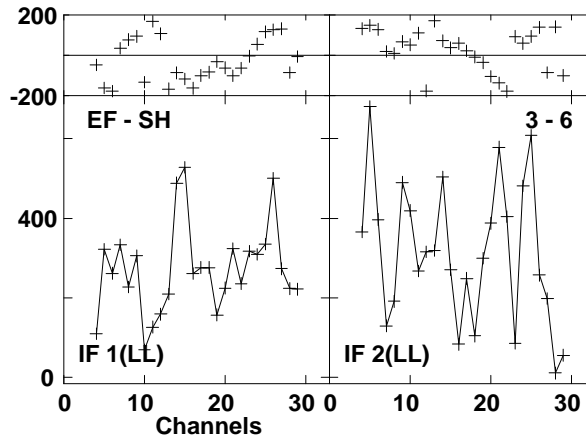
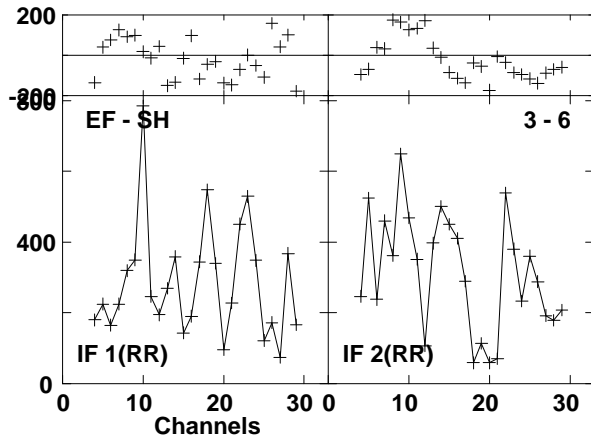
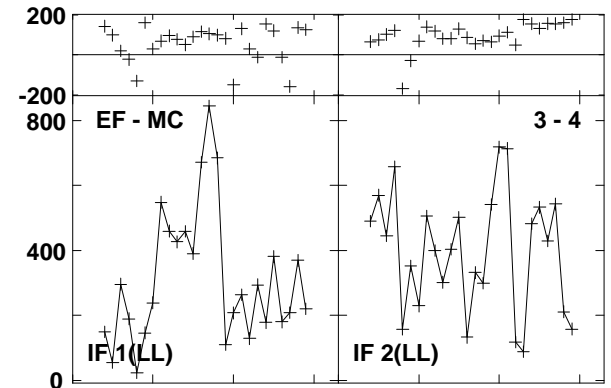
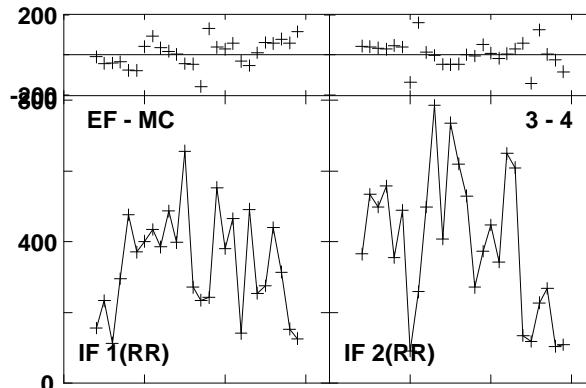
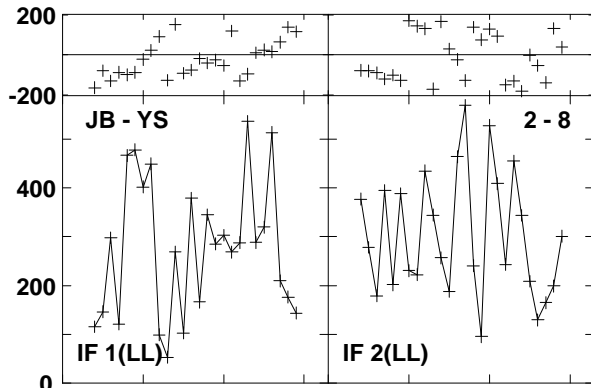
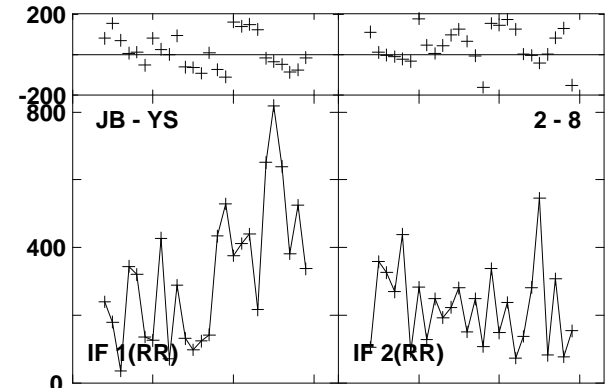
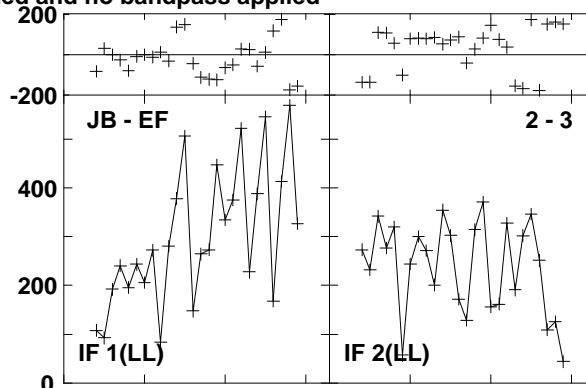
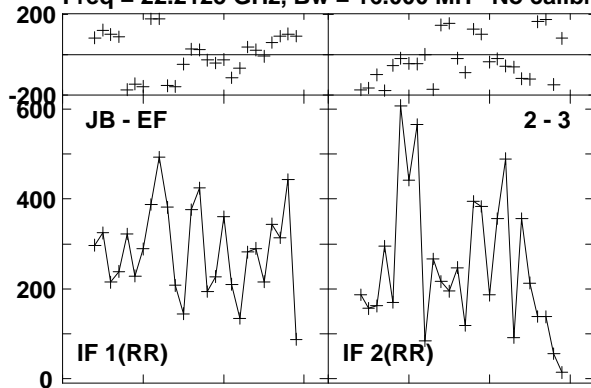

Lower frame: Micro Ampl Jy Top frame: Phas deg

Vector averaged cross-power spectrum Baseline: JB (02) - EF (03)

Timerange: 00/13:28:50 to 00/13:29:10

Plot file version 500 created 23-AUG-2016 15:00:58

0219+628 GA035B 1.UVDATA.1

Freq = 22.2125 GHz, Bw = 16.000 MH No calibration applied and no bandpass applied

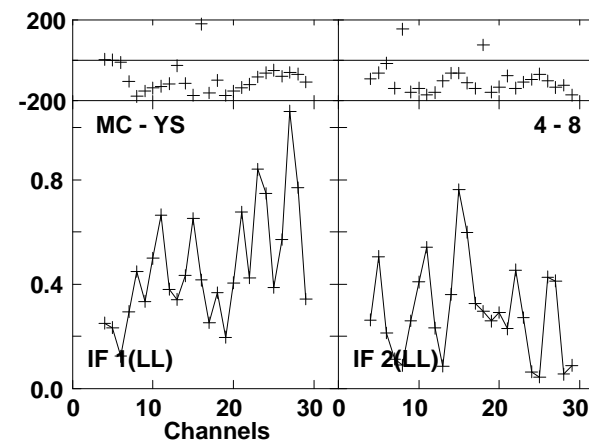
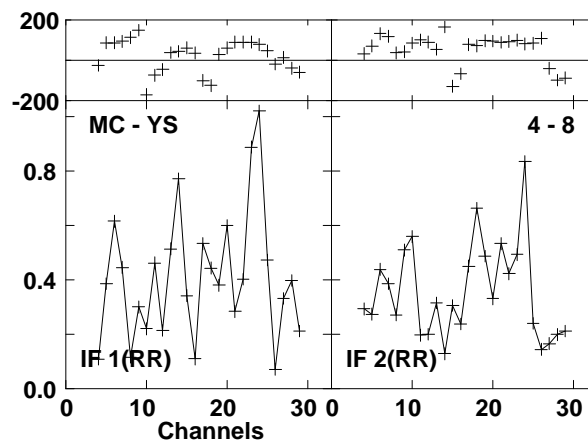
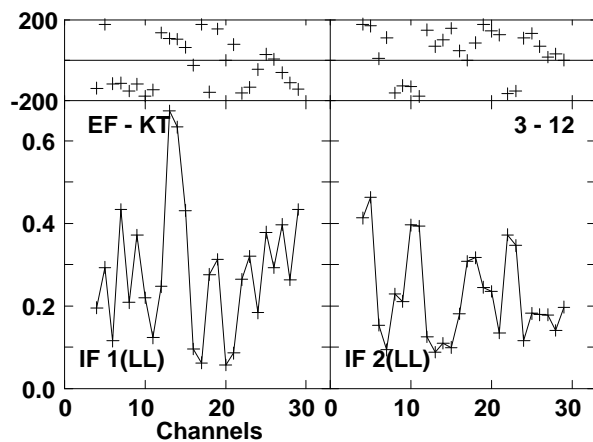
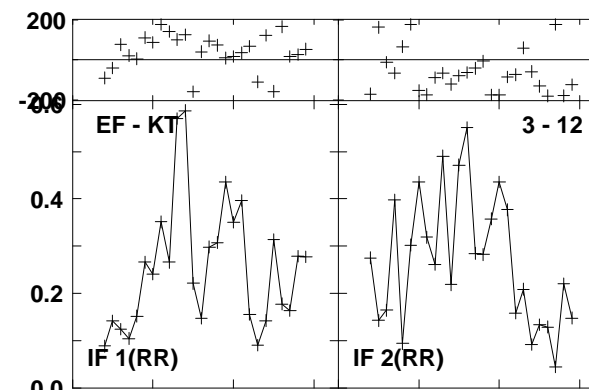
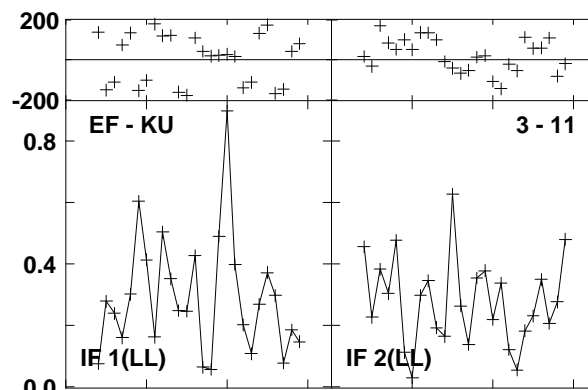
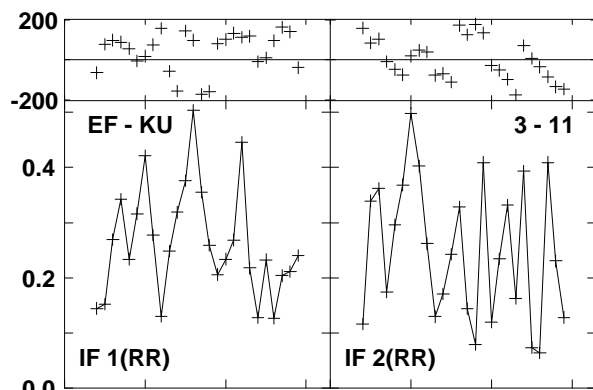
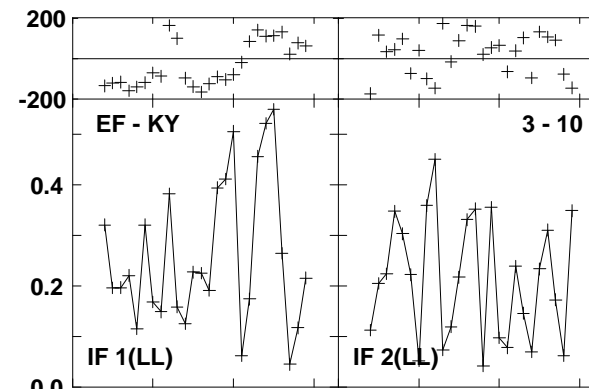
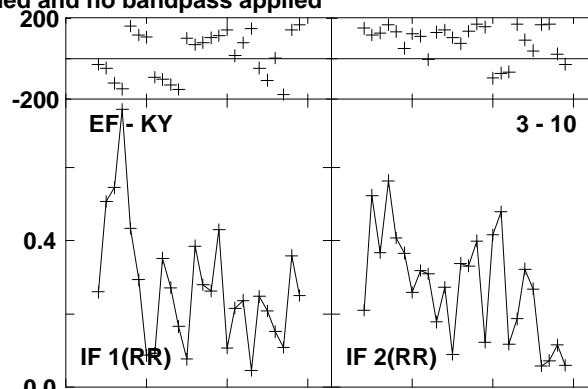
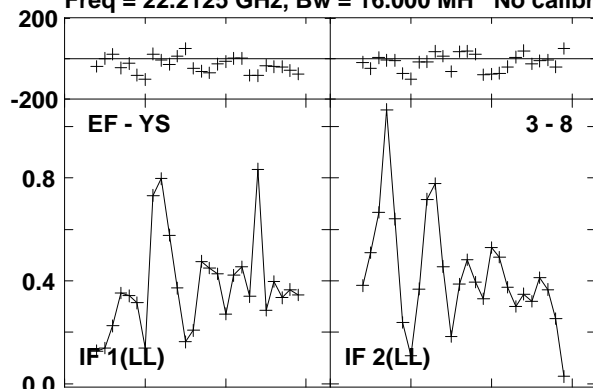

Lower frame: Milli Ampl Jy Top frame: Phas deg

Vector averaged cross-power spectrum Baseline: EF (03) - YS (08)

Timerange: 00/13:28:50 to 00/13:29:10

Plot file version 501 created 23-AUG-2016 15:00:58

0219+628 GA035B 1.UVDATA.1

Freq = 22.2125 GHz, Bw = 16.000 MH No calibration applied and no bandpass applied

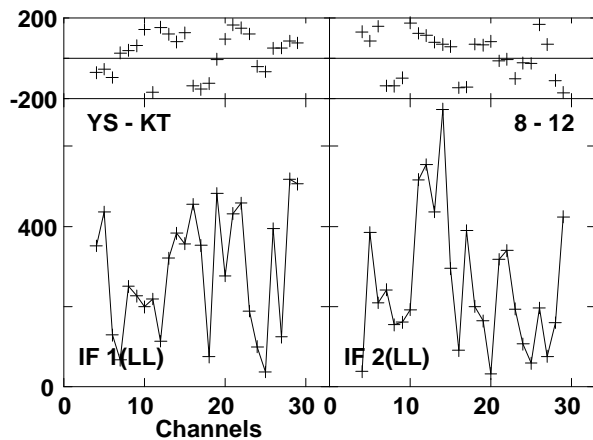
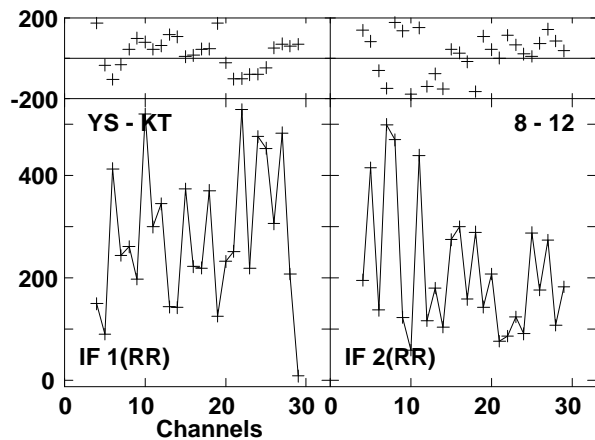
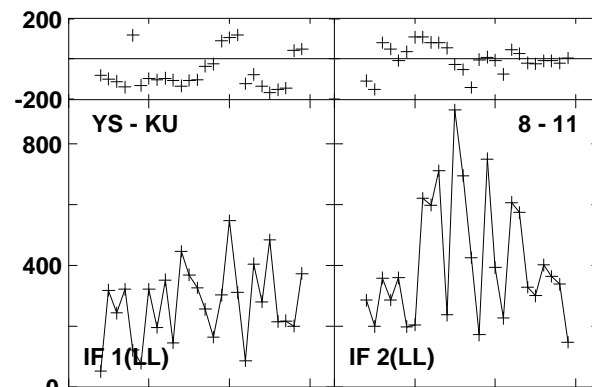
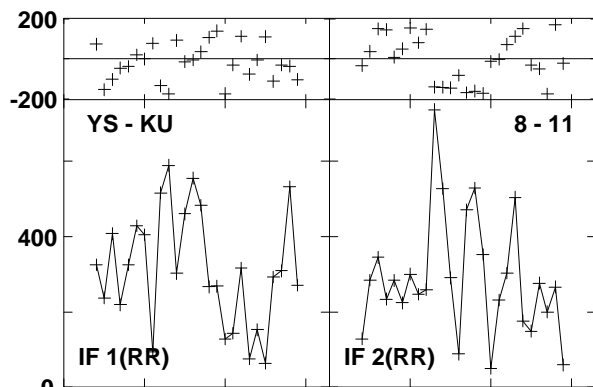
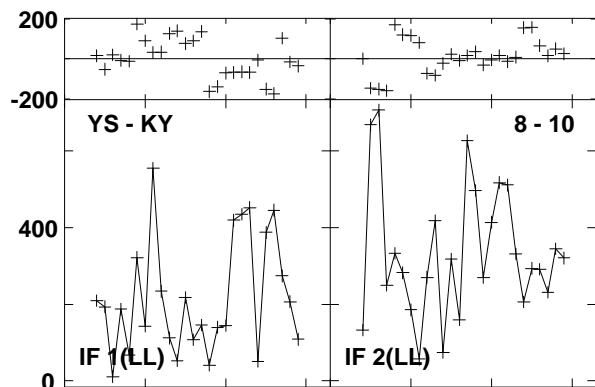
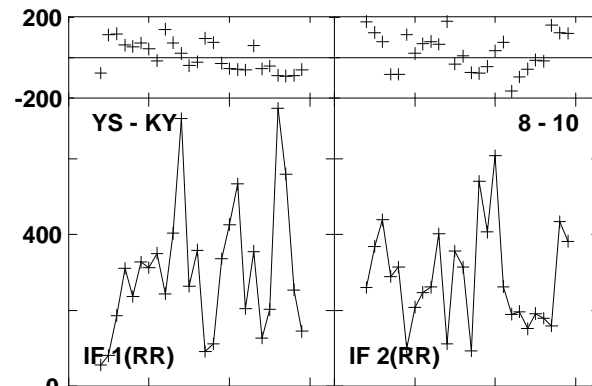
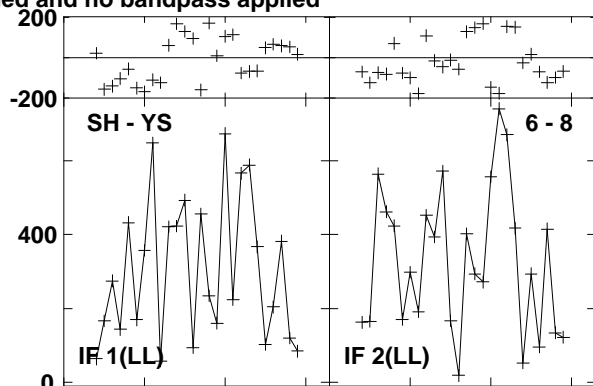
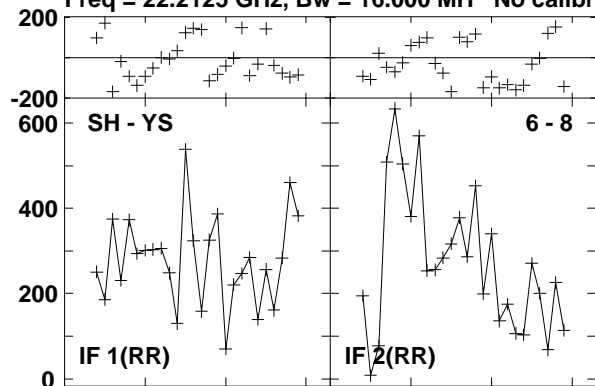

Lower frame: Micro Ampl Jy Top frame: Phas deg

Vector averaged cross-power spectrum Baseline: SH (06) - YS (08)

Timerange: 00/13:28:50 to 00/13:29:10

Plot file version 502 created 23-AUG-2016 15:00:58

W3IRS5 GA035B 1.UVDATA.1

Freq = 22.2125 GHz, Bw = 16.000 MH No calibration applied and no bandpass applied

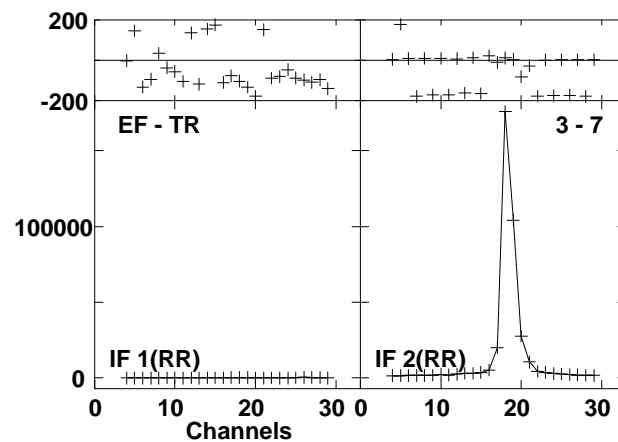
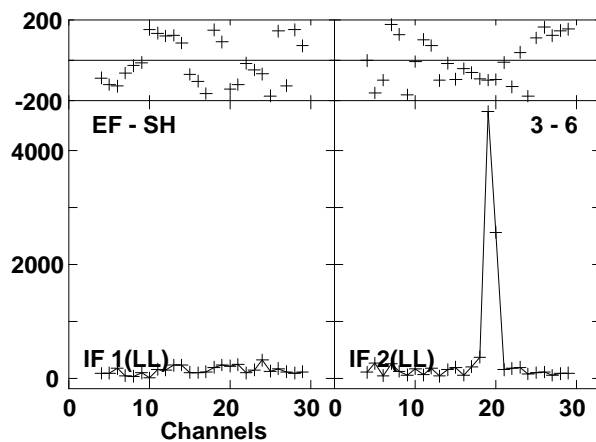
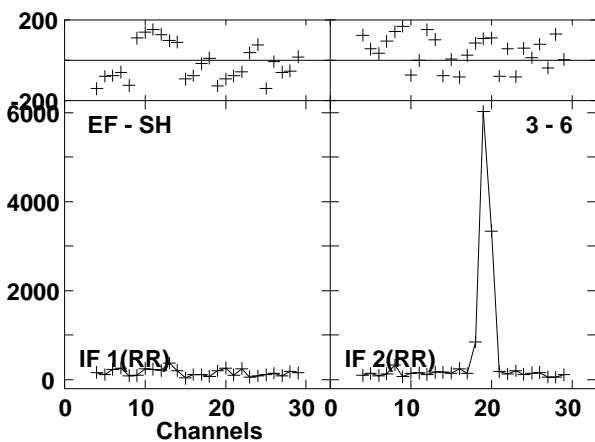
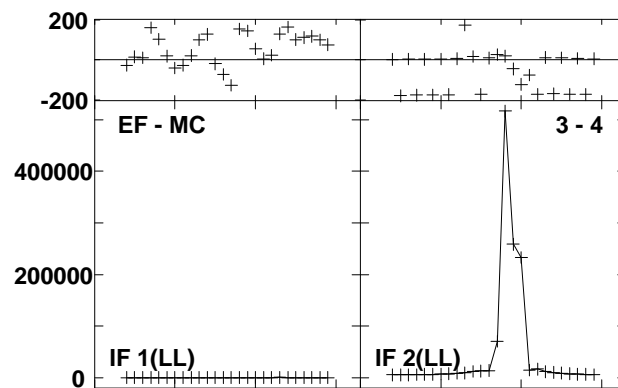
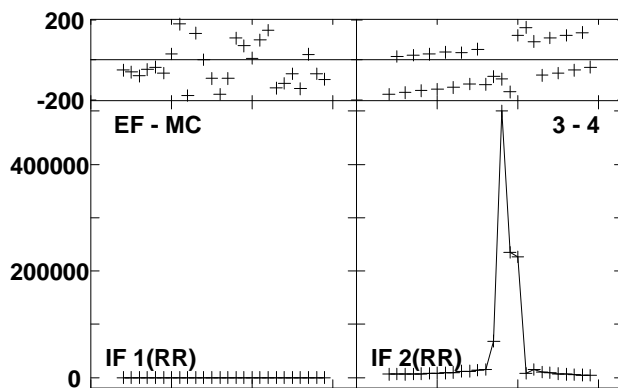
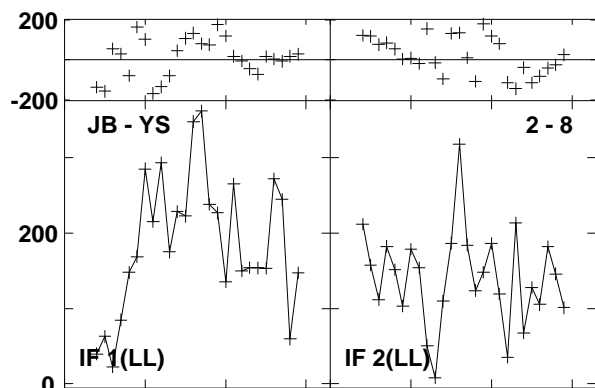
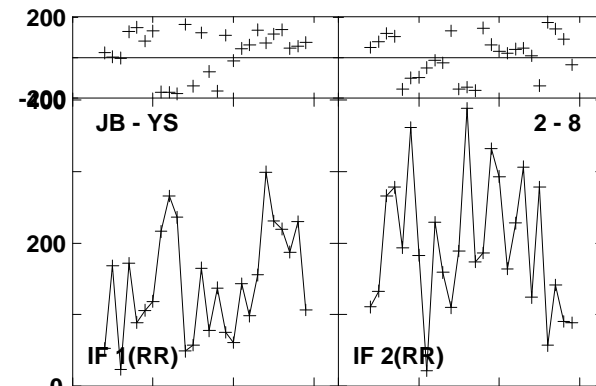
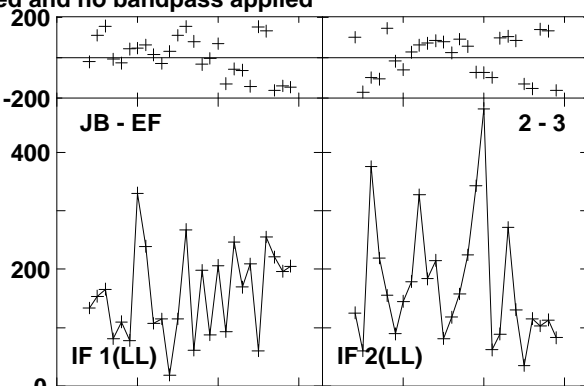
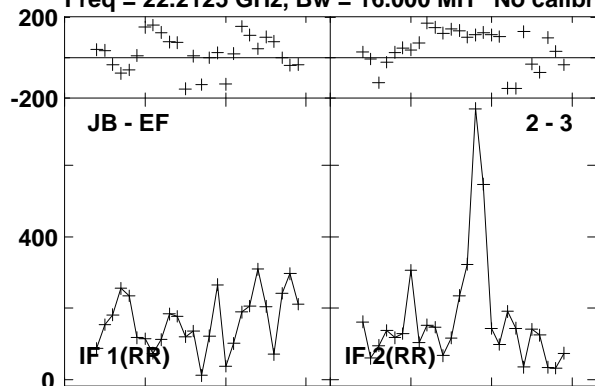

Lower frame: Micro Ampl Jy Top frame: Phas deg  
Vector averaged cross-power spectrum Baseline: JB (02) - EF (03)  
Timerange: 00/13:29:41 to 00/13:30:39

Plot file version 503 created 23-AUG-2016 15:00:58

W3IRS5 GA035B 1.UVDATA.1

Freq = 22.2125 GHz, Bw = 16.000 MH No calibration applied and no bandpass applied

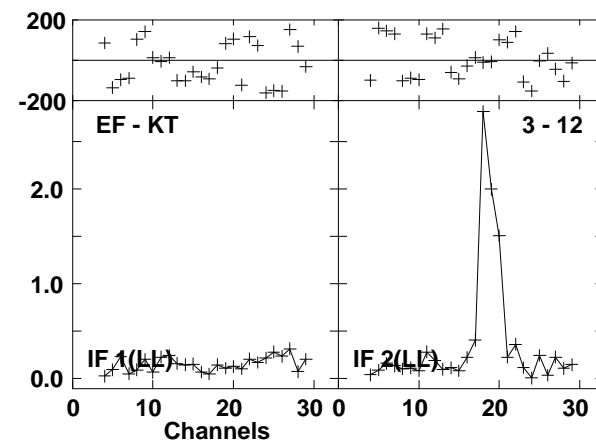
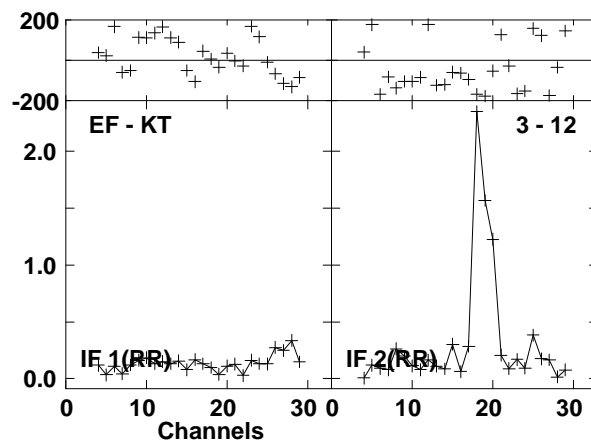
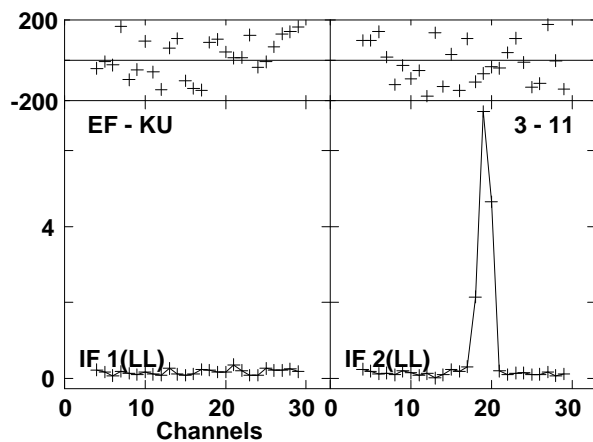
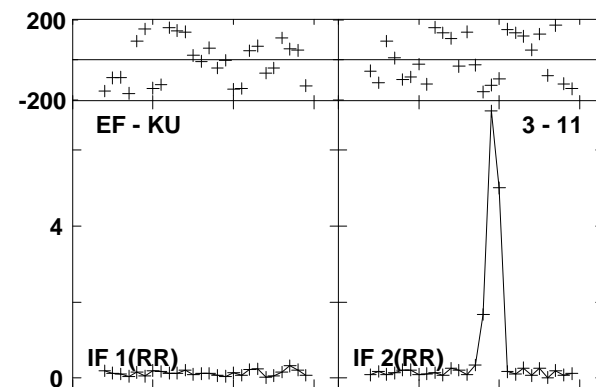
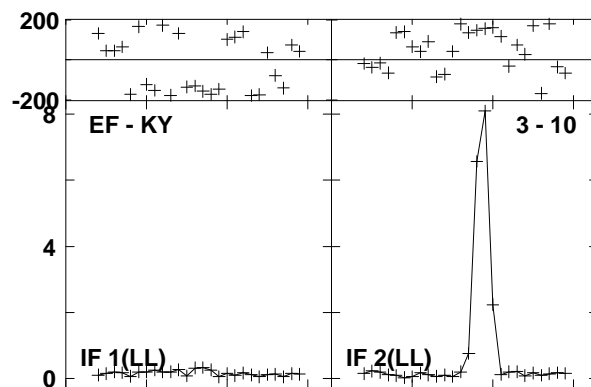
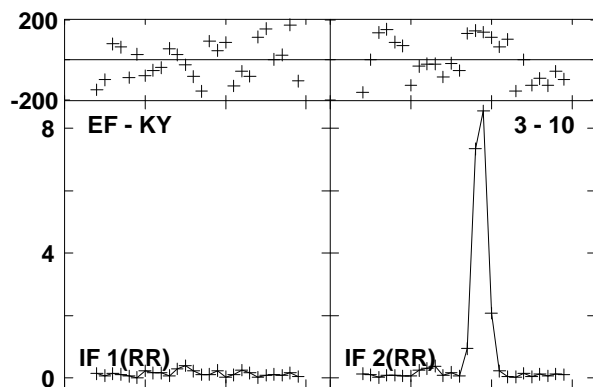
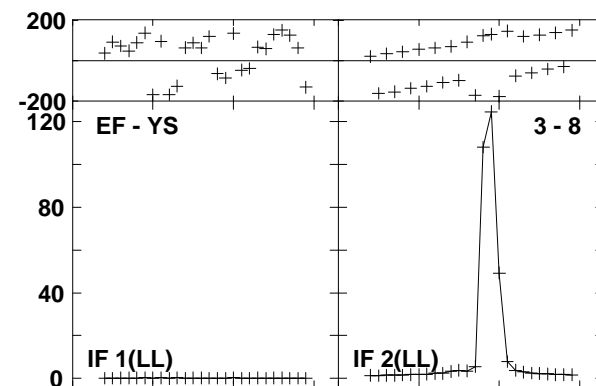
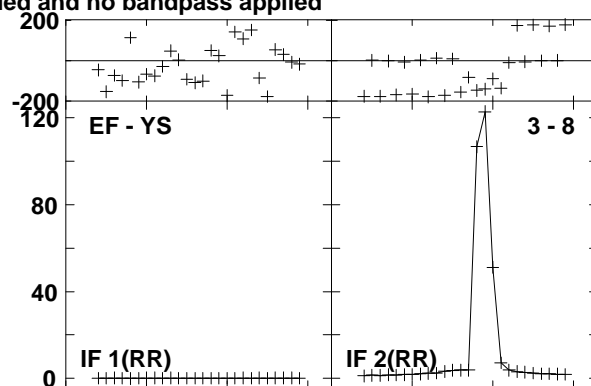
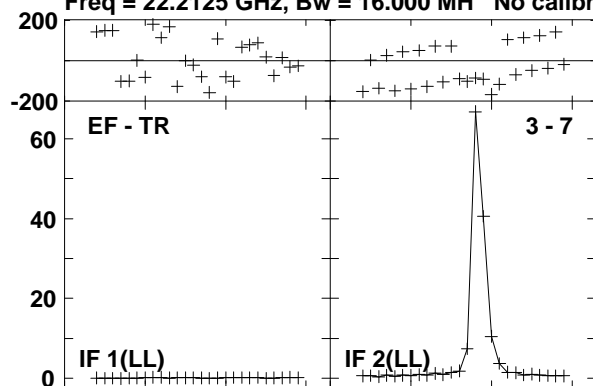

Lower frame: Milli Ampl Jy Top frame: Phas deg  
Vector averaged cross-power spectrum Baseline: EF (03) - TR (07)  
Timerange: 00/13:29:41 to 00/13:30:39

Plot file version 504 created 23-AUG-2016 15:00:58

W3IRS5 GA035B 1.UVDATA.1

Freq = 22.2125 GHz, Bw = 16.000 MH No calibration applied and no bandpass applied

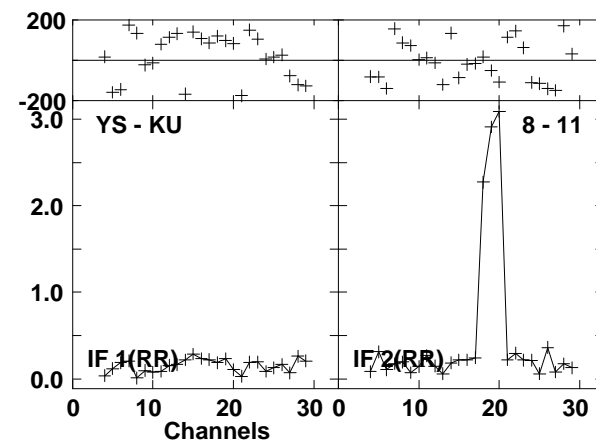
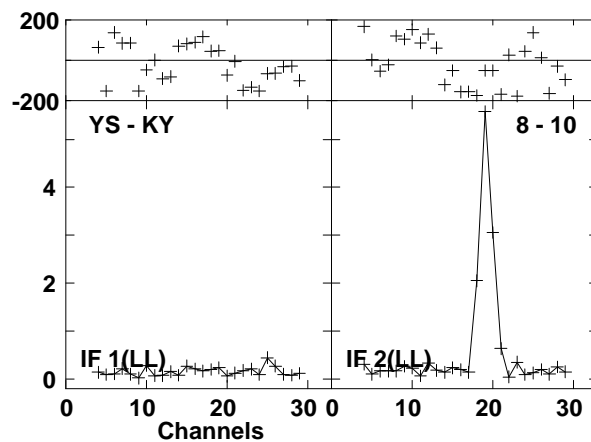
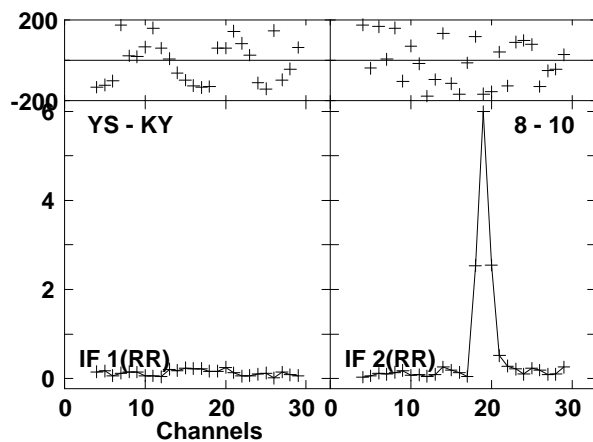
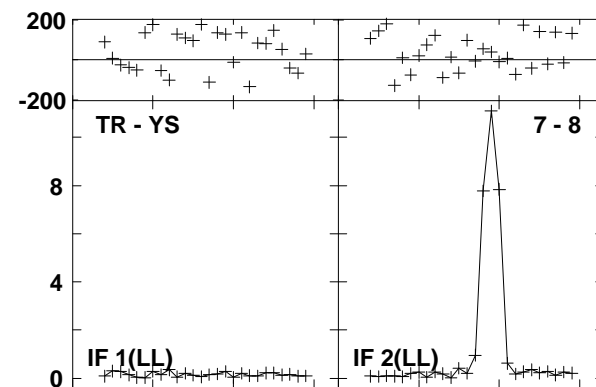
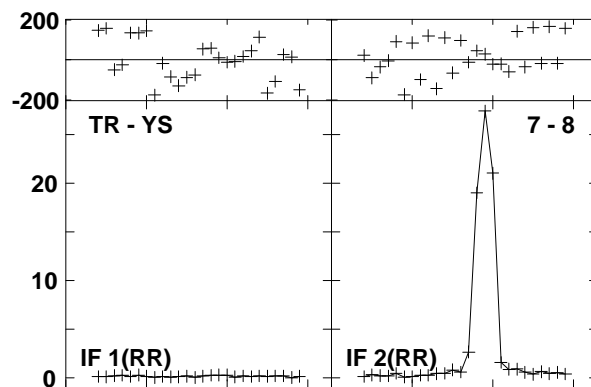
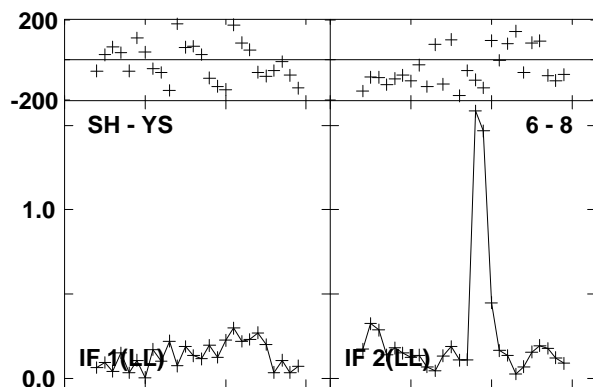
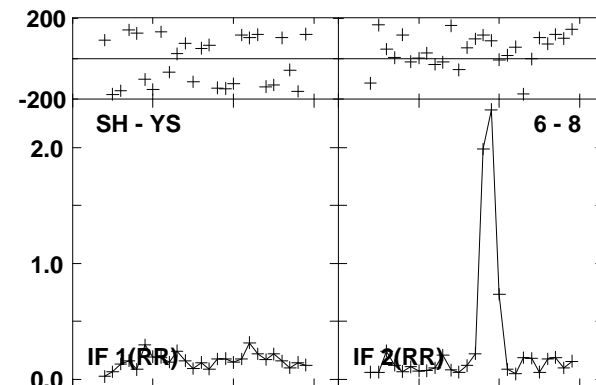
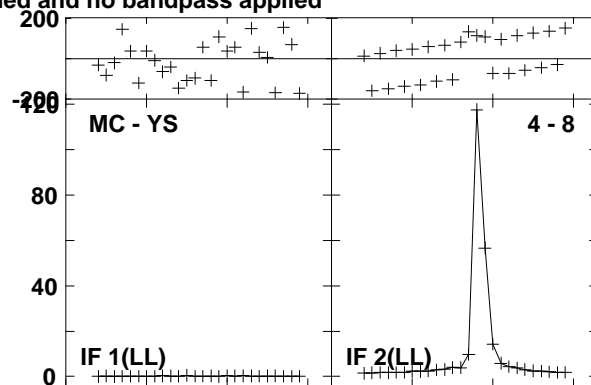
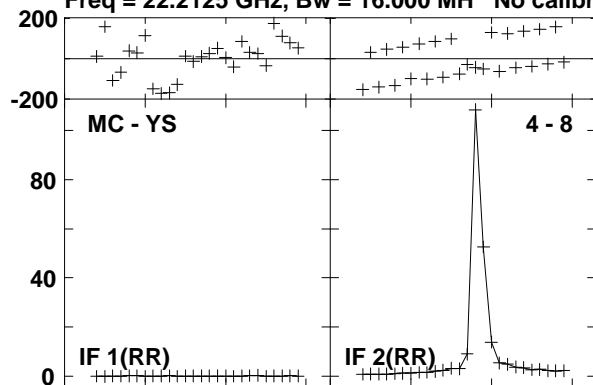

Lower frame: Milli Ampl Jy Top frame: Phas deg  
Vector averaged cross-power spectrum Baseline: MC (04) - YS (08)  
Timerange: 00/13:29:41 to 00/13:30:39



Plot file version 505 created 23-AUG-2016 15:00:58

W3IRS5 GA035B 1.UVDATA.1

Freq = 22.2125 GHz, Bw = 16.000 MH No calibration applied and no bandpass applied

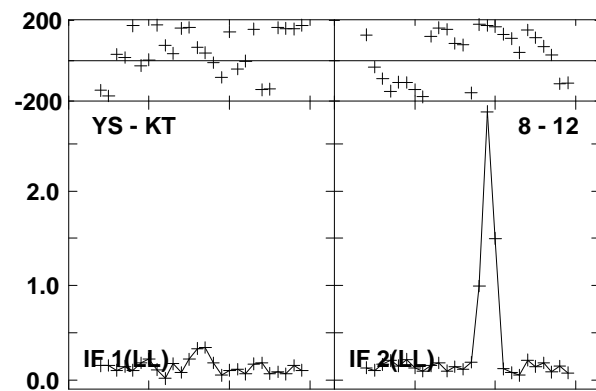
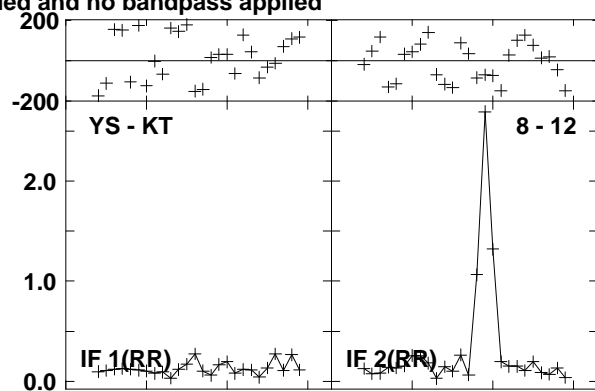
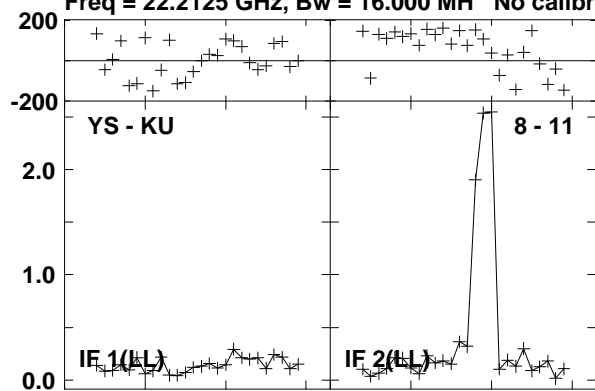

Lower frame: Milli Ampl Jy Top frame: Phas deg  
Vector averaged cross-power spectrum Baseline: YS (08) - KU (11)  
Timerange: 00/13:29:41 to 00/13:30:39

Plot file version 506 created 23-AUG-2016 15:00:58

0219+628 GA035B 1.UVDATA.1

Freq = 22.2125 GHz, Bw = 16.000 MH No calibration applied and no bandpass applied

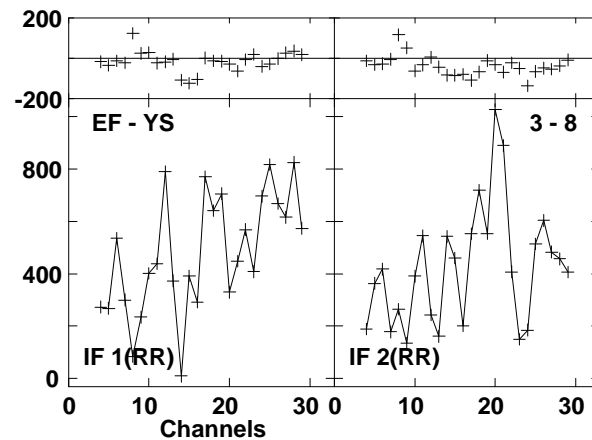
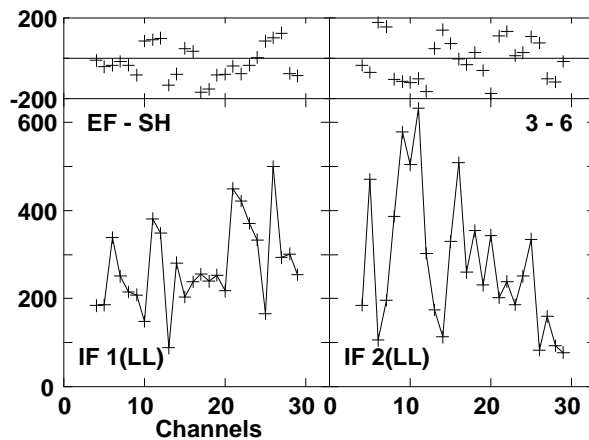
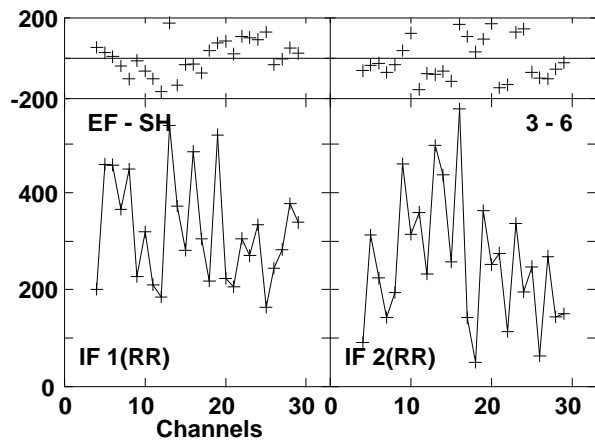
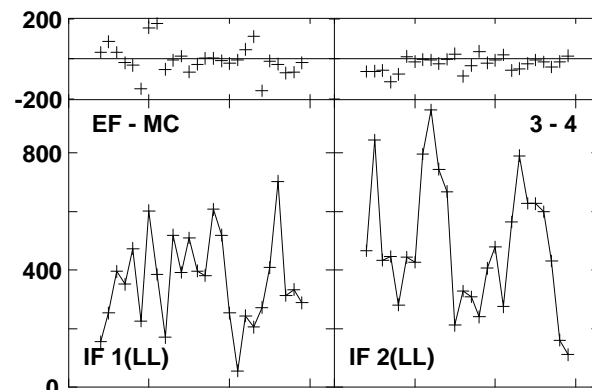
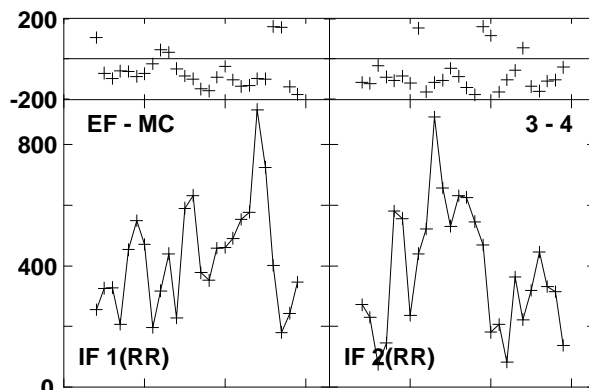
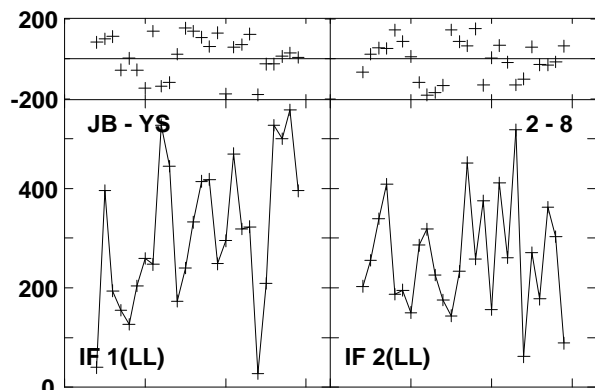
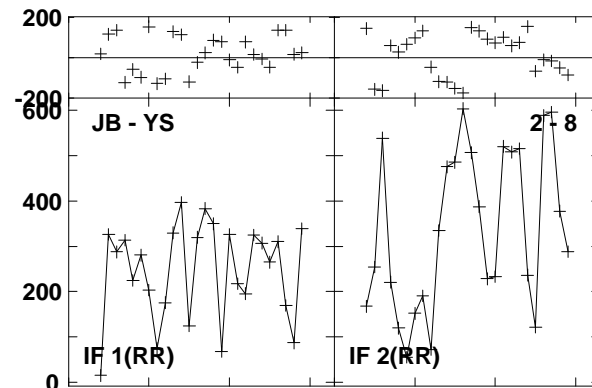
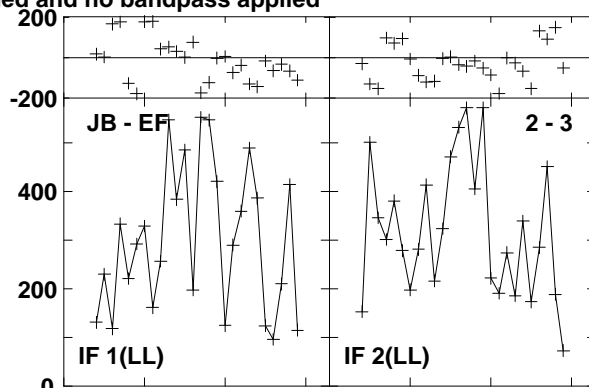
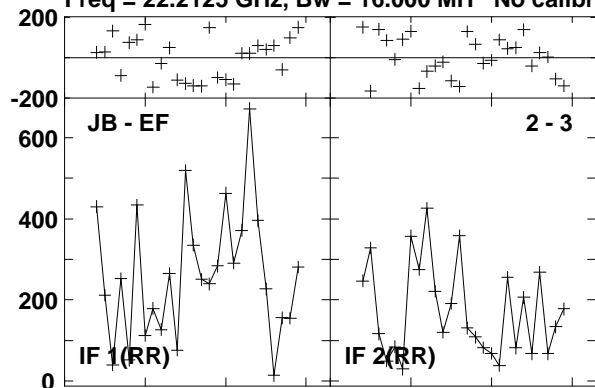

Lower frame: Micro Ampl Jy Top frame: Phas deg  
Vector averaged cross-power spectrum Baseline: JB (02) - EF (03)  
Timerange: 00/13:31:11 to 00/13:31:29

Plot file version 507 created 23-AUG-2016 15:00:58

0219+628 GA035B 1.UVDATA.1

Freq = 22.2125 GHz, Bw = 16.000 MH No calibration applied and no bandpass applied

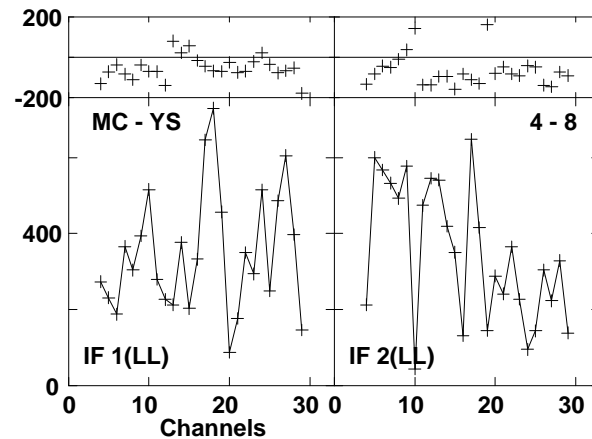
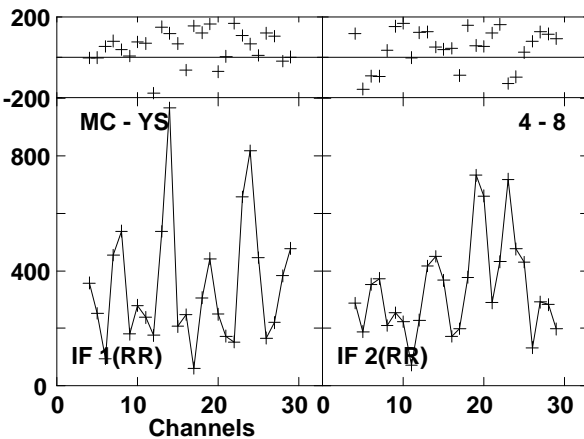
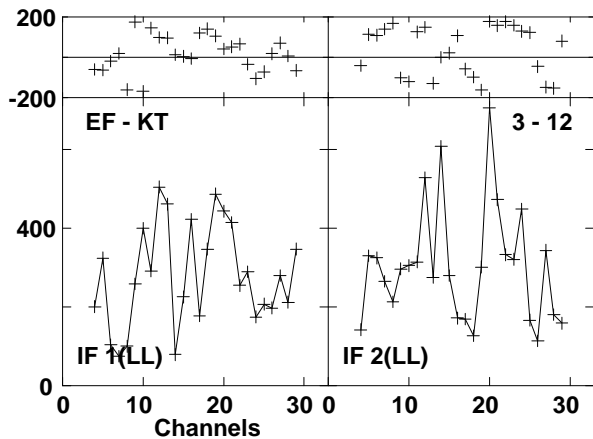
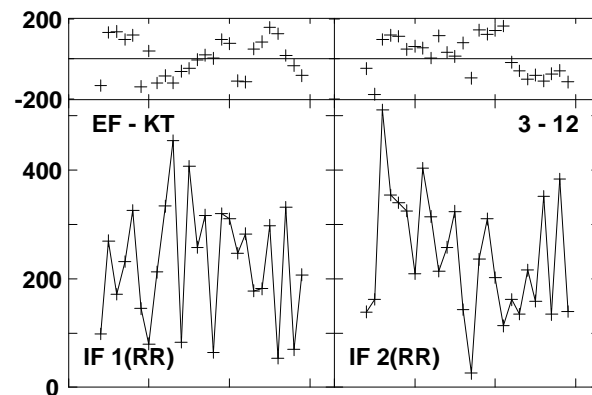
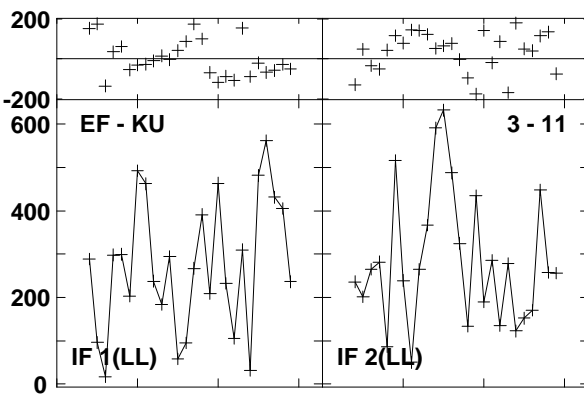
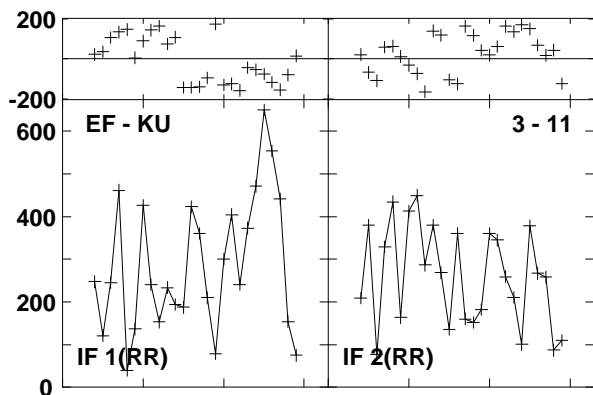
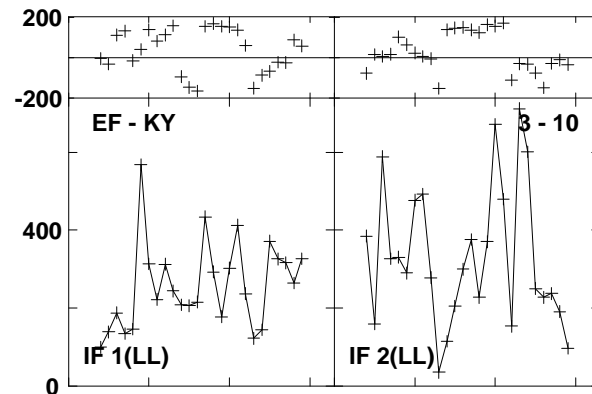
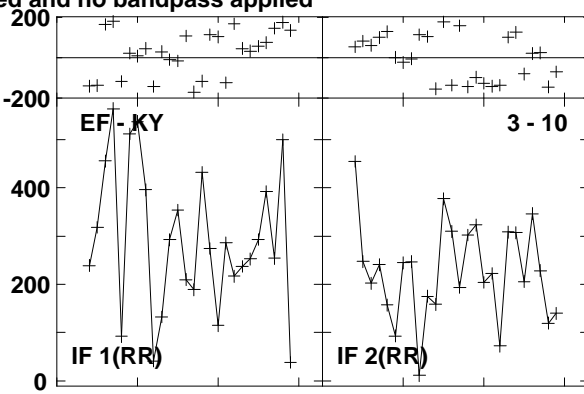
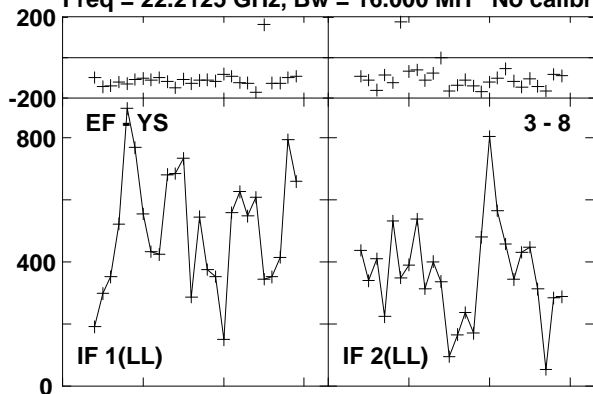

Lower frame: Micro Ampl Jy Top frame: Phas deg  
Vector averaged cross-power spectrum Baseline: EF (03) - YS (08)  
Timerange: 00/13:31:11 to 00/13:31:29

Plot file version 508 created 23-AUG-2016 15:00:58

0219+628 GA035B 1.UVDATA.1

Freq = 22.2125 GHz, Bw = 16.000 MH No calibration applied and no bandpass applied

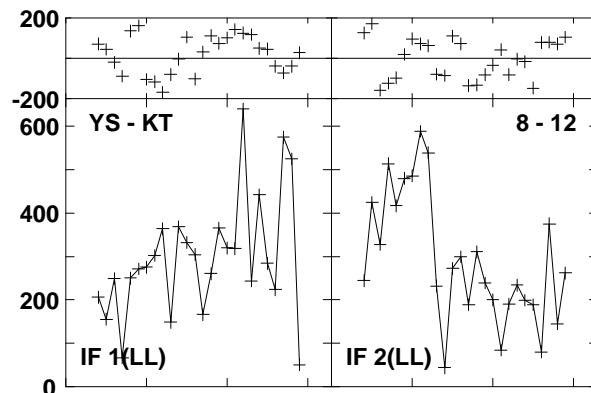
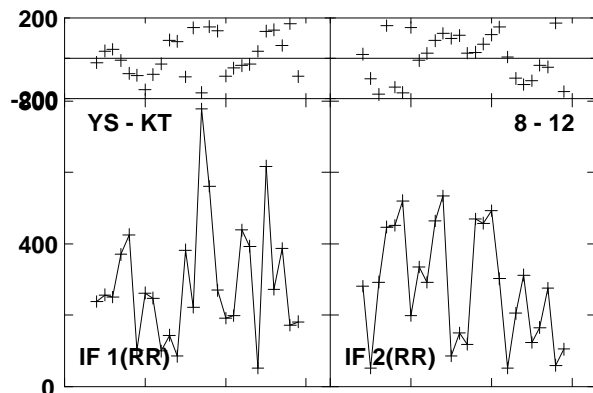
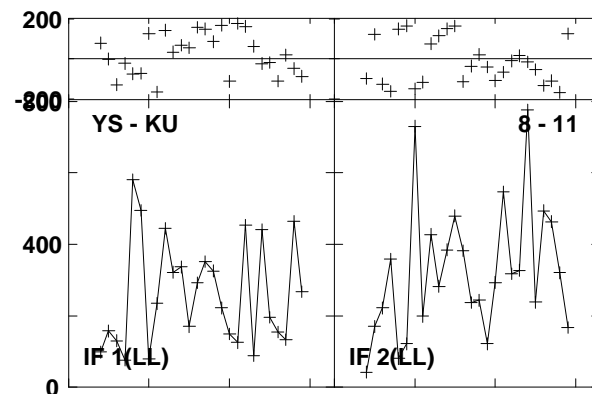
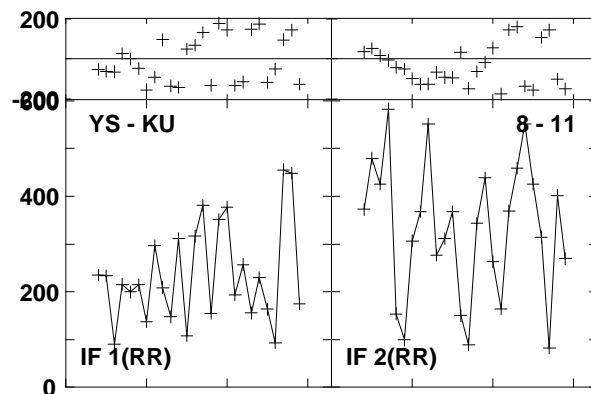
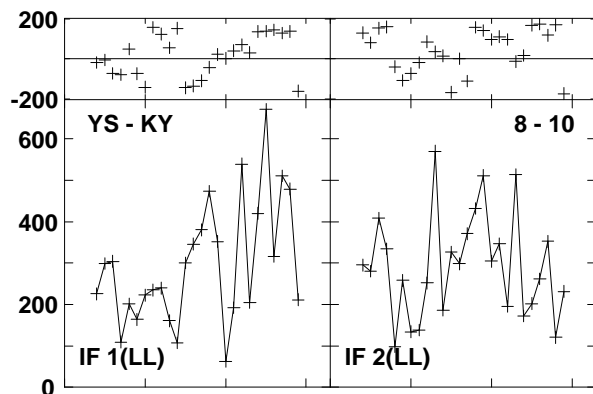
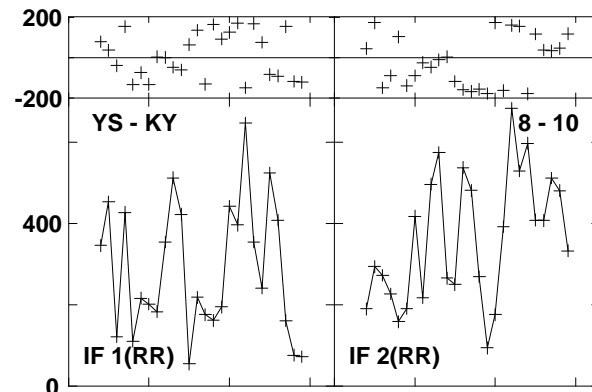
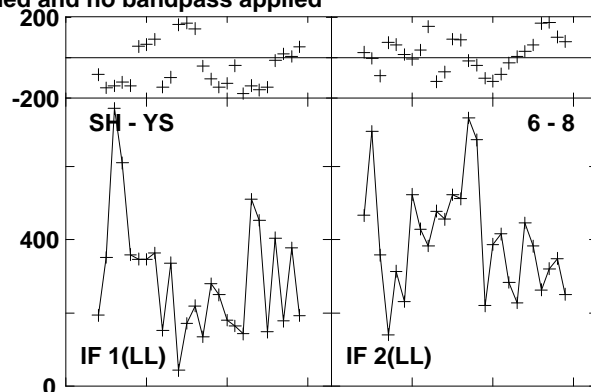
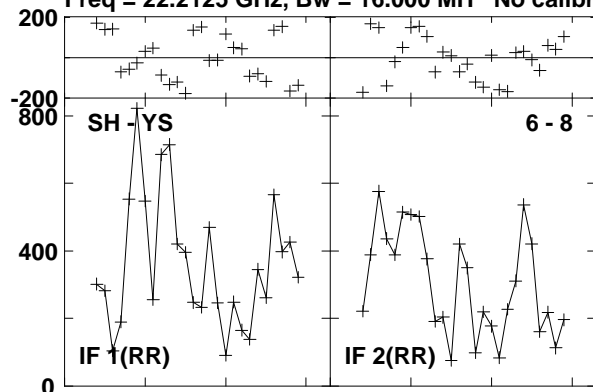

Lower frame: Micro Ampl Jy Top frame: Phas deg  
Vector averaged cross-power spectrum Baseline: SH (06) - YS (08)  
Timerange: 00/13:31:11 to 00/13:31:29

Plot file version 509 created 23-AUG-2016 15:00:58  
 W3IRS5 GA035B 1.UVDATA.1

Freq = 22.2125 GHz, Bw = 16.000 MH No calibration applied and no bandpass applied

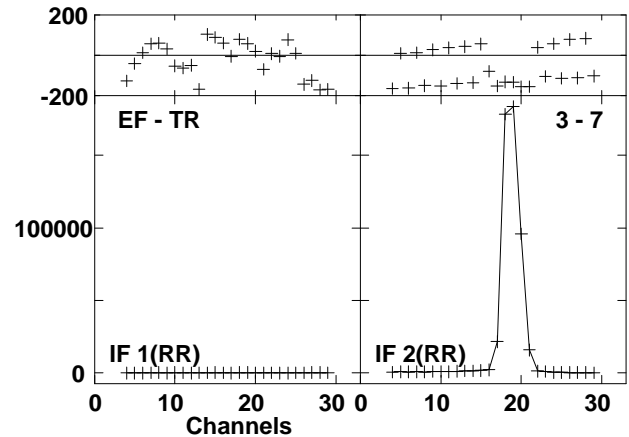
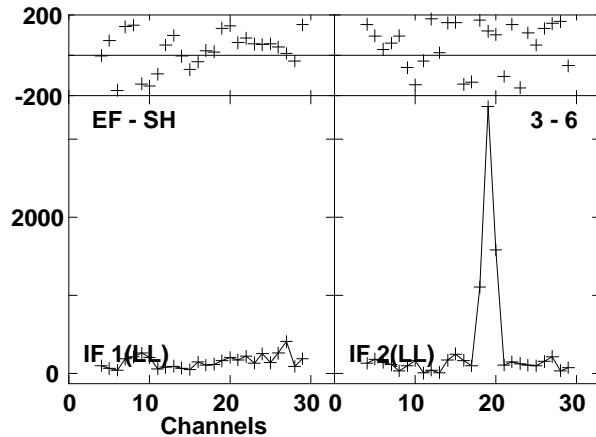
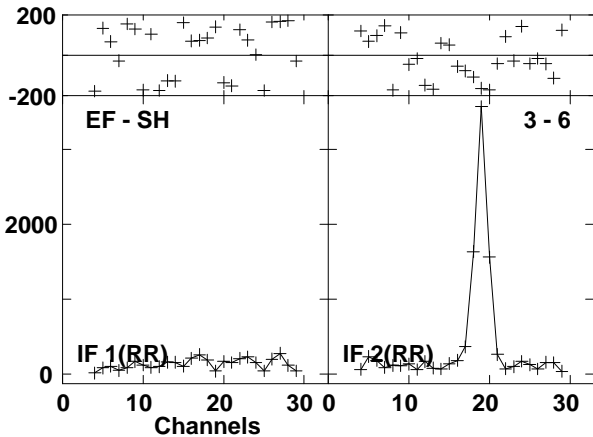
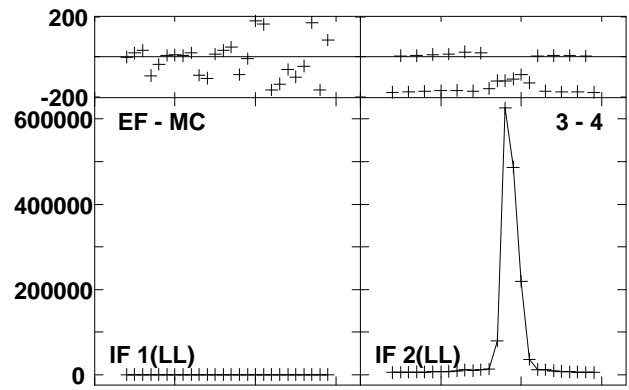
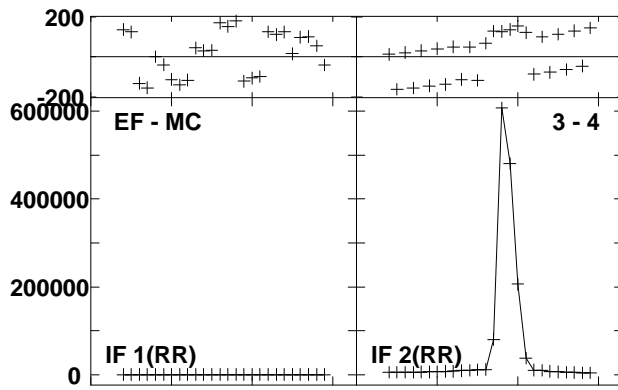
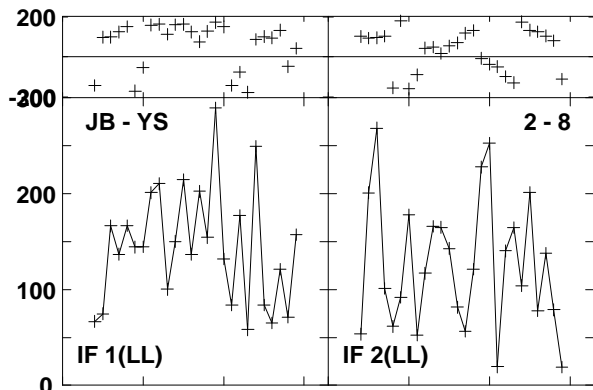
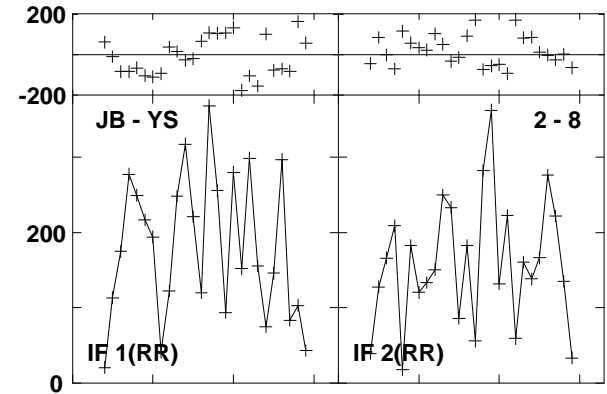
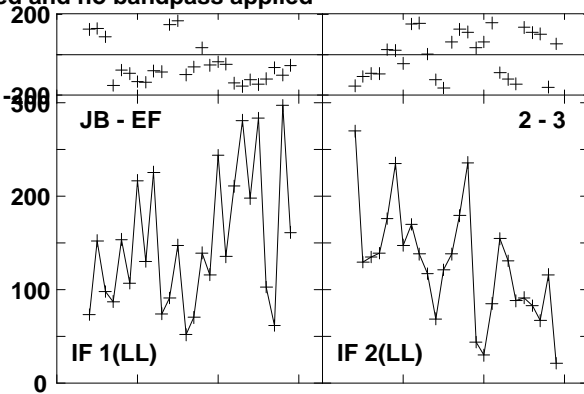
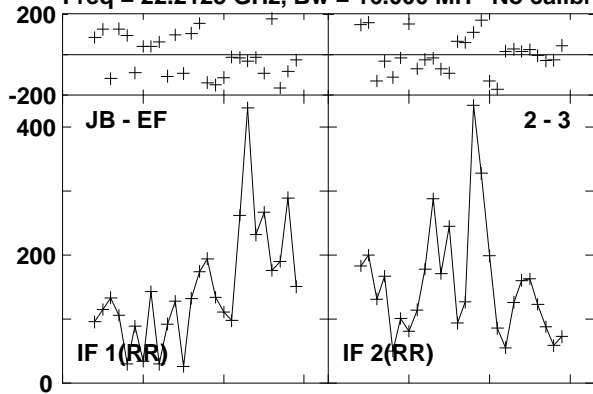

Lower frame: Micro Ampl Jy Top frame: Phas deg  
 Vector averaged cross-power spectrum Baseline: JB (02) - EF (03)  
 Timerange: 00/13:32:00 to 00/13:32:59

Plot file version 510 created 23-AUG-2016 15:00:59

W3IRS5 GA035B 1.UVDATA.1

Freq = 22.2125 GHz, Bw = 16.000 MH No calibration applied and no bandpass applied

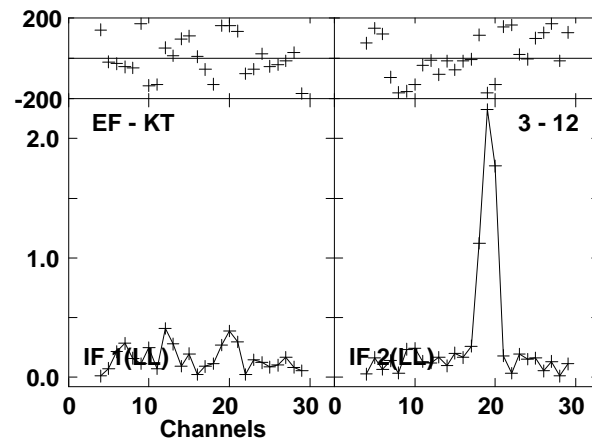
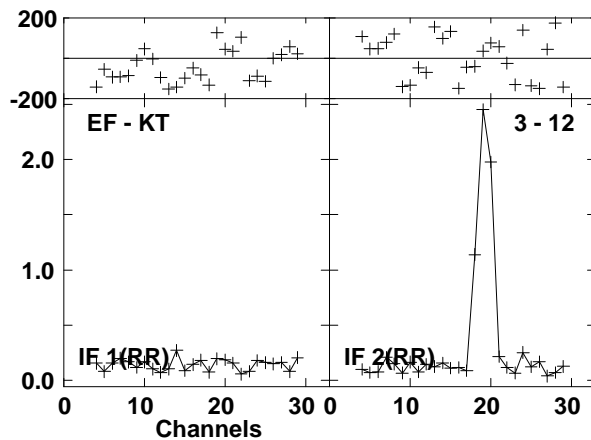
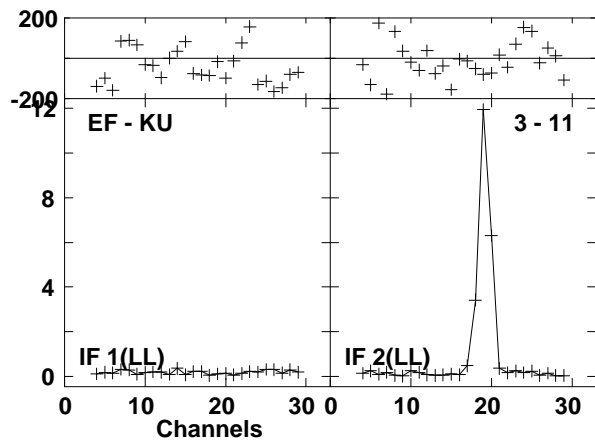
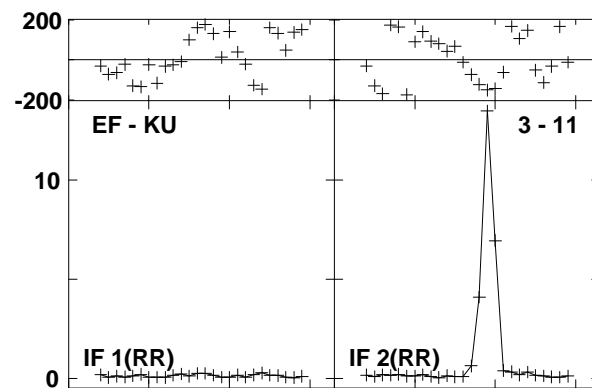
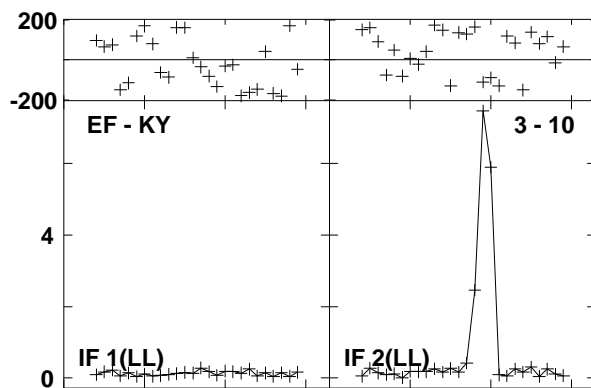
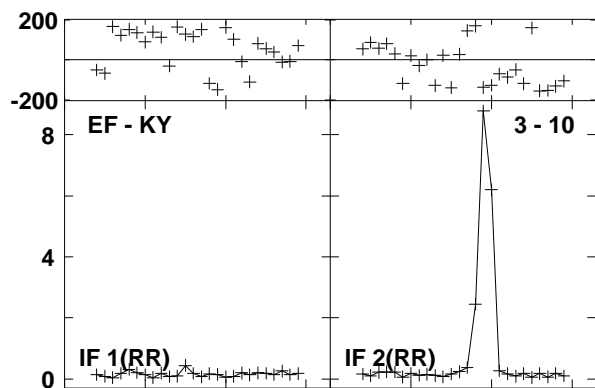
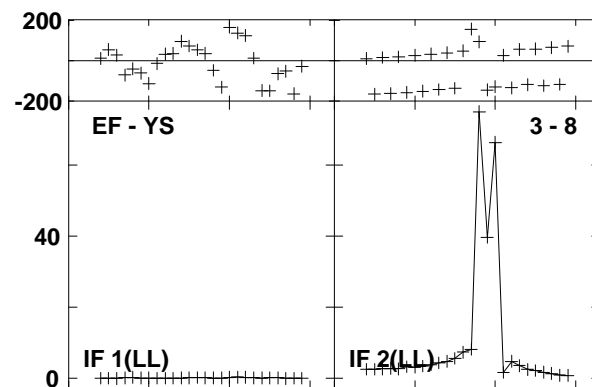
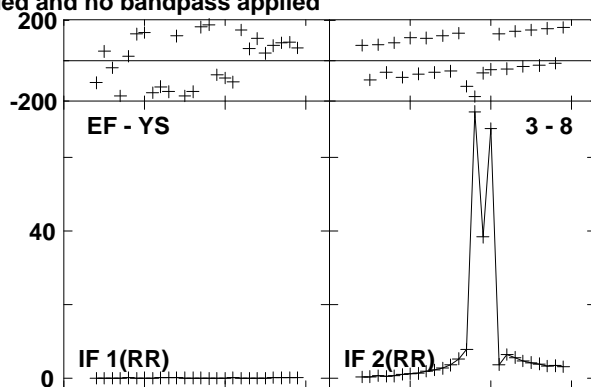
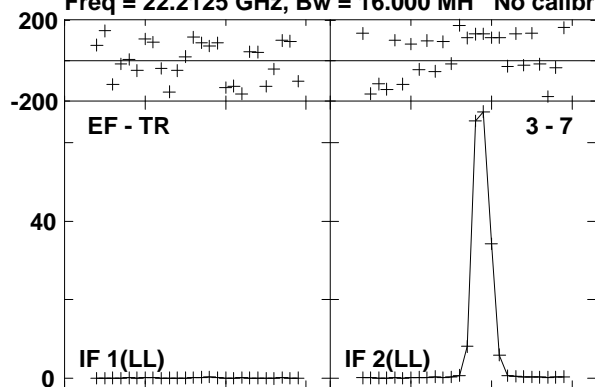

Lower frame: Milli Ampl Jy Top frame: Phas deg  
Vector averaged cross-power spectrum Baseline: EF (03) - TR (07)  
Timerange: 00/13:32:00 to 00/13:32:59

Plot file version 511 created 23-AUG-2016 15:00:59

W3IRS5 GA035B 1.UVDATA.1

Freq = 22.2125 GHz, Bw = 16.000 MH No calibration applied and no bandpass applied

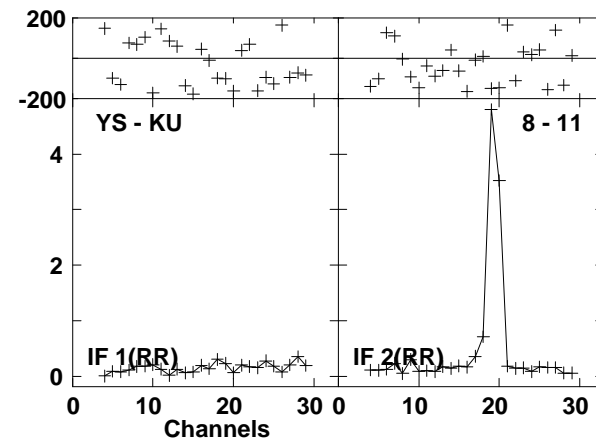
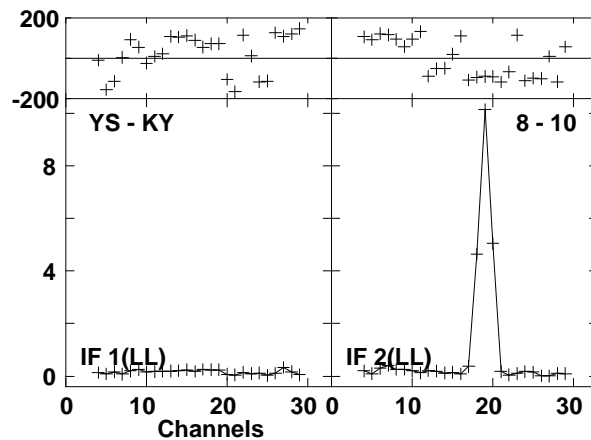
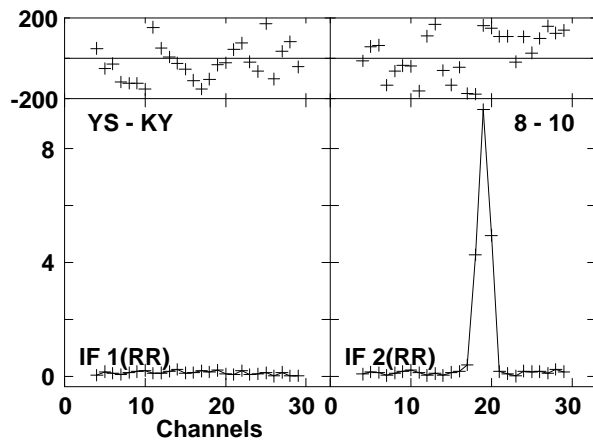
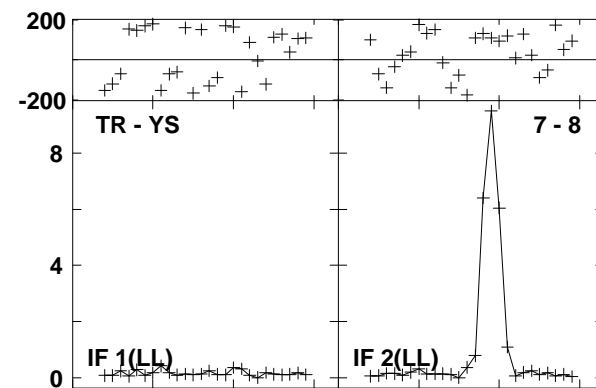
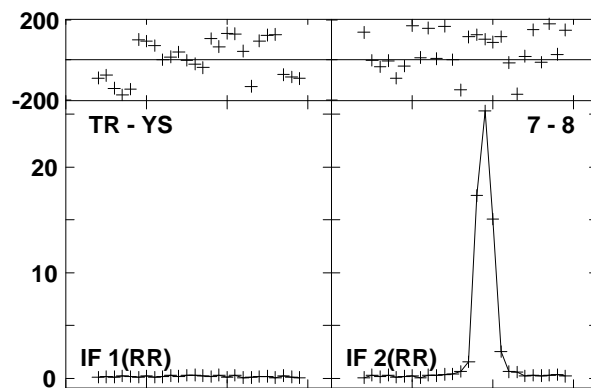
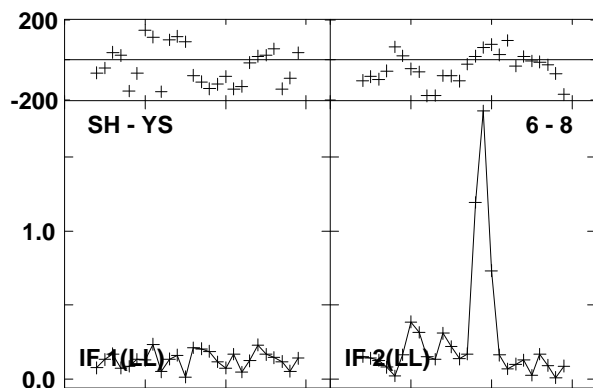
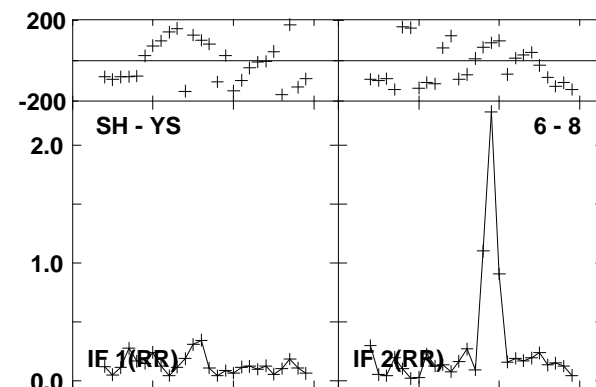
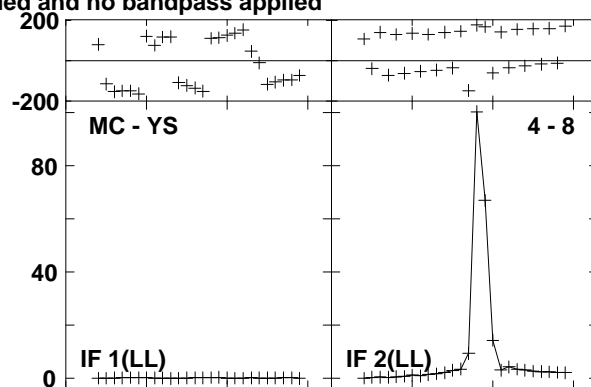
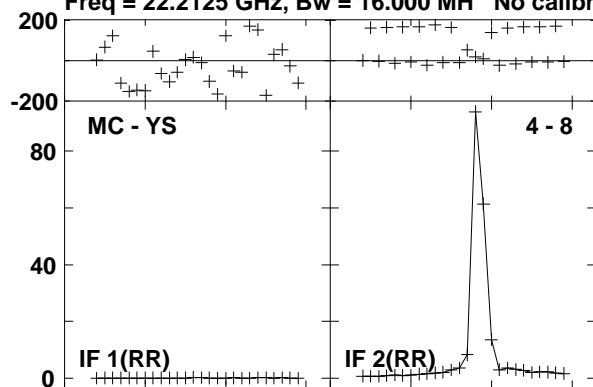

Lower frame: Milli Ampl Jy Top frame: Phas deg  
Vector averaged cross-power spectrum Baseline: MC (04) - YS (08)  
Timerange: 00/13:32:00 to 00/13:32:59

Plot file version 512 created 23-AUG-2016 15:00:59

W3IRS5 GA035B 1.UVDATA.1

Freq = 22.2125 GHz, Bw = 16.000 MH No calibration applied and no bandpass applied

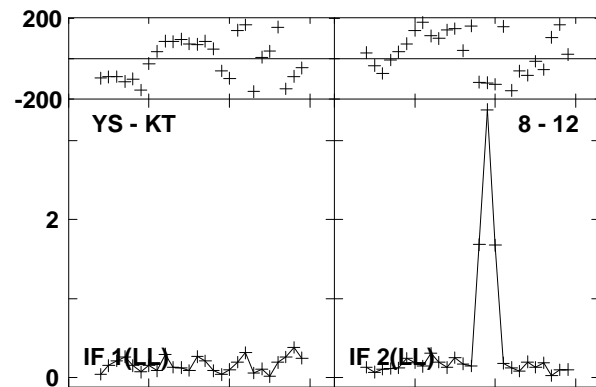
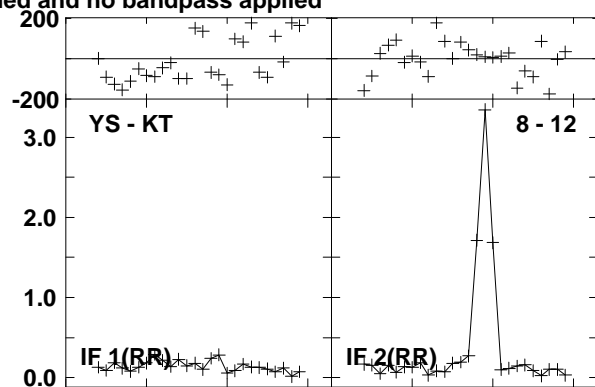
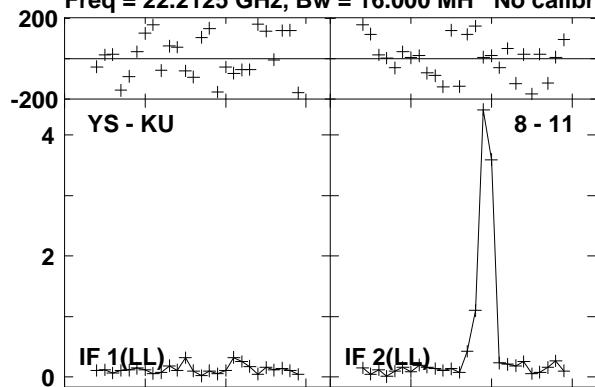

Lower frame: Milli Ampl Jy Top frame: Phas deg  
Vector averaged cross-power spectrum Baseline: YS (08) - KU (11)  
Timerange: 00/13:32:00 to 00/13:32:59



Plot file version 513 created 23-AUG-2016 15:00:59

0219+628 GA035B 1.UVDATA.1

Freq = 22.2125 GHz, Bw = 16.000 MH No calibration applied and no bandpass applied

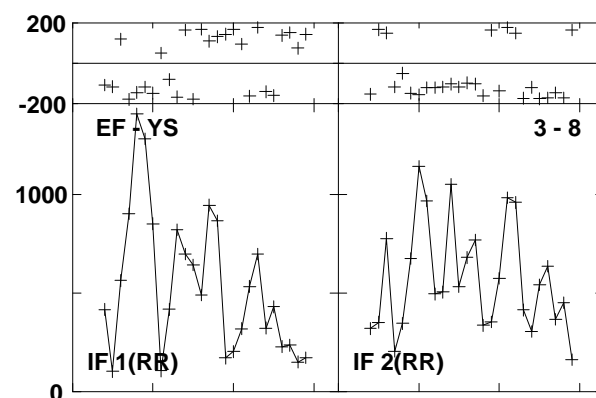
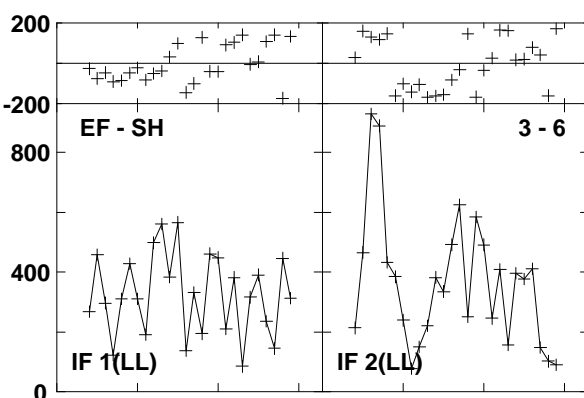
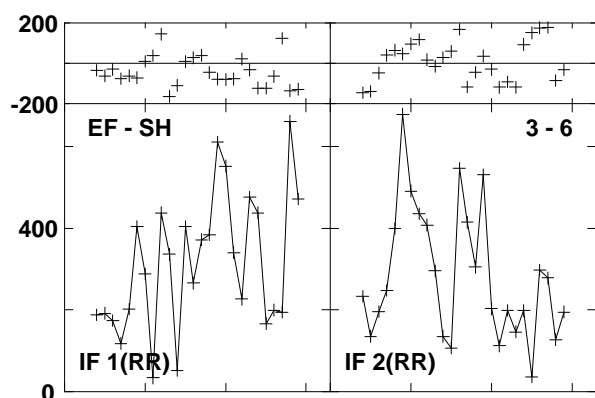
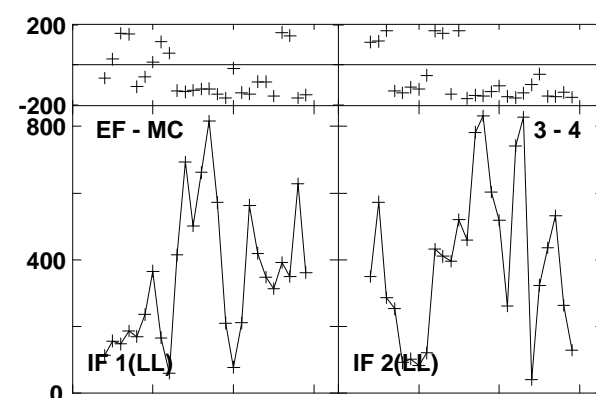
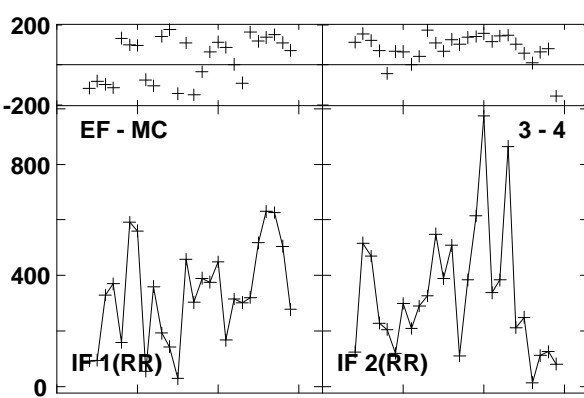
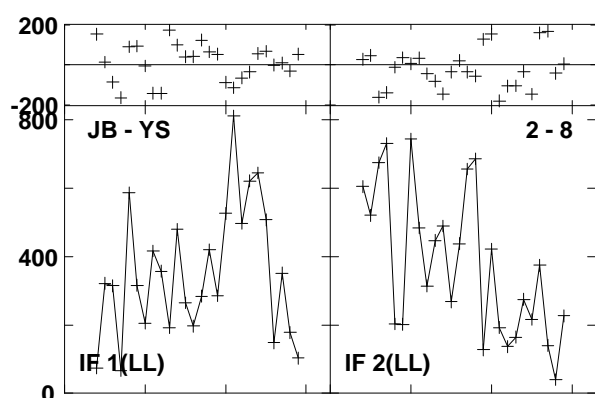
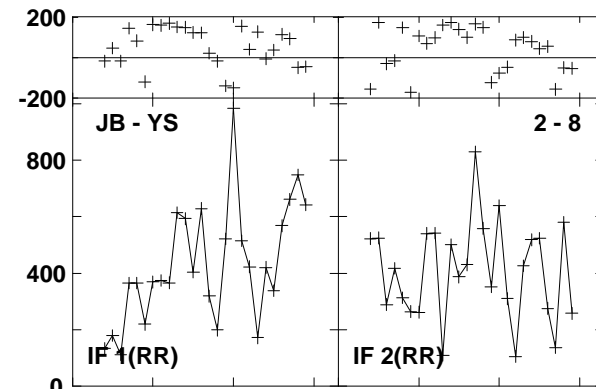
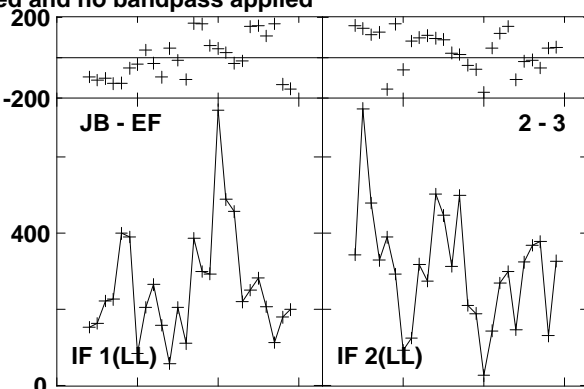
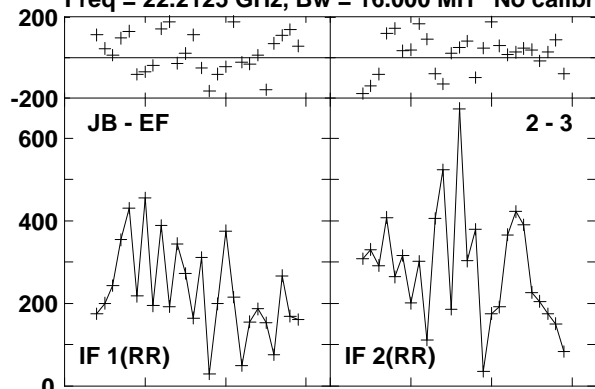

Lower frame: Micro Ampl Jy Top frame: Phas deg  
Vector averaged cross-power spectrum Baseline: JB (02) - EF (03)  
Timerange: 00/13:33:31 to 00/13:33:49

Plot file version 514 created 23-AUG-2016 15:00:59

0219+628 GA035B 1.UVDATA.1

Freq = 22.2125 GHz, Bw = 16.000 MH No calibration applied and no bandpass applied

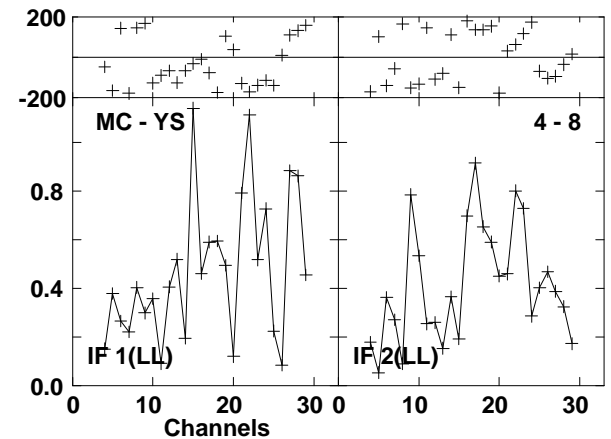
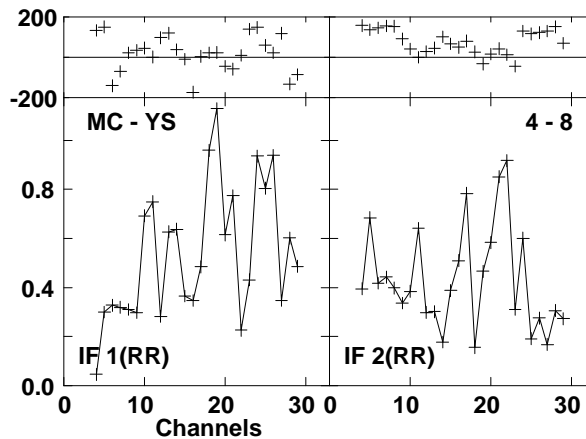
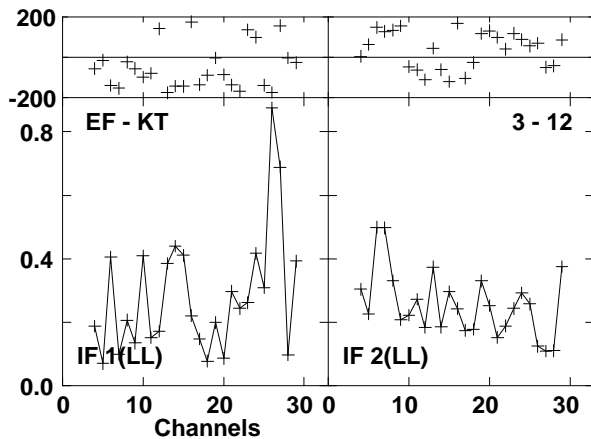
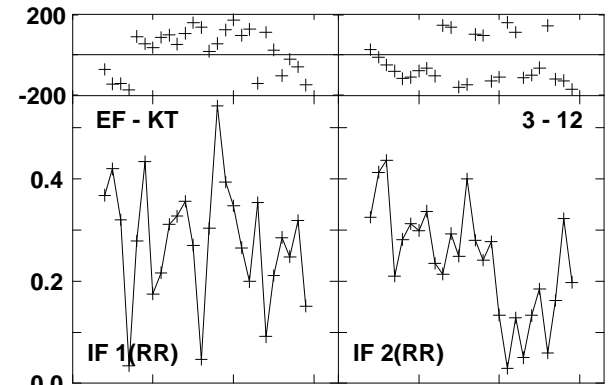
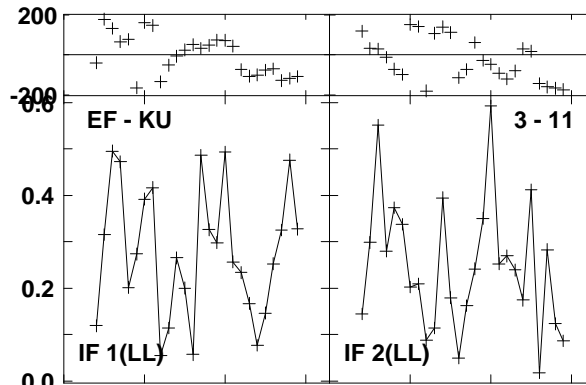
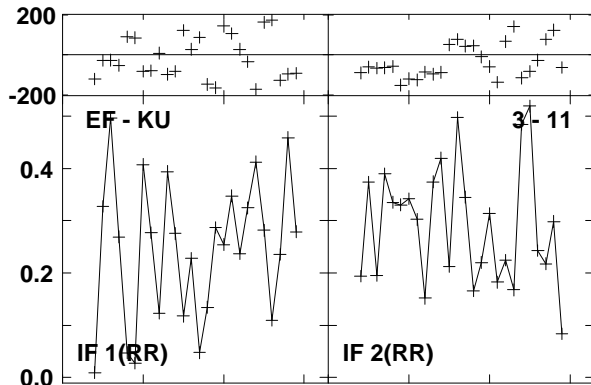
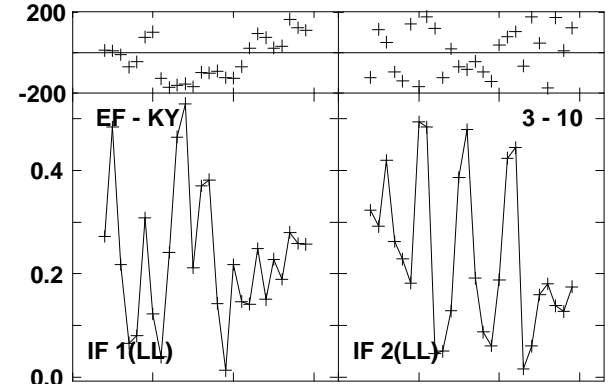
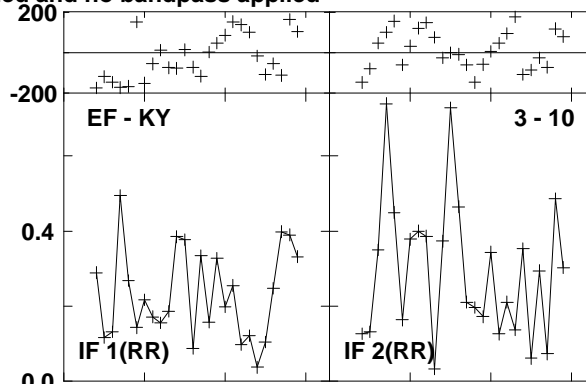
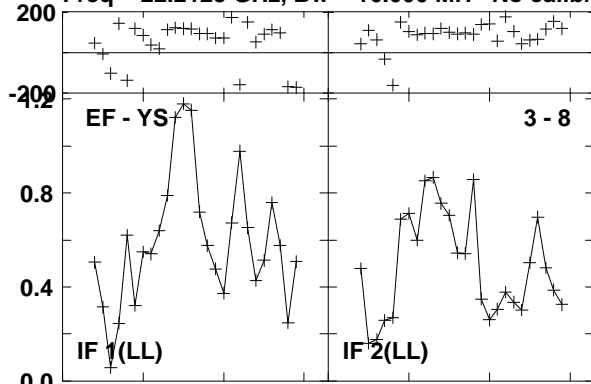

Lower frame: Milli Ampl Jy Top frame: Phas deg

Vector averaged cross-power spectrum Baseline: EF (03) - YS (08)

Timerange: 00/13:33:31 to 00/13:33:49

Plot file version 515 created 23-AUG-2016 15:00:59

0219+628 GA035B 1.UVDATA.1

Freq = 22.2125 GHz, Bw = 16.000 MH No calibration applied and no bandpass applied

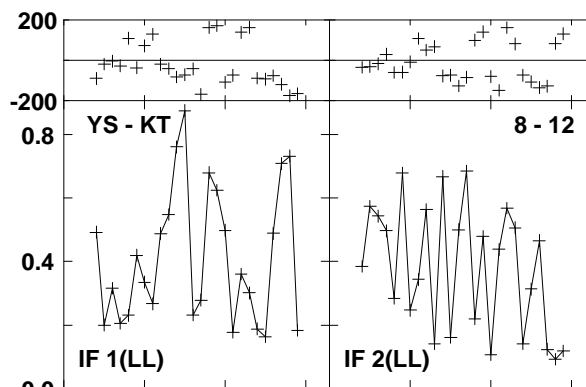
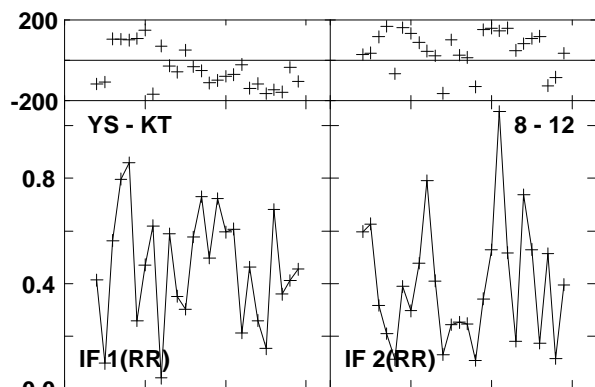
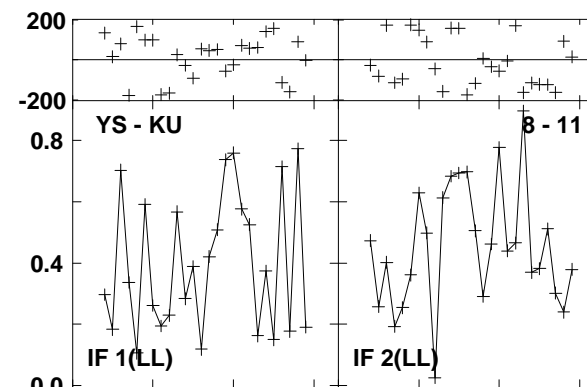
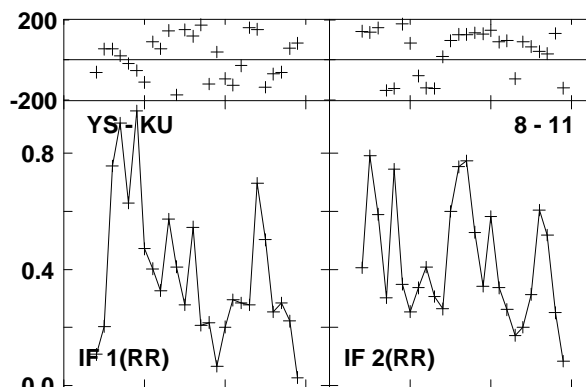
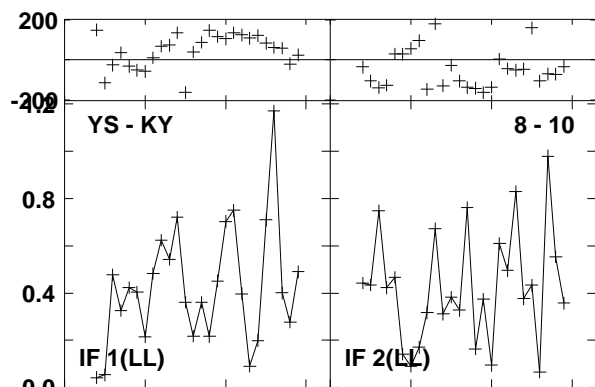
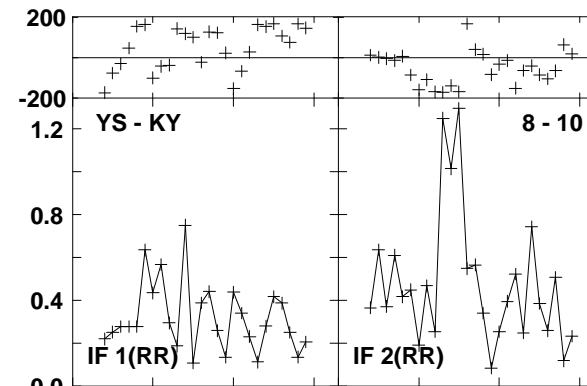
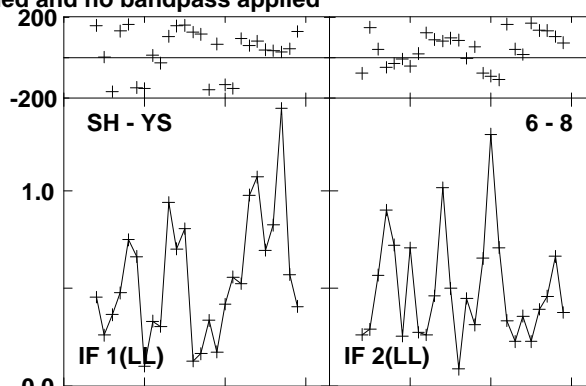
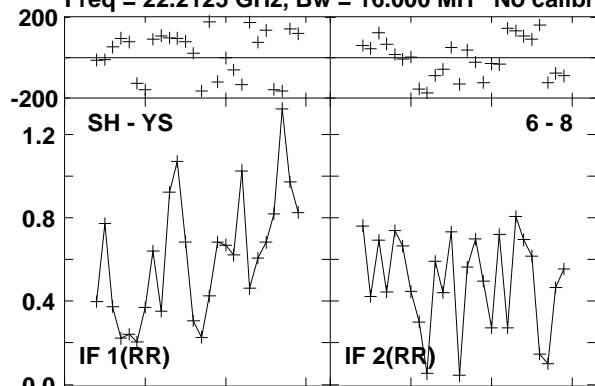

Channels

Lower frame: Milli Ampl Jy Top frame: Phas deg

Vector averaged cross-power spectrum Baseline: SH (06) - YS (08)

Timerange: 00/13:33:31 to 00/13:33:49

Plot file version 516 created 23-AUG-2016 15:00:59

W3IRS5 GA035B 1.UVDATA.1

Freq = 22.2125 GHz, Bw = 16.000 MH No calibration applied and no bandpass applied

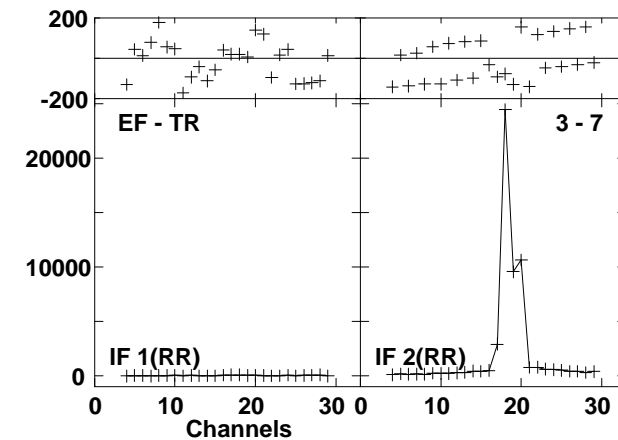
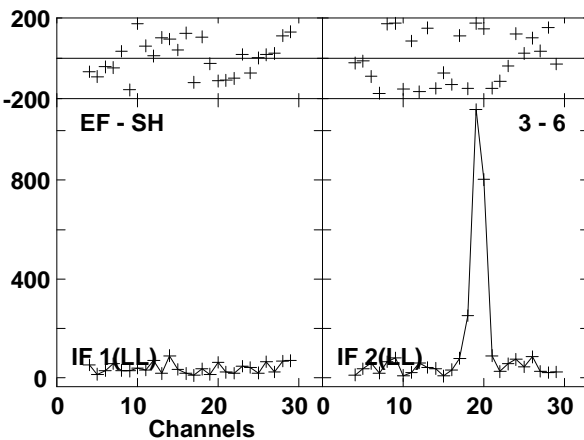
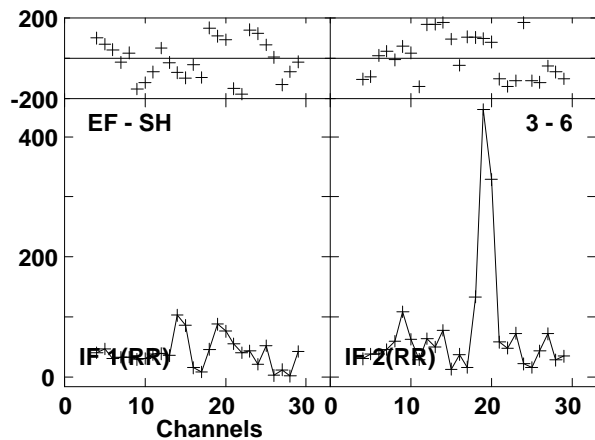
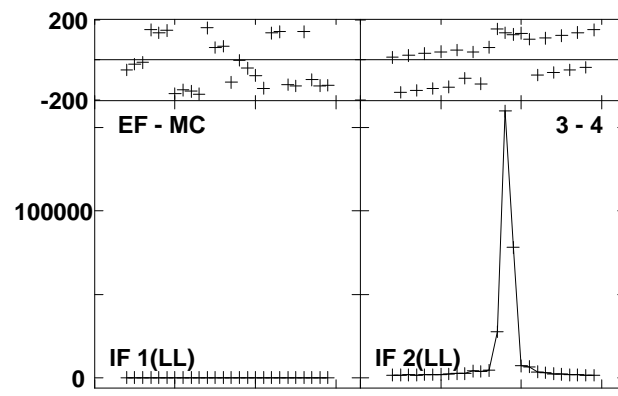
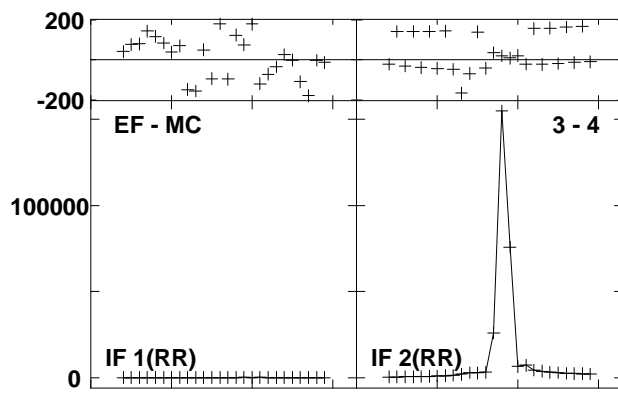
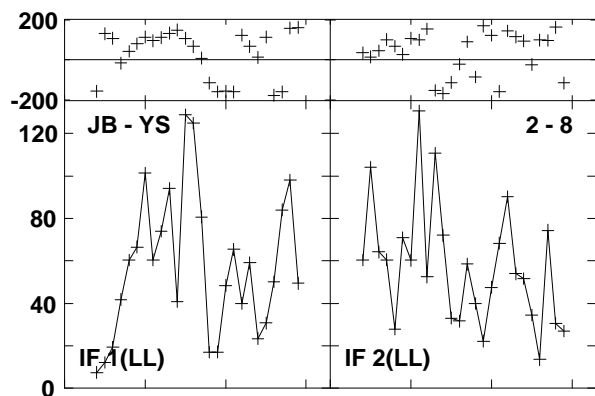
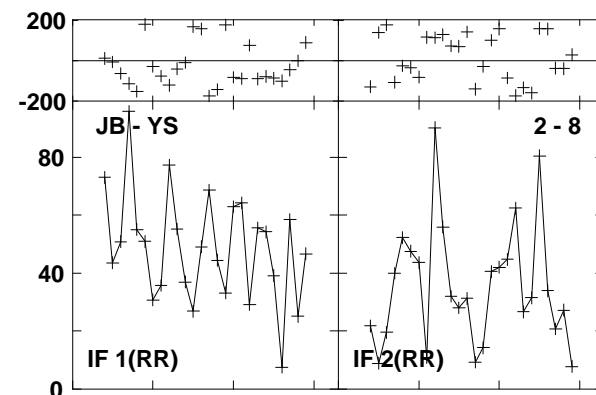
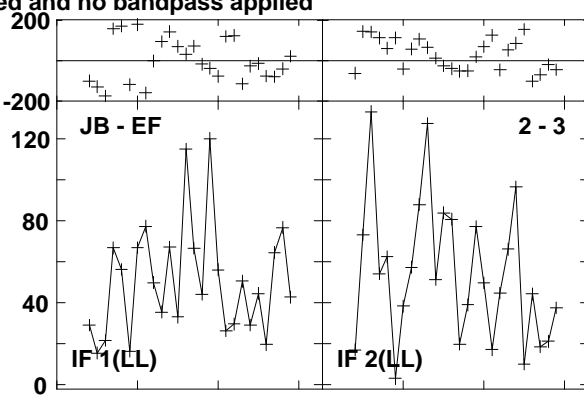
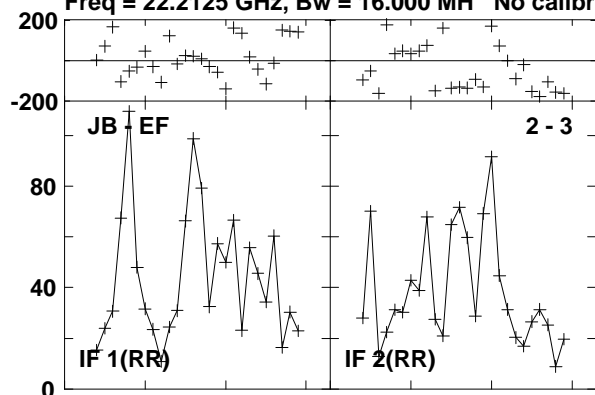

Lower frame: Micro Ampl Jy Top frame: Phas deg  
Vector averaged cross-power spectrum Baseline: JB (02) - EF (03)  
Timerange: 00/13:35:01 to 00/13:44:29

Plot file version 517 created 23-AUG-2016 15:00:59

W3IRS5 GA035B 1.UVDATA.1

Freq = 22.2125 GHz, Bw = 16.000 MH No calibration applied and no bandpass applied

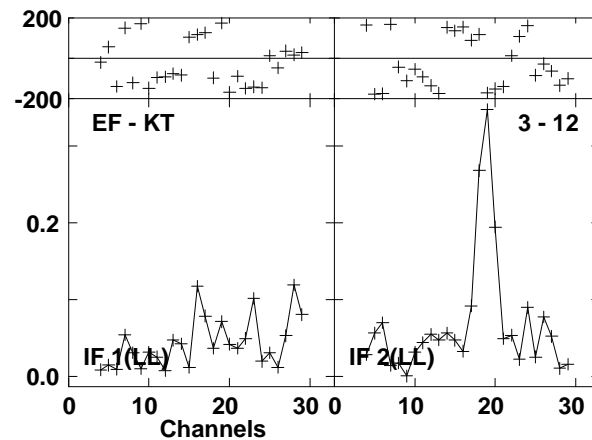
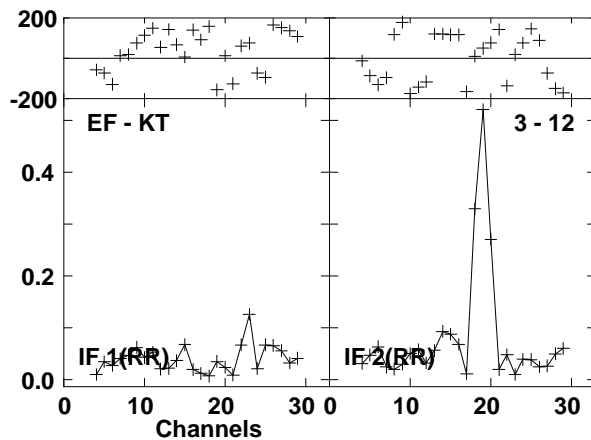
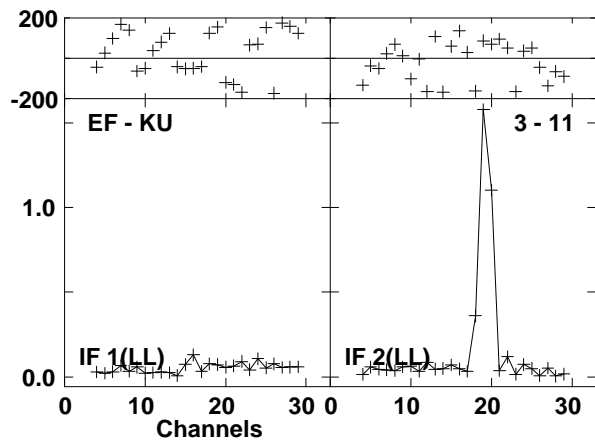
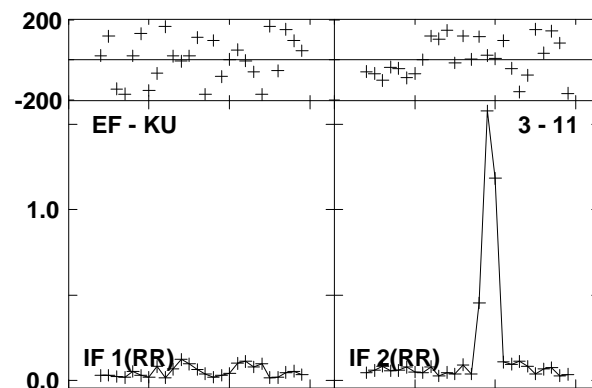
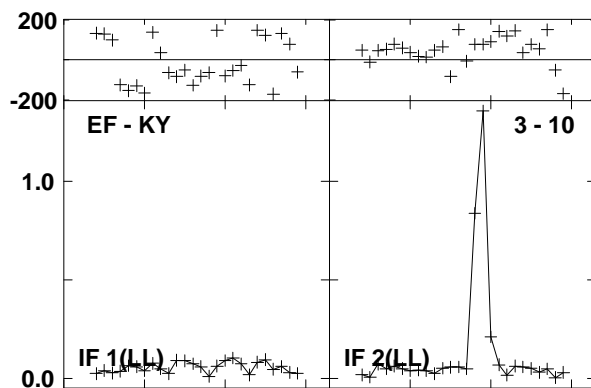
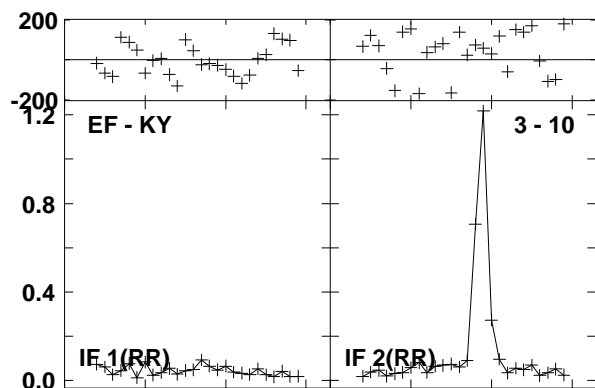
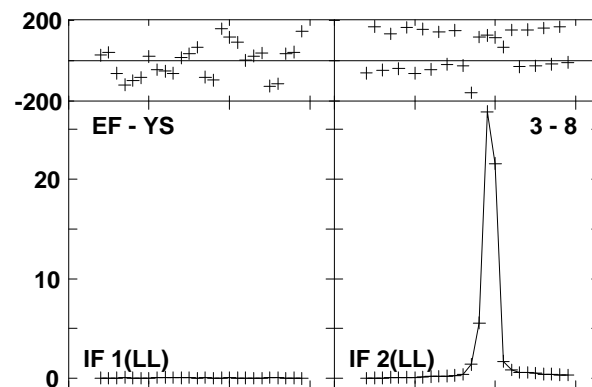
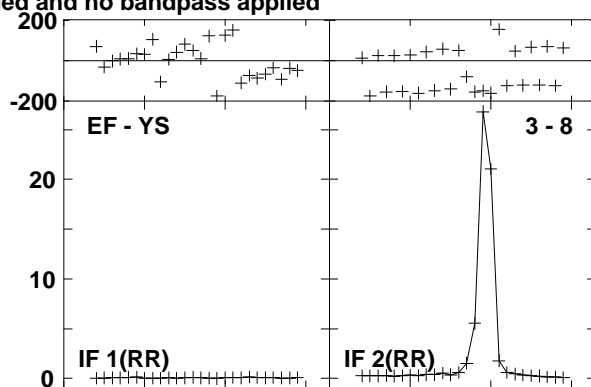
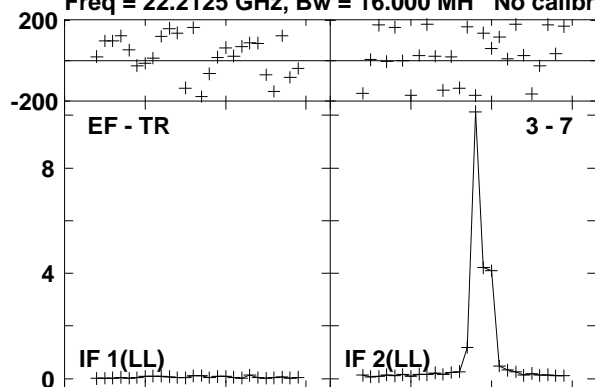

Lower frame: Milli Ampl Jy Top frame: Phas deg  
Vector averaged cross-power spectrum Baseline: EF (03) - TR (07)  
Timerange: 00/13:35:01 to 00/13:44:29

Plot file version 518 created 23-AUG-2016 15:00:59

W3IRS5 GA035B 1.UVDATA.1

Freq = 22.2125 GHz, Bw = 16.000 MH No calibration applied and no bandpass applied

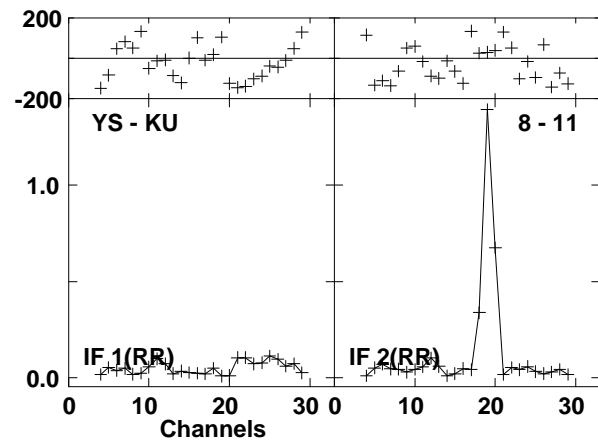
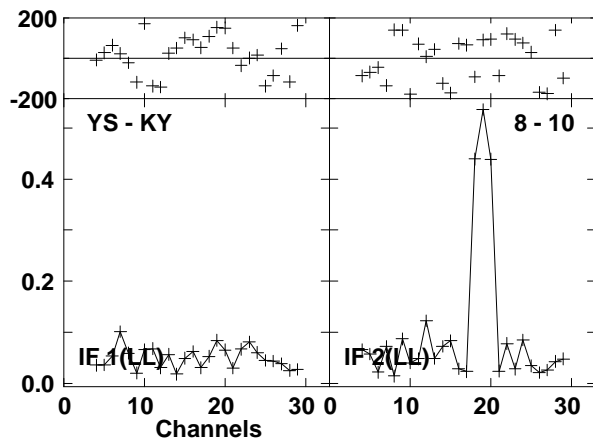
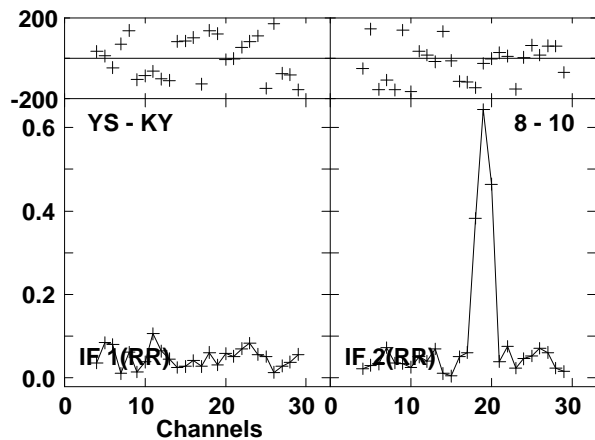
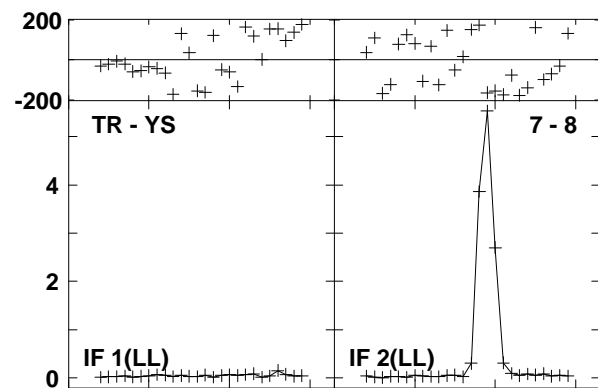
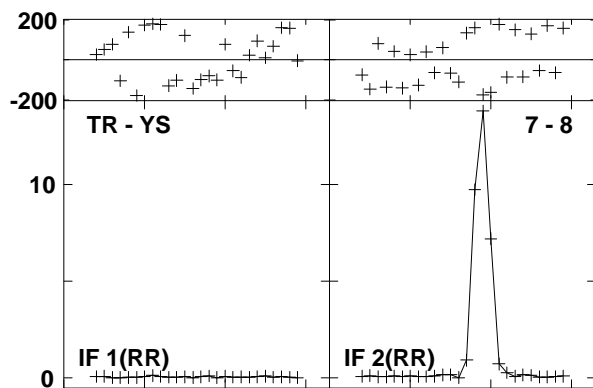
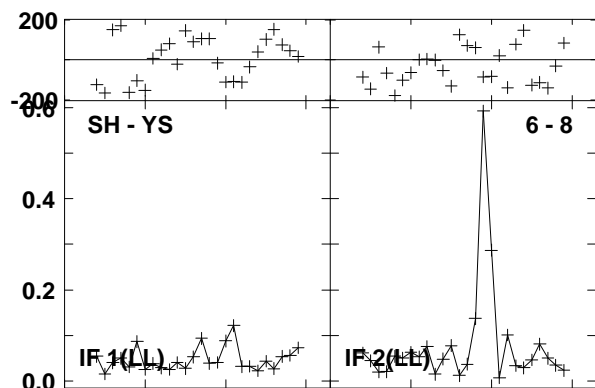
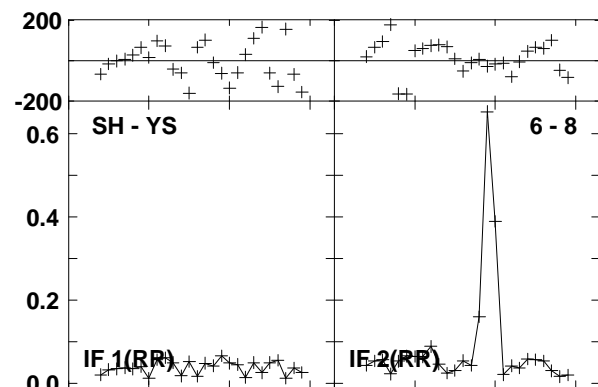
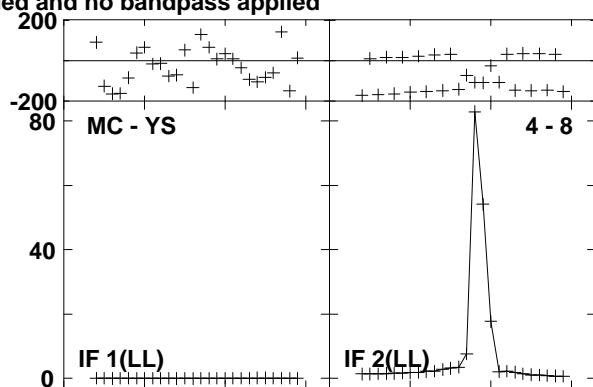
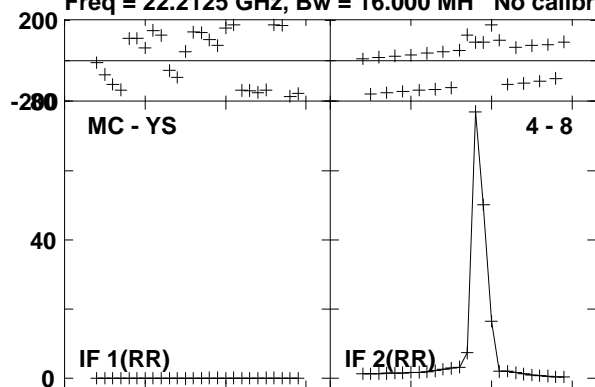

Lower frame: Milli Ampl Jy Top frame: Phas deg

Vector averaged cross-power spectrum Baseline: MC (04) - YS (08)

Timerange: 00/13:35:01 to 00/13:44:29

Plot file version 519 created 23-AUG-2016 15:01:00

W3IRS5 GA035B 1.UVDATA.1

Freq = 22.2125 GHz, Bw = 16.000 MH No calibration applied and no bandpass applied

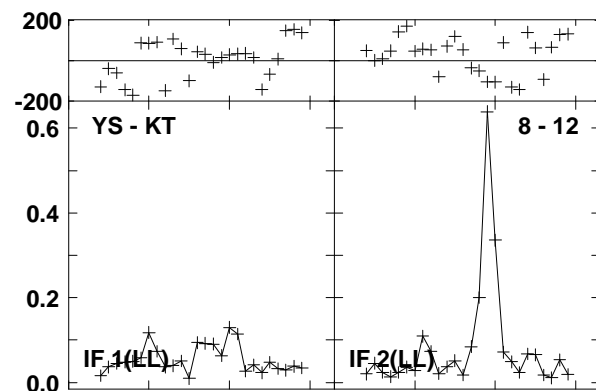
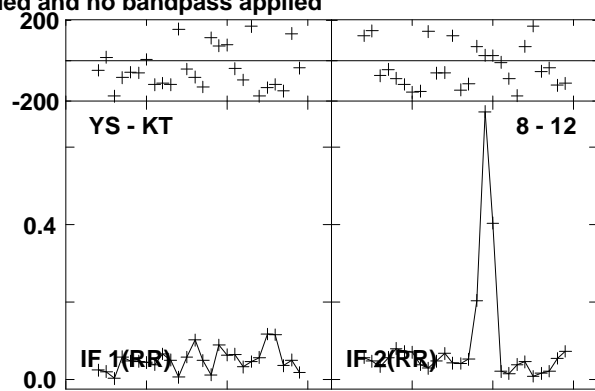
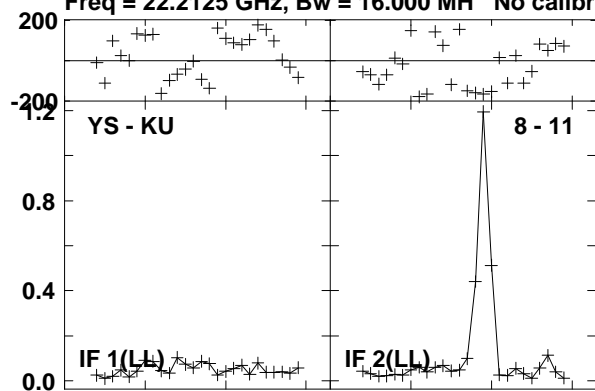

Lower frame: Milli Ampl Jy Top frame: Phas deg  
Vector averaged cross-power spectrum Baseline: YS (08) - KU (11)  
Timerange: 00/13:35:01 to 00/13:44:29

Plot file version 520 created 23-AUG-2016 15:01:00

W3IRS5 GA035B 1.UVDATA.1

Freq = 22.2125 GHz, Bw = 16.000 MH No calibration applied and no bandpass applied

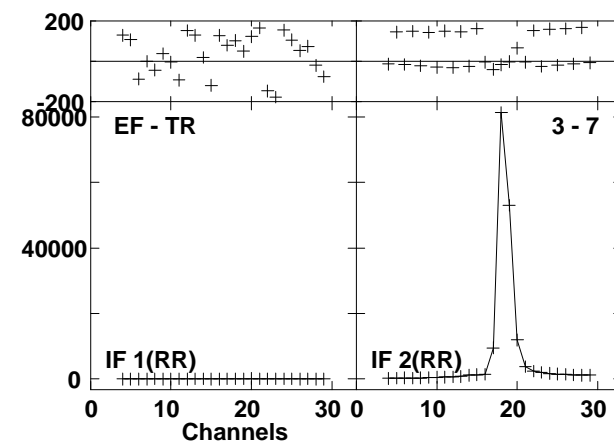
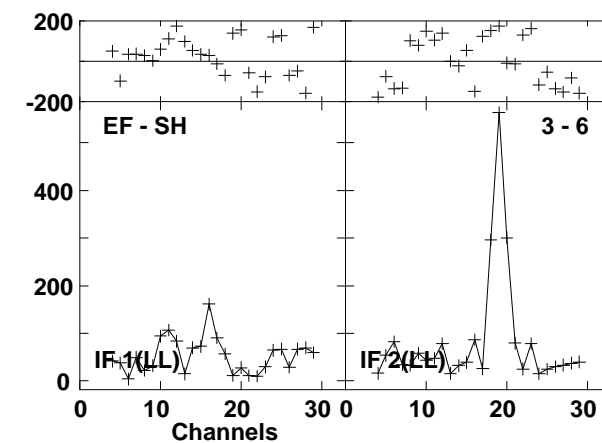
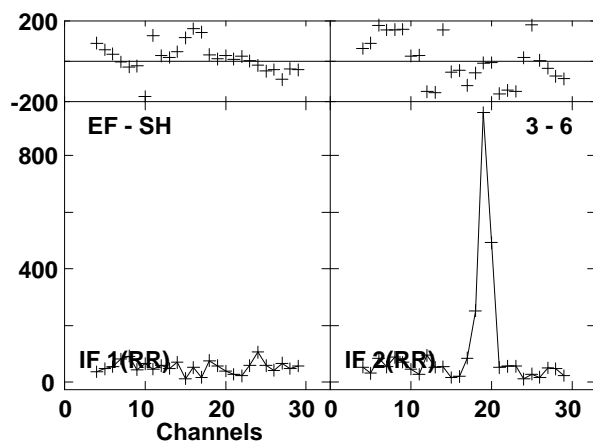
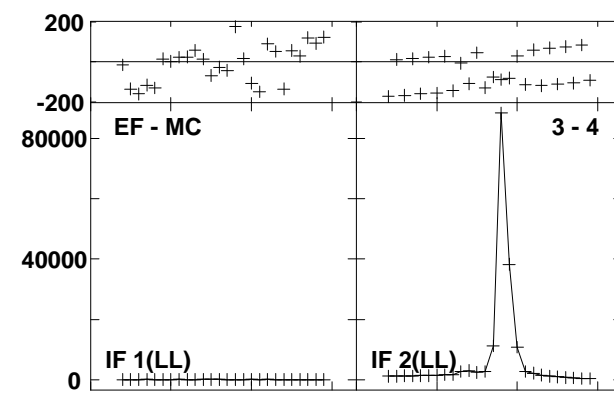
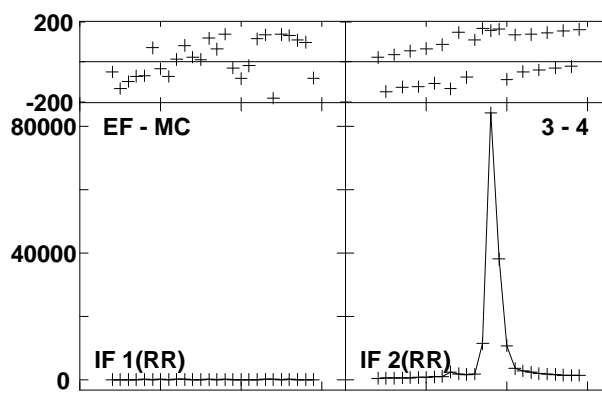
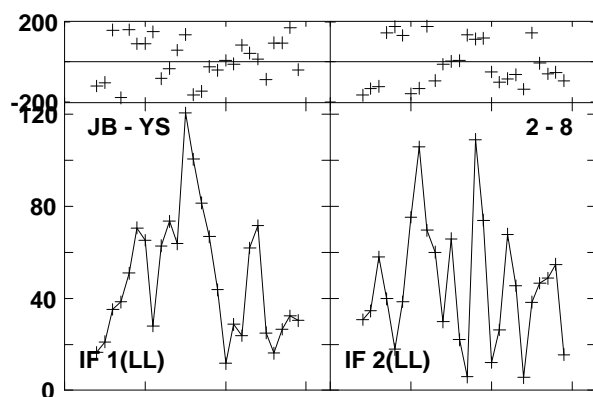
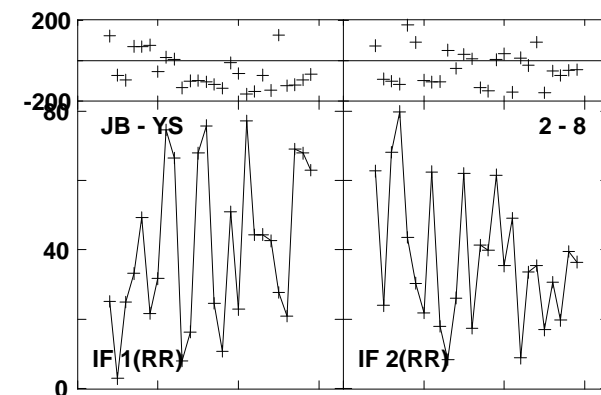
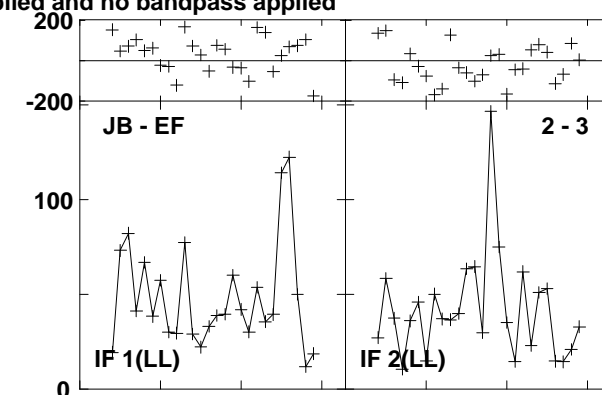
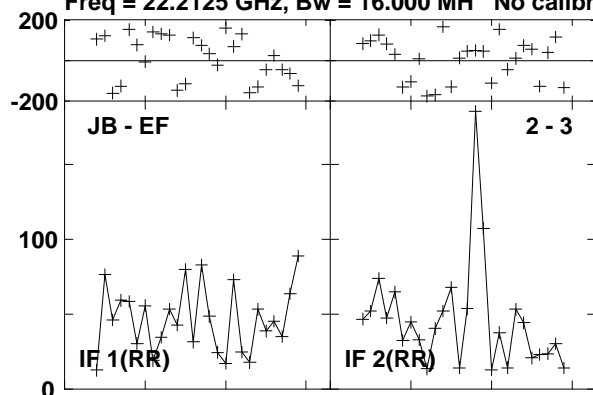

Lower frame: Micro Ampl Jy Top frame: Phas deg  
Vector averaged cross-power spectrum Baseline: JB (02) - EF (03)  
Timerange: 00/13:45:01 to 00/13:54:29



Plot file version 521 created 23-AUG-2016 15:01:00

W3IRS5 GA035B 1.UVDATA.1

Freq = 22.2125 GHz, Bw = 16.000 MH No calibration applied and no bandpass applied

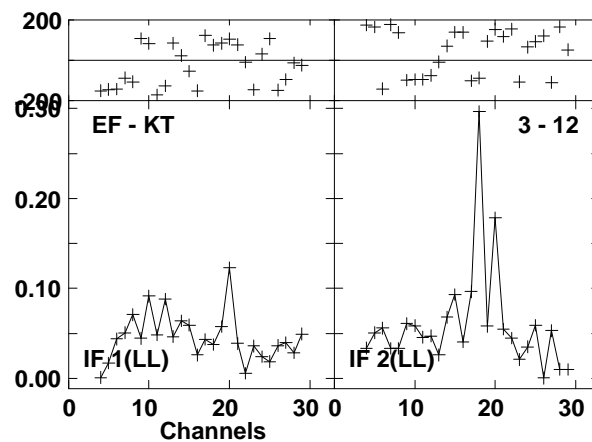
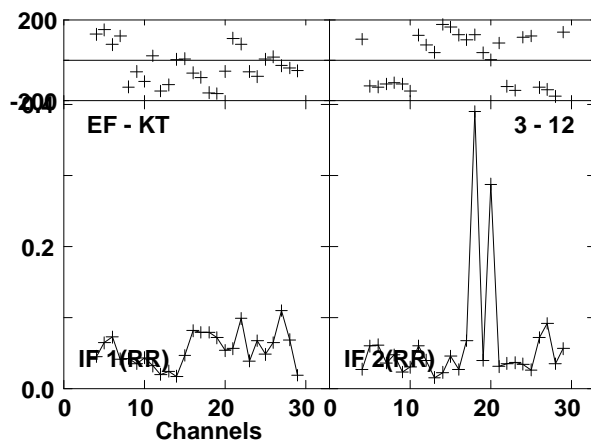
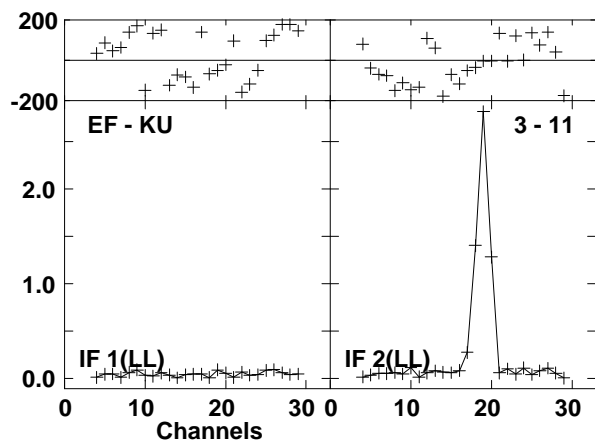
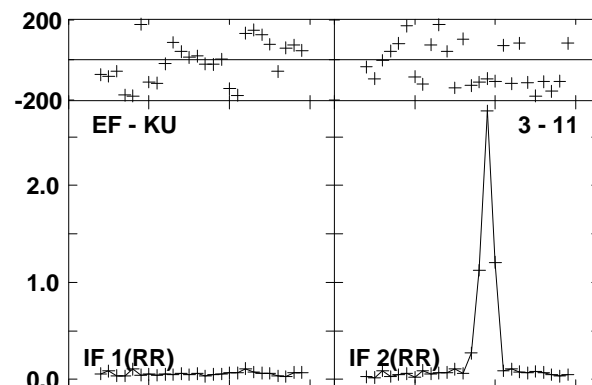
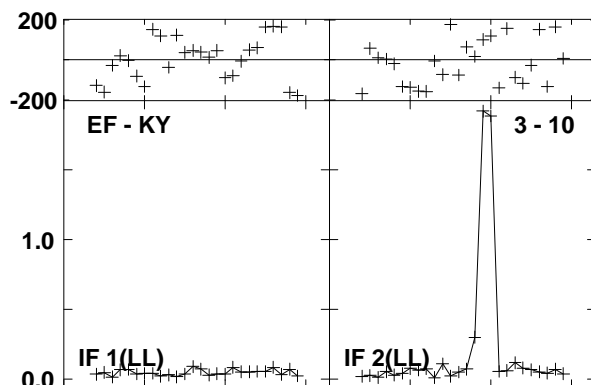
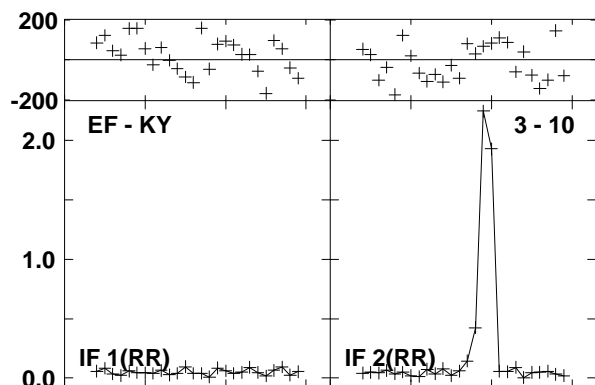
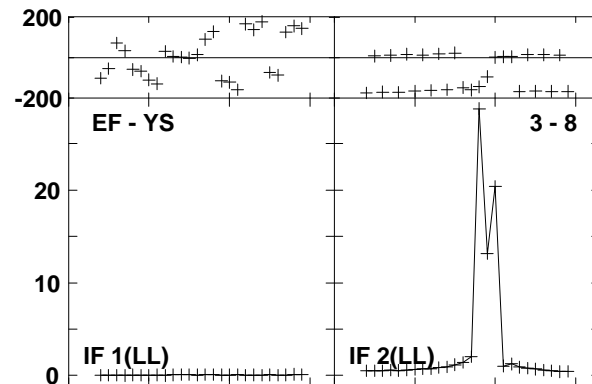
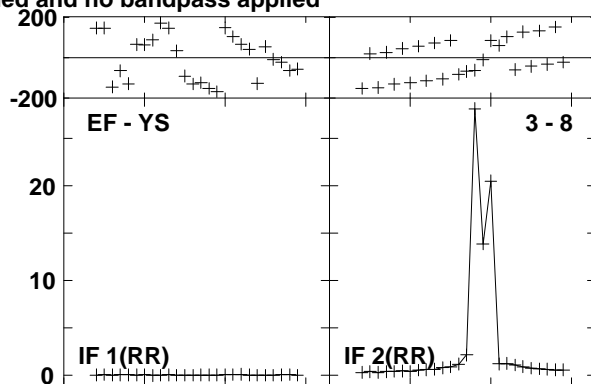
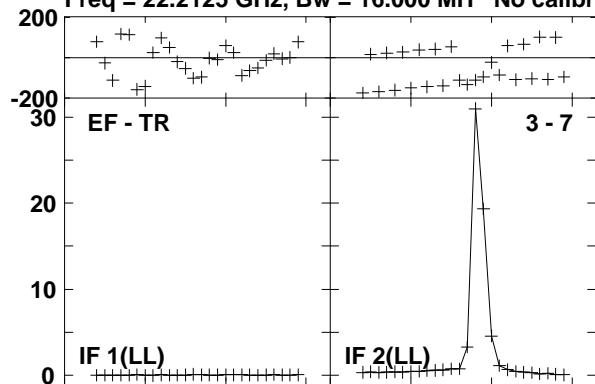

Lower frame: Milli Ampl Jy Top frame: Phas deg

Vector averaged cross-power spectrum Baseline: EF (03) - TR (07)

Timerange: 00/13:45:01 to 00/13:54:29

Plot file version 522 created 23-AUG-2016 15:01:00

W3IRS5 GA035B 1.UVDATA.1

Freq = 22.2125 GHz, Bw = 16.000 MH No calibration applied and no bandpass applied

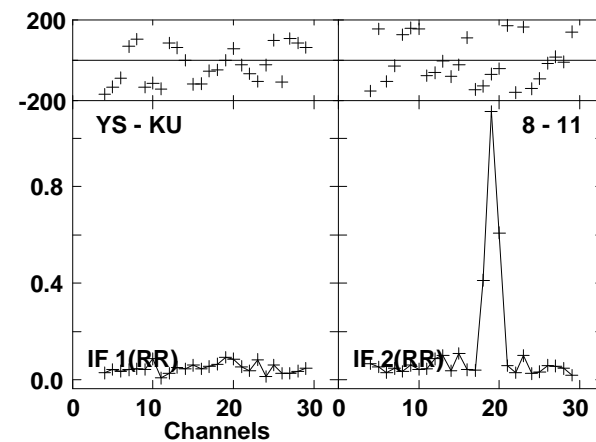
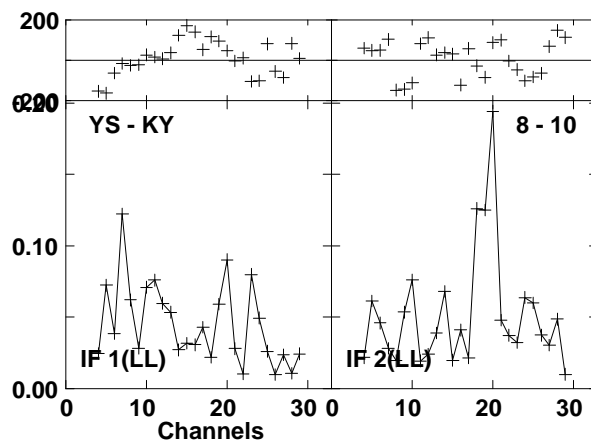
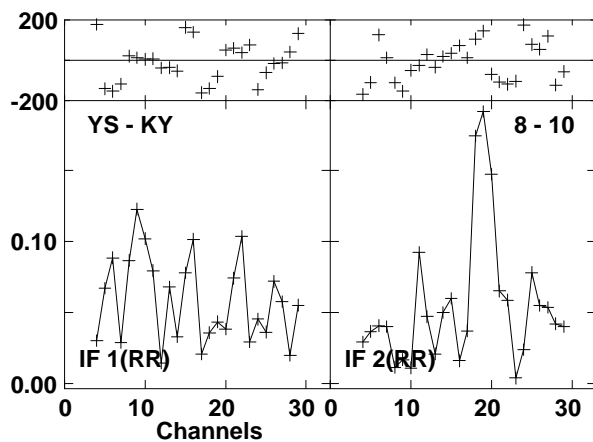
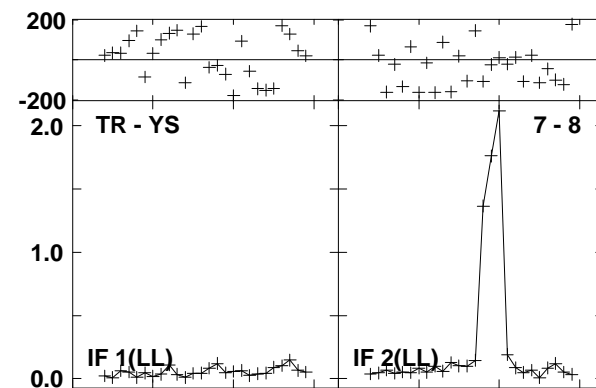
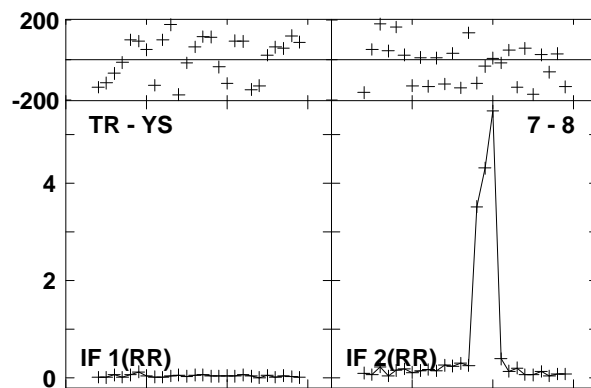
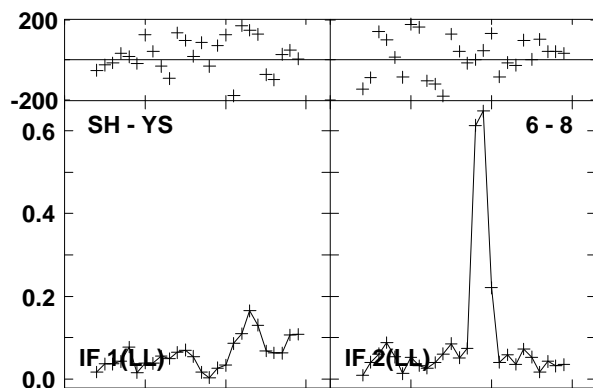
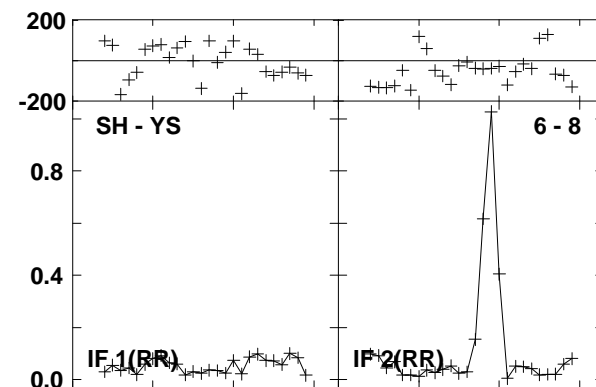
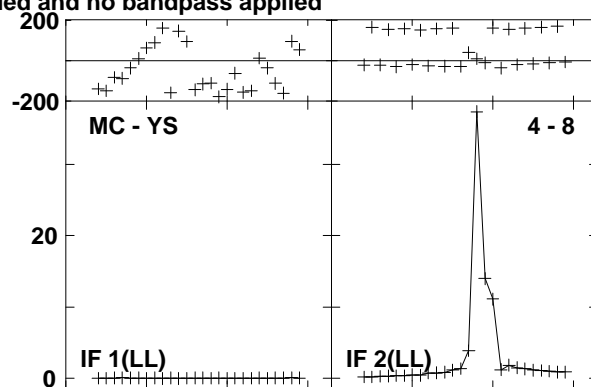
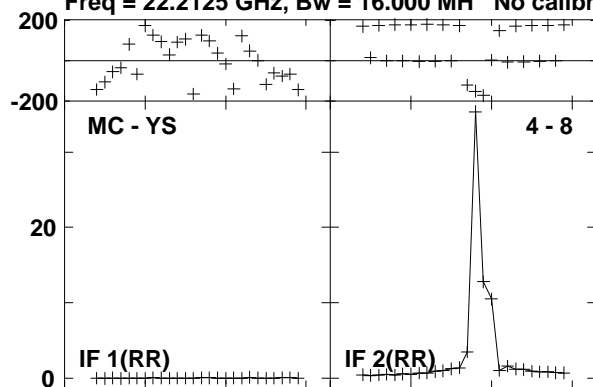

Lower frame: Milli Ampl Jy Top frame: Phas deg  
Vector averaged cross-power spectrum Baseline: MC (04) - YS (08)  
Timerange: 00/13:45:01 to 00/13:54:29

Plot file version 523 created 23-AUG-2016 15:01:00

W3IRS5 GA035B 1.UVDATA.1

Freq = 22.2125 GHz, Bw = 16.000 MH No calibration applied and no bandpass applied

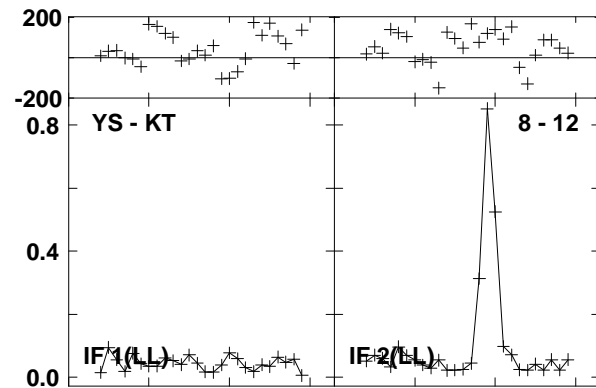
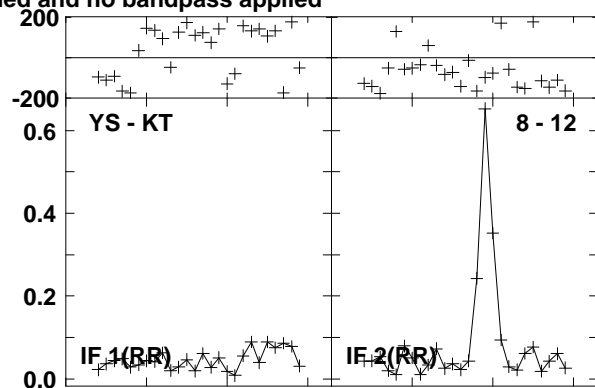
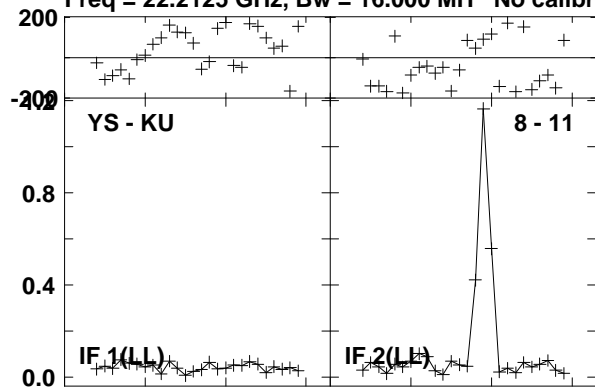

Lower frame: Milli Ampl Jy Top frame: Phas deg  
Vector averaged cross-power spectrum Baseline: YS (08) - KU (11)  
Timerange: 00/13:45:01 to 00/13:54:29

Plot file version 524 created 23-AUG-2016 15:01:01

W3IRS5 GA035B 1.UVDATA.1

Freq = 22.2125 GHz, Bw = 16.000 MH No calibration applied and no bandpass applied

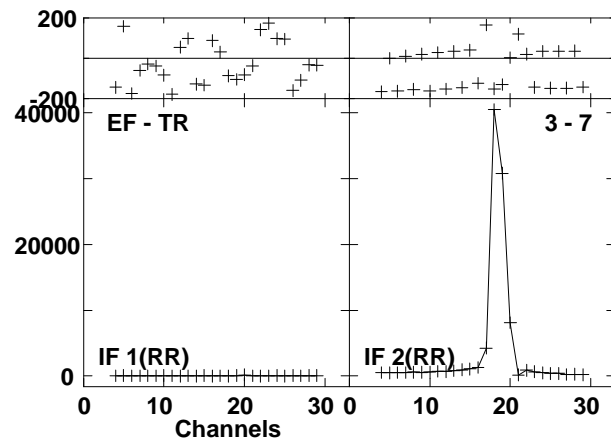
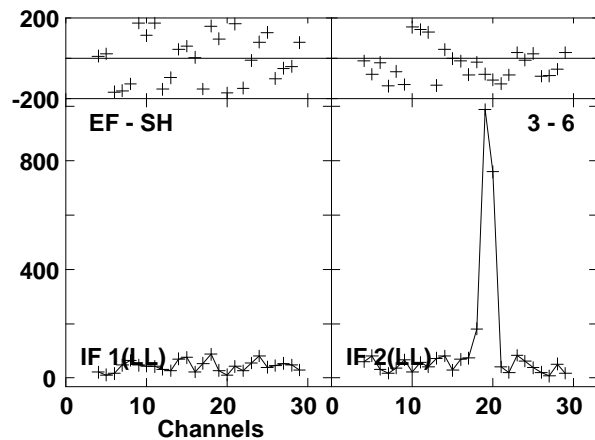
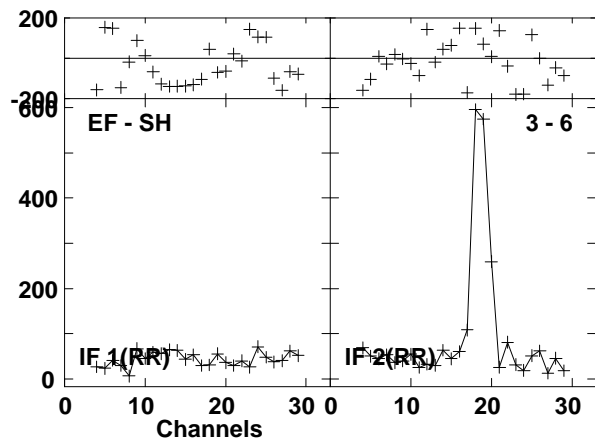
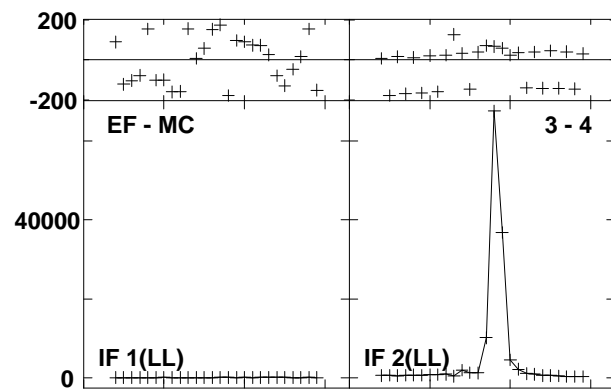
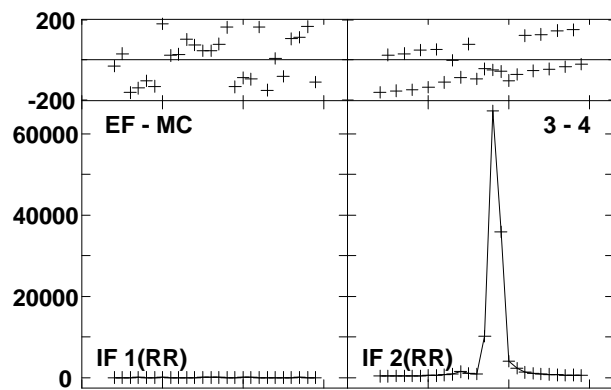
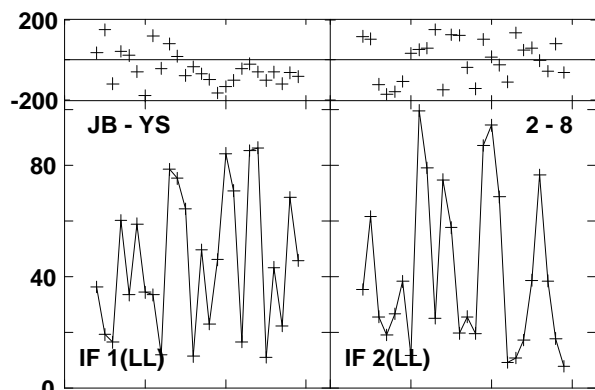
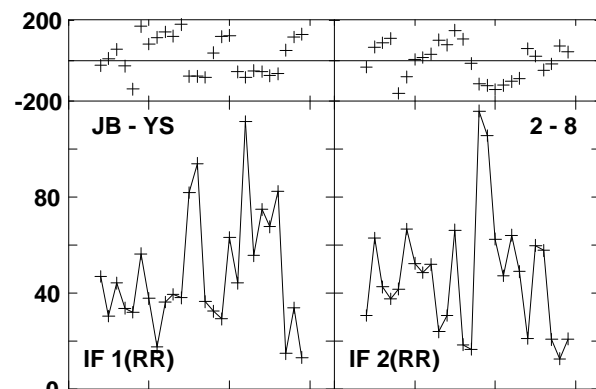
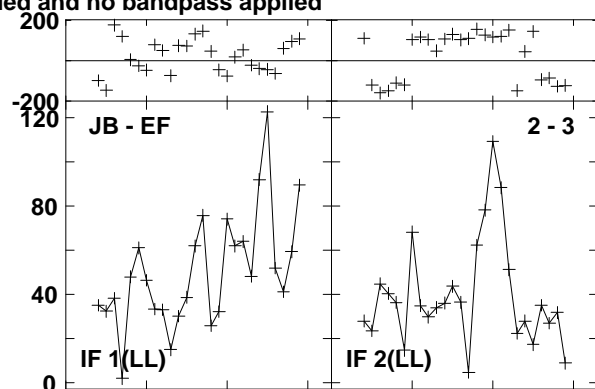
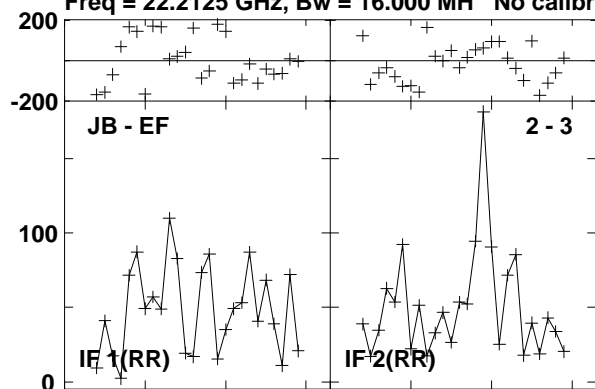

Lower frame: Micro Ampl Jy Top frame: Phas deg  
Vector averaged cross-power spectrum Baseline: JB (02) - EF (03)  
Timerange: 00/13:55:00 to 00/14:04:59

Plot file version 525 created 23-AUG-2016 15:01:01  
W3IRS5 GA035B 1.UVDATA.1

Freq = 22.2125 GHz, Bw = 16.000 MH No calibration applied and no bandpass applied

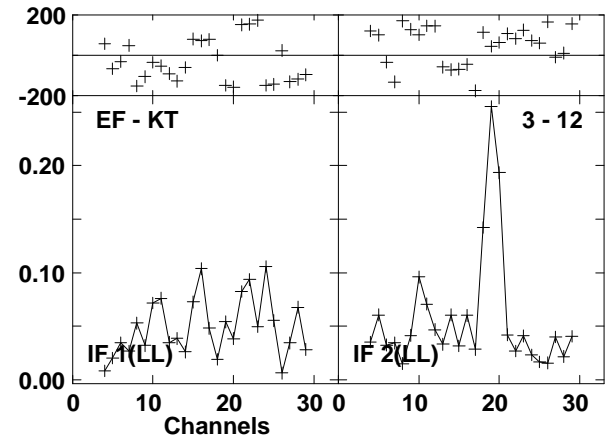
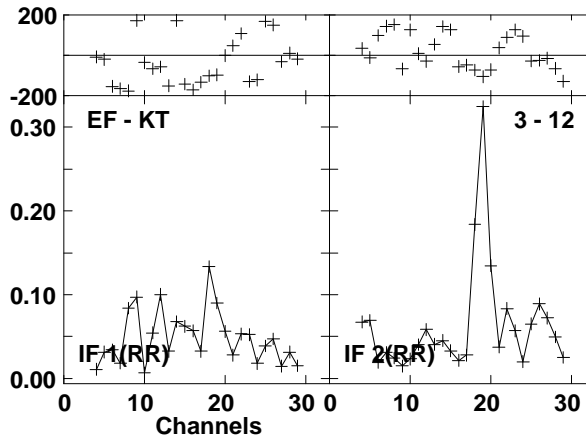
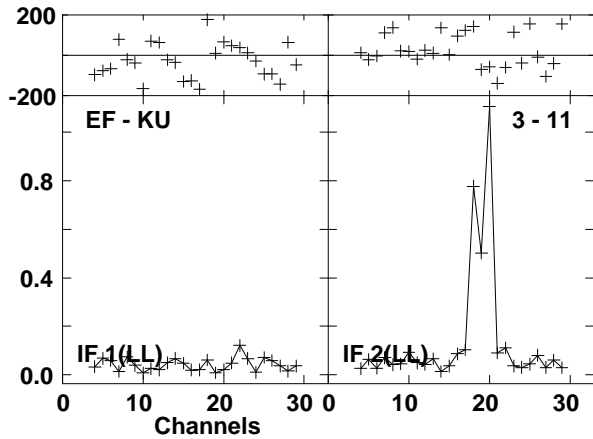
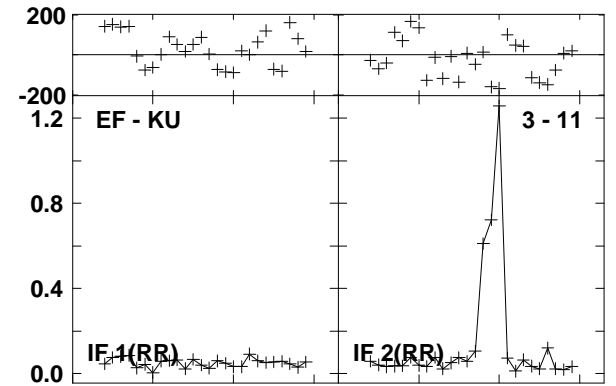
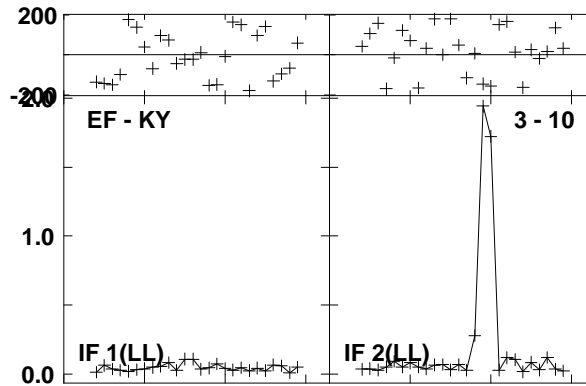
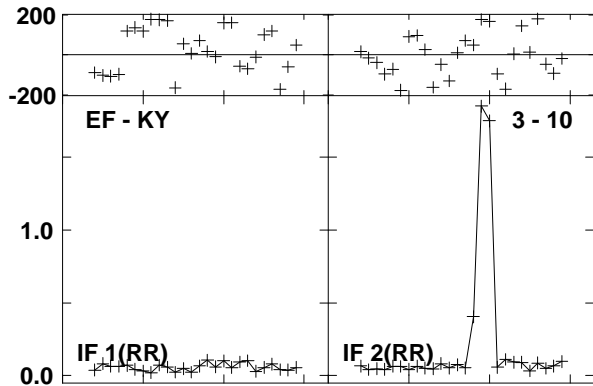
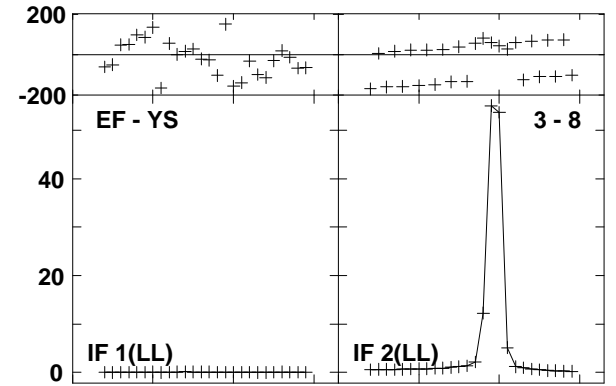
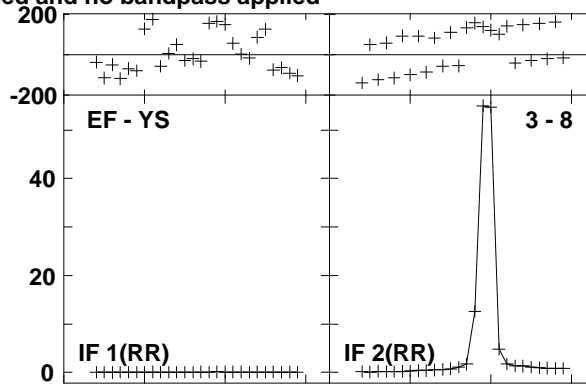
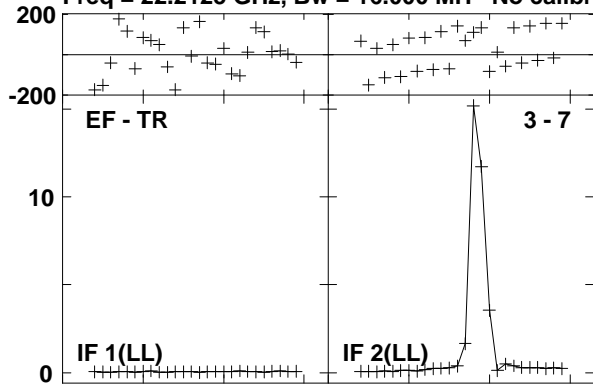

Lower frame: Milli Ampl Jy Top frame: Phas deg  
Vector averaged cross-power spectrum Baseline: EF (03) - TR (07)  
Timerange: 00/13:55:00 to 00/14:04:59

Plot file version 526 created 23-AUG-2016 15:01:01

W3IRS5 GA035B 1.UVDATA.1

Freq = 22.2125 GHz, Bw = 16.000 MH No calibration applied and no bandpass applied

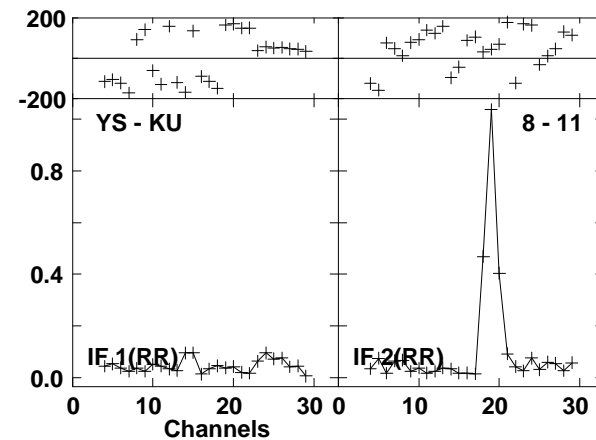
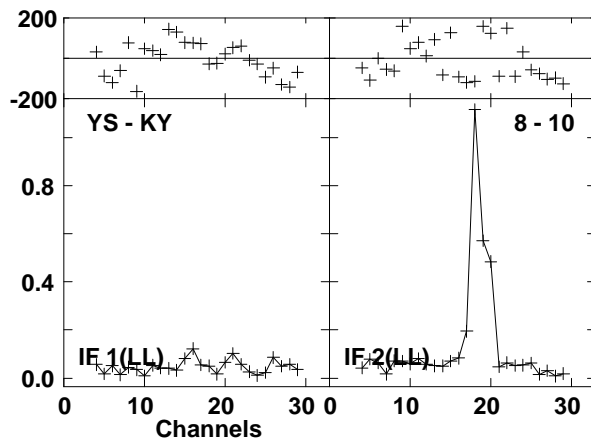
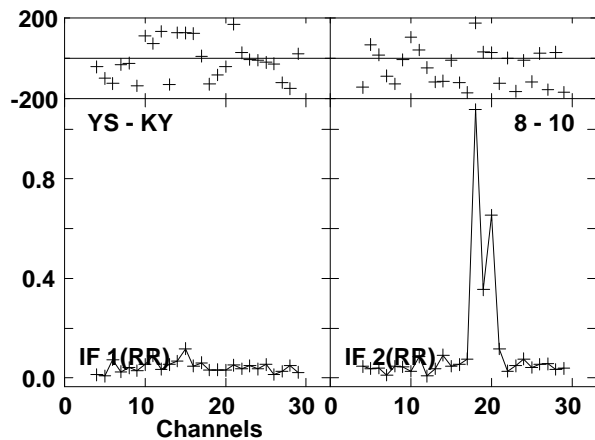
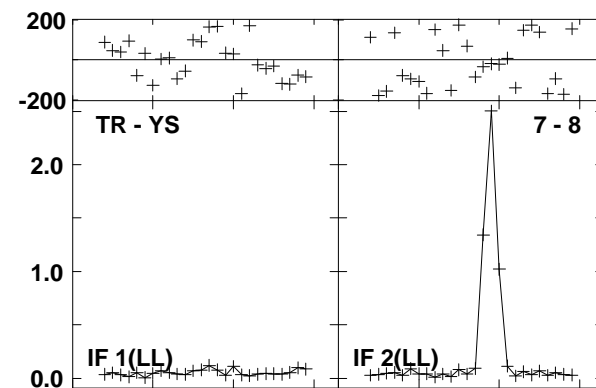
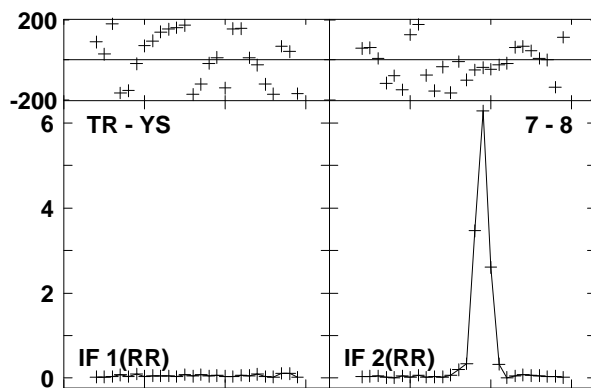
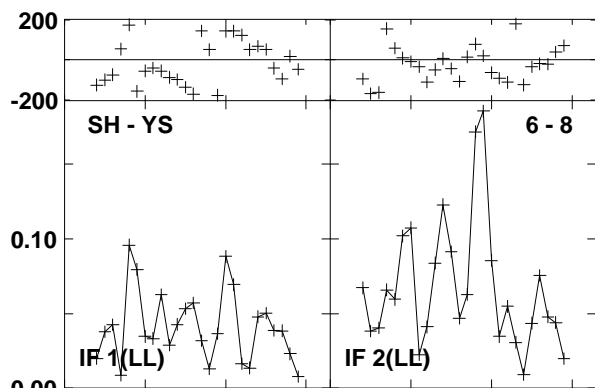
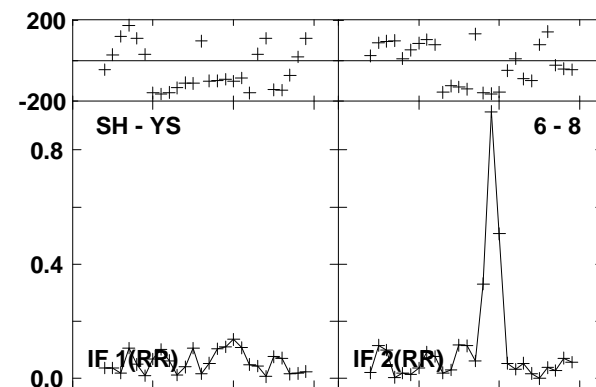
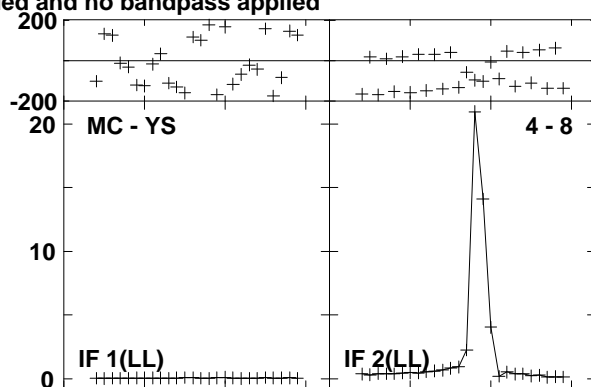
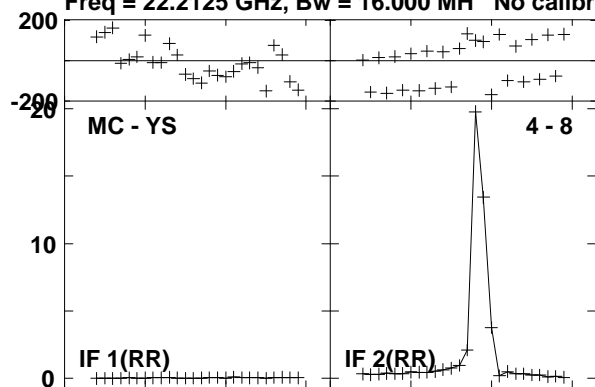

Lower frame: Milli Ampl Jy Top frame: Phas deg  
Vector averaged cross-power spectrum Baseline: MC (04) - YS (08)  
Timerange: 00/13:55:00 to 00/14:04:59

Plot file version 527 created 23-AUG-2016 15:01:01

W3IRS5 GA035B 1.UVDATA.1

Freq = 22.2125 GHz, Bw = 16.000 MH No calibration applied and no bandpass applied

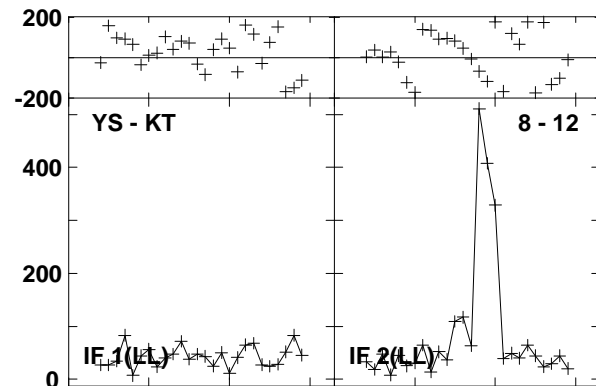
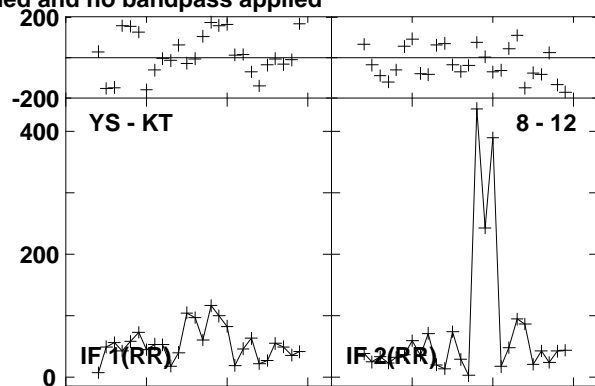
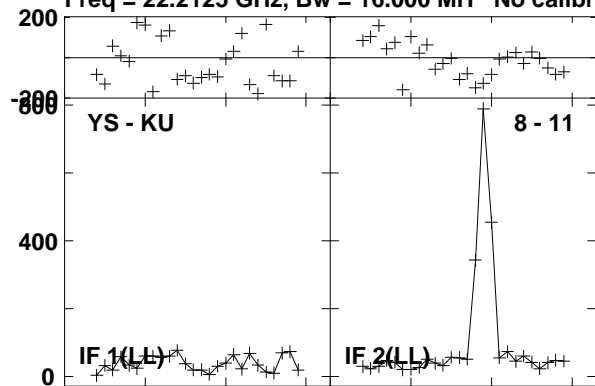

Lower frame: Micro Ampl Jy Top frame: Phas deg  
Vector averaged cross-power spectrum Baseline: YS (08) - KU (11)  
Timerange: 00/13:55:00 to 00/14:04:59

Plot file version 528 created 23-AUG-2016 15:01:01

W3IRS5 GA035B 1.UVDATA.1

Freq = 22.2125 GHz, Bw = 16.000 MH No calibration applied and no bandpass applied

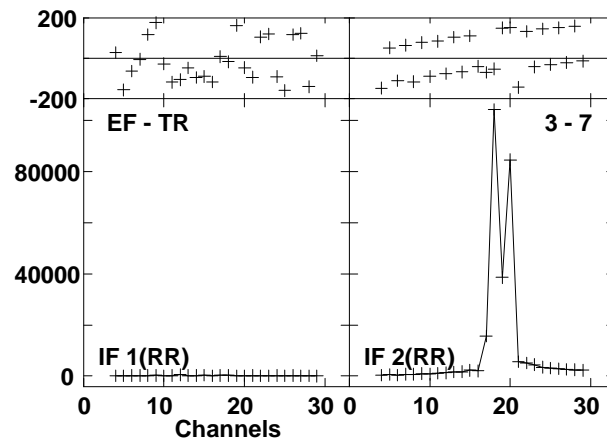
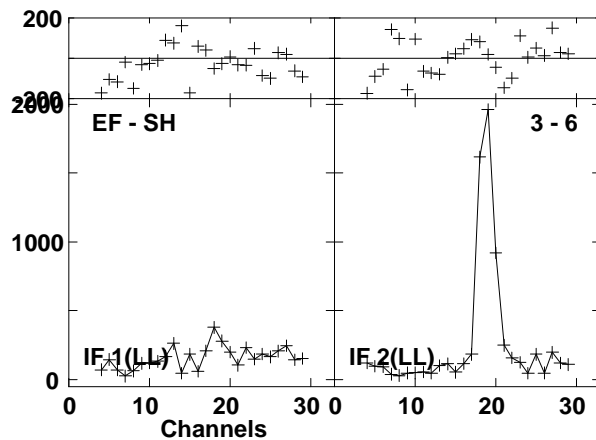
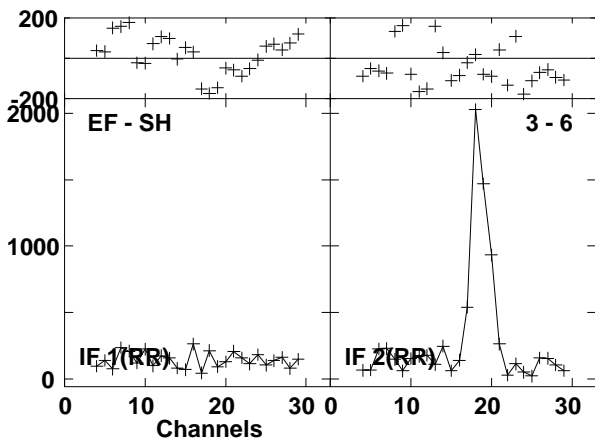
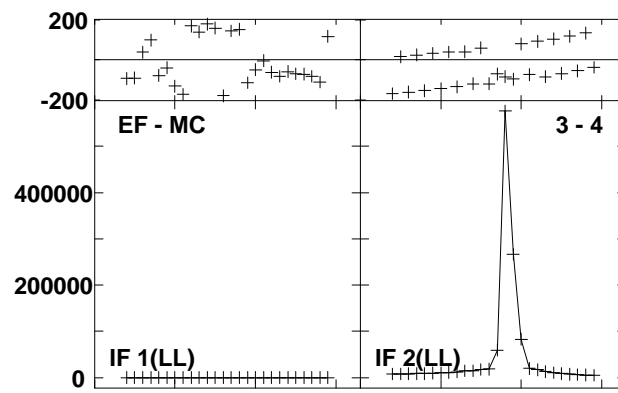
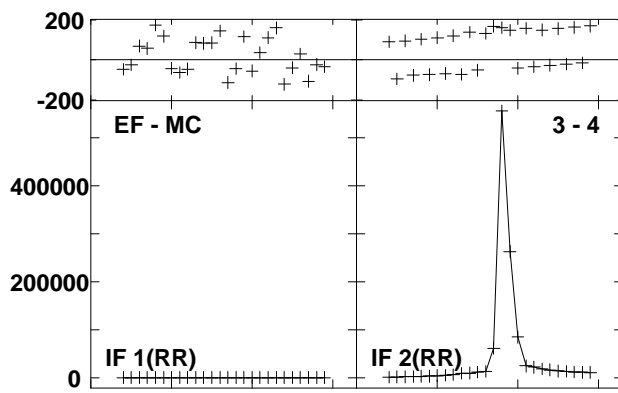
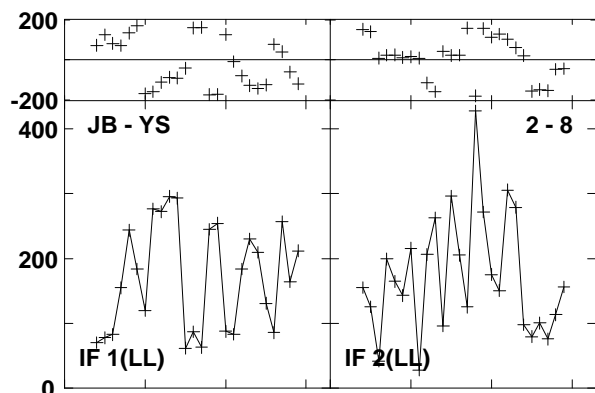
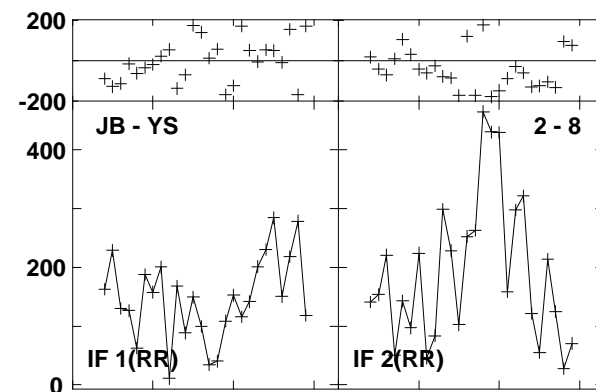
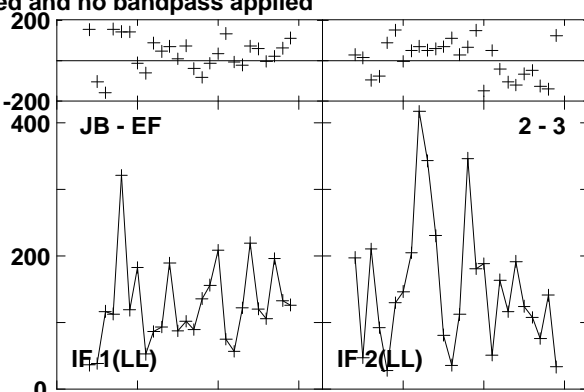
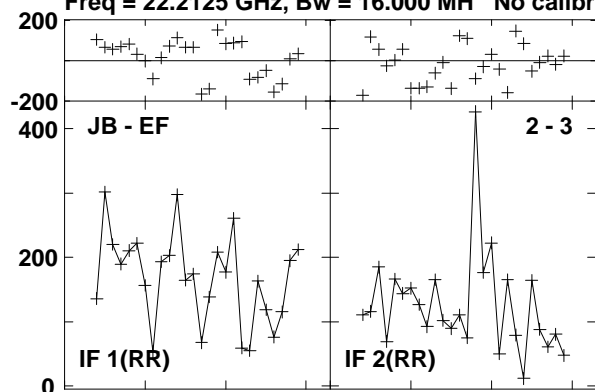

Lower frame: Micro Ampl Jy Top frame: Phas deg  
Vector averaged cross-power spectrum Baseline: JB (02) - EF (03)  
Timerange: 00/14:06:01 to 00/14:06:59



Plot file version 529 created 23-AUG-2016 15:01:01  
W3IRS5 GA035B 1.UVDATA.1

Freq = 22.2125 GHz, Bw = 16.000 MH No calibration applied and no bandpass applied

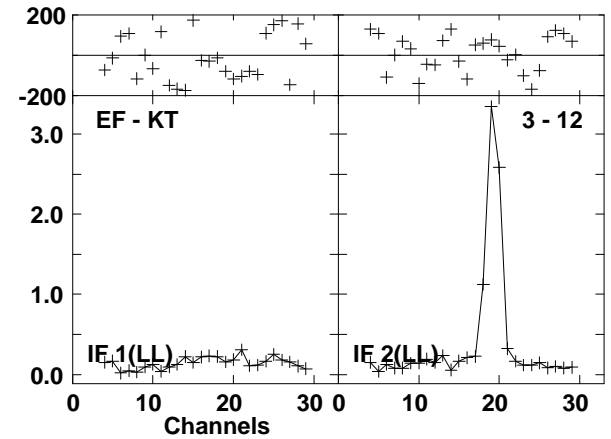
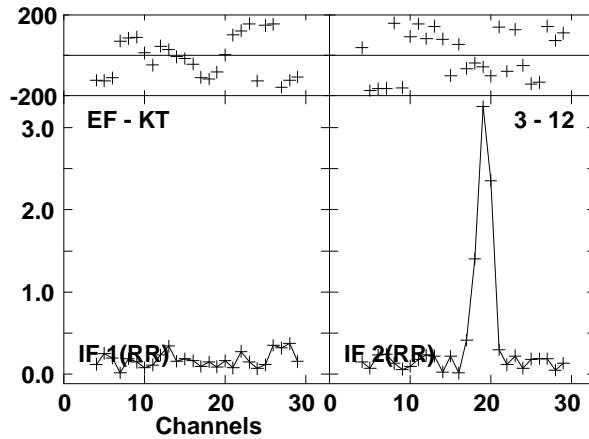
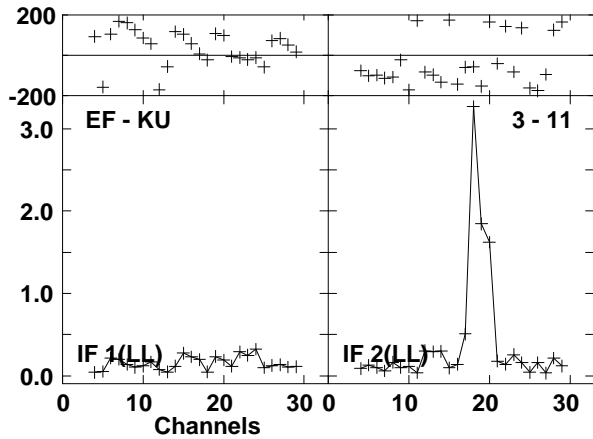
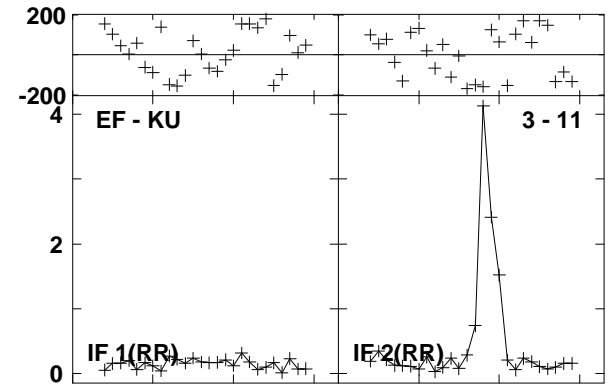
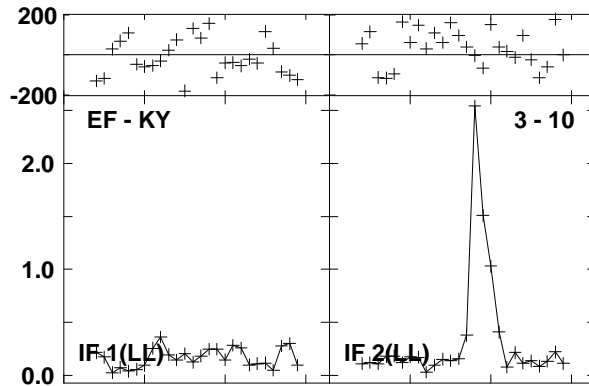
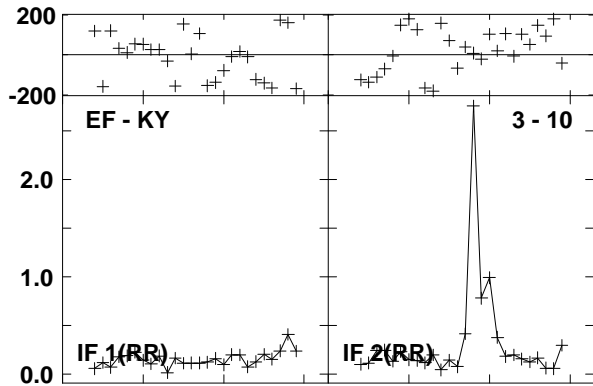
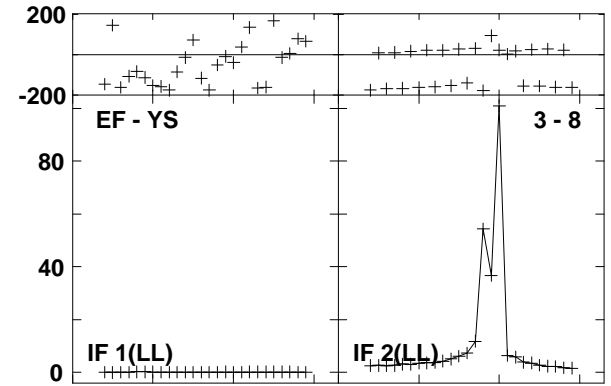
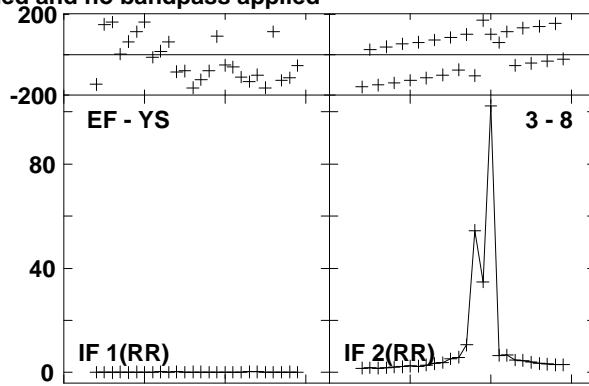
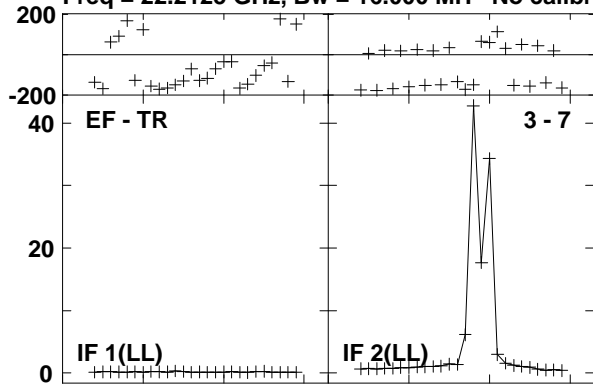

Lower frame: Milli Ampl Jy Top frame: Phas deg  
Vector averaged cross-power spectrum Baseline: EF (03) - TR (07)  
Timerange: 00/14:06:01 to 00/14:06:59

Plot file version 530 created 23-AUG-2016 15:01:01

W3IRS5 GA035B 1.UVDATA.1

Freq = 22.2125 GHz, Bw = 16.000 MH No calibration applied and no bandpass applied

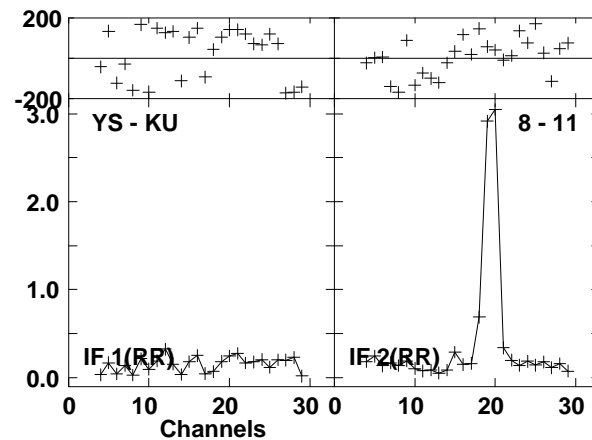
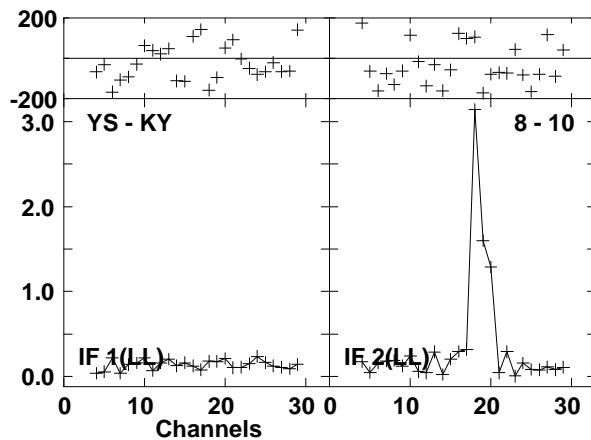
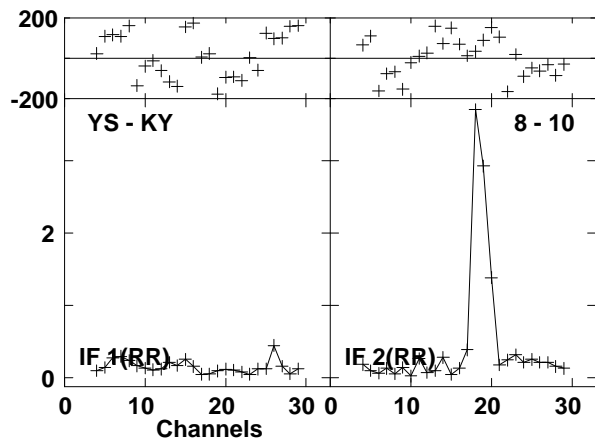
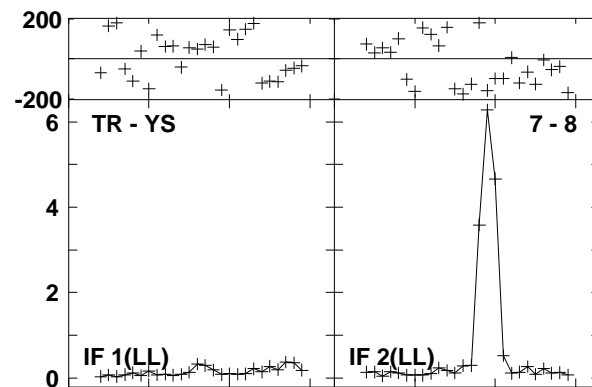
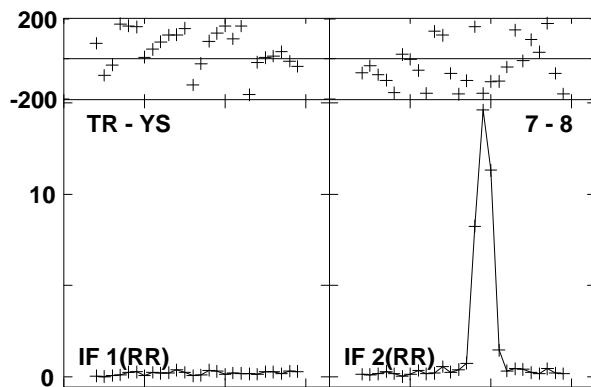
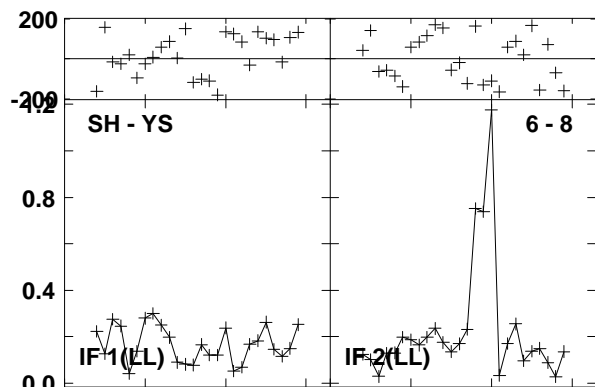
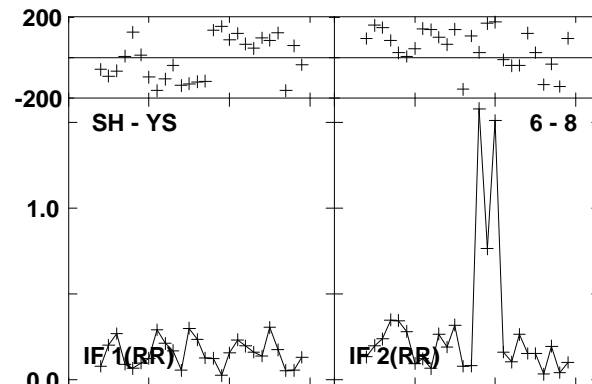
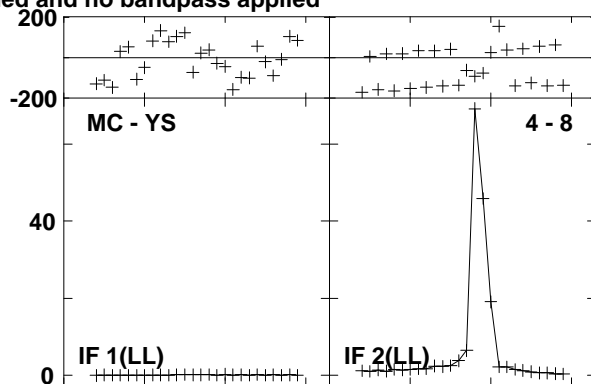
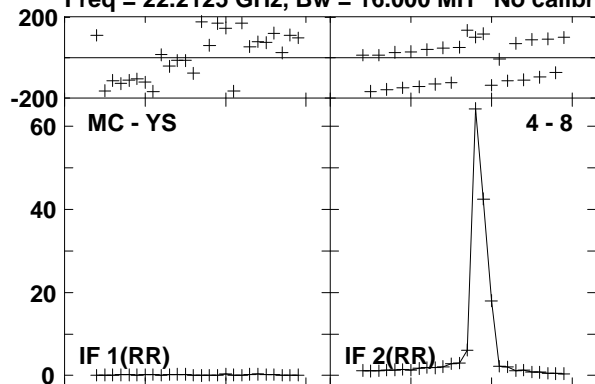

Lower frame: Milli Ampl Jy Top frame: Phas deg  
Vector averaged cross-power spectrum Baseline: MC (04) - YS (08)  
Timerange: 00/14:06:01 to 00/14:06:59

Plot file version 531 created 23-AUG-2016 15:01:01  
W3IRS5 GA035B 1.UVDATA.1

Freq = 22.2125 GHz, Bw = 16.000 MH No calibration applied and no bandpass applied

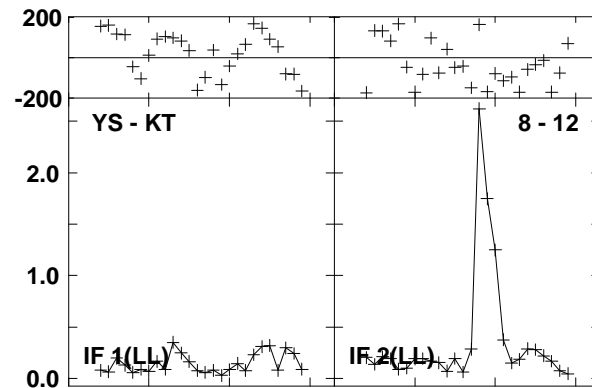
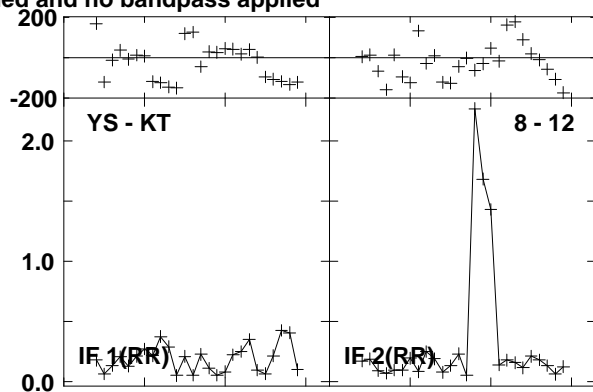
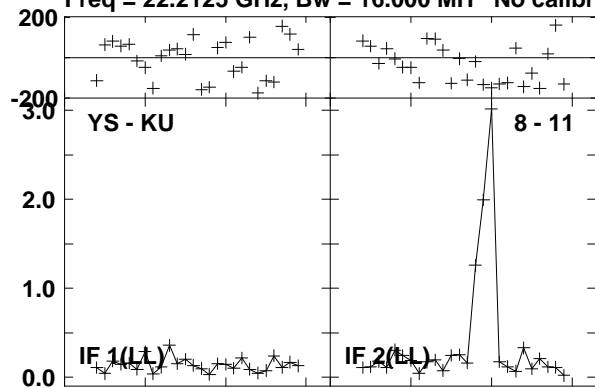

Lower frame: Milli Ampl Jy Top frame: Phas deg  
Vector averaged cross-power spectrum Baseline: YS (08) - KU (11)  
Timerange: 00/14:06:01 to 00/14:06:59

Plot file version 532 created 23-AUG-2016 15:01:01

0219+628 GA035B 1.UVDATA.1

Freq = 22.2125 GHz, Bw = 16.000 MH No calibration applied and no bandpass applied

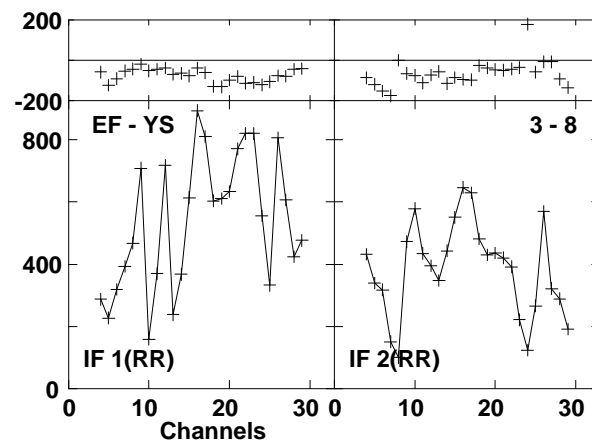
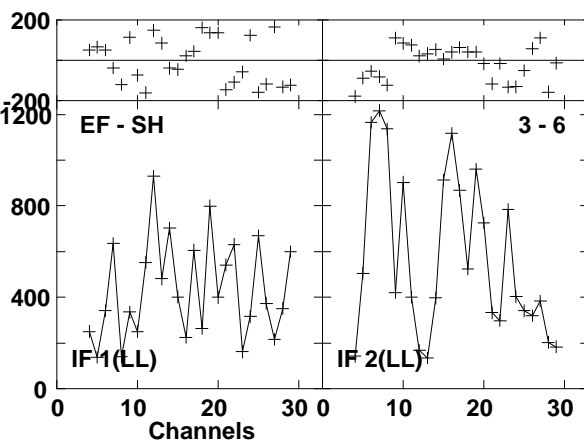
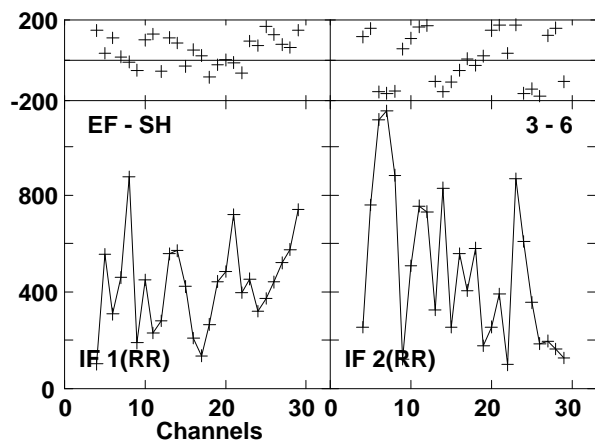
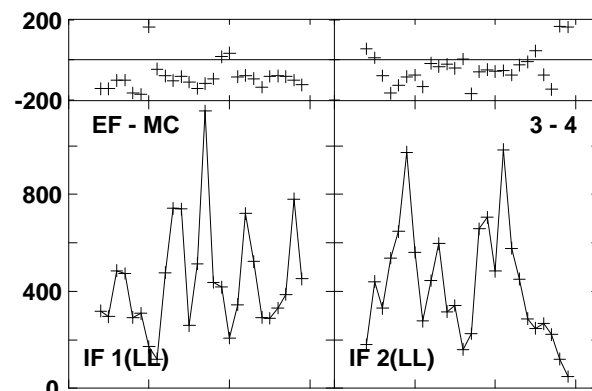
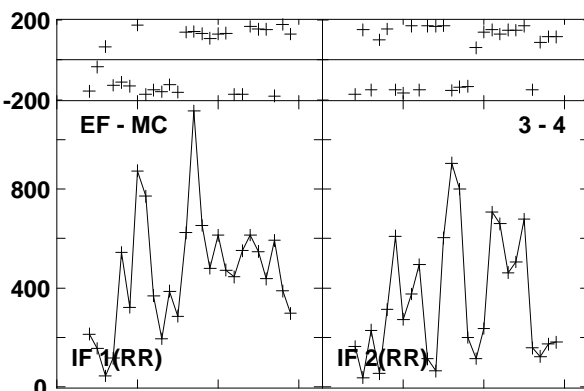
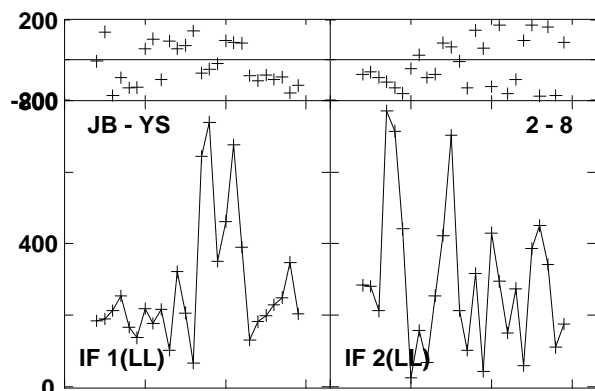
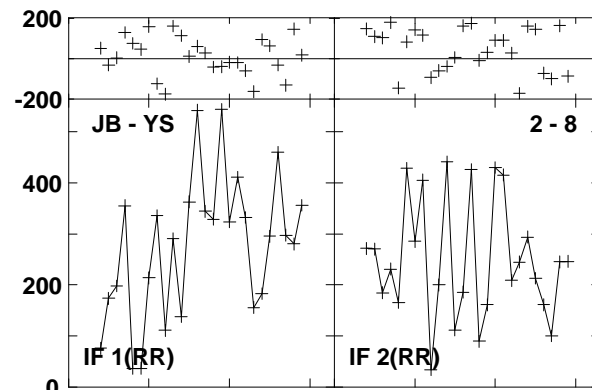
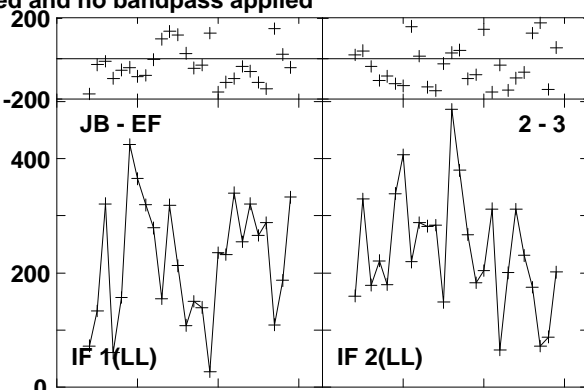
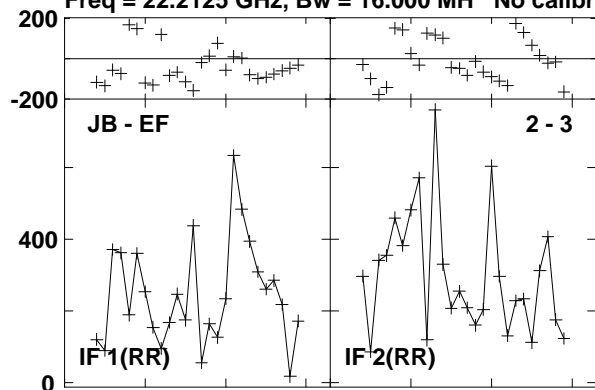

Lower frame: Micro Ampl Jy Top frame: Phas deg  
Vector averaged cross-power spectrum Baseline: JB (02) - EF (03)  
Timerange: 00/14:07:32 to 00/14:07:52

Plot file version 533 created 23-AUG-2016 15:01:01

0219+628 GA035B 1.UVDATA.1

Freq = 22.2125 GHz, Bw = 16.000 MH No calibration applied and no bandpass applied

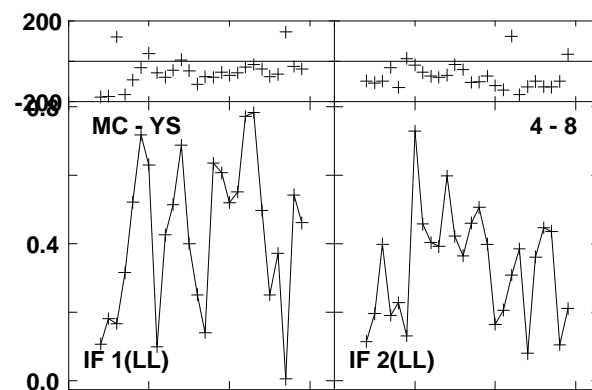
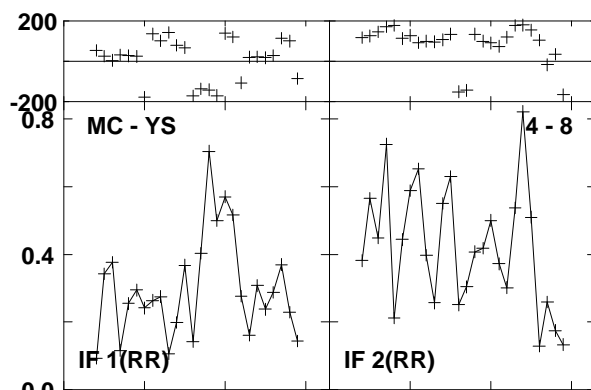
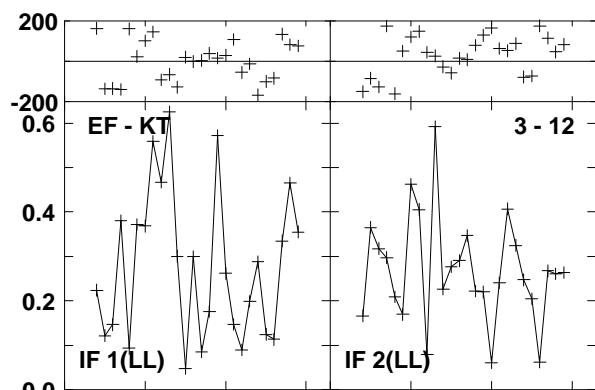
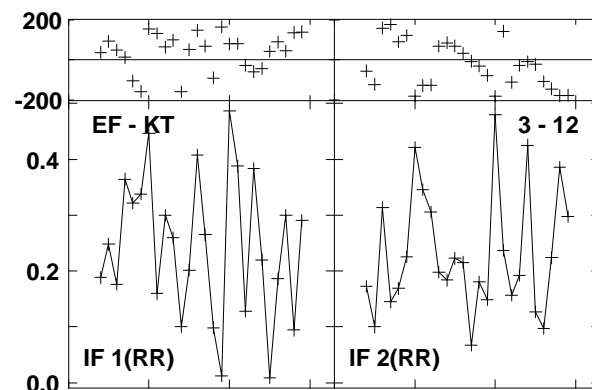
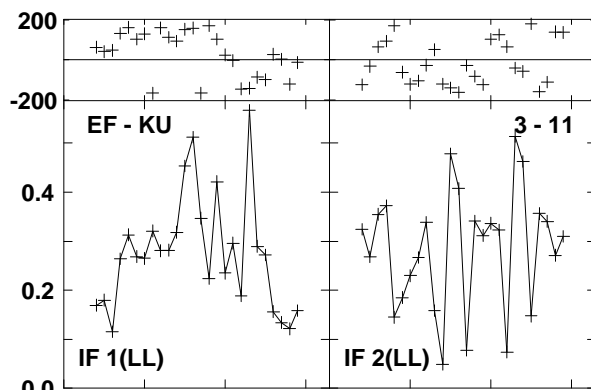
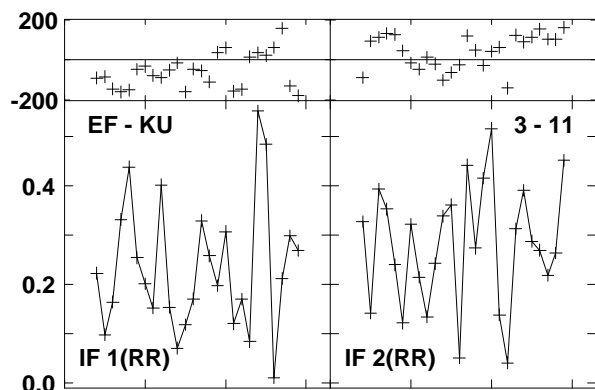
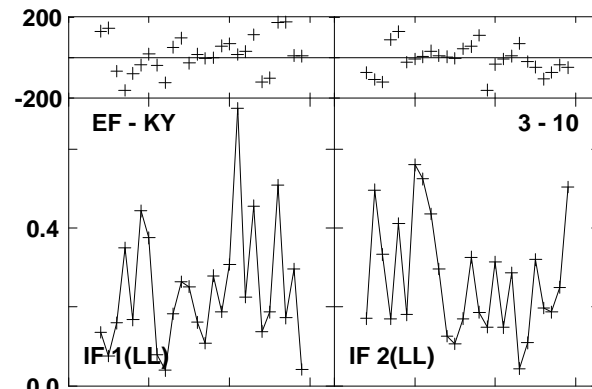
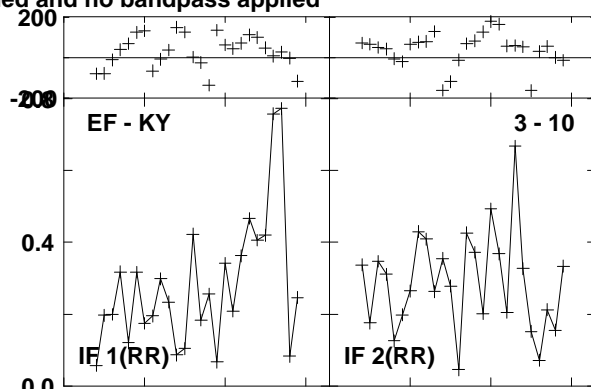
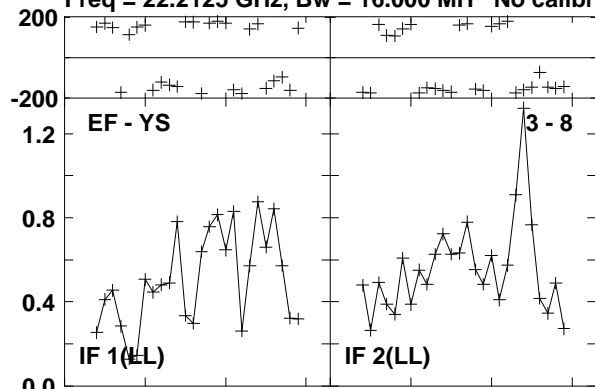

Lower frame: Milli Ampl Jy Top frame: Phas deg  
Vector averaged cross-power spectrum Baseline: EF (03) - YS (08)  
Timerange: 00/14:07:32 to 00/14:07:52

Plot file version 534 created 23-AUG-2016 15:01:01

0219+628 GA035B 1.UVDATA.1

Freq = 22.2125 GHz, Bw = 16.000 MH No calibration applied and no bandpass applied

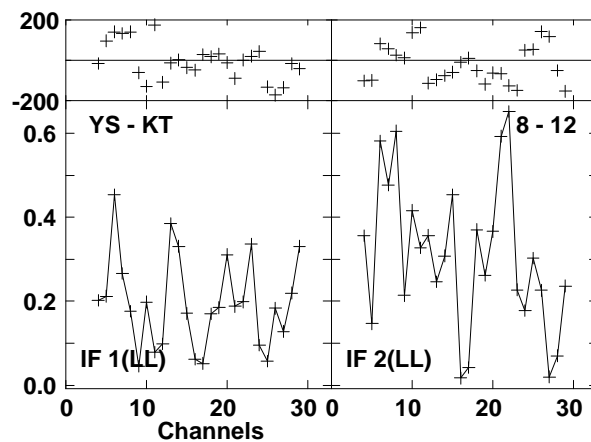
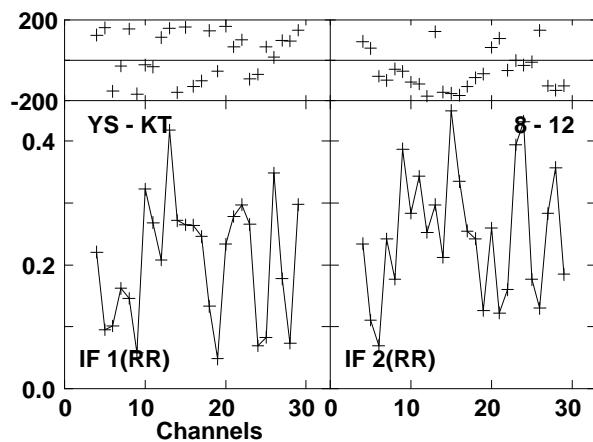
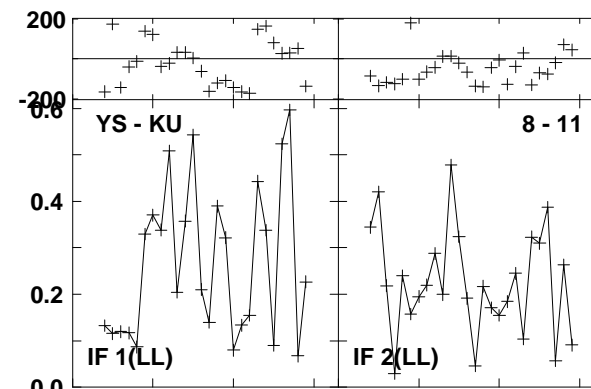
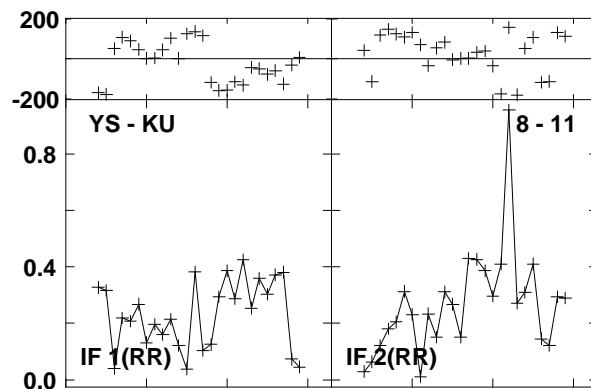
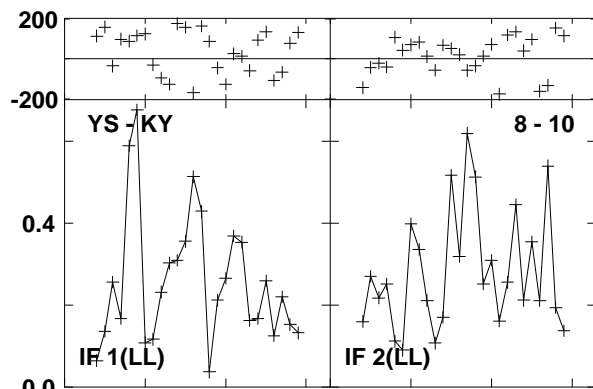
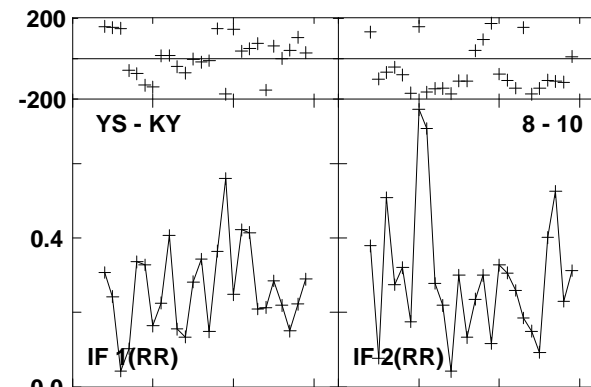
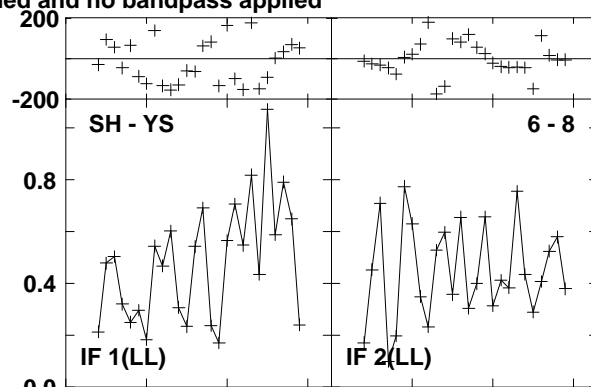
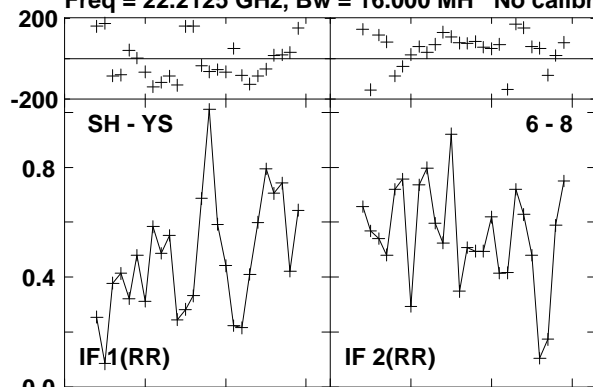

Lower frame: Milli Ampl Jy Top frame: Phas deg

Vector averaged cross-power spectrum Baseline: SH (06) - YS (08)

Timerange: 00/14:07:32 to 00/14:07:52

Plot file version 535 created 23-AUG-2016 15:01:01

W3IRS5 GA035B 1.UVDATA.1

Freq = 22.2125 GHz, Bw = 16.000 MH No calibration applied and no bandpass applied

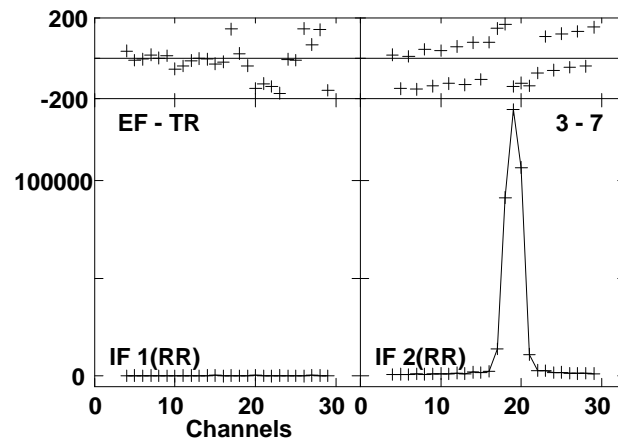
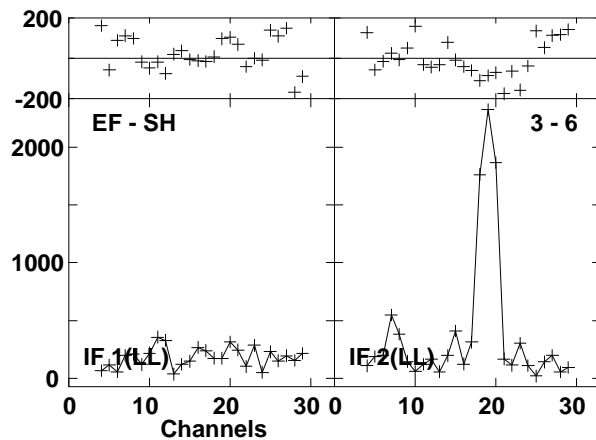
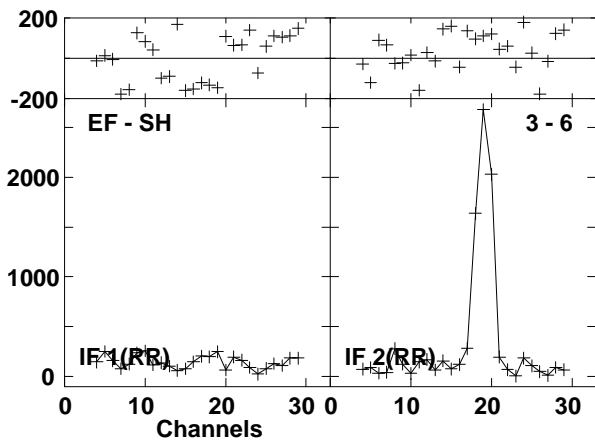
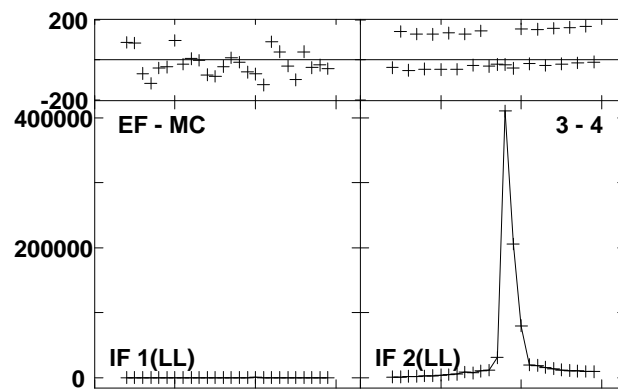
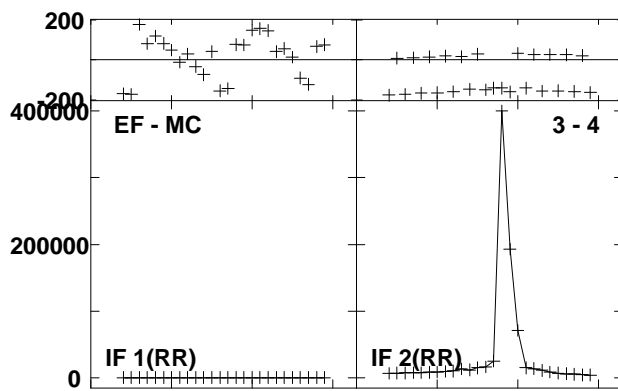
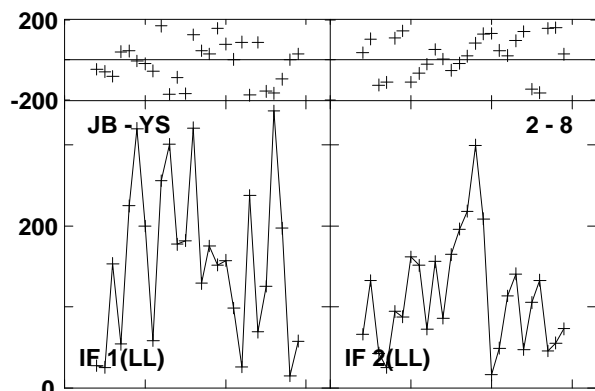
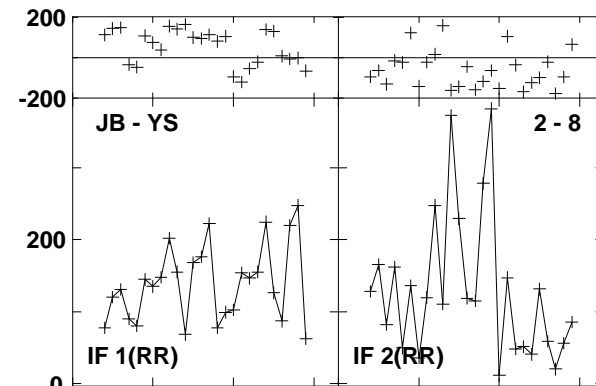
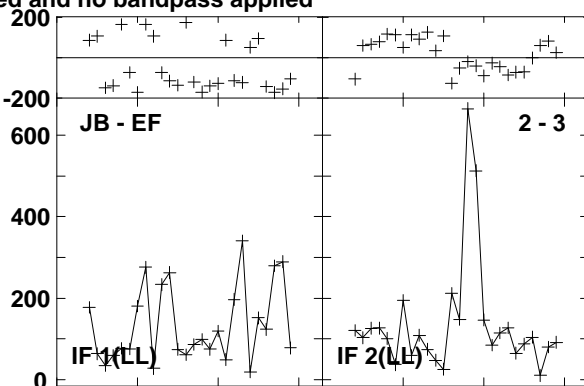
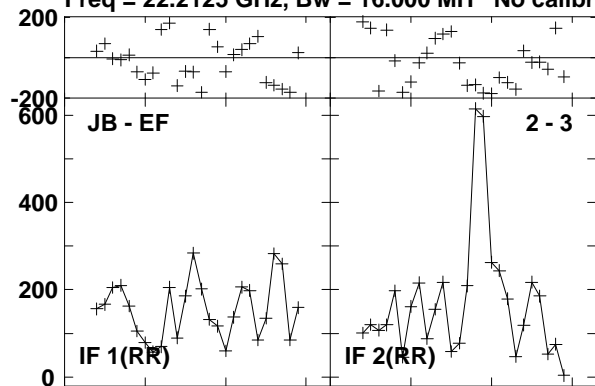

Lower frame: Micro Ampl Jy Top frame: Phas deg  
Vector averaged cross-power spectrum Baseline: JB (02) - EF (03)  
Timerange: 00/14:08:25 to 00/14:09:23

Plot file version 536 created 23-AUG-2016 15:01:01

W3IRS5 GA035B 1.UVDATA.1

Freq = 22.2125 GHz, Bw = 16.000 MH No calibration applied and no bandpass applied

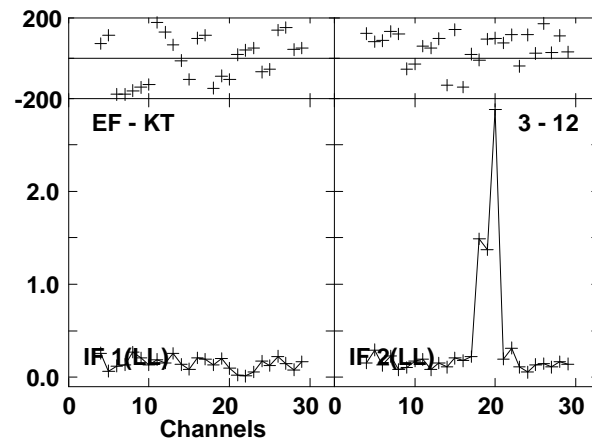
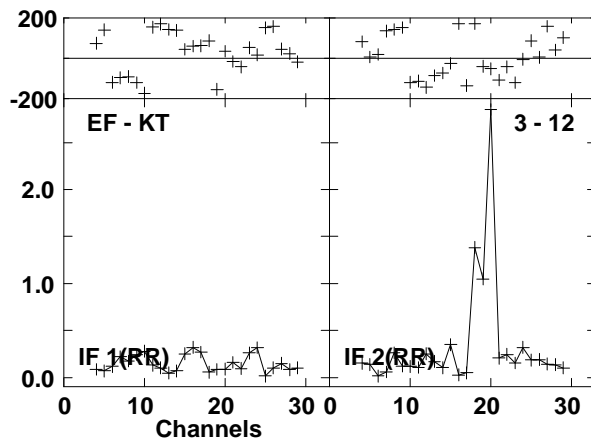
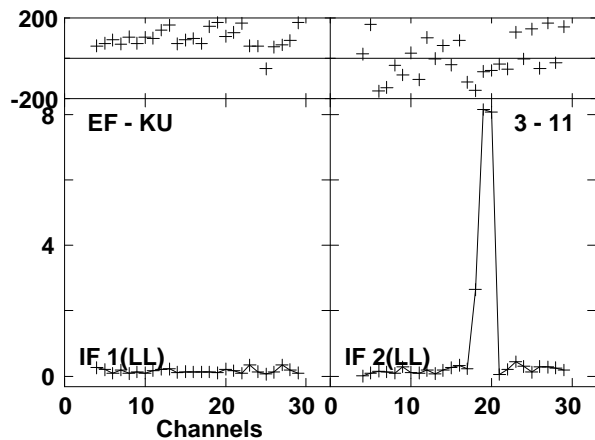
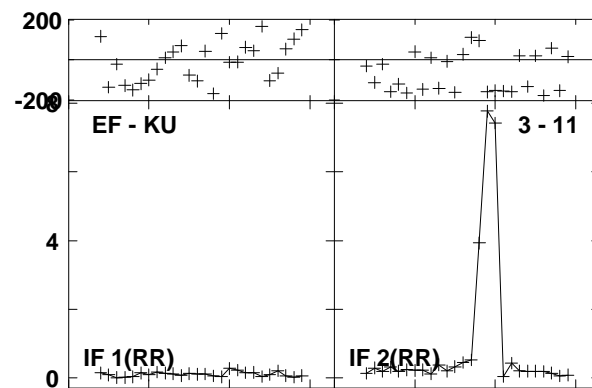
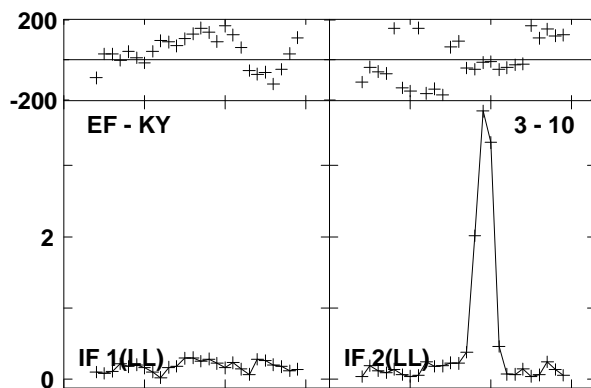
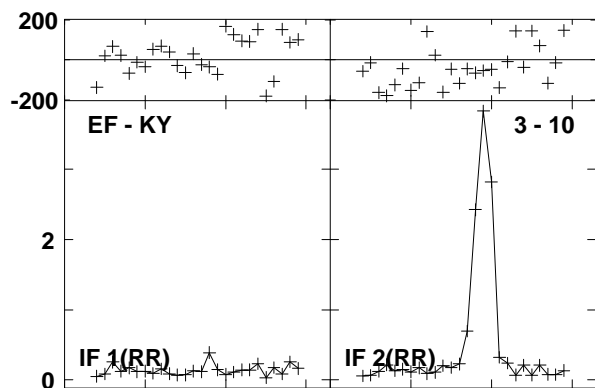
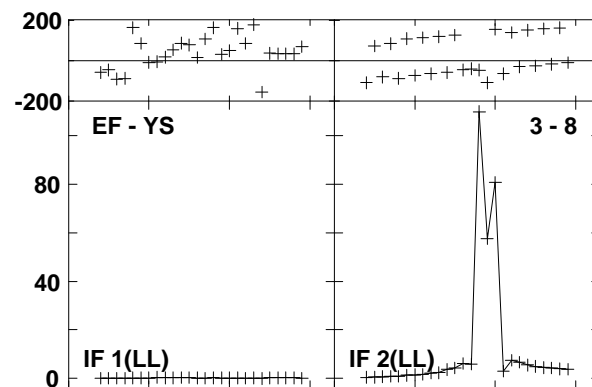
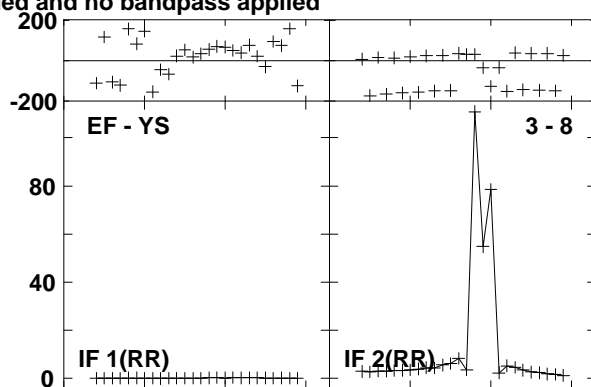
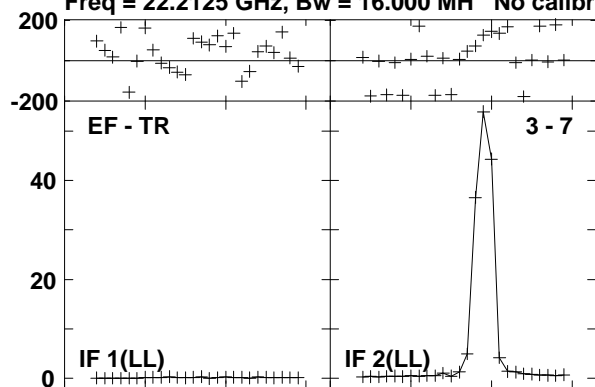

Lower frame: Milli Ampl Jy Top frame: Phas deg  
Vector averaged cross-power spectrum Baseline: EF (03) - TR (07)  
Timerange: 00/14:08:25 to 00/14:09:23



Plot file version 537 created 23-AUG-2016 15:01:01  
 W3IRS5 GA035B 1.UVDATA.1

Freq = 22.2125 GHz, Bw = 16.000 MH No calibration applied and no bandpass applied

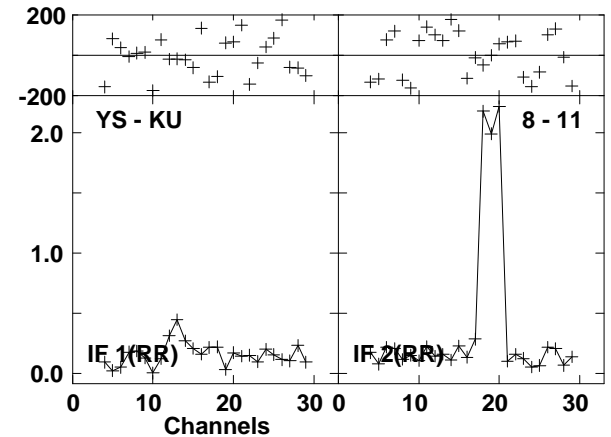
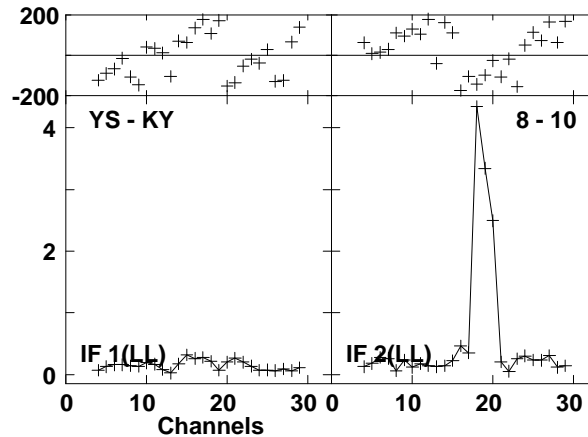
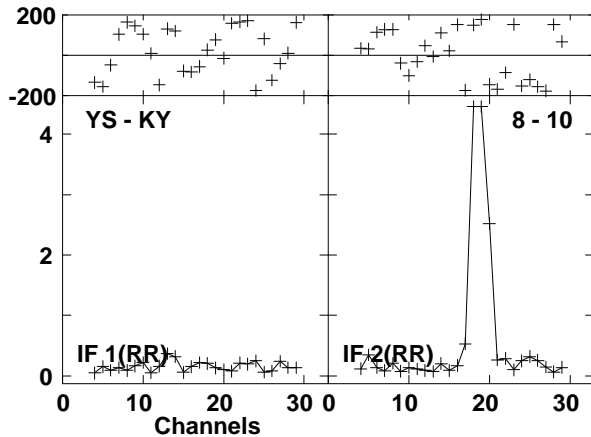
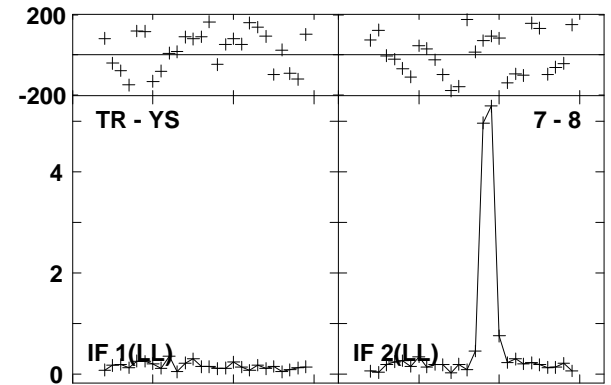
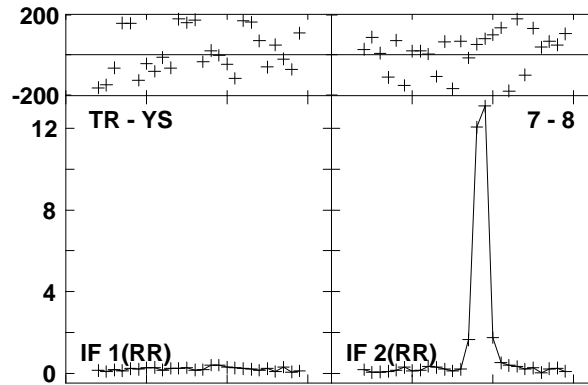
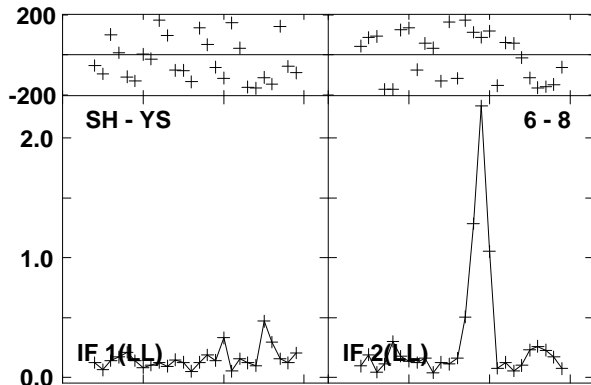
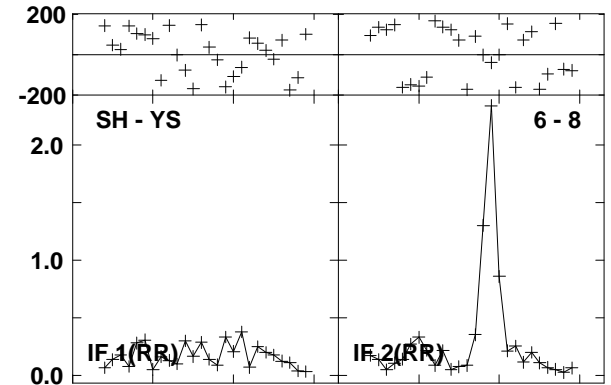
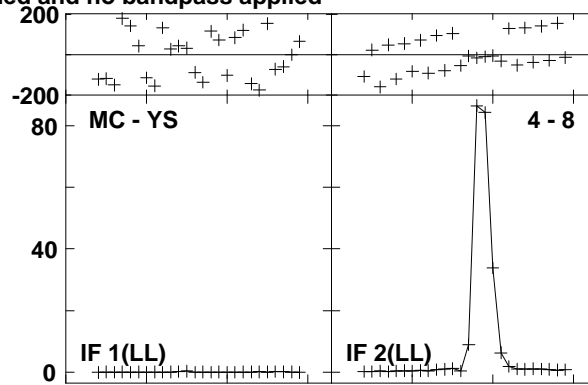
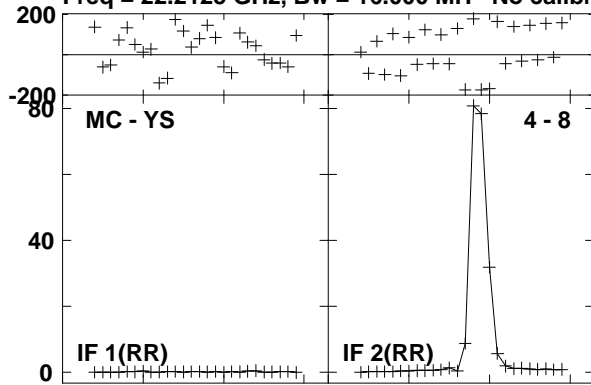

Lower frame: Milli Ampl Jy Top frame: Phas deg  
 Vector averaged cross-power spectrum Baseline: MC (04) - YS (08)  
 Timerange: 00/14:08:25 to 00/14:09:23

Plot file version 538 created 23-AUG-2016 15:01:01  
W3IRS5 GA035B 1.UVDATA.1

Freq = 22.2125 GHz, Bw = 16.000 MH No calibration applied and no bandpass applied

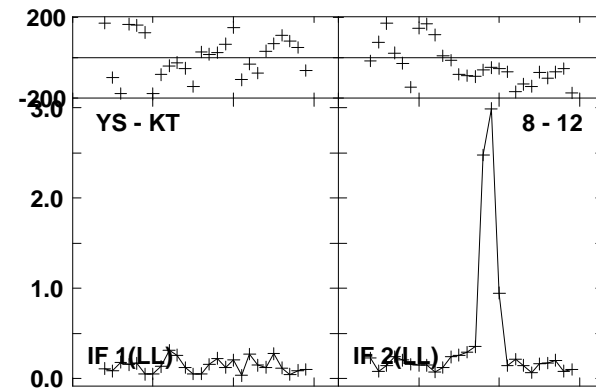
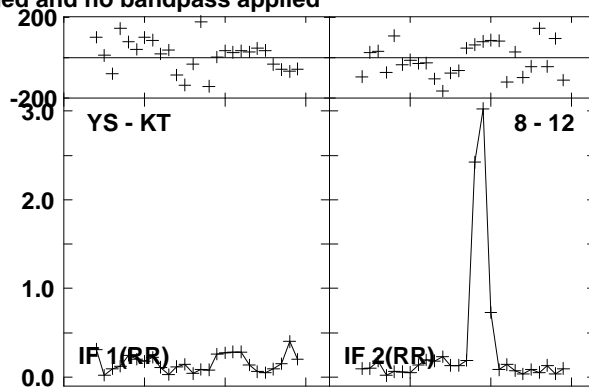
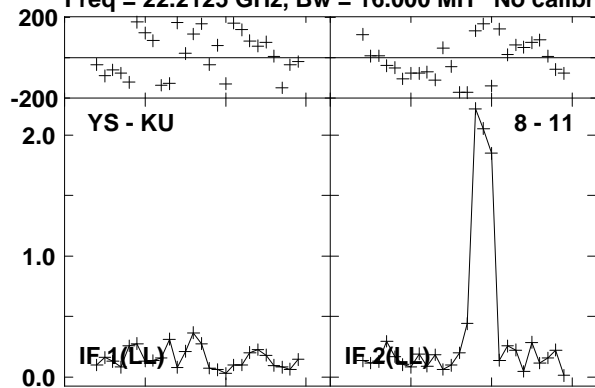

Lower frame: Milli Ampl Jy Top frame: Phas deg  
Vector averaged cross-power spectrum Baseline: YS (08) - KU (11)  
Timerange: 00/14:08:25 to 00/14:09:23

Plot file version 539 created 23-AUG-2016 15:01:01  
 0219+628 GA035B 1.UVDATA.1

Freq = 22.2125 GHz, Bw = 16.000 MH No calibration applied and no bandpass applied

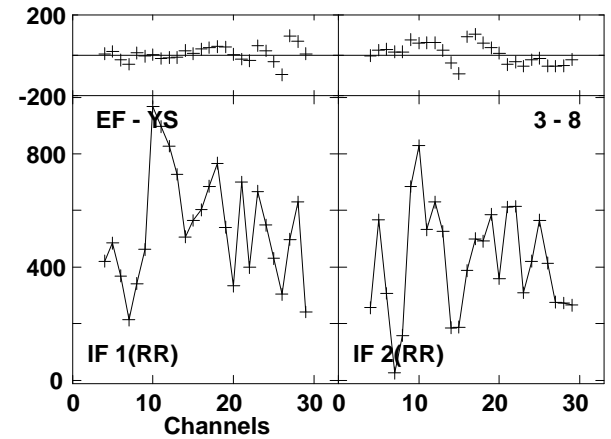
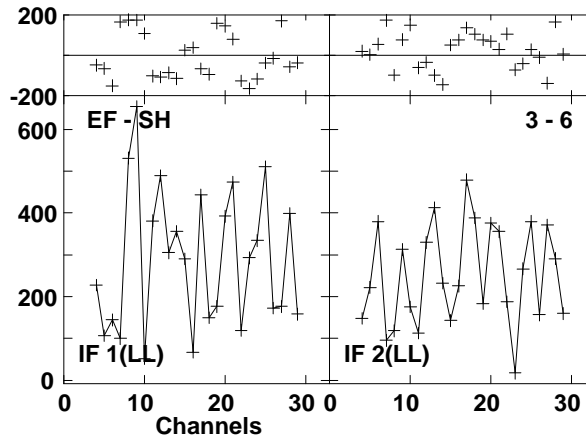
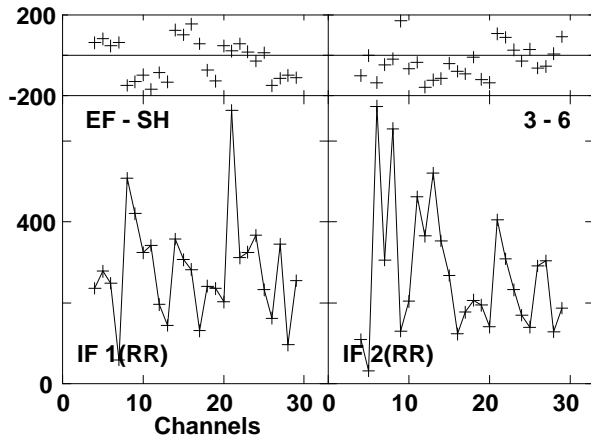
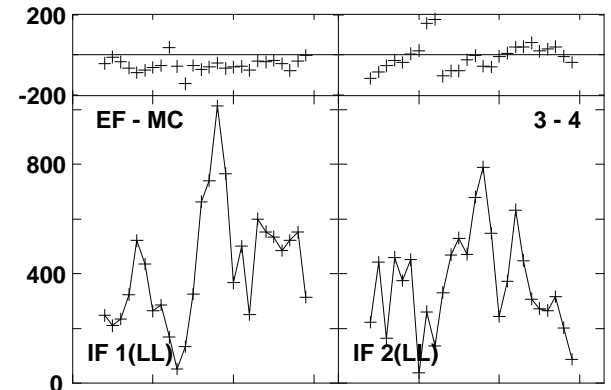
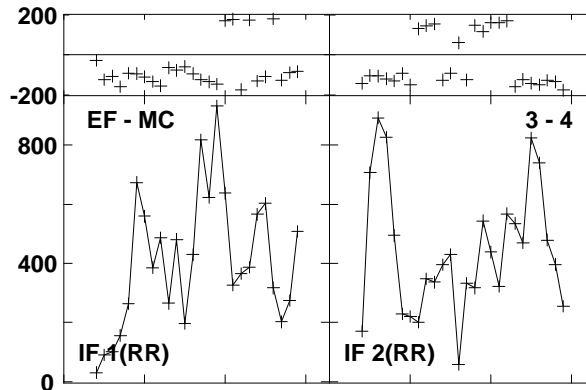
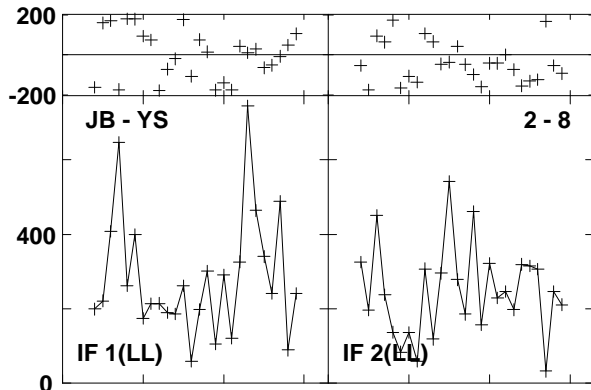
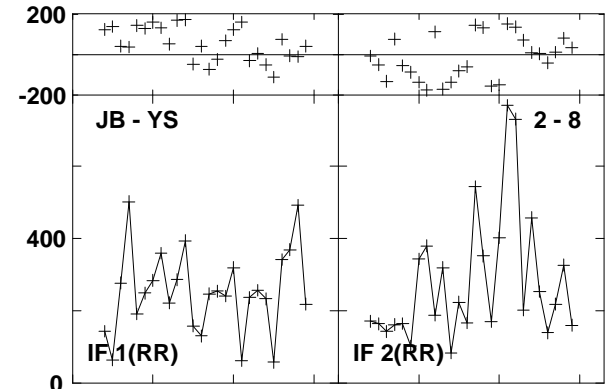
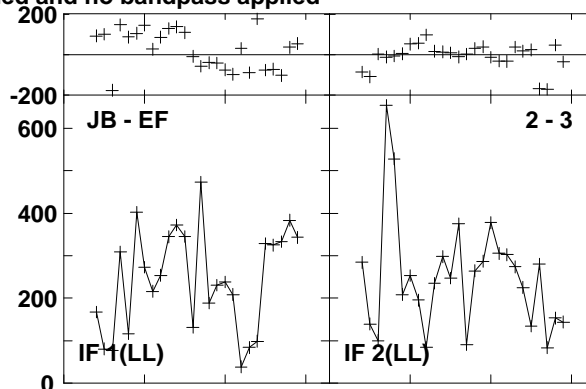
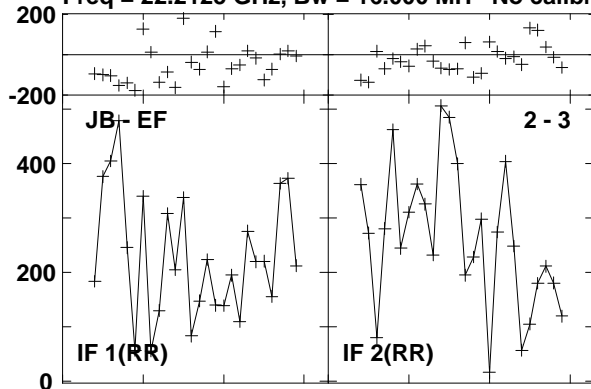

Lower frame: Micro Ampl Jy Top frame: Phas deg  
 Vector averaged cross-power spectrum Baseline: JB (02) - EF (03)  
 Timerange: 00/14:09:56 to 00/14:10:16

Plot file version 540 created 23-AUG-2016 15:01:01

0219+628 GA035B 1.UVDATA.1

Freq = 22.2125 GHz, Bw = 16.000 MH No calibration applied and no bandpass applied

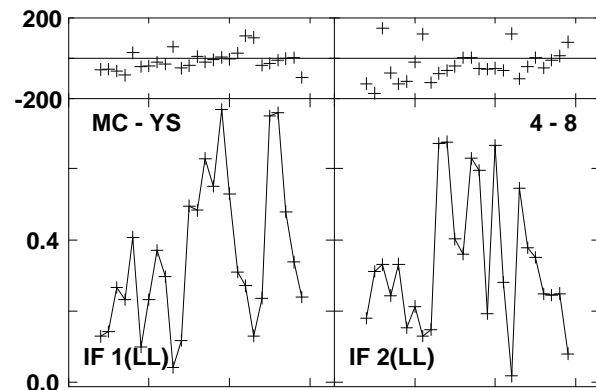
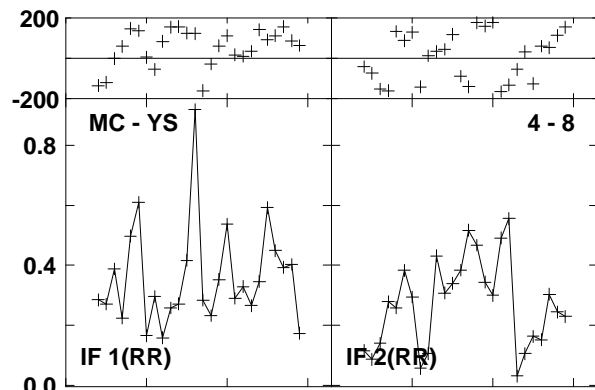
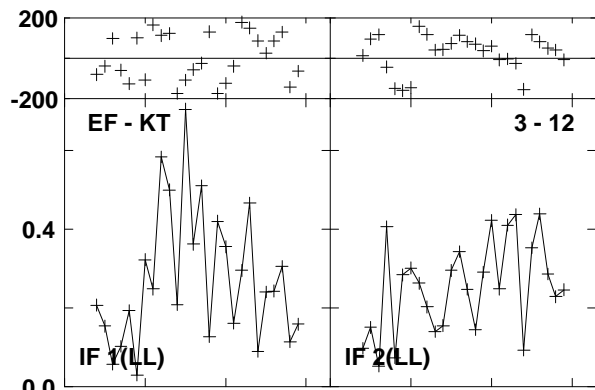
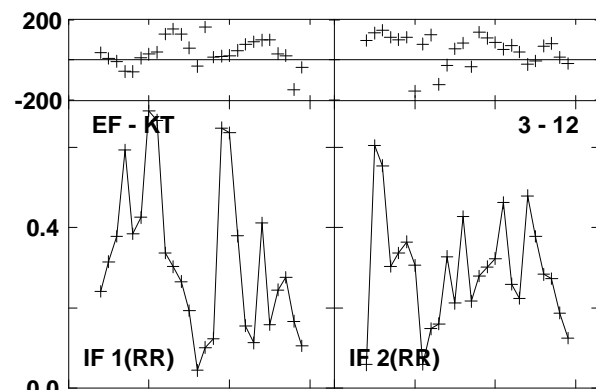
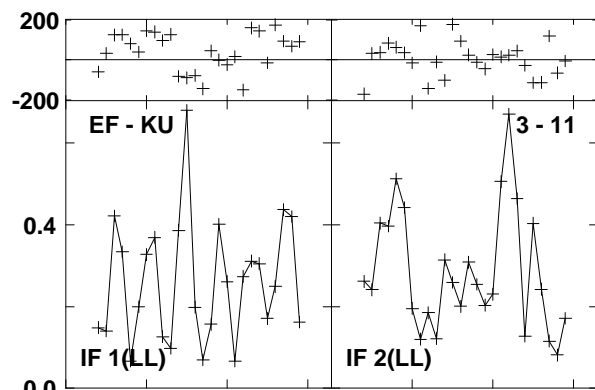
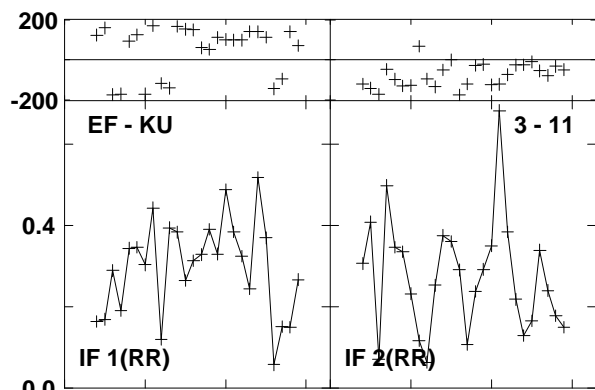
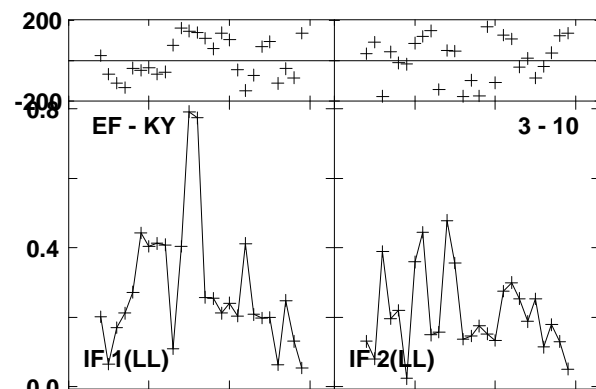
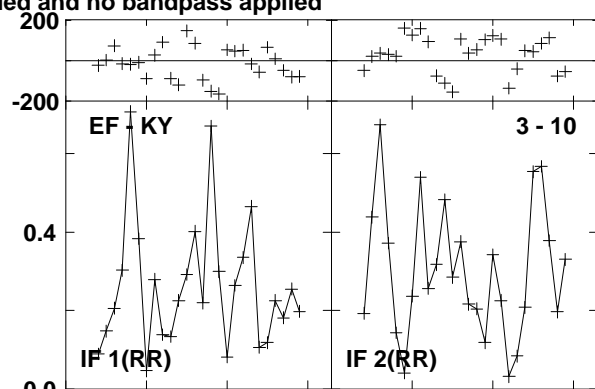
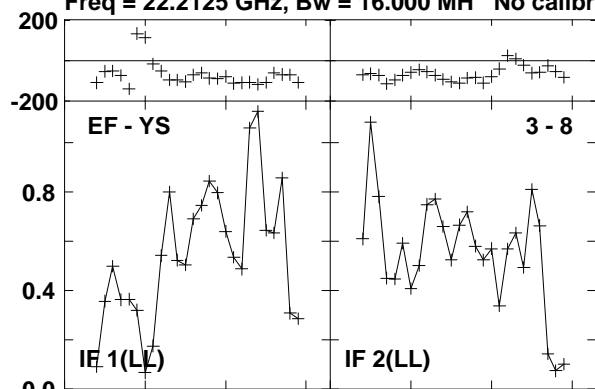

Lower frame: Milli Ampl Jy Top frame: Phas deg

Vector averaged cross-power spectrum Baseline: EF (03) - YS (08)

Timerange: 00/14:09:56 to 00/14:10:16

Plot file version 541 created 23-AUG-2016 15:01:01

0219+628 GA035B 1.UVDATA.1

Freq = 22.2125 GHz, Bw = 16.000 MH No calibration applied and no bandpass applied

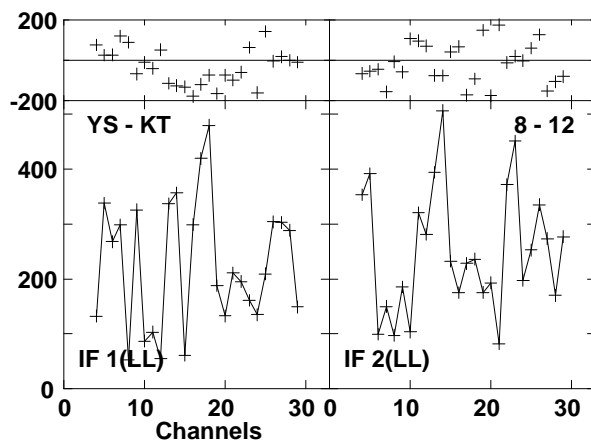
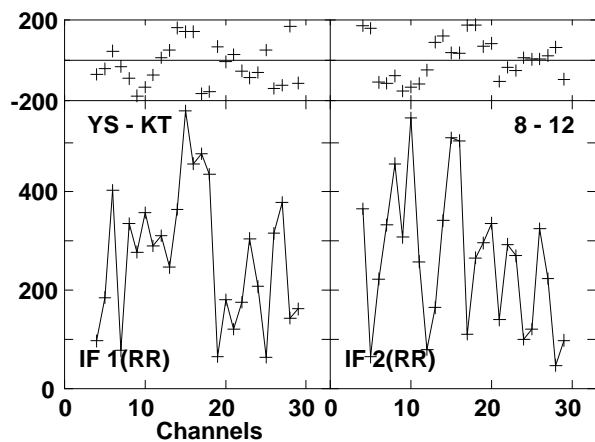
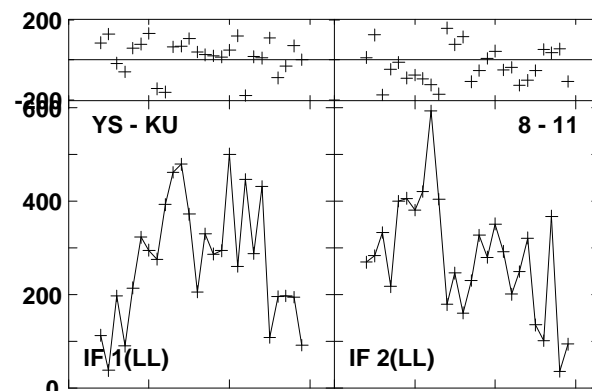
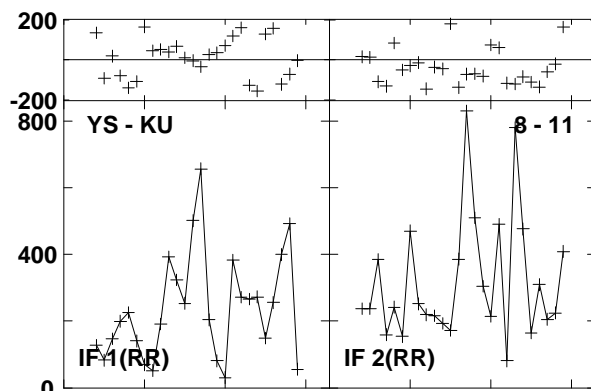
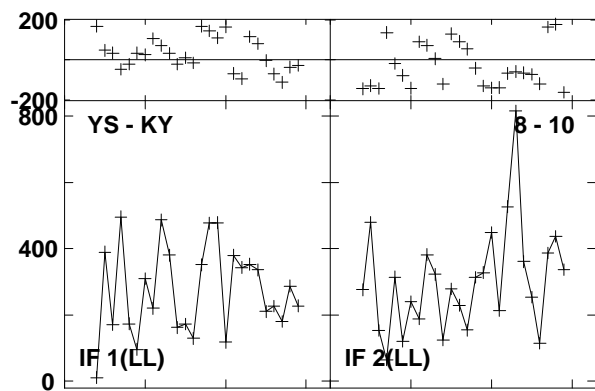
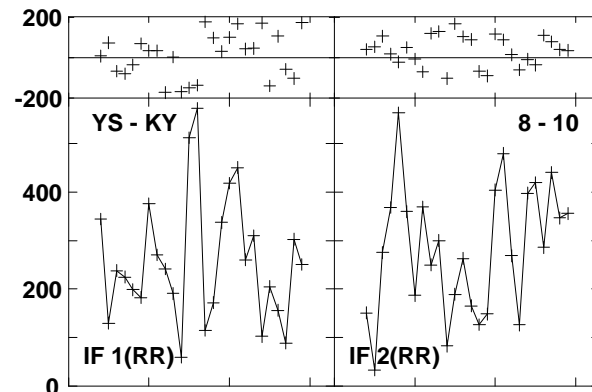
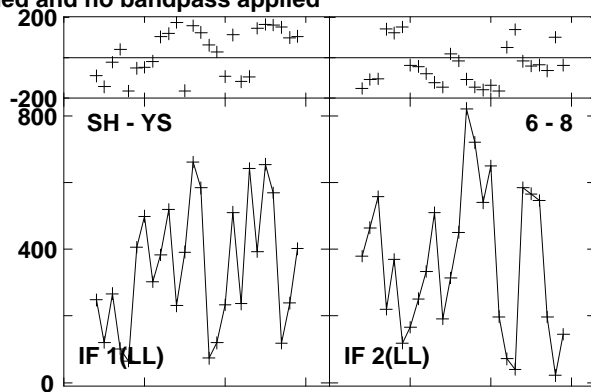
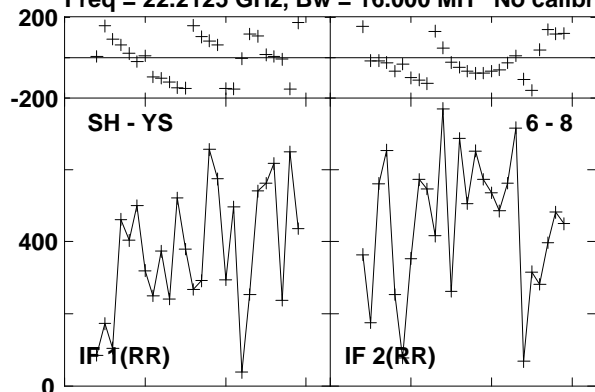

Lower frame: Micro Ampl Jy Top frame: Phas deg  
Vector averaged cross-power spectrum Baseline: SH (06) - YS (08)  
Timerange: 00/14:09:56 to 00/14:10:16

Plot file version 542 created 23-AUG-2016 15:01:02

W3IRS5 GA035B 1.UVDATA.1

Freq = 22.2125 GHz, Bw = 16.000 MH No calibration applied and no bandpass applied

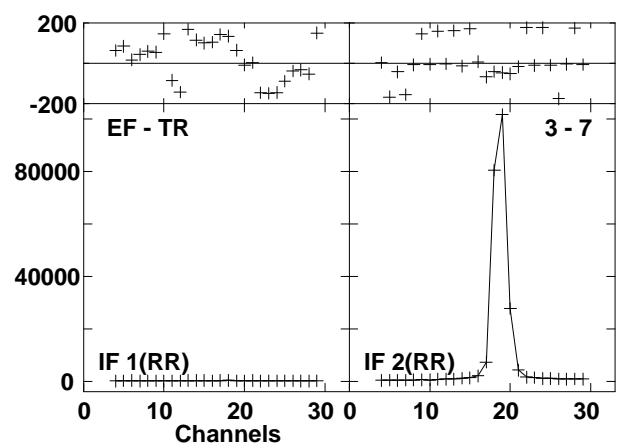
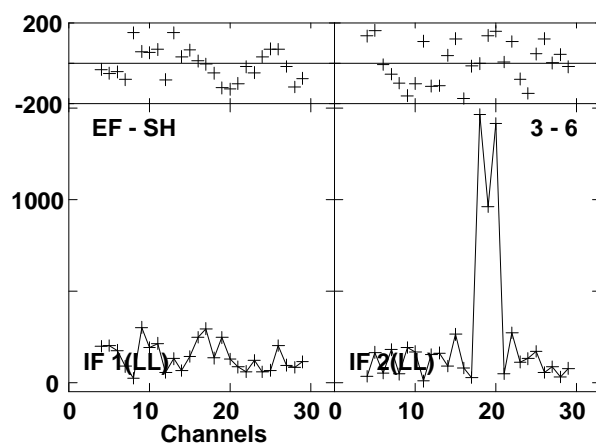
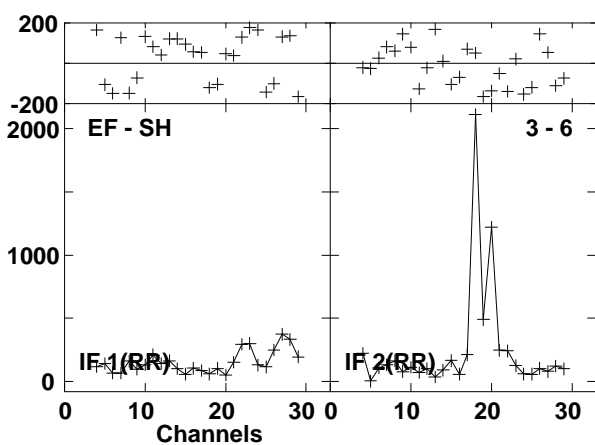
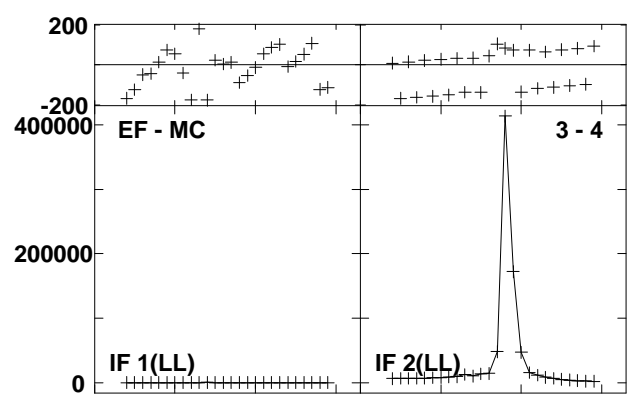
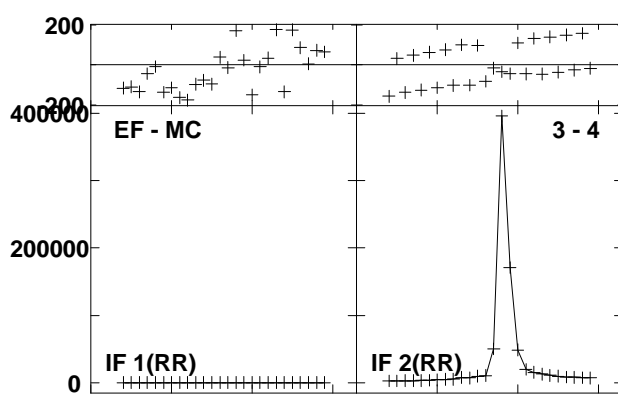
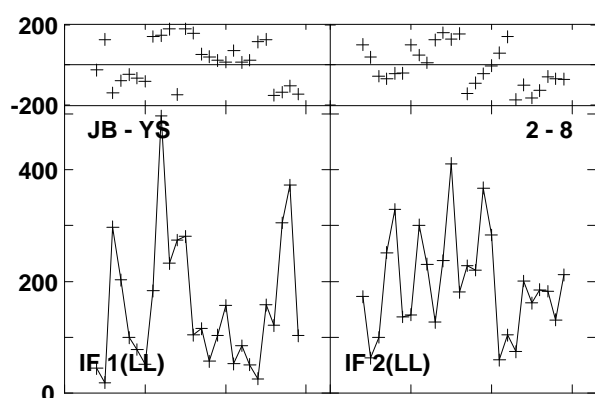
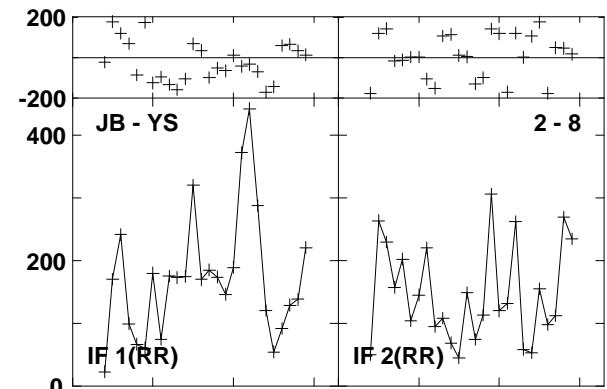
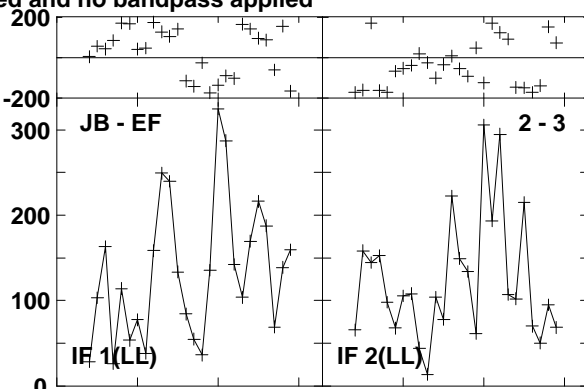
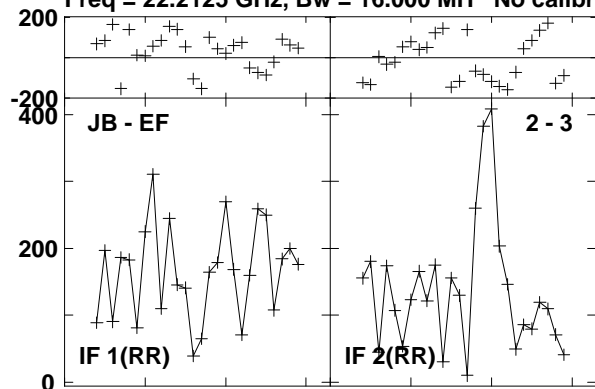

Lower frame: Micro Ampl Jy Top frame: Phas deg  
Vector averaged cross-power spectrum Baseline: JB (02) - EF (03)  
Timerange: 00/14:10:49 to 00/14:11:47

Plot file version 543 created 23-AUG-2016 15:01:02

W3IRS5 GA035B 1.UVDATA.1

Freq = 22.2125 GHz, Bw = 16.000 MH No calibration applied and no bandpass applied

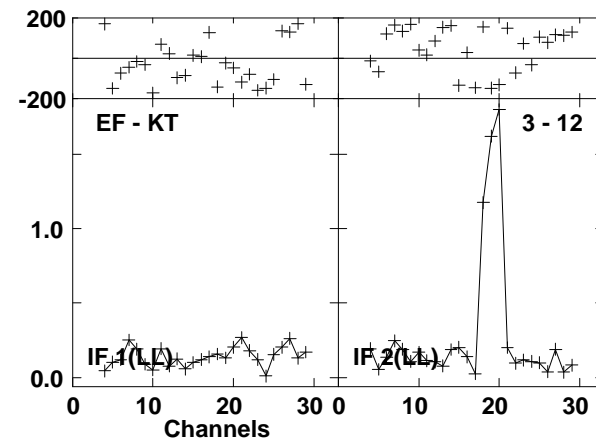
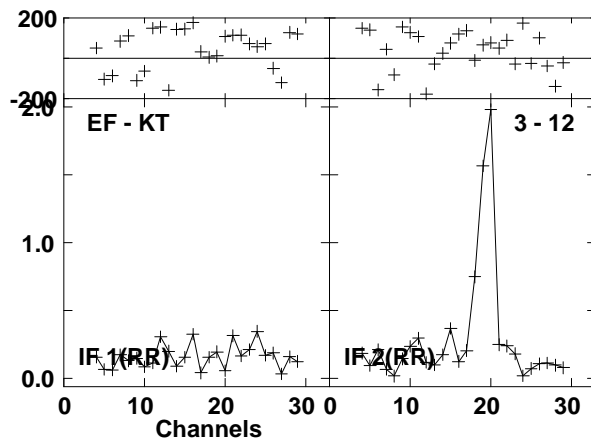
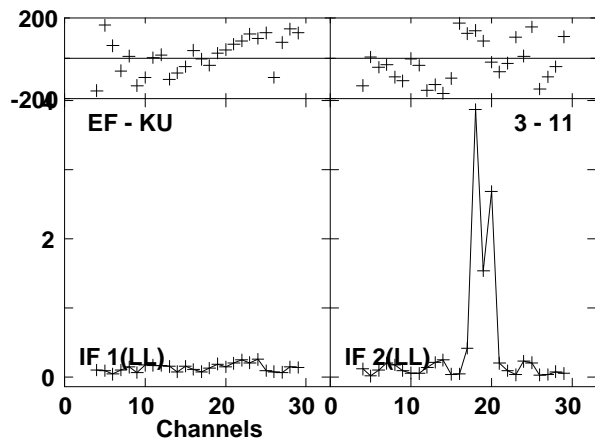
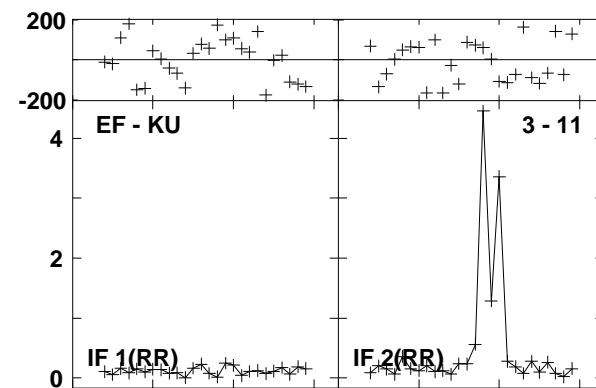
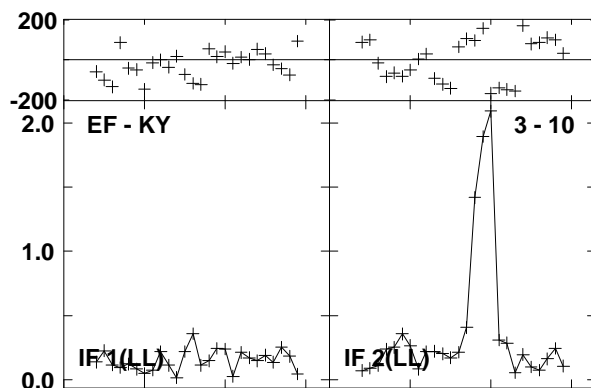
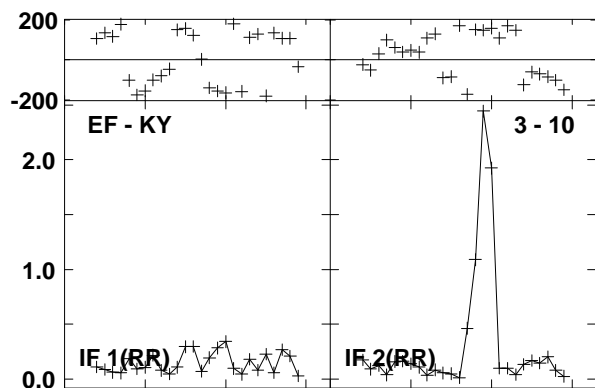
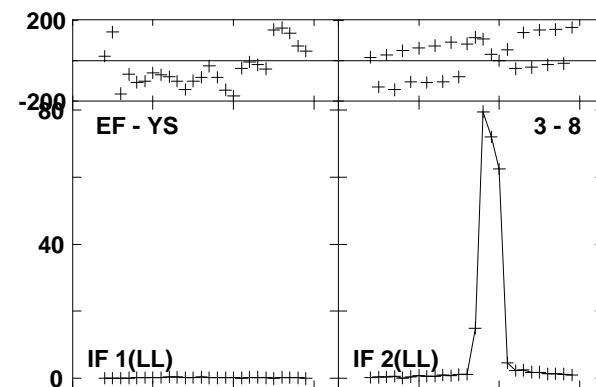
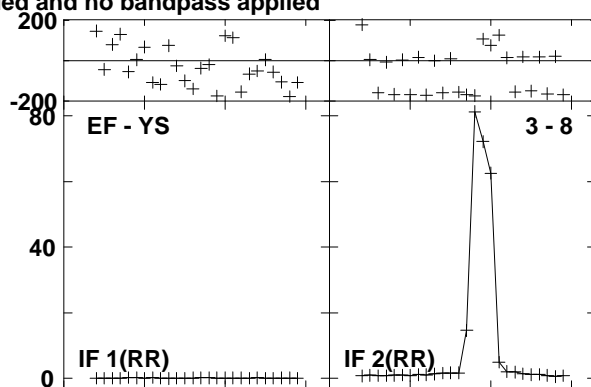
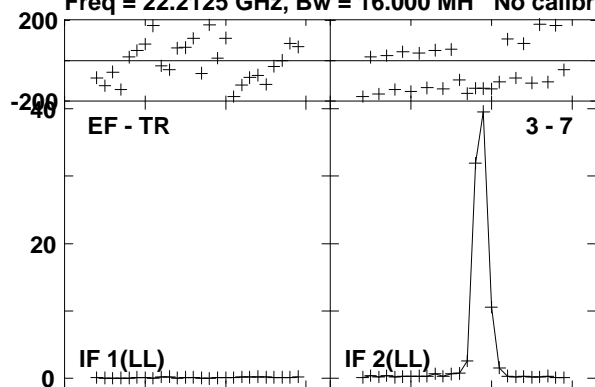

Lower frame: Milli Ampl Jy Top frame: Phas deg  
Vector averaged cross-power spectrum Baseline: EF (03) - TR (07)  
Timerange: 00/14:10:49 to 00/14:11:47

Plot file version 544 created 23-AUG-2016 15:01:02

W3IRS5 GA035B 1.UVDATA.1

Freq = 22.2125 GHz, Bw = 16.000 MH No calibration applied and no bandpass applied

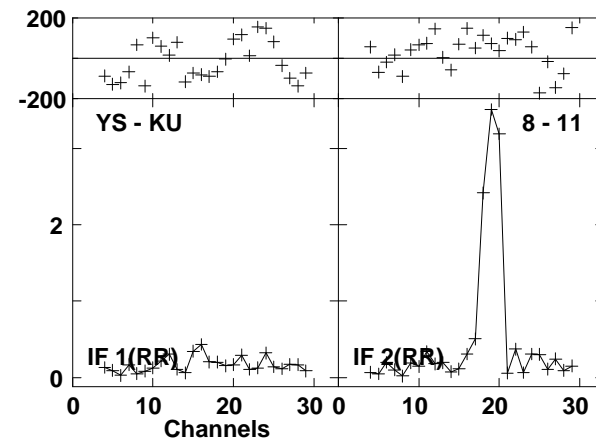
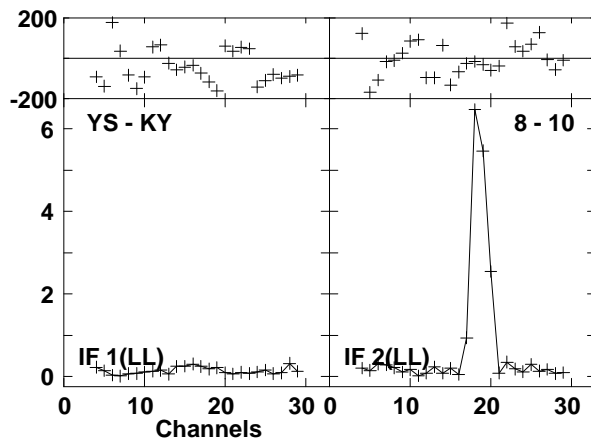
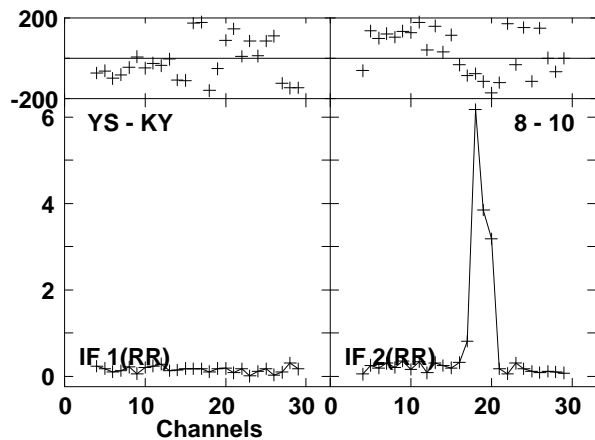
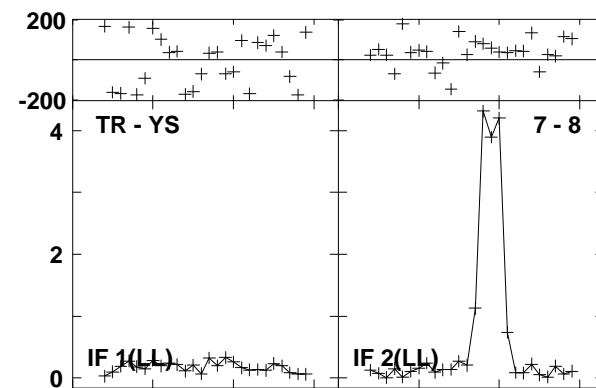
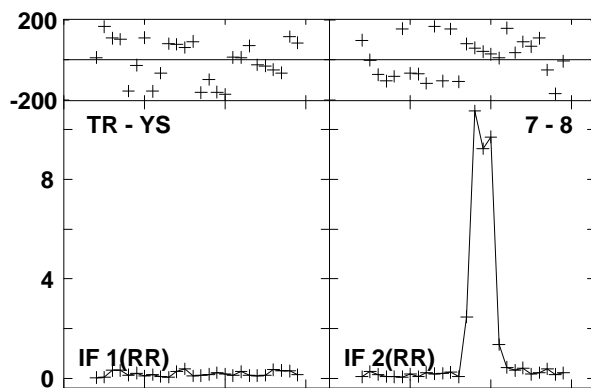
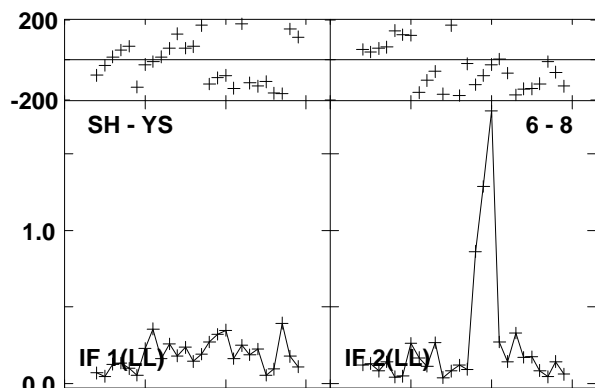
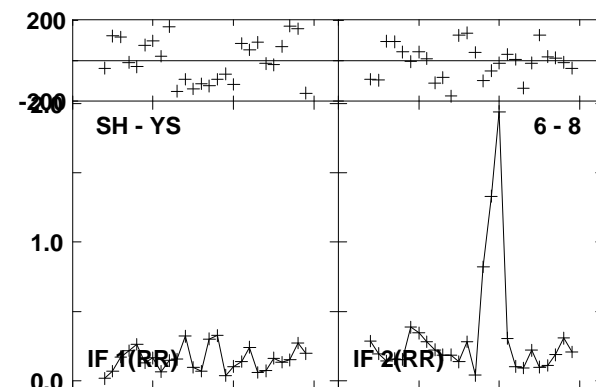
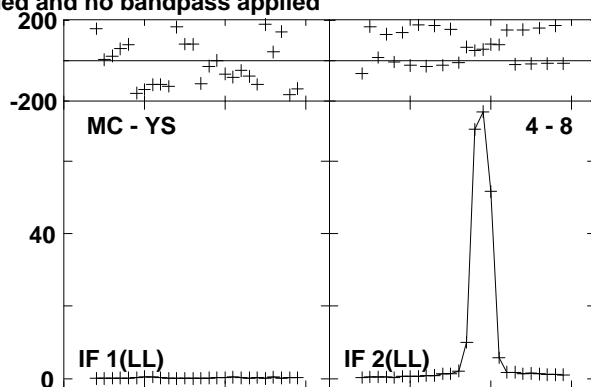
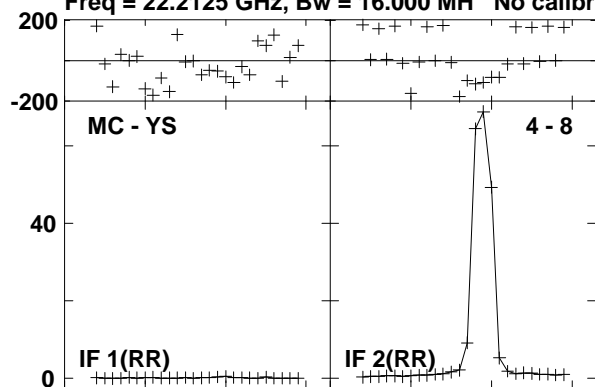

Lower frame: Milli Ampl Jy Top frame: Phas deg  
Vector averaged cross-power spectrum Baseline: MC (04) - YS (08)  
Timerange: 00/14:10:49 to 00/14:11:47



Plot file version 545 created 23-AUG-2016 15:01:02

W3IRS5 GA035B 1.UVDATA.1

Freq = 22.2125 GHz, Bw = 16.000 MH No calibration applied and no bandpass applied

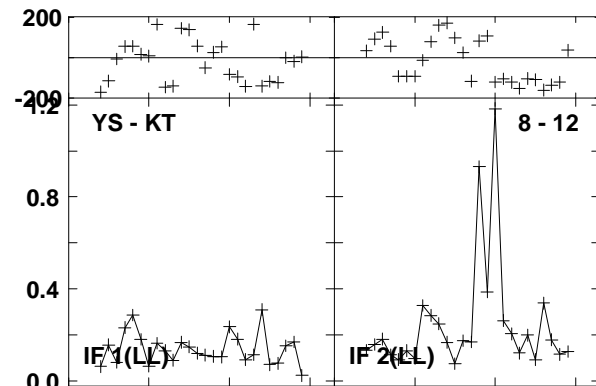
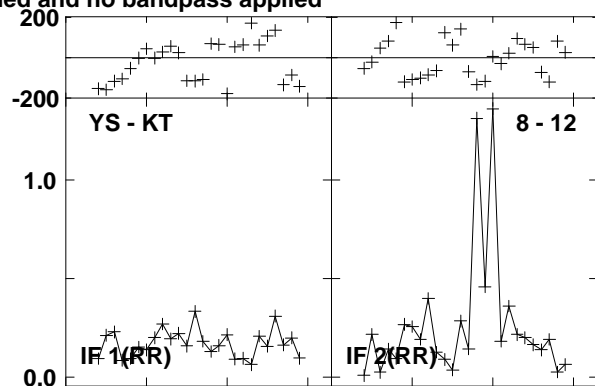
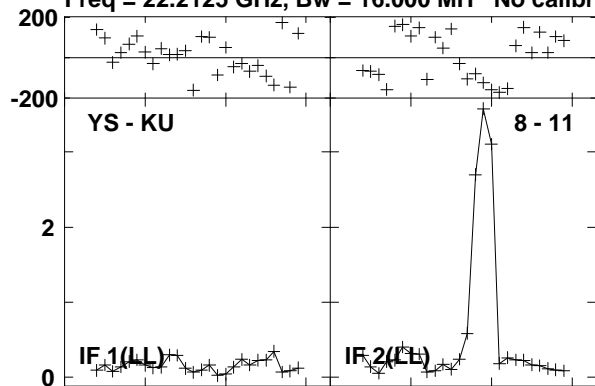

Lower frame: Milli Ampl Jy Top frame: Phas deg  
Vector averaged cross-power spectrum Baseline: YS (08) - KU (11)  
Timerange: 00/14:10:49 to 00/14:11:47

Plot file version 546 created 23-AUG-2016 15:01:02

0219+628 GA035B 1.UVDATA.1

Freq = 22.2125 GHz, Bw = 16.000 MH No calibration applied and no bandpass applied

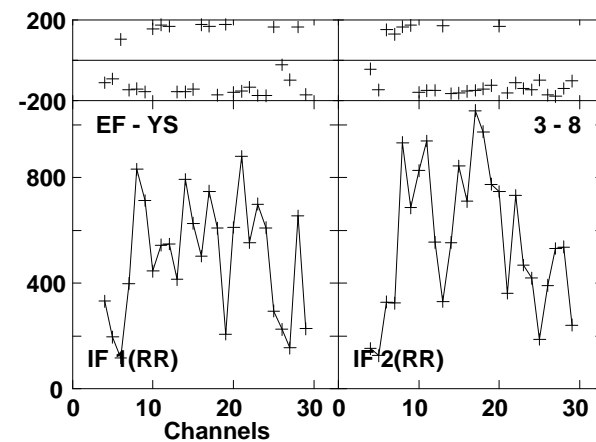
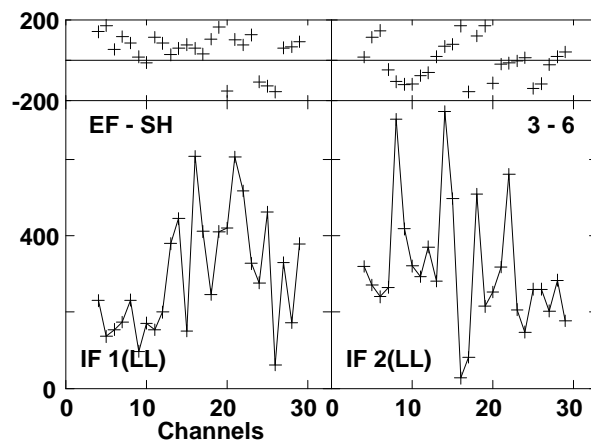
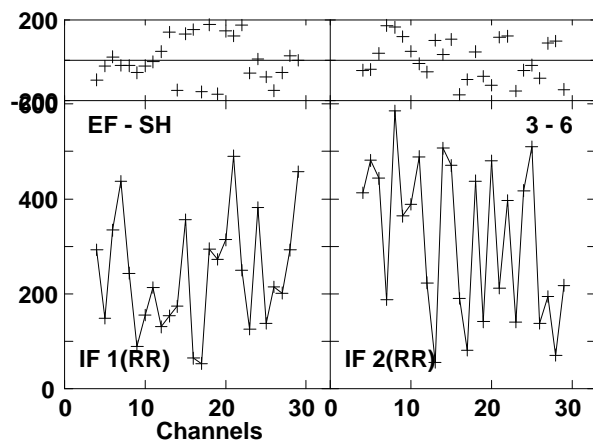
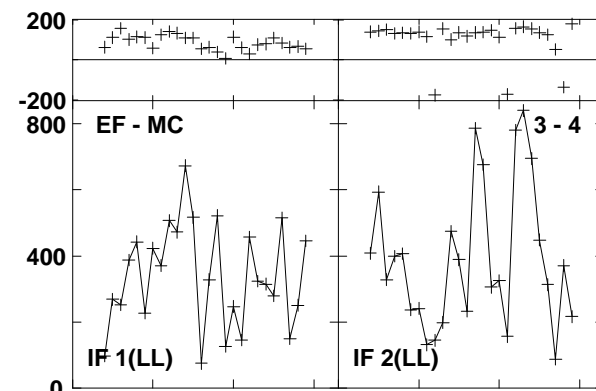
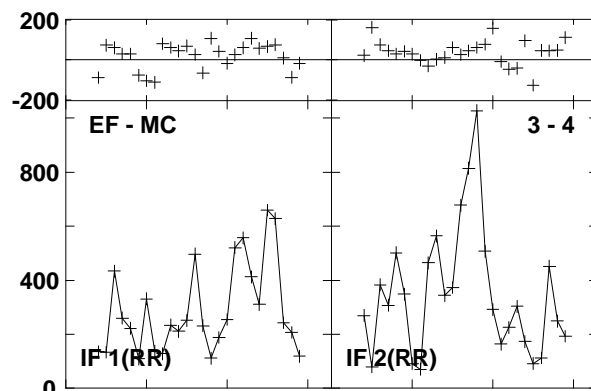
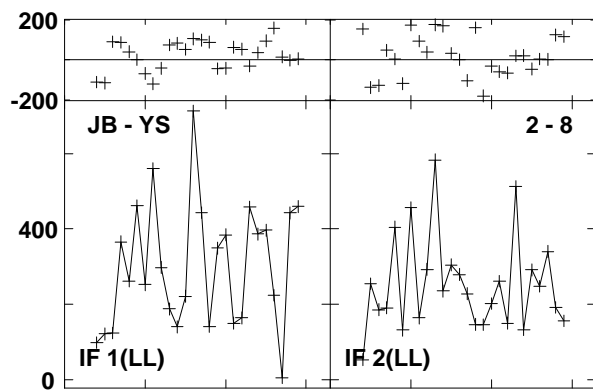
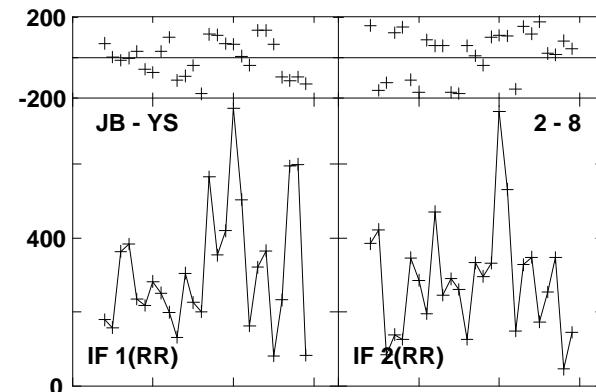
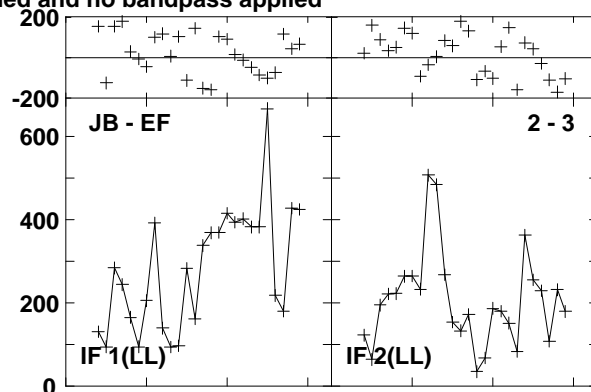
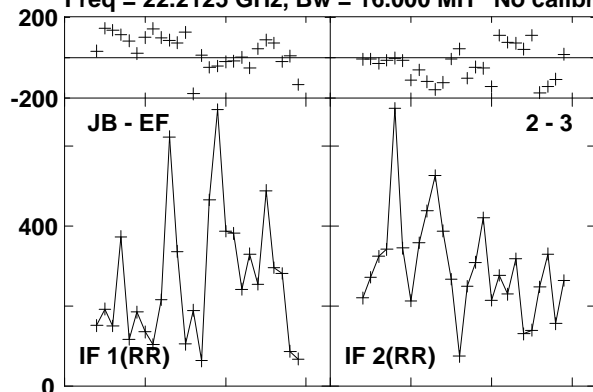

Lower frame: Micro Ampl Jy Top frame: Phas deg  
Vector averaged cross-power spectrum Baseline: JB (02) - EF (03)  
Timerange: 00/14:12:20 to 00/14:12:40

Plot file version 547 created 23-AUG-2016 15:01:02

0219+628 GA035B 1.UVDATA.1

Freq = 22.2125 GHz, Bw = 16.000 MH No calibration applied and no bandpass applied

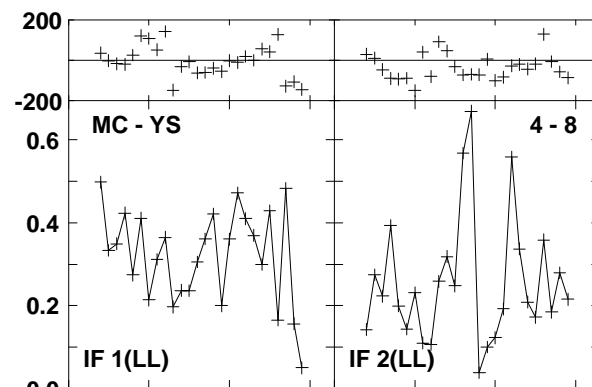
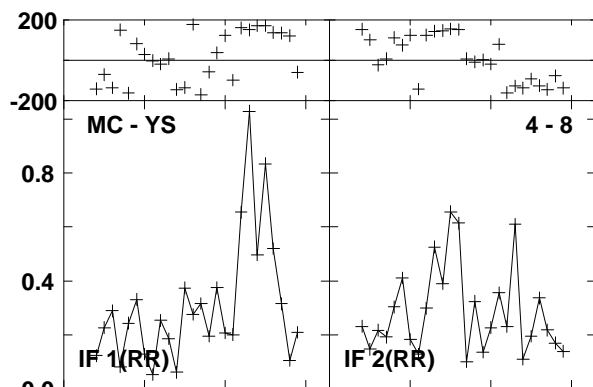
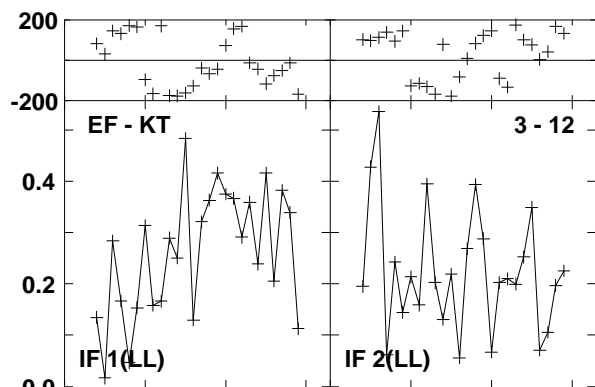
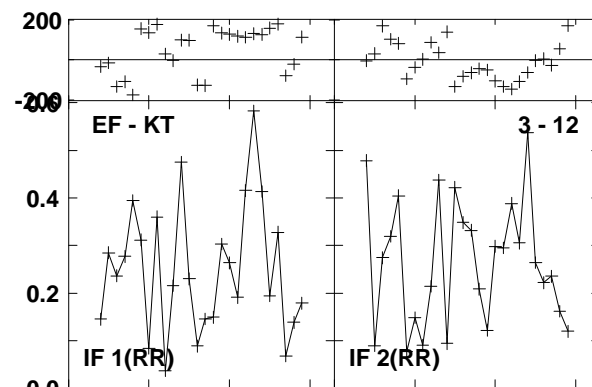
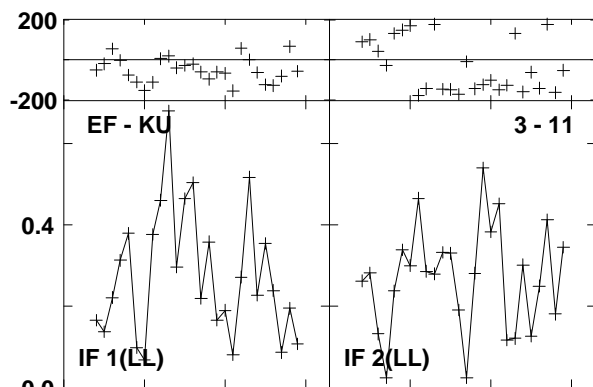
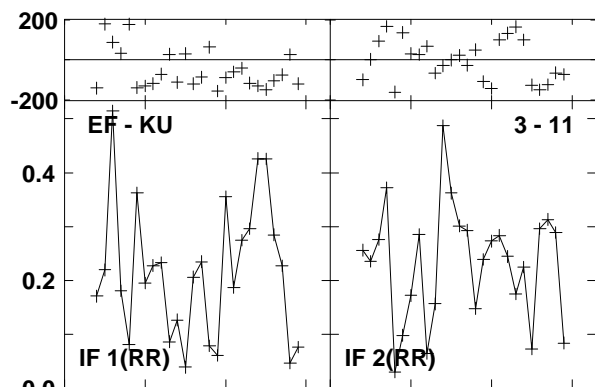
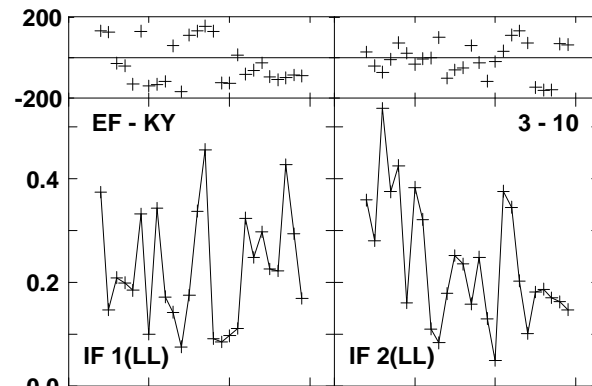
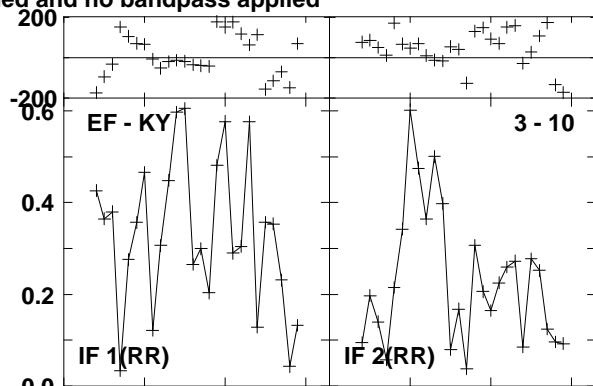
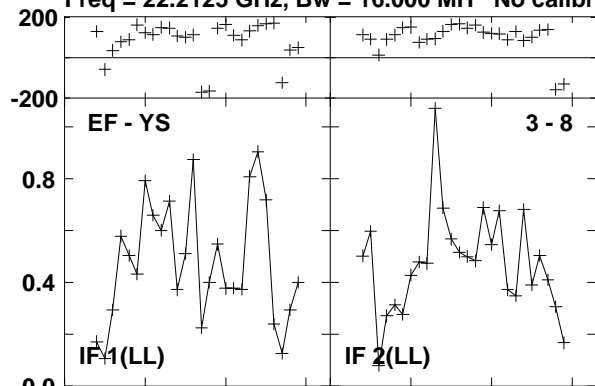

Lower frame: Milli Ampl Jy Top frame: Phas deg  
Vector averaged cross-power spectrum Baseline: EF (03) - YS (08)  
Timerange: 00/14:12:20 to 00/14:12:40

Plot file version 548 created 23-AUG-2016 15:01:02

0219+628 GA035B 1.UVDATA.1

Freq = 22.2125 GHz, Bw = 16.000 MH No calibration applied and no bandpass applied

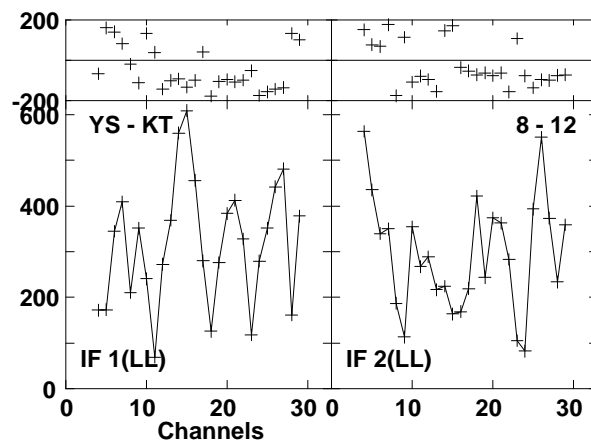
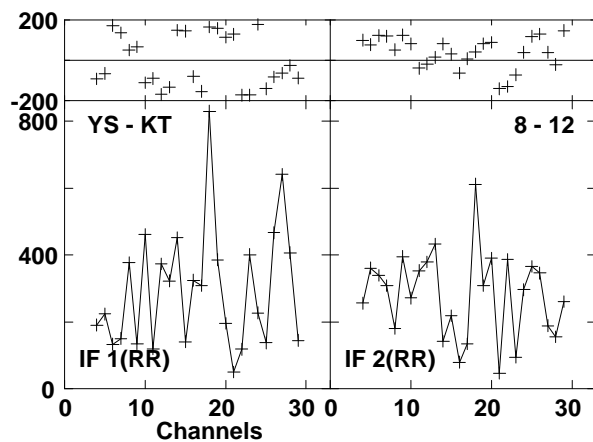
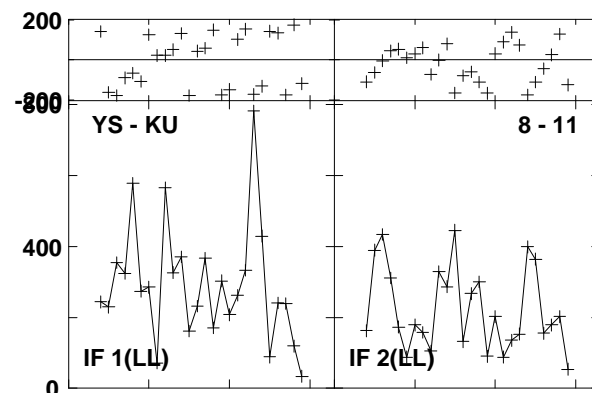
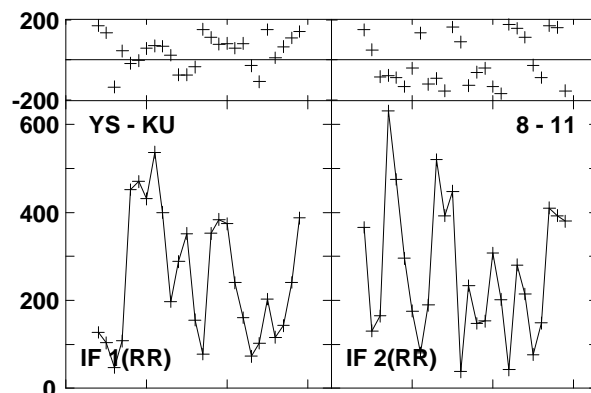
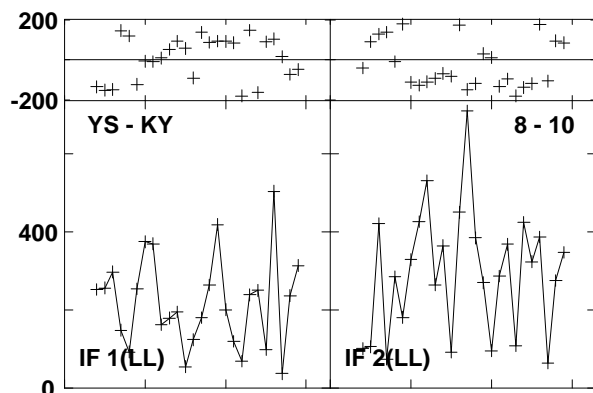
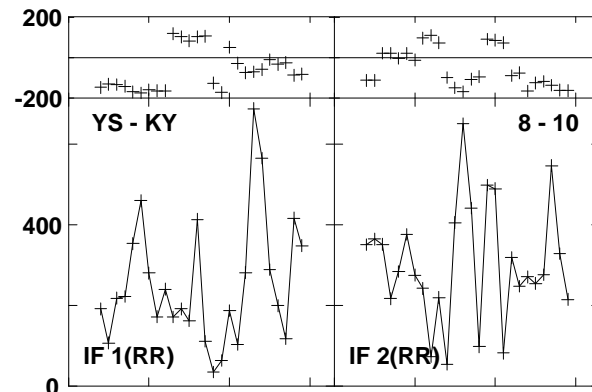
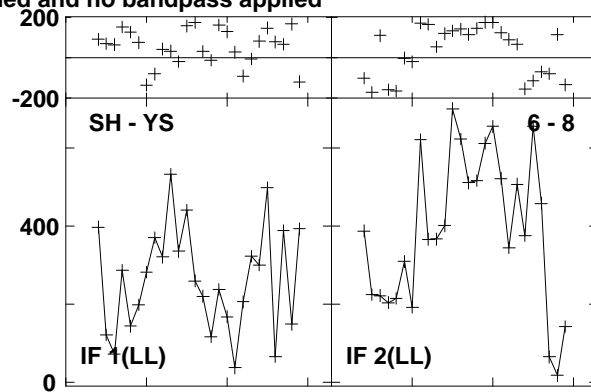
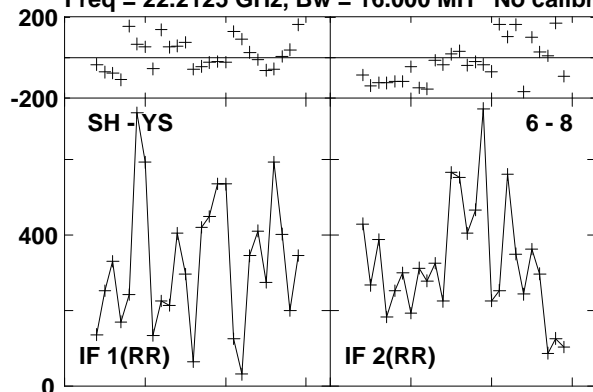

Lower frame: Micro Ampl Jy Top frame: Phas deg  
Vector averaged cross-power spectrum Baseline: SH (06) - YS (08)  
Timerange: 00/14:12:20 to 00/14:12:40

Plot file version 549 created 23-AUG-2016 15:01:02

W3IRS5 GA035B 1.UVDATA.1

Freq = 22.2125 GHz, Bw = 16.000 MH No calibration applied and no bandpass applied

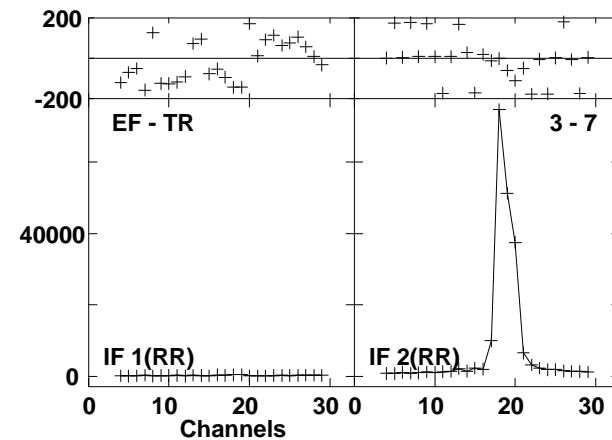
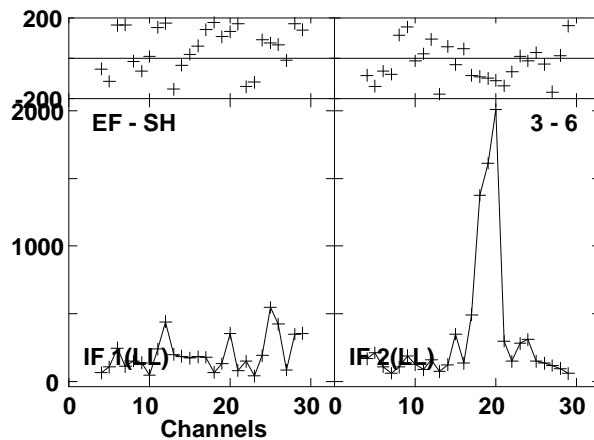
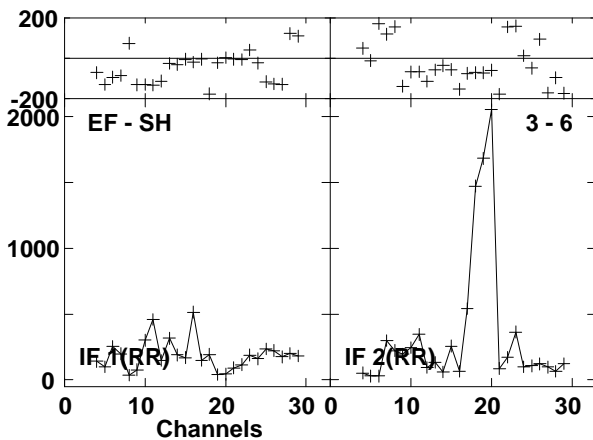
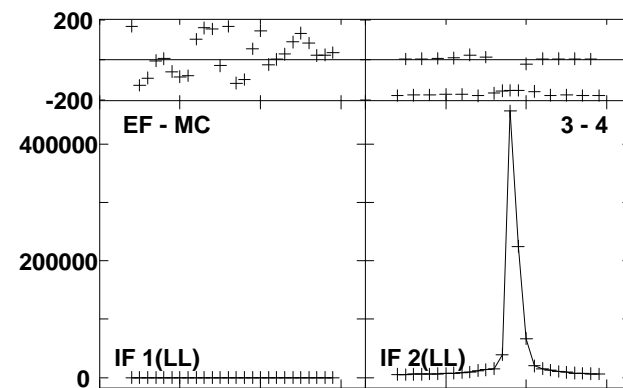
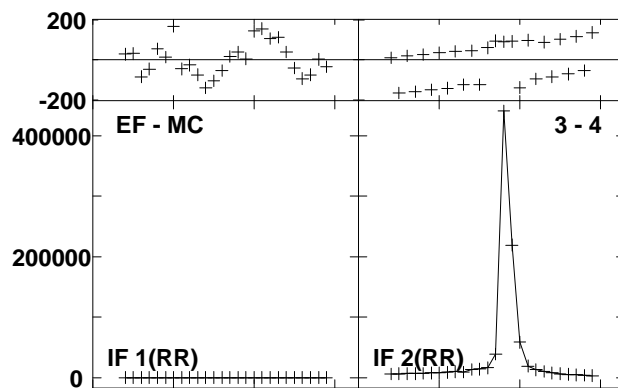
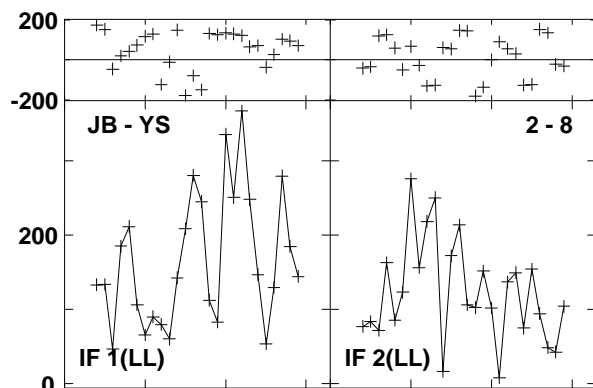
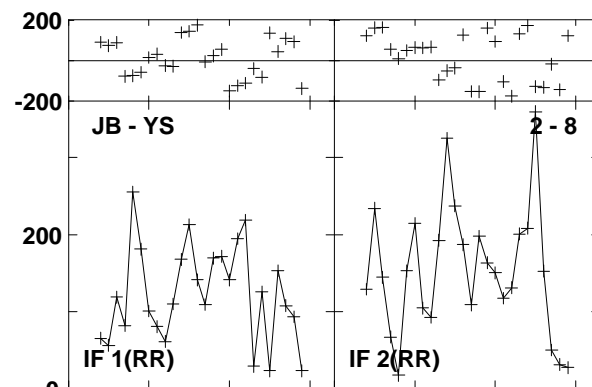
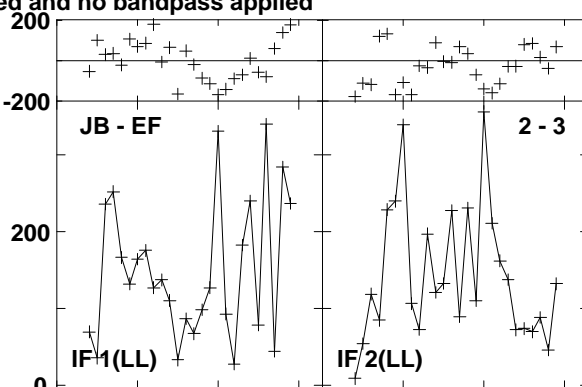
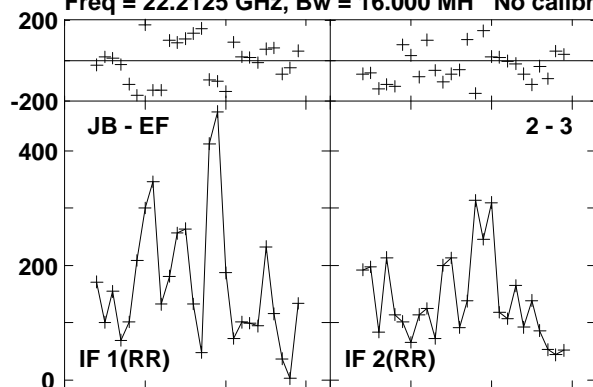

Lower frame: Micro Ampl Jy Top frame: Phas deg  
Vector averaged cross-power spectrum Baseline: JB (02) - EF (03)  
Timerange: 00/14:13:13 to 00/14:14:11

Plot file version 550 created 23-AUG-2016 15:01:02

W3IRS5 GA035B 1.UVDATA.1

Freq = 22.2125 GHz, Bw = 16.000 MH No calibration applied and no bandpass applied

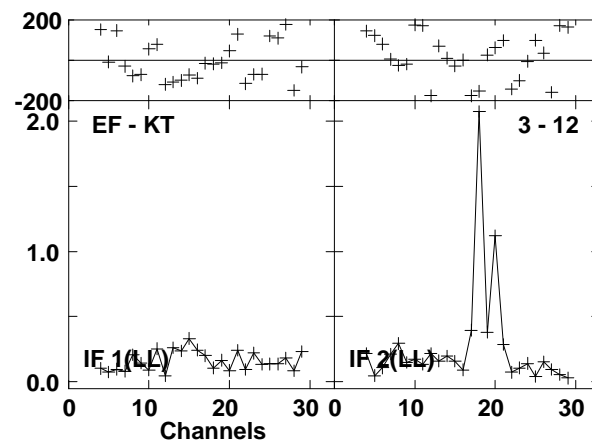
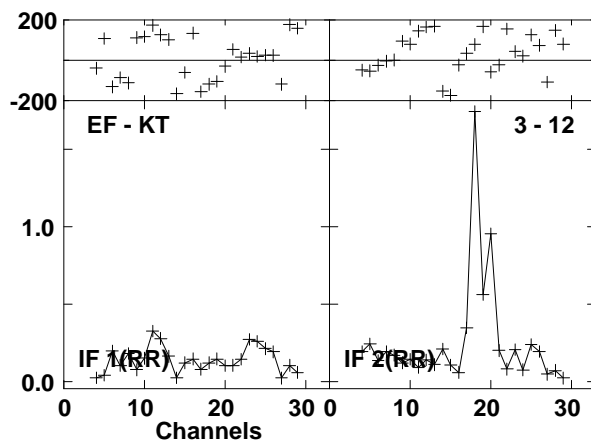
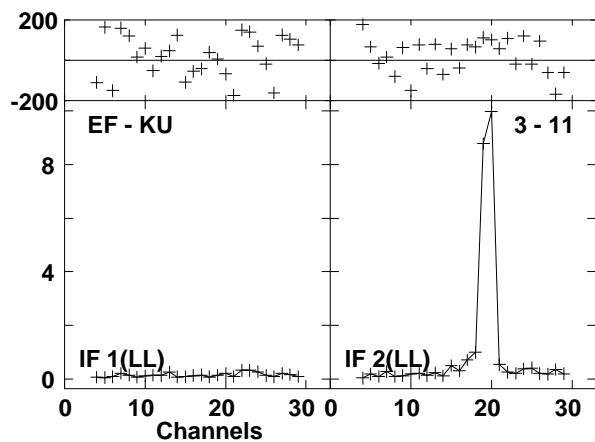
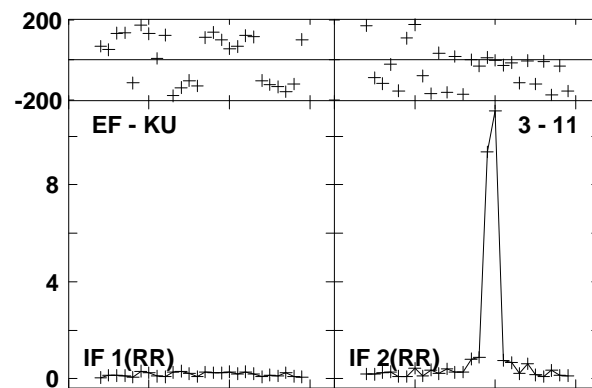
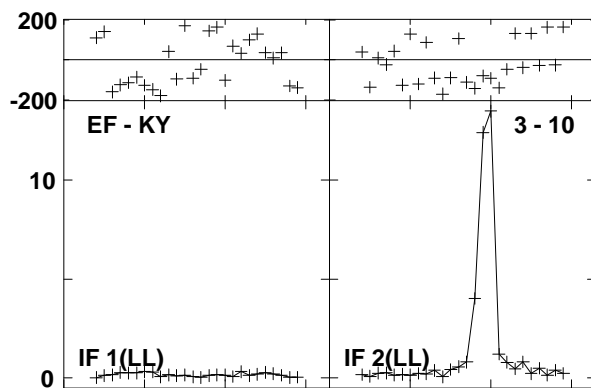
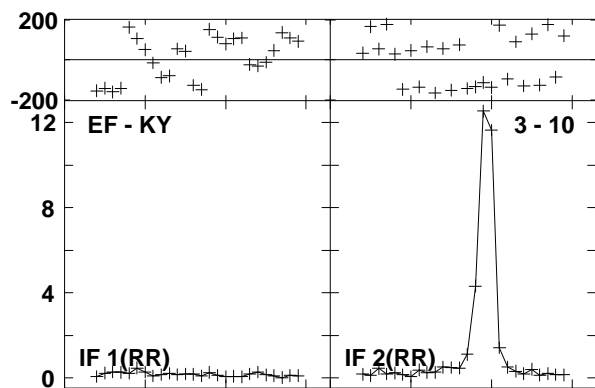
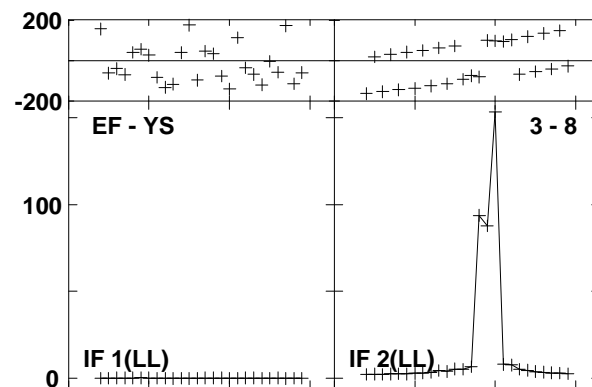
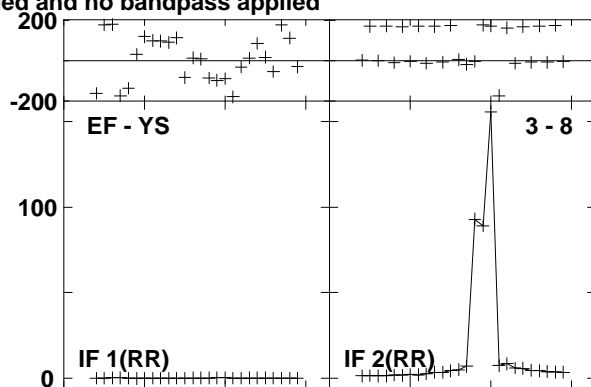
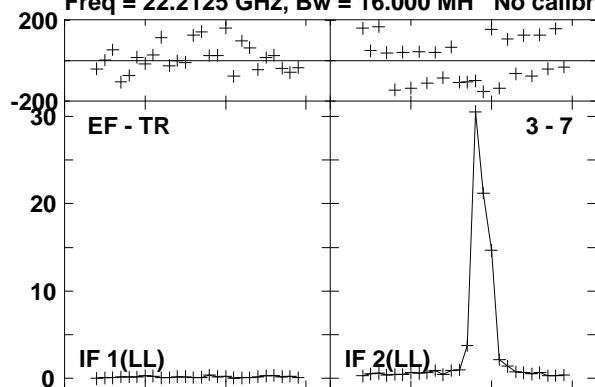

Lower frame: Milli Ampl Jy Top frame: Phas deg  
Vector averaged cross-power spectrum Baseline: EF (03) - TR (07)  
Timerange: 00/14:13:13 to 00/14:14:11

Plot file version 551 created 23-AUG-2016 15:01:02

W3IRS5 GA035B 1.UVDATA.1

Freq = 22.2125 GHz, Bw = 16.000 MH No calibration applied and no bandpass applied

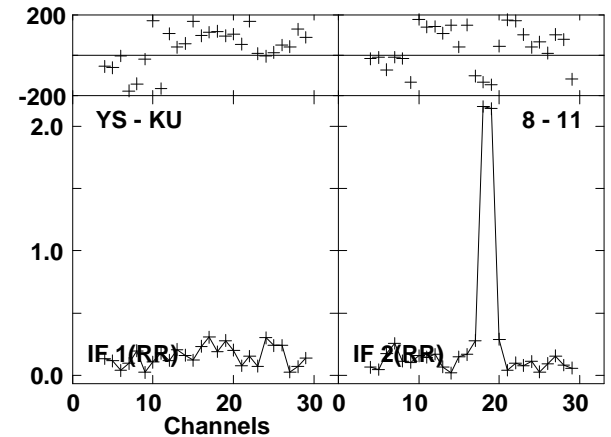
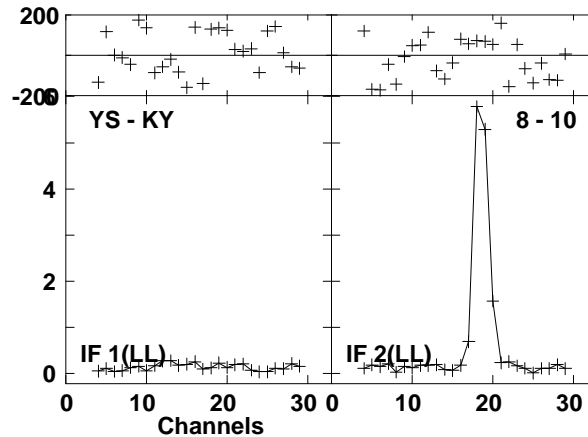
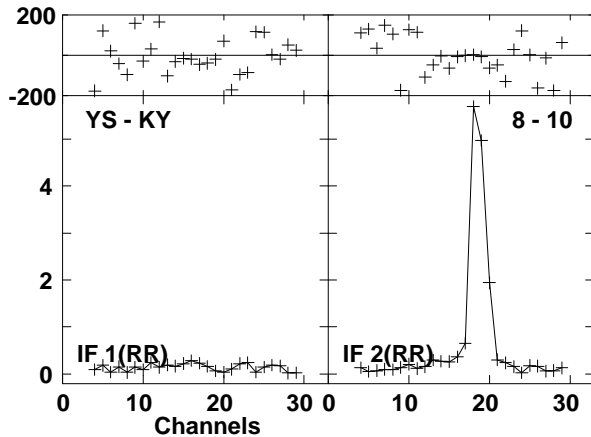
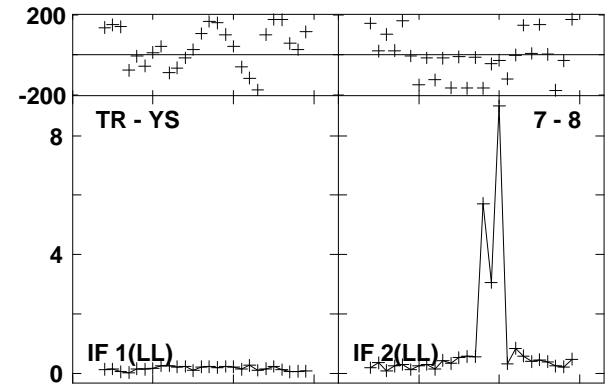
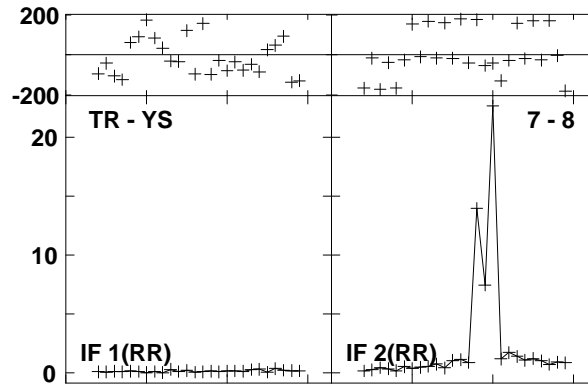
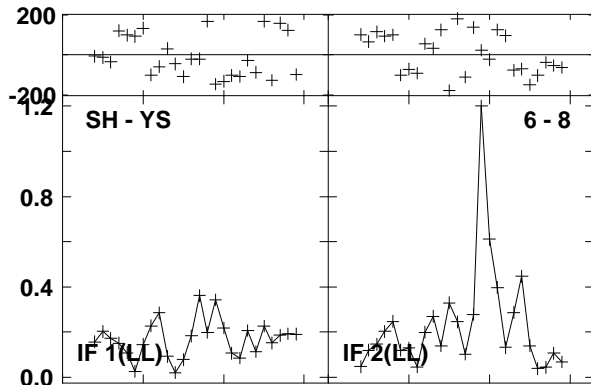
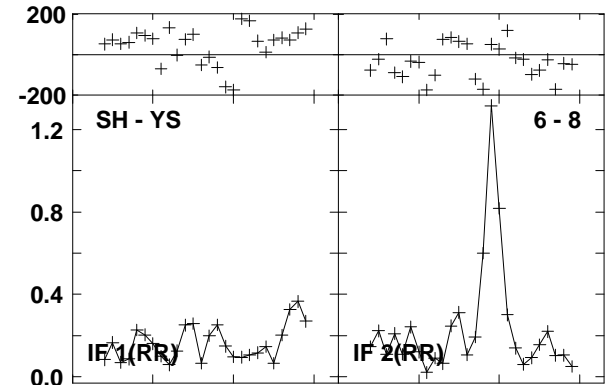
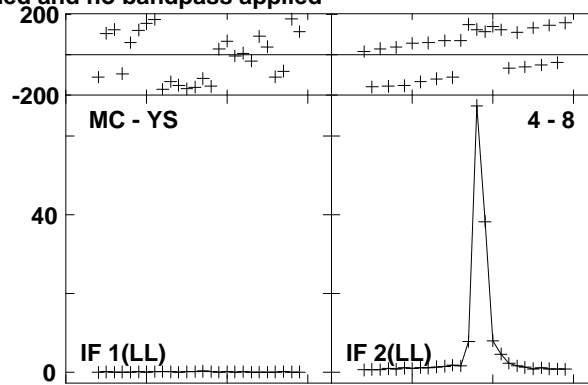
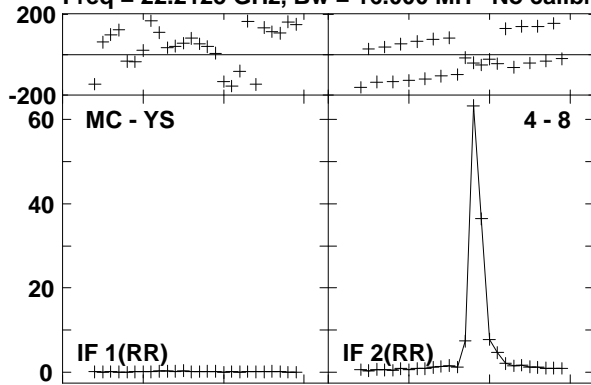

Lower frame: Milli Ampl Jy Top frame: Phas deg  
Vector averaged cross-power spectrum Baseline: MC (04) - YS (08)  
Timerange: 00/14:13:13 to 00/14:14:11

Plot file version 552 created 23-AUG-2016 15:01:02  
W3IRS5 GA035B 1.UVDATA.1

Freq = 22.2125 GHz, Bw = 16.000 MH No calibration applied and no bandpass applied

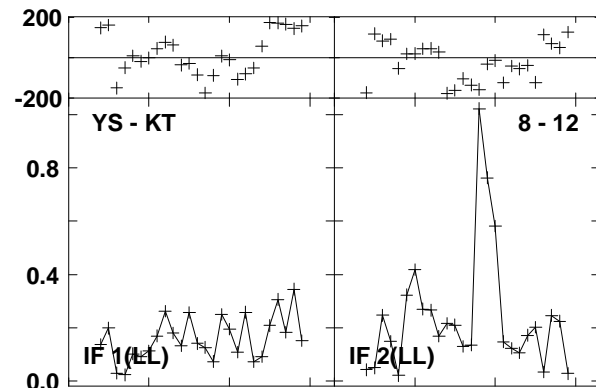
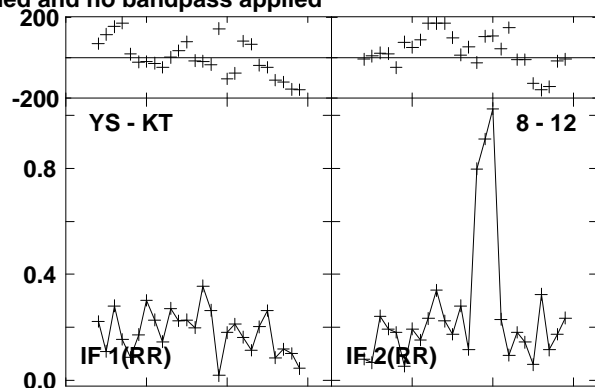
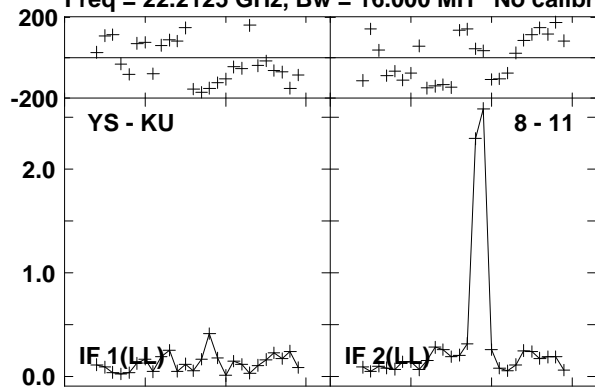

Lower frame: Milli Ampl Jy Top frame: Phas deg  
Vector averaged cross-power spectrum Baseline: YS (08) - KU (11)  
Timerange: 00/14:13:13 to 00/14:14:11



Plot file version 553 created 23-AUG-2016 15:01:02

0219+628 GA035B 1.UVDATA.1

Freq = 22.2125 GHz, Bw = 16.000 MH No calibration applied and no bandpass applied

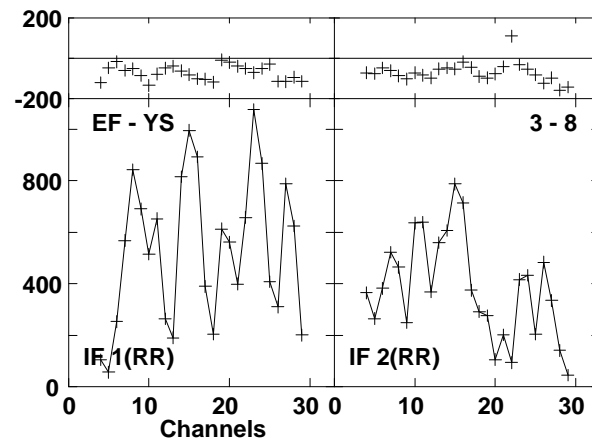
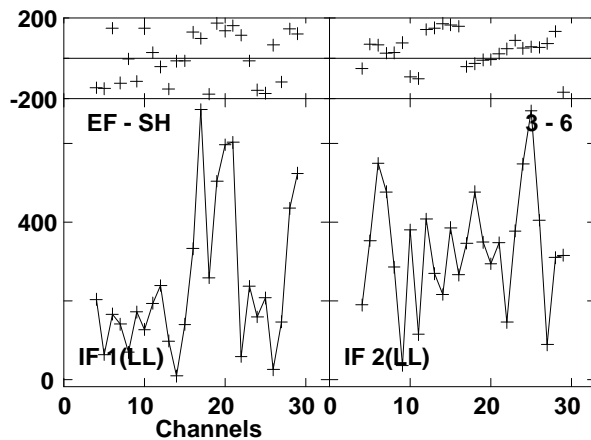
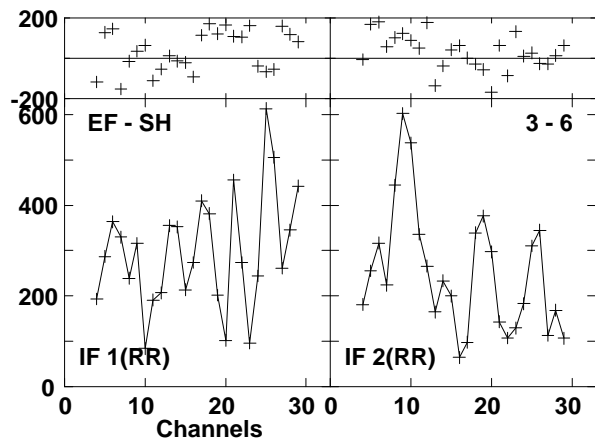
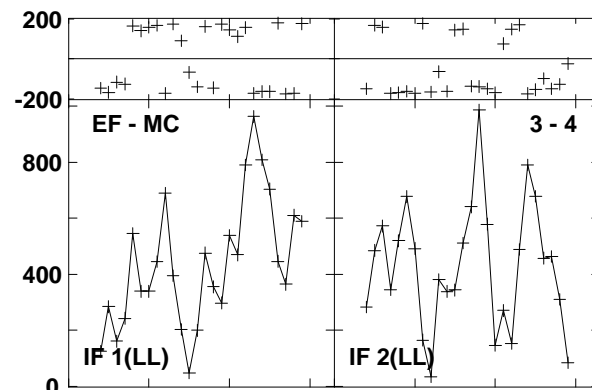
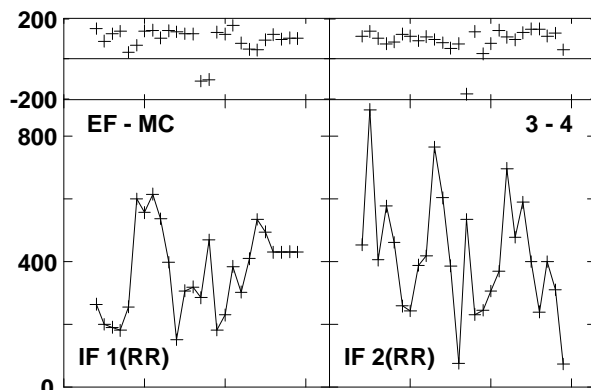
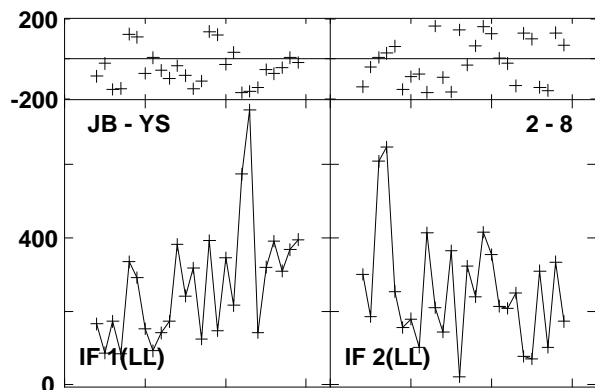
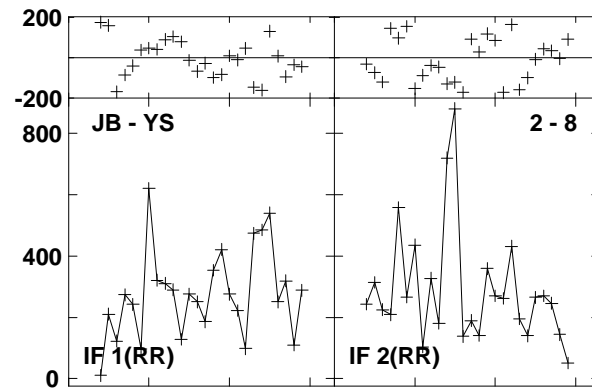
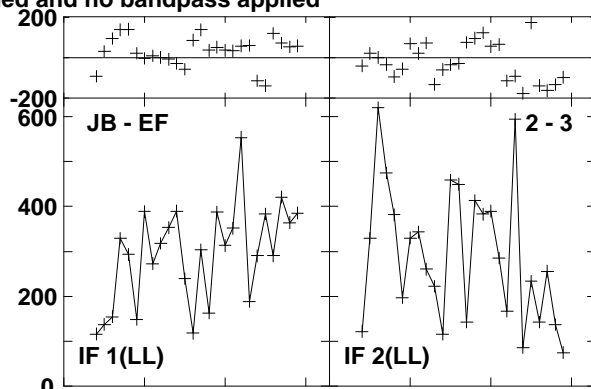
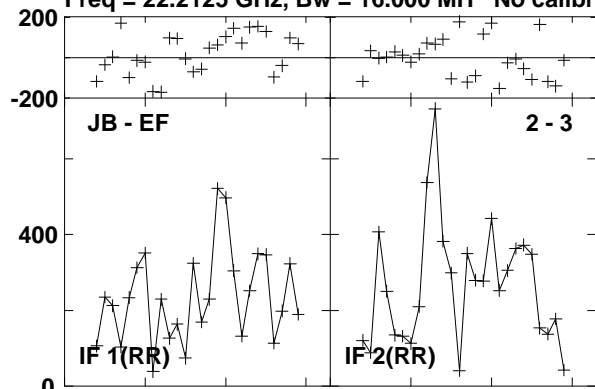

Lower frame: Micro Ampl Jy Top frame: Phas deg  
Vector averaged cross-power spectrum Baseline: JB (02) - EF (03)  
Timerange: 00/14:14:44 to 00/14:15:04

Plot file version 554 created 23-AUG-2016 15:01:02

0219+628 GA035B 1.UVDATA.1

Freq = 22.2125 GHz, Bw = 16.000 MH No calibration applied and no bandpass applied

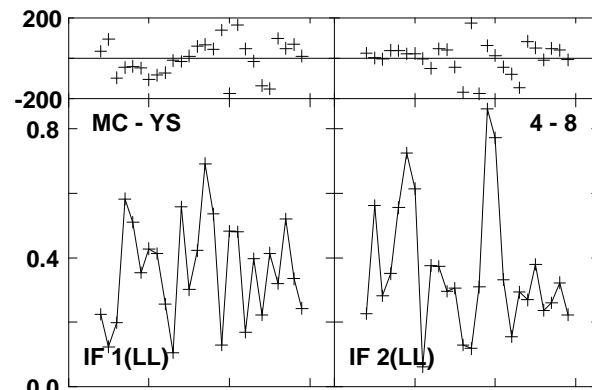
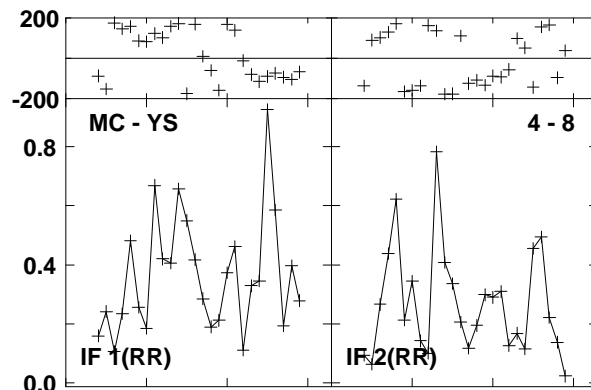
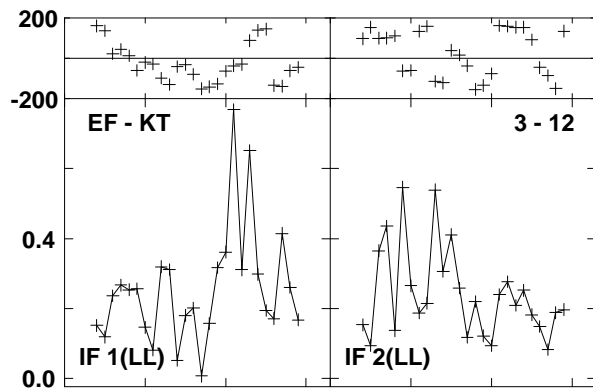
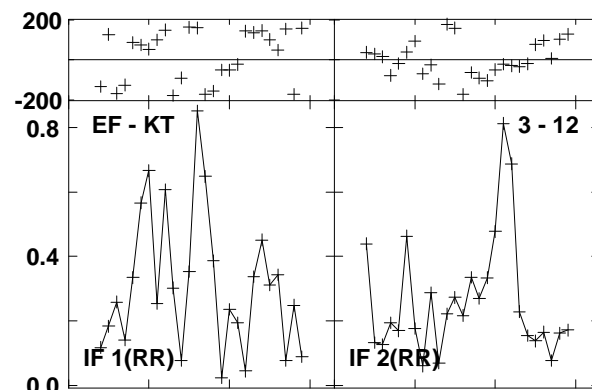
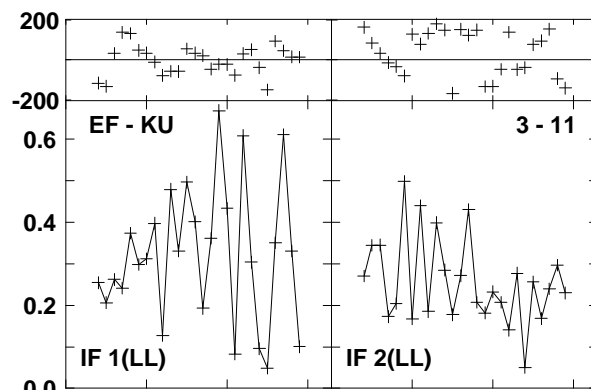
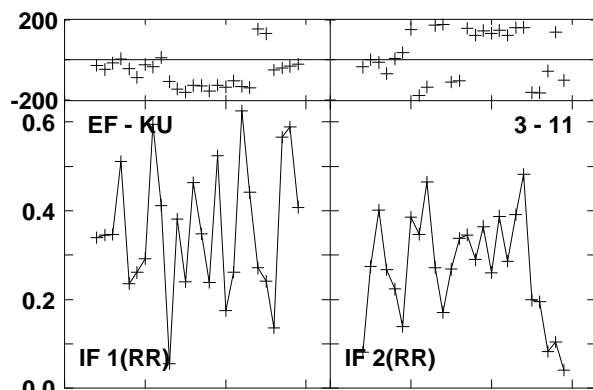
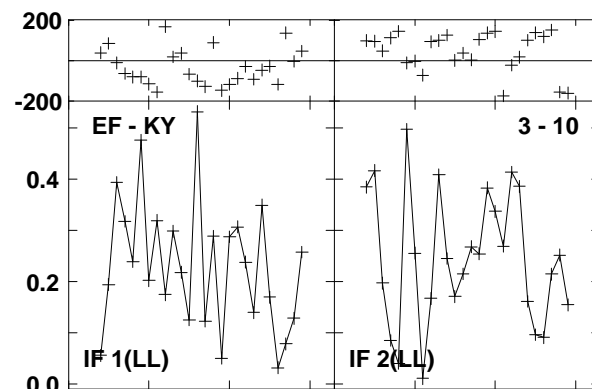
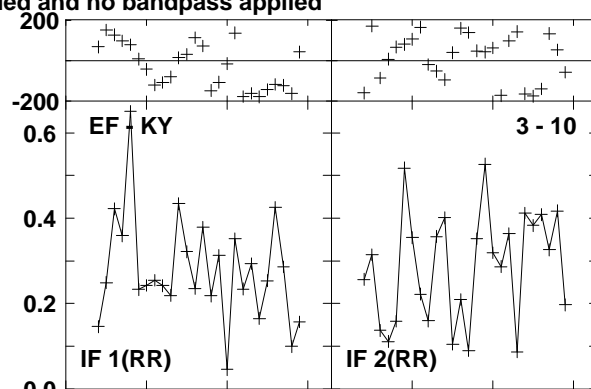
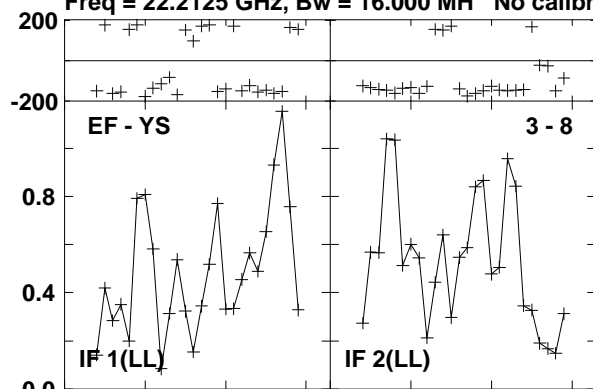

Lower frame: Milli Ampl Jy Top frame: Phas deg

Vector averaged cross-power spectrum Baseline: EF (03) - YS (08)

Timerange: 00/14:14:44 to 00/14:15:04

Plot file version 555 created 23-AUG-2016 15:01:02

0219+628 GA035B 1.UVDATA.1

Freq = 22.2125 GHz, Bw = 16.000 MH No calibration applied and no bandpass applied

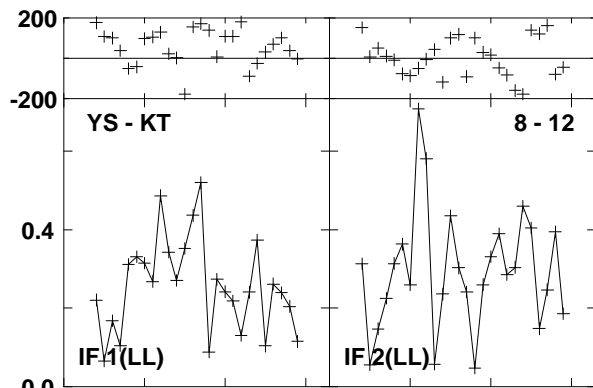
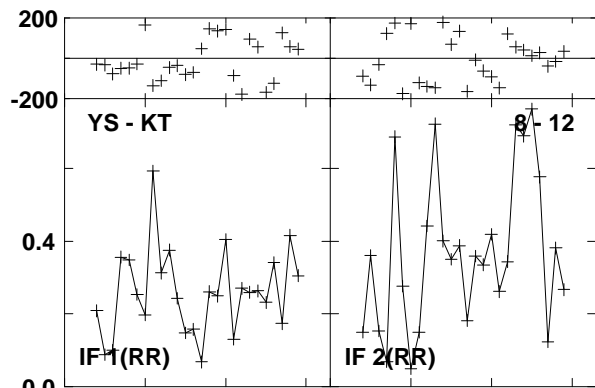
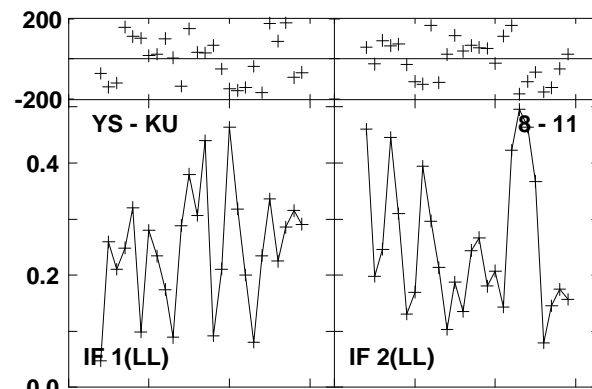
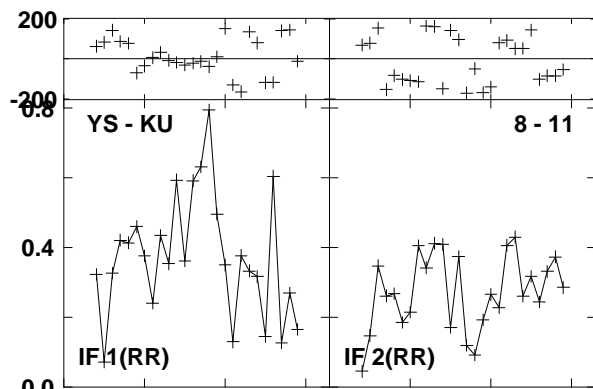
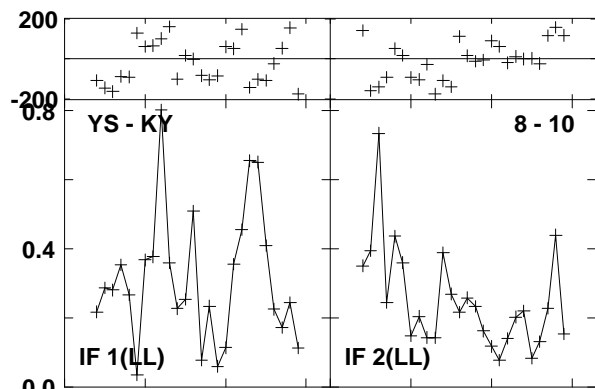
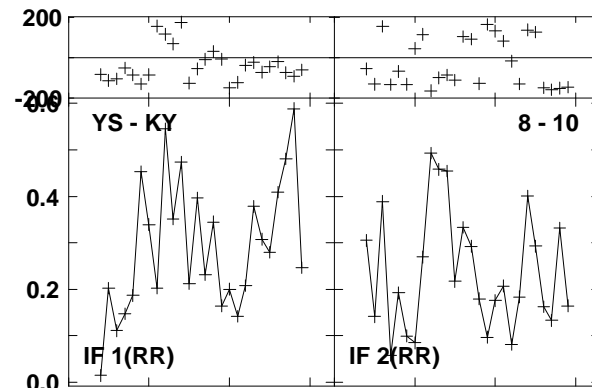
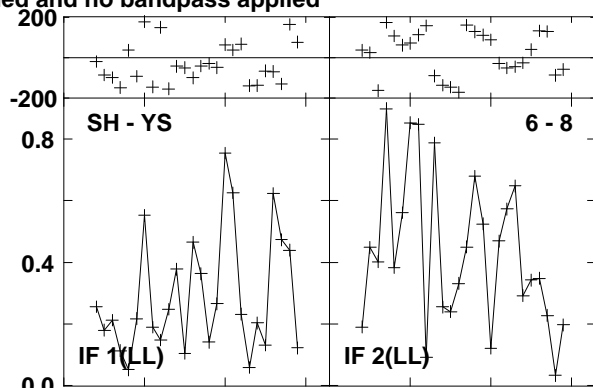
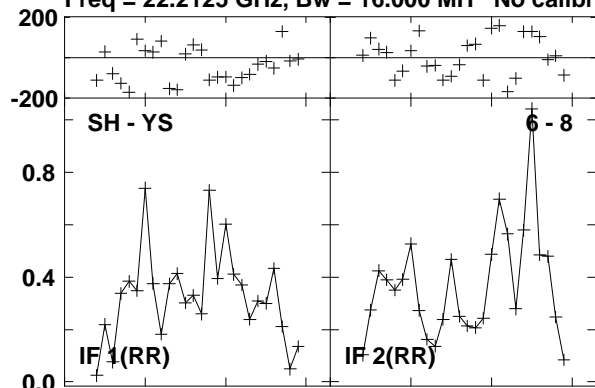

Lower frame: Milli Ampl Jy Top frame: Phas deg

Vector averaged cross-power spectrum Baseline: SH (06) - YS (08)

Timerange: 00/14:14:44 to 00/14:15:04

Plot file version 556 created 23-AUG-2016 15:01:02

W3IRS5 GA035B 1.UVDATA.1

Freq = 22.2125 GHz, Bw = 16.000 MH No calibration applied and no bandpass applied

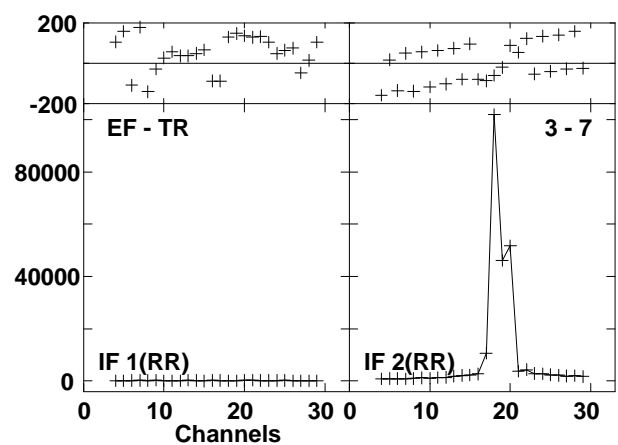
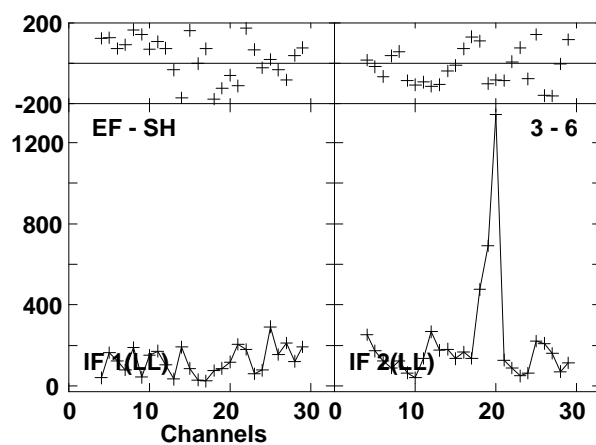
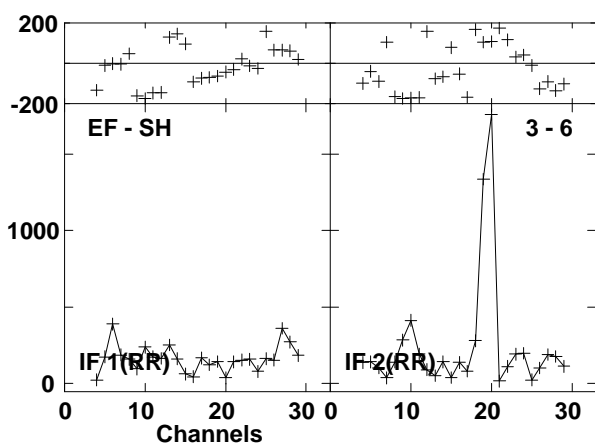
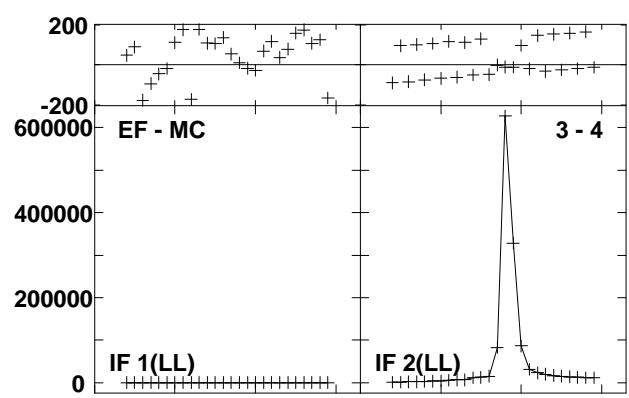
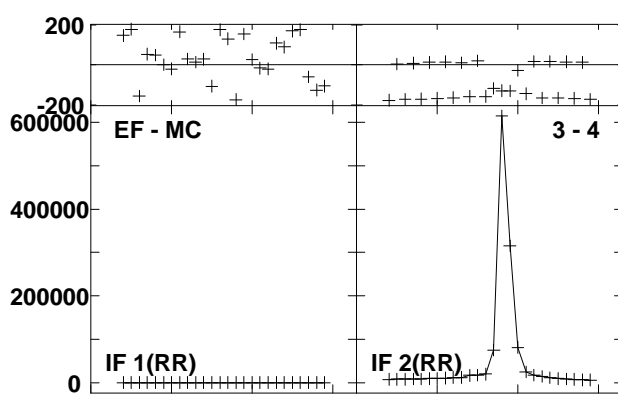
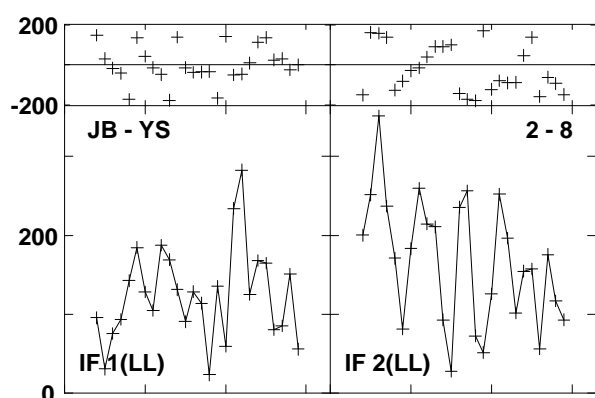
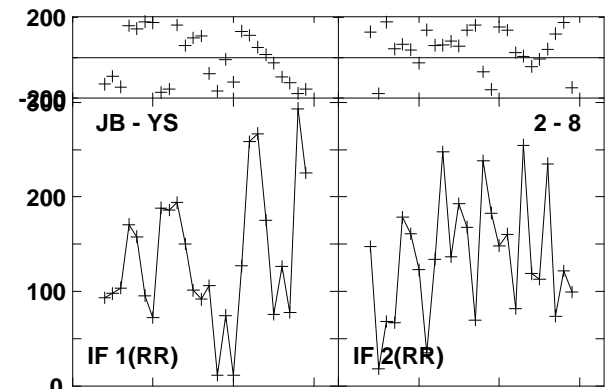
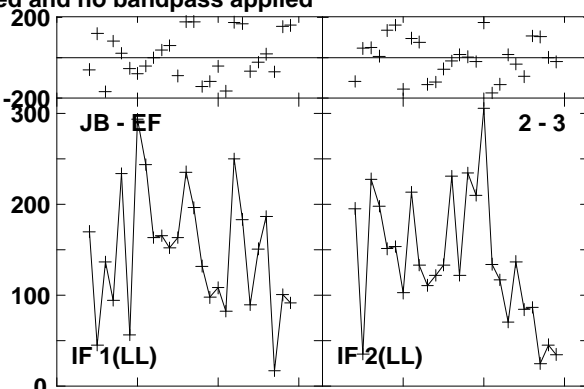
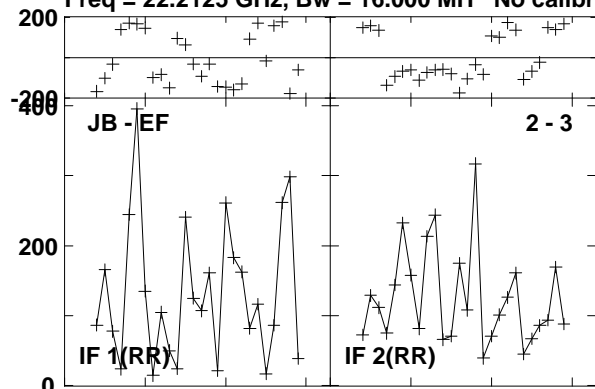

Lower frame: Micro Ampl Jy Top frame: Phas deg  
Vector averaged cross-power spectrum Baseline: JB (02) - EF (03)  
Timerange: 00/14:15:37 to 00/14:16:35

Plot file version 557 created 23-AUG-2016 15:01:02

W3IRS5 GA035B 1.UVDATA.1

Freq = 22.2125 GHz, Bw = 16.000 MH No calibration applied and no bandpass applied

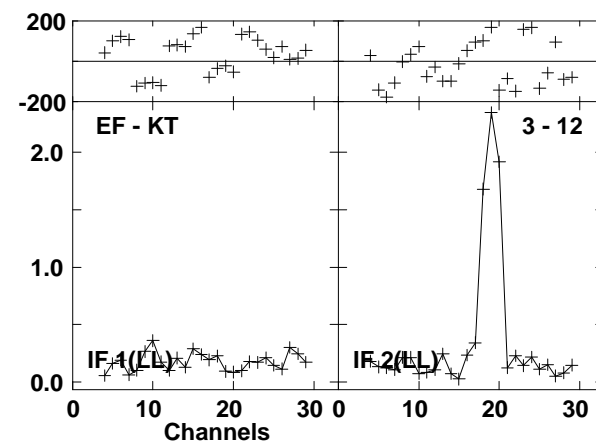
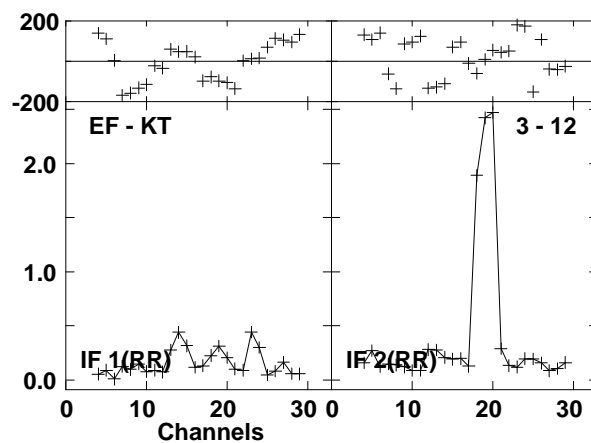
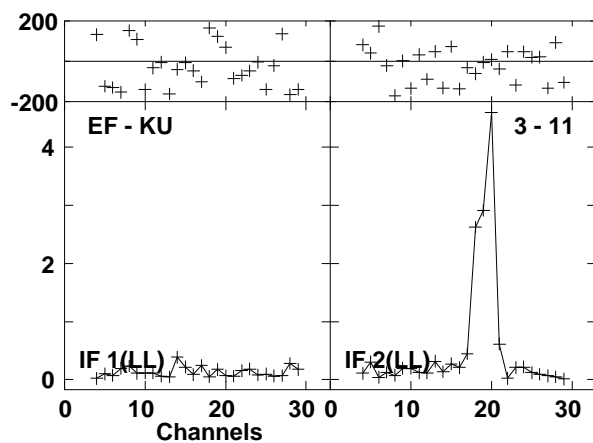
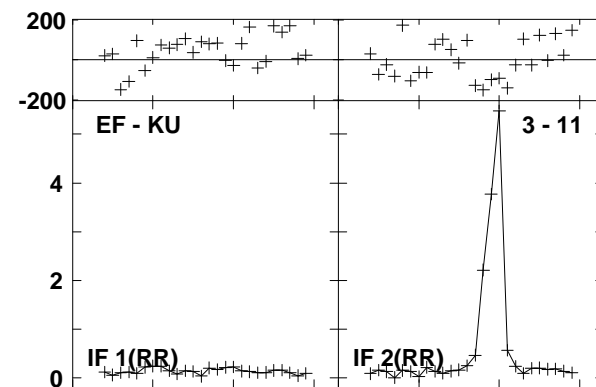
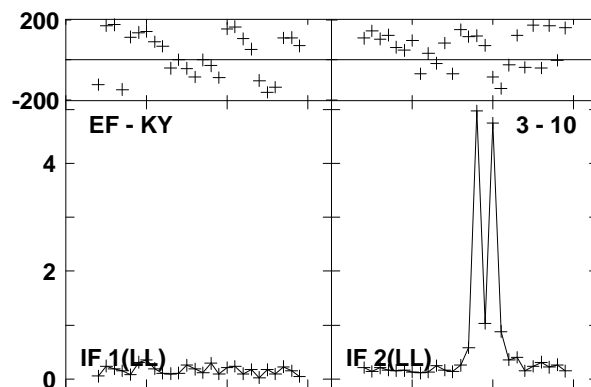
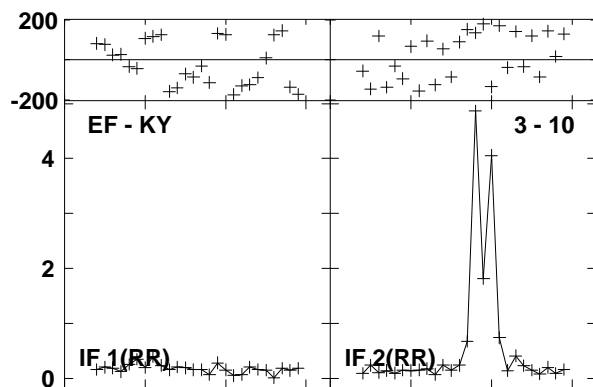
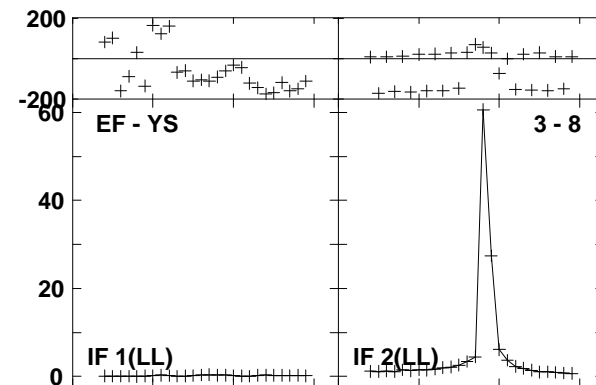
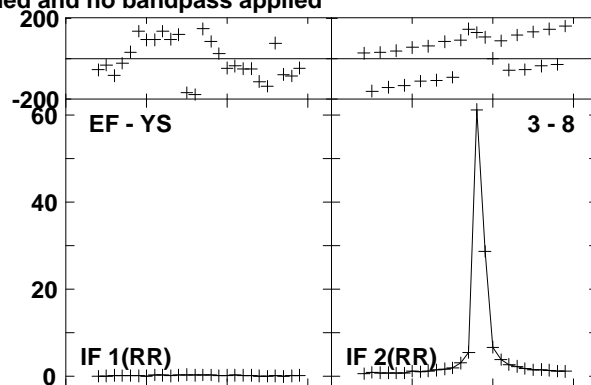
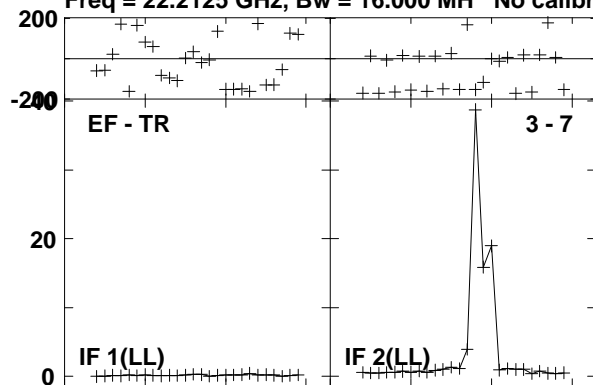

Lower frame: Milli Ampl Jy Top frame: Phas deg  
Vector averaged cross-power spectrum Baseline: EF (03) - TR (07)  
Timerange: 00/14:15:37 to 00/14:16:35

Plot file version 558 created 23-AUG-2016 15:01:02

W3IRS5 GA035B 1.UVDATA.1

Freq = 22.2125 GHz, Bw = 16.000 MH No calibration applied and no bandpass applied

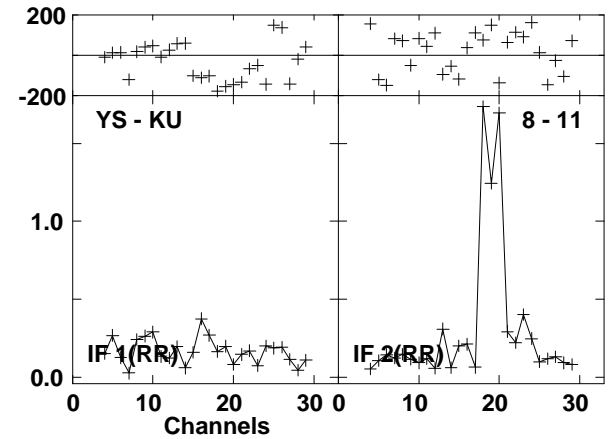
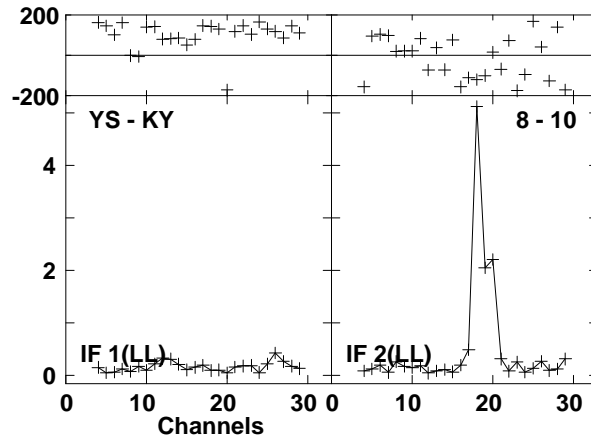
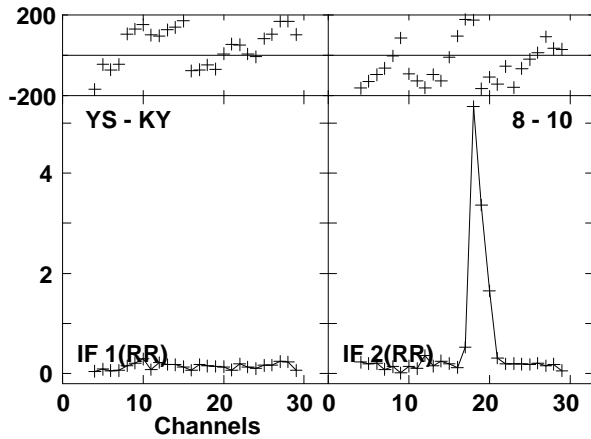
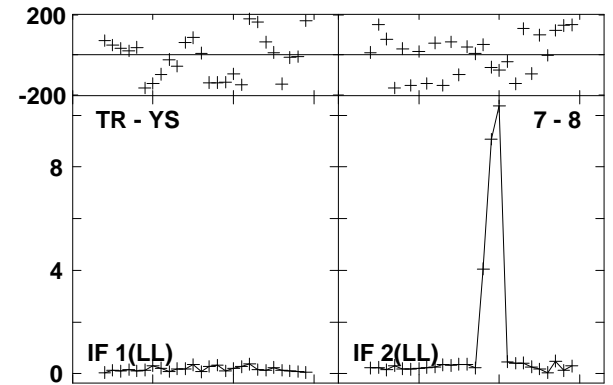
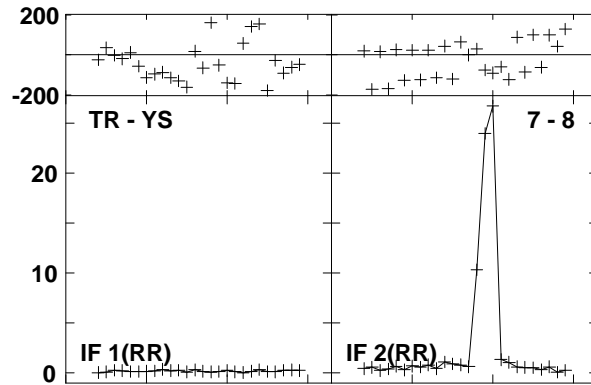
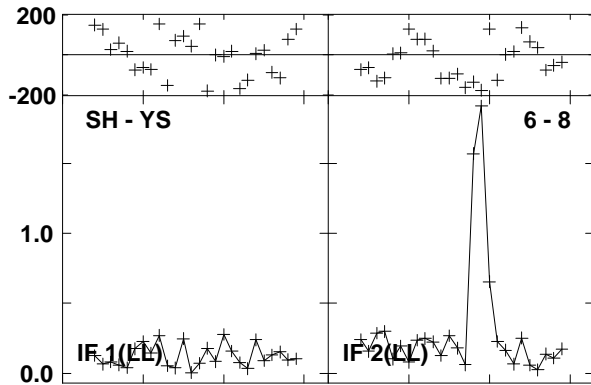
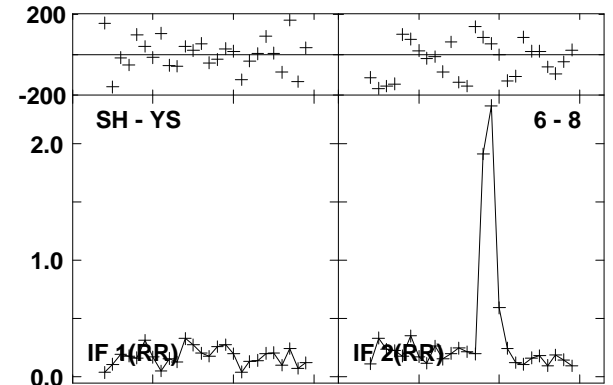
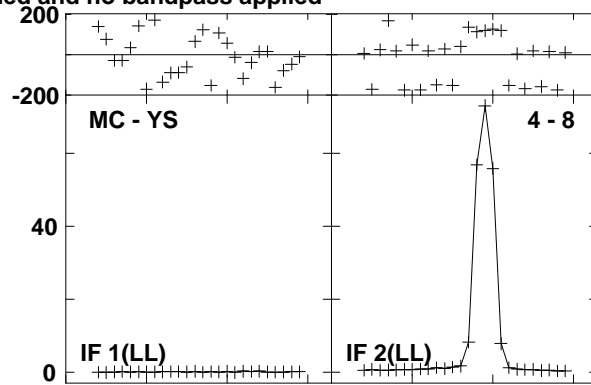
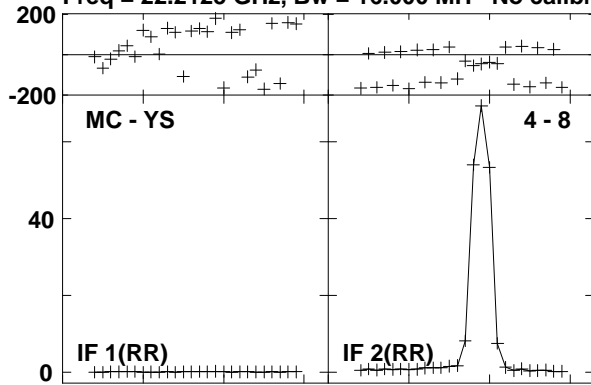

Lower frame: Milli Ampl Jy Top frame: Phas deg  
Vector averaged cross-power spectrum Baseline: MC (04) - YS (08)  
Timerange: 00/14:15:37 to 00/14:16:35

Plot file version 559 created 23-AUG-2016 15:01:02

W3IRS5 GA035B 1.UVDATA.1

Freq = 22.2125 GHz, Bw = 16.000 MH No calibration applied and no bandpass applied

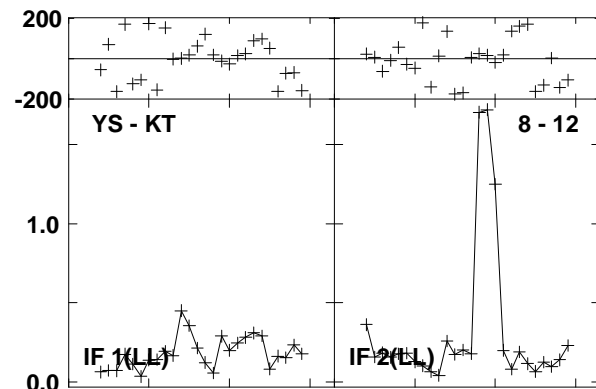
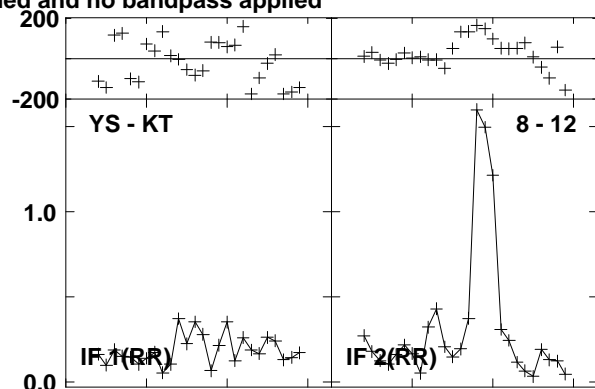
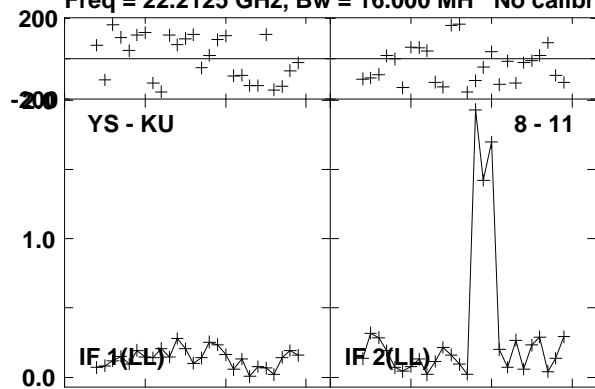

Lower frame: Milli Ampl Jy Top frame: Phas deg  
Vector averaged cross-power spectrum Baseline: YS (08) - KU (11)  
Timerange: 00/14:15:37 to 00/14:16:35

Plot file version 560 created 23-AUG-2016 15:01:02

0219+628 GA035B 1.UVDATA.1

Freq = 22.2125 GHz, Bw = 16.000 MH No calibration applied and no bandpass applied

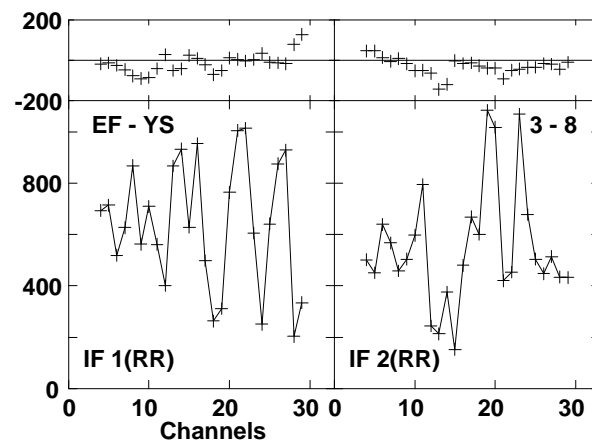
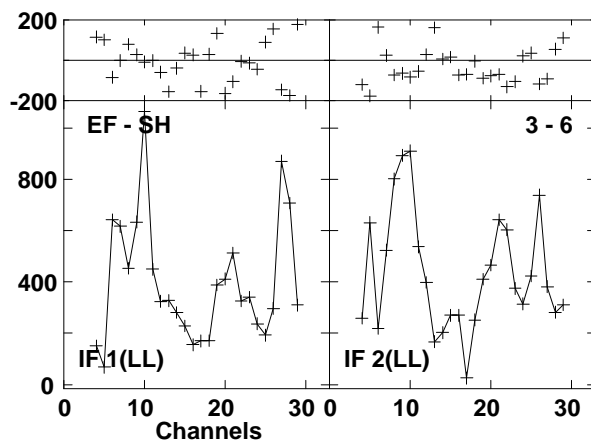
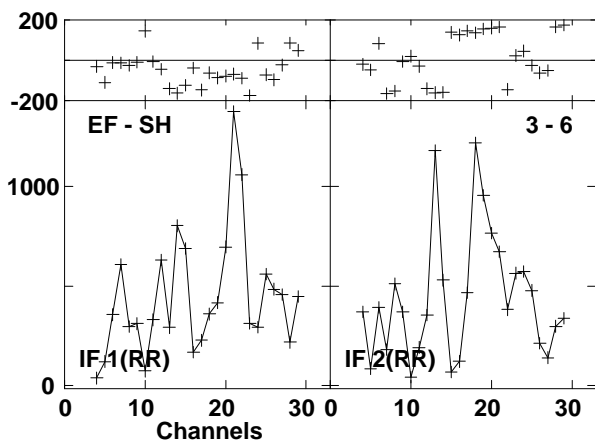
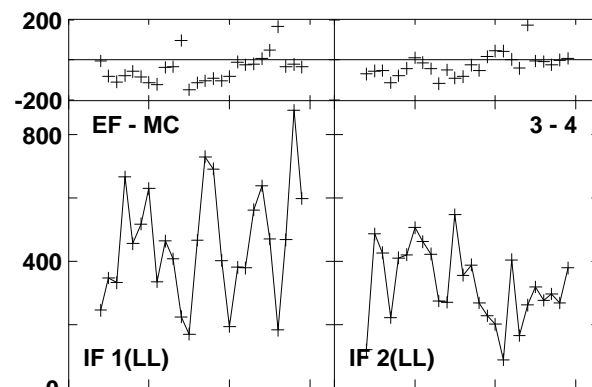
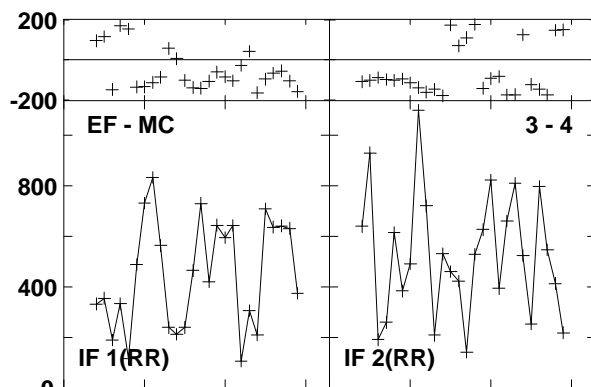
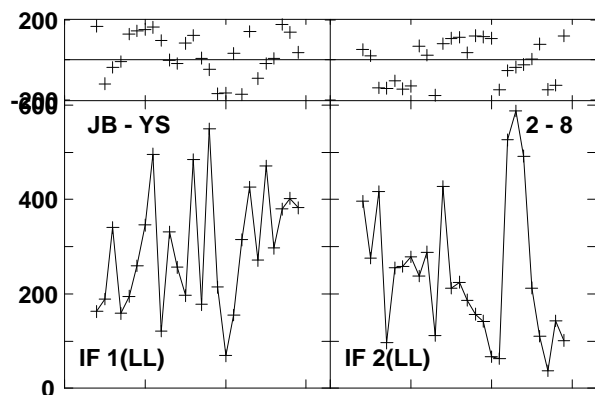
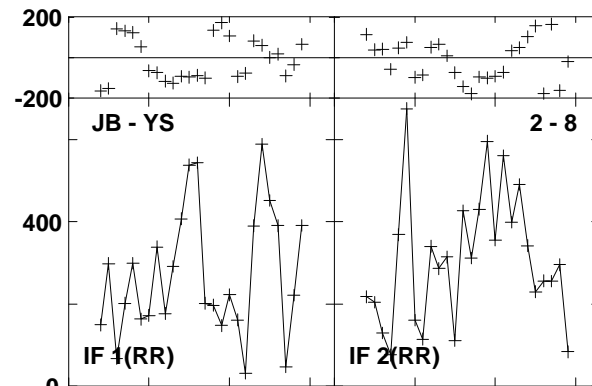
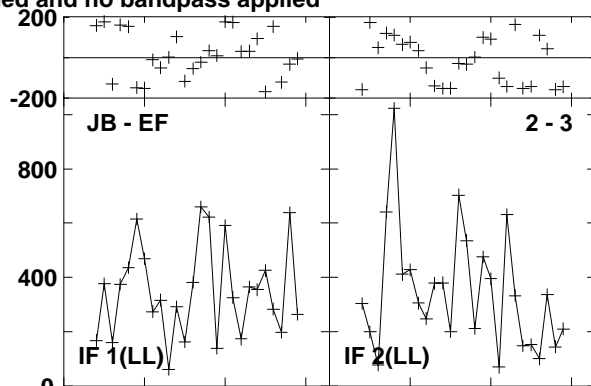
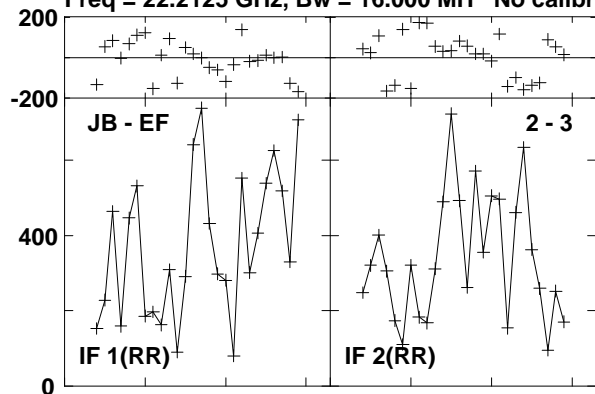

Lower frame: Micro Ampl Jy Top frame: Phas deg  
Vector averaged cross-power spectrum Baseline: JB (02) - EF (03)  
Timerange: 00/14:17:08 to 00/14:17:28



Plot file version 561 created 23-AUG-2016 15:01:02

0219+628 GA035B 1.UVDATA.1

Freq = 22.2125 GHz, Bw = 16.000 MH No calibration applied and no bandpass applied

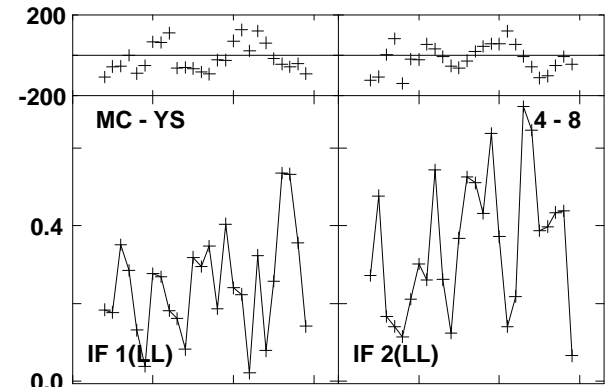
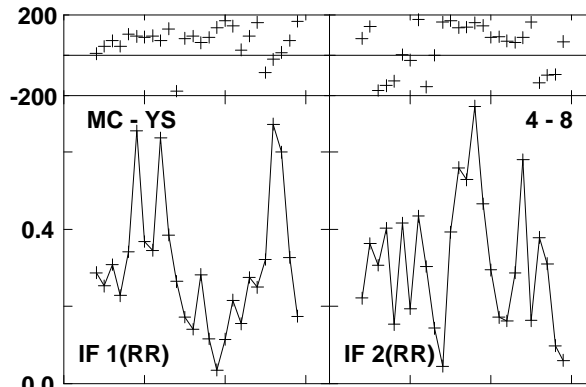
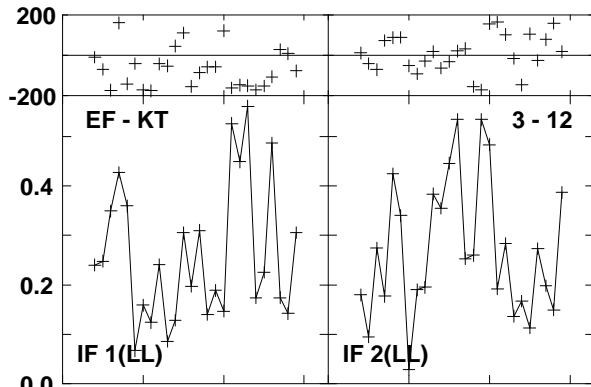
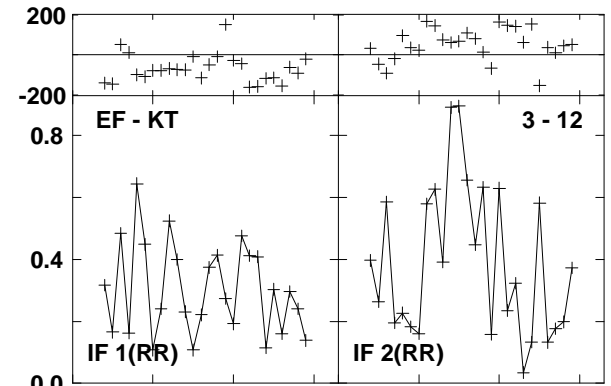
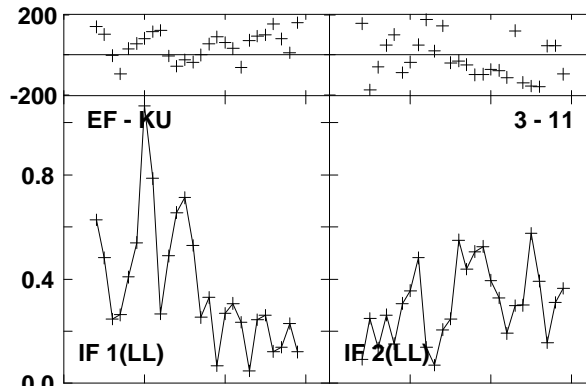
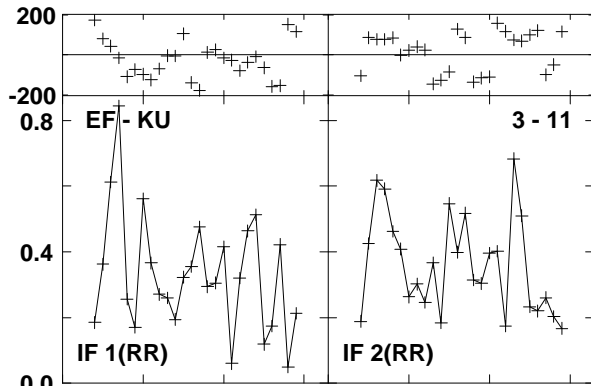
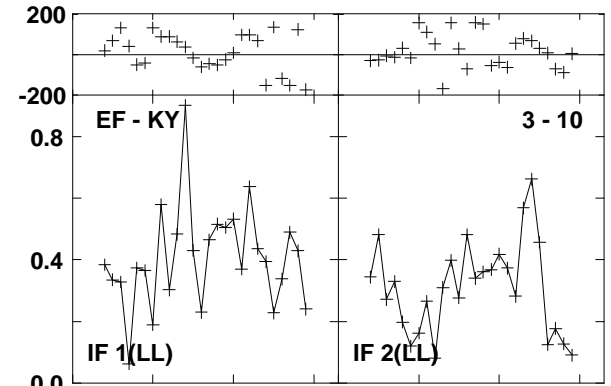
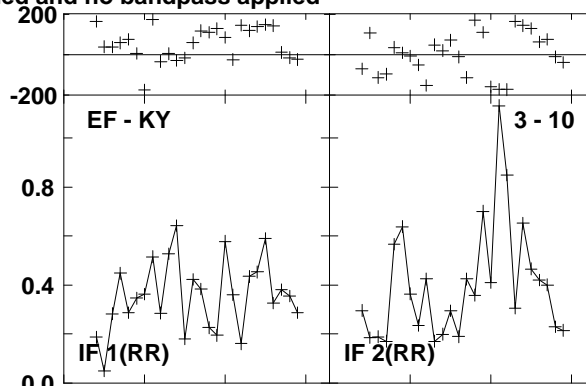
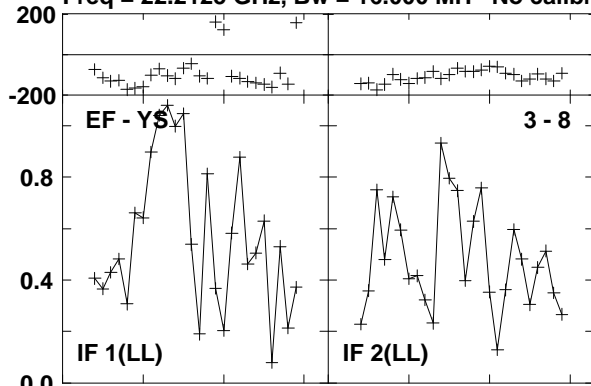

Lower frame: Milli Ampl Jy Top frame: Phas deg

Vector averaged cross-power spectrum Baseline: EF (03) - YS (08)

Timerange: 00/14:17:08 to 00/14:17:28

Plot file version 562 created 23-AUG-2016 15:01:02

0219+628 GA035B 1.UVDATA.1

Freq = 22.2125 GHz, Bw = 16.000 MH No calibration applied and no bandpass applied

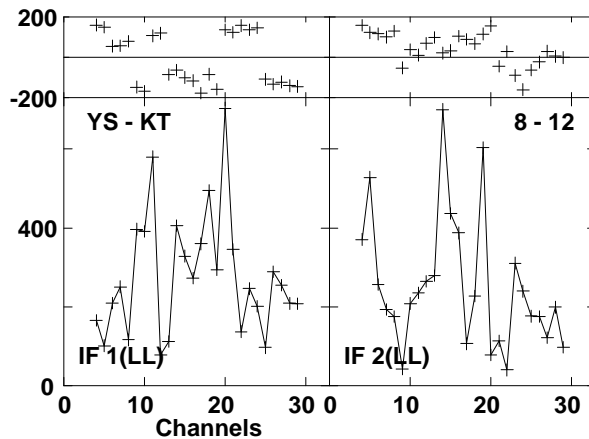
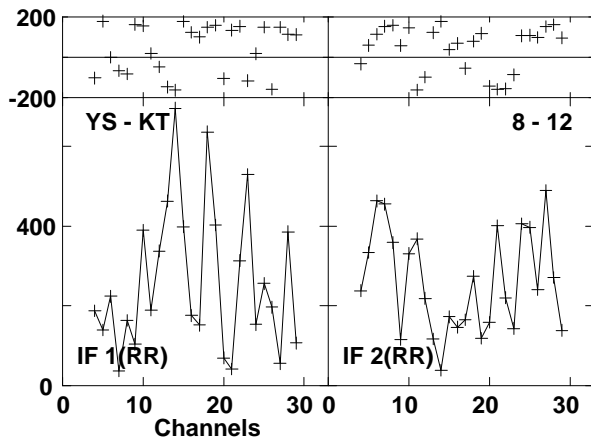
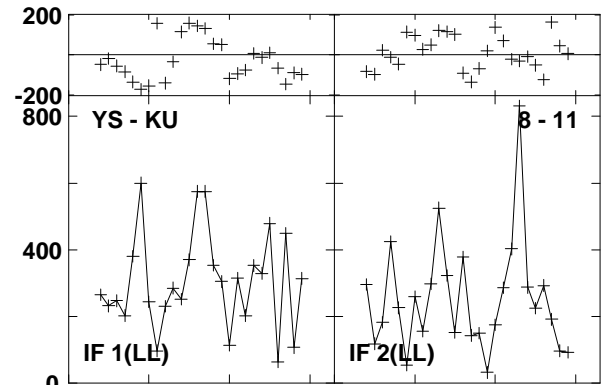
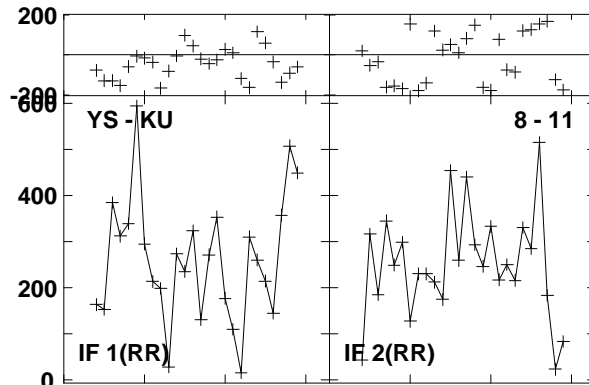
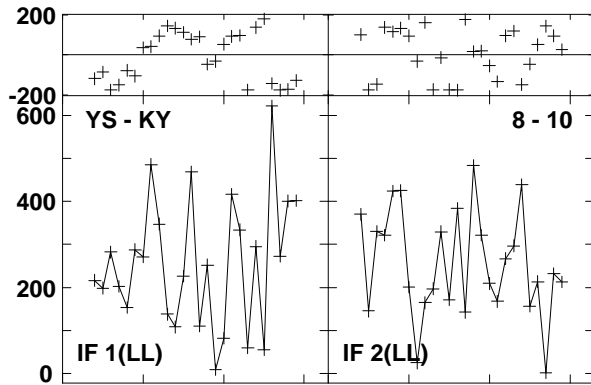
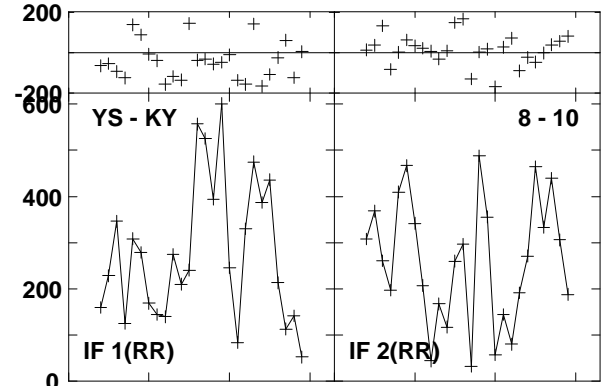
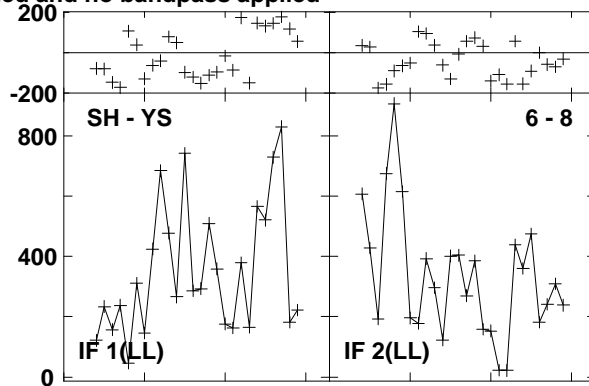
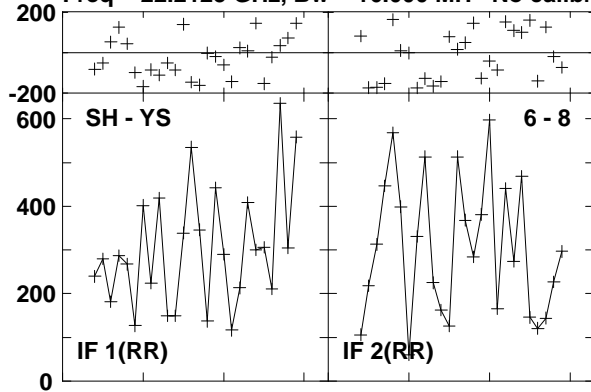

Lower frame: Micro Ampl Jy Top frame: Phas deg

Vector averaged cross-power spectrum Baseline: SH (06) - YS (08)

Timerange: 00/14:17:08 to 00/14:17:28

Plot file version 563 created 23-AUG-2016 15:01:02

0716+714 GA035B 1.UVDATA.1

Freq = 22.2125 GHz, Bw = 16.000 MH No calibration applied and no bandpass applied

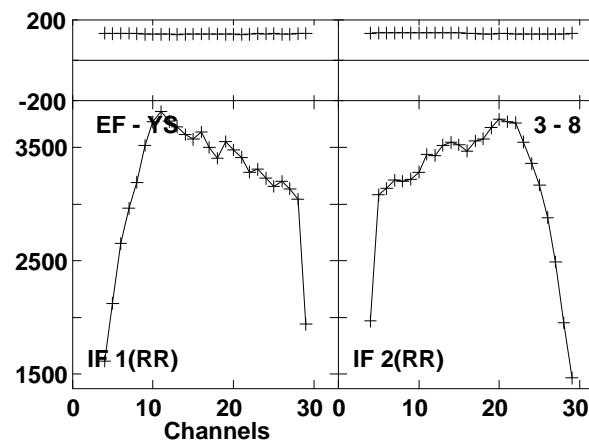
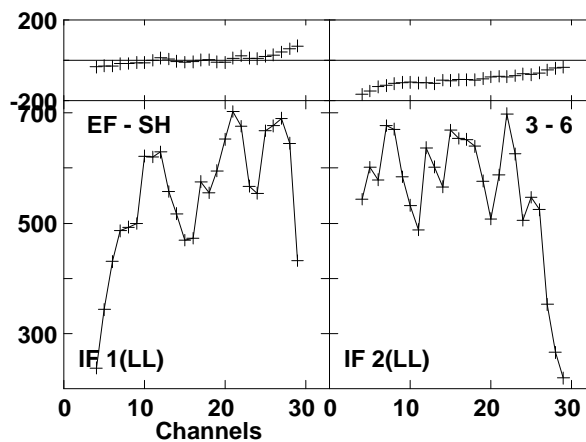
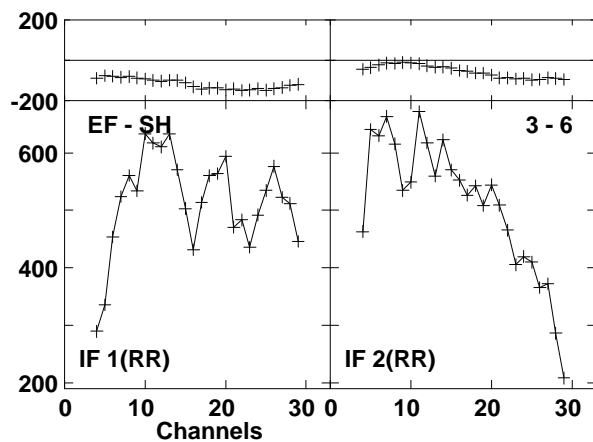
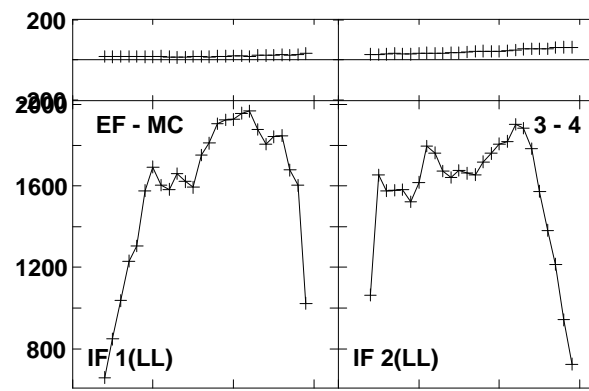
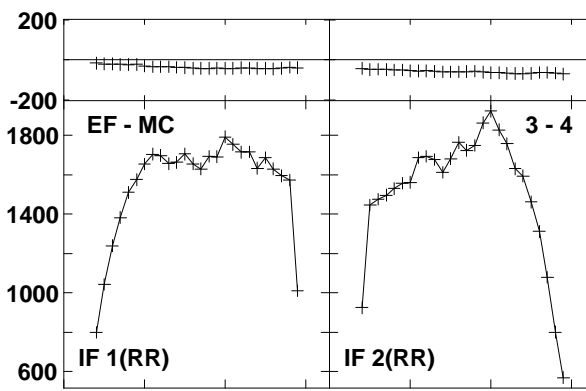
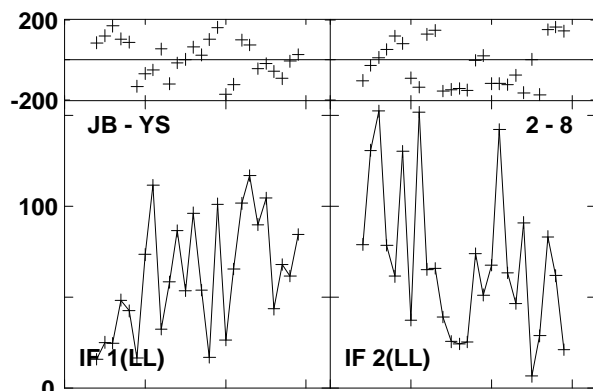
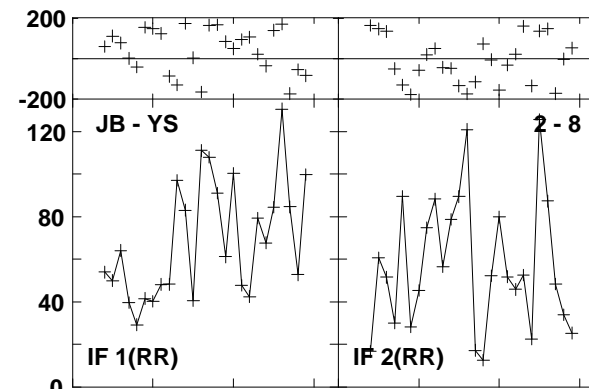
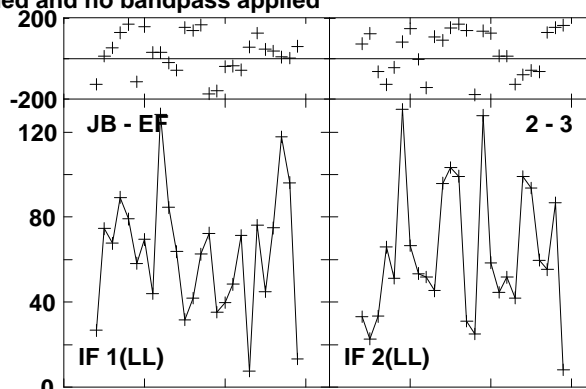
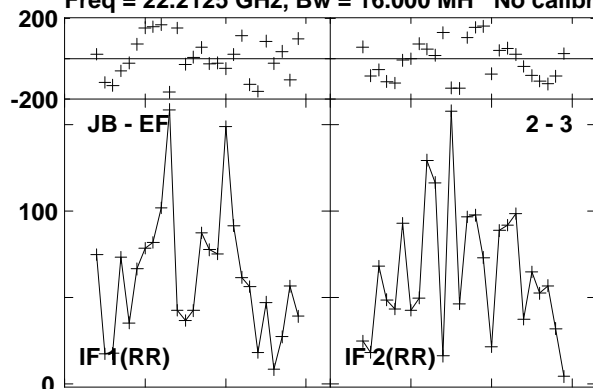

Lower frame: Micro Ampl Jy Top frame: Phas deg  
Vector averaged cross-power spectrum Baseline: JB (02) - EF (03)  
Timerange: 00/14:19:38 to 00/14:24:37

Plot file version 564 created 23-AUG-2016 15:01:02

0716+714 GA035B 1.UVDATA.1

Freq = 22.2125 GHz, Bw = 16.000 MH No calibration applied and no bandpass applied

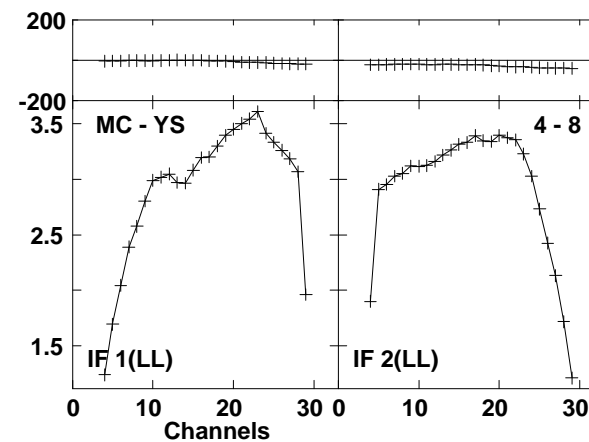
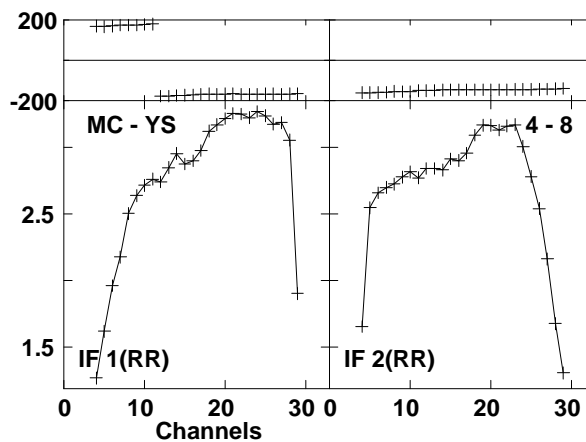
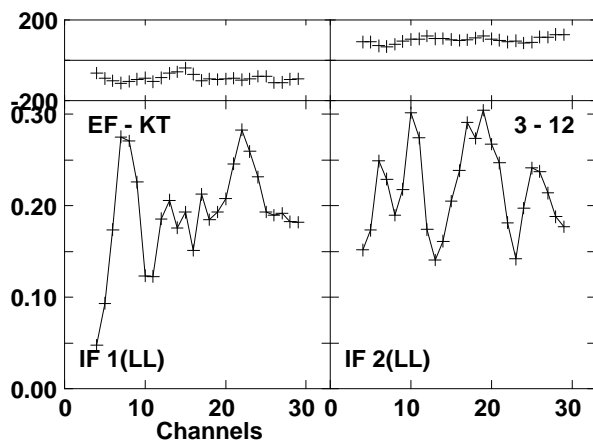
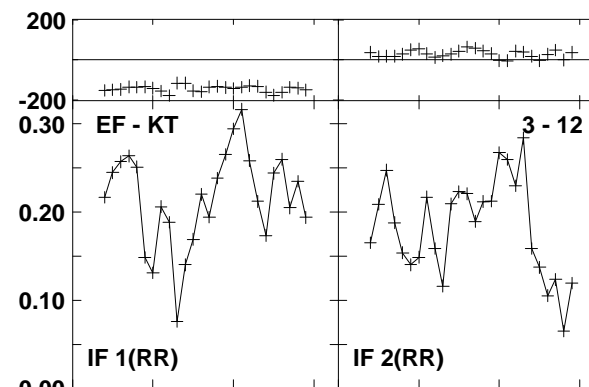
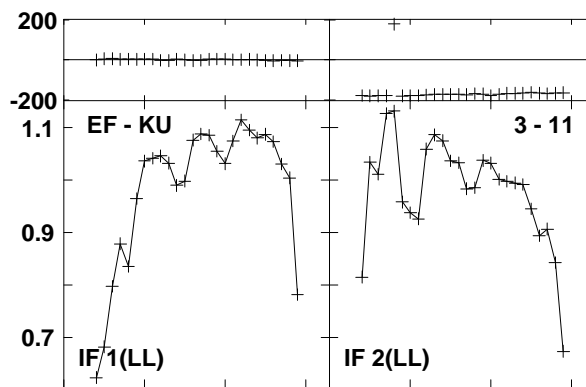
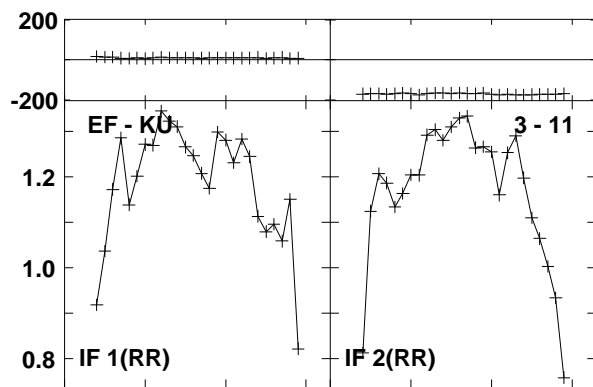
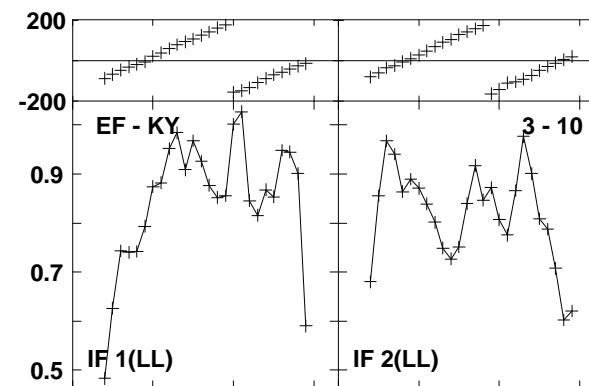
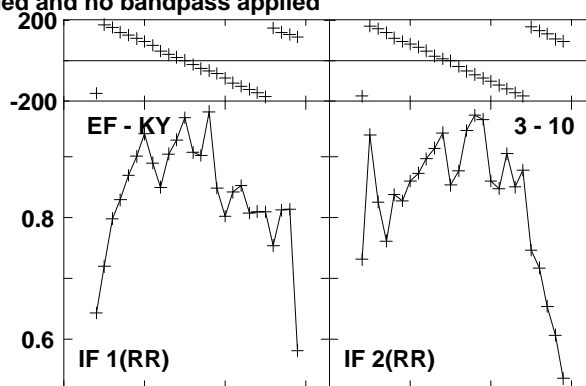
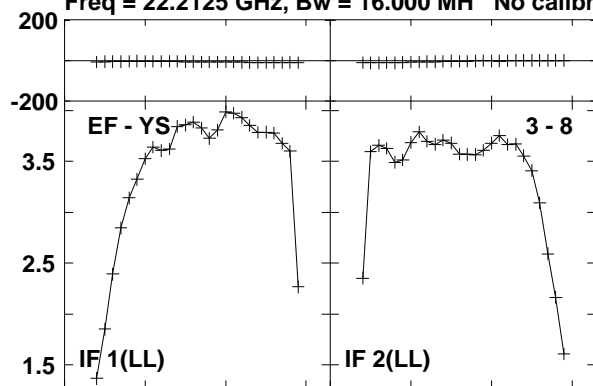

Lower frame: Milli Ampl Jy Top frame: Phas deg  
Vector averaged cross-power spectrum Baseline: EF (03) - YS (08)  
Timerange: 00/14:19:38 to 00/14:24:37

Plot file version 565 created 23-AUG-2016 15:01:02

0716+714 GA035B 1.UVDATA.1

Freq = 22.2125 GHz, Bw = 16.000 MH No calibration applied and no bandpass applied

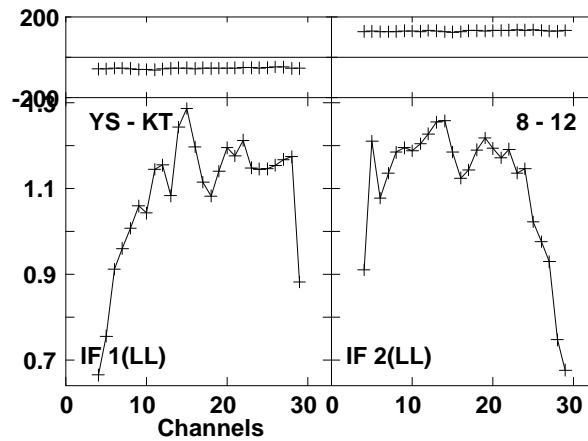
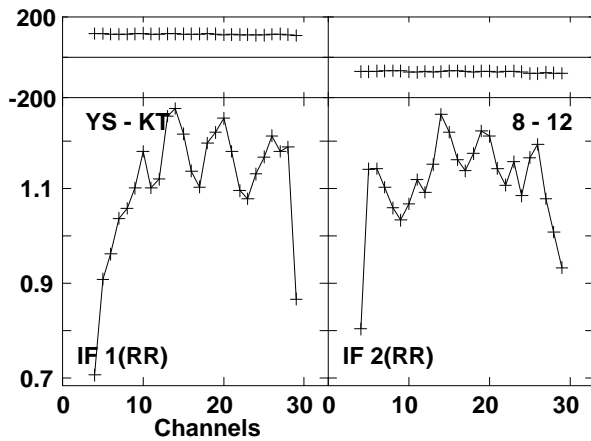
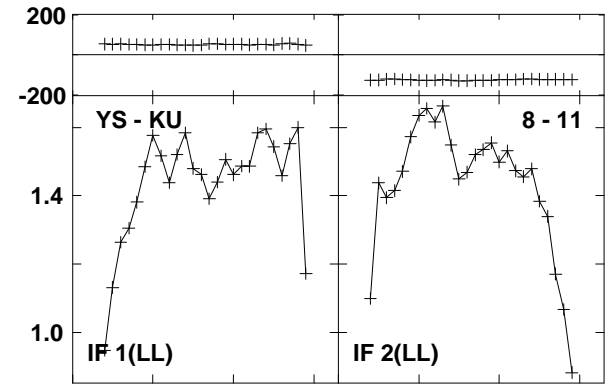
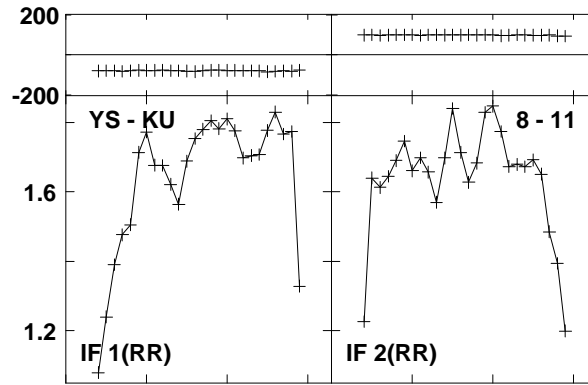
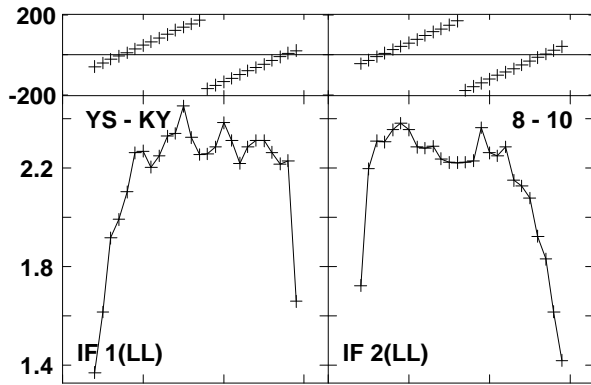
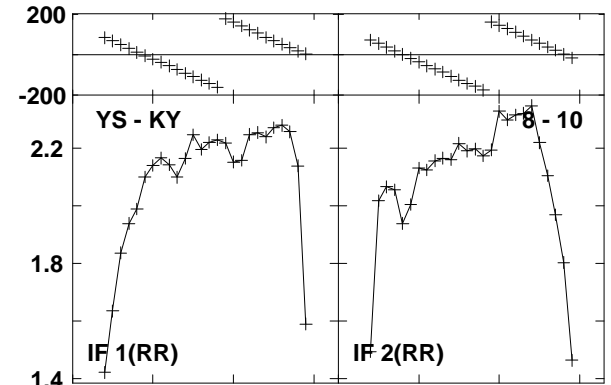
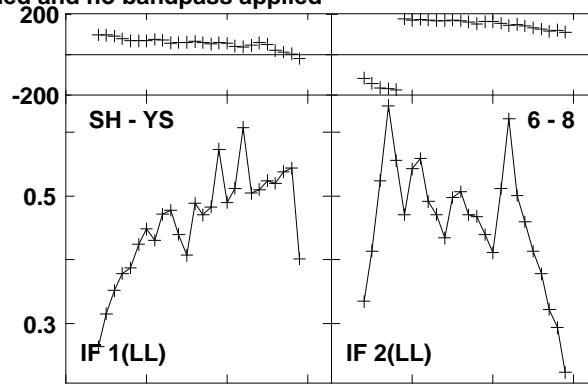
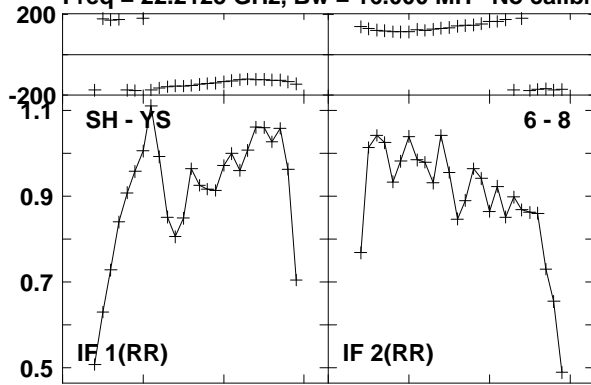

Lower frame: Milli Ampl Jy Top frame: Phas deg  
Vector averaged cross-power spectrum Baseline: SH (06) - YS (08)  
Timerange: 00/14:19:38 to 00/14:24:37

Plot file version 566 created 23-AUG-2016 15:01:02

0219+628 GA035B 1.UVDATA.1

Freq = 22.2125 GHz, Bw = 16.000 MH No calibration applied and no bandpass applied

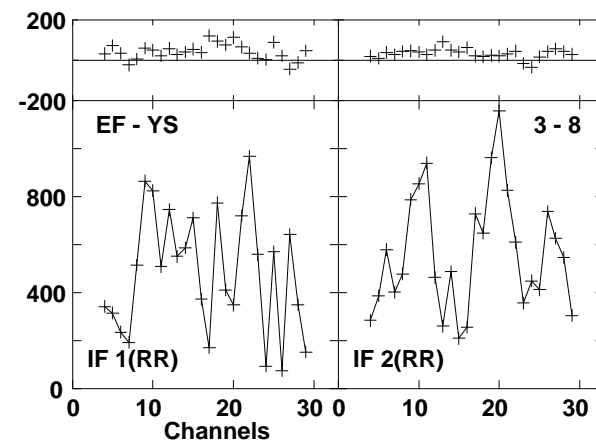
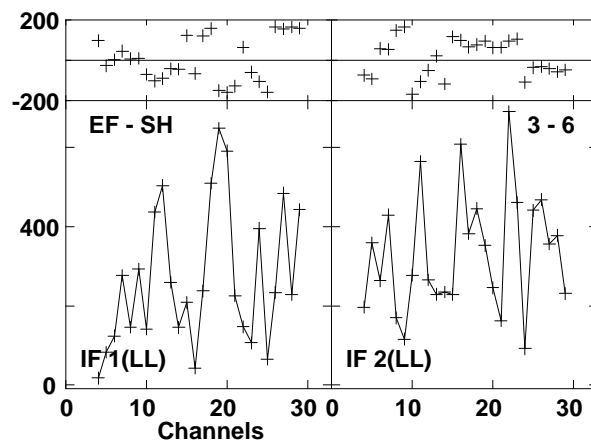
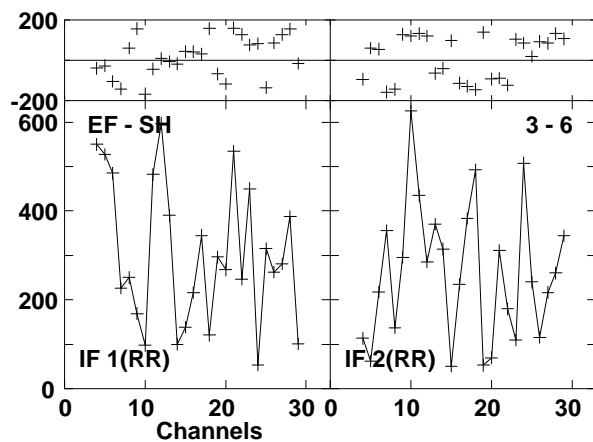
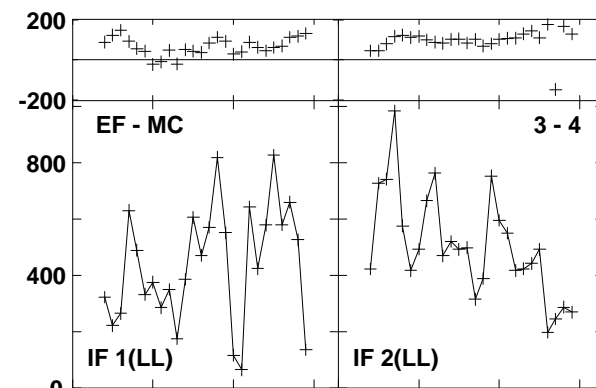
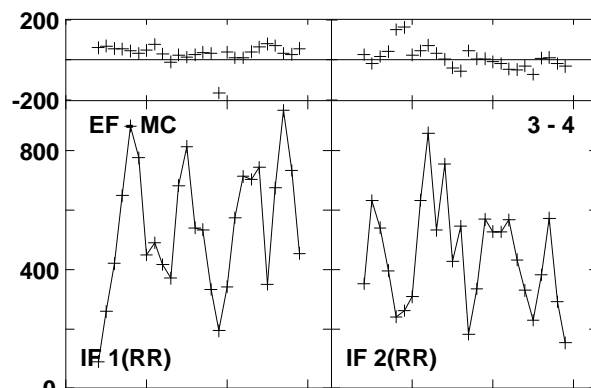
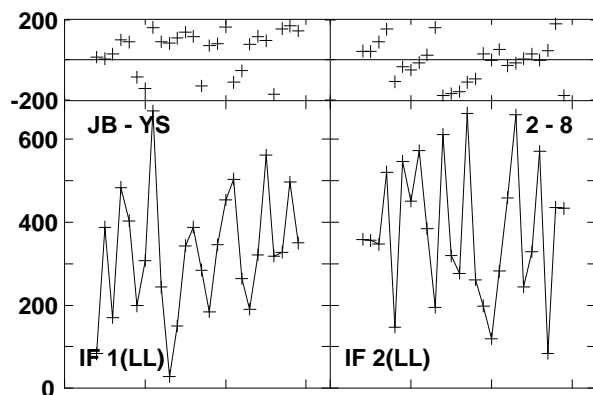
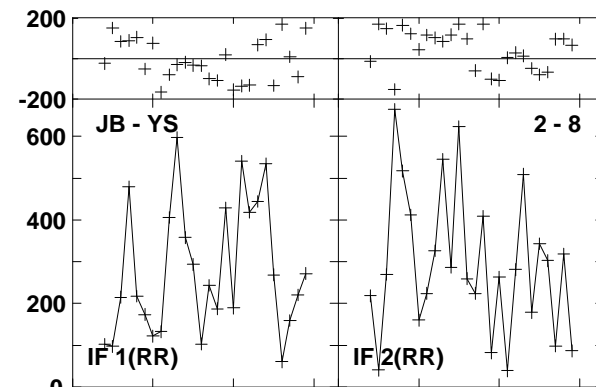
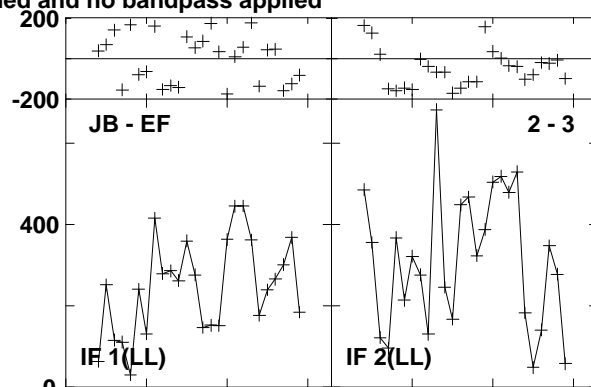
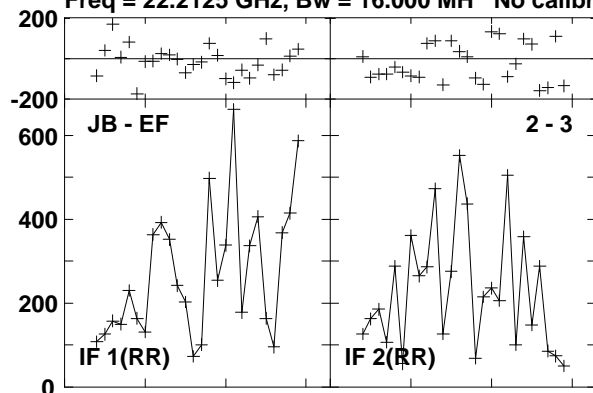

Lower frame: Micro Ampl Jy Top frame: Phas deg  
Vector averaged cross-power spectrum Baseline: JB (02) - EF (03)  
Timerange: 00/14:26:49 to 00/14:27:07

Plot file version 567 created 23-AUG-2016 15:01:02

0219+628 GA035B 1.UVDATA.1

Freq = 22.2125 GHz, Bw = 16.000 MH No calibration applied and no bandpass applied

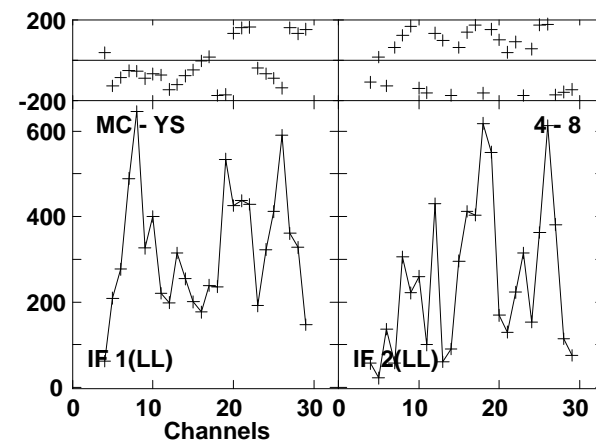
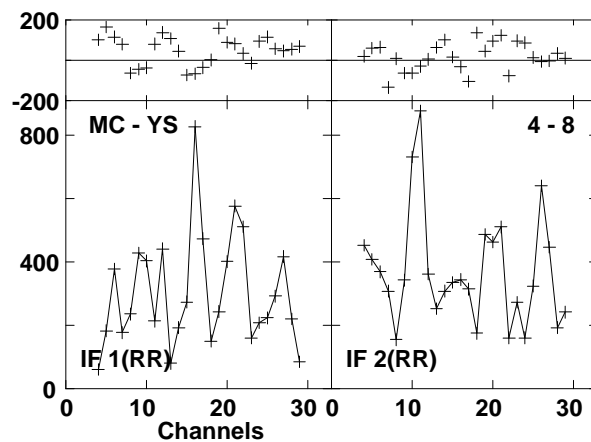
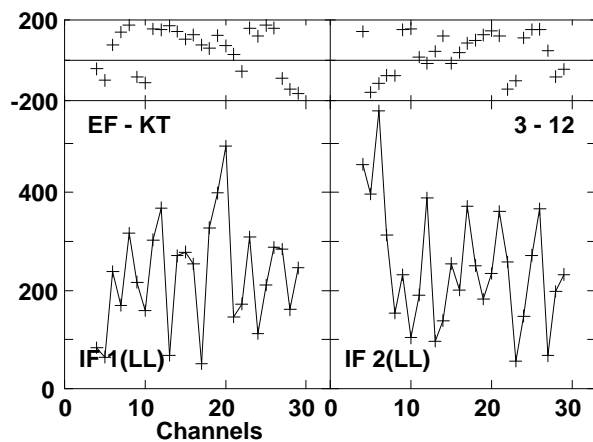
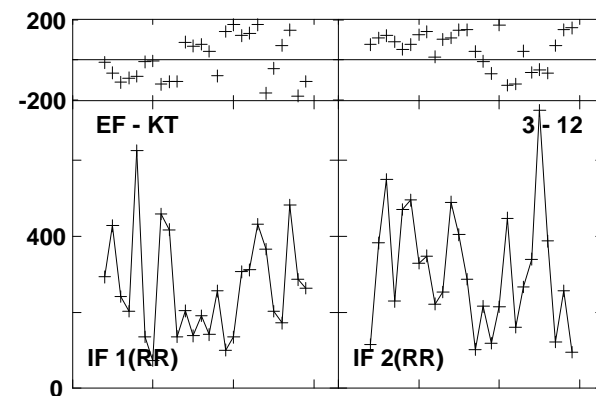
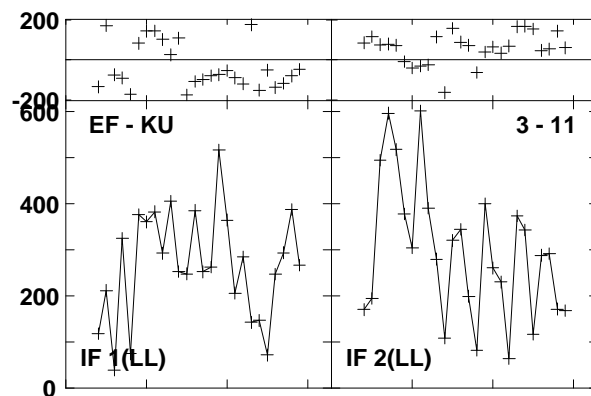
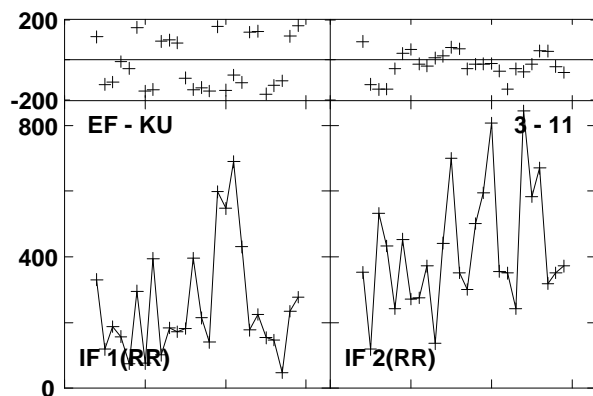
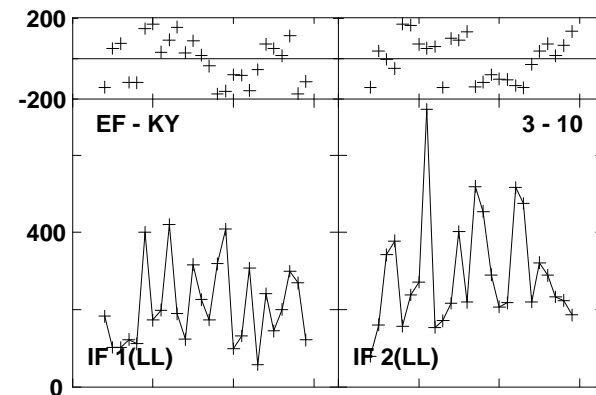
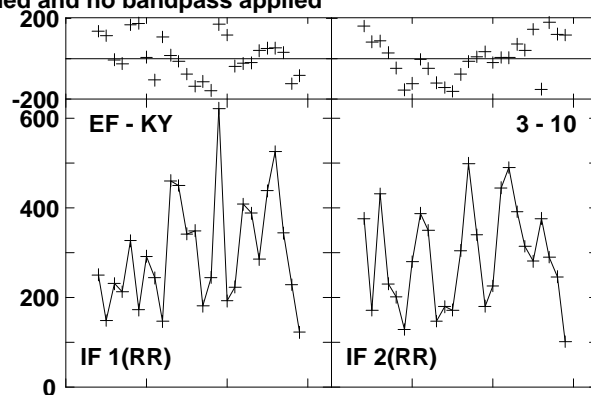
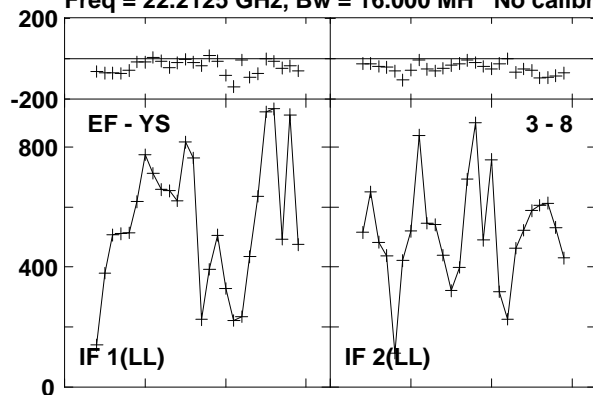

Lower frame: Micro Ampl Jy Top frame: Phas deg  
Vector averaged cross-power spectrum Baseline: EF (03) - YS (08)  
Timerange: 00/14:26:49 to 00/14:27:07

Plot file version 568 created 23-AUG-2016 15:01:03

0219+628 GA035B 1.UVDATA.1

Freq = 22.2125 GHz, Bw = 16.000 MH No calibration applied and no bandpass applied

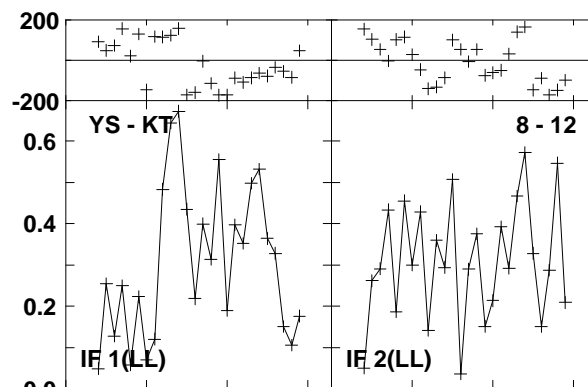
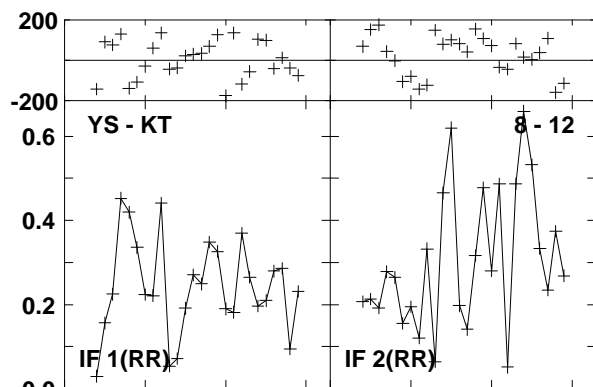
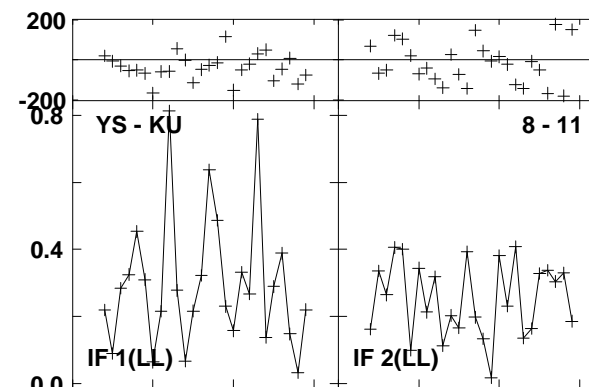
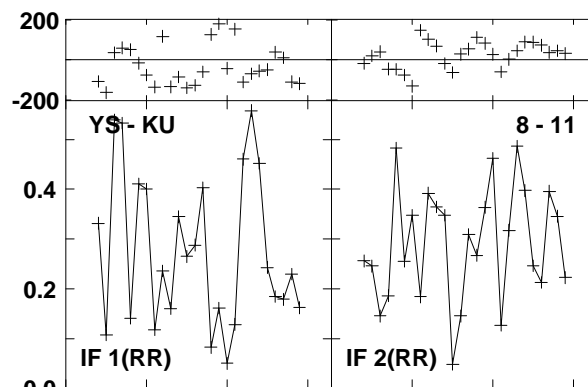
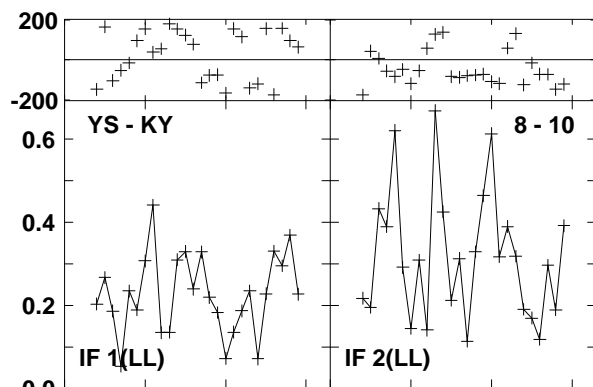
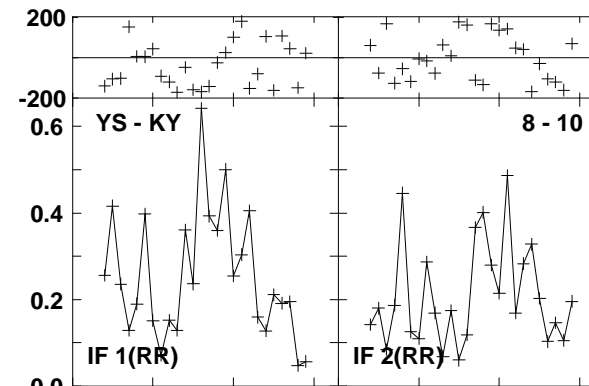
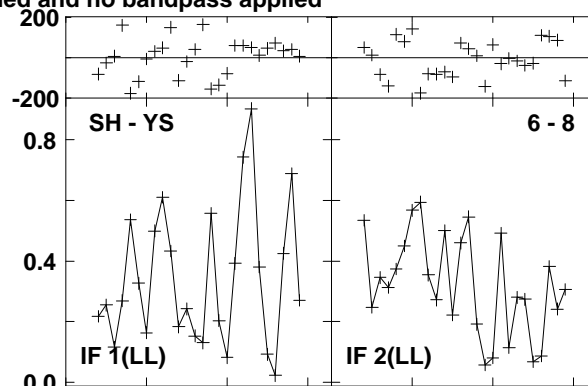
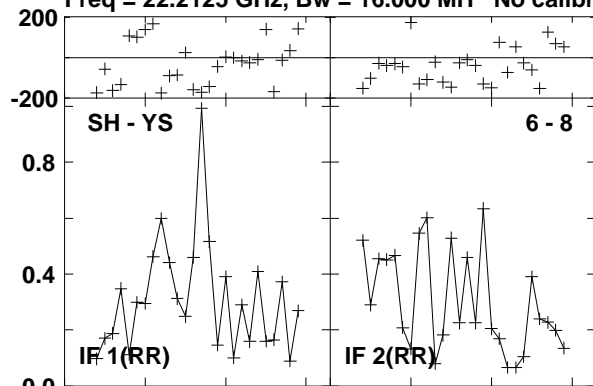

Lower frame: Milli Ampl Jy Top frame: Phas deg  
Vector averaged cross-power spectrum Baseline: SH (06) - YS (08)  
Timerange: 00/14:26:49 to 00/14:27:07



Plot file version 569 created 23-AUG-2016 15:01:03  
 W3IRS5 GA035B 1.UVDATA.1

Freq = 22.2125 GHz, Bw = 16.000 MH No calibration applied and no bandpass applied

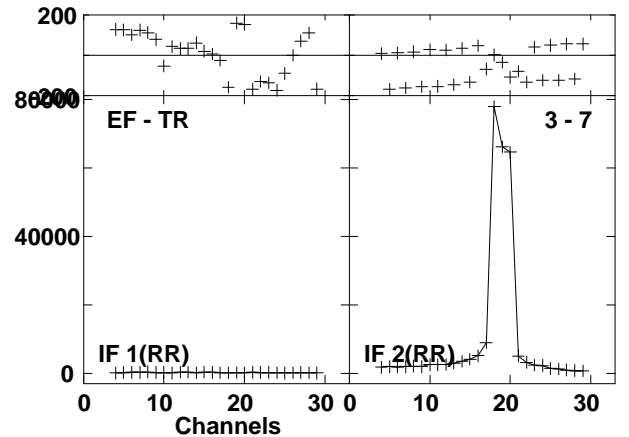
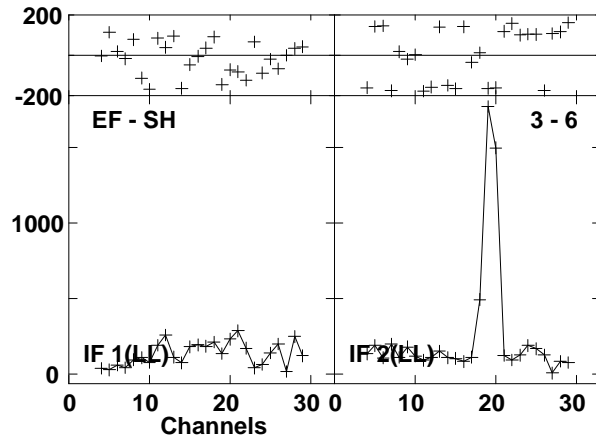
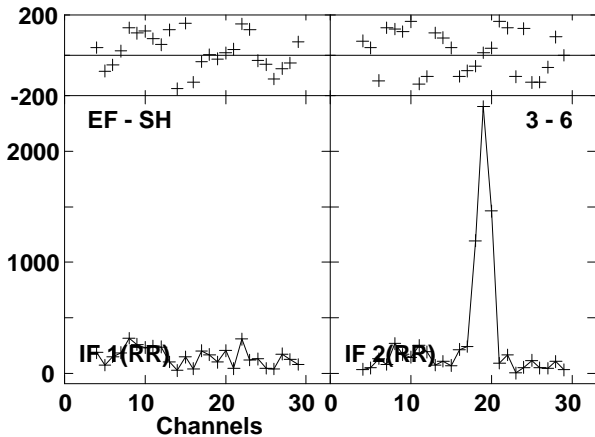
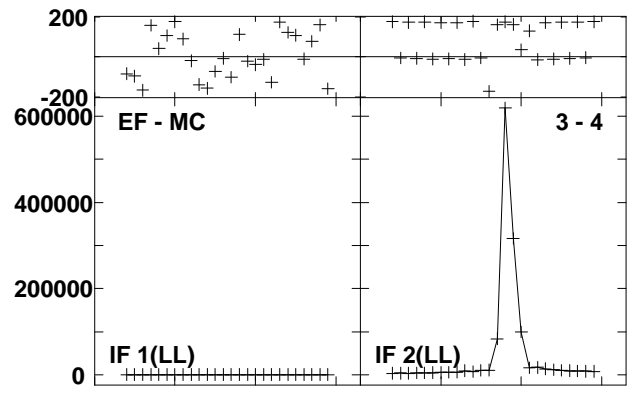
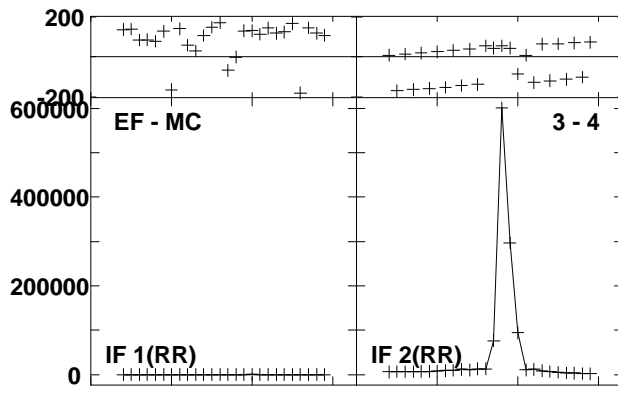
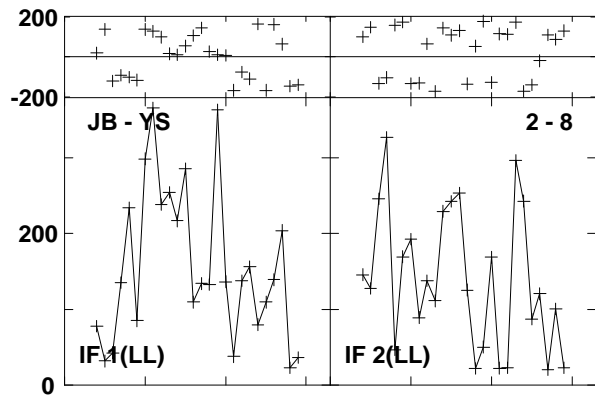
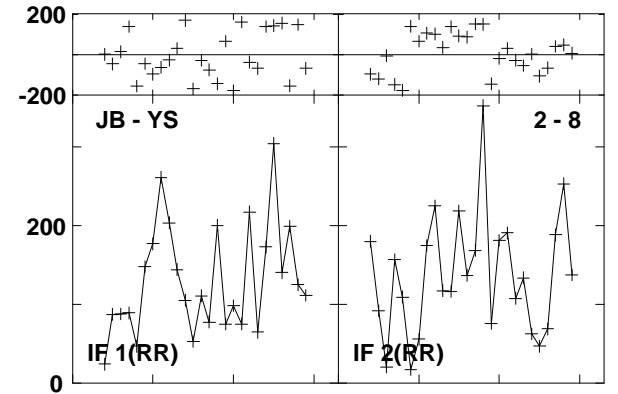
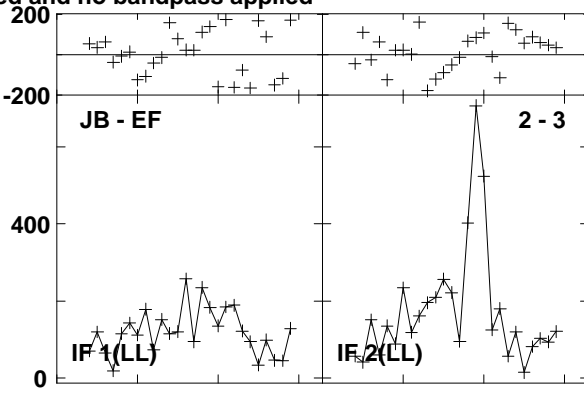
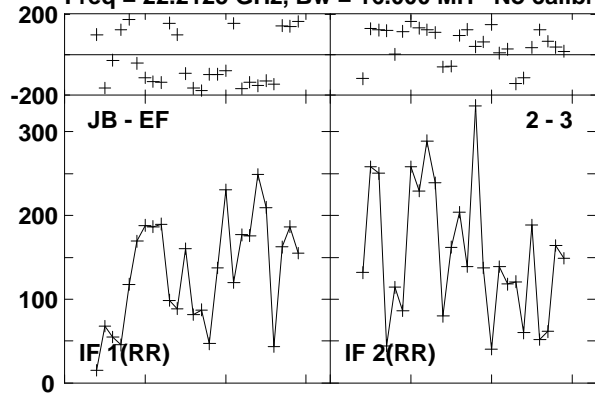

Lower frame: Micro Ampl Jy Top frame: Phas deg  
 Vector averaged cross-power spectrum Baseline: JB (02) - EF (03)  
 Timerange: 00/14:27:40 to 00/14:28:39

Plot file version 570 created 23-AUG-2016 15:01:03

W3IRS5 GA035B 1.UVDATA.1

Freq = 22.2125 GHz, Bw = 16.000 MH No calibration applied and no bandpass applied

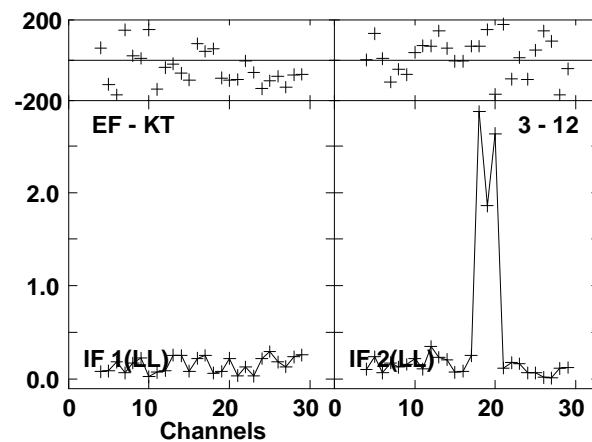
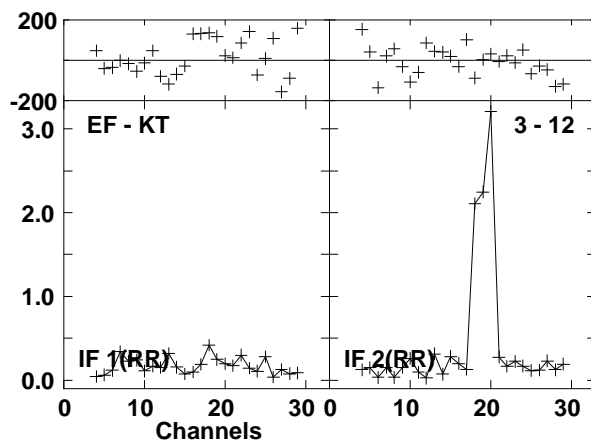
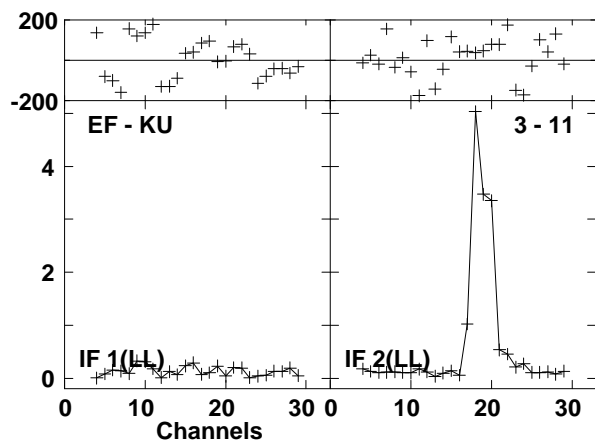
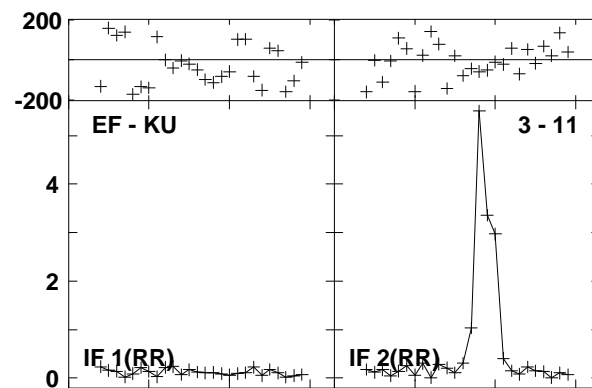
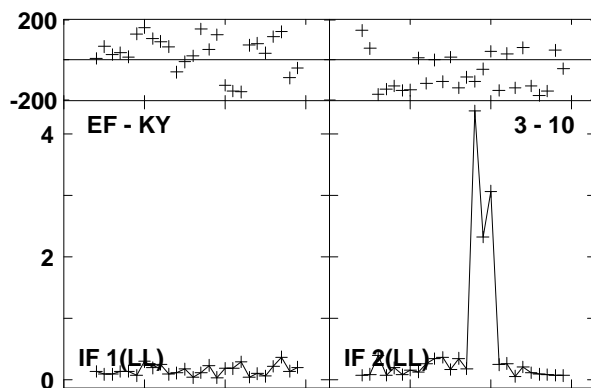
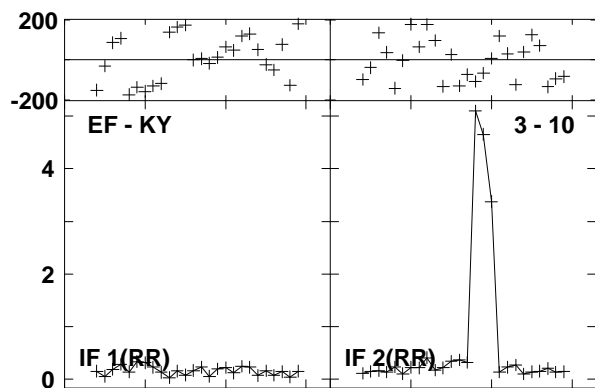
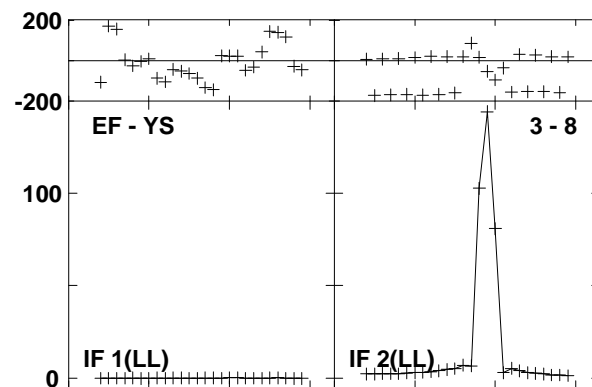
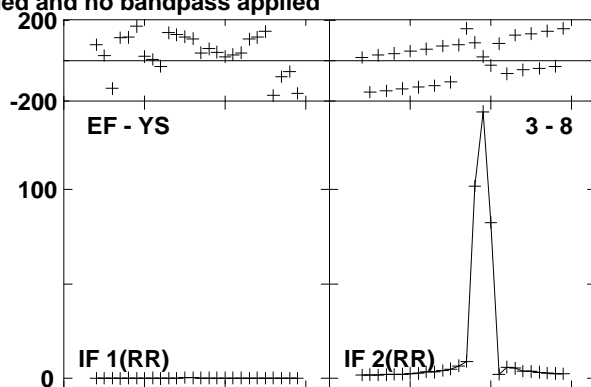
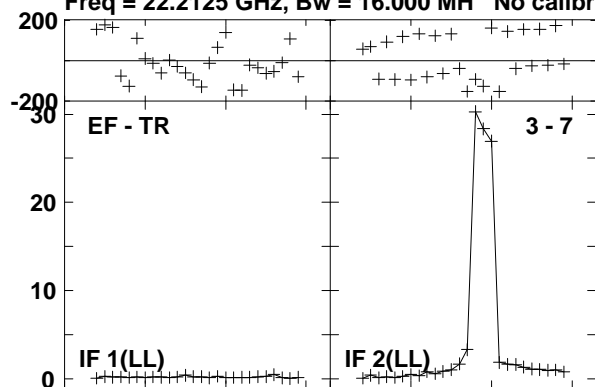

Lower frame: Milli Ampl Jy Top frame: Phas deg  
Vector averaged cross-power spectrum Baseline: EF (03) - TR (07)  
Timerange: 00/14:27:40 to 00/14:28:39

Plot file version 571 created 23-AUG-2016 15:01:03

W3IRS5 GA035B 1.UVDATA.1

Freq = 22.2125 GHz, Bw = 16.000 MH No calibration applied and no bandpass applied

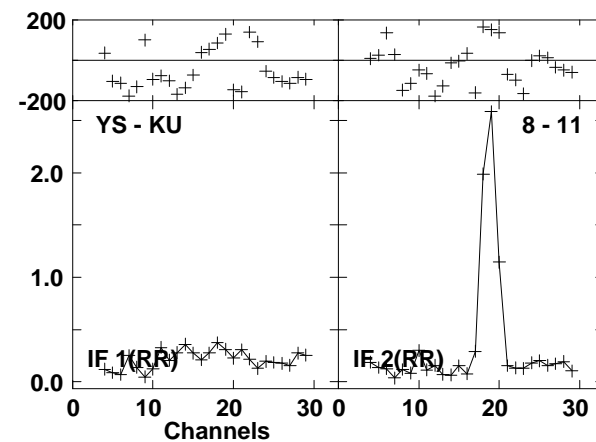
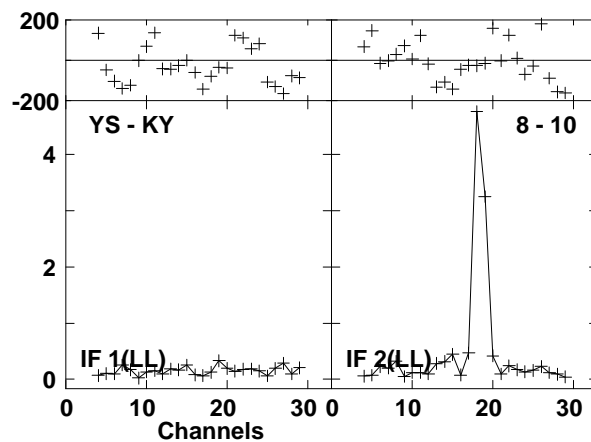
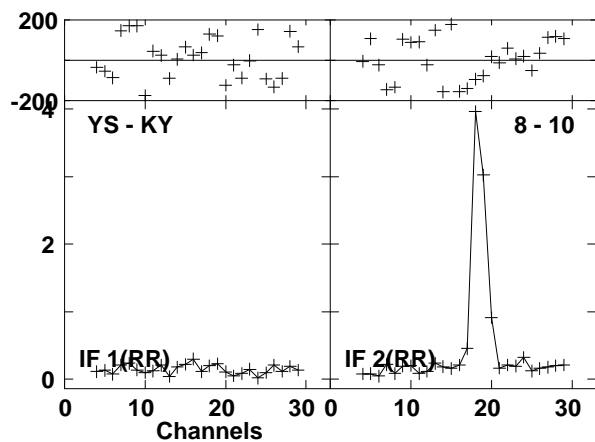
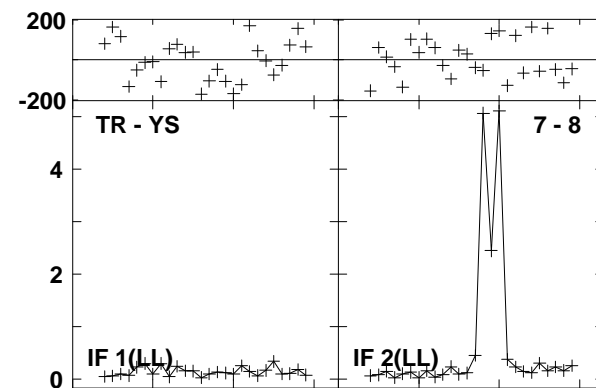
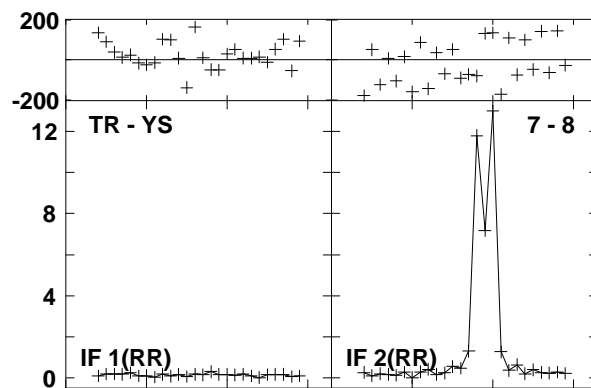
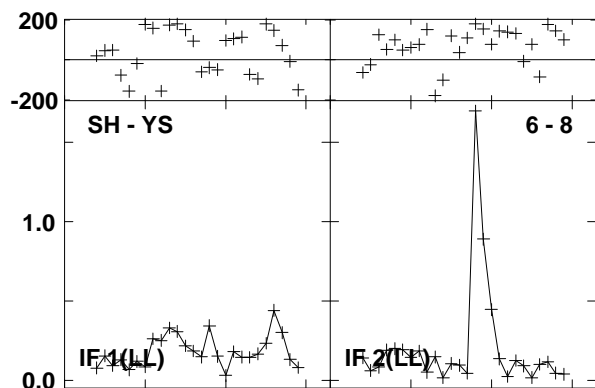
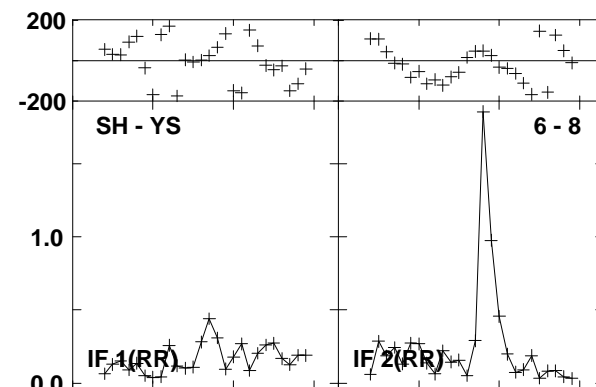
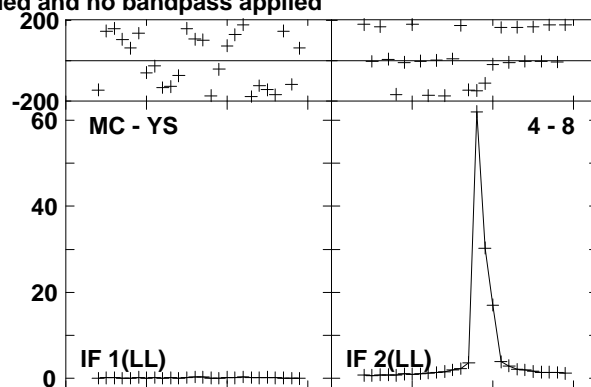
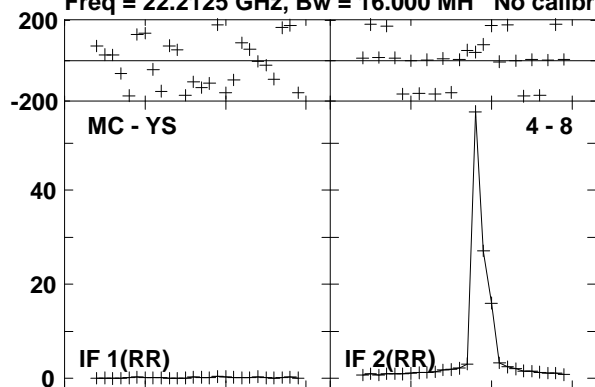

Lower frame: Milli Ampl Jy Top frame: Phas deg  
Vector averaged cross-power spectrum Baseline: MC (04) - YS (08)  
Timerange: 00/14:27:40 to 00/14:28:39

Plot file version 572 created 23-AUG-2016 15:01:03  
W3IRS5 GA035B 1.UVDATA.1

Freq = 22.2125 GHz, Bw = 16.000 MH No calibration applied and no bandpass applied

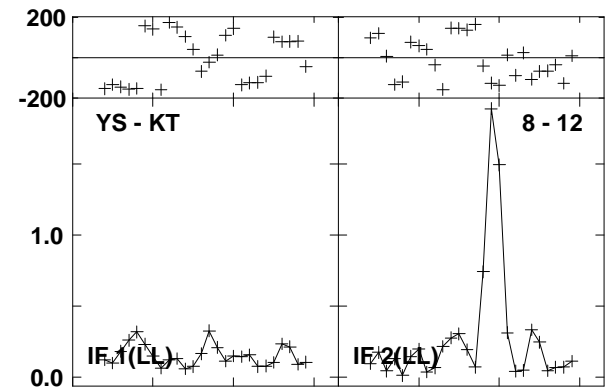
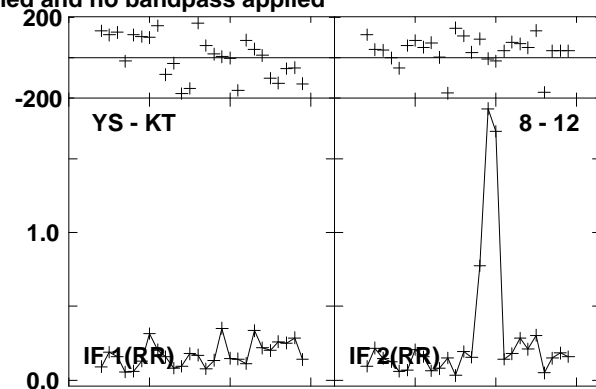
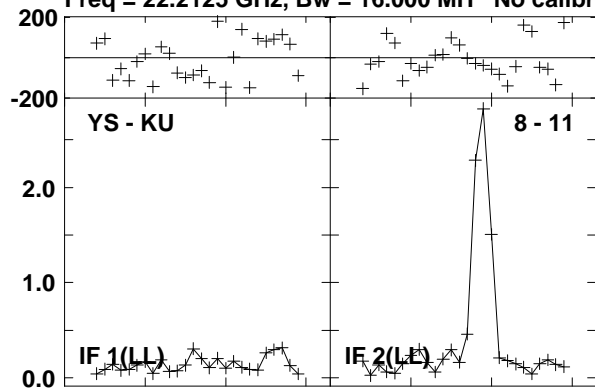

Lower frame: Milli Ampl Jy Top frame: Phas deg  
Vector averaged cross-power spectrum Baseline: YS (08) - KU (11)  
Timerange: 00/14:27:40 to 00/14:28:39

Plot file version 573 created 23-AUG-2016 15:01:03

0219+628 GA035B 1.UVDATA.1

Freq = 22.2125 GHz, Bw = 16.000 MH No calibration applied and no bandpass applied

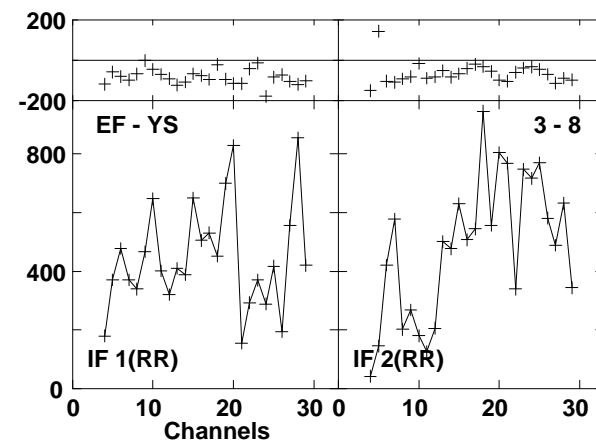
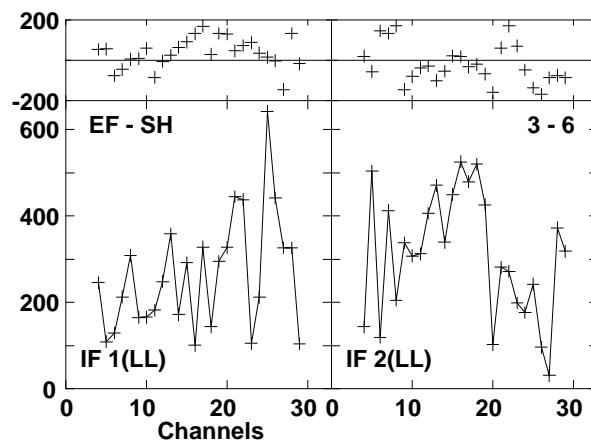
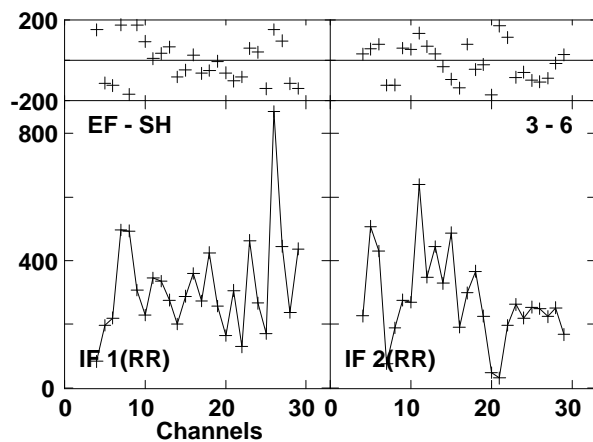
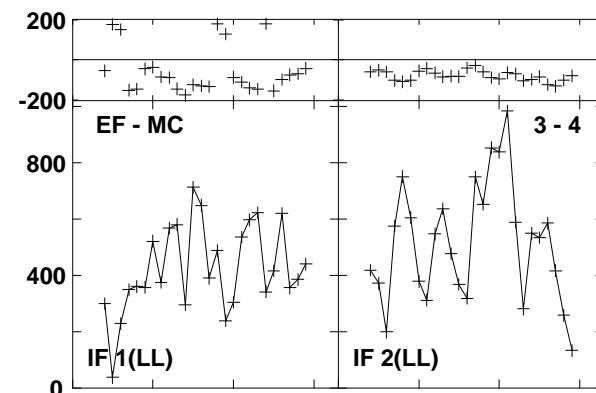
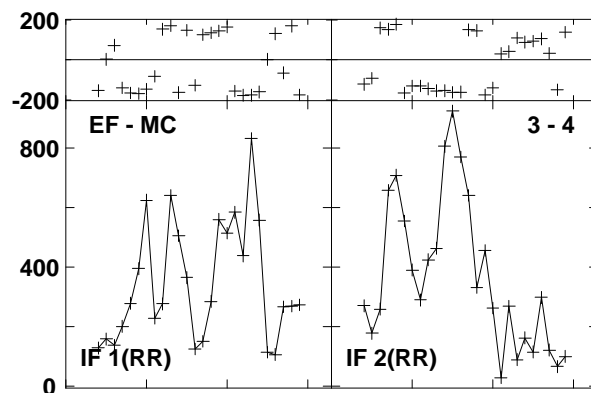
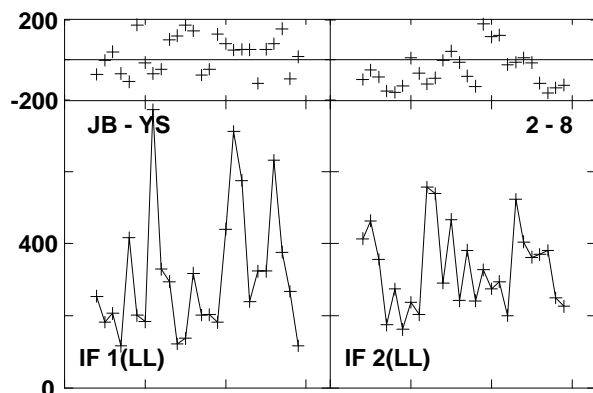
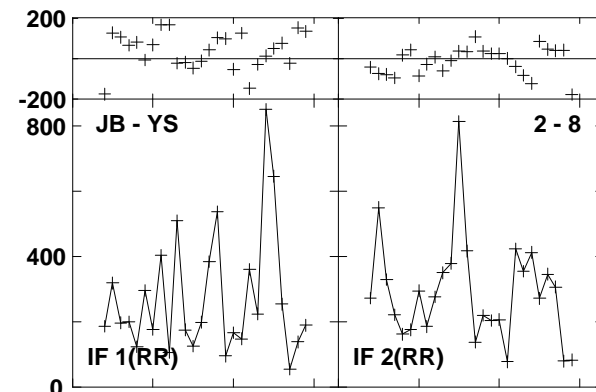
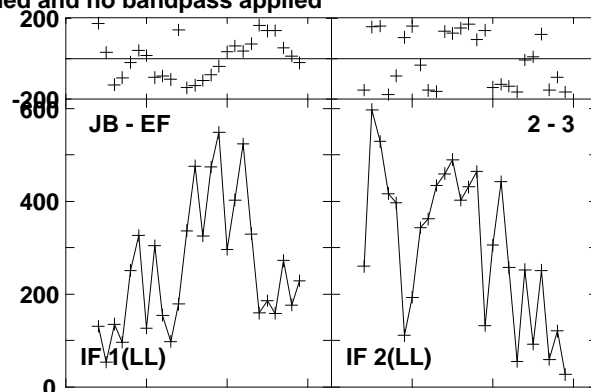
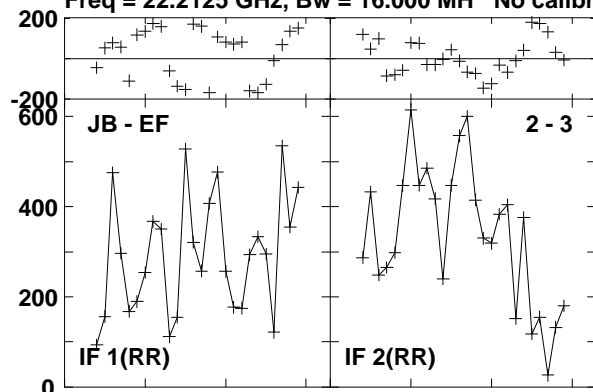

Lower frame: Micro Ampl Jy Top frame: Phas deg  
Vector averaged cross-power spectrum Baseline: JB (02) - EF (03)  
Timerange: 00/14:29:12 to 00/14:29:32

Plot file version 574 created 23-AUG-2016 15:01:03

0219+628 GA035B 1.UVDATA.1

Freq = 22.2125 GHz, Bw = 16.000 MH No calibration applied and no bandpass applied

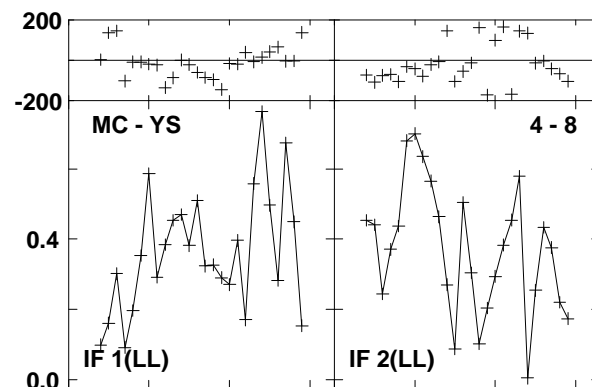
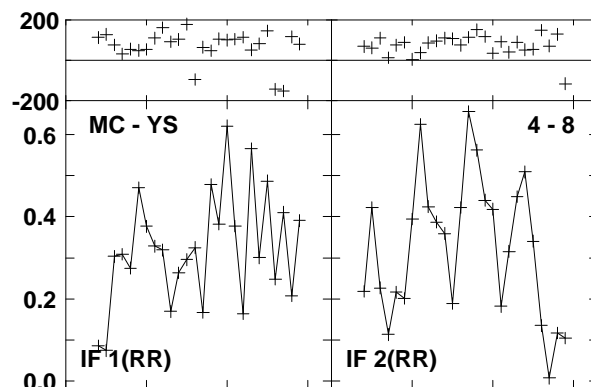
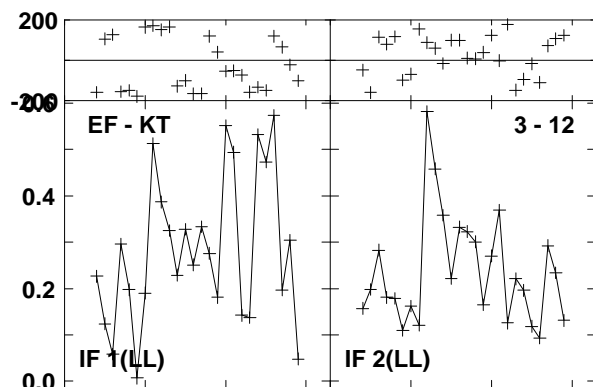
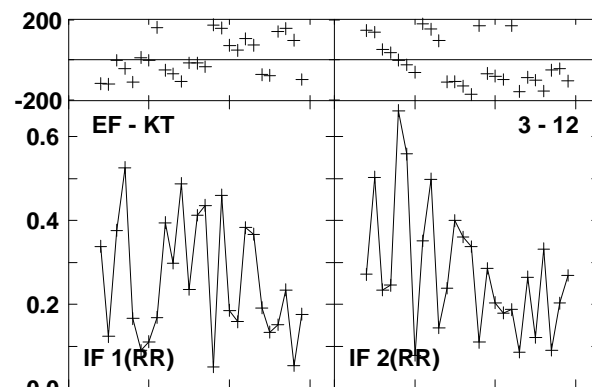
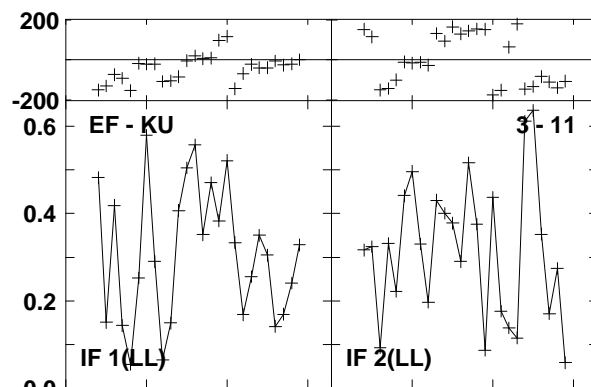
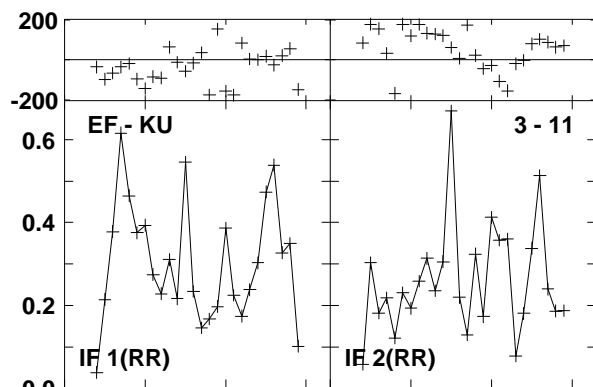
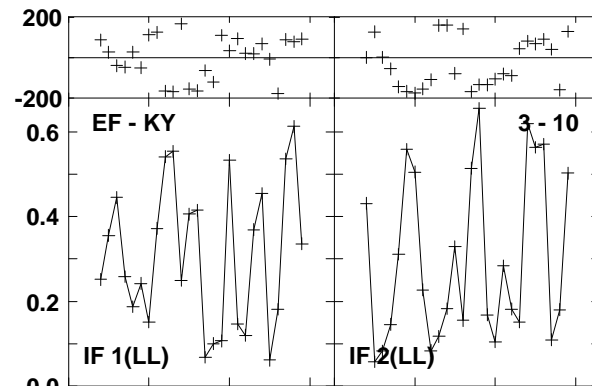
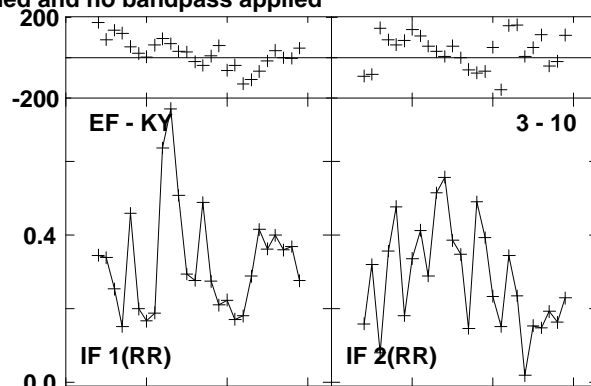
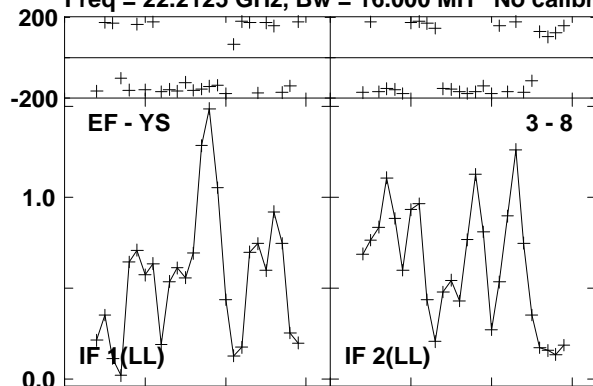

Channels

Lower frame: Milli Ampl Jy Top frame: Phas deg

Vector averaged cross-power spectrum Baseline: EF (03) - YS (08)

Timerange: 00/14:29:12 to 00/14:29:32

Plot file version 575 created 23-AUG-2016 15:01:03  
 0219+628 GA035B 1.UVDATA.1

Freq = 22.2125 GHz, Bw = 16.000 MH No calibration applied and no bandpass applied

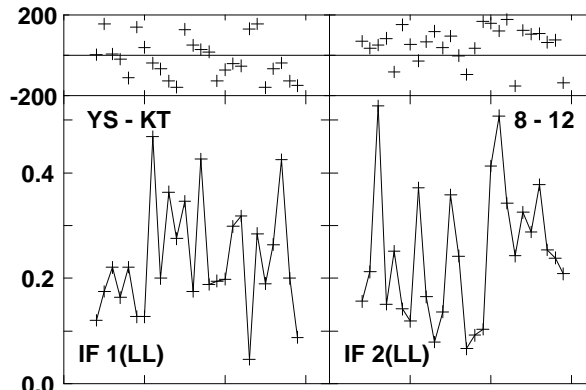
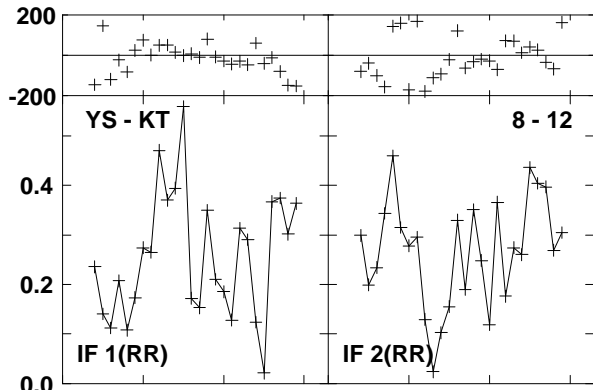
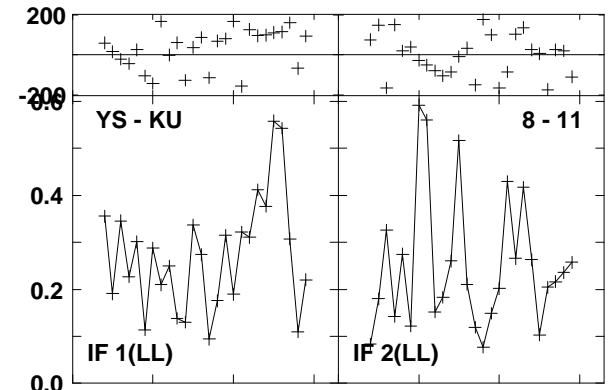
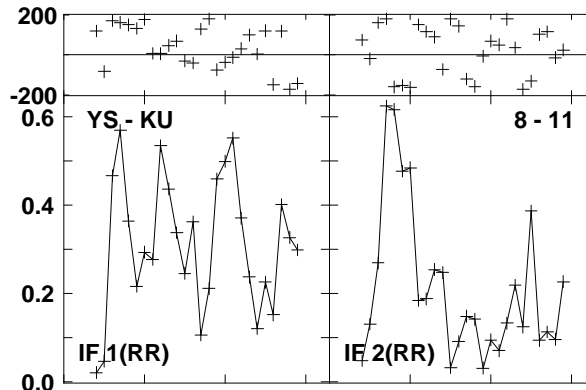
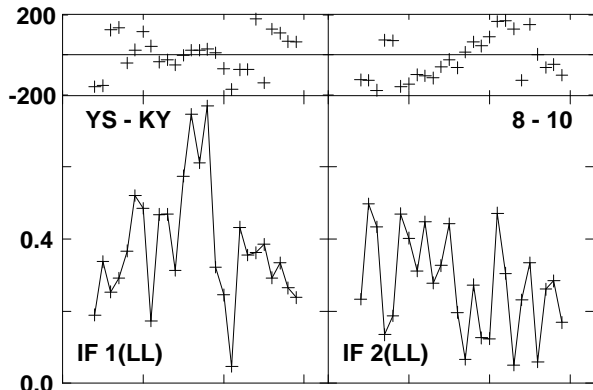
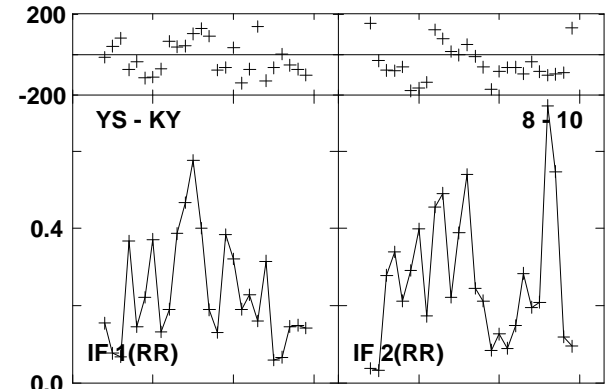
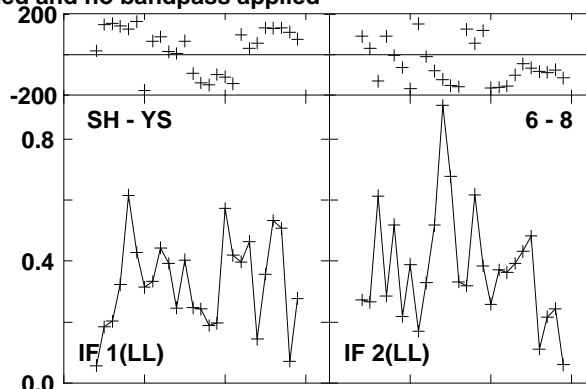
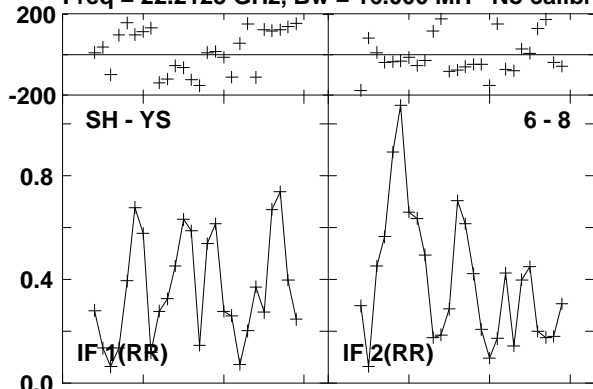

Lower frame: Milli Ampl Jy Top frame: Phas deg  
 Vector averaged cross-power spectrum Baseline: SH (06) - YS (08)  
 Timerange: 00/14:29:12 to 00/14:29:32

Plot file version 576 created 23-AUG-2016 15:01:03  
 W3IRS5 GA035B 1.UVDATA.1

Freq = 22.2125 GHz, Bw = 16.000 MH No calibration applied and no bandpass applied

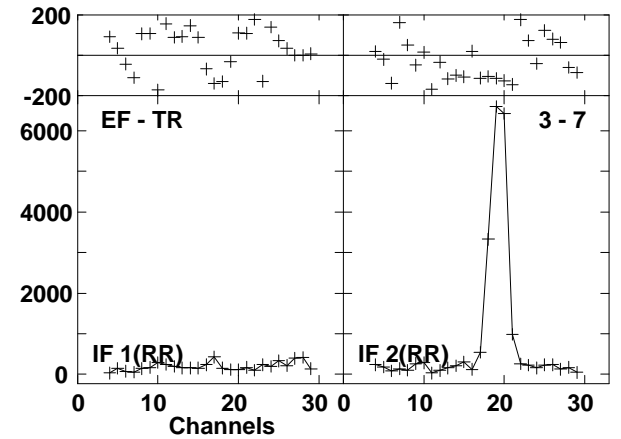
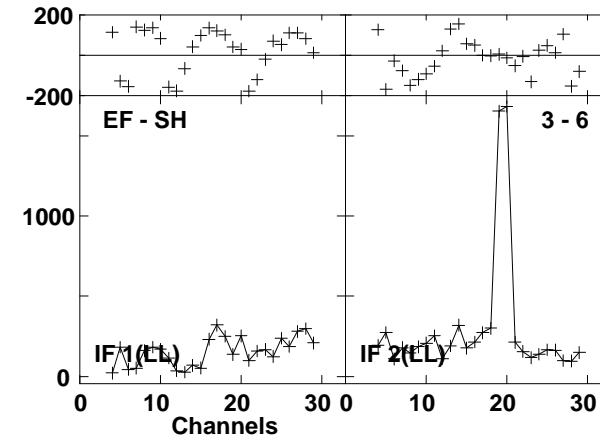
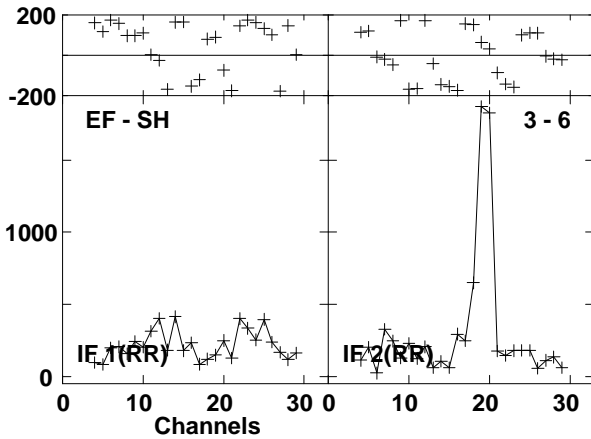
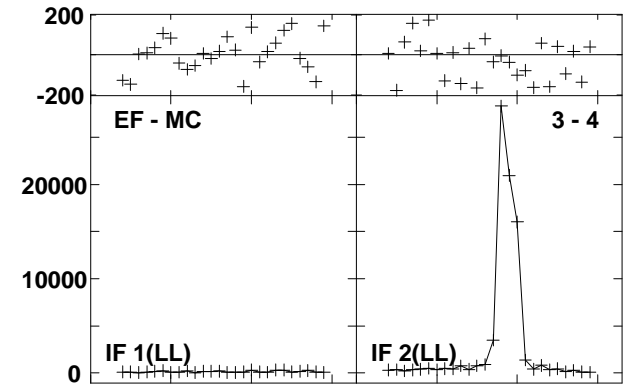
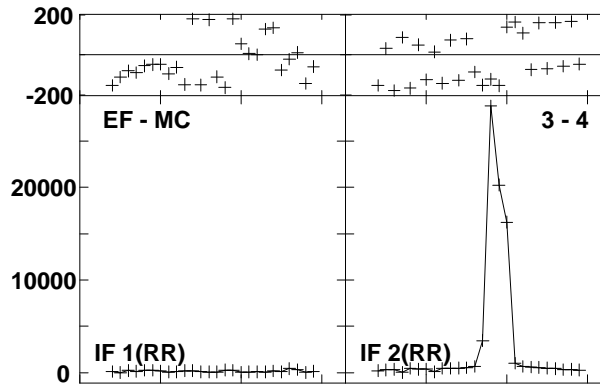
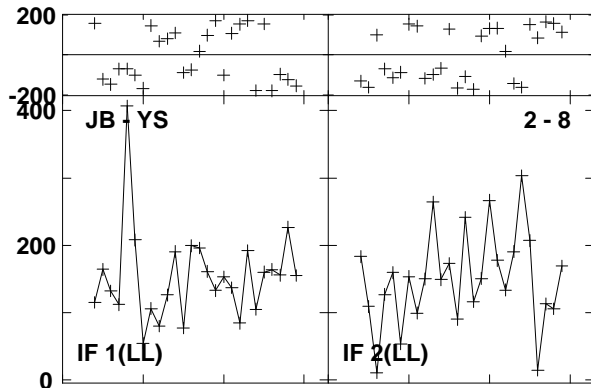
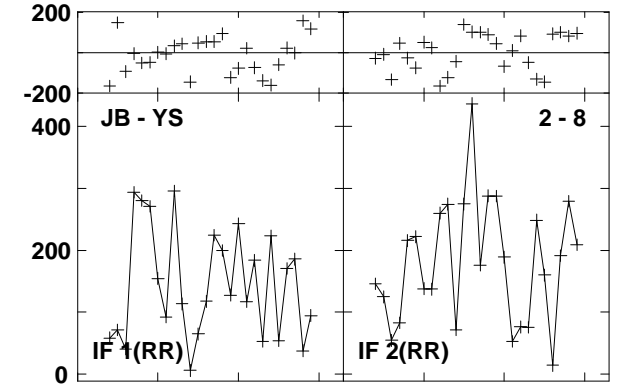
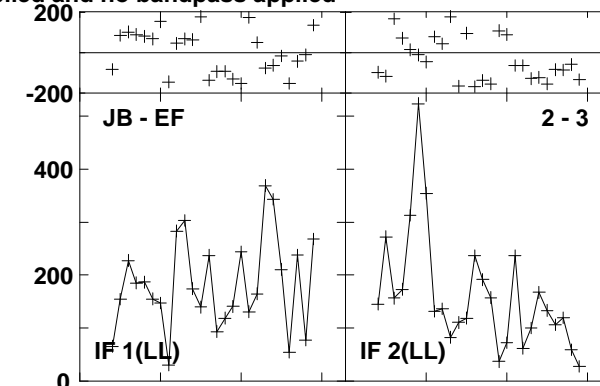
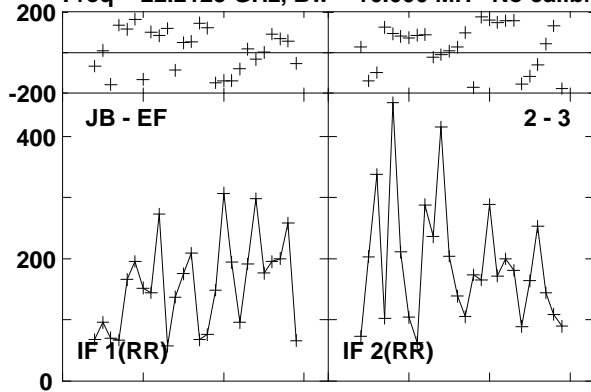

Lower frame: Micro Ampl Jy Top frame: Phas deg  
 Vector averaged cross-power spectrum Baseline: JB (02) - EF (03)  
 Timerange: 00/14:30:04 to 00/14:31:03



Plot file version 577 created 23-AUG-2016 15:01:03

W3IRS5 GA035B 1.UVDATA.1

Freq = 22.2125 GHz, Bw = 16.000 MH No calibration applied and no bandpass applied

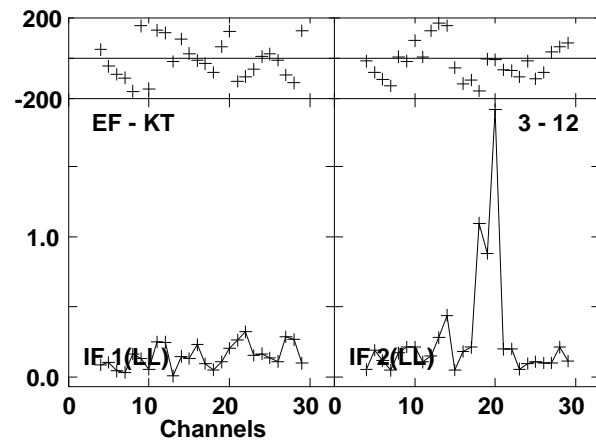
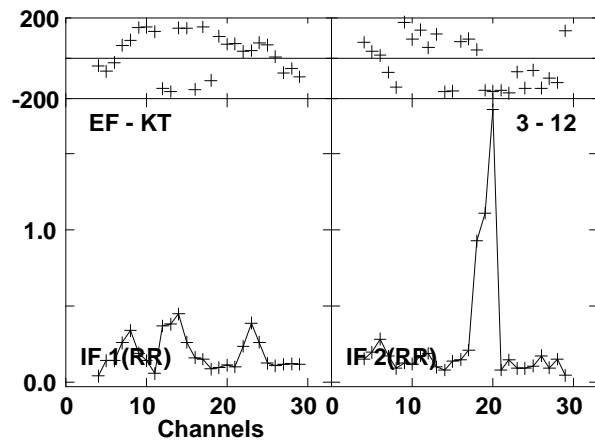
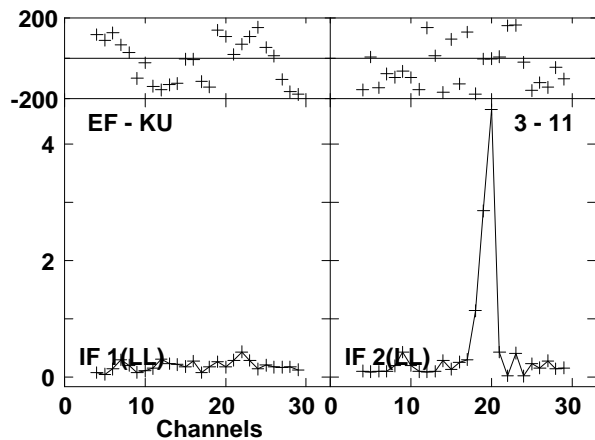
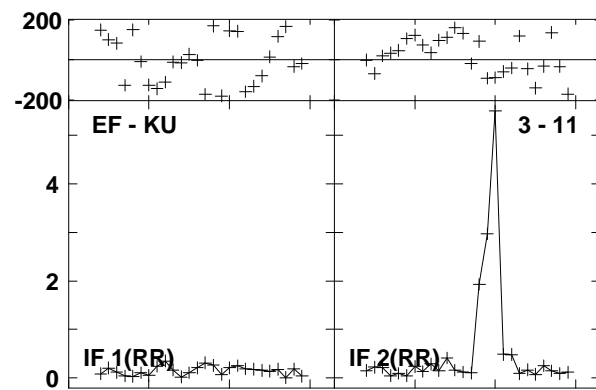
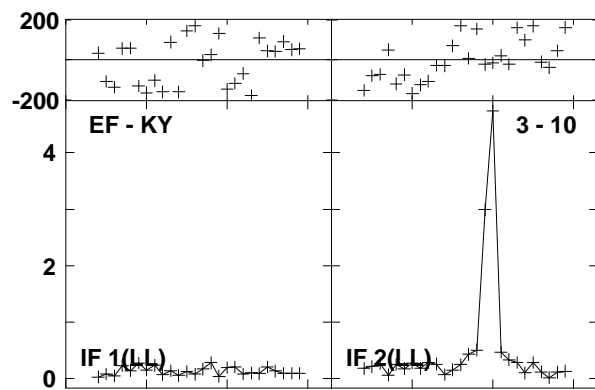
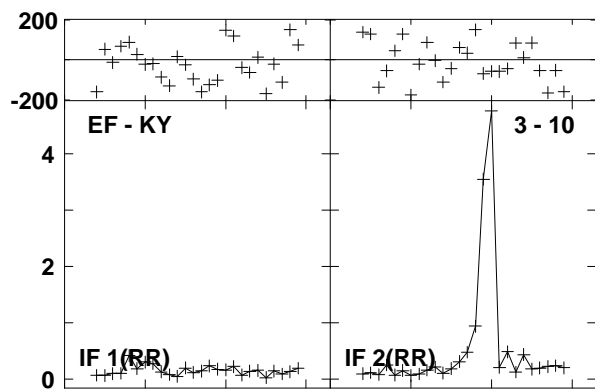
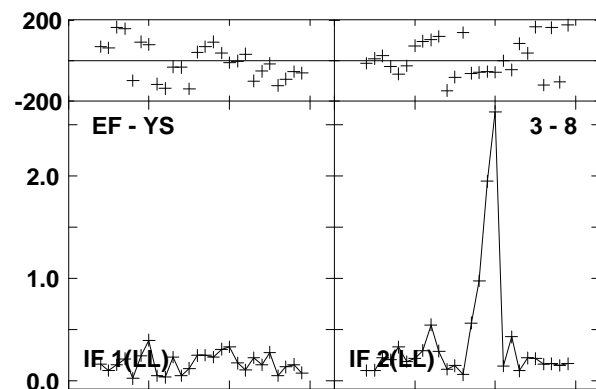
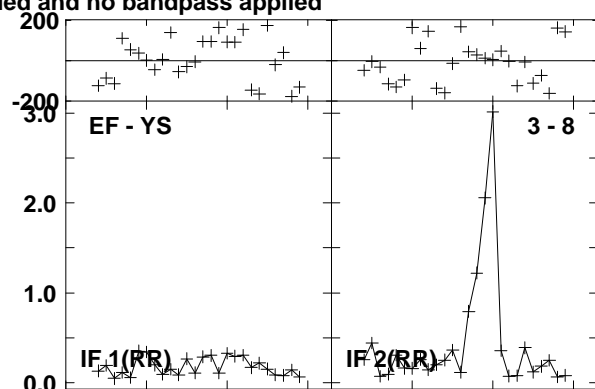
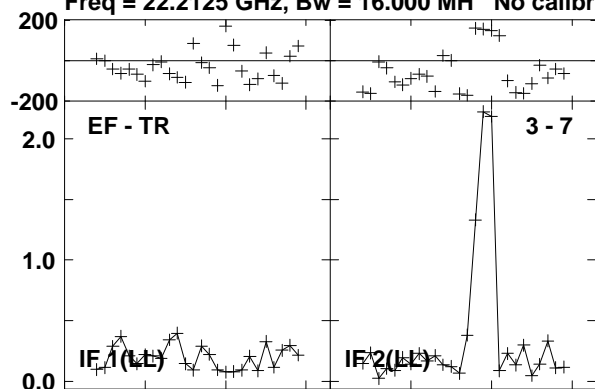

Lower frame: Milli Ampl Jy Top frame: Phas deg  
Vector averaged cross-power spectrum Baseline: EF (03) - TR (07)  
Timerange: 00/14:30:04 to 00/14:31:03

Plot file version 578 created 23-AUG-2016 15:01:03

W3IRS5 GA035B 1.UVDATA.1

Freq = 22.2125 GHz, Bw = 16.000 MH No calibration applied and no bandpass applied

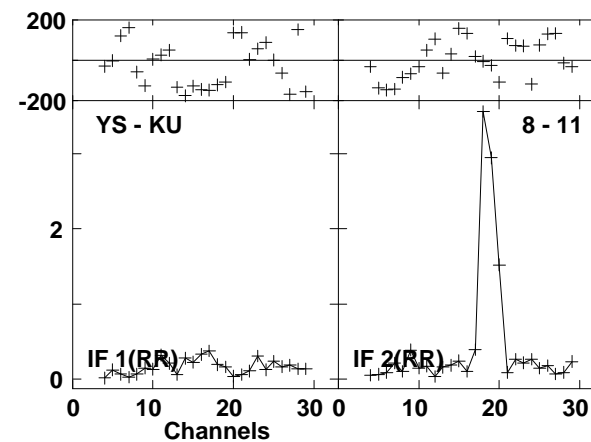
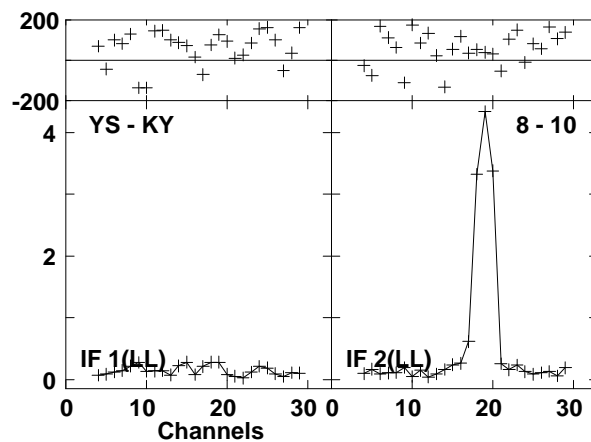
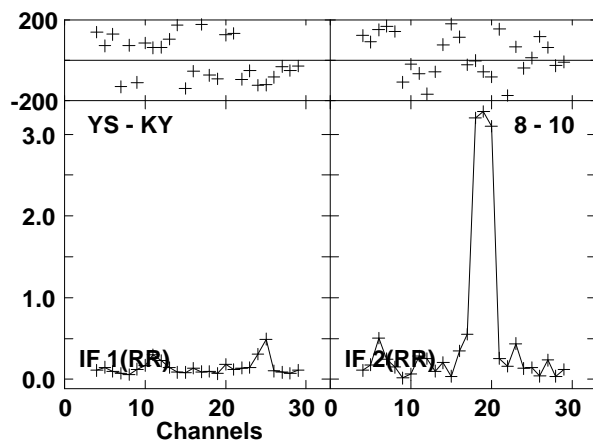
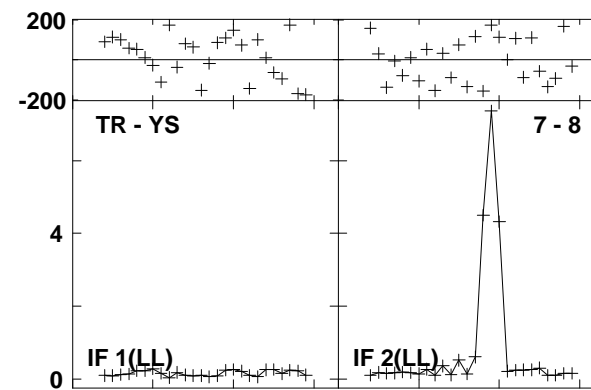
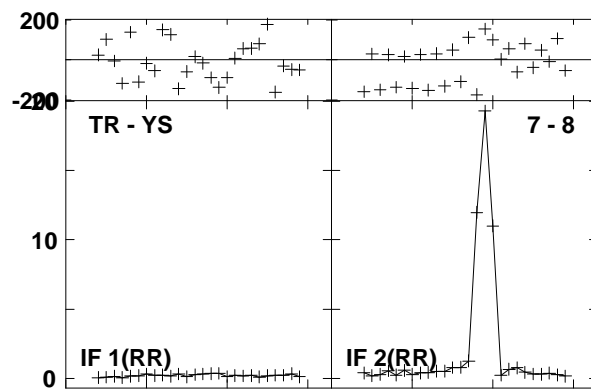
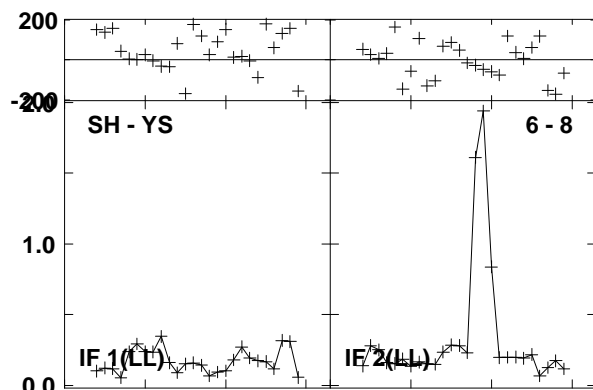
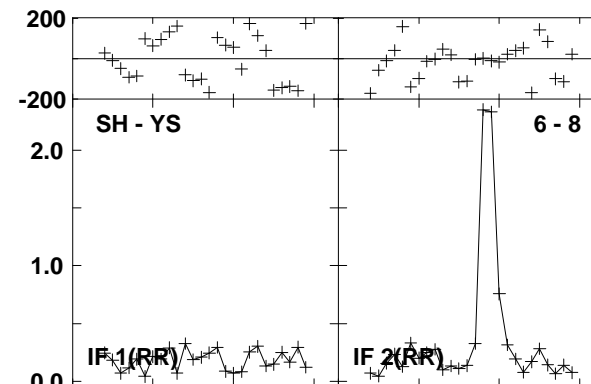
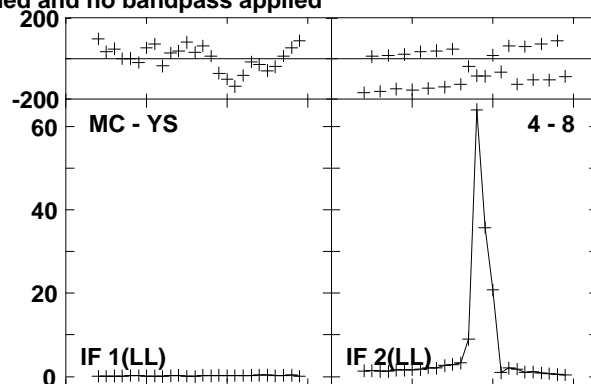
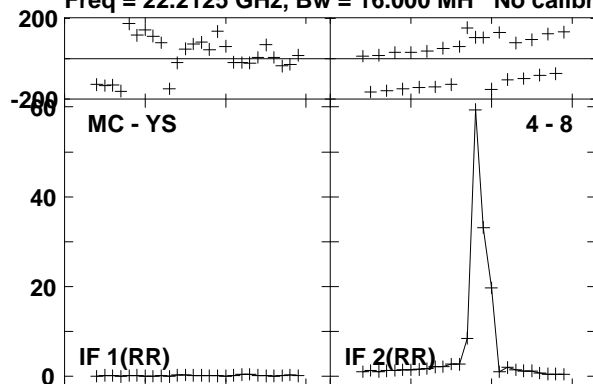

Lower frame: Milli Ampl Jy Top frame: Phas deg  
Vector averaged cross-power spectrum Baseline: MC (04) - YS (08)  
Timerange: 00/14:30:04 to 00/14:31:03

Plot file version 579 created 23-AUG-2016 15:01:03

W3IRS5 GA035B 1.UVDATA.1

Freq = 22.2125 GHz, Bw = 16.000 MH No calibration applied and no bandpass applied

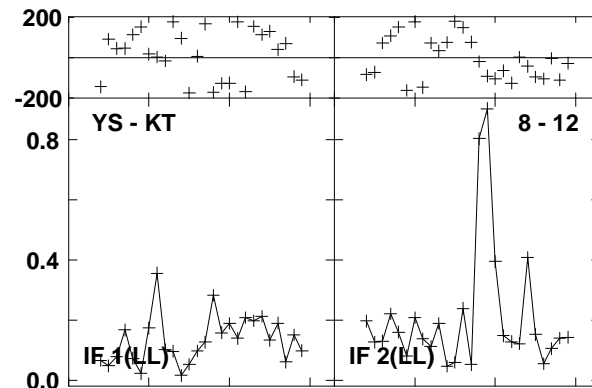
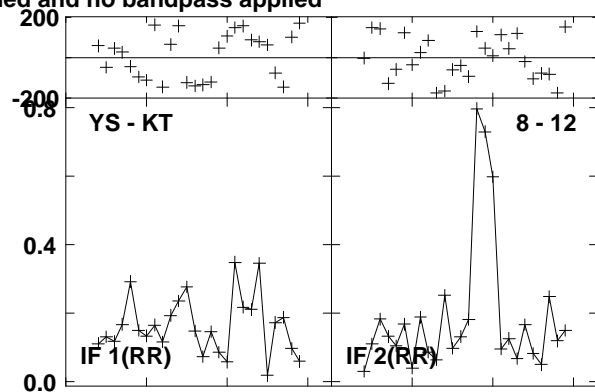
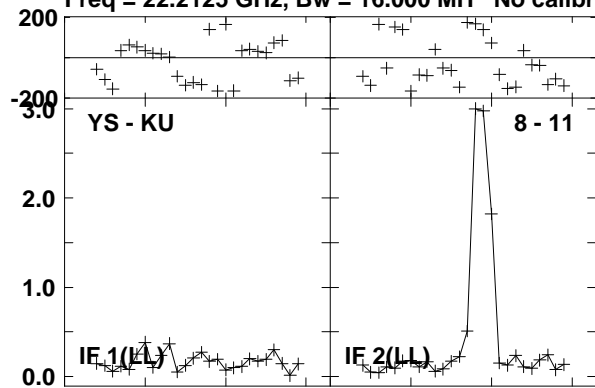

Lower frame: Milli Ampl Jy Top frame: Phas deg  
Vector averaged cross-power spectrum Baseline: YS (08) - KU (11)  
Timerange: 00/14:30:04 to 00/14:31:03

Plot file version 580 created 23-AUG-2016 15:01:03

0219+628 GA035B 1.UVDATA.1

Freq = 22.2125 GHz, Bw = 16.000 MH No calibration applied and no bandpass applied

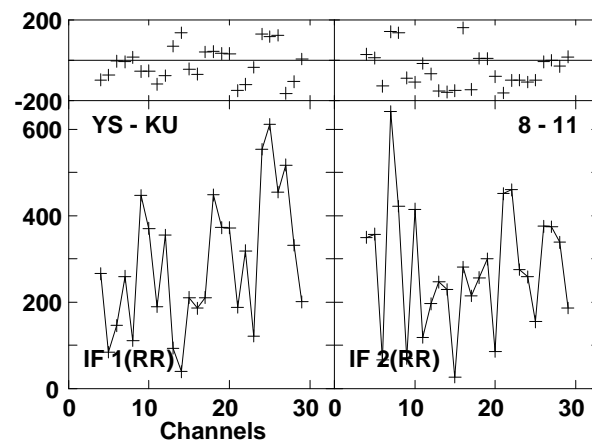
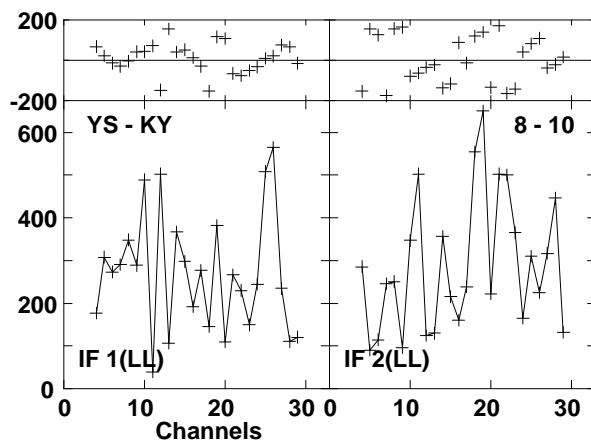
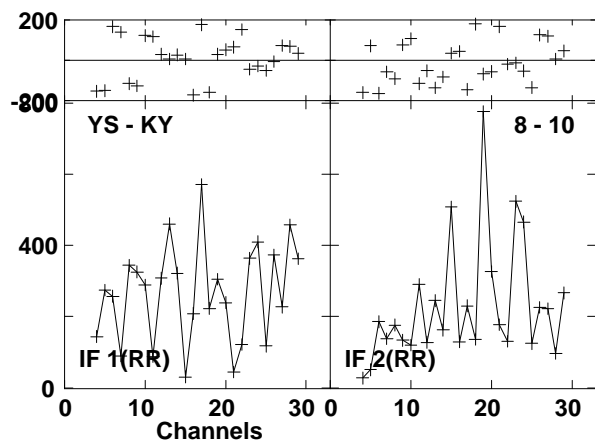
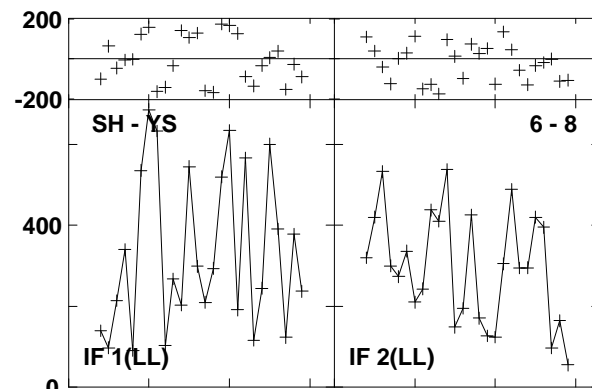
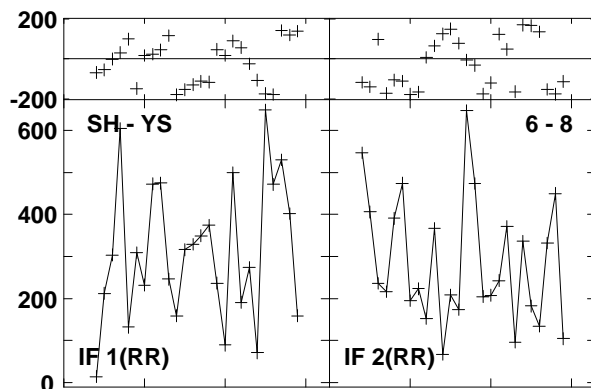
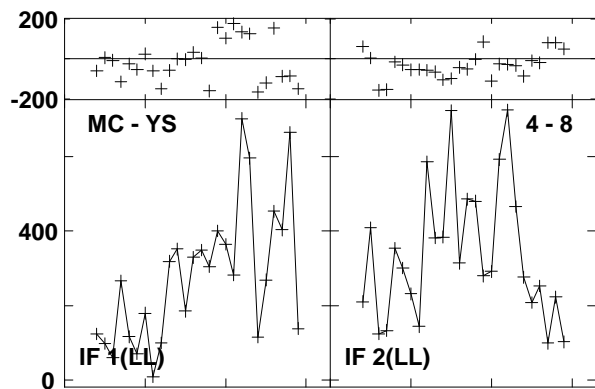
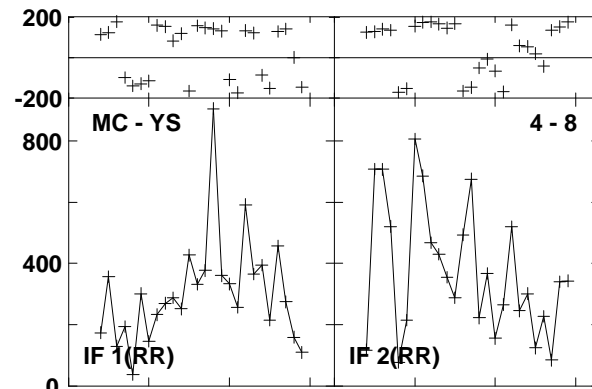
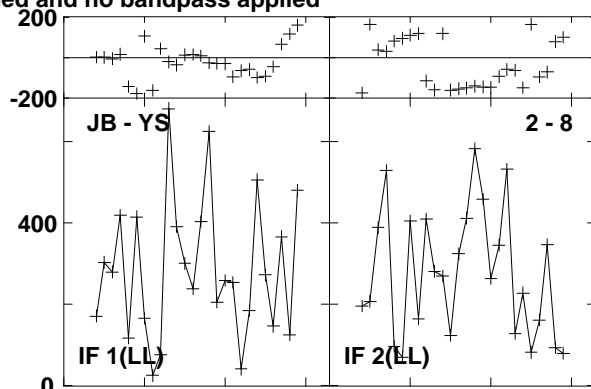
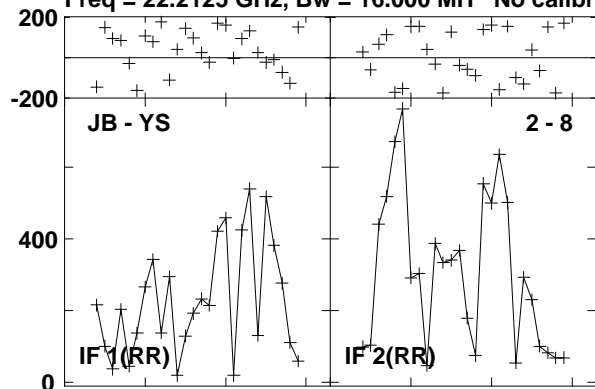

Lower frame: Micro Ampl Jy Top frame: Phas deg  
Vector averaged cross-power spectrum Baseline: JB (02) - YS (08)  
Timerange: 00/14:31:37 to 00/14:31:56

Plot file version 581 created 23-AUG-2016 15:01:03

0219+628 GA035B 1.UVDATA.1

Freq = 22.2125 GHz, Bw = 16.000 MH No calibration applied and no bandpass applied

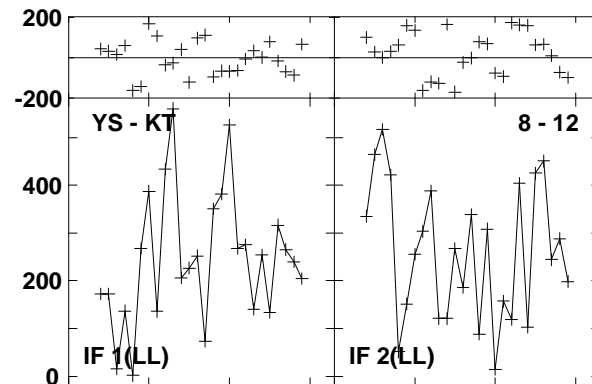
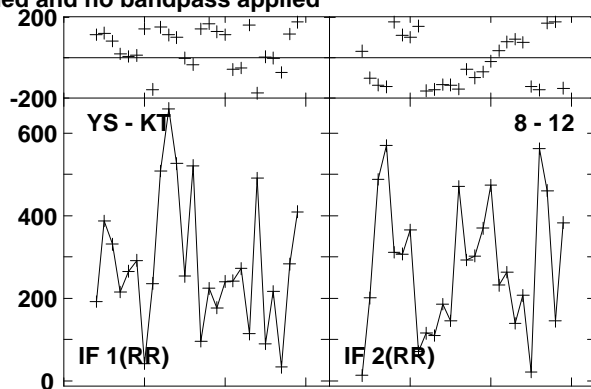
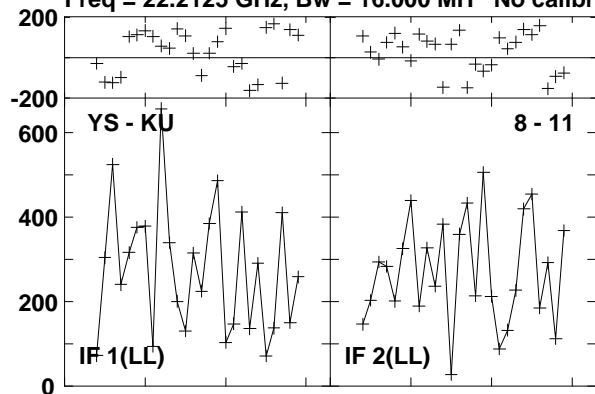

Lower frame: Micro Ampl Jy Top frame: Phas deg  
Vector averaged cross-power spectrum Baseline: YS (08) - KU (11)  
Timerange: 00/14:31:37 to 00/14:31:56

Plot file version 582 created 23-AUG-2016 15:01:03

W3IRS5 GA035B 1.UVDATA.1

Freq = 22.2125 GHz, Bw = 16.000 MH No calibration applied and no bandpass applied

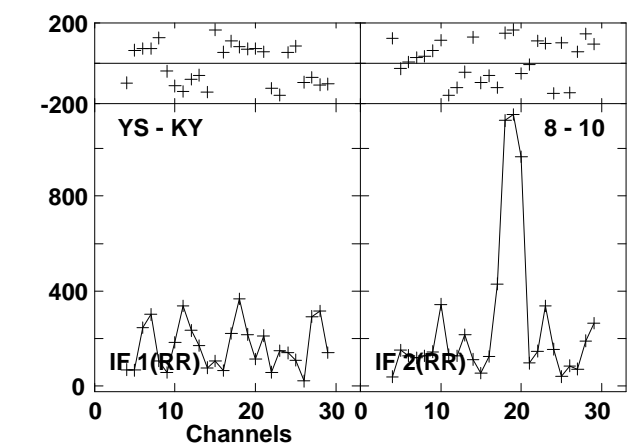
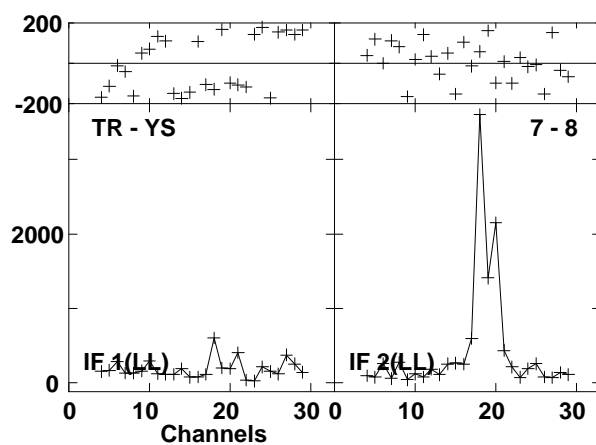
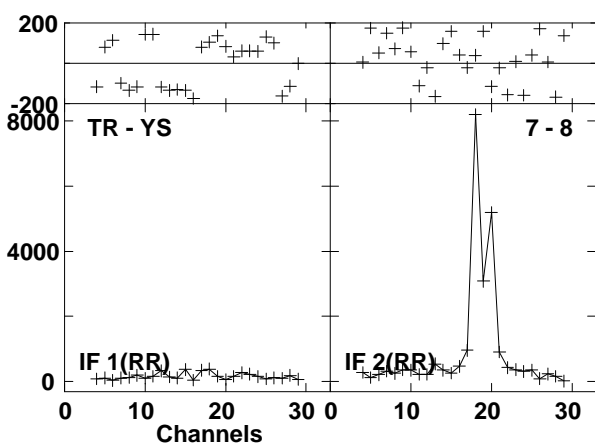
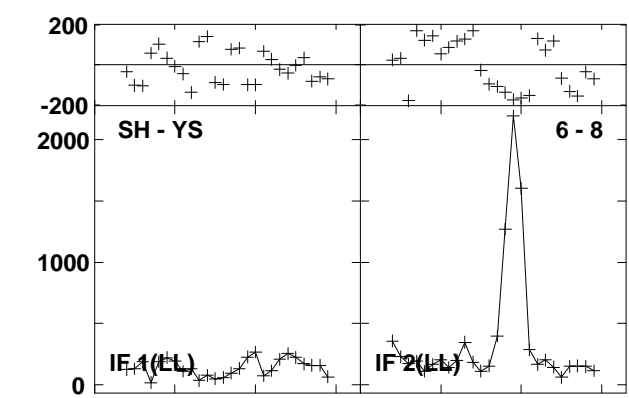
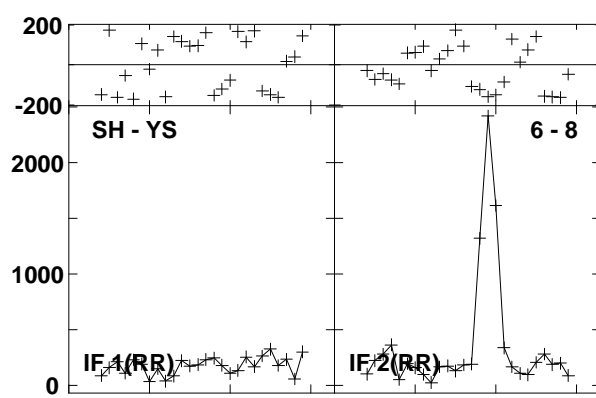
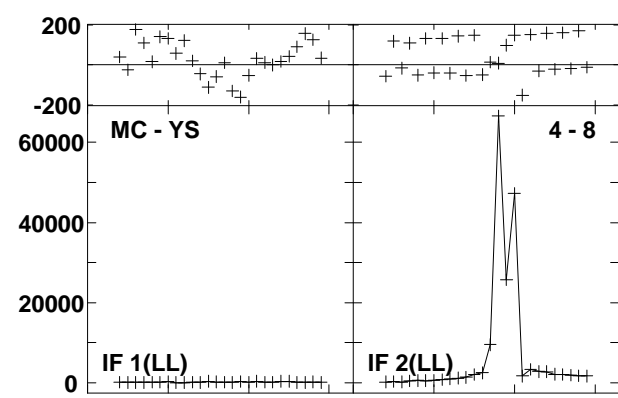
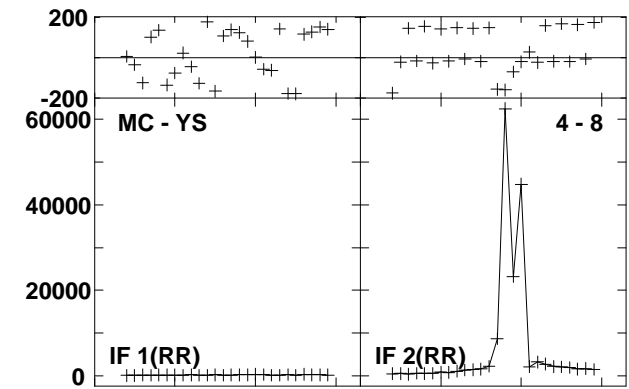
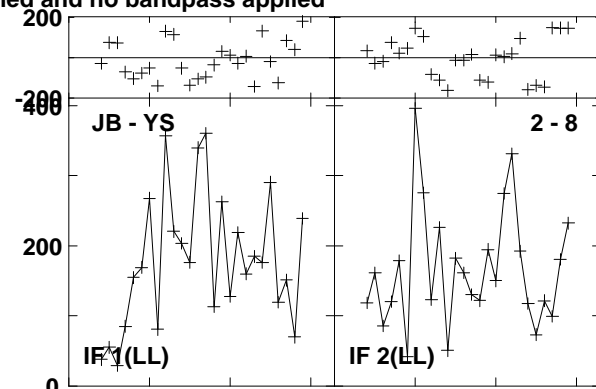
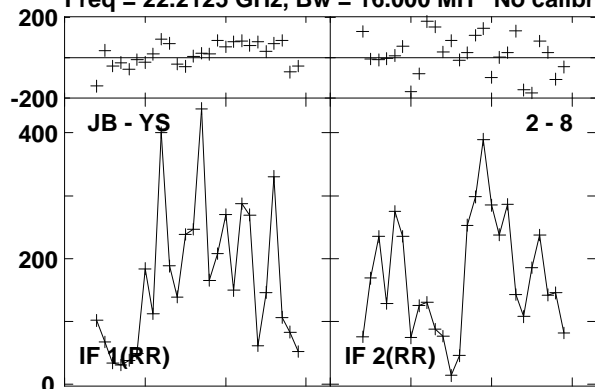

Lower frame: Micro Ampl Jy Top frame: Phas deg  
Vector averaged cross-power spectrum Baseline: JB (02) - YS (08)  
Timerange: 00/14:32:29 to 00/14:33:27

Plot file version 583 created 23-AUG-2016 15:01:03

W3IRS5 GA035B 1.UVDATA.1

Freq = 22.2125 GHz, Bw = 16.000 MH No calibration applied and no bandpass applied

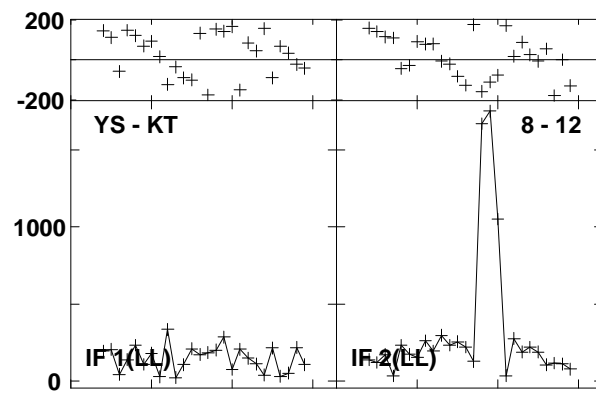
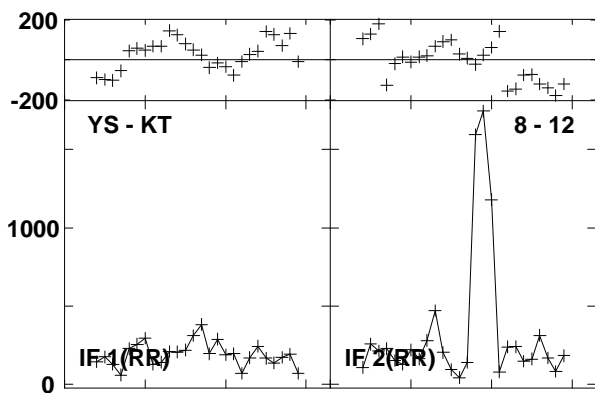
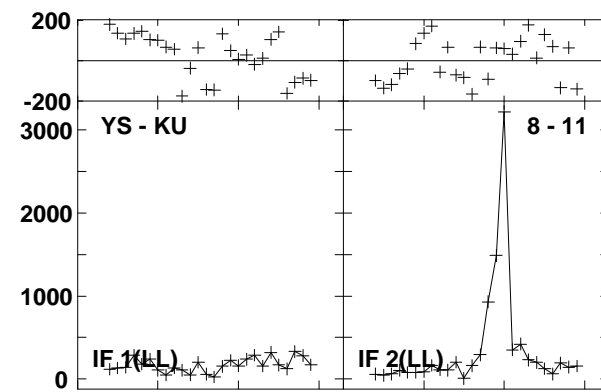
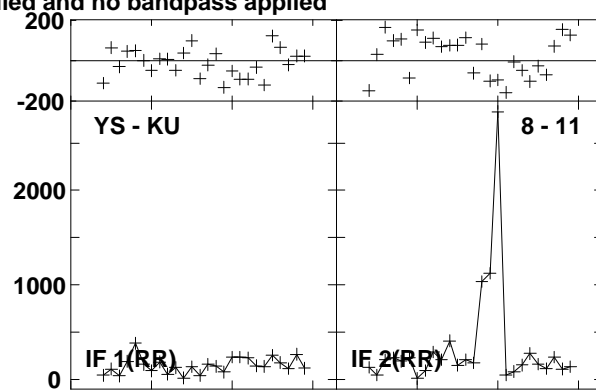
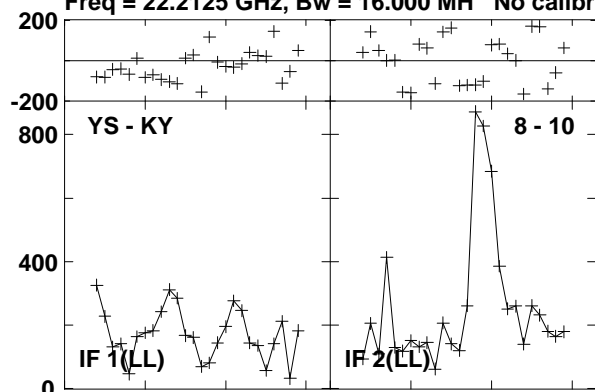

Lower frame: Micro Ampl Jy Top frame: Phas deg  
Vector averaged cross-power spectrum Baseline: YS (08) - KY (10)  
Timerange: 00/14:32:29 to 00/14:33:27

Plot file version 584 created 23-AUG-2016 15:01:03

0219+628 GA035B 1.UVDATA.1

Freq = 22.2125 GHz, Bw = 16.000 MH No calibration applied and no bandpass applied

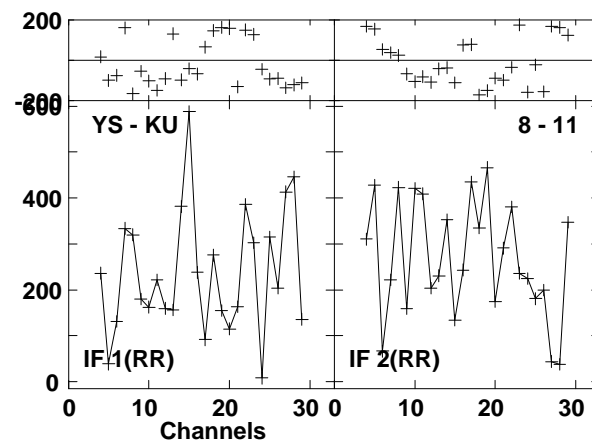
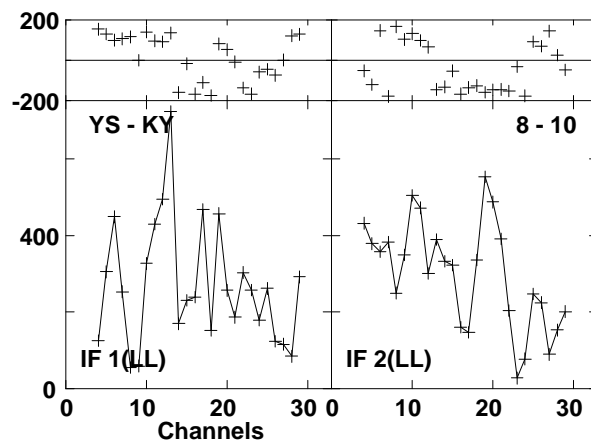
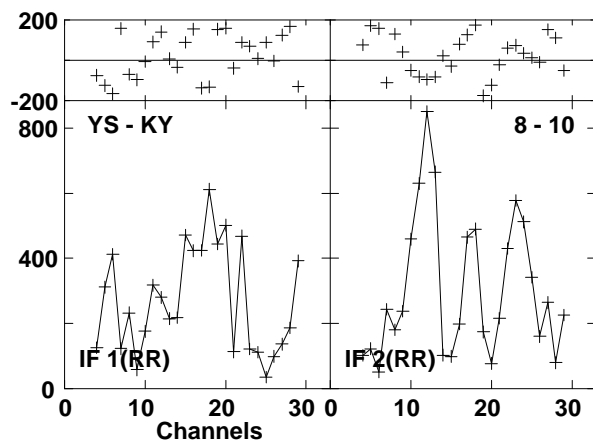
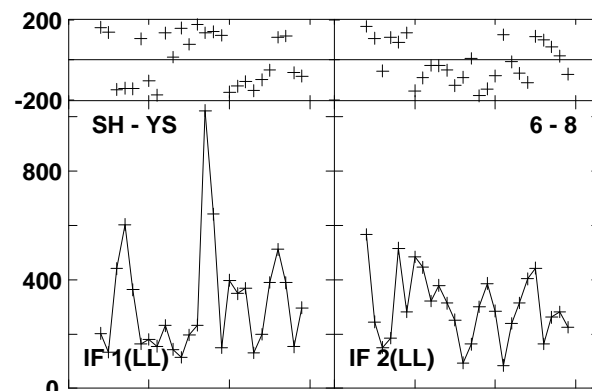
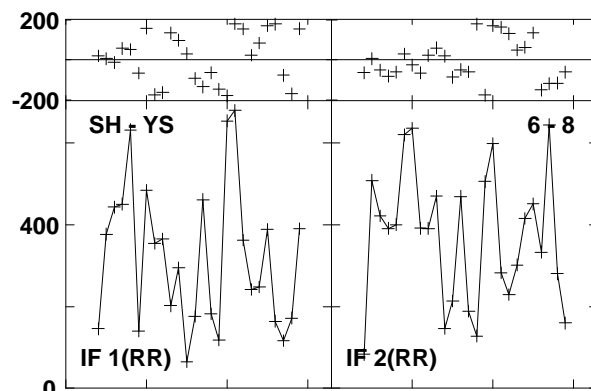
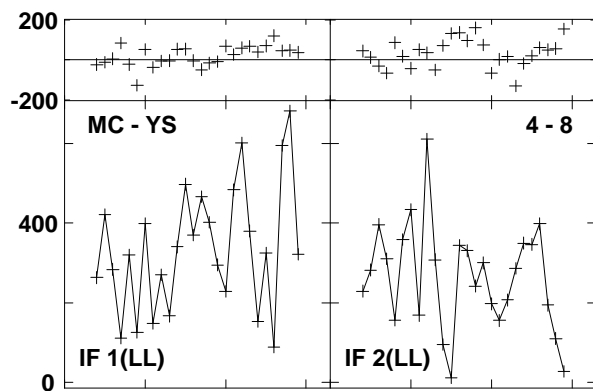
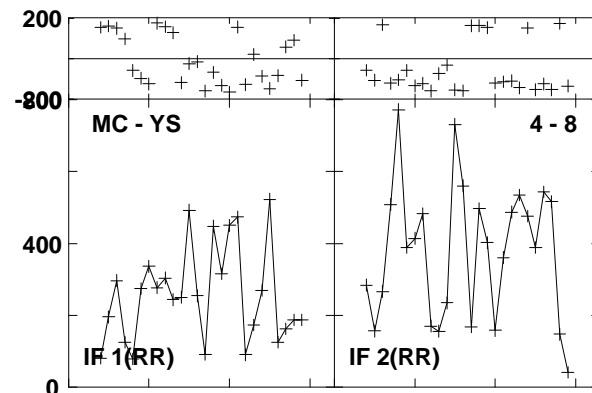
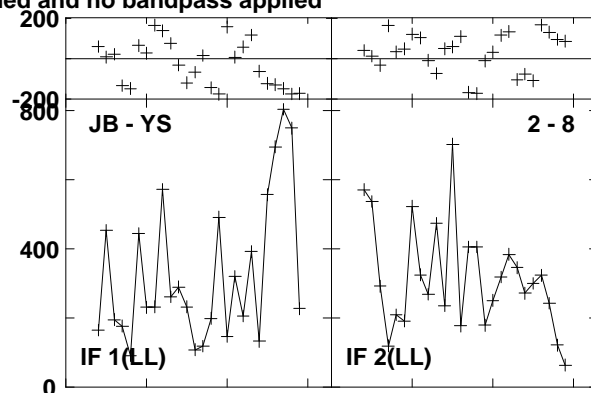
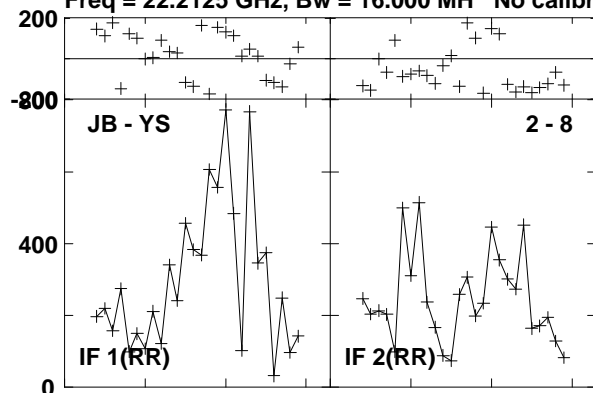

Lower frame: Micro Ampl Jy Top frame: Phas deg  
Vector averaged cross-power spectrum Baseline: JB (02) - YS (08)  
Timerange: 00/14:34:00 to 00/14:34:20



Plot file version 585 created 23-AUG-2016 15:01:03

0219+628 GA035B 1.UVDATA.1

Freq = 22.2125 GHz, Bw = 16.000 MH No calibration applied and no bandpass applied

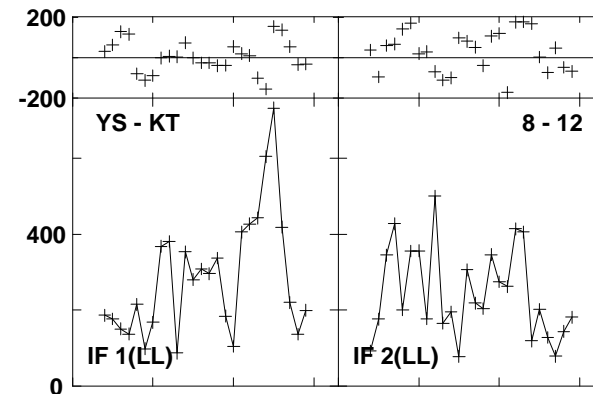
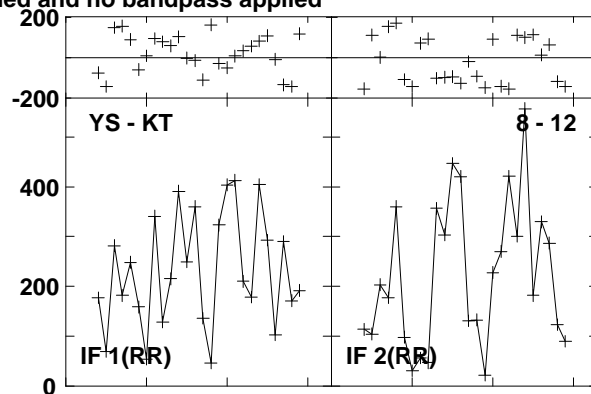
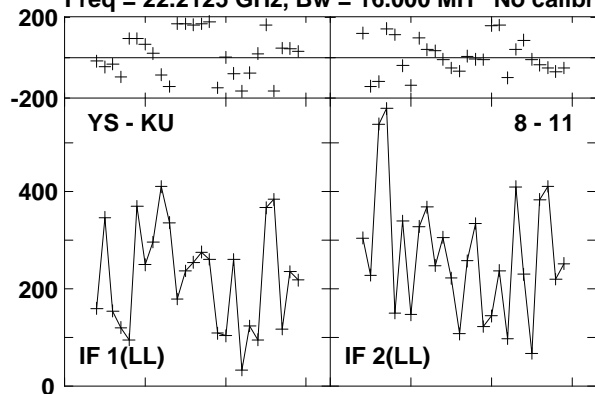

Lower frame: Micro Ampl Jy Top frame: Phas deg  
Vector averaged cross-power spectrum Baseline: YS (08) - KU (11)  
Timerange: 00/14:34:00 to 00/14:34:20

Plot file version 586 created 23-AUG-2016 15:01:03  
 W3IRS5 GA035B 1.UVDATA.1

Freq = 22.2125 GHz, Bw = 16.000 MH No calibration applied and no bandpass applied

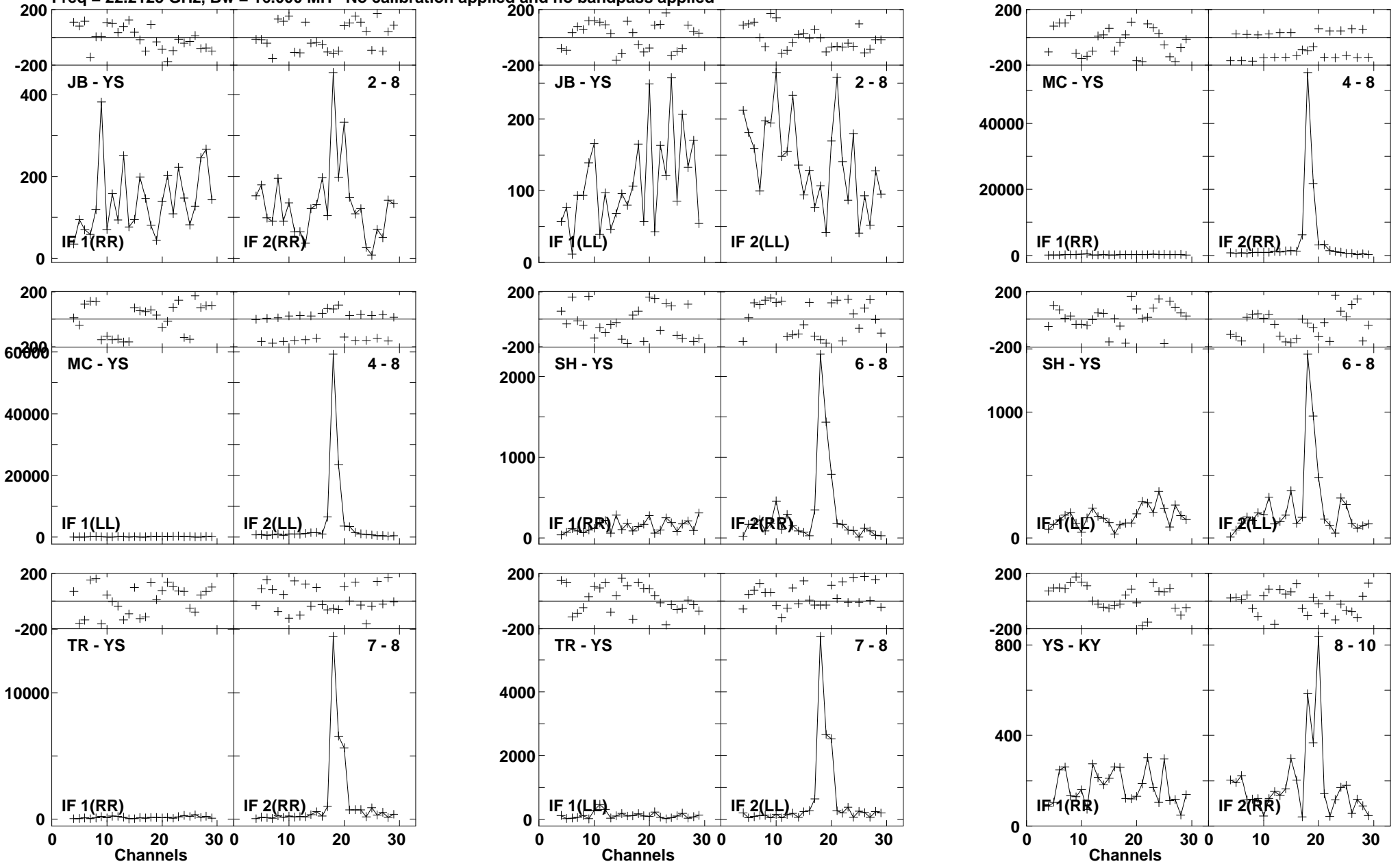

Lower frame: Micro Ampl Jy Top frame: Phas deg  
 Vector averaged cross-power spectrum Baseline: JB (02) - YS (08)  
 Timerange: 00/14:34:53 to 00/14:35:52

Plot file version 587 created 23-AUG-2016 15:01:03

W3IRS5 GA035B 1.UVDATA.1

Freq = 22.2125 GHz, Bw = 16.000 MH No calibration applied and no bandpass applied

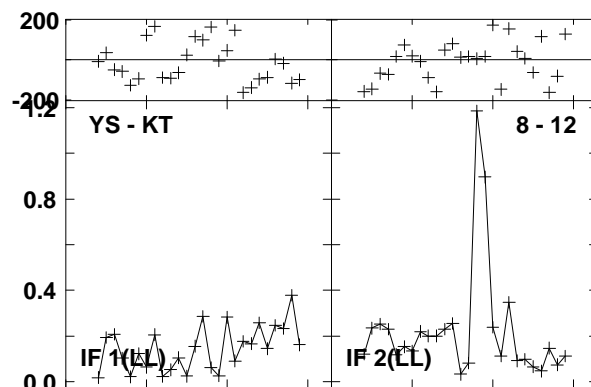
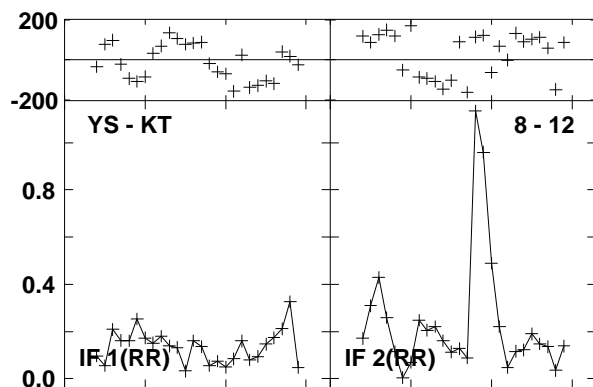
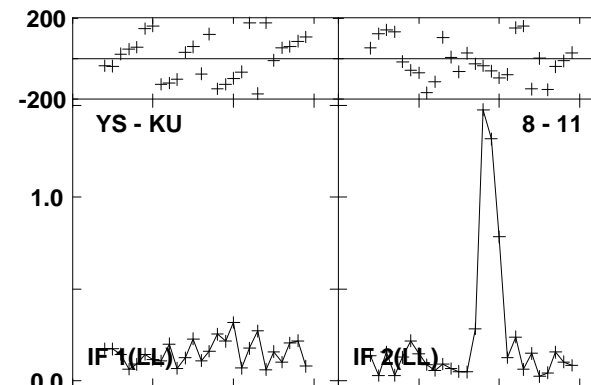
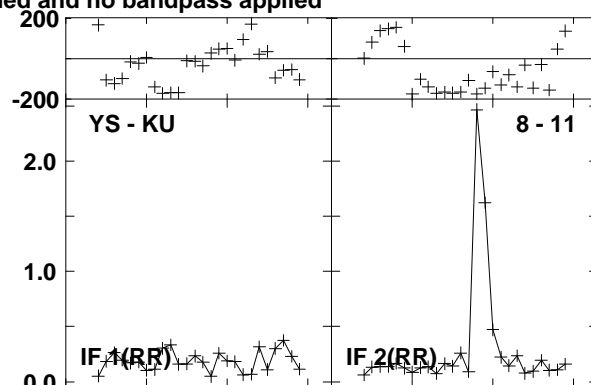
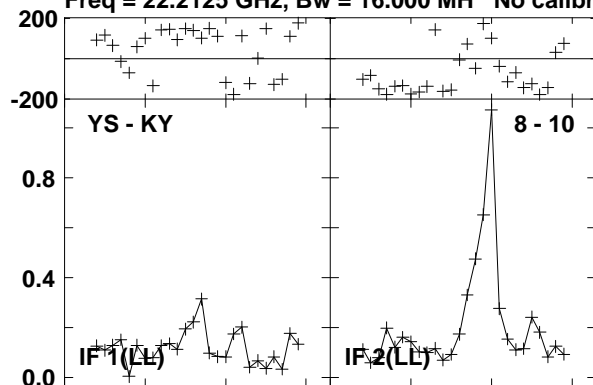

Lower frame: Milli Ampl Jy Top frame: Phas deg  
Vector averaged cross-power spectrum Baseline: YS (08) - KY (10)  
Timerange: 00/14:34:53 to 00/14:35:52

Plot file version 588 created 23-AUG-2016 15:01:03

0219+628 GA035B 1.UVDATA.1

Freq = 22.2125 GHz, Bw = 16.000 MH No calibration applied and no bandpass applied

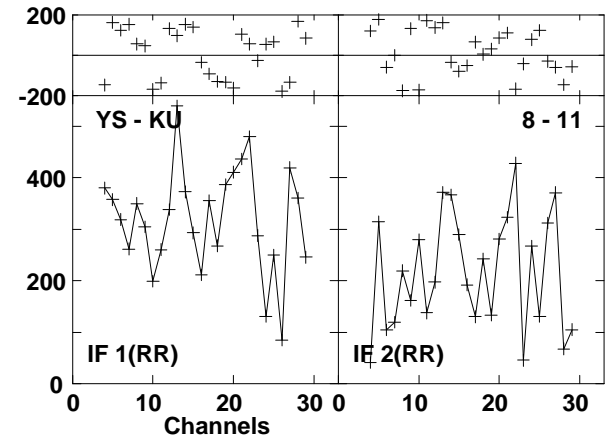
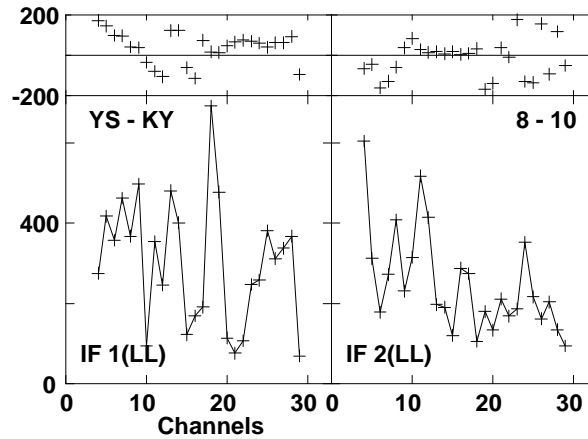
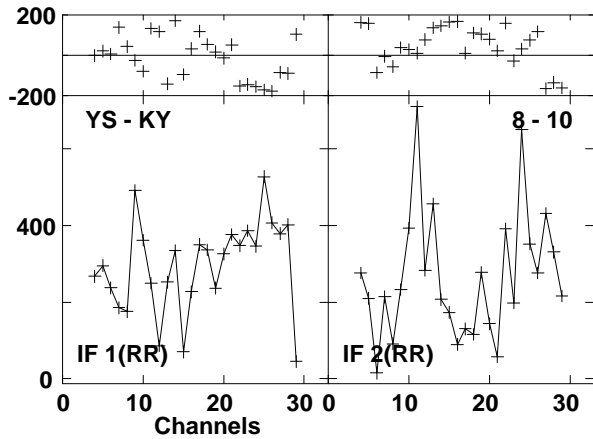
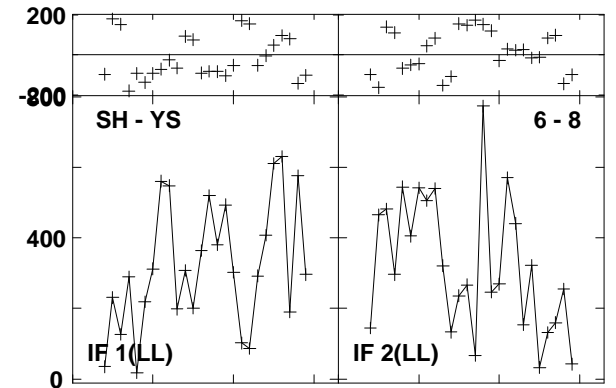
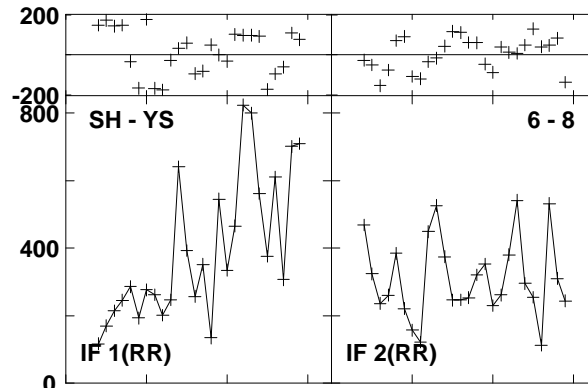
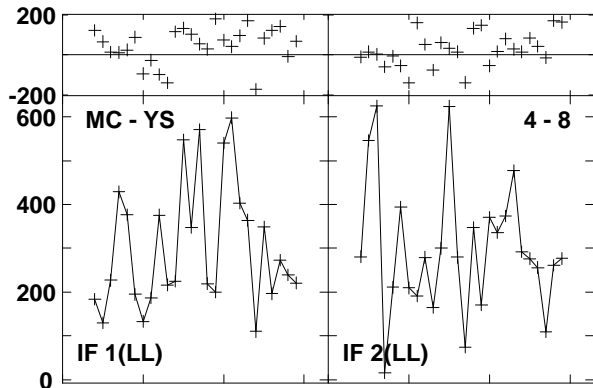
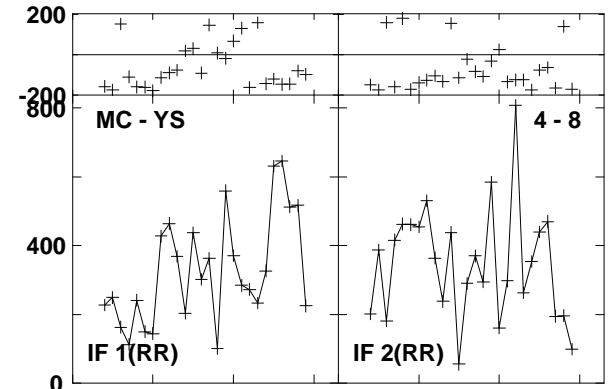
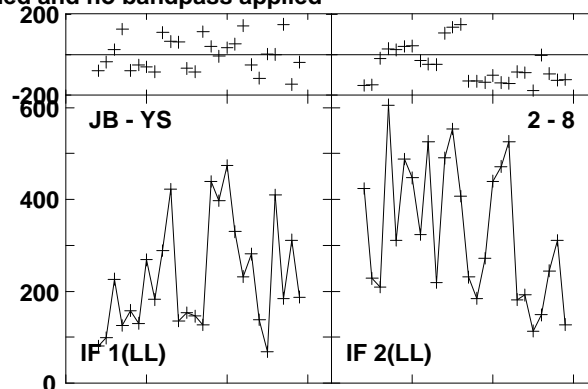
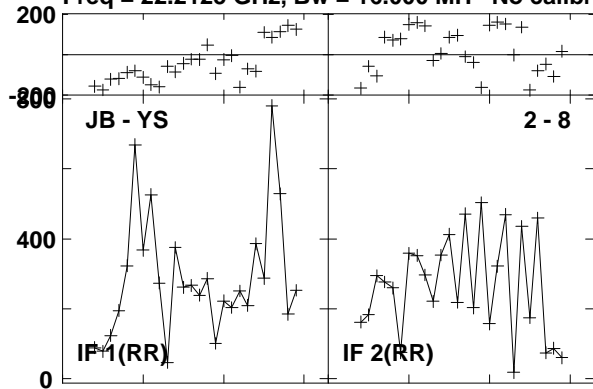

Lower frame: Micro Ampl Jy Top frame: Phas deg  
Vector averaged cross-power spectrum Baseline: JB (02) - YS (08)  
Timerange: 00/14:36:25 to 00/14:36:44

Plot file version 589 created 23-AUG-2016 15:01:03

0219+628 GA035B 1.UVDATA.1

Freq = 22.2125 GHz, Bw = 16.000 MH No calibration applied and no bandpass applied

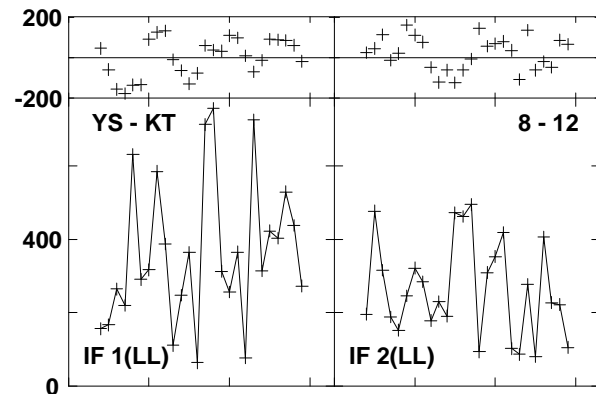
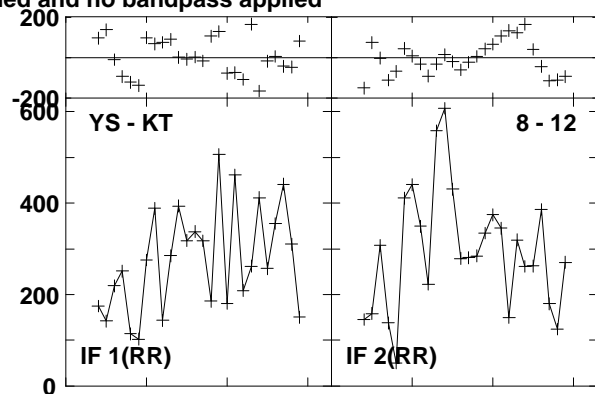
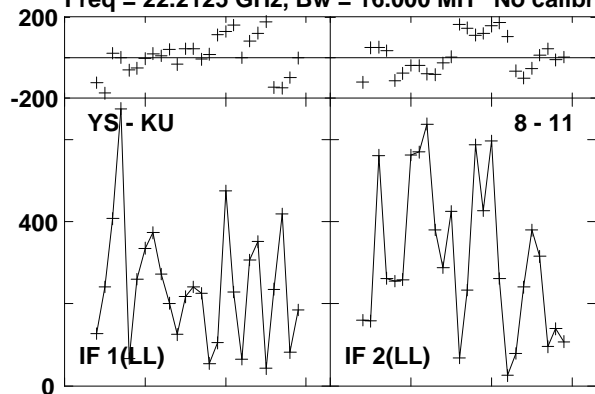

Lower frame: Micro Ampl Jy Top frame: Phas deg  
Vector averaged cross-power spectrum Baseline: YS (08) - KU (11)  
Timerange: 00/14:36:25 to 00/14:36:44

Plot file version 590 created 23-AUG-2016 15:01:03

W3IRS5 GA035B 1.UVDATA.1

Freq = 22.2125 GHz, Bw = 16.000 MH No calibration applied and no bandpass applied

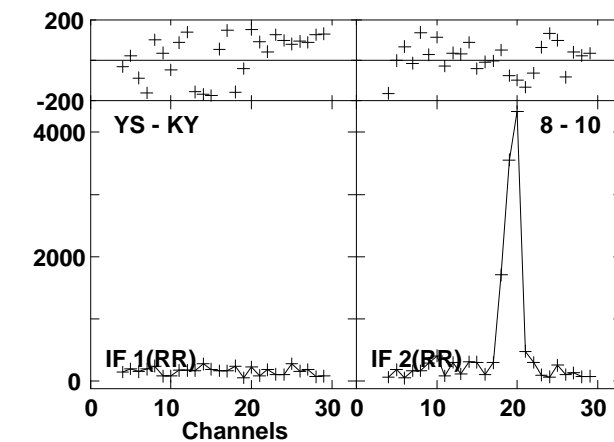
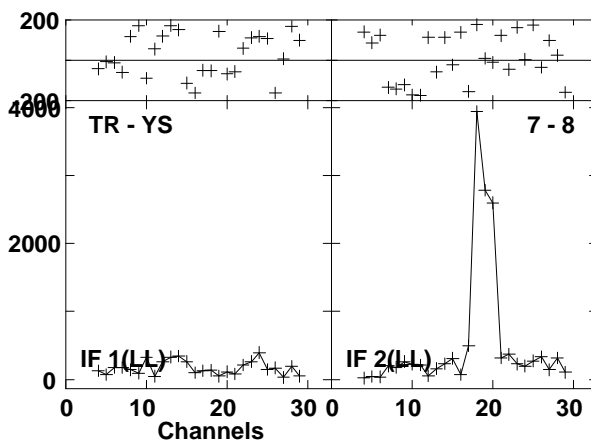
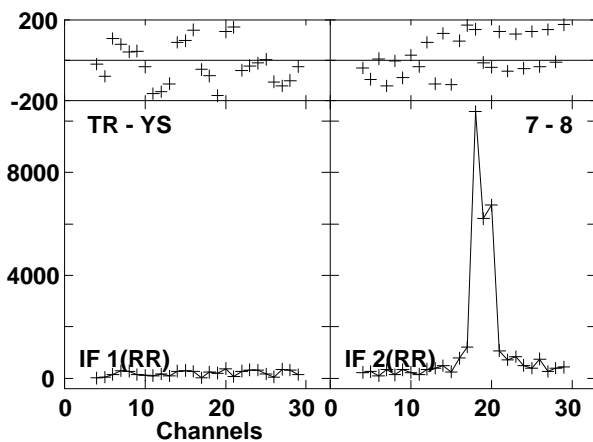
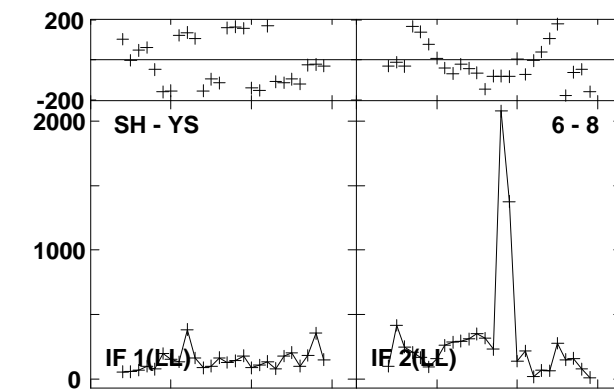
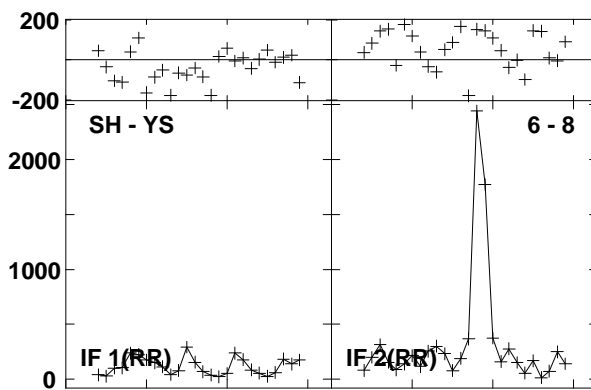
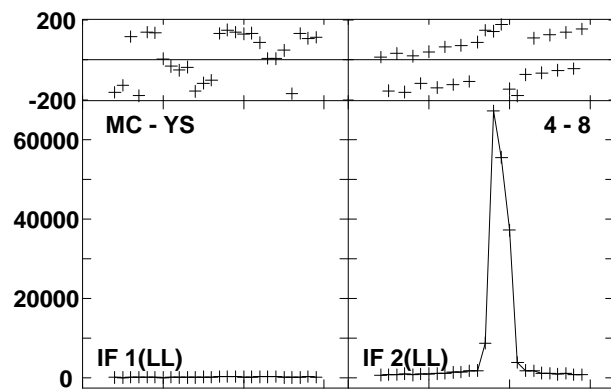
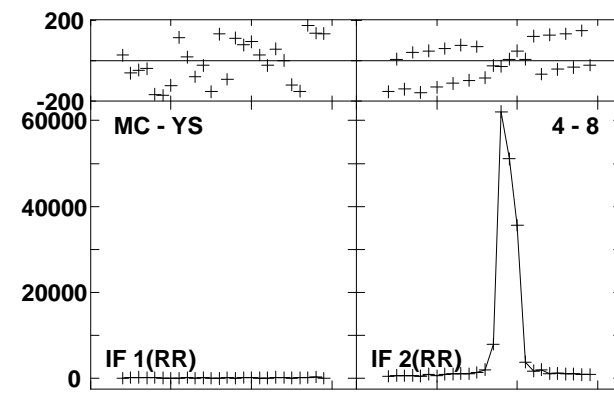
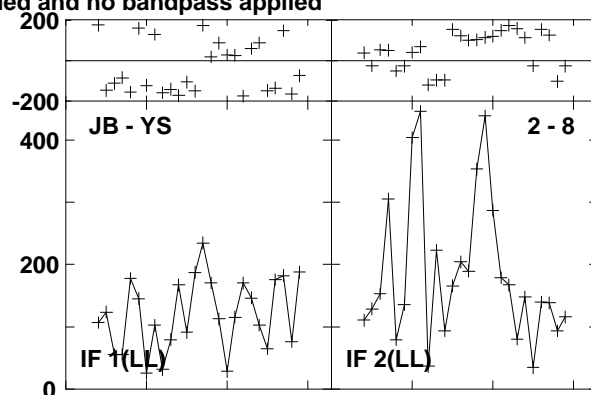
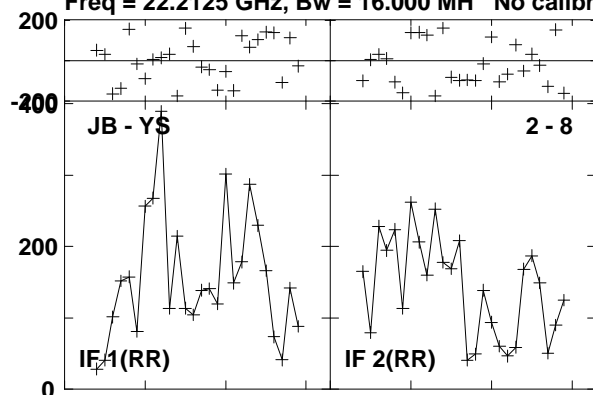

Lower frame: Micro Ampl Jy Top frame: Phas deg  
Vector averaged cross-power spectrum Baseline: JB (02) - YS (08)  
Timerange: 00/14:37:17 to 00/14:38:15

Plot file version 591 created 23-AUG-2016 15:01:03

W3IRS5 GA035B 1.UVDATA.1

Freq = 22.2125 GHz, Bw = 16.000 MH No calibration applied and no bandpass applied

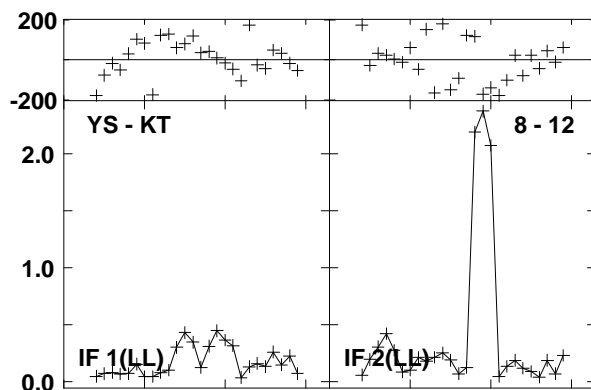
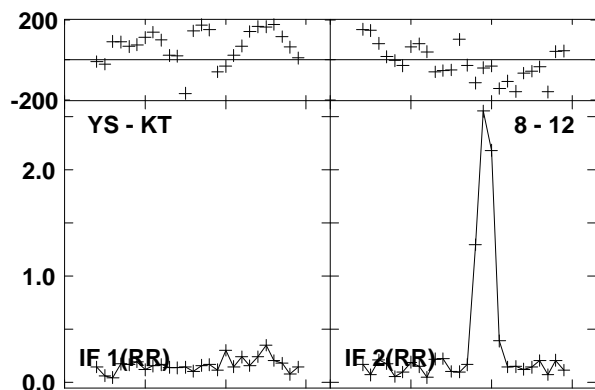
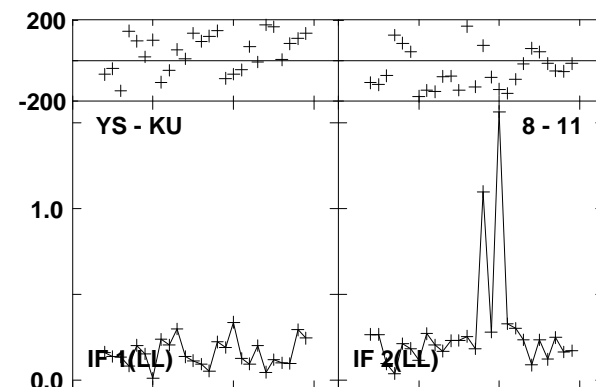
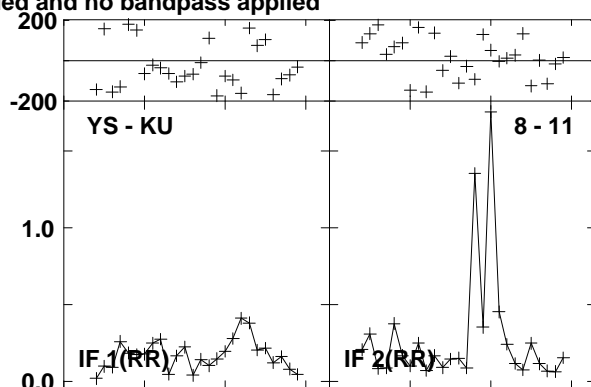
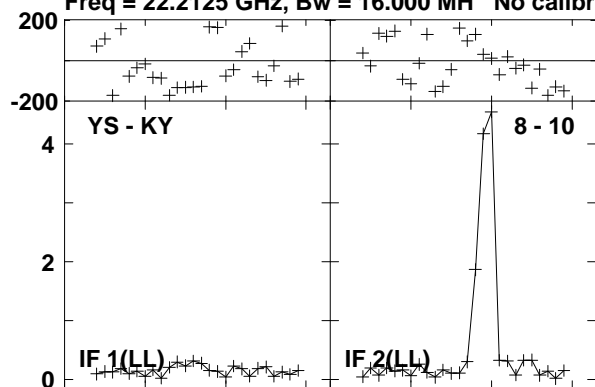

Lower frame: Milli Ampl Jy Top frame: Phas deg  
Vector averaged cross-power spectrum Baseline: YS (08) - KY (10)  
Timerange: 00/14:37:17 to 00/14:38:15

Plot file version 592 created 23-AUG-2016 15:01:03

0219+628 GA035B 1.UVDATA.1

Freq = 22.2125 GHz, Bw = 16.000 MH No calibration applied and no bandpass applied

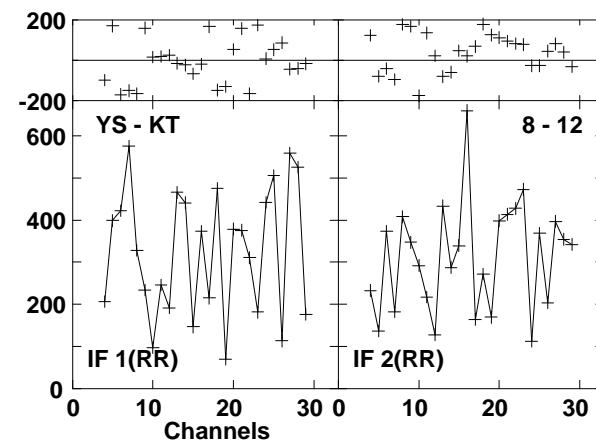
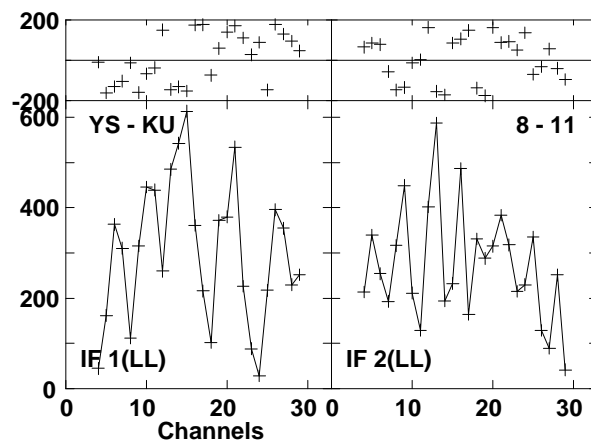
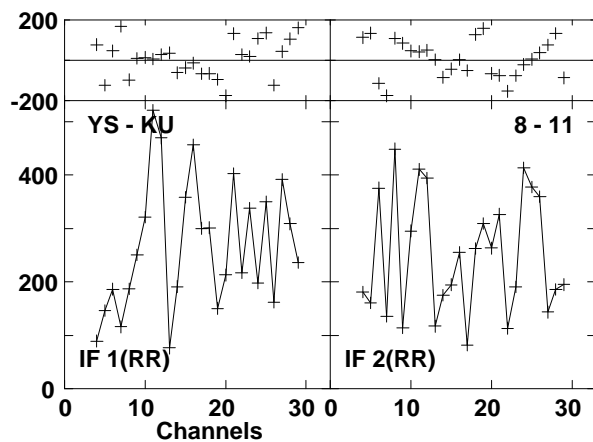
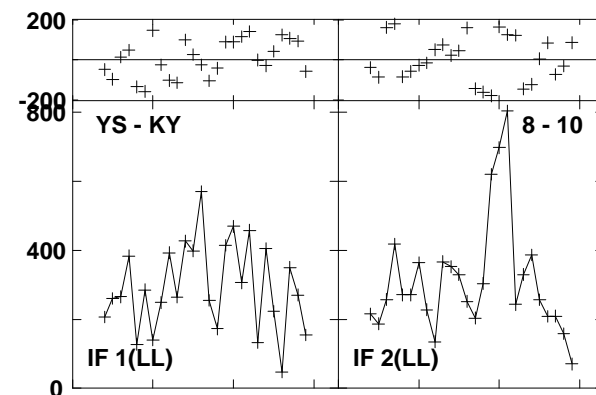
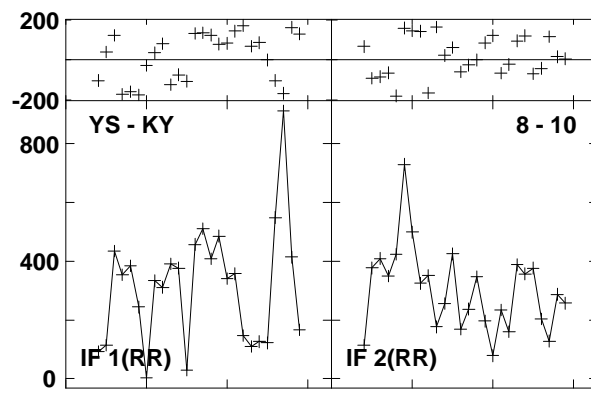
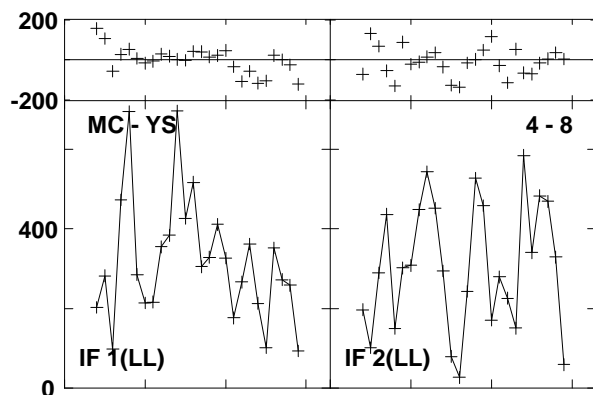
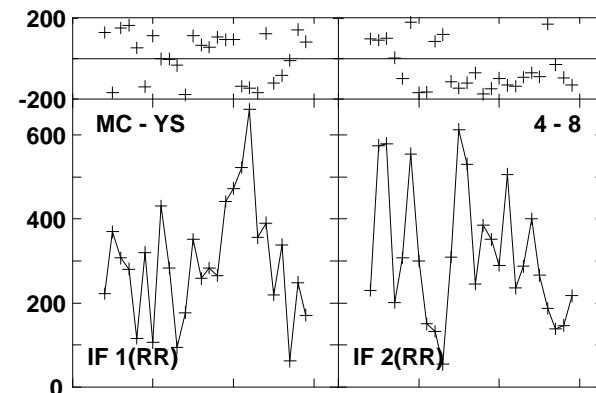
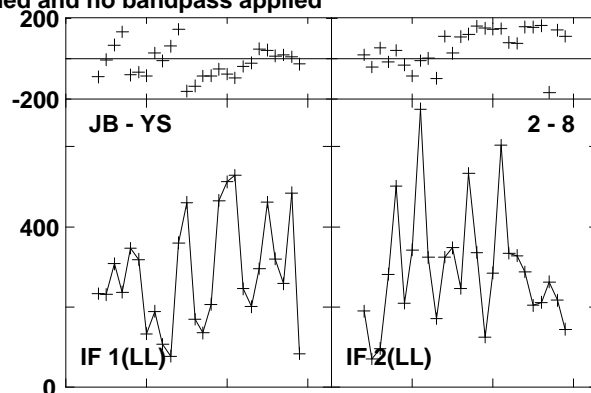
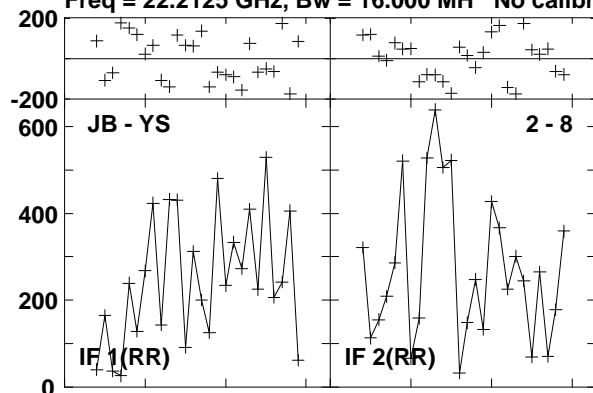

Lower frame: Micro Ampl Jy Top frame: Phas deg  
Vector averaged cross-power spectrum Baseline: JB (02) - YS (08)  
Timerange: 00/14:38:48 to 00/14:39:08



Plot file version 593 created 23-AUG-2016 15:01:03  
0219+628 GA035B 1.UVDATA.1  
Freq = 22.2125 GHz, Bw = 16.000 MH No calibration applied and no bandpass applied

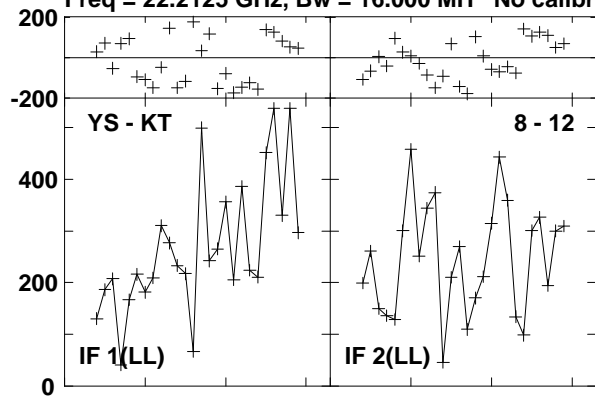

Lower frame: Micro Ampl Jy Top frame: Phas deg  
Vector averaged cross-power spectrum Baseline: YS (08) - KT (12)  
Timerange: 00/14:38:48 to 00/14:39:08

Plot file version 594 created 23-AUG-2016 15:01:03  
 W3IRS5 GA035B 1.UVDATA.1

Freq = 22.2125 GHz, Bw = 16.000 MH No calibration applied and no bandpass applied

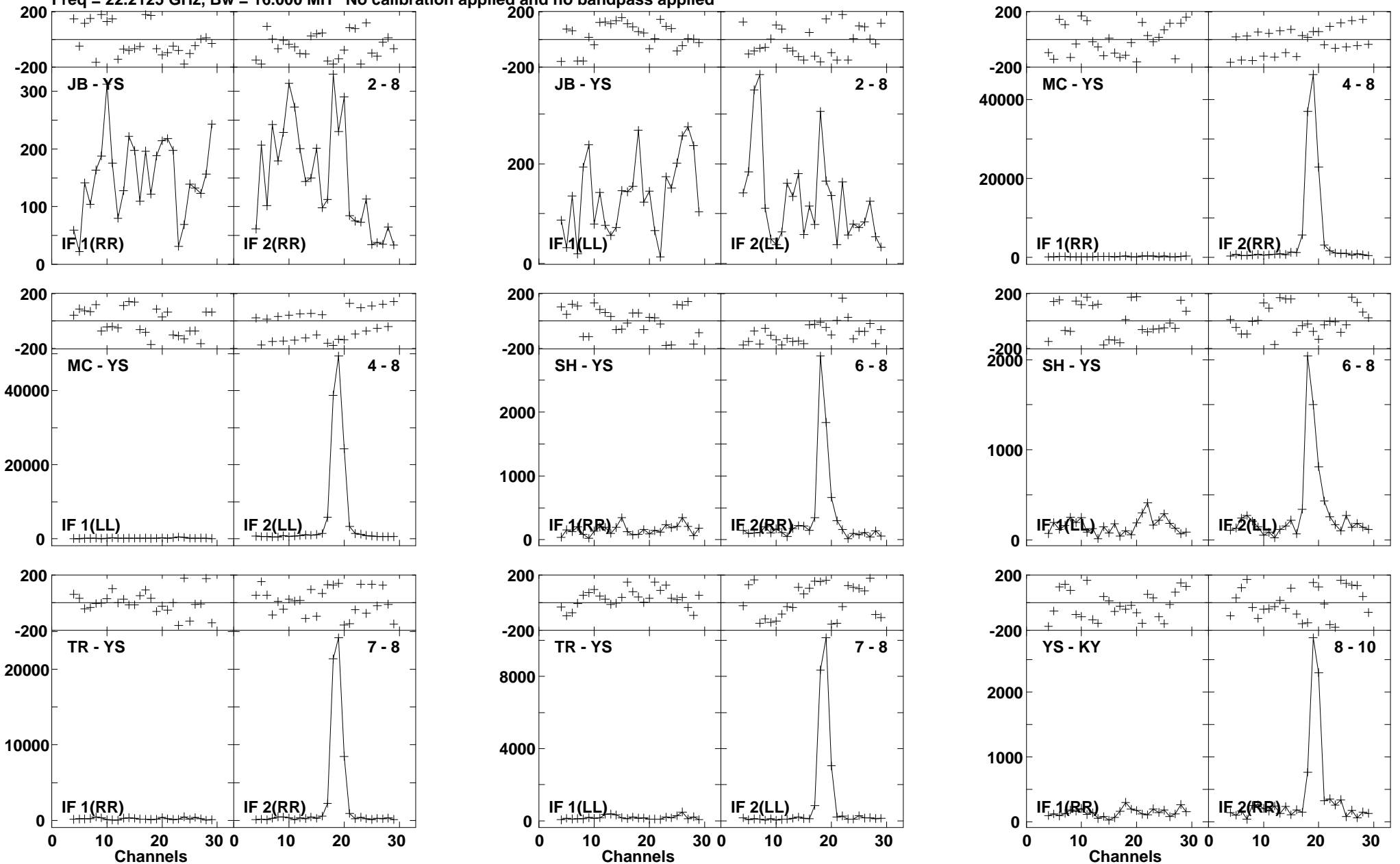

Lower frame: Micro Ampl Jy Top frame: Phas deg  
 Vector averaged cross-power spectrum Baseline: JB (02) - YS (08)  
 Timerange: 00/14:39:41 to 00/14:40:40

Plot file version 595 created 23-AUG-2016 15:01:03

W3IRS5 GA035B 1.UVDATA.1

Freq = 22.2125 GHz, Bw = 16.000 MH No calibration applied and no bandpass applied

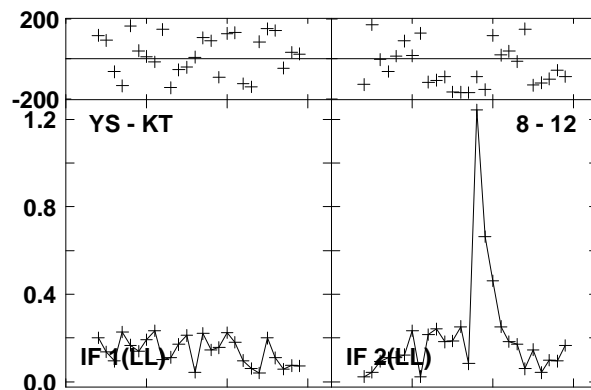
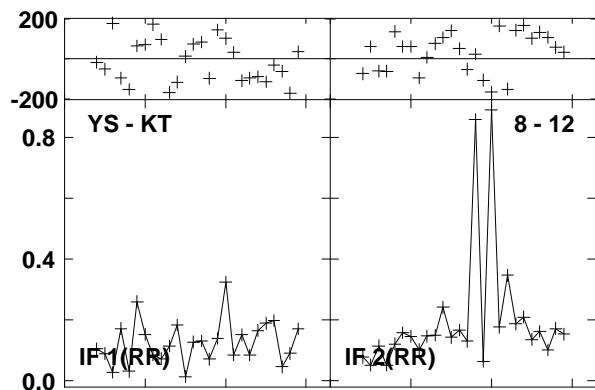
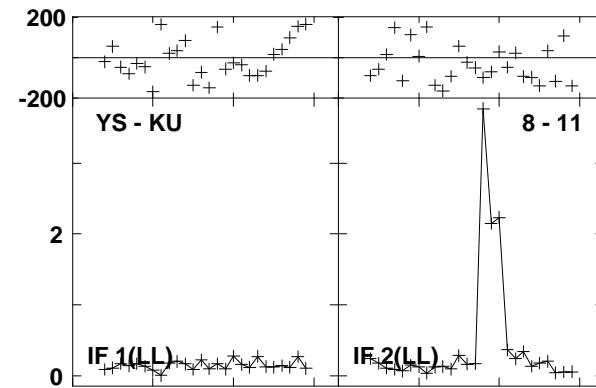
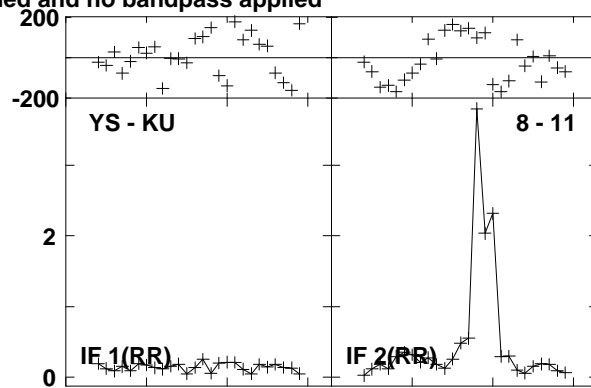
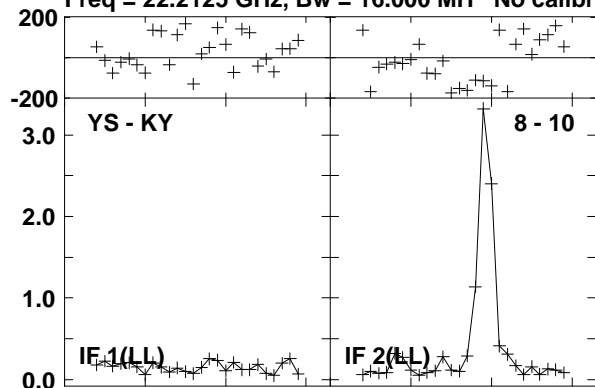

Lower frame: Milli Ampl Jy Top frame: Phas deg

Vector averaged cross-power spectrum Baseline: YS (08) - KY (10)

Timerange: 00/14:39:41 to 00/14:40:40

Plot file version 596 created 23-AUG-2016 15:01:03

0219+628 GA035B 1.UVDATA.1

Freq = 22.2125 GHz, Bw = 16.000 MH No calibration applied and no bandpass applied

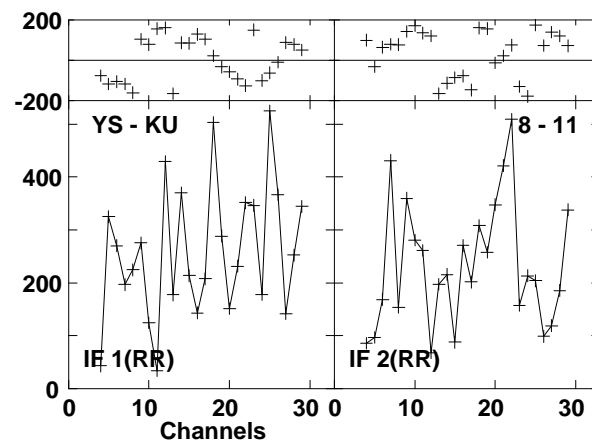
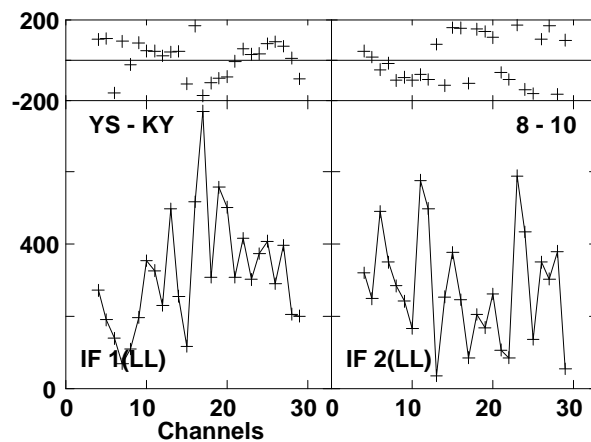
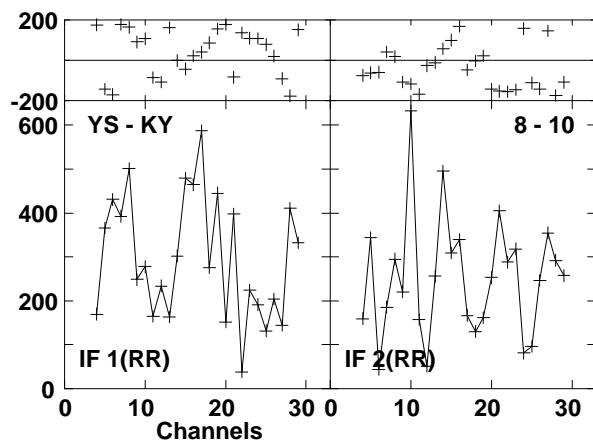
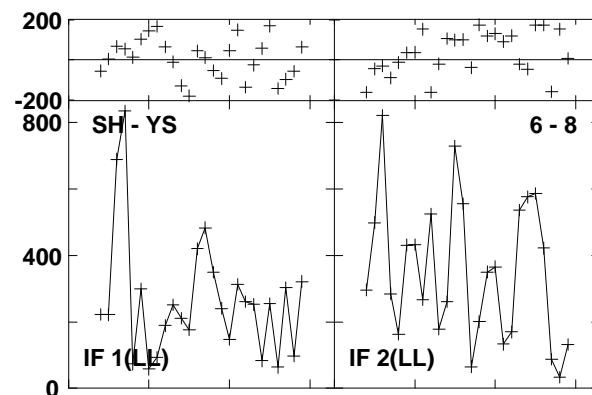
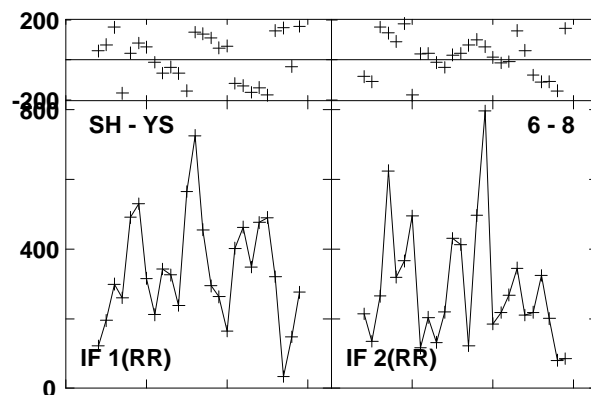
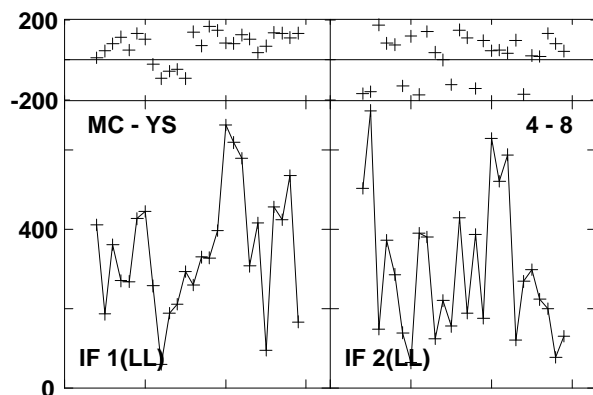
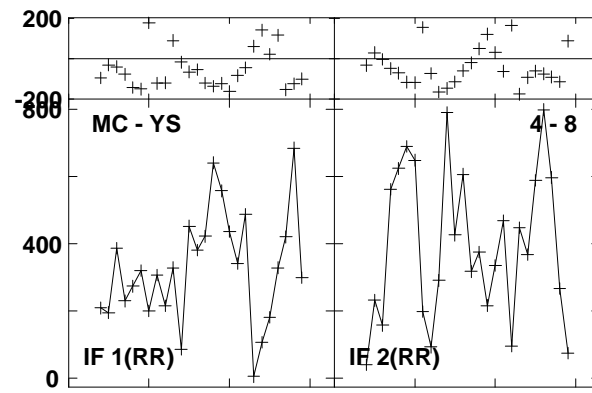
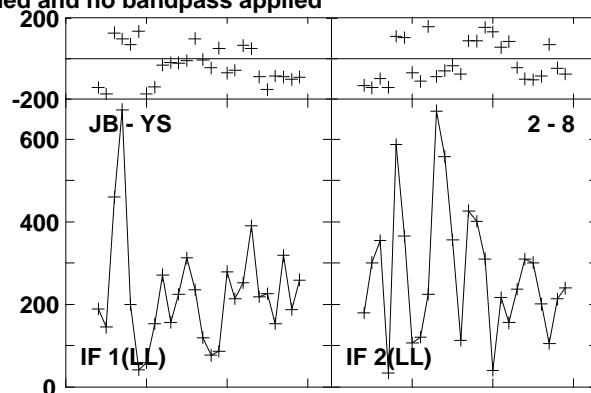
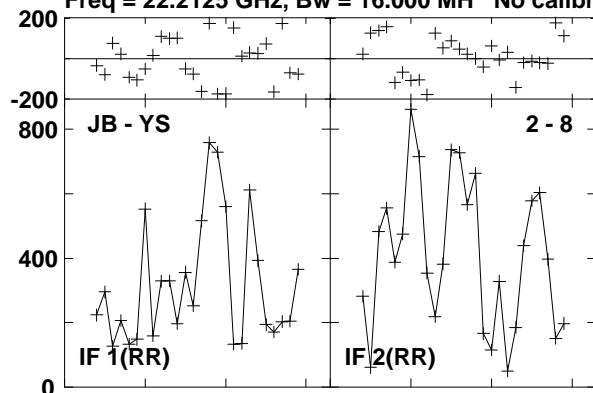

Lower frame: Micro Ampl Jy Top frame: Phas deg  
Vector averaged cross-power spectrum Baseline: JB (02) - YS (08)  
Timerange: 00/14:41:13 to 00/14:41:32

Plot file version 597 created 23-AUG-2016 15:01:03

0219+628 GA035B 1.UVDATA.1

Freq = 22.2125 GHz, Bw = 16.000 MH No calibration applied and no bandpass applied

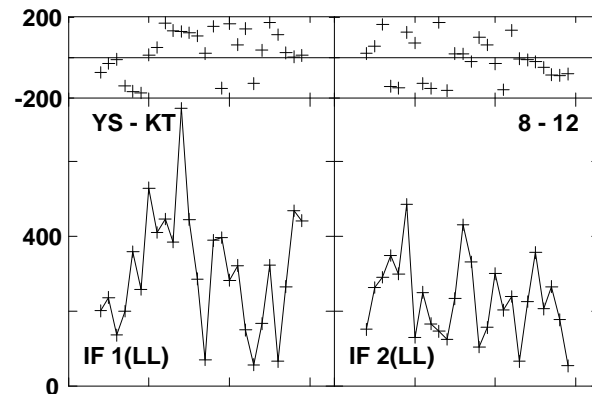
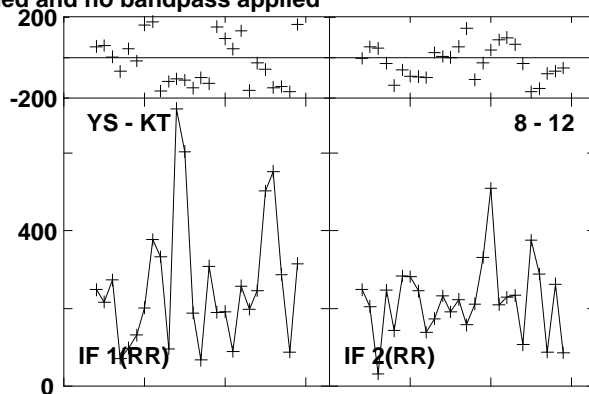
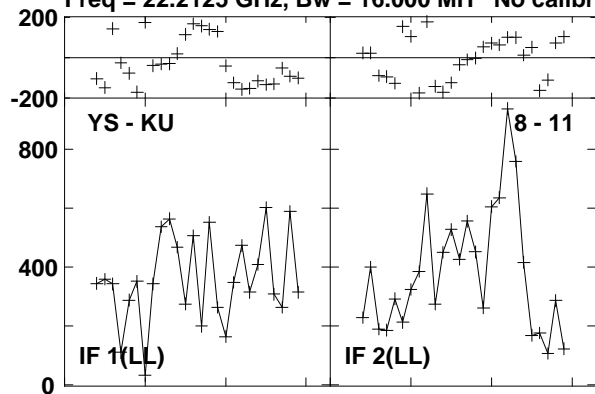

Lower frame: Micro Ampl Jy Top frame: Phas deg  
Vector averaged cross-power spectrum Baseline: YS (08) - KU (11)  
Timerange: 00/14:41:13 to 00/14:41:32

Plot file version 598 created 23-AUG-2016 15:01:03

W3IRS5 GA035B 1.UVDATA.1

Freq = 22.2125 GHz, Bw = 16.000 MH No calibration applied and no bandpass applied

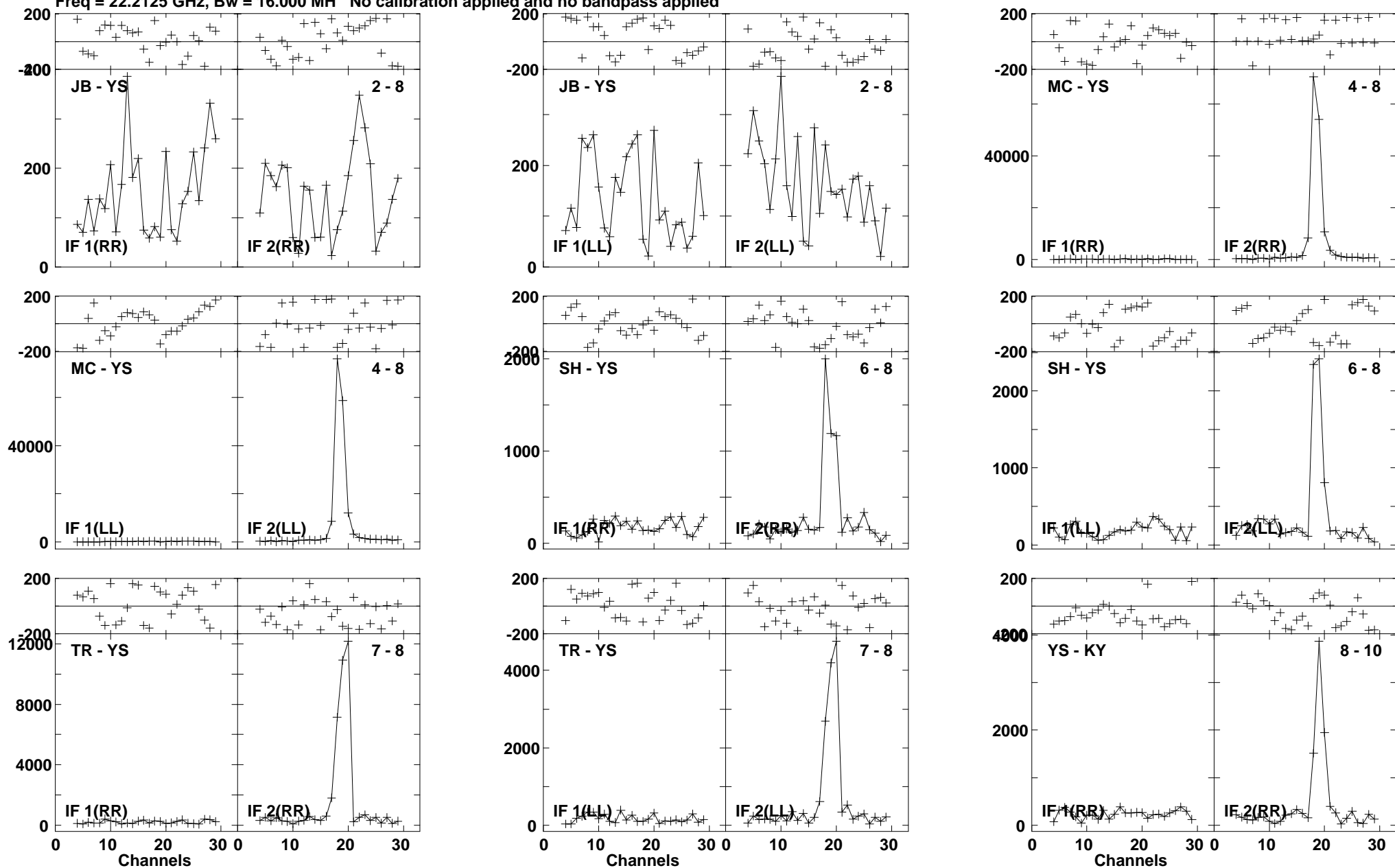

Lower frame: Micro Ampl Jy Top frame: Phas deg  
Vector averaged cross-power spectrum Baseline: JB (02) - YS (08)  
Timerange: 00/14:42:05 to 00/14:43:03

Plot file version 599 created 23-AUG-2016 15:01:03

W3IRS5 GA035B 1.UVDATA.1

Freq = 22.2125 GHz, Bw = 16.000 MH No calibration applied and no bandpass applied

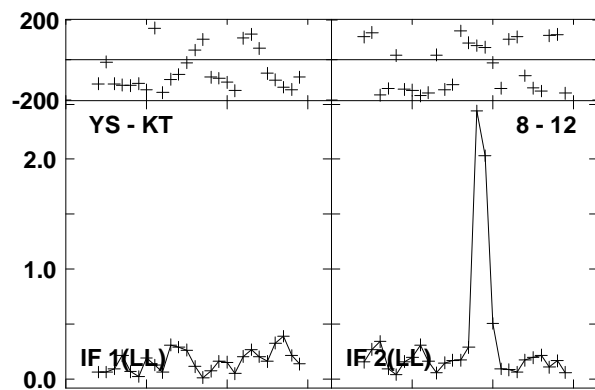
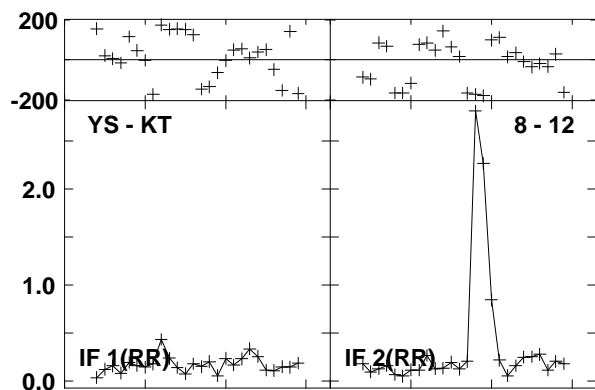
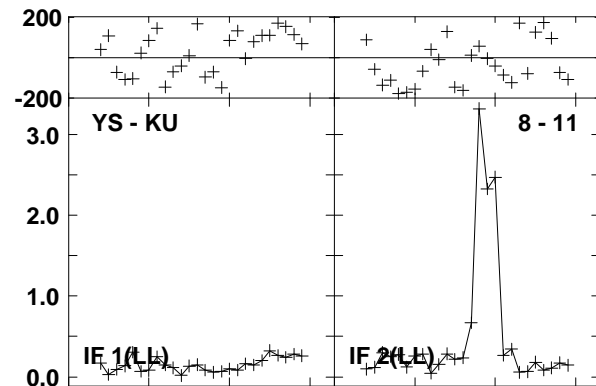
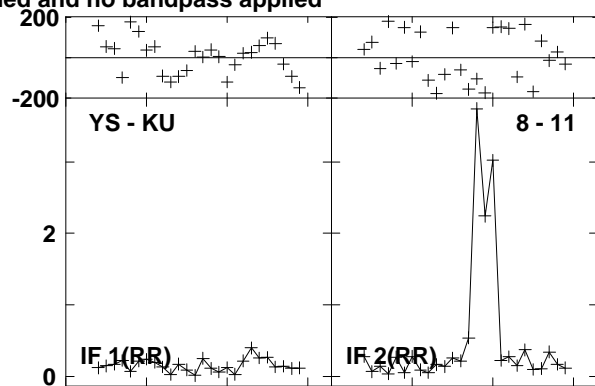
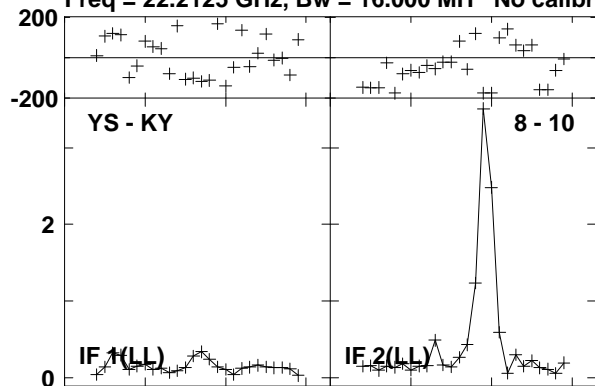

Lower frame: Milli Ampl Jy Top frame: Phas deg  
Vector averaged cross-power spectrum Baseline: YS (08) - KY (10)  
Timerange: 00/14:42:05 to 00/14:43:03

Plot file version 600 created 23-AUG-2016 15:01:03

0219+628 GA035B 1.UVDATA.1

Freq = 22.2125 GHz, Bw = 16.000 MH No calibration applied and no bandpass applied

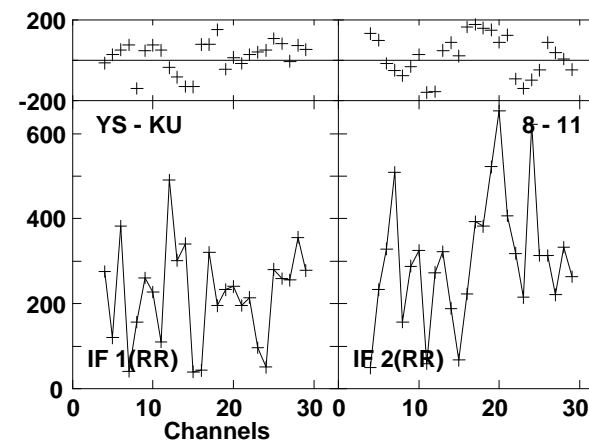
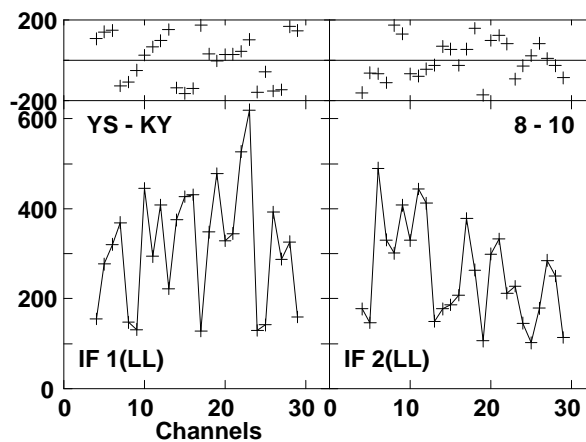
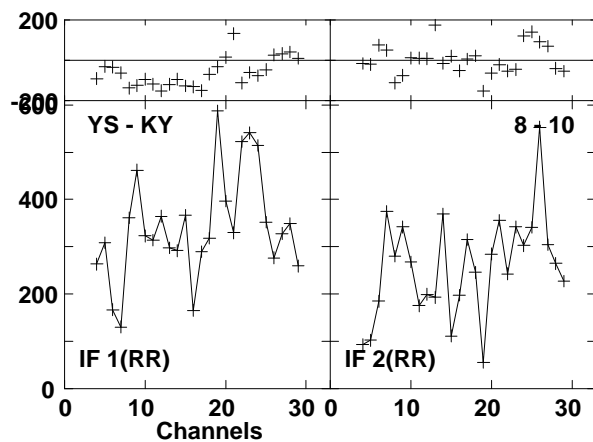
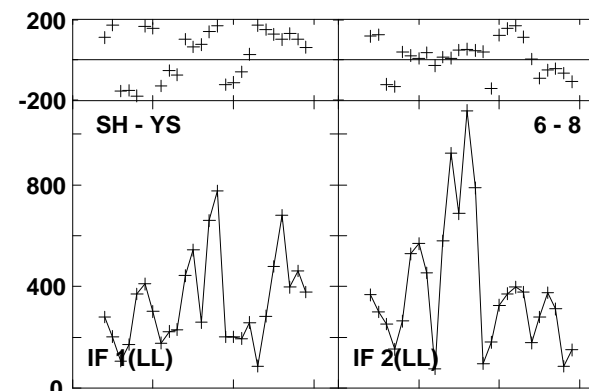
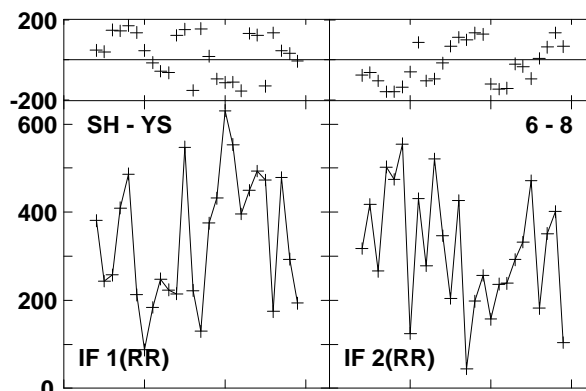
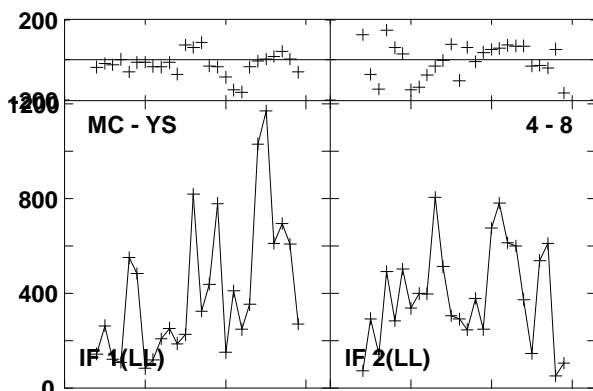
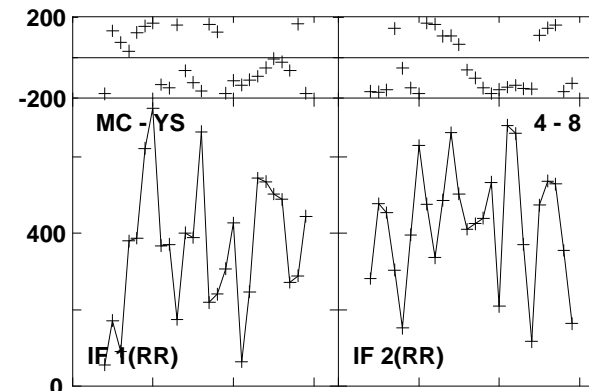
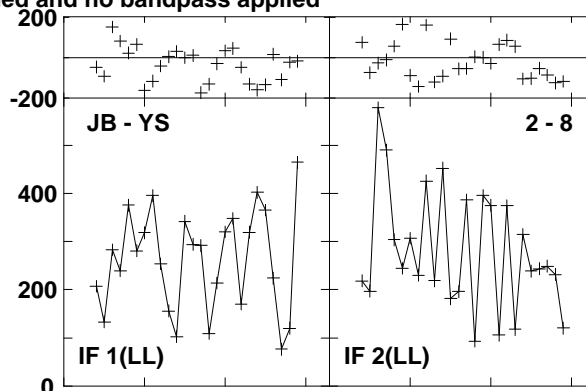
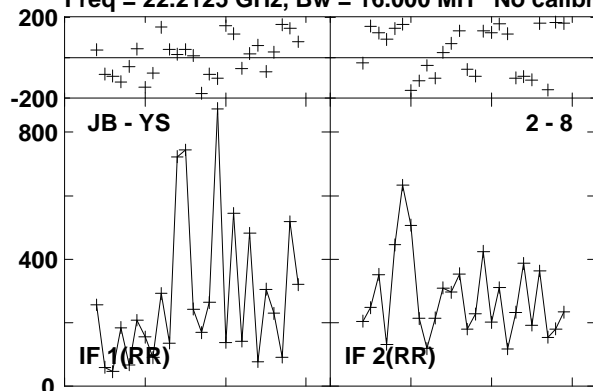

Lower frame: Micro Ampl Jy Top frame: Phas deg  
Vector averaged cross-power spectrum Baseline: JB (02) - YS (08)  
Timerange: 00/14:43:36 to 00/14:43:56



Plot file version 601 created 23-AUG-2016 15:01:03

0219+628 GA035B 1.UVDATA.1

Freq = 22.2125 GHz, Bw = 16.000 MH No calibration applied and no bandpass applied

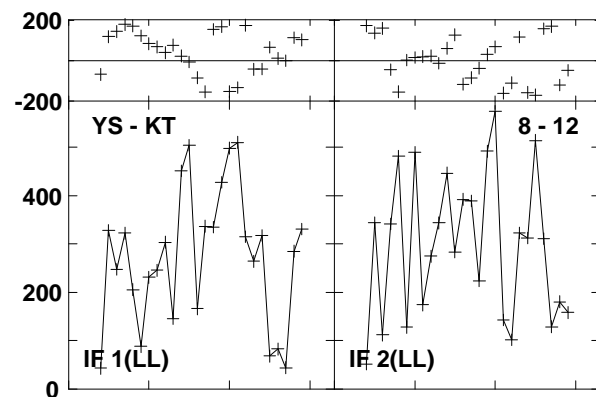
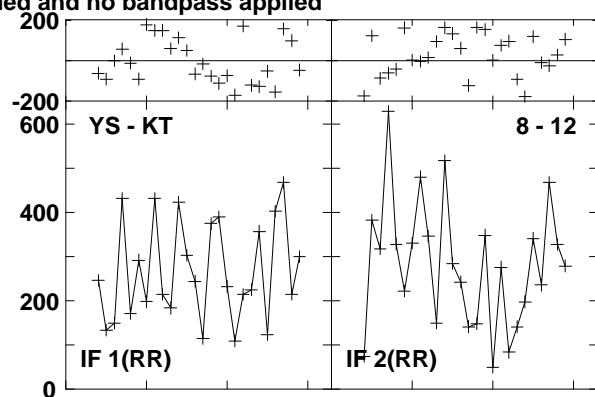
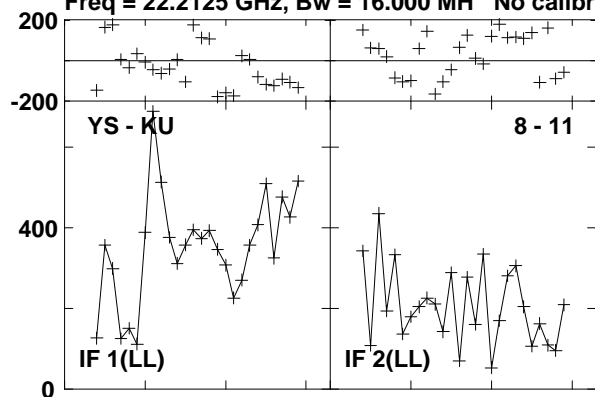

Lower frame: Micro Ampl Jy Top frame: Phas deg  
Vector averaged cross-power spectrum Baseline: YS (08) - KU (11)  
Timerange: 00/14:43:36 to 00/14:43:56

Plot file version 602 created 23-AUG-2016 15:01:03  
 W3IRS5 GA035B 1.UVDATA.1

Freq = 22.2125 GHz, Bw = 16.000 MH No calibration applied and no bandpass applied

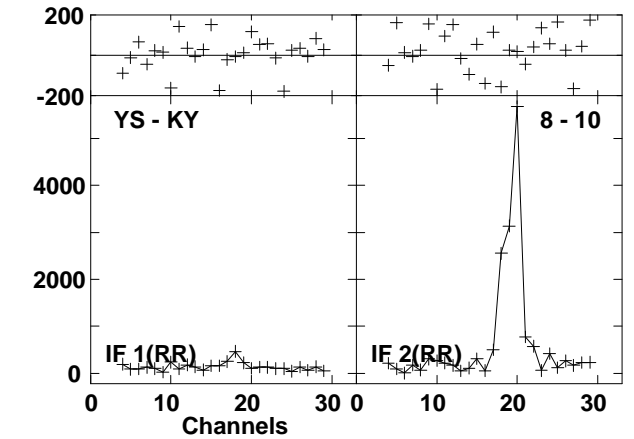
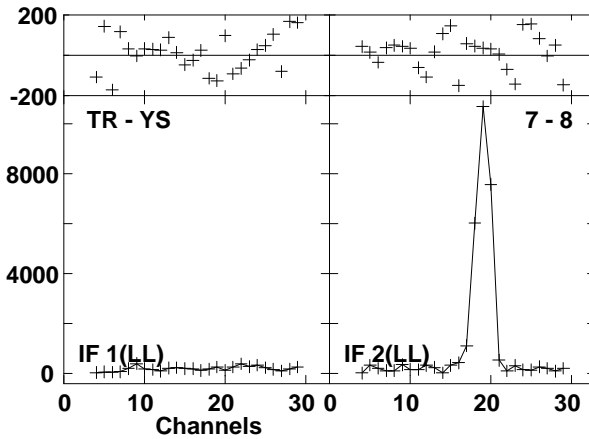
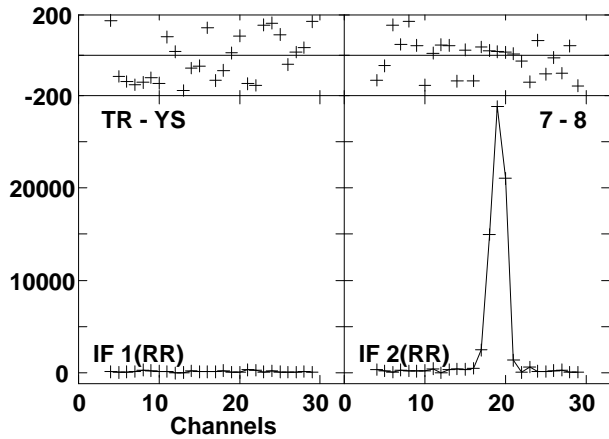
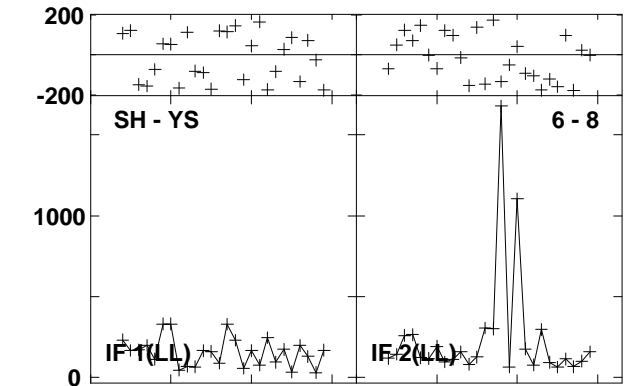
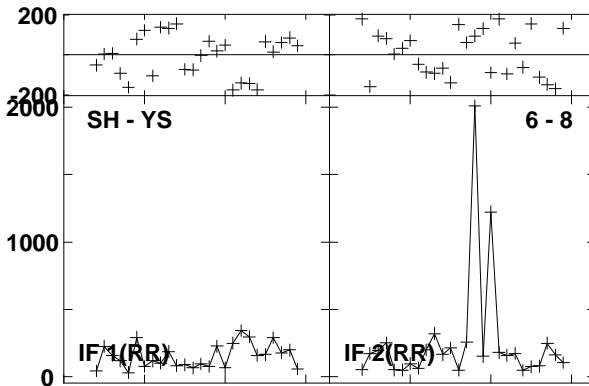
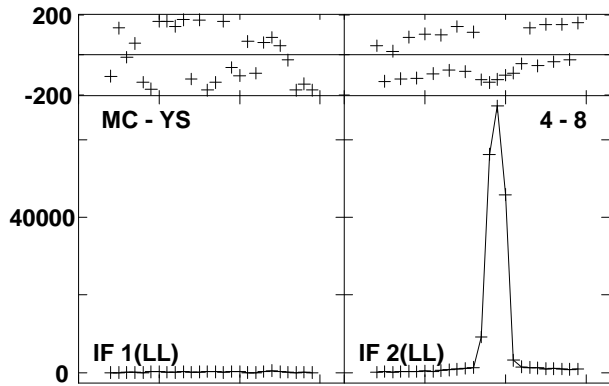
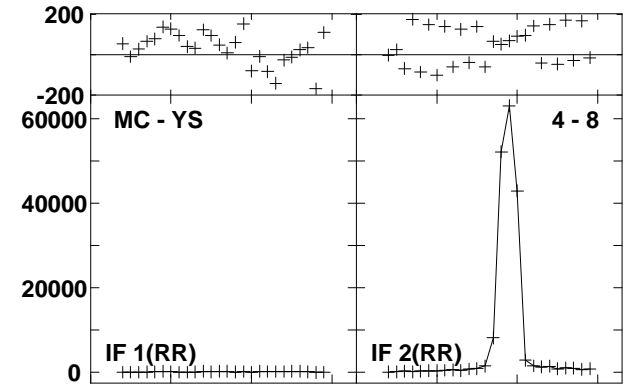
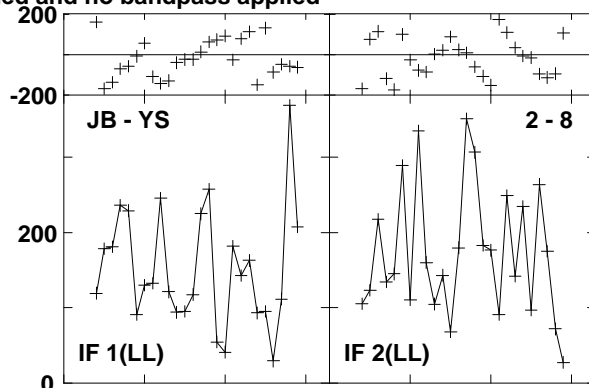
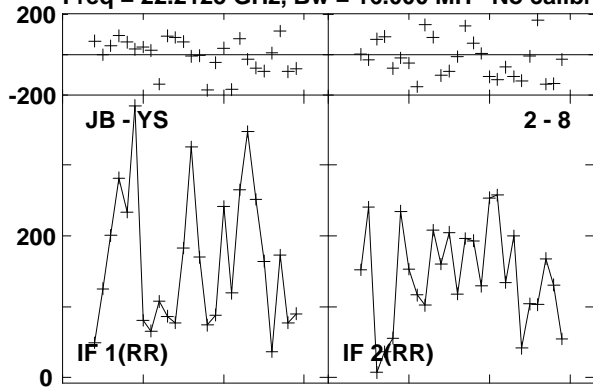

Lower frame: Micro Ampl Jy Top frame: Phas deg  
 Vector averaged cross-power spectrum Baseline: JB (02) - YS (08)  
 Timerange: 00/14:44:29 to 00/14:45:28

Plot file version 603 created 23-AUG-2016 15:01:03

W3IRS5 GA035B 1.UVDATA.1

Freq = 22.2125 GHz, Bw = 16.000 MH No calibration applied and no bandpass applied

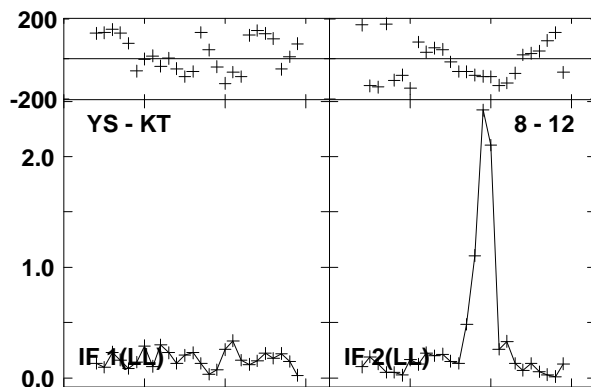
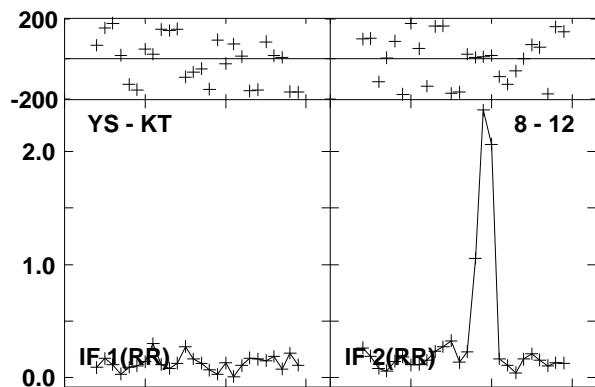
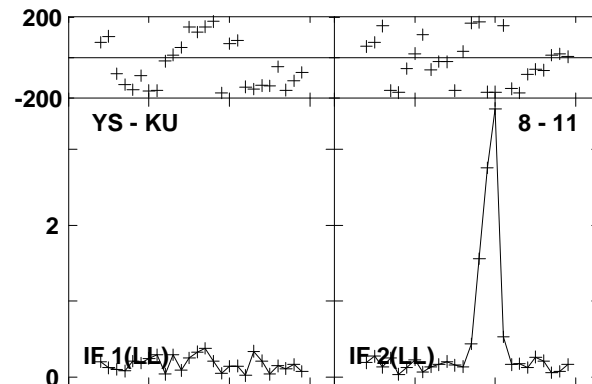
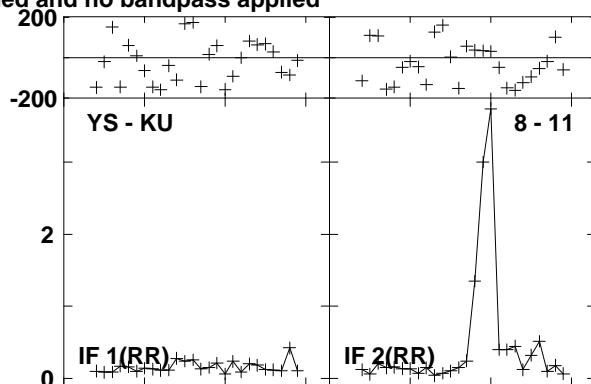
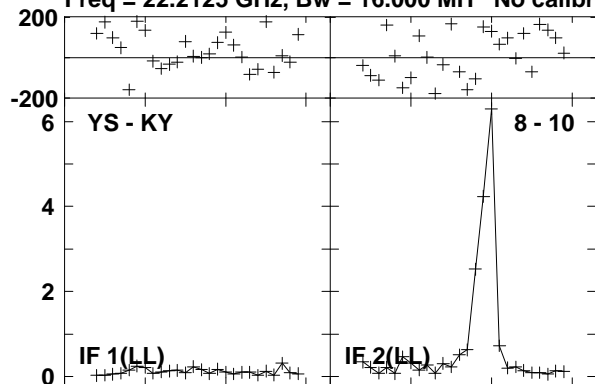

Lower frame: Milli Ampl Jy Top frame: Phas deg  
Vector averaged cross-power spectrum Baseline: YS (08) - KY (10)  
Timerange: 00/14:44:29 to 00/14:45:28

Plot file version 604 created 23-AUG-2016 15:01:03

0219+628 GA035B 1.UVDATA.1

Freq = 22.2125 GHz, Bw = 16.000 MH No calibration applied and no bandpass applied

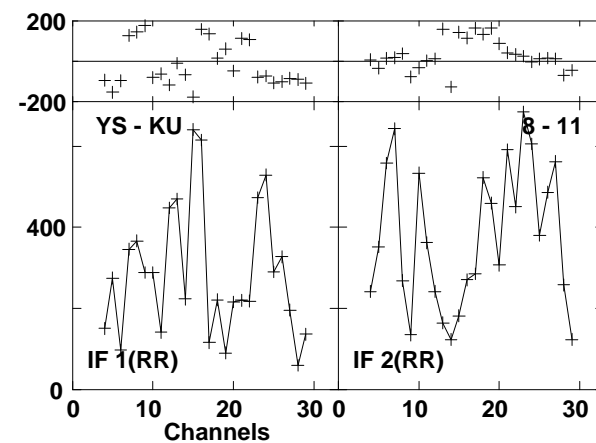
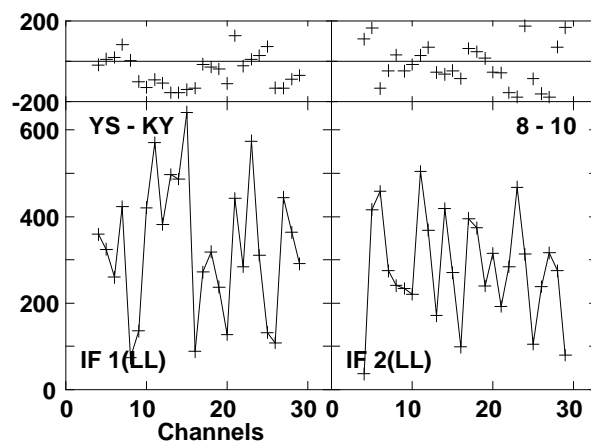
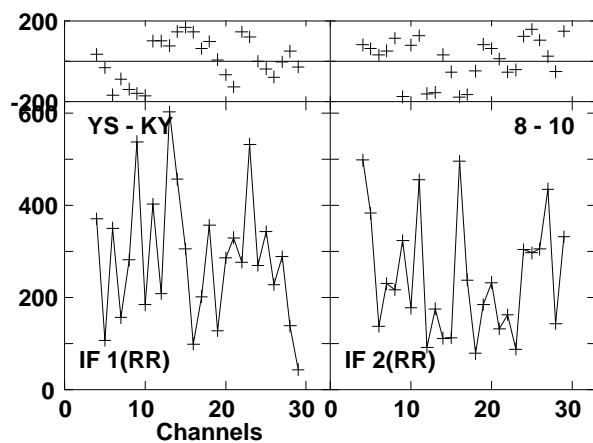
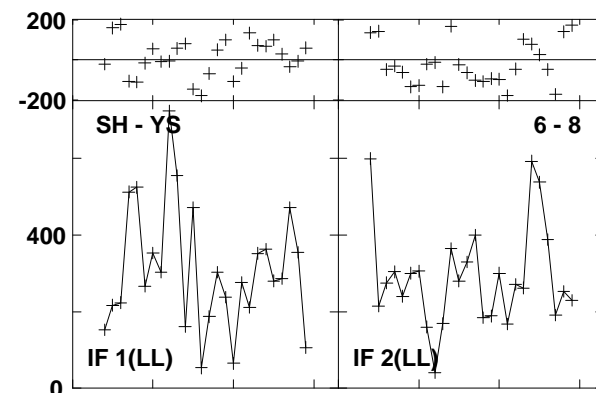
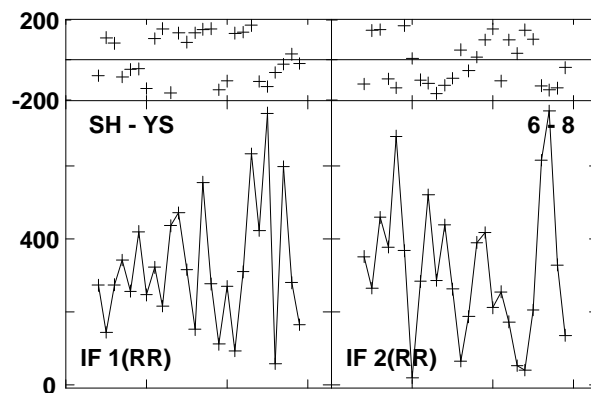
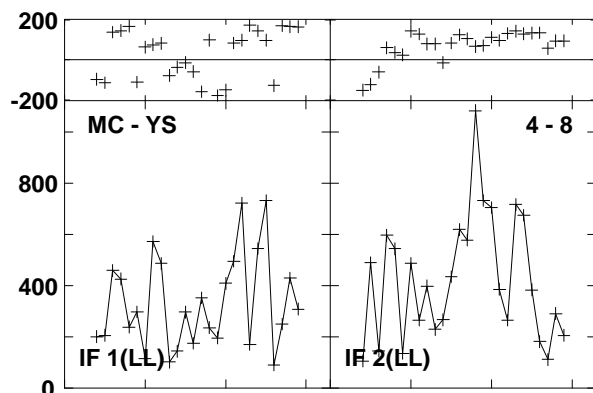
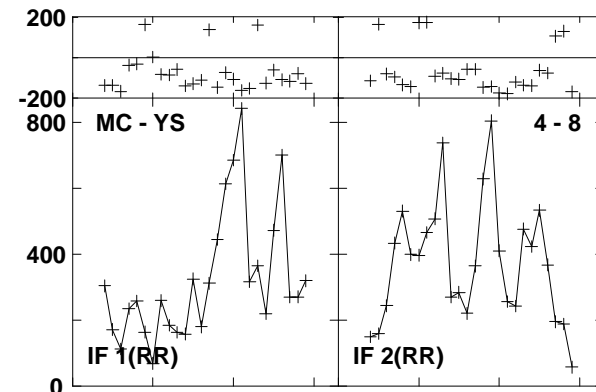
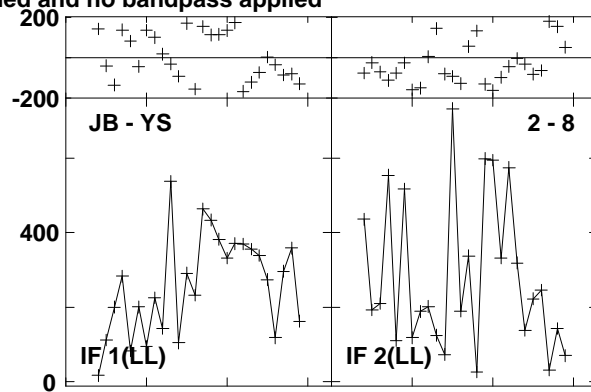
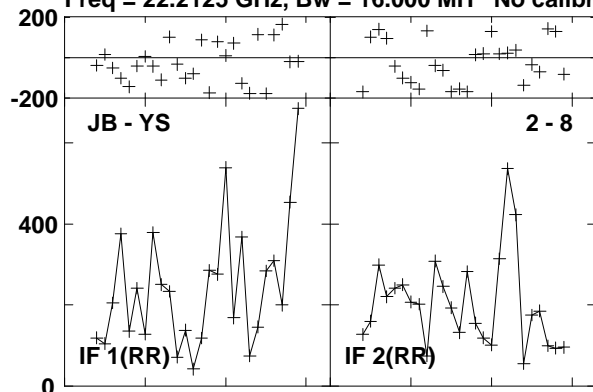

Lower frame: Micro Ampl Jy Top frame: Phas deg  
Vector averaged cross-power spectrum Baseline: JB (02) - YS (08)  
Timerange: 00/14:46:01 to 00/14:46:19

Plot file version 605 created 23-AUG-2016 15:01:03

0219+628 GA035B 1.UVDATA.1

Freq = 22.2125 GHz, Bw = 16.000 MH No calibration applied and no bandpass applied

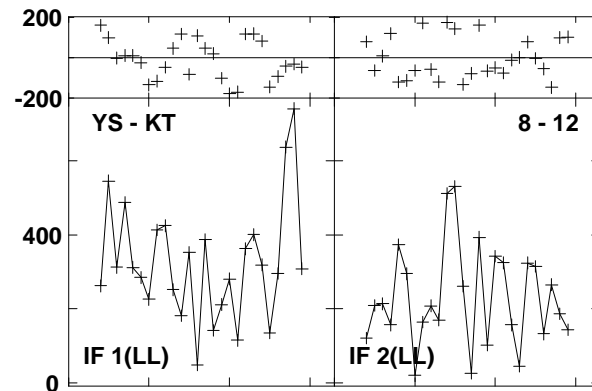
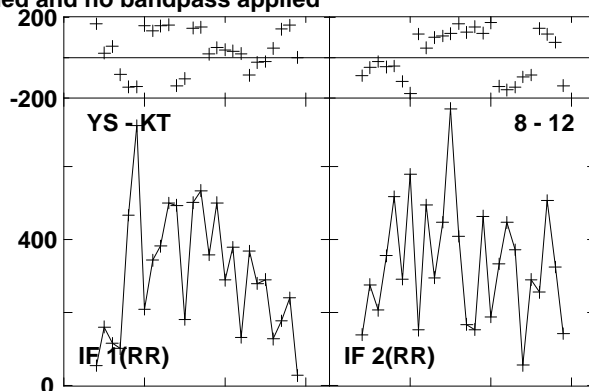
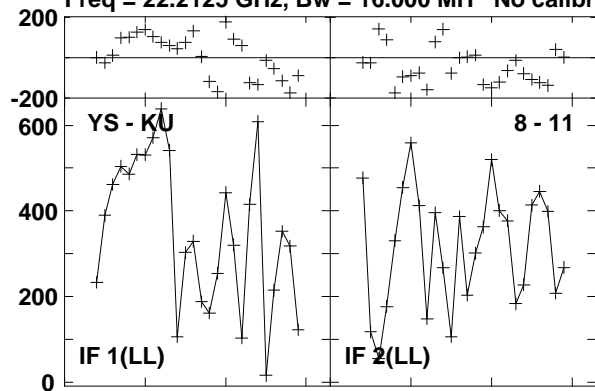

Lower frame: Micro Ampl Jy Top frame: Phas deg  
Vector averaged cross-power spectrum Baseline: YS (08) - KU (11)  
Timerange: 00/14:46:01 to 00/14:46:19

Plot file version 606 created 23-AUG-2016 15:01:03

W3IRS5 GA035B 1.UVDATA.1

Freq = 22.2125 GHz, Bw = 16.000 MH No calibration applied and no bandpass applied

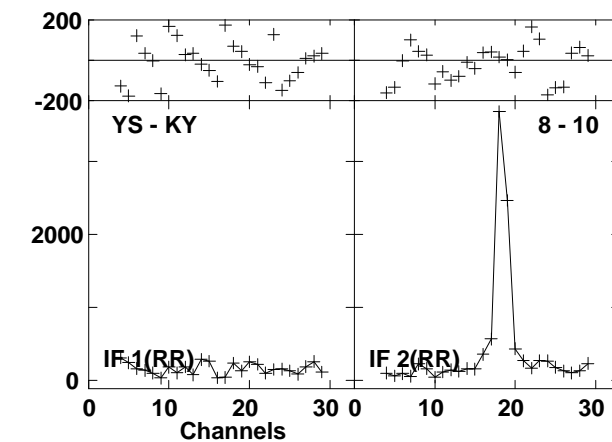
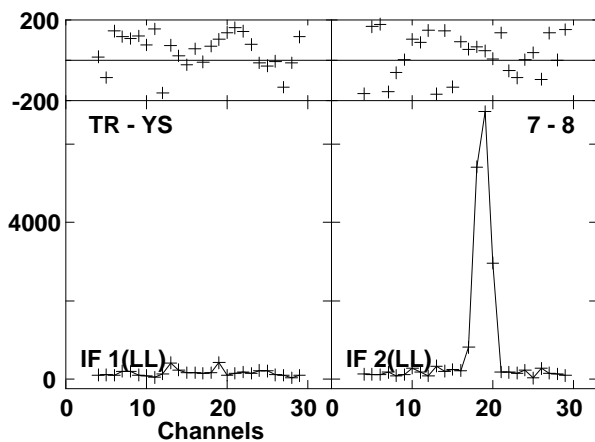
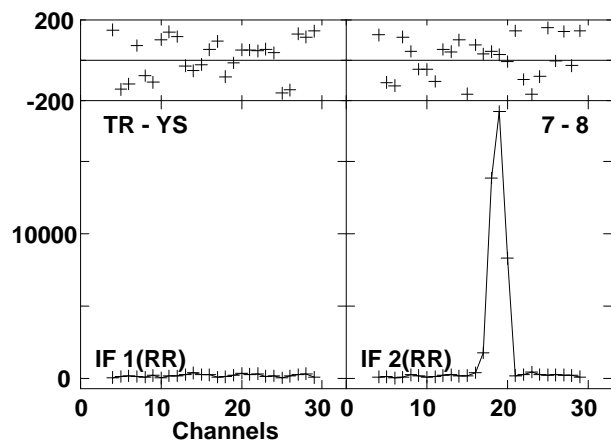
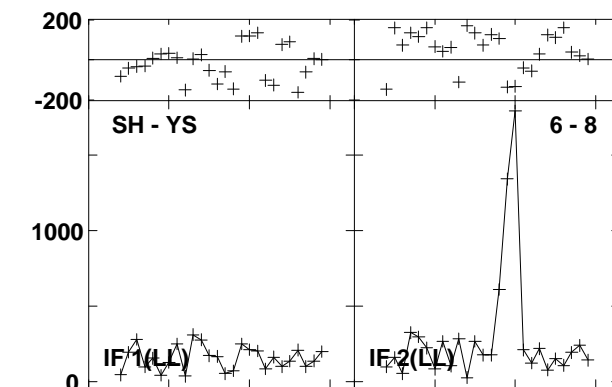
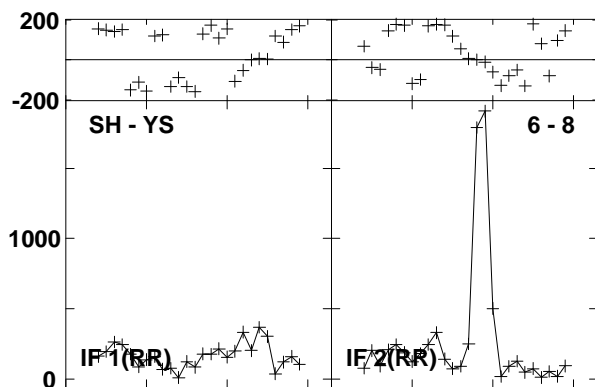
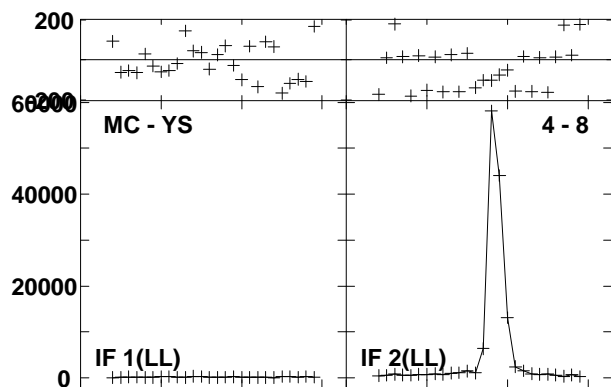
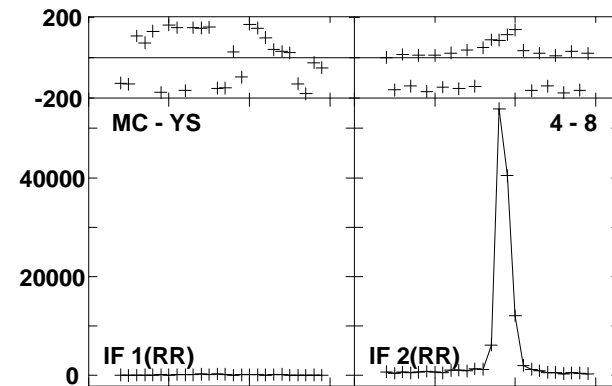
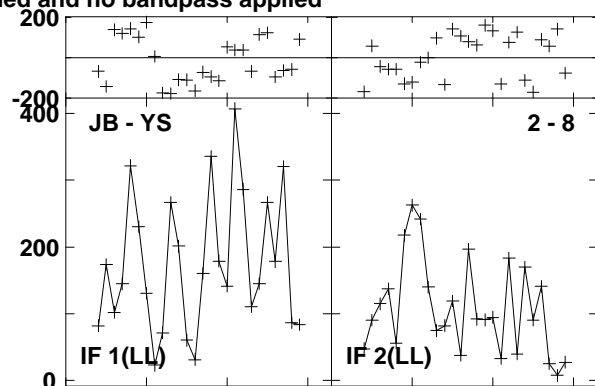
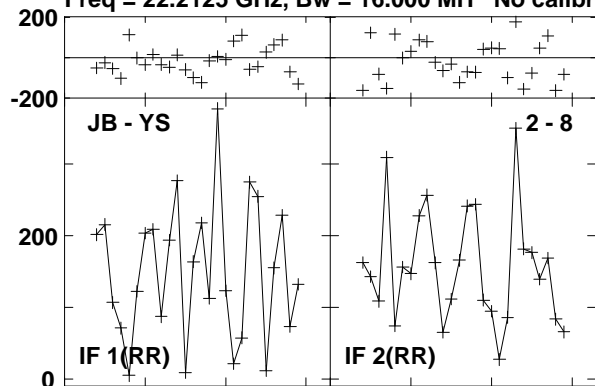

Lower frame: Micro Ampl Jy Top frame: Phas deg  
Vector averaged cross-power spectrum Baseline: JB (02) - YS (08)  
Timerange: 00/14:46:53 to 00/14:47:51

Plot file version 607 created 23-AUG-2016 15:01:04

W3IRS5 GA035B 1.UVDATA.1

Freq = 22.2125 GHz, Bw = 16.000 MH No calibration applied and no bandpass applied

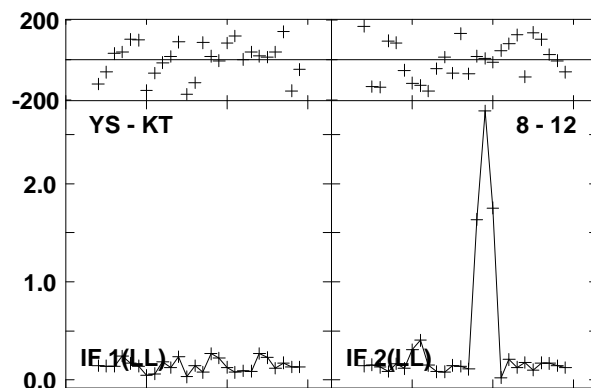
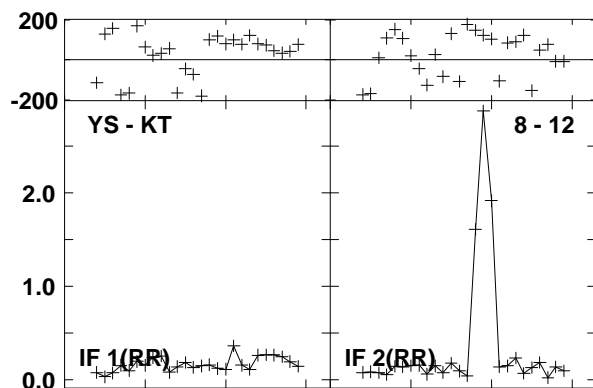
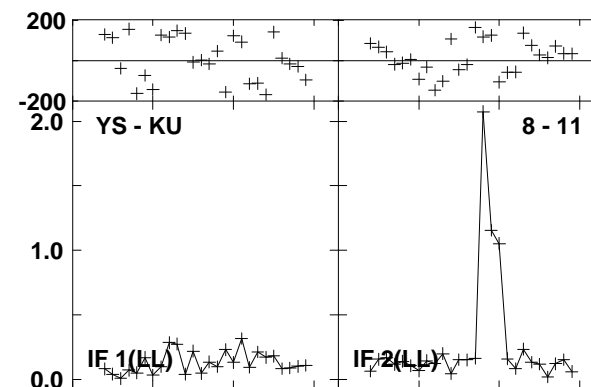
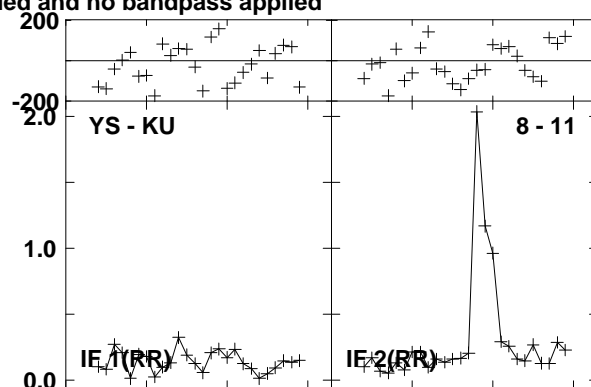
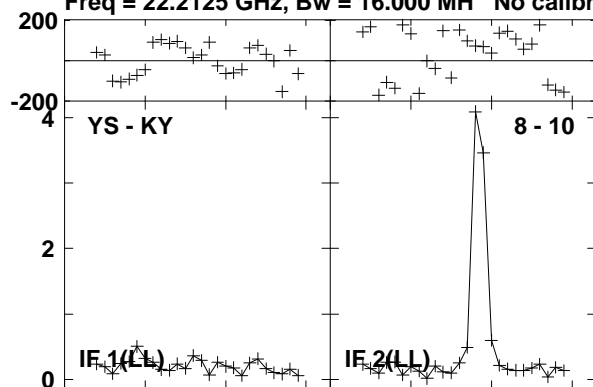

Lower frame: Milli Ampl Jy Top frame: Phas deg  
Vector averaged cross-power spectrum Baseline: YS (08) - KY (10)  
Timerange: 00/14:46:53 to 00/14:47:51

Plot file version 608 created 23-AUG-2016 15:01:04  
 0219+628 GA035B 1.UVDATA.1

Freq = 22.2125 GHz, Bw = 16.000 MH No calibration applied and no bandpass applied

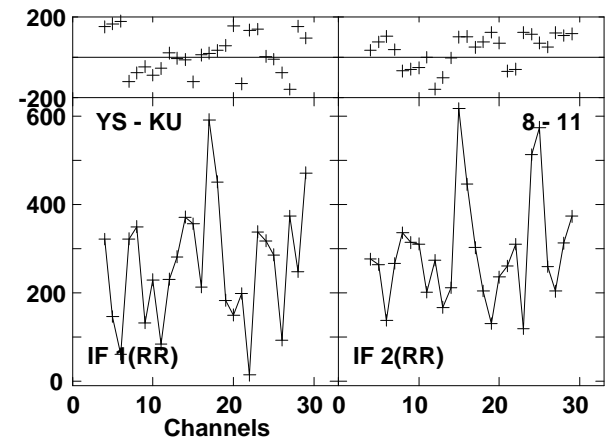
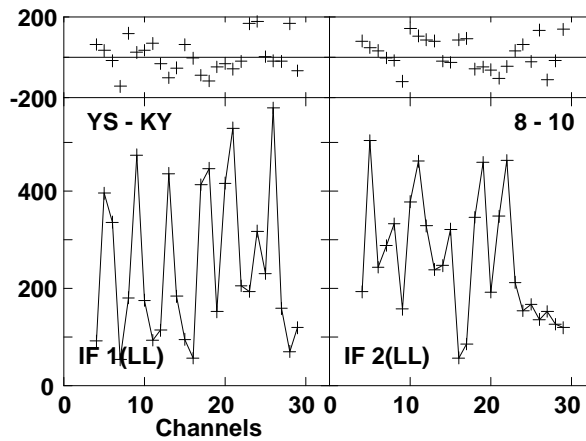
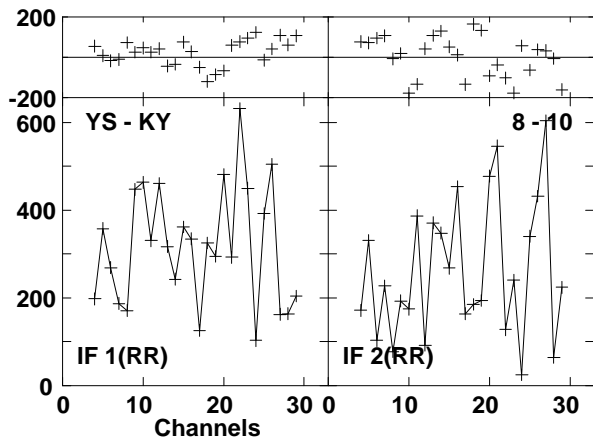
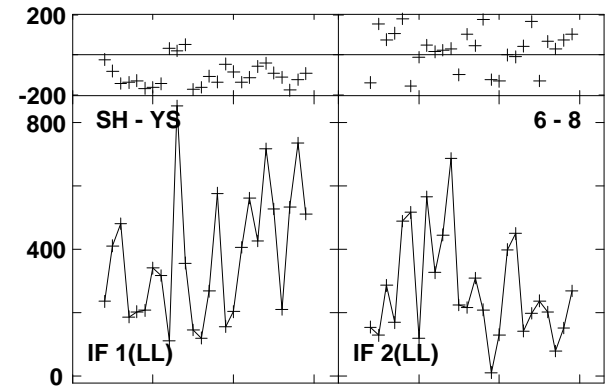
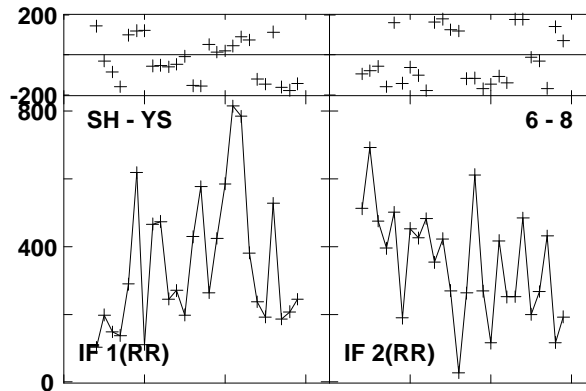
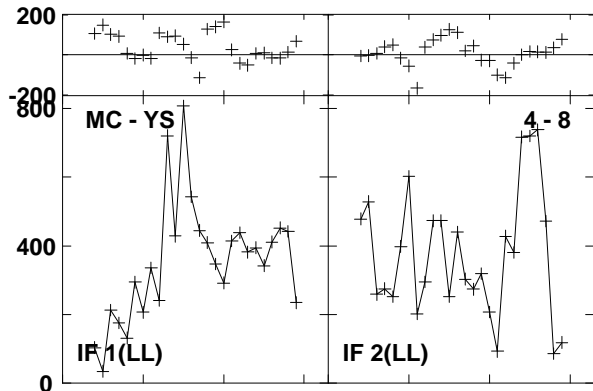
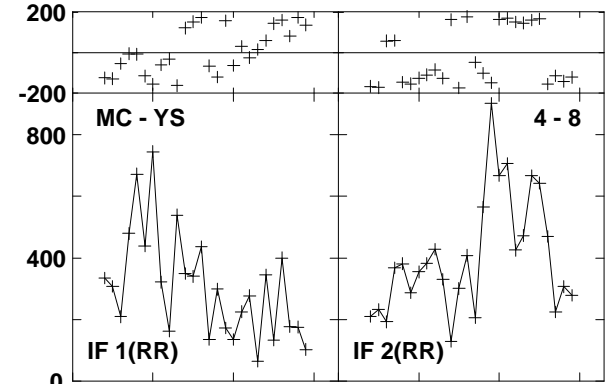
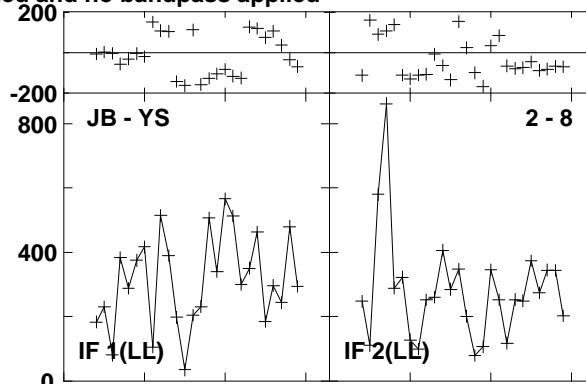
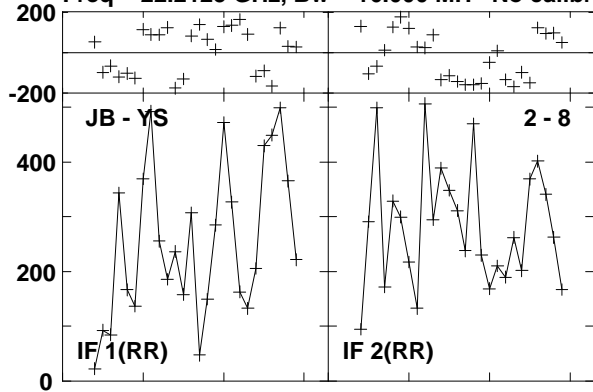

Lower frame: Micro Ampl Jy Top frame: Phas deg  
 Vector averaged cross-power spectrum Baseline: JB (02) - YS (08)  
 Timerange: 00/14:48:24 to 00/14:48:44



Plot file version 609 created 23-AUG-2016 15:01:04

0219+628 GA035B 1.UVDATA.1

Freq = 22.2125 GHz, Bw = 16.000 MH No calibration applied and no bandpass applied

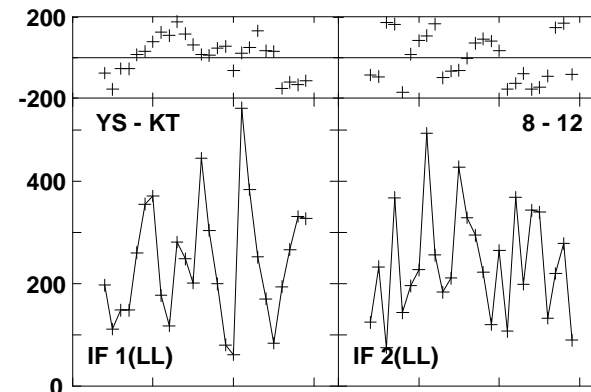
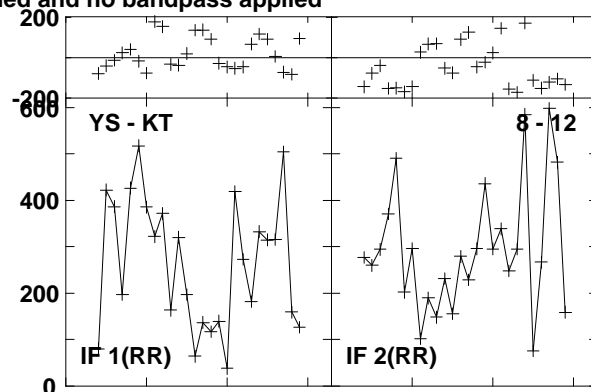
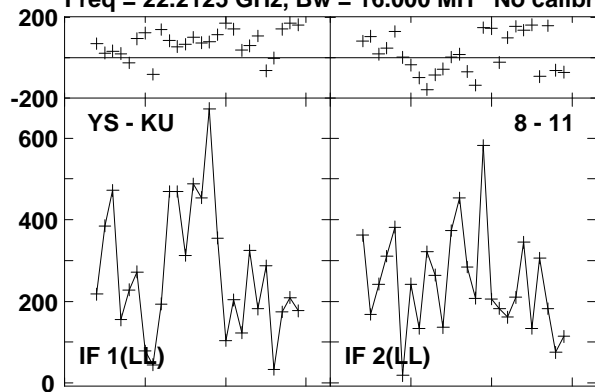

Lower frame: Micro Ampl Jy Top frame: Phas deg  
Vector averaged cross-power spectrum Baseline: YS (08) - KU (11)  
Timerange: 00/14:48:24 to 00/14:48:44

Plot file version 610 created 23-AUG-2016 15:01:04

W3IRS5 GA035B 1.UVDATA.1

Freq = 22.2125 GHz, Bw = 16.000 MH No calibration applied and no bandpass applied

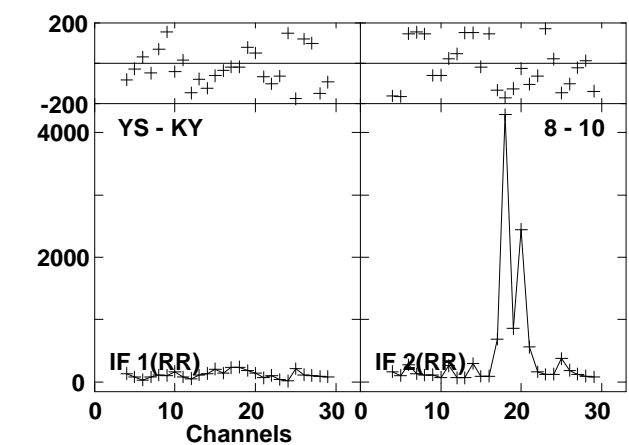
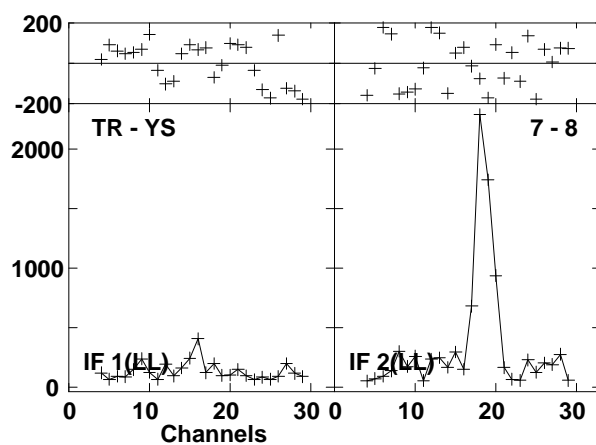
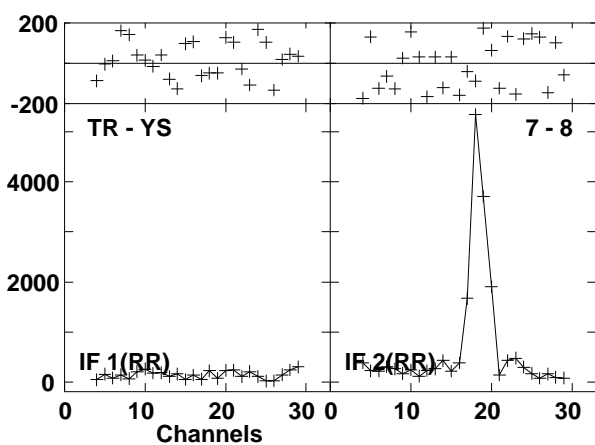
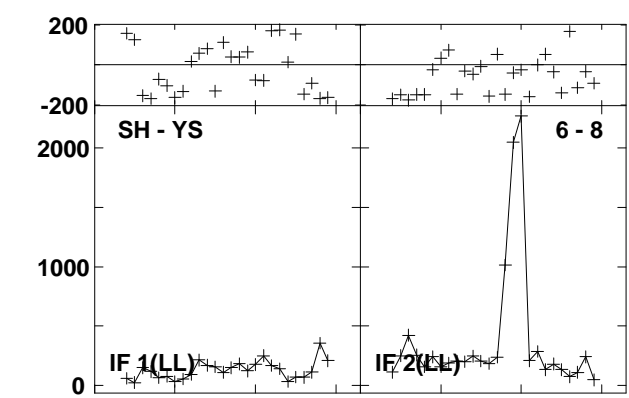
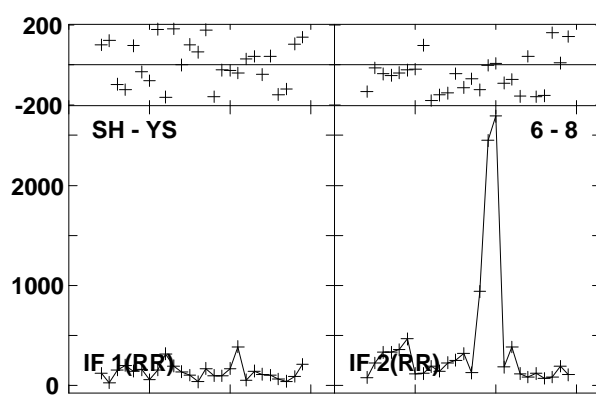
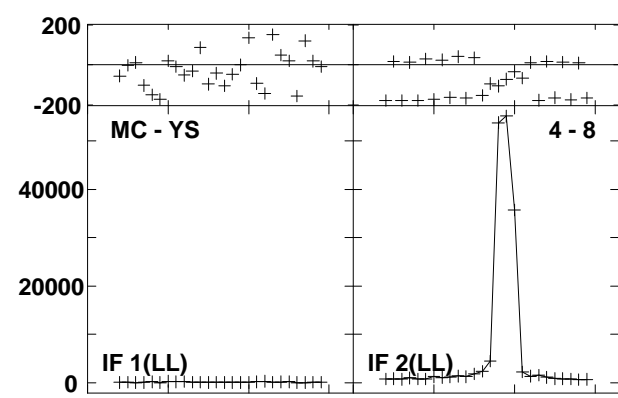
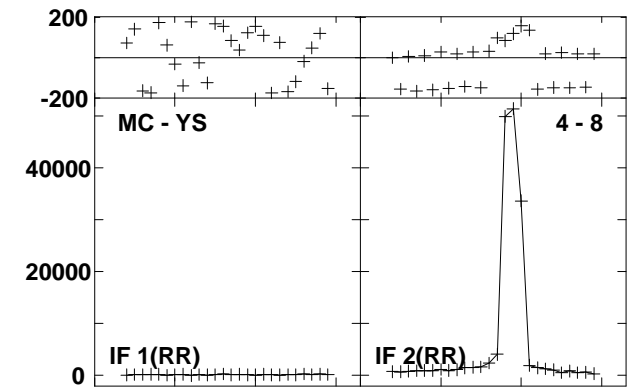
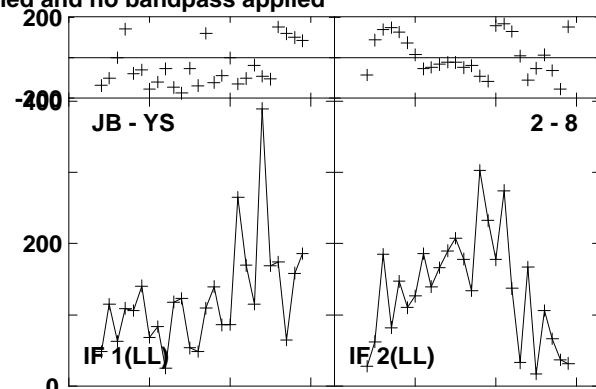
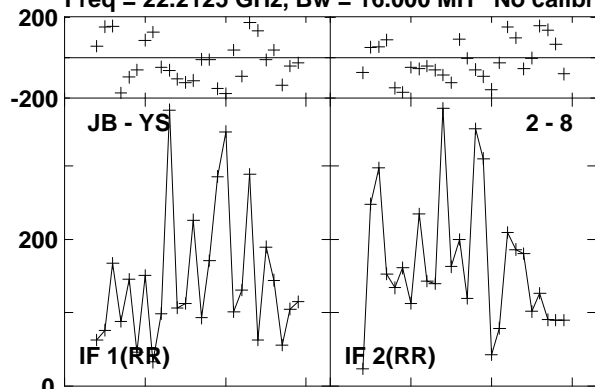

Lower frame: Micro Ampl Jy Top frame: Phas deg  
Vector averaged cross-power spectrum Baseline: JB (02) - YS (08)  
Timerange: 00/14:49:17 to 00/14:50:15

Plot file version 611 created 23-AUG-2016 15:01:04  
W3IRS5 GA035B 1.UVDATA.1

Freq = 22.2125 GHz, Bw = 16.000 MH No calibration applied and no bandpass applied

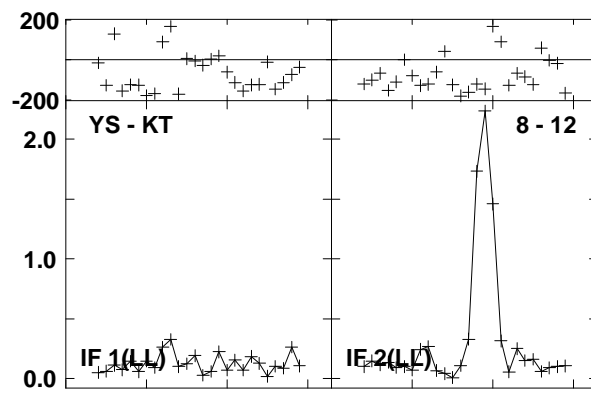
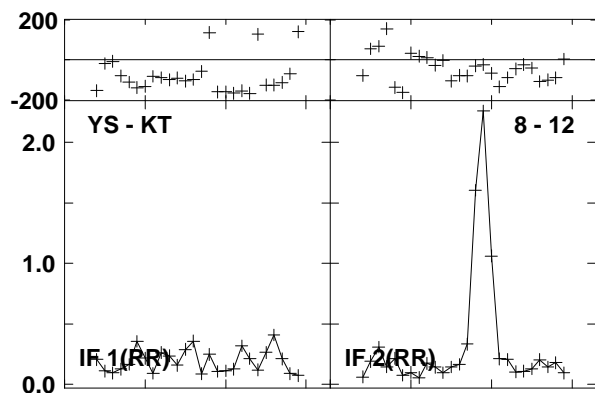
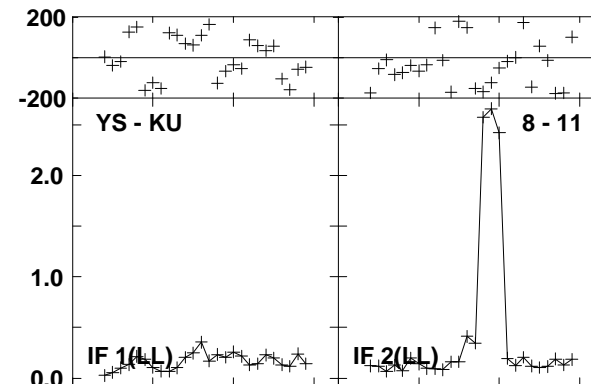
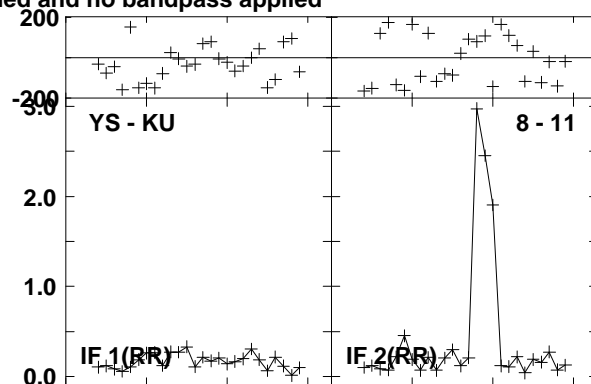
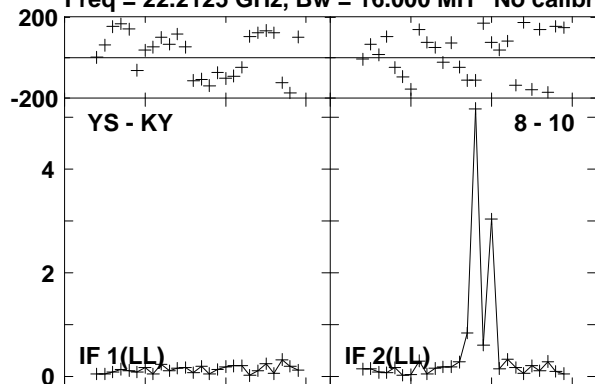

Lower frame: Milli Ampl Jy Top frame: Phas deg  
Vector averaged cross-power spectrum Baseline: YS (08) - KY (10)  
Timerange: 00/14:49:17 to 00/14:50:15

Plot file version 612 created 23-AUG-2016 15:01:04

0219+628 GA035B 1.UVDATA.1

Freq = 22.2125 GHz, Bw = 16.000 MH No calibration applied and no bandpass applied

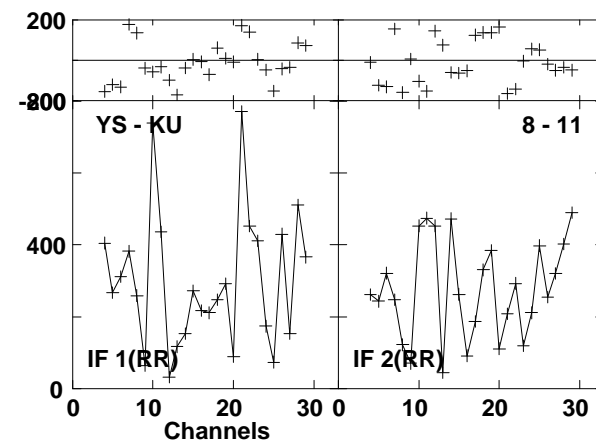
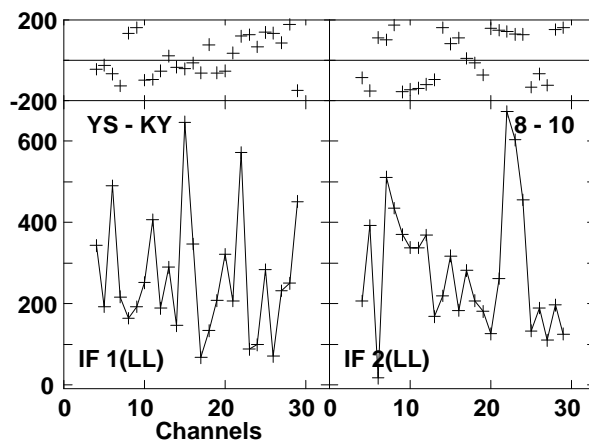
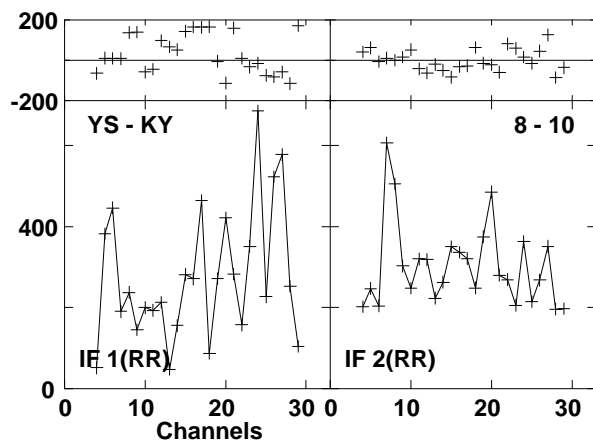
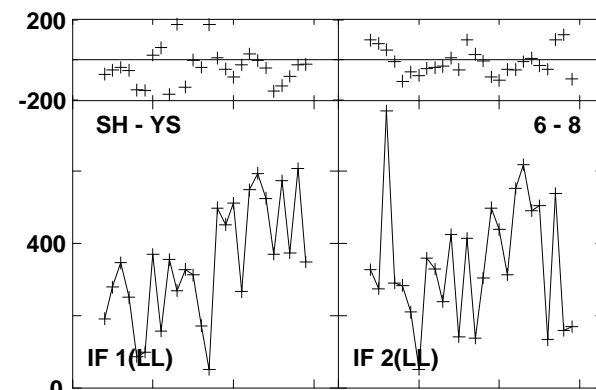
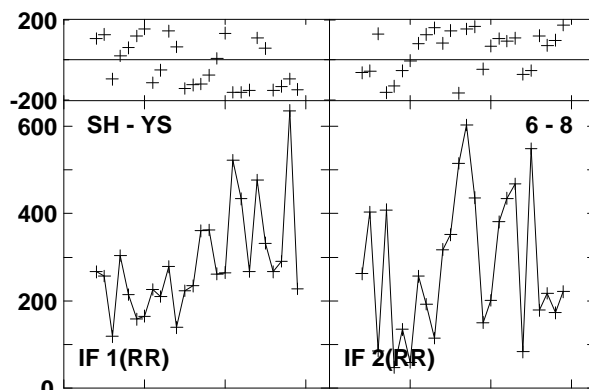
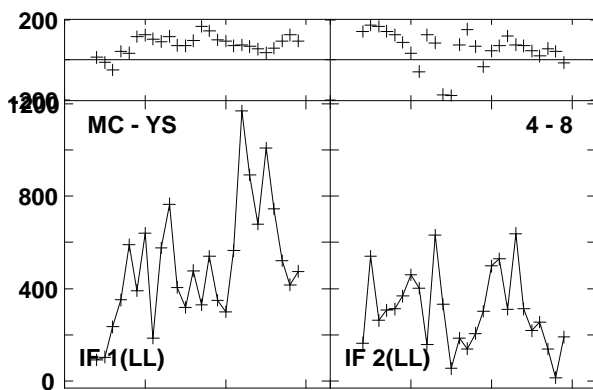
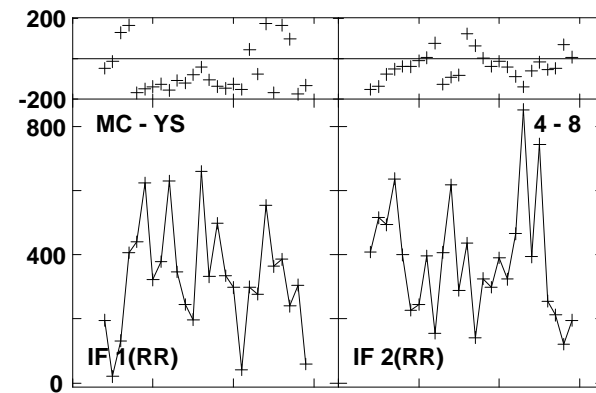
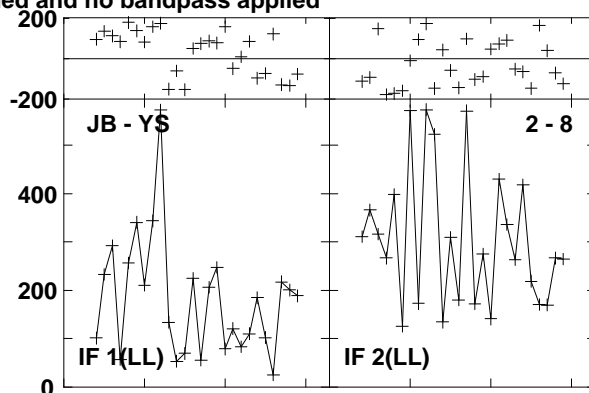
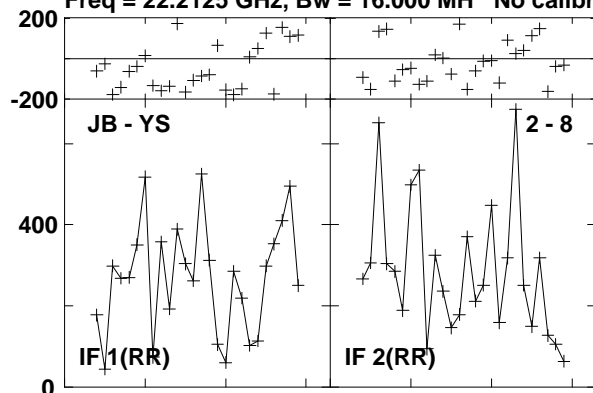

Lower frame: Micro Ampl Jy Top frame: Phas deg  
Vector averaged cross-power spectrum Baseline: JB (02) - YS (08)  
Timerange: 00/14:50:49 to 00/14:51:07

Plot file version 613 created 23-AUG-2016 15:01:04

0219+628 GA035B 1.UVDATA.1

Freq = 22.2125 GHz, Bw = 16.000 MH No calibration applied and no bandpass applied

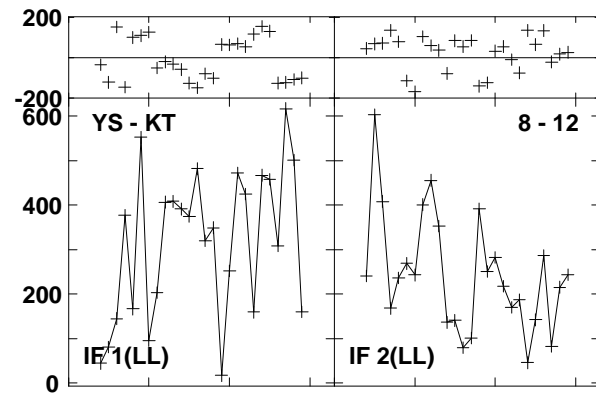
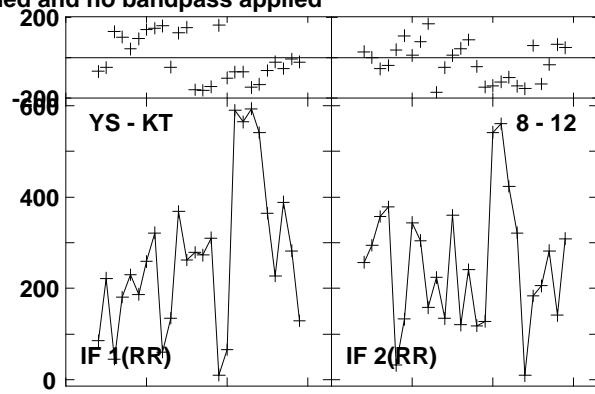
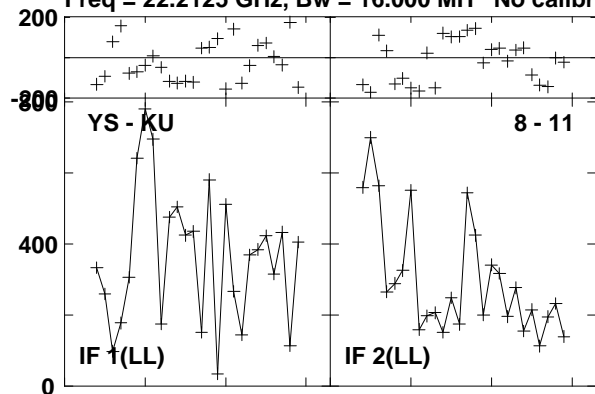

Lower frame: Micro Ampl Jy Top frame: Phas deg  
Vector averaged cross-power spectrum Baseline: YS (08) - KU (11)  
Timerange: 00/14:50:49 to 00/14:51:07

Plot file version 614 created 23-AUG-2016 15:01:04  
 W3IRS5 GA035B 1.UVDATA.1

Freq = 22.2125 GHz, Bw = 16.000 MH No calibration applied and no bandpass applied

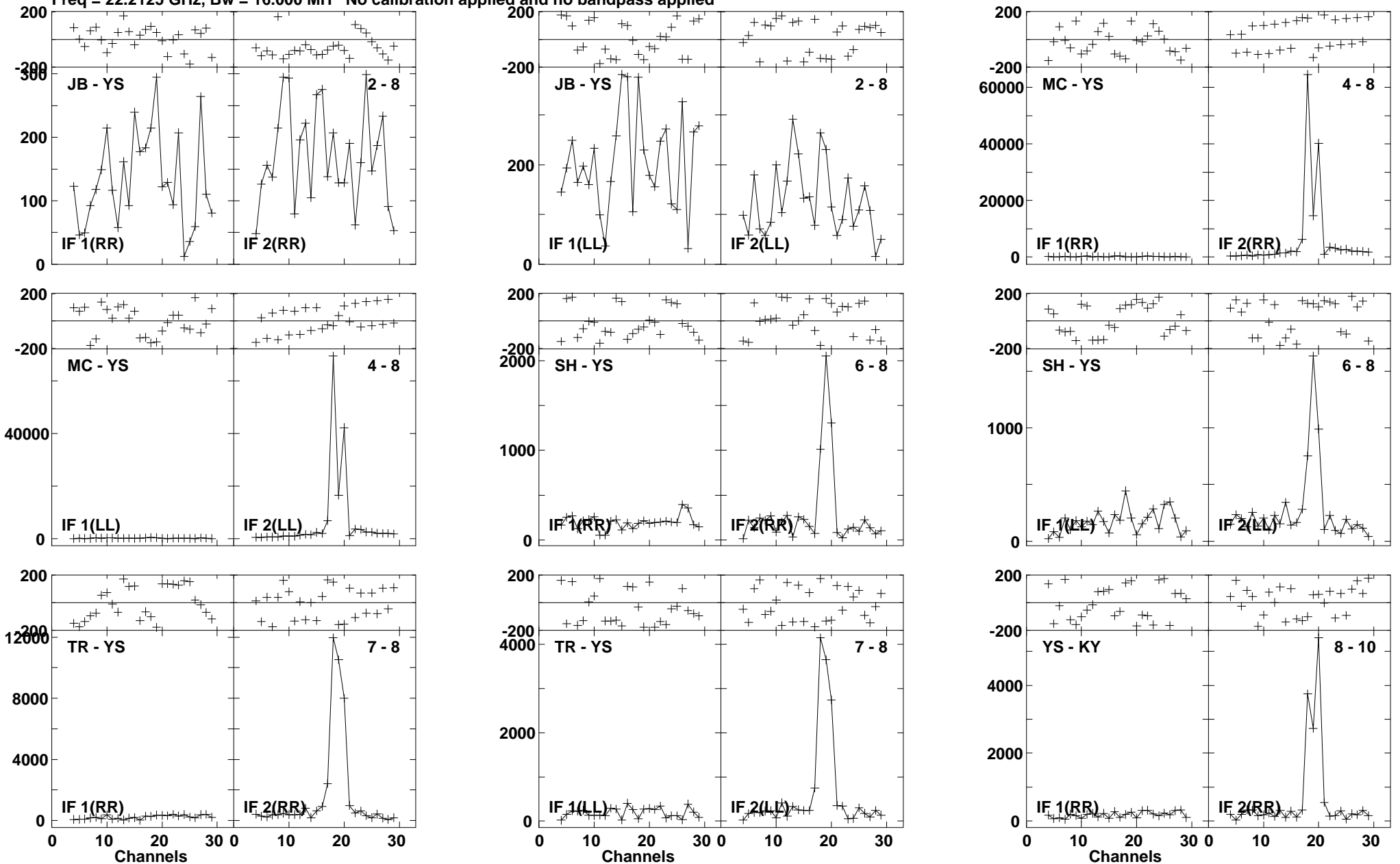

Lower frame: Micro Ampl Jy Top frame: Phas deg  
 Vector averaged cross-power spectrum Baseline: JB (02) - YS (08)  
 Timerange: 00/14:51:40 to 00/14:52:39

Plot file version 615 created 23-AUG-2016 15:01:04

W3IRS5 GA035B 1.UVDATA.1

Freq = 22.2125 GHz, Bw = 16.000 MH No calibration applied and no bandpass applied

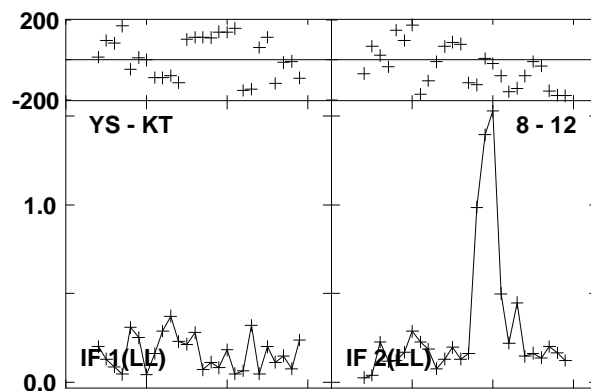
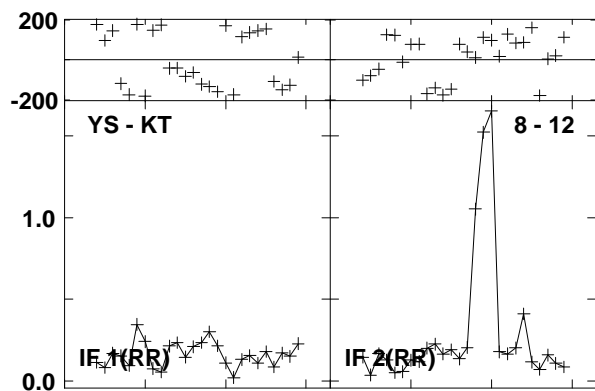
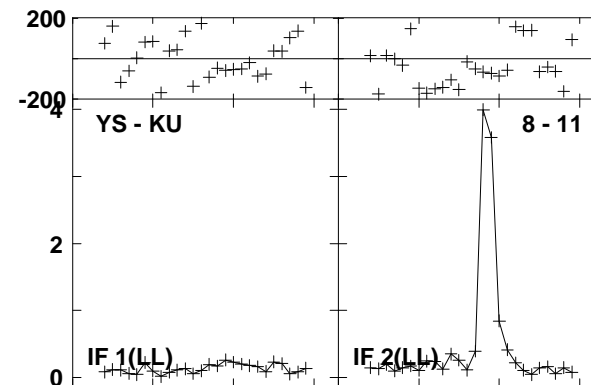
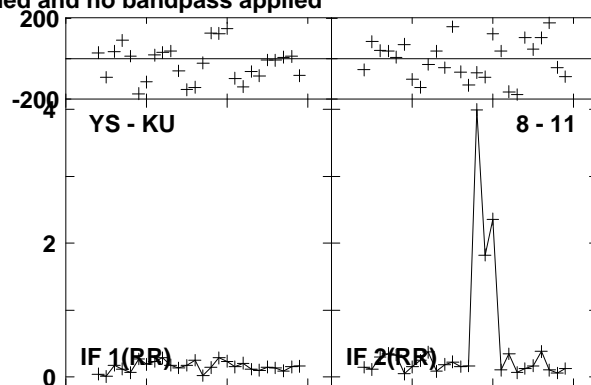
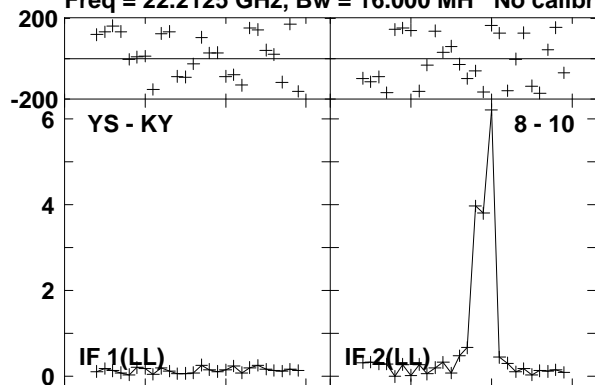

Lower frame: Milli Ampl Jy Top frame: Phas deg

Vector averaged cross-power spectrum Baseline: YS (08) - KY (10)

Timerange: 00/14:51:40 to 00/14:52:39

Plot file version 616 created 23-AUG-2016 15:01:04

0219+628 GA035B 1.UVDATA.1

Freq = 22.2125 GHz, Bw = 16.000 MH No calibration applied and no bandpass applied

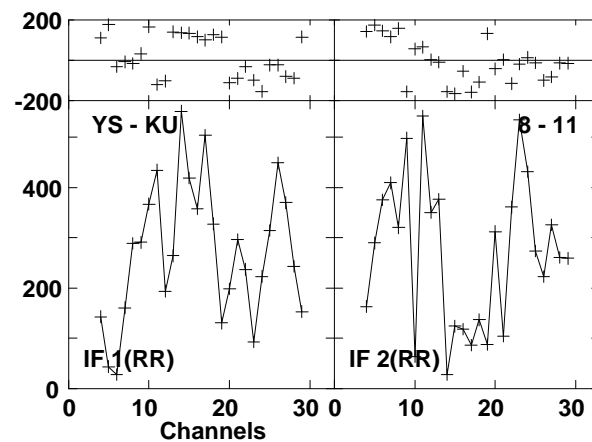
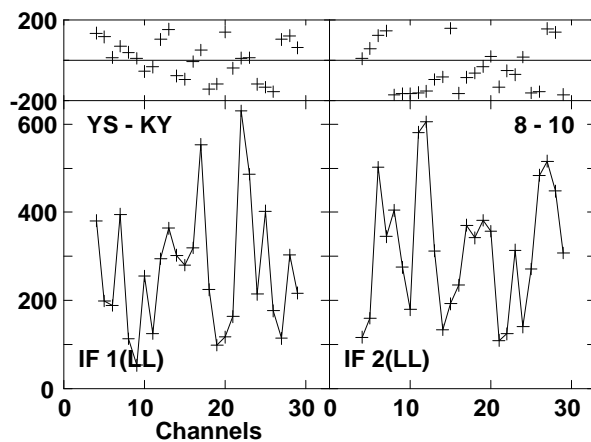
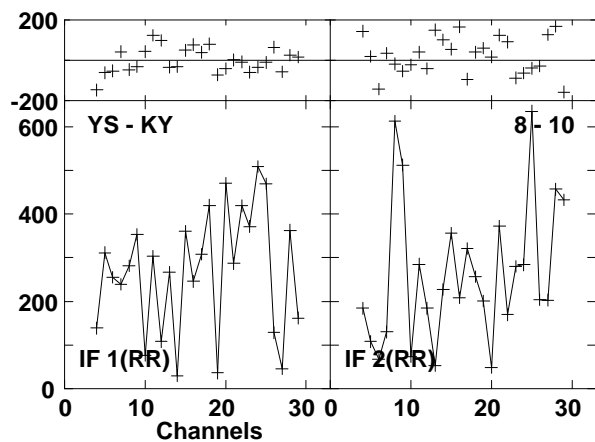
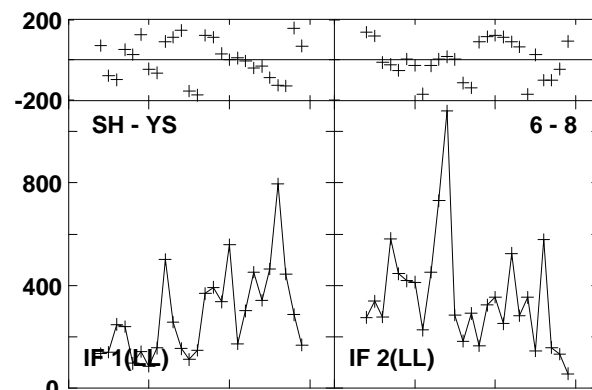
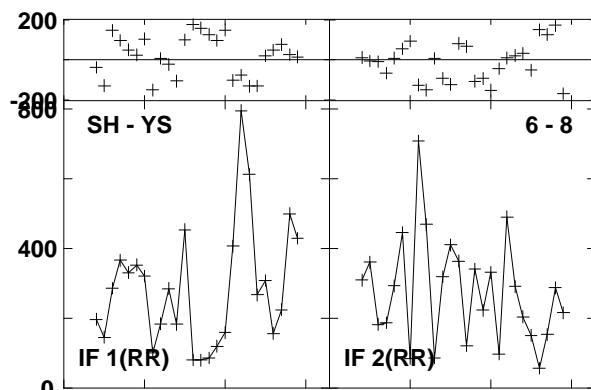
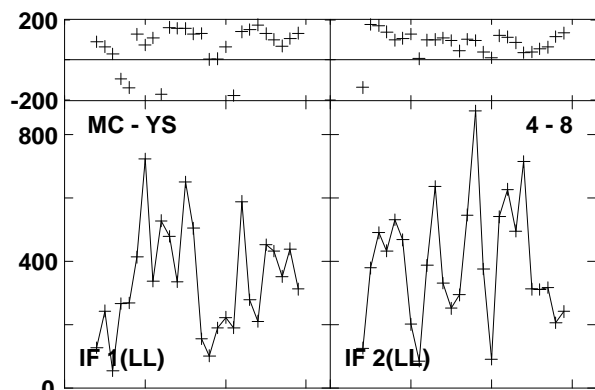
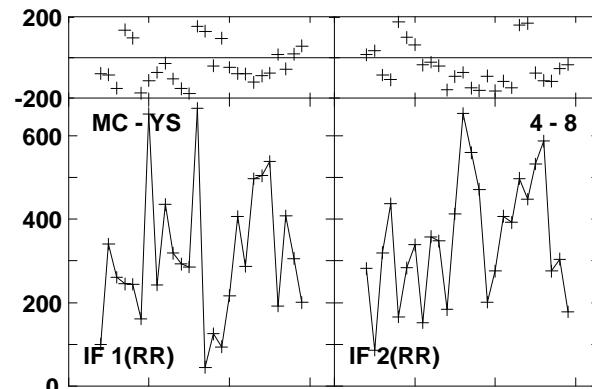
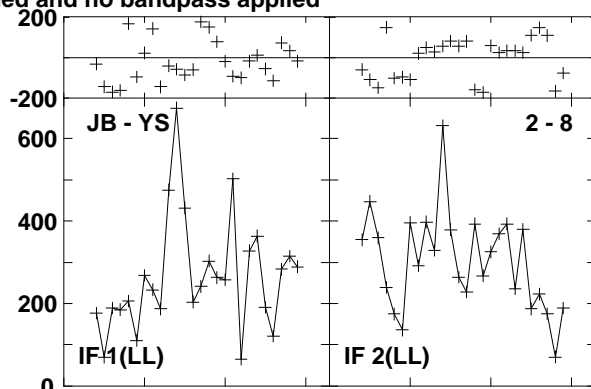
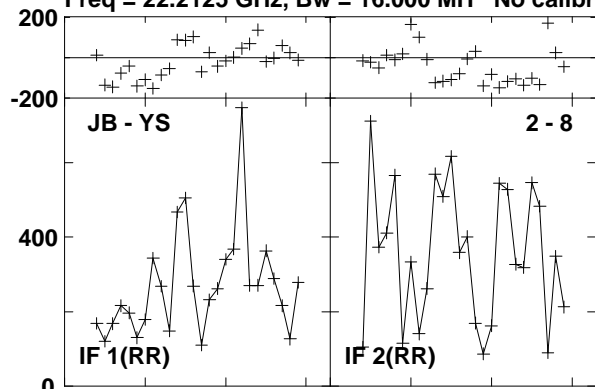

Lower frame: Micro Ampl Jy Top frame: Phas deg  
Vector averaged cross-power spectrum Baseline: JB (02) - YS (08)  
Timerange: 00/14:53:12 to 00/14:53:32



Plot file version 617 created 23-AUG-2016 15:01:04

0219+628 GA035B 1.UVDATA.1

Freq = 22.2125 GHz, Bw = 16.000 MH No calibration applied and no bandpass applied

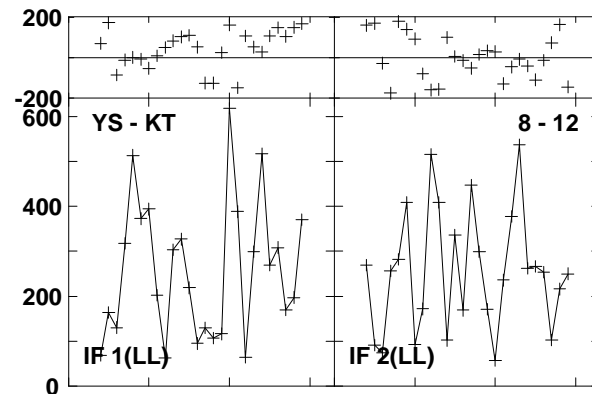
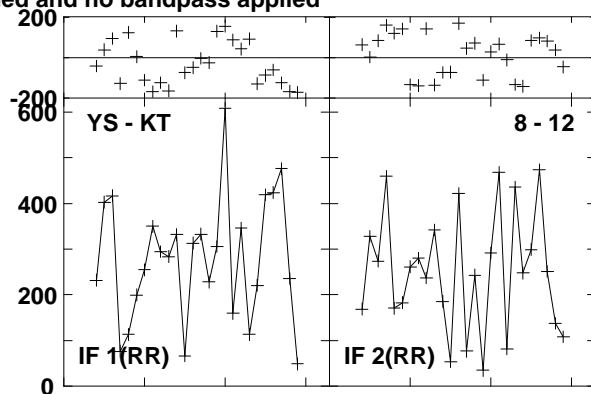
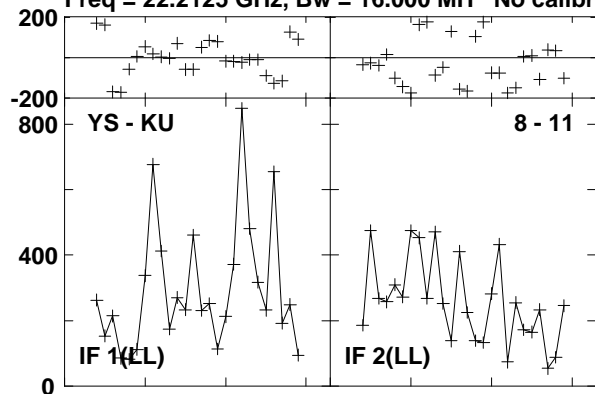

Lower frame: Micro Ampl Jy Top frame: Phas deg  
Vector averaged cross-power spectrum Baseline: YS (08) - KU (11)  
Timerange: 00/14:53:12 to 00/14:53:32

Plot file version 618 created 23-AUG-2016 15:01:04  
 W3IRS5 GA035B 1.UVDATA.1

Freq = 22.2125 GHz, Bw = 16.000 MH No calibration applied and no bandpass applied

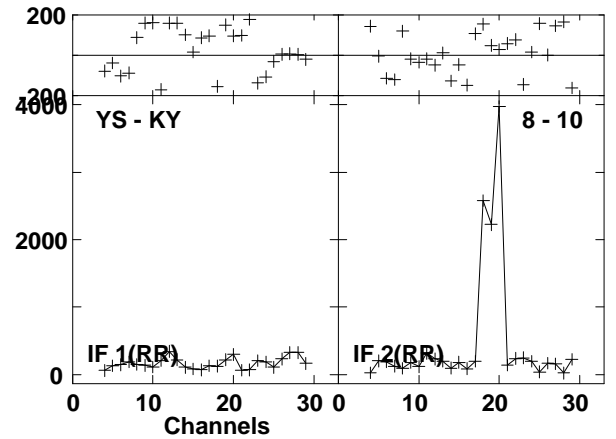
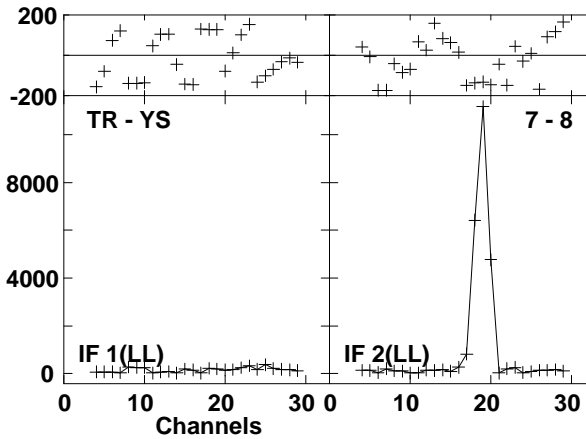
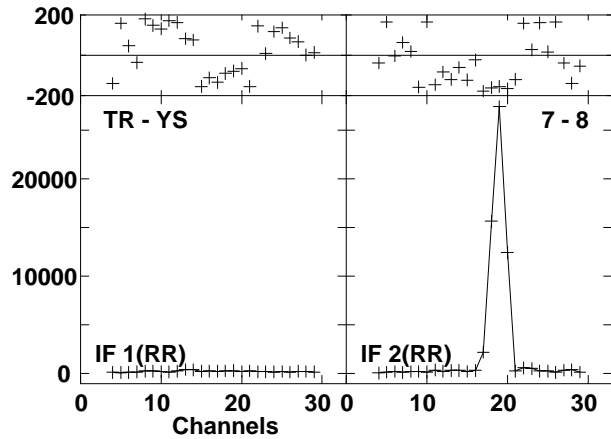
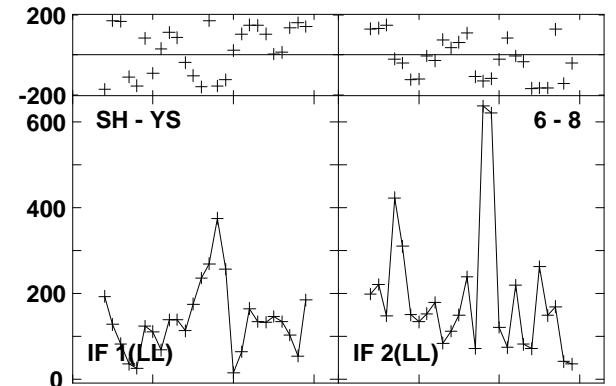
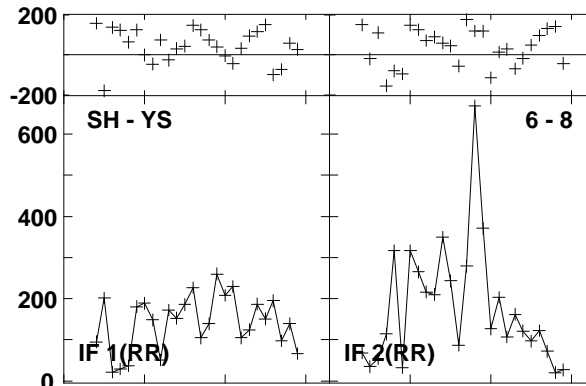
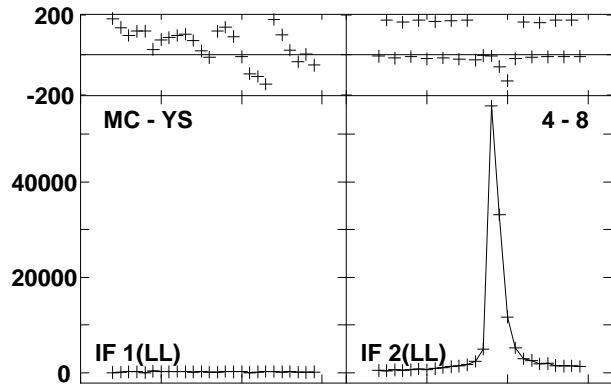
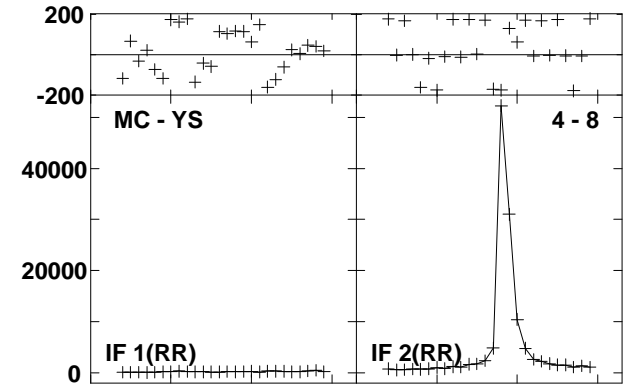
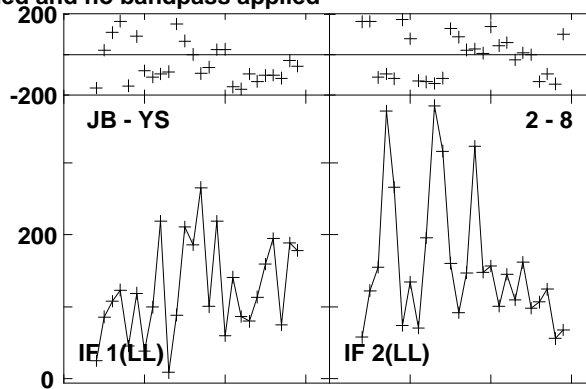
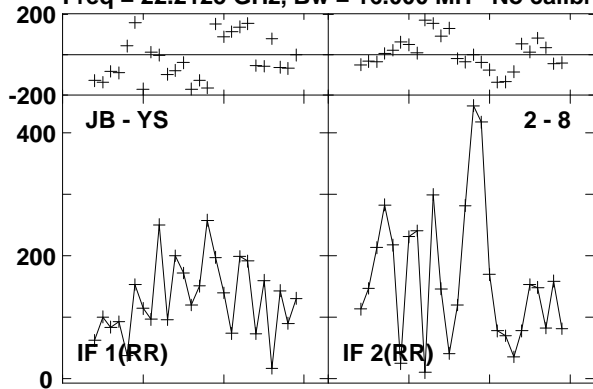

Lower frame: Micro Ampl Jy Top frame: Phas deg  
 Vector averaged cross-power spectrum Baseline: JB (02) - YS (08)  
 Timerange: 00/14:54:05 to 00/14:55:03

Plot file version 619 created 23-AUG-2016 15:01:04  
W3IRS5 GA035B 1.UVDATA.1

Freq = 22.2125 GHz, Bw = 16.000 MH No calibration applied and no bandpass applied

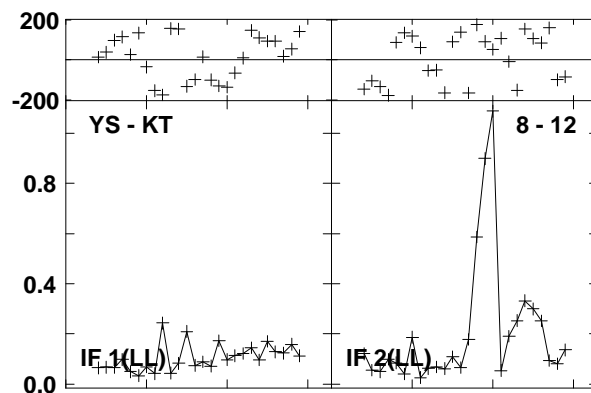
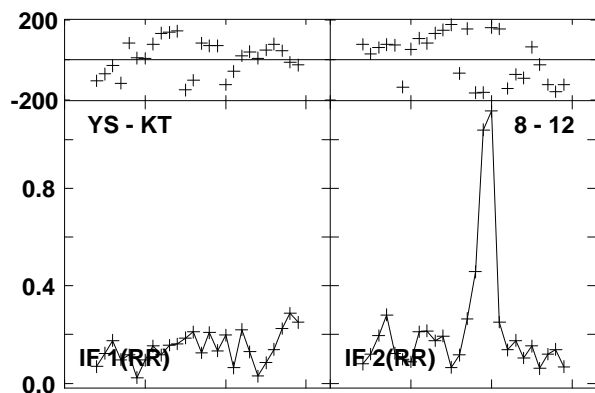
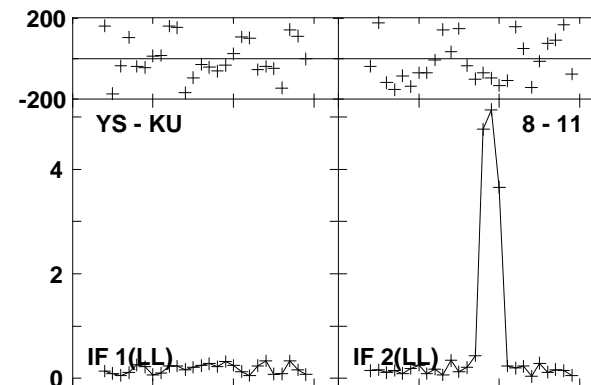
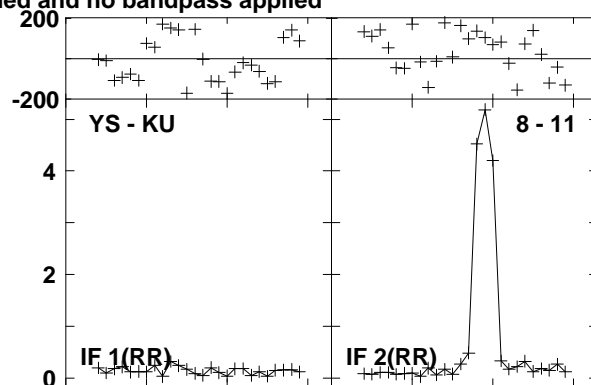
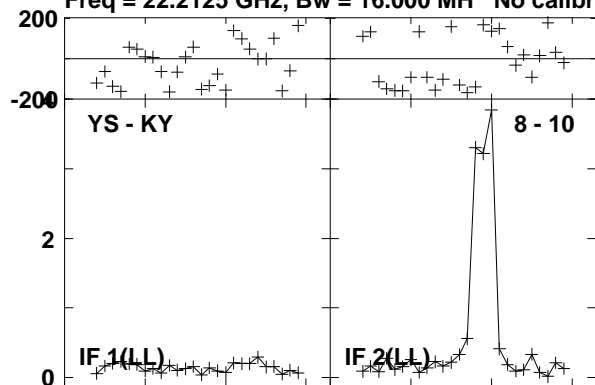

Lower frame: Milli Ampl Jy Top frame: Phas deg  
Vector averaged cross-power spectrum Baseline: YS (08) - KY (10)  
Timerange: 00/14:54:05 to 00/14:55:03

Plot file version 620 created 23-AUG-2016 15:01:04

0219+628 GA035B 1.UVDATA.1

Freq = 22.2125 GHz, Bw = 16.000 MH No calibration applied and no bandpass applied

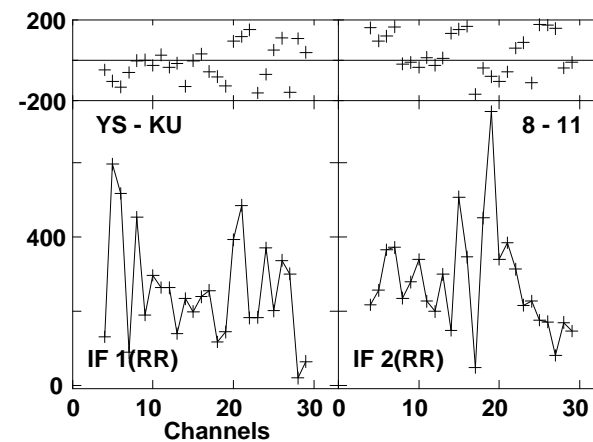
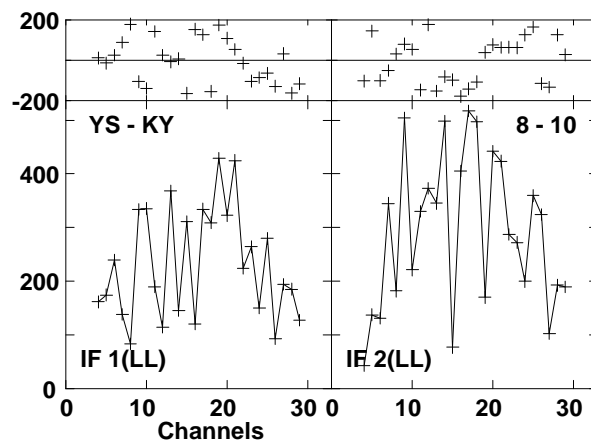
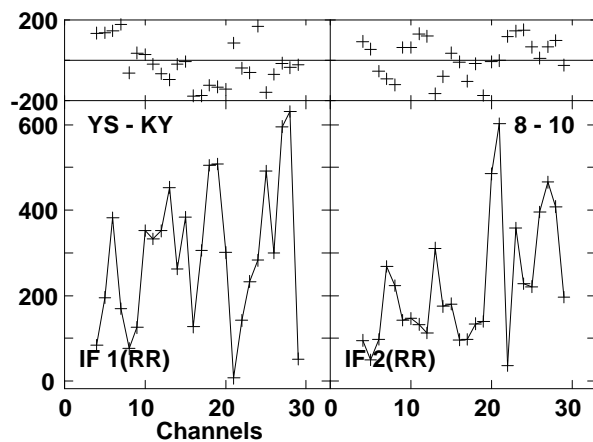
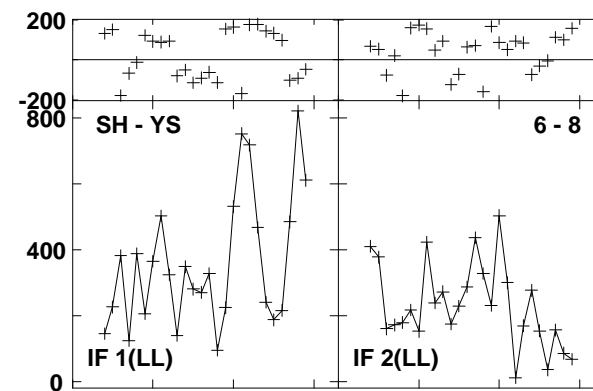
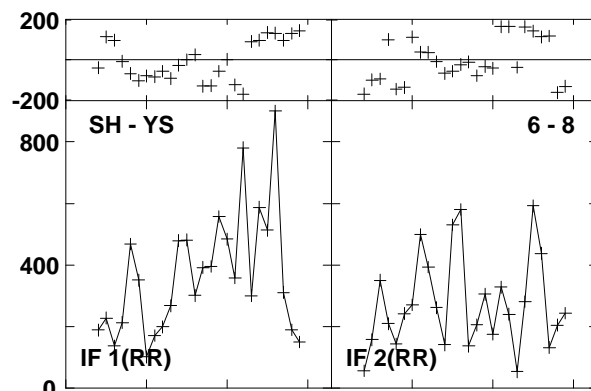
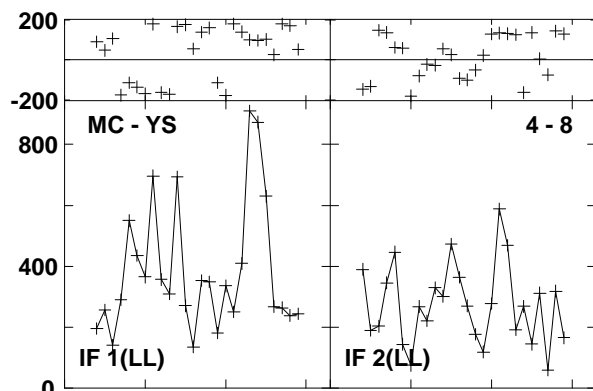
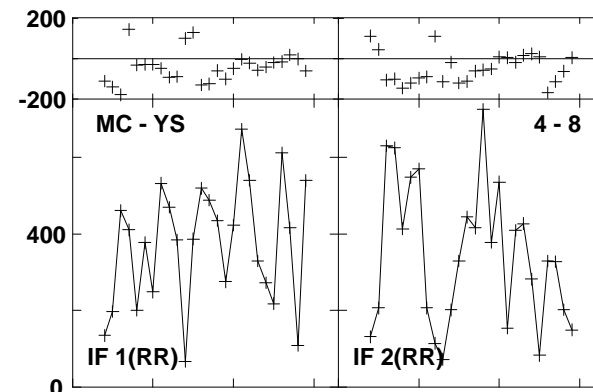
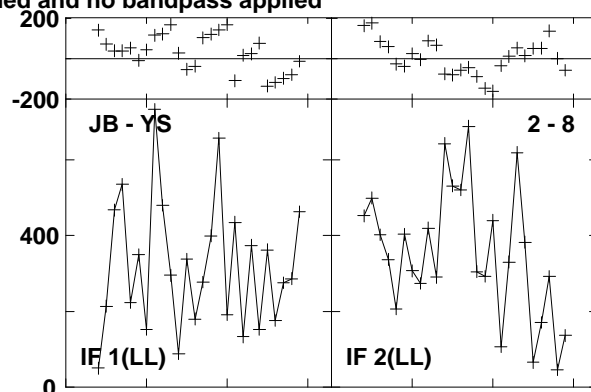
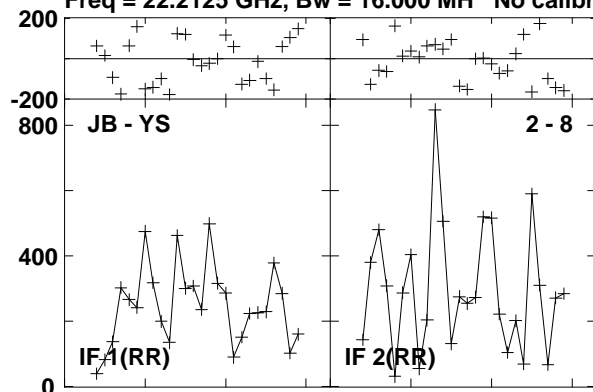

Lower frame: Micro Ampl Jy Top frame: Phas deg  
Vector averaged cross-power spectrum Baseline: JB (02) - YS (08)  
Timerange: 00/14:55:36 to 00/14:55:55

Plot file version 621 created 23-AUG-2016 15:01:04

0219+628 GA035B 1.UVDATA.1

Freq = 22.2125 GHz, Bw = 16.000 MH No calibration applied and no bandpass applied

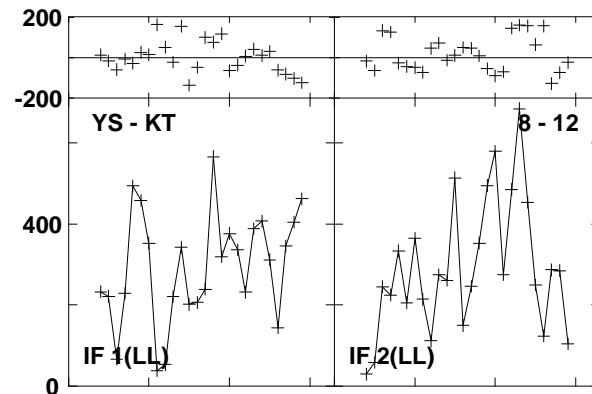
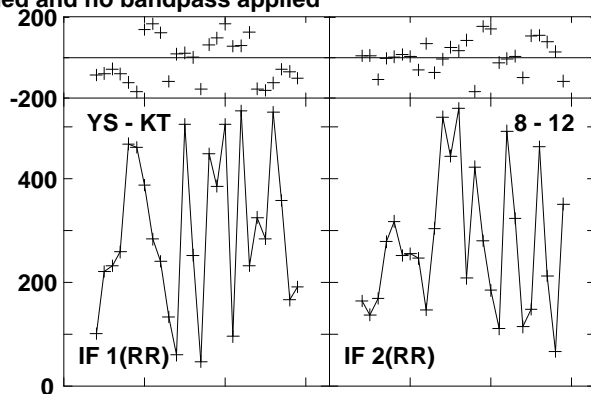
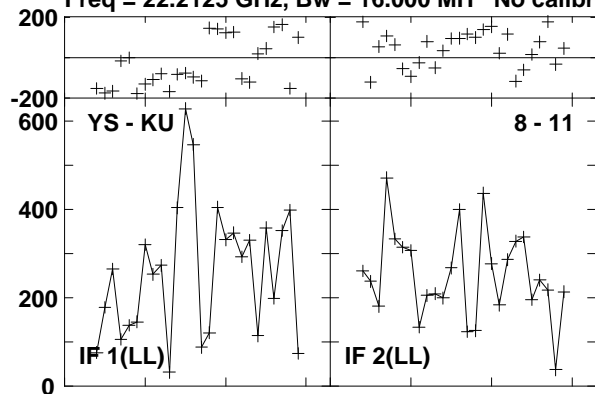

Lower frame: Micro Ampl Jy Top frame: Phas deg  
Vector averaged cross-power spectrum Baseline: YS (08) - KU (11)  
Timerange: 00/14:55:36 to 00/14:55:55

Plot file version 622 created 23-AUG-2016 15:01:04

W3IRS5 GA035B 1.UVDATA.1

Freq = 22.2125 GHz, Bw = 16.000 MH No calibration applied and no bandpass applied

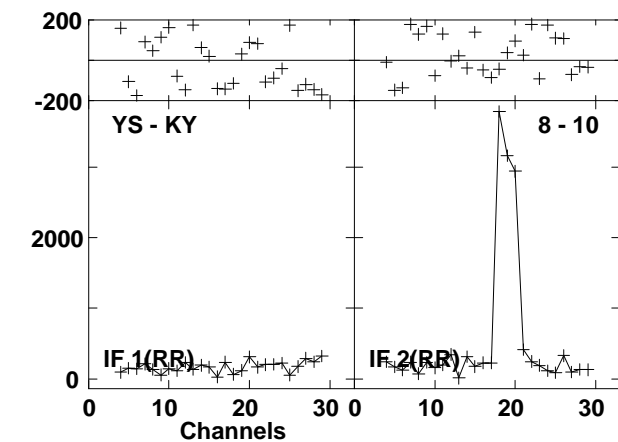
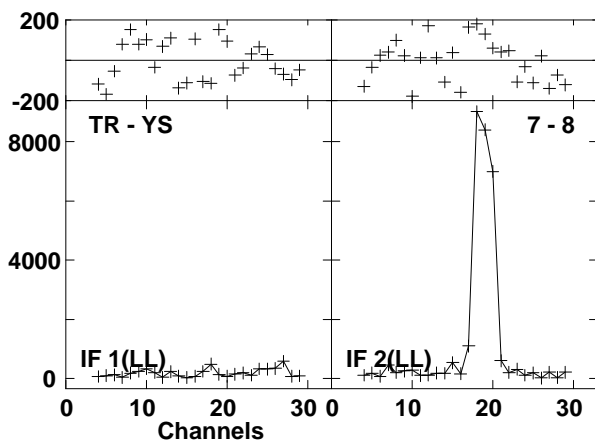
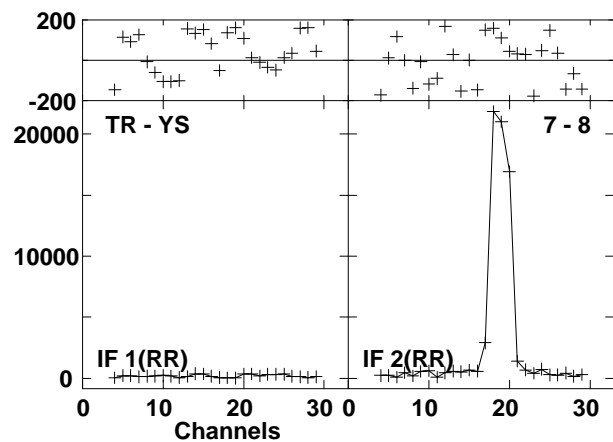
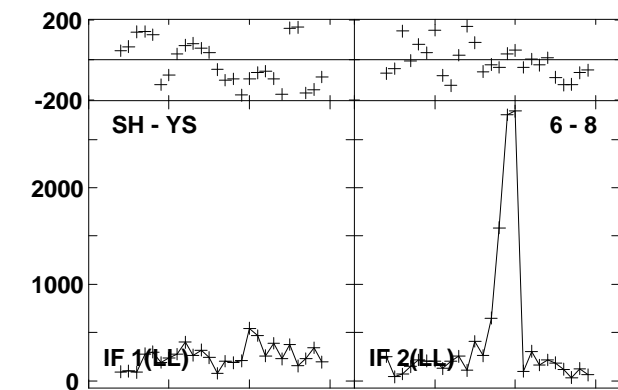
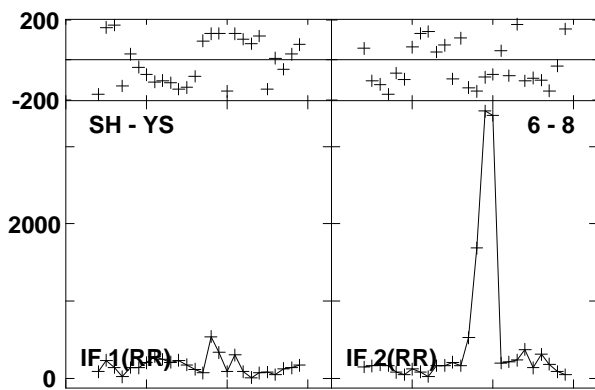
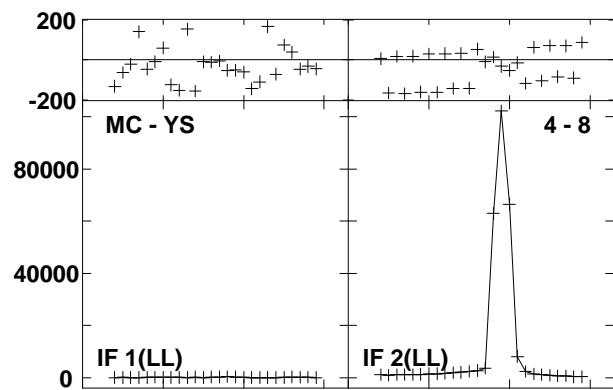
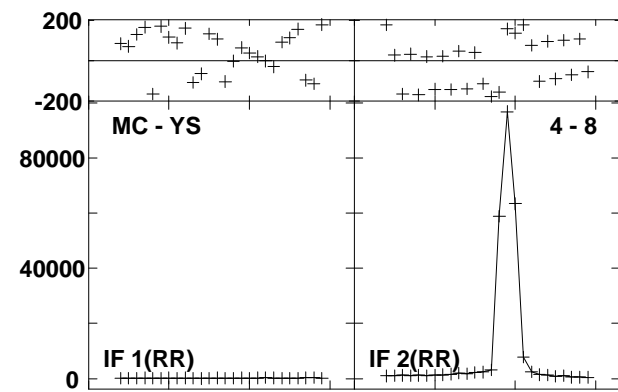
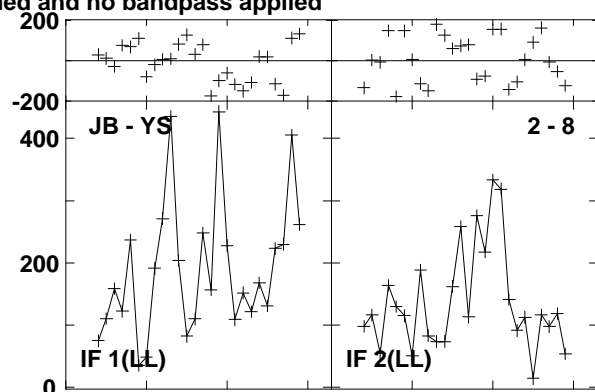
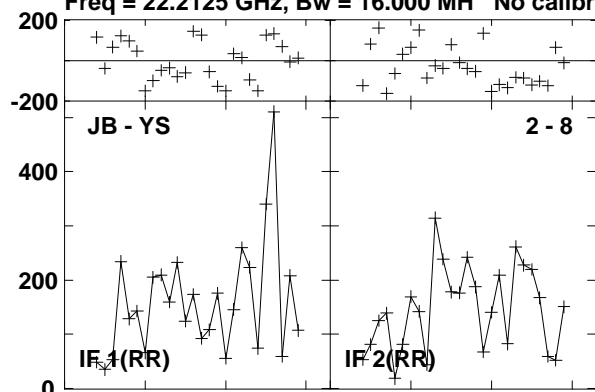

Lower frame: Micro Ampl Jy Top frame: Phas deg  
Vector averaged cross-power spectrum Baseline: JB (02) - YS (08)  
Timerange: 00/14:56:28 to 00/14:57:27

Plot file version 623 created 23-AUG-2016 15:01:04

W3IRS5 GA035B 1.UVDATA.1

Freq = 22.2125 GHz, Bw = 16.000 MH No calibration applied and no bandpass applied

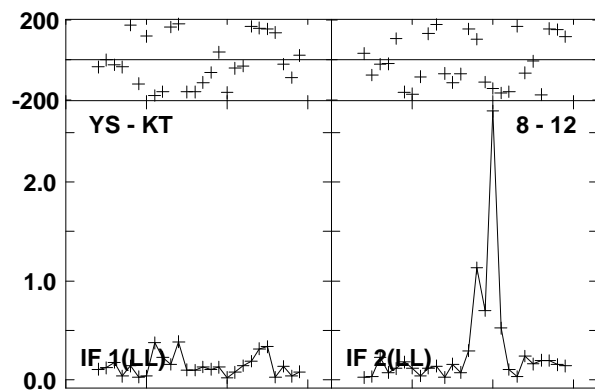
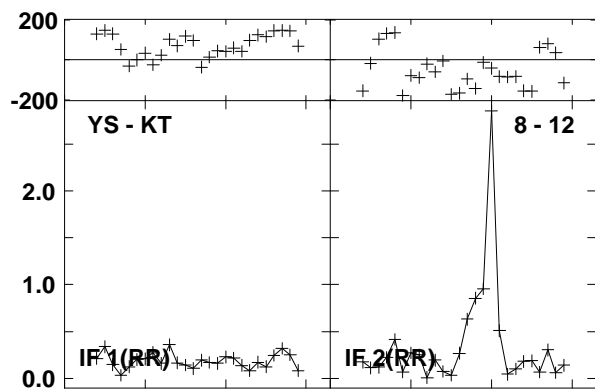
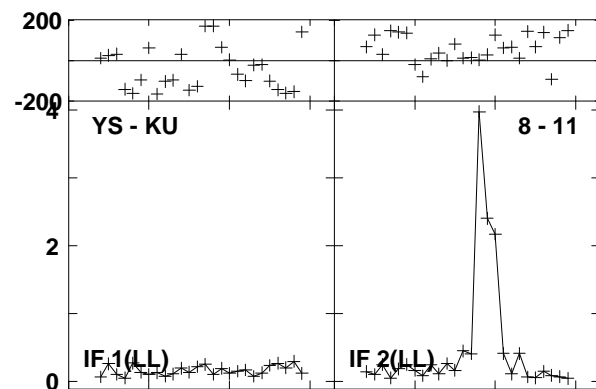
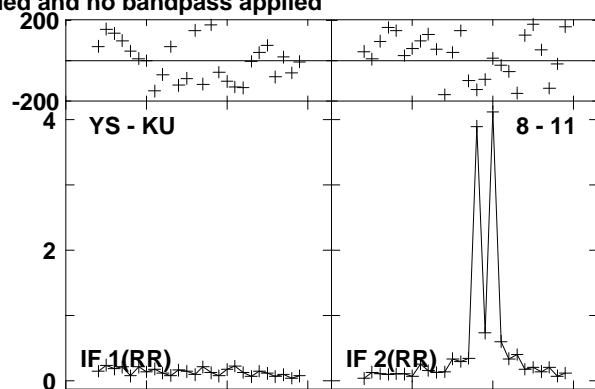
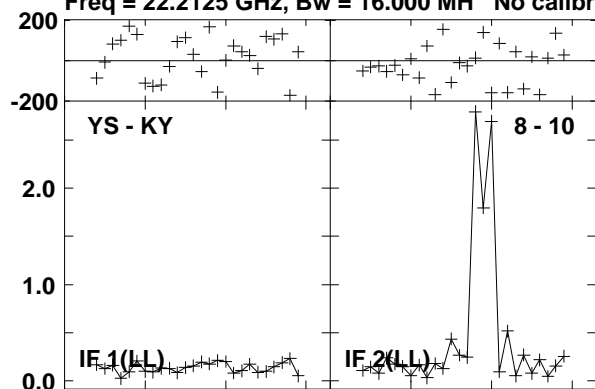

Lower frame: Milli Ampl Jy Top frame: Phas deg  
Vector averaged cross-power spectrum Baseline: YS (08) - KY (10)  
Timerange: 00/14:56:28 to 00/14:57:27

Plot file version 624 created 23-AUG-2016 15:01:04

0241+622 GA035B 1.UVDATA.1

Freq = 22.2125 GHz, Bw = 16.000 MH No calibration applied and no bandpass applied

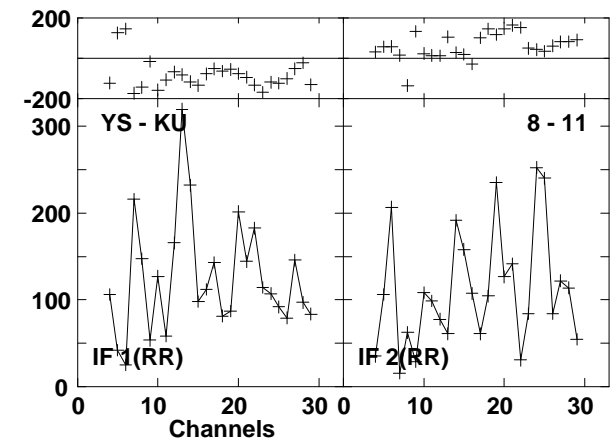
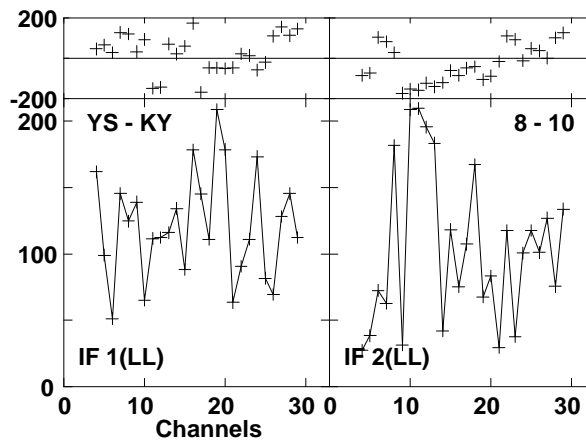
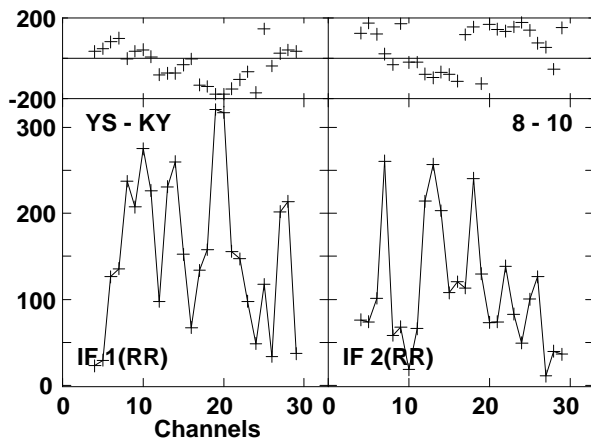
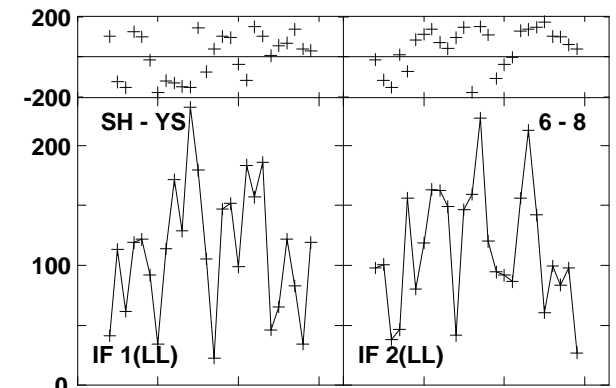
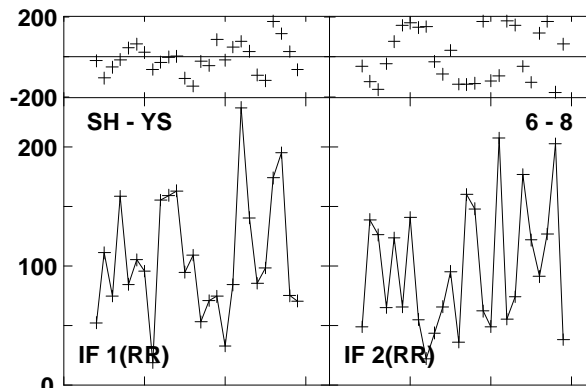
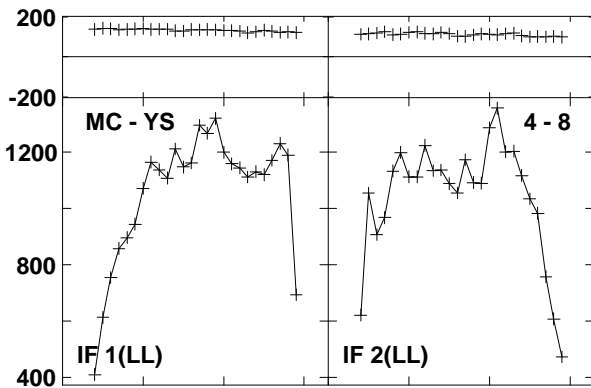
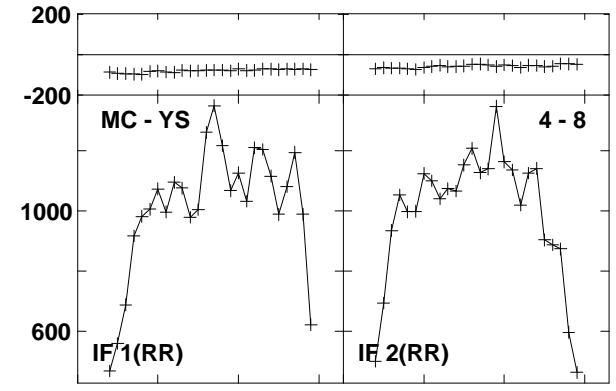
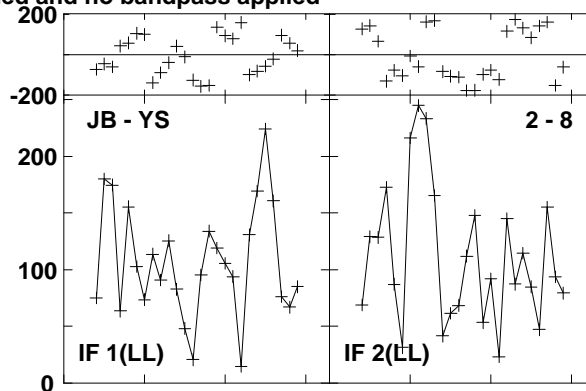
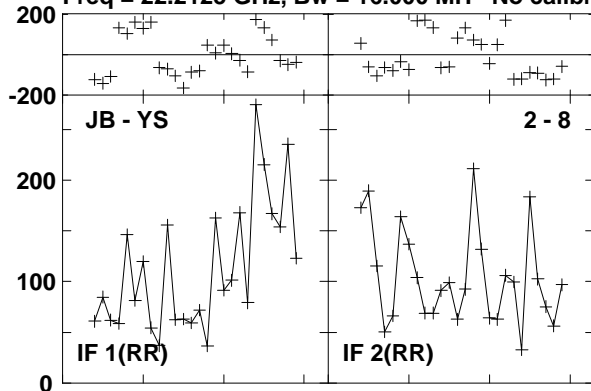

Lower frame: Micro Ampl Jy Top frame: Phas deg  
Vector averaged cross-power spectrum Baseline: JB (02) - YS (08)  
Timerange: 00/14:58:08 to 00/15:00:07



Plot file version 625 created 23-AUG-2016 15:01:04

0241+622 GA035B 1.UVDATA.1

Freq = 22.2125 GHz, Bw = 16.000 MH No calibration applied and no bandpass applied

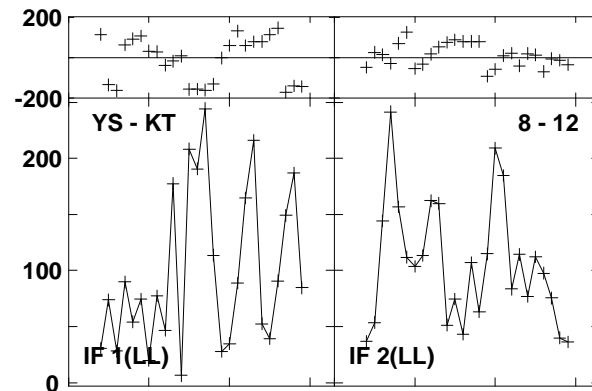
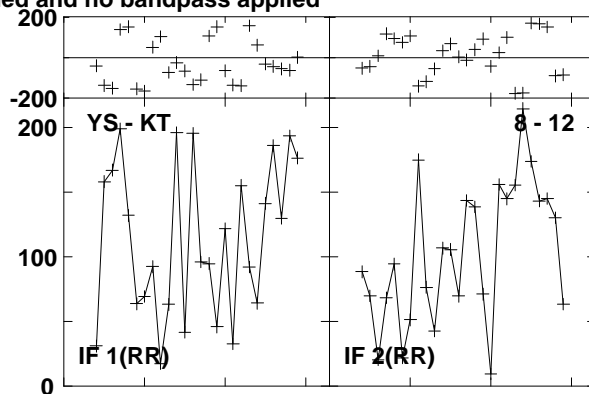
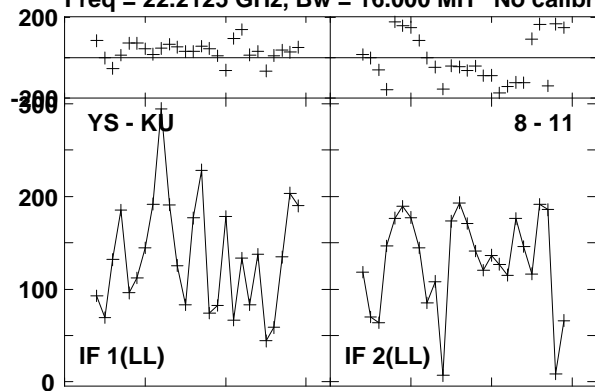

Lower frame: Micro Ampl Jy Top frame: Phas deg  
Vector averaged cross-power spectrum Baseline: YS (08) - KU (11)  
Timerange: 00/14:58:08 to 00/15:00:07

Plot file version 626 created 23-AUG-2016 15:01:04

W3IRS5 GA035B 1.UVDATA.1

Freq = 22.2125 GHz, Bw = 16.000 MH No calibration applied and no bandpass applied

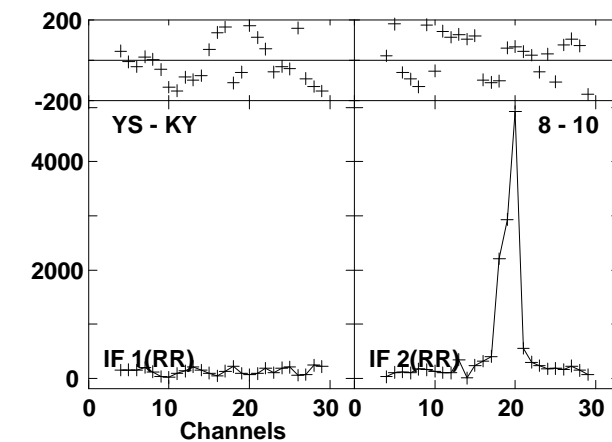
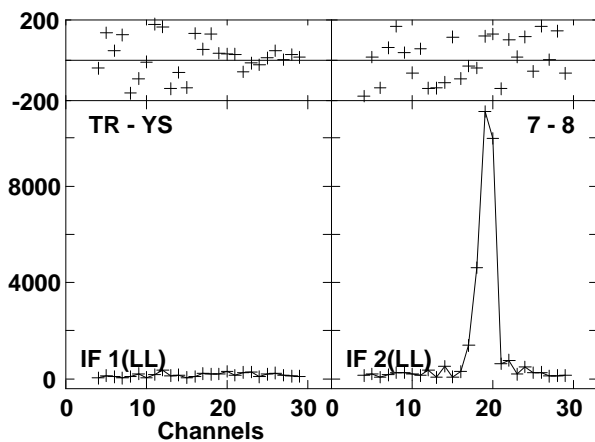
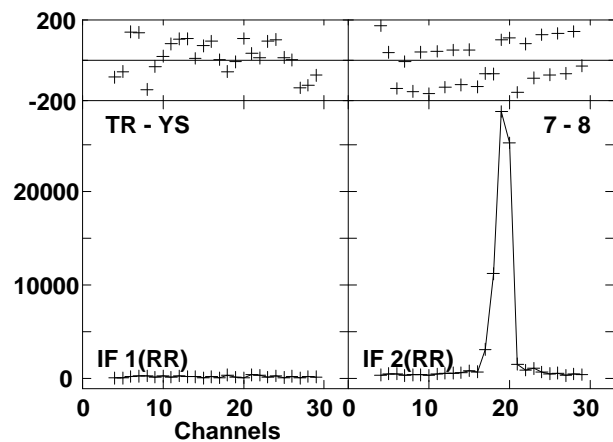
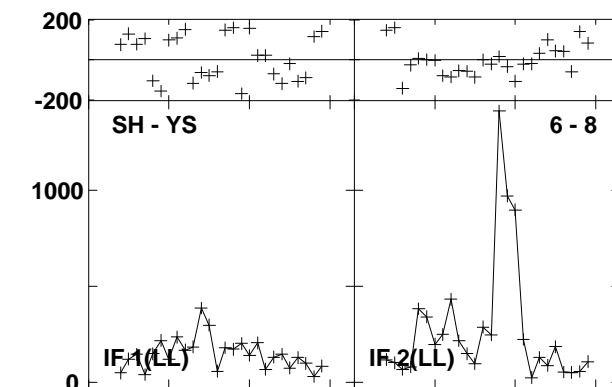
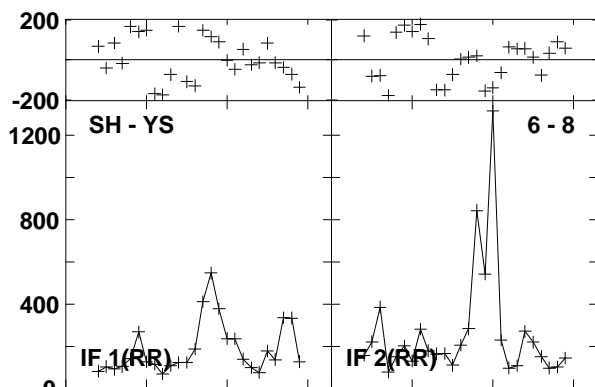
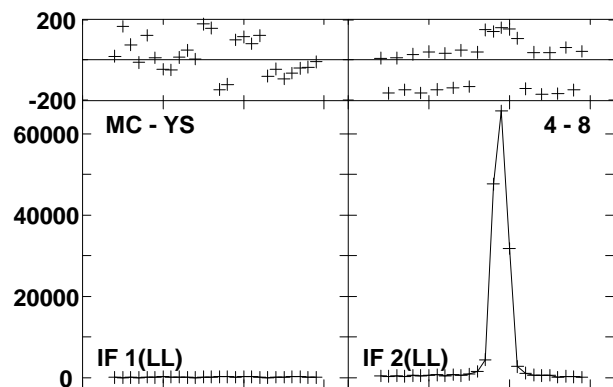
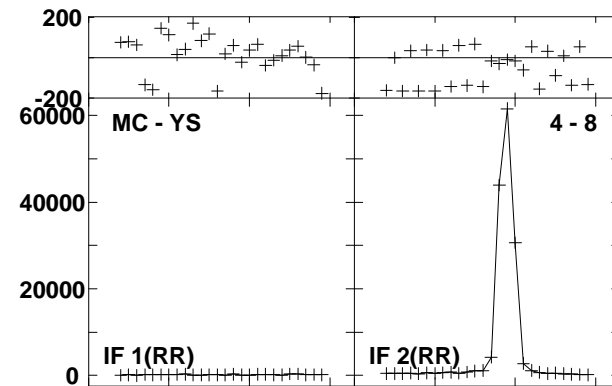
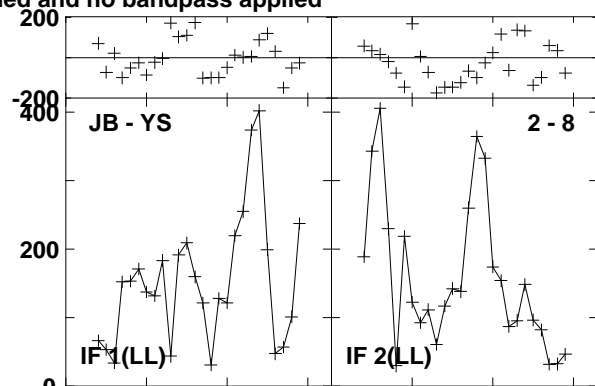
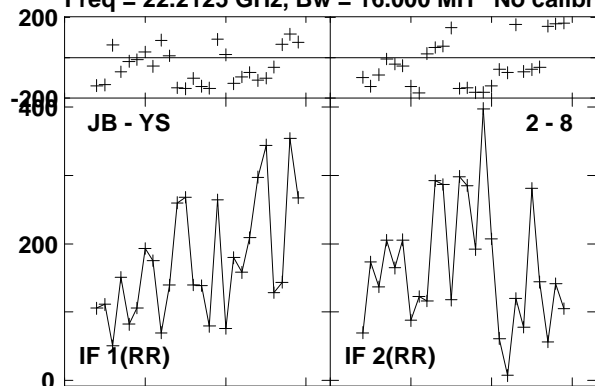

Lower frame: Micro Ampl Jy Top frame: Phas deg  
Vector averaged cross-power spectrum Baseline: JB (02) - YS (08)  
Timerange: 00/15:00:39 to 00/15:01:37

Plot file version 627 created 23-AUG-2016 15:01:04  
W3IRS5 GA035B 1.UVDATA.1

Freq = 22.2125 GHz, Bw = 16.000 MH No calibration applied and no bandpass applied

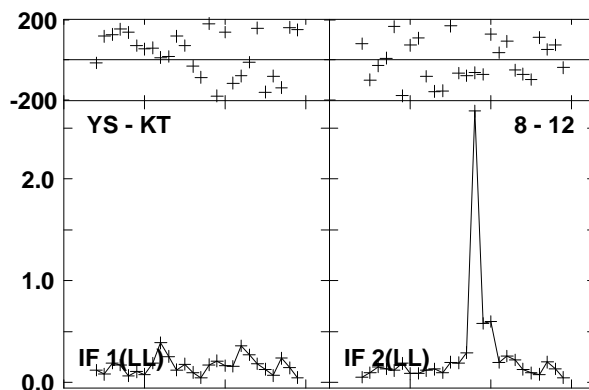
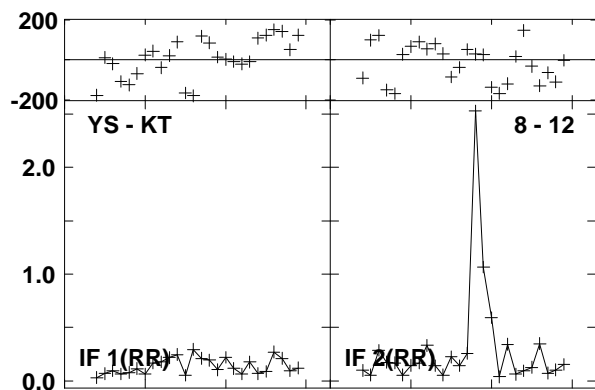
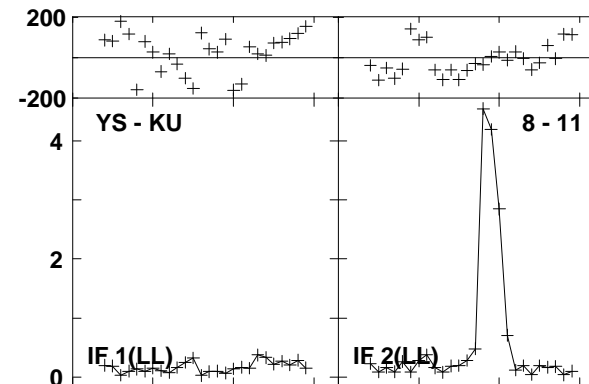
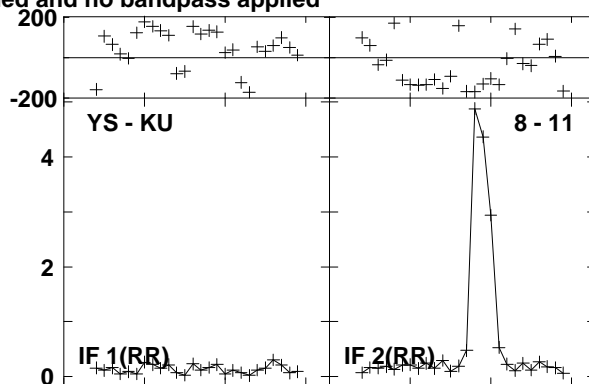
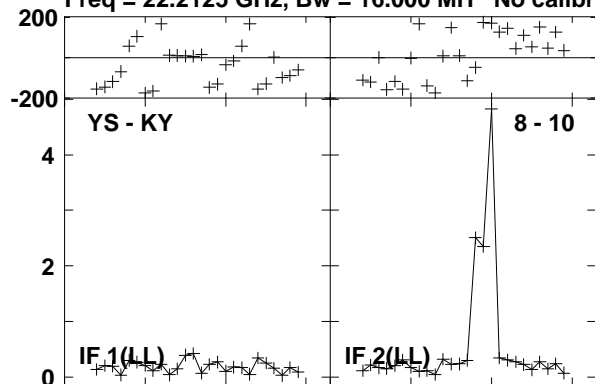

Lower frame: Milli Ampl Jy Top frame: Phas deg  
Vector averaged cross-power spectrum Baseline: YS (08) - KY (10)  
Timerange: 00/15:00:39 to 00/15:01:37

Plot file version 628 created 23-AUG-2016 15:01:04

0219+628 GA035B 1.UVDATA.1

Freq = 22.2125 GHz, Bw = 16.000 MH No calibration applied and no bandpass applied

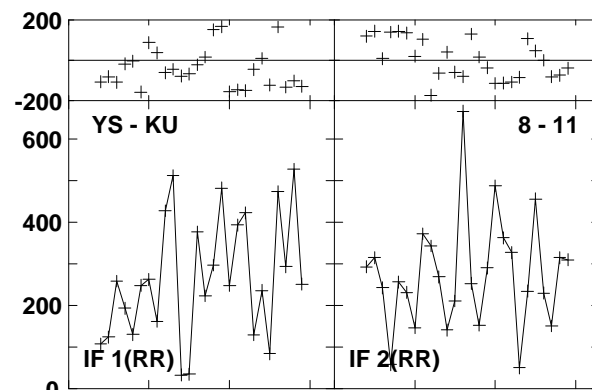
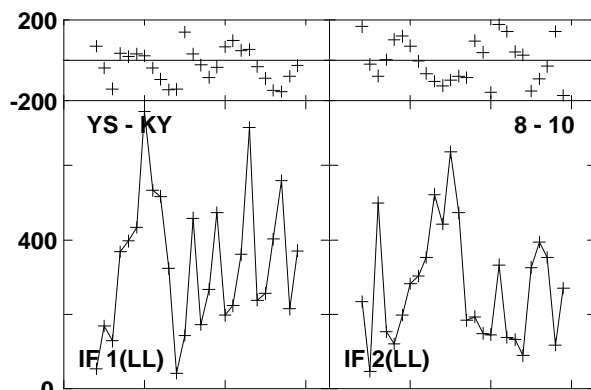
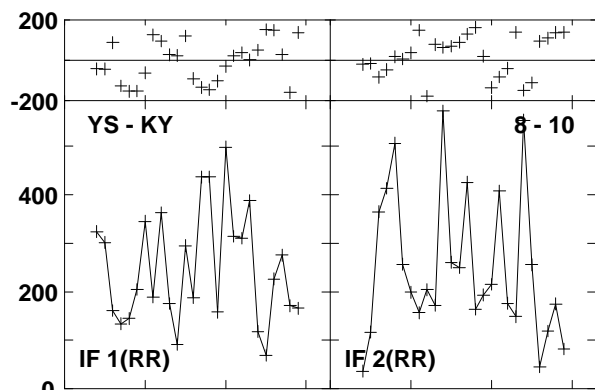
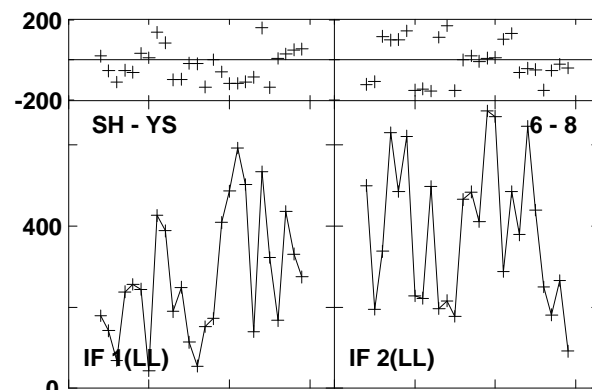
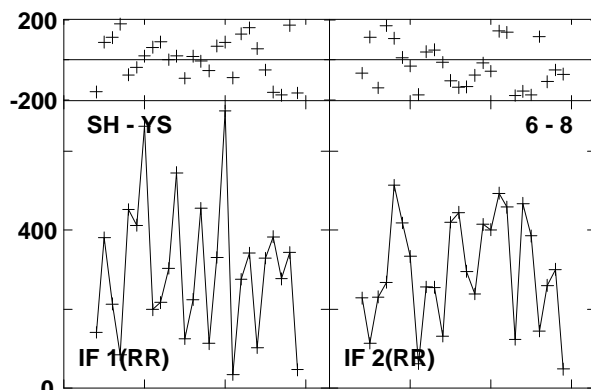
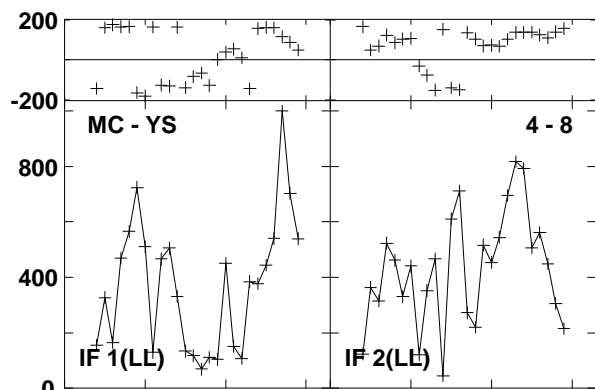
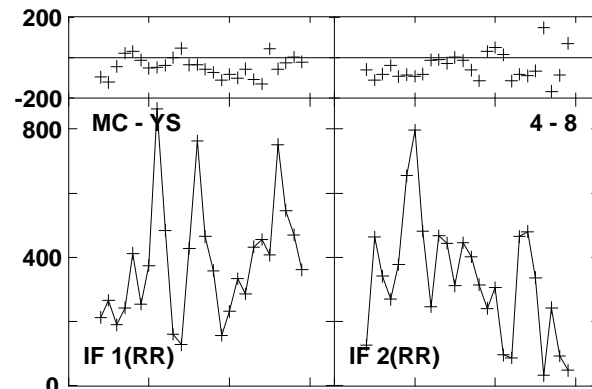
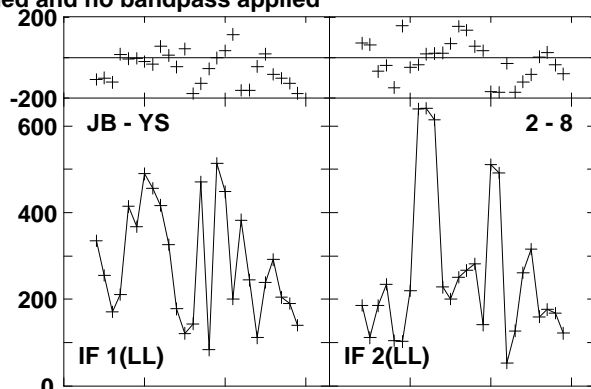
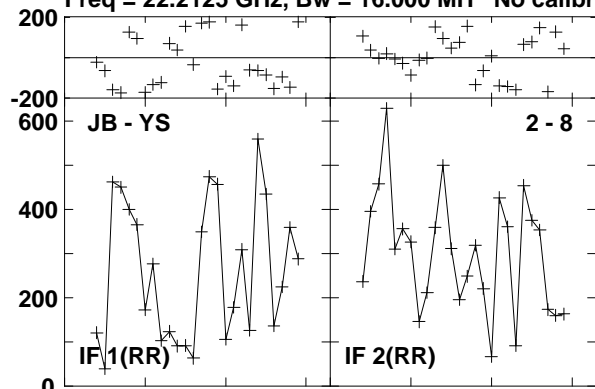

Channels

Lower frame: Micro Ampl Jy Top frame: Phas deg

Vector averaged cross-power spectrum Baseline: JB (02) - YS (08)

Timerange: 00/15:02:08 to 00/15:02:28

Plot file version 629 created 23-AUG-2016 15:01:04

0219+628 GA035B 1.UVDATA.1

Freq = 22.2125 GHz, Bw = 16.000 MH No calibration applied and no bandpass applied

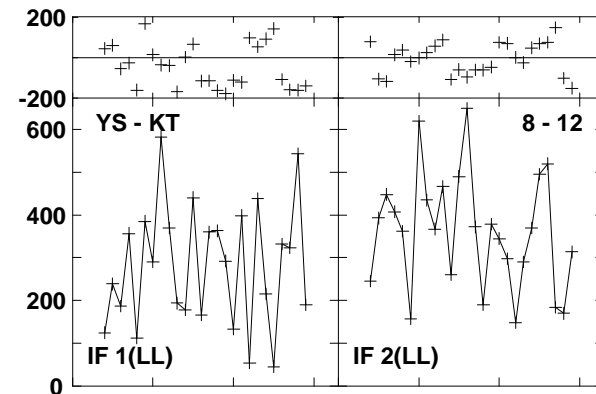
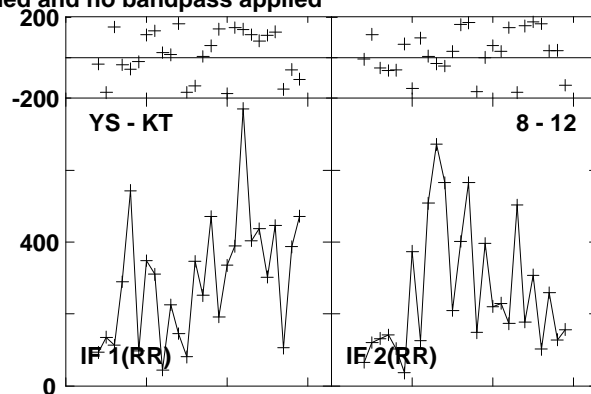
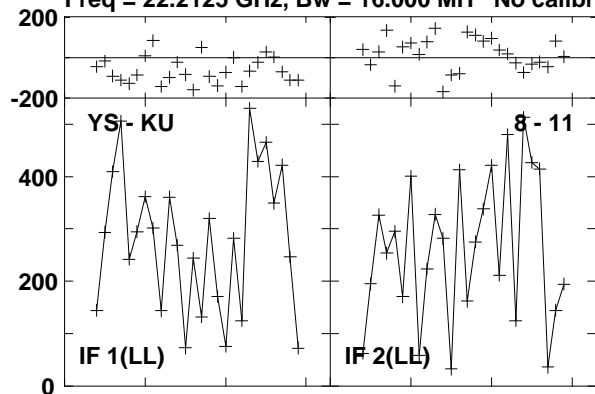

Lower frame: Micro Ampl Jy Top frame: Phas deg  
Vector averaged cross-power spectrum Baseline: YS (08) - KU (11)  
Timerange: 00/15:02:08 to 00/15:02:28

Plot file version 630 created 23-AUG-2016 15:01:04  
 W3IRS5 GA035B 1.UVDATA.1

Freq = 22.2125 GHz, Bw = 16.000 MH No calibration applied and no bandpass applied

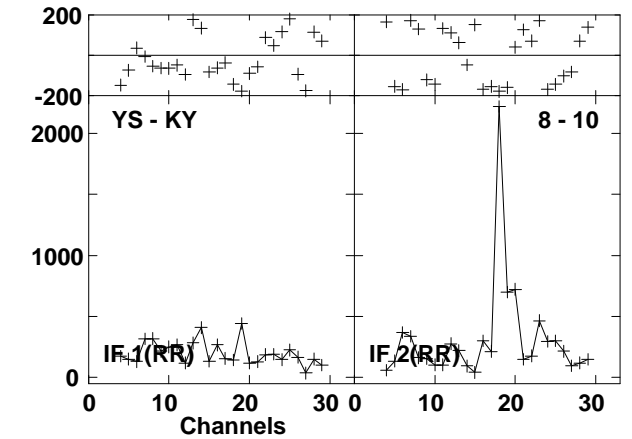
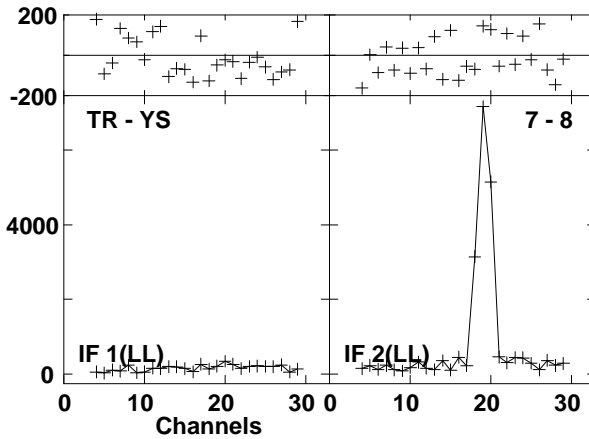
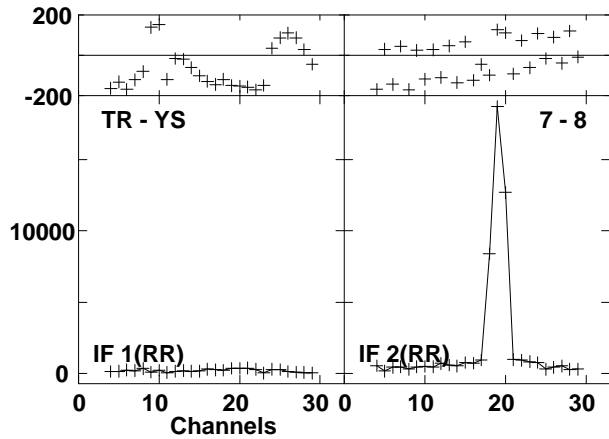
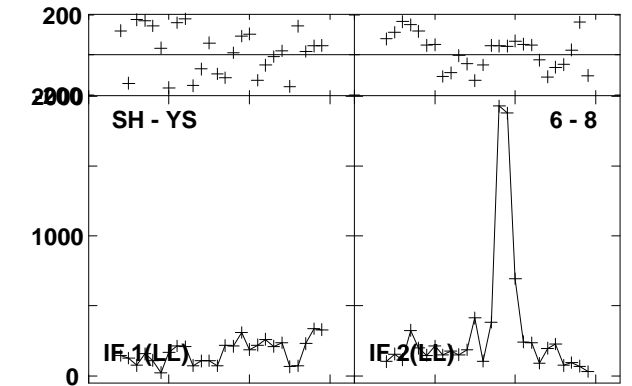
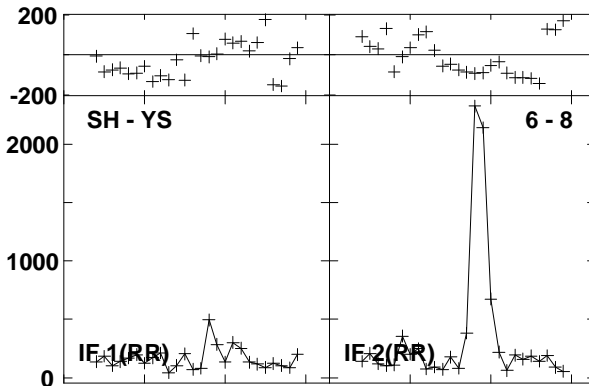
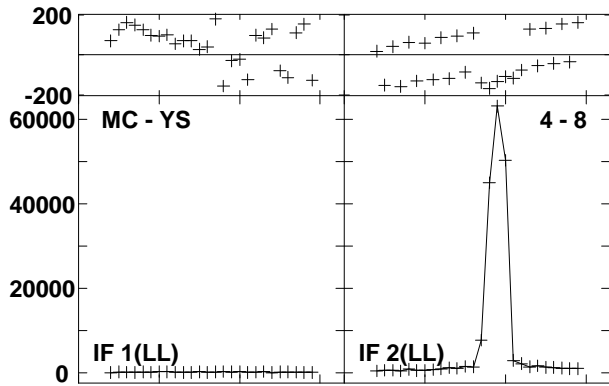
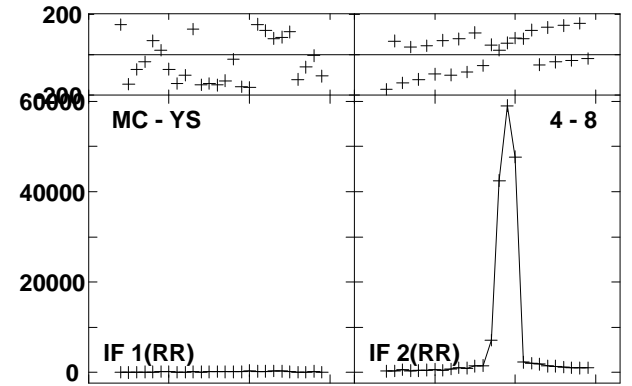
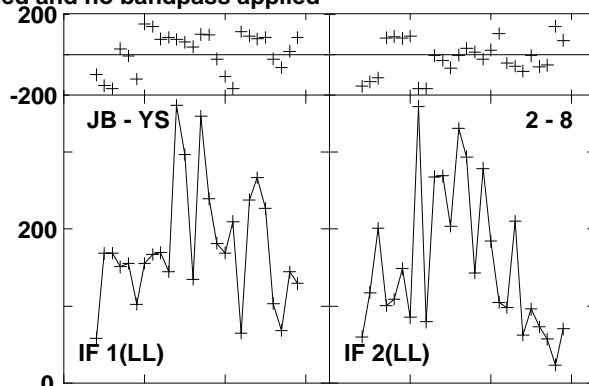
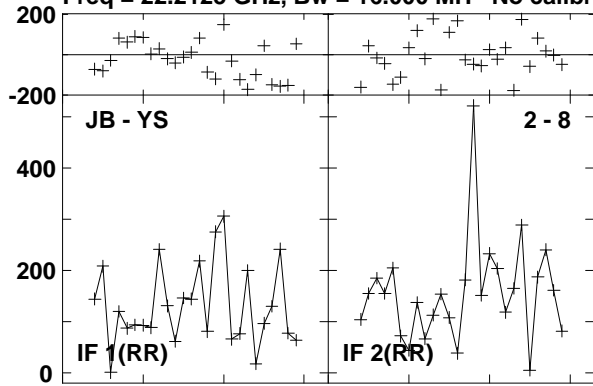

Lower frame: Micro Ampl Jy Top frame: Phas deg  
 Vector averaged cross-power spectrum Baseline: JB (02) - YS (08)  
 Timerange: 00/15:03:06 to 00/15:04:05

Plot file version 631 created 23-AUG-2016 15:01:04

W3IRS5 GA035B 1.UVDATA.1

Freq = 22.2125 GHz, Bw = 16.000 MH No calibration applied and no bandpass applied

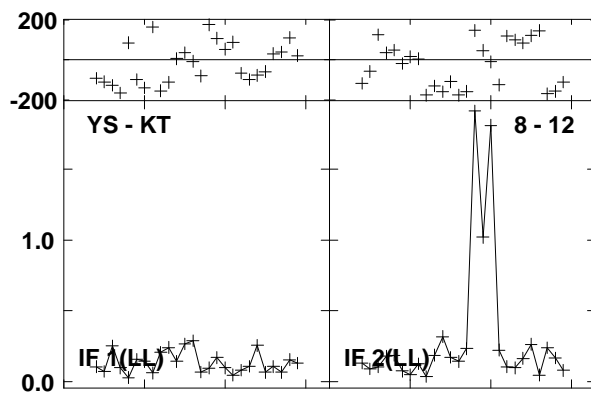
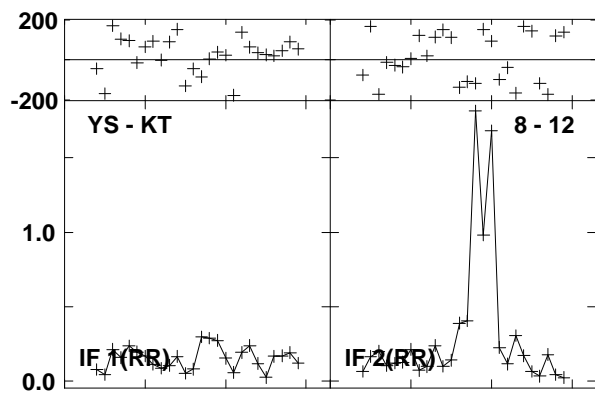
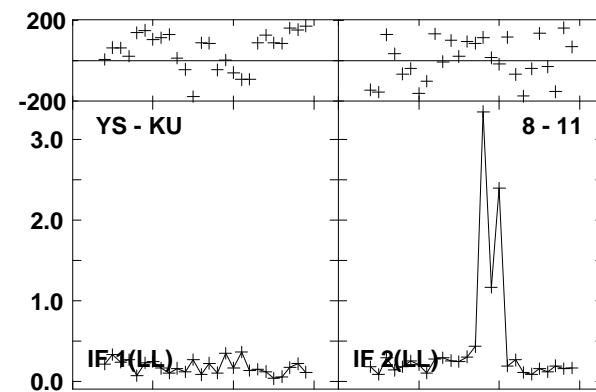
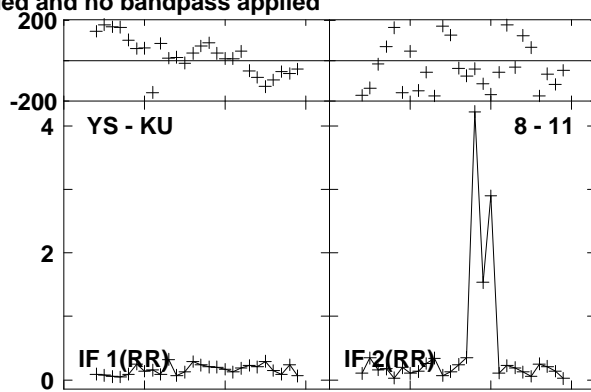
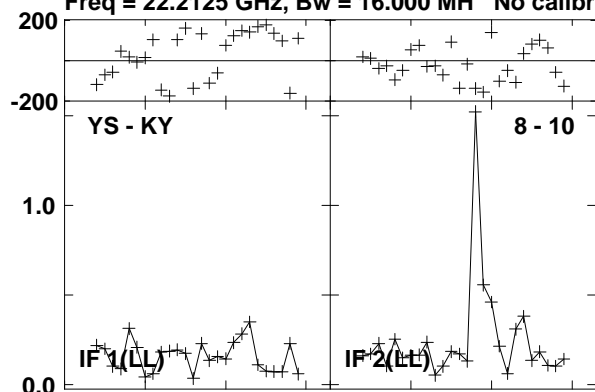

Lower frame: Milli Ampl Jy Top frame: Phas deg  
Vector averaged cross-power spectrum Baseline: YS (08) - KY (10)  
Timerange: 00:15:03:06 to 00:15:04:05

Plot file version 632 created 23-AUG-2016 15:01:04

0219+628 GA035B 1.UVDATA.1

Freq = 22.2125 GHz, Bw = 16.000 MH No calibration applied and no bandpass applied

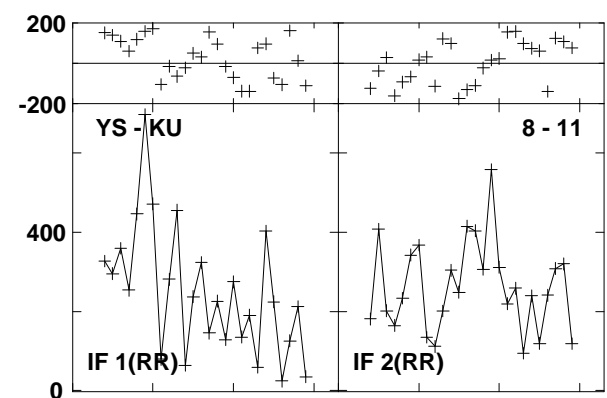
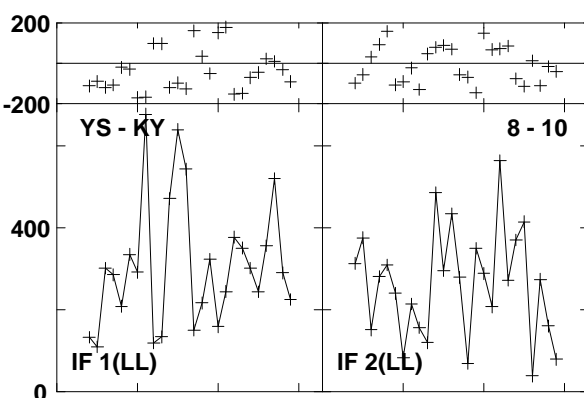
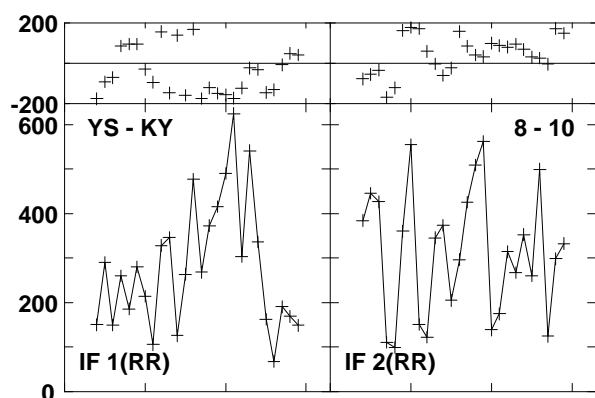
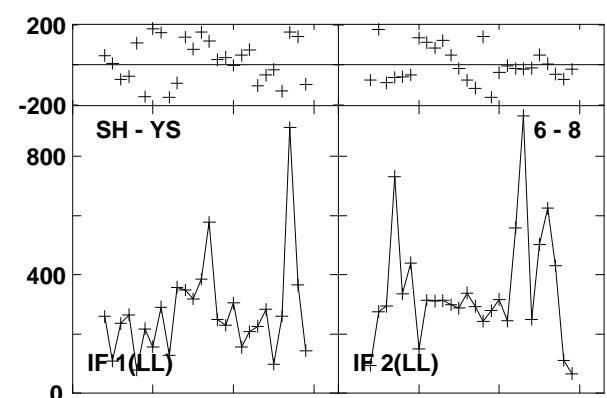
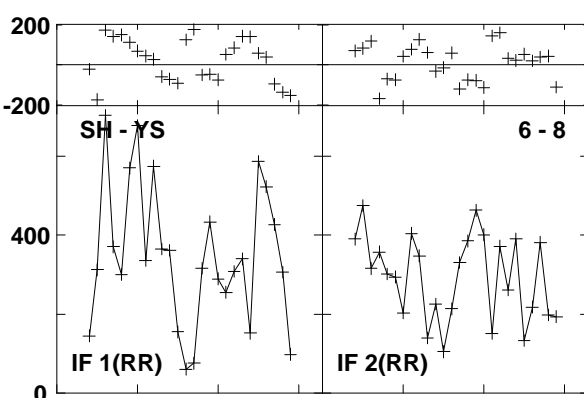
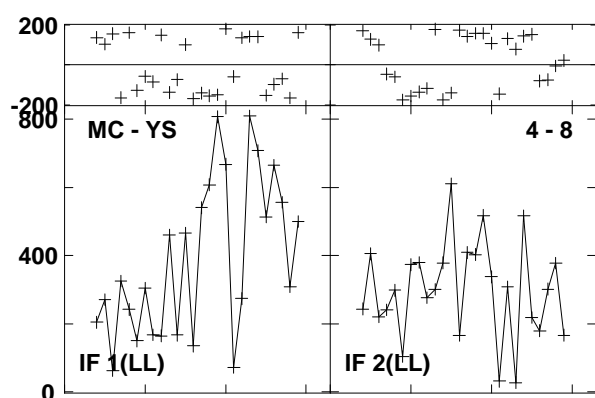
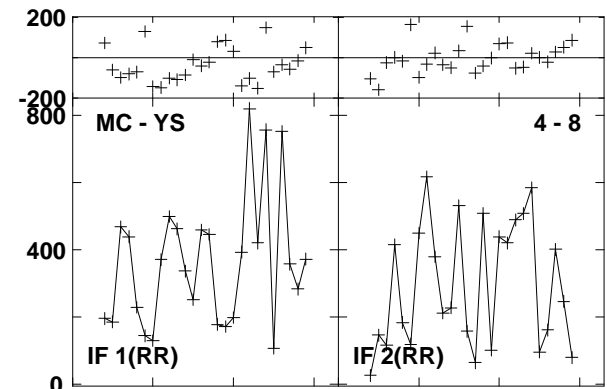
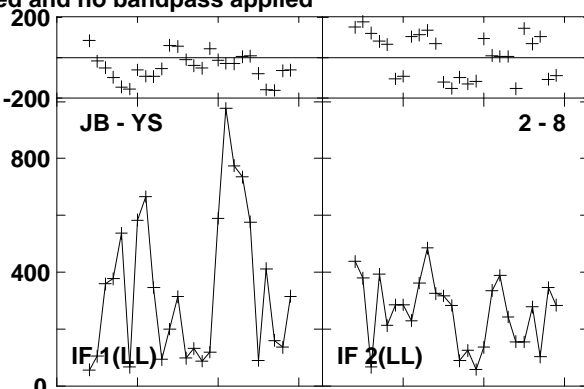
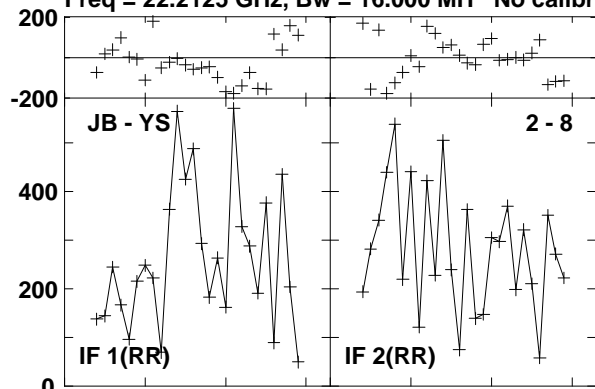

Lower frame: Micro Ampl Jy Top frame: Phas deg  
Vector averaged cross-power spectrum Baseline: JB (02) - YS (08)  
Timerange: 00/15:04:44 to 00/15:05:04



Plot file version 633 created 23-AUG-2016 15:01:04

0219+628 GA035B 1.UVDATA.1

Freq = 22.2125 GHz, Bw = 16.000 MH No calibration applied and no bandpass applied

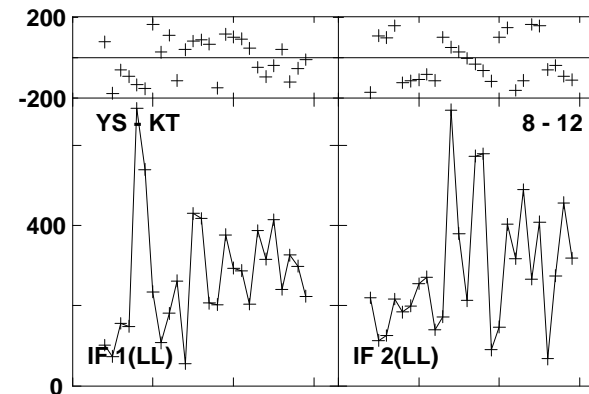
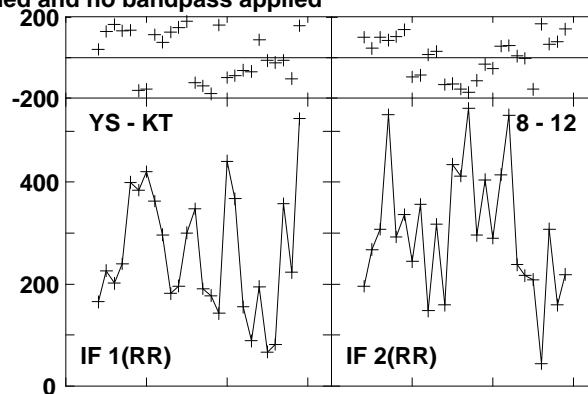
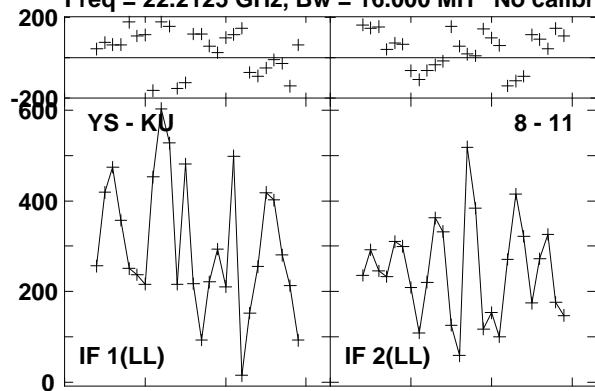

Lower frame: Micro Ampl Jy Top frame: Phas deg  
Vector averaged cross-power spectrum Baseline: YS (08) - KU (11)  
Timerange: 00/15:04:44 to 00/15:05:04

Plot file version 634 created 23-AUG-2016 15:01:04

W3IRS5 GA035B 1.UVDATA.1

Freq = 22.2125 GHz, Bw = 16.000 MH No calibration applied and no bandpass applied

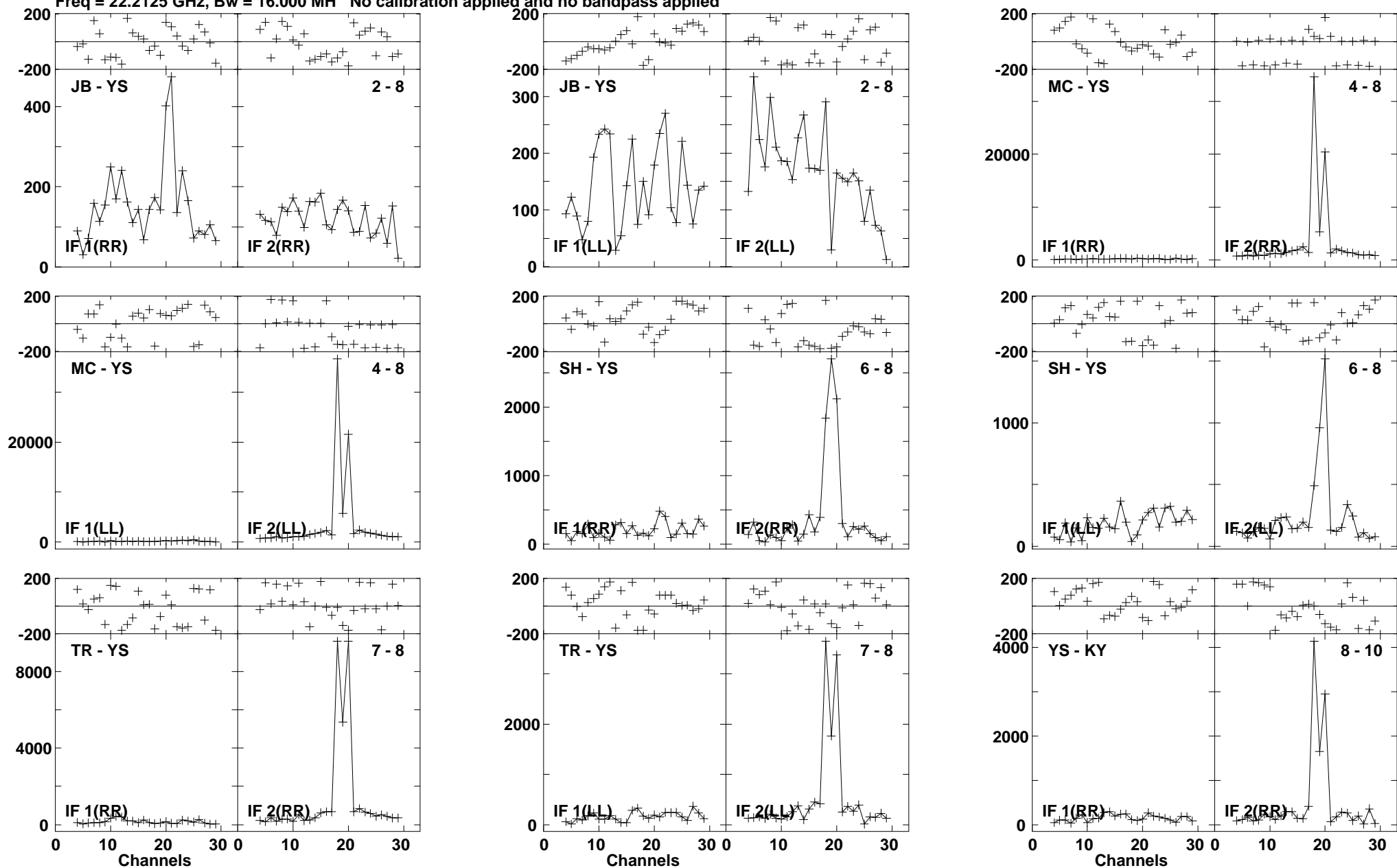

Lower frame: Micro Ampl Jy Top frame: Phas deg  
Vector averaged cross-power spectrum Baseline: JB (02) - YS (08)  
Timerange: 00/15:05:43 to 00/15:06:42

Plot file version 635 created 23-AUG-2016 15:01:04

W3IRS5 GA035B 1.UVDATA.1

Freq = 22.2125 GHz, Bw = 16.000 MH No calibration applied and no bandpass applied

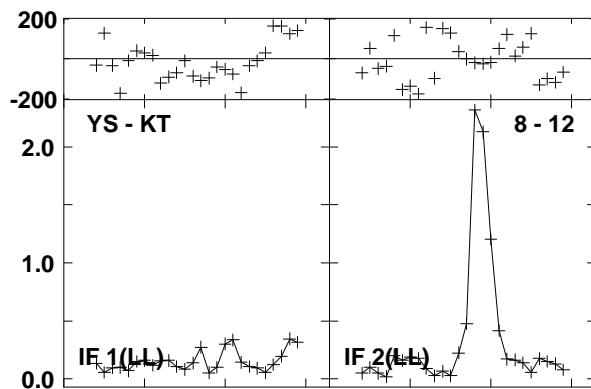
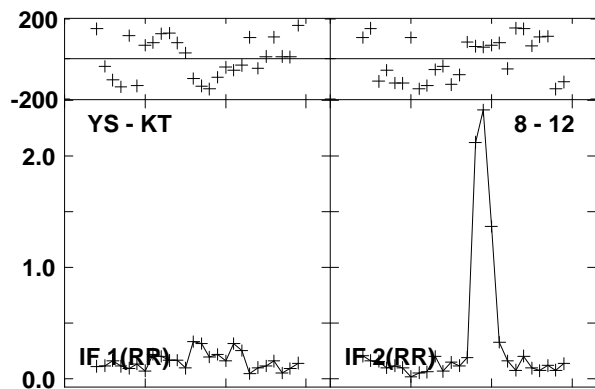
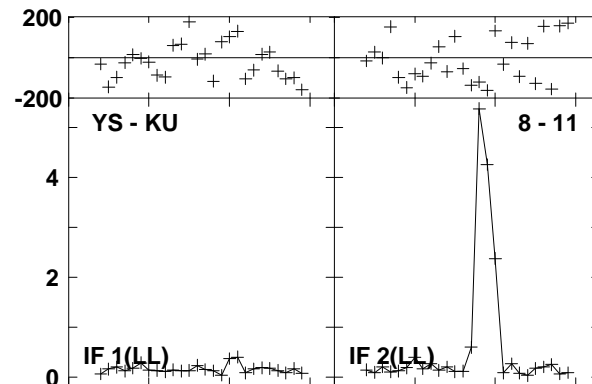
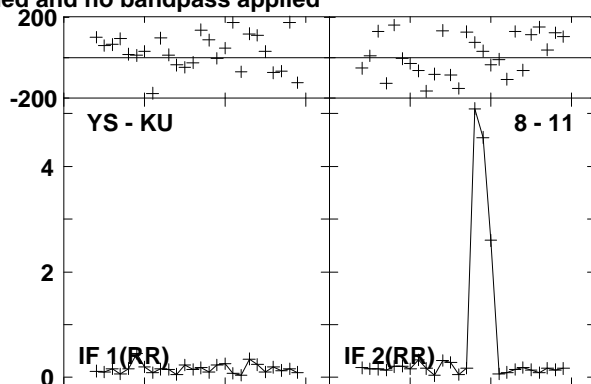
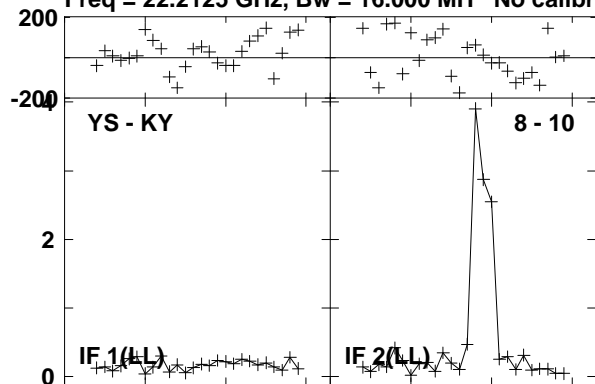

Lower frame: Milli Ampl Jy Top frame: Phas deg

Vector averaged cross-power spectrum Baseline: YS (08) - KY (10)

Timerange: 00/15:05:43 to 00/15:06:42

Plot file version 636 created 23-AUG-2016 15:01:04

0219+628 GA035B 1.UVDATA.1

Freq = 22.2125 GHz, Bw = 16.000 MH No calibration applied and no bandpass applied

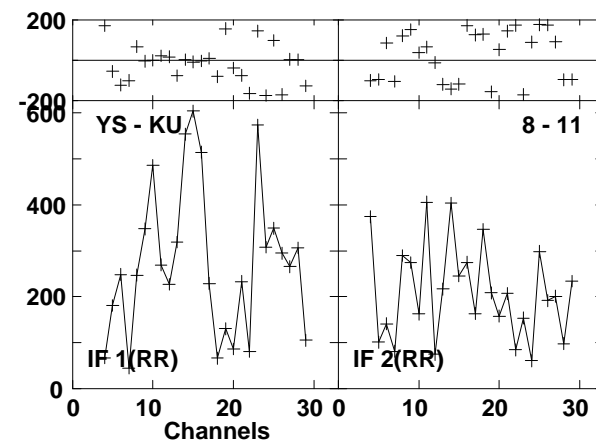
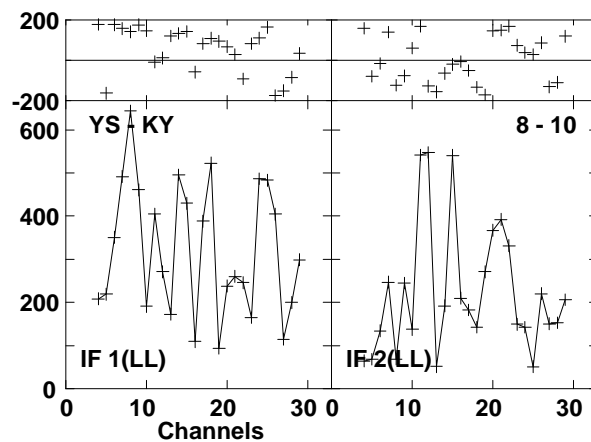
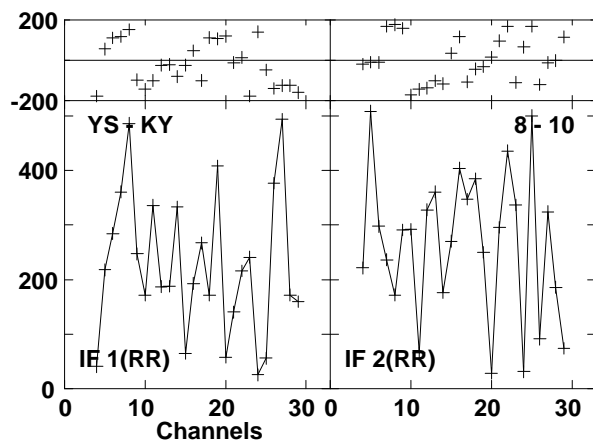
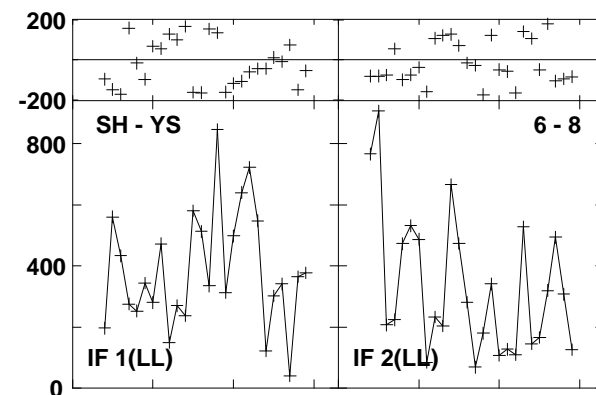
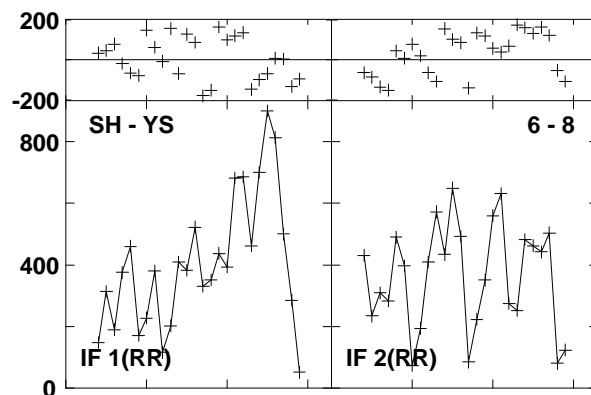
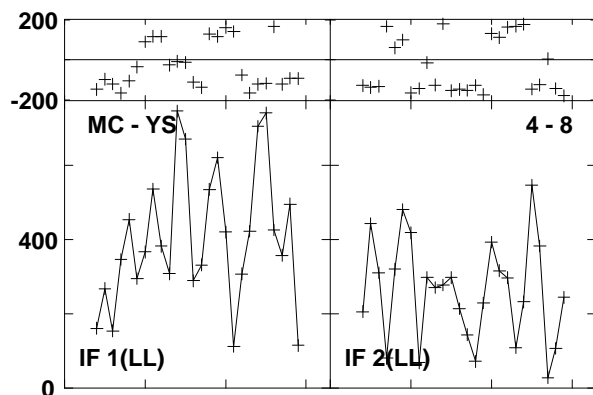
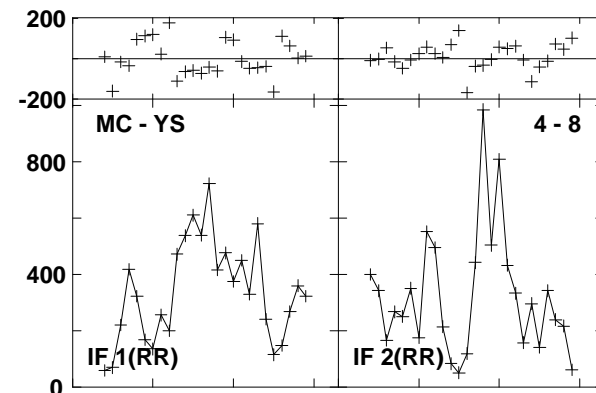
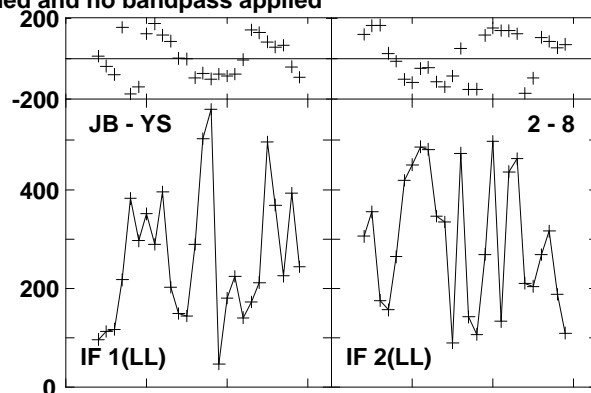
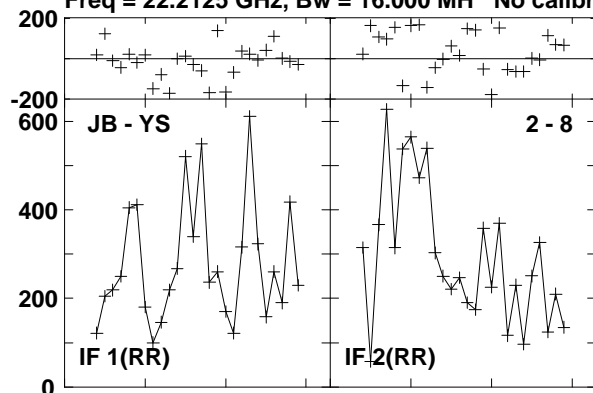

Lower frame: Micro Ampl Jy Top frame: Phas deg  
Vector averaged cross-power spectrum Baseline: JB (02) - YS (08)  
Timerange: 00/15:07:21 to 00/15:07:39

Plot file version 637 created 23-AUG-2016 15:01:04

0219+628 GA035B 1.UVDATA.1

Freq = 22.2125 GHz, Bw = 16.000 MH No calibration applied and no bandpass applied

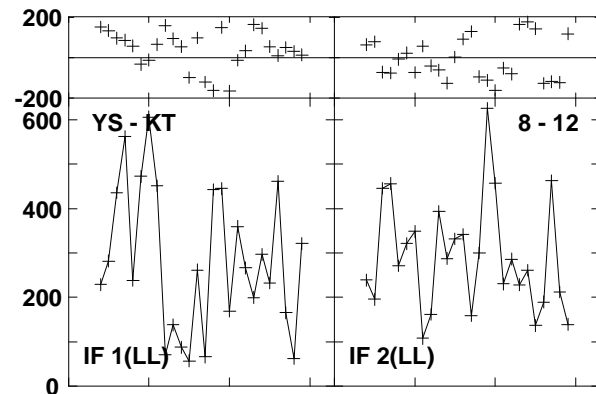
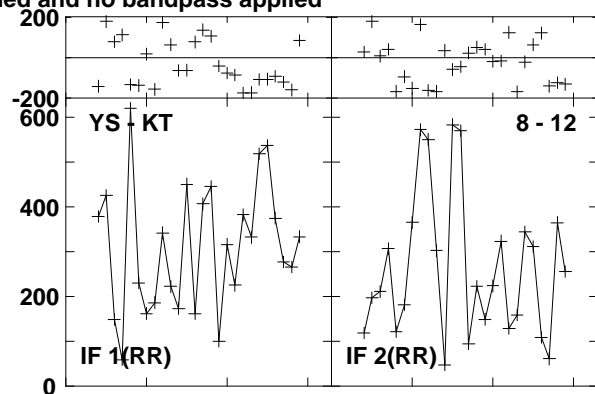
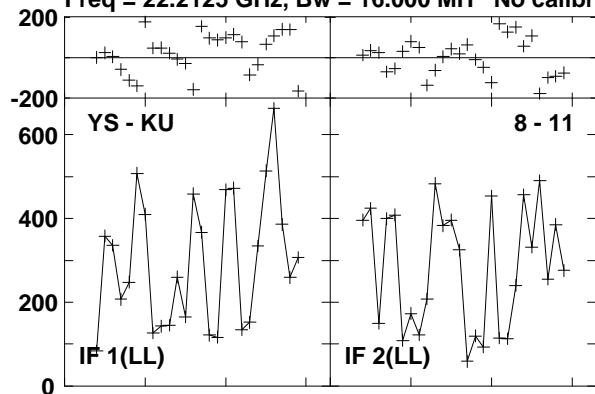

Lower frame: Micro Ampl Jy Top frame: Phas deg  
Vector averaged cross-power spectrum Baseline: YS (08) - KU (11)  
Timerange: 00/15:07:21 to 00/15:07:39

Plot file version 638 created 23-AUG-2016 15:01:04

W3IRS5 GA035B 1.UVDATA.1

Freq = 22.2125 GHz, Bw = 16.000 MH No calibration applied and no bandpass applied

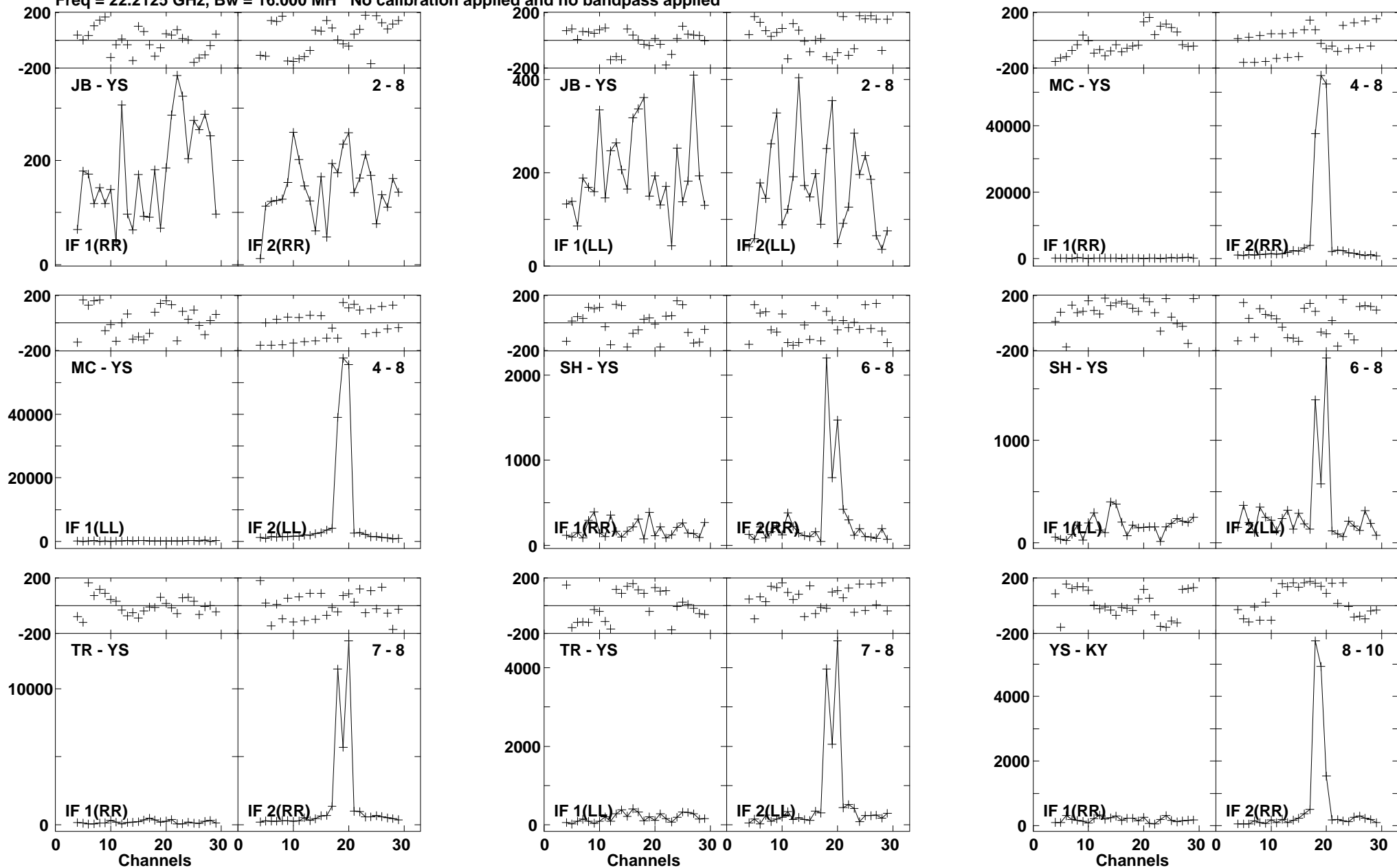

Lower frame: Micro Ampl Jy Top frame: Phas deg  
Vector averaged cross-power spectrum Baseline: JB (02) - YS (08)  
Timerange: 00/15:08:19 to 00/15:09:18

Plot file version 639 created 23-AUG-2016 15:01:04

W3IRS5 GA035B 1.UVDATA.1

Freq = 22.2125 GHz, Bw = 16.000 MH No calibration applied and no bandpass applied

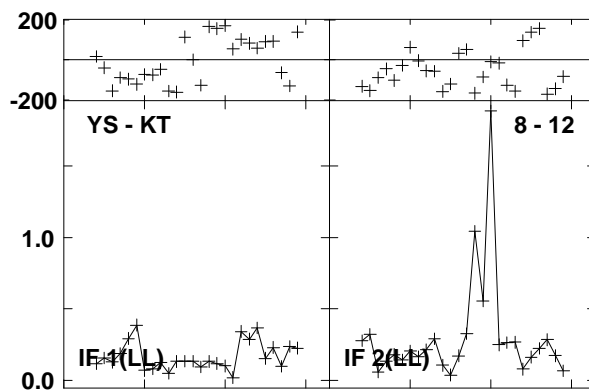
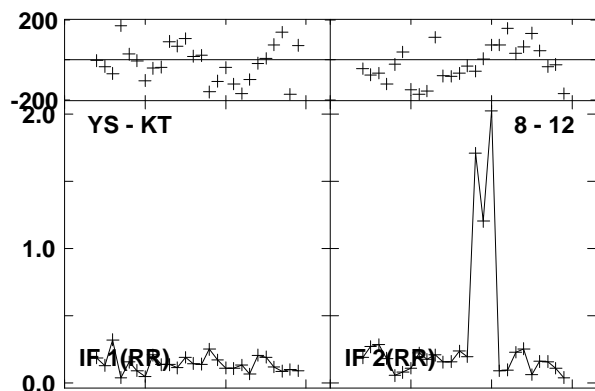
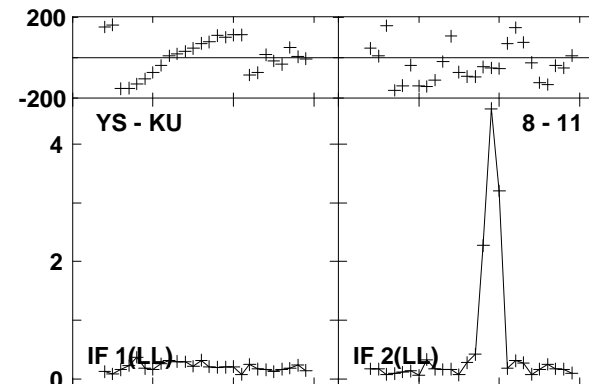
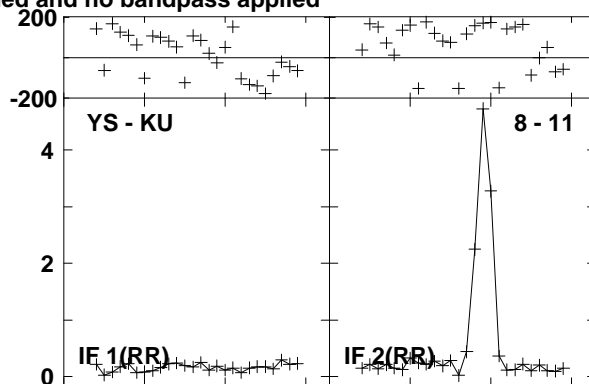
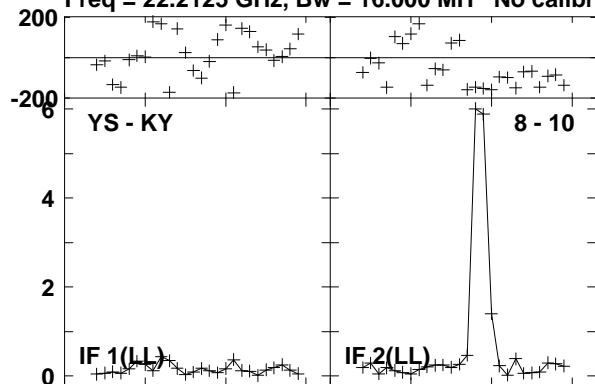

Lower frame: Milli Ampl Jy Top frame: Phas deg  
Vector averaged cross-power spectrum Baseline: YS (08) - KY (10)  
Timerange: 00/15:08:19 to 00/15:09:18

Plot file version 640 created 23-AUG-2016 15:01:05

0219+628 GA035B 1.UVDATA.1

Freq = 22.2125 GHz, Bw = 16.000 MH No calibration applied and no bandpass applied

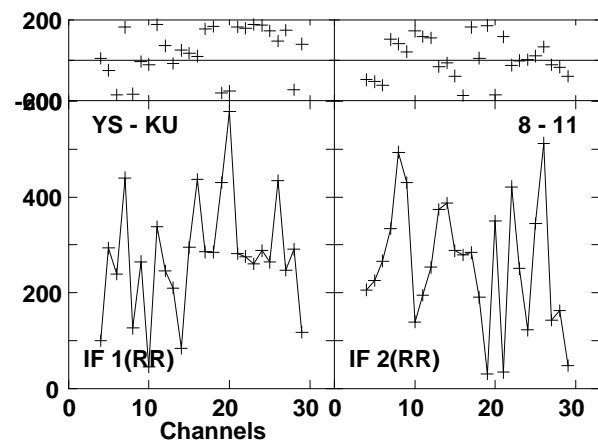
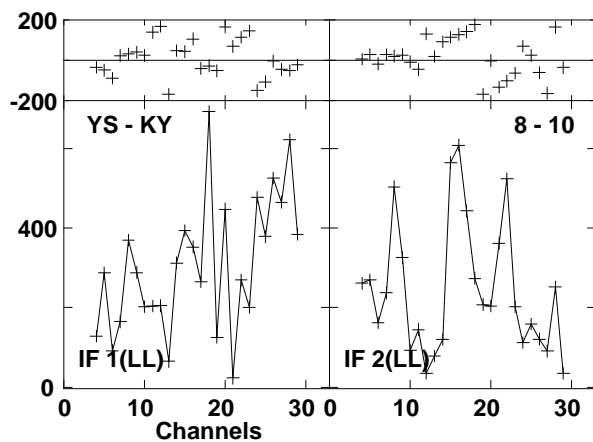
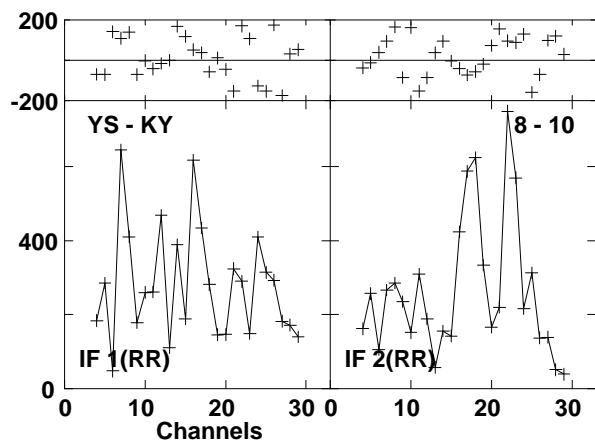
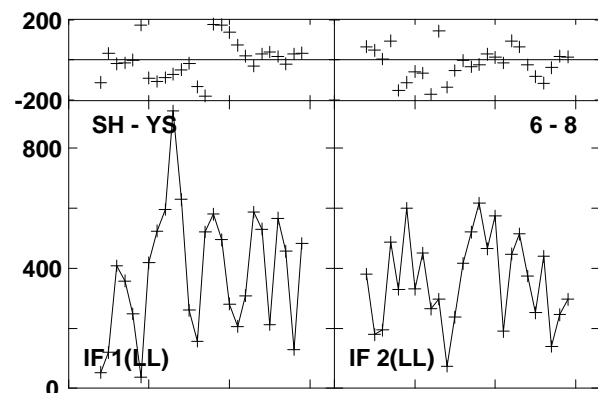
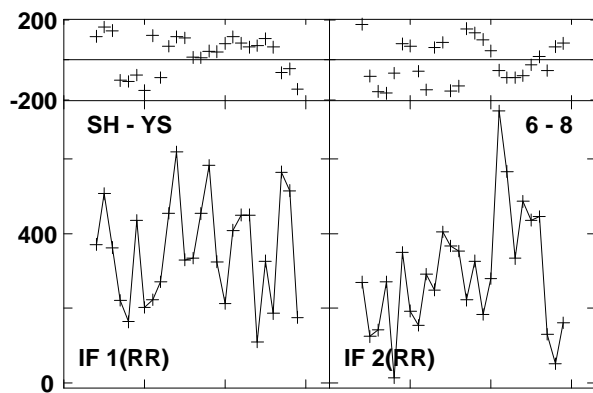
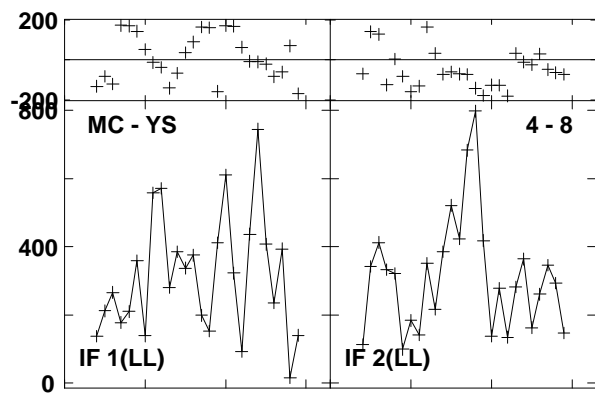
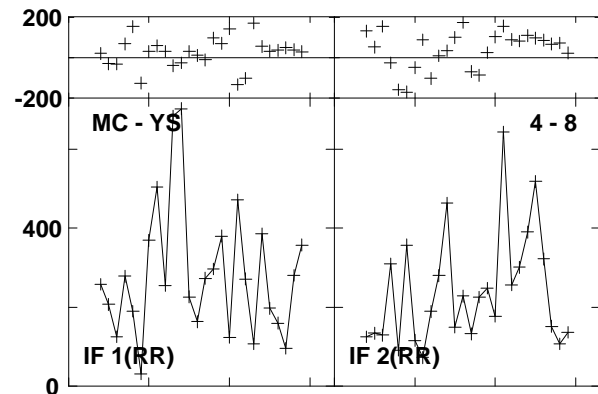
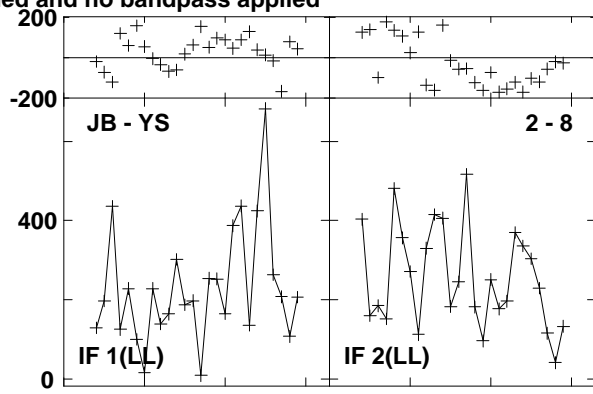
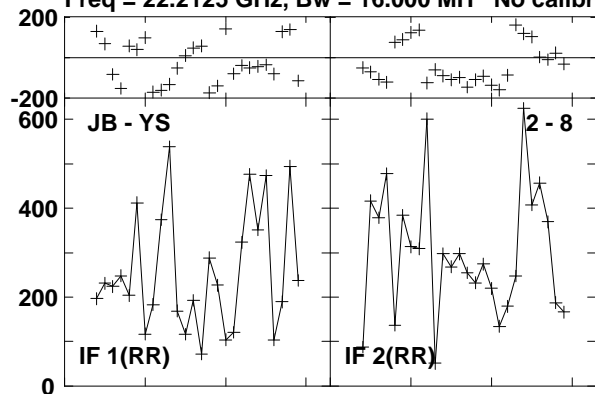

Lower frame: Micro Ampl Jy Top frame: Phas deg  
Vector averaged cross-power spectrum Baseline: JB (02) - YS (08)  
Timerange: 00/15:09:57 to 00/15:10:15



Plot file version 641 created 23-AUG-2016 15:01:05

0219+628 GA035B 1.UVDATA.1

Freq = 22.2125 GHz, Bw = 16.000 MH No calibration applied and no bandpass applied

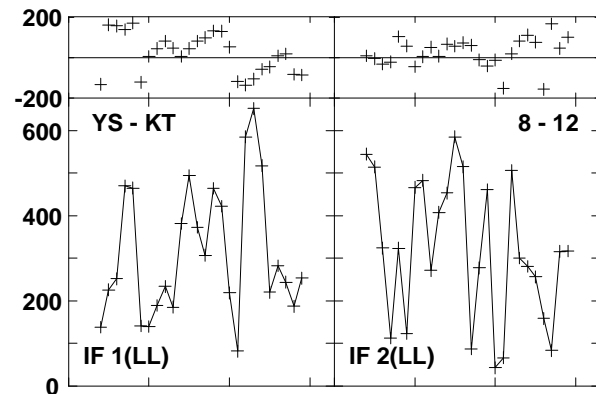
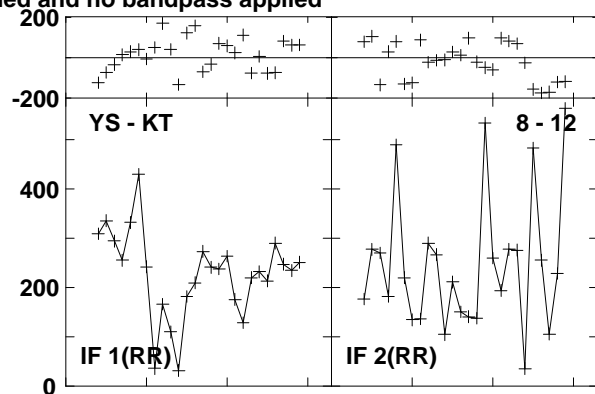
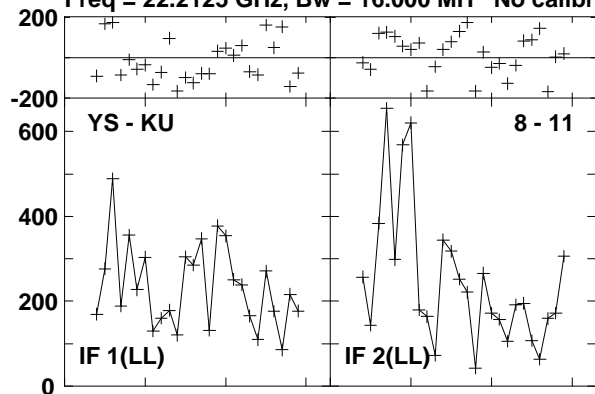

Lower frame: Micro Ampl Jy Top frame: Phas deg  
Vector averaged cross-power spectrum Baseline: YS (08) - KU (11)  
Timerange: 00/15:09:57 to 00/15:10:15

Plot file version 642 created 23-AUG-2016 15:01:05  
 W3IRS5 GA035B 1.UVDATA.1

Freq = 22.2125 GHz, Bw = 16.000 MH No calibration applied and no bandpass applied

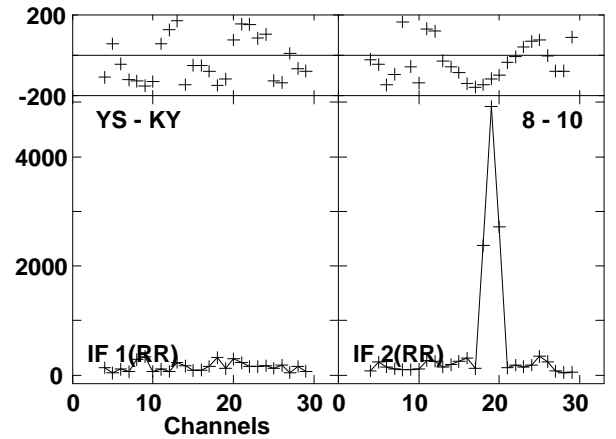
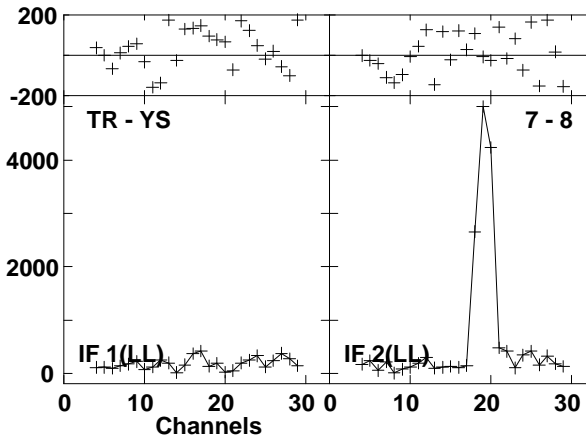
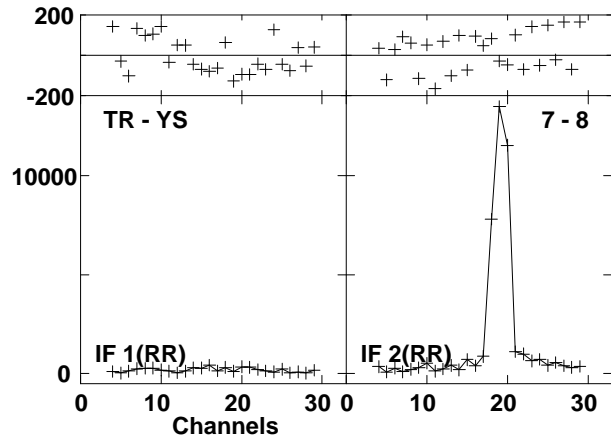
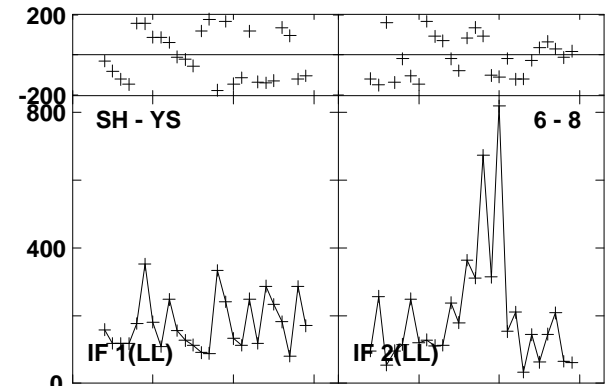
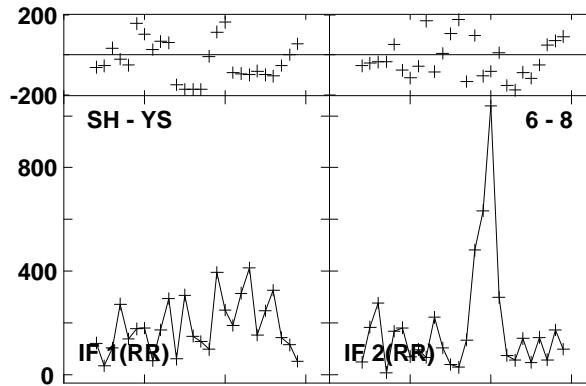
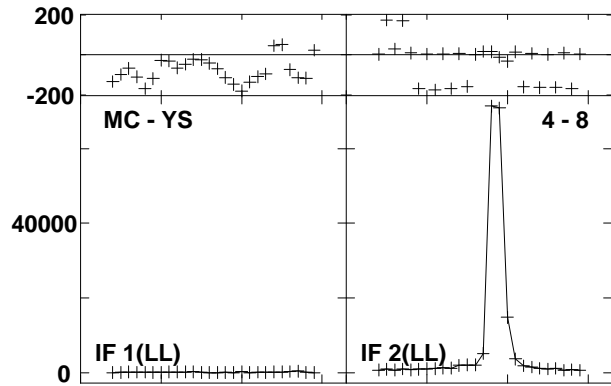
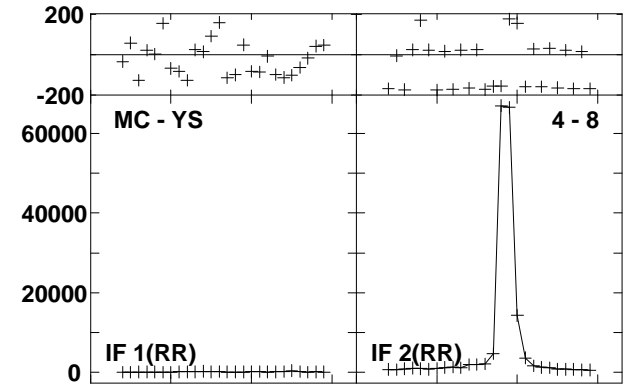
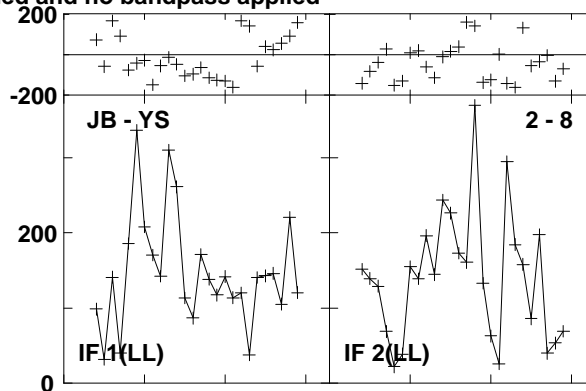
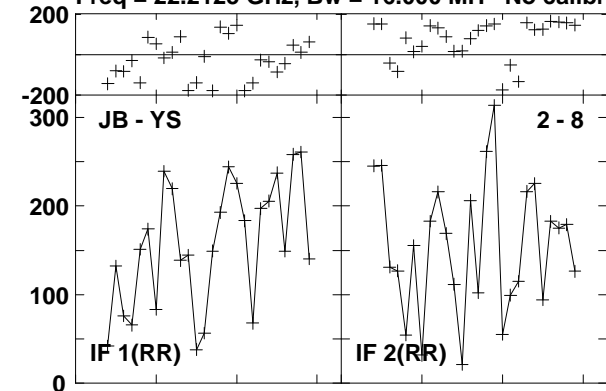

Lower frame: Micro Ampl Jy Top frame: Phas deg  
 Vector averaged cross-power spectrum Baseline: JB (02) - YS (08)  
 Timerange: 00/15:10:55 to 00/15:11:54

Plot file version 643 created 23-AUG-2016 15:01:05

W3IRS5 GA035B 1.UVDATA.1

Freq = 22.2125 GHz, Bw = 16.000 MH No calibration applied and no bandpass applied

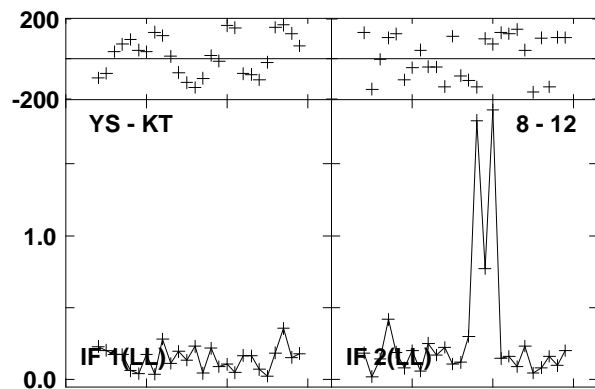
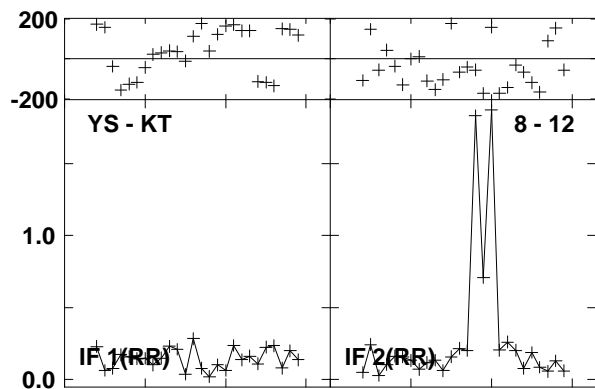
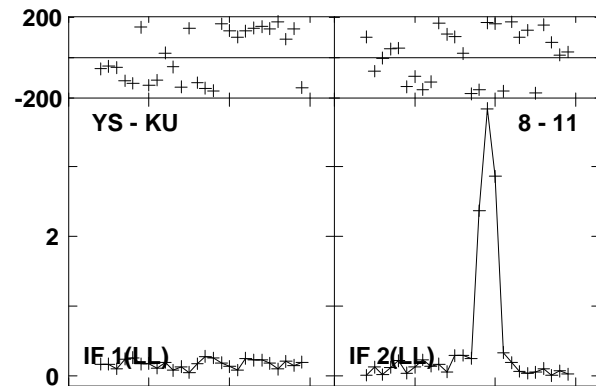
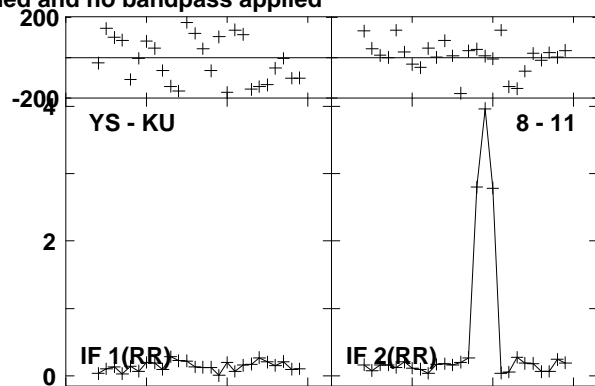
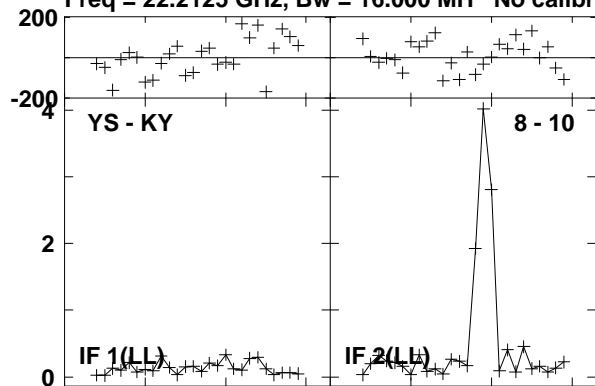

Lower frame: Milli Ampl Jy Top frame: Phas deg

Vector averaged cross-power spectrum Baseline: YS (08) - KY (10)

Timerange: 00/15:10:55 to 00/15:11:54

Plot file version 644 created 23-AUG-2016 15:01:05

0219+628 GA035B 1.UVDATA.1

Freq = 22.2125 GHz, Bw = 16.000 MH No calibration applied and no bandpass applied

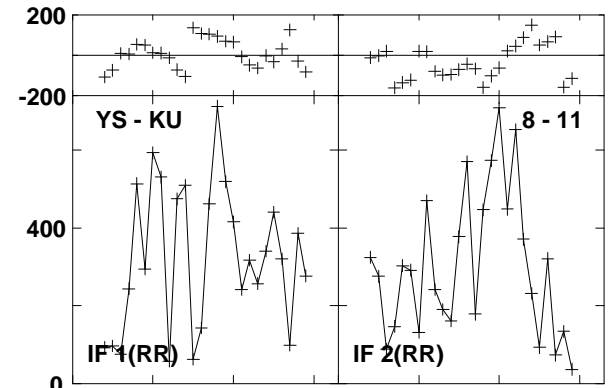
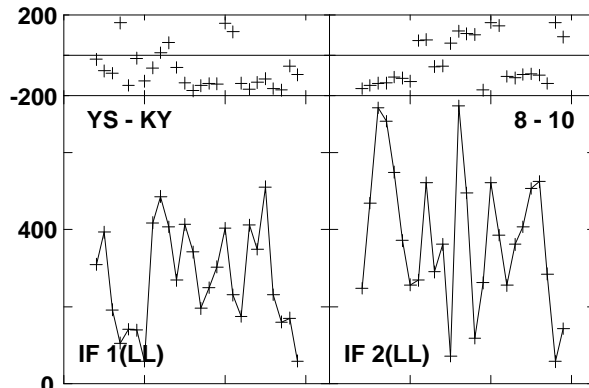
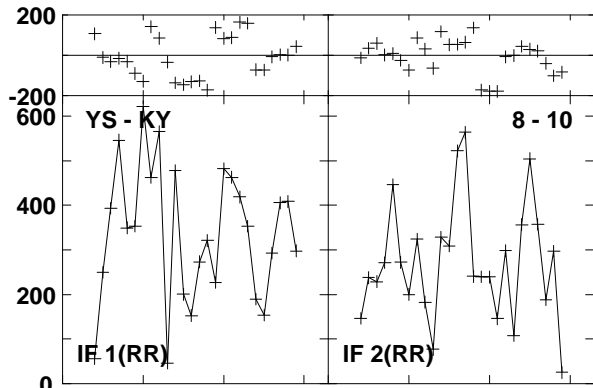
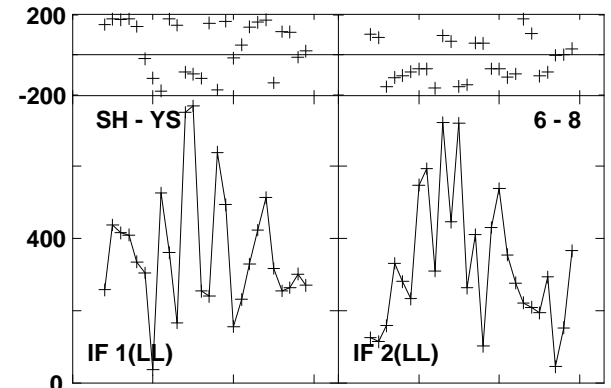
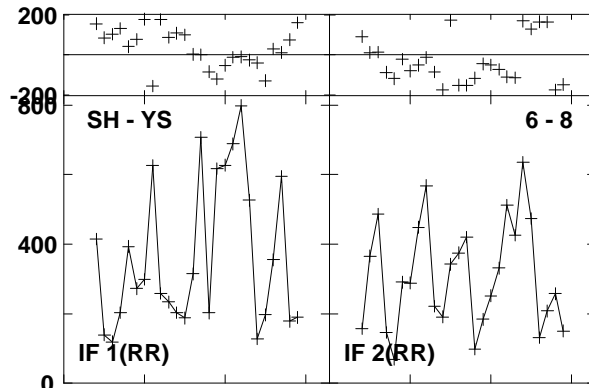
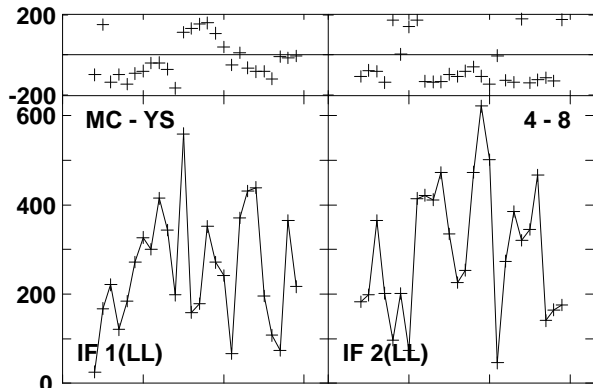
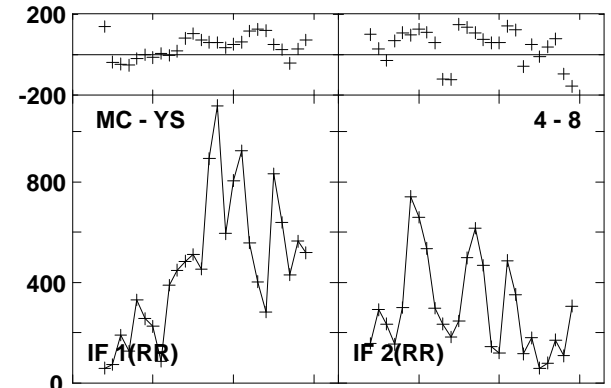
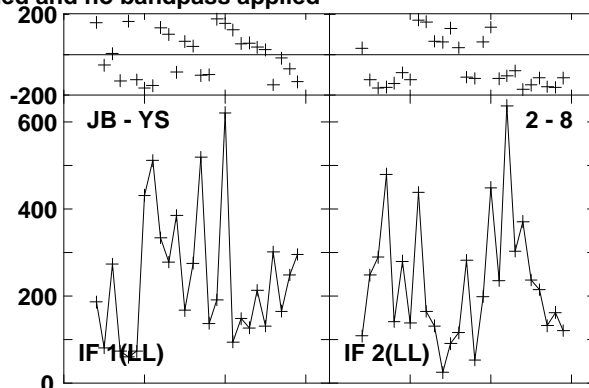
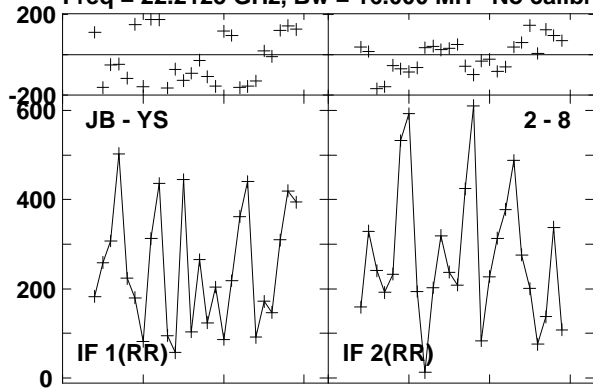

Lower frame: Micro Ampl Jy Top frame: Phas deg  
Vector averaged cross-power spectrum Baseline: JB (02) - YS (08)  
Timerange: 00/15:12:33 to 00/15:12:51

Plot file version 645 created 23-AUG-2016 15:01:05

0219+628 GA035B 1.UVDATA.1

Freq = 22.2125 GHz, Bw = 16.000 MH No calibration applied and no bandpass applied

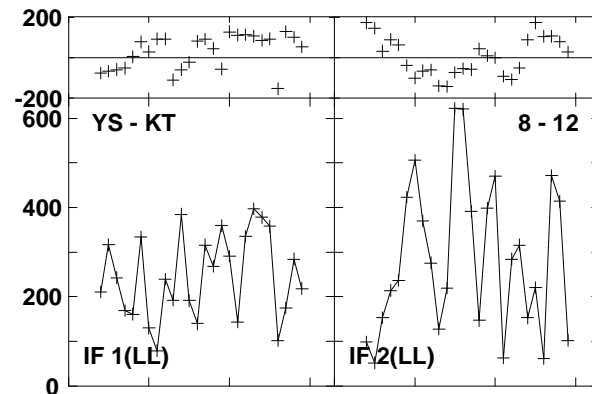
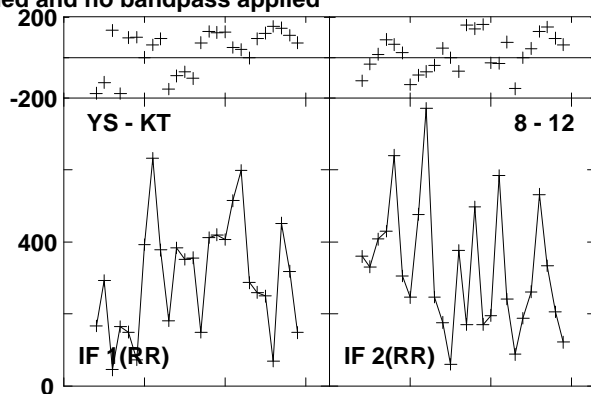
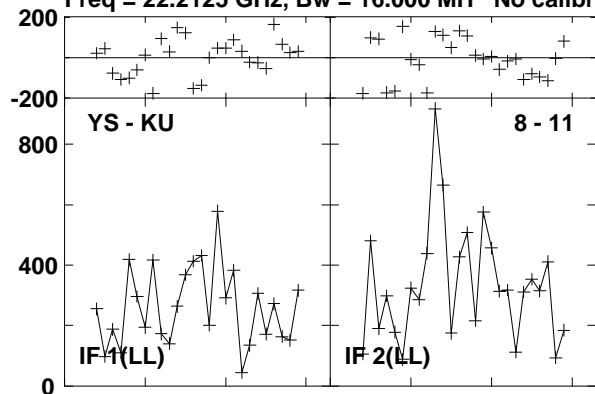

Lower frame: Micro Ampl Jy Top frame: Phas deg  
Vector averaged cross-power spectrum Baseline: YS (08) - KU (11)  
Timerange: 00/15:12:33 to 00/15:12:51

Plot file version 646 created 23-AUG-2016 15:01:05

W3IRS5 GA035B 1.UVDATA.1

Freq = 22.2125 GHz, Bw = 16.000 MH No calibration applied and no bandpass applied

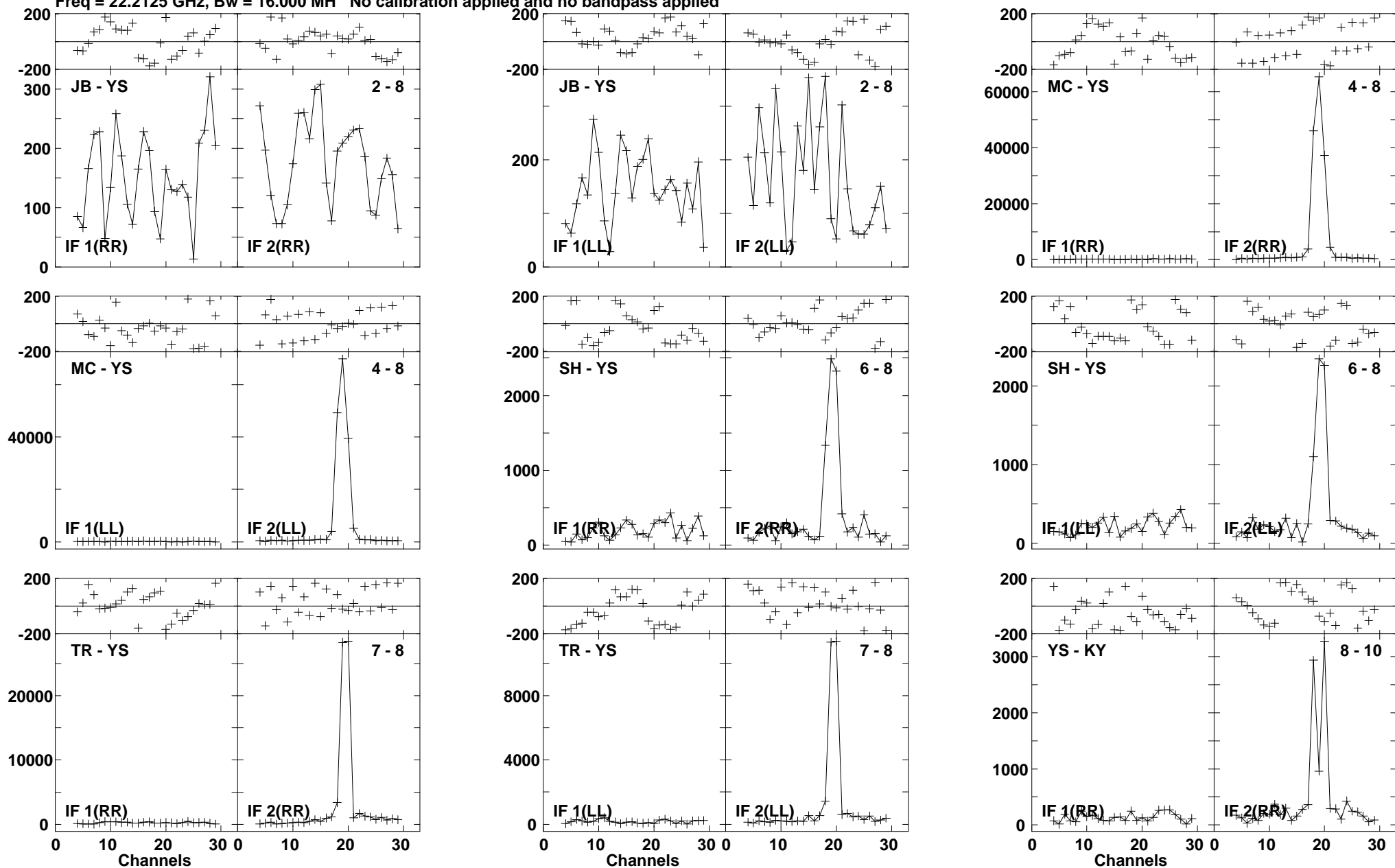

Lower frame: Micro Ampl Jy Top frame: Phas deg  
Vector averaged cross-power spectrum Baseline: JB (02) - YS (08)  
Timerange: 00/15:13:31 to 00/15:14:29

Plot file version 647 created 23-AUG-2016 15:01:05

W3IRS5 GAO35B 1.UVDATA.1

Freq = 22.2125 GHz, Bw = 16.000 MH No calibration applied and no bandpass applied

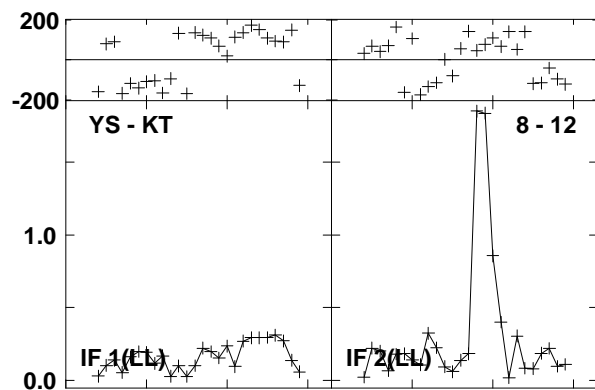
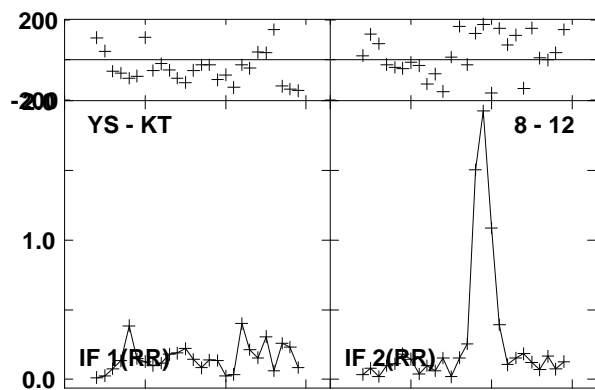
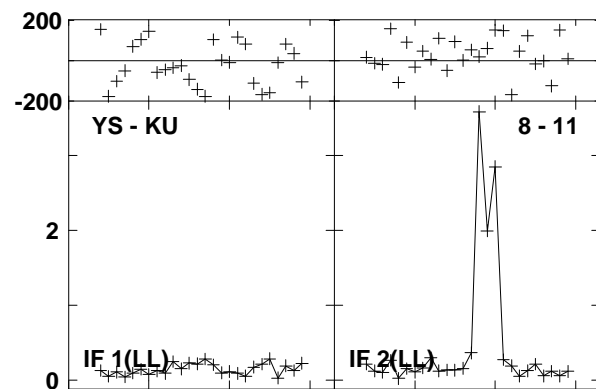
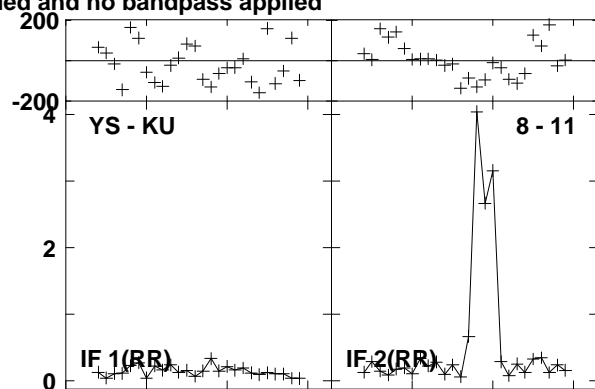
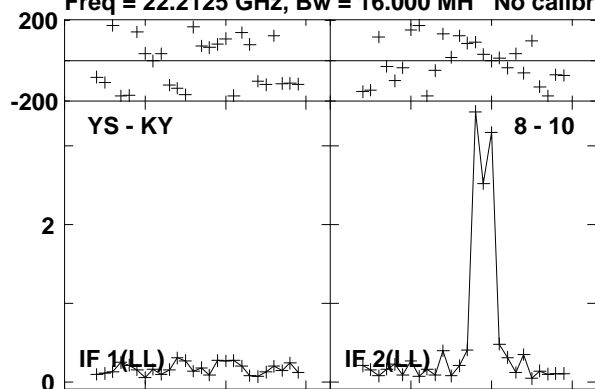

Lower frame: Milli Ampl Jy Top frame: Phas deg

Vector averaged cross-power spectrum Baseline: YS (08) - KY (10)

Timerange: 00/15:13:31 to 00/15:14:29

Plot file version 648 created 23-AUG-2016 15:01:05

0219+628 GA035B 1.UVDATA.1

Freq = 22.2125 GHz, Bw = 16.000 MH No calibration applied and no bandpass applied

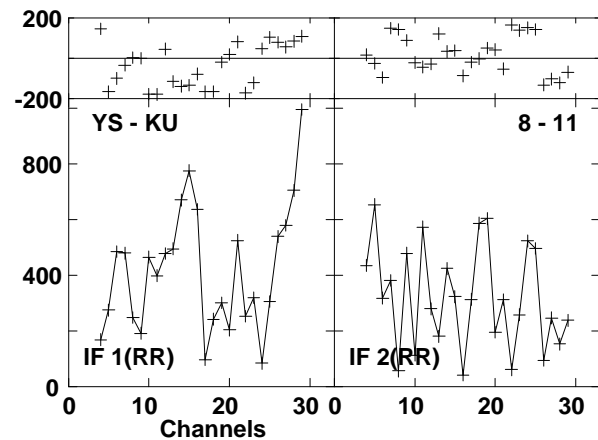
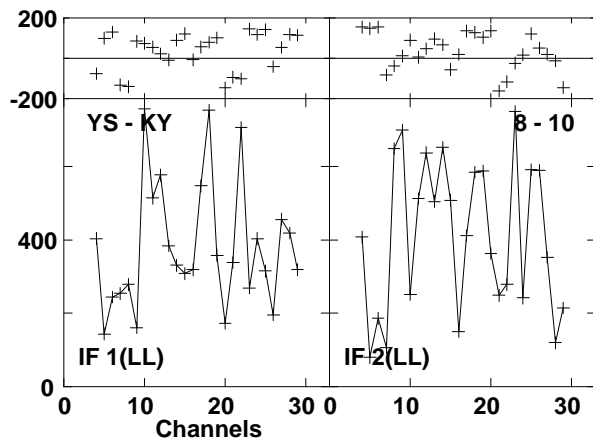
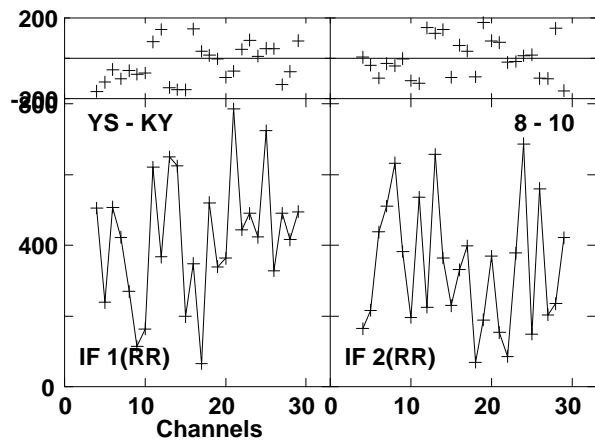
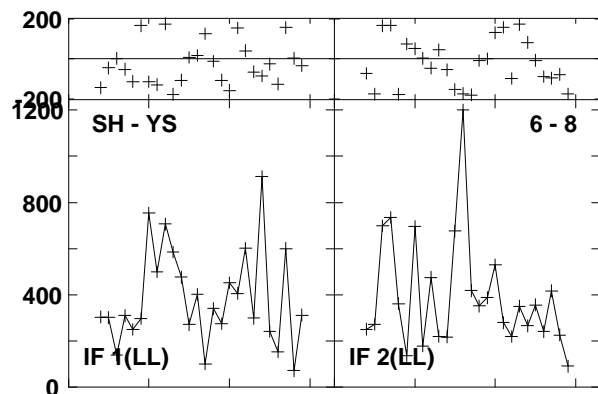
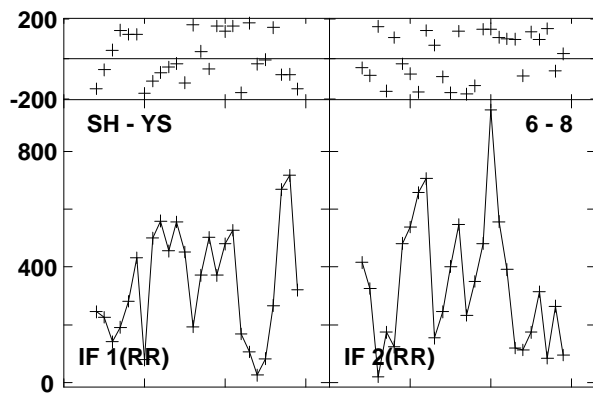
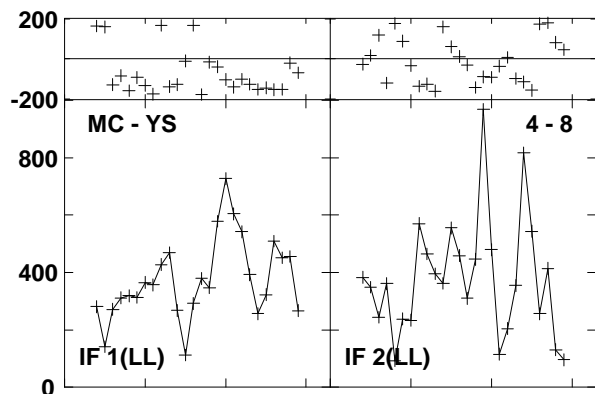
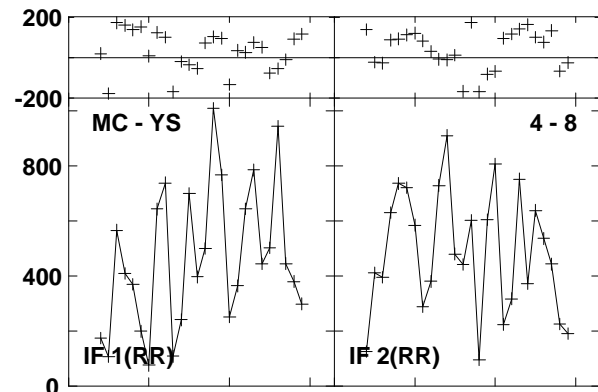
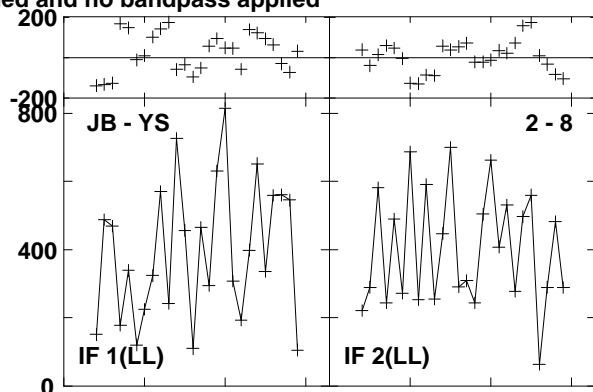
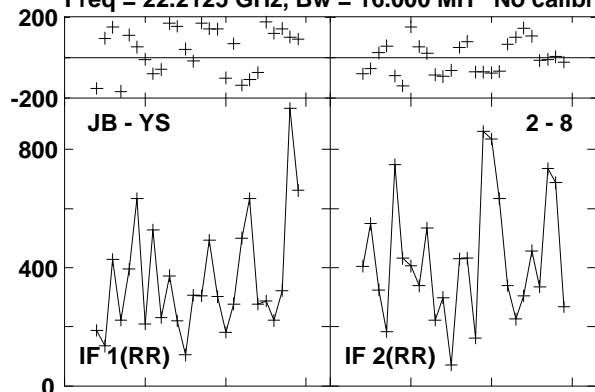

Lower frame: Micro Ampl Jy Top frame: Phas deg  
Vector averaged cross-power spectrum Baseline: JB (02) - YS (08)  
Timerange: 00/15:15:09 to 00/15:15:28



Plot file version 649 created 23-AUG-2016 15:01:05  
 0219+628 GA035B 1.UVDATA.1  
 Freq = 22.2125 GHz, Bw = 16.000 MH No calibration applied and no bandpass applied

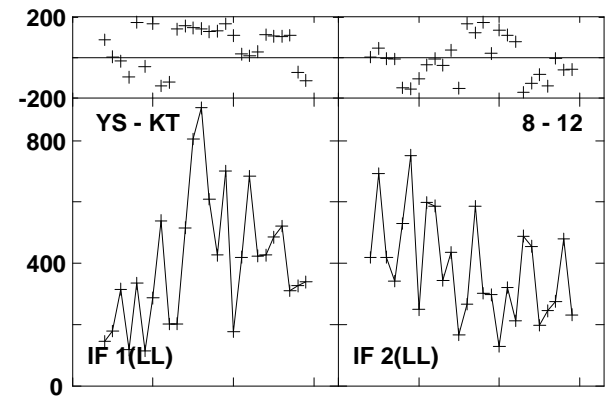
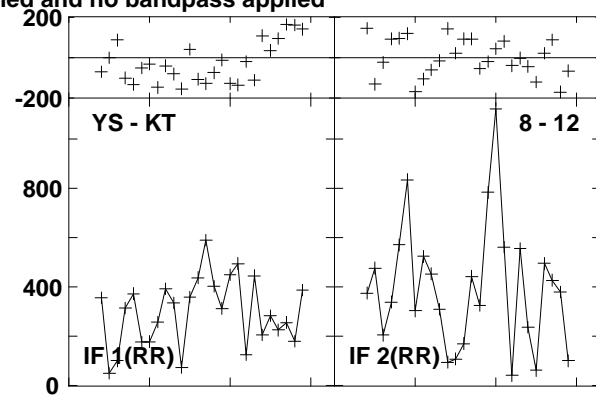
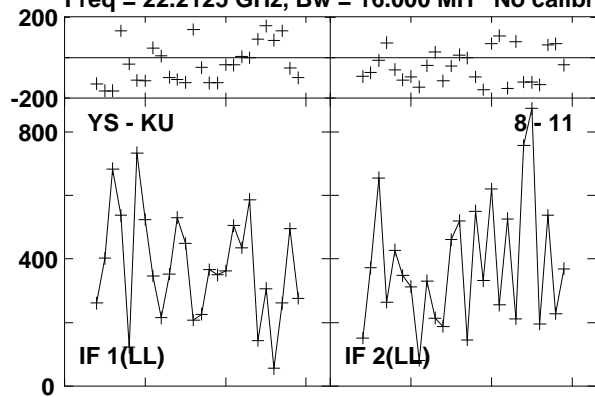

Lower frame: Micro Ampl Jy Top frame: Phas deg  
 Vector averaged cross-power spectrum Baseline: YS (08) - KU (11)  
 Timerange: 00/15:15:09 to 00/15:15:28

Plot file version 650 created 23-AUG-2016 15:01:05  
 W3IRS5 GA035B 1.UVDATA.1

Freq = 22.2125 GHz, Bw = 16.000 MH No calibration applied and no bandpass applied

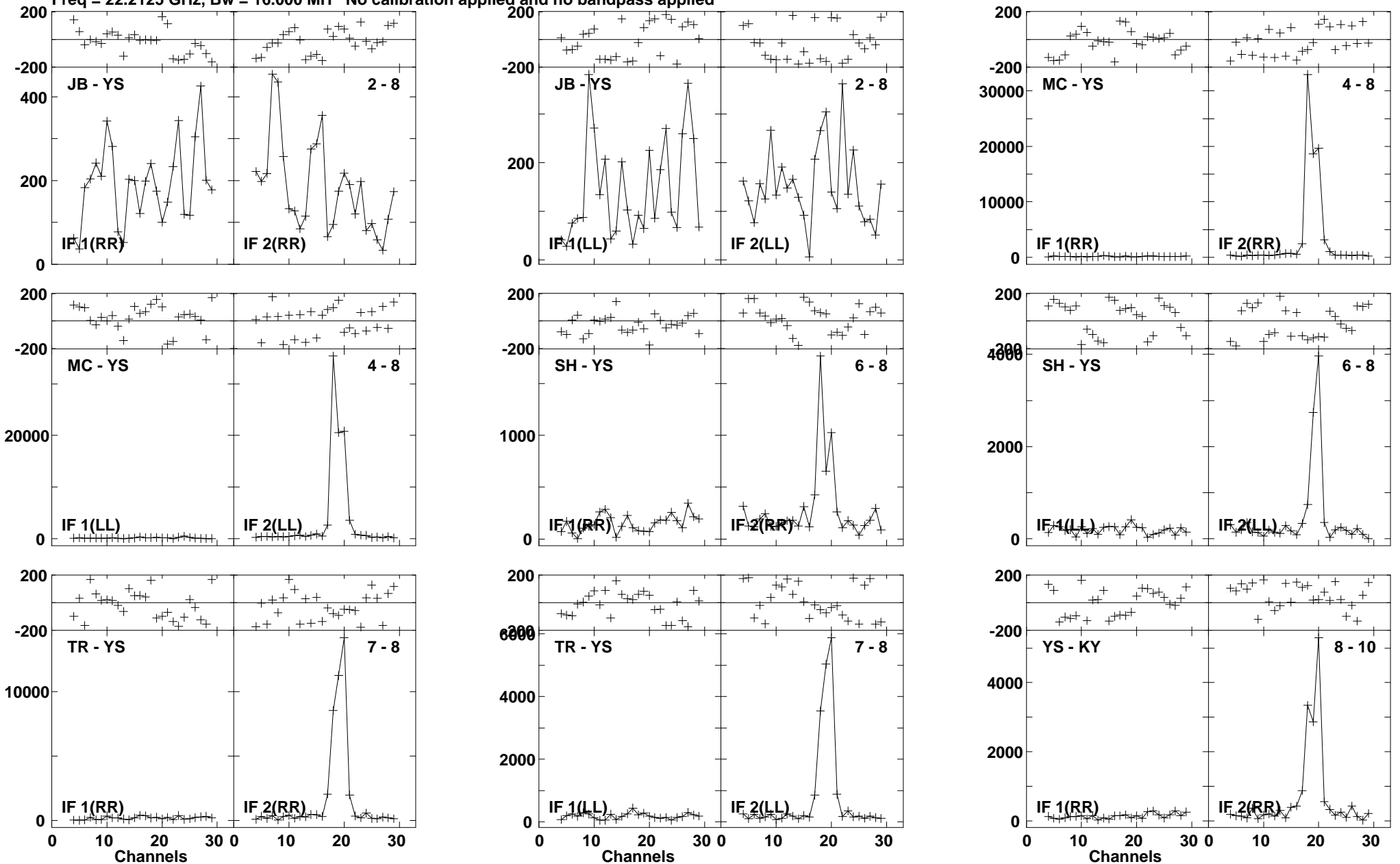

Lower frame: Micro Ampl Jy Top frame: Phas deg  
 Vector averaged cross-power spectrum Baseline: JB (02) - YS (08)  
 Timerange: 00/15:16:07 to 00/15:17:05

Plot file version 651 created 23-AUG-2016 15:01:05

W3IRS5 GA035B 1.UVDATA.1

Freq = 22.2125 GHz, Bw = 16.000 MH No calibration applied and no bandpass applied

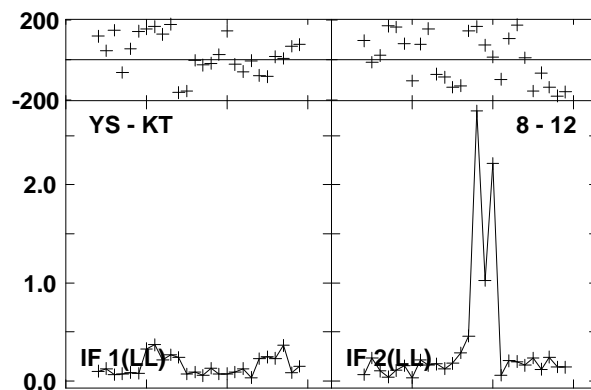
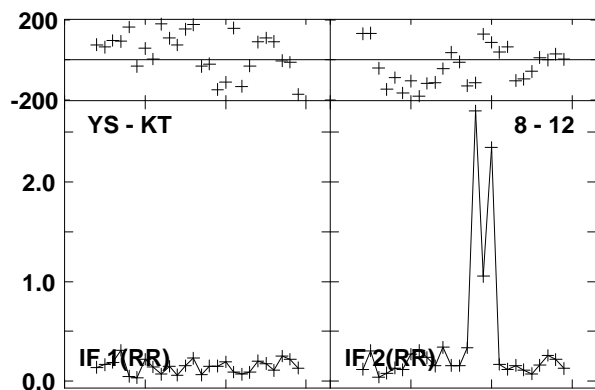
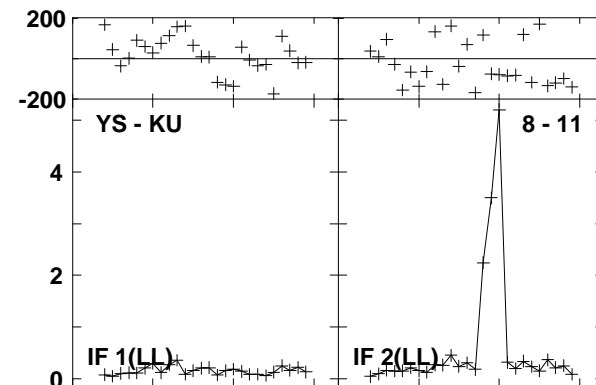
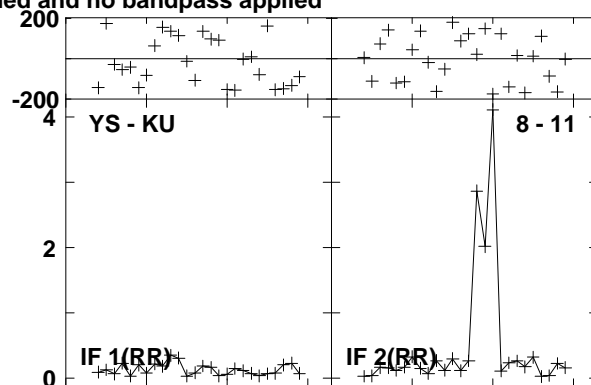
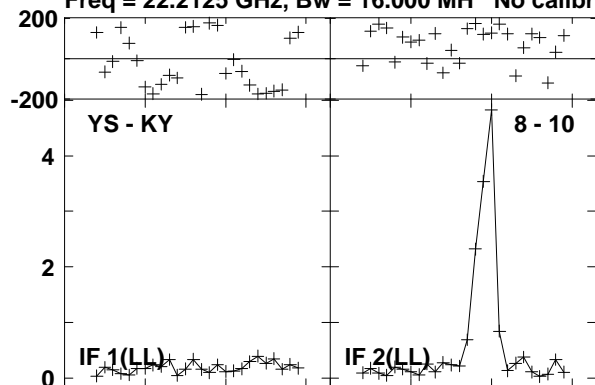

Lower frame: Milli Ampl Jy Top frame: Phas deg

Vector averaged cross-power spectrum Baseline: YS (08) - KY (10)

Timerange: 00/15:16:07 to 00/15:17:05

Plot file version 652 created 23-AUG-2016 15:01:05

0219+628 GA035B 1.UVDATA.1

Freq = 22.2125 GHz, Bw = 16.000 MH No calibration applied and no bandpass applied

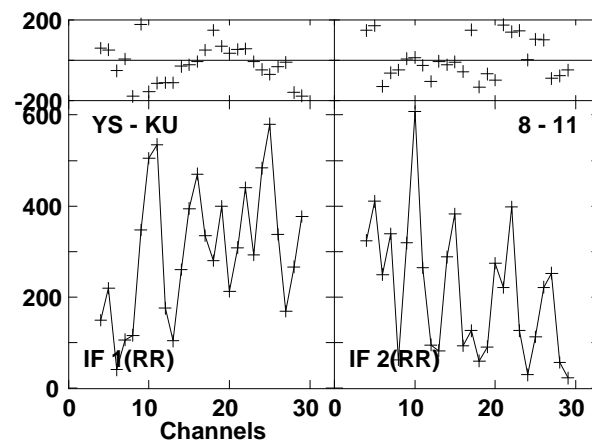
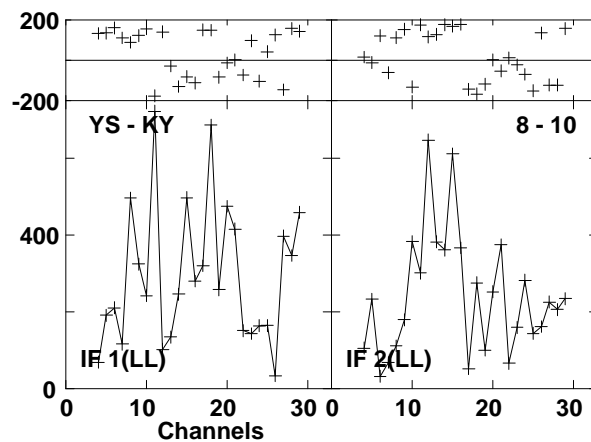
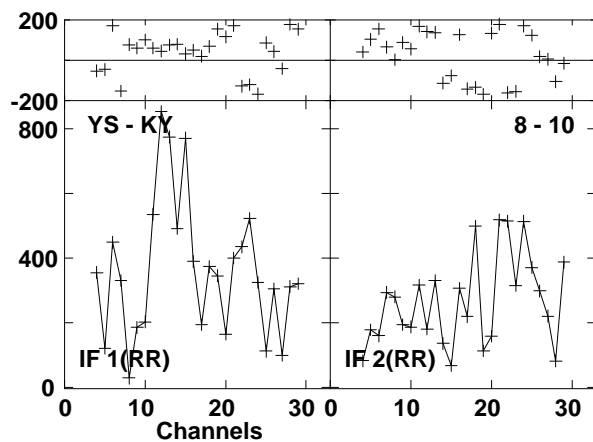
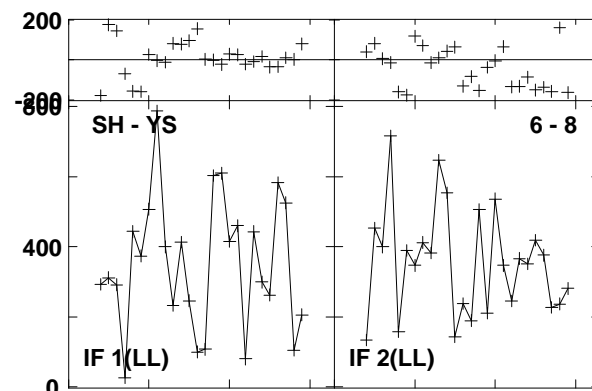
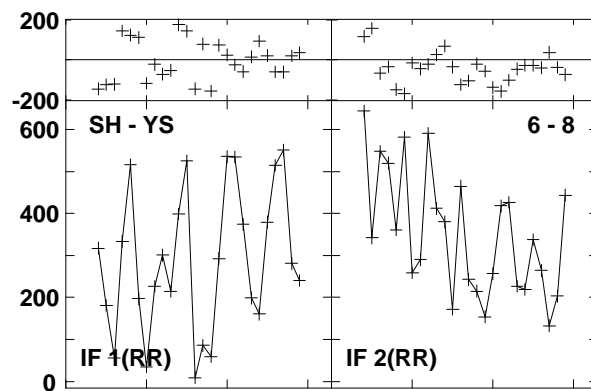
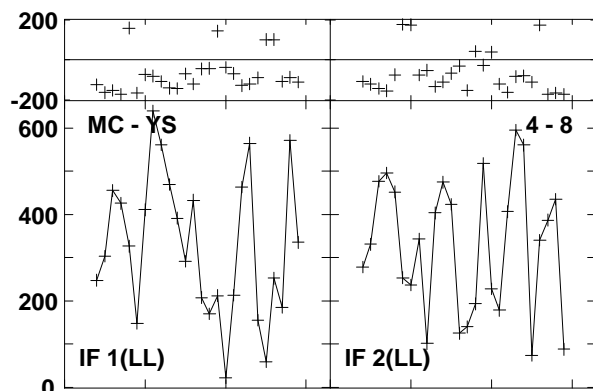
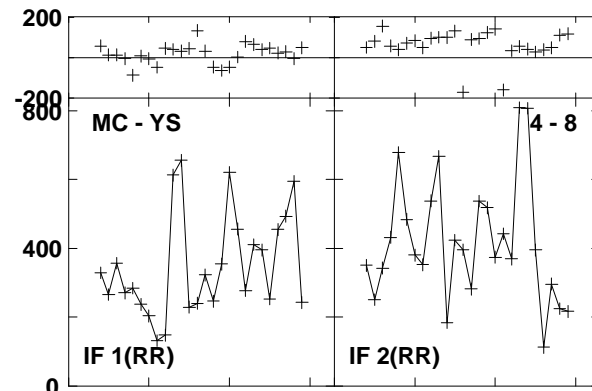
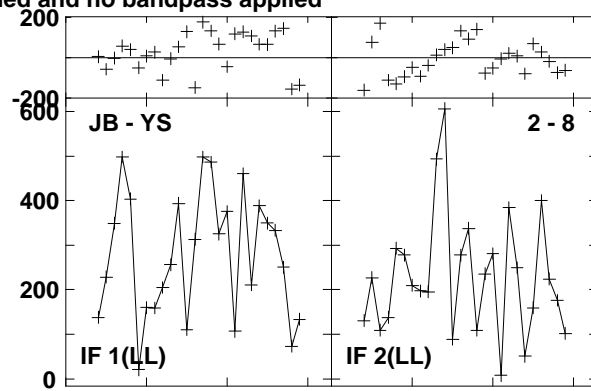
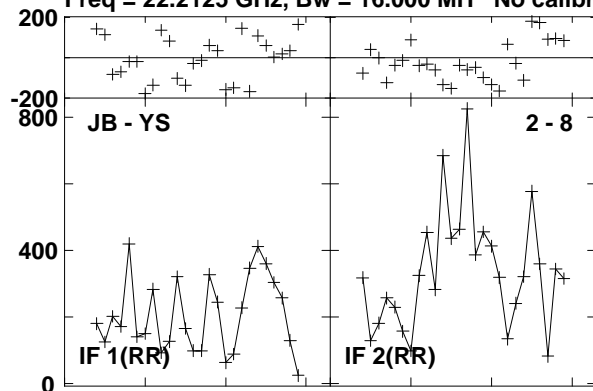

Lower frame: Micro Ampl Jy Top frame: Phas deg  
Vector averaged cross-power spectrum Baseline: JB (02) - YS (08)  
Timerange: 00/15:17:44 to 00/15:18:03

Plot file version 653 created 23-AUG-2016 15:01:05

0219+628 GA035B 1.UVDATA.1

Freq = 22.2125 GHz, Bw = 16.000 MH No calibration applied and no bandpass applied

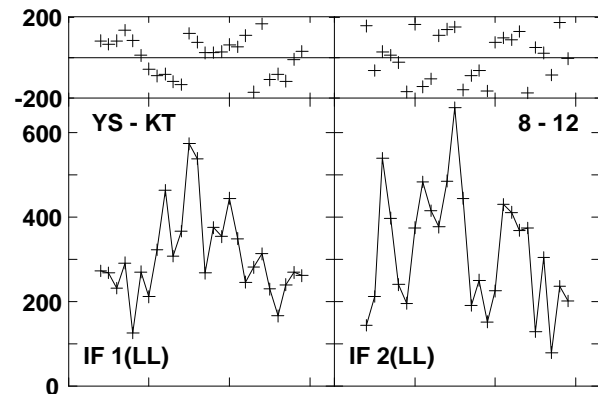
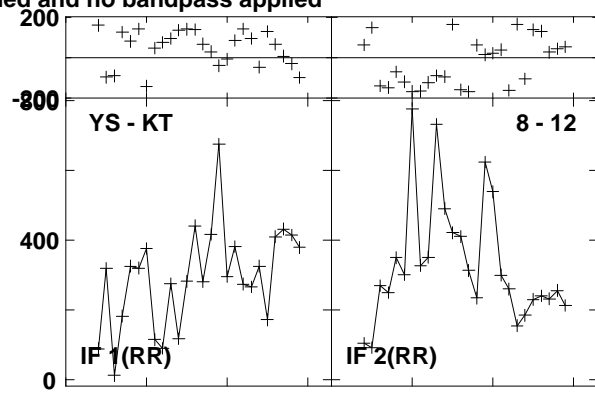
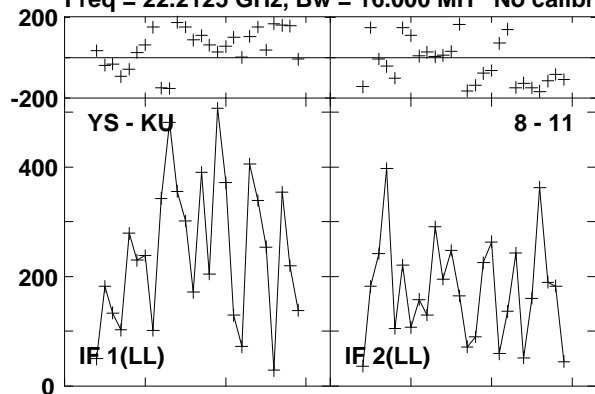

Lower frame: Micro Ampl Jy Top frame: Phas deg  
Vector averaged cross-power spectrum Baseline: YS (08) - KU (11)  
Timerange: 00/15:17:44 to 00/15:18:03

Plot file version 654 created 23-AUG-2016 15:01:05

W3IRS5 GA035B 1.UVDATA.1

Freq = 22.2125 GHz, Bw = 16.000 MH No calibration applied and no bandpass applied

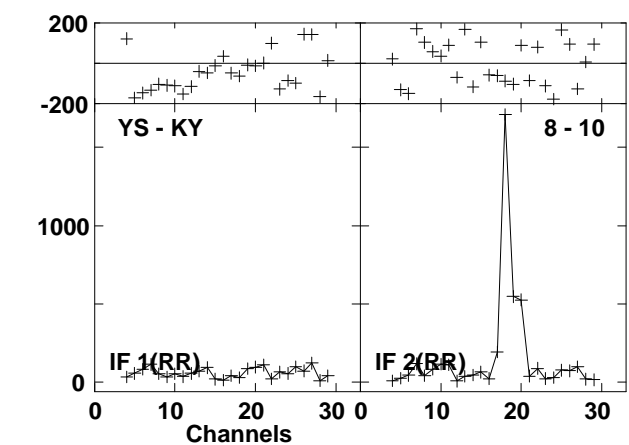
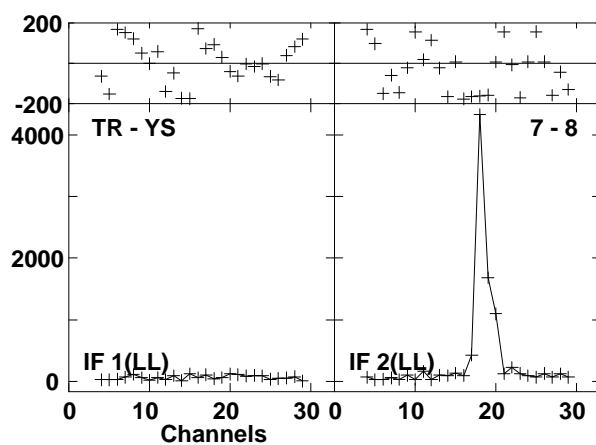
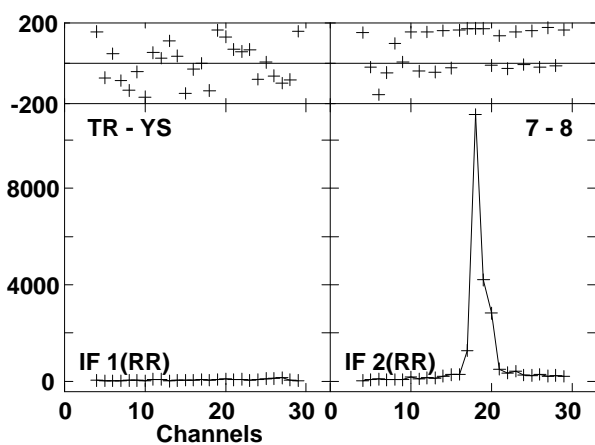
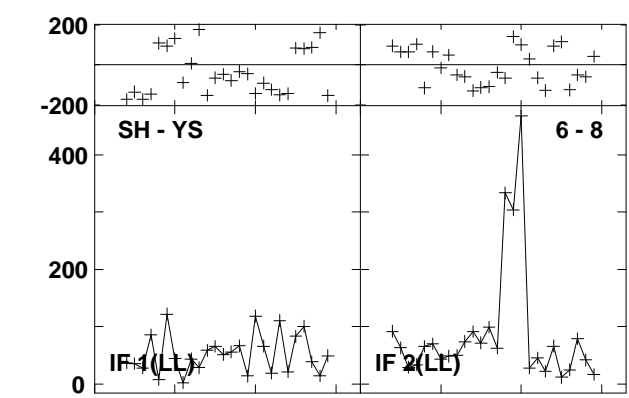
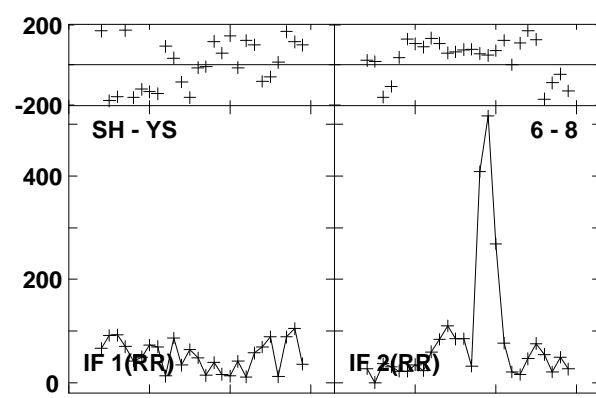
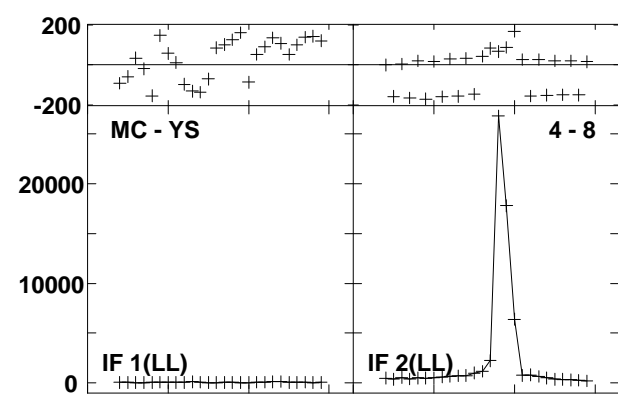
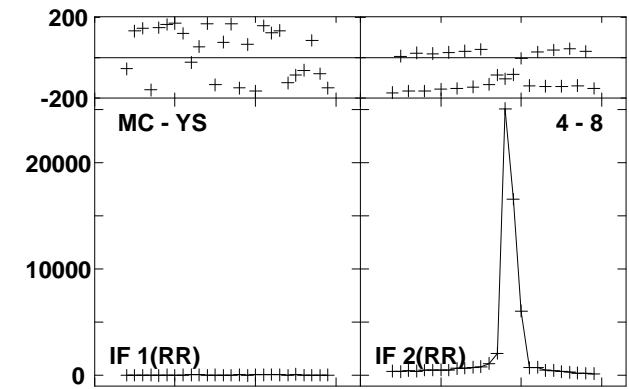
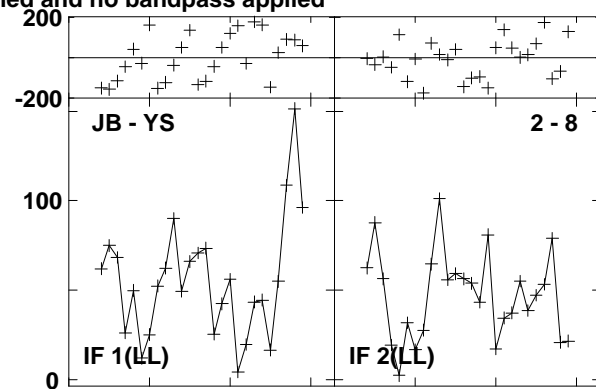
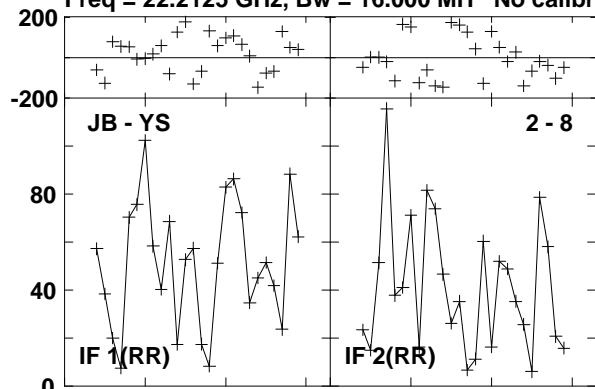

Lower frame: Micro Ampl Jy Top frame: Phas deg  
Vector averaged cross-power spectrum Baseline: JB (02) - YS (08)  
Timerange: 00/15:20:01 to 00/15:29:00

Plot file version 655 created 23-AUG-2016 15:01:06

W3IRS5 GA035B 1.UVDATA.1

Freq = 22.2125 GHz, Bw = 16.000 MH No calibration applied and no bandpass applied

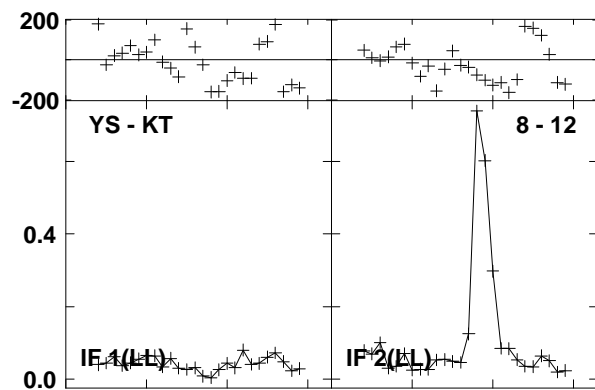
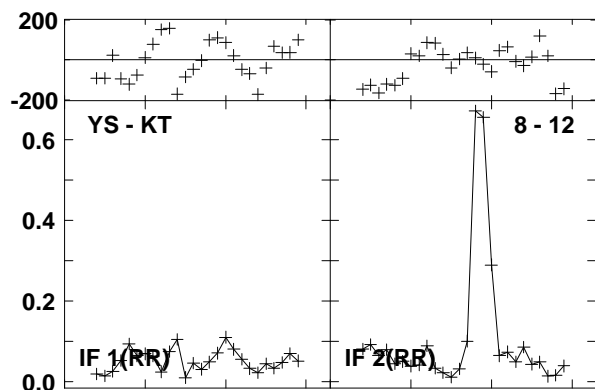
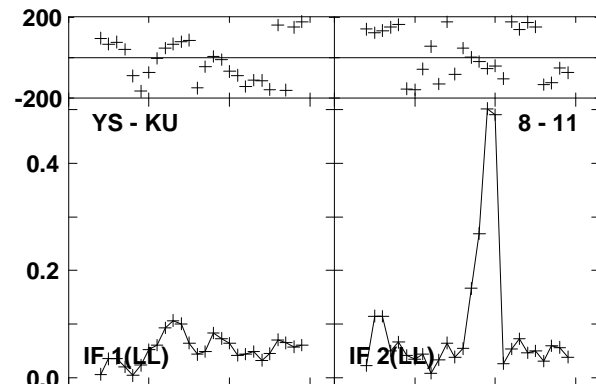
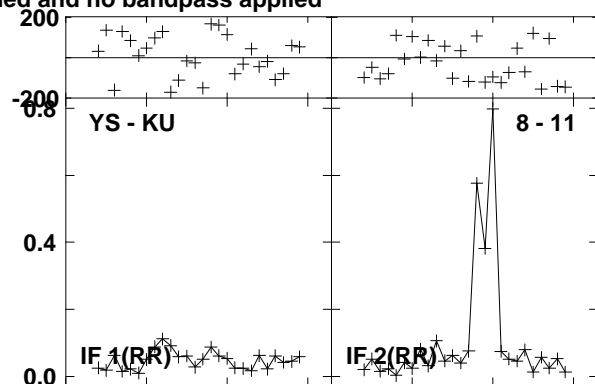
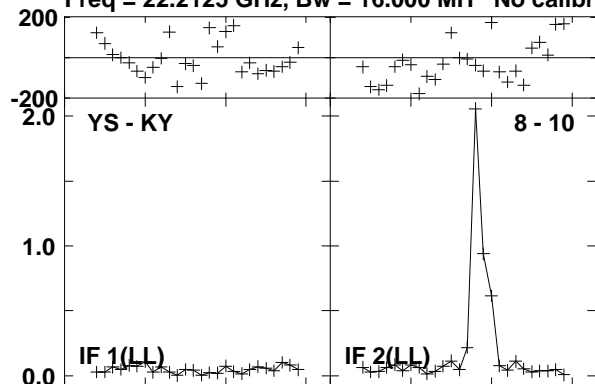

Lower frame: Milli Ampl Jy Top frame: Phas deg

Vector averaged cross-power spectrum Baseline: YS (08) - KY (10)

Timerange: 00/15:20:01 to 00/15:29:00

Plot file version 656 created 23-AUG-2016 15:01:06  
 W3IRS5 GA035B 1.UVDATA.1

Freq = 22.2125 GHz, Bw = 16.000 MH No calibration applied and no bandpass applied

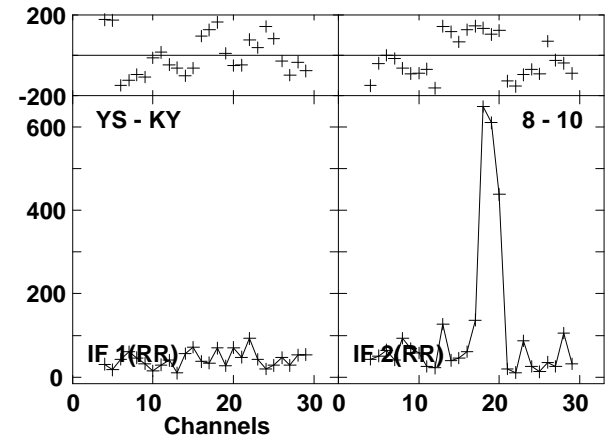
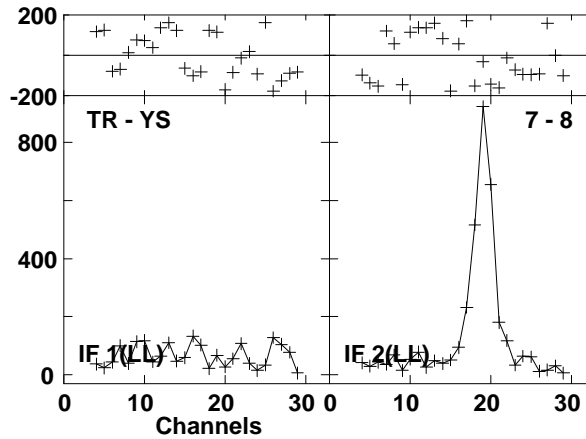
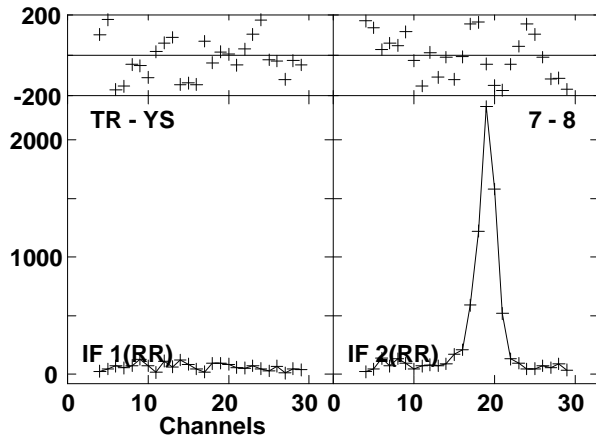
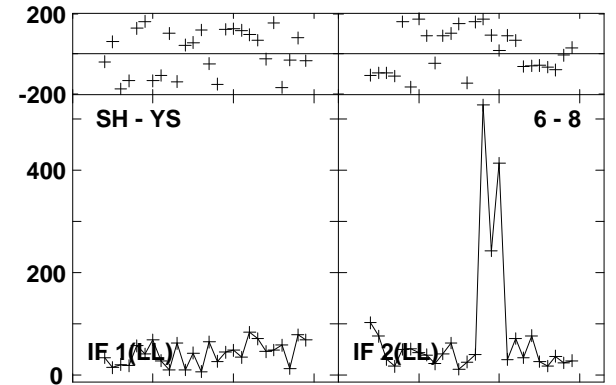
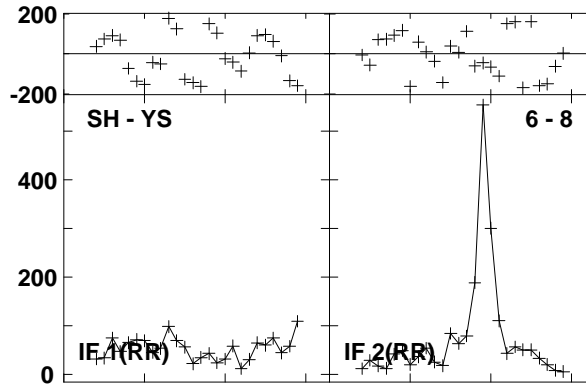
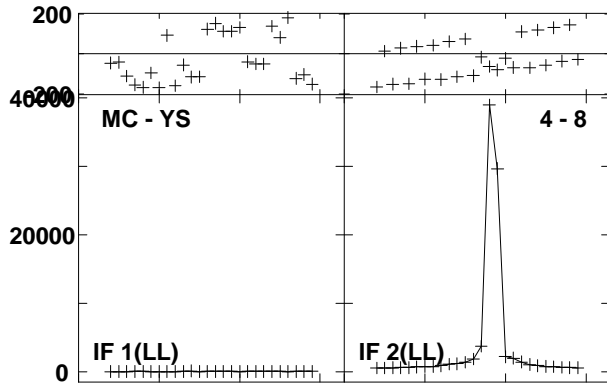
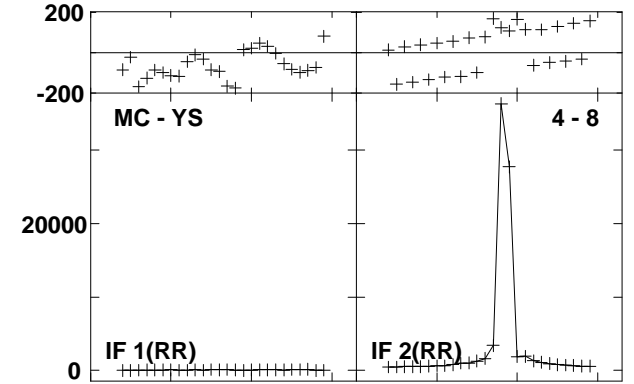
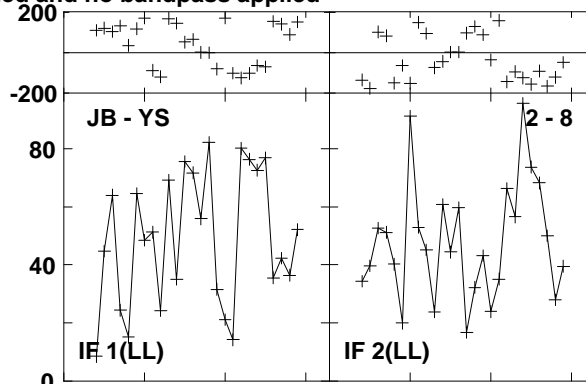
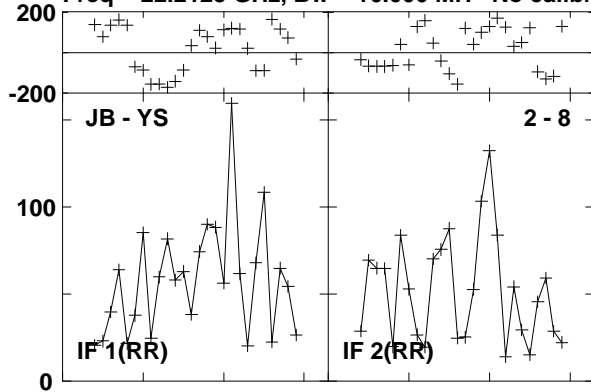

Lower frame: Micro Ampl Jy Top frame: Phas deg  
 Vector averaged cross-power spectrum Baseline: JB (02) - YS (08)  
 Timerange: 00/15:30:31 to 00/15:39:30



Plot file version 657 created 23-AUG-2016 15:01:06  
W3IRS5 GA035B 1.UVDATA.1

Freq = 22.2125 GHz, Bw = 16.000 MH No calibration applied and no bandpass applied

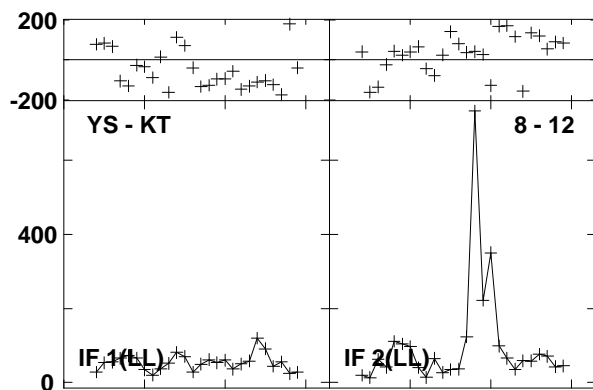
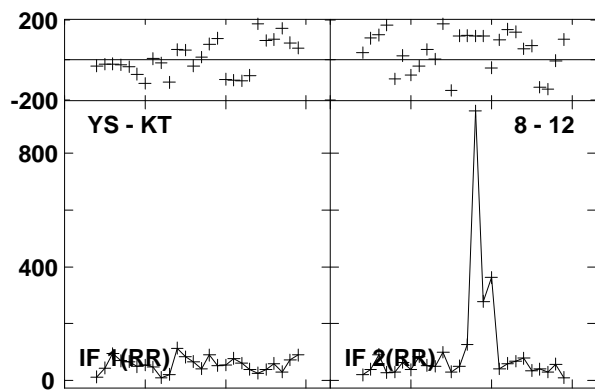
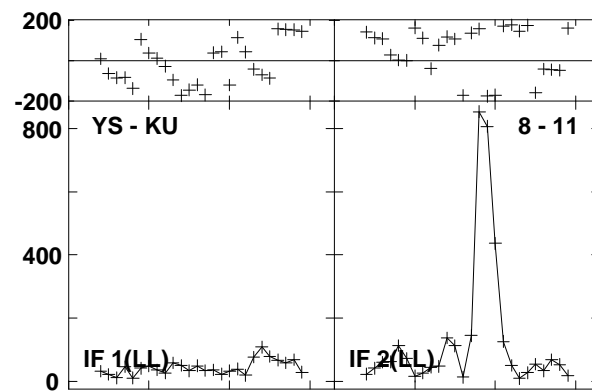
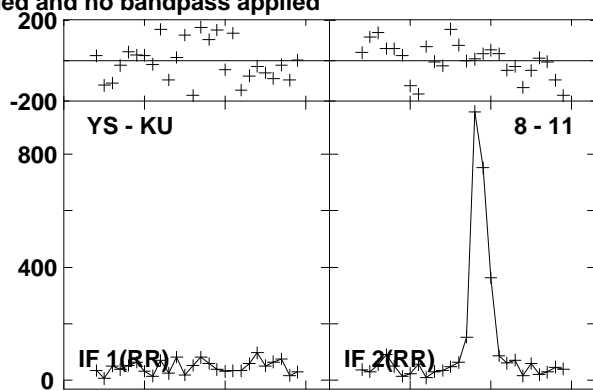
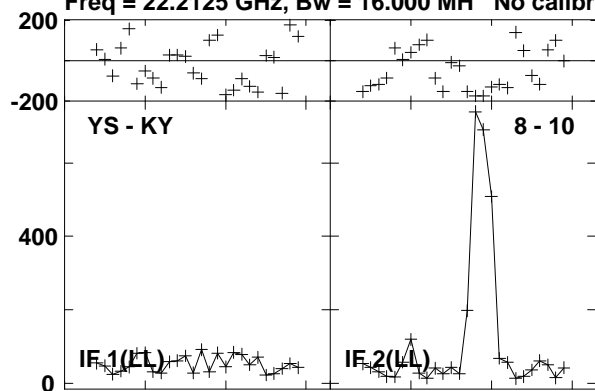

Lower frame: Micro Ampl Jy Top frame: Phas deg  
Vector averaged cross-power spectrum Baseline: YS (08) - KY (10)  
Timerange: 00/15:30:31 to 00/15:39:30

Plot file version 658 created 23-AUG-2016 15:01:06  
W3IRS5 GA035B 1.UVDATA.1

Freq = 22.2125 GHz, Bw = 16.000 MH No calibration applied and no bandpass applied

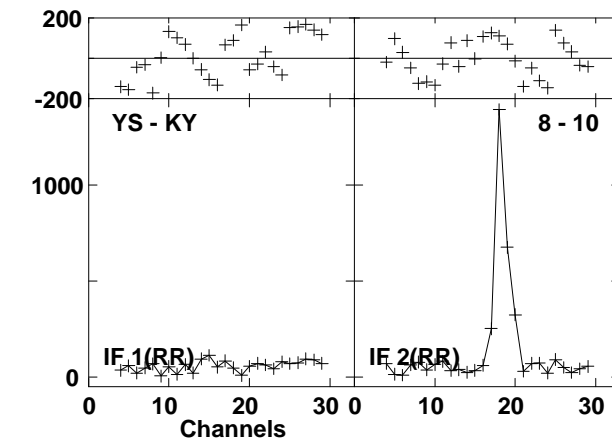
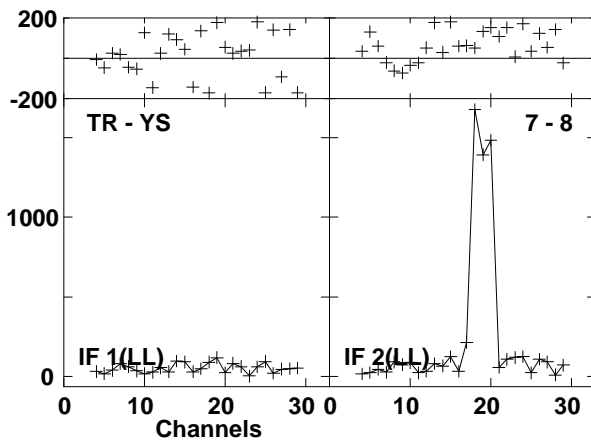
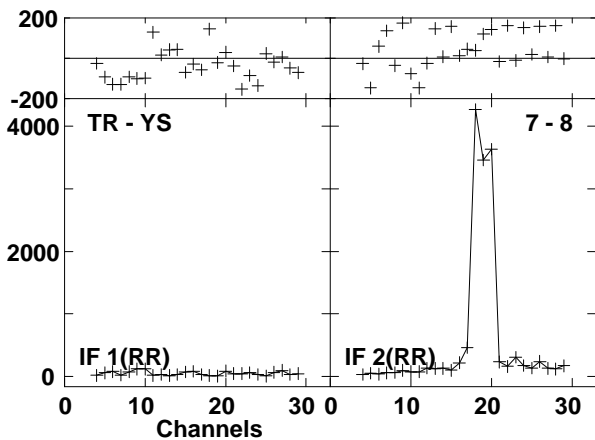
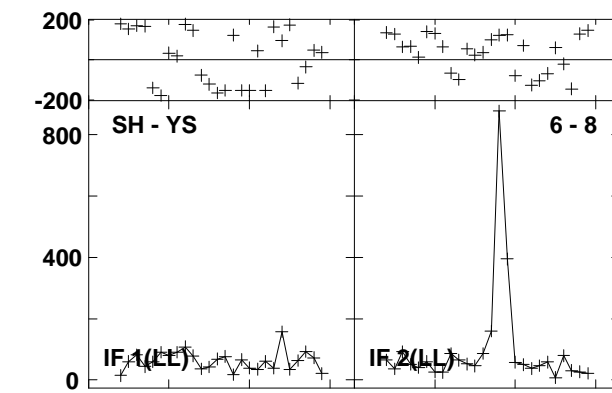
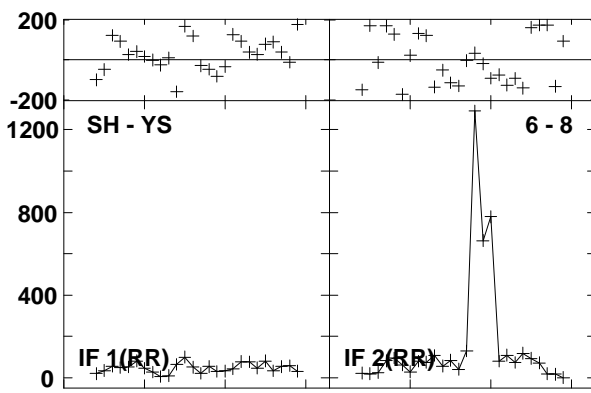
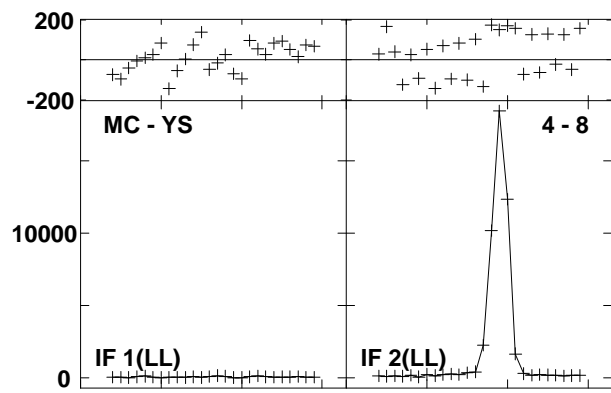
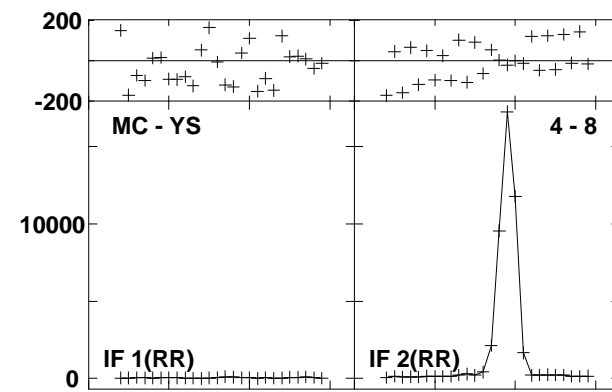
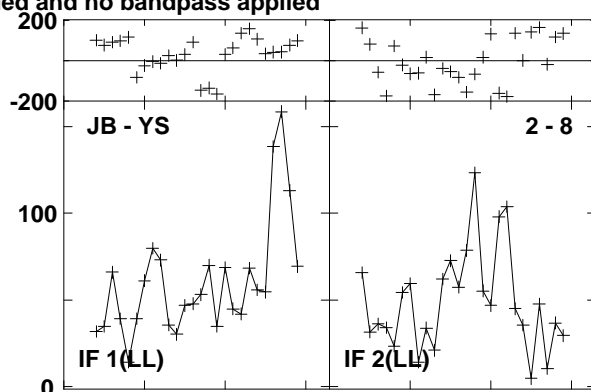
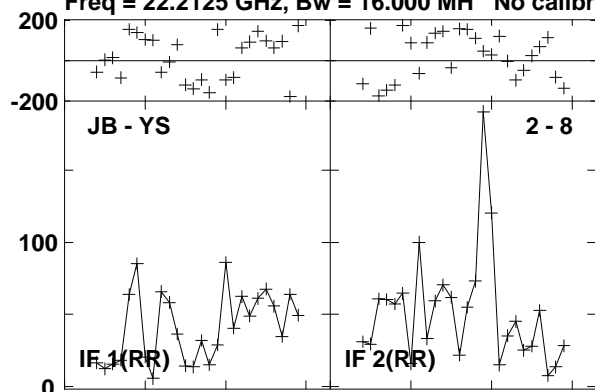

Lower frame: Micro Ampl Jy Top frame: Phas deg  
Vector averaged cross-power spectrum Baseline: JB (02) - YS (08)  
Timerange: 00/15:41:01 to 00/15:50:00

Plot file version 659 created 23-AUG-2016 15:01:07

W3IRS5 GA035B 1.UVDATA.1

Freq = 22.2125 GHz, Bw = 16.000 MH No calibration applied and no bandpass applied

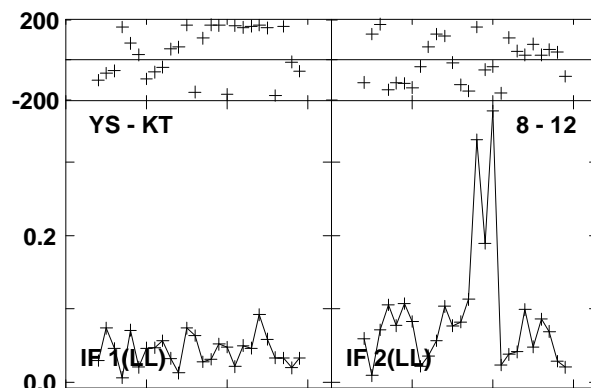
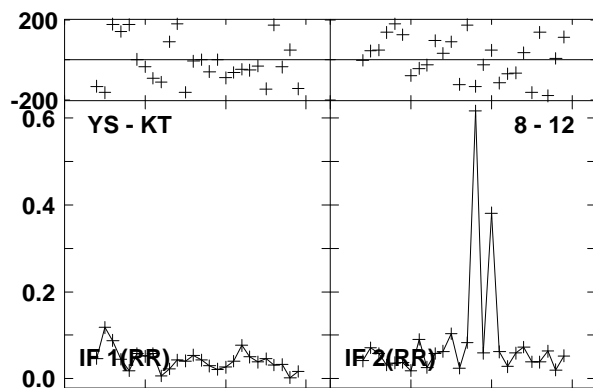
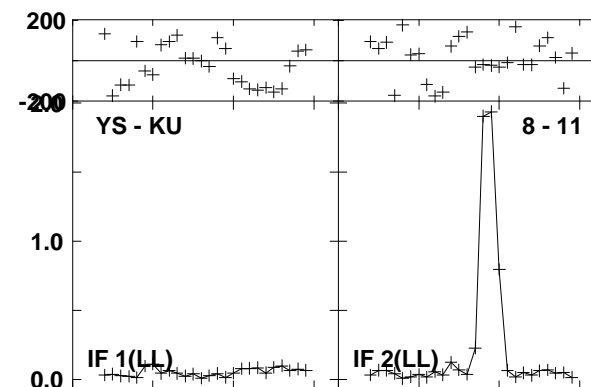
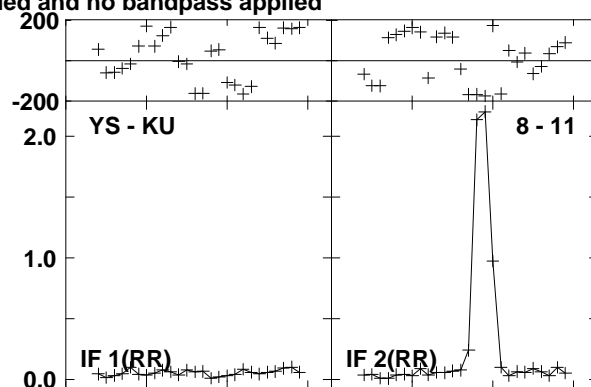
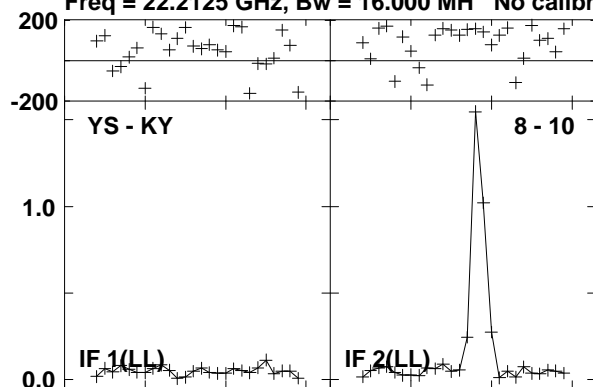

Lower frame: Milli Ampl Jy Top frame: Phas deg  
Vector averaged cross-power spectrum Baseline: YS (08) - KY (10)  
Timerange: 00/15:41:01 to 00/15:50:00

Plot file version 660 created 23-AUG-2016 15:01:07  
 W3IRS5 GA035B 1.UVDATA.1

Freq = 22.2125 GHz, Bw = 16.000 MH No calibration applied and no bandpass applied

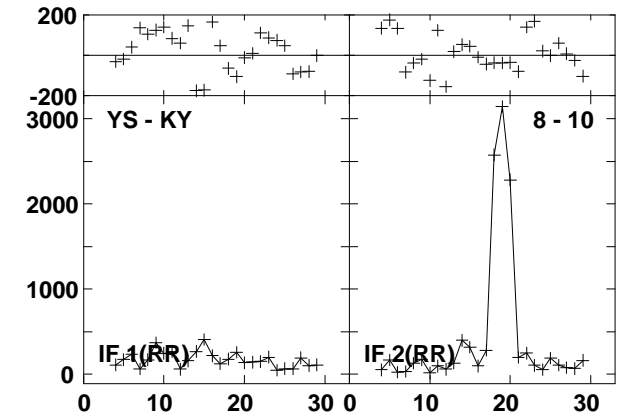
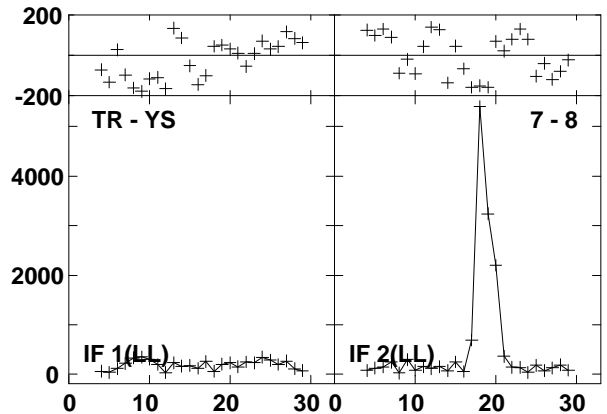
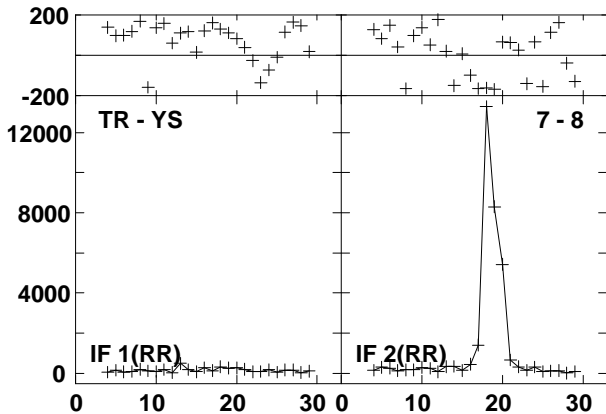
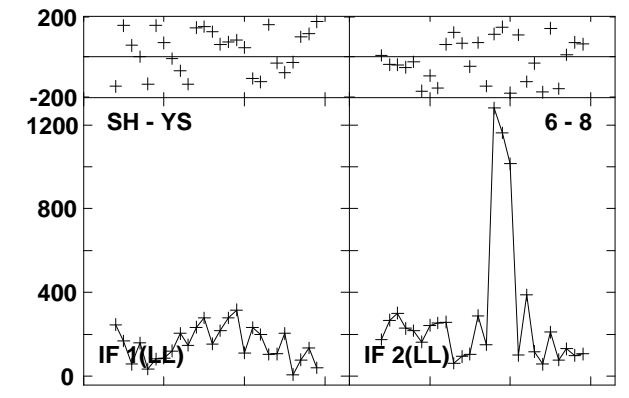
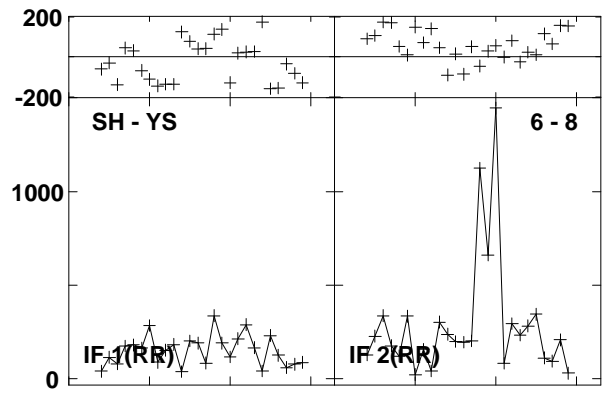
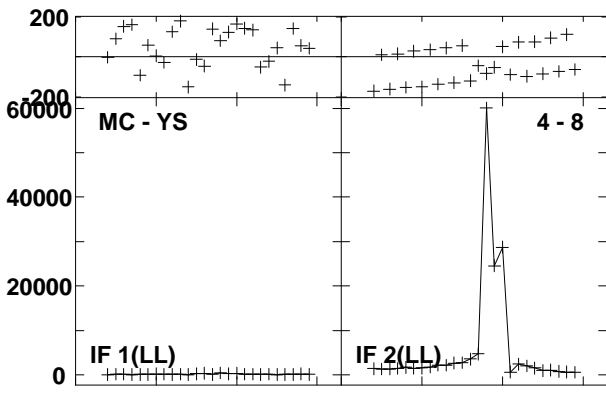
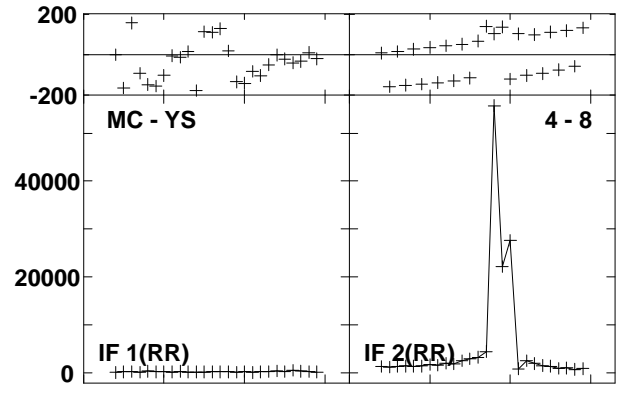
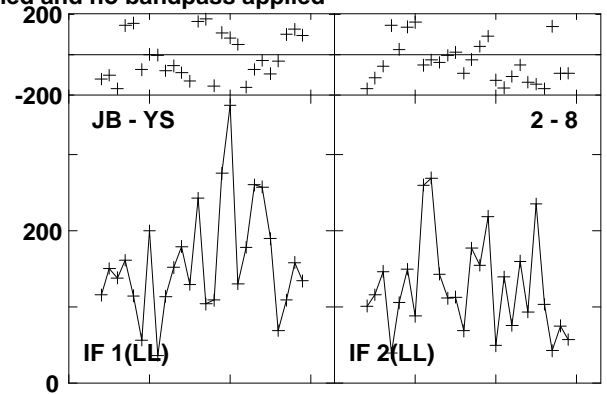
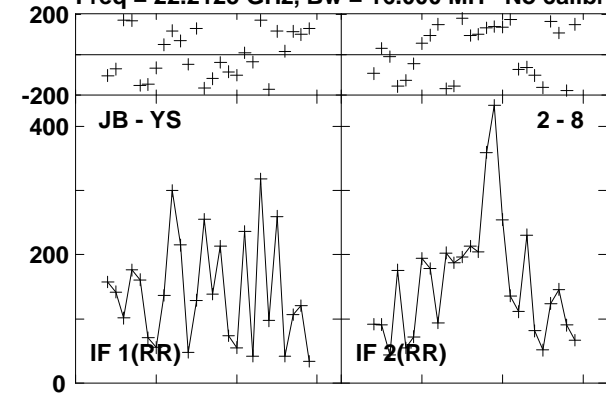

Lower frame: Micro Ampl Jy Top frame: Phas deg  
 Vector averaged cross-power spectrum Baseline: JB (02) - YS (08)  
 Timerange: 00/15:52:16 to 00/15:53:14

Plot file version 661 created 23-AUG-2016 15:01:07

W3IRS5 GA035B 1.UVDATA.1

Freq = 22.2125 GHz, Bw = 16.000 MH No calibration applied and no bandpass applied

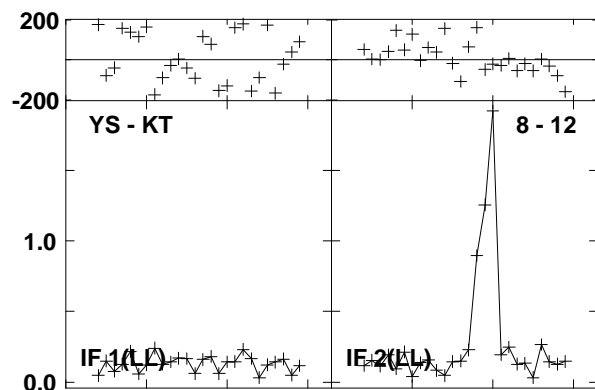
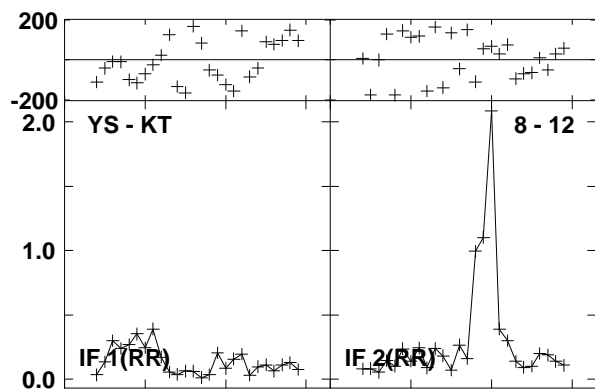
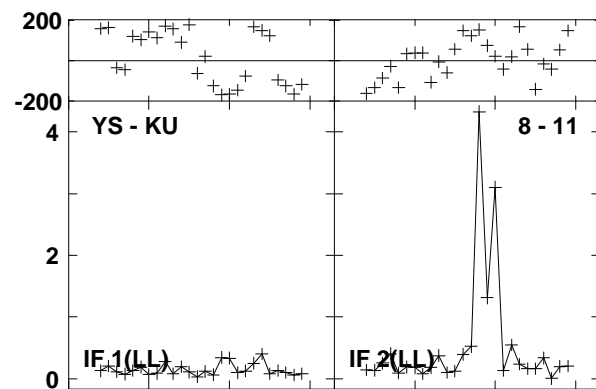
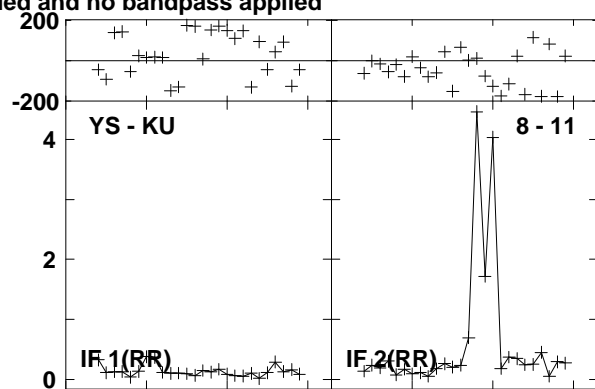
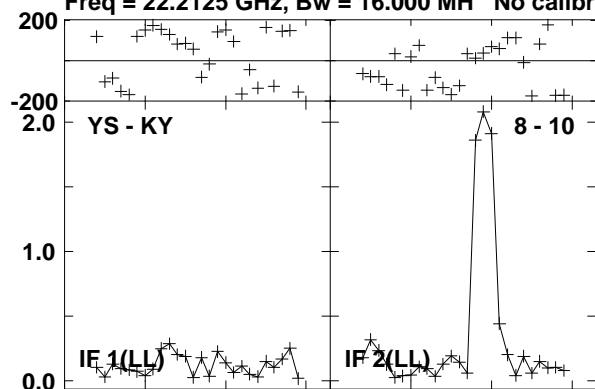

Lower frame: Milli Ampl Jy Top frame: Phas deg

Vector averaged cross-power spectrum Baseline: YS (08) - KY (10)

Timerange: 00/15:52:16 to 00/15:53:14

Plot file version 662 created 23-AUG-2016 15:01:07

0219+628 GA035B 1.UVDATA.1

Freq = 22.2125 GHz, Bw = 16.000 MH No calibration applied and no bandpass applied

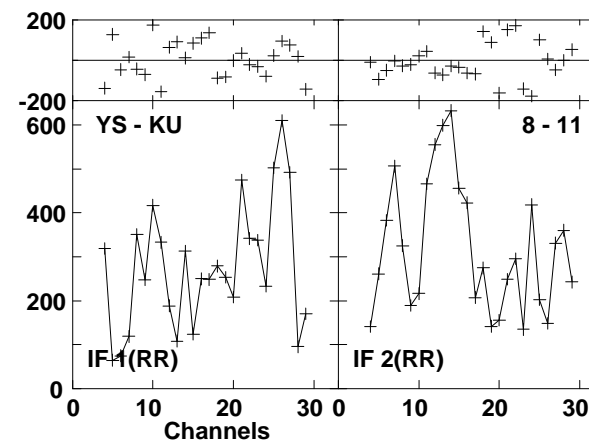
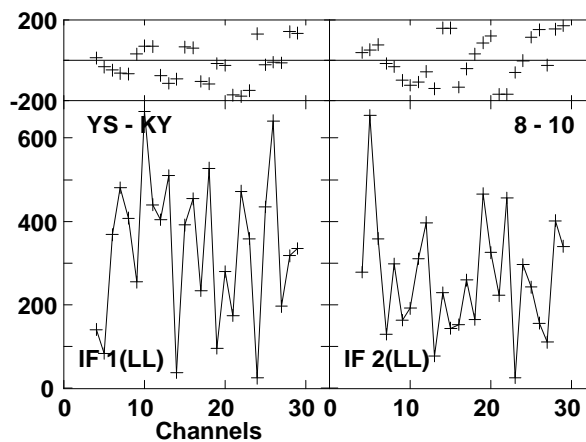
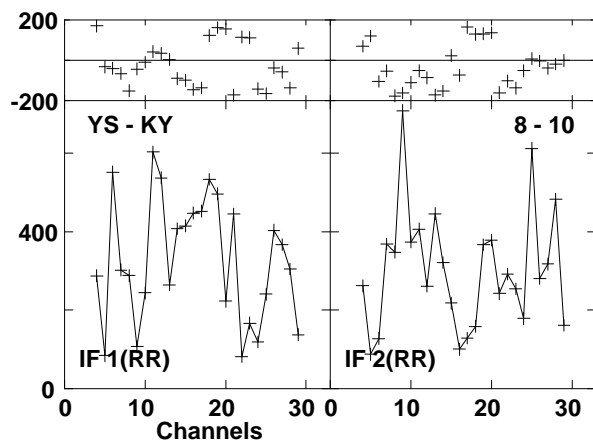
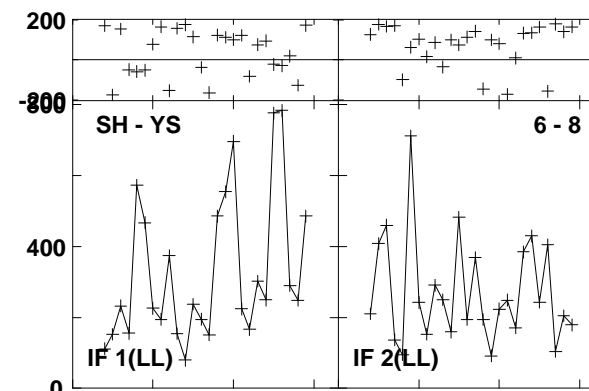
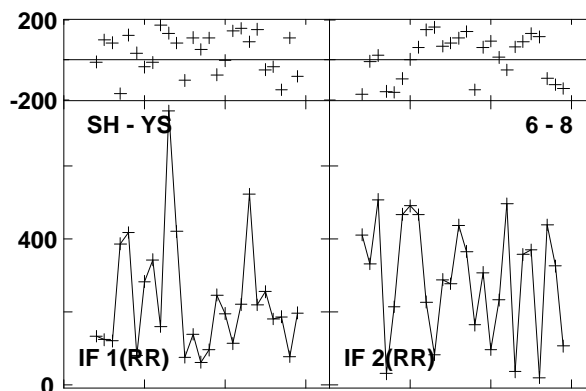
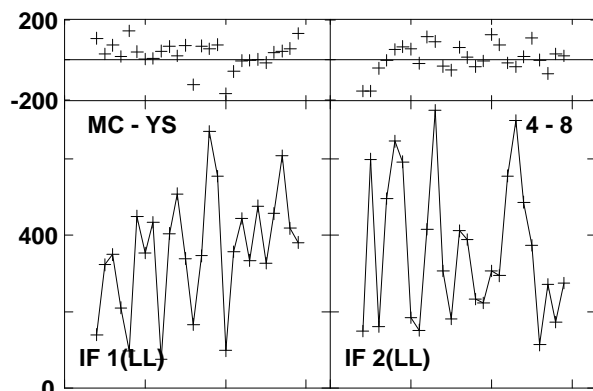
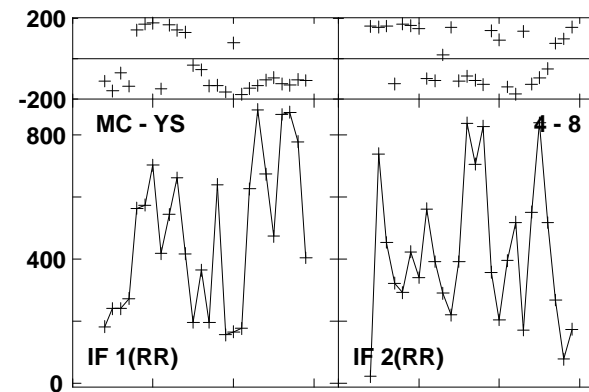
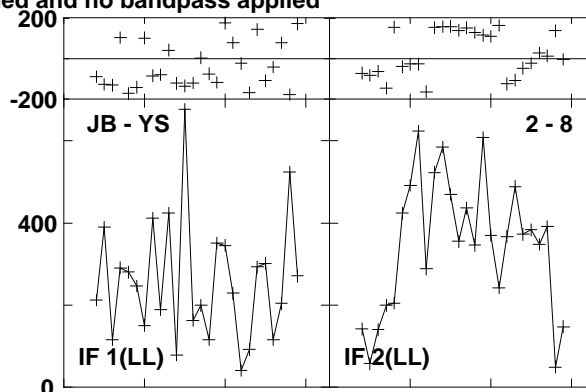
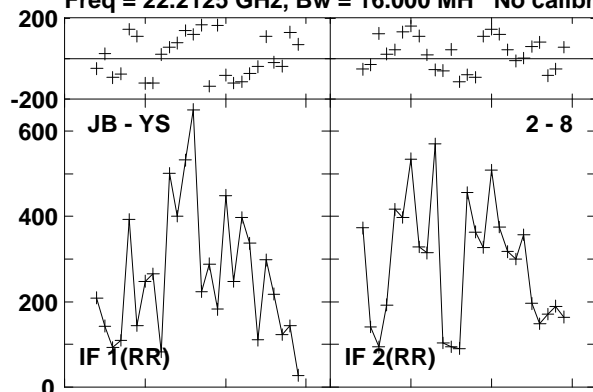

Lower frame: Micro Ampl Jy Top frame: Phas deg  
Vector averaged cross-power spectrum Baseline: JB (02) - YS (08)  
Timerange: 00/15:53:52 to 00/15:54:10

Plot file version 663 created 23-AUG-2016 15:01:07

0219+628 GA035B 1.UVDATA.1

Freq = 22.2125 GHz, Bw = 16.000 MH No calibration applied and no bandpass applied

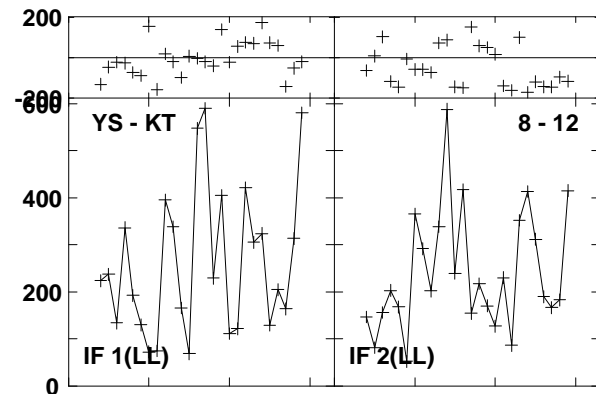
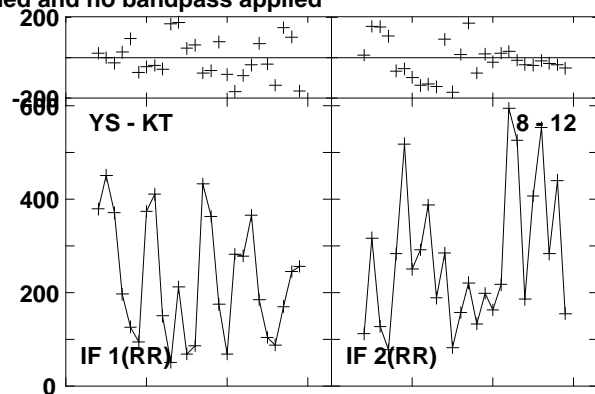
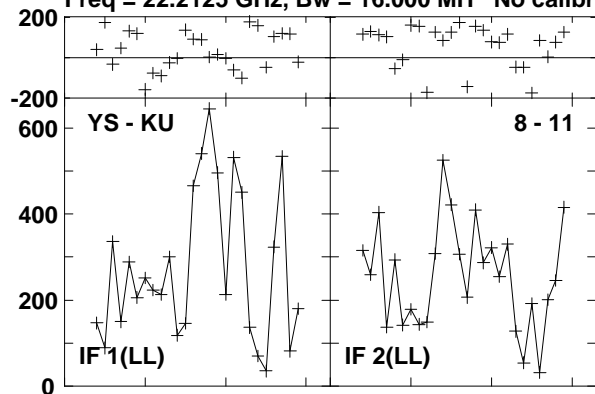

Lower frame: Micro Ampl Jy Top frame: Phas deg  
Vector averaged cross-power spectrum Baseline: YS (08) - KU (11)  
Timerange: 00/15:53:52 to 00/15:54:10

Plot file version 664 created 23-AUG-2016 15:01:07  
 W3IRS5 GA035B 1.UVDATA.1

Freq = 22.2125 GHz, Bw = 16.000 MH No calibration applied and no bandpass applied

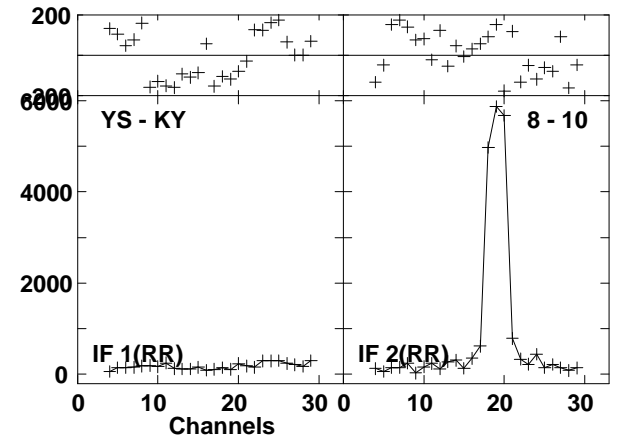
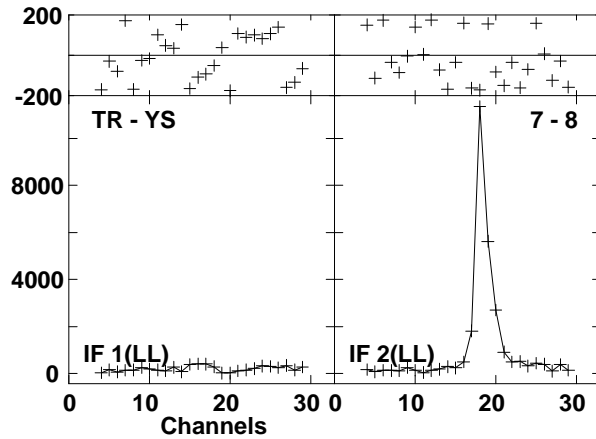
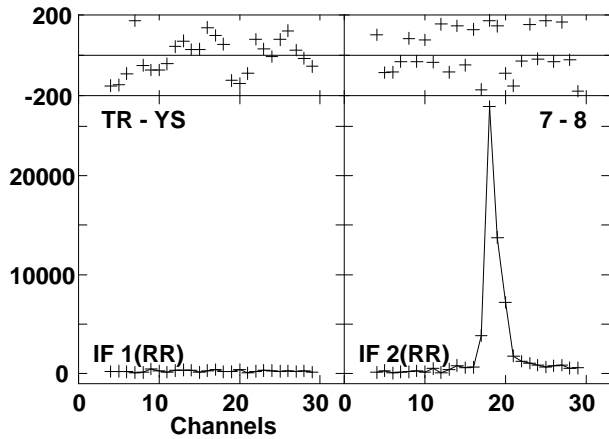
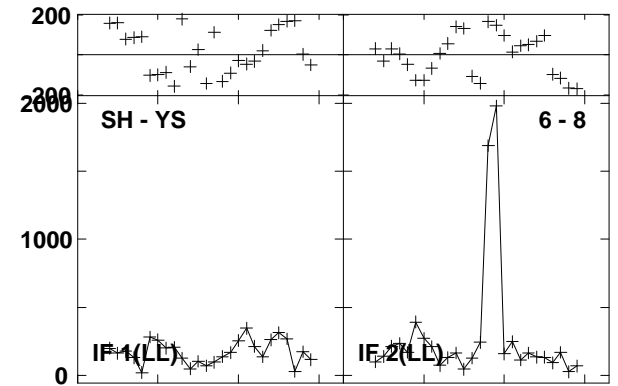
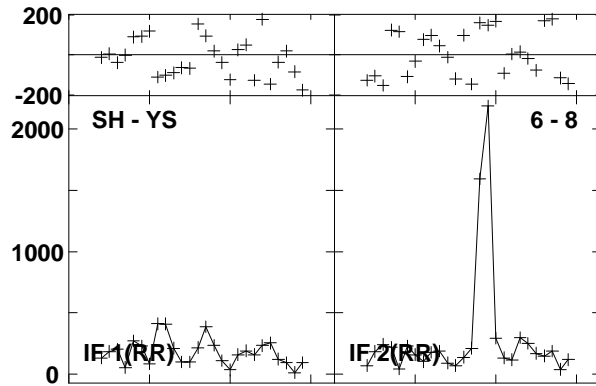
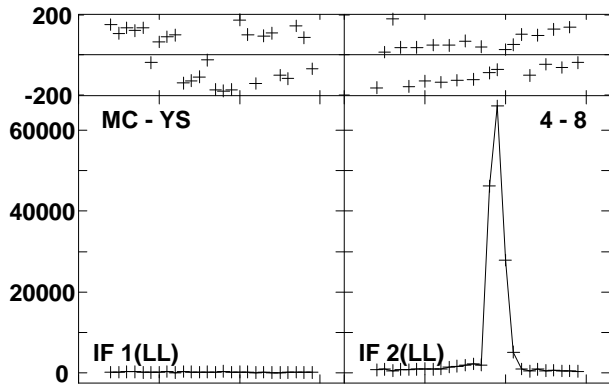
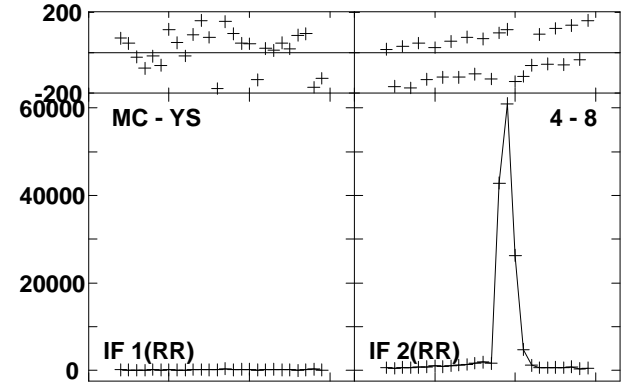
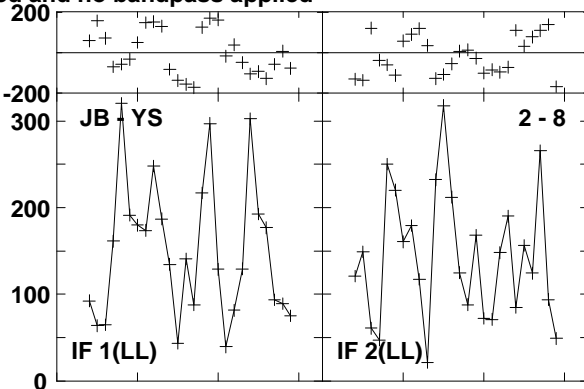
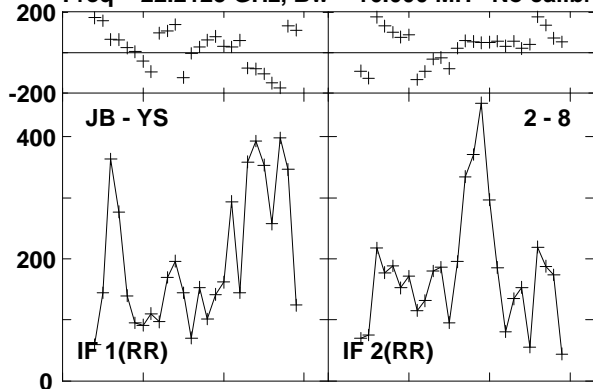

Lower frame: Micro Ampl Jy Top frame: Phas deg  
 Vector averaged cross-power spectrum Baseline: JB (02) - YS (08)  
 Timerange: 00/15:54:48 to 00/15:55:47



Plot file version 665 created 23-AUG-2016 15:01:07

W3IRS5 GA035B 1.UVDATA.1

Freq = 22.2125 GHz, Bw = 16.000 MH No calibration applied and no bandpass applied

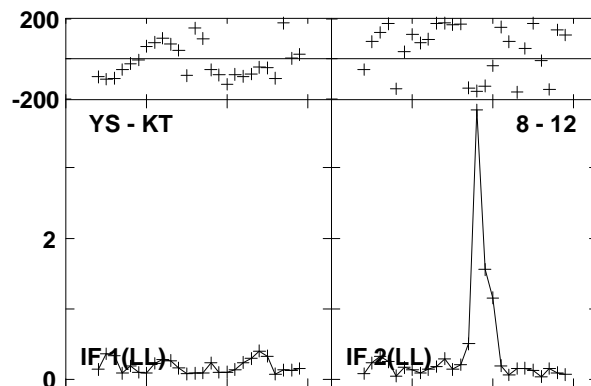
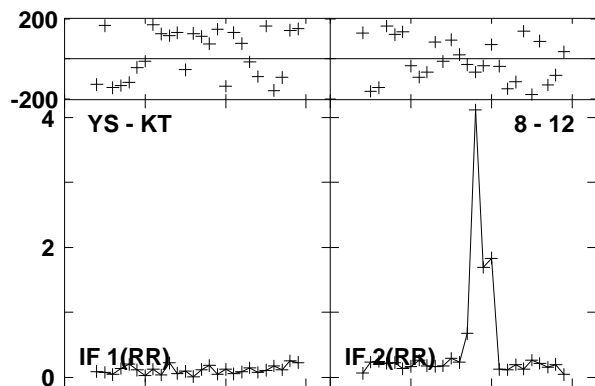
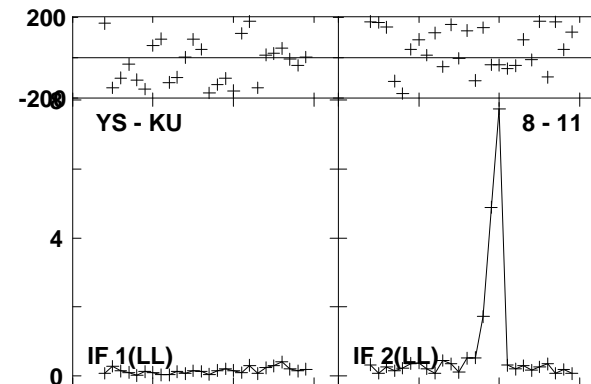
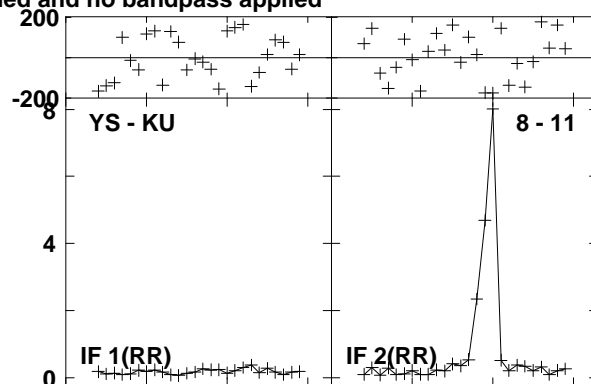
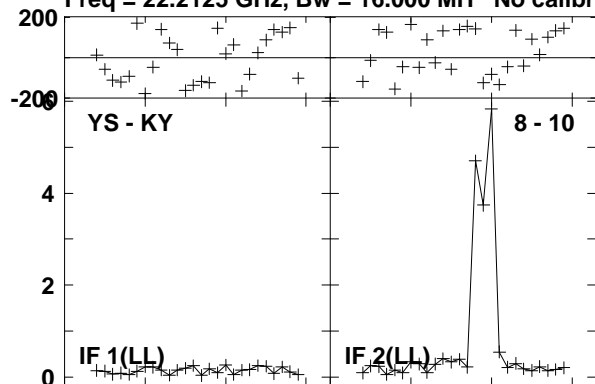

Lower frame: Milli Ampl Jy Top frame: Phas deg

Vector averaged cross-power spectrum Baseline: YS (08) - KY (10)

Timerange: 00/15:54:48 to 00/15:55:47

Plot file version 666 created 23-AUG-2016 15:01:07

0219+628 GA035B 1.UVDATA.1

Freq = 22.2125 GHz, Bw = 16.000 MH No calibration applied and no bandpass applied

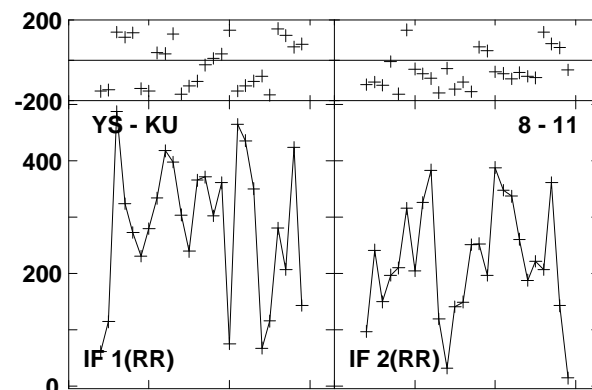
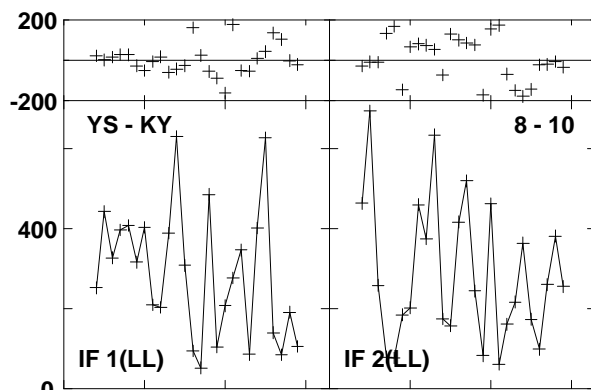
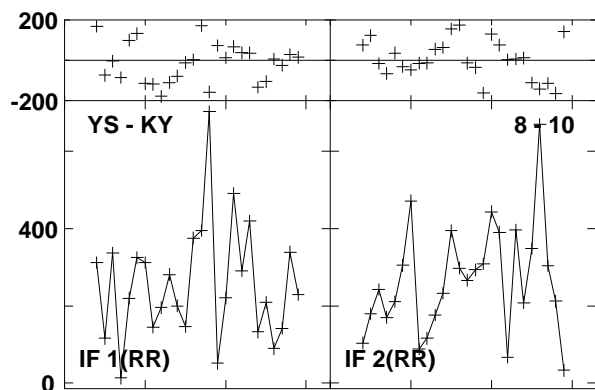
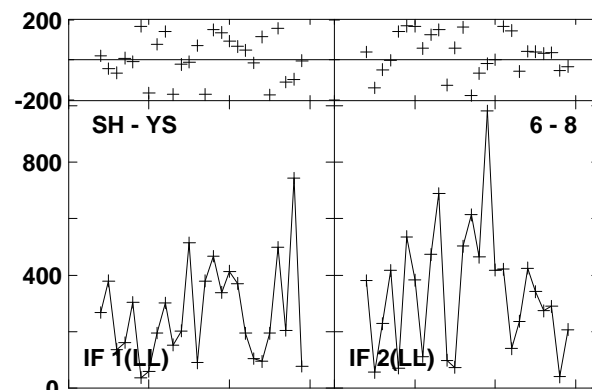
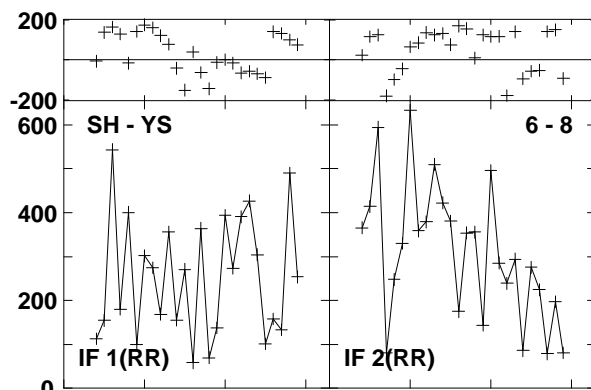
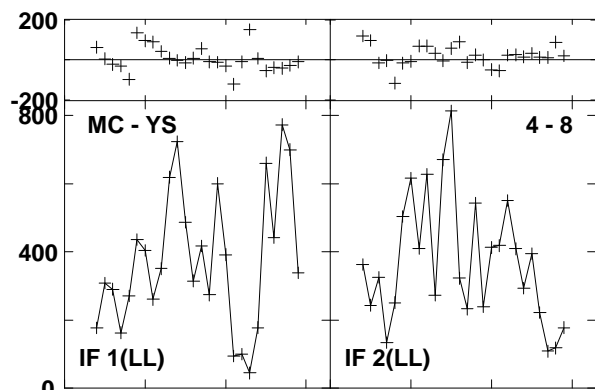
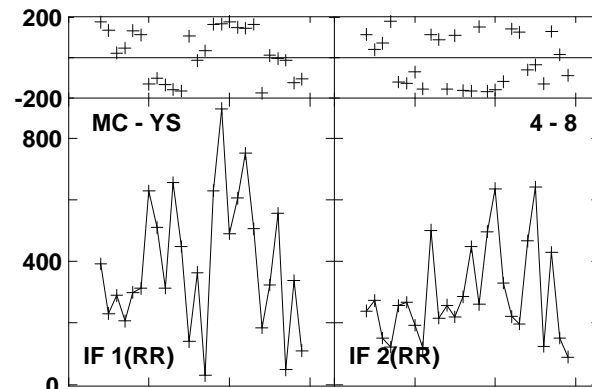
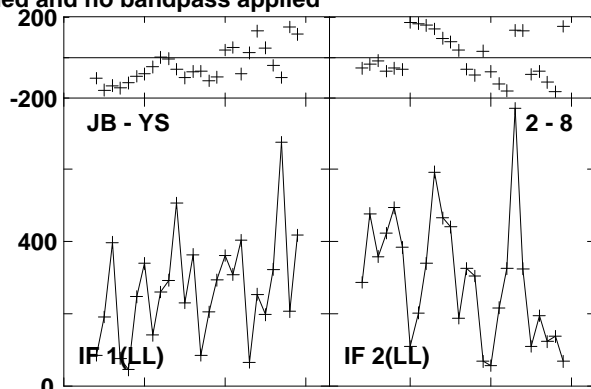
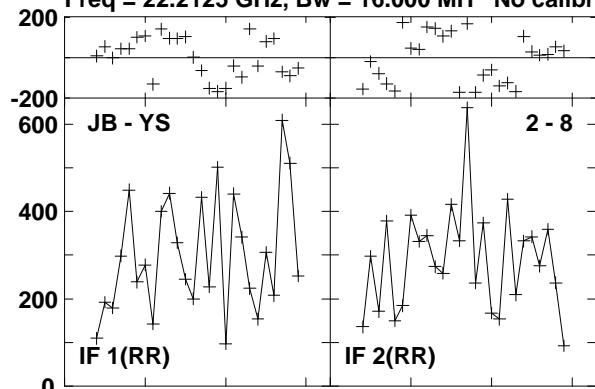

Channels

Lower frame: Micro Ampl Jy Top frame: Phas deg

Vector averaged cross-power spectrum Baseline: JB (02) - YS (08)

Timerange: 00/15:56:24 to 00/15:56:43

Plot file version 667 created 23-AUG-2016 15:01:07

0219+628 GA035B 1.UVDATA.1

Freq = 22.2125 GHz, Bw = 16.000 MH No calibration applied and no bandpass applied

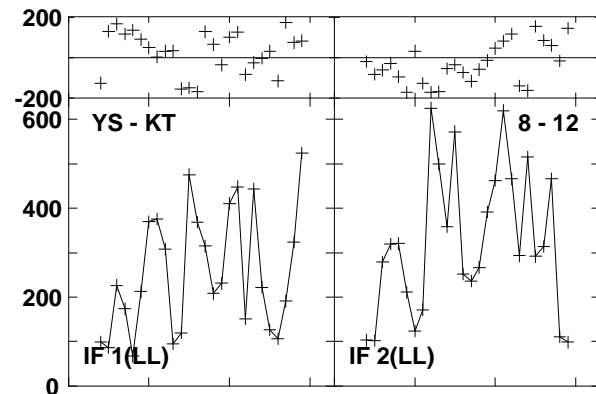
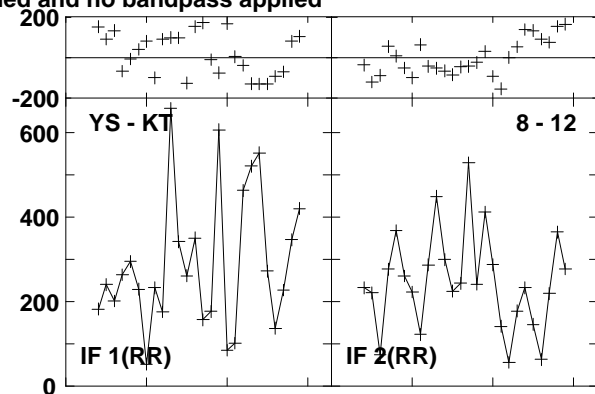
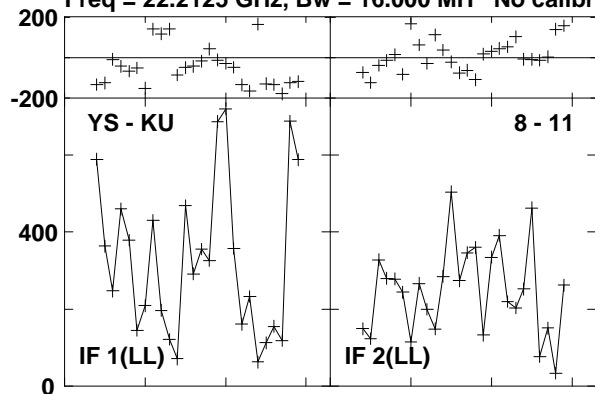

Lower frame: Micro Ampl Jy Top frame: Phas deg  
Vector averaged cross-power spectrum Baseline: YS (08) - KU (11)  
Timerange: 00/15:56:24 to 00/15:56:43

Plot file version 668 created 23-AUG-2016 15:01:07

W3IRS5 GA035B 1.UVDATA.1

Freq = 22.2125 GHz, Bw = 16.000 MH No calibration applied and no bandpass applied

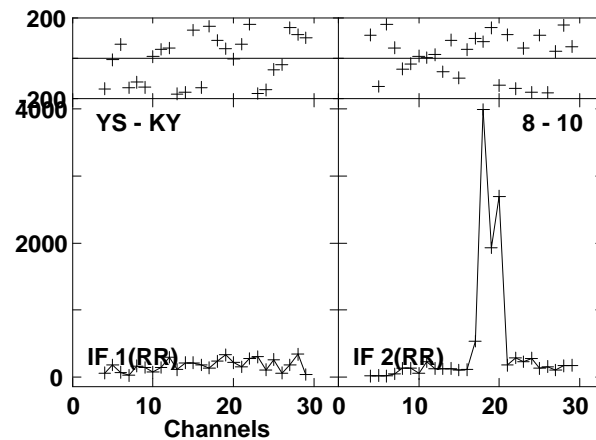
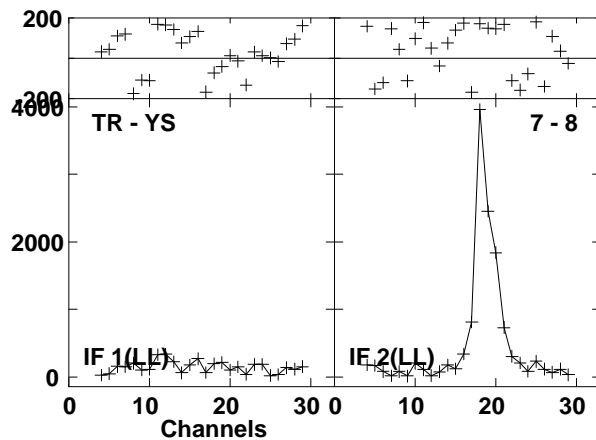
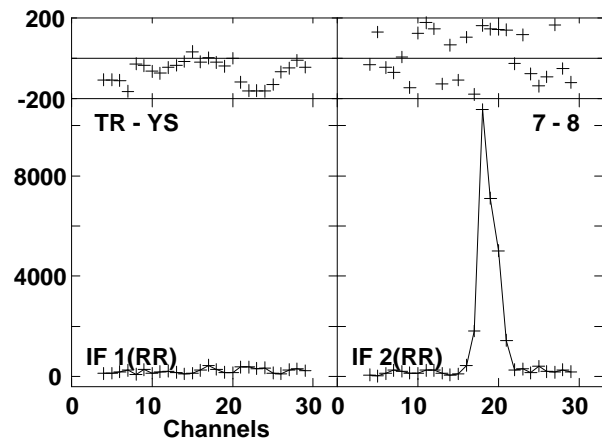
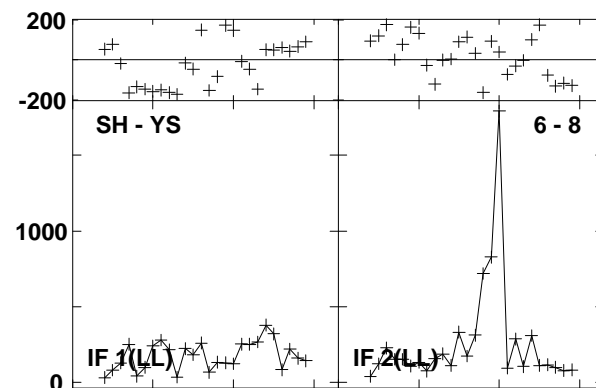
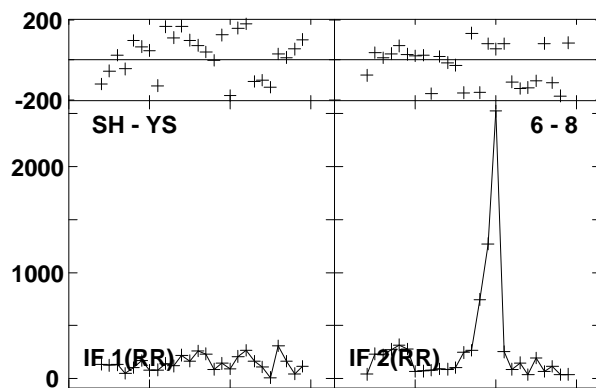
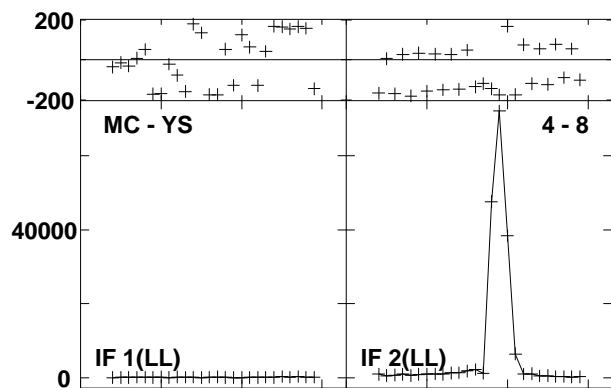
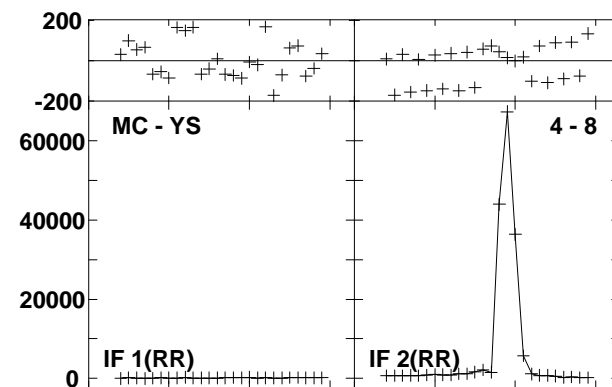
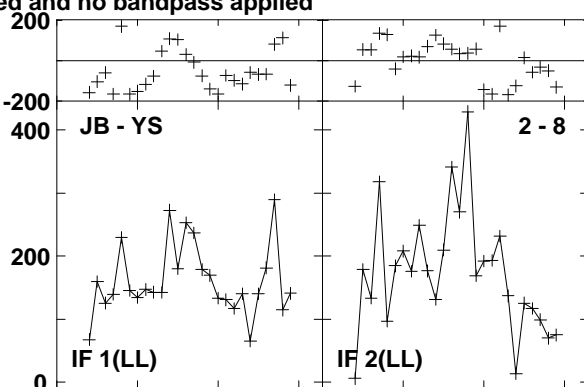
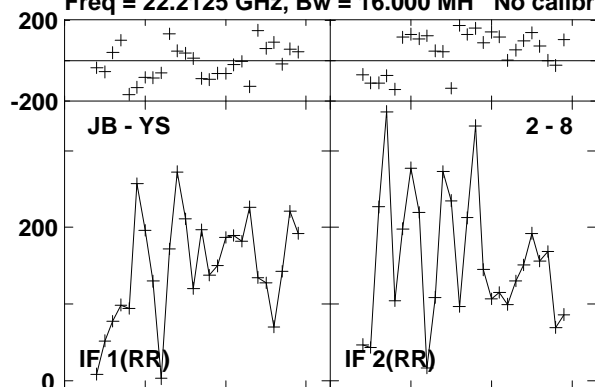

Lower frame: Micro Ampl Jy Top frame: Phas deg  
Vector averaged cross-power spectrum Baseline: JB (02) - YS (08)  
Timerange: 00/15:57:20 to 00/15:58:19

Plot file version 669 created 23-AUG-2016 15:01:07

W3IRS5 GA035B 1.UVDATA.1

Freq = 22.2125 GHz, Bw = 16.000 MH No calibration applied and no bandpass applied

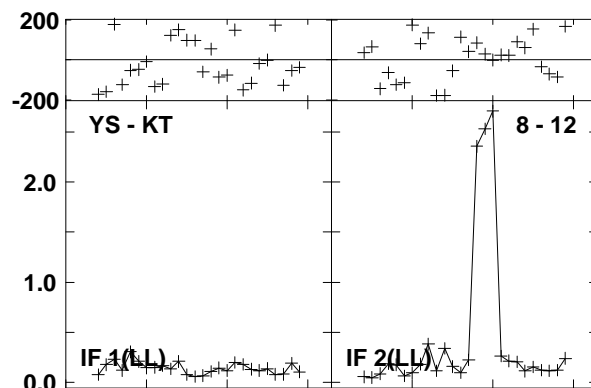
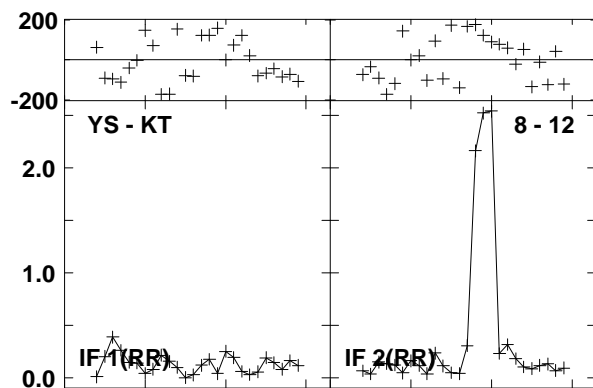
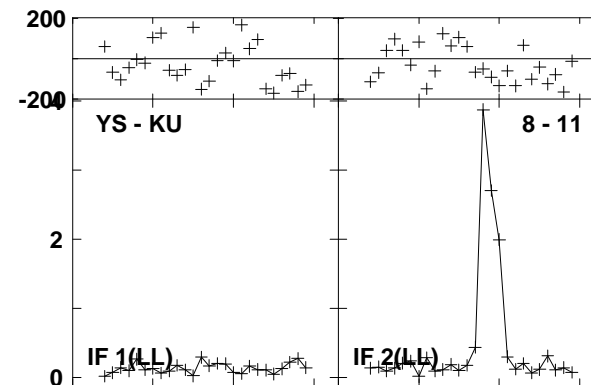
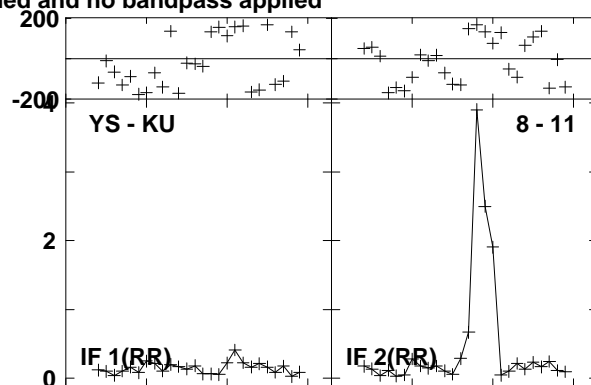
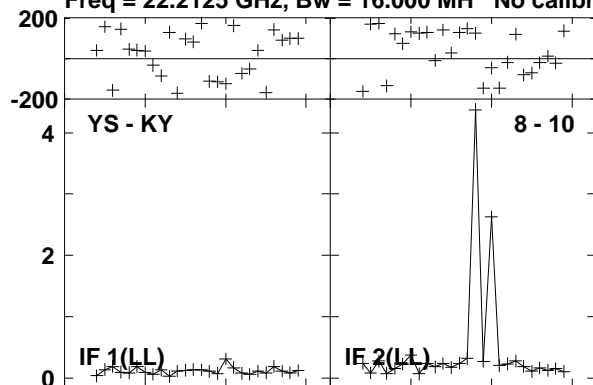

Lower frame: Milli Ampl Jy Top frame: Phas deg  
Vector averaged cross-power spectrum Baseline: YS (08) - KY (10)  
Timerange: 00/15:57:20 to 00/15:58:19

Plot file version 670 created 23-AUG-2016 15:01:07

0219+628 GA035B 1.UVDATA.1

Freq = 22.2125 GHz, Bw = 16.000 MH No calibration applied and no bandpass applied

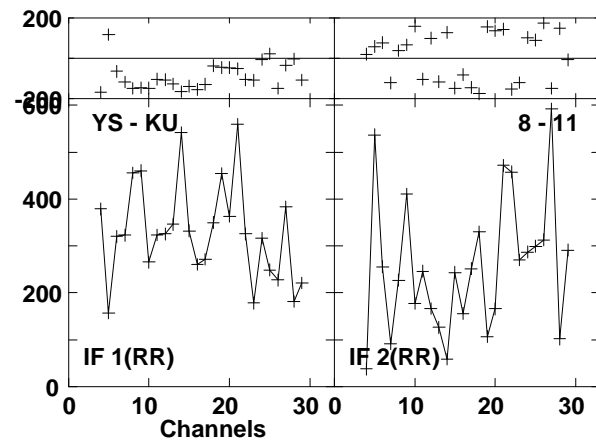
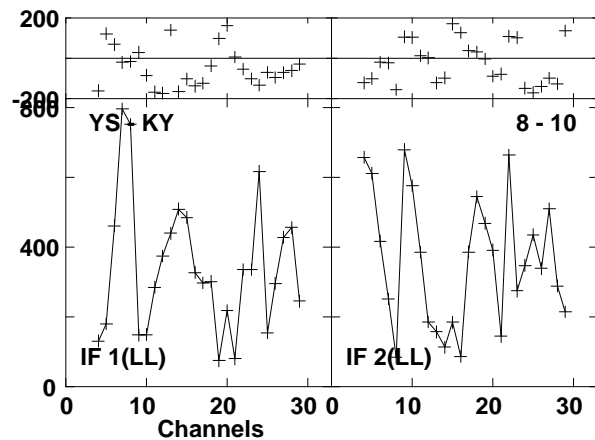
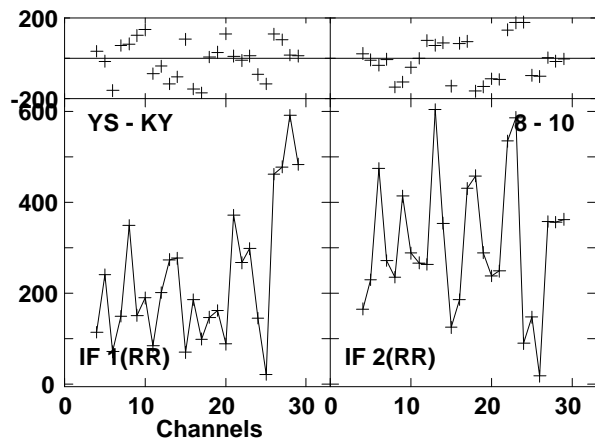
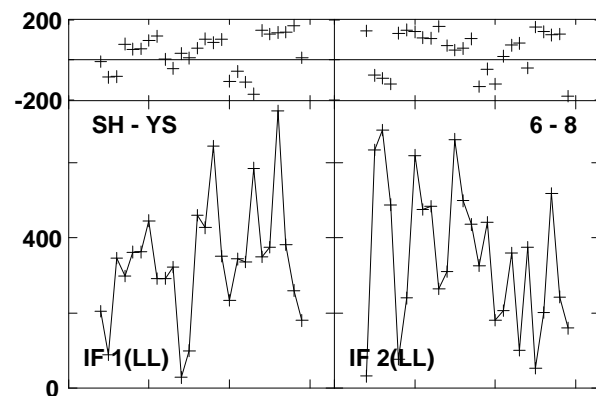
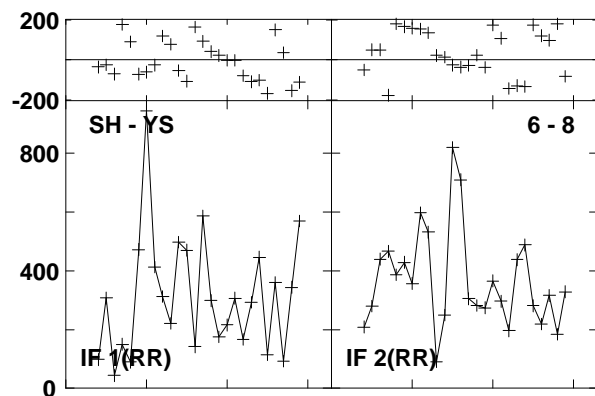
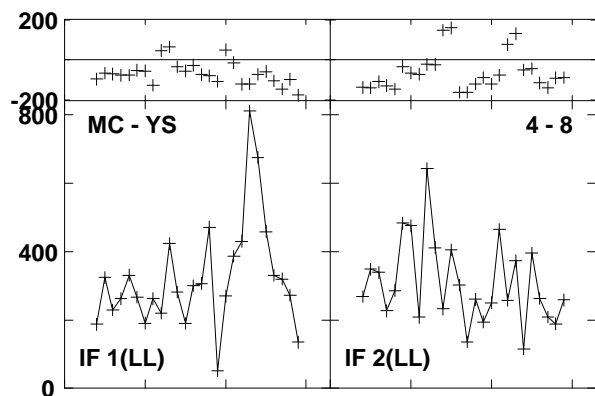
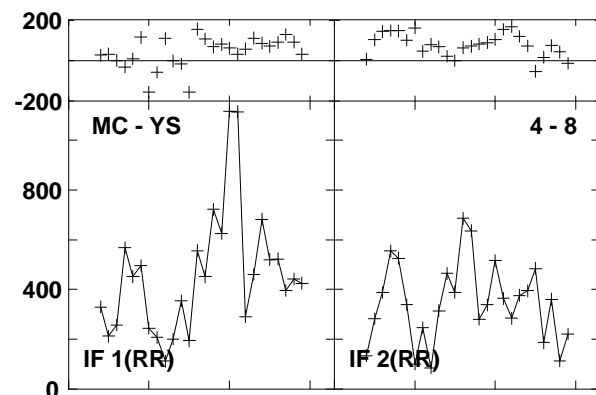
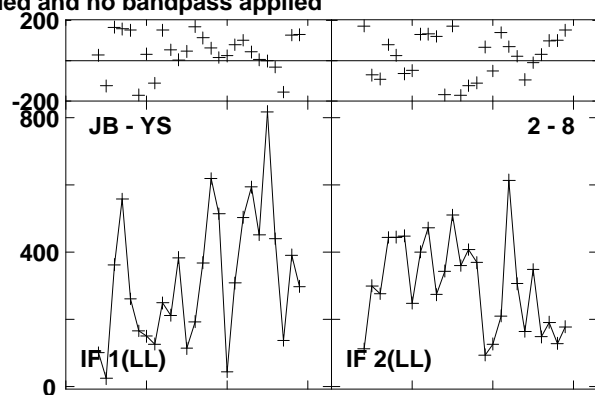
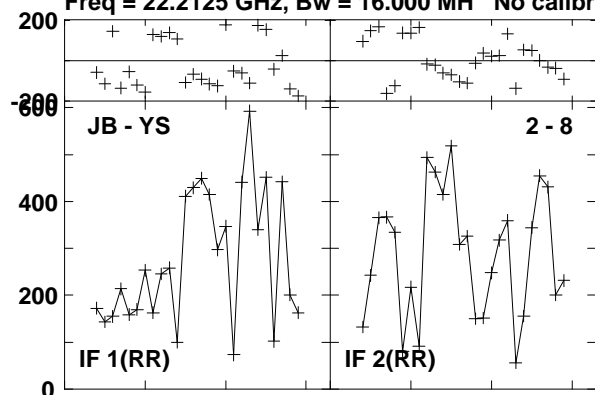

Lower frame: Micro Ampl Jy Top frame: Phas deg  
Vector averaged cross-power spectrum Baseline: JB (02) - YS (08)  
Timerange: 00/15:58:55 to 00/15:59:14

Plot file version 671 created 23-AUG-2016 15:01:07  
0219+628 GA035B 1.UVDATA.1

Freq = 22.2125 GHz, Bw = 16.000 MH No calibration applied and no bandpass applied

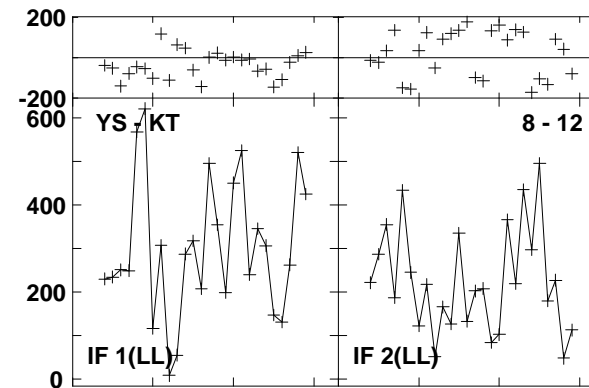
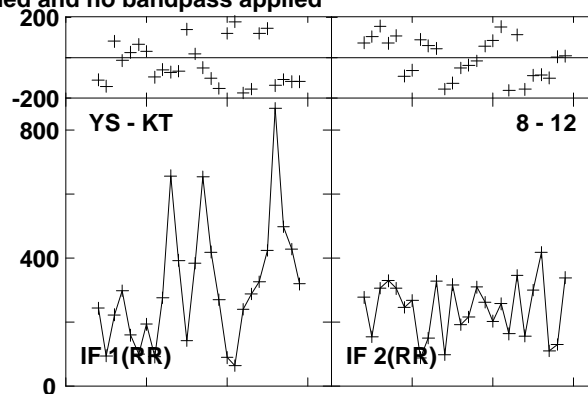
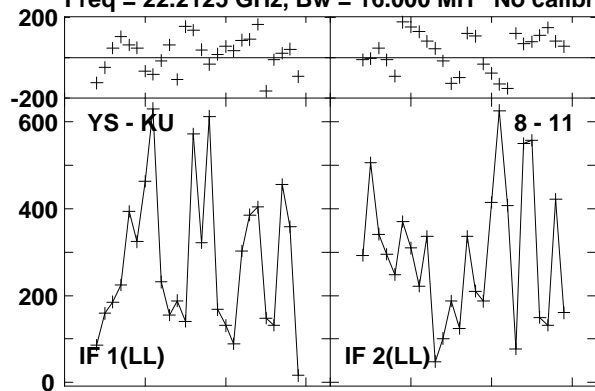

Lower frame: Micro Ampl Jy Top frame: Phas deg  
Vector averaged cross-power spectrum Baseline: YS (08) - KU (11)  
Timerange: 00/15:58:55 to 00/15:59:14

Plot file version 672 created 23-AUG-2016 15:01:07  
 W3IRS5 GA035B 1.UVDATA.1

Freq = 22.2125 GHz, Bw = 16.000 MH No calibration applied and no bandpass applied

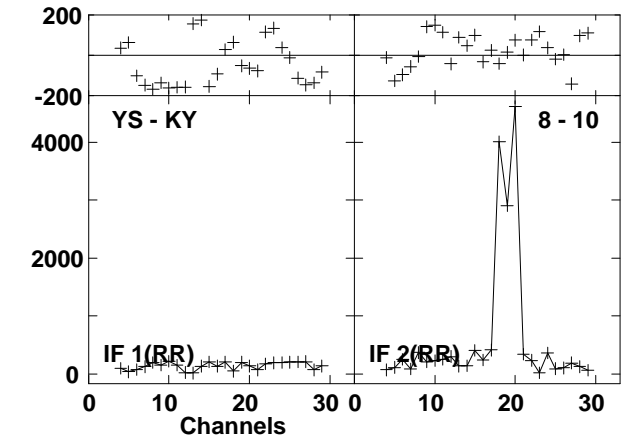
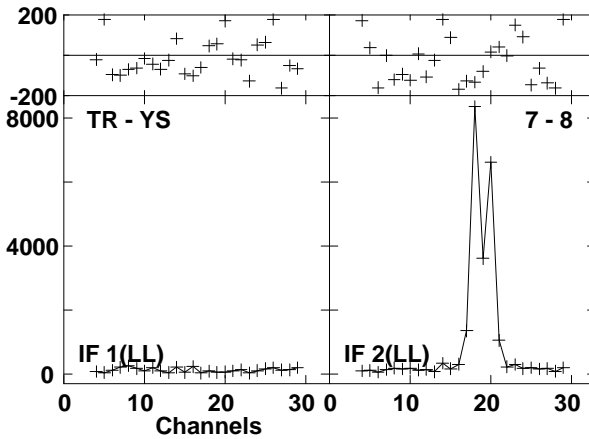
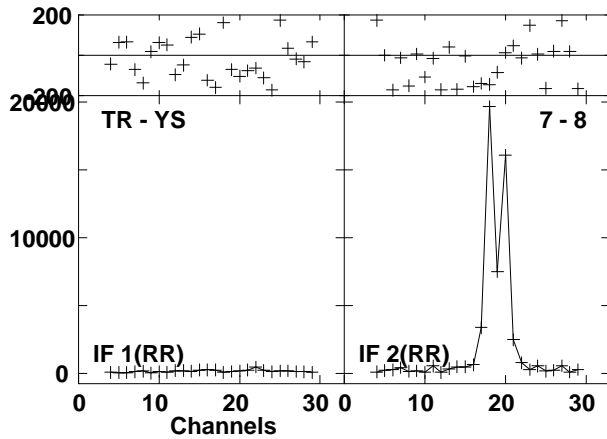
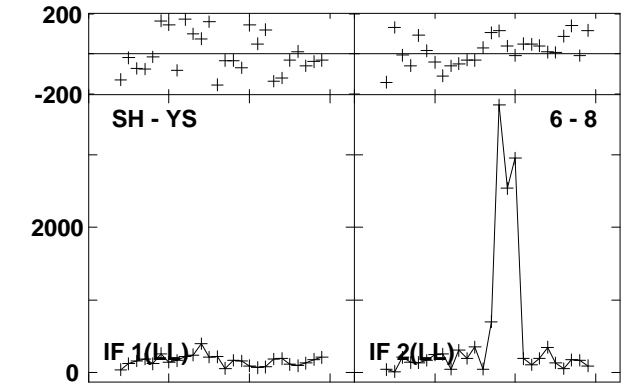
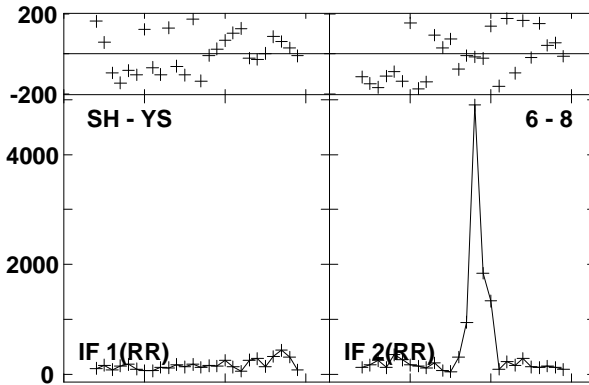
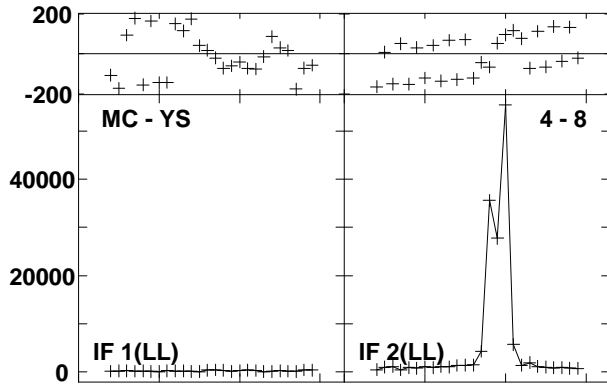
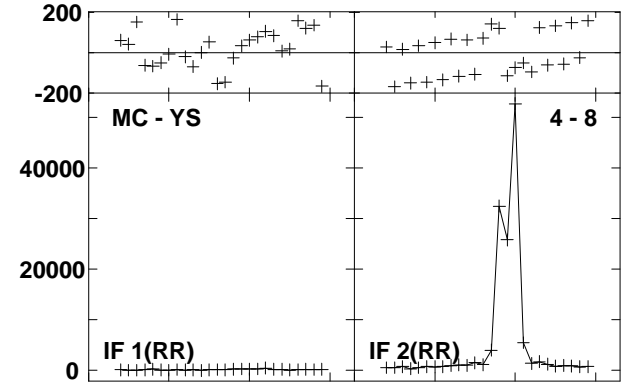
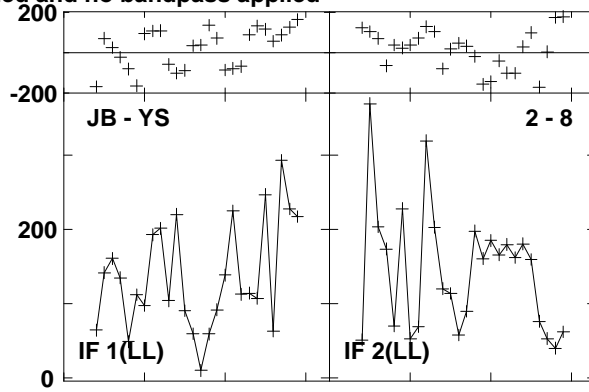
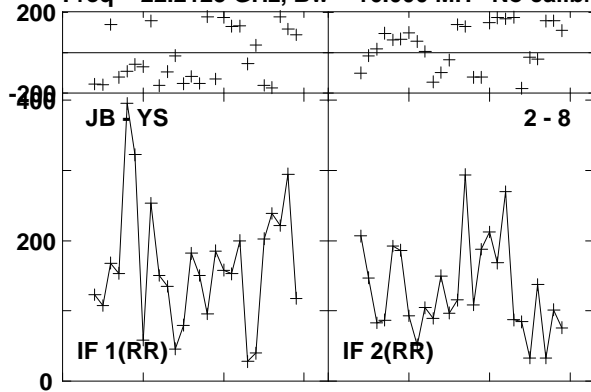

Lower frame: Micro Ampl Jy Top frame: Phas deg  
 Vector averaged cross-power spectrum Baseline: JB (02) - YS (08)  
 Timerange: 00/15:59:51 to 00/16:00:50



Plot file version 673 created 23-AUG-2016 15:01:07

W3IRS5 GA035B 1.UVDATA.1

Freq = 22.2125 GHz, Bw = 16.000 MH No calibration applied and no bandpass applied

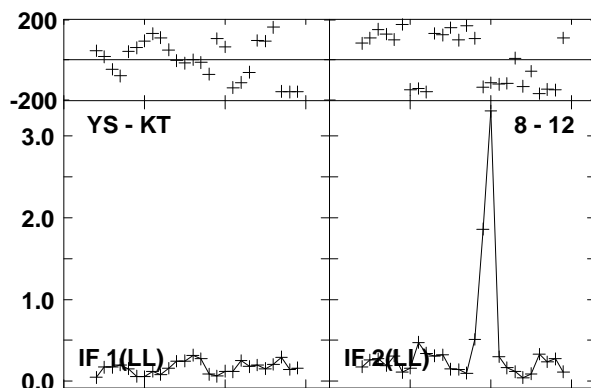
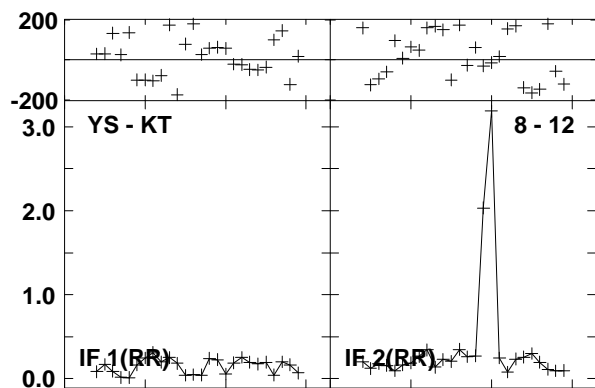
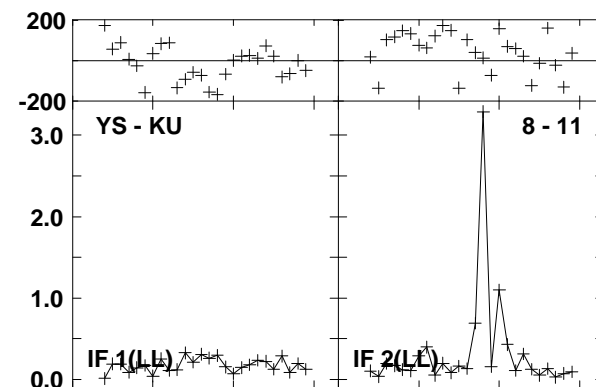
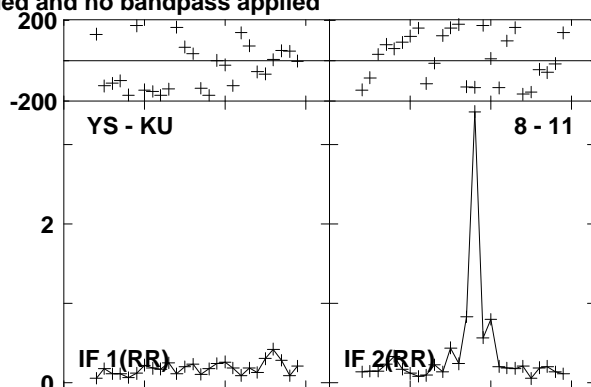
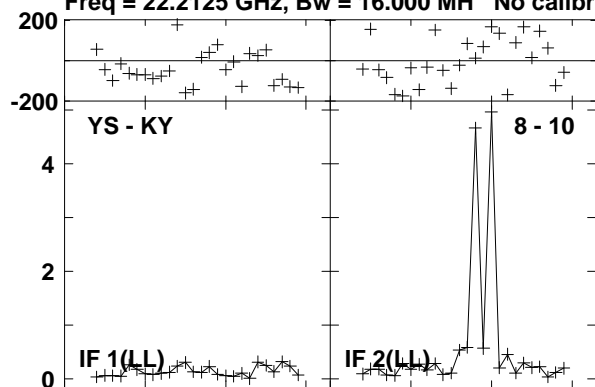

Lower frame: Milli Ampl Jy Top frame: Phas deg  
Vector averaged cross-power spectrum Baseline: YS (08) - KY (10)  
Timerange: 00/15:59:51 to 00/16:00:50

Plot file version 674 created 23-AUG-2016 15:01:07

0219+628 GA035B 1.UVDATA.1

Freq = 22.2125 GHz, Bw = 16.000 MH No calibration applied and no bandpass applied

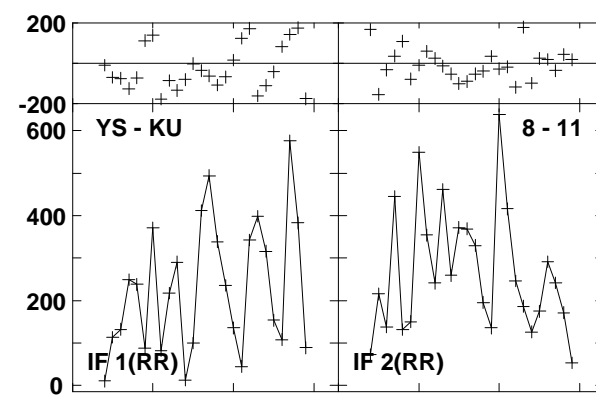
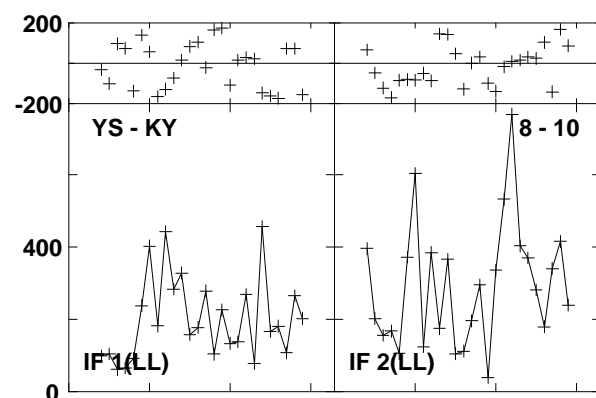
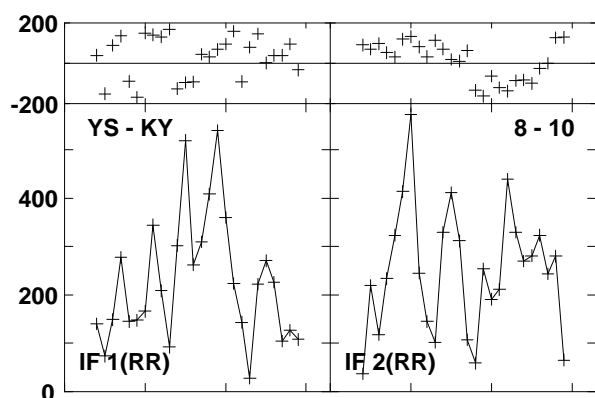
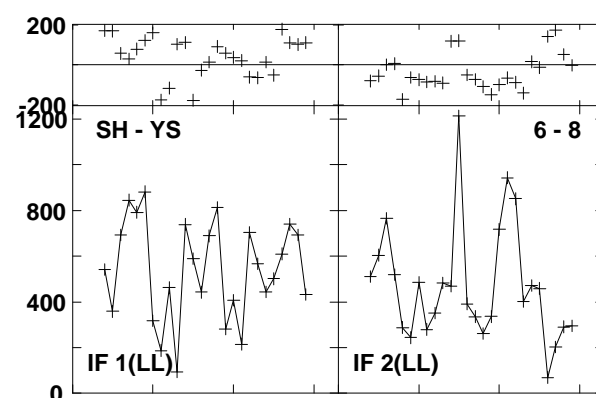
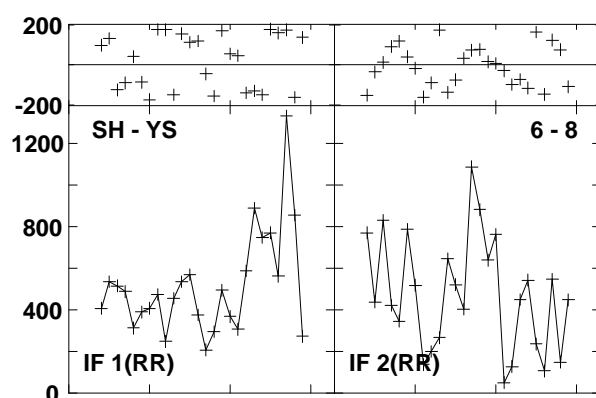
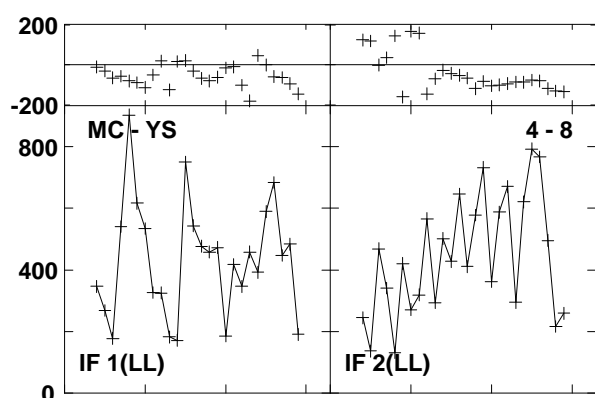
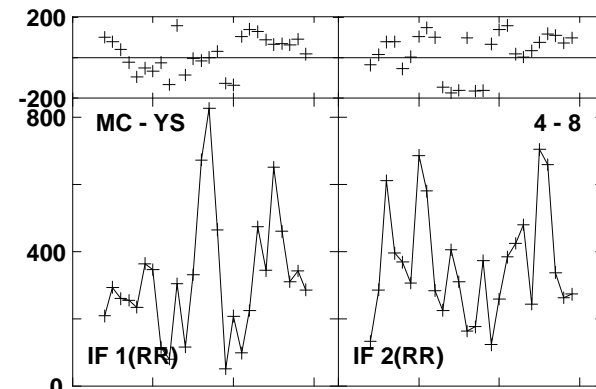
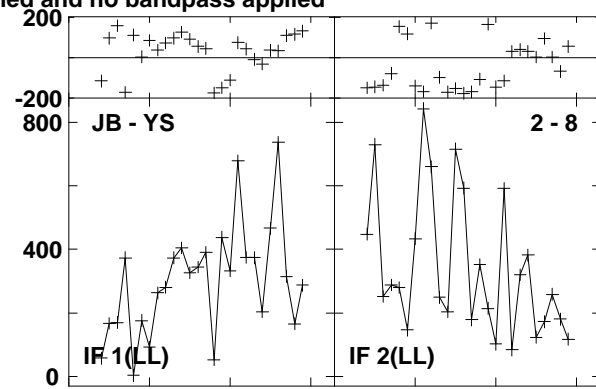
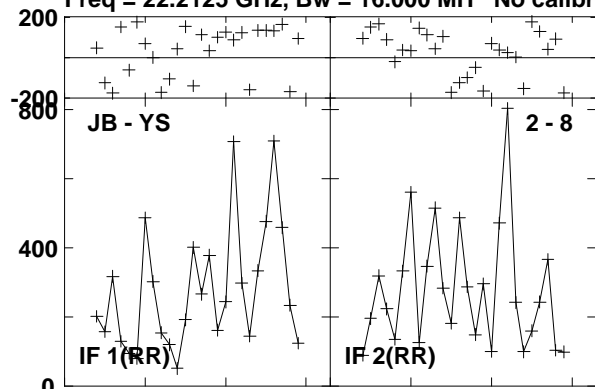

Lower frame: Micro Ampl Jy Top frame: Phas deg  
Vector averaged cross-power spectrum Baseline: JB (02) - YS (08)  
Timerange: 00/16:01:27 to 00/16:01:46

Plot file version 675 created 23-AUG-2016 15:01:07

0219+628 GA035B 1.UVDATA.1

Freq = 22.2125 GHz, Bw = 16.000 MH No calibration applied and no bandpass applied

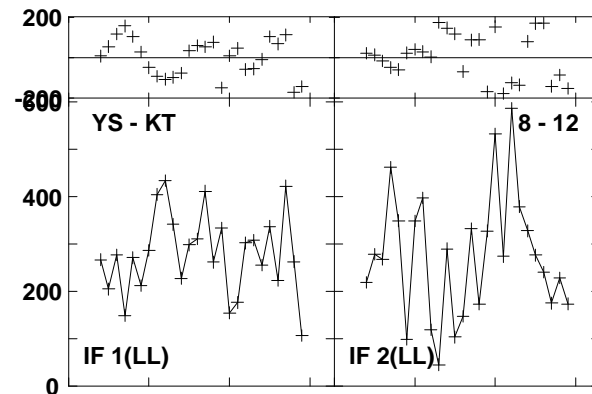
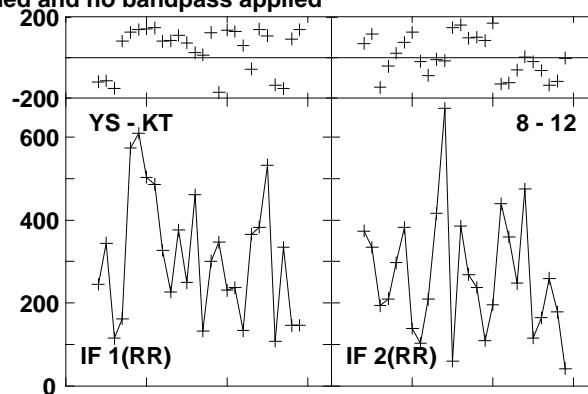
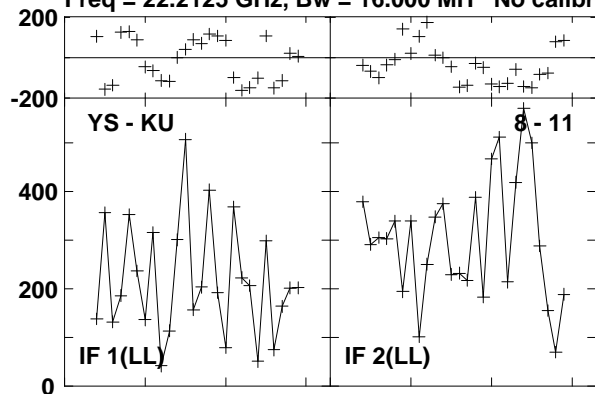

Lower frame: Micro Ampl Jy Top frame: Phas deg  
Vector averaged cross-power spectrum Baseline: YS (08) - KU (11)  
Timerange: 00/16:01:27 to 00/16:01:46

Plot file version 676 created 23-AUG-2016 15:01:07

W3IRS5 GA035B 1.UVDATA.1

Freq = 22.2125 GHz, Bw = 16.000 MH No calibration applied and no bandpass applied

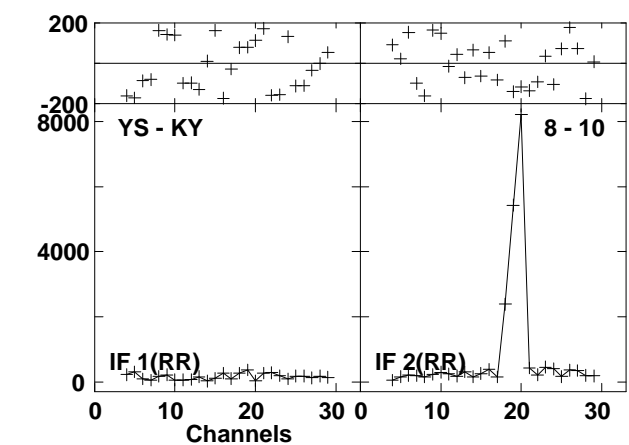
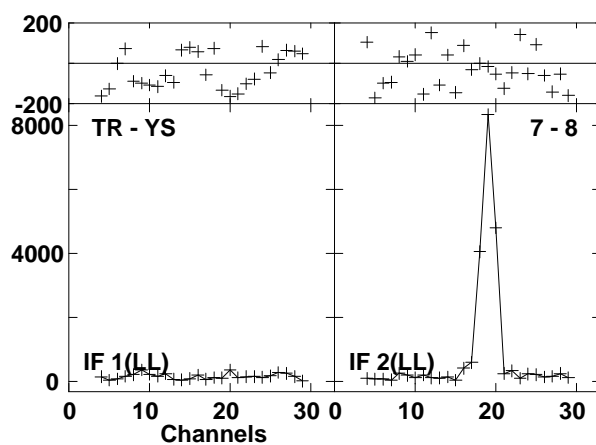
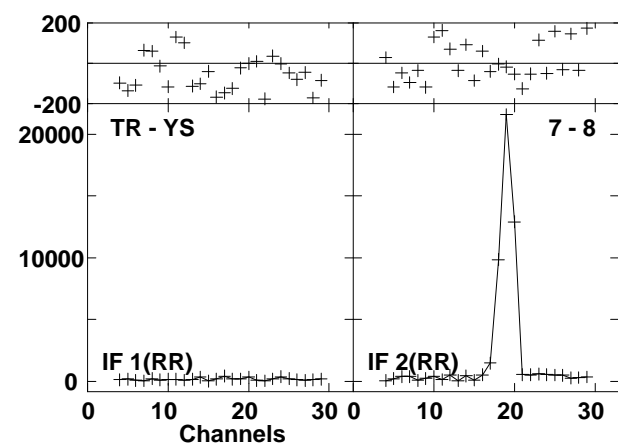
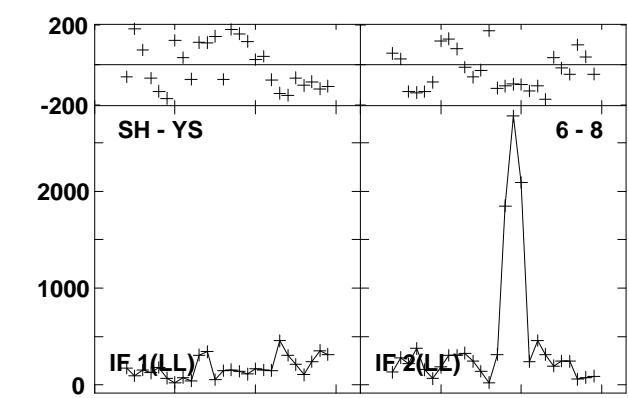
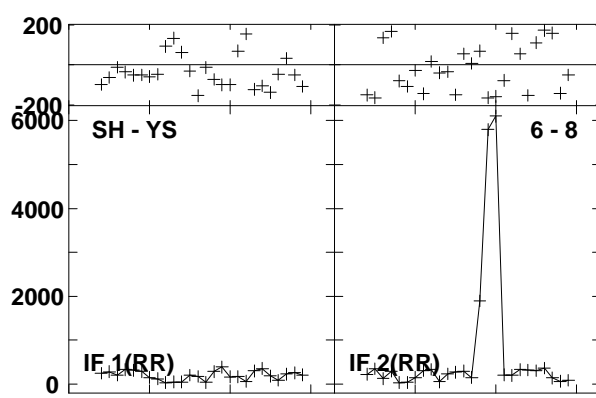
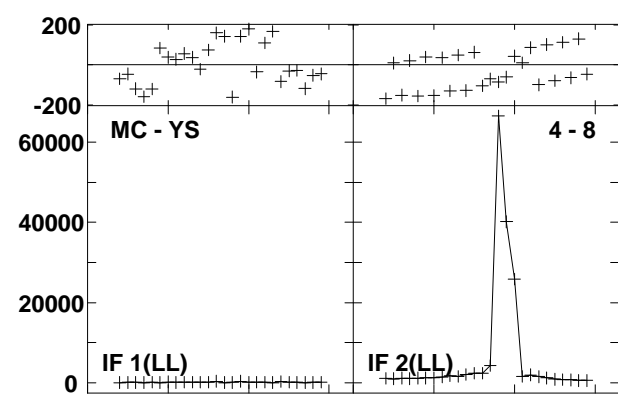
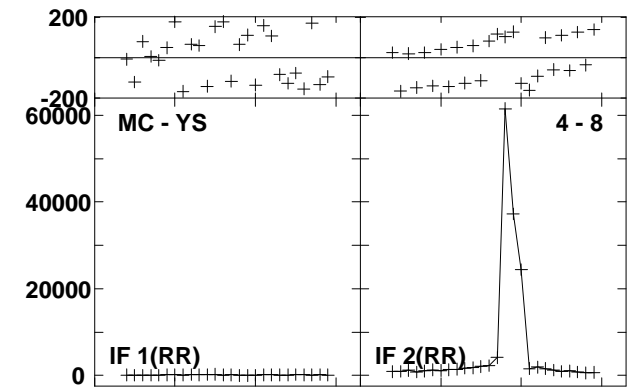
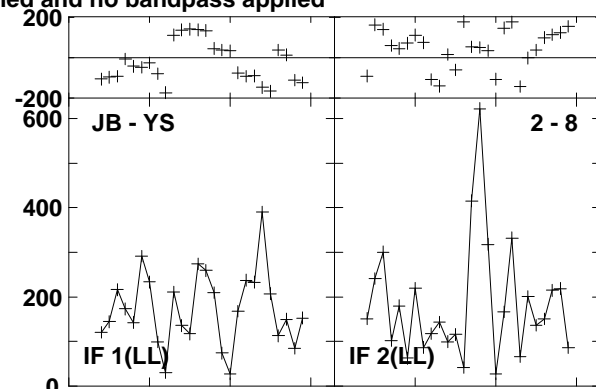
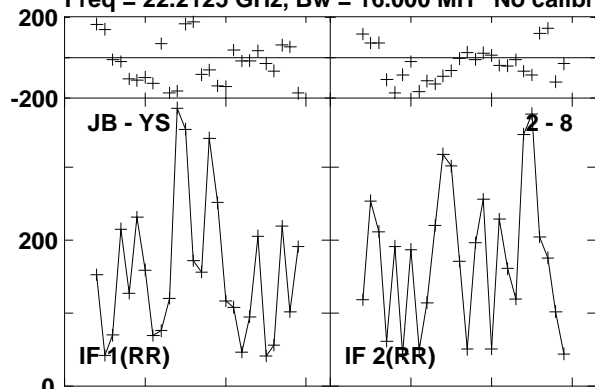

Lower frame: Micro Ampl Jy Top frame: Phas deg  
Vector averaged cross-power spectrum Baseline: JB (02) - YS (08)  
Timerange: 00/16:02:24 to 00/16:03:22

Plot file version 677 created 23-AUG-2016 15:01:07

W3IRS5 GA035B 1.UVDATA.1

Freq = 22.2125 GHz, Bw = 16.000 MH No calibration applied and no bandpass applied

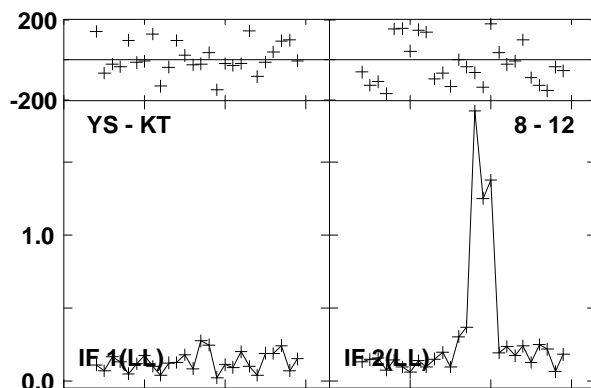
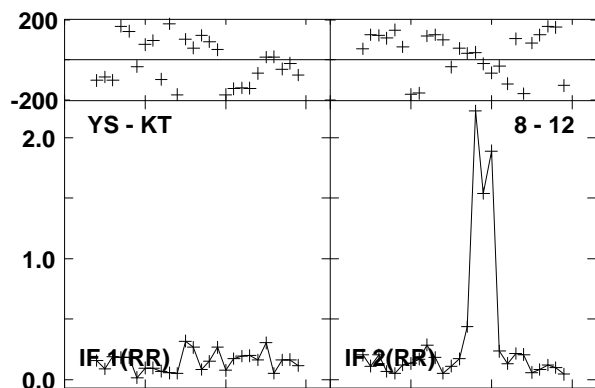
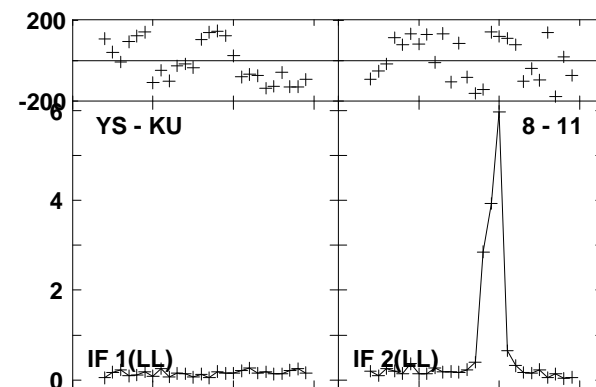
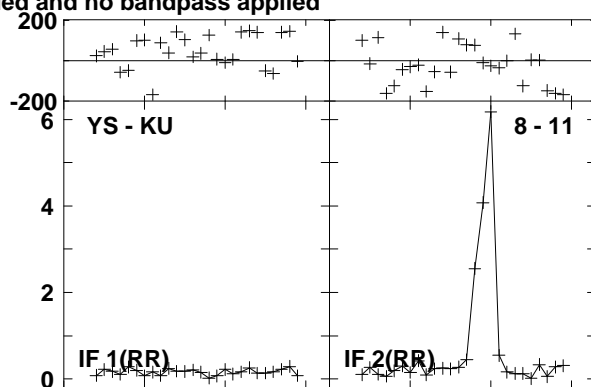
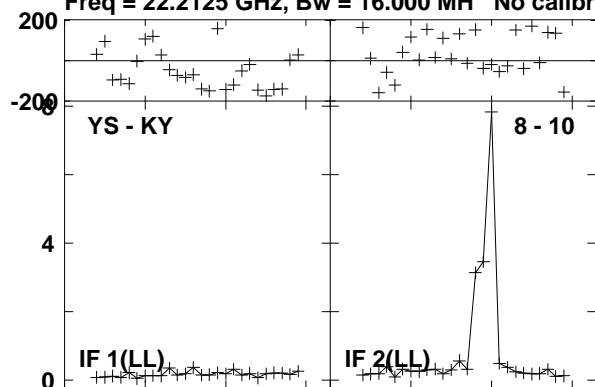

Lower frame: Milli Ampl Jy Top frame: Phas deg  
Vector averaged cross-power spectrum Baseline: YS (08) - KY (10)  
Timerange: 00/16:02:24 to 00/16:03:22

Plot file version 678 created 23-AUG-2016 15:01:07

0241+622 GA035B 1.UVDATA.1

Freq = 22.2125 GHz, Bw = 16.000 MH No calibration applied and no bandpass applied

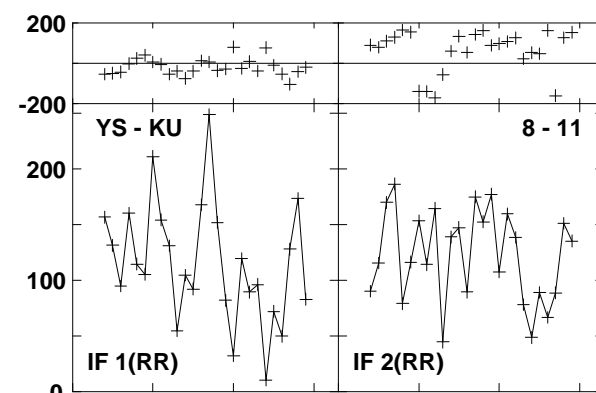
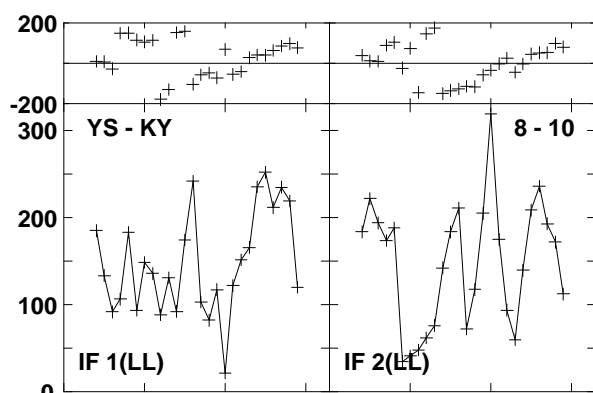
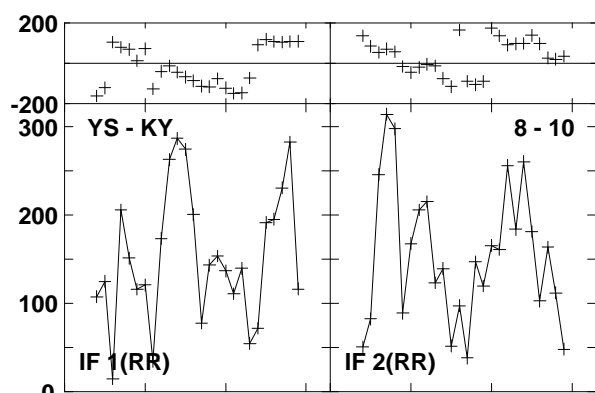
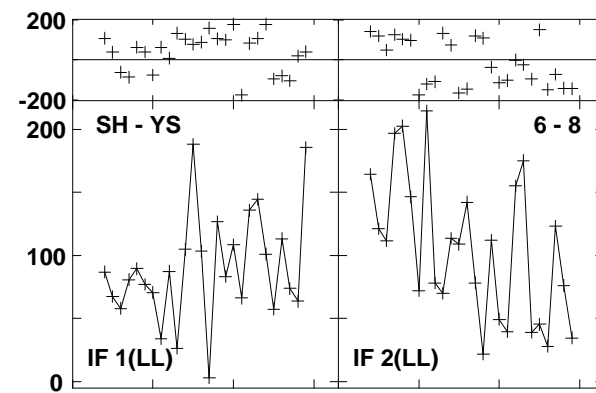
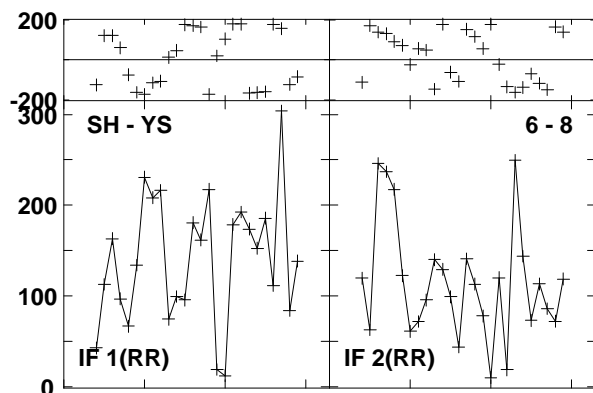
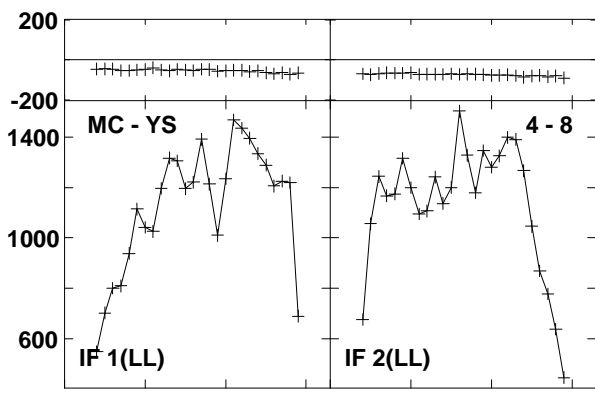
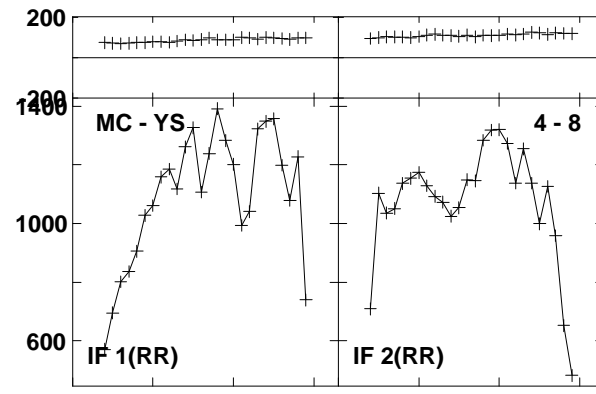
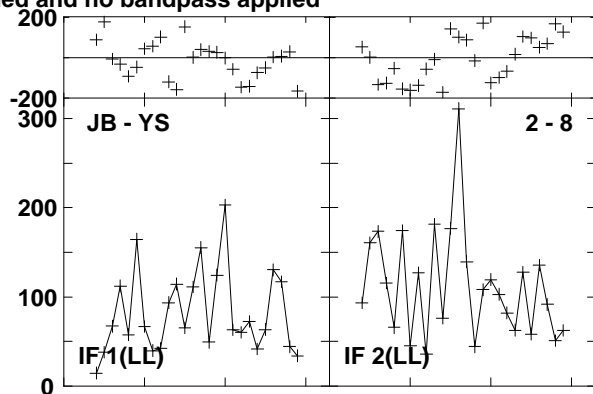
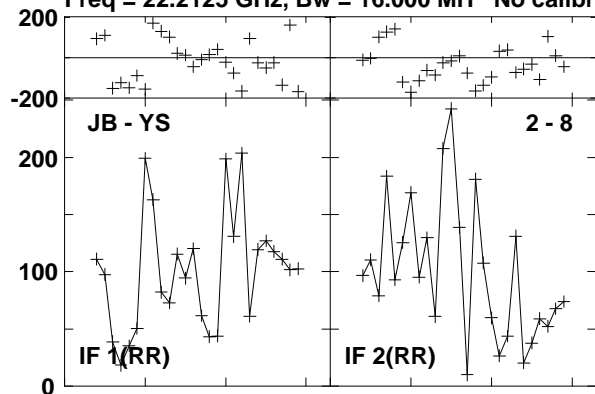

Lower frame: Micro Ampl Jy Top frame: Phas deg  
Vector averaged cross-power spectrum Baseline: JB (02) - YS (08)  
Timerange: 00/16:04:43 to 00/16:06:42

Plot file version 679 created 23-AUG-2016 15:01:07

0241+622 GA035B 1.UVDATA.1

Freq = 22.2125 GHz, Bw = 16.000 MH No calibration applied and no bandpass applied

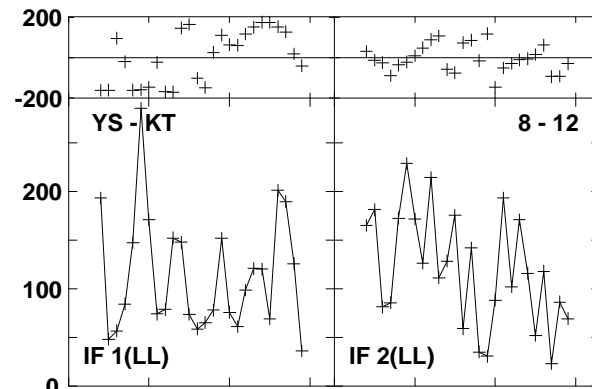
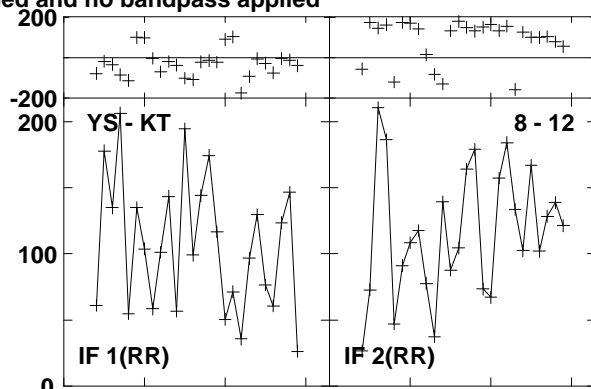
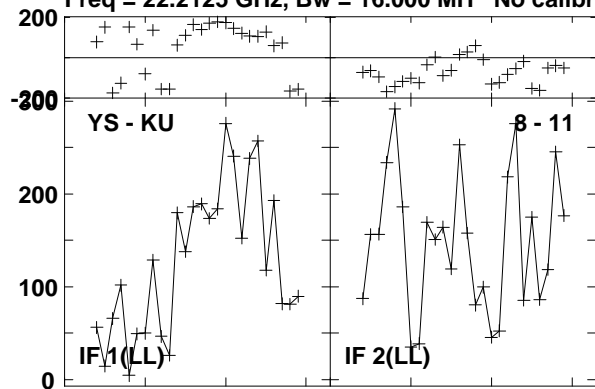

Lower frame: Micro Ampl Jy Top frame: Phas deg  
Vector averaged cross-power spectrum Baseline: YS (08) - KU (11)  
Timerange: 00/16:04:43 to 00/16:06:42

Plot file version 680 created 23-AUG-2016 15:01:07  
 W3IRS5 GA035B 1.UVDATA.1

Freq = 22.2125 GHz, Bw = 16.000 MH No calibration applied and no bandpass applied

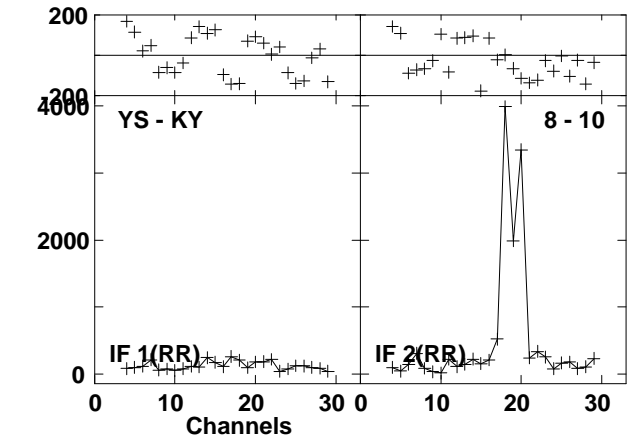
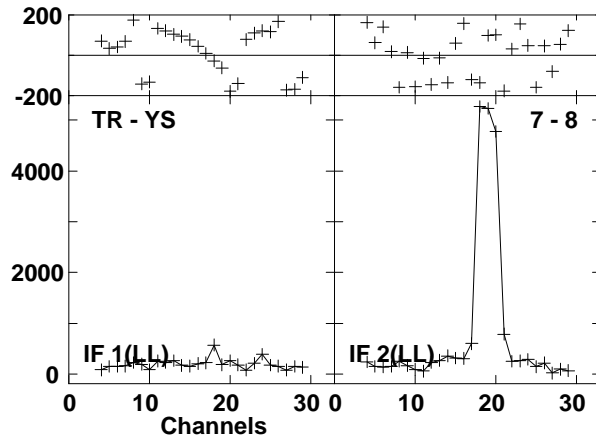
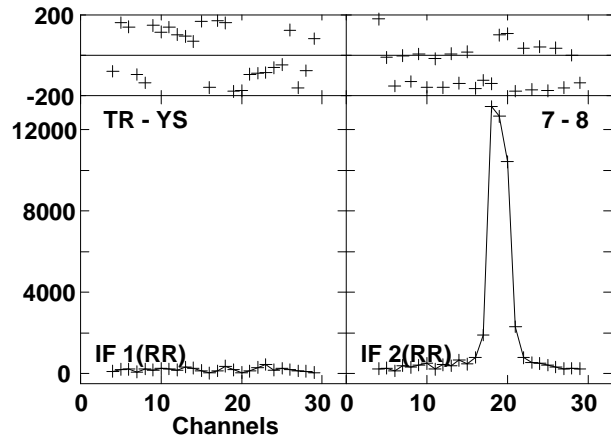
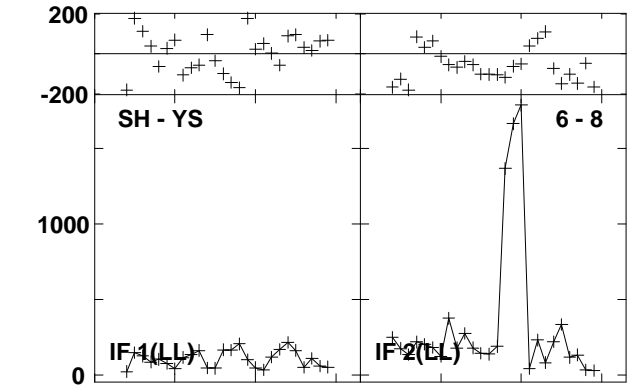
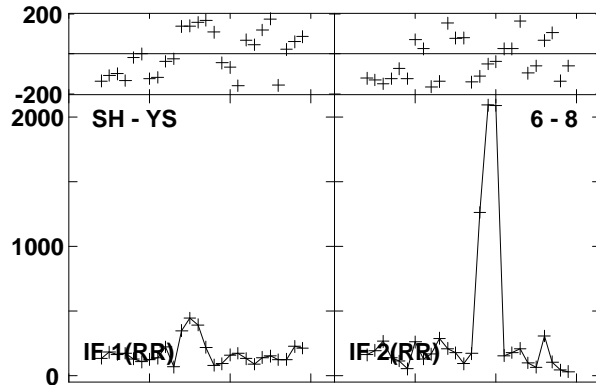
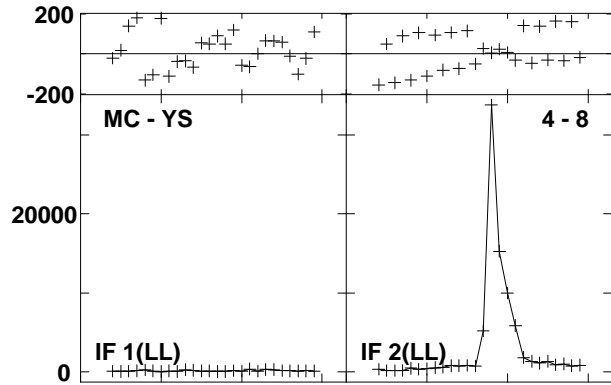
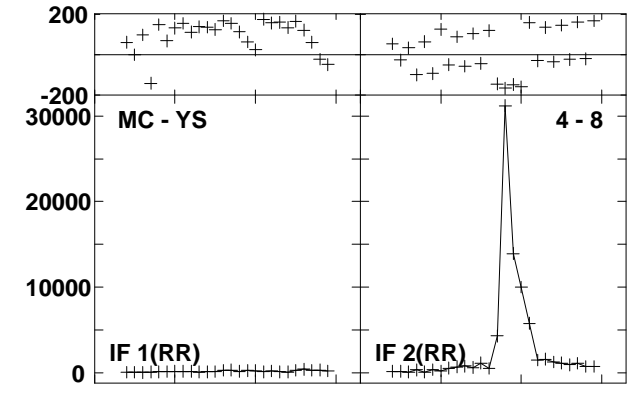
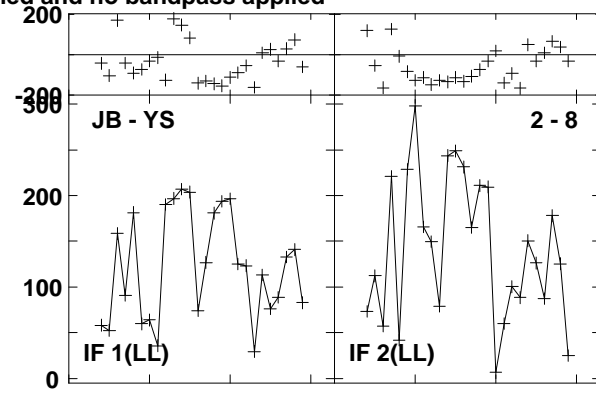
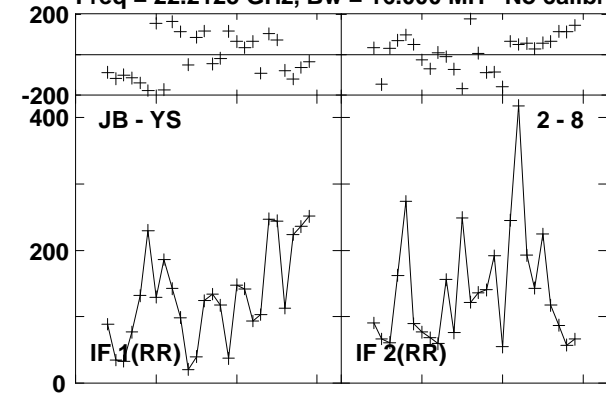

Lower frame: Micro Ampl Jy Top frame: Phas deg  
 Vector averaged cross-power spectrum Baseline: JB (02) - YS (08)  
 Timerange: 00/16:07:29 to 00/16:08:27



Plot file version 681 created 23-AUG-2016 15:01:07

W3IRS5 GA035B 1.UVDATA.1

Freq = 22.2125 GHz, Bw = 16.000 MH No calibration applied and no bandpass applied

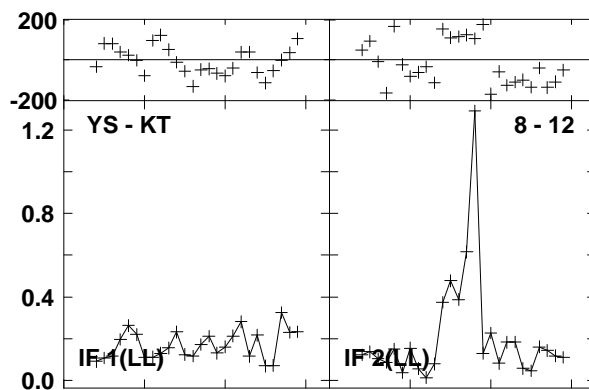
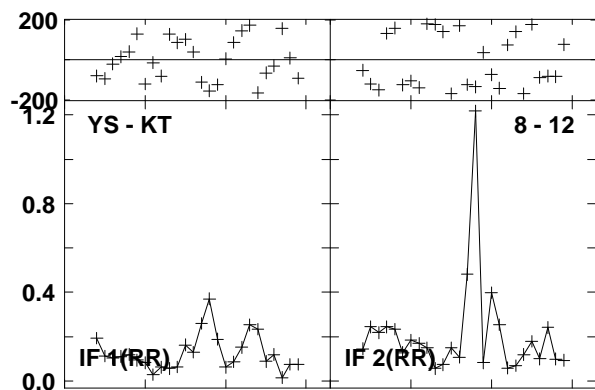
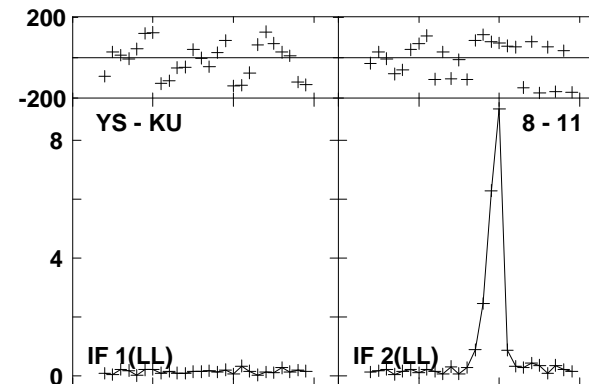
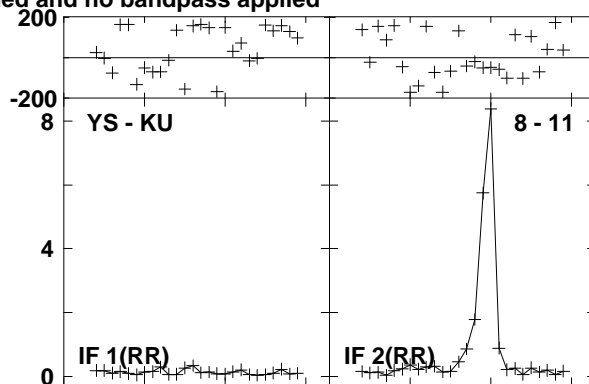
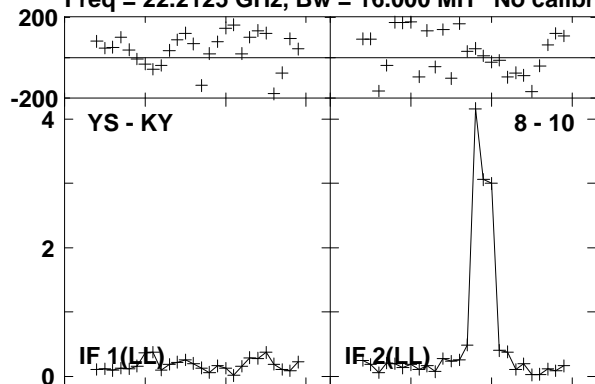

Lower frame: Milli Ampl Jy Top frame: Phas deg

Vector averaged cross-power spectrum Baseline: YS (08) - KY (10)

Timerange: 00/16:07:29 to 00/16:08:27

Plot file version 682 created 23-AUG-2016 15:01:07

0219+628 GA035B 1.UVDATA.1

Freq = 22.2125 GHz, Bw = 16.000 MH No calibration applied and no bandpass applied

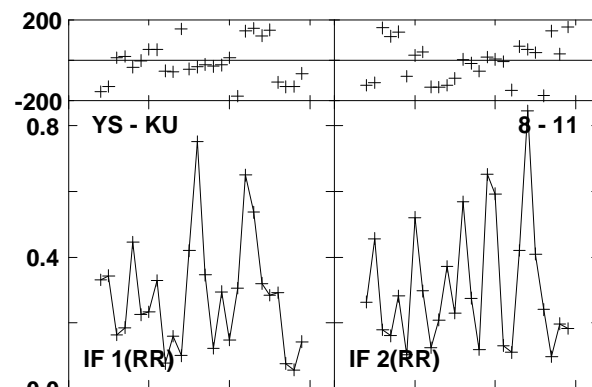
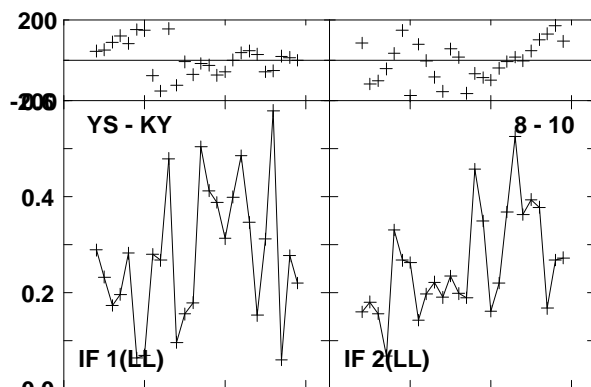
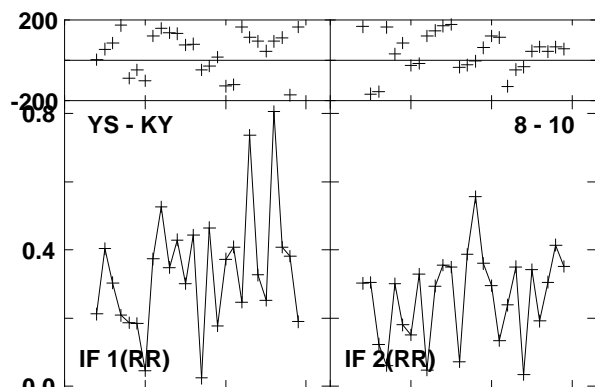
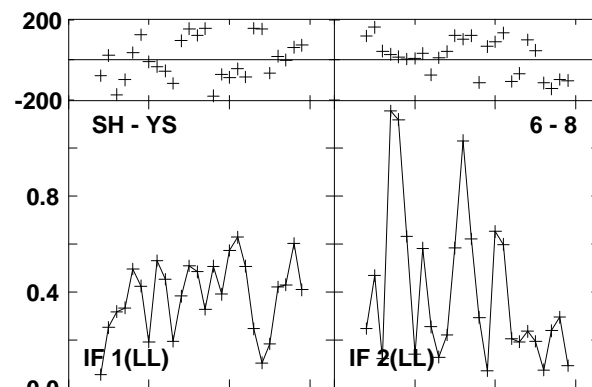
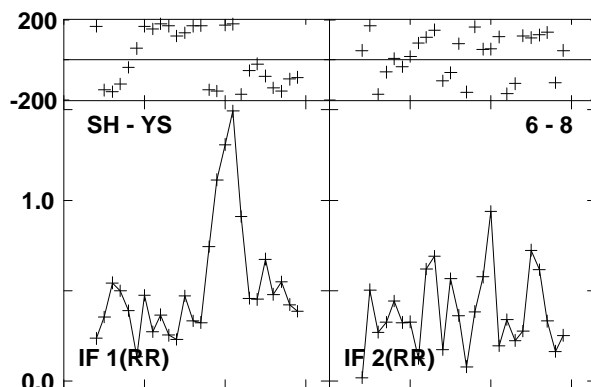
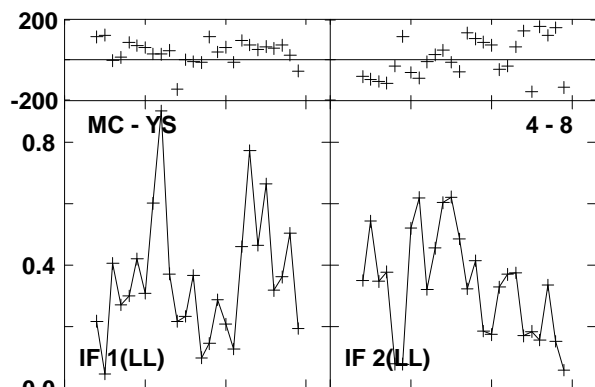
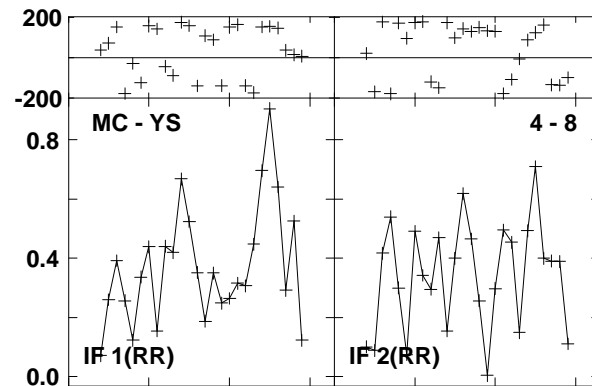
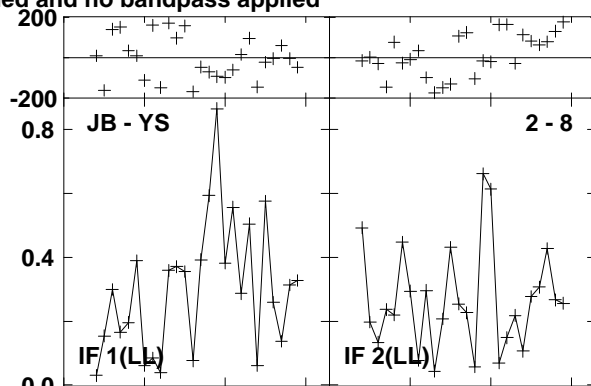
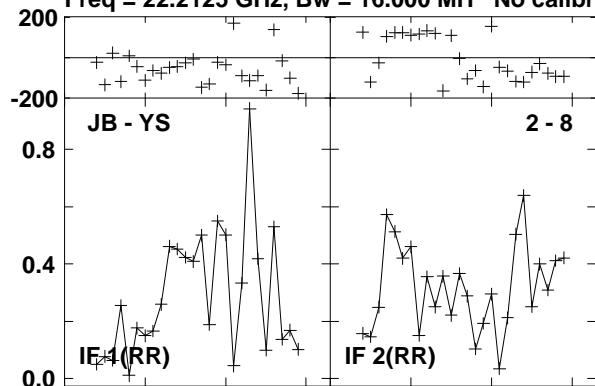

Channels

Lower frame: Milli Ampl Jy Top frame: Phas deg

Vector averaged cross-power spectrum Baseline: JB (02) - YS (08)

Timerange: 00/16:09:04 to 00/16:09:24

Plot file version 683 created 23-AUG-2016 15:01:07

0219+628 GA035B 1.UVDATA.1

Freq = 22.2125 GHz, Bw = 16.000 MH No calibration applied and no bandpass applied

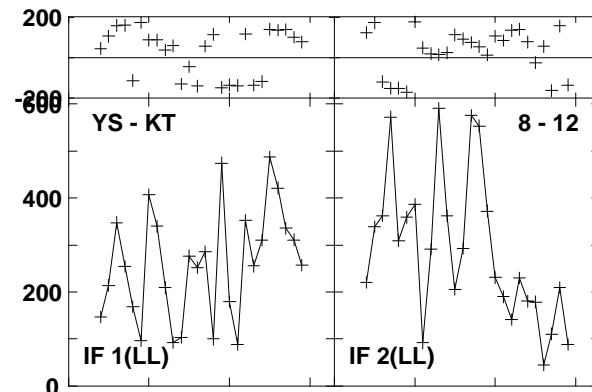
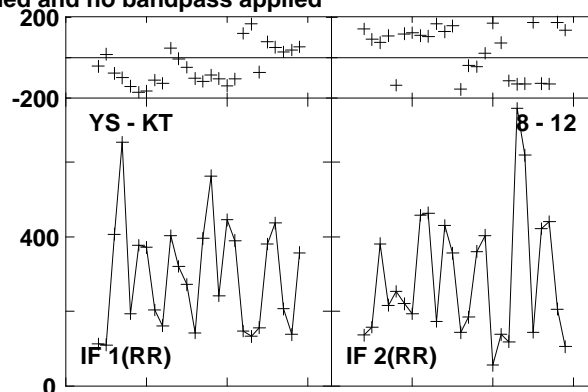
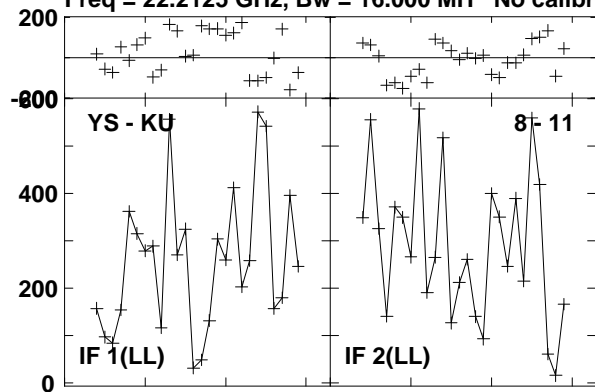

Lower frame: Micro Ampl Jy Top frame: Phas deg  
Vector averaged cross-power spectrum Baseline: YS (08) - KU (11)  
Timerange: 00/16:09:04 to 00/16:09:24

Plot file version 684 created 23-AUG-2016 15:01:07  
 W3IRS5 GA035B 1.UVDATA.1

Freq = 22.2125 GHz, Bw = 16.000 MH No calibration applied and no bandpass applied

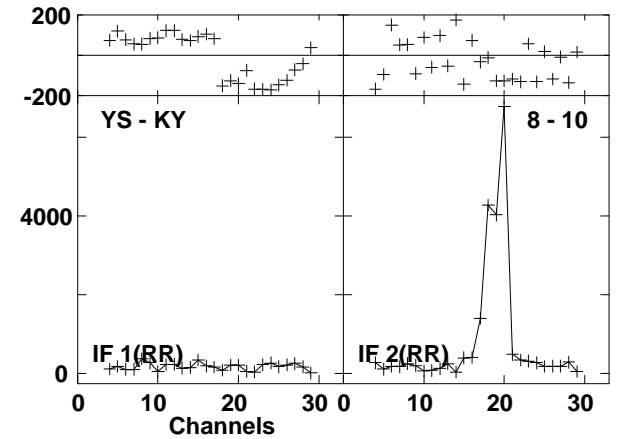
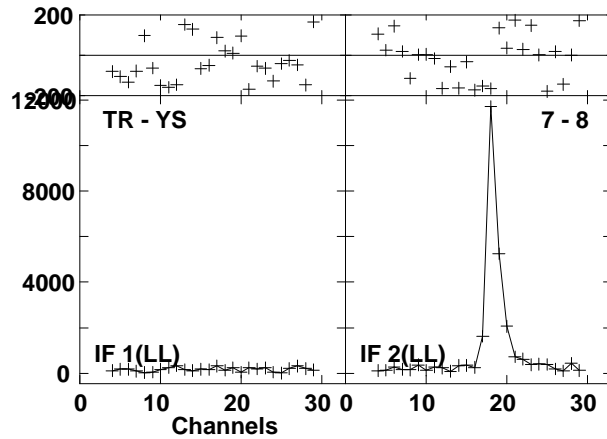
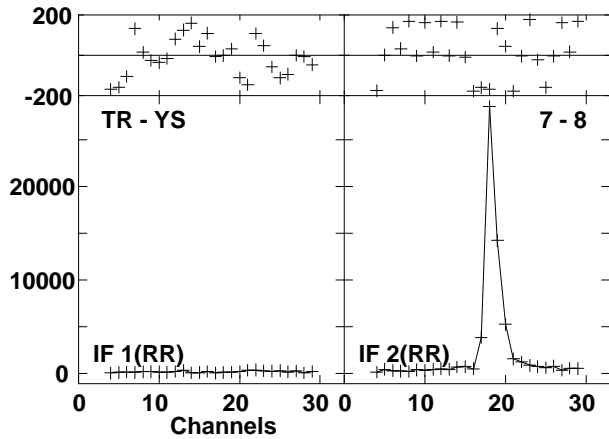
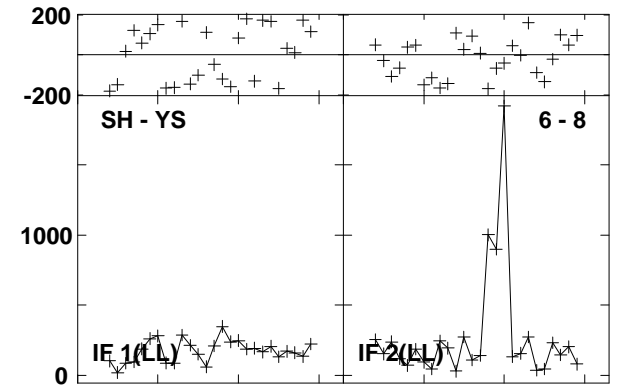
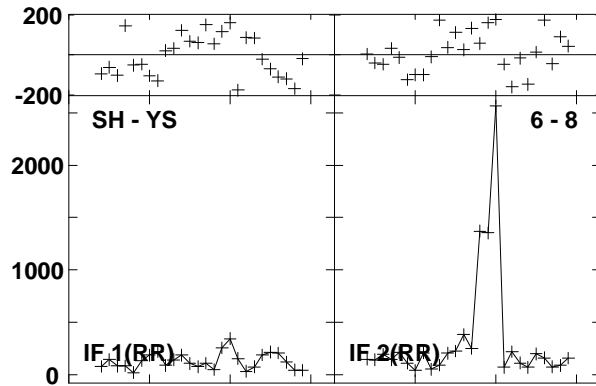
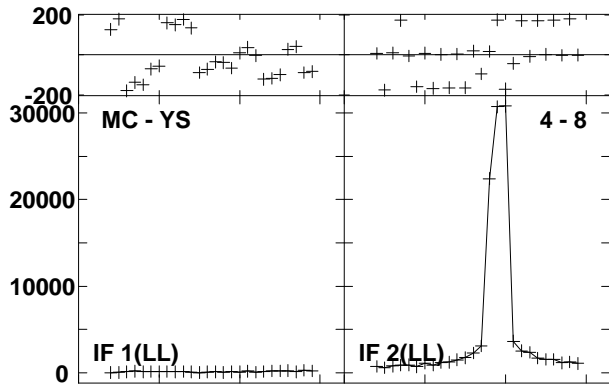
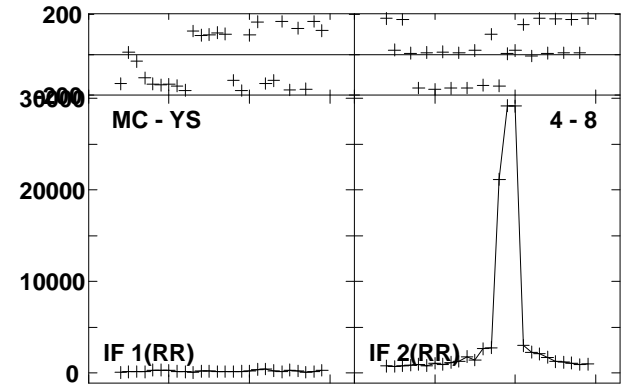
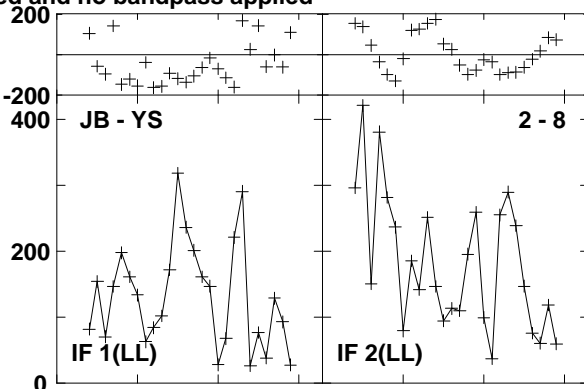
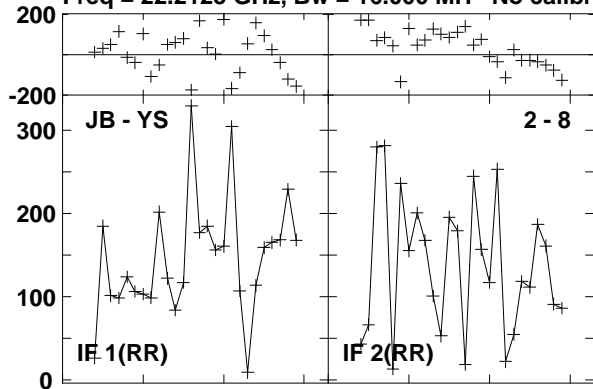

Lower frame: Micro Ampl Jy Top frame: Phas deg  
 Vector averaged cross-power spectrum Baseline: JB (02) - YS (08)  
 Timerange: 00/16:10:00 to 00/16:10:59

Plot file version 685 created 23-AUG-2016 15:01:07  
W3IRS5 GA035B 1.UVDATA.1

Freq = 22.2125 GHz, Bw = 16.000 MH No calibration applied and no bandpass applied

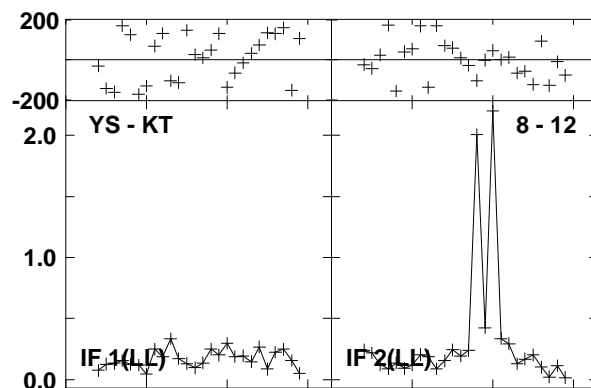
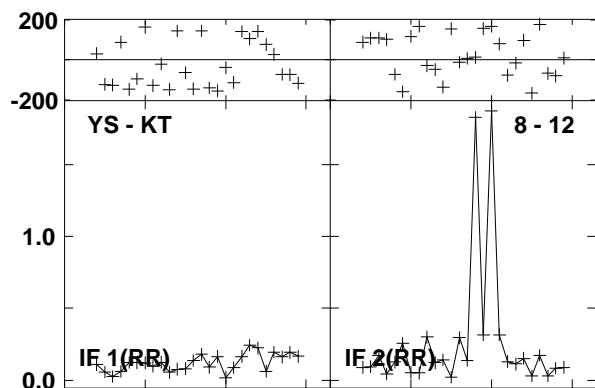
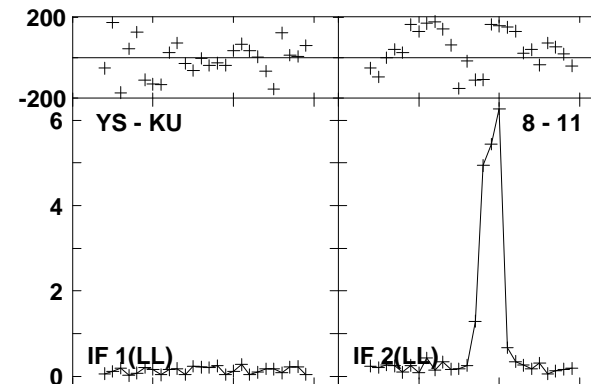
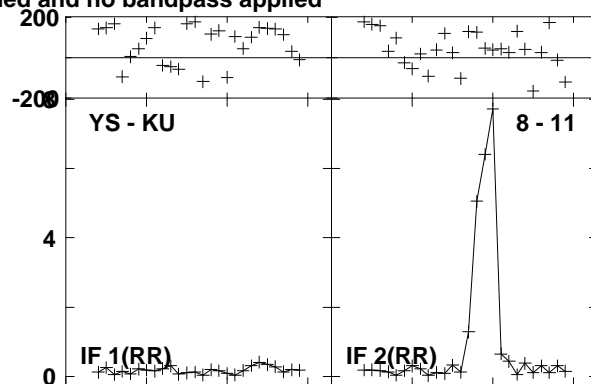
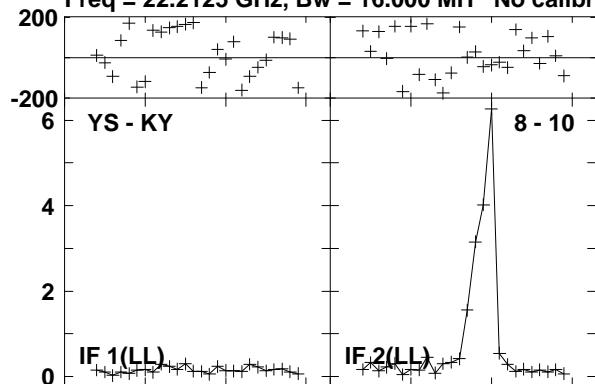

Lower frame: Milli Ampl Jy Top frame: Phas deg  
Vector averaged cross-power spectrum Baseline: YS (08) - KY (10)  
Timerange: 00/16:10:00 to 00/16:10:59

Plot file version 686 created 23-AUG-2016 15:01:07

0219+628 GA035B 1.UVDATA.1

Freq = 22.2125 GHz, Bw = 16.000 MH No calibration applied and no bandpass applied

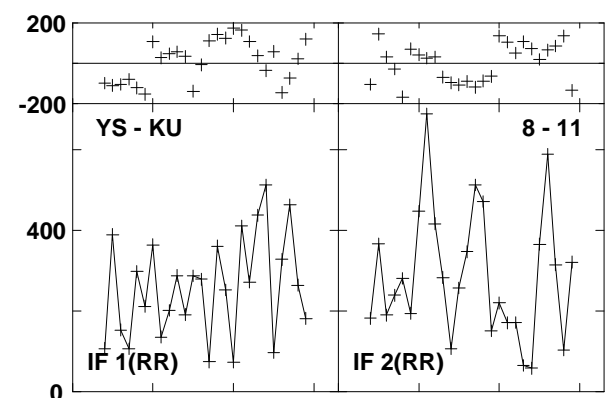
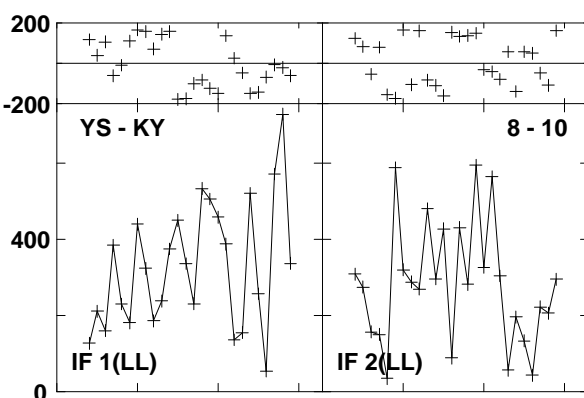
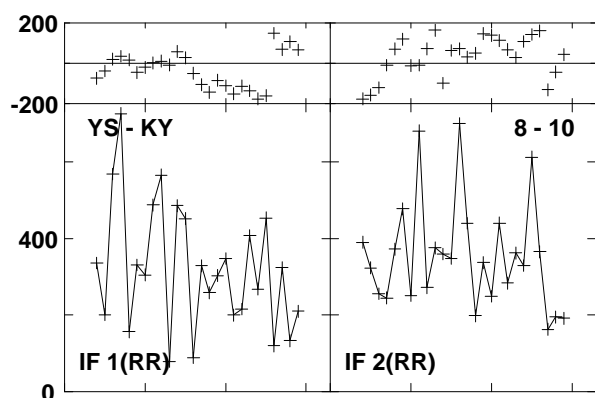
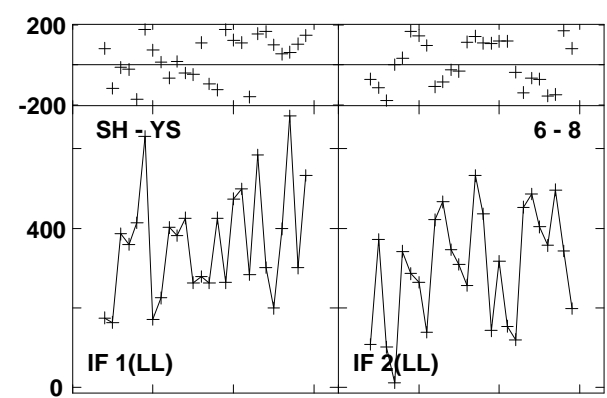
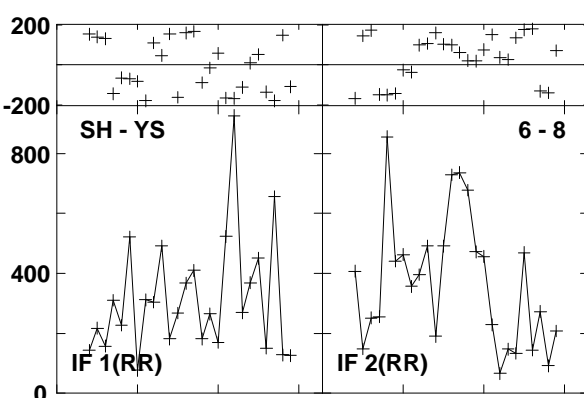
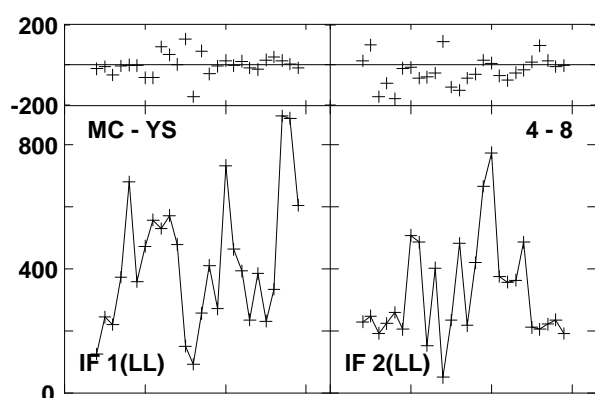
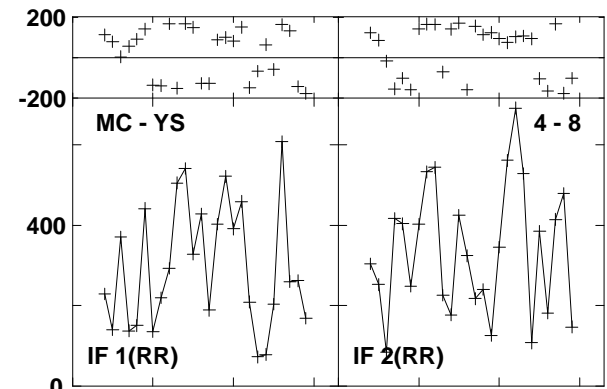
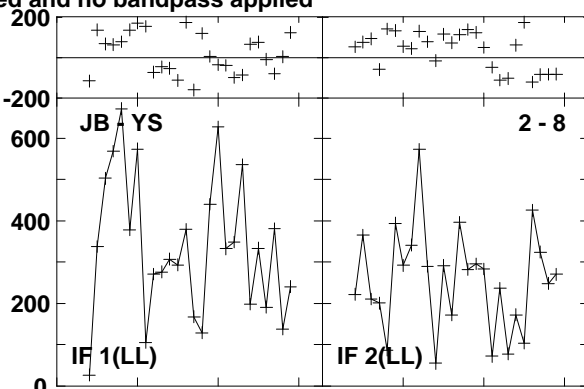
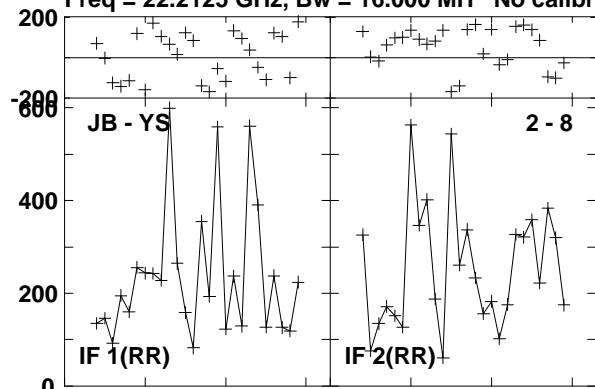

Lower frame: Micro Ampl Jy Top frame: Phas deg  
Vector averaged cross-power spectrum Baseline: JB (02) - YS (08)  
Timerange: 00/16:11:37 to 00/16:11:55

Plot file version 687 created 23-AUG-2016 15:01:07

0219+628 GA035B 1.UVDATA.1

Freq = 22.2125 GHz, Bw = 16.000 MH No calibration applied and no bandpass applied

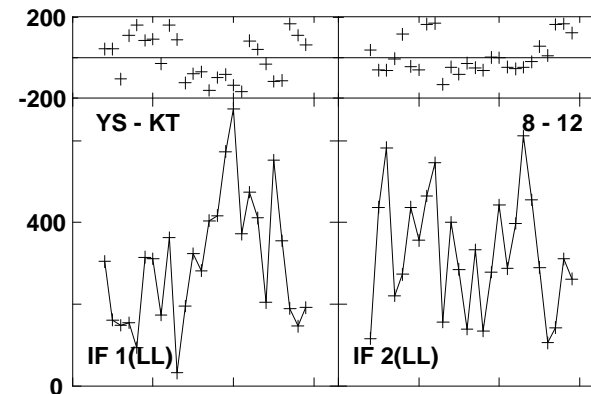
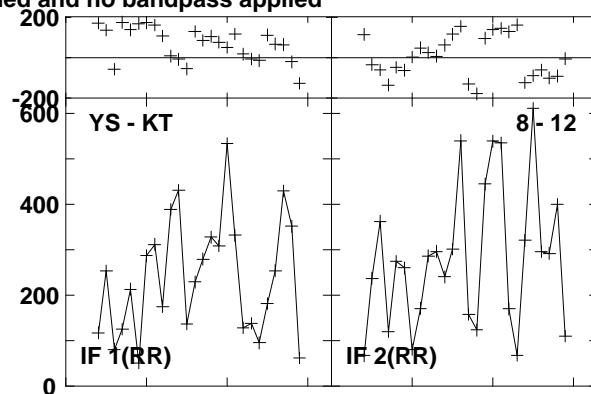
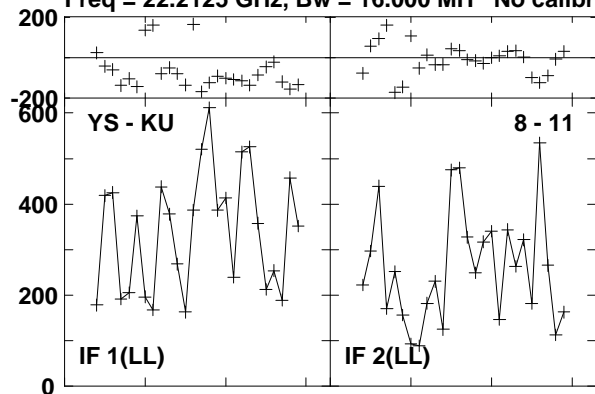

Lower frame: Micro Ampl Jy Top frame: Phas deg  
Vector averaged cross-power spectrum Baseline: YS (08) - KU (11)  
Timerange: 00/16:11:37 to 00/16:11:55

Plot file version 688 created 23-AUG-2016 15:01:07  
 W3IRS5 GA035B 1.UVDATA.1

Freq = 22.2125 GHz, Bw = 16.000 MH No calibration applied and no bandpass applied

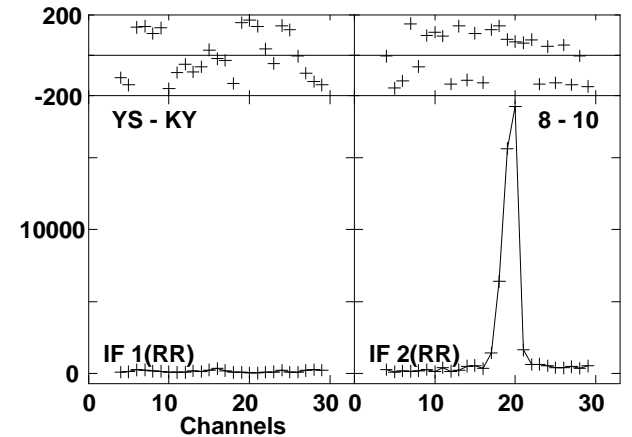
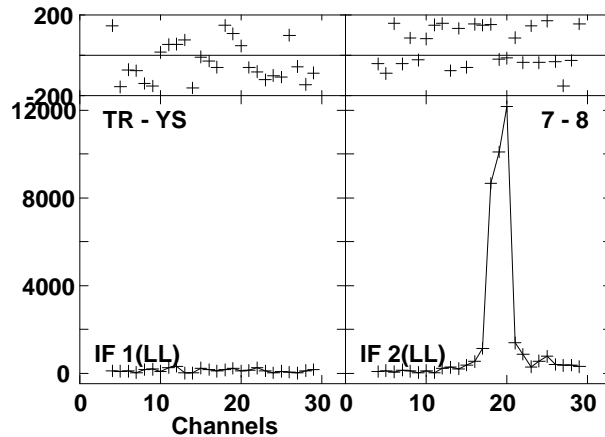
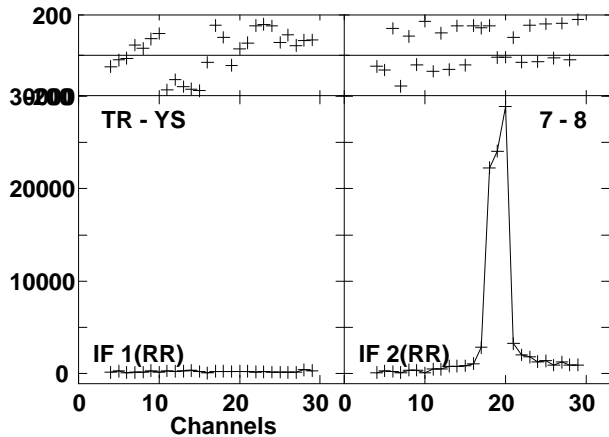
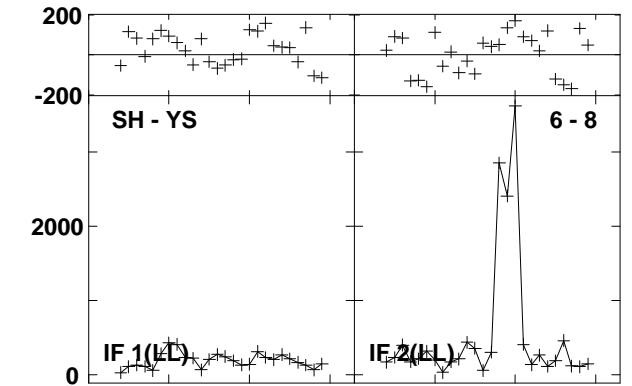
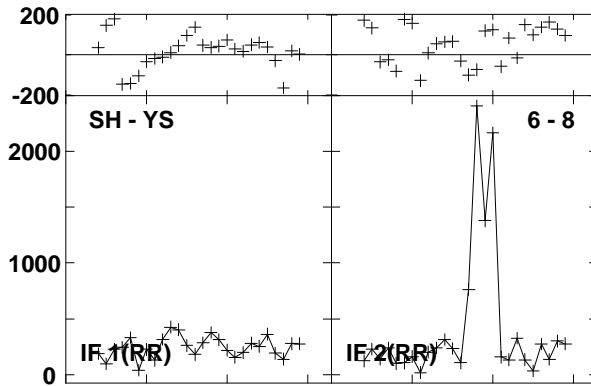
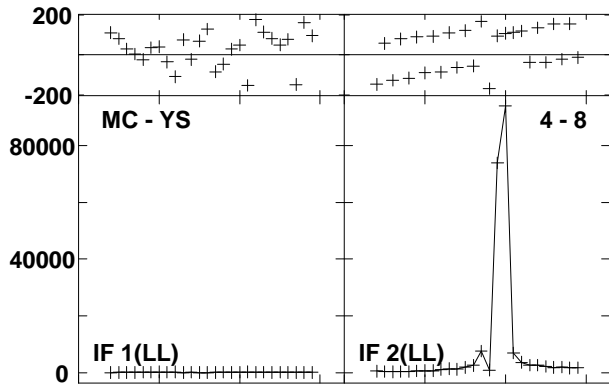
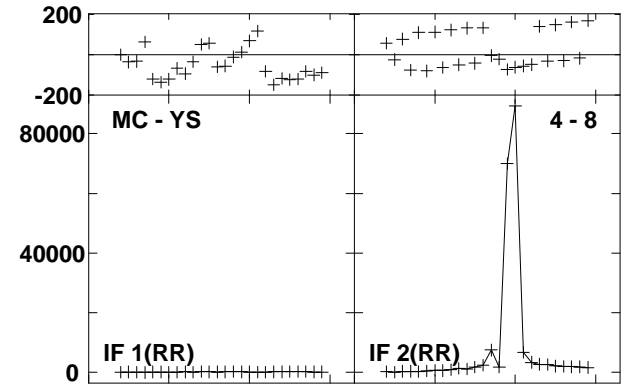
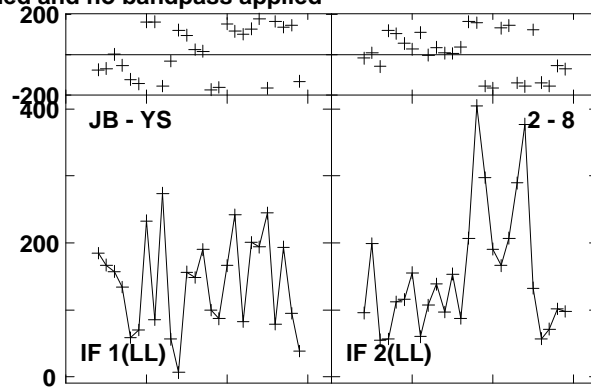
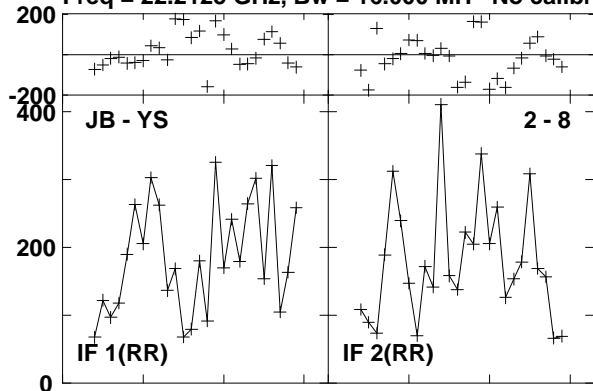

Lower frame: Micro Ampl Jy Top frame: Phas deg  
 Vector averaged cross-power spectrum Baseline: JB (02) - YS (08)  
 Timerange: 00/16:12:33 to 00/16:13:31



Plot file version 689 created 23-AUG-2016 15:01:08

W3IRS5 GA035B 1.UVDATA.1

Freq = 22.2125 GHz, Bw = 16.000 MH No calibration applied and no bandpass applied

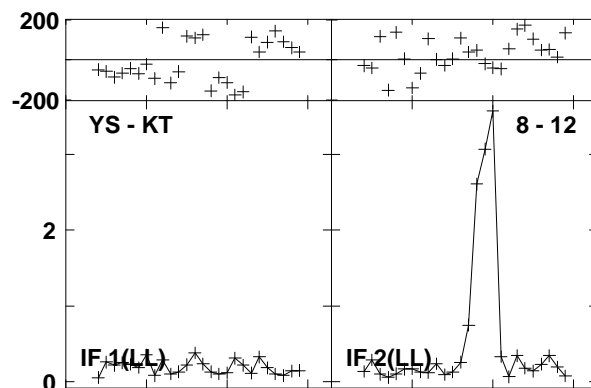
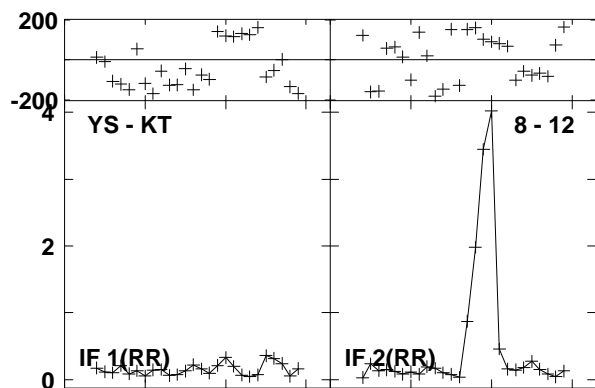
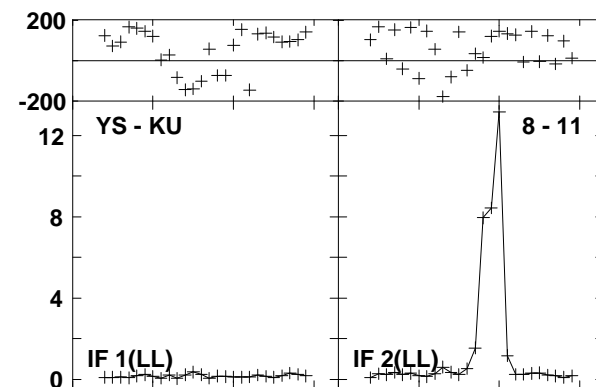
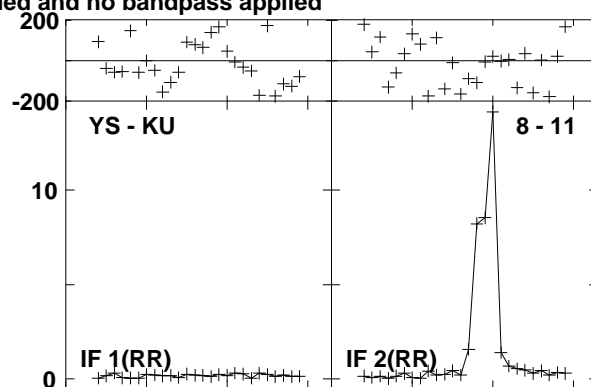
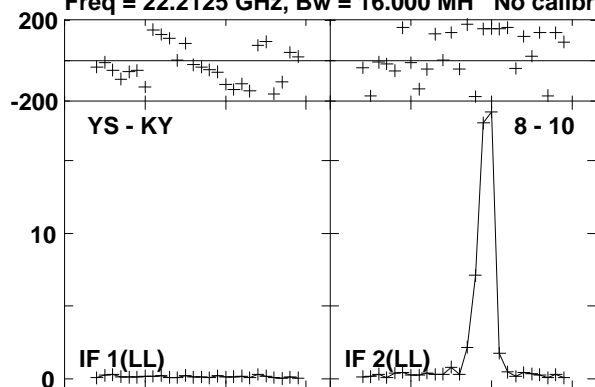

Lower frame: Milli Ampl Jy Top frame: Phas deg

Vector averaged cross-power spectrum Baseline: YS (08) - KY (10)

Timerange: 00/16:12:33 to 00/16:13:31

Plot file version 690 created 23-AUG-2016 15:01:08

0219+628 GA035B 1.UVDATA.1

Freq = 22.2125 GHz, Bw = 16.000 MH No calibration applied and no bandpass applied

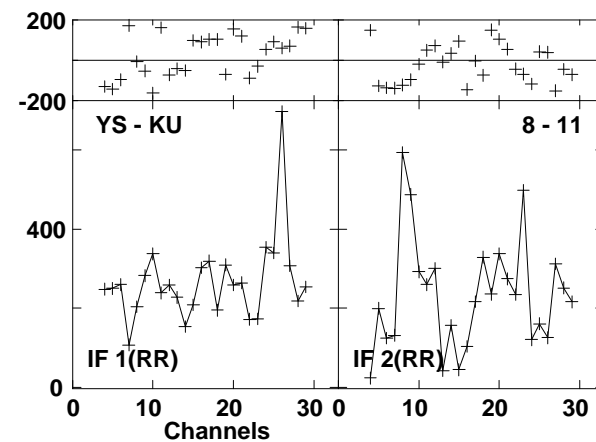
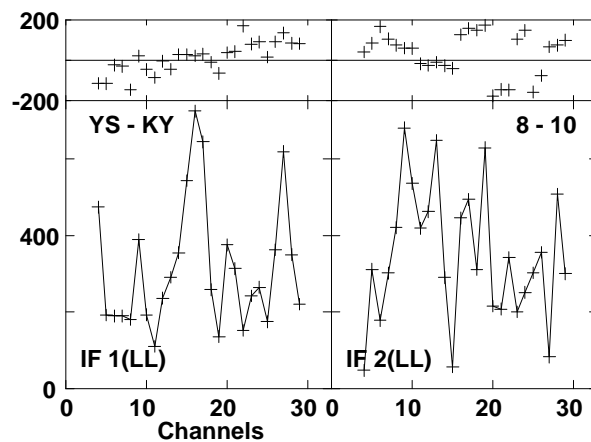
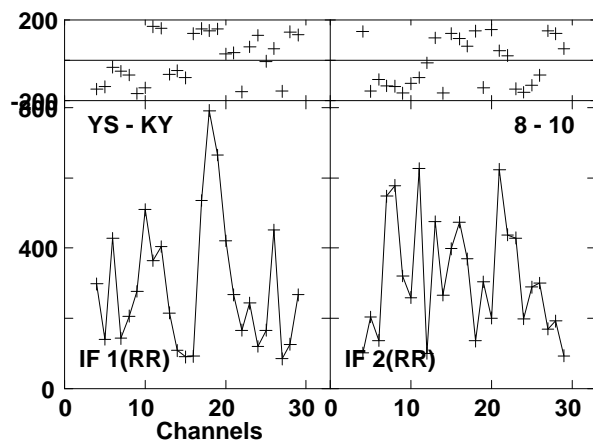
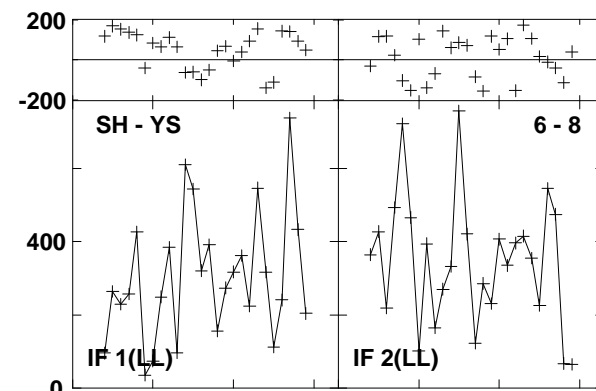
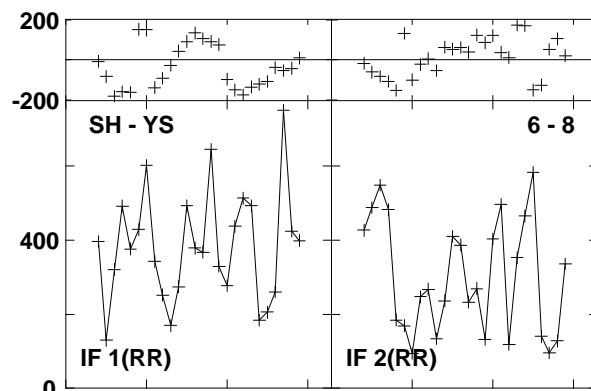
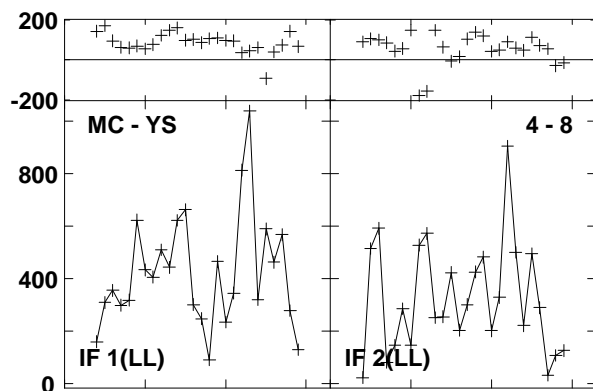
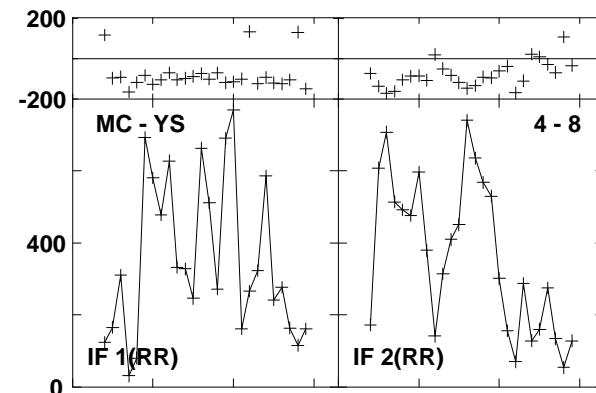
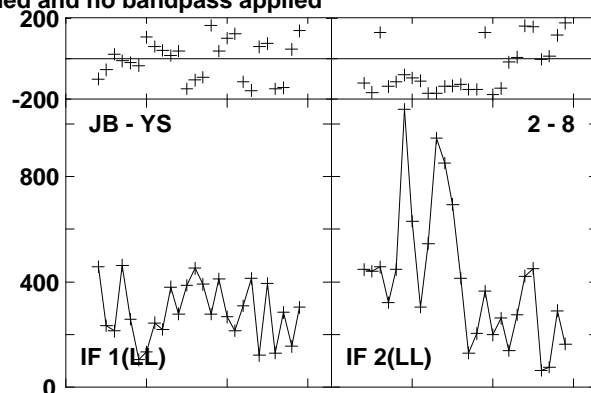
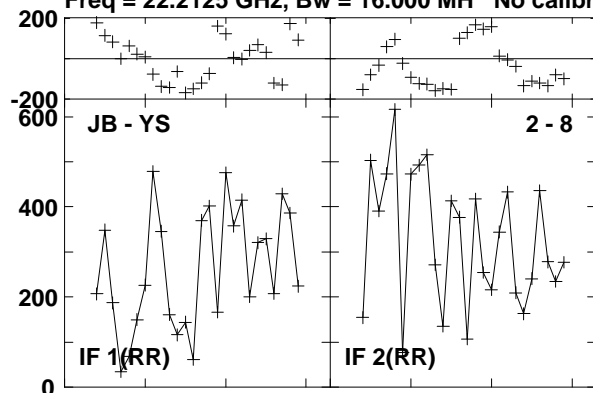

Lower frame: Micro Ampl Jy Top frame: Phas deg  
Vector averaged cross-power spectrum Baseline: JB (02) - YS (08)  
Timerange: 00/16:14:09 to 00/16:14:27

Plot file version 691 created 23-AUG-2016 15:01:08  
0219+628 GA035B 1.UVDATA.1

Freq = 22.2125 GHz, Bw = 16.000 MH No calibration applied and no bandpass applied

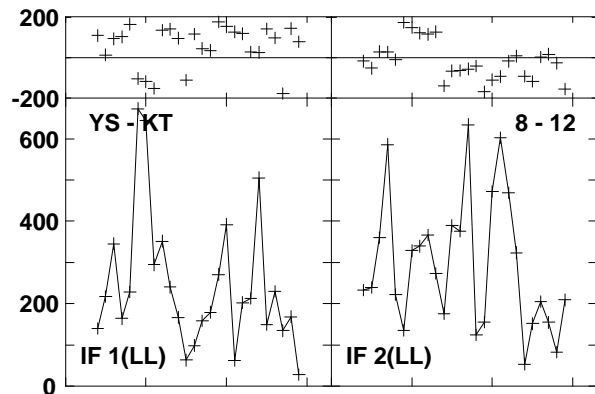
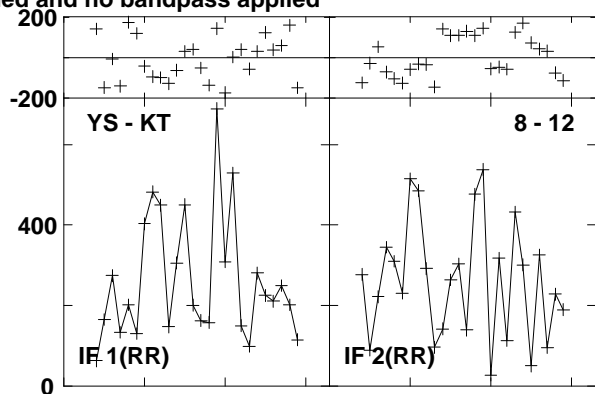
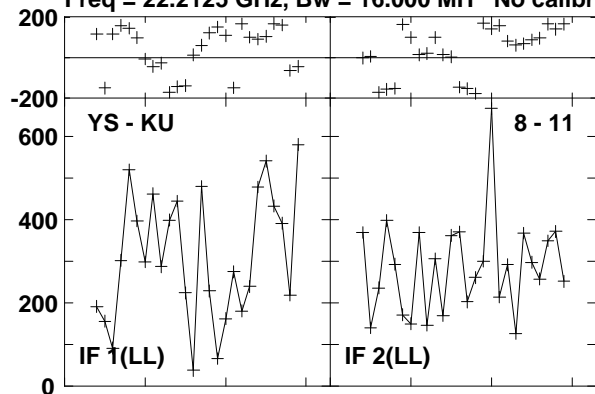

Lower frame: Micro Ampl Jy Top frame: Phas deg  
Vector averaged cross-power spectrum Baseline: YS (08) - KU (11)  
Timerange: 00/16:14:09 to 00/16:14:27

Plot file version 692 created 23-AUG-2016 15:01:08

W3IRS5 GA035B 1.UVDATA.1

Freq = 22.2125 GHz, Bw = 16.000 MH No calibration applied and no bandpass applied

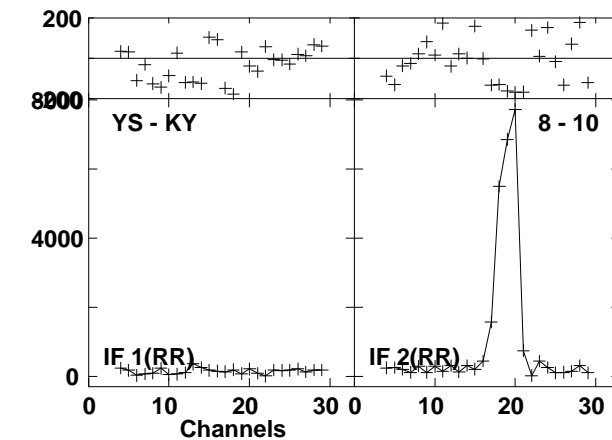
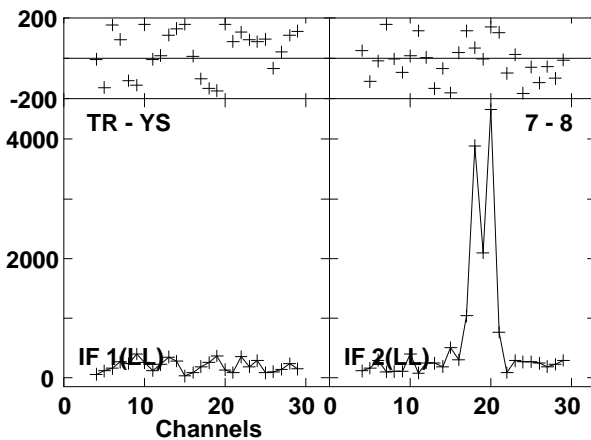
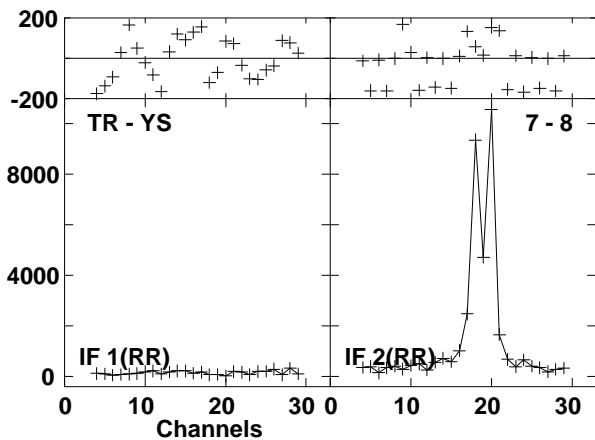
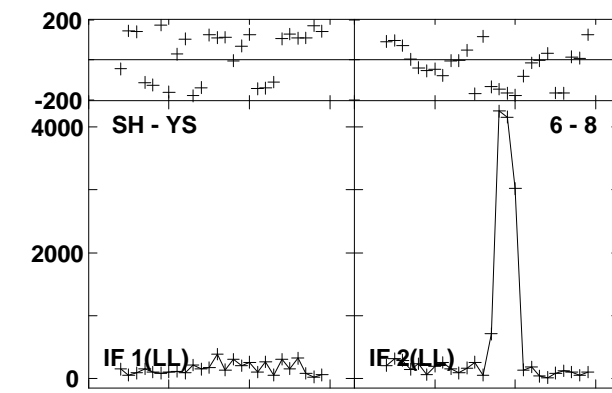
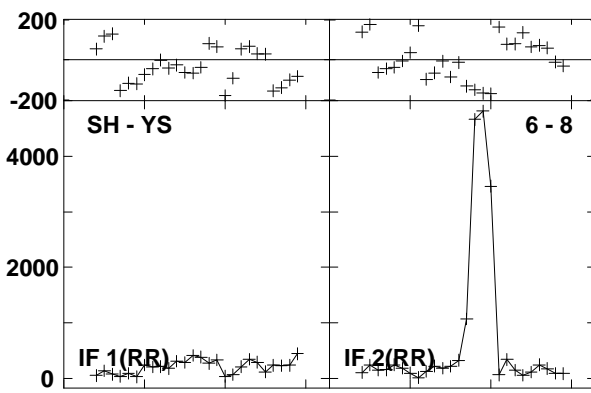
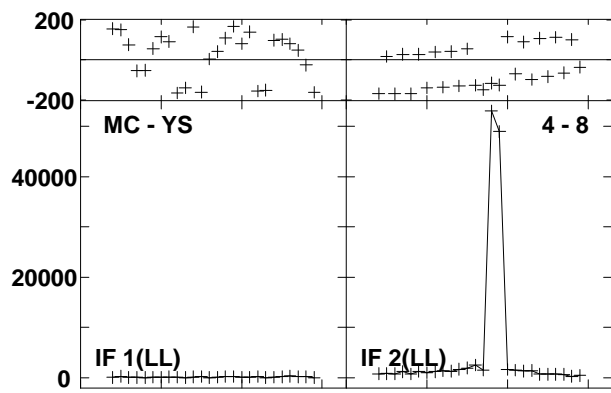
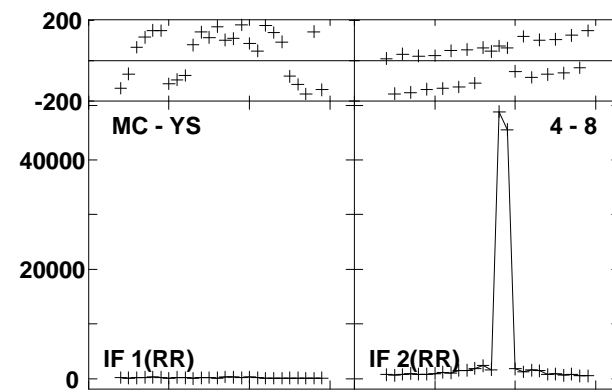
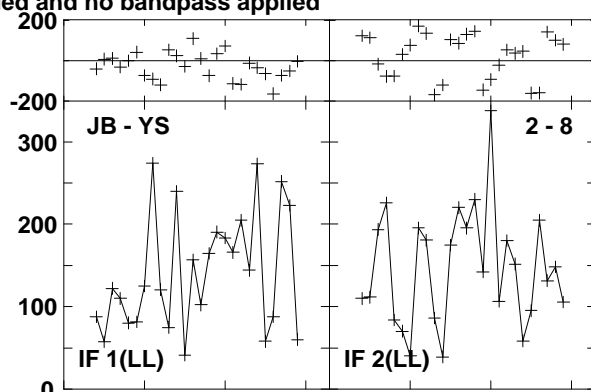
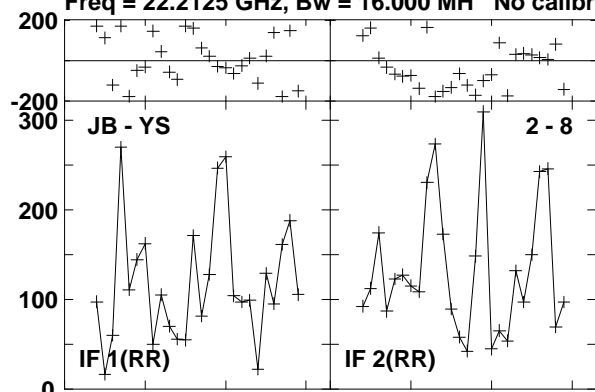

Lower frame: Micro Ampl Jy Top frame: Phas deg  
Vector averaged cross-power spectrum Baseline: JB (02) - YS (08)  
Timerange: 00/16:16:24 to 00/16:17:23

Plot file version 693 created 23-AUG-2016 15:01:08

W3IRS5 GA035B 1.UVDATA.1

Freq = 22.2125 GHz, Bw = 16.000 MH No calibration applied and no bandpass applied

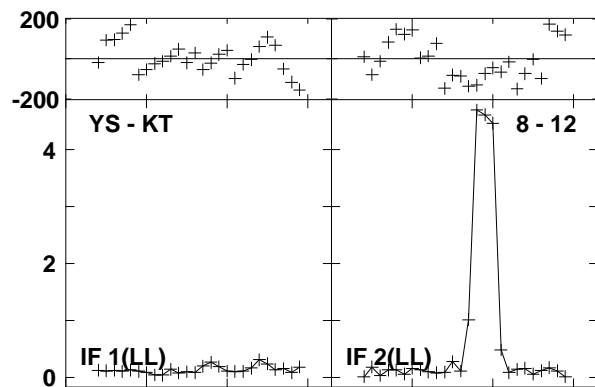
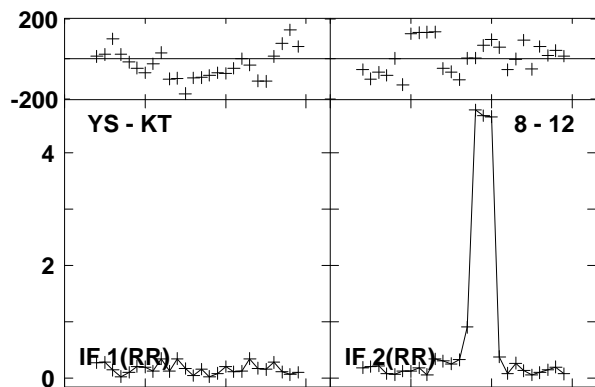
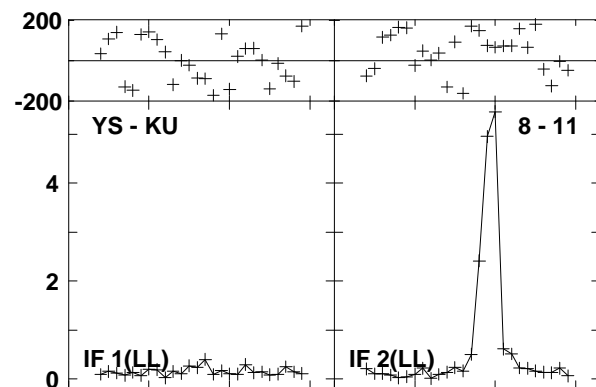
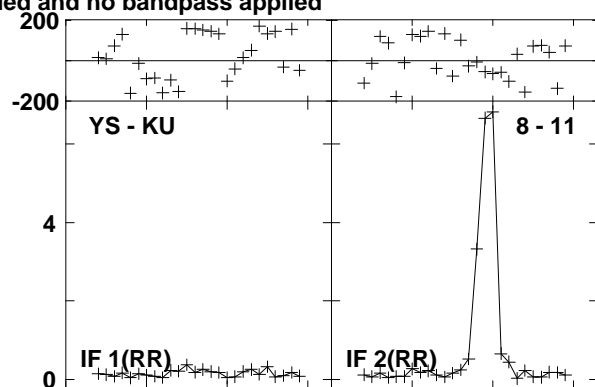
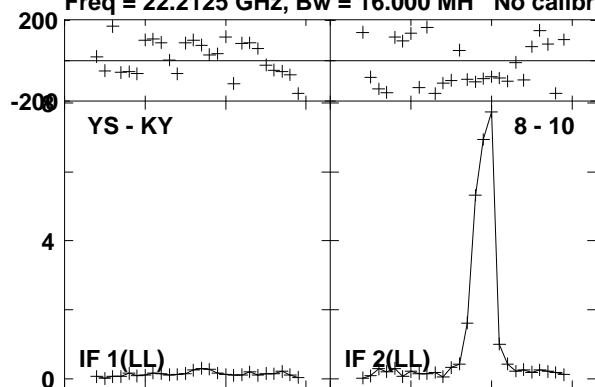

Lower frame: Milli Ampl Jy Top frame: Phas deg

Vector averaged cross-power spectrum Baseline: YS (08) - KY (10)

Timerange: 00/16:16:24 to 00/16:17:23

Plot file version 694 created 23-AUG-2016 15:01:08

0219+628 GA035B 1.UVDATA.1

Freq = 22.2125 GHz, Bw = 16.000 MH No calibration applied and no bandpass applied

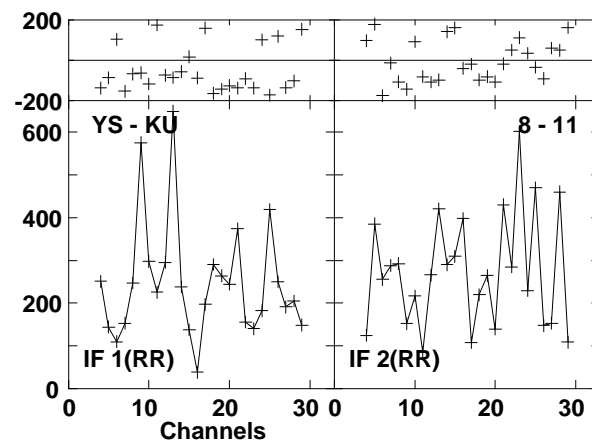
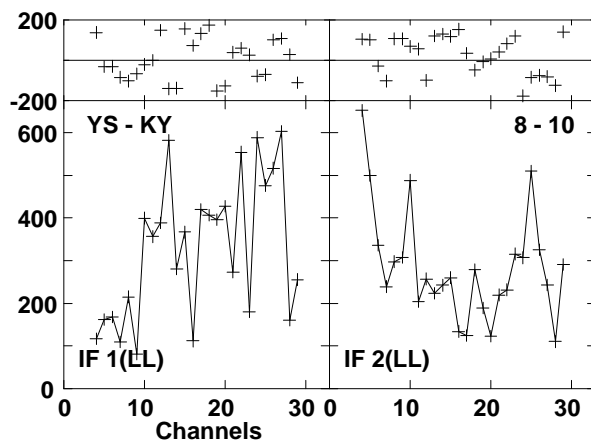
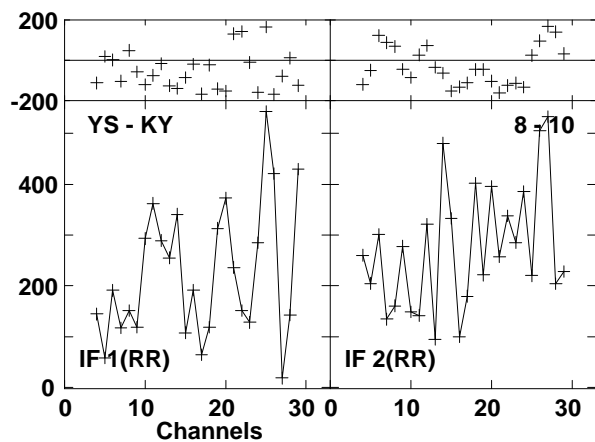
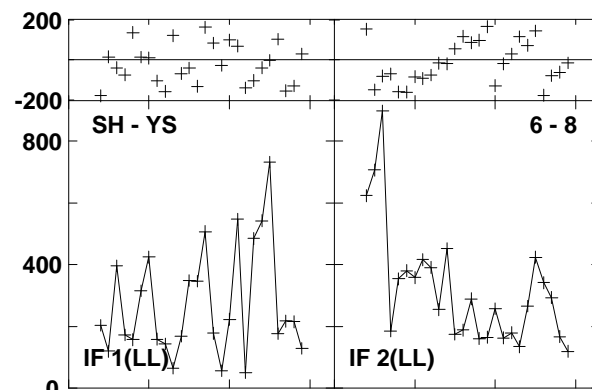
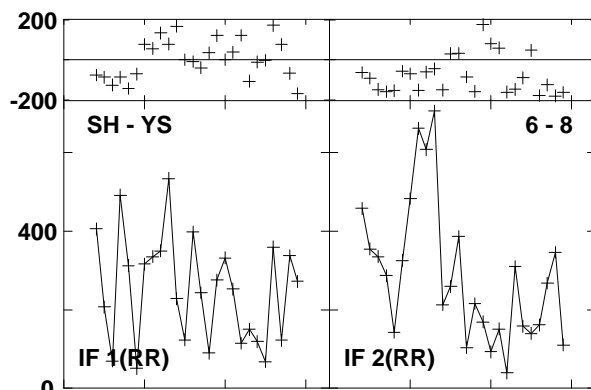
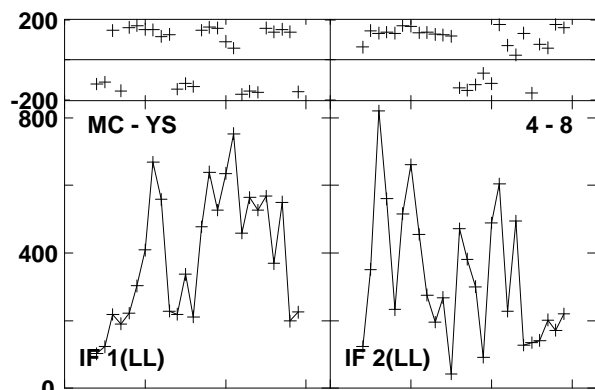
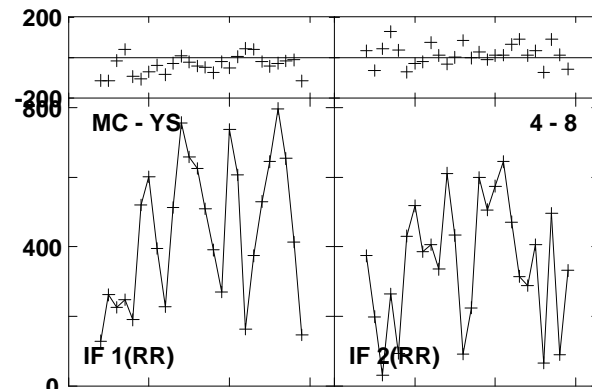
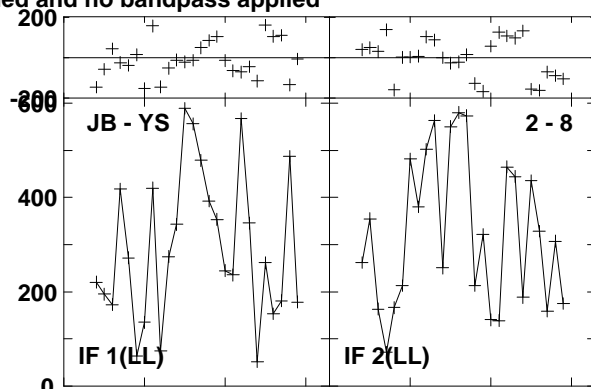
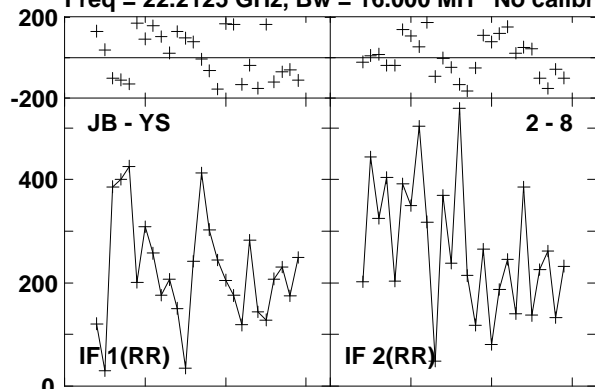

Lower frame: Micro Ampl Jy Top frame: Phas deg  
Vector averaged cross-power spectrum Baseline: JB (02) - YS (08)  
Timerange: 00/16:18:01 to 00/16:18:19

Plot file version 695 created 23-AUG-2016 15:01:08

0219+628 GA035B 1.UVDATA.1

Freq = 22.2125 GHz, Bw = 16.000 MH No calibration applied and no bandpass applied

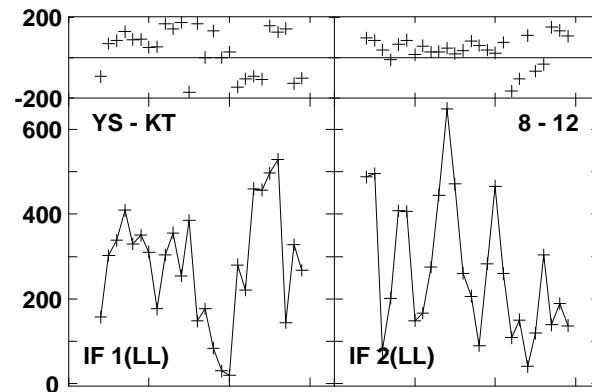
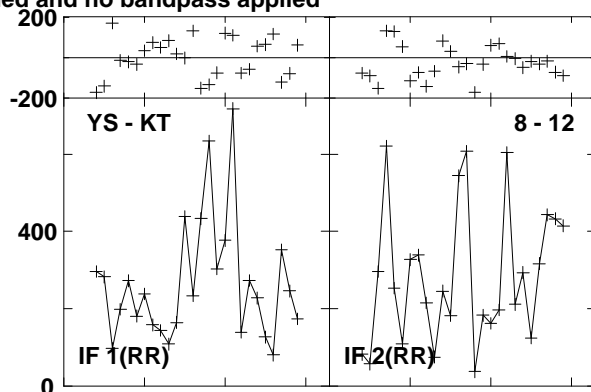
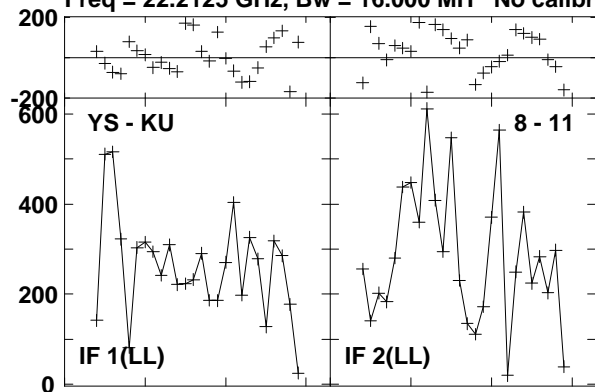

Lower frame: Micro Ampl Jy Top frame: Phas deg  
Vector averaged cross-power spectrum Baseline: YS (08) - KU (11)  
Timerange: 00/16:18:01 to 00/16:18:19

Plot file version 696 created 23-AUG-2016 15:01:08  
W3IRS5 GA035B 1.UVDATA.1

Freq = 22.2125 GHz, Bw = 16.000 MH No calibration applied and no bandpass applied

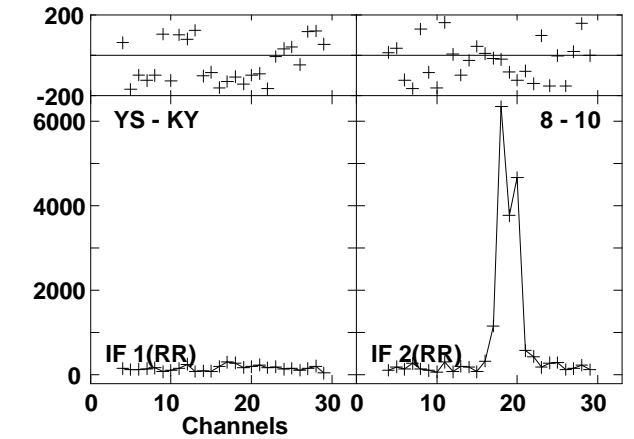
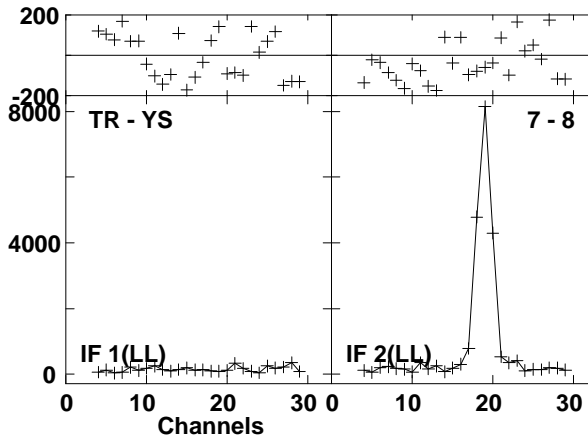
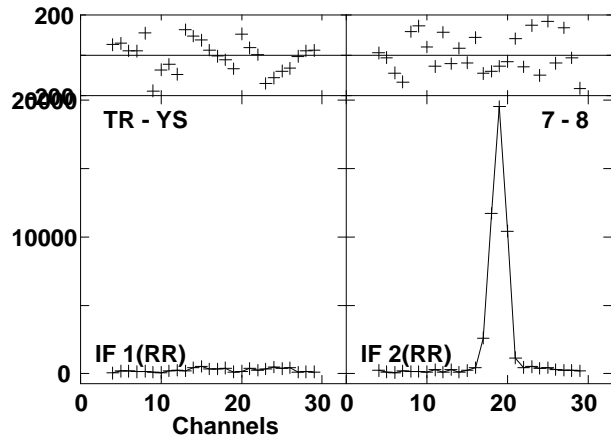
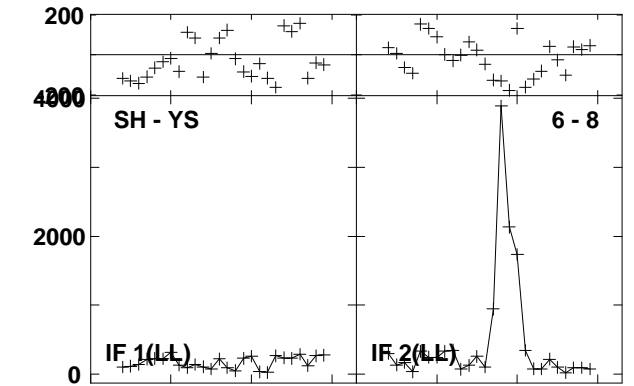
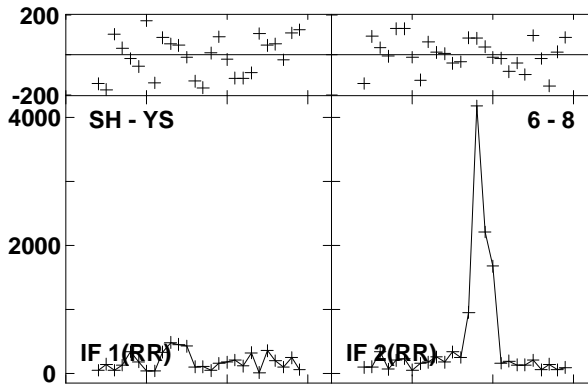
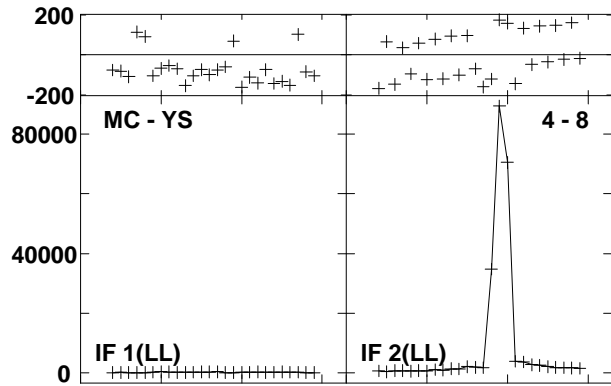
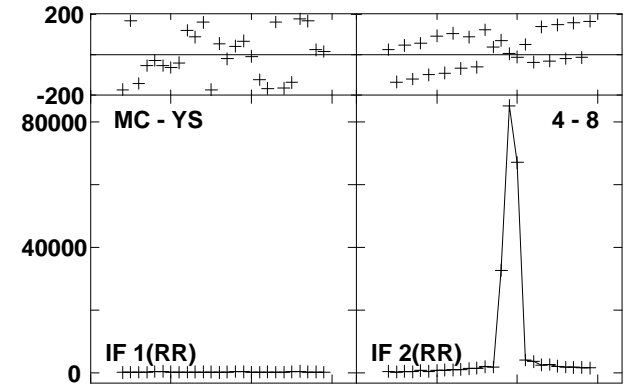
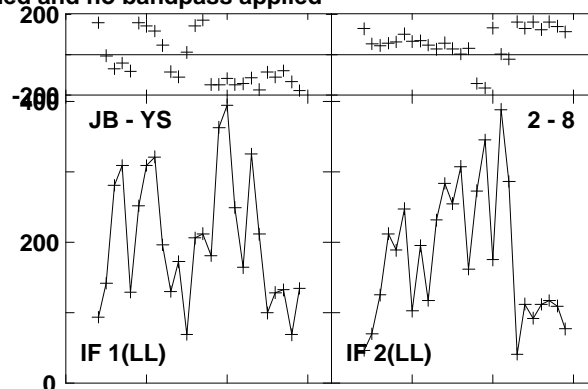
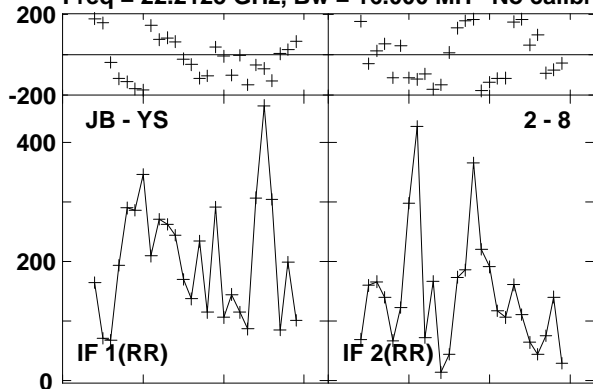

Lower frame: Micro Ampl Jy Top frame: Phas deg  
Vector averaged cross-power spectrum Baseline: JB (02) - YS (08)  
Timerange: 00/16:18:57 to 00/16:19:56



Plot file version 697 created 23-AUG-2016 15:01:08  
W3IRS5 GA035B 1.UVDATA.1

Freq = 22.2125 GHz, Bw = 16.000 MH No calibration applied and no bandpass applied

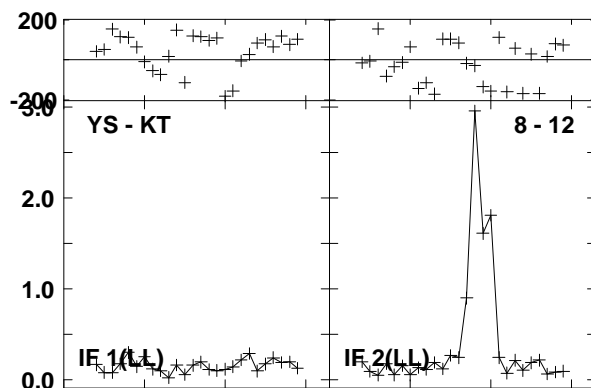
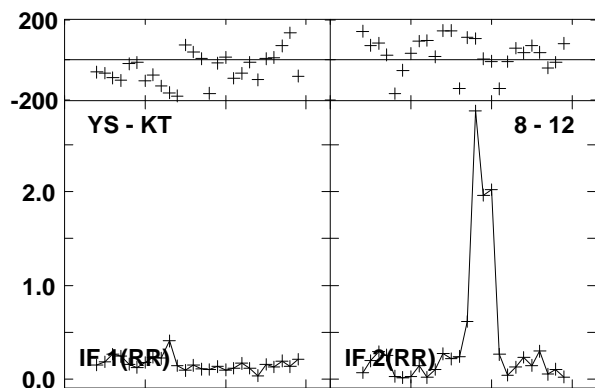
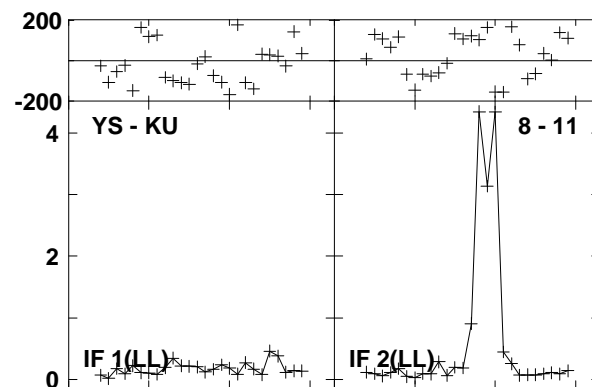
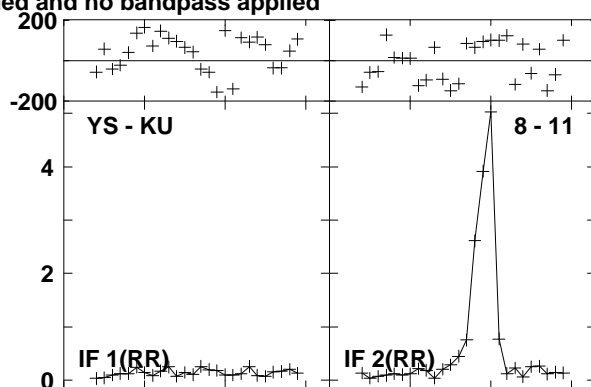
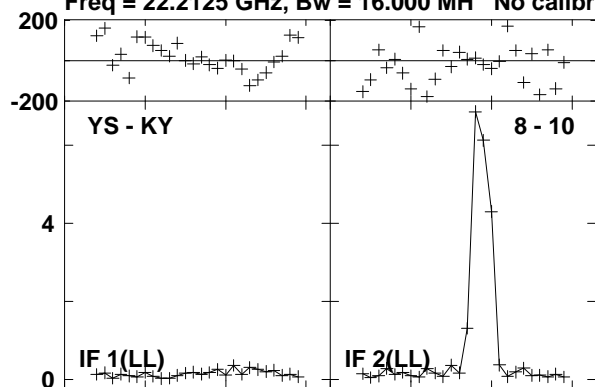

Lower frame: Milli Ampl Jy Top frame: Phas deg  
Vector averaged cross-power spectrum Baseline: YS (08) - KY (10)  
Timerange: 00/16:18:57 to 00/16:19:56

Plot file version 698 created 23-AUG-2016 15:01:08

0219+628 GA035B 1.UVDATA.1

Freq = 22.2125 GHz, Bw = 16.000 MH No calibration applied and no bandpass applied

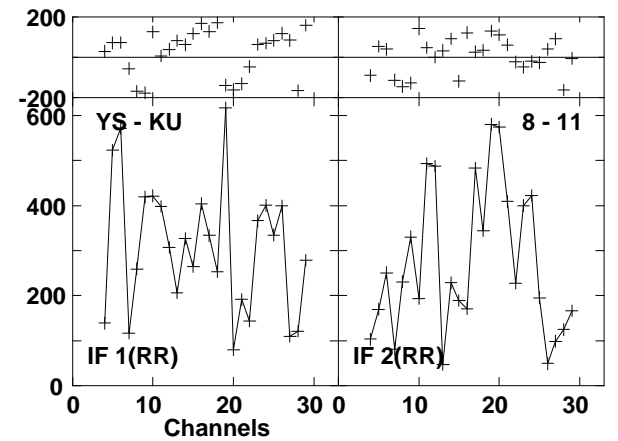
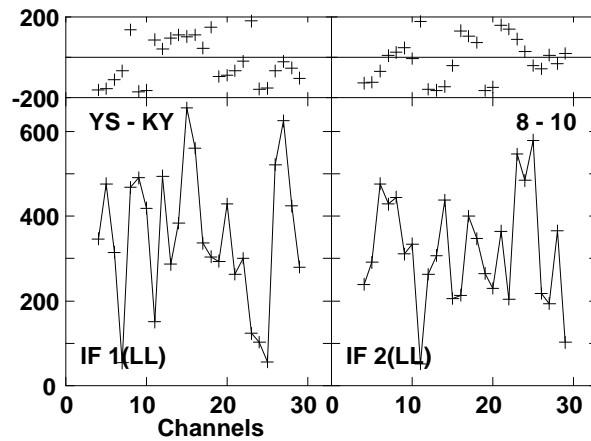
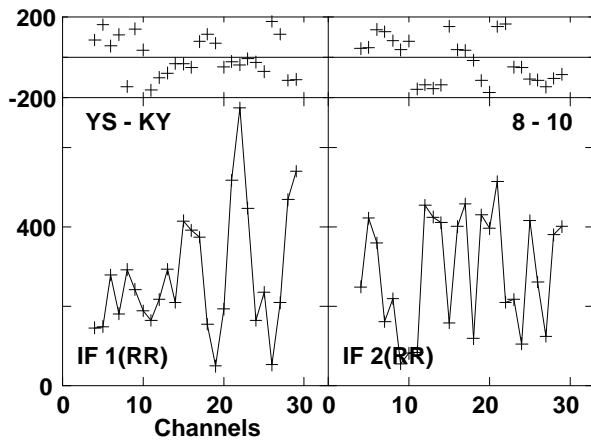
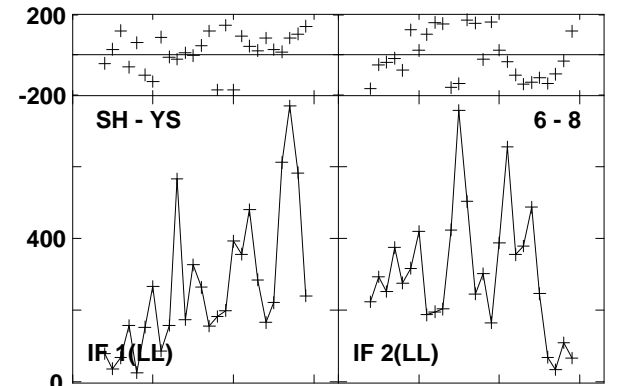
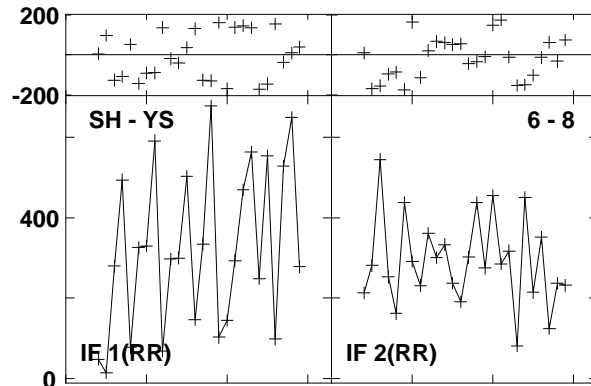
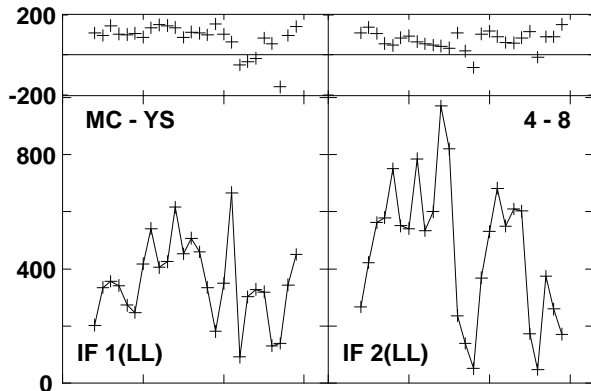
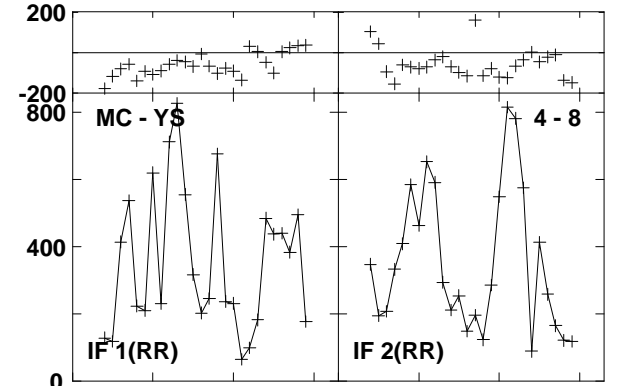
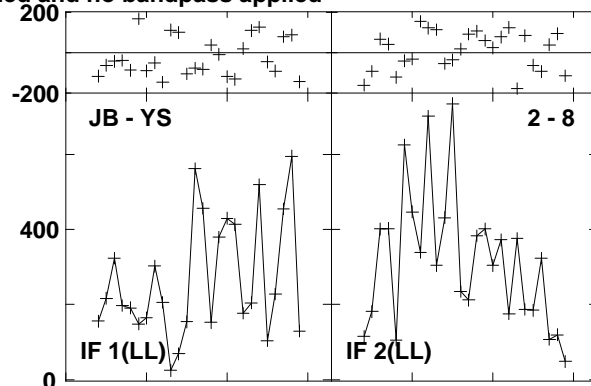
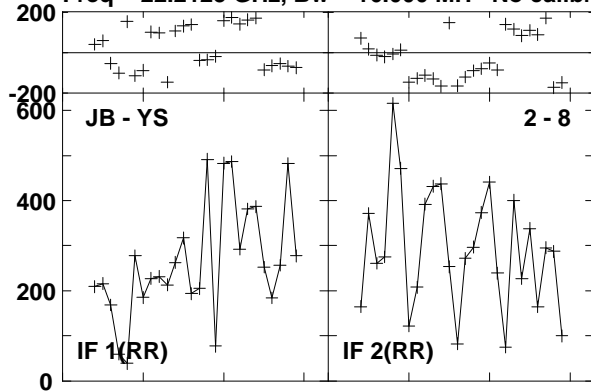

Lower frame: Micro Ampl Jy Top frame: Phas deg  
Vector averaged cross-power spectrum Baseline: JB (02) - YS (08)  
Timerange: 00/16:20:33 to 00/16:20:52

Plot file version 699 created 23-AUG-2016 15:01:08

0219+628 GA035B 1.UVDATA.1

Freq = 22.2125 GHz, Bw = 16.000 MH No calibration applied and no bandpass applied

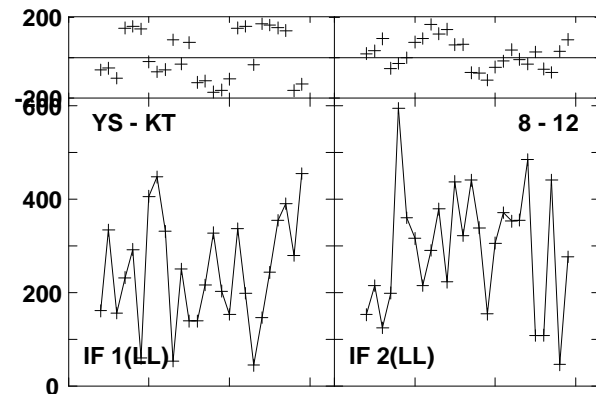
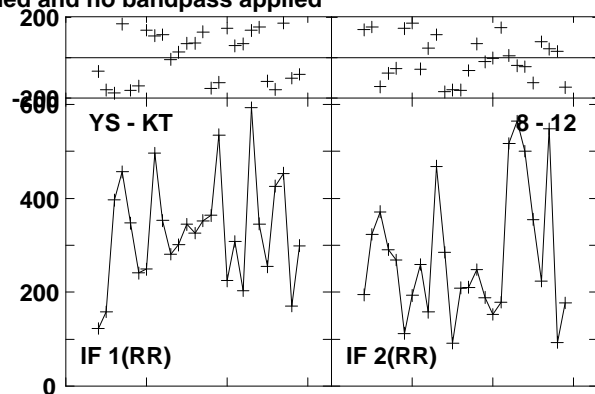
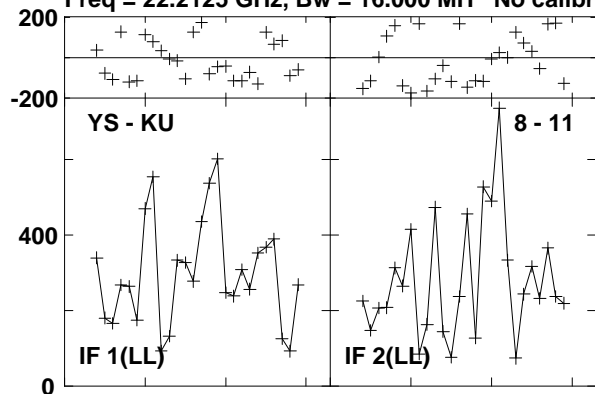

Lower frame: Micro Ampl Jy Top frame: Phas deg  
Vector averaged cross-power spectrum Baseline: YS (08) - KU (11)  
Timerange: 00/16:20:33 to 00/16:20:52

Plot file version 700 created 23-AUG-2016 15:01:08  
W3IRS5 GA035B 1.UVDATA.1

Freq = 22.2125 GHz, Bw = 16.000 MH No calibration applied and no bandpass applied

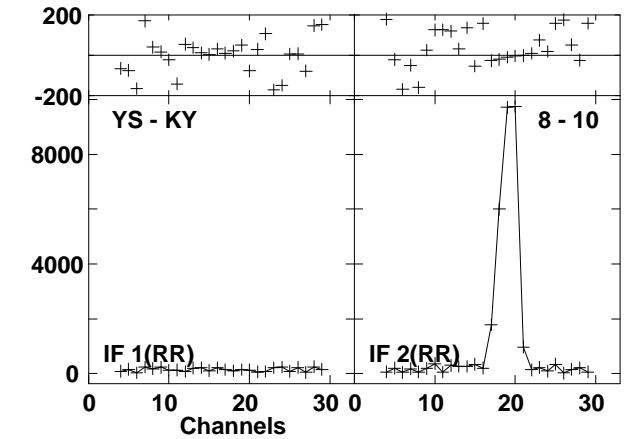
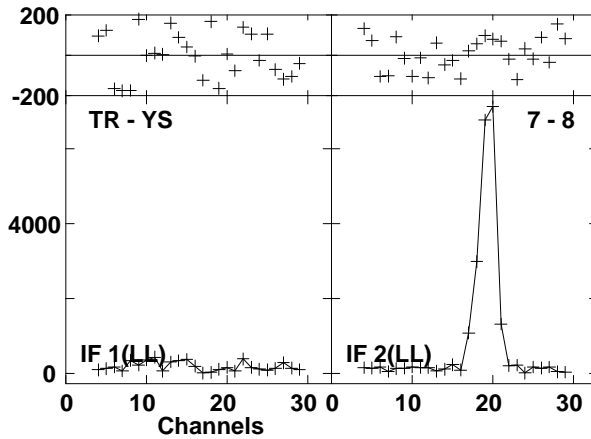
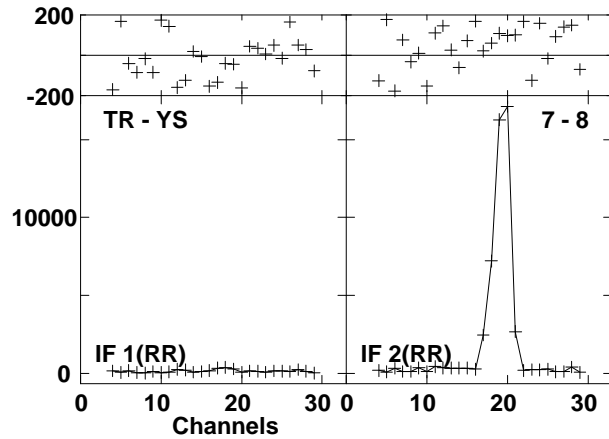
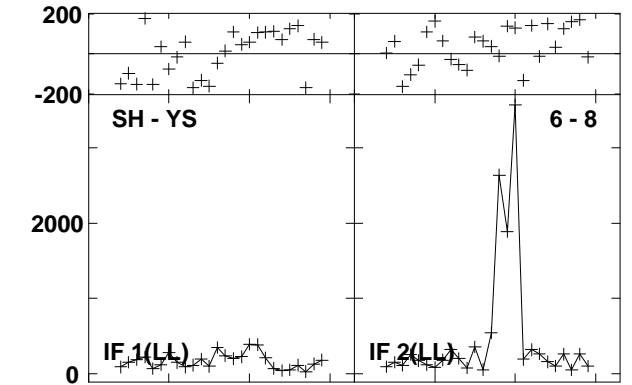
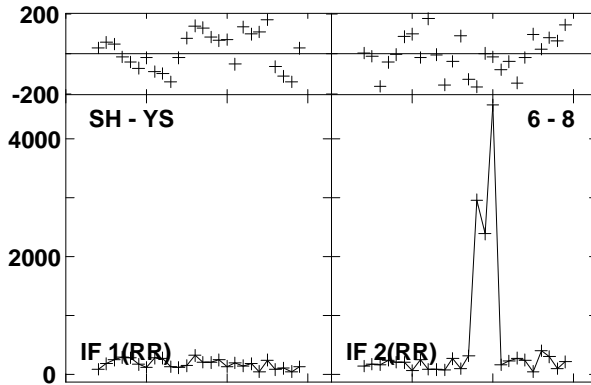
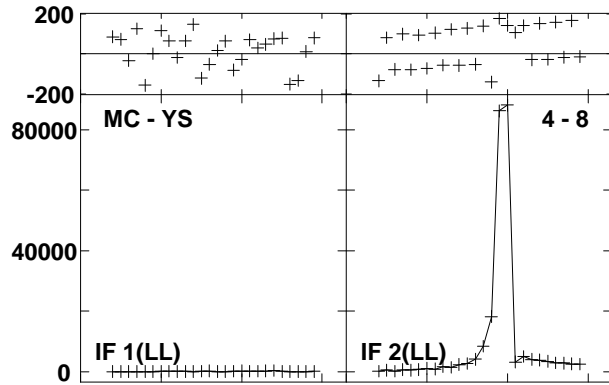
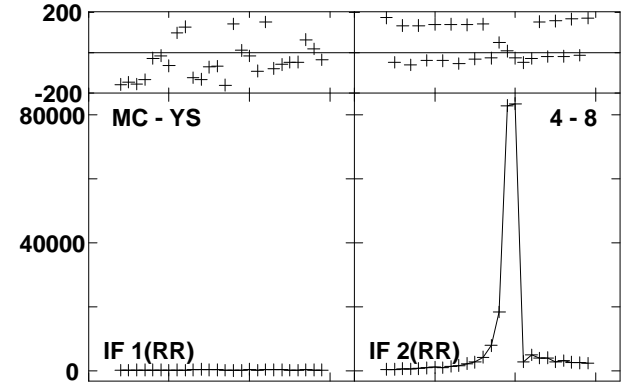
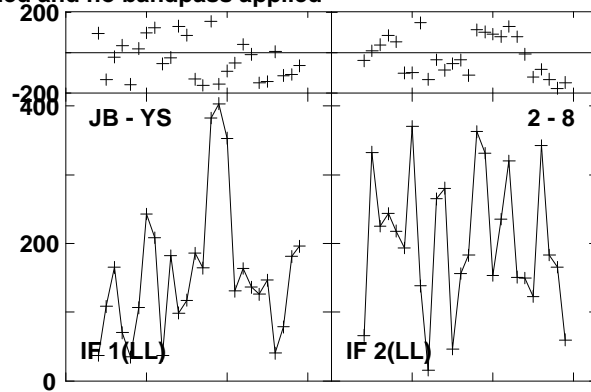
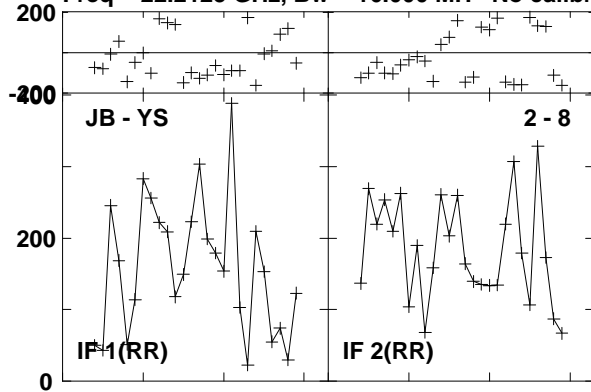

Lower frame: Micro Ampl Jy Top frame: Phas deg  
Vector averaged cross-power spectrum Baseline: JB (02) - YS (08)  
Timerange: 00/16:21:29 to 00/16:22:28

Plot file version 701 created 23-AUG-2016 15:01:08

W3IRS5 GA035B 1.UVDATA.1

Freq = 22.2125 GHz, Bw = 16.000 MH No calibration applied and no bandpass applied

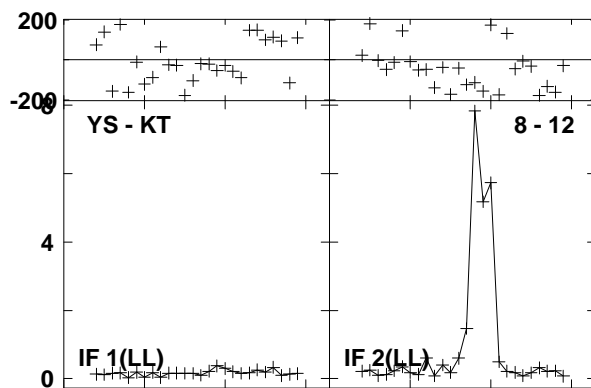
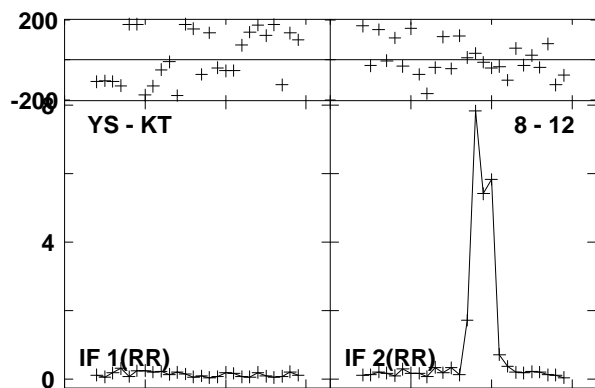
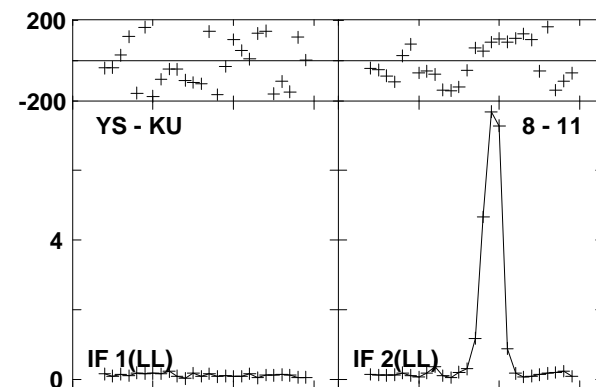
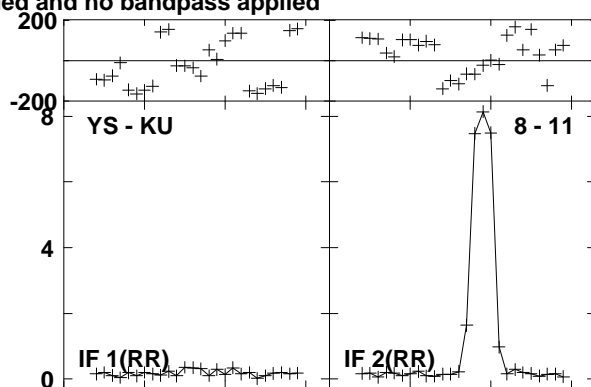
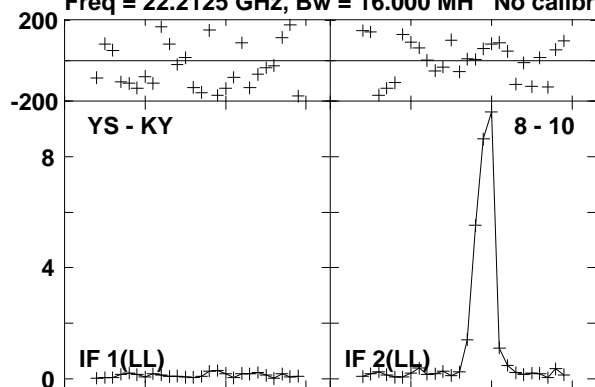

Lower frame: Milli Ampl Jy Top frame: Phas deg  
Vector averaged cross-power spectrum Baseline: YS (08) - KY (10)  
Timerange: 00/16:21:29 to 00/16:22:28

Plot file version 702 created 23-AUG-2016 15:01:08

0219+628 GA035B 1.UVDATA.1

Freq = 22.2125 GHz, Bw = 16.000 MH No calibration applied and no bandpass applied

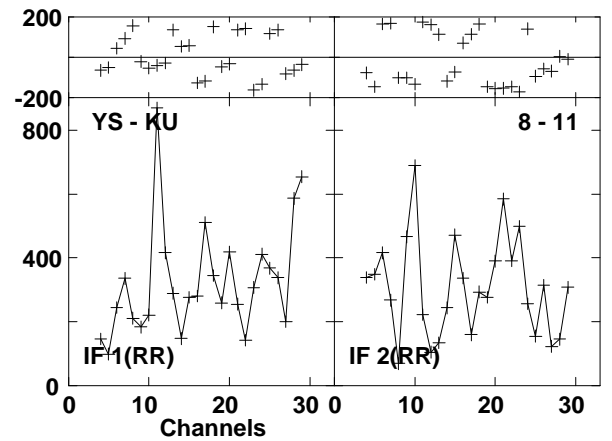
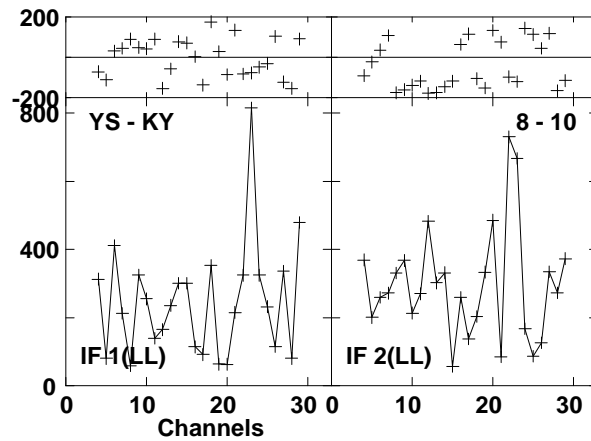
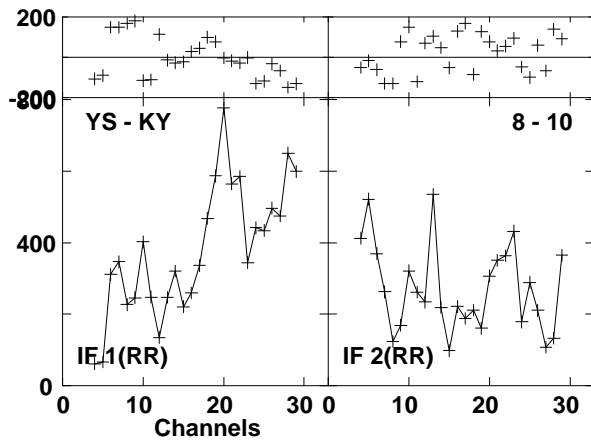
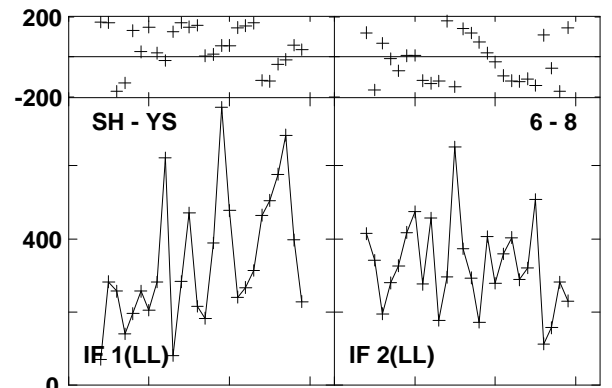
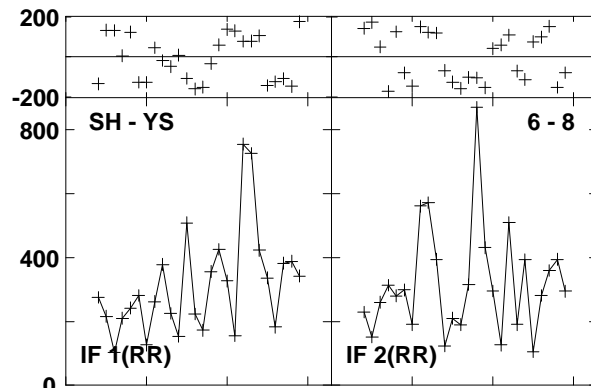
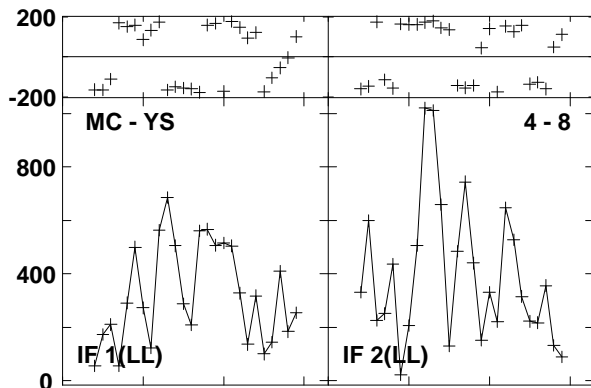
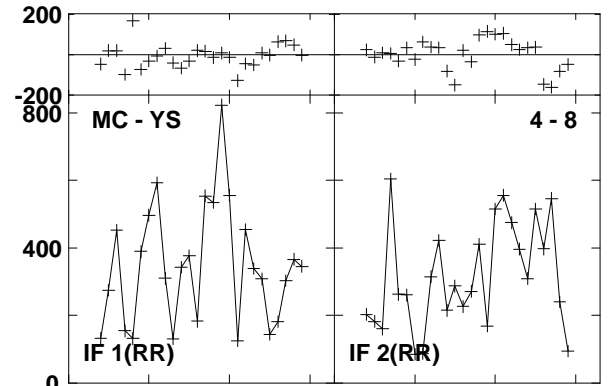
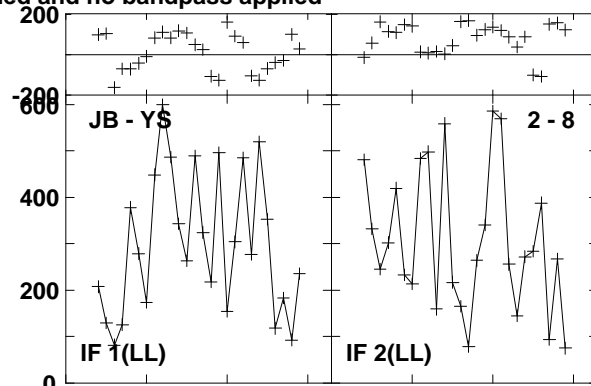
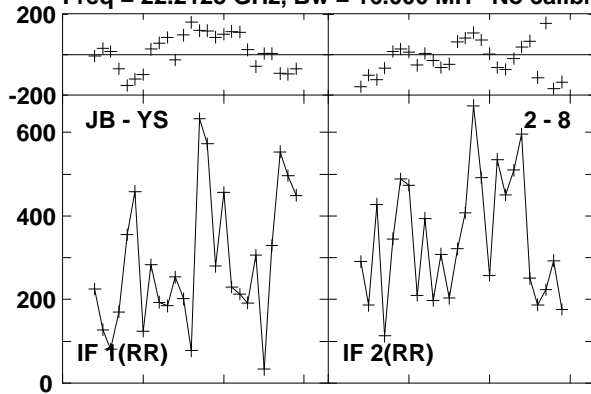

Lower frame: Micro Ampl Jy Top frame: Phas deg  
Vector averaged cross-power spectrum Baseline: JB (02) - YS (08)  
Timerange: 00/16:23:04 to 00/16:23:23

Plot file version 703 created 23-AUG-2016 15:01:08

0219+628 GA035B 1.UVDATA.1

Freq = 22.2125 GHz, Bw = 16.000 MH No calibration applied and no bandpass applied

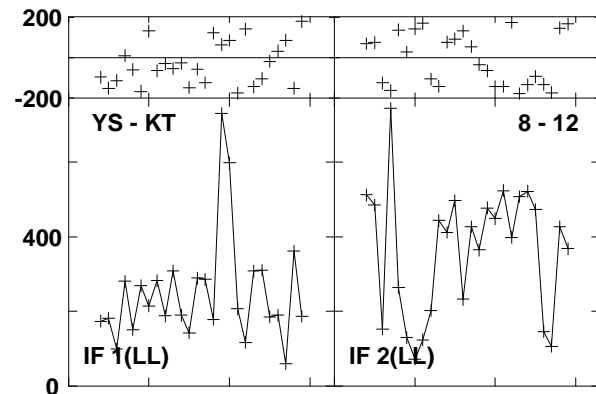
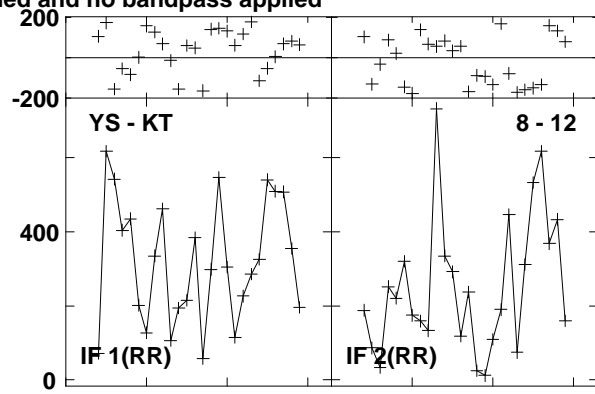
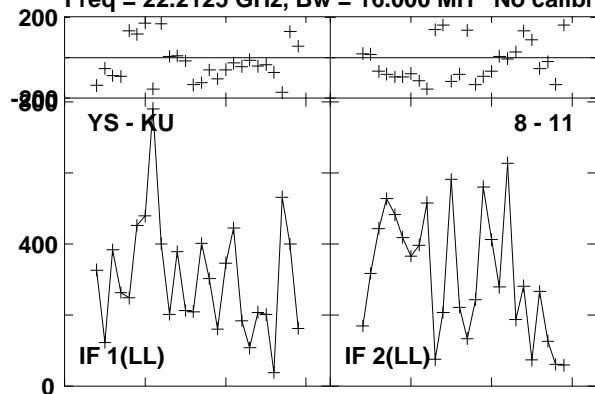

Lower frame: Micro Ampl Jy Top frame: Phas deg  
Vector averaged cross-power spectrum Baseline: YS (08) - KU (11)  
Timerange: 00/16:23:04 to 00/16:23:23

Plot file version 704 created 23-AUG-2016 15:01:08

W3IRS5 GA035B 1.UVDATA.1

Freq = 22.2125 GHz, Bw = 16.000 MH No calibration applied and no bandpass applied

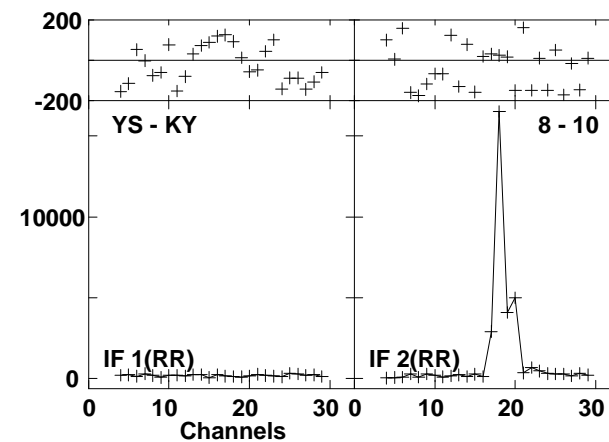
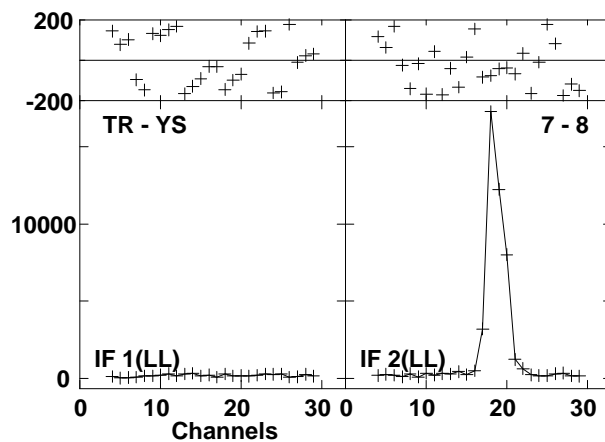
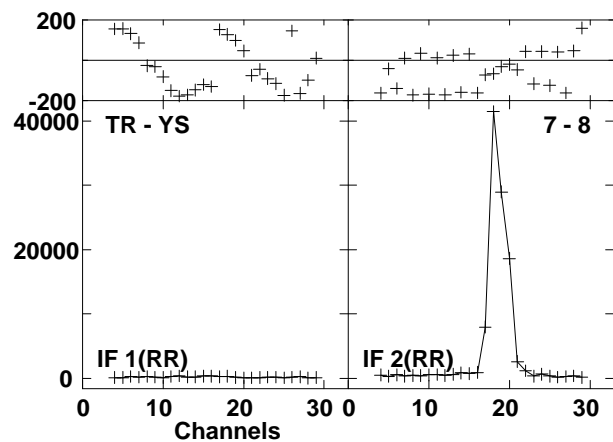
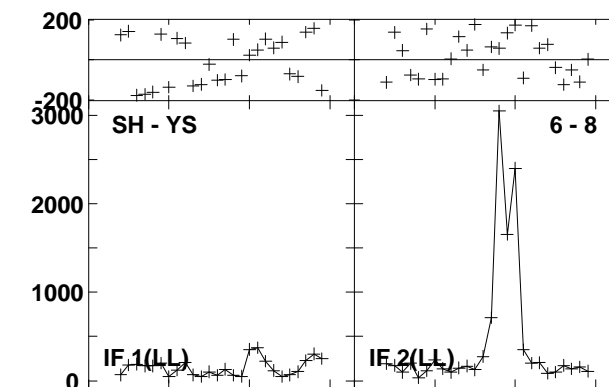
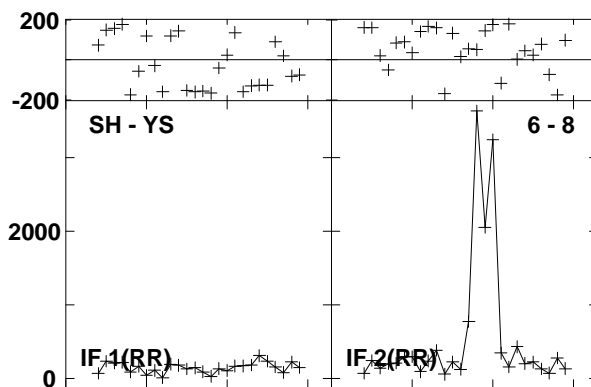
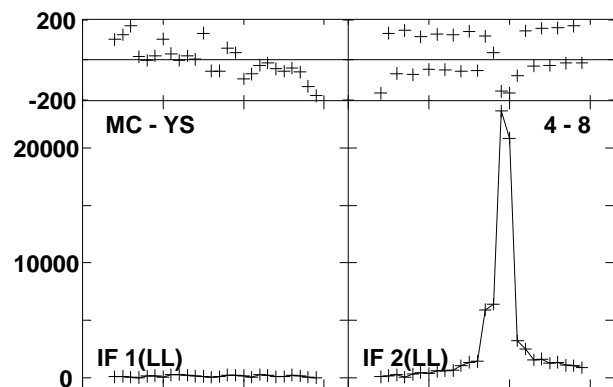
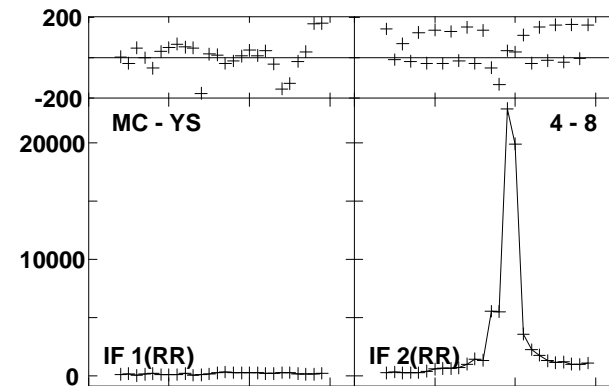
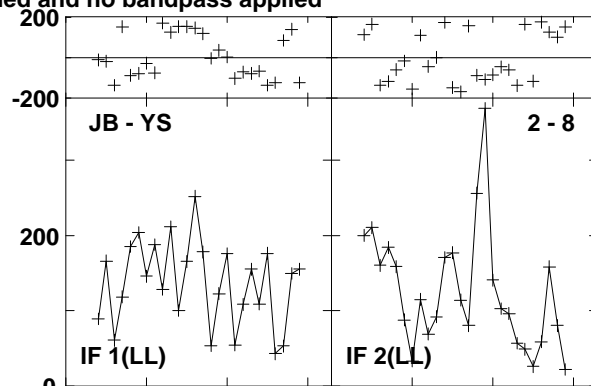
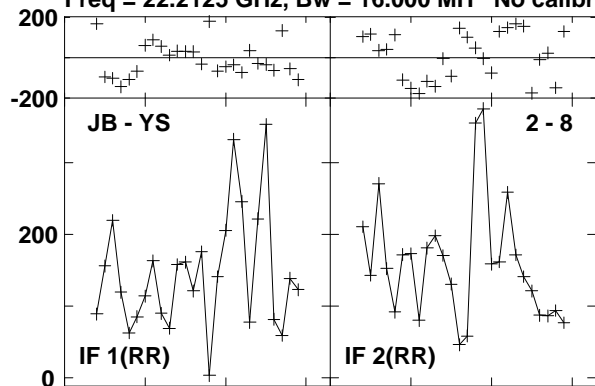

Lower frame: Micro Ampl Jy Top frame: Phas deg  
Vector averaged cross-power spectrum Baseline: JB (02) - YS (08)  
Timerange: 00/16:24:00 to 00/16:24:59



Plot file version 705 created 23-AUG-2016 15:01:08  
W3IRS5 GA035B 1.UVDATA.1

Freq = 22.2125 GHz, Bw = 16.000 MH No calibration applied and no bandpass applied

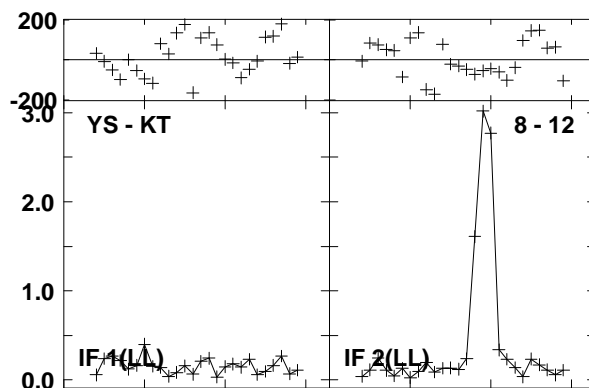
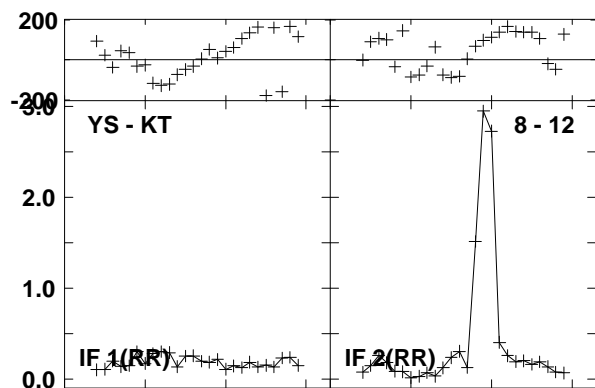
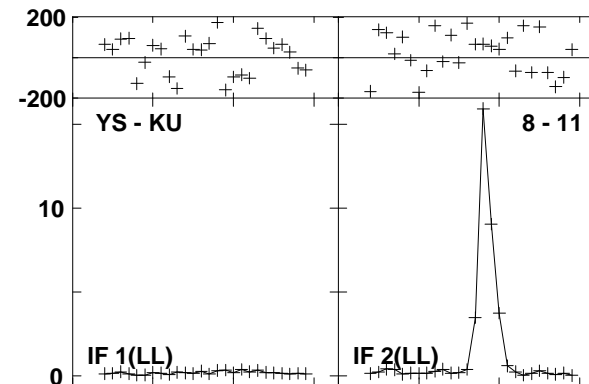
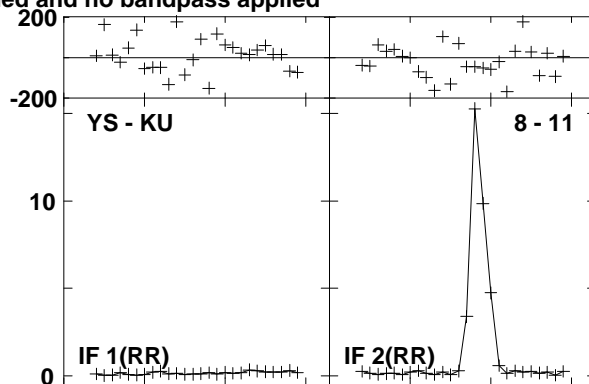
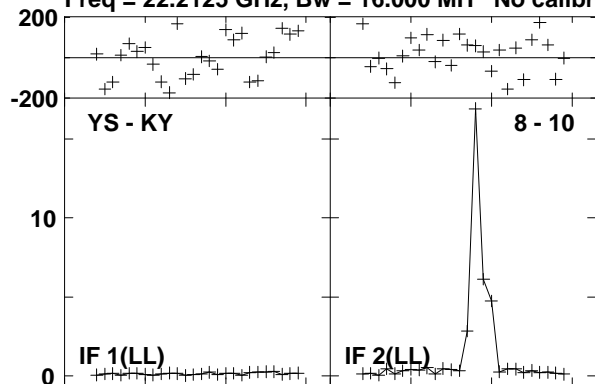

Lower frame: Milli Ampl Jy Top frame: Phas deg  
Vector averaged cross-power spectrum Baseline: YS (08) - KY (10)  
Timerange: 00/16:24:00 to 00/16:24:59

Plot file version 706 created 23-AUG-2016 15:01:08

0219+628 GA035B 1.UVDATA.1

Freq = 22.2125 GHz, Bw = 16.000 MH No calibration applied and no bandpass applied

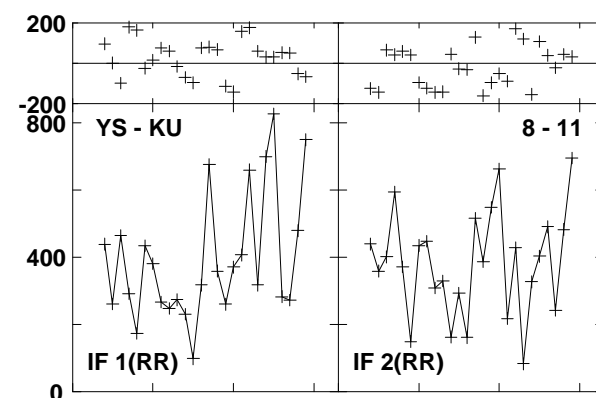
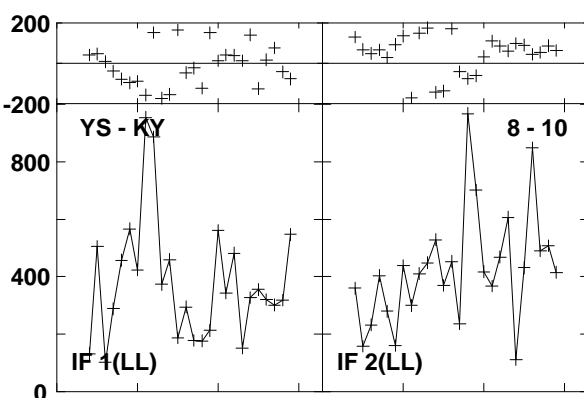
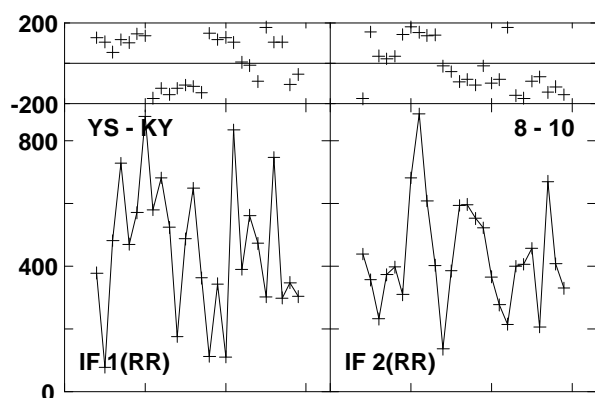
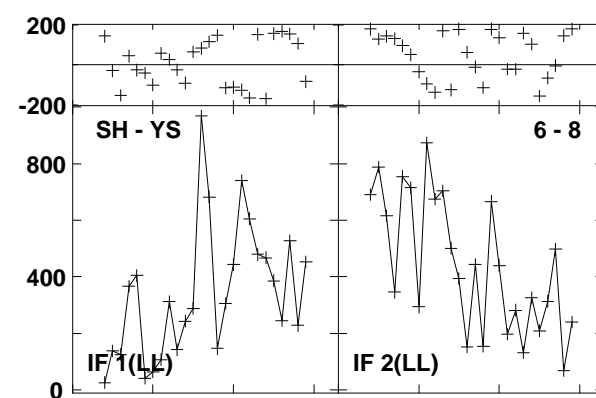
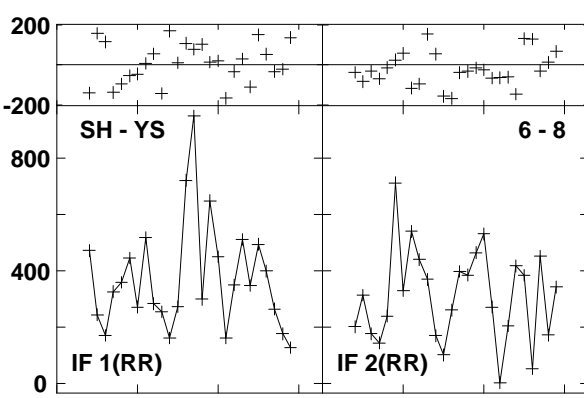
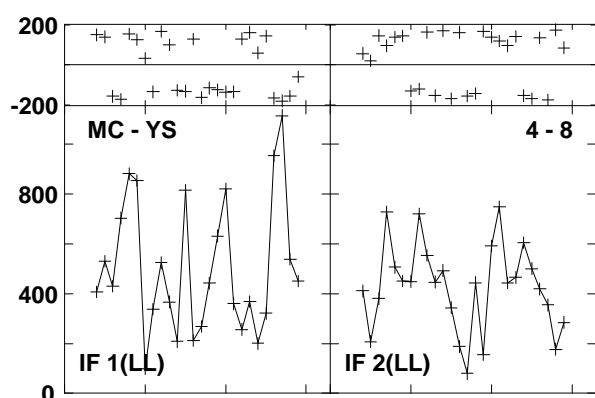
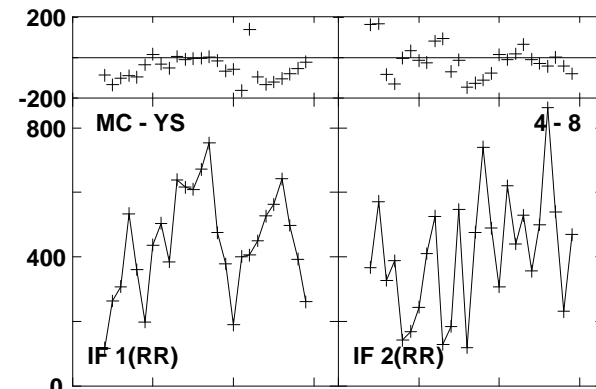
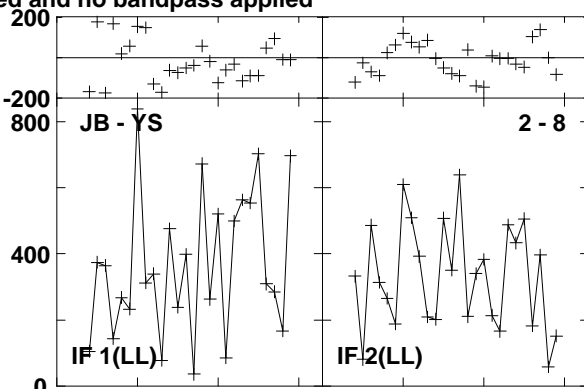
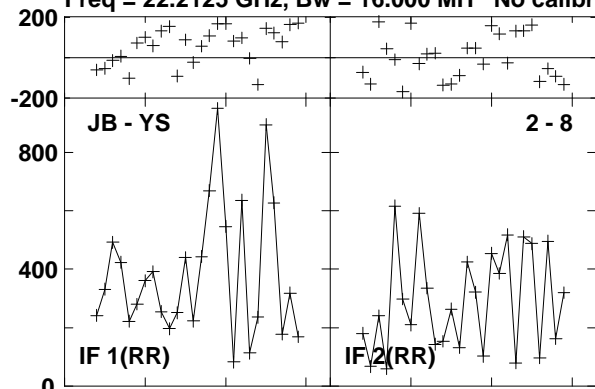

Lower frame: Micro Ampl Jy Top frame: Phas deg  
Vector averaged cross-power spectrum Baseline: JB (02) - YS (08)  
Timerange: 00/16:25:36 to 00/16:25:55

Plot file version 707 created 23-AUG-2016 15:01:08

0219+628 GA035B 1.UVDATA.1

Freq = 22.2125 GHz, Bw = 16.000 MH No calibration applied and no bandpass applied

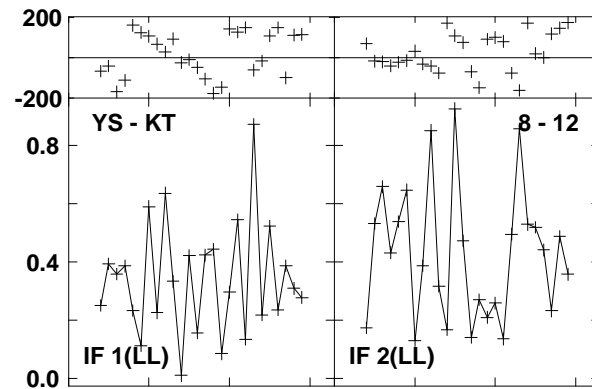
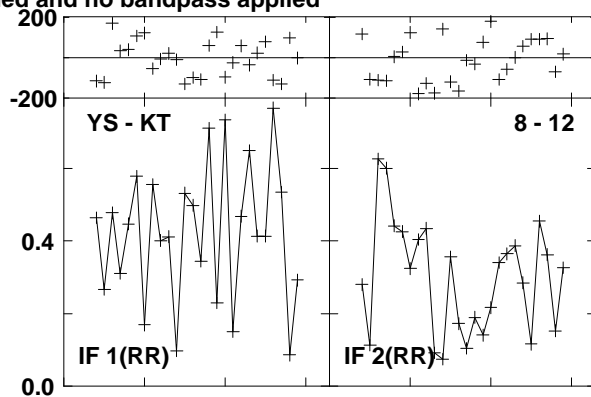
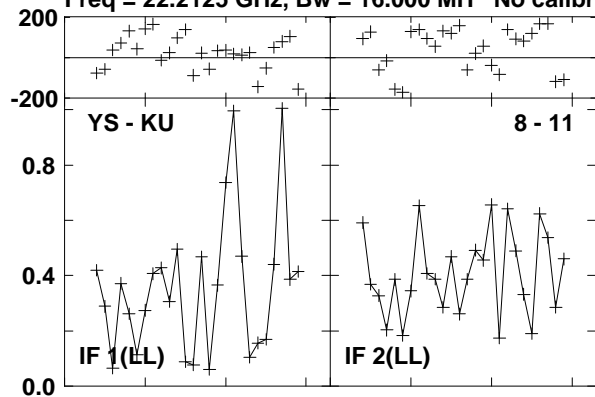

Lower frame: Milli Ampl Jy Top frame: Phas deg  
Vector averaged cross-power spectrum Baseline: YS (08) - KU (11)  
Timerange: 00/16:25:36 to 00/16:25:55

Plot file version 708 created 23-AUG-2016 15:01:08  
 W3IRS5 GA035B 1.UVDATA.1

Freq = 22.2125 GHz, Bw = 16.000 MH No calibration applied and no bandpass applied

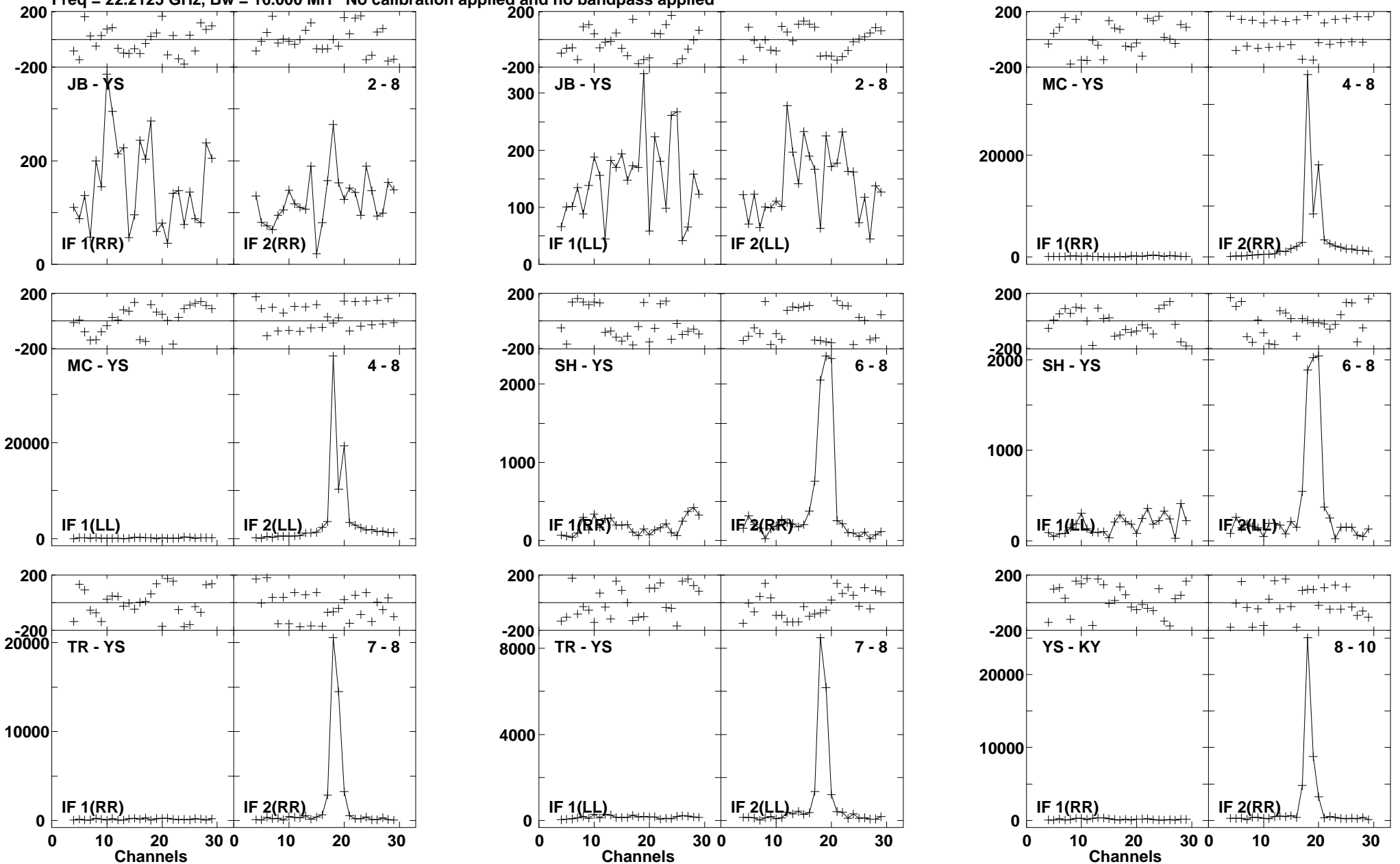

Lower frame: Micro Ampl Jy Top frame: Phas deg  
 Vector averaged cross-power spectrum Baseline: JB (02) - YS (08)  
 Timerange: 00/16:27:53 to 00/16:28:52

Plot file version 709 created 23-AUG-2016 15:01:08

W3IRS5 GA035B 1.UVDATA.1

Freq = 22.2125 GHz, Bw = 16.000 MH No calibration applied and no bandpass applied

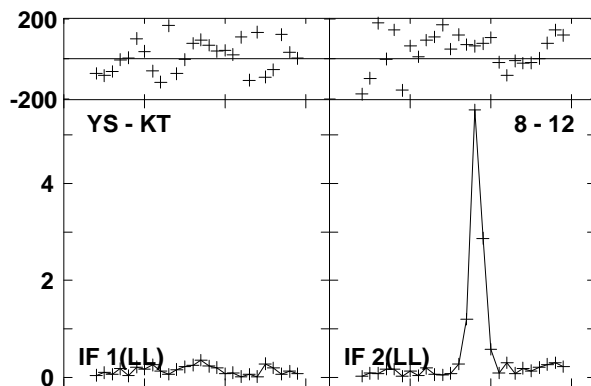
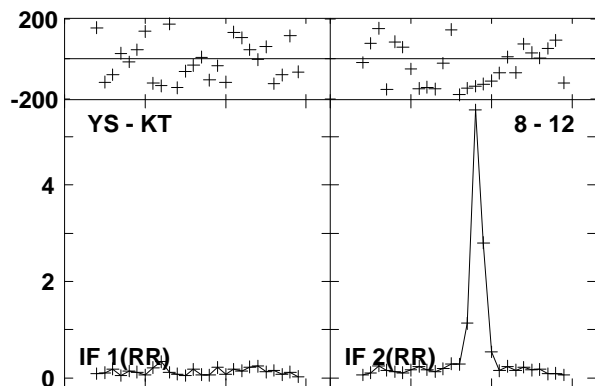
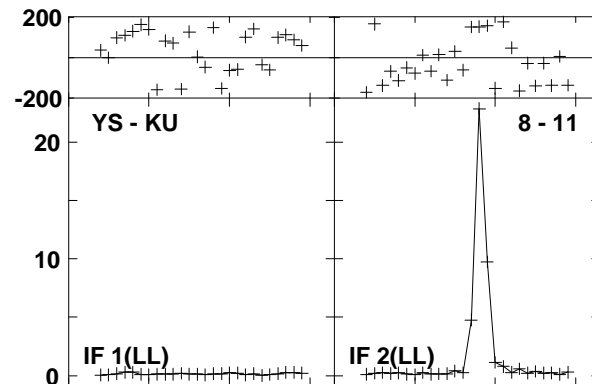
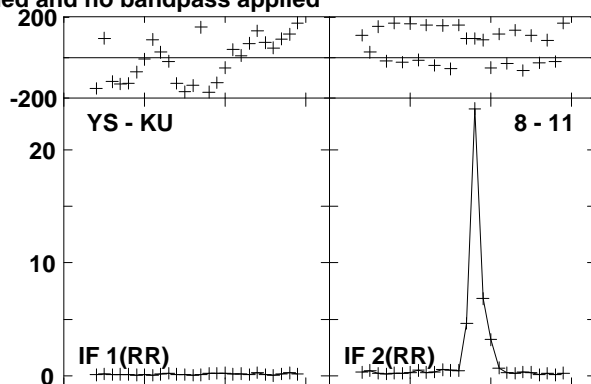
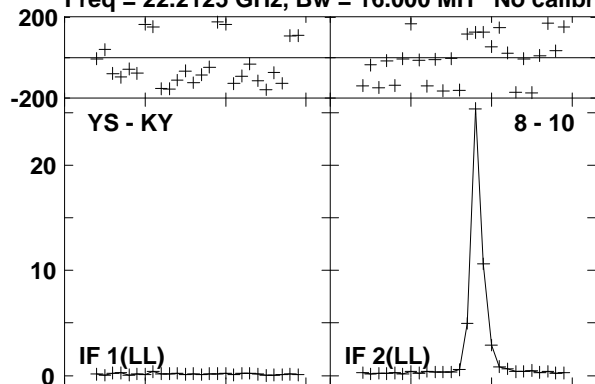

Lower frame: Milli Ampl Jy Top frame: Phas deg

Vector averaged cross-power spectrum Baseline: YS (08) - KY (10)

Timerange: 00/16:27:53 to 00/16:28:52

Plot file version 710 created 23-AUG-2016 15:01:08

0219+628 GA035B 1.UVDATA.1

Freq = 22.2125 GHz, Bw = 16.000 MH No calibration applied and no bandpass applied

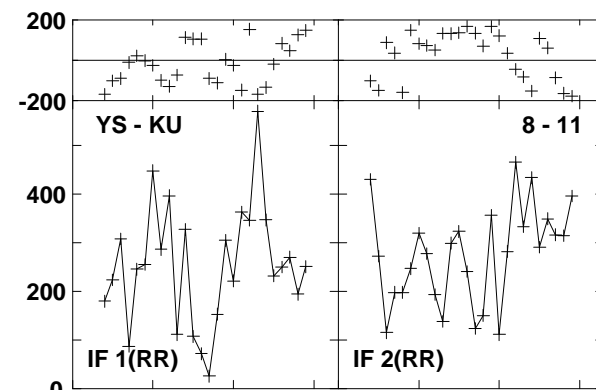
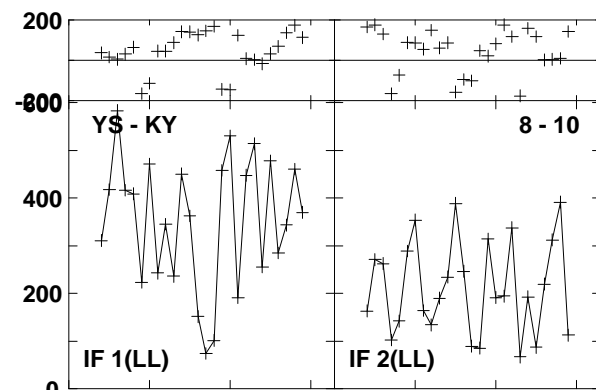
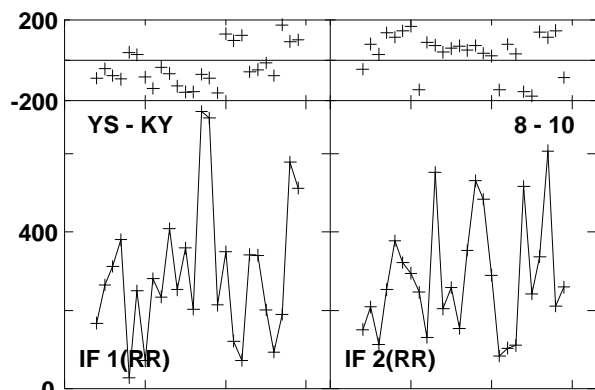
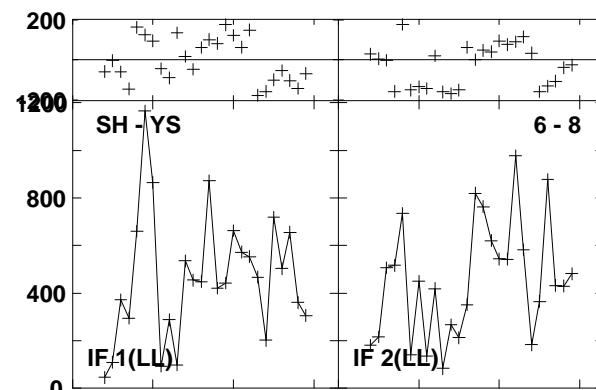
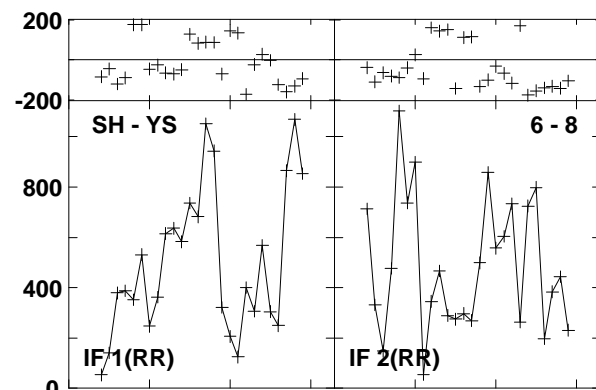
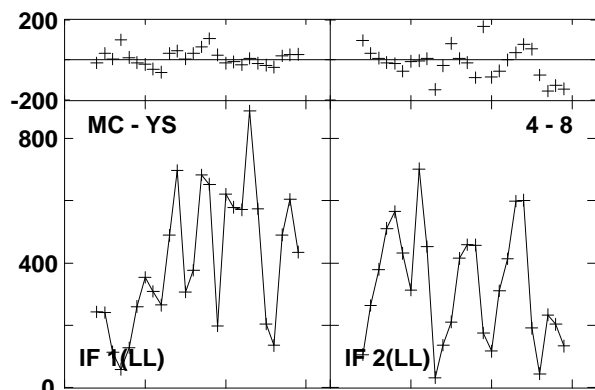
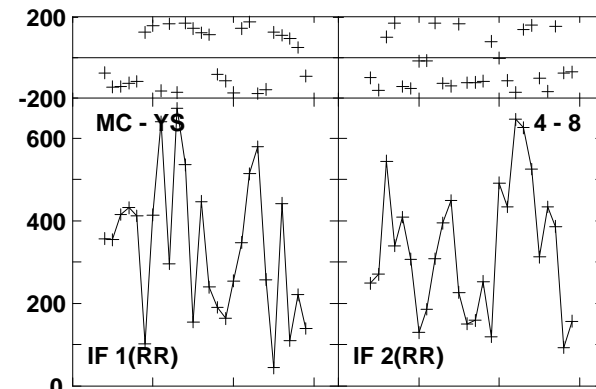
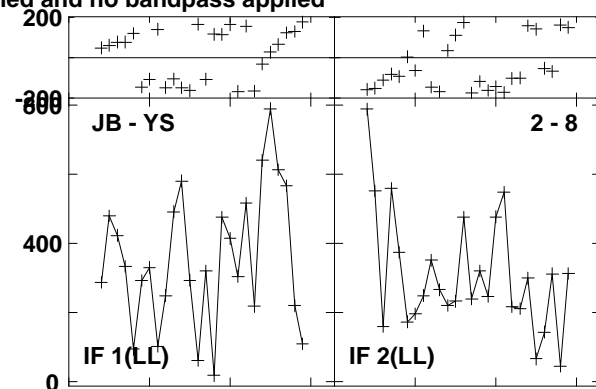
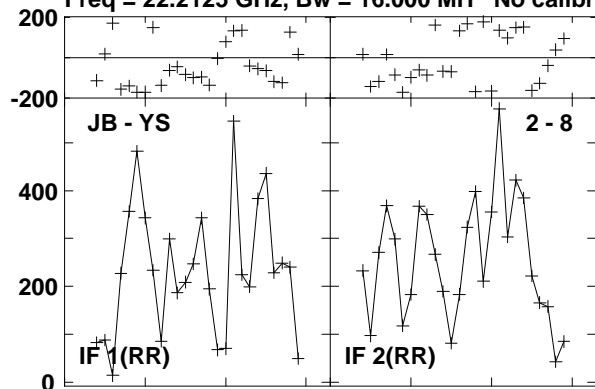

Lower frame: Micro Ampl Jy Top frame: Phas deg  
Vector averaged cross-power spectrum Baseline: JB (02) - YS (08)  
Timerange: 00/16:29:28 to 00/16:29:48

Plot file version 711 created 23-AUG-2016 15:01:08

0219+628 GA035B 1.UVDATA.1

Freq = 22.2125 GHz, Bw = 16.000 MH No calibration applied and no bandpass applied

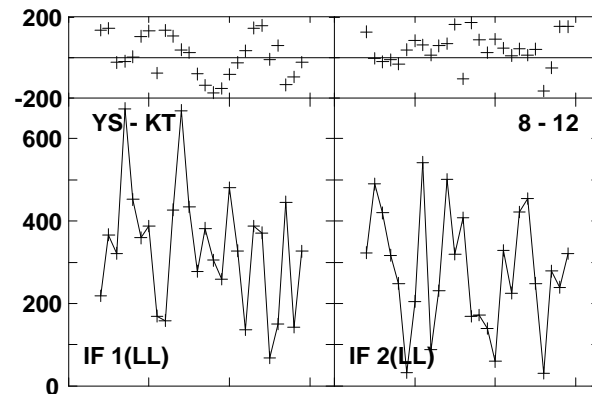
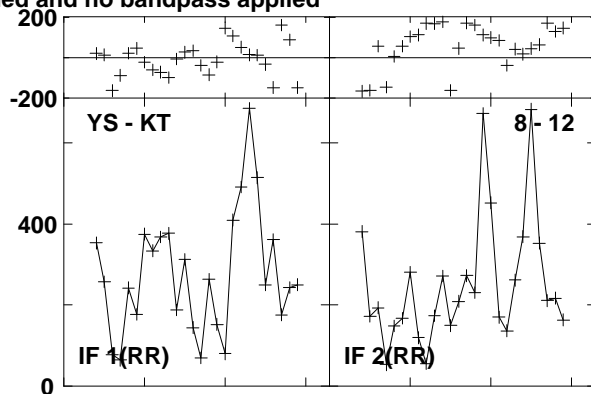
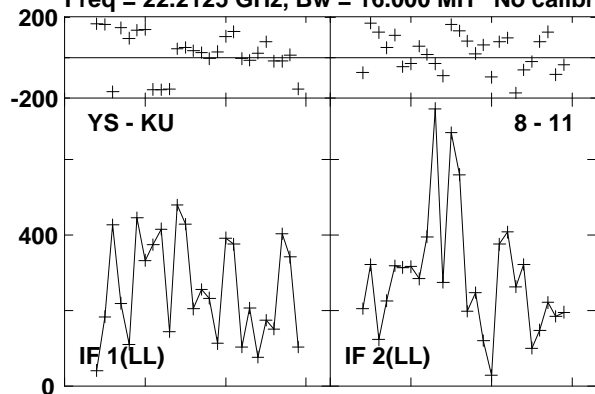

Lower frame: Micro Ampl Jy Top frame: Phas deg  
Vector averaged cross-power spectrum Baseline: YS (08) - KU (11)  
Timerange: 00/16:29:28 to 00/16:29:48

Plot file version 712 created 23-AUG-2016 15:01:08  
 W3IRS5 GA035B 1.UVDATA.1

Freq = 22.2125 GHz, Bw = 16.000 MH No calibration applied and no bandpass applied

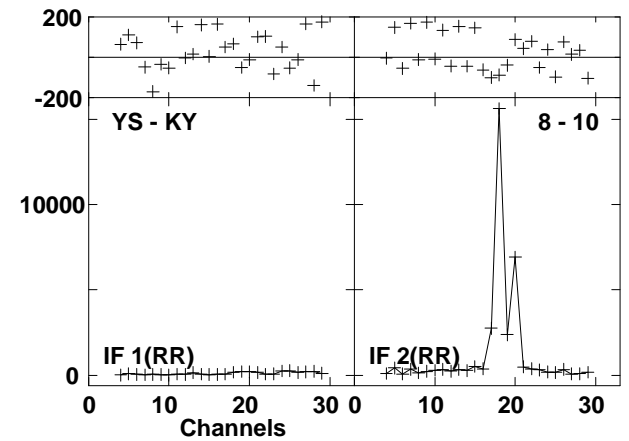
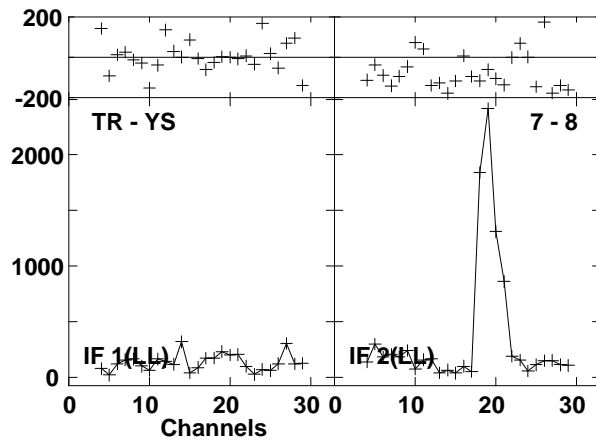
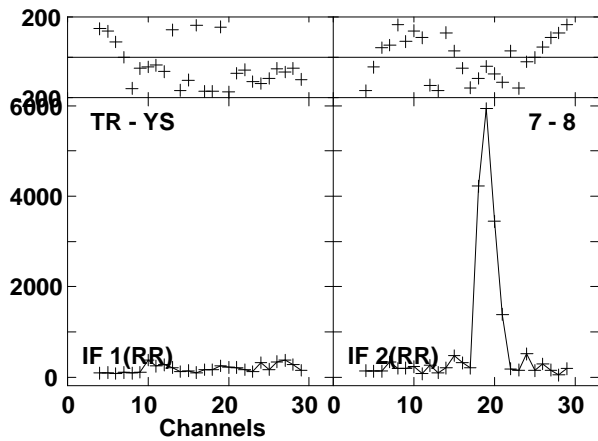
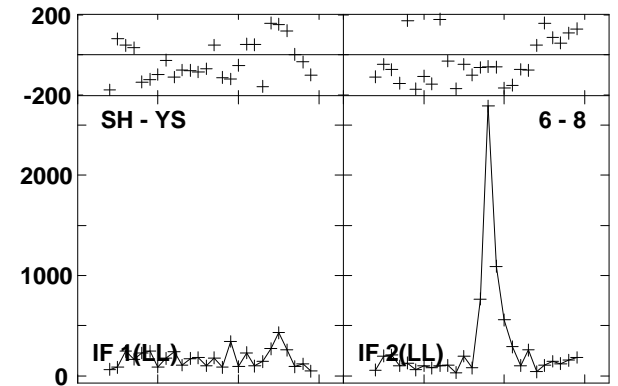
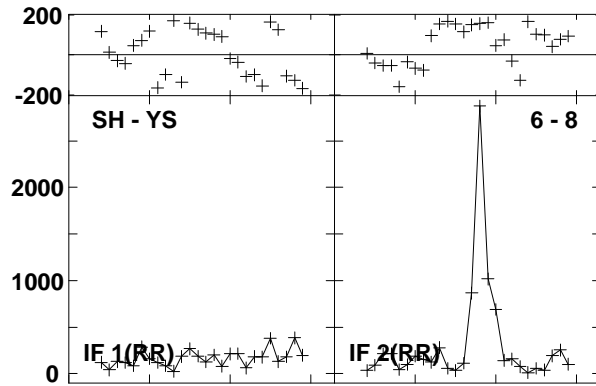
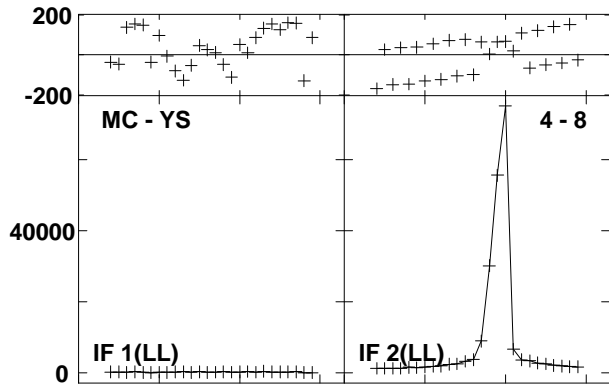
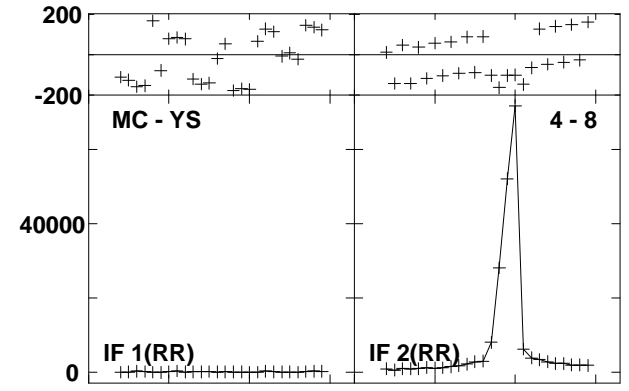
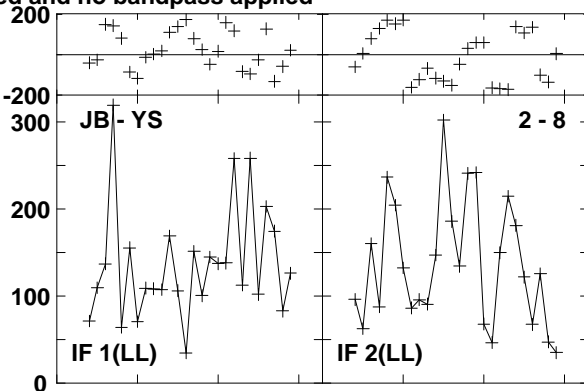
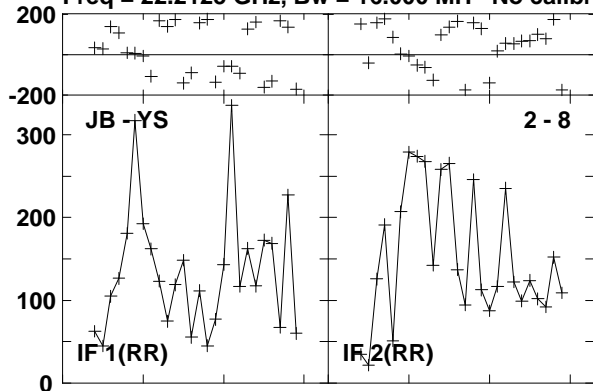

Lower frame: Micro Ampl Jy Top frame: Phas deg  
 Vector averaged cross-power spectrum Baseline: JB (02) - YS (08)  
 Timerange: 00/16:30:24 to 00/16:31:23



Plot file version 713 created 23-AUG-2016 15:01:08

W3IRS5 GA035B 1.UVDATA.1

Freq = 22.2125 GHz, Bw = 16.000 MH No calibration applied and no bandpass applied

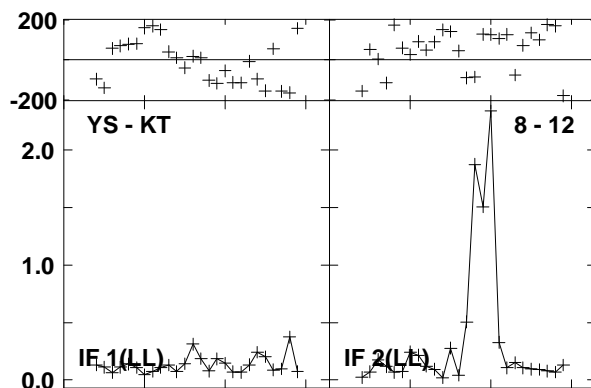
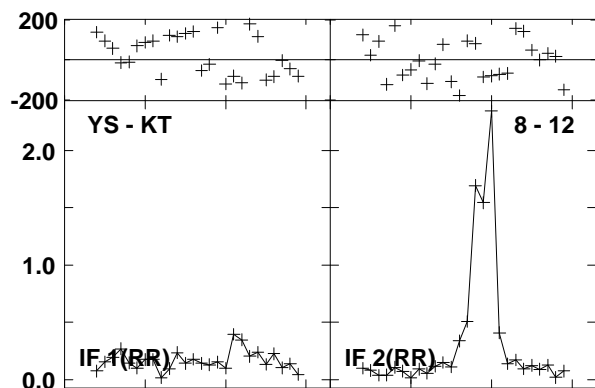
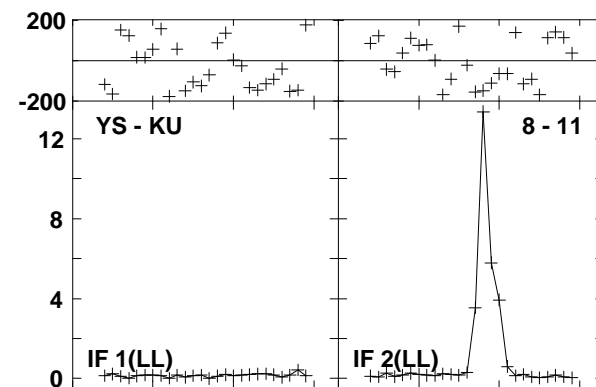
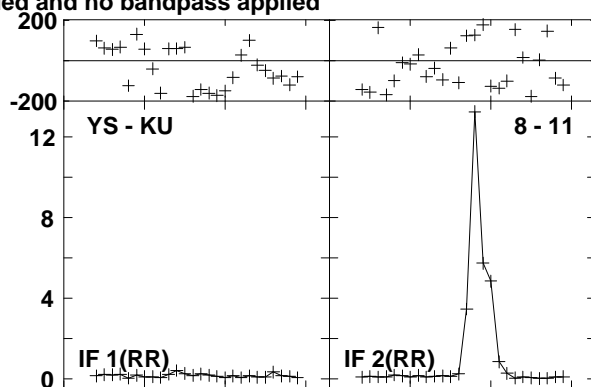
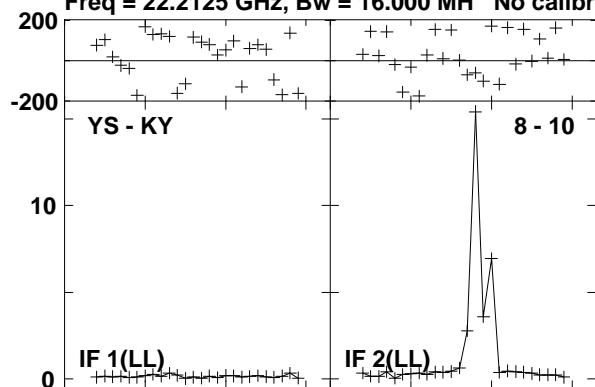

Lower frame: Milli Ampl Jy Top frame: Phas deg

Vector averaged cross-power spectrum Baseline: YS (08) - KY (10)

Timerange: 00/16:30:24 to 00/16:31:23

Plot file version 714 created 23-AUG-2016 15:01:08  
 0219+628 GA035B 1.UVDATA.1

Freq = 22.2125 GHz, Bw = 16.000 MH No calibration applied and no bandpass applied

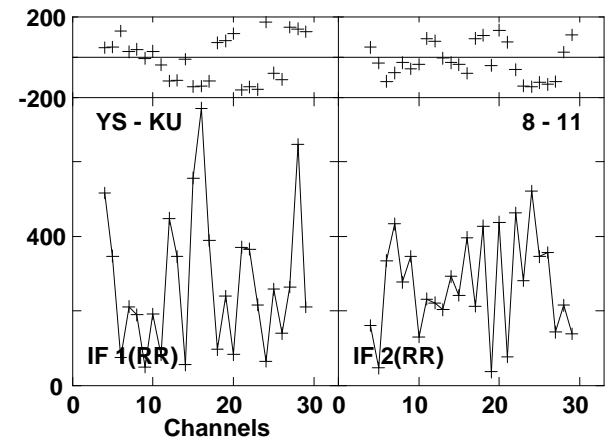
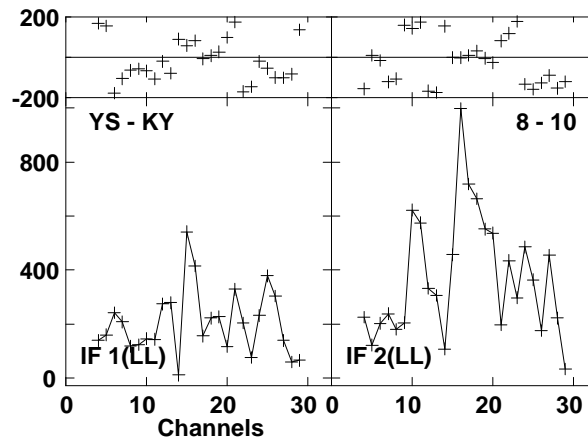
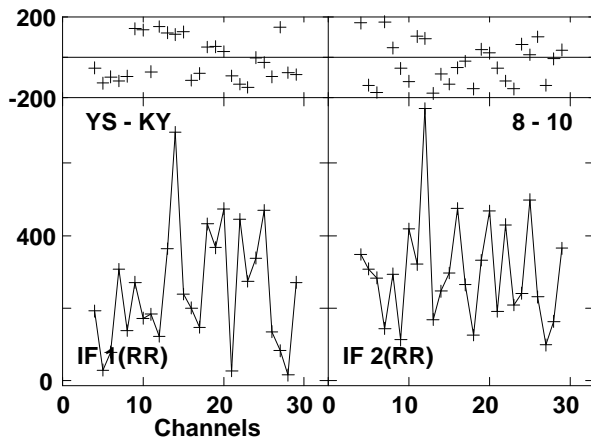
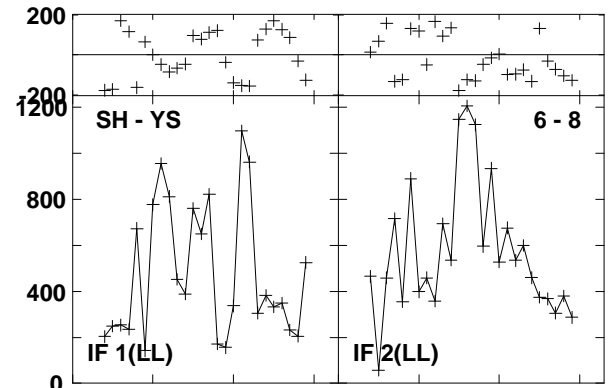
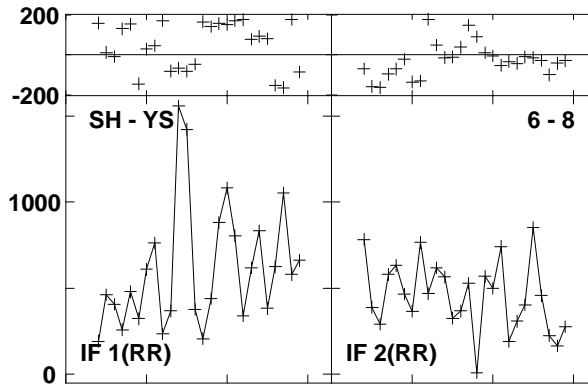
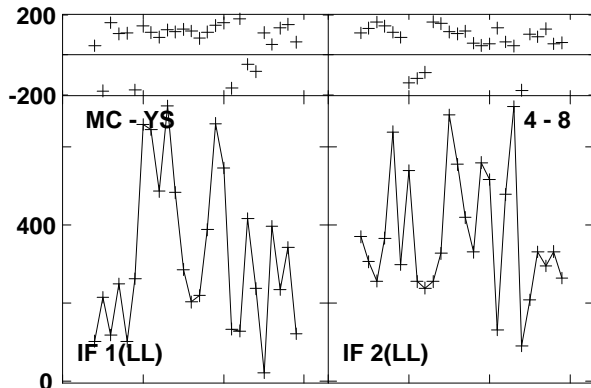
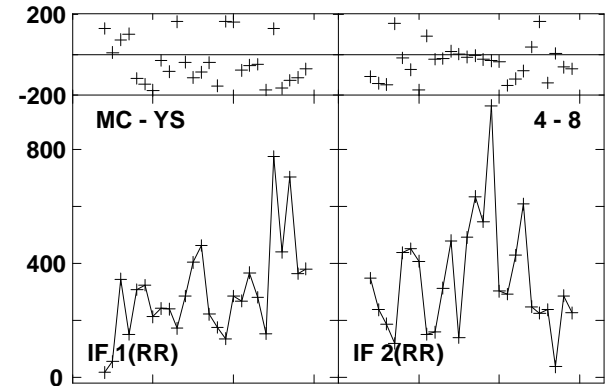
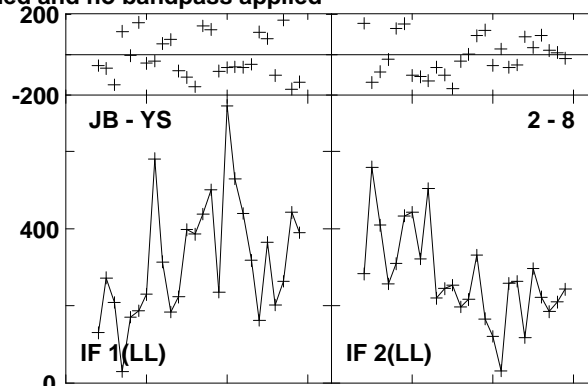
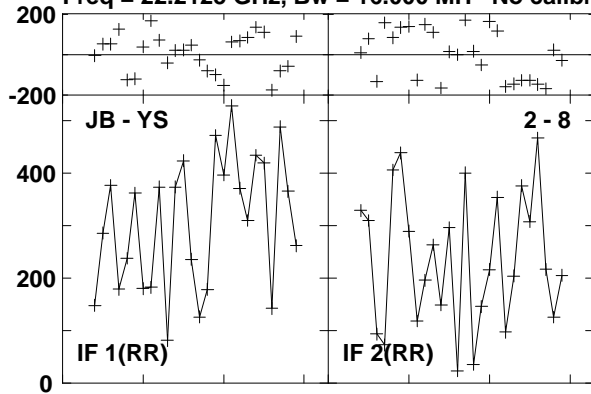

Lower frame: Micro Ampl Jy Top frame: Phas deg  
 Vector averaged cross-power spectrum Baseline: JB (02) - YS (08)  
 Timerange: 00/16:32:01 to 00/16:32:19

Plot file version 715 created 23-AUG-2016 15:01:08

0219+628 GA035B 1.UVDATA.1

Freq = 22.2125 GHz, Bw = 16.000 MH No calibration applied and no bandpass applied

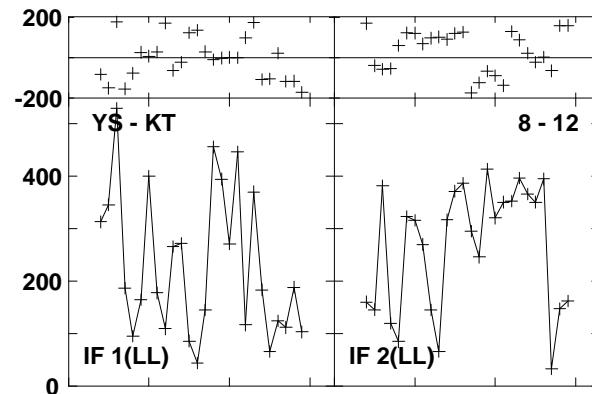
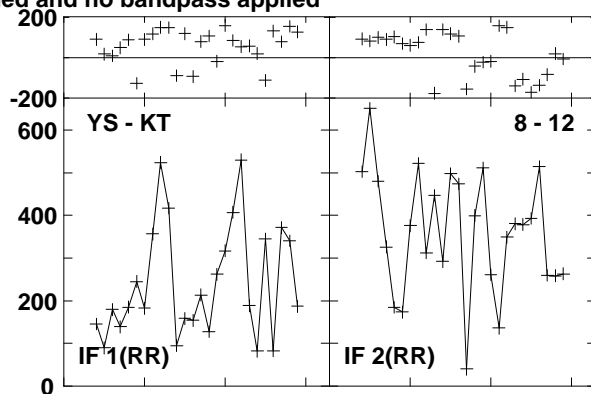
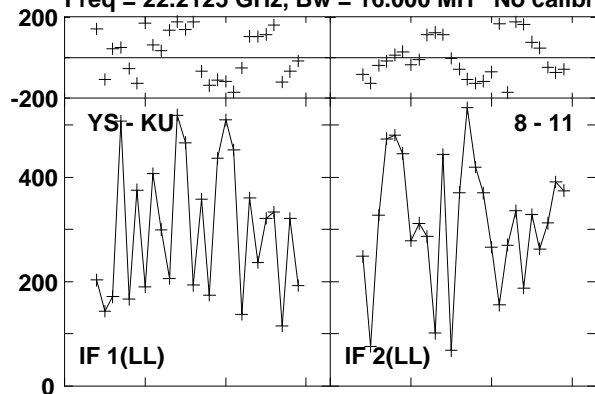

Lower frame: Micro Ampl Jy Top frame: Phas deg  
Vector averaged cross-power spectrum Baseline: YS (08) - KU (11)  
Timerange: 00/16:32:01 to 00/16:32:19

Plot file version 716 created 23-AUG-2016 15:01:08  
W3IRS5 GA035B 1.UVDATA.1

Freq = 22.2125 GHz, Bw = 16.000 MH No calibration applied and no bandpass applied

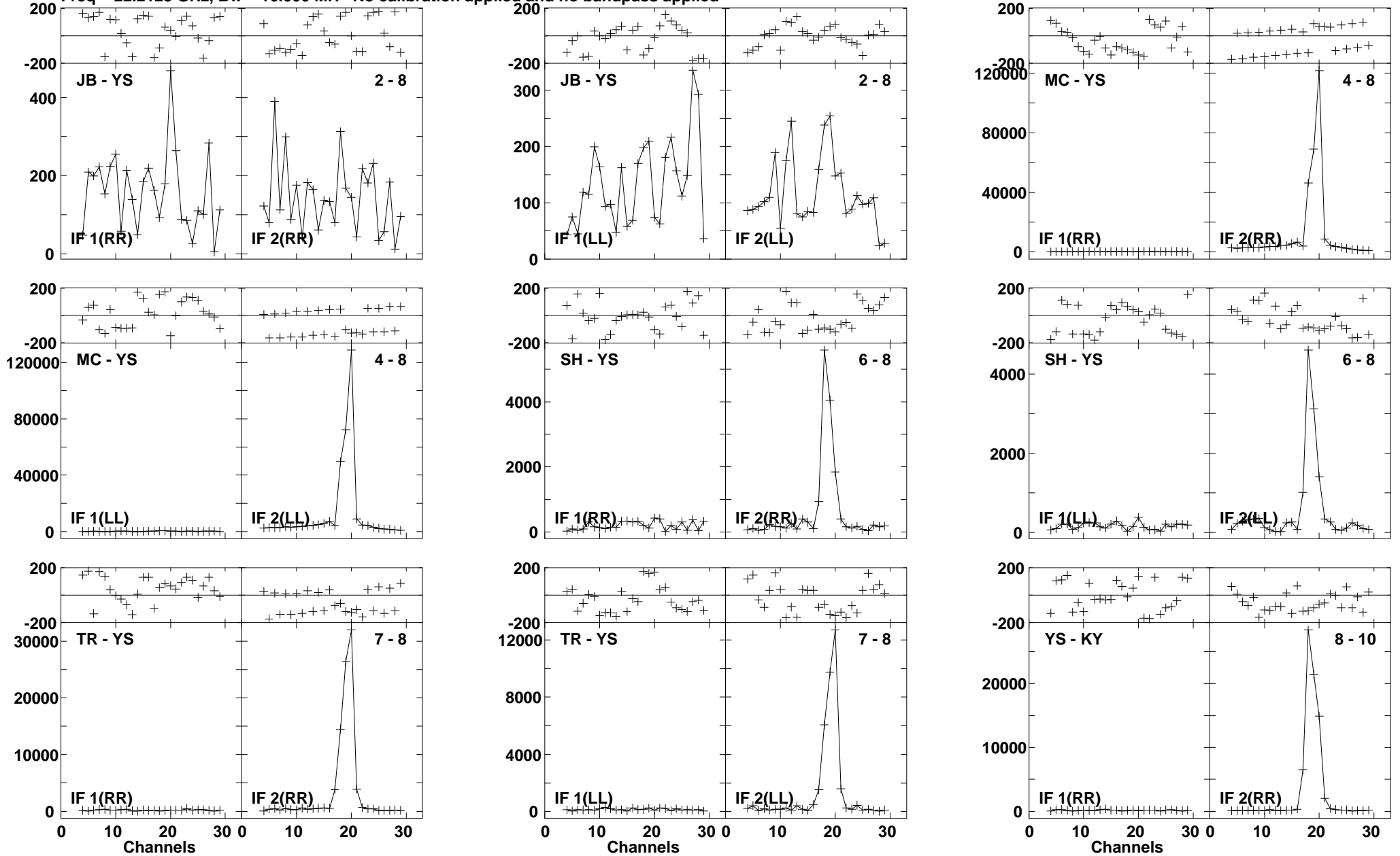

Lower frame: Micro Ampl Jy Top frame: Phas deg  
Vector averaged cross-power spectrum Baseline: JB (02) - YS (08)  
Timerange: 00/16:32:57 to 00/16:33:56

Plot file version 717 created 23-AUG-2016 15:01:08  
W3IRS5 GA035B 1.UVDATA.1

Freq = 22.2125 GHz, Bw = 16.000 MH No calibration applied and no bandpass applied

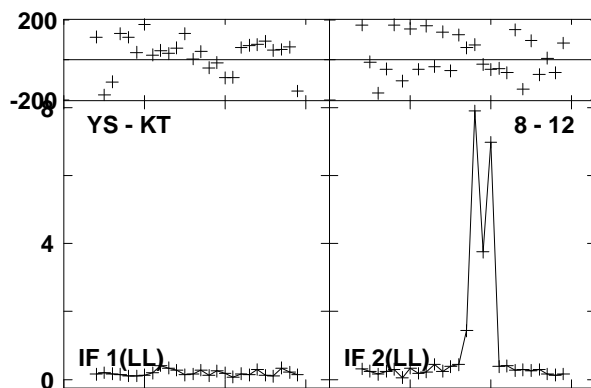
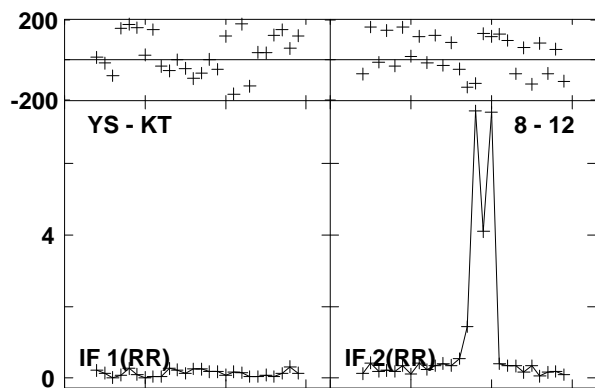
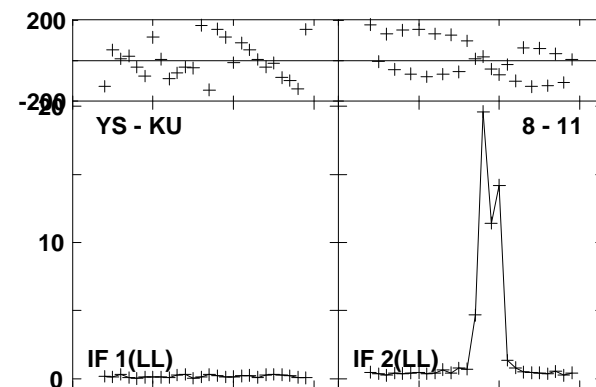
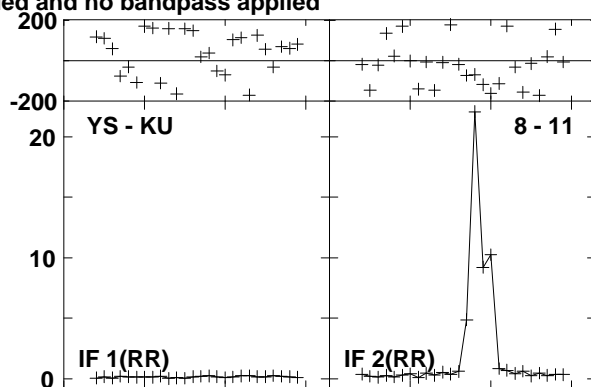
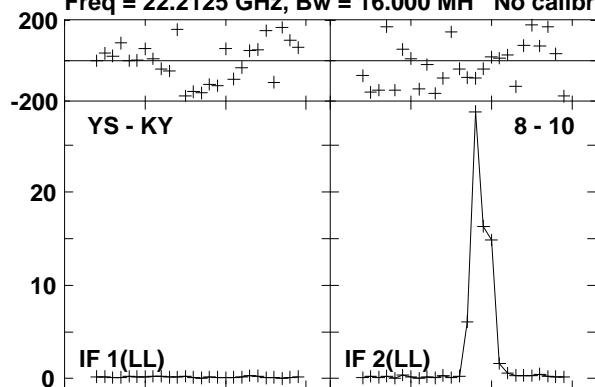

Lower frame: Milli Ampl Jy Top frame: Phas deg  
Vector averaged cross-power spectrum Baseline: YS (08) - KY (10)  
Timerange: 00/16:32:57 to 00/16:33:56

Plot file version 718 created 23-AUG-2016 15:01:08

0219+628 GA035B 1.UVDATA.1

Freq = 22.2125 GHz, Bw = 16.000 MH No calibration applied and no bandpass applied

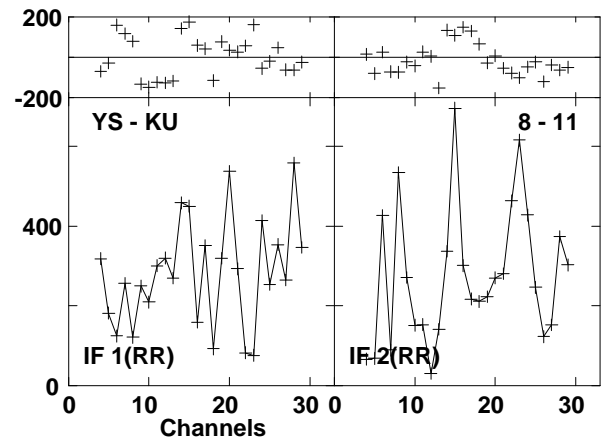
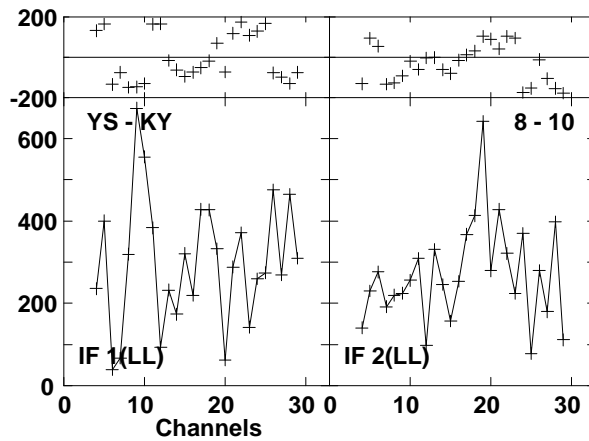
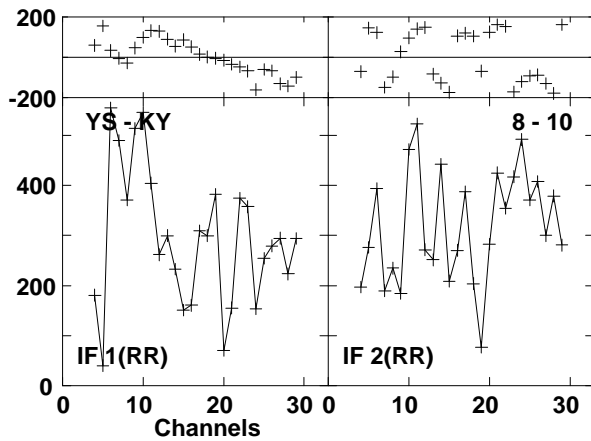
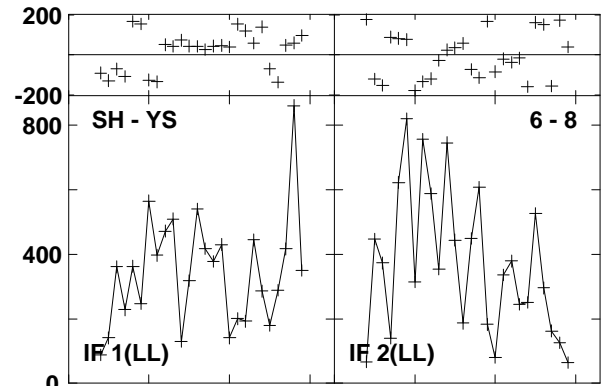
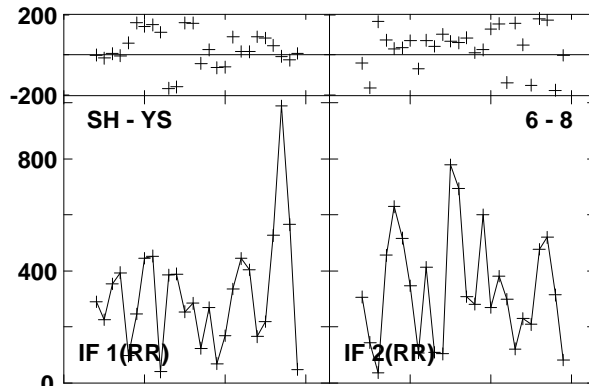
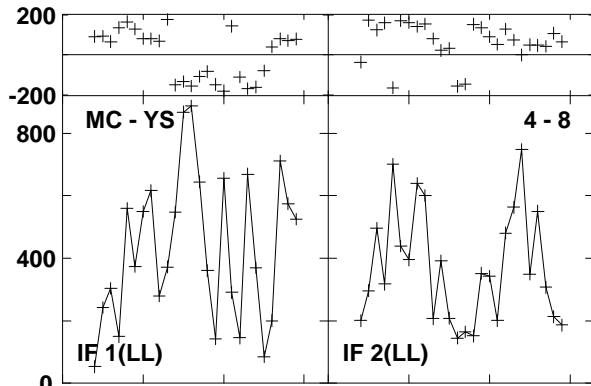
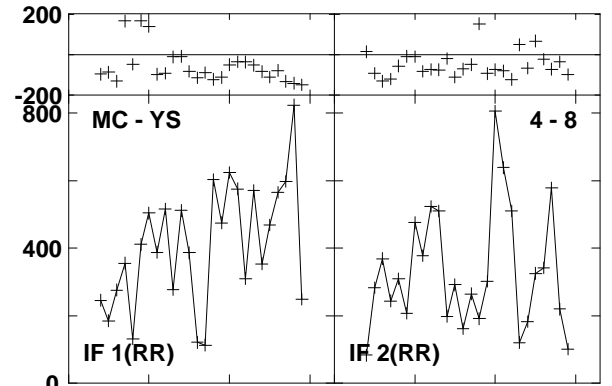
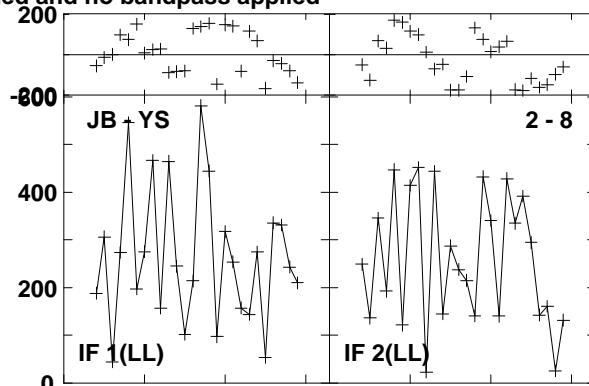
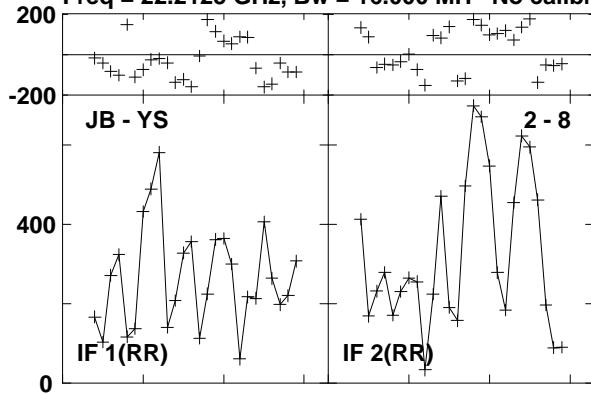

Lower frame: Micro Ampl Jy Top frame: Phas deg  
Vector averaged cross-power spectrum Baseline: JB (02) - YS (08)  
Timerange: 00/16:34:33 to 00/16:34:52

Plot file version 719 created 23-AUG-2016 15:01:08

0219+628 GA035B 1.UVDATA.1

Freq = 22.2125 GHz, Bw = 16.000 MH No calibration applied and no bandpass applied

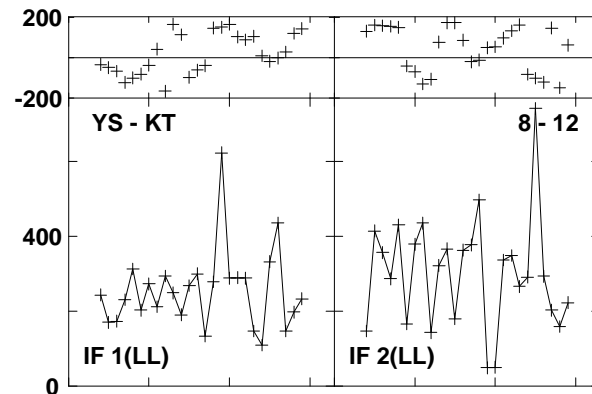
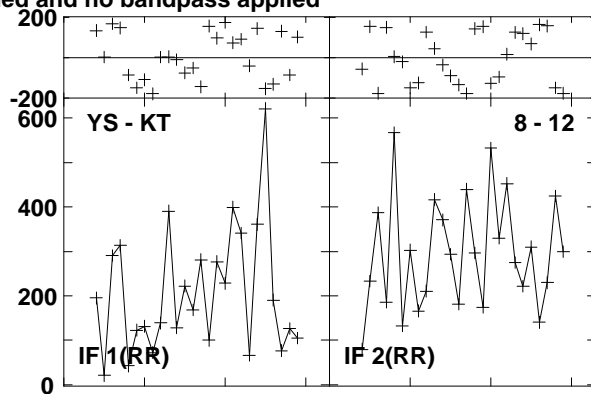
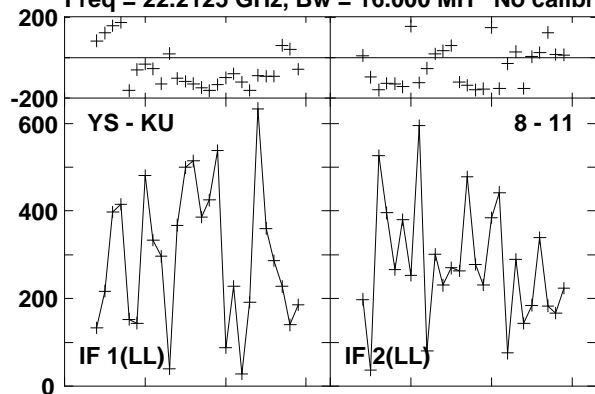

Lower frame: Micro Ampl Jy Top frame: Phas deg  
Vector averaged cross-power spectrum Baseline: YS (08) - KU (11)  
Timerange: 00/16:34:33 to 00/16:34:52

Plot file version 720 created 23-AUG-2016 15:01:08  
 W3IRS5 GA035B 1.UVDATA.1

Freq = 22.2125 GHz, Bw = 16.000 MH No calibration applied and no bandpass applied

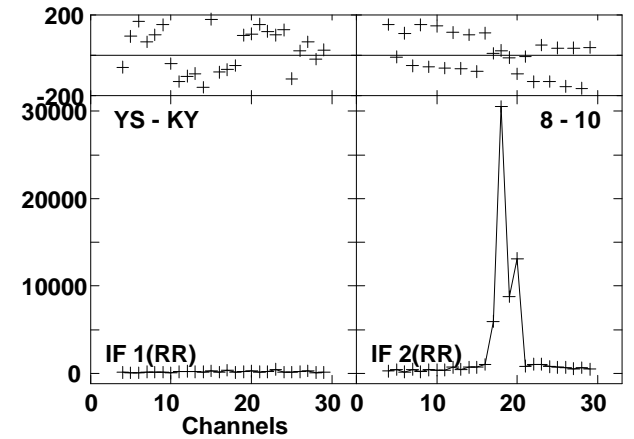
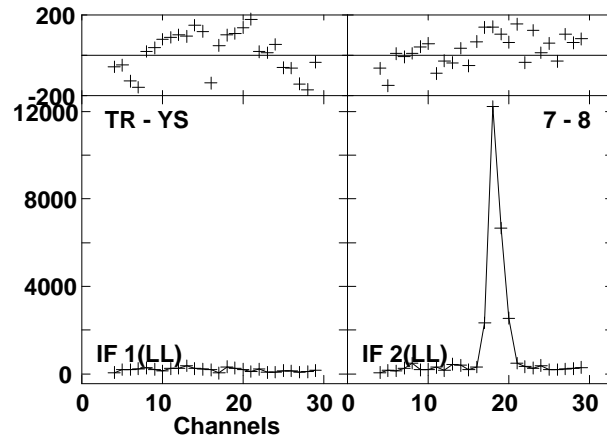
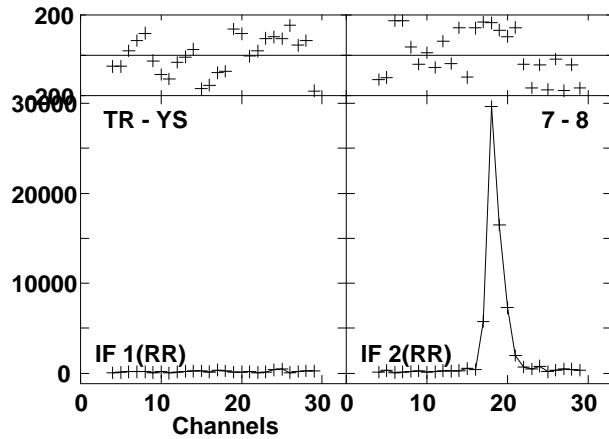
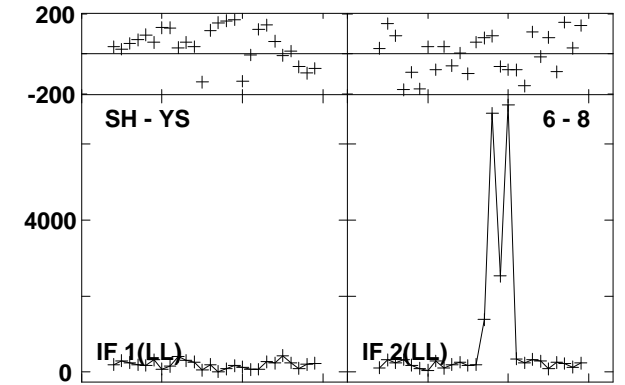
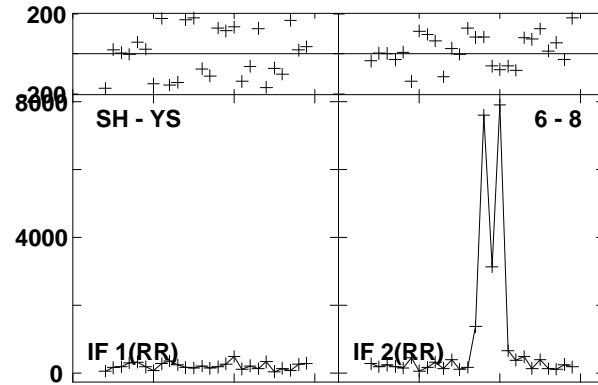
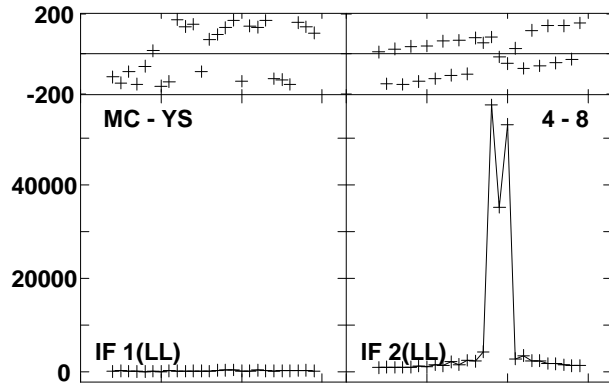
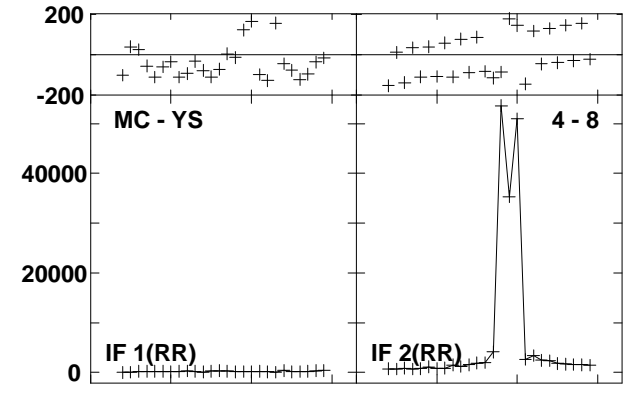
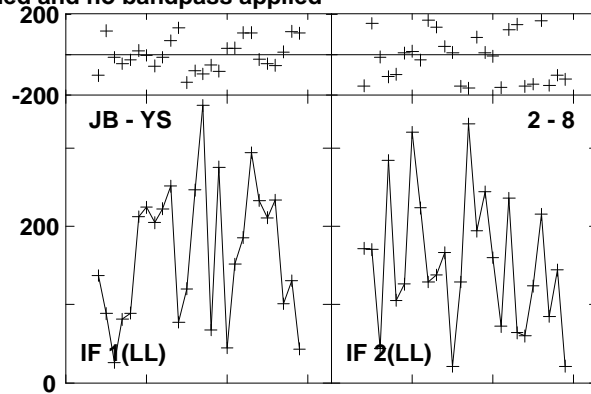
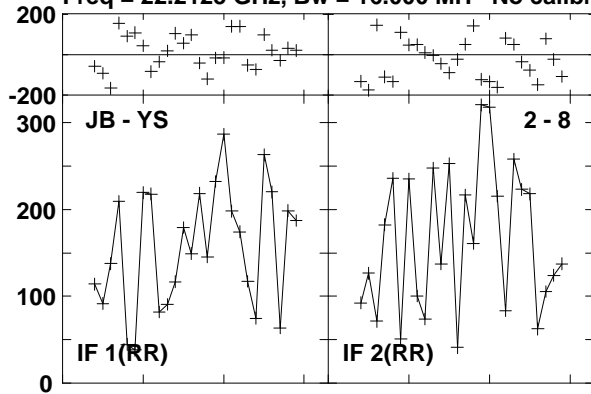

Lower frame: Micro Ampl Jy Top frame: Phas deg  
 Vector averaged cross-power spectrum Baseline: JB (02) - YS (08)  
 Timerange: 00/16:35:28 to 00/16:36:27



Plot file version 721 created 23-AUG-2016 15:01:08

W3IRS5 GA035B 1.UVDATA.1

Freq = 22.2125 GHz, Bw = 16.000 MH No calibration applied and no bandpass applied

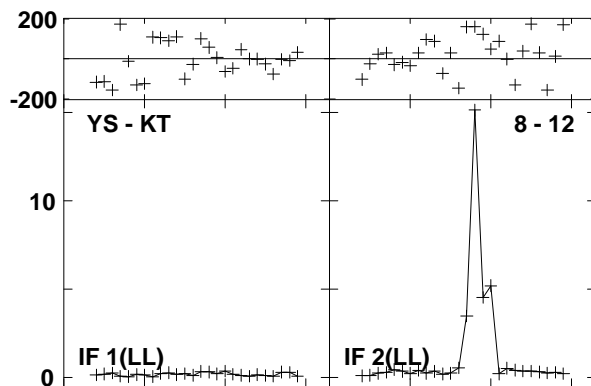
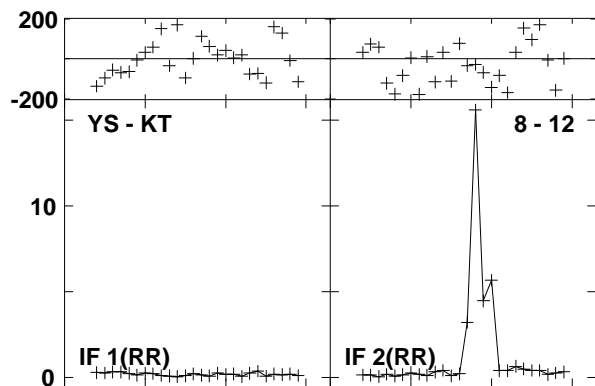
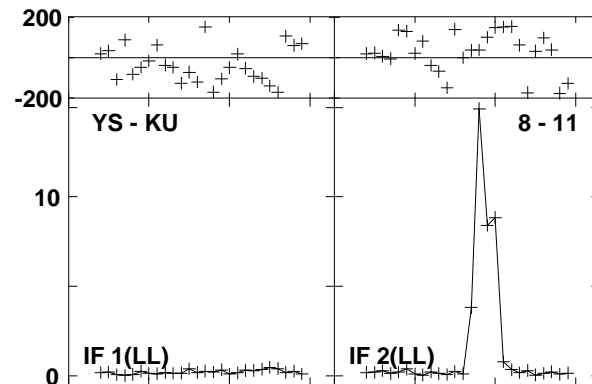
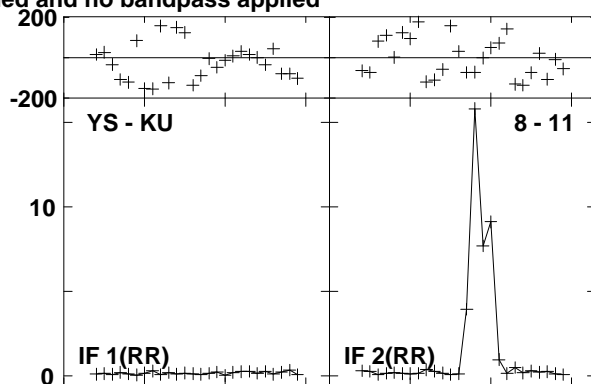
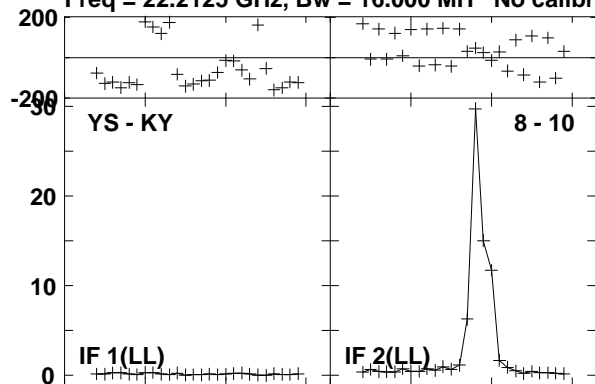

Lower frame: Milli Ampl Jy Top frame: Phas deg

Vector averaged cross-power spectrum Baseline: YS (08) - KY (10)

Timerange: 00/16:35:28 to 00/16:36:27

Plot file version 722 created 23-AUG-2016 15:01:08

0219+628 GA035B 1.UVDATA.1

Freq = 22.2125 GHz, Bw = 16.000 MH No calibration applied and no bandpass applied

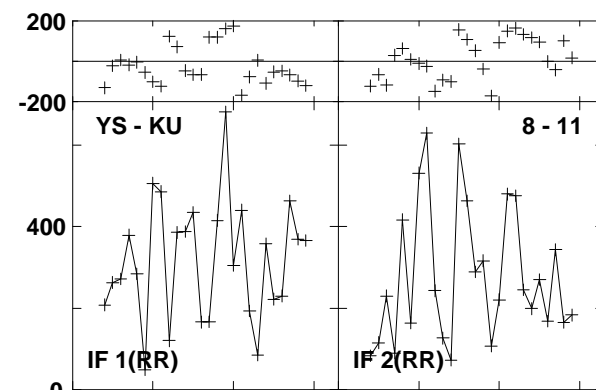
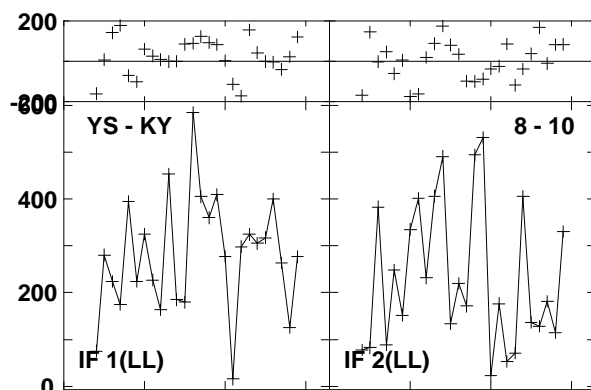
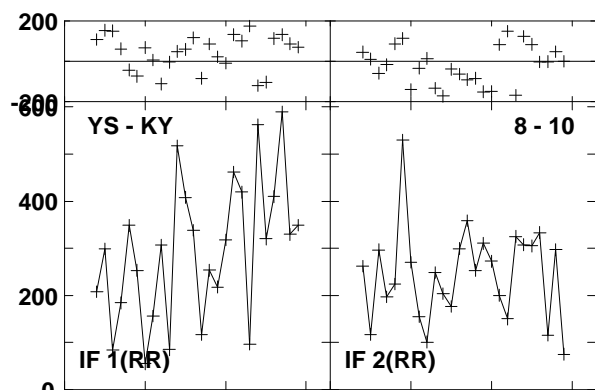
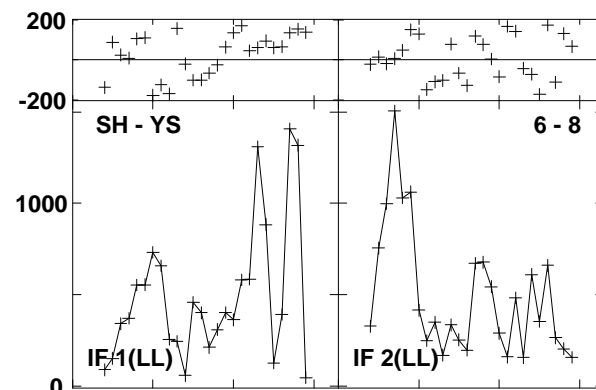
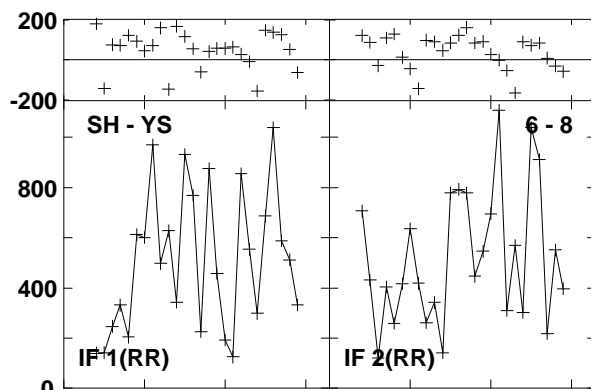
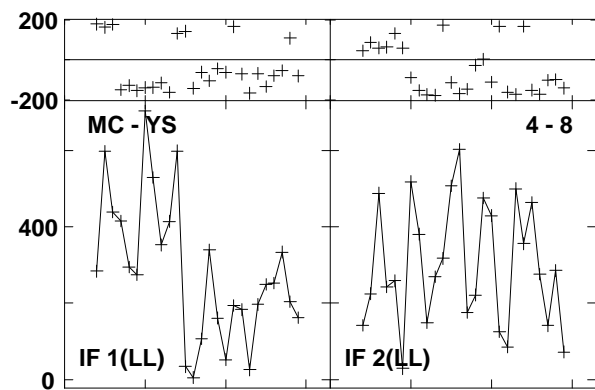
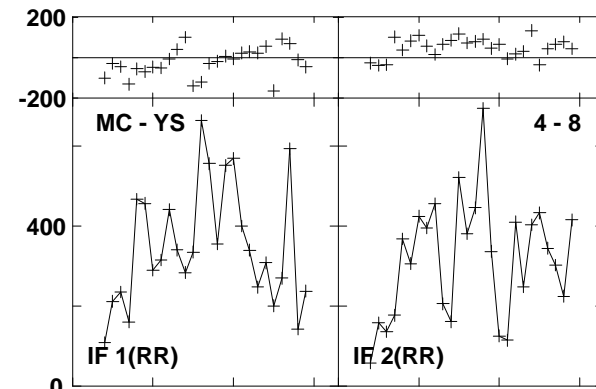
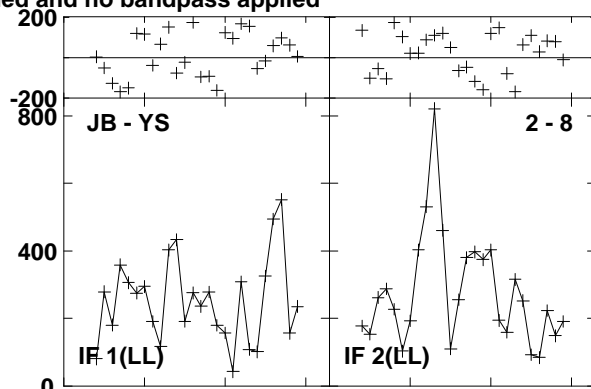
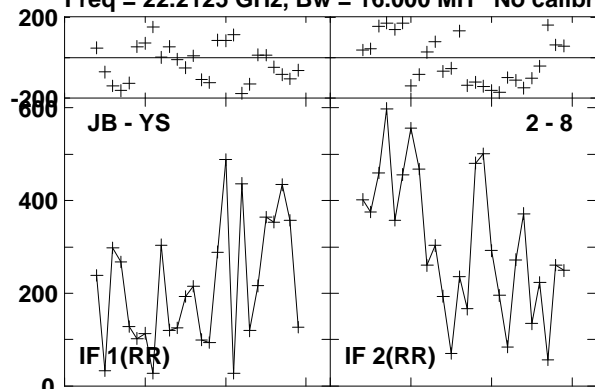

Channels

Lower frame: Micro Ampl Jy Top frame: Phas deg

Vector averaged cross-power spectrum Baseline: JB (02) - YS (08)

Timerange: 00/16:37:04 to 00/16:37:23

Plot file version 723 created 23-AUG-2016 15:01:08

0219+628 GA035B 1.UVDATA.1

Freq = 22.2125 GHz, Bw = 16.000 MH No calibration applied and no bandpass applied

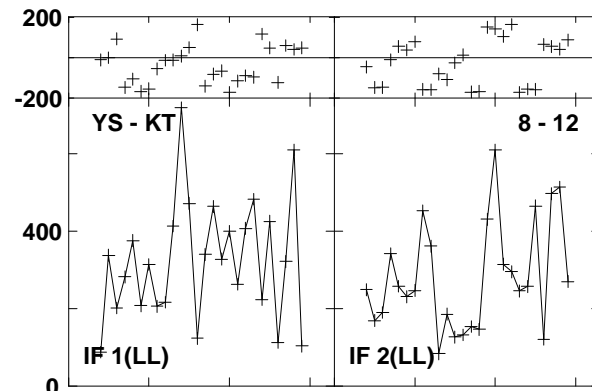
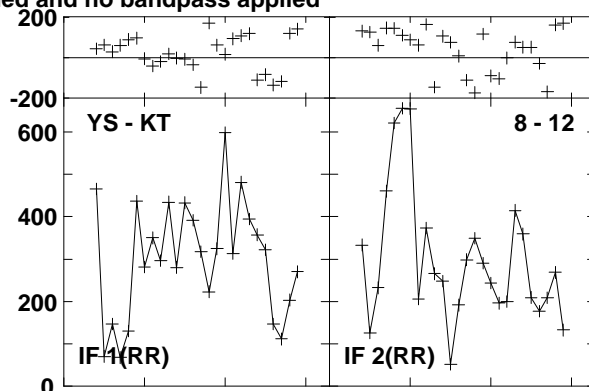
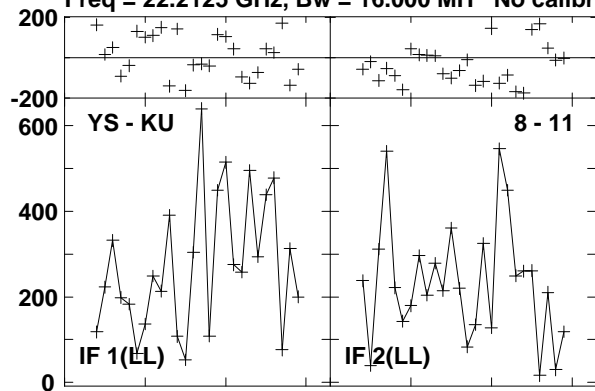

Lower frame: Micro Ampl Jy Top frame: Phas deg  
Vector averaged cross-power spectrum Baseline: YS (08) - KU (11)  
Timerange: 00/16:37:04 to 00/16:37:23

Plot file version 724 created 23-AUG-2016 15:01:08  
 W3IRS5 GA035B 1.UVDATA.1

Freq = 22.2125 GHz, Bw = 16.000 MH No calibration applied and no bandpass applied

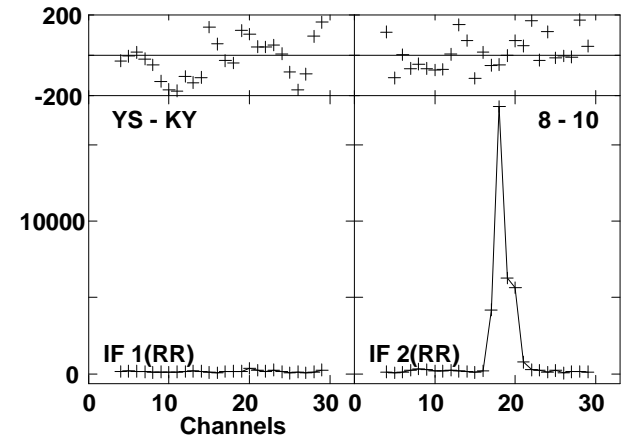
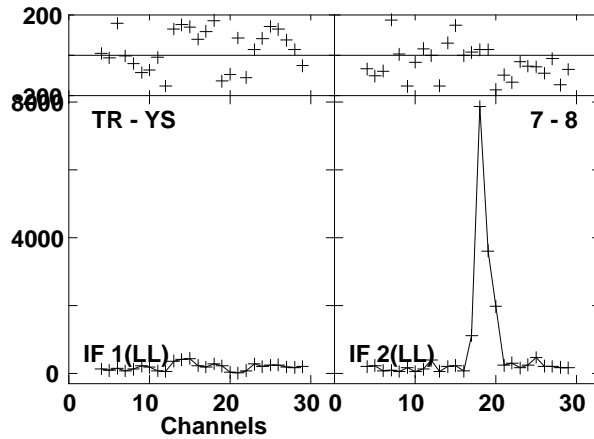
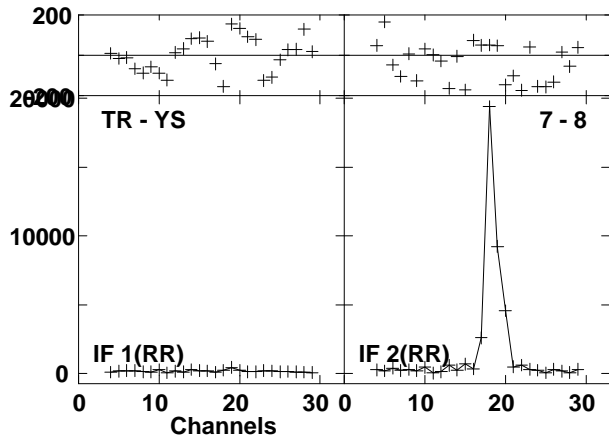
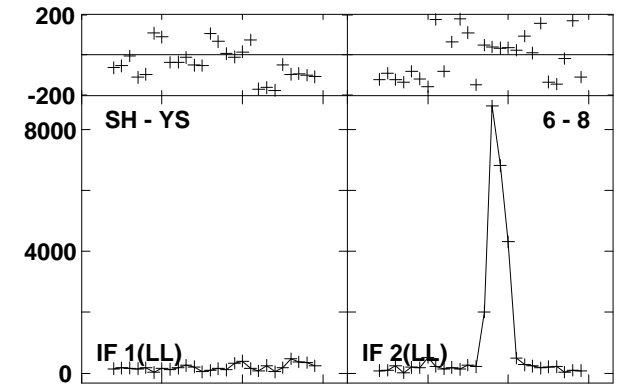
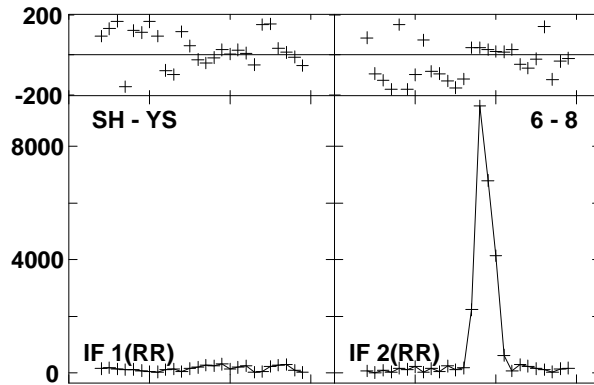
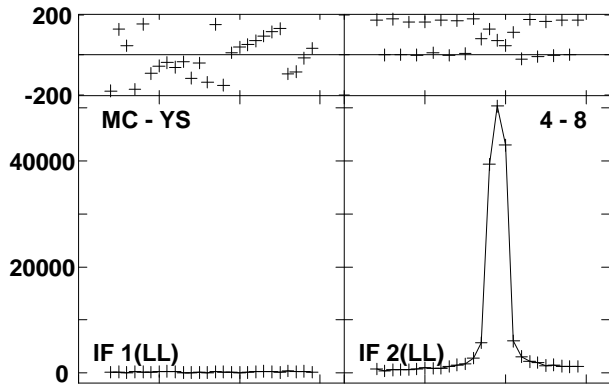
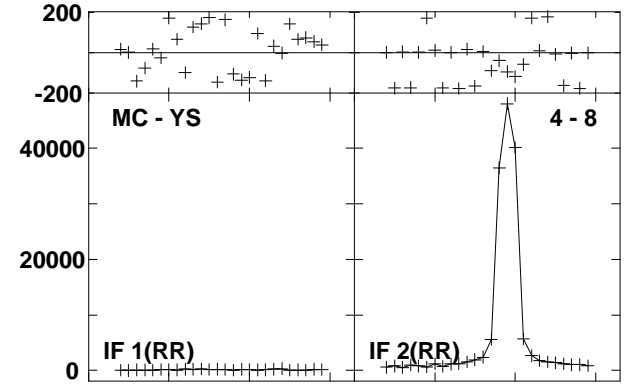
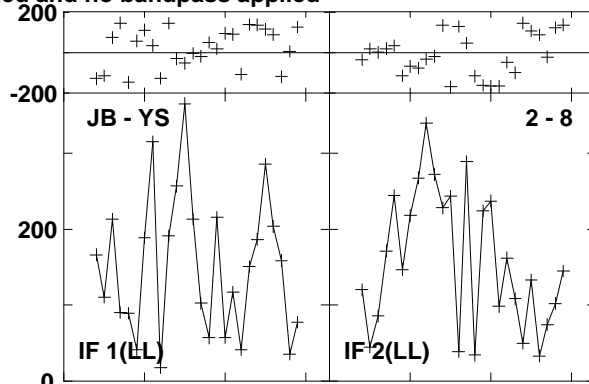
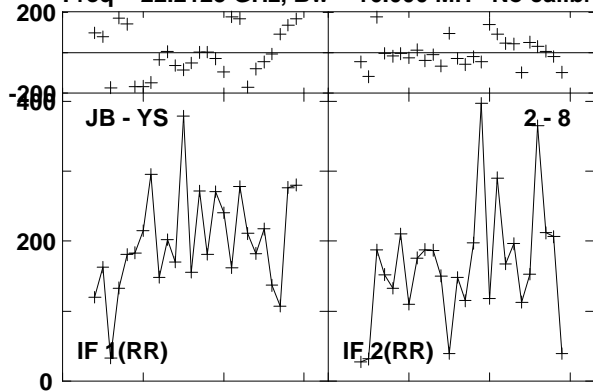

Lower frame: Micro Ampl Jy Top frame: Phas deg  
 Vector averaged cross-power spectrum Baseline: JB (02) - YS (08)  
 Timerange: 00/16:39:20 to 00/16:40:19

Plot file version 725 created 23-AUG-2016 15:01:08

W3IRS5 GA035B 1.UVDATA.1

Freq = 22.2125 GHz, Bw = 16.000 MH No calibration applied and no bandpass applied

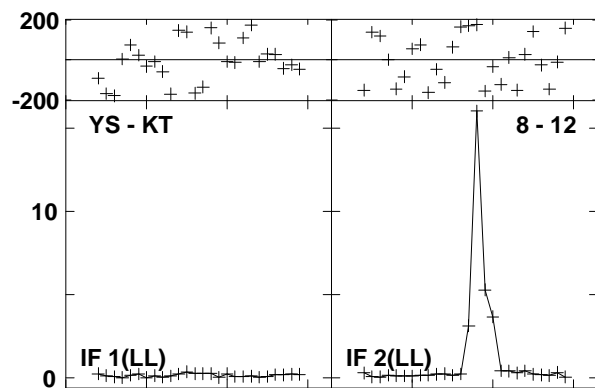
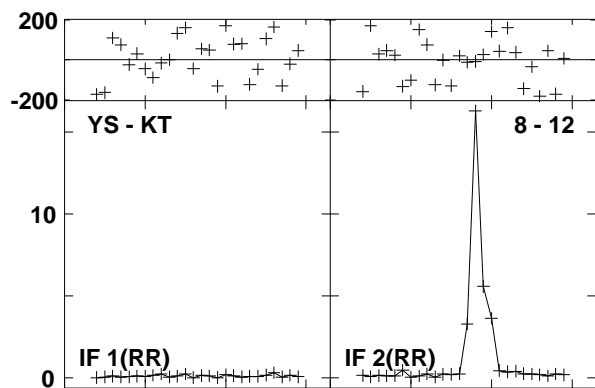
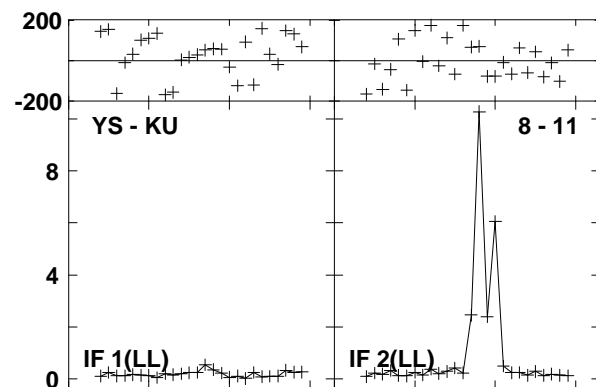
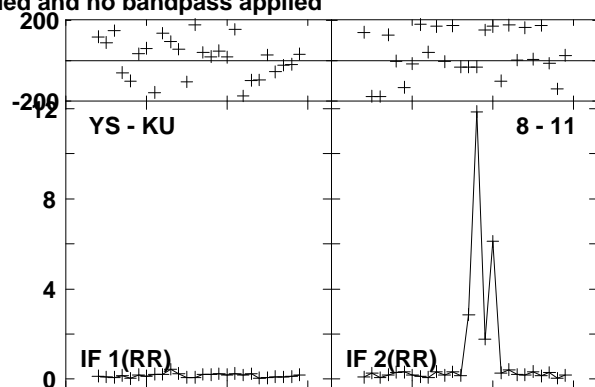
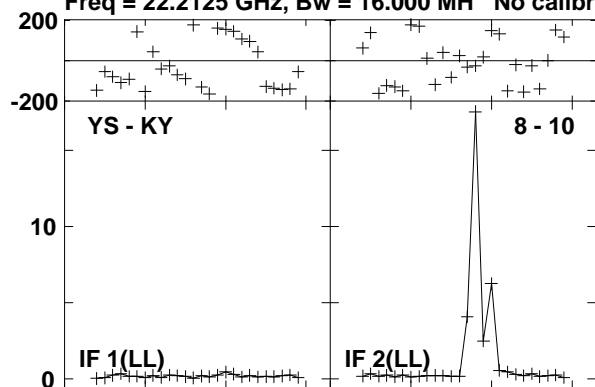

Lower frame: Milli Ampl Jy Top frame: Phas deg  
Vector averaged cross-power spectrum Baseline: YS (08) - KY (10)  
Timerange: 00/16:39:20 to 00/16:40:19

Plot file version 726 created 23-AUG-2016 15:01:08

0219+628 GA035B 1.UVDATA.1

Freq = 22.2125 GHz, Bw = 16.000 MH No calibration applied and no bandpass applied

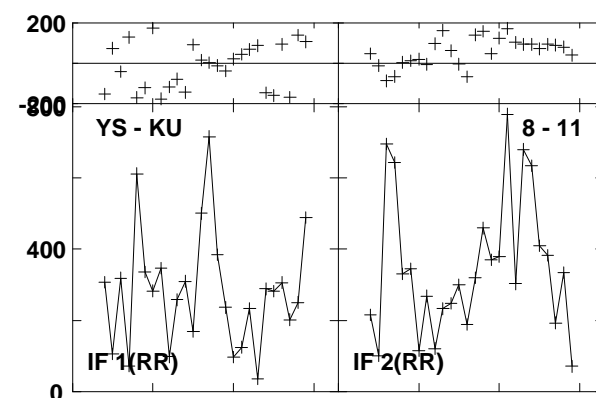
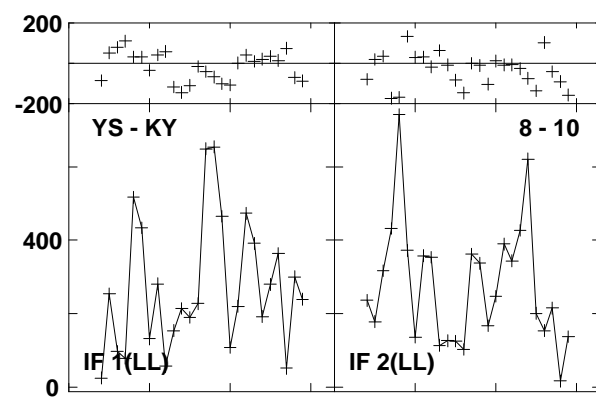
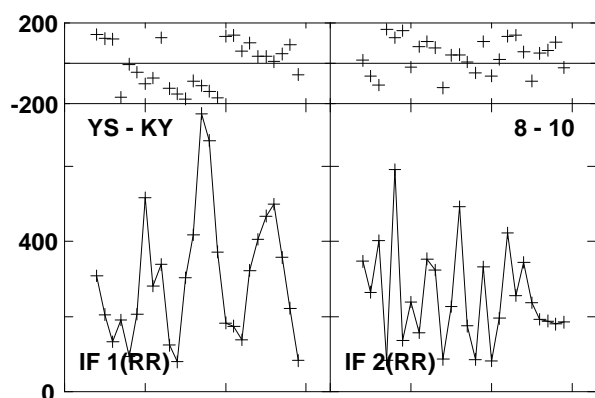
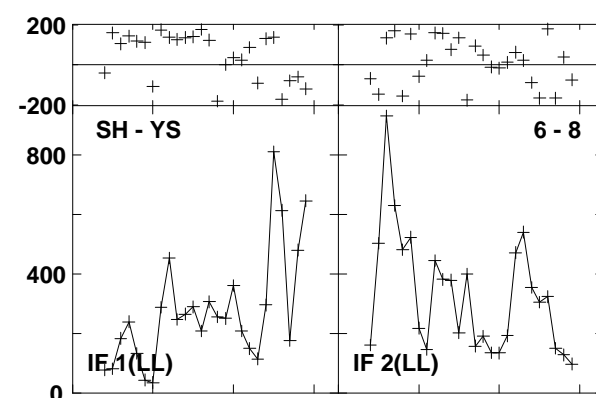
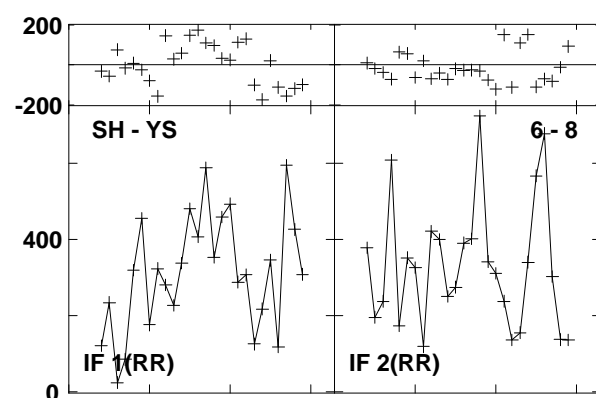
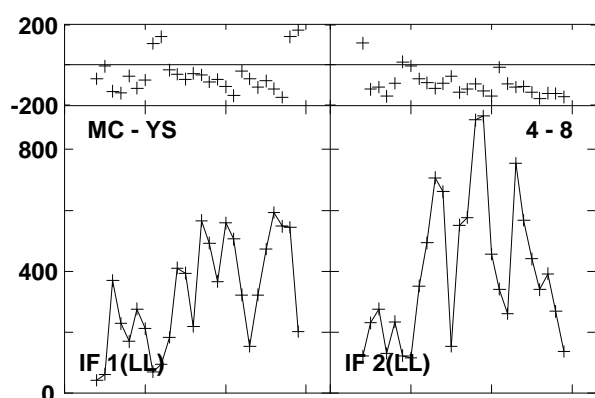
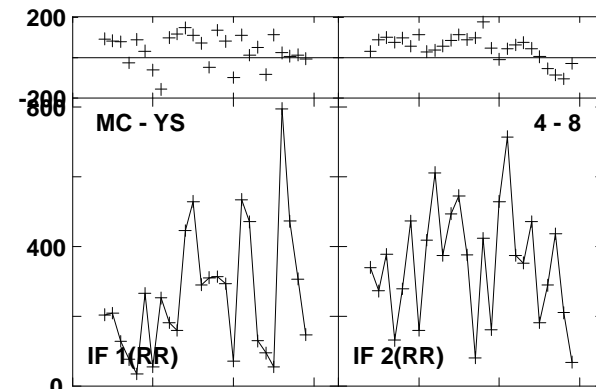
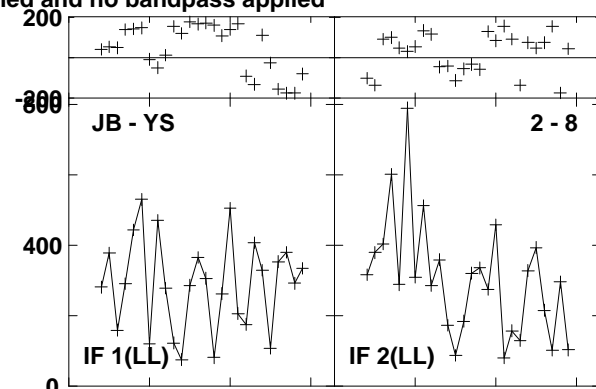
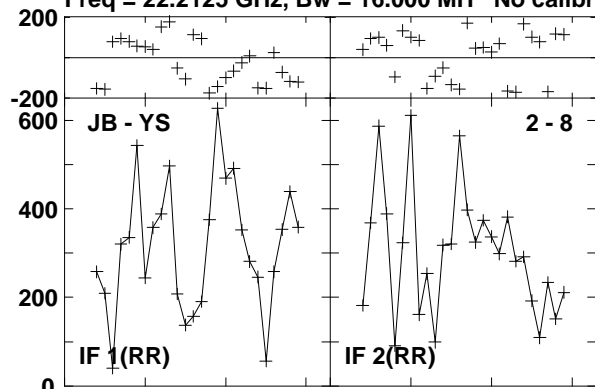

Lower frame: Micro Ampl Jy Top frame: Phas deg  
Vector averaged cross-power spectrum Baseline: JB (02) - YS (08)  
Timerange: 00/16:40:57 to 00/16:41:15

Plot file version 727 created 23-AUG-2016 15:01:09  
0219+628 GA035B 1.UVDATA.1

Freq = 22.2125 GHz, Bw = 16.000 MH No calibration applied and no bandpass applied

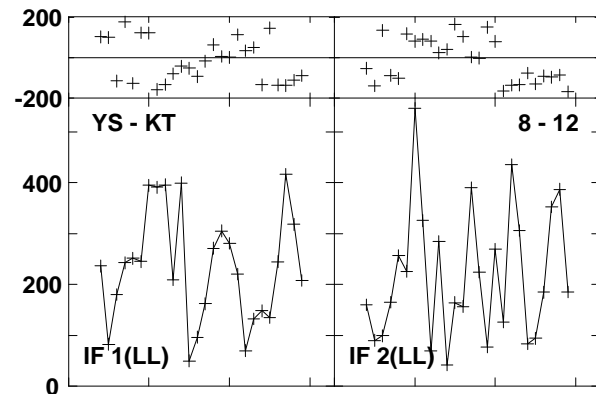
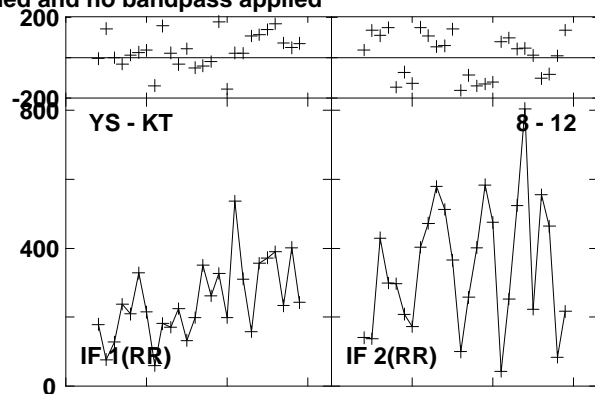
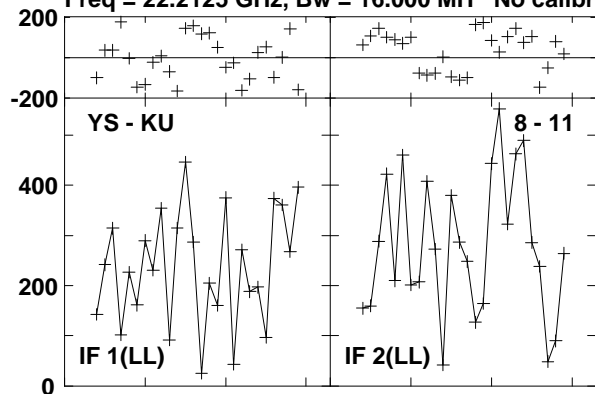

Lower frame: Micro Ampl Jy Top frame: Phas deg  
Vector averaged cross-power spectrum Baseline: YS (08) - KU (11)  
Timerange: 00/16:40:57 to 00/16:41:15

Plot file version 728 created 23-AUG-2016 15:01:09  
 W3IRS5 GA035B 1.UVDATA.1

Freq = 22.2125 GHz, Bw = 16.000 MH No calibration applied and no bandpass applied

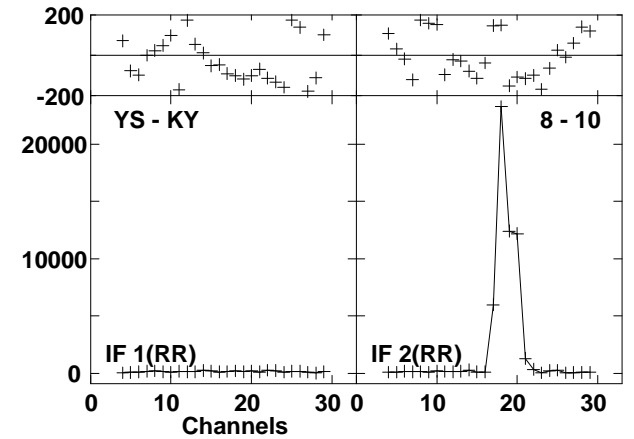
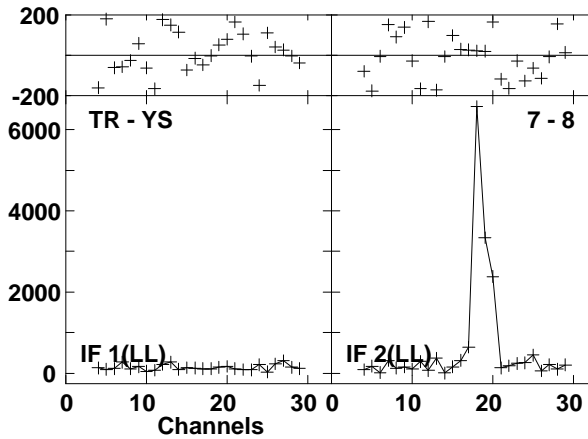
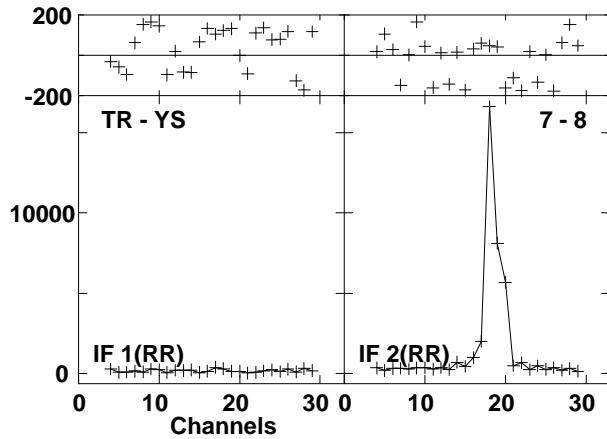
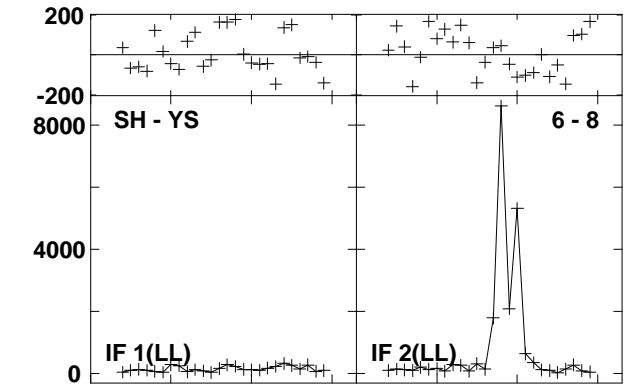
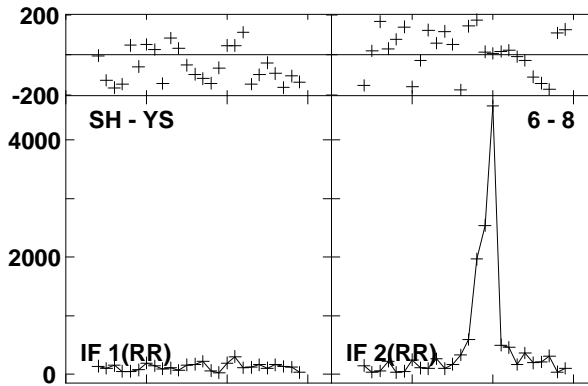
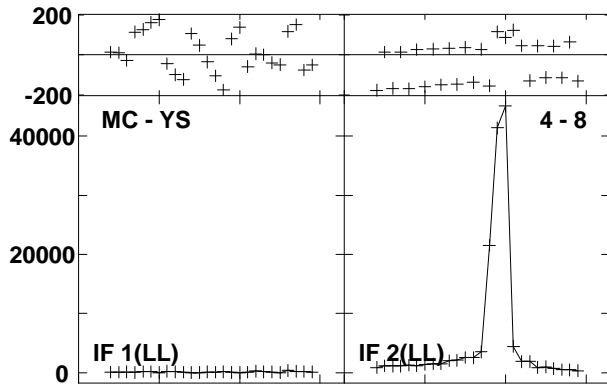
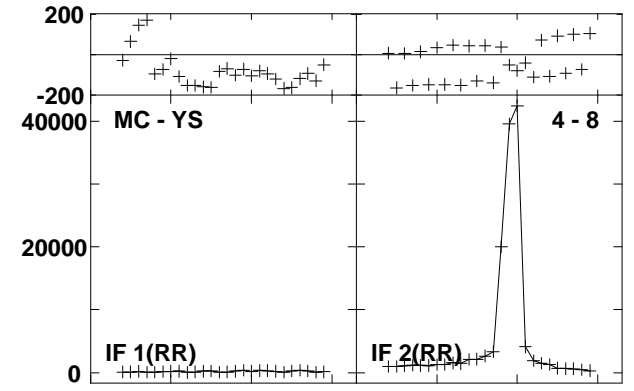
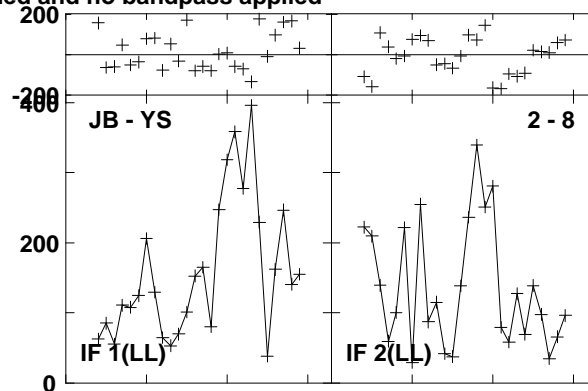
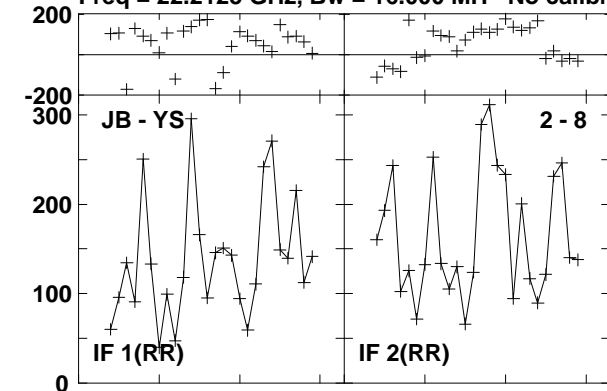

Lower frame: Micro Ampl Jy Top frame: Phas deg  
 Vector averaged cross-power spectrum Baseline: JB (02) - YS (08)  
 Timerange: 00/16:41:53 to 00/16:42:52



Plot file version 729 created 23-AUG-2016 15:01:09

W3IRS5 GA035B 1.UVDATA.1

Freq = 22.2125 GHz, Bw = 16.000 MH No calibration applied and no bandpass applied

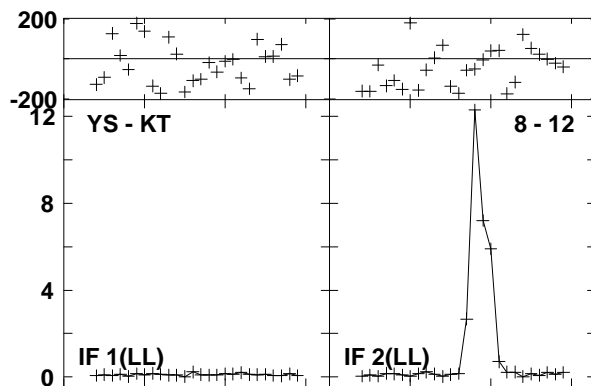
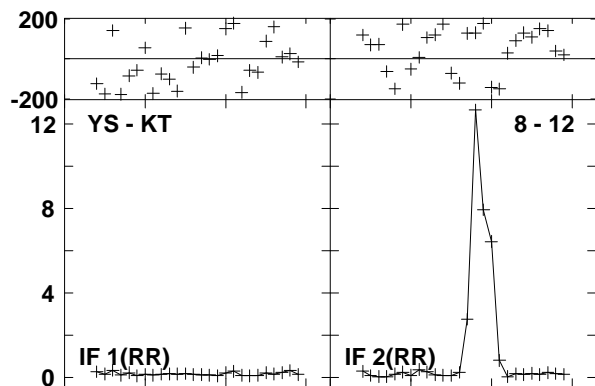
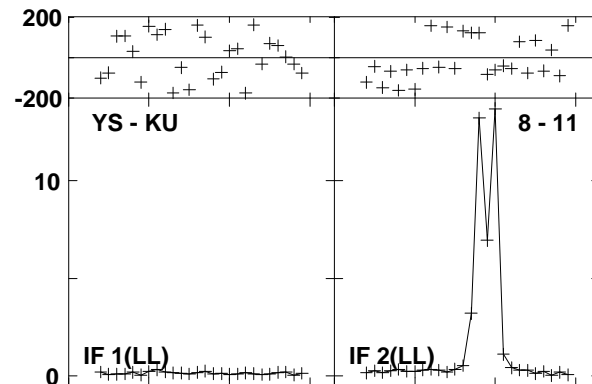
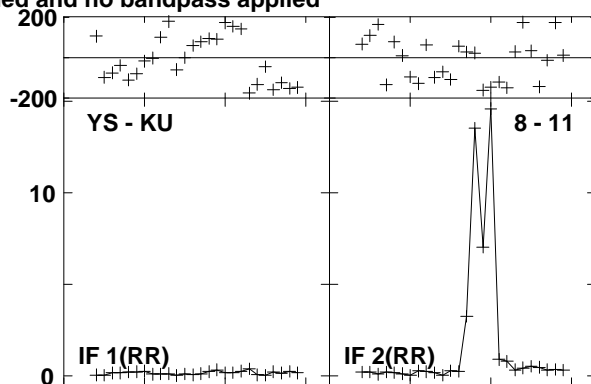
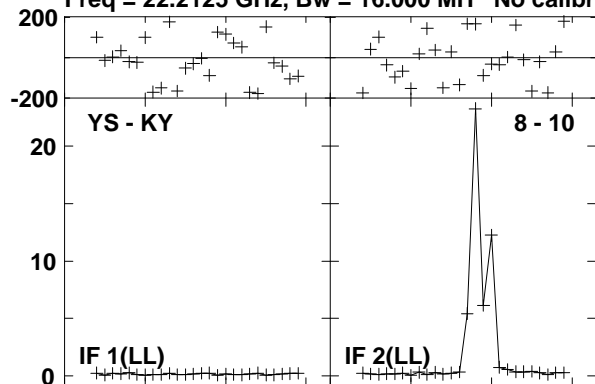

Lower frame: Milli Ampl Jy Top frame: Phas deg  
Vector averaged cross-power spectrum Baseline: YS (08) - KY (10)  
Timerange: 00/16:41:53 to 00/16:42:52

Plot file version 730 created 23-AUG-2016 15:01:09

0219+628 GA035B 1.UVDATA.1

Freq = 22.2125 GHz, Bw = 16.000 MH No calibration applied and no bandpass applied

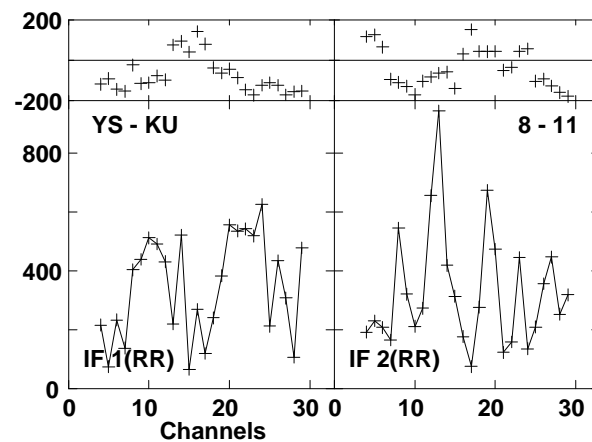
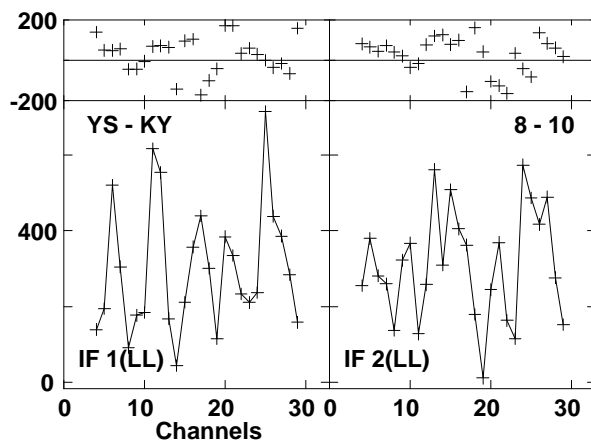
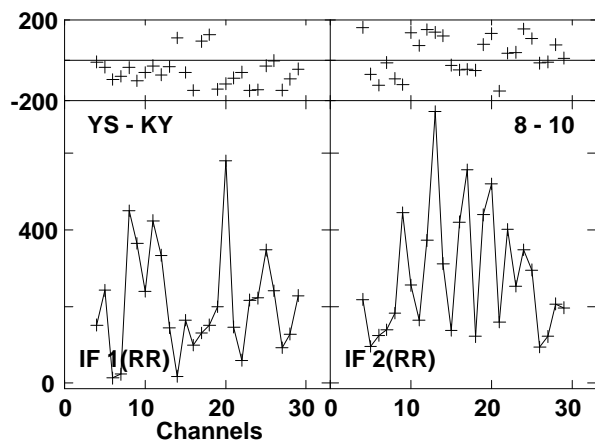
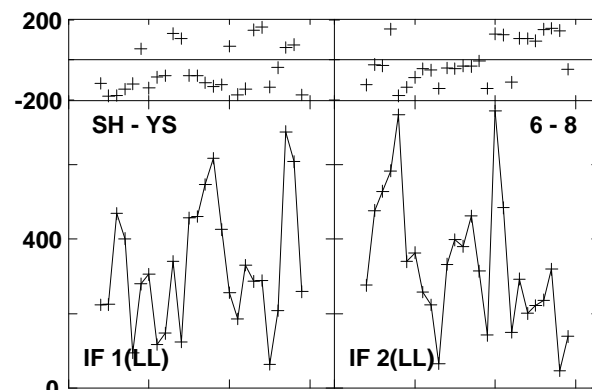
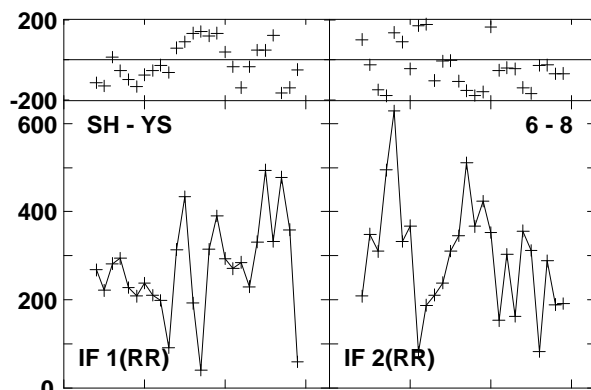
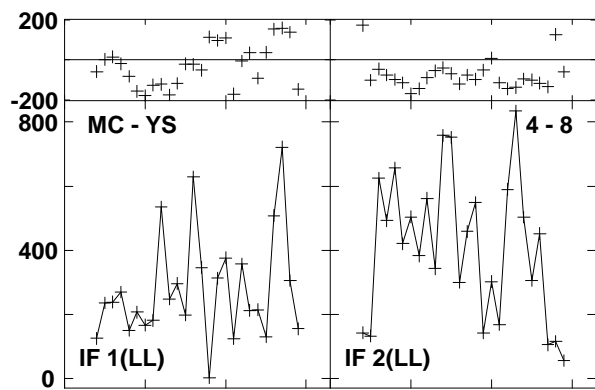
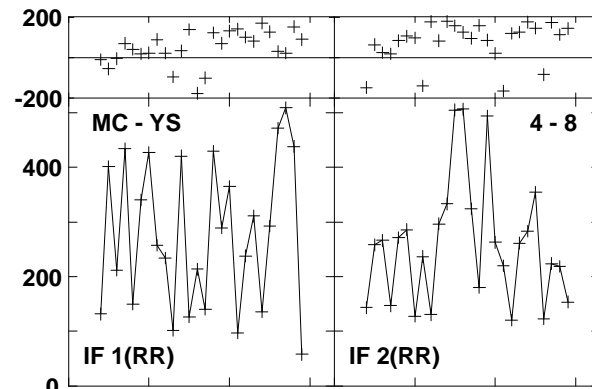
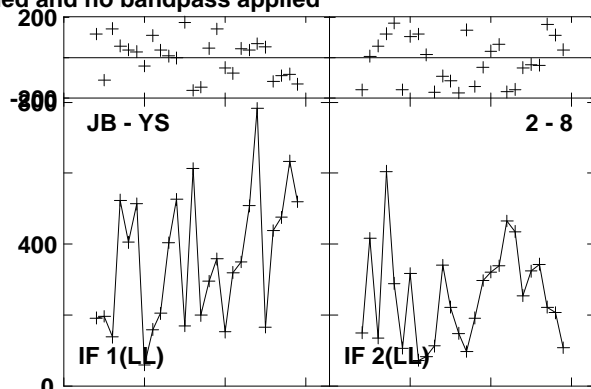
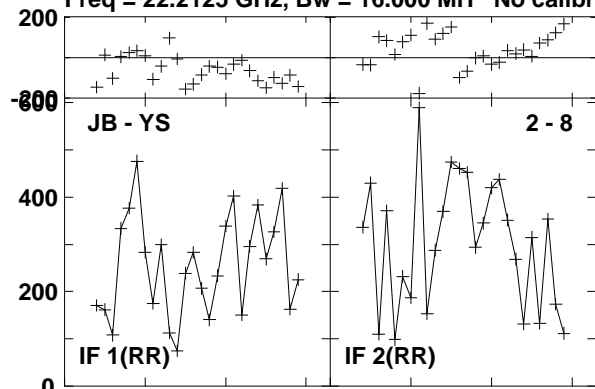

Lower frame: Micro Ampl Jy Top frame: Phas deg  
Vector averaged cross-power spectrum Baseline: JB (02) - YS (08)  
Timerange: 00/16:43:28 to 00/16:43:48

Plot file version 731 created 23-AUG-2016 15:01:09

0219+628 GA035B 1.UVDATA.1

Freq = 22.2125 GHz, Bw = 16.000 MH No calibration applied and no bandpass applied

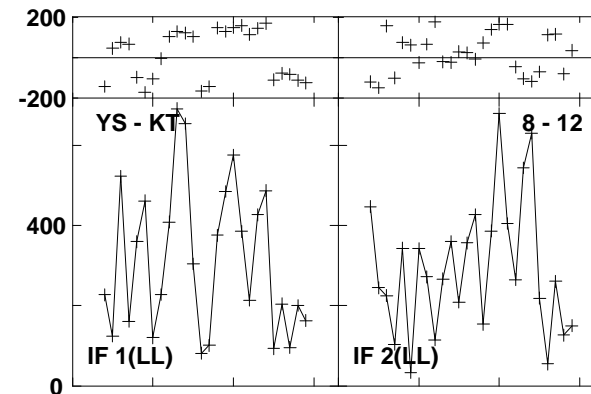
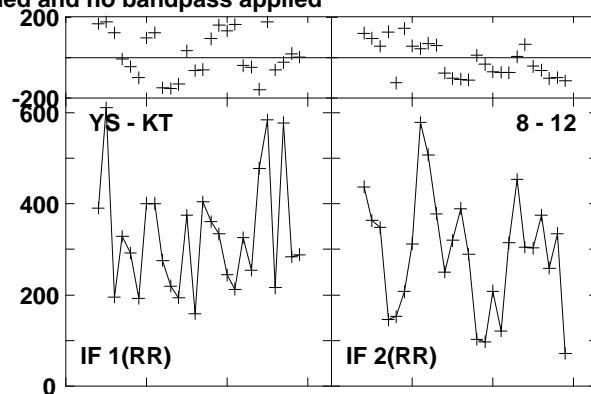
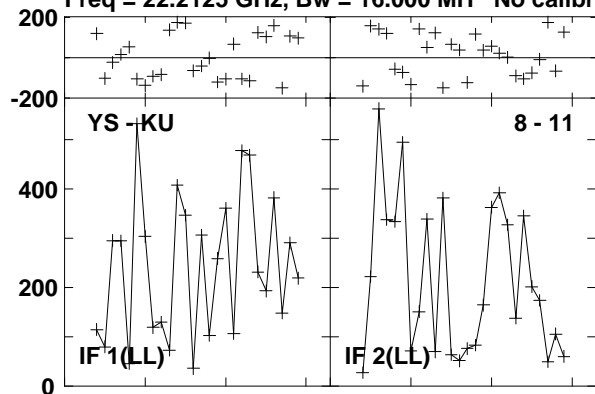

Lower frame: Micro Ampl Jy Top frame: Phas deg  
Vector averaged cross-power spectrum Baseline: YS (08) - KU (11)  
Timerange: 00/16:43:28 to 00/16:43:48

Plot file version 732 created 23-AUG-2016 15:01:09

W3IRS5 GA035B 1.UVDATA.1

Freq = 22.2125 GHz, Bw = 16.000 MH No calibration applied and no bandpass applied

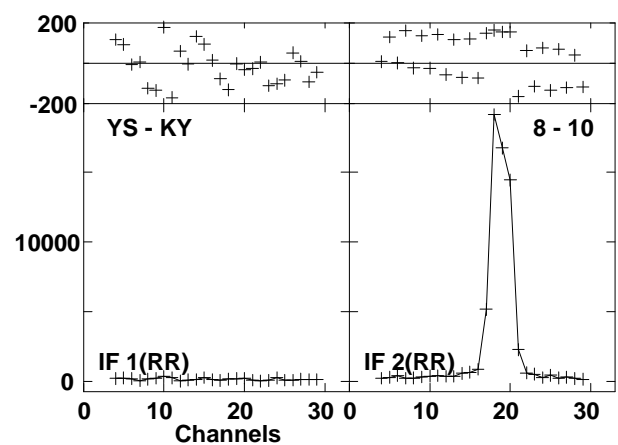
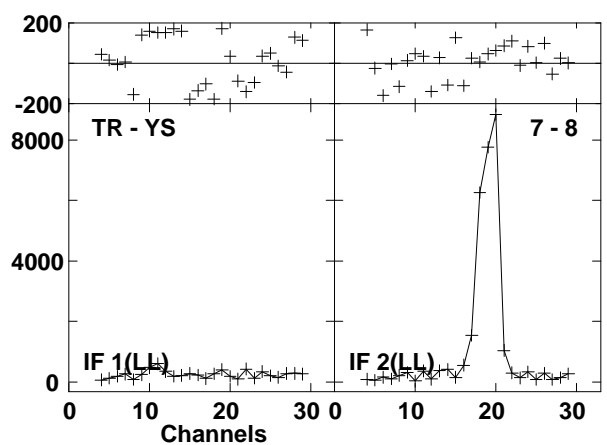
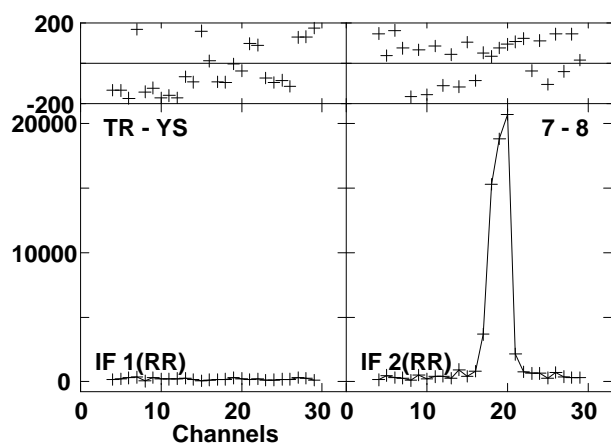
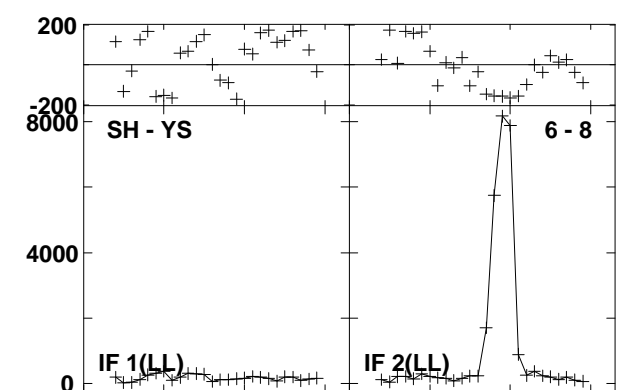
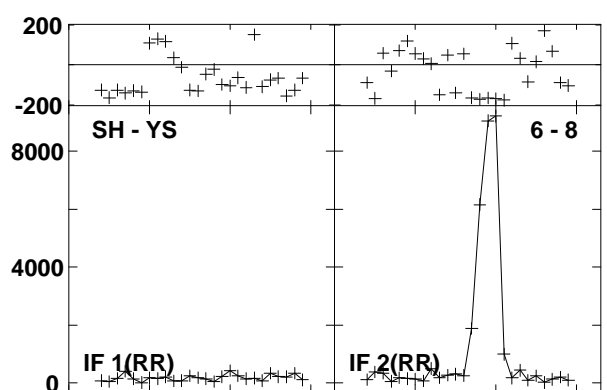
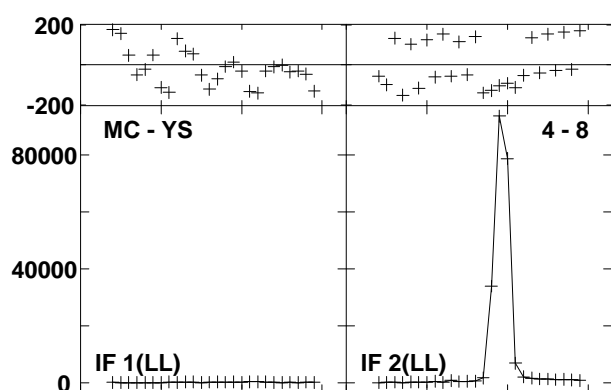
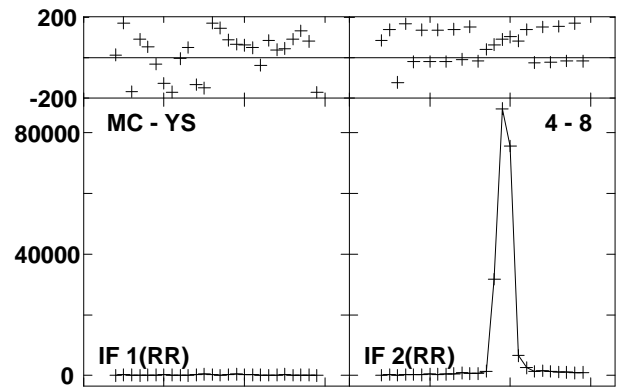
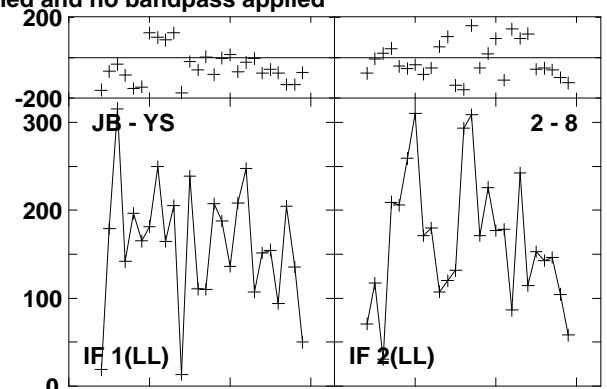
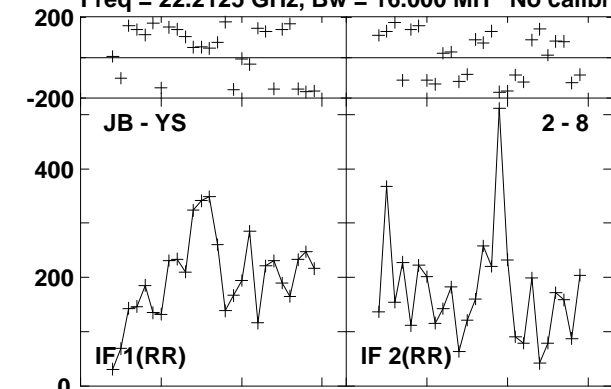

Lower frame: Micro Ampl Jy Top frame: Phas deg  
Vector averaged cross-power spectrum Baseline: JB (02) - YS (08)  
Timerange: 00/16:44:25 to 00/16:45:23

Plot file version 733 created 23-AUG-2016 15:01:09  
W3IRS5 GA035B 1.UVDATA.1

Freq = 22.2125 GHz, Bw = 16.000 MH No calibration applied and no bandpass applied

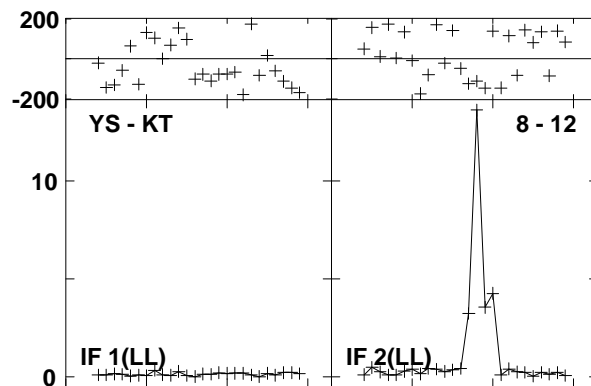
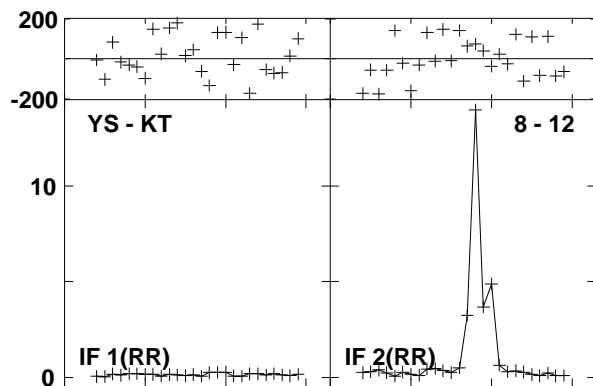
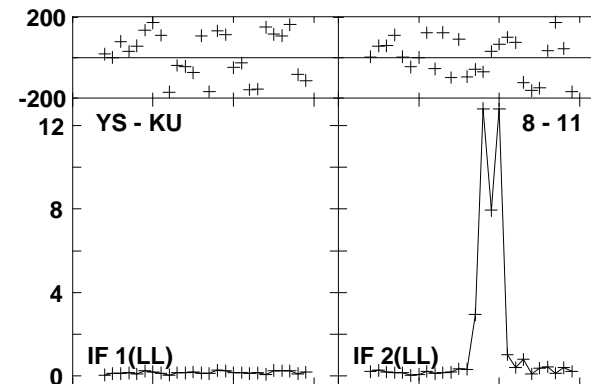
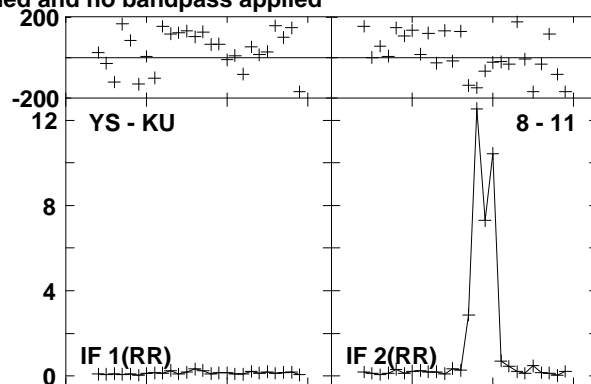
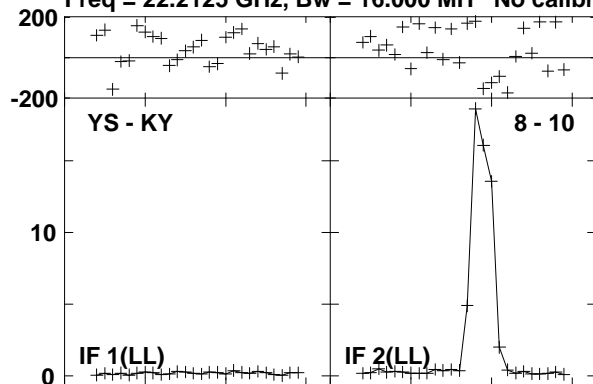

Lower frame: Milli Ampl Jy Top frame: Phas deg  
Vector averaged cross-power spectrum Baseline: YS (08) - KY (10)  
Timerange: 00/16:44:25 to 00/16:45:23

Plot file version 734 created 23-AUG-2016 15:01:09

0219+628 GA035B 1.UVDATA.1

Freq = 22.2125 GHz, Bw = 16.000 MH No calibration applied and no bandpass applied

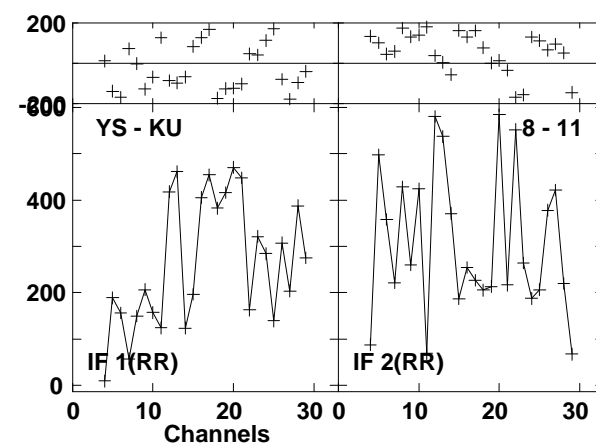
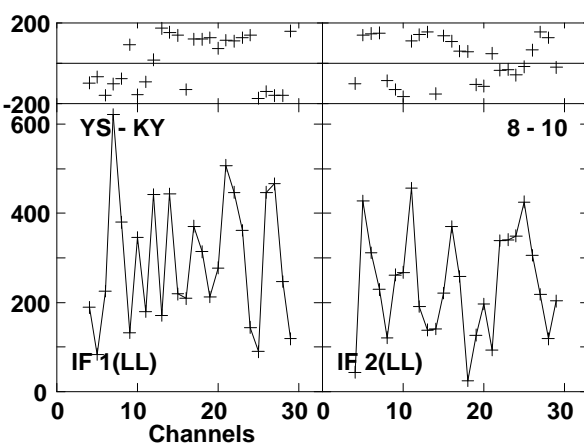
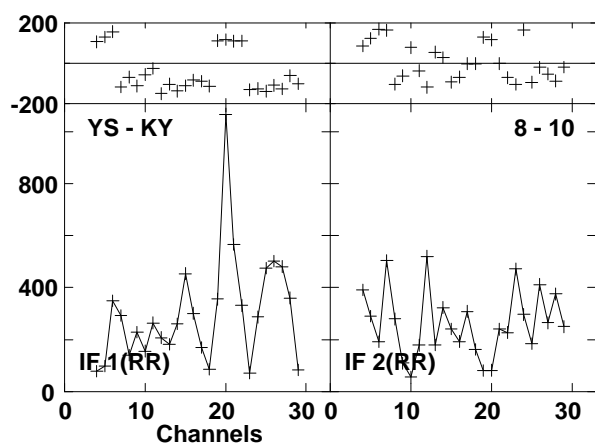
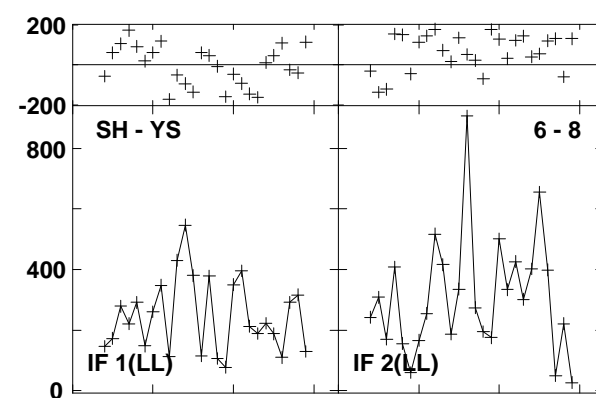
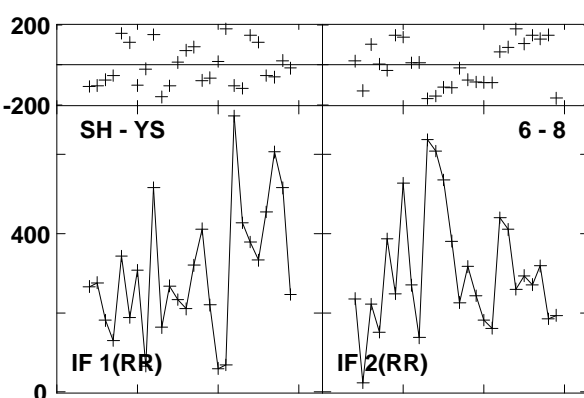
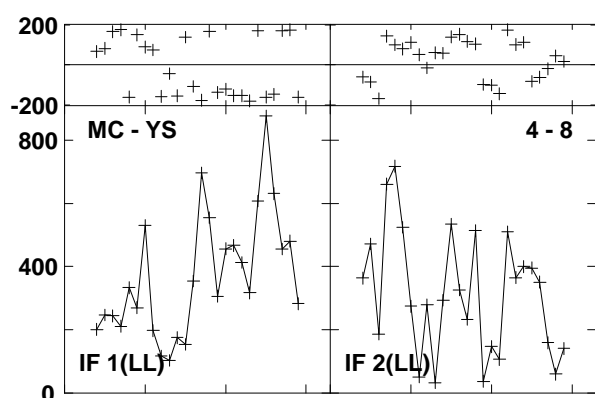
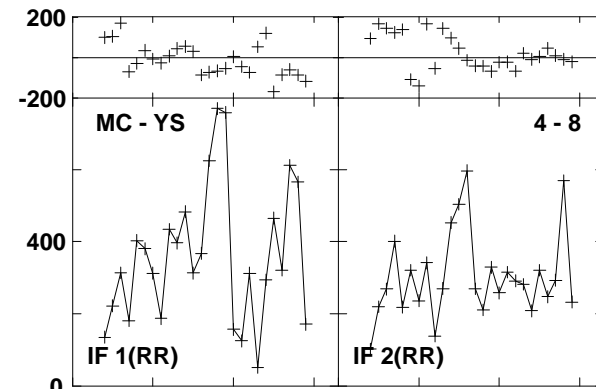
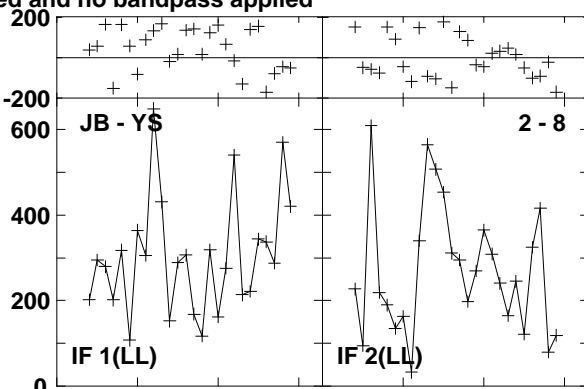
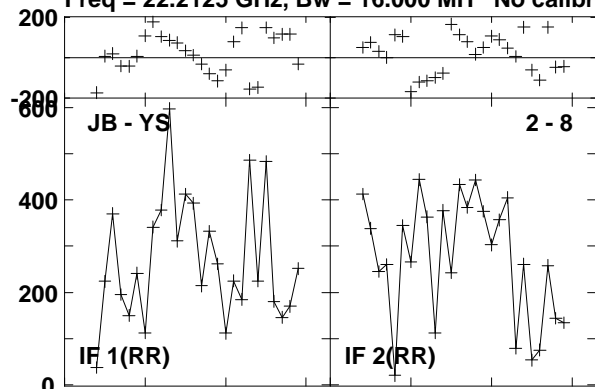

Lower frame: Micro Ampl Jy Top frame: Phas deg  
Vector averaged cross-power spectrum Baseline: JB (02) - YS (08)  
Timerange: 00/16:46:01 to 00/16:46:19

Plot file version 735 created 23-AUG-2016 15:01:09

0219+628 GA035B 1.UVDATA.1

Freq = 22.2125 GHz, Bw = 16.000 MH No calibration applied and no bandpass applied

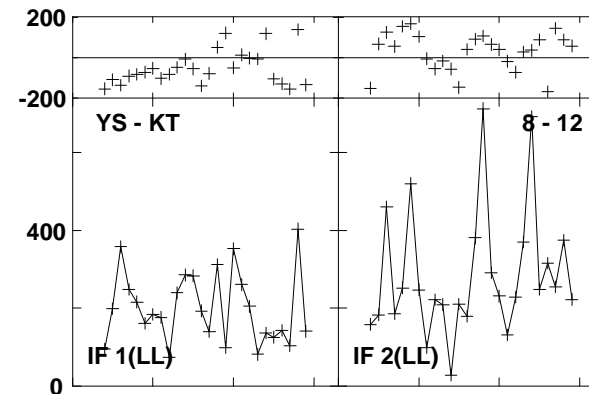
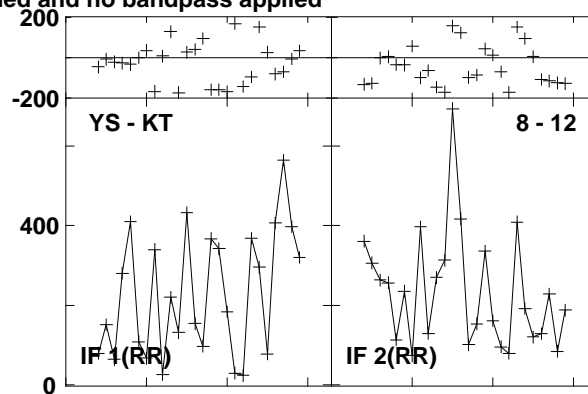
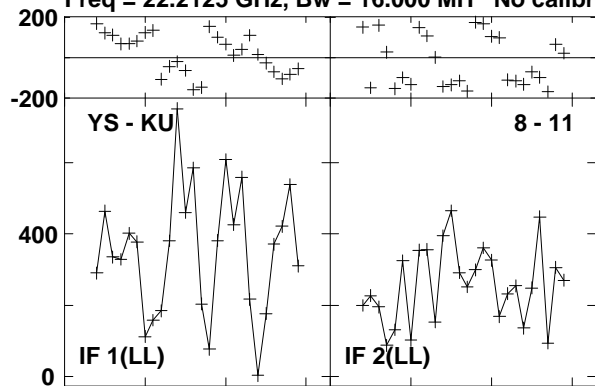

Lower frame: Micro Ampl Jy Top frame: Phas deg  
Vector averaged cross-power spectrum Baseline: YS (08) - KU (11)  
Timerange: 00/16:46:01 to 00/16:46:19

Plot file version 736 created 23-AUG-2016 15:01:09

W3IRS5 GA035B 1.UVDATA.1

Freq = 22.2125 GHz, Bw = 16.000 MH No calibration applied and no bandpass applied

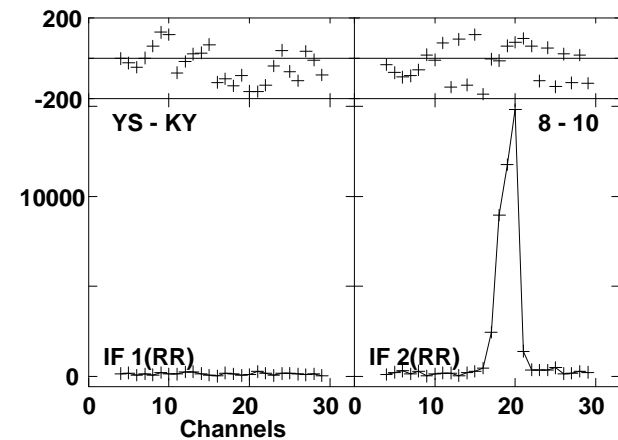
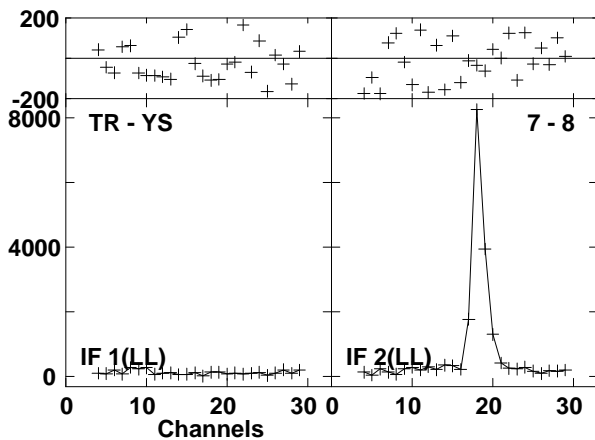
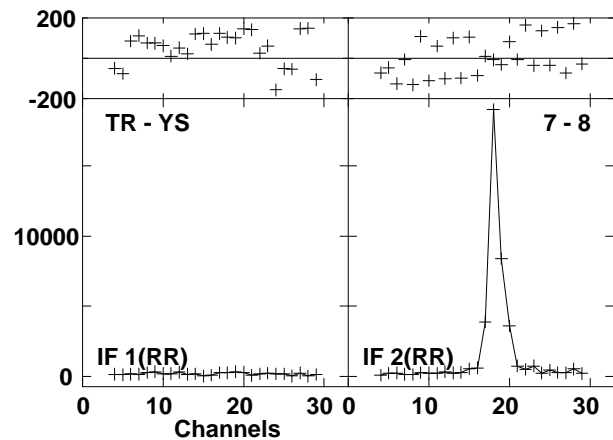
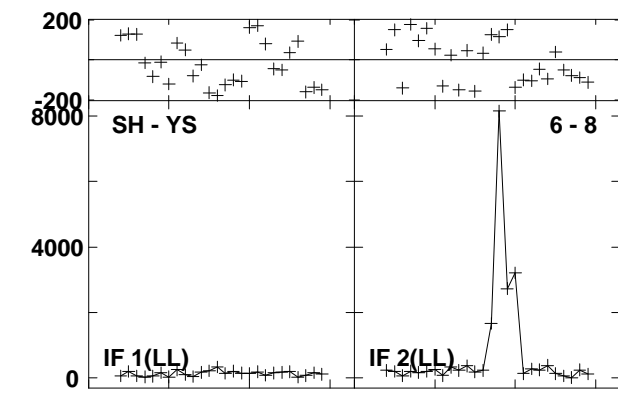
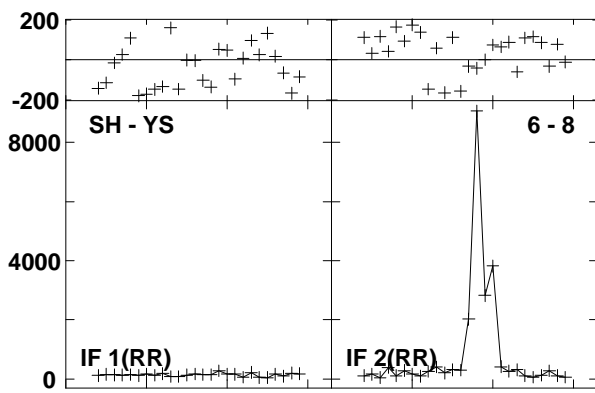
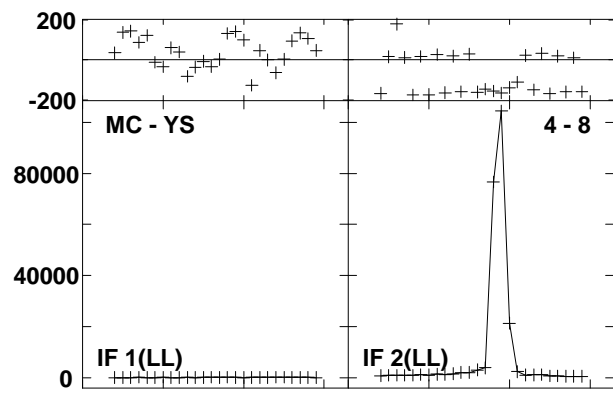
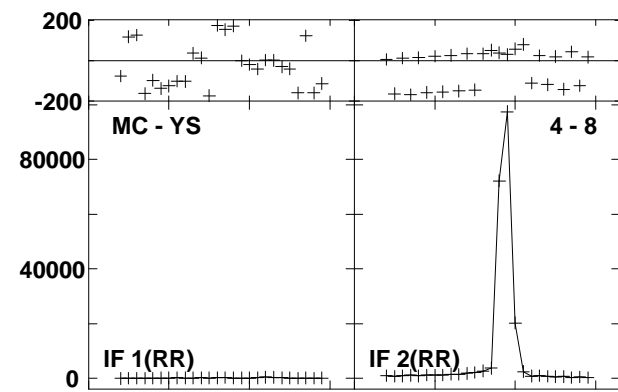
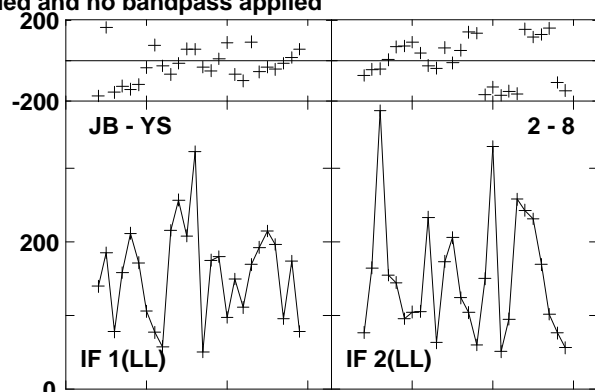
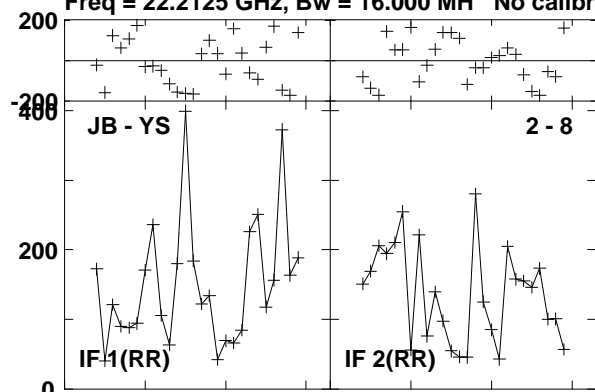

Lower frame: Micro Ampl Jy Top frame: Phas deg  
Vector averaged cross-power spectrum Baseline: JB (02) - YS (08)  
Timerange: 00/16:46:57 to 00/16:47:55



Plot file version 737 created 23-AUG-2016 15:01:09

W3IRS5 GA035B 1.UVDATA.1

Freq = 22.2125 GHz, Bw = 16.000 MH No calibration applied and no bandpass applied

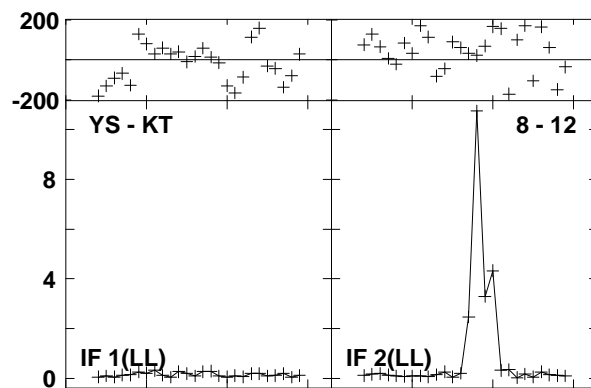
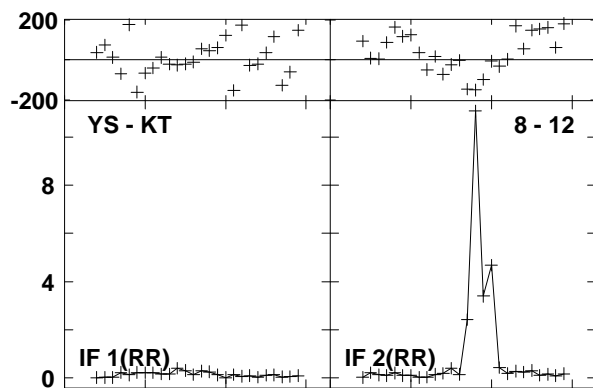
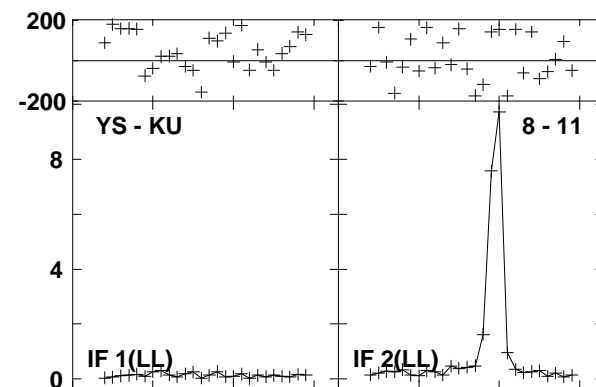
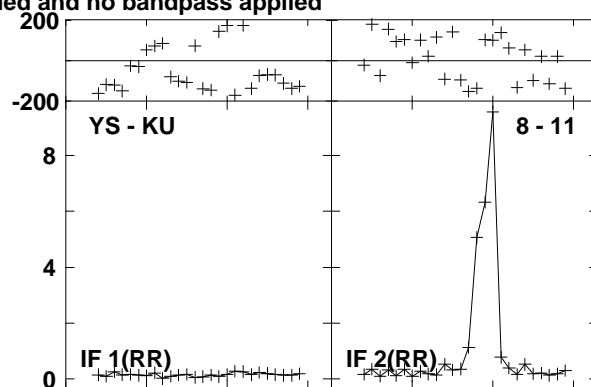
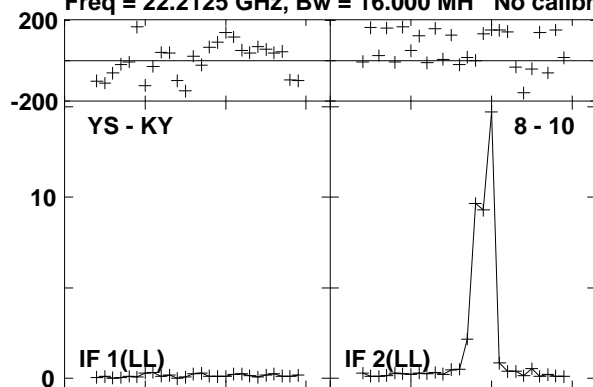

Lower frame: Milli Ampl Jy Top frame: Phas deg  
Vector averaged cross-power spectrum Baseline: YS (08) - KY (10)  
Timerange: 00/16:46:57 to 00/16:47:55

Plot file version 738 created 23-AUG-2016 15:01:09

0219+628 GA035B 1.UVDATA.1

Freq = 22.2125 GHz, Bw = 16.000 MH No calibration applied and no bandpass applied

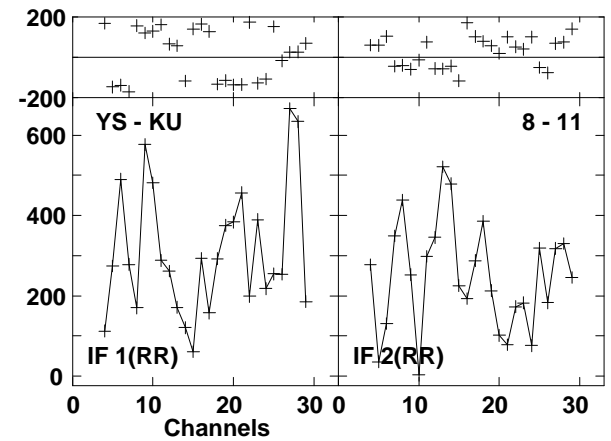
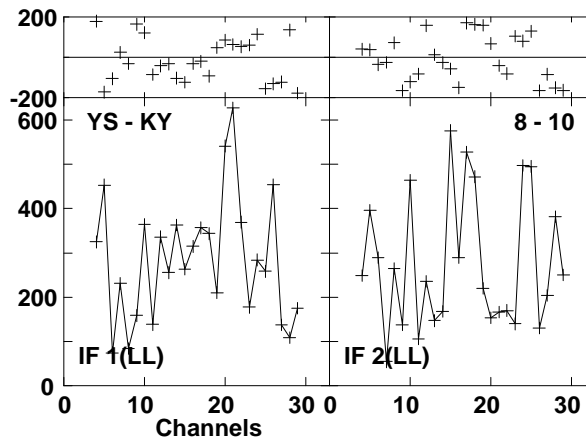
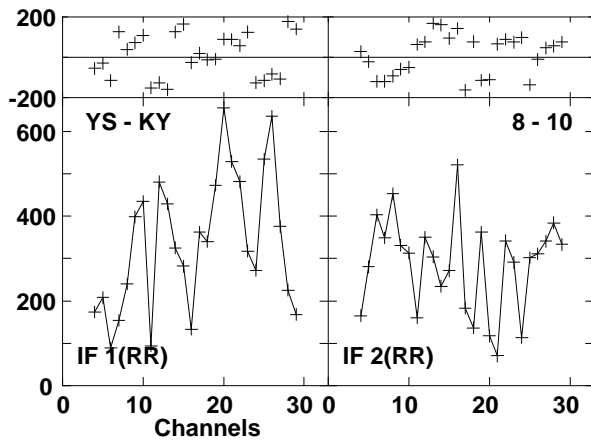
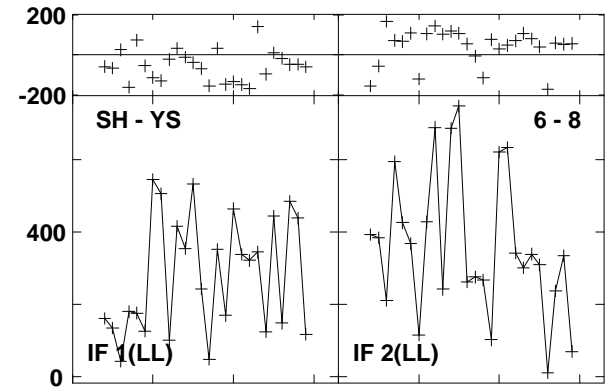
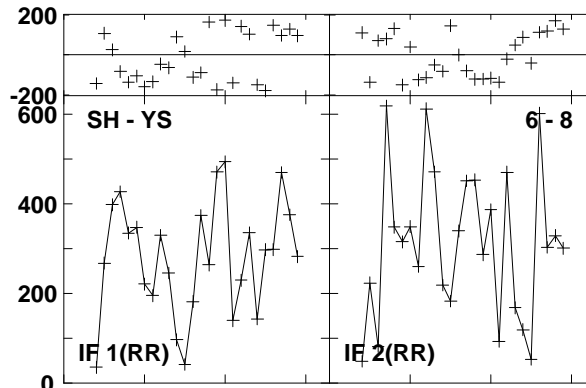
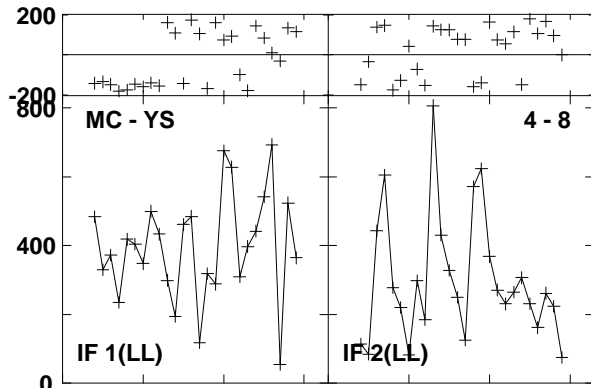
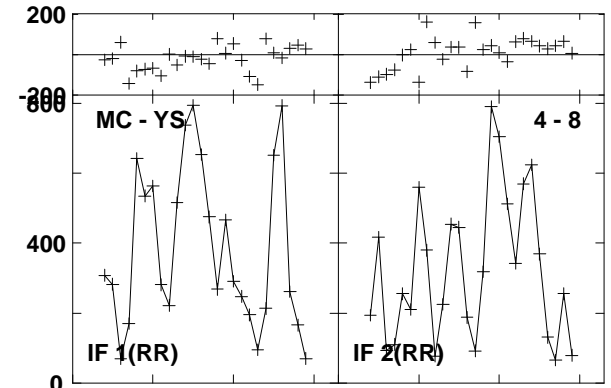
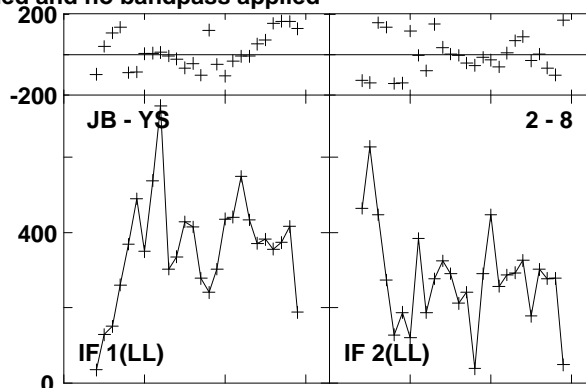
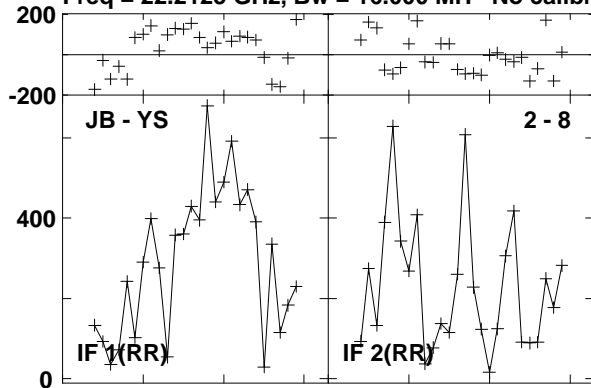

Lower frame: Micro Ampl Jy Top frame: Phas deg  
Vector averaged cross-power spectrum Baseline: JB (02) - YS (08)  
Timerange: 00/16:48:33 to 00/16:48:52

Plot file version 739 created 23-AUG-2016 15:01:09

0219+628 GA035B 1.UVDATA.1

Freq = 22.2125 GHz, Bw = 16.000 MH No calibration applied and no bandpass applied

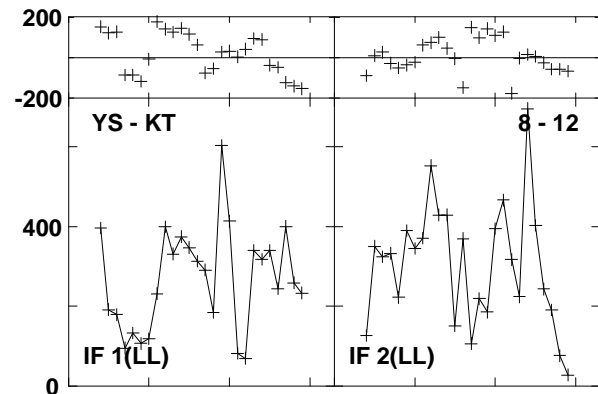
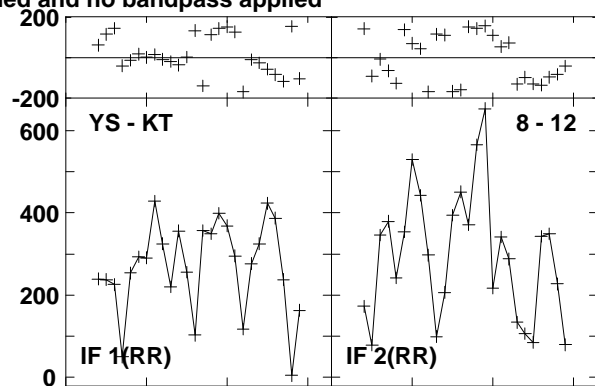
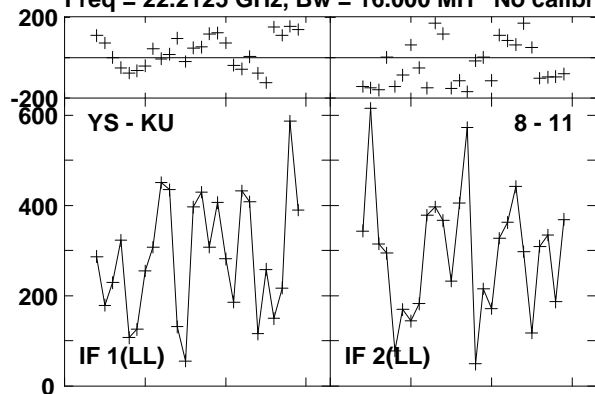

Lower frame: Micro Ampl Jy Top frame: Phas deg  
Vector averaged cross-power spectrum Baseline: YS (08) - KU (11)  
Timerange: 00/16:48:33 to 00/16:48:52

Plot file version 740 created 23-AUG-2016 15:01:09

0716+714 GA035B 1.UVDATA.1

Freq = 22.2125 GHz, Bw = 16.000 MH No calibration applied and no bandpass applied

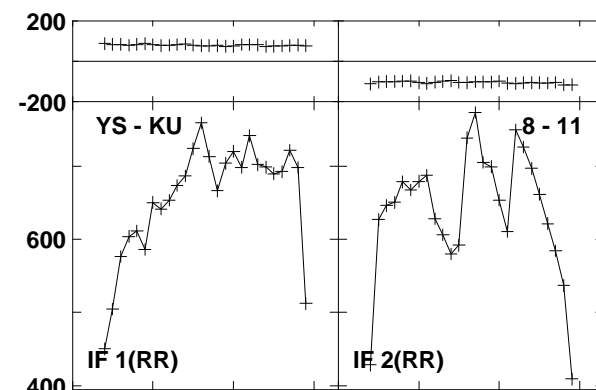
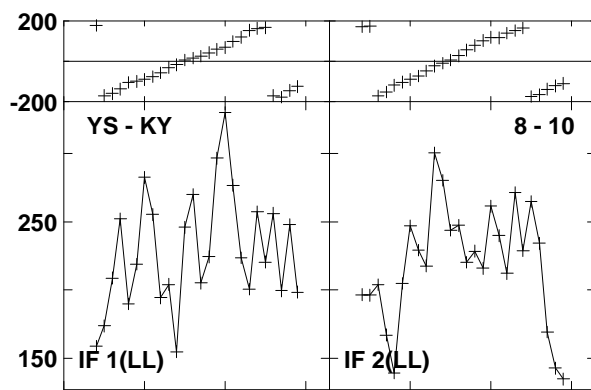
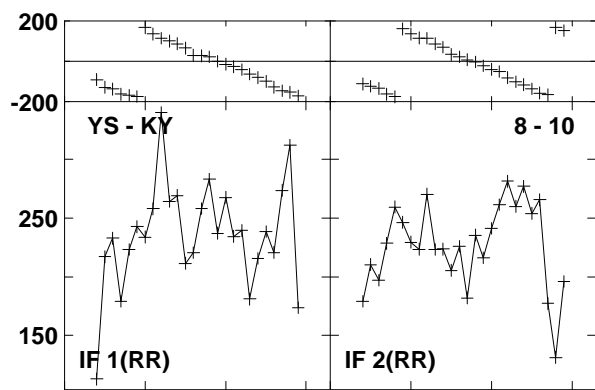
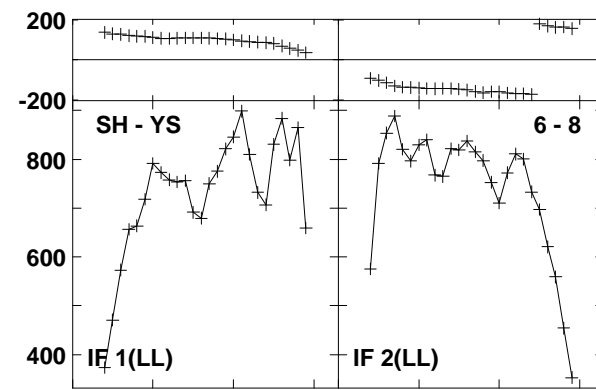
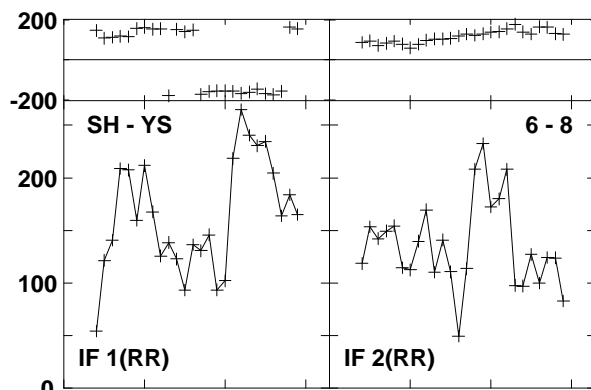
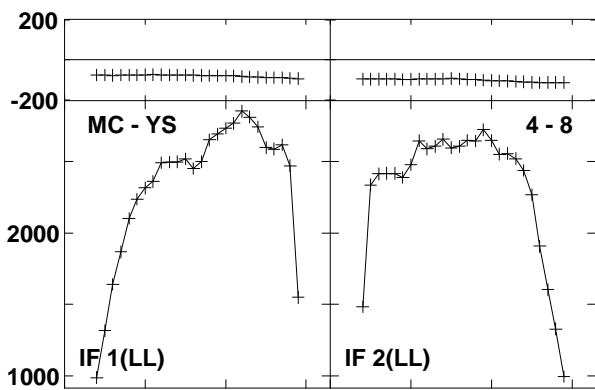
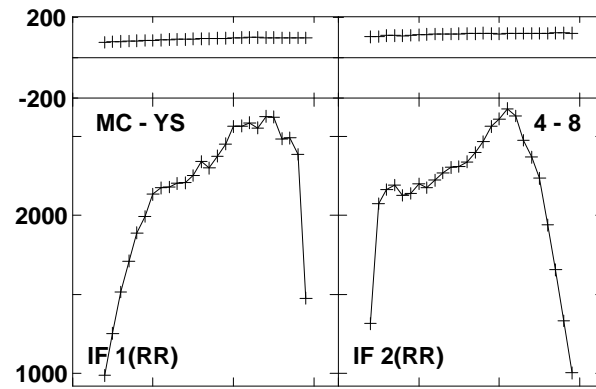
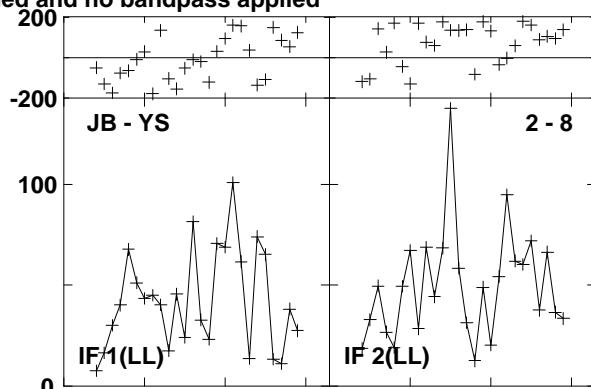
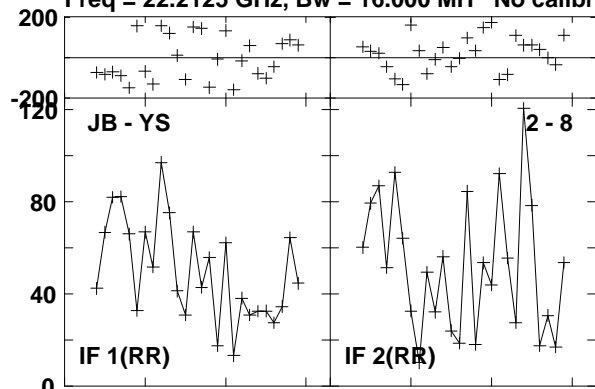

Lower frame: Micro Ampl Jy Top frame: Phas deg  
Vector averaged cross-power spectrum Baseline: JB (02) - YS (08)  
Timerange: 00/16:55:00 to 00/17:04:00

Plot file version 741 created 23-AUG-2016 15:01:10

0716+714 GA035B 1.UVDATA.1

Freq = 22.2125 GHz, Bw = 16.000 MH No calibration applied and no bandpass applied

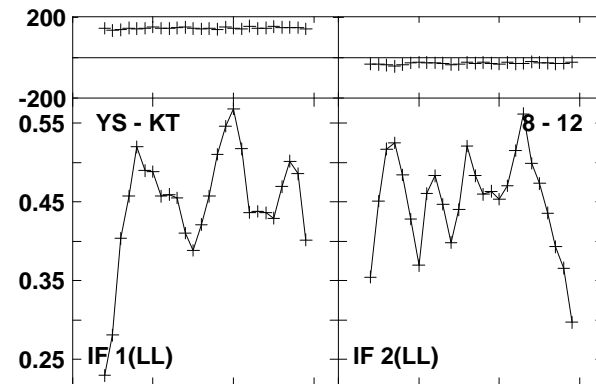
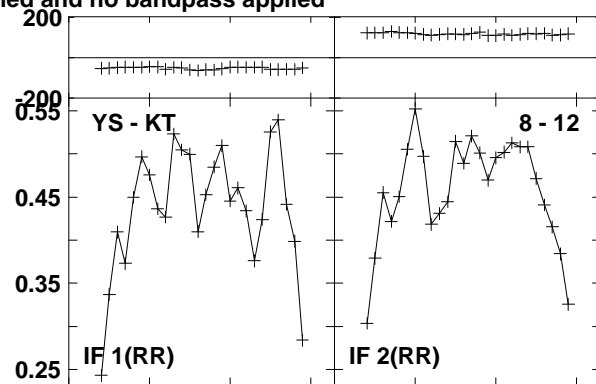
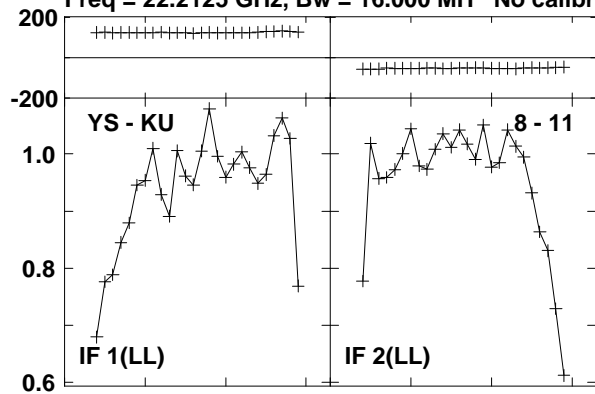

Lower frame: Milli Ampl Jy Top frame: Phas deg  
Vector averaged cross-power spectrum Baseline: YS (08) - KU (11)  
Timerange: 00/16:55:00 to 00/17:04:00

Plot file version 742 created 23-AUG-2016 15:01:10  
 0716+714 GA035B 1.UVDATA.1  
 Freq = 22.2125 GHz, Bw = 16.000 MH No calibration applied and no bandpass applied

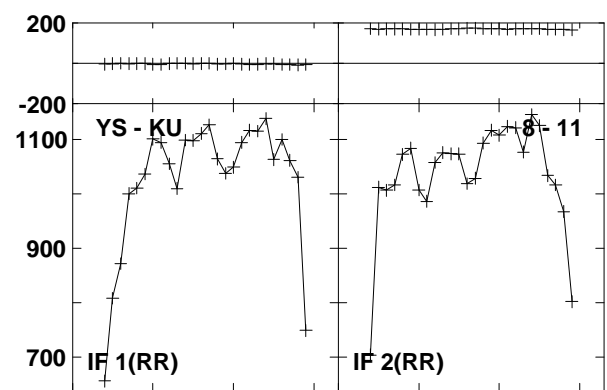
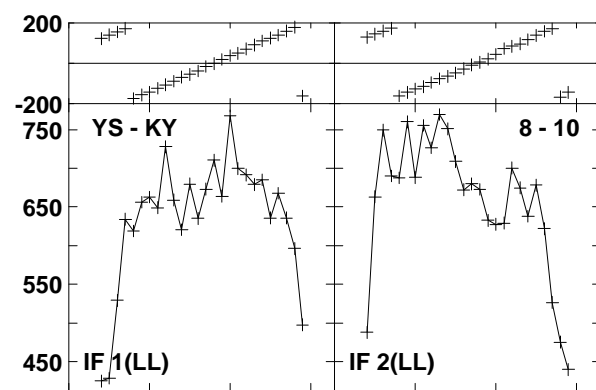
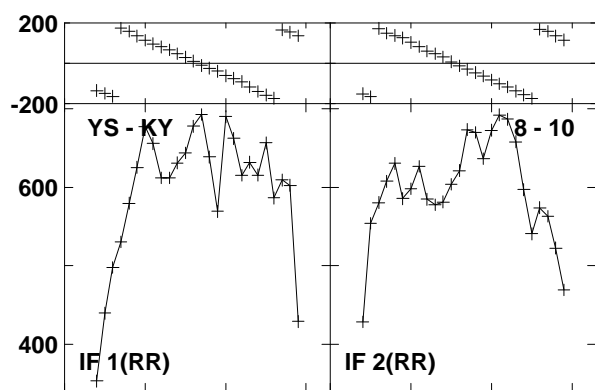
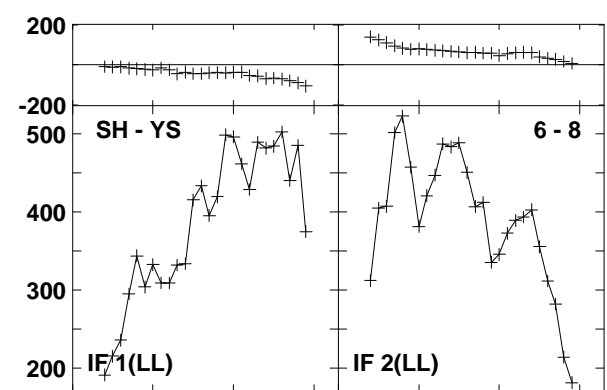
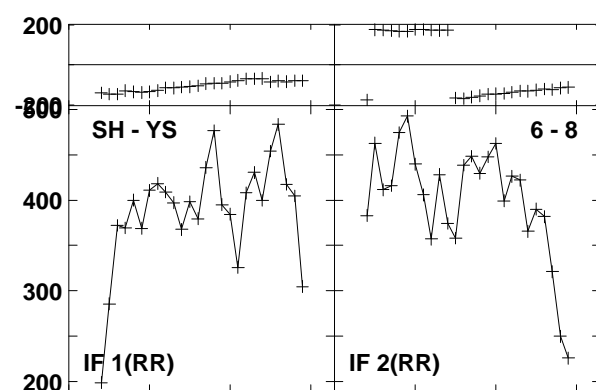
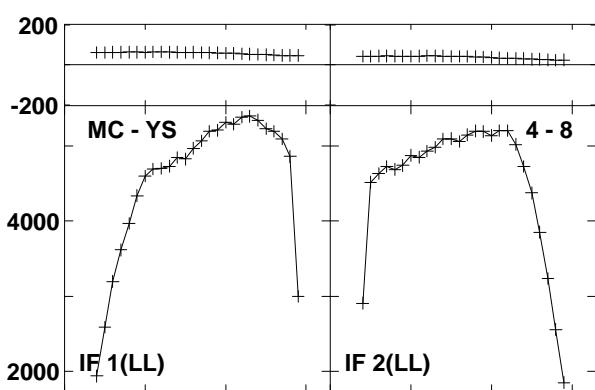
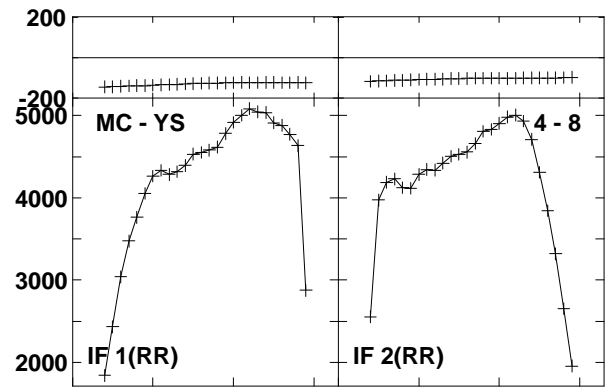
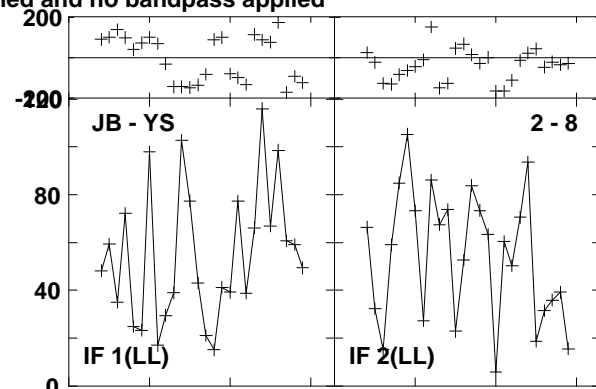
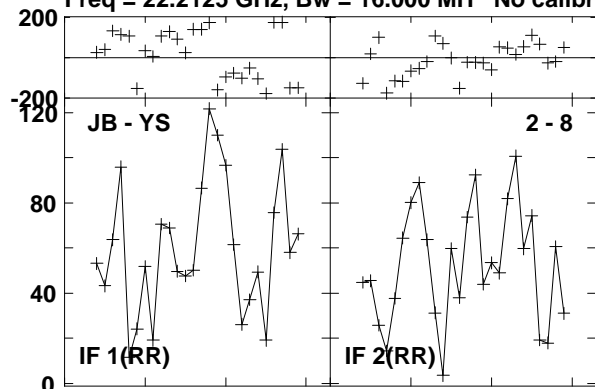

Lower frame: Micro Ampl Jy Top frame: Phas deg  
 Vector averaged cross-power spectrum Baseline: JB (02) - YS (08)  
 Timerange: 00/17:05:30 to 00/17:14:29

Plot file version 743 created 23-AUG-2016 15:01:10

0716+714 GA035B 1.UVDATA.1

Freq = 22.2125 GHz, Bw = 16.000 MH No calibration applied and no bandpass applied

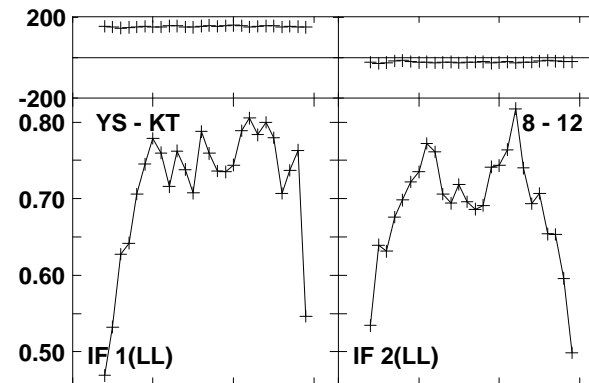
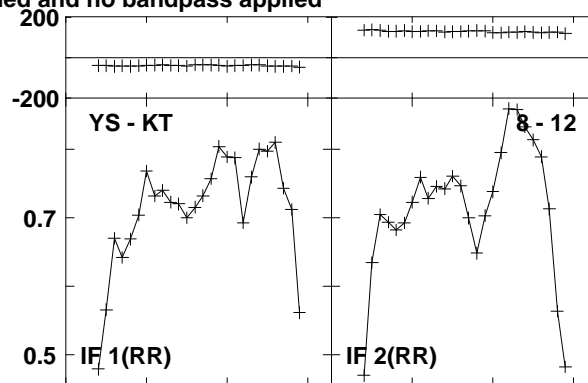
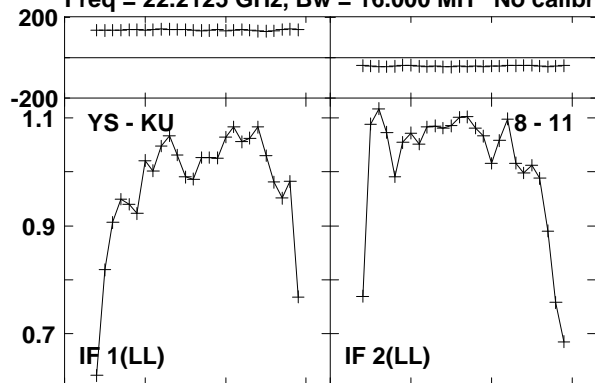

Lower frame: Milli Ampl Jy Top frame: Phas deg  
Vector averaged cross-power spectrum Baseline: YS (08) - KU (11)  
Timerange: 00/17:05:30 to 00/17:14:29

Plot file version 744 created 23-AUG-2016 15:01:10

0716+714 GA035B 1.UVDATA.1

Freq = 22.2125 GHz, Bw = 16.000 MH No calibration applied and no bandpass applied

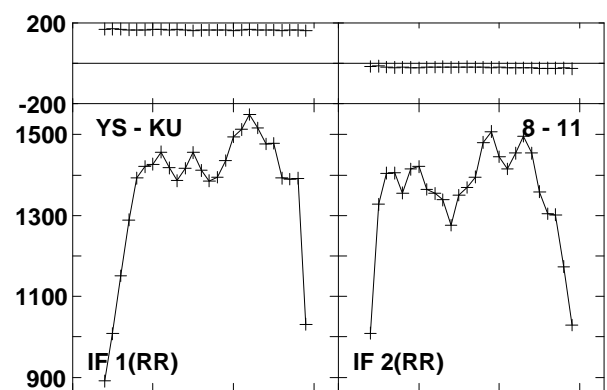
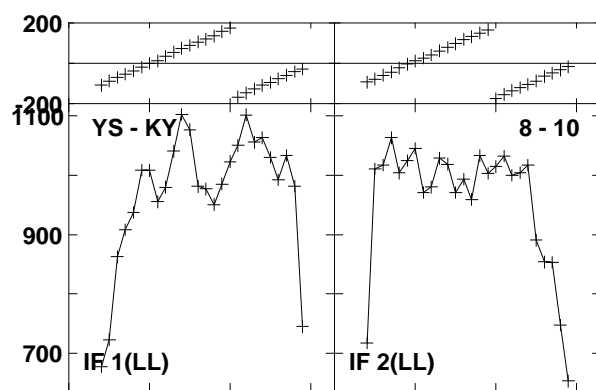
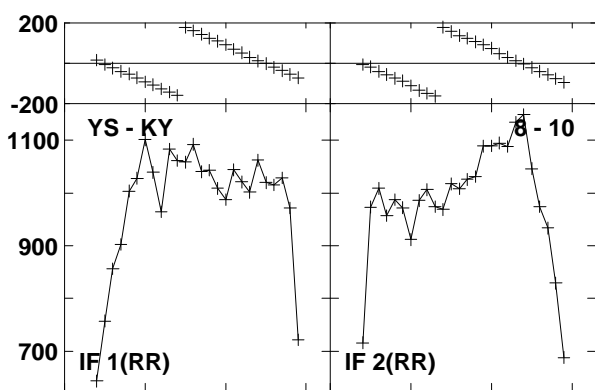
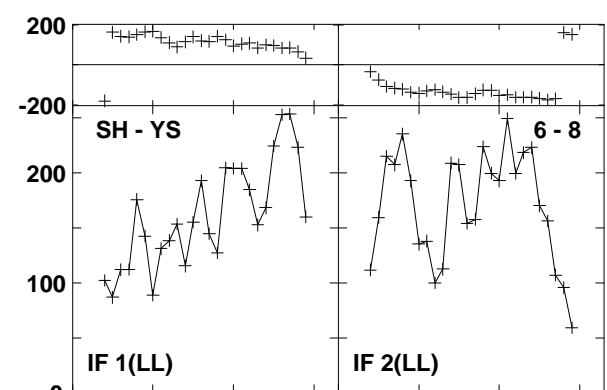
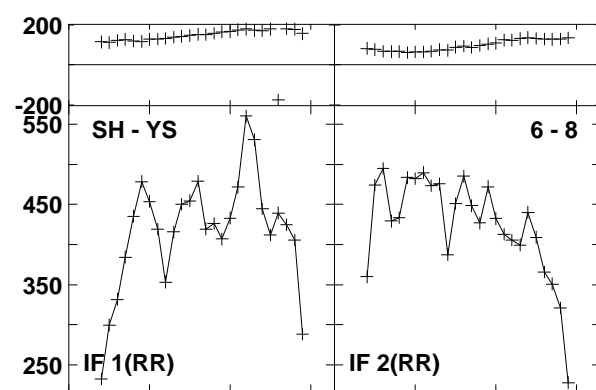
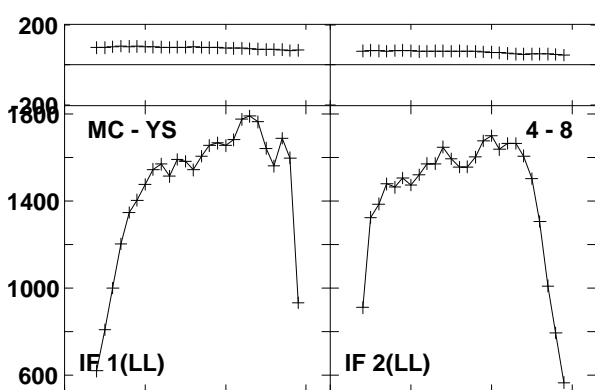
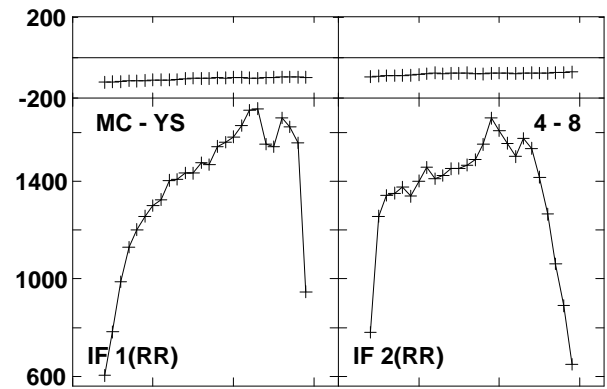
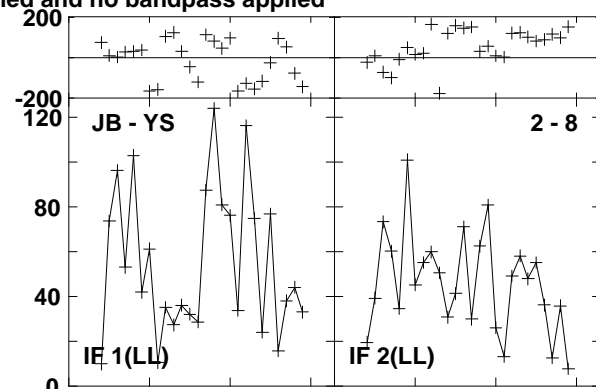
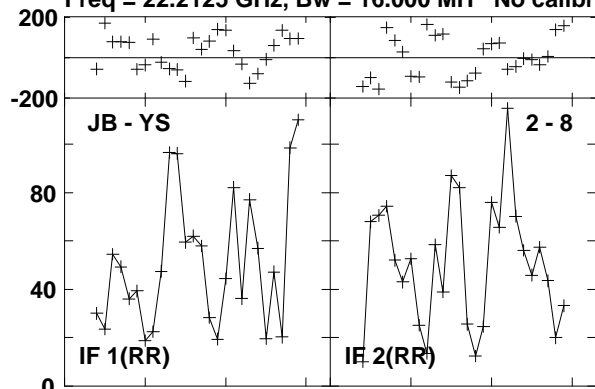

Lower frame: Micro Ampl Jy Top frame: Phas deg  
Vector averaged cross-power spectrum Baseline: JB (02) - YS (08)  
Timerange: 00/17:16:01 to 00/17:25:00



Plot file version 745 created 23-AUG-2016 15:01:11

0716+714 GA035B 1.UVDATA.1

Freq = 22.2125 GHz, Bw = 16.000 MH No calibration applied and no bandpass applied

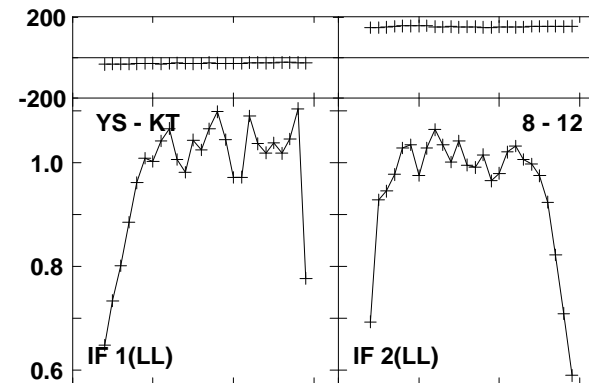
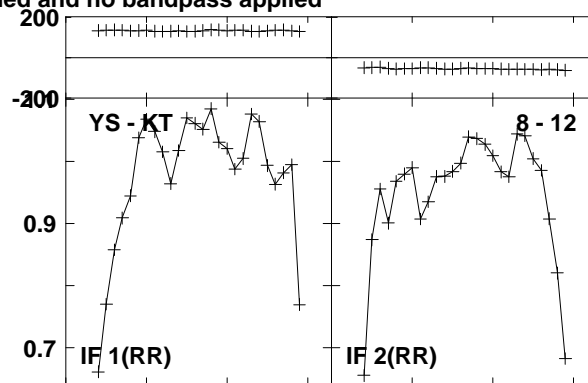
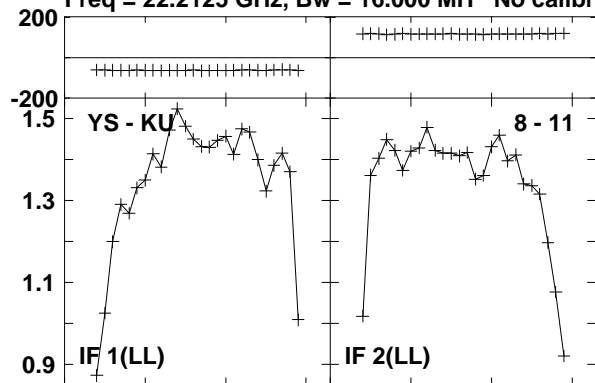

Lower frame: Milli Ampl Jy Top frame: Phas deg  
Vector averaged cross-power spectrum Baseline: YS (08) - KU (11)  
Timerange: 00/17:16:01 to 00/17:25:00

Plot file version 746 created 23-AUG-2016 15:01:11

W3IRS5 GA035B 1.UVDATA.1

Freq = 22.2125 GHz, Bw = 16.000 MH No calibration applied and no bandpass applied

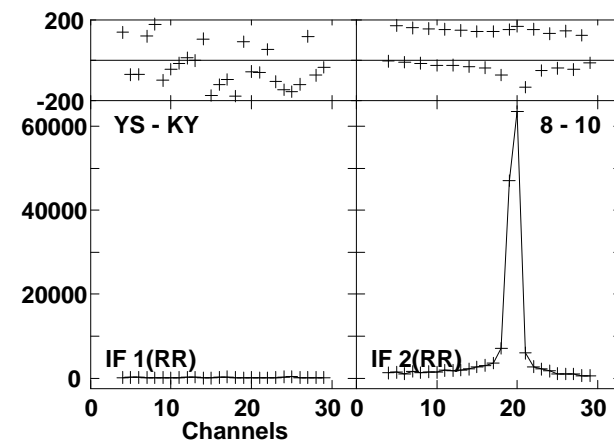
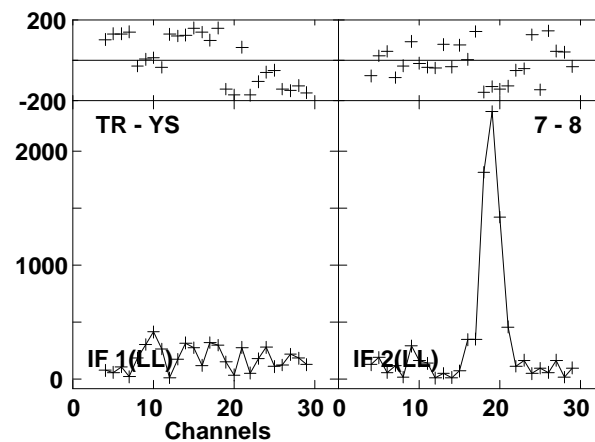
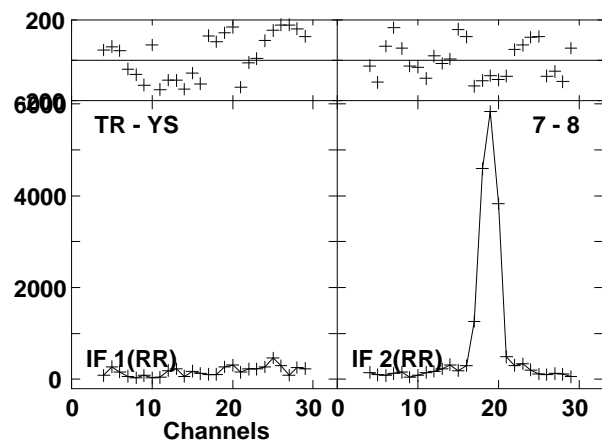
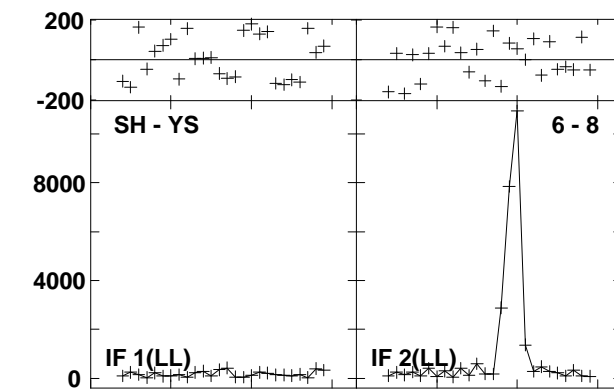
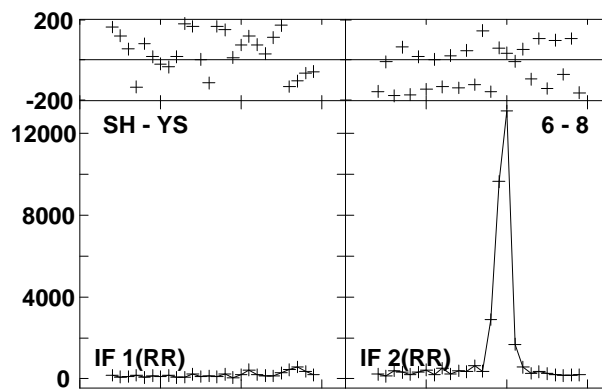
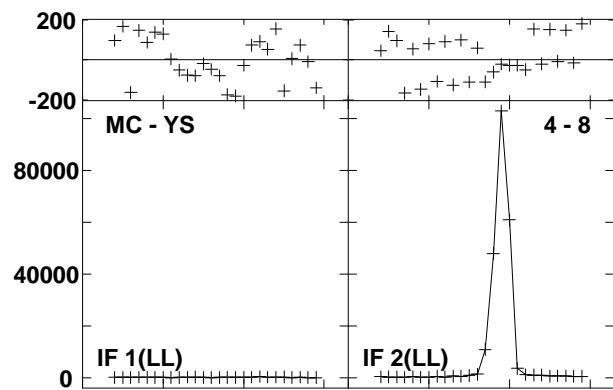
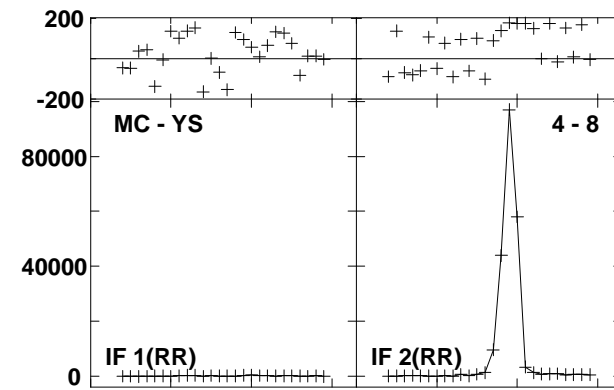
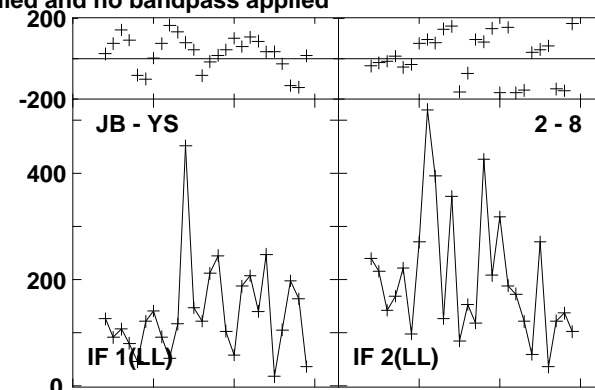
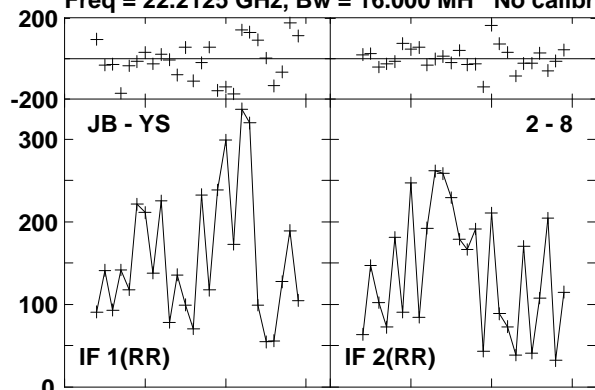

Lower frame: Micro Ampl Jy Top frame: Phas deg  
Vector averaged cross-power spectrum Baseline: JB (02) - YS (08)  
Timerange: 00/17:30:31 to 00/17:31:29

Plot file version 747 created 23-AUG-2016 15:01:11

W3IRS5 GA035B 1.UVDATA.1

Freq = 22.2125 GHz, Bw = 16.000 MH No calibration applied and no bandpass applied

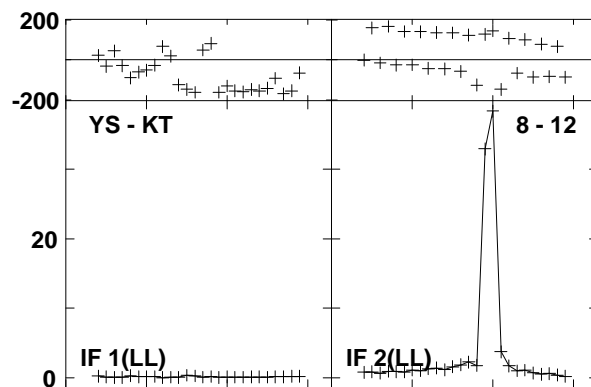
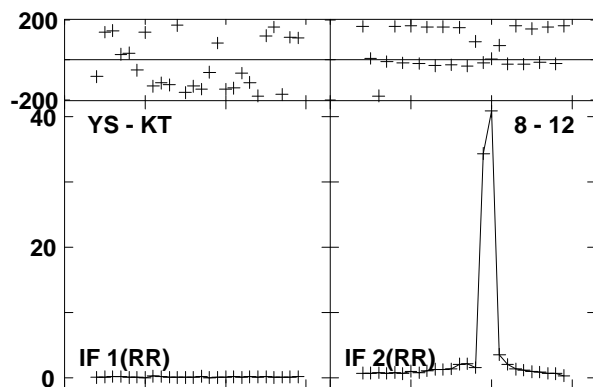
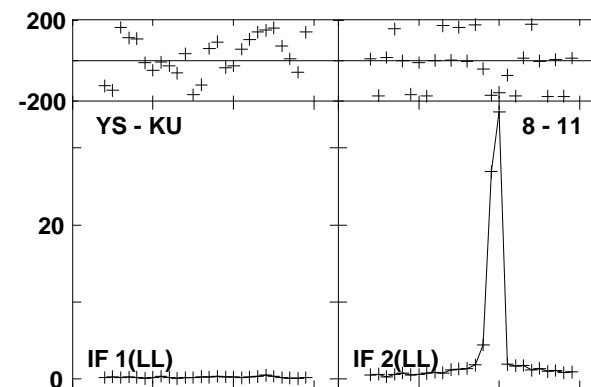
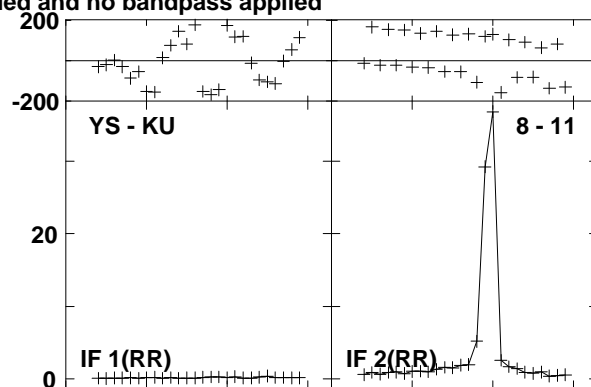
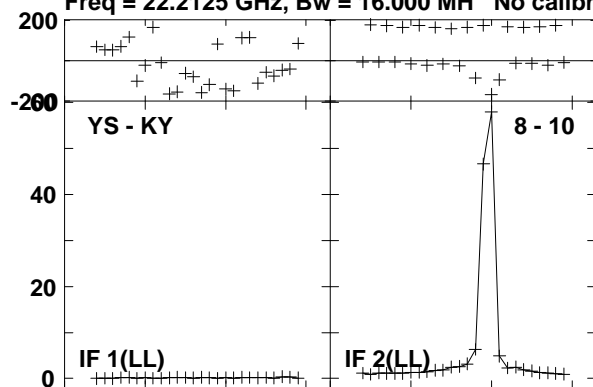

Lower frame: Milli Ampl Jy Top frame: Phas deg  
Vector averaged cross-power spectrum Baseline: YS (08) - KY (10)  
Timerange: 00/17:30:31 to 00/17:31:29

Plot file version 748 created 23-AUG-2016 15:01:11

0219+628 GA035B 1.UVDATA.1

Freq = 22.2125 GHz, Bw = 16.000 MH No calibration applied and no bandpass applied

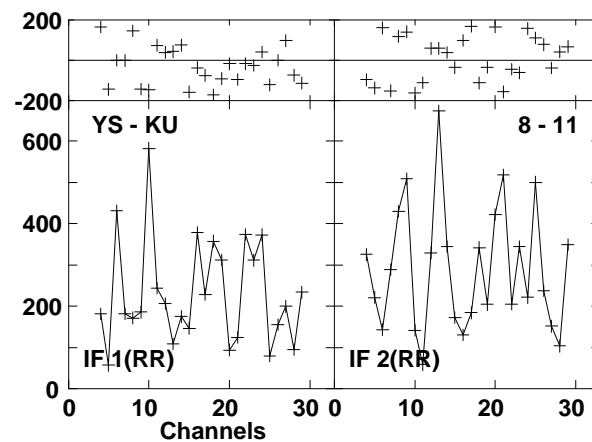
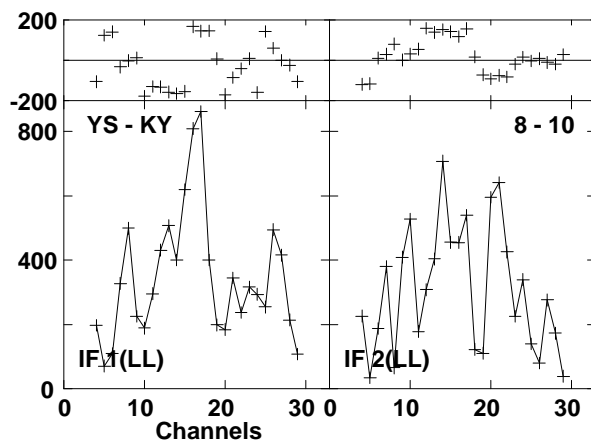
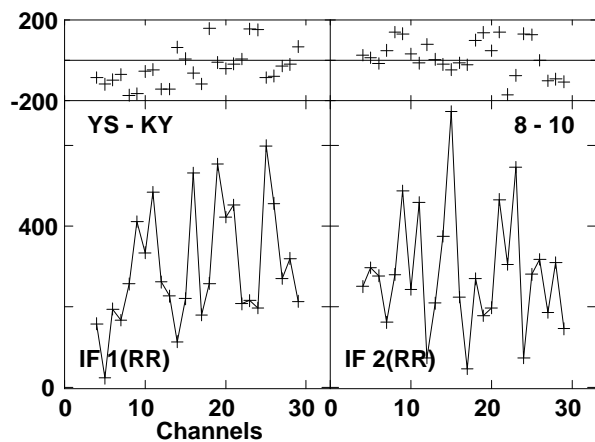
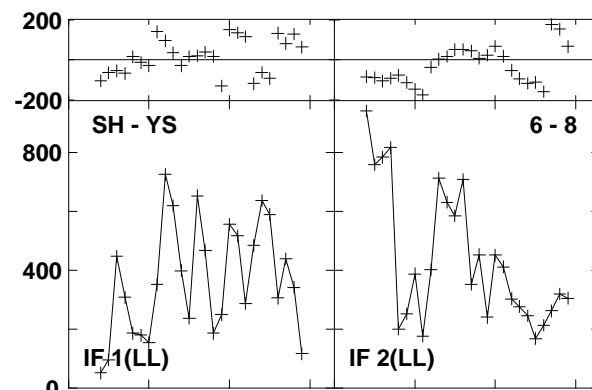
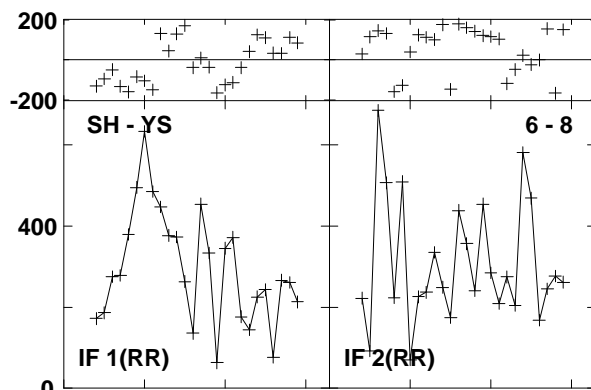
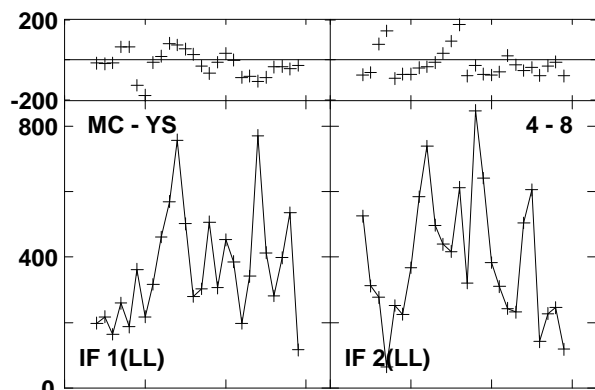
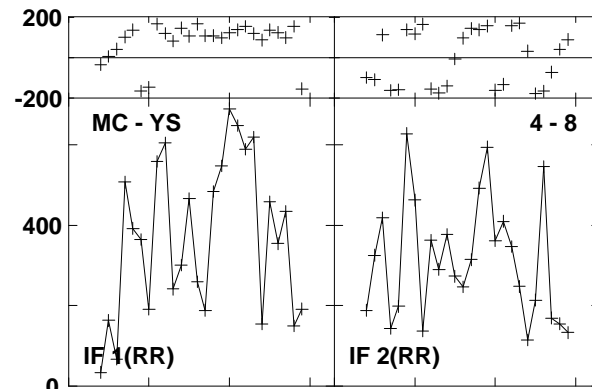
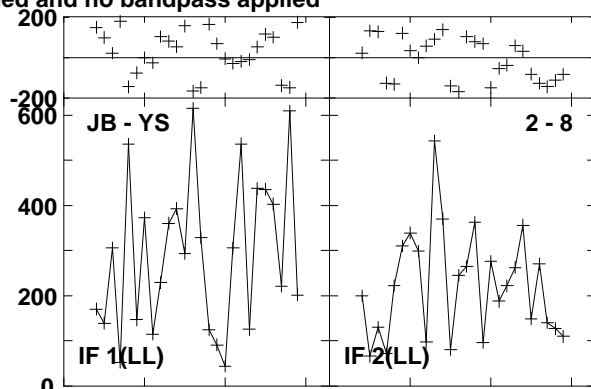
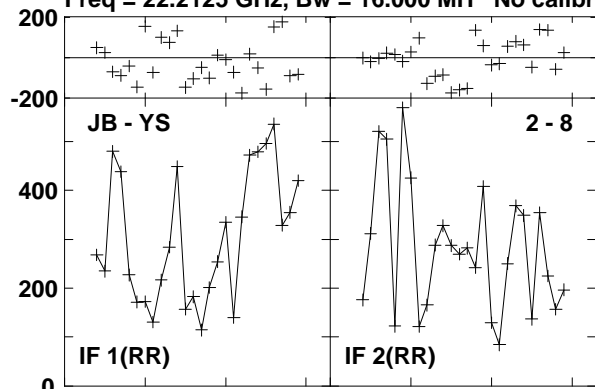

Lower frame: Micro Ampl Jy Top frame: Phas deg  
Vector averaged cross-power spectrum Baseline: JB (02) - YS (08)  
Timerange: 00/17:32:05 to 00/17:32:24

Plot file version 749 created 23-AUG-2016 15:01:11

0219+628 GA035B 1.UVDATA.1

Freq = 22.2125 GHz, Bw = 16.000 MH No calibration applied and no bandpass applied

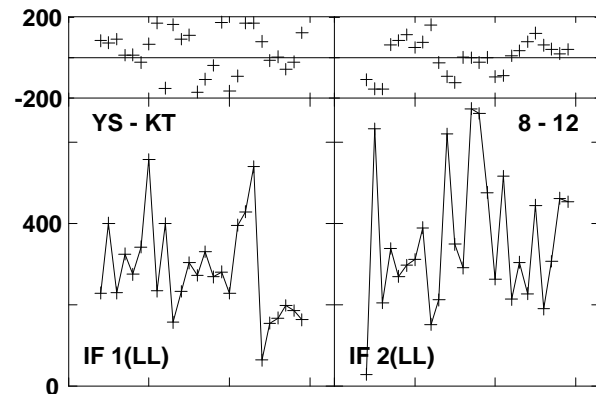
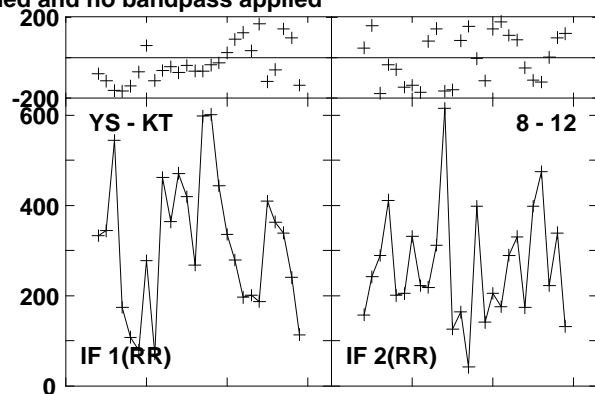
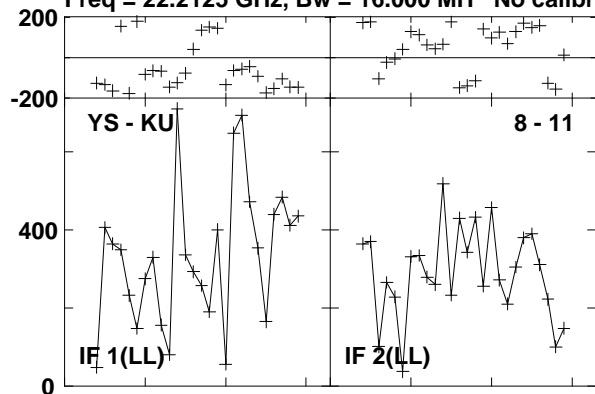

Lower frame: Micro Ampl Jy Top frame: Phas deg  
Vector averaged cross-power spectrum Baseline: YS (08) - KU (11)  
Timerange: 00/17:32:05 to 00/17:32:24

Plot file version 750 created 23-AUG-2016 15:01:11  
 W3IRS5 GA035B 1.UVDATA.1

Freq = 22.2125 GHz, Bw = 16.000 MH No calibration applied and no bandpass applied

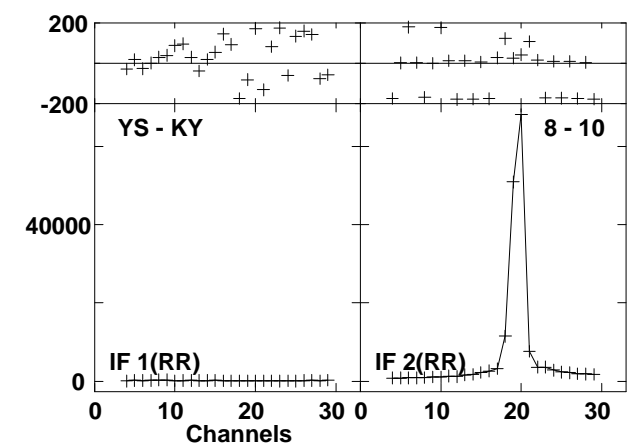
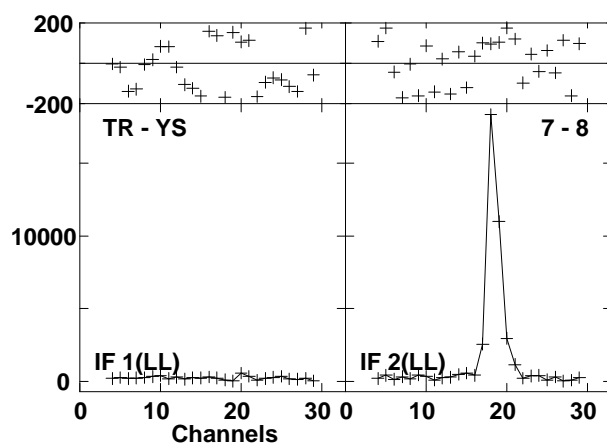
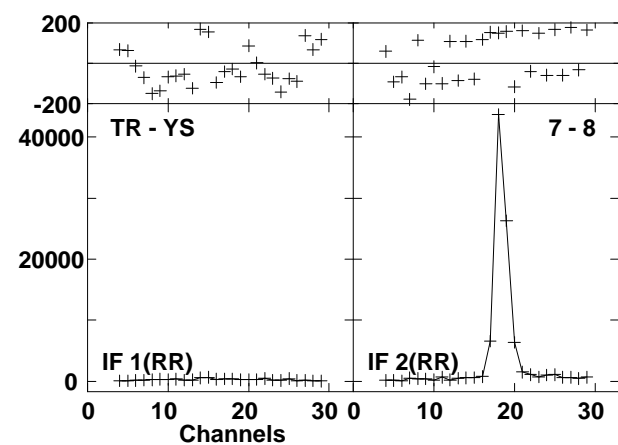
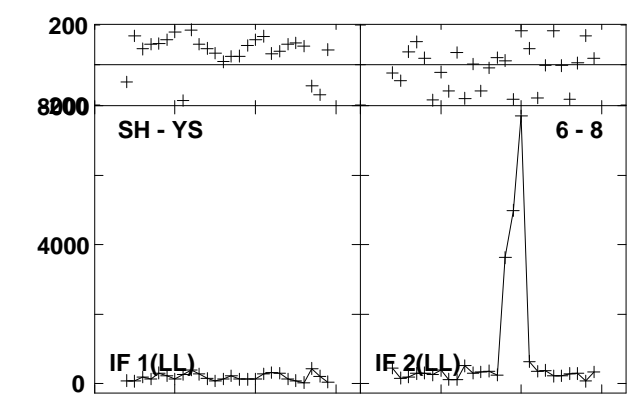
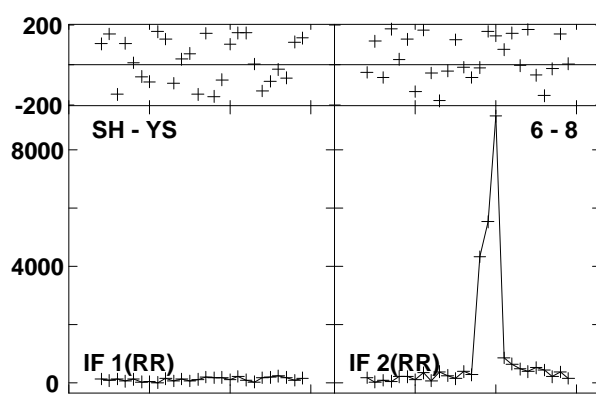
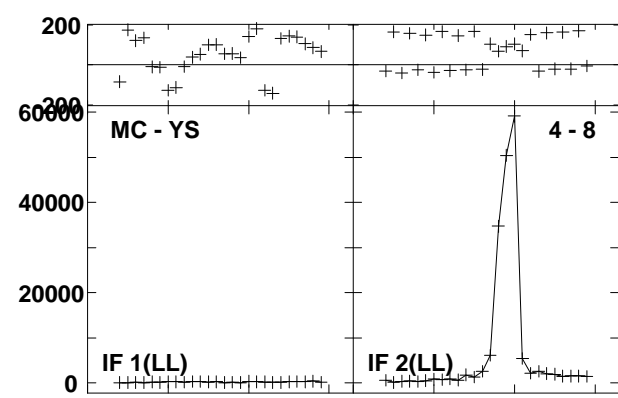
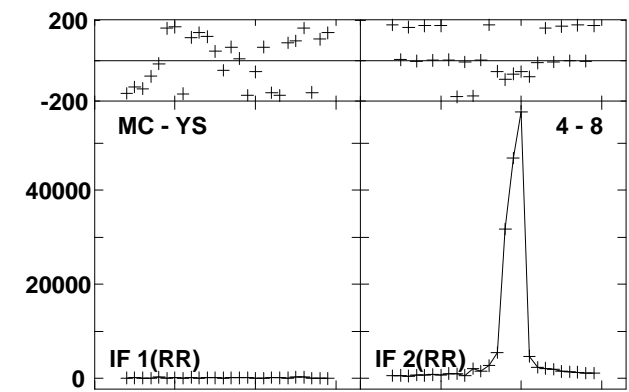
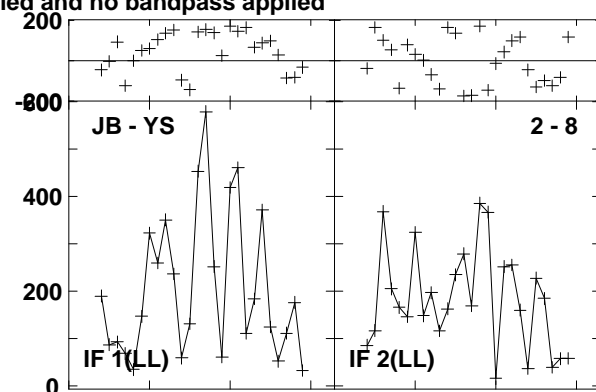
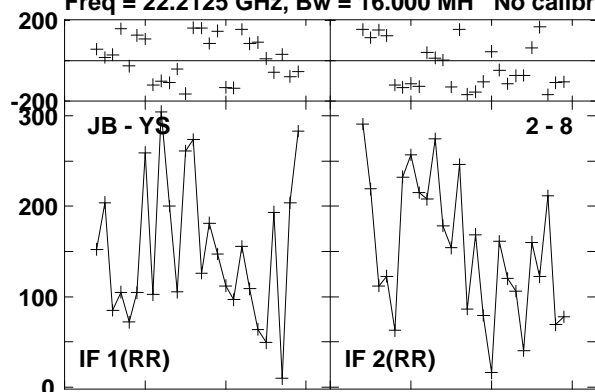

Lower frame: Micro Ampl Jy Top frame: Phas deg  
 Vector averaged cross-power spectrum Baseline: JB (02) - YS (08)  
 Timerange: 00/17:33:00 to 00/17:33:59

Plot file version 751 created 23-AUG-2016 15:01:11  
W3IRS5 GA035B 1.UVDATA.1

Freq = 22.2125 GHz, Bw = 16.000 MH No calibration applied and no bandpass applied

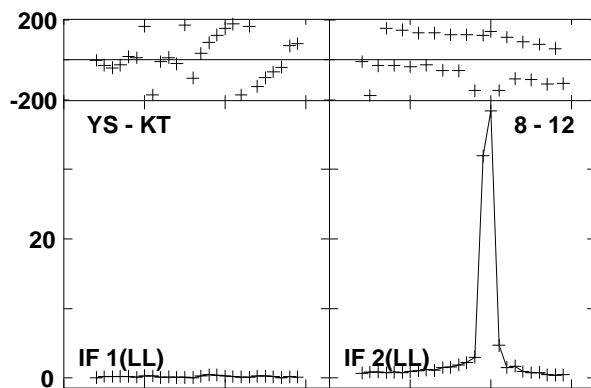
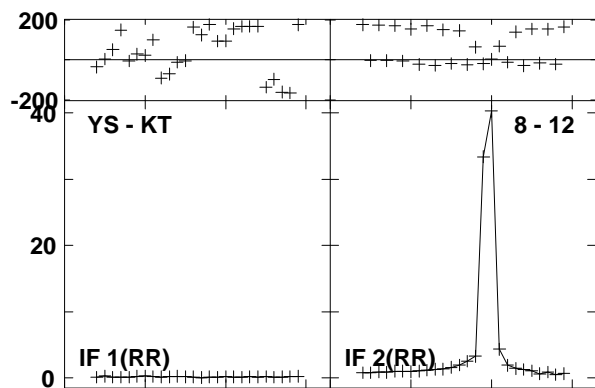
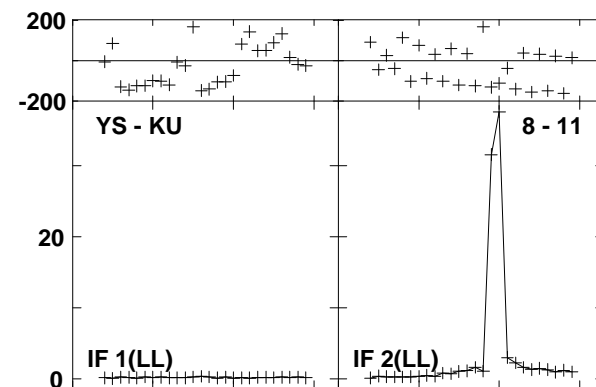
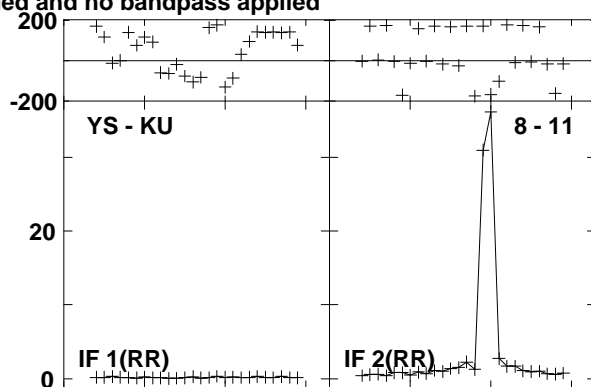
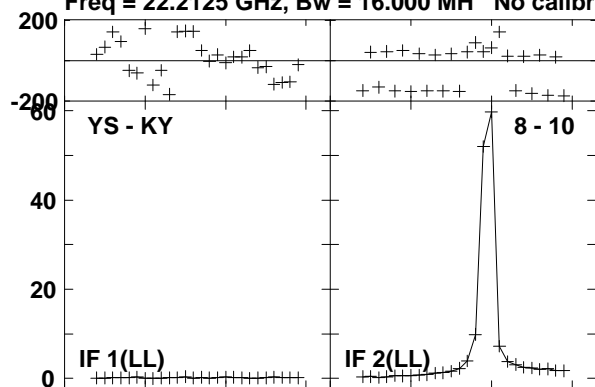

Lower frame: Milli Ampl Jy Top frame: Phas deg  
Vector averaged cross-power spectrum Baseline: YS (08) - KY (10)  
Timerange: 00/17:33:00 to 00/17:33:59

Plot file version 752 created 23-AUG-2016 15:01:11

0219+628 GA035B 1.UVDATA.1

Freq = 22.2125 GHz, Bw = 16.000 MH No calibration applied and no bandpass applied

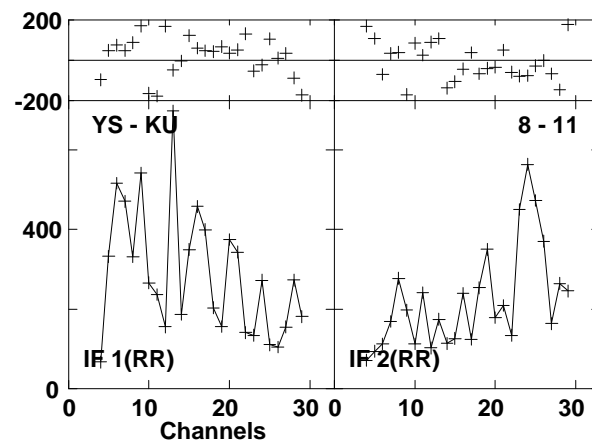
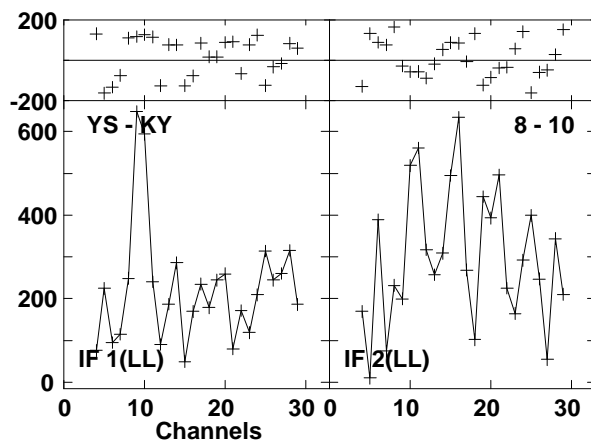
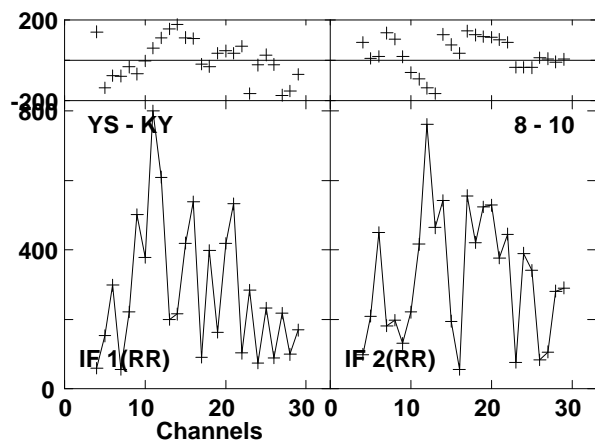
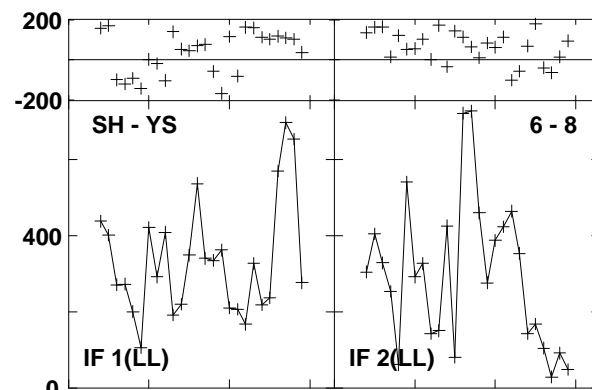
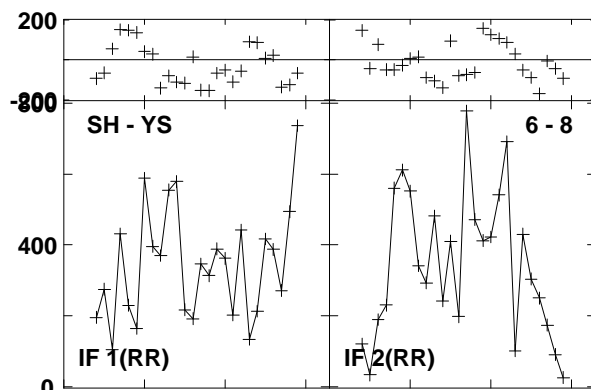
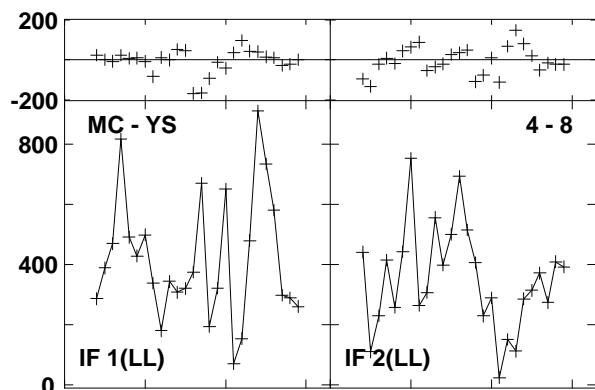
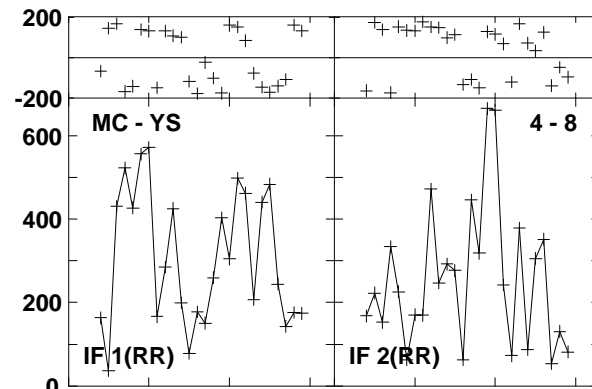
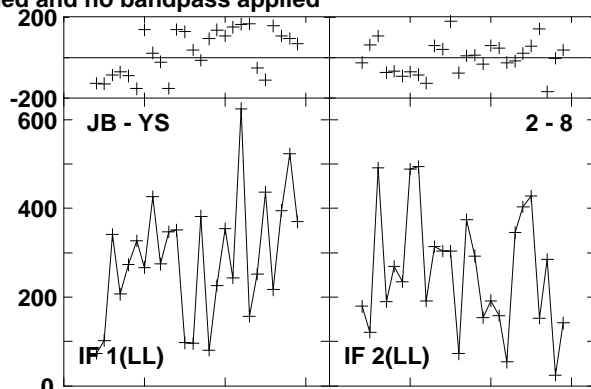
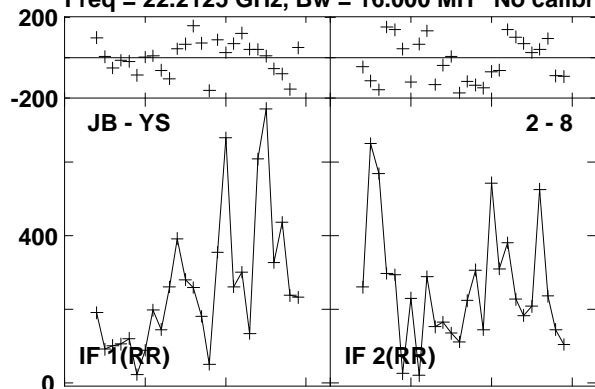

Lower frame: Micro Ampl Jy Top frame: Phas deg  
Vector averaged cross-power spectrum Baseline: JB (02) - YS (08)  
Timerange: 00/17:34:35 to 00/17:34:55



Plot file version 753 created 23-AUG-2016 15:01:11

0219+628 GA035B 1.UVDATA.1

Freq = 22.2125 GHz, Bw = 16.000 MH No calibration applied and no bandpass applied

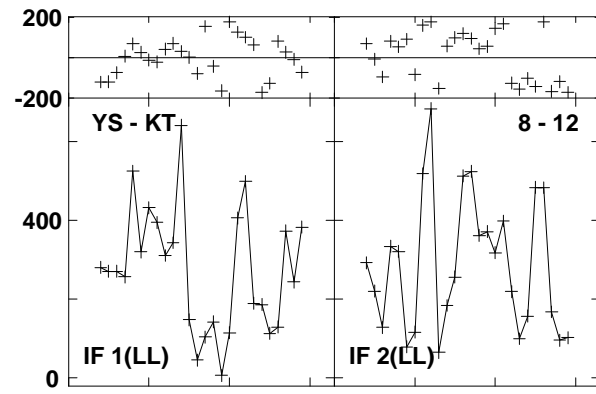
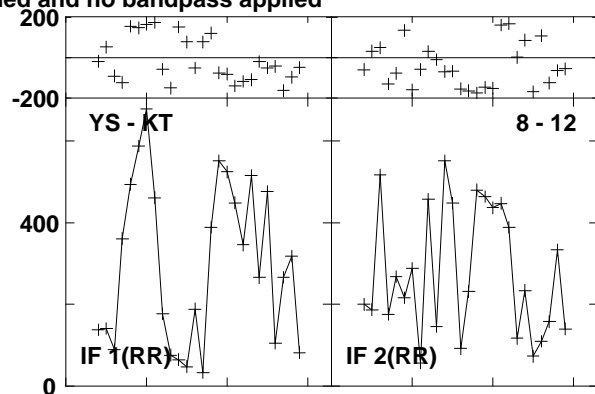
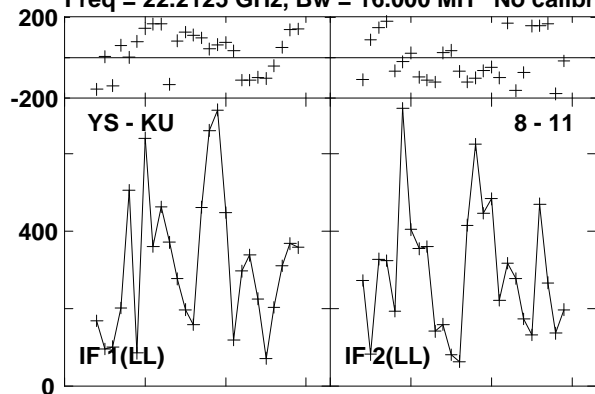

Lower frame: Micro Ampl Jy Top frame: Phas deg  
Vector averaged cross-power spectrum Baseline: YS (08) - KU (11)  
Timerange: 00/17:34:35 to 00/17:34:55

Plot file version 754 created 23-AUG-2016 15:01:11  
 W3IRS5 GA035B 1.UVDATA.1

Freq = 22.2125 GHz, Bw = 16.000 MH No calibration applied and no bandpass applied

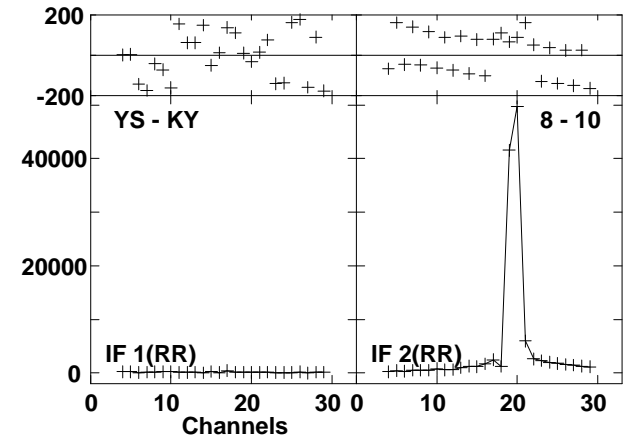
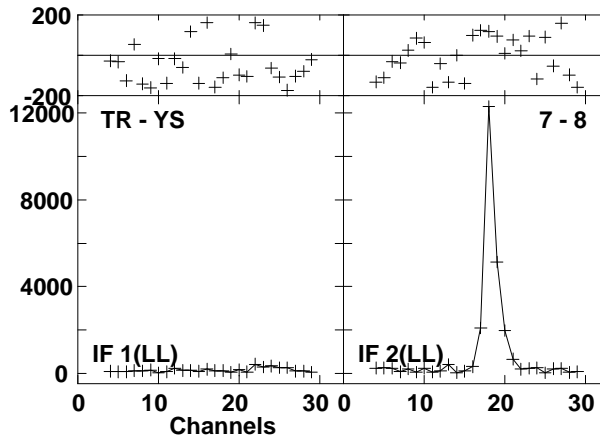
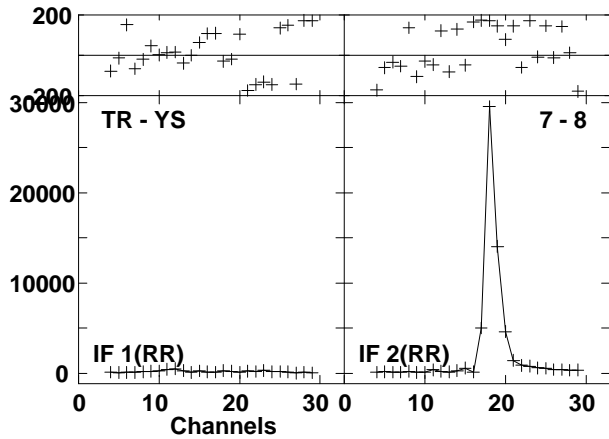
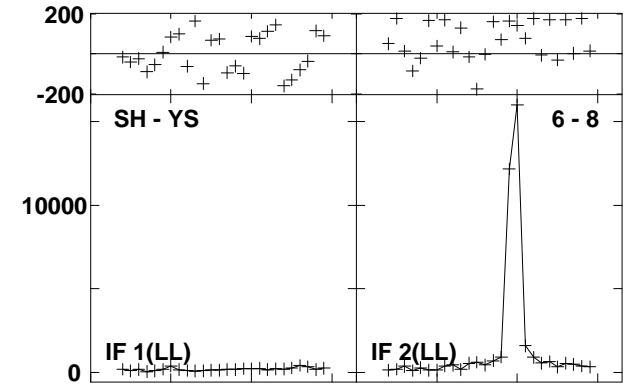
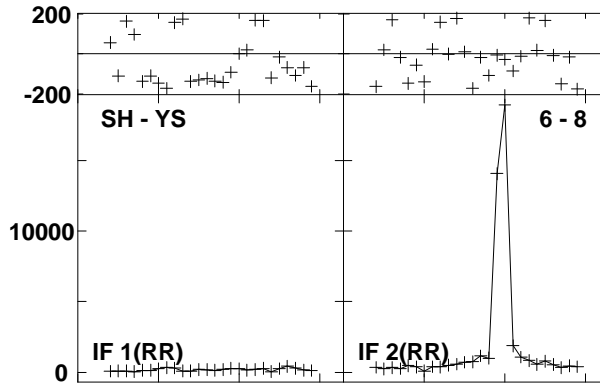
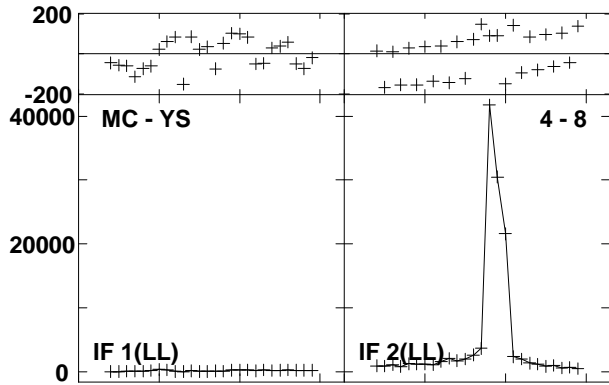
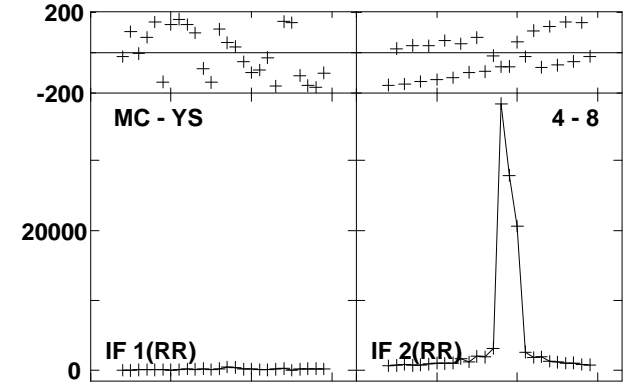
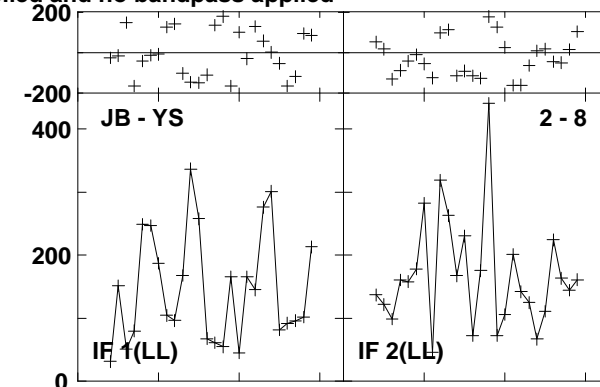
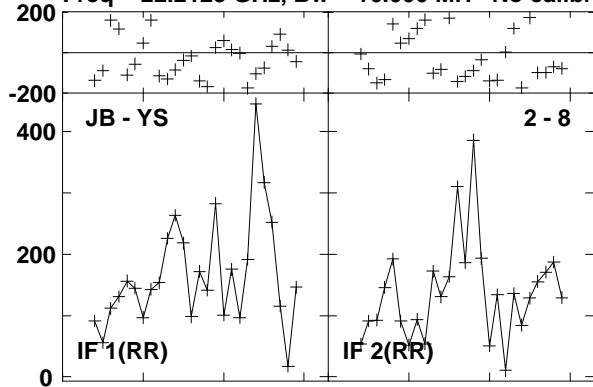

Lower frame: Micro Ampl Jy Top frame: Phas deg  
 Vector averaged cross-power spectrum Baseline: JB (02) - YS (08)  
 Timerange: 00/17:35:31 to 00/17:36:29

Plot file version 755 created 23-AUG-2016 15:01:11  
W3IRS5 GA035B 1.UVDATA.1

Freq = 22.2125 GHz, Bw = 16.000 MH No calibration applied and no bandpass applied

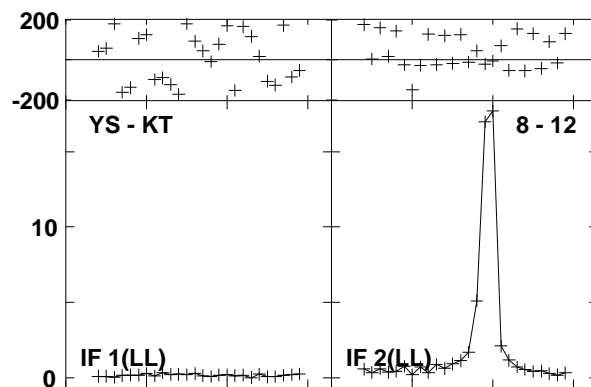
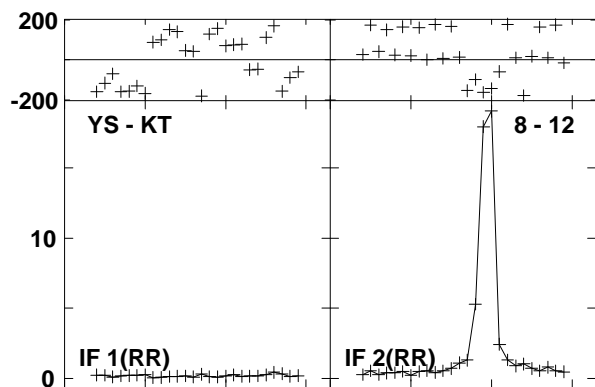
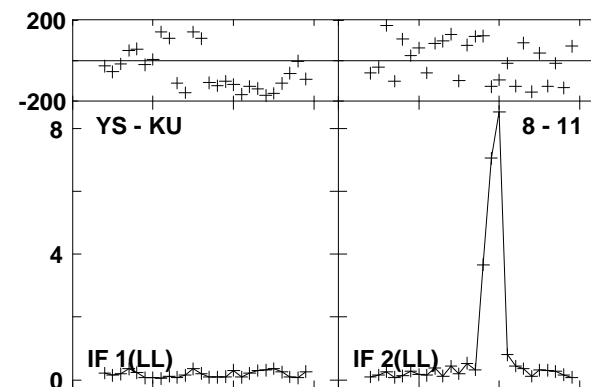
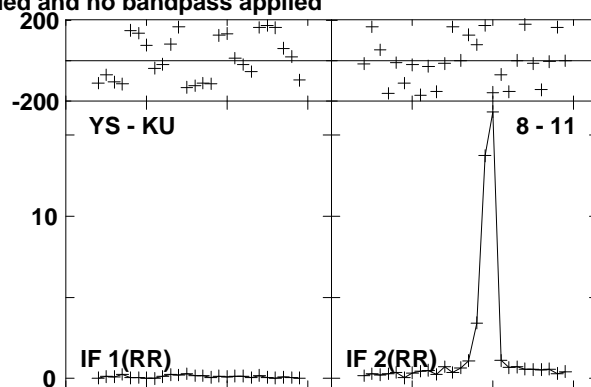
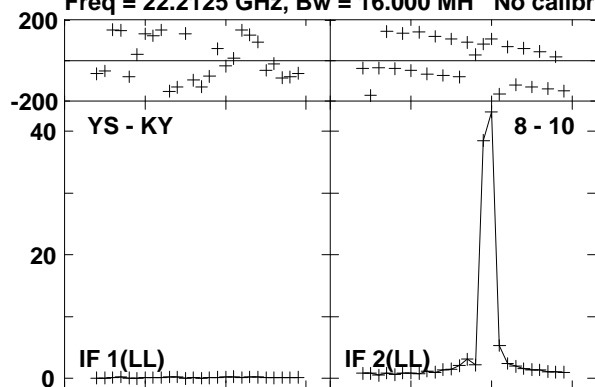

Lower frame: Milli Ampl Jy Top frame: Phas deg  
Vector averaged cross-power spectrum Baseline: YS (08) - KY (10)  
Timerange: 00/17:35:31 to 00/17:36:29

Plot file version 756 created 23-AUG-2016 15:01:11

0219+628 GA035B 1.UVDATA.1

Freq = 22.2125 GHz, Bw = 16.000 MH No calibration applied and no bandpass applied

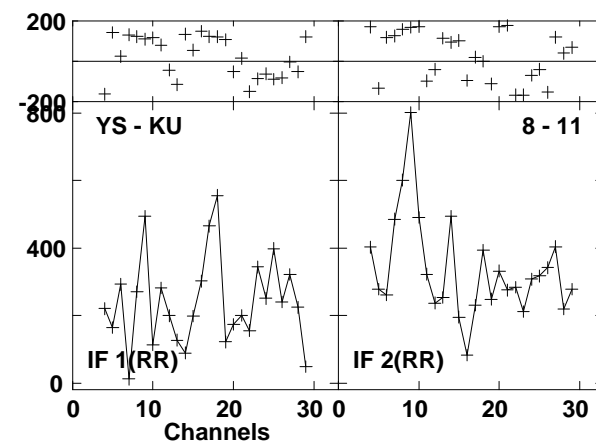
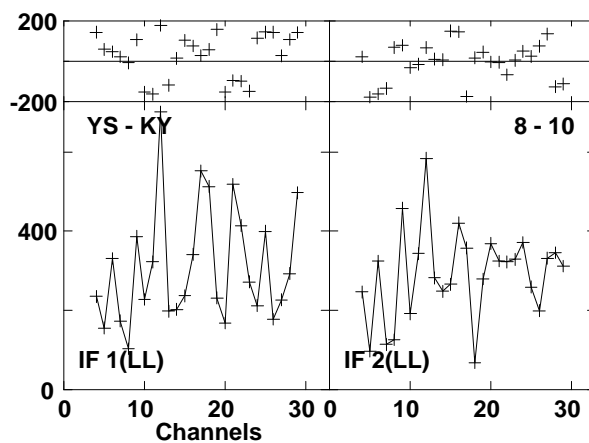
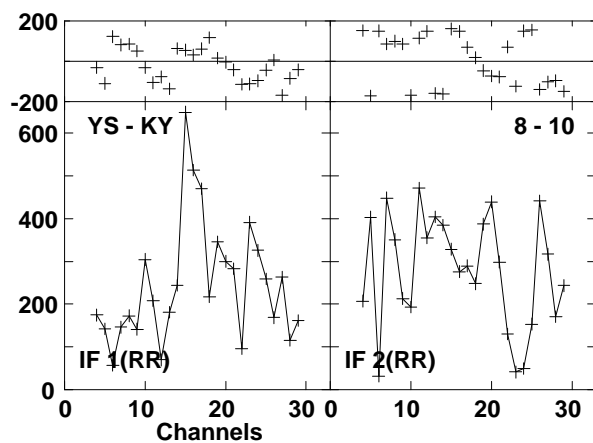
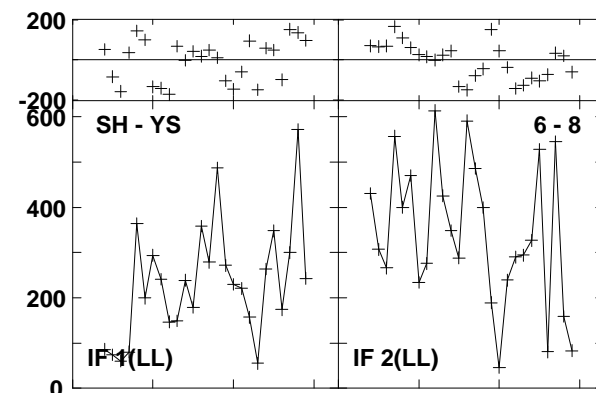
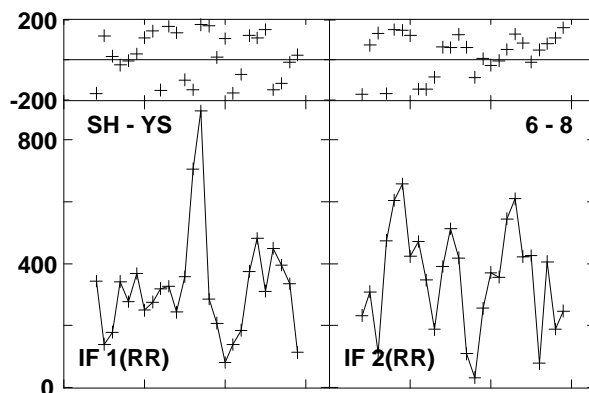
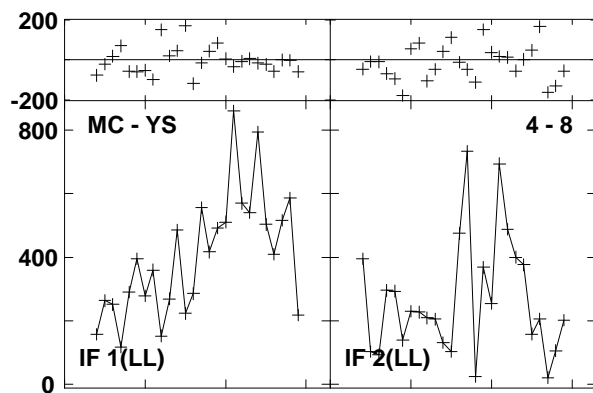
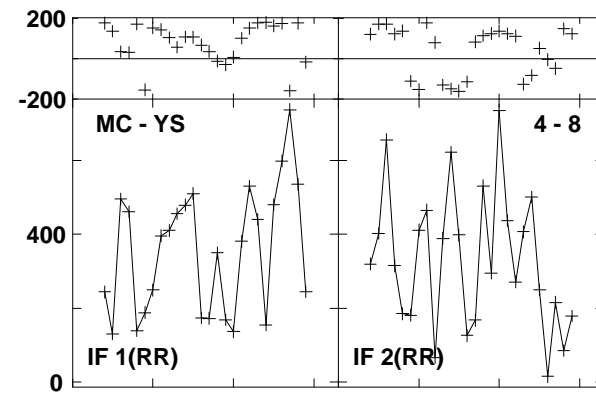
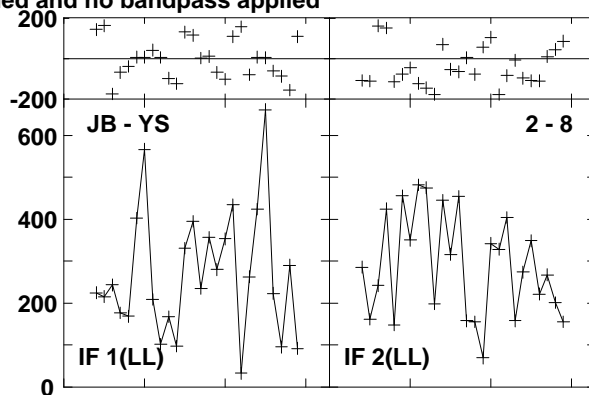
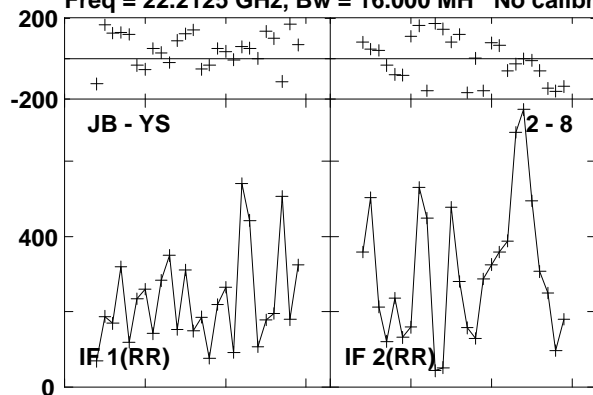

Lower frame: Micro Ampl Jy Top frame: Phas deg  
Vector averaged cross-power spectrum Baseline: JB (02) - YS (08)  
Timerange: 00/17:37:06 to 00/17:37:24

Plot file version 757 created 23-AUG-2016 15:01:11

0219+628 GA035B 1.UVDATA.1

Freq = 22.2125 GHz, Bw = 16.000 MH No calibration applied and no bandpass applied

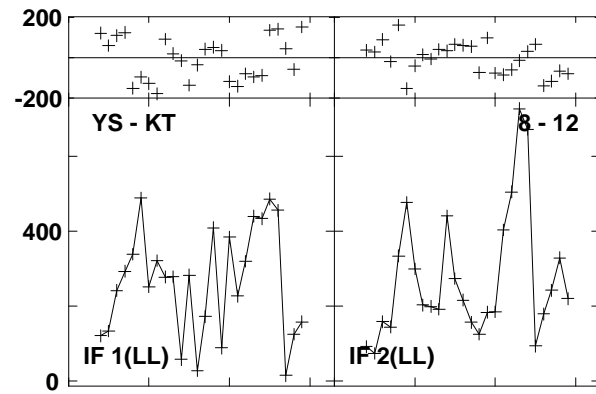
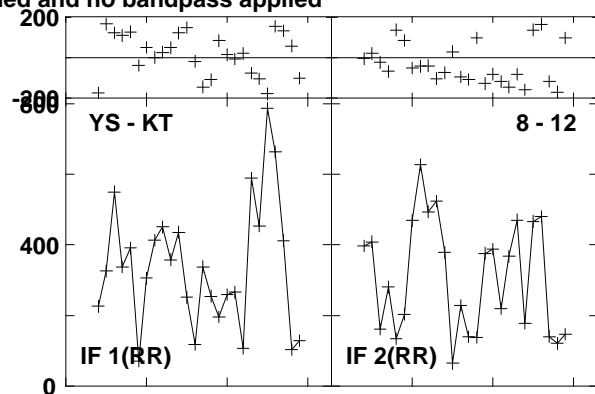
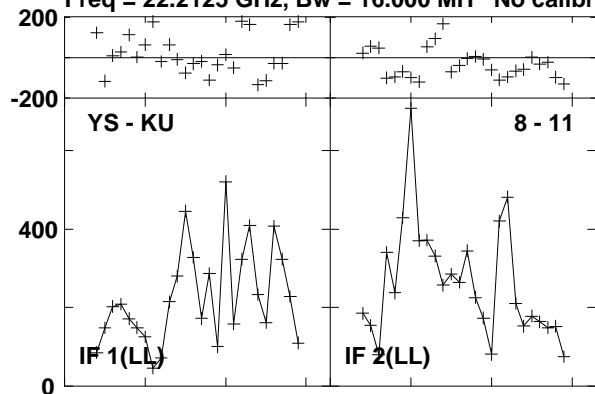

Lower frame: Micro Ampl Jy Top frame: Phas deg  
Vector averaged cross-power spectrum Baseline: YS (08) - KU (11)  
Timerange: 00/17:37:06 to 00/17:37:24

Plot file version 758 created 23-AUG-2016 15:01:11  
W3IRS5 GA035B 1.UVDATA.1

Freq = 22.2125 GHz, Bw = 16.000 MH No calibration applied and no bandpass applied

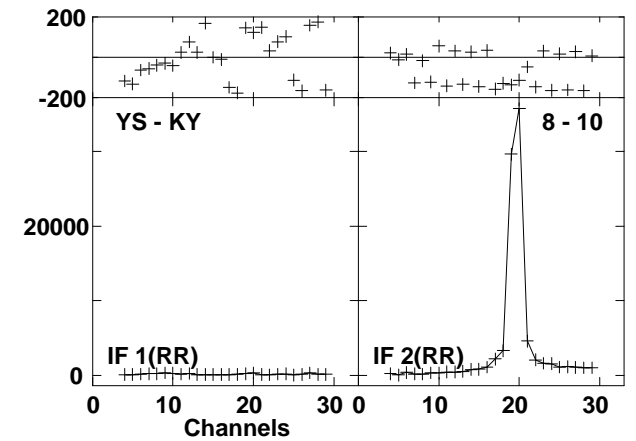
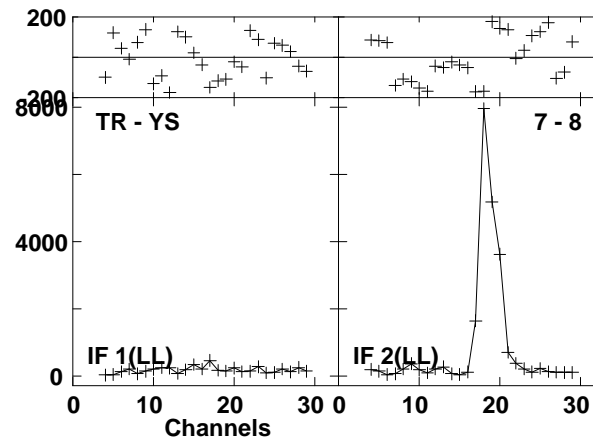
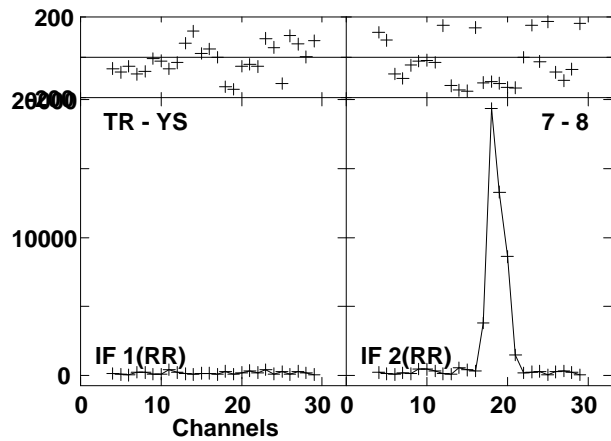
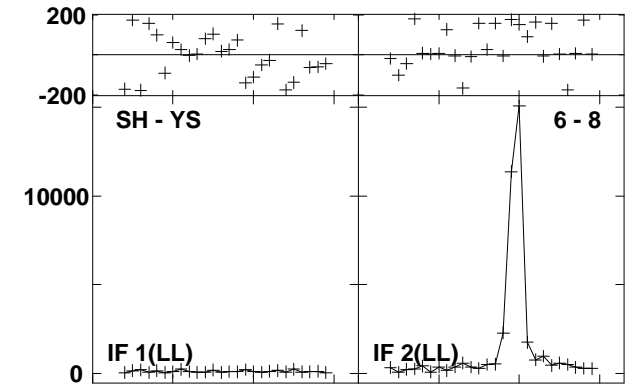
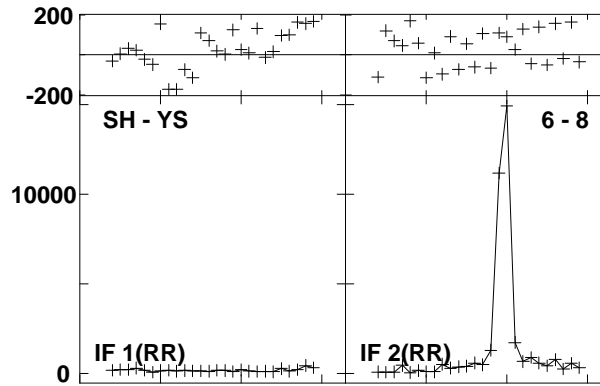
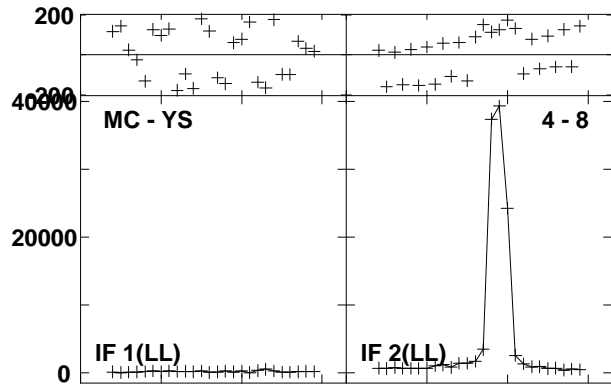
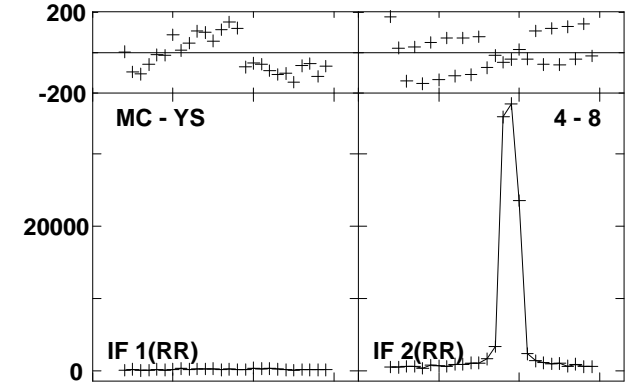
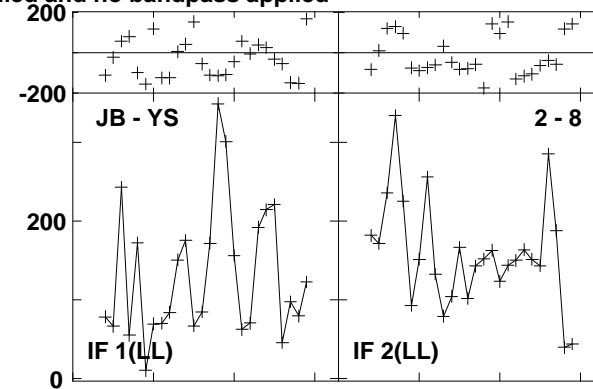
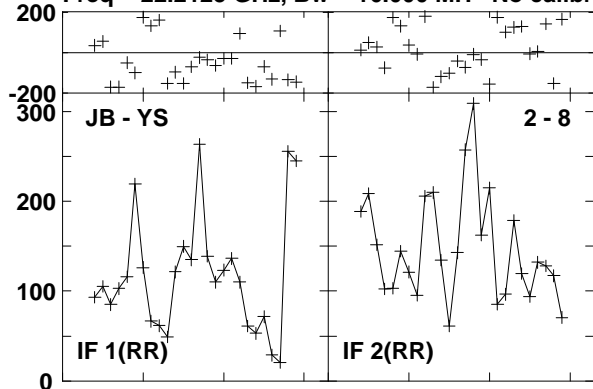

Lower frame: Micro Ampl Jy Top frame: Phas deg  
Vector averaged cross-power spectrum Baseline: JB (02) - YS (08)  
Timerange: 00/17:38:01 to 00/17:38:59

Plot file version 759 created 23-AUG-2016 15:01:11  
W3IRS5 GA035B 1.UVDATA.1

Freq = 22.2125 GHz, Bw = 16.000 MH No calibration applied and no bandpass applied

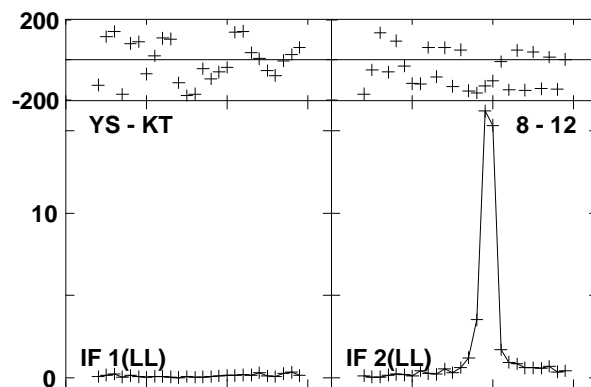
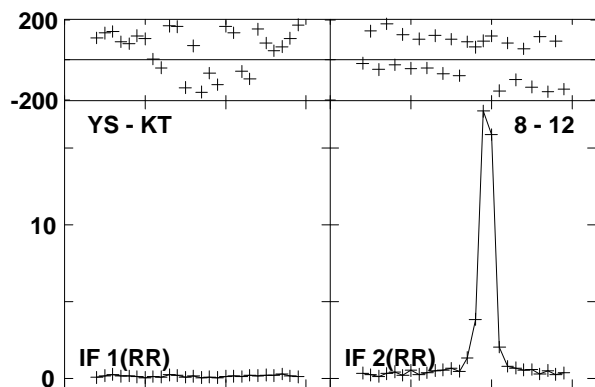
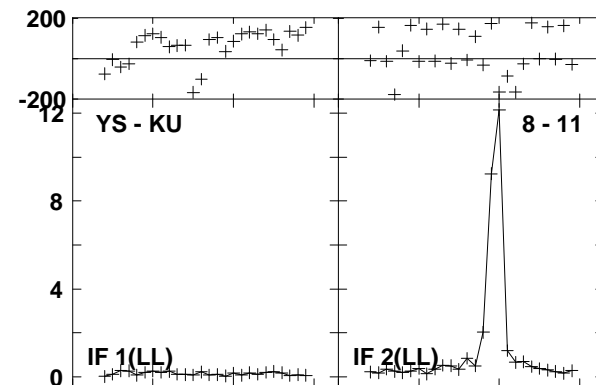
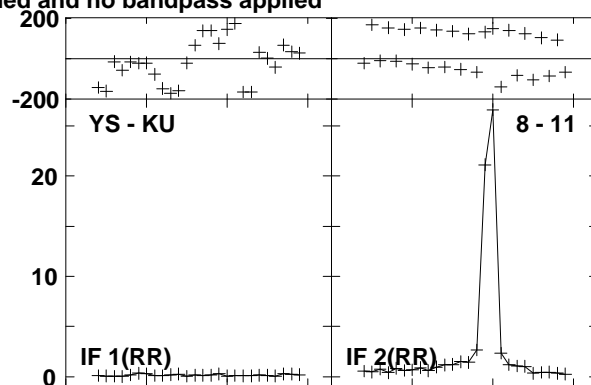
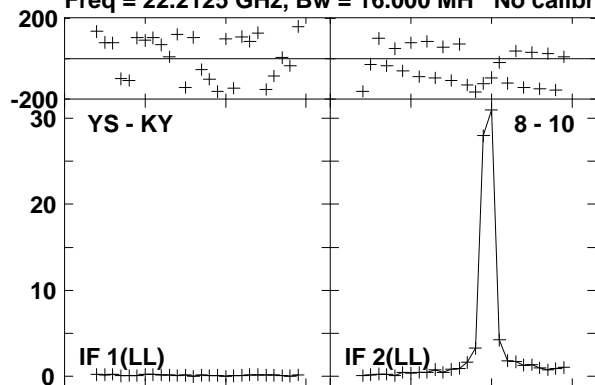

Lower frame: Milli Ampl Jy Top frame: Phas deg  
Vector averaged cross-power spectrum Baseline: YS (08) - KY (10)  
Timerange: 00/17:38:01 to 00/17:38:59

Plot file version 760 created 23-AUG-2016 15:01:12

0219+628 GA035B 1.UVDATA.1

Freq = 22.2125 GHz, Bw = 16.000 MH No calibration applied and no bandpass applied

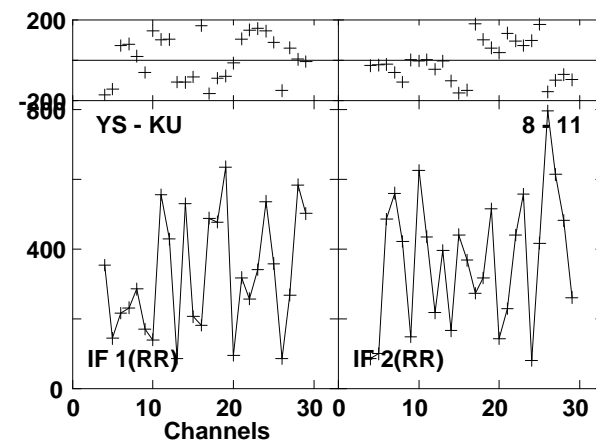
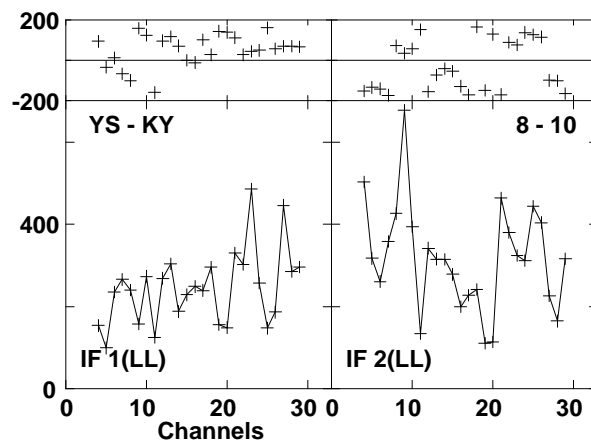
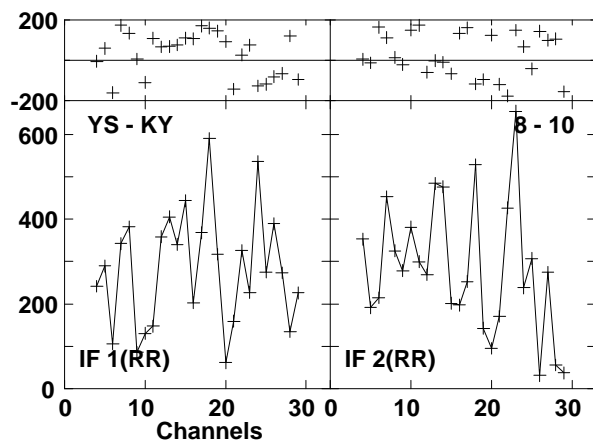
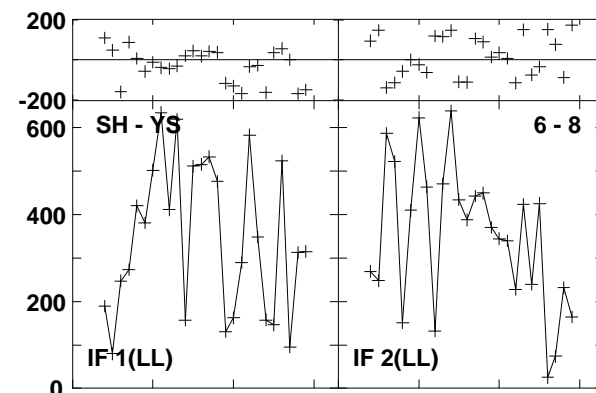
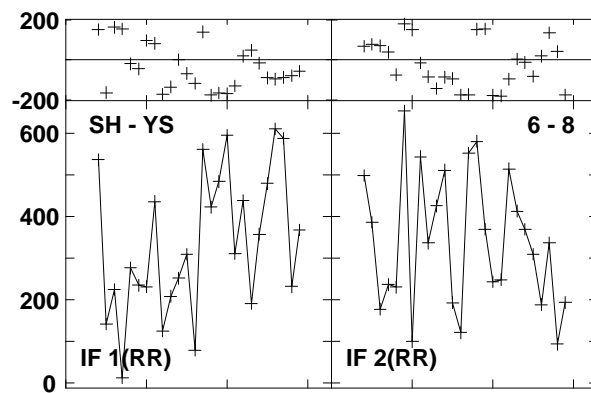
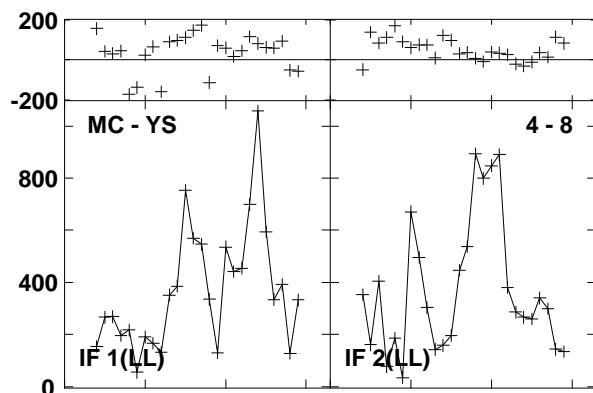
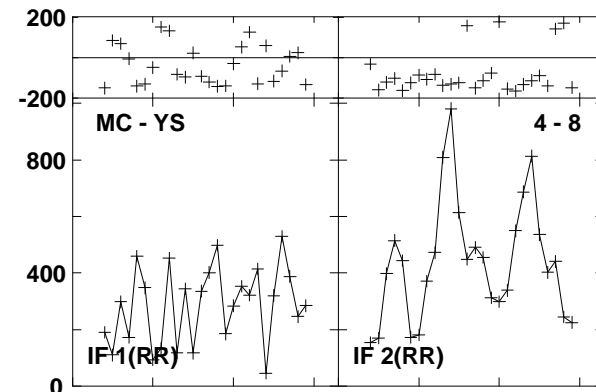
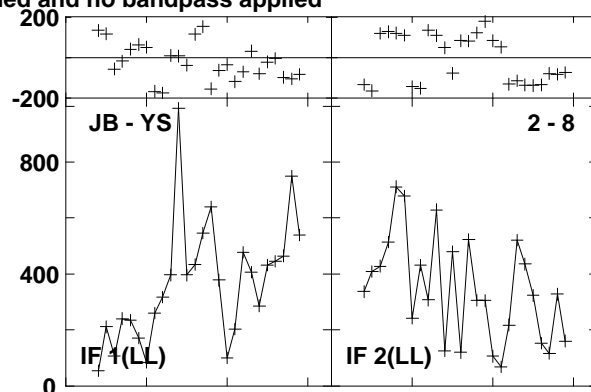
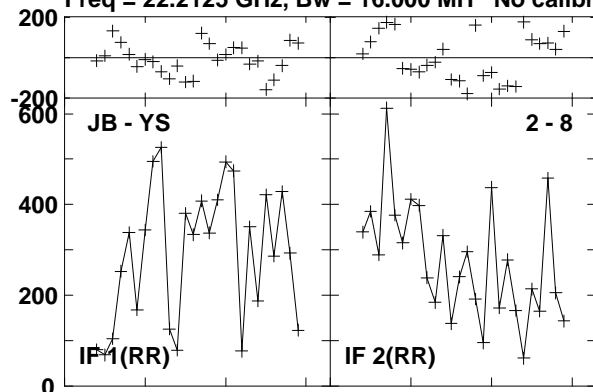

Lower frame: Micro Ampl Jy Top frame: Phas deg  
Vector averaged cross-power spectrum Baseline: JB (02) - YS (08)  
Timerange: 00/17:39:36 to 00/17:39:54



Plot file version 761 created 23-AUG-2016 15:01:12

0219+628 GA035B 1.UVDATA.1

Freq = 22.2125 GHz, Bw = 16.000 MH No calibration applied and no bandpass applied

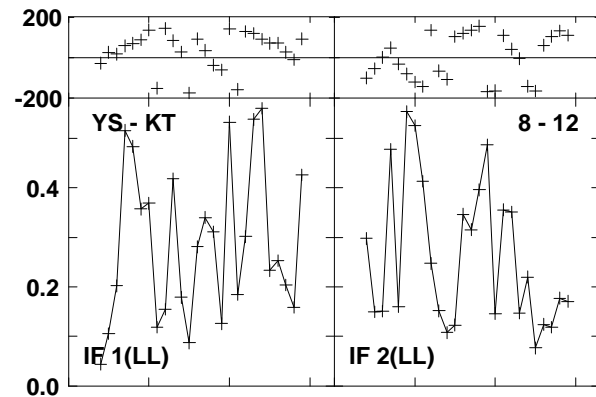
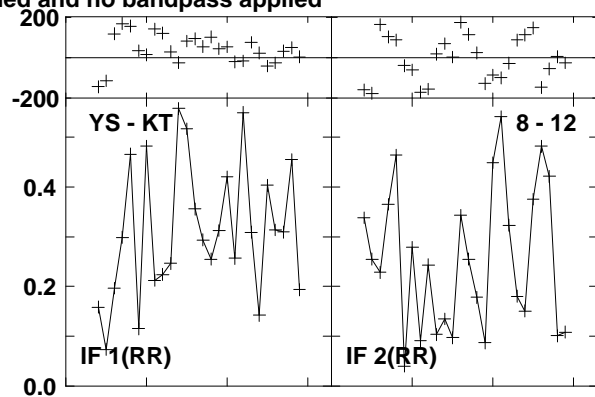
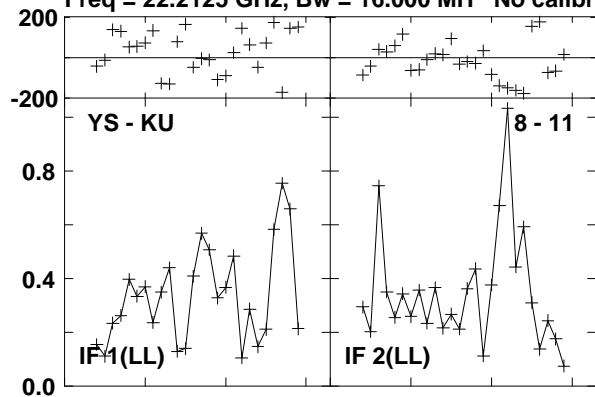

Lower frame: Milli Ampl Jy Top frame: Phas deg  
Vector averaged cross-power spectrum Baseline: YS (08) - KU (11)  
Timerange: 00/17:39:36 to 00/17:39:54

Plot file version 762 created 23-AUG-2016 15:01:12

0241+622 GA035B 1.UVDATA.1

Freq = 22.2125 GHz, Bw = 16.000 MH No calibration applied and no bandpass applied

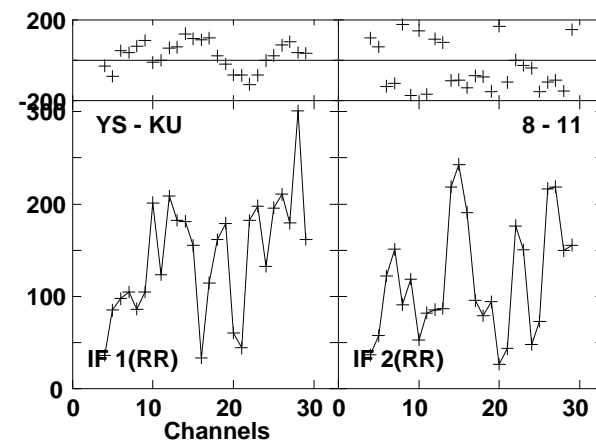
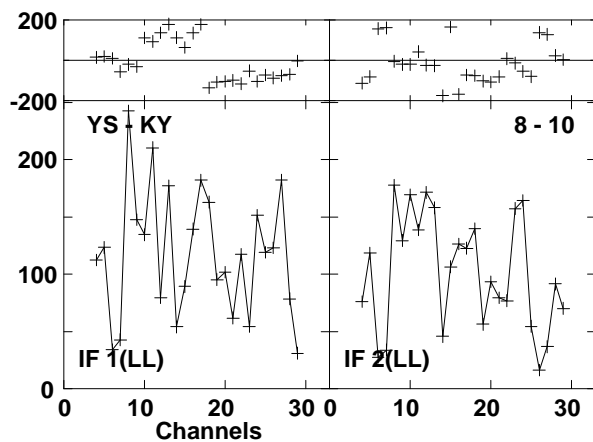
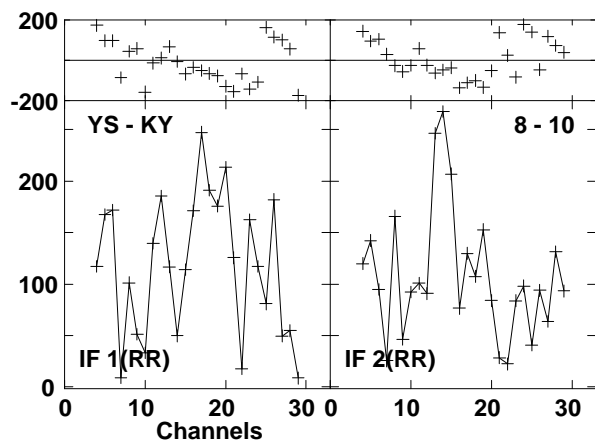
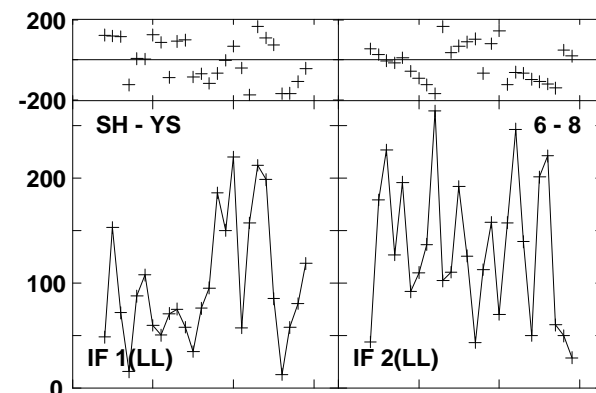
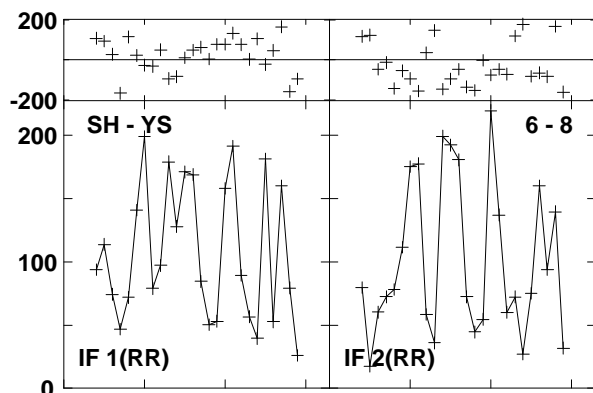
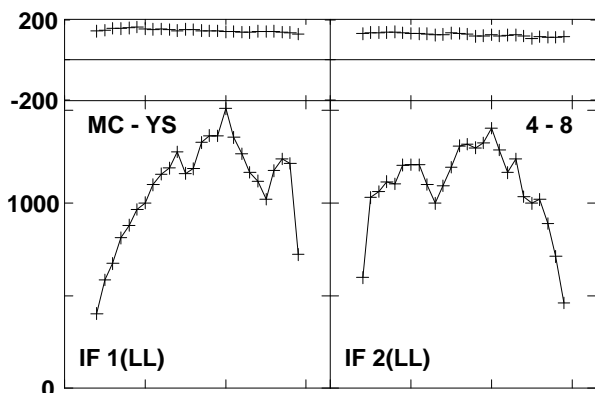
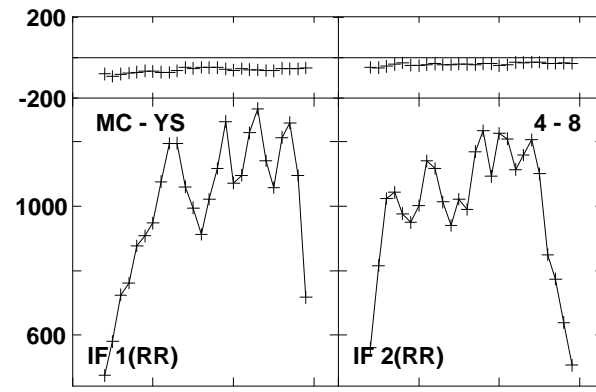
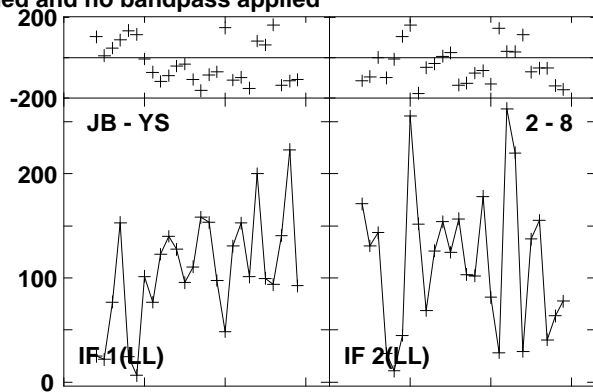
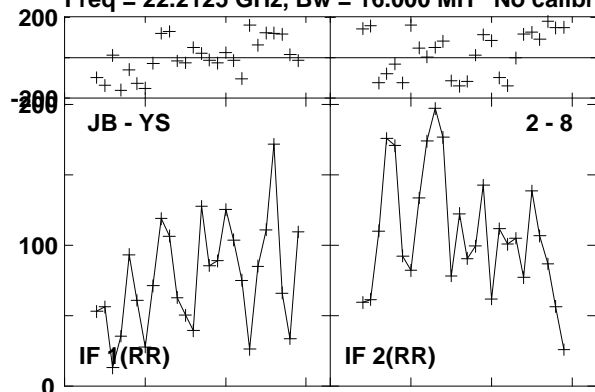

Lower frame: Micro Ampl Jy Top frame: Phas deg  
Vector averaged cross-power spectrum Baseline: JB (02) - YS (08)  
Timerange: 00:17:41:26 to 00:17:43:25

Plot file version 763 created 23-AUG-2016 15:01:12

0241+622 GA035B 1.UVDATA.1

Freq = 22.2125 GHz, Bw = 16.000 MH No calibration applied and no bandpass applied

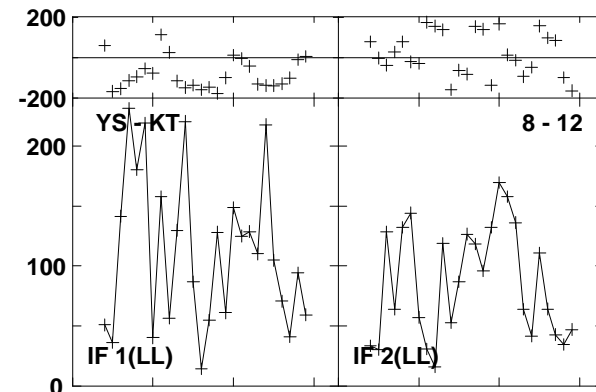
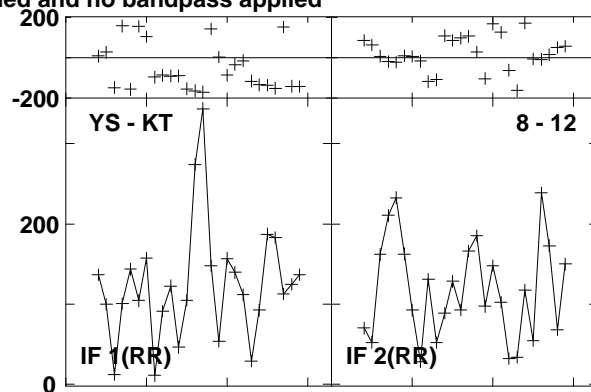
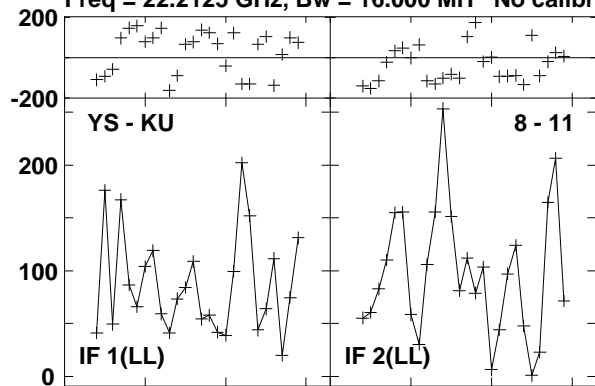

Lower frame: Micro Ampl Jy Top frame: Phas deg  
Vector averaged cross-power spectrum Baseline: YS (08) - KU (11)  
Timerange: 00/17:41:26 to 00/17:43:25

Plot file version 764 created 23-AUG-2016 15:01:12

0219+628 GA035B 1.UVDATA.1

Freq = 22.2125 GHz, Bw = 16.000 MH No calibration applied and no bandpass applied

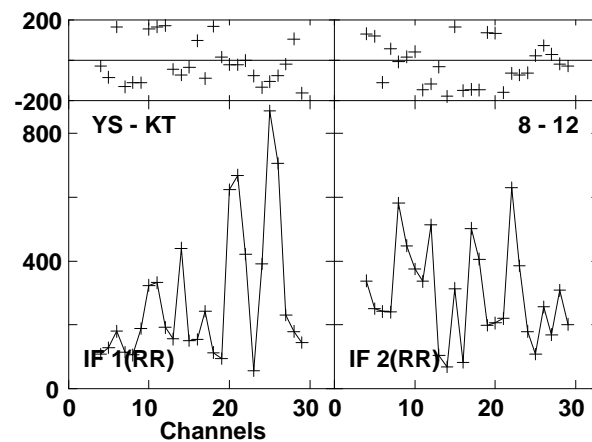
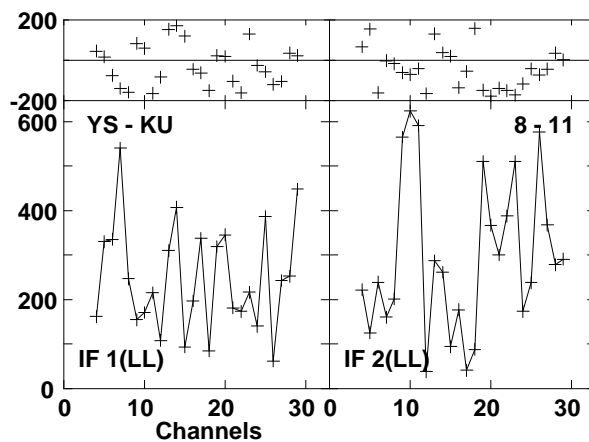
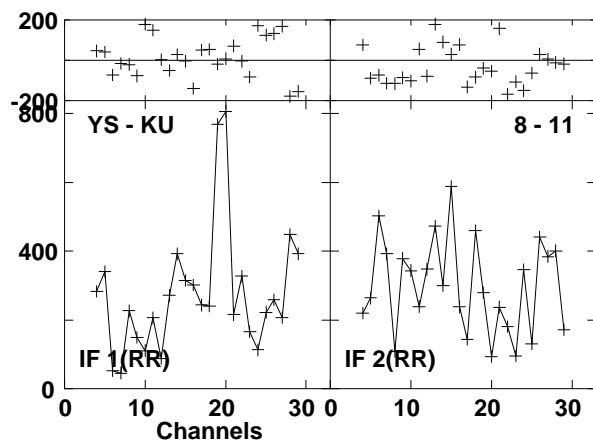
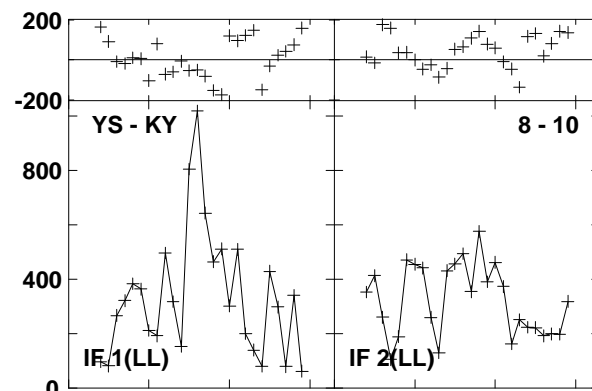
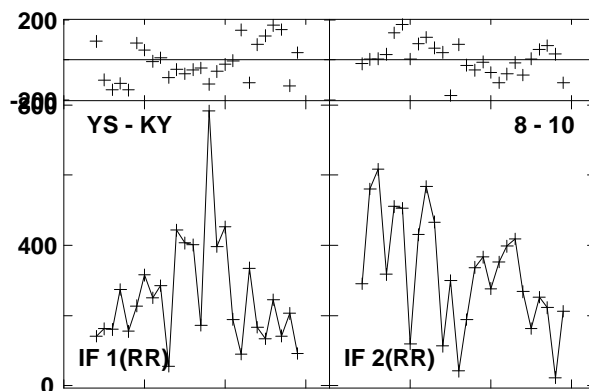
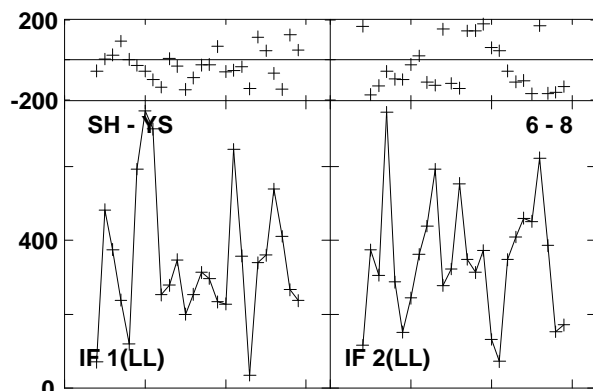
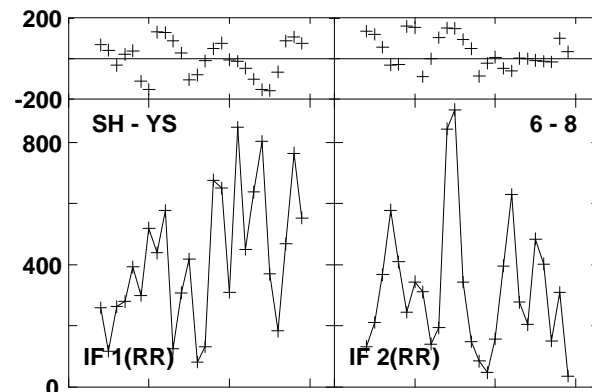
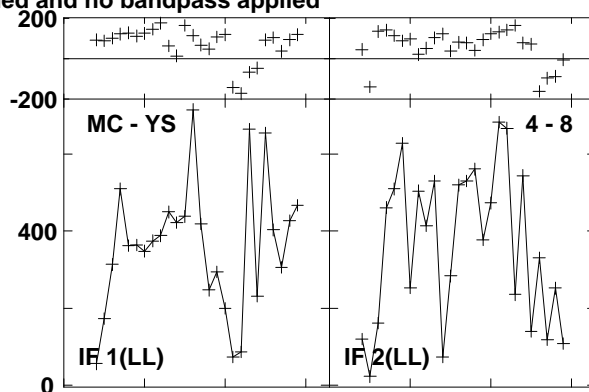
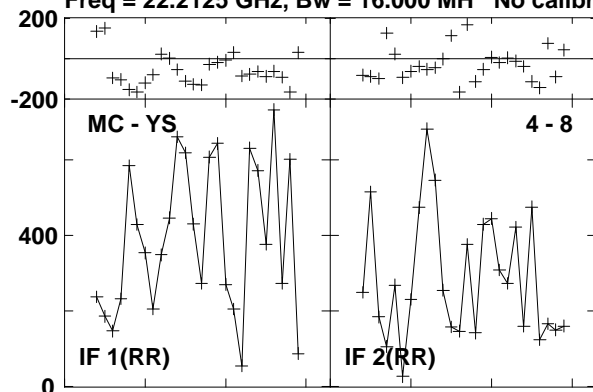

Lower frame: Micro Ampl Jy Top frame: Phas deg  
Vector averaged cross-power spectrum Baseline: MC (04) - YS (08)  
Timerange: 00/17:44:01 to 00/17:44:20

Plot file version 765 created 23-AUG-2016 15:01:12  
0219+628 GA035B 1.UVDATA.1  
Freq = 22.2125 GHz, Bw = 16.000 MH No calibration applied and no bandpass applied

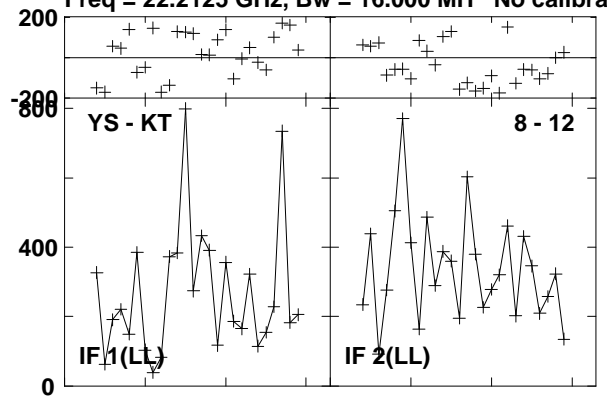

Lower frame: Micro Ampl Jy Top frame: Phas deg  
Vector averaged cross-power spectrum Baseline: YS (08) - KT (12)  
Timerange: 00/17:44:01 to 00/17:44:20

Plot file version 766 created 23-AUG-2016 15:01:12

W3IRS5 GA035B 1.UVDATA.1

Freq = 22.2125 GHz, Bw = 16.000 MH No calibration applied and no bandpass applied

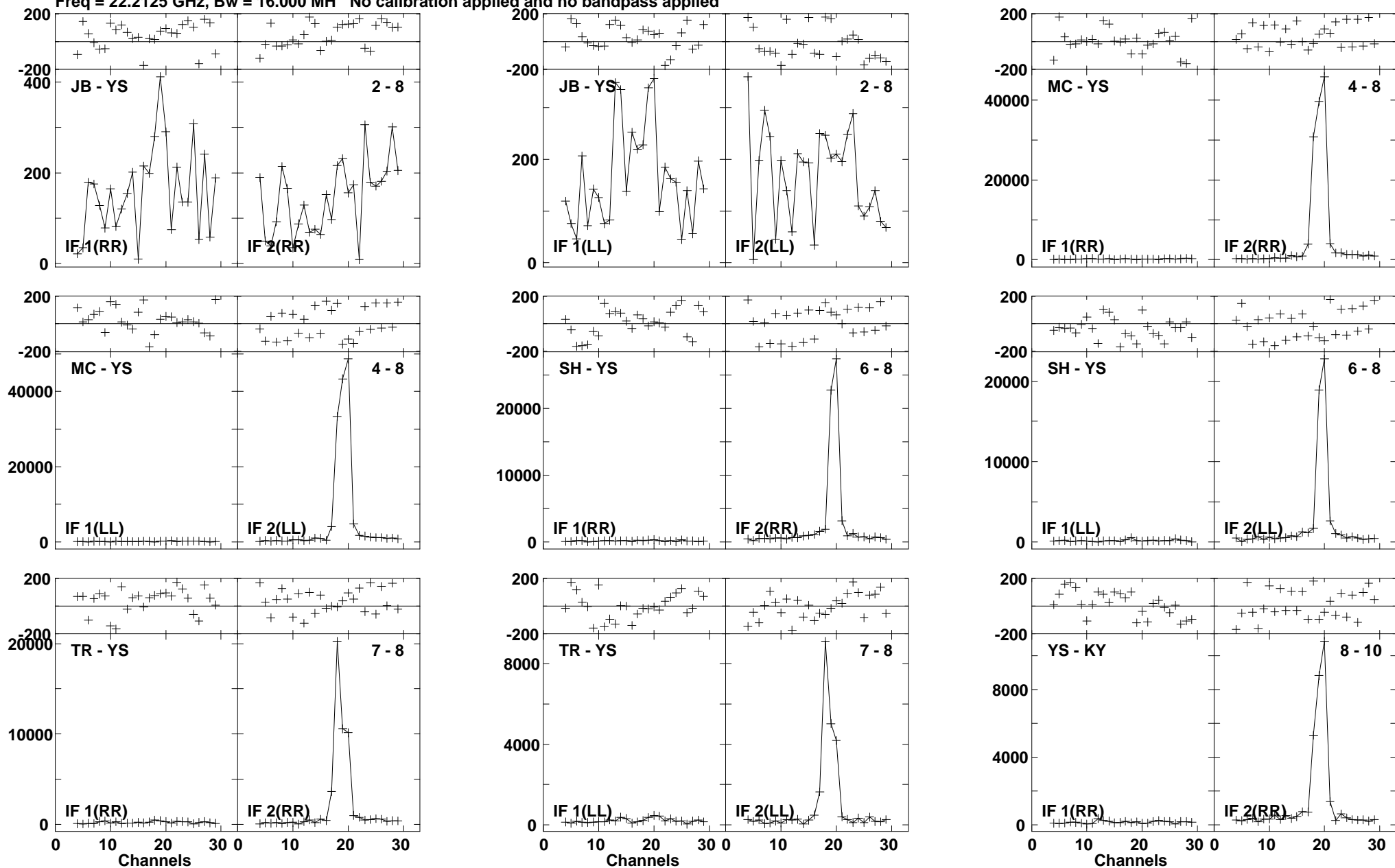

Lower frame: Micro Ampl Jy Top frame: Phas deg  
Vector averaged cross-power spectrum Baseline: JB (02) - YS (08)  
Timerange: 00/17:44:56 to 00/17:45:55

Plot file version 767 created 23-AUG-2016 15:01:12

W3IRS5 GA035B 1.UVDATA.1

Freq = 22.2125 GHz, Bw = 16.000 MH No calibration applied and no bandpass applied

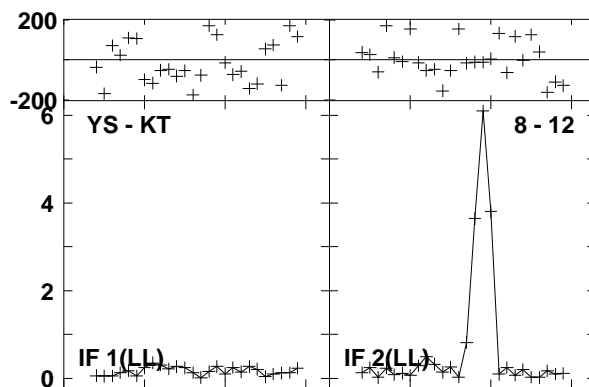
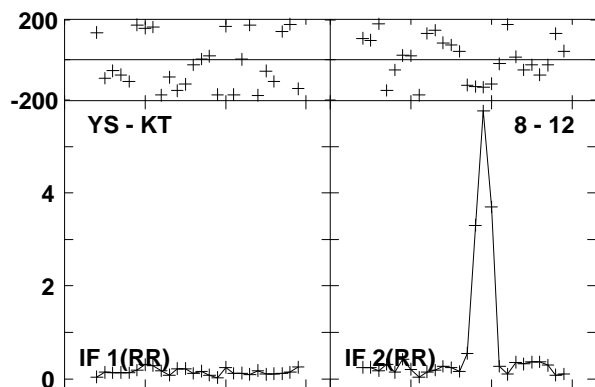
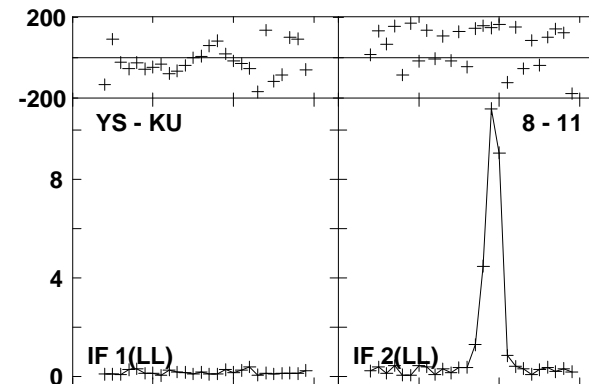
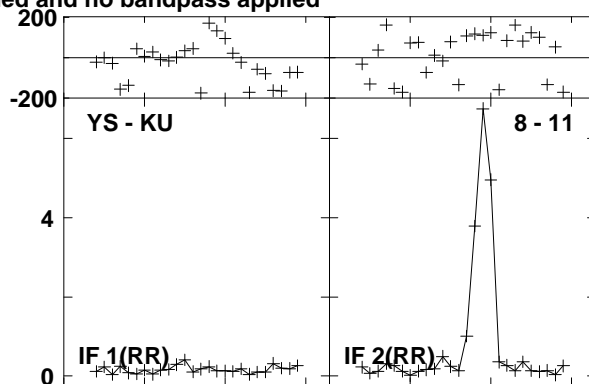
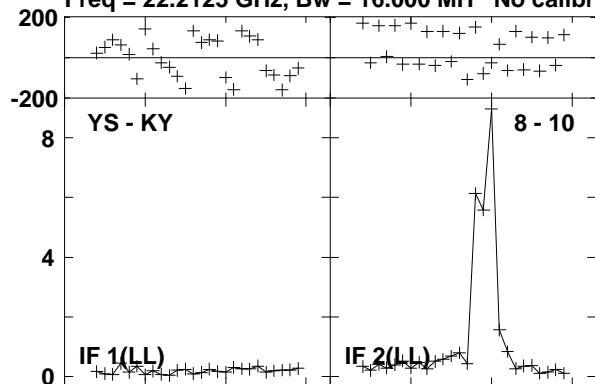

Lower frame: Milli Ampl Jy Top frame: Phas deg  
Vector averaged cross-spectrum Baseline: YS (08) - KY (10)  
Timerange: 00/17:44:56 to 00/17:45:55

Plot file version 768 created 23-AUG-2016 15:01:12

0219+628 GA035B 1.UVDATA.1

Freq = 22.2125 GHz, Bw = 16.000 MH No calibration applied and no bandpass applied

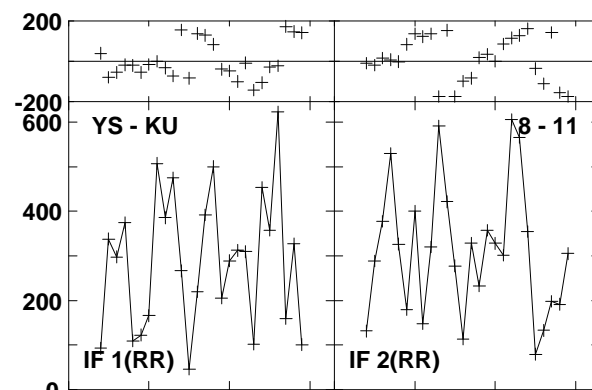
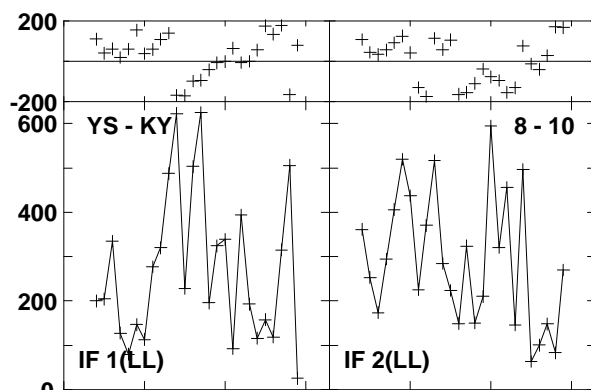
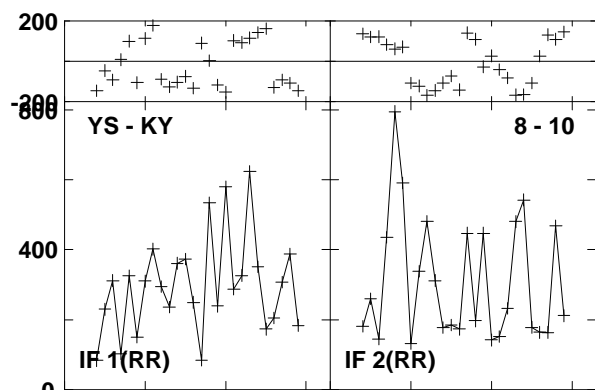
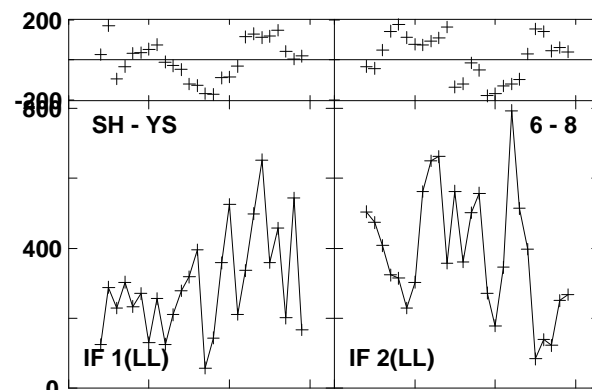
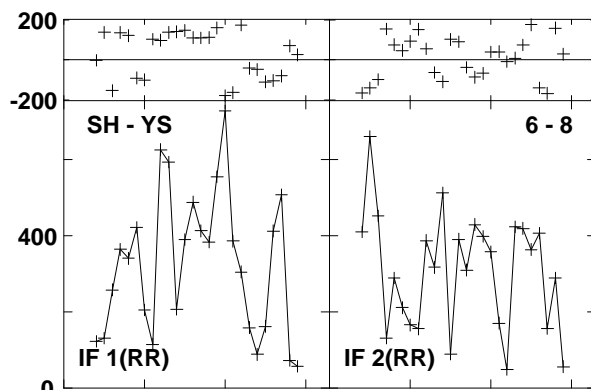
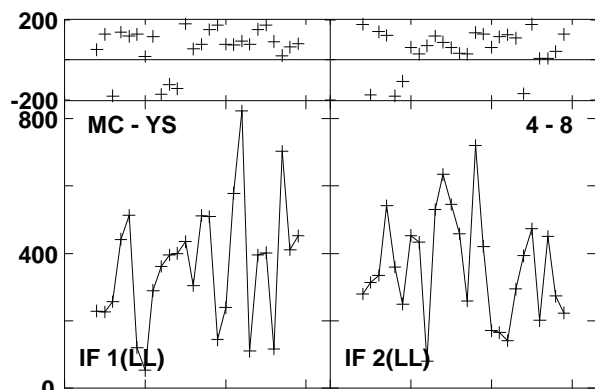
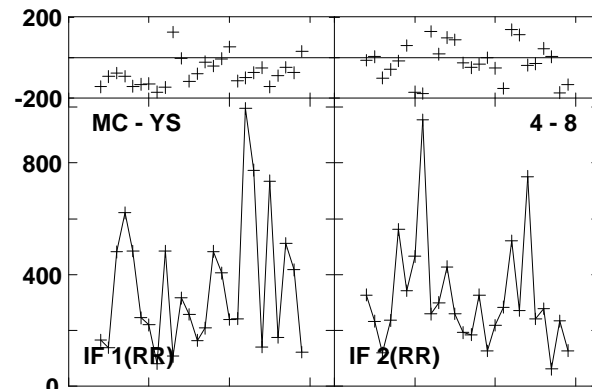
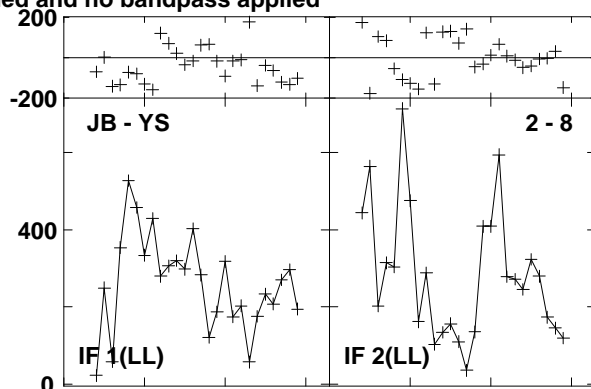
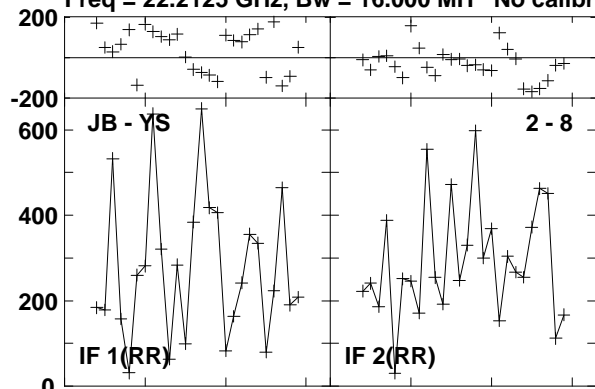

Lower frame: Micro Ampl Jy Top frame: Phas deg  
Vector averaged cross-power spectrum Baseline: JB (02) - YS (08)  
Timerange: 00/17:46:32 to 00/17:46:50



Plot file version 769 created 23-AUG-2016 15:01:12

0219+628 GA035B 1.UVDATA.1

Freq = 22.2125 GHz, Bw = 16.000 MH No calibration applied and no bandpass applied

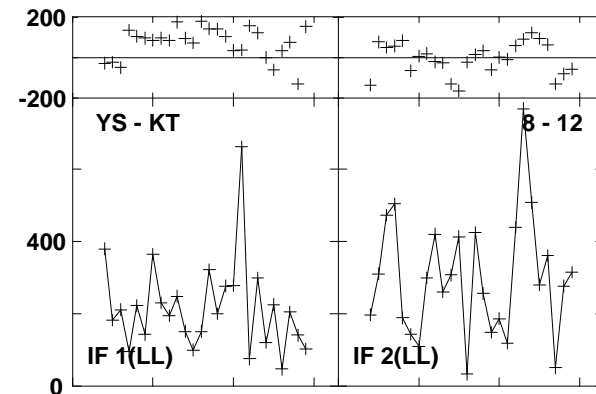
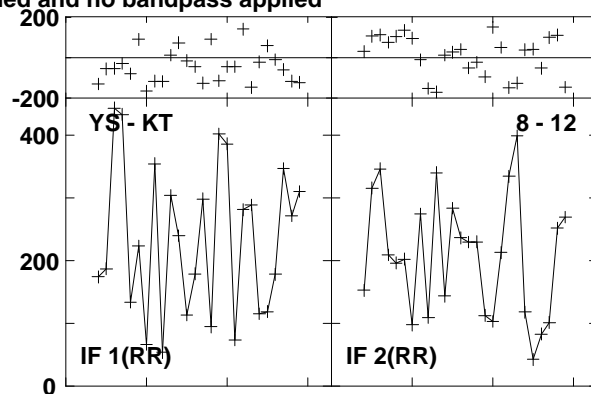
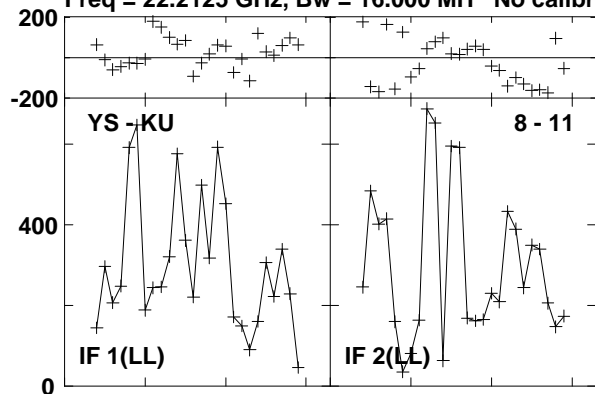

Lower frame: Micro Ampl Jy Top frame: Phas deg  
Vector averaged cross-power spectrum Baseline: YS (08) - KU (11)  
Timerange: 00/17:46:32 to 00/17:46:50

Plot file version 770 created 23-AUG-2016 15:01:12  
 W3IRS5 GA035B 1.UVDATA.1

Freq = 22.2125 GHz, Bw = 16.000 MH No calibration applied and no bandpass applied

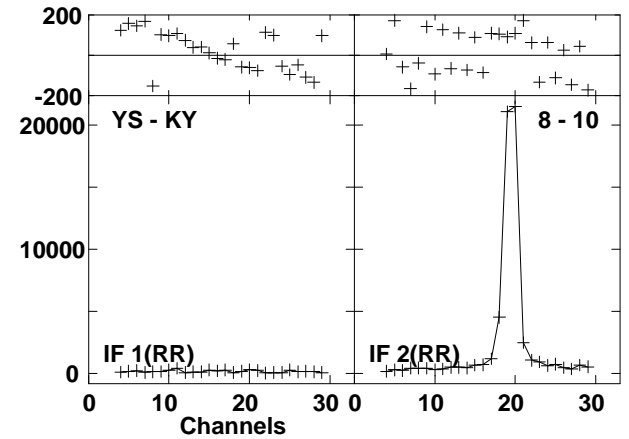
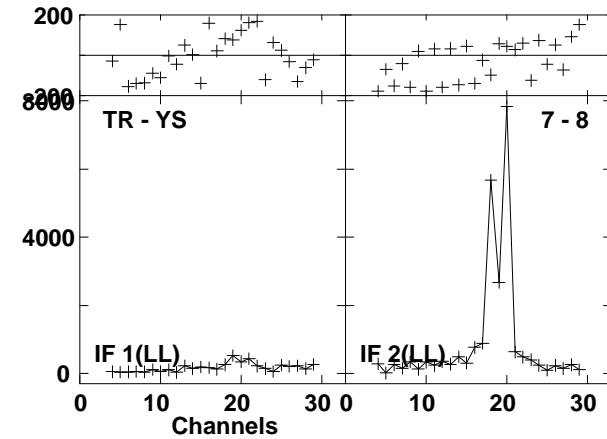
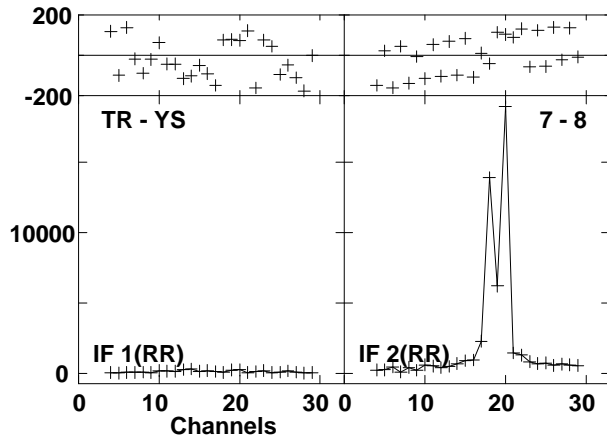
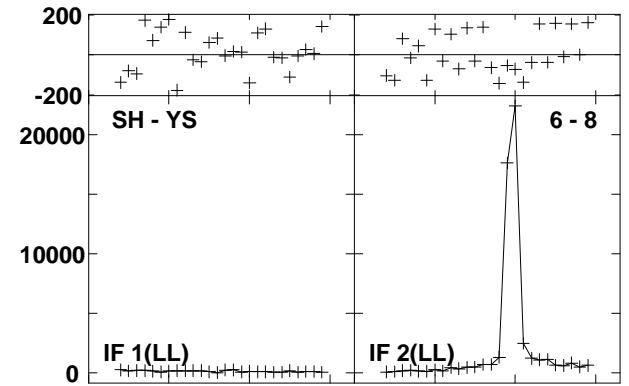
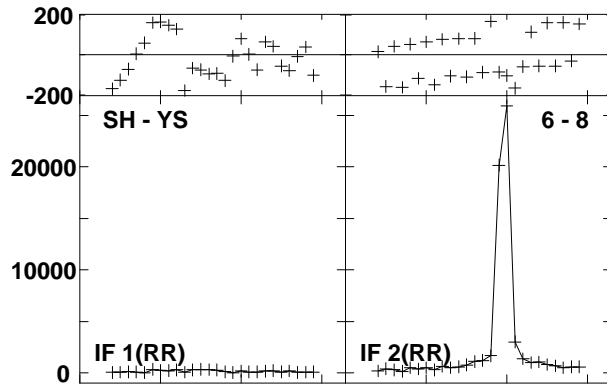
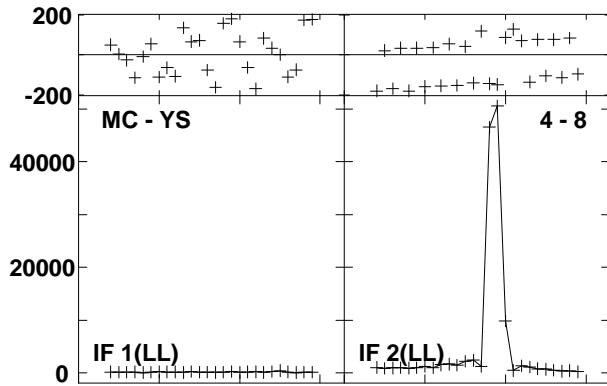
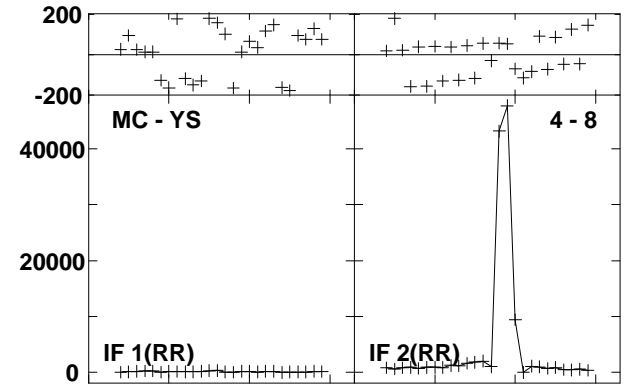
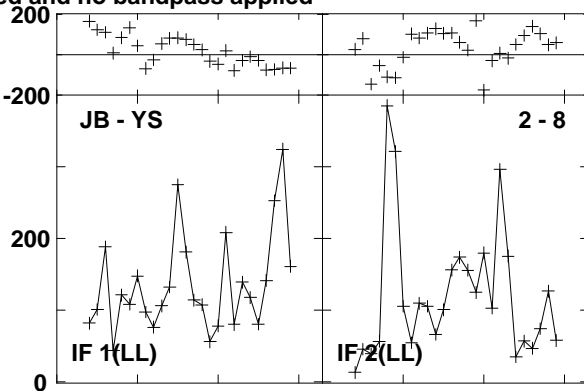
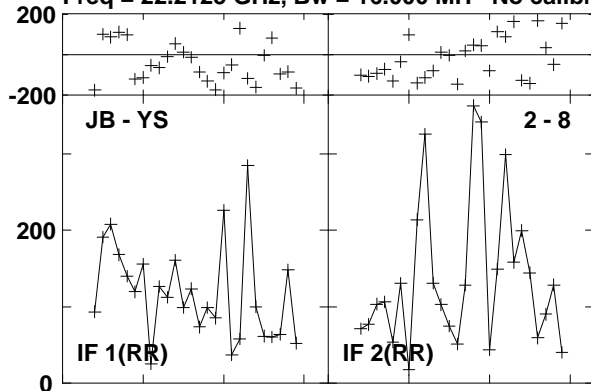

Lower frame: Micro Ampl Jy Top frame: Phas deg  
 Vector averaged cross-power spectrum Baseline: JB (02) - YS (08)  
 Timerange: 00/17:47:27 to 00/17:48:25

Plot file version 771 created 23-AUG-2016 15:01:12

W3IRS5 GA035B 1.UVDATA.1

Freq = 22.2125 GHz, Bw = 16.000 MH No calibration applied and no bandpass applied

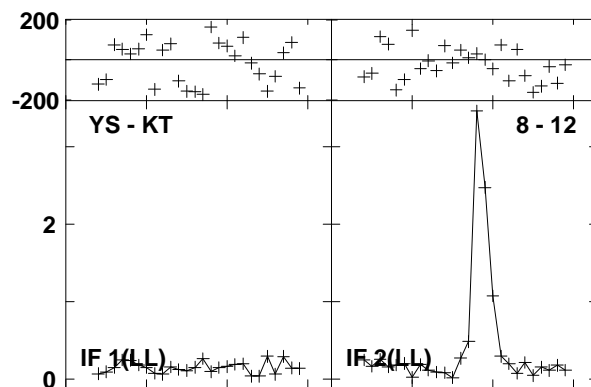
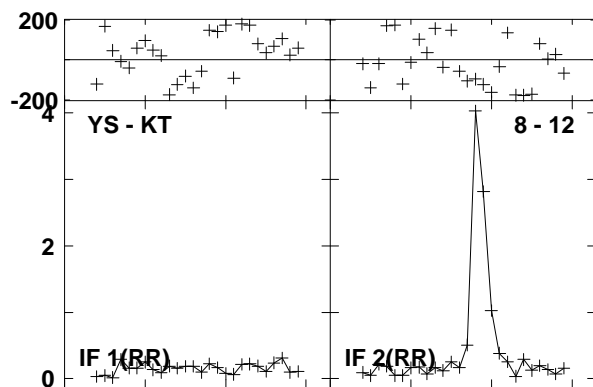
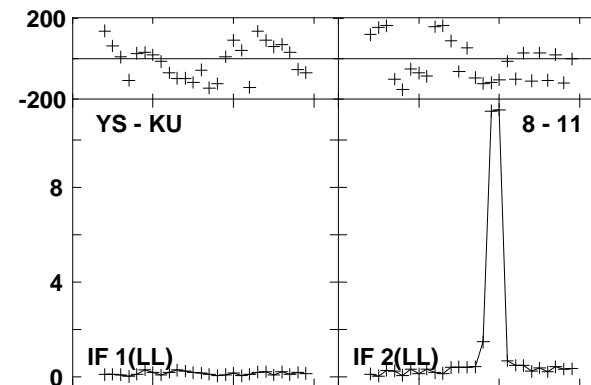
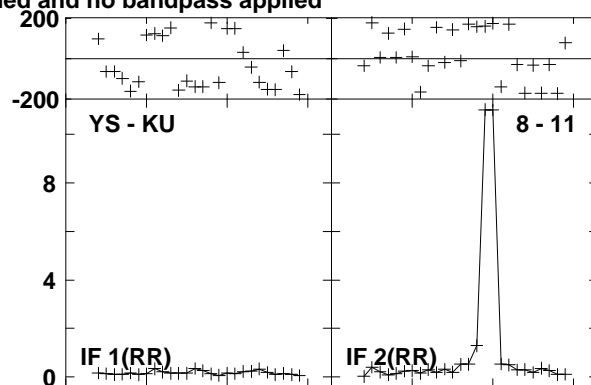
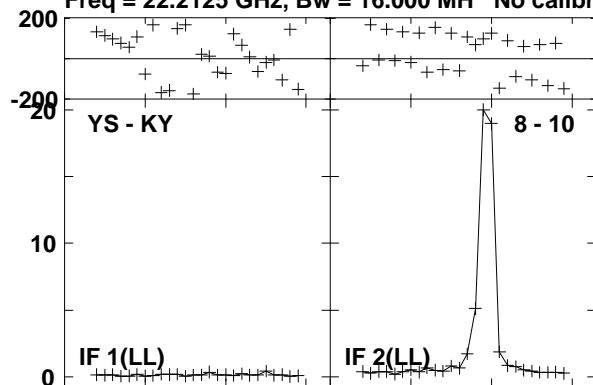

Lower frame: Milli Ampl Jy Top frame: Phas deg

Vector averaged cross-power spectrum Baseline: YS (08) - KY (10)

Timerange: 00/17:47:27 to 00/17:48:25

Plot file version 772 created 23-AUG-2016 15:01:12

0219+628 GA035B 1.UVDATA.1

Freq = 22.2125 GHz, Bw = 16.000 MH No calibration applied and no bandpass applied

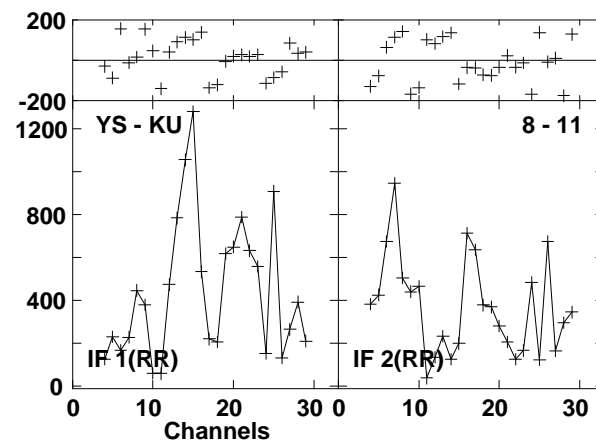
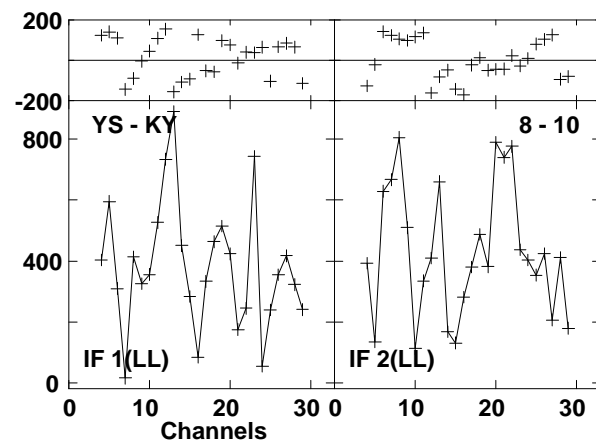
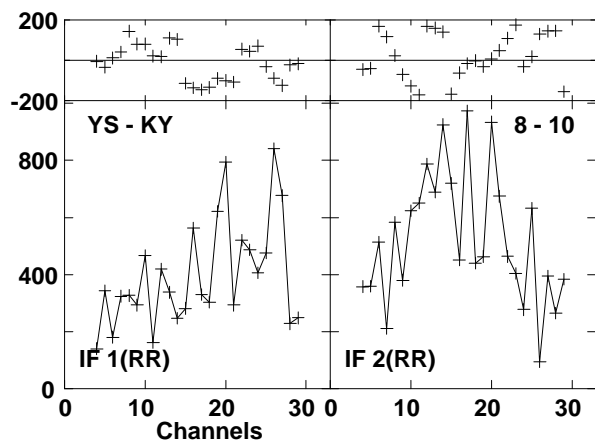
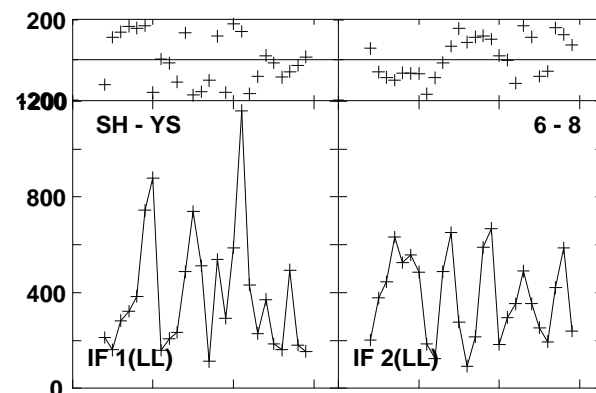
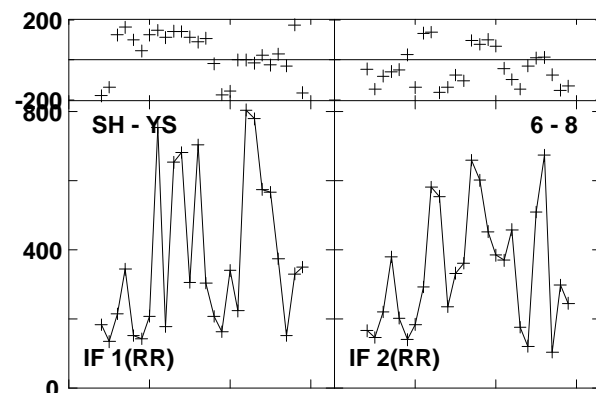
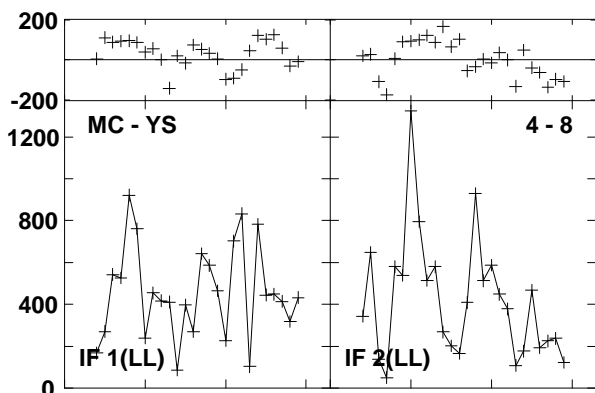
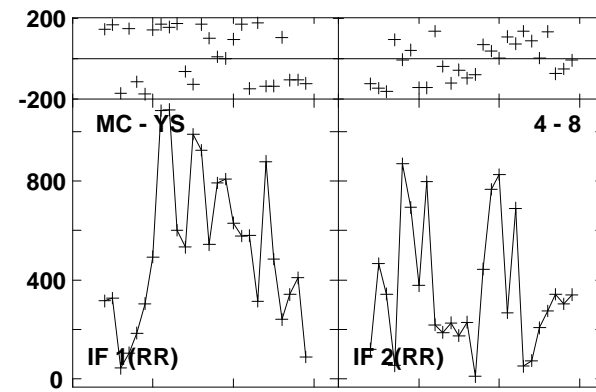
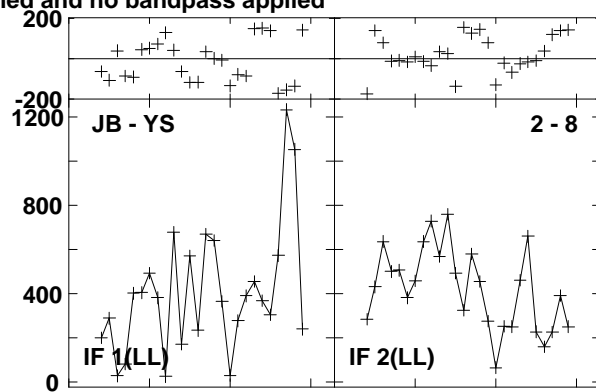
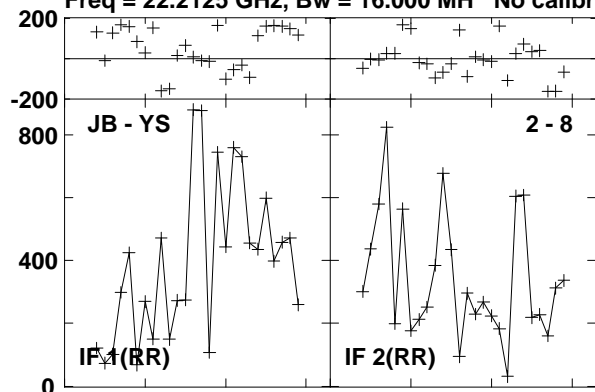

Lower frame: Micro Ampl Jy Top frame: Phas deg  
Vector averaged cross-power spectrum Baseline: JB (02) - YS (08)  
Timerange: 00/17:49:02 to 00/17:49:20

Plot file version 773 created 23-AUG-2016 15:01:12

0219+628 GA035B 1.UVDATA.1

Freq = 22.2125 GHz, Bw = 16.000 MH No calibration applied and no bandpass applied

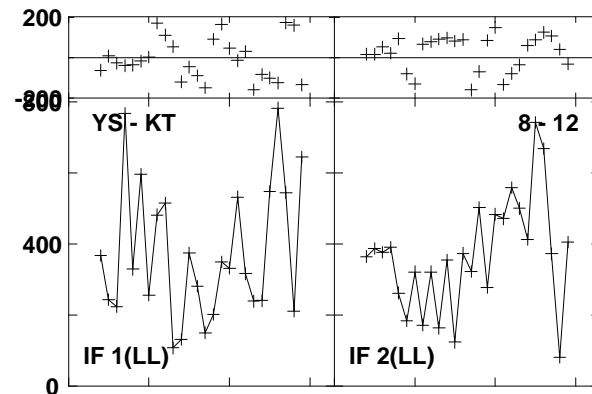
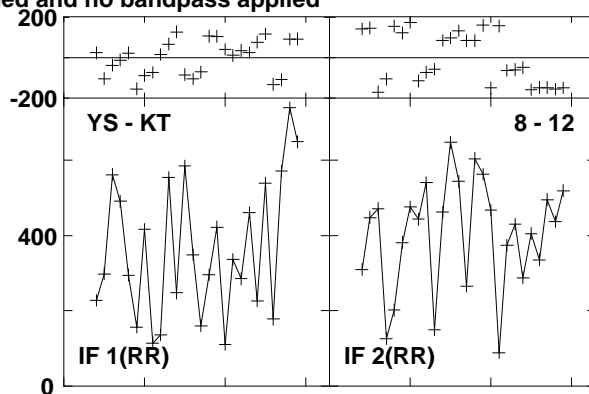
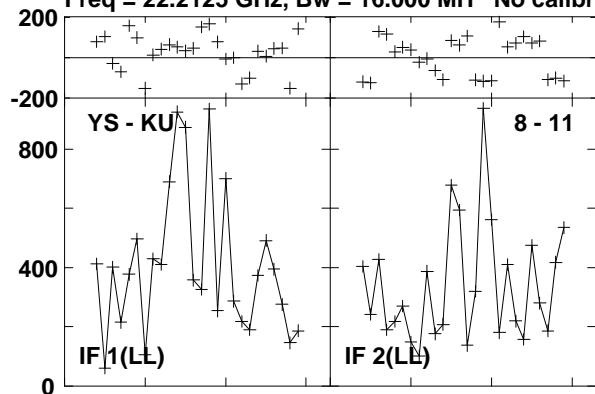

Lower frame: Micro Ampl Jy Top frame: Phas deg  
Vector averaged cross-power spectrum Baseline: YS (08) - KU (11)  
Timerange: 00/17:49:02 to 00/17:49:20

Plot file version 774 created 23-AUG-2016 15:01:12  
 W3IRS5 GA035B 1.UVDATA.1

Freq = 22.2125 GHz, Bw = 16.000 MH No calibration applied and no bandpass applied

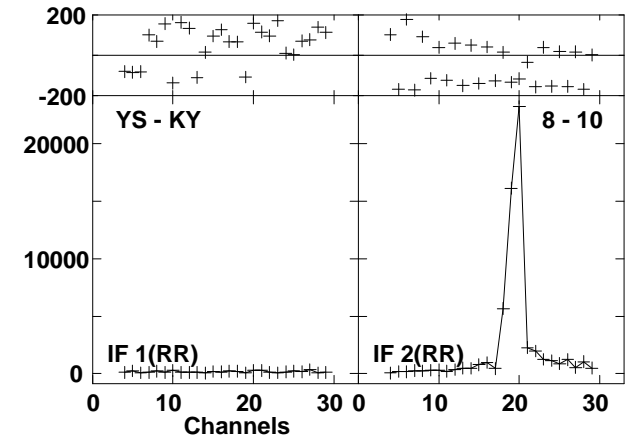
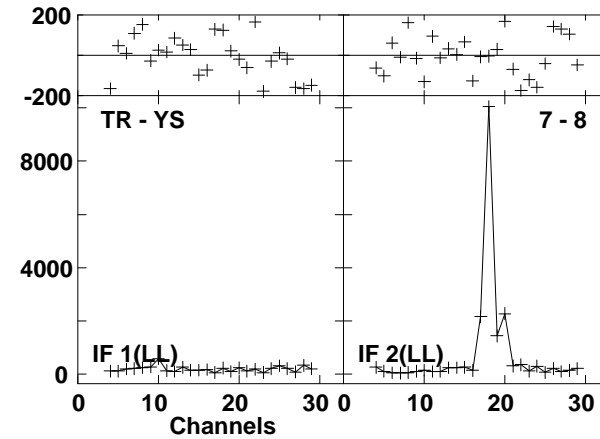
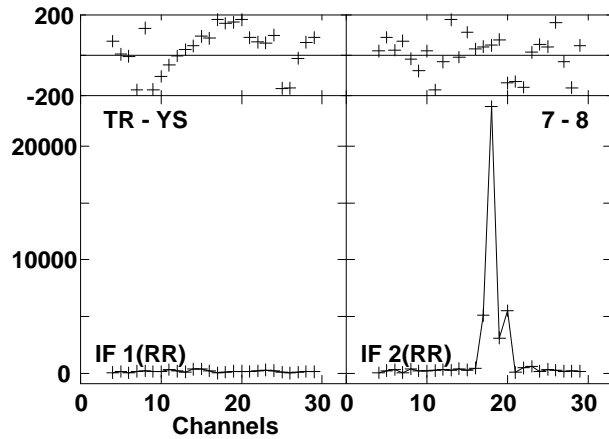
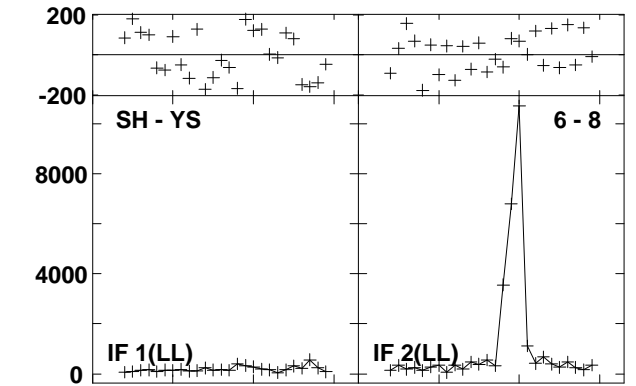
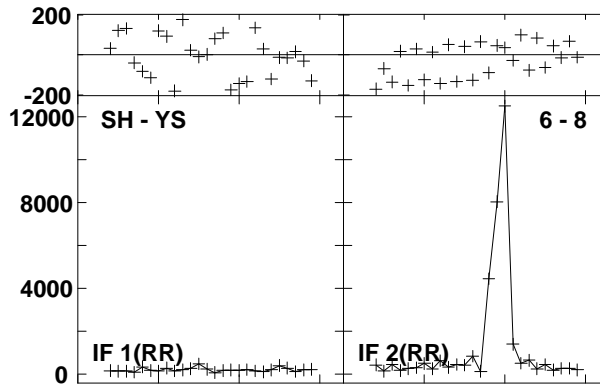
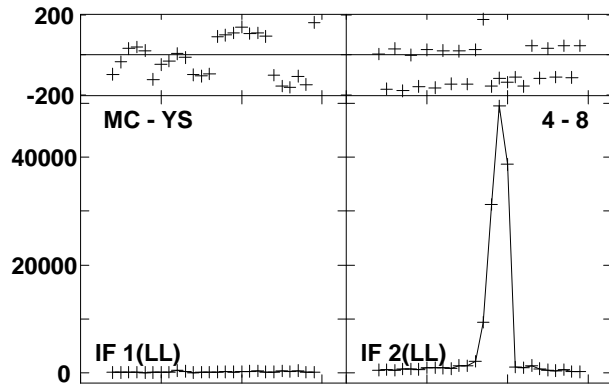
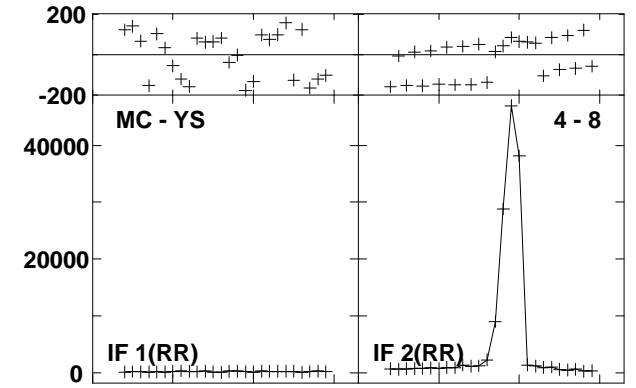
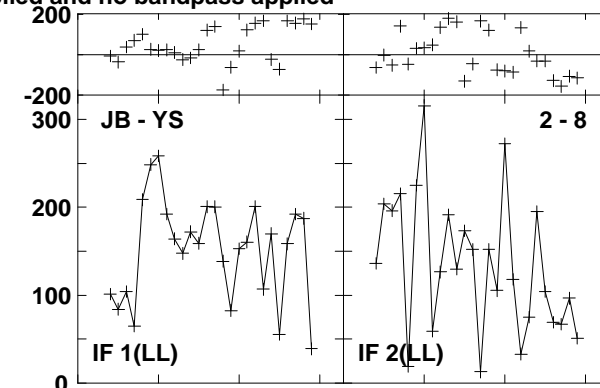
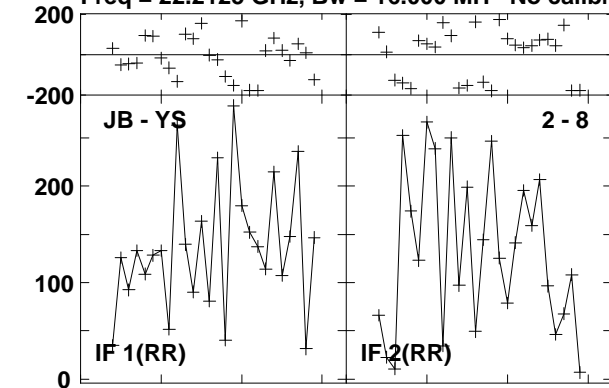

Lower frame: Micro Ampl Jy Top frame: Phas deg  
 Vector averaged cross-power spectrum Baseline: JB (02) - YS (08)  
 Timerange: 00/17:51:02 to 00/17:52:01

Plot file version 775 created 23-AUG-2016 15:01:12

W3IRS5 GA035B 1.UVDATA.1

Freq = 22.2125 GHz, Bw = 16.000 MH No calibration applied and no bandpass applied

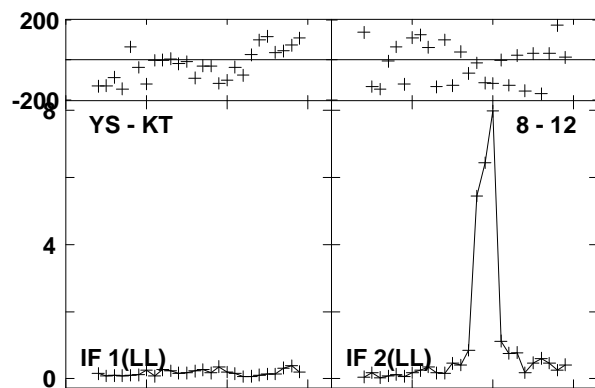
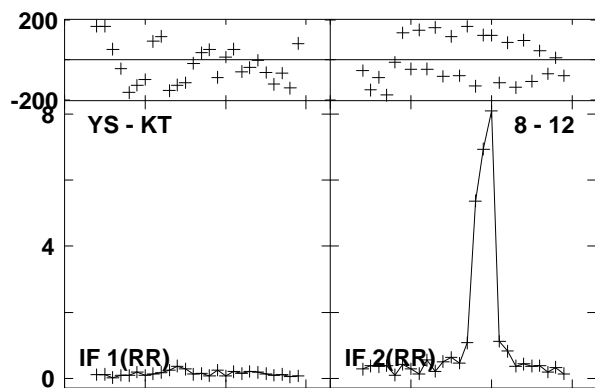
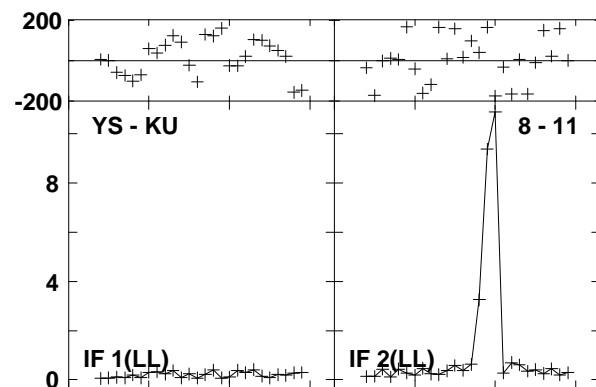
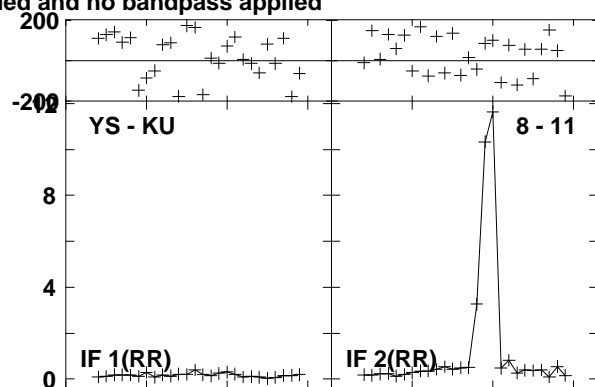
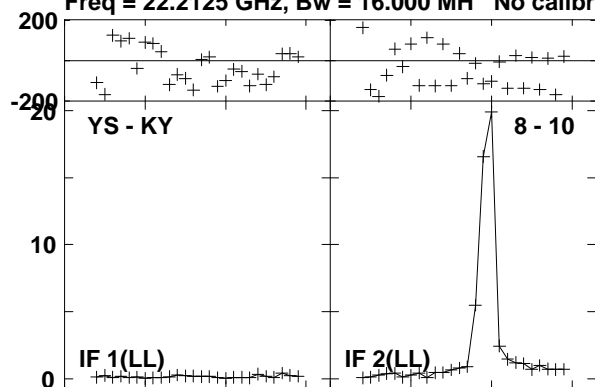

Lower frame: Milli Ampl Jy Top frame: Phas deg  
Vector averaged cross-power spectrum Baseline: YS (08) - KY (10)  
Timerange: 00/17:51:02 to 00/17:52:01

Plot file version 776 created 23-AUG-2016 15:01:12

0219+628 GA035B 1.UVDATA.1

Freq = 22.2125 GHz, Bw = 16.000 MH No calibration applied and no bandpass applied

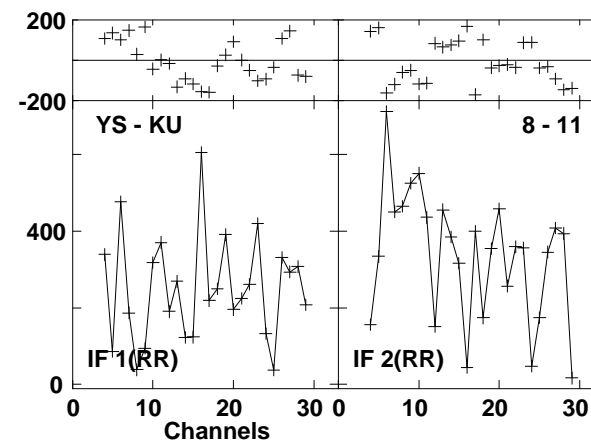
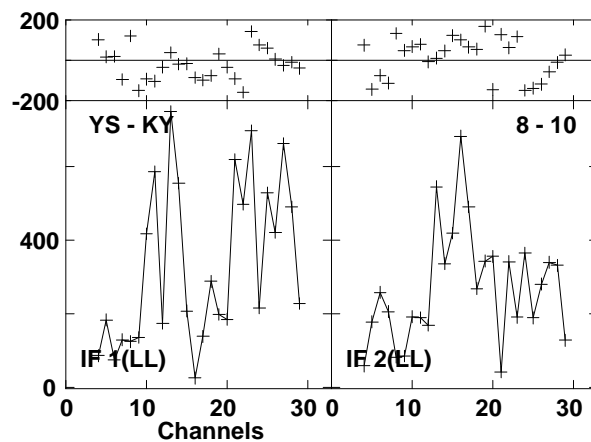
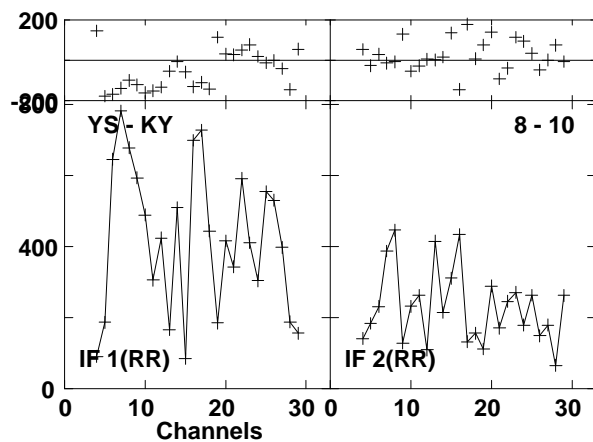
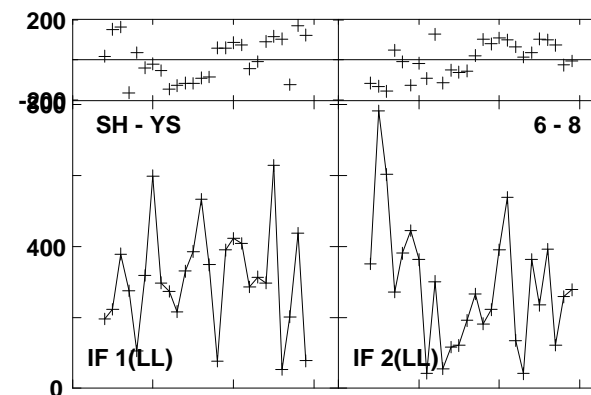
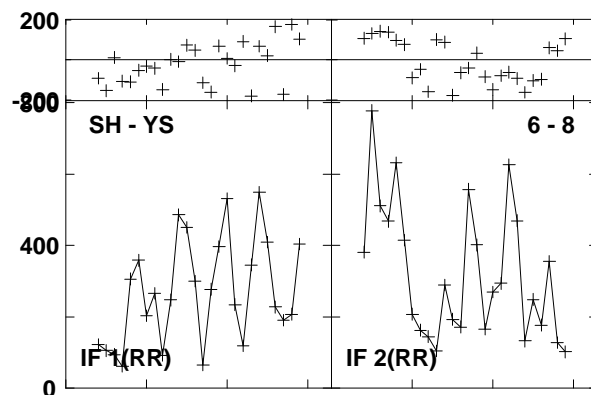
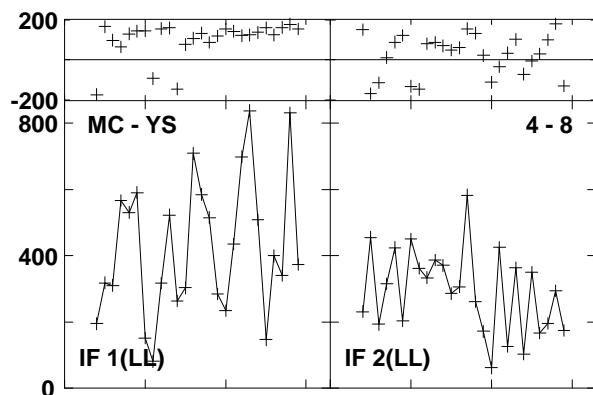
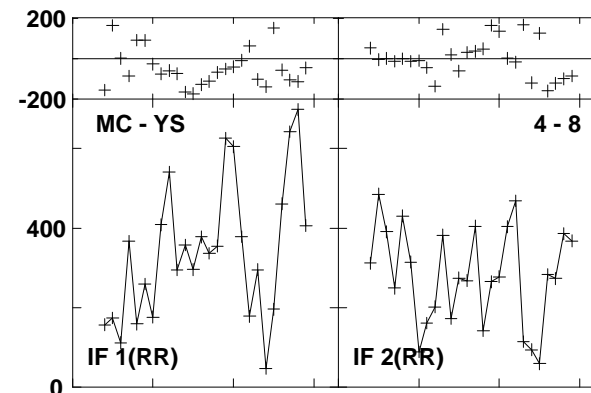
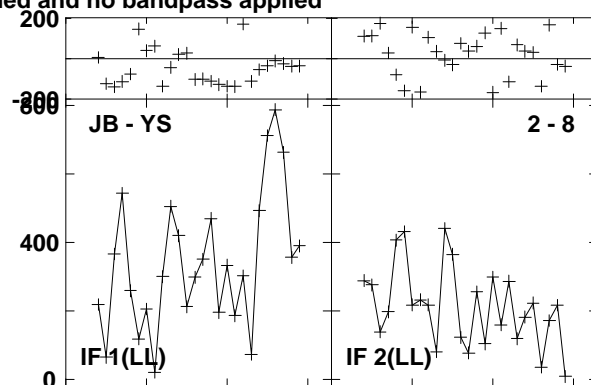
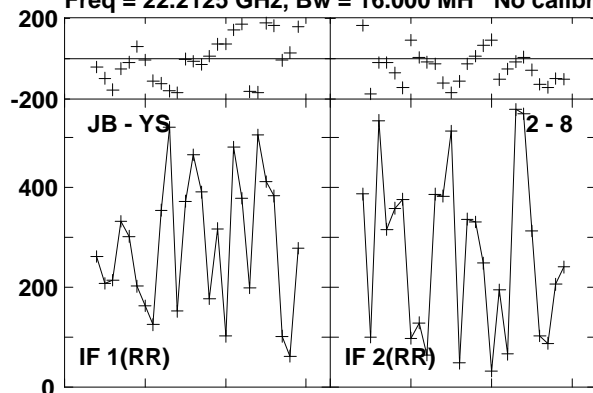

Lower frame: Micro Ampl Jy Top frame: Phas deg  
Vector averaged cross-power spectrum Baseline: JB (02) - YS (08)  
Timerange: 00/17:52:31 to 00/17:52:50



Plot file version 777 created 23-AUG-2016 15:01:12

0219+628 GA035B 1.UVDATA.1

Freq = 22.2125 GHz, Bw = 16.000 MH No calibration applied and no bandpass applied

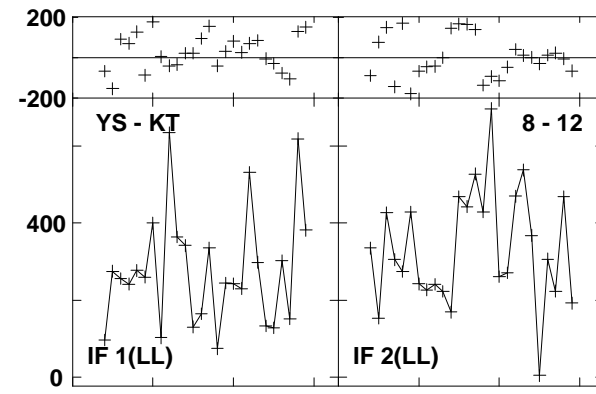
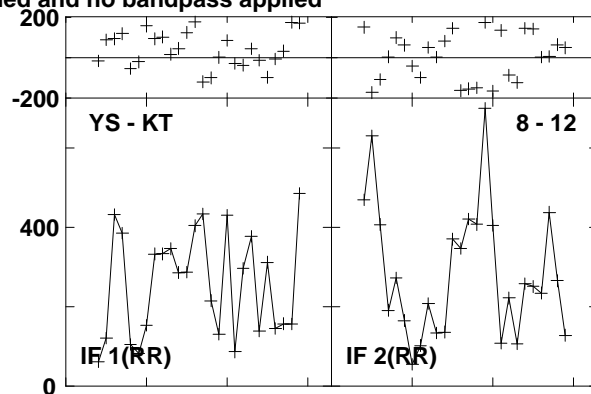
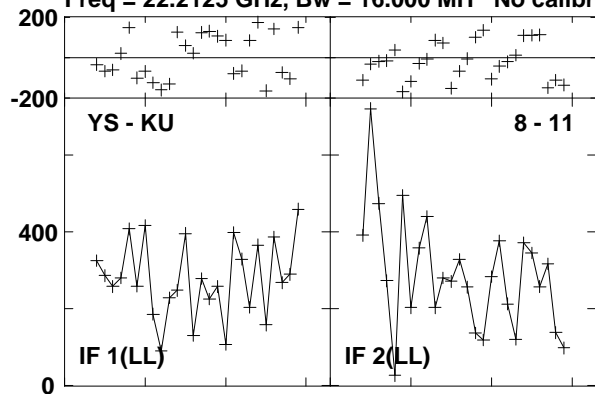

Lower frame: Micro Ampl Jy Top frame: Phas deg  
Vector averaged cross-power spectrum Baseline: YS (08) - KU (11)  
Timerange: 00/17:52:31 to 00/17:52:50

Plot file version 778 created 23-AUG-2016 15:01:12

W3IRS5 GA035B 1.UVDATA.1

Freq = 22.2125 GHz, Bw = 16.000 MH No calibration applied and no bandpass applied

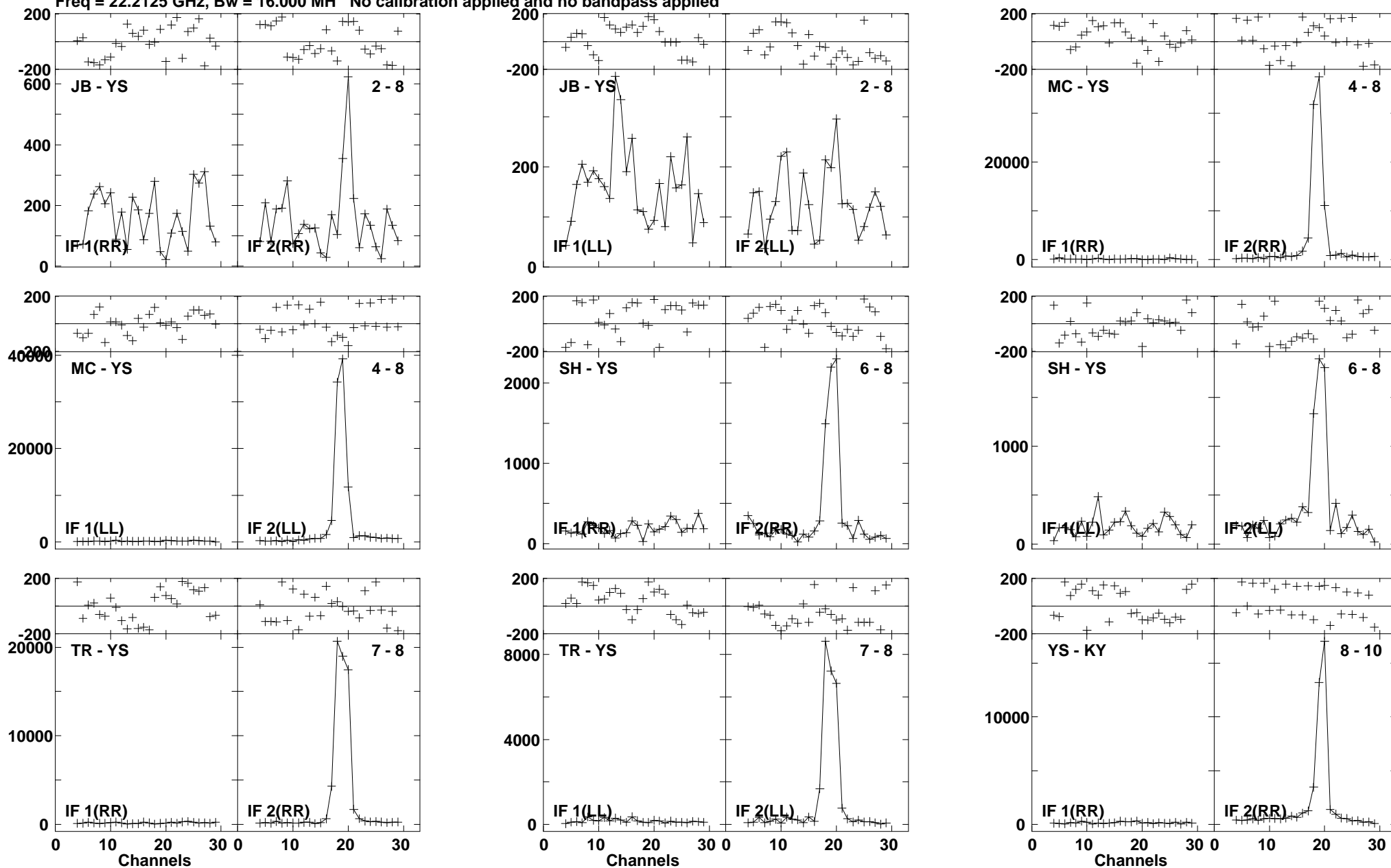

Lower frame: Micro Ampl Jy Top frame: Phas deg  
Vector averaged cross-power spectrum Baseline: JB (02) - YS (08)  
Timerange: 00/17:53:22 to 00/17:54:21

Plot file version 779 created 23-AUG-2016 15:01:12

W3IRS5 GA035B 1.UVDATA.1

Freq = 22.2125 GHz, Bw = 16.000 MH No calibration applied and no bandpass applied

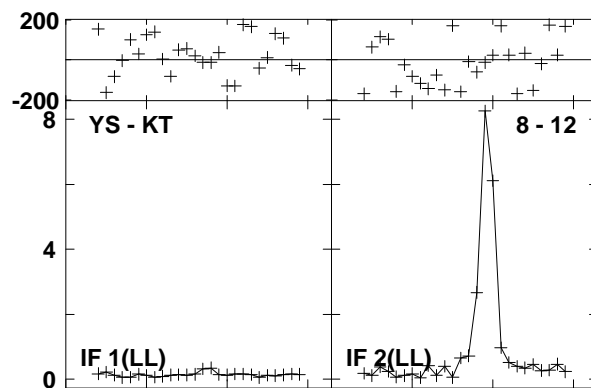
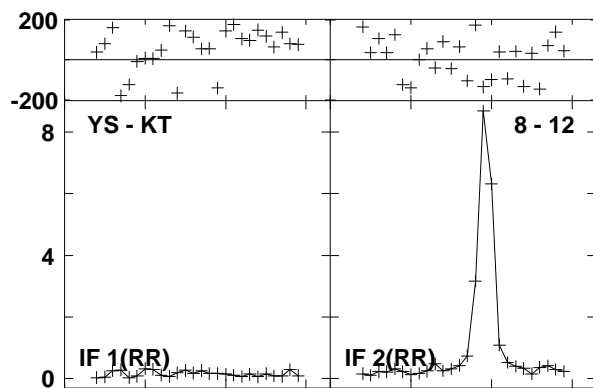
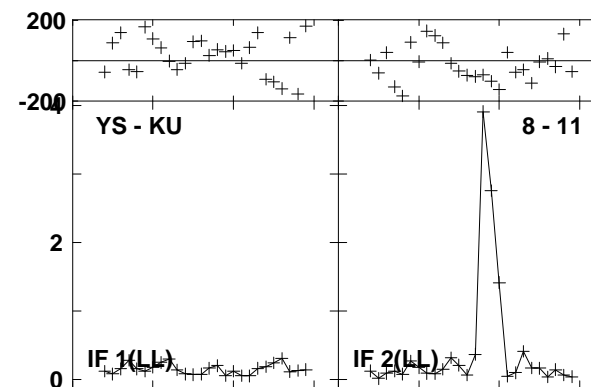
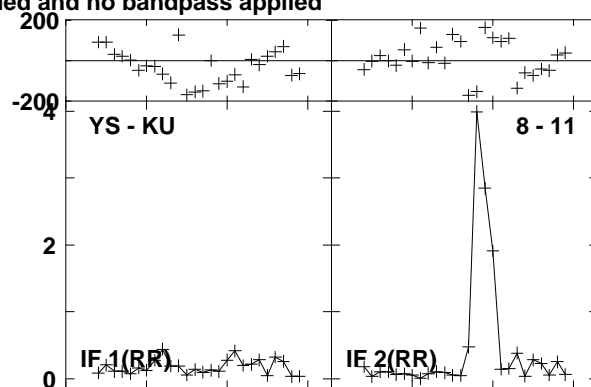
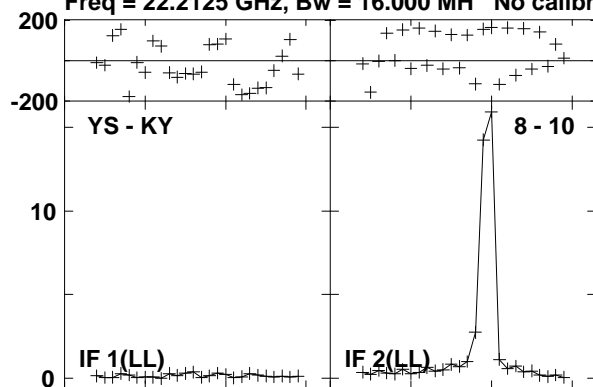

Lower frame: Milli Ampl Jy Top frame: Phas deg  
Vector averaged cross-power spectrum Baseline: YS (08) - KY (10)  
Timerange: 00/17:53:22 to 00/17:54:21

Plot file version 780 created 23-AUG-2016 15:01:12

0219+628 GA035B 1.UVDATA.1

Freq = 22.2125 GHz, Bw = 16.000 MH No calibration applied and no bandpass applied

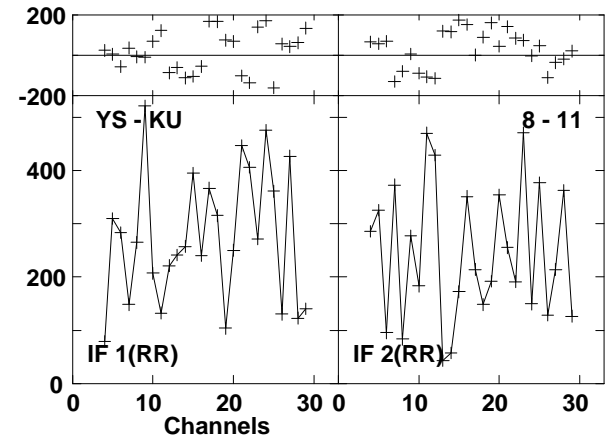
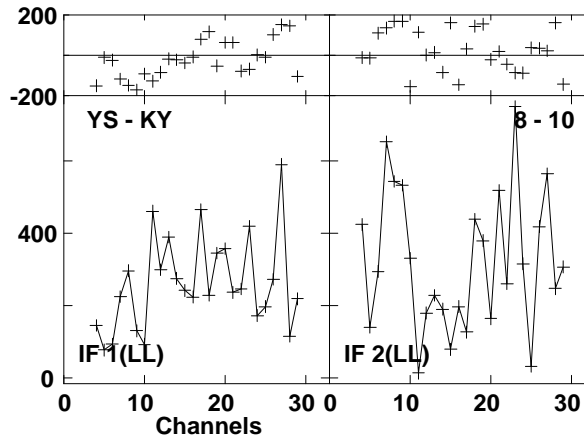
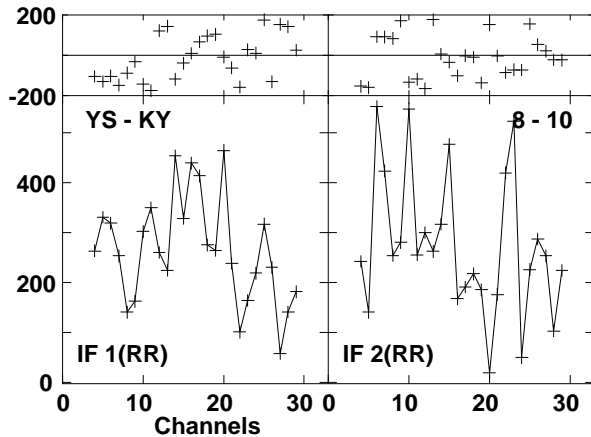
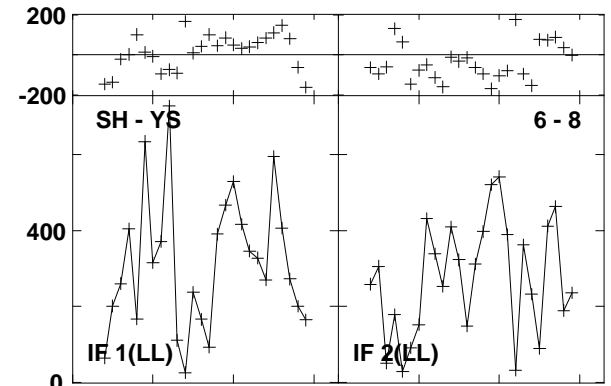
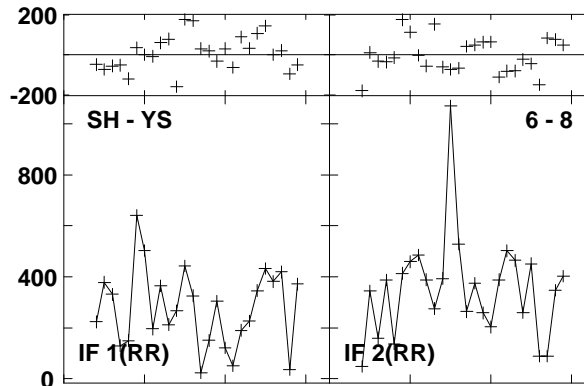
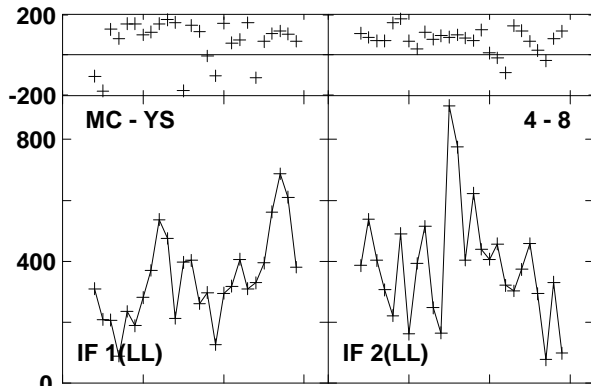
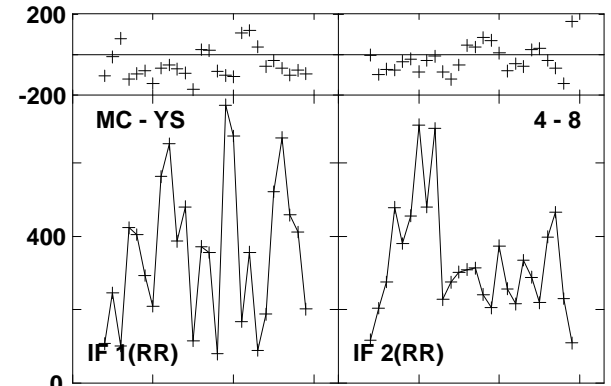
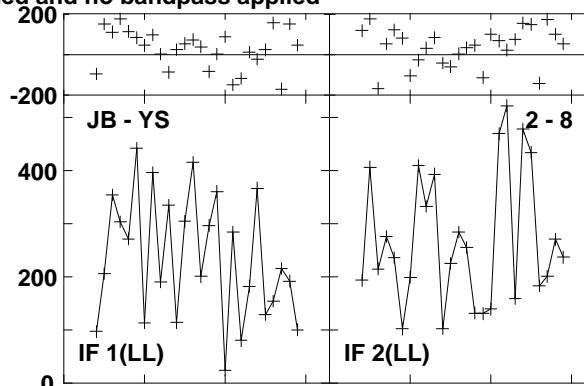
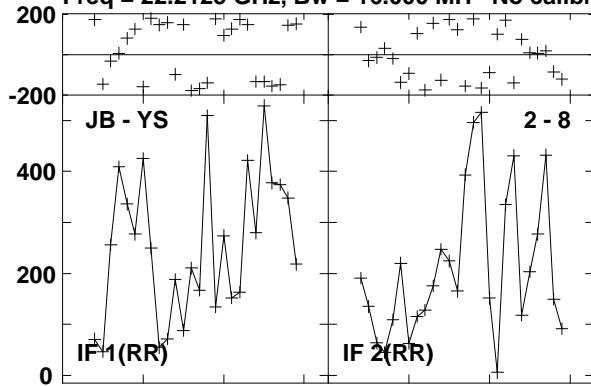

Lower frame: Micro Ampl Jy Top frame: Phas deg  
Vector averaged cross-power spectrum Baseline: JB (02) - YS (08)  
Timerange: 00/17:54:51 to 00/17:55:11

Plot file version 781 created 23-AUG-2016 15:01:12

0219+628 GA035B 1.UVDATA.1

Freq = 22.2125 GHz, Bw = 16.000 MH No calibration applied and no bandpass applied

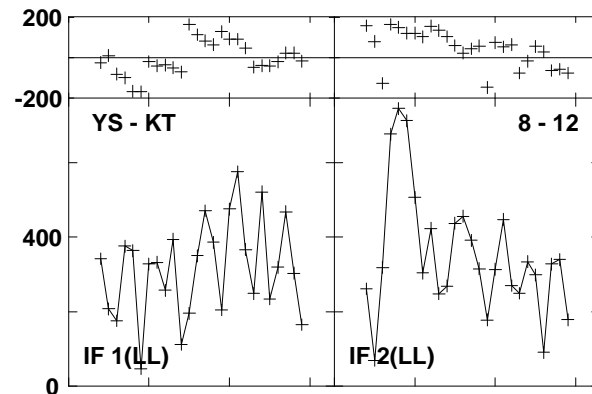
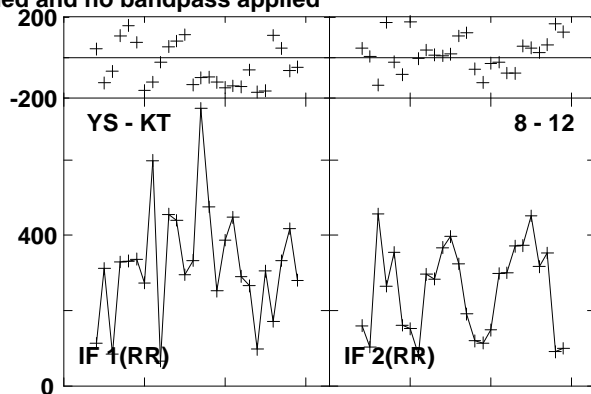
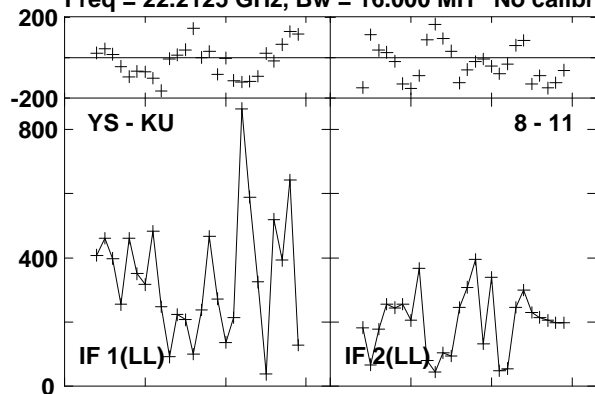

Lower frame: Micro Ampl Jy Top frame: Phas deg  
Vector averaged cross-power spectrum Baseline: YS (08) - KU (11)  
Timerange: 00/17:54:51 to 00/17:55:11

Plot file version 782 created 23-AUG-2016 15:01:12  
 W3IRS5 GA035B 1.UVDATA.1

Freq = 22.2125 GHz, Bw = 16.000 MH No calibration applied and no bandpass applied

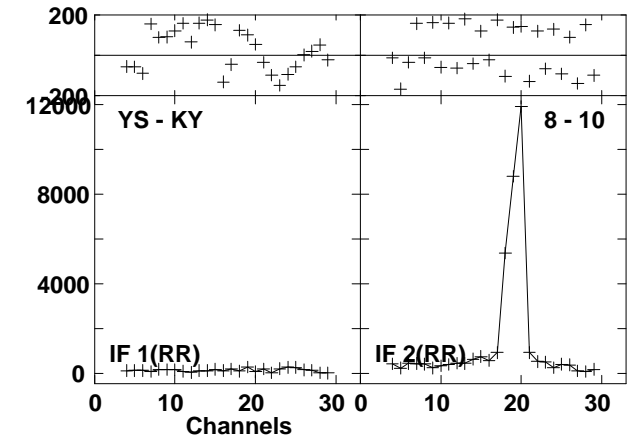
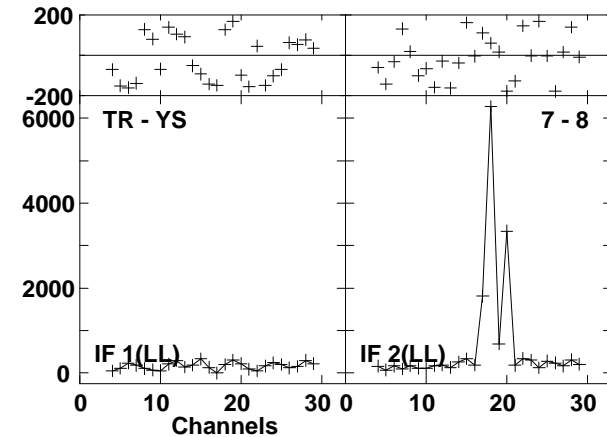
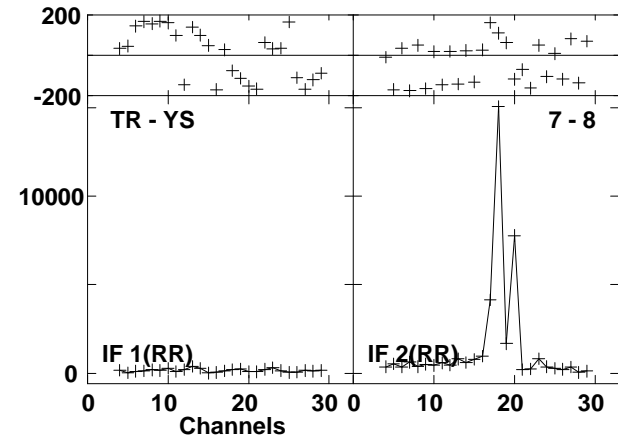
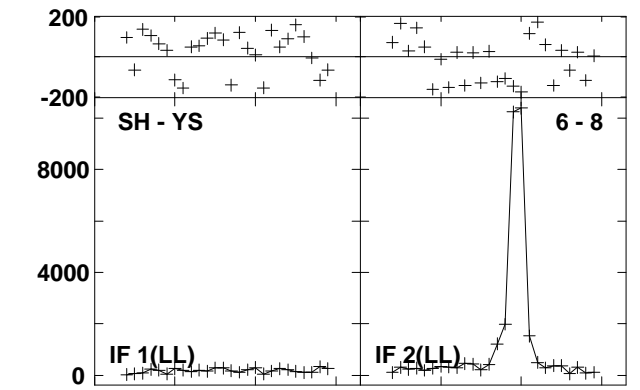
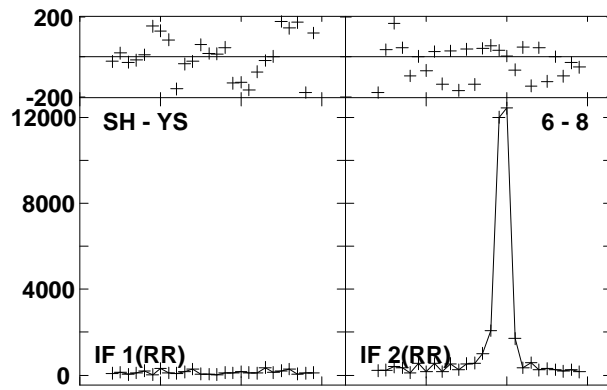
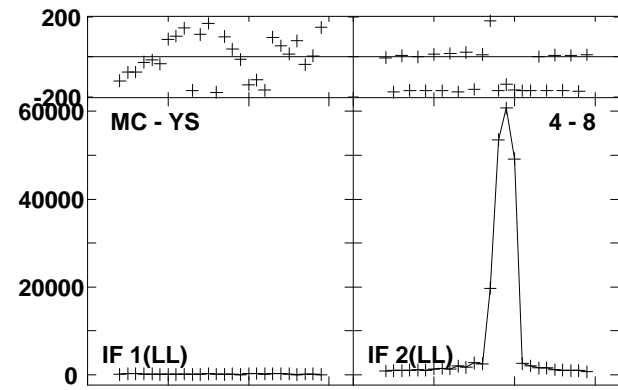
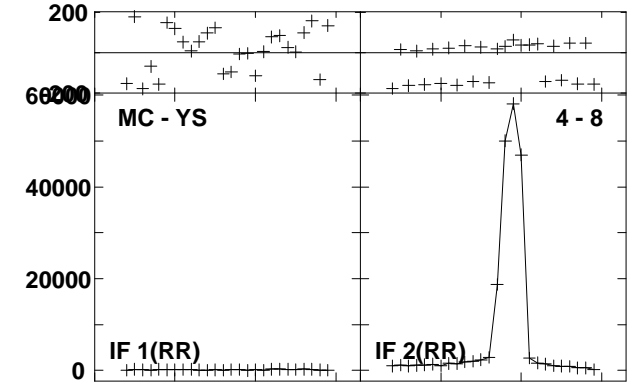
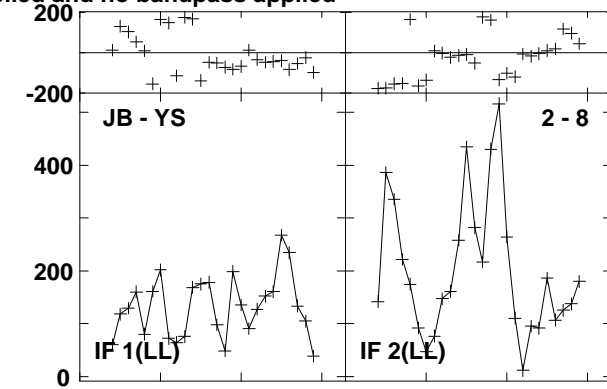
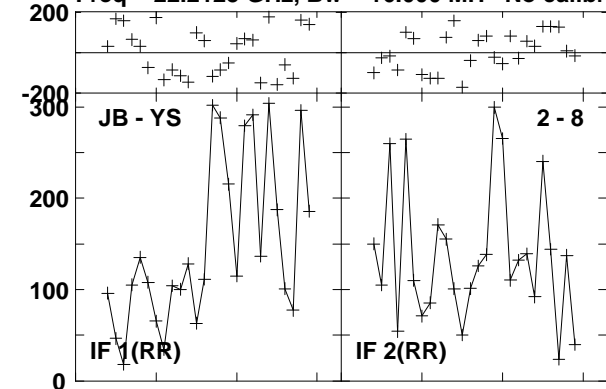

Lower frame: Micro Ampl Jy Top frame: Phas deg  
 Vector averaged cross-power spectrum Baseline: JB (02) - YS (08)  
 Timerange: 00/17:55:41 to 00/17:56:40

Plot file version 783 created 23-AUG-2016 15:01:12  
W3IRS5 GA035B 1.UVDATA.1

Freq = 22.2125 GHz, Bw = 16.000 MH No calibration applied and no bandpass applied

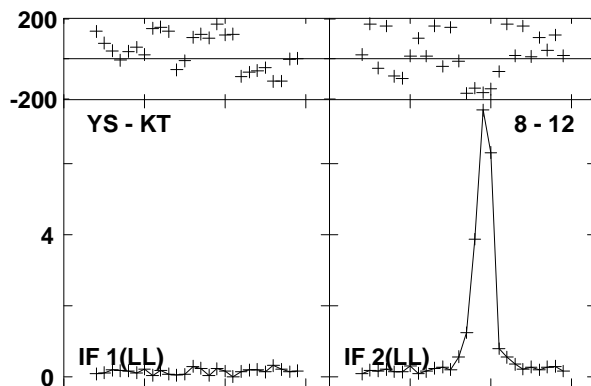
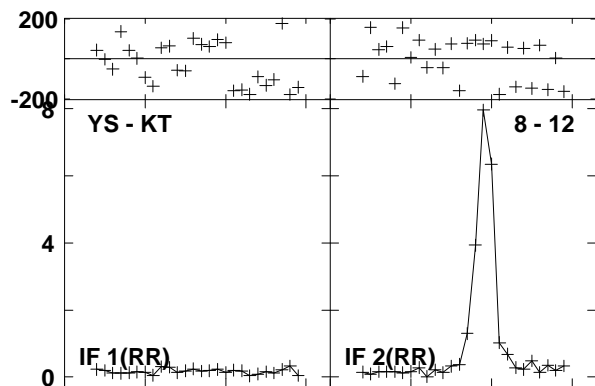
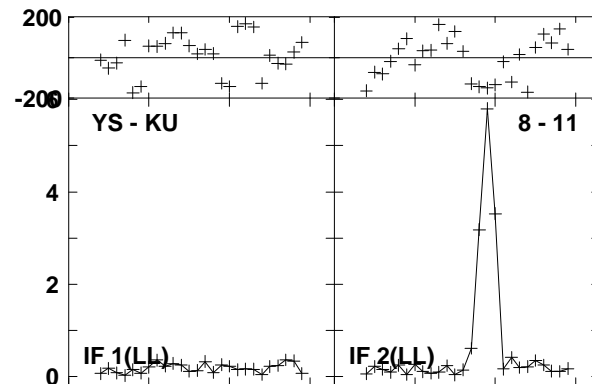
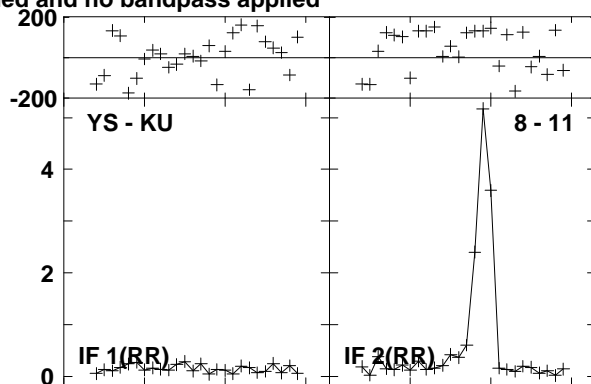
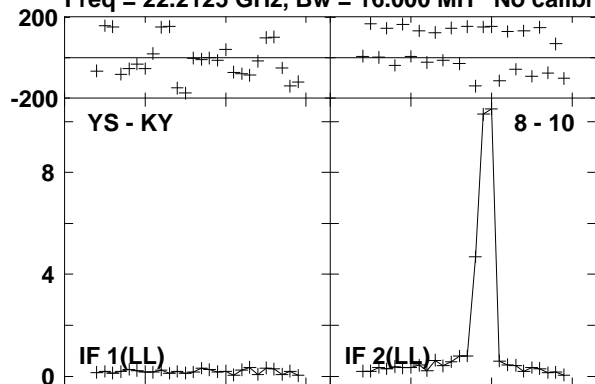

Lower frame: Milli Ampl Jy Top frame: Phas deg  
Vector averaged cross-power spectrum Baseline: YS (08) - KY (10)  
Timerange: 00/17:55:41 to 00/17:56:40

Plot file version 784 created 23-AUG-2016 15:01:12

0219+628 GA035B 1.UVDATA.1

Freq = 22.2125 GHz, Bw = 16.000 MH No calibration applied and no bandpass applied

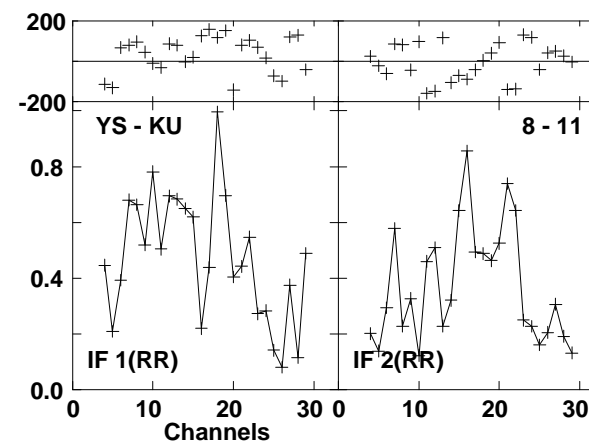
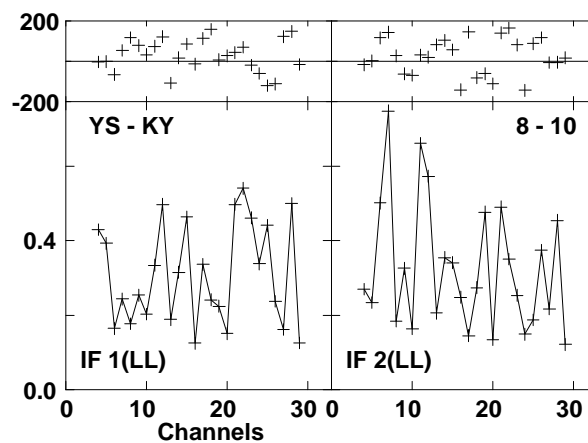
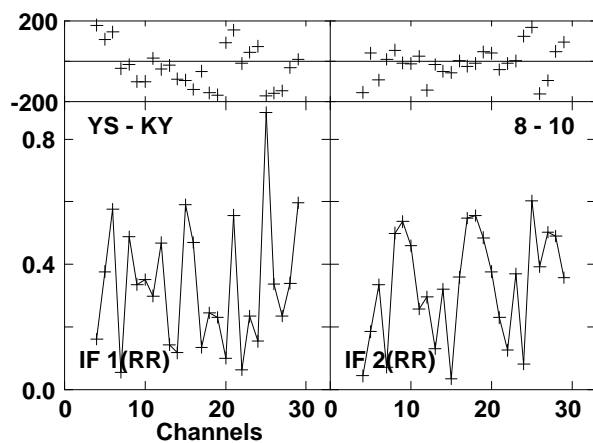
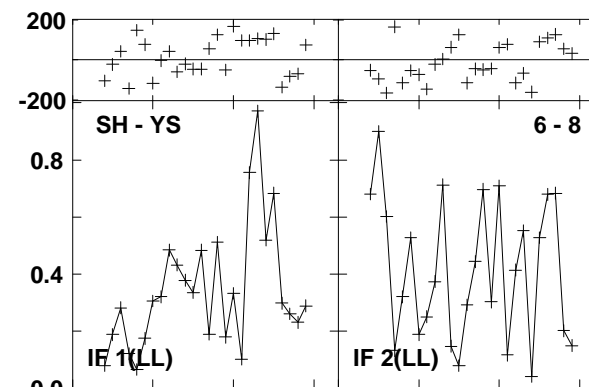
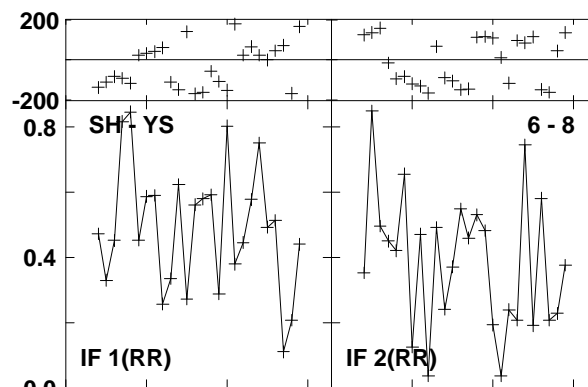
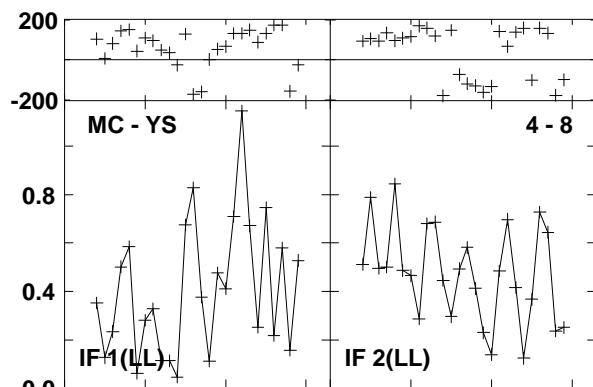
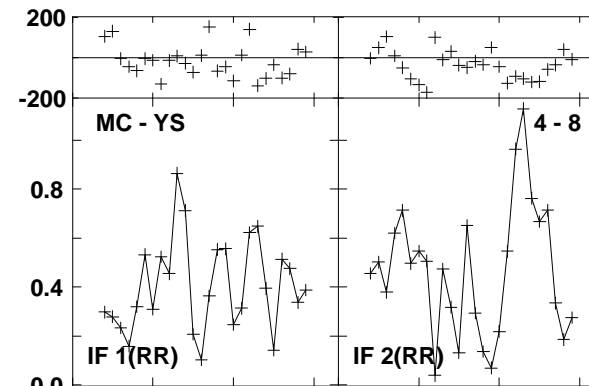
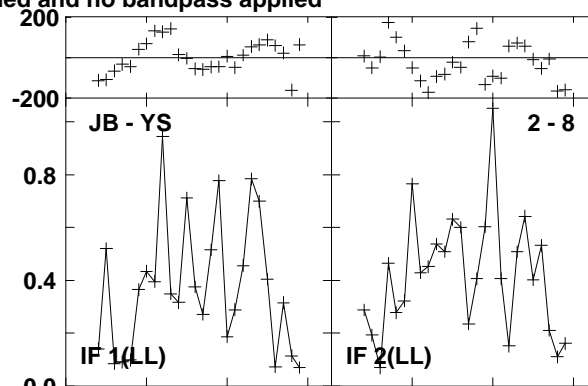
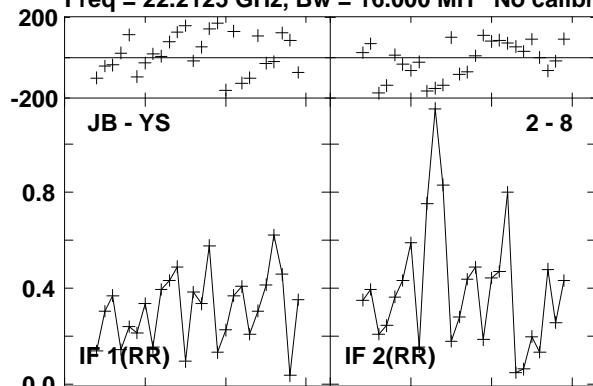

Lower frame: Milli Ampl Jy Top frame: Phas deg  
Vector averaged cross-power spectrum Baseline: JB (02) - YS (08)  
Timerange: 00/17:57:12 to 00/17:57:31



Plot file version 785 created 23-AUG-2016 15:01:12

0219+628 GA035B 1.UVDATA.1

Freq = 22.2125 GHz, Bw = 16.000 MH No calibration applied and no bandpass applied

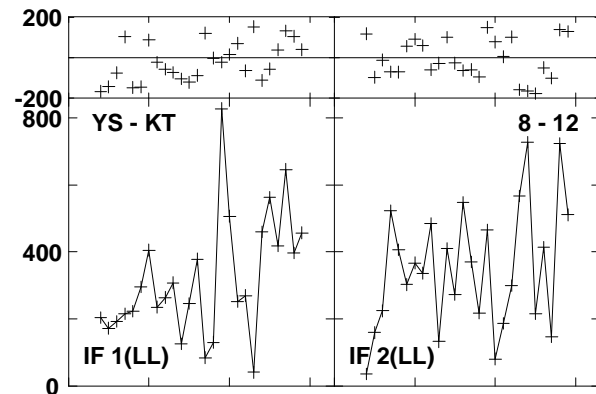
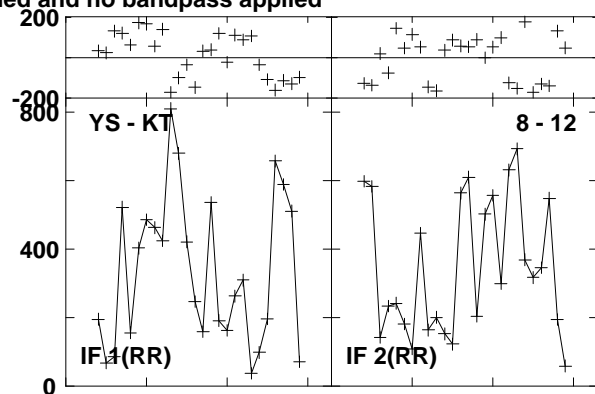
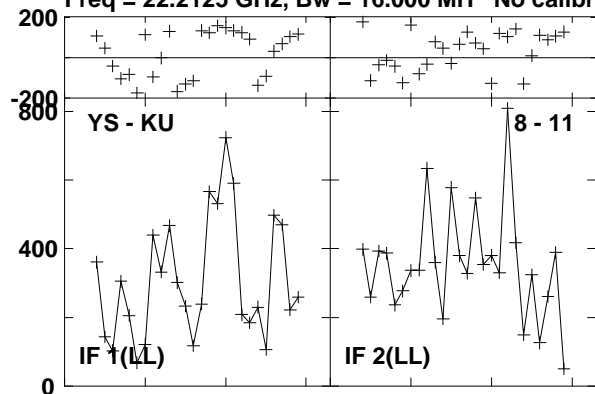

Lower frame: Micro Ampl Jy Top frame: Phas deg  
Vector averaged cross-power spectrum Baseline: YS (08) - KU (11)  
Timerange: 00/17:57:12 to 00/17:57:31

Plot file version 786 created 23-AUG-2016 15:01:12  
 W3IRS5 GA035B 1.UVDATA.1

Freq = 22.2125 GHz, Bw = 16.000 MH No calibration applied and no bandpass applied

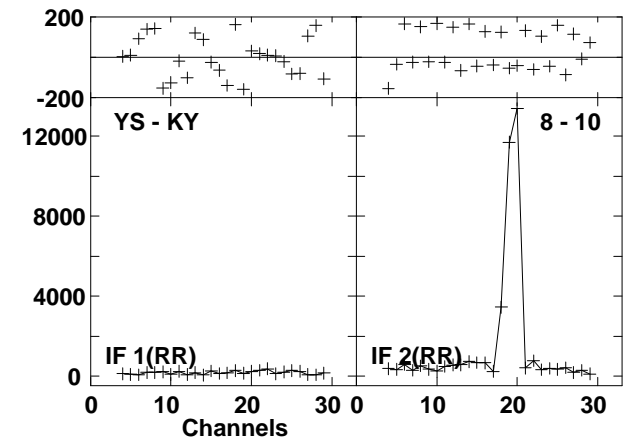
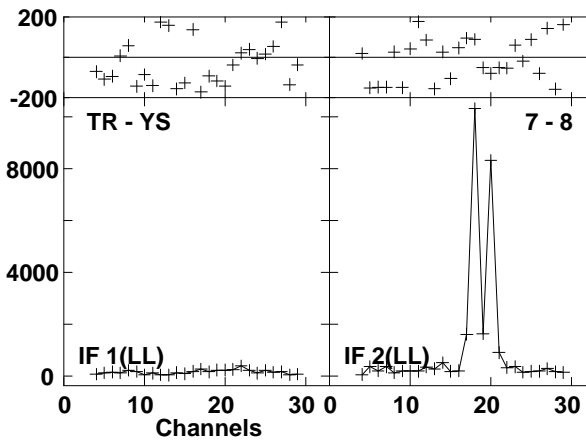
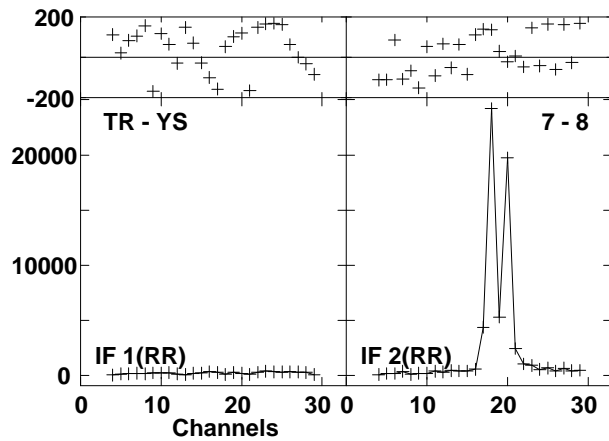
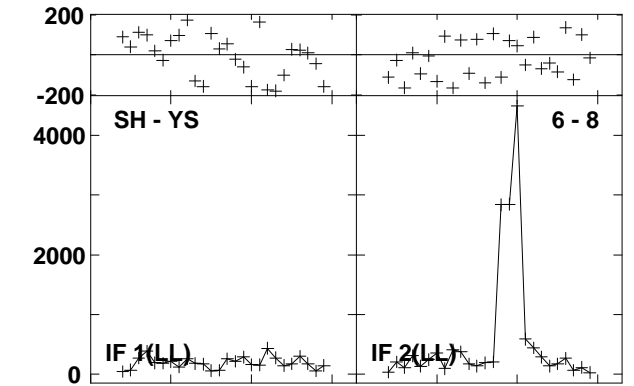
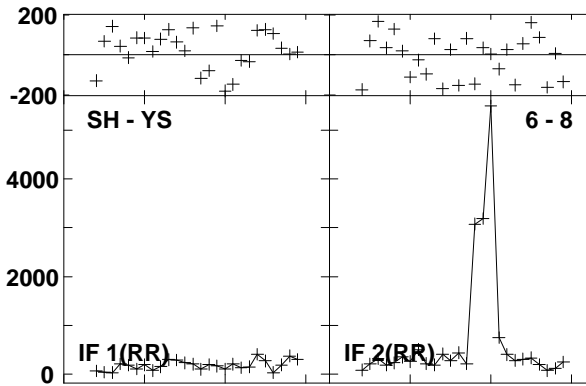
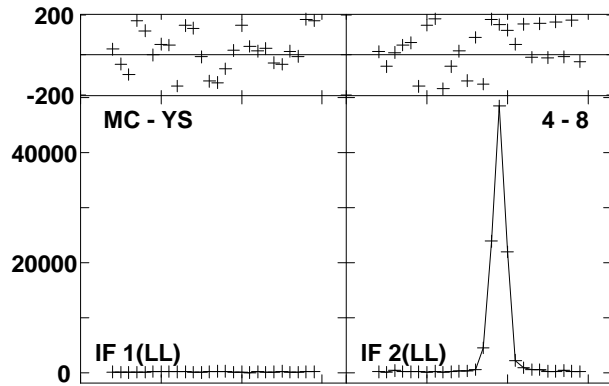
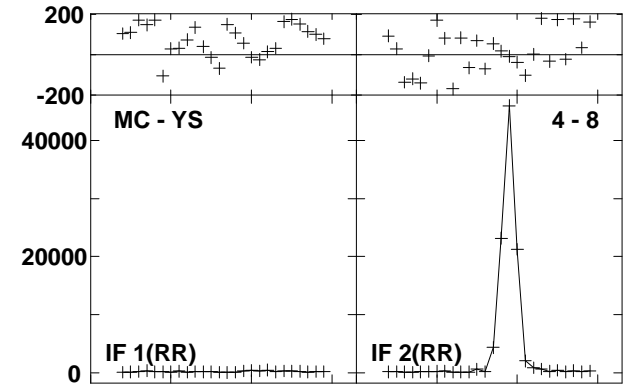
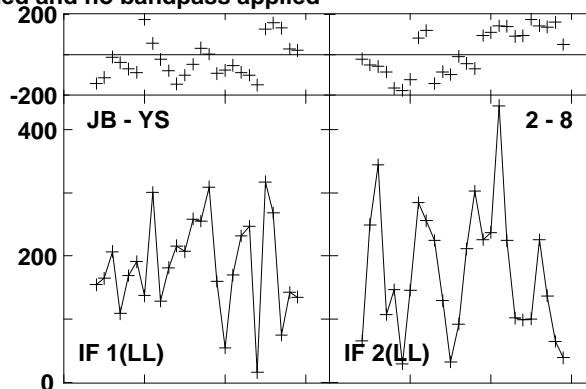
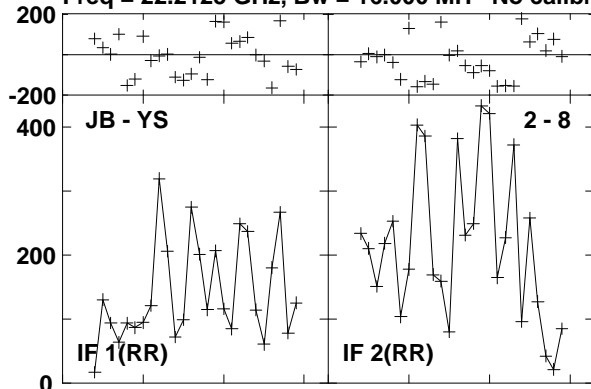

Lower frame: Micro Ampl Jy Top frame: Phas deg  
 Vector averaged cross-power spectrum Baseline: JB (02) - YS (08)  
 Timerange: 00/17:58:01 to 00/17:59:00

Plot file version 787 created 23-AUG-2016 15:01:12

W3IRS5 GA035B 1.UVDATA.1

Freq = 22.2125 GHz, Bw = 16.000 MH No calibration applied and no bandpass applied

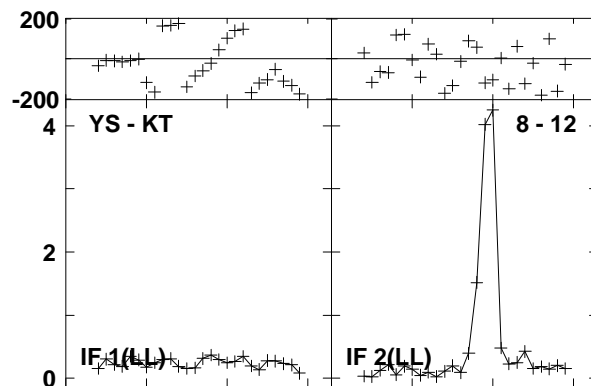
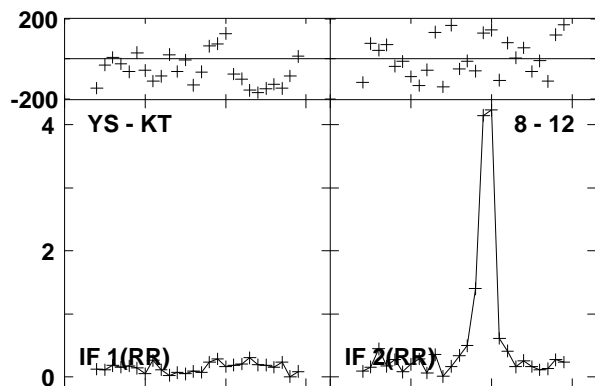
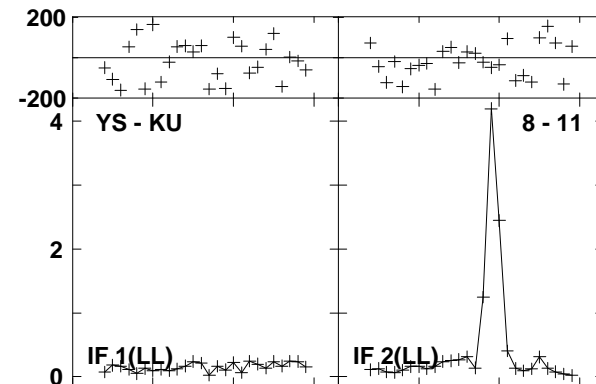
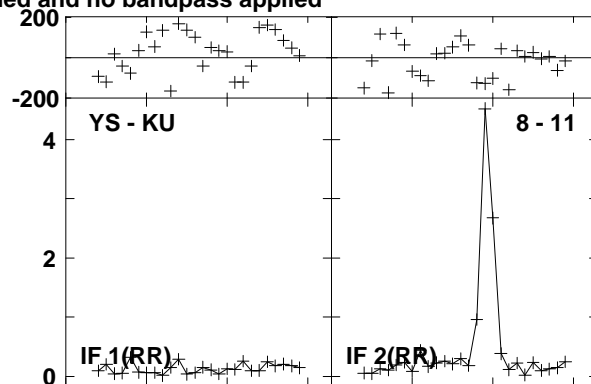
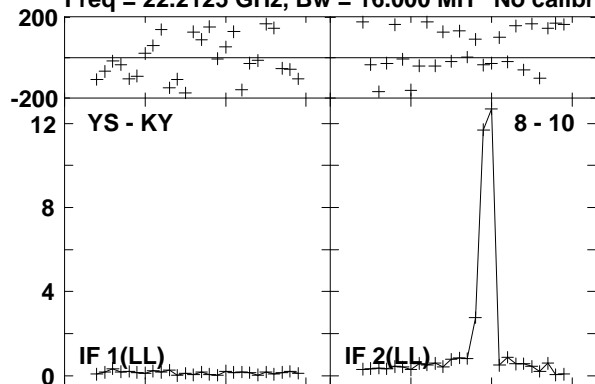

Lower frame: Milli Ampl Jy Top frame: Phas deg

Vector averaged cross-power spectrum Baseline: YS (08) - KY (10)

Timerange: 00/17:58:01 to 00/17:59:00

Plot file version 788 created 23-AUG-2016 15:01:12  
 0219+628 GA035B 1.UVDATA.1

Freq = 22.2125 GHz, Bw = 16.000 MH No calibration applied and no bandpass applied

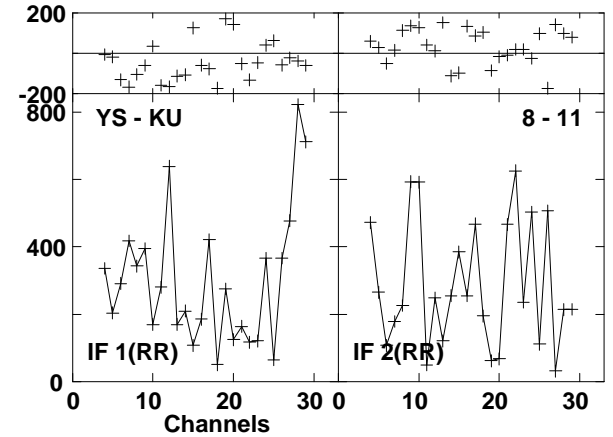
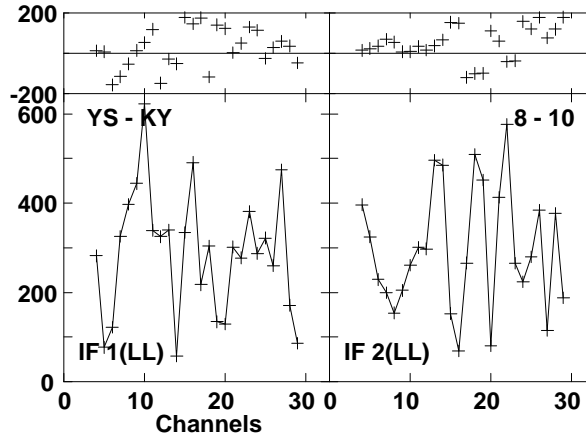
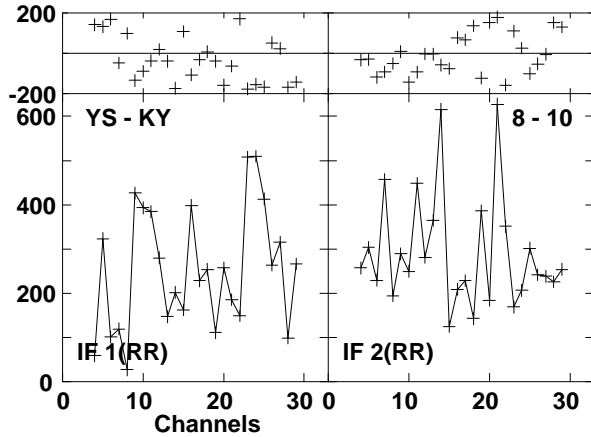
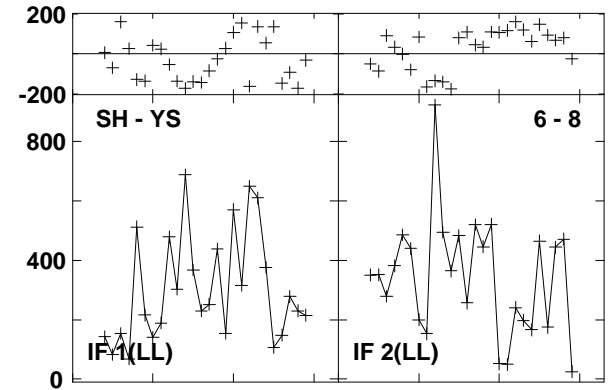
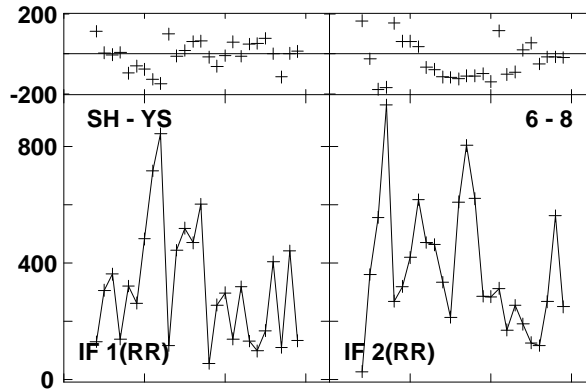
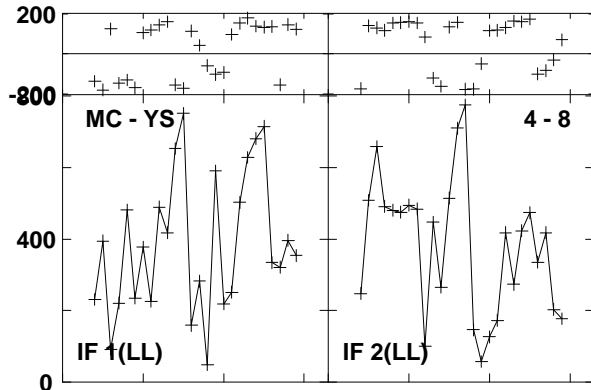
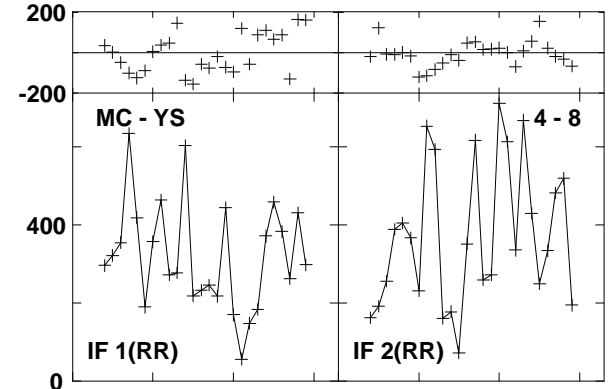
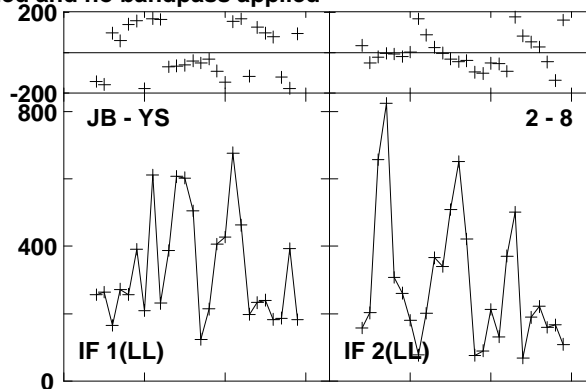
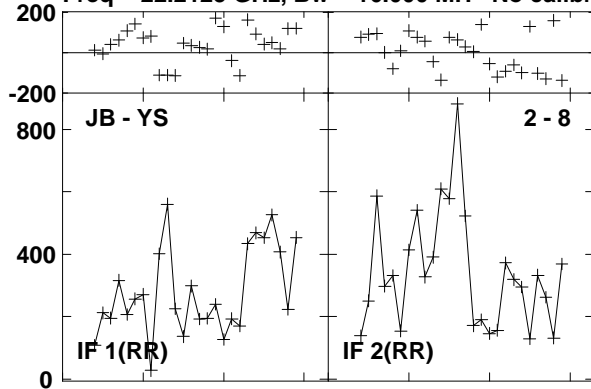

Lower frame: Micro Ampl Jy Top frame: Phas deg  
 Vector averaged cross-power spectrum Baseline: JB (02) - YS (08)  
 Timerange: 00/17:59:32 to 00/17:59:50

Plot file version 789 created 23-AUG-2016 15:01:12

0219+628 GA035B 1.UVDATA.1

Freq = 22.2125 GHz, Bw = 16.000 MH No calibration applied and no bandpass applied

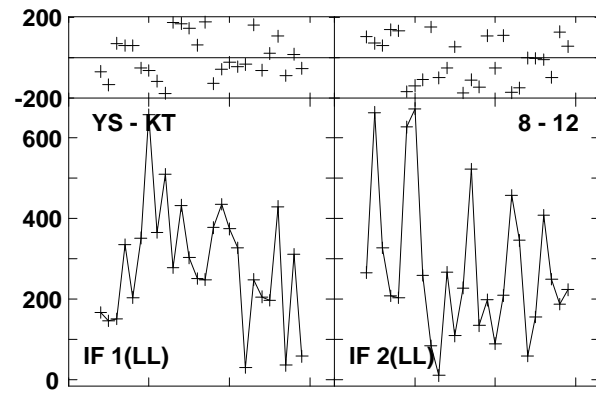
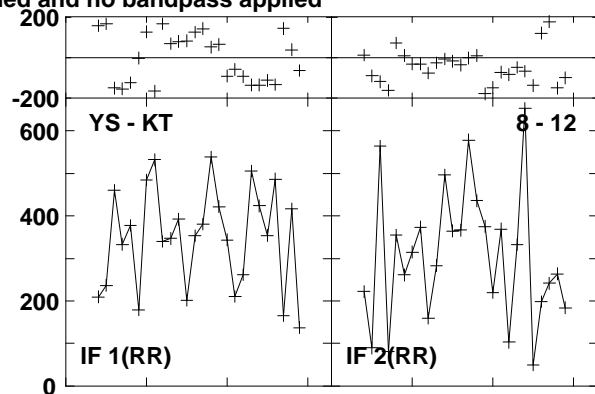
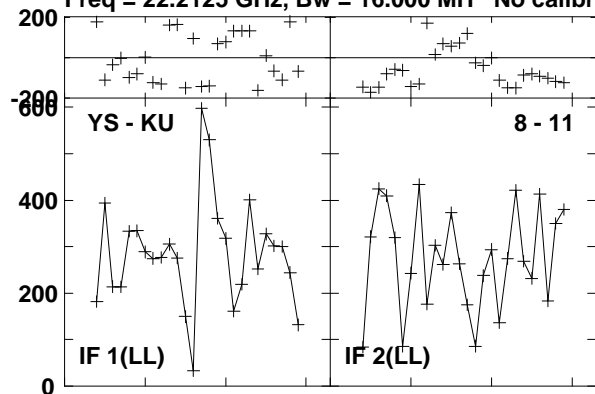

Lower frame: Micro Ampl Jy Top frame: Phas deg  
Vector averaged cross-power spectrum Baseline: YS (08) - KU (11)  
Timerange: 00/17:59:32 to 00/17:59:50

Plot file version 790 created 23-AUG-2016 15:01:12

2021+614 GA035B 1.UVDATA.1

Freq = 22.2125 GHz, Bw = 16.000 MH No calibration applied and no bandpass applied

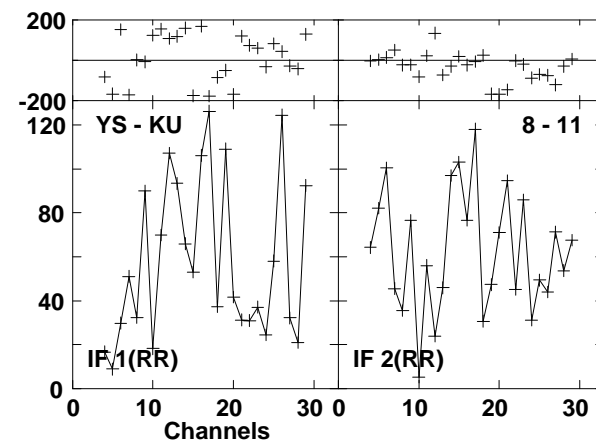
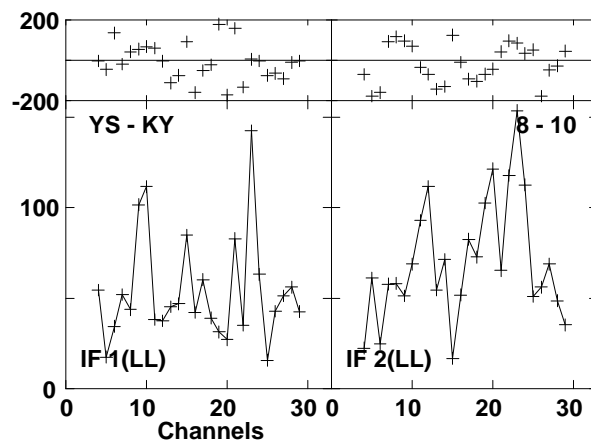
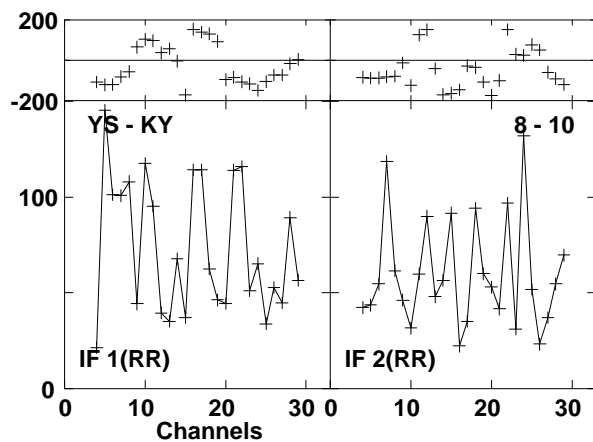
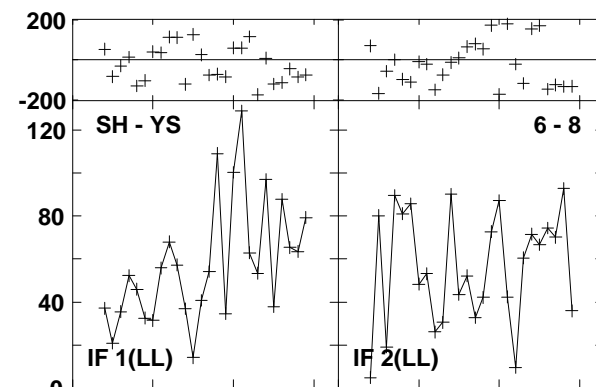
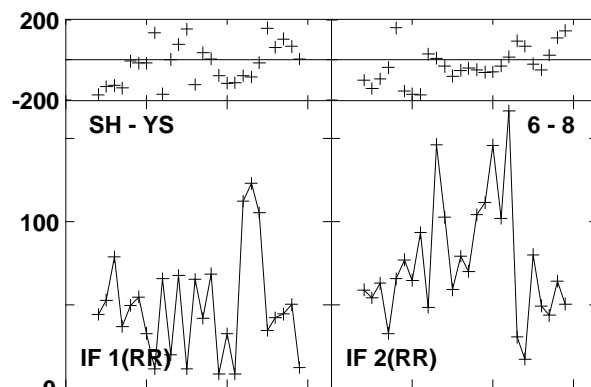
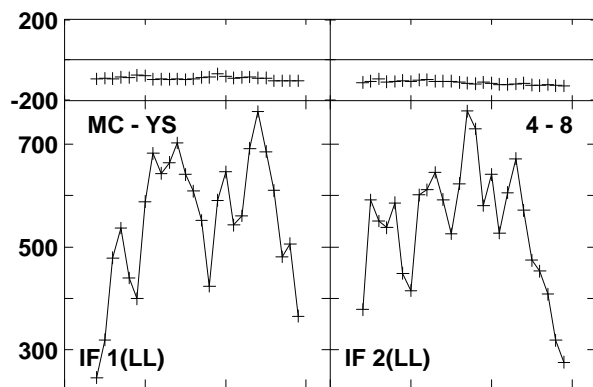
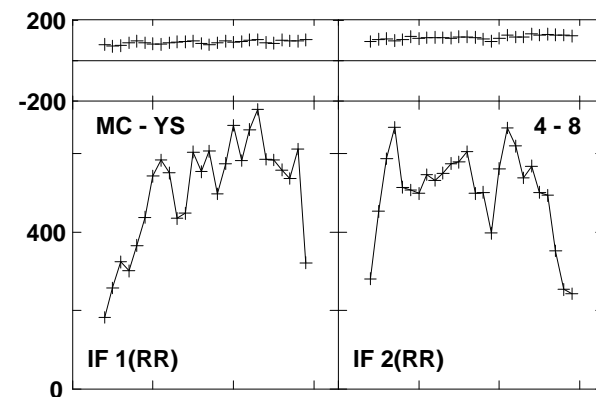
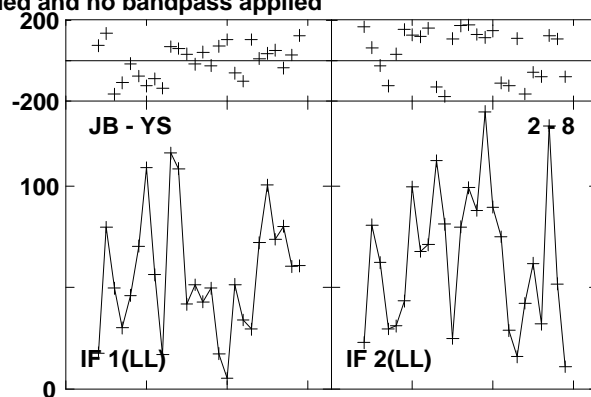
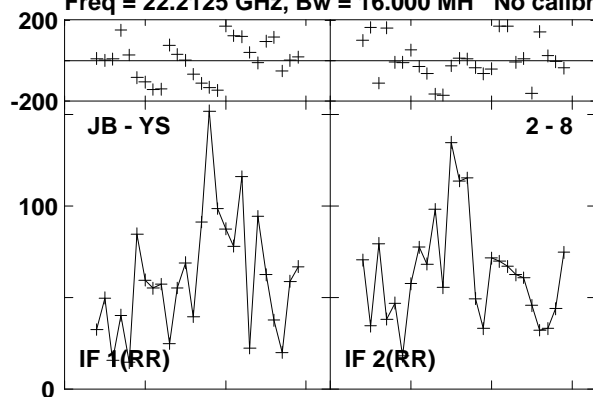

Lower frame: Micro Ampl Jy Top frame: Phas deg  
Vector averaged cross-power spectrum Baseline: JB (02) - YS (08)  
Timerange: 00/18:02:51 to 00/18:08:51

Plot file version 791 created 23-AUG-2016 15:01:13

2021+614 GA035B 1.UVDATA.1

Freq = 22.2125 GHz, Bw = 16.000 MH No calibration applied and no bandpass applied

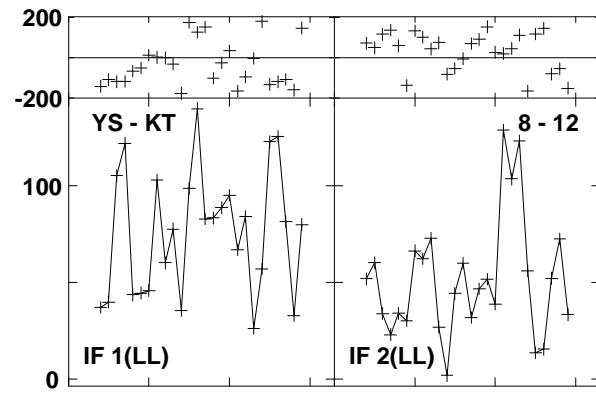
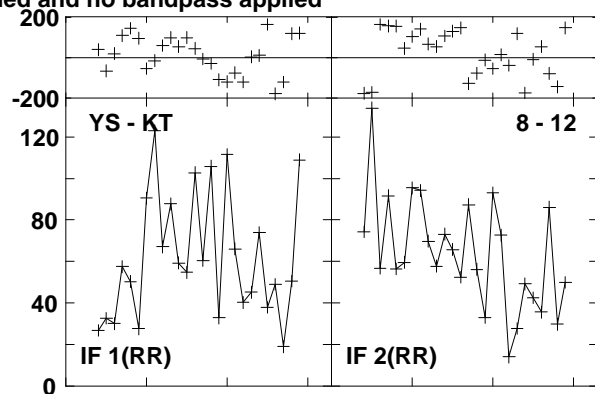
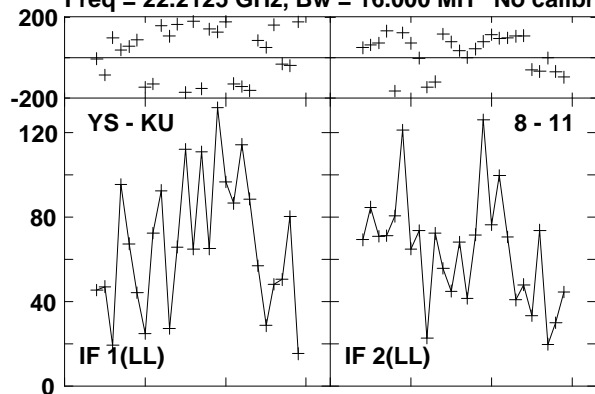

Lower frame: Micro Ampl Jy Top frame: Phas deg  
Vector averaged cross-power spectrum Baseline: YS (08) - KU (11)  
Timerange: 00/18:02:51 to 00/18:08:51

Plot file version 792 created 23-AUG-2016 15:01:13

W3IRS5 GA035B 1.UVDATA.1

Freq = 22.2125 GHz, Bw = 16.000 MH No calibration applied and no bandpass applied

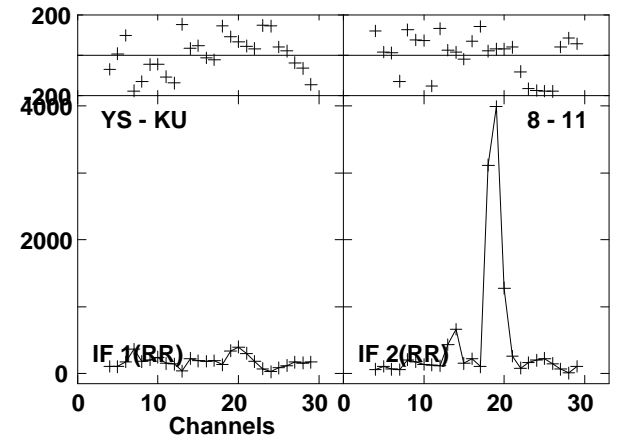
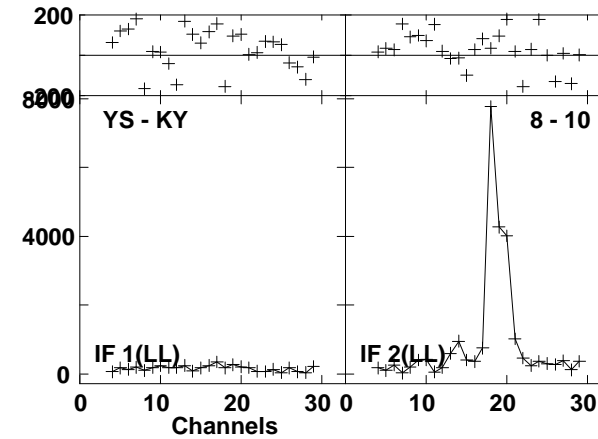
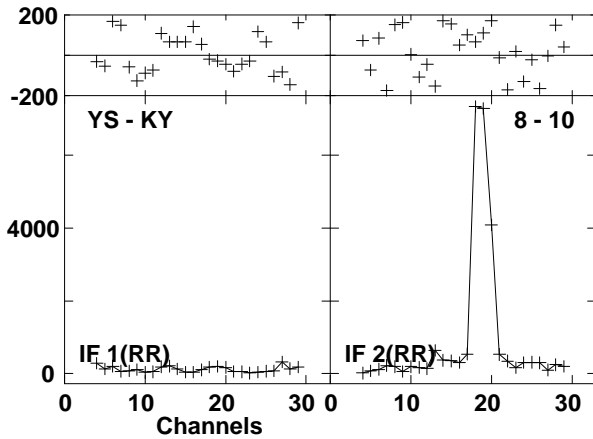
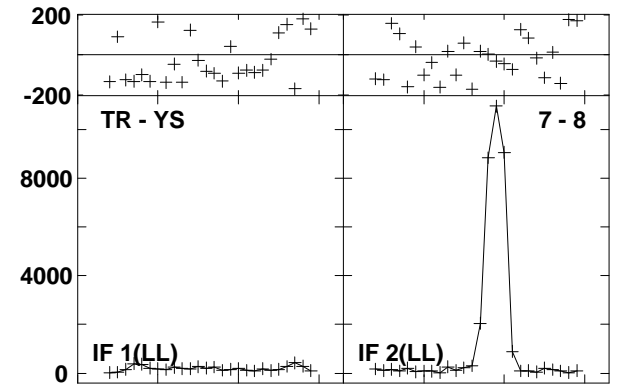
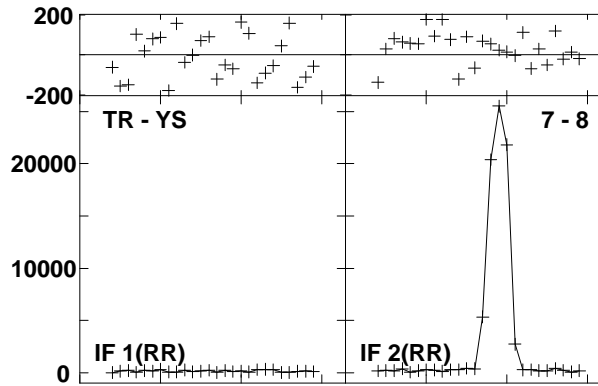
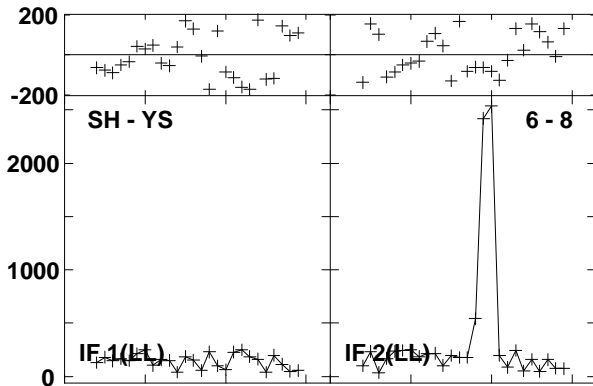
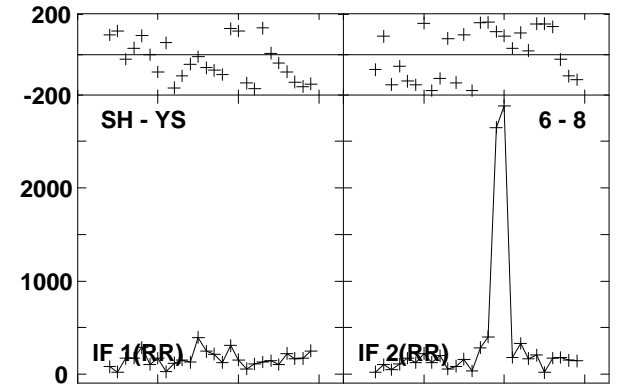
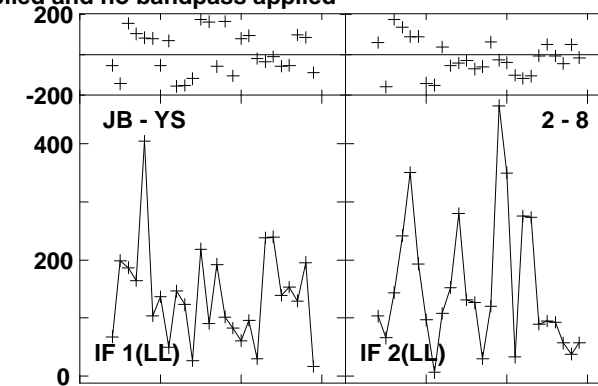
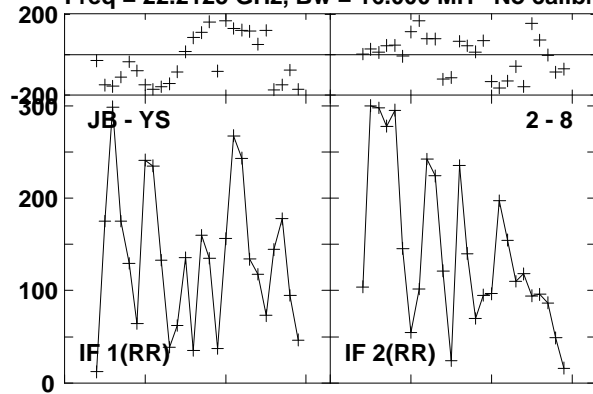

Lower frame: Micro Ampl Jy Top frame: Phas deg  
Vector averaged cross-power spectrum Baseline: JB (02) - YS (08)  
Timerange: 00/18:11:52 to 00/18:12:50



Plot file version 793 created 23-AUG-2016 15:01:13

W3IRS5 GA035B 1.UVDATA.1

Freq = 22.2125 GHz, Bw = 16.000 MH No calibration applied and no bandpass applied

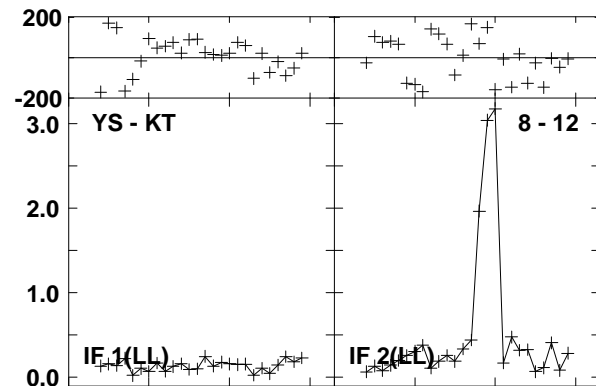
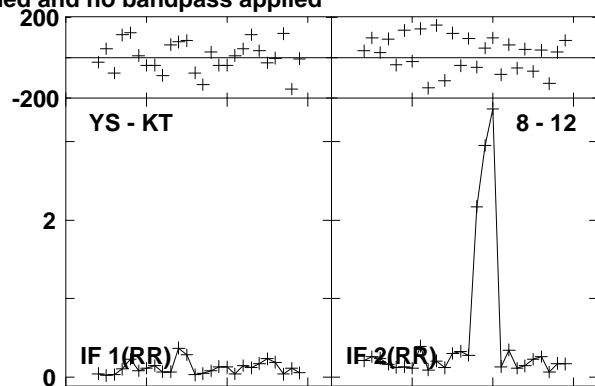
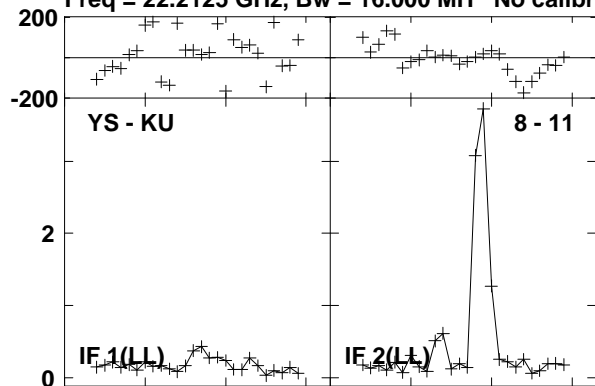

Lower frame: Milli Ampl Jy Top frame: Phas deg  
Vector averaged cross-power spectrum Baseline: YS (08) - KU (11)  
Timerange: 00/18:11:52 to 00/18:12:50

Plot file version 794 created 23-AUG-2016 15:01:13

0219+628 GA035B 1.UVDATA.1

Freq = 22.2125 GHz, Bw = 16.000 MH No calibration applied and no bandpass applied

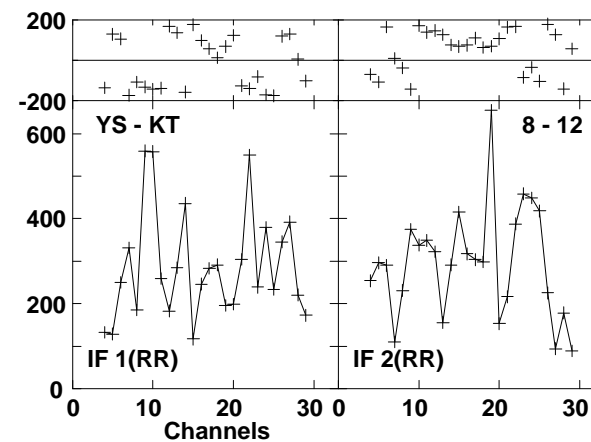
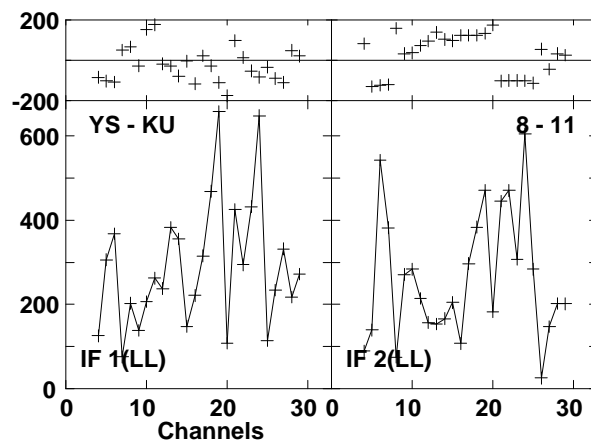
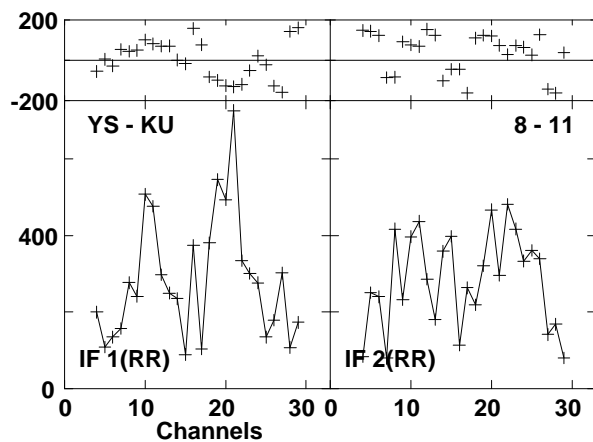
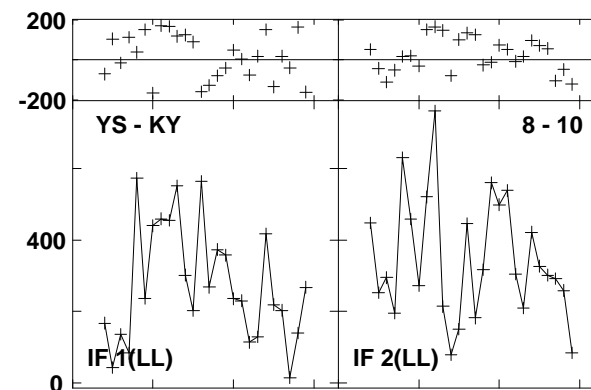
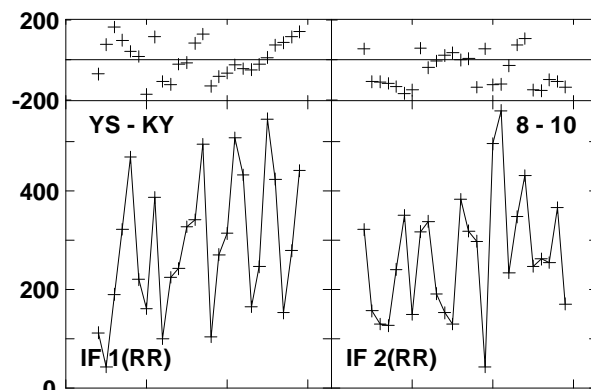
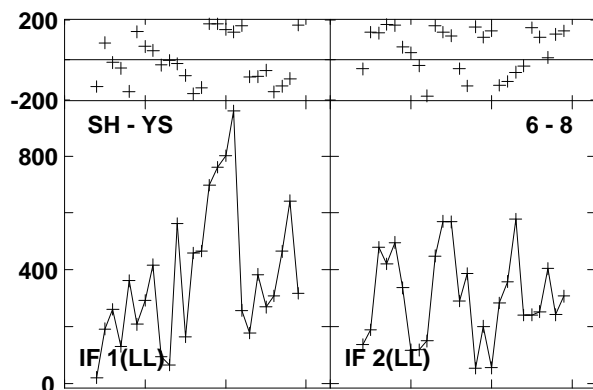
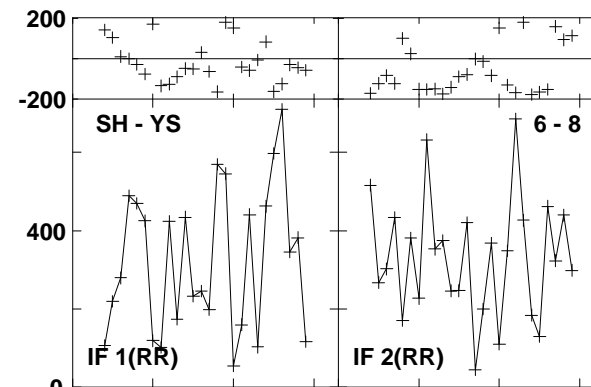
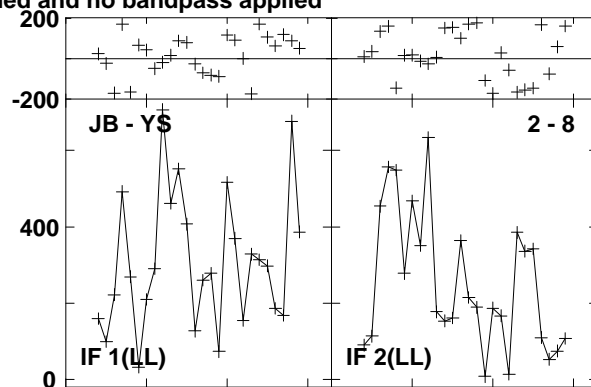
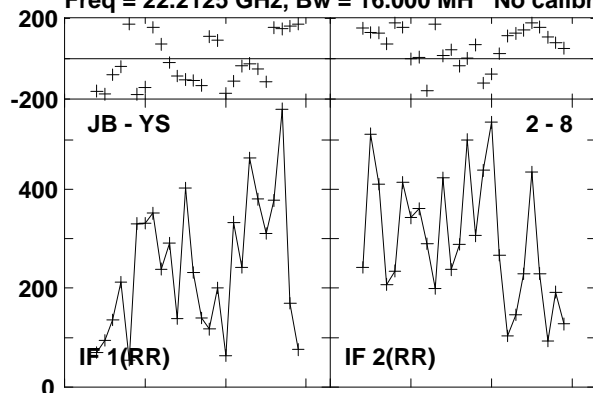

Lower frame: Micro Ampl Jy Top frame: Phas deg  
Vector averaged cross-power spectrum Baseline: JB (02) - YS (08)  
Timerange: 00/18:13:22 to 00/18:13:40

Plot file version 795 created 23-AUG-2016 15:01:13  
0219+628 GA035B 1.UVDATA.1  
Freq = 22.2125 GHz, Bw = 16.000 MH No calibration applied and no bandpass applied

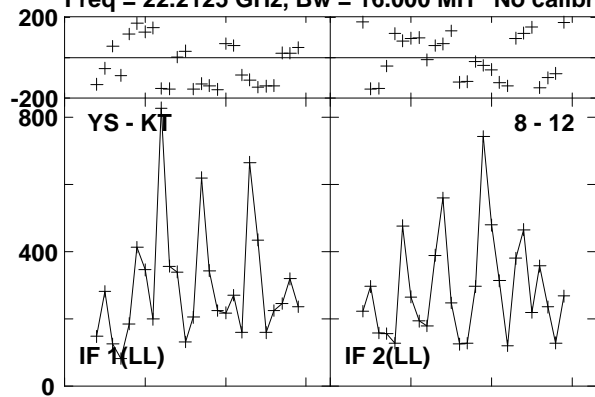

Lower frame: Micro Ampl Jy Top frame: Phas deg  
Vector averaged cross-power spectrum Baseline: YS (08) - KT (12)  
Timerange: 00/18:13:22 to 00/18:13:40

Plot file version 796 created 23-AUG-2016 15:01:13  
 W3IRS5 GA035B 1.UVDATA.1

Freq = 22.2125 GHz, Bw = 16.000 MH No calibration applied and no bandpass applied

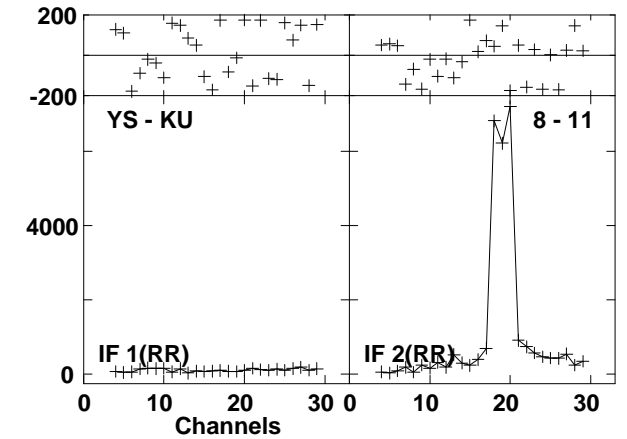
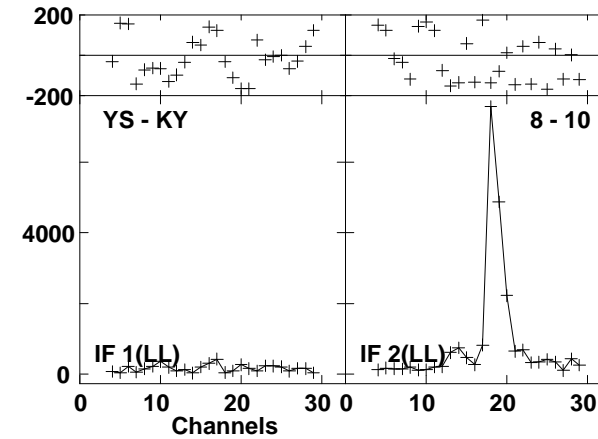
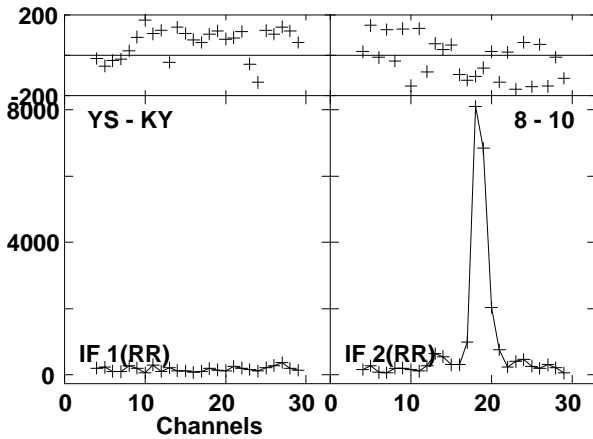
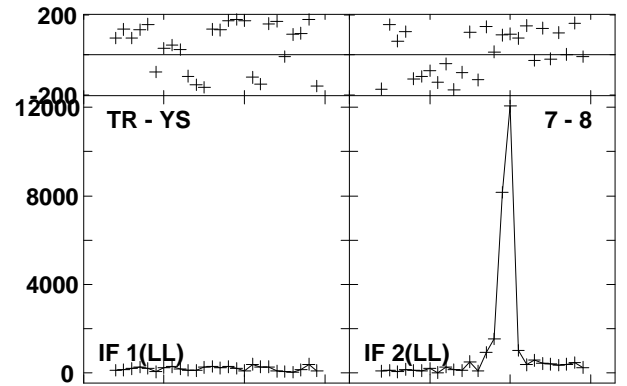
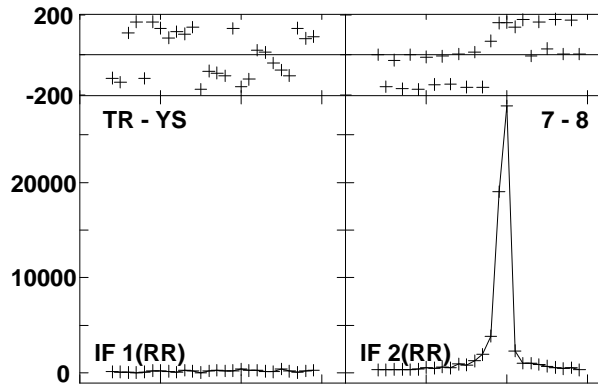
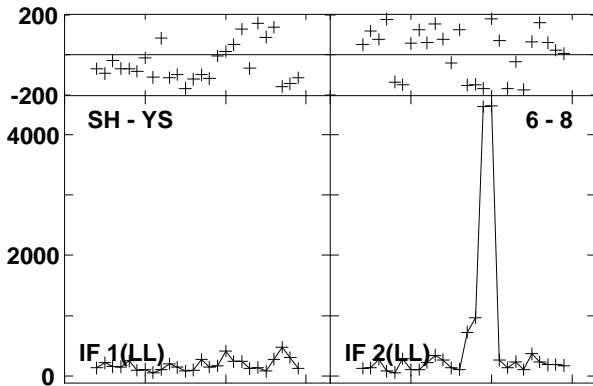
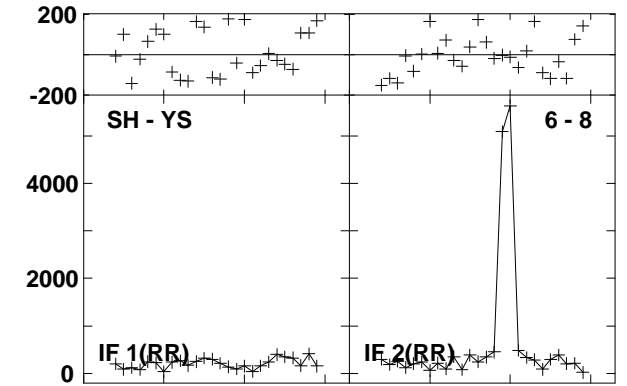
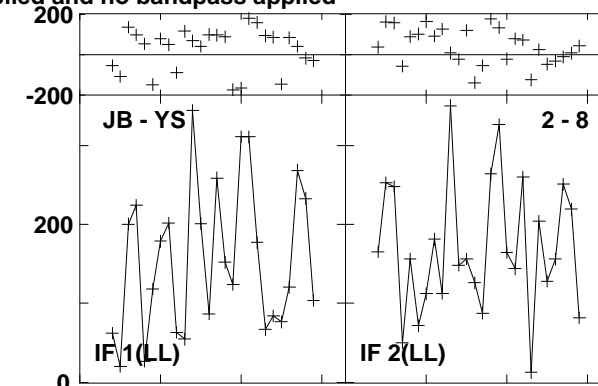
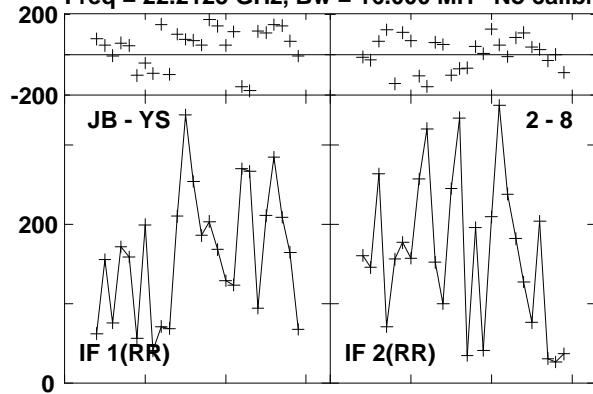

Lower frame: Micro Ampl Jy Top frame: Phas deg  
 Vector averaged cross-power spectrum Baseline: JB (02) - YS (08)  
 Timerange: 00/18:14:12 to 00/18:15:11

Plot file version 797 created 23-AUG-2016 15:01:13

W3IRS5 GA035B 1.UVDATA.1

Freq = 22.2125 GHz, Bw = 16.000 MH No calibration applied and no bandpass applied

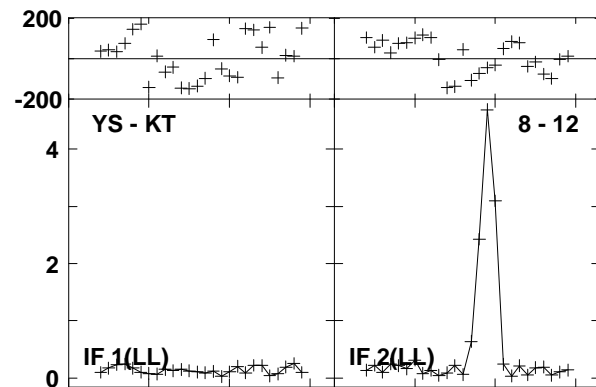
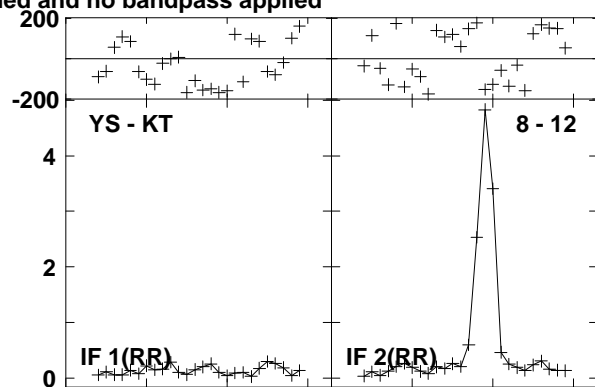
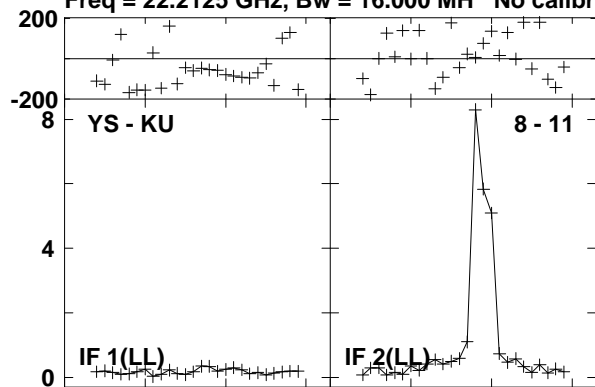

Lower frame: Milli Ampl Jy Top frame: Phas deg  
Vector averaged cross-power spectrum Baseline: YS (08) - KU (11)  
Timerange: 00/18:14:12 to 00/18:15:11

Plot file version 798 created 23-AUG-2016 15:01:13

0219+628 GA035B 1.UVDATA.1

Freq = 22.2125 GHz, Bw = 16.000 MH No calibration applied and no bandpass applied

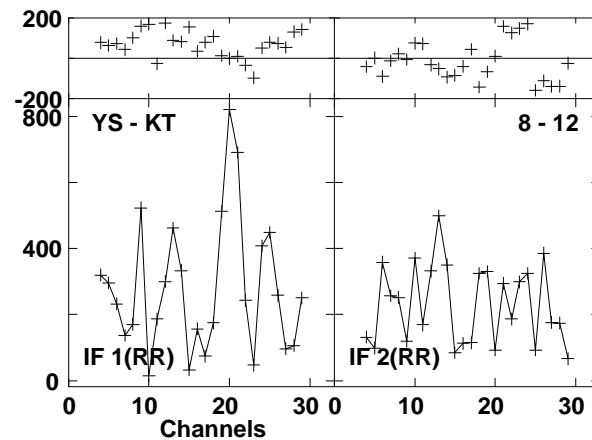
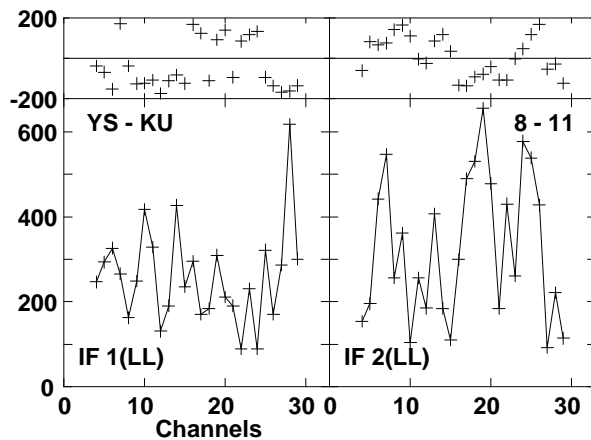
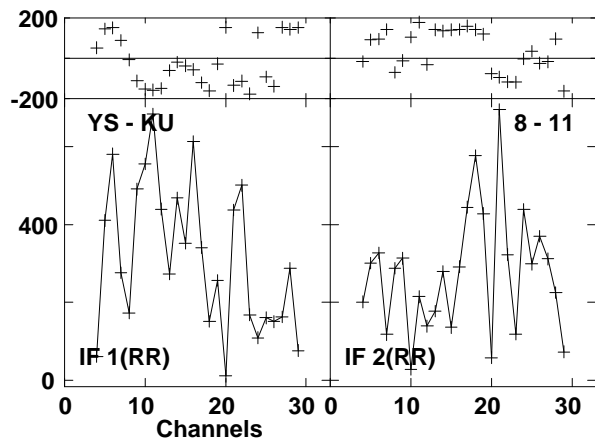
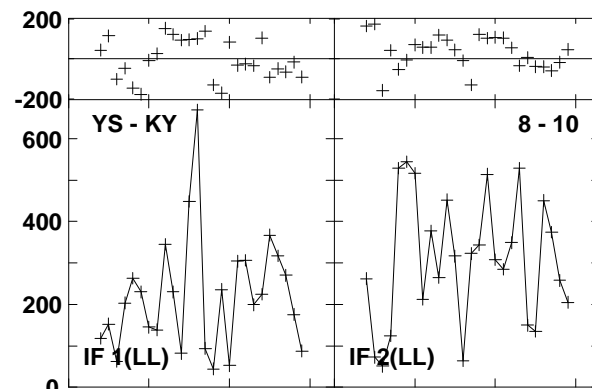
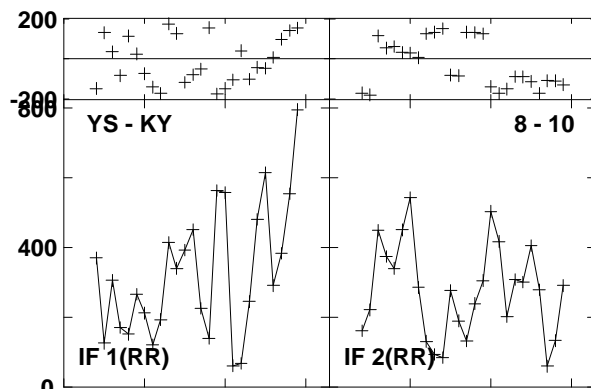
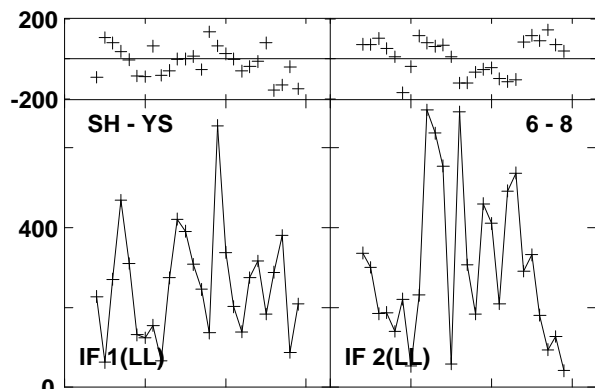
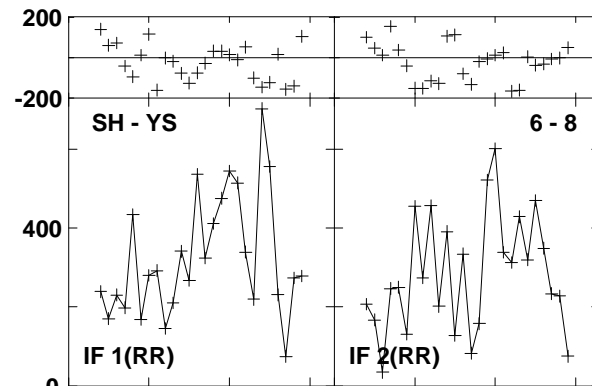
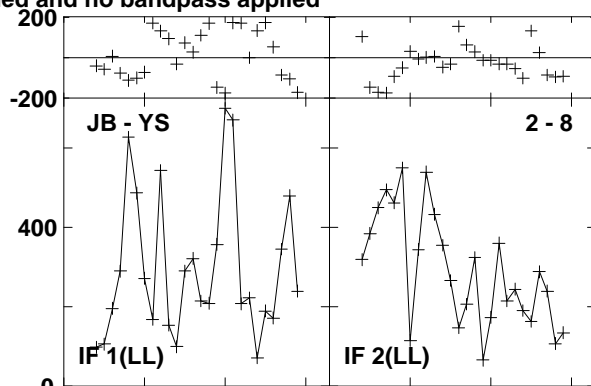
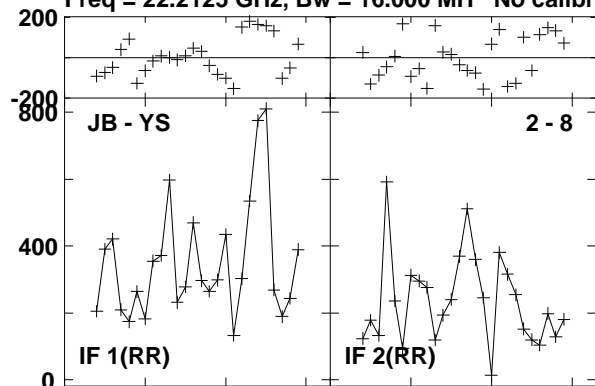

Lower frame: Micro Ampl Jy Top frame: Phas deg  
Vector averaged cross-power spectrum Baseline: JB (02) - YS (08)  
Timerange: 00/18:15:42 to 00/18:16:01

Plot file version 799 created 23-AUG-2016 15:01:13  
0219+628 GA035B 1.UVDATA.1  
Freq = 22.2125 GHz, Bw = 16.000 MH No calibration applied and no bandpass applied

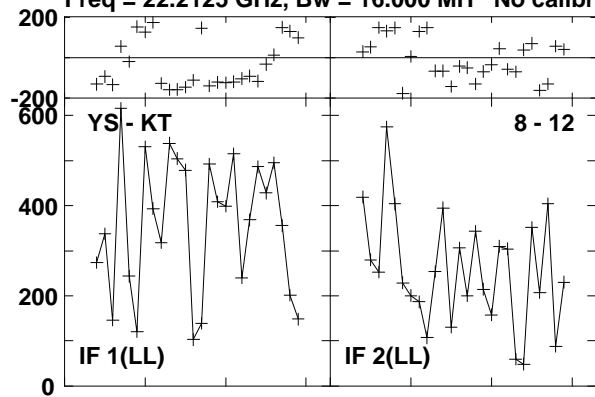

Lower frame: Micro Ampl Jy Top frame: Phas deg  
Vector averaged cross-power spectrum Baseline: YS (08) - KT (12)  
Timerange: 00/18:15:42 to 00/18:16:01

Plot file version 800 created 23-AUG-2016 15:01:13

W3IRS5 GA035B 1.UVDATA.1

Freq = 22.2125 GHz, Bw = 16.000 MH No calibration applied and no bandpass applied

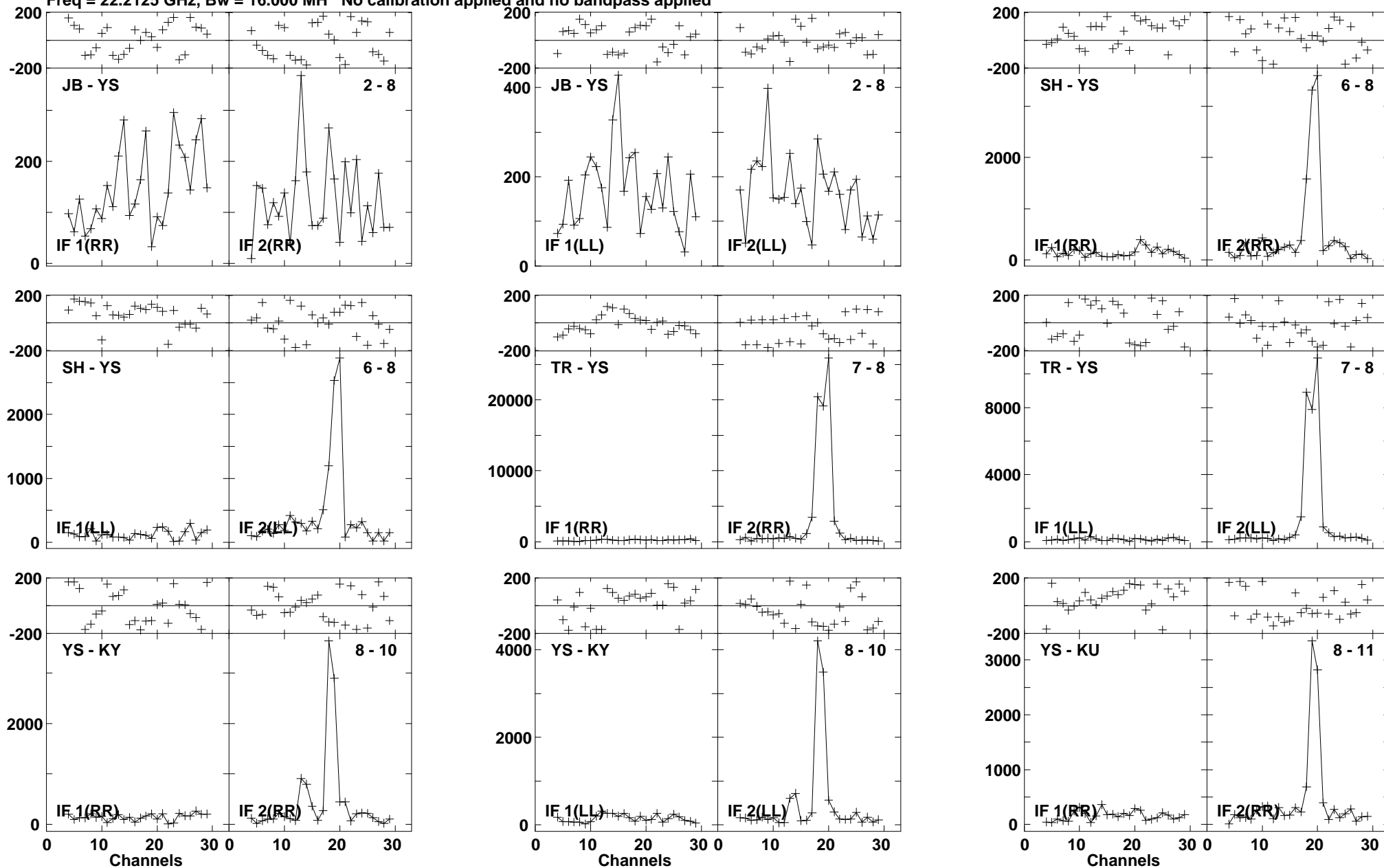

Lower frame: Micro Ampl Jy Top frame: Phas deg  
Vector averaged cross-power spectrum Baseline: JB (02) - YS (08)  
Timerange: 00/18:16:32 to 00/18:17:30



Plot file version 801 created 23-AUG-2016 15:01:13  
W3IRS5 GA035B 1.UVDATA.1

Freq = 22.2125 GHz, Bw = 16.000 MH No calibration applied and no bandpass applied

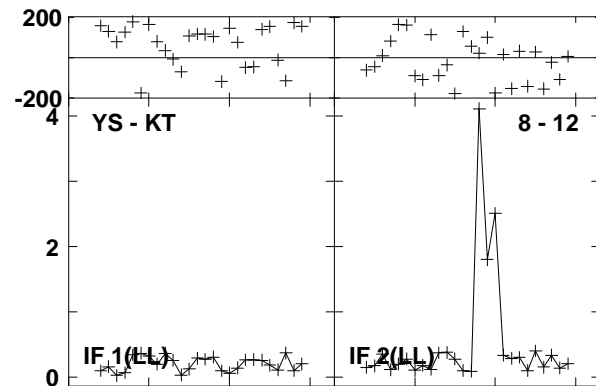
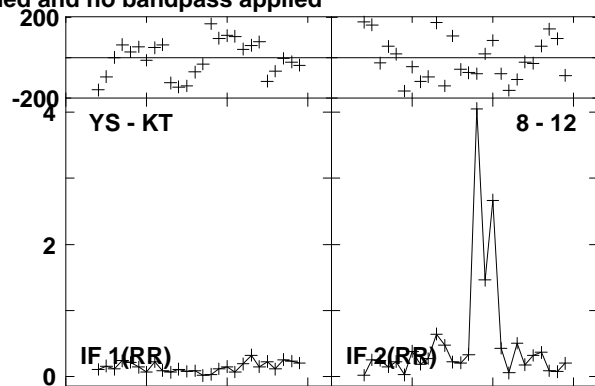
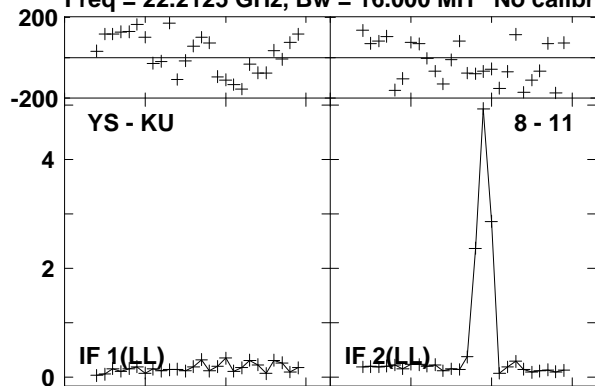

Lower frame: Milli Ampl Jy Top frame: Phas deg  
Vector averaged cross-power spectrum Baseline: YS (08) - KU (11)  
Timerange: 00/18:16:32 to 00/18:17:30

Plot file version 802 created 23-AUG-2016 15:01:13

0219+628 GA035B 1.UVDATA.1

Freq = 22.2125 GHz, Bw = 16.000 MH No calibration applied and no bandpass applied

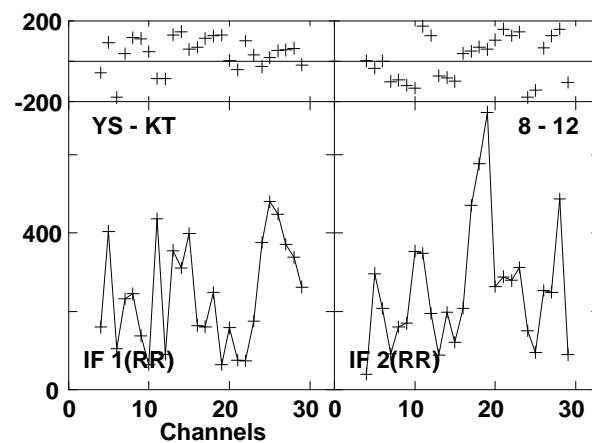
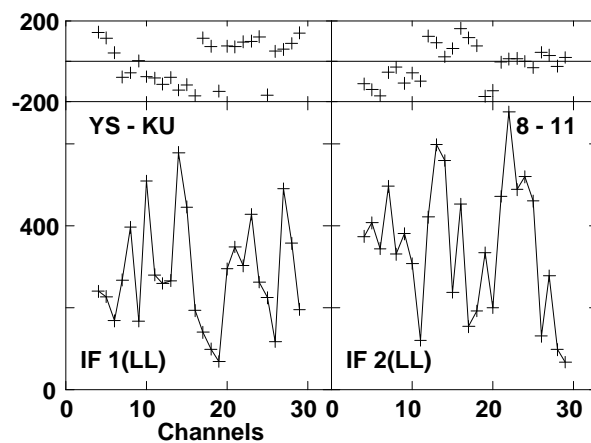
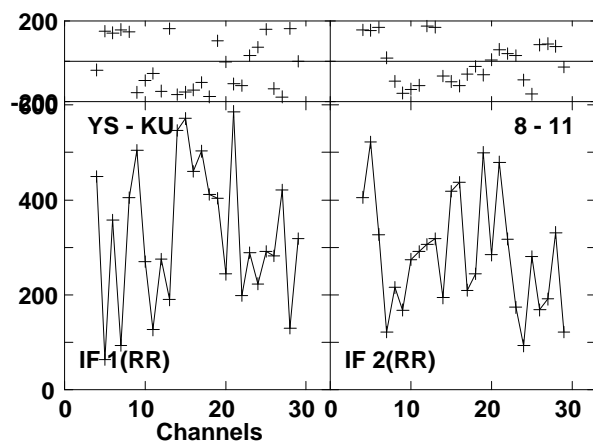
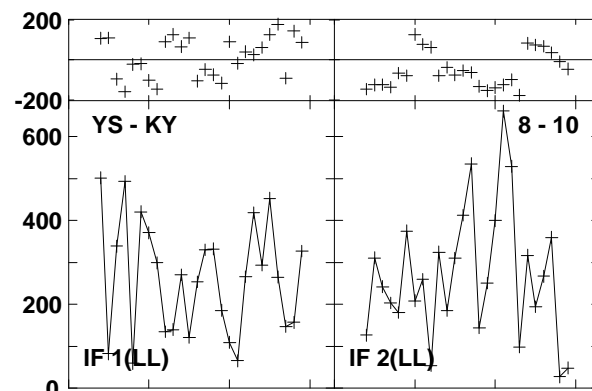
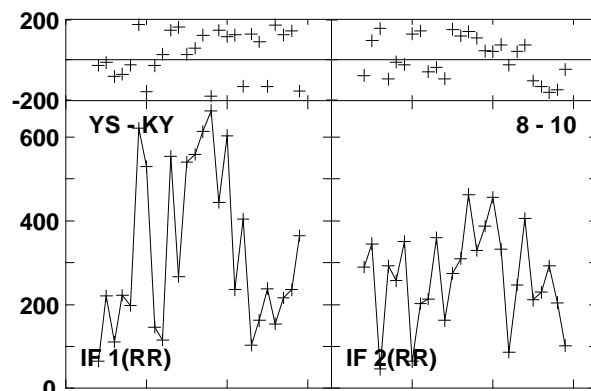
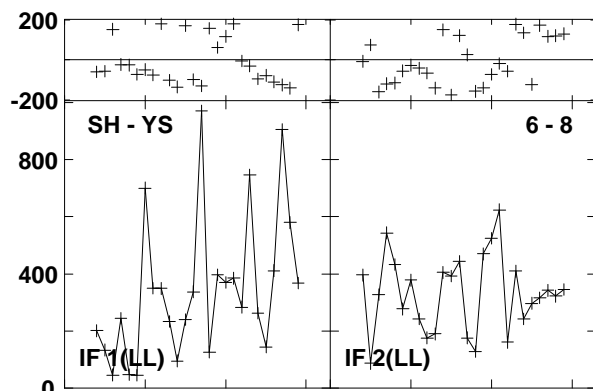
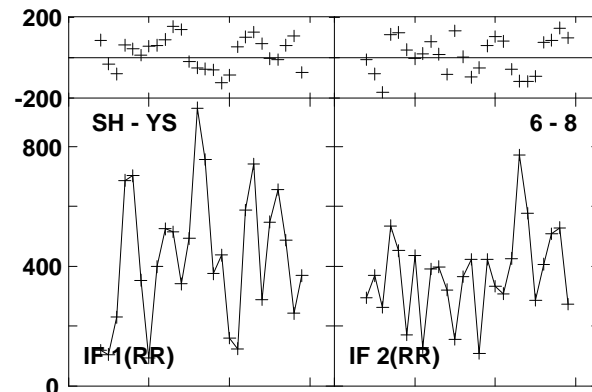
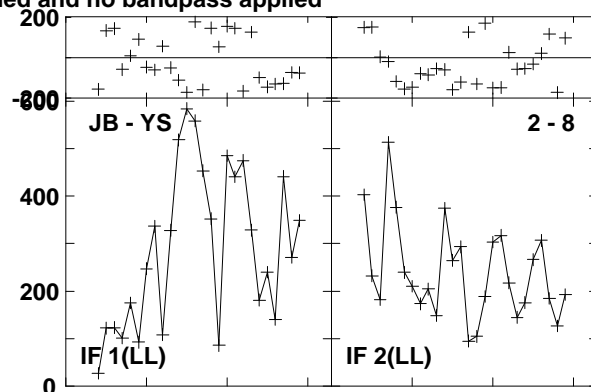
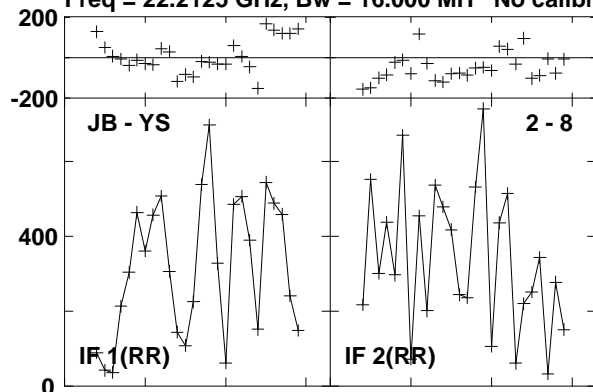

Lower frame: Micro Ampl Jy Top frame: Phas deg  
Vector averaged cross-power spectrum Baseline: JB (02) - YS (08)  
Timerange: 00/18:18:01 to 00/18:18:21

Plot file version 803 created 23-AUG-2016 15:01:13  
0219+628 GA035B 1.UVDATA.1  
Freq = 22.2125 GHz, Bw = 16.000 MH No calibration applied and no bandpass applied

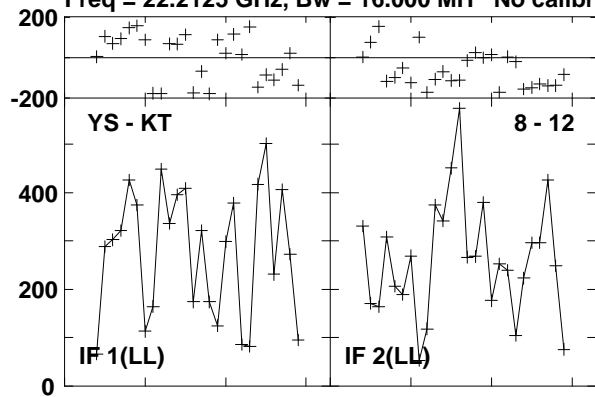

Lower frame: Micro Ampl Jy Top frame: Phas deg  
Vector averaged cross-power spectrum Baseline: YS (08) - KT (12)  
Timerange: 00/18:18:01 to 00/18:18:21

Plot file version 804 created 23-AUG-2016 15:01:13  
 W3IRS5 GA035B 1.UVDATA.1

Freq = 22.2125 GHz, Bw = 16.000 MH No calibration applied and no bandpass applied

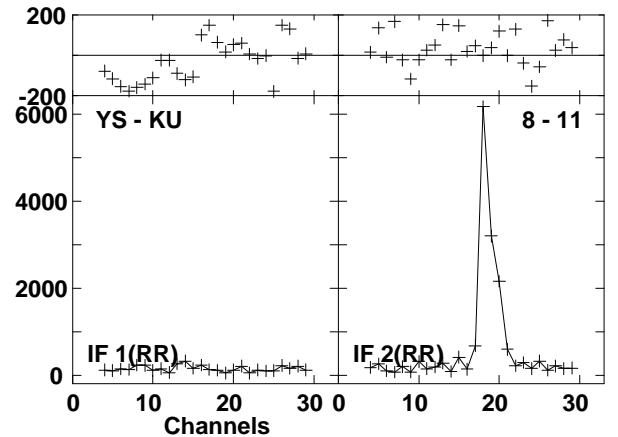
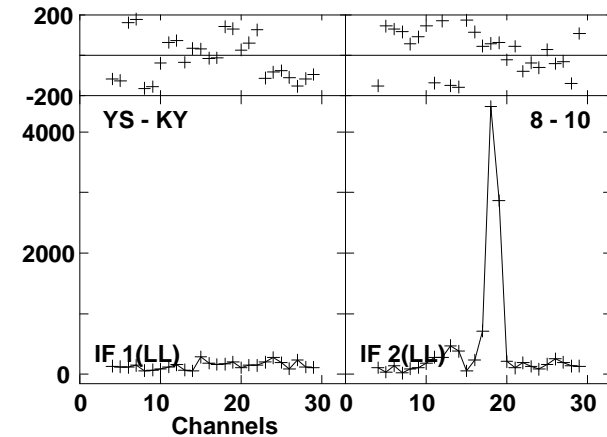
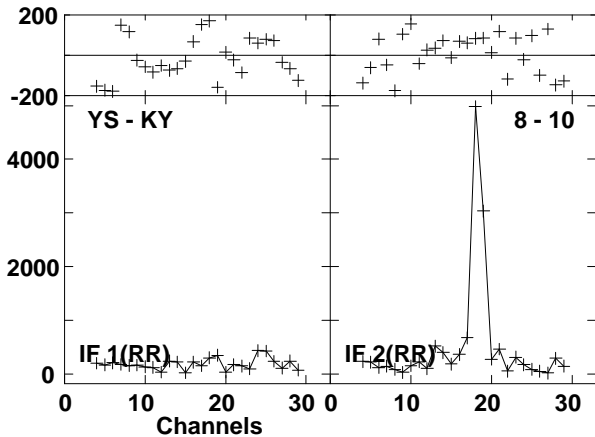
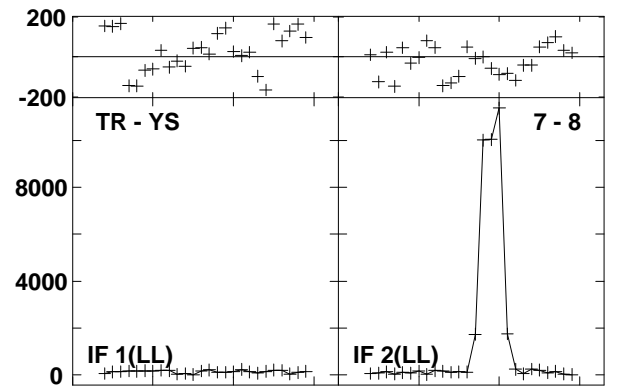
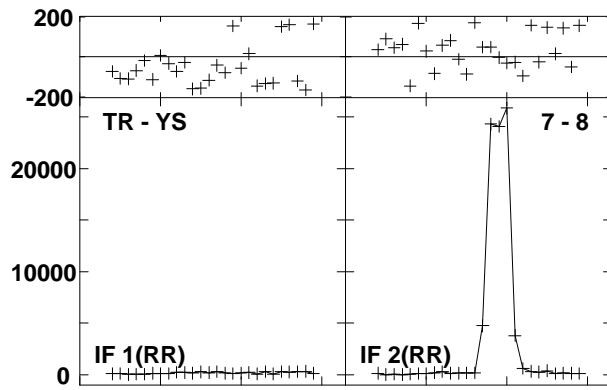
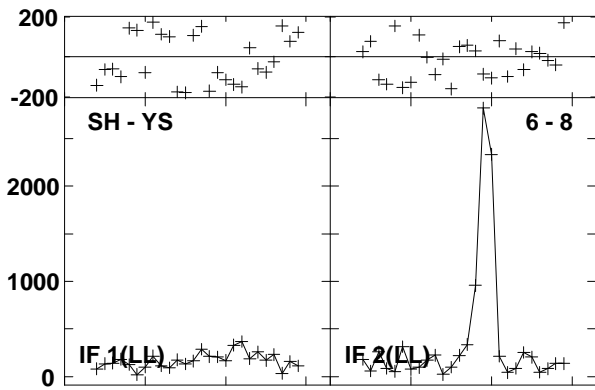
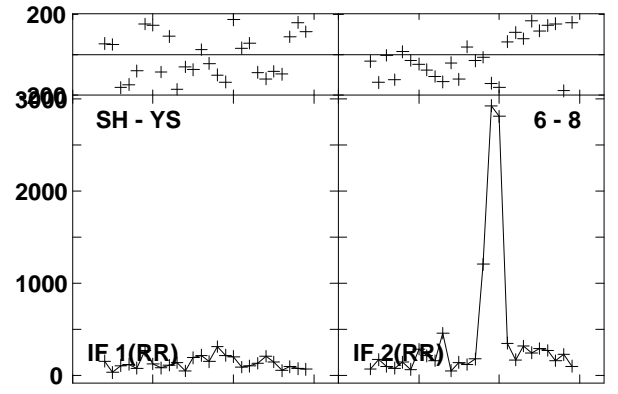
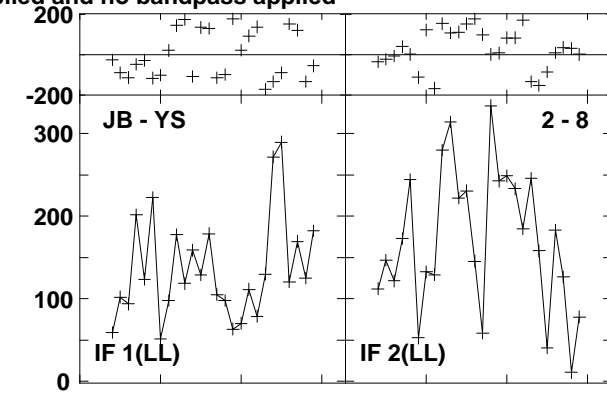
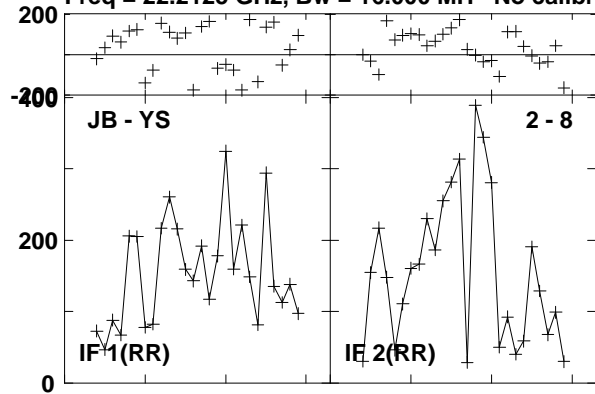

Lower frame: Micro Ampl Jy Top frame: Phas deg  
 Vector averaged cross-power spectrum Baseline: JB (02) - YS (08)  
 Timerange: 00/18:18:52 to 00/18:19:50

Plot file version 805 created 23-AUG-2016 15:01:13  
W3IRS5 GA035B 1.UVDATA.1

Freq = 22.2125 GHz, Bw = 16.000 MH No calibration applied and no bandpass applied

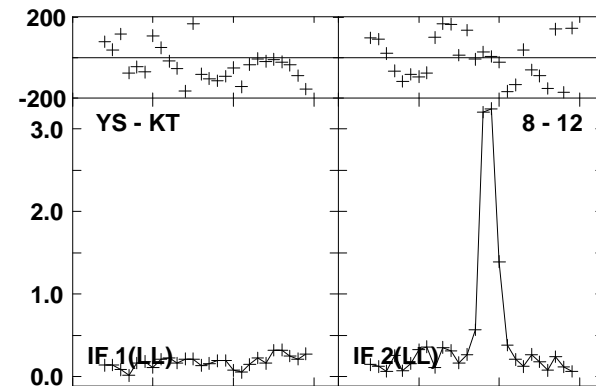
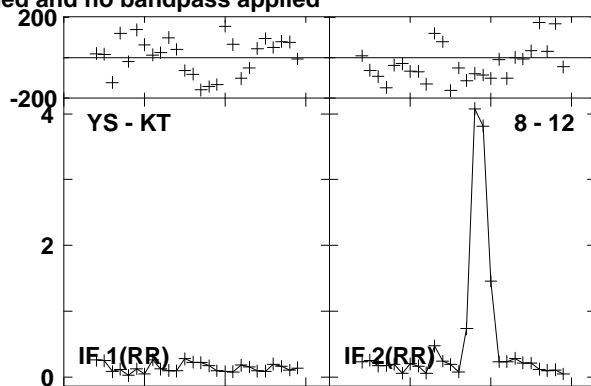
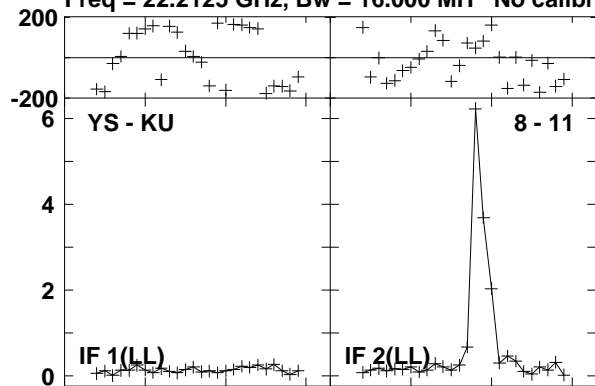

Lower frame: Milli Ampl Jy Top frame: Phas deg  
Vector averaged cross-power spectrum Baseline: YS (08) - KU (11)  
Timerange: 00/18:18:52 to 00/18:19:50

Plot file version 806 created 23-AUG-2016 15:01:13

0219+628 GA035B 1.UVDATA.1

Freq = 22.2125 GHz, Bw = 16.000 MH No calibration applied and no bandpass applied

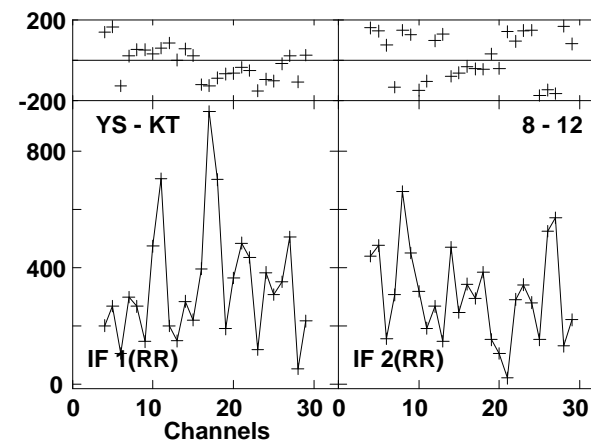
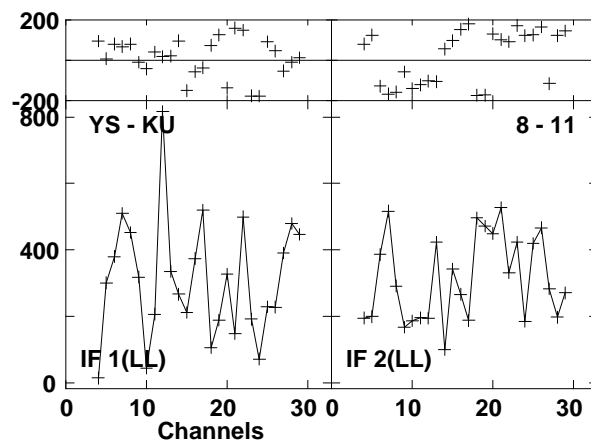
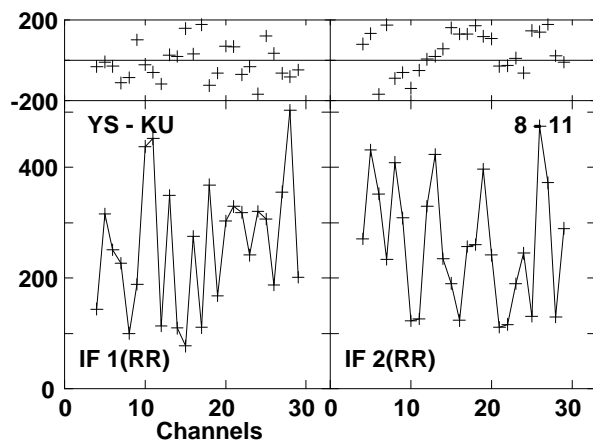
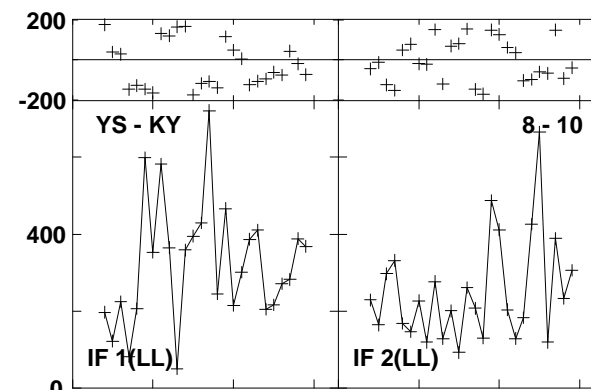
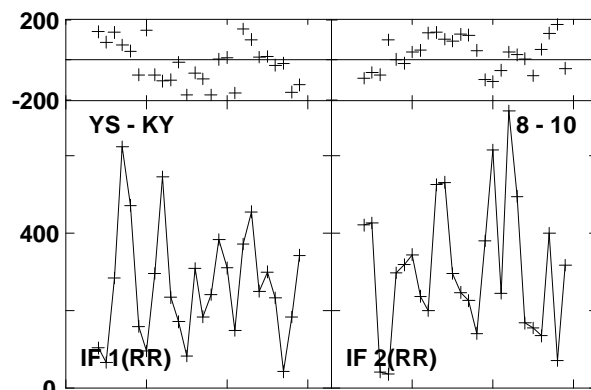
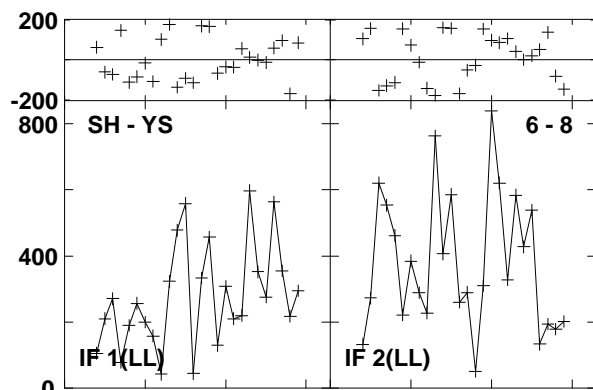
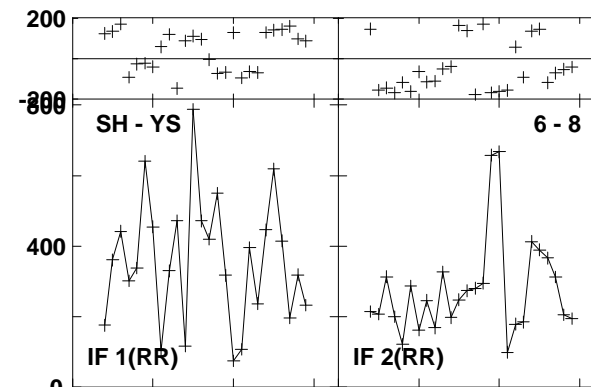
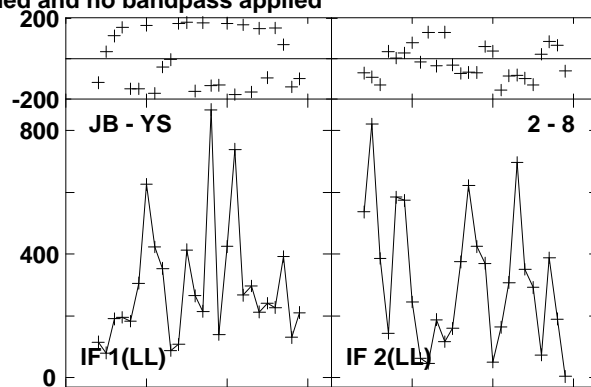
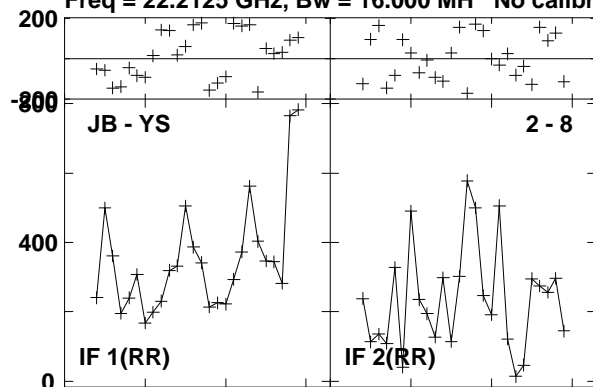

Lower frame: Micro Ampl Jy Top frame: Phas deg  
Vector averaged cross-power spectrum Baseline: JB (02) - YS (08)  
Timerange: 00/18:20:22 to 00/18:20:40

Plot file version 807 created 23-AUG-2016 15:01:13

0219+628 GA035B 1.UVDATA.1

Freq = 22.2125 GHz, Bw = 16.000 MH No calibration applied and no bandpass applied

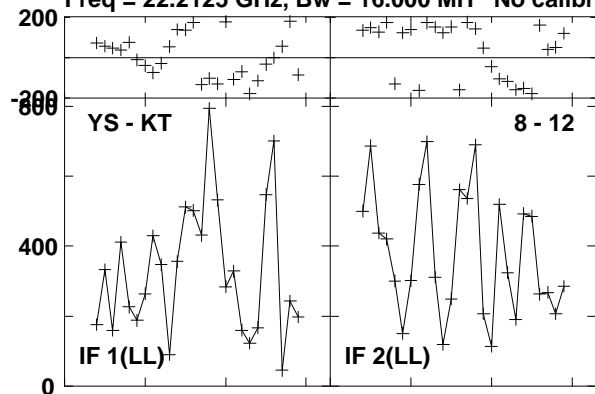

Lower frame: Micro Ampl Jy Top frame: Phas deg  
Vector averaged cross-power spectrum Baseline: YS (08) - KT (12)  
Timerange: 00/18:20:22 to 00/18:20:40

Plot file version 808 created 23-AUG-2016 15:01:13

W3IRS5 GA035B 1.UVDATA.1

Freq = 22.2125 GHz, Bw = 16.000 MH No calibration applied and no bandpass applied

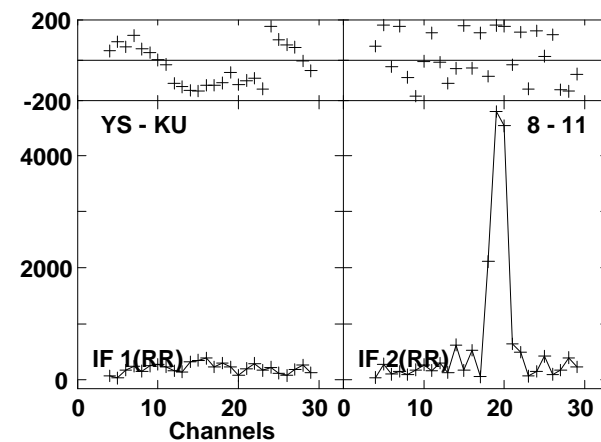
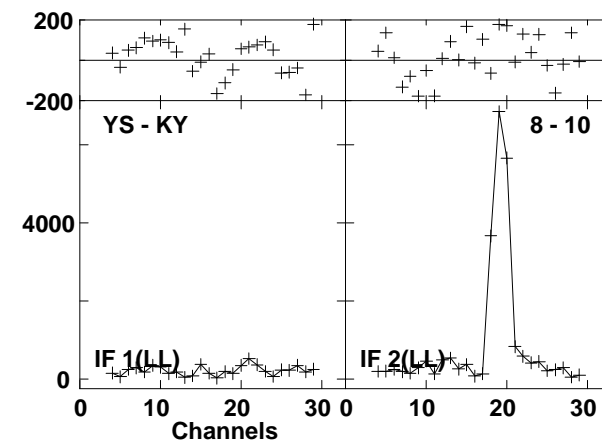
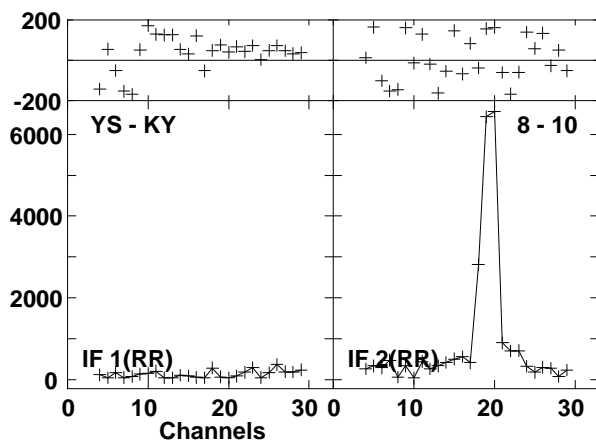
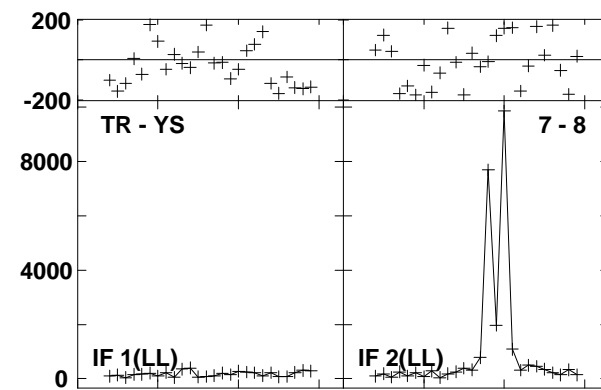
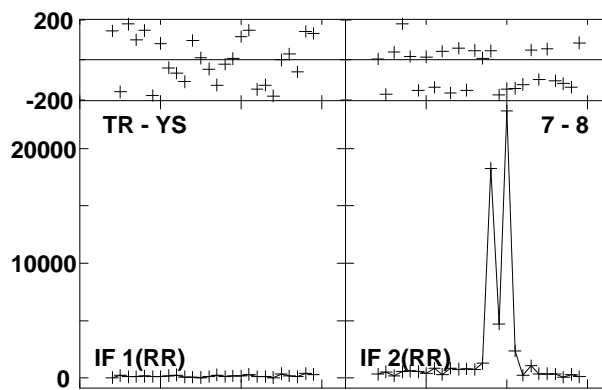
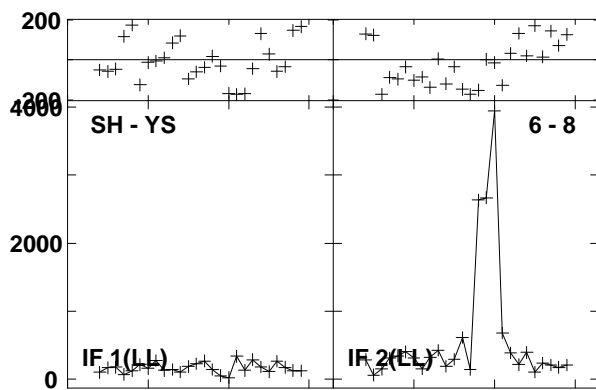
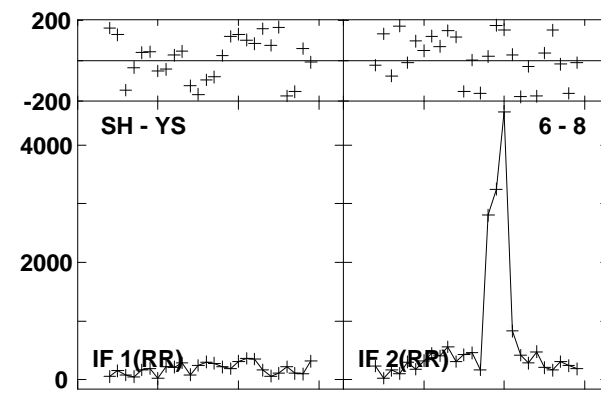
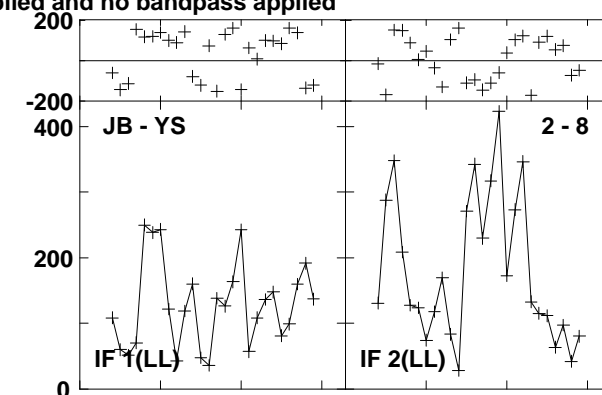
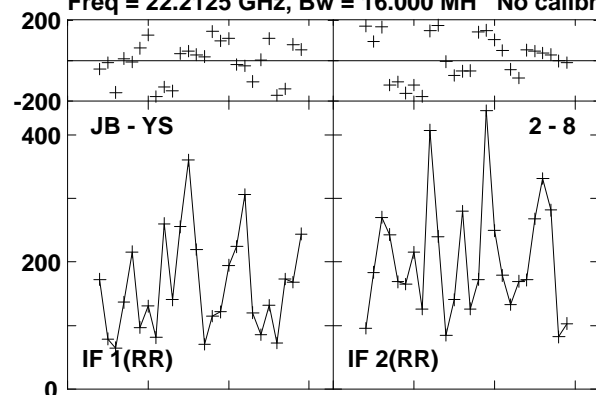

Lower frame: Micro Ampl Jy Top frame: Phas deg  
Vector averaged cross-power spectrum Baseline: JB (02) - YS (08)  
Timerange: 00/18:22:17 to 00/18:23:15



Plot file version 809 created 23-AUG-2016 15:01:13  
W3IRS5 GA035B 1.UVDATA.1

Freq = 22.2125 GHz, Bw = 16.000 MH No calibration applied and no bandpass applied

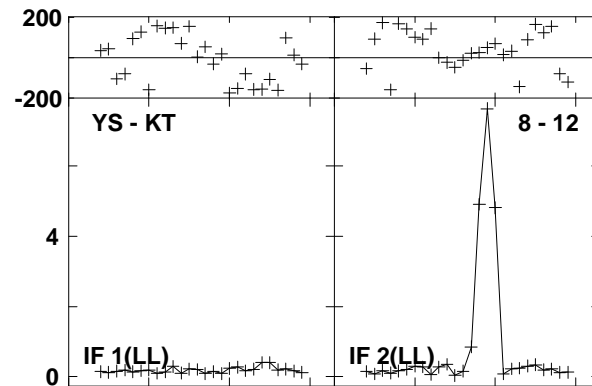
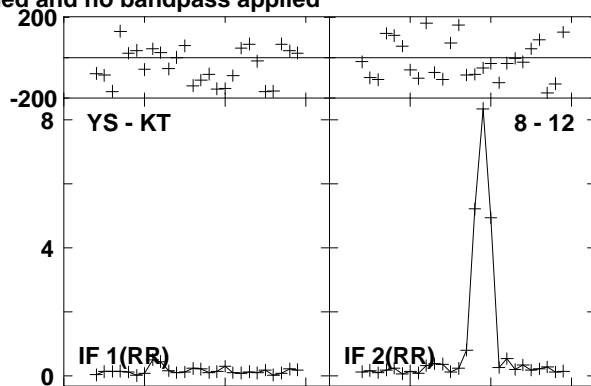
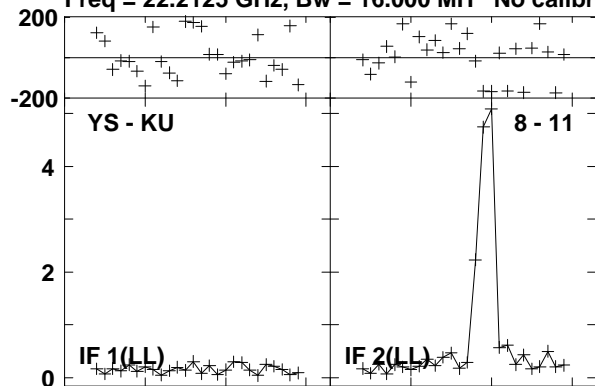

Lower frame: Milli Ampl Jy Top frame: Phas deg  
Vector averaged cross-power spectrum Baseline: YS (08) - KU (11)  
Timerange: 00/18:22:17 to 00/18:23:15

Plot file version 810 created 23-AUG-2016 15:01:13

0219+628 GA035B 1.UVDATA.1

Freq = 22.2125 GHz, Bw = 16.000 MH No calibration applied and no bandpass applied

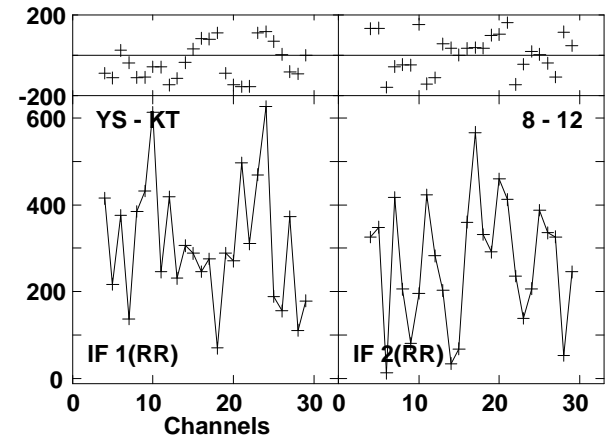
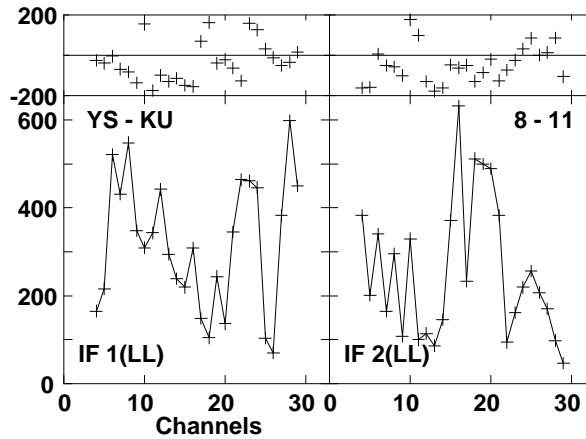
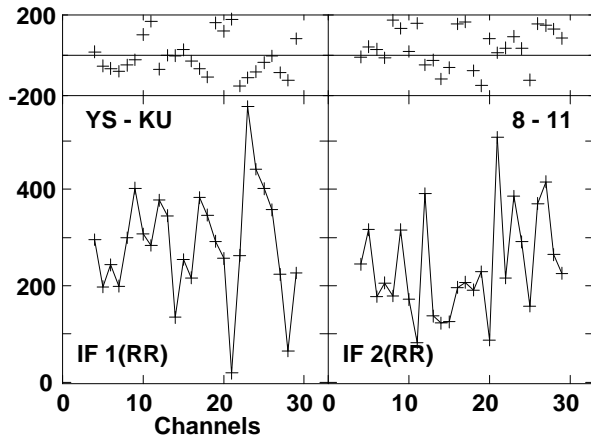
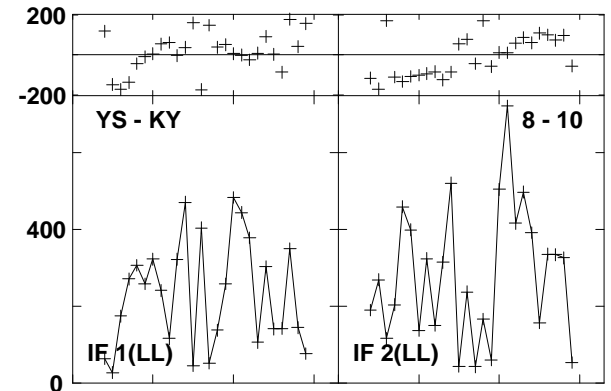
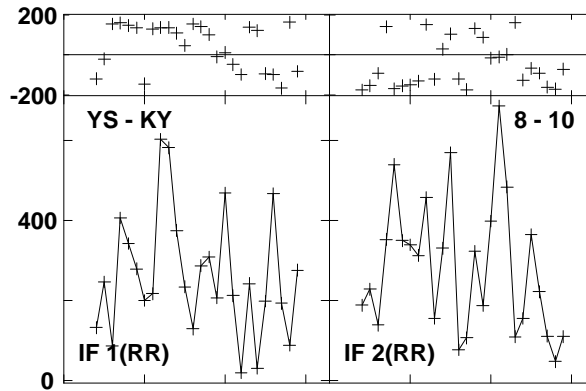
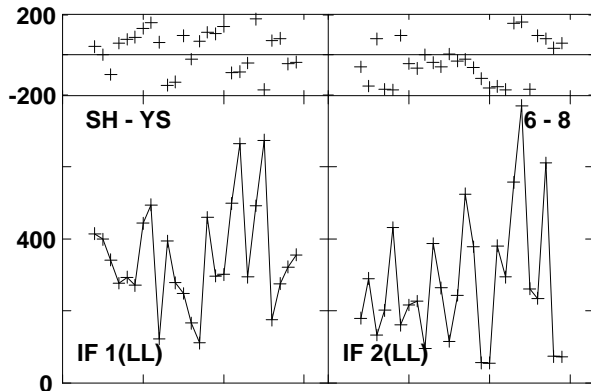
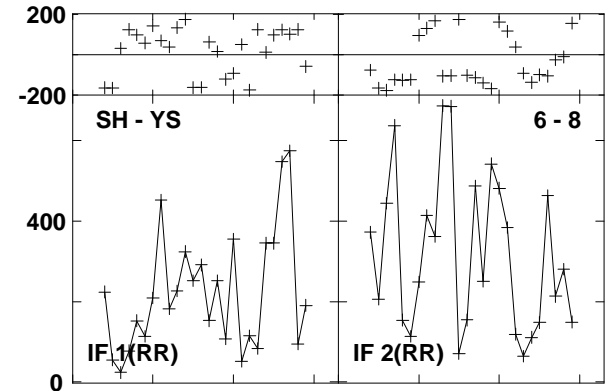
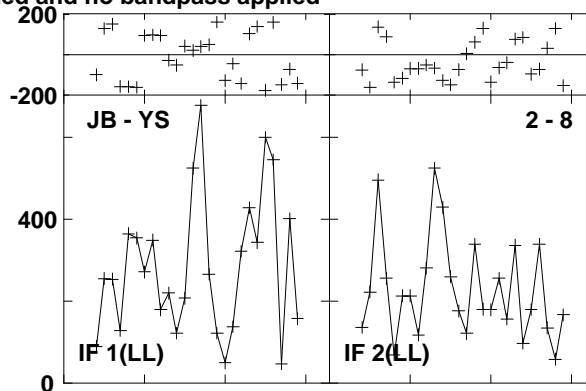
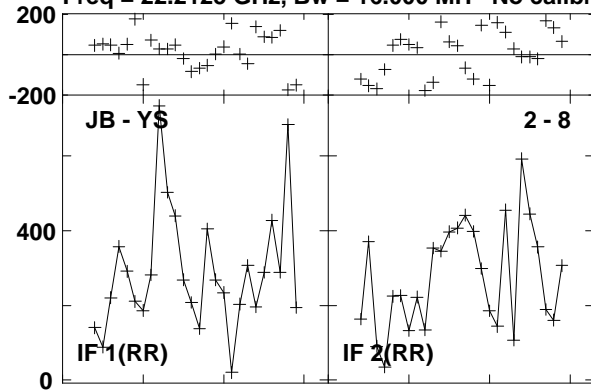

Lower frame: Micro Ampl Jy Top frame: Phas deg  
Vector averaged cross-power spectrum Baseline: JB (02) - YS (08)  
Timerange: 00/18:23:47 to 00/18:24:05

Plot file version 811 created 23-AUG-2016 15:01:13  
0219+628 GA035B 1.UVDATA.1  
Freq = 22.2125 GHz, Bw = 16.000 MH No calibration applied and no bandpass applied

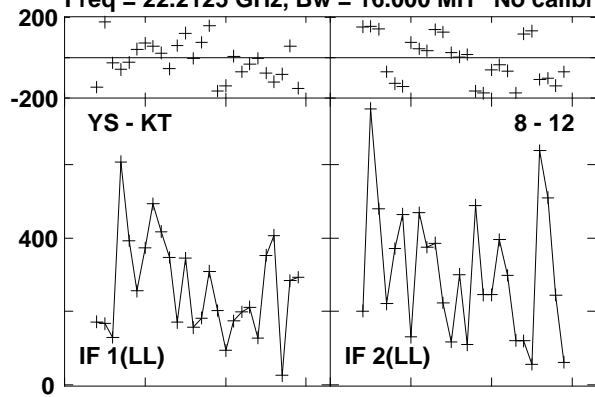

Lower frame: Micro Ampl Jy Top frame: Phas deg  
Vector averaged cross-power spectrum Baseline: YS (08) - KT (12)  
Timerange: 00/18:23:47 to 00/18:24:05

Plot file version 812 created 23-AUG-2016 15:01:13  
 W3IRS5 GA035B 1.UVDATA.1

Freq = 22.2125 GHz, Bw = 16.000 MH No calibration applied and no bandpass applied

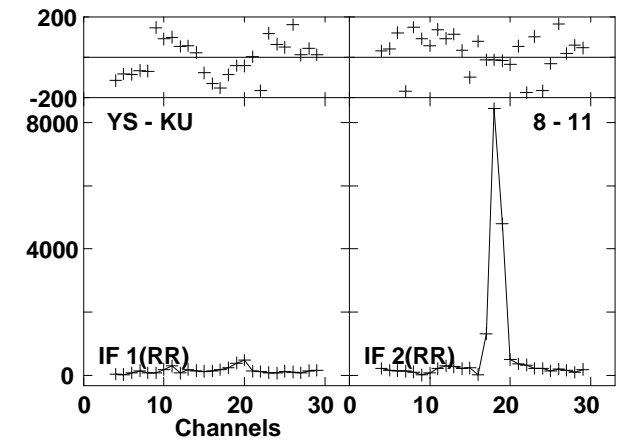
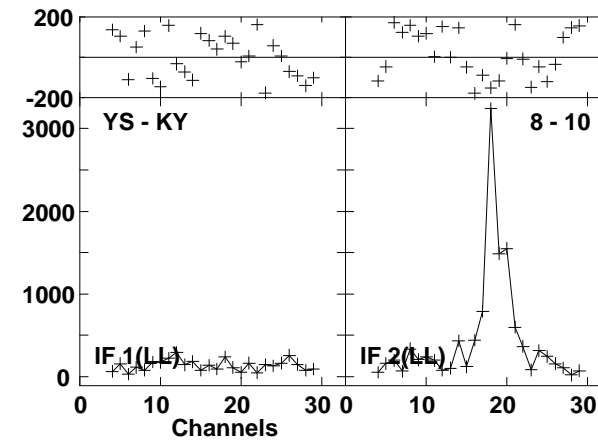
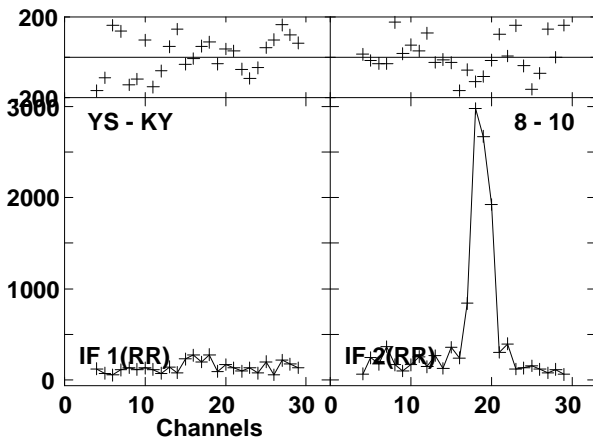
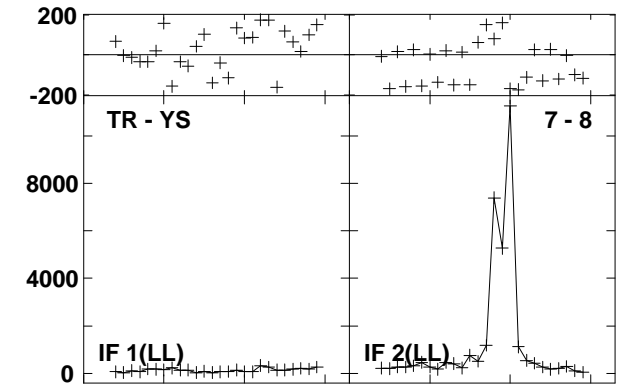
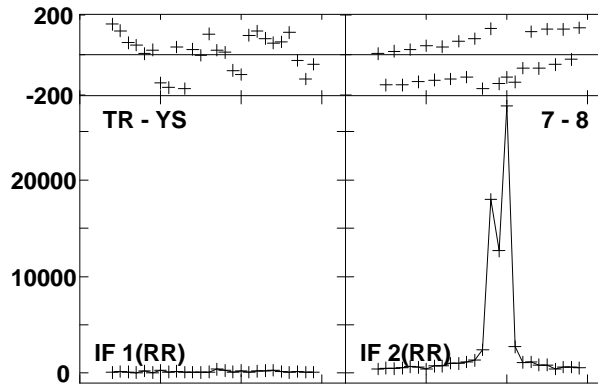
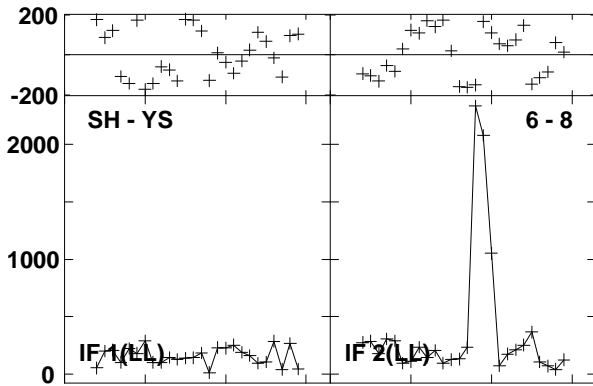
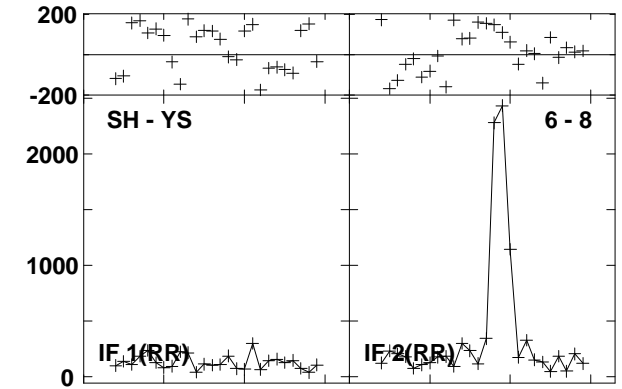
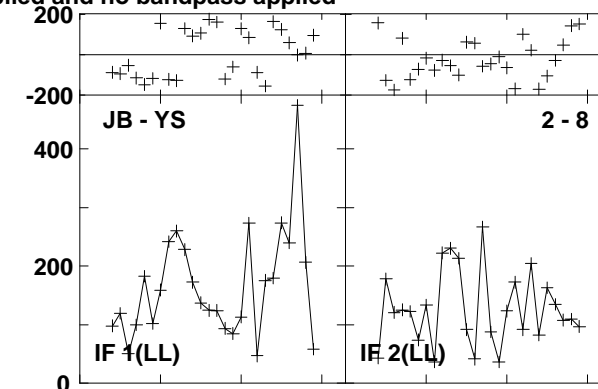
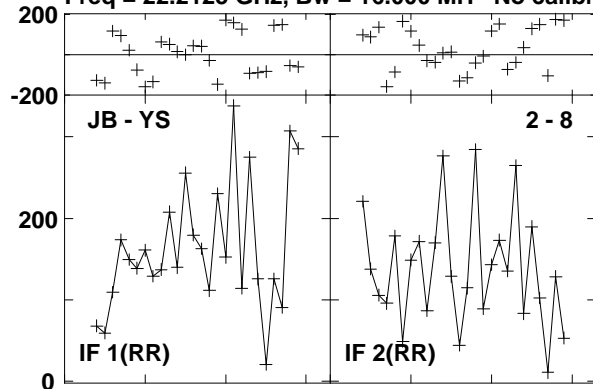

Lower frame: Micro Ampl Jy Top frame: Phas deg  
 Vector averaged cross-power spectrum Baseline: JB (02) - YS (08)  
 Timerange: 00/18:24:37 to 00/18:25:35

Plot file version 813 created 23-AUG-2016 15:01:13  
W3IRS5 GA035B 1.UVDATA.1

Freq = 22.2125 GHz, Bw = 16.000 MH No calibration applied and no bandpass applied

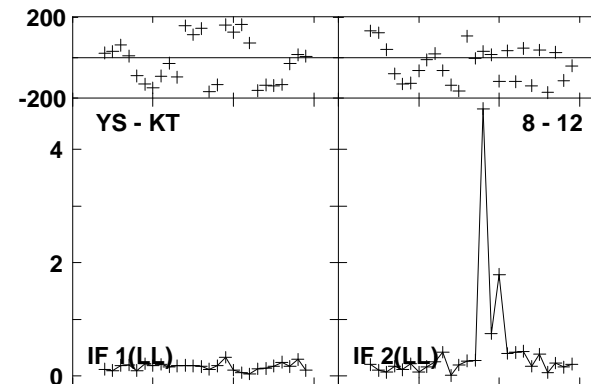
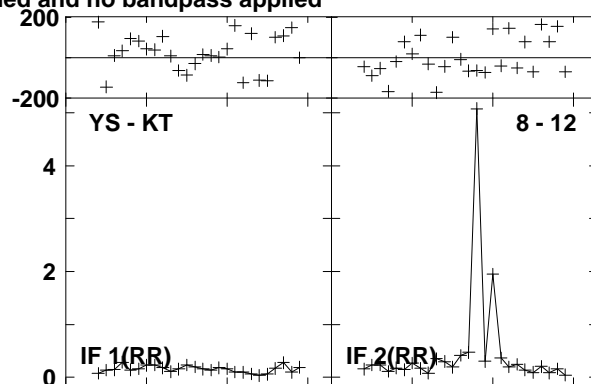
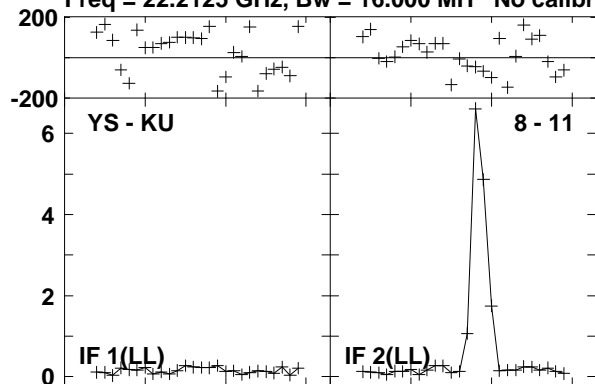

Lower frame: Milli Ampl Jy Top frame: Phas deg  
Vector averaged cross-power spectrum Baseline: YS (08) - KU (11)  
Timerange: 00/18:24:37 to 00/18:25:35

Plot file version 814 created 23-AUG-2016 15:01:13

0219+628 GA035B 1.UVDATA.1

Freq = 22.2125 GHz, Bw = 16.000 MH No calibration applied and no bandpass applied

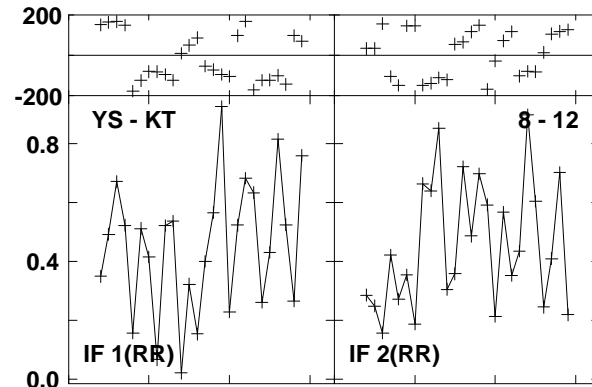
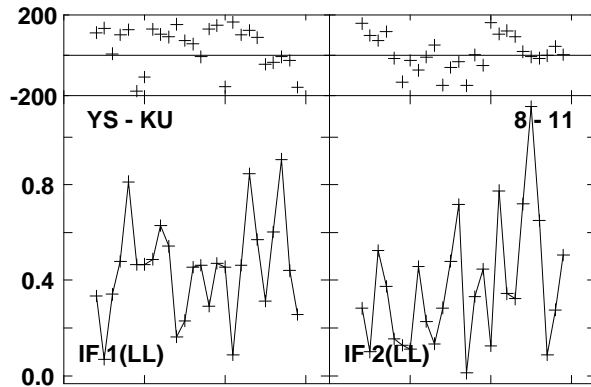
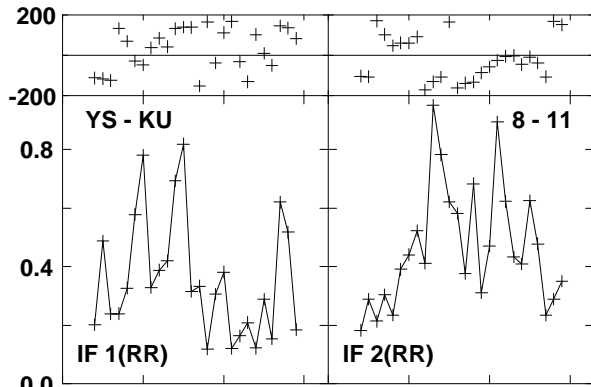
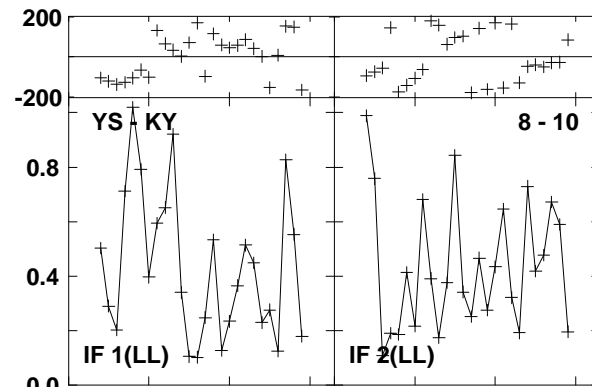
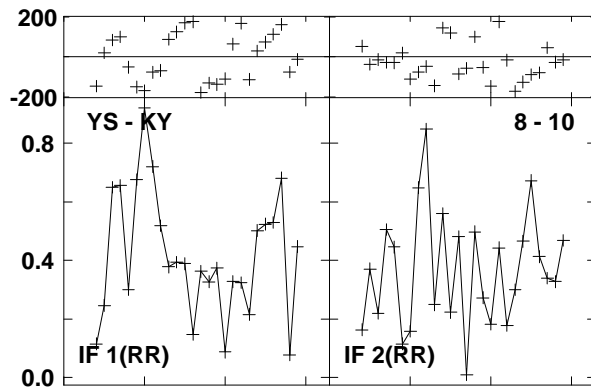
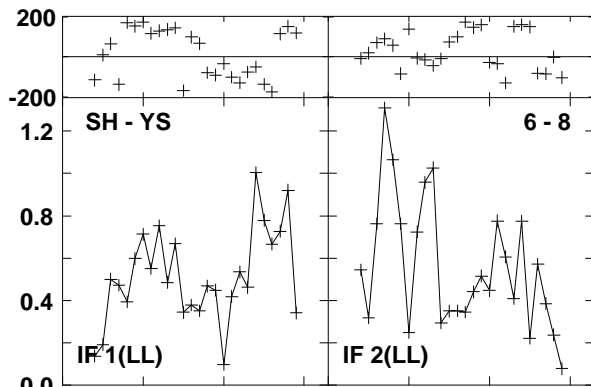
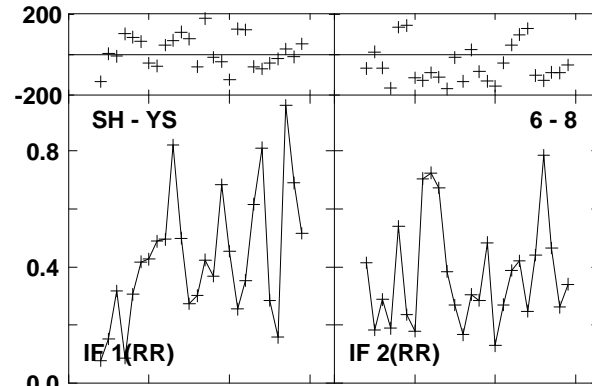
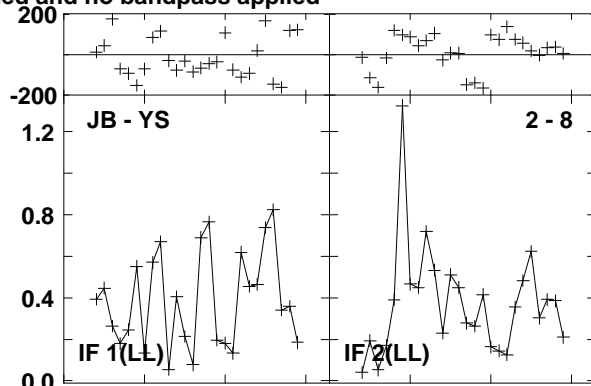
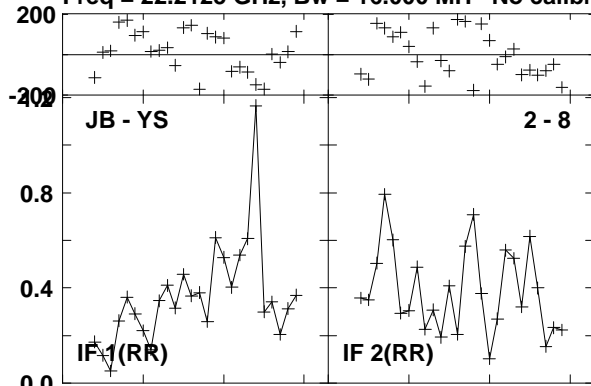

Lower frame: Milli Ampl Jy Top frame: Phas deg  
Vector averaged cross-power spectrum Baseline: JB (02) - YS (08)  
Timerange: 00/18:26:06 to 00/18:26:26

Plot file version 815 created 23-AUG-2016 15:01:13  
0219+628 GA035B 1.UVDATA.1  
Freq = 22.2125 GHz, Bw = 16.000 MH No calibration applied and no bandpass applied

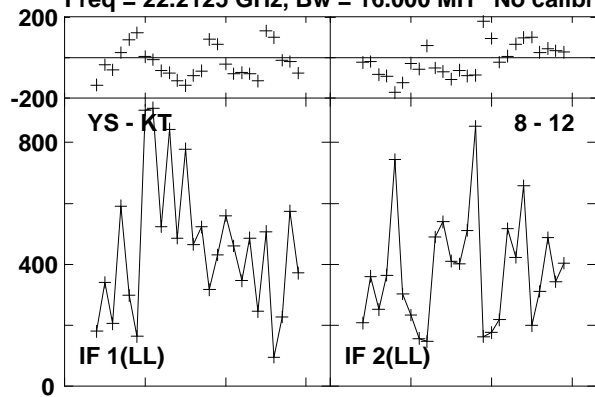

Lower frame: Micro Ampl Jy Top frame: Phas deg  
Vector averaged cross-power spectrum Baseline: YS (08) - KT (12)  
Timerange: 00/18:26:06 to 00/18:26:26

Plot file version 816 created 23-AUG-2016 15:01:13

W3IRS5 GA035B 1.UVDATA.1

Freq = 22.2125 GHz, Bw = 16.000 MH No calibration applied and no bandpass applied

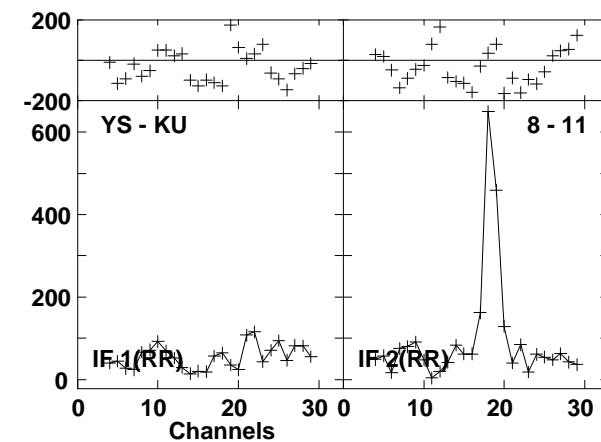
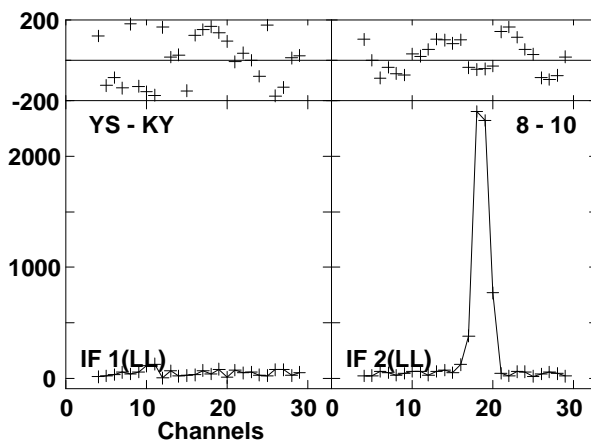
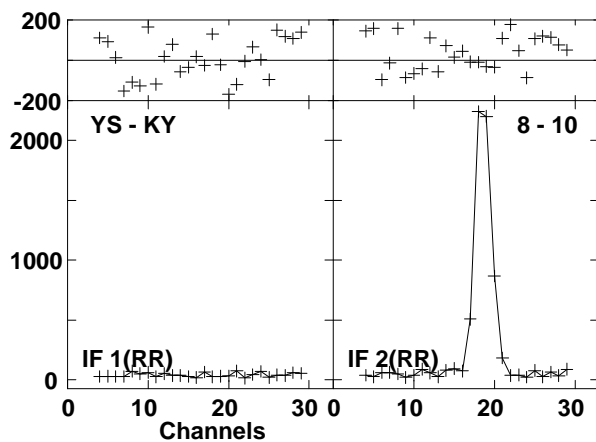
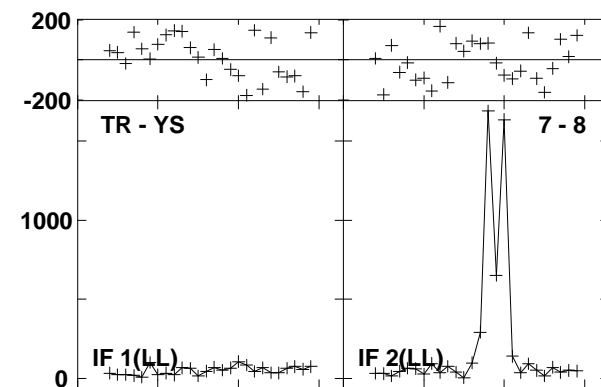
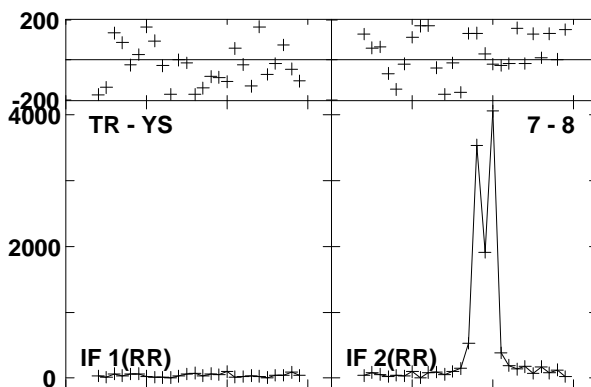
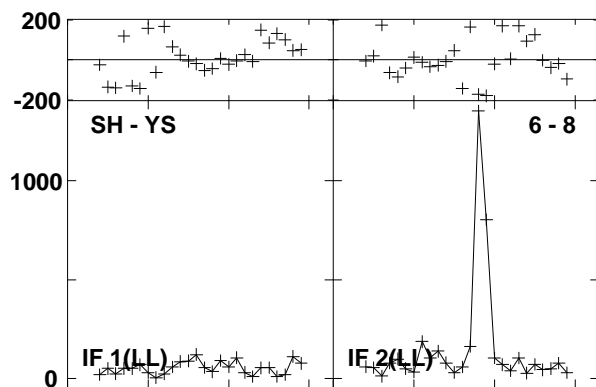
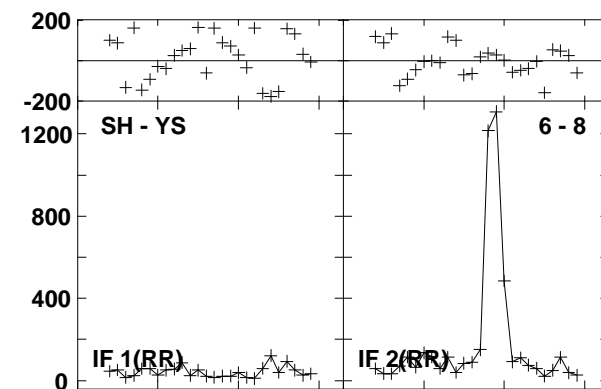
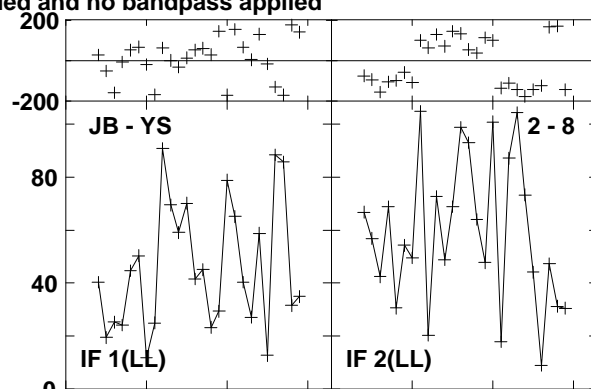
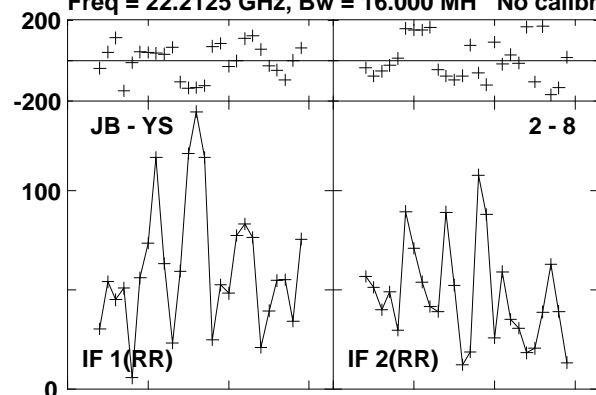

Lower frame: Micro Ampl Jy Top frame: Phas deg  
Vector averaged cross-power spectrum Baseline: JB (02) - YS (08)  
Timerange: 00/18:30:00 to 00/18:38:59



Plot file version 817 created 23-AUG-2016 15:01:14  
W3IRS5 GA035B 1.UVDATA.1

Freq = 22.2125 GHz, Bw = 16.000 MH No calibration applied and no bandpass applied

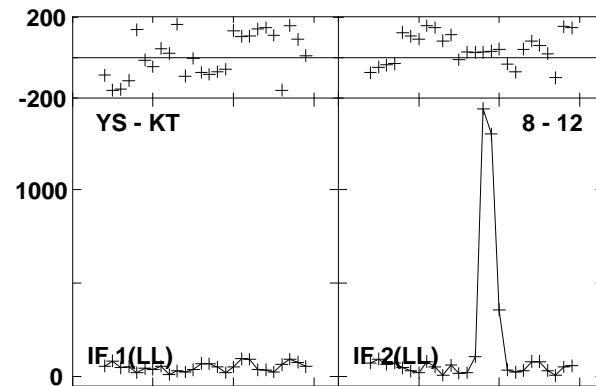
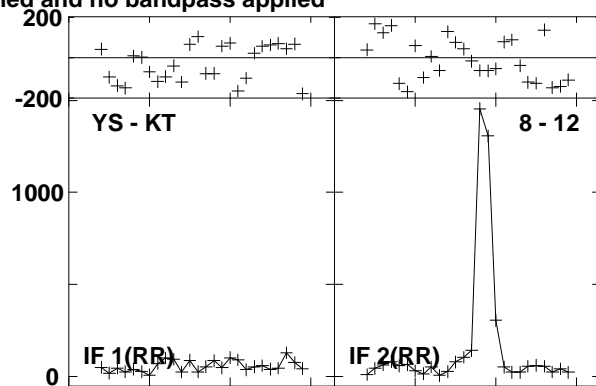
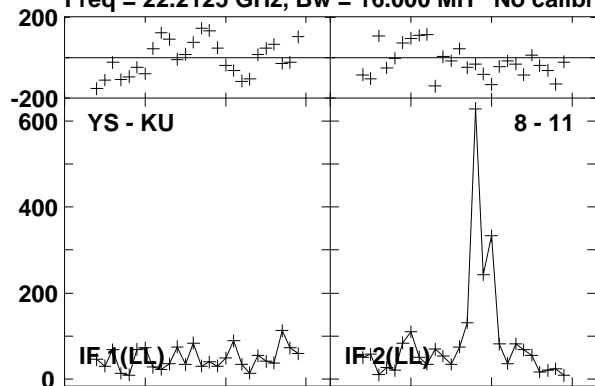

Lower frame: Micro Ampl Jy Top frame: Phas deg  
Vector averaged cross-power spectrum Baseline: YS (08) - KU (11)  
Timerange: 00/18:30:00 to 00/18:38:59

Plot file version 818 created 23-AUG-2016 15:01:14  
 W3IRS5 GA035B 1.UVDATA.1

Freq = 22.2125 GHz, Bw = 16.000 MH No calibration applied and no bandpass applied

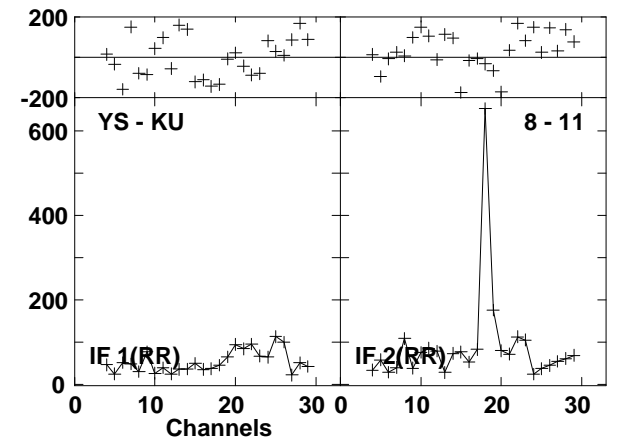
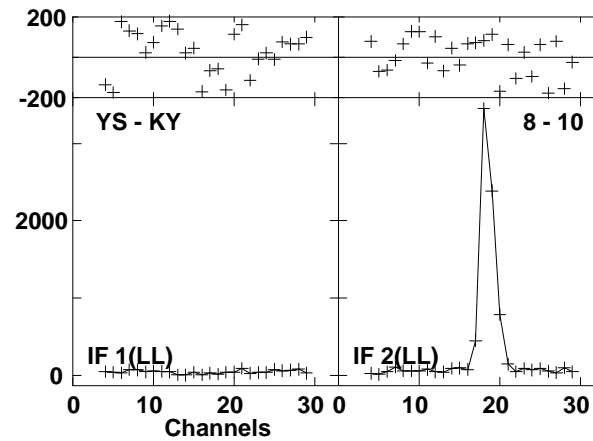
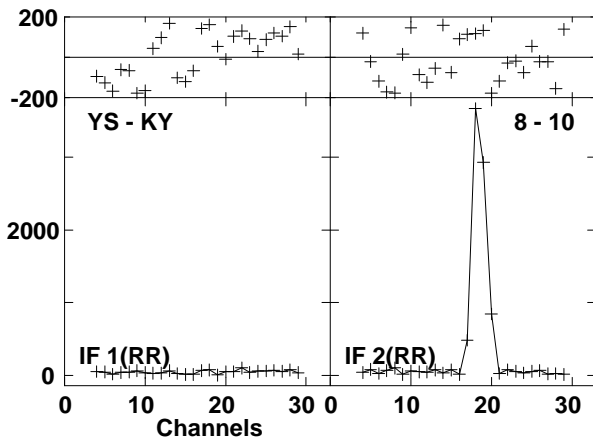
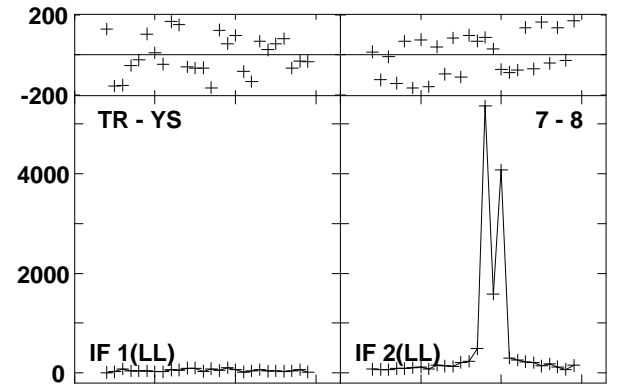
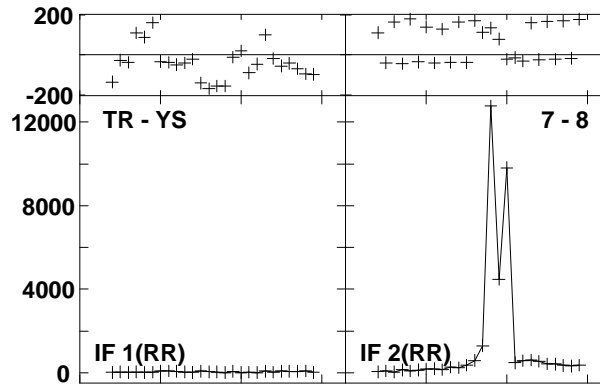
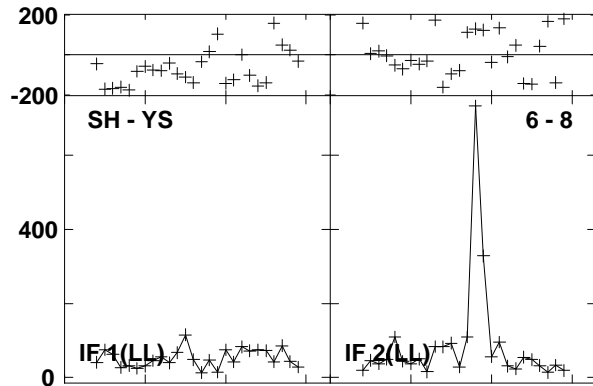
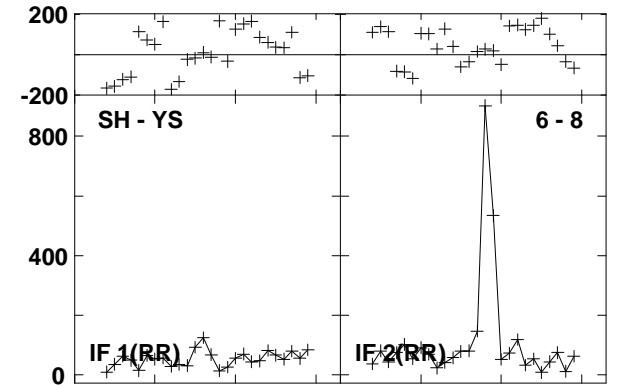
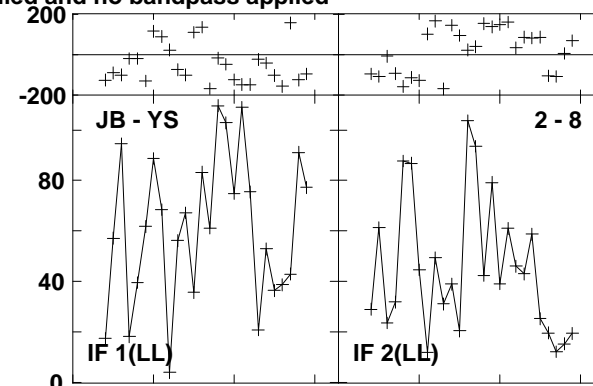
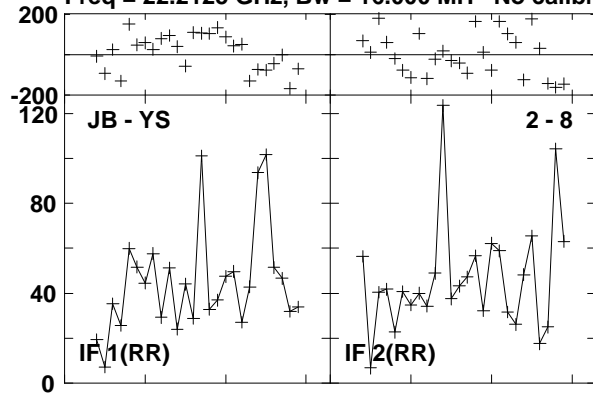

Lower frame: Micro Ampl Jy Top frame: Phas deg  
 Vector averaged cross-power spectrum Baseline: JB (02) - YS (08)  
 Timerange: 00/18:40:30 to 00/18:49:30

Plot file version 819 created 23-AUG-2016 15:01:14  
W3IRS5 GA035B 1.UVDATA.1

Freq = 22.2125 GHz, Bw = 16.000 MH No calibration applied and no bandpass applied

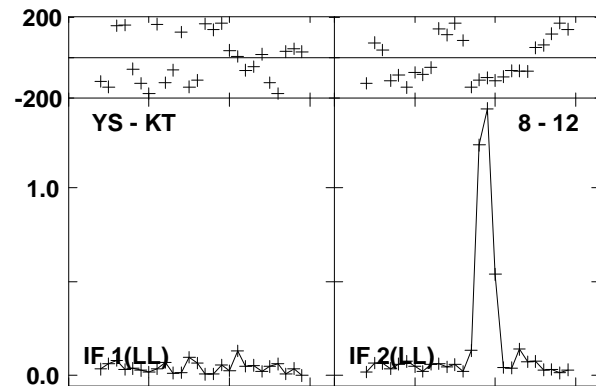
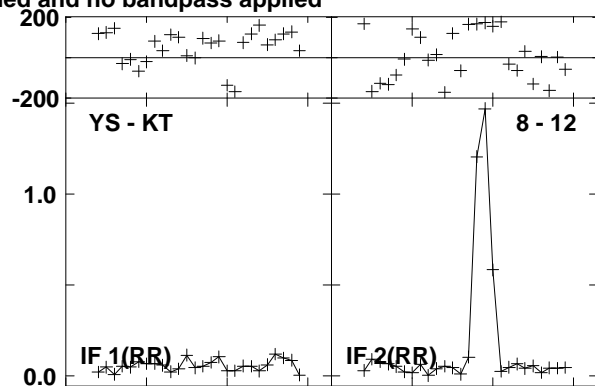
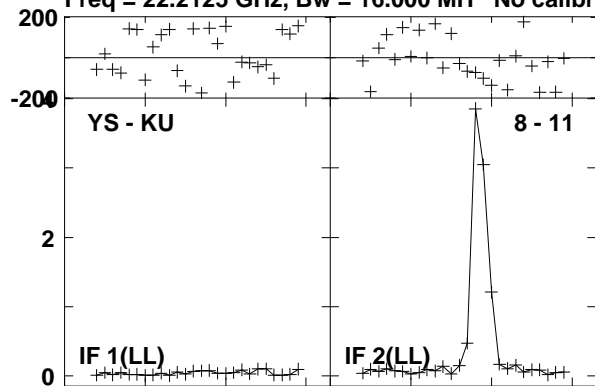

Lower frame: Milli Ampl Jy Top frame: Phas deg  
Vector averaged cross-power spectrum Baseline: YS (08) - KU (11)  
Timerange: 00/18:40:30 to 00/18:49:30

Plot file version 820 created 23-AUG-2016 15:01:14  
 W3IRS5 GA035B 1.UVDATA.1

Freq = 22.2125 GHz, Bw = 16.000 MH No calibration applied and no bandpass applied

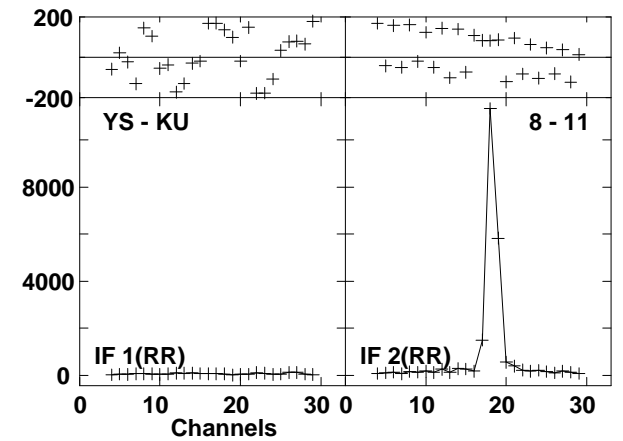
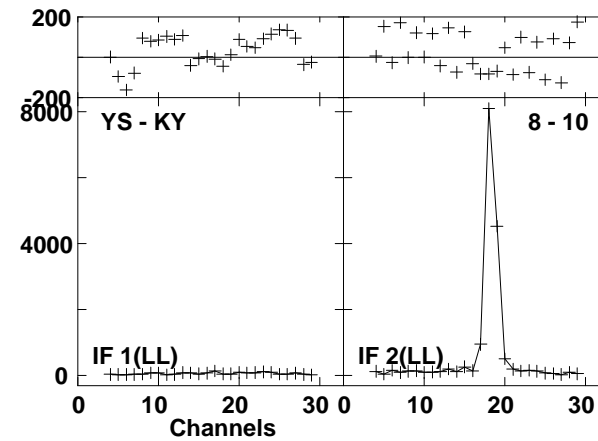
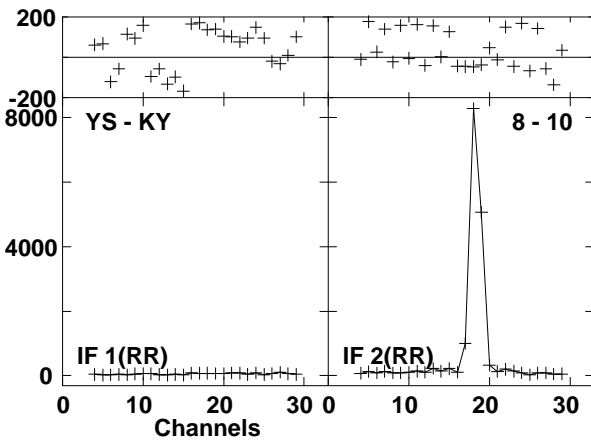
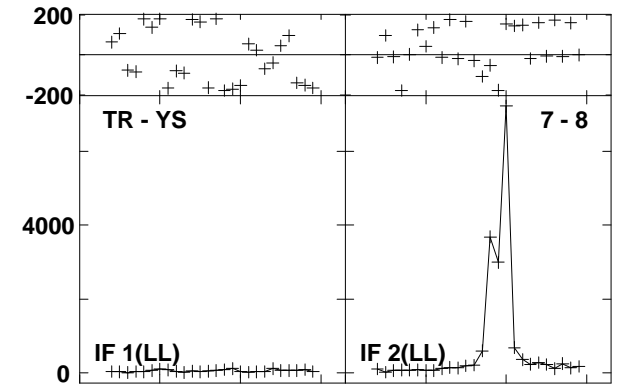
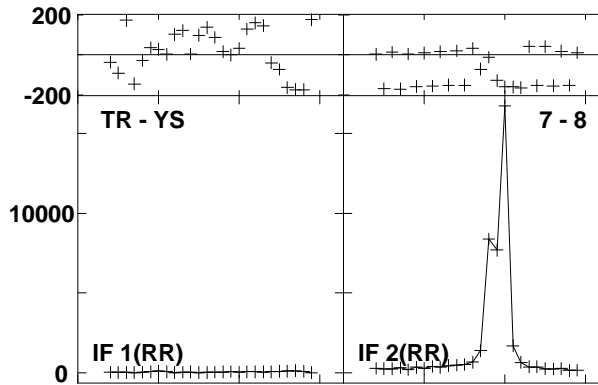
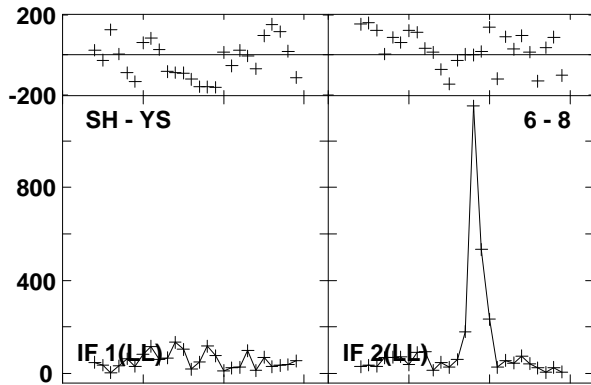
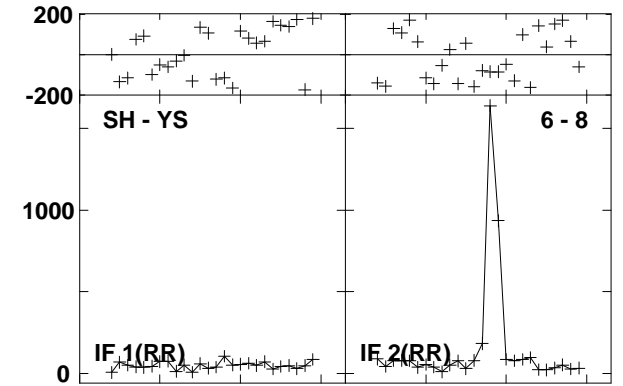
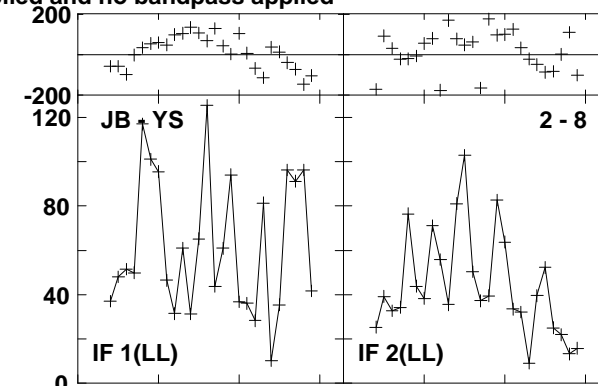
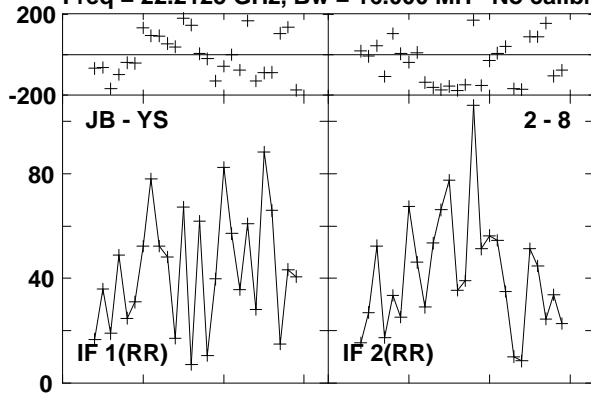

Lower frame: Micro Ampl Jy Top frame: Phas deg  
 Vector averaged cross-power spectrum Baseline: JB (02) - YS (08)  
 Timerange: 00/18:51:01 to 00/19:00:00

Plot file version 821 created 23-AUG-2016 15:01:14  
W3IRS5 GA035B 1.UVDATA.1

Freq = 22.2125 GHz, Bw = 16.000 MH No calibration applied and no bandpass applied

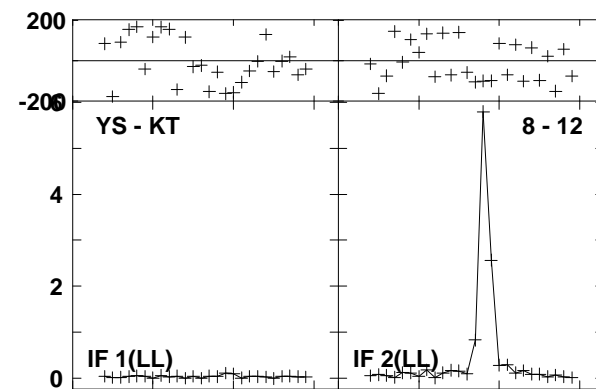
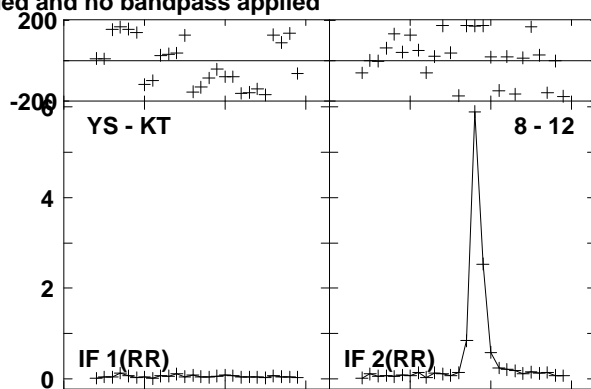
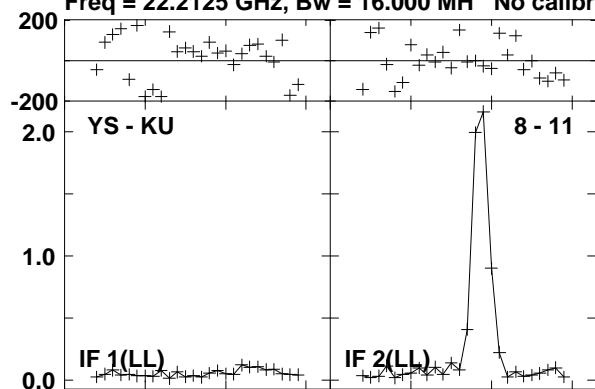

Lower frame: Milli Ampl Jy Top frame: Phas deg  
Vector averaged cross-power spectrum Baseline: YS (08) - KU (11)  
Timerange: 00/18:51:01 to 00/19:00:00